



# REGULATORY GUIDE

OFFICE OF NUCLEAR REGULATORY RESEARCH

## REGULATORY GUIDE 1.180

(Draft was issued as DG-1119)

### GUIDELINES FOR EVALUATING ELECTROMAGNETIC AND RADIO-FREQUENCY INTERFERENCE IN SAFETY-RELATED INSTRUMENTATION AND CONTROL SYSTEMS

#### A. INTRODUCTION

This regulatory guide has been revised to provide guidance to licensees and applicants on additional methods acceptable to the NRC staff for complying with the NRC's regulations on design, installation, and testing practices for addressing the effects of electromagnetic and radio-frequency interference (EMI/RFI) and power surges on safety-related instrumentation and control (I&C) systems. The changes in this revision include endorsing Military Standard MIL-STD-461E and the International Electrotechnical Commission (IEC) 61000 series of EMI/RFI test methods, extending the guidance to cover signal line testing, incorporating frequency ranges where portable communications devices are experiencing increasing use, and relaxing the operating envelopes (test levels) when experience and confirmatory research warrants. Exemptions from specific test criteria are also offered based on technical considerations such as plant conditions and the intended location of the safety-related I&C equipment.

The NRC's regulations in Part 50, "Domestic Licensing of Production and Utilization Facilities," of Title 10 of the Code of Federal Regulations (10 CFR Part 50) state that structures, systems, and components important to safety in a nuclear power plant are to be designed to accommodate the effects of environmental

---

Regulatory guides are issued to describe and make available to the public such information as methods acceptable to the NRC staff for implementing specific parts of the NRC's regulations, techniques used by the staff in evaluating specific problems or postulated accidents, and data needed by the NRC staff in its review of applications for permits and licenses. Regulatory guides are not substitutes for regulations, and compliance with them is not required. Methods and solutions different from those set out in the guides will be acceptable if they provide a basis for the findings requisite to the issuance or continuance of a permit or license by the Commission.

This guide was issued after consideration of comments received from the public. Comments and suggestions for improvements in these guides are encouraged at all times, and guides will be revised, as appropriate, to accommodate comments and to reflect new information or experience. Written comments may be submitted to the Rules and Directives Branch, ADM, U.S. Nuclear Regulatory Commission, Washington, DC 20555-0001.

Regulatory guides are issued in ten broad divisions: 1, Power Reactors; 2, Research and Test Reactors; 3, Fuels and Materials Facilities; 4, Environmental and Siting; 5, Materials and Plant Protection; 6, Products; 7, Transportation; 8, Occupational Health; 9, Antitrust and Financial Review; and 10, General.

Single copies of regulatory guides (which may be reproduced) may be obtained free of charge by writing the Distribution Services Section, U.S. Nuclear Regulatory Commission, Washington, DC 20555-0001, or by fax to (301)415-2289, or by email to [DISTRIBUTION@NRC.GOV](mailto:DISTRIBUTION@NRC.GOV). Electronic copies of this guide and other recently issued guides are available at NRC's home page at [WWW.NRC.GOV](http://WWW.NRC.GOV) through the Electronic Reading Room, Accession Number ML032740277.

---

conditions (i.e., remain functional under all postulated service conditions) and that design control measures such as testing are to be used to check the adequacy of design. Section 50.55a(h) of 10 CFR Part 50 states that protection systems must meet the requirements of the Institute of Electrical and Electronics Engineers (IEEE) standard (Std) 603-1991, “Criteria for Safety Systems for Nuclear Power Generating Stations,”<sup>1</sup> or IEEE Std 279-1971, “Criteria for Protection Systems for Nuclear Power Generating Stations,”<sup>1</sup> contingent on the date of construction permit issuance. The design basis criteria identified in those standards, or by similar provisions in the licensing basis for such facilities, include the range of transient and steady state environmental conditions during normal, abnormal, and accident circumstances throughout which the equipment must perform. Criterion III, “Design Control,” Criterion XI, “Test Control,” and Criterion XVII, “Quality Assurance Records,” of Appendix B, “Quality Assurance Criteria for Nuclear Power Plants and Fuel Reprocessing Plants,” to 10 CFR Part 50 establish practices to confirm that a design fulfills its technical requirements. Furthermore, 10 CFR 50.49 and 50.55a address validation measures such as testing that can be used to check the adequacy of design. Related requirements are contained in General Design Criteria 1, 2, 4, 13, 21, 22, and 23 of Appendix A, “General Design Criteria for Nuclear Power Plants,” to 10 CFR Part 50. Additionally, Subpart B, “Standard Design Certifications,” of 10 CFR Part 52, “Early Site Permits; Standard Design Certifications; and Combined Licenses for Nuclear Power Plants,” addresses verification requirements for advanced reactor designs. Specifically, 10 CFR 52.47(a)(vi) requires that an application for design certification must state the tests, inspections, analyses, and acceptance criteria that are necessary and sufficient to provide reasonable assurance that a plant will operate within the design certification. Methods for addressing electromagnetic compatibility (EMC) constitute Tier 2\* information under the 10 CFR Part 52 requirements.<sup>2</sup>

Electromagnetic interference (EMI), radio-frequency interference (RFI), and power surges have been identified as environmental conditions that can affect the performance of safety-related electrical equipment. Confirmatory research findings to support this observation can be found in NUREG/CR-5700, “Aging Assessment of Reactor Instrumentation and Protection System Components”<sup>3</sup> (July 1992); NUREG/CR-5904, “Functional Issues and Environmental Qualification of Digital Protection Systems of Advanced Light-Water Nuclear Reactors”<sup>3</sup> (April 1994); NUREG/CR-6406, “Environmental Testing of an Experimental Digital Safety Channel”<sup>3</sup> (September 1996); and NUREG/CR-6579, “Digital I&C Systems in Nuclear Power Plants: Risk-Screening of Environmental Stressors and a Comparison of Hardware Unavailability With an Existing Analog System”<sup>3</sup> (January 1998). Therefore, controlling electrical noise and the susceptibility of I&C systems to EMI/RFI and power surges is an important step in meeting the aforementioned requirements.

---

<sup>1</sup> IEEE publications may be purchased from the IEEE Service Center, 445 Hoes Lane, Piscataway, NJ 08855-1331.

<sup>2</sup> An applicant who references an advanced reactor certification is not allowed to depart from the Tier 2\* commitments without NRC approval. Thus, changes cannot be made under a process such as that in 10 CFR 50.59.

<sup>3</sup> Copies are available at current rates from the U.S. Government Printing Office, P.O. Box 37082, Washington, DC 20402-9328 (telephone (202)512-1800); or from the National Technical Information Service by writing NTIS at 5285 Port Royal Road, Springfield, VA 22161; <<http://www.ntis.gov/ordernow>> (telephone (703)487-4650). Copies are available for inspection or copying for a fee from the NRC Public Document Room at 11555 Rockville Pike, Rockville, MD; the PDR’s mailing address is USNRC PDR, Washington, DC 20555; telephone (301)415-4737 or (800)397-4209; fax (301)415-3548; email is PDR@NRC.GOV.

This regulatory guide endorses design, installation, and testing practices acceptable to the NRC staff for addressing the effects of EMI/RFI and power surges on safety-related I&C systems in a nuclear power plant environment. The design and installation practices described in IEEE Std 1050-1996, “IEEE Guide for Instrumentation and Control Equipment Grounding in Generating Stations,”<sup>1</sup> are endorsed for limiting EMI/RFI subject to the conditions stated in the Regulatory Position. EMC testing practices from military and commercial standards are endorsed to address electromagnetic emissions, EMI/RFI susceptibility, and power surge withstand capability (SWC). Selected EMI/RFI test methods from MIL-STD-461E, “Requirements for the Control of Electromagnetic Interference Characteristics of Subsystems and Equipment,”<sup>4</sup> and the IEC 61000 Series are endorsed to evaluate conducted and radiated EMI/RFI phenomena for safety-related I&C systems. The IEC standards include IEC 61000-3, “Electromagnetic Compatibility (EMC) - Part 3: Limits,”<sup>5</sup> IEC 61000-4, “Electromagnetic Compatibility (EMC) - Part 4: Testing and Measurement Techniques,”<sup>5</sup> and IEC 61000-6, “Electromagnetic Compatibility (EMC) - Part 6: Generic Standards.”<sup>5</sup> This regulatory guide provides acceptable suites of EMI/RFI emissions and susceptibility methods from the most recent versions of the military standard and international commercial standards. These suites of test methods can be applied as alternative sets (guidance is provided in the Regulatory Position). This regulatory guide also endorses electromagnetic operating envelopes corresponding to the MIL-STD-461E test methods. These operating envelopes were tailored from the MIL-STD-461E test limits to represent the characteristic electromagnetic environment in key locations at nuclear power plants. Comparable operating envelopes for the IEC 61000 test methods are also endorsed. The operating envelopes are presented within the Regulatory Position, along with descriptions of the endorsed MIL-STD-461E and IEC 61000 test methods.

The SWC practices described in IEEE Std C62.41-1991 (reaffirmed in 1995), “IEEE Recommended Practice on Surge Voltages in Low-Voltage AC Power Circuits,”<sup>1</sup> and IEEE Std C62.45-1992 (reaffirmed in 1997), “IEEE Guide on Surge Testing for Equipment Connected to Low-Voltage AC Power Circuits,”<sup>1</sup> are acceptable to the NRC staff regarding the effect of power surges on safety-related I&C systems in nuclear power plants. A specific set of surge test waveforms are endorsed from IEEE Std C62.41-1991<sup>1</sup> as acceptable SWC test criteria. The associated test methods in IEEE Std C62.45-1992<sup>1</sup> are endorsed to describe the approach to be employed when assessing SWC. General withstand levels are endorsed for use with the SWC test criteria and are presented within the Regulatory Position, along with the description of the endorsed surge waveforms. Alternative SWC practices from IEC 61000-4<sup>5</sup> are acceptable to the NRC staff and are also presented within the Regulatory Position.

The practices endorsed in this regulatory guide apply to both safety-related I&C systems and non-safety-related I&C systems whose failures can affect safety functions. The rationale for the selection of the practices depicted in this guide is that they provide a well established, systematic approach for ensuring EMC and the capability to withstand power surges in I&C equipment within the environment in

---

<sup>4</sup> Military Standards are available from the Department of Defense, Standardization Documents Order Desk, Building 4D, 700 Robbins Avenue, Philadelphia, PA 19111-5094.

<sup>5</sup> IEC publications may be purchased from the International Electrotechnical Commission, 3 rue de Varembe, Geneva, Switzerland. Telefax: +41 22 919 0300.

which it operates. The technical basis for selecting these particular practices is given in NUREG/CR-5941, “Technical Basis for Evaluating Electromagnetic and Radio-Frequency Interference in Safety-Related I&C Systems”<sup>3</sup> (April 1994), NUREG/CR-6431, “Recommended Electromagnetic Operating Envelopes for Safety-Related I&C Systems in Nuclear Power Plants”<sup>3</sup> (April 1999), NUREG/CR-5609, “Electromagnetic Compatibility Testing for Conducted Susceptibility Along Interconnecting Signal Lines”<sup>3</sup> (May 2003), and NUREG/CR-6782, “Comparison of U.S. Military and International Electromagnetic Compatibility Guidance”<sup>3</sup> (May 2003).

In general, information provided by regulatory guides is reflected in the Standard Review Plan (NUREG-0800, “Standard Review Plan for the Review of Safety Analysis Reports for Nuclear Power Plants”).<sup>3</sup> NRC’s Office of Nuclear Reactor Regulation uses the Standard Review Plan to review applications to construct and operate nuclear power plants. This regulatory guide conforms to the revised Chapter 7, “Instrumentation and Controls,” of the Standard Review Plan.

The information collections contained in this regulatory guide are covered by the requirements of 10 CFR Part 50, which were approved by the Office of Management and Budget (OMB), approval number 3150-0011. The NRC may not conduct or sponsor, and a person is not required to respond to, a request for information or an information collection requirement unless the requesting document displays a currently valid OMB control number.

## **B. DISCUSSION**

Existing I&C equipment in nuclear power plants is currently being replaced with computer-based digital I&C systems or advanced analog systems. However, these technologies may exhibit greater vulnerability to the nuclear power plant EMI/RFI environment than existing I&C systems. This regulatory guide provides an acceptable method for qualifying digital and advanced analog systems for the projected electromagnetic environment in nuclear power plants.

The typical environment in a nuclear power plant includes many sources of electrical noise, for example, hand-held two-way radios, arc welders, switching of large inductive loads, high fault currents, and high-energy fast transients associated with switching at the generator or transmission voltage levels. The increasing use of advanced analog- and microprocessor-based I&C systems in reactor protection and other safety-related plant systems has introduced concerns with respect to the creation of additional noise sources and the susceptibility of this equipment to the electrical noise already present in the nuclear power plant environment.

Digital technology is constantly evolving, and manufacturers of digital systems are incorporating increasingly higher clock frequencies and lower logic level voltages into their designs. However, these performance advancements may have an adverse impact on the operation of digital systems with respect to EMI/RFI and power surges because of the increased likelihood of extraneous noise being misinterpreted as legitimate logic signals. With recent advances in analog electronics, many of the functions presently being performed by several analog circuit boards could be combined into a single

analog circuit board operating at reduced voltage levels, thereby making analog circuitry more susceptible to EMI/RFI and power surges as well. Hence, operational and functional issues related to safety in the nuclear power plant environment must address the possibility of upsets and malfunctions in I&C systems caused by EMI/RFI and power surges.

The NRC staff accepted the Electric Power Research Institute (EPRI) topical report TR-102323, "Guidelines for Electromagnetic Interference Testing in Nuclear Power Plants," in a Safety Evaluation Report (SER) by letter dated April 17, 1996, as one method of addressing issues of EMC for safety-related digital I&C systems in nuclear power plants. The original Regulatory Guide 1.180 (January 2000) and this revision complement the position set forth in the SER. The guidance in these documents constitutes acceptable methods for addressing EMC considerations for qualifying safety-related I&C systems for the expected electromagnetic environment in nuclear power plants. This guide provides additional acceptable methods and includes guidance on testing to address signal line susceptibility and very high frequency (> 1 Ghz) phenomena.

The EMI/RFI practices, SWC practices, and operating envelopes endorsed in this guide are only elements of the total package that is needed to ensure EMC within nuclear power plants. In addition to assessing the electromagnetic environment, plants should apply sound engineering practices for non-safety-related upgrades and I&C maintenance as part of an overall EMC program. While non-safety-related systems are not part of the regulatory guidance being developed, control of EMI/RFI from these systems is necessary to ensure that safety-related I&C systems can continue to perform properly in the nuclear power plant environment. When feasible, the emissions from non-safety-related systems should be held to the same levels as safety-related systems.

As with the original Regulatory Guide 1.180, this revision endorses IEEE Std 1050-1996 with one exception as stated in Regulatory Position 2. The exception was cited in NUREG/CR-5941. IEEE Std 1050-1996 provides guidance on the engineering practices needed to control upsets and malfunctions in safety-related I&C systems when exposed to EMI/RFI and power surges. IEEE Std 1050-1996 was developed to provide guidance on the design and installation of grounding systems for I&C equipment specific to power generating stations. Further purposes of the standard are to achieve both a suitable level of protection for personnel and equipment and suitable electrical noise immunity for signal ground references in power generating stations.

IEEE Std 1050-1996 addresses grounding and noise-minimization techniques for I&C systems in a generating station environment. This standard recommends practices for the treatment of both analog and digital systems that address the grounding and shielding of electronic circuits on the basis of minimizing emissions and their susceptibility to EMI/RFI and power surges. The standard is comprehensive in that it covers both the theoretical and practical aspects of grounding and electromagnetic compatibility.

Design verification measures for EMI/RFI testing (emissions and susceptibility) are beyond the scope of IEEE Std 1050-1996. To determine the adequacy of safety-related I&C system designs, the NRC staff has endorsed the applicable EMI/RFI test methods in MIL-STD-461E and the IEC 61000

Series (i.e., the most recently issued military and international commercial guidance), along with custom operating envelopes developed to represent the characteristic electromagnetic environment for nuclear power plants. The test methods and operating envelopes are cited in Regulatory Positions 3, 4, and 6 of this guide. MIL-STD-461E is included in this revision because it replaced MIL-STD-461D and MIL-STD-462D. The associated changes are discussed in NUREG/CR-6782. The original Regulatory Guide 1.180 cited EMI/RFI test guidance from MIL-STD-461C, 461D, -462, and -462D. MIL-STD-461E was developed as a measure to ensure the electromagnetic compatibility of equipment. The application of the MIL-STD-461E test methods is tailored for the intended function of the equipment and the characteristic environment (i.e., which tests are applied and what levels are used depend on the function to be performed and the location of operation). Previous versions of the standard have been used successfully by the U.S. Department of Defense for many years and are commonly referenced in commercial applications. The IEC 61000 series of tests include IEC 61000-3, IEC 61000-4, and IEC 61000-6.

Regulatory Position 3 describes the conducted EMI/RFI emissions tests and operating envelopes acceptable to the NRC staff. In turn, Regulatory Position 4 describes the acceptable EMI/RFI susceptibility tests and operating envelopes. The rationale for the selection of the particular EMI/RFI tests and operating envelopes is discussed in NUREG/CR-6782. These discussions include how the EMI/RFI tests were selected, how the IEC 61000 tests should be applied, the exemptions that can be applied with the use of some tests, and the adjustments made to the operating envelopes recommended in MIL-STD-461E.

In addition, Regulatory Position 4 also describes the conducted EMI/RFI susceptibility tests and operating envelopes that are acceptable to the NRC staff for addressing the susceptibility of signal lines to interference. The rationale for the selection of the test methods and operating envelopes is discussed in detail in NUREG/CR-5609. Regulatory Position 6 describes the guidance that is acceptable to the NRC staff for validating the performance of safety-related I&C systems above 1 GHz, and its rationale is cited in NUREG/CR-6782.

Design verification measures for power surge withstand testing are also beyond the scope of IEEE Std 1050-1996. Accordingly, the NRC in the original regulatory guide endorsed the test criteria recommended in IEEE Std C62.41-1991 and the associated test methods recommended in IEEE Std C62.45-1992. This revision would update that guidance to also include the IEC 61000-4 tests relevant to power surge withstand testing. The entire complement of SWC test criteria, test methods, and operating envelopes endorsed by the NRC are described in Regulatory Position 5. Comparisons of the IEEE and IEC power surge withstand tests, along with rationale for adjusting test levels, are discussed in NUREG/CR-6782.

General operating envelopes that form the basis for establishing EMI/RFI and power surge testing levels are cited in this regulatory guide. The technical basis for the electromagnetic operating envelopes is presented in NUREG/CR-6431, NUREG/CR-5609, and NUREG/CR-6782. The operating envelopes are applicable for locations within a nuclear power plant where safety-related I&C systems either are or are likely to be installed. These locations include control rooms, remote shutdown

panels, cable spreading rooms, equipment rooms, relay rooms, auxiliary instrument rooms, and other areas (e.g., the turbine deck) where safety-related I&C system installations are planned. The operating envelopes are also applicable for both analog and digital system installations.

Any modifications to the electromagnetic operating envelopes (e.g., lower site-specific envelopes) should be based on technical evidence comparable to that presented in NUREG/CR-6431, NUREG/CR-5609, and NUREG/CR-6782. Relaxation in the operating envelopes should be based on actual measurement data collected in accordance with IEEE Std 473-1985 (reaffirmed in 1997), "IEEE Recommended Practice for an Electromagnetic Site Survey (10 kHz to 10 GHz)."

## **C. REGULATORY POSITION**

### **1. GENERAL**

Establishing and continuing an EMC program for safety-related I&C systems in nuclear power plants contributes to the assurance that safety-related structures, systems, and components are designed to accommodate the effects of and to be compatible with the environmental conditions associated with nuclear power plant service conditions. Application of consensus standard practices regarding the design, testing, and installation of safety-related I&C system modifications or new installations constitutes an important element of such a program. This guidance recommends design and installation practices to limit the impact of electromagnetic effects, testing practices to assess the emissions and susceptibility of equipment, and testing practices to evaluate the power SWC of the equipment. Operating envelopes characteristic of the electromagnetic environment in nuclear power plants are cited in this guidance as the basis for establishing acceptable testing levels. Table 1 lists the specific regulatory positions on EMC that are set forth below. This guidance is applicable to all new safety-related systems or modifications to existing safety-related systems that include analog, digital, or hybrid (i.e., combined analog and digital) electronics equipment. The endorsed test methods for evaluating the electromagnetic emissions, EMI/RFI susceptibility, and power surge withstand capability of safety-related equipment are intended for application in test facilities or laboratories before installation.

The electromagnetic conditions at the point of installation for safety-related I&C systems should be assessed to identify any unique EMI/RFI sources that may generate local interference. The EMI/RFI sources could include both portable and fixed equipment (e.g., portable transceivers, arc welders, power supplies, and generators). Steps should be taken during installation to ensure that systems are not exposed to EMI/RFI levels from the identified sources that are greater than 8 dB below the specified operating envelopes.

To ensure that the operating envelopes are being used properly, equipment should be tested in the same physical configuration as that specified for its actual installation in the nuclear power plant. In addition, the equipment should be in its normal mode of operation (i.e., performing its intended function) during the testing. Following the tests, the physical configuration of the safety-related I&C system should be maintained and all changes in the configuration controlled. The design specifications that should be

maintained and controlled include wire and cable separations, shielding techniques, shielded enclosure integrity, apertures, gasketing, grounding techniques, EMI/RFI filters, circuit board layouts, and other design parameters that may impact the EMC qualification testing results.

Exclusion zones should be established through administrative controls to prohibit the activation of portable EMI/RFI emitters (e.g., welders and transceivers) in areas where safety-related I&C systems have been installed. An exclusion zone is defined as the minimum distance permitted between the point of installation and where portable EMI/RFI emitters are allowed to be activated. The size of the exclusion zones should be site-specific and depend on the effective radiated power and antenna gain of the portable EMI/RFI emitters used within a particular nuclear

**Table 1 Specific Regulatory Positions for EMC Guidance**

<b>Regulatory Position</b>	<b>EMC Issue Addressed</b>	<b>Standards Endorsed</b>	<b>Comments/Conditions</b>
2	EMI/RFI limiting practices	IEEE Std 1050-1996	Full standard endorsed with one exception taken.
3, 4, 6	EMI/RFI emissions and susceptibility (radiated, conducted power line and conducted signal line) testing	MIL-STD-461E IEC 61000-3 IEC 61000-4 IEC 61000-6	Selected MIL-STD-461E test methods and operating envelopes endorsed.  Selected IEC 61000 test methods and operating envelopes endorsed.  Option of alternative test suites from most recent versions of MIL-STD and IEC guidelines.  General electromagnetic operating envelopes for key nuclear power plant locations are included in Regulatory Positions 3, 4, and 6.



5	SWC testing	IEEE Std C62.41-1991	Selected IEEE Std C62.41-1991 surge test waveforms endorsed with associated IEEE Std C62.45-1992 test methods.
		IEEE Std C62.45-1992	
		IEC 61000-4	Selected IEC 61000-4 surge test waveforms and test methods endorsed.
			General withstand levels for nuclear power plants are included in Regulatory Position 5.

power plant. The size of exclusion zones should also depend on the allowable electric field emission levels designated for the area in the vicinity of the installed safety-related I&C system. To establish the size of an exclusion zone, an 8 dB difference between the susceptibility operating envelope and the allowed emissions level should be maintained. For the radiated electric field operating envelope of 10 V/m (140 dB $\mu$ V/m), the size of the exclusion zones should be set such that the radiated electric fields emanating from the portable EMI/RFI emitters are limited to 4 V/m (132 dB $\mu$ V/m) in the vicinity of safety-related I&C systems. The minimum distance of an exclusion zone (d) in meters should be calculated by the following equation derived from the free space propagation model:

$$d = \frac{\sqrt{30P_t G_t}}{E} (\text{meters})$$

where:

- P<sub>t</sub> = the effective radiated power of the EMI/RFI emitter (in Watts);
- G<sub>t</sub> = the gain of the EMI/RFI emitter (dimensionless); and,
- E = the allowable radiated electric field strength of the EMI/RFI emitter (in Volts/meter) at the point of installation.

Note that unintentional transmitters (welders, motors, etc.) will typically have a gain that is less than or equal to 1 (the gain of an isotropic emitter), and the gain for intentional transmitters (two-way radios, cell phones, etc.) will typically be greater than 1. Typical values for the gain of intentional transmitters might vary from 1.5 for a short dipole antenna to 3 for a monopole antenna, and to 6 for a horn antenna.

## 2. IEEE Std 1050-1996

IEEE Std 1050-1996, "IEEE Guide for Instrumentation and Control Equipment Grounding in Generating Stations,"<sup>1</sup> describes design and installation practices that are acceptable to the NRC staff regarding EMI/RFI- and power surge-related effects on safety-related I&C systems employed in nuclear power plants with the following exception.

Section 4.3.7.4, “Radiative Coupling,” of the standard maintains that the “field strength” of propagating electromagnetic waves is inversely proportional to the square of the distance from the source of radiation. This statement needs to be re-evaluated because radiative coupling is a far-field effect. A distance,  $r$ , greater than the wavelength divided by  $2\pi$  ( $r > \lambda/2\pi$ ) from the source of radiation is considered to be far field, which is the region where the wave impedance is equal to the characteristic impedance of the medium. Both the electric and magnetic “field strengths” fall off as  $1/r$  in the far field, i.e., in inverse proportion to distance (not as its square). This concept is not to be confused with the propagation of electromagnetic waves in the near field ( $r < \lambda/2\pi$ ) where the wave impedance is determined by the characteristics of the source and the distance from the source. In the near field, if the source impedance is high ( $>377\Omega$ ), the electric and magnetic “field strengths” attenuate at rates of  $1/r^3$  and  $1/r^2$ , respectively. If the source impedance is low ( $<377\Omega$ ), the rates of attenuation are reversed: the electric “field strength” will fall off at a rate of  $1/r^2$  and the magnetic “field strength” at a rate of  $1/r^3$ . The user should understand that radiative coupling is a far-field effect and the “field strength” falls off as  $1/r$ , not as  $1/r^2$ .

IEEE Std 1050-1996 references other standards that contain complementary and supplementary information. In particular, IEEE Std 518-1982 (reaffirmed in 1996), “IEEE Guide for the Installation of Electrical Equipment To Minimize Noise Inputs to Controllers from External Sources,” and IEEE Std 665-1995 (reaffirmed in 2001), “IEEE Guide for Generating Station Grounding,” are referenced frequently. The portions of IEEE Std 518-1982 and IEEE Std 665-1995 referenced in IEEE Std 1050-1996 are endorsed by this guide and are to be used in a manner consistent with the practices in IEEE Std 1050-1996.

### **3. EMI/RFI EMISSIONS TESTING**

MIL-STD-461E, “Requirements for the Control of Electromagnetic Interference Characteristics of Subsystems and Equipment,” contains test practices that can be applied to characterize EMI/RFI emissions. IEC 61000-6, “Electromagnetic Compatibility (EMC) – Part 6: Generic Standards,” also specifies test practices that can be applied to characterize EMI/RFI emissions for industrial environments. The specific test methods acceptable to the NRC staff in regard to emissions testing for safety-related I&C systems in nuclear power plants are presented in Tables 2 and 3. Table 2 lists the EMI/RFI emissions test methods in MIL-STD-461E while Table 3 lists the corresponding criteria in IEC 61000-6-4, “Electromagnetic Compatibility (EMC) – Part 6: Generic Standards – Section 4: Emission standard for industrial environments.” These test methods cover conducted (along power leads) and radiated interference emitted from equipment under test.

**Table 2 MIL-STD-461E Test Methods for EMI/RFI Emissions**

<b>Method</b>	<b>Description</b>
CE101	Conducted emissions, low-frequency, 30 Hz to 10 kHz
CE102	Conducted emissions, high-frequency, 10 kHz to 2 MHz
RE101	Radiated emissions, magnetic field, 30 Hz to 100 kHz
RE102	Radiated emissions, electric field, 2 MHz to 1 GHz

C = conducted, R = radiated, and E = emissions.

**Table 3 IEC 61000-6-4 Test Methods for EMI/RFI Emissions**

<b>Method</b>	<b>Description</b>
None	Conducted emissions, low-frequency, 30 Hz to 10 kHz
CISPR 11	Conducted emissions, high-frequency, 150 kHz to 30 MHz
None	Radiated emissions, magnetic field, 30 Hz to 100 kHz
CISPR 11	Radiated emissions, electric field, 30 MHz to 1 GHz

MIL-STD-461E provides the latest revision of domestic guidance for emissions test methods (including improvements based on experience and the most recent technical information), thus it represents current practice. IEC 61000-6-4 provides the most recent international guidance for emissions test practices and incorporates by reference the test methods of CISPR 11, “Limits and Methods of Measurement of Electromagnetic Disturbance Characteristics of Industrial, Scientific and Medical (ISM) Radio-Frequency Equipment.” It is intended that either set of test methods be applied in its entirety, without selective application of individual methods (i.e., no mixing and matching of test methods) for emissions testing. Because of the absence of IEC 61000 test methods to address low-frequency conducted emissions testing, low-frequency (magnetic field) radiated emissions testing, and high-frequency conducted emissions testing in the frequency range from 10 kHz to 150 kHz, the IEC emissions testing option is only acceptable under conditions that correspond to the special exemption conditions for the MIL-STD emissions testing option related to power quality control and proximity to equipment sensitive to magnetic fields.

The MIL-STD-461E test methods listed in Table 2 have associated operating envelopes that serve to establish test levels. General operating envelopes that are acceptable to the NRC staff are given below in the discussion of the listed MIL-STD-461E test methods. Likewise, operating envelopes for the IEC 61000-6-4<sup>5</sup> test methods have been identified that are comparable to the corresponding MIL-STD counterparts and are given below in the IEC discussion. These operating envelopes are acceptable for locations where safety-related I&C systems either are or are likely to be installed and include control rooms, remote shutdown panels, cable spreading rooms, equipment rooms, auxiliary instrument rooms,

relay rooms, and other areas (e.g., the turbine deck) where safety-related I&C system installations are planned. The operating envelopes are acceptable for analog, digital, and hybrid system installations.

The detailed technical basis for the electromagnetic operating envelopes is presented in NUREG/CR-6431, NUREG/CR-5609, and NUREG/CR-6782. The technical basis for the operating envelopes begins with the MIL-STD envelopes corresponding to the electromagnetic environment for military ground facilities, which were judged to be comparable to that of nuclear power plants based on general layout and equipment type considerations. Plant emissions data were used to confirm the adequacy of the operating envelopes. From the MIL-STD starting point, adjustments to the equipment emissions envelopes were based on consideration of the primary intent of the MIL-STD envelopes (e.g., whether the envelopes were based on protecting sensitive receivers on military platforms) and maintaining some margin with the susceptibility envelopes. When changes to the operating envelopes from the MIL-STD origin were motivated by technical considerations, consistency among the envelopes for comparable test methods was promoted and commercial emissions envelopes for industrial environments were factored into adjustments of the operating envelopes. As a result of these considerations, the operating envelopes presented in this regulatory guide are equivalent or less restrictive than the MIL-STD envelopes that served as their initial basis.

Generic envelopes for industrial environments were identified in IEC 61000-6-4 for both conducted and radiated emissions. These envelopes were compared with the plant-data-based operating envelopes and selected based on their compatibility with the nuclear power plant environment. As a result, the IEC 61000-6-4 envelopes are equivalent or as restrictive as the plant-data-based operating envelopes.

The MIL-STD-461E test methods that demonstrate EMI/RFI emissions compliance are discussed below. These methods are acceptable to the NRC staff for accomplishing EMI/RFI emissions testing for safety-related I&C systems intended for installation in nuclear power plants. Where applicable, conditions permitting exemption of specific tests are described.

### **3.1 CE101—Conducted Emissions, Low Frequency**

The CE101 test measures the low-frequency conducted emissions on power leads of equipment and subsystems in the frequency 30 Hz to 10 kHz. Equipment could be exempt from this test if the following two conditions exist. First, the power quality requirements of the equipment are consistent with the existing power supply; and second, the equipment will not impose additional harmonic distortions on the existing power distribution system that exceed 5% total harmonic distortion (THD) or other power quality criteria established with a valid technical basis. When the test is to be performed, it is applicable to ac and dc power leads, including grounds and neutrals, that obtain power from other sources not part of the equipment under test. Conducted emissions on power leads should not exceed the applicable root mean square (rms) values shown in Figure 3.1. Alternative envelopes are given for ac-operated equipment based on power consumption (less than or equal to 1 kVA and greater than 1kVA). For ac-operated equipment with a fundamental current (i.e., load current at the power line frequency) greater than 1 ampere, the envelopes in Figure 3.1 may be relaxed as follows:

dB relaxation = 20 log (fundamental current)

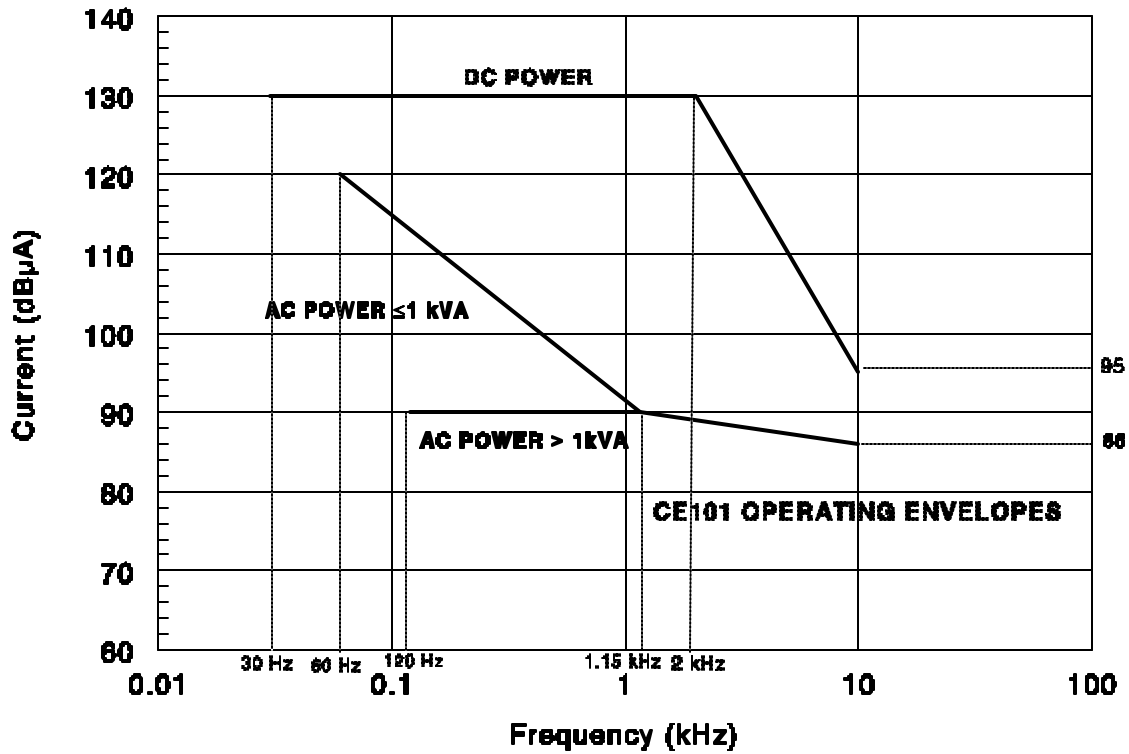

Figure 3.1 Low-Frequency Emissions Envelopes

### 3.2 CE102—Conducted Emissions, High Frequency

The CE102 test measures the high-frequency conducted emissions on power leads of equipment and subsystems in the frequency range 10 kHz to 2 MHz. The test is applicable to ac and dc power leads, including grounds and neutrals, that obtain power from other sources that are not part of the equipment under test. Conducted emissions on power leads should not exceed the applicable rms values shown in Figure 3.2. The values are specified according to the voltage of the power source feeding the equipment under test. Equipment could be exempted from application of this test in the frequency range 10 kHz to 450 kHz if the nuclear power plant has power quality control (see the conditions for exemption of the CE101 test). In addition, the following exemptions are permissible at higher frequencies. FCC Class A certification is acceptable in lieu of CE102 testing in the frequency range from 450 kHz to 2

MHz. CISPR 11 Class A certification is acceptable in lieu of CE102 testing in the frequency range from 150 kHz to 2 MHz. Otherwise, the CE102 test should be performed over the full frequency range from 10 kHz to 2 MHz.

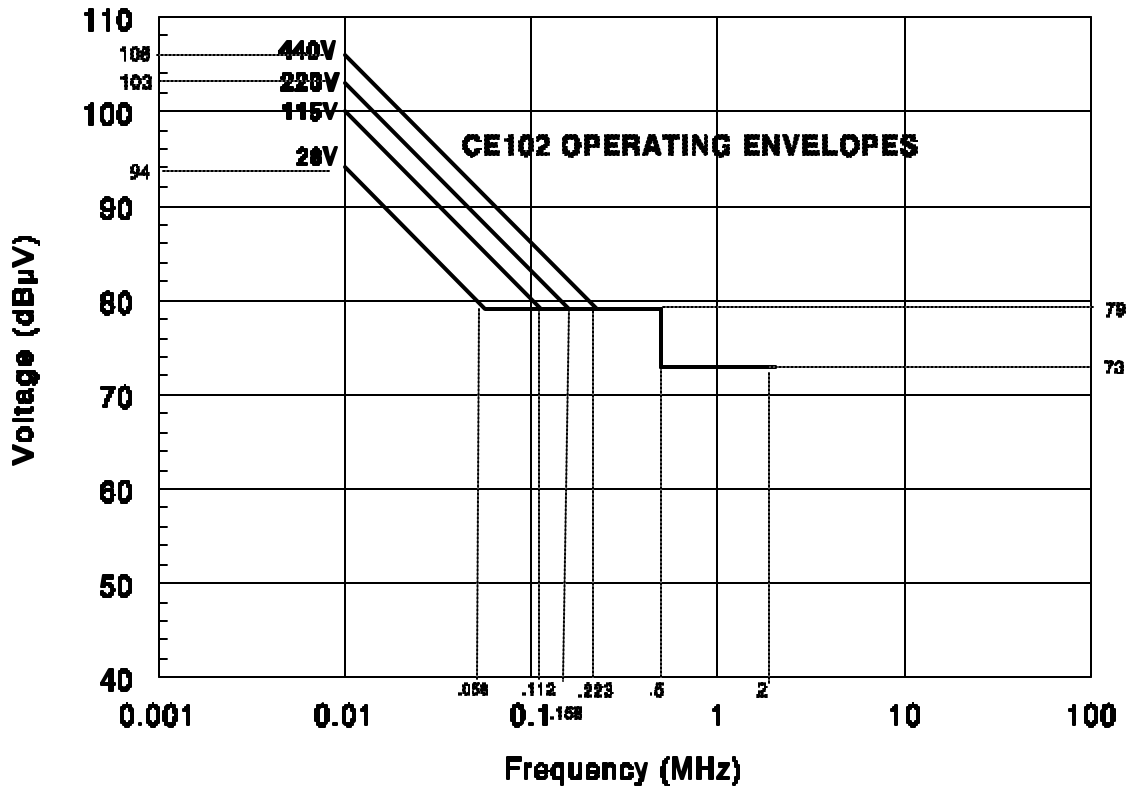
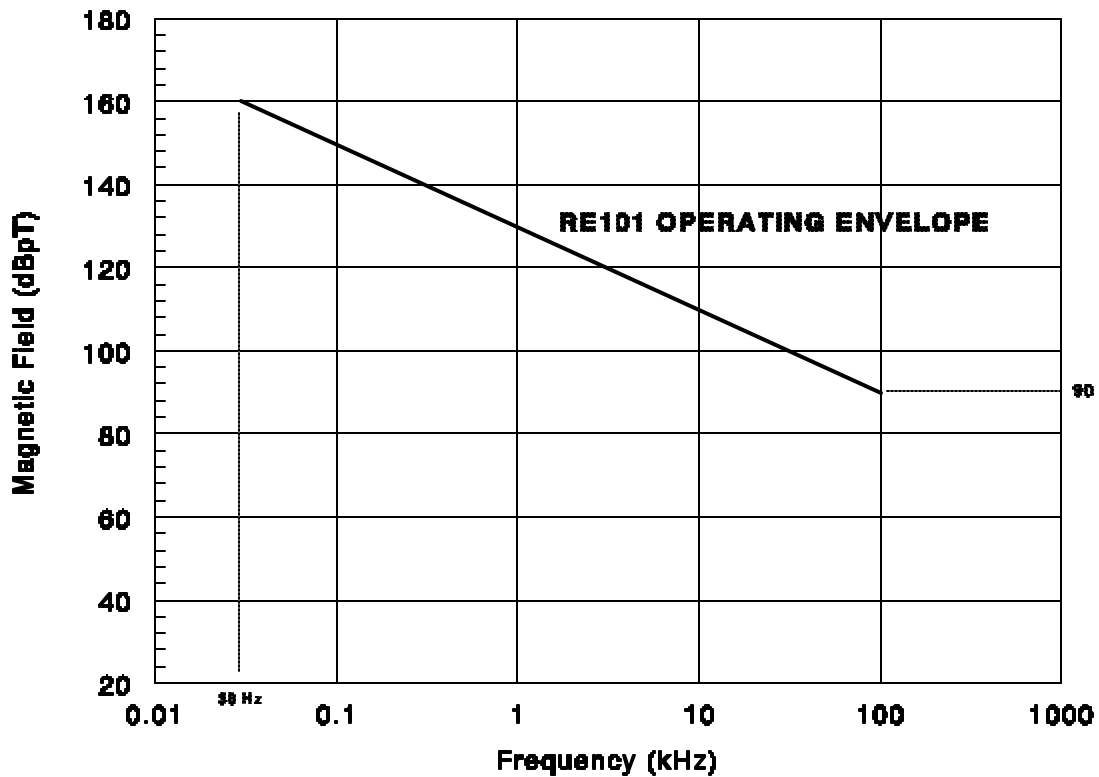

Figure 3.2 High-Frequency Conducted Emissions Envelopes

### 3.3 RE101—Radiated Emissions, Magnetic Field

The RE101 test measures radiated magnetic field emissions in the frequency range 30 Hz to 100 kHz. Equipment not intended to be installed in areas with other equipment sensitive to magnetic fields could be exempt from this test. The test is applicable for emissions from equipment and subsystem enclosures, as well as all interconnecting leads. The test does not apply at transmitter fundamental frequencies or to radiation from antennas. Magnetic field emissions should not be radiated in excess of the levels shown in Figure 3.3. Magnetic field emissions are measured at the specified distances of 7 cm and compared against the corresponding envelope.

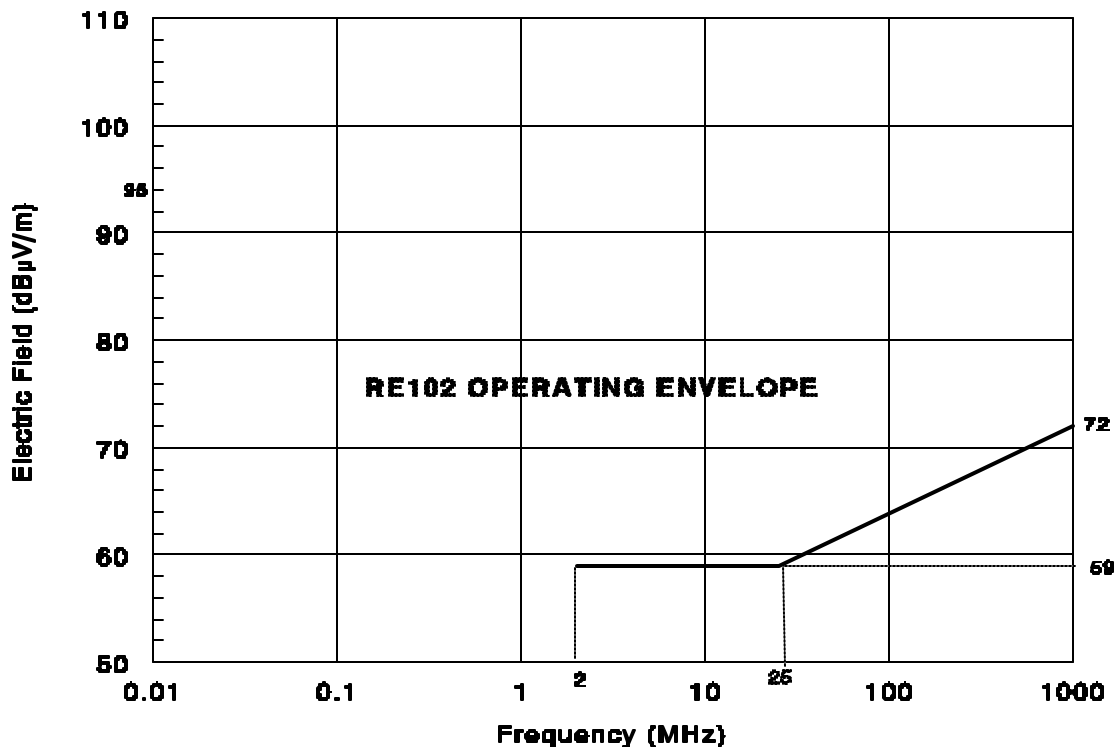

**Figure 3.3 Magnetic-Field Radiated Emissions Envelope**

### **3.4 RE102—Radiated Emissions, Electric Field**

The RE102 test addresses measurement of radiated electric field emissions in the frequency range of interest, 2 MHz to 1 GHz. This test is also applicable at frequencies above 1 GHz and the criteria for those applications are given in Position 6. It is applicable for emissions from equipment and subsystem enclosures, as well as all interconnecting leads. The test does not apply at transmitter fundamental frequencies or to radiation from antennas.

Electric field emissions should not be radiated in excess of the rms values shown in Figure 3.4. At frequencies above 30 MHz, the test method should be performed for both horizontally and vertically polarized fields.



**Figure 3.4 Electric-Field Radiated Emissions Envelopes**

### 3.5 IEC Emissions Tests

The IEC 61000-6-4 test practices that demonstrate EMI/RFI emissions compliance incorporate the test methods of CISPR 11 by reference. Under the following conditions, these methods are acceptable to the NRC staff for accomplishing EMI/RFI emissions testing for safety-related I&C systems intended for installation in nuclear power plants. For the IEC emissions testing option to be acceptable, two conditions must be met. First, power quality controls must be in place, which eliminates the need to perform the CE101 test. Second, separation from equipment that is sensitive to magnetic fields must be maintained, hence it is unnecessary to perform the RE101 test.

The specifications for the IEC 61000-6-4 test call for employing the CISPR 11 measurement techniques. These techniques are similar to those used in the MIL-STD-461E CE102 and RE102 tests, with some differences. For example, CISPR 11 requires a quasi-peak or average test signal detector, while CE102 requires a peak detector. Also, CISPR 11 requires that radiated electric field measurements be made at 30 meters and 10 meters in an open area site, while RE102 requires that the testing be performed in a shielded enclosure and that measurements be made at a distance of 1 meter. Despite the differences, the tests are expected to yield similar results. Values for the IEC 61000-6-4 envelope comparable to CE102 are given in Table 4. Since the CISPR 11 Class A operating envelopes



are the same as the IEC 61000-6-4 operating envelopes, the CISPR 11 Class A certification for conducted emissions satisfies IEC 61000-6-4 in the frequency range from 150 kHz to 2 MHz. In turn, the CISPR 11 Class A certification for radiated emissions satisfies IEC 61000-6-4 in the frequency range from 2 MHz to 1 GHz. Values for the IEC 61000-6-4 envelope comparable to RE102 are given in Table 5.

**Table 4 IEC 61000-6-4 Conducted Emissions Envelopes**  
(CISPR 11 Class A)

Frequency Range	Test Level (dB $\mu$ V)
150 kHz to 500 kHz	79 quasi-peak, 66 average
500 kHz to 5 MHz	73 quasi-peak, 60 average
5 MHz to 30 MHz	73 quasi-peak, 60 average

**Table 5 IEC 61000-6-4 Radiated Emissions Envelopes**  
(CISPR 11 Class A)

Frequency Range	Test Level (dB $\mu$ V/m)
30 MHz to 230 MHz	30 quasi-peak, measured at 30 m
230 MHz to 1 GHz	37 quasi-peak, measured at 30 m

### 3.6 EMI/RFI Emissions Test Summary

The CE101, CE102, RE101, and RE102 tests represent the baseline emissions testing program. Alternative programs are allowed if the conditions for two exemptions for low frequency emissions testing are met. A CE101 exemption is allowed if power quality control is employed and a RE101 exemption is allowed for equipment not intended to be installed in the proximity of magnetic field emitters. Alternatively, either emissions testing based on IEC 61000-6-4 or that satisfying FCC Part 15 Class A requirements is acceptable under the identified conditions. Figure 3.5 shows all of the acceptable testing programs and notes that the alternative programs are acceptable only when the conditions for exemption are satisfied. Thus, when the identified conditions for exempting low frequency emissions testing are met, any of the three alternative emissions testing programs may be selected. However, regardless of the emissions testing program selected, it is intended that each be applied in its entirety, without selective application of individual methods (i.e., no mixing and matching of test methods) for emissions testing.

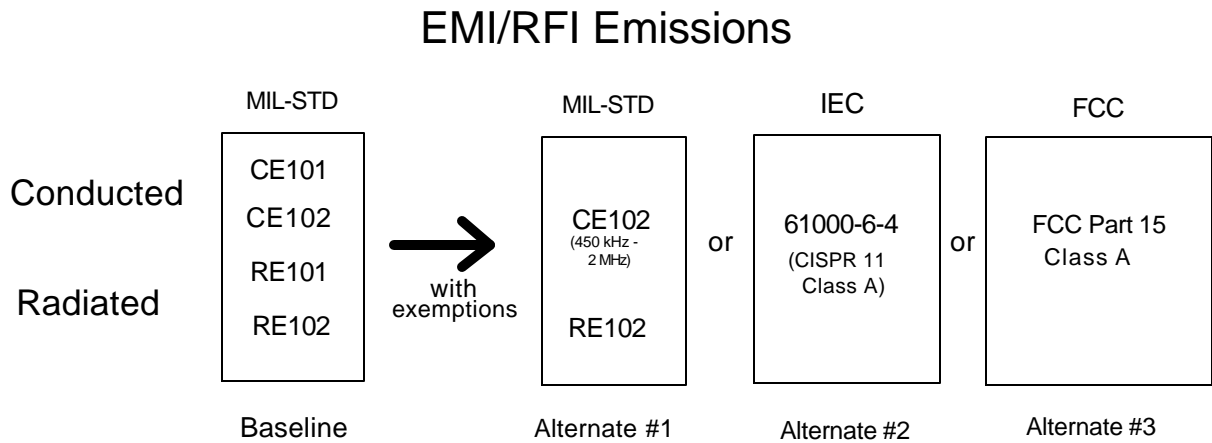

**Figure 3.5 Acceptable Alternatives for Emissions Testing**

#### 4. EMI/RFI SUSCEPTIBILITY TESTING

MIL-STD-461E contains test methods that can be applied to address EMI/RFI susceptibility for a selection of environments. IEC 61000-4, “Electromagnetic Compatibility (EMC) – Part 4: Testing and Measurement Techniques,” also specifies test methods that can be applied to characterize equipment susceptibility to conducted and radiated EMI/RFI. The specific test methods acceptable to the NRC staff in regard to susceptibility testing for safety-related I&C systems in nuclear power plants are presented in Tables 6 and 7. Table 6 lists the EMI/RFI test methods in MIL-STD-461E while Table 7 lists the corresponding methods in IEC 61000-4. It is intended that either set of test methods be applied in its entirety, without selective application of individual methods (i.e., no mixing and matching of test methods) for susceptibility testing. These methods cover susceptibility to conducted and radiated interference resulting from exposure to electric and magnetic fields and noise coupling through power and signal leads.

**Table 6 MIL-STD-461E EMI/RFI Susceptibility Test Methods**

<b>Method</b>	<b>Description</b>
CS101	Conducted susceptibility, low frequency, 30 Hz to 150 kHz
CS114	Conducted susceptibility, high frequency, 10 kHz to 30 MHz
CS115	Conducted susceptibility, bulk cable injection, impulse excitation
CS116	Conducted susceptibility, damped sinusoidal transients, 10 kHz to 100 MHz
RS101	Radiated susceptibility, magnetic field, 30 Hz to 100 kHz
RS103	Radiated susceptibility, electric field, 30 MHz to 1 GHz

C = conducted, R = radiated, and S = susceptibility.

**Table 7 IEC 61000-4 EMI/RFI Susceptibility Test Methods**

<b>Method</b>	<b>Description</b>
61000-4-4	Conducted susceptibility, electrically fast transients/bursts
61000-4-5	Conducted susceptibility, surges
61000-4-6	Conducted susceptibility, disturbances induced by radio-frequency fields
61000-4-12	Conducted susceptibility, 100 kHz ring wave
61000-4-13	Conducted susceptibility, low frequency, 16 Hz to 2.4 kHz
61000-4-16	Conducted susceptibility, low frequency, 15 Hz to 150 kHz
61000-4-8	Radiated susceptibility, magnetic field, 50 Hz and 60 Hz
61000-4-9	Radiated susceptibility, magnetic field, 50/60 Hz to 50 kHz
61000-4-10	Radiated susceptibility, magnetic field, 100 kHz and 1 MHz
61000-4-3	Radiated susceptibility, electric field, 26 MHz to 1 GHz

The MIL-STD-461E test methods listed in Table 6 have associated operating envelopes that serve to establish test levels. General operating envelopes that are acceptable to the NRC staff are given below in the discussion of the MIL-STD 461E test methods. Likewise, operating envelopes for the IEC 61000 test methods have been identified that are comparable to the corresponding MIL-STD

counterparts and are given below in the discussion of the MIL-STD 461E test methods. These operating envelopes are acceptable for locations where safety-related I&C systems either are or are likely to be installed and include control rooms, remote shutdown panels, cable spreading rooms, equipment rooms, auxiliary instrument rooms, relay rooms, and other areas (e.g., the turbine deck) where safety-related I&C system installations are planned. The operating envelopes are acceptable for analog, digital, and hybrid system installations.

The detailed technical basis for the electromagnetic operating envelopes is presented in NUREG/CR-6431, NUREG/CR-5609, and NUREG/CR-6782. The technical basis for the operating envelopes begins with the MIL-STD envelopes corresponding to the electromagnetic environment for military ground facilities, which were judged to be comparable to that of nuclear power plants based on general layout and equipment type considerations. Plant emissions data were used to confirm the adequacy of the operating envelopes. From the MIL-STD starting point, susceptibility envelopes were adjusted to account for the plant emissions data reported in NUREG/CR-6436, “Survey of Ambient Electromagnetic and Radio-Frequency Interference Levels in Nuclear Power Plants” (November 1996) and EPRI TR-102323. When changes to the operating envelopes from the MIL-STD origin were motivated by technical considerations, consistency among the envelopes for comparable test criteria was promoted. As a result of these considerations, the operating envelopes presented in this regulatory guide are equivalent or less restrictive than the MIL-STD envelopes that served as their initial basis.

The MIL-STD-461E and IEC test methods that demonstrate EMI/RFI susceptibility compliance are discussed below. These methods are acceptable to the NRC staff for accomplishing EMI/RFI susceptibility testing for safety-related I&C systems intended for installation in nuclear power plants. Where applicable, conditions permitting exemption of specific test methods are described.

#### 4.1 EMI/RFI Conducted Susceptibility Testing—Power Leads

The MIL-STD-461E test methods that are acceptable to the NRC staff to address conducted EMI/RFI susceptibility along power leads are listed in Table 8. The comparable IEC 61000-4 test methods that are acceptable to characterize equipment susceptibility to conducted EMI/RFI along power leads are listed in Table 9. These test methods cover susceptibility to conducted interference resulting from noise coupling through the power leads of safety-related I&C systems in nuclear power plants. Discussions of the test methods and operating envelopes follow below.

**Table 8 MIL-STD-461E EMI/RFI Conducted Susceptibility Test Methods—Power Leads**

<b>Method</b>	<b>Description</b>
CS101	Conducted susceptibility, low-frequency, 30 Hz to 150 kHz
CS114	Conducted susceptibility, high-frequency, 10 kHz to 30 MHz

C = conducted and S = susceptibility.

**Table 9 IEC 61000-4 EMI/RFI Conducted Susceptibility Test Methods—Power Leads**

<b>Method</b>	<b>Description</b>
61000-4-6	Conducted susceptibility, disturbances induced by radio-frequency fields
61000-4-13	Conducted susceptibility, low-frequency, 16 Hz to 2.4 kHz
61000-4-16	Conducted susceptibility, low-frequency, 15 Hz to 150 kHz

#### **4.1.1 CS101—Conducted Susceptibility, Low Frequency**

The CS101 test ensures that equipment and subsystems are not susceptible to EMI/RFI present on power leads in the frequency range 30 Hz to 150 kHz. The test is applicable to ac and dc input power leads, not including grounds and neutrals. If the equipment under test is dc operated, this test is applicable over the frequency range 30 Hz to 150 kHz. If the equipment under test is ac operated, this test is applicable starting from the second harmonic of the power line frequency and extending to 150 kHz.

The equipment under test should not exhibit any malfunction or degradation of performance beyond specified operational tolerances when subjected to a test signal with the rms voltage levels specified in Figure 4.1. Alternative envelopes are given for equipment with nominal source voltages at or below 28 V and those operating above 28 V. Acceptable performance should be defined in the test plan by the end user or testing organization according to the applicable equipment, subsystem, or system specifications.

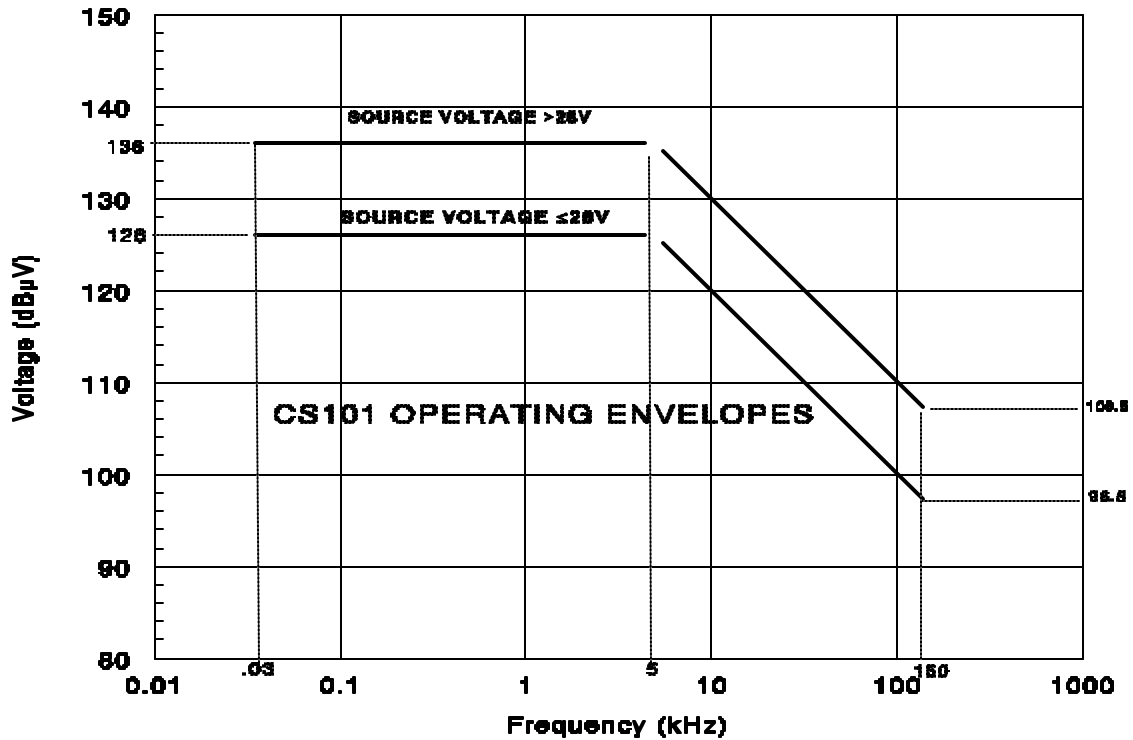
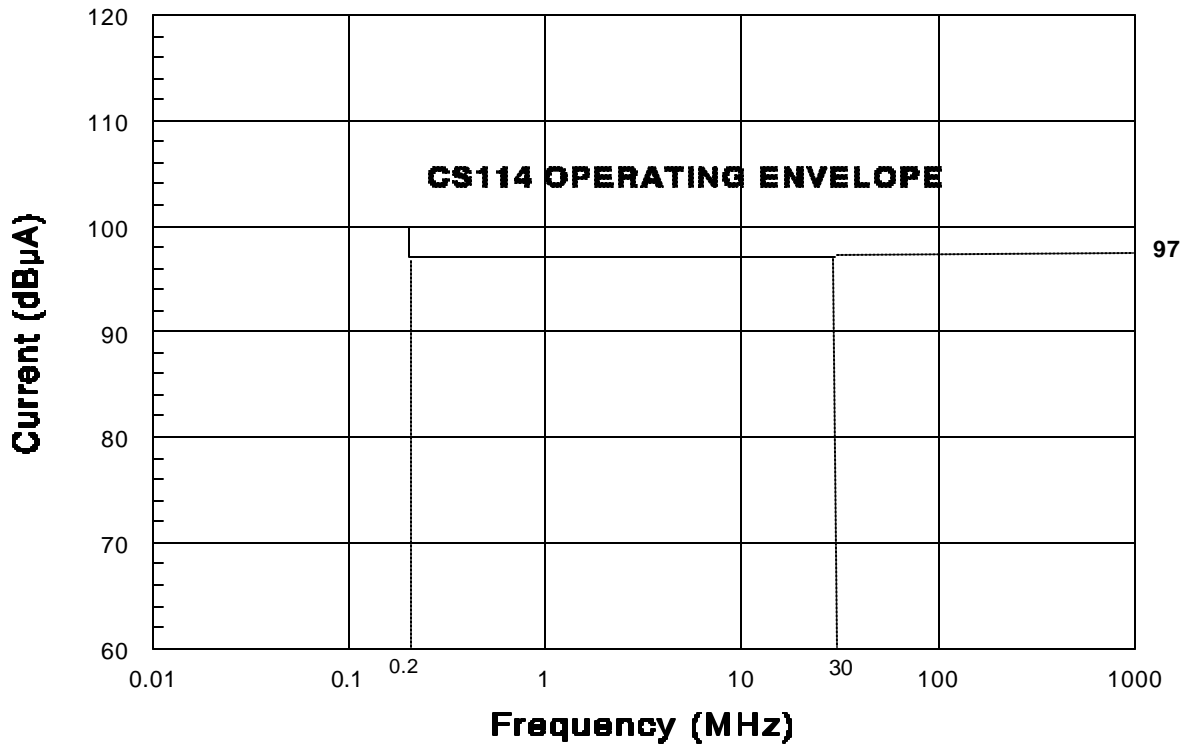

Figure 4.1 Low-Frequency Conducted Susceptibility Operating Envelopes

#### 4.1.2 CS114—Conducted Susceptibility, High Frequency

The CS114 test simulates currents that will be developed on leads as a result of EMI/RFI generated by antenna transmissions. The test covers the frequency range 10 kHz to 30 MHz and is applicable to all interconnecting leads, including the power leads of the equipment under test. Although the CS114 test can be applied to assess signal line susceptibility, the test levels given in this section apply only to power and control lines.

The equipment under test should not exhibit any malfunction or degradation of performance beyond specified operational tolerances when subjected to a test signal with the rms levels shown in Figure 4.2. Acceptable performance should be defined in the test plan by the end user or testing organization according to the applicable equipment, subsystem, or system specifications.



**Figure 4.2 High-Frequency Conducted Susceptibility Operating Envelopes for Power Leads**

#### **4.1.3 IEC Conducted Susceptibility Tests—Power Leads**

The IEC counterparts to the CS101 and CS114 tests are IEC 61000-4-13, IEC 61000-4-16, and IEC 61000-4-6. The Class 2 devices in IEC 61000-4-13 are similar to the industrial-grade devices used in nuclear power plants and the Class 2 operating envelope is shown in Table 10. For the IEC 61000-4-16 test, the Level 3 (typical industrial) environment is representative of the nuclear power plant environment. The Level 3 operating envelopes for the IEC 61000-4-16 test are shown in Table 11. The Level 3 test level for IEC 61000-4-6 is 140 dB $\mu$ V and is most similar to the CS114 operating envelope recommended for a typical industrial environment. These are the levels acceptable to NRC staff.

**Table 10 IEC 61000-4-13 Operating Envelope for 115-V System  
(Class 2)**

<b>Harmonic no. (n)</b>	<b>Class 2 (% of supply voltage)</b>	<b>Class 2 (voltage level)</b>
2	3	3.5
3	8	9.2
4	1.5	1.7
5	8	9.2
6	n.a.	—
7	6.5	7.5
8	n.a.	—
9	2.5	2.9
10	n.a.	—
11	5	5.8
12	n.a.	—
13	4.5	5.2
15	n.a.	—
17	3	3.5
19	2	2.3
21	n.a.	—
23	2	2.3
25	2	2.3
27	n.a.	—
29	1.5	1.7
31	1.5	1.7
33	n.a.	—
35	1.5	1.7
37	1.5	1.7
39	n.a.	—

**Table 11 Operating Envelopes for IEC 61000-4-16 Conducted Susceptibility Tests  
(Level 3)**

<b>Disturbance</b>	<b>Selected level</b>	<b>Test level</b>
dc and power line frequency, continuous disturbance	Level 3—typical industrial environment	10 Vrms
dc and power line frequency, short-duration disturbance	Level 3—typical industrial environment	100 Vrms
Conducted disturbance, 15 Hz to 150 kHz	Level 3—typical industrial environment	10–1 Vrms (15–150 Hz) 1 Vrms (150–1.5 kHz) 1–10 Vrms (1.5–15 kHz) 10 Vrms (15–150 kHz)



## 4.2 EMI/RFI Conducted Susceptibility Testing—Signal Leads

MIL-STD-461E contains test methods that can be applied to address conducted EMI/RFI susceptibility for interconnecting signal leads. In addition, IEC 61000-4 specifies test methods that can be applied to characterize equipment susceptibility to conducted EMI/RFI along interconnecting signal leads. The specific test methods acceptable to the NRC staff in regard to conducted susceptibility testing for signal leads of safety-related I&C systems in nuclear power plants are presented in Tables 12 and 13. Table 12 lists the EMI/RFI test methods for signal leads in MIL-STD-461E, while Table 13 lists the corresponding methods in specific sections of IEC 61000-4. These test methods cover susceptibility to conducted interference resulting from noise coupling through interconnecting signal leads.

**Table 12 MIL-STD-461E Conducted Susceptibility Test Methods—Signal Leads**

Method	Description
CS114	Conducted susceptibility, high-frequency, 10 kHz to 30 MHz
CS115	Conducted susceptibility, bulk cable injection, impulse excitation
CS116	Conducted susceptibility, damped sinusoidal transients, 10 kHz to 100 MHz

C = conducted and S = susceptibility.

**Table 13 IEC 61000-4 Conducted Susceptibility Test Methods—Signal Leads**

Method	Description
61000-4-4	Electrical fast transient/burst immunity test
61000-4-5	Surge immunity test
61000-4-6	Immunity to conducted disturbances, induced by radio-frequency fields
61000-4-12	Oscillatory waves immunity test
61000-4-16	Test for immunity to conducted, common mode disturbances in the frequency range 0 Hz to 150 kHz

The MIL-STD-461E test methods listed in Table 12 have associated operating envelopes that serve to establish test levels for signal leads. General operating envelopes that are acceptable to the NRC staff are shown in Table 14. Likewise, signal lead operating envelopes for the IEC 61000-4 test criteria listed in Table 13 have been identified in Table 15 and are comparable to their corresponding MIL-STD counterparts. Note that the withstand level is based on the location of a cable, along with its level of exposure. Most locations in the interior of a facility, which are typical for signal leads, correspond to a *Category B* classification, as described in IEEE Std C62.41-1991 and discussed in Regulatory Position 5.

Most signal leads are expected to be subject to surge environments that correspond to *Low Exposure* levels (see IEEE Std C62.41-1991 and Regulatory Position 5). However, for I&C systems that are implemented in plant areas that are characterized by surge environments corresponding to *Medium Exposure* levels (see IEEE Std C62.41-1991 and Regulatory Position 5), the operating envelopes for signal leads that are given in Table 14 should be doubled. For the IEC tests, the operating envelopes in Table 16 should be used for I&C systems that are implemented in plant areas that are characterized by surge environments corresponding to *Medium Exposure* levels.

**Table 14 MIL-STD-461E Conducted Susceptibility Operating Envelopes—Signal Leads**

<b>Method</b>	<b>Description</b>
CS114	91 dB $\mu$ A
CS115	2 A
CS116	5 A

**Table 15 IEC 6100-4 Conducted Susceptibility Operating Envelopes for *Low Exposure*—Signal Leads**

<b>Method</b>	<b>Description</b>
61000-4-4	Level 3: 1 kV test voltage
61000-4-5	Level 2: 1 kV open circuit test voltage and 0.5 kA short circuit current
61000-4-6	Level 2: 130 dB $\mu$ V test voltage,
61000-4-12	Ring wave: Level 2 - 1 kV test voltage
61000-4-16	Level 2: 3/10 of the values in Table 11

**Table 16 IEC 6100-4 Conducted Susceptibility Operating Envelopes  
for *Medium Exposure*—Signal Leads**

<b>Method</b>	<b>Description</b>
61000-4-4	Level 4: 2 kV test voltage
61000-4-5	Level 3: 2 kV open circuit test voltage and 1 kA short circuit current
61000-4-6	Level 3: 140 dB $\mu$ V test voltage,
61000-4-12	Ring wave: Level 3 - 2 kV test voltage
61000-4-16	Level 3: see Table 11

### 4.3 EMI/RFI Radiated Susceptibility Testing

The MIL-STD-461E test methods that are acceptable to the NRC staff for addressing the radiated EMI/RFI susceptibility of safety-related I&C systems in nuclear power plants are listed in Table 17. The comparable IEC 61000-4 test methods deemed acceptable to characterize equipment susceptibility to radiated EMI/RFI are listed in Table 18. These test methods cover susceptibility to radiated interference resulting from electromagnetic emissions in nuclear power plants. Discussions of the test methods and operating envelopes follow below.

**Table 17 MIL-STD-461E EMI/RFI Radiated Susceptibility Test Methods**

<b>Method</b>	<b>Description</b>
RS101	Radiated susceptibility, magnetic field, 30 Hz to 100 kHz
RS103	Radiated susceptibility, electric field, 30 MHz to 1 GHz

R = radiated and S = susceptibility.

**Table 18 IEC 61000-4 EMI/RFI Radiated Susceptibility Test Methods**

<b>Method</b>	<b>Description</b>
61000-4-8	Radiated susceptibility, magnetic field, 50 Hz and 60 Hz
61000-4-9	Radiated susceptibility, magnetic field, 50/60 Hz to 50 kHz
61000-4-10	Radiated susceptibility, magnetic field, 100 kHz and 1 MHz
61000-4-3	Radiated susceptibility, electric field, 26 MHz to 1 GHz

### 4.3.1 RS101—Radiated Susceptibility, Magnetic Fields

The RS101 test ensures that equipment and subsystems are not susceptible to radiated magnetic fields in the frequency range 30 Hz to 100 kHz. Equipment that is not intended to be installed in areas with strong sources of magnetic fields (e.g., CRTs, motors, cable bundles carrying high currents) and that follows the limiting practices endorsed in this regulatory guide could be exempt from this test. The test is applicable to equipment and subsystem enclosures and all interconnecting leads. The test is not applicable for electromagnetic coupling via antennas.

The equipment under test should not exhibit any malfunction or degradation of performance beyond specified operational tolerances when subjected to the rms magnetic field levels shown in Figure 4.3. Acceptable performance should be defined in the test plan by the end user or testing organization according to the applicable equipment, subsystem, or system specifications.

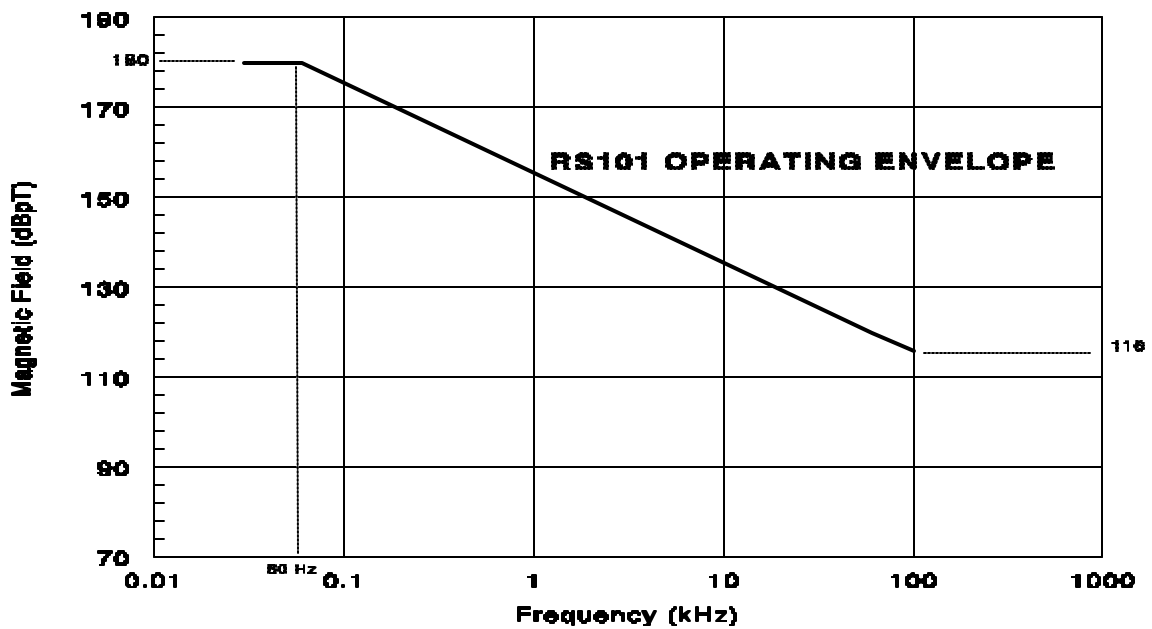

Figure 4.3 Low-Frequency Radiated Susceptibility Envelopes

### 4.3.2 RS103—Radiated Susceptibility, Electric Fields

The RS103 test ensures that equipment and subsystems are not susceptible to radiated electric fields in the frequency range 30 MHz to 1 GHz. This test is also applicable at frequencies above 1 GHz and the criteria for those applications are given in Position 6. The test is applicable to equipment and subsystem enclosures and all interconnecting leads. The test is not applicable at the tuned frequency of antenna-connected receivers unless otherwise specified.

The equipment under test should not exhibit any malfunction or degradation of performance

beyond specified operational tolerances when subjected to the radiated electric fields. The impressed electric field level should be 10 V/m (rms), measured in accordance with the techniques specified in the RS103 test method. The test method should be performed for both horizontally and vertically polarized fields. According to MIL-STD-461E, circularly polarized fields are not acceptable because radiated electric fields are typically linearly polarized. Acceptable performance should be defined in the test plan by the end user or testing organization according to the applicable equipment, subsystem, or system specifications.

### 4.3.3 IEC Radiated Susceptibility Tests

The IEC counterparts for the RS101 test are IEC 61000-4-8, IEC 61000-4-9, and IEC 61000-4-10. Operating envelopes for the typical industrial environment (Class 4) are shown in Table 19. The IEC counterpart for the RS103 test is IEC 61000-4-3 and its frequency range is 26 MHz to 1 GHz. The Level 3 in IEC 61000-4-3 is most similar to the nuclear power plant environment and requires a test level of 10 V/m. This level is equal to the RS103 operating envelope of 10 V/m. These levels are acceptable to NRC staff for the IEC radiated susceptibility tests.

**Table 19 IEC 61000-4-8, -4-9, and -4-10 Operating Envelopes**

Method	Selected Class	Test Level
IEC 61000-4-8	Continuous pulses: Class 4 – typical industrial environment	30 A/m (152 dBpT)
	Short duration pulses: Class 4 – typical industrial environment	300 A/m (172 dBpT)
IEC 61000-4-9	Class 4 – typical industrial environment	300 A/m (172 dBpT)
IEC 61000-4-10	Class 4 – typical industrial environment	30 A/m (152 dBpT)

### 4.4 EMI/RFI Susceptibility Test Summary

The CS101 and CS114 tests for power leads, the CS114, CS115, and CS116 tests for signal leads, and the RS101 and RS103 tests represent the baseline susceptibility testing program. An alternative susceptibility testing program based on IEC 61000 is acceptable for establishing susceptibility characteristics of safety-related I&C systems. Figure 4.4 shows the two acceptable susceptibility testing programs. While there is no restriction on the selection of either susceptibility testing program, it is intended that each be applied in its entirety, without selective application of individual methods (i.e., no mixing and matching of test methods) for susceptibility testing.

## EMI/RFI Susceptibility

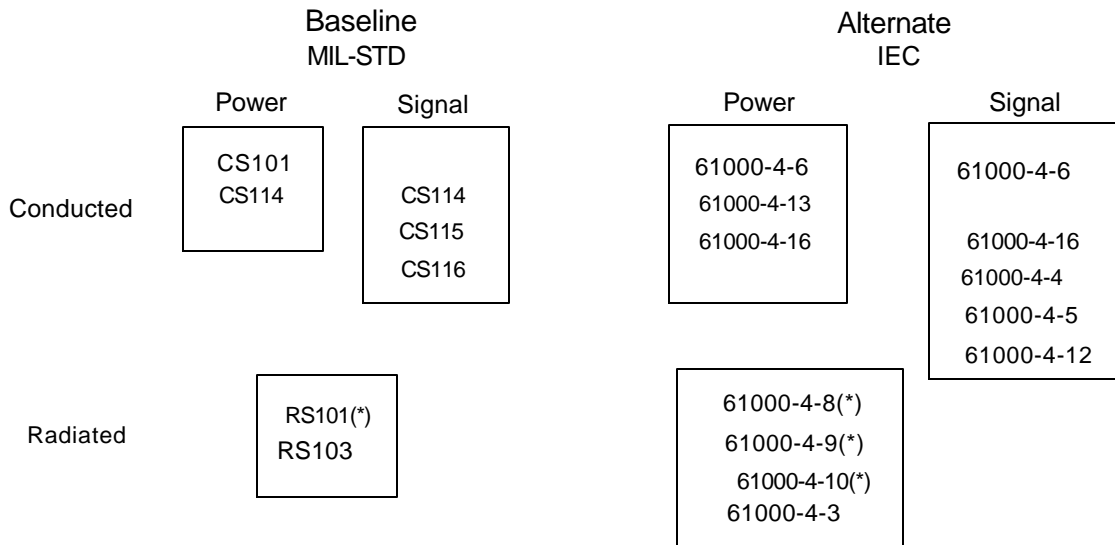

(\*) Exemption based on proximity to magnetic field emitters

**Figure 4.4 Acceptable Alternatives for EMI/RFI Susceptibility Testing**

### 5. SURGE WITHSTAND CAPABILITY

The SWC practices described in IEEE Std C62.41-1991 (reaffirmed in 1995), “IEEE Recommended Practice on Surge Voltages in Low-Voltage AC Power Circuits,” and IEEE Std C62.45-1992 (reaffirmed in 1997), “IEEE Guide on Surge Testing for Equipment Connected to Low-Voltage AC Power Circuits,” are acceptable to the NRC staff regarding the effect of power surges on safety-related I&C systems in nuclear power plants. IEEE Std C62.41-1991 defines a set of surge test waveforms that has manageable dimensions and represents a baseline surge environment. IEEE Std C62.45-1992 describes the associated test methods and equipment to be employed when performing the surge tests. Typical environmental conditions for power surges in a nuclear power plant can be represented by the waveforms given in Table 20.

**Table 20 IEEE C62.41-1991 Power Surge Waveforms**

Parameter	Ring Wave	Combination Wave		EFT
Waveform	Open-circuit voltage	Open-circuit voltage	Short-circuit current	Pulses in 15-ms bursts
Rise time	0.5 μs	1.2 μs	8 μs	5 ns
Duration	100 kHz ringing	50 μs	20 μs	50 ns

The IEC 61000-4 tests comparable to the IEEE C62.41-1991 tests are listed in Table 21. The test waveforms are the same and the test procedures are very similar. Hence, a direct interchange of the test methods is acceptable to the NRC staff. Test levels for the IEC 61000-4 tests are specified according to the intended environment.

**Table 21 Comparable SWC Test Methods**

<b>IEEE C62.41-1991</b>	<b>IEC Method</b>
Ring Wave	61000-4-12
Combination Wave	61000-4-5
EFT	61000-4-4

IEEE Std C62.41-1991 describes location categories and exposure levels that define applicable amplitudes for the surge waveforms that should provide an appropriate degree of SWC. Location categories depend on the proximity of equipment to the service entrance and the associated line impedance. Exposure levels relate to the rate of surge occurrence versus the voltage level (e.g., surge crest) to which equipment is exposed. The withstand levels presented in this regulatory position are based on *Category B* and *Category C* locations, *along with Low Exposure and Medium Exposure* levels. *Category B* covers feeders and short branch circuits extending to interior locations from the service entrance. *Category C* covers the exterior and service entrance. *Low Exposure* levels encompass systems in areas known for little load or capacitor switching and low-power surge activity. *Medium Exposure* levels encompass systems in areas subject to significant switching transients and medium to high lightning activity. Table 22 lists the withstand levels that are acceptable for nuclear power plant application. Interior locations where safety-related I&C systems either are or are likely to be installed include control rooms, remote shutdown panels, cable spreading rooms, equipment rooms, auxiliary instrument rooms, relay rooms, and other areas (e.g., the turbine deck). Many of these areas can be classified as *Category B* locations with *Low Exposure* levels. However, locations where primary power is provided through connection to external lines or there are sources of significant switching transients present (e.g., switchgear, large motors) should be treated as *Category B* locations with *Medium Exposure* levels. A determination of the exposure level classification that characterizes a location is necessary to select the applicable withstand levels.

**Table 22 Surge Withstand Levels for Power Lines**

<b>Surge Waveform</b>	<b>Category B Low Exposure</b>	<b>Category B Medium Exposure</b>	<b>Category C Exterior</b>
Ring Wave	2 kV	4 kV	N/A

Surge Waveform	Category B Low Exposure	Category B Medium Exposure	Category C Exterior
Combination Wave	2 kV / 1 kA	4 kV / 2 kA	6 kV / 3 kA
EFT	2 kV	4 kV	N/A

### 5.1 IEEE C62.41 Ring Wave and IEC 61000-4-12

The Ring Wave simulates oscillatory surges of relatively high frequency on the ac power leads of equipment and subsystems and is represented by an open-circuit voltage waveform. The waveform, 100-kHz sinusoid, has an initial rise time of 0.5  $\mu$ s and continually decaying amplitude. A plot of the waveform is shown in Figure 5.1. The rise time is defined as the time difference between the 10% and 90% amplitude points on the leading edge of the waveform. The amplitude of the waveform decays with each peak being 60% of the amplitude of the preceding peak of the opposite polarity.

The peak voltage value of the Ring Wave is given in Table 22. For the IEC test, the withstand levels correspond to Level 3 and Level 4 for the *Low Exposure* and *Medium Exposure* categories, respectively. During the performance of the test, the equipment under test should not exhibit any malfunction or degradation of performance beyond specified operational tolerances when subjected to the Ring Wave. Acceptable performance of the equipment under test should be defined in the test plan by the end user or testing organization according to the applicable equipment, subsystem, or system specifications.

### 5.2 IEEE C62.41 Combination Wave and IEC 61000-4-5

The Combination Wave involves two exponential waveforms, an open-circuit voltage and a short-circuit current. It is intended to represent direct lightning discharges, fuse operation, or capacitor switching on the ac power leads of equipment and subsystems. The open-circuit voltage waveform has a 1.2- $\mu$ s rise time and an exponential decay with a duration (to 50% of initial peak level) of 50  $\mu$ s. The short-circuit current waveform has an 8- $\mu$ s rise time and a duration of 20  $\mu$ s. Plots of the waveforms are shown in Figures 5.2 and 5.3.

The rise time is defined as the time difference between the 10% and 90% amplitude points on the leading edge of the waveform. The duration is defined as the time between virtual origin and the time at the 50% amplitude point on the tail of the waveform. Virtual origin is the point where a straight line between the 30% and 90% points on the leading edge of the waveform intersects the V=0 line for the open-circuit voltage and the i=0 line for the short-circuit current.

The peak value of the open-circuit voltage of the Combination Wave and the peak value of the short-circuit current are given in Table 22. For the IEC test, the withstand levels correspond to Level 3 and Level 4 for the *Low Exposure* and *Medium Exposure* categories, respectively. The *Category C*



withstand level corresponds to the special class, Level x , for the IEC test. During the performance of the test, the equipment under test should not exhibit any malfunction or degradation of performance beyond specified operational tolerances when subjected to the Combination Wave. Acceptable performance of the equipment under test should be defined in the test plan by the end user or testing organization according to the applicable equipment, subsystem, or system specifications.

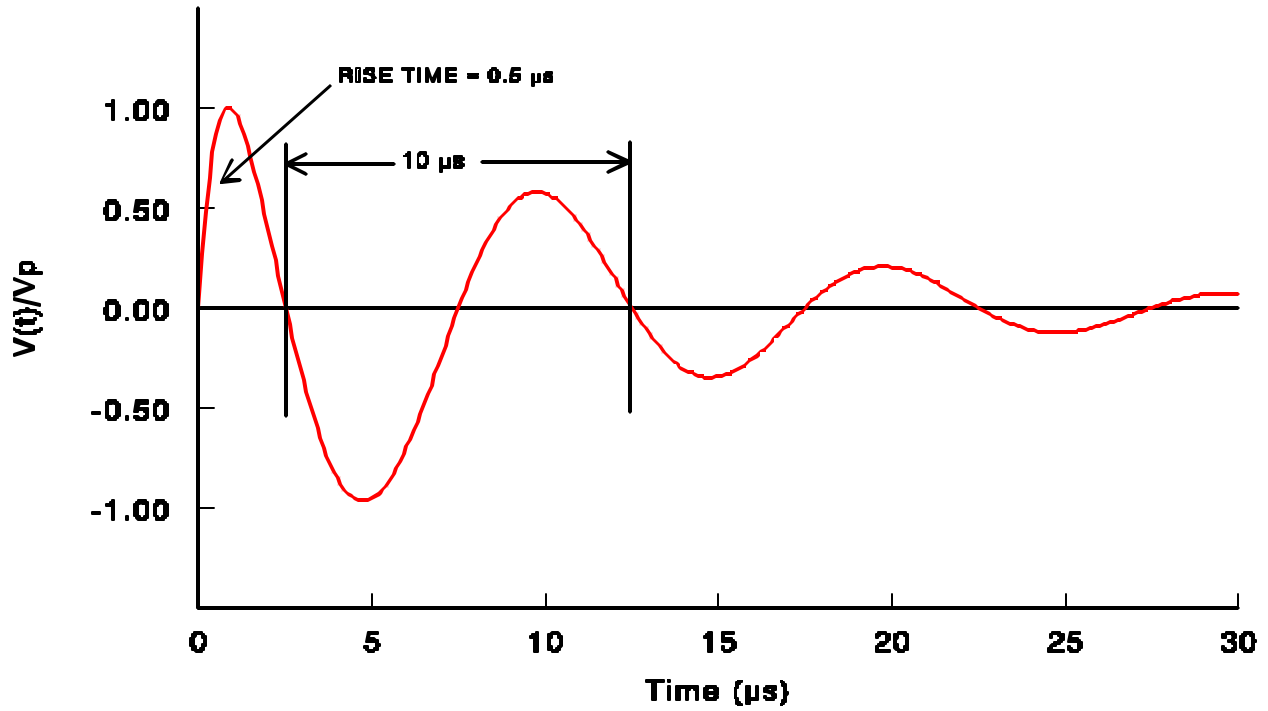

Figure 5.1 100-kHz Ring Wave

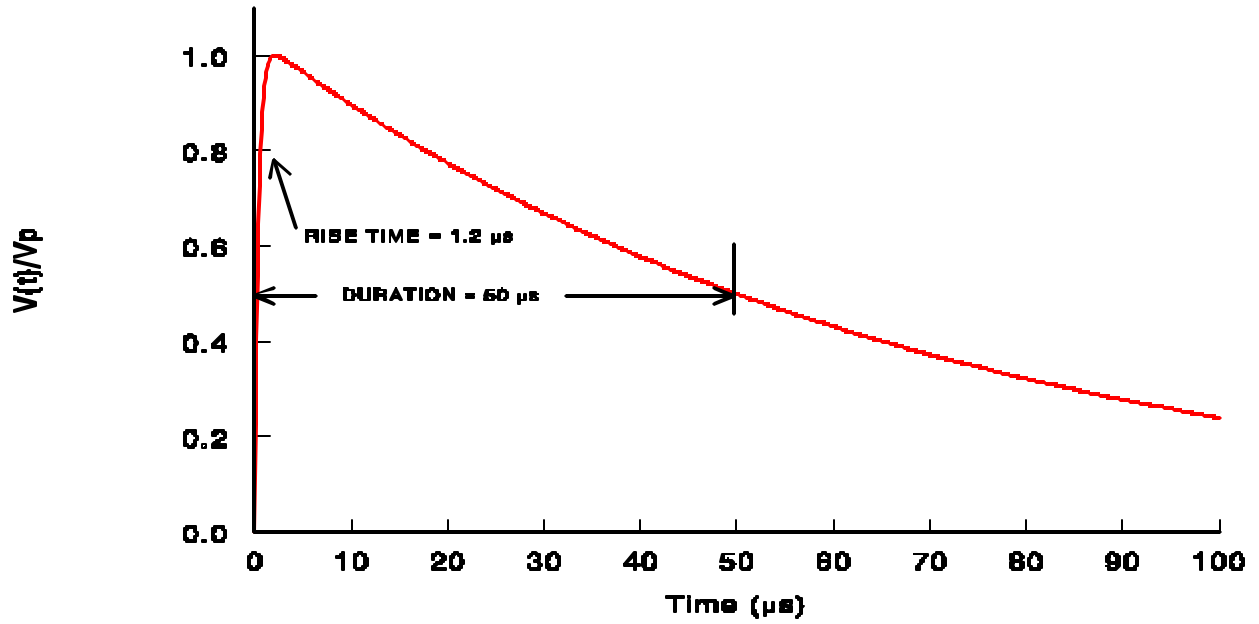

Figure 5.2 Combination Wave, Open-Circuit Voltage

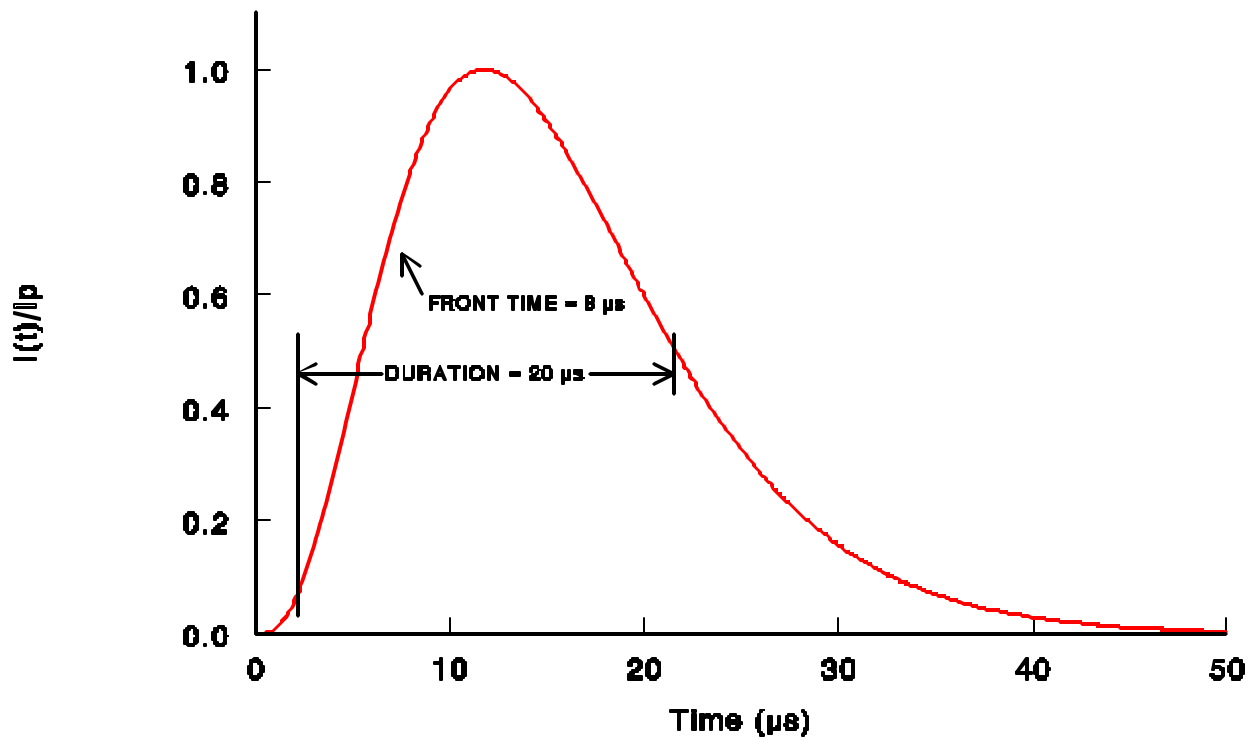

Figure 5.3 Combination Wave, Short-Circuit Current

### 5.3 IEEE C62.41 Electrically Fast Transients and IEC 61000-4-4

The EFT waveform consists of repetitive bursts, with each burst containing individual unidirectional pulses, and is intended to represent local load switching on the ac power leads of equipment and subsystems. The individual EFT pulses have a 5-ns rise time and a duration (width at half-maximum) of 50 ns. Plots of the EFT pulse waveform and the pattern of the EFT bursts are shown in Figures 5.4 and 5.5. The number of pulses in a burst is determined by the pulse frequency. For peaks less than or equal to 2 kV, the pulse frequency will be  $5 \text{ kHz} \pm 1 \text{ kHz}$ . For peaks greater than 2 kV, the pulse frequency will be  $2.5 \text{ kHz} \pm 0.5 \text{ kHz}$ .

The rise time is defined as the time difference between the 10% and 90% amplitude points on the leading edge of the waveform. The duration is defined as the time between the 50% amplitude points on the leading and trailing edges of each individual pulse. Individual pulses occur in bursts of 15 ms duration.

The peak value of the individual EFT pulses is given in Table 22. For the IEC test, the withstand levels correspond to Level 3 and Level 4 for the *Low Exposure* and *Medium Exposure* categories, respectively. During the performance of the test, the equipment under test should not exhibit any malfunction or degradation of performance beyond specified operational tolerances when subjected to the EFT pulses.

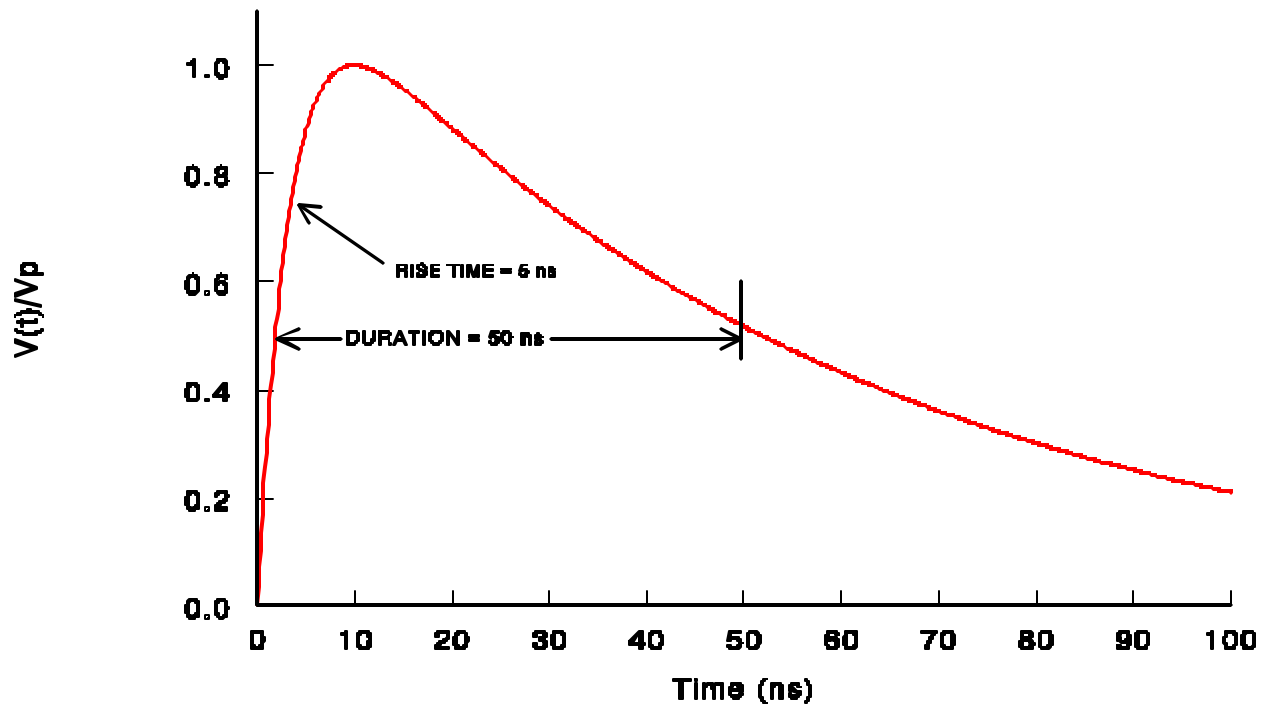
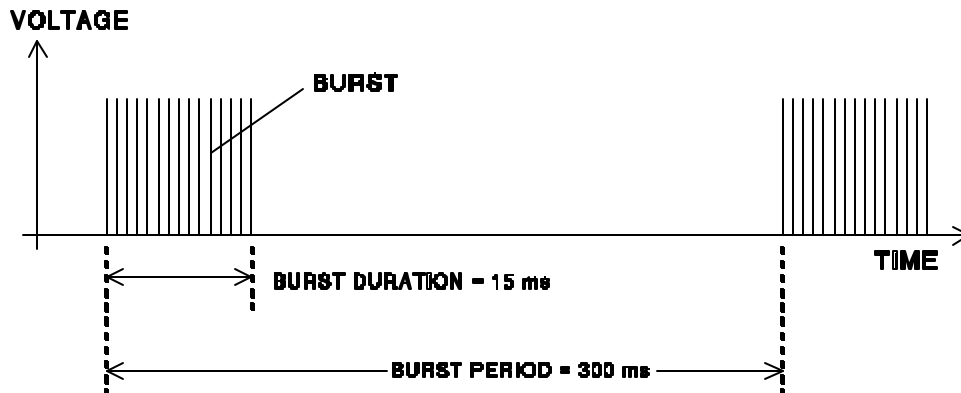

Figure 5.4 Waveform of the EFT Pulse



**Figure 5.5 Pattern of EFT Bursts**

Acceptable performance of the equipment under test should be defined in the test plan by the end user or testing organization according to the applicable equipment, subsystem, or system specifications.

## **6. RADIATED EMI/RFI TESTING ABOVE 1 GHz**

MIL-STD-461E contains test methods and criteria that can be applied to address radiated EMI/RFI emissions and susceptibility above 1 GHz for a selection of environments. IEC 61000-3 and IEC 61000-4 do not. The RE102 test is applicable above 1 GHz for up to 10 times the highest intentionally generated frequency within the equipment under test. The associated emissions operating envelope is shown in Figure 6.1. The specific test method acceptable to the NRC staff in regard to radiated susceptibility testing above 1 GHz is contained in the MIL-STD-461E presentation of RS103. This method covers susceptibility above 1 GHz to radiated interference resulting from exposure to electric fields.

The need for radiated susceptibility testing in the frequency range 1 GHz to 10 GHz has arisen because of the development of faster speed microprocessors and wireless communications, which contribute to interference concerns in the very high frequency band. Susceptibility testing in this range covers the unlicensed frequency bands where much of the communications activity is taking place (2.45 GHz and 5.7 GHz). The new developments are not expected to be strong emitters because of FCC restrictions, so the susceptibility test operating envelope will remain the same as at lower frequencies, 10 V/m (rms).

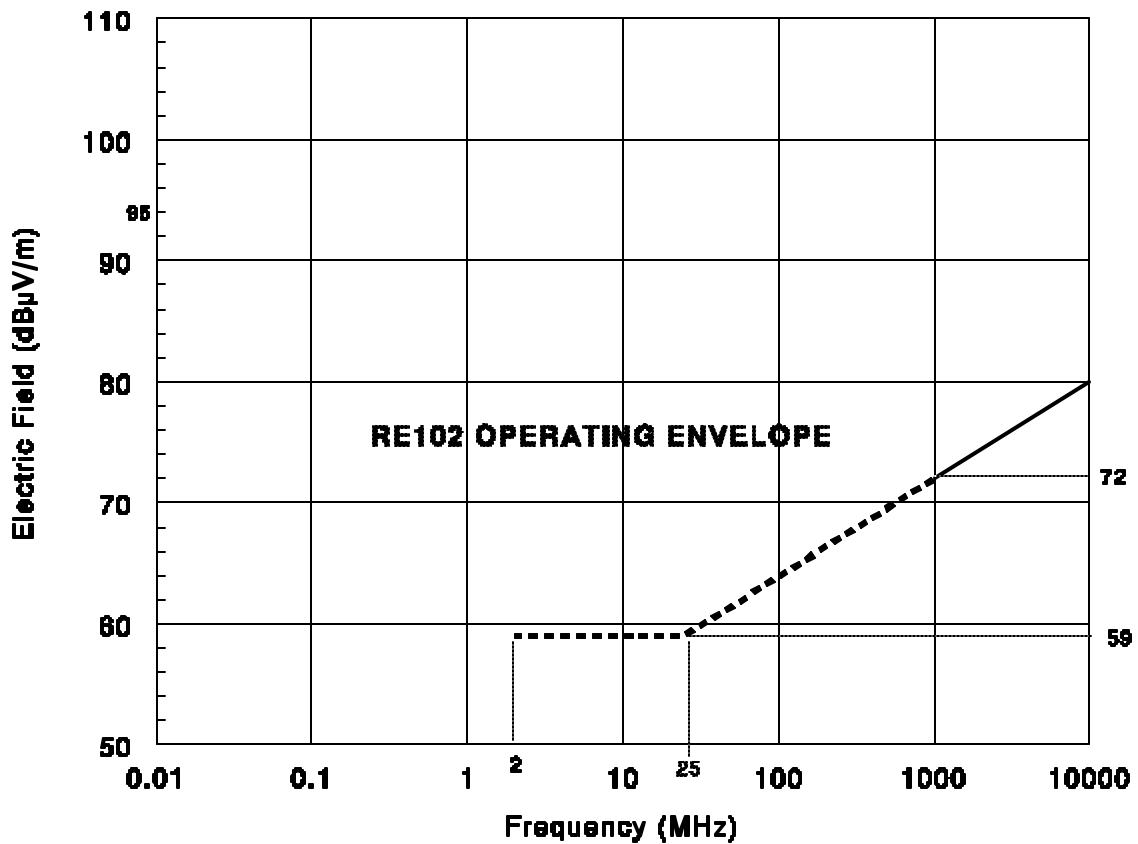

**Figure 6.1 Electric-Field Radiated Emissions Envelope Above 1 GHz**

**7. DOCUMENTATION**

Electromagnetic compatibility documentation should provide evidence that safety-related I&C equipment meets its specification requirements and is compatible with the projected electromagnetic environment, that the user adheres to acceptable installation practices, and that administrative controls have been established covering the allowable proximity of portable EMI/RFI sources. Data used to demonstrate the compatibility of the equipment with its projected environment should be pertinent to the application and be organized in a readily understandable and traceable manner that permits independent auditing of the conclusion presented.

The content of electromagnetic compatibility documentation should contain the information listed below, as well as any additional information specified in the standards cited by this regulatory guide. These items, as a minimum, could be included as part of a qualification or dedication file.

1. Identification of the equipment
2. Specifications on the equipment
3. Identification of safety functions to be demonstrated by test data
4. Test plan
5. Test results, including
  - 5.1 Objective of the test
  - 5.2 Detailed description of test item
  - 5.3 Description of test setup, instrumentation, and calibration data
  - 5.4 Test procedure
  - 5.5 Summary of test data, accuracy, and anomalies
6. The installation practices employed and administrative controls established to alleviate potential EMI/RFI and power surge exposure
7. Summary and conclusions
8. Approval signature and date.

#### **D. IMPLEMENTATION**

The purpose of this section is to provide information to applicants and licensees regarding the NRC staff's plans for using this regulatory guide. No backfitting is intended or approved in connection with the issuance of this guide.

Except when an applicant or licensee proposes or has previously established an acceptable alternative method for complying with the specified portions of the NRC's regulations, the methods described in this guide will be used in the evaluation of submittals in connection with applications for construction permits, operating licenses, and combined licenses. This guide will also be used to evaluate submittals from operating reactor licensees who propose system modifications that are voluntarily initiated by the licensee if there is a clear connection between the proposed modifications and this guidance.

## REFERENCES

CISPR 11, "Industrial, Scientific, and Medical Radio-Frequency Equipment—Electromagnetic Disturbance Characteristics—Limits and Methods of Measurement," International Special Committee on Radio Interference, 1997.<sup>1</sup>

IEC 61000-3-2, "Electromagnetic Compatibility (EMC) - Part 3-2: Limits—Limits for Harmonic Current Emissions," International Electrotechnical Commission, 2001.<sup>1</sup>

IEC 61000-3-4, "Electromagnetic Compatibility (EMC) - Part 3-4: Limits—Limitation of Emission of Harmonic Currents in Low-voltage Power Supply Systems for Equipment with Rated Current Greater than 16 A," International Electrotechnical Commission, 1998.<sup>1</sup>

IEC 61000-4-1, "Electromagnetic Compatibility (EMC) - Part 4: Testing and Measurement Techniques, Section 1: Overview of Immunity Tests," International Electrotechnical Committee, 1992.<sup>1</sup>

IEC 61000-4-2, "Electromagnetic Compatibility (EMC) - Part 4: Testing and Measurement Techniques, Section 2: Electrostatic Discharge Immunity Test," International Electrotechnical Committee, 1995.<sup>1</sup>

IEC 61000-4-3, "Electromagnetic Compatibility (EMC) - Part 4: Testing and Measurement Techniques, Section 3: Radiated, Radio-Frequency, Electromagnetic Field Immunity Test," International Electrotechnical Committee, 1995.<sup>1</sup>

IEC 61000-4-4, "Electromagnetic Compatibility (EMC) - Part 4: Testing and Measurement Techniques, Section 4: Electrical Fast Transient/Burst Immunity Test," International Electrotechnical Committee, 1995.<sup>1</sup>

IEC 61000-4-5, "Electromagnetic Compatibility (EMC) - Part 4: Testing and Measurement Techniques, Section 5: Surge Immunity Test," International Electrotechnical Committee, 1995.<sup>1</sup>

IEC 61000-4-6, "Electromagnetic Compatibility (EMC) - Part 4: Testing and Measurement Techniques, Section 6: Immunity to Conducted Disturbances, Induced by Radio-Frequency Fields," International Electrotechnical Committee, 1996.<sup>1</sup>

IEC 61000-4-7, "Electromagnetic Compatibility (EMC) - Part 4: Testing and Measurement Techniques, Section 7: General Guide on Harmonics and Interharmonics Measurements and Instrumentation, for Power Supply Systems and Equipment Connected Thereto," International Electrotechnical Committee, 1991.<sup>1</sup>

---

<sup>1</sup> International Electrotechnical Commission documents are available from the IEC at 3 rue de Varembe, PO Box 131, 1211 Geneva 20, Switzerland.

IEC 61000-4-8, "Electromagnetic Compatibility (EMC) - Part 4: Testing and Measurement Techniques, Section 8: Power Frequency Magnetic Field Immunity Test," International Electrotechnical Committee, 1993.<sup>1</sup>

IEC 61000-4-9, "Electromagnetic Compatibility (EMC) - Part 4: Testing and Measurement Techniques, Section 9: Pulse Magnetic Field Immunity Test," International Electrotechnical Committee, 1993.<sup>1</sup>

IEC 61000-4-10, "Electromagnetic Compatibility (EMC) - Part 4: Testing and Measurement Techniques, Section 10: Damped Oscillatory Magnetic Field Immunity Test," International Electrotechnical Committee, 1993.<sup>1</sup>

IEC 61000-4-11, "Electromagnetic Compatibility (EMC) - Part 4: Testing and Measurement Techniques, Section 11: Voltage Dips, Short Interruptions, and Voltage Variations Immunity Test," International Electrotechnical Committee, 1994.<sup>1</sup>

IEC 61000-4-12, "Electromagnetic Compatibility (EMC) - Part 4: Testing and Measurement Techniques, Section 12: Oscillatory Waves Immunity Tests," International Electrotechnical Committee, 1996.<sup>1</sup>

IEC 61000-4-13, "Electromagnetic Compatibility (EMC) - Part 4: Testing and Measurement Techniques, Section 13: Immunity to Harmonics and Interharmonics," International Electrotechnical Committee, 1998.<sup>1</sup>

IEC 61000-4-16, "Electromagnetic Compatibility (EMC) - Part 4: Testing and Measurement Techniques, Section 16: Test for Immunity to Conducted, Common Mode Disturbances in the Frequency Range 0 Hz to 150 kHz," International Electrotechnical Committee, 1998.<sup>1</sup>

IEC 61000-6-4, "Electromagnetic Compatibility (EMC) - Part 6: Generic Standards, Section 4: Emission Standard for Industrial Environments," International Electrotechnical Committee, 1997.<sup>1</sup>

IEEE Std 279-1971, "Criteria for Protection Systems for Nuclear Power Generating Stations," Institute of Electrical and Electronics Engineers, issued 1971.<sup>2</sup>

IEEE Std 473-1985, "IEEE Recommended Practice for an Electromagnetic Site Survey (10 kHz to 10 GHz)," Institute of Electrical and Electronics Engineers, issued 1985, reaffirmed 1997.<sup>2</sup>

IEEE Std 518-1982, "IEEE Guide for the Installation of Electrical Equipment To Minimize Noise Inputs to Controllers from External Sources," Institute of Electrical and Electronics Engineers, issued 1982, reaffirmed 1996.<sup>2</sup>

---

<sup>2</sup> IEEE publications may be purchased from the IEEE Service Center, 445 Hoes Lane, Piscataway, NJ 08855.



IEEE Std 603-1991, "Criteria for Safety Systems for Nuclear Power Generating Stations," Institute of Electrical and Electronics Engineers, issued 1991.<sup>2</sup>

IEEE Std 665-1995, "IEEE Guide for Generating Station Grounding," Institute of Electrical and Electronics Engineers, issued 1995, reaffirmed 2001.<sup>2</sup>

IEEE Std 1050-1996, "IEEE Guide for Instrumentation and Control Equipment Grounding in Generating Stations," Institute of Electrical and Electronics Engineers, issued 1996.<sup>2</sup>

IEEE Std C62.41-1991, "IEEE Recommended Practice on Surge Voltages in Low-Voltage AC Power Circuits," Institute of Electrical and Electronics Engineers, issued 1991, reaffirmed 1995.<sup>2</sup>

IEEE Std C62.45-1992, "IEEE Guide on Surge Testing for Equipment Connected to Low-Voltage AC Power Circuits," Institute of Electrical and Electronics Engineers, issued 1992, reaffirmed in 1997.<sup>2</sup>

MIL-STD-461C, "Electromagnetic Emission and Susceptibility Requirements for the Control of Electromagnetic Interference," Department of Defense, August 4, 1986.<sup>3</sup>

MIL-STD-461D, "Electromagnetic Emission and Susceptibility Requirement for the Control of Electromagnetic Interference," Department of Defense, January 11, 1993.<sup>3</sup>

MIL-STD-461E, "Requirements for the Control of Electromagnetic Interference Characteristics of Subsystems and Equipment," U.S. Department of Defense, August 20, 1999.<sup>3</sup>

MIL-STD-462, "Measurement of Electromagnetic Interference Characteristics," Department of Defense, July 31, 1967.<sup>3</sup>

MIL-STD-462D, "Measurement of Electromagnetic Interference Characteristics, Department of Defense, Jan 11, 1993.<sup>3</sup>

NUREG-0800, "Standard Review Plan for the Review of Safety Analysis Reports for Nuclear Power Plants," Chapter 7, "Instrumentation and Controls," USNRC, June 1997.<sup>4</sup>

NUREG/CR-5609, "Electromagnetic Compatibility Testing for Conducted Susceptibility Along Interconnecting Signal Lines," USNRC, August 2003.<sup>4</sup>

---

<sup>3</sup> Military Standards are available from the Department of Defense, Standardization Documents Order Desk, Building 4D, 700 Robbins Avenue, Philadelphia, PA 19111-5094.

<sup>4</sup> Copies are available at current rates from the U.S. Government Printing Office, P.O. Box 37082, Washington, DC 20402-9328 (telephone (202)512-1800); or from the National Technical Information Service by writing NTIS at 5285 Port Royal Road, Springfield, VA 22161; (<<http://www.ntis.gov/ordernow>>; telephone (703)487-4650;. Copies are available for inspection or copying for a fee from the NRC Public Document Room at 11555 Rockville Pike, Rockville, MD; the PDR's mailing address is USNRC PDR, Washington, DC 20555; telephone (301)415-4737 or (800)397-4209; fax (301)415-3548; email is PDR@NRC.GOV.

NUREG/CR-5700, "Aging Assessment of Reactor Instrumentation and Protection System Components," USNRC, July 1992.<sup>4</sup>

NUREG/CR-5904, "Functional Issues and Environmental Qualification of Digital Protection Systems of Advanced Light-Water Nuclear Reactors," USNRC, April 1994.<sup>4</sup>

NUREG/CR-5941, "Technical Basis for Evaluating Electromagnetic and Radio-Frequency Interference in Safety-Related I&C Systems" April 1994.<sup>4</sup>

NUREG/CR-6431, "Recommended Electromagnetic Operating Envelopes for Safety-Related I&C Systems in Nuclear Power Plants," USNRC, April 1999.<sup>4</sup>

NUREG/CR-6436, "Survey of Ambient Electromagnetic and Radio-Frequency Interference Levels in Nuclear Power Plants," USNRC, November 1996.<sup>4</sup>

NUREG/CR-6406, "Environmental Testing of an Experimental Digital Safety Channel," USNRC, September 1996.<sup>4</sup>

NUREG/CR-6579, "Digital I&C Systems in Nuclear Power Plants: Risk-Screening of Environmental Stressors and a Comparison of Hardware Unavailability With an Existing Analog System," USNRC, January 1998.<sup>4</sup>

NUREG/CR-6782, "Comparison of U.S. Military and International Electromagnetic Compatibility Guidance," USNRC, August 2003.<sup>4</sup>

Safety Evaluation Report (SER), issued by USNRC by letter dated April 17, 1996, to Carl Yoder, EPRI, from Eric Lee, NRC, Subject: Review of EPRI Utility Working Group Topical Report TR-102323, "Guidelines for Electromagnetic Interference Testing in Power Plants."<sup>5</sup>

TR-102323, "Guidelines for Electromagnetic Interference Testing in Power Plants," Electric Power Research Institute (EPRI) topical report, September 1994.<sup>6</sup>

---

<sup>5</sup> Copies are available for inspection or copying for a fee from the NRC Public Document Room at 11555 Rockville Pike (first floor), Rockville, MD; the PDR's mailing address is USNRC PDR, Washington, DC 20555; telephone (301)415-4737 or 1-(800)397-4209; fax (301)415-3548; e-mail <PDR@NRC.GOV>.

<sup>6</sup> EPRI publications may be purchased from the EPRI Distribution Center, 207 Coggins Drive, P.O. Box 23205, Pleasant Hill, CA 94523, telephone (510) 934-4212.

## REGULATORY ANALYSIS

### 1. PROBLEM

Part 50 of Title 10 of the Code of Federal Regulations (10 CFR 50), “Domestic Licensing of Production and Utilization Facilities,” delineates the NRC’s design and qualification regulations for commercial nuclear power plants. Appendix A, “General Design Criteria for Nuclear Power Plants,” to 10 CFR Part 50 “establishes minimum requirements for the principal design criteria for water-cooled nuclear power plants,” and 10 CFR 50.55a(h) requires that reactor protection systems also satisfy the criteria of the Institute of Electrical and Electronics Engineers (IEEE) standard (Std) 603-1991, “Criteria for Safety Systems for Nuclear Power Generating Stations,”<sup>1</sup> or IEEE Std 279-1971, “Criteria for Protection Systems for Nuclear Power Generating Stations,”<sup>1</sup> contingent on the date of construction permit issuance. In particular, General Design Criterion (GDC) 4 in Appendix A to 10 CFR Part 50 requires that structures, systems, and components be designed “to accommodate the effects of and to be compatible with the environmental conditions associated with normal operation, maintenance, testing, and postulated accidents, including loss-of-coolant accidents.” Furthermore, 10 CFR 50.49 and 50.55a(a)(1) address verification measures such as testing that can be used to confirm the adequacy of design.

While these regulations address environmental compatibility for electrical equipment that is important to safety, they do not explicitly identify approaches to establishing electromagnetic compatibility (EMC). As a result, Regulatory Guide 1.180, “Guidelines for Evaluating Electromagnetic and Radio-Frequency Interference in Safety-Related Instrumentation and Control Systems,”<sup>2</sup> was developed to identify practices acceptable to the NRC staff that can be employed to establish EMC for safety-related instrumentation and control (I&C) systems in nuclear power plants. In addition, Electric Power Research Institute (EPRI) topical report TR-102323, “Guidelines for Electromagnetic Interference Testing in Power Plants,”<sup>3</sup> was accepted in a Safety Evaluation Report (SER) by letter dated April 17, 1996,<sup>4</sup> with some exceptions and clarifications. The guidance offered in the regulatory guide and the SER constitute consistent approaches to addressing issues of EMC for safety-related digital I&C systems in nuclear power plants, with each serving as equally valid, acceptable methods. However, experience in the nuclear industry has indicated some concern that the available guidance incorporates some conservatism that could be reduced through development of an enhanced technical basis. In addition, certain EMC

---

<sup>1</sup> IEEE publications may be purchased from the IEEE Service Center, 445 Hoes Lane, Piscataway, NJ 08855.

<sup>2</sup> Requests for single copies of draft or active regulatory guides (which may be reproduced) or for placement on an automatic distribution list for single copies of future draft guides in specific divisions should be made in writing to the U.S. Nuclear Regulatory Commission, Washington, DC 20555, Attention: Reproduction and Distribution Services Section, or by fax to (301)415-2289; email <DISTRIBUTION@NRC.GOV>. Copies are available for inspection or copying for a fee from the NRC Public Document Room at 11555 Rockville Pike (first floor), Rockville, MD; the PDR’s mailing address is USNRC PDR, Washington, DC 20555; telephone (301)415-4737 or 1-(800)397-4209; fax (301)415-3548; e-mail <PDR@NRC.GOV>.

<sup>3</sup> EPRI publications may be purchased from the EPRI Distribution Center, 207 Coggins Drive, P.O. Box 23205, Pleasant Hill, CA 94523, telephone (510) 934-4212.

<sup>4</sup> Copies are available for inspection or copying for a fee from the NRC Public Document Room at 11555 Rockville Pike (first floor), Rockville, MD; the PDR’s mailing address is USNRC PDR, Washington, DC 20555; telephone (301)415-4737 or 1-(800)397-4209; fax (301)415-3548; e-mail <PDR@NRC.GOV>.

considerations (i.e., radiated emissions and susceptibility in the frequency band from 1 to 10 gigahertz and conducted susceptibility along signal lines) have been identified by the NRC staff and the EPRI EMI Working Group as open issues that should be addressed. Finally, a revised complete series of EMC standards by the International Electrotechnical Commission (IEC), which has been issued recently, warrants consideration for use by the U.S. nuclear power industry. The need to develop and maintain specific practices for the nuclear power industry to address the effects of EMI/RFI and power surges on safety-related I&C systems is stated in SECY-91-273, "Review of Vendors' Test Programs To Support the Design Certification of Passive Light Water Reactors."<sup>4</sup>

## **2. ALTERNATIVE APPROACHES**

The existing guidance is based on military and industrial methods for ensuring the compatibility of I&C equipment with the electromagnetic conditions to which they are subjected in nuclear power plants. This guidance relies on consensus standards in the EMC community to ensure widespread familiarity and reasonable levels of agreement. Recently, the U.S. Department of Defense (DoD) issued a revision of the EMC testing standards, replacing military standard (MIL-STD) 461D and 462D with MIL-STD 461E.<sup>5</sup> In addition, the IEC has revised the complete series of standards (IEC 61000)<sup>6</sup> that offer a potential alternative to the military EMC standards. The approach taken was to evaluate the recent standards to establish conditions under which they can be applied as equivalent suites of test methods that are relevant to the nuclear power plant electromagnetic environment. The revised standards contain test methods that are applicable for assessing conducted susceptibility along signal lines so that issue was addressed. The issue of high-frequency radiated EMC was also addressed with the identification of test methods that are applicable for assessing radiated emissions and susceptibility above 1 GHz. The alternative approach considered was to take no action and retain the existing guidance for EMC at nuclear power plants. Thus, the two approaches considered are:

1. Take no action,
2. Update the existing guidance through development of an enhanced technical basis.

The first alternative, taking no action, requires no additional cost for the NRC staff or applicants over current conditions since no change to the process would occur. The existing guidance in the regulatory guide and SER provides clear, systematic approaches that are acceptable for ensuring electromagnetic compatibility. However, the guidance endorses dated versions of EMC standards that have been superseded by recent revisions. While there is currently substantial experience among testing laboratories with the test methods from the previous versions of the standards, it is anticipated that such capabilities will diminish in a few years as most industries adopt the methods of the current versions. Thus, taking no action places the responsibility for justifying the use of the most recent domestic and international standards on the applicants at some future time. Continuing with the existing guidance unchanged does not address the issues of high-frequency radiated EMC and conducted susceptibility

---

<sup>5</sup> Military Standards are available from the Department of Defense, Standardization Documents Order Desk, Building 4D, 700 Robbins Avenue, Philadelphia, PA 19111-5094.

<sup>6</sup> International Electrotechnical Commission documents are available from the IEC at 3 rue de Varembe, PO Box 131, 1211 Geneva 20, Switzerland.

along signal lines. As a result, the process of establishing EMC for safety-related I&C modifications of new installations may involve significant effort on the part of the applicant to anticipate the type and level of evidence that is acceptable to the NRC staff to demonstrate compatibility of equipment in response to these phenomena. In addition, the NRC staff review may involve considerable effort in evaluating submitted approaches for addressing the open issues and reviewing the use of the revised standards on a case-by-case basis.

The second alternative, updating the existing guidance by developing an enhanced technical basis, was considered. Consensus standards on methods for establishing EMC are available and represent current good practice as agreed upon by responsible professionals in the U.S. military and industrial (domestic and international) EMC community. These standards are maintained by their respective standards bodies and each revision permits refinement of the consensus positions and improvement of the standards through the resolution of open issues. Endorsing the current version of EMC standards allows the staff and applicants to obtain the benefit of the work of responsible EMC professional standards committee volunteers. In addition to the availability of a revised EMC standard from the U.S. DoD, the recent completion of a series of international EMC standards by IEC offers the opportunity to introduce greater flexibility in the choice of acceptable methods. Also, the issues related to high-frequency radiated EMC and conducted susceptibility along signal lines can be addressed through identification of acceptable test methods in the recent EMC standards. Adopting this approach requires NRC staff effort to review the revised or new standards to select for endorsement those criteria and methods that address EMC issues of concern for safety-related I&C systems in nuclear power plants. In addition, NRC staff effort for this approach includes a review of existing evidence characterizing the electromagnetic conditions at nuclear power plants and the rationale for electromagnetic operating envelopes to determine whether any conservatism can be identified and justifiably reduced (i.e., by relaxing the operating envelopes as warranted). The level of effort for each application is reduced for both NRC staff and applicant over that involved with Alternative 1 because systematic review and endorsement of current standards by NRC staff and up-front resolution of open EMC issues is a more effective use of resources than an *ad hoc*, case-by-case method of handling the transition to recent standards that more fully address the range of EMC issues. The result of this approach is an up-to-date, more complete guide on acceptable EMC practices with the flexibility to select among suites of test methods from domestic and international standards. Of course, the applicant retains the flexibility to establish an equivalent technical basis for different criteria and operating envelopes by performing its own detailed assessment of the electromagnetic conditions at the point of installation and evaluating any emerging practices.

### 3. VALUES AND IMPACTS

Values and impacts for each of the two identified approaches are analyzed below. In this analysis, the probability of an alternative approach having a positive effect on EMC and the probability of that effect on the achievement of overall safety goals are not known quantitatively. However, based on a qualitative assessment of experience in the military and commercial industries, as well as the nuclear industry, EMI/RFI and power surges clearly hold the potential for inducing an undesirable safety consequence. Therefore, a positive correlation between EMC and the achievement of safety goals is inferred from the negative effects of EMI/RFI and power surge susceptibility. Thus, EMC is a necessary but not wholly sufficient factor by itself in achieving safety goals.

In the summary below, an impact is a cost in schedule, budget, or staffing or an undesired property or attribute that would accrue from taking the proposed approach. Both values and impacts may be functions of time.

#### 3.1 Alternative 1—Take No Action

This alternative has the attraction that its initial cost is low since there are no “start-up” activities. However, the burden of establishing the technical basis for the suitability of revised or new EMC standards would rest with the applicants. In addition, it would remain for the applicant to determine what practices, test criteria, and test methods are necessary to resolve the issues of high-frequency radiated EMC and conducted susceptibility along signal lines. NRC staff would have to act on a case-by-case basis for applications or requests to review safety questions involving the open issues or employing unreviewed versions of EMC standards. The absence of a clearly established technical basis regarding use of these revised standards or the resolution of these open issues could have adverse effects on the level of staff effort required to conduct reviews or to ensure consistency among reviews of the EMC for each I&C system modification. Thus, NRC staff review could take longer and require greater effort. From the applicant’s perspective, the marketplace will ultimately drive the industry to use the revised or new standards as the testing resources that support the older standards diminish. As a result, the absence of guidance regarding the revised standards and the open issues could lead to higher costs for the applicants because of potential unknowns associated with demonstrating compliance with regulations using unreviewed methods. Thus, although the initial cost would apparently be low, taking no action could result in greater total costs, both to the NRC staff and the applicant, during the safety evaluation process.

Value – No value beyond the status quo

Impact – Schedule, budget, and staffing cost, to the staff and applicant, associated with remaining regulatory uncertainty regarding technical basis for use of revised or new standards and resolution of open issues on a case-by-case basis

### 3.2 Alternative 2—Update Existing Guidance

If the NRC staff endorses revised or new consensus EMC standards on the basis of a systematic review, the staff and applicants obtain the benefit of the effort of expert professional organizations to establish methods and practices to achieve and assess EMC. In addition, the update of the existing guidance provides the opportunity to address open issues and reduce conservatism as warranted. The cost of this approach involves NRC staff effort in reviewing the revised or new EMC standards, identifying practices to address the open issues, and reevaluating the technical basis for plant operating envelopes. Given the participation of NRC staff members on standards committees that are considered to address issues important to safety, this cost can be kept to a minimum. The value in this alternative is the common understanding between the NRC staff and applicants of approaches that have current acceptance as good practice in the expert technical community. The benefit of this approach would be a more comprehensive understanding of current EMC practices by the NRC staff and reduction of the burden on the applicants. From the applicant's perspective, a clear determination of acceptable resolutions to open EMC issues, the flexibility of using methods from current domestic and international EMC standards, and the potential reduction in conservatism would reduce the regulatory burden.

- Value – Maintenance and evolution of the current definition of good practices by the EMC community in military and commercial industries
- Probable improvement in the likelihood of achieving safety goals as a consequence of resolution of open EMC issues
- Greater flexibility added in establishing EMC through the endorsement of equivalent suites of test methods from both domestic and international standards
- Reduction of conservatism in existing guidance as warranted by the enhanced technical basis
- Impact – Staff cost of evaluating revised or new EMC practices for endorsement
- Reduction of burden for applicants

## 4. CONCLUSIONS

There is clear evidence that the electromagnetic conditions can adversely affect the performance of safety-related I&C equipment. The Code of Federal Regulations requires that systems, structures, and components important to safety be compatible with and accommodate the effects of environmental conditions associated with nuclear power plant service conditions. EMC is an element of addressing that requirement. Addressing open EMC issues and adopting improved or revised consensus practices, where the safety case is maintained, can enhance the assurance of safety while potentially reducing regulatory burden. Two approaches to maintaining existing EMC guidance were examined.

Taking no action may result in accumulating regulatory expense as applicants propose *ad hoc* solutions to open EMC issues or adopt unreviewed methods from revised or new standards as the basis for providing evidence to the staff that safety-related equipment is compatible with the electromagnetic conditions at the site and, thus, meet the requirements of NRC's regulations.

General endorsement of military and commercial EMC standards addresses the stated problem with good value and minimal impact. However, regulatory uncertainty regarding the applicability of each technical element embodied in the standards and the means to adequately determine the electromagnetic service conditions could still lead to accumulating regulatory expense as applicants submit proposed methods based on the general practices for staff review. Eventually, a *de facto* standard set of practices would emerge through an inefficient review process.

The second alternative, updating the existing guidance through development of an enhanced technical basis, provides good value with minimal impact. While this approach involves some additional NRC staff effort, it maintains the long-term relevance of the existing guidance through adoption of current versions of EMC standards, introduces greater flexibility in the generation of the safety case by offering the option of equivalent suites of test methods from domestic and international EMC standards, and reduces the potential burden on the applicants by addressing open EMC issues in a systematic manner and reducing conservatism as warranted by the enhanced technical basis. Therefore, the second alternative provides the highest value with reasonable impact on NRC staff and the greatest potential for reducing the regulatory burden for applicants. Note that neither of these approaches present new regulatory requirements; they define acceptable approaches for meeting existing requirements.

## **5. DECISION RATIONALE**

Based on the highest value and reasonable impact for problem solution capability (especially regulatory burden), the second alternative, updating existing guidance by developing an enhanced technical basis, has been chosen. The highest value will be achieved by reviewing revised and new consensus EMC standards (both domestic and international), assessing the applicability and equivalence of each technical element embodied in the standards, reevaluating the electromagnetic environment characteristic of nuclear power plants and the technical basis for the current operating envelopes, determining testing methods that can address the open EMC issues, and identifying equivalent suites of test methods from the alternative standards and the conditions under which they may be applied. This approach will contribute to satisfying the safety goal for nuclear power plants.