

Lockheed's Aerospaceplane concept. The alternate hypersonic in-flight refueling system approach called for propellant transfer at Mach 6. (Art by Dennis Jenkins)



Republic's Aerospaceplane concept showed extensive engine-airframe integration. (Republic Aviation)

For takeoff, Lockheed expected to use Turbo-LACE. This was a LACE variant that sought again to reduce the inherently hydrogen-rich operation of the basic system. Rather than cool the air until it was liquid, Turbo-Lace chilled it deeply but allowed it to remain gaseous. Being very dense, it could pass through a turbocompressor and reach pressures in the hundreds of psi. This saved hydrogen because less was needed to accomplish this cooling. The Turbo-LACE engines were to operate at chamber pressures of 200 to 250 psi, well below the internal pressure of standard rockets but high enough to produce 300,000 pounds of thrust by using turbocompressed oxygen.⁶⁷

Republic Aviation continued to emphasize the scramjet. A new configuration broke with the practice of mounting these engines within pods, as if they were turbojets. Instead, this design introduced the important topic of engine-airframe integration by setting forth a concept that amounted to a single enormous scramjet fitted with wings and a tail. A conical forward fuselage served as an inlet spike. The inlets themselves formed a ring encircling much of the vehicle. Fuel tankage filled most of its capacious internal volume.

This design study took two views regarding the potential performance of its engines. One concept avoided the use of LACE or ACES, assuming again that this craft could scram all the way to orbit. Still, it needed engines for takeoff so turbo-ramjets were installed, with both Pratt & Whitney and General Electric providing candidate concepts. Republic thus was optimistic at high Mach but conservative at low speed.

The other design introduced LACE and ACES both for takeoff and for final ascent to orbit and made use of yet another approach to derichening the hydrogen. This was SuperLACE, a concept from Marquardt that placed slush hydrogen rather than standard liquid hydrogen in the main tank. The slush consisted of liquid that contained a considerable amount of solidified hydrogen. It therefore stood at the freezing point of hydrogen, 14 K, which was markedly lower than the 21 K of liquid hydrogen at the boiling point.⁶⁸

SuperLACE reduced its use of hydrogen by shunting part of the flow, warmed in the LACE heat exchanger, into the tank. There it mixed with the slush, chilling again to liquid while melting some of the hydrogen ice. Careful control of this flow ensured that while the slush in the tank gradually turned to liquid and rose toward the 21 K boiling point, it did not get there until the air-collection phase of a flight was finished. As an added bonus, the slush was noticeably denser than the liquid, enabling the tank to hold more fuel.⁶⁹

LACE and ACES remained in the forefront, but there also was much interest in conventional rocket engines. Within the Aerospaceplane effort, this approach took the name POBATO, Propellants On Board At Takeoff. These rocket-powered vehicles gave points of comparison for the more exotic types that used LACE and scramjets, but here too people used their imaginations. Some POBATO vehicles ascended vertically in a classic liftoff, but others rode rocket sleds along a track while angling sharply upward within a cradle.⁷⁰

In Denver, the Martin Company took rocket-powered craft as its own, for this firm expected that a next-generation launch vehicle of this type could be ready far sooner than one based on advanced airbreathing engines. Its concepts used vertical liftoff, while giving an opening for the ejector rocket. Martin introduced a concept of its own called RENE, Rocket Engine Nozzle Ejector (RENE), and conducted experiments at the Arnold Engineering Development Center. These tests went forward during 1961, using a liquid rocket engine, with nozzle of 5-inch diameter set within a shroud of 17-inch width. Test conditions corresponded to flight at Mach 2 and 40,000 feet, with the shrouds or surrounding ducts having various lengths to achieve increasingly thorough mixing. The longest duct gave the best performance, increasing the rated 2,000-pound thrust of the rocket to as much as 3,100 pounds.⁷¹

A complementary effort at Marquardt sought to demonstrate the feasibility of LACE. The work started with tests of heat exchangers built by Garrett AiResearch that used liquid hydrogen as the working fluid. A company-made film showed dark liquid air coming down in a torrent, as seen through a porthole. Further tests used this liquefied air in a small thrust chamber. The arrangement made no attempt to derich the hydrogen flow; even though it ran very fuel-rich, it delivered up to 275 pounds of thrust. As a final touch, Marquardt crafted a thrust chamber of 18-inch diameter and simulated LACE operation by feeding it with liquid air and gaseous

hydrogen from tanks. It showed stable combustion, delivering thrust as high as 5,700 pounds.⁷²

Within the Air Force, the SAB's Ad Hoc Committee on Aerospaceplane continued to provide guidance along with encouraging words. A review of July 1962 was less skeptical in tone than the one of 18 months earlier, citing "several attractive arguments for a continuation of this program at a significant level of funding":

It will have the military advantages that accrue from rapid response times and considerable versatility in choice of landing area. It will have many of the advantages that have been demonstrated in the X-15 program, namely, a real pay-off in rapidly developing reliability and operational pace that comes from continuous re-use of the same hardware again and again. It may turn out in the long run to have a cost effectiveness attractiveness... the cost per pound may eventually be brought to low levels. Finally, the Aerospaceplane program will develop the capability for flights in the atmosphere at hypersonic speeds, a capability that may be of future use to the Defense Department and possibly to the airlines.⁷³

Single-stage-to-orbit (SSTO) was on the agenda, a topic that merits separate comment. The space shuttle is a stage-and-a-half system; it uses solid boosters plus a main stage, with all engines burning at liftoff. It is a measure of progress, or its lack, in astronautics that the Soviet R-7 rocket that launched the first Sputniks was also stage-and-a-half.⁷⁴ The concept of SSTO has tantalized designers for decades, with these specialists being highly ingenious and ready to show a can-do spirit in the face of challenges.

This approach certainly is elegant. It also avoids the need to launch two rockets to do the work of one, and if the Earth's gravity field resembled that of Mars, SSTO would be the obvious way to proceed. Unfortunately, the Earth's field is considerably stronger. No SSTO has ever reached orbit, either under rocket power or by using scramjets or other airbreathers. The technical requirements have been too severe.

The SAB panel members attended three days of contractor briefings and reached a firm conclusion: "It was quite evident to the Committee from the presentation of nearly all the contractors that a single stage to orbit Aerospaceplane remains a highly speculative effort." Reaffirming a recommendation from its 1960 review, the group urged new emphasis on two-stage designs. It recommended attention to "development of hydrogen fueled turbo ramjet power plants capable of accelerating the first stage to Mach 6.0 to 10.0.... Research directed toward the second stage which will ultimately achieve orbit should be concentrated in the fields of high pressure hydrogen rockets and supersonic burning ramjets and air collection and enrichment systems."⁷⁵

Convair, home of Space Plane, had offered single-stage configurations as early as 1960. By 1962 its managers concluded that technical requirements placed such a vehicle out of reach for at least the next 20 years. The effort shifted toward a two-stage concept that took form as the 1964 Point Design Vehicle. With a gross takeoff weight of 700,000 pounds, the baseline approach used turboramjets to reach Mach 5. It cruised at that speed while using ACES to collect liquid oxygen, then accelerated anew using ramjets and rockets. Stage separation occurred at Mach 8.6 and 176,000 feet, with the second stage reaching orbit on rocket power. The payload was 23,000 pounds with turboramjets in the first stage, increasing to 35,000 pounds with the more speculative SuperLACE.

The documentation of this 1964 Point Design, filling 16 volumes, was issued during 1963. An important advantage of the two-stage approach proved to lie in the opportunity to optimize the design of each stage for its task. The first stage was a Mach 8 aircraft that did not have to fly to orbit and that carried its heavy wings, structure, and ACES equipment only to staging velocity. The second-stage design showed strong emphasis on re-entry; it had a blunted shape along with only modest requirements for aerodynamic performance. Even so, this Point Design pushed the state of the art in materials. The first stage specified superalloys for the hot underside along with titanium for the upper surface. The second stage called for coated refractory metals on its underside, with superalloys and titanium on its upper surfaces.⁷⁶

Although more attainable than its single-stage predecessors, the Point Design still relied on untested technologies such as ACES, while anticipating use in aircraft structures of exotic metals that had been studied merely as turbine blades, if indeed they had gone beyond the status of laboratory samples. The opportunity nevertheless existed for still greater conservatism in an airbreathing design, and the man who pursued it was Ernst Steinhoff. He had been present at the creation, having worked with Wernher von Braun on Germany's wartime V-2, where he headed up the development of that missile's guidance. After 1960 he was at the Rand Corporation, where he examined Aerospaceplane concepts and became convinced that single-stage versions would never be built. He turned to two-stage configurations and came up with an outline of a new one: ROLS, the Recoverable Orbital Launch System. During 1963 he took the post of chief scientist at Holloman Air Force Base and proceeded to direct a formal set of studies.⁷⁷

The name of ROLS had been seen as early as 1959, in one of the studies that had grown out of SR-89774, but this concept was new. Steinhoff considered that the staging velocity could be as low as Mach 3. At once this raised the prospect that the first stage might take shape as a modest technical extension of the XB-70, a large bomber designed for flight at that speed, which at the time was being readied for flight test. ROLS was to carry a second stage, dropping it from the belly like a bomb, with that stage flying on to orbit. An ACES installation would provide the liquid

oxidizer prior to separation, but to reach from Mach 3 to orbital speed, the second stage had to be simple indeed. Steinhoff envisioned a long vehicle resembling a torpedo, powered by hydrogen-burning rockets but lacking wings and thermal protection. It was not reusable and would not reenter, but it would be piloted. A project report stated, "Crew recovery is accomplished by means of a reentry capsule of the Gemini-Apollo class. The capsule forms the nose section of the vehicle and serves as the crew compartment for the entire vehicle."⁷⁸

ROLS appears in retrospect as a mirror image of NASA's eventual space shuttle, which adopted a technically simple booster—a pair of large solid-propellant rockets—while packaging the main engines and most other costly systems within a fully-recoverable orbiter. By contrast, ROLS used a simple second stage and a highly intricate first stage, in the form of a large delta-wing airplane that mounted eight turbojet engines. Its length of 335 feet was more than twice that of a B-52. Weighing 825,000 pounds at takeoff, ROLS was to deliver a payload of 30,000 pounds to orbit.⁷⁹

Such two-stage concepts continued to emphasize ACES, while still offering a role for LACE. Experimental test and development of these concepts therefore remained on the agenda, with Marquardt pursuing further work on LACE. The earlier tests, during 1960 and 1961, had featured an off-the-shelf thrust chamber that had seen use in previous projects. The new work involved a small LACE engine, the MA117, that was designed from the start as an integrated system.

LACE had a strong suit in its potential for a very high specific impulse, I_{sp} . This is the ratio of thrust to propellant flow rate and has dimensions of seconds. It is a key measure of performance, is equivalent to exhaust velocity, and expresses the engine's fuel economy. Pratt & Whitney's RL10, for instance, burned hydrogen and oxygen to give thrust of 15,000 pounds with an I_{sp} of 433 seconds.⁸⁰ LACE was an airbreather, and its I_{sp} could be enormously higher because it took its oxidizer from the atmosphere rather than carrying it in an onboard tank. The term "propellant flow rate" referred to tanked propellants, not to oxidizer taken from the air. For LACE this meant fuel only.

The basic LACE concept produced a very fuel-rich exhaust, but approaches such as RENE and SuperLACE promised to reduce the hydrogen flow substantially. Indeed, such concepts raised the prospect that a LACE system might use an optimized mixture ratio of hydrogen and oxidizer, with this ratio being selected to give the highest I_{sp} . The MA117 achieved this performance artificially by using a large flow of liquid hydrogen to liquefy air and a much smaller flow for the thrust chamber. Hot-fire tests took place during December 1962, and a company report stated that "the system produced 83% of the idealized theoretical air flow and 81% of the idealized thrust. These deviations are compatible with the simplifications of the idealized analysis."⁸¹

The best performance run delivered 0.783 pounds per second of liquid air, which burned a flow of 0.0196 pounds per second of hydrogen. Thrust was 73 pounds; I_{sp} reached 3,717 seconds, more than eight times that of the RL10. Tests of the MA117 continued during 1963, with the best measured values of I_{sp} topping 4,500 seconds.⁸²

In a separate effort, the Marquardt manager Richard Knox directed the preliminary design of a much larger LACE unit, the MA116, with a planned thrust of 10,000 pounds. On paper, it achieved substantial derichening by liquefying only one-fifth of the airflow and using this liquid air in precooling, while deeply cooling the rest of the airflow without liquefaction. A turbocompressor then was to pump this chilled air into the thrust chamber. A flow of less than four pounds per second of liquid hydrogen was to serve both as fuel and as primary coolant, with the anticipated I_{sp} exceeding 3,000 seconds.⁸³

New work on RENE also flourished. The Air Force had a cooperative agreement with NASA's Marshall Space Flight Center, where Fritz Pauli had developed a subscale rocket engine that burned kerosene with liquid oxygen for a thrust of 450 pounds. Twelve of these small units, mounted to form a ring, gave a basis for this new effort. The earlier work had placed the rocket motor squarely along the centerline of the duct. In the new design, the rocket units surrounded the duct, leaving it unobstructed and potentially capable of use as an ejector ramjet. The cluster was tested successfully at Marshall in September 1963 and then went to the Air Force's AEDC. As in the RENE tests of 1961, the new configuration gave a thrust increase of as much as 52 percent.⁸⁴

While work on LACE and ejector rockets went forward, ACES stood as a particularly critical action item. Operable ACES systems were essential for the practical success of LACE. Moreover, ACES had importance distinctly its own, for it could provide oxidizer to conventional hydrogen-burning rocket engines, such as those of ROLS. As noted earlier, there were two techniques for air separation: by chemical methods and through use of a rotating fractional distillation apparatus. Both approaches went forward, each with its own contractor.

In Cambridge, Massachusetts, the small firm of Dynatech took up the challenge of chemical separation, launching its effort in May 1961. Several chemical reactions appeared plausible as candidates, with barium and cobalt offering particular promise:

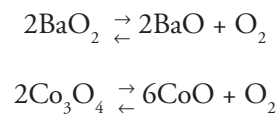

The double arrows indicate reversibility. The oxidation reactions were exothermic, occurring at approximately 1,600°F for barium and 1,800°F for cobalt. The reduction reactions, which released the oxygen, were endothermic, allowing the oxides to cool as they yielded this gas.

Dynatech's separator unit consisted of a long rotating drum with its interior divided into four zones using fixed partitions. A pebble bed of oxide-coated particles lined the drum interior; containment screens held the particles in place while allowing the drum to rotate past the partitions with minimal leakage. The zones exposed the oxide alternately to high-pressure ram air for oxidation and to low pressure for reduction. The separation was to take place in flight, at speeds of Mach 4 to Mach 5, but an inlet could slow the internal airflow to as little as 50 feet per second, increasing the residence time of air within a unit. The company proposed that an array of such separators weighing just under 10 tons could handle 2,000 pounds per second of airflow while producing liquid oxygen of 65 percent purity.⁸⁵

Ten tons of equipment certainly counts within a launch vehicle, even though it included the weight of the oxygen liquefaction apparatus. Still it was vastly lighter than the alternative: the rotating distillation system. The Linde Division of Union Carbide pursued this approach. Its design called for a cylindrical tank containing the distillation apparatus, measuring nine feet long by nine feet in diameter and rotating at 570 revolutions per minute. With a weight of 9,000 pounds, it was to process 100 pounds per second of liquefied air—which made it 10 times as heavy as the Dynatech system, per pound of product. The Linde concept promised liquid oxygen of 90 percent purity, substantially better than the chemical system could offer, but the cited 9,000-pound weight left out additional weight for the LACE equipment that provided this separator with its liquefied air.⁸⁶

A study at Convair, released in October 1963, gave a clear preference to the Dynatech concept. Returning to the single-stage Space Plane of prior years, Convair engineers considered a version with a weight at takeoff of 600,000 pounds, using either the chemical or the distillation ACES. The effort concluded that the Dynatech separator offered a payload to orbit of 35,800 using barium and 27,800 pounds with cobalt. The Linde separator reduced this payload to 9,500 pounds. Moreover, because it had less efficiency, it demanded an additional 31,000 pounds of hydrogen fuel, along with an increase in vehicle volume of 10,000 cubic feet.⁸⁷

The turn toward feasible concepts such as ROLS, along with the new emphasis on engineering design and test, promised a bright future for Aerospaceplane studies. However, a commitment to serious research and development was another matter. Advanced test facilities were critical to such an effort, but in August 1963 the Air Force canceled plans for a large Mach 14 wind tunnel at AEDC. This decision gave a clear indication of what lay ahead.⁸⁸

A year earlier Aerospaceplane had received a favorable review from the SAB Ad Hoc Committee. The program nevertheless had its critics, who existed particularly

within the SAB's Aerospace Vehicles and Propulsion panels. In October 1963 they issued a report that dealt with proposed new bombers and vertical-takeoff-and-landing craft, as well as with Aerospaceplane, but their view was unmistakable on that topic:

The difficulties the Air Force has encountered over the past three years in identifying an Aerospaceplane program have sprung from the facts that the requirement for a fully recoverable space launcher is at present only vaguely defined, that today's state-of-the-art is inadequate to support any real hardware development, and the cost of any such undertaking will be extremely large.... [T]he so-called Aerospaceplane program has had such an erratic history, has involved so many clearly infeasible factors, and has been subject to so much ridicule that from now on this name should be dropped. It is also recommended that the Air Force increase the vigilance that no new program achieves such a difficult position.⁸⁹

Aerospaceplane lost still more of its rationale in December, as Defense Secretary Robert McNamara canceled Dyna-Soar. This program was building a mini-space shuttle that was to fly to orbit atop a Titan III launch vehicle. This craft was well along in development at Boeing, but program reviews within the Pentagon had failed to find a compelling purpose. McNamara thus disposed of it.⁹⁰

Prior to this action, it had been possible to view Dyna-Soar as a prelude to operational vehicles of that general type, which might take shape as Aerospaceplanes. The cancellation of Dyna-Soar turned the Aerospaceplane concept into an orphan, a long-term effort with no clear relation to anything currently under way. In the wake of McNamara's decision, Congress deleted funds for further Aerospaceplane studies, and Defense Department officials declined to press for its restoration within the FY 1964 budget, which was under consideration at that time. The Air Force carried forward with new conceptual studies of vehicles for both launch and hypersonic cruise, but these lacked the focus on advanced airbreathing propulsion that had characterized Aerospaceplane.⁹¹

There nevertheless was real merit to some of the new work, for this more realistic and conservative direction pointed out a path that led in time toward NASA's space shuttle. The Martin Company made a particular contribution. It had designed no Aerospaceplanes; rather, using company funding, its technical staff had examined concepts called Astrorockets, with the name indicating the propulsion mode. Scramjets and LACE won little attention at Martin, but all-rocket vehicles were another matter. A concept of 1964 had a planned liftoff weight of 1,250 tons, making it intermediate in size between the Saturn I-B and Saturn V. It was a two-stage fully-reusable configuration, with both stages having delta wings and flat undersides. These undersides fitted together at liftoff, belly to belly.

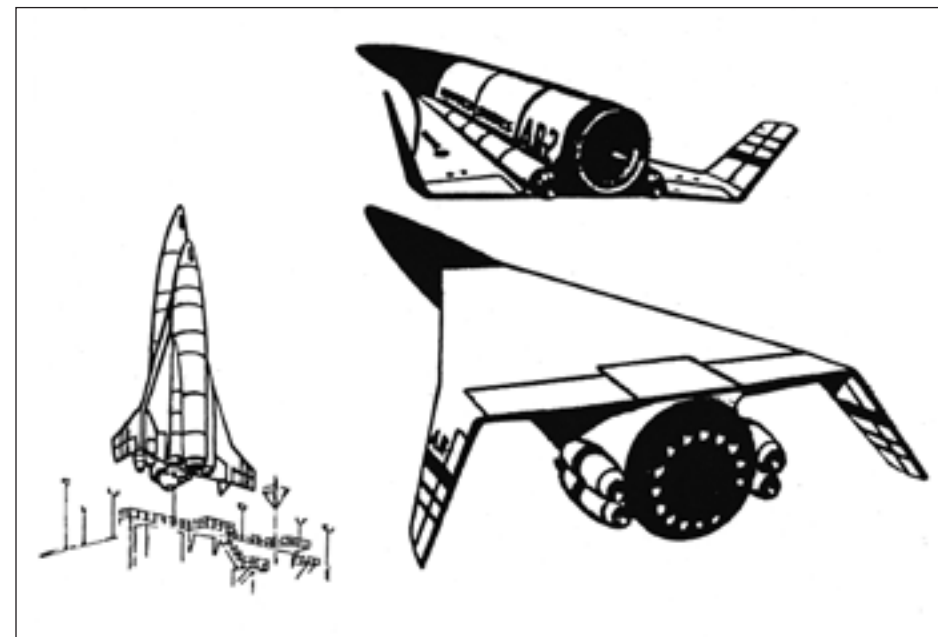

Martin's Astrorocket. (U.S. Air Force)

The design concepts of that era were meant to offer glimpses of possible futures, but for this Astrorocket, the future was only seven years off. It clearly foreshadowed a class of two-stage fully reusable space shuttles, fitted with delta wings, that came to the forefront in NASA-sponsored studies of 1971. The designers at Martin were not clairvoyant; they drew on the background of Dyna-Soar and on studies at NASA-Ames of winged re-entry vehicles. Still, this concept demonstrated that some design exercises were returning to the mainstream.⁹²

Further work on ACES also proceeded, amid unfortunate results at Dynatech. That company's chemical separation processes had depended for success on having a very large area of reacting surface within the pebble-bed air separators. This appeared achievable through such means as using finely divided oxide powders or porous particles impregnated with oxide. But the research of several years showed that the oxide tended to sinter at high temperatures, markedly diminishing the reacting surface area. This did not make chemical separation impossible, but it sharply increased the size and weight of the equipment, which robbed this approach of its initially strong advantage over the Linde distillation system. This led to abandonment of Dynatech's approach.⁹³

Linde's system was heavy and drastically less elegant than Dynatech's alternative, but it amounted largely to a new exercise in mechanical engineering and went forward to successful completion. A prototype operated in test during 1966, and

while limits to the company's installed power capacity prevented the device from processing the rated flow of 100 pounds of air per second, it handled 77 pounds per second, yielding a product stream of oxygen that was up to 94 percent pure. Studies of lighter-weight designs also proceeded. In 1969 Linde proposed to build a distillation air separator, rated again at 100 pounds per second, weighing 4,360 pounds. This was only half the weight allowance of the earlier configuration.⁹⁴

In the end, though, Aerospaceplane failed to identify new propulsion concepts that held promise and that could be marked for mainstream development. The program's initial burst of enthusiasm had drawn on a view that the means were in hand, or soon would be, to leap beyond the liquid-fuel rocket as the standard launch vehicle and to pursue access to orbit using methods that were far more advanced. The advent of the turbojet, which had swiftly eclipsed the piston engine, was on everyone's mind. Yet for all the ingenuity behind the new engine concepts, they failed to deliver. What was worse, serious technical review gave no reason to believe that they could deliver.

In time it would become clear that hypersonics faced a technical wall. Only limited gains were achievable in airbreathing propulsion, with single-stage-to-orbit remaining out of reach and no easy way at hand to break through to the really advanced performance for which people hoped.

- 1 See, for instance, Emme, *History*; Ley, *Rockets*; McDougall, *Heavens*; Neufeld, *Ballistic*; NASA SP-4206; and Heppenheimer, *Countdown*.
- 2 NASA SP-4404; SP-4221, pp. 105-08, 423-25.
- 3 *Johns Hopkins APL Technical Digest*, Vol. 13, No. 1 (1992), p. 57; Lay, *Thermodynamics*, pp. 574-76.
- 4 Miller, *X-Planes*, ch. 11.
- 5 *Ibid.*, pp. 116-17. X-2 record: NASA SP-4303, p. 316.
- 6 Peterson, "Evaluation." 4130 steel: Miller, *X-Planes*, p. 119.
- 7 Ritchie, "Evaluation."
- 8 Miller, *X-Planes*, p. 117; Crickmore, *SR-71*, pp. 154-55.
- 9 "Standard Missile Characteristics: IM-99A Bomarc." Its name: Cornett, "Overview," p. 109. Extended range: *Jane's*, 1967-1968, p. 490.
- 10 "Development of Bomarc," pp. 10-12; Bagwell, "History," pp. 12-13.
- 11 Bagwell, "History," p. 17 (includes quotes); Pfeifer, "Bomarc," p. 1; Report Boeing D-11532 (Boeing), pp. 43-44.
- 12 *Jane's*, 1960-61, p. 447; Cornett, "Overview," pp. 118, 124-25.
- 13 *Johns Hopkins APL Technical Digest*, Vol. 3, No. 2 (1982), pp. 117-22; *Jane's*, 1960-61, p. 446.
- 14 "Standard Missile Characteristics: XSM-64 Navaho"; Gibson, *Navaho*, pp. 35-36, 45-48.
- 15 Gibson, *Navaho*, pp. 63-77; "Development of the SM-64," 1954-58, pp. 100-07. Author interview, J. Leland Atwood, 18 July 1988. Folder 18649, NASA Historical Reference Collection, NASA History Division, Washington, D.C. 20546.
- 16 *Air Enthusiast*, July-September 1978, pp. 198-213 (quote, p. 213). XF-103, XF-104: Gunston, *Fighters*, pp. 121-22, 193.
- 17 Author interview, Frederick Billig, 27 June 1987. Folder 18649, NASA Historical Reference Collection, NASA History Division, Washington, D.C. 20546. See also CASI 88N-12321, p. 12-6.
- 18 Fletcher, "Supersonic"; NACA: TN 2206, RM E51K26.
- 19 Fletcher, "Supersonic."
- 20 NACA TN 4386 (quote, p. 22).
- 21 Fletcher, "Supersonic," p. 737.
- 22 *Johns Hopkins APL Technical Digest*, Vol. 11, Nos. 3 and 4 (1990), pp. 319-35 (quotes, pp. 328-29).
- 23 "Statement Regarding the Military Service of Antonio Ferri"; Kaufman et al., *Moe Berg*, pp. 182-88 (quote, p. 186).
- 24 *Journal of Aircraft*, January-February 1968, p. 3; *Journal of the Royal Aeronautical Society*. September 1964, p. 575; *Johns Hopkins Magazine*, December 1988 p. 53; author interview, Louis Nucci, 24 June 1987.
- 25 Author interviews: John Erdos, 22 July 1985. Folder 18649, NASA Historical Reference Collection, NASA History Division, Washington, D.C. 20546; Robert Sanator, 1 February 1988. NASA Historical Reference Collection, NASA History Division, Washington, D.C. 20546.

- 26 Author interview, Louis Nucci, 24 June 1988 (includes quote). Folder 18649, NASA Historical Reference Collection, NASA History Division, Washington, D.C. 20546.
- 27 ISABE Paper 97-7004, p. 1.
- 28 Quote: *Journal of the Royal Aeronautical Society*, September 1964, p. 577.
- 29 ISABE Paper 97-7004, p. 2. Quote: *Astronautics & Aeronautics*, August 1964, p. 33.
- 30 Shapiro, *Compressible*, pp. 198-99.
- 31 Ferri and Fox, "Analysis."
- 32 Quotes: *Astronautics & Aeronautics*, August 1964, p. 33; *Journal of the Royal Aeronautical Society*, September 1964, p. 577.
- 33 Shapiro, *Compressible*, pp. 147-51; *Lockheed Horizons*, Winter 1981/1982, 11-12; Crickmore, *SR-71*, pp. 26, 94-95.
- 34 Author interview, James Eastham, 1 May 1988. Folder 18649, NASA Historical Reference Collection, NASA History Division, Washington, D.C. 20546.
- 35 Ibid.
- 36 Crickmore, *SR-71*, pp. 125-26.
- 37 Ferri, "Possible Directions"; *Journal of the Royal Aeronautical Society*, September 1964, pp. 575-97 (quotes, pp. 595, 597).
- 38 Ferri and Fox, "Analysis" (quotes, p. 1111). Arthur Thomas quotes: Arthur Thomas, author interview, 24 September 1987. Folder 18649, NASA Historical Reference Collection, History Division, Washington, D.C. 20546.
- 39 *Journal of Spacecraft and Rockets*, September 1968, pp. 1076-81. Quote: Fred Billig interview, 16 October 1987. Folder 18649, NASA Historical Reference Collection, NASA History Division, Washington, D.C. 20546.
- 40 *Air Enthusiast*, July-September 1978, p. 210.
- 41 Heppenheimer, *First Flight*, pp. 63, 142.
- 42 Gunston, *Fighters*, p. 121; Crickmore, *SR-71*, pp. 94-95.
- 43 U.S. Patents 2,735,263 (Charshafian), 2,883,829 (Africano), 3,172,253 (Schelp), 3,525,474 (Von Ohain). For Ohain and Schelp, see Schlaifer and Heron, *Development*, pp. 377-79, 383-86.
- 44 Crickmore, *SR-71*, pp. 94-95.
- 45 U.S. Patents 2,922,286, 3,040,519, 3,040,520 (all to Rae).
- 46 AIAA Paper 86-1680.
- 47 AIAA Paper 92-3499.
- 48 DTIC AD-351239.
- 49 Author interview, Arthur Thomas, 24 September 1987. Folder 18649, NASA Historical Reference Collection, NASA History Division, Washington, D.C. 20546.
- 50 *Johns Hopkins APL Technical Digest*, Vol. 11, Nos. 3 and 4 (1990), pp. 332-33; Boeing 707s: *Pedigree*, pp. 55-57.
- 51 Jenkins, *Space Shuttle*, p. 52; DTIC AD-372320.
- 52 "Reusable Space Launch Vehicle Systems Study" (Convair); Convair Report GD/C-DCJ 65-004.

- 53 Jenkins, *Space Shuttle*, p. 54; Convair ZP-M-095 (quote, p. ix).
- 54 *Los Angeles Times*, 15 January 1961, pp. 1, 3.
- 55 *Republic Aviation News*, 9 September 1960, pp. 1, 5.
- 56 Ibid. F-105: Gunston, *Fighters*, pp. 194-200.
- 57 *Republic Aviation News*, 9 September 1960, pp. 1, 5.
- 58 Author interview, Colonel Edward Hall, 25 January 1989. Folder 18649, NASA Historical Reference Collection, NASA History Division, Washington, D.C. 20546. Also Hallion, *Hypersonic*, p. 751.
- 59 DTIC AD-342992, p. i. Nine of these 11 reports are available from DTIC: AD-342992 through AD-343000.
- 60 *Aviation Week*, 31 October 1960, p. 26.
- 61 *Los Angeles Times*, 3 November 1960, p. 3A.
- 62 *Los Angeles Times*, 15 January 1961, pp. 1, 3.
- 63 Author interview, Robert Sanator, February 1988. Folder 18649, NASA Historical Reference Collection, NASA History Division, Washington, D.C. 20546.
- 64 "Memorandum of the Scientific Advisory Board Ad Hoc Committee on Aerospace Plane," December 1960.
- 65 Ibid. (includes all quotes.)
- 66 *Los Angeles Times*, 3 November 1960, p. 3A; Lockheed LAC 571375, cover and chart 6.
- 67 Lockheed LAC 571375, chart 6. For Turbo-LACE, see Heppenheimer, *Hypersonic*, p. 165.
- 68 Jenkins, *Space Shuttle*, pp. 55-57; DTIC ADC-053100, AD-351039 through AD-351041, AD-351581 through AD-351584.
- 69 AIAA Paper 86-1680.
- 70 Jenkins, *Space Shuttle*, p. 56.
- 71 Martin M-63-1 (RENE, pp. IV-2 to IV-5).
- 72 DTIC AD-318628, AD-322199; film, "Liquid Air Cycle Engine" (Marquardt, March 1961).
- 73 "Report of the Scientific Advisory Board Ad Hoc Committee on Aerospaceplane," 23-25 July 1962.
- 74 NASA SP-2000-4408, p. 131; Heppenheimer, *Countdown*, pp. 110, 119.
- 75 "Report of the Scientific Advisory Board Ad Hoc Committee on Aerospaceplane," 23-25 July 1962 (includes quotes).
- 76 AIAA Paper 92-3499, p. 4.
- 77 Neufeld, *Rocket*, p. 101; Cornett, "History," pp. 1-3.
- 78 Hallion, *Hypersonic*, p. 949; Cornett, "History," pp. 2, 7-8. Quote: DTIC AD-359545, p. 11.
- 79 Cornett, "History," pp. 7, 11.
- 80 For RL10, see NASA SP-4206, p. 139.
- 81 DTIC AD-335212, pp. 5-7 (quote, p. 1).
- 82 Ibid., pp. 18-19; CASI 75N-75668, pp. ii, 15.
- 83 DTIC AD-350952, AD-384302 (performance, p. 2).

FACING THE HEAT BARRIER: A HISTORY OF HYPERSONICS

- 84 AIAA Paper 99-4896, p. 4; DTIC AD-359763, p. II-2.
- 85 DTIC AD-336169, pp. 1, 13, 26-28.
- 86 DTIC AD-351207, pp. iii, 3-4.
- 87 DTIC AD-345178, pp. 22, 397.
- 88 Cornett, "History," p. 2.
- 89 "Report of the USAF Scientific Advisory Board Aerospace Vehicles/Propulsion Panels on Aerospaceplane, VTOL, and Strategic Manned Aircraft," 24 October 1963; extended quote also in Hallion, *Hypersonic*, p. 951.
- 90 NASA SP-4221, pp. 49-54. For general overviews of Dyna-Soar, see Hallion, *Hypersonic*, Case II; Miller, *X-Planes*, ch. 24; DTIC ADA-303832.
- 91 Hallion, *Hypersonic*, pp. 951-52; Jenkins, *Space Shuttle*, pp. 66-67; Cornett, "History," p. 4.
- 92 Hallion, *Hypersonic*, pp. 952-54; Jenkins, *Space Shuttle*, p. 62.
- 93 DTIC: AD-353898, AD-461220.
- 94 1966 work: AIAA Paper 92-3499, pp. 5-6; DTIC AD-381504, p. 10. 1969 proposal: DTIC AD-500489, p. iv.

5

WIDENING PROSPECTS FOR RE-ENTRY

The classic spaceship has wings, and throughout much of the 1950s both NACA and the Air Force struggled to invent such a craft. Design studies addressed issues as fundamental as whether this hypersonic rocket plane should have one particular wing-body configuration, or whether it should be upside down. The focus of the work was Dyna-Soar, a small version of the space shuttle that was to ride to orbit atop a Titan III. It brought remarkable engineering advances, but Pentagon policy makers, led by Defense Secretary Robert McNamara, saw it as offering little more than technical development, with no mission that could offer a military justification. In December 1963 he canceled it.

Better prospects attended NASA's effort in manned spaceflight, which culminated in the Apollo piloted flights to the Moon. Apollo used no wings; rather, it relied on a simple cone that used the Allen-Eggers blunt-body principle. Still, its demands were stringent. It had to re-enter successfully with twice the energy of an entry from Earth orbit. Then it had to navigate a corridor, a narrow range of altitudes, to bleed off energy without either skipping back into space or encountering g-forces that were too severe. By doing these things, it showed that hypersonics was ready for this challenge.

WINGED SPACECRAFT AND DYNA-SOAR

Boost-glide rockets, with wings, entered the realm of advanced conceptual design with postwar studies at Bell Aircraft called Bomi, Bomber Missile. The director of the work, Walter Dornberger, had headed Germany's wartime rocket development program and had been in charge of the V-2. The new effort involved feasibility studies that sought to learn what might be done with foreseeable technology, but Bomi was a little too advanced for some of Dornberger's colleagues. Historian Roy Houchin writes that when Dornberger faced "abusive and insulting remarks" from an Air Force audience, he responded by declaring that his Bomi would be receiving more respect if he had had the chance to fly it against the United States during the war. In Houchin's words, "The silence was deafening."¹

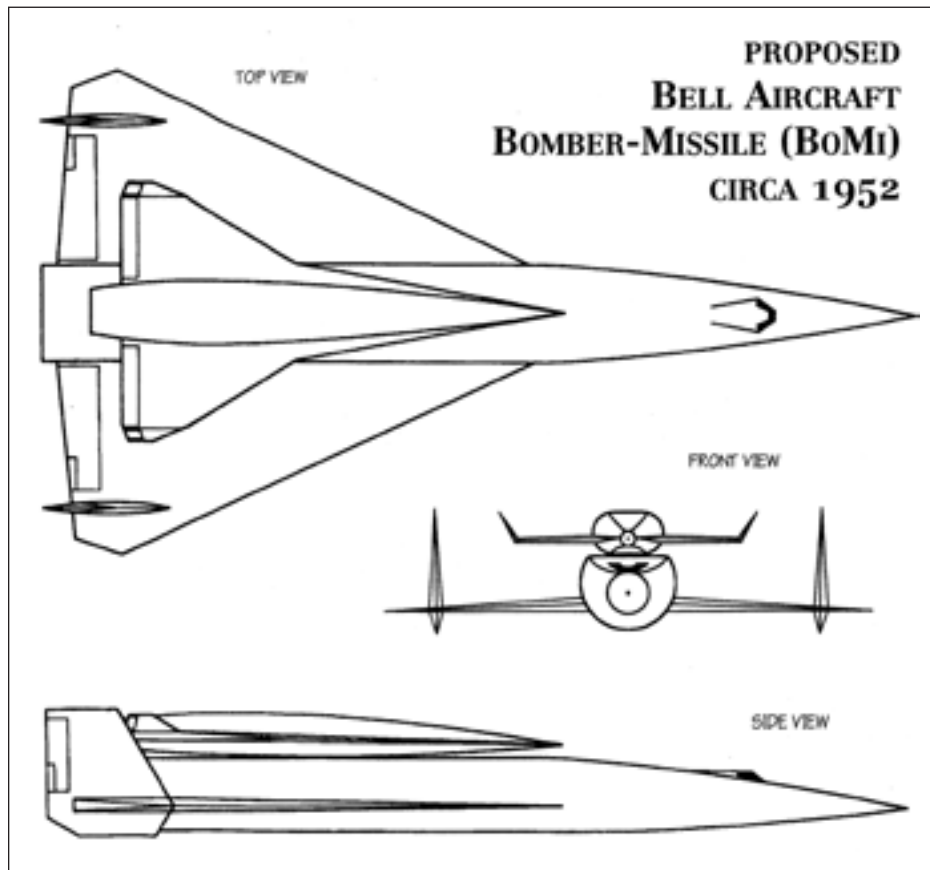

The Bomi concept. (Art by Dennis Jenkins)

The initial Bomi concept, dating back to 1951, took form as an in-house effort. It called for a two-stage rocket, with both stages being piloted and fitted with delta wings. The lower stage was mostly of aluminum, with titanium leading edges and nose; the upper stage was entirely of titanium and used radiative cooling. With an initial range of 3,500 miles, it was to come over the target above 100,000 feet and at speeds greater than Mach 4. Operational concepts called for bases in England or Spain, targets in the western Soviet Union, and a landing site in northern Africa.²

During the spring of 1952, Bell officials sought funds for further study from Wright Air Development Center (WADC). A year passed, and WADC responded with a firm no. The range was too short. Thermal protection and onboard cooling raised unanswered questions. Values assumed for L/D appeared highly optimistic, and no information was available on stability, control, or aerodynamic flutter at the proposed speeds. Bell responded by offering to consider higher speeds and greater

range. Basic feasibility then lay even farther in the future, but the Air Force's interest in the Atlas ICBM meant that it wanted missiles of longer range, even though shorter-range designs could be available sooner. An intercontinental Bomi at least could be evaluated as a potential alternative to Atlas, and it might find additional roles such as strategic reconnaissance.³

In April 1954, with that ICBM very much in the ascendancy, WADC awarded Bell its desired study contract. Bomi now had an Air Force designation, MX-2276. Bell examined versions of its two-stage concept with 4,000- and 6,000-mile ranges while introducing a new three-stage configuration with the stages mounted belly-to-back. Liftoff thrust was to be 1.2 million pounds, compared with 360,000 for the three-engine Atlas. Bomi was to use a mix of liquid oxygen and liquid fluorine, the latter being highly corrosive and hazardous, whereas Atlas needed only liquid oxygen, which was much safer. The new Bomi was to reach 22,000 feet per second, slightly less than Atlas, but promised a truly global glide range of 12,000 miles. Even so, Atlas clearly was preferable.⁴

But the need for reconnaissance brought new life to the Bell studies. At WADC, in parallel with initiatives that were sparking interest in unpowered reconnaissance satellites, officials defined requirements for Special Reconnaissance System 118P. These called initially for a range of 3,500 miles at altitudes above 100,000 feet. Bell won funding in September 1955, as a follow-on to its recently completed MX-2276 activity, and proposed a two-stage vehicle with a Mach 15 glider. In March 1956 the company won a new study contract for what now was called Brass Bell. It took shape as a fairly standard advanced concept of the mid-1950s, with a liquid-fueled expendable first stage boosting a piloted craft that showed sharply swept delta wings. The lower stage was conventional in design, burning Atlas propellants with uprated Atlas engines, but the glider retained the company's preference for fluorine. Officials at Bell were well aware of its perils, but John Sloop at NACA-Lewis was successfully testing a fluorine rocket engine with 20,000 pounds of thrust, and this gave hope.⁵

The Brass Bell study contract went into force at a moment when prospects for boost-glide were taking a sharp step upward. In February 1956 General Thomas Power, head of the Air Research and Development Command (ARDC), stated that the Air Force should stop merely considering such radical concepts and begin developing them. High on his list was a weapon called Robo, Rocket Bomber, for which several firms were already conducting in-house work as a prelude to funded study contracts. Robo sought to advance beyond Brass Bell, for it was to circle the globe and hence required near-orbital speed. In June ARDC Headquarters set forth System Requirement 126 that defined the scope of the studies. Convair, Douglas, and North American won the initial awards, with Martin, Bell, and Lockheed later participating as well.

The X-15 by then was well along in design, but it clearly was inadequate for the performance requirements of Brass Bell and Robo. This raised the prospect of a new and even more advanced experimental airplane. At ARDC Headquarters, Major George Colchagoff took the initiative in pursuing studies of such a craft, which took the name HYWARDS: Hypersonic Weapons Research and Development Supporting System. In November 1956 the ARDC issued System Requirement 131, thereby placing this new X-plane on the agenda as well.⁶

The initial HYWARDS concept called for a flight speed of Mach 12. However, in December Bell Aircraft raised the speed of Brass Bell to Mach 18. This increased the boost-glide range to 6,300 miles, but it opened a large gap between the performance of the two craft, inviting questions as to the applicability of HYWARDS results. In January a group at NACA-Langley, headed by John Becker, weighed in with a report stating that Mach 18, or 18,000 feet per second, was appropriate for HYWARDS. The reason was that “at this speed boost gliders approached their peak heating environment. The rapidly increasing flight altitudes at speeds above Mach 18 caused a reduction in the heating rates.”⁷

With the prospect now strong that Brass Bell and HYWARDS would have the same flight speed, there was clear reason not to pursue them as separate projects but to consolidate them into a single program. A decision at Air Force Headquarters, made in March 1957, accomplished this and recognized their complementary characters. They still had different goals, with HYWARDS conducting flight research and Brass Bell being the operational reconnaissance system, but HYWARDS now was to stand as a true testbed.⁸

Robo still was a separate project, but events during 1957 brought it into the fold as well. In June an ad hoc review group, which included members from ARDC and WADC, looked at Robo concepts from contractors. Robert Graham, a NACA attendee, noted that most proposals called for “a boost-glide vehicle which would fly at Mach 20-25 at an altitude above 150,000 feet.” This was well beyond the state of the art, but the panel concluded that with several years of research, an experimental craft could enter flight test in 1965, an operational hypersonic glider in 1968, and Robo in 1974.⁹

On 10 October—less than a week after the Soviets launched their first Sputnik—ARDC endorsed this three-part plan by issuing a lengthy set of reports, “Abbreviated Systems Development Plan, System 464L—Hypersonic Strategic Weapon System.” It looked ahead to a research vehicle capable of 18,000 feet per second and 350,000 feet, to be followed by Brass Bell with the same speed and 170,000 feet, and finally Robo, rated at 25,000 feet per second and 300,000 feet but capable of orbital flight.

The ARDC’s Lieutenant Colonel Carleton Strathy, a division chief and a strong advocate of program consolidation, took the proposed plan to Air Force Headquarters. He won endorsement from Brigadier General Don Zimmerman, Deputy

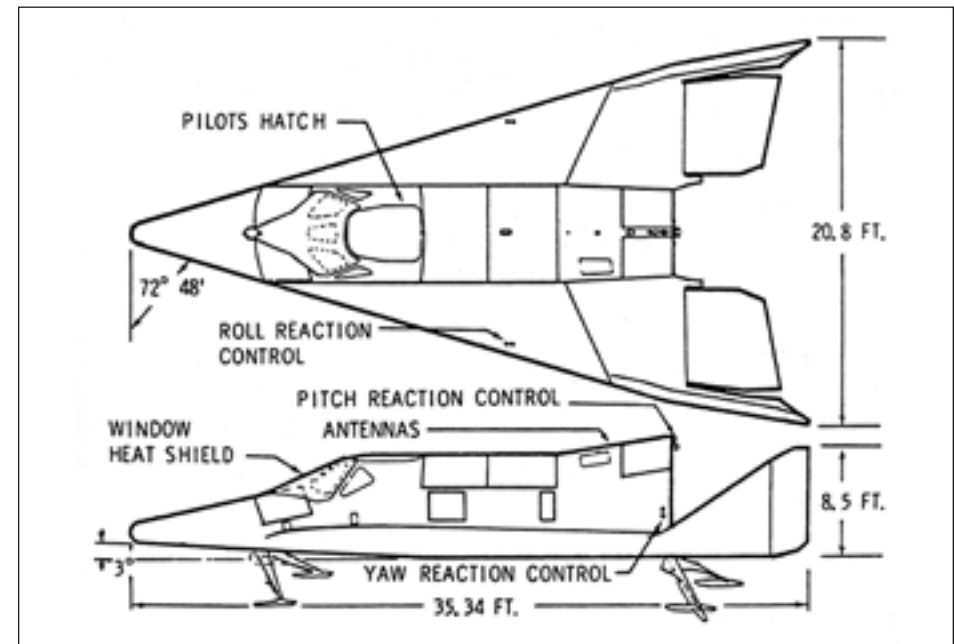

Top and side views of Dyna-Soar. (U.S. Air Force)

Director of Development Planning, and from Brigadier General Homer Boushey, Deputy Director of Research and Development. NACA’s John Crowley, Associate Director for Research, gave strong approval to the proposed test vehicle, viewing it as a logical step beyond the X-15. On 25 November, having secured support from his superiors, Boushey issued Development Directive 94, allocating \$3 million to proceed with more detailed studies following a selection of contractors.¹⁰

The new concept represented another step in the sequence that included Eugen Sänger’s *Silbervogel*, his suborbital skipping vehicle, and among live rocket craft, the X-15. It was widely viewed as a tribute to Sänger, who was still living. It took the name Dyna-Soar, which drew on “dynamic soaring,” Sänger’s name for his skipping technique, and which also stood for “dynamic ascent and soaring flight,” or boost-glide. Boeing and Martin emerged as the finalists in June 1958, with their roles being defined in November 1959. Boeing was to take responsibility for the winged spacecraft. Martin, described as the associate contractor, was to provide the Titan missile that would serve as the launch vehicle.¹¹

The program now demanded definition of flight modes, configuration, structure, and materials. The name of Sänger was on everyone’s lips, but his skipping flight path had already proven to be uncompetitive. He and his colleague Bret had treated its dynamics, but they had not discussed the heating. That task fell to NACA’s Allen and Eggers, along with their colleague Stanford Neice.

In 1954, following their classic analysis of ballistic re-entry, Eggers and Allen turned their attention to comparison of this mode with boost-glide and skipping entries. They assumed the use of active cooling and found that boost-glide held the advantage:

The glide vehicle developing lift-drag ratios in the neighborhood of 4 is far superior to the ballistic vehicle in ability to convert velocity into range. It has the disadvantage of having far more heat convected to it; however, it has the compensating advantage that this heat can in the main be radiated back to the atmosphere. Consequently, the mass of coolant material may be kept relatively low.

A skip vehicle offered greater range than the alternatives, in line with Sanger's advocacy of this flight mode. But it encountered more severe heating, along with high aerodynamic loads that necessitated a structurally strong and therefore heavy vehicle. Extra weight meant extra coolant, with the authors noting that "ultimately the coolant is being added to cool coolant. This situation must obviously be avoided." They concluded that "the skip vehicle is thought to be the least promising of the three types of hypervelocity vehicle considered here."¹²

Following this comparative assessment of flight modes, Eggers worked with his colleague Clarence Syvertson to address the issue of optimum configuration. This issue had been addressed for the X-15; it was a mid-wing airplane that generally resembled the high-performance fighters of its era. In treating Dyna-Soar, following the Robo review of mid-1957, NACA's Robert Graham wrote that "high-wing, mid-wing and low-wing configurations were proposed. All had a highly swept wing, and a small angle cone as the fuselage or body." This meant that while there was agreement on designing the fuselage, there was no standard way to design the wing.¹³

Eggers and Syvertson proceeded by treating the design problem entirely as an exercise in aerodynamics. They concluded that the highest values of L/D were attainable by using a high-wing concept with the fuselage mounted below as a slender half-cone and the wing forming a flat top. Large fins at the wing tips, canted sharply downward, directed the airflow under the wings downward and increased the lift. Working with a hypersonic wind tunnel at NACA-Ames, they measured a maximum L/D of 6.65 at Mach 5, in good agreement with a calculated value of 6.85.¹⁴

This configuration had attractive features, not the least of which was that the base of its half-cone could readily accommodate a rocket engine. Still, it was not long before other specialists began to argue that it was upside down. Instead of having a flat top with the fuselage below, it was to be flipped to place the wing below the fuselage, giving it a flat bottom. This assertion came to the forefront during Becker's HYWARDS study, which identified its preferred velocity as 18,000 feet

per second. His colleague Peter Korycinski worked with Becker to develop heating analyses of flat-top and flat-bottom candidates, with Roger Anderson and others within Langley's Structures Division providing estimates for the weight of thermal protection.

A simple pair of curves, plotted on graph paper, showed that under specified assumptions the flat-bottom weight at that velocity was 21,400 pounds and was increasing at a modest rate at higher speeds. The flat-top weight was 27,600 pounds and was rising steeply. Becker wrote that the flat-bottom craft placed its fuselage "in the relatively cool shielded region on the top or lee side of the wing—i.e., the wing was used in effect as a partial heat shield for the fuselage.... This 'flat-bottomed' design had the least possible critical heating area...and this translated into least circulating coolant, least area of radiative heat shields, and least total thermal protection in flight."¹⁵

These approaches—flat-top at Ames, flat-bottom at Langley—brought a debate between these centers that continued through 1957. At Ames, the continuing strong interest in high L/D reflected an ongoing emphasis on excellent supersonic aerodynamics for military aircraft, which needed high L/D as a matter of course. To ease the heating problem, Ames held for a time to a proposed speed of 11,000 feet per second, slower than the Langley concept but lighter in weight and more attainable in technology while still offering a considerable leap beyond the X-15. Officials at NACA diplomatically described the Ames and Langley HYWARDS concepts respectively as "high L/D" and "low heating," but while the debate continued, there remained no standard approach to the design of wings for a hypersonic glider.¹⁶

There was a general expectation that such a craft would require active cooling. Bell Aircraft, which had been studying Bomi, Brass Bell, and lately Robo, had the most experience in the conceptual design of such arrangements. Its Brass Bell of 1957, designed to enter its glide at 18,000 feet per second and 170,000 feet in altitude, featured an actively cooled insulated hot structure. The primary or load-bearing structure was of aluminum and relied on cooling in a closed-loop arrangement that used water-glycol as the coolant. Wing leading edges had their own closed-loop cooling system that relied on a mix of sodium and potassium metals. Liquid hydrogen, pumped initially to 1,000 pounds per square inch, flowed first through a heat exchanger and cooled the heated water-glycol, then proceeded to a second heat exchanger to cool the hot sodium-potassium. In an alternate design concept, this gas cooled the wing leading edges directly, with no intermediate liquid-metal coolant loop. The warmed hydrogen ran a turbine within an onboard auxiliary power unit and then was exhausted overboard. The leading edges reached a maximum temperature of 1,400°F, for which Inconel X was a suitable material.¹⁷

During August of that year Becker and Korycinski launched a new series of studies that further examined the heating and thermal protection of their flat-bottom

glider. They found that for a glider of global range, flying with angle of attack of 45 degrees, an entry trajectory near the upper limit of permissible altitudes gave peak uncooled skin temperatures of 2,000°F. This appeared achievable with improved metallic or ceramic hot structures. Accordingly, no coolant at all was required!¹⁸



Artist's rendering showing Dyna-Soar boosted by a Titan III launch vehicle. (Boeing Company archives)

During subsequent years the booster changed from Martin's Titan I to the more capable Titan II and then to the powerful Titan III-C, which could easily boost it to orbit. A new plan, approved in December 1961, dropped suborbital missions and called for "the early attainment of orbital flight." Subsequent planning anticipated that Dyna-Soar would reach orbit with the Titan III upper stage, execute several circuits of the Earth, and then come down from orbit by using this stage as a retrorocket.¹⁹

After that, though, advancing technical capabilities ran up against increasingly stringent operational requirements. The Dyna-Soar concept had grown out of HYWARDS, being intended initially to serve as a testbed for the reconnaissance

This conclusion, published early in 1959, influenced the configuration of subsequent boost-glide vehicles—Dyna-Soar, the space shuttle—much as the Eggers-Allen paper of 1953 had defined the blunt-body shape for ballistic entry. Preliminary and unpublished results were in hand more than a year prior to publication, and when the prospect emerged of eliminating active cooling, the concepts that could do this were swept into prominence. They were of the flat-bottom type, with Dyna-Soar being the first to proceed into mainstream development.

This uncooled configuration proved robust enough to accommodate substantial increases in flight speed and performance. In April 1959 Herbert York, the Defense Director of Research and Engineering, stated that Dyna-Soar was to fly at 15,000 miles per hour. This was well above the planned speed of Brass Bell but still below orbital velocity.

During subsequent years the booster



Full-scale model of Dyna-Soar, on display at an Air Force exhibition in 1962. The scalloped pattern on the base was intended to suggest Sänger's skipping entry. (Boeing Company archives)

boost-glider Brass Bell and for the manned rocket-powered bomber Robo. But the rationale for both projects became increasingly questionable during the early 1960s. The hypersonic Brass Bell gave way to a new concept, the Manned Orbiting Laboratory (MOL), which was to fly in orbit as a small space station while astronauts took reconnaissance photos. Robo fell out of the picture completely, for the success of the Minuteman ICBM, which used solid propellant, established such missiles as the nation's prime strategic force. Some people pursued new concepts that continued to hold out hope for Dyna-Soar applications, with satellite interception standing in the forefront. The Air Force addressed this with studies of its Saint project, but Dyna-Soar proved unsuitable for such a mission.²⁰

Dyna-Soar was a potentially superb technology demonstrator, but Defense Secretary Robert McNamara took the view that it had to serve a military role in its own right or lead to a follow-on program with clear military application. The cost of Dyna-Soar was approaching a billion dollars, and in October 1963 he declared that he could not justify spending such a sum if it was a dead-end program with no ultimate purpose. He canceled it on 10 December, noting that it was not to serve as a cargo rocket, could not carry substantial payloads, and could not stay in orbit for



Artist's rendering showing Dyna-Soar in orbit. (Boeing Company archives)

long durations. He approved MOL as a new program, thereby giving the Air Force continuing reason to hope that it would place astronauts in orbit, but stated that Dyna-Soar would serve only "a very narrow objective."²¹

At that moment the program called for production of 10 flight vehicles, and Boeing had completed some 42 percent of the necessary tasks. McNamara's decision therefore was controversial, particularly because the program still had high-level supporters. These included Eugene Zuckert, Air Force Secretary; Alexander Flax, Assistant Secretary for Research and Development; and Brockway McMillan, Zuckert's Under Secretary and Flax's predecessor as Assistant Secretary. Still, McNamara gave more attention to Harold Brown, the Defense Director of Research and Engineering, who made the specific proposal that McNamara accepted: to cancel Dyna-Soar and proceed instead with MOL.²²

Dyna-Soar never flew. The program had expended \$410 million when canceled, but the schedule still called for another \$373 million, and the vehicle was still some two and a half years away from its first flight. Even so, its technology remained available for further development, contributing to the widening prospects for reentry that marked the era.²³

THE TECHNOLOGY OF DYNA-SOAR

Its thermal environment during re-entry was less severe than that of an ICBM nose cone, allowing designers to avoid not only active structural cooling but ablative thermal protection as well. This meant that it could be reusable; it did not have to change out its thermal protection after every flight. Even so, its environment imposed temperatures and heat loads that pervaded the choice of engineering solutions throughout the vehicle.

Dyna-Soar used radiatively-cooled hot structure, with the primary or load-bearing structure being of Rene 41. Trusses formed the primary structure of the wings and fuselage, with many of their beams meeting at joints that were pinned rather than welded. Thermal gradients, imposing differential expansion on separate beams, caused these members to rotate at the pins. This accommodated the gradients without imposing thermal stress.

Rene 41 was selected as a commercially available superalloy that had the best available combination of oxidation resistance and high-temperature strength. Its yield strength, 130,000 psi at room temperature, fell off only slightly at 1,200°F and retained useful values at 1,800°F. It could be processed as sheet, strip, wire, tubes, and forgings. Used as the primary structure of Dyna-Soar, it supported a design specification that indeed called for reusability. The craft was to withstand at least four re-entries under the most severe conditions permitted.

As an alloy, Rene 41 had a standard composition of 19 percent chromium, 11 percent cobalt, 10 percent molybdenum, 3 percent titanium, and 1.5 percent alu-

minum, along with 0.09 percent carbon and 0.006 percent boron, with the balance being nickel. It gained strength through age hardening, with the titanium and aluminum precipitating within the nickel as an intermetallic compound. Age-hardening weldments initially showed susceptibility to cracking, which occurred in parts that had been strained through welding or cold working. A new heat-treatment process permitted full aging without cracking, with the fabricated assemblies showing no significant tendency to develop cracks.²⁴

As a structural material, the relatively mature state of Rene 41 reflected the fact that it had already seen use in jet engines. It nevertheless lacked the temperature resistance necessary for use in the metallic shingles or panels that were to form the outer skin of the vehicle, reradiating the heat while withstanding temperatures as high as 3,000°F. Here there was far less existing art, and investigators at Boeing had to find their way through a somewhat roundabout path.

Four refractory or temperature-resistant metals initially stood out: tantalum, tungsten, molybdenum, and columbium. Tantalum was too heavy, and tungsten was not available commercially as sheet. Columbium also appeared to be ruled out for it required an antioxidation coating, but vendors were unable to coat it without rendering it brittle. Molybdenum alloys also faced embrittlement due to recrystallization produced by a prolonged soak at high temperature in the course of coating formation. A promising alloy, Mo-0.5Ti, overcame this difficulty through addition of 0.07 percent zirconium. The alloy that resulted, Mo-0.5Ti-0.07Zr, was called TZM. For a time it appeared as a highly promising candidate for all the other panels.²⁵

Wing design also promoted its use, for the craft mounted a delta wing with a leading-edge sweep of 73 degrees. Though built for hypersonic re-entry from orbit, it resembled the supersonic delta wings of contemporary aircraft such as the B-58 bomber. However, this wing was designed using the Eggers-Allen blunt-body principle, with the leading edge being curved or blunted to reduce the rate of heating. The wing sweep then reduced equilibrium temperatures along the leading edge to levels compatible with the use of TZM.²⁶

Boeing's metallurgists nevertheless held an ongoing interest in columbium because in uncoated form it showed superior ease of fabrication and lack of brittleness. A new Boeing-developed coating method eliminated embrittlement, putting columbium back in the running. A survey of its alloys showed that they all lacked the hot strength of TZM. Columbium nevertheless retained its attractiveness because it promised less weight. Based on coatability, oxidation resistance, and thermal emissivity, the preferred alloy was Cb-10Ti-5Zr, called D-36. It replaced TZM in many areas of the vehicle but proved to lack strength against creep at the highest temperatures. Moreover, coated TZM gave more of a margin against oxidation than coated D-36, again at the most extreme temperatures. D-36 indeed was chosen to cover

most of the vehicle, including the flat underside of the wing. But TZM retained its advantage for such hot areas as the wing leading edges.²⁷

The vehicle had some 140 running feet of leading edges and 140 square feet of associated area. This included leading edges of the vertical fins and elevons as well as of the wings. In general, D-36 served where temperatures during re-entry did not exceed 2,700°F, while TZM was used for temperatures between 2,700 and 3,000°F. In accordance with the Stefan-Boltzmann law, all surfaces radiated heat at a rate proportional to the fourth power of the temperature. Hence for equal emissivities, a surface at 3,000°F radiated 43 percent more heat than one at 2,700°F.²⁸

Panels of both TZM and D-36 demanded antioxidation coatings. These coatings were formed directly on the surfaces as metallic silicides (silicon compounds), using a two-step process that employed iodine as a chemical intermediary. Boeing introduced a fluidized-bed method for application of the coatings that cut the time for preparation while enhancing uniformity and reliability. In addition, a thin layer of silicon carbide, applied to the surface, gave the vehicle its distinctive black color. It enhanced the emissivity, lowering temperatures by as much as 200°F.

Development testing featured use of an oxyacetylene torch, operated with excess oxygen, which heated small samples of coated refractory sheet to temperatures as high as 3,000°F, measured by optical pyrometer. Test durations ran as long as four hours, with a published review noting that failures of specimens "were easily detected by visual observation as soon as they occurred." This work showed that although TZM had better oxidation resistance than D-36, both coated alloys could resist oxidation for more than two hours at 3,000°F. This exceeded design requirements. Similar tests applied stress to hot samples by hanging weights from them, thereby demonstrating their ability to withstand stress of 3,100 psi, again at 3,000°F.²⁹

Other tests showed that complete panels could withstand aerodynamic flutter. This issue was important; a report of the Aerospace Vehicles Panel of the Air Force Scientific Advisory Board (SAB)—a panel on panels, as it were—came out in April 1962 and singled out the problem of flutter, citing it as one that called for critical attention. The test program used two NASA wind tunnels: the 4 by 4-foot Unitary facility at Langley that covered a range of Mach 1.6 to 2.8 and the 11 by 11-foot Unitary installation at Ames for Mach 1.2 to 1.4. Heaters warmed test samples to 840°F as investigators started with steel panels and progressed to versions fabricated from Rene nickel alloy.

"Flutter testing in wind tunnels is inherently dangerous," a Boeing review declared. "To carry the test to the actual flutter point is to risk destruction of the test specimen. Under such circumstances, the safety of the wind tunnel itself is jeopardized." Panels under test were as large as 24 by 45 inches; actual flutter could easily have brought failure through fatigue, with parts of a specimen being blown through the tunnel at supersonic speed. The work therefore proceeded by starting

at modest dynamic pressures, 400 and 500 pounds per square foot, and advancing over 18 months to levels that exceeded the design requirement of close to 1,400 pounds per square foot. The Boeing report concluded that the success of this test program, which ran through mid-1962, "indicates that an adequate panel flutter capability has been achieved."³⁰

Between the outer panels and the inner primary structure, a corrugated skin of Rene 41 served as a substructure. On the upper wing surface and upper fuselage, where temperatures were no higher than 2,000°F, the thermal-protection panels were also of Rene 41 rather than of a refractory. Measuring 12 by 45 inches, these panels were spot-welded directly to the corrugations of the substructure. For the wing undersurface, and for other areas that were hotter than 2,000°F, designers specified an insulated structure. Standoff clips, each with four legs, were riveted to the underlying corrugations and supported the refractory panels, which also were 12 by 45 inches in size.

The space between the panels and the substructure was to be filled with insulation. A survey of candidate materials showed that most of them exhibited a strong tendency to shrink at high temperatures. This was undesirable; it increased the rate of heat transfer and could create uninsulated gaps at seams and corners. Q-felt, a silica fiber from Johns-Manville, also showed shrinkage. However, nearly all of it occurred at 2,000°F and below; above 2,000°F, further shrinkage was negligible. This meant that Q-felt could be "pre-shrunk" through exposure to temperatures above 2,000°F for several hours. The insulation that resulted had density no greater than 6.2 pounds per cubic foot, one-tenth that of water. In addition, it withstood temperatures as high as 3,000°F.³¹

TZM outer panels, insulated with Q-felt, proved suitable for wing leading edges. These were designed to withstand equilibrium temperatures of 2,825°F and short-duration overtemperatures of 2,900°F. However, the nose cap faced temperatures of 3,680°F, along with a peak heat flux of 143 BTU per square foot-second. This cap had a radius of curvature of 7.5 inches, making it far less blunt than the Project Mercury heat shield that had a radius of 120 inches.³² Its heating was correspondingly more severe. Reliable thermal protection of the nose was essential, and so the program conducted two independent development efforts that used separate approaches. The firm of Chance Vought pursued the main line of activity, while Boeing also devised its own nose-cap design.

The work at Vought began with a survey of materials that paralleled Boeing's review of refractory metals for the thermal-protection panels. Molybdenum and columbium had no strength to speak of at the pertinent temperatures, but tungsten retained useful strength even at 4,000°F. However, this metal could not be welded, while no known coating could protect it against oxidation. Attention then turned to nonmetallic materials, including ceramics.

Ceramics of interest existed as oxides such as silica and magnesia, which meant that they could not undergo further oxidation. Magnesia proved to be unsuitable because it had low thermal emittance, while silica lacked strength. However, carbon in the form of graphite showed clear promise. It held considerable industrial experience; it was light in weight, while its strength actually increased with temperature. It oxidized readily but could be protected up to 3,000°F by treating it with silicon, in a vacuum and at high temperatures, to form a thin protective layer of silicon carbide. Near the stagnation point, the temperatures during re-entry would exceed that level. This brought the concept of a nose cap with siliconized graphite as the primary material, with an insulating layer of a temperature-resistant ceramic covering its forward area. With graphite having good properties as a heat sink, it would rise in temperature uniformly and relatively slowly, while remaining below the 3,000°F limit through the full time of re-entry.

Suitable grades of graphite proved to be available commercially from the firm of National Carbon. Candidate insulators included hafnia, thoria, magnesia, ceria, yttria, beryllia, and zirconia. Thoria was the most refractory but was very dense and showed poor resistance to thermal shock. Hafnia brought problems of availability and of reproducibility of properties. Zirconia stood out. Zirconium, its parent metal, had found use in nuclear reactors; the ceramic was available from the Zirconium Corporation of America. It had a melting point above 4,500°F, was chemically stable and compatible with siliconized graphite, offered high emittance with low thermal conductivity, provided adequate resistance to thermal shock and thermal stress, and lent itself to fabrication.³³

For developmental testing, Vought used two in-house facilities that simulated the flight environment, particularly during re-entry. A ramjet, fueled with JP-4 and running with air from a wind tunnel, produced an exhaust with velocity up to 4,500 feet per second and temperature up to 3,500°F. It also generated acoustic levels above 170 decibels, reproducing the roar of a Titan III booster and showing that samples under test could withstand the resulting stresses without cracking. A separate installation, built specifically for the Dyna-Soar program, used an array of propane burners to test full-size nose caps.

The final Vought design used a monolithic shell of siliconized graphite that was covered over its full surface by zirconia tiles held in place using thick zirconia pins. This arrangement relieved thermal stresses by permitting mechanical movement of the tiles. A heat shield stood behind the graphite, fabricated as a thick disk-shaped container made of coated TZM sheet metal and filled with Q-felt. The nose cap attached to the vehicle with a forged ring and clamp that also were of coated TZM. The cap as a whole relied on radiative cooling. It was designed to be reusable; like the primary structure, it was to withstand four re-entries under the most severe conditions permitted.³⁴

The backup Boeing effort drew on that company's own test equipment. Study of samples used the Plasma Jet Subsonic Splash Facility, which created a jet with temperature as high as 8,000°F that splashed over the face of a test specimen. Full-scale nose caps went into the Rocket Test Chamber, which burned gasoline to produce a nozzle exit velocity of 5,800 feet per second and an acoustic level of 154 decibels. Both installations were capable of long-duration testing, reproducing conditions during re-entries that could last for 30 minutes.³⁵

The Boeing concept used a monolithic zirconia nose cap that was reinforced against cracking with two screens of platinum-rhodium wire. The surface of the cap was grooved to relieve thermal stress. Like its counterpart from Vought, this design also installed a heat shield that used Q-felt insulation. However, there was no heat sink behind the zirconia cap. This cap alone provided thermal protection at the nose through radiative cooling. Lacking both pinned tiles and an inner shell, its design was simpler than that of Vought.³⁶

Its fabrication bore comparison to the age-old work of potters, who shape wet clay on a rotating wheel and fire the resulting form in a kiln. Instead of using a potter's wheel, Boeing technicians worked with a steel die with an interior in the shape of a bowl. A paper honeycomb, reinforced with Elmer's Glue and laid in place, defined the pattern of stress-relieving grooves within the nose cap surface. The working material was not moist clay, but a mix of zirconia powder with binders, internal lubricants, and wetting agents.

With the honeycomb in position against the inner face of the die, a specialist loaded the die by hand, filling the honeycomb with the damp mix and forming layers of mix that alternated with the wire screens. The finished layup, still in its die, went into a hydraulic press. A pressure of 27,000 psi compacted the form, reducing its porosity for greater strength and less susceptibility to cracks. The cap was dried at 200°F, removed from its die, dried further, and then fired at 3,300°F for 10 hours. The paper honeycomb burned out in the course of the firing. Following visual and x-ray inspection, the finished zirconia cap was ready for machining to shape in the attachment area, where the TZM ring-and-clamp arrangement was to anchor it to the fuselage.³⁷

The nose cap, outer panels, and primary structure all were built to limit their temperatures through passive methods: radiation, insulation. Active cooling also played a role, reducing temperatures within the pilot's compartment and two equipment bays. These used a "water wall," which mounted absorbent material between sheet-metal panels to hold a mix of water and a gel. The gel retarded flow of this fluid, while the absorbent wicking kept it distributed uniformly to prevent hot spots.

During reentry, heat reached the water walls as it penetrated into the vehicle. Some of the moisture evaporated as steam, transferring heat to a set of redundant water-glycol cooling loops resembling those proposed for Brass Bell of 1957. In Dyna-Soar, liquid hydrogen from an onboard supply flowed through heat exchang-

ers and cooled these loops. Brass Bell had called for its warmed hydrogen to flow through a turbine, operating the onboard Auxiliary Power Unit. Dyna-Soar used an arrangement that differed only slightly: a catalytic bed to combine the stream of warm hydrogen with oxygen that again came from an onboard supply. This produced gas that drove the turbine of the Dyna-Soar APU, which provided both hydraulic and electric power.

A cooled hydraulic system also was necessary to move the control surfaces as on a conventional aircraft. The hydraulic fluid operating temperature was limited to 400°F by using the fluid itself as an initial heat-transfer medium. It flowed through an intermediate water-glycol loop that removed its heat by cooling with hydrogen. Major hydraulic system components, including pumps, were mounted within an actively cooled compartment. Control-surface actuators, along with their associated valves and plumbing, were insulated using inch-thick blankets of Q-felt. Through this combination of passive and active cooling methods, the Dyna-Soar program avoided a need to attempt to develop truly high-temperature hydraulic arrangements, remaining instead within the state of the art.³⁸

Specific vehicle parts and components brought their own thermal problems. Bearings, both ball and antifriction, needed strength to carry mechanical loads at high temperatures. For ball bearings, the cobalt-base superalloy Stellite 19 was known to be acceptable up to 1,200°F. Investigation showed that it could perform under high load for short durations at 1,350°F. However, Dyna-Soar needed ball bearings qualified for 1,600°F and obtained them as spheres of Rene 41 plated with gold. The vehicle also needed antifriction bearings as hinges for control surfaces, and here there was far less existing art. The best available bearings used stainless steel and were suitable only to 600°F, whereas Dyna-Soar again faced a requirement of 1,600°F. A survey of 35 candidate materials led to selection of titanium carbide with nickel as a binder.³⁹

Antenna windows demanded transparency to radio waves at similarly high temperatures. A separate program of materials evaluation led to selection of alumina, with the best grade being available from the Coors Porcelain Company. Its emittance had the low value of 0.4 at 2,500°F, which meant that waveguides beneath these windows faced thermal damage even though they were made of columbium alloy. A mix of oxides of cobalt, aluminum, and nickel gave a suitable coating when fired at 3,000°F, raising the emittance to approximately 0.8.⁴⁰

The pilot needed his own windows. The three main ones, facing forward, were the largest yet planned for a manned spacecraft. They had double panes of fused silica, with infrared-reflecting coatings on all surfaces except the outermost. This inhibited the inward flow of heat by radiation, reducing the load on the active cooling of the pilot's compartment. The window frames expanded when hot; to hold the panes in position, the frames were fitted with springs of Rene 41. The windows also needed thermal protection, and so they were covered with a shield of D-36.

The cockpit was supposed to be jettisoned following re-entry, around Mach 5, but this raised a question: what if it remained attached? The cockpit had two other windows, one on each side, which faced a less severe environment and were to be left unshielded throughout a flight. The test pilot Neil Armstrong flew approaches and landings with a modified Douglas F5D fighter and showed that it was possible to land Dyna-Soar safely with side vision only.⁴¹

The vehicle was to touch down at 220 knots. It lacked wheeled landing gear, for inflated rubber tires would have demanded their own cooled compartments. For the same reason, it was not possible to use a conventional oil-filled strut as a shock absorber. The craft therefore deployed tricycle landing skids. The two main skids, from Goodyear, were of Waspaloy nickel steel and mounted wire bristles of Rene 41. These gave a high coefficient of friction, enabling the vehicle to skid to a stop in a planned length of 5,000 feet while accommodating runway irregularities. In place of the usual oleo strut, a long rod of Inconel stretched at the moment of touchdown and took up the energy of impact, thereby serving as a shock absorber. The nose skid, from Bendix, was forged from Rene 41 and had an undercoat of tungsten carbide to resist wear. Fitted with its own energy-absorbing Inconel rod, the front skid had a reduced coefficient of friction, which helped to keep the craft pointing straight ahead during slideout.⁴²

Through such means, the Dyna-Soar program took long strides toward establishing hot structures as a technology suitable for operational use during re-entry from orbit. The X-15 had introduced heat sink fabricated from Inconel X, a nickel steel. Dyna-Soar went considerably further, developing radiation-cooled insulated structures fabricated from Rene 41 superalloy and from refractory materials. A chart from Boeing made the point that in 1958, prior to Dyna-Soar, the state of the art for advanced aircraft structures involved titanium and stainless steel, with temperature limits of 600°F. The X-15 with its Inconel X could withstand temperatures above 1,200°F. Against this background, Dyna-Soar brought substantial advances in the temperature limits of aircraft structures:⁴³

TEMPERATURE LIMITS BEFORE AND AFTER DYNA-SOAR (in °F)

<u>Element</u>	<u>1958</u>	<u>1963</u>
Nose cap	3,200	4,300
Surface panels	1,200	2,750
Primary structure	1,200	1,800
Leading edges	1,200	3,000
Control surfaces	1,200	1,800
Bearings	1,200	1,800

Meanwhile, while Dyna-Soar was going forward within the Air Force, NASA had its own approaches to putting man in space.

HEAT SHIELDS FOR MERCURY AND CORONA

In November 1957, a month after the first Sputnik reached orbit, the Soviets again startled the world by placing a much larger satellite into space, which held the dog Laika as a passenger. This clearly presaged the flight of cosmonauts, and the question then was how the United States would respond. No plans were ready at the moment, but whatever America did, it would have to be done quickly.

HYWARDS, the nascent Dyna-Soar, was proceeding smartly. In addition, at North American Aviation the company's chief engineer, Harrison Storms, was in Washington, DC, with a concept designated X-15B. Fitted with thermal protection for return from orbit, it was to fly into space atop a cluster of three liquid-fueled boosters for an advanced Navaho, each with thrust of 415,000 pounds.⁴⁴ However, neither HYWARDS nor the X-15B could be ready soon. Into this breach stepped Maxime Faget of NACA-Langley, who had already shown a talent for conceptual design during the 1954 feasibility study that led to the original X-15.

In 1958 he was a branch chief within Langley's Pilotless Aircraft Research Division. Working on speculation, amid full awareness that the Army or Air Force might win the man-in-space assignment, he initiated a series of paper calculations and wind-tunnel tests of what he described as a "simple nonlifting satellite vehicle which follows a ballistic path in reentering the atmosphere." He noted that an "attractive feature of such a vehicle is that the research and production experiences of the ballistic-missile programs are applicable to its design and construction," and "since it follows a ballistic path, there is a minimum requirement for autopilot, guidance, or control equipment."⁴⁵

In seeking a suitable shape, Faget started with the heat shield. Invoking the Allen-Eggers principle, he at first considered a flat face. However, it proved to trap heat by interfering with the rapid airflow that could carry this heat away. This meant that there was an optimum bluntness, as measured by radius of curvature.

Calculating thermal loads and heat-transfer rates using theories of Lees and of Fay and Riddell, and supplementing these estimates with experimental data from his colleague William Stoney, he considered a series of shapes. The least blunt was a cone with a rounded tip that faced the airflow. It had the highest heat input and the highest peak heating rate. A sphere gave better results in both areas, while the best estimates came with a gently rounded surface that faced the flow. It had only two-thirds the total heat input of the rounded cone—and less than one-third the peak heating rate. It also was the bluntest shape of those considered, and it was selected.⁴⁶

With a candidate heat-shield shape in hand, he turned his attention to the complete manned capsule. An initial concept had the shape of a squat dome that was recessed slightly from the edge of the shield, like a circular Bundt cake that does not quite extend to the rim of its plate. The lip of this heat shield was supposed to

produce separated flow over the afterbody to reduce its heating. When tested in a wind tunnel, however, it proved to be unstable at subsonic speeds.

Faget's group eliminated the open lip and exchanged the domed afterbody for a tall cone with a rounded tip that was to re-enter with its base end forward. It proved to be stable in this attitude, but tests in the 11-inch Langley hypersonic wind tunnel showed that it transferred too much heat to the afterbody. Moreover, its forward tip did not give enough room for its parachutes. This brought a return to the domed afterbody, which now was somewhat longer and had a cylinder on top to stow the chutes. Further work evolved the domed shape into a funnel, a conic frustum that retained the cylinder. This configuration provided a basis for design of the Mercury and later of the Gemini capsules, both of which were built by the firm of McDonnell Aircraft.⁴⁷

Choice of thermal protection quickly emerged as a critical issue. Fortunately, the thermal environment of a re-entering satellite proved to be markedly less demanding than that of an ICBM. The two vehicles were similar in speed and kinetic energy, but an ICBM was to slam back into the atmosphere at a steep angle, decelerating rapidly due to drag and encountering heating that was brief but very severe. Re-entry from orbit was far easier, taking place over a number of minutes. Indeed, experimental work showed that little if any ablation was to be expected under the relatively mild conditions of satellite entry.

But satellite entry involved high total heat input, while its prolonged duration imposed a new requirement for good materials properties as insulators. They also had to stay cool through radiation. It thus became possible to critique the usefulness of ICBM nose-cone ablators for the prospective new role of satellite reentry.⁴⁸

Heat of ablation, in BTU per pound, had been a standard figure of merit. For satellite entry, however, with little energy being carried away by ablation, it could be irrelevant. Phenolic glass, a fine ICBM material with a measured heat of 9,600 BTU per pound, was unusable for a satellite because it had an unacceptably high thermal conductivity. This meant that the prolonged thermal soak of re-entry could have time enough to fry a spacecraft. Teflon, by contrast, had a measured heat only one-third as large. It nevertheless made a superb candidate because of its excellent properties as an insulator.⁴⁹

Such results showed that it was not necessary to reopen the problem of thermal protection for satellite entry. With appropriate caveats, the experience and research techniques of the ICBM problem could carry over to this new realm. This background made it possible for the Central Intelligence Agency to build operational orbital re-entry vehicles at a time when nose cones for Atlas were still in flight test.

This happened beginning in 1958, when Richard Bissell, a senior manager within the CIA, launched a highly classified reconnaissance program called Corona. General Electric, which was building nose cones for Atlas, won a contract to build the film-return capsule. The company selected ablation as the thermal-protection method, with phenolic nylon as the ablative material.⁵⁰

The second Corona launch, in April 1959, flew successfully and became the world's first craft to return safely from orbit. It was supposed to come down near Hawaii, and a ground controller transmitted a command to have the capsule begin re-entry at a particular time. However, he forgot to press a certain button. The director of the recovery effort, Lieutenant Colonel Charles "Moose" Mathison, then learned that it would actually come down near the Norwegian island of Spitzbergen.

Mathison telephoned a friend in Norway's air force, Major General Tufte Johnsen, and told him to watch for a small spacecraft that was likely to be descending by parachute. Johnsen then phoned a mining company executive on the island and had him send out ski patrols. A three-man patrol soon returned with news: They had seen the orange parachute as the capsule drifted downward near the village of Barentsburg. That was not good because its residents were expatriate Russians. General Nathan Twining, Chairman of the Joint Chiefs, summarized the craft's fate in a memo: "From concentric circular tracks found in the snow at the suspected impact point and leading to one of the Soviet mining concessions on the island, we strongly suspect that the Soviets are in possession of the capsule."⁵¹

Meanwhile, NASA's Maxime Faget was making decisions concerning thermal protection for his own program, which now had the name Project Mercury. He was well aware of ablation but preferred heat sink. It was heavier, but he doubted that industrial contractors could fabricate an ablative heat shield that had adequate reliability.⁵²

The suitability of ablation could not be tested by flying a subscale heat shield atop a high-speed rocket. Nothing less would do than to conduct a full-scale test using an Atlas ICBM as a booster. This missile was still in development, but in December 1958 the Air Force Ballistic Missile Division agreed to provide one Atlas C within six months, along with eight Atlas Ds over the next several years. This made it possible to test an ablative heat shield for Mercury as early as September 1959.⁵³

The contractor for this shield was General Electric. The ablative material, phenolic-fiberglass, lacked the excellent insulating properties of Teflon or phenolic-nylon. Still, it had flown successfully as a ballistic-missile nose cone. The project engineer Aleck Bond adds that "there was more knowledge and experience with fiberglass-phenolic than with other materials. A great deal of ground-test information was available.... There was considerable background and experience in the fabrication, curing, and machining of assemblies made of Fiberglass." These could be laid up and cured in an autoclave.⁵⁴

The flight test was called Big Joe, and it showed conservatism. The shield was heavy, with a density of 108 pounds per cubic foot, but designers added a large safety factor by specifying that it was to be twice as thick as calculations showed to be necessary. The flight was to be suborbital, with range of 1,800 miles but was to

simulate a re-entry from orbit that was relatively steep and therefore demanding, producing higher temperatures on the face of the shield and on the afterbody.⁵⁵

Liftoff came after 3 a.m., a time chosen to coincide with dawn in the landing area so as to give ample daylight for search and recovery. “The night sky lit up and the beach trembled with the roar of the Rocketdyne engines,” notes NASA’s history of Project Mercury. Two of those engines were to fall away during ascent, but they remained as part of the Atlas, increasing its weight and reducing its peak velocity by some 3,000 feet per second. What was more, the capsule failed to separate. It had an onboard attitude-control system that was to use spurts of compressed nitrogen gas to turn it around, to enter the atmosphere blunt end first. But this system used up all its nitrogen trying fruitlessly to swing the big Atlas that remained attached. Separation finally occurred at an altitude of 345,000 feet, while people waited to learn what would happen.⁵⁶

The capsule performed better than planned. Even without effective attitude control, its shape and distribution of weights gave it enough inherent stability to turn itself around entirely through atmospheric drag. Its reduced speed at re-entry meant that its heat load was only 42 percent of the planned value of 7,100 BTU per square foot. But a particularly steep flight-path angle gave a peak heating rate of 77 percent of the intended value, thereby subjecting the heat shield to a usefully severe test. The capsule came down safely in the Atlantic, some 500 miles short of the planned impact area, but the destroyer USS *Strong* was not far away and picked it up a few hours later.

Subsequent examination showed that the heating had been uniform over the face of the heat shield. This shield had been built as an ablating laminate with a thickness of 1.075 inches, supported by a structural laminate half as thick. However, charred regions extended only to a depth of 0.20 inch, with further discoloration reaching to 0.35 inch. Weight loss due to ablation came to only six pounds, in line with experimental findings that had shown that little ablation indeed would occur.⁵⁷

The heat shield not only showed fine thermal performance, it also sustained no damage on striking the water. This validated the manufacturing techniques used in its construction. The overall results from this flight test were sufficiently satisfactory to justify the choice of ablation for Mercury. This made it possible to drop heat sink from consideration and to go over completely to ablation, not only for Mercury but for Gemini, which followed.⁵⁸

GEMINI AND APOLLO

An Apollo spacecraft, returning from the Moon, had twice the kinetic energy of a flight in low orbit and an aerodynamic environment that was nearly three times as severe. Its trajectory also had to thread a needle in its accuracy. Too steep a return

would subject its astronauts to excessive g-forces. Too shallow a re-entry meant that it would show insufficient loss of speed within the upper atmosphere and would fly back into space, to make a final entry and then land at an unplanned location. For a simple ballistic trajectory, this “corridor” was as little as seven miles wide, from top to bottom.⁵⁹

At the outset, these issues raised two problems that were to be addressed in flight test. The heat shield had to be qualified, in tests that resembled those of the X-17 but took place at much higher velocity. In addition, it was necessary to show that a re-entering spacecraft could maneuver with some precision. It was vital to broaden the corridor, and the only way to do this was to use lift. This meant demonstrating successful maneuvers that had to be planned in advance, using data from tests in ground facilities at near-orbital speeds, when such facilities were most prone to error.

Apollo’s Command Module, which was to execute the re-entry, lacked wings. Still, spacecraft of this general type could show lift-to-drag ratios of 0.1 or 0.2 by flying at a nonzero angle of attack, thereby tilting the heat shield and turning it into a lifting surface. Such values were far below those achievable with wings, but they brought useful flexibility during re-entry by permitting maneuver, thereby achieving a more accurate splashdown.

As early as 1958, Faget and his colleagues had noted three methods for trimming a capsule to a nonzero angle. Continuous thrust from a reaction-control system could do this, tilting the craft from its equilibrium attitude. A drag flap could do it as well by producing a modest amount of additional air resistance on one side of the vehicle. The simplest method required no onboard mechanism that might fail in flight and that expended no reaction-control propellant. It called for nothing more than a nonsymmetrical distribution of weight within the spacecraft, creating an offset in the location of the center of gravity. During re-entry, this offset would trim the craft to a tilted attitude, again automatically, due to the extra weight on one side. An astronaut could steer his capsule by using attitude control to roll it about its long axis, thereby controlling the orientation of the lift vector.⁶⁰

This center-of-gravity offset went into the Gemini capsules that followed those of Project Mercury. The first manned Gemini flight carried the astronauts Virgil “Gus” Grissom and John Young on a three-orbit mission in March 1965. Following re-entry, they splashed down 60 miles short of the carrier USS *Intrepid*, which was on the aim point. This raised questions as to the adequacy of the preflight hypersonic wind-tunnel tests that had provided estimates of the spacecraft L/D used in mission planning.

The pertinent data had come from only two facilities. The Langley 11-inch tunnel had given points near Mach 7, while an industrial hotshot installation covered Mach 15 to 22, which was close to orbital speed. The latter facility lacked

instruments of adequate precision and had produced data points that showed a large scatter. Researchers had averaged and curve-fit the measurements, but it was clear that this work had introduced inaccuracies.⁶¹

During that year flight data became available from the Grissom-Young mission and from three others, yielding direct measurements of flight angle of attack and L/D. To resolve the discrepancies, investigators at the Air Force's Arnold Engineering Development Center undertook further studies using two additional facilities. Tunnel F, a hotshot, had a 100-inch-diameter test section and reached Mach 20, heating nitrogen with an electric arc and achieving run times of 0.05 to 0.1 seconds. Tunnel L was a low-density, continuous-flow installation that also used arc-heated nitrogen. The Langley 11-inch data was viewed as valid and was retained in the reanalysis.

This work gave an opportunity to benchmark data from continuous-flow and hotshot tunnels against flight data, at very high Mach numbers. Size did not matter, for the big Tunnel F accommodated a model at one-fifteenth scale that incorporated much detail, whereas Tunnel L used models at scales of 1/120 and 1/180, the latter being nearly small enough to fit on a tie tack. Even so, the flight data points gave a good fit to curves derived using both tunnels. Billy Griffith, supervising the tests, concluded: "Generally, excellent agreement exists" between data from these sources.

The preflight data had brought estimated values of L/D that were too high by 60 percent. This led to a specification for the re-entry trim angle that proved to be off by 4.7 degrees, which produced the miss at splashdown. Julius Lukasiewicz, long-time head of the Von Karman Gas Dynamics Facility at AEDC, later added that if AEDC data had been available prior to the Grissom-Young flight, "the impact point would have been predicted to within ± 10 miles."⁶²

The same need for good data reappeared during Apollo. The first of its orbital missions took place during 1966, flying atop the Saturn I-B. The initial launch, designated AS-201, flew suborbitally and covered 5,000 miles. A failure in the reaction controls produced uncontrolled lift during entry, but the craft splashed down 38 miles from its recovery ship. AS-202, six months later, was also suborbital. It executed a proper lifting entry—and undershot its designated aim point by 205 miles. This showed that its L/D had also been mispredicted.⁶³

Estimates of the Apollo L/D had relied largely on experimental data taken during 1962 at Cornell Aeronautical Laboratory and Mach 15.8, and at AEDC and Mach 18.7. Again these measurements lacked accuracy, and once more Billy Griffith of AEDC stepped forward to direct a comprehensive set of new measurements. In addition to Tunnels F and L, used previously, the new work used Tunnels A, B, and C, which with the other facilities covered a range from Mach 3 to 20. To account for effects due to model supports in the wind tunnels, investigators also used a gun range that fired small models as free-flight projectiles, at Mach 6.0 to 8.5.

The 1962 estimates of Apollo L/D proved to be off by 20 percent, with the trim angle being in error by 3 degrees.⁶⁴ As with the Gemini data, these results showed anew that one could not obtain reliable data by working with a limited range of facilities. But when investigators broadened their reach to use more facilities, and sought accuracy through such methods as elimination of model-support errors, they indeed obtained results that matched flight test. This happened twice, with both Gemini and Apollo, with researchers finally getting the accurate estimates they needed.

These studies dealt with aerodynamic data at hypervelocity. In a separate series, other flights sought data on the re-entry environment that could narrow the range of acceptable theories of hypervelocity heating. Two such launches constituted Project Fire, which flew spacecraft that were approximately two feet across and had the general shape of Apollo's Command Module. Three layers of beryllium served as calorimeters, with measured temperature rises corresponding to total absorbed heat. Three layers of phenolic-asbestos alternated with those layers to provide thermal protection. Windows of fused quartz, which is both heat-resistant and transparent over a broad range of optical wavelengths, permitted radiometers to directly observe the heat flux due to radiation, at selected locations. These included the nose, where heating was most intense.

The Fire spacecraft rode atop Atlas boosters, with flights taking place in April 1964 and May 1965. Following cutoff of the Atlas, an Antares solid-fuel booster, modified from the standard third stage of the Scout booster, gave the craft an additional 17,000 feet per second and propelled it into the atmosphere at an angle of nearly 15 degrees, considerably steeper than the range of angles that were acceptable for an Apollo re-entry. This increased the rate of heating and enhanced the contribution from radiation. Each beryllium calorimeter gave useful data until its outer surface began to melt, which took only 2.5 seconds as the heating approached its maximum. When decelerations due to drag reached specified levels, an onboard controller ejected the remnants of each calorimeter in turn, along with its underlying layer of phenolic-asbestos. Because these layers served as insulation, each ejection exposed a cool beryllium surface as well as a clean set of quartz windows.

Fire 1 entered the atmosphere at 38,000 feet per second, markedly faster than the 35,000 feet per second of operational Apollo missions. Existing theories gave a range in estimates of total peak heating rate from 790 to 1,200 BTU per square foot-second. The returned data fell neatly in the middle of this range. Fire 2 did much the same, re-entering at 37,250 feet per second and giving a measured peak heating rate of just over 1,000 BTU per square foot-second. Radiative heating indeed was significant, amounting to some 40 percent of this total. But the measured values, obtained by radiometer, were at or below the minimum estimates obtained using existing theories.⁶⁵

Earlier work had also shown that radiative heating was no source of concern. The new work also validated the estimates of total heating that had been used in designing the Apollo heat shield. A separate flight test, in August 1964, placed a small vehicle—the R-4—atop a five-stage version of the Scout. As with the X-17, this fifth stage ignited relatively late in the flight, accelerating the test vehicle to its peak speed when it was deep in the upper atmosphere. This speed, 28,000 feet per second, was considerably below that of an Apollo entry. But the increased air density subjected this craft to a particularly high heating rate.⁶⁶

This was a materials-testing flight. The firm of Avco had been developing ablaters of lower and lower weight and had come up with its 5026-39 series. They used epoxy-novolac as the resin, with phenolic microballoons added to the silica-fiber filler of an earlier series. Used with a structural honeycomb made of phenolic reinforced with fiberglass, it cut the density to 35 pounds per cubic foot and, with subsequent improvements, to as little as 31 pounds per cubic foot. This was less than three-tenths the density of the ancestral phenolic-fiberglass of Mercury—which merely orbited the Earth and did not fly back from the Moon.⁶⁷

The new material had the designation Avcoat 5026-39G. The new flight sought to qualify it under its most severe design conditions, corresponding to re-entry at the bottom of the corridor with deceleration of 20 g. The peak aerodynamic load occurred at Mach 16.4 and 102,000 feet. Observed ablation rates proved to be much higher than expected. In fact, the ablative heat shield eroded away completely! This caused serious concern, for if that were to happen during a manned mission, the spacecraft would burn up in the atmosphere and would kill its astronauts.⁶⁸

The relatively high air pressure had subjected the heat shield to dynamic pressures three times higher than those of an Apollo re-entry. Those intense dynamic pressures corresponded to a hypersonic wind that had blown away the ablative char soon after it had formed. This char was important; it protected the underlying virgin ablator, and when it was severely thinned or removed, the erosion rate on the test heat shield increased markedly.

Much the same happened in October 1965, when another subscale heat shield underwent flight test atop another multistage solid rocket, the Pacemaker, that accelerated its test vehicle to Mach 10.6 at 67,500 feet. These results showed that failure to duplicate the true re-entry environment in flight test could introduce unwarranted concern, causing what analysts James Pavlosky and Leslie St. Leger described as “unnecessary anxiety and work.”⁶⁹

An additional Project Fire flight could indeed have qualified the heat shield under fully realistic re-entry conditions, but NASA officials had gained confidence through their ability to understand the quasi-failure of the R-4. Rather than conduct further ad hoc heat-shield flight tests, they chose to merge its qualification with unmanned flights of complete Apollo spacecraft. Following three shots aboard the

Saturn I-B that went no further than earth orbit, and which included AS-201 and -202, the next flight lifted off in November 1967. It used a Saturn V to simulate a true lunar return.

No larger rocket had ever flown. This one was immense, standing 36 stories tall. The anchorman Walter Cronkite gave commentary from a nearby CBS News studio, and as this behemoth thundered upward atop a dazzling pillar of yellow-white flame, Cronkite shouted, “Oh, my God, our building is shaking! Part of the roof has come in here!” The roar was as loud as a major volcanic eruption. People saw the ascent in Jacksonville, 150 miles away.⁷⁰

Heat-shield qualification stood as a major goal. The upper stages operated in sequence, thrusting the spacecraft to an apogee of 11,242 miles. It spent several hours coasting, oriented with the heat shield in the cold soak of shadow to achieve the largest possible thermal gradient around the shield. Re-ignition of the main engine pushed the spacecraft into re-entry at 35,220 feet per second relative to the atmosphere of the rotating Earth. Flying with an effective L/D of 0.365, it came down 10 miles from the aim point and only six miles from the recovery ship, close enough for news photos that showed a capsule in the water with one of its chutes still billowing.

The heat shield now was ready for the Moon, for it had survived a peak heating rate of 425 BTU per square foot-second and a total heat load of 37,522 BTU per pound. Operational lunar flights imposed loads and heating rates that were markedly less demanding. In the words of Pavlosky and St. Leger, “the thermal protection subsystem was overdesigned.”⁷¹

A 1968 review took something of an offhand view of what once had been seen as an extraordinarily difficult problem. This report stated that thermal performance of ablative material “is one of the lesser criteria in developing a TPS.” Significant changes had been made to enhance access for inspection, relief of thermal stress, manufacturability, performance near windows and other penetrations, and control of the center of gravity to achieve design values of L/D, “but never to obtain better thermal performance of the basic ablator.”⁷²

Thus, on the eve of the first lunar landing, specialists in hypersonics could look at a technology of re-entry whose prospects had widened significantly. A suite of materials now existed that were suitable for re-entry from orbit, having high emissivity to keep the temperature down, along with low thermal conductivity to prevent overheating during the prolonged heat soak. Experience had shown how careful research in ground facilities could produce reliable results and could permit maneuvering entry with accuracy in aim. This had been proven to be feasible for missions as demanding as lunar return.

Dyna-Soar had not flown, but it introduced metallic hot structures that brought the prospect of reusability. It also introduced wings for high L/D and particular

freedom during maneuver. Indeed, by 1970 there was only one major frontier in re-entry: the development of a lightweight heat shield that was simpler than the hot structure of Dyna-Soar and was reusable. This topic was held over for the following decade, amid the development of the space shuttle.

-
- 1 Quotes: DTIC ADA-303832, p. 78.
 - 2 Hallion, *Hypersonic*, p. 189; *Spaceflight*, July-August 1980, pp. 270-272.
 - 3 Hallion, *Hypersonic*, pp. 189-91; DTIC ADA-303832, pp. 82-87.
 - 4 Hallion, *Hypersonic*, p. 192; *Spaceflight*, July-August 1980, p. 270; Bell Aircraft D143-981-009.
 - 5 DTIC ADA-303832, pp. 93-100; Hallion, *Hypersonic*, pp. 193-95; Bell Aircraft D143-945-055; Sloop, *Astronautics & Aeronautics*, October 1972, pp. 52-57.
 - 6 Hallion, *Hypersonic*, pp. 195-97; DTIC ADA-303832, pp. 106-08.
 - 7 Hallion, *Hypersonic*, pp. 195, 388-90 (quote, p. 390); DTIC ADA-303832, pp. 122-23.
 - 8 Hallion, *Hypersonic*, p. 198; DTIC ADA-303832, pp. 126-28.
 - 9 Hallion, *Hypersonic*, pp. 199-201; DTIC ADA-303832, pp. 128-30. Quote: Memo, Graham to Associate Director, 3 July 1957.
 - 10 Hallion, *Hypersonic*, pp. 201-204; Houchin, *Air Power History*, Fall 1999, pp. 15-16; DTIC ADA-303832, pp. 134-40.
 - 11 Jenkins, *Space Shuttle*, pp. 22-25; Sunday and London, "X-20," pp. 259, 262.
 - 12 NACA TN 4046 (quotes, pp. 1, 29).
 - 13 Quote: Memo, Graham to Associate Director, 3 July 1957.
 - 14 NACA RM A55L05.
 - 15 NASA SP-4305, pp. 367-69; Hallion, *Hypersonic*, pp. 388-91 (quote, p. 390).
 - 16 NASA SP-4305, pp. 369-73; Hallion, *Hypersonic*, pp. 392-400.
 - 17 Bell Aircraft D143-945-055.
 - 18 Hallion, *Hypersonic*, pp. 406-07.
 - 19 Sunday and London, "X-20," pp. 260-61, 264-69 (quote, p. 266).
 - 20 NASA SP-4221, p. 203; Jenkins, *Space Shuttle*, p. 26.
 - 21 Geiger, "Termination"; Sunday and London, "X-20," pp. 274-75 (includes quote). Cancellation documents: McNamara news briefing, 10 December 1963; telex, AFCVC-1918/63, HQ USAF to All Commands, 10 December 1963.
 - 22 Sunday and London, "X-20," p. 275; Hallion, *Hypersonic*, pp. 294-310. Technical issues: DTIC AD-449685, p. 61.
 - 23 Hallion, *Hypersonic*, p. II-xvi.
 - 24 DTIC AD-346912, pp. III-3-1-2 to -5, III-3-1-18 to -23, III-4-2-2 to -8. Rene 41: AD-449685, pp. 28, 41.
 - 25 DTIC AD-609169; AD-449685, pp. 3-5, 20; AD-346912, pp. III-3-1-7, III-4-1-2 to -3.
 - 26 DTIC AD-346912, p. III-3-1-8; Hallion, *Hypersonic*, p. II-xv; NACA RM A55E26.
 - 27 DTIC AD-609169; AD-449685, pp. 3-5, 20; AD-346912, pp. III-3-1-7, III-4-1-2 to -3.
 - 28 DTIC AD-346912, p. III-3-1-8; AD-449685, p. iii.
 - 29 DTIC AD-441740; AD-449685, pp. 5-7, 20 (quote, p. 7).
 - 30 "Scientific Advisory Board Memo Report of the Aerospace Vehicles Panel on Dyna Soar Panel Flutter," 20 April 1962; DTIC AD-346912, pp. III-3-6-2 to -15 (quotes, pp. -8, -11).
 - 31 DTIC AD-449685, pp. 49-50; AD-609169, pp. 13, 29; AD-346912, pp. III-3-1-6 to -7, III-

- 3-6-2, III-3-6-13 to -14.
- 32 DTIC AD-346912, pp. III-3-1-8, III-3-4-4; *Aviation Week*, 21 September 1959, p. 53.
- 33 DTIC AD-346912, pp. III-4-5-3 to -6, III-4-5-16.
- 34 *Ibid.*, pp. III-4-5-13 to -18, III-4-5-35.
- 35 *Ibid.*, pp. III-3-4-4 to -6, III-3-4-20.
- 36 *Ibid.*, p. III-3-4-4; Hallion, *Hypersonic*, p. 357.
- 37 DTIC AD-346912, pp. III-4-6-5 to -7.
- 38 *Ibid.*, pp. III-3-1-10 to -12; Hallion, *Hypersonic*, pp. 361-368.
- 39 DTIC AD-346912, pp. III-4-6-9 to -11; AD-449685, pp. 63-65.
- 40 DTIC AD-346912, pp. III-4-6-7 to -8; AD-449685, pp. 57-59.
- 41 DTIC AD-346912, pp. III-3-1-10 to -11; Jenkins, *Space Shuttle*, p. 28.
- 42 DTIC AD-346912, pp. III-3-1-14 to -15; Hallion, *Hypersonic*, pp. 347-49, 360-61.
- 43 Hallion, *Hypersonic*, pp. 344-46; Sunday and London, "X-20," p. 278. X-15: Schleicher, *Journal of the Royal Aeronautical Society*, October 1963, pp. 618-36.
- 44 Wolfe, *Right Stuff*, p. 56.
- 45 Faget: NASA SP-4201, p. 86. Quotes: NACA RM L58E07a, p. 1.
- 46 NACA RM L58E07a, Table I.
- 47 *Aviation Week*, 21 September 1959, pp. 52-59; NASA SP-4201, pp. 94-95.
- 48 Riddell and Teare, "Differences," p. 184.
- 49 Steg, *ARS Journal*, September 1960, pp. 815-22.
- 50 Day et al., *Eye*, pp. 112-14; Greer, "Corona," pp. 5-6; DTIC AD-328815.
- 51 *Time*, 27 April 1959, pp. 16, 65; Richelson: *Espionage*, p. 184; *Secret Eyes*, pp. 34-35. Twining quote: Day et al., *Eye*, p. 53.
- 52 NASA SP-4201, pp. 64-65, 95, 127-28.
- 53 NASA SP-4201, pp. 123, 125-26, 207.
- 54 Bond, "Big Joe" (quote, pp. 8-9).
- 55 Bond, "Big Joe"; memo with attachment, Grimwood to Everline, 3 July 1963; NASA TM X-490.
- 56 *Ibid.*; pp. 16-17; NASA SP-4201, pp. 203-205 (quote, p. 203).
- 57 NASA TM X-490.
- 58 Bond, "Big Joe"; Erb and Stephens, "Project Mercury."
- 59 NASA TN D-7564; AIAA Paper 68-1142.
- 60 Lukasiewicz, *Experimental*, pp. 2-3; NASA RM L58E07a.
- 61 Lukasiewicz, *Experimental*, pp. 3-4.
- 62 *Ibid.*, pp. 4-6 (quote, p. 6); AIAA Paper 67-166 (Griffith quote, p. 10).
- 63 NASA SP-4206, p. 340; Ley, *Rockets*, p. 495; Lukasiewicz, *Experimental*, p. 6.
- 64 AIAA Paper 68-1142; Lukasiewicz, *Experimental*, pp. 6-11; *Journal of Spacecraft and Rockets*, July 1968, pp. 843-48.
- 65 NASA TN D-2996, TN D-7564, TM X-1053, TM X-1120, TM X-1222, TM X-1305.
- 66 NASA TN D-7564, TM X-1182; Langley Working Paper LWP-54.
- 67 AIAA Paper 69-98; NASA TN D-7564, TM X-490, TM X-1407.
- 68 NASA TN D-7564, TM X-1182; Langley Working Paper LWP-54.
- 69 AIAA Paper 68-1142; NASA TN D-4713, TN D-7564 (quote, p. 16).
- 70 *Time*, 17 November 1967, 84-85 (includes quote).
- 71 NASA TN D-7564 (quote, p. 19).
- 72 AIAA Paper 68-1142 (quotes, p. 11).

6

HYPERSONICS AND THE SPACE SHUTTLE

During the mid-1960s, two advanced flight projects sought to lay technical groundwork for an eventual reusable space shuttle. ASSET, which flew first, progressed beyond Dyna-Soar by operating as a flight vehicle that used a hot structure, placing particular emphasis on studies of aerodynamic flutter. PRIME, which followed, had a wingless and teardrop-shaped configuration known as a lifting body. Its flight tests exercised this craft in maneuvering entries. Separate flights, using piloted lifting bodies, were conducted for landings and to give insight into their handling qualities.

From the perspective of ASSET and PRIME then, one would have readily concluded that the eventual shuttle would be built as a hot structure and would have the aerodynamic configuration of a lifting body. Indeed, initial shuttle design studies, late in the 1960s, followed these choices. However, they were not adopted in the final design.

The advent of a highly innovative type of thermal protection, Lockheed's reusable "tiles," completely changed the game in both the design and the thermal areas. Now, instead of building the shuttle with the complexities of a hot structure, it could be assembled as an aluminum airplane of conventional type, protected by the tiles. Lifting bodies also fell by the wayside, with the shuttle having wings. The Air Force insisted that these be delta wings that would allow the shuttle to fly long distances to the side of a trajectory. While NASA at first preferred simple straight wings, in time it agreed.

The shuttle relied on carbon-carbon for thermal protection in the hottest areas. It was structurally weak, but this caused no problem for more than 100 missions. Then in 2003, damage to a wing leading edge led to the loss of *Columbia*. It was the first space disaster to bring the death of astronauts due to failure of a thermal protection system.

PRELUDES: ASSET AND LIFTING BODIES

At the end of the 1950s, ablatives stood out both for the ICBM and for return from space. Insulated hot structures, as on Dyna-Soar, promised reusability and

lighter weight but were less developed. As early as August 1959, the Flight Dynamics Laboratory at Wright-Patterson Air Force Base launched an in-house study of a small recoverable boost-glide vehicle that was to test hot structures during re-entry. From the outset there was strong interest in problems of aerodynamic flutter. This was reflected in the concept name: ASSET or Aerothermodynamic/elastic Structural Systems Environmental Tests.

ASSET won approval as a program late in January 1961. In April of that year the firm of McDonnell Aircraft, which was already building Mercury capsules, won a contract to develop the ASSET flight vehicles. Initial thought had called for use of the solid-fuel Scout as the booster. Soon, however, it became clear that the program could use the Thor for greater power. The Air Force had deployed these missiles in England. When they came home, during 1963, they became available for use as launch vehicles.

ASSET took shape as a flat-bottomed wing-body craft that used the low-wing configuration recommended by NASA-Langley. It had a length of 59 inches and a span of 55 inches. Its bill of materials closely resembled that of Dyna-Soar, for it used TZM to withstand 3,000°F on the forward lower heat shield, graphite for similar temperatures on the leading edges, and zirconia rods for the nose cap, which was rated at 4,000°F. But ASSET avoided the use of Rene 41, with cobalt and columbium alloys being employed instead.¹

ASSET was built in two varieties: the Aerothermodynamic Structural Vehicle (ASV), weighing 1,130 pounds, and the Aerothermodynamic Elastic Vehicle (AEV), at 1,225 pounds. The AEVs were to study panel flutter along with the behavior of a trailing-edge flap, which represented an aerodynamic control surface in hypersonic flight. These vehicles did not demand the highest possible flight speeds and hence flew with single-stage Thors as the boosters. But the ASVs were built to study materials and structures in the re-entry environment, while taking data on temperatures, pressures, and heat fluxes. Such missions demanded higher speeds. These boost-glide craft therefore used the two-stage Thor-Delta launch vehicle, which resembled

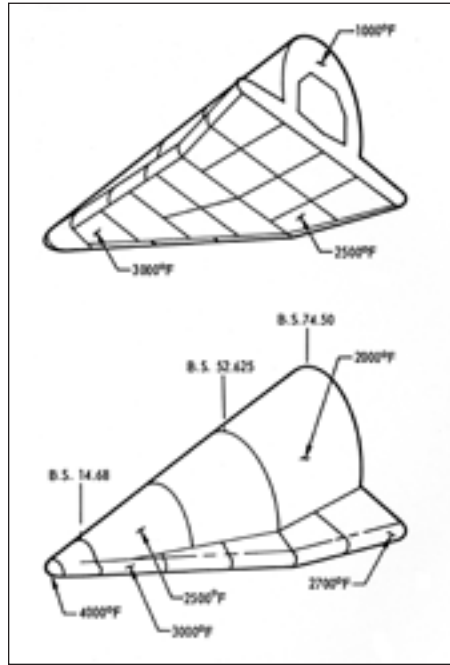

ASSET, showing peak temperatures. (U.S. Air Force)

the Thor-Able that had conducted nose-cone tests at intercontinental range as early as 1958.²

The program conducted six flights, which had the following planned values of range and of altitude and velocity at release:

ASSET FLIGHT TESTS

Date	Vehicle	Booster	Velocity, feet/second	Altitude, feet	Range, nautical miles
18 September 1963	ASV-1	Thor	16,000	205,000	987
24 March 1964	ASV-2	Thor-Delta	18,000	195,000	1800
22 July 1964	ASV-3	Thor-Delta	19,500	225,000	1830
27 October 1964	AEV-1	Thor	13,000	168,000	830
8 December 1964	AEV-2	Thor	13,000	187,000	620
23 February 1965	ASV-4	Thor-Delta	19,500	206,000	2300

Source: Hallion, *Hypersonic*, pp. 505, 510-519.

Several of these craft were to be recovered. Following standard practice, their launches were scheduled for the early morning, to give downrange recovery crews the maximum hours of daylight. This did not help ASV-1, the first flight in the program, which sank into the sea. Still, it flew successfully and returned good data. In addition, this flight set a milestone. In the words of historian Richard Hallion, “for the first time in aerospace history, a lifting reentry spacecraft had successfully returned from space.”³

ASV-2 followed, using the two-stage Thor-Delta, but it failed when the second stage did not ignite. The next one carried ASV-3, with this mission scoring a double achievement. It not only made a good flight downrange but was successfully recovered. It carried a liquid-cooled double-wall test panel from Bell Aircraft, along with a molybdenum heat-shield panel from Boeing, home of Dyna-Soar. ASV-3 also had a new nose cap. The standard ASSET type used zirconia dowels, 1.5 inches long by 0.5 inch in diameter, that were bonded together with a zirconia cement. The new cap, from International Harvester, had a tungsten base covered with thorium oxide and was reinforced with tungsten.

A company advertisement stated that it withstood re-entry so well that it “could have been used again,” and this was true for the craft as a whole. Hallion writes

that “overall, it was in excellent condition. Water damage...caused some problems, but not so serious that McDonnell could not have refurbished and reflowed the vehicle.” The Boeing and Bell panels came through re-entry without damage, and the importance of physical recovery was emphasized when columbium aft leading edges showed significant deterioration. They were redesigned, with the new versions going into subsequent ASV and AEV spacecraft.⁴

The next two flights were AEVs, each of which carried a flutter test panel and a test flap. AEV-1 returned only one high-Mach data point, at Mach 11.88, but this sufficed to indicate that its panel was probably too stiff to undergo flutter. Engineers made it thinner and flew a new one on AEV-2, where it returned good data until it failed at Mach 10. The flap experiment also showed value. It had an electric motor that deflected it into the airstream, with potentiometers measuring the force required to move it, and it enabled aerodynamicists to critique their theories. Thus, one treatment gave pressures that were in good agreement with observations, whereas another did not.

ASV-4, the final flight, returned “the highest quality data of the ASSET program,” according to the flight test report. The peak speed of 19,400 feet per second, Mach 18.4, was the highest in the series and was well above the design speed of 18,000 feet per second. The long hypersonic glide covered 2,300 nautical miles and prolonged the data return, which presented pressures at 29 locations on the vehicle and temperatures at 39. An onboard system transferred mercury ballast to trim the angle of attack, increasing L/D from its average of 1.2 to 1.4 and extending the trajectory. The only important problem came when the recovery parachute failed to deploy properly and ripped away, dooming ASV-4 to follow ASV-1 into the depths of the Atlantic.⁵

On the whole, ASSET nevertheless scored a host of successes. It showed that insulated hot structures could be built and flown without producing unpleasant surprises, at speeds up to three-fourths of orbital velocity. It dealt with such practical issues of design as fabrication, fasteners, and coatings. In hypersonic aerodynamics, ASSET contributed to understanding of flutter and of the use of movable control surfaces. The program also developed and successfully used a reaction control system built for a lifting re-entry vehicle. Only one flight vehicle was recovered in four attempts, but it complemented the returned data by permitting a close look at a hot structure that had survived its trial by fire.

A separate prelude to the space shuttle took form during the 1960s as NASA and the Air Force pursued a burgeoning interest in lifting bodies. The initial concept represented one more legacy of the blunt-body principle of H. Julian Allen and Alfred Eggers at NACA's Ames Aeronautical Laboratory. After developing this principle, they considered that a re-entering body, while remaining blunt to reduce its heat load, might produce lift and thus gain the ability to maneuver at hypersonic

speeds. An early configuration, the M-1 of 1957, featured a blunt-nosed cone with a flattened top. It showed some capacity for hypersonic maneuver but could not glide subsonically or land on a runway. A new shape, the M-2, appeared as a slender half-cone with its flat side up. Its hypersonic L/D of 1.4 was nearly triple that of the M-1. Fitted with two large vertical fins for stability, it emerged as a basic configuration that was suitable for further research.⁶

Dale Reed, an engineer at NASA's Flight Research Center, developed a strong interest in the bathtub-like shape of the M-2. He was a sailplane enthusiast and a builder of radio-controlled model aircraft. With support from the local community of airplane model builders, he proceeded to craft the M-2 as a piloted glider. Designating it as the M2-F1, he built it of plywood over a tubular steel frame. Completed early in 1963, it was 20 feet long and 13 feet across.

It needed a vehicle that could tow it into the air for initial tests. However, it produced too much drag for NASA's usual vans and trucks, and Reed needed a tow car with more power. He and his friends bought a stripped-down Pontiac with a big engine and a four-barrel carburetor that reached speeds of 110 miles per hour. They took it to a funny-car shop in Long Beach for modification. Like any other flightline vehicle, it was painted yellow with “National Aeronautics and Space Administration” on its side. Early tow tests showed enough success to allow the project to use a C-47, called the Gooney Bird, for true aerial flights. During these tests the Gooney Bird towed the M2-F1 above 10,000 feet and then set it loose to glide to an Edwards AFB lakebed. Beginning in August 1963, the test pilot Milt Thompson did this repeatedly. Reed thus showed that although the basic M-2 shape had been crafted for hypersonic re-entry, it could glide to a safe landing.

As he pursued this work, he won support from Paul Bikle, the director of NASA Flight Research Center. As early as April 1963, Bikle alerted NASA Headquarters that “the lifting-body concept looks even better to us as we get more into it.” The success of the M2-F1 sparked interest within the Air Force as well. Some of its officials, along with their NASA counterparts, went on to pursue lifting-body programs that called for more than plywood and funny cars. An initial effort went beyond the M2-F1 by broadening the range of lifting-body shapes while working to develop satisfactory landing qualities.⁷

NASA contracted with the firm of Northrop to build two such aircraft: the M2-F2 and HL-10. The M2-F2 amounted to an M2-F1 built to NASA standards; the HL-10 drew on an alternate lifting-body design by Eugene Love of NASA-Langley. This meant that both Langley and Ames now had a project. The Air Force effort, the X-24A, went to the Martin Company. It used a design of Frederick Raymes at the Aerospace Corporation that resembled a teardrop fitted with two large fins.

All three flew initially as gliders, with a B-52 rather than a C-47 as the mother ship. The lifting bodies mounted small rocket engines for acceleration to supersonic

speeds, thereby enabling tests of stability and handling qualities in transonic flight. The HL-10 set records for lifting bodies by making safe approaches and landings at Edwards from speeds up to Mach 1.86 and altitudes of 90,000 feet.⁸

Acceptable handling qualities were not easy to achieve. Under the best of circumstances, a lifting body flew like a brick at low speeds. Lowering the landing gear made the problem worse by adding drag, and test pilots delayed this deployment as long as possible. In May 1967 the pilot Bruce Peterson, flying the M2-F2, failed to get his gear down in time. The aircraft hit the lakebed at more than 250 mph, rolled over six times, and then came to rest on its back minus its cockpit canopy, main landing gear, and right vertical fin. Peterson, who might have died in the crash, got away with a skull fracture, a mangled face, and the loss of an eye. While surgeons reconstructed his face and returned him to active duty, the M2-F2 underwent surgery as well. Back at Northrop, engineers installed a center fin and a roll-control system that used reaction jets, while redistributing the internal weights. Gerauld Gentry, an Air Force test pilot, said that these changes turned “something I really did not enjoy flying at all into something that was quite pleasant to fly.”⁹

The manned lifting-body program sought to turn these hypersonic shapes into aircraft that could land on runways, but the Air Force was not about to overlook the need for tests of their hypersonic performance during re-entry. The program that addressed this issue took shape with the name PRIME, Precision Recovery Including Maneuvering Entry. Martin Marietta, builder of the X-24A, also developed the PRIME flight vehicle, the SV-5D that later was referred to as the X-23. Although it was only seven feet in length, it faithfully duplicated the shape of the X-24A, even including a small bubble-like protrusion near the front that represented the cockpit canopy.

PRIME complemented ASSET, with both programs conducting flight tests of boost-glide vehicles. However, while ASSET pushed the state of the art in materials and hot structures, PRIME used ablative thermal protection for a more straightforward design and emphasized flight performance. Accelerated to near-orbital velocities by Atlas launch vehicles, the PRIME missions called for boost-glide flight from Vandenberg AFB to locations in the western Pacific near Kwajalein Atoll. The SV-5D had higher L/D than Gemini or Apollo, and as with those NASA programs, it was to demonstrate precision re-entry. The plans called for crossrange, with the vehicle flying up to 710 nautical miles to the side of a ballistic trajectory and then arriving within 10 miles of its recovery point.¹⁰

The X-24A was built of aluminum. The SV-5D used this material as well, for both the skin and primary structure. It mounted both aerodynamic and reaction controls, with the former taking shape as right and left body-mounted flaps set well aft. Used together, they controlled pitch; used individually, they produced yaw and roll. These flaps were beryllium plates that provided thermal heat sink. The fins were of steel honeycomb with surfaces of beryllium sheet.



Lifting bodies. Left to right: the X-24A, the M2-F3 which was modified from the M2-F2, and the HL-10. (NASA)



Landing a lifting body. The wingless X-24B required a particularly high angle of attack. (NASA)

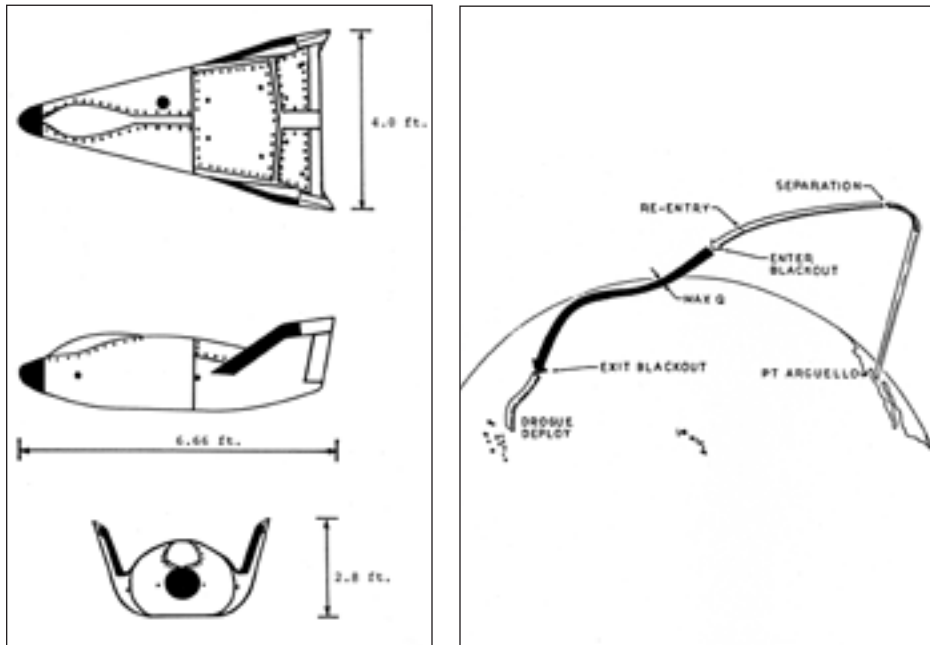

Martin SV-5D, which became the X-23. (U.S. Air Force)

Mission of the SV-5D. (U.S. Air Force)

Most of the vehicle surface obtained thermal protection from ESA 3560 HF, a flexible ablative blanket of phenolic fiberglass honeycomb that used a silicone elastomer as the filler, with fibers of nylon and silica holding the ablative char in place during re-entry. ESA 5500 HF, a high-density form of this ablator, gave added protection in hotter areas. The nose cap and the beryllium flaps used a different material: a carbon-phenolic composite. At the nose, its thickness reached 3.5 inches.¹¹

The PRIME program made three flights, which took place between December 1966 and April 1967. All returned data successfully, with the third flight vehicle also being recovered. The first mission reached 25,300 feet per second and flew 4,300 miles downrange, missing its target by only 900 feet. The vehicle executed pitch maneuvers but made no attempt at crossrange. The next two flights indeed achieved crossrange, of 500 and 800 nautical miles, and the precision again was impressive. Flight 2 missed its aim point by less than two miles. Flight 3 missed by more than four miles, but this still was within the allowed limit. Moreover, the terminal guidance radar had been inoperative, which probably contributed to the lack of absolute accuracy.¹²

By demonstrating both crossrange and high accuracy during maneuvering entry, PRIME broadened the range of hypersonic aircraft configurations and completed a line of development that dated to 1953. In December of that year the test pilot Chuck Yeager had nearly been killed when his X-1A fell out of the sky at Mach 2.44 because it lacked tail surfaces that could produce aerodynamic stability. The X-15 was to fly to Mach 6, and Charles McLellan of NACA-Langley showed that it could use vertical fins of reasonable size if they were wedge-shaped in cross section. Meanwhile, Allen and Eggers were introducing their blunt-body principle. This led to missile nose cones with rounded tips, designed both as cones and as blunted cylinders that had stabilizing afterbodies in the shape of conic frustums.

For manned flight, Langley's Maxime Faget introduced the general shape of a cone with its base forward, protected by an ablative heat shield. Langley's John Becker entered the realm of winged re-entry configurations with his low-wing flat-bottom shapes that showed advantage over the high-wing flat-top concepts of NACA-Ames. The advent of the lifting body then raised the prospect of a structurally efficient shape that lacked wings, demanded thermal protection and added weight, and yet could land on a runway. Faget's designs had found application in Mercury, Gemini, and Apollo, while Becker's winged vehicle had provided a basis for Dyna-Soar. As NASA looked to the future, both winged designs and lifting bodies were in the forefront.¹³

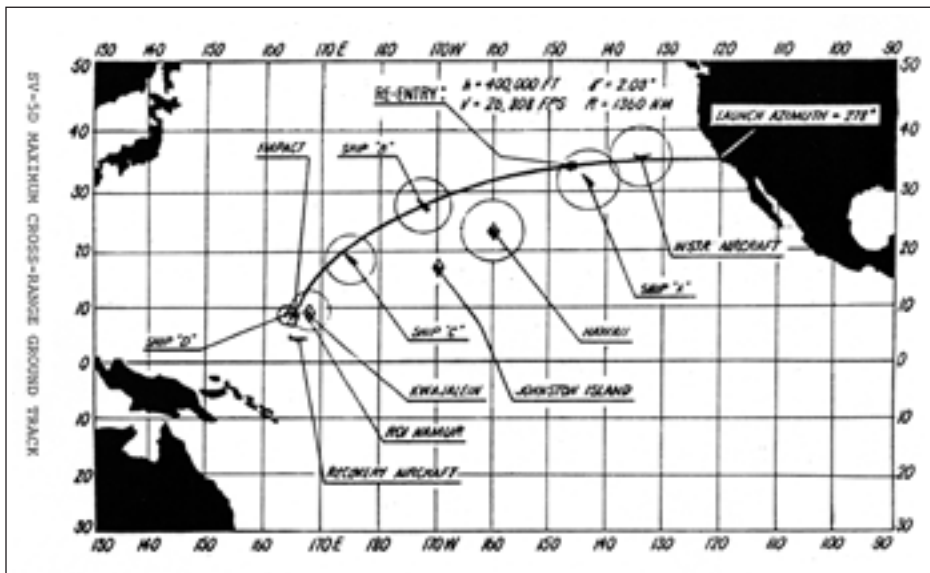

Trajectory of the SV-5D, showing crossrange. (U.S. Air Force)

REUSABLE SURFACE INSULATION

As PRIME and the lifting bodies broadened the choices of hypersonic shape, work at Lockheed made similar contributions in the field of thermal protection. Ablatives were unrivaled for once-only use, but during the 1960s the hot structure continued to stand out as the preferred approach for reusable craft such as Dyna-Soar. As noted, it used an insulated primary or load-bearing structure with a skin of outer panels. These emitted heat by radiation, maintaining a temperature that was high but steady. Metal fittings supported these panels, and while the insulation could be high in quality, these fittings unavoidably leaked heat to the underlying structure. This raised difficulties in crafting this structure of aluminum or even of titanium, which had greater heat resistance. On Dyna-Soar, only Rene 41 would do.¹⁴

Ablatives avoided such heat leaks, while being sufficiently capable as insulators to permit the use of aluminum, as on the SV-5D of PRIME. In principle, a third approach combined the best features of hot structure and ablatives. It called for the use of temperature-resistant tiles, made perhaps of ceramic, that could cover the vehicle skin. Like hot-structure panels, they would radiate heat while remaining cool enough to avoid thermal damage. In addition, they were to be reusable. They also were to offer the excellent insulating properties of good ablators, preventing heat from reaching the underlying structure—which once more might be of aluminum. This concept, known as reusable surface insulation (RSI), gave rise in time to the thermal protection of the shuttle.

RSI grew out of ongoing work with ceramics for thermal protection. Ceramics had excellent temperature resistance, light weight, and good insulating properties. But they were brittle, and they cracked rather than stretched in response to the flexing under load of an underlying metal primary structure. Ceramics also were sensitive to thermal shock, as when heated glass breaks when plunged into cold water. This thermal shock resulted from rapid temperature changes during re-entry.¹⁵

Monolithic blocks of the ceramic zirconia had been specified for the nose cap of Dyna-Soar, but a different point of departure used mats of ceramic fiber in lieu of the solid blocks. The background to the shuttle's tiles lay in work with such mats that dated to the early 1960s at Lockheed Missiles and Space Company. Key people included R. M. Beasley, Ronald Banas, Douglas Izu, and Wilson Schramm. A Lockheed patent disclosure of December 1960 gave the first presentation of a reusable insulation made of ceramic fibers for use as a heat shield. Initial research dealt with casting fibrous layers from a slurry and bonding the fibers together.

Related work involved filament-wound structures that used long continuous strands. Silica fibers showed promise and led to an early success: a conical radome of 32-inch diameter built for Apollo in 1962. Designed for re-entry, it had a filament-wound external shell and a lightweight layer of internal insulation cast from short fibers of silica. The two sections were densified with a colloid of silica particles and

sintered into a composite. This resulted in a non-ablative structure of silica composite, reinforced with fiber. It never flew, as design requirements changed during the development of Apollo. Even so, it introduced silica fiber into the realm of re-entry design.

Another early research effort, Lockheed, fabricated test versions of fibrous mats that had controlled porosity and microstructure. These were impregnated with organic fillers such as Plexiglas (methyl methacrylate). These composites resembled ablative materials, although the filler did not char. Instead it evaporated or volatilized, producing an outward flow of cool gas that protected the heat shield at high heat-transfer rates. The Lockheed studies investigated a range of fibers that included silica, alumina, and boria. Researchers constructed multilayer composite structures of filament-wound and short-fiber materials that resembled the Apollo radome. Impregnated densities were 40 to 60 pounds per cubic foot, the higher number being close to the density of water. Thicknesses of no more than an inch resulted in acceptably low back-face temperatures during simulations of re-entry.

This work with silica-fiber ceramics was well under way during 1962. Three years later a specific formulation of bonded silica fibers was ready for further development. Known as LI-1500, it was 89 percent porous and had a density of 15 pounds per cubic foot, one-fourth that of water. Its external surface was impregnated with filler to a predetermined depth, again to provide additional protection during the most severe re-entry heating. By the time this filler was depleted, the heat shield was to have entered a zone of more moderate heating, where the fibrous insulation alone could provide protection.

Initial versions of LI-1500, with impregnant, were intended for use with small space vehicles, similar to Dyna-Soar, that had high heating rates. Space shuttle concepts were already attracting attention—the January 1964 issue of the trade journal *Astronautics & Aeronautics* presents the thinking of the day—and in 1965 a Lockheed specialist, Max Hunter, introduced an influential configuration called Star Clipper. His design called for LI-1500 as the thermal protection.

Like other shuttle concepts, Star Clipper was to fly repeatedly, but the need for an impregnant in LI-1500 compromised its reusability. In contrast to earlier entry vehicle concepts, Star Clipper was large, offering exposed surfaces that were sufficiently blunt to benefit from the Allen-Eggers principle. They had lower temperatures and heating rates,

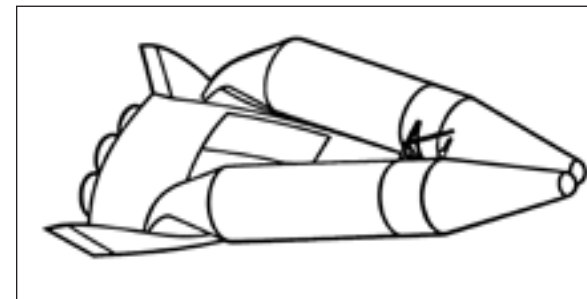

Star Clipper concept. (Art by Dan Gautier)

which made it possible to dispense with the impregnant. An unfilled version of LI-1500, which was inherently reusable, now could serve.

Here was the first concept of a flight vehicle with reusable insulation, bonded to the skin, that could reradiate heat in the fashion of a hot structure. However, the matted silica by itself was white and had low thermal emissivity, making it a poor radiator of heat. This brought excessive surface temperatures that called for thick layers of the silica insulation, adding weight. To reduce the temperatures and the thickness, the silica needed a coating that could turn it black, for high emissivity. It then would radiate well and remain cooler.

The selected coating was a borosilicate glass, initially with an admixture of chromium oxide and later with silicon carbide, which further raised the emissivity. The glass coating and silica substrate were both silicon dioxide; this assured a match of their coefficients of thermal expansion, to prevent the coating from developing cracks under the temperature changes of re-entry. The glass coating could soften at very high temperatures to heal minor nicks or scratches. It also offered true reusability, surviving repeated cycles to 2,500°F. A flight test came in 1968, as NASA-Langley investigators mounted a panel of LI-1500 to a Pacemaker re-entry test vehicle, along with several candidate ablaters. This vehicle carried instruments, and it was recovered. Its trajectory reproduced the peak heating rates and temperatures of a re-entering Star Clipper. The LI-1500 test panel reached 2,300°F and did not crack, melt, or shrink. This proof-of-concept test gave further support to the concept of high-emittance reradiative tiles of coated silica for thermal protection.¹⁶

Lockheed conducted further studies at its Palo Alto Research Center. Investigators cut the weight of RSI by raising its porosity from the 89 percent of LI-1500 to 93 percent. The material that resulted, LI-900, weighed only nine pounds per cubic foot, one-seventh the density of water.¹⁷ There also was much fundamental work on materials. Silica exists in three crystalline forms: quartz, cristobalite, tridymite. These not only have high coefficients of thermal expansion but also show sudden expansion or contraction with temperature due to solid-state phase changes. Cristobalite is particularly noteworthy; above 400°F it expands by more than 1 percent as it transforms from one phase to another. Silica fibers for RSI were to be glass, an amorphous rather than crystalline state having a very low coefficient of thermal expansion and absence of phase changes. The glassy form thus offered superb resistance to thermal stress and thermal shock, which would recur repeatedly during each return from orbit.¹⁸

The raw silica fiber came from Johns-Manville, which produced it from high-purity sand. At elevated temperatures it tended to undergo “devitrification,” transforming from a glass into a crystalline state. Then, when cooling, it passed through phase-change temperatures and the fiber suddenly shrank, producing large internal tensile stresses. Some fibers broke, giving rise to internal cracking within the RSI

and degradation of its properties. These problems threatened to grow worse during subsequent cycles of re-entry heating.

To prevent devitrification, Lockheed worked to remove impurities from the raw fiber. Company specialists raised the purity of the silica to 99.9 percent while reducing contaminating alkalis to as low as six parts per million. Lockheed did these things not only at the laboratory level but also in a pilot plant. This plant took the silica from raw material to finished tile, applying 140 process controls along the way. Established in 1970, the pilot plant was expanded in 1971 to attain a true manufacturing capability. Within this facility, Lockheed produced tiles of LI-1500 and LI-900 for use in extensive programs of test and evaluation. In turn, the increasing availability of these tiles encouraged their selection for shuttle thermal protection, in lieu of a hot-structure approach.¹⁹

General Electric also became actively involved, studying types of RSI made from zirconia and from mullite, as well as from silica. The raw fibers were commercial grade, with the zirconia coming from Union Carbide and the mullite from Babcock and Wilcox. Devitrification was a problem, but whereas Lockheed had addressed it by purifying its fiber, GE took the raw silica from Johns-Manville and tried to use it with little change. The basic fiber, the Q-felt of Dyna-Soar, also had served as insulation on the X-15. It contained 19 different elements as impurities. Some were present at a few parts per million, but others—aluminum, calcium, copper, lead, magnesium, potassium, sodium—ran from 100 to 1000 parts per million. In total, up to 0.3 percent was impurity. General Electric treated this fiber with a silicone resin that served as a binder, pyrolyzing the resin and causing it to break down at high temperatures. This transformed the fiber into a composite, sheathing each strand with a layer of amorphous silica that had a purity of 99.98 percent and higher. This high purity resulted from that of the resin. The amorphous silica bound the fibers together while inhibiting their devitrification. General Electric’s RSI had a density of 11.5 pounds per cubic foot, midway between that of LI-900 and LI-1500.²⁰

In January 1972, President Richard Nixon gave his approval to the space shuttle program, thereby raising it to the level of a presidential initiative. Within days, NASA’s Dale Myers spoke to a lunar science conference in Houston and stated that the agency had made the basic decision to use RSI. Requests for proposal soon went out, inviting leading aerospace corporations to bid for the prime contract on the shuttle orbiter, and North American won this \$2.6-billion prize in July. It specified mullite RSI for the undersurface and forward fuselage, a design feature that had been held over from the fully-reusable orbiter of the previous year.

Most of the primary structure was aluminum, but that of the nose was titanium, with insulation of zirconia lining the nose cap. The wing and fuselage upper surfaces, which had been titanium hot structure, now went over to an elastomeric RSI

consisting of a foamed methylphenyl silicone, bonded to the orbiter in panel sizes as large as 36 inches. This RSI gave protection to 650°F.²¹

Still, was mullite RSI truly the one to choose? It came from General Electric and had lower emissivity than the silica RSI of Lockheed but could withstand higher temperatures. Yet the true basis for selection lay in the ability to withstand a hundred re-entries, as simulated in ground test. NASA conducted these tests during the last five months of 1972, using facilities at its Ames, Johnson, and Kennedy centers, with support from Battelle Memorial Institute.

The main series of tests ran from August to November and gave a clear advantage to Lockheed. That firm's LI-900 and LI-1500 went through 100 cycles to 2,300°F and met specified requirements for maintenance of low back-face temperatures and minimal thermal conductivity. The mullite showed excessive back-face temperatures and higher thermal conductivity, particularly at elevated temperatures. As test conditions increased in severity, the mullite also developed coating cracks and gave indications of substrate failure.

The tests then introduced acoustic loads, with each cycle of the simulation now subjecting the RSI to loud roars of rocket flight along with the heating of re-entry. LI-1500 continued to show promise. By mid-November it demonstrated the equivalent of 20 cycles to 160 decibels, the acoustic level of a large launch vehicle, and 2,300°F. A month later NASA conducted what Lockheed describes as a "sudden death shootout": a new series of thermal-acoustic tests, in which the contending materials went into a single large 24-tile array at NASA-Johnson. After 20 cycles, only Lockheed's LI-900 and LI-1500 remained intact. In separate tests, LI-1500 withstood 100 cycles to 2,500°F and survived a thermal overshoot to 3,000°F as well as an acoustic overshoot to 174 decibels. Clearly, this was the material NASA wanted.²²

As insulation, they were astonishing. You could heat a tile in a furnace until it was white-hot, remove it, allow its surface to cool for a couple of minutes—and pick it up at its edges using your fingers, with its interior still at white heat. Lockheed won the thermal-protection subcontract in 1973, with NASA specifying LI-900 as the baseline RSI. The firm responded with preparations for a full-scale production facility in Sunnyvale, California. With this, tiles entered the mainstream of thermal protection.

DESIGNING THE SHUTTLE

In its overall technologies, the space shuttle demanded advances in a host of areas: rocket propulsion, fuel cells and other onboard systems, electronics and computers, and astronaut life support. As an exercise in hypersonics, two issues stood out: configuration and thermal protection. The Air Force supported some of the early studies, which grew seamlessly out of earlier work on Aerospaceplane. At

Douglas Aircraft, for instance, Melvin Root had his two-stage Astro, a fully-reusable rocket-powered concept with both stages shaped as lifting bodies. It was to carry a payload of 37,150 pounds, and Root expected that a fleet of such craft would fly 240 times per year. The contemporary Astrorocket of Martin Marietta, in turn, looked like two flat-bottom Dyna-Soar craft set belly to belly, foreshadowing fully-reusable space shuttle concepts of several years later.²³

These concepts definitely belonged to the Aerospaceplane era. Astro dated to 1963, whereas Martin's Astrorocket studies went forward from 1961 to 1965. By mid-decade, though, the name "Aerospaceplane" was in bad odor within the Air Force. The new concepts were rocket-powered, whereas Aerospaceplanes generally had called for scramjets or LACE, and officials referred to these rocket craft as Integrated Launch and Re-entry Vehicles (ILRVs).²⁴

Early contractor studies showed a definite preference for lifting bodies, generally with small foldout wings for use when landing. At Lockheed, Hunter's Star Clipper introduced the stage-and-a-half configuration that mounted expendable propellant tanks to a reusable core vehicle. The core carried the flight crew and payload along with the engines and onboard systems. It had a triangular planform and fitted neatly into a large inverted V formed by the tanks. The McDonnell Tip Tank concept was broadly similar; it also mounted expendable tanks to a lifting-body core.²⁵

At Convair, people took the view that a single airframe could serve both as a core and, when fitted with internal tankage, as a reusable carrier of propellants. This led to the Triamese concept, whereby a triplet of such vehicles was to form a single ILRV that could rise into the sky. All three were to have thermal protection and would re-enter, flying to a runway and deploying their extendable wings. The concept was excessively hopeful; the differing requirements of core and tankage vehicles proved to militate strongly against a one-size-fits-all approach to airframe design. Still, the Triamese approach showed anew that designers were ready to use their imaginations.²⁶

NASA became actively involved in the ongoing ILRV studies during 1968. George Mueller, the Associate Administrator for Manned Space Flight, took a particular interest and introduced the term "space shuttle" by which such craft came to be known. He had an in-house design leader, Maxime Faget of the Manned Spacecraft Center, who was quite strong-willed and had definite ideas of his own as to how a shuttle should look. Faget particularly saw lifting bodies as offering no more than mixed blessings: "You avoid wing-body interference," which brings problems of aerodynamics. "You have a simple structure. And you avoid the weight of wings." He nevertheless saw difficulties that appeared severe enough to rule out lifting bodies for a practical design.

They had low lift and high drag, which meant a dangerously high landing speed. As he put it, "I don't think it's charming to come in at 250 knots." Deployable wings could not be trusted; they might fail to extend. Lifting bodies also posed

serious difficulties in development, for they required a fuselage that could do the work of a wing. This ruled out straightforward solutions to aerodynamic problems; the attempted solutions would ramify throughout the entire design. “They are very difficult to develop,” he added, “because when you’re trying to solve one problem, you’re creating another problem somewhere else.”²⁷ His colleague Milton Silveira, who went on to head the Shuttle Engineering Office at MSC, held a similar view:

“If we had a problem with the aerodynamics on the vehicle, where the body was so tightly coupled to the aerodynamics, you couldn’t simply go out and change the wing. You had to change the whole damn vehicle, so if you make a mistake, being able to correct it was a very difficult thing to do.”²⁸

Faget proposed instead to design his shuttle as a two-stage fully-reusable vehicle, with each stage being a winged airplane having low wings and a thermally-protected flat bottom. The configuration broadly resembled the X-15, and like that craft, it was to re-enter with its nose high and with its underside acting as the heat shield.

Faget wrote that “the vehicle would remain in this flight attitude throughout the entire descent to approximately 40,000 feet, where the velocity will have dropped to less than 300 feet per second. At this point, the nose gets pushed down, and the vehicle dives until it reaches adequate velocity for level flight.” The craft then was to approach a runway and land at a moderate 130 knots, half the landing speed of a lifting body.²⁹

During 1969 NASA sponsored a round of contractor studies that examined anew the range of alternatives. In June the agency issued a directive that ruled out the use of expendable boosters such as the Saturn V first stage, which was quite costly. Then in August, a new order called for the contractors to consider only two-stage fully reusable concepts and to eliminate partially-reusable designs such as Star Clipper and Tip Tank. This decision also was based in economics, for a fully-reusable shuttle could offer the lowest cost per flight. But it also delivered a new blow to the lifting bodies.³⁰

There was a strong mismatch between lifting-body shapes, which were dictated by aerodynamics, and the cylindrical shapes of propellant tanks. Such tanks had to be cylindrical, both for ease in manufacturing and to hold internal pressure. This pressure was unavoidable; it resulted from boiloff of cryogenic propellants, and it served such useful purposes as stiffening the tanks’ structures and delivering propellants to the turbopumps. However, tanks did not fit well within the internal volume of a lifting body; in Faget’s words, “the lifting body is a damn poor container.” The Lockheed and McDonnell designers had bypassed that problem by mounting their tanks externally, with no provision for reuse, but the new requirement of full reusability meant that internal installation now was mandatory. Yet although lifting

bodies made poor containers, Faget’s wing-body concept was an excellent one. Its fuselage could readily be cylindrical, being given over almost entirely to propellant tankage.³¹

The design exercises of 1969 covered thermal protection as well as configuration. McDonnell Douglas introduced orbiter designs derived from the HL-10 lifting body, examining 13 candidate configurations for the complete two-stage vehicle. The orbiter had a titanium primary structure, obtaining thermal protection from a hot-structure approach that used external panels of columbium, nickel-chromium, and Rene 41. This study also considered the use of tiles made of a “hardened compacted fiber,” which was unrelated to Lockheed’s RSI. However, the company did not recommend this. Those tiles were heavier than panels or shingles of refractory alloy and less durable.³²

North American Rockwell took Faget’s two-stage airplane as its preferred approach. It also used a titanium primary structure, with a titanium hot structure protecting the top of the orbiter, which faced a relatively mild thermal environment. For the thermally-protected bottom, North American adopted the work of Lockheed and specified LI-1500 tiles. The design also called for copious use of fiberglass insulation, which gave internal protection to the crew compartment and the cryogenic propellant tanks.³³

Lockheed turned the Star Clipper core into a reusable second stage that retained its shape as a lifting body. Its structure was aluminum, as in a conventional airplane. The company was home to LI-1500, and designers considered its use for thermal protection. They concluded, though, that this carried high risk. They recommended instead a hot-structure approach that used corrugated Rene 41 along with shingles of nickel-chromium and columbium. The Lockheed work was independent of that at McDonnell Douglas, but engineers at the two firms reached similar conclusions.³⁴

Convair, home of the Triamese concept, came in with new variants. These included a triplet launch vehicle with a core vehicle that was noticeably smaller than the two propellant carriers that flanked it. Another configuration placed the orbiter on the back of a single booster that continued to mount retractable wings. The orbiter had a primary structure of aluminum, with titanium for the heat-shield supports on the vehicle underside. Again this craft used a hot structure, with shingles of cobalt superalloy on the bottom and of titanium alloy on the top and side surfaces.

Significantly, these concepts were not designs that the companies were prepared to send to the shop floor and build immediately. They were paper vehicles that would take years to develop and prepare for flight. Yet despite this emphasis on the future, and notwithstanding the optimism that often pervades such preliminary design exercises, only North American was willing to recommend RSI as the baseline. Even Lockheed, its center of development, gave it no more than a highly equivocal recommendation. It lacked maturity, with hot structures standing as the approach that held greater promise.³⁵

In the wake of the 1969 studies, NASA officials turned away from lifting bodies. Lockheed continued to study new versions of the Star Clipper, but the lifting body now was merely an alternative. The mainstream lay with Faget's two-stage fully-reusable approach, showing rocket-powered stages that looked like airplanes. Very soon, though, the shape of the wings changed anew, as a result of problems in Congress.

The space shuttle was a political program, funded by federal appropriations, and it had to make its way within the environment of Washington. On Capitol Hill, an influential viewpoint held that the shuttle was to go forward only if it was a national program, capable of meeting the needs of military as well as civilian users. NASA's shuttle studies had addressed the agency's requirements, but this proved not to be the way to proceed. Matters came to a head in the mid-1970 as Congressman Joseph Karth, a longtime NASA supporter, declared that the shuttle was merely the first step on a very costly road to Mars. He opposed funding for the shuttle in committee, and when he did not prevail, he made a motion from the floor of the House to strike the funds from NASA's budget. Other congressmen assured their colleagues that the shuttle had nothing to do with Mars, and Karth's measure went down to defeat—but by the narrowest possible margin: a tie vote of 53 to 53. In the Senate, NASA's support was only slightly greater.³⁶

Such victories were likely to leave NASA undone, and the agency responded by seeking support for the shuttle from the Air Force. That service had tried and failed to build Dyna-Soar only a few years earlier; now it found NASA offering a much larger and more capable space shuttle on a silver platter. However, the Air Force was quite happy with its Titan III launch vehicles and made clear that it would work with NASA only if the shuttle was redesigned to meet the needs of the Pentagon. In particular, NASA was urged to take note of the views of the Air Force Flight Dynamics Laboratory (FDL), where specialists had been engaged in a running debate with Faget since early 1969.

The FDL had sponsored ILRV studies in parallel with the shuttle studies of NASA and had investigated such concepts as Lockheed's Star Clipper. One of its managers, Charles Cosenza, had directed the ASSET program. Another FDL scientist, Alfred Draper, had taken the lead in questioning Faget's approach. Faget wanted his shuttle stages to come in nose-high and then dive through 15,000 feet to pick up flying speed. With the nose so high, these airplanes would be fully stalled, and the Air Force disliked both stalls and dives, regarding them as preludes to an out-of-control crash. Draper wanted the shuttle to enter its glide while still supersonic, thereby maintaining much better control.

If the shuttle was to glide across a broad Mach range, from supersonic to subsonic, then it would face an important aerodynamic problem: a shift in the wing's center of lift. A wing generates lift across its entire lower surface, but one may regard this lift as concentrated at a point, the center of lift. At supersonic speeds, this

center is located midway between the wing's leading and trailing edges. At subsonic speeds, this center moves forward and is much closer to the leading edge. To keep an airplane in proper balance, it requires an aerodynamic force that can compensate for this shift.

The Air Force had extensive experience with supersonic fighters and bombers that had successfully addressed this problem, maintaining good control and satisfactory handling qualities from Mach 3 to touchdown. Particularly for large aircraft—the B-58 and XB-70 bombers and the SR-71 spy plane—the preferred solution was a delta wing, triangular in shape. Delta wings typically ran along much of the length of the fuselage, extending nearly to the tail. Such aircraft dispensed with horizontal stabilizers at the tail and relied instead on elevons, control surfaces resembling ailerons that were set at the wing's trailing edge. Small deflections of these elevons then compensated for the shift in the center of lift, maintaining proper trim and balance without imposing excessive drag. Draper therefore proposed that both stages of Faget's shuttle have delta wings.³⁷

Faget would have none of this. He wrote that because the only real flying was to take place during the landing approach, a wing design “can be selected solely on the basis of optimization for subsonic cruise and landing.” The wing best suited to this limited purpose would be straight and unswept, like those of fighter planes in World War II. A tail would provide directional stability, as on a conventional airplane, enabling the shuttle to land in standard fashion. He was well aware of the center-of-lift shift but expected to avoid it by avoiding reliance on his wings until the craft was well below the speed of sound. He also believed that the delta would lose on its design merits. To achieve a suitably low landing speed, he argued that the delta would need a large wingspan. A straight wing, narrow in distance between its leading and trailing edges, would be light and would offer relatively little area demanding thermal protection. A delta of the same span, necessary for a moderate landing speed, would have a much larger area than the straight wing. This would add a great deal of weight, while substantially increasing the area that needed thermal protection.³⁸

Draper responded with his own view. He believed that Faget's straight-wing design would be barred on grounds of safety from executing its maneuver of stall, dive, and recovery. Hence, it would have to glide from supersonic speeds through the transonic zone and could not avoid the center-of-lift problem. To deal with it, a good engineering solution called for installation of canards, small wings set well forward on the fuselage that would deflect to give the desired control. Canards produce lift and would tend to push the main wings farther to the back. They would be well aft from the outset, for they were to support an airplane that was empty of fuel but that had heavy rocket engines at the tail, placing the craft's center of gravity far to the rear. The wings' center of lift was to coincide closely with this center of gravity.

Draper wrote that the addition of canards “will move the wings aft and tend to close the gap between the tail and the wing.” The wing shape that fills this gap is the delta, and Draper added that “the swept delta would most likely evolve.”³⁹

Faget had other critics, while Draper had supporters within NASA. Faget’s thoughts indeed faced considerable resistance within NASA, particularly among the highly skilled test and research pilots at the Flight Research Center. Their spokesman, Milton Thompson, was certainly a man who knew how to fly airplanes, for he was an X-15 veteran and had been slated to fly Dyna-Soar as well. But in addition, these aerodynamic issues involved matters of policy, which drove the Air Force strongly toward the delta. The reason was that a delta could achieve high crossrange, whereas Faget’s straight wing could not.

Crossrange was essential for single-orbit missions, launched from Vandenberg AFB on the California coast, which were to fly in polar orbit. The orbit of a spacecraft is essentially fixed with respect to distant stars, but the Earth rotates. In the course of a 90-minute shuttle orbit, this rotation carries the Vandenberg site eastward by 1,100 nautical miles. The shuttle therefore needed enough crossrange to cover that distance.

The Air Force had operational reasons for wanting once-around missions. A key example was rapid-response satellite reconnaissance. In addition, the Air Force was well aware that problems following launch could force a shuttle to come down at the earliest opportunity, executing a “once-around abort.” NASA’s Leroy Day, a senior shuttle manager, emphasized this point: “If you were making a polar-type launch out of Vandenberg, and you had Max’s straight-wing vehicle, there was no place you could go. You’d be in the water when you came back. You’ve got to go crossrange quite a few hundred miles in order to make land.”⁴⁰

By contrast, NASA had little need for crossrange. It too had to be ready for once-around abort, but it expected to launch the shuttle from Florida’s Kennedy Space Center on trajectories that ran almost due east. Near the end of its single orbit, the shuttle was to fly across the United States and could easily land at an emergency base. A 1969 baseline program document, “Desirable System Characteristics,” stated that the agency needed only 250 to 400 nautical miles of crossrange, which Faget’s straight wing could deliver with straightforward modifications.⁴¹

Faget’s shuttle had a hypersonic L/D of about 0.5. Draper’s delta-wing design was to achieve an L/D of 1.7, and the difference in the associated re-entry trajectories increased the weight penalty for the delta. A delta orbiter in any case needed a heavier wing and a larger area of thermal protection, and there was more. The straight-wing craft was to have a relatively brief re-entry and a modest heating rate. The delta orbiter was to achieve its crossrange by gliding hypersonically, executing a hypersonic glide that was to produce more lift and less drag. It also would increase both the rate of heating and its duration. Hence, its thermal protection had to be

more robust and therefore heavier still. In turn, the extra weight ramified throughout the entire two-stage shuttle vehicle, making it larger and more costly.⁴²

NASA’s key officials included the acting administrator, George Low, and the Associate Administrator for Manned Space Flight, Dale Myers. They would willingly have embraced Faget’s shuttle. But on the military side, the Undersecretary of the Air Force for Research and Development, Michael Yarymovich, had close knowledge of the requirements of the National Reconnaissance Office. He played a key role in emphasizing that only a delta would do.

The denouement came at a meeting in Williamsburg, Virginia, in January 1971. At nearby Yorktown, in 1781, Britain’s Lord Charles Cornwallis had surrendered to General George Washington, thereby ending America’s war of independence. One hundred and ninety years later NASA surrendered to the Air Force, agreeing particularly to build a delta-wing shuttle with full military crossrange of 1,100 miles. In return, though, NASA indeed won the support from the Pentagon that it needed. Opposition faded on Capitol Hill, and the shuttle program went forward on a much stronger political foundation.⁴³

The design studies of 1969 had counted as Phase A and were preliminary in character. In 1970 the agency launched Phase B, conducting studies in greater depth, with North American Rockwell and McDonnell Douglas as the contractors. Initially they considered both straight-wing and delta designs, but the Williamsburg decision meant that during 1971 they were to emphasize the deltas. These remained as two-stage fully-reusable configurations, which were openly presented at an AIAA meeting in July of that year.

In the primary structure and outer skin of the wings and fuselage, both contractors proposed to use titanium freely. They differed, however, in their approaches to thermal protection. McDonnell Douglas continued to favor hot structures. Most of the underside of the orbiter was covered with shingles of Hastelloy-X nickel superalloy. The wing leading edges called for a load-bearing structure of columbium, with shingles of coated columbium protecting these leading edges as well as other areas that were too hot for the Hastelloy. A nose cap of carbon-carbon completed the orbiter’s ensemble.⁴⁴

North American had its own interest in titanium hot structures, specifying them as well for the upper wing surfaces and the upper fuselage. Everywhere else possible, the design called for applying mullite RSI directly to a skin of aluminum. Such tiles were to cover the entire underside of the wings and fuselage, along with much of the fuselage forward of the wings. The nose and leading edges, both of the wings, and the vertical fin used carbon-carbon. In turn, the fin was designed as a hot structure with a skin of Inconel 718 nickel alloy.⁴⁵

By mid-1971, though, hot structures were in trouble. The new Office of Management and Budget had made clear that it expected to impose stringent limits on funding for the shuttle, which brought a demand for new configurations that could

cut the cost of development. Within weeks, the contractors did a major turnabout. They went over to primary structures of aluminum. They also abandoned hot structures and embraced RSI. Managers were aware that it might take time to develop for operational use, but they were prepared to use ablatives for interim thermal protection, switching to RSI once it was ready.⁴⁶

What brought this dramatic change? The advent of RSI production at Lockheed was critical. This drew attention from Faget, who had kept his hand in the field of shuttle design, offering a succession of conceptual configurations that had helped to guide the work of the contractors. His most important concept, designated MSC-040, came out in September 1971 and served as a point of reference. It used aluminum and RSI.⁴⁷

“My history has always been to take the most conservative approach,” Faget declared. Everyone knew how to work with aluminum, for it was the most familiar of materials, but titanium was literally a black art. Much of the pertinent shop-floor experience had been gained within the SR-71 program and was classified. Few machine shops had the pertinent background, for only Lockheed had constructed an airplane—the SR-71—that used titanium hot structure. The situation was worse for columbium and the superalloys because these metals had been used mostly in turbine blades. Lockheed had encountered serious difficulties as its machinists and metallurgists wrestled with the use of titanium. With the shuttle facing cost constraints, no one wanted to risk an overrun while machinists struggled with the problems of other new materials.⁴⁸

NASA-Langley had worked to build a columbium heat shield for the shuttle and had gained a particularly clear view of its difficulties. It was heavier than RSI but offered no advantage in temperature resistance. In addition, coatings posed serious problems. Silicides showed promise of reusability and long life, but they were fragile and damaged easily. A localized loss of coating could result in rapid oxygen embrittlement at high temperatures. Unprotected columbium oxidized readily, and above the melting point of its oxide, 2,730°F, it could burst into flame.⁴⁹ “The least little scratch in the coating, the shingle would be destroyed during re-entry,” said Faget. Charles Donlan, the shuttle program manager at NASA Headquarters, placed this in a broader perspective in 1983:

“Phase B was the first really extensive effort to put together studies related to the completely reusable vehicle. As we went along, it became increasingly evident that there were some problems. And then as we looked at the development problems, they became pretty expensive. We learned also that the metallic heat shield, of which the wings were to be made, was by no means ready for use. The slightest scratch and you are in trouble.”⁵⁰

Other refractory metals offered alternatives to columbium, but even when proposing to use them, the complexity of a hot structure also militated against their selection. As a mechanical installation, it called for large numbers of clips, brackets, stand-offs, frames, beams, and fasteners. Structural analysis loomed as a formidable task. Each of many panel geometries needed its own analysis, to show with confidence that the panels would not fail through creep, buckling, flutter, or stress under load. Yet this confidence might be fragile, for hot structures had limited ability to resist overtemperatures. They also faced the continuing issue of sealing panel edges against ingestion of hot gas during re-entry.⁵¹

In this fashion, having taken a long look at hot structures, NASA did an about-face as it turned toward the RSI that Lockheed’s Max Hunter had recommended as early as 1965. The choice of aluminum for the primary structure reflected the excellent insulating properties of RSI, but there was more. Titanium offered a potential advantage because of its temperature resistance; hence, its thermal protection might be lighter. However, the apparent weight saving was largely lost due to a need for extra insulation to protect the crew cabin, payload bay, and onboard systems. Aluminum could compensate for its lack of heat resistance because it had higher thermal conductivity than titanium. Hence, it could more readily spread its heat throughout the entire volume of the primary structure.

Designers expected to install RSI tiles by bonding them to the skin, and for this, aluminum had a strong advantage. Both metals form thin layers of oxide when exposed to air, but that of aluminum is more strongly bound. Adhesive, applied to aluminum, therefore held tightly. The bond with titanium was considerably weaker and appeared likely to fail in operational use at approximately 500°F. This was not much higher than the limit for aluminum, 350°F, which showed that the temperature resistance of titanium did not lend itself to operational use.⁵²

The move toward RSI and aluminum simplified the design and cut the development cost. Substantially larger cost savings came into view as well, as NASA moved away from full reusability of its two-stage concepts. The emphasis now was on partial reusability, which the prescient Max Hunter had advocated as far back as 1965 when he placed the liquid hydrogen of Star Clipper in expendable external tanks. The new designs kept propellants within the booster, but they too called for the use of external tankage for the orbiter. This led to reduced sizes for both stages and had a dramatic impact on the problem of providing thermal protection for the shuttle’s booster.

On paper, a shuttle booster amounted to the world’s largest airplane, combining the size of a Boeing 747 or C-5A with performance exceeding that of the X-15. It was to re-enter at speeds well below orbital velocity, but still it needed thermal protection, and the reduced entry velocities did not simplify the design. North American, for one, specified RSI for its Phase B orbiter, but the company also had to show

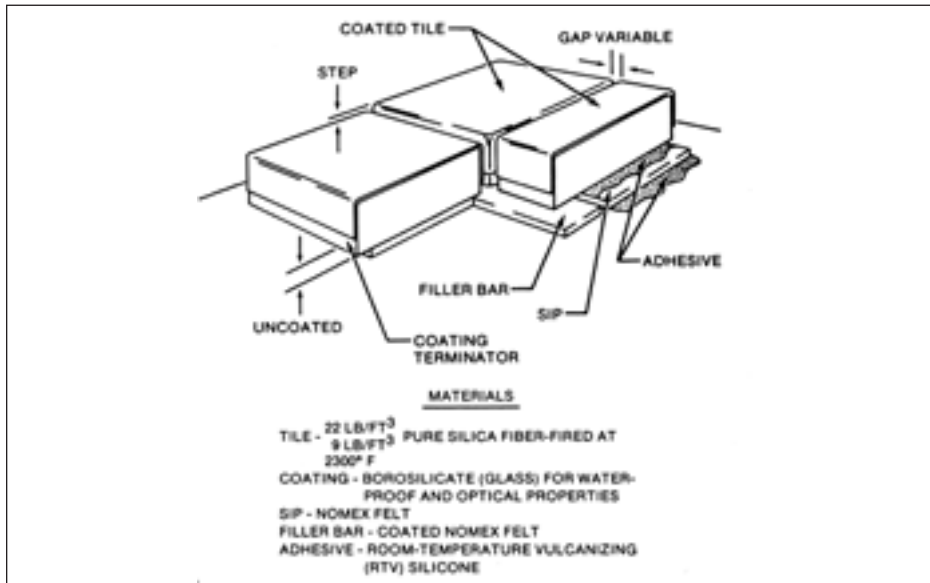

Thermal-protection tiles for the space shuttle. (NASA)

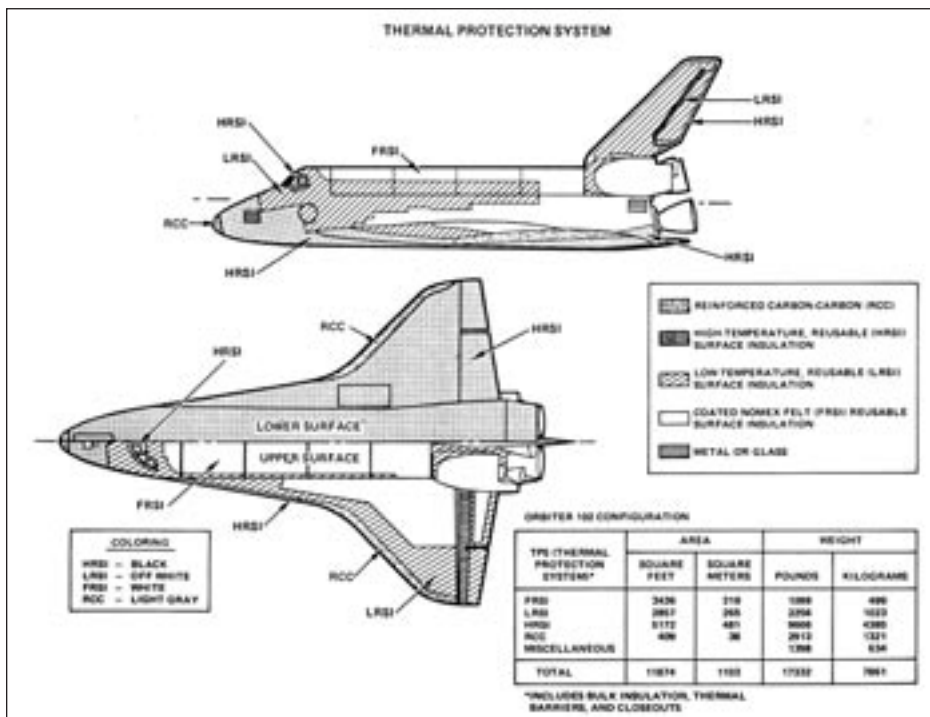

Thermal-protection system for the space shuttle. (NASA)

that it understood hot structures. These went into the booster, which protected its hot areas with titanium, Inconel 718, carbon-carbon, Rene 41, Haynes 188 steel—and coated columbium.

The move toward external tankage brought several advantages, the most important of which was a reduction in staging velocity. When designing a two-stage rocket, standard methods exist for dividing the work load between the two stages so as to achieve the lowest total weight. These methods give an optimum staging velocity. A higher value makes the first stage excessively large and heavy; a lower velocity means more size and weight for the orbiter. Ground rules set at NASA's Marshall Space Flight Center, based on such optimization, placed this staging velocity close to 10,000 feet per second.

But by offloading propellants into external tankage, the orbiter could shrink considerably in size and weight. The tanks did not need thermal protection or heavy internal structure; they might be simple aluminum shells stiffened with internal pressure. With the orbiter being lighter, and being little affected by a change in staging velocity, a recalculation of the optimum value showed advantage in making the tanks larger so that they could carry more propellant. This meant that the orbiter was to gain more speed in flight—and the booster would gain less. Hence, the booster also could shrink in size. Better yet, the reduction in staging velocity eased the problem of booster thermal protection.

Grumman was the first company to pursue this line of thought, as it studied alternative concepts alongside the mainstream fully reusable designs of McDonnell Douglas and North American. Grumman gave a fully-reusable concept of its own, for purposes of comparison, but emphasized a partially-reusable orbiter that put the liquid hydrogen in two external tanks. The liquid oxygen, which was dense and compact, remained aboard this vehicle, but the low density of the hydrogen meant that its tanks could be bulky while remaining light in weight.

The fully-reusable design followed the NASA Marshall Space Flight Center ground rules and showed a staging velocity of 9,750 feet per second. The external-tank configuration cut this to 7,000 feet per second. Boeing, which was teamed with Grumman, found that this substantially reduced the need for thermal protection as such. The booster now needed neither tiles nor exotic metals. Instead, like the X-15, it was to use its structure as a heat sink. During re-entry, it would experience a sharp but brief pulse of heat, which a conventional aircraft structure could absorb without exceeding temperature limits. Hot areas continued to demand a titanium hot structure, which was to cover some one-eighth of the booster. However, the rest of this vehicle could make considerable use of aluminum.

How could bare aluminum, without protection, serve in a shuttle booster? It was common understanding that aluminum airframes lost strength due to aerodynamic heating at speeds beyond Mach 2, with titanium being necessary at higher speeds. However, this held true for aircraft in cruise, which faced their temperatures con-

tinually. The Boeing booster was to re-enter at Mach 7, matching the top speed of the X-15. Even so, its thermal environment resembled a fire that does not burn your hand when you whisk it through quickly. Across part of the underside, the vehicle was to protect itself by the simple method of metal with more than usual thickness to cope with the heat. Even these areas were limited in extent, with the contractors noting that “the material gauges [thicknesses] required for strength exceed the minimum heat-sink gauges over the majority of the vehicle.”⁵³

McDonnell Douglas went further. In mid-1971 it introduced its own external-tank orbiter that lowered the staging velocity to 6,200 feet per second. Its winged booster was 82 percent aluminum heat sink. Their selected configuration was optimized from a thermal standpoint, bringing the largest savings in the weight of thermal protection.⁵⁴ Then in March 1972 NASA selected solid-propellant rockets for the boosters. The issue of their thermal protection now went away entirely, for these big solids used steel casings that were 0.5 inch thick and that provided heat sink very effectively.⁵⁵

Amid the design changes, NASA went over to the Air Force view and embraced the delta wing. Faget himself accepted it, making it a feature of his MSC-040 concept. Then the Office of Management and Budget asked whether NASA might return to Faget’s straight wing after all, abandoning the delta and thereby saving money. Nearly a year after the Williamsburg meeting, Charles Donlan, acting director of the shuttle program office at Headquarters, ruled this out. In a memo to George Low, he wrote that high crossrange was “fundamental to the operation of the orbiter.” It would enhance its maneuverability, greatly broadening the opportunities to abort a mission and perhaps save the lives of astronauts. High crossrange would also provide more frequent opportunities to return to Kennedy Space Center in the course of a normal mission.

Delta wings also held advantages that were entirely separate from crossrange. A delta orbiter would be stable in flight from hypersonic to subsonic speeds, throughout a wide range of nose-high attitudes. The aerodynamic flow over such an orbiter would be smooth and predictable, thereby permitting accurate forecasts of heating during re-entry and giving confidence in the design of the shuttle’s thermal protection. In addition, the delta vehicle would experience relatively low temperatures of 600 to 800°F over its sides and upper surfaces.

By contrast, straight-wing configurations produced complicated hypersonic flow fields, with high local temperatures and severe temperature changes on the wing, body, and tail. Temperatures on the sides of the fuselage would run from 900 to 1,300°F, making the design and analysis of thermal protection more complex. During transition from supersonic to subsonic speeds, the straight-wing orbiter would experience unsteady flow and buffeting, making it harder to fly. This combination of aerodynamic and operational advantages led Donlan to favor the delta for reasons that were entirely separate from those of the Air Force.⁵⁶

THE LOSS OF *COLUMBIA*

Thermal protection was delicate. The tiles lacked structural strength and were brittle. It was not possible even to bond them directly to the underlying skin, for they would fracture and break due to their inability to follow the flexing of the skin under its loads. Designers therefore placed an intermediate layer between tiles and skin that had some elasticity and could stretch in response to shuttle skin flexing without transmitting excessive strain to the tiles. It worked; there never was a serious accident due to fracturing of tiles.⁵⁷

The same was not true of another piece of delicate work: a thermal-protection panel made of carbon that had the purpose of protecting one of the wing leading edges. It failed during re-entry in virtually the final minutes of a flight of *Columbia*, on 1 February 2003. For want of this panel, that spacecraft broke up over Texas in a shower of brilliant fireballs. All aboard were killed.

The background to this accident lay in the fact that for the nose and leading edges of the shuttle, silica RSI was not enough. These areas needed thermal protection with greater temperature resistance, and carbon was the obvious candidate. It was lighter than aluminum and could be protected against oxidation with a coating. It also had a track record, having formed the primary structure of the Dyna-Soar nose cap and the leading edge of ASSET. Graphite was the standard form, but in contrast to ablative materials, it failed to enter the aerospace mainstream. It was brittle and easily damaged and did not lend itself to use with thin-walled structures.

The development of a better carbon began in 1958, with Vought Missiles and Space Company in the forefront. The work went forward with support from the Dyna-Soar and Apollo programs and brought the advent of an all-carbon composite consisting of graphite fibers in a carbon matrix. Existing composites had names such as carbon-phenolic and graphite-epoxy; this one was carbon-carbon.

It retained the desirable properties of graphite in bulk: light weight, temperature resistance, and resistance to oxidation when coated. It had the useful property of actually gaining strength with temperature, being up to 50 percent stronger at 3,000°F than at room temperature. It had a very low coefficient of thermal expansion, which reduced thermal stress. It also had better damage tolerance than graphite.

Carbon-carbon was a composite. As with other composites, Vought engineers fabricated parts of this material by forming them as layups. Carbon cloth gave a point of departure, produced by oxygen-free pyrolysis of a woven organic fiber such as rayon. Sheets of this fabric, impregnated with phenolic resin, were stacked in a mold to form the layup and then cured in an autoclave. This produced a shape made of laminated carbon cloth phenolic. Further pyrolysis converted the resin to its basic carbon, yielding an all-carbon piece that was highly porous due to the loss of volatiles. It therefore needed densification, which was achieved through multiple cycles of reimpregnation under pressure with an alcohol, followed by further pyrolysis. These cycles continued until the part had its specified density and strength.⁵⁸

Researchers at Vought conducted exploratory studies during the early 1960s, investigating resins, fibers, weaves, and coatings. In 1964 they fabricated a Dyna-Soar nose cap of carbon-carbon, with this exercise permitting comparison of the new nose cap with the standard versions that used graphite and zirconia tiles. In 1966 this firm crafted a heat shield for the Apollo afterbody, which lay leeward of the curved ablative front face. A year and a half later the company constructed a wind-tunnel model of a Mars probe that was designed to enter the atmosphere of that planet.⁵⁹

These exercises did not approach the full-scale development that Dyna-Soar and ASSET had brought to hot structures. They definitely were in the realm of the preliminary. Still, as they went forward along with Lockheed's work on silica RSI and GE's studies of mullite, the work at Vought made it clear that carbon-carbon was likely to take its place amid the new generation of thermal-protection materials.

The shuttle's design specified carbon-carbon for the nose cap and leading edges, and developmental testing was conducted with care. Structural tests exercised their methods of attachment by simulating flight loads up to design limits, with design temperature gradients. Other tests, conducted within an arc-heated facility, determined the thermal responses and hot-gas leakage characteristics of interfaces between the carbon-carbon and RSI.⁶⁰

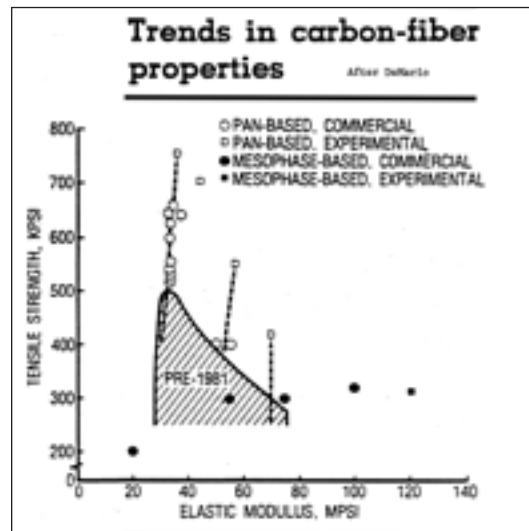

Improvements in strength of carbon-carbon after 1981. (AIAA)

There was no doubt that left to themselves, the panels of carbon-carbon that protected the leading edges would have continued to do so. Unfortunately, they were not left to themselves. During the ascent of *Columbia*, on 16 January 2003, a

large piece of insulating foam detached itself from a strut that joined the external tank to the front of the orbiter. The vehicle at that moment was slightly more than 80 seconds into the flight, traveling at nearly Mach 2.5. This foam struck a carbon-carbon panel and delivered what proved to be a fatal wound.

Ground controllers became aware of this the following day, during a review of high-resolution film taken at the time of launch. The mission continued for two weeks, and in the words of the accident report, investigators concluded that "some localized heating damage would most likely occur during re-entry, but they could not definitively state that structural damage would result."⁶²

Yet the damage was mortal. Again, in words of the accident report,

Columbia re-entered Earth's atmosphere with a pre-existing breach in the leading edge of its left wing... This breach, caused by the foam strike on ascent, was of sufficient size to allow superheated air (probably exceeding 5,000°F) to penetrate the cavity behind the RCC panel. The breach widened, destroying the insulation protecting the wing's leading edge support structure, and the superheated air eventually melted the thin aluminum wing spar. Once in the interior, the superheated air began to destroy the left wing... Finally, over Texas,...the increasing aerodynamic forces the Orbiter experienced in the denser levels of the atmosphere overcame the catastrophically damaged left wing, causing the Orbiter to fall out of control.⁶³

It was not feasible to go over to a form of thermal protection, for the wing leading edges, that would use a material other than carbon-carbon and that would be substantially more robust. Even so, three years of effort succeeded in securing the foam and the shuttle returned to flight in July 2006 with foam that stayed put.

In addition, people took advantage of the fact that most such missions had already been intended to dock with the International Space Station. It now became a rule that the shuttle could fly only if it were to go there, where it could be inspected minutely prior to re-entry and where astronauts could stay, if necessary, until a damaged shuttle was repaired or a new one brought up. In this fashion, rather than the thermal protection being shaped to fit the needs of the missions, the missions were shaped to fit the requirements of having safe thermal protection.⁶⁴

- 1 "Advanced Technology Program: Technical Development Plan for Aerothermodynamic/Elastic Structural System Environmental Tests (ASSET)." Air Force Systems Command, 9 September 1963.
- 2 Ibid., pp. 4, 11-13; Hallion, *Hypersonic*, pp. 451, 464-65.
- 3 Hallion, *Hypersonic*, pp. 510-12 (quote, p. 512).
- 4 Ibid., pp. 512-16 (quote, p. 515); DTIC AD-357523; advertisement, *Aviation Week*, 24 May 1965, p. 62.
- 5 *Aviation Week*, 2 November 1964, pp. 25-26; DTIC AD-366546 (quote, p. 156); Hallion, *Hypersonic*, pp. 516-19.
- 6 Hallion, *Hypersonic*, pp. 524, 529, 535, 864-66.
- 7 NASA: SP-4220, pp. 33-39; SP-4303, pp. 148-52 (quote, p. 151).
- 8 NASA: SP-4220, index references; SP-4303, ch. 8; Jenkins, *Space Shuttle*, p. 34.
- 9 NASA SP 4220, pp. 106-09, 111-16 (quote, p. 116).
- 10 Miller, *X-Planes*, pp. 256-61; Martin Marietta Report ER 14465.
- 11 Hallion, *Hypersonic*, pp. 641, 648-49; Martin Marietta Report ER 14465, ch. VI; *Aviation Week*, 16 May 1966, pp. 64-75.
- 12 Martin Marietta Report ER 14465, p. I-1; Hallion, *Hypersonic*, pp. 694-702; *Aviation Week*, 10 July 1967, pp. 99-101.
- 13 See index references in the present volume.
- 14 AIAA Paper 71-443.
- 15 Schramm et al., "Space Shuttle" (*Lockheed Horizons*).
- 16 Ibid.
- 17 Korb et al., "Shuttle," p. 1189; Schramm, "HRSI," p. 1194.
- 18 NASA TM X-2273, pp. 57-58; Korb et al., "Shuttle," pp. 1189-90; CASI 72A-10764.
- 19 Schramm et al., "Space Shuttle," p. 11 (*Lockheed Horizons*); Schramm, "HRSI," p. 1195.
- 20 CASI 72A-10764; NASA TM X-2273, pp. 39-93.
- 21 *Aviation Week*, 17 January 1972, p. 17; North American Rockwell Report SV 72-19.
- 22 Schramm et al., "Space Shuttle," pp. 11-14 (*Lockheed Horizons*); *Aviation Week*, 27 March 1972, p. 48.
- 23 Root and Fuller, *Aeronautics & Aeronautics*, January 1964, pp. 42-51; Hallion, *Hypersonic*, pp. 952-54.
- 24 Jenkins, *Space Shuttle*, pp. 60-62, 67; Hallion, *Hypersonic*, pp. 951, 995.
- 25 Hunter, "Origins"; Schnyer and Voss, "Review," pp. 17-22, 35-39; Jenkins, *Space Shuttle*, pp. 67-70.
- 26 NASA SP-4221, pp. 89-91; General Dynamics Reports GDC-DCB-67-031, GDC-DCB-68-017.
- 27 NASA SP-4221, pp. 92-94; author interview, Max Faget, 4 March 1997 (includes quote). Folder 18649, NASA Historical Reference Collection, NASA History Division, Washington, D.C. 20546.
- 28 Milton Silveira interview by Joe Guilmartin and John Mauer, 14 November 1984. Oral His-

- torical Series, Shuttle Interviews Box 2. JSC History Collection, University of Houston-Clear Lake.
- 29 Faget, *Aeronautics & Aeronautics*, January 1970, pp. 52-61 (quote, p. 53).
- 30 NASA SP-4221, pp. 218-219.
- 31 Author interview, Max Faget, 4 March 1997 (includes quote). Folder 18649, NASA Historical Reference Collection, NASA History Division, Washington, D.C. 20546.
- 32 McDonnell Douglas Report MDC E0056; Jenkins, *Space Shuttle*, pp. 84-86.
- 33 North American Rockwell Report SD 69-573-1; Jenkins, *Space Shuttle*, pp. 87-89.
- 34 Lockheed Report LMSC-A959837; Jenkins, *Space Shuttle*, pp. 90-91.
- 35 General Dynamics Report GDC-DCB-69-046; Jenkins, *Space Shuttle*, pp. 92-95.
- 36 NASA SP-4221, pp. 179-86, 219-21.
- 37 Ibid., pp. 215-16; Draper et al., *Aeronautics & Aeronautics*, January 1971, pp. 26-35; Hallion, *Hypersonic*, pp. 459, 1032; Jenkins, *Space Shuttle*, pp. 66-68.
- 38 Faget, *Aeronautics & Aeronautics*, January 1970, pp. 52-61 (quote, p. 57).
- 39 AIAA Paper 70-1249; Draper et al., *Aeronautics & Aeronautics*, January 1971, pp. 26-35 (quotes, p. 29).
- 40 Personal discussions with John Pike, Federation of American Scientists, July 1997; Pace, *Engineering*, pp. 146-49. Quote: John Mauer interview with Leroy Day, 17 October 1983, p. 41. Oral Historical Series, Shuttle Interviews Box 1, JSC History Collection, University of Houston-Clear Lake.
- 41 Day, *Task Group Report*, Vol. II, pp. 40-42; Faget, *Aeronautics & Aeronautics*, January 1970, p. 59.
- 42 NASA SP-4221, p. 217; Faget and Silveira, "Fundamental."
- 43 Pace, *Engineering*, p. 116; NASA SP-4221, pp. 230-31, 233-34.
- 44 NASA SP-4221, pp. 223-25; AIAA Papers 71-804, 71-805; McDonnell Douglas Report MDC E0308.
- 45 North American Rockwell SV 71-28, SD 71-114-1.
- 46 Grumman Reports B35-43 RP-33, p. 19; North American Rockwell SV 71-50, p. 9 and SV 71-59, p. 3; McDonnell Douglas "Interim Report," p. 36.
- 47 NASA SP-4221, pp. 341-346; Jenkins, *Space Shuttle*, pp. 141-50.
- 48 Heppenheimer, *Turbulent*, pp. 209-210; author interview, Max Faget, 4 March 1997. Folder 18649, NASA Historical Reference Collection, NASA History Division, Washington, D.C. 20546.
- 49 CASI 81A-44344; Korb et al., "Shuttle," p. 1189.
- 50 John Mauer interview, Charles Donlan, 19 October 1983. Oral Historical Series, Shuttle Interviews Box 1, JSC History Collection, University of Houston-Clear Lake. Also, author interview, Max Faget, 4 March 1997. Folder 18649, NASA Historical Reference Collection, NASA History Division, Washington, D.C. 20546.
- 51 CASI 81A-44344.
- 52 Pace, *Engineering*, pp. 179-88.
- 53 NASA SP-4221, pp. 335-40, 348-49; Grumman Report B35-43 RP-11; *Aviation Week*, 12 July 1971, pp. 36-39.

FACING THE HEAT BARRIER: A HISTORY OF HYPERSONICS

- 54 McDonnell Douglas Report MDC E0376-1.
- 55 NASA SP-4221, pp. 420-22; Heppenheimer, *Development*, p. 188.
- 56 Jenkins, *Space Shuttle*, p. 147; memo, Donlan to Low, 5 December 1971 (includes quote).
- 57 *Space World*, June-July 1979, p. 23; CASI 77A-35304; Korb et al., "Shuttle."
- 58 Becker, "Leading"; Korb et al., "Shuttle."
- 59 Becker, "Leading"; "Technical" (Vought).
- 60 *Astronautics & Aeronautics*, January 1976, pp. 60, 63-64.
- 61 *Aviation Week*, 31 March 1975, p. 52; AIAA Paper 78-485.
- 62 *Columbia*, p. 38.
- 63 *Ibid.*, p. 12.
- 64 *Ibid.*, pp. 225-227.

7

THE FADING, THE COMEBACK

During the 1960s and 1970s, work in re-entry went from strength to strength. The same was certainly not true of scramjets, which reached a peak of activity in the Aerospaceplane era and then quickly faded. Partly it was their sheer difficulty, along with an appreciation that whatever scramjets might do tomorrow, rockets were already doing today. Yet the issues went deeper.

The 1950s saw the advent of anti-aircraft missiles. Until then, the history of air power had been one of faster speeds and higher altitudes. At a stroke, though, it became clear that missiles held the advantage. A hot fighter plane, literally hot from aerodynamic heating, now was no longer a world-class dogfighter; instead it was a target for a heat-seeking missile.

When anti-aircraft no longer could outrace defenders, they ceased to aim at speed records. They still needed speed but not beyond a point at which this requirement would compromise other fighting qualities. Instead, aircraft were developed with an enhanced ability to fly low, where missiles could lose themselves in ground clutter, and became stealthy. In 1952, late in the dogfight era, Clarence “Kelly” Johnson designed the F-104 as the “missile with a man in it,” the ultimate interceptor. No one did this again, not after the real missiles came in.

This was bad news for ramjets. The ramjet had come to the fore around 1950, in projects such as Navaho, Bomarc, and the XF-103, because it offered Mach 3 at a time when turbojets could barely reach Mach 1. But Mach 3, when actually achieved in craft such as the XB-70 and SR-71, proved to be a highly specialized achievement that had little to do with practical air power. No one ever sent an SR-71 to conduct close air support at subsonic speed, while the XB-70 gave way to its predecessor, the B-52, because the latter could fly low whereas the XB-70 could not.

Ramjets also faltered on their merits. The ramjet was one of two new airbreathers that came forth after the war, with the other being the turbojet. Inevitably this set up a Darwinian competition in which one was likely to render the other extinct. Ramjets from the start were vulnerable, for while they had the advantage of speed, they needed an auxiliary boost from a rocket or turbojet. Nor was it small; the Navaho booster was fully as large as the winged missile itself.

The problem of compressor stall limited turbojet performance for a time. But from 1950 onward, several innovations brought means of dealing with it. They led to speedsters such as the F-104 and F-105, operational aircraft that topped Mach 2, along with the B-58 which also did this. The SR-71, in turn, exceeded Mach 3. This meant that there was no further demand for ramjets, which were not selected for new aircraft.

The ramjet thus died not only because its market was lost to advanced turbojets, but because the advent of missiles made it clear that there no longer was a demand for really fast aircraft. This, in turn, was bad news for scramjets. The scramjet was an advanced ramjet, likely to enter the aerospace mainstream only while ramjets remained there. The decline of the ramjet trade meant that there was no industry that might build scramjets, no powerful advocates that might press for them.

The scramjet still held the prospective advantage of being able to fly to orbit as a single stage. With Aerospaceplane, the Air Force took a long look as to whether this was plausible, and the answer was no, at least not soon. With this the scramjet lost both its rationale in the continuing pursuit of high speed and the prospect of an alternate mission— ascent to orbit—that might allow it to bypass this difficulty.

In its heyday the scramjet had stood on the threshold of mainstream research and development, with significant projects under way at General Electric and United Aircraft Research Laboratories, which was affiliated with Pratt & Whitney. As scramjets faded, though, even General Applied Science Laboratories (GASL), a scramjet center that had been founded by Antonio Ferri himself, had to find other activities. For a time the only complete scramjet lab in business was at NASA-Langley.

And then—lightning struck. President Ronald Reagan announced the Strategic Defense Initiative (SDI), which brought the prospect of a massive new demand for access to space. The Air Force already was turning away from the space shuttle, while General Lawrence Skantze, head of the Air Force Systems Command, was strongly interested in alternatives. He had no background in scramjets, but he embraced the concept as his own. The result was the National Aerospace Plane (NASP) effort, which aimed at airplane-like flight to orbit.

In time SDI faded as well, while lessons learned by researchers showed that NASP offered no easy path to space flight. NASP faded in turn and with it went hopes for a new day for hypersonics. Final performance estimates for the prime NASP vehicle, the X-30, were not terribly far removed from the early and optimistic estimates that had made the project appear feasible. Still, the X-30 design was so sensitive that even modest initial errors could drive its size and cost beyond what the Pentagon was willing to accept.

SCRAMJETS PASS THEIR PEAK

From the outset, scramjets received attention for the propulsion of tactical missiles. In 1959 APL's Gordon Dugger and Frederick Billig disclosed a concept that took the name SCRAM, Supersonic Combustion Ramjet Missile. Boosted by a solid-fuel rocket, SCRAM was to cruise at Mach 8.5 and an altitude of 100,000 feet, with range of more than 400 miles. This cruise speed resulted in a temperature of 3,800°F at the nose, which was viewed as the limit attainable with coated materials.¹

The APL researchers had a strong interest in fuels other than liquid hydrogen, which could not be stored. The standard fuel, a boron-rich blend, used ethyl decaborane. It ignited easily and gave some 25 percent more energy per pound than gasoline. Other tests used blends of pentaborane with heavy hydrocarbons, with the pentaborane promoting their ignition. The APL group went on to construct and test a complete scramjet of 10-inch diameter.²

Paralleling this Navy-sponsored work, the Air Force strengthened its own efforts in scramjets. In 1963 Weldon Worth, chief scientist at the Aero Propulsion Laboratory, joined with Antonio Ferri and recommended scramjets as a topic meriting attention. Worth proceeded by funding new scramjet initiatives at General Electric and Pratt & Whitney. This was significant; these firms were the nation's leading builders of turbojet and turbofan engines.

GE's complete scramjet was axisymmetric, with a movable centerbody that included the nose spike. It was water-cooled and had a diameter of nine inches, with this size being suited to the company's test facility. It burned hydrogen, which was quite energetic. Yet the engine failed to deliver net thrust, with this force being more than canceled out by drag.³

The Pratt & Whitney effort drew on management and facilities at nearby United Aircraft Research Laboratories. Its engine also was axisymmetric and used a long cowl that extended well to the rear, forming the outer wall of the nozzle duct. This entire cowl moved as a unit, thereby achieving variable geometry for all three major components: inlet, combustor, and nozzle. The effort culminated in fabrication of a complete water-cooled test unit of 18-inch diameter.⁴

A separate Aero Propulsion Lab initiative, the Incremental Flight Test Vehicle (IFTV), also went forward for a time. It indeed had the status of a flight vehicle, with Marquardt holding the prime contract and taking responsibility for the engine. Lockheed designed and built the vehicle and conducted wind-tunnel tests at its Rye Canyon facility, close to Marquardt's plant in Van Nuys, California.

The concept called for this craft to ride atop a solid-fuel Castor rocket, which was the second stage of the Scout launch vehicle. Castor was to accelerate the IFTV to 5,400 feet per second, with this missile then separating and entering free flight. Burning hydrogen, its engines were to operate for at least five seconds, adding an

“increment” of velocity of at least 600 feet per second. Following launch over the Pacific from Vandenberg AFB, it was to telemeter its data to the ground.

This was the first attempt to develop a scramjet as the centerpiece of a flight program, and much of what could go wrong did go wrong. The vehicle grew in weight during development. It also increased its drag and found itself plagued for a time with inlets that failed to start. The scramjets themselves gave genuine net thrust but still fell short in performance.

The flight vehicle mounted four scramjets. The target thrust was 597 pounds. The best value was 477 pounds. However, the engines needed several hundred pounds of thrust merely to overcome drag on the vehicle and accelerate, and this reduction in performance meant that the vehicle could attain not quite half of the desired velocity increase of 600 feet per second.⁵

Just then, around 1967, the troubles of the IFTV were mirrored by troubles in the overall scramjet program. Scramjets had held their promise for a time, with a NASA/Air Force Ad Hoc Working Group, in a May 1965 report, calling for an expanded program that was to culminate in a piloted hypersonic airplane. The SAB had offered its own favorable words, while General Bernard Schriever, head of the Air Force Systems Command—the ARDC, its name having changed in 1961—attempted to secure \$50 million in new funding.⁶

He did not get it, and the most important reason was that conventional ramjets, their predecessors, had failed to win a secure role. The ramjet-powered programs of the 1950s, including Navaho and Bomarc, now appeared as mere sidelines within a grand transformation that took the Air Force in only 15 years from piston-powered B-36 and B-50 bombers to the solid-fuel Minuteman ICBM and the powerful Titan III launch vehicle. The Air Force was happy with both and saw no reason for scramjet craft as alternatives. This was particularly true because Aerospaceplane had come up with nothing compelling.

The Aero Propulsion Laboratory had funded the IFTV and the GE and Pratt scramjets, but it had shown that it would support this engine only if it could be developed quickly and inexpensively. Neither had proved to be the case. The IFTV effort, for one, had escalated in cost from \$3.5 million to \$12 million, with its engine being short on power and its airframe having excessive drag and weight.⁷

After Schriever’s \$50-million program failed to win support, Air Force scramjet efforts withered and died. More generally, between 1966 and 1968, three actions ended Air Force involvement in broad-based hypersonic research and brought an end to a succession of halcyon years. The Vietnam War gave an important reason for these actions, for the war placed great pressure on budgets and led to cancellation of many programs that lacked urgency.

The first decision ended Air Force support for the X-15. In July 1966 the joint NASA-Air Force Aeronautics and Astronautics Coordinating Board determined

that NASA was to accept all budgetary responsibility for the X-15 as of 1 January 1968. This meant that NASA was to pay for further flights—which it refused to do. This brought an end to the prospect of using this research airplane for flight testing of hypersonic engines.⁸

The second decision, in August 1967, terminated IFTV. Arthur Thomas, the Marquardt program manager, later stated that it had been a major error to embark on a flight program before ground test had established attainable performance levels. When asked why this systematic approach had not been pursued, Thomas pointed to the pressure of a fast-paced schedule that ruled out sequential development. He added that Marquardt would have been judged “nonresponsive” if its proposal had called for sequential development at the outset. In turn, this tight schedule reflected the basic attitude of the Aero Propulsion Lab: to develop a successful scramjet quickly and inexpensively, or not to develop one at all.⁹

Then in September 1968 the Navy elected to close its Ordnance Aerophysics Laboratory (OAL). This facility had stood out because it could accommodate test engines of realistic size. In turn, its demise brought a premature end to the P & W scramjet effort. That project succeeded in testing its engine at OAL at Mach 5, but only about 20 runs were conducted before OAL shut down, which was far too few for serious development. Nor could this engine readily find a new home; its 18-inch diameter had been sized to fit the capabilities of OAL. This project therefore died both from withdrawal of Air Force support and from loss of its principal test facility.¹⁰

As dusk fell on the Air Force hypersonics program, Antonio Ferri was among the first to face up to the consequences. After 1966 he became aware that no major new contracts would be coming from the Aero Propulsion Lab, and he decided to leave GASL, where he had been president. New York University gave him strong encouragement, offering him the endowed Astor Professorship. He took this appointment during the spring of 1967.¹¹

He proceeded to build new research facilities in the Bronx, as New York University bought a parcel of land for his new lab. A landmark was a vacuum sphere for his wind tunnel, which his friend Louis Nucci called “the hallmark of hypersonic flow” as it sucks high-pressure air from a stored supply. Ferri had left a trail of such spheres at his previous appointments: NACA-Langley, Brooklyn Polytechnic, GASL. But his new facilities were far less capable than those of GASL, and his opportunities were correspondingly reduced. He set up a consulting practice within an existing firm, Advanced Technology Labs, and conducted analytical studies. Still, Nucci recalls that “Ferri’s love was to do experiments. To have only [Advanced Technology Labs] was like having half a body.”

GASL took a significant blow in August 1967, as the Air Force canceled IFTV. The company had been giving strong support to the developmental testing of its

engine, and in Nucci's words, "we had to use our know-how in flow and combustion." Having taken over from Ferri as company president, he won a contract from the Department of Transportation to study the aerodynamics of high-speed trains running in tubes.

"We had to retread everybody," Nucci adds. Boeing held a federal contract to develop a supersonic transport; GASL studied its sonic boom. GASL also investigated the "parasol wing," a low-drag design that rode atop its fuselage at the end of a pylon. There also was work on pollution for the local utility, Long Island Lighting Company, which hoped to reduce its smog-forming emissions. The company stayed alive, but its employment dropped from 80 people in 1967 to only 45 five years later.¹²

Marquardt made its own compromises. It now was building small rocket engines, including attitude-control thrusters for Apollo and later for the space shuttle. But it too left the field of hypersonics. Arthur Thomas had managed the company's work on IFTV, and as he recalls, "I was chief engineer and assistant general manager. I got laid off. We laid off two-thirds of our people in one day." He knew that there was no scramjet group he might join, but he hoped for the next-best thing: conventional ramjets, powering high-speed missiles. "I went all over the country," he continues. "Everything in ramjet missiles had collapsed." He had to settle for a job working with turbojets, at McDonnell Douglas in St. Louis.¹³

Did these people ever doubt the value of their work? "Never," says Billig. Nucci, Ferri's old friend, gives the same answer: "Never. He always had faith." The problem they faced was not to allay any doubts of their own, but to overcome the misgivings of others and to find backers who would give them new funding. From time to time a small opportunity appeared. Then, as Billig recalls, "we were highly competitive. Who was going to get the last bits of money? As money got tighter, competition got stronger. I hope it was a friendly competition, but each of us thought he could do the job best."¹⁴

Amid this dark night of hypersonic research, two candles still flickered. There was APL, where a small group continued to work on missiles powered by scramjets that were to burn conventional fuels. More significantly, there was the Hypersonic Propulsion Branch at NASA-Langley, which maintained itself as the one place where important work on hydrogen-fueled scramjets still could go forward. As scramjets died within the Air Force, the Langley group went ahead, first with its Hypersonic Research Engine (HRE) and then with more advanced airframe-integrated designs.

SCRAMJETS AT NASA-LANGLEY

The road to a Langley scramjet project had its start at North American Aviation, builder of the X-15. During 1962 manager Edwin Johnston crafted a proposal to modify one of the three flight vehicles to serve as a testbed for hypersonic engines.

This suggestion drew little initial interest, but in November a serious accident reopened the question. Though badly damaged, the aircraft, Tail Number 66671, proved to be repairable. It returned to flight in June 1964, with modifications that indeed gave it the option for engine testing.

The X-15 program thus had this flight-capable testbed in prospect during 1963, at a time when engines for test did not even exist on paper. It was not long, though, before NASA responded to its opportunity, as Hugh Dryden, the Agency's Deputy Administrator, joined with Robert Seamans, the Associate Administrator, in approving a new program that indeed sought to build a test engine. It took the name of Hypersonic Research Engine (HRE).

Three companies conducted initial studies: General Electric, Marquardt, and Garrett AiResearch. All eyes soon were on Garrett, as it proposed an axisymmetric configuration that was considerably shorter than the others. John Becker later wrote that it "was the smallest, simplest, easiest to cool, and had the best structural approach of the three designs." Moreover, Garrett had shown strong initiative through the leadership of its study manager, Anthony duPont.¹⁵

He was a member of the famous duPont family in the chemical industry. Casual and easygoing, he had already shown a keen eye for the technologies of the future. As early as 1954, as a student, he had applied for a patent on a wing made of

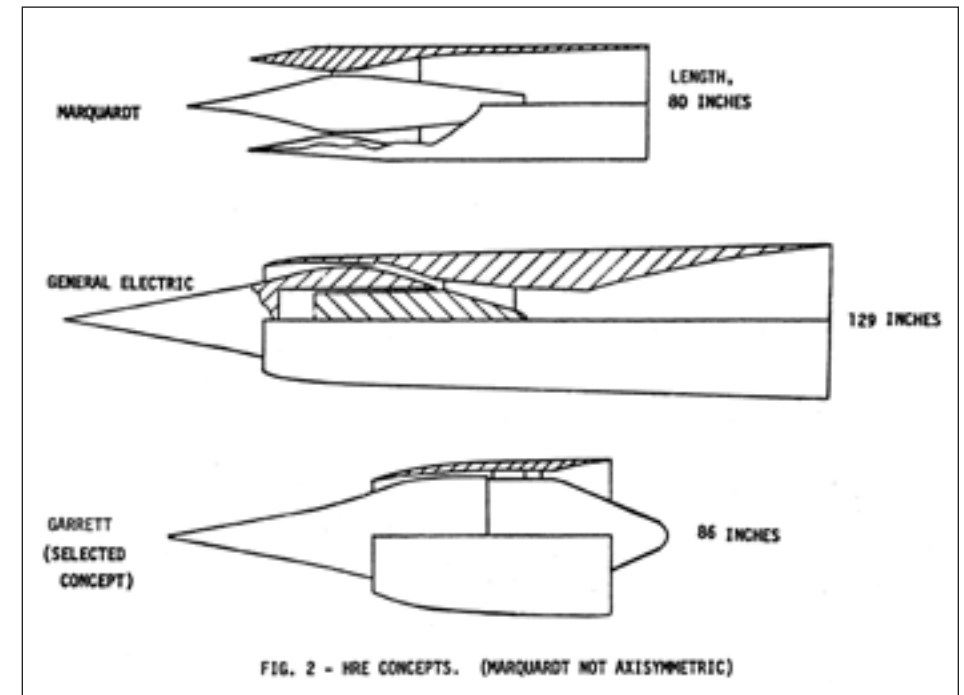

The HRE concepts of three competing contractors. (NASA)

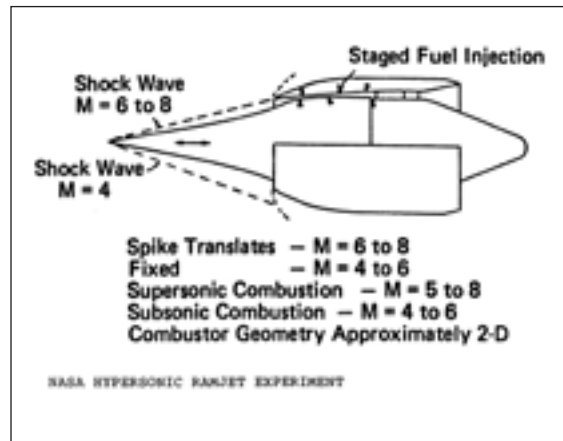

The selected HRE design. (NASA)

The Ordnance Aerophysics Laboratory was still in business, and any of them could spend a month there testing hardware—if they could build scramjet components on short notice. Drawing on \$250,000 in company funds, DuPont crafted a full-scale HRE combustor in only sixty days. At OAL, it yielded more than five hours of test data. Neither GE nor Marquardt showed similar adroitness, while DuPont's initiative suggested that the final HRE combustor would be easy to build. With this plus the advantages noted by Becker, Garrett won the contract. In July 1966 the program then moved into a phase of engine development and test.¹⁷

Number 66671 was flying routinely, and it proved possible to build a dummy HRE that could be mounted to the lower fin of that X-15. This led to a flight-test program that approached disaster in October 1967, when the test pilot Pete Knight flew to Mach 6.72. "We burned the engine off," Knight recalls. "I was on my way back to Edwards; my concern was to get the airplane back in one piece." He landed safely, but historian Richard Hallion writes that the airplane "resembled burnt firewood.... It was the closest any X-15 came to structural failure induced by heating."¹⁸

Once again it went back to the shops, marked for extensive repair. Then in mid-November another X-15 was lost outright in the accident that killed its test pilot, Mike Adams. Suddenly the X-15 was down from three flight-rated airplanes to only one, and while Number 66671 returned to the flight line the following June, it never flew again. Nor would it fly again with the HRE. This dummy engine had set up the patterns of airflow that had caused the shock-impingement heating that had nearly destroyed it.¹⁹

In a trice then the HRE program was completely turned on its head. It had begun with the expectation of using the X-15 for flight test of advanced engines, at a moment when no such engines existed. Now Garrett was building them—but

composite materials. He flew as a co-pilot with Pan American, commemorating those days with a framed picture of a Stratocruiser airliner in his office. He went on to Douglas Aircraft, where he managed studies of Aerospaceplane. Then Clifford Garrett, who had a strong interest in scramjets, recruited him to direct his company's efforts.¹⁶

NASA's managers soon offered an opportunity to the HRE competitors. The Ordnance



Test pilot William "Pete" Knight initiates his record flight, which reached Mach 6.72. (NASA)

the X-15 could not be allowed to fly with them. Indeed, it soon stopped flying altogether. Thus, during 1968, it became clear that the HRE could survive only through a complete shift in focus to ground test.

Earlier plans had called for a hydrogen-cooled lightweight engine. Now the program's research objectives were to be addressed using two separate wind-tunnel versions. Each was to have a diameter of 18 inches, with a configuration and flow path matching those of the earlier flight-rated concept. The test objectives then were divided between them.

A water-cooled Aerothermodynamic Integration Model (AIM) was to serve for hot-fire testing. Lacking provision for hydrogen cooling, it stood at the technical level of the General Electric and Pratt & Whitney test scramjets. In addition, continuing interest in lightweight hydrogen-cooled engine structures brought a requirement for the Structures Assembly Model (SAM), which did not burn fuel. It operated at high temperature in Langley's eight-foot diameter High Temperature Structures Tunnel, which reached Mach 7.²⁰

SAM arrived at NASA-Langley in August 1970. Under test, its inlet lip showed robustness for it stood up to the impact of small particles, some of which blocked thin hydrogen flow passages. Other impacts produced actual holes as large as 1/16

inch in diameter. The lip nevertheless rode through the subsequent shock-impingement heating without coolant starvation or damage from overheating. This represented an important advance in scramjet technology, for it demonstrated the feasibility of crafting a lightweight fuel-cooled structure that could withstand foreign object damage along with very severe heating.²¹

AIM was also on the agenda. It reached its test center at Plum Brook, Ohio, in August 1971, but the facility was not ready. It took a year before the program undertook data runs, and then most of another year before the first run that was successful. Indeed, of 63 test runs conducted across 18 months, 42 returned little or no useful data. Moreover, while scramjet advocates had hoped to achieve shock-free flow, it certainly did not do this. In addition, only about half of the injected fuel actually burned. But shocks in the subsonic-combustion zone heated the downstream flow and unexpectedly enabled the rest of the fuel to burn. In Becker's words, "without this bonanza, AIM performance would have been far below its design values."²²

The HRE was axisymmetric. A practical engine of this type would have been mounted in a pod, like a turbojet in an airliner. An airliner's jet engines use only a small portion of the air that flows past the wings and fuselage, but scramjets have far less effectiveness. Therefore, to give enough thrust for acceleration at high Mach, they must capture and process as much as possible of the air flowing along the vehicle.

Podded engines like the HRE cannot do this. The axisymmetry of the HRE made it easy to study because it had a two-dimensional layout, but it was not suitable for an operational engine. The scramjet that indeed could capture and process most of the airflow is known as an airframe-integrated engine, in which much of the aircraft serves as part of the propulsion system. Its layout is three-dimensional and hence is more complex, but only an airframe-integrated concept has the additional power that can make it practical for propulsion.

Paper studies of airframe-integrated concepts began at Langley in 1968, breaking completely with those of HRE. These investigations considered the

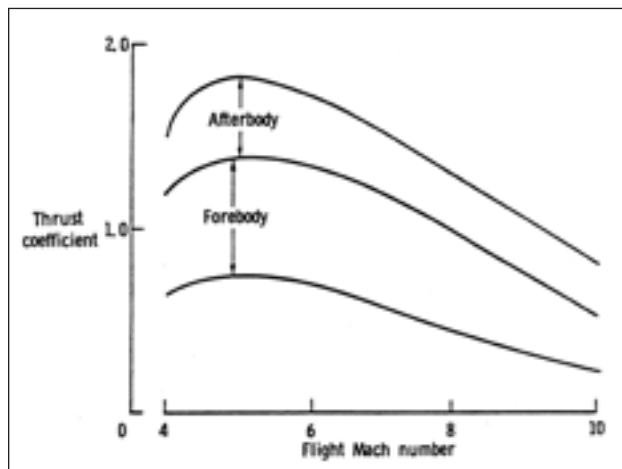

Contributions to scramjet thrust from airframe integration. (NASA)

entire undersurface of a hypersonic aircraft as an element of the propulsion system. The forebody produced a strong oblique shock that precompressed the airflow prior to its entry into the inlet. The afterbody was curved and swept upward to form a half-nozzle. This concept gave a useful shape for the airplane while retaining the advantages of airframe-integrated scramjet operation.

Within the Hypersonic Propulsion Branch, John Henry and Shimer Pinckney developed the initial concept. Their basic installation was a module, rectangular in shape, with a number of them set side by side to encircle the lower fuselage and achieve the required high capture of airflow. Their inlet had a swept opening that angled backward at 48 degrees. This provided a cutaway that readily permitted spillage of airflow, which otherwise could choke the inlet when starting.

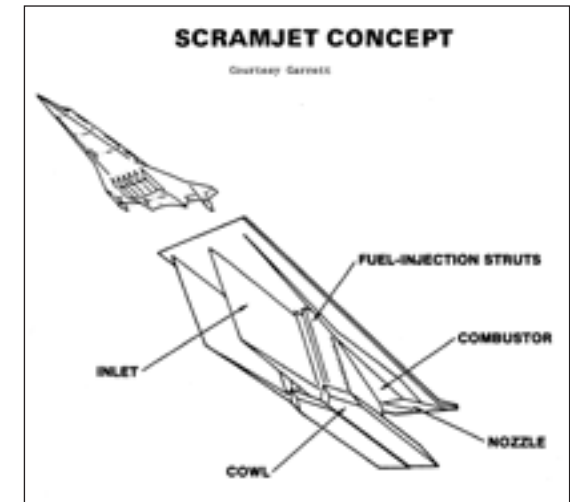

Airframe-integrated scramjet concept. (Garrett Corp.)

The bow shock gave greater compression of the flow at high Mach, thereby reducing the height of the cowl and the required size of the engine. At Mach 10 this reduction was by a factor of three. While this shock compressed the flow vertically, wedge-shaped sidewalls compressed it horizontally. This two-plane compression diminished changes in the inlet flow field with increasing Mach, making it possible to cover a broad Mach range in fixed geometry.

Like the inlet, the combustor was to cover a large Mach range in fixed geometry. This called for thermal compression, and Langley contracted with Antonio Ferri at New York University to conduct analyses. This brought Ferri back into the world of scramjets. The design called for struts as fuel injectors, swept at 48 degrees to parallel the inlet and set within the combustor flow path. They promised more effective fuel injection than the wall-mounted injectors of earlier designs.

The basic elements of the Langley concept thus included fixed geometry, airframe integration, a swept inlet, thermal compression, and use of struts for fuel injection. These elements showed strong synergism, for in addition to the aircraft undersurface contributing to the work of the inlet and nozzle, the struts also served as part of the inlet and thereby made it shorter. This happened because the flow from the inlet underwent further compression as it passed between the struts.²³

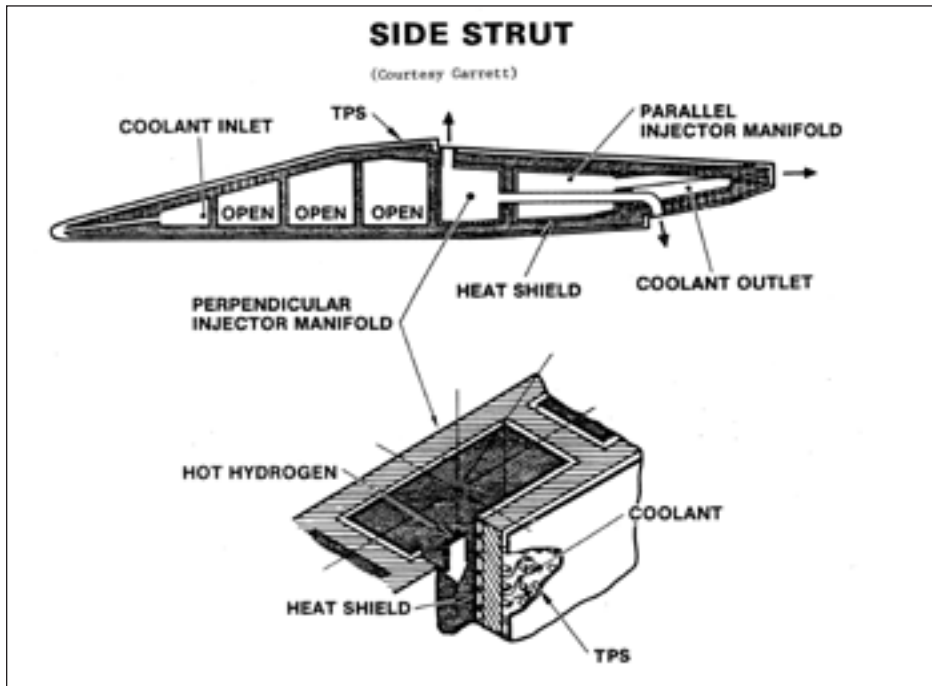

Fuel-injecting strut. Arrows show how hydrogen is injected either parallel or perpendicular to the flow. (Garrett Corporation)

Experimental work paced the Langley effort as it went forward during the 1970s and much of the 1980s. Early observations, published in 1970, showed that struts were practical for a large supersonic combustor in flight at Mach 8. This work supported the selection of strut injection as the preferred mode.²⁴

Initial investigations involved inlets and combustors that were treated as separate components. These represented preludes to studies made with complete engine modules at two critical simulated flight speeds: Mach 4 and Mach 7. At Mach 4 the inlet was particularly sensitive to unstarts. The inlet alone had worked well, as had the strut, but now it was necessary to test them together and to look for unpleasant surprises. The Langley researchers therefore built a heavily instrumented engine of nickel and tested it at GASL, thereby bringing new work in hypersonics to that center as well.

Mach 7 brought a different set of problems. Unstarts now were expected to be less of a difficulty, but it was necessary to show that the fuel indeed could mix and burn within the limited length of the combustor. Mach 7 also approached the limitations of available wind tunnels. A new Langley installation, the Arc-Heated Scramjet Test Facility, reached temperatures of 3,500°F and provided the appropriate flows.

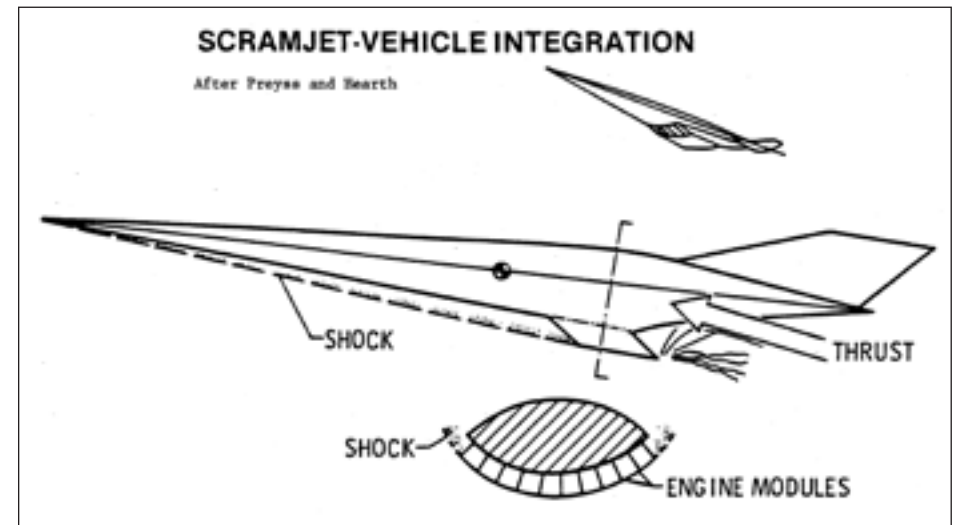

Integration of scramjets with an aircraft. (NASA)

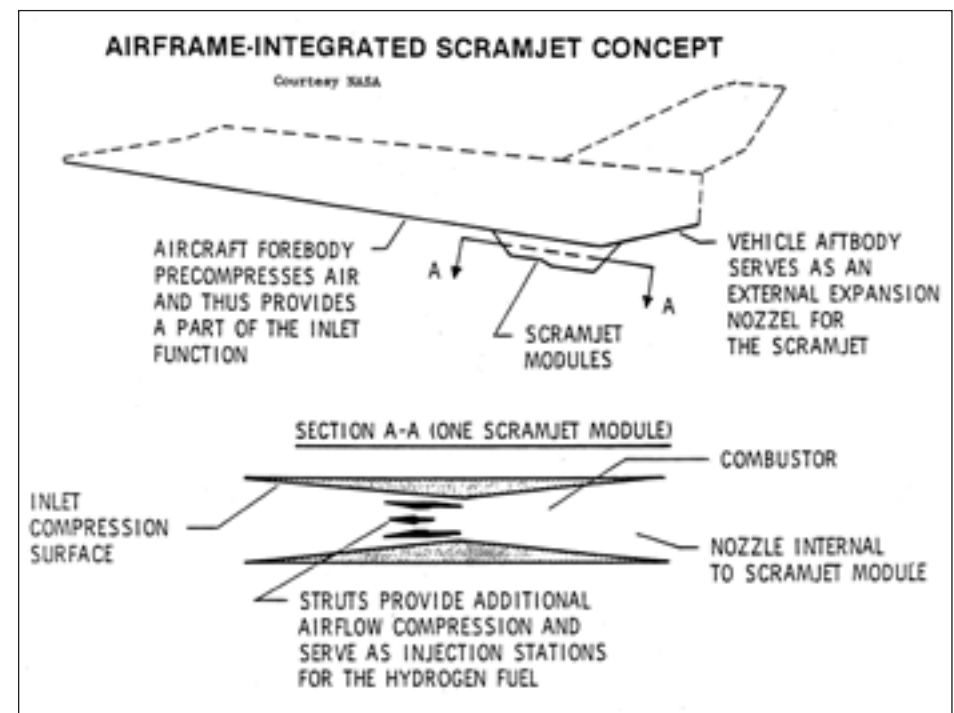

Airflow within an airframe-integrated scramjet. (NASA)

Separate engines operated at GASL and Langley. Both used heat sink, with the run times being correspondingly short. Because both engines were designed for use in research, they were built for easy substitution of components. An inlet, combustor, nozzle, or set of fuel-injecting struts could be installed without having to modify the rest of the engine. This encouraged rapid prototyping without having to construct entirely new scramjets.

More than 70 runs at Mach 4 were made during 1978, first with no fuel injection to verify earlier results from inlet tests, and then with use of hydrogen. Simple theoretical calculations showed that “thermal choking” was likely, with heat addition in the combustor limiting the achievable flow rate, and indeed it appeared. Other problems arose from fuel injection. The engine used three struts, a main one on the centerline flanked by two longer ones, and fuel from these side struts showed poor combustion when injected parallel to the flow. Some unwanted inlet-combustor interactions sharply reduced the measured thrust. These occurred because the engine ingested boundary-layer flow from the top inner surface of the wind-tunnel duct. This simulated the ingestion of an aircraft boundary layer by a flight engine.

The thermal choking and the other interactions were absent when the engine ran very fuel-lean, and the goal of the researchers was to eliminate them while burning as much fuel as possible. They eased the problem of thermal choking by returning to a fuel-injection method that had been used on the HRE, with some fuel being injected downstream as the wall. However, the combustor-inlet interactions proved to be more recalcitrant. They showed up when the struts were injecting only about half as much fuel as could burn in the available airflow, which was not the formula for a high-thrust engine.²⁵

Mach 7 brought its own difficulties, as the Langley group ran off 90 tests between April 1977 and February 1979. Here too there were inlet-combustor interactions, ranging from increased inlet spillage that added drag and reduced the thrust, to complete engine unstarts. When the latter occurred, the engine would put out good thrust when running lean; when the fuel flow increased, so did the measured force. In less than a second, though, the inlet would unstart and the measured thrust would fall to zero.²⁶

No simple solution appeared capable of addressing these issues. This meant that in the wake of those tests, as had been true for more than a decade, the Langley group did not have a working scramjet. Rather, they had a research problem. They addressed it after 1980 with two new engines, the Parametric Scramjet and the Step-Strut Engine. The Parametric engine lacked a strut but was built for ease of modification. In 1986 the analysts Burton Northam and Griffin Anderson wrote:

This engine allows for easy variation of inlet contraction ratio, internal area ratio and axial fuel injection location. Sweep may be incorporated in the

inlet portion of the engine, but the remainder of the engine is unswept. In fact, the hardware is designed in sections so that inlet sweep can be changed (by substituting new inlet sidewalls) without removing the engine from the wind tunnel.

The Parametric Scramjet explored techniques for alleviating combustor-inlet interactions at Mach 4. The Step-Strut design also addressed this issue, mounting a single long internal strut fitted with fuel injectors, with a swept leading edge that resembled a staircase. Northam and Anderson wrote that it “was also tested at Mach 4 and demonstrated good performance without combustor-inlet interaction.”²⁷

How, specifically, did Langley develop a workable scramjet? Answers remain classified, with Northam and Anderson noting that “several of the figures have no dimension on the axes and a discussion of the figures omits much of the detail.” A 1998 review was no more helpful. However, as early as 1986 the Langley researchers openly published a plot showing data taken at Mach 4 and at Mach 7. Curves showed values of thrust and showed that the scramjets of the mid-1980s

indeed could produce net thrust. Even at Mach 7, at which the thrust was less, these engines could overcome the drag of a complete vehicle and produce acceleration. In the words of Northam and Anderson, “at both Mach 4 and Mach 7 flight conditions, there is ample thrust for acceleration and cruise.”²⁸

THE ADVENT OF NASP

With test engines well on their way in development, there was the prospect of experimental aircraft that might exercise them in flight test. Such a vehicle might come forth as a successor to Number 66671, the X-15 that had been slated to fly the

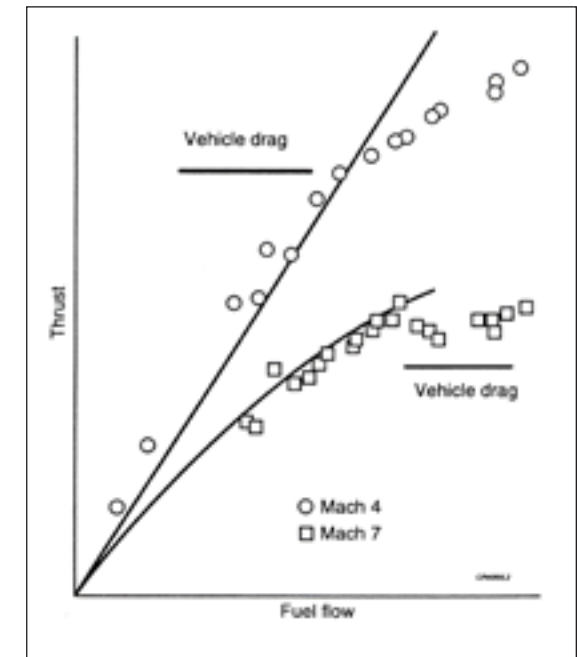

Performance of scramjets. Note that figures are missing from the axes. (NASA)