



**CORPOSALUD-UNIVERSIDAD DE CARABOBO
LABORATORIO REGIONAL DE DIAGNOSTICO E
INVESTIGACION DEL DENGUE Y OTRAS
ENFERMEDADES VIRALES
(LARDIDEV)**



**RE-INTRODUCTION OF DENGUE 3 IN ARAGUA VENEZUELA:
CLINICAL, EPIDEMIOLOGICAL AND LABORATORY FEATURES
OF A NEW OUTBREAK**



COMACH G., JIMENEZ M., DE QUINTANA M., CAMACHO D., ET AL.

DENGUE CASES REPORTED IN VENEZUELA: 1989 - 2001

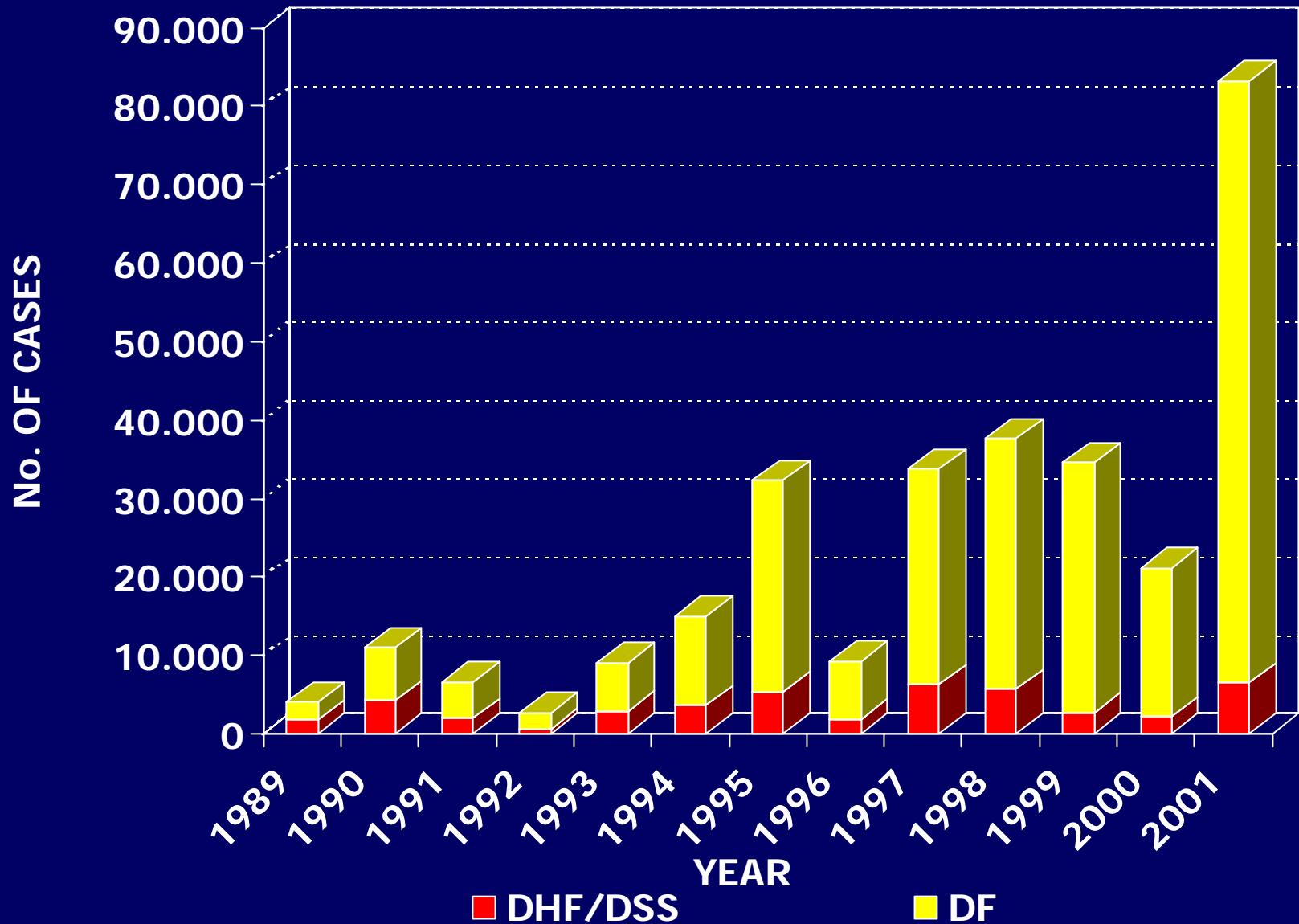

DENGUE VIRUS SEROTYPES DETECTED IN ARAGUA, VENEZUELA: LATE SEPTEMBER 2000 - DECEMBER 2001

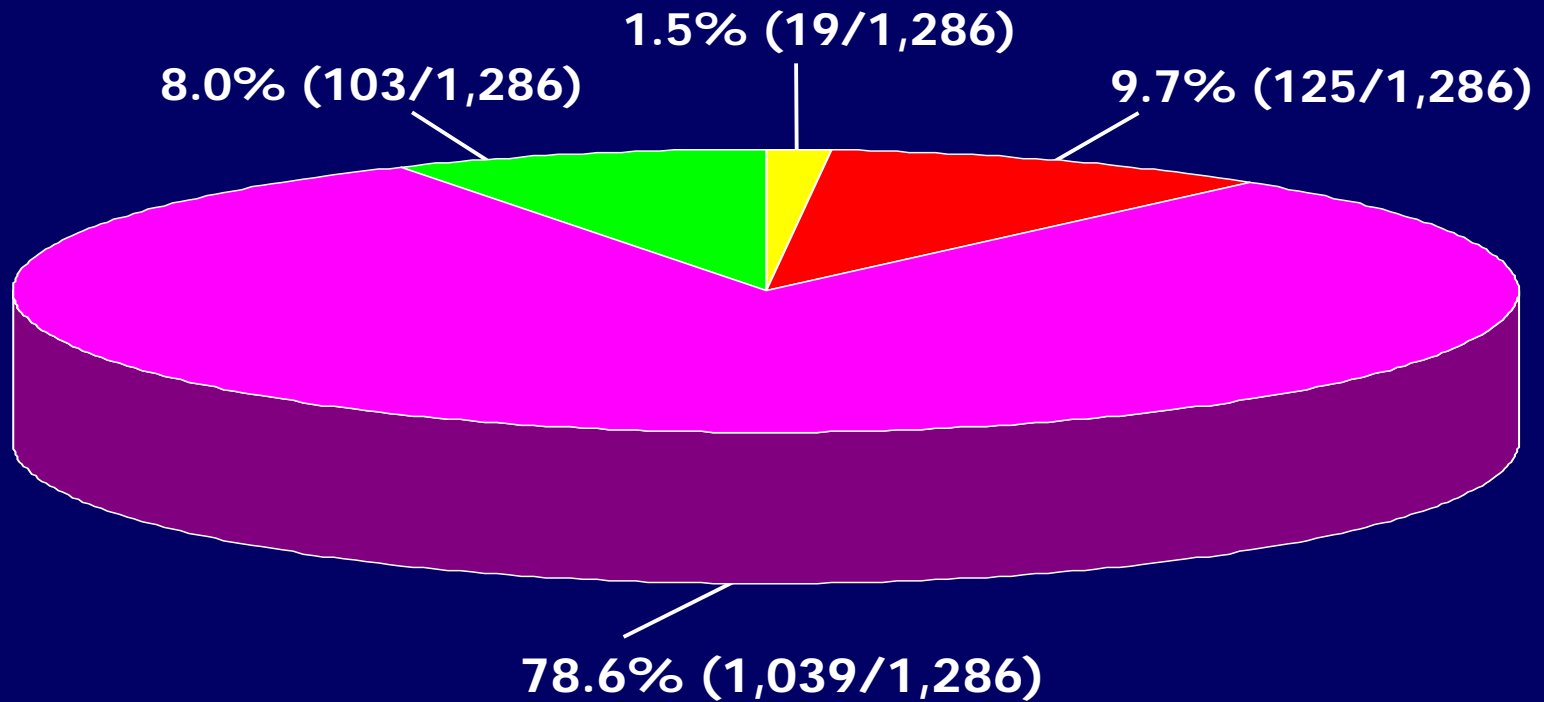

■ Den-1

■ Den-2

■ Den-3

■ Den-4

DENGUE VIRUS SEROTYPES DETECTED IN ARAGUA, VENEZUELA: LATE SEP 2000 - DEC 2001

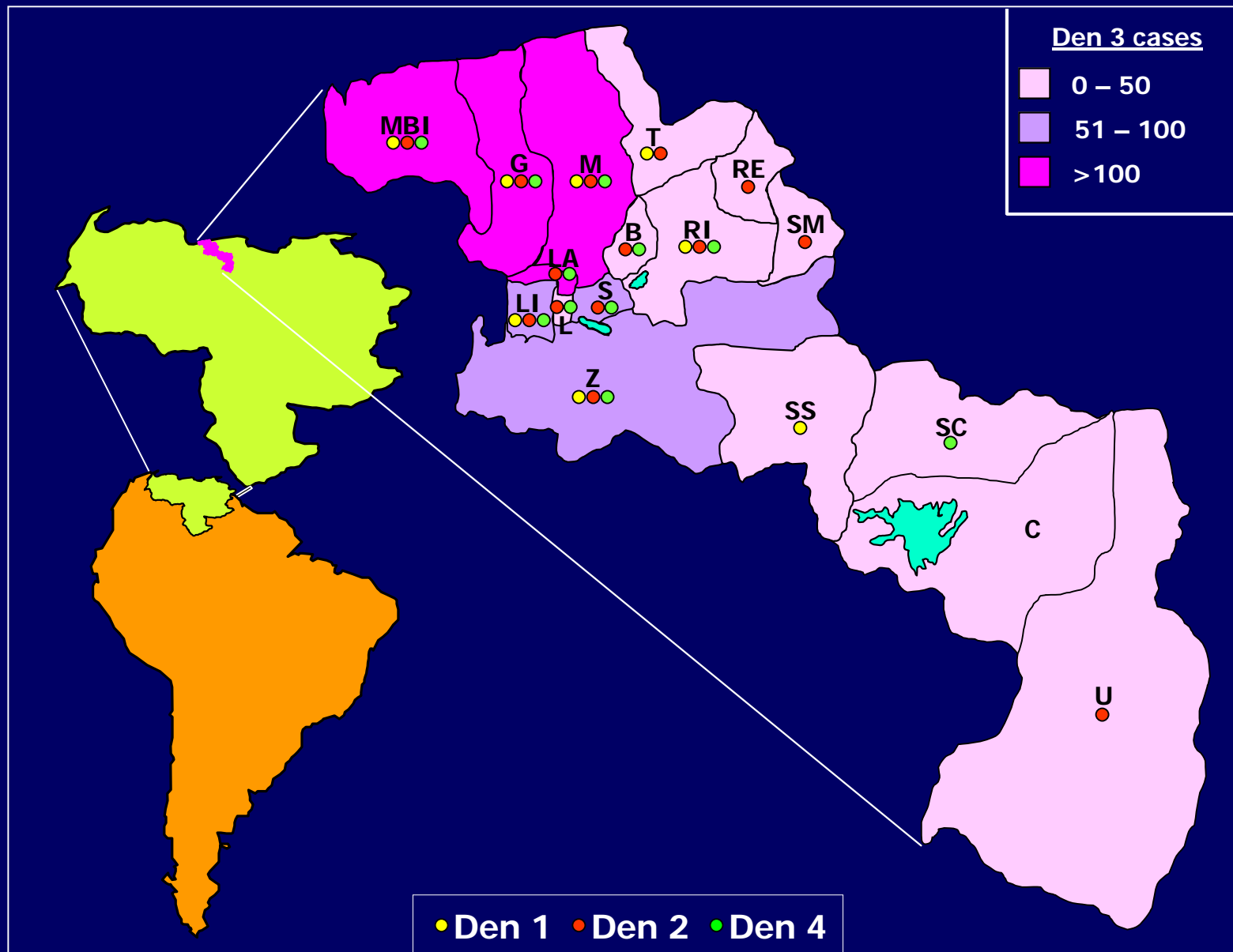

Municipalities: Bolivar (B), Camatagua (C), Girardot (G), J.F. Rivas (RI), L. Alcantara (LA), Lamas (L), Libertador (LI), M.B. Iragorry (MBI), Mariño (M), Revenga (RE), San Casimiro (SC), S. Michelena (SM), S. Sebastian (SS), Sucre (S), Tovar (T), Urdaneta (U) y Zamora (Z)

DENGUE VIRUS SEROTYPES DETECTED IN ARAGUA, VENEZUELA: LATE SEPTEMBER 2000 - DECEMBER 2001

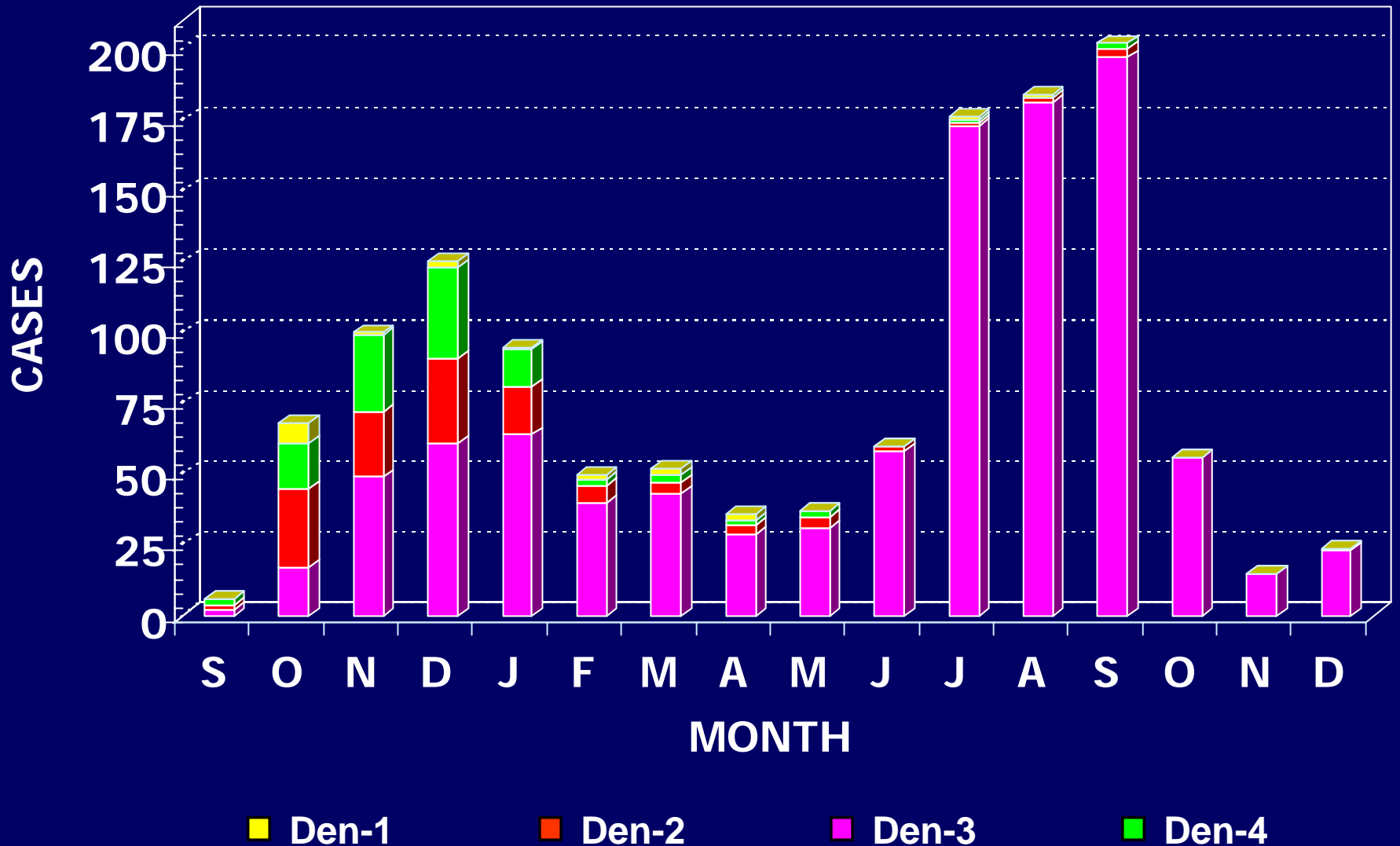

**DENDOGRAM* OF DEN 3 ISOLATES
FROM ARAGUA, VENEZUELA &
WORLDWIDE**
— 0.005 substitutions/site

*Uzcategui N. et al. 2001, unpublished

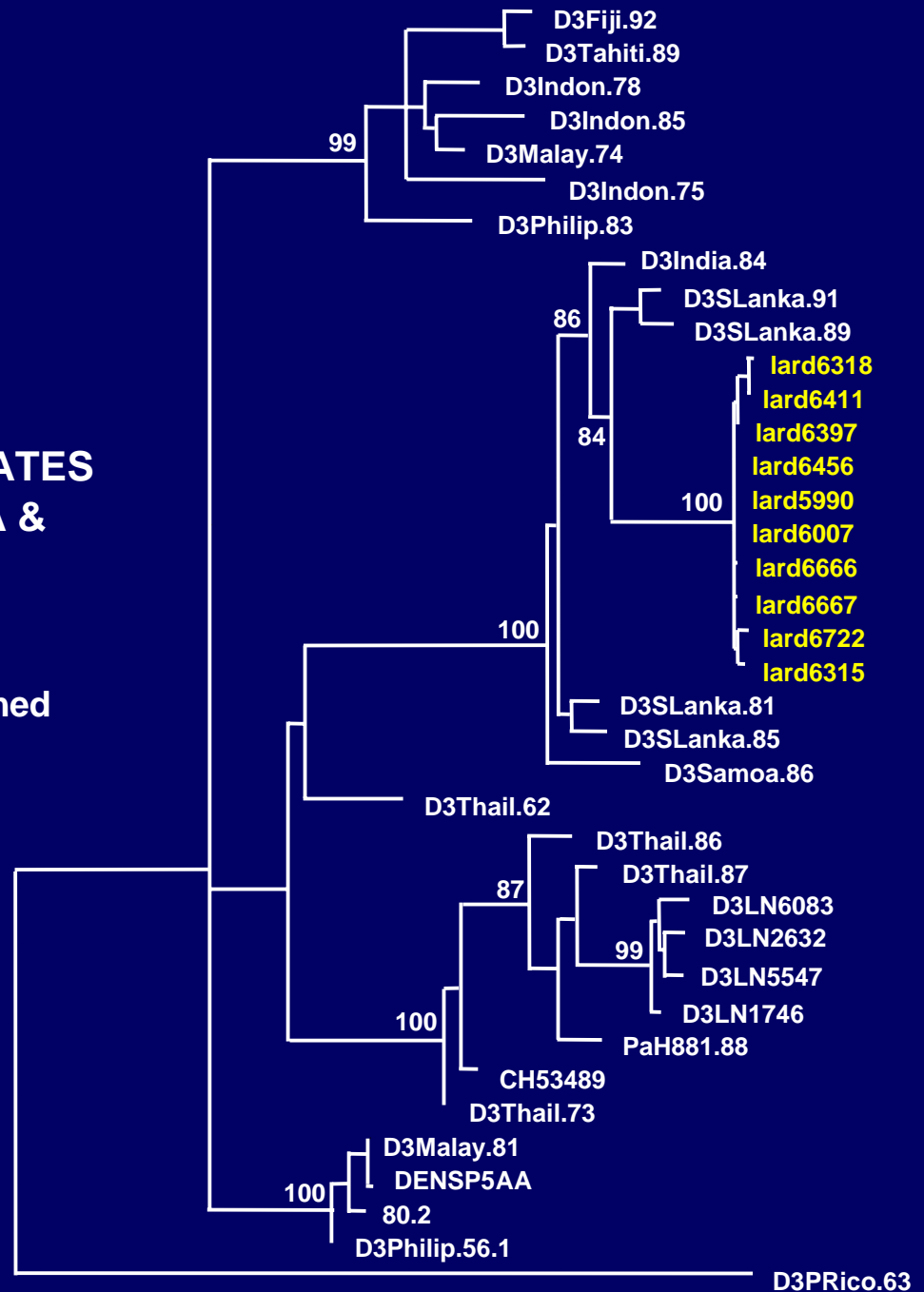

SEX AND AGE DISTRIBUTION OF DEN 3 DETECTED IN ARAGUA, VENEZUELA: LATE SEPTEMBER 2000 - DECEMBER 2001

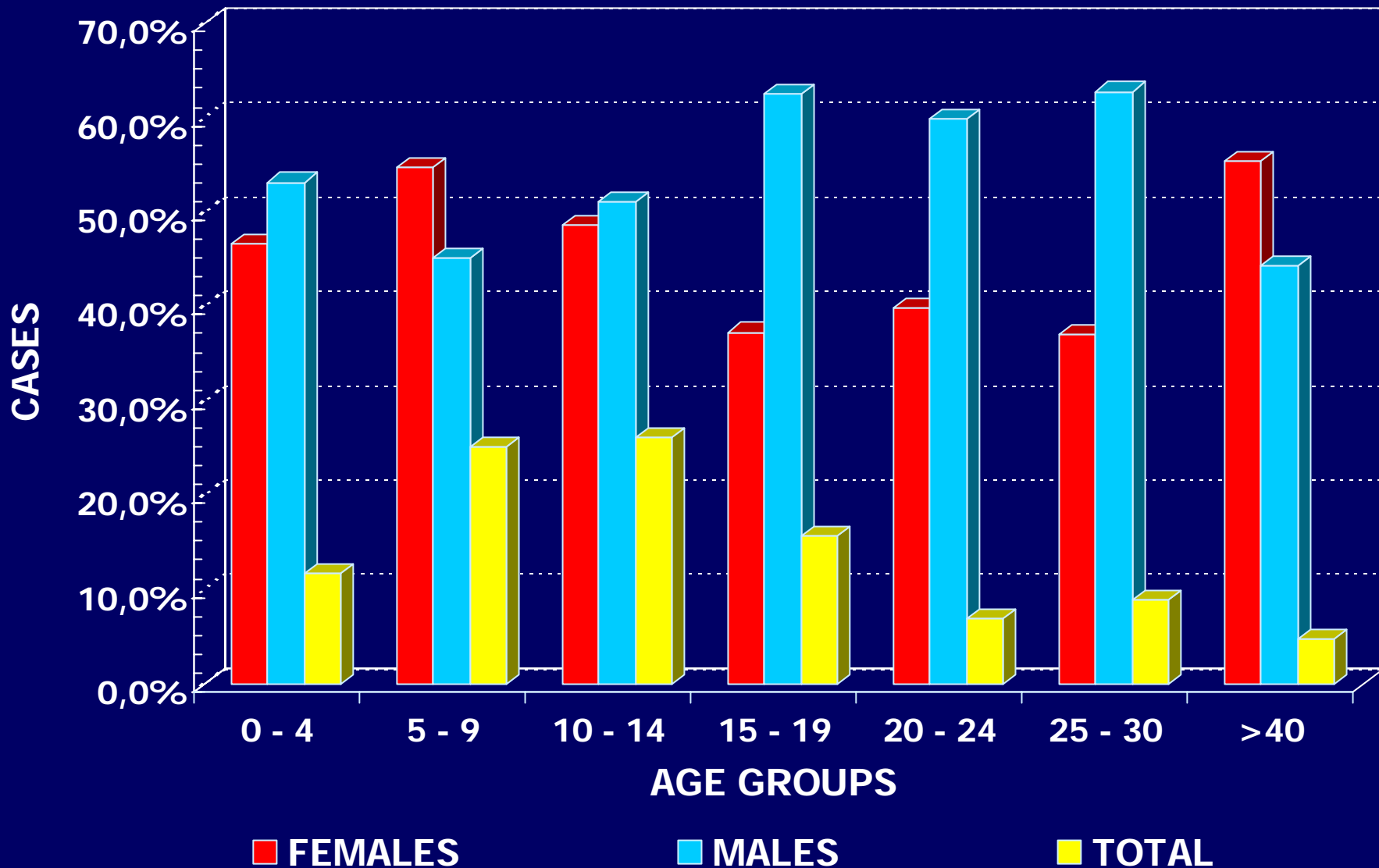

CONFIRMED DENGUE CASES(*) IN ARAGUA: SEP 2000 - DEC 2001

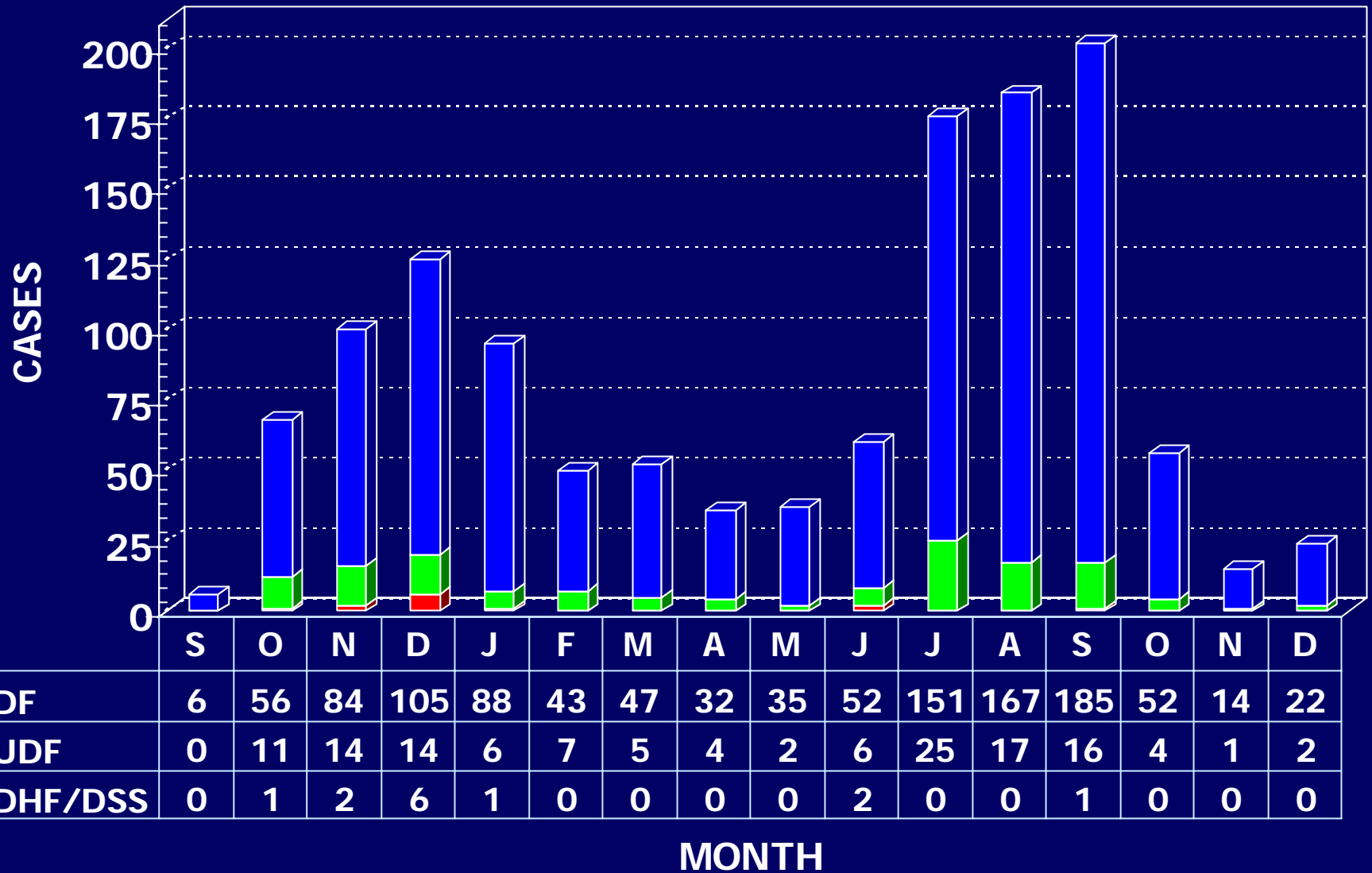

(*) POSITIVES TO VI AND/OR RT-PCR



