



UNITED STATES
NUCLEAR REGULATORY COMMISSION

REGION I
475 ALLENDALE ROAD
KING OF PRUSSIA, PA 19406-1415

August 31, 2000

EA No. 00-179

Mr. A. Alan Blind
Vice President - Nuclear Power
Consolidated Edison Company of
New York, Inc.
Indian Point 2 Station
Broadway and Bleakley Avenue
Buchanan, NY 10511

SUBJECT: NRC SPECIAL INSPECTION REPORT - INDIAN POINT UNIT 2
STEAM GENERATOR TUBE FAILURE - REPORT NO. 05000247/2000-010

Dear Mr. Blind:

This letter transmits the results of a special inspection conducted by an NRC team at your Indian Point Unit 2 reactor facility from March 7 through July 20, 2000, to review the causes of the failure of a steam generator tube on February 15, 2000. The NRC team members included personnel from Region I and the Office of Nuclear Reactor Regulation, as well as NRC-contracted specialists in steam generator eddy current testing. The team reviewed the adequacy of Con Edison's performance during the 1997 steam generator inspections and assessed Con Edison's root cause evaluation, dated April 14, 2000. On July 20, 2000, the results were discussed with you and other members of your staff. The preliminary team findings were sent to you by letter dated July 27, 2000.

The overall direction and execution of the 1997 SG inservice examinations were deficient in several respects. Despite opportunities, Con Edison did not recognize and take appropriate corrective actions for significant conditions adverse to quality that affected the steam generation inspection program. Con Edison did not adequately account for conditions which adversely affected the detectability of, and increased the susceptibility to, tube flaws. As a result, tubes with primary water stress corrosion cracking (PWSCC) flaws in their small radius U-bends were left in service following the 1997 inspection, until the failure of one of these tubes occurred on February 15, 2000, while the reactor was at 100-percent power.

Using the Reactor Safety Significance Determination Process (SDP), we preliminarily characterized this inspection finding as high risk significance (Red). While there were no public health and safety consequences from the tube failure event itself, leaving the degraded tubes in-service resulted in a significant reduction in safety margin based on the increased risk of a steam generator tube rupture (SGTR) during Operating Cycle 14. Risk insights from the Indian Point 2 individual plant examination and other probabilistic risk assessments indicate that SGTR events are a significant contributor to plant risk. We concluded that Con Edison's failure to identify and adjust or modify the inspection methods and analysis to account for significant conditions that affected the quality of the 1997 steam generator inspection was an apparent violation of 10 CFR 50, Appendix B, Criterion XVI, Corrective Actions.

As discussed with Mr. John McCann of your staff, we have scheduled a Regulatory Conference for September 26, 2000, in the Region I office to discuss any differences with the NRC evaluation prior to our final significance determination on the 10 CFR 50, Appendix B, Criterion XVI, issue discussed above. The Regulatory Conference is an opportunity to provide us with additional information, including your position on the significance of this issue discussed in the attached report, the bases for your position, and any disagreement with the apparent violation. The Regulatory Conference on this matter will be open for public observation. Accordingly, no enforcement is presently being issued for these inspection findings. Following the conference, we will finalize our significance determination and enforcement decision. You will be advised by separate correspondence of the results of our deliberations on this matter.

The NRC also identified an issue involving improper calibration and set-up of the eddy current technique used to examine the U-bend areas of low-row tubes. Using the Reactor Safety SDP we determined this issue to be of very low safety significance (Green). The issue involved a violation of NRC requirements, but because of the very low safety significance, the violation was not cited. If you contest this non-cited violation, you should provide a response within 30 days of the date of this inspection report, with the basis for your denial, to the Nuclear Regulatory Commission, ATTN.: Document Control Desk, Washington DC 20555-0001; with copies to the Regional Administrator Region I; the Director, Office of Enforcement, United States Nuclear Regulatory Commission, Washington, DC 20555-0001; and the NRC Resident Inspector at Indian Point Unit 2. Should you have any questions regarding this report, please contact Mr. David C. Lew at (610) 337-5120.

In accordance with 10 CFR 2.790 of the NRC's "Rules of Practice," a copy of this letter and its enclosure will be available electronically for public inspection in the NRC Public Document Room or from the Publicly Available Records (PARS) component of NRC's document system (ADAMS). ADAMS is accessible from the NRC Web site at <http://www.nrc.gov/NRC/ADAMS/index.html> (the Public Electronic Reading Room).

Sincerely,

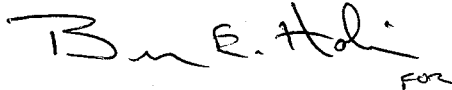
Handwritten signature of Wayne D. Lanning in black ink, with the word "FOR" written in small letters below the signature.

Wayne D. Lanning, Director
Division of Reactor Safety

Docket No. 05000247
License No. DPR-26

Enclosure: Inspection Report 05000247/2000-010

cc w/encl:

J. Groth, Senior Vice President - Nuclear Operations
J. Baumstark, Vice President, Nuclear Power Engineering
J. McCann, Manager, Nuclear Safety and Licensing
B. Brandenburg, Assistant General Counsel
C. Faison, Director, Nuclear Licensing, NYPA
J. Ferrick, Operations Manager
C. Donaldson, Esquire, Assistant Attorney General, New York Department of Law
P. Eddy, Electric Division, Department of Public Service, State of New York
T. Rose, NFSC Secretary
F. William Valentino, President, New York State Energy Research
and Development Authority
J. Spath, Program Director, New York State Energy Research
and Development Authority
County Clerk, West Chester County Legislature
Westchester County Executive
Putnam County Executive
Rockland County Executive
Orange County Executive
T. Judson, Central NY Citizens Awareness Network
M. Elie, Citizens Awareness Network

Mr. A. Alan Blind

4

Distribution w/encl:

- H. Miller, RA
- J. Wiggins, DRA
- R. Borchardt, OE (2) (RidsOEMailCenter)
- J. Shea, RI EDO Coordinator
- W. Raymond, SRI - Indian Point 2
- E. Adensam, NRR (RidsNrrDlpmLpdi)
- P. Eselgroth, DRP
- P. Milano, NRR
- G. Wunder, NRR
- M. Gamberoni, NRR
- W. Scott, NRR
- J. Wilcox, NRR
- B. Summers, OE (BTS)
- S. Barber, DRP
- L. Harrison, DRP
- R. Junod, DRP
- Region I Docket Room (w/concurrences)
- M. Oprendeck, DRP
- W. Lanning, DRS
- B. Holian, DRS
- D. Lew, DRS
- W. Schmidt, DRS
- B. Sheron, ADPT, NRR
- D. Holody, EO
- R. Urban, ORA
- D. Dambly, OGC
- G. Matakas, ORA
- J. Johnson, NRR

DOCUMENT NAME: G:\PERF EVAL\SCHMIDT\IP2000010.WPD

After declaring this document "An Official Agency Record" it **will/will not** be released to the Public.

To receive a copy of this document, indicate in the box: "C" = Copy without attachment/enclosure "E" = Copy with attachment/enclosure "N" = No copy

OFFICE	RI/DRS	RI/DRS	RI/DRP	HQ/NRR	RI/DRS	E
NAME	WSchmidt <i>W. Schmidt</i>	DLew (WLS for) <i>W. Lew</i>	PEselgroth <i>P. Eselgroth</i>	JStrosnider (via phone) <i>WLS</i>	WLanning <i>W. Lanning</i>	<i>BEA for</i>
DATE	08/31/00	08/31/00	08/31/00	08/30/00	08/31/00	

OFFICIAL RECORD COPY

U.S. NUCLEAR REGULATORY COMMISSION

REGION I

Docket No. 05000247

License No. DPR-26

Report No. 05000247/2000-010

Licensee: Consolidated Edison Company of New York, Inc.

Facility: Indian Point 2 Nuclear Power Plant

Location: Broadway and Bleakley Avenue
Buchanan, New York 10511

Dates: March 7 through July 20, 2000

Team Manager: David C. Lew, Performance Evaluation Branch

Team Leader: Wayne L. Schmidt, Senior Reactor Inspector, DRS

Inspectors: G. Cranston, Reactor Inspector, DRS
I. Barnes, NRC Contractor
E. Murphy, Senior Engineer, Materials and Chemical Engineering Branch,
(EMCB), Division of Engineering, Office of Nuclear Reactor
Regulation (NRR)
S. Coffin, Engineer, EMCB, DE, NRR
C. Dodd, Part-Time, EMCB, DE, NRR
M. Modes, Senior Reactor Inspector, DRS
L. Dudes, Senior Resident Inspector, Oyster Creek
J. Trapp, Senior Reactor Analyst, DRS
S. Long, Senior Risk Analyst, Probability Safety Assessment Branch,
Division of Systems Safety and Analysis, NRR

Approved by: David C. Lew, Chief
Performance Evaluation Branch
Division of Reactor Safety

SUMMARY OF FINDINGS

Indian Point 2 Nuclear Power Plant NRC Inspection Report 05000247/2000-010

IR 05000247-00-010, March 7 thru July 20, 2000; Consolidated Edison of New York, Inc.; Indian Point Unit 2; Special Team; steam generator tube failure, visual, eddy current inspection, technique qualification, corrective actions.

The team members included personnel from the Office of Nuclear Reactor Regulation and Region I, and NRC-contracted specialists in steam generator (SG) eddy current testing (ECT). The risk significance of issues is indicated by their color (Green, White, Yellow, or Red) and is determined by the Significance Determination Process (SDP) in Inspection Manual Chapter 0609 (See Attachment 1). This inspection identified one preliminarily Red finding, characterized as 'to be determined (TBD)'. The NRC will make the final determination of significance following a scheduled Regulatory Conference. Section 1R4 discusses the basis for this preliminary Red inspection finding. The team also identified one Green finding.

This special inspection examines the causes of the steam generator tube failure (SGTF), which were outside the scope of previous NRC inspections concerning the February 15, 2000, event. The NRC conducted an Augmented Inspection Team (AIT), Inspection Report No. (IR) 05000247/2000-002 to promptly establish the event facts. To review Con Edison's short term corrective actions for issues identified during the AIT, an emergency preparedness inspection, IR 05000247/2000-06, and an AIT followup inspection, IR 05000247/2000-007, were conducted.

REACTOR SAFETY

Cornerstone: Barrier Integrity

- **TBD** - The overall direction and execution of the 1997 SG inservice examinations were deficient in several respects. Despite opportunities, Con Edison did not identify and correct a significant condition adverse to quality, the presence of primary water stress corrosion cracking (PWSCC) flaws in row 2 steam generator (SG) tubes in the small-radius, low-row U-bend apex area. Con Edison did not adequately account for conditions which adversely affected the detectability of, and increased the susceptibility to, tube flaws. Specifically, during the 1997 SG eddy current test (ECT) and secondary side visual examinations,
 1. a PWSCC defect was identified for the first time, at the apex of one row 2 tube, signifying the potential for other similar cracks in the low-row tubes. However, Con Edison did not adequately evaluate the susceptibility of low-row tubes to PWSCC, the extent to which this degradation existed, and the increased probability of such a defect to rupture during operation.
 2. indications of tube denting were identified for the first time in low-row tubes at the upper tube support plate (TSP) when restrictions were encountered as ECT probes were inserted into those tubes. Restrictions in 19 low-row tubes signified increased probability of deformed flow slots (hour-glassing) at the upper TSP. Hour-glassing of the upper TSP increases the stresses at the U-bend apex of tubes. These stresses are the leading contributor to low-row U-bend apex

PWSCC. However, Con Edison did not adequately evaluate the potential for hour-glassing based on the indications of the low-row tube denting and the identified apex PWSCC defect. Further, Con Edison did not have established procedures and practices to determine if significant hour-glassing in the upper TSP flow slot was occurring.

3. significant ECT signal interference (noise) was encountered in the data obtained during the actual ECT of several low-row U-bend tubes. This significant noise level reduced the probability of identifying an existing PWSCC tube defect. However, the 1997 SG inspection program was not adjusted to compensate for the negative effects of the noise in detecting flaws, particularly when conditions that increased susceptibility to PWSCC existed, e.g., did not develop specific criteria for plugging tubes based on noise and/or enhance the analysis of existing data.

As a result, tubes with PWSCC flaws in their small radius U-bends were left in service following the 1997 inspection, until the failure of one of these tubes occurred on February 15, 2000, while the reactor was at 100-percent power.

The team preliminarily characterized this inspection finding as high risk significance (Red). Leaving the degraded tubes in-service resulted in a significant reduction in safety margin based on the increased risk of a steam generator tube rupture (SGTR) during Operating Cycle 14. Risk insights from the Indian Point 2 individual plant examination and other probabilistic risk assessments indicate that SGTR events are a significant contributor to plant risk. The team concluded that Con Edison's failure to identify and adjust or modify the inspection methods and analysis to account for significant conditions that affected the quality of the 1997 steam generator inspection was an apparent violation of 10 CFR 50, Appendix B, Criterion XVI, Corrective Actions. Con Edison disagreed with the characterization of this issue as a violation during the exit meeting. (Section 4OA2.1)

- **Green** - During the 1997 refueling outage the U-bend mid-range Plus Point ECT probe, used for SG tube inspection, was not properly set up to the correct calibration standard. Specification NPE-72217 required the use of an Electric Power Research Institute (EPRI)-qualified technique. The probe was not set up with the calibration standard or with the phase rotation specified on the EPRI qualified technique #96511, dated May 1996. This issue did not have a substantial impact on the ability to detect PWSCC flaws. This issue involved matters with very low risk significance, because it did not directly affect the ability to detect tube flaws and as such, did not affect the reactor coolant system integrity. The team identified a non-cited violation of 10 CFR 50, Appendix B, Criterion IX, Special Processes. (Section IR3.1)
- **No Color** - The team concluded that Con Edison's root cause analysis for the SGTF, dated April 14, 2000, did not identify and address significant SG inspection program performance issues as they related to the failure of tube R2C5 in SG 24 on February 15, 2000. While the root cause analysis attributed the SGTF to a flaw that was obscured by ECT signal noise, it did not identify or address deficiencies in the processes and practices during the 1997 SG inspection. (Section 4OA2.2)

TABLE OF CONTENTS

	PAGE
SUMMARY OF FINDINGS	ii
BACKGROUND	1
1. REACTOR SAFETY	6
1R1 Initial Review of Eddy Current Data Following the Tube Failure	6
1R2 Review of 1997 Inspection Relative to Low-Row U-Bends	7
.1 Review of the 1997 U-Bend Primary Water Stress Corrosion Cracking Indication	7
.2 Denting and Hour-Glassing	8
.3 Eddy Current Data Review	9
1R3 Review of the 1997 Eddy Current Inspection Program	11
.1 Eddy Current Technique Qualification	11
.2 Data Analysis Guideline Review	13
.3 Analyst Training Review	14
1R4 Risk Significance - Event and Core Damage Frequency and Large Early Release	15
.1 Actual Consequences	15
.2 Inspection Finding Risk	15
4. OTHER ACTIVITIES	17
4OA2 Identification and Resolution of Problems	17
.1 1997 Steam Generator Inspection Program	17
.2 Review of Con Edison's Root Cause Analysis for the Tube Failure ...	18
4OA6 Management Meetings	18
.1 Exit Meeting Summary	18
PARTIAL LIST OF PERSONS CONTACTED	20
ITEMS OPENED AND CLOSED	20
LIST OF DOCUMENTS REVIEWED	21
LIST OF ACRONYMS USED	24
REFERENCED FIGURES 1 THROUGH 19	25
ATTACHMENT 1	
ATTACHMENT 2: Risk Assessment and Significance Determination	

Report Details

BACKGROUND

Summary of Plant Event

Following the steam generator tube failure (SGTF) at the Indian Point 2 nuclear power plant on February 15, 2000, Consolidated Edison Company of New York, Inc. (Con Edison) took the unit to a cold shutdown condition. Con Edison conducted an evaluation and found that the tube that failed was row 2, column 5 (R2C5) in steam generator (SG) 24. This low-row tube cracked at the apex of the small-radius U-bend due to primary water stress corrosion cracking (PWSCC). Subsequent to the SGTF, Con Edison conducted an eddy current test (ECT) examination of the SG tubes and conducted visual inspections of the secondary side of the SGs. During these ECT inspections, Con Edison found greater than 1-percent of the tubes in SGs 21 and 24 contained defects placing the unit in a condition that required NRC approval before restarting the plant in accordance with the technical specifications (TSs). At the conclusion of the inspection, the unit remained in cold shutdown pending NRC restart approval. On August 11, 2000, during documentation of this report, Con Edison announced plans to replace the SGs prior to restarting the unit.

The NRC conducted an Augmented Inspection Team (AIT), Inspection Report No. (IR) 05000247/2000-002 to promptly establish the event facts. To review Con Edison's short term corrective actions for issues identified during the AIT, an emergency preparedness inspection, IR 05000247/2000-06, and an AIT Followup inspection, IR 05000247/2000-007, were conducted. This special inspection examines the causes of the February 15, 2000, SGTF.

Steam Generator Description

Indian Point 2 is a four-loop pressurized water reactor, meaning that there are four SGs, one per loop, that transfer heat from the reactor coolant system (RCS) to the secondary water. This heat causes the secondary water to boil, and the resulting steam is used to turn the turbine, which turns the electrical generator. Figure 1 shows a Westinghouse Model 44 SG, like those in use at Indian Point 2. The four SGs are identified as SG 21 through SG 24.

Each SG contains 3,260 tubes. Reactor coolant flows inside these tubes, with the secondary water/steam on the outside. The tubes are made of mill-annealed Inconel Alloy 600 and are arranged in an inverted U fashion, with increasing distances and heights from the inner-most row (row 1) outward. The tubing has an outside diameter (OD) of 0.875 inches and a wall thickness of 0.050 inches average. Each tube is identified by its row number, counting from the center out, and its column number, counting from one side of the SG. The "low-row" tubes (rows 1 - 4) each have 92 tubes. The row 1 tubes were removed from service, by plugging, prior to initial operation.

The tubes are supported vertically by the thick tube sheet at the bottom of the SG and horizontally as they pass through drilled-holes in the six evenly spaced carbon steel tube support plates (TSPs). In each TSP, there are holes cut to allow water/steam flow around the tubes. Also, there are six evenly spaced flow slots that run across the diameter, between the two legs of the adjacent row 1 tubes. The flow slot openings are about 15-inches long (spanning about twelve tubes) and about 3-inches wide. The U-bend area is located above the upper TSP.

During operation, the RCS is pressurized to approximately 2,235 psig. Normal SG secondary-side pressure varies with plant load between approximately 1,000 psig at no load to approximately 700 psig at 100-percent power.

The pressure difference between the RCS and the secondary-side of the SGs can cause leakage from radioactive RCS water to the secondary side of the SG. This is referred to as primary-to-secondary leakage. Primary-to-secondary leakage occurs through several pathways, including existing tube defects and through leakage by plugs in tubes that have been removed from service.

Technical Specifications

SG tubes have an important safety role because they constitute a barrier between the radioactive primary side and non-radioactive secondary side of the plant. During operation, SG tubing can degrade due to corrosion mechanisms and mechanical wear on the OD or the inside diameter (ID) of the tubing.

The plant's TS require that a representative sample of the SG tubes be examined using ECT, once every two years during a plant shutdown, to ensure identification of degraded tubes and the removal from service of tubes with defects. If degradation is found, the sample of tubes is expanded to ensure that the sample remains representative of the overall SG conditions. Tubes with degradation greater than 40-percent through wall (TW) are considered defective and must be removed from service. Tubes are normally removed from service by inserting a plug at both ends of the tube.

The primary-to-secondary leakage rate is limited by the plant technical specifications to 0.3 gallons per minute (gpm). The primary-to-secondary leakage is monitored through radiological analysis (knowing the primary coolant activity and comparing it to the secondary water activity) and by continuous radiation monitors on the steam lines, SG blowdown lines, and condenser air ejector discharge (off-gas).

The TS also contain a requirement to report significant deformation of the upper TSP flow slots (hour-glassing) since it can have a significant effect on the integrity of tubes beyond row 1. To allow visual inspection in this region, Con Edison, prior to 1997, installed inspection ports on SG 21 and SG 23. (See Applicable Steam Generator Degradation Mechanisms below.)

Eddy Current Test Examination Technique

ECT is a method of inspecting SG tubes by passing a probe that generates an electromagnetic field through the tubes. The probe senses the disturbance of the field caused by defects in the tubing. The technique is based on the principle of electromagnetic impedance of a coil in an alternating current circuit. In such a circuit, the impedance of the coil causes the circuit voltage and current to be out of phase. Changes in the coil impedance are observed as variations in the voltage across the coil and by the degree that the voltage and current are out of phase (referred to as the phase angle).

An eddy current is an electrical current caused to flow in a conductor due to the variation of an electromagnetic field. In ECT, a varying electromagnetic field is generated when an alternating current is passed through the probe, which consists of a wire coil. The eddy current induced is

opposite to the probe current. The eddy current is directly affected by a defect that is perpendicular to its direction of flow. When the probe is inside a tube, the ECT analyst looks for changes in the coil impedance due to a defect that is obstructing the eddy current flow within a tube. The defect can be detected by observing the amplitude and phase angle of the coil voltage.

Single coil probes as shown in Figure 2 will induce the eddy current in only one direction, which is a compressed mirror image of the current in the coils. Defects that are perpendicular to the eddy current flow, interrupt the eddy current flow and the probe coil voltage will be affected. Specially designed ECT probes can classify defects as axial cracks, circumferential cracks or both.

The frequency of the alternating current sent to the probe and the size of the probe affect how deep the eddy current penetrates into the tube, the higher the frequency the less the penetration. Probes have been designed that operate at several frequencies at one time. One probe may collect different frequency data during an examination.

The Plus Point probe consists of two coils wound at 90 degrees to each other, as shown in Figure 3. The coils are mounted on a shoe that rotates as it passes through the tube to allow a complete examination. The turns of the two coils are interleaved so that both are effectively the same distance from the surface of the tube. The coils are connected in a bridge circuit, as shown in Figure 4, and the voltage difference between the two signals is amplified. The two coils allow the scanning for both axial and circumferential defects. The mid-range Plus Point probe used during the 1997 examination is a multifrequency probe, operating at 10, 100, 300, and 400 kHz.

Noise in ECT is defined as any non-relevant signal that tends to interfere with the normal reception or processing of a desired flaw signal. Signal-to-noise ratio is a way of evaluating the magnitudes of a relevant signal (defect) to the non-relevant signal (noise). The higher the signal-to-noise ratio, the easier it is to detect a defect.

The American Society of Mechanical Engineers (ASME) code Section XI, specifies the use of ECT for SG tube inservice examination. The Electric Power Research Institute (EPRI) has provided industry guidance on ECT recommended practices, in 1997, through their PWR Steam Generator Examination Guidelines, Rev. 4 (EPRI SG Guidelines).

EPRI maintains the list of qualified ECT techniques for use during SG inspections. This qualification includes the verification that the technique can identify known defects with a probability of detection (POD) of greater than 80-percent, with a 90-percent confidence. The POD of flaws is calculated based on the detectability in a sample of tubes with known flaws (defects). These defects may be actual flaws in tubes removed from SGs across the industry or man made notches in tubes using laser-machining or a process called electro-discharge machining (EDM).

In accordance with ASME Section XI and the EPRI SG Guidelines, the ECT techniques are calibrated, as with any measurement instrument, to calibration standards during their use. These calibration standards include notches of known depth and length against which the analyst calibrates the instrument.

ECT information may be displayed in numerous forms, as shown in Figures 5-14. During an ECT examination, the data and the analyses conducted are electronically stored and maintained as part of the plant inspection record. The c-scan plot is a topographical picture of the changes in probe impedance, as if the tube was split and laid out flat. The signal shows a voltage reading that has been adjusted for phase angle (referred to as the vertical component). The strip chart is a look at the high and low values shown on the c-scan, as if the c-scan was viewed from the side. The lissajous is a graphical view of the voltage and phase angle effects at a specific point in the tube.

ECT signals may be affected by deposits (e.g., copper and magnetite) that collect on the OD surface of the tubes. Different types of flaws within the tube wall, deposits outside the tube, and SG structures, such as TSPs and the tube roll transitions, all have an effect on the ECT signal and have a characteristic lissajous signal.

Through extensive training and qualification, the ECT analyst becomes familiar with the different effects and is able to detect a flaw. Through different techniques and data analysis, the analyst can make an estimate of the size (depth and length) of a defect.

Applicable Steam Generator Degradation Mechanisms

Stress corrosion cracking (SCC) is caused by the simultaneous presence of a tensile stress, a specific corrosive medium, and a susceptible material. SCC can initiate from either the tube's ID or OD. When initiated on the ID, it is referred to as PWSCC, and, on the OD, it is referred to as ODSCC.

Based on the crack characteristics, a PWSCC defect (and a SCC defect in general) may not yield an ECT signal of the same amplitude of a similarly sized calibration standard EDM defect. Further as stated in NRC Information Notice 97-16, *"There continues to be an absence of pulled tube information to confirm that the detection threshold for these cracks is better than 40 - 50-percent through wall. In addition, available inspection techniques are not capable of reliably sizing crack depths and, for this reason, it has been industry's practice to 'plug on detection' U-bend indications that are found."*

PWSCC in particular is associated with areas of high stresses and thus are most commonly found in the tubesheet expansion transitions, in the U-bend transition and apex regions of the low-row tubes, and in the TSP intersections (especially if the tubes are dented).

Denting of the tubes is the direct result of secondary side corrosion of the carbon steel TSPs, in the radial area between the tube wall outer surface and the drilled hole in the TSP through which the tube passes. Low concentrations of dissolved oxygen form magnetite (Fe_3O_4) on the surfaces of the drilled holes in the TSPs at elevated pH and temperatures above 212°F. In the presence of chlorides or sulfates, the magnetite exhibits linear growth and becomes non-protective to the carbon steel TSPs. The forces generated by growth of the magnetite cause several things to happen:

- The TSP exerts a circumferential force on the tube, permanently denting it.
- Eventually, the denting process can continue until the tube ID is so closed that an ECT probe will not pass through. This is a restricted tube. The denting induces tensile stresses in the tube ID or OD in the dented region, leading to localized SCC.

- The forces causing the denting also act against the TSP. In the area of the flow slots where the structural resistance is low enough, deformation and/or cracking of the TSP can occur. If this happens on both sides of the flow slot, the sides of the flow slot are forced inward at the middle, causing the previously rectangular shaped flow opening to develop the shape of an hour-glass. This is referred to as hour-glassing. In the low-row U-bends, PWSCC is significantly more likely to occur if hour-glassing forces the tube legs closer together, since a small movement of the tube legs will concentrate tensile stress at the apex of the U-bend.

Steam Generator History

In a review of plant history, prior to 1997, the team found that the Indian Point 2 SGs have experienced a broad range of tube degradation modes, requiring plugging of tubes. The causes include: tube sheet roll transition PWSCC, ODSCC in the area between the roll transition and the top of the tube sheet (crevice), ODSCC in the sludge pile area, ODSCC and PWSCC and probe restrictions in dented areas, and U-bend ODSCC.

Due to the composition of some secondary system components at Indian Point 2, deposits on the OD wall of the tubes contain hematite (Fe_2O_3), interspersed with metallic copper. These deposits can increase the noise in an ECT signal.

In May 1995, Con Edison completed refueling outage 12 (RFO 12). During that SG inspection, no PWSCC defects were identified in the U-bend region; however, PWSCC was identified at the roll transitions in the tube sheet.

In May 1997, the unit was shut down for RFO 13. The SG inspection plan included a 100-percent Plus Point probe examination of the low-row U-bends. The examination, completed in June 1997, identified the first low-row U-bend apex PWSCC indication (at the apex of R2C67 in SG24). This tube was plugged prior to restart. Also during this examination, Con Edison identified the first instances of probe restrictions caused by denting at the upper TSP in low-row U-bend tubes. These tubes were preventively plugged in accordance with TS requirements for restricted tubes.

Con Edison returned Indian Point 2 to operation in early July 1997 to begin Operating Cycle 14. The unit was shut down in October 1997 due to problems with the operation of DB-50 circuit breakers. Following extensive corrective action, the unit was returned to operation in August 1998. The unit remained in operation until August 1999, when a loss of offsite power caused an automatic trip. The unit restarted in October 1999.

Steam Generator Tube Failure

On February 15, 2000, at 7:17 p.m., the operators received indications of a SGTF when they noticed that the operating charging pump could not maintain a constant pressurizer level and radiation monitor alarms actuated (main steam line N-16, air ejector discharge, and SG24 blowdown). The operators started the second charging pump, which did not stabilize pressurizer level. The operators manually tripped the reactor, and declared an ALERT, in accordance with the site emergency plan. Operators continued to stabilize conditions and to cooldown the plant.

Con Edison estimated, in the event root cause report (CR 2000-00983), the SGTF primary-to-secondary leak rate at approximately 110 gpm, with the two charging pumps operating, prior to the reactor trip (i.e., no cooldown taking place). The initial NRC estimate, as documented in the AIT report, was approximately 150 gpm. Both of these estimates were greater than the capacity of two charging pumps, but less than the specific design basis SG tube rupture (SGTR) leak rate of between 400 and 600 gpm.

Prior primary-to-secondary leakage remained low (less than 2 gallons per day (gpd)) through December 1999. By early February 2000, total leakage was approximately 2.1 gpd, with 1.2 gpd attributed to SG 24. On February 15, 2000, initial primary-to-secondary leakage was 3.1 gpd.

1. REACTOR SAFETY

Cornerstones: Initiating Events, Barrier Integrity

1R1 Initial Review of Eddy Current Data Following the Tube Failure

a. Inspection Scope

The team initially conducted onsite reviews of Plus Point ECT data being taken on the U-bend locations during the plant outage following the SGTF.

b. Issues and Findings

Initially, Con Edison used the same data analysis guidelines as used in 1997. There had been no revisions.

The year 2000 data displayed low signal-to-noise ratios that were indicative of high noise in the U-bend areas. There were no specific criteria to ensure the quality of the data with respect to high noise levels masking defects. As a result of NRC questioning of the high noise, Con Edison and its ECT contractor developed additional guidance which provided detail on how to interpret noise and repeated some examinations and evaluations.

The team reviewed the ECT Analysis Technique Specification Sheet # IP2-97-E (ANTS #IP2-97-E), Rev. 0, dated May 8, 1997, that was used during the 1997 outage. The team found that the probe had been set up incorrectly; that is, not in accordance with the EPRI qualification of the probe, Examination Technique Specification Sheet # 96511Pwsc_ubend.doc (ETSS # 96511), dated May 1996 (see Section 1R3.1). Con Edison and its ECT contractor subsequently corrected this problem during the re-evaluation phase of stored 1997 data.

Initially for the 2000 outage, the U-bend Plus Point phase set-up, ANTS # IP2-00-E, Rev. 1, dated February 27, 2000, was not properly set up, and had not changed from the erroneous set-up in 1997. In early March 2000, Con Edison issued ANTS # IP2-00-E, Rev. 2, dated March 4, 2000, to conform with ETSS # 96511. All the year 2000 U-bend examinations that had previously been completed were repeated using the corrected set-up.

The team identified that in 2000 the mid-range Plus Point probe was not properly calibrated and set up during its initial use. Con Edison corrected the calibration and set-up issues at that time. This U-bend probe calibration and set-up issue is discussed and assessed in Section 1R3.1.

1R2 Review of 1997 Inspection Relative to Low-Row U-Bends

.1 Review of the 1997 U-Bend Primary Water Stress Corrosion Cracking Indication

a. Inspection Scope

The team reviewed the 1997 ECT data and the actions taken upon discovery of a PWSCC flaw at the apex of tube R2C67 in SG 24. Con Edison used the mid-range Plus Point technique to conduct the U-bend examination.

The team reviewed the 1995 and 1997 Indian Point 2 Steam Generator Life Predictions reports (SG Life report) with respect to U-bend PWSCC. These reports used industry data to predict the number of SG tubes that would have to be plugged due to PWSCC during the life of the unit and were completed, by an engineering contractor, following the 1995 outage, and were redone following completion of the 1997 outage.

b. Issues and Findings

The c-scan plot of the 1997 data from R2C67 is shown in Figure 5. The crack sits beside a noise ridge, in a valley, and is in an easily detectable portion of the tube. The large amplitude of the voltage signal, in relation to the standard calibration notch, would indicate that this is a "mature" crack. No year 2000 data is available since the tube was plugged in 1997.

While the flaw was identified and the tube plugged, neither Con Edison nor its ECT contractor identified the discovery of the low-row U-bend apex indication as a significant condition adverse to quality. There was no specific review as to the significance of this flaw or the possible extent of the condition. Identification of this flaw was significant, because it was the first observation of this type of degradation at the apex of a low-row U-bend SG tube at Indian Point 2. Further, apex cracks, if not detected and removed from service, have a greater likelihood of causing a tube rupture than other U-bend cracks, based on past industry events including the Surry 1 tube rupture in 1976 and the Doel (Belgium) tube rupture in 1979. This issue was not entered into the corrective action program.

Further, the discovery of a U-bend PWSCC flaw at the end of cycle (EOC) 13 represented a significant difference from the 1995 SG Life Report prediction and Con Edison did not follow up on this difference. While, it was unclear if the report was directly referring to defects in the apex of the U-bend tubes or other areas of the U-bends, it did provide notice of the potential for PWSCC defects in these areas. The report predicted a best case estimate of no PWSCC cracks in the U-bend area throughout the entire licensed life of Indian Point 2. A pessimistic estimate predicted one PWSCC U-bend crack at the end of the last cycle of operation, EOC 21.

The team's findings in this area relative to the Con Edison's corrective action program are further discussed in Section 4OA2.1.

.2 Denting and Hour-Glassing

a. Inspection Scope

The team reviewed the 1997 SG Examination Refueling Outage report, dated July 29, 1997, NRC requests for additional information following the SGTF and Con Edison subsequent responses, the Indian Point 2 Steam Generator Data Book, dated December 1, 1997, and the 1995 SG Life report, to assess SG conditions in 1997 relative to tube denting and hour-glassing. (See Applicable Steam Generator Degradation Mechanisms above).

b. Issues and Findings

The team found that Con Edison did not have a procedure, a method, or criteria for determining if significant hour-glassing had taken place. TS 4.13 required reporting of significant hour-glassing because of the SG tube integrity concerns developed following the low-row, small radius U-bend apex tube failure at Surry. Con Edison conducted visual examinations in the two SGs that had inspection ports in the upper TSP region using boroscopic techniques, but had no procedure for the examination, no method of measuring the amount of hour-glassing, or no criterion for when hour-glassing was significant. As such, Con Edison did not identify the hour-glassing that had occurred, as determined by the measurements discussed below, and never reported any significant hour-glassing.

The team questioned whether TSP hour-glassing could have contributed to the development of PWSCC, leading to the failure of tube R2C5 in SG 24. Based on this questioning, Con Edison installed an inspection port on SG 24 and developed a technique to measure the row 1 tube deflection resulting from hour-glassing near tube R2C5. Con Edison found that 0.46-inch deflection had occurred. Con Edison also conducted an engineering study to determine the amount of movement necessary to cause an abnormal stress in the apex of the U-bends for row 2, row 3 and row 4 tubes. The amount of movement to cause the abnormal stress increases with the increasing row numbers, since the tube legs above the upper TSP are longer, further apart, and have larger radius U-bends. The required movement for row 2 tubes was 0.1 inch. The Con Edison evaluation concluded that the stress in R2C5 was above the threshold for PWSCC.

The 1997 SG inspection identified 37 tubes that needed to be plugged due to denting at TSPs. Nineteen tubes were recorded in the 1997 SG Examination Refueling Outage report as having U-bend restrictions. Through discussions with Con Edison, the team found that the 19 U-bend restrictions were actually restrictions due to denting at the upper TSP in low-row tubes (15 in row 2, three in row 3, and one in row 4). These tubes were preventively plugged in accordance with TS requirements for restricted tubes.

Con Edison did not recognize this first occurrence of 19 low-row tube restrictions due to denting at the upper TSP and the potential for flow slot hour-glassing as a significant condition adverse to quality that could impact the integrity of tubes beyond row 1. Additionally, the significance of the apex defect identified in R2C67 in SG24 (See Section 1R2.1) was not assessed relative to the potential that hour-glassing caused the stress which led to the PWSCC. These issues were not entered into the corrective action program.

Further, the total of 37 dented tubes (19 at low-row upper TSPs and 18 at other TSPs) was above the 1995 SG life prediction best estimate of 25 such tubes during the 1997 outage and was a significant increase above the numbers of restrictions identified in the last several outages (all at non-upper TSPs; one during RFO-15, zero during RFO-14, and one during RFO-13).

The team's findings in this area relative to the Con Edison's corrective action program are further discussed in Section 4OA2.1.

3 Eddy Current Data Review

a. Inspection Scope

On March 20, 2000, Con Edison initiated CRS 200001939 which documented that four tubes contained defects in 1997, based on its review of the 1997 data. The team independently reviewed and assessed the quality of the 1997 data for these four tubes.

The team also reviewed the recommendation in the EPRI SG Guidelines relative to data quality and the probability of defect detection.

b. Issues and Findings

The data showed generally high noise signals and poor signal-to-noise ratios. It should be noted that the review of the 1997 data discussed below was performed with the benefit of the data and defect locations from the 2000 examination.

1. R2C5 in SG 24 - Figure 6 is a c-scan plot of the vertical component of the ECT voltage signal. The defect signal, indicated by the arrow, sits on a noise ridge that runs the length of the tube. This noise ridge is about 1-volt in amplitude. This ridge makes both the detection and sizing of this defect difficult, because of the very low signal-to-noise ratio. Figures 7 and 8 are the lissajous plots for the flaw area and the noise ridge, respectively. No year 2000 data is available since the tube failed.
2. R2C69 in SG 24 - Figure 9 shows the c-scan plot for the 1997 data. There is considerable noise present. For comparison, the c-scan plot for the 2000 data is included as Figure 10. The noise features between the 1997 and 2000 data are similar enough to verify that this is the same defect at the same location. The defect voltage is only about 1 volt, and there is a considerable amount of noise on the tube relative to the defect signal, i.e., low signal-to-noise ratio.

3. R2C72 in SG 24 - Figure 11 shows the c-scan plot of the 1997 data. There is considerable noise present. The crack is sitting in a ridge of noise and barely extends above the ridge. For comparison, the c-scan plot for the 2000 data is included as Figure 12. The crack barely extends above a 1-volt amplitude for a short length and exhibits a low signal-to-noise ratio.
4. R2C87 in SG 21 - this tube was identified as having several cracks. Figure 13 shows the c-scan plot of the 1997 data. The most prominent crack is sitting in a relatively clean area of the tube. For comparison, the c-scan plot for the 2000 data is included as Figure 14.

The 1997 data contained significant noise, which made detection difficult. However, in 1997, Con Edison did not increase the level of review or more carefully examine existing data as high noise conditions, which could mask defects, were encountered. This was particularly important as conditions which indicated increased susceptibility to PWSCC were identified. Techniques to minimize the effects of the noise on data quality were not used and/or criteria for rejecting data based on high noise were not provided. Additionally, following identification of the apex PWSCC defect in tube R2C67 in SG 24 (See Section 1R2.1), Con Edison did not investigate the potential masking effects of noise in the U-bend areas. Con Edison did not identify the possible effect that the noise could have on flaw POD as a significant condition adverse to quality. This issue was not entered into the corrective action program. The team conducted such a detailed review, which indicated that defects were present in the 1997 data.

While the EPRI SG Guidelines provided no noise criteria recommendations, the team determined that Con Edison did not evaluate the potential for this level of noise to mask signals produced by significant flaws. The team noted that the adverse relationship of signal noise to flaw POD was not a new concern and has been addressed for various forms of SG degradation in NRC documents:

- Draft NUREG 1477, dated June 1993, section 3.5.3, states, relative to ECT testing and analysis guidelines, that *"noise criteria should be incorporated that would require that a certain specified noise level not be exceeded, consistent with the objective of the inspection. Data failing to meet these criteria should be rejected and the tube should be reinspected. These criteria should be broken down into criteria for electrical noise, tube noise, and calibration standard noise."*
- NRC Information Notice 94-88 Inservice Inspection Deficiencies Result in Severely Degraded Steam Generator Tubes, dated December 1994, stated in part *".... This difficulty in obtaining accurate eddy current test results also demonstrates the importance of (1) optimizing the test methods to minimize electrical noise and signal interference and to maximize flaw sensitivity; (2) anticipating potential sources of interfering signals, such as from probe liftoff caused by tube transition geometry and from dents and understanding their potential effect on flaw detection; (3) developing test and analysis procedures that will allow the flaw signal to be discriminated from any unavoidable signal noise or interference; and (4) being alert to plant unique circumstances (e.g., dents, copper deposits) which may necessitate special test procedures found not to be necessary at other similarly designed steam generators or not included as part of a generic technique qualification. ..."*

The EPRI qualification of the U-bend mid-range Plus Point probe used a set of EDM notches supplemented by a small number of actual SG tubes with cracks. If the proportion of noisy tubes to non-noisy tubes is greater in a specific SG than in the qualification sample (as it was at Indian Point 2 in 1997) the POD could be affected. Con Edison did not question the use of the generically qualified technique relative to the observable noise in the Indian Point 2 SGs.

The team's findings in this area relative to the Con Edison's corrective action program are further discussed in Section 4OA2.1.

1R3 Review of the 1997 Eddy Current Inspection Program

.1 Eddy Current Technique Qualification

a. Inspection Scope

The team reviewed the overall qualification of the Plus Point ECT probe for use during the 1997 inspections. Specifically the team reviewed:

- Specification No. NPE-72217, "Eddy Current Examination of Nuclear Steam Generator Tubes, Indian Point 2," Revision 10, which contained the technical requirements for the 1997 SG tube examinations (RFO 13) and specified the use of EPRI Steam Generator Examination Guidelines, Rev. 4, by the ECT contractor.
- EPRI Steam Generator Examination Guidelines, Rev. 4, (EPRI Guidelines) Appendix H.
- "Eddy Current Low-row U-bend Examination, MIZ-18A and TC6700, Non-Mag. Bias and Mag. Bias Equivalency Qualification." The purpose of this equivalency qualification was to demonstrate that the magnetic bias Plus Point probe (which was used for examination of the Indian Point 2 low radius U-bends) had comparable detection capability to the non-magnetic bias Plus Point probe.
- ETSS #96511, dated May 1996 - the EPRI Performance Demonstration Data Base document that qualified the Plus Point probe for detection of circumferential and axial PWSCC in low radius U-bends.
- ANTS # IP2-97-E, Rev. 0 - documentation of the analysis method of SG low radius U-bends at Indian Point 2 including requirements for setting of phase rotation and use of calibration standards.
- Westinghouse Drawing 1B79882, Revision 0, pertaining to the ACGT-006-97 EDM, the calibration standard that was used for the 1997 Plus Point probe examinations of low radius U-bends at Indian Point 2.

b. Issues and Findings

Specification No. NPE-72217, Paragraph 4.3 stated, in part, "...*The examination technique shall be performed using qualified methods that are capable of detecting axial, skew, and circumferential cracking. The techniques used shall be qualified to the EPRI Steam Generator Examination Guidelines, Appendix H,.....*".

Paragraph H.1 in Appendix H, "Performance Demonstration For Eddy Current Examination," of the EPRI Guidelines states, in part, "... *Each organization that performs ECT examinations shall use techniques and equipment qualified in accordance with this Appendix....*" Paragraph H.2.1.1 in Appendix H identifies that calibration method is an essential variable to ensure proper data acquisition. Paragraph H.2.1.2 in Appendix H further requires the ANTS to define the method of calibration used for signal characterization.

Paragraph 7.1 in the EPRI Guidelines states, "*Nondestructive examination of SG tubes shall be conducted using techniques capable of detecting and/or sizing the types of degradation known or reasonably expected to exist in accordance with industry experience. An inspection technique is qualified if sensors (coils, transducers, etc.) used have been proven capable by performance demonstration to meet the requirements of Appendices H and/or J.*"

ETSS # 96511 was the EPRI Performance Demonstration Data Base that qualified the mid-range Plus Point probe for detection of circumferential and axial PWSCC in low radius U-bends. This technique utilized a calibration standard containing 100-percent through wall (TW) axial, and 40-percent TW axial and circumferential inside diameter EDM notches. A phase rotation setting of 10° was specified in the section of the ETSS entitled, "Data Analysis," for the 40-percent TW circumferential and axial notches. The "Analysis Guidelines" portion indicated, however, the use of a 10-15° phase rotation setting for the 40-percent TW EDM notches.

The team identified two instances in the 1997 implementation of the mid-range Plus Point U-bend technique where the requirements of ETSS # 96511 were not met.

- The calibration standard ACGT-006-97 manufactured in accordance with Westinghouse Drawing 1B79882 did not include the required 40-percent TW inside diameter axial and circumferential EDM notches.
- The required phase rotation set-up was not used. The ANTS sheet instructed the analyst to adjust phase rotation so that probe motion was horizontal. This was not in accordance with ETSS # 96511. The team considered the ANTS to be technically deficient, due to the insensitivity of the Plus Point probe to probe motion, resulting in too small of a signal to allow the adjustment to be accurately accomplished. The ANTS sheet additionally provided no instructions to the analyst with respect to the phase rotation criteria to be used for axial or circumferential notches.

These issues resulted in performance of 1997 production analyses with calibration setting requirements for EDM notches that were both unclear and not in accordance with the EPRI-qualified technique.

Review of the Eddy Current Low-row U-bend Examination, MIZ-18A and TC6700, Non-Mag. Bias and Mag. Bias Equivalency Qualification showed that a phase rotation setting of 40° for a 100-percent TW EDM notch was utilized in the qualification process. The team estimated that this resulted in the rotation setting for a 20-percent TW EDM notch being ~15° and the rotation setting for a 40-percent TW EDM notch being of the order of 23°. These values suggested that the technique, in the absence of complicating factors such as noise, were intended to ensure the ability to detect small PWSCC flaws. ANTS # IP2-97-E, Rev. 0, was not prepared, however, to comply with the phase rotation requirements of the equivalent qualification.

The team found that Con Edison did not conduct the 1997 SG low radius U-bend inspections in accordance with Specification NPE72217, which specified the use of an EPRI-qualified technique for SG inspections. The EPRI-qualified technique specified for U-bend inspections was ETSS # 96511. Specifically, the proper calibration standard and phase rotation specified by the ETSS were not used. The team determined that these issues did not have a substantial impact on the ability to detect PWSCC flaws. Further, Con Edison corrected the techniques used in the 2000 inspection as discussed in Section 1R1. In accordance with the Reactor Safety Significance Determination Process (SDP) Phase 1, a very low safety significance is attributed to this matter (Green), because it did not affect RCS integrity. In 1997, Con Edison did not ensure the use of properly qualified ECT techniques for U-bend inspection since the Plus Point ECT probe was not set up properly for use. In accordance with the NRC Enforcement Policy and the Reactor Safety SDP, the failure to adhere to 10 CFR 50, Criterion IX, Special Processes for ECT inspection is being treated as a Non-Cited violation, consistent with Section VI.A. of the Enforcement Policy, issued on May 1, 2000 (65 FR 25368). (NCV 05000247/2000-010-01)

.2 Data Analysis Guideline Review

a. Inspection Scope

The team reviewed the data analysis guidelines requirements for use of the mid-range Plus Point probe for use in the U-bend areas, contained in Westinghouse Procedure DAT-IP2-001, "Data Analysis Technique Procedure," Rev. 0, and compared them with the EPRI Guidelines. Eddy Current Probe Authorization List, Revision 1, dated May 14, 1997, provided the specific probes and their authorized uses for the outage.

b. Issues and Findings

The team identified no findings during this review. However, the team identified a weakness in that no specific data analysis guidance was prepared with respect to the use of the U-bend mid-range Plus Point probe. The only guidance was provided in the context of the use of other rotating probes including: a standard pancake coil (115 mils

diameter), a Plus Point (not the U-bend) probe, and a high-frequency shielded pancake coil (80 mils diameter). These probes were not qualified for use in the U-bends, but for characterization of indications in dented intersections and restricted tubes.

.3 Analyst Training Review

a. Inspection Scope

The team reviewed the training provided to the data analysts in accordance with the criteria contained in the EPRI Guidelines, Section 6.2 (Site-Specific Performance Demonstration) which states, in part, "...*The actual preparation and administration of the analyst demonstration program should be approved by the utility with assistance from the ISI vendor [inservice inspection vendor or ECT contractor], another vendor not involved in the SG examination, or other qualified individuals. It is important that strict rules be established during the initial preparation and future maintenance and updating of the performance demonstration so that the overall integrity of the program is maintained....*"

On July 14, 2000, Con Edison provided additional information to supplement test scores that had been previously provided. The received information consisted of: (a) a copy of a handwritten log for May 4-10, 1997, describing onsite activities; (b) a one-page training introduction outline, (c) set up instructions for the combined Cecco-5 and bobbin probe, and (d) information regarding the contents of the practice data sets. No information was received regarding the contents of the written and practical tests. The practice data sets for the Plus Point probe (Reels 12 and 20) were noted to contain ID flaws at free span locations. Due to the lack of identification at Indian Point 2 of PWSCC in low radius U-bends prior to 1997, data from other SGs was used for the Plus Point practice data sets.

b. Issues and Findings

The team identified no findings during this review. However, the team considered the incomplete documentation of the ECT analyst training and testing information an indicator that the site-specific performance demonstration requirements of the EPRI Guidelines had not been appropriately implemented for the 1997 refueling outage. Specifically, the reviewed information was not indicative of the establishment of strict rules relative to preparation, maintenance, and updating of the site-specific performance demonstration. As evidenced by the delay in obtaining records, the degree of involvement of the Con Edison in the process for training and testing of ECT analysts was not established. The team characterized this as a minor violation not subject to enforcement action.

1R4 Risk Significance - Event and Core Damage Frequency and Large Early Releasea. Inspection Scope

The team reviewed potential risks of a SGTR given the performance finding discussed in Section 4OA2.1. This analysis was conducted in accordance with the Reactor Safety SDP - Phase 3.

b. Risk Assessments.1 Actual Consequences

There were no actual consequences of the February 15, 2000, event. No radioactivity was measured offsite above normal background levels and, consequently, the event did not impact the public health and safety. The operators appropriately took those actions in the emergency operating procedures to trip the reactor, isolate the affected SG, and depressurize the reactor coolant system. Additionally, the necessary event mitigation systems worked properly.

.2 Inspection Finding Risk

The following is a synopsis of the more detailed risk assessment developed by the NRC staff, included as Attachment 2 to this report.

The current guidance for assigning risk significance for inspection findings is provided in Inspection NRC Manual Chapter (MC) 0609, Appendix H, "Containment Integrity SDP." The following thresholds are provided in MC 0609 for establishing the risk significance color for inspection findings.

Table 1 Risk Significance Based on LERF and CDF		
Frequency Range/ry	SDP Based on CDF	SDP Based on LERF
$\geq 10^{-4}$ (1 in $\geq 10,000$ years)	Red	Red
$< 10^{-4} - 10^{-5}$ (1 in $< 10,000 - 100,000$ years)	Yellow	Red
$< 10^{-5} - 10^{-6}$ (1 in $< 100,000 - 1,000,000$ years)	White	Yellow
$< 10^{-6} - 10^{-7}$ (1 in $< 1,000,000$ to $10,000,000$ years)	Green	White
$< 10^{-7}$ (1 in $< 10,000,000$ years)	Green	Green

The guidance also states that for SGTR events, the change in large early release frequency (delta LERF) is equivalent to the change in core damage frequency (delta CDF). This assumption is made because the majority of the SGTR sequences which result in core damage assume that a secondary main steam pressure relief valve fails to

close. A failed open main steam pressure relief valve would allow a direct pathway from the core to the environment following a SGTR.

The primary-to-secondary leakage from the apex crack in SG 24 tube R2C5 did not reach the maximum SGTR flow rate assumed in the accident analysis. The maximum flow rate was not experienced possibly because the remaining crack ligaments in the flaw area limited the size of the opening. However, under different conditions such as SG depressurization or RCS pressurization events, the flaw could have resulted in a larger opening and thus a higher SGTR leak rate. Therefore, the risk analysis estimated the probability that the flawed tube could have ruptured. Based on historical information provided in NUREG/CR 6365, "Steam Generator Tube Failures," the probability of a tube rupturing for the type of tube flaws identified at Indian Point was estimated to be 0.5.

The risk associated with the condition of the tubes during Operating Cycle 14 comes from several potential initiating events:

1. Spontaneous rupture of a tube, not successfully mitigated by plant operators, causing core damage and bypass of the containment by large radioactive releases.
2. Rupture of one or more tubes induced by a steam system depressurization event, not successfully mitigated by plant operators, causing core damage and bypass of the containment by large radioactive releases.
3. Rupture of one or more tubes induced by a reactor system over-pressurization event, causing core damage and bypass of the containment by large radioactive releases.
4. A core damage event that occurs with the reactor system at normal operating pressure, inducing tube rupture by increasing tube temperature and/or tube differential pressure, causing bypass of the containment by large radioactive releases.

The NRC staff determined that the performance issues identified in this inspection report, changed the SGTR frequency to 1 failure per year of operation, above the Indian Point 2 individual plant examination (IPE) assumed frequency of 1 SGTR per approximately 80 years of operation. This assumption was based on the condition of the steam generator tubes following the 1997 inspection, in Operating Cycle 14. Based on these assumptions, a delta CDF/LERF for an SGTR of approximately one in 10,000 years of reactor operations ($1E-04$ /reactor year (RY)) was calculated. In accordance with MC 0609, findings with a delta-CDF in excess of $1E-4$ or delta-LERF greater than $1E-5$ (one in 100,000 years of reactor operations) are assigned a risk significance color of red. Therefore, this finding is classified as having high risk significance (Red) as determined by the SDP.

4. OTHER ACTIVITIES (OA)

4OA2 Identification and Resolution of Problems CROSS-CUTTING ISSUE - Corrective Action

.1 1997 Steam Generator Inspection Program

a. Inspection Scope

The team reviewed the 1997 SG inspection program and identified performance issues as documented in Sections 1R2.1, 1R2.2, and 1R2.3. The team assessed these issues relative to the standards established by 10 CFR 50, Appendix B.

b. Issues and Findings

The team concluded that the overall technical direction and execution of the 1997 SG inspection program were deficient in several respects. Con Edison did not take appropriate corrective actions for significant conditions adverse to quality that affected ECT data collection/analysis. Con Edison did not adequately account for conditions which adversely affected the detectability of, and increased the susceptibility to, tube flaws. Con Edison did not identify and adjust or modify the inspection methods and analysis to account for significant conditions that affected the quality of the 1997 steam generator inspection. This increased the likelihood that detectable flaws in low-row U-bend tubes were not identified.

During the 1997 refueling outage, based on the information available at the time, Con Edison reasonably should have identified, reviewed, and taken actions to assure that Indian Point 2 was not returned to service with SG tubes that contained detectable PWSCC indications in the low-row U-bend area. The significant noise present in the ECT data for the low-row U-bends hampered the capability to detect flaws in this region. Further, the identification of the first PWSCC defect in a low-row U-bend, and the first 19 tubes plugged due to restrictions at the upper TSP, provided sufficient evidence of the potential for PWSCC at the apex of other low-row U-bend tubes. More specifically, Con Edison did not:

1. Take appropriate corrective actions following identification, for the first time, of a significant tube degradation mechanism, PWSCC at the apex of one row 2 tube. Operating experience indicates that apex cracks have a greater likelihood of causing a tube rupture than other U-bend cracks. The 1997 SG inspection program did not fully assess the implications of this new degradation mechanism and adjust, as appropriate, the inspection methods and analyses. (See Section 1R2.1)
2. Appropriately establish procedures and implement practices to address the potential for hour-glassing in the upper TSP flow slots. Hour-glassing in this location is indicative of increased stresses on the SG tubes, which increase the likelihood of tube cracks. The potential existence and impact of upper TSP hour-

glassing were not assessed following the identification in 1997 of ECT probe restrictions at the upper TSP and the identification of a PWSCC indication at the apex of a SG tube. Further, Con Edison did not have established procedures and practices to determine if significant hour-glassing in the upper support plate flow slots was occurring. (See Section IR2.2)

3. Recognize the significance of, and fully evaluate, the flaw masking effects of the high noise encountered in the ECT signal. In the case of the SG tube that failed, the magnitude of the noise was a problem that negatively impacted the probability of detection. The data acquisition and analysis techniques were not adjusted to compensate for the noise to improve the identification of a flaw signal and ensure the appropriate probability of detection, particularly when conditions which increased susceptibility to tube degradation existed. (See Section 1R2.3)

Using the Reactor Safety SDP as documented in Section 1R4, the team's preliminary evaluation was that this is a Red finding. In accordance with NRC Enforcement Policy and Reactor Safety SDP, this matter is considered an apparent violation of 10 CFR 50, Appendix B, Criterion XVI, Corrective Actions. **(AV 50000247/2000-010-02; EA 000-179)**

.2 Review of Con Edison's Root Cause Analysis for the Tube Failure

a. Inspection Scope

The team reviewed Con Edison's root cause analysis for the SGTF, dated April 14, 2000, and the corrective action system condition reports generated on SG issues.

b. Issues and Findings

The team observed that Con Edison's root cause analysis did not identify and address the SG program performance issues identified above in Section 1R2 and 1R3 as they related to the SGTF on February 15, 2000. While Con Edison's root cause analysis attributed the failure to a flaw that was obscured by ECT signal noise, it did not identify, or address, deficiencies in the processes and practices during the 1997 SG inspection.

4OA6 Management Meetings

.1 Exit Meeting Summary

On July 20, 2000, the team leader presented the team's overall findings to members of Con Edison management led by Mr. J. Groth. At the exit meeting, Con Edison disagreed with the team's preliminary findings. Specifically, it is our understanding that Con Edison's position is that: 1) all 1997 SG inspection requirements were met; 2) the team had not identified any specific requirements, standards or guidelines that were not met; 3) no specific noise criteria existed relative to the probability of detection of flaws using ECT examination; 4) the PWSCC indication was expected and no additional assessment was warranted after this discovery; 5) the root cause submitted was complete and

accurate; and, 6) the NRC team's preliminary findings are not in agreement with NRC Inspection Report 50-247/97007, dated July 16, 1997. Many of these viewpoints had been discussed during the inspection. The NRC considered these issues during the finalization of the inspection report and, as described in the body of the report, the NRC determined that 10 CFR 50, Appendix B, Criterion XVI, Corrective Actions, is being applied appropriately.

Finally, during the inspection, Con Edison provided the team with some contractor proprietary information. This information was not included in this report and the proprietary information will be returned to Con Edison.

PARTIAL LIST OF PERSONS CONTACTED

Con Edison:

J. Groth, Chief Nuclear Officer
A. Blind, Vice President
J. Baumstark, Vice President, Nuclear Power Engineering
J. McCann, Manager, Nuclear Safety and Licensing
A. Spaziani, Nuclear Safety and Licensing Engineer
J. Mark, SG Program
J. Parry, SG program
G. Turley, Independent, Quality Data Analyst

Westinghouse:

D. Adomonis
R. Maurer
S. Ira
J. Maris

ITEMS OPENED AND CLOSED

Opened

05000247/2000-010-01	NCV	Failure to Use a Qualified Steam Generator Eddy Current Inspection Technique for U-Bend Areas During the 1997 Outage
05000247/2000-010-02	AV	Steam Generator Program Ineffective Corrective Actions during 1997 Outage

LIST OF DOCUMENTS REVIEWED

Industry Steam Generator Guidance

- EPRI SG Inspection Guidance
 - Rev. 4, June 1996
 - Rev. 5, September 1997
 - Performance Demonstration Database - ETSS #965121 Pwsc_ubend.doc, May 1996
- NEI SG Program Guidelines 97-06, December 1997

NRC Generic Information

- Reg Guide 1.83, Rev 1, July 1975
- Draft Reg Guide 1.121, PWR Steam Generator Tube Plugging Limits, August 1976
- Draft NUREG 1477 - Voltage -Based Plugging Criteria for SG Tubes, June 1993
- Information Notice 94-88 Inservice Inspection Deficiencies Result in Severely Degraded Steam Generator Tubes, December 1994,
- Generic Letter 95-03: Circumferential Cracking of SG Tubes, April 28, 1995
- Generic Letter 95-05 Voltage Based Repair Criteria for Westinghouse SG Tubes Affected by ODSCC
- Information Notice 96-38: Results of SG Tube Examinations, June 21, 1996
- SECY 98-248: Proposed GL 98-XX SG Tube Integrity, dated October 28, 1998
- Draft Reg Guide 1074 - Steam Generator Tube Integrity, December 1998
- IN 97-26 Degradation in Small-Radius U-bends , May 19, 1997
- EGM 96-003, Updated June 2000 SG Tube Inspections

NRC Correspondence:

- Proposed SG Inspection plan approval 1997 - Refueling Outage, May 29, 1997
- Request for Additional Information (RAI)AI Re: Proposed SG Tube Examination Program - six questions, March 14, 2000
- Lessons Learned Evaluation - Includes attachments, March 20, 2000
- RAI Re: Proposed SG Examination Program - 21 questions, March 24, 2000
- Notice for May 3, 2000, meeting - 17 questions, April 28, 2000

Con Edison Information:

- 1997 IP2 Spring 1997 Inspection Evaluation - Westinghouse to Con Ed with CMOA as an attachment, July 24, 1997
- IP-2 Steam Generator Handbook, through 1997 Outage
- IP-2 Steam Generator Status Report, April 22, 1998, based on the results of 1997 outage
- Inservice Tube Examination 1995 Refueling Outage - TS 4.13.C.2 report, June 14, 1995
- RAI response - SG Tube Acceptance Criteria TS Amendment Request, January 10, 1997
- 1997 SG Inspection Plan, February 7, 1997
- Outage Inspection Plan - from NRC meeting, April 24, 1997
- Response to staff questions, July 24, 1997
- SG Tube Inservice Examination 1997 Refueling Outage - TS 4.13.C.2 Submittal, July 29, 1997

- Proposed Amendment to TS Regarding SG Tube Inservice Inspection Frequency, December 7, 1998
- Response to RAI - Proposed Amendment to TS Regarding SG Tube ISI Frequency, May 12, 1999
- 2000 Outage Inspection Plan
- Root caused Evaluation, April 14, 2000
- Answers to Questions 2,7, and 17 from March 24, April 18, 2000
- RAI Response - proposed SG Tube Examination Program - EPRI Appendix K Report, May 15, 2000
- Response to Staff Question on Root cause Evaluation, June 13, 2000
- Response to the Staff's Questions Regarding the Root Cause Evaluation, June 15, 2000
- RAI Response - Proposed SG Examination Program - NRC letters March 14 and 24, 2000, June 15, 2000 -
- RAI Response, June 16, 2000
- RAI Responses (2), June 19, 2000 June 19, 2000
- RAI Response, June 20, 2000
- Licensee Event Reports
- March 17, 2000 - 2000-001 - Manual Trip following SGTR
- April 24, 2000 - 2000-003 - SG 21 and 24 in C-3
- Purchase Spec - MPE-72217 - Rev 10 - ECT examination of SG tubes, Dec 17 , 1996
- Station Admin Order - 180 Administrative SG Program Plan, Rev 0, April 2000
- Strategic Water (secondary) Chemistry Plan, Rev 1, March 1999
- Primary-to-secondary leakage, IPC-A-110, June 4, 1997
- Corrective Action Program Condition Reports
 - 1997-2282 - IN 97-26, June 12, 1997
 - 2000-983 - SG Tube Leak Alert, SL 1 Report, March 28, 2000
 - 2000-1623 - Use of probes bigger than 0.610inches after 0.700" could not be passed, March 9, 2000
 - 2000 -1939 - SG 21 1 tube >40 -percent and SG 24 three tubes >40-percent re-review of 1997 data, March 20, 2000
 - 2000- 2049 - SG 21 and 24 - C3, March 23, 2000
- QA Surveillances
 - SR 97-056 - May 12, 1997
 - SR-97-105, May 21, 1997
 - SR 97-106, Mat 24, 1997
- QA Audits
 - 95-8-01-H, August 31, 1995
 - 97-01-H, November 7, 1997
 - 98-01-D, Chemistry Surveillance - includes the CRs generated based on the Audit, September 25,1998
 - 00-01-H, draft - SG Inspection and maintenance. June 16, 2000
- Vendor Audits
 - 2000 - Trip Report and Associated CRs
 - 924-34 - Based on NUPIC Audit, April 29, 1992
 - 941-13 - Class A Vendor Evaluation, January 31, 1994
 - 953-14 - Review of West. NDE Certifications, March 20, 1995

- Independent Quality Data Analyst
 - 1997 Outage Contact- ConEd to CoreStar, January 13, 1997
 - Letter documenting completed actions - CoreStar to Con Ed, May 29, 1997
 - 2000 Outage Contract - ABB/CE to Con Ed, March 3, 2000
- Eddy Current Testing Information
 - Cal Standard used in 1997
 - 1997 Cal Groups
 - Reel 058 2110 - 2359, with the beginning of reel standard
 - Reel 060 0243 - 0613, with the beginning and end of reel standard.
 - 1997 ANTS
- SG Life Prediction Analysis
 - DEI- 442, Draft, October 1995
 - DEI - 519 - Draft, December 1997
 - Update to DEI 519 - Draft, April 10, 2000

Westinghouse Information:

- Team Generator Primary Side Service Module - Contract For 1997 outage
- SG Tube ECT Inspection Techniques
- Documentation of Appendix H Compliance and Equivalency DDM-96-009
- Eddy Current Low-row U-bend Examination Equivalency Qualification
- Eddy Current Probe Authorization List Rev. 1, May 14, 1997
- letter from Westinghouse to ConEd - Use of Appendix H Qualification Techniques at IP2 Spring Inspection, May 16, 2000
- 1997 Examination Technique Specification Sheets
- Analyst Training
- Steam Gen Maintenance Services Memo - Copy of log book and Training schedule and information
- Site Specific Test Scores
- T-list & Summaries from Training & Testing Optical
- Corrective Action Program
 - CAR 00-1076 - Missed indications in previous outages - SG 24 R34C51 in sludge pile above TTS and R2C69 U-bend
 - CAR 00-1075 - inconsistent implementation of analyst performance tracking.
 - CAR 00-1113 - tubes left off the plugging list
- Analyst Procedures for assessing ECT Data
 - 1997 DAT-IP2-001 Rev 0, date April 28, 1997
 - 2000 DAT-IP2-001, Rev 0 with Field Change 001-003, April 1, 2000
- 2000 - Probe Authorization sheet and Acquisition Technique Specification Sheets
- Assessment of NDE Personnel Qualification Assessment - May 17, 2000

LIST OF ACRONYMS USED

AIT	Augmented Inspection Team
ASME	American Society of Mechanical Engineers
ANTS	Analysis Technique Specification Sheet (ECT)
CCDP	Conditional Core Damage Probability
CFR	Code of Federal Regulations
CDF	Core Damage Frequency
Con Edison	Consolidated Edison Company of New York, Inc.
CR	Condition Report
ECT	Eddy Current Test
EPRI	Electric Power Research Institute
ETSS	Examination Technique Specification Sheet (ECT)
gpd	gallons per day
gpm	gallons per minute
ID	Inside Diameter
IPE	individual plant examination
IR	Inspection Report
LERF	Large Early Release Frequency
MC	NRC Manual Chapter
NEI	Nuclear Energy Institute
NRC	Nuclear Regulatory Commission
OD	Outside Diameter
POD	Probability of Detection (POD)
PWSCC	Primary Water Stress Corrosion Cracking
RCS	Reactor Coolant System
RFO	Refueling Outage
RPC	Rotating Pancake Probe (ECT)
RROP	Revised Reactor Oversight Program
RY	Reactor Year of Operations
SCC	Stress Corrosion Cracking
SDP	Significance Determination Process
SG	Steam Generator
SGTF	Steam Generator Tube Failure
SGTR	Steam Generator Tube Rupture
TBD	To Be Determined (SDP)
TSP	Tube Support Plates
TS	Technical Specification
TW	Through Wall (tubing)

REFERENCED FIGURES 1 THROUGH 19
Figure 1 - Westinghouse Model 44 Steam Generator

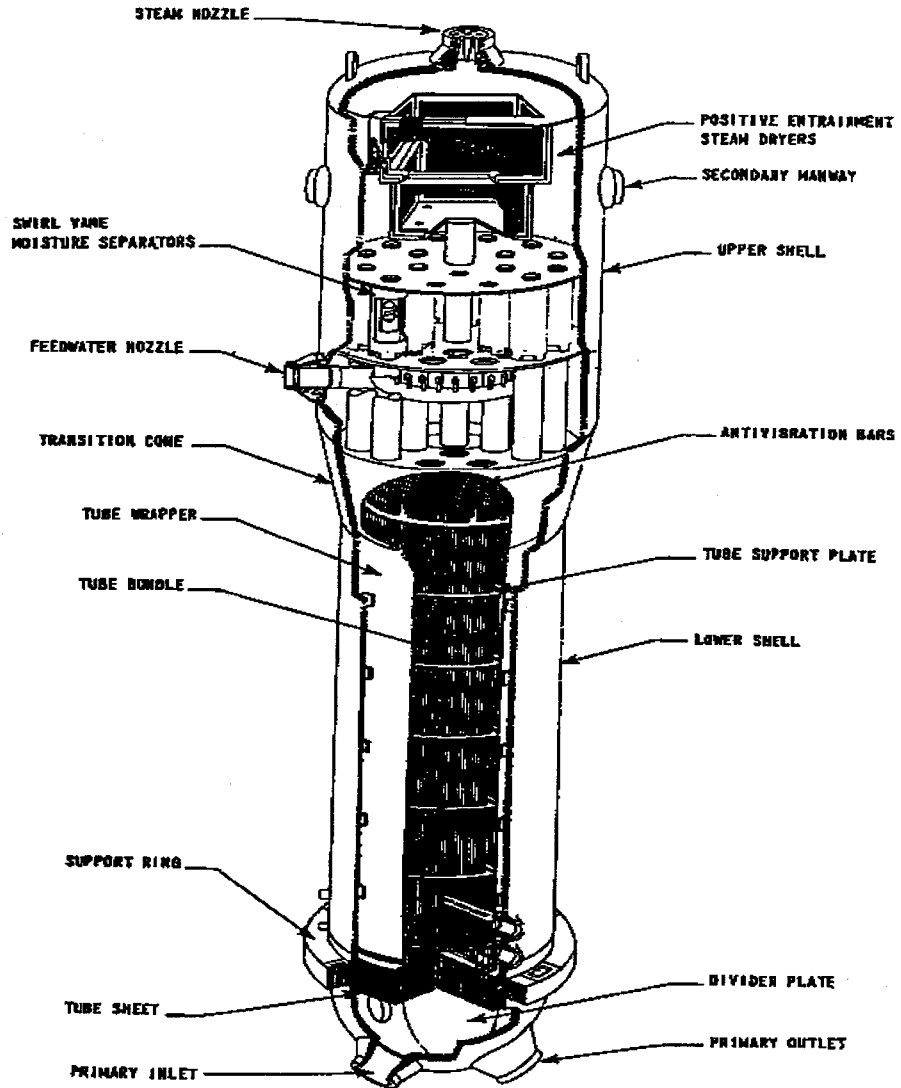

Figures 2 thru 4 - EDDY CURRENT EXAMINATION

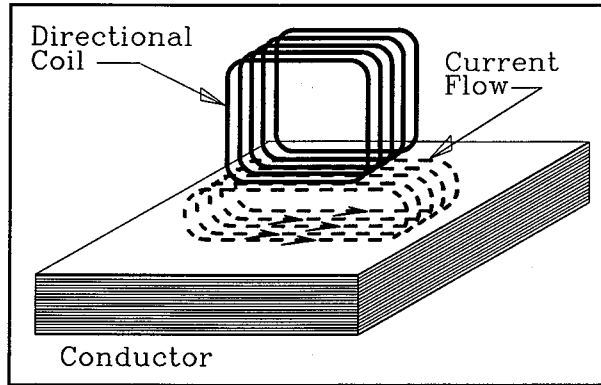

Figure 2 Directional pancake probe

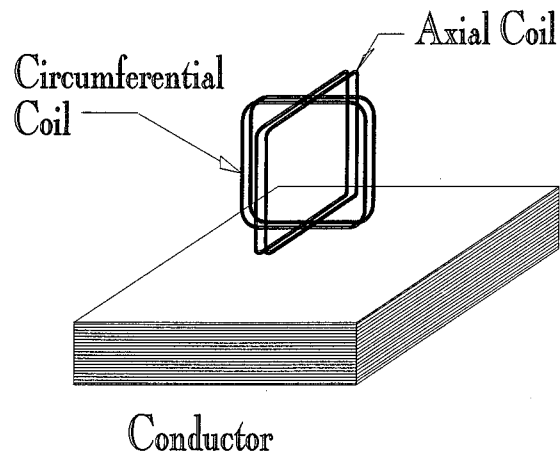
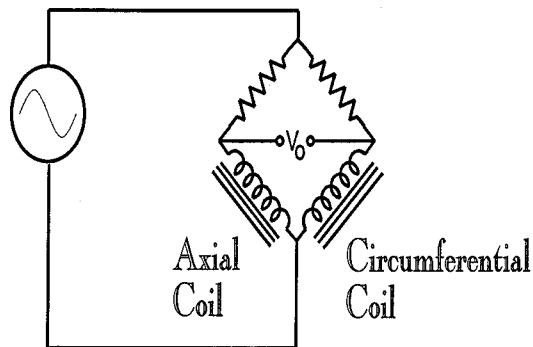

Figure 3 Plus Point probe



Electrical Connections

Figure 4 Difference signal from axial and circumferential coils are amplified

REFERENCED FIGURE 5 - Eddy Current Inspection - Tube R2C67 in SG24

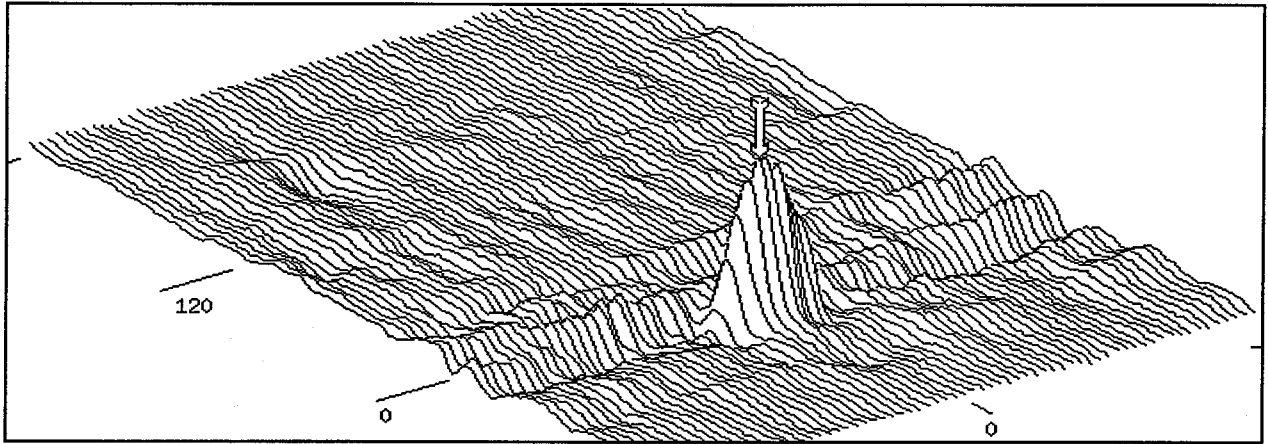

Figure 5 - Crack in tube 2-67 of steam generator 24, found in 1997.

REFERENCED FIGURES 6 thru 8 - Eddy Current Inspection -Tube R2C5 in SG24

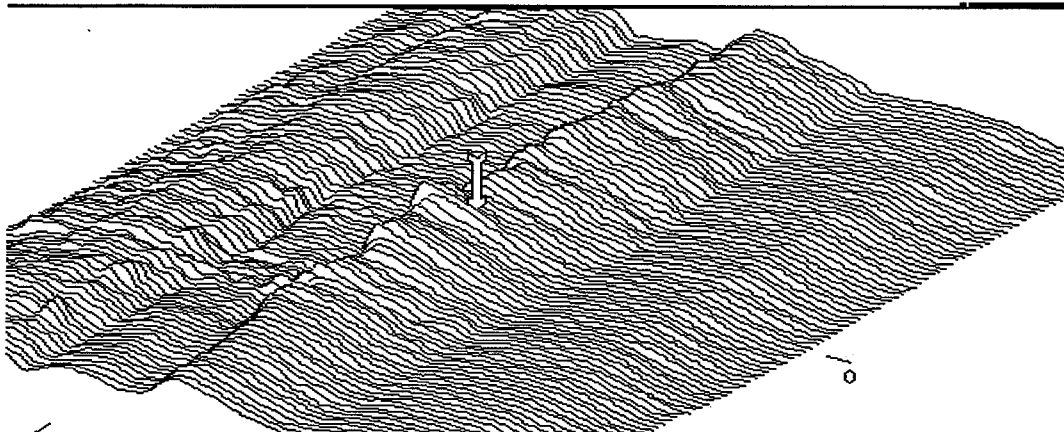
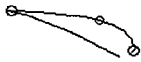

Figure 6 R2C5C-scan with 1997 phase setting.

300	G0	C1
8 v/d	span 50	rot 81



MxB	Vmx	GAN
0.78 volts	0 deg	0

Figure 7 Lissajous of defect with 1997 phase setting.

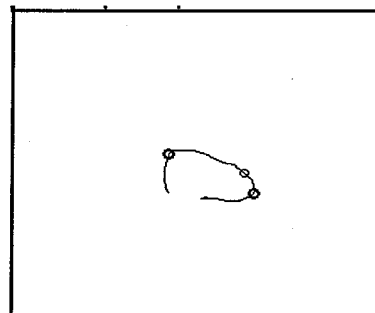

Vpp	MxB	Vmx	GAN
0.90 volts	28 deg	81ID	
	08H	+ 4.51	

Figure 8 Noise signal that runs the length of the U-bend.

REFERENCED FIGURES - 9 thru 10 - Eddy Current Inspection - Tube R2C69 in SG 24

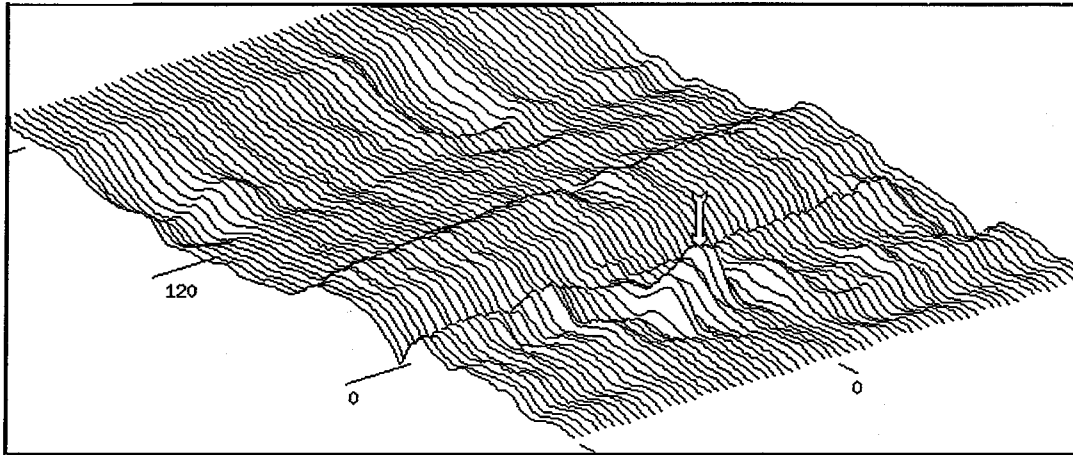

Figure 9 - 1997 mid-range scan

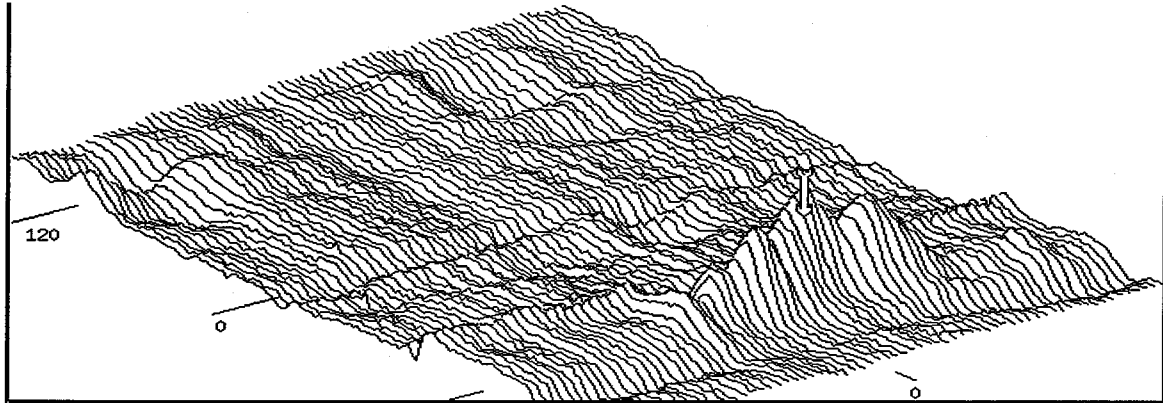

Figure 10 - 2000 mid-range scan

REFERENCED FIGURES 11 thru -12 - Eddy Current Inspection Tube R2C72 in SG 24

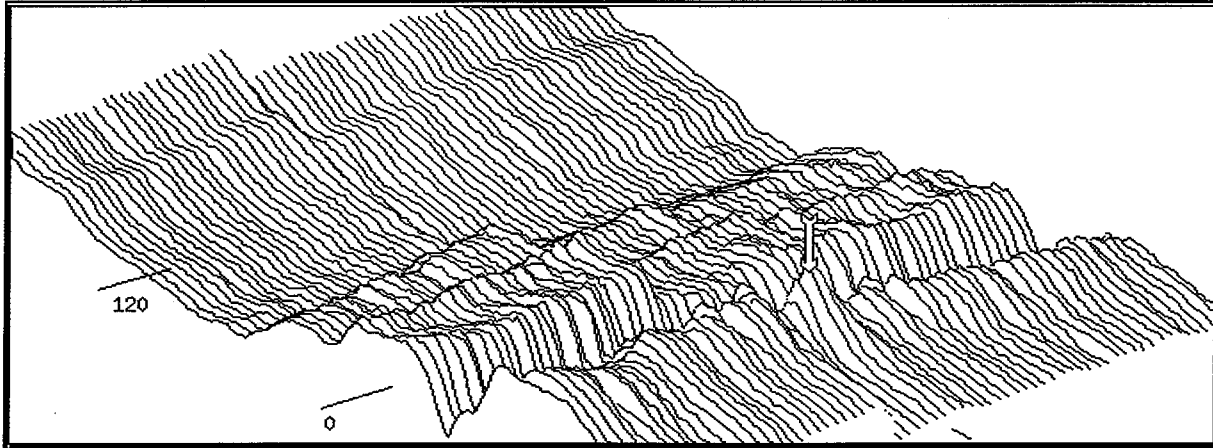

Figure 11 - 1997 scan

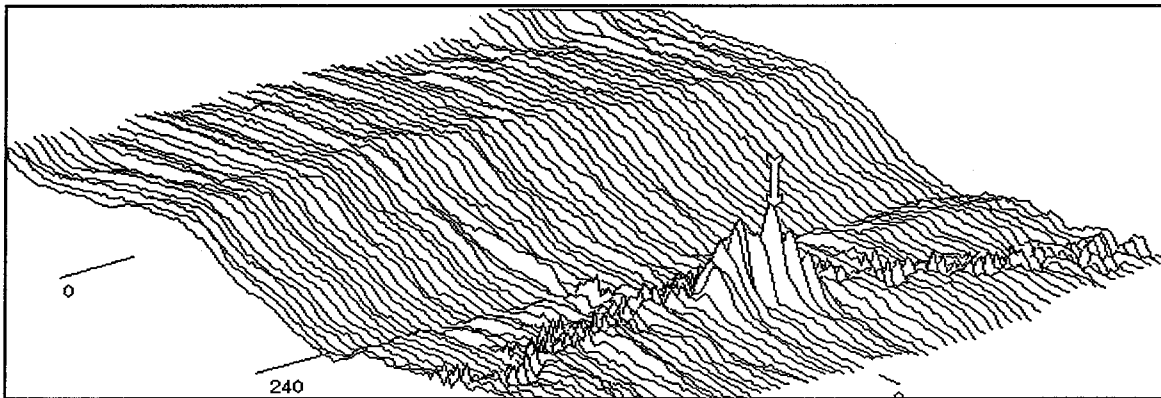

Figure 12 - 2000 scan

REFERENCED FIGURES 13 thru 14 - Eddy Current Inspection- Tube R2C87 in SG 21

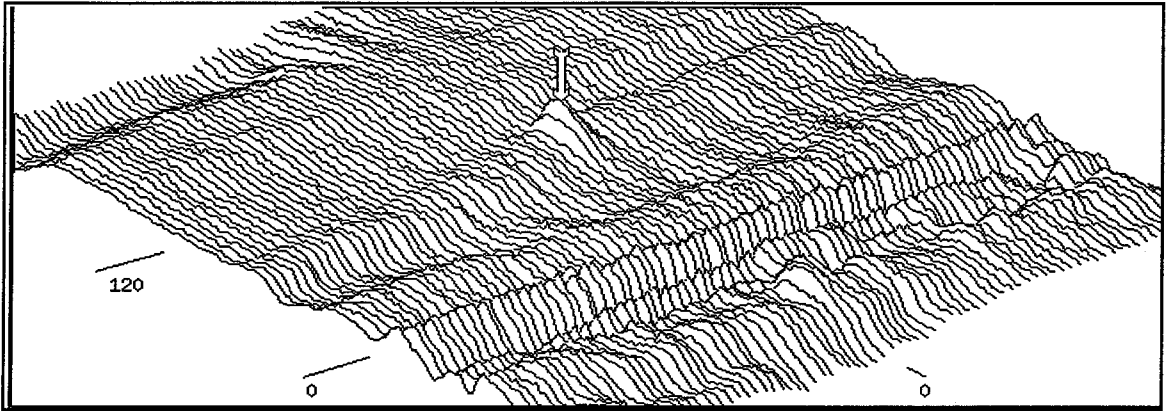

Figure 13 - 1997 scan

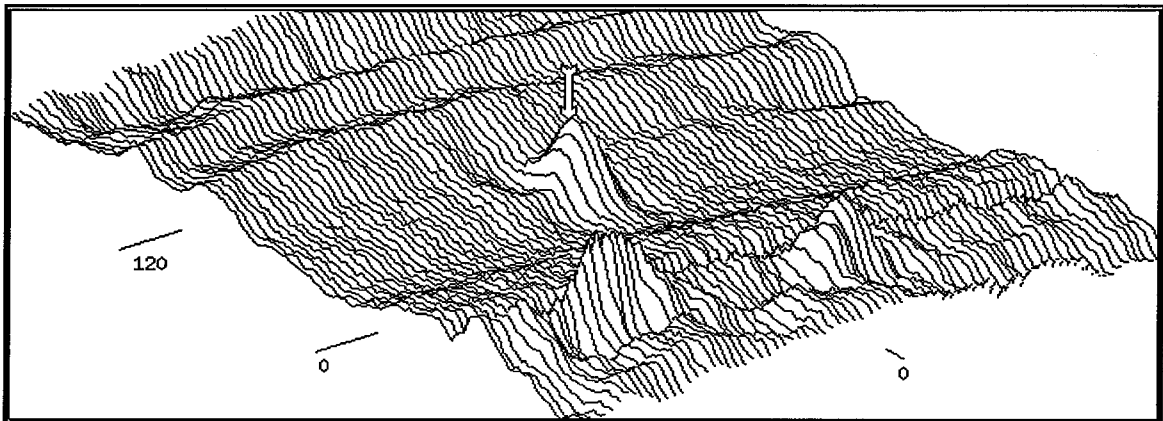

Figure 14 - 2000 scan

ATTACHMENT 1 NRC's REVISED REACTOR OVERSIGHT PROCESS

The federal Nuclear Regulatory Commission (NRC) recently revamped its inspection, assessment, and enforcement programs for commercial nuclear power plants. The new process takes into account improvements in the performance of the nuclear industry over the past 25 years and improved approaches of inspecting and assessing safety performance at NRC licensed plants.

The new process monitors licensee performance in three broad areas (called strategic performance areas): reactor safety (avoiding accidents and reducing the consequences of accidents if they occur), radiation safety (protecting plant employees and the public during routine operations), and safeguards (protecting the plant against sabotage or other security threats). The process focuses on licensee performance within each of seven cornerstones of safety in the three areas:

Reactor Safety	Radiation Safety	Safeguards
<ul style="list-style-type: none">● Initiating Events● Mitigating Systems● Barrier Integrity● Emergency Preparedness	<ul style="list-style-type: none">● Occupational● Public	<ul style="list-style-type: none">● Physical Protection

To monitor these seven cornerstones of safety, the NRC uses two processes that generate information about the safety significance of plant operations: inspections and performance indicators. Inspection findings will be evaluated according to their potential significance for safety, using the Significance Determination Process, and assigned colors of GREEN, WHITE, YELLOW or RED. GREEN findings are indicative of issues that, while they may not be desirable, represent very low safety significance. WHITE findings indicate issues that are of low to moderate safety significance. YELLOW findings are issues that are of substantial safety significance. RED findings represent issues that are of high safety significance with a significant reduction in safety margin.

Performance indicator data will be compared to established criteria for measuring licensee performance in terms of potential safety. Based on prescribed thresholds, the indicators will be classified by color representing varying levels of performance and incremental degradation in safety: GREEN, WHITE, YELLOW, and RED. GREEN indicators represent performance at a level requiring no additional NRC oversight beyond the baseline inspections. WHITE corresponds to performance that may result in increased NRC oversight. YELLOW represents performance that minimally reduces safety margin and requires even more NRC oversight. And RED indicates performance that represents a significant reduction in safety margin but still provides adequate protection to public health and safety.

The assessment process integrates performance indicators and inspection so the agency can reach objective conclusions regarding overall plant performance. The agency will use an Action Matrix to determine in a systematic, predictable manner which regulatory actions should be taken based on a licensee's performance. The NRC's actions in response to the significance (as represented by the color) of issues will be the same for performance indicators as for inspection findings. As a licensee's safety performance degrades, the NRC will take more and increasingly significant action, which can include shutting down a plant, described in the Action Matrix. More information can be found at <http://www.nrc.gov/NRR/OVERSIGHT/index.html>

ATTACHMENT 2
RISK ASSESSMENT AND SIGNIFICANCE DETERMINATION

The Probabilistic Safety Assessment Branch performed this risk assessment.

The significance determination process (SDP) for the Reactor Oversight Process is based on changes to core damage frequency (CDF) associated with a condition at a power reactor unit. Some accident sequences result in core damage and a bypassing of the containment resulting in a radioactive releases reaching the environment, is referred to as large early release frequency (LERF). A steam generator tube rupture (SGTR) is considered as a LERF sequence. The risk associated with the condition of the tubes during Cycle 14 (July 1997 through February 2000) comes from several potential accident sequences:

1. Spontaneous rupture of a tube, not successfully mitigated by plant operators, causing core damage and bypass of the containment by large radioactive releases.
2. Rupture of one or more tubes induced by a steam system depressurization event, not successfully mitigated by plant operators, causing core damage and bypass of the containment by large radioactive releases.
3. Rupture of one or more tubes induced by a reactor system over-pressurization event, causing core damage and bypass of the containment by large radioactive releases.
4. A core damage event that occurs with the reactor system at normal operating pressure, inducing tube rupture by increasing tube temperature and/or tube differential pressure, causing bypass of the containment by large radioactive releases.

Of these, the first two increase both the CDF and LERF. The latter two sequences are already included in the plant's CDF estimate, but would not normally be included in the LERF. The induced tube ruptures cause them to make contributions to LERF.

Spontaneous Tube Rupture:

The Indian Point, Unit 2, probabilistic risk assessment (PRA) includes this sequence. The probability of the initiating event, spontaneous tube rupture, was assumed to be 1.3×10^{-2} per reactor-year of operation (RY) and the resulting CDF was estimated as 1.0×10^{-6} /RY. From this, the conditional probability for failing to mitigate a rupture after it occurs is inferred to be 7.7×10^{-5} . This number is comparable to the conditional probability values obtained from the NUREG-1150 model for Surry, 1.4×10^{-4} , and from the NRC's Rev. 2 QA SPAR model for Indian Point, Unit 2, 3.3×10^{-4} . So, given that the spontaneous rupture initiating event did occur at Indian Point, Unit 2, the conditional probability of core damage is estimated to be about 1×10^{-4} . Because most of the core damage sequences resulting from spontaneous tube rupture involve loss of steam system integrity, approximately the same conditional probability applies to the occurrence of a large early release of radioactive material to the environment.

The most probable reasons for a spontaneous rupture event to cause core damage involve human errors while attempting to cool down the unit. The probability of the operators making (and not correcting) these errors depends on the amount of time available to them, which

2
ATTACHMENT 2
RISK ASSESSMENT AND SIGNIFICANCE DETERMINATION

depends on the leak rate through the ruptured tube. The PRAs assume that the rupture is as large as can occur with one tube, which creates a leak flow of 400 - 600 gallons per minute (gpm). The Indian Point, Unit 2, tube failure resulted in only about 150 gpm of leakage. So, the operators had much more time to correct the situation than is assumed in the PRA models that were used above to estimate the conditional probability of core damage. Thus, it can be argued that the probability of the Indian Point operators failing to mitigate this particular rupture was much lower than 10^{-4} . However, the flaw that failed in the Indian Point tube was about 2 inches long, and a flaw this long is capable of bursting to the extent assumed in the PRAs. The fact that the tube flaw was held partially closed by several ligaments across the flaw is the reason that it did not open completely and leak much more. Experience has shown that the probability is about 0.5 that tubes with large flaws will leak or partially break open prior to failing completely, thus allowing operators an opportunity to intercede before complete failure occurs. The fact that the type of degradation that occurred can result in large flaws and that the flaw that failed was indeed large indicates that the risk associated with the degradation at Indian Point, Unit 2, is best estimated as having about 10^{-4} conditional probability of core damage and large release from the spontaneous rupture sequence.

Ruptures Induced by Steam System Depressurization:

Core damage sequences of this type are not generally included in licensees' PRAs, but have been evaluated by the NRC in NUREGs-0844, -1477 and -1570. They are similar to the spontaneous rupture sequences in licensees' PRAs except that the loss of steam system integrity comes first and causes the tube rupture instead of *vice versa*. As in the spontaneous rupture sequences, the most probable path to core damage involves errors in the operators' response to the conditions that occur. For a tube rupture induced by a steam system depressurization, the errors are estimated to be more probable because the events are more complicated and the operators do not normally drill on this type of sequence.

In the case of Indian Point, Unit 2, it is clear that a secondary depressurization event would have caused tube R2C5 to rupture when it was in the weakened condition just prior to its spontaneous rupture. During that period, the CDF (and large release frequency) is estimated using a steam system depressurization frequency of $7.6 \times 10^{-3}/RY$, the assumption that only one of four steam generators was susceptible, a conditional rupture probability of 1.0, and a human error probability of 10^{-2} . The result is an increase in both the CDF and the large release frequency of about $1.9 \times 10^{-5}/RY$.

However, in order to estimate the increase in probability of core damage and large release, it is necessary to consider the length of time that this increase in frequency is applicable. Based on the currently available information, the period of time the tube was susceptible to this accident sequence is estimated as approximately 4 to 11 months or 0.3 to 0.9 year, based on the information provided below. Thus, the number of ruptures that would be mathematically "expected" for this frequency over this period is 6×10^{-6} to 1.7×10^{-5} . For such small expectation values, the probability of occurrence of a single event is numerically indistinguishable, so the increase in the probability of core damage and large release from this sequence for this condition is estimated to be about 1×10^{-5} .

3
ATTACHMENT 2
RISK ASSESSMENT AND SIGNIFICANCE DETERMINATION

Ruptures Induced by Reactor System Over-Pressurization Events:

Tube ruptures that are induced by the normal operational occurrences that involve slight elevations in reactor system pressure are considered to be captured by the value used for the frequency of spontaneous ruptures. The additional sequences considered here are those involving gross over-pressure events that, by themselves, would produce core damage. These result from failure of the reactor control system to shut down the nuclear chain reaction when required by a design-basis transient, such as loss of feed water to the steam generators. These events are called anticipated transients without scram (ATWS) events. Most licensees' PRAs include core damage sequences due to ATWS events, but do not consider the probability that such an event could also rupture a steam generator tube, causing containment bypass by the radioactive material it would release from the damaged reactor core.

The PRA for Indian Point, Unit 2, estimates a CDF contribution of $1.81 \times 10^{-6}/RY$ due to ATWS events. ATWS events that create a reactor coolant system pressure above 3,200 psi are assumed to lead to core damage. During the period of extreme reactor system pressure, the steam system pressure is expected to be at the steam system safety valve setpoint, producing a pressure differential across the steam generator tube walls of at least 2,100 psid. Based on the estimated rate of degradation discussed below tube R2C5 would have been susceptible to rupture during an ATWS event during a period of plant operation greater than 3 months. In the same manner described above for steam system depressurization sequences, this results in an estimated increase in the large early release probability that is $> 4 \times 10^{-7}$, perhaps by a factor > 3 . There is no increase in the core damage probability because the ATWS sequences that would induce the tube rupture are already part of the CDF estimate, and the addition of the tube rupture potential is not assumed to change the frequency with which ATWS would cause core damage.

Flawed Tube Strength as A Function of Time

Based on the license's reanalysis of their eddy current results from 1997, it appears that an inside diameter flaw approximately 2.4 inches long and averaging approximately 72 percent through wall was present in steam generator 24 tube R2C5 when the plant was returned to service.

Based on these flaw size measurements, NRC staff in the Division of Engineering performed burst pressure estimates for the subject tube at the time it was returned to service. Available burst pressure prediction models apply specifically to straight tubes rather than to u-bend geometries. These straight tube models indicate a burst pressure in the range of 3200 to 3620 psi. Westinghouse work in the early 1980's indicates that tubes exhibit higher burst strengths in the u-bends for a given size flaw than in the straight length portions due to the cold-worked state of the material in the u-bends. This Westinghouse work is not well documented nor is there much corroborating evidence for this work. The best that can be drawn from this information at this time is that burst pressures are somewhere between zero and 58 percent higher in the u-bend than the straight length regions for given size flaws. Thus, the staff concludes that the

ATTACHMENT 2
RISK ASSESSMENT AND SIGNIFICANCE DETERMINATION

subject tube had a burst capability in the range of 3200 to 5700 psi at the time the plant was returned to service in 1997.

When the tube burst during operation, its burst pressure had decreased to the plant's normal operating pressure differential, 1600 psid. The period of power operation that elapsed between these times was 22.5 months.

Assuming that the growth in the flaw created a decrease in strength that was linear with time, the following table was constructed for the duration of the periods that the flawed tube was susceptible to rupture at various pressure levels that are important thresholds for the risk assessment process.

Initial strength	= 3,200 - 5,700 psid	at	23 months
TI-SGTR threshold	< 2,800 psid*	for	7 - 17 months
PI-SGTR threshold	< 2,350 psid	for	4 - 11 months
Spontaneous rupture	= 1,600 psid		(instantaneous)

* This value is an approximation, based on the stress magnification factor that resulted in a 50 percent failure probability in the analysis previously performed for the Farley, Unit 1, license amendment application review. Of the analyses currently available to the staff, that one is the most similar to the Indian Point, Unit 2, reactor. However, that analysis contained many assumptions about the location of the flaw and the spatial distribution of tube temperatures that are not identical to the situation at Indian Point, Unit 2. In addition, these two reactors have not been verified to produce the same thermal-hydraulic conditions for severe accident sequences. However, because the value is not crucial to the conclusion, it is considered sufficient and useful to indicate the nature of the situation.

Tube Ruptures Induced by Other Core Damage Sequences:

Other core damage sequences that are included in licensees' and NRC's PRAs may also cause large releases by inducing steam generator tube ruptures, but this effect is rarely included in the results of current PRAs. The studies documented in NUREG-1150 and particularly NUREG 1570 do address this potential for large releases to bypass containment due to tube failures. For accident sequences in which the reactor coolant system (RCS) remains at high pressure, the failures of flawed tubes may be caused by steam system depressurization that sometimes occurs as an essential or incidental part of the event sequence that leads to core damage. Also, for sequences with high-RCS pressure and dry steam generators (hi/dry sequences), tube failure may be induced when the overheating reactor core causes the tube temperatures to rise so high that their metal weakens. Tubes with flaws that would not fail upon steam system depressurization may still fail when the tube temperatures increase, later in the accident sequence. This is clearly the case for the Indian Point tube for some period during the last cycle, before it was susceptible to failure by steam system depressurization, alone. It also is

ATTACHMENT 2
RISK ASSESSMENT AND SIGNIFICANCE DETERMINATION

clear that, for some shorter period of time, tube R2C5 would have failed if dry and overheated by a high-pressure core damage accident, even if the steam system remained pressurized.

To accurately estimate the additional probability of a large release due to a core damage accident during the last cycle, it is necessary to separately identify the hi/dry core damage sequence frequency and subdivide it into cases with and without steam system depressurization. It also is necessary to estimate the time periods during which tube R2C5 was susceptible to rupture 1) from steam system depressurization, alone, 2) from high temperature without steam system depressurization, and 3) from the combination of high temperatures and steam system depressurization.

However, without expending the effort to perform this detailed analysis, it can be seen that the result would not substantially change the overall risk estimate for the situation at Indian Point Unit 2, during Cycle 14. This is based on the fact that the total CDF is estimated to be $2.6 \times 10^{-5}/RY$. Although the majority of this frequency is expected to be hi/dry sequences, and about half of those sequences may involve steam system depressurization, the contribution to the total increase in the large release probability would still be about an order of magnitude less than the dominant contribution from spontaneous tube rupture, even if tube R2C5 was susceptible for about a year.

Summarization of Overall Risk Increase:

The risk from spontaneous rupture is the dominant contributor to the increases in both the core damage and the large release probabilities. The risk contribution from ruptures induced by steam system depressurizations adds about 10 percent of these totals, and the risk contribution from other core damage sequences that induce tube failure adds perhaps another 10 percent to the probability of large release, without increasing the core damage probability. More detailed analysis is not expected to change the magnitude of this estimate.

Indian Point, Unit 2, was returned to service in 1997 in a condition that deteriorated with time to the point that a steam generator tube rupture occurred within approximately 19 months of operation. The risk assessment indicates that the reactor was susceptible to the various accident sequences primarily during the last year of this period. If the licensee's tube inspection and operational assessment processes that led to this event were repeated without improvement, it is expected that a similar result would occur. This is used to establish an average frequency for the steam generator tube rupture initiating event of about $0.5/RY$. Because the condition deteriorated with time, it can also be argued the initiating event frequency had zero increase over the first year and was increased about $1.0/RY$ during the second year. Multiplying these two estimates of the initiating event frequency by the probability that core damage would not be averted (about 1×10^{-4}) results in estimates for the incremental CDF of $5 \times 10^{-5}/RY$ and $1 \times 10^{-4}/RY$, respectively. Consideration of the other pertinent sequences (where tube rupture is induced instead of initiating the sequence) is expected to add an additional increase on the order of $10^{-5}/RY$.