



U.S. Department  
of Transportation

**Federal Highway  
Administration**

Publication No. FHWA-TS-89-037  
July 1989

---

# **Work Zone Traffic Management Synthesis:**

## **Use of Rumble Strips in Work Zones**

---

Research, Development, and Technology  
Turner-Fairbank Highway Research Center  
6300 Georgetown Pike  
McLean, Virginia 22101-2296

## NOTICE

This document is disseminated under the sponsorship of the Department of Transportation in the interest of information exchange. The United States Government assumes no liability for its contents or use thereof.

The contents of this report reflect the views of the contractors who are responsible for the facts and the accuracy of the data presented herein. The contents do not necessarily reflect the official views or policy of the Department of Transportation.

This report does not constitute a standard specification, or regulation.

The United States Government does not endorse products or manufacturers. Trademarks or manufacturers' names appear herein only because they are considered essential to the object of this document.

1. Report No. <b>FHWA-TS-89-037</b>		2. Government Accession No.		3. Recipient's Catalog No.	
4. Title and Subtitle <b>Work Zone Traffic Management Synthesis ; Use of Rumble Strips in Work Zones</b>				5. Report Date <b>July 1989</b>	
				6. Performing Organization Code	
				8. Performing Organization Report No.	
7. Author(s) <b>Errol C. Noel, Ziad A. Sabra, Conrad L. Dudek</b>					
9. Performing Organization Name and Address <b>Contractor: Daniel Consultants, Inc. Columbia, Maryland Subcontractor: Dudek &amp; Assoc., Bryan, Texas</b>				10. Work Unit No. (TRIS) <b>NCP 3A9a 0073</b>	
				11. Contract or Grant No. <b>DTFH61-88-X-00007</b>	
12. Sponsoring Agency Name and Address <b>Federal Highway Administration Turner-Fairbank Highway Research Center 6300 Georgetwon Pike McLean, Virginia 22101-2296</b>				13. Type of Report and Period Covered <b>Final Report May 1988 - May 1989</b>	
				14. Sponsoring Agency Code	
15. Supplementary Notes <b>FHWA Contract Manager: Guenther Lerch, HRT-20</b>					
16. Abstract  This report is a synthesis of research findings and current practices in the design, selection, and application of rumble strips at work zones. The information presented here is based on a review of research reports and work zone manuals from a selection of state and local highway agencies, discussions with highway officials, and field observations of a selection of highway construction projects. The report presents an assessment of the state-of-the-practice and makes recommendations for further research and inclusions in the future revisions of the <u>Manual on Uniform Traffic Control Devices</u> .					
17. Key Words <b>rumble strips, audible delineators, audible stimuli, work zones, raised pavement, grooved pavement</b>			18. Distribution Statement <b>No restrictions. This document is available to the public through the National Technical Information Service, Springfield, VA 22161</b>		
19. Security Classif. (of this report) <b>Unclassified</b>		20. Security Classif. (of this page) <b>Unclassified</b>		21. No. of Pages <b>55</b>	22. Price

# SI\* (MODERN METRIC) CONVERSION FACTORS

## APPROXIMATE CONVERSIONS TO SI UNITS

Symbol	When You Know	Multiply By	To Find	Symbol
--------	---------------	-------------	---------	--------

### LENGTH

in	inches	25.4	millimetres	mm
ft	feet	0.305	metres	m
yd	yards	0.914	metres	m
mi	miles	1.61	kilometres	km

### AREA

in <sup>2</sup>	square inches	645.2	millimetres squared	mm <sup>2</sup>
ft <sup>2</sup>	square feet	0.093	metres squared	m <sup>2</sup>
yd <sup>2</sup>	square yards	0.836	metres squared	m <sup>2</sup>
ac	acres	0.405	hectares	ha
mi <sup>2</sup>	square miles	2.59	kilometres squared	km <sup>2</sup>

### VOLUME

fl oz	fluid ounces	29.57	millilitres	mL
gal	gallons	3.785	litres	L
ft <sup>3</sup>	cubic feet	0.028	metres cubed	m <sup>3</sup>
yd <sup>3</sup>	cubic yards	0.765	metres cubed	m <sup>3</sup>

NOTE: Volumes greater than 1000 L shall be shown in m<sup>3</sup>.

### MASS

oz	ounces	28.35	grams	g
lb	pounds	0.454	kilograms	kg
T	short tons (2000 lb)	0.907	megagrams	Mg

### TEMPERATURE (exact)

°F	Fahrenheit temperature	5(F-32)/9	Celsius temperature	°C
----	------------------------	-----------	---------------------	----

## APPROXIMATE CONVERSIONS FROM SI UNITS

Symbol	When You Know	Multiply By	To Find	Symbol
--------	---------------	-------------	---------	--------

### LENGTH

mm	millimetres	0.039	inches	in
m	metres	3.28	feet	ft
m	metres	1.09	yards	yd
km	kilometres	0.621	miles	mi

### AREA

mm <sup>2</sup>	millimetres squared	0.0016	square inches	in <sup>2</sup>
m <sup>2</sup>	metres squared	10.764	square feet	ft <sup>2</sup>
ha	hectares	2.47	acres	ac
km <sup>2</sup>	kilometres squared	0.386	square miles	mi <sup>2</sup>

### VOLUME

mL	millilitres	0.034	fluid ounces	fl oz
L	litres	0.264	gallons	gal
m <sup>3</sup>	metres cubed	35.315	cubic feet	ft <sup>3</sup>
m <sup>3</sup>	metres cubed	1.308	cubic yards	yd <sup>3</sup>

### MASS

g	grams	0.035	ounces	oz
kg	kilograms	2.205	pounds	lb
Mg	megagrams	1.102	short tons (2000 lb)	T

### TEMPERATURE (exact)

°C	Celsius temperature	1.8C + 32	Fahrenheit temperature	°F
----	---------------------	-----------	------------------------	----

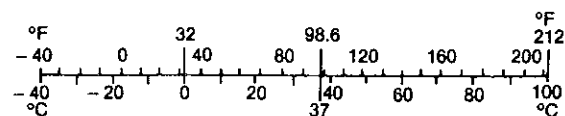

\* SI is the symbol for the International System of Measurement

(Revised April 1989)

## TABLE OF CONTENTS

	Page
LIST OF FIGURES .....	iv
LIST OF TABLES .....	iv
I. INTRODUCTION .....	1
A. Overview .....	1
B. Driver Needs .....	2
C. Rumble Strip Concepts .....	2
D. Summary of National and State Practice .....	2
II. RESEARCH FINDINGS .....	6
A. On-Road Rumble Strips .....	6
1. Continuous Rumble Strip Patterns .....	6
2. Intermittent Patterns .....	8
3. Combination Patterns .....	10
B. Construction Methods and Material .....	16
1. Rumble Bars .....	16
2. Rumble Strip Overlays .....	18
III. RUMBLE STRIP APPLICATIONS .....	23
A. Work Zone Applications .....	23
B. State Specifications .....	28
C. Non-Work Zone Applications .....	37
IV. ENVIRONMENTAL ISSUES .....	39
A. Noise Tolerance .....	39
B. Driver Understanding of Rumble Strips .....	39
C. Rumble Strips Effect on Cyclists .....	42
D. Maintenance .....	42
V. CONCLUSIONS .....	43
VI. RECOMMENDATIONS .....	45
LIST OF REFERENCES .....	48

**LIST OF FIGURES**

		Page
Figure 1.	Rumble strips .....	3
Figure 2.	Continuous rumble strip patterns .....	7
Figure 3.	Intermittent rumble strips for stop-sign controlled intersections .....	9
Figure 4.	Rumble strip patterns .....	11
Figure 5.	Rumble strip patterns: change in size and/or spacing .....	12
Figure 6.	Rumble strip patterns: change in size and/or spacing (Figure 5 continued) .....	14
Figure 7.	On-road rumble bars .....	17
Figure 8.	On-road rumble bars (Figure 7 continued) .....	19
Figure 9.	Grooved rumble bars .....	20
Figure 10.	Rumble strip application and spacing detail .....	24
Figure 11.	Speed reduction potential of rumble strip designs .....	25
Figure 12.	Rumble strip application in work zones .....	27
Figure 13.	Pennsylvania's rumble strip patterns .....	30
Figure 14.	Pennsylvania's standard drawing of rumble strip application .....	32
Figure 15.	Temporary rumble strips of Illinois .....	33
Figure 16.	Schematic of Illinois' application of rumble strips .....	34
Figure 17.	Ohio's rumble strip patterns and applications .....	35
Figure 18.	Kentucky's on-road rumble strips .....	36
Figure 19.	Details of the rumble strip sign used in Pennsylvania .....	38
Figure 20.	Rumble strip configurations .....	40
Figure 21.	Rumble strip configurations .....	41

**LIST OF TABLES**

Table 1.	Availability of rumble strips standards in selected states .....	5
Table 2.	Rumble strips in work zones .....	29

## I. INTRODUCTION

A. Overview. Rumble strips are grooved or raised pavement corrugations placed perpendicular to the path of vehicles and across the full width of a roadway approach to alert inattentive drivers of hazards that may not be readily apparent but which require substantial speed reduction or other cautionary maneuvers. Such conditions are occasionally experienced at work zones on high-speed and high-volume highways. Rumble strips have been used from time to time on approaches to stop-sign controlled intersections, at the end of expressways or freeways, in advance of toll booths, in advance of high-accident signalized intersections, on airport circulation roadways, and along shoulders in conjunction with or without other standard traffic control devices. In work zones, however, rumble strips are used exclusively in combination with other construction warning devices such as signs, flashing lights, arrow panels, and barricades.

Rumble strips are grouped into two categories: 1) on-road devices, and 2) off-road devices. The latter are used to delineate the traveled lanes and sections of the roadway that are not intended for routine traffic, such as shoulders and medians. The design of off-road rumble strips relies more on the tactile stimulus than the audible stimulus. The design of on-road rumble devices, however, relies more on the audible stimulus, because they are intended to be traversed by every passing vehicle.

Since their inception in the early 1950s, rumble strips have been used in work zones, but applications have been few due to a mixture of opinions about their suitability and effectiveness. Temporary applications of rumble strips have not become standard practice because of continuing concerns with proper design, maintenance, liability, noise, car handling, and a lack of sufficient supportive research on durability, effectiveness, and driver behavior.

This synthesis discusses current practices in the design and application of rumble strips at work zones based on a review of the literature and state standards, field observations, and discussions with state highway officials in California, Illinois, Maryland, Michigan, New York, Virginia, and Pennsylvania. Discussions were also held with local highway officials in San Francisco, Washington, D.C., Chicago, Detroit, New York City, Baltimore, Richmond, and Philadelphia. The coverage of on-road rumble strip devices is not necessarily limited to work zones but also includes several other applications that are perceived valuable to the development of temporary rumble strips. For the purposes of this report,

however, only on-road rumble strips are discussed.

**B. Driver Needs.** Construction warning devices such as warning signs, flashers, pavement markings, and arrow panels are usually sufficient to alert and guide drivers safely around or through work zones. Occasionally, however, there are exceptional circumstances where drivers become inattentive and, thus, fail to respond to hazardous situations quickly enough or may entirely misjudge conditions. Such problems in work zones are usually indicated by the number and severity of accidents and traffic conflicts. A common approach to solving this problem has been to provide a more articulated stimulus in advance of the work zone to alert drivers and warn them that unusual maneuvers may be necessary. Theoretically, a stronger and more timely response is usually achieved by combining audible and tactile stimuli, partially because drivers react faster to audible and tactile stimuli than to the usual visual stimuli. Audible and tactile stimuli are characteristics of rumble strips.

**C. Rumble Strip Concepts.** Rumble strips are usually constructed in three basic ways: 1) bars pre-formed and then bonded to the pavement, or formed in place; 2) grooves cut into the pavement, and 3) overlays constructed with exposed aggregate surfaces. In either approach, a variety of aggregate types and sizes and synthetic materials are used to produce audible and tactile stimuli. The patterns may be designed to produce either an intermittent or continuous rumble.

The fundamental principle underlying the design of rumble strips is the creation of an audible signal when drivers cross over them. The vibratory signal is a function of the material used and the type, size, and spacing of the strips. According to Capelli, the basic theory is that a stronger and more rapid driver reaction results from a combination of audible and tactile stimuli, because they differ from the usual visual stimulus (3). The noise and vibration could vary substantially depending on type and spacing between corrugations. Off-road rumble strip devices produce a more severe stimulus than the on-road strips due to their more widely spaced and deeper corrugations. Figure 1 illustrates several rumble strip types that are currently used today.

**D. Summary of National and State Practice.** Currently, the Manual on Uniform Traffic Control Devices, (MUTCD) and the Traffic Control Devices Handbook (TCDH) make no reference to rumble strips (1, 2). Several states, however, have already developed standard plans, specifications and guidelines for rumble strips application (6, 7, 8, 9, 10, 11, 12). In general, these specifications cover both work zone and non-work zone applications of rumble strips.



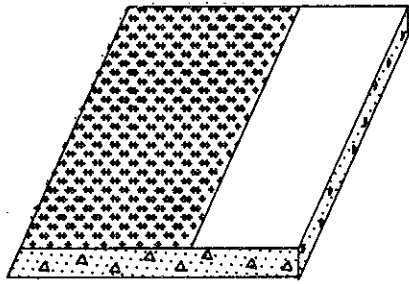

A. EXPOSED COARSE AGGREGATE  
OVERLAY

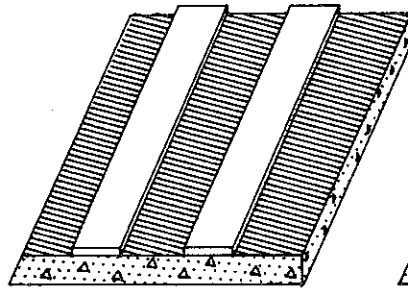

RAISED BARS

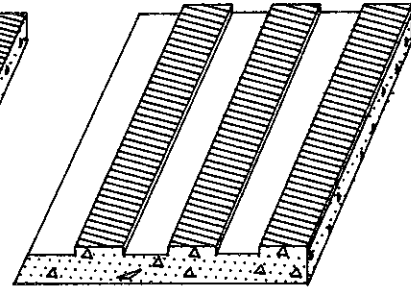

GROOVED BARS

B. CLOSELY SPACED BARS

3

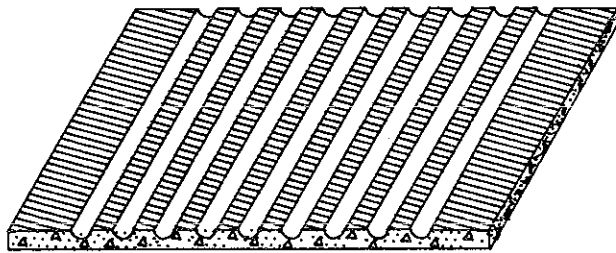

C. CORRUGATED CONCRETE

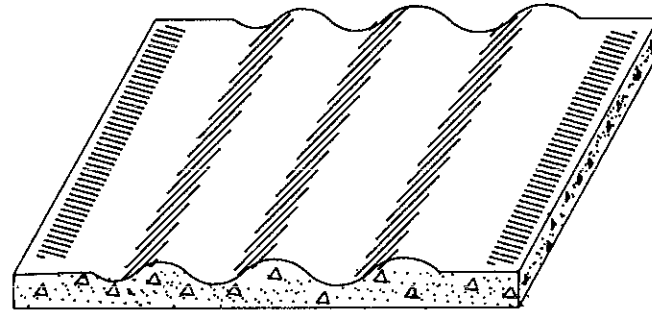

D. CONCRETE WITH MORE WIDELY  
SPACED CORRUGATIONS

Figure 1. Rumble strips

Since the early 1950s, some states have been using rumble strips occasionally along shoulders and at isolated, high-accident rural intersections. Most of the applications were of the non-work zone type. Since the late 1960s, however, Illinois, Pennsylvania, Michigan, California, and Kentucky have introduced rumble strips to work zone applications as temporary warning devices for providing audible and tactile stimuli and to compliment the visual stimuli of traffic control signs, barricades, flashers, and the like.

Ohio, Pennsylvania, Maryland, and Illinois have developed standards for the use of rumble strips in work zones; however, in practice, they are only occasionally used. In the majority of work zone applications, rumble strips are usually associated with lane closures, crossovers, drastic speed changes, and lane transitions. Table 1 summarizes the availability of rumble strip standards in the states surveyed. Four highway agencies in the eight states visited do not have plans, specifications or guidelines for rumble strips. While some states seem to encourage use of rumble strips, others (e.g., California and Virginia) are very reluctant to use them, partially due to a lack of research that supports their use (7, 21).

**Table 1. Availability of rumble strips standards  
in selected states**

State	Plans	Rumble Strip Standards Specifications	Guidelines
California	No	Yes	Yes
Delaware	No	No	No
Maryland	U/NP	U/NP	U/NP
Michigan	Yes	Yes	Yes
New York	No	No	No
Ohio	Yes	Yes	Yes
Pennsylvania	Yes	Yes	Yes
Virginia	No	No	No
Illinois	Yes	Yes	Yes
District of Columbia	No	No	No

Yes - Denotes availability  
 No - Denotes non-availability  
 U/NP - Denotes used but not published

## II. RESEARCH FINDINGS

The body of research on rumble strips discusses on-road and off-road rumble strip categories, but little has been written about temporary work zone applications. This report focuses only on the on-road applications and research findings, partially due to their potential adaptability and suitability at work zones. The design of some off-road rumble strips (e.g. corrugated concrete) does not make them readily adaptable to work zone applications. However, the concept of alerting drivers when they are about to leave a travel lane or enter into a closed lane does have merit and deserves further investigation. Some states use raised jiggle bars on shoulders, for example, to discourage motorists from driving on the shoulders. On-road rumble strips have been used, for the most part, as permanent installations in advance of hazardous locations, but only when the roadway conditions presented undesirable physical or geometric constraints. Furthermore, rumble strips are generally used only after suitable standard traffic control devices fail to resolve a problem satisfactorily. Because of the infrequency of such cases, the use of rumble strips is rare, and therefore, very little is known about the effectiveness and drawbacks of various kinds of designs.

The following section identifies and discusses the different designs and types, construction methods, applications, and unresolved rumble strip issues.

**A. On-Road Rumble Strips.** There are basically two types of on-road rumble strips: continuous and intermittent. Over the past three decades, several rumble strip designs were tested as a means of encouraging drivers to reduce their speeds by alerting them to unexpected maneuvers or potentially hazardous locations.

1. **Continuous Rumble Strip Patterns.** The earliest rumble strips were constructed by the Illinois Highway Department in 1954 as a means of alerting drivers to stop-signs at rural intersections (13). The rumble strips were constructed across the entire width of the approach lanes and extended 150 feet upstream of the stop signs (see Figure 2). Field evaluations indicated that the rumble strips did not allow sufficient time for the drivers to react. To improve this situation, the length of the continuous rumble strip pattern was increased to 300 feet and tests were run at 84 more rural stop-sign controlled intersections (14, 15). Simultaneously, other highway agencies also began experimenting with

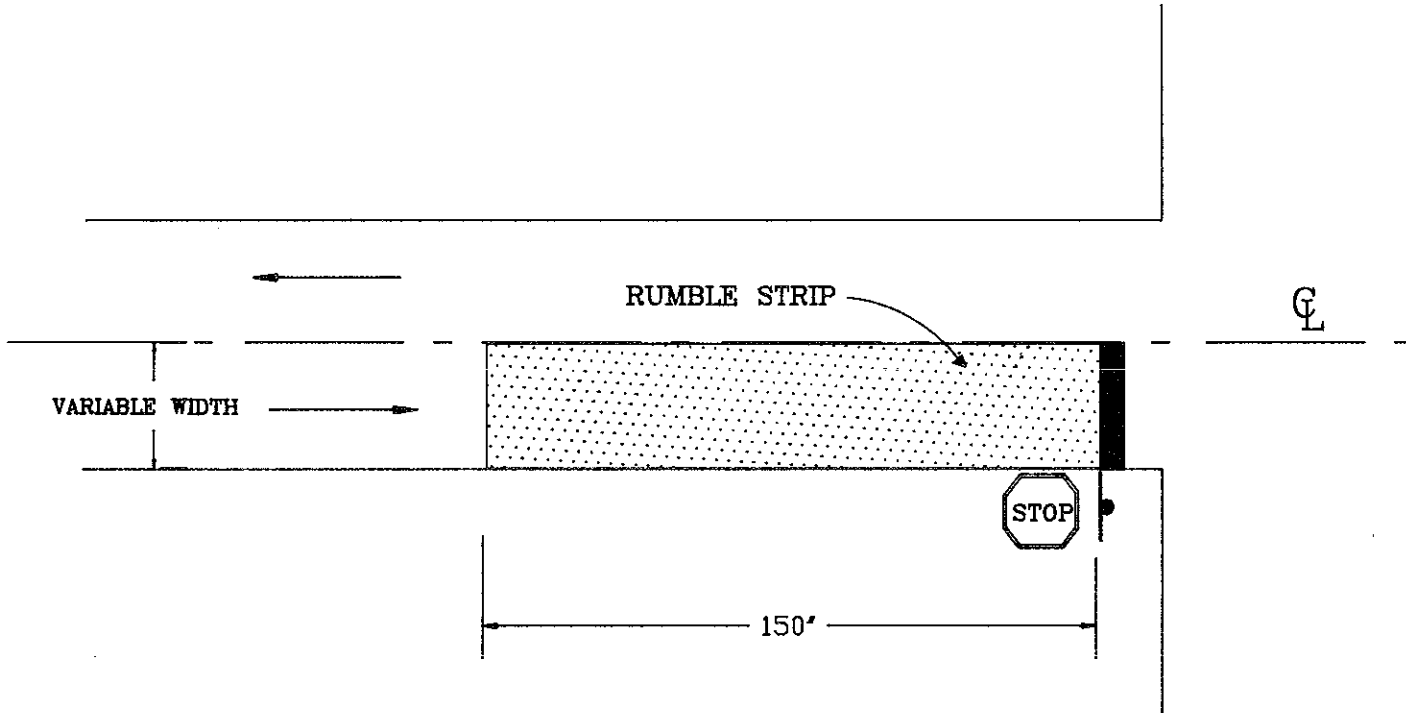

7

Figure 2. Continuous rumble strip patterns

continuous rumble strips that were as long as 700 feet (16, 17). The longer continuous rumble strips were found to be more effective in increasing driver compliance with the stop signs and in reducing accidents at the rural stop-sign controlled intersections. However, there were indications that the longer rumble strips were distracting to drivers and caused some drivers to have difficulty with braking (16, 18, 19). In addition, there was an indication that the rumble strips were too close to the intersections (within 25 feet) (19).

The above shortcomings stimulated the development of different rumble strip patterns in the 1960s and 1970s. Intermittent rumble strip patterns emerged and continuous rumble strips were phased out. Illinois, for example, developed intermittent strip patterns which were later improved upon by other highway agencies (16).

2. **Intermittent Patterns.** Since the early 1960s, intermittent rumble strip patterns progressed from designs using evenly sized and spaced strips to designs having variable sizes and spacings. In addition to developing intermittent patterns for rumble strips, highway agencies also began to install the strips farther upstream from the stop-sign controlled intersections. Thus, not only were drivers provided more timely stimulus from the strips, but there was also a more economical use of materials.

Early studies established the greater effectiveness of intermittent patterns and the desirability of locating them sufficiently in advance of the hazard. Figure 3 illustrates several rumble strip intermittent designs that were tested by state highway agencies. The Virginia Department of Highways compared continuous 400-foot installations with 80-foot intermittent rumble strip overlays placed in a 400-foot section of highway (Figure 3a). They found that the intermittent strips were more effective in improving driver observance of stop signs (3). Although the 400-foot section was considered relatively short in length, the results were comparable to those at a number of other installations at longer sections of highway (Figure 3a, 3b, 3c, 3d). The effectiveness of the intermittent rumble strips was partly attributed to the placement of the strips farther upstream of the stop signs.

UNIFORM SIZE AND SPACING

(A). VIRGINIA

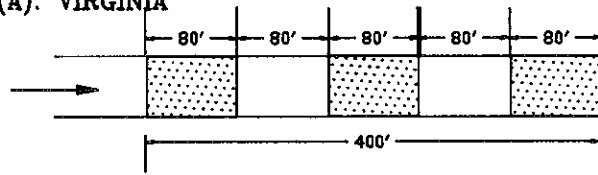

(B). CONNECTICUT

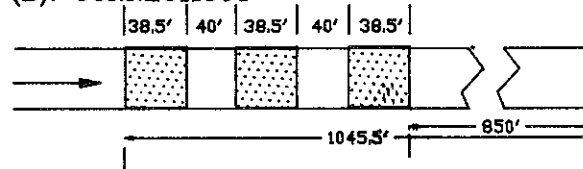

(C). VIRGINIA

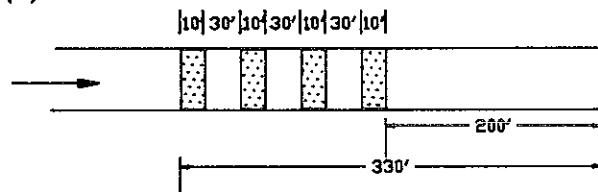

(D)

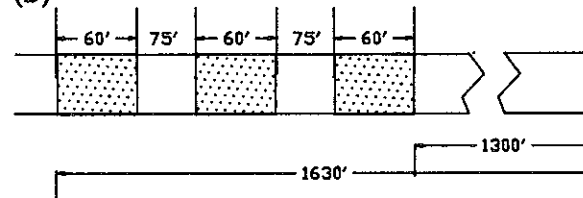

VARIABLE SIZE AND SPACING

(E). ILLINOIS

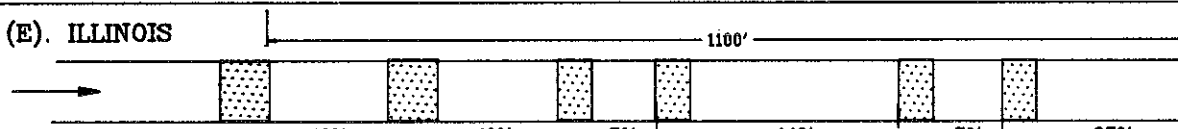

(F).

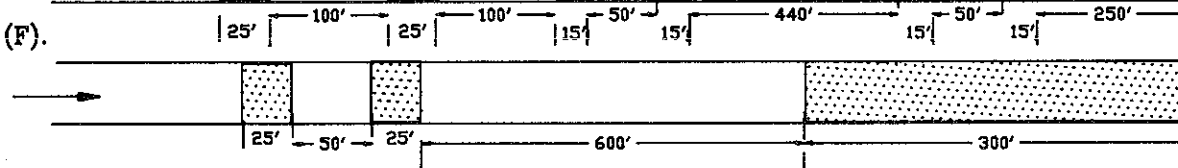

(G). MICHIGAN



(H).

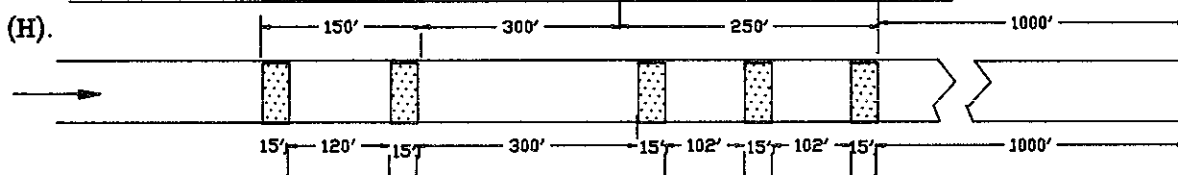

Figure 3. Intermittent rumble strips for stop-sign controlled intersections

Source: ( 3 )

3. **Combination Patterns.** Prior to the exclusive use of intermittent rumble strip patterns, several highway agencies experimented with combinations of continuous and intermittent patterns (16, 20). In 1962, the Illinois Highway Department reported on tests employing two types of rumble strip patterns: one with a combination of continuous and intermittent and one with intermittent strips (16, 18, 19, 20). The strips were made with a bituminous mixture that contained 1/2-inch aggregates. As shown in Figure 4a, the continuous/intermittent patterns incorporated a 300-foot continuous strip near the intersection and two 25-foot strips spaced at 50-foot apart and located 1,000 feet in advance of the intersection. Following several installations of this type, the Illinois Highway Department experienced a 27 percent reduction in total accidents at the intersections (20). The durability of the rumble strips was found to be satisfactory except for the few applications that were constructed during cold weather.

Driver reaction to the rumble strips was also studied (20). Observations made by the Illinois Highway Department indicated a tendency by some drivers to cross the centerline in order to avoid driving over the rumble strips. Police records indicated that 30 drivers received tickets for this type of violation in a one year period. The tendency to cross the centerline decreased with time. Driver surveys indicated that 73 percent of the drivers perceived the rumble strips as a warning device, 9 percent thought they were experiencing vehicle mechanical failure, and 18 percent of the drivers thought that the road was bad (20).

Probably the most significant of the intermittent designs was developed by the Contra Costa County Highway Department in California (22, 23, 24, 25) and later used with some variations by at least six other agencies. The Contra Costa County practice became an accepted standard for the long intermittent pattern, and began a trend toward an orderly variation in the size and spacing of strips. As shown in Figures 5a and 5b, the design consisted of patterns approximately 1000-foot long. The individual strips were most often 25 feet long, although for some installations the lengths have ranged from 15 to 30 feet. They were spaced at 100-foot intervals for the first half of the pattern and 50-foot intervals for the other half. On the approaches to stop-sign controlled intersections, a skid-resistant surfacing of up to 100 feet was commonly used as the last strip. Most variations on these patterns have differed only in total length, with individual strips added or deleted according to conditions of approach speed, geometry, etc. (Figures 5c and 5d). The prevailing theory apparently had



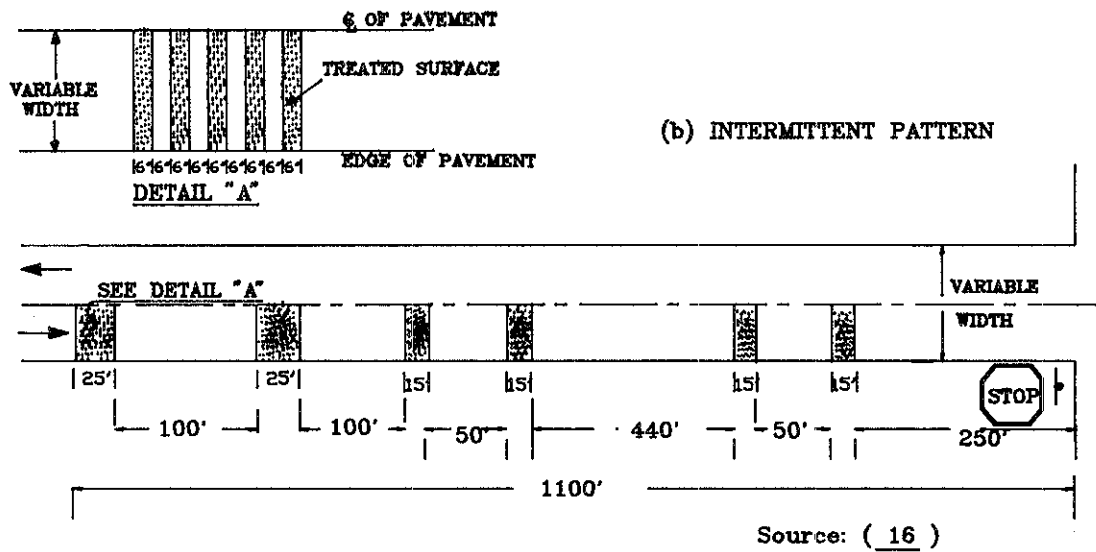
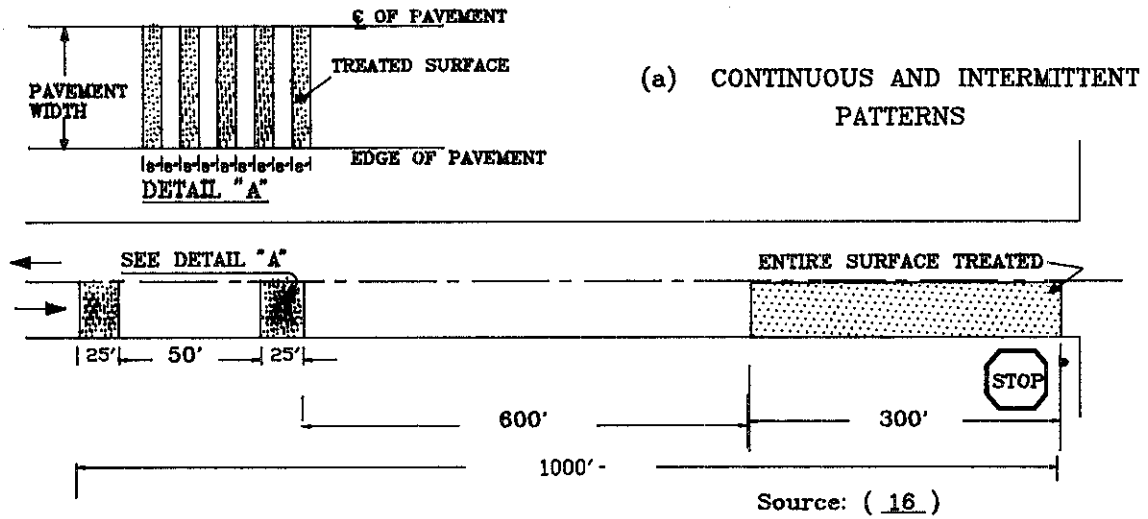
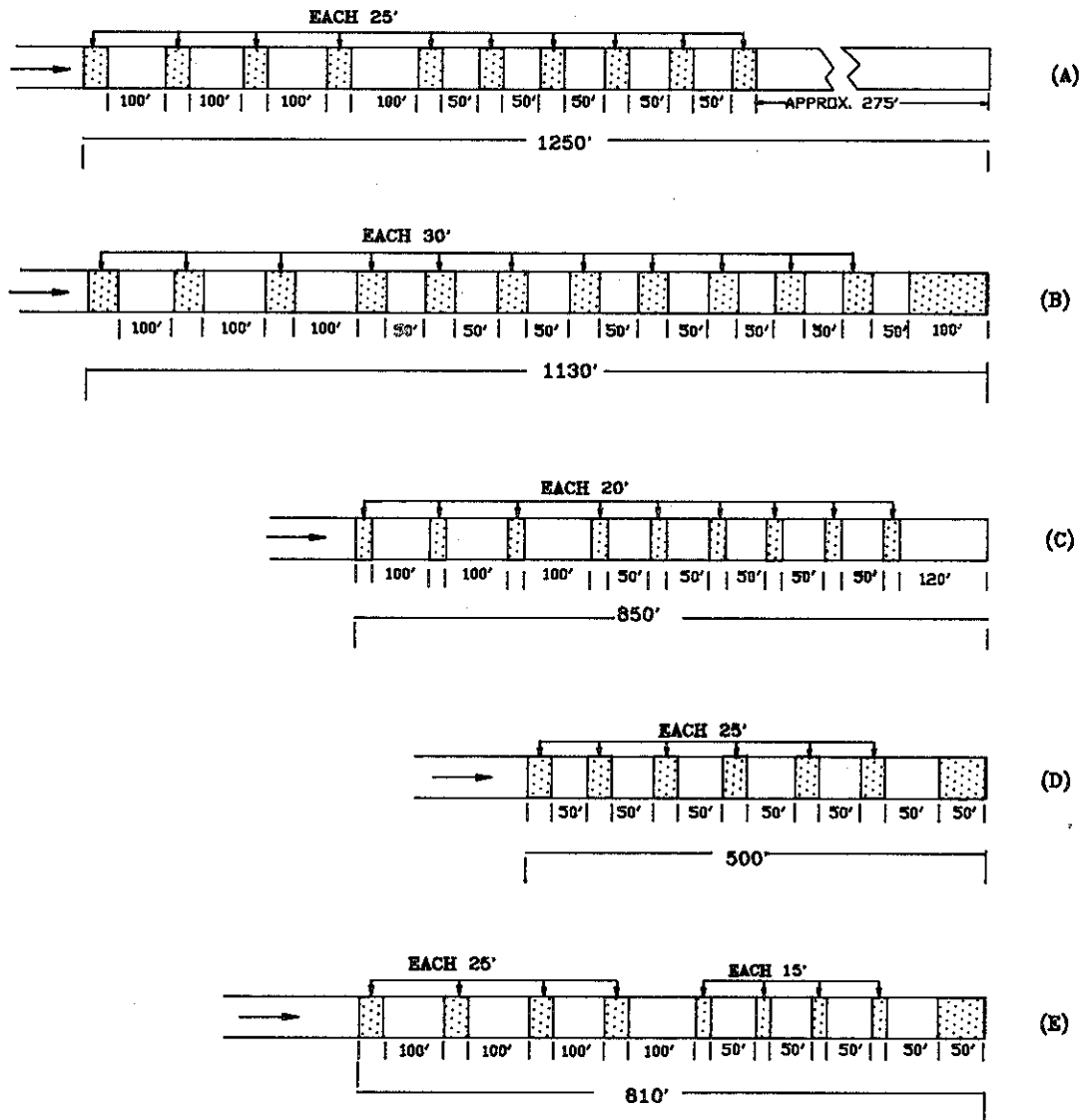

Figure 4. Rumble strip patterns



Source: ( 3 )

Figure 5. Rumble strip patterns: change in size and/or spacing.

been to lengthen the pattern for higher approach speeds by adding strips to the beginning and deleting them at the end if a full stop was not required.

All agencies that evaluated the Contra Costa County design reported success. The measures of effectiveness that had been considered included changes in speed and deceleration patterns, effects on accident history, driver observance of stop controls, and driver observance of centerlines after turning at intersections. One of the principal advantages reported for this design was the change in spacing which resulted in an increase in the sense of urgency as a driver traversed the strips. This led to greater variation of the basic pattern in order to stress this feature. These variations have included the usual spacings but two different sizes of strips -- the usual 25 feet for the first half of the pattern and then 15 feet for the last half -- and changes in both the size and spacing of the strips (Figures 5e and 6f).

The Michigan Department of State Highways also followed the trend with intermittent rumble strips with decreasing lengths along the sections of highway where they were installed (26). The design that Michigan developed is shown in Figure 6g. Initially, Michigan installed and tested a rumble strip pattern, shown in Figure 3g, which consisted of two long 3/4-inch thick bituminous asphalt overlays. The overlays evidently lacked sufficient surface texture, and it became obvious almost immediately that they would not be effective. The rumble strips were replaced with strips constructed with a coarse, exposed aggregate surface. Six-inch wide grooves spaced at 36 inches and cut at an angle of 45 degrees were cut into the overlays. Studies revealed a speed decrease of nine mph during the night and four mph during the day. However, it was observed that about five percent of the vehicles left the travel lane after the first long rumble strip and used the shoulder to drive around the second strip.

The investigators drove over the rumble strips at speeds between 50 and 70 mph and noted a moderate thumping noise and slight vibration of the vehicle. Both problems increased with decreasing speed, and the drivers experienced a tendency to compensate for the grooves by driving toward the outside lane.

To reduce shoulder usage, 6-inch wide 1/2-inch thick strips with bituminous concrete formed at the same angle as the grooves on the pavement were formed on the shoulder. The grooves in the pavement mats were subsequently increased to 12 inches. This change, however, resulted in additional problems. One truck lost a load of bricks while traveling over the rumble strips and several vehicles lost hub caps. In addition, one small vehicle was observed vaulting into the air. Although this design resulted in lower average speeds, drivers accelerated after passing the second mat to the extent that the 85th percentile speed increased by 6 mph.

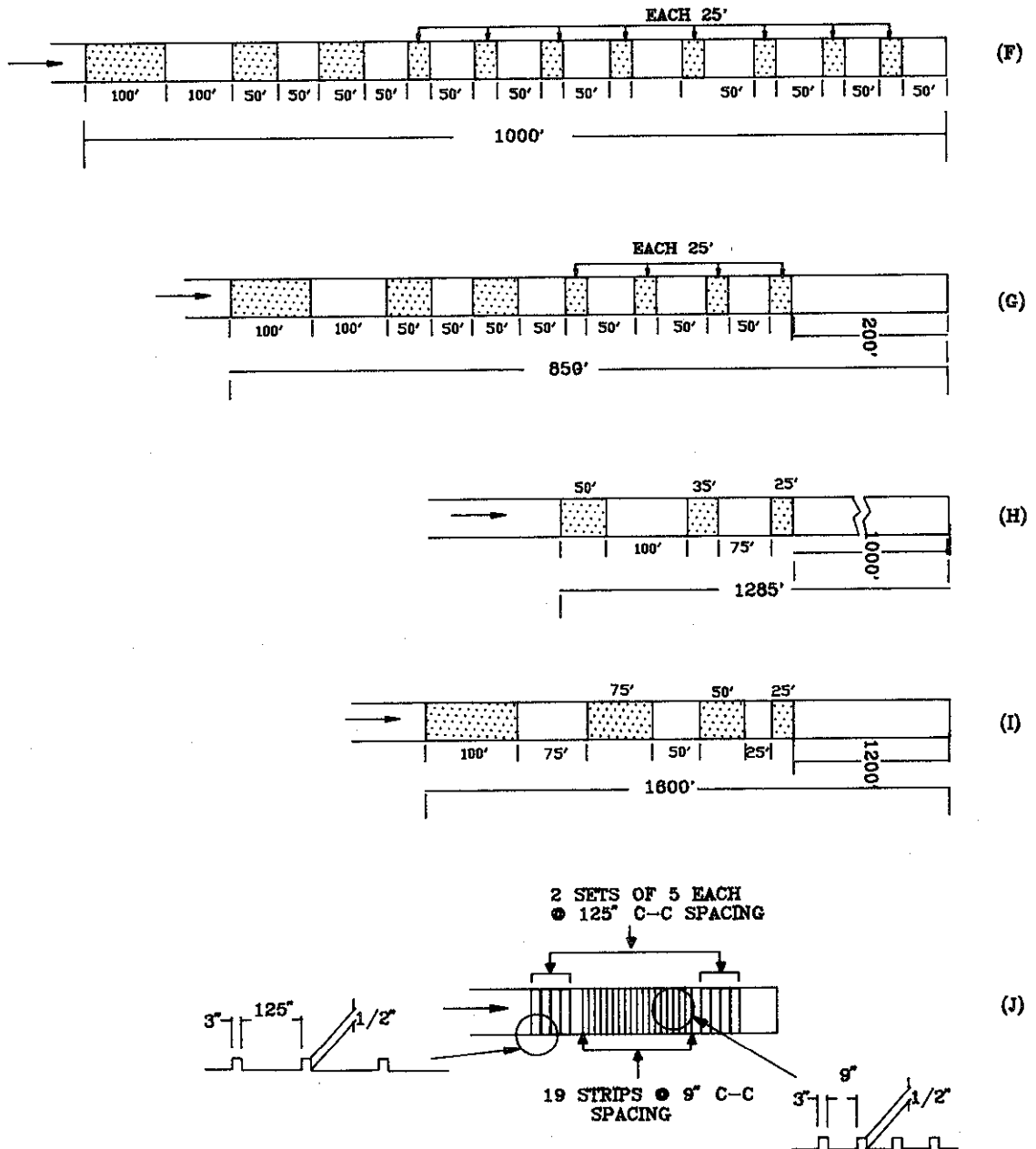

Source: ( 3 )

Figure 6. Rumble strip patterns: change in size and/or spacing (Figure 5 continued)

The next set of tests involved rumble strips using exposed coarse aggregate similar to the design shown in Figure 6g. Initially, only the first, fourth, and seventh strips were installed. This pattern was found to have only a very slight effect in reducing speeds. The remaining strips, shown in Figure 6g, were installed and a study revealed a speed reduction of four to five mph at the first three strips and an overall reduction of 15 mph from the approach speed. Speeds beyond the rumble strips remained below the desirable speed of 50 mph. Two additional field studies determined that the rumble strips did not lose their effectiveness with time (26). However, it was noticed that some drivers tended to ride the shoulders to avoid the rumble strips. Bituminous bars were, therefore, installed on the shoulders.

As a result of these studies, the investigators concluded that the exposed aggregate rumble strips with the width and spacing used were effective, and that the grooved overlays were not suitable. Michigan developed a standard design, shown in Figure 6f, for use at intersections. It consists of the same pattern tested in the field (Figure 6g) but with four additional evenly spaced strips at the end.

The Connecticut Department of Transportation field tested rumble strips which were constructed using raised bars at toll plazas. Driver surveys revealed that 88 to 95 percent of the drivers reported that they had been warned by the rumble bars. More drivers reported that they felt them rather than heard them (27). The researchers considered them to be well received by the drivers even though some drivers objected to them. However, there were enough driver objections so that in later installations, the use of bars was discarded in favor of exposed aggregate rumble strips.

The New Jersey Department of Transportation developed a unique design utilizing bars placed at two spacings, intended to provide both an optimum jolting and an optimum vibration (28). Preliminary tests were conducted using three-inch wide strips of 1/2-inch plywood with edges bevelled at 45 degrees. These were nailed to a concrete pavement at a variety of spacings. To determine the spacing providing the optimum jolting effect, they were first placed 116 inches apart (center-to-center); that distance representing the wheel base of the average car. This installation was tested at speeds of 10 to 50 mph, and the spacing was gradually varied at 6-inch intervals throughout the range of 86 to 140 inches. To test for the spacing producing the most effective vibration, the wooden strips were also installed at a variety of close intervals. The results indicated that a 125-inch center-to-center spacing resulted in optimum jolting, while a nine-inch center-to-center spacing provided optimum vibration. As a result, an installation using a combination of these two spacings (Figure 6j) with bars of

the same dimensions as the wooden strips but formed in place using epoxy mortar was placed on the approach to a traffic circle. A comparison of accident histories for two-years before and after revealed a 20 percent reduction in accidents (from ten to eight) and 40-percent reduction in injuries on the treated approach (from five to three), while the corresponding approach without rumble strips experienced increases of 113 and 233 percent (from 8 to 17 and 3 to 10), respectively.

**B. Construction Methods and Materials.** Rumble strips have traditionally been constructed in two basic approaches: 1) bars preformed and then bonded to the pavement, or produced by grinding grooves into the pavement, and 2) overlays constructed with exposed aggregate surfaces. In both cases, the strips are usually made of a variety of aggregate types and sizes, and asphaltic and synthetic materials.

1. **Rumble Bars.** Early studies conducted by several highway agencies in Connecticut, Kentucky, Indiana, Colorado, North Carolina, and New Jersey explored several rumble strip cross sections where the bars never exceeded one inch in thickness and no more than one foot in width. Spacings between bars, however, ranged from as little as 12 inches to more than 120 inches (16, 17, 27, 28,). The shorter spacing caused a thumping noise when passed over by the vehicles; the longer spacing, however, created a slightly discomfoting jolt.

Bars constructed from synthetic material appeared to be more durable than those constructed from asphalt. Connecticut experimented with smoothed-surface raised bars that were made of tar cold patch, polysulfide-epoxy resin concrete with polysulfide adhesive, slurry of carbo-rubber resin cement, or hot-mix asphalt concrete with cationic emulsion prime (27). With the exception of the polysulfide-epoxy resin concrete materials, all bars were formed in place on tack-coated surface and then beveled by hand tamping and truck rolling. The bar sizes varied slightly. See Figure 7. Connecticut found asphalt bars to be more economical than either formed-in-place synthetic or a precast synthetic material (27). Previous studies by other agencies, however, determined that information on bars constructed with synthetics were not sufficient to determine whether their higher cost was justified. The New Jersey Department of Highways found that formed-in-place synthetic bars performed satisfactorily (28). Bars made of quartzite sand-epoxy resin mortar with epoxy prime were tested for optimum jolting and vibration spacings. The pavement was grooved and the bars were placed in the grooves so that they were exposed above

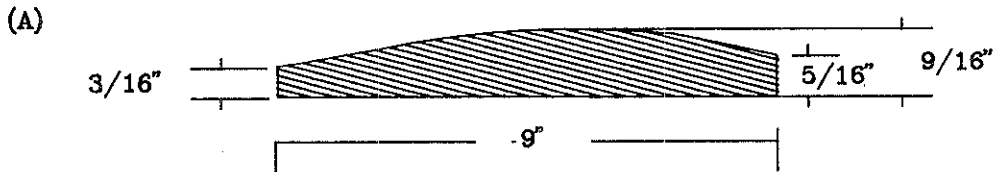

**MATERIAL:** Tar Cold Patch  
**CONSTRUCTION METHOD:** Formed in place  
**CENTER-TO-CENTER SPACING:** VARIED

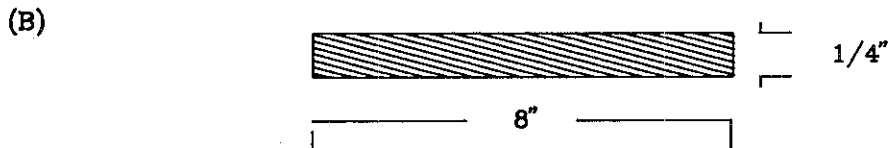

**MATERIAL:** Polysulfide - epoxy resin concrete with polysulfide adhesive  
**CONSTRUCTION METHOD:** Precast and bonded to pavement  
**CENTER-TO-CENTER SPACING:** Varried; 2'9" to 5'6"

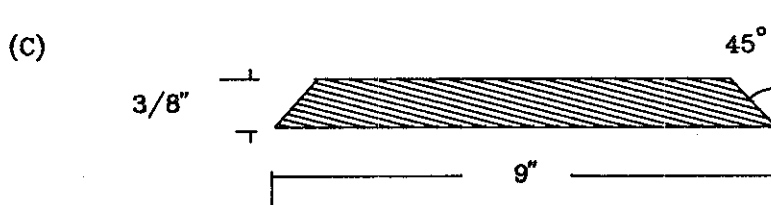

**MATERIAL:** Hot-mix asphalt concrete with cationic emulsion prime  
**CONSTRUCTION METHOD:** Formed on tack-coated surface, then beveled by hand tamping, and truck-rolling  
**CENTER-TO-CENTER SPACING:** 5'6"

Source: ( 27 )

Figure 7. On-road rumble bars.

the pavement surface. This, provided a mechanical interlocking of the bars and pavement, supplementing the usual adhesive bond. See Figure 8e. The optimum center-to-center spacings for jolting and vibration were found to be five feet five inches and nine inches, respectively (28). This study, however, did not report the ultimate durability, cost, and service life for these installations.

Most of the earlier installations and designs considered uniform thickness and a smooth surface, but there have been few variations from such practices, particularly to study the severity of impact and jolting affects. Connecticut, for example, constructed air foiled shaped bars (Figure 7a) to reduce the impact affect via a thinner leading edge than trailing edge. This design, however, produced severe audible and vibration signal and was less economical than other designs such as those in Figure 7c (27). Other installations by Connecticut succeeded in reducing the severity of impact by using bars with bevelled edges (Figures 7c and 8e). These designs were constructed from hot-mix asphalt concrete which was reshaped by passing vehicles, reducing the severity of the stimulus.

A number of other agencies experimented with raised bars on exposed aggregate surfaces (16, 17, 18, 30, 31). The studies reported by Illinois indicated that harder aggregate and a double application of binder increased durability. The size of the individual raised bars (1/2 inch in thickness by six to eight inches in width) were relatively identical in all applications.

Rumble bars have also been constructed by grinding the pavement to produce routed grooves and form rumble strips of untreated pavement between them. See Figure 9. According to studies conducted by Michigan, Wisconsin, and Florida, these grooves resulted in the same stimulus as a series of bars of comparable dimensions and spacings placed on the pavement, because the extent and frequency of vertical movement of a vehicle is the same (32, 33, 34, 35). Among the four studies conducted by these agencies, the installations shown in Figure 9a and 9c were found to generate stimuli which were too severe and were not audible enough, respectively.

2. **Rumble Strip Overlays.** Rumble strip overlays are formed rumble areas made of surface treatment or overlay of exposed coarse aggregate (see Figure 1a). This approach provides both an audible stimulus and a slight tactile stimulus consisting of a low-



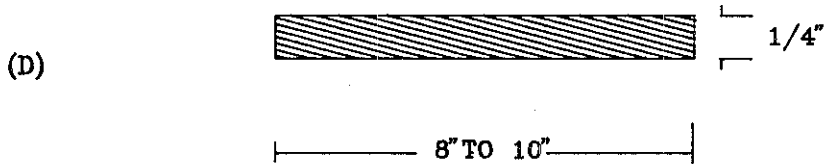

**MATERIAL:** 3/8", stone with cutback asphalt  
**CONSTRUCTION METHOD:** Formed in place  
**CENTER-TO-CENTER SPACING:** 1'2" TO 10'

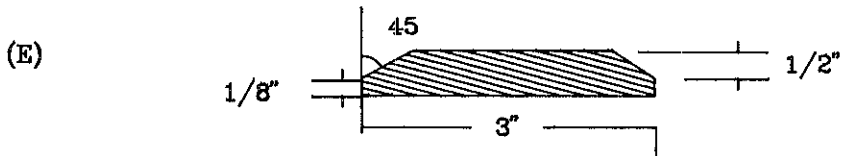

**MATERIAL:** Quartzite sand-epoxy resin mortar, with epoxy prime  
**CONSTRUCTION METHOD:** Overlay grooved; primer applied; bars formed in place to extend above overlay surface  
**CENTER-TO-CENTER SPACING:** 5'5" to 9"

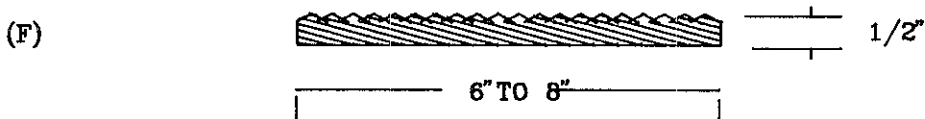

**MATERIAL:** \* Rock chips and epoxy slurry with epoxy prime (17, 30)  
 \* Stone with epoxy resin (16, 17, 18)  
 \* Slag with epoxy sand mortar, with epoxy prime (31)  
**CONSTRUCTION METHOD:** \* Formed in place after priming (17, 30)  
 \* Inverted penetration surface treatment with second application of binder as cover coat (16, 17, 18)  
 \* Pavement primed, mortar placed, aggregate tamped in and another binder coat added (31)  
**CENTER-TO-CENTER SPACING:** 1 foot to 1'6"

Figure 8. On-road rumble bars.  
 (Continuation of Figure 7)

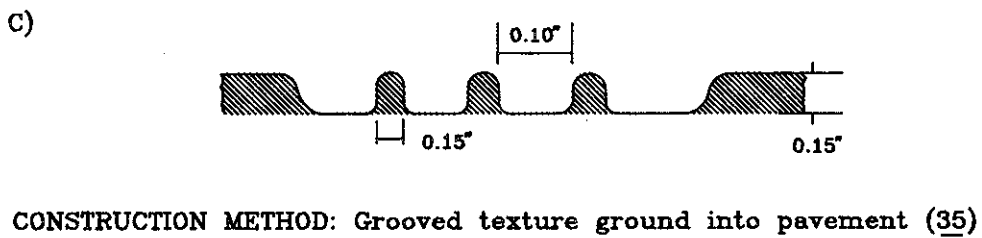
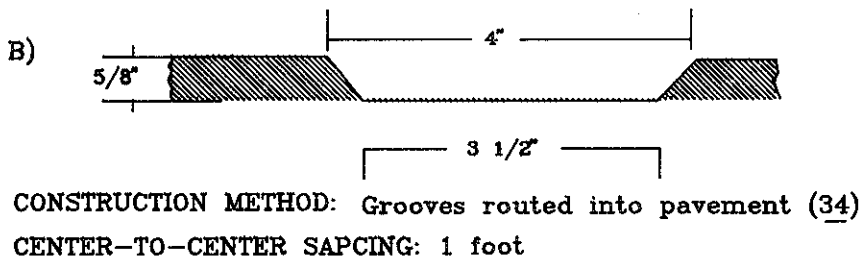
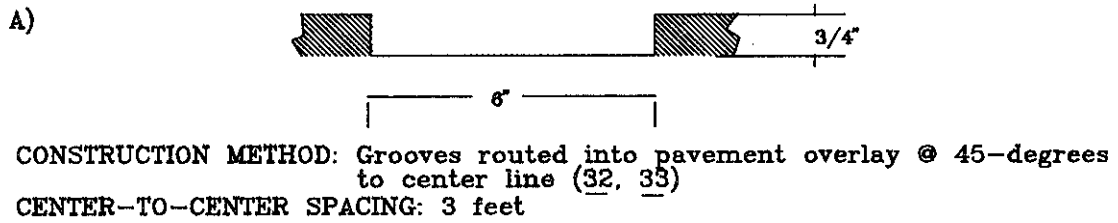

Figure 9. Grooved rumble bars

amplitude, high-frequency vibration. Rumble strip overlays are generally constructed using surface treatment procedures with asphalt and a synthetic binder. In the majority of cases, overlays consisted of an inverted penetration with the binder applied first and the aggregate spread on it. This procedure was followed by surface preparation which varied from surface cleaning to etching. Applications of a fog seal coat were used to seal voids surrounding the aggregate and assure its retention.

During the 1960s, several states had experimented with rumble strip overlays. Maryland, Delaware, North Carolina, Minnesota, California, Michigan, and Illinois experimented with several aggregate mixtures in order to produce satisfactory stimuli without increasing the noise level (14, 17, 33, 36, 37). The binder used to construct the overlays consisted of cationic asphalt emulsion, cutback asphalt, tar, asphalt seal coat, coal tar epoxy, or epoxy resin. The aggregate size varied from 3/8 inches to 2 inches at an application rate of 20 to 50 pounds per square yard. According to the studies that were conducted then, the cationic emulsion binder was the most popular and superior to other binder materials (17, 19, 37). A binder application rate of 0.35 to 0.45 gallons per square yard was found to maximize aggregate retention and minimize asphalt bleeding when 3/4 inch stone was used. Durability was improved substantially when a fog seal coat was applied.

Installation of rumble strip overlays were also reported to result in several types of failure. Chief among these types of failure was the loss of aggregates in the wheelpaths and at the leading edge of each overlay. A study conducted by Contra Costa County in California, for example, reported that 60 percent of the aggregates were lost in the first year of application (38). Aggregate loss is an important safety issue because it reduces the effectiveness of the overlays and creates hazardous roadway conditions. The problem of aggregate loss was overcome by increasing the depth of the overlays and/or using sealing coat materials. The overlays tested by the Contra Costa County were reconstructed from 3/4 by 1 inch aggregates which were applied at 30 pounds per square yard; a polyester resin fog seal coat was applied at 20 gallons per square yard with sand applied at 10 pounds per square yard. As a result of this application, aggregate loss was minimal. It appeared that the use of a resin fog seal coat helped reduce aggregate loss significantly (38).

In the late 1960s, several agencies discovered problems with exposed aggregate overlays. Overlays were mistaken by many drivers for poor pavement sections and, therefore, caused drivers to bypass them by crossing the centerline. Also, overlays required more materials than other similar installations constructed with bars and thus were more expensive to construct and use. Some agencies overcame these deficiencies by providing color contrast for easier recognition of rumble devices.

### III. RUMBLE STRIP APPLICATIONS

A. Work Zone Applications. Researchers began to experiment with temporary rumble strips in the early 1960s and 1970s. At that time, research on rumble strips focused on the development of patterns and construction methods rather than applications. The majority of applications were permanent. Recently, however, interest in rumble strip applications for work zones was stimulated by the increasing demand for improvements in work zone speed control techniques and more effective methods for alerting drivers of unusual conditions.

Rumble strips in construction and maintenance work zones are not recognized as traditional traffic control devices. However, rumble strips are used by some states (7, 9, 10, 11) in work zones on high-volume highways. In general, rumble strips, when used, are intended to supplement warning signs and other devices in advance of freeway work zones involving lane restrictions, width reductions, sharp detour transitions, or other conditions that might warrant major speed reductions.

Rumble strips in work zones have been studied under a limited number of applications, and the studies have produced inconsistent findings. Some studies examined the potential of rumble strips for speed control, while others were more concerned about late merges and traffic congestion in lane closures (39, 40, 41, 42).

Recent studies by Richards et al. (39) indicated that rumble strips were ineffective treatments for controlling work zone speeds. Rumble strips were compared to several other techniques such as flagging, law enforcement, changeable message signs, effective lane width reduction, and conventional regulatory and advisory speed signing (39). In their study, a series of eight raised strips with decreasing logarithmic spacings were installed upstream of the hazard area. The design of the rumble treatments are indicated in Figure 10. The design consisted of eight 1/2-inch high polycarbonate strips. It was noted, however, that rumble strips were difficult to adhere to the pavement, and therefore, only one application was installed on three stations on a two-lane, two-way rural highway in advance of the work zone. The same study examined driver's preference to three rumble strip treatments: 1) individual strips, 2) clusters-equal spacing, and 3) clusters-unequal spacing. Seventeen subjects responded to a questionnaire survey which indicated that about one-half (47 percent) of the drivers believed that the "clusters-equal spacing" treatment produced the greatest speed reduction (39). Three-fourths (76 percent) of the drivers said that the individual strips produced the least speed reduction. As can be seen in Figure 11 the rumble strip designs did not produce any statistically significant change in driver speeds.

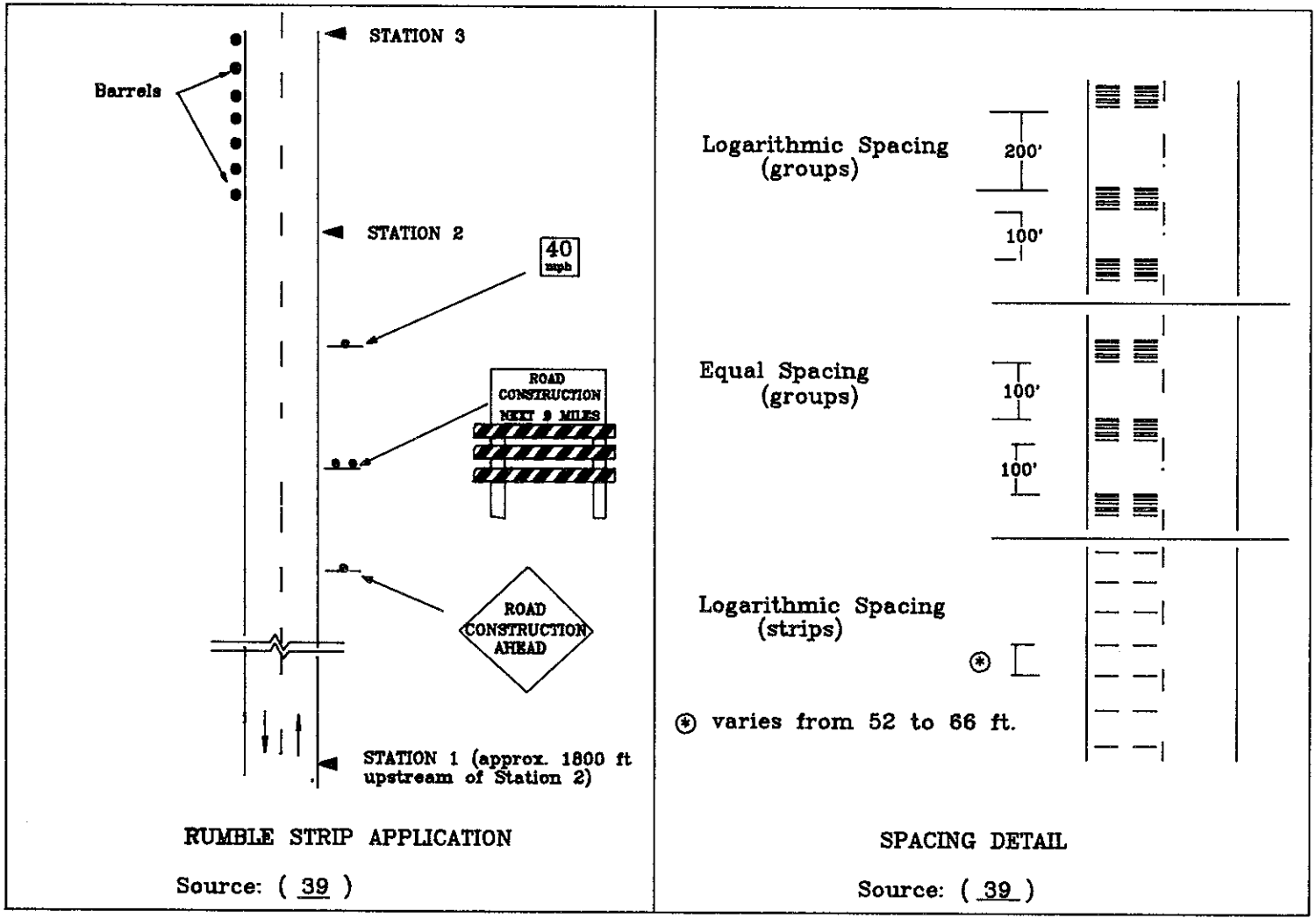
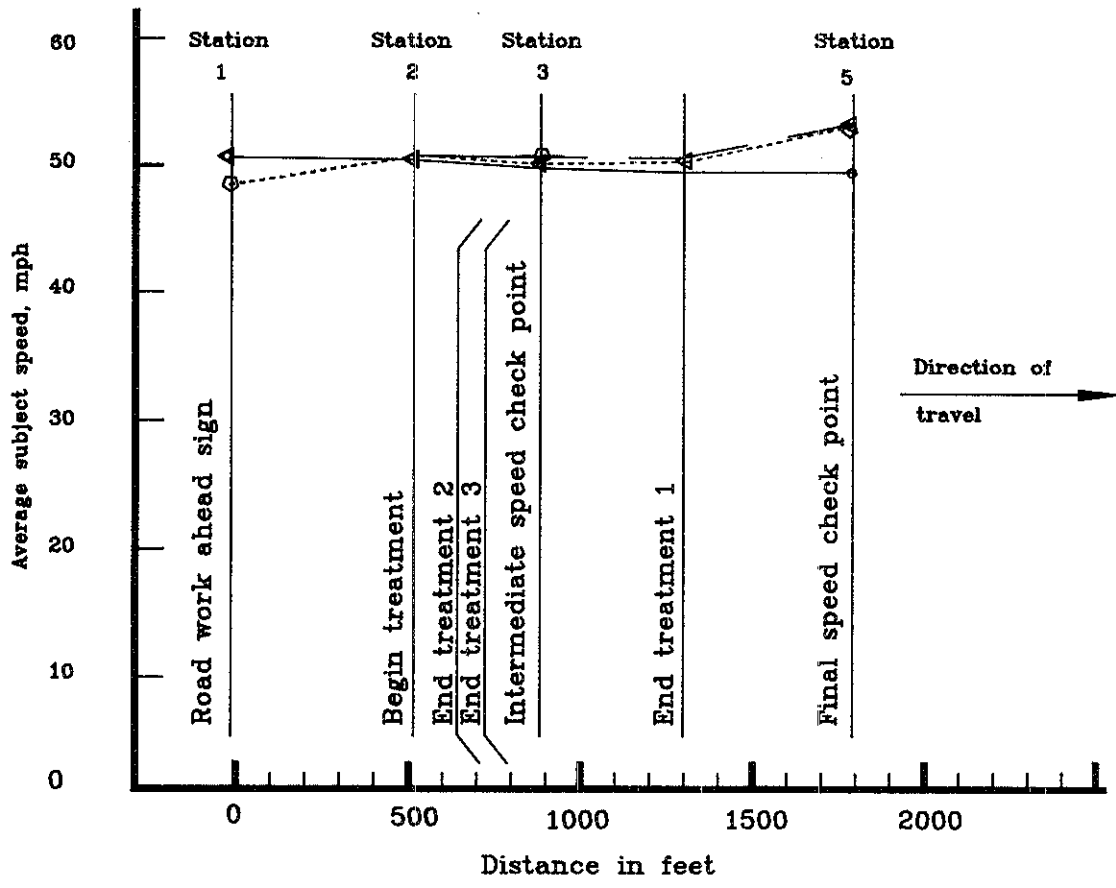

Figure 10. Rumble strip application and spacing detail.



- — ○ Individual strips (1)
- ◻ — ◻ Clusters—equal spacing (2)
- ◁ — ▷ Clusters—unequal spacing (3)

Source: ( 39 )

Figure 11. Speed reduction potential of rumble strip designs

Pigman and Agent reported on rumble strip studies where the devices were used to reduce the number of late merges from lanes that are closed due to road work, thus helping to reduce traffic congestion resulting from the late merges at low speeds (40). These devices consisted of eight strips per set with a 24-inch spacing between successive strips. The strips were installed in the lane to be closed at distances of 1.5, 1.0, 0.6, 0.3, and 0.1 miles in advance of the taper. The strips were made of hard plastic - vinyl material having dimensions of 1/2 inch x 4 inches x 23-3/4 inches; each set consisted of 48 side-by-side strips or 240 strips for five sets. Every six side-by-side strips covered one 12-foot lane. The rumble strips were used in conjunction with construction warning signs. The study reported that the percentage of traffic -- at 0.1 mile in advance of the taper -- in the lane to be closed decreased from 11.0 percent to 4.1 percent when rumble strips were installed at distances of 1.5, 1.0, 0.6, 0.3 and 0.1 miles in advance of the taper. A noticeable decrease in speed as traffic approached the taper was also observed, but the speed still averaged more than 55 mph in the range of 1 mile to 1/2 mile in advance of the taper (40).

AKT temporary rumble strips (41), which are currently being tested in New Mexico, have already been tested by AKT Corporation and indicated acceptable results (41). In the test evaluation, vehicle speeds were checked in three scenarios: 1) using standard construction signs; 2) adding 35 mph regulatory signs; and 3) adding AKT rumble strips. The test showed that by adding the rumble strips, the average vehicle speed was reduced more than 8 mph as compared to the use of standard construction signs and more than 4.5 mph as compared to using both construction signs and 35 mph regulatory signs (41). The profile of the AKT temporary rumble strips consists of ten tiny noise steps, a short landing and a 90-degree, 1/2 inch drop off at its trailing edge, and formed in length and width of approximately 24 and 3-1/2 inches, respectively. See Figure 12. AKT's recommended practice is to place a series of six strips with 10-inch separation between centers across the pavement and 200 feet in advance of work zone signs (41). These strips are bonded to the pavement with epoxy. The thin leading edge prevents dislodgement. Also, the 90-degree, 1/2-inch high trailing edge makes it possible to remove the rumble strips at the completion of work by inserting a blade between the pavement and the trailing edge. Each individual strip costs approximately \$4.00. Therefore, as per AKT's recommendation for rumble strip placement in Figure 12, the total estimated cost would be \$864.00 for all three rumble strip sets on a two-lane roadway.

Rumble strips are sometimes used for special operational and geometric problems. Rumble strips have been considered by some highway officials (42) as being relatively effective in mitigating potential safety problems that could result from



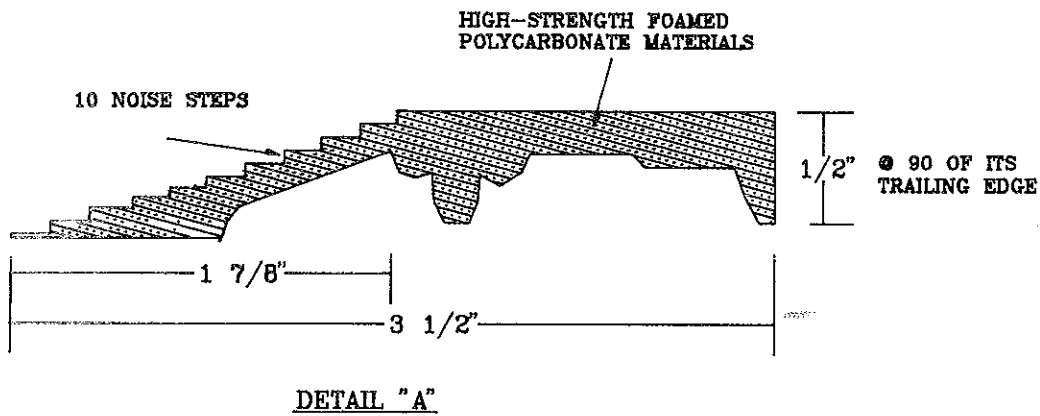
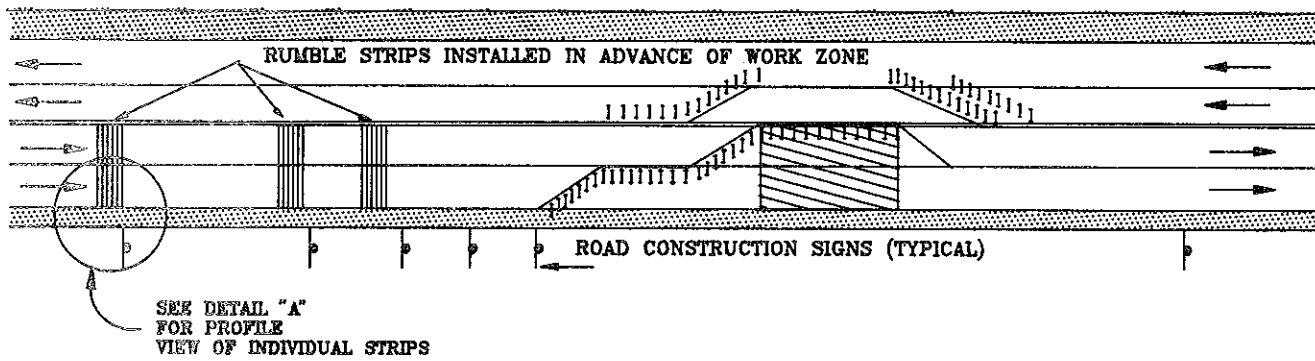

Source: ( 41 )

Figure 12. Rumble strip application in work zones

such conditions. For example, during joint repair and resurfacing of Interstate 77 in Ohio, two-way traffic was maintained on one side of the roadway. The crossover section was severely affected by a long downgrade and vertical and horizontal curvature with opposing superelevations. Rumble strips were installed because of concerns with vehicle speeds and the geometrics. The construction project was zoned for a speed of 50 mph. Speed checks using radar were made at two points within the work zone. The first location was at a point at the end of the transition taper to the single lane. This location was just over a crest vertical curve and just past one 50 mph regulatory sign. The 85th percentile speed was found to be 62 mph. The second location where speeds were measured was at a point between the last rumble strip and the start of the crossover which was at the end of a downgrade. The 85th percentile speed was found to be 55 mph -- 7 mph less than that measured at the first point. Construction personnel and officials of the Ohio Department of Highways (42) believed that the speed reduction was significant and that the rumble strips were very effective in keeping speed in the construction area down to a more reasonable level. The study, however, did not provide any specific rumble strip design details.

Both number of studies and the reported applications of rumble strips in work zones have been very limited. The results of studies to evaluate the effectiveness of rumble strips for speed control in work zones differ, and thus there is inconclusive evidence that rumble strips are an effective means of speed control in work zones.

**B. State Specifications.** Specifications for rumble strip design and applications in work zones for the visited states are summarized in Table 2.

Pennsylvania's work zone traffic control manual includes rumble strips among its miscellaneous devices and materials. The manual approves the use of rumble strips in work zones for alerting drivers to unusual maneuvers and references the standard design shown in Figure 13. The manual specifies that rumble strips should be extended onto the shoulder whenever possible in order to discourage drivers from making erratic maneuvers to avoid those devices. Pennsylvania has developed standard drawings for the design and application of rumble strips. Figure 13 illustrates the two patterns, A and B, used by Pennsylvania. Pattern A involves five sets of rumble strips with the separation distance decreasing from 200 feet to 50 feet. The strips span the entire traveled way, are extended across the paved shoulders, and are constructed from bituminous overlays (10). Pattern B is constructed in a unique method whereby 1/2-inch deep and 4-inch wide plywood strips are nailed in place at 12-inch spacing to form grooves with a separation distance decreasing from 200 feet to 50 feet. A bituminous overlay is applied to cover the full width of the strip area and the plywood strips are then removed. This application

Table 2. Rumble strips in work zones

RUMBLE STRIPS				
STATE	TYPE	DESIGN	APPLICATION	PROBLEMS
Pennsylvania (10)	Intermittent raised strips of bituminous overlay	1/2-inch x 4-inches @ 12" spacing. See Figure 13.	In advance of crossovers, but not for speed control	. Noise . No effect on trucks
Illinois (9)	Raised high-strength polycarbonate (intermittent)	See Figure 15. (one piece of construction material with two channels.	In advance of construction tapers.	
California (7)	Raised and grooved strips (intermittent)	3/4 inches or less in height if raised & one-inch or less in depth if indented	In advance of workers	. Noise & virbration . Unusual maneuvers to avoid rumble strips . bicyclists & motorcyclists
Kentucky (48)	Intermittent raised bit-uminous asphalt	See Figure 18.	Construction zones, but only with approval from Central Office Division	
Ohio (11)	Intermittent raised strips of asphaltic concrete or depressed grooves. See Figure 17.	Grooved: 1/2" x 3.5" x 11.3' @ 8" spacing Raised: 1/2" x 8" x 12.5' @ 8" spacing	In advance of construction taper	. Hazard for bicycle travel

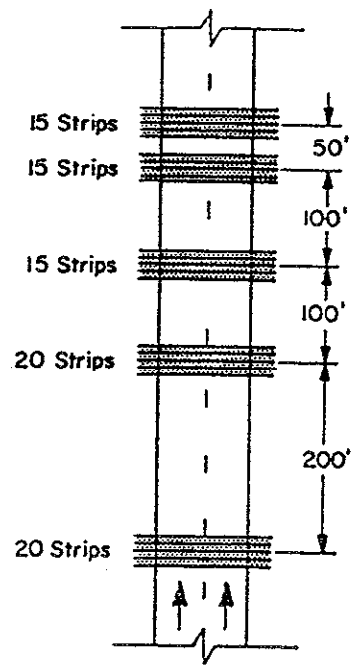

RUMBLE STRIP PATTERN A

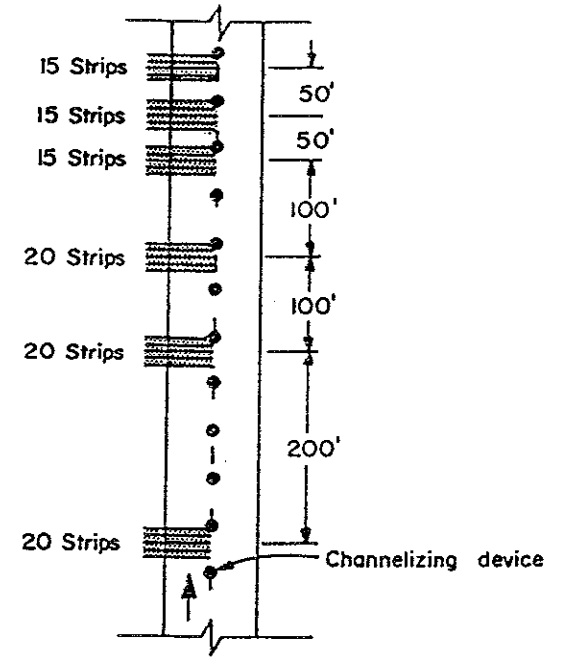

RUMBLE STRIP PATTERN B

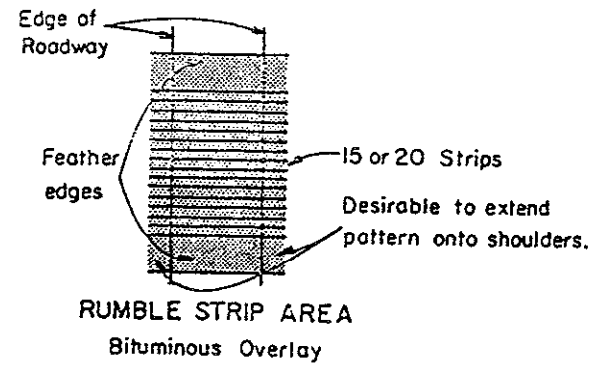

RUMBLE STRIP AREA  
Bituminous Overlay

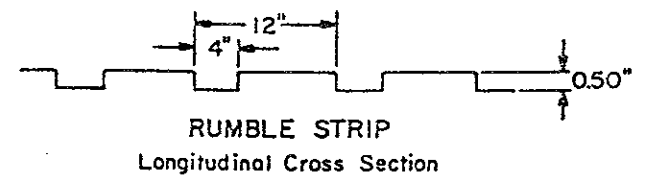

RUMBLE STRIP  
Longitudinal Cross Section

INSTALLATION  $\frac{1}{2}$ " x 4" plywood strips nailed in place at 12" spacing to form grooves.  
INSTRUCTIONS Apply bituminous overlay, then remove plywood strips.

Source: Reference No. 10

Figure 13. Pennsylvania's rumble strip patterns

minimizes construction and repair of the existing pavement surface and provides for easy removal. In both patterns the upstream sets have more strips than the downstream sets. The standard drawing (see Figure 14) shows that Pattern A is used in advance of the taper, and Pattern B is used in the transition area in advance of the temporary bituminous detour.

Illinois uses prefabricated black strips made of polycarbonated foam as indicated in Figure 15. The strip is grouped in sets of five with a uniform strip spacing of 5 feet. The sets are uniformly positioned at 200 feet apart. Part VI of the Illinois MUTCD provides standard drawings on the design and application of rumble strips on work zones on two-lane roadways where one lane is closed and temporary traffic signals are used to control traffic. A schematic of this situation is presented in Figure 16. Illinois covers the entire width of the traveled lane with rumble strips and does not specify extension across the shoulders to discourage maneuvers to avoid them.

Ohio and Kentucky have developed rumble strip standards for permanent on-road applications, but their specifications also imply that the same designs could be used in construction zones (11, 48). Both states use intermittent patterns (see Figures 17 and 18) with and without uniform sizes and spacing. Ohio's design consists of ten sets of either raised or grooved strips. These sets vary in size from 10 to 14 strips per set. Similarly, the spacing between sets of strips varies from 50 to 250 feet and is a function of the operating speeds. Kentucky's design provides for uniform rumble strip dimensions and variable spacing between sets of strips and between individual strips according to the prevailing operation speeds.

New York has not developed standard rumble strip specifications as yet, but they are considering Kentucky's design. Also under consideration is a design that would consist of three sets of groups of raised bituminous strips placed across the full width of the roadway in advance of work zone (29). The individual raised strips under consideration are 8 inches wide, 1/2 inch high, separated by 16 inches, and grouped in three sets which are spaced at 300 to 400 feet (29).

Maryland, Delaware, California, Virginia, and Michigan do not allow the use of rumble strips in work zones without prior written approval. Some states would not even consider the possibility of using or exploring rumble strips in work zones. Michigan has phased out rumble strips in work zones due to driver confusion and liability potential. Currently, Michigan has no standard plans nor specifications for using rumble strips in work zones (6). In California, rumble strips are not used on highway work zones unless their use is determined to be the only reasonable solution to the identified problem (7). When used, however, rumble strips are less than 3/4 inch high, if raised, and less than 1 inch deep, if indented, and must extend across the travel lanes. Virginia has shown no interest

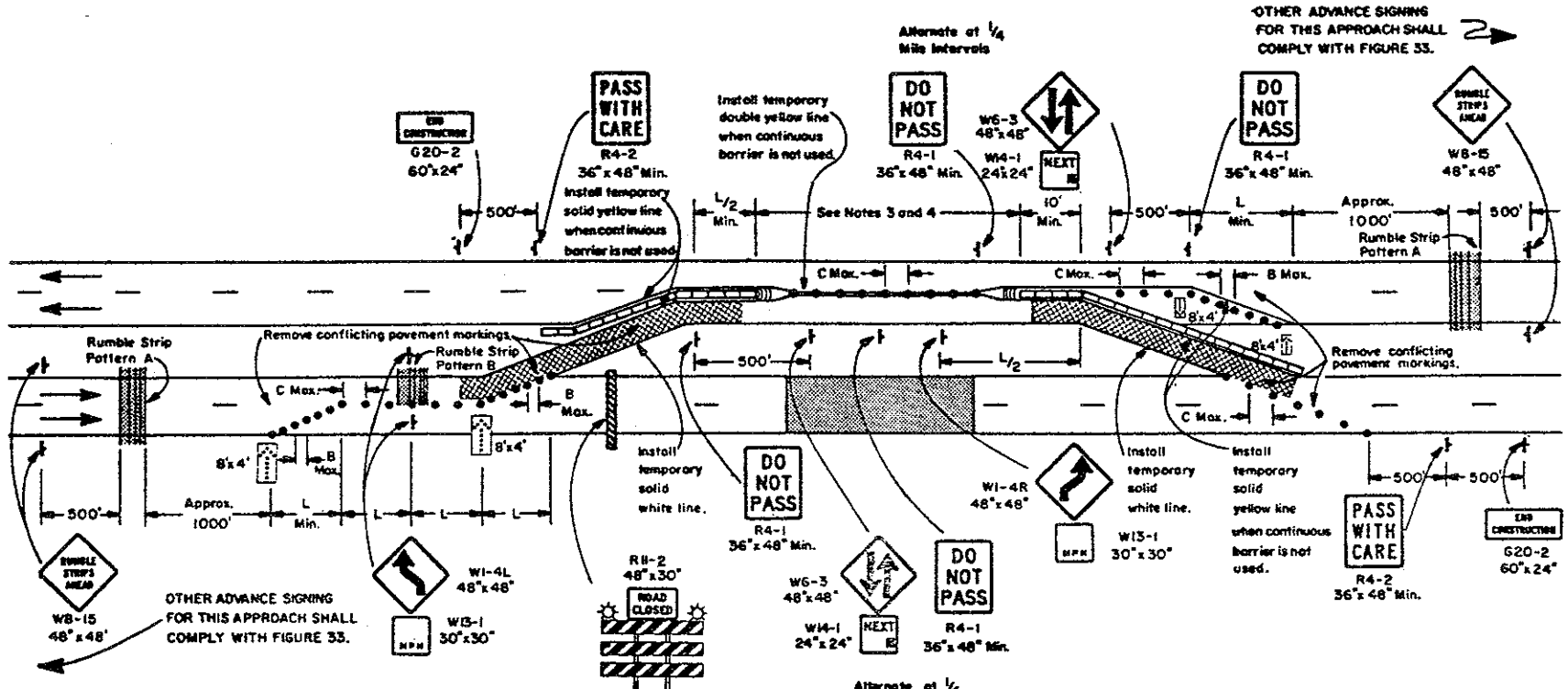

**SYMBOLS**

- Work area
- Sign
- Channelizing device
- Type B light
- Arrow board
- See Table 3
- Temporary concrete median barrier (See § 203.61)
- Approved temporary impact attenuator (See § 203.101)

- Temporary bituminous rumble strips (See § 203.102 and Figure 30b)
- Temporary bituminous overlay
- Normal speed limit

S	B	C
(MPH)	(FT)	(FT)
25	25	50
30	30	60
35	35	70
40	40	80
45	45	90
50	50	100
55	55	110

**NOTES**

1. All distances may be adjusted slightly to fit field conditions.
2. During hours of darkness, all signs shall be reflectorized or illuminated.
3. Continuous temporary concrete median barrier, or other channelizing devices in conjunction with temporary concrete median barrier at each transition, shall be used between opposing traffic except in the following situations:
  - a. Where the opposing traffic is located on an urban-type street or arterial where operating speeds are low.
  - b. Where drivers entering the section with opposing traffic can see the transition back to normal one-way operation on each roadway.
  - c. Where release of these separation devices is approved in advance, based on unusual circumstances:
    - (i) By the FHWA on all federal-aid projects,
    - (ii) By the Department's Engineering District on non-federal-aid projects on State-designated highways, or
    - (iii) By the local authority's engineer on non-federal-aid projects on highways under its jurisdiction.
4. The maximum length of temporary one-lane operation, excluding transitions, should not exceed approximately 3 miles. Temporary one-lane operation longer than approximately 3 miles shall only be permitted if justified by an engineering analysis of crossover locations, traffic operations, safety, and other related factors.
5. When continuous temporary concrete median barrier is used between opposing traffic, Do Not Pass (R4-1), Pass With Care (R4-2), and Two-Way Traffic (W6-3) Signs are not required. Two-Way Traffic Signs (W6-3) with appropriate Advisory Mile Signs (W4-1) shall be used at a maximum spacing of 1/2 mile where continuous temporary concrete median barrier is not used between opposing traffic.
6. Crossovers should be designed for speeds not more than 10 mph below S, but definitely shall not be designed for speeds more than 20 mph below S.
7. For existing concrete pavements, temporary bituminous overlays should be used as shown to cover misleading pavement joints.
8. The use of rumble strips and associated W6-15 Signs is optional.

Source: (10)

Figure 14. Pennsylvania's standard drawing of rumble strip application

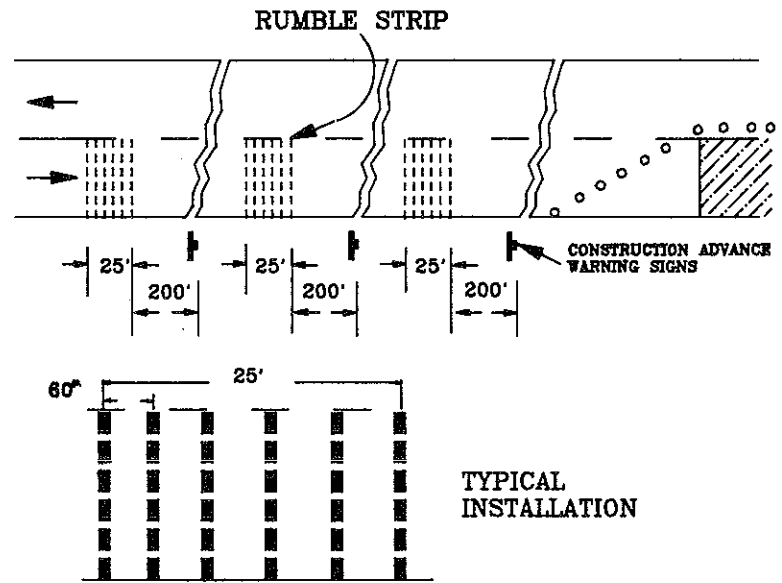
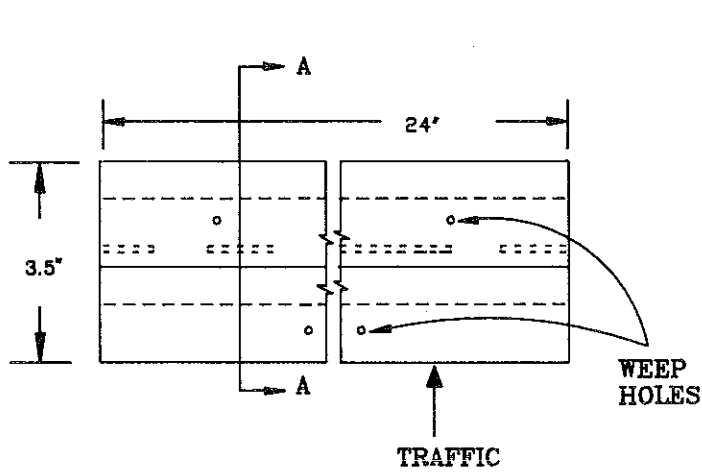

33

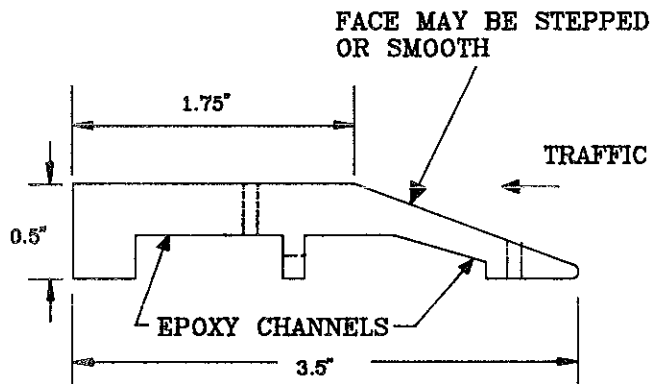

A-A  
DETAIL OF RUMBLE STRIPS

Source: Report Part VI of the Illinois MUTCD, 1987

Figure 15. Temporary rumble strips of Illinois

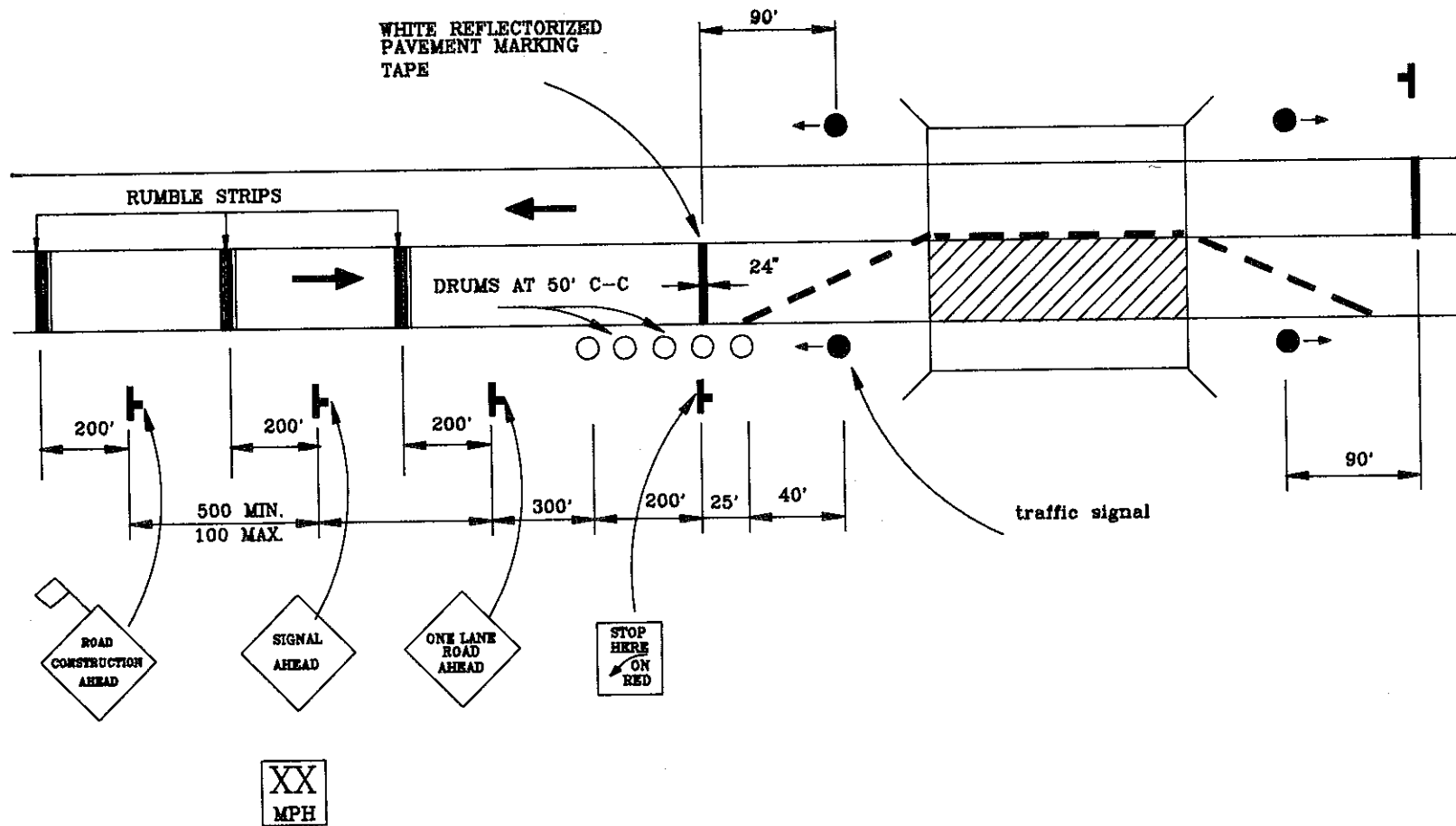

Note: Rumble Strips and other control devices are applied to both approaches of the bridge in the schematic.

Source: ( 9 )

Figure 16. Schematic of Illinois' application of rumble strips.



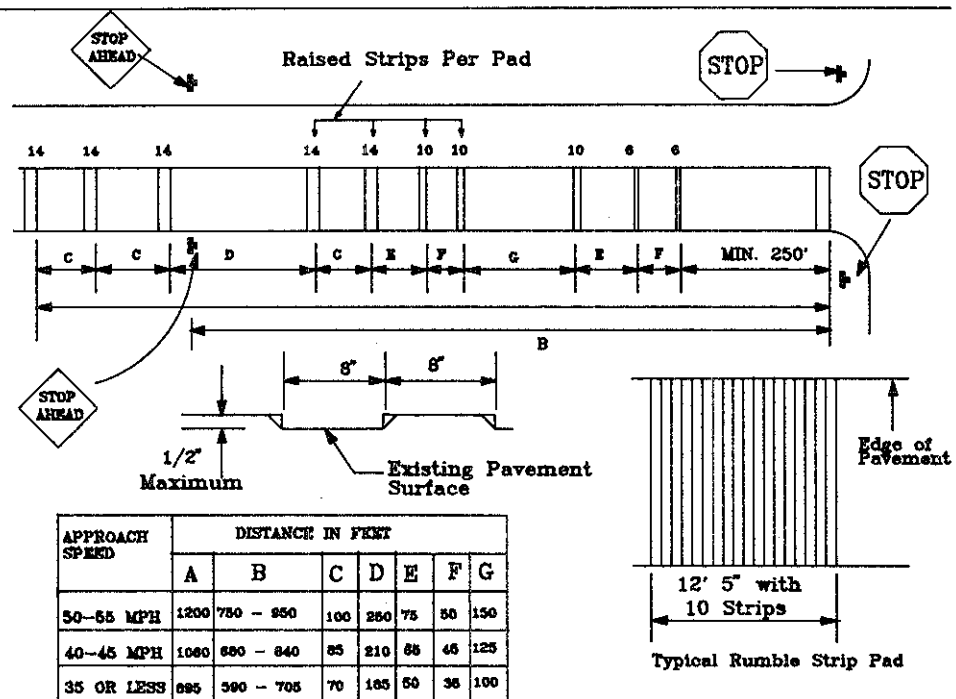
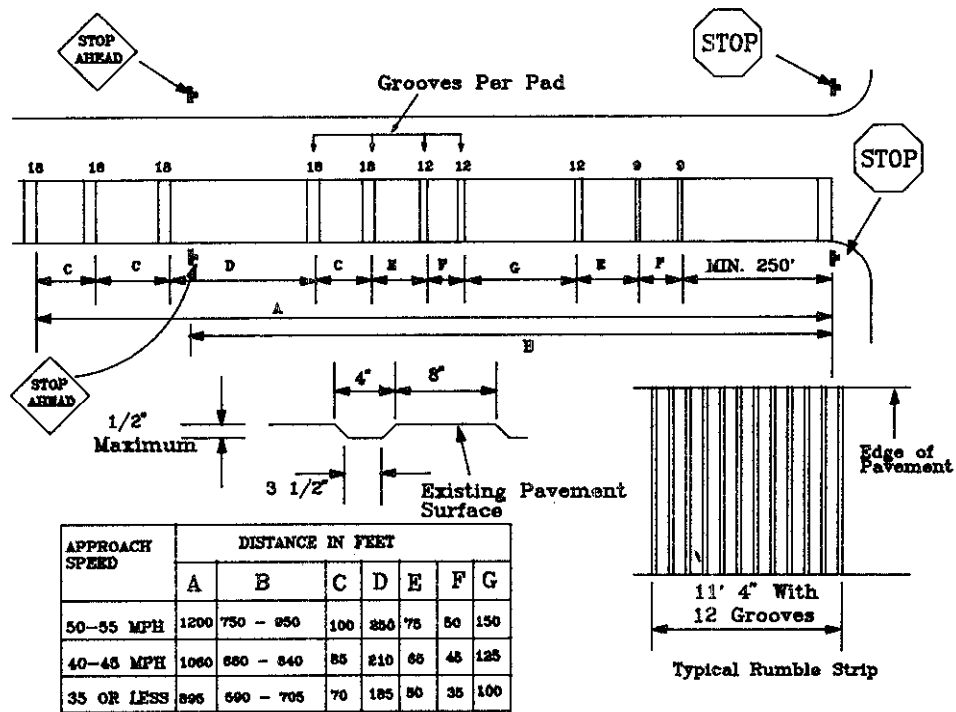

Source: ( 11 )

Figure 17. Ohio's rumble strip patterns and applications.

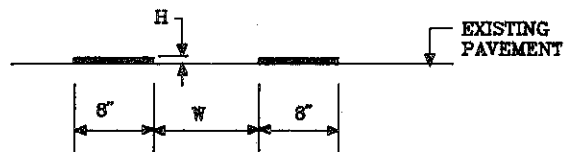
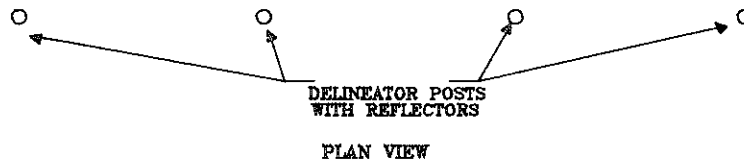
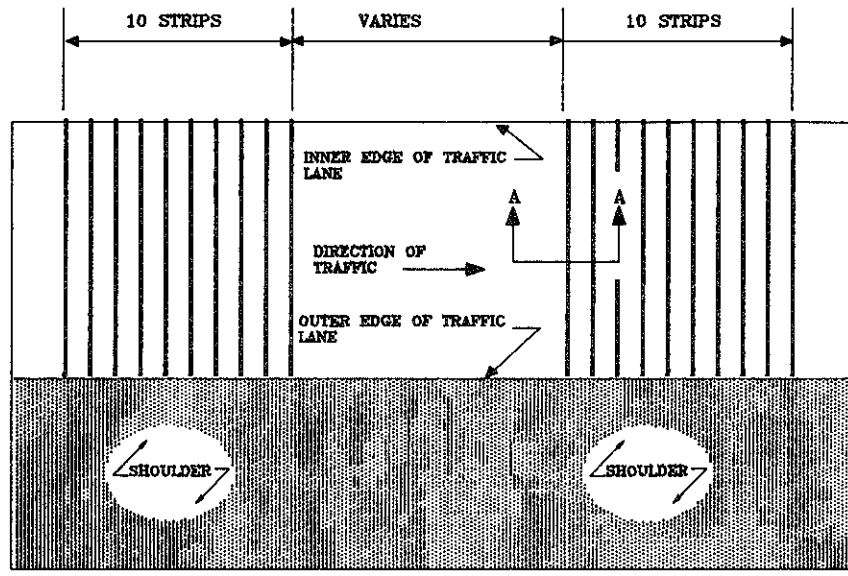

PART-SECTION A-A

TYPE	M.P.H	H	W
1	0 - 45	1/4" - 3/8"	12"
2	OVER 45	3/8" - 1/2"	24"

Source: ( 48 )

Figure 18. Kentucky's on-road rumble strips

in rumble strips.

Specifications for rumble strip advance warning signs are non-existent except in Pennsylvania. A rumble strip warning sign is usually installed 500 feet upstream of the first application. Details of the Pennsylvania rumble strip warning sign are shown in Figure 19.

**C. Non-Work Zone Applications.** The performance of rumble strips in non-work zone applications has been measured and quantified in terms of their ability to reduce accidents, speeds, late merges, and drivers' non-compliance to traffic control devices, particularly at stop-sign controlled intersections. Two recent studies evaluated the rumble strip effectiveness at stop-sign controlled intersections (46, 47).

Before-and-after accident studies were conducted by Carstens (46) in 1979 at 88 stop-sign controlled intersections on secondary roads. Comparisons were made on the basis of both the total number of accidents and the number of accidents attributed to running a stop sign. Carstens (46) found no differences in the accident experience during the periods before and after the installation of rumble strips.

Other studies examined the influence of rumble strips on speeds, deceleration, and stopping behavior. Zaidel et al. (47) conducted an experiment on the two minor approaches to the same four-way rural low-volume intersection. Prior to conducting this study, the intersection had suffered three fatal accidents, and an additional seven injury accidents had occurred involving 45 casualties -- 15 seriously injured over a three year period. Rumble strips -- 1/2 to 5/8 inch high -- were laid on one of the two minor legs while paint stripes were used on the other leg. Speeds were monitored at eight points on each leg along a 420-meter distance preceding the intersection area. A sample of 2500 approaching vehicles was observed. The study reported that rumble strips lowered speeds by an average of 40 percent; they caused drivers to decelerate before the vehicle passed the first strip and caused an additional deceleration -- approximately 50 percent reduction in mean speed -- within the last 175 meters (47). This performance remained unchanged after a year. Four years after the rumble strips were installed, this same intersection experienced only four accidents with seven casualties -- two seriously injured -- and no fatalities, although traffic volume increased (47). The study concluded that a 150-meter (492 feet) treatment of 1/2 inch strips is long enough to produce positive effects of rumble strips at stop-sign controlled intersections (47). According to Zaidel et al., drivers understood the purpose of the rumble strips, rated them as quite tolerable, endorsed their use, but disliked strips higher than 5/8 to 3/4-inch (47).

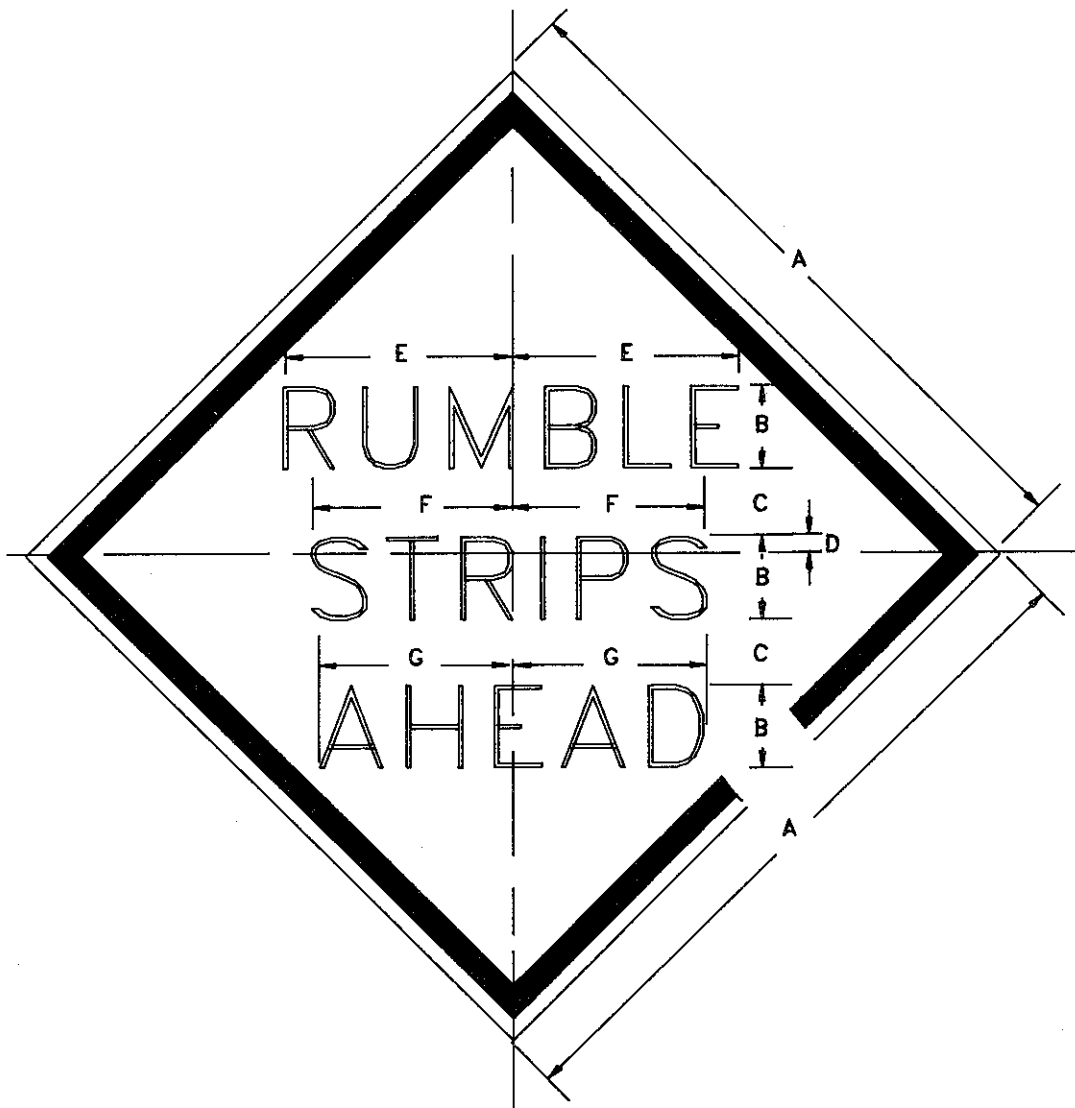

SIGN SIZE (in.)	DIMENSIONS (inches)						
	A	B	C	D	E	F	G
36 X 36	36	5	2 1/2	2	10 3/4	9 3/8	8 5/8
48 X 48	48	7	3	2	15 1/16	13 1/8	11 7/8

SIGN SIZE (in.)	SERIES LINES			MARGIN (in.)	BORDER (in.)	BLANK STD
	1	2	3			
36 X 36	C	C	C	5/8	7/8	B3-36
48 X 48	C	C	C	3/4	1 1/4	B3-48

Figure 19. Details of the rumble strip sign used in Pennsylvania.

#### IV. ENVIRONMENTAL ISSUES

Several agencies have avoided the use of rumble strips in some cases because of environmental issues such as noise tolerance, driver misunderstanding, cyclists, maintenance, car handling, and snow plowing. Only the first four of these issues have been addressed in the literature.

**A. Noise Tolerance.** The Illinois Department of Transportation (IDOT) placed rumble strips near the end of an expressway to alert drivers that they were approaching a signalized intersection. The strips were installed at four locations where previous safety measures were not significantly effective in lowering the number and severity of the accidents (43). Studies were conducted to measure, at various rumble strip spacings, vehicle noise amplitude and frequency, and vehicle vibration inside and outside a semi-trailer. Four strip configurations were studied. The first configuration consisted of grooves with rounded edges. The second consisted of grooves that were sharper. The third consisted of four sets of grooves, each with a different cut. The fourth configuration consisted of grooves that were slightly deeper than the others but were filled with a small lift of asphalt. All four configurations are presented schematically in Figures 20 and 21. Noise and vibration were measured from the outside using up to eight microphones, a real-time analyzer, and a computer. The study concluded that the rumble strips tested produced a low frequency noise that increased the noise level by up to 6 or 7 dB(A) over noise levels produced by traffic on normal pavements. This same study found that the number and severity of accidents at the intersection location were reduced due to rumble strip applications (43).

**B. Driver Understanding of Rumble Strips.** Driver understanding of rumble strips in work zones continues to be an issue. Some highway officials feel that drivers are not able to differentiate between patched or rougher resurfaced sections and the rumble pavement (4). Rumble strips for shoulder application are usually designed differently from those for use on the traveled way, and thus, they generate different audible signals. While research on driver understanding of off-road rumble devices has not been conclusive, few studies have been conducted on driver behavior and understanding of rumble strips at work zones.

According to the California Highway Patrol, conversations with drivers stopped along the shoulder where rumble strips were installed disclosed that the drivers were apparently asleep or dozing when they were aroused by an unusual noise caused by rumble strips on the shoulder and stopped their vehicles to inspect the tires or undercarriage for problems (5).

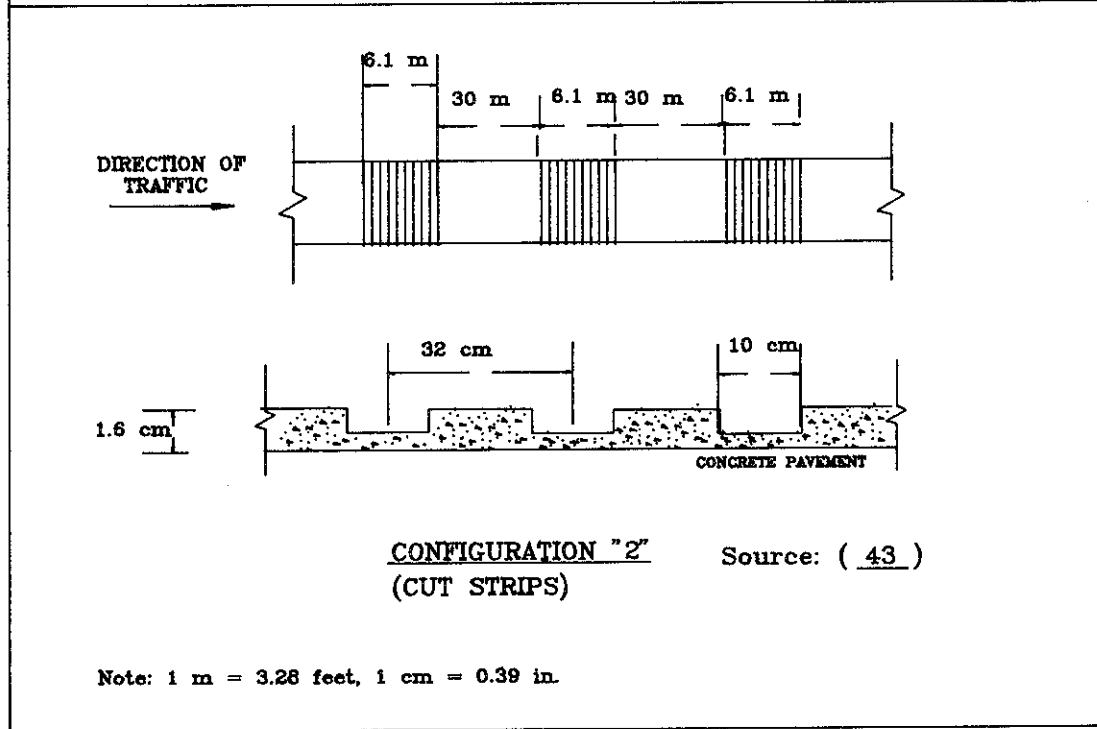
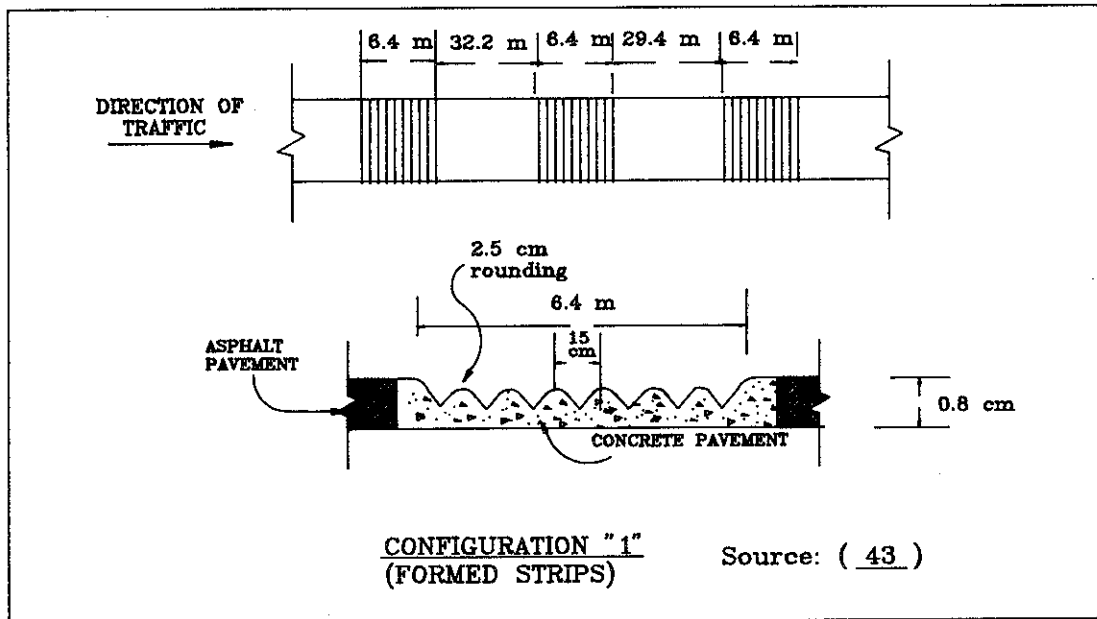

Figure 20. Rumble strip configurations.

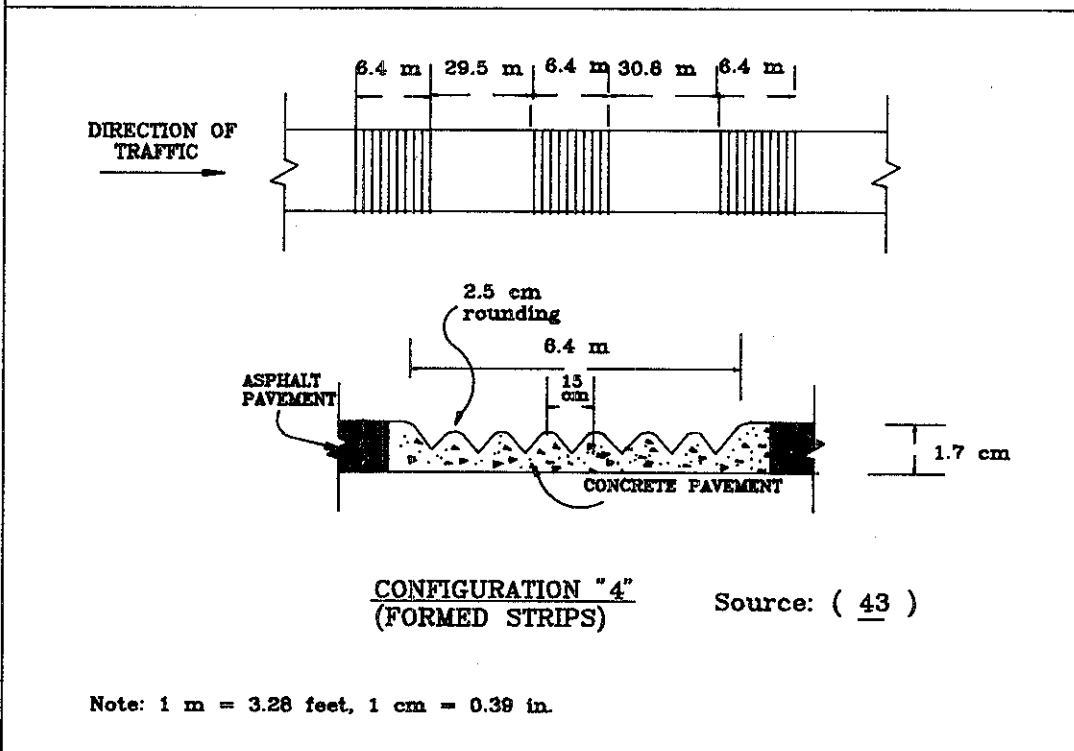
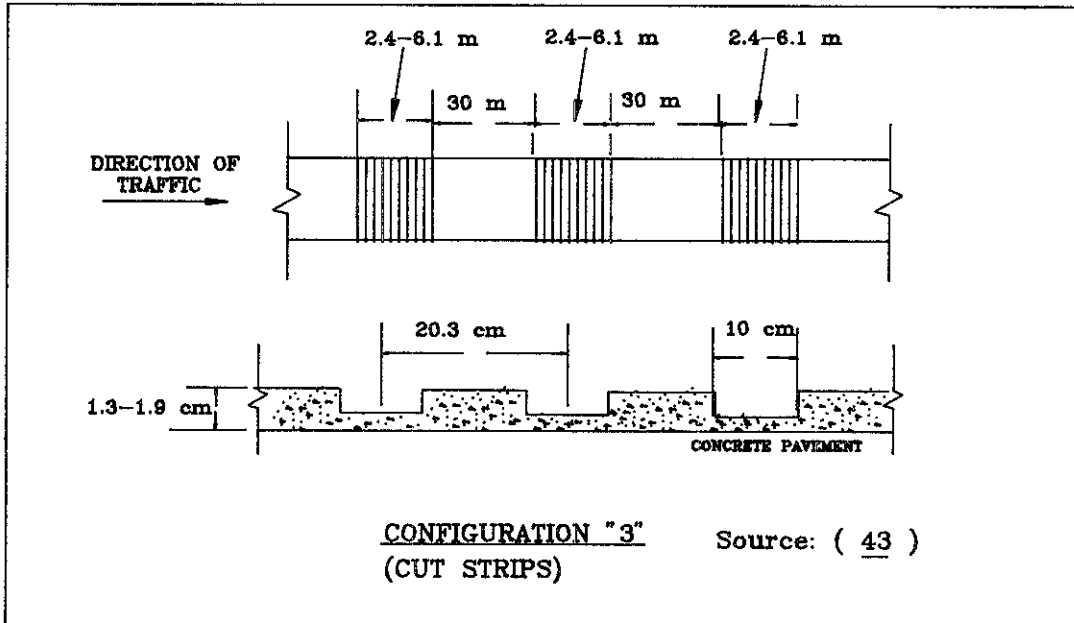

Figure 21. Rumble strip configurations

The lack of national standards and specifications for rumble strips and variations in the design of their occasional application make it more difficult for drivers to understand the meaning and purpose of rumble strips. Based on discussions with several state officials, rumble strips ought to be clearly visible during the day and night in order to increase driver understanding. Also, advance warning signs and diagrammatical signs depicting rumble strips in work zones were suggested as measures to increase and enhance drivers' understanding of rumble strips in work zones.

**C. Rumble Strips Effect on Cyclists.** According to Feldman (44), rumble strips in the travel lane or along shoulders are not only a nuisance, but they are also a hazard to bicycle traffic. Commenting on research conducted by the California Department of Transportation (5), Feldman indicated that rumble strips should not be installed where bicycle traffic is legally permitted to operate (44).

Rumble strips could cause bicyclists who inadvertently ride over them to lose control and be involved in severe accidents. Bicyclists are legitimate users of the roadways and their safety should not be compromised in an attempt to solve other problems. Due to concern by bicycle commuter associations in Ohio, the Department of Transportation has developed a policy in regard to rumble strip applications (45). The policy indicates that when rumble strips are installed in the travel lane, a minimum width of two feet should be left intact at the outside edge of the pavement to accommodate bicyclists and motorcyclists (45).

**D. Maintenance.** Very little research was found that addresses maintenance problems of rumble strips. It would seem likely that considerable failure would result from snow-plowing, particularly for rumble strips on overlays. For grooved pavement, however, it is very likely that snow and ice will accumulate between successive grooves. Provisions for drainage and maintenance have been lacking. Lack of adequate maintenance could result in hazardous conditions. A possible increase in stopping distance due to loss of tire contact with the frozen pavement surface could render the rumble strips ineffective and hazardous.



## V. CONCLUSIONS

- A. Driver understanding of rumble strips at work zones is a continuing issue. Driver response to rumble strips does not always result in the expected behavior.
- B. There have been only a few studies of the use of rumble strips in work zones. The results have varied, and there are diverse opinions as to the effectiveness of rumble strips in work zones.
- C. Research has shown that continuous rumble strip patterns are not economical, could be mistaken for poor pavement sections, and are less effective than the intermittent patterns. Rather than providing a single stimulus and sensation, intermittent patterns provide a series of stimuli or changes in sensation and are more effective and durable.
- D. Individual rumble strips can be constructed in two basic ways: raised/grooved pavement or overlays. Raised bars made of hot-mix asphalt concrete with cationic emulsion prime and formed on tack-coated surface, then beveled by hand tamping, and truck-rolled, appear to be the most durable of the previously tested raised bars with smooth surfaces, are economical, and cause less severe stimuli.
- E. In practice, the height of raised bars varies from 1/4 inch to 3/4 inch, and the width from 6 to 12 inches. Center-to-center spacings range from 9 to 65 inches.
- F. Grooved strips made of temporary overlays appear to be more acceptable to drivers than those made by sawcutting an existing pavement surface.
- G. Rumble strip overlays are as effective as the raised or grooved pavement designs but only if a sufficient resin seal coat is applied.
- H. Studies have shown that severe noise and vibration effects could be overcome by installing proper sizes of raised bars, grooved strips, or overlays. Other environmental issues, however, such as snowplowing, drainage, and regular maintenance have not been thoroughly addressed in the literature.
- I. There are no uniform standards for design and application of rumble strips for work zones. There appears to be general agreement that rumble strips should only be used for special problem locations where standard traffic control devices have proven ineffective.

- J. Rumble strips have been used in alerting motorists to unanticipated construction or maintenance activities such as in partial roadway closures where the temporary roadway alignment is a substandard design or where the construction taper is short due to geometric constraints.
- K. Some states have found that rumble strips reduce speeds in construction zones. Research, however, has indicated that rumble strips are not very effective in reducing speeds in work zones.
- L. For work zone applications, variation of the basic size and spacing pattern in rumble strips is necessary in order to increase drivers' alertness as they traverse the strips. The length of rumble strip application should vary according to the work zone operating speed and the desirable motorist behavior.
- M. Three highway agencies tested high-strength formed polycarbonate material for raised bars and found it to be durable and provide good service.
- N. Rumble strips on pavements sometimes result in drivers traveling on the shoulder to avoid the strips. Under such circumstances, it would be desirable to extend the strips onto the shoulder to discourage erratic maneuvers.
- O. There is need for more research on rumble strips in work zones.

## RECOMMENDATIONS

- A. Part VI of the MUTCD should include a separate section on rumble strips which presents the concepts in their operation, design, and application, without including detail specifications which should be treated elsewhere as design standards. The operational concept should focus on the principles involved in generating appropriate stimuli and motorist responses. The design concept should focus on characteristics of the rumble surface and their effect on the intensity and severity of the stimulus. Conceptual application should underscore the fact that rumble strips are last-resort auxiliary devices, the need for extreme care in deciding their use, and should present one or two illustrations of typical work-zone applications and a number of guidelines.
- B. Rumble strips are unique devices and need to enjoy a separate classification as "rumble devices," leaving open the opportunity for research to advance the state-of-the-art on non-strip types of rumble surfaces. Rumble devices should not be grouped with pavement markers used for delineation and channelization, although these markers may be assembled to form rumble devices.
- C. The following presents topical information that could be presented in the MUTCD.
1. **Definition of Rumble Devices.** Rumble devices include all texturized treatments of highway pavement such that motor vehicles on passing over the surface generate simultaneous audible and vibratory stimuli, warning the driver of approaching roadway conditions which would require especially careful maneuvers. Pavement surfaces can be texturized to create sets of parallel undulations which are perpendicular to the path of vehicles and are known as rumble strips. Rumble devices may be prefabricated and then attached to desirable locations on highway pavements. The design characteristics of rumble devices must adhere to the specifications of design standards.
  2. **Appropriateness of Rumble Devices in Work Zones.** Rumble devices should be considered supplemental traffic control devices, and they may be used to alert drivers of unusual traffic conditions that may not be easily detected and to alert drivers' attention to other standard construction warning devices. Rumble devices are considered

preventive measures and should only be used in work zones where the potential for accidents can be readily identified by failure to observe and comply with conventional traffic control devices.

3. **Procedure for Rumble Device Installation**

**Approval.** Rumble devices should not be approved for installation unless a comprehensive traffic engineering study is made and submitted to review by experienced traffic engineers. The study should outline the objectives of the installation, define the problem in terms of accident history or potential, determine desirable operating speeds or desirable motorist behavior, and specify, by means of drawings, the location of the rumble devices with reference to the work area and other traffic control devices. The study should also identify the type, size, spacing, and construction methods for the rumble devices if no such standards are already developed.

The responsible agency should emphasize the need for a documented before-and-after study for verifying the effectiveness of rumble device applications. Such procedures would assist in overcoming the deficiencies of rumble devices and of discouraging applications which are not significantly more effective than using only traditional traffic control devices.

Rumble devices must be sufficiently durable to cover the period of need. They should be regularly inspected and maintained. Rumble devices that are exposed to a high volume of truck traffic may need extra maintenance to prevent loss of effectiveness due to wear. When they are no longer needed, rumble devices should be removed from the pavement, and the pavement should be cleaned and restored to normal conditions. All signs relating to rumble strips must also be removed.

4. **Rumble Device Placement.** For lane closures and diversions on high-speed roadways, rumble devices that are to be located in the advance and approach zones should begin at approximately 3500 feet from the beginning of the taper and terminate at approximately 750 feet before the taper. Rumble devices should be placed on the open lanes in the work zones in order to sustain reduced speeds or reinforce the need to be alert. Rumble devices should extend across the

entire width of the pavement and across shoulders to discourage erratic maneuvers by drivers who may try to avoid them. Appropriate warning signs must be installed in advance of the rumble devices and within the rumble area to make cyclists and motorists aware that the rumble strips are deliberate.

5. **Rumble Device Application.** Rumble devices should be considered in the planning stages of construction traffic control, particularly if operational difficulties can be anticipated or drivers need to be alerted to potential hazards. When used, rumble devices should be installed at two locations: 1) prior to entering the construction zone, and 2) at the hazard zone. The hazard zone being identified as the construction or maintenance activity zone.

Rumble devices may be considered at lane closures, crossovers, lane transitions, and detours. Design specifications for rumble devices in these conditions should be developed. Figures 14 and 16 can be the basis for developing preliminary standard drawings for the MUTCD.

- D. Several areas for further research are very apparent. There is a need to develop warrants to establish the most effective type and designs of rumble devices for work zone applications, to identify the most economical construction material and methods, to determine whether visually distinguishable rumble devices can increase driver understanding and reduce erratic responses, to determine the environmental impacts of various designs, and to improve driver understanding and response to rumble devices. Although previous studies have examined several rumble device patterns, there is a need to experiment with these patterns in lane closures in work zones of short and long duration. Future research should aim at developing application standards, including the identification of minimum operating speeds when rumble devices are used in work zones.

## LIST OF REFERENCES

1. U.S. Department of Transportation, Manual on Uniform Traffic Control Devices, Federal Highway Administration, Washington, D.C., July, 1978.
2. U.S. Department of Transportation, Traffic Control Devices Handbook, Federal Highway Administration, Washington, D.C., 1983.
3. Capelli, J. T., "Audible Roadway Delineators," New York State Department of Transportation, Report NYSDOT-ERD-73-SR14.
4. "Rumble Strips at Hazardous Locations," Better Roads, Vol. 35, No. 1, January, 1965.
5. "Rumble Strips Alert Drivers, Saves Lives and Money," TR News, Transportation Research Board, National Research Council, Number 135, March-April, 1988.
6. Michigan Department of Transportation, Michigan Manual on Uniform Traffic Control Devices, Part VI, Construction and Maintenance, Lansing, Michigan, January 1987.
7. California Department of Transportation, State of California Manual on Traffic Controls for Construction and Maintenance Work Zones, Sacramento, California, 1985.
8. Delaware Department of Transportation, Traffic Control for Streets and Highway Construction and Maintenance Operations, Dover, Delaware, January 1984.
9. Illinois Department of Transportation, Illinois Manual on Uniform Traffic Control Devices, Springfield, Illinois, April 1987.
10. Pennsylvania Department of Transportation, Work Zone Traffic Control, Publication No. 203, Harrisburg, Pennsylvania, August 1984.
11. Ohio Department of Transportation, Ohio Manual on Uniform Traffic Control Devices, Columbus, Ohio, 1982.
12. Maryland Department of Transportation, Construction Traffic Control Plans Manual, Glen Burnie, Maryland, April, 1985.
13. Rumble Passes Test," Cook County Highways, Vol. 3, No. 6, Nov. 1955, p. 2.

14. "Rumble Strips at 55 More Stop Signs," Cook County Highways, Vol. 7, No. 5, Oct. 1959, p. 3.
15. "Rumble Strips at 29 More Locations," Cook County Highways, Vol. 9, No. 5, Oct. 1961, p. 3.
16. "Rumble Strips at Hazardous Locations," Better Roads, Vol. 35, No. 1, Jan. 1965.
17. "Roads Rumble for Safety's Sake," Engineering News-Record, Vol. 177, No. 11, Sept. 15, 1966, pp. 85-86.
18. Rumble Strips Used as a Traffic Control Device: An Engineering Analysis, Bureau of Traffic, Illinois Department of Public Works and Buildings, February 15, 1966.
19. Rumble Strips Used as a Traffic Control Device: An Engineering Analysis, Revised Edition. Accident Study Report 102, Bureau of Traffic, Illinois Department of Public Works and Buildings, April 1, 1970.
20. "Rumble Strips at Hazardous Locations," Better Roads, Vol. 35, No. 1, March 1965.
21. Virginia Department of Transportation, Virginia Work Area Protection Manual, Standards and Guidelines, Richmond, Virginia, January 1987.
22. Kermit, M. L., "Intermittent Rumble Strips Cut Accidents," Rural Roads, Vol. 11, No. 5, May 1961.
23. Kermit, M. L., and Hein, T. C., "Effect of Rumble Strips on Traffic Control and Driver Behavior," Proceedings, Highway Research Board, Vol. 41, 1962.
24. Kermit, M. L., "Rumble Strips Jar Dreamy Drivers," American City, Vol. 80, No. 11, November 1965.
25. Kermit, M. L., "Rumble Strips Revisited," Traffic Engineering, Vol. 38, No. 5, February 1968.
26. Jones, M. L., "Rumble Strip Experiments on a Freeway Ramp," Public Works, Vol. 98, No. 4, April 1967, pp. 102-104.
27. Miller, L., Strassenmeyer, O. A., and Wilson, J. O., Effect on Accident Experience of Rumble Area Installation at Connecticut Barrier Toll Stations, Division of Research and Development, Connecticut State Highway Department, July 1966.

28. Bellis, W. R., "Development of an Effective Rumble Strip Pattern," Traffic Engineering, Vol. 39, No. 7, April 1969.
29. New York Department of Transportation, New York Manual on Uniform Traffic Control Devices, Albany, New York, 1983.
30. "Rumble Strips in Nebraska," Public Works, Vol. 99, No. 4, April 1967.
31. "Illinois Shakes Down Accident Rate with Epoxy-Mortar Rumble Strips," SIKA News, Vol. 5, No. 1, Spring 1968.
32. Jones, M. L., "Rumble Strip Experiments on a Freeway Ramp," Public Works, Vol. 98, No. 4, April 1967.
33. Lindman, G. J., "Rumble Strips for Safety," Highway Focus, Vol. 1, No. 2, August 1969, pp. 21-26.
34. "Safety Bulletin," Christensen Diamond Services, Inc. Salt Lake City, Utah, n.d.
35. Mosher, L. G., "Results from Studies on Highway Grooving and Texturing by Several State Highway Departments," Clipper Manufacturing Co., n.d.
36. Korfhage, G. R., Special Rumble Seal Coat Strips for Traffic Warning, Final Report on Special Study 279, Engineering Standards Division, Minnesota Department of Highways, 1968.
37. Owens, R. D., "Effect of Rumble Strips at Rural Stop Locations on Traffic Operation," Highway Research Record 170, Highway Research Board, 1967, pp. 35-55.
38. Schmidt, R. J., Rercival, D. F., and Hein, T.C., "Pavement Overlays Using Polyester Resin and Asphalt Laminates," Bulletin 300, Highway Research Board, 1961, pp. 32-43.
39. Richards, S. H., Wunderlich, R. C. and Dudek, C. L., "Field Evaluation of Work Zone Speed Control Techniques," Transportation Research Record No. 1035, Transport Research Board, Washington, D.C., 1985.
40. Pigman, J. G. and Agent, K. R., Evaluation of I-75 Lane Closures, Final Report, Report No. UKTRP-86-19, Kentucky Transportation Cabinet, State Office Building, Clinton and High Streets, Frankfort, Kentucky, August 1986.
41. "AKT Temporary Rumble Strips," AKT Corporation, Wauwatosa, Wisconsin, not dated.
42. "Rumble Strips," Memoranda prepared by the Ohio Department of Transportation, October 21, 1987.



43. Higgins, John S. and Barbel, William, "Rumble Strip Noise," Transportation Research Record No. 983, Transportation Research Board, Washington, D.C., 1984.
44. Feldman, William, "Rumble Strips and Bicycles," TR News, Transportation Research Board, National Research Council, Washington, D.C., July-August 1988, Number 136.
45. "Rumble Strips," Memorandum prepared by the Ohio Department of Transportation, June 1988.
46. Carstens, R. L., "Safety Effects of Rumble Strips on Secondary Roads," Transportation Research Record No. 926, Transportation Research Board, Washington, D.C., 1983.
47. Zaidel, David, Hakkert, Alfred-Shalom, and Barkan, Rachel, "Rumble Strips and Paint Stripes at a Rural Intersection," Transportation Research Record No. 1069, Transportation Research Board, Washington, D.C., 1986. the shoulder to discourage erratic maneuvers.
48. Kentucky Department of Transportation, Kentucky Manual on Uniform Traffic Control Devices, Standard Drawings No. RPM-140-01, November 1984.