Petrographic Methods of Examining Hardened Concrete: A Petrographic Manual

Revised 2004

PUBLICATION NO. FHWA-HRT-04-150

JULY 2006



U.S. Department of Transportation
Federal Highway Administration

Research, Development, and Technology
Turner-Fairbank Highway Research Center
6300 Georgetown Pike
McLean, VA 22101-2296



FOREWORD

Petrographic Methods of Examining Hardened Concrete: A Petrographic Manual was originally published in 1992 by the Virginia Transportation Research Council (VTRC) as Report VTRC-92-R14. Authored by Hollis N. Walker, it was the culmination of a quarter century of work by her in concrete petrography at the VTRC.

This edition, revised by D. Stephen Lane, senior research scientist at the VTRC, builds on the original work. It has been revised and updated to reflect recent advances in techniques and work in concrete petrography. Major additions to the manual include a new chapter (chapter 14, written by Paul E. Stutzman, physical scientist, National Institute of Standards and Technology) on the use of the scanning electron microscope to examine concrete and concrete-making materials, and additional information on the identification and classification of rocks and minerals in aggregates (appendix D). Chapter 10, Alkali-Aggregate Reactions, was reorganized to outline the process one would follow to investigate a case of concrete deterioration and illustrate the features that provide evidence of alkali-silica or alkali-carbonate reactions. It is hoped that the manual will be of great use both to those entering the field of concrete petrography and to the experienced petrographer.

This edition is an example of the continuing cooperation in infrastructure research and development between State and Federal agencies.

The following quotation from K. Mather (1966), serves as a mission statement for concrete petrographers:

The best petrographic examination is the one that finds the right questions and answers them with maximum economy in minimum time, with a demonstration clear to all concerned that the right questions were answered with all necessary and no superfluous detail. In practice, the approach to the ideal varies depending on the problem, the skill with which the questions are asked, and the skill of the petrographer. One measure of the petrographer's skill is knowing when to stop, either because the problem is adequately solved, or, in some cases, because it has been shown to be insoluble under the circumstances.

Katherine Mather served as chair of the American Society for Testing and Materials Subcommittee on Petrography of Concrete and Aggregates for many years. She was an expert in the practice and use of petrography, contributed to many publications, and participated actively in cement and concrete research carried on by the U.S. Army Corps of Engineers, Vicksburg, Mississippi.

Gary L. Henderson, Director
Office of Infrastructure Research
and Development

NOTICE

This document is disseminated under the sponsorship of the U.S. Department of Transportation in the interest of information exchange. The U.S. Government assumes no liability for its contents or use thereof. This report does not constitute a standard, specification, or regulation.

The U.S. Government does not endorse products or manufacturers. Trade and manufacturers' names appear in this report only because they are considered essential to the object of the document.

QUALITY ASSURANCE STATEMENT

The Federal Highway Administration (FHWA) provides high-quality information to serve Government, industry, and the public in a manner that promotes public understanding. Standards and policies are used to ensure and maximize the quality, objectivity, utility, and integrity of its information. FHWA periodically reviews quality issues and adjusts its programs and processes to ensure continuous quality improvement.

| | | | | | |
|--|--|---|---|---|------------------|
| 1. Report No. FHWA-HRT-04-150 | | 2. Government Accession No. | | 3. Recipient's Catalog No. | |
| 4. Title and Subtitle Petrographic Methods of Examining Hardened Concrete: A Petrographic Manual Revised 2004 | | | | 5. Report Date July 2006 | |
| | | | | 6. Performing Organization Code | |
| 7. Author(s) Hollis N. Walker, D. Stephen Lane, and Paul E. Stutzman | | | | 8. Performing Organization Report No. VTRC 04-R21 | |
| 9. Performing Organization Name and Address Virginia Transportation Research Council 530 Edgemont Road Charlottesville, VA 22903 | | | | 10. Work Unit No. (TRAIS) | |
| | | | | 11. Contract or Grant No. | |
| 12. Sponsoring Agency's Name and Address Virginia Department of Transportation 1401 East Broad Street Richmond, VA 23219 Federal Highway Administration Office of Infrastructure R&D 6300 Georgetown Pike, McLean, VA 22101 | | | | 13. Type of Report and Period Covered Revised Manual 1997-2004 | |
| | | | | 14. Sponsoring Agency's Code | |
| 15. Supplementary Notes Contracting Officer's Technical Representative (COTR): Richard Meininger, HRDI-11 | | | | | |
| 16. Abstract This manual provides a comprehensive discussion of equipment and techniques that have been found useful in performing petrographic examinations of hardened concrete and its constituent materials. It includes an introduction and chapters on equipment, general initial procedures, cracks, preparation of specimens, and voids (including determination of the air-void system); determination of volumetric proportions of constituents; examination with the stereomicroscope; the water-cementitious materials ratio; alkali-aggregate reactions; cementitious materials; and examinations with the petrographic, polarizing/epifluorescence, and scanning electron microscopes. An extensive reading list, glossary, and other appendixes are included. | | | | | |
| 17. Key Words Petrography, hydraulic cements, portland cement, concrete, aggregate, cracking, voids, microscope, alkali silica reaction (ASR), alkali carbonate reaction (ACR). | | | 18. Distribution Statement No restrictions. This document is available to the public through the National Technical Information Service, Springfield, VA 22161. | | |
| 19. Security Classif. (of this report) Unclassified | | 20. Security Classif. (of this page) Unclassified | | 21. No. of Pages 351 | 22. Price |

SI* (MODERN METRIC) CONVERSION FACTORS

APPROXIMATE CONVERSIONS TO SI UNITS

| Symbol | When You Know | Multiply By | To Find | Symbol |
|--|----------------------------|-----------------------------|-----------------------------|-------------------|
| LENGTH | | | | |
| in | inches | 25.4 | millimeters | mm |
| ft | feet | 0.305 | meters | m |
| yd | yards | 0.914 | meters | m |
| mi | miles | 1.61 | kilometers | km |
| AREA | | | | |
| in ² | square inches | 645.2 | square millimeters | mm ² |
| ft ² | square feet | 0.093 | square meters | m ² |
| yd ² | square yard | 0.836 | square meters | m ² |
| ac | acres | 0.405 | hectares | ha |
| mi ² | square miles | 2.59 | square kilometers | km ² |
| VOLUME | | | | |
| fl oz | fluid ounces | 29.57 | milliliters | mL |
| gal | gallons | 3.785 | liters | L |
| ft ³ | cubic feet | 0.028 | cubic meters | m ³ |
| yd ³ | cubic yards | 0.765 | cubic meters | m ³ |
| NOTE: volumes greater than 1000 L shall be shown in m ³ | | | | |
| MASS | | | | |
| oz | ounces | 28.35 | grams | g |
| lb | pounds | 0.454 | kilograms | kg |
| T | short tons (2000 lb) | 0.907 | megagrams (or "metric ton") | Mg (or "t") |
| TEMPERATURE (exact degrees) | | | | |
| °F | Fahrenheit | 5 (F-32)/9 or (F-32)/1.8 | Celsius | °C |
| ILLUMINATION | | | | |
| fc | foot-candles | 10.76 | lux | lx |
| fl | foot-Lamberts | 3.426 | candela/m ² | cd/m ² |
| FORCE and PRESSURE or STRESS | | | | |
| lbf | poundforce | 4.45 | newtons | N |
| lbf/in ² | poundforce per square inch | 6.89 | kilopascals | kPa |

APPROXIMATE CONVERSIONS FROM SI UNITS

| Symbol | When You Know | Multiply By | To Find | Symbol |
|-------------------------------------|-----------------------------|-------------|----------------------------|---------------------|
| LENGTH | | | | |
| mm | millimeters | 0.039 | inches | in |
| m | meters | 3.28 | feet | ft |
| m | meters | 1.09 | yards | yd |
| km | kilometers | 0.621 | miles | mi |
| AREA | | | | |
| mm ² | square millimeters | 0.0016 | square inches | in ² |
| m ² | square meters | 10.764 | square feet | ft ² |
| m ² | square meters | 1.195 | square yards | yd ² |
| ha | hectares | 2.47 | acres | ac |
| km ² | square kilometers | 0.386 | square miles | mi ² |
| VOLUME | | | | |
| mL | milliliters | 0.034 | fluid ounces | fl oz |
| L | liters | 0.264 | gallons | gal |
| m ³ | cubic meters | 35.314 | cubic feet | ft ³ |
| m ³ | cubic meters | 1.307 | cubic yards | yd ³ |
| MASS | | | | |
| g | grams | 0.035 | ounces | oz |
| kg | kilograms | 2.202 | pounds | lb |
| Mg (or "t") | megagrams (or "metric ton") | 1.103 | short tons (2000 lb) | T |
| TEMPERATURE (exact degrees) | | | | |
| °C | Celsius | 1.8C+32 | Fahrenheit | °F |
| ILLUMINATION | | | | |
| lx | lux | 0.0929 | foot-candles | fc |
| cd/m ² | candela/m ² | 0.2919 | foot-Lamberts | fl |
| FORCE and PRESSURE or STRESS | | | | |
| N | newtons | 0.225 | poundforce | lbf |
| kPa | kilopascals | 0.145 | poundforce per square inch | lbf/in ² |

*SI is the symbol for the International System of Units. Appropriate rounding should be made to comply with Section 4 of ASTM E380.
(Revised March 2003)

TABLE OF CONTENTS

| | |
|---|-----------|
| CHAPTER 1. INTRODUCTION | 1 |
| 1.1 Historical Background | 1 |
| 1.2 CURRENT PRACTICES | 2 |
| 1.3 HOW TO USE THIS MANUAL | 3 |
| CHAPTER 2. EQUIPMENT, MATERIALS, AND ENVIRONMENT | 5 |
| 2.1 OVERVIEW | 5 |
| 2.2 FOR SAMPLE PREPARATION ROOM | 7 |
| 2.2.1 General Comments | 7 |
| 2.2.2 Equipment..... | 7 |
| 2.3 FOR PREPARATION OF SLICES | 9 |
| 2.3.1 General Comments | 9 |
| 2.3.2 Equipment..... | 9 |
| 2.4 FOR PRODUCTION OF THIN SECTIONS | 15 |
| 2.4.1 General Comments | 15 |
| 2.4.2 For Examination With Petrographic Microscope | 16 |
| 2.4.3 For Examination With Polarizing/Epifluorescence Microscope..... | 19 |
| 2.5 FOR EXAMINATION OF SPECIMENS | 21 |
| 2.5.1 General Comments | 21 |
| 2.5.2 Equipment..... | 21 |
| 2.6 EXPENDABLE MATERIALS | 25 |
| 2.6.1 General Comments | 25 |
| 2.6.2 Lapping Oil..... | 25 |
| 2.6.3 Grinding Compounds | 25 |
| 2.6.4 Dyes and Epoxies | 26 |
| 2.6.5 Miscellaneous Supplies | 27 |
| CHAPTER 3. GENERAL PROCEDURES | 31 |
| 3.1 OVERVIEW | 31 |
| 3.2 RECEIPT OF SPECIMEN | 32 |
| 3.3 INITIAL EXAMINATION | 38 |
| 3.4 PRELIMINARY PLAN OF ANALYSIS | 44 |
| 3.5 FILING OF APPROPRIATE DOCUMENTS | 49 |
| 3.5.1 Permanent Case Files..... | 49 |
| 3.5.2 Temporary and Archive Files | 49 |
| CHAPTER 4. CRACKS | 51 |
| 4.1 OVERVIEW | 51 |
| 4.2 TYPES OF CRACKS | 51 |
| 4.2.1 Microcracks | 51 |
| 4.2.2 Crazeing | 51 |
| 4.2.3 Scaling..... | 52 |
| 4.2.4 Cracks Caused by Cycles of Freezing and Thawing While Concrete Is Critically Saturated..... | 52 |
| 4.2.5 Cracks Caused by Reinforcement Corrosion..... | 52 |
| 4.2.6 Cracks Caused by a Chemical Reaction | 52 |
| 4.2.7 Cracks Caused by Drying Shrinkage..... | 52 |
| 4.2.8 Cracks Caused by Thermal Volume Change..... | 53 |
| 4.2.9 Cracks Caused by Plastic Shrinkage..... | 53 |
| 4.3 DISTINGUISHING BETWEEN PLASTIC SHRINKAGE CRACKING AND DRYING SHRINKAGE CRACKING | 54 |
| 4.3.1 Overview | 54 |
| 4.3.2 Analogy With Clay Materials..... | 55 |
| 4.3.3 Procedures | 56 |

| | |
|--|------------|
| CHAPTER 5. PREPARATION OF SPECIMENS FOR OPTICAL MICROSCOPY | 63 |
| 5.1 OVERVIEW | 63 |
| 5.2 SLICES..... | 63 |
| 5.2.1 Basic Lapped Slice | 63 |
| 5.2.1.1 Overview | 63 |
| 5.2.1.2 Procedures | 64 |
| 5.2.2 Vertical Section of Horizontal Slice (or Vice Versa) | 70 |
| 5.2.3 Acid-Etched Slice | 70 |
| 5.2.3.1 Overview | 70 |
| 5.2.3.2 Procedures | 72 |
| 5.3 THIN SECTIONS..... | 73 |
| 5.3.1 Basic Thin Section..... | 73 |
| 5.3.1.1 Overview | 73 |
| 5.3.1.2 Procedures | 74 |
| 5.3.2 Thin Section for Detecting Alkali-Reactive Textures in Carbonate Rock..... | 75 |
| 5.3.2.1 Overview | 75 |
| 5.3.2.2 Procedures | 76 |
| 5.3.3 Thin Section Showing Profile of Wearing Surface..... | 77 |
| 5.3.3.1 Overview | 77 |
| 5.3.3.2 Procedures | 77 |
| 5.3.4 Thin Section for Epifluorescent Illumination | 77 |
| 5.3.4.1 Overview | 77 |
| 5.3.4.2 Procedures | 77 |
| 5.4 GRAIN MOUNTS | 82 |
| 5.4.1 Overview | 82 |
| 5.4.2 Procedures | 83 |
| 5.4.2.1 Temporary Mount..... | 83 |
| 5.4.2.2 Permanent Mount..... | 83 |
| 5.5 AGGREGATE SPECIMENS..... | 84 |
| 5.5.1 Overview | 84 |
| 5.5.2 Procedures | 84 |
| 5.5.2.1 Hand Specimen and Large Fragment of Rock | 84 |
| 5.5.2.2 Sand, Gravel, Crushed Stone, and Slag | 84 |
| CHAPTER 6. VOIDS | 87 |
| 6.1 OVERVIEW | 87 |
| 6.2 TYPES OF VOIDS..... | 89 |
| 6.2.1 Capillary Voids..... | 89 |
| 6.2.2 Entrained Air Voids..... | 90 |
| 6.2.3 Entrapped Voids and Water Voids | 91 |
| 6.3 QUANTITATIVE DETERMINATION OF AIR-VOID PARAMETERS..... | 92 |
| 6.3.1 Overview | 92 |
| 6.3.2 Methods and Equipment..... | 93 |
| 6.3.2.1 Overview | 93 |
| 6.3.2.2 Linear Traverse..... | 95 |
| 6.3.2.3 Point Count | 95 |
| 6.3.2.4 Image Analysis | 96 |
| 6.3.2.5 Other Considerations | 98 |
| 6.3.3 Preparation of Specimens | 99 |
| 6.3.4 Technician Considerations..... | 99 |
| 6.4 CLASSIFICATION OF VOIDS..... | 101 |
| 6.4.1 Overview | 101 |
| 6.4.2 Distinguishing Entrapped Air Voids From Water Voids..... | 104 |
| 6.4.3 Distinguishing Entrained Voids From Entrapped Voids | 104 |
| 6.4.4 Procedures | 105 |
| 6.5 MEANING OF AIR-VOID PARAMETERS..... | 106 |

| | |
|--|------------|
| CHAPTER 7. QUANTITATIVE ANALYSES OF PASTE, AGGREGATE, AND OTHER COMPONENTS..... | 109 |
| 7.1 PASTE..... | 109 |
| 7.1.1 Overview..... | 109 |
| 7.1.2 Procedures..... | 109 |
| 7.1.2.1 Calculation From Mixture Design..... | 109 |
| 7.1.2.2 Estimation..... | 109 |
| 7.1.2.3 Microscopical Determination..... | 109 |
| 7.2 AGGREGATE AND OTHER COMPONENTS..... | 118 |
| CHAPTER 8. EXAMINATION WITH THE STEREOMICROSCOPE..... | 121 |
| 8.1 OVERVIEW..... | 121 |
| 8.2 REVIEW OF AVAILABLE INFORMATION..... | 121 |
| 8.3 PREPARATION OF EQUIPMENT..... | 122 |
| 8.4 EXAMINATION AND MARKING OF SLICES..... | 122 |
| 8.5 ENHANCEMENT OF MARKED FEATURES..... | 143 |
| 8.6 PHOTOGRAPHING OF SLICES AND THE MAKING OF PHOTOMICROGRAPHS..... | 143 |
| 8.6.1 Photographs of Marked Slice..... | 144 |
| 8.6.2 Photomicrographs..... | 144 |
| 8.7 CHEMICAL SPOT TESTS AND STAINING TECHNIQUES..... | 144 |
| CHAPTER 9. WATER-CEMENTITIOUS MATERIALS RATIO..... | 151 |
| 9.1 OVERVIEW..... | 151 |
| 9.2 PROCEDURES..... | 151 |
| 9.2.1 Estimation..... | 151 |
| 9.2.2 Chemical Determination..... | 153 |
| CHAPTER 10. ALKALI-AGGREGATE REACTIONS..... | 155 |
| 10.1 OVERVIEW..... | 155 |
| 10.2 REACTIONS..... | 156 |
| 10.2.1 Alkali-Silica Reaction..... | 156 |
| 10.2.2 Alkali-Carbonate Reaction..... | 158 |
| 10.3 Field Examination..... | 159 |
| 10.3.1 Cracking Pattern..... | 159 |
| 10.3.2 Structural Evidence of Expansion..... | 163 |
| 10.3.3 Exudations, Coatings, and Pore Fillings..... | 164 |
| 10.3.4 Sufficient Sampling..... | 165 |
| 10.4 Laboratory Examination..... | 166 |
| 10.5 ASSESSMENT..... | 179 |
| CHAPTER 11. CEMENTITIOUS MATERIALS..... | 181 |
| 11.1 OVERVIEW..... | 181 |
| 11.2 PROCEDURES..... | 182 |
| 11.2.1 Cementitious Powders..... | 182 |
| 11.2.2 Hydraulic Cement Concrete..... | 184 |
| 11.2.2.1 Ground Granulated Blast-Furnace Slag..... | 184 |
| 11.2.2.2 Fly Ash..... | 186 |
| 11.2.2.3 Silica Fume..... | 190 |
| CHAPTER 12. EXAMINATION WITH THE PETROGRAPHIC MICROSCOPE..... | 191 |
| 12.1 OVERVIEW..... | 191 |
| 12.2 USES OF THE PETROGRAPHIC MICROSCOPE..... | 193 |
| 12.3 PROCEDURES..... | 193 |
| CHAPTER 13. EXAMINATION WITH THE POLARIZING/EPIFLUORESCENCE MICROSCOPE..... | 197 |
| 13.1 OVERVIEW..... | 197 |
| 13.2 USES OF THE P/EF MICROSCOPE..... | 202 |

| | |
|--|------------|
| 13.2.1 Cracks..... | 202 |
| 13.2.1.1 In Aggregate..... | 202 |
| 13.2.1.2 In Paste..... | 202 |
| 13.2.2 Air-Void Parameters..... | 203 |
| 13.2.3 Porosity Related to Carbonation..... | 204 |
| 13.2.4 Water-Cement Ratio and Permeability..... | 204 |
| 13.2.5 Hydration..... | 204 |
| 13.2.6 Effect of Fine Aggregate..... | 204 |
| 13.2.7 Photomicrographs..... | 204 |
| 13.3 PROCEDURES..... | 205 |
| 13.3.1 General Techniques..... | 205 |
| 13.3.2 Cracks..... | 207 |
| 13.3.3 Air-Void Parameters..... | 207 |
| 13.3.4 Porosity Related to Carbonation..... | 208 |
| 13.3.5 Water-Cement Ratio and Permeability..... | 208 |
| 13.3.6 Hydration..... | 211 |
| 13.3.7 Quality of Fine Aggregate..... | 214 |
| 13.3.8 Photography..... | 214 |
| CHAPTER 14. SAMPLE PREPARATION FOR AND EXAMINATION WITH THE SCANNING ELECTRON MICROSCOPE..... | 221 |
| 14.1 OVERVIEW..... | 221 |
| 14.2 Scanning Electron Microscope..... | 221 |
| 14.2.1 Secondary Electron Imaging..... | 222 |
| 14.2.2 Backscattered Electron Imaging..... | 222 |
| 14.2.3 X-Ray Microanalysis..... | 230 |
| 14.3 Specimen Preparation..... | 233 |
| 14.3.1 Overview..... | 233 |
| 14.3.2 Materials for Sample Preparation..... | 237 |
| 14.3.3 Polished Sections of Cement and Pozzolan Powders..... | 237 |
| 14.3.4 Preparation of Cement Paste, Mortar, and Concrete Sections..... | 238 |
| 14.3.5 Cutting and Grinding..... | 238 |
| 14.3.6 Polishing..... | 239 |
| 14.3.7 Coating for Examination..... | 239 |
| 14.4 Imaging Strategies for SEM..... | 239 |
| 14.5 Quantitative Methods in Microscopy..... | 240 |
| 14.5.1 Point-Count Analysis..... | 240 |
| 14.5.2 Image Processing and Analysis..... | 243 |
| 14.6 Summary..... | 245 |
| APPENDIX A. OBTAINING SPECIMENS OF HCC FOR PETROGRAPHIC EXAMINATION..... | 247 |
| A.1 OVERVIEW..... | 247 |
| A.2 TYPES OF SPECIMENS..... | 247 |
| A.3 SAMPLING PLAN..... | 248 |
| A.4 SAMPLING PROCEDURES..... | 249 |
| A.5 SPECIAL CONSIDERATIONS..... | 249 |
| A.5.1 Air-Void Samples..... | 249 |
| A.5.2 Overlay Material..... | 250 |
| A.5.2.1 Cracking..... | 250 |
| A.5.2.2 Delamination..... | 250 |
| A.5.3 Frozen Concrete..... | 250 |
| A.5.4 Unusual Conditions..... | 250 |
| A.5.5 Aggregate Specimens..... | 252 |
| A.6 COMPARISON OF FIELD AND LABORATORY SPECIMENS..... | 252 |
| REFERENCES..... | 253 |

| | |
|--|------------|
| APPENDIX B. CAUSES AND PREVENTION OF PLASTIC SHRINKAGE | |
| CRACKING | 255 |
| B.1 CAUSES..... | 255 |
| B.2 PREVENTION..... | 257 |
| B.3 LEGAL INVESTIGATIONS..... | 257 |
| REFERENCES | 257 |
| APPENDIX C. RETEMPERING..... | 259 |
| C.1 OVERVIEW | 259 |
| C.2 LIKELY RETEMPERING SCENARIO..... | 259 |
| C.3 EFFECT OF RETEMPERING..... | 260 |
| C.3.1 On HCC Paste | 260 |
| C.3.2 On Air Voids..... | 260 |
| C.3.2.1 Quantity..... | 260 |
| C.3.2.2 Shape..... | 261 |
| C.3.2.3 Size..... | 261 |
| REFERENCES | 261 |
| APPENDIX D. AGGREGATES USED IN HYDRAULIC CEMENT CONCRETE..... | 263 |
| D.1 OVERVIEW | 263 |
| D.2 COARSE AGGREGATE..... | 264 |
| D.3 FINE AGGREGATE..... | 266 |
| D.4 IDENTIFICATION OF MINERALS AND ROCKS | 266 |
| D.4.1 Mineral Identification | 267 |
| D.4.2 Rock Identification | 274 |
| D.4.3 Identification of Alkali-Silica Reactive Aggregates | 276 |
| D.4.4 Identification of Alkali-Carbonate Reactive Aggregates | 277 |
| D.5 AGGREGATE CONCERNS IN D-CRACKING | 280 |
| D.6 SPECIAL-PURPOSE AGGREGATES..... | 282 |
| D.6.1 Skid Resistance..... | 282 |
| D.6.2 Lightweight Aggregates..... | 282 |
| D.6.3 Radiation Shielding | 285 |
| REFERENCES | 285 |
| APPENDIX E. EXAMPLES OF REASONS PETROGRAPHIC SERVICES ARE | |
| REQUESTED AND CORRESPONDING PLANS FOR ANALYSIS..... | 291 |
| GLOSSARY..... | 297 |
| ACKNOWLEDGMENTS | 307 |
| REFERENCES..... | 309 |
| READING LIST..... | 325 |
| Aggregates (also see Petrographic Methods)..... | 325 |
| Aggregate-Paste Reactions..... | 326 |
| Air-Voids | 328 |
| ASTM Standards..... | 329 |
| Cements | 330 |
| D-Cracking..... | 330 |
| Paste..... | 330 |
| Petrographic Methods..... | 331 |
| Reference Collections | 333 |
| Terminology | 333 |

LIST OF FIGURES

| | |
|---|----|
| Figure 1. Water-cooled drill press. | 8 |
| Figure 2. Rock trimmer (with chisel points and hydraulic jack to apply up to 4500 newtons (N)). | 8 |
| Figure 3. Water-cooled, segmented, diamond-edged rotary saw with overhead arm (360-mm blade is diamond-edged and slotted into wide teeth; foot pedal controls the height of the saw). | 10 |
| Figure 4. Large, oil-cooled, continuous diamond-edged rotary saw. | 10 |
| Figure 5. The smooth-edged blade, at least 610 mm in diameter, runs in an oil bath and vise that holds the specimen firmly and automatically moves it into the saw. | 11 |
| Figure 6. Rotary saw with thin, continuous diamond-edged blade (diameter of 150 mm; arrow points to the sliding table on which the specimen can be braced). | 11 |
| Figure 7. Bench lap (diameter of 200 mm, for rough-grinding rock and concrete specimens; suspended bottle is for water or another lubricant; grinding compounds may be shaken like salt from plastic bottles with a pierced cover). | 12 |
| Figure 8. Lap (diameter of 400 mm). | 13 |
| Figure 9. Weights rest on the back of the slices, fitting loosely inside the rings to provide the downward force needed to produce smoothly lapped surfaces. (Here, cans of an appropriate diameter, weighted with lead shot, are used.) | 14 |
| Figure 10. Automated grinding, lapping, and polishing machine uses interchangeable grinding and polishing discs to simplify specimen preparation. | 14 |
| Figure 11. Ultrasonic cleaner (tank is of a material that will resist most solvents). | 15 |
| Figure 12. Ingram-Ward thin-sectioning equipment: Diamond-edged cutoff saw with very thin blade (see arrow) used to slice off excess specimen material. | 17 |
| Figure 13. Ingram-Ward thin-sectioning equipment: Diamond-bearing, cupped ceramic grinder (see arrow). | 17 |
| Figure 14. Glass coated with grinding-compound slurry. | 18 |
| Figure 15. Drying oven (thermostatically controlled). | 18 |
| Figure 16. Vacuum oven: Thin-section stock in liquid dyed epoxy in small disposable dishes. . | 19 |
| Figure 17. Closeup of bubbling of liquid epoxy as vacuum removes air and water from specimen. | 20 |
| Figure 18. Mounted set of clamps (small Lucite [®] rectangles are used to distribute clamping force over the entire section surface) (Walker and Marshall, 1979). | 20 |
| Figure 19. Syntron vibratory polisher and weights (weights have sponge rubber bumpers) (Walker and Marshall, 1979). | 21 |
| Figure 20. Stereomicroscope with light source and accessories. | 22 |
| Figure 21. Microtools (including needles, shovels, and scrapers small enough to be useful in the cracks and crevices of concrete and to fit in the working distance under the stereomicroscope). | 23 |
| Figure 22. Types of sieves used in examination of concrete and concrete materials (203-mm and 76-mm sizes). | 24 |
| Figure 23. Flowchart of petrographic examination process (adapted from Van Dam, et al., 2002b). | 31 |
| Figure 24. Core with P-number. | 35 |
| Figure 25. Page from VTRC logbook. | 36 |

| | |
|--|----|
| Figure 26. VTRC Request for Petrographic Services form. | 37 |
| Figure 27. Scaling caused by cycles of freezing and thawing (occurred in concrete unprotected by a proper air-void system). | 40 |
| Figure 28. Cracking on surface and side of core with associated corrosion and expansion of the reinforcing bar. | 40 |
| Figure 29. Delamination around reinforcing bars (there is no cracking on the surface). | 41 |
| Figure 30. Fragments of concrete destroyed by freezing before final setting. | 43 |
| Figure 31. Surface sawed through concrete slab that froze before final setting. | 43 |
| Figure 32. Core marked with identification, cutting planes, and match marks. | 48 |
| Figure 33. Plastic shrinkage cracking was covered up by mortar filling over it on top of a 100-mm core. | 57 |
| Figure 34. Plastic shrinkage cracking occurred before a surface texture was formed. | 57 |
| Figure 35. Plastic shrinkage cracking occurred in a latex-modified concrete overlay (top view of core (small threads of latex span the crack)). | 59 |
| Figure 36. Plastic shrinkage cracking: Small bridges of latex paste connect sides of crack. | 59 |
| Figure 37. Small bridge of paste across a crack caused by shrinkage that took place while the ordinary portland cement concrete was not hardened (100-mm core, road surface at right). | 60 |
| Figure 38. Bridge of paste across plastic shrinkage crack: Closeup of bridge. | 60 |
| Figure 39. Tortuous path of a plastic shrinkage crack in a concrete that has not completely separated. | 61 |
| Figure 40. Plastic shrinkage crack on a lapped surface (wearing surface is at the top of the photograph). | 62 |
| Figure 41. Undercutting. | 64 |
| Figure 42. Well-prepared surface viewed in ordinary illumination. | 69 |
| Figure 43. Well-prepared surface viewed at a very low angle toward a source of illumination (an illuminated screen). | 69 |
| Figure 44. Properly finished slice (same as that shown in figures 42 and 43). | 70 |
| Figure 45. Slice cut at right angles to original slice: Edges of thin top surfaces of a concrete core embedded in epoxy and repotted in mortar in a mold 152 mm in diameter and then resliced and finely lapped to allow examination of the vertical surface. | 71 |
| Figure 46. Slice cut at right angles to original slice: Left portion of middle slice shown in figure 45 is enlarged. | 71 |
| Figure 47. Thin section wedged to one end to observe dolomite rhombs in micrite as an indicator of possible alkali-carbonate reactivity (glass mount is 27 by 46 mm). | 76 |
| Figure 48. Stage in the preparation of this section to show the details of the wearing surface: (1) Small blocks of wearing surface. | 78 |
| Figure 49. Stage in the preparation of this section to show the details of the wearing surface: (2) Blocks cemented to microscope slide. | 78 |
| Figure 50. Stage in the preparation of this section to show the details of the wearing surface: (3) Thin section of blocks. | 79 |
| Figure 51. Specimen mounted between work glasses and final slide (dotted line indicates the plane the saw will cut). | 82 |
| Figure 52. Concrete that increased in volume because of corrosion of aluminum fragments. | 88 |
| Figure 53. Surface of finely lapped slice of concrete containing 5.6 percent total air voids. | 90 |
| Figure 54. Surface of finely lapped slice of concrete containing 17 percent total air voids. | 91 |

| | |
|---|-----|
| Figure 55. Concrete core with about 4 percent large, irregularly shaped voids. | 92 |
| Figure 56. Partially automated linear traverse equipment for determining air-void parameters.. | 96 |
| Figure 57. Image analysis equipment. | 97 |
| Figure 58. Illustration of various sizes of sections that may be expressed on a randomly placed plane. | 102 |
| Figure 59. Two equally spaced arrays of voids. | 103 |
| Figure 60. Void system produced by early types of high-range water reducers..... | 105 |
| Figure 61. Finely lapped slices of concrete with normal paste content: Rounded to subangular quartz gravel coarse aggregate and fine sand aggregate. | 110 |
| Figure 62. Finely lapped slices of concrete with normal paste content: Angular crushed granite coarse aggregate and fine sand aggregate. | 110 |
| Figure 63. Finely lapped slices of concrete with abnormal paste content: High paste content..... | 111 |
| Figure 64. Finely lapped slices of concrete with abnormal paste content: Low paste content..... | 111 |
| Figure 65. Lapped surface..... | 112 |
| Figure 66. Flaws in lapped surface. | 112 |
| Figure 67. Knot of cement exposed on finely lapped slice (rounded shape was caused by tumbling in the mixer). | 114 |
| Figure 68. Etched slice: Etched surface on concrete fabricated with quartz sand fine aggregate. | 116 |
| Figure 69. Etched slice: Etched surface on concrete fabricated with crushed limestone fine aggregate..... | 116 |
| Figure 70. Cross section of surface demonstrating problems of boundary distinction..... | 118 |
| Figure 71. Varying amounts of aggregate size fractions: Concrete fabricated without larger sizes of coarse aggregate. | 120 |
| Figure 72. Varying amounts of aggregate size fractions: Concrete fabricated with coarse aggregate that is larger than what is now considered to be normal for bridge deck concrete. | 120 |
| Figure 73. Two-page Petrographic Examination of Hardened Concrete form used by the Ontario Ministry of Transportation..... | 124 |
| Figure 74. Excess air at surface of concrete (top)..... | 126 |
| Figure 75. Clustering of voids apparently caused by excess air-entraining admixture and incomplete mixing (field width is 50 mm). | 128 |
| Figure 76. Overwatered concrete: Rain and snow occurring after the concrete was placed caused overwatering near the surface (top). (The aggregate sunk out of the overwatered zone.)..... | 130 |
| Figure 77. Cement coating on aggregate..... | 132 |
| Figure 78. Fly-ash particles on the surface of a lapped slice of concrete. | 134 |
| Figure 79. Cracks at the bond between the aggregate, rebar, and paste (see arrows)..... | 137 |
| Figure 80. Cracks typical of damage caused by cycles of freezing and thawing. | 138 |
| Figure 81. Microcracks: Smoothly lapped surface (A) with ink-marked microcracks..... | 139 |
| Figure 82. Microcracks: Wearing surface near figure 81. | 139 |
| Figure 83. Finely lapped surface of beam tested for resistance to cycles of freezing and thawing. | 141 |

| | |
|---|-----|
| Figure 84. Finely lapped surface of beam tested for resistance to cycles of freezing and thawing: Mixtures in figures 83 and 84 were identical except that the mixture shown here contained an experimental admixture. | 141 |
| Figure 85. Lapped surface of slice of concrete containing prestressing strand. | 142 |
| Figure 86. Cracking just below the bond in the concrete deck with latex-modified concrete overlay..... | 143 |
| Figure 87. Sheet used in VTRC stereomicroscopy photograph notebook..... | 145 |
| Figure 88. Specimen treated with phenolphthalein (high-alkalinity, uncarbonated paste stains pink; carbonated paste does not stain). | 146 |
| Figure 89. Specimen from retaining wall with destructive ASR treated with uranyl acetate: Ordinary light..... | 147 |
| Figure 90. Specimen from retaining wall with destructive ASR treated with uranyl acetate: Ultraviolet illumination causes silica gel to fluoresce (darkroom photograph)..... | 147 |
| Figure 91. Polished specimen treated with sodium cobaltinitrite, which stains the potassium-bearing compounds yellow. | 148 |
| Figure 92. Fractured surface treated with BaCl-KMnO ₄ (secondary deposits containing sulfate are stained pink). | 149 |
| Figure 93. Idealized sketch of cracking pattern in concrete mass caused by internal expansion as a result of AAR..... | 160 |
| Figure 94. Map cracking with preferred longitudinal trend in continuously reinforced concrete pavement. | 161 |
| Figure 95. Typical destructive ASR in plain or lightly reinforced pavement..... | 161 |
| Figure 96. Destructive ASR in anchor block..... | 162 |
| Figure 97. Cracking of pavement as a result of ACR..... | 162 |
| Figure 98. Upper portion of backwall sheared by expansion of bridge deck. | 163 |
| Figure 99. Expanding median barrier crushes itself. | 164 |
| Figure 100. Closing of joint caused by bridge deck expansion as a result of ACR..... | 165 |
| Figure 101. Bridge deck..... | 168 |
| Figure 103. ASR in longitudinally reinforced pavement constructed with dark metabasalt aggregate..... | 168 |
| Figure 104. ASR in longitudinally reinforced pavement constructed with dark metabasalt aggregate: 100-mm core that fractured on this surface upon removal from the pavement. | 169 |
| Figure 105. Fracture face of splitting tensile specimen: Examine for aggregate fracture and deterioration, as well as secondary deposits. | 169 |
| Figure 106. Destructive ASR in pavement. | 170 |
| Figure 107. Destructive ASR in pavement: Alkali-silica gel in a 2-mm void in a lapped slice from the pavement in figure 106 (dark aggregate is siltstone). | 171 |
| Figure 108. ASR damage expressed on lapped slab (cracks highlighted in yellow, deposits of reaction product highlighted in red). | 171 |
| Figure 109. Lapped surface showing type of aggregates and ASR products. | 172 |
| Figure 110. Lapped surface of specimen affected by ACR exhibiting rim and areas of altered paste at corners of aggregate..... | 172 |
| Figure 111. Paste cracking and alteration of paste. | 172 |
| Figure 112. Lapped surfaces of ACR specimen showing aggregate cracking and alteration of paste..... | 173 |

| | |
|--|-----|
| Figure 113. Internal cracking of aggregate particle..... | 173 |
| Figure 114. Thin section showing void containing crystallized ASR product. | 174 |
| Figure 115. Thin section showing aggregate crack | 174 |
| Figure 116. Thin section in plane polarized light. | 174 |
| Figure 117. Thin section with crossed polars. | 174 |
| Figure 118. Backscattered electron image of ASR-damaged concrete..... | 175 |
| Figure 119. Optical image of lapped section showing ASR product associated with damaged chert particles..... | 175 |
| Figure 120. Similar feature in backscattered electron image as associated EDX elemental plots for K, Si, and Ca..... | 175 |
| Figure 121. Thin section of ACR rock (lower left of image) and adjacent altered paste in plane polarized light..... | 176 |
| Figure 122. Thin section of ACR rock (lower left of image) with crossed polars | 176 |
| Figure 123. Backscattered electron image of polished thin section showing area of altered paste adjacent to ACR rock in lower left. | 176 |
| Figure 124. Thin section of fracture in ACR rock at low magnification..... | 177 |
| Figure 125. Thin section of fracture in ACR rock at high magnification..... | 177 |
| Figure 126. Backscattered electron images of outer rim of reacting ACR rock..... | 177 |
| Figure 127. Interior of same particle..... | 177 |
| Figure 128. Powder mount of ASR product in plane polarized light. | 178 |
| Figure 129. Powder mount of ASR product in crossed polarized light. | 178 |
| Figure 130. Polished specimen treated with sodium cobaltinitrite solution. | 178 |
| Figure 131. Integration of field observations with laboratory investigations..... | 179 |
| Figure 132. Immersion mount of portland cement in plane polarized light showing alite crystals. | 183 |
| Figure 133. Immersion mount of belite cluster with darker interstitial aluminates and ferrite.... | 183 |
| Figure 134. Immersion mount of fly ash showing spherical particle shape. | 183 |
| Figure 135. Immersion mount of agglomerate of minute silica-fume particles. | 183 |
| Figure 136. Immersion mount of natural pozzolan (calcined shale). | 183 |
| Figure 137. Immersion mount of slag..... | 183 |
| Figure 138. SEM images illustrating the size difference of various cementitious materials..... | 184 |
| Figure 139. Cut surface on HCC containing slag exposed to air for 6 months. | 185 |
| Figure 140. Interior of beam of HCC containing slag, illustrating the partially dry two- color stage. | 185 |
| Figure 141. Thin section of concrete containing slag: At 28 days hydration (note the angularity of the slag fragments). | 187 |
| Figure 142. Thin section of concrete containing slag: At 56 days hydration (note the slight rounding of the slag fragments). | 187 |
| Figure 143. Thin section of concrete containing slag: At 6 months hydration (note the further rounding of the slag fragments). | 187 |
| Figure 144. Etched area of lapped surface of concrete containing fly ash. | 188 |
| Figure 145. Fly ash in thin section of HCC, viewed in plane polarized light with a petrographic microscope (note the broken fly-ash particle that is composed of dark and light glass, 100X). | 189 |

| | |
|---|-----|
| Figure 146. Fly ash in thin section of HCC, viewed in plane polarized light with a petrographic microscope (cenospheres of fly ash filled with smaller cenospheres, 400X)..... | 189 |
| Figure 147. Petrographic microscope..... | 191 |
| Figure 148. Light paths and features of the P/EF microscope..... | 199 |
| Figure 149. P/EF microscope..... | 200 |
| Figure 150. Relationship of filters to dye emittance spectrum..... | 201 |
| Figure 151. Swing-out filter over light port on base of microscope..... | 202 |
| Figure 152. Cracks in the thin section of the concrete..... | 203 |
| Figure 153. Fluorescence from porous clay pocket shining through edge of quartz particle..... | 205 |
| Figure 154. Void in thin section with focus plane on top surface of section..... | 206 |
| Figure 155. Void in thin section (same as figure 154) with focus plane at bottom of section, 100X..... | 206 |
| Figure 156. Thin section of exterior portion of the HCC: Surface exposed to the air is at the top..... | 209 |
| Figure 157. Same view as figure 156, but viewed with crossed nicols: Bright area shows the high birefringence of the calcite of the carbonated area..... | 209 |
| Figure 158. Same view as figures 156 and 157, but viewed with ultraviolet light, causing fluorescence of the pore structure of the HCC (note that there is more porosity indicated by fluorescence in the portion of the HCC farthest from the surface than there is in the carbonated zone)..... | 209 |
| Figure 159. Thin section of interior portion of HCC: Viewed with crossed nicols (bright area shows the high birefringence of the calcite of the carbonated area)..... | 210 |
| Figure 160. Thin section of interior portion of HCC: Same area as figure 159, but viewed with ultraviolet light, causing fluorescence of the pore structure within the carbonated area..... | 210 |
| Figure 161. Thin section of 50-year-old concrete. At the center is the remnant of a very large cement grain (cement was more coarsely ground then). Modern cement is usually about the size of the completely hydrated and filled cement grain indicated by the arrow (viewed with plane polarized illumination)..... | 212 |
| Figure 162. Same location as figure 161, but viewed with crossed nicols. Note the original birefringence still present in the unhydrated central portion of the grain..... | 212 |
| Figure 163. Same location as figure 161, but viewed with ultraviolet light, causing fluorescence of the dye in the pore structure. The structure indicates that the original external boundary of the cement grain was the thin line (indicated by the arrows)...... | 212 |
| Figure 164. Thin section of 25-year-old concrete viewed with plane polarized light..... | 213 |
| Figure 165. Thin section of 25-year-old concrete viewed with incident ultraviolet illumination, causing fluorescence of the dye-filled space..... | 213 |
| Figure 166. Thin section of HCC made with smooth, rounded sand: Viewed with plane polarized light..... | 216 |
| Figure 167. Thin section of HCC made with smooth, rounded sand: Same view as figure 166, but with ultraviolet illumination, causing fluorescence in the pore structure impregnated with dye (note the even texture of the paste)..... | 216 |
| Figure 168. Thin section of HCC made with angular, dirty sand: Viewed with plane polarized light (there are numerous reentrant angles)..... | 217 |

| | |
|--|-----|
| Figure 169. Thin section of HCC made with angular, dirty sand: Same view as figure 168, but with ultraviolet illumination, causing fluorescence that delineates the pore structure..... | 217 |
| Figure 170. Thin section of porous, iron-stained particle of sand: Viewed with plane polarized light. | 218 |
| Figure 171. Thin section of porous, iron-stained particle of sand: Viewed with incident ultraviolet illumination, causing fluorescence of the dye in the pore structure of the sand grain and indicating a zone of water accumulation and weakness. | 218 |
| Figure 172. Page from VTRC P/EF photomicroscopy notebook. | 219 |
| Figure 173. Scanning electron microscope..... | 221 |
| Figure 174. SE image showing platy or foil-like CSH, fine bundles of CSH fibers and platy CH (top). | 223 |
| Figure 175. SE image showing platy CH and ettringite needles and also plate-like CH morphology (bottom). | 223 |
| Figure 176. Equation to estimate backscatter coefficient from Goldstein, et al. (1992). | 224 |
| Figure 177. Equation to estimate BE coefficient of a multielement phase. | 224 |
| Figure 178. Equation to calculate contrast between constituents..... | 224 |
| Figure 179. Stereomicroscopic image..... | 226 |
| Figure 180. Backscattered electron image (same specimen). | 227 |
| Figure 181. Secondary electron image of a fresh-fracture surface from concrete..... | 227 |
| Figure 182. Top. Paired image at successively greater magnification of stereomicroscope (white light) images and SEM BE images: Field width is 11 mm..... | 228 |
| Figure 183. Middle. Field width is 3 mm. | 228 |
| Figure 184. Bottom. Field width is 1.5 mm. | 228 |
| Figure 185. Backscattered electron image of an epoxy-impregnated, polished cross section of concrete (field width is 2 mm). | 229 |
| Figure 186. Backscattered electron image of an epoxy-impregnated, polished cross section of concrete (field width is 1 mm). | 229 |
| Figure 187. EDX spectrum. | 230 |
| Figure 188. EDX spectra for ettringite (top left), monosulfate (top right), calcium hydroxide (bottom left), and calcium-silicate-hydrate (bottom right) aid in phase identification characteristics. | 231 |
| Figure 189. Fence diagram created by collecting a series of EDX spectra along an emplacement of ASR gel (the gel composition rapidly becomes much like the bulk CSH once outside the aggregate and the source of reaction). | 232 |
| Figure 190. Plots of element spatial distribution are generated through x-ray imaging..... | 232 |
| Figure 191. Effects of different accelerating voltage on x-ray spectra of ettringite show the loss of low-energy peaks at high accelerating voltages and the opposite effect at low voltages. | 233 |
| Figure 192. BE images of unimpregnated, sawed surface (the sawed surface is rough with residual particulate matter, yielding poor contrast and shadowing that make interpretation of BE and EDX images difficult). | 235 |
| Figure 193. BE images of the impregnated, polished surface from the same concrete (polished surface presents optimum BE and EDX imaging characteristics). | 235 |
| Figure 194. Polished section of hardened portland cement paste imaged using the BE signal clearly shows the constituent phases (residual cement (RC) appears | |

| | |
|--|-----|
| brightest, followed by CH, CSH, and other hydration products) (top); EDX image (bottom) shows regions of intermediate-intensity calcium (blue), intermediate-intensity aluminum (purple), and high-intensity sulfur (yellow), defining locations of monosulfate that could not be distinguished on a rough surface (field width is 73 μm). | 236 |
| Figure 195. Equation for percent error in the point-count method (at the 96-percent confidence level) based on the the proportion of points on the phase of interest and the total number of all points counted..... | 243 |
| Figure 196. BE image (right) of carbonate aggregate composed of darker gray dolomite (1) rhombs in fine-grained matrix containing lighter gray calcite (6) (the gray-level intensity of calcite and dolomite is distinct, and they can also be distinguished on the basis of the EDX spectra (left); field width is approximately 100 μm). | 242 |
| Figure 197. BE images of carbonate aggregate in concrete at 15X (field width of 8 mm). | 242 |
| Figure 198. BE images of carbonate aggregate in concrete at 400X (field width of 300 μm) ... | 242 |
| Figure 199. Gray-level histogram of hardened cement paste. | 243 |
| Figure 200. BE image of hardened cement paste (field width is 73 μm). | 243 |
| Figure 201. Pseudocolored image based on BE gray scale of figures 198 and 199 (red = residual cement, blue = CH, black = CSH, and green = coarse porosity). Counting the number of pixels for each color allows an estimate of the phase area fractions for this field of view..... | 244 |
| Figure 202. Processing of BE and calcium x-ray images here highlights the CH location (analysis of the binary image of CH distribution calculated 12 percent of the image field to be occupied by CH). | 245 |
| Figure 203. Giant popout caused by a piece of glass (accompanying it are several small popouts of a more usual size caused by porous chert particles). | 251 |
| Figure 204. Glass particle. | 251 |
| Figure 205. Effect of concrete temperature, air temperature, wind velocity, and relative humidity on the rate of evaporation of surface moisture from a concrete surface. | 256 |
| Figure 206. Shaley particle shape of crushed slate aggregate. | 265 |
| Figure 207. Aggregate particles from a fissile gneiss (a particle shape such as this can cause a high water demand). | 265 |
| Figure 208. Mohs comparative hardness scale. | 270 |
| Figure 209. Cubic habit, brassy yellow color, metallic luster of pyrite..... | 270 |
| Figure 210. Granite aggregate exhibiting cleavage traces at right angles in orthoclase (right box) and no cleavage in quartz (left box) (scratch test with metal tool leaves metal (arrows) on both quartz and orthoclase, which are harder than the metal). | 271 |
| Figure 211. Metal tool scratches upper limestone (calcite) aggregate and leaves metal on lower quartzite particle. | 271 |
| Figure 212. Immersion mount of chert in plane polarized light. | 272 |
| Figure 213. Immersion mount of chert with crossed polars, showing microcrystalline texture (refractive index matches that of quartz). | 272 |
| Figure 214. Thin section of marble (calcic schist) in plane polarized light..... | 272 |
| Figure 215. Thin section of marble (calcic schist) in crossed polarized light. | 272 |
| Figure 216. Quantitative XRD analysis to determine mineral composition of aggregate shown in figures 182 through 184. | 273 |

| | |
|---|-----|
| Figure 217. Coupling the knowledge of the mineral present (figure 215) with the elemental EDX maps shown here allows identification of the minerals present at specific locations within the fine-grained rock. | 273 |
| Figure 218. Thin section of strained quartzite: Crossed polars. | 277 |
| Figure 219. Alkali-reactive microtexture in four carbonate rocks. | 278 |
| Figure 220. Nonreactive microtextures of carbonate rocks (examples are shown to illustrate the difference between these crystalline textures and the partially crystalline reactive textures shown in figure 218). | 279 |
| Figure 221. D-cracking of a pavement caused by destruction of the aggregate by cycles of freezing and thawing (cracking parallel to the joint and wrapping around at the juncture of joints defines D-cracking). | 281 |
| Figure 222. Pavement surface with a flaw caused by freezing and thawing of water trapped in aggregate particle. | 282 |
| Figure 223. Traffic-worn rounded surface of feldspar aggregate particle (this will not provide good skid resistance). | 283 |
| Figure 224. Traffic-worn surface of granite aggregate particle (zones of weakness provide an irregular skid-resistant surface). | 283 |
| Figure 225. Lapped slice of HCC containing expanded-shale lightweight aggregate. | 284 |

LIST OF TABLES

| | |
|--|-----|
| Table 1. Equipment for a petrographic laboratory..... | 6 |
| Table 2. Useful sieves for petrographic laboratory using 76-mm frames..... | 24 |
| Table 3. Reference specimens of materials used in making hydraulic cement concrete..... | 28 |
| Table 4. Reference specimens of hydraulic cement concrete representing various conditions or features..... | 29 |
| Table 5. Typical types of specimens..... | 32 |
| Table 6. Procedure for formal receipt of a specimen in the laboratory..... | 32 |
| Table 7. Procedure for initial examination of specimen..... | 38 |
| Table 8. Procedure for preliminary analysis of specimen..... | 44 |
| Table 9. Outline of typical low strength analysis..... | 46 |
| Table 10. Outline of typical laboratory deterioration analysis..... | 47 |
| Table 11. Outline of typical rain damage analysis..... | 48 |
| Table 12. Procedure for distinguishing between plastic and drying shrinkage cracking..... | 56 |
| Table 13. Procedure for producing lapped slice..... | 64 |
| Table 14. Procedure for etching slice..... | 72 |
| Table 15. Types of voids..... | 89 |
| Table 16. Procedure for determining paste percentage..... | 114 |
| Table 17. Stereomicroscopic examination procedure..... | 121 |
| Table 18. Checklist for examination with the stereomicroscope..... | 123 |
| Table 19. Procedure for estimating w/cm..... | 151 |
| Table 20. Paste characteristics reflective of w/cm..... | 152 |
| Table 21. Silica minerals in order of decreasing reactivity..... | 157 |
| Table 22. Potentially alkali-silica reactive rocks..... | 157 |
| Table 23. Visual features and rating indices from field observations (British Cement Association, 1992; Lane, 2001)..... | 159 |
| Table 24. Petrographic features and weighting factors for ASR distress (Lane, 2001)..... | 166 |
| Table 25. Damage categorization to provide neutral assessment (Lane, 2001)..... | 167 |
| Table 26. Cement and hydration product constituents, chemical composition, and backscattered electron coefficient (η)..... | 225 |
| Table 27. Equipment and supplies for preparation of polished sections..... | 237 |
| Table 28. Typical SEM settings for routine examinations..... | 240 |
| Table 29. Keys to mineral identification..... | 268 |
| Table 30. Selected properties of common minerals (FHWA, 1991)..... | 269 |
| Table 31. Keys to rock identification..... | 275 |
| Table 32. Igneous rock classification..... | 275 |
| Table 33. Classification of carbonate rocks..... | 275 |
| Table 34. Classification of clastic sedimentary rocks..... | 276 |
| Table 35. Classification of metamorphic rocks..... | 276 |
| Table 36. Alkali-silica reactive constituents..... | 277 |

LIST OF ACRONYMS AND ABBREVIATIONS

| | |
|--------|---|
| AAR | Alkali-Aggregate Reaction or Alkali-Aggregate Reactivity |
| AASHTO | American Association of State Highway and Transportation Officials |
| ACI | American Concrete Institute |
| ACR | Alkali-Carbonate Reaction or Alkali-Carbonate Reactivity |
| ASR | Alkali-Silica Reaction or Alkali-Silica Reactivity |
| ASTM | American Society for Testing and Materials |
| AVA | Air-Void Analyzer |
| BE | Backscattered Electrons |
| BEI | Backscattered Electron Imaging |
| BF | Barrier Filters |
| CH | Calcium Hydroxide |
| COTR | Contracting Officer's Technical Representative |
| CSA | Canadian Standards Association |
| CSH | Calcium Silicate Hydrate |
| CTE | Coefficient of Thermal Expansion |
| DM | Dichroic Mirrors |
| DOT | Department of Transportation |
| EDS | Energy-Dispersive X-Ray Spectrometer |
| EDX | Energy-Dispersive X-Ray Analysis |
| FHWA | Federal Highway Administration |
| GGBFS | Ground Granulated Blast-Furnace Slag |
| HCC | Hydraulic Cement Concrete |
| HRB | Highway Research Board (now the Transportation Research Board) |
| ICMA | International Cement Microscopy Association |
| ISO | International Standards Organization |
| ITZ | Interface Transition Zone |
| NIST | National Institute for Standards and Technology |
| P/EF | Polarizing/Epifluorescence |
| PCA | Portland Cement Association |
| PCC | Portland Cement Concrete (more inclusive term HCC, above, is used throughout) |
| RH | Relative Humidity |
| SE | Secondary Electrons |
| SEI | Secondary Electron Imaging |
| SEM | Scanning Electron Microscope |
| SHRP | Strategic Highway Research Program |
| SI | International System of Units (metric system) |
| TFHRC | Turner-Fairbank Highway Research Center |
| TRB | Transportation Research Board (formerly the Highway Research Board) |
| VTRC | Virginia Transportation Research Council |
| w/cm | Water-Cementitious Materials Ratio |
| XR | X-Ray Imaging |
| XRD | X-Ray Diffraction |
| XRF | X-Ray Fluorescence |

CHAPTER 1. INTRODUCTION

1.1 HISTORICAL BACKGROUND

The methods used to examine hydraulic cement concrete (HCC) and related concretes are akin to the methods used by the petrologist and mineralogist to examine naturally occurring ores, minerals, and rocks. The more inclusive term HCC is used throughout, instead of the more common portland cement concrete (PCC.) The word *petrography* is derived from the Greek words *petros*, meaning *rock* or *stone*, and *graphikos*, meaning *written*. *Petrography* has come to mean the description and classification of rock by any means—from simply describing the color or form to using highly technical chemical and instrumental methods (e.g., scanning electron microscopy, x-ray fluorescence analysis, and x-ray diffraction). Petrography is a branch of the science of petrology, which, in addition to description and classification, includes the deciphering of the origin of rocks, study of the relationships between various rock and mineral deposits, study of the effects of various geologic processes, and unraveling of the complex history of rocks.

The petrography of HCC and its aggregates can be traced to the early part of the 20th century and is a natural extension of the science given the geologic origin of the materials used in concrete construction. This application of petrography underwent rapid growth in the 1940s with the identification of alkali-aggregate reactions (AAR) as a cause of deterioration (DePuy, 1990). Geologists working at five institutions (U.S. Bureau of Public Roads (now the Federal Highway Administration (FHWA)), National Bureau of Standards (now the National Institute for Standards and Technology (NIST)), U.S. Bureau of Reclamation, U.S. Army Corps of Engineers, and Portland Cement Association (PCA)) were instrumental in establishing petrography as a fundamental tool for quality and condition assessment, as well as the fault diagnosis of concrete. Seminal works include Woolf's (1950) *The Identification of Rock Types*, Insley and Frechette's (1955) *Microscopy of Ceramics and Cements*, Brown's (1959) *Petrography of Cement and Concrete*, Mielenz's (1962) *Petrography Applied to Portland Cement Concrete*, K. Mather's (1966) *Petrographic Examination of Hardened Concrete*, and Erlin's (1966) *Methods Used in Petrographic Studies of Concrete*. Concrete petrography has evolved from these beginnings more as an individual pursuit, with most petrographers either being self-taught or having the good fortune to work with the pioneers of the field in experiences similar to those reported by Erlin (1998).

Most of the people presently doing concrete petrography are geologists with formal training in optical mineralogy and petrography. Many of the techniques used in these two fields are also related to the branch of engineering generally called *materials science*. Many universities have an excellent department of materials science, and entire libraries are devoted to the subject. However, the techniques and skills required for the examination of concrete do not seem to be the subject of systematic study or training at any known institution of higher education (hence the need for this manual).

1.2 CURRENT PRACTICES

The petrography of concrete must often be accomplished rapidly, on a limited budget, and often with a minimum of the sorts of equipment required for instrumental analysis of the chemical and microstructural features of the material. Because the experienced concrete petrographer can make a useful assessment of the quality and possible problems associated with HCC within a limited amount of time, the associated basic scientific studies that would use instrumental analysis are almost never performed in the course of solving construction problems.

The petrographic examination of HCC is, in many respects, more qualitative than quantitative. Other than the parameters of the air-void system, the information used most by the HCC petrographer is the macroscopic appearance of the specimen, appearance of the concrete in the placement, and appearance of variously prepared surfaces of the concrete as viewed with the stereomicroscope. Even the examination of thin sections of HCC with the petrographic microscope is usually a qualitative procedure, with the examination taking the form of ascertaining the presence or absence of particular features and the relative abundance of a few others.

Generally, the concrete petrographer is consulted only when the material in question has failed to perform to expectations, has failed a particular physical test, or is suspected of having a serious flaw. For example, concrete from a construction project may be submitted to the petrographer because the compressive strength is lower than required or the air-content values determined in the field are questioned. Commonly, the specimens of HCC are submitted because it is known that the construction procedure was not standard in some way and the engineers want to determine whether the nonstandard practice adversely affected the durability or appearance of the material produced. For example, if the HCC was placed during a driving rainstorm, the engineers may want to know if the HCC was overwatered or if the surface was weakened by the extra water. If a placement shows cracking soon after construction, the petrographer may be called to determine the nature of the cracking and to speculate as to its cause. If an HCC placement shows distress before its expected life span has elapsed, the engineers may want a petrographic analysis of the material to determine the cause of the distress. The cause might be one or a combination of the various physical responses or chemical reactions of the concrete or a factor unrelated to the nature of the material. Rarely are petrographic examinations performed to determine why a concrete has performed to or beyond expectations. To answer such a question, the petrographer must have experience with or at least be familiar with a wide variety of concrete-making materials.

After years of experience in examining concrete, the concrete petrographer has usually seen hundreds of pieces of concrete, and his or her memory associates particular appearances of the concrete with the histories of durability or failure that accompanied the specimens. Thus, the concrete petrographer's memory is the data bank against which all new specimens of concrete are compared. It is difficult to transmit this sort of data bank to a petrographer who, although trained in the techniques of optical mineralogy or materials science, has little or no experience in examining HCC and identifying the various features that may indicate the quality of the material.

The main written works on the petrography of concrete are in the applicable publications of the Transportation Research Board (TRB) (formerly the Highway Research Board (HRB)); the

American Society for Testing and Materials (ASTM); the American Concrete Institute (ACI); Construction Technology Laboratories, Inc.; the Portland Cement Association (PCA); the National Research Council of Canada; and the International Cement Microscopy Association (ICMA). Some of these works provide detailed instructions for the petrographic examination of concrete or aggregates for concrete. Many mention that the work should be done by persons qualified by training and experience to operate the microscopes and other equipment used, record the important information, recognize which data will have a bearing on any problems associated with the specimens or on the intended use of the material in question, and interpret the observations and record them in a form that will be understood by the people who will be using the petrographic information.

1.3 HOW TO USE THIS MANUAL

This manual was created to provide a set of instructions for the petrographic examination of HCC used in transportation systems. There are many good reference works on the petrography of the constituents of natural mineral aggregates and their use in concrete. This manual discusses the petrography of HCC, the chemical reactions of rocks and minerals in HCC, and the identification of common rocks and minerals and other constituents necessary for a complete description of the concrete.

The instructions were heavily influenced by problems occurring during the construction of highway pavements and bridge decks under conditions where delays could be very costly. No attempt was made to include all of the instructions that are available in the literature. Rather, an effort was made to report and suggest ways of performing examinations of HCC that have been found to be useful in practice.

The emphasis is on the procedures possible with simple stereomicroscopes and the necessary sample preparation methods. This manual includes photographs for study by a microscopist who wants to become highly familiar with the features of HCC. Also included are descriptions of particular features and theoretical discussions of a few features that seem to have been incompletely discussed in the literature. When considered appropriate, particular lines of reasoning that have been developed at the Virginia Transportation Research Council (VTRC) and are not clearly described elsewhere in the literature are discussed. It is hoped that such procedures, instructions, and photographs will be of use to persons who have no specific petrographic training, but who have a great familiarity with and a great interest in HCC. *Concrete Petrography: A Handbook of Investigative Techniques* (St. John, Poole, and Sims, 1998) will be of interest to those doing petrographic work.

Particular features of HCC and aggregate materials are discernible only in thin sections by using the various procedures possible with the petrographic and polarizing/epifluorescence (P/EF) microscopes. Instructions for the use of the petrographic microscope are included when the specialized techniques for the observation of the particular features of HCC differ from the classic geological petrographic methods. These instructions should lead the reader to an understanding of the value of this microscope and a study of some of the various texts on the subject. Instructions for fabricating thin sections of a specimen for viewing with the petrographic and P/EF microscopes are included when the procedure was developed at VTRC or was not generally described in the literature (see also Roy, et al., 1993). Procedures requiring more

complex equipment (e.g., differential thermal analysis, atomic absorption spectroscopy) and complex chemical tests are mentioned only if they have been used at VTRC.

Procedures for using scanning electron microscopes (SEM), microprobe energy-dispersive x-ray spectrometers (EDS), and x-ray diffractometers (XRD) in the examination of HCC employed at NIST have been included in the manual.

Numerous references are cited throughout and additional information is provided in the Reading List. The bibliographies in the works cited and the works in the Reading List provide directions to information and instructions that, although not included in this manual, may be very useful to petrographers. A glossary is included to provide information concerning the terms used by geologists and concrete technologists.

The client, as referred to in this manual, is generally considered to be someone other than the petrographer. In general, the client is the person, group of people, or organization that has decided on the necessity for petrographic examination. In the case of a petrographer working for a transportation department, the client may be a division of the department, a highway engineer, a fellow concrete technologist, or a fellow researcher. Throughout this manual, the word *client* is used to signify the person or organization making the request for the petrographic examination.

CHAPTER 2. EQUIPMENT, MATERIALS, AND ENVIRONMENT

2.1 OVERVIEW

In this chapter, brands and makes of equipment are not specified; rather, the function of the equipment and the reason the equipment is required are described and explained. The successful operation of a petrographic laboratory is dependent on the skill, knowledge, and judgment of the petrographers and petrographic technicians, and the quality, sufficiency, and operating convenience of the equipment available to these people. The better the quality of the equipment, the more efficient and accurate the results of the petrographic examination. Table 1 is a list of the equipment found in a well-equipped petrographic laboratory. Not all of the equipment is necessary; however, its inclusion will permit the greatest flexibility in approaching a given problem. Much of this equipment is demonstrated in Walker (1988).

Table 1. Equipment for a petrographic laboratory.

| For Sample Preparation Room: | |
|--|---|
| <ul style="list-style-type: none"> • Exhaust system • Table • Hood • Running water | <ul style="list-style-type: none"> • Sink • Floor drains • Water-cooled drill press and diamond-edged drill bits • Rock trimmer |
| For Preparation of Slices: | |
| <ul style="list-style-type: none"> • Water-cooled, diamond-edged rotary saw with an overhand arm • Large oil-cooled, diamond-edged rotary saw • Diamond-edged trim saw • Lapping machines | <ul style="list-style-type: none"> • Weights • Safety-approved container • Ultrasonic cleaner |
| For Production of Thin Sections: | |
| <ul style="list-style-type: none"> • Thin-sectioning equipment • Glass plate • Drying oven | <ul style="list-style-type: none"> • Vacuum oven • Set of clamps • Vibrating lap |
| For Examination of Specimens: | |
| <ul style="list-style-type: none"> • Stereomicroscope • Microtools • Equipment for determination of air-void parameters • Petrographic microscope • P/EF microscope | <ul style="list-style-type: none"> • Ultraviolet lamp • Sieves • Hand lenses or loupes • SEM with energy-dispersive x-ray (EDX) • XRD |
| Expendable Materials: | |
| <ul style="list-style-type: none"> • Lapping oil or other vehicle • Degreasing agent • Ethanol • Grinding compounds, diamond pastes, abrasive discs, lapping film • Fluorescent or colored (e.g., blue) dye • Impregnating epoxy • Mounting epoxy • Flat glass petrographic slides • Carpet tape • Carnauba wax or colorless nylon fingernail hardener • Pens | <ul style="list-style-type: none"> • 10 percent HCl acid • Notebooks • Glass trays • Dropper bottles or rods • Glass dishes • Absorbent cotton, paper towels, etc. • Index of refraction oils • Disposable 305-millimeter (mm) liners for vibrating lap • Disposable plastic petri dishes (60-mm diameter) • Equipment or materials (e.g., chemical stains) for specific tests • Reference specimens |

2.2 FOR SAMPLE PREPARATION ROOM

2.2.1 General Comments

The initial sample preparation room is a “dirty” room because it is usually the room to which new specimens, complete with any adhering dust or soil, including concrete in all stages of disintegration, are brought and in which loose grinding compounds and lapping oils are stored and used. Water, oil, specimen fragments, mud, and grinding compounds may accumulate on the floor or other surfaces and may necessitate periodic cleaning and sorting to keep dirt and waste under control and make the room a practical and convenient space in which to work.

2.2.2 Equipment

The following equipment is needed in the sample preparation room:

1. **Exhaust system:** For exchanging the air frequently and ridding the room of the chemical fumes and oil vapors produced from cutting, lapping, and cleaning specimens.
2. **Table:** For sorting and labeling specimens and preparing them for additional preparation procedures. Equipment for marking specimens, paper, pens, and pencils should be available at this table.
3. **Hood with outside vent:** For enclosing any area where strong solvents (e.g., acetone) and epoxy components are stored and used.
4. **Running water:** For cooling and lubricating some of the saws and the drill press. Usually, it is most convenient to have adjustable, mixable, hot and cold water permanently supplied to each piece of equipment. Hoses that drape across the floor and must be reattached to each piece of equipment as it is put into use are a safety hazard and are inefficient. In many cases, the operator’s hands must stay in the running water for long periods. Thus, although the main purpose of the water is to remove heat from the specimen, it must be possible to adjust the water temperature so that the operator is comfortable and can maintain a firm grip on the specimen being shaped.
5. **Sink:** For washing hands, pieces of equipment, and specimens.
6. **Floor drains:** For draining spilled and splashed water. A large sump should be placed under the areas where oil may be spilled.
7. **Water-cooled drill press and diamond-edged core bits (figure 1):** For fabricating small cores of rock or concrete. Bits should be of the internal-diameter sizes required for any tests using small cores of rock. This item will not be required unless the preparation of rock specimens for tests such as those specified in ASTM C 586 is a function of the petrography laboratory. Quantity: 1.
8. **Rock trimmer (figure 2):** Hydraulic press that by means of opposing chisel points produces controlled cracks in rock, concrete, and similar materials.

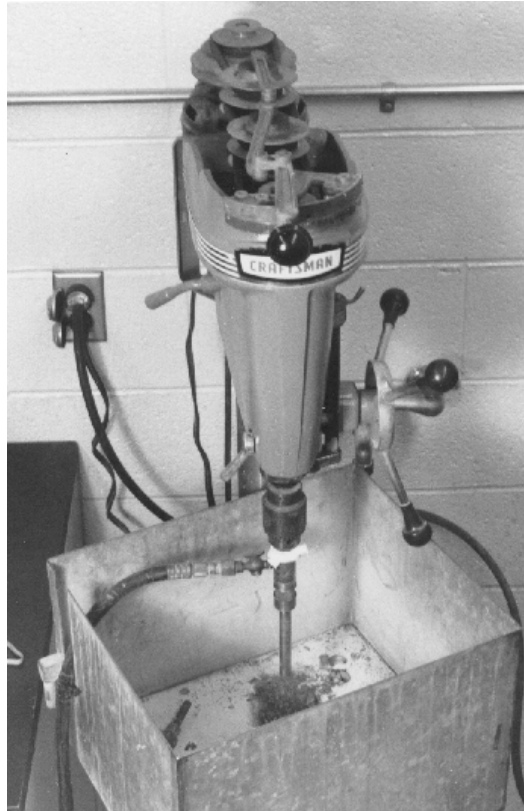

Figure 1. Water-cooled drill press.

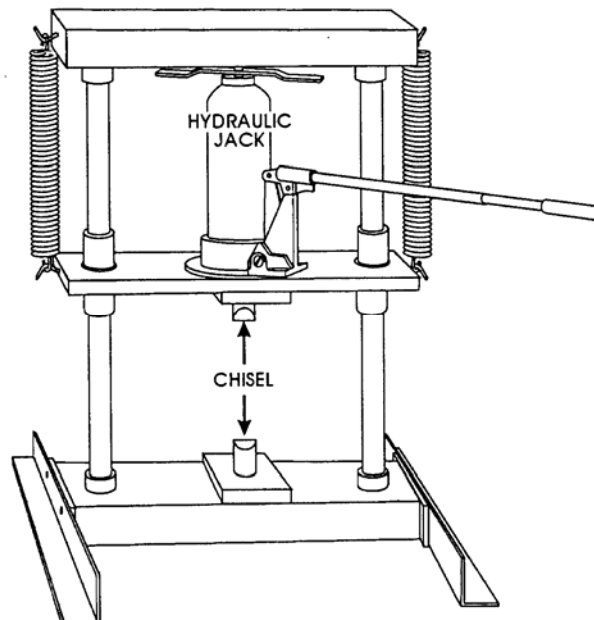

Figure 2. Rock trimmer (with chisel points and hydraulic jack to apply up to 4500 newtons (N)).

2.3 FOR PREPARATION OF SLICES

2.3.1 General Comments

Apparatus and materials for the preparation of surfaces of HCC specimens for microscopic observation are described in ASTM C 856, "Apparatus." Other apparatus may be equally suitable. Water should be used as little as possible on portions of HCC that are to be examined microscopically. Water dissolves particular components of HCC (see section 6.3.3). With this in mind, whenever a choice is possible, equipment for sawing concrete that uses an oil bath should be selected rather than equipment that uses running water or a water bath containing a rust inhibitor. The diameters listed for the rotary saw blades reflect the fact that the depth of the cuts made with a rotary saw cannot exceed the distance from the supporting central plate to the edge, a distance that is always less than half the diameter of the saw blade. Some blades thicken or bow in the middle and cause binding.

2.3.2 Equipment

The following equipment is needed for shaping and lapping slices:

1. **Water-cooled, diamond-edged rotary saw with an overhand arm (figure 3):** For reducing large fragments and long cores and cylinders to sizes that may be held in the vise of the next saw. The 360-mm diamond-edged blade is usually slotted into wide teeth. The saw is cooled with running water to allow specimens to be hand-held for quick setup and to obviate the need for a cover. Both hands are often needed to hold the specimen and roll the table. The foot pedal for adjusting the height is a necessity. Quantity: 1.
2. **Large oil-cooled, diamond-edged rotary saw (figures 4 and 5):** For cutting specimens. The 610-mm (minimum) diamond-edged, continuous-rim blade produces a smooth cut with few ridges and minimizes the difficulty of producing finely lapped surfaces. A vise that holds the specimen firmly and automatically moves it into the saw is an integral part of this equipment. The saw blade should be flat and true, and carefully aligned in the saw so that it is parallel to the travel of the vise. The saw is covered to contain the splashing oil and oil vapors. Quantity: 1 (minimum).
3. **Diamond-edged trim saw:** For shaping small specimens of rock or concrete, such as thin-section blanks. The saw in use at VTRC (figure 6) is water-cooled; however, an oil-cooled saw is preferable so that specimens are not exposed to water that might dissolve particular phases in the concrete. The diamond-edged blade should be 200 mm or less in diameter. Quantity: 1.
4. **Bench lap (figure 7):** For smoothing surfaces of hand-held specimens of rock or concrete. The usual lubricant is water added by hand or dripped from an overhead container. The grinding compounds are usually dispensed from small shakers. Quantity: 1.



Figure 3. Water-cooled, segmented, diamond-edged rotary saw with overhead arm (360-mm blade is diamond-edged and slotted into wide teeth; foot pedal controls the height of the saw).



Figure 4. Large, oil-cooled, continuous diamond-edged rotary saw.

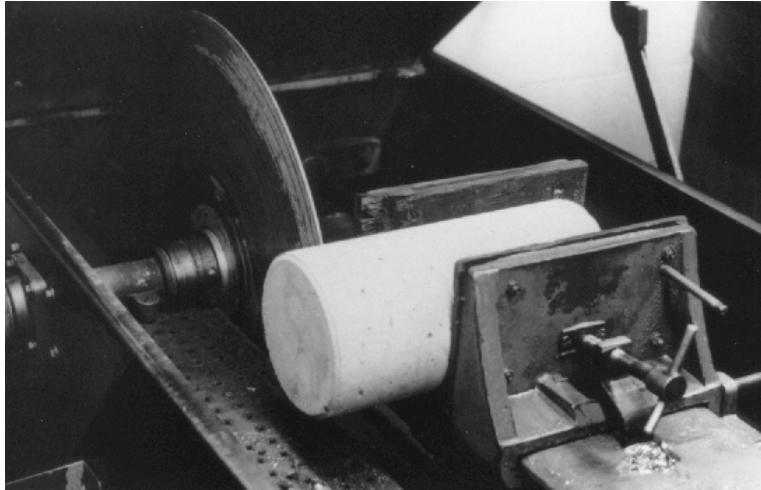

Figure 5. The smooth-edged blade, at least 610 mm in diameter, runs in an oil bath and vise that holds the specimen firmly and automatically moves it into the saw.

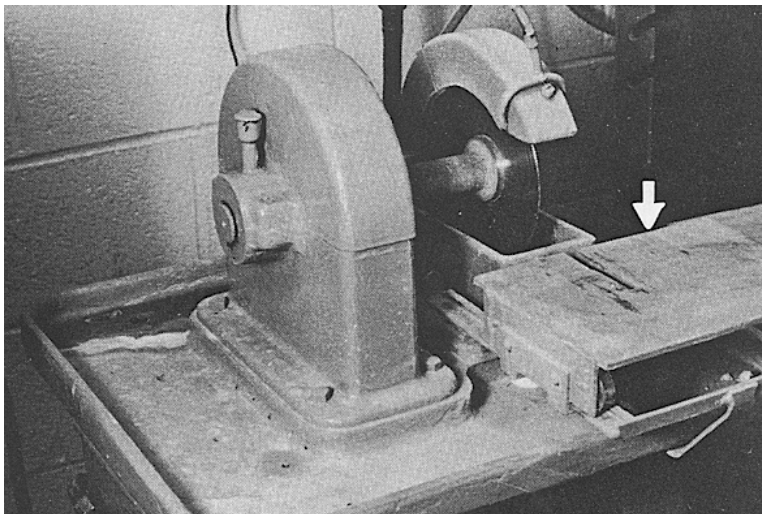
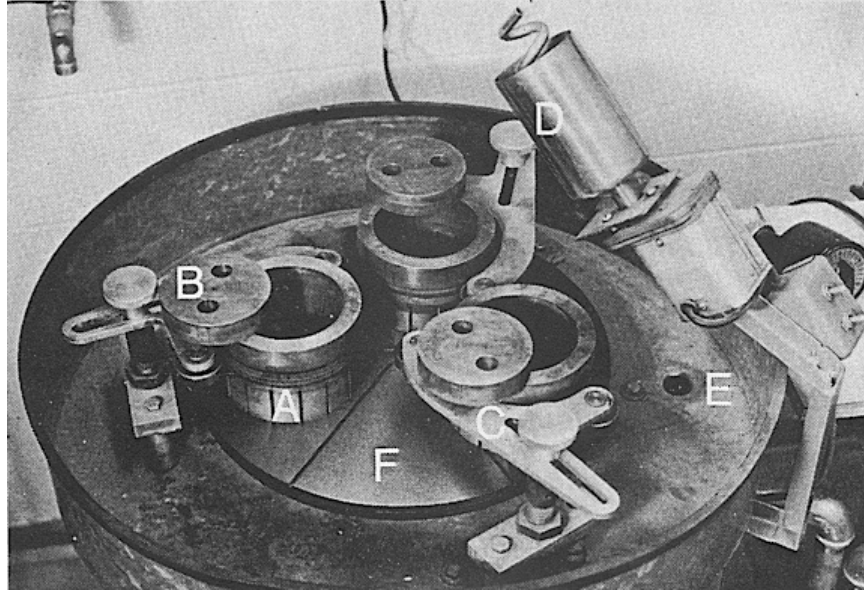

Figure 6. Rotary saw with thin, continuous diamond-edged blade (diameter of 150 mm; arrow points to the sliding table on which the specimen can be braced).



Figure 7. Bench lap (diameter of 200 mm, for rough-grinding rock and concrete specimens; suspended bottle is for water or another lubricant; grinding compounds may be shaken like salt from plastic bottles with a pierced cover).

5. **Rotating laps:** For producing finely lapped surfaces for microscopic examination and air-void analysis. The laps should be fabricated of cast iron with radial grooves cut in the surface to provide drainage. The equipment includes an adjustable timer and automatic feed for the slurry of lapping oil and grinding compound. A lap 400 mm in diameter will handle three 100-mm specimens or two 150-mm specimens. The lapping equipment includes slotted, rotating, sample-holding rings (sized to fit common slice sizes), yokes to hold the rings, and cover plates to rest between the slice and its weight. The lapping of concrete or rock slices is time-consuming. Two laps speed up operations. If there is only one horizontal lap wheel, great care must be taken to clean the iron wheel and the associated equipment carefully (such as the feeder for grinding compound) whenever a change is made to a finer compound. A very small amount of coarser grit left in the equipment can significantly damage a lapped surface produced with fine grit. The finest grinding compound should be used on one lap, and all coarser grit on the other. The lap wheels (figure 8) should be sturdy and have durable bearings to withstand the stresses of unbalanced samples and heavy weights. Quantity: 2.



- A: Rotating slotted specimen holder
- B: Cover plate to set on top of specimen
- C: Guide yoke that retains specimen holder
- D: Grit-slurry cup mounted on its motor and containing spiral agitator-pump
- E: Drain
- F: Grooved lap

Figure 8. Lap (diameter of 400 mm).

6. **Weights (figure 9):** For lapping slices smoothly. Weights fit on the back of the slices, loosely inside the rings. The weights press the specimen firmly against the lap to prevent the lapping away of the softer material and the leaving of the hard material as high spots. The weight increases the wear on the high (hard) portions of the specimen and prevents a buildup of grinding compound on the softer portions. Without the weights, the softer portions would be worn away more deeply. The weights should cover nearly all of the back of the specimen and should weigh 6 to 7 kilograms (kg) for a specimen 100 mm in diameter and 7 to 8 kg for a specimen 150 mm in diameter. Coffee cans of appropriate diameter weighted with lead shot have been found to be satisfactory. Quantity: Equal to the number of specimens it is possible to lap at one time.
7. **Automated combination grinding, lapping, and polishing machines:** Machines such as those shown in figure 10 (Abramin by Struers, Inc.) are available and are in use at the Turner-Fairbank Highway Research Center (TFHRC) and the Missouri Department of Transportation (DOT). This equipment uses easily interchangeable grinding and polishing discs together with a continuously variable pneumatic system for applying downward force on the specimen, thus eliminating the need for loose abrasives and weights.

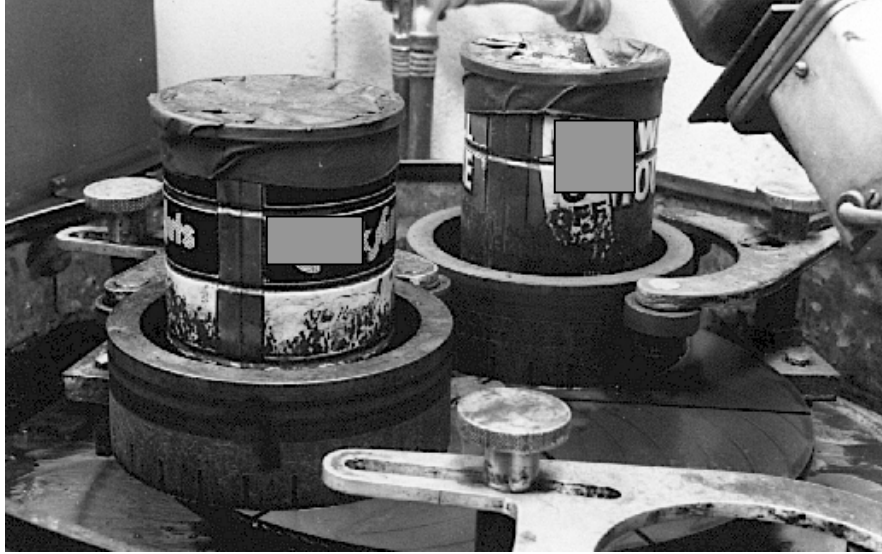

Figure 9. Weights rest on the back of the slices, fitting loosely inside the rings to provide the downward force needed to produce smoothly lapped surfaces. (Here, cans of an appropriate diameter, weighted with lead shot, are used.)



Figure 10. Automated grinding, lapping, and polishing machine uses interchangeable grinding and polishing discs to simplify specimen preparation.

8. **Safety-approved container:** For cleaning specimens. Specimens are cleaned in solvents (such as isopropyl alcohol (99 percent) or acetone) to remove oil and grinding compound accumulated during lapping.

9. **Ultrasonic cleaner (figure 11):** For cleaning specimens. The cleaner should be of sufficient size to easily submerge the largest lapped specimen that will require cleaning. The cleaner bath must be of a material that can hold acetone or isopropyl alcohol. Quantity: 1.



Figure 11. Ultrasonic cleaner (tank is of a material that will resist most solvents).

CAUTION: It has been reported that the use of ultrasonic cleaning equipment may be harmful to the surface of concrete specimens; therefore, such treatment should be used with care and only after experimentation with the specific frequencies of the equipment (ASTM C 457).

2.4 FOR PRODUCTION OF THIN SECTIONS

2.4.1 General Comments

To fabricate a specimen chip of concrete or rock that will fit the glass to be used to support the thin section will usually require the use of at least one of the two large saws and the small trim saw. The room used for further fabrication of thin sections should be isolated from the area where lapped slices are prepared, and it must have an efficient exhaust system or two hoods because the cutting and grinding of thin sections to the required thickness produce an oil vapor and the production of thin sections requires the use of epoxy (which is toxic in large quantities). The method any particular laboratory uses to produce thin sections will depend on the equipment available and the preference of the technical personnel. Pacific Northwest Laboratories of Battelle in Richland, WA, recommended the use of a belt sander and a bench lapping machine with diamond-impregnated laps (Beauchamp, Williford, and Gafford, 1972). Wilk, Dobrolubov, and Romer (1974) recommended the use of a diamond-tooled milling machine. A variety of techniques are described by St. John, et al. (1998). VTRC has Ingram-Ward thin-section machines; TFHRC uses PETROTHIN[®] by Buehler, Inc.; and the U.S. Bureau of Reclamation

has equipment from Microtec Engineering Laboratories, Inc. The preparation of thin sections requires skilled technicians, and when experienced personnel are not available, it may be more practical to have them prepared by a laboratory that specializes in making thin sections.

2.4.2 For Examination With Petrographic Microscope

The following equipment is needed for examination with a petrographic microscope:

1. **Thin-sectioning equipment:** For producing thin sections of rock and similar materials for examination with the petrographic microscope. This manual describes the use of Ingram-Ward equipment (figures 12 and 13). The instructions can probably be adapted for use with any type of thin-sectioning equipment that permits variability in section thickness and thus will make possible ultrathin and extra-thick sections. Part A of the set is a rotating cutoff saw with a very thin blade used to slice off excess specimen material, thus reducing the specimen chip (mounted on a glass slide and held in a vacuum chuck) from 50 to 30 micrometers (μm) in thickness. Generally, the thinner the slice of specimen chip remaining on the glass slide, the better. Part B of the set holds the specimen in another similar vacuum chuck and permits it to be moved carefully and evenly over a rotating, diamond-bearing, cupped ceramic grinder to grind it to nearly the desired thinness. The relative position of the chuck to the saw or grinder can be adjusted with a small dial at the right-hand end of each piece of equipment. The lubricant (denatured kerosene with 1/10th motor oil) is collected in the surrounding tank and pumped to the top of the saw or wheel to cool and lubricate the work. Quantity: 1 set.
2. **Glass plate firmly supported in a flat pan (figure 14):** For catching spilling slurry when thin sections are hand-lapped after they have been cut and ground on the Ingram-Ward equipment. Ordinary window glass is usually sufficient. Used for final grinding of ordinary and intermediate grinding of fluorescent ultrathin sections for use with the petrographic and P/EF microscopes. Quantity: 1.
3. **Drying oven (figure 15):** For evaporating water or lapping oil from slices, thin sections, or rock fragments and curing the epoxy of specimens impregnated for thin sections. Vented to allow the escape of vapors. A thermometer is mounted near the center of the oven. Steam must not form in the HCC; therefore, the temperature in the oven must be thermostatically controllable (adjustable to less than 100 degrees Celsius ($^{\circ}\text{C}$)). Quantity: 1.

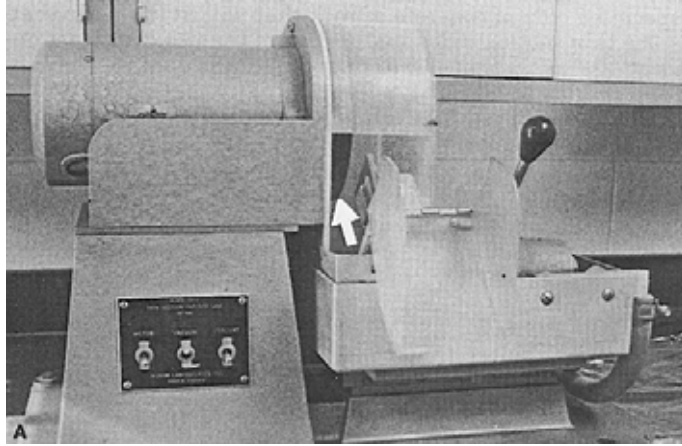
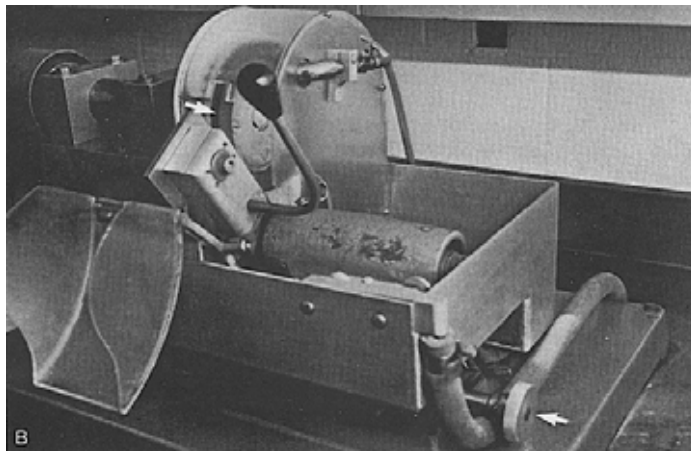
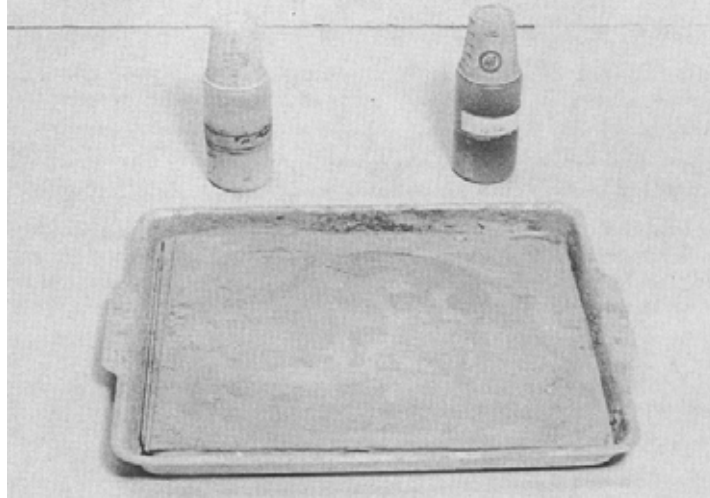

Figure 12. Ingram-Ward thin-sectioning equipment: Diamond-edged cutoff saw with very thin blade (see arrow) used to slice off excess specimen material.



The handle and chuck permit the specimen to be moved carefully and evenly over the rotating, diamond-bearing, cupped ceramic grinder. The relative position of the chuck to the saw or grinder can be adjusted with a small dial (bottom arrow) at the right-hand end of each piece of equipment.

Figure 13. Ingram-Ward thin-sectioning equipment: Diamond-bearing, cupped ceramic grinder (see arrow).



The pan used to catch the grinding slurry, which overflows the edge of the glass. The two plastic bottles have holes in the screw-on covers and waxed paper cups for dust covers. Dry grit is shaken from the bottles and mixed on the plate with a lubricant to produce a slurry.

Figure 14. Glass coated with grinding-compound slurry.



Figure 15. Drying oven (thermostatically controlled).

2.4.3 For Examination With Polarizing/Epifluorescence Microscope

The following equipment is needed for examination with a P/EF microscope:

1. **Vacuum oven (figures 16 and 17):** For vacuum-impregnating thin-section stock with epoxy and slow, even drying of specimens. For fluorescence, fluorescent dye is added to the epoxy. Quantity: 1.
2. **Set of clamps mounted on a sturdy metal plate (figure 18):** For cementing an impregnated thin-section chip to the final glass slide. Quantity: 1.
3. **Vibrating lap with weights (figure 19):** For producing the final surface of thin sections. The thin sections are attached to the bottom of the weights. The circular pan is lined with Pellon Pan-W, a specially formulated lapping pad, which is coated with diamond paste thinned with thin oil. Quantity: 1.



Figure 16. Vacuum oven: Thin-section stock in liquid dyed epoxy in small disposable dishes.



Figure 17. Closeup of bubbling of liquid epoxy as vacuum removes air and water from specimen.

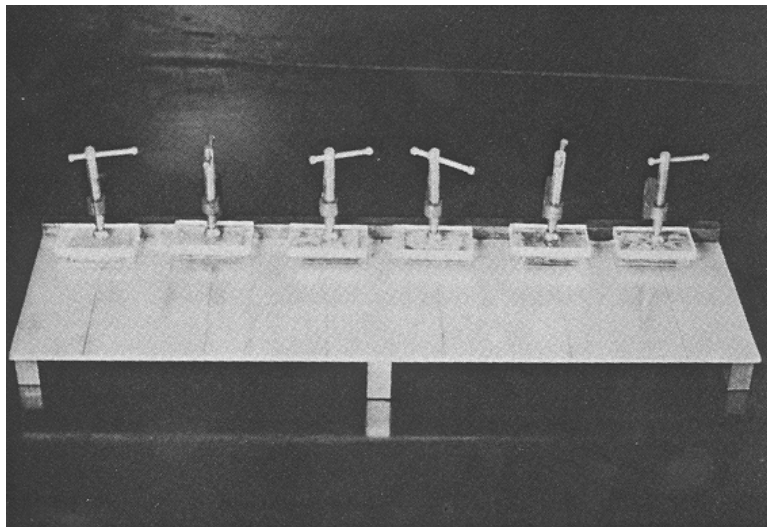

Figure 18. Mounted set of clamps (small Lucite[®] rectangles are used to distribute clamping force over the entire section surface) (Walker and Marshall, 1979).



Figure 19. Syntron vibratory polisher and weights (weights have sponge rubber bumpers) (Walker and Marshall, 1979).

2.5 FOR EXAMINATION OF SPECIMENS

2.5.1 General Comments

The room in which specimens are examined is also where the microscopes are stored and used and should be as close to a “clean” room as can be managed without the use of special clothing. A worker whose hands or clothing are contaminated with grinding compounds, excessive dust, lapping oil, grease, soil, or materials used to mix concrete should remove the contaminants from his or her person before approaching a microscope. It is best if the air in the room is under positive pressure and an anteroom is equipped with an exhaust system to create the concomitant negative pressure. The room should be furnished with tables and microscope benches and a number of adjustable-height stools and chairs.

2.5.2 Equipment

The following equipment is needed for examination of specimens:

1. **Stereomicroscope (figure 20):** For conducting a general examination of specimens. May also be used in the quantitative determination of air-void parameters. This is the instrument most used by concrete petrographers. The stereomicroscope should have a magnification variable between 25 and 120 diameters. The higher magnifications may be attainable with a 2X accessory lens below the objective. It is most convenient to have a zoom objective; however, excellent observations can be made with turret-mounted objectives. It is tedious and annoying to have to change objectives by dismounting them and remounting them. The eyepieces should be the wide-field type. A measuring reticle in one eyepiece can be convenient (must be calibrated for each magnification). Video-imaging systems are available with integral or separate software packages that

have measurement tools. Measurement calibrations can be saved to match the various magnifications used for easy application during an examination. By the use of this microscope, decisions are made concerning concrete quality and the planning of further testing. If there is a difference in the quality of the microscopes available, the one with the least distortion and the widest field of view should be the one used in the quantitative determination of air-void parameters. Quantity: At least 2.

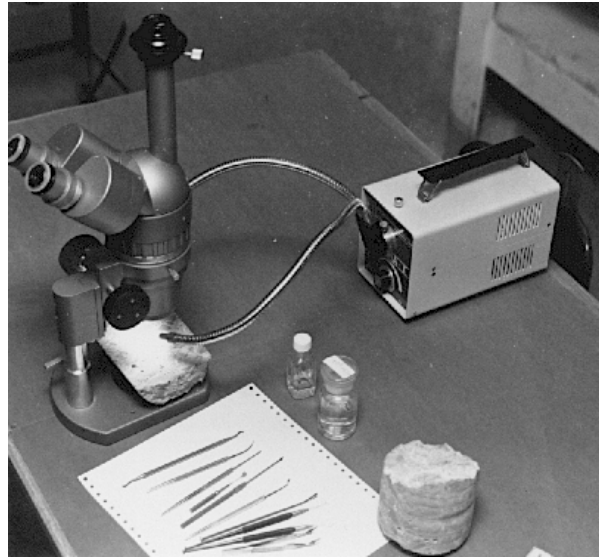

Figure 20. Stereomicroscope with light source and accessories.

2. **Microtools:** For measuring, manipulating, and removing portions of slices of concrete and manipulating the grains of grain mounts under any kind of magnification. The most useful microtools will probably be those that have been fabricated in the petrographic laboratory (figure 21). Sets of microtools are commercially available; however, they often do not meet the needs of the concrete petrographer. The best sets have a variety of needles, shovels, and scrapers. The tiny tools must be small enough to use in the cracks, crevices, and voids of the concrete; however, they must be strong and resilient to resist breaking. Some of these sets are constructed with the microtools as detachable pieces that screw or clamp into a handle. Such sets should have more than one handle. The needles used for biological dissection are usually strong enough; however, the point thickens so rapidly that the tool may not be of use in tight cracks and voids. Sewing needles with the handle of a section of a small dowel rod can be very useful. They are strong and sharp and come in a variety of sizes. Often what is required is an assortment of needles with bends of different radii, well within the working distance of the microscope, to allow the needle to attack the concrete from a variety of angles. Such needles are commercially available for biological microscopy; however, they may not be strong enough to pick out reaction products and small pieces of aggregate from the concrete. Duplicate tools should be obtained so that breakage will not cause a delay in the progress of the work.



The arrow indicates a small scale engraved on very thin, flexible metal attached to a thin rod that is attached to a handle. The scale has 5 mm marked into tenths of a millimeter on one side and 0.1 inch marked into five thousandths of an inch on the other.

Figure 21. Microtools (including needles, shovels, and scrapers small enough to be useful in the cracks and crevices of concrete and to fit in the working distance under the stereomicroscope).

The most irreplaceable, commercially available microtool is a small scale engraved on very thin flexible metal attached to a thin rod, which is attached to a handle. The scale may have 5 to 10 mm marked into tenths of a millimeter on one side and 0.1 to 0.2 inch marked into five thousandths of an inch on the other side. This flexibility allows better positioning of the scale. The thinness allows the scale to be more nearly in the same focal plane as the item examined. Unfortunately, the solder joint between the flexible metal and the stiff rod connection to the handle may be fragile. It is good to have a replacement scale available. For less precise measurements, a transparent scale (usually the International System of Units (SI) (metric system)), used by the microscopist viewing through the scale with the markings down on the concrete (to allow for the best focus) is useful. Such scales may be found in stationery and variety stores.

Excellent picks, miniature knives, shovels, and scrapers can usually be obtained from most dentists if a request for used tools is made. These tools are strong and designed for approaching the work area in close quarters. They may require sharpening and reshaping to suit the needs of the concrete petrographer. For this purpose, a stick or two of abrasive dressing compound is useful. These tools may corrode in the presence of chemicals and must be kept clean and sharp. Quantity: Minimum of 1 each.

3. **Equipment for air-void determinations:** An example of this equipment is described in chapter 6.
4. **Petrographic microscope:** An example of this microscope is described in chapter 12.

5. **P/EF microscope:** An example of this microscope is described in chapter 13.
6. **Sieves (figure 22):** For sorting aggregate particles (pebbles, sands, and crushed fragments) by size and preparing specimens for microscopic examination. Sieves should comply with the requirements of ASTM E 11. Two sizes of frames are required: 203 mm and 76 mm. Both sets of sieves should include standard covers and pans. The 203-mm size is used for sizing and sorting aggregate material to determine compliance with the client's specifications and to prepare aggregate specimens for various testing procedures. The 203-mm set should include the mesh sizes necessary to determine the compliance of an aggregate with the client's specifications. If other laboratories concerned with aggregates are on the premises, this size of sieve will probably be available. The smaller 76-mm frame size is used to prepare sands and rock and concrete fragments for grain mounts or other microscopic studies. The 76-mm set should include the mesh sizes of the 203-mm set that are smaller than 9.5 mm and an assortment similar to those listed in table 2.



Figure 22. Types of sieves used in examination of concrete and concrete materials (203-mm and 76-mm sizes).

Table 2. Useful sieves for petrographic laboratory using 76-mm frames.

| Alternate Designation | ASTM E 11 (SI) Standard Designation |
|------------------------------|--|
| No. 30 | 600 μm |
| No. 40 | 425 μm |
| No. 60 | 250 μm |
| No. 100 | 150 μm |
| No. 200 | 75 μm |
| No. 400 | 38 μm |

7. **Other equipment:** Various instrumental methods of analysis (e.g., x-ray diffraction (XRD), elemental analysis by x-ray dispersion (EDX), SEM, differential thermal analysis, infrared spectroscopy, x-ray fluorescence (XRF), and analytical chemical methods) may be employed in the identification of the raw materials and reaction products and deleterious substances that may be associated with HCC. XRD, SEM, and EDX are discussed in chapter 14.

2.6 EXPENDABLE MATERIALS

2.6.1 General Comments

WARNING: Persons unfamiliar with the hazards of these compounds, or any chemicals and materials used or examined, are referred to the Chemical Safety Data Sheets published by the Manufacturing Chemists Association, Inc., 1825 Connecticut Avenue, NW, Washington, DC 20009, or to the Materials Safety Data Sheet that may be obtained from the supplier of the particular compound, chemical, or material.

2.6.2 Lapping Oil

Water should not be used on any surface of an HCC specimen that is to be examined under magnification. The lubricant used for cutting and lapping specimens should be low-viscosity, water-free lapping oil, such as denatured kerosene (e.g., Exxon Isopar™ M) mixed with 1/10th 30-weight motor oil. The motor oil lessens the production of vapors from the kerosene. A number of light oils are sold specifically as lubricants for cutting with diamond saws. Specialized lubricants are required for grinding and polishing thin sections with diamond grinding compounds (an example of such a lubricant is Formula C (Glennel Corporation, Chester Springs, PA)).

Oil-based lubricants will not dissolve reaction products and secondary minerals as readily as will water-based lubricants. It is convenient to use a lapping lubricant that will evaporate and leave the surface of the specimen oil-free. At magnifications such as those used in the analysis of concrete, an oil film can obscure the exact edges of voids and aggregate particles. The evaporation of the oil may be hastened by treatment in a warm (< 70 °C), not hot, drying oven. High heat can crack the concrete specimen or heat the oil to its flash point. The oil drained from the laps may be reused after filtering and decanting.

2.6.3 Grinding Compounds

For preparing finely lapped surfaces on concrete specimens. The grit numbers and sizes listed are given only as a guide. The grinding compounds produced by one manufacturer may vary from those produced by another.

- **Abrasives:**
 - No. 100 (nominal 150 μm) silicon-carbide abrasive.
 - No. 220 (nominal 75 μm) silicon-carbide abrasive.
 - No. 320 (nominal 35 μm) silicon-carbide abrasive.
 - No. 600 (nominal 17.5 μm) silicon-carbide abrasive.
 - No. 800 (nominal 12.5 μm) silicon-carbide abrasive.
 - 5- μm aluminum-oxide abrasive.

- **0.3- μm Linde, an aluminum-oxide grinding compound:** For use in the epoxy of impregnated thin sections to prevent excess wearing of the epoxy-rich areas of ultrathin sections. The distinctive particle shape will not be confused with any ingredient of concrete or aggregate.

- **Oil-soluble diamond paste compounds:**
 - 6 μm .
 - 3 μm .
 - 1 μm .
 - 0.25 μm .

- **Diamond-impregnated lapping film for use with bench laps:** The film is self-adhesive for use on a removable platen. An assortment of decreasing sizes allows rapid lapping of small (25 by 50 mm) specimens (equipment and material supplied by A.B. Buehler, Lake Bluff, IL, has been found to be satisfactory).
 - 125 μm .
 - 70 μm .
 - 45 μm .
 - 15 μm .
 - 9 μm .
 - 6 μm .

2.6.4 Dyes and Epoxies

The following dyes and epoxies are needed:

1. **Fluorescent dye:** For inclusion in the impregnating epoxy of sections to create fluorescence in the voids and cracks. This is available only as samples (believed to be a paint ingredient). The dye currently used is Fluorol Yellow 088, available as samples from BASF Wyandotte Corp., Holland, MI. This dye dissolves completely in epoxy; no dye particles can be seen at 600X magnification and the epoxy is evenly colored by the dissolved dye. An ultraviolet light source is required for the use of this material.

2. **Colored dye:** For use in impregnating thin sections when observations will be made with transmitted light. A blue-colored dye is commonly used to highlight voids and cracks.

3. **Impregnating epoxy:** For strengthening thin-section stock and carrying fluorescent or colored dye. EPO-TEK 301-2 from Epoxy Technology, Billerica, MA, is a good impregnating epoxy. It dissolves the dye completely. It has sufficient shelf life to be

useful after a year or so, although it may have to be warmed a little. It has a sufficient pot life to remain fluid through several hours of vacuum impregnation and can be formulated to cure with a little heat treatment over several days to a hard brittle substance that shows no plasticity. When properly cured, the hardened epoxy is not soluble or softened in oil, alcohol, or acetone. LR White is a one-part epoxy with extremely low viscosity and is routinely used to impregnate specimens for SEM examination.

4. **Mounting epoxy:** For attaching the smoothed thin-section stock to the final supporting glass slide. The mounting epoxy currently used can be either Epoxide from A.B. Buehler, Lake Bluff, IL, or Section-Lok epoxy mounting medium from Microtech Engineering Laboratory, Inc., Clifton, CO. Of the two, the Section-Lok product has the longer shelf life.

2.6.5 Miscellaneous Supplies

The following miscellaneous supplies are needed:

1. **Flat glass petrographic slides (27 by 46 mm):** For mounting thin sections and grain mounts for examination with the petrographic microscope. A standard item in most scientific catalogs. The slides used for temporary grain mounts can be cleaned and reused.
2. **Carpet tape or other strong, double-sided tape:** For attaching thin sections to the bottom of weights.
3. **Carnauba wax or colorless nylon fingernail hardener:** For impregnating fragile concrete.
4. **Pens:** For fine marking of concrete slices. The pen used should be such that when the inky point is positioned on a crack a very small portion of the ink will flow into the crack and be drawn along the crack and will thus indicate the next direction of the crack.
5. **10 percent HCl:** For etching entire slices or portions of slices.
6. **Notebooks:** For recording observations.
7. **Glass trays:** For etching or other chemical treatment of finely lapped specimens.
8. **Dropper bottles or glass rods:** For dropping acid and water.
9. **Glass or ceramic dishes:** For use in chemical tests.
10. **Absorbent cotton, tissues, paper towels, lintless cloth, etc.**
11. **Index of refraction oils:** For determining the optical properties of minerals and other translucent substances with polarized light microscopy. The oils should range in index from 1.40 to 1.50 in steps of 0.04, from 1.500 to 1.600 in steps of 0.002, and from 1.600 to 1.700 in steps of 0.01. Index oils change with age and must be checked periodically with a refractometer or standard solids.

12. **Disposable 305-mm liners for the vibrating lap:** Pellon Pan-W polishing pads.
13. **Disposable plastic petri dishes, 60 mm in diameter, 20 mm in depth:** For potting thin-section specimens in fluorescent- or color-dyed epoxy.
14. **Equipment and materials for specific tests:** Examples are the concrete molds and the length comparators required by particular ASTM procedures. The equipment required for the uranyl acetate fluorescence test for the presence of alkali-silica gels is listed in section 10.2.3. Chemicals needed for staining techniques.
15. **Reference specimens:** For comparison between materials under study and carefully labeled and documented specimens in a reference collection. Two general kinds of materials should be included in such a collection: (1) raw materials from which concrete is fabricated and (2) various kinds of HCC in both rough fragments and finely lapped slices. If storage space is limited, photographs may have to be substituted for the larger specimens. Ideally, enough of each specimen should be available for various destructive testing procedures. Some of the items to be included are listed in tables 3 and 4.

Table 3. Reference specimens of materials used in making hydraulic cement concrete.

Aggregates

- Coarse
- Fine
- Those known to have caused problems (e.g., alkali-reactive aggregates, unsound aggregates, aggregates that create a high water demand)

Cementitious materials approved for use (in moisture-resistant containers)

- Portland cement
- Portland cement blended with slag, fly ash, silica fume, etc.
- Other cements, such as ground slag
- Fly ash
- Silica fume
- Natural pozzolans
- Other

Note: Specimens should include as many types of each as are available locally. They should be labeled as to source and type, and stored in transparent containers.

Table 4. Reference specimens of hydraulic cement concrete representing various conditions or features.

1. Each of the materials listed in table 3 used in the proper manner in hardened HCC mixtures.

2. Materials used in varying amounts:

- Several lapped slices of HCC with a high water-cementitious materials ratio (w/cm)
- Several lapped slices of HCC with a normal w/cm
- Several lapped slices of HCC with a low w/cm
- Lapped slices of HCC subjected to moist curing of varying duration
- Lapped slices of inadequately cured HCC
- Lapped slice of HCC with a normal amount of visible cement ferrites
- Lapped slice of HCC with a less-than-normal amount of visible cement ferrites

3. Various forms of distress (in large fragments) according to occurrence in the area and accompanied by photographs of the surface condition:

- Examples of deterioration caused by lack of resistance to cycles of freezing and thawing resulting from an insufficient air-void system (including layered scaling)
- Examples of deterioration caused by expansive alkali-aggregate reaction (generally alkali-silica, but also alkali-carbonate if such rocks occur in the region)
- Examples of concrete deteriorated by D-cracking caused by aggregate susceptibility
- Examples of plastic shrinkage cracking (including specimens with lapped surface cutting across the cracks)
- Examples of shrinkage (drying or thermal) cracking

CHAPTER 3. GENERAL PROCEDURES

3.1 OVERVIEW

Clients submit a specimen to the petrographic laboratory for a variety of reasons (e.g., low cylinder strengths or excessive cracking in new construction, concrete deterioration in an existing structure). Specific examples are described in appendix E. FHWA has recently published, in three volumes, *Guidelines for Detection, Analysis, and Treatment of Materials-Related Distress in Concrete Pavements*. Of particular interest are volume 1 (Van Dam, et al., 2002a), which provides a systematic guide to field surveying and sampling of pavements, and volume 2 (Van Dam, et al., 2002b), which provides a detailed and comprehensive approach to laboratory analyses of field specimens of deteriorating concrete. Volume 3 (Sutter, et al., 2002) describes case studies in which the guidelines were applied. The information is very useful and can be adapted for investigations of other types of structures.

Figure 23 provides an overview of the petrographic examination process. Assessments made during the visual examination stage are used to make a preliminary examination plan, with feedback from each stage used to direct the remaining course of the examination. Initial visual examinations performed with the unaided eye or with low-power magnifiers are discussed in

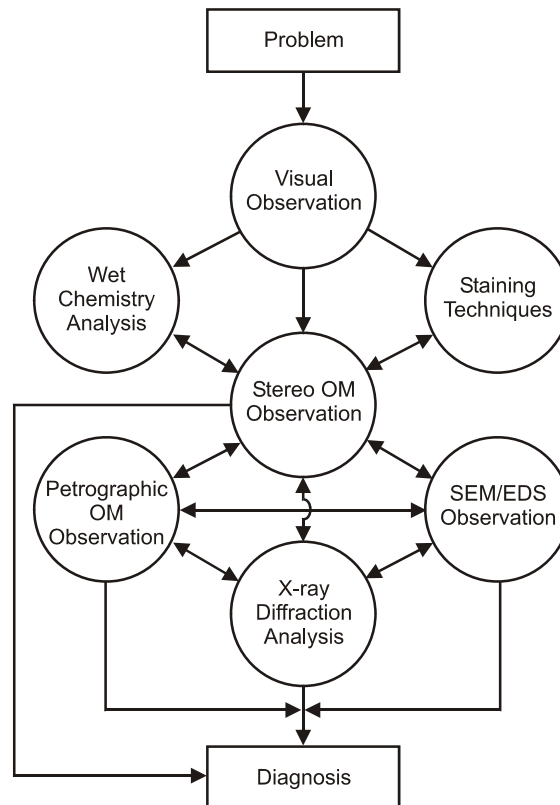

Figure 23. Flowchart of petrographic examination process (adapted from Van Dam, et al., 2002b).

section 3.3 and form the basis for the preliminary examination plan covered in section 3.4. The various types of cracks, which may be observed at this stage, are discussed in chapter 4. Chapter 5 covers the preparation of various specimens for more detailed microscopic examinations. As illustrated in figure 23, stereomicroscopic examinations play a central role in most petrographic analyses. Procedures for the quantitative analyses of the air-void system and concrete constituents are given in chapters 6 and 7. General stereoscopic examinations and staining techniques are covered in chapter 8. The petrographic microscope and its use are discussed in chapters 12 and 13. The use of SEM and EDX are covered in chapter 14.

The different types of specimens that may be submitted are listed in table 5. For HCC, the word *specimen* is used and the word *sample* is usually avoided because the specimen is seldom a truly representative sample of the HCC placement. Clients may also submit a suite of related specimens. For the sake of brevity, the word *specimen* is used even when a suite of specimens is meant.

No matter what the reason or type of specimen, four general procedures are performed for each specimen received for petrographic examination:

1. Formally receive the specimen.
2. Perform an initial examination.
3. Make a plan for analysis of the specimen based on its size/condition and the request.
4. File the appropriate documents.

Table 5. Typical types of specimens.

| |
|--|
| <ul style="list-style-type: none"> • Cores • Cylinders, beams, or bars fabricated for various concrete testing procedures • Fragments that cracked off a placement or were purposefully broken off with a sledge hammer or jackhammer • Bags or boxes of loose pieces of deteriorated concrete • Chips or popouts of concrete • Sand, gravel, or crushed stone |
|--|

3.2 RECEIPT OF SPECIMEN

Upon receipt of a specimen, six tasks are performed (as listed in table 6):

Table 6. Procedure for formal receipt of a specimen in the laboratory.

| |
|---|
| <ol style="list-style-type: none"> 1. Study the accompanying documentation and carefully consider any oral instructions from the client. 2. Make written notes concerning the condition of the specimen and any obvious forms of deterioration. 3. Make sure the specimen is suitable for the analysis requested by the client. 4. Make sure the specimen agrees with its accompanying documentation. 5. Mark and log the specimen. 6. Fill out a Request for Petrographic Services form (figure 26). |
|---|

1. **Study the accompanying documentation and carefully consider any oral instructions from the client:** Take careful note of any indication that the results of the analysis are needed within a short time or that they may be required as evidence in any litigation. Obtain as much information as possible about the reasons for the examination and the context surrounding the sampled concrete, such as test results and descriptions or photographs of the element. This information will greatly assist in determining the extent and course of the examination. Keep in mind that during the course of the examination, additional information of this nature may be required.
2. **Make written notes concerning the condition of the specimen and any obvious forms of deterioration.**
3. **Make sure the specimen is suitable for the analysis requested by the client (see appendix A):** If, for example, the client requests an analysis of the air-void parameters or a complete petrographic examination and the specimen was reduced to rubble or thoroughly cracked during sampling or compressive strength testing, it will be impossible to prepare the necessary representative lapped surface. If the client's concern is the lithology of the aggregate, such a specimen will be suitable. If the specimen is only slightly cracked or can be easily glued back together, it is often possible to prepare a lapped surface of at least a portion of the specimen. The cracking from testing will make it impossible to study some of the causes of deterioration because it will be impossible to distinguish cracks resulting from testing from the cracking in situ. If there is reason to suspect that the specimen has not been properly cared for (improper storage and curing, treated roughly, broken, etc.) and its condition will not allow an accurate reply to the client's request, the use of the specimen will be impossible. If, for any reason, the specimen is not adequate to obtain the necessary data for the examinations requested, inform the client of the consequences of proceeding and request a more representative specimen. In all cases where a patched, undersized, or otherwise imperfect specimen must be used, discuss the matter in the final report on the specimen.
4. **Make sure the specimen agrees with its accompanying documentation:** The documentation should indicate the source of the specimen, the date of the placement, the amount of traffic it has been exposed to (in the case of a pavement surface), the method of removal from the placement, any testing procedures that have been performed, and any results of such testing. If the documentation does not make note of readily visible features or provide sufficient data concerning the specimen in regard to the reasons for the examination, contact the client for further explanatory material.

The documentation and oral exchanges between the petrographer and the client should make clear the proposed use of the data obtained by the petrographic examination. If the data obtained from the specimen will become part of a legal controversy, note this fact and consider it throughout the entire analysis. Particular shortcuts may be considered permissible for work done within one organization; however, data collected for presentation by an expert witness must be gathered in accordance with the exact procedures detailed by the test method employed. For example, ASTM C 457 states that

three randomly selected test specimens are required to determine the compliance of the air-void structure with specification requirements.

Keep the original container (if any), the specimen, any documentation, letters of request, field notes, photographs, maps of the sampling plan, and other identifying papers together until all of these items have been entered into the logging system and the files of the petrographic laboratory.

5. **Mark and log the specimen:** Mistakes are made in all laboratories; however, it is most important to avoid mistakes at the time the specimen is received. Many other errors can be corrected if one can be assured that the identifying marks on all of the individual fragments of the specimen and the original entries in the logbook and on the request documents are correct. Therefore, it is extremely important that this work be performed correctly and checked carefully. Do not do part of the job one day and leave the remainder to be done the next. The most important procedure is the marking so that the specimen will always be identifiable and never confused with any other specimen. Never assume that this or that specimen or this or that fact will be easy to remember. *No petrographic procedure is more important than proper identification of the specimen.* There can be no reason to postpone specimen identification until some other procedure is begun on the specimen.

Experimentation has shown that the most durable markings are those made with graphite (ordinary “lead” pencil, or carpenter’s pencil). Unfortunately, graphite markings are often difficult to find and distinguish on concrete surfaces. If a felt marker is used, the marks may have to be refreshed after the specimen is subjected to oil, acetone, or alcohol. Even India ink cannot always withstand the rigors of the solvents used in the petrographic laboratory. Great marking security can be achieved with the heavy use of graphite, with additional identification clearly marked with a felt marker.

The in-house specimen numbering system of the petrographic laboratory must be individual to the laboratory and nearly impossible to confuse with any other numbering system that may be associated with the specimen. For example, at VTRC, specimens fabricated in the concrete mixing laboratory have a numbering system called *master numbers*. The petrography laboratory receives specimens from the concrete laboratory with master numbers on them; however, it creates confusion if the petrography staff tries to use the master numbers as the sole means of identification. A petrography number is assigned to the specimen, and the master number is recorded in the logbook, as are all other identification marks that accompany the specimen.

Petrography specimen numbers are preceded by a “P” (e.g., P-1222). The appropriate petrography number (including the “P”) is clearly marked on each specimen with a felt marker and graphite (see figure 24). Such numbers are called *P-numbers*. The use of P-numbers is the major method of tracking specimens and facilitating the location of data when questions concerning a specimen are received. The number is included on all correspondence in order that recipients of the correspondence may use the number for making inquiries concerning the specimen.

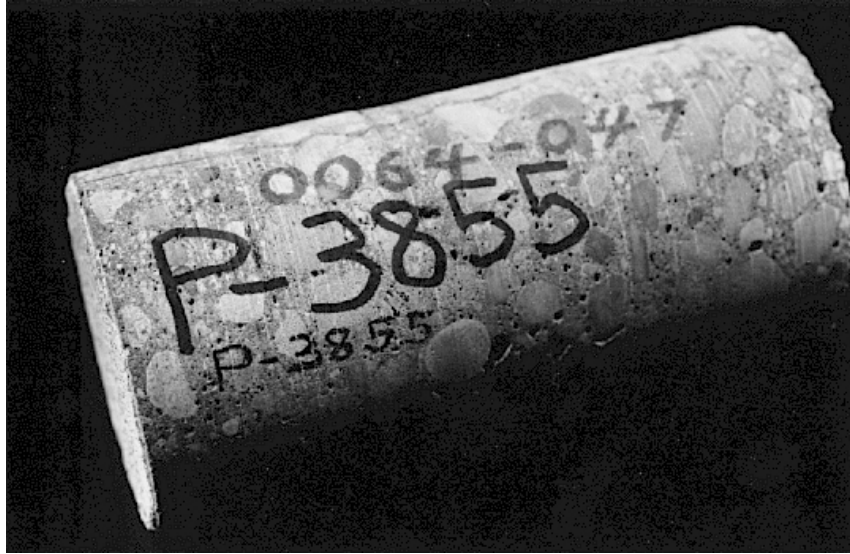

The original construction number is not obscured, and the P-number is marked with a felt marker and graphite.

Figure 24. Core with P-number.

CAUTION: Many ordinary inks begin to fade after they have been in contact with HCC paste for a few days.

In the petrographic laboratories of VTRC, the most useful documentation of the receipt of a specimen was found to be a chronological log of all specimens entering the system (see figure 25). It is often used long after the original investigation has been concluded to discover when and how many specimens were submitted from a placement, what examinations were performed, where the specimens are currently, and how the data can be found. The logbook stays in one place and thus can be easily found. The log provides a guide to all the information available concerning a specimen from any source.

Entering the initial data must be easy and not very time-consuming. In its simplest form, the log might merely record the date; any specimen identification marking received on or with the specimen; the type of specimen received; the file number under which correspondence will be stored; and, most importantly, the petrography in-house specimen number. Indicate the general size of the specimen and whether the material: (1) was cored with a diamond-core drill from a hardened concrete placement; (2) was cast in a cylinder when the concrete was placed; (3) was produced in the laboratory or field as a cylinder, beam, or bar; (4) was found as a fragment; or (5) is a fragment that was sawed or hammered from a placement. Information that cannot be derived from the specimen should be available in the original documentation. In addition, the logbook can be used to record the progress of the investigation, tests performed, and disposal of the specimen or portions of the specimen.

| P.E.S.T. P# | I.T.# | PROJECT INFORMATION SPECIFIC DESCRIPTION | P.N. | P.N. # | P.N. # | LINEAR TRAVERSE | | PETROGRAPHIC EXAMINATION | | CONCRETE LAB | CHEMISTRY | TABLE |
|----------------|-------|---|--------|---------|--------|-----------------|-------|--------------------------|--------------|--------------|-----------|-------|
| | | | | | | A/C | PASTE | SLAB | THIN SECTION | | | |
| | | TECH. SERV. W/Janet | | 26.4.65 | | | | | | | | 1 |
| | | Suffolk 9395-CHO 940 | | 28.81A | | | | | | | | 2 |
| | | Richmond Proj. RBp-157 | | | | | | | | | | 3 |
| 1368 | 2108 | Cope Slabbed vertically | 219 | | | | X | X | | | received | 4 |
| 1369 | 2109 | " | 262 | | | | | | | | received | 5 |
| | | | | | | | | | | | | 6 |
| | | Tech. Serv. Newton | | 26.4.65 | | | | | | | | 7 |
| | | 91-0995-1010 9301 2609 643 | | 28.81A | | | | | | | | 8 |
| | | Suffolk | | | | | | | | | | 9 |
| 1365 | | chunk + processor, busy | | | | | X | X | | | received | 10 |
| | | | | | | | | | | | | 11 |
| | | | | | | | | | | | | 12 |
| | | Polymer Concrete Overlay | | 26.4.29 | | | | | | | | 13 |
| | | (sprinkled) FBp 92" Parney #2 | | 97.81C | | | | | | | | 14 |
| | | 9202-025 940 | | | | | | | | | | 15 |
| 1366 | | chloride | 1-A 2 | | | | | | | | received | 16 |
| 1367 | | samples | 2-A 2 | | | | | | | | 7 Nov 81 | 17 |
| 1368 | | ground | 3-A 2 | | | | | | | | | 18 |
| 1369 | | concrete | 4-A 2 | | | | | | | | | 19 |
| 1370 | | in | 5-A 2 | | | | | | | | | 20 |
| 1371 | | small | 6-A 2 | | | | | | | | | 21 |
| 1372 | | rails | 7-A 2 | | | | | | | | | 22 |
| 1373 | | " | 8-A 2 | | | | | | | | | 23 |
| 1374 | | " | 9-A 2 | | | | | | | | | 24 |
| 1375 | | " | 10-A 2 | | | | | | | | | 25 |
| 1376 | | " | 11-A 2 | | | | | | | | | 26 |
| 1377 | | " | 12-A 2 | | | | | | | | | 27 |
| 1378 | | " | 13-A 2 | | | | | | | | | 28 |
| 1379 | | " | 14-A 2 | | | | | | | | | 29 |
| 1380 | | " | 15-A 2 | | | | | | | | | 30 |
| 1381 | | " | 16-A 2 | | | | | | | | | 31 |
| 1382 | | " | 17-A 2 | | | | | | | | | 32 |
| 1383 | | " | 18-A 2 | | | | | | | | | 33 |
| 1384 | | " | 19-A 2 | | | | | | | | | 34 |
| 1385 | | " | 20-A 2 | | | | | | | | | 35 |
| 1386 | | " | 21-A 2 | | | | | | | | | 36 |
| | | etc. continued on following page | | | | | | | | | | 37 |

Figure 25. Page from VTRC logbook.

- Fill out a Request for Petrographic Services form:** The form used by VTRC is depicted in figure 26 and can be adapted to the specific needs of an individual laboratory. If the client is a person who is nearby (in the building), he or she should fill out the request form; otherwise, a petrographer should fill it out after the specimen is logged. The form should provide places for the project name, dates, charge numbers, file numbers, the source of the specimen, a brief description of the specimen, requested examinations, instructions to technicians, P-numbers, and the client's original numbers. Place the original of this request form with any other documents associated with the specimen. Send a copy to the client to notify him or her of the P-numbers assigned and that the specimen is in the system. Include a copy of the request form with the specimen as it is moved from the office to the preparation room and then to the examination rooms for the microscopical procedures.

TO BE COMPLETED BY PETROGRAPHY

Request Book Page 299

CLASS OF WORK A

Sheet 1 of 1

Date: 1 JAN 91

REQUEST FOR PETROGRAPHIC SERVICES

Project Title: DETERIORATION OF BRIDGE DECK

| A | B | C | D | E | F | |
|-----|-------|----------|---------|---------|-----------|----------|
| CO. | ROUTE | CITY/CO. | SECTION | JOB NO. | LAND OWN. | ACTIVITY |
| CO. | ROUTE | SECTION | CREW | | | |
| 26 | 68 | 071 | | | | 940 |

Section: BRIDGE

District: NORTHERN

VTRC File No.: 3.2.5 Submitted by: BOOKING

(Petrography: 26. 4. 3. 2. 5 / 91)

Source: BOOKING

Reason for Submittal
(e.g. Type of Deterioration) DEEP SCALING

Analyses Desired if Known AIR VOID & GENERAL EXAMINATION

Description of Samples
(core, cylinder, rock,
gravel, etc.)
Include your Designation
of sample numbers

| | TO BE COMPLETED BY PETROGRAPHY | | | |
|-------------------------|--------------------------------|---|-----------------------|------------------------|
| | P.E.S.T.# | Sample Prep. (ground slabs thin sec., etc.) | Analyses Performed | Brief Data Obtained |
| Description - Field No. | | LAPPED SLABS | | |
| CORES, CRACKED | | | | |
| A 1 | 3033 | | | |
| A 2 | 3034 | | | |
| B 1 | 3035 | | | |
| B 2 | 3036 | | | |

Date Data Required: ASAP

Remarks: _____

Copies: Request Book
Project File
H. E. Brown

B. F. Marshall
Other: _____

Date of
Report Memo: _____

Figure 26. VTRC Request for Petrographic Services form.

3.3 INITIAL EXAMINATION

The first laboratory notes on the specimen are written during the initial examination. The specimen as received may be large; however, do not cut it to size until a complete plan of specimen examination has been drawn up. Use a hand lens or magnifying glass for examination until a reduction in size is a scheduled part of the plan. These preliminary notes and the client's request provide the directions for the plan of petrographic analysis as discussed in section 3.4.

The initial examination is accomplished in six steps, as listed in table 7.

Table 7. Procedure for initial examination of specimen.

| |
|---|
| <ol style="list-style-type: none">1. Describe the type and size of the specimen.2. Note and describe any cracks.3. Note the location and condition of metal or any other material purposely embedded in the HCC.4. Note the condition of the wearing surface.5. Note the condition of the paste, any reaction products, the general size and distribution of the aggregate and air voids, and any other unusual features.6. Photograph the specimen. |
|---|

1. **Describe the type and size of the specimen** (e.g., pavement core, D = 100 mm, L = 275 mm).
2. **Note and describe any cracks:** Pay particular attention to cracks that are on surfaces that were visible before the specimen was removed from the placement; these cracks may have initiated the request for petrographic services. If it appears that cracks on the top of the specimen may be part of a system of cracking and the client has not indicated the extent of this system, contact the client and make arrangements to obtain further information on the form of both verbal description and photographs. A personal visit to the placement is desirable as this allows the petrographer to place the specimen in context and usually allows direct contact with field personnel knowledgeable about the situation.

Become familiar with the material in chapters 4 and 10 so that you can recognize cracks and crack patterns symptomatic of particular phenomena such as plastic or drying shrinkage, AAR, and freezing and thawing damage. Take precautions to preserve evidence of these forms of deterioration.

Cracking that appears to be caused by plastic shrinkage (see chapter 4) is often cause for legal action and must be thoroughly investigated and photographed before any further procedures are performed on the specimen. Cracking that is caused by insufficient protection by an air-void system may be cause for litigation if it occurred soon after placement when the contractor could be held responsible.

Cracking resulting from AAR will usually not be a cause for legal action unless the materials used were not those specified. It is probable that the client will want a complete description of the aggregates, the reaction, the reaction products, and how the reaction affects the concrete. Contact the client and inquire concerning the required breadth of the petrographic investigation. The study of thin sections, photographs, and

photomicrographs may be requested. The client will probably want sufficient information so that the reaction can be avoided in future concretes.

Cast cylinders submitted as specimens for determining the cause of low strength test results should be examined carefully for cracks, poor consolidation, or other signs of mishandling (improper storage or fabrication or both) that implicate flawed test specimens as the reason for low strengths. Contact the client and suggest compressive strength testing of specimens cored from the placement. If petrographic examination is required for other reasons, request replacement specimens (preferably cores). If replacement specimens are not available, try to avoid the flaws when planning the specimen preparation and make sure that the final report describes the condition of the cylinder and mentions the fact that the data obtained were not from the entire specimen.

In the case of a core or other specimen obtained from a hardened placement, try to judge which cracks are indigenous to the concrete in place and which cracks can be ignored because they were produced by the sampling procedures employed. Cracks produced by sampling procedures will usually appear fresh and will contain no reaction products; however, these criteria alone do not mean that sampling caused the cracks. If reaction products are present in the cracks or road dirt (dirt not caused by drilling the sample) is present in the vertical cracks, such features can be assumed to be indigenous.

A system of cracks parallel with the exposed surface (called *scaling*), especially if the cracks become more widely spaced with distance from the surface, is probably caused by cycles of freezing and thawing of saturated concrete either unprotected by a proper air-void system or containing unsound aggregates (see figure 27). The most important determination to be made on such concrete is an analysis of the air-void system.

Systems of vertical cracks visible on the surface and most closely spaced at joints and pavement edges are called *D-cracking*. In the Midwest, such cracks are usually caused by the deterioration of particular impure dolomitic aggregates under the conditions of cycles of freezing and thawing (Schwartz, 1987). In concretes containing sound (freeze-thaw durable) aggregates, such crack patterns may result from deterioration of the paste caused by the lack of an air-void system capable of providing protection from cycles of freezing and thawing (Andrews, 1953). When D-cracking is present, both the aggregate and the air-void parameters should be determined.

- Note the location and condition of metal or any other material purposely embedded in the HCC:** If the material is not part of a commonly used reinforcement system, contact the client to inquire as to its origin. Notice whether the location of any of the surface cracking is related to the reinforcement (figures 28 and 29). Note the placement (record depth of cover) and condition of any reinforcing steel. Check for corrosion products near the steel and any associated cracking. If there is a system of cracks on the concrete surface that appears to lie directly over the reinforcement, this cracking may be caused by settlement of concrete around the bar shortly after placement (tensile cracking of concrete while still in a plastic state, or plastic cracking) or corrosion of the steel at later ages (tensile cracking of hardened concrete, or brittle failure).

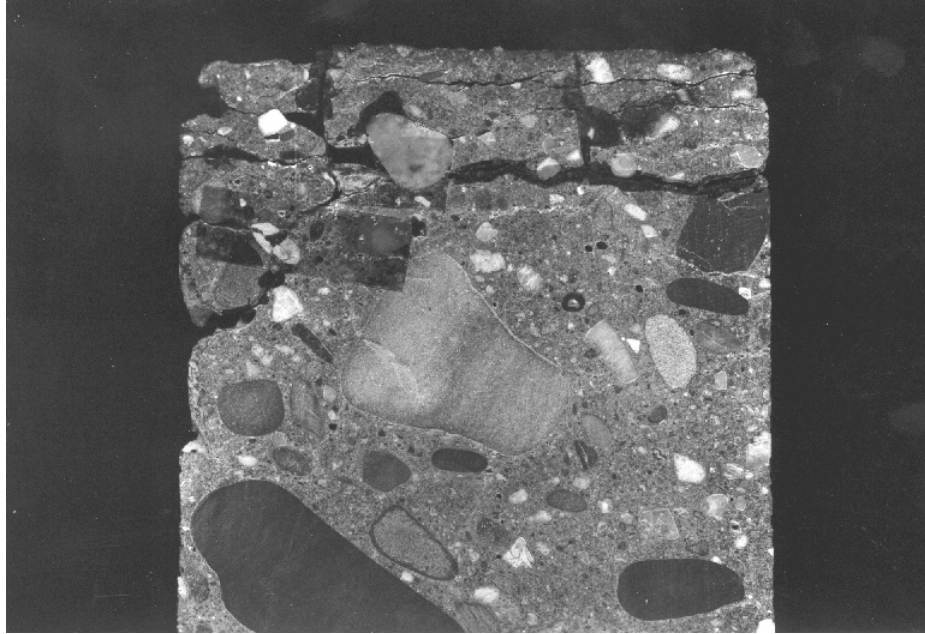

To photograph the cracking, the specimen was glued back together with a dark glue and then cut vertically across the layered cracking.

Figure 27. Scaling caused by cycles of freezing and thawing (occurred in concrete unprotected by a proper air-void system).



Figure 28. Cracking on surface and side of core with associated corrosion and expansion of the reinforcing bar.

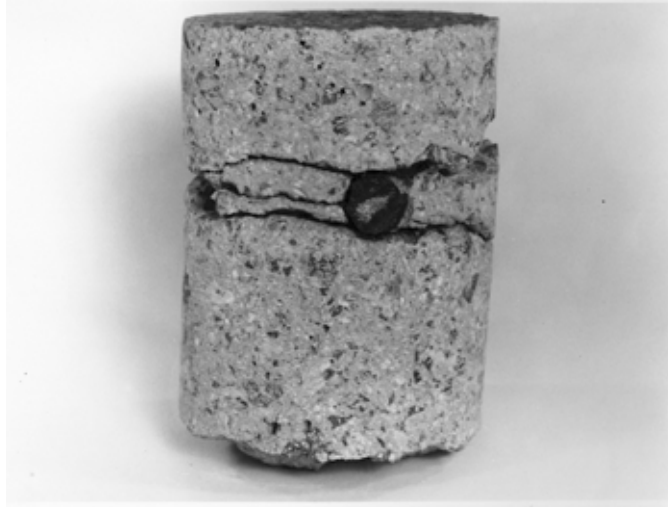

Figure 29. Delamination around reinforcing bars (there is no cracking on the surface).

The thickness of the concrete over the reinforcement is an important aspect in reducing the tendency for settlement cracking (Dakhil, Cady, and Carrier, 1975; Price, 1982) and corrosion of reinforcement (Dakhil, et al., 1975; Cady, 1978; Perenchio, 1994).

Note any horizontal cracks on the specimens and record the depth of the occurrence of these cracks. Often these are indications of delamination at the level of the top steel.

Examine the bond between the paste and any other materials (such as reinforcement or anchoring pins) that are purposely present. Usually the bond should be tight and leave no space for the migration of fluids, wobble, or abrasive wear between the concrete and the other material (Lutz, 1994). Aluminum, zinc, glass, and many plastics may be used in HCC as connectors, electrical conduit, coatings on steel, and, recently, fiber reinforcement. These materials are subject to corrosion to varying degrees when enclosed in HCC in the presence of moisture, corrosive gases, or both. Some of these materials (e.g., aluminum) may prove quite deleterious (Erlin, 1994). Others, such as zinc, which has been used as galvanizing on steel reinforcement, usually only suffers superficial damage prior to the onset of active reinforcement corrosion. However, zinc will hydrolyze in highly alkaline plastic concrete with the evolution of hydrogen gas. This reaction is normally controlled with chromate treatments (Erlin, 1994). If not properly controlled, the reaction can result in a trail of voids to the surface. Note the condition of these materials and any associated cracks and reaction products.

4. **If a finished roadway surface (wearing surface) is present on the specimen, note the texture of the surface:** If the surface appears unusual or unable to provide skid-resistance, consider the age, amount of traffic carried by the roadway, location of core with respect to wheelpaths, original specified texture, and weather during placement. Unless these data are already available, obtain information concerning these factors from the client. Consider preparing a thin section (see section 5.3.3).

5. **Note general condition and unusual features insofar as is possible without the use of a microscope and with no preparation of the specimens:** Wetting and partial-to-thorough drying of the specimen may reveal features such as fine cracking that are difficult to distinguish otherwise. If the client has submitted more than one specimen, be specific and note on which specimen the feature occurs. Observations should include, but not be limited to, the following:

- Condition of the paste (make a preliminary assessment of its friability, porosity, and maturity).
- Secondary deposits in voids or in or around aggregate particles.
- Segregation or alignment of aggregate particles.
- Areas of abnormal (high or low) paste content.
- Areas of abnormal (high or low) void content.
- Textural differences of the paste in different areas of the concrete (near the wearing surface, middle portion, and deepest portion of the specimen).
- Occurrences of unusually large voids.
- Pockets of high concentrations of voids.
- Patches of paste completely lacking in voids.
- Pockets or aggregate rims of highly concentrated cement paste.
- Contaminants (e.g., twigs, parts of shoes, and metal fragments).
- Unusual exterior marks made by forms.
- Unusual dyes or paints on exposed surfaces.
- Adequacy of coverage of liquid-membrane curing compound on recently placed concrete.
- Evidence of early freezing or later deterioration caused by freezing and thawing.

Casts of ice crystals are evidence of early freezing. If the concrete is fragmented and casts of ice crystals are abundant on almost all of the fragments (as seen in figure 30), the concrete was forced apart by the expansion of the ice formed before the paste achieved final setting.

Ice crystal patterns, such as “jack frost” patterns, may be visible on the molded surface of cylinders. Take these patterns at face value. The cylinders were subjected to freezing temperatures; however, the patterns do not provide any evidence that the placed concrete was likewise frozen. Obtain a temperature history of the placed concrete and the cylinder concrete from the client before making any conclusions regarding these ice crystal molds. If the cylinders were treated as was the placed concrete, examine them for evidence of curing procedures and molds of ice crystals that may occur in freezing temperatures in fresh, improperly protected concrete (Rhodes, 1978).

A surface layer of concrete in which molds of ice crystals are prevalent (see figure 31) indicates that the immature concrete was subjected to extremely chilling conditions (cooled below freezing, often with a wind that removed the heat of hydration). The unhardened concrete can freeze to a depth of several inches and develop casts of the ice crystals, which become zones of weakness and channels for solutions.



Scale is in intervals of 3 mm.

Figure 30. Fragments of concrete destroyed by freezing before final setting.

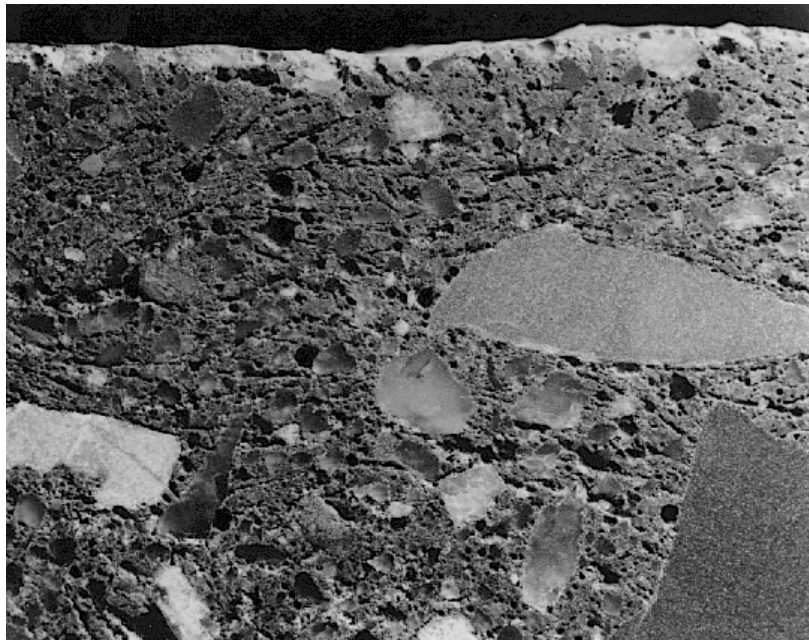

The blades of ice were, in general, parallel with the surface, and their orientation can be easily seen. The molds of the ice crystals are now empty and create zones of weakness throughout the concrete. Field width is 76 mm.

Figure 31. Surface sawed through concrete slab that froze before final setting.

6. **Photograph the specimen with a scale and identifying P-number labels:** This step may be omitted if previous photographs of the specimen have recorded all visible features that caused concern to the client, the important features, and any differences among a suite of specimens submitted as one sample.

If the initial observations seem to answer the client's questions completely, contact the client and ask if the investigation should proceed further. If the client is satisfied with the data already obtained, prepare all necessary written replies, permanent documentation, and the files as described in section 3.5.

3.4 PRELIMINARY PLAN OF ANALYSIS

Preparing a plan to analyze the specimen may be accomplished in four steps, as indicated in table 8. Van Dam, et al. (2002b) provide a series of flowcharts that can be used to help map out the examination plan.

Table 8. Procedure for preliminary analysis of specimen.

- | |
|--|
| <ol style="list-style-type: none">1. Develop a plan for analysis that will fulfill the client's needs and explain unusual features.2. Mark the planes to be cut.3. Photograph the marked specimen.4. Prepare and file documentation explaining the plan for analysis. |
|--|

1. **Develop a plan for analysis that will answer the client's questions, explain unusual features, be performed within the specified time frame, and be consistent with the likelihood of the results of the analysis having to withstand scrutiny by hostile expert witnesses in a court of law:** From an assessment of the given situation, develop a plan for the petrographic examination that will adequately describe the concrete and provide the necessary information to determine the causes of any distress or unusual features (see ACI 201.1R; ACI 201.2R; Mather, 1978; Erlin, 1994; Van Dam, 2002b). The sample preparation plan should include deciding which portion of the specimens will be prepared for which test and which portions will be reserved for further reference. If any thin sections will be required, it is best if the location of these sections can be decided as soon as possible and the process of fabricating them begun. Tables 9 through 11 provide examples of the types of plans that might be developed. Additional examples are provided in appendix E.
2. **With a felt marker, mark the first planes to be cut with the diamond-edged saw with full consideration of the need for a detailed examination of the various crack patterns (see chapter 4) and the likelihood of the need for an analysis of the air-void system:** If the cutting plan is complex or if particular determinations must be made before the sawing is completed, it may not be possible to mark the cutting lines for all of the planes.

A slice approximately 15 mm in thickness is generally required for air-void determinations and general petrographic examinations. This thickness generally yields a slice that is strong enough to withstand normal laboratory wear and handling.

If the HCC is badly deteriorated, has an extremely high air content, or is otherwise fragile, it may be necessary to use a somewhat thicker slice so that the integrity of the slice will be preserved during subsequent handling. In cases where one or two major cracks exist in the specimen in the area to be sliced and the specimen has fallen apart or is about to fall apart, a strong epoxy may be used to keep the specimen together. Take care to prevent the epoxy from being squeezed or dripped into areas where it might obscure important features.

It is often necessary to reconstruct the specimen after cutting; therefore, place marks across all cutting planes (see figure 32). These marks are called *match marks*. Match marks should be unique to the cutting plane (one mark for the first plane, two marks for the second, etc.). Take care to avoid marking any surface that will be subjected to any form of analysis. Most inks (from pens and markers alike) can sink deeply into porous concrete and will probably not be completely removed by the lapping procedures. Ink marks can cause erroneous identification of aggregates and crack features and make the visualization of the paste features difficult.

Plan to cut across (at approximate right angles) any major cracks observed. Lapped surfaces produced on these cuts will enable better observation of the crack pattern.

The surface produced should allow the petrographer to see into cracks from the finely lapped surface.

Most commonly, surfaces are prepared by the technician cutting the material in a direction approximately perpendicular to a formed or finished surface of the HCC, and preferably across the layers in which the HCC was placed, thus producing a slice from the center of the material to be examined. This method is good when the size of the section produced does not exceed the capacity of the lapping equipment available or there are no obvious differences to be seen between the top and the bottom of the cores and the bottom portion can be ignored.

On occasion, it may be necessary to determine the differences between the individual air-void systems at various depths. When this is the case, the cutting plan will include taking horizontal slices at various depths and preparing each slice individually. Often, facing surfaces separated by only the thickness of the sawcut are considered as one specimen.

When the full depth of a core must be examined and the length of the core exceeds the size capacity of the lapping equipment, it may be necessary to saw the core horizontally into two or more pieces before preparing the slices to be surfaced.

Table 9. Outline of typical low strength analysis.

Client's request: Explain the low strength results (strength data enclosed). A very prompt reply is requested. Telephone any preliminary data.

Specimens: Three cores 100 mm in diameter and 125 mm in depth

Preliminary examination: A visual estimate of the air-void content indicates that two of the three specimens have areas of abnormally high air-void content and there are patches of paste that are low in aggregate.

Telephone report: The low strength is probably caused by a high void content. The patchy nature of the concrete may indicate retempering.

Further client request: Conduct an analysis of the air-void parameters and complete a megascopic and stereomicroscopic petrographic examination.

Plan of analysis:

1. Prepare vertical, finely lapped slices from each specimen.
2. Conduct a brief stereomicroscopic examination of the slices to confirm the original estimate of a high void content in two specimens and a normal content in the other. Consider whether it is necessary to have additional slices prepared to represent the specimens properly.
3. Conduct an analysis of the air-void parameters of each type of specimen.
4. Conduct a detailed stereomicroscopic examination of each specimen slice to locate all features that might contribute to low strength and especially search for any features that might indicate retempering.
5. Obtain photographs of the slices.
6. Prepare notes for the report and briefly report the results to the client by telephone. Briefly record the results in the logbook. Record the data necessary to relocate negatives and proofs (see section 3.5.1).
7. Prepare a memorandum, letter, or whatever is required as a formal report to this particular class of Client.

Table 10. Outline of typical laboratory deterioration analysis.

Client's request: Examine the specimens fabricated and tested in the concrete laboratory to determine if the differences in dynamic modulus can be explained by visual evidence.

Specimens: Two beams (75 by 100 by 400 mm) prepared for testing in accordance with ASTM C 666. They were subjected to identical treatment; however, an experimental chemical admixture was used in one beam. The concrete containing the admixture had a low dynamic modulus after the test.

Preliminary examination: Conduct a cursory examination of the exterior of the beams.

Plan of analysis:

1. Prepare finely lapped slices from the interior of each specimen. Obtain a sufficient slice from each specimen to satisfy the area requirements specified in ASTM C 457.
2. Conduct a visual examination (without marking any of the slices) of each finely lapped slice to survey the deterioration and plan further action in view of the following: aggregates, cement remnants, etc. appear identical; abundant microcracks are noted in both specimens. No comparison between the intensity of cracking is usually available at this stage of the investigation.
3. Conduct an analysis of the air-void parameters of each specimen and report the results to the client.
4. Obtain photographs or digital images of each slice. Record the roll and frame or file locations of the negatives and proofs or files.
5. On each specimen slice, using a tape, mark off test areas of similar size and with a similar amount of paste.
6. Conduct a detailed stereomicroscopic examination and mark in ink all microcracks within the marked test areas and other features (such as reaction products) detectable on the slices.
7. Obtain photographs of each marked slice. Record the roll and frame or file numbers of negatives and proofs.
8. Make a visual megascopic assessment of the comparison between the interior damage in the two specimens.
9. Prepare notes for the report.
10. Oral report: Present the marked slices or photographs to the client with the assessment. Suggest having a technician count the cracks on a series of traverse lines across the slices or the pictures.
11. Written report: Produce a written record of the examination. If the client requires no record other than the pictures, briefly record the results in the logbook and make note of the data necessary to relocate the photographs and negatives (see section 3.5.1).

Table 11. Outline of typical rain damage analysis.

Client's request: Determine the seriousness of the damage to the concrete caused by a driving rainstorm during placement. A prompt reply is requested.

Specimen: One core 100 mm in diameter, 75 mm in depth

Preliminary examination of top and sides of core: Visual estimate of depth of damage.

Telephone call by petrographer to client: How much pavement area looks just like the surface of the specimen sent to us? How many intermediate types of surface are there? If the area is extensive and the damage looks serious, send a sketch with the dimensions of the areas involved and a core specimen of each of the different portions of the placement affected by the rainstorm. Send pictures if possible. (Client sent three additional specimens of the surface and sketches.)

Further client request: Detailed comments concerning damaged area and durability prognosis.

Plan of analysis:

1. Prepare vertical, finely lapped slices on which to examine the depth and nature of any distress.
2. Describe the distressed concrete and measure the depth of the distress in each type of area. Include the condition of texturing, description of any color change between the surface layer and interior of the concrete, any cracking in the affected area, description of the air-void system near the surface (the surface layer is too narrow to permit a full air-void determination on a vertical section), and comments on the w/cm near the surface.
3. Obtain photographs of the surface textures (particularly in cross section) showing the depth of any discoloration, layer of excess voids, or other indicator of condition. Record the roll and frame or file numbers of the negatives and proofs.
4. Compose a report including an estimate for each definable area of the depth to which the concrete will quickly wear away or how much concrete should be removed or textured to restore usefulness. If the damage is very slight, so state. Include photographs that illustrate the reasons for the conclusions.



Figure 32. Core marked with identification, cutting planes, and match marks.

3. **Photograph the marked specimens** (see figure 32).
4. **Prepare and file documentation explaining the plan for analysis:** In any document produced concerning the specimen, report the cutting plan used and explain it. Protect yourself in case any litigation should ensue by always reserving some portion of each of the significant parts of the specimen for at least 5 years. Longer storage is recommended if possible.

If specimens are photographed in the petrographic laboratory, keep the negatives and prints in the permanent file for the specimen. If the photography is performed by another division of the organization that maintains possession of all negatives, place a note to this effect in the file with the information needed to retrieve the negatives and prints.

3.5 FILING OF APPROPRIATE DOCUMENTS

3.5.1 Permanent Case Files

Keep a permanent file in the petrography laboratory for each specimen that enters the system, even if the client's questions have been answered. In the file, place copies of all the original documents, notes on any oral communications with the client, the updated request sheet, laboratory notes, printouts of the results of the tests, and copies of all correspondence. Correspondence will probably be filed by clerks or secretaries in a more formal filing system; however, that system may not have as much accessory data as does the file in the petrography laboratory. Keep a record of all testing procedures (such as air-void determinations). Such files are probably best organized by P-number and may be kept in the laboratory where the test was performed.

3.5.2 Temporary and Archive Files

Keep a temporary file of request sheets of work in progress. As a job is completed, update a copy of the pertinent request form and move it to an archive file. This archive file will be useful when a question comes in concerning an old specimen and the date and P-number are unknown.

CHAPTER 4. CRACKS

4.1 OVERVIEW

Cracks in HCC may have several causes (see ACI 201.1R and ACI 224.1R): plastic shrinkage, settlement, drying shrinkage, thermal stresses, chemical reactions, weathering (freezing and thawing, wetting and drying, heating and cooling), corrosion of reinforcement, poor construction practices (e.g., retempering), construction overloads, errors in design and detailing, and externally applied loads. For our purposes, nine types of cracks are discussed:

1. Microcracks.
2. Crazeing.
3. Scaling.
4. Cracks caused by insufficient air-void content.
5. Cracks caused by delamination at the reinforcement.
6. Cracks caused by a chemical reaction.
7. Cracks caused by drying shrinkage.
8. Cracks caused by thermal volume change.
9. Cracks caused by plastic shrinkage.

4.2 TYPES OF CRACKS

4.2.1 Microcracks

The term *microcracks* includes all very fine cracks, in any direction, at the surface or within the mass of the concrete that are not easily visible with the unaided eye, but may be seen with a magnifying glass or microscope. Microcracks are often extremely difficult to observe on the textured surface of a placement. Chapter 8 provides instructions on the observation and recording of microcracks.

4.2.2 Crazeing

Crazeing is a fine, very shallow pattern of cracking that occurs in the exposed surface of a concrete placement. Usually it cannot be seen while the observer is in motion in a vehicle. It occurs when the thin surface layer shrinks significantly relative to the interior mass of the concrete and may result from excessive paste or water content in the surface layer or rapid drying. Crazeing usually has a very fine pattern, with the individual uncracked central portions usually no more than 50 mm across. The depth of craze cracking should be recorded. Paste-rich surface layers can also impede the rise of bleed water, trapping it just beneath the surface. If the surface layer flakes off, usually to a depth of about 3 mm, it may be called *paper scaling*. The underside of any loose flakes of concrete should be examined for clean sand grains and calcium hydroxide that would indicate trapping of bleed water and the casts of ice crystals that would indicate freezing before hardening.

4.2.3 Scaling

Scaling is a local flaking or peeling of the mortar at the surface and can be classified as light (without exposure of coarse aggregate), medium (5 to 10 mm deep), severe (11 to 20 mm deep), or very severe (> 20 mm deep) (ACI 201.1R). Scaling is usually attributable to a weak surface layer exposed to the physical effects of freezing and thawing cycles or deicing chemicals.

4.2.4 Cracks Caused by Cycles of Freezing and Thawing While Concrete Is Critically Saturated

Concrete that lacks either sufficient strength (maturity) or an adequate air-void system will develop laminar cracking if critically saturated and exposed to freezing and thawing cycles (see figures 26 and 80). The deterioration will usually proceed from the exterior inward as progressive scaling.

4.2.5 Cracks Caused by Reinforcement Corrosion

Corrosion and the resulting expansion of the reinforcement will cause lateral cracking in the plane in which the reinforcement is situated. Normally, the high pH of concrete protects the reinforcing steel from oxidation. The passivating effect of concrete on steel can be negated by the intrusion of chloride ions or by carbonation of the paste surrounding the reinforcement. The concrete between the reinforcement and the outer surface of the element thus serves as a barrier to the ingress of chloride ions or carbon dioxide. Construction plans should specify the concrete cover thickness, usually around 50 to 68 mm. Cracks extending from the exposed surfaces toward the level of the reinforcement may significantly decrease the effectiveness of the cover concrete as a barrier, especially if the cracking is over an extensive area. The concrete is considered to have only the depth of protection that exists from the bottom of the cracks to the reinforcement (see figures 27 and 28).

4.2.6 Cracks Caused by a Chemical Reaction

Chemical reactions may take place between concrete constituents (the aggregates and the paste) and ionic species in solution within the concrete mass. Cracking resulting from AAR is discussed in chapter 10.

4.2.7 Cracks Caused by Drying Shrinkage

The term *drying shrinkage* is commonly used in connection with shrinkage cracking that occurs after the HCC has attained final set and a particular degree of bonding has developed between the aggregate and the paste. After the concrete has reached final set, the paste behaves as a brittle material.

Most HCC shows evidence of drying shrinkage. Cracking can be minimized by good workmanship, proper proportioning of the mixture, and sufficient jointing performed soon after hardening. In jointed concrete, uncontrolled cracks may form if the joints were not formed early enough, are not working properly, or the shrinkage in the hardened state is excessive. In continuously reinforced HCC, very narrow, fairly regularly spaced transverse cracks are expected to form. The cracks allow for the changes in volume of the concrete with drying and varying temperatures.

4.2.8 Cracks Caused by Thermal Volume Change

Thermal effects on concrete volume can cause cracking with a disposition similar to that caused by drying shrinkage and, in fact, thermal and drying effects will often occur in concert. The coefficient of thermal expansion (CTE) of concrete is a proportional function of the CTE of its constituent materials. Since common aggregate materials differ considerably in their CTE, they consequently exert considerable influence on the concrete CTE (Scanlon and McDonald, 1994; Lane, 1994).

Thermal cracking is a predominant concern in mass concrete placements if the heat of hydration is not controlled and large temperature differences are allowed to develop between the inner core and cooling outer skin of the placement. In thin members, such as pavements and bridge decks, thermal cracking is most likely to present problems when the concrete undergoes large temperature swings during the first several days after placement. Such effects are most pronounced in heavily reinforced structures such as continuously reinforced concrete pavement and decks; however, they can present serious problems for plain jointed pavements if midslab cracks result. HIPERPAV software, published by FHWA, provides a means to predict potential thermal cracking problems for pavements (FHWA, 2003).

4.2.9 Cracks Caused by Plastic Shrinkage

Plastic shrinkage is a form of drying shrinkage that occurs while the HCC is unhardened and malleable, and the bond between the components of the material is very weak. Plastic shrinkage cracking is caused by excessive evaporation of the water at the concrete surface because of improper curing procedures for a concrete under the climatic conditions existing at the time of placement (see appendix B and Lerch, 1957; Price, 1982; and Scott, Lane, and Weyers, 1997). Plastic shrinkage occurs in the first few hours after placement before final set (when the rate of evaporation exceeds the rate of bleeding). At this stage, the HCC has some properties of a solid, but no appreciable bond exists between the aggregate particles and the cement paste. This sort of cracking is also called *early cracking* or *morning cracking*, the latter because it is often the concrete that was placed in the morning and then exposed to afternoon drying conditions that exhibits this type of cracking (see figures 33 through 40).

Plastic shrinkage cracking often occurs in high-quality HCCs when curing is not promptly or adequately applied and appropriate measures to avoid excessive evaporation have not been taken. The intrinsic quality of the concrete is not necessarily adversely affected by plastic cracking. Provided the concrete was adequately moisture cured, the defect is more cosmetic in nature, except in situations where the concrete is intended to provide protection for the reinforcement.

A form of early cracking where the cracks are located directly over the steel can occur when the depth of cover over the reinforcement is shallow (Price, 1982; Dakhil, et al., 1975). This cracking is directly related to shrinkage and settlement of the concrete over the steel as the bleed water leaves the concrete and the volume of the paste is diminished. It may be accompanied by segregation of the coarse aggregate from the paste. As with HCCs with a lower w/cm, this condition is exacerbated by drying atmospheric conditions. Evidence of this type of fault can be seen on interior surfaces of specimens of these HCCs. This type of cracking is commonly called *settlement* or *subsidence cracking* (ACI 224R).

Occasionally, there may be severe bleed channels in HCC that might be confused with plastic shrinkage cracking. However, upon close inspection, such bleed channels show clear evidence of being a waterway, whereas plastic shrinkage cracks show clear evidence of having been pulled open by the shrinkage of the concrete. Bleed channels are trains of water voids caused by the upward movement of mixing water as the fine solids settle. Such trains of voids may occur in HCCs with a high w/cm. Some forms of plastic shrinkage cracking may have zones of such void trains. In HCCs with a low w/cm, incomplete consolidation may cause fold lines and collections of voids. Cracks occurring in HCCs can usually be distinguished by the nature of the associated voids and the appearance of the fracture surfaces (showing signs of either brittle or plastic deformation) (see section 4.3).

The following may occur in unusual and extreme cases of rapid evaporation, causing drying of the HCC before hardening:

- Surface carbonation and associated shrinkage may take place when the relative humidity at the surface falls much below the saturated state.
- As surface paste loses its moisture by evaporation, unhydrated cement may be concentrated in a weak, thin, surface zone.

These are features of extreme drying and are not usually present in HCCs affected by plastic shrinkage cracking. The absence of these features in HCC exhibiting plastic cracking does not indicate that it was not subjected to deleterious drying conditions during or shortly after placement.

4.3 DISTINGUISHING BETWEEN PLASTIC SHRINKAGE CRACKING AND DRYING SHRINKAGE CRACKING

4.3.1 Overview

For transportation departments and other purchasers of concrete placed by a contractor (or other agency), it is frequently important to distinguish between early plastic shrinkage cracking and the brittle cracking that may occur because of structural stress or later drying shrinkage. The contractor is obligated to prevent the dehydration (and consequent cracking) of the fresh concrete that can occur when wind, low humidity, or both promote rapid drying. HCC with a low w/cm (0.40 or less) and latex-modified concretes are more apt to suffer this sort of failure than are concretes with a high w/cm ratio. When it can be shown that the cracking is caused by a failure of the contractor to refrain from placing concrete during unfavorable weather conditions, employ sufficient methods to prevent drying, or both, the contractor may be obligated to provide a new surface or accept a lower payment.

The usual rule of thumb in the literature is: If the cracks go through the aggregate particles and cause them to break, the cracking should not be considered plastic cracking. Many observers call any crack that goes around the aggregate particles a plastic/early shrinkage crack. This can be in error. There may be other reasons for the crack to go around the aggregate particles.

Some aggregates are more fragile than others and some may crack during final placing and finishing. It is possible to judge a crack to be a later crack on the criterion of broken aggregate

when, in reality, the aggregate particle just happened to have a zone of weakness in the crack plane and the crack was an early crack. The specimen examined (a cross section of a crack) is a very small portion of a crack. The interior of the crack surface is a very small, nonrepresentative portion of the crack.

Cracks that preferentially go around aggregate particles indicate that the bond between the aggregate and paste was a weak point at the time the cracking occurred. The bond may be weak because of any of the following:

- Immature concrete.
- Excess water or air voids at the aggregate surface.
- Coating on the aggregate surface.
- $\text{Ca}(\text{OH})_2$ at the paste-aggregate interface that dissolved because of percolating waters or solutions, thus weakening the bond late in the life of the concrete.

Thus, it is necessary that the criteria for deciding that a specific crack is a plastic shrinkage crack be more than the fact that the crack skirts the aggregate particles.

4.3.2 Analogy With Clay Materials

The difference between drying shrinkage cracking and plastic shrinkage cracking can be explained further by use of an analogy using clay materials.

Hard brittle materials (drying shrinkage cracking): Consider a broken ceramic object (pottery) or rock. If all the pieces can be found and fitted back together, the material will solidly fill the same space as did the original object. Any internal voids will almost invariably be recognizable by either their shape or the nature of the interior surface (different from a fracture surface). If all the chips are available, the expression of the crack on the surface of a hard brittle material will be a thin sharp line.

If the material is sandy clay that was fired in a kiln (“fired” is analogous to the hardening of concrete), all the cracked surfaces will fit back together if all the fragments are preserved and there are no air pockets present. If the bond and the tensile strength of the ceramic are as strong as the tensile strength of the sand, then the crack will fracture the sand and the crack surfaces will neatly and completely fit back together. If the sand has much greater tensile strength than the fired ceramic, any cracks occurring in the material are likely to detour around the sand grains.

This logic may be directly extrapolated to cracks in hardened HCCs, hardened latex-modified HCC, and many other highway materials. In the case of these materials, the general type of void and the nature and luster of the interior of the voids should be carefully studied so that they can be recognized in the path of any crack under study.

It may be that a macrocrack occurring on the riding surface of HCC that was originally a thin sharp line was worn wider by the abrasive action of traffic. The course of the crack below the surface expression should be examined. Care must be taken to extrapolate the evidence in light of all relevant facts, including the age of the placement, the amount of traffic, the pertinent weather conditions, and the strength and general condition of the concrete placement.

Malleable materials (plastic shrinkage cracking): Now, consider a crack caused by the pulling apart of a piece of modeling clay or other such material. Because of the plastic nature of the material, there may be small “bridges” of the material spanning the crack, there will be deformation of the sides of the crack, and the two sides of the crack will not be able to be fitted back together without reshaping of the crack walls. A crack of this nature starts at the exposed surface. In the case of unhardened HCC, this is the driest portion. Here, the crack is the widest because the surface is the origin and tension is greatest as there is no adhesion above to resist the pulling apart. The edges of the crack are often rounded back. If the material is ceramic clay and the material was baked in a kiln in the cracked condition, it would be obvious in the finished piece that the two interior surfaces of the crack would not fit back together. If the material is malleable sandy clay, then the crack will go around the sand and the crack surfaces will show that deformation occurred while the material was plastic.

This is entirely analogous to the situation in plastic shrinkage cracking in HCC. The crack occurs while the material is plastic and is then “baked” (the shape is preserved) by the continuing hydration of the cement and the complete hardening of the HCC.

4.3.3 Procedures

Distinguishing between drying shrinkage cracking and plastic shrinkage cracking is a five-step procedure, as shown in table 12.

Table 12. Procedure for distinguishing between plastic and drying shrinkage cracking.

1. Study the intersection of the sidewalls of the specimen with the wearing surface.
2. Study the wearing surface of the specimen.
3. Study the expression of the crack on all cut, cored, and lapped surfaces, and focus down into the crack.
4. Examine the interior surface of the crack.
5. If necessary, study the types of voids present in other areas of the HCC and compare their surface with the various types of surfaces within the crack.

1. **Study the intersection of the sidewalls of the specimen with the wearing surface:** Plastic shrinkage cracking may occur before or just after the surface is screeded and the wearing surface texture is created. In these cases, it may happen that one or more of the specimens submitted may show that mortar was worked into the top of the crack. Sometimes portions of the plug of mortar will have fallen out or been chipped off the specimen during coring and handling. It is clear that the plug is a definite indication of early plastic shrinkage cracking (see figure 33).

If the cracking occurred just before texturing, the creation of the wearing surface would naturally work mortar into the crack (see figure 34). If cracking occurred after texturing and was observed by the workers, a deliberate effort may have been made to correct the flaw.

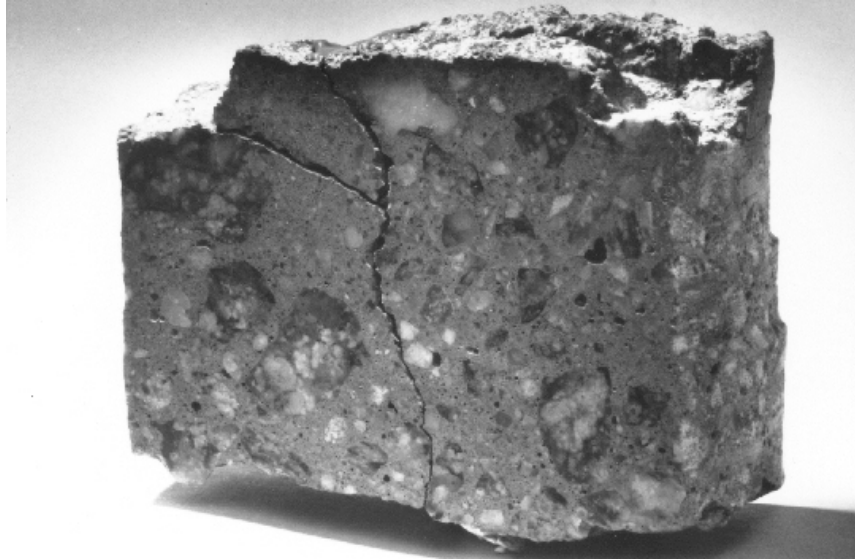

Mortar was worked into the top of this set of cracks before the concrete hardened. Later, the concrete cracked in the same area. Because of the lack of interlock, the new crack follows the mortar boundaries. At the right side of the picture is a depression in the surface where a mortar plug was lost before the photograph was taken. (This specimen had to be glued together to enable the photograph to be made.)

Figure 33. Plastic shrinkage cracking was covered up by mortar filling over it on top of a 100-mm core.



The defect became hidden by the finishing procedures that pushed unhardened mortar over the crack.

Figure 34. Plastic shrinkage cracking occurred before a surface texture was formed.

2. **Study the wearing surface of the specimen:** With the microscope, look for features that will define the crack. Check for any features that will indicate the nature of the cracks. If photographs can be obtained of the wearing surface just after cracking but before the surface is worn by any traffic, small bridges of material may be seen stretching across the crack, which will indicate plastic shrinkage cracking (see figures 35 and 36).
3. **Study the expression of the crack on all cut, cored, and lapped surfaces, and focus down into the crack:** If you see any little bridges of paste that tie the two sides together or if any uncracked aggregate particle bridges the crack, the crack plane existing all around the particle, and the aggregate firmly attached to the hardened paste on either side, you can conclude that the crack was caused by plastic shrinkage (see figures 37 through 39). Bridges of paste or aggregate are not found in all plastic shrinkage cracks. The defining feature is the fact that the sides of the cracks have been distorted by the tensile forces because of shrinkage that occurred while the HCC was still malleable.

The greater the difference between the width of the crack at or near (beneath any mortar plug) the wearing surface and the width of the crack at its deep end, and the more quickly it tapers to nearly nothing, the greater the likelihood of the crack having been caused by plastic shrinkage. The V-shape of the crack is part of the distortion of the edges of the crack caused by the tensile forces. Commonly, the crack is a plastic shrinkage crack near the surface; however, with depth, the crack is straighter and the zone of weakness has been extended after the final set by other forms of drying shrinkage or by structural stress, sometimes completely through the slab.

The path of a plastic shrinkage crack on any vertical concrete surface is usually quite tortuous because it is deflected by each piece of aggregate. Typically, the crack is wider at the top than at the bottom; however, even at the bottom, it is not the sort of crack found in a brittle ceramic (see figure 40).

Do not be confused or alarmed by the presence of abundant road dirt or mud created by the drilling of the cores. This mud may appear layered and flaky, but the structures will be fragile.

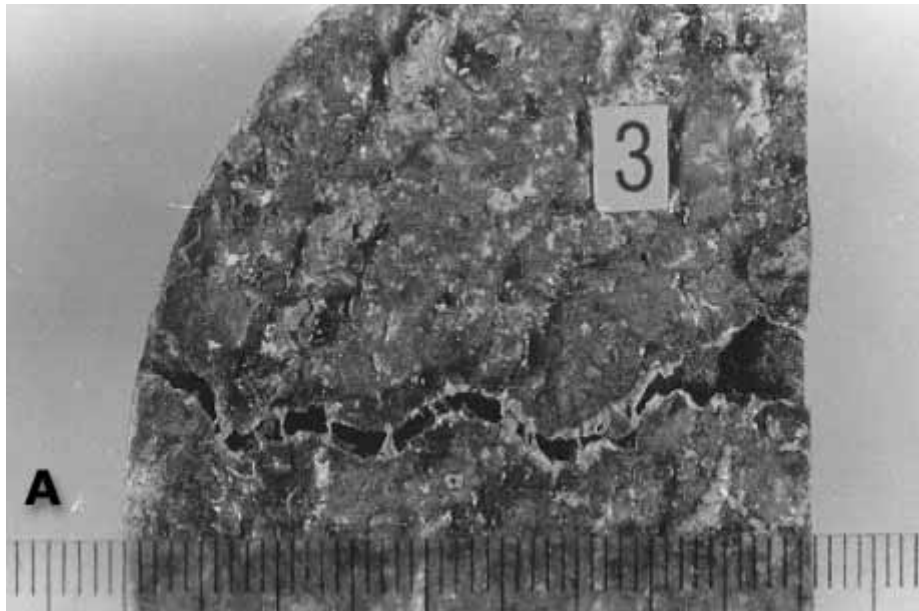

Rules are graduated in millimeters.

The crack shows the distortion that accompanies tension cracking in an unhardened medium. This specimen was collected before traffic destroyed these delicate structures.

Figure 35. Plastic shrinkage cracking occurred in a latex-modified concrete overlay (top view of core (small threads of latex span the crack)).

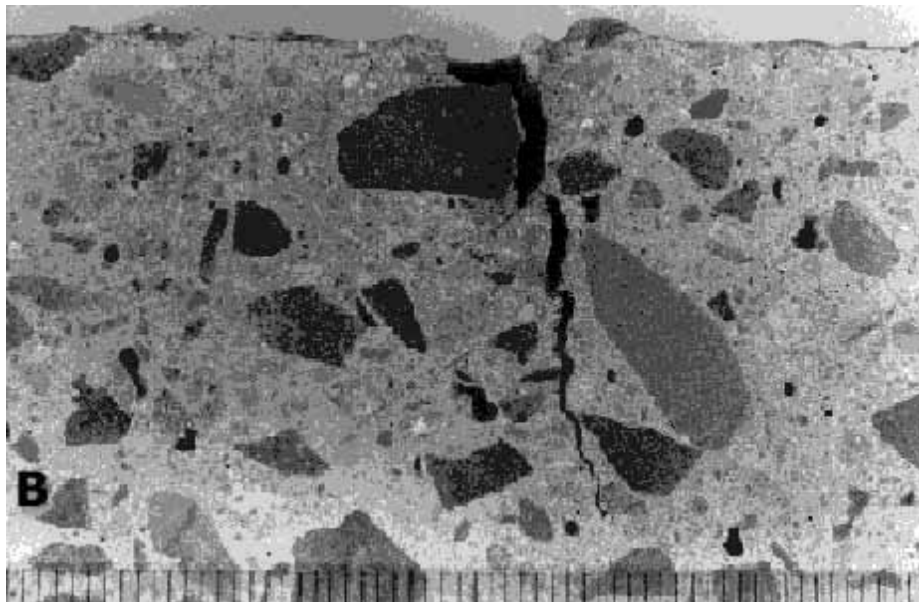

Rules are graduated in millimeters.

Figure 36. Plastic shrinkage cracking: Small bridges of latex paste connect sides of crack.

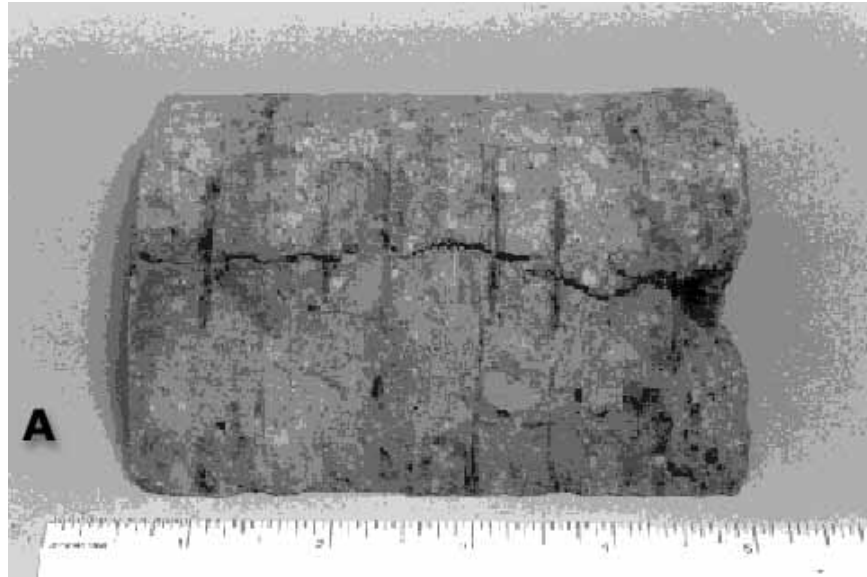

Rules are graduated in inches.

These little bridges may occasionally be found on broken, sawed, cored, or lapped surfaces.

Figure 37. Small bridge of paste across a crack caused by shrinkage that took place while the ordinary portland cement concrete was not hardened (100-mm core, road surface at right).



Rules are graduated in inches.

Figure 38. Bridge of paste across plastic shrinkage crack: Closeup of bridge.



It is easy to envision how little bridges of concrete form when a crack system of this nature is stretched further. Narrow microcracks are emphasized with ink. The specimen is approximately 100 mm top to bottom.

Figure 39. Tortuous path of a plastic shrinkage crack in a concrete that has not completely separated.

4. **Examine the interior surface of the crack:** Delay any destructive procedures until the total surface has been studied and any air-void determinations have been made. Then, break the HCC with a hammer blow in an area away from the crack and examine the surface produced. In the most common case of a crack produced in an area not including a plastic shrinkage crack, the interior surface will be made up of a multitude of tiny angular planes with the exception of the interior of the air voids. There may be an occasional rounded surface of an aggregate particle or of the cast of an aggregate particle; however, the major portion of the surface will be a collection of planes.

Break the HCC on the crack and examine the interior surface. Usually the interior surface of a crack produced by plastic shrinkage is made up of very tiny globules of cement paste. The surface of the paste inside the crack does not look like a cracked surface. Rather, the paste appears, as one might imagine it would, as if, when the sides of the crack were no longer in contact, minute stringers of paste had momentarily bridged the crack and then, as the tensile strength of the stringers was exceeded, the stringers coalesced into tiny globules. Each globule appears as if a paste stringer shrunk in on itself. If it is water-worn sand, none of the sand grains will be broken and they will present a naturally rounded surface. A few fragments of the coarse aggregate may be broken, as will occur in all concrete construction. If the aggregate is shaley or naturally fragile and contains a plane of weakness approximately parallel with the plane of the plastic shrinkage crack, the crack may preferentially traverse this aggregate.



**Figure 40. Plastic shrinkage crack on a lapped surface
(wearing surface is at the top of the photograph).**

5. **If necessary, study the types of voids present in other areas of the HCC and compare their surface with the various types of surfaces within the crack.**

CHAPTER 5. PREPARATION OF SPECIMENS FOR OPTICAL MICROSCOPY

5.1 OVERVIEW

Various methods of specimen preparation are used, depending on the nature of the specimen and the information to be obtained. Smoothly lapped specimens are required for quantitative examination with the stereomicroscope. Small loose particles and many fracture surfaces do not require extensive preparation. Examination with the transmitted-light microscopes (i.e., the petrographic and P/EF microscopes) requires very thin specimens mounted on glass or very small grains of the specimen mounted in an index of refraction oil or epoxy. The fluorescence features of the P/EF microscope necessitate that the specimen not only be very thin, but also be impregnated with an epoxy containing a fluorescent dye. The features of large specimens of aggregate rock can be displayed best through sawing, lapping, and etching. It is often necessary to crush such material for use in specific tests. Bulk specimens of sand, gravel, and crushed aggregate usually require a reduction in overall volume and separation into size-graded fractions.

5.2 SLICES

There are three types of slices prepared for stereomicroscopic examination: (1) basic lapped slices, (2) vertical sections of horizontal slices (or vice versa), and (3) acid-etched slices.

5.2.1 Basic Lapped Slice

5.2.1.1 Overview

The determination of the components, ingredient boundaries, reaction products, and parameters of the air-void system requires the use of a stereomicroscope (see figure 19). The types of items perceivable with the stereomicroscope are described in chapter 8. Because it is impossible to focus clearly on a rough surface at the magnifications required for the petrographic examination of HCC with a stereomicroscope, it is necessary that smooth (finely lapped) surfaces be prepared on sawed slices of the specimens. The smoother the sawcut, the easier the lapping routine will be.

Unless specific precautions are taken to avoid it, undercutting is common during the production of finely lapped surfaces. It is the process in which softer constituents are removed more rapidly than harder constituents so that the harder material (usually the aggregate) stands up higher than the softer components (see figure 41). During the lapping process, the slice rides on the high, hard portions and grinding compound collects under the soft portions. Hard aggregate standing above an undercut paste has a rounded edge, and the area of visible aggregate is increased. There is no sharp line or change in surface texture at the point where the theoretical flat-lapped surface changes to a slope down into the paste. No exercise of logic or mental reconstruction of what the surface should be will allow an accurate determination of the paste-aggregate boundary or the paste-aggregate ratio in such a slice.

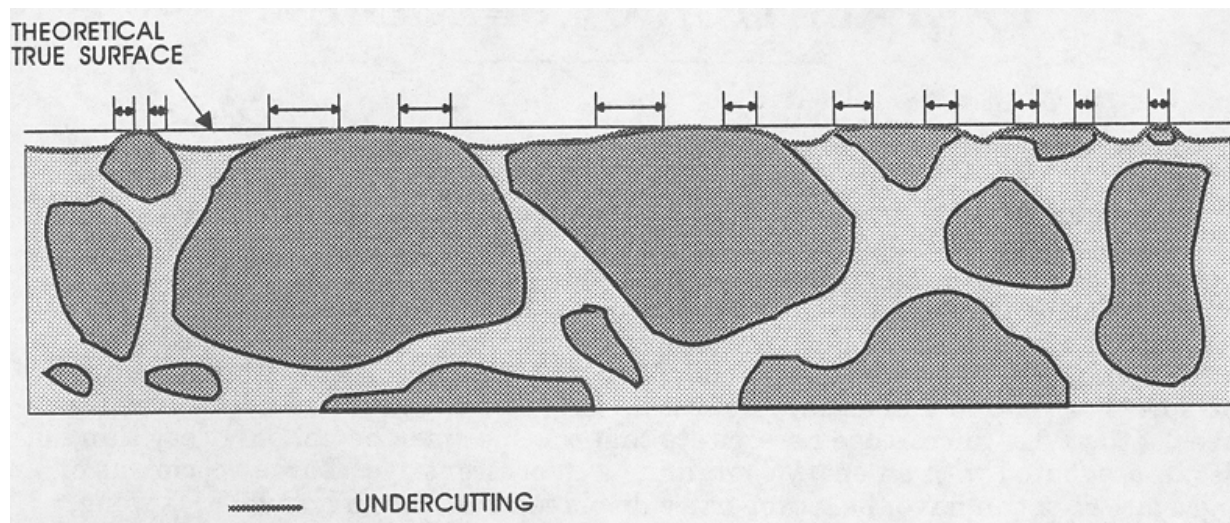

Where the surface falls below the theoretical true surface, the paste-aggregate boundary is rounded over and cannot be defined by a view from above, as through a microscope. Arrows indicate the length of each questionable area.

Figure 41. Undercutting.

Undercutting is very common on surfaces that are finished on soft polishing laps. It can also occur on hard cast-iron laps, but may be greatly minimized with the use of sufficient weight on the back of the specimen to hold the specimen closer to the lap and to create additional wear on the high areas. If the specimen is riding on pieces of high, hard aggregate, the buildup of grinding compound in the low, soft portions of the specimen will erode this softer material. This can cause a general rounding of the surface contours with ensuing enlargement of voids, as well as the loss of sharpness and clarity on the edges of cracks and other features. It can also reduce the distinction at the boundaries of differing components and can lead to a loss of secondary reaction products.

5.2.1.2 Procedures

Producing a lapped slice is a five-step process, as listed in table 13. Additional details on the preparation of surfaces for microscopical analysis may be found in many references (e.g., ASTM C 856 (petrographic examination) and ASTM C 457 (determination of air-void systems)).

Table 13. Procedure for producing lapped slice.

- | |
|--|
| <ol style="list-style-type: none"> 1. Cut and shape the slice. 2. Strengthen fragile HCC. 3. Lap the slice. 4. Clean the slice. 5. Check the quality of the lapped surface. |
|--|

1. **Cut and shape the slice:** If the specimen is a full-depth core or an irregular fragment of HCC, it may be so large that it cannot be held in the vise of the large oil-cooled saw (see figure 5). In this case, bring the specimen down to a more reasonable shape and size by using the large water-cooled saw (see figure 3).

Cut a slice of the HCC from the specimen according to the plan for petrographic analysis as devised in chapter 3. The oil-cooled saw produces smoother surfaces that require less lap time than do surfaces produced with a water-cooled saw. As mentioned in chapter 3, label all fragments of the original specimen to identify their origin and, whenever possible, their orientation. A slice thickness of 15 mm is recommended; however, inspect the material after the first cut to make sure that a thicker slice is not required because of the presence of a previously unseen crack or other weakness. If the specimen crumbles or cracks into several fragments after the first sawcut, you may have to cement the specimen back together with a strong epoxy before you can shape a slice.

The slice must usually be trimmed to fit the slice holder of the lapping device. Most holders are circular to allow free rotation. Be careful not to trim away any portion of the area of greatest interest to the client. Often the portion of greatest interest will be the top, or wearing, surface. In such cases, any trimming will have to be done on the bottom. If there are no obvious differences to be seen between the top and the bottom of the core and the section does not exceed the diameter of the specimen-holding ring of the lap (150 mm for VTRC equipment) in any dimension, a lapped section can be produced that will be representative of the full depth of the specimen. Very often the lowest 20 to 25 mm or so does not require examination unless it is very different from the upper portions.

2. **Strengthen fragile HCC:** If the concrete is immature, further carbonation of the paste may help produce a satisfactory surface. Carbonation may often be achieved by exposure of the cut surface to laboratory air of moderate humidity (50 to 80 percent relative humidity (RH)) for 48 hours (h). For most intensive carbonation, the cut specimen can be supported for 10 h over water that is kept agitated by dry ice. If the container is loosely covered, carbonation will continue until all the carbon dioxide is dispersed, even after the dry ice has completely sublimed.

Very fragile specimens may require impregnation. A number of materials and techniques for impregnation are available. Carnauba wax is recommended in ASTM C 457; however, it must be used with safety precautions to prevent explosion during heating to remove excess wax. Roberts and Scali (1984) recommended the use of a 1:5 solution of colorless nylon fingernail hardener in acetone. Methanol may be used as an alternate solvent with the nail hardener. They prefer the commercial nail hardener to a solution of pure nylon because some of the softening ingredients in the commercial preparation are valuable in preventing chipping. The nylon solution may be applied to the HCC at any stage of the lapping as seems necessary. The hardener is brushed on the surface until it fills the cracks and thoroughly coats the interior of the voids. The hardener is allowed to dry before lapping is continued. Fragile HCC may require the use of the hardener during all stages of the lapping; other HCCs will require the hardener only during the last portion of the lapping procedures. Before examination and determination of the air-void parameters, the hardener should be removed by soaking in the appropriate solvent until the plastic shine is dissolved. The choice of an impregnating agent should include consideration of the desirability and difficulty of removing the impregnating agent from the surface to be examined.

If epoxy or another permanent substance is used for impregnation, it will become a lasting part of the specimen, make detection of subtle textural differences in the HCC more difficult in reflected light, and obscure the viewing of reaction products (in voids) and internal surfaces. This may or may not be important, depending on the purposes of the investigation for which the specimen is being prepared. Usually in cases where impregnation is necessary because of extreme friability of the HCC, the examination of the paste microstructure by transmitted light or an SEM will be called for and the impregnation will be beneficial for these examinations. Various techniques may be used to impregnate HCC slices with numerous types of substances. LR White, a one-part, extremely low-viscosity embedding material, has been found to work very well. To provide contrast in optical microscopy, it can be dyed with a solution of methylene blue in ethanol.

3. **Lap the slice:** If the surface of the specimen is quite smooth as it comes from the saw, the coarsest abrasive need not be used. If the grooves from the saw are very distinct, any fine aggregate has loosened, or other gross irregularities are present, begin lapping the surface with the coarsest abrasive. Usually this is done by holding the specimen by hand and hand-feeding the grit on a small lap (figure 7).

Once you are satisfied that the surface has been made as flat as possible with the coarsest abrasive and all saw marks are gone, continue to work on the two mechanical laps with the automatic abrasive feed (figure 8). Place the specimen slice in the slotted specimen holder on the lap. Adjust the yokes so that the grinding slurry does not drop inside the slotted specimen holders and the specimens rotate freely as the lap moves beneath them. Place the cover plate on the back of the specimen and place any weights on top of the cover plate. Load the abrasive cup with about 20 ml of the appropriate abrasive and fill it about three-quarters full of lapping oil. Set the clock for 20 minutes (min) of lapping. Inspect the specimens and make a judgment concerning the next abrasive. Each abrasive should be finer than the last one used and should be used repeatedly until the marks from the coarser abrasive are gone. A good system is to use one lap for all but the finest abrasive and change to the other lap for the finest one. Lap the surface with successively finer abrasives (see list in chapter 2) until it is suitable for microscopical observation.

4. **Clean the slice:** From time to time during lapping, when changing to a finer abrasive, when changing laps, and when lapping is completed, clean all surfaces of the specimen gently and thoroughly to remove the grinding compound and debris. Air voids, cracks, and surfaces of reaction products should be free of such materials.

CAUTION: If the cleaning of lapped slices is not done promptly, the volatile oils will evaporate and the grinding compound deposits will cake and become hard to remove. Therefore, do not allow a specimen that requires cleaning to lose volatile oils or solvents by evaporation.

CAUTION: Use of ultrasonic cleaning equipment may be harmful to the surface of concrete specimens; therefore, such treatment should not be used without care and experimentation (see ASTM C 457).

WARNING: Do not immerse any portion of your hand in an ultrasonic bath while the ultrasound is on. The cavitation caused by the ultrasound can erode fingernails and damage skin.

If cleaning of lapped slices must be delayed, submerge the slice in a solvent such as isopropyl alcohol (99 percent). Caked grinding compound can make viewing of the interior surfaces and the crystal forms of the paste and reaction products impossible and can contribute to undercutting and destruction of the specimen. A few minutes of ultrasonic cleaning in solvent may be used for cleaning lapped specimens.

At VTRC, we have not experienced any loss of reaction products or loosening of the aggregates or other surface degradation because of brief ultrasonic cleaning. As an alternative to ultrasonic cleaning, the specimen can be carefully cleaned of grinding compound and loose particles with a soft brush (soft as a baby's hairbrush) while it is immersed in a safety-approved container of isopropyl alcohol. It has been reported that a fine, high-velocity spray of solvent (used in an efficient hood) will clean lapped slices efficiently. This procedure has not been tried at VTRC, and we have no evidence concerning the proper pressure and velocity of the spray that would be required to clean without causing damage. Whatever cleaning method is used, as much grinding compound and debris as possible should be removed without damaging the surface or any reaction products in the voids.

WARNING: Persons unfamiliar with the hazards of these cleaning compounds are referred to the Chemical Safety Data Sheets published by the Manufacturing Chemists Association, Inc., 1825 Connecticut Avenue, NW, Washington, DC 20009, or the Materials Safety Data Sheet that may be obtained from the supplier of the compound.

5. **Check the quality of the lapped surface:** A surface that is satisfactory for microscopical examination (either a general petrographic examination with the stereomicroscope or an analysis of the air-void system) will show an excellent reflection of a distant light source when viewed at a low incident angle. There should be no noticeable relief between the paste and the aggregate surfaces (see ASTM C 457). Such a surface is shown in figures 42 and 43.

If the day is reasonably bright, scan the light from a window as it is reflected at a very low angle from a finely lapped slice. It should be possible to discern objects such as buildings and trees (see figure 44).

Alternatively, hold the slice so that it reflects light from an overhead light fixture. It should be possible to see the small details of the diffusion cover of the light or even discern the presence of writing on the light bulb. The edges of the sections of the air voids will be sharp and not eroded or crumbled, air-void sections as small as 10 μm in diameter will be clearly distinguishable at magnifications of less than 150X, and all cracks will be easily visible and free of debris.

The lapped surface needs to show all reaction products, the inner surface of the voids, the hydration, etc., in an as-received condition. At VTRC, space and technician time are premium commodities, and the slice used for the air-void determination must be the same surface used for all microscopic evaluations of the concrete sampled and is usually the only slice kept in the archives.

If difficulty is encountered in preparing a lapped surface of the proper quality, a common cause is a weak cement paste matrix. The problem is manifested by the plucking of sand grains from the surface during lapping, with consequent scratching of the surface (as the loose aggregate moves under the surface being prepared) and undercutting of the paste around the harder aggregate particles. A second cause of difficulty may be friable particles of aggregate. For any quantitative analyses, areas that are scratched or imperfect indicate the need for additional preparation of the specimen. Often, additional cleaning and more time on the free-abrasive laps are all that is required.

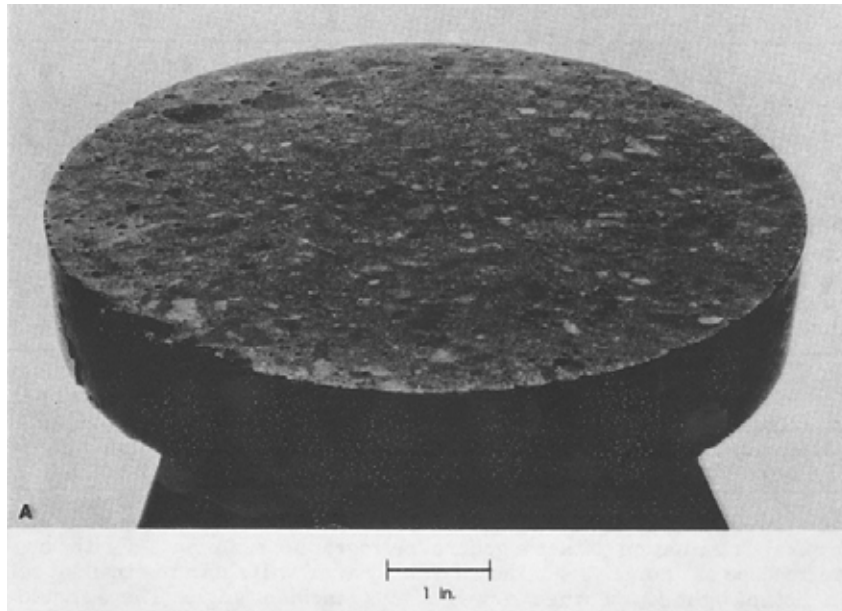

1 inch = 25.4 mm

Exhibits the quality of the surfaces required for microscopical examination and analyses.

Figure 42. Well-prepared surface viewed in ordinary illumination.

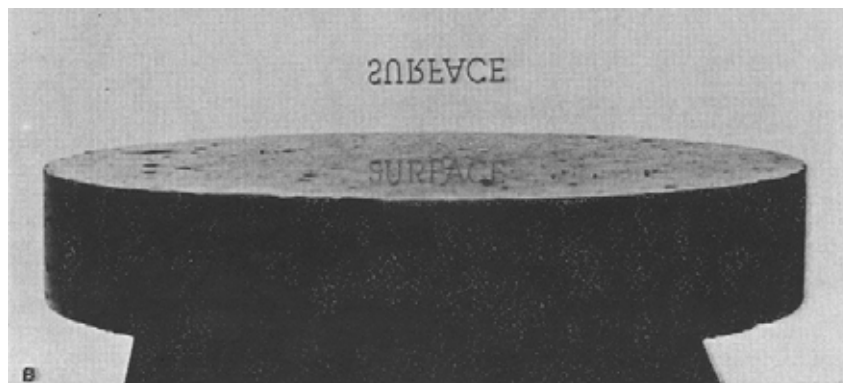

The quality of the reflection of a distant object (here, the quality of the reflection of the reversed word SURFACE on the screen) indicates the flatness of the lapped surface.

Figure 43. Well-prepared surface viewed at a very low angle toward a source of illumination (an illuminated screen).



Reflection of outdoor objects as seen on a bright day. The camera was focused on the reflection; thus, to the camera, the slice is out of focus. The human eye sees both in focus.

Figure 44. Properly finished slice (same as that shown in figures 42 and 43).

5.2.2 Vertical Section of Horizontal Slice (or Vice Versa)

If a horizontal slice was taken from a core to study changes in the air-void system (or other feature) with depth, it may later be desirable to lap finely and examine a vertical slice of one or more of the lapped slices already available (or vice versa). In such a case, the slice in question must be secured in an upright position in a mounting medium so that a slice that is at right angles to the direction of the first slice can be cut and lapped (see figures 45 and 46).

5.2.3 Acid-Etched Slice

5.2.3.1 Overview

Etching is performed to enhance the differences in acid resistance or solubility that might exist between the phases of a rock or HCC. Some of the phase differences that the petrographer might wish to enhance are rhombic dolomite crystals in micritic-carbonate rock, fly-ash particles and carbonated areas in HCC, and aggregate particles in HCC paste. Lapped slices of concrete and lapped surfaces on carbonate rock specimens are often etched to make visible and emphasize various phase differences and phase boundaries in the specimen. These differences may be the contrasts between aggregate and paste, various mineralogical differences, and even the differences caused by the depositional and metamorphic history of the rock.

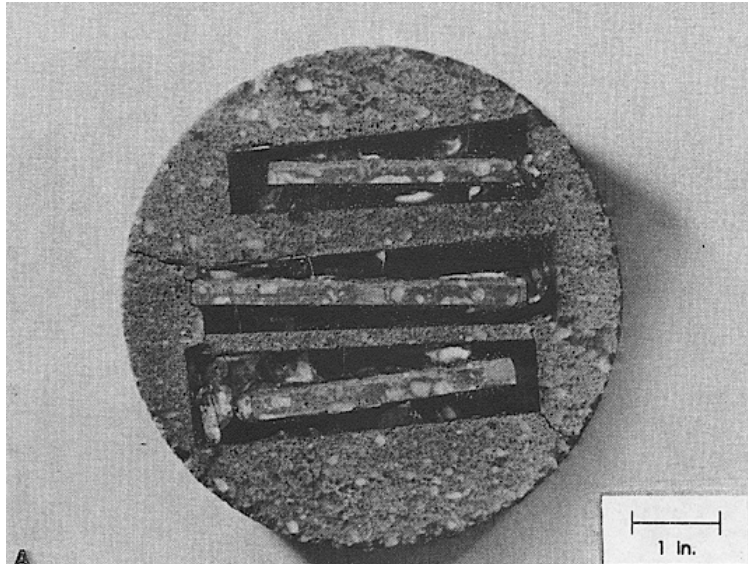

1 inch = 25.4 mm

In this case, the concrete was slightly etched with weak HCl to delineate the depth of carbonation.

Figure 45. Slice cut at right angles to original slice: Edges of thin top surfaces of a concrete core embedded in epoxy and repotted in mortar in a mold 152 mm in diameter and then resliced and finely lapped to allow examination of the vertical surface.

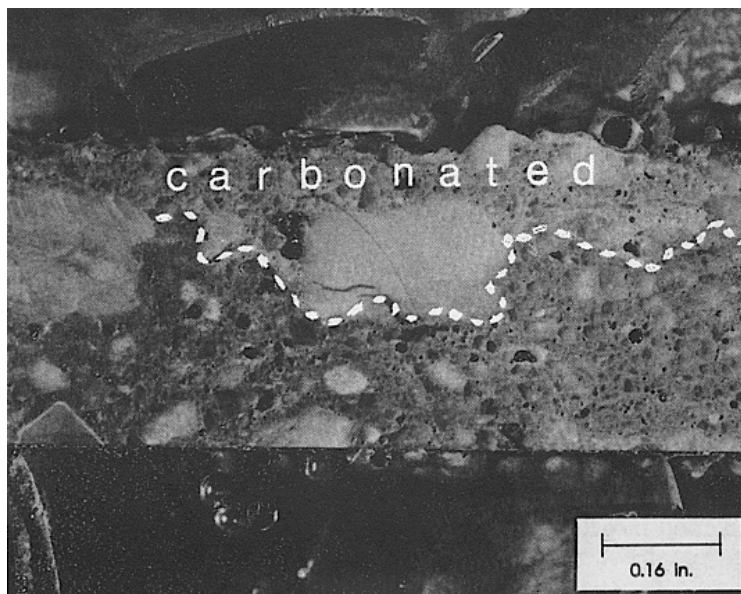

1 inch = 25.4 mm

The carbonated area is the area above the lower edge of the whiter area near the wearing surface.

Figure 46. Slice cut at right angles to original slice: Left portion of middle slice shown in figure 45 is enlarged.

The etching of finely lapped specimens of HCC must be delayed until after the specimen has been thoroughly examined and any analysis of the percentage and shape of any constituents that might be changed by the etching is completed (e.g., air). If the etching is being performed to aid in the determination of the paste content for use in the formulae for air-void parameters, the etching and paste determination must be performed on the same surface as was the air-content determination.

5.2.3.2 Procedures

Procedures for acid-etching of slices are outlined in table 14. Before proceeding with etching, ensure that the slice is free of oil and, if heated, allow it to cool to room temperature. The oil used as a lubricant for lapping must have been removed from the slice by long exposure or oven treatment. Steam must not form in the HCC; therefore, the temperature in the oven must not exceed 90 °C.

Table 14. Procedure for etching slice.

| |
|---|
| <p>Etching portion of slice:</p> <ol style="list-style-type: none"> 1. After ensuring that the microscope has a working distance sufficient to prevent splattering of the lenses (or the lenses are otherwise protected), drop 10 percent HCl acid onto the slice from a rod or dropper while the slice is under the microscope. Observation of the active effervescence of CO₂ from CaCO₃ can help locate various mineral species. 2. Take care to distinguish aggregate composed of carbonate minerals from the CaCO₃ of the paste caused by exposure to the carbon dioxide of the atmosphere under conditions of moderate humidity. |
| <p>Etching entire slice:</p> <ol style="list-style-type: none"> 1. Flood a shallow, acid-resistant container (e.g., a shallow glass baking dish) with room-temperature 10 percent HCl acid. Because the acid should be replaced frequently, a shallow bath is recommended. 2. Support the slice in the acid bath with very small glass, quartz (sand or pebbles), or plastic supports so that the surface does not touch the bottom of the container and the lapped surface is submerged. (If the slice is not too large or heavy, it may be held in a gloved hand.) 3. Move the slice around for a few seconds or vibrate it or agitate the acid while the slice is in contact with the acid. 4. Rinse the slice, partially dry it, and microscopically determine if the procedure should be repeated. If the etching is insufficient, return the slice to the acid bath and repeat the procedure. It is generally satisfactory to perform the etching for 5 to 20 seconds (s). The exact time used depends on the maturity and condition of the HCC and the features to be examined. 5. After the etching is completed, rinse the surface with tap water and partially dry it. Drain the slice onto a paper towel and pat it lightly with a tissue. The slice will usually air dry sufficiently for microscopic examination in 1 h; however, it may be dried in a slightly warm oven. |

5.3 THIN SECTIONS

Thin sections must be thin enough for sufficient light to pass through them to enable the microscopist to observe the specimen using the particular features of the microscopes (see chapters 12 and 13). Thus, the sections should be as thin as is practical.

Instructions for fabricating standard thin sections from rock for examination with the petrographic microscope are available in many good books on optical mineralogy or petrology and are usually included with any equipment purchased for this purpose. Special instructions for preparing thin sections of HCC, thin sections for study with fluorescent light, and thin sections of particular aggregates are included here. Additional information, particularly covering the preparation of large-area thin sections, can be found in *Concrete Petrography: A Handbook of Investigative Techniques* (St. John, et al., 1998).

5.3.1 Basic Thin Section

5.3.1.1 Overview

The thickness of the thin sections fabricated for the usual geologic/petrologic/mineralogic examination of rocks and minerals is 25 to 30 μm . If rock or rocklike specimens are sent to a company that fabricates thin sections without further instructions, the thin sections produced will be 25 to 30 μm . For the determination of the component minerals in coarse-grained igneous and metamorphic rocks, this thickness generally works fairly well. Some rock-oriented petrographers depend on thin sections being a standard thickness so that they can more easily judge the birefringence of a mineral grain under observation by the dispersion caused by the standard thickness. On the other hand, many concrete petrographers prefer to work with much thinner sections. They have become accustomed to judging birefringence by comparison between mineral species.

When the size of the individual particles of interest is less than the thickness of the thin section, the particle boundaries tend to become obscured by the overlap of the particles. The finer the size of the particles, the more difficult it is to observe and define the boundaries. The less difference among the various optical properties of the particles (index of refraction, color, and birefringence), the more difficult it becomes to identify the boundaries and determine the identity of the particles.

Some of the aggregates whose structure must be determined accurately in concrete petrography are very fine-grained. The microstructure of the deleteriously reactive carbonate aggregates cannot usually be deciphered in thin sections of standard thicknesses. These rocks are composed of rhombic crystals of dolomite (5 to 20 μm across) “floating” in a murky calcite micrite. The murky appearance of the background is caused by submicroscopic particles of organic material, iron oxides, sulfides, and various other insoluble substances that are included in the micrite. When these materials include a relatively high percentage of opaque material, it can be impossible to discern details in a thin section as thick as 20 μm . The micrite itself may have a grain size of less than 5 μm .

The undulating extinction of alkali-reactive coarse-grained quartz can usually be seen in sections 25 to 30 μm in thickness; however, much of the reactive quartz present in metabasalts,

mylonites, and siltstones is exceedingly fine-grained and cannot be detected in thin sections of standard thicknesses.

Most cement is very fine. The greater portion will pass a No. 200 (75- μm) mesh sieve. The cement hydrates into even finer particles of low to negligible birefringence with nearly identical color and low indices of refraction. Observation of a thin section of HCC 25 μm in thickness could lead a rock-oriented petrographer to state that the material between the aggregate grains is groundmass. The term *groundmass* has long been used by geologic petrographers to indicate that the material is too fine for determinative microscopy. Examples of groundmass are the submicroscopic clay background of some sedimentary rocks and the material between phenocrysts in lavas or very fine-grained basalts. Thin sections with thicknesses on the order of 10 to 15 μm permit examination of the paste fraction, in which unhydrated portland cement grains, fly ash, and ground slag particles can be discerned. Much more detailed examinations of the HCC paste can be made using the SEM (see chapter 14).

Ideally, thin sections should be flat and cover a large portion of the glass on which they are mounted. Unless special equipment (not available at VTRC) is used, flaws, including lack of flatness and small areal extent, will sometimes have to be overlooked and the data will have to be collected from small thin sections that are thicker in the middle than at the edges.

5.3.1.2 Procedures

Because these specimens are so thin, they must be mounted on glass microscope slides. Because of the thinness, the chance of lapping too far and losing the entire thin section is great. The procedure for examining thin sections consists of five steps:

1. **Prepare the specimen:** Begin fabrication with a number of shaped pieces of specimen so that the likelihood of two or more pieces surviving the procedure is good. Shape these blanks slightly smaller than the size of a petrographic glass slide with a small thin-bladed rotary diamond saw (figure 6). If ultrathin fluorescent sections are being produced, size the shaped pieces to fit the well of the slide.
2. **Prepare the glass slide:** Ensure that the two sides of the flat glass slides are parallel and that the slides are all of the same thickness. Accomplish this by mounting the slides in the vacuum chuck of the grinder (see figures 12 and 13) and grinding them to a standard thickness as measured on the dial on the right side of the machine. If this is done, it then becomes possible to use the reading on the dial as an indicator of the thickness of the specimen and thus grind all thin sections to a standard thickness before hand-lapping is begun. The matte surface produced by the grinding of the slide to parallelism and standard thickness may provide a less slippery surface to which the mounting epoxy can cling. If it appears that the cutting and grinding equipment has lost its accurate parallelism between the face of the chuck and the saw or cupped grinder, place a mark on the glass slide indicating the orientation of the glass on the vacuum chuck so that after the specimen is mounted, the glass may be replaced on the chucks in the same position and thus compensate for any errors in the equipment itself. The 50-year-old equipment at VTRC is still free of this sort of deterioration.

3. **Make the first thickness reduction:** Mount the piece of specimen for the thin section on the prepared glass slide. Place the glass slide on the vacuum chuck of the cutoff saw (see figure 12) and use the handle to move the work into position up against the saw to remove all but 100 μm or less of the specimen. The optimum thickness will depend on the physical stability of the specimen. The relative position of the chuck to the saw or grinder can be adjusted with a small dial at the right-hand end of each piece of equipment.
4. **Make the second thickness reduction:** Transfer the specimen chip on glass to the vacuum chuck on the grinder. Gradually advance the thin-section blank to the grinder by using the micrometer dial at the right-hand end. An attempt to grind off a great thickness all at once will induce stresses and may cause breakage or debonding of the specimen and the glass.
5. **Perform the final finishing.** After the grinder has reduced the section to about 30 μm in thickness, hand-finish the section with No. 600 SiC and 5 μm Al_2O_3 in a water or oil slurry on a glass plate (see figure 14) until the section is approximately 25 μm or less in thickness, depending on the material being sectioned and the purposes of the examination. The grinding motion used should be that of making a figure eight and should cover as much of the entire surface of the glass as possible without letting the edge of the glass touch the section being produced. The figure eights should move over the glass surface and rotate, crossing as many different places on the glass as possible. For most purposes, the pressure on the back of the thin section should be evenly distributed and just sufficient to slide the section around on the abrasive when sufficient fluid lubricant is used.

CAUTION: Examine the glass plate regularly for flatness. When it becomes dished because of the grinding action, discard and replace it.

5.3.2 Thin Section for Detecting Alkali-Reactive Textures in Carbonate Rock

5.3.2.1 Overview

Because the most reactive textures in carbonate rock contain dolomite crystals that are very small (less than 25 μm across), it is necessary to make the thin section used to discern the reactive texture thinner than the usual 25 to 30 μm so that the tiny rhombs of dolomite (often only half the thickness of a standard mineralogical thin section) can be seen without being obscured by other overlapping phases.

5.3.2.2 Procedures

The thin section may be lapped down to zero thickness at one end and wedged toward a more standard thickness at the other (see figure 47). This may be accomplished by pressing more heavily on one end of the back of the section during the final finishing. By this method, there will exist at least a small area that is of the correct thickness to allow visibility of very small dolomite crystals. The pressure on the back of the section should be kept nearly evenly distributed until the section is down to about 25 μm in thickness.

The best thickness for viewing the texture of carbonate materials is usually achieved when observation with crossed polarizers indicates that much of the carbonate has begun to change colors; and it shows pink of the fourth order (or less) and the overall glaring is high -order white, generally typical of the carbonates. Experienced technicians may thin the entire section to the thickness best suited for viewing; however, the likelihood of losing the entire section is very great.

The best compromise thickness for sections of concrete and some aggregates is about 10 μm . Each material studied will probably have its own optimum thickness. Unfortunately, the optimum is often quite thin and difficult to achieve without loss of the entire specimen cemented to the glass.

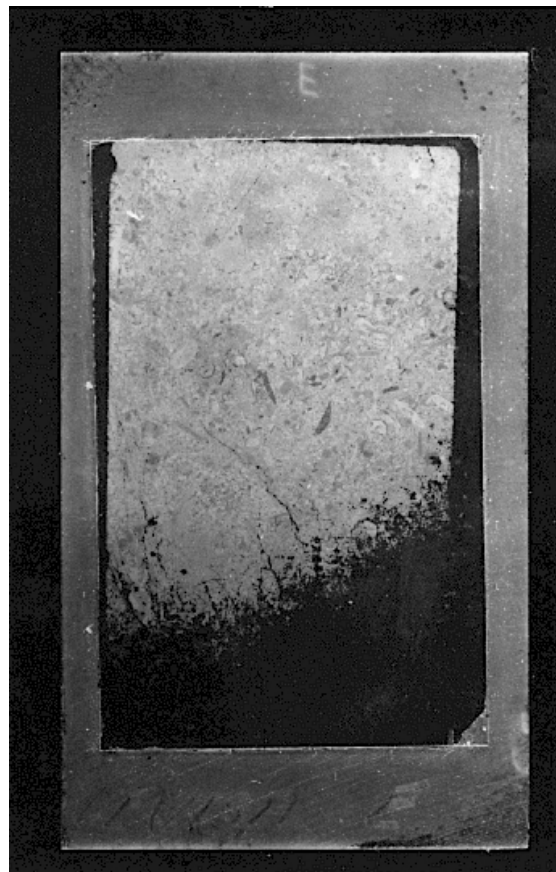

Figure 47. Thin section wedged to one end to observe dolomite rhombs in micrite as an indicator of possible alkali-carbonate reactivity (glass mount is 27 by 46 mm).

5.3.3 Thin Section Showing Profile of Wearing Surface

5.3.3.1 Overview

On occasion, the exact details of the texture and the aggregates of the wearing surface of an HCC pavement require examination and study with the petrographic microscope (Webb, 1970).

5.3.3.2 Procedures

Cement two small portions of the surface under study to a slide with the wearing surfaces together in the center (to protect the area of interest from the greatest thinning action) and produce a thin section of the thickness appropriate for the material and the purposes of the study. Figures 48 through 50 illustrate some of the steps in this process.

5.3.4 Thin Section for Epifluorescent Illumination

5.3.4.1 Overview

Sections for use with epifluorescent illumination (see chapter 13) are much like ordinary thin sections. The person fabricating the thin sections should become familiar with the material in section 5.3.1. The major difference is that the thin sections are impregnated with a fluorescent-dyed epoxy (Walker and Marshall, 1979; Wilk, et al., 1974; Roy, et al., 1993; St. John, et al., 1998; Jakobsen, Laugesen, and Thaulow, 2000). In these sections, the light emitted by the fluorescent dye is not collimated by the condenser because it is produced in the section closer to the objective lens than is the condenser. Therefore, the thinness of the section is of great importance in preventing the obscuring of the fluorescent details with fluorescent light from greater depths. Because the section is epoxy-impregnated and thus strengthened, it is not so difficult as might be thought to produce sections of 15 μm or less in thickness.

5.3.4.2 Procedures

The methods used by VTRC to fabricate fluorescent thin sections (Walker and Marshall, 1979) were those that would involve the least cost for equipment. The Ingram-Ward thin-section equipment was already available, and the major purchases were the vacuum oven and the Syntron vibratory polishing lap.

It is necessary to make sure that the most impregnated side of the thin-section blank is very flat and that this side is cemented down to the final slide because the impregnation usually penetrates to a depth of only about 1.5 mm. With the Ingram-Ward equipment, a series of steps is necessary. Laboratories can easily devise satisfactory procedures for producing these sections using the equipment available to them. Jakobsen, et al. (2000) provides a detailed description of their techniques.

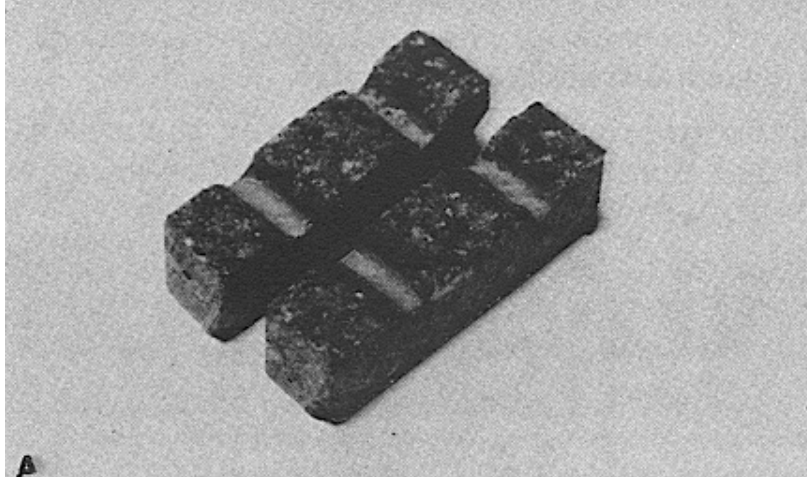

Figure 48. Stage in the preparation of this section to show the details of the wearing surface: (A) Small blocks of wearing surface.

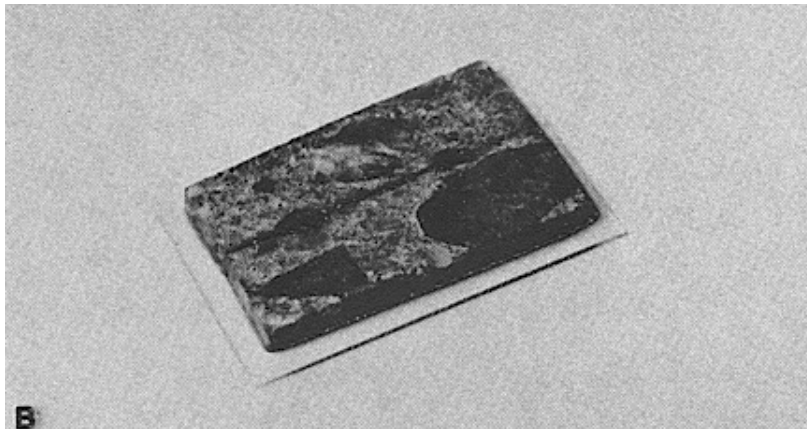
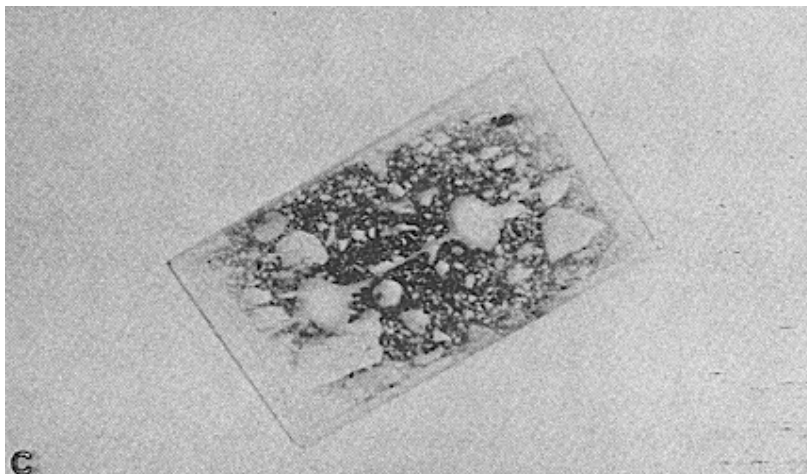

Figure 49. Stage in the preparation of this section to show the details of the wearing surface: (B) Blocks cemented to microscope slide.



This section is about 50 μm in thickness because the study for which it was fabricated was concerned with the profile of the wearing surface and not with the identity and interrelationship of the component materials.

Figure 50. Stage in the preparation of this section to show the details of the wearing surface: (C) Thin section of blocks.

The fabrication of fluorescent thin sections is a 23-step process (as follows). When they are not in use, store specimens in a dark, airtight cabinet (to prevent fading of the fluorescence). To prevent carbonation, use an effective desiccant (e.g., Drierite[®]) and a carbon dioxide absorbant (e.g., Ascarite[®]).

1. **Select and mark the specimen area:** Generally, the area selected should be centered on mortar rather than on coarse aggregate.
2. **With the small diamond-blade saw, and preferably an oil lubricant, cut a small specimen about 4 mm in thickness from the specimen area:** Extremely fragile specimens may necessitate thicker specimen chips.
3. **Rinse the specimen well in acetone or isopropyl alcohol and allow to dry:** Carefully (to ensure parallelism) mount the specimen on a flat work slide with a mounting epoxy.

WARNING: Persons unfamiliar with the hazards of these compounds are referred to the Chemical Safety Data Sheets published by the Manufacturing Chemists Association, Inc., 1825 Connecticut Avenue, NW, Washington, DC 20009, or to the Materials Safety Data Sheet that should be obtained from the supplier of the compound.

4. **Mount the glass slide in the vacuum chuck of the Ingram-Ward grinder, and grind the specimen chip with the cupped ceramic diamond grinder until the entire surface of the specimen is free of saw-damaged material.**

5. **Wash by soaking in four changes of acetone over a period of 2 h to remove the lubricant oil. Air dry.**
6. **Dehydrate the specimen overnight in a vacuum oven at 80 °C. Maintain a vacuum of 10 mm Hg for about 1 h before leaving for the night. In the morning, turn off the heat and allow the closed oven and slice to come to room temperature before releasing the vacuum.**
7. **Pot the specimen with the ground surface up (glass down) in a container of liquid fluorescent epoxy:** At VTRC, a disposable plastic petri dish (50- or 80-mm in diameter) is used as a potting container. (If the corners of the work glass have to be snapped off to make the preparation fit in the dish, a second work glass will have to be cemented onto the back of the first one before the preparation can be held in a vacuum chuck again.) The use of the larger container allows potting of two or three blanks.
8. **Place the container in the vacuum oven at room temperature and bring the vacuum intermittently and slowly down as low as possible (10 mm Hg):** Keep it there until outgassing stops. This step is best done in stages to prevent overflow of the bubbling epoxy (see figure 17) and to allow the impregnating epoxy time to penetrate the slice. Release the vacuum and allow the air pressure to force the epoxy into all portions of the void system. Repeat the procedure as many times as necessary until very few bubbles form while the preparation is under a vacuum. On the last treatment, continue the vacuum until outgassing essentially stops. The entire procedure can take up to 3 h.
9. **Cure the epoxy in a warm oven overnight and then at room temperature for 36 h or until the epoxy is hard and brittle and does not show any plasticity when tested with a pick:** There must not be any possibility that the epoxy in the air voids or cracks will become distorted and drag onto adjacent phases. If experimentation concerning the curing is performed, be aware that subjecting the epoxy to a vacuum may remove some of the more volatile components of the epoxy mixture and may thus change the curing regime required. Treat any experimental curing slices the same as any impregnated material.
10. **Trim excess hardened epoxy, plastic (from the container), and glass from around the sides of the specimen with the small rotary saw. Peel the external hardened epoxy from the bottom glass of the impregnated slab. Attach an additional work glass with glue that sets quickly:** This work glass is required for the next step to ensure that all the ports of the vacuum chuck are fully covered and are working efficiently.
11. **Clean the final mounting surface by placing the new work glass on the vacuum chuck of the Ingram-Ward grinder and carefully grinding off the hardened epoxy coating on the surface of the specimen:** The sound of the grinding will change when the epoxy layer is gone. Remove as little of the specimen as possible. This highly impregnated area is the best portion to use as the thin section.
12. **Lap the mounting surface by hand with a 5- μm Al_2O_3 and water slurry on glass.**

13. **Clean the specimen.**

CAUTION: Examine the glass plate regularly for flatness. When it becomes dished because of the grinding action, discard and replace it.

WARNING: Do not immerse any portion of your hand in an ultrasonic bath while the ultrasound is on. The cavitation caused by the ultrasound can erode fingernails and damage skin.

14. **Place the specimen under a 10-mm vacuum at 50 °C for 3 h or more to remove all oil and water:** Do not use excessive heat as it may soften the epoxy.
15. **Mount the specimen (with the lapped impregnated surface down) on a petrographic slide with an undyed epoxy:** Perform the mounting carefully to eliminate air pockets and ensure a good bond.
16. **Firmly (but without destructive force) clamp the specimen to the slide and allow it to cure overnight:** Take care to limit the forces to those that will clamp the specimen to the glass. Do not twist or slide the specimen relative to the glass slide. The clamp stand used for this procedure is shown in figure 18.
17. **Cut off the excess thickness of the specimen by mounting the slide containing the specimen against the vacuum chuck of the Ingram-Ward saw (as shown in figure 51):** The specimen will be made reasonably thin and the two work glasses will be removed.
18. **Reduce the specimen to about 30 µm in thickness in the Ingram-Ward grinder.**
19. **Rinse the specimen well with acetone or isopropyl alcohol.**
20. **Lap the specimen by hand with a 5-µm Al₂O₃ and water slurry on glass:** Refer to the instructions in section 5.3.1.
21. **Clean the specimen.**
22. **Attach the glass of the specimen slide to the flat side of the weights of the Syntro vibratory polisher with strong double-sided adhesive tape (carpet tape):** Place rubber bumper rings on the weights. Place the Pellon pad on the vibrator with a slurry of diamond compound (the coarser one first) and lapping oil. Place the weighted specimen down on the treated Pellon pad (see figure 19) and activate the vibrator for as long as necessary to reduce the specimen to the required thinness and produce a very finely textured flat surface free of scratches. The vibration may require 8 to 16 h. Particular

types of concrete with hard aggregate (i.e., quartz) will require further polishing to remove scratches. In such cases, thoroughly clean the specimen and weights, and repeat the polishing procedure with a 1- μm diamond compound on a second pad. The use of a second bowl makes it possible to save the first Pellon pad and the associated diamond compound for later use.

23. **Clean the specimen carefully with acetone or isopropyl alcohol:** When the sections are not in use, store them in a dark (to prevent fading of the fluorescence), airtight cabinet. To prevent carbonation, use an effective desiccant (e.g., Drierite) and a carbon dioxide absorbant (e.g., Ascarite).

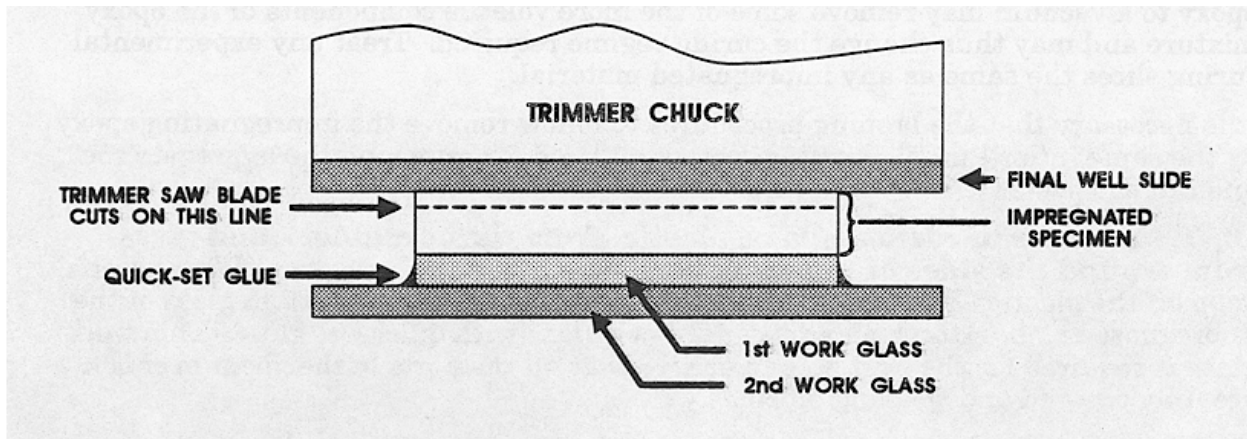

Figure 51. Specimen mounted between work glasses and final slide (dotted line indicates the plane the saw will cut).

5.4 GRAIN MOUNTS

5.4.1 Overview

Small particles of rock, paste, reaction products, and sand grains can be identified and examined with the petrographic microscope; however, they cannot be examined unmounted. The relief between the index of refraction of the substance and the index of refraction of air is so great that the internal reflection within the particle prohibits observation of any useful properties. Therefore, it is necessary to prepare mounts in which these particles are submerged in a transparent substance with an appropriate refractive index. Such mounts are called *grain mounts*. Temporary grain mounts are usually made with refractive index (immersion) oil for the purpose of determining the index of refraction and other optical properties of small particles of material. The oil can easily run off the mount and, in time, will evaporate. Permanent grain mounts are made with epoxy and can be kept indefinitely for demonstration and archival purposes. Permanent grain mounts can be thinned in the Ingram-Ward equipment, as are thin sections (see section 5.3.1), to increase the transparency of the particles and facilitate the observation of many of the optical properties of the material.

5.4.2 Procedures

Grain mounts are more satisfactory if the particles in any one mount are nearly the same size. Use the 76-mm sieves to separate the sizes. If the examination is concerned with the relative amounts of the sizes, weigh each sieve fraction.

5.4.2.1 Temporary Mount

This procedure is a five-step process:

1. **Crush or size the particles so that they may be distributed evenly on a microscope slide.**
2. **Distribute the grains over a small area of the slide and place a cover slip on the grains.**
3. **Place a drop of index of refraction oil at the edge of the cover slip so that the oil is drawn under the slip by capillary suction, repeating this action until the grains are sufficiently immersed.**
4. **Manipulate the mixture to remove bubbles by moving the cover slip around by means of a clean pencil eraser:** If the particles are so large that the cover slip is not in contact with the oil across the total preparation, either add more oil or discard the grain mount and begin again with smaller particles. If the grain mount is being made to aid in the determination of the index of refraction, it is best to start with a supply of particles less than 25 μm in diameter. A number of grain mounts using different oils will probably be required and, in the interests of economic use of the expensive oils and neatness, each should be as thin and small as is practical. Moving the cover slip and thus rolling the fragments may reorient the individual grains and assist in the identification of its optical properties relative to a specific crystallographic axis.
5. **Label each preparation:** It is easy to forget which preparation is which when several are on the table beside the microscope. Temporary labeling may be accomplished by placing the grain mount over a label on a sheet of paper. Such preparations may also be used for cursory examination of hydrated cement paste or reaction products when the information needed is easy to obtain (such as with birefringence).

5.4.2.2 Permanent Mount

This procedure is a one-step process: Fabricate a permanent grain mount with epoxy, Canada balsam, or a similar substance of a known refractive index. Such mounting materials may be used purely to preserve the specimen or to provide a secure base, so that once the mounting material is properly cured, the preparation can be thinned and finely lapped as a thin section of the material.

5.5 AGGREGATE SPECIMENS

5.5.1 Overview

Rock as large fragments, crushed and sized for use, or as sand and gravel may be submitted to the petrographer in order to determine its suitability for use as aggregate in HCC. Specimens may be submitted as part of ongoing research concerning some form of HCC deterioration or for comparison with the aggregate found in HCC specimens presently undergoing investigation. The aggregate specimens can be best examined and tested if they are properly prepared for the proposed examination and testing (see ASTM D 75).

Particulate materials can become segregated into sizes or into mineralogical portions when they are stockpiled or even when they are shoveled or poured into small piles. The ability of the particles to move over each other and the substrate is affected by the density, geometry, shape, and surface texture of the particles (Mullen, 1978). Air resistance may affect the placement movement of very fine sizes of materials. Each type of material has its own characteristics that affect its manner of movement, thus allowing both vertical and horizontal segregation within a pile of particles.

5.5.2 Procedures

5.5.2.1 *Hand Specimen and Large Fragment of Rock*

This procedure is a four-step process:

1. **For each type of rock represented, prepare freshly broken surfaces and sawed surfaces in at least three directions at approximately 90 degrees to each other.**
2. **If the rock contains a large percentage of carbonate minerals, finely lap the sawed surfaces and etch (with 10 percent HCl) the lapped surfaces to ascertain the direction of the bedding and emphasize the different mineral compositions.**
3. **Examine the broken and etched surfaces:** Describe the color, condition, parting, and lithology. Pay special attention to any indication of reactive aggregate.
4. **Crush the specimens to the size required for testing:** Take care that the portion selected is representative of all the kinds of aggregate submitted as one specimen. Treat the crushed aggregate as if it had been submitted in the crushed state. Refer to the instructions in section 5.5.2.2.

5.5.2.2 *Sand, Gravel, Crushed Stone, and Slag*

This procedure is a three-step process:

1. **Ensure that the specimen is treated (washed or not) and sized the same as the aggregate that is being considered for use in HCC:** Dust and mud coatings may wash away. Sizing may allow exclusion of particular types of particles from consideration by indicating that they are such a small fraction that they can be ignored. When the specimen becomes beneficiated by such procedures, these procedures may be required of the

aggregate supplier before the aggregate is accepted for use. Refer to Dolar-Mantuani (1983) and other applicable references in the Reading List for more information.

2. **Inspect the entire specimen for the presence of the types of particles whose presence in even a small amount can cause the aggregate to fail the client's specifications:** Roughly estimate the percentage of such particles.

3. **Select a number of small portions to represent the whole for use in tests and examinations:** Each portion to be tested must contain the same proportion of lithologic and mineralogic types and the same proportion of sizes, coatings, and impurities as the original specimen (see ASTM C 702). Take care that the reduction in sample size does not change the percentage of the undesirable types of particles mentioned in step 2. The best method for reducing the quantity of the specimen to an amount usable by any test proposed should include the use of a number of sizes of sample splitters. For the finer sizes of sand, very small sample splitters may have to be constructed in the laboratory from such materials as flat wood sticks . If the aggregate is fairly dust-free and sample splitters of the proper size are not available, the material may be repeatedly halved by the cone and alternate quarter removal method: Construct a cone-shaped pile of the aggregate (on canvas-covered floor, table, etc.). Quarter the sample using a thin board or trowel. Carefully remove and combine alternate quarters. Sweep clean the area beneath each quarter removed and place the small fragments and dust with the removed material. Repeat the procedure as many times as is necessary to reduce the total specimen of aggregate to the quantity required for whatever testing is to be performed. Do not reduce the specimen below the amount required by the examination or test to be performed.

CHAPTER 6. VOIDS

6.1 OVERVIEW

In hardened HCC, a void is an empty space (other than a crack) in the cement paste that contains nothing but air. The type, size, shape, arrangement, and abundance of the voids are factors controlling many important properties (e.g., compressive strength, resistance to destruction by cycles of freezing and thawing, and resistance to chemical attack on the reinforcing steel and the cement paste). The percentage of air-void volume is generally specified by the design of the mixture. A large number of very small (most are not visible without magnification) air voids are desirable so that the average distance between any point in the paste and a void (spacing factor) is very short and, thus, the paste is protected from freezing and thawing. However, because voids weaken the HCC, spacing factors much less than the maximum ensuring protection from freezing and thawing are counterproductive and should be avoided.

The total air-void content (of voids larger than capillary size) of an unhardened concrete mixture is routinely determined in accordance with ASTM C 231 (pressure method) or ASTM C 173 (volumetric method). The unit weight of fresh concrete (ASTM C 138) may also be used to determine the percentage of air in the mixture. These methods do not ascertain the type of voids present; they merely measure the total void content. These measurements are important. As Bartel (1978) stated:

Tests for air content and unit weight of fresh concrete, carefully made in accordance with the appropriate ASTM test method, will yield an accurate measurement of the amount of air, weight, and volume of concrete being produced. Tests for air content, coupled with intelligently selected specification limits, can ensure the beneficial effects of entrained air in hardened concrete (p. 130).

Specially formed specimens of hardened HCC mixtures may be tested for resistance to the destructive forces of freezing and thawing in accordance with ASTM C 666 (resistance to rapid freezing and thawing). An HCC that is resistant generally indicates that an adequate air-void system is present and the aggregates are sound or that the HCC has not become critically saturated.

It has been variously claimed that the total air-void content increases or decreases as the concrete hardens. It appears that what really happens is that the determination of the total air-void content with field equipment made on the fresh concrete does not agree with the total air-void content determined by microscopical analysis of the hardened concrete. Except in the case of hydrogen gas being evolved by the corrosion of aluminum fragments (Newlon and Ozol, 1969) (see figure 52), no evidence has been offered showing volumetric changes in field placements or test cylinders to corroborate an increase or decrease in total air-void content.

Careful investigation by a combination of controlled sampling and testing with petrographic analyses has shown that air-void content does not change upon hardening. Rather, it may change because of outside influences (e.g., excessive vibration, the further addition of water and retempering, or pumping operations with long vertical drops). The void content in the hardened



After it was cast in the cylinder mold, the concrete increased in volume as hydrogen gas evolved from the chemical reaction of aluminum (from an aluminum delivery pipe) with the alkaline fluids of the fresh cement paste.

Figure 52. Concrete that increased in volume because of corrosion of aluminum fragments.

state will usually agree within 1 percent of the void content determined in the fresh, unhardened state. When they do not closely agree, either one of the measurements is in error or the two specimens tested do not represent the same concrete subjected to the same influences (see appendix C and Ozyildirim, 1991).

An air-void content in excess of the amount required for protection against the destructive forces of alternate freezing and thawing that occur in saturated concrete adds no benefit to concrete expected to bear loads and resist abrasion. (For a discussion of the high-air cellular concretes, see Legatski, 1994.) An excessive air-void content will lower the compressive strength of the concrete by about 5 percent for each excess percentage of voids. Because of this dual-edged nature of air entrainment, maintaining control of the air content is one of the most important facets in concrete production. It requires knowledge of the various materials and potential interactions, batching and mixing equipment and operations, and careful testing. Whiting and Nagi (1998) provide excellent information on this critical function.

6.2 TYPES OF VOIDS

The overall void content in HCC is composed of four general types of voids (as listed in table 15).

Table 15. Types of voids.

1. **Capillary voids:** Capillary voids are irregularly shaped and are very small (less than 5 μm on the lapped surface of the slice examined). They represent space originally filled by mixing water, remain after the hydration of the cement gels, and are an integral part of the paste. Although they contain air at the time of examination, they are not considered part of the air-void system.
2. **Entrained air voids:** Entrained air voids are defined by VTRC as spherical voids larger than the capillaries, but less than 1 mm on the lapped surface of the slice examined. They are formed by the folding action of the concrete mixer, and their shape, size, and abundance are influenced by the addition of surface-active, air-entraining admixtures to the mixture.
3. **Entrapped air voids:** Entrapped air voids are voids that are larger than the entrained voids, but have internal surfaces that indicate that they were formed by air bubbles or pockets. They may be spherical or irregularly shaped.
4. **Water voids:** Water voids are irregularly shaped voids whose shape, location, or internal surface indicates that they were formed by water. Usually, they are larger than entrained air voids.

6.2.1 Capillary Voids

The smallest optically visible voids in HCC are the various sizes of capillaries. A few of the larger capillary voids can be seen at the higher magnifications used to determine the parameters of the void system; however, they are generally not that large. Hearn, Hooton, and Mills (1994) provide an excellent discussion of the capillary void system in HCC. Capillary voids are spaces formed by the shape of the hydrated cement gel structures and spaces left between the gel structures as water is used in the self-desiccation of the hydration process. They were occupied by water or gas when the concrete was fresh and are larger and more abundant in concretes with a high w/cm. The extent (volume and continuity) of the capillary system is thus controlled by the w/cm and the degree of maturity of the concrete. The evenness of the distribution of the pores and capillaries is controlled by the distribution of the water. As the concrete hydrates, the water in the pores is used in the hydration of the cement. As the concrete matures, much of the capillary space becomes filled with the products of hydration and the products of any reactions occurring between the chemicals of the paste and the aggregate. Some of the finer capillaries are spaces created by differential crystal growth.

The capillaries are detected only when specialized methods are used. In laboratories thus equipped, the various types of electron microscopes can be used to view the capillary void system. In the VTRC laboratory, the abundance and location of the capillary voids are detected by use of the P/EF microscope in the study of fluorescent thin sections of the specimen concrete (see chapter 13). At the NIST laboratory, the SEM is used (see chapter 14). Rarely, capillary voids can be noted during the determination of the parameters of the void system. In that event, capillary voids are considered to be paste.

6.2.2 Entrained Air Voids

Entrained voids are small spherical voids enfolded by the mixer. Surface-active, air-entraining admixtures are added to the mixture to stabilize a specified percentage of these voids and thus protect the hardened HCC against the destructive forces of freezing and thawing. Thus, the entrained air void is a desirable void. Entrained air voids are generally considered to be larger than the capillaries (at least 5 μm in diameter), but smaller than the entrapped voids (Verbeck, 1966, 1978; Hearn, et al., 1994). Entrained air voids have so much surface tension relative to their volume that they are little affected by the shape of nearby particles. Distortion occurs in these small voids only when external forces distort the concrete after the beginning of hardening.

The presence of the proper quantity of well-distributed entrained air voids can prevent deterioration of the concrete by relieving the pressures that can develop during the freezing and thawing process (Helms, 1978; Hover, 1994; Newlon, 1978; Newlon and Mitchell, 1994; Pigeon and Pleau, 1995). Entrained air also facilitates the placement of the concrete because the entrained air voids increase the fluidity of the paste.

Very irregularly shaped small voids (maximum dimension of less than 1 mm) cannot be properly called entrained voids because they lack the characteristic shape showing that they were formed by the surface tension of the air-entraining admixture. It is not known if such voids function to protect the concrete against the deterioration caused by freezing and thawing. Small, irregular voids (particularly if not at an aggregate boundary or a wearing surface) may be evidence of retempering (see appendix C).

Figures 53 and 54 show concretes with different percentages of air voids.

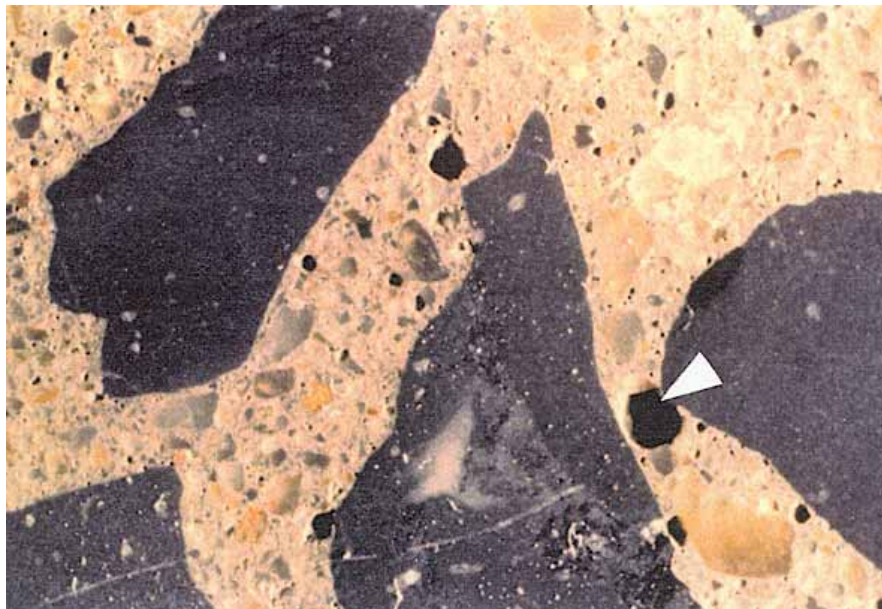

The void content of this concrete is in the middle of the specification range. The large void marked with an arrow is about 2 mm across (larger than an entrained air void). Notice the very fine voids throughout the paste.

Figure 53. Surface of finely lapped slice of concrete containing 5.6 percent total air voids.



The void content of this concrete is way above the upper limit of the specification range. The void indicated by the arrow is about 1 mm across. The area of darker paste (lower left) has a lower void content. If an HCC contains more than one kind of paste, this generally indicates that the mixture had begun to hydrate before additional water was added (see section 8.4 and appendix C).

Figure 54. Surface of finely lapped slice of concrete containing 17 percent total air voids.

6.2.3 Entrapped Voids and Water Voids

All voids, regardless of shape, that have a maximum dimension (on the surface examined) of more than 1 mm are defined by VTRC as entrapped voids (large spherical) or water voids (large irregular). If voids occur flattened out at the boundary between the aggregate (usually coarse aggregate) and the paste, they are a class of entrapped voids called *boundary voids*.

Voids larger than entrained voids have no appreciable beneficial effect and weaken the HCC. Such voids are controlled by the efficiency of whatever system of consolidation is in use and the workability of the concrete at the time of consolidation. Particular voids may be caused by too much water in the HCC, a strong affinity of a particular aggregate lithology for water, improper consolidation, and occasionally by the dissolving away of $\text{Ca}(\text{OH})_2$. Water- or air-filled pockets not removed by consolidation will leave irregularly shaped voids (see figure 55). Water voids are irregularly shaped voids created in the HCC by bleed water prevented from rising to the surface by an aggregate particle or the hardening of the paste. Water voids contained water when the HCC was fresh and unhardened; however, in the hardened state, these voids are filled with air and thus might be more properly termed *water-formed air voids*.

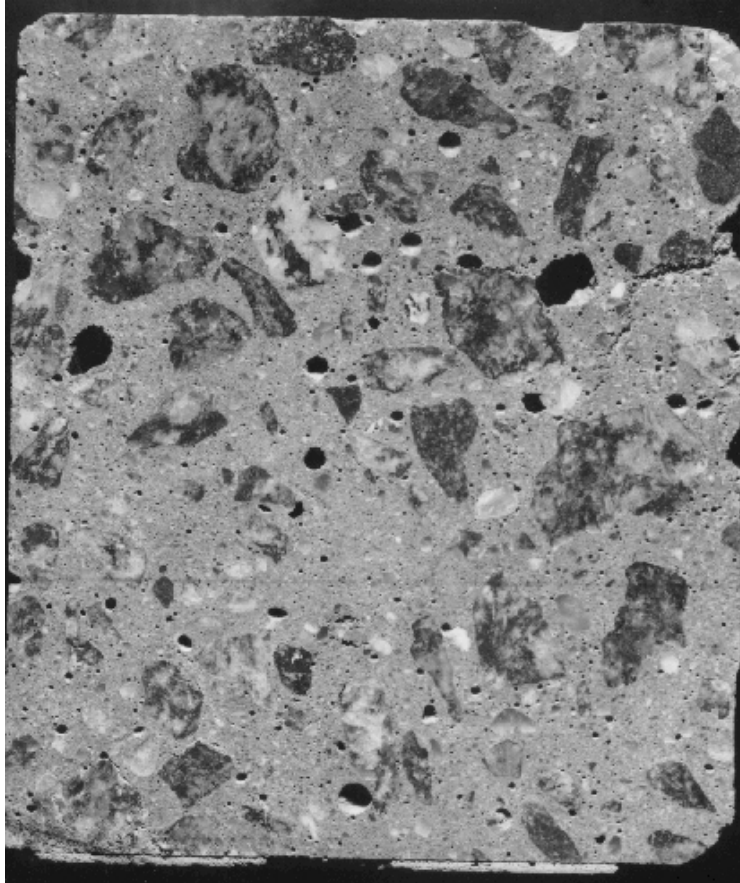

In this instance, the concrete, which had not yet been consolidated, became hard and unworkable while repairs were being made on the paving equipment. The specimen is 100 mm across.

Figure 55. Concrete core with about 4 percent large, irregularly shaped voids.

6.3 QUANTITATIVE DETERMINATION OF AIR-VOID PARAMETERS

6.3.1 Overview

In hardened concrete, the air-void system may be characterized by one of two methods described in ASTM C 457—the *linear traverse method* or the *modified point-count method*. The parameters calculated include:

- **Air-void content (symbolized in ASTM C 457 by *A*):** It is a percentage by volume. A particular spacing of air voids is required to protect the concrete from the expansion of water during freezing. Empirical relationships were established between the void spacing and the total air content so that air content is used as the concrete design and control parameter. However, since the development of these relationships, a variety of new air-entraining admixture formulations are being used that produce void systems with characteristics significantly different from those upon which the relationships were established. Consequently, extremely low spacing factors may occur with air contents at the upper end of the specified range. Excess air-void content or very low spacing factors

(i.e., < 0.10 mm) will cause the concrete to have less than the intended compressive strength.

- **Void frequency (symbolized in ASTM C 457 by n):** It is the number of voids per unit length of traverse. The void frequency is required in the calculation of the average chord in the modified point-count method.
- **Average chord length (symbolized in ASTM C 457 by l):** It is the length of the sum of the chords of the air voids divided by the number of voids encountered in the traverse.
- **Specific surface (symbolized in ASTM C 457 by α):** It is the surface area of the average void divided by the volume of the average void. It is calculated from the average chord. The unit involved can be expressed as squared units divided by cubed units or as units to the -1 power. The higher values (higher void surface area per void internal volume) indicate smaller voids. Small voids (with a shorter average chord) are desirable because they disperse throughout the concrete with small unprotected volumes of paste in between. If the same air-void content were present in larger voids, the unprotected volumes of paste would be much larger.
- **Spacing factor (ASTM C 457):** It is calculated from the specific surface, the percentage of air voids, and the percentage of paste (see section 7.1) that must be protected. It is expressed as a decimal value of the measurement unit. The spacing factor is a theoretical measure of the average distance water or expansive force must travel in HCC before it contacts an air void (i.e., half the average distance between air voids).

The air-void analyzer (AVA) is an apparatus that determines the characteristics of the air-void system from a sample of fresh concrete. Developed in Europe, the device measures the rate of air loss from a sample of mortar mixed with a viscous liquid and then uses Stoke's law to determine the size of the bubbles rising through a water column. The device reports the air content by volume of concrete contained in the entrained air voids, the specific surface of the entrained air-void system, and a value for the spacing factor. The AVA is a focus technology of the American Association of State Highway and Transportation Officials (AASHTO) Technology Implementation Group. See http://www.aashtotig.org/focus_technologies/index.stm for more information.

6.3.2 Methods and Equipment

6.3.2.1 Overview

New methods and equipment are continually being devised to monitor and determine the air-void parameters of hardened concrete. It is part of the job of the petrographer to assess the value of new methods and equipment and to decide which method is of value in which situation and, therefore, which equipment is worthy of a place in the budget of the organization. If the results of an air-void determination are to be presented in court and the testimony of opposing expert witnesses will be heard, any deviation from the principles of ASTM C 457 that has not been agreed upon by the litigants may invalidate the results of the analysis. Within an organization, particular deviations from the strict interpretation of ASTM C 457 may be acceptable if justified by their experience.

According to ASTM C 457, air-void system analyses can be efficiently performed with several methods and kinds of equipment. Suitable equipment for the determination of air-void parameters in hardened concrete includes, but is not necessarily limited to: (1) linear traverse, (2) modified point-count, and (3) image analysis equipment. Typically, the types of equipment to be used permit or facilitate the movement of the specimen of HCC on the stage of a microscope so that data may be collected over the specified area and from the specified length of traverse. Generally, the data collected are:

1. **Total length of the traverse over which the determination is made:** In the modified point-count method, the total number of points examined and the distance the equipment moves between the points are required for the calculations.
2. **Portion of the traverse that is across air voids:** In the linear traverse method, this portion is the sum of the chord lengths across air voids; in the modified point-count method, this portion is the number of points that occur in air voids multiplied by the distance the equipment moves between points.
3. **Number of voids occurring in the traverse examined:** The accuracy of the determination of the specific surface and spacing factor is completely dependent on the accuracy of the count of the number of voids on the line traversed. In the linear traverse method, the number of voids in the traverse is the number of chords collected; in the modified point-count method, it is the number of voids counted along the traverse line.

The procedures detailed in ASTM C 457 are those to be used with nonelectronic types of equipment (see ASTM C 457, figures 2 and 6). When equipment is used that includes automatic devices for moving the specimen, electric or electronic counters or totalizers and calculators, or measuring devices, the equipment must allow adherence to the principles of ASTM C 457 and permit or perform the calculation of the same parameters of the air-void system from the same data. The exact procedures followed for the operation of the equipment must be those described and specified by the fabricator of the equipment.

It is not known which type of equipment produces the most accurate results or how accurate the results need to be. Modified point-count equipment is favored by those who need speed. If the air-void parameters of spacing factor and specific surface are not required, a simple point count can be performed. Those who want a record of the chord-length distribution for research purposes favor linear traverse equipment, whereas those who want speed and the ability to collect a lot of data and manipulate them on a computer in many different ways favor image analysis equipment. Image analysis equipment can strain the equipment budget, but requires less operator time since a human does not actually perform the examination. Research laboratories will usually require either point-count or image analysis equipment for speed in making routine determinations, and linear traverse equipment for its ability to determine chord-length distribution on a surface unaltered by the fillers and dyes required by image analysis.

NOTE: The air-paste ratio method of calculation detailed in ASTM C 457 is to be used ONLY: (1) when proportions of the ingredients in the mixture are known with some certainty; (2) when it can be assumed that no change in mixture proportions has occurred (e.g., retempering has not occurred (i.e., the amount of paste can be closely calculated)); AND (3) when, because of the lack of exposure of a generalized specimen of the HCC or because of the extremely large size of the aggregate, it is impossible to obtain a specimen of the HCC for microscopical analysis with an aggregate distribution that is representative of the placement. The air-paste ratio calculations use the aggregate-paste ratio of the mixture design to transform mathematically the air-paste ratio and other air-void properties determined microscopically to an estimated percentage of air voids, specific surface, and spacing factor for the concrete. In these situations, it is convenient to select a specimen of HCC that is low in aggregate so that the microscopist will not have to spend excess time moving over aggregate.

6.3.2.2 Linear Traverse

Using the linear traverse equipment (see figure 56), the operator tabulates the chord lengths across all phases of interest and records them for later analysis (Walker, 1988). This sort of data permits the straightforward calculation of the void parameters by the summing of the lengths of the chords and the counting of each occurrence of a phase. Because the calculations are extremely sensitive to errors made in the determination of the number of voids traversed, the method of deciding whether a void is or is not touched or transected by the line of traverse must be consistently applied throughout the analysis. If the individual lengths of the chords of the air voids are recorded and particular shape assumptions are made, a graphical representation of the chord lengths will indicate the size distribution of the air voids. The collection of the air-void data requires one pass of the microscope along the traverse line. The data necessary for calculation of the paste content may be collected at the same time or a separate determination can be made for the paste content. This procedure is further discussed in section 7.1.2. With some types of linear traverse equipment, all the air-void parameters are automatically calculated; with others, the calculations must be performed on a calculator or computer.

6.3.2.3 Point Count

With the point-count equipment, the operator records the type of substance (air void, paste, or aggregate) appearing at the index point of the reticle at a large number of points as provided by the click stop locations on the HCC specimen as the stage and specimen are moved under the microscope. The points may be randomly distributed or regularly distributed on a randomly placed grid or on a traverse line. Data concerning the relative amounts of all the phases and the voids encountered can be collected from one pass along the traverse line. If difficulty in distinguishing the exact paste-aggregate boundary is encountered, the operator may consider a separate pass over a lightly etched surface to collect these data (see section 7.1.2). The air-void parameters may be calculated by the analysis equipment or separately calculated using a calculator or computer.



Either linear traverse or point-count software can be used to control the motion of the stage and to collect data.

Figure 56. Partially automated linear traverse equipment for determining air-void parameters.

6.3.2.4 Image Analysis

Image analysis systems incorporating a variety of equipment have been used to examine HCC. The typical setup uses a video camera with a magnifying lens (see figure 57) or a standard stereomicroscope with a video camera (see figure 56). Peterson, Swartz, Sutter, and Van Dam (2001) describe the use of a flatbed scanner for imaging. The collected images are then analyzed by computer software to calculate the air-void parameters. To enable the image analysis software to recognize air voids as distinct from other features requires that the specimen be specially prepared so that each of the three major phases of interest (voids, paste, and aggregate) is a distinct tone (e.g., white, black, and medium gray). A typical surface preparation is to ink the surface black, fill the voids with a white powder (e.g., kaolin) and remove the excess from the surface, and finally ink out any filled voids that the system should not classify as air voids (i.e., voids in aggregate particles). Peterson, et al. (2001) used a three-step procedure by collecting

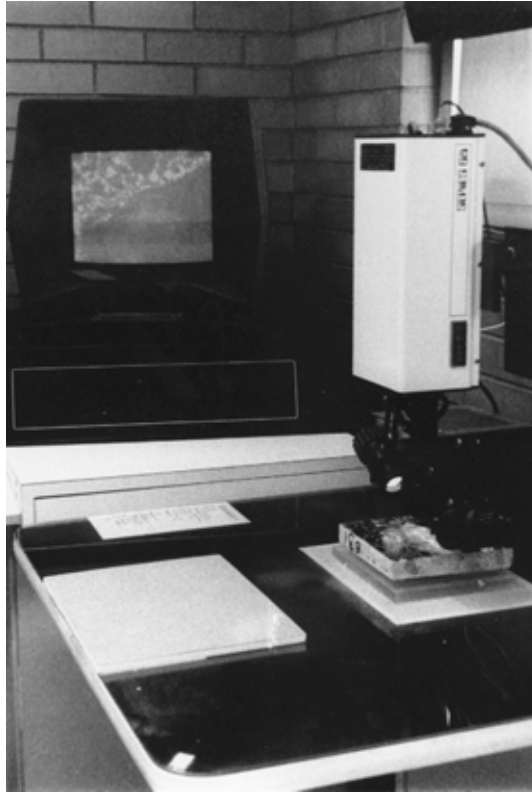

Photograph by R.H. Howe, courtesy of PennDOT

The instrument is shown in the process of analyzing the air-void system of a slice of concrete. The screen in the background shows the progress of the analysis.

Figure 57. Image analysis equipment.

images of: (1) the untreated surface, (2) the surface treated with phenolphthalein (to differentially stain the paste), and (3) the inked and filled surface. The specimen preparation methods for image analysis can be exacting and can make the surface used useless for ordinary stereomicroscopic examination (as described in chapter 8). If it is desirable to perform normal examinations, these should be performed before the special surface treatments or, alternately, on an opposing lapped surface. Missouri DOT is currently managing a pooled-fund study to develop image analysis software with processing and pattern recognition capabilities to determine the air-void parameters from an ordinary lapped surface (Missouri DOT, 2000).

Automatic systems that require filling the voids (thus hiding their interior surface) cannot make particular distinctions by a human operator possible. The human operator can often mentally reconstruct what the surface examined would have been if this or that flaw had not occurred. The human operator can judge whether an observed void is an air void, a fly-ash cenosphere, or the hole left where a small round grain of sand has fallen out. These distinctions are generally possible by the study of the reaction products and the luster of the interior of the void.

6.3.2.5 Other Considerations

At VTRC, it has long been recognized that the accuracy of a linear traverse determination of the air-void parameters is as dependent or more dependent on the number of voids encountered and measured along the traverse as it is on the length of the traverse. Once 1000 voids have been measured and counted, the results from the data obtained subsequently change very little. Snyder, Hover, and Natesaiyer (1991) conducted an analytical investigation of the effect of the number of voids and the length of the traverse on the minimum expected error that can be encountered in a linear traverse determination of the void parameters in hardened HCC. Their work supports the belief that little additional accuracy is achieved if the determination includes more than 1000 voids and that almost no additional accuracy is achieved with more than 2000 voids.

When the air-void parameters are determined for intradepartmental purposes, the traverse length can be limited to that needed to count the 1000 or more voids. In such cases, the traverse length needed should be estimated and the specimen set up so that the traverse length is evenly distributed over the available surface. Under circumstances when ASTM C 457 requires 2540 mm of traverse, it is estimated that only 1270 to 1778 mm are required for the collection of data from 1000 voids in ordinary within-specification concrete. Should a legal controversy arise concerning the subject concrete, any traverse length deficiency can be made up by collecting additional data from traverse lines (also evenly distributed over the surface). If the traverse direction and starting point are randomly chosen, in both cases, the randomness of the data collection will be maintained. It is our view that spreading the data collection area over as large a surface area as possible so that any irregularities of void distribution (any clumping or areas devoid of voids) become part of the data recorded and examined is more important than the length of the traverse line.

The corollary is that if the number of voids is very small because of low air content or large voids, the length of traverse recommended in ASTM C 457 is probably not sufficient to obtain accurate air-void parameter data (Snyder, et al., 1991). Under such circumstances and with borderline compliance with specifications, it may be wise to use an additional length of traverse to ensure accuracy. In most cases, the small specific surface and large spacing factors caused by the lack of sufficient small voids will decisively indicate the inadequacy of the void system to provide freezing-thawing durability.

The method of deciding whether a void is or is not touched or transected by the line of traverse must be a simple rule that is firmly adhered to throughout any particular analysis. Pleau, et al. (1990), using the point-count method, recommended: "A simple way to guarantee a random choice is to systematically choose the constituent located in a given quadrant (of the field viewed), say the upper-left corner of the crosshairs" (p. 5). A similar method can be devised for whatever type reference point, reticle, and counting method are in use. Other researchers (e.g., Mather, 1989) have suggested that points in dispute be collected in a separate register and later distributed to the totals of the constituents in the same proportion as are the data concerning which there is no dispute.

6.3.3 Preparation of Specimens

The importance of the proper preparation of the surface of the slice of concrete cannot be overemphasized (see figures 42 through 44). In most laboratories, skilled, highly trained technicians prepare specimens. A poorly prepared specimen can cause a determination of the percentage of air present in a specimen to deviate from the true value by as much as 2 percentage points (20 percent to 50 percent of the true value). A rough surface makes it impossible to detect small voids. This will have the effect of lowering the detected percentage of air, decidedly lowering the specific surface, and thus raising the spacing factor. Quantitative determination on a surface that is undercut and wherein the edges of the voids have been chipped or worn away can provide data that indicate the presence of more air than really exists.

Chapter 5 has several suggestions for the treatment of weak or immature concrete before lapping. Pleau, et al. (1990) suggests soaking the slices (slabs) in water for a few days to promote further curing and cement hydration and thus produce a strengthened paste for lapping. This is a satisfactory procedure for recently cast concretes when the intent of the examination is merely to determine the parameters of the air-void system and its effectiveness may be improved by saturating the soaking water with lime, since soaking in plain water may leach lime and thus weaken the paste. Concretes that contain pozzolans or slag will benefit from gentle moist-heat curing (i.e., at 38 °C). However, if the investigation requires a detailed examination of the paste microstructure, the potential altering effects of plain or lime-saturated water must be considered. More important, these and other effects (e.g., dissolving reaction products or liquefying expansive alkali-silica gels) must be considered before using this method in the examination of mature concretes for condition assessment or fault diagnosis.

Each method of producing a finely lapped specimen surface for microscopical study will probably produce different effects on different types of concrete (different w/cm, different kinds of aggregates, different degrees of maturity and deterioration).

In particular concretes in which the shape of the air voids has become distorted (see appendix C), all manner of overlaps and crushing of voids may occur. The operator should be alert and ready to record the data for each void in a logical and consistent manner.

6.3.4 Technician Considerations

The linear traverse and the modified point-count methods are tedious and hard on the eyes. A single determination of the air-void parameters of a concrete by means of the linear traverse method can take up to 7 h, depending on the size and quantity of the voids. A technician cannot spend more than 4 h per day doing this sort of work on a day-to-day basis. Everyone who has tried has found that the ability of their eyes to focus has deteriorated on the following day. The training and keeping of good microscopical technicians can be a major undertaking, requiring tact, skill, understanding, and a flexible schedule of rest periods.

Image analysis systems do not require that the operator be with the equipment after the initial adjustment; thus, eye fatigue and the need to train technicians to perform microscopical analyses are eliminated.

The following points are important considerations in the hiring and training of technicians for the microscopical analysis of air-void systems:

- **Try to avoid using operators for linear traverse and point-count determinations of air-void parameters who do not have good binocular vision.**
- **Keep available standard specimens of concrete with a range of different types of air-void systems:** Air-void contents of 2 percent to 14 percent are recommended. These should be specimens that have been analyzed by a number of different operators. The results previously obtained should be kept in a secure place by the supervisor. Each new operator who is trained for this work should be tested on the standard specimens, and training should continue until the results obtained by the new operator are comparable to the range of results recorded in the past.
- **Make sure that each operator knows how to adjust the positioning of the specimen so that it is flat and so that the specimen can move under the microscope and remain in the same focal plane:** Although this procedure can be tedious, it is not nearly the nuisance that continual focusing of the microscope during the traverse will prove to be if it is neglected.
- **Make sure that each operator knows how to adjust the ocular spacing for his or her interpupillary distance; the height of the chair; and any other items available for greatest visual acuity, comfort, and convenience:** The operator must understand that these adjustments are emphasized because proper adjustment adds to the accuracy of the determination. An operator suffering from a headache or backache is not as able to produce good data as a comfortable, healthy operator.
- **Make sure that the operators understand the need for good focus and how to achieve good focus on the reticle for their main eye and simultaneous good focus on the specimen for both eyes:** Each person has one eye that looks straight ahead (the main eye). The other eye observes things at an angle. Whenever an optical technique requires a reticle in one eyepiece of a binocular system, the reticle should be placed in the lens system used by the main eye.
- **If more than one person uses the microscope, make it a routine practice for each operator when beginning work to check the focus of the reticle and the focus of the surface being examined:** Emphasize that the surface should be in focus throughout an entire traverse across the specimen. If focus is lost, errors will be great and the ability to judge the type and origin of a flaw in the finish of the surface being examined will be seriously diminished.
- **Observe the actions of the operators and determine if they are following instructions:** From time to time, have the work of the operators checked by having another operator repeat the measurement of a specimen, have the operator repeat a specimen done some months ago, or have the operator repeat one or more of the standard training specimens.

- **Teach operators that great care must be taken to include in the count every void crossed by the traverse:** The air-void count should be performed slowly and accurately. Very small voids and voids that are just barely touched by the traverse line must be counted. When the linear traverse procedure is used, it may be necessary to slow the motion along the traverse almost to a stop (if not completely) to register very small voids in the count. If it is realized that a void with an essentially zero chord length (because the traverse line is tangent to the void or because the void is very tiny) has not been counted, it is possible with some equipment to bring the motion along the traverse to a halt (so that zero chord length is recorded) and to momentarily press the button that registers the presence of the appropriate void type. The location of a void along the traverse line is not a matter of concern, and the operator can record it anywhere. In the modified point-count method, no automatic motion is usually used while air voids existing along the traverse line are counted; therefore, this error will not be made in the same way.

6.4 CLASSIFICATION OF VOIDS

6.4.1 Overview

The determination of the abundance of the various types of voids is very useful in concrete research. It can make data available that can change various practices in the mixing and placing of HCC. As an example, it was once thought that the speed of the screed pulling the vibrators through freshly placed concrete did not affect the degree of consolidation. This did not seem logical to some. The Ballenger Construction Company of North Carolina set up a series of test sections of pavement in which the speed of the screed was carefully controlled. A detailed petrographic laboratory analysis of the abundance of the various sizes of voids in the air-void system of 24 cores that had been removed from these test sections showed that there is a good inverse relationship between the speed of the screed and the degree of consolidation (Walker, 1972). As a result, the maximum speed of the screed is now limited in many specifications.

The quantitative determination of the abundance of various types of voids can be an important part of the petrographic analysis of a specimen. In the VTRC petrographic laboratory, air voids are classified as entrained or entrapped during routine point-count analyses (see table 15). With equipment designed for this purpose, this determination may be performed concurrently with the determination of the other parameters of the air-void system.

In a finely lapped slab or thin section, the size and shape of the voids can be used as indicators of the void origin and type. The luster and texture of the interior of the voids may sometimes be used in the recognition of voids caused by accumulation of water and passageways for water. The properties on which distinctions may be made between the various types of voids are arbitrary and may vary from one laboratory to the next. Because these distinctions are made on the appearance of a void on the surface of a slice (where the third dimension of the void cannot be seen), many large voids will be classified as entrained voids when they are really entrapped voids. As indicated in figures 58 and 59, a small section through a large void can be indistinguishable in two dimensions from a large section through a small void. A cross section that is larger than the defined maximum for entrained voids must be a section of an entrapped air void or a water-formed void. A significant number of large cross sections indicate a great number of large voids.

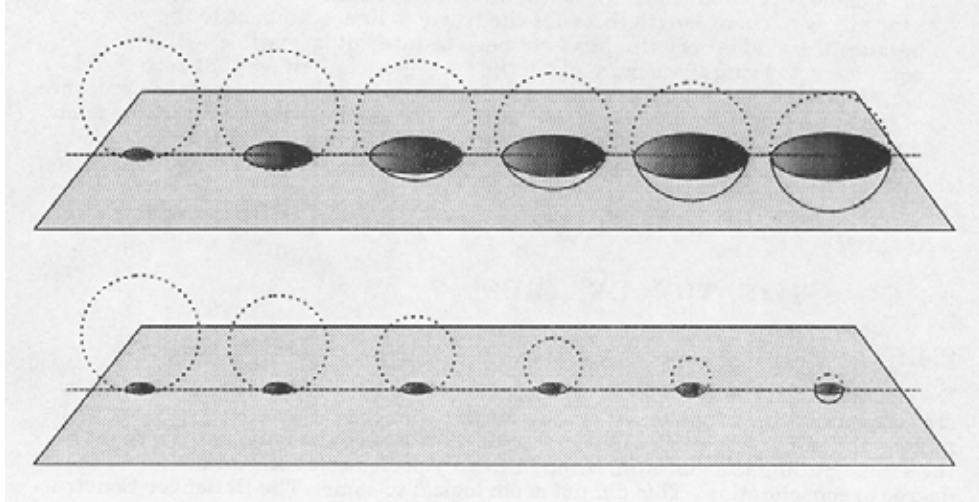
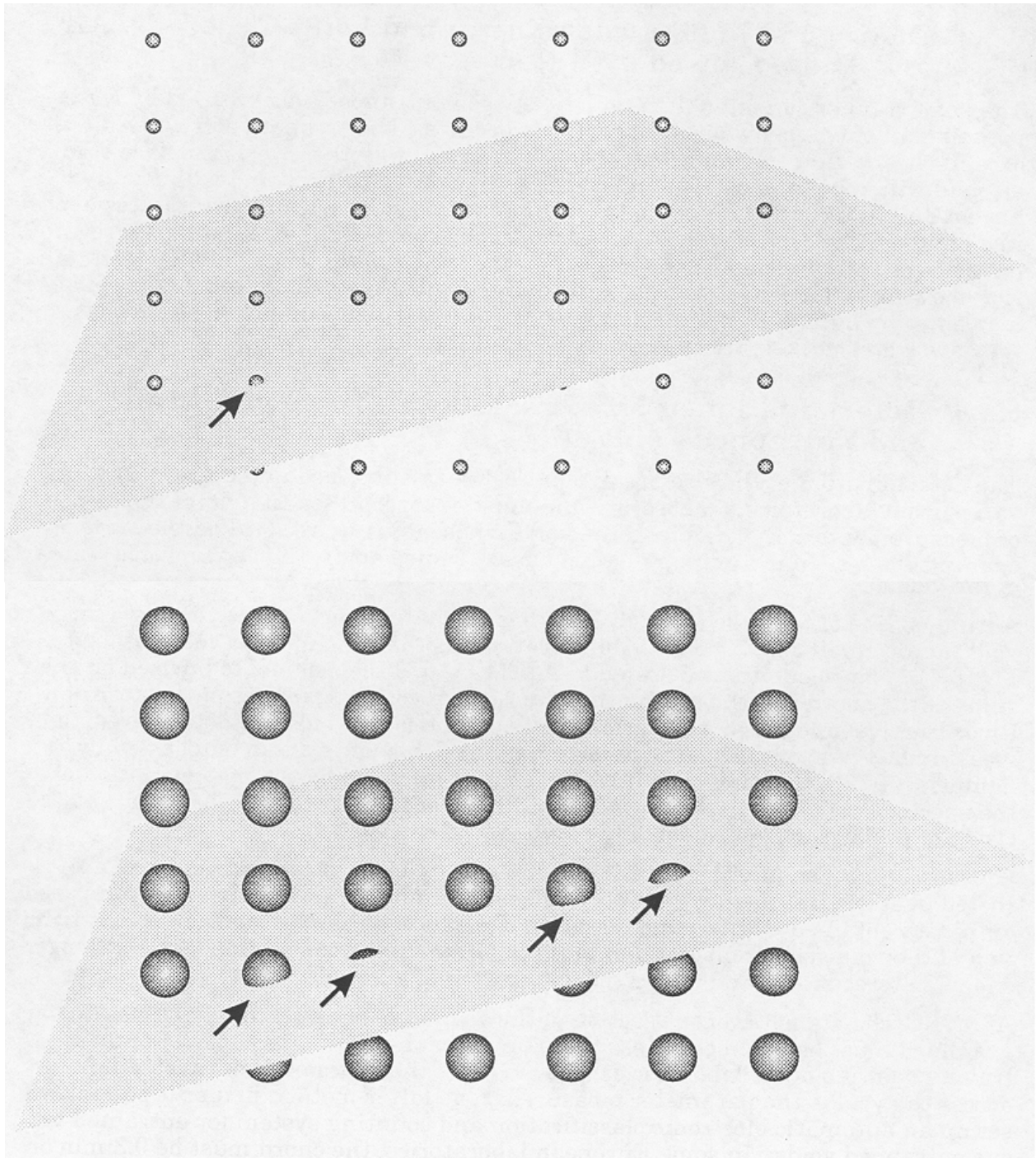

Figure 58. Illustration of various sizes of sections that may be expressed on a randomly placed plane.



Each array of voids is crossed by a randomly oriented plane. There is the same number of voids in a unit area in each array. Note that the plane touches more voids (see arrows) when the voids are large than when the voids are small.

Figure 59. Two equally spaced arrays of voids.

6.4.2 Distinguishing Entrapped Air Voids From Water Voids

The petrographer can often distinguish between entrapped voids caused by water pockets and entrapped voids caused by air pockets. The estimate will necessitate careful observation and some extrapolation. In general, the interior surface of an air void will appear smoother, sometimes even shiny. A water void will usually have a dull interior that appears to have had small particles and precipitates deposited onto it. In the case of water-formed voids, the shapes of the bounding aggregate particles are often visible in the interior of the void. Water voids may have an interior showing water movement patterns, may be interconnected bleed-water voids, or may show by the nature of the internal deposits and asperities and by their position that they are water pockets trapped by aggregate particles.

6.4.3 Distinguishing Entrained Voids From Entrapped Voids

The determination of the size breakpoint between entrained and entrapped voids varies from laboratory to laboratory and must be interpreted in light of the method of measurement. For example, if the voids whose maximum chord on the surface examined is less than 1 mm are defined as entrained voids, then some voids whose true diameter is larger but not observable because the diameter is not in the plane of observation will be classified as entrained voids. The petrographer should maintain a clear idea of the meaning of the methods of determination in the size sorting of the voids.

A random line of traverse through HCC has a greater chance of traversing a large void than a small one. The probability ratio is the ratio of their volumes (see figure 60). The calculations detailed in ASTM C 457 use the sums of the chord lengths and the count of the voids regardless of the desirability or relative amounts of the various sizes. If the large voids are not counted and measured as part of the overall determination of the void system (suggested by Sommer, 1979), the control against large voids provided by the determination of the specific surface and spacing factor will have been blocked and the apparent precision of the method spuriously improved (Walker, 1980).

Unless the method and the criteria used to obtain data concerning void size are rooted in statistics, the data are only rules of thumb and valid only when compared with data obtained by the same methods. Calculations can be made on the distribution of the void sizes from chord data if particular assumptions are made concerning shape, heterogeneity, and isometric distribution of air voids.

At VTRC, the diameter of the section of the void as seen on the finely lapped surface examined must be equal to or less than 1 mm for the void to be considered an entrained void. In other laboratories, the length of the chord on the traverse line across the void is the parameter measured. The latter method makes it possible to set up an automatic electronic classification and counting system for entrained versus entrapped voids. In some European laboratories, the chord must be 0.3 mm or less for the void to be considered an entrained void (Wilk, et al., 1974). A void viewed in a lapped surface may be transected by the surface either above or below its true diameter, and there is no known way to measure an actual internal diameter. Efforts have been made to peer into a void to try to get an estimate of the true diameter; however, these efforts may serve only to confuse the issue. In many laboratories, decisions on individual void size are made on the lapped surface as viewed. A large void, more than 1 mm in diameter, may be so oriented that the surface examined truncates only a small portion of the void (the extreme top or bottom)

when considered from the finely lapped surface. Thus, there will always exist a larger proportion of large voids than can be recognized on the surface examined (see figure 58).

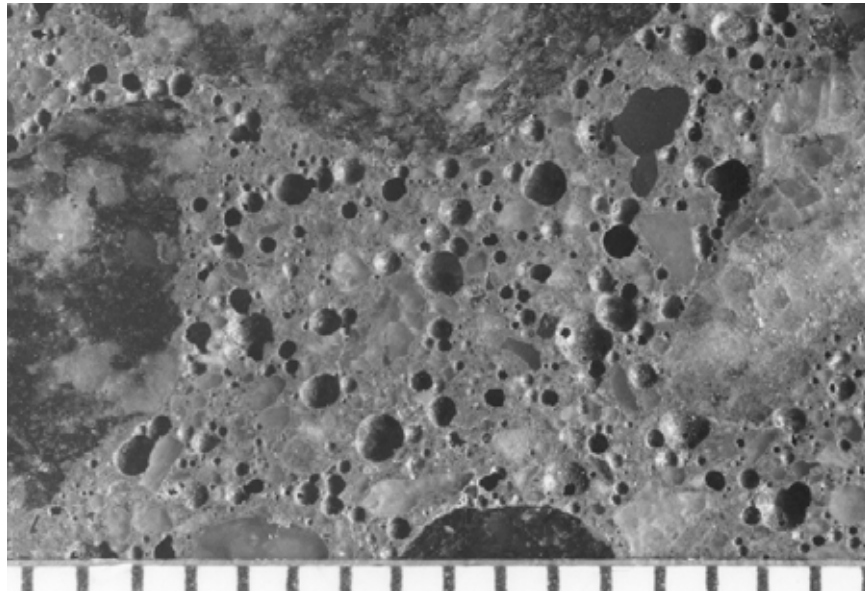

Scale is in millimeters.

Such large voids do not add to the resistance of the concrete to cycles of freezing and thawing, but do lower the compressive strength.

Figure 60. Void system produced by early types of high-range water reducers.

6.4.4 Procedures

The procedures given here are for the linear traverse method when the chord lengths are collected by an operator depressing an electronic recording device (Walker, 1988). The point-count method does not survey every void on the traverse during the percentage portion of the examination and, therefore, does not allow a classification of every void. Image analysis procedures are not discussed in detail.

This procedure is a three-step process:

1. **Examine each void when the void's leading edge comes to the index point (usually the center of the crosshairs) and determine which type of void is present:** With the wide-angle lenses and a magnification of 100X or less, voids of less than 1 mm in diameter will be completely visible in the field of view. Most voids can be classified at a glance as either entrained, entrapped, or water-formed. When borderline cases occur, use a finely marked metric ruler on the slice, in the field of the microscope, to determine void size (at low magnification, an eyepiece micrometer may be used).
2. **Record the presence of the void and the length of the chord across it in the usual manner for a linear traverse determination (by pushing down a button and holding it down until the trailing edge of the void is at the index point):** If three buttons are available for the three types of voids, each with its own tabulating device that separately

measures, totals, and counts the voids, depress the appropriate button for the type of void determined in step 1. If the chord lengths are recorded by using only one button and are individually printed on paper and the void encountered is not an entrained void, stop the motion of the traverse stage and mark the paper tape at the chord measurement with a symbol to indicate the classification of the void measured. Continue with the analysis. Repeat from step 1 for each void.

3. **When the analysis has been completed, add the lengths of the chords for each type of void (if not added by the linear traverse device employed) and report the percentage by volume and the count (individual voids per specified inches of traverse) of each in the total concrete.**

6.5 MEANING OF AIR-VOID PARAMETERS

The major parameters of the air-void system are interdependent. Most concrete specifiers require only that the air-void content be within particular limits. Recently, the trend toward end-result or performance-related specifications has introduced the requirement that the spacing factor be below a particular limit or the specific surface be above a particular limit (Holley, et al., 1999; Kaderbek, Tracy, and Krauss, 2002; Schell and Konecny, 2003). Although one-sided limits on the spacing factor or specific surface do not preclude air-void contents that are too high, compressive strength requirements serve as a limit on excessive air.

Although the parameters described in ASTM C 457 remain those commonly used to describe and evaluate air-void systems, there have been attempts to develop a more meaningful descriptor. Philleo (1983) began the process using void-size distribution to determine the volume of the paste within a particular distance (0.20 mm) of an air void and thus unprotected from cycles of freezing and thawing. Furthermore, the distance at which only about 10 percent of the paste remained unprotected was coined the *Philleo factor*. Similar concepts are discussed by Attiogbe (1993); Pleau and Pigeon, 1996; Pleau, et al., 1996; and Snyder, 1997. Snyder, et al. (2001) provides a detailed examination of the practical and theoretical basis for the measurement of air-void systems.

The following are some of the issues the air-void parameters will determine:

- **Resistance to deterioration caused by cycles of freezing and thawing:** The spacing factor is generally considered to be the most relevant measure of freezing-thawing durability provided that the concrete has adequate maturity. Adequate maturity is generally considered to have been achieved when a compressive strength of 26 to 28 megapascals (MPa) has been reached. The most often quoted maximum spacing factor value for ensuring frost resistance is 0.20 mm, with occasional references to higher values (Pigeon and Pleau, 1995). The Canadian Standards Association (CSA) has adopted a maximum average spacing factor of 0.23 mm with no single test exceeding 0.26 mm for frost resistance (Holley, et al., 1999; Schell and Konecny, 2003). Pigeon and Pleau (1995) point out that there is no clear benefit to spacing factors much below the maximum recommended values and, in fact, that excessively low values adversely affect concrete compressive strength. Specific surface values in excess of 25 mm^{-1} (mm^2/mm^3) will generally provide satisfactory spacing factors.

- **Use of specific admixtures:** The petrographer is often asked whether a particular admixture or an excess amount of a particular admixture has been used in a specific concrete. Extraordinarily low spacing factors accompanied by a high specific surface can indicate either excessive air-entraining admixture or (if the total air content is within specifications) the use of a highly specialized admixture. In the past, most air-entraining admixtures were formulations of neutralized vinsol resins. More recently, a wider variety of compounds, including vinsol rosins, tall oils, and synthetic detergents are being used. Some of these newer materials produce more stable void systems with significantly smaller bubbles. For a complete discussion of the various air-entraining admixtures being used and the production of air-entrained concrete, see Whiting and Nagi (1998).

During the first trials of some of the high-range water reducers, the paste was exceedingly compact; however, many of the voids were large. This created a specific texture, as illustrated in figure 60. The high-range water reducers used in present-day mixtures do not create such a high content of large voids; however, some concrete with this texture is still in service and requests to examine these concretes still come in.

- **Flaws:** An unusually large number of voids that appear to have held water when the concrete was fresh indicate flaws in either proportioning or workmanship. An abundance of entrapped voids indicates either poor consolidation or early loss of slump.
- **Placement issues:** The data concerning the distribution of the types of voids as detailed in section 6.4 can be used to discover particular placement conditions, such as the efficiency of the consolidation and the reasons for various nonstandard conditions (such as low compressive strength or high permeability). Sometimes, when hand-held vibrators are used, there is excess entrapped air because of the persistent but erroneous belief that the specified amount of vibration will cause a loss of a portion of the required entrained air. Adequately consolidating the concrete to remove entrapped air voids will not adversely affect the ability of the entrained air-void system to provide resistance to cycles of freezing and thawing (Simon, Jenkins, and Hover, 1992).

Visually apparent “vibrator trails” have been reported from some paving operations, with longitudinal cracks developing in the trail. The distinctive “trails” result from segregation of the concrete as mortar moves into the vibrator’s zones of influence. Comparison of air-void characteristics suggested that the vibrator trails had higher spacing factors than the areas of the slab less affected by vibration (Gress, 1997).

Although the quantity of large voids and specific surface are generally not addressed in current specifications, it is important to consider these parameters and to be able to explain their meaning. In general, it is much easier to talk about a significant quantity of large voids than to explain the mathematical derivation of the specific surface. A percentage of large voids exceeding 1.5 percent is considered to be high. More than 2 percent is considered to be excessive, and explanations for the prevalence of the large voids are sought. Does the concrete appear to have been retempered? Improperly mixed or consolidated? What is the reason?

CHAPTER 7. QUANTITATIVE ANALYSES OF PASTE, AGGREGATE, AND OTHER COMPONENTS

7.1 PASTE

7.1.1 Overview

It is necessary to calculate, estimate, or determine microscopically the volume of air-free paste in an HCC specimen in order to calculate the specific surface and the spacing factor by means of the equations in ASTM C 457 (see chapter 6).

7.1.2 Procedures

7.1.2.1 Calculation From Mixture Design

When the design of the mixture is known and it is fairly certain that all additions of water or other changes in the mixture have been properly documented, the percentage of paste can be calculated from the mixture design by adding the volumes of water and cementitious materials and expressing the volume as a percentage of the total volume of HCC produced by the mixture (ACI 211.1, ACI 211.2, ACI 211.3).

7.1.2.2 Estimation

Slight variations in paste content used in the calculations of air-void parameters do not cause much change in the values obtained. Therefore, for ordinary intradepartmental work, for preliminary work, and whenever accuracy of the spacing factor and specific surface is not required, the paste content is estimated. The normal range of paste content is 23 to 32 percent; 27 percent has often been used as a good estimate of paste content in normal concrete (ACI 211.1, ACI 211.3, ACI 221R). The petrographer should use his or her judgment to adjust this figure based on the appearance of the specimen (see figures 61 and 62). If the quantity of the paste appears to be far from normal (see figures 63 and 64), a microscopical determination of the percentage of the paste should be made to permit an accurate determination of the air-void parameters. If an estimate is to be used, the calculations may proceed and the data and method recorded in the notes for the report.

7.1.2.3 Microscopical Determination

The amount of air-free paste present is most easily determined by making a microscopical determination (linear traverse or point-count method) of the amount of aggregate present. The aggregate occurrence (the sum of the aggregate chords or the sum of the points falling in the aggregate) is calculated by dividing by the total (total traverse length or total number of points) to determine the percentage of the aggregate. Most laboratories using point-count equipment perform paste content determinations concurrently with air content determinations; therefore, separate paste determinations are most often needed when linear traverse analyses are performed. The paste percentage is determined by subtracting the aggregate and the air percentages from 100 percent.

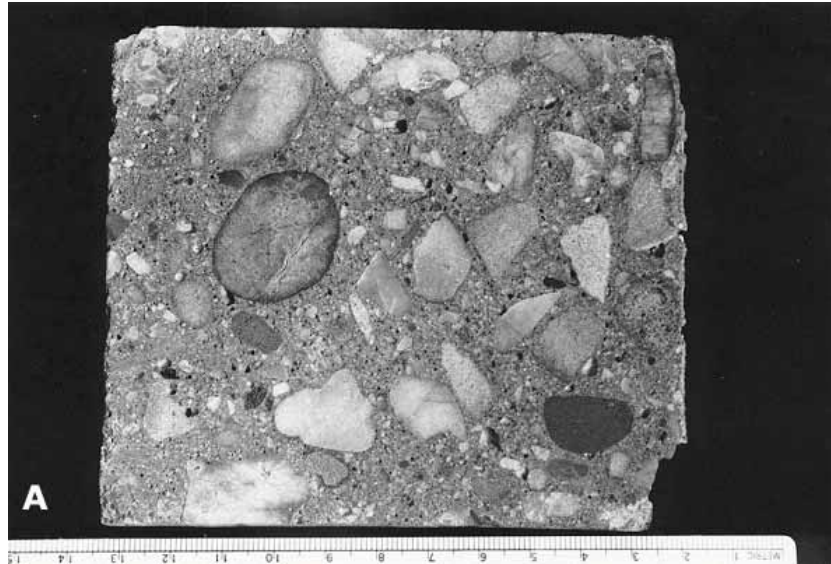

**Figure 61. Finely lapped slices of concrete with normal paste content (actual size):
Rounded to subangular quartz gravel coarse aggregate and fine sand aggregate.**



**Figure 62. Finely lapped slices of concrete with normal paste content (actual size):
Angular crushed granite coarse aggregate and fine sand aggregate.**

To obtain the same accuracy in a microscopical determination of the aggregate as that of the air voids, at least 1000 occurrences (fragments) of the aggregate must be counted (point count) or measured (linear traverse). To determine the percentage of a substance of which there are only 200 occurrences in the traverse of the surface on which the percentage of air was determined, five such slices would have to be prepared and examined. Examining such a large number of surfaces is often economically impossible, and unless the air-void determination included these surfaces, the air content determined may not be relevant to the paste content. When there are

fewer than 1000 aggregate particles along a microscopical traverse, the percentage of paste or aggregate determined should be considered an estimate.

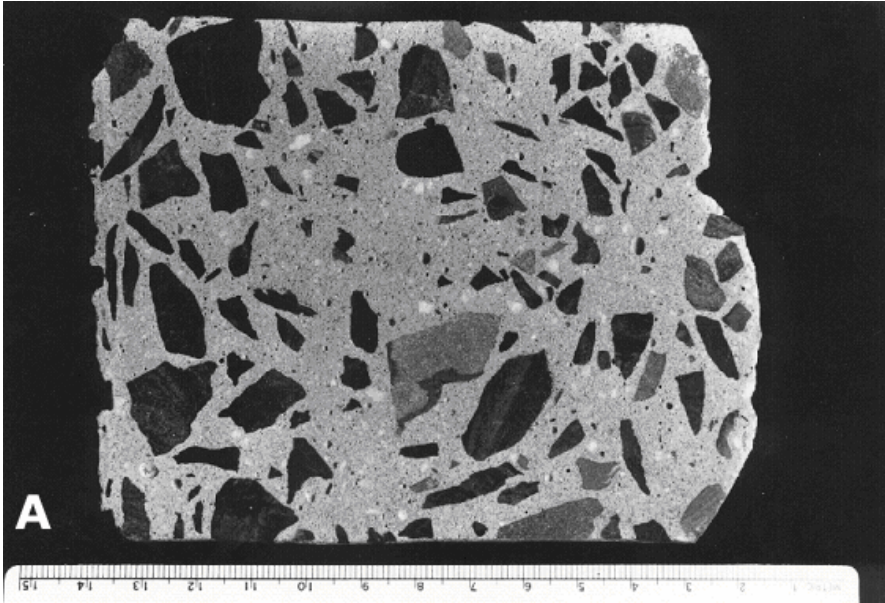

The coarse and medium-sized aggregate is a fine-grained metamorphosed shale, and the fine aggregate is a quartzose sand.

Figure 63. Finely lapped slices of concrete with abnormal paste content (actual size): High paste content.



The coarse aggregate is a granitic gneiss, and the fine aggregate is a river sand.

Figure 64. Finely lapped slices of concrete with abnormal paste content (actual size): Low paste content.

Paste can usually be distinguished from aggregate on the basis of color, luster, internal structure, and the sort of surface produced by the lapping procedures. However, occasionally, aggregate particles so closely resemble the paste in color, luster, and finely lapped texture that it is possible to miss small corners of coarse aggregates and fragments of sand and be quite uncertain about the exact location of the boundary between these phases. Strangely enough, carbonate aggregate is usually distinguishable by color, luster, translucence, and crystal structure. It is usually the light brown to creamy gray quartz pebbles and sands that are the most difficult to distinguish from paste.

When aggregate particles are lapped in a slice of concrete, they are ground off to the level of the paste and a fine matte surface is produced on the aggregate surface remaining in the slice of concrete (see figures 65 and 66). This matte surface will be a little different for each aggregate

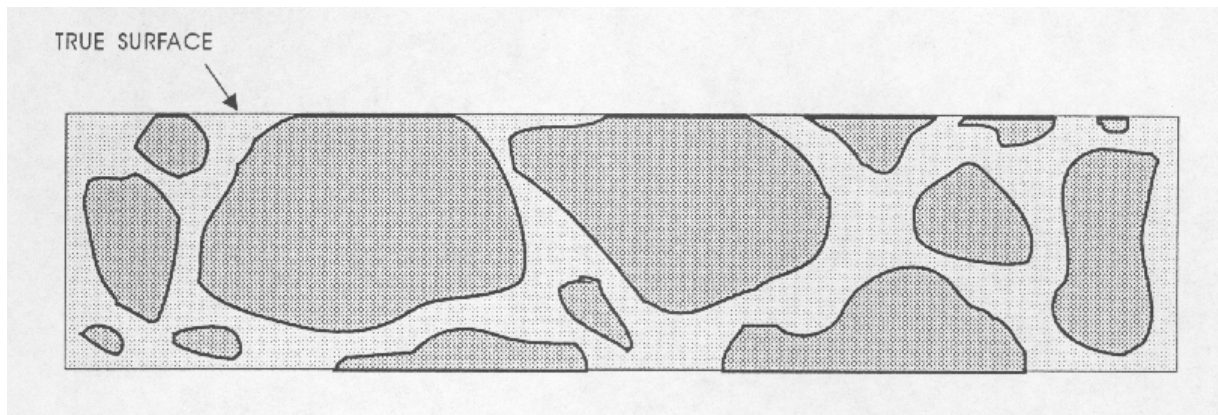

The darker line at the top surface represents the lapped, matte aggregate surface.

Figure 65. Lapped surface.

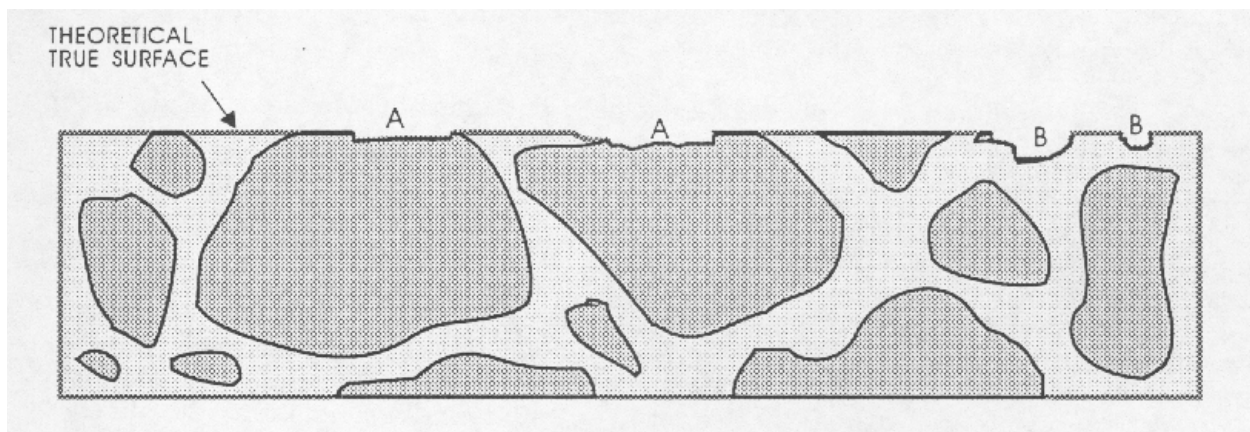

The darker line at the top surface represents the lapped, matte aggregate surface. This is an illustration of the type of flaw caused by aggregate that is fragile and recognizable by the broken aggregate surface (marked “A” flaws caused by a fragment of aggregate flaking off), and the type of flaw caused by complete or nearly complete loss of an aggregate particle that is recognizable by the shape of the cavity remaining and the texture of the paste surface within the cavity (marked “B” flaws caused by a piece of aggregate falling out).

Figure 66. Flaws in lapped surface.

lithology exposed in the surface; however, it is generally sufficiently different from a broken surface or a natural water-worn surface of the type of aggregate for a technician to be able to distinguish a matte-lapped surface from all others. Because of the generally higher capillarity of the paste and the greater hardness of the aggregate, the matte surface on an aggregate particle is usually quite different from the surface of a finely lapped paste. The lower the w/cm, the denser the paste becomes and the more the lapped surface on the paste becomes like the lapped surface on the aggregate. When the problem of distinguishing paste from aggregate becomes difficult, the differences in solubility in weak acid or the differences in porosity indicated by dye absorption can be used to differentiate between aggregate and paste.

The problem cannot be solved by adhering to statements such as: “The paste content calculated from the known mixture proportions is approximately 12 percent higher than the one obtained from the ASTM C 457 measurements” (Pleau, et al., 1990, p. 5). Pleau, et al. called this sort of error “an unavoidable artifact of the measurement process” (p. 6). In their work, no effort seemed to have been made to enhance the paste-aggregate boundary and lessen their error. They used the point-count method, determining paste concurrently with the analysis of the air content. They explained the difference between their mixture proportion and their point-count results by stating that there were errors made in determining the proper outlines of the aggregates when the aggregate occurred close to the surface being examined. In their specimens, the paste seemed to have been more translucent than may have normally been encountered. Reportedly, their operators frequently saw through the paste and counted an aggregate particle beneath. Also, they had occurrences of discolored portions of the paste that appeared to be aggregate particles and thus were counted as such.

Other than the dark blue-green blotchy appearance often seen in pastes containing ground granulated blast-furnace slag, the only such “discolorations” seen in the VTRC laboratory, when studied in thin section, have been determined to be lumps of cement (see figure 67) caused by either exposure of the cement to moisture during storage or an improper batching sequence. The example shown in figure 67 was found in a lump of concrete, commonly referred to as a “cement ball,” found tumbling down the discharge chute of a concrete truck mixer.



Figure 67. Knot of cement exposed on finely lapped slice (rounded shape was caused by tumbling in the mixer).

A discussion of the factors that can result in this type of nonhomogeneity can be found in Gaynor and Mullarky (1975). In retempered concrete (see appendix C), some of the aggregate may have coatings of dense, partially hydrated cement. Obviously, counting a cement lump or coating as aggregate in the point-count method will decrease the ratio of paste to aggregate determined. Although Pleau, et al. (1990), found a consistent 12 percent shortage in the microscopically determined paste content in the laboratory-mixed specimens they used, they did not present any evidence that indicated that all paste contents determined microscopically should be increased by such an amount.

The percentage of paste is determined in six steps, as listed in table 16:

Table 16. Procedure for determining paste percentage.

- | |
|--|
| <ol style="list-style-type: none"> 1. Etch the slice if necessary. 2. Examine the etched slice and become familiar with the way the paste and aggregates reacted to the acid. 3. Prepare to recognize the true lapped surface of the aggregate. 4. Survey the slice to become familiar with any features that could cause confusion. 5. Perform the microscopical determination of the amount of aggregate in the slice. 6. Calculate the percentage of paste. |
|--|

1. **Etch the slice if necessary:** Determine if etching the slice will enhance the visibility of the boundary between the aggregate and the paste. Test etchings can be performed by dropping a small quantity of acid on companion surfaces or even on the slice under examination. Most users of point-count or image analysis equipment make the paste determination concurrent with the air-void determination and forgo the greater definition of boundaries available by etching. When the color of the paste and the aggregate match and the lapped surfaces are similar, the determination of the exact boundaries between the

aggregate and the paste is very difficult. If the results of the determination will have to be presented as legal evidence (and perhaps questioned by opposing expert witnesses) and sufficient specimen material is available, VTRC subjects the specimen surface to a *very* brief etching procedure (see section 5.2.3) so that the exact aggregate-paste boundaries can be distinguished by the different solubility of the phases in the dilute acid. Avoid etching the specimen to determine an accurate paste percentage unless sufficient slices can be obtained so that the slice etched will not have to be used for other purposes and an unetched slice will remain available for archival purposes.

CAUTION: Perform the etching procedure after the air-void determinations have been made because the acid will round off the void edges and make the voids appear larger. Therefore, if an acid etching procedure is to be used, determining the paste content must be a separate procedure from the air-void determination.

2. **Examine the slice and become familiar with the manner in which the paste and the various lithologies of aggregate reacted to the lapping and the acid:** Usually, the paste is more soluble than the aggregate and is etched down to a lower level (see figure 68). Occasionally, there may exist pieces of pure calcite in the aggregate. Calcite itself is much more soluble in weak HCl than concrete paste and will be dissolved to an even greater level. Thus, there exists a solubility difference, and the boundary can be distinguished. Unless the aggregate rock used is exceptionally rich in pure calcite, this should not occur often. Impure carbonate (calcitic and dolomitic) rocks are not removed to such a great extent. The pyrites, clays, and other minerals included in the more complex carbonate rocks remain at the level to which the specimen was lapped, even if a layer of the carbonate is removed (see figure 69).

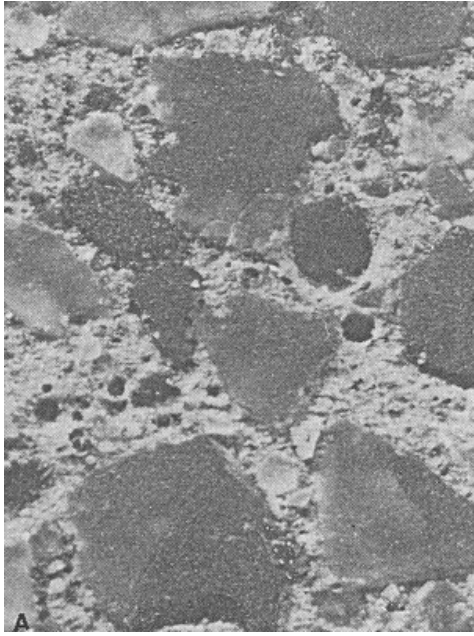

Width of image is 10 mm.

Figure 68. Etched slice: Etched surface on concrete fabricated with quartz sand fine aggregate.

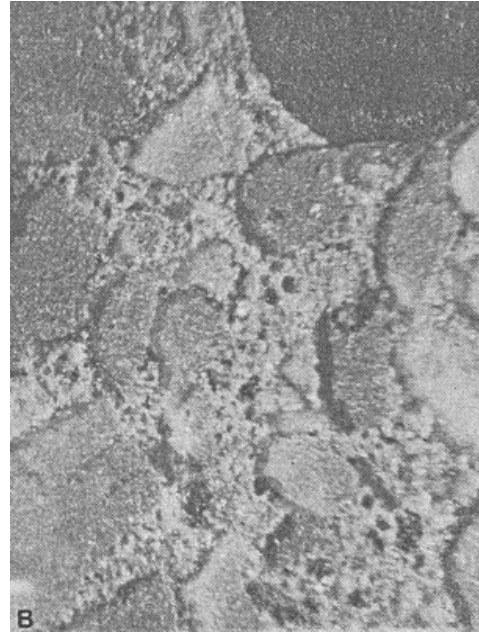

Width of image is 10 mm.

Figure 69. Etched slice: Etched surface on concrete fabricated with crushed limestone fine aggregate.

3. **Prepare to recognize the true lapped surface of the aggregate as distinguished from any broken or water-worn natural gravel aggregate surfaces:** Whether the paste determination is made on a flat lapped surface or an etched surface (whether the quantity of paste is determined at the same time as the quantity of voids or not), think clearly about the fact that the matte surface on the aggregate is the portion of the aggregate that exists on the plane on which the determinations are being made. Other surfaces of the aggregate will have a natural broken or water-worn surface. Figure 66 illustrates: (1) the type of flaws caused by aggregate that is fragile and recognizable by the broken aggregate surface and (2) the type of flaws caused by the complete or nearly complete loss of an aggregate particle that are recognizable by the shape of the cavity remaining and the texture within the cavity. These flaws are not a common occurrence; however, when they are present, a mental reconstruction of the surface will usually indicate that they should be counted as aggregate. If these flaws are common and a mental reconstruction of the true surface does not indicate the proper location of the boundaries between the paste and the aggregate, the slice should be refinished or replaced with one of a better quality. For highest accuracy, the air-void determination should be made on the better prepared slice. In cases other than the flaws indicated in figure 66, refrain from recognizing as aggregate any area that is below the finely lapped surface. If a part of the aggregate that should be covered with paste is exposed, count such areas as paste. If the paste surface has been removed from over an aggregate surface (chipped off or etched off), the aggregate particle will not exhibit the finely lapped matte surface of the properly exposed aggregate particle and it is likely that at a magnification of 100X (or larger) there will be a decided difference in the location of the planes of focus between the true lapped

surface and any aggregate surface beneath. This difference in focus (which must be adjusted for if the surface is to be kept in focus) should alert you to the fact that you are viewing a surface that is farther from the objective lens than was the surface on which the focus was originally located.

None of these problems should cause errors if you think clearly about the view seen and mentally reconstruct the view that would have been seen if the paste area on the lapped surface accurately indicated the true proportion of the paste present. Avoid errors by allowing sufficient time for the analysis. Figure 70 illustrates some of the flawed and etched artifacts that may be observed in surfaces during the microscopical determination of the paste-aggregate ratio. These surfaces are different from the undercut surfaces discussed in section 5.2.1 (see figure 41). The undercut surfaces have a somewhat similar high relief; however, the features are rounded and there is no way a mental reconstruction of the surface will yield a good estimate of the position of the paste-aggregate boundary. Undercutting must be overcome by proper surface preparation.

4. **Survey the slice and become familiar with any portions of the paste that could be mistaken for aggregate because of coloration, carbonation, or other factors:** Paste that is dark because of concentrations of unhydrated cementitious material or paste that has been carbonated and therefore not etched as deeply as the surrounding paste will not have a lapped matte surface as the aggregate particles do. Although the calcite in carbonated areas is soluble in HCl with effervescence, these areas are seldom etched as deeply as uncarbonated paste. The calcite is completely dissolved; however, usually there remains a porous layer of material that is not soluble in the acid and is often as high as was the original lapped surface. It appears that the siliceous components of the uncarbonated paste are more soluble than the siliceous portion of the carbonated paste or that more acid is consumed dissolving the more plentiful nonsiliceous component of carbonated paste and thus attacks the siliceous component to a lesser degree than in uncarbonated paste.
5. **Perform the microscopical determination of the amount of aggregate in the surface:** With the exception of the kinds of flaws shown in figure 66, be careful to count as aggregate only those portions of the aggregate that were at the surface when the air-void determination was made (i.e., the high matte-lapped surfaces of the aggregate).
6. **Calculate the air-free percentage of paste:** The percent of paste in the concrete is determined by subtracting from 100 percent the sum of the percent of aggregate and the percent of air voids, as shown below:

$$\% \text{ Paste} = 100 \% \text{ minus } (\% \text{ aggregate plus } \% \text{ air voids})$$

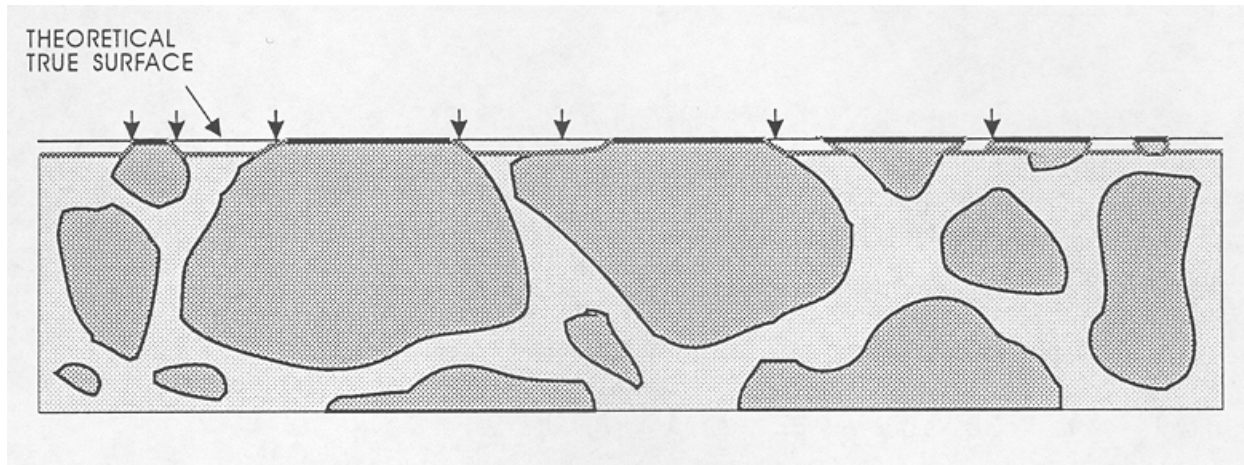

The darker line at the top surface represents the lapped, matte aggregate surface, and the shaded line just below the top represents the etched surface with possible misinterpretations at arrows. Acid-etched surface shows the need for counting as aggregate only the matte-lapped surface of the aggregate.

Figure 70. Cross section of surface demonstrating problems of boundary distinction.

7.2 AGGREGATE AND OTHER COMPONENTS

The percentage of a specific type of aggregate or other substance should be determined when deemed important by the client or the petrographer. Any substance that can be recognized when seen on the surface of the slice as being composed of a particular material can be counted by the point-count method or measured by linear traverse equipment and an estimated volume percentage of the substance can be determined. The accuracy of such determinations is dependent on the frequency of the occurrence of the particles of the substance, as discussed in section 7.1.2.

Substances cannot be distinguished on the basis of size. It is possible to know only that the exposed cross section of an object indicates that the object is large enough to have the particular cross section. The object may be much larger.

Occasionally, the petrographer is requested to determine the relative amounts of coarse aggregate and fine aggregate. If there is a distinct lithologic difference between the two (e.g., a fine-grained greenstone coarse aggregate and quartz sand fine aggregate), an estimate of the percentage of each can be made using point-count or linear traverse equipment. If there is no readily recognizable lithologic difference (most often the case when crushed limestone is used for the fine as well as the coarse aggregate), it is impossible to make a percentage determination of the relative amounts of these materials by readily available optical methods (see section 12.3). The calculation of diameters from chords such as that of Lord and Willis (1951) that are dependent on the spherical shape of the item measured cannot be used for aggregate particles. The distinction cannot be made on the size of the area of the particle exposed on the lapped surface because a piece of coarse aggregate may be almost hidden, with only a tiny corner showing. At present, the available methods include removing the paste with an acid or disaggregating the

concrete by freezing with liquid nitrogen and subsequent sieve analysis of the aggregate. Both methods can be confounded—the acid dissolution approach if the aggregate contains a carbonate component and the freezing approach if the aggregate contains unsound or sensitive components.

An experienced petrographer will usually be able to tell by comparison with other specimens of concrete if an unusual amount of either coarse or fine aggregate is present. The original design of the mixture should indicate the sizes intended to be used (see figures 71 and 72).

If the petrographer feels that the aggregate is not sized according to the intended grading, an investigation of the sizes of the materials in the stockpiles can be made. If the sizes in the stockpiles are within specification, the problem may be in the proportioning of the aggregates during fabrication of the concrete mixture.

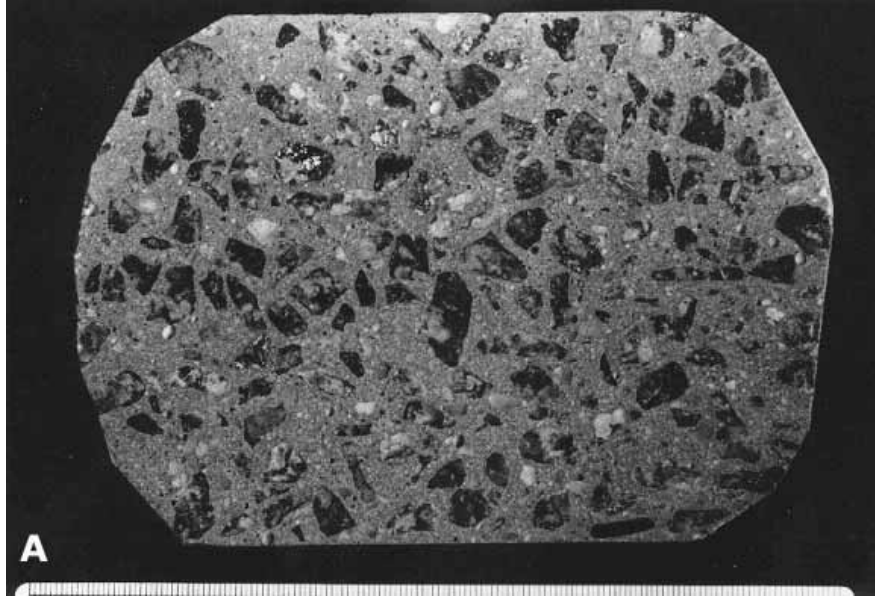

**Figure 71. Varying amounts of aggregate size fractions (actual size):
(A) Concrete fabricated without larger sizes of coarse aggregate.**

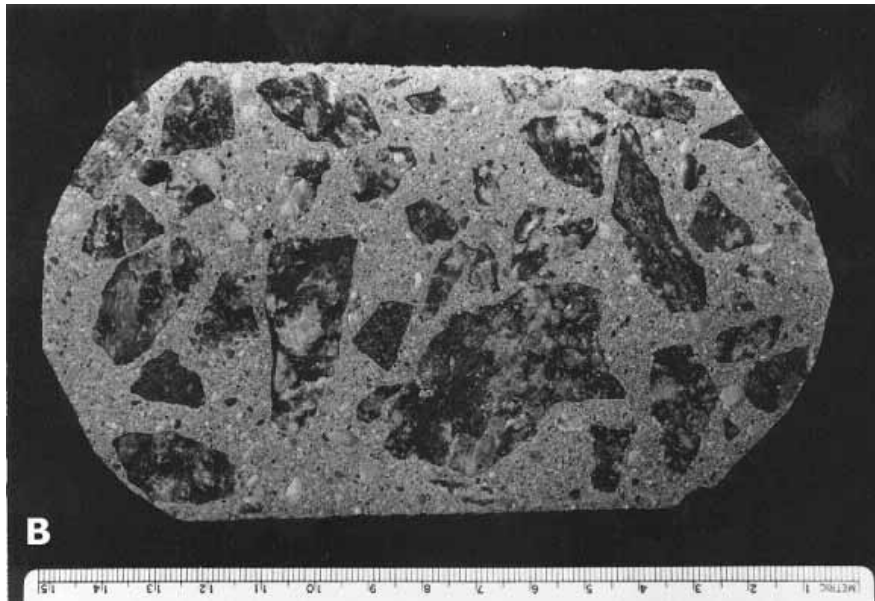

**Figure 72. Varying amounts of aggregate size fractions (actual size):
(B) Concrete fabricated with coarse aggregate that is larger than
what is now considered to be normal for bridge deck concrete.**

CHAPTER 8. EXAMINATION WITH THE STEREOMICROSCOPE

8.1 OVERVIEW

The stereomicroscopic examination of the lapped surfaces of the specimen is usually the procedure that controls the course of the analysis of the specimen. If the specimen was submitted for a particular analysis and the petrographer is fairly certain that the other parameters of the concrete do not require investigation (as may be the case when the concrete has been fabricated in a concrete laboratory), the stereomicroscopic examination of the concrete may be omitted. Usually, the petrographer cannot be sure that the examination requested will provide sufficient information to determine all of the possible problems of the concrete submitted and will perform a general stereomicroscopic examination to allow analysis of all of the features of the specimen.

The concerns of the client must be considered throughout any examination of the specimen. However, the observations made should not be confined to these concerns. All of the features of the entire suite of specimens should be inspected and examined in detail. Often, the petrographer is asked to confirm or deny the presence of a particular form of distress, but then finds that there are other kinds of problems present as well.

After any planned quantitative analysis of the constituents (see chapters 6 and 7), five procedures are performed in a general examination with the stereomicroscope, as listed in table 17:

Table 17. Stereomicroscopic examination procedure.

- | |
|--|
| <ol style="list-style-type: none">1. Review the available information.2. Prepare the equipment.3. Examine the slice, and mark and label it appropriately.4. Enhance the marked features.5. Photograph the slice and make photomicrographs. |
|--|

8.2 REVIEW OF AVAILABLE INFORMATION

In the normal course of events, the preliminary examination (described in chapter 3) is performed and then the specimen is prepared according to the preliminary plan of analysis. If the plan of analysis includes the determination of the air-void parameters, a technician usually performs the procedure. Thus, several days may have elapsed between the original preliminary examination by a petrographer and the stereomicroscopic examination. Occasionally, a petrographer other than the one performing the stereomicroscopic examination may have sketched out the plan of analysis. If the petrographer's workload is heavy, the time when it is convenient to perform the stereomicroscopic analysis of the specimens may be a few weeks after receipt of the specimen. Therefore, it is usually necessary that the petrographer review the complete history of the HCC and be aware of anything unusual about the design of the mixture and any unusual procedures or occurrences during placement. With this information, the microscopist will be best able to notice and report on any features that might be attributable to new methods, materials, or admixtures, or that might have been caused by incidents that occurred during placement of the HCC. Therefore, the petrographer should review the following: (1) the history of the concrete being studied as reported by the client, either in accompanying documents or orally; (2) any unusual methods of sample preparation that were required; (3) any

features noted by the technician during the preparation of the specimens and the air-void analysis; and (4) the results of the air-void analysis.

8.3 PREPARATION OF EQUIPMENT

The stereomicroscope (see figure 20) should be placed on a table or stand that is a convenient height for the microscopist. A variety of microtools (see figure 21), bottles, and droppers to supply water and 10 percent HCl, and a variety of marking equipment to make both temporary and permanent marks on the surface of the lapped slice should be available. A variety of pens; soft, colored pencils; and sticky paper arrows, dots, or other labels for use on the surface of the lapped slice should also be available.

Various pens should be tested on some fine microcracking on an unimportant lapped, oil-free slice of HCC. No particular brand of pen is recommended because inks and pens change as manufacturers find new ways to please the public or economize their operations. The soft or fiber-point disposable pens that have a medium-thick ink work well. While using the stereomicroscope, the microscopist positions the pen on a microcrack and causes a very small portion of the ink to flow onto the visible expression of a crack. If the ink enters the crack (as opposed to beading up on the surface) and by capillary action is drawn a short distance along the crack (without bleeding into the mass of the paste), this small leading portion of the ink, visible with the stereomicroscope, indicates the next direction of the crack. By use of the proper pen to trace the direction of the crack with ink, it is possible to detect and mark microcracks and connections between cracks that cannot be seen against the general paste background at the magnifications of the stereomicroscope. If such pens are available in several colors that will contrast with the HCC, various features can be marked with different colors.

Other pens and pencils are for marking on aggregate surfaces. Light pencil marks are not easily seen on the lapped surface of paste, and heavy pencil marks may damage the surface or fill cavities with graphite or colored flakes.

8.4 EXAMINATION AND MARKING OF SLICES

NOTE: Most of the features of the lapped slice are easier to see if any shine caused by the lapping oil has been removed from the slice by evaporation (sufficient exposure to room air or overnight treatment in a warm oven). Check the slice during the last stages of the evaporation process to make note of any areas that have absorbed extra oil. Such areas may indicate cold joints, overlay bonds, boundaries of carbonated zones, or transitions between various qualities of the HCC.

Table 18 is a checklist of the features that should be examined. Figure 73 is a reproduction of a two-page form used by the Ontario Ministry of Transportation. Similar checklists can be found in Van Dam, et al. (2002b).

Table 18. Checklist for examination with the stereomicroscope.

| Item | Remarks |
|--|---------|
| <input type="checkbox"/> Cross sections of exterior surfaces (quality of original) <input type="checkbox"/> Foreign objects <input type="checkbox"/> Reinforcing bars, supports, or both <input type="checkbox"/> Voids | |
| General Appearance: <input type="checkbox"/> Shape <input type="checkbox"/> Distribution <input type="checkbox"/> Size <input type="checkbox"/> Aggregate: <input type="checkbox"/> Lithology and mineralogy <input type="checkbox"/> Orientation <input type="checkbox"/> Aggregate-paste ratio <input type="checkbox"/> Distribution <input type="checkbox"/> Cracks <input type="checkbox"/> Coatings <input type="checkbox"/> Aggregate-cement reactions <input type="checkbox"/> Paste <input type="checkbox"/> Water-cement ratio <input type="checkbox"/> Discolored areas <input type="checkbox"/> Carbonation <input type="checkbox"/> Cementitious materials (portland cement, ground granulated blast-furnace slag, or pozzolans) <input type="checkbox"/> Cracks at aggregate bond <input type="checkbox"/> Cracks within paste | |

The following procedures should be used:

- When there is any possibility of the labeling obscuring your ability to see details in the paste (usually the case when using ink to emphasize microcracks), delay any permanent marking and labeling on the paste until you examine the slice for all of the other items on the checklist:** When marks and labels can be placed on aggregate surfaces or the labeling can be easily removed, perform such markings as instructed under the various features (concurrent with the general stereomicroscopic examination). Features that may be easily observed with the stereomicroscope may be difficult or impossible to see with the naked eye and are often impossible to record photographically unless they are enhanced by some form of marking or emphasis that can be seen without magnification.

PETROGRAPHIC EXAMINATION OF HARDENED CONCRETE

SAMPLE NO.:

| | | | |
|---|-------------------------|-----------------------------|---------|
| LOCATION | | | |
| Highway | Crossing Over/Under | | |
| County Site # | District | Region | |
| DETAILS OF STRUCTURE | | | |
| Year of Construction | | Contract # | |
| Description of Structure | | | |
| Description of Deterioration/Problem | | | |
| CONCRETE DESCRIPTION | | | |
| (1) Total Concrete: Hit with Hammer - Ring <input type="checkbox"/> Dull <input type="checkbox"/> Break with Fingers - Powdery <input type="checkbox"/> Friable <input type="checkbox"/> Particles Not Dislodged <input type="checkbox"/> Strength - Very Strong <input type="checkbox"/> Strong <input type="checkbox"/> Weak <input type="checkbox"/> Very Weak <input type="checkbox"/> During Sawing - Clean Cut <input type="checkbox"/> Tears Easily <input type="checkbox"/> Unusually Wet or Dry Areas - Yes <input type="checkbox"/> No <input type="checkbox"/> Cement/Coarse Aggregate Bond - Good <input type="checkbox"/> Bad <input type="checkbox"/> Cement/Fine Aggregate Bond - Good <input type="checkbox"/> Bad <input type="checkbox"/> Other - | | | |
| (2) Coarse Aggregate: Source - % of Total - % Material Type - Gravel <input type="checkbox"/> Quarried <input type="checkbox"/> Mixture <input type="checkbox"/> Shape - Rounded <input type="checkbox"/> Partly Crushed <input type="checkbox"/> 100% Crushed <input type="checkbox"/> Distribution - Even <input type="checkbox"/> Uneven <input type="checkbox"/> Grading - Even <input type="checkbox"/> Uneven <input type="checkbox"/> Maximum Size (mm) - 10 <input type="checkbox"/> 15 <input type="checkbox"/> 20 <input type="checkbox"/> 25 <input type="checkbox"/> ___ <input type="checkbox"/> Preferred Orientation - Present <input type="checkbox"/> Not Observed <input type="checkbox"/> | | | |
| LITHOLOGICAL TYPES | % OF COARSE AGGR. | REACTION RIMS/GEL/FRACTURES | REMARKS |
| | | | |
| Other - (3) Fine Aggregate: % of Total - % Material Type - Natural <input type="checkbox"/> Manufactured <input type="checkbox"/> Mixture <input type="checkbox"/> Shape - Rounded <input type="checkbox"/> Subangular <input type="checkbox"/> Angular <input type="checkbox"/> Distribution - Even <input type="checkbox"/> Uneven <input type="checkbox"/> Grading - Even <input type="checkbox"/> Uneven <input type="checkbox"/> Preferred Orientation - Present <input type="checkbox"/> Not Observed <input type="checkbox"/> | | | |

Courtesy of Christopher A. Rogers, Ministry of Transportation, Ontario, Canada

Figure 73. Two-page Petrographic Examination of Hardened Concrete form used by the Ontario Ministry of Transportation.

| LITHOLOGICAL TYPES | % OF FINE AGGR. | REACTION RIMS/GEL/FRACTURES | REMARKS |
|---|-----------------|-----------------------------|---------|
| | | | |
| <p>Other -</p> <p>(4) Cement Paste:</p> <p>% of Total - %</p> <p>Appearance in Broken Concrete - Subtranslucent <input type="checkbox"/> Dull <input type="checkbox"/> Chalky <input type="checkbox"/></p> <p>Colour - Grey <input type="checkbox"/> Light Grey <input type="checkbox"/> White <input type="checkbox"/> Blue Green <input type="checkbox"/></p> <p>Colour Distribution - Even <input type="checkbox"/> Mottled <input type="checkbox"/> Gradational <input type="checkbox"/></p> <p>Strength - Strong <input type="checkbox"/> Friable <input type="checkbox"/> Powdery <input type="checkbox"/></p> <p>Bleeding - Observed <input type="checkbox"/> Not Observed <input type="checkbox"/></p> <p>Carbonation - Outer Skin Only <input type="checkbox"/> Along Fractures <input type="checkbox"/> Partial <input type="checkbox"/> Total <input type="checkbox"/></p> <p>Slag Cement (Greenish Blue, Greenish) - Observed <input type="checkbox"/> Not Observed <input type="checkbox"/></p> <p>Evidence of Retempering - Yes <input type="checkbox"/> No <input type="checkbox"/></p> <p>Other -</p> <p>(5) Voids:</p> <p>% of Total - %</p> <p>Grading - Even <input type="checkbox"/> Uneven <input type="checkbox"/> Very Large <input type="checkbox"/> Well Air-Entrained <input type="checkbox"/> Poorly Air-Entrained <input type="checkbox"/></p> <p>Interior Lustre - Dull <input type="checkbox"/> Shining <input type="checkbox"/></p> <p>Interior Condition - Empty <input type="checkbox"/> Lined <input type="checkbox"/> Partly Filled <input type="checkbox"/> Filled <input type="checkbox"/></p> <p>% Voids with Mineralization - Most <input type="checkbox"/> About Half <input type="checkbox"/> Few <input type="checkbox"/> None <input type="checkbox"/></p> <p>Mineralization - Alkali-Silica Gel <input type="checkbox"/> Ettringite <input type="checkbox"/> Portlandite <input type="checkbox"/> Calcium Carbonate <input type="checkbox"/></p> <p>Other -</p> <p>(6) Cracks:</p> <p>Amount - Frequent <input type="checkbox"/> Occasional <input type="checkbox"/> None <input type="checkbox"/></p> <p>Continuity and Distribution -</p> <p>Location - Through Aggregate Particles <input type="checkbox"/> Around Aggregate Particles <input type="checkbox"/></p> <p>Width (mm) -</p> <p>Filling Material - Alkali-Silica Gel <input type="checkbox"/> Ettringite <input type="checkbox"/> Portlandite <input type="checkbox"/> Calcium Carbonate <input type="checkbox"/></p> <p>Associated with Embedded Items - Yes <input type="checkbox"/> No <input type="checkbox"/></p> <p>Other -</p> <p>(7) Embedded Items:</p> <p>Description -</p> <p>Location -</p> <p>Condition - Clean <input type="checkbox"/> Corroded <input type="checkbox"/> Decayed <input type="checkbox"/></p> <p>Size (mm) -</p> <p>Associated Voids, Cracks, Mineralization, Etc. -</p> <p>Other -</p> <p>CONCLUSIONS:</p> <p style="text-align: center;">_____</p> <p style="text-align: center;">SIGNATURE DATE</p> | | | |

Courtesy of Christopher A. Rogers, Ministry of Transportation, Ontario, Canada

Figure 73. Two-page Petrographic Examination of Hardened Concrete form used by the Ontario Ministry of Transportation—Continued

2. **Examine any cross sections of formed, finished surfaces or wearing surfaces on the slice:** The surface of a concrete placement that is not against a form and is generally smoothed and finished by a float, trowel, or texturing device (such as a tine rake or burlap drag) is the finished surface. Ascertain if the paste within a few millimeters of the finished surface is about the same color as the rest of the paste and if the air-void content of the surface layer is not abnormally high. (If the concrete was too stiff to finish easily, the contractor may have added water to the top layer and thus changed the consistency.) A light-colored surface layer (may be no more than 1 mm thick), often with a froth of very fine air voids, may be evidence of the use of excess water during the finishing process or the occurrence of rain. Such a froth will not have much strength and will wear away rapidly; however, fortunately, such zones are usually very shallow and do not greatly affect the durability of the placement.

Overworking with the finishing equipment can cause a thin layer at the surface to be exceedingly rich in paste and low in aggregate and air. Excess water will weaken the concrete and sometimes cause cracking and crazing. Excess and misshapen voids, zones of streaked paste, and zones low in air are additional evidence of problems occurring during finishing (see figure 74).

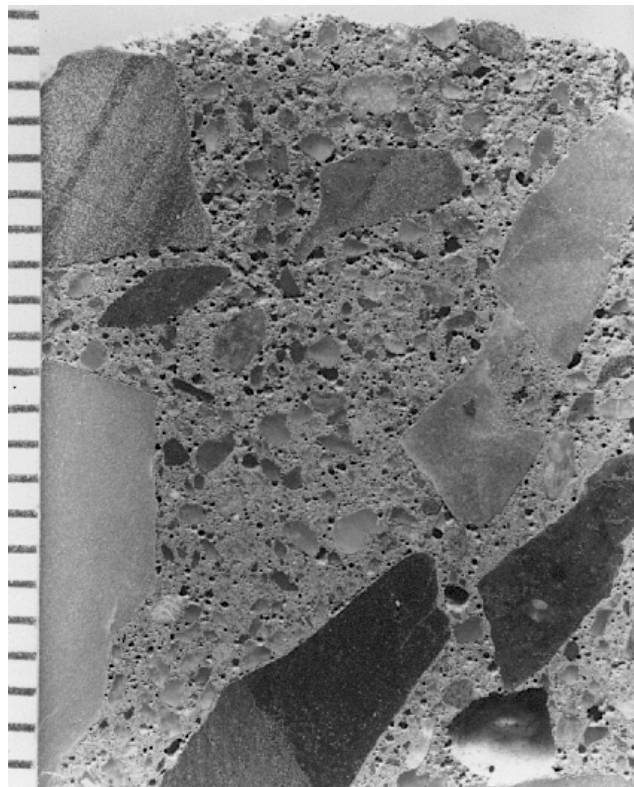

Scale is in millimeters.

Water was added to facilitate finishing. The elongated, angular coarse aggregate caused the mixture to be difficult to place. Notice the angular voids that exist down to a depth of 10 mm.

Figure 74. Excess air at surface of concrete (top).

Unless the concrete is old and worn by heavy traffic, the texture of the wearing surface or that of any finished surface should conform to the texture specified. Thin sections that show the profile of the cross sections of the surface can be fabricated (see section 5.3.3). Skid resistance is aided by the production of asperities and the provision of channels in the surface for the escape of water in order to prevent skidding and hydroplaning. Report the condition of the texture on any surface on which traffic moves. Report any differences between the microstructure of the major portion of the paste and the paste adjacent to any exterior surface.

3. **Note the presence of any foreign objects in the concrete:** Such objects might be pieces of glass, wood, metal, or fabric. If such objects are common in the concrete under study, the cause is either a massive accident occurring nearby while the concrete was fresh, poor workmanship, or sabotage. Look for evidence of any chemical reactions between such foreign objects and the chemicals in the paste. Some glass will react with the highly alkaline paste and cause deleterious expansion. Fine aluminum fragments will cause the evolution of hydrogen gas, concomitant voids, and zones of weakness. Zinc galvanizing can also react with highly alkaline fresh paste evolving gas. Other substances may cause similar deleterious reactions.
4. **Report any portions of reinforcing bars or portions of the supports for the bars (called chairs) present in the slice:** Rust-colored portions of the lapped surface may indicate nearby corrosion of ferrous metal. Check the back of the slice, the opposing sawed surface, and the remaining (unsliced) portions of the specimen for corroded reinforcing bars and related material. Report their presence.
5. **Examine the voids:**
 - **General appearance:** Examine the appearance of the void system. It should be in conformance with the data obtained by the air-void analysis. Consider the number of voids and their size. If the voids are unusually small and numerous, the air content may be greater than it first appeared. If there is an apparent discrepancy: (1) ensure that the air-void analysis was conducted on the slice being examined and the analysis was performed properly and spread over the entire surface of the slice, or (2) request that the air-void analysis be repeated and/or conducted on additional slices. In the report to the client, discuss an apparent conflict between data obtained in accordance with ASTM C 457 and that seen with the unaided eye.
 - **Shape:** Hydrostatic pressures within the unhardened HCC paste cause small voids to tend toward a spherical shape. Most of these are the entrained air voids. They are sometimes mentioned in the literature as if their sphericity defined them. Under extreme circumstances, even these small voids can become distorted by various forces. The shape and distribution of the various types of voids are important. Note any areas of unusual void angularity and describe or label the location.

Voids that are within the thin zone that become worked as the concrete is finished and textured can be quite angular. It is only the extremely small voids that maintain their individual integrity when they have been distorted by these procedures. The larger voids are usually broken and thus expelled from the surface; however, many of the tiny ones remain, often angular and distorted. A minimum magnification of 100X is required to discern the presence, shape, and condition of very small voids.

Rarely, retempering (see appendix C) that occurs after the paste has started to harden and the individual voids have developed a “skin” will cause the majority of the medium and small voids in a concrete to take on an ovoid shape. Most commonly, these voids will have a vertical long dimension. This is a rare condition and is clear evidence of an inappropriate attempt to renew workability.

- **Distribution:** When the voids are unevenly distributed (see figure 75), the location of large concentrations of voids can be important, particularly if the voids are consistently associated with certain other features, such as a particular type of aggregate. If these concentrations are thought to be an important indicator of the condition of the concrete, mark or otherwise make note of their location on the slice. (See the description of the types of air voids in table 15.) Concentrations of voids that do not appear to be related to any other specific feature may often be attributed to retempering or incomplete mixing.

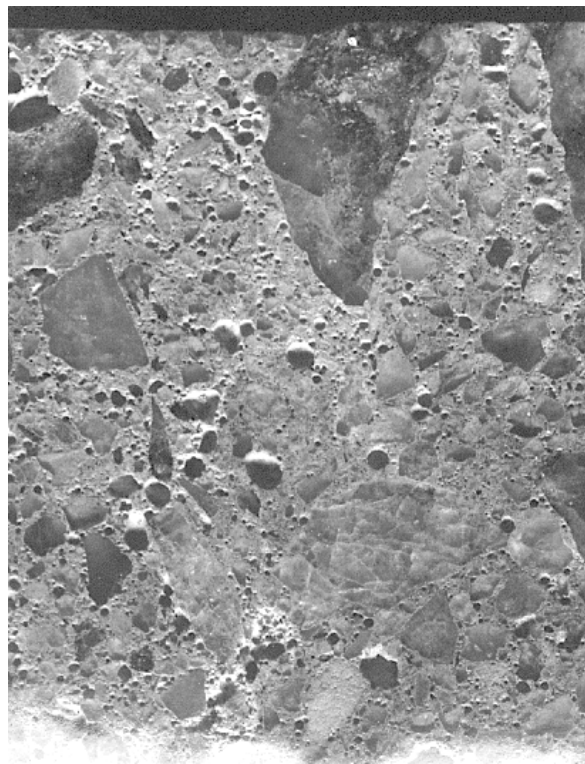

Figure 75. Clustering of voids apparently caused by excess air-entraining admixture and incomplete mixing (field width is 50 mm).

- **Size:** The overall void system (including the size of the voids) is measured and documented by the analysis of the air-void parameters as detailed in chapter 6. However, if there is anything unusual about the size of the voids that can be seen with or without magnification, document it. For example, if one extremely large void (e.g., 50 mm by 15 mm) is present in the slice being examined and it is decided that the void is not typical of the overall concrete, the area of the slice in which the void occurs should be excluded from the area examined in accordance with ASTM C 457. Such a void should be measured, and its shape and internal surface described in the notes and report on the specimen.

6. Examine the aggregate:

- **Lithology and mineralogy:** Briefly describe the general types of rocks and minerals seen in the aggregate of the HCC being examined (see appendix D). Include particle shape and color in the description. This description can be very helpful when you are trying to find a particular lapped specimen among all of the specimens in the laboratory. If a particular type is present in only a very small amount, it may be a contaminant and should be so noted. As an example, if the major portion of the coarse aggregate is crushed limestone and a few rounded pebbles of quartzite are present, the quartzite is probably a contaminant. Such a situation should be considered in light of other factors regarding the concrete. Does it provide an explanation for some other noted fault? Is it an acceptable deviation given the scale of concrete/aggregate production?

If the aggregate does not seem to be the aggregate specified in the design of the mixture as reported in the accompanying documentation, contact the client to resolve this inconsistency. Are the specimens received the ones that were meant to be sent? Is the documentation incorrect? Is there some other explanation? To achieve assurance in the identification of the aggregate, it may be necessary to request bulk specimens of the specified aggregate and perhaps specimens of aggregate from other sources. Perform a detailed study of the frequency of occurrence of the various lithologies; determine particle shape, soundness, staining, natural rims, and cleanliness; and study the microstructure and optical properties of these aggregates in thin sections with the petrographic microscope.

Note any deterioration of the HCC that is associated with any particular lithology. Such deterioration includes microcracking; popouts on the surface; reaction rims; and any deposits, particularly those that might indicate an expansive reaction (see chapter 10).

- **Orientation:** In some HCC specimens, the preferred orientation of the long dimension of the aggregate particles or general parallelism of flaky aggregate particles can be observed. Such orientation may indicate an abnormally high w/cm, improper mixing or placement procedures, or both. Note any patches of paste that seem particularly devoid of aggregate and, conversely, any areas in which the aggregate is crowded together. These evidences of segregation of the

unhardened concrete mixture may indicate an abnormally high w/cm, improper timing of the placement sequence, or just generally shoddy workmanship.

- **Aggregate-paste ratio:** An experienced concrete petrographer can usually tell at a glance if the aggregate-paste ratio is within the normal range of 75:25 to 68:32 (see figures 61 through 64). A more exact determination can be made with the linear traverse, point-count, or image analysis method. Differentiation of coarse and fine aggregate is possible only where they are clearly of the lithologic type.
- **Distribution:** If the heavier and larger pieces of aggregate have settled to the bottom of the placement, it can usually be assumed that the segregation took place because the mixture contained an excess of mortar or the paste was too fluid because it contained excess water. It has also been found that such segregation can be attributed to excessive vibration during consolidation of a mixture having more water than desirable or may be a result of improper placement techniques.

If there is a zone at the top of the placement that is nearly devoid of aggregate, but the aggregate distribution appears normal in the remainder of the placement (as in figure 76), the cause of this distribution is probably the addition of water to the mixture after placement. This water may be added by a rainstorm or possibly even purposefully in order to facilitate placement.



Figure 76. Overwatered concrete: Rain and snow occurring after the concrete was placed caused overwatering near the surface (top). (The aggregate sunk out of the overwatered zone.)

- **Cracks:** During the study of cracks in the aggregate of hardened concrete, give continual thought and recognition to the fact that the aggregate has withstood the stresses of concrete fabrication.

If the aggregate cracks are narrow (or do not seem to separate the aggregate into fragments) or the cracking seems to be in a regular pattern that echoes the surface of the aggregate, the cracking may be a result of the intrinsic cleavage or parting of the aggregate or artifacts of aggregate production. Shaley rocks and mono-mineralic aggregate particles of particular minerals might be good examples of this type of cracking.

Cracks in the aggregate that do not appear to be a result of the structural nature of the material of the aggregate, that break the aggregate into separate pieces, or that start in the aggregate and extend out into the paste may be caused by reactions and forces to which the concrete has been subjected since hardening. For an example of this, refer to chapter 10.

- **Coatings:** Note any coatings on the surface of the aggregate particles (such as clay, iron oxide, or manganese oxide). These coatings may help identify the environment, source, and degree of beneficiation of the particles (Forster, 1994). Such coatings, if porous, may act as reservoirs of water that cause weak zones of high capillarity in the hardened concrete.
- **Aggregate-cement reactions:** Make special note of evidence of chemical reactions of the aggregate with the paste (e.g., rims, cracks, or reaction deposits, such as gel). Refer to chapter 10.
- **Specialized aggregate materials:** Refer to appendix D for descriptions of specialized aggregate materials.

7. Study the paste:

- **Water-cement ratio:** Estimate the w/cm of the paste as either high, medium, or low by means of the following factors: (1) the observable texture of the paste; (2) the distribution of unhydrated cement grains; (3) the speed with which water is absorbed into a clean, oil-free surface; and (4) the manner in which the paste reacts (as observed with the microscope) when scratched and picked at. The petrographic evidence of the w/cm in HCC or mortar is very subtle. Generally, it cannot be considered as firm evidence, but may be used to indicate the necessity of a chemical determination of the cement content. Further details may be found in chapter 9.

Because of retempering (see appendix C) or other mixing conditions, HCCs may have areas of low w/cm and areas of high w/cm in the same placement and even in the same specimen or slice. The strength of the HCC will depend on which type of concrete is most prevalent and most continuous through the mass.

- **Discolored areas:** Take special note of areas of the paste that are a different color than the remainder of the paste. If the concrete mixture contains ground slag, is quite young, has been kept moist, and the dark areas are a dusky bluish green, the areas of concern are probably nothing more than the wetter zones of the slag-bearing HCC that are commonly this color until the material has dried and oxidized for the first time (Mather, 1957). Later moistening of slag-bearing HCC will not recreate the color.

Areas of a darker color than the major portion of the paste are probably zones with a high cement content and hence a lower w/cm, and were probably formed before all of the water was added. If sufficiently hydrated, these areas may be very strong. If dry cement is encapsulated in these areas, it will have very little strength and the area will be a zone of weakness. Such areas may indicate retempering (see appendix C) or improper mixing. They occur as two general types: (1) as coatings on and in reentrant angles of the aggregate particles, and/or (2) as knots or blobs of various sizes in the main area of the paste. If such areas are present, mark the slice in such a way that a number of these areas will be noticed in a photograph.

Occasionally, there are zones near the aggregate that are made up of cement that contain little water. These are caused by moist aggregate having come in contact with dry cement and having picked up a cement coating (see figure 77). If these coated aggregates are used in a concrete mixture, the very outside of the cement coating becomes moistened in its new environment; if the coating is thick, the inside can be preserved in a dry condition. If this concrete becomes subject to stress before water permeates the cement shells and hydrates them, these dry cement coatings will be a zone of weakness.

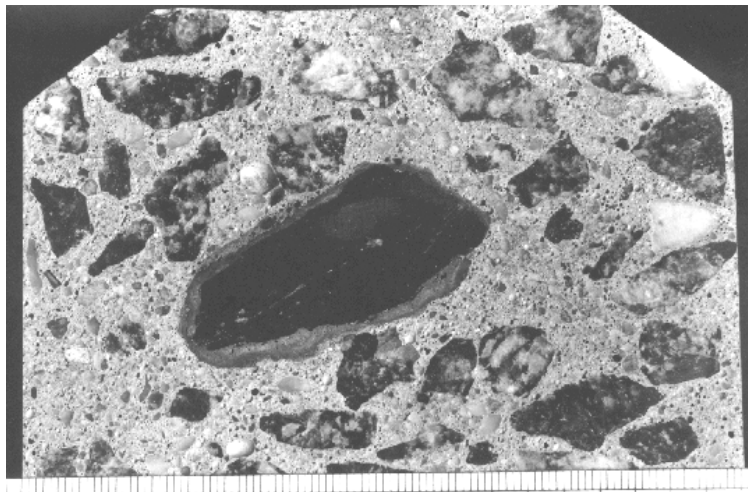

Damp aggregate came in contact with dry cement and picked up a layer that did not become hydrated. This layer is much denser than the zone surrounding the aggregate in figure 54.

Figure 77. Cement coating on aggregate (actual size).

Clumps or balls of cement may be caused by water reaching the cement before use or by particular batch procedures. These clumps can be so large and dense that they may be mistaken for aggregates. These areas are usually rounded by the action of the mixer. If a large portion of the cement is formed into balls or coatings on aggregate that survive mixing, the remainder of the concrete will be depleted in cement and will have a high w/cm and be weak.

Variations in the color of the paste may indicate variations in the w/cm (see chapter 9).

If the surface of the slice is rusty looking, it may be because the slice, while it contained a little water, was allowed to sit for many hours on a nonmoving iron lap. Question the support staff concerning this and, if necessary, remind them that laps become pitted by rusting and then must be demounted, resurfaced, or replaced and then remounted on the motor assembly.

- **Carbonation:** Carbonation of the paste may be indicated by very slight color or textural variations within the paste or differential absorption of lapping oil. Occasionally, a narrow zone of the paste that is nearest to the carbonated area has been depleted of calcium hydroxide and is sufficiently porous to absorb a larger amount of lapping oil. This absorbent area may be seen as a dark line before the slice is completely oil-free. Lightly etch the portion of the slice suspected of being carbonated (see section 5.2.3). Carbonation is most prevalent near the surface, along cracks, along “cold joints,” and at cracks and aggregate boundaries.

Carbonation is a process wherein particular constituents of the HCC paste chemically combine with the CO_2 of the atmosphere. $\text{Ca}(\text{OH})_2$ within the affected zone reacts with CO_2 to form the mineral calcite (CaCO_3) and water (H_2O). Some loosely held calcium ions in the calcium silicate hydrates of the cement paste might alter to form fine crystals of the carbonate minerals, mostly calcite. When the paste is treated with acid (see section 5.2.3), the CaCO_3 dissolves with effervescence. The uncarbonated paste is very soluble in the acid, and often the carbonated zone (now with the calcite removed) appears porous, but remains higher than the etched uncarbonated paste. After acid treatment, the portion that had been carbonated is usually cream or white in color. There is often a ridge of especially high relief at the line of contact between the carbonated and uncarbonated areas (see figures 45 and 46).

If the etching does not clarify the difference between carbonated and uncarbonated paste, fabricate thin sections for examination with the petrographic microscope. The high birefringence and the fine crystallite size of the products of carbonation, when viewed through crossed nicols, will indicate the presence of this alteration of the paste (see figures 156 through 160).

- **Cementitious particulate admixtures:** Examine the paste for evidence of any cementitious materials other than portland cement. Fly ash can often be seen on a

finely lapped slice of the specimen. Consider using an acid etch (see section 5.2.3) to enhance the visibility of the fly ash (see figures 78, 136, and 137). Some of the particulate admixtures of the cements, such as ground slag, cannot be seen on a lapped surface, but may be detected in a thin section when studied with the petrographic microscope. Ground slag can be suspected when the color of the concrete is either mottled with the dark blue-green or is the light cream color associated with aged slag concrete; however, the ground slag particles can be seen only in thin sections. Particulate materials other than portland cement are discussed in chapter 11.

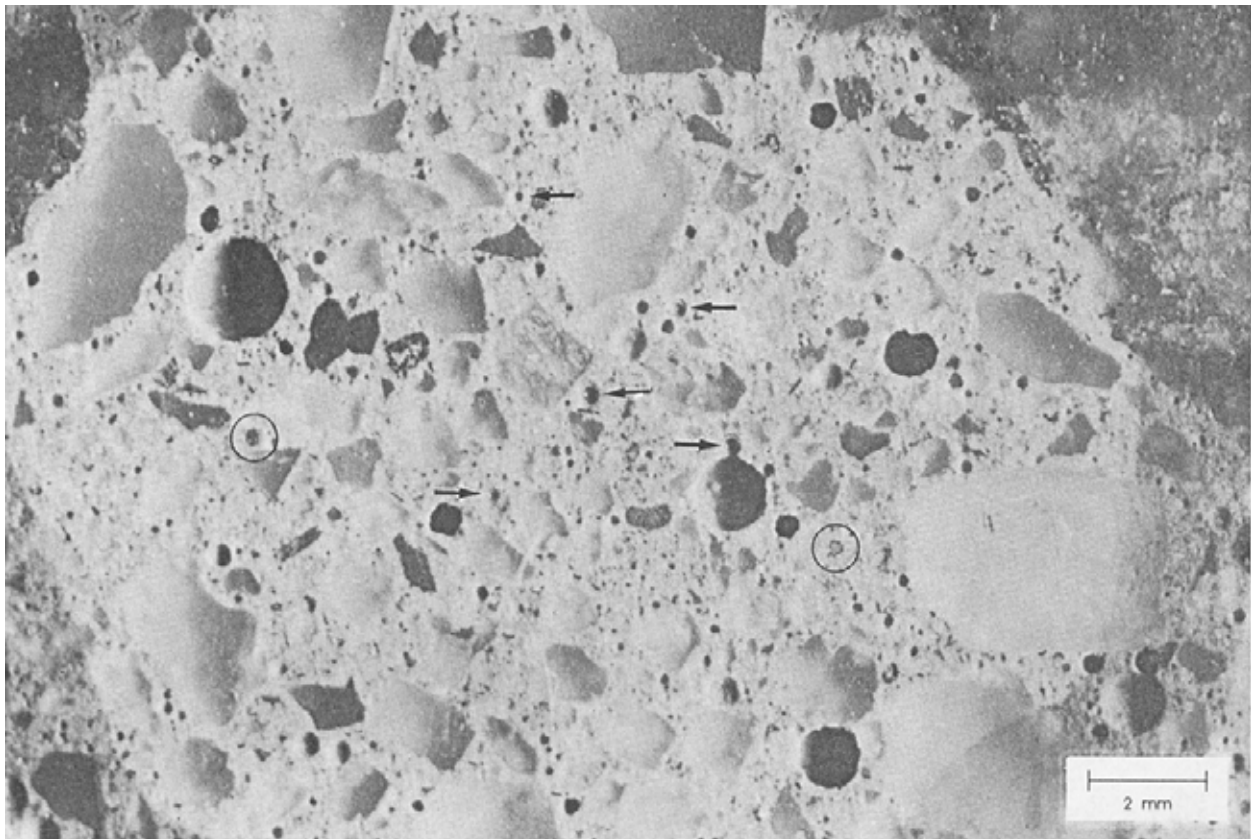

These particles can be recognized by their glassy interiors. Lighter colored fly ash is marked with arrows; the black fly ash is encircled. If the slice had been etched, more fly-ash particles would have been detected.

Figure 78. Fly-ash particles on the surface of a lapped slice of concrete.

- **Cracks at aggregate bond:** The area where the paste meets the aggregate surface is sometimes called the *interface transition zone* (ITZ). The quality of the ITZ or the paste-aggregate bond has obvious implications for the strength and durability of concrete. Narrow separations between the coarse aggregate and the paste are sometimes referred to as *bond cracks*. Mark bond cracks by placing a small arrow on the aggregate. These separations are particularly common with quartz-rich

rock and gravel aggregate. Water has an affinity for the quartz surface, and this layer of water may remain on the aggregate uncombined with cement as the cement hardens around it. Aggregate surfaces that attract water are often described as *hydrophilic*. Surfaces that repel water are described as *hydrophobic*.

These bond cracks are more apt to occur in mixtures with a high w/cm. The layer of water attracted to the aggregate creates an interface transition zone primarily filled with calcium hydroxide. Pockets of calcium hydroxide are not as strong as calcium silicate hydrate, and thus weak zones are created. In very old porous concrete subject to the action of running water or groundwater, calcium hydroxide in the ITZ may leach out and leave an empty boundary crack.

Conflicting evidence exists concerning the prevalence of bond cracks in concrete containing expanded aggregate. In some, the aggregates seem to have developed a surface that repels water and makes a tight bond with the cement paste. In others, they seem to develop as many, if not more, bond cracks than do quartz gravel aggregates (see appendix D). Be conscious of the condition of the ITZ and for any means of explaining poor paste-aggregate bond. Voids or cracks at the ITZ can be serious zones of weakness and contribute significantly to permeability (see figure 79).

- **Cracks within paste:** Interior cracks in concretes that can be easily seen with the unaided eye are usually observed only in HCC that has been badly deteriorated by structural cracking, drying shrinkage cracking, plastic shrinkage cracking (see chapter 4), AAR (see chapter 10), or freezing and thawing (see figure 80). In the early stages of deterioration, they were much smaller. The interior cracks that become visible with close observation and with magnification are called *microcracks*. Note all cracks within the paste.

Microcracking and similar fine details are very difficult to see on a rough surface and usually cannot be observed on anything but a well-prepared finely lapped surface. Sometimes, the microcracking seen on a finely lapped interior surface will indicate the general location of the cracks on a nearby rough exterior surface. The thinner the slice, the more relationship will be found between the nearly invisible surface microcracks and the microcracks found on the lapped surface (see figures 81 and 82).

The field of view seen through a microscope is very limited, and it is very difficult to construct a mental image of how one feature relates to another and be constantly aware of which portion of the specimen is under observation. A crack seen in one view may be followed across the specimen until it disappears, gets to the edge of the specimen, or abuts another feature; however, the overall relationship of all cracks to each other can be determined only by marking the cracks with ink and examining the specimen without magnification.

The procedure for marking microcracks in the paste is as follows: While viewing the slice with the stereomicroscope, carefully mark the microcracks with a pen. Use the movement of the ink as it follows the minute cracks by capillary action to find all the connections between the microcracks (Walker, 1988). The visibility of microcracks depends a great deal on the angle of the illumination and the angle of viewing. As the specimen is turned and moved under the microscope, more and more cracks become visible. The mind and eyes become concentrated on the view in the microscope, and the hands become totally engaged in the tasks of marking and moving the slice of HCC. Thus, a sort of hypnotic state is created that leaves no part of the mind free to relate the area being marked to a larger view of the slice as a whole. Many operators find that they are quite startled when the crack being marked extends to the edge of the slice and the crack falls into oblivion.

When control or other comparison specimens of HCC are available, mark the microcracks in at least one slice of the specimens of the control concrete and one slice of any specimen of an intermediate degree of distress (see appendix C).

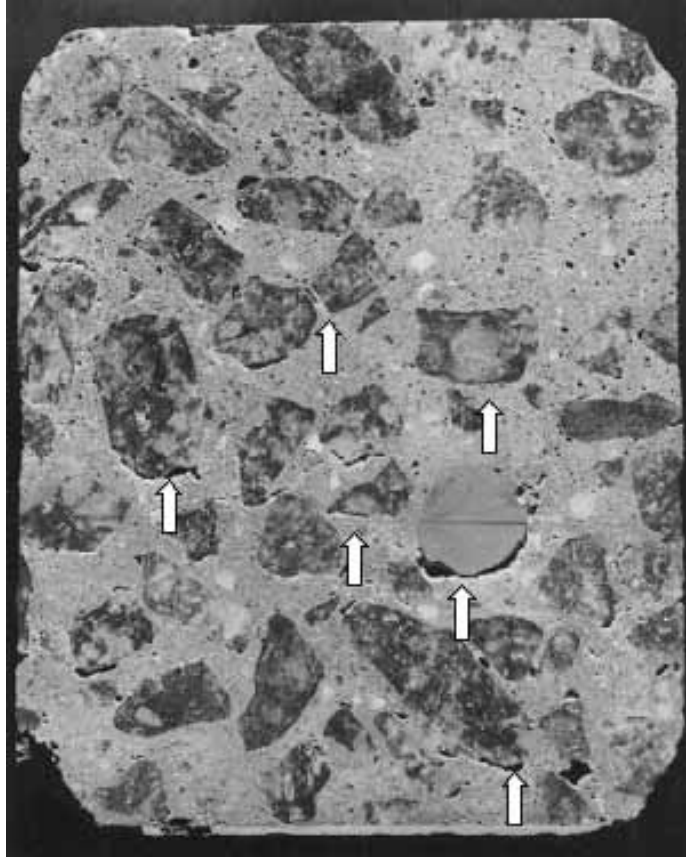

Specimen is 100 mm in width.

In this instance, the bond cracks occur most frequently on the underside of the aggregate and, therefore, can probably be attributed to bleeding or poor consolidation.

Figure 79. Cracks at the bond between the aggregate, rebar, and paste (see arrows).

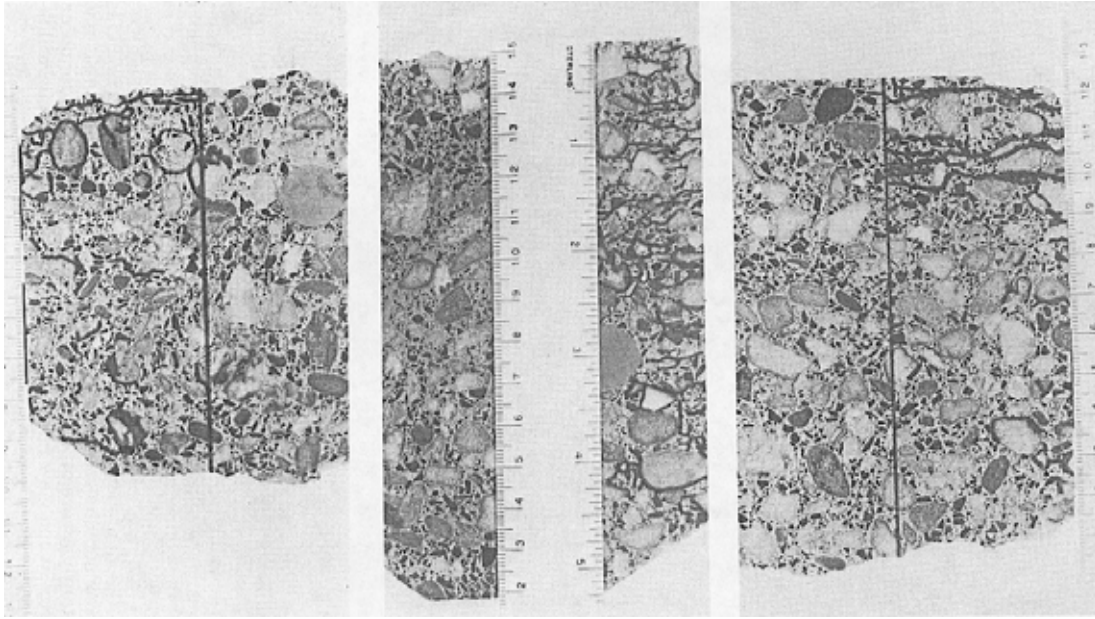

Such cracks occur in non-air-entrained concrete (cracks are emphasized with ink).

Figure 80. Cracks typical of damage caused by cycles of freezing and thawing.

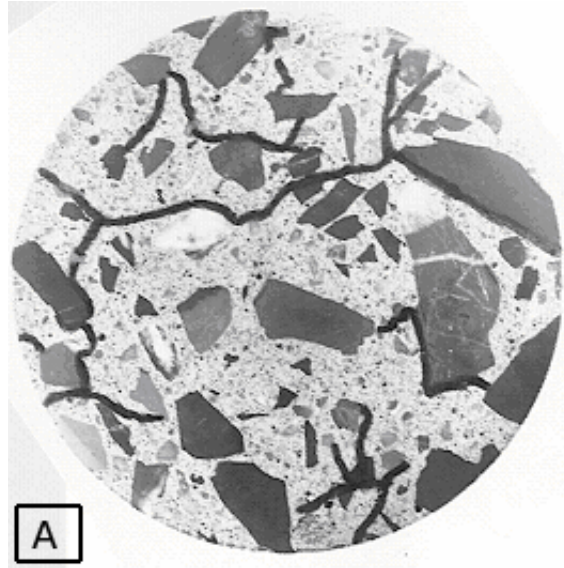

Figure 81. Microcracks: Smoothly lapped surface (A) with ink-marked microcracks.



Specimen is 100 mm in diameter.

The crack pattern seen in figure 81 in surface (A) was used to guide the finding of the cracks in surface (B) the reverse side of the same specimen, figure 82.

Figure 82. Microcracks: Wearing surface (B) near figure 81.

This method can be very time-consuming if there is a great amount of microcracking. Moving the slice of concrete under the microscope in an effort to check and mark the cracks and the connecting cracks of the total area can be a seemingly endless task. To get the work done in a reasonable amount of time, a possible procedure is to mark off a randomly selected portion of surface on each slice to be examined and compared. The size of the portion should be governed by the uniformity of the cracking and its frequency (50 by 50 mm might seem like a lot of area when magnified). Do not use a pen to mark off the portion. Ink may follow capillaries into the area to be examined. Use a narrow adhesive tape or a soft pencil in a bright color. The marking of the cracks and other important features can then be performed on these smaller portions of the surfaces (see figures 83 and 84).

Once the microcracks are marked, the patterns of microcracking will be visible to the unaided eye and varied HCCs can be compared, and photographs of the microcrack pattern may be prepared and used as evidence of the true condition of the HCC, as shown in figure 85.

If the placement has been overlaid with another material, such as latex concrete, the client may ask if there is a crack at the bond line. In such a case, study a vertical lapped surface and mark all microcracks with ink. Often, any separation between the overlay and the substrate concrete is not at the bond line, but is in the weaker material of the substrate (see figure 86). This just-below-the-bond cracking is often discontinuous; however, cycles of freezing and thawing and traffic may well cause complete delamination. This type of cracking usually indicates that the surface preparation techniques used were inadequate. The use of a milling machine to remove a layer of concrete will leave a damaged substrate surface that will impede bonding of the overlay. This milled surface layer should be removed by shotblasting or a similar technique before the overlay is applied.

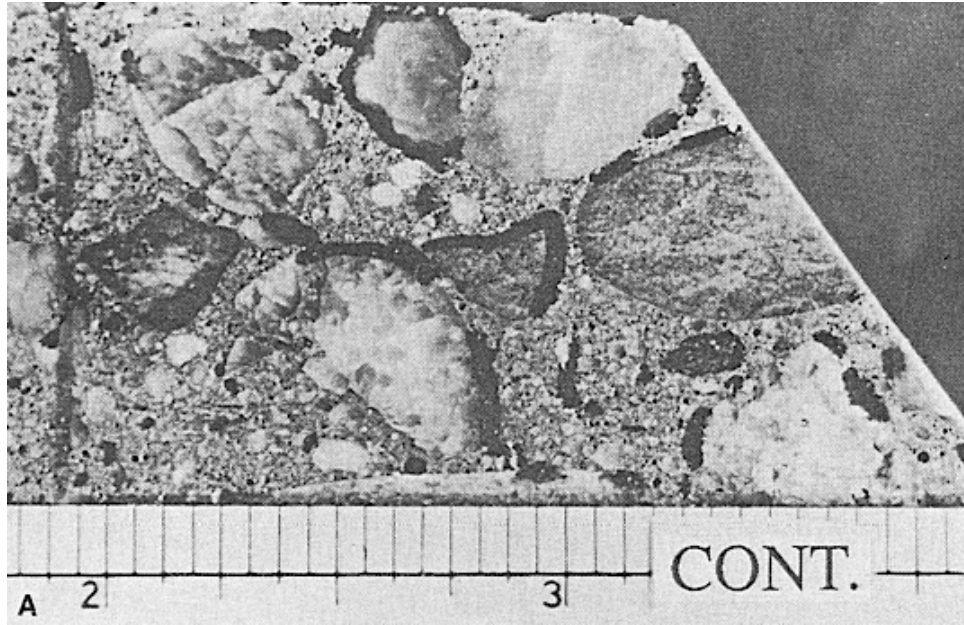

Scale is in inches.

Figure 83. Finely lapped surface of beam tested for resistance to cycles of freezing and thawing.

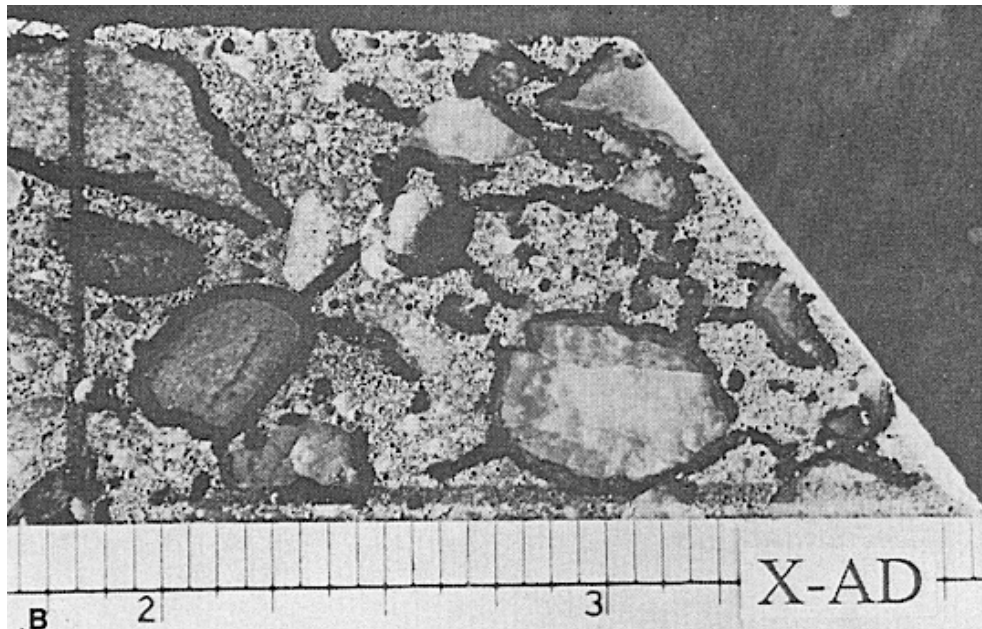

Scale is in inches.

Figure 84. Finely lapped surface of beam tested for resistance to cycles of freezing and thawing: Mixtures in figures 83 and 84 were identical except that the mixture shown here contained an experimental admixture.

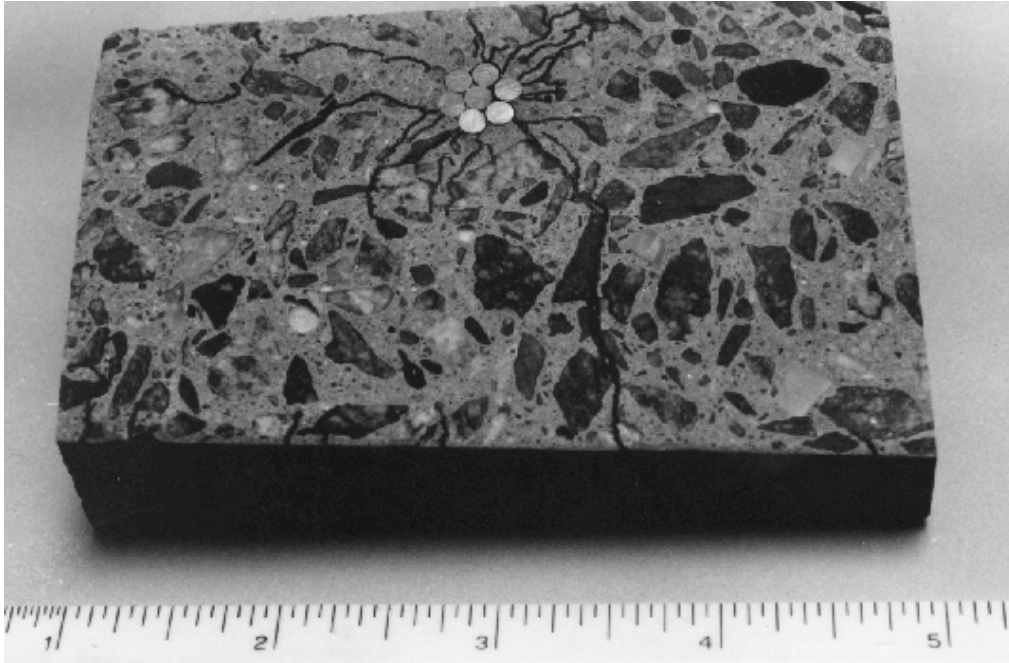

Scale is in inches.

With the stereomicroscope, the specimen could be seen to contain many fine cracks; however, the relationship between all of the cracks and the reinforcing cable could not be noted until the cracks had been marked with ink and the crack pattern examined without magnification. The field of view (the portion of the slice) seen at the magnification necessary for observation of the fine crack system is about the size of one wire of the cable.

Figure 85. Lapped surface of slice of concrete containing prestressing strand.

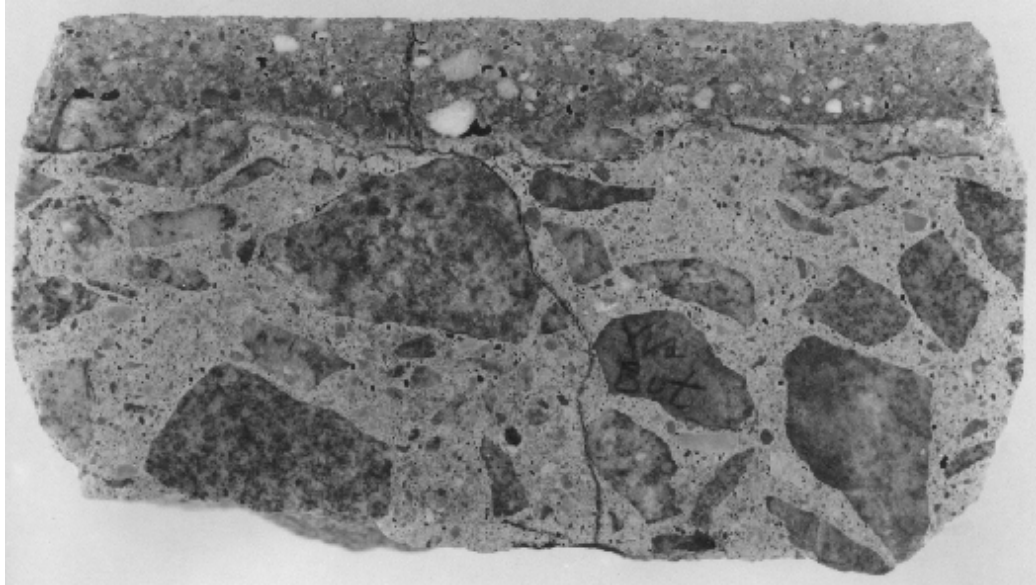

Specimen is 100 mm in width.

Notice that the vertical crack in the substrate continues through the latex concrete and is expressed at the wearing surface.

Figure 86. Cracking just below the bond in the concrete deck with latex-modified concrete overlay.

8.5 ENHANCEMENT OF MARKED FEATURES

All the notes produced during the examination of the slice should be reviewed, and all of the marks that are intended to be visible in photographs should be made permanent and clear enough to be recorded in a photograph. If they are not, they should be enhanced.

8.6 PHOTOGRAPHING OF SLICES AND THE MAKING OF PHOTOMICROGRAPHS

CAUTION: Most inks begin to fade after they have been in contact with HCC paste for a few days. Therefore, obtain any photographs promptly and make any necessary assessments of the condition of the concrete within a day or two. It is not known whether this fading is more rapid on young or old concrete or if it is a result of the ionic movement of the ink (sinking into and being distributed in a dilute condition throughout the HCC) or a chemical reaction.

Each exposure should be recorded in a notebook or file expressly designed for such data. Data that will aid in improving future photographs should be included: (1) record the illumination and the adjustments to the light meter or shutter control and (2) record the ground cloth and background when appropriate. A system for identifying all negatives should be devised and this identification should be recorded with the negatives, on any archive prints, and in all notes

concerning the photographs or specimens. Figure 87 is a sample of a sheet used in the VTRC stereomicroscopy photograph notebook.

8.6.1 Photographs of Marked Slice

The photographs may include the entire slice, or small areas of the slice may be recorded as enlarged by a camera lens or enlarger. Such photographs should be included in any important final report; they will be invaluable in any legal controversy. A permanent record should be made in the file regarding the roll and frame numbers or photographic file numbers.

8.6.2 Photomicrographs

Important features that are visible only with magnification should be recorded in photomicrographs so that they can be easily discussed with the client. A record of their appearance should be included in the data file on these specimens. Such pictures can be taken with a camera on the upright port of the stereomicroscope (see figure 19).

8.7 CHEMICAL SPOT TESTS AND STAINING TECHNIQUES

At various stages throughout an examination, it may be beneficial to use stains or spot tests to develop information on the chemical nature of the material in the specimens. These tests can be used on freshly sawed or fractured surfaces, lapped surfaces (either slabs or thin sections), or material plucked or otherwise extracted from specimens. The most common of these is the use of phenolphthalein to indicate the pH of the paste (figure 88). These tests have their origins in basic qualitative chemical analysis (Feigl, 1939; Jungreis, 1997), relying in most cases on ion-exchange principles to detect the presence of particular elements. As such, they do not positively identify the character of the tested material (e.g., as alkali-silica gel), but rather provide information regarding the chemical composition of the material (the presence of sodium or potassium) that aids in its identification and origin.

Two such tests have been identified as useful for alkali-silica reactivity (ASR) products—one for sodium using a uranyl acetate solution (Stark, 1990), the other for potassium using a sodium cobaltinitrite solution (Guthrie and Carey, 1997, 1999). The uranyl acetate test is detailed in section 10.2.3 and is an annex to ASTM C 856. It uses the principal of ultraviolet fluorescence of the uranyl ion and consequently requires a source of electric power and an opaque viewing box (portable darkroom) for use in an outdoor environment. The potassium spot test is simpler since potassium cobaltinitrite has a strong yellow color in normal light. It is also more environmentally friendly than the uranyl acetate test (Guthrie and Carey, 1997, 1999). It is important to emphasize that positive indications in these tests merely signify the presence of the particular ion in an exchangeable form in the substance being tested. Poole, McLachlan, and Ellis (1988) report the use of cuprammonium sulfate for detecting ASR products.

R-366a

PHOTOMICROGRAPHIC DATA SHEET # _____

DATE _____ / _____ / _____ ROLL# _____ FR# _____
 DAY MONTH YEAR

FILM _____ ASA _____ INCR? _____

CAM. OC.

ZOOM

OBJ.

SPECIMEN IDENTIFICATION :

SKETCH

SET: ASA _____ ASA _____ CTR . . T D . .

CHECK: 0 | | | | | | | |

UP-PATH ~~W~~ G ~~X~~ LO-PATH ~~W~~ G R out

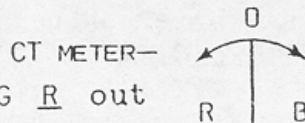

RELEASE EST. EX. _____ TIME OFF, USED ON PRESET.

REMARKS:

Figure 87. Sheet used in VTRC stereomicroscopy photograph notebook.

If the uranyl acetate test is used, care must be taken to follow all the safety precautions described. A fresh concrete surface free of laitance and carbonation is required. In the laboratory, a fresh surface can be sawed or produced by breaking the specimen with a sledgehammer or in a trimmer (figure 11). In the laboratory, the uranyl acetate-treated specimen is viewed in ultraviolet light in a dark place (closet or darkroom).

Any powdered concrete is rinsed from the surface. The uranyl acetate solution is sprayed on the surface, allowed to react for 5 min, and then rinsed away. The concrete is examined for fluorescent gel with the ultraviolet light (figures 89 and 90).

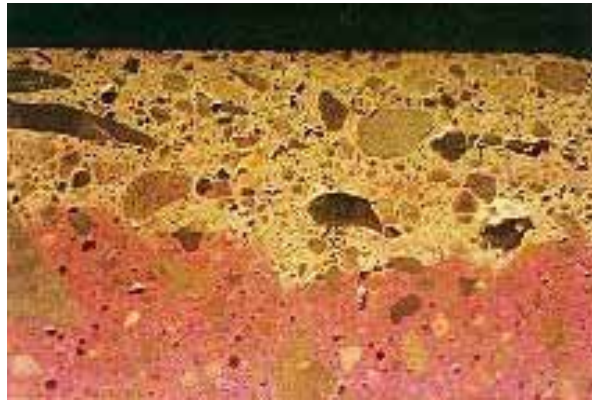

Field width is 20 mm.

Figure 88. Specimen treated with phenolphthalein (high-alkalinity, uncarbonated paste stains pink; carbonated paste does not stain).

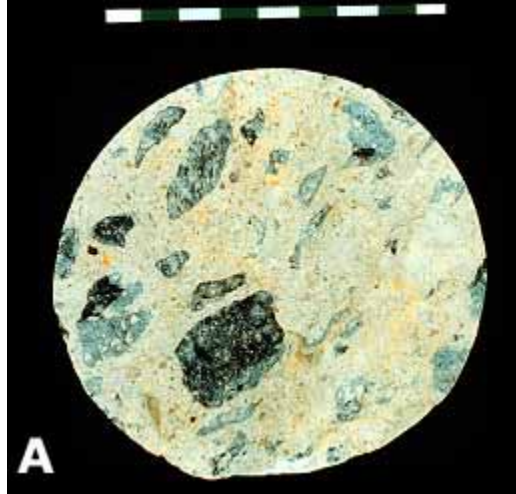

Figure 89. Specimen from retaining wall with destructive ASR treated with uranyl acetate: Ordinary light.

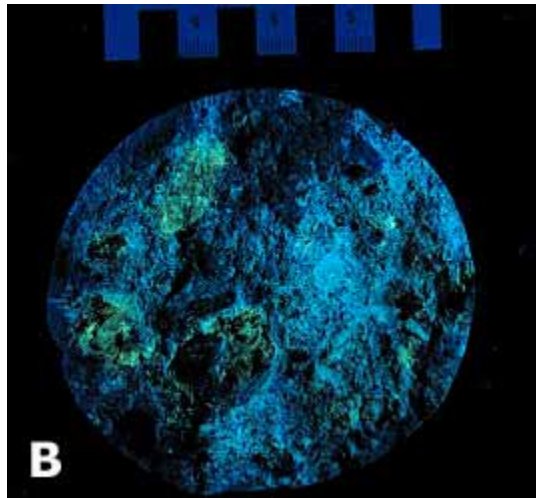

Figure 90. Specimen from retaining wall with destructive ASR treated with uranyl acetate: Ultraviolet illumination causes silica gel to fluoresce (darkroom photograph).

For the sodium cobaltinitrite test, the freshly fractured or polished surface is dampened with water and then the test solution is applied. Excess solution is rinsed from the specimen with water after several minutes of treatment. Observe the treated surface for evidence of the yellow precipitate (figure 91).

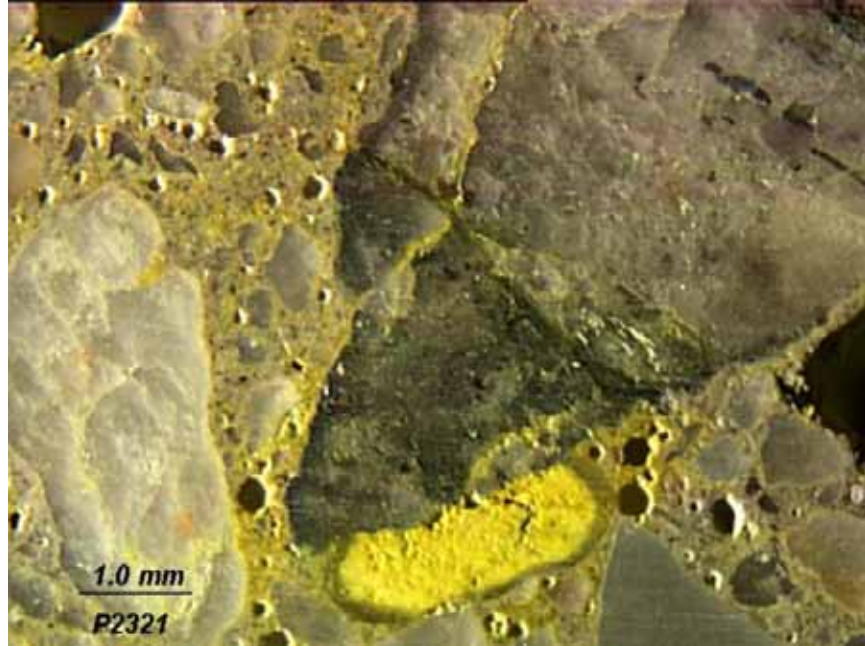

Figure 91. Polished specimen treated with sodium cobaltinitrite, which stains the potassium-bearing compounds yellow.

Sulfate compounds often exist as cryptocrystalline clear to white secondary deposits in voids or cracks and can be distinguished using a barium chloride, potassium permanganate solution (Poole and Thomas, 1975). If sulfate ions are present, BaSO_4 will precipitate, trapping permanganate in the crystal structure, thus staining purple (figure 92). Ray (2000) describes the use of Alizarin Red S solution that stains ettringite bright orange, whereas thaumasite, another sulfate mineral (containing carbonate) of similar appearance, stains pink to red. Alizarin Red-S solution also has use in differentiating carbonate minerals by their chemical makeup (Heinrich, 1965; St. John, et al., 1998).



Scale in millimeters.

Figure 92. Fractured surface treated with BaCl-KMnO_4 (secondary deposits containing sulfate are stained pink).

CHAPTER 9. WATER-CEMENTITIOUS MATERIALS RATIO

9.1 OVERVIEW

The w/cm, water to cementitious materials ratio, (here the cementitious materials include pozzolans such as fly ash and silica fume in addition to the hydraulic cements—portland cement and ground slag) is an exceedingly important parameter of the quality of the HCC. It is the main control of the compressive strength, abrasion resistance, and permeability. The w/cm can be estimated by petrographic means, or the cement content can be determined by chemical analysis and compared with the cement content specified. The petrographer may be requested to estimate the w/cm whenever concrete does not meet the compressive strength specifications. Whether requested or not, an estimate of this ratio should be a regularly scheduled portion of any general examination of the HCC. This chapter is primarily focused on the examination of hand specimens or polished surfaces. Thin-section examinations are covered in chapter 13 and SEM examinations are discussed in chapter 14.

9.2 PROCEDURES

9.2.1 Estimation

The w/cm can be estimated by following a five-step procedure, as listed in table 19. Liu and Khan (2000) describe the use of these techniques and report that satisfactory estimations of w/cm of field concretes can be made if an appropriate suite of standard specimens with known w/cm is available.

Table 19. Procedure for estimating w/cm.

- | |
|---|
| <ol style="list-style-type: none">1. Consider the air-void parameters.2. Consider the quantity of the paste.3. Consider the appearance of the paste.4. Study the reaction to needles and picks.5. Estimate the absorption and permeability. |
|---|

1. **Consider the air-void parameters:** Determine if there is any indication of an excess amount of air voids or excess size of air voids (see figures 53 and 54). Usually, the air-void system is the first-noticed indication of a high w/cm. The changes in the air-void parameters are because: (1) more air is generated and stabilized in mixtures where there is more water and (2) air-entraining admixtures are diluted (the surface tension inside the air voids is less effective). The dilution causes irregular voids and excessively large voids to be more prevalent. In concrete with a low-to-medium w/cm, the air-void system appears normal and the specific surface is high. There are few large and irregular voids (usually less than 1.5 percent by volume).
2. **Consider the quantity of the paste:** In HCCs with a high w/cm that has occurred because excess water was added to the mixture, the paste content appears high (i.e., the aggregate content may appear low). This is because water is a component of the paste and excess water expands the paste volume relative to the aggregate volume (see figure 63).

3. **Consider the appearance of the paste:** Study a finely lapped slice of the specimen with the stereomicroscope at 100X for the characteristics listed in table 20. Compare the appearance of the finely lapped surface with that of specimens in the reference collection that have a known w/cm.

Examine the tiny dark particles that are the remnants of the ferrite (iron-bearing interstitial) portions of the cement. Determine whether these particles are more or less prevalent in the specimen under study than in the specimens in the reference collection of normal HCC fabricated with the same type of cement. If the cement type is not known, study the concretes of all of the cement types in the collection.

Study the texture of the paste and compare it with that of specimens in the reference collection. If the paste has a very smooth, uniform surface resembling a plastic or ceramic, the w/cm is low. Careful observation of the texture of the paste at 80X to 100X magnification will indicate that the matrix of HCCs with a high w/cm is different (it is almost sugary (i.e., it appears to be composed of a mass of individual particles, as is a sugar cube)). This is why it fragments so readily. In extreme cases, these particles may seem to be equant individuals just barely stuck together. When the w/cm is only moderately high, this feature is beyond the resolving power of the stereomicroscope; however, an experienced observer will be able to see that the paste texture is more open than desirable and there is not a compact tight structure as in HCC with a low w/cm.

HCC paste with a high w/cm looks and is more fragile than paste in normal HCC. It is typically lighter in color than would normally be expected.

The average HCC with a medium-to-low w/cm has a dense, solid appearance. In HCCs with a very low w/cm or when particular particulate admixtures are used, the paste appears very smooth and dense, almost like a plastic.

Table 20. Paste characteristics reflective of w/cm.

| Characteristic | Lower ← w/cm → Higher |
|---|--|
| Color, tone | Darker Lighter |
| Hardness | Harder Softer |
| Density | Denser Less dense |
| Porosity (color intensity of dye-impregnated specimens) | Less Porous More porous |
| Cementitious materials: | |
| Size of residual and relict grains | Larger Smaller |
| Abundance of residual and relict grains | More Less |
| Calcium hydroxide: | |
| Size | Smaller Larger |
| Abundance | Less More |
| Morphology | Anhedral Euhedral |
| Degree of carbonation | Low High |
| Texture, polished surface | Porcelaneous Sugary |

4. **Study the reaction to needles and picks:** Scratch and pick at the paste while observing the reactions of the paste with the stereomicroscope. If the w/cm is high, edges will seem to come off by fragmentation rather than by the cracking or bending that is common in HCCs with a low w/cm.
5. **Estimate the absorption and permeability:** Place a drop of water on the finely lapped (oil-free) slice and observe the drop. If the water beads up from surface tension (looks as if it could roll around) before it sinks in, the w/cm is normal or low. If the drop spreads out with a feathery edge and sinks into the concrete quickly, the w/cm is high. The more slowly the water drop disappears into the concrete, the lower the w/cm and the permeability.

9.2.2 Chemical Determination

If the compressive strength of the concrete is low, the chloride ion permeability is high, the microstructure of the paste appears to be sugary, an aggregate with a known high water demand was used, or more quantitative data are required, a chemically determined cement content of the hardened concrete may be indicated. The cost of this analysis and the arrangements with the chemist or testing laboratory are usually the responsibility of the client. The methods used over the years for this chemical determination are discussed by Hime (1978) and in ASTM C 1084. Other methods are discussed by Clemeña (1972) and Pistilli (1976). If the amount of water used is known (rare in field concrete), the w/cm can be calculated from this determination.

The proper chemical determination of the cement content requires the use of a method appropriate for the type of aggregate present. A chemical determination of the cement content gives a result that is an average of the cement content of the specimen and provides no information on the extreme conditions that may exist in local zones in the specimen and whose extent and continuity may be critical to the strength and durability of the subject concrete. The selection of the particular portion of a specimen for analysis will affect the results. The chemical method cannot distinguish between cement that has been tied up in only partially hydrated rims and balls and cement that has dispersed and hydrated and thus contributes to the strength of the HCC. If the portion selected has a large proportion of knots of cement or cement rims on aggregates or both, the results will indicate sufficient cement content. If the portion selected is a light-colored portion containing excess air voids, less than a normal amount of unhydrated cement, and paste with a sugary texture, the results will indicate a low cement content. The petrographer must use good judgment in selecting the portion of the specimen for chemical analysis to ensure that it is as representative as possible. There may be no representative portion of the specimen that is of sufficient size for chemical analysis. In such cases, the petrographer might inform the client about the data already obtained and recommend procuring additional specimens.

The result of the cement analysis is reported (usually to the client) in kilograms per cubic meter (kg/m^3). If the reported amount of cement is significantly less than the amount of cement intended to have been used in the mixture, then the w/cm is high and either the volume of the concrete increased (usually because of excess water) or less than the prescribed amount of cement was used. Because the analysis is not performed on specimens of HCC suspected of having a normal or low w/cm, we have never had to report a case where the cement content indicated that a significant excess of cement was added or that a significant amount of water was omitted.

CHAPTER 10. ALKALI-AGGREGATE REACTIONS

10.1 OVERVIEW

The concrete petrographer is often called upon to explain the causes of deterioration of an HCC placement. The determination of the severity and the extent of the distress must include an examination of the placement. The laboratory work of the petrographer includes identification of the cause(s) of distress through an examination of the cracks and crack surfaces, paste and aggregate condition, and identification and study of the nature of the aggregates and any secondary reaction products by performance of various tests.

Concrete is fabricated by placing aggregate consisting of gravel, sand, or rock fragments or other mineral material in a very chemically active environment. The fluid of fresh cement paste is a saturated solution of calcium hydroxide. This solution is very alkaline (a pH of 13.5 is not uncommon and the high pH level can be maintained long after the concrete hardens absent chemical reactions (e.g., pozzolanic reactions) to reduce it). These alkaline solutions are so strong that they will chemically burn skin and etch glass and are much stronger than the solutions to which rock might typically be subjected during the natural weathering cycles. In hardened concrete, these solutions can cause dissolution of particular siliceous minerals or glass in aggregates, or cause chemical and volume changes in particular carbonate rocks. These reactions are collectively called alkali-aggregate reactions, which are subdivided into ASR in the case of the former and alkali-carbonate reactions (ACR) in the latter. Both of these reactions are deleterious when they cause sufficient expansive force within concrete to rupture the concrete despite the restraint of the mass of the placement and the powerful bonding within the cement paste. If the expansive force is so minor that it cannot overcome the restraint imposed by the concrete, then no deterioration occurs (Hilton, 1974; Houston, 1969).

The alkali metals (sodium and potassium) in cement are reported in terms of sodium oxide equivalent (Na_2Oeq) calculated as the sum of the sodium oxide (Na_2O) mass percentage plus 0.658 of the potassium oxide (K_2O) mass percentage. The factor 0.658 accounts for the difference in the atomic mass between Na_2O and K_2O . Gebhardt (1995), in a survey of North American portland cements, reports alkali contents ranging from 0.11 to 1.2 percent Na_2Oeq , with Na_2O ranging from 0.03 to 0.47 percent and K_2O ranging from 0.07 to 1.20 percent. However, cement is not always the only source of the alkalis involved in the deleterious reactions. Deleterious alkalis may come from groundwater, seawater, deicing chemicals, or other sources (e.g., aggregates).

The identification of AAR as a cause of concrete deterioration requires an integration of field and laboratory evidence (British Cement Association, 1992; Lane, 2001). In the field, a differential volume change between the exterior and interior portions of the concrete mass resulting from AAR is manifested by pattern cracking on the surface, with an overall expansion of the element. Laboratory investigations will focus on determining the cause of the expansion, specifically: Are aggregate particles reacting? If so, which ones and what is the nature of the reaction?

10.2 REACTIONS

10.2.1 Alkali-Silica Reaction

T.E. Stanton (1940), working in California, first identified reactions between the alkalis in cement and aggregates as a cause of concrete distress. In the early literature, prior to the discovery of ACR, the reaction was simply called the alkali-aggregate reaction (Diamond, 1978). The reactive constituent in the California aggregates studied by Stanton was opal.

In light of Stanton's discovery, some cases of previously identified but unexplained concrete deterioration were revisited and were found also to be explainable by a similar phenomenon; a notable example from Virginia is the Buck Hydroelectric Plant (Kammer and Carlson, 1941), involving a crushed phyllite aggregate. Since the reactive constituents in these early cases were silica minerals or siliceous glasses, the subgroup *alkali-silica reaction* was coined. Mielenz (1956) mapped known ASR occurrences in 17 States: California, Arizona, and Nevada; Idaho, Washington, and Oregon; Colorado, Wyoming, Kansas, Nebraska, and Missouri; Indiana and Ohio; Alabama; Georgia; New Jersey; and Virginia. An updated map (Mielenz, 1994) shows occurrences in 33 States. A nationwide survey of State highway departments for the Strategic Highway Research Program (SHRP) received positive responses from 19 States, negative responses from 18 States, and no response from 5 States (Stark, et al., 1993). From this knowledge of alkali-reactive constituents, it is probably safe to conclude that alkali-silica reactive aggregates occur in virtually all of the 48 contiguous States.

It is somewhat of a misnomer that the reaction has been given the name *alkali* since it is actually the hydroxide ions associated with the sodium and potassium ions in solution that cause the deleterious reactions. The alkalis are not always present in sufficient amounts to cause a deleterious reaction, thus explaining why deleteriously affected concrete is not as widespread as potentially reactive aggregates. In a closing comment to the discussion of his paper, Stanton (1940) suggests that, based on work to date, deleterious ASR would not occur with cements having alkali contents below 0.60 percent $\text{Na}_2\text{O}_{\text{eq}}$, with the caveat that the future developments would settle the issue. The 0.60 percent $\text{Na}_2\text{O}_{\text{eq}}$ value was then adopted in 1959 (Frohnsdorff, Clifton, and Brown, 1978) and remains as the designating limit for "low-alkali cement" as specified in ASTM C 150. Tuthill (1982), citing field evidence, reported that the 0.60 percent limit was set too high and that 0.40 percent was a more appropriate limit to avoid deleterious reactions.

This reaction occurs between the hydroxide ions associated with the dissolved salts of sodium and potassium and the silica molecules of particular imperfectly crystallized siliceous rocks and minerals, such as opal, chert, and cristobalite, or highly siliceous volcanic glasses or highly strained or granulated siliceous rocks, such as the metaquartzites, other stressed silicates, and exceptionally fine-grained siliceous rocks (such as siltstones and phyllites). The reaction produces a silica gel that will expand in the presence of moisture. The expanding gel causes cracks in the aggregate and paste. The cracks allow more moisture to enter and expansive gel to fill the cracks and cause more expansion.

As the reaction proceeds, the gel forms and can expand. The expansion ruptures the aggregate particles, allowing the gel to migrate out of the particle where it can permeate the paste and collect in entrapped voids, pores, and microcracks. These gel deposits may continue to expand, opening microcracks and creating new cracks.

Sometimes, the entire center of a highly reactive aggregate particle, such as chert, may be converted to an expansive gel that can create, ooze out into, and enlarge microcracks. When the concrete is broken or cut open, many large cracks may be seen radiating from reactive particles. Destructive cracks may also be found radiating from gel-filled pores and voids.

The gel formed at the aggregate surface and that formed before hardening (usually distributed interstitially throughout the paste) are high in lime. These high-lime gels are thought to be unable to expand and therefore innocuous. Pozzolanic materials and ground slag react with hydroxyl in a similar reaction, incorporating the alkalis in the (nonswelling) silicate hydrate produced, thus removing them from the pore solution and reducing pore solution alkalinity.

With the exception of the pure limestones and dolomites, almost all rocks contain some silica. Silica is the most common oxide in the earth's solid crust. The more soluble the form of the silica, the faster and more intense is the reaction. Varieties of naturally occurring silica minerals are listed in rough order of decreasing reactivity in table 21. This list is very general because, of course, the order is dependent on the degree of disorder to be found within the particular variety and mode of occurrence of the species.

Table 22 lists rocks that have been found to be deleteriously reactive and thus can be considered potentially reactive. The actual reactivity of any given rock is dependent on the type and amount of reactive constituent (see table 21) present, as well as other factors. The list in table 22 is not exhaustive and will likely grow with the passage of time.

Table 21. Silica minerals in order of decreasing reactivity.

- | |
|---|
| <ol style="list-style-type: none"> 1. Amorphous silica: Volcanic glass (a volcanic glass that is only partially devitrified and/or mostly recrystallized may still be reactive) 2. Opal 3. Unstable crystalline silica (tridymite and cristobalite) 4. Chalcedony 5. Other cryptocrystalline forms of silica 6. Metamorphically granulated and distorted quartz 7. Stressed quartz 8. Imperfectly crystallized quartz 9. Pure quartz occurring in perfect crystals |
|---|

Table 22. Potentially alkali-silica reactive rocks.

- | |
|---|
| <ul style="list-style-type: none"> • Volcanic rocks, including tuffs (high and intermediate siliceous varieties are more reactive than basaltic varieties; however, some basaltic rocks may contain siliceous interstitial glass) • Sedimentary rocks containing opal (e.g., shale, sandstone) • Metaquartzite (metamorphosed sandstones), metagraywackes • Gneiss, schist, phyllite, argillite, slate • Granite, granodiorite, charnockite • Quartzite, sandstone, siltstone, shale, graywacke, siliceous limestone • Chert |
|---|

Once the reaction has started in a concrete, it will continue as long as deleterious alkali ions, reactive aggregate, and water are available in sufficient supply. The rate of the reaction depends on the solubility of the silica-bearing minerals involved, the type of gel formed, the amount of water-soluble alkali present, the availability of water, paste permeability (the ability of water and ions to migrate), and temperature.

10.2.2 Alkali-Carbonate Reaction

ACR was first observed by Swenson (1957) in Kingston, Ontario, Canada, and was found by Newlon and Sherwood (1962) to occur in Virginia. This reaction occurs between particular impure dolomitic limestones of a specific petrographic type (Newlon, Sherwood, and Ozol, 1972; Swenson, 1957; Swenson and Gillot, 1960; Walker, 1978) and the hydroxide ions associated with the dissolved salts of sodium and potassium alkalis in the pore solution. ACR is not as well understood as ASR, but it involves de-dolomitization (decomposition of dolomite to brucite and calcite) (ACI 221.1R; Ozol, 1994). The expansion produced occurs within the aggregate particle causing cracks within the aggregate and the paste and, therefore, deleterious expansion of the mass. The dolomite crystals in the aggregate are chemically altered by the alkali solutions in what is apparently a multistep process. Which step causes the expansion has not been determined.

All known reactive carbonate rocks are from the geologic time period known as the Ordovician period. Fortunately, the particular proportion of minerals and the microstructure of the reactive carbonate rocks involved are not very common. This rock has been suspected of not being a geologically stable combination of minerals (Steidtmann, 1917). De-dolomitization, although rare, has been observed in rocks and experimentally at low (less than 50 °C) temperatures in the presence of solutions with a high calcium-to-magnesium ratio (Pettijohn, 1975), conditions not unlike those to which the aggregate would be exposed in concrete.

The carbonate aggregate that is associated with this reaction is an impure dolomitic limestone. The two major carbonate minerals, calcite and dolomite, are present in nearly equal amounts in the most common ACR rocks; however, some reactive rocks have dolomite contents of up to about 90 percent of the carbonate fraction (Ozol, 1994). Noncarbonate minerals (insoluble in weak HCl), usually of submicroscopic size, make up 10 to 25 percent of the mass and generally consist of clay, various iron sulfides, and quartz. Small quantities of other minerals may also be present. The aggregate is often (but not always) dark gray or nearly black because of the finely divided iron sulfides. The fracture in a hand specimen is subconchoidal because the individual crystals are so small and interwoven that their cleavage and parting do not affect the surface.

When the cement alkali content is less than about 0.45 percent $\text{Na}_2\text{O}_{\text{eq}}$, the cement has been considered to be too low in alkali content to contribute to a significant chemical reaction and concomitant expansion as a result of ACR (Swenson and Gillott, 1960). At this time, we do not know if this low limit for the alkali content will prevent ACR in every case.

ACR is not related to the aggregate soundness problem found in the Midwest that has been termed *D-cracking*. *D-cracking* has not been found in Virginia and, therefore, VTRC has not had any experience with it. Refer to appendix D for more details on *D-cracking*.

10.3 FIELD EXAMINATION

AAR causes internal volume expansion that is manifested on the exterior surfaces of the concrete by map or pattern cracking (figures 93 through 97) (see also ACI 201.1R, SHRP C/FR-91-101). Field observations can be critical to a proper determination of the cause(s) of distress and should be made by the petrographer and/or other qualified personnel following appropriate protocol (see Van Dam, et al., 2002a,b). In performing the examination, careful attention should be given to features suggestive of AAR (British Cement Association, 1992; Lane, 2001). (Note that although these documents are addressing ASR, the field manifestations of ASR and ACR will be similar, with the exception of possible exuding of ASR reaction products as outlined in table 23.) Table 23 also provides factors for rating the extent and severity of the observed features.

Table 23. Visual features and rating indices from field observations (British Cement Association, 1992; Lane, 2001).

| Features, observations | |
|---|---|
| Cracking | Position, disposition, and pattern |
| Discoloration | Surface patches, along cracks |
| Efflorescence, exudations | Position, extent, quantity |
| Popouts | Number, size, distribution, particle nature |
| Classification, index extent, and severity of each feature | |
| Extent of features, ranking value: | |
| Not significant | 1 |
| Slight, up to 5 percent area or length | 2 |
| Moderate, 5 to 20 percent | 3 |
| Extensive, more than 20 percent, but not all | 4 |
| Total, all areas affected | 5 |
| Severity of features, ranking value: | |
| Not significant | 1 |
| Minor feature, non-urgent, cosmetic | 2 |
| Unacceptable features requiring attention | 3 |
| Severe defects requiring immediate attention | 4 |
| Structurally unsafe | 5 |

10.3.1 Cracking Pattern

The pattern of cracking that indicates expansion of the concrete can be very similar to cracks generated in masses of mud when the top layer dries and shrinks, plastic shrinkage cracks (see chapter 4), and cracks in particular lava flows that occur when the surface cools rapidly and shrinks. Each portion of the surface pulls away from every other portion, generating an irregular honeycomb pattern. The size and regularity of the pattern depend on the cohesiveness, uniformity, and isotropy of the material and the speed of shrinkage.

This pattern is generated because there is a differential volume change between the exposed surface material and the attached massive substrate. In plastic or drying shrinkage cracking, mud cracking, or cooling lavas, the surface has shrunk relative to the substrate. In expansive AAR, the pattern is generated by an increase in volume of the substrate relative to the volume of the overlying surface material. The surface cracking pattern has been called *pattern cracking*, *map cracking*, *Isle of Man cracking*, and *crow's foot cracking*.

In ordinary concrete that is free to expand equally in all directions parallel with the plane of the surface, the classical cracking pattern is usually very evident on the surface in all stages of deterioration (see figure 93). In continuously reinforced HCC pavement or in concrete units that are much longer than they are wide (such as beams), the concrete is not free to expand equally in all directions. In the early stages of deterioration, concrete can expand only at right angles to the length and the cracks will, of necessity, be at right angles to the direction of the expansion and therefore parallel with the long dimension (and the reinforcing steel when present) (see figure 94). In the early stages, longitudinal cracking caused by AAR is sometimes mistaken for cracking caused by expansion of the corrosion products of the reinforcing steel. If a nonreinforced, relatively equant concrete member fabricated with similar materials (such as a bridge approach slab) and placed at the same time is available, it may show classical pattern cracking long before the longitudinal or reinforced unit exhibits anything other than longitudinal cracking. Figures 95 through 97 show examples of concrete distressed by AAR.

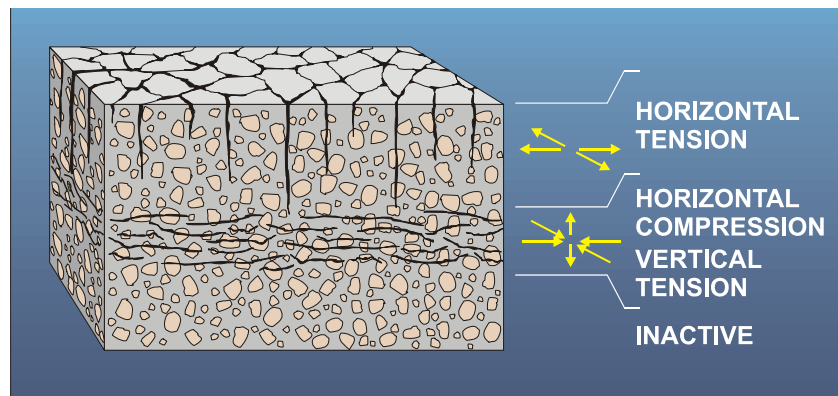

Figure 93. Idealized sketch of cracking pattern in concrete mass caused by internal expansion as a result of AAR.

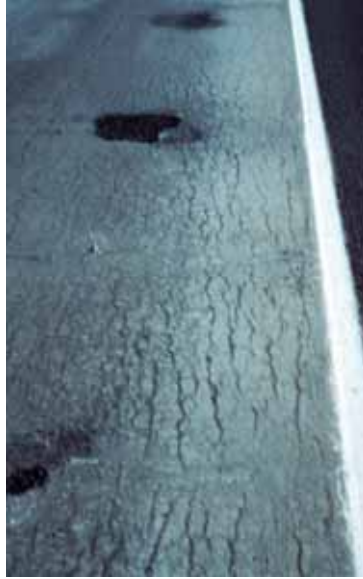

Figure 94. Map cracking with preferred longitudinal trend in continuously reinforced concrete pavement.

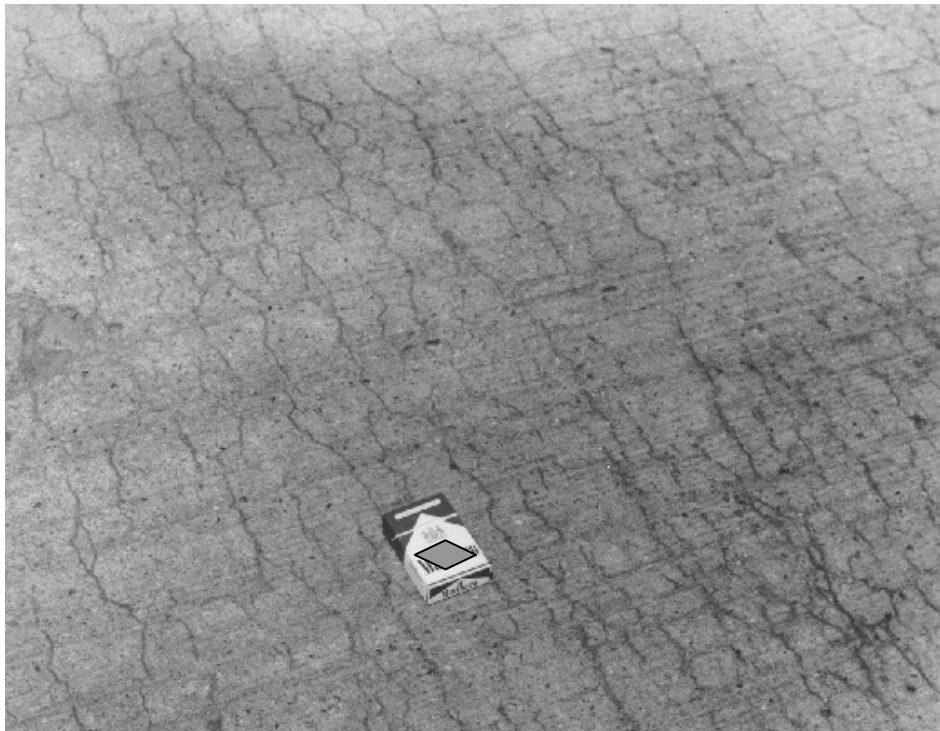

Figure 95. Typical destructive ASR in plain or lightly reinforced pavement.



Figure 96. Destructive ASR in anchor block.

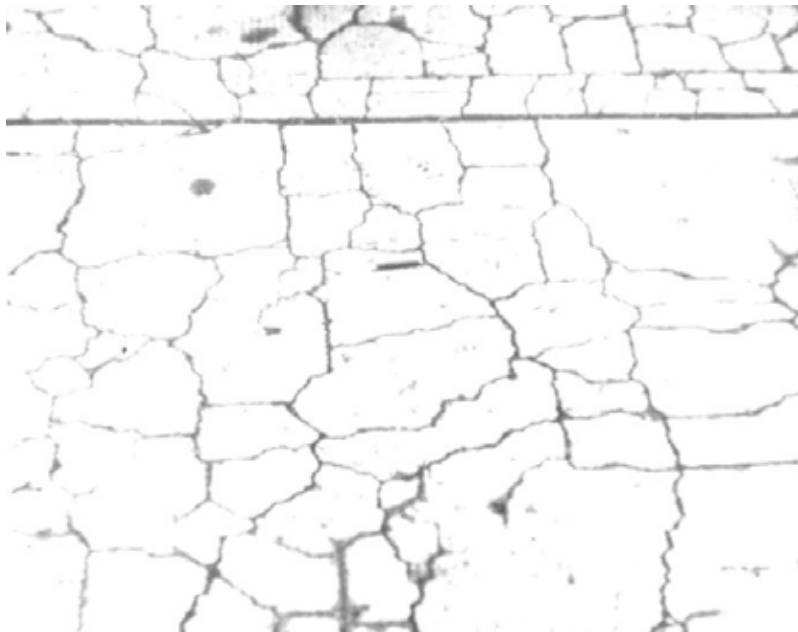

Figure 97. Cracking of pavement as a result of ACR.

10.3.2 Structural Evidence of Expansion

The expansion of the placement may be very evident. Expansion joints may have closed, with the joint compound having been squeezed out. Guardrail sections that had been planned with a space between may be abutting and grinding together and destroying each other. Occasionally, the expansion may cause blowups, with slabs of concrete bowing upward off the base because they no longer fit the space. The expansion can cause shearing of bolts and, occasionally, humping of nearby flexible pavement on the shoulders. Figures 98, 99, and 100 show examples of structural expansion.



Figure 98. Upper portion of backwall sheared by expansion of bridge deck.



Expansion caused by ASR of quartzose coarse aggregate.

Figure 99. Expanding median barrier crushes itself.

If elements of the placement are being forced together or the cracking pattern indicates that the lower or damper portions of the concrete may have expanded relative to the upper drier portions, or both, the concrete is probably deteriorating by internal expansion.

The expansion is not always clearly shown and may be difficult to understand and document. Expansion is greatest in the areas that have the least optimum combination of factors (i.e., areas that combine the reactive aggregate in sufficient amounts; a sufficient amount of alkali in the pore solution; and, most variable of all, sufficient amounts of moisture and a sufficiently high permeability to permit the reaction and expansion to occur). Because the reaction cannot occur without moisture, the reaction and expansion are greatest at the depths in the concrete that very seldom become dry. The surface zone of the concrete is the driest portion, does not react as much, and does not expand as much; however, the surface portion is bonded to the concrete beneath and must move with it and, therefore, cracks. An internal RH of 80 percent is needed for ASR to proceed with deleterious expansion. Nearly all concrete will have an internal RH of more than 80 percent if one side is on the ground and the RH is measured at a depth of 50 mm from the exposed surface, even in the desert (Stark, 1991).

10.3.3 Exudations, Coatings, and Pore Fillings

ASR produces an expansive silica gel that may be visible on the surface of the concrete in most advanced cases of deterioration. The gel may be translucent and moist or sticky, but often becomes dehydrated and carbonated to an opaque white coating or an efflorescence (see figure 96). Such exudates should be sampled for analysis in the laboratory as they may consist of merely carbonated hydroxides (see section 10.4).



Figure 100. Closing of joint caused by bridge deck expansion as a result of ACR.

Occasionally, as the gel dehydrates on a pavement surface, it becomes polished to a translucent glaze. In a severely deteriorated bridge, the silica gel and leached-out calcareous reaction products may form stalactites hanging under the bridge. In cases of an ASR with little or no deterioration caused by expansion, the silica gels may exist within the concrete as void fillings or as fillings in cracks produced by structural strains or deterioration caused by cycles of freezing and thawing.

10.3.4 Sufficient Sampling

Guidance on the sampling of concrete suspected of materials-related distress can be found in Van Dam, et al. (2002b). Sampling of HCC in the early stages of alkali-aggregate deterioration may need to be more complete than the sampling suggested in appendix A. The surface evidence of AAR is not usually evenly distributed on the placement and is not often indicative of the condition of the HCC beneath the surface. Whereas it is important to obtain specimens of the most deteriorated areas, it is equally important to study specimens of concrete from areas that have no surface deterioration so that an assessment of the extent of the underlying expansion can be made. Full-depth cores should be taken of several areas showing surface distress, of apparently undamaged HCC halfway between such areas, and at regular distances between the halfway cores and the most distressed areas.

10.4 LABORATORY EXAMINATION

At this stage, field examinations have suggested differential volume change between the interior and exterior of the concrete mass. The goal of the laboratory examination is to determine whether the interior is expanding and, if so, which concrete components and what mechanisms are involved in causing the expansion.

To maintain objectivity in the petrographic assessment of damage, several authors have proposed rating systems (Grattan-Bellew, 1995; Clemeña, et al., 2000; Rivard, Fournier, and Ballivy, 2000). The use of such rating procedures is further described in CSA A864-00 (CSA International, 2000). In these rating procedures, the number of occurrences of specific features observed during a low-magnification examination of a lapped surface is weighted according to the specific feature and summed, and the rating is normalized for the area observed. Features and suggested weighting values specific to ASR are shown in table 24. The weighting assigned to a particular feature is somewhat subjective based on consideration of its indication of damage related to ASR. Thus, this type of process provides a means of achieving an objective quantitative rating of ASR-related damage from a petrographic examination.

Table 24. Petrographic features and weighting factors for ASR distress (Lane, 2001).

| Feature Observed | Factor (Grattan-Bellew, 1995; Rivard, et al., 2000) | Factor (Clemeña, et al., 2000) |
|--------------------------------------|---|--------------------------------|
| Coarse aggregate with cracks | X 0.25 | 2 |
| Coarse aggregate with cracks and gel | X 2 | 4 |
| Coarse aggregate debonded | X 3 | 0.5 |
| Reaction rims on aggregate | X 0.5 | 4 |
| Corroded aggregate | — | 4 |
| Cement paste with cracks | X 2 | 4 |
| Paste with cracks and gel | X 4 | 6 |
| Air voids lined with gel | X 0.5 | 0.25 |

When developing rating systems, careful consideration should be given to the selection and interpretation of features to be rated. Preexisting rims on aggregates (i.e., weathering rims on gravel sand particles) must be distinguished and discounted. Rims that have formed in situ in the concrete are clear evidence of alteration; however, such alteration can often be innocuous. Likewise, cracks resulting from natural processes or aggregate processing may be present in particles prior to their introduction into concrete, and this possibility must be considered when examining the concrete for signs of internal distress.

Applying a similar approach, but categorizing damage-related features into damage-specific, aggregate-specific, and ASR-specific groups, a rating scheme that will objectively assist in ascribing responsibility among the active deterioration mechanisms can be developed (table 25).

Table 25. Damage categorization to provide neutral assessment (Lane, 2001).

| Category | | |
|---------------------|--|--------------------------------------|
| A: Concrete Damage | B: Aggregate Involvement | C: ASR-Specific |
| Cracks in paste | Cracks in aggregate | Gel in aggregates |
| Cracks in aggregate | Cracks at aggregate periphery | Intergranular corrosion of aggregate |
| Aggregate debonded | Aggregate reaction rims (formed in concrete) | Gel in paste cracks |

The laboratory examination can be conducted in four steps:

1. **Study cut or cored specimen surfaces and crack surfaces produced by the reaction (see chapter 8):** Study the crack structure and the surface of the cracks to develop initial information on crack dispositions, associations, and the relative age of the concrete when the cracks occurred (see chapter 4).

Examine the surfaces for the presence of any reaction products and for the relationship of the cracks in the paste to any deterioration of the aggregate particles (figures 101 and 102). Place particular emphasis on the specimens of the interior portion of the placement. The material of the severely cracked drier surface portion has not expanded so much and may not exhibit so abundantly evidence of the cause of the deterioration. Examine the ends of partial-depth cores and observe whether the fracture plane passes through or around coarse aggregate particles (figures 103 and 104). Fracture surfaces of tested splitting tensile specimens are also useful for studying these relationships (figure 105). Study the aggregate to determine its nature and the evidence of alteration by an AAR. Such evidence may be: (1) rims on the aggregate that seem to make the exterior of the aggregate less permeable; (2) cracks extending out into the paste; (3) intergranular corrosion of either grain boundaries or cements; in extreme cases, the centers of particles (e.g., sandstone) may be hollowed out because the original cement between the sand grains has been corroded by the reaction so that the centers are more friable than the rims; and (4) aggregate particles that have been cracked by deposits of gel and dehydrated gel that occur as rims within and around the particles, often on bedding planes or other partings intrinsic to the aggregate. Report the various types of deterioration observed.

When liquid gels exude onto the surface, saturating the paste, filling the cracks, and oozing from the surfaces, or dehydrated, carbonated gels can be seen as a white deposit, the ASR is in its most easily identifiable phase (see figures 103 and 104). These white deposits are common as rims around coarse aggregate in the paste and the cracks and bedding or foliation planes in the aggregate and as fillings in voids. These deposits are more common with depth. In the near-surface portions of the concrete, the rims may be difficult to see. The rims that occur inside the aggregate are most easily seen on surfaces that have been forced apart by the reaction (i.e., in cracks caused by the reaction (figure 104)). On the surfaces of the cores and on sawed and lapped surfaces, there may be no evidence of rims whatsoever and the only hint of an ASR may be scattered white void fillings of dehydrated silica gel.



Note the vertical crack from the surface to a depth of approximately 60 mm where damaged coarse aggregate particles are situated. Coarse aggregate is a quartzose gravel susceptible to ASR.

Figure 101. Bridge deck.

Figure 102. Extracted core.



Note pattern of cracking on the surface.

Figure 103. ASR in longitudinally reinforced pavement constructed with dark metabasalt aggregate.



Note the dried, white carbonated gel around each piece of aggregate.

Figure 104. ASR in longitudinally reinforced pavement constructed with dark metabasalt aggregate: 100-mm core that fractured on this surface upon removal from the pavement.



Figure 105. Fracture face of splitting tensile specimen: Examine for aggregate fracture and deterioration, as well as secondary deposits.

2. **Examine a number of finely lapped slices (see chapter 8):** Observe and note the general features of the concrete: paste characteristics, void structure, aggregate types, cracking, secondary deposits, etc. Pay particular attention to clues relative to possible expansion. Cracking through the paste with peripheral gaps around aggregate particles are suggestive of paste expansion, whereas cracking through aggregate particles indicates mechanisms involving the aggregates. If aggregates show signs of in situ damage such as cracking, corrosion, rim development, or reaction products, make note of the lithology and nature of the distress (figures 106 through 113). Make note of any secondary deposits for further study under step 4.

The most easily detected identifying characteristic of the alkali-reactive carbonate rocks is the microtexture of the aggregate. Invariably, this texture is that of small rhombic crystals of dolomite suspended in a calcite, micrite matrix that contains the fine, particulate, insoluble constituents. This texture may occur evenly throughout the aggregate or may be confined to particular seams and crack fillings. All occurrences of carbonate rock that have been found to be reactive have portions in which this particular texture exists. However, not all dolomitic limestones with this texture expand with sufficient force to cause distress.

If the dolomite rhombs are large enough, they may, in some cases, be observed with a hand lens or stereomicroscope on a lightly etched, finely lapped surface of the aggregate. This surface may be fabricated on a large fragment (e.g., 76 by 100 mm) of the rock or may be a lapped surface produced on a slice of the HCC.



Photograph by M.C. Thomson, courtesy of PennDOT

Figure 106. Destructive ASR in pavement.



Photograph by M.C. Thomson, courtesy of PennDOT

Figure 107. Destructive ASR in pavement: Alkali-silica gel in a 2-mm void in a lapped slice from the pavement in figure 106 (dark aggregate is siltstone).

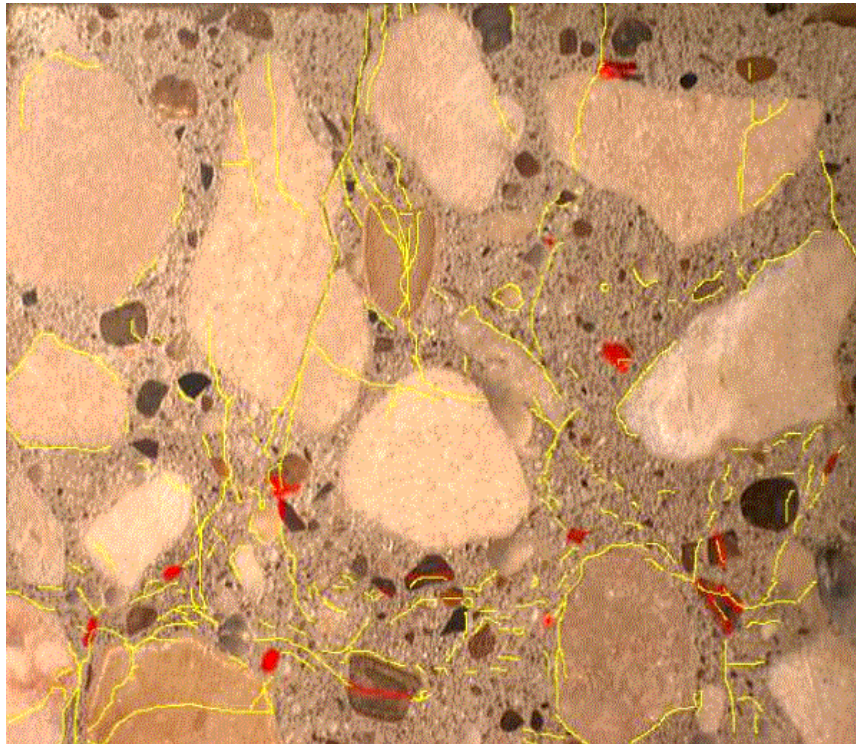
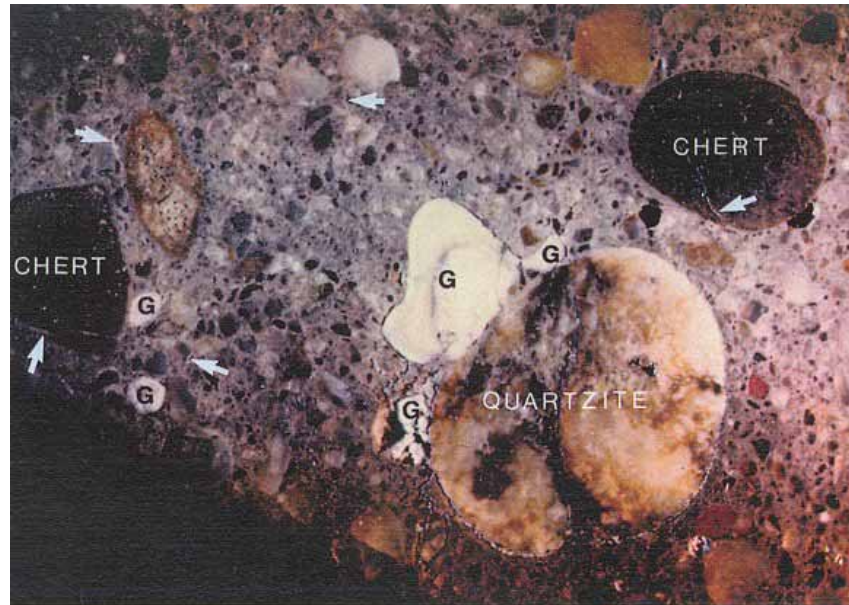

Figure 108. ASR damage expressed on lapped slab (cracks highlighted in yellow, deposits of reaction product highlighted in red).



1 in.

1 inch = 25.4 mm

G = Pocket of alkali-silica gel, arrows indicate gel-filled cracks (field width is 100 mm)

Figure 109. Lapped surface showing type of aggregates and ASR products.

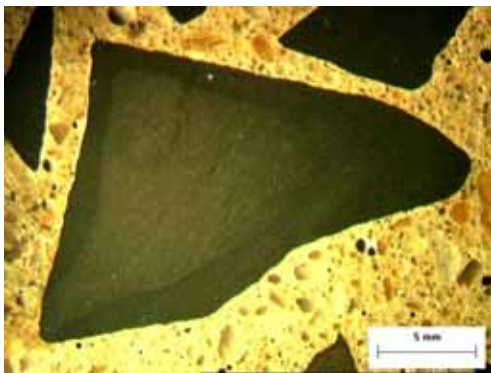

Figure 110. Lapped surface of specimen affected by ACR exhibiting rim and areas of altered paste at corners of aggregate.

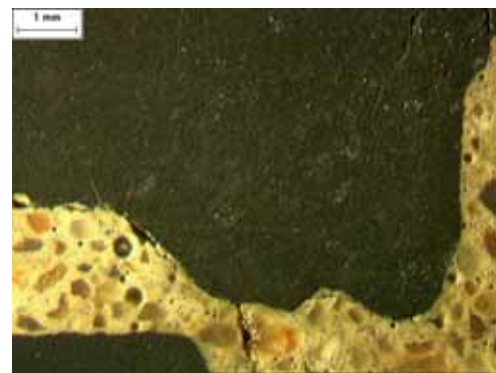
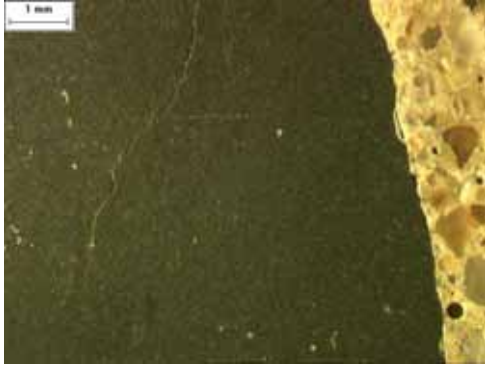

Figure 111. Paste cracking and alteration of paste.



Note the extremely fine-grained texture of the aggregate.

Figure 112. Lapped surfaces of ACR specimen showing aggregate cracking and alteration of paste.

Figure 113. Internal cracking of aggregate particle.

3. **Select a variety of aggregate particles for study with the petrographic microscope, P/EF microscope, or SEM:** Mark the surface of the specimen, usually a lapped surface, to indicate the location of the desired thin sections. Prepare thin sections (about 15 μm in thickness) and/or polished blanks of these aggregates and adjacent areas of paste as necessary for the type of microscope to be used. Identify the constituents and determine the structure of the reactive components by use of the petrographic microscope, P/EF microscope, or SEM. Report the structure and mineralogic and lithologic identity of reactive particles.

Examples of ASR are shown in figures 114 through 120. Note that the ASR product may exhibit different characteristics depending on its state. Gels will exhibit optical isotropy. The originally gelatinous reaction product can develop a more orderly structure in response to the chemical environment. Such reaction products will exhibit a degree of anisotropy observed as slight to increasing birefringence. Presumably, the isotropic reaction product possesses the capability for continued expansion, whereas the crystallized reaction product probably does not, or does to a greatly reduced degree.

Examples of ACR are shown in figures 121 through 127. The formation of rims is a feature of ACR; however, it is not uncommon with many carbonate rocks and should not be taken as clear evidence of the deleterious nature of the reaction as many rocks form rims without evidence of distress (Mather and Mather, 1991). Localized alteration (carbonation) of the paste adjacent to the aggregate particles can be observed in polished slabs and thin sections. This alteration proceeds from reactions associated with de-dolomitization rather than the more common carbonation by atmospheric CO_2 (Mather, Buck, and Luke, 1964). In thin sections or polished sections (using SEM), aggregate particles should be examined for the characteristic ACR texture, as well as evidence of corrosion of dolomite crystals. Brucite, hydrotalcite, or other secondary minerals resulting from de-dolomitization may be present (Walker, 1967).

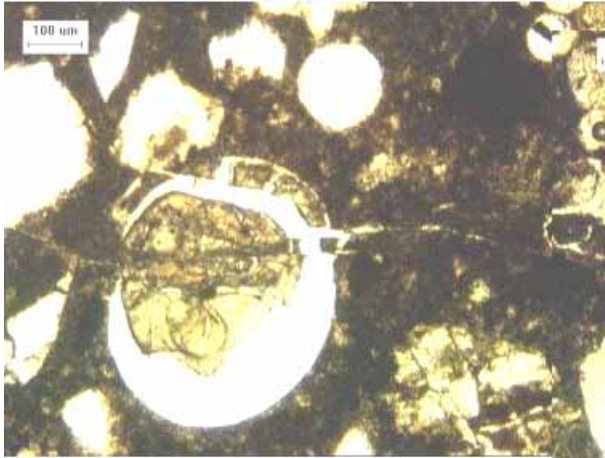

Figure 114. Thin section showing void containing crystallized ASR product.

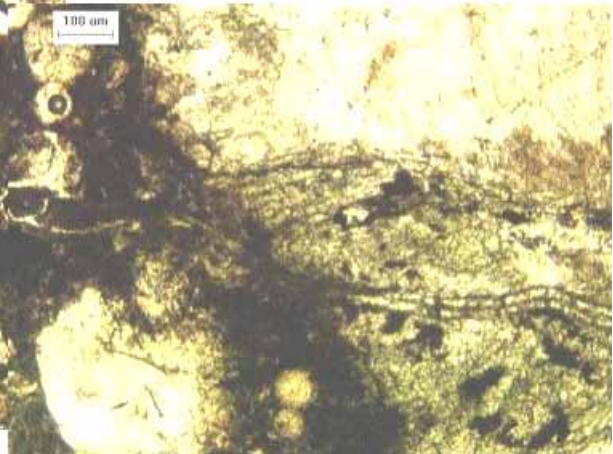
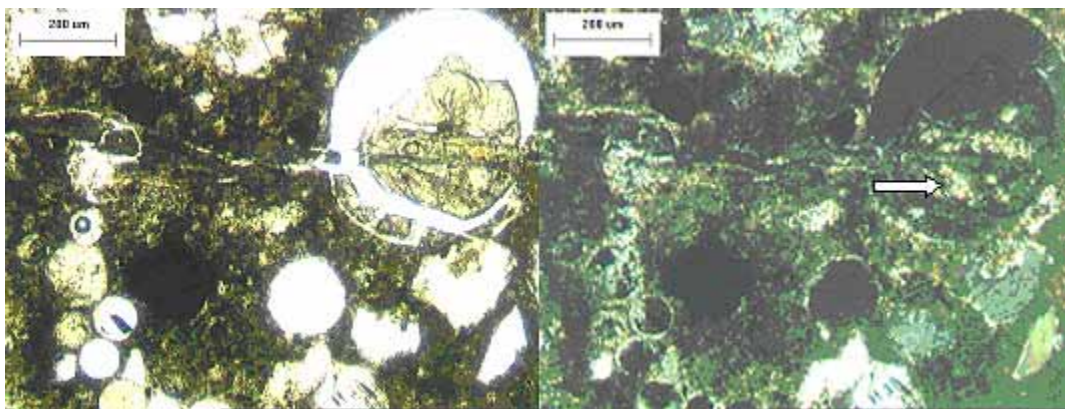

Figure 115. Thin section showing aggregate crack.



Note that reaction product exhibits birefringence.

Figure 116. Thin section in plane polarized light.

Figure 117. Thin section with crossed polars.

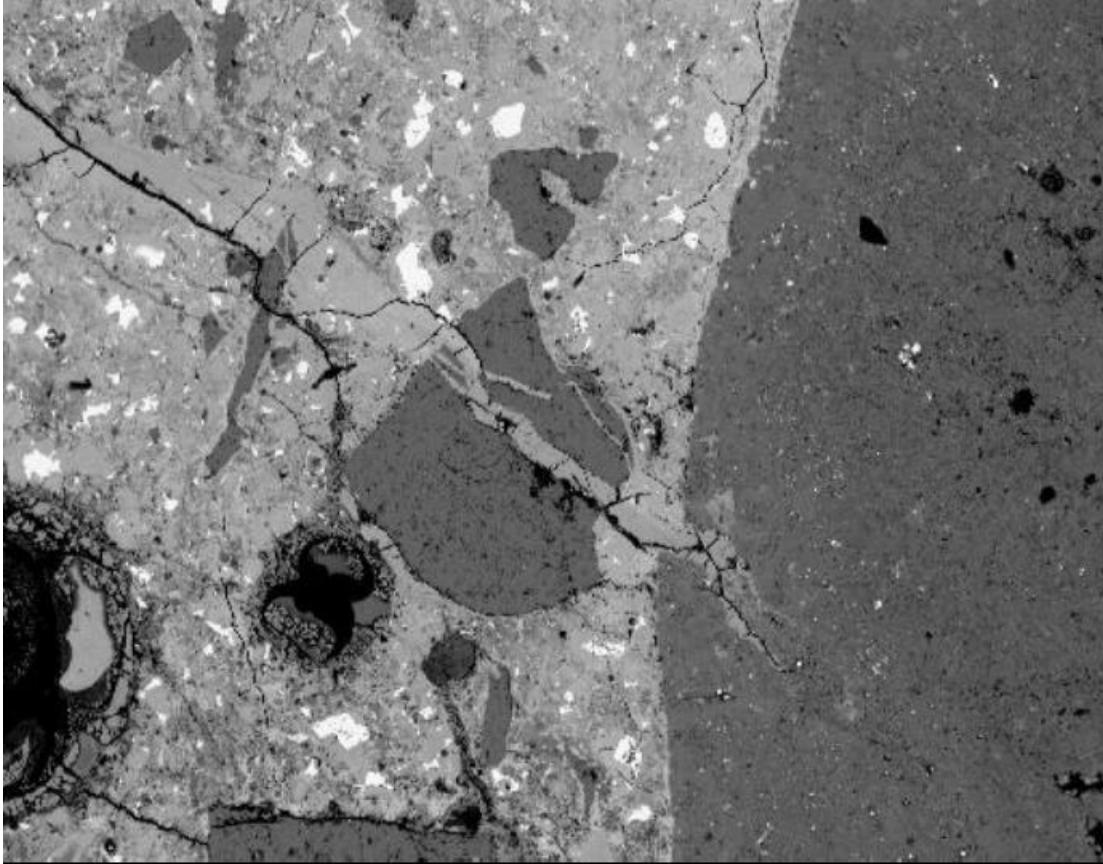

Reaction product-filled crack extends from coarse aggregate particle on right through mortar (field width is approximately 10 mm).

Figure 118. Backscattered electron image of ASR-damaged concrete.

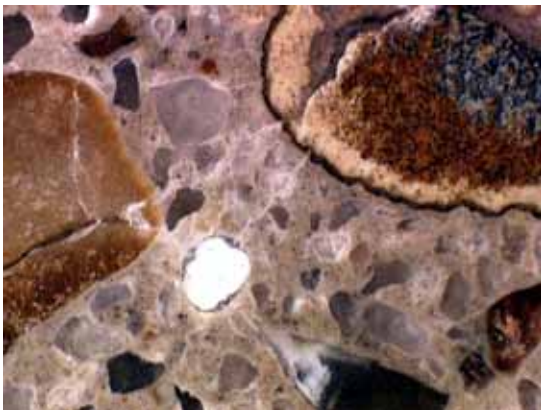

Field width is 15 mm.

Figure 119. Optical image of lapped section showing ASR product associated with damaged chert particles.

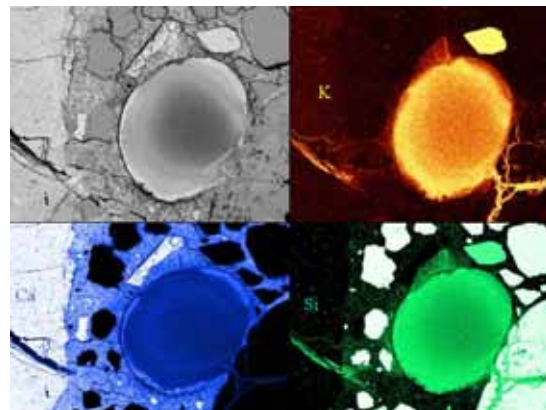

Figure 120. Similar feature in backscattered electron image as associated EDX elemental plots for K, Si, and Ca.

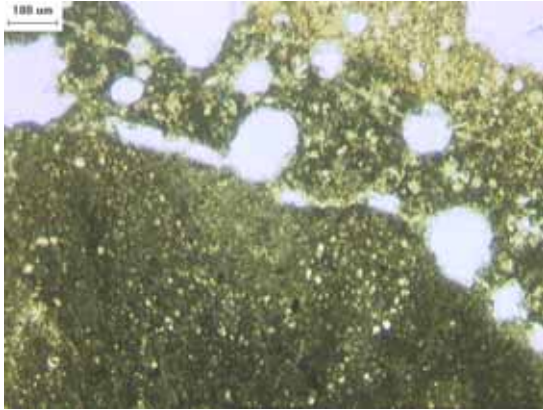

Figure 121. Thin section of ACR rock (lower left of image) and adjacent altered paste in plane polarized light.

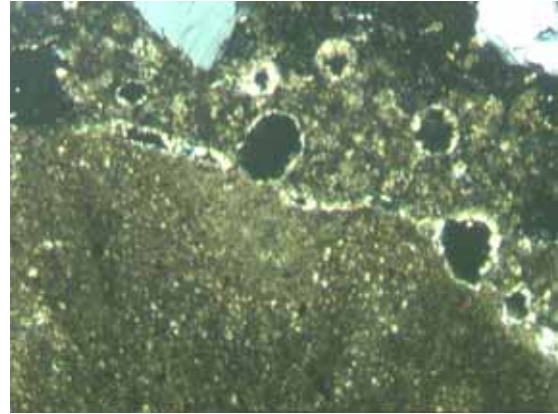

Figure 122. Thin section of ACR rock (lower left of image) and adjacent altered paste with crossed polars.

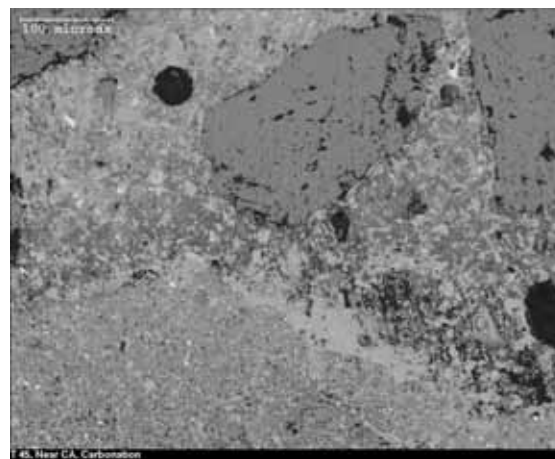

Figure 123. Backscattered electron image of polished thin section showing area of altered paste adjacent to ACR rock in lower left.

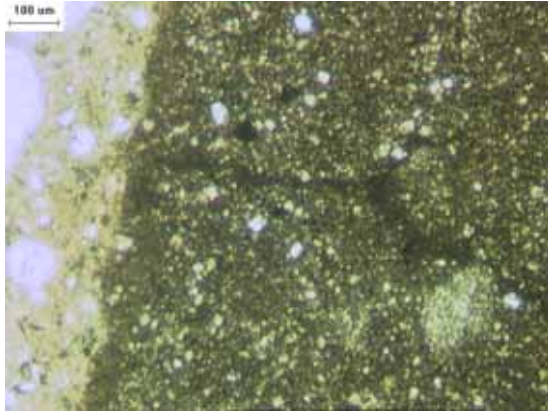

Figure 124. Thin section of fracture in ACR rock at low magnification.

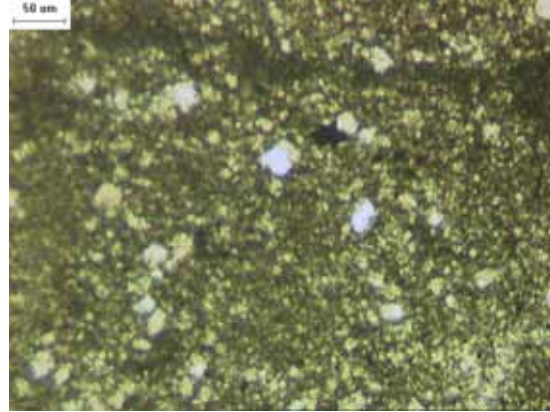

Figure 125. Thin section of fracture in ACR rock at high magnification.

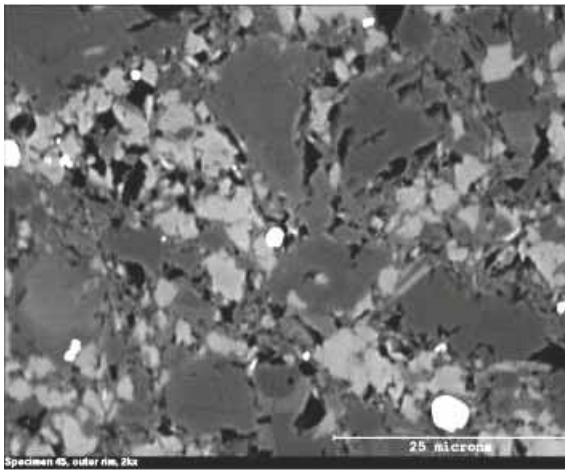

Figure 126. Backscattered electron images of outer rim of reacting ACR rock.

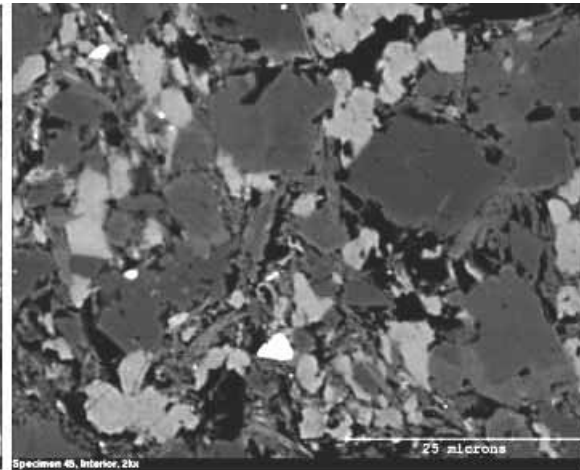
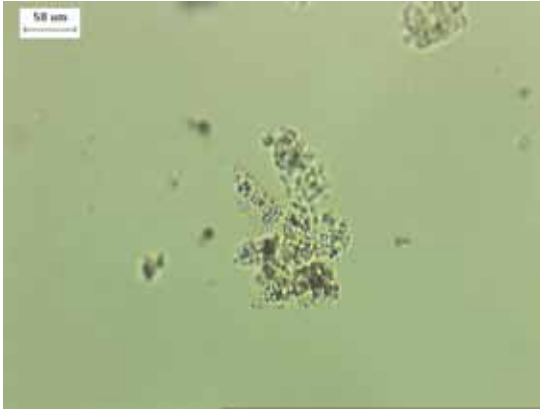

Figure 127. Interior of same particle.

4. **Characterize the materials in exudations, and secondary deposits along aggregate rims, and in cracks and pore fillings:** Optical properties can be evaluated by means of immersion mounts (figures 128 and 129) or in thin sections (figures 114 through 117). ASTM C 856 contains optical data for common secondary deposits found in concrete. Chemical composition of deposits can be evaluated by means of spot tests (chapter 8) (figure 130) or SEM-EDX (chapter 14) (figures 119 and 120).

In cases where ASR has caused significant distress, the reaction product is often readily visible. However, in cases with particular aggregates (e.g., granitic rocks), significant distress may have occurred with minimal amounts of gel. In addition, concretes with low distress levels either at an early stage of development or when fully developed may



Immersion oil index of refraction = 1.532, reaction product index is slightly lower. Birefringence exhibited with crossed polars demonstrates developing crystallinity.

Figure 128. Powder mount of ASR product in plane polarized light.

Figure 129. Powder mount of ASR product in crossed polarized light.

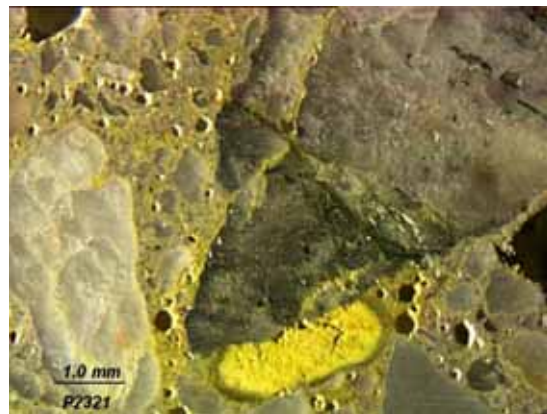

Potassium in secondary deposits in void and paste are stained yellow.

Figure 130. Polished specimen treated with sodium cobaltinitrite solution.

exhibit minimal amounts of reaction product. In cases with aggregates suspected of ASR, but with no readily observable reaction products, the spot tests may help locate deposits of gel. If deterioration is determined to be caused by the expansion of the concrete of the placement and there is no evidence of alkali-silica gels (even when the HCC is examined in thin sections with the petrographic or P/EF microscope), the distress must be the result of a cause other than the ASR. If the aggregate is fine-grained, limy dolomite, the ACR is likely. Discoveries of new reactions will occur only if the petrographer and the client or engineer consider all of the facts with an open mind.

If the alkali-silica gels exist and the major portion of the aggregate is carbonate rock, then a sufficient quantity of chert, opal, microcrystalline quartz, or other siliceous material must be present within the carbonate rock, such as vein fillings, siliceous fossils, or other inclusions.

10.5 ASSESSMENT

The findings of the laboratory examination should be integrated with the field observations to characterize the condition of the structure and to attribute responsibility among mechanisms (figure 131).

In the evaluation of structures where the noted AAR-related damage is slight or marginal, the age of the structure should be carefully considered. In a younger structure, the reaction may be in progress and consideration should be given to expansion and damage monitoring over an extended period. If affected by ASR, the presence of fresh, unaltered gel reaction product would serve as an indicator of an active ASR condition. On the other hand, if the structure is relatively old (20+ years) or the noted reaction product is carbonated or crystallized (exhibiting slight birefringence), the reaction has probably run its course for the given conditions of the concrete materials and exposure conditions.

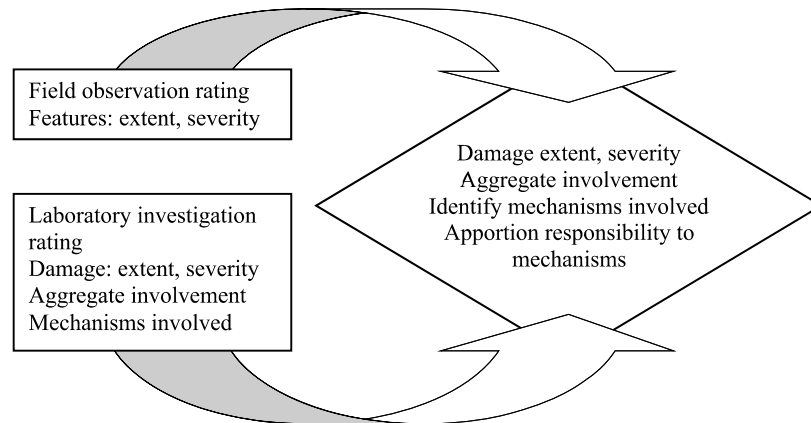

Figure 131. Integration of field observations with laboratory investigations.

CHAPTER 11. CEMENTITIOUS MATERIALS

11.1 OVERVIEW

The concrete petrographer is often called upon to ascertain the presence or absence of particulate materials other than portland cement in a specimen of HCC. These materials include all of the finely comminuted solid substances that may be added to HCC to improve its properties or reduce its cost. These substances are of relatively small grain size, usually at least as small as that of portland cement. Included are pulverized limestone (Kleiger and Hooton, 1988), hydrated lime, natural pozzolans, fly ash, slag, and silica fume (see ACI 232.1R, 232.2R, 233R, and 234R; Cain, 1994; TRB, 1990).

In general, when these materials have been used in a concrete mixture as prescribed, the resulting concrete has higher ultimate strength and is less permeable than a similar concrete that does not include these materials. Historically, some of these substances were considered to be adulterants and their use was considered to be an effort to dilute the cement and produce a less costly, less energy-intensive product (e.g., ground limestone). However, materials such as ground slag or pozzolans improve key HCC properties that directly impact durability. A potential drawback to their use when the mixture is not proportioned properly is delayed strength gain (except with silica fume and other high-fineness pozzolans). In cold weather, this delay can be sufficient to mandate against their use.

These materials should not be considered as adulterants when they have been specified for use. The particulate materials that are rich in amorphous silicates (slag, fly ash, silica fume, and natural pozzolan) are hydraulic (slag) or pozzolanic and will combine with the calcium hydroxide of HCC to form silicate hydrates that are cementitious and indistinguishable from the hydrated products of portland cement. The reaction of these materials cause the sequestration of deleterious alkalis in nonswelling silicate hydrates (see appendix D) that are widely disseminated throughout the paste. Thus, these pozzolanic materials prevent the deterioration that might be caused by the AARs provided that they are used in sufficient amounts.

The fine grain size; slow hydration; and, in some cases, particular particle shape add desirable properties to HCC. The heat of hydration is generated more slowly and, therefore, the temperature of the HCC does not rise so high. One of the most important desirable properties conferred by these materials is the decreased permeability of the resulting HCC. The decreased permeability is not only desirable in and of itself, it also decreases the movement of solutions and the diffusion of ions and thus any chemical activity, such as that of alkali reactivity or the activity of invasive deleterious substances such as chlorides. Pozzolanic materials are reported to be effective in increasing the acid resistance of concrete (Cain, 1994). Natural pozzolans and fly ash should comply with the requirements of ASTM C 618, slag with ASTM C 989, and silica fume with ASTM C 1240. Pozzolans and slag may also be used as components in hydraulic cements covered by ASTM C 595 and ASTM C 1157.

The appearance of a mature concrete in which these materials have been used is generally that of concrete with a low w/cm (see chapter 9). Pulverized limestone, cement kiln dust, or hydrated lime may be suspected in HCC that appears to have the texture of an HCC with a low w/cm and numerous minute particles of high birefringence when viewed in thin sections with crossed

polarized light using a petrographic microscope. It is impossible to be certain with mature concrete and without any magnification if fly ash, slag, or silica fume is present or if the paste characteristics are solely a result of a low w/cm.

11.2 PROCEDURES

Detecting the presence of pozzolans or slag in HCC is dependent on the characteristics of the particular material, as discussed here. The presence of fly ash or slag can sometimes be established in hand specimens, whereas establishing the absence of the material or estimating its relative proportion requires more detailed examination of specimens using the petrographic microscope (chapters 12 and 13) or SEM (see chapter 14). Hooton and Rogers (1995) describe quantitative techniques for estimating the percentage of slag and fly ash in HCC by examination of thin sections and XRD analyses. Schlorholtz and Dubberke (1995) used XRF to measure trace elements (Ba and Sr, in this case) to estimate fly-ash content.

As mentioned in chapter 2, reference samples of the common cementitious materials encountered should be maintained in the laboratory for preparation of immersion mounts and thin or polished sections as described in sections 5.4 or 14.3.3. These specimens are examined in either transmitted light (immersion mounts and thin sections) as discussed here or with the SEM (thin and polished sections) as discussed in chapter 14.

11.2.1 Cementitious Powders

This is a one-step procedure:

Examine the specimens and describe the particles present: Portland cement is a multiphase material consisting of four major clinker minerals and sulfate. Campbell (1986, 1999) provides an excellent discussion of the microscopic characteristics of portland cements. Figures 132 and 133 show alite (C_3S) and belite (C_2S) in an immersion mount of portland cement. Crystal morphology and birefringence are keys to identifying the phases in cements and distinguishing them from pozzolans and ground slag. Ground slag and pozzolans are characterized by particle size, shape, and isotropic optical properties resulting from their amorphous nature. Figures 134 through 137 illustrate fly ash (low lime, class F), silica fume, calcined shale natural pozzolan (class N), and ground slag. In crossed polarized light (not shown), the slag and silica fume demonstrate their amorphous character by an essentially total lack of birefringent grains. The bulk of fly ash and natural pozzolans should be amorphous; some crystalline grains exhibiting low birefringence are usually observed. These materials can also be observed using the SEM (chapter 14) where the higher resolving power is particularly useful because of the small particle sizes. In figure 138, SEM images of portland cement, fly ash, an ultrafine fly ash, and silica fume contrast the difference in particle size of these materials.

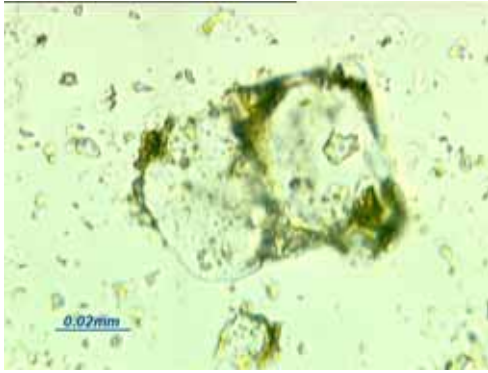

Figure 132. Immersion mount of portland cement in plane polarized light showing alite crystals.



Figure 133. Immersion mount of belite cluster with darker interstitial aluminates and ferrite.

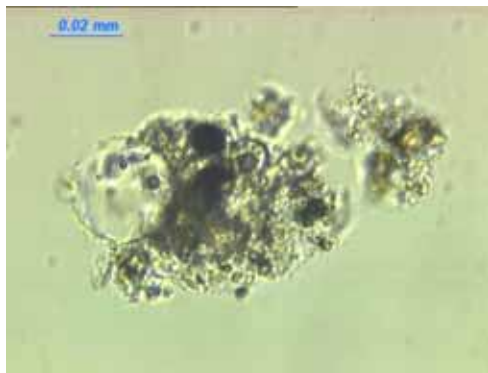

Figure 134. Immersion mount of fly ash showing spherical particle shape.

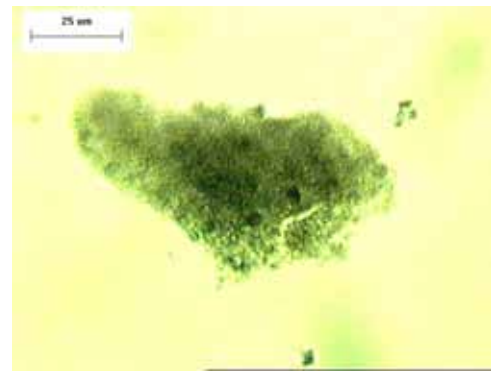

Figure 135. Immersion mount of agglomerate of minute silica-fume particles.

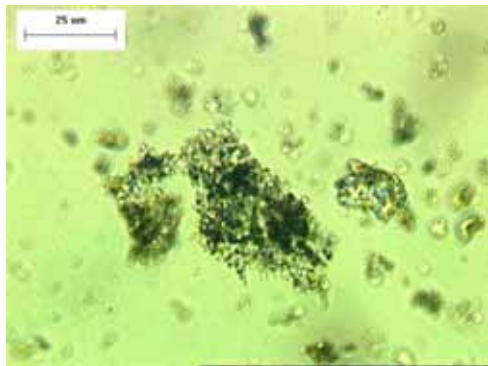

Figure 136. Immersion mount of natural pozzolan (calcined shale).

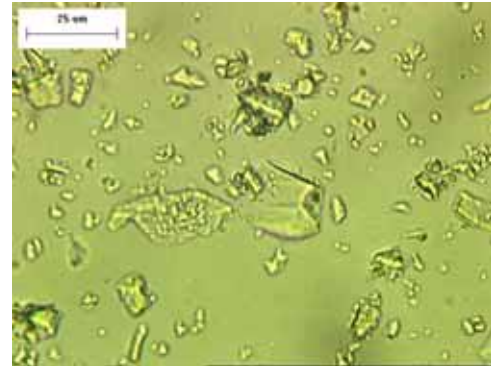

Figure 137. Immersion mount of ground cement slag.

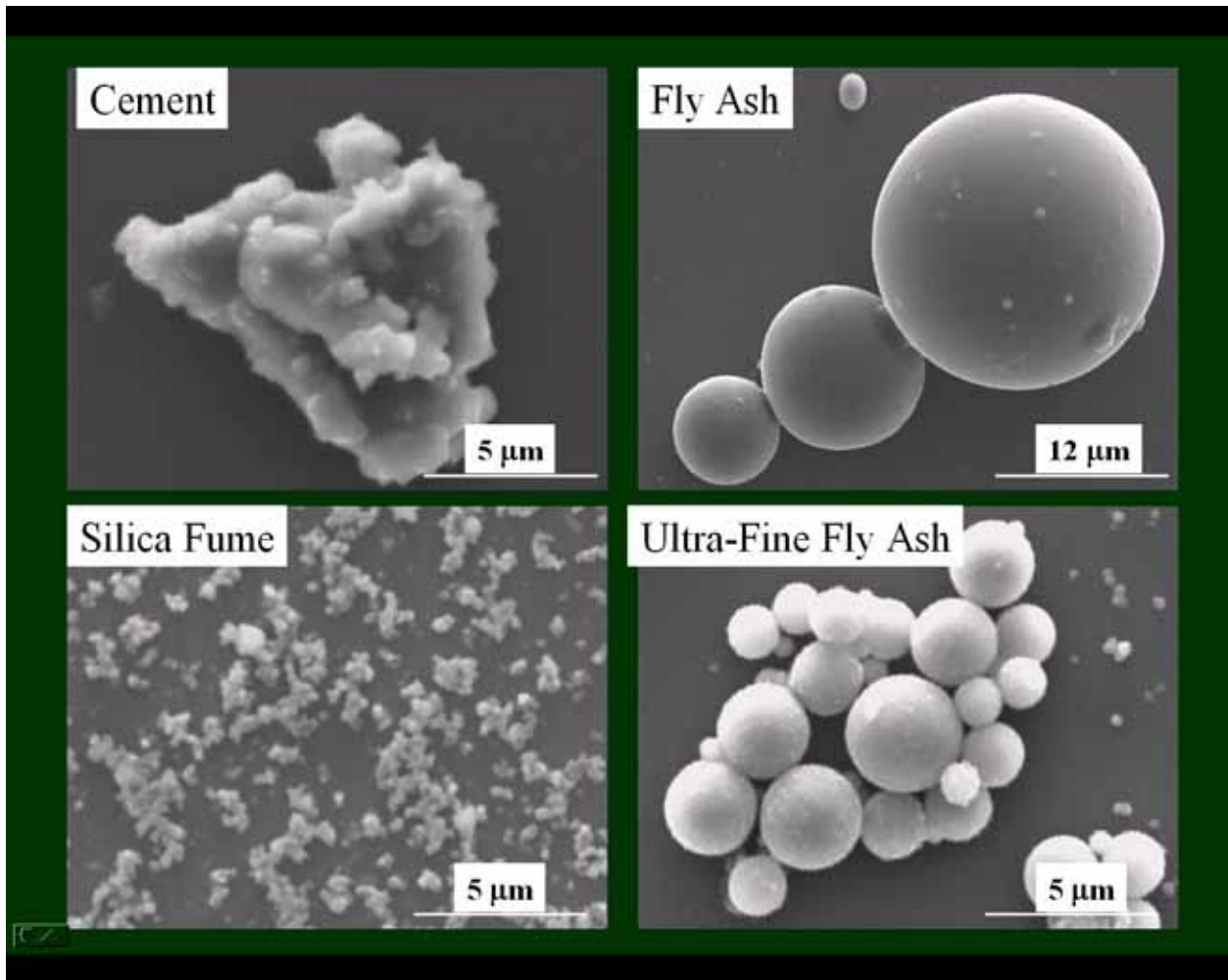

Figure 138. SEM images illustrating the size difference of various cementitious materials.

11.2.2 Hydraulic Cement Concrete

11.2.2.1 *Ground Granulated Blast-Furnace Slag*

This is a three-step procedure:

1. **Examine exterior surfaces, broken surfaces, and lapped slices of the HCC:** When very young, the pastes containing slag are a characteristic dark bluish green. Mather (1957) investigated the reasons for this color in portland slag cements and concluded that the development of the color varies from cement to cement and is a result of the presence of sulfur compounds in a reduced state (sulfide), the color being lost on oxidation. Regardless of maturity, if these pastes are kept underwater and are not allowed to dry, they will retain this color. As the concrete begins to dry, the surface color fades. If the HCC is sawed or broken while it is only partially dry, it can be seen to be mottled with dark and light places. When it is dry throughout, it will be a uniform light color (see figures 139 and 140). This color is not the same color as ordinary HCC. It is not a gray

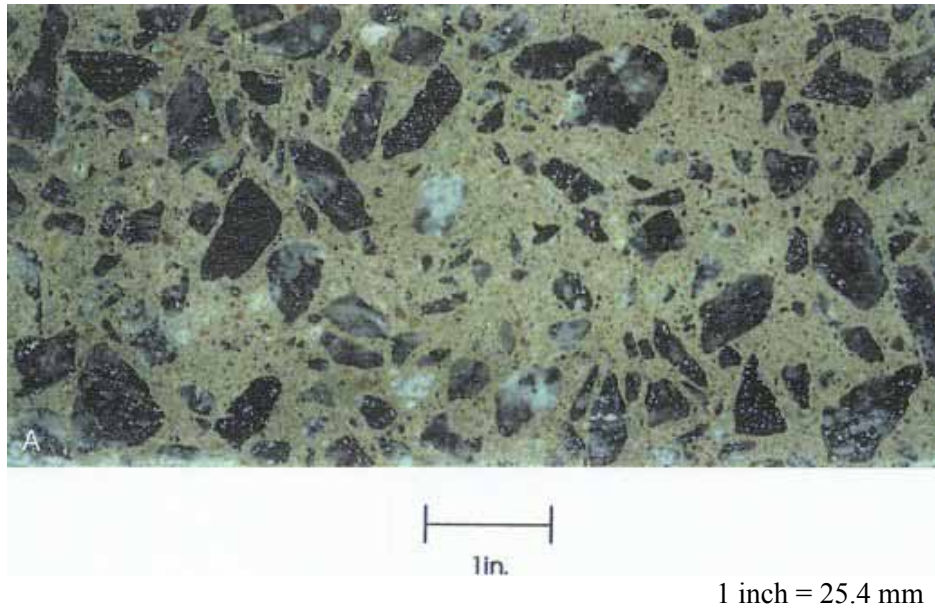

Figure 139. Cut surface on HCC containing slag exposed to air for 6 months.



Figure 140. Interior of beam of HCC containing slag, illustrating the partially dry two-color stage.

color, but rather a very light shade of slightly greenish tan or cream. The mottled appearance of an interior surface of slag-bearing concrete of intermediate age is often of concern to field personnel. It has often been thought that the mixing of the HCC was incomplete. In thin sections examined with the petrographic microscope, the dark-colored areas appear to be no different from the faded areas and both types of areas seem to have about the same concentration of slag. If slag was used in the mixture, this mottling is inconsequential and will fade. Slag cannot be detected in mature, fully dried concrete with the stereomicroscope.

2. **Examine several thin sections of the paste of the specimen with the petrographic microscope:** Slag can be seen in thin sections and is quite distinctive in appearance. Unhydrated slag is primarily glass and, therefore, almost completely lacking in birefringence.
3. **Compare the view observed with the views in figures 141 through 143:** If slag cannot be found by examination of the paste in a thin section, report that it was not detected in the specimen. Figures 141 through 143 illustrate the appearance of slag at three stages of hydration.

11.2.2.2 Fly Ash

This is a four-step procedure:

1. **Examine a lapped slice of the HCC with a stereomicroscope:** Fly ash is usually of quite varied particle sizes, and the larger particles can be seen with the stereomicroscope. Most of the individual particles of fly ash approved for use in HCC are colorless to white. Some of the larger particles are hollow spheres (cenospheres). The walls of the cenospheres are frequently thin enough and the cenospheres are large enough to be mistaken for entrained air voids (see Walker, 1983). Sometimes, little dark (black or brown) balls of fly ash (sometimes hollow) can be seen; sometimes, agglomerations of fine fly-ash froth are present (see figure 78).
2. **To detect all of the particles of fly ash and to distinguish them from air voids, etch the slice or a portion of the slice, rinse, blot, allow to dry, and examine with the stereomicroscope (see section 5.2.3):** Observe the acid-resistant glass walls of any fly-ash particles (see figure 144). These glass walls are very thin, but can be seen with low-angle illumination projecting above the paste that has been etched away. Air voids will not have such projecting walls.
3. **Examine thin sections with the petrographic microscope (see figures 145 and 146).**
4. **If fly ash cannot be detected on an etched lapped slice and cannot be found in the thin section, report that it could not be found in the specimen.**

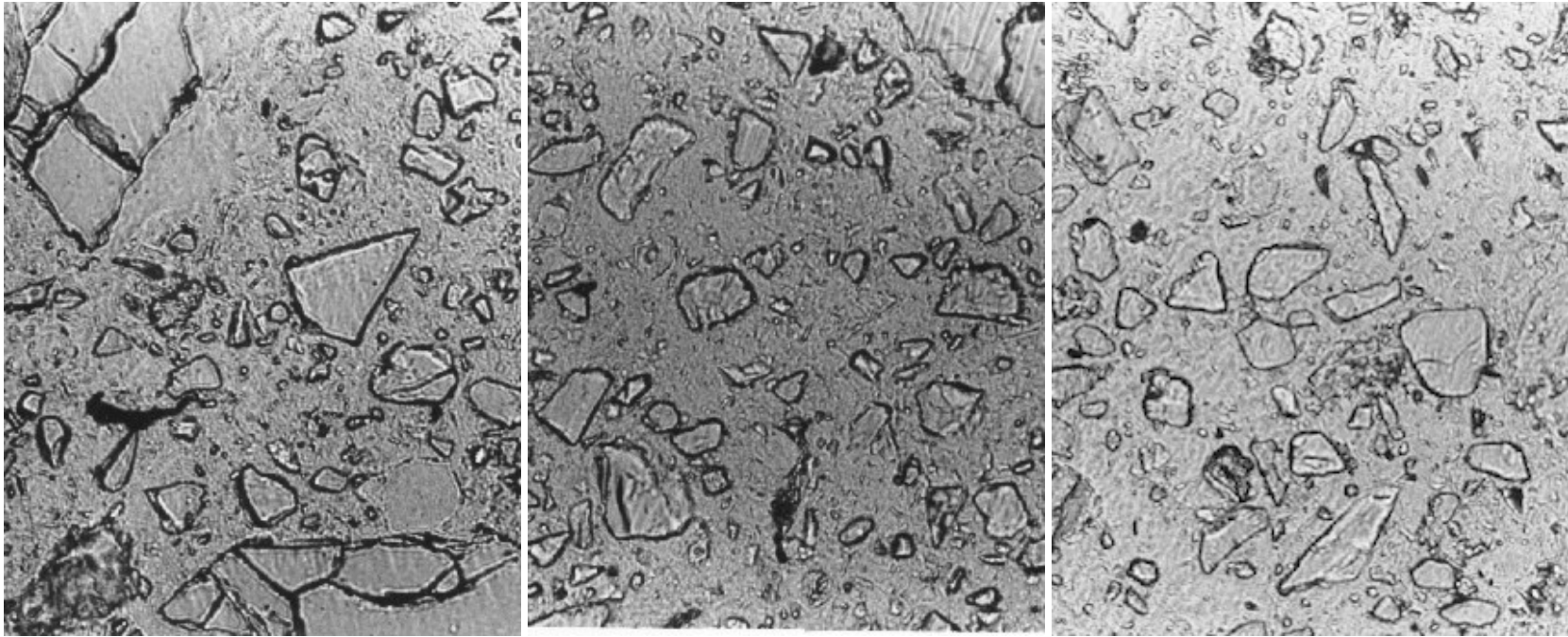

Concentration is 65 percent of cementitious material.

Figure 141. Thin section of concrete containing slag: At 28 days hydration (note the angularity of the slag fragments).

Figure 142. Thin section of concrete containing slag: At 56 days hydration (note the slight rounding of the slag fragments).

Figure 143. Thin section of concrete containing slag: At 6 months hydration (note the further rounding of the slag fragments)

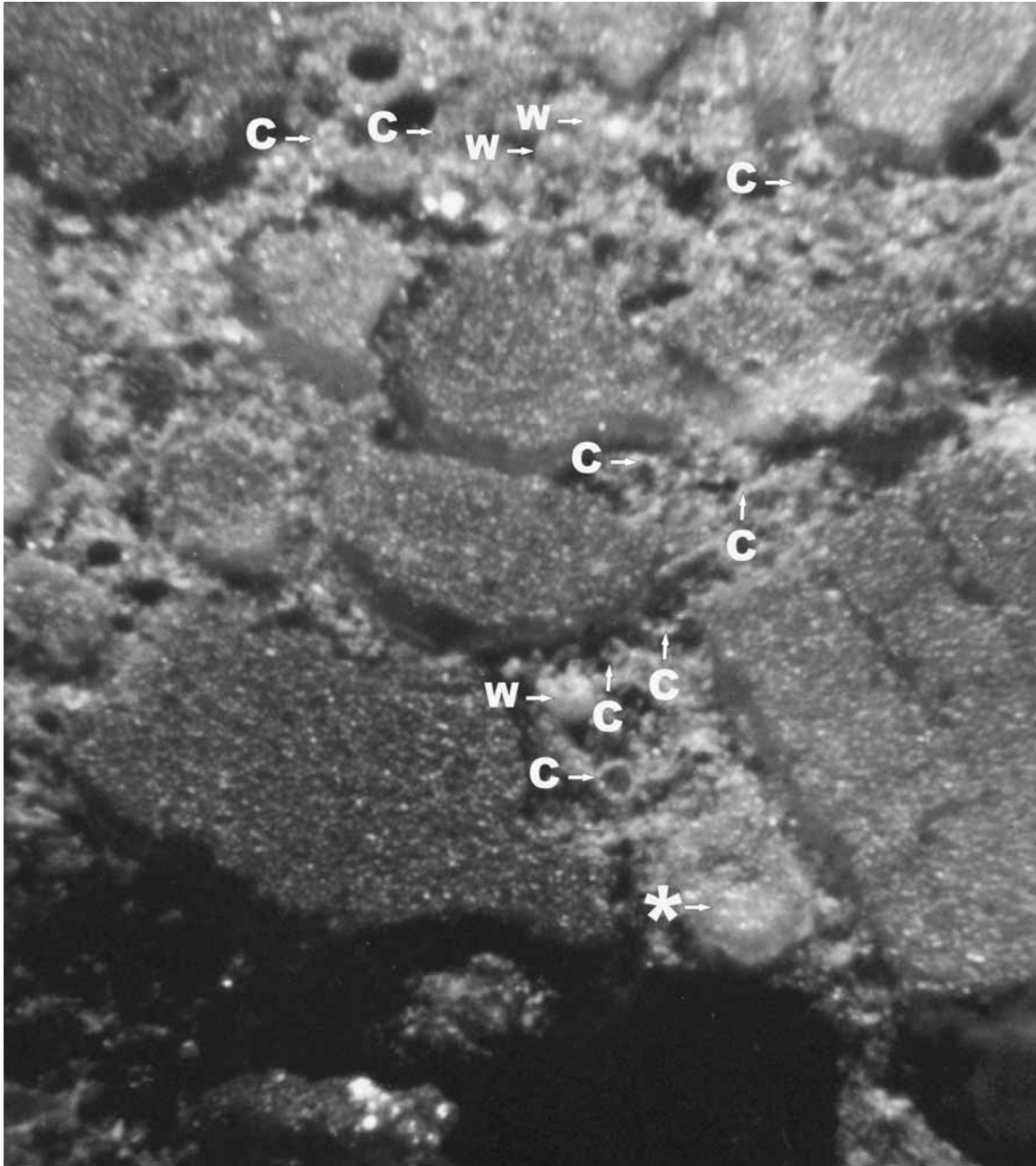

The partial fly-ash particles are indicated by arrows. The particle at the starred arrow is a frothy fly-ash agglomeration. Nearly complete white cenospheres probably filled with froth or a multitude of smaller cenospheres are marked with a "W". These whole cenospheres have been almost completely exposed by the etching procedure; some small whole cenospheres may have been lost during the etching procedure. Cup-shaped portions of cenospheres are marked with a "C".

Figure 144. Etched area of lapped surface of concrete containing fly ash.

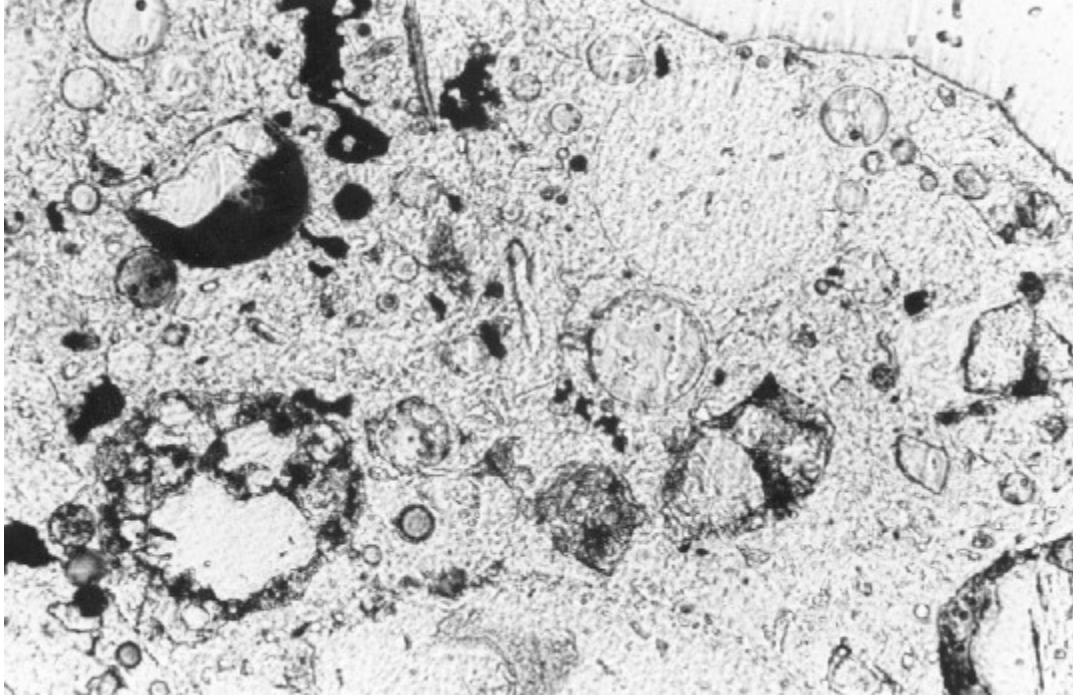

Figure 145. Fly ash in thin section of HCC, viewed in plane polarized light with a petrographic microscope (note the broken fly-ash particle that is composed of dark and light glass, 100X).

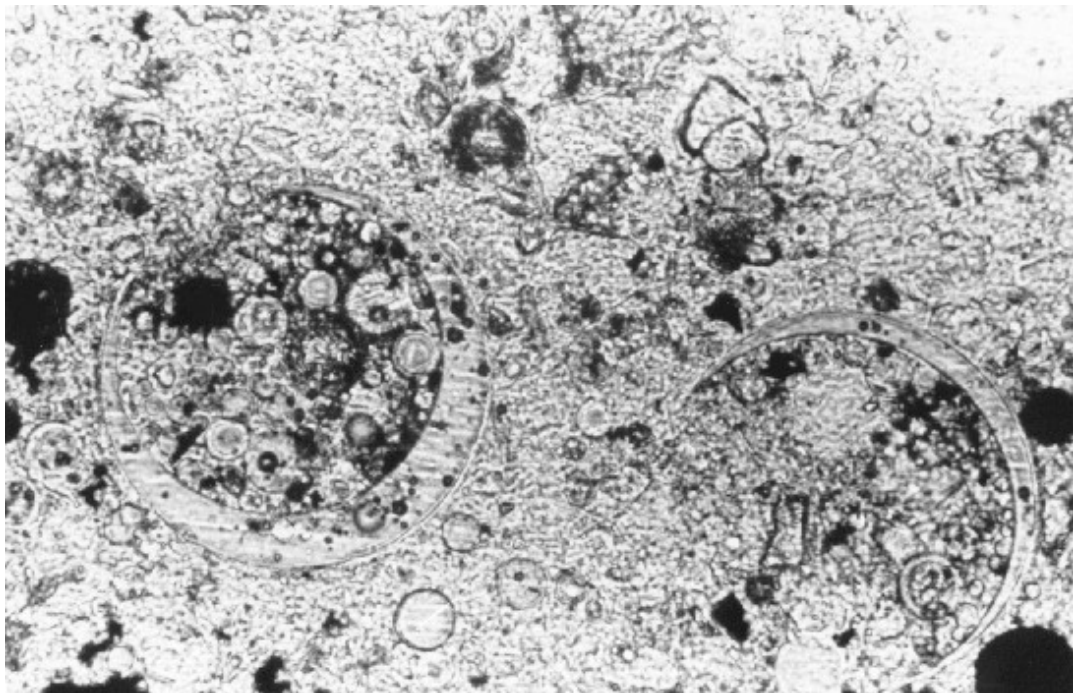

Figure 146. Fly ash in thin section of HCC, viewed in plane polarized light with a petrographic microscope (cenospheres of fly ash filled with smaller cenospheres, 400X).

11.2.2.3 Silica Fume

Properly dispersed silica fume has such small particles and is so lacking in birefringence that its presence cannot be detected even in thin sections at 400X. Report that the presence of silica fume cannot be detected by the laboratory. Dry-densified silica fume that is not dispersed or is poorly dispersed will appear as small, dark gray to black particles in reflected light. In transmitted light, they will appear clear, extremely fine-grained, and isotropic. Undispersed silica-fume pellets can cause damage as a result of ASR. Laboratories that have the capability of examining specimens with a SEM can detect and photograph this material.

CHAPTER 12. EXAMINATION WITH THE PETROGRAPHIC MICROSCOPE

12.1 OVERVIEW

A petrographic microscope, also called a *polarizing microscope*, is best described as a compound, transmitted-light microscope to which components have been added to enable the determination of the optical properties of translucent substances. The designation of the microscope as a compound microscope indicates that it has an ocular that focuses on a virtual image of the subject produced in the tube of the microscope by the objective lens.

The professional petrographic microscope has a substage condenser that can be centered and focused. The substage has field and aperture diaphragms. The polarizing components are the upper and lower polarizing devices, the Bertrand lens and its mounting (between the upper polarizing device and the ocular), an accessory flip-in lens for convergent light mounted as the top element of the condenser, and a graduated rotating stage with a removable click stop that can be activated to indicate a 45-degree rotation from any selected direction. The focus knob(s) and the stand are graduated to permit the determination of thickness by differential focusing. Figure 147 shows a petrographic microscope.

The first polarizing devices were prisms fabricated from crystals of the mineral calcite specially cut and cemented back together according to the plan of Nicol (Nicol, 1828, as cited in Johannsen, 1968). Such devices were originally called *nicol prisms* (Johannsen, 1968). Now they are called *nicols*. Crystals of calcite, CaCO_3 , were chosen because light that goes through this



Figure 147. Petrographic microscope.

substance in particular directions is split into two distinctly different rays that are strongly polarized at 90 degrees to each other and that travel at widely different indices of refraction; thus, calcite has a high birefringence. Nicol used the plane on which he cemented the crystals back together as a plane of total reflection for the ray with the index of refraction most different from that of the cement.

In modern petrographic microscopes, the nicols are polarizing plates fabricated in much the same way as are the lenses in polarized sunglasses. If two polarizing plates of sufficient thickness and quality are superimposed with their polarization directions at right angles to each other (thus, crossed nicols), no light can penetrate the pair. This is because the first polarizing plate excludes all light that is polarized perpendicular to the direction of the plate polarization, concomitantly polarizing the remaining light parallel with the plate polarization, and then the second plate does likewise. Together, all light is excluded. An indication of this effect can be observed by looking through two polarized sunglass lenses superimposed 90 degrees to each other. Polarized sunglasses work because all reflected light is (at least partially) polarized parallel with the substance from which it is reflected and the polarizing material prevents the passage of rays polarized in a horizontal direction, such as that reflected from puddles, snow, automobile surfaces, and pavement. The effect may be observed if you look through a polarized lens at a patch of reflected glare while turning the lens to various orientations relative to the polarization of the glare. (The sky is polarized by reflection from the molecules of the atmosphere.)

A properly adjusted petrographic microscope with nicols of sufficient quality allows no light discernable to the eye to penetrate the upper and lower polarizing devices when their polarization directions are 90 degrees to each other and there is no birefringent substance between them. However, if a birefringent substance (such as a crumpled piece of cellophane) is placed between two polarizing plates that are positioned with their polarization directions 90 degrees to each other, the birefringence of the inner substance polarizes the light that travels through the first polarizing plate in directions parallel to the optical directions of the substance and the optical system will transmit light. The intensity and color of this transmitted light are controlled by the birefringence, optical orientation, and thickness of the interior substance. The lower and upper nicols, or polarizing plates (called the *polarizer* and *analyzer*, respectively), of the petrographic microscope act as do the plates of polarized material. If both nicols are in the optical path and are oriented at right angles to each other and a birefringent specimen material is on the stage, the amount of the birefringence and many other optical properties may be determined.

In the petrographic microscope, the light is collimated by the condenser into a bundle of beams, all parallel to the optical axis of the microscope. The specimens examined are transparent to translucent thin sections or grain mounts of the material under study (see sections 5.3 and 5.4). The light beams are polarized in one direction (by the polarizer) before the light reaches the specimen. This light is called *plane polarized* light.

The direction of polarization produced by the polarizer varies from microscope to microscope (usually north-south) and is often adjustable. The analyzer may be placed in the path of the light after it leaves the specimen whenever birefringence or optical directions are being determined. The analyzer is identical in nature to the polarizer and, for most work, the polarization of the analyzer is perpendicular to that of the polarizer (i.e., the analyzer polarization is east-west). In

the standard orientation, the analyzer allows the transmission of light that is not polarized at right angles to the light from the polarizer.

When both nicols are in use in this standard orientation, the object on the stage is said to be viewed with crossed nicols or polars. In addition, most petrographic microscopes are equipped with a slot at 45 degrees to the main polarization directions and various retardation plates that can be used in this slot in the determination of a number of optical properties. The most common and most useful of these plates is the 1/4 (one-quarter) wave plate [is correct], or gypsum plate.

12.2 USES OF THE PETROGRAPHIC MICROSCOPE

The uses of the petrographic microscope include identifying translucent substances by means of their optical properties and by reference to the various charts and tables in the literature (Bloss, 1961; Kerr, 1959; Larsen and Berman, 1964; Rogers and Kerr, 1942). Thus, the composition and identity of these substances and the relationships between the various phases of the material under study may be discovered. From these data, facts concerning the history and the method of formation of the subject material can be deduced. The optical properties of substances given in texts, charts, and graphs have generally been accurately determined by the use of a universal stage on which the substance can be oriented at any desired angle to the optical axis of the microscope and the plane of rotation. In this manner, the optical properties have been determined for various substances. The concrete petrographer does not usually try to attain this degree of accuracy.

12.3 PROCEDURES

Courses on the use of the petrographic microscope are available at most colleges and universities that have departments of mineralogy or geology, in most departments of materials engineering, and in some departments of chemistry. The textbooks available on this subject vary widely in their emphasis. Certain texts concentrate on the theories of the behavior of light in various types of crystal structures, use of the Bertrand lens, and various optical axis figures. Some are oriented toward identifying and naming the minerals, others concentrate on teaching recognition of individual types of rock.

The recommended procedures vary from one author to the next. For example, Bloss (1961) taught that birefringence is the most important property by which to identify a mineral substance. His book has charts and graphs that start out with the determination of this property and then branch out to include other properties. The charts and lists of Larsen and Berman (1964) have their first subdivision of lists of minerals on the number of optical axes possessed by the substance, the second subdivision on the optical sign, and the third on the index of refraction. Deer, Howie, and Zussman (1962, 1975, 1992) and Palache, Berman, and Frondel (1951–1963) wrote important mineralogic reference books that list the optical properties of minerals in the part of the text that describes the mineral under discussion.

The standard texts written for geologists and mineralogists assume that all thin sections are 25 to 30 μm thick. With thin sections of HCC and similar materials, the grain size is so small that much thinner sections are often desirable (see section 5.3.1). Unless highly specialized equipment is used, it is impossible to produce ultrathin sections that are the same thickness across their areal extent. Often, a thin section will vary in thickness from 20 μm in one area to

nothing in another. At first, this lack of flatness will seem objectionable to the average classically trained petrographer; however, having become accustomed to this, the microscopist will realize that the lack of flatness can allow a mineral substance to be viewed in a greater variety of ways than if the section were the same thickness everywhere.

The identification of aggregate minerals and rocks and concrete reaction products may usually be most efficiently accomplished by knowing which mineral substances are likely; noting the outward physical properties, color, cleavage, and hardness either in a hand specimen or with the stereomicroscope; and using the petrographic microscope to observe the general appearance in polarized light to determine the approximate birefringence, indices of refraction, and some of the other optical properties. The procedures involved include determining some of the following optical properties, listed in order of most common usage:

1. **Distinctive cleavage, growth lines, inclusions, and parting patterns**
2. **Positions of extinction (directions in the substance where crossed nicols permit the passage of least light)**
3. **Alignment of the positions of extinction with specific directions (crystallographic axes, cleavage planes, growth lines, etc.) within the subject substance**
4. **Birefringence as estimated from the maximum double refraction (highest order of color seen when the positions of extinction are 45 degrees to the nicols) and the thickness of the crystal being examined:** The thickness of the subject substance may be determined by differential focusing or by the double refraction exhibited by adjacent substances of known birefringence. The birefringence of the mineral substances is listed in the various charts and tables of mineral properties (Bloss, 1961; Kerr, 1959; Larsen and Berman, 1964; Rogers and Kerr, 1942) and is the difference between the highest and lowest index of refraction of the substance. The maximum diffraction is used to determine this property. For this purpose, grain mounts are much more suitable than thin sections. If the substance has a pronounced cleavage or crystal shape that influences the orientation of the particles on the glass slide of a grain mount, some particles should be induced to roll to a new orientation by the nudging of the cover glass with a needle. Birefringence is one of the least variable of the easily determined optical properties. It is relatively constant throughout a family of minerals (such as the feldspar family); the indices of refraction and color may vary from one family member to another.
5. **Pleochroic properties (if any) as determined by the change in color and the intensity of the color observed in plane polarized light as translucent substances are rotated through the various positions of extinction (the orientation of these color changes with respect to cleavage and crystallographic axes is an important part of the data on pleochroism)**
6. **Indices of refraction of a substance determined by comparison in plane polarized light with the index of refraction of the medium (other minerals, mounting epoxy, index of refraction oil, etc.) by which it is surrounded:** This is usually done by noting

the motion of the Becke line (the bright line that develops as the objective lens is moved out of focus). This determination is aided by the contrast (relief) with which the substance is seen. The greater the difference in the index of refraction between the subject substance and its surroundings, the greater the difference in relief between the substances. This contrast will change as a highly birefringent mineral is rotated from one position of extinction to another and a light ray with a different index of refraction is made parallel with the polarizer. For more exact work, the substance is isolated and fragments are mounted in various standard index of refraction oils.

7. **Alignment of the individual indices of refraction of a substance with specific directions (crystal axes, cleavage planes, growth lines, etc.) within the *subject* substance**

8. **Number of optical axes, optical sign, and angle between the optical axes:** These are determined by means of the conoscopic lens arrangement (i.e., using convergent light and the Bertrand lens). If the Bertrand lens cannot be focused or is otherwise imperfect, smaller but often sharper optical axis figures may be observed without it by removing the eyepiece lens and looking down the microscope tube at the back lens of the objective. To center the microscopist's eye, a pinhole eyepiece is often used. The data concerning the optical axes and optical sign are often not required in the petrographic study of HCC.

Many identifications can be made from the general appearance, parting, color, cleavage, estimated index of refraction, and approximate birefringence. The experienced petrographer can accurately recognize a large number of minerals by observing the general appearance in plane polarized light and the birefringence as viewed with crossed nicols. Of course, unfamiliar substances will require the determination of a number of various properties before identification can be made.

CHAPTER 13. EXAMINATION WITH THE POLARIZING/EPIFLUORESCENCE MICROSCOPE

13.1 OVERVIEW

The use of fluorescence microscopy in the study of HCC was initiated by Wilk, Dobrolubov, and Romer (1974) in Switzerland and was then used mainly as a tool to determine the quality of the air-void system in HCC. Wilk and associates used ultraviolet light transmitted through a thin section. The design of the P/EF, polarizing / epi-fluorescence, microscope makes it possible to view any spot on a thin section with all of the illumination modes of a petrographic microscope, along with incident ultraviolet light, and is thus easily adaptable to this purpose (Walker and Marshall, 1979). All the modes of viewing that are possible with a petrographic microscope were combined with the ability to view the fluorescence (when illuminated by ultraviolet light) within a thin section impregnated with specially dyed epoxy (see section 5.3.4). The design is such that changing the exciter filters by adjusting a turret housing and the dichroic mirrors (DM) by moving a slide across a slot, exchanging barrier filters (BF), and flipping shutters are all that are required to switch from one mode to another. Soeder (1990) used epifluorescence microscopy with a different dye, DM, and BFs to study the pore structure of rocks of low permeability.

It was found that when ultraviolet illumination was transmitted through the thin section, it caused fluorescence of all the fluorescent dye throughout the thickness of the section. The dye was distributed through all the capillary pores, in all the cracks no matter how small, and in all the small voids remaining in the paste as the cement hydrated. The fluorescence existed throughout the thickness of the section and produced a haze of uncollimated light that confused all viewing with a cloud in which any opaque particles (such as cement ferrites) seemed to float. If the section was more than 25 μm in thickness, even some of the air voids would be difficult to distinguish from the background haze. The work of Beauchamp and Williford (1974) and Beauchamp, et al. (1972) indicated that thinner sections would provide more definition. It was determined that the ultraviolet illumination must be incident (come from the direction of the objective, i.e., be what is termed “epi illumination”) upon the thin section so that the portion of the specimen being viewed was the first part of the specimen illuminated; thus, the ultraviolet light exciting the most clearly viewed fluorescence was not shaded by other portions of the specimen (Walker and Marshall, 1979).

The question has been asked: Why use a thin section? Why not just use a highly polished slice for this incident light microscopy? After all, that is how one studies ore specimens. The answer is twofold:

1. Ore specimens are opaque and only the features on the surface are visible in incident illumination. Most of the components of HCC are translucent, and light penetrates the specimen. Ultraviolet light causes fluorescence throughout the entire thickness of the specimen and creates a pervasive yellow glow caused by the fluorescent-impregnated porous areas of the paste throughout. This glow of uncollimated fluorescence looks like a pool of glowing liquid in which any opaque particles seem to float. Other details are masked. It is necessary to make the specimen being examined thin so that the unwanted ultraviolet light can go through and not bounce around and make noisy, meaningless fluorescence.

2. We need to be able to look at any spot of interest with the standard petrographic methods (which require transmitted collimated light), as well as with ultraviolet illumination, and we need to do it without switching microscopes and losing our place on the section.

The incident arrangement of the ultraviolet illumination necessitated using uncovered thin sections and the type of objective lenses required by uncovered thin sections. The light created within the specimen by the fluorescence of the dye is uncollimated and radiates from every fluorescent point. Such uncollimated light strikes a cover glass at random angles. Only light that strikes a cover slip at 90 degrees to the surface will travel straight through. The light produced at other angles bounces around under the cover slip and from the highly finished surface of the thin section and creates a yellow haze that obscures viewing at all but the lowest magnifications.

Because the incident ultraviolet light is collimated by the objective lens, there is a greater concentration of this light at the point of focus with the higher power lenses (i.e., more ultraviolet light reaches each fluorescent molecule of the dye when the higher power objectives are used). Therefore, the fluorescence is brighter when the higher power objectives are used. At very high magnifications (60X objective), the lens and lens mounting are so close to the specimen that a yellow haze is produced by light bounced from the lens surface to the specimen surface and back, just as when a cover slip is used. This effect precludes the use of oil immersion lenses and lenses of greater power than 40X.

The P/EF microscope is diagrammatically shown in figure 148, and a photograph of the equipment is shown in figure 149 (see Walker, 1988). The P/EF microscope described in this chapter was obtained in 1977 under strict budget requirements. A more modern P/EF microscope that was specifically designed for this use would be more convenient than the model described here. Such a microscope might have different exciter filters, DMs, and BFs built into the instrument and would probably have different engravings for the various filters.

The ultraviolet light is incident on the specimen and is produced by a 200-watt (W) mercury arc lamp. Incident microscope illumination requires a vertical illuminator to direct the light to a special mirror (DM) above the objective lens that will direct the light down through the objective without hindering light traveling from the objective to the ocular. For ultraviolet illumination, the wavelength of the light is controlled by the exciter filters, DMs, and BFs.

The vertical illuminator has a built-in turret for exciter filters:

- UG-5, ultraviolet light (U engraving).
- BG-3, violet light (V engraving).
- BG-12, blue-violet light (B engraving).
- IF-545 and BG-36, green light (G engraving).

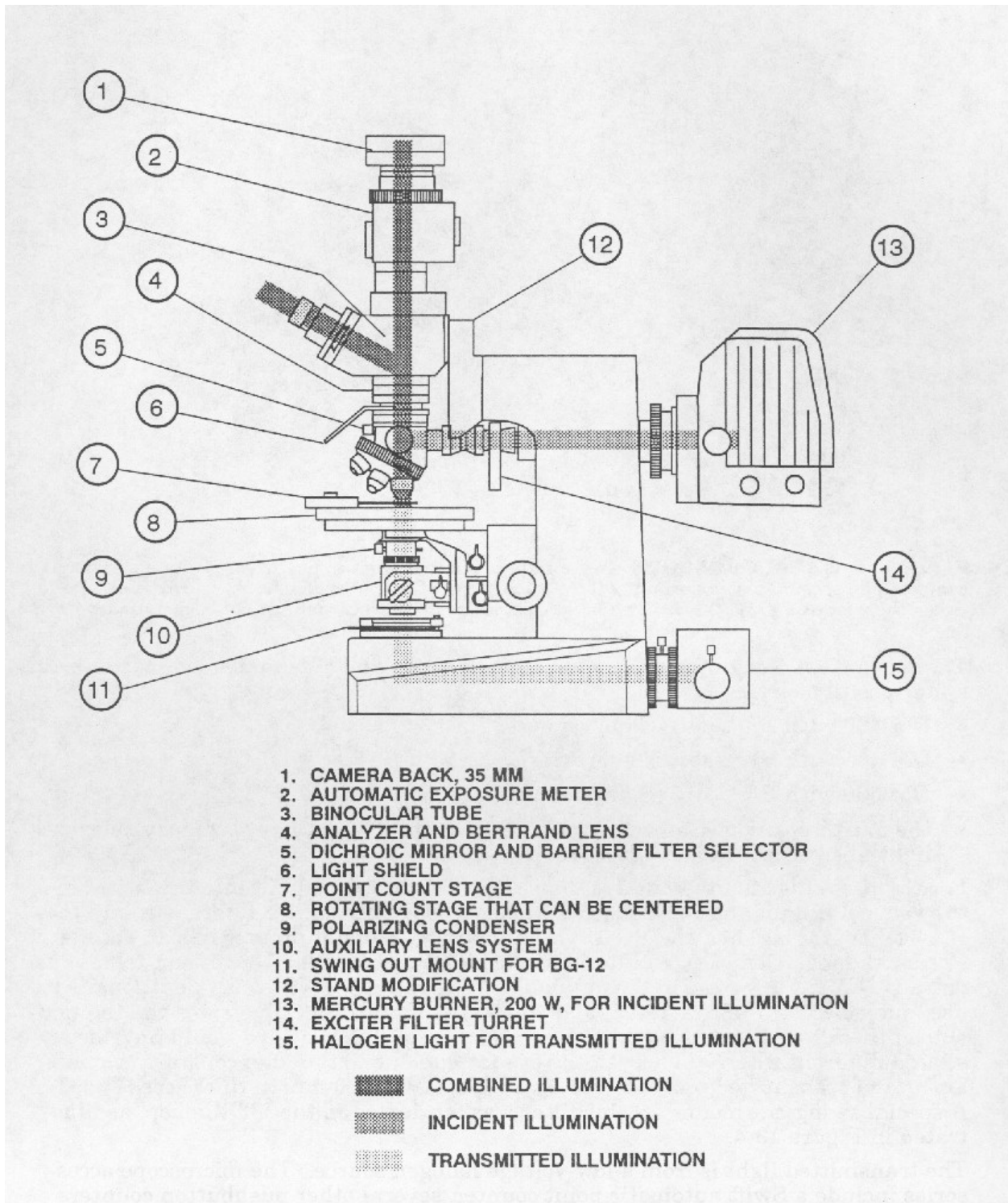

Figure 148. Light paths and features of the P/EF microscope.



In the right foreground are two pushbutton counters. The camera and exposure meter are on top of the microscope. The control for the exposure meter is between the microscope and the automatic point-counter keyboard in the left background.

Figure 149. P/EF microscope.

For the particular fluorescent dye in use, the exciter filters built into the turret in the vertical illuminator are usually sufficient. The only exciter filters used are the BG-3 (V engraving) and the BG-12 (B engraving). The illuminator has an accessory slot for the insertion of extra filters. Occasionally, it has been convenient to have an extra BG-12 filter for use in the optional exciter filter slot. The only additional BFs used have been a Y-485, a Y-495, and a 0-515. Figure 150 illustrates the relationship of the filters to the dye emittance spectrum. A different dye would have necessitated different filters. To lessen eye fatigue caused by the high contrast, a small amount of transmitted light filtered by a BG-12 filter, 3.0 mm in thickness, is used. A special swing-out mount for this filter was fabricated in the VTRC shop, as illustrated in figure 151.

The transmitted light is from a low-voltage halogen source. The microscope accessories include an automatic point counter, several other pushbutton counters (for counting voids, cracks, and traverses), and a filar micrometer.

The fluorescence elements are used in the study of HCC mainly because much of the paste (especially the hydration products of the cement) is colorless, has a fairly uniform low index of refraction, and has essentially no birefringence. In addition, the paste is a porous material wherein the internal (capillary) porosity is submicroscopic in size. The optical properties of the paste have a tendency to render it featureless and thus difficult to distinguish from empty space. The ability to distinguish empty space from colorless substances with zero birefringence is the

major reason the fluorescence is such a useful complement to the microscopist's repertory of determinative methods. Included in the apparent empty space are those areas that contained water or air before the drying and vacuum impregnation of the concrete specimen with the dyed epoxy. Such features include cracks in both the aggregate and the paste, the porosity of the aggregate, and the capillary system of the paste.

With this one microscope, the microscopist, while examining one particular area, can switch back and forth between the fluorescence features and the polarizing features (plane polarized illumination and crossed nicols); thus, it is possible to detect and assess areas of empty space and define their relationship to the reaction products, minerals, rock types, coatings and shapes of the aggregate particles, and other components of the concrete. A feature not readily recognizable in one mode can be easily examined in another. The aggregates, secondary mineralization, and reaction products can be identified and studied with the polarizing capabilities, whereas the areas of empty space and their distinction from some of the hydration products can be determined best by use of the fluorescence of the spaces impregnated by the dyed epoxy.

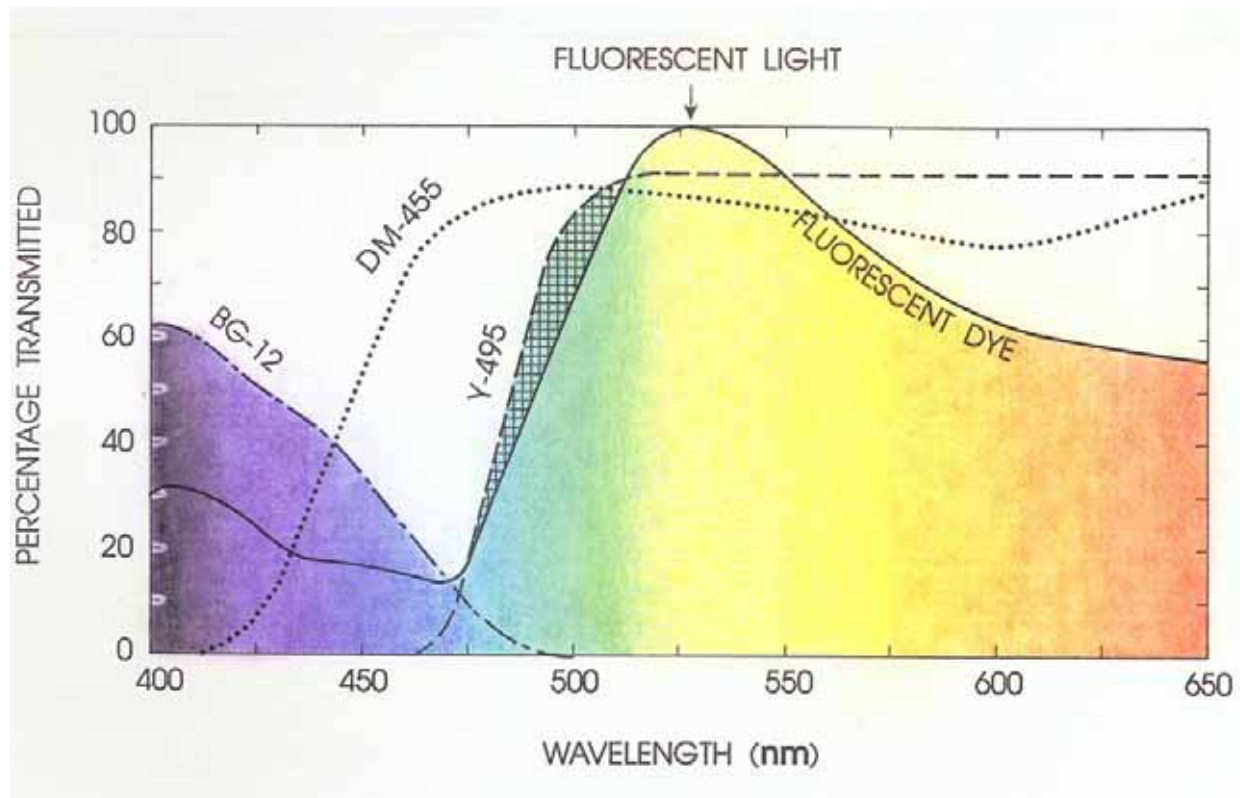

Percentage transmittance of exciter filters, dichroic mirrors, and barrier filters of a microscope compared with the excitation spectrum of fluorescent dye.

Figure 150. Relationship of filters to dye emittance spectrum.

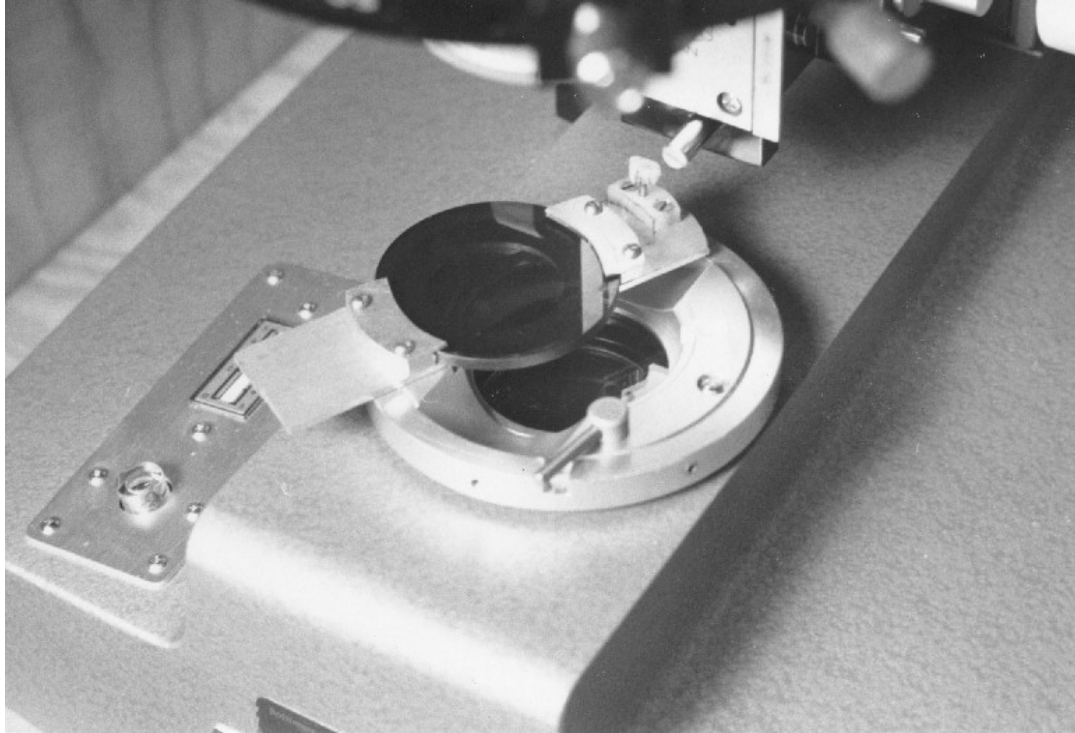

Filter holder was fabricated in the VTRC shop.

Figure 151. Swing-out filter over light port on base of microscope.

13.2 USES OF THE P/EF MICROSCOPE

There are seven main uses of the P/EF microscope: cracks, air-void parameters, porosity related to carbonation, w/cm and permeability, hydration, effect of fine aggregate, and photomicrographs.

13.2.1 Cracks

13.2.1.1 In Aggregate

Because the impregnation with the fluorescent dye precedes the thinning of the section to the point that will create new cracks in the aggregate, it is possible to know whether a particular crack (such as a cleavage crack in aggregate) was indigenous to the specimen or was caused by the processes used in the thinning of the section. If the crack is filled with the fluorescent dye, the crack preceded thinning and can be assumed to be a feature of the specimen that was present before it came to the laboratory.

13.2.1.2 In Paste

In concrete, the cracks may go in any direction and often skirt the edges of the aggregate particles. Even if the thin section is very thin, there may be no direct path along a crack for transmitted light to come through (see figure 152). The fluorescence of the impregnating epoxy mixture creates light within all the cracks. Even those cracks whose width is below the resolving

power of the lenses used may be detected and their location identified. Because of the uncollimated nature of this fluorescent light, the apparent width of these very fine cracks is somewhat increased.

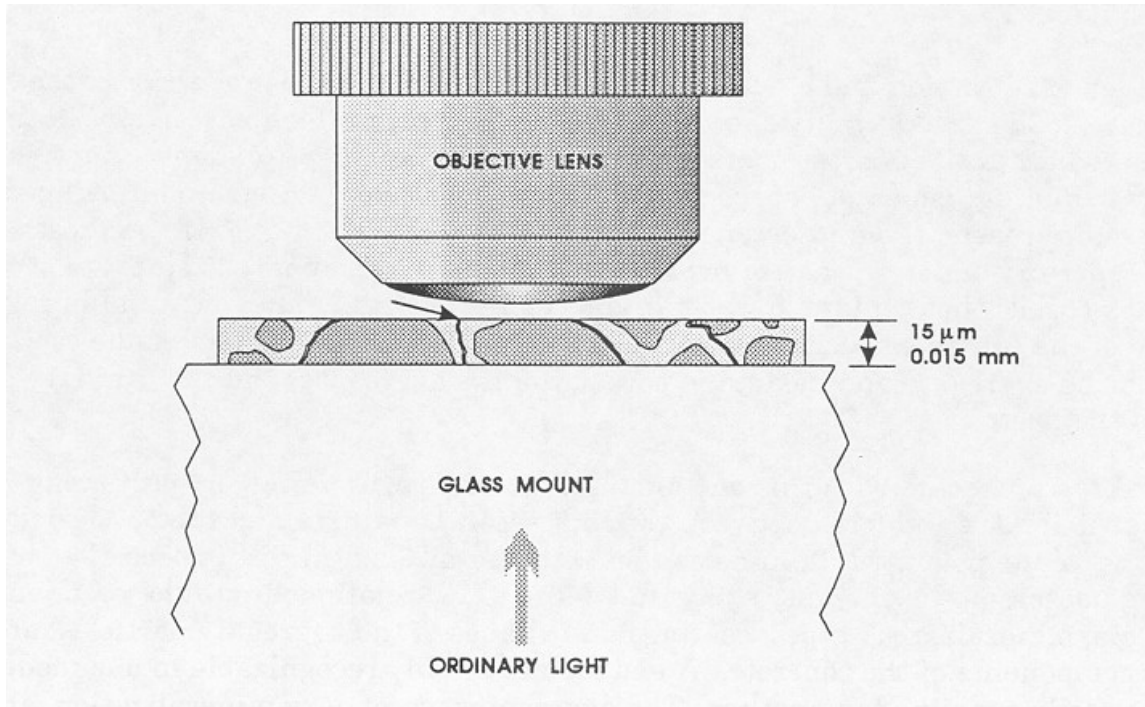

The arrow indicates the only crack that would be visible with transmitted illumination. Impregnation with a fluorescent dye and illumination with ultraviolet light would make possible the observation of the fluorescence of the dye in the other cracks. (The supporting glass slide would be about 100 times the thickness of the thin section of the concrete.)

Figure 152. Cracks in the thin section of the concrete.

13.2.2 Air-Void Parameters

For laboratory-produced concrete examined at a moderate magnification of about 200X, it was found that air-content determinations made on two thin sections of HCC (more were considered too costly) by the fluorescence method had no correlation with the air-content determinations made on a finely lapped slice of the concrete by the linear traverse method of ASTM C 457 even though great care was taken to focus on the edges of the voids (see Walker, 1979). Although there was no correlation in the air-void determinations, a good correlation was found with the determinations of the specific surface and spacing factor. In the original work done by Wilk, et al. (1974), the spacing factor was considered to be the most important parameter to be determined. Because the Virginia specifications for air content are in terms of percentage of air voids, it was decided that this technique did not fill the needs of the Virginia DOT.

13.2.3 Porosity Related to Carbonation

The carbonation reaction results in a densification of the paste (the products occupy a smaller volume than the reactants). The product mineral, calcite, is relatively insoluble in pore solution and its presence results in a permanent reduction in the capillary porosity of the paste. Consequently, less dyed epoxy will penetrate into these areas, and they will exhibit lower fluorescence compared to the uncarbonated areas of the same concrete. If the carbonation is extensive, some cracking may develop in response to the accompanying shrinkage. Such cracks will be highlighted by the fluorescence.

13.2.4 Water-Cement Ratio and Permeability

The capillary porosity (permeability) of the paste is directly affected by the w/cm. As a consequence, less epoxy penetrates into lower w/cm pastes than higher w/cm pastes, and the degree of fluorescence is lower. The degree of hydration and the type(s) of cementitious materials present affect paste permeability and thus the determination of w/cm by this method. Jakobsen, Laugesen, and Thaulow (2000) discuss in detail the use of this method to determine the w/cm.

13.2.5 Hydration

The optical properties of the cement and the empty space in and near a cement grain when compared with similar properties of cement grains of known age and similar size and history will indicate the approximate age and degree of hydration of the cement. Because of the much higher resolving power of the SEM, the SEM is very useful for evaluating the extent of hydration of cementitious materials (see chapter 14).

13.2.6 Effect of Fine Aggregate

A smooth-surfaced, sound, fine aggregate (few reentrant angles, low porosity, and cracks) will produce a concrete mixture that is easy to finish without additional water. An irregularly shaped or porous fine aggregate will create a harsh mixture with a high water demand and prompt the contractor to add more water (see appendix C, Walker, 1988). Because of the additional water, the concrete may have low strength. The irregular shape and porosity of the sand particles, pockets of excess water, and concomitant clumped distribution of the cement particles may be observed with the P/EF microscope.

13.2.7 Photomicrographs

Photographing the views seen is very useful for demonstrating to a client the characteristics of the concrete specimen. The photographs taken have also been useful in explaining the problems that can occur with particular materials, such as sand with a high void content or high internal porosity.

13.3 PROCEDURES

13.3.1 General Techniques

There are three important general points with regard to examination with the P/EF microscope:

1. **Examine fluorescent-impregnated ultrathin sections of HCC with the illuminator set for violet light (V settings):** Use the accessory BF Y-485. Under these conditions of illumination, the areas of bright fluorescence (empty areas, air voids, and very porous paste) are bright yellow; areas of lower fluorescence (ordinary paste) are greener; and areas of no fluorescence, such as nonporous aggregate particles, are dark blue.
2. **Continually check to ensure that the focus of the microscope is in the proper plane:** Even sections as thin as 10 μm can be focused on in more than one plane. Keep the focus on the surface of the section that is closest to the objective lens. Be alert to changes in the focal plane as different thicknesses of the thin section are moved under the microscope. Be aware when objects outside the plane are viewed in an out-of-focus manner. The light from the fluorescence can be so intense that the microscopist may become tempted to register objects that fluoresce as empty space without checking the plane of focus and ascertaining that the fluorescence is truly from the plane being examined.
3. **Make all quantitative determinations (point counting, chord accumulation, and size measurements) on the surface of the section nearest the objective lens (see figure 153):** An object may be seen differently at two different planes of focus (see figures 154 and 155).

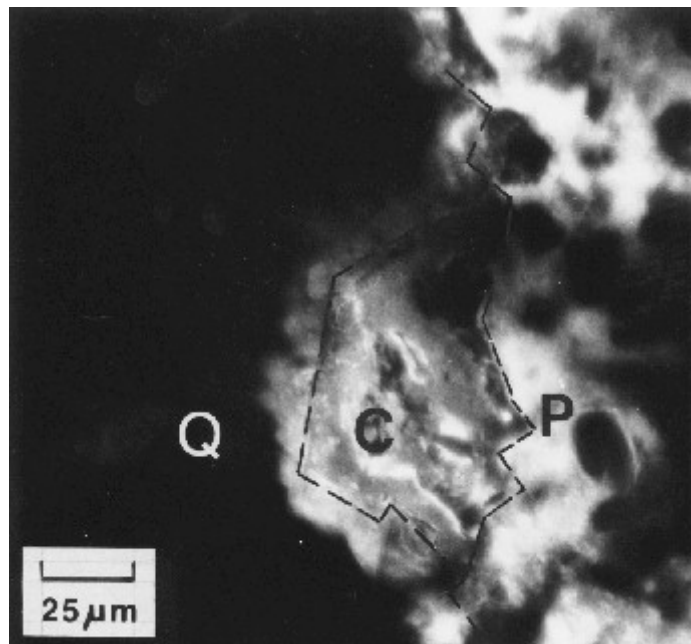

P = paste, C = clay pocket, Q = quartz aggregate; focus plane is within the section (Walker, 1981)

Figure 153. Fluorescence from porous clay pocket shining through edge of quartz particle.

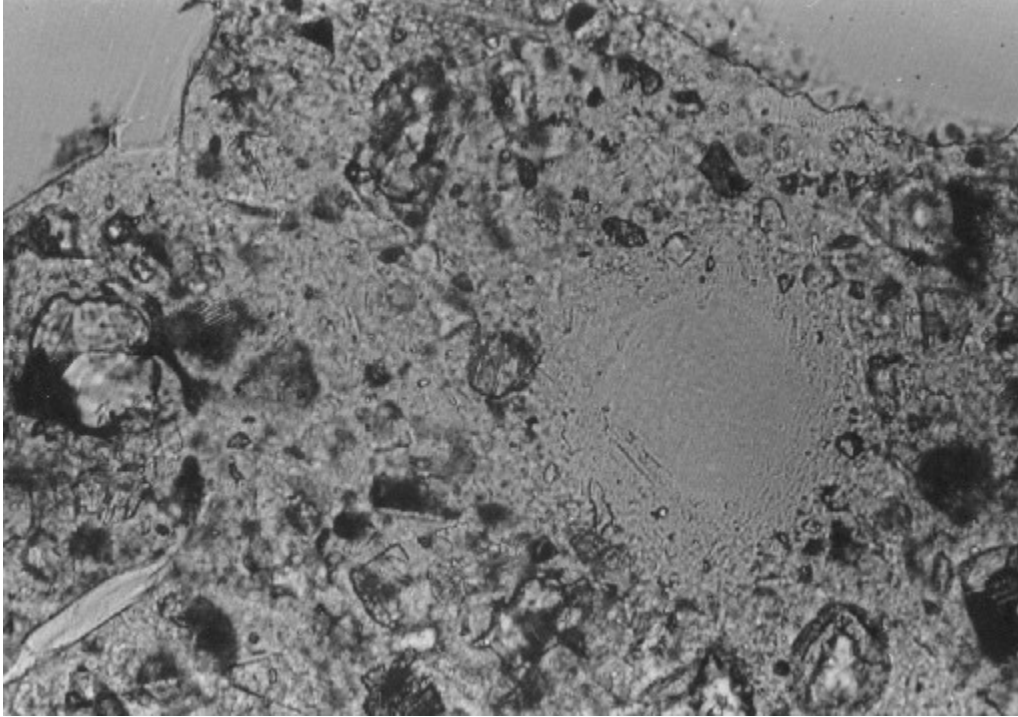

Figure 154. Void in thin section with focus plane on top surface of section.

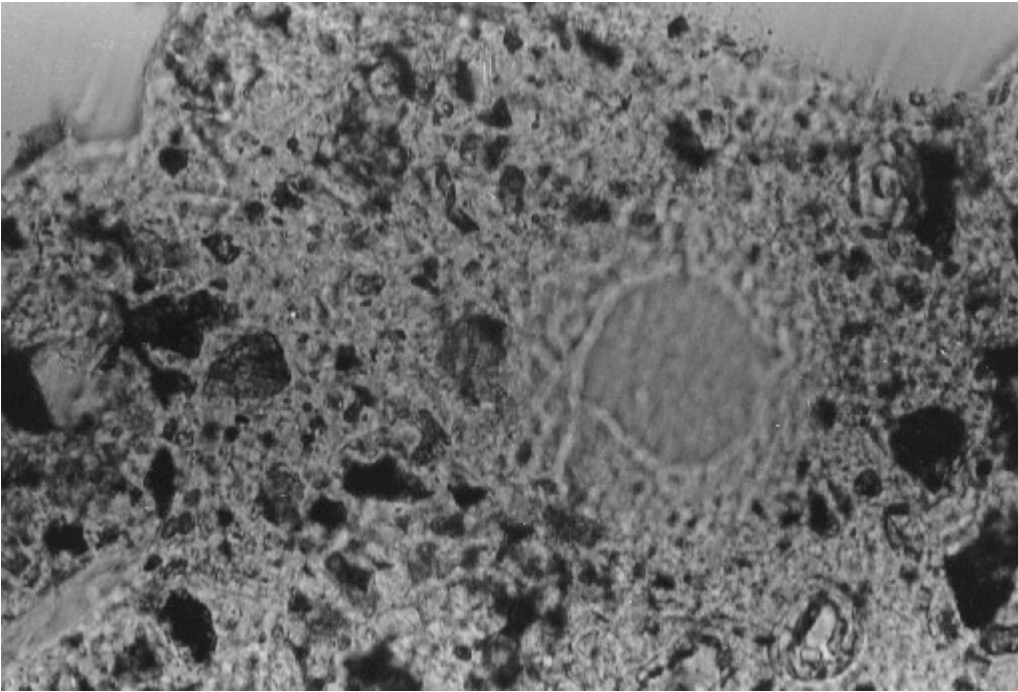

Figure 155. Void in thin section (same as figure 154) with focus plane at bottom of section, 100X.

13.3.2 Cracks

The examination of cracks is a three-step procedure:

1. **Check all cracks (in aggregate as well as in paste) seen with the polarizing features of the microscope with the fluorescent features to make sure that they contain fluorescent dye.**
2. **If fluorescence is lacking, change to the polarization mode and check for very faint birefringence and any relief within the crack that differs from that of the mounting medium:** Faint birefringence and unexpected relief indicate the presence of a substance filling the crack (e.g., silica gel or another secondary reaction product). If the nonfluorescent crack is really empty, it occurred during the thinning of the sample and is not indigenous to the specimen.
3. **Check the extent of cracking by examining the specimen with ultraviolet illumination so that the very fine cracks may be observed (see figure 152):** Fluorescence will indicate the fine continuation of the wider, more easily seen cracks and the fine cracks occurring at the boundaries of the aggregate.

13.3.3 Air-Void Parameters

The examination of air-void parameters is a seven-step procedure:

1. **When the specific surface, spacing factor, or both, are the required data and the specimen is too small to allow a sufficient slice to be prepared or the equipment necessary to perform an examination in accordance with ASTM C 457 is lacking, examine a minimum of two fluorescent-impregnated ultrathin sections with ultraviolet illumination and an automatic stage, such as the point counter or a similar device.**
2. **With the automatic motion of the point counter, make traverses across the sections at intervals of 2 min or greater:** The traverses must cover the entire usable area of the thin sections.
3. **Record all aggregate, paste, and voids that occur at the points defined by the automatic stage.**
4. **Continually check to ascertain that the focus is on the near surface of the section and that the edge of the void defining the boundary of the void is at the surface:** If the void boundary is beneath the surface, ignore the void and record for the point of the substance (aggregate or paste) that occurs on the surface plane of examination.
5. **Record the number of voids traversed by use of an accessory pushbutton counter:** Unless the distance between points is so small that the entire section is scanned during step 3, this must be performed during a second pass over each traverse.

6. **Calculate the data obtained by the method prescribed in the modified point-count method of ASTM C 457.**
7. **Unless the sum of the areas of the thin sections, the total length of traverse, and the number of points counted are at least the minimum prescribed by tables 1 and 2 in ASTM C 457, do not report the percentage of air voids.**

13.3.4 Porosity Related to Carbonation

Study the degree of carbonation and the consequences to the integrity of the HCC by switching back and forth between the polarizing and fluorescence features of the microscope as shown in figures 156 through 160. Figures 156 through 158 show that carbonation on the exterior of the HCC can provide a tighter, less permeable structure than exists below the carbonation. Figures 159 and 160 show the high porosity that is often associated with and is likely the cause of carbonation in the interior of the HCC.

13.3.5 Water-Cement Ratio and Permeability

The examination for permeability is a two-step procedure:

1. **Examine the permeability and w/cm of the HCC by estimating the amount of open area shown by the fluorescence of the dye in the cracks, pores, and capillary system:** These methods are best used when there are companion thin-section specimens of high-quality HCC. Jakobsen, Laugesen, and Thaulow (2000) provide a detailed description of this method and discuss some of its pitfalls. Further discussion can be found in Erlin (2002) and Jakobsen, et al. (2002). Whiting (1999) used the technique to study poor pavement durability in Minnesota and found it to be useful in differentiating between better performing concretes with low-to-moderate homogenous capillary porosity and poor-performing concretes with highly variable capillary porosity.

Similar evaluations can be made using the standard petrographic microscope (chapter 12) if the thin section has been impregnated with a colored (usually blue) epoxy. Liu and Khan (2000) discuss the use of this technique in conjunction with the standard techniques mentioned in chapter 9.

2. **To compare the permeability of an HCC containing a specific cement with pozzolan or slag or aggregate from a specific source with the permeability of an HCC of known quality, examine fluorescent-impregnated ultrathin sections of both materials:** The material with the fewer fluorescent cracks and capillaries is the one that is less permeable and probably has the lower w/cm.

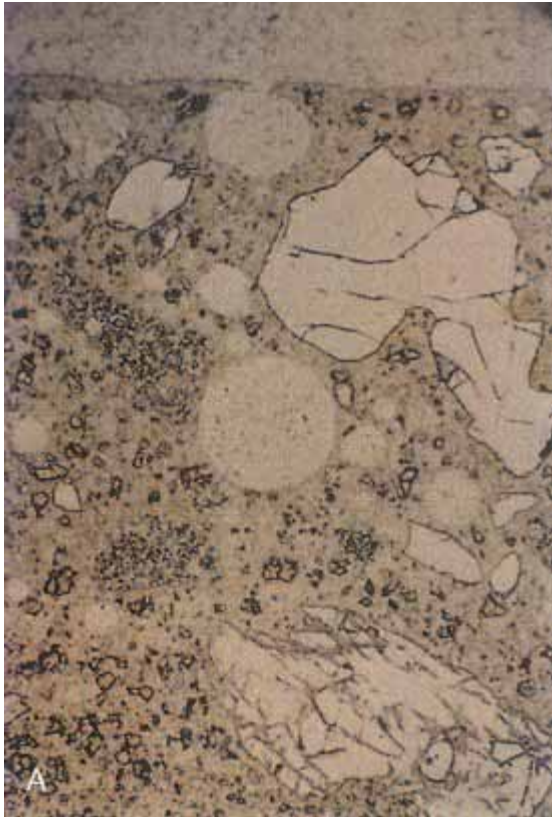

**Figure 156. Thin section of exterior portion of the HCC:
(A) Surface exposed to the air is at the top.**

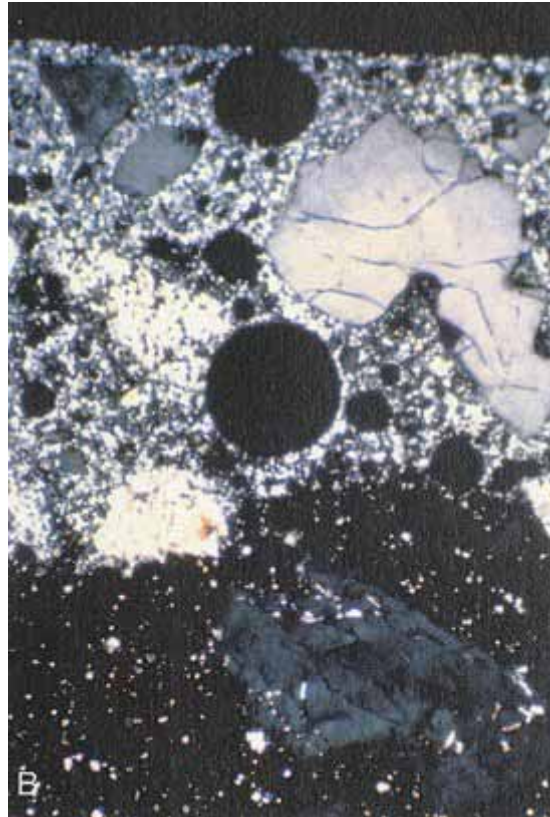

**Figure 157. Same view as figure 156, but viewed with crossed nicols:
(B) Bright area shows the high birefringence of the calcite of the carbonated area.**

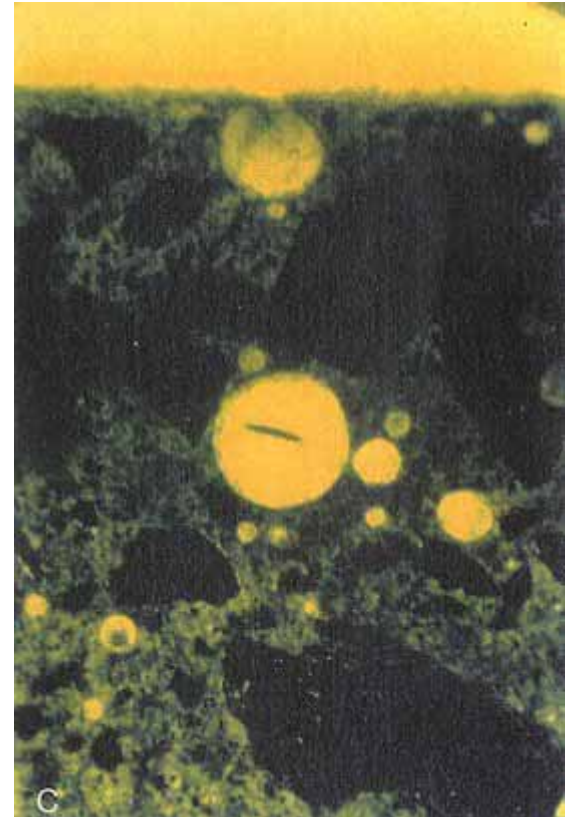

Figure 158. Same view as figures 156 and 157, but (C) viewed with ultraviolet light, causing fluorescence of the pore structure of the HCC (note that there is more porosity indicated by fluorescence in the portion of the HCC farthest from the surface than there is in the carbonated zone).

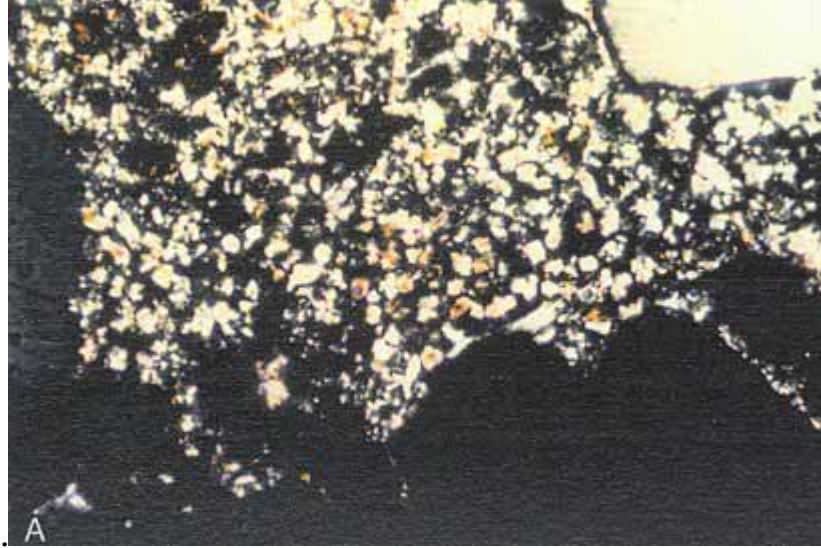

Figure 159. Thin section of interior portion of HCC: (A) Viewed with crossed nicols (bright area shows the high birefringence of the calcite of the carbonated area).

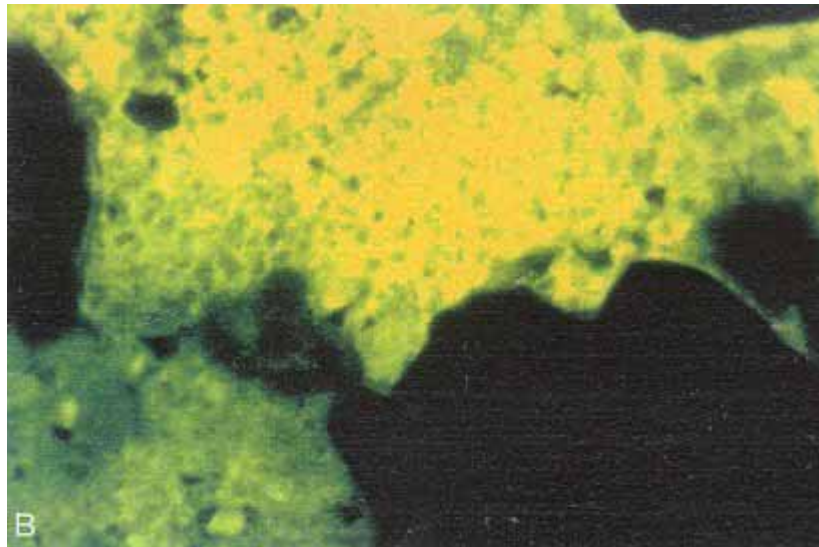

Figure 160. Thin section of interior portion of HCC: Same area as figure 159, but (B) viewed with ultraviolet light, causing fluorescence of the pore structure within the carbonated area.

13.3.6 Hydration

The examination for hydration is a two-step process:

1. **Examine cement grains with the polarizing and the fluorescence features of the microscope:** The center of an only partially hydrated cement particle will still have the birefringence of the unhydrated cement (see figures 161 through 163).
2. **Compare the birefringence of the center of the cement grain with that of cement grains of similar size and history:** When a cement particle is completely hydrated, the center may become empty or filled with reaction products (see figures 164 and 165). The size of the compared grains is important because the outer hydrated portion of a very large cement grain can protect the inner portion from hydration.

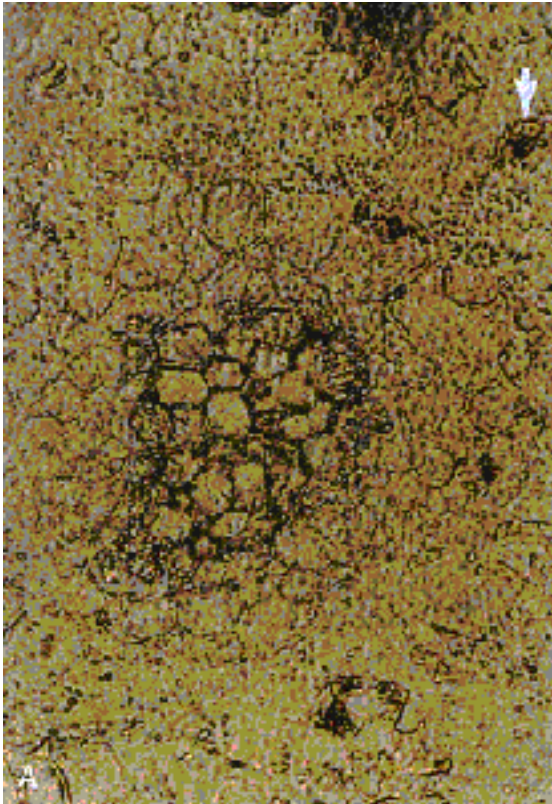

Figure 161. Thin section of 50-year-old concrete. (A) At the center is the remnant of a very large cement grain (cement was more coarsely ground then). Modern cement is usually about the size of the completely hydrated and filled cement grain indicated by the arrow (viewed with plane polarized illumination).

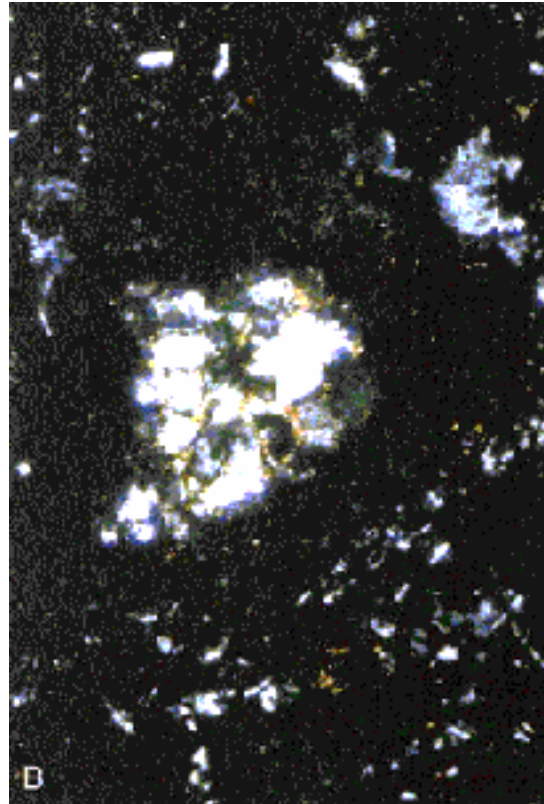

Figure 162. Same location as figure 161, but (B) viewed with crossed nicols. Note the original birefringence still present in the unhydrated central portion of the grain.

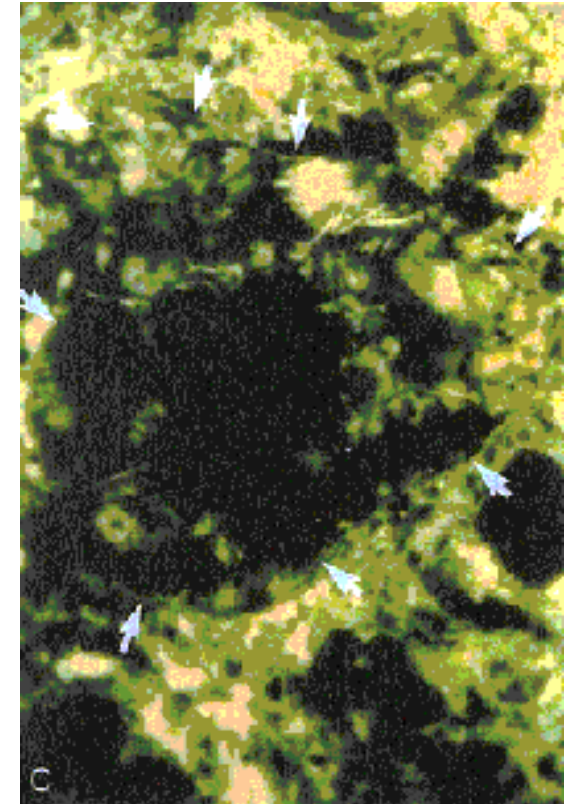
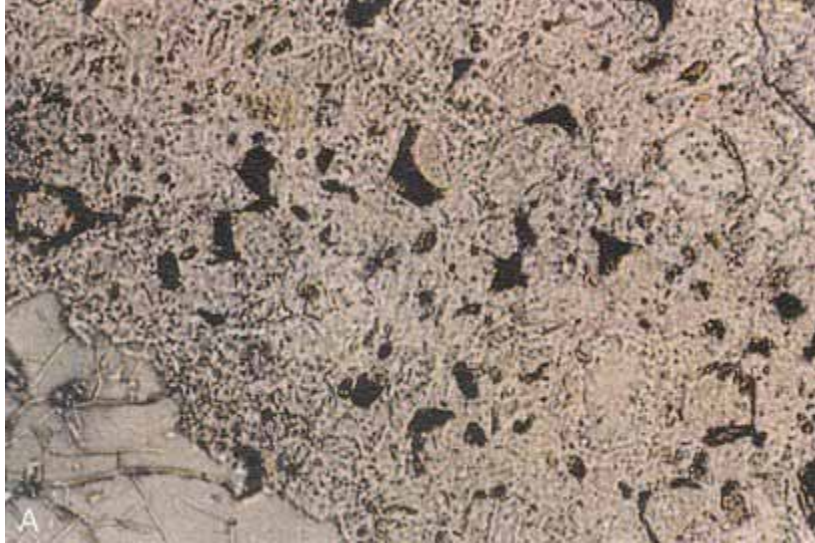

Figure 163. Same location as figure 161, but (C) viewed with ultraviolet light, causing fluorescence of the dye in the pore structure. The structure indicates that the original external boundary of the cement grain was the thin line (indicated by the arrows).



The cement grains are completely hydrated. Some cement grain centers are empty, others contain secondary mineralization.

Figure 164. Thin section of 25-year-old concrete viewed with plane polarized light.

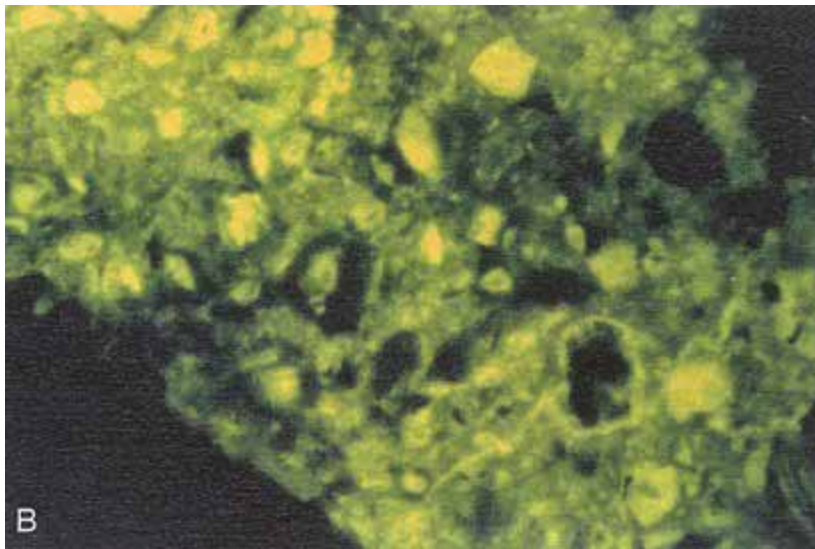

Figure 165. Thin section of 25-year-old concrete viewed with incident ultraviolet illumination, causing fluorescence of the dye-filled space.

13.3.7 Quality of Fine Aggregate

The examination of the fine aggregate is a four-step process:

1. **By means of the polarizing features, examine numerous sand particles in fluorescent-impregnated ultrathin sections of the concrete under study:** Identify the minerals and describe the shape of the particles and any coatings on them.
2. **With fluorescent illumination, study the sand particles and the paste in which they are embedded.**
3. **Examine the effect of the quality of fine aggregate on the surrounding paste:** Notice the bond between the paste and the aggregate, any cracking or porosity within the aggregate, and the distribution of the cement particles.
4. **Compare with thin sections of an HCC made with a fine aggregate with a known low-void content that has performed well in concrete mixtures:** The void content of sand is explained in appendix D. If lacking good comparative thin sections, draw your conclusions by a study of figures 166 through 171, which illustrate the appearance of various qualities of fine aggregate in different forms of illumination.

13.3.8 Photography

Five points are important in making photomicrographs:

1. **The best black-and-white photomicrography is obtained when the BG-12 exciter (B engraving) and the DM 500 with the BF 0-515 (B slot position) are employed:** When viewed with the eye, the fluorescence is orange-yellow and the aggregates are black; in photographs, the contrast is good, but some paste details are lost.
2. **Color photomicrography requirements vary with the intensity of fluorescence; however, the quality is generally good with the violet settings (BG-3, DM 455, and Y-455) and the addition of Y-485:** No transmitted light is used in the photomicrography of fluorescent images.
3. **Completely satisfactory exposures for photomicrography with fluorescence or with crossed nicols have not been obtained:** In both cases, it has been necessary to try many different exposure times. When the automatic exposure meter is used, the ability of the equipment to produce the correct exposure seems to depend on whether a bright or a dark object is centered in the view to be photographed. Bracketing the exposure with this light meter is done by setting the light meter for many different International Standards Organization (ISO) film speed numbers and photographing with each.
4. **Similarly, with video or digital cameras, the settings must be experimented with to obtain satisfactory images that display the desired features.**
5. **Standardize a method of keeping track of all photomicrographs taken:** Each exposure should have a reference number and be recorded with any data that will aid in

improving future exposures. The data recorded should include the source and type of illumination, the position of any intensity controls, the filters used, the amount of opening of all diaphragms (akin to an f-stop), the film used, and the ISO number used to set the exposure meter. If roll film is used, a system of identifying rolls should be devised and this identification should be recorded with the negatives and on any contact sheets or other archive prints.

Figure 172 is a page in the P/EF photomicroscopy notebook used at VTRC. The information to be recorded will depend on the nature of the specimen, camera, illumination, and adjustments on the light meter or shutter control.

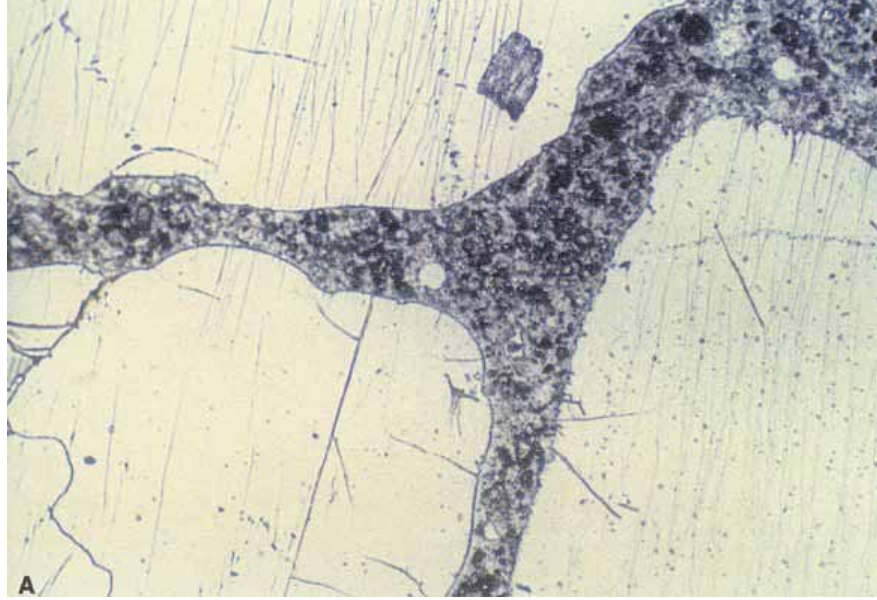

**Figure 166. Thin section of HCC made with smooth, rounded sand:
Viewed with plane polarized light.**

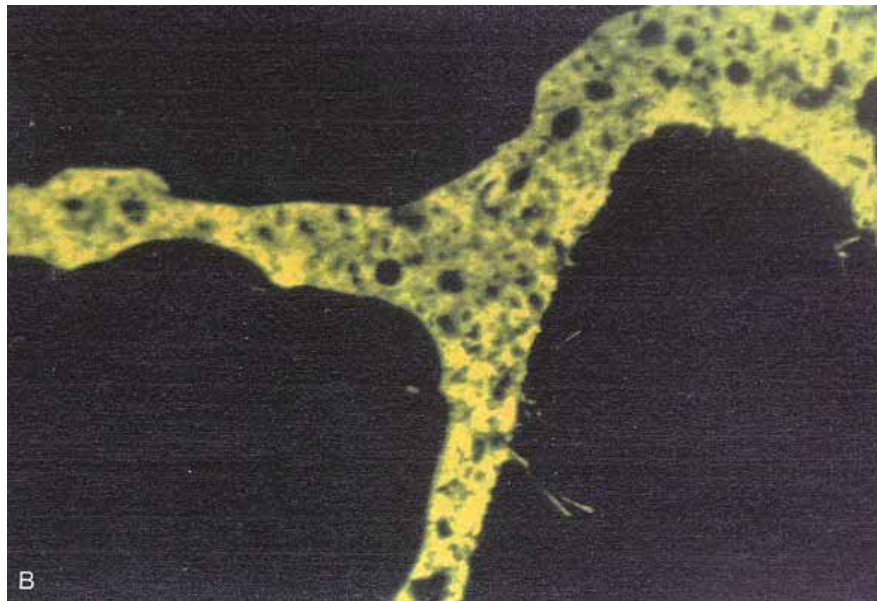

**Figure 167. Thin section of HCC made with smooth, rounded sand: Same view
as figure 166, but with ultraviolet illumination, causing fluorescence in the
pore structure impregnated with dye (note the even texture of the paste).**

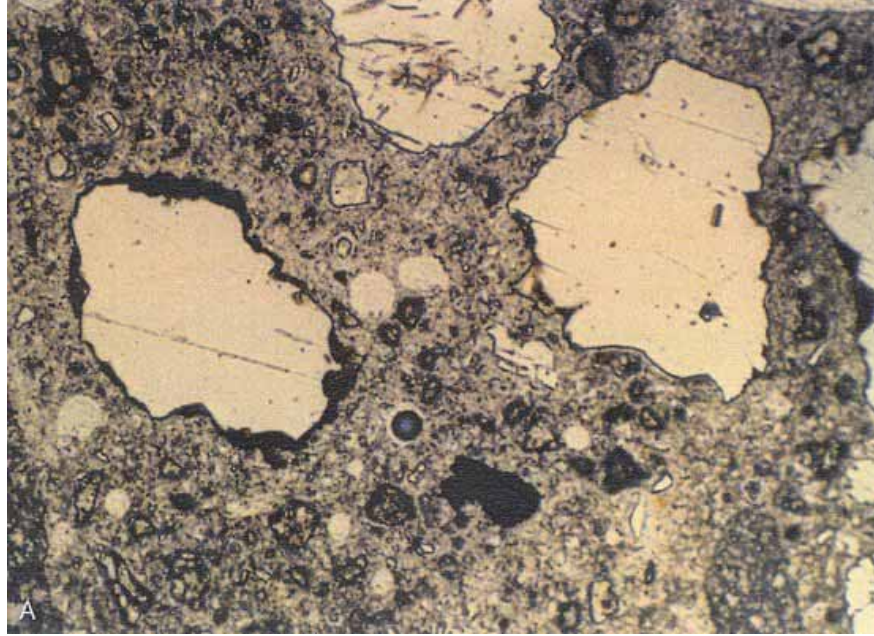
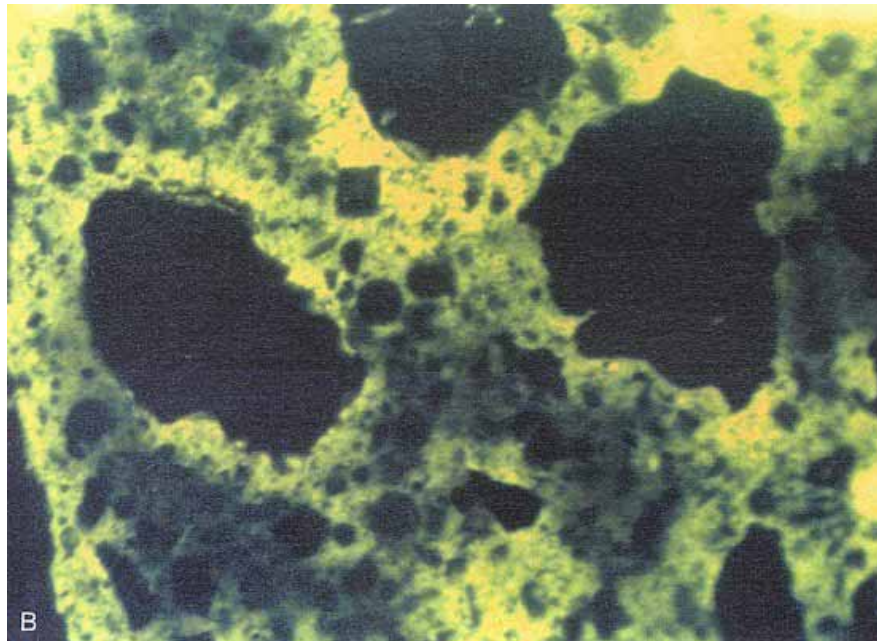
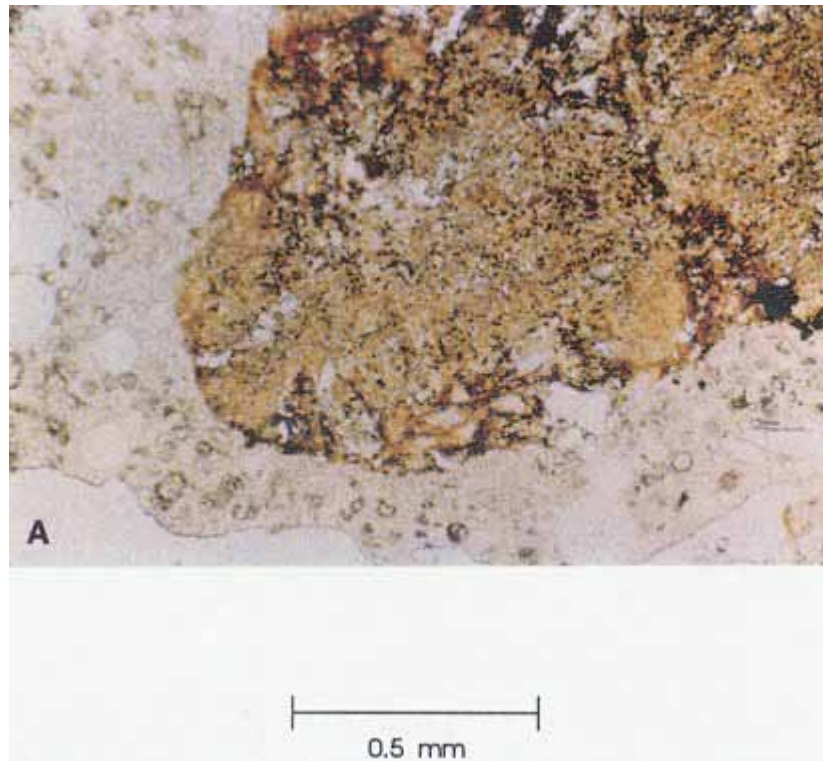

Figure 168. Thin section of HCC made with angular, dirty sand: (A) Viewed with plane polarized light (there are numerous reentrant angles).



Note the clumping of the cement grains, abundance of pores (shown by the fluorescence) at the edge of the sand, structure of the clay coatings, and general uneven texture of the paste. Such uneven texture indicates zones of weakness through the HCC.

Figure 169. Thin section of HCC made with angular, dirty sand: Same view as figure 168, but (B) with ultraviolet illumination, causing fluorescence that delineates the pore structure.



**Figure 170. Thin section of porous, iron-stained particle of sand:
Viewed with plane polarized light.**

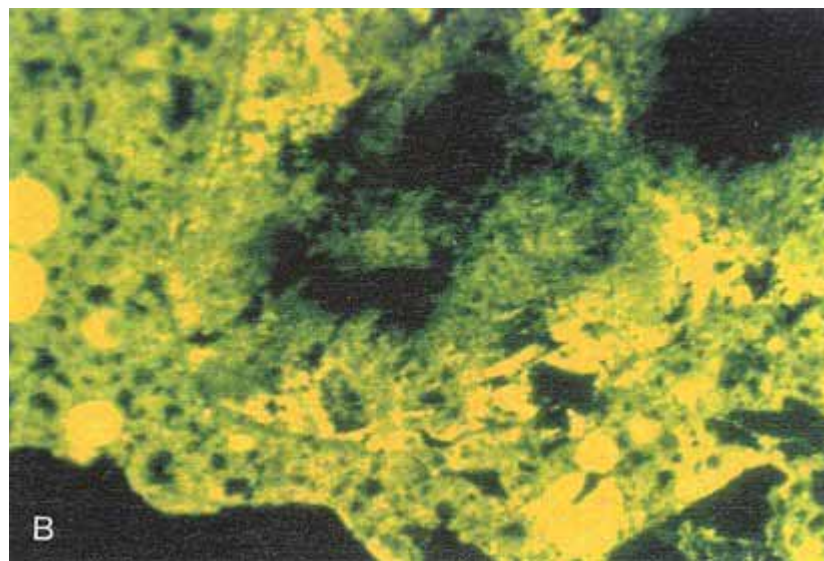

Figure 171. Thin section of porous, iron-stained particle of sand: Viewed with incident ultraviolet illumination, causing fluorescence of the dye in the pore structure of the sand grain and indicating a zone of water accumulation and weakness.

R-366

PHOTOMICROGRAPHIC DATA SHEET # _____

DATE _____ / _____ / _____ ROLL# _____ FR# _____
DAY MONTH YEAR

FILM _____ ASA _____ INCR? _____

CAM. OC. 2.5, 6.7

OBJ. 5X, 10X, 40X, FL40X, 60X, 100X

ILLUMINATION

SECTION-SAMPLE

TRANS-HALOGEN MAX

ULTRAVIOLET REFL.

TYPE- S O DP FL

CONDENSER

TURRET

SKETCH,
LOCATE VIEW

FLIP-- IN OUT

U V B G

FOCUS? CENTER?

SLIDE

U V B G

APERTURE _____

EXCITER _____

AUX. COND. HUL OR L

BARRIER _____

SWING LENS V OR H

FILTERS

FIELD _____

ND B G GG _____

APERT. _____

PHOTO OF _____

UPPER POL. OUT, +, || OR _____

ACC: GYP., MICA. _____

SET: ASA _____ ASA _____ CTR . . T D . .

CHECK: 0 | | | | |

UP-PATH ~~W~~ G ~~X~~ LO-PATH ~~W~~ G R

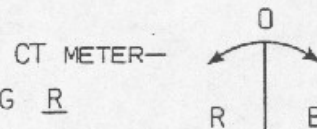

RELEASE EST. EX. _____ TIME OFF, USED ON PRESET.

REMARKS:

PICTURE SKETCH:

(STAGE SCREW & KNOB)

Figure 172. Page from VTRC P/EF photomicroscopy notebook.

CHAPTER 14. SAMPLE PREPARATION FOR AND EXAMINATION WITH THE SCANNING ELECTRON MICROSCOPE

14.1 OVERVIEW

The application of the SEM in petrographic analysis of cementitious materials and concrete microstructure (Bentz and Stutzman, 1993; Struble and Stutzman, 1989; Stutzman, 1990, 1991, 1993; Stutzman and Bentz, 1993) is becoming increasingly common. SEM imaging provides detailed images of the microstructure that augment those from stereo and optical microscopy. The primary advantages are the high-contrast images of the microstructure, the high spatial resolution of the images, and the ability to perform simultaneous imaging and chemical analysis. This chapter presents an overview of the SEM and includes guidelines for specimen preparation, common imaging methods, and image processing and analysis for quantitative microscopy.

14.2 SCANNING ELECTRON MICROSCOPE

The SEM (figure 173) scans a focused beam of electrons across the specimen and measures any of several signals resulting from the electron beam interaction with the specimen. The most commonly used imaging modes are secondary electron, backscattered electron, and x ray. Images are monochrome since they reflect the electron or x-ray flux resulting from the beam/specimen interaction. Computer-based image processing and analysis make routine quantitative imaging possible.

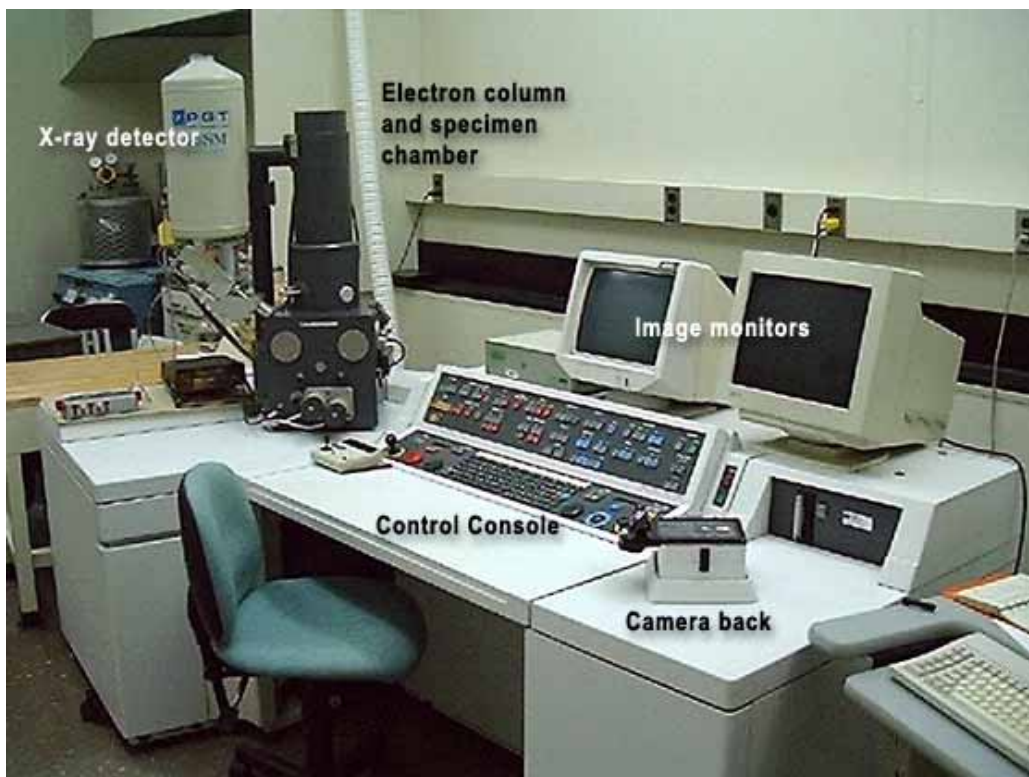

Figure 173. Scanning electron microscope.

14.2.1 Secondary Electron Imaging

Secondary electrons (SE) are low-energy electrons produced as a result of an inelastic collision of a primary beam electron with an electron of an atom within the specimen (Goldstein, et al., 1992). Because of their low energy, they are readily absorbed and only those produced near the surface escape, producing the detailed images of surface topography. The apparent shadowing in the image is a result of the absorption of the SEs by intermediary parts of the specimen. The maximum depth of SE emission is reported to be about 1 nanometer (nm) in metals and 10 nm in insulating materials, depending on the beam accelerating voltage (Goldstein, et al., 1992).

Specimens intended for secondary imaging benefit from a conductive coating of a heavy metal such as gold or gold/palladium to increase secondary electron flux, improving the imaging signal. SE images are used to study particle size, shape, surface roughness, and fracture surfaces.

SE images of fracture surfaces of hardened cement paste (figures 174 and 175) show a platy, or foil-like, calcium silicate hydrate (CSH) (figure 174)—slender fibers of calcium silicate hydrate and, along the base of the image, calcium hydroxide (CH) (platy habit). Figure 175 exhibits plates of CH (typical hexagonal habit) and the needle-like habit of ettringite. The existence of the characteristic morphologies depends on the availability of void space for uninhibited growth.

SE imaging is therefore particularly useful in the examination of early-age paste microstructure, high-magnification imaging, examination of secondary crystal growth and fragments of material that may be plucked from a larger specimen, and examination of aggregate texture. Knowledge of the morphological characteristics and bulk chemistries of the hardened cement paste and mineral constituents aids in their identification. Although SE imaging is useful for examining surface texture, the rough surface makes measurements of phase abundance unreliable. As the hardened cement paste matures, filling of the void spaces eliminates the well-formed crystals shown in these figures, with the resulting microstructure appearing to be nondescript.

Backscattered electron and x-ray imaging are ultimately more useful in the examination of these microstructures.

14.2.2 Backscattered Electron Imaging

Backscattered electrons (BE) are high-energy electrons (typically greater than 50 electronvolts (eV)) that have undergone multiple elastic scattering events within the specimen. The greater energy results in a larger interaction volume and lower spatial resolution compared to the SE image. However, the BE image contrast is generated by the composition of the different phases relative to their average atomic number and is observed by the differential brightness in the image.

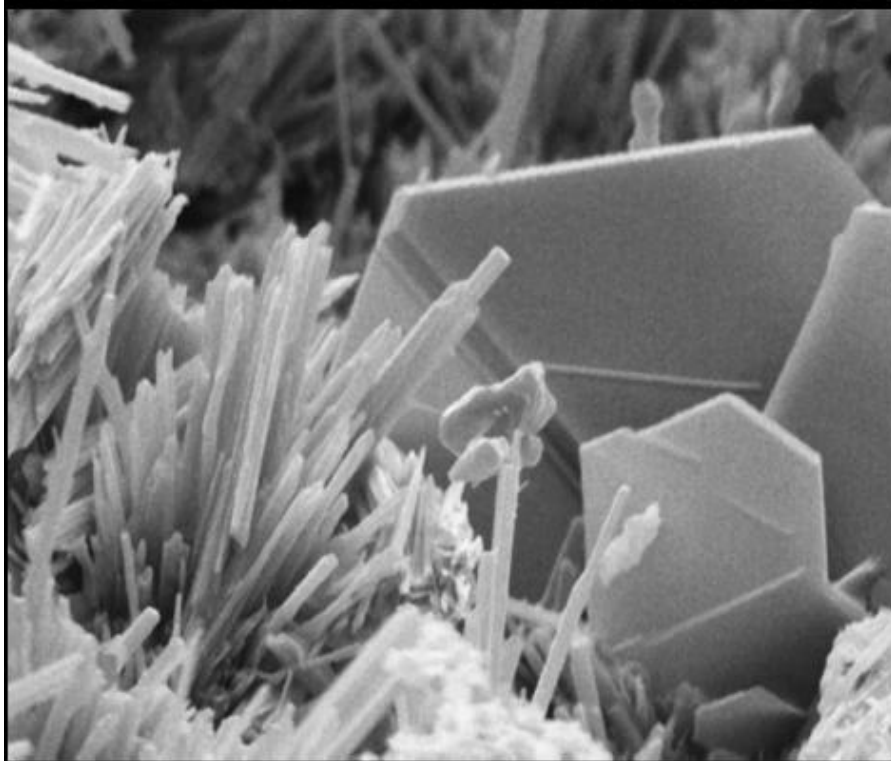
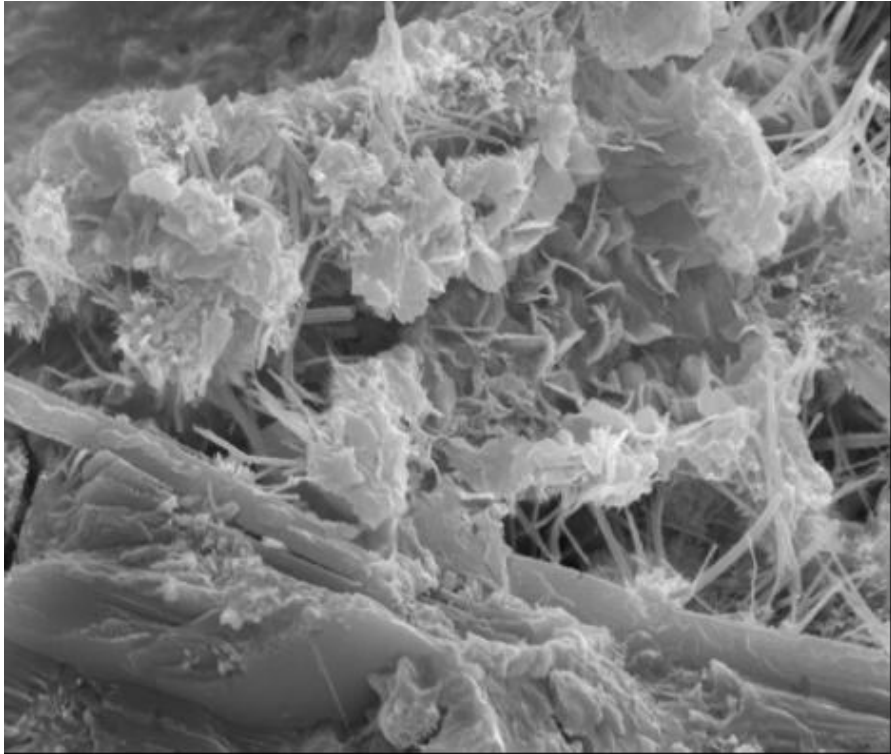

Figure 174. SE image showing platy or foil-like CSH, fine bundles of CSH fibers and platy CH (top).

Figure 175. SE image showing platy CH and ettringite needles and also plate-like CH morphology (bottom).

The backscatter coefficient (η) is a measure of the BE fraction for a pure element (Z), which may be estimated using the equation in figure 176 from Goldstein, et al. (1992):

$$\eta = -0.0254 + 0.016Z - 1.86 \times 10^{-4} Z^2 + 8.3 \times 10^{-7} Z^3$$

Figure 176. Equation to estimate backscatter coefficient from Goldstein, et al. (1992).

The BE coefficient of a multi-element phase is estimated using the mass fractions (C_i) and η values for each constituent:

$$\eta = \sum_i C_i \eta_i$$

Figure 177. Equation to estimate BE coefficient of a multielement phase.

Contrast between constituents can be calculated as:

$$C = \frac{(\eta_2 - \eta_1)}{\eta_2}$$

Figure 178. Equation to calculate contrast between constituents.

Table 26 lists some phases found in cements and hardened cement pastes, in descending order of their gray-level intensity. Using the contrast equation (figure 178), initial estimates may be made to see if constituents can be distinguished on the basis of their BE intensities. The contrast (6.8 percent) between alite ($\bar{z} = 15.06$) and belite ($\bar{z} = 14.56$) is relatively strong, whereas that between belite and cubic aluminate ($\bar{z} = 14.34$) at 1.5 percent is usually too weak to distinguish these constituents. Detector specifications usually quote a 0.5 \bar{z} resolution. In difficult situations, a slower scan rate may improve the signal-to-noise ratio to allow distinction. In many of these cases, however, the phases are chemically distinct and the use of x-ray microanalysis will allow their discrimination and identification. Two factors do affect the gray-level intensity of a constituent: (1) porosity within a phase lowers its \bar{z} value and will make it appear darker than expected and (2) a solid solution, if present, will also influence the intensity of a phase proportional to its deviation from these idealized compositions. Examples of these include porosity within CSH for the former and zoning within the ferrite phase for the latter. In general though, anhydrous cement appears brightest, followed by calcium hydroxide, calcium silicate hydrate, and aggregate. Voids appear dark.

Figures 179 through 181 provide a comparison of stereomicroscopy and SEM BE and SE imaging. The stereomicroscopic image (figure 179) has a field width of about 26 mm, showing a cross section of pavement concrete exhibiting alkali-aggregate reaction. The SEM image (figure 180) illustrates the same microstructure, but with image contrast based on BE. Figure 181 is another section of the same pavement, but with an SE image of the surface topography. Features such as aggregate, air voids, and fractures are visible in each of the micrographs. The SEM BE and stereomicroscopic images are the most similar as they are both of polished sections.

For both image types, feature identification is made by recognizing a feature as an aggregate, cement paste binder, air void, or fracture. The sand in the SEM image appears as a uniform shade of gray with some brighter grains. The coarse aggregate has a more varied BE signal reflecting the multiphase composition. Identification of the aggregate mineralogy is made in subsequent figures.

Table 26. Cement and hydration product constituents, chemical composition, and backscattered electron coefficient (η).

| Phase | Composition | \bar{Z} | η |
|--|--|-----------|--------|
| Cement phases: | | | |
| Ferrite | $\text{Ca}_2(\text{Al,Fe})_2\text{O}_5$ | 16.65 | 0.1860 |
| Free lime | CaO | 16.58 | 0.1882 |
| Alite | Ca_3SiO_5 | 15.06 | 0.1716 |
| Belite | Ca_2SiO_4 | 14.56 | 0.1662 |
| Arcanite | K_2SO_4 | 14.41 | 0.1652 |
| Aluminate-cub. | $\text{Ca}_3\text{Al}_2\text{O}_6$ | 14.34 | 0.1639 |
| Aluminate-ort. | $\text{NaCaAl}_3\text{O}_9$ | 13.87 | 0.1588 |
| Aphthitolite | $(\text{Na,K})_2\text{SO}_4$ | 13.69 | 0.1577 |
| Syngenite | $\text{K}_2\text{Ca}(\text{SO}_4)_2\text{H}_2\text{O}$ | 13.60 | 0.1556 |
| Anhydrite | CaSO_4 | 13.41 | 0.1535 |
| Bassanite | $2\text{CaSO}_4\cdot\text{H}_2\text{O}$ | 13.03 | 0.1489 |
| Gypsum | $\text{Ca}(\text{SO}_4)\cdot 2\text{H}_2\text{O}$ | 12.12 | 0.1381 |
| Thenardite | Na_2SO_4 | 10.77 | 0.1249 |
| Periclase | MgO | 10.41 | 0.1213 |
| Hydration and secondary products: | | | |
| Portlandite | $\text{Ca}(\text{OH})_2$ | 14.30 | 0.1617 |
| Tobermorite | $\text{Ca}_5\text{Si}_6\text{O}_{18}\text{H}_2$ | 13.16 | 0.1539 |
| Hemicarbonate | $[\text{Ca}_2\text{Al}(\text{OH})_6][0.5 \text{H}_2\text{O} 0.25 \text{CO}_3 \text{aq}]$ | 12.39 | 0.1406 |
| Hydrogarnet | $\text{Ca}_3\text{Al}_2(\text{OH})_{12}$ | 12.30 | 0.1398 |
| Gypsum | $\text{Ca}(\text{SO}_4)\cdot 2\text{H}_2\text{O}$ | 12.12 | 0.1381 |
| Plombierite | $\text{Ca}_5\text{Si}_6\text{O}_{16}(\text{OH})_2 8\text{H}_2\text{O}$ | 12.09 | 0.1380 |
| Monosulfate | $[\text{Ca}_2\text{Al}(\text{OH})_6][0.5(\text{SO}_4)3\text{H}_2\text{O}]$ | 11.66 | 0.1324 |
| Ettringite | $\{\text{Ca}_6[\text{Al}(\text{OH})_6]_2\cdot 24\text{H}_2\text{O}\}[(\text{SO}_4)_3\cdot 1.5 \text{H}_2\text{O}]$ | 10.79 | 0.1222 |
| Thaumasite | $\text{Ca}_3\text{Si}(\text{OH})_6\cdot 24\text{H}_2\text{O} (\text{CO}_3)(\text{SO}_4)$ | 9.74 | 0.1097 |
| Brucite | $\text{Mg}(\text{OH})_2$ | 9.43 | 0.1085 |
| Hydrotalcite | $[\text{Mg}0.75\text{Al}0.25(\text{OH})_2](\text{CO}_3)0.125(\text{H}_2\text{O}) 0.5$ | 9.09 | 0.1042 |
| Aggregate phases: | | | |
| Calcite | CaCO_3 | 12.56 | 0.1422 |
| Dolomite | $\text{CaMg}(\text{CO}_3)_2$ | 10.87 | 0.1237 |
| Quartz | SiO_2 | 10.80 | 0.1254 |

The fracture surface (figure 181) at about the same magnification shows the hardened cement paste, aggregates, and some air voids; however, the rough surface makes identification of these constituents more difficult. This mode of SEM imaging is best suited for higher magnification examinations of microstructural features.

The images presented in figures 179 through 184 show that the SEM can work like a stereomicroscope in low-magnification screening of concrete microstructures. It may also be used to examine paste microstructures as seen in figures 185 and 186 with lower and higher magnification images.



Field width is about 20 mm.

Figure 179. Stereomicroscopic image.

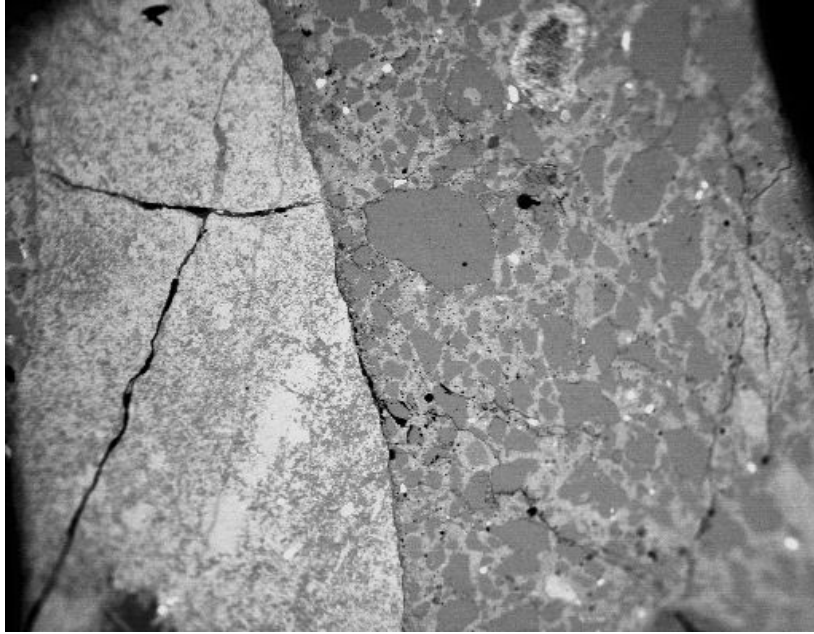

Field width is about 15 mm.

Figure 180. Backscattered electron image (same specimen).

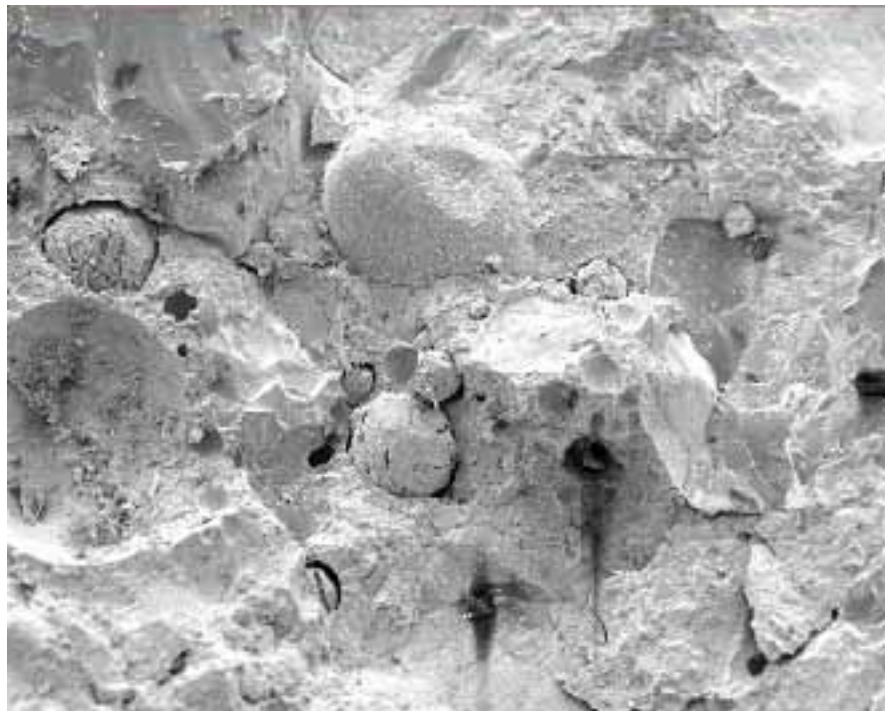

Field width is about 15 mm.

Figure 181. Secondary electron image of a fresh-fracture surface from concrete.

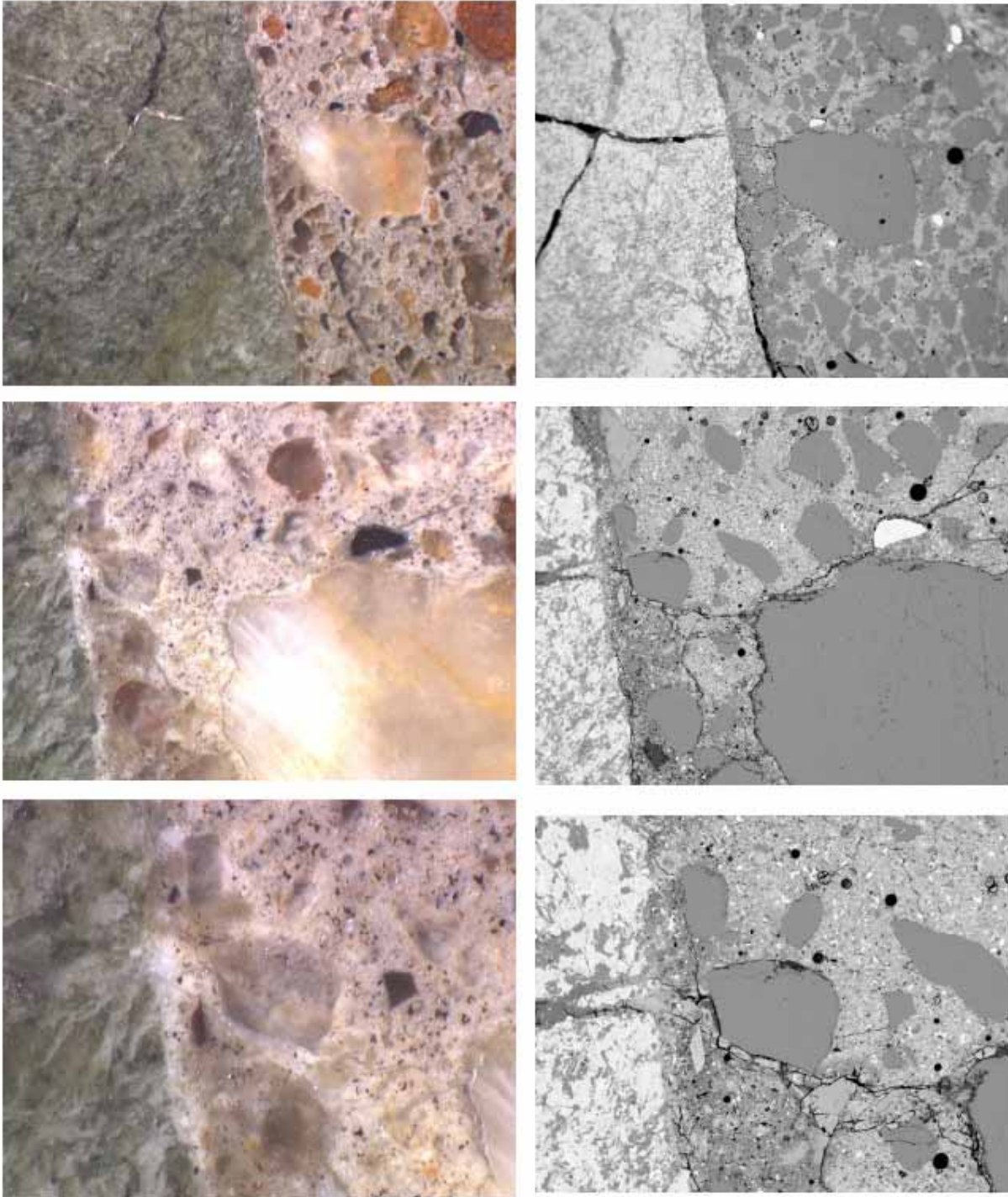
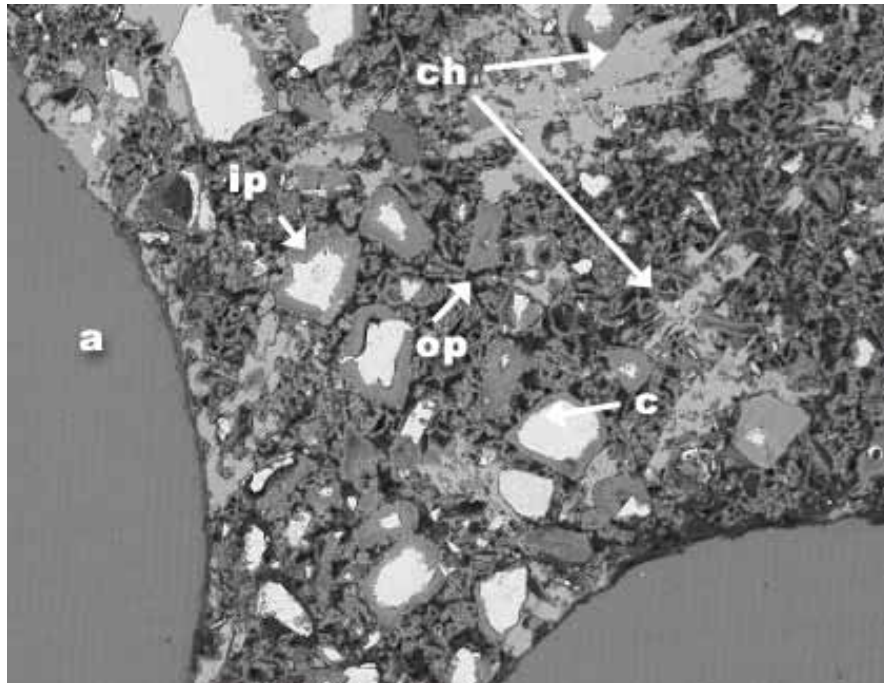

Figure 182. Top. Paired image at successively greater magnification of stereomicroscope (white light) images and SEM BE images: Field width is 11 mm.

Figure 183. Middle. Field width is 3 mm.

Figure 184. Bottom. Field width is 1.5 mm.



a = aggregate, c = residual cement, ch = calcium hydroxide, ip = calcium-silicate-hydrate, inner product, and op = calcium-silicate-hydrate, outer product

Figure 185. Backscattered electron image of an epoxy-impregnated, polished cross section of concrete (field width is 2 mm).

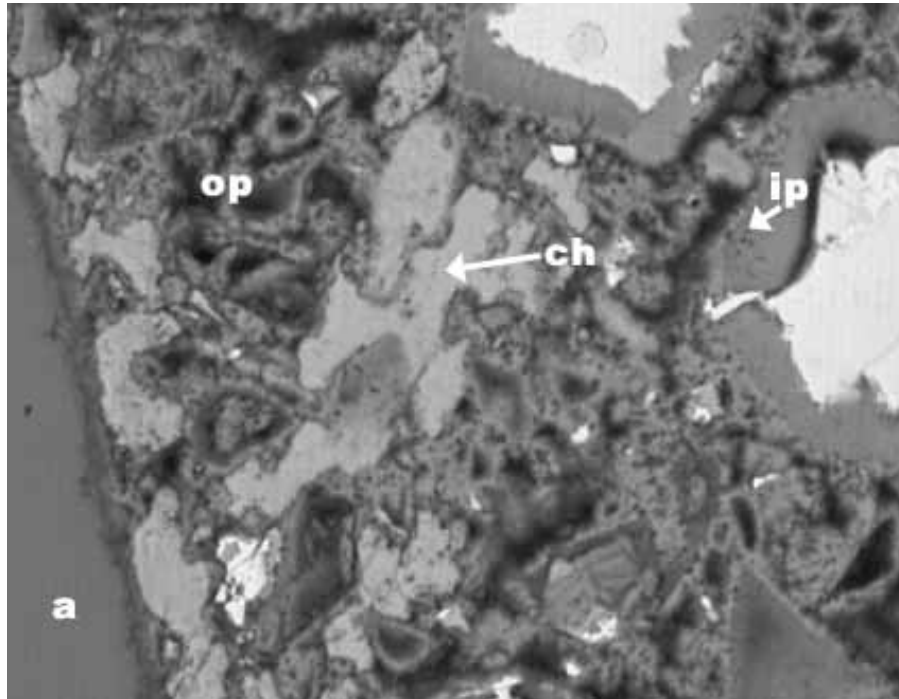

a = aggregate, c = residual cement, ch = calcium hydroxide, ip = calcium-silicate-hydrate, inner product, and op = calcium-silicate-hydrate, outer product

Figure 186. Backscattered electron image of an epoxy-impregnated, polished cross section of concrete (field width is 1 mm).

14.2.3 X-Ray Microanalysis

X-radiation is produced when a specimen is bombarded by high-energy electrons. The beam electrons eject inner-shell electrons that are then replaced by outer-shell electrons. This replacement results in emission of an x ray characteristic for that element. The x-ray energy level is displayed as the number of counts at each energy interval and appears as peaks on a continuous background (figure 187), referred to as an energy-dispersive x-ray spectrum (EDX).

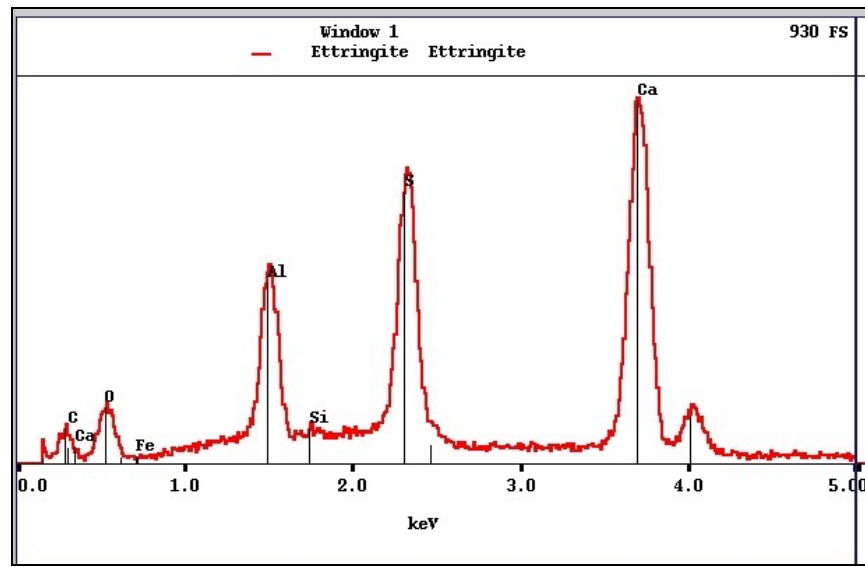

Peak positions are specific to a particular element, intensity (height) is proportional to its relative abundance. This spectrum, from ettringite, exhibits that mineral's characteristic composition with oxygen, aluminum, sulfur, and calcium. Note that units on the horizontal axis are kiloelectronvolts (keV).

Figure 187. EDX spectrum.

The peaks are designated as k, l, or m. The positions of the peaks are characteristic of a specific element, so phase identifications are made by examination of peak positions and relative intensities (figure 188).

The x-ray signal is used for: (1) spectrum analysis for qualitative and quantitative chemical analyses (figure 188), (2) line scan analysis to plot relative concentration of selected elements along a line (figure 189), (3) x-ray imaging (XR) of element spatial distribution and relative concentrations (figure 190), and (4) an aid in phase identification through its chemical signature. Phase identification is not absolute as in x-ray powder diffraction; however, combining criteria (e.g., BE signal brightness, morphology, associations with other constituents, and chemical composition) provides a rather strong basis for identification. Coupling microscopy with x-ray powder diffraction data is also useful as it can be used to limit the elements in the potential compounds to those present in the specimen. Mass concentration to a few tenths of a percent can be detected using an energy dispersive x-ray detector. The relative accuracy of quantitative analysis (using certified standards) is about ± 20 percent for concentrations of about 1 percent, and ± 2 percent for concentrations greater than 50 percent. More details on x-ray microanalysis may be found in Goldstein, et al. (1992).

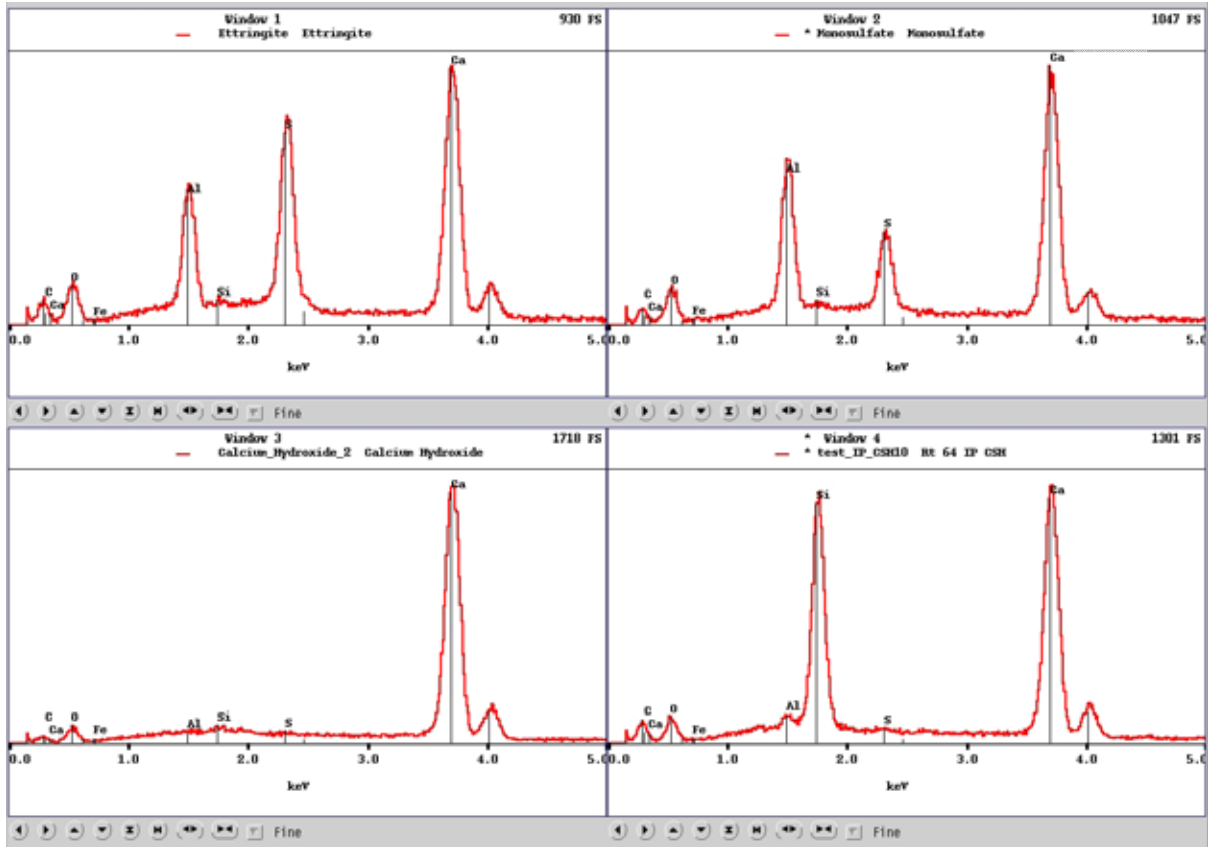

Figure 188. EDX spectra for ettringite (top left), monosulfate (top right), calcium hydroxide (bottom left), and calcium-silicate-hydrate (bottom right) aid in phase identification characteristics.

The peaks and their relative intensities are affected by the accelerating voltage of the microscope beam (figure 191). If the voltage is too low, then the beam energy may not be capable of generating the characteristic radiation. For example, the iron K line occurs at 6.4 keV and requires about 11 keV for adequate excitation. Accelerating voltages between 12 and 15 keV provide for reasonable BE and x-ray imaging. Lower accelerating voltages decrease the interaction volume, increasing resolution, but with a loss in efficiency in generating higher energy x rays.

Lower beam energies are not as efficient in exciting high-energy x rays, and the lower x-ray absorption accentuates the low-energy x rays. High beam energies result in greater absorption in the lower energy range. For cements, an accelerating voltage of 12 to 15 keV balances the need for adequate beam energy without excessive absorption of lower energy x rays. Higher beam energies are favored for SE imaging as they result in increased depth of field and smaller beam diameters and, thus, greater resolution.

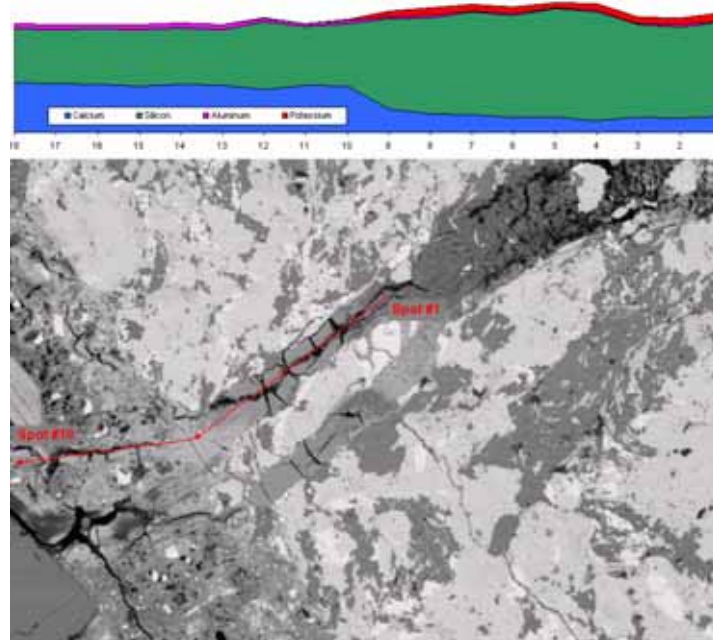

Figure 189. Fence diagram created by collecting a series of EDX spectra along an emplacement of ASR gel (the gel composition rapidly becomes much like the bulk CSH once outside the aggregate and the source of reaction).

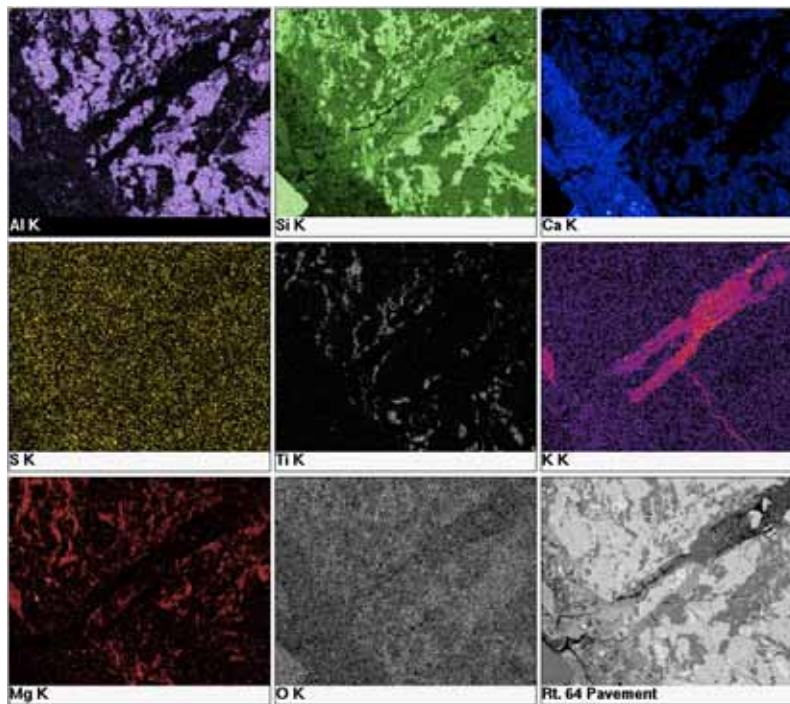
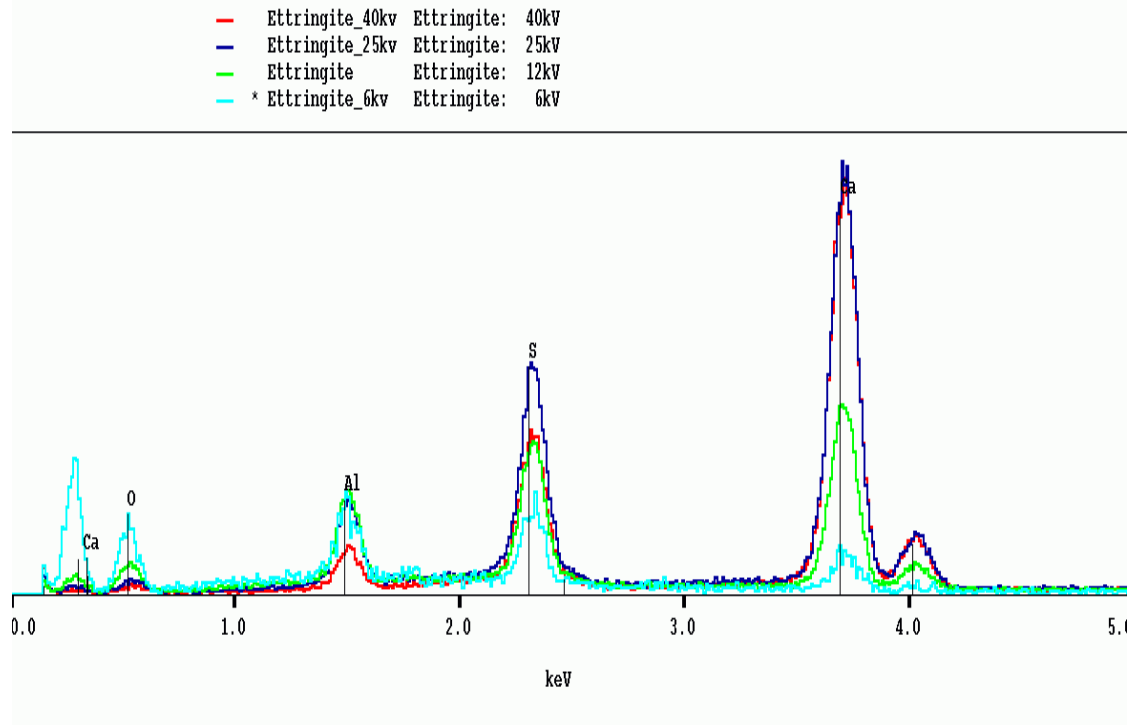

Figure 190. Plots of element spatial distribution are generated through x-ray imaging.



X-ray spectra (low to high energy, keV, left to right) for different accelerating voltages. Note that, in this case, accelerating voltages are given as “kv,” which are the same as keV, as discussed earlier.

Figure 191. Effects of different accelerating voltage on x-ray spectra of ettringite show the loss of low-energy peaks at high accelerating voltages and the opposite effect at low voltages.

14.3 SPECIMEN PREPARATION

14.3.1 Overview

The SEM may be used to examine portland cement clinker, cement powder, cement pastes, mortars, and hardened portland cement concrete. Specimen preparation uses an epoxy-impregnated, polished section where the epoxy resin permeates the material’s pore system or encases powder particles. The specimens are then cut or ground to expose a fresh surface, and that surface is then polished using a series of successively finer grades of diamond paste. This polishing stage is necessary to remove cutting and grinding damage, exposing an unaltered cross section of the material’s microstructure. Polished thin sections prepared as described in section 5.3.4 can be examined both with transmitted light and with the SEM (see figures 121 through 123). Sahu, et al. (2001) described coupled transmitted-light and SEM examinations of thin sections.

Epoxy impregnation of the pore system serves two purposes: (1) it fills the voids and, upon curing, supports the microstructure, serving to restrain it against shrinkage cracking, and (2) it enhances contrast among the pores, hydration products, and cementitious material. With

relatively high-permeability materials or powders such as clinker or portland cement, an epoxy of low viscosity is necessary, whereas for the less-permeable cement pastes and concretes, an ultra-low viscosity epoxy aids in rapid infiltration of the pore structure. Examples of epoxies that are used for impregnation/embedment are LR White (hard grade) (ultra-low viscosity) and EPO-TEK 301 (medium low viscosity) (chapter 2); other suitable materials may be used.

BE and x-ray imaging requires a highly polished surface for optimum imaging and x-ray microanalysis (Stutzman and Clifton, 1999). Rough-textured surfaces diminish the image quality by reducing contrast and loss of feature definition. In addition, the lack of a polished specimen makes quantitative estimates arduous, as the surface is no longer planar. Sawcut surfaces that have not been epoxy-impregnated, or polished, do not present the true microstructure and are difficult to examine and interpret without bias. The sawing operation damages the microstructure through the creation of a series of fractures, which are then enhanced with subsequent drying shrinkage. For SE imaging, the saw damage dominates the topographic features, and particulate matter deposited on the surface may be mistaken for undisturbed material. Polished, epoxy-impregnated specimens are relatively simple to prepare and the above-mentioned difficulties can be avoided.

A comparison of BE images of a sawcut surface (figure 192) with an epoxy-impregnated, polished surface (figure 193) of the same concrete core illustrates the marked differences in feature clarity and artifacts. In figure 192, the sawcut surface exhibits cracking that resulted from drying shrinkage of a surface-damaged specimen. The surface, being rough and partly covered with particulate matter, exhibits little phase-related contrast. The image shows an aggregate at the base; however, aside from the uniform hardened paste, no distinct hydration products can be discerned. The epoxy-impregnated, polished specimen (figure 193) shows microstructural feature clarity not seen in the images in figure 192. Here, the aggregate is not only clearly seen, but one can also distinguish between siliceous and carbonate aggregate by gray level. The residual cement grains appear bright, and large voids within both the paste and the aggregate are dark. In the higher magnification image (bottom), the hardened cement paste/aggregate interfacial zone is shown. The residual cement grains are the brightest feature, followed by CH, carbonate aggregate, CSH, and finally the black pores. A highly polished surface also aids in x-ray imaging. Figure 194 illustrates the use of x-ray imaging of a region shown in the BE image (top) to examine element spatial distribution (bottom). In this example, visual assessment of calcium, aluminum, and sulfur images allow one to locate monosulfate within the hardened cement paste. Referring back to the BE image shows the monosulfate as a uniform gray that is slightly darker than CSH, with a platy parting.

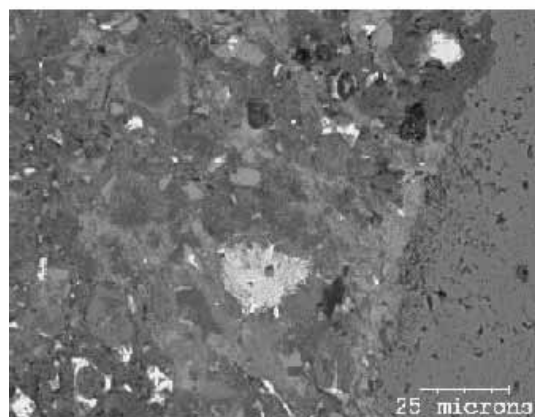
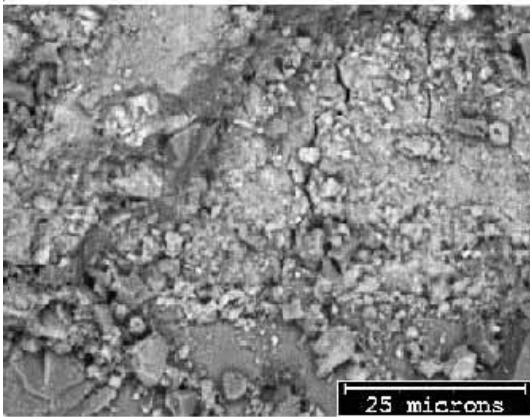
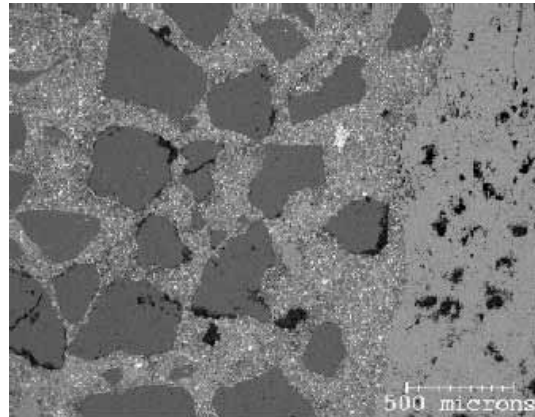
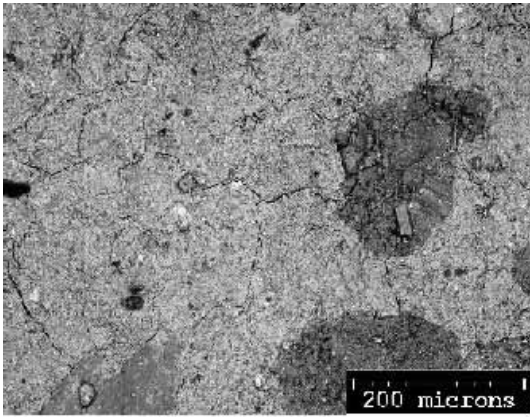

Figure 192. BE images of unimpregnated, sawed surface (the sawed surface is rough with residual particulate matter, yielding poor contrast and shadowing that make interpretation of BE and EDX images difficult).

Figure 193. BE images of the impregnated, polished surface from the same concrete (polished surface presents optimum BE and EDX imaging characteristics).

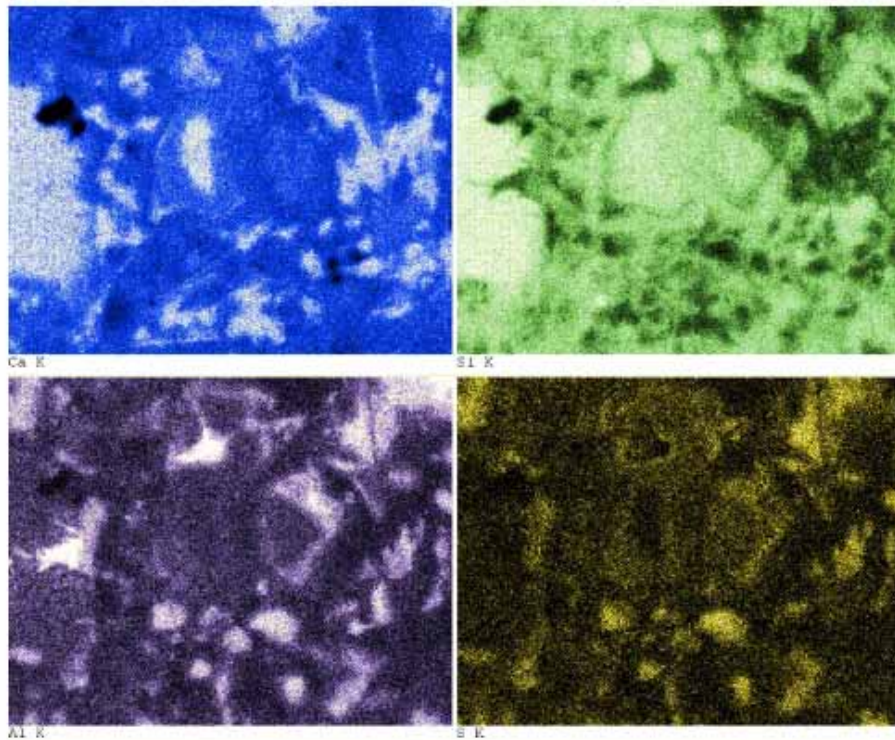
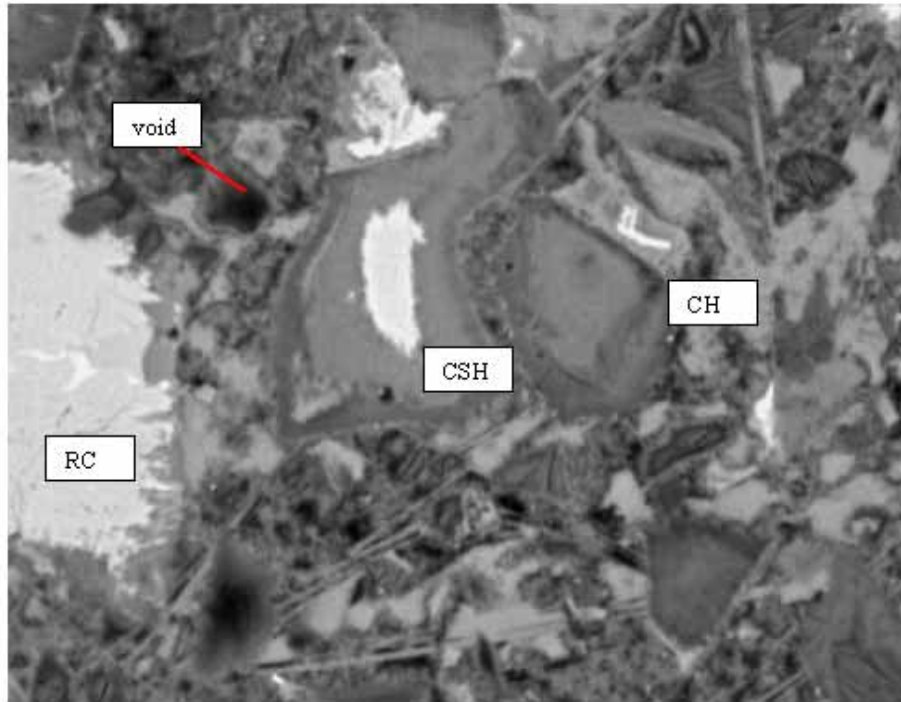

Figure 194. Polished section of hardened portland cement paste imaged using the BE signal clearly shows the constituent phases (residual cement (RC) appears brightest, followed by CH, CSH, and other hydration products) (top); EDX image (bottom) shows regions of intermediate-intensity calcium (blue), intermediate-intensity aluminum (purple), and high-intensity sulfur (yellow), defining locations of monosulfate that could not be distinguished on a rough surface (field width is 73 μm).

14.3.2 Materials for Sample Preparation

A list of equipment and materials necessary for the preparation of polished specimens is given in table 27. For some items, substitution may be possible if comparable supplies are available in the laboratory. The list is presented in order of use of the equipment or supplies.

Table 27. Equipment and supplies for preparation of polished sections.

| Item | Purpose |
|--|---|
| Diamond blade slab saw | Large-sized sample slabbing |
| Diamond blade wafering saw | Cutting of thin (millimeter-sized) sections |
| Propylene glycol | Diamond-saw cutting lubricant |
| Alcohol: 200-proof ethanol | Cutting lubricant, cleaning aid |
| Ultrasonic bath | Specimen cleaning |
| Specimen jars and lids | For replacement steps |
| Potting epoxies (medium and low viscosity) | For powders and hardened pastes |
| Dye, blue or red, alcohol-miscible | To estimate alcohol replacement depth |
| Refrigerator | Epoxy storage |
| Vacuum chamber and pump | Vacuum impregnation |
| Drying/curing oven | Capable of at least 65 °C |
| Glass plate (400 by 400 mm) | Smooth surface for grinding |
| Lapidary wheel (minimum 200 mm) | Grinding and polishing |
| Mold cups | Potting specimens |
| Aluminum foil (extra heavy duty) | For forming odd-sized specimen molds |
| Mold release | Facilitates removal of specimen/epoxy |
| Metal trays to hold specimens | Contains any leaking epoxy |
| Diamond pen | Label engraving |
| Abrasive papers (silicon carbide) | Coarse to fine grinding, 100 to 600 grit |
| Polishing cloths (low-relief) | 6 μm and finer polishing |
| Diamond paste for polishing | 6, 3, 1, 0.25 μm in non-aqueous suspension |
| Lint-free cloths | Specimen handling and cleaning |
| Compressed air | Specimen cleaning and drying |
| Vacuum desiccators | Specimen storage |

14.3.3 Polished Sections of Cement and Pozzolan Powders

Powder mounts are prepared by suspending cement powder in epoxy, curing the epoxy, and cutting and polishing a surface of the powder/epoxy composite. The cement powder is mixed in about 5 grams (g) of epoxy, using enough cement to form a stiff ball. The cement/epoxy mixture is placed in a mold container and pressed to fill the base of the mold. The mixture is then consolidated in the sample mold by sharply tapping it on the laboratory bench top, and the epoxy is cured in accordance with the manufacturer's guidelines. After curing, the specimen is removed from the mold and labeled and a fresh surface is exposed using a wafering saw or by grinding. Examples of this application may be found in Struble and Stutzman (1989) and Stutzman (1990).

14.3.4 Preparation of Cement Paste, Mortar, and Concrete Sections

Cement pastes, mortars, and concretes may be prepared in two ways: (1) dry potting and (2) wet potting. Dry potting is used when the specimen has been dried before, when drying shrinkage-related cracking is not of concern, or when rapid preparation is needed. Wet potting is used to prepare a polished section where the material has not been dried and therefore has not undergone any drying shrinkage. Cracks observed in wet-potted specimens may then be ascribed to physical or chemical processes acting upon the concrete prior to specimen preparation, and not to drying-related shrinkage resulting from preparation techniques.

Dry-specimen potting involves taking a sawed section or block of material and drying the specimen at a low temperature (less than 65 °C). Removal of water is necessary as it can interfere with polymerization of the epoxy. The specimen is then placed in a container and surrounded by epoxy, leaving the top surface exposed to laboratory air, allowing the low-viscosity epoxy to be drawn into the microstructure by capillary suction. To speed infiltration, or when using a medium-viscosity epoxy, the specimen may be immersed in epoxy and a vacuum drawn to remove the remaining air. Vacuum-impregnation procedures are described in chapter 5 (section 5.3.4.2). Upon release of the vacuum, the epoxy is forced into the pore system. The epoxy is cured at a low temperature (65 °C) and is then ready for cutting and polishing.

Wet-specimen potting is a three-step process: (1) the pore solution is replaced with alcohol (200-proof ethanol), (2) the ethanol is replaced with a low-viscosity epoxy, and (3) the epoxy is then cured. The slab and wafering saws are lubricated with propylene glycol or isopropyl alcohol to keep the specimen from drying when cutting. The cut section is then placed in a lidded jar filled with 200-proof ethanol for the alcohol-pore solution replacement stage. The use of a companion specimen allows one to gauge the time necessary for the alcohol-pore solution replacement. This companion specimen is usually a remnant from the specimen after trimming. This specimen is placed in a jar filled with ethanol dyed a deep red or blue using any alcohol-miscible dye. By splitting or sawing the companion specimen after a period of time, the depth of replacement can be observed by the depth of dye coloration. When this front is equal to half the section thickness, the pore solution in the section has been replaced by alcohol. The section is then placed in a container with the low-viscosity epoxy. The time necessary for epoxy replacement of the alcohol is at least equal to that required for the first replacement stage. In the NIST laboratory, we allow about 1.5 times the pore solution-alcohol replacement time for that of the epoxy-alcohol replacement. Implicit in this method is that the thinner the section, the shorter the time that is required for each stage. The specimen is placed in a mold with fresh epoxy, which is then cured at low temperatures according to the manufacturer's directions. The specimen is then ready for the cutting and polishing stages.

14.3.5 Cutting and Grinding

The cutting, grinding, and polishing steps are common to all preparations in order to expose a fresh surface. Diamond-blade slab or wafering saws, lubricated using propylene glycol, are suitable for exposing a fresh surface. This surface needs to be smoothed by grinding. Abrasive papers of 220, 320, 400, and 600 grit (silicon carbide paper) used dry are also suitable for rapid removal of material by grinding. VTRC uses diamond-impregnated lapping films (chapter 2) (available in 125, 75, 45, 30, 15, 9, and 6 μm) at this stage. Using successively finer grades of

abrasive paper removes damage produced by the earlier step. After grinding with the 600 grit paper, the surface is smooth enough for polishing with the diamond pastes. Visual examination of the specimen allows one to identify when the abrasive has cut the entire surface. Grinding striations on the specimen surface indicate that the grit has removed a layer of material. By alternating grinding directions by 90 degrees, one can ensure that the entire surface has been ground. These operations damage the specimen surface, necessitating a polishing step that is described next.

14.3.6 Polishing

Polishing removes the damage imparted by the sawing and grinding operations (figures 192 and 193). This stage involves use of a sequence of successively finer particle-size diamond polishing pastes ranging from 6 to 0.25 μm , and a lap wheel covered with a low-relief polishing cloth. This may be performed manually or, for greater sample throughput, a semi-automated polisher may be used.

14.3.7 Coating for Examination

Variable-pressure electron microscopes are operable with excellent results when using uncoated specimens. For those systems that require a high vacuum, a thin coating of carbon serves to dissipate excess charge from the specimen while exhibiting little effect on image contrast and little interference with elements of interest. Metal coatings such as gold or gold palladium are suitable for secondary imaging of topographic features. However, their x-ray lines interfere with elements of interest in cementitious materials (sulfur) and the heavy metal decreases BE contrast.

14.4 IMAGING STRATEGIES FOR SEM

The various SEM examination modes are discussed in section 14.2. That information, together with the specific issues regarding the study at hand, guided mode selection. For general concrete characterization and investigation of materials-related distress, the coupling of information gained through BE and EDX examination modes has been found most useful. Review information in chapters 3, 8, and 10 through 13 and Van Dam (2002b) regarding the planning of examinations. Typical settings for routine examinations in the three basic modes are outlined in table 28.

Examples of the use of BE and EDX techniques are given in sections 14.2.2 and 14.2.3. Examples of their use in investigating AAR are shown in chapter 10. The high resolution and the ability to perform chemical analyses make these modes ideal for examining HCC paste. The hydration products appear as an intermediate gray, and the residual cement appears to be bright. The aggregate may be recognized using both its gray level and uniformity and its shapes. Silicates such as quartz appear to be slightly darker than the cement paste (figures 185 and 186), whereas feldspars can be distinguished by the presence of Ca, or Na and K. Calcium carbonate aggregate appears similar in gray level to that of the paste; dolomite can be distinguished from calcite by its slightly darker gray level and the presence of Mg (figure 196). In differentiating carbonate aggregates from hydration products, the feature's uniformity and shape are characteristics that are useful in distinguishing aggregates from the hardened paste matrix (figures 197 and 198).

Close examination of the microstructure of a 28-day hardened portland cement paste is demonstrated in figure 194 in which BE and EDX images display constituents of the paste.

Table 28. Typical SEM settings for routine examinations.

| | |
|---|---|
| Secondary electron imaging (SEI) | <ul style="list-style-type: none"> • Moderate accelerating voltage (higher values gain image depth) • Low probe current (smaller probe size provides greater resolution) • Relatively heavy metal coating (to provide continuous film and increase SE yield) |
| Backscattered electron imaging (BEI) | <ul style="list-style-type: none"> • Low accelerating voltage • High probe current (resolution limited by accelerating voltage) • Carbon coating or no coating • Longer dwell times because of lower BE flux |
| X-ray imaging/x-ray microanalysis (EDX) | <ul style="list-style-type: none"> • 12 to 10 keV, to about 8 keV if no Fe • High probe current; coating rules same as for BEI • Longer dwell times because of much lower x-ray flux |

For cement pastes, residual cement grains appear brightest, followed by the hydration products CH, CSH, and the darkest, being the epoxy-filled pore spaces (review table 26). Other constituents such as ettringite and monosulfate appear similar in gray level to that of CSH and require x-ray analysis for location and identification. Both of these phases do show greater uniformity and perhaps a slightly darker gray than that of CSH, and they also exhibit a platy parting that is, in part, a result of desiccation. X-ray imaging (figure 194, lower images) demonstrates how examination for regions of intermediate-intensity calcium (blue), intermediate-intensity aluminum (purple), and high-intensity sulfur (yellow) define locations of monosulfoaluminate.

For the cement grain (figure 194), the ferrite phase appears brightest in the BE (upper) image, followed by alite, belite, aluminite, and periclase. X-ray imaging facilitates identification of periclase, alkali sulfates, and calcium sulfates. Figures 198 and 199 show that for a 28-day hardened cement paste microstructure, polishing yields clear definition of the constituents—the black pore space filled with the cured epoxy, the bright grains of residual cement (C), the intermediate-gray CSH, and the somewhat brighter gray CH.

14.5 QUANTITATIVE METHODS IN MICROSCOPY

14.5.1 Point-Count Analysis

The relationship between area fraction and volume fraction has been recognized for a long time and was mathematically derived by Chayes (1956).

There are three established methods for determining the area percentage of a phase in a planar section (also review section 6.3.2): (1) the Delesse method of tracing and weighing each phase group, (2) the Rosiwal-Shand linear traverse method, and (3) the Glagolev-Chayes point-count method.

The Glagolev-Chayes method, or point-count method, is perhaps the most widely used technique in quantitative mineralogical analysis using a microscope. As the name implies, this technique involves sampling the microstructure using a grid of points and identifying the phase falling

underneath each point. The rule for selecting a grid, magnification, and crystal size is to select a point spacing slightly greater than the crystal size (i.e., adjacent points should not fall on the same crystal). Additional points are measured by moving the specimen to a new field of view and again counting the phases under the points. The point-count method is relatively simple, yet provides a reliable means to measure phase abundance physically, using a direct measure of the microstructure.

Three principal sources of error were identified by Hofmänner (1975) for consideration when point counting:

- Random sample errors.
- Errors in identification by the observer.
- Measurement errors.

For these exercises, it is assumed that a representative sample was collected and that the sample size was reduced using proper practices. The measurement error of the analysis is related to the total number of points counted, with the absolute error at the 96-percent confidence interval given using the equation in figure 195:

$$\delta = 2.0235 \times \sqrt{\frac{P \times (100 - P)}{N}}$$

Figure 195. Equation for percent error in the point-count method (at the 96-percent confidence level) based on the the proportion of points on the phase of interest and the total number of all points counted.

where:

- δ = absolute error in percent
- P = percentage of points of a phase
- N = total of all points

The total error becomes smaller as the number of points counted increases; therefore, the greater the number of points counted, the more reliable the measurement. An analysis of 4000 points should provide acceptable precision for phase abundance analysis.

Mass percentages may be calculated by multiplying the volume fractions by the specific gravity of the corresponding clinker phase and normalizing the totals to 100 percent.

In addition to phase abundance, measurement of crystal size, shape, and other parameters may be recorded.

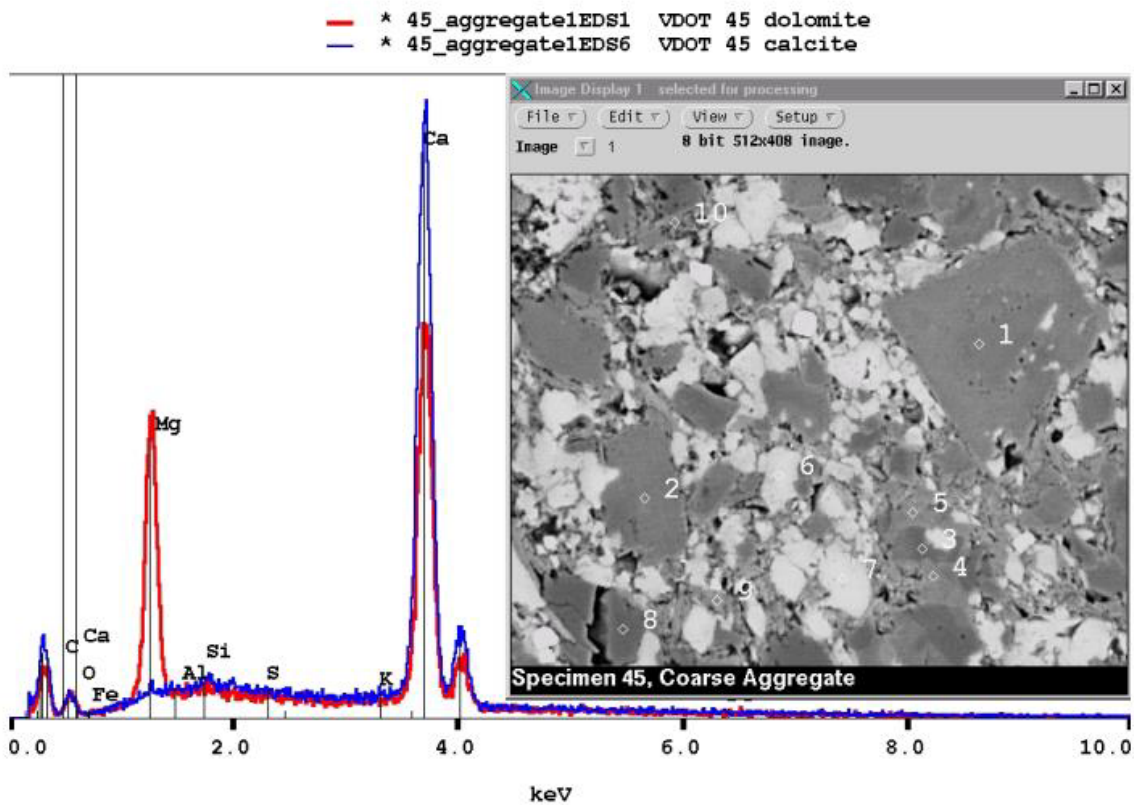
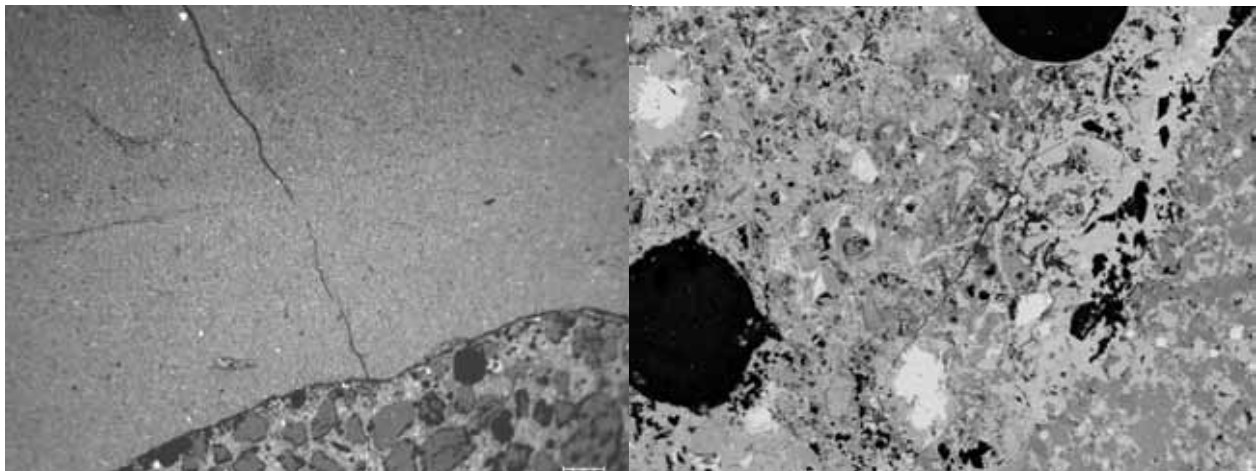

Figure 196. BE image (right) of carbonate aggregate composed of darker gray dolomite (1) rhombs in fine-grained matrix containing lighter gray calcite (6) (the gray-level intensity of calcite and dolomite is distinct, and they can also be distinguished on the basis of the EDX spectra (left); field width is approximately 100 μm).



Aggregate particle is to upper left in left image and lower right in right image. Uniformity and shape are useful in distinguishing carbonate aggregate from a mortar matrix that contains phases of similar gray-level intensity.

Figure 197. BE images of carbonate aggregate in concrete at 15X (field width of 8 mm).

Figure 198. BE images of carbonate aggregate in concrete at 400X (field width of 300 μm).

14.5.2 Image Processing and Analysis

Computer-based image processing and analysis may also be used to extract information from images, or combinations of images. The BE and x-ray images of polished sections are best suited for this approach as they use the planar section necessary for measurements. Features may be identified on the basis of their gray level (figures 199 and 200) or through combinations of features from images, making use of both x-ray and BE information (figure 201). Identification and measurement of residual cement particles in hydrated cement can be accomplished by taking advantage of the cement particles' bright appearance in the BE image. They may be isolated on the BE brightness alone. Similarly, coarse porosity appears black in the BE image and may also be isolated and measured on this basis.

Figure 202 illustrates the use of BE and EDX images to calculate the percentage of CH in the paste. Information from the analyses similar to those shown in figures 199 through 202 provide data on unhydrated cement, CH, and paste porosity. As noted in chapter 9, these parameters can be used to form a comparative estimate of w/cm . Badger, et al. (2001) reports on quantifying porosity by means of contrast in BE images to estimate w/cm .

A more difficult feature would be mapping the distribution of monosulfate in a hydrated cement paste. The BE coefficient is not such that it is easily distinguishable from CSH. It does exhibit a greater uniformity and, occasionally, platy parting. However, it is compositionally distinct, composed of calcium, aluminum, and sulfur, and may be both identified and mapped using both the BE and x-ray images (figure 194) and quantified as described here.

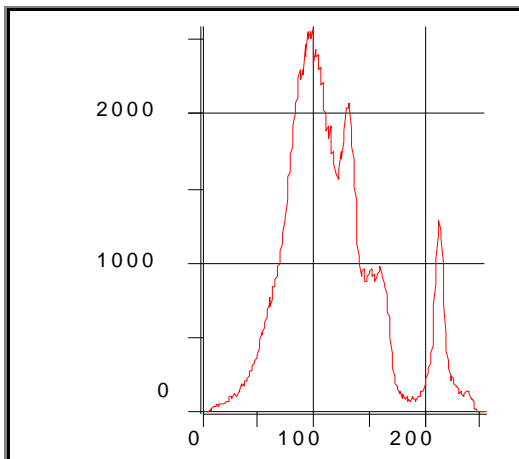

Figure 199. Gray-level histogram of hardened cement paste.

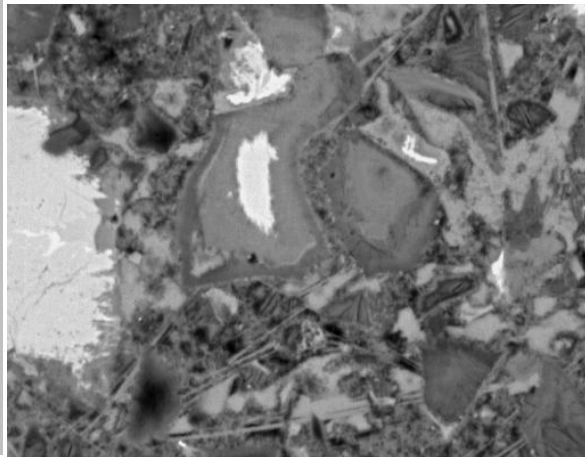

Figure 200. BE image of hardened cement paste (field width is 73 μm).

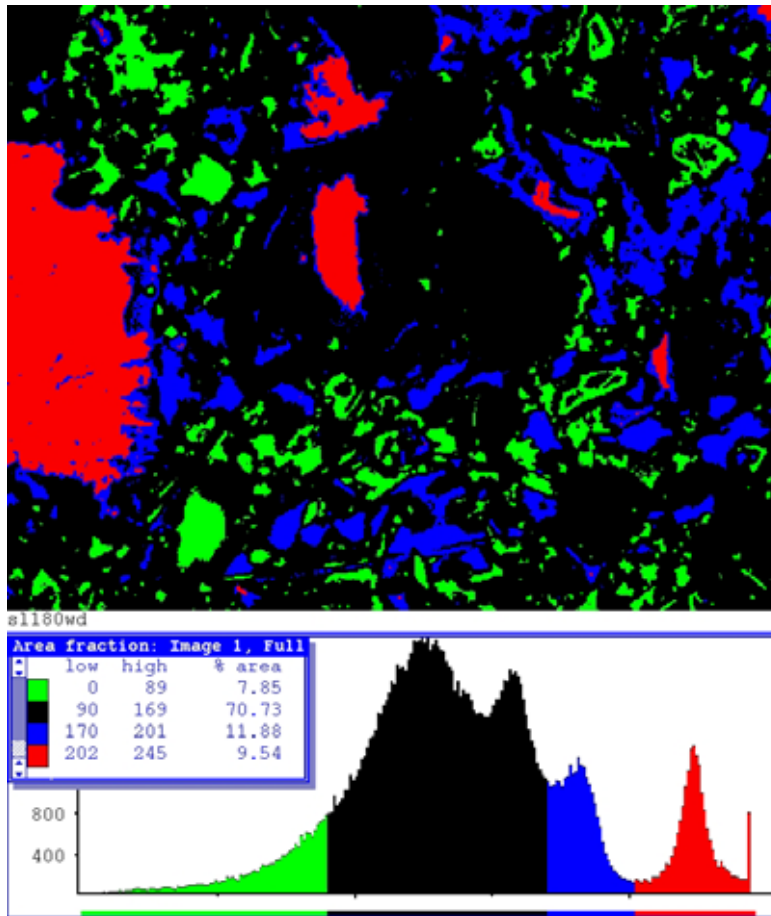

Figure 201. Pseudocolored image based on BE gray scale of figures 199 and 200 (red = residual cement, blue = CH, black = CSH, and green = coarse porosity). Counting the number of pixels for each color allows an estimate of the phase area fractions for this field of view.

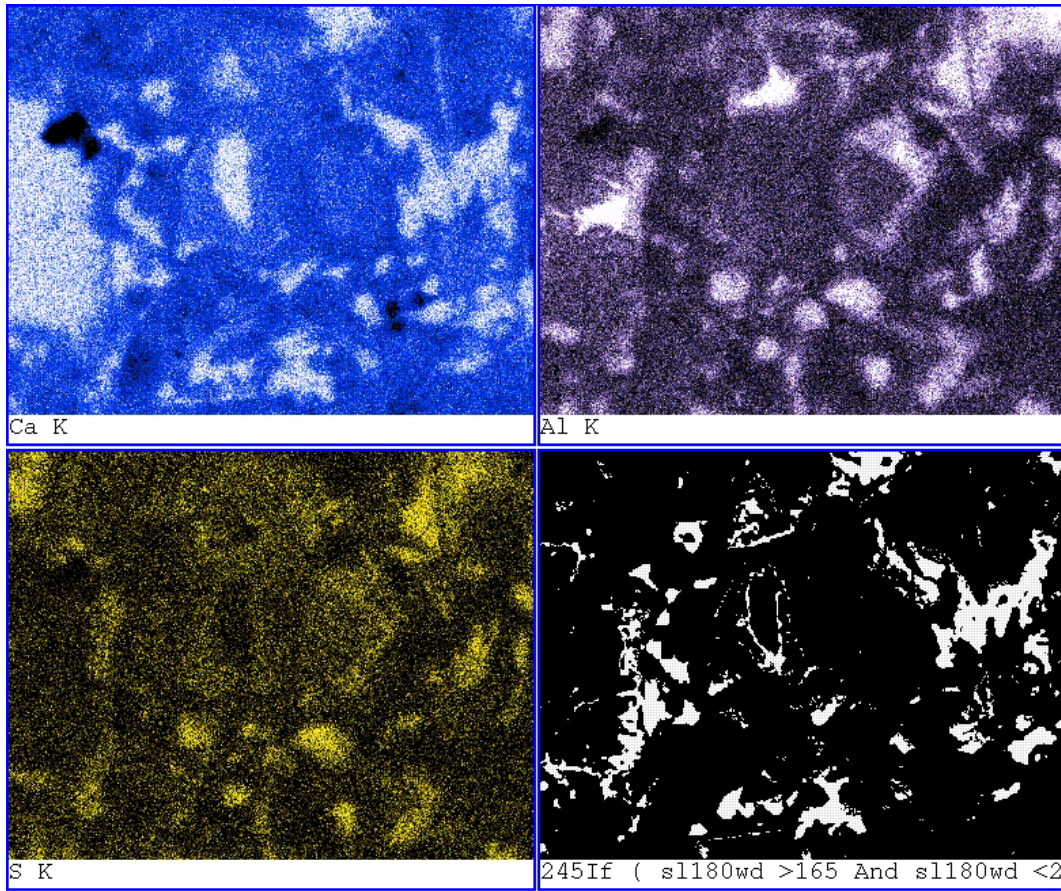

Figure 202. Processing of BE and calcium x-ray images here highlights the CH location (analysis of the binary image of CH distribution calculated 12 percent of the image field to be occupied by CH).

14.6 SUMMARY

Proper specimen preparation is necessary when using the SEM for the study of cementitious materials and hardened HCC. Rough surfaces, such as those prepared using only fracture, sawcut, or rough-lapped preparations, are not suitable. These preparations may actually create preparation-induced artifacts that are not representative of the microstructure; create a surface that is difficult to describe; and not being planar, are unsuitable for estimates of phase abundance. The BE and x-ray imaging modes are particularly sensitive to rough surfaces, which affect the definition of the constituents through loss of contrast and signal shadowing.

Comparison of SEM and optical microscopic examinations of HCC show that the important features are recognizable in both technologies. The much higher resolving power of the SEM, together with the elemental analysis capabilities of the EDX microprobe, creates a tool that greatly expands our capabilities to study the microstructure of HCC, including the interaction between the various cementitious materials being used today and the microstructural effects of deterioration mechanisms.

APPENDIX A. OBTAINING SPECIMENS OF HCC FOR PETROGRAPHIC EXAMINATION

A.1 OVERVIEW

The petrographer can examine any specimen(s) of concrete the client wishes to submit for his or her scrutiny; however, unless the petrographer has been informed of any problem(s) that the concrete has developed and how the specimens were collected relative to the location of any problem areas, the examination may not yield any meaningful information. Complete documentation describing the placement and any problems concerning it must accompany the specimens.

Unless samples of concrete are obtained according to a statistically based sampling plan (see ACI 201.1R; ASTM C 42; ASTM C 823, “Sampling Concrete in Constructions”; ASTM C 856, “Samples”), the results of any examination or testing cannot be considered to apply to any portion of the HCC not thus sampled. Information concerning the statistical sampling of concrete and concrete-making materials can be found in Abdun-Nur and Poole (1994) and Steele (1994). The bibliographies and appendix of these references provide source material to cover most sampling problems.

A.2 TYPES OF SPECIMENS

The specimens for petrographic examination may be of several types: (1) cores (drilled from the hardened concrete with a diamond core drill); (2) cylinders cast from the unhardened mixture at the time the HCC was placed; (3) fragments broken naturally or by sledge or pneumatic hammer from the placement; and (4) laboratory specimens, such as mortar bars, beams, and test cylinders. It is important that the concrete in the specimens be as nearly like the HCC under investigation as practical.

1. **Cores:** Cores should be at least 100 mm in diameter and, if possible, at least 203 mm in depth. Full-depth cores are preferred. Cores must be virgin, not specimens that have been previously tested for compressive strength or used for other destructive tests. A minimum of three cores from any area concerning which petrographic information is sought and from any comparison area should be submitted. The cores must be unaltered by any testing. When cores are taken for any destructive testing, three companion cores should be taken and reserved for petrographic examination. In general, cores are more useful than cast cylinders.
2. **Cylinders:** Cylinders cast during placement may differ from the body of the HCC because of exposure to different temperatures (different maturation rate), and may be subjected to different degrees and types of consolidation and curing. If water has been added to the mixture since it arrived at the job site, the cylinders will not be representative of the mixture placed unless they were fabricated after the water was added. When such differences are known, they should be reported in the documentation accompanying the cylinders submitted for petrographic examination.
3. **Fragments:** Fragments of concrete, particularly deteriorated concrete, must be considered representative only of the zone of the placement most like the fragments. Such fragments may be valuable as preliminary specimens that can be studied to plan further

examination of the placement, a more extensive sampling, or both. If the HCC is so deteriorated that full-depth cores are impossible to obtain, pieces of cores or even fragments will have to be studied.

4. **Laboratory specimens:** Specimens of HCC produced in the laboratory may be submitted to the petrographer to determine the microstructural effects of various materials used or of experimental treatments of the HCC. Control specimens of HCC of known quality should be simultaneously submitted.

When the specimens of HCC submitted to the petrographer are insufficient in number, size, depth, or distribution of the source locations, they must be treated as preliminary specimens that are to be examined to determine the necessity for a more complete examination of the placement and a more extensive sampling program.

A.3 SAMPLING PLAN

Despite the fact that most clients would prefer to take specimens of only the most questionable area (often an area they wish to remove anyway), the petrographer must become familiar with the material of the entire placement. For example, if one portion of a placement is showing distress or exhibits failure of some sort, specimens should be obtained not only from the area of failure, but also from nearby HCC that is presumably of the same mixture, but that is free of failure. These companion specimens should be sufficiently large and numerous to represent the “healthy” condition. They should be composed of the same materials (aggregates, cement, and admixtures) and should have been specified to have been made from the same mixture proportions. In addition, if various degrees of failure of the material exist, the specimens submitted must also represent these intermediate conditions.

The steps taken to develop a sampling plan should include the following:

1. Define the nature and extent of the investigation.
2. Procure a sketch or plan view of the site under investigation.
3. Locate all areas of questionable material on the plan view.
4. Describe the ways in which the questionable areas differ from areas that are considered good.
5. Locate areas of intermediate quality and describe them.
6. With the intent of finding out how the materials, weather, and incidents that occurred during placement differ between the questionable areas and the good areas, collect pertinent data from the inspector’s notebooks, casual observers, and, if possible, the contractor.
7. Determine the questions to be asked of the petrographer.

The client should furnish the petrographer with complete information concerning the sampling plan used and the sketch showing the relationships between the specimens. Specimens must be labeled so that their source location can be identified.

The results of any testing already performed on the concrete in question, the data collected, their relationship to the specimens submitted, and the reasoning used in selecting the locations sampled (see ASTM C 856, “Samples”) should be reported to the petrographer.

A.4 SAMPLING PROCEDURES

The location from which the samples are obtained will depend on the objectives of the investigation. Specimens of concrete should be as little damaged by the removal methods as possible; otherwise, the petrographer will not be able to ascertain which cracks are indigenous to the HCC of the placement and which were caused by the collection procedures. Core specimens are usually preferred.

A.5 SPECIAL CONSIDERATIONS

A.5.1 Air-Void Samples

Air-void determinations may be required whenever it is suspected that the air-void content is not sufficient to provide protection from freezing and thawing deterioration or whenever it is suspected that the cause of low strength might be excess air content. If the air-void content of the entire placement is in question, sampling should follow the instructions detailed in ASTM C 457, “Sampling,” as follows:

To determine the compliance of hardened concrete with the requirements of the specifications on the air-void content or the specific surface and spacing factor of the void system, a sample of the concrete should be obtained from at least three locations in the body of the concrete and measurements should be taken using a microscope on at least one section prepared from each of at least three such samples.

The three locations sampled must be selected from the entire body of the placement under study according to a rigorously random plan without regard for areas of extreme deterioration. The areas exhibiting specific features should be sampled separately. These sampling guidelines may be followed for any concrete suspected to deviate from the required quality. Each sample should be large enough to allow the petrographic staff to prepare at least the minimum area of finished surface given in ASTM C 457, table 1. The petrographer should be consulted in any case of doubt.

A.5.2 Overlay Material

A.5.2.1 Cracking

Core specimens of overlays that have cracked must be taken with special care. All cores must be the full depth of the overlay. Each core should be centered on a crack and should be examined as it is removed from the placement. If the crack extends to the bottom of the core, subsequent cores should be deep enough to include the full depth of the crack system.

A.5.2.2 Delamination

Core specimens of delaminated overlays must include at least 50 mm of the substrate concrete. If the core comes apart at the bond line during coring, the two pieces will grind on each other and will destroy the evidence of the nature of the bond. In this event, additional cores should be taken in an effort to obtain specimens of the bond itself.

A.5.3 Frozen Concrete

If freezing of the HCC while fresh is suspected, at least one specimen should be obtained from the edge of the placement, from up against the form or from a place exposed to the ambient temperature. It is in such an exposed area that the casts of ice crystals will form first. If companion cylinders were cast and cured as was the placement, they may show ice crystal casts on the surface in contact with the mold. An ambient freezing temperature while the concrete is fresh usually affects the wearing surface only if the curing material is insufficient to retain the heat generated by the hydration of the cement or if the curing material is prematurely removed (possibly by wind).

A.5.4 Unusual Conditions

Unusual conditions may necessitate unusual methods of sampling. For example, the giant popout (shown in figure 203) was found lying loose on a railroad tie beneath a concrete highway bridge. It was a curiosity, and we were concerned only with the reason for the popout and not with the main mass of the concrete. A method of reaching the spot on the overhead concrete was found, and the hygroscopic glass shown in figure 204 was recovered from the matching depression. The ordinary popouts (photographed for size contrast in figure 203) were recovered loose from a highway surface. Each of these contained a fragment of porous chert at its apex. These may be considered classic popouts, pushed out of the pavement surface by the freezing and expansion of water in the porous chert. These specimens are useful reference specimens, and the chert popouts are sufficient evidence to allow the petrographer to recommend against further use of this particular aggregate in wearing courses; however, the sampling procedures, although sufficient, are hardly those classically specified.



Figure 203. Giant popout caused by a piece of glass (accompanying it are several small popouts of a more usual size caused by porous chert particles).

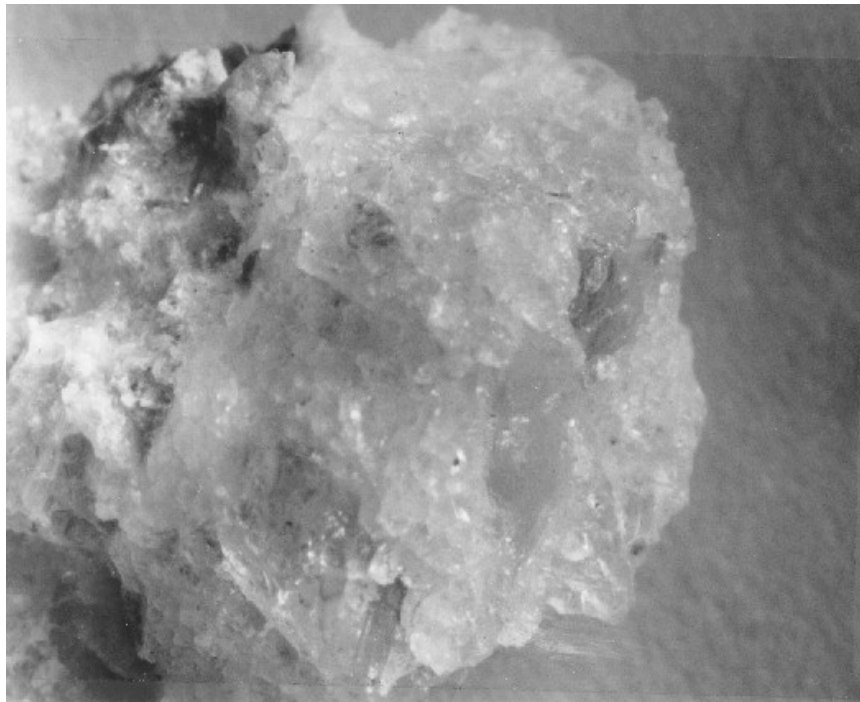

Figure 204. Glass particle.

A.5.5 Aggregate Specimens

It is important that the field sampling of aggregate specimens be such that the aggregate sample is truly representative of the material proposed for use and that the ratios between the various lithologies and sizes have not been influenced by the sampling procedures (Landgren, 1994; Galloway, 1994).

A.6 COMPARISON OF FIELD AND LABORATORY SPECIMENS

Access to laboratory-produced specimens of HCC and the mixture proportions by which they were fabricated can prove to be very useful to the concrete petrographer. They provide an excellent opportunity for the study of specimens of HCC produced with various experimental materials. They can also provide examples of HCC produced with a large variety of aggregate and numerous different admixtures so that the variations among the specimens can be correlated with known differences in the design of the mixture. Various curing methods under various conditions and at various degrees of maturity can also be studied. The results of the petrographic observations can be compared with the data obtained in the laboratory. The data obtained from the concrete mixing laboratory and made available to the petrographer should include the exact nature and source of the ingredients, the proportions of the mixture, and the results of any testing, such as the following:

- Slump.
- Unit weight.
- Air content when fresh.
- Curing method.
- Maturity.
- Compressive strength.
- Permeability.
- Results of testing for resistance to freezing and thawing.
- Results of any other testing.

The concrete mixing laboratory and the concrete petrographic laboratory supplement each other. When the results of the testing done in the concrete mixing laboratory do not seem to make sense or do not explain the problem under consideration, petrographic examination may be able to provide illumination.

Construction problems usually require rapid solutions that cannot wait for results from long laboratory procedures. Waiting until a laboratory mixture is prepared, cured, and tested so that the resulting concrete can be compared with the concrete at a particular problem site is often not possible. Such experimentation must usually be performed later under more deliberate, controlled conditions. In any case, it is widely recognized that it is difficult to duplicate bad concrete in the laboratory. Features that are a result of poor workmanship or incomplete mixing are especially difficult to duplicate. This may be partially caused by the difference in size between a ready-mix truck and a laboratory mixer and partially caused by the natural reluctance of laboratory-trained concrete technicians to violate normal procedures. Particular difficulty may be found when trying to duplicate problems that have been caused by field alteration of the mixture at the construction site. It is all too common that water was added to the mixture after

the concrete began to stiffen and after the air-content determinations were made. This retempering (see appendix C) is usually not documented and must be inferred from the parameters of the concrete (Erlin, 1994; Mielenz, 1994).

Investigations that include the fabrication of special concrete mixtures are really research projects, but must often be undertaken before a truly informed opinion can be made about the quality, the cause of the particular features, or the reason for the failure of HCC from particular construction site

REFERENCES

Abdun-Nur, E.A., and Poole, T.S. 1994. "Techniques, Procedures, and Practices of Sampling of Concrete and Concrete-Making Materials," *Significance of Tests and Properties of Concrete and Concrete-Making Materials*, P. Klieger and J.F. Lamond, Eds., Report No. ASTM STP 169C. American Society for Testing and Materials, West Conshohocken, PA, pp. 15-22.

American Concrete Institute. ACI 201.1R: Guide for Making a Condition Survey of Concrete in Service, *ACI Manual of Concrete Practice: Part 1, Materials and General Properties of Concrete*. Farmington Hills, MI.

American Society for Testing and Materials. ASTM C 42: Standard Test Method for Obtaining and Testing Drilled Cores and Sawed Beams of Concrete, *Annual Book of ASTM Standards: Volume 04.02, Concrete and Aggregates*. American Society for Testing and Materials, West Conshohocken, PA.

American Society for Testing and Materials. ASTM C 457: Standard Test Method for Microscopical Determination of Parameters of the Air-Void System in Hardened Concrete, *Annual Book of ASTM Standards: Volume 04.02, Concrete and Aggregates*. West Conshohocken, PA.

American Society for Testing and Materials. ASTM C 823: Standard Practice for Examination and Sampling of Hardened Concrete in Constructions, *Annual Book of ASTM Standards: Volume 04.02, Concrete and Aggregates*. West Conshohocken, PA.

American Society for Testing and Materials. ASTM C 856: Standard Practice for Petrographic Examination of Hardened Concrete, *Annual Book of ASTM Standards: Volume 04.02, Concrete and Aggregates*. West Conshohocken, PA.

Erlin, B. 1994. "Petrographic Examination," *Significance of Tests and Properties of Concrete and Concrete-Making Materials*, P. Klieger and J.F. Lamond, Eds., Report No. ASTM STP 169C. American Society for Testing and Materials, West Conshohocken, PA, pp. 210-218.

Galloway, J.E. 1994. "Grading, Shape, and Surface Properties," *Significance of Tests and Properties of Concrete and Concrete-Making Materials*, P. Klieger and J.F. Lamond, Eds., Report No. ASTM STP 169C. American Society for Testing and Materials, West Conshohocken, PA, pp. 401-410.

Landgren, R. 1994. "Unit Weight, Specific Gravity, Absorption, and Surface Moisture," *Significance of Tests and Properties of Concrete and Concrete-Making Materials*, P. Klieger and J.F. Lamond, Eds., Report No. ASTM STP 169C. American Society for Testing and Materials, West Conshohocken, PA, pp. 421-428.

Mielenz, R.C. 1994. "Petrographic Evaluation of Concrete Aggregates," *Significance of Tests and Properties of Concrete and Concrete-Making Materials*, P. Klieger and J.F. Lamond, Eds., Report No. ASTM STP 169C. American Society for Testing and Materials, West Conshohocken, PA, pp. 341-364.

Steele, G.W. 1994. "Statistical Considerations in Sampling and Testing," *Significance of Tests and Properties of Concrete and Concrete-Making Materials*, P. Klieger and J.F. Lamond, Eds., Report No. ASTM STP 169C. American Society for Testing and Materials, West Conshohocken, PA.

APPENDIX B. CAUSES AND PREVENTION OF PLASTIC SHRINKAGE CRACKING

B.1 CAUSES

Plastic shrinkage cracks occur when the rate of evaporation from the surface of the HCC exceeds the rate of bleeding (see ACI 224R). Bleeding is a process whereby the solids of the HCC, including the cement and other fine particles, settle and water rises to the top. (The process is thought to be a form of syneresis by some.) The bleed water forms a “sheen” on the top of the HCC. When the process proceeds as it should, water is evenly distributed throughout the thickness of the HCC placement. The water sheen on the surface prevents the top portion of the HCC from becoming drier than the bottom portion (i.e., the water on the surface maintains 100-percent humidity throughout the concrete). The condition of 100-percent humidity is required so that there will be sufficient water for the remainder of the hydration to take place and so that the HCC will fill the space appropriately and not shrink.

When the proper humidity is not maintained, the top portion of the HCC becomes drier than the lower portions of the HCC, and shrinkage (loss of volume) occurs within the drier portion. When HCC shrinks, it can no longer fill the space it occupies. The lower portion (where there is 100-percent humidity) does not shrink and, therefore, the entire body does not change size. The drier top (the smaller portion) cracks to accommodate the shrinkage, but remains attached to the larger bottom portion.

When plastic shrinkage cracking of any great extent is observed, careful inquiry into the inspector’s records and the observations of others who were near the placement will almost always indicate that one or more of the following occurred:

1. The drying conditions were so severe (see figure 205) that the work should have been postponed until more favorable climatic conditions existed.
2. The paving train became so strung out that there was too much time for evaporation between loss of surface water and the finishing and curing operations.
3. Curing was not begun as specified.
4. Curing was not maintained as specified:
 - Misting was not continued.
 - The burlap dried.
 - Polyethylene, burlap, or both were removed by the wind.

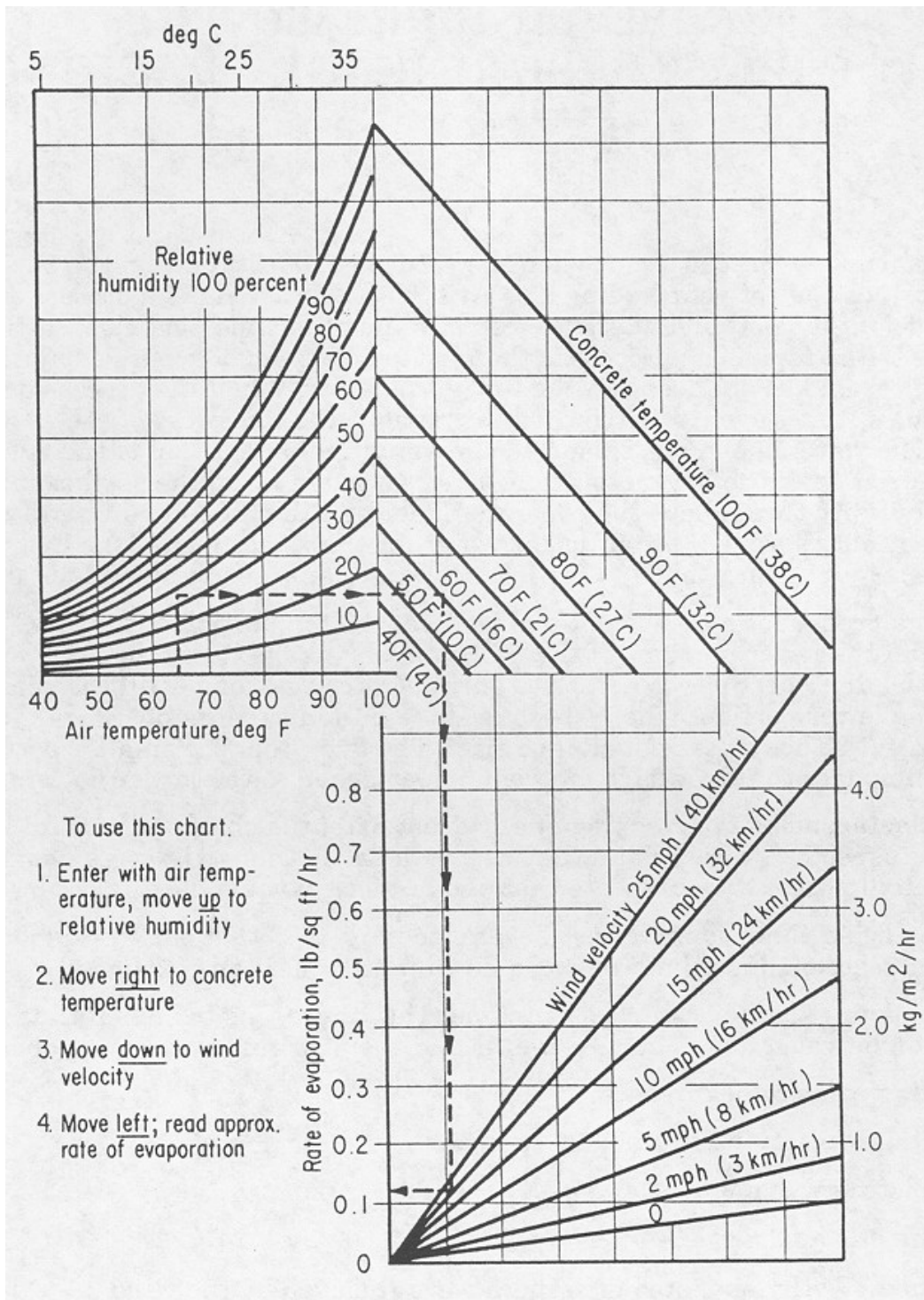

If the rate of evaporation approaches the danger point for the concrete being used, precautions against plastic shrinkage cracking are necessary (*ACI Manual of Concrete Practice* (updated yearly)).

Figure 205. Effect of concrete temperature, air temperature, wind velocity, and relative humidity on the rate of evaporation of surface moisture from a concrete surface.

B.2 PREVENTION

When finishing is completed and the sheen disappears by evaporation of the surface bleed water, curing procedures must begin promptly. At this point, there is no layer of water to protect the HCC from drying or to maintain the 100-percent humidity within the HCC. If there is a wind blowing, the humidity is low, the ambient temperature is high, or the temperature of the HCC is high, the rate of evaporation will be especially rapid. Promptness is the essence of efficient curing. Figure 204 shows how all of these conditions combine to contribute to the rate of evaporation.

For ordinary bridge deck concrete, the rate of evaporation should not exceed 0.5 kilograms per square meter per hour ($\text{kg}/\text{m}^2/\text{h}$). For latex-modified concrete overlays and other cement concrete with a w/cm less than 0.40, the maximum evaporation rate must not exceed $0.25 \text{ kg}/\text{m}^2/\text{h}$ (Kuhlman, 1991).

The curing procedures must be maintained properly. When climatic conditions are very unfavorable, it may be necessary to raise the humidity by misting the air over the concrete, erecting wind breaks or sunshades, or limiting the placement of HCC to cooler nighttime hours. The moisture must be maintained in the HCC throughout the curing period. It will be necessary to remoisten any curing cover (such as burlap) periodically.

B.3 LEGAL INVESTIGATIONS

The client or an adversarial witness in a court proceeding may wish to inquire concerning the following:

1. Was the shrinkage cracking noticed before the finishing operations were completed?
2. Did the finishing procedures tend to hide the cracking (see figure 33)?
3. Did the inspector warn the contractor against proceeding with the placement for any reason, at any time? Why?
4. What corrections in the procedures did the inspector recommend?
5. What were the data concerning concrete temperature, air temperature, humidity, wind velocity, and direction? If the climatological data are not available from the inspector's records, they can usually be obtained from a nearby airport.

REFERENCES

American Concrete Institute. ACI 224R: Control of Cracking in Concrete Structures, *ACI Manual of Concrete Practice: Part 2, Construction Practices and Inspection*. Farmington Hills, MI.

American Concrete Institute. *ACI Manual of Concrete Practice, Volumes 1–5* (revised yearly). Farmington Hills, MI.

Kuhlman, L.A. 1991. "Cracks in LMC Overlays: How Do They Get There?, How Serious Are They?, What to Do About Them?," *Transportation Research Record No. 1301*. Transportation Research Board, Washington, DC, pp. 17–21.

APPENDIX C. RETEMPERING

C.1 OVERVIEW

Retempering is the process of changing the consistency of a concrete mixture by adding water and remixing. As it is common to send the concrete to the placement site with slightly less water than the maximum that may be used, it is expected that a specified amount of water can be added if necessary. The contractor may add the water because the mixture arrives at the site in a condition that would make placement and finishing difficult. These difficult HCCs are often called *harsh mixtures*. They lack workability. (The only quantitative measure of workability is slump.) (See sections 6.1 and 8.4, Gaynor and Meininger, 1983; Pigeon, Saucier, and Plante, 1990.)

The usual cause of a harsh mixture is sand with a high void content (see appendix D). Sands with a high void content are usually irregular in shape with an abundance of re-entrant angles and internal fractures and voids. Iron-stained clay coatings are common. Other causes of concrete that seems too dry are improper grading (size distribution) of the aggregate and the presence of mud or mud coatings on the aggregate. In addition, a deficiency of fine aggregate or coarse aggregate that is oversized or has a very poor particle shape can create fresh concretes with a difficult texture.

Mixtures with a low w/cm (below 0.45) can be difficult to place unless an effective water reducer is used. A good air-void system or the presence of fly ash as a substitute for part of the cement can help make a mixture with a low w/cm more workable. Apparently the air acts as a fluid and the particles of fly ash are more equant than those of cement and act as ball bearings.

C.2 LIKELY RETEMPERING SCENARIO

Rims of cement on the aggregate and knots of cement in the paste (see section 8.7) suggest that the following typical scenario may have occurred. When the ready-mix truck arrived at the job site, it was quickly noted that the fresh HCC had a rough texture and looked as if it required more water. If the mixture was designed to have a low w/cm, each of the aggregate particles in the mixture was coated with this very adhesive mixture. Such HCC may be very difficult to place unless a sufficient quantity of a water-reducing admixture was used. If the coarse aggregate is oversized or has a poor shape or the sand is present in an insufficient amount, is unusually angular, contains many cracks, or has many re-entrant angles, the mixture will look stiff and difficult to place (harsh mixtures). It is common under such circumstances for water to be added to the mixture to increase the slump and workability. The additional water must not increase the total water above that designed for the mixture lest the concrete become weakened because of the higher w/cm.

C.3 EFFECT OF RETEMPERING

C.3.1 On HCC Paste

When water is added after hydration of the cement has begun and mixing is restarted, it commonly happens (especially in mixtures with a low w/cm) that the water is not distributed throughout the entire mixture, but is mixed only into the larger spaces between the aggregates. The material already adhering to the aggregates remains as a rim of darker material with a low w/cm around the aggregate particles and in the re-entrant angles. Patches of the original paste (unaltered by the additional water) may remain and can be found to be completely surrounded by the paste with a higher water content. The problems of incomplete mixing are akin to the problems encountered in particular cooking situations. With gravy or white sauce, the thickening agent (such as flour) must be completely mixed with the cool water before the flour is affected by heat and begins to hydrate. If the flour and hot water mixture becomes too coherent, it may be impossible to add more water and create a smooth paste. The added water will mix with only a portion of the paste, and lumps of flour coated with stiff hydrated material will remain no matter how much mixing takes place.

Whenever water is added to the mixture without additional cement being added, the w/cm is raised. The higher the w/cm, the weaker the HCC. When more than the allowable amount of water for a given amount of cement is added to the mixture, the HCC will not have the designed strength. When the rims indicating incomplete mixing are present, a large portion of the cement can be concentrated in the thin bands of very rich paste around the aggregate and in the lumps of the original paste. The remainder of the paste is relatively depleted of cement and is thereby weaker than would be expected from the w/cm calculated from the originally delivered mixture plus the additional water. Thus, it can be seen that areas of HCC with a high w/cm can exist in close proximity to areas with a low w/cm.

It must be remembered that any material is only as strong as its weakest zone. Stress in HCC in service or in a testing apparatus will cause cracking. Cracks will always follow the zones of weakness. In HCCs that have paste areas with different w/cm's, the cracks are going to develop in the areas of higher w/cm and thus the strength will be dependent on the extent and continuity of those areas.

The skeptic will mention the fact that the bond between the aggregate and the paste in many HCCs is the weakest area and say that the dark rims of high cement content eliminate this problem. Although this is true, the fact that weak bond areas are not as continuous throughout the paste as are the light-colored areas with a high w/cm (low cement content, high water content) obviates the value of rims with a high cement content as bonding agents.

C.3.2 On Air Voids

C.3.2.1 Quantity

Air-entraining agents are more active in the presence of additional water. When retempering has occurred and the mixing has not been completed, petrographic examination will show that many portions of the paste have a much higher void content than does the HCC of the rims and dark patches. Thus, the weakness of the portion with a high w/cm is compounded by the portion containing more than its proportionate share of air voids. In moderate cases, the spacing factor of

the air-void system may change very little because the spacing factor is most dependent on the very small voids. Pigeon, et al. (1990), reported that there was little change in the spacing factor in the mixtures they studied if the retempering did not increase the slump by more than 100 mm.

C.3.2.2 Shape

When remixing takes place after some coalescence of the HCC has occurred, the remixing may occur after the individual integrity of some of the small air voids has formed. In such cases, many of these voids will retain their surface area, but lose their original spherical shape and become ovoid, or squashed, or develop an angular shape. Many angular voids may be seen in figure 74.

C.3.2.3 Size

Retempering can cause an increase in the size of air voids, the number of air voids, or both. The size of the voids caused by retempering as evidenced by the microscopical examination shows that the larger voids (more than 1 mm across) nearly all occur within the portion with the higher w/cm. In normal, well-proportioned HCC, the percentage of voids whose diameter expressed on the surface examined exceeds 1 mm should be less than 2 percent of the total concrete.

REFERENCES

Gaynor, R.D., and Meininger, R.C. 1983. "Evaluating Concrete Sands," *Concrete International*, Volume 5, No. 12, pp. 53–60.

Pigeon, M.; Saucier, F.; and Plante, P. 1990. "Air-Void Stability: Part IV, Retempering," *ACI Materials Journal*, Volume 87, No. 3, pp. 252-259.

APPENDIX D. AGGREGATES USED IN HYDRAULIC CEMENT CONCRETE

D.1 OVERVIEW

Usually, the aggregates used in HCC are naturally occurring earth materials that have been crushed, graded, and washed as needed to meet the requirements for the concrete being produced. The amount of beneficiation required will depend on the nature of the aggregate and the requirements of the specifications. Often transporting the aggregate is more costly than obtaining it from the quarry (presumably cleaned and sized). Therefore, aggregate sources near the concrete production plant are often preferred over sources of higher quality material located at a greater distance. The preparation of aggregate specimens for petrographic examination is described briefly in section 5.5.

Not all natural rocks are suitable for use as aggregate, although a wide variety have been successfully used (Mather and Mather, 1991). The material used must pass specific tests as specified in ASTM C 33 and in any specification document provided by the client, customer, or purchaser. In Virginia, the document is *Road and Bridge Specifications* (Virginia DOT, 2002).

The petrographic description of the aggregate should be guided by ASTM C 125 (standard terminology for concrete) and ASTM C 294 (descriptive nomenclature for aggregates). The procedures given in ASTM C 295 (petrographic examination of aggregates) can be used when a supply of the aggregate is available. Detailed information may be found in ACI 221.1R, Dolar-Mantuani (1983), Forster (1994), Galloway (1994), Mielenz (1994), Meininger (1994), Mullen (1978), Ozol (1978), Price (1978), and Schmitt (1990). Basic texts on petrology, petrography, and mineralogy should be available and familiar to all persons doing this work (see the Reading List). Any person performing petrographic examinations of HCC or aggregates or who is engaged in specifying aggregate properties should carefully study the literature on earth materials and works on concrete aggregates.

The HCC petrographer who generally works with concretes fabricated in a given area, such as a State or group of States, will find that the more familiar he or she becomes with the aggregates from that area, the easier aggregate identification will become. A collection of reference aggregates is very helpful. The aggregates should be identified as to quarry, approximate date quarried, geologic formation, and rock type. The collection should include specimens of concrete containing the aggregate, as well as specimens of the unused aggregate.

The ability of aggregate to withstand the stresses induced during the mixing of HCC is very important and, therefore, aggregates must be able to conform to the abrasion resistance requirements specified in ASTM C 33 (specification for concrete aggregates) as tested in accordance with ASTM C 131 (resistance to degradation of small-size coarse aggregate) or ASTM C 535 (resistance to degradation of large-size coarse aggregate). Commonly, the external characteristics of the aggregate (such as the distribution of the particle sizes, shape, texture, surface coatings, type of fracture, surface area, etc.) are more important to the behavior of aggregates in HCC than is the mineral and chemical composition of the aggregate. Forster (1994) and Galloway (1994) provide excellent explanations of these properties. A summary of some of these testing procedures may be found in ASTM R0030, *Manual of Aggregate and Concrete*

Testing (2002). The fine aggregate (i.e., those passing a No. 4 (4.75-mm) sieve) requires specialized testing (Gaynor and Meininger, 1983).

The particle shape and texture of the aggregates are important characteristics as they can have a significant impact on concrete workability and thus water demand. The particle shape can be evaluated by determining the loose or uncompacted void content by methods such as Virginia Test Method No. 5 (Virginia DOT) or the test method described in Gaynor and Meininger (1983) (subsequently adopted as ASTM C 1252). The preceding methods are specific for use with fine aggregates; however, Hossain, Parker, and Kandhal (2000) report on the development of a similar procedure for coarse aggregates. ASTM C 29 can be used to determine a compacted (by rodding or jiggling) or uncompacted (shoveling) void content of coarse or fine aggregate. These tests measure the unforced or forced packability of the aggregate and are thus indirect measurements of the water demand of the aggregate. The void content obtained by these methods is affected by grading, as well as by shape factors, so if one is trying to use the methods to compare the shape of different aggregates, a standard grading must be used. More recently, efforts have focused on developing automated imaging systems to evaluate particle characteristics (Kuo and Freeman, 2000; Masad, Button, and Papagannakis, 2000; Rao and Tutumluer, 2000; Kim, Haas, Rauch, and Browne, 2002; and Rao, Tutumluer, and Kim, 2002).

D.2 COARSE AGGREGATE

Coarse aggregates (i.e., those retained on a No. 4 (4.75-mm) sieve) for use in HCC are selected mainly on the basis of durability, size, general shape, mineral composition, economy, and availability. Figures 206 and 207 illustrate aggregate particle shapes that are avoided when economic reasons permit.

The requirements of the proposed HCC placement must be fully considered. A placement that has many reinforcing bars close together will require a much smaller coarse aggregate than one with no reinforcement. Pre-placed aggregate is often very large and always lacking in the finer sizes (Lamberton, 1978; Davis, 1994). In particular cases, the density or mineral composition of the aggregate is important. A high density will make it more difficult to prevent segregation; however, the use of aggregate of high density may be dictated by the availability of aggregate or specific use of the concrete. Refer to any specifying document from the client to determine the fitness of a coarse aggregate to meet the requirements of the HCC (see section E.6).



Figure 206. Shaley particle shape of crushed slate aggregate.



Figure 207. Aggregate particles from a fissile gneiss (a particle shape such as this can cause a high water demand).

D.3 FINE AGGREGATE

Sand (fine aggregate) for use in concrete should be tested for shape and surface smoothness. If the particles have angular shapes with abundant re-entrant angles, the sand has a high void content and a high water demand. It takes more fluid (or cement paste) to surround an angular particle than to surround an equant particle. Among solid shapes, the ratio of the surface area to volume is smallest for spheres and largest for extremely lath-shaped particles and particles with deep re-entrant angles and internal cracks and cavities. If the fluid present is insufficient to coat the surface area, the concrete mixture is harsh and difficult to place and finish. This condition is perceived, during construction, as a need for more water.

It can be difficult to estimate the void content of a fine aggregate from a petrographic examination of a finely lapped slab because the visual contrast between the paste and the sand particles is very low unless the sand is stained or coated. In thin sections, the outline of the sand particles can be easily distinguished from the paste by means of the birefringence of the sand particle. (Very few sand particles have a birefringence as low as that of the paste.) In fluorescent microscopy, where the thin section is impregnated with a fluorescent dye, the outline of the aggregate is emphasized because the aggregate is not illuminated by fluorescence and the porous paste is illuminated. The weak zones caused by high water demand are exceedingly porous, contain very large capillaries, and become brightly illuminated by the fluorescence of the impregnating dye (see figures 168 through 171).

D.4 IDENTIFICATION OF MINERALS AND ROCKS

Often a general identification of minerals or rocks present in an aggregate will suffice for routine purposes. Such identifications can be performed on hand samples with simple tools and hand lenses (FHWA, 1991). The same techniques can be used to examine and identify aggregates in polished slabs of concrete. When required, the exact mineralogical identification of natural and artificial aggregates can be accomplished by determining the optical properties by use of the petrographic microscope when the aggregate is examined in grain mount, thin section, or both; by using various methods of determining the chemicals present (spot tests, EDX, XRF); and by collecting an x-ray diffraction pattern for positive identification.

Such identification is necessary only when the distinction between similar rocks might elucidate the reasons for differences in durability or other behavior when the aggregate in question is used in HCC. There are many excellent books written on these methods, and courses on these methods are taught in the materials engineering and geology departments of numerous universities (see the Reading List).

Most often, exact identification is not necessary. Usually, the most detailed examinations are required when AARs are suspected or carbonate rocks are suspected of causing D-cracking (Schwartz, 1987). For more data on alkali-reactive aggregates, refer to chapter 10 and the associated figures and references; the related ASTM standards (Reading List); and the section on thin-section preparation (section 5.2).

D.4.1 Mineral Identification

Minerals are naturally occurring chemical elements or compounds with well-defined molecular structures. The chemistry and structure of minerals result in their having a unique set of properties that can be used to identify them (table 29). *Rock and Mineral Identification for Engineers* (Report No. FHWA-HI-91-025) (FHWA, 1991) provides a detailed outline for identifying minerals in hand specimens. These techniques can also be applied in identifying minerals in aggregates in lapped slabs of concrete. In using these characteristics, it can sometimes be misleading to base identification on a single characteristic; a more positive approach is to use the sum of several characteristics. Table 30 provides selected characteristics of common minerals. Figure 208 shows the Mohs scale (a comparative hardness scale).

Figure 209 illustrates the use of crystal habit, color, and luster to identify pyrite in a rock. Cleavage traces can be used to differentiate between feldspars and quartz (minerals of similar hardness) (figure 210). Hardness (figure 211), as well as acid solubility, is used to differentiate between fine-grained limestones and quartzites.

If the optical properties are needed to help in identifying the minerals (or rocks), grain mounts or thin sections can be made for study. Data on the optical properties of minerals can be found in a number of sources (e.g., Larsen and Berman (1964), Winchell and Winchell (1964), Heinrich (1965), and Deer, et al. (1992)). MacKenzie and Guilford (1980) provide excellent photomicrographs of the major rock-forming minerals. The measurement of the refractive index is often useful in distinguishing between minerals of similar characteristics, such as chalcedony (microfibrous silica with a refractive index of 1.537) and quartz (microcrystalline, with a refractive index greater than 1.54), both of which may form chert particles (figures 212 and 213). Figures 214 and 215 show the identification of quartz grains dispersed in a calcic schist.

Using the specimen illustrated in chapter 14, a petrographer may combine information derived from both microscopy and x-ray powder diffraction to identify minerals within an aggregate. The x-ray powder diffraction patterns are unique for each crystalline phase; they are produced independent of each other; and, in a mixture, the pattern intensity is proportional to phase abundance. Qualitative and quantitative analysis of aggregate phase composition may then be made by x-ray powder diffraction (figure 216) with the aggregate being composed of albite (24 percent), anorthite (4 percent), quartz (12 percent), epidote (22 percent), hornblende (19 percent), augite (3 percent), and chlorite (15 percent). The SEM/EDX data on texture and bulk chemistry may then be used to identify the mineral constituents in the aggregate of this pavement (figure 217) where the minerals adjacent to the reaction area are identified as albite ((Na,Ca)Al(Si,Al)₃O₈) and chlorite ((Mg,Fe)Al₃(Si,Al)₄O₁₀(OH)₂).

Table 29. Keys to mineral identification.

- Crystal form, habit: Characteristic shape in which the mineral grows
- Cleavage: Tendency to split along planes defined by crystal structure
- Hardness (Mohs scale, see figure 207)
- Luster: Appearance of reflected light off of the surface (vitreous, dull, waxy, metallic)
- Acid solubility: Effervescence
- Color, streak (on ceramic plate)
- Density
- Optical properties: Grain (immersion) mounts, thin sections

Table 30. Selected properties of common minerals (FHWA, 1991).

| Mineral | Hardness | Cleavage | Other |
|-----------------------|--------------------|--------------------------|--|
| Pyrite | 6 to 6.5 | None | Brassy, fool's gold; weathers easily to give iron stain; common accessory mineral in many rock types |
| Hematite | 5.5 to 6.5 | None (in massive form) | Red-brown; common accessory in many rocks; cement in many sandstones |
| Magnetite | 6 | None (in granular form) | Black; magnetic; common accessory mineral in many rock types |
| Limonite | 5 to 5.5 | None | Yellow-brown; earthy; may appear softer than 5; formed by alteration of other iron minerals |
| Fluorite | 4 | 1 plane | Common accessory mineral in limestones and dolostones; translucent to transparent |
| Calcite | 3 | 3 planes at 75° | Very common; occurs in many rock types; chief mineral in limestone; vigorous reaction with dilute HCl |
| Dolomite | 3.5 to 4 | 3 planes at 74° | Common; with calcite in dolomitic limestone or dolostone (> 50 percent dolomite); vigorous reaction with dilute HCl <i>only</i> when powdered |
| Apatite | 5 | 1 plane, poor | Common minor accessory mineral in all rock classes |
| Gypsum | 2 | 4 planes, 1 perfect | Common mineral, especially in limestones and shales; may occur in layers |
| Quartz | 7 | None | Silica; very common; may occur in many rock types; glassy; translucent to transparent; may be colored; very resistant to weathering; chief mineral in sandstones |
| Chert | 7 | None | Cryptocrystalline (microscopic crystals) variety of quartz; appears massive to naked eye; common in limestones or in complete layers associated with limestones; light tan to light brown |
| Chalcedony | 7 | None | Microfibrous silica with water inclusions; tan to brown; varieties: flint (dark brown to black), jasper (red), agate (banded) |
| Orthoclase | 6 | 2 planes at 90° | A feldspar; very common in many rock types; white to gray to red-pink; translucent to transparent; distinguished from quartz by cleavage |
| Plagioclase | 6 | 2 planes at 94° | A feldspar; very common in many rock types; appears similar to orthoclase; distinguished by the presence of thin, parallel lines on cleavage faces because of crystal structure (twinning) |
| Olivine | 6.5 to 7 | None | Transparent to translucent; olive green; glassy; common accessory mineral in the darker igneous rocks |
| Garnet | 6.5 to 7.5 | None | Red to red-brown; translucent to transparent; common accessory mineral in metamorphic and some igneous rocks, also in sands and sandstones |
| Zircon | 7.5 | None | Usually colorless to brown; usually translucent; common accessory mineral in igneous rocks and some metamorphic rocks, also in sands and sandstones |
| Pyroxene (group) | 5 to 7 | 2 planes at 87° and 93° | Most common in darker igneous rocks; usually green to black; translucent to transparent; most common mineral: augite |
| Amphibole (group) | 5 to 6 | 2 planes at 56° and 124° | Most common in metamorphic rocks and darker igneous rocks; usually dark green to brown to black; translucent to transparent; most common mineral: hornblende; distinguished from pyroxenes by cleavage |
| Clay minerals (group) | 2 to 2.5 | 1 plane | Usually fine-grained; earthy; often derived from weathering of feldspars; montmorillonite is the swelling clay that expands with the absorption of water; illite is the common clay mineral in many shales |
| Talc | 1 | 1 plane | Very soft; greasy; cleavage may be hard to see because of fineness of particles; commonly white to pale green; usually in metamorphic or altered igneous rocks |
| Serpentine | 2 to 5 (usually 4) | None | Massive to fibrous; greasy to waxy; various shades of green; found in altered igneous or metamorphic rocks; fibrous variety is the source of asbestos |
| Muscovite | 2 to 2.5 | 1 plane | A mica; perfect cleavage allows splitting into thin, clear transparent sheets; usually light yellow to light brown; common in light-colored igneous rocks and metamorphic rocks |
| Biotite | 2.5 to 3 | 1 plane | A mica; perfect cleavage allows splitting into thin smoky transparent sheets; usually dark green to brown to black; found in light- to medium-colored igneous rocks and metamorphic rocks |
| Chlorite | 2 to 2.5 | 1 plane | Similar to micas; usually occurs in small particles so cleavage produces flakes; flakes are flexible, but not elastic as are the micas; usually some shade of green |

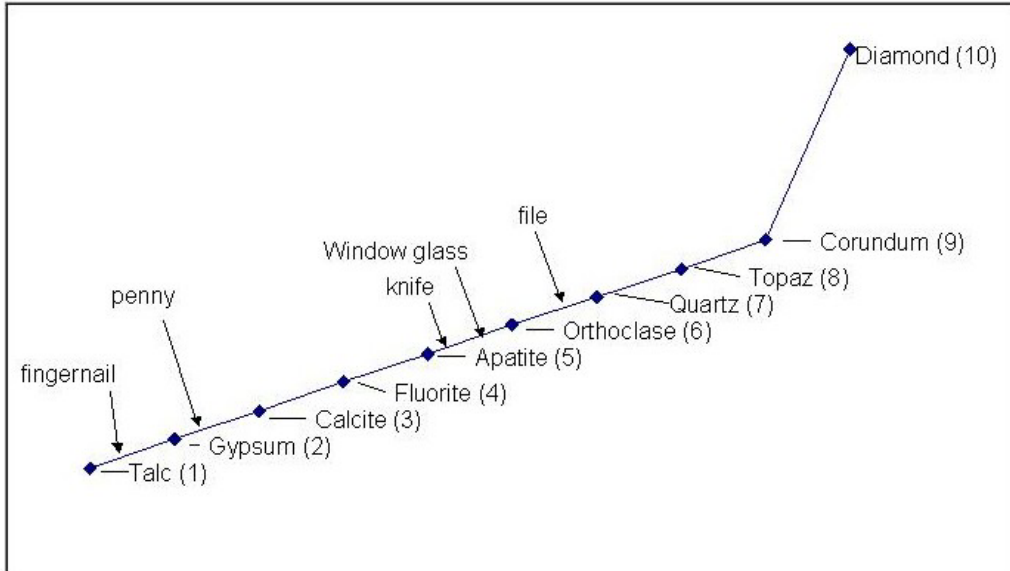

Figure 208. Mohs comparative hardness scale.

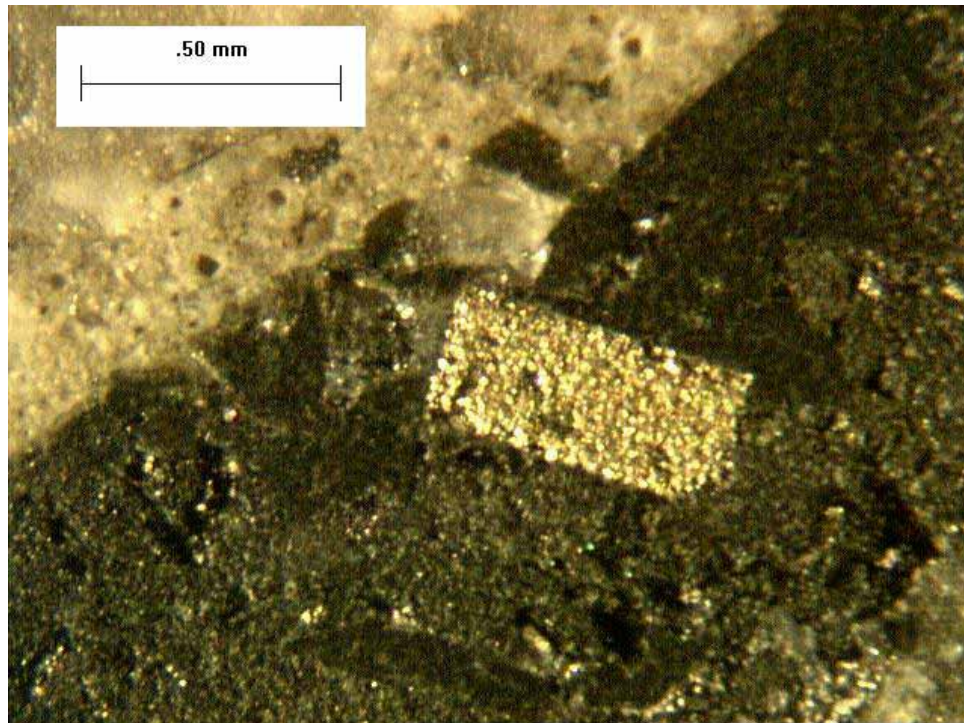

Figure 209. Cubic habit, brassy yellow color, metallic luster of pyrite.

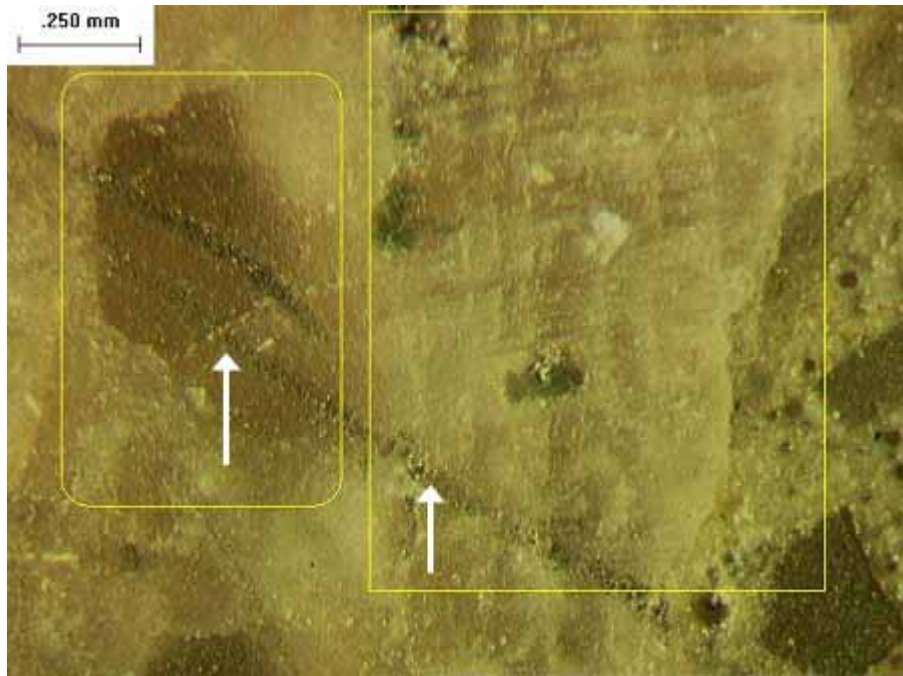

Figure 210. Granite aggregate exhibiting cleavage traces at right angles in orthoclase (right box) and no cleavage in quartz (left box) (scratch test with metal tool leaves metal (arrows) on both quartz and orthoclase, which are harder than the metal).

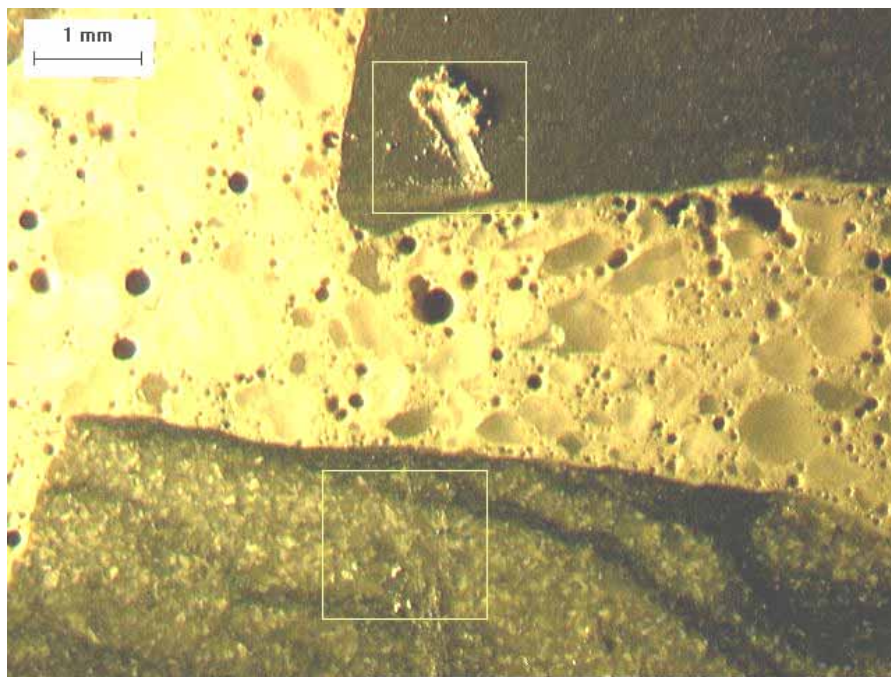

Figure 211. Metal tool scratches upper limestone (calcite) aggregate and leaves metal on lower quartzite particle.

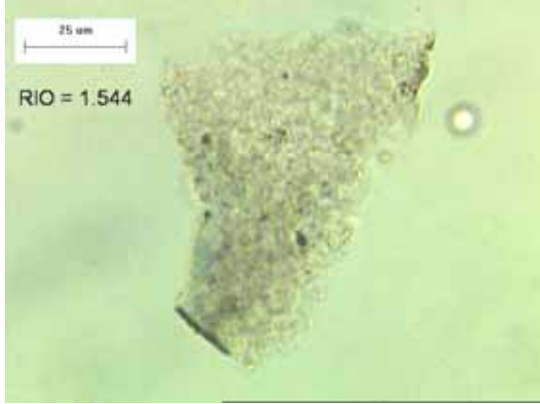

Figure 212. Immersion mount of chert in plane polarized light.

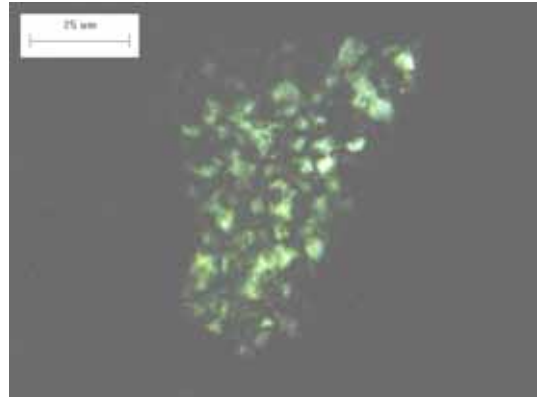
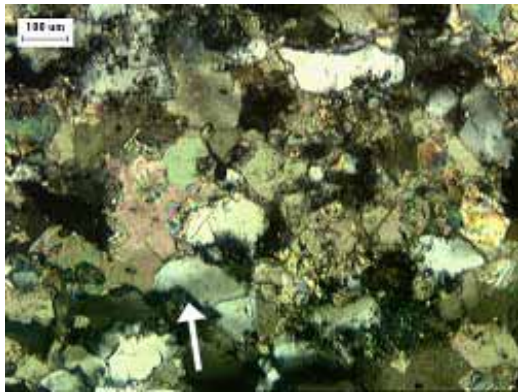

Figure 213. Immersion mount of chert with crossed polars, showing microcrystalline texture (refractive index matches that of quartz).



Note elongated quartz grains (white-gray in right image) set apart from the predominant calcite crystals by their low birefringence and high negative relief. Undulose extinction of quartz (arrow in left image) indicates strain of crystal and suggests increased susceptibility to ASR.

Figure 214. Thin section of marble (calcic schist) in plane polarized light.

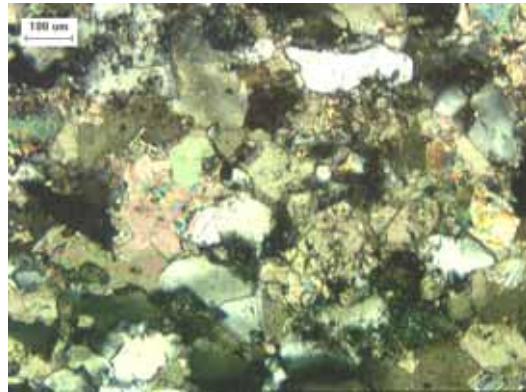
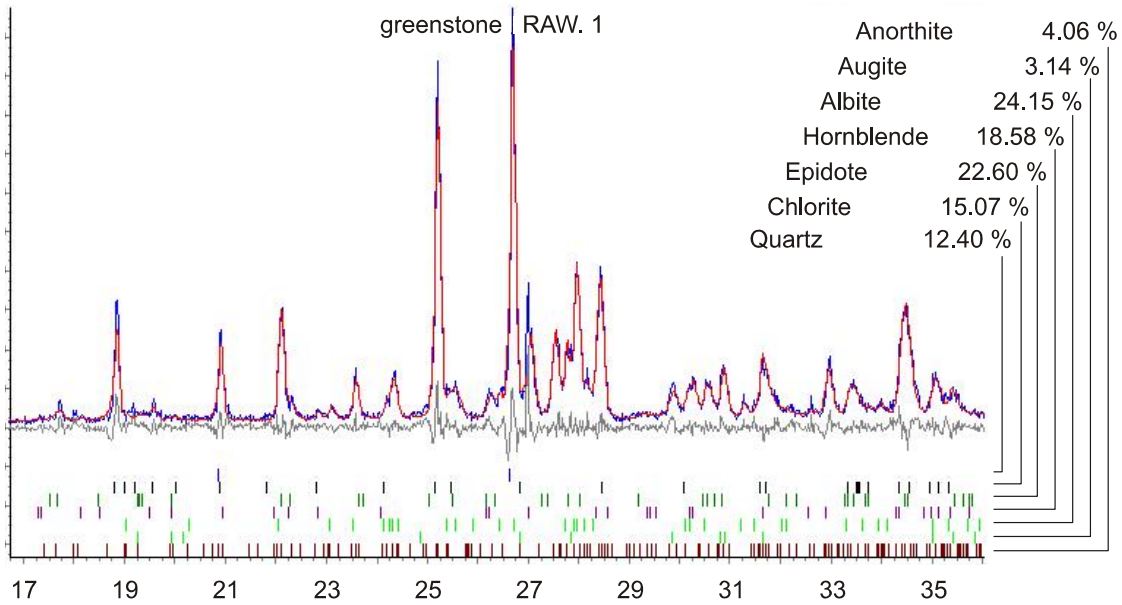

Figure 215. Thin section of marble (calcic schist) in crossed polarized light.



Example XRD composite pattern (plotted with degrees of the angle 2-theta along the horizontal axis) can be used for both qualitative and quantitative analysis.

Figure 216. Quantitative XRD analysis to determine mineral composition of aggregate shown in figures 182 through 184.

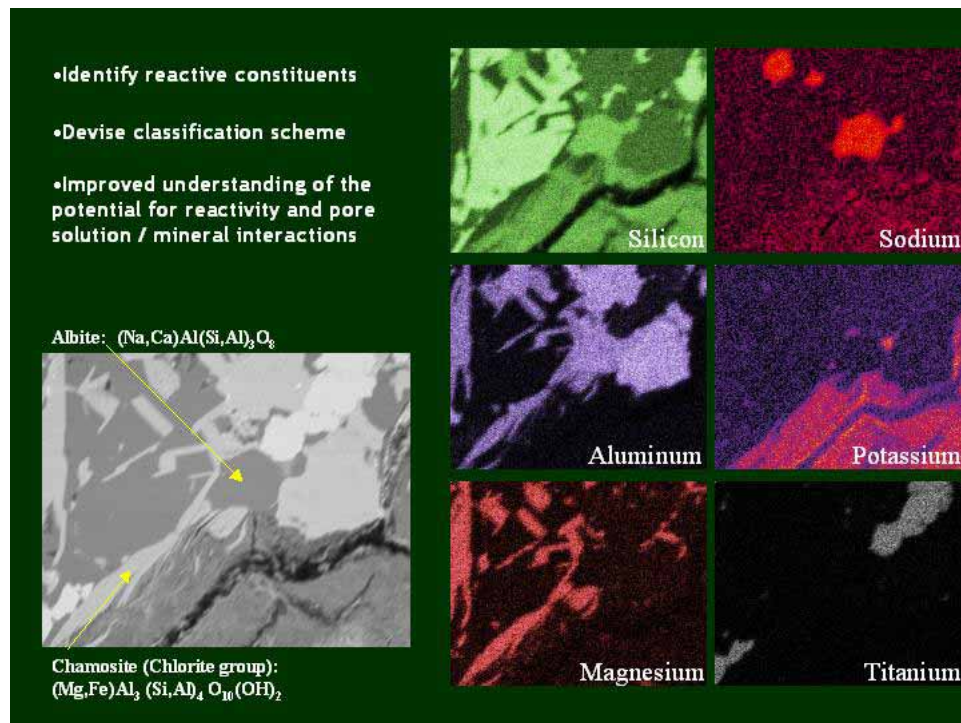

Figure 217. Coupling the knowledge of the mineral present (figure 216) with the elemental EDX maps shown here allows identification of the minerals present at specific locations within the fine-grained rock.

D.4.2 Rock Identification

Rocks are assemblages of one or more minerals. They are classified according to their origin, mineralogy (mineral assemblage), and texture (fabric: size, shape, arrangement, and orientation of individual component grains). There are three origin groupings:

- **Igneous:** Formed from a molten mass.
- **Sedimentary:** Formed by consolidation of accumulated sediment.
- **Metamorphic:** Formed by recrystallization of preexisting rocks under high temperature and/or pressure.

Rock and Mineral Identification for Engineers (Report No. FHWA-HI-91-025) (FHWA, 1991) provides a detailed outline for identifying rocks in hand specimens. The key elements to rock identification are given in table 31. Many excellent texts and reference books are available on the identification and classification of rocks. Examples are Pettijohn (1975), Hyndman (1972), and Williams, et al. (1954). However, it is recommended that the nomenclature in ASTM C 294 be used in reports to facilitate communication between the petrographer and engineers.

Classification of igneous rocks is based on grain size and mineral assembly. Grain size is indicative of cooling rate; thus, coarser grains indicate slow cooling at depth (plutonic), whereas very fine crystals or glassy textures indicate rapid cooling of volcanic rocks. The rocks can be broken down into three basic groups based on predominant mineral assemblage:

- **Felsic (lighter colored):** Quartz, feldspar, feldspathoids.
- **Mafic (darker colored):** Pyroxenes, amphiboles, biotite, plagioclase, and little, if any, quartz.
- **Ultramafic (very dark):** Pyroxenes, olivine (virtually no feldspar or quartz).

Table 32 provides a simple classification chart for igneous rocks. Texts should be reviewed for details in classifying igneous rocks (e.g., Hyndman, 1972, Williams, et al., 1954). Coarser grained rocks can usually be adequately classified in hand specimens with the use of low-powered magnification. If more detail is needed, thin sections can be examined. MacKenzie, Donaldson, and Guilford (1982) provide an excellent collection of photomicrographs of igneous rocks in thin sections.

Sedimentary rocks are grouped into carbonates, classified by calcite-dolomite ratio and noncarbonates. Table 33 provides a simple classification for carbonate rocks. Initial identification of carbonate rocks is accomplished with scratch hardness testing (figure 211) and acid solubility. Acid etching of lapped surfaces will help in differentiating dolomite from calcite in mixtures of the two, as dolomite is less soluble. Because of the fine-grained nature of most carbonates, thin-section examination is often called for. A collection of photomicrographs of carbonate rocks can be found in Adams, et al. (1984). When detailed differentiation between the carbonate minerals is needed, staining with Alizarin Red solutions, followed by examination of the thin section, or an acetate peel are useful (see Heinrich, 1965; Adams, et al., 1984). Many carbonate rocks in the central States are susceptible to D-cracking and various petrographic means for differentiating among them have been developed. These are discussed in section E.5. Alkali-carbonate reactions are discussed in chapter 10 and further information on identifying ACR rocks is given in section E.4.4.

Table 31. Keys to rock identification.

| | |
|---|--|
| <ul style="list-style-type: none"> • Constituent grain size • Easily visible: Medium- to coarse-grained • Mineral assembly (relative amounts) • Fabric (grain orientation and distribution) • Hardness • Acid solubility (carbonates effervesce) • Color | <ul style="list-style-type: none"> • Not easily visible: Fine-grained |
|---|--|

Table 32. Igneous rock classification.

| Rock (coarse-grained/ fine-grained) | Minerals (primary) | Minerals (accessory) |
|---|-------------------------|--|
| Granite/Rhyolite | Quartz, Orthoclase | Mica, Plagioclase, Pyroxene, Amphibole |
| Trachyte/Syenite | Orthoclase, Plagioclase | Mica, Pyroxene, Amphibole |
| Diorite/Andesite | Plagioclase, Amphibole | Mica, Pyroxene |
| Gabbro, Diabase/ Basalt (Trap) | Plagioclase/Pyroxene | Biotite, Magnetite |
| Peridotite | Pyroxene, Olivine | Magnetite, Chromite |

Noncarbonate rocks are classified based on the size, shape, and composition of the constituent grains. A simple classification scheme is presented in table 34. Thin-section examination may be needed to provide more detailed information about the composition of the rock, in particular, the matrix or cementing material. Adams, MacKenzie, and Guilford (1984) provide a collection of photomicrographs of clastic sedimentary rocks.

Table 33. Classification of carbonate rocks.

| CaCO_3 (> 90 percent) | CaCO_3 (50 to 90 percent) | $\text{CaMg}(\text{CO}_3)_2$ (50 to 90 percent) | $\text{CaMg}(\text{CO}_3)_2$ (> 90 percent) |
|--|--|--|--|
| Limestone | Dolomitic limestone | Calcitic dolomite | Dolomite |
| HCl: Readily effervescent | Grades toward Depends on amount of insoluble material | → | HCl: Slowly effervescent |
| Scratched with a knife blade: Relative hardness depends on internal porosity (compactness), nature, and amount of insoluble constituents | | | |
| Most contain some component of noncarbonate constituents (e.g., fine quartz, chert, clay (argillaceous material), pyrite, gypsum) | | | |

Table 34. Classification of clastic sedimentary rocks.

| Texture | Composition | | |
|--|---|--|--|
| | Quartz > 90 percent | Quartz < 90 percent of framework grains | |
| Coarse-grained > 30 percent > 2 mm | Conglomerate or Breccia Framework grains rounded Framework grains angular | | |
| Medium-grained 0.06 to 2 mm | Quartz sandstone | Graywacke (> 25 percent feldspar, dark mica matrix) | Arkose (> 15 percent feldspar, other than dark mica matrix) |
| Fine-grained < 0.06 mm | > 66 percent framework is quartz silt | Siltstone | |
| | > 50 percent clay-sized | Shale or mudstone | |

The classification of metamorphic rocks is based on composition, grain size, and fabric. They are usually foliated to some degree, but the extent is dependent on the mineral assemblage and the degree of force exerted on the rock. Simple classifications are given in table 35. Details of classification systems can be found in many texts and other reference materials (e.g., Hyndman, 1972; Williams, et al., 1954; Yardley, et al., 1990). Yardley, et al. (1990) provides photomicrographs of the major metamorphic rock types and textures.

Table 35. Classification of metamorphic rocks.

| | |
|---|--|
| Fine-grained  Coarse-grained | Slate: Laminated, parallel cleavage; mineral grains not distinguishable; metamorphosed shale |
| | Phyllite: Layered; micaceous minerals distinguishable; metamorphosed argillite |
| | Schist: Thinly layered, nearly parallel cleavage; quartz and feldspar with abundant mica, chlorite, or amphiboles |
| | Gneiss: Foliated; alternating layers of mica, amphiboles with granular quartz and feldspar |
| | Metaquartzite: Metamorphosed quartz sandstone |
| | Metagraywacke: Metamorphosed graywacke |
| | Hornfels: Equigranular; massive; high-temperature alteration by contact metamorphism |
| | Marble: Medium- to coarse-grained carbonate |

D.4.3 Identification of Alkali-Silica Reactive Aggregates

ASR is discussed in chapter 10. Aggregate examinations should identify known reactive rock types and the petrographer should look for the presence of reactive constituents (table 36). In some cases (e.g., opal, which may occur as coatings or filling voids), as little as 0.5 percent is sufficient to cause deleterious expansion. These examinations will require preparation of immersion mounts, thin sections, or polished sections, and can be supplemented by XRD (see figures 212 through 218). More detail can be found in ACI 221.1R, ASTM C 295, and other ASR-related references. Van Epps and Erlin (1990) describe a case study of an aggregate with opal coatings.

Table 36. Alkali-silica reactive constituents.

| Volcanic Glasses | Silica (SiO ₂) Minerals |
|--|---|
| Felsic (> 66 percent SiO ₂) | Cristobalite, tridymite Opal Chalcedony |
| Intermediate (> 0 percent SiO ₂) | Quartz Cryptocrystalline, microcrystalline, strained, granulated |

D.4.4 Identification of Alkali-Carbonate Reactive Aggregates

ACRs are described in chapter 10, which discusses the characteristics of susceptible rocks. Because the rocks are fine-grained and texture is an important component in differentiating the expansive rocks, thin-section examinations are invariably called for. Examples of expansive ACR textures are shown in figure 219 and can be compared with the non-expansive textures shown in figure 220. A variety of other methods available for evaluating the potential expansion of ACR rocks are discussed in ACI 221.1R, Ozol (1994), and Famy and Kosmatka (1997).

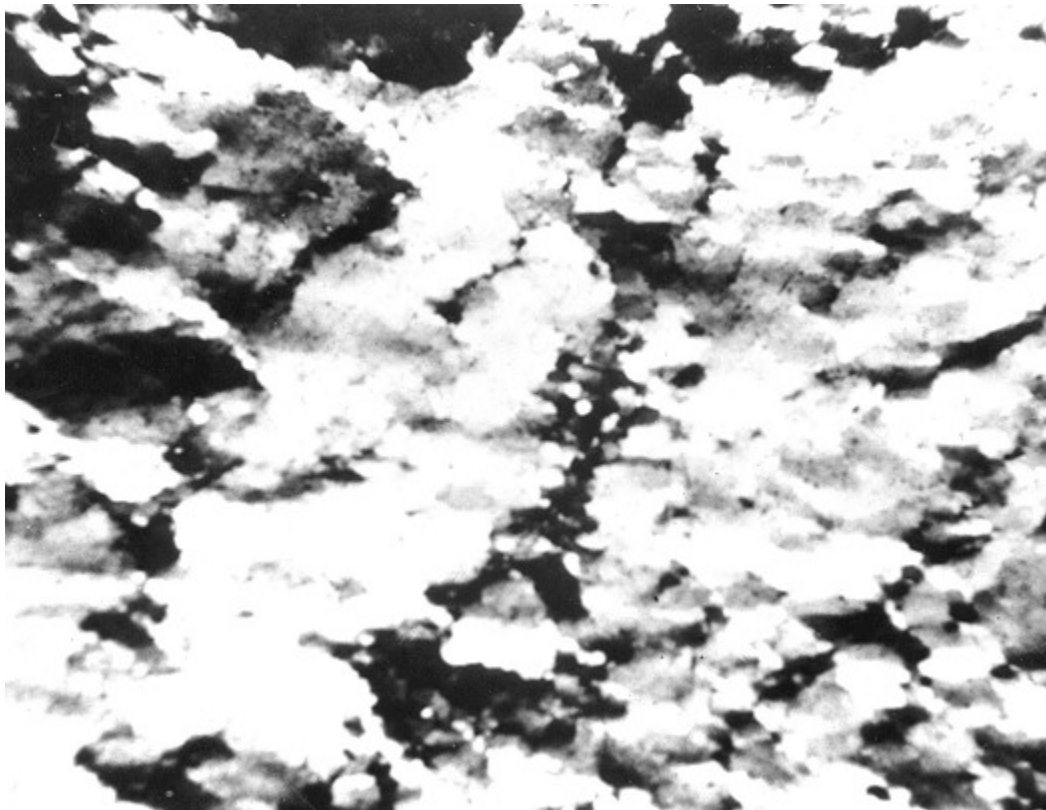

Field is 15 mm across.

Figure 218. Thin section of strained quartzite: Crossed polars.

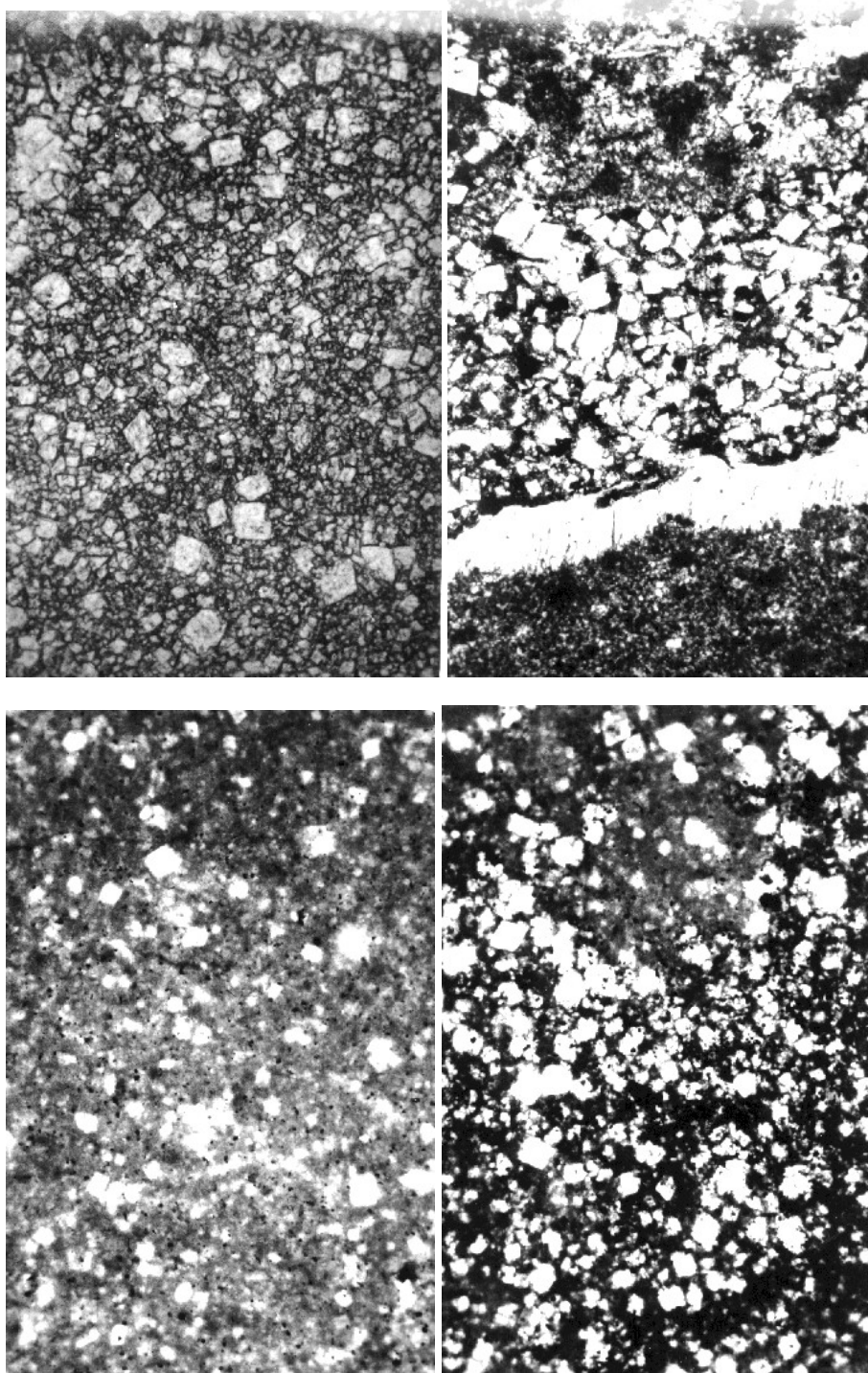

Figure 219. Alkali-reactive microtexture in four carbonate rocks.

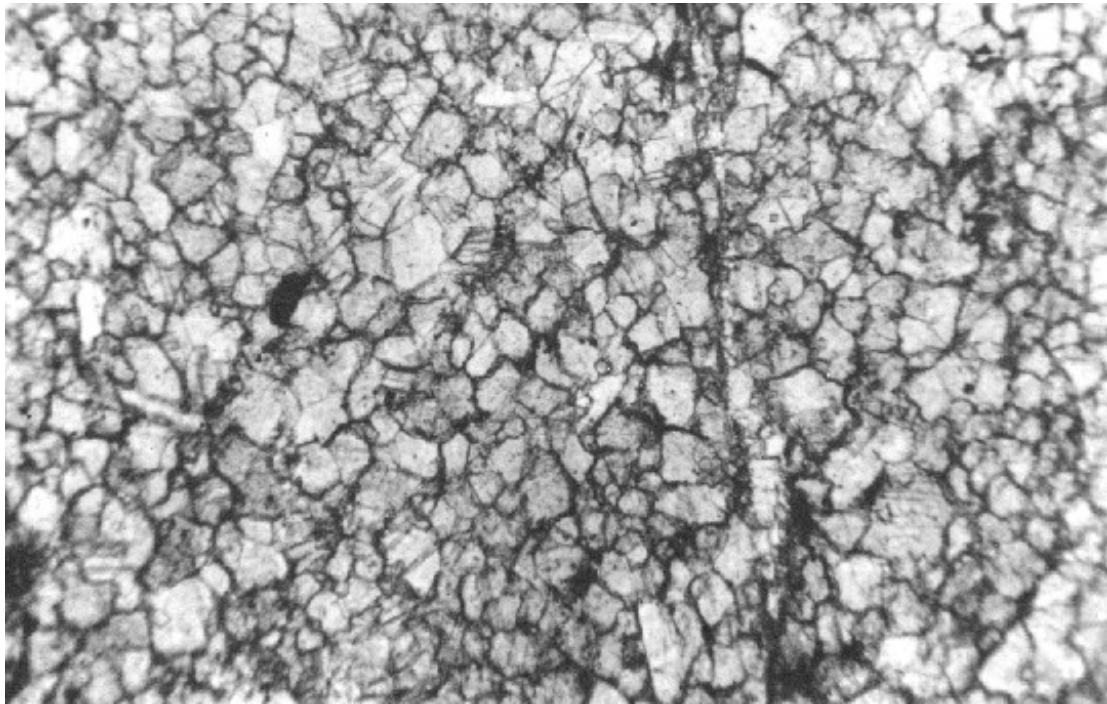

Figure 220. Nonreactive microtextures of carbonate rocks (examples are shown to illustrate the difference between these crystalline textures and the partially crystalline reactive textures shown in figure 219).

D.5 AGGREGATE CONCERNS IN D-CRACKING

D-cracking that is caused by destruction of the aggregate by cycles of freezing and thawing has been well documented in the literature, and much information concerning it can be easily found (Schwartz, 1987). Both the ACR and D-cracking involve dolomitic limestones whose composition includes a large portion of insoluble material. Dolomites involved in D-cracking are thought to have a particular fine pore structure and/or contain a minor amount of iron, strontium, or both, in their crystal structure (Dubberke and Marks, 1987; Schwartz, 1987). A specific pore structure and iron or strontium do not seem to be necessary conditions for ACR. The crack patterns produced by these two reactions are very different. D-cracking deterioration is first evident at the edges and near the joints of a pavement. The cracking is parallel with the joint or edge (see figure 221 and compare with figures 94-95, 97, 103-104, and 106-107). ACR is an expansive chemical reaction with the alkalis, whereas D-cracking is caused by freezing and thawing of moisture in the particles of particular susceptible dolomites and does not involve alkalis.

Regarding D-cracking aggregates, Schwartz (1987) stated:

D-cracking is a form of portland cement deterioration associated primarily with the use of coarse aggregates in the concrete that disintegrate when they become saturated and are subject to repeated cycles of freezing and thawing. It is defined by a characteristic crack pattern that appears at the wearing surface of the pavement as a series of closely spaced fine cracks adjacent and generally parallel to transverse and longitudinal joints and cracks and to the free edges of the pavement (p. 5).

It is generally accepted that pore size is the most important characteristic of coarse aggregate influencing its susceptibility to D-cracking (p. 10).

It is generally agreed that the brand or composition of cement does not significantly influence D-cracking (p. 11).

In Iowa, Dubberke and Marks (1987) found that D-cracking is not necessarily related to the pore structure of the aggregate and came to the conclusion that the incidence of D-cracking is higher with ferroan-dolomite aggregates than with other compositions, and D-cracking may be caused or hastened by a chemical reaction with deicing salts.

When unsound aggregate particles are situated just below the concrete surface, they can cause popouts (figure 222). Unsound carbonates, shales, and low-density chert particles have been associated with this type of distress (a conical break with the offending particle at the base). ASR of chert and shale particles can also cause popouts.



Figure 221. D-cracking of a pavement caused by destruction of the aggregate by cycles of freezing and thawing (cracking parallel to the joint and wrapping around at the juncture of joints defines D-cracking).



Figure 222. Pavement surface with a flaw caused by freezing and thawing of water trapped in aggregate particle.

D.6 SPECIAL-PURPOSE AGGREGATES

D.6.1 Skid Resistance

Skid resistance is usually desirable for any aggregates used in a surface of HCC that supports traffic. Skid resistance requires that the surface of an HCC pavement be fabricated with hard, nonpolishing aggregates. This generally means that nonsiliceous carbonate rocks cannot be used. In areas where carbonate aggregate is much less expensive than harder aggregate from more distant sources, two-course construction may be the most economic alternative. Not all types of siliceous aggregate provide the same wearing-surface microtexture as others. Despite their hardness, some quartz and feldspar pebbles and quartzitic and granitic rocks may tend to wear with a rounded surface and to polish (see figure 223). Others with particular zones of weakness (e.g., particular granites and graywackes) wear and then break with a microtexture that creates a very skid-resistant wearing surface (see figure 224) (Webb, 1970).

D.6.2 Lightweight Aggregates

Lightweight aggregates may be specified whenever the weight of conventional aggregates might be a problem. They are frequently used for long-span bridges to alleviate the dead load on the support structures. They may be used when bridge decks require widening and it is considered more economical to widen with the more expensive expanded aggregates than to increase the strength of the support structure.

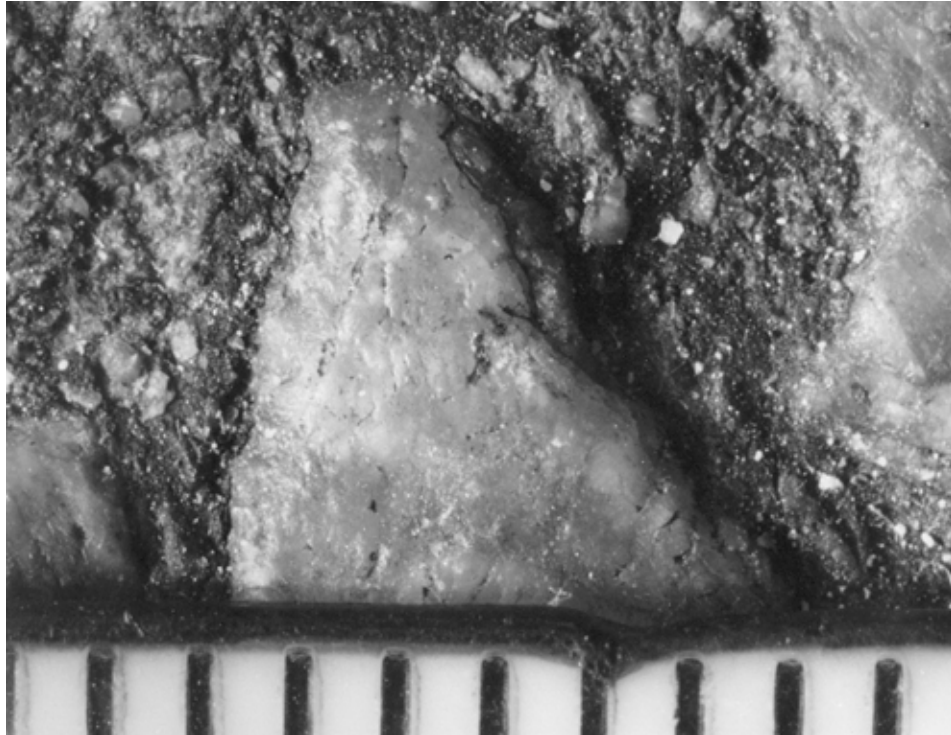

Scale is in millimeters.

Figure 223. Traffic-worn rounded surface of feldspar aggregate particle (this will not provide good skid resistance).

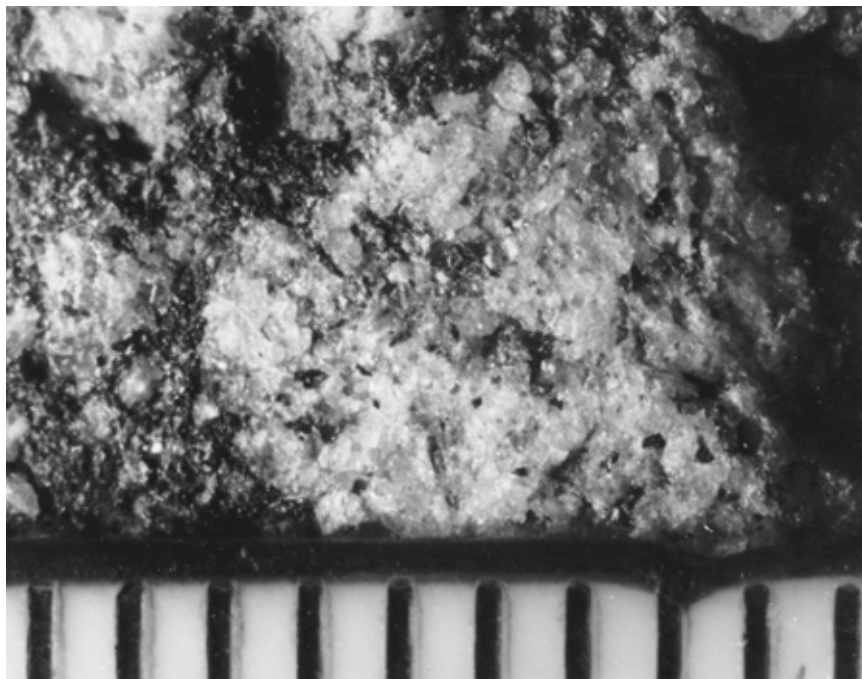

Scale is in millimeters.

Figure 224. Traffic-worn surface of granite aggregate particle (zones of weakness provide an irregular skid-resistant surface).

Manufactured lightweight aggregates are usually shale or slate that has been expanded by treatment at very high heat. The exterior of the particles becomes fluid, and the gases and vapors inside expand to create a very porous substance with a fused exterior shell. Figure 225 shows this sort of aggregate exposed on a lapped slice of HCC.

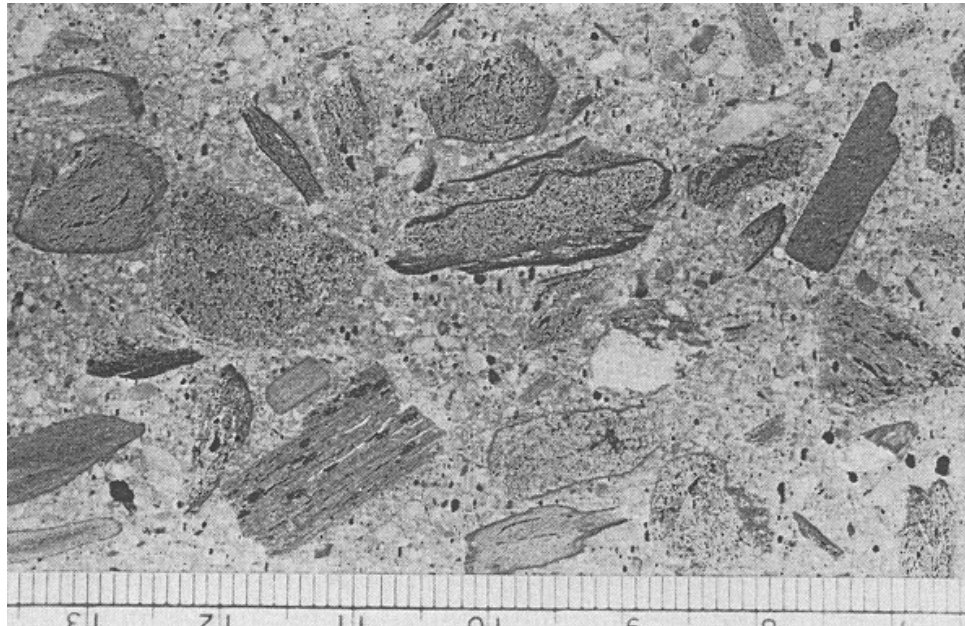

Scale is in millimeters.

These expanded aggregates vary considerably with the source material used and the nature of the heat treatment (temperature, time, oxidation conditions, etc.). Much depends on the depth and continuity of the fused surface of the aggregate particles. If this surface is continuous, the aggregate will have low permeability despite its high porosity.

Figure 225. Lapped slice of HCC containing expanded-shale lightweight aggregate.

It is suspected that the chemical composition of the fused layer may have an important effect on the ability of these aggregates to bond with cement paste. Particular expanded aggregate materials produce concretes in which the bond between the aggregate and the paste is extremely good. In other cases, the bond is no better than would be expected of a quartz-pebble aggregate. In examples of a good bond, the aggregate surface does not seem to have an attraction for water, as does quartz and many other highly siliceous materials. These layers of water on the surface of aggregate particles create space along the bond line in the finished concrete that, whether or not it fills with calcium hydroxide, is a zone of weakness in the concrete and a possible channel for water, salt solutions, and other liquid materials. It has been shown that this attraction for water, which lessens the paste-aggregate bond, is most often present in materials that are acidic by nature, whereas the materials that may be considered mafic or alkaline, such as the carbonates and iron-rich minerals, generally have a much tighter bond (Walker, 1972). It has not yet been shown that the chemical composition of the fused layer in expanded aggregate has a direct effect on the properties of the bond. We suspect that such research would probably yield interesting and useful results.

Particular rocks can be used as lightweight aggregates without heat treatment. These may include volcanic ashes, tuffs, and pumices.

D.6.3 Radiation Shielding

Concrete for radiation shielding is designed using heavyweight or special composition aggregates so that the maximum amount of radiation may be contained. These requirements are covered in ASTM C 637 and ASTM C 638. Many of the aggregate minerals used in radiation shielding are opaque, and they cannot be identified with the petrographic microscope. If the exact mineral identification is required, x-ray diffraction and some form of chemical testing or examination with a metallographic microscope will have to be performed.

REFERENCES

Adams, A.F.; MacKenzie, W.S.; and Guilford, C. 1984. *Atlas of Sedimentary Rocks Under the Microscope*. John Wiley and Sons, New York, NY.

American Concrete Institute. ACI 211.1: Standard Practice for Selecting Proportions for Normal, Heavyweight, and Mass Concrete, *ACI Manual of Concrete Practice: Part 1, Materials and General Properties of Concrete*. Farmington Hills, MI.

American Concrete Institute. ACI 211.2: Standard Practice for Selecting Proportions for Structural Lightweight Concrete, *ACI Manual of Concrete Practice: Part 1, Materials and General Properties of Concrete*. Farmington Hills, MI.

American Concrete Institute. ACI 221R: Guide for Use of Normal Weight and Heavyweight Aggregates in Concrete. *ACI Manual of Concrete Practice: Part 1, Materials and General Properties of Concrete*. Farmington Hills, MI.

American Society for Testing and Materials. ASTM C 29: Standard Test Method for Bulk Density (Unit Weight) and Voids in Aggregate, *Annual Book of ASTM Standards: Volume 04.02, Concrete and Aggregates*. West Conshohocken, PA.

American Society for Testing and Materials. ASTM C 33: Standard Specification for Concrete Aggregates, *Annual Book of ASTM Standards: Volume 04.02, Concrete and Aggregates*. West Conshohocken, PA.

American Society for Testing and Materials. ASTM C 125: Standard Terminology Relating to Concrete and Concrete Aggregates, *Annual Book of ASTM Standards: Volume 04.02, Concrete and Aggregates*. West Conshohocken, PA.

American Society for Testing and Materials. ASTM C 131: Standard Test Method for Resistance to Degradation of Small-Size Coarse Aggregate by Abrasion and Impact in the Los Angeles Machine, *Annual Book of ASTM Standards: Volume 04.02, Concrete and Aggregates*. West Conshohocken, PA.

American Society for Testing and Materials. ASTM C 294: Standard Descriptive Nomenclature for Constituents of Concrete Aggregates, *Annual Book of ASTM Standards: Volume 04.02, Concrete and Aggregates*. West Conshohocken, PA.

American Society for Testing and Materials. ASTM C 295: Standard Guide for Petrographic Examination of Aggregates for Concrete, *Annual Book of ASTM Standards: Volume 04.02, Concrete and Aggregates*. West Conshohocken, PA.

American Society for Testing and Materials. ASTM C 330: Standard Specification for Lightweight Aggregates for Structural Concrete, *Annual Book of ASTM Standards: Volume 04.02, Concrete and Aggregates*. West Conshohocken, PA.

American Society for Testing and Materials. ASTM C 535: Standard Test Method for Resistance to Degradation of Large-Size Coarse Aggregate by Abrasion and Impact in the Los Angeles Machine, *Annual Book of ASTM Standards: Volume 04.02, Concrete and Aggregates*. West Conshohocken, PA.

American Society for Testing and Materials. ASTM C 637: Standard Specification for Aggregates for Radiation-Shielding Concrete, *Annual Book of ASTM Standards: Volume 04.02, Concrete and Aggregates*. West Conshohocken, PA.

American Society for Testing and Materials. ASTM C 638: Standard Descriptive Nomenclature of Constituents of Aggregates for Radiation-Shielding Concrete, *Annual Book of ASTM Standards: Volume 04.02, Concrete and Aggregates*. West Conshohocken, PA.

American Society for Testing and Materials. ASTM R 0030: Manual of Aggregate and Concrete Testing, *Annual Book of ASTM Standards: Volume 04.02, Concrete and Aggregates* (related material). West Conshohocken, PA.

Davis, R.E. 1994. "Preplaced Aggregate Concrete," *Significance of Tests and Properties of Concrete and Concrete-Making Materials*, P. Klieger and J.F. Lamond, Eds, Report No. ASTM STP 169C. American Society for Testing and Materials, West Conshohocken, PA, pp. 562-566.

Deer, W.A.; Howie, R.A.; and Zussman, J. 1992. *An Introduction to the Rock-Forming Minerals*. Longman, Green, and Co., Ltd., London, England.

Dolar-Mantuani, L. 1983. *Handbook of Concrete Aggregates*. Noyes Publications, Park Ridge, NJ.

Dubberke, W., and Marks, V.J. 1987. "The Relationship of Ferroan Dolomite to Rapid Concrete Deterioration," *Transportation Research Record 1110*. Transportation Research Board, Washington, DC, pp. 1-10.

Farny, J.A., and Kosmatka, S.H. 1997. *Diagnosis and Control of Alkali-Aggregate Reactions in Concrete*. Portland Cement Association, Skokie, IL.

Federal Highway Administration. *Rock and Mineral Identification for Engineers*, Report No. FHWA-HI-91-025. Washington, DC.

Forster, S.W. 1994. "Soundness, Deleterious Substances, and Coatings," *Significance of Tests and Properties of Concrete and Concrete-Making Materials*, P. Klieger and J.F. Lamond, Eds., Report No. ASTM STP 169C. American Society for Testing and Materials, West Conshohocken, PA, pp. 411-420.

Galloway, J.E. 1994. "Grading, Shape, and Surface Properties," *Significance of Tests and Properties of Concrete and Concrete-Making Materials*, P. Klieger and J.F. Lamond, Eds., Report No. ASTM STP 169C. American Society for Testing and Materials, West Conshohocken, PA, pp. 401-410.

Gaynor, R.D., and Meininger, R.C. 1983. "Evaluating Concrete Sands," *Concrete International*, Volume 5, No. 12, pp. 53-60.

Heinrich, E.W. 1965. *Microscopic Identification of Minerals*. McGraw-Hill, New York, NY.

Hossain, M.S.; Parker, F.; and Kandhal, P. 2000. "Uncompacted Voids and Particle Index Tests for Evaluating Coarse Aggregate," *Transportation Research Record No. 1721*. Transportation Research Board, Washington, DC, pp. 100-105.

Hyndman, D.W. 1972. *Petrology of Igneous and Metamorphic Rocks*. McGraw-Hill, New York, NY.

Kim, H.; Haas, C.T.; Rauch, A.F.; and Browne, C. 2002. "Wavelet-Based Three-Dimensional Descriptors of Aggregate Particles," *Transportation Research Record No. 1787*. Transportation Research Board, Washington, DC, pp. 109-116.

Kuo, C.-Y., and Freeman, R.B. 2000. "Imaging Indices for Quantification of Shape, Angularity, and Surface Texture of Aggregates," *Transportation Research Record No. 1721*. Transportation Research Board, Washington, DC, pp. 157-165.

Landgren, R. 1994. "Unit Weight, Specific Gravity, Absorption, and Surface Moisture," *Significance of Tests and Properties of Concrete and Concrete-Making Materials*, P. Klieger and J.F. Lamond, Eds., Report No. ASTM STP 169C. American Society for Testing and Materials, West Conshohocken, PA, pp. 421-428.

Larsen, E.S., and Berman, H. 1964. "The Microscopic Determination of the Non-Opaque Minerals," *U.S. Geological Survey Bulletin 848*. U.S. Government Printing Office, Washington, DC.

MacKenzie, W.S.; Donaldson, C.H.; and Guilford, C. 1982. *Atlas of Igneous Rocks and Their Textures*. John Wiley and Sons, New York, NY.

MacKenzie, W.S., and Guilford, C. 1980. *Atlas of Rock-Forming Minerals in Thin Section*. John Wiley and Sons, New York, NY.

Masad, E.; Button, J.W.; and Papagannakis, T. 2000. "Fine-Aggregate Angularity: Automated Image Analysis Approach," *Transportation Research Record 1721*. Transportation Research Board, Washington, DC, pp. 66-72.

Mather, K., and Mather, B. 1991. "Aggregates," *Centennial Special, Volume 3*. Geological Society of America, Boulder, CO, pp. 323-332.

Meininger, R.C. 1994. "Degradation Resistance, Strength, and Related Properties," *Significance of Tests and Properties of Concrete and Concrete-Making Materials*, P. Klieger and J.F. Lamond, Eds., ASTM STP [Special Technical Publication] 169C. American Society for Testing and Materials, West Conshohocken, PA, pp. 388-400.

Mielenz, R.C. 1994. "Petrographic Examination of Concrete Aggregates," *Significance of Tests and Properties of Concrete and Concrete-Making Materials*, P. Klieger and J.F. Lamond, Eds., Report No. ASTM STP 169C. American Society for Testing and Materials, West Conshohocken, PA, pp. 342-364.

Mullen, W.G. 1978. "Weight, Density, Absorption and Surface Moisture," *Significance of Tests and Properties of Concrete and Concrete-Making Materials*, Report No. ASTM STP 169B. American Society for Testing and Materials, West Conshohocken, PA, pp. 629-645.

Ozol, M.A. 1978. "Shape, Surface Texture, Surface Area, and Coatings," *Significance of Tests and Properties of Concrete and Concrete-Making Materials*, Report No. ASTM STP 169B. American Society for Testing and Materials, West Conshohocken, PA, pp. 584-628.

Ozol, M.A. 1994. "Alkali-Carbonate Rock Reaction," *Significance of Tests and Properties of Concrete and Concrete-Making Materials*, P. Klieger and J.F. Lamond, Eds., Report No. ASTM STP 169C. American Society for Testing and Materials, West Conshohocken, PA, pp. 372-387.

Pettijohn, F.J. 1975. *Sedimentary Rocks*. Harper and Row, New York, NY.

Price, W.H. 1978. "Grading," *Significance of Tests and Properties of Concrete and Concrete-Making Materials*, Report No. ASTM STP 169B. American Society for Testing and Materials, West Conshohocken, PA, pp. 573-583.

Rao, C., and Tutumluer, E. 2000. "Determination of Volume of Aggregates: New Image-Analysis Approach," *Transportation Research Record 1721*. Transportation Research Board, Washington, DC, pp. 73-80.

Rao, C.; Tutumluer, E.; and Kim, I.T. 2002. "Quantification of Coarse Aggregate Angularity Based on Image Analysis," *Transportation Research Record 1787*. Transportation Research Board, Washington, DC, pp. 117-124.

- Schmitt, J.W. 1990. "Effects of Mica, Aggregate Coatings, and Water-Soluble Impurities on Concrete," *Concrete International, Volume 12, No. 12*, pp. 54-57.
- Schwartz, D.R. 1987. "D-Cracking of Concrete Pavements," *NCHRP Synthesis No. 134*. Transportation Research Board, Washington, DC.
- Stark, D. 1994. "Alkali-Silica Reactions in Concrete," *Significance of Tests and Properties of Concrete and Concrete-Making Materials*, P. Klieger and J.F. Lamond, Eds., Report No. ASTM STP 169C. American Society for Testing and Materials, West Conshohocken, PA, pp. 365-371.
- Van Epps, R.J., and Erlin, B. 1990. "Opal-Coated Aggregates: Investigation and Processing for Use," *Petrography Applied to Concrete and Aggregates*, Report No. ASTM STP 106. American Society for Testing and Materials, West Conshohocken, PA, pp. 121-128.
- Virginia DOT. 2002. *Road and Bridge Specifications* (revisions scheduled every 4 years). Richmond, VA.
- Virginia DOT, Materials Division. *Virginia Test Methods Manual* (various) (revisions individually, as required). Richmond, VA.
- Walker, H.N. 1972. *The Stripping of Penetration 85-100 Asphalt From Silicate Aggregate Rocks: A Laboratory Study*, Report No. VTRC 71-R29. Virginia Transportation Research Council, Charlottesville, VA.
- Webb, J.W. 1970. *The Wearing Characteristics of Mineral Aggregates in Highway Pavements*, Report No. VTRC 70-R7. Virginia Transportation Research Council, Charlottesville, VA.
- Williams, H.; Turner, F.J.; and Gilbert, C.M. 1954. *Petrography: An Introduction to the Study of Rocks in Thin Section*. Freeman, San Francisco, CA.
- Winchell, A.N., and Winchell, H. 1964. *The Microscopical Characters of Artificial Inorganic Solid Substances: Optical Properties of Artificial Minerals*. Academic Press, New York, NY, and London, England.
- Yardley, W.D.; MacKenzie, W.S.; and Guilford, C. 1990. *Atlas of Metamorphic Rocks and Their Textures*. John Wiley and Sons, New York, NY.

APPENDIX E. EXAMPLES OF REASONS PETROGRAPHIC SERVICES ARE REQUESTED AND CORRESPONDING PLANS FOR ANALYSIS

Situation: Concrete submitted failed test for required compressive strength.

- **Client's question:** What makes this concrete so much weaker than it was designed to be?
- **Preliminary plan of analysis:** (1) Perform analysis of air-void system to determine if excess air is a major cause of low strength and (2) perform general examination with stereomicroscope with an emphasis on paste quality and aggregate-paste bond.

Situation: Mixture was harsh and workability was very poor.

- **Client's question:** Why? Is the coarse aggregate too large, of a difficult shape, or both? Does the aggregate have abundant reentrant angles and angular particle shapes? Was the void content of the fine aggregate within specifications?
- **Preliminary plan of analysis:** (1) Perform general examination with stereomicroscope with an emphasis on size, shape, and lithology of aggregates and the quantity of paste and (2) consult with client and any involved testing laboratories to acquire test results on aggregates or obtain samples of aggregates for testing.

Situation: Inspector reported that contractor added water because workability was poor.

- **Client's question:** Did the contractor add too much water? Did he or she add it too late? Was it mixed in properly?
- **Preliminary plan of analysis:** (1) Perform analysis of air-void system and (2) perform general examination with stereomicroscope with an emphasis on variations in paste color and quality throughout mass, condition of aggregate-paste bond, and distribution and size of air voids.

Situation: Inspector reported that tines used for surface texturing seemed to tear concrete surface rather than produce usual continuous lands and grooves.

- **Client's question:** Why? What is the depth of the damage?
- **Preliminary plan of analysis:** (1) Perform general examination with stereomicroscope with an emphasis on size and shape of aggregates and condition of paste and (2) prepare several lapped surfaces that are at right angles to both wearing surface and grooves for examination of depth of damage. Consider using special preparation methods (see section 5.3.3).

Situation: Inspector reported that vibrating screed failed to operate and the concrete was hand-screeded.

- **Client's question:** Was the quality of the concrete adversely affected? Was the consolidation sufficient?
- **Preliminary plan of analysis:** (1) Perform analysis of air-void system, including sorting voids encountered into entrained, entrapped, and irregular and (2) perform general examination with stereomicroscope with an emphasis on paste quality.

Situation: Air-meter test showed that mixture had low air content; however, contractor placed mixture anyway.

- **Client's question:** Is the air-void system sufficient to provide durable concrete that is able to resist damage from cycles of freezing and thawing?
- **Preliminary plan of analysis:** (1) Perform analysis of air-void system and (2) perform general examination with stereomicroscope.

Situation: There was a driving rainstorm during placement of concrete.

- **Client's question:** Is the concrete overwatered? Depth of damage? Durability of the surface texture? Ability of the surface to resist abrasion?
- **Preliminary plan of analysis:** Perform general examination with stereomicroscope of several lapped surfaces that are at right angles to both wearing surface and grooves to examine depth of damage and quality of paste and check air-void distribution, size, and stability. Consider using special preparation methods (see section 5.3.3).

Situation: Specimens are from a test mixture employing a new material or construction practice.

- **Client's request:** General petrographic examination and a report on anything unusual.
- **Preliminary plan of analysis:** (1) Perform analysis of air-void system and (2) perform general examination with stereomicroscope.

Situation: A crack system is developing in a pavement (or bridge deck) soon after placement.

- **Client's question:** Is this plastic shrinkage cracking? Why did it happen?
- **Preliminary plan of analysis:** Perform careful examination of specimens according to recommendations and suggestions in chapter 4. A visit to the site and additional specimens may be required. **Note:** The data necessary to answer the "why" part of this question cannot be found in the petrographic laboratory, but must be sought in the inspector's notes, an analysis of the weather conditions, and the recorded observations of any people who passed by the site.

Situation: Placement developed a severe crack system over many portions of the surface.

Deterioration is becoming worse at an ever-increasing rate, and concrete is requiring constant work from maintenance crews. (Obviously, the younger the placement, the more mystifying and crucial the problem. However, even when a pavement's life has surpassed its planned life cycle, the need for extensive repairs can seem to be a disaster to a transportation department's budget.)

- **Client's question:** What is causing this problem? How bad is it going to get? What can be done to stop the deterioration?
- **Preliminary plan of analysis:** (1) Identify aggregate lithologies (thin sections may be required), (2) perform careful examination of specimens according to recommendations and suggestions in chapter 10, (3) inspect placement to determine extent of use of materials present in deteriorated areas and advise client on number and location of specimens required, and (4) obtain copy of chemical analysis of cement batch used if alkali-aggregate reaction is the likely cause. **Note:** If the deterioration is caused by an alkali-aggregate reaction, the client should be advised that the deterioration may proceed to complete destruction and that there is no known way to stop it. In the case of an alkali-silica reaction, the same materials can be used in the future if sufficient pozzolanic material or ground granulated blast-furnace slag is included in the mixture.

Situation: Shortage of a material from one source necessitated use of an unapproved material.

- **Client's question:** Is there anything wrong with the concrete? (Make sure that the concrete fabricated with the approved material is available for comparison with the concrete fabricated with the substitute material.)
- **Preliminary plan of analysis:** (1) Perform analysis of air-void systems of the two concretes and (2) perform general examination with stereomicroscope of the two specimens.

Situation: Concrete telephone conduit (or drainage ditch lining) in contact with soil was distressed by some mechanism that seems to be dissolving it.

- **Client's question:** What is happening?
- **Preliminary plan of analysis:** (1) Perform general examination with stereomicroscope with an emphasis on aggregate type and presence of minerals that may produce acid during weathering and (2) if no acid-producing agents are found in the concrete, perform petrographic examination of soil and nearby rock outcrops and chemical analysis for contaminants of soil and groundwater.

Client's question: What is this slick-looking coating (or this dark coating or this white coating) that we find near the cracks in the placement? Does it indicate serious problems?

- **Preliminary plan of analysis:** (1) Determine composition of exudation (often this may be accomplished by examination of grain-mount preparations using petrographic microscope), (2) request specimens that will include a full specimen of concrete (a depth of 127 or 152 mm is usually sufficient), and (3) perform general examination of specimen of full concrete with stereomicroscope with an emphasis on aggregate types and any possible reaction products.

Client's question: Why is this concrete such a funny color? Does it mean the concrete was made from the wrong materials? How durable is this sort of concrete?

- **Preliminary plan of analysis:** (1) Obtain copy of design of mixture and (2) explain to client how particular materials produce different colors.

Client's question: Why is there a peculiar dark blue-green color so unevenly distributed in this concrete? Does it mean that the mixing was not sufficient? Are there weaker and stronger places in this concrete? (Suspected: Ground granulated blast-furnace slag (GGBFS) was used in the mixture.)

- **Preliminary plan of analysis:** (1) Inquire if GGBFS was included in mixture or examine thin sections to check paste for presence of GGBFS and (2) explain to client that dark color exists in portions of concrete that retain original moisture and that it fades unevenly as concrete becomes drier. Reassure client that mottled color does not indicate variation in the distribution of cementitious material. **Note:** The color cannot be restored by rewetting.

Client's question: Why didn't this concrete that was placed 3 weeks ago ever set? The concrete can be shoveled like gravel and is almost dry.

- **Preliminary plan of analysis:** (1) Rewet finer material and test for setting properties, (2) conduct chemical analysis to determine amount of retarder, and (3) recommend an investigation of admixture dispensing system at concrete plant to determine the likelihood of the addition of too much retarder.

Client's question: What material is in these stalactites found hanging under this concrete bridge? Or, What is this white (gray, beige, etc.) material occurring as a coating on this concrete? What do they mean concerning the durability and strength of the bridge?

- **Preliminary plan of analysis:** (1) Collect some of material and determine its composition (often this may be accomplished by examination of grain-mount preparations using the petrographic microscope), (2) determine presence or absence of alkali-silica gel (see section 10.2.3), and (3) visit placement and evaluate condition of concrete.

Situation: This concrete set much faster than expected.

- **Client's question:** What is wrong with it? Did it get properly consolidated?
- **Preliminary plan of analysis:** (1) Perform analysis of air-void system, including sorting voids encountered into entrained, entrapped, and irregular; (2) perform general examination with stereomicroscope with an emphasis on paste quality; and (3) perform chemical analysis to determine if admixtures (accelerators, water reducers, etc.) are present in specified amounts.

Situation: This concrete had a very high slump and a runny consistency.

- **Client's question:** What is the water-cement ratio of this concrete?
- **Preliminary plan of analysis:** (1) Perform examination of specimens for aggregate segregation; (2) perform analysis of air-void system, including sorting voids encountered into entrained, entrapped, and irregular; (3) perform general examination with stereomicroscope with an emphasis on paste quality and an estimate of water-cement ratio; and (4) if necessary, perform chemical determination of cement content.

Situation: Pavement is pushing out and causing humps in adjacent bituminous concrete.

- **Client's question:** Can concrete grow? How? Why?
- **Reply:** Yes. Particular concretes are made using expansive cement and are designed to expand and thus minimize cracking. This type of concrete may have been used as a repair material. If an original placement appears to be expanding, the concrete may be affected by one of the alkali-aggregate reactions that cause expansion of the concrete (see chapter 10).
- **Recommendation:** Investigation of problem site by petrographer or engineer experienced in techniques in section 10.2.2, probably including a complete sampling program.

Client's question: How deep are these cracks? Will they cause corrosion of the reinforcing rods?

- **Preliminary plan of analysis:** Measure depth of cracks and distance from end of crack (as visible with the stereomicroscope) to reinforcement. If distance to reinforcement is less than 50 mm, report that cracks will probably cause corrosion.

Concrete researcher's question: Can you (the petrographer) actually see a difference between concrete with a low chloride ion permeability and that with a high permeability (see ASTM C 1202)?

- **Reply:** In extreme cases, yes. We can sometimes see the differences with the stereomicroscope. In other cases, we can see the differences in fluorescent-impregnated thin sections by the use of the P/EF microscope.

Concrete researcher's request: Measure these cracks (depth and width at 25-mm intervals) and give me the data so that we can calculate the volume of the crack.

- **Plan:** (1) Prepare lapped surfaces at right angles to surface; (2) gently mark lapped surfaces with graphite as close to wearing surface as possible and then at 25-mm intervals down the depth of the cracks; and (3) using a stereomicroscope and various stage micrometers, measure the width of the cracks at marks; report results.

Concrete researcher's request: Compare these two beams subjected to testing for resistance to freezing and thawing and report any internal differences.

- **Plan:** (1) Prepare lapped internal surfaces and mark microcracks as described in section 8.4 and (2) either count cracks along traverse lines in specimens or visually compare markings.

Concrete researcher's request: Compare the bond in these different types of overlay (or different methods of achieving overlay bond) and report the location of any cracking or debonding.

- **Preliminary plan of analysis:** (1) Prepare lapped surfaces that cut across bond at right angles; (2) using stereomicroscope and a pen as described in section 8.4, mark all microcracks; and (3) study relationship of microcracks and any obvious debonding to line of bond between overlay and substrate. **Hint:** In many cases, especially when removal of damaged material has been vigorous, the break between the overlay and the substrate will not occur on the bond between the two materials, but rather in the substrate 2 or 3 mm below the bond.

Client's question: "Why is this concrete so good?" (Only once in the more than 35 years of our experience was any HCC submitted with this request.)

- **Plan:** Examine a number of lapped internal surfaces.
- **In this case, the answer is:** The concrete in question had a low water-cement ratio and had been fabricated with a particular sort of expanded aggregate that provided a paste-aggregate bond that was much better than that usually found in concrete fabricated with natural crushed stone or gravel.

GLOSSARY

Acid (felsic)-igneous rocks: Igneous rocks rich in quartz and the potassium-sodium feldspars. May contain mica, amphibole, etc. Examples are granite and granodiorite. These rocks are often light colored and/or mottled. It is common (except in extrusive volcanic rocks) for the individual grains to be large enough to be easily distinguished by the unaided eye.

Alkali-aggregate reaction (AAR): Any potentially expansive chemical reaction between the aggregate and the hydroxide ions associated with the ions of sodium and potassium in solution in the paste. Can be very deleterious (see **Alkali-carbonate reaction** and **Alkali-silica reaction**).

Alkali-carbonate reaction (ACR): A potentially expansive chemical reaction between a carbonate aggregate and the hydroxide ions associated with the ions of sodium and potassium in solution in the paste. The only rock known to so react is an impure dolomitic limestone with a specific internal structure. Can be very deleterious if the forces generated by the reaction exceed the cohesive forces of the concrete. (See chapter 10.)

Alkali-silica reaction (ASR): A potentially expansive chemical reaction between siliceous aggregate and the hydroxide ions associated with the ions of sodium and potassium in solution in the paste. The siliceous rocks involved in this reaction are those with an imperfect crystal structure or those that are not crystalline. Can be very deleterious if the forces generated by the expanding silica gels exceed the cohesive forces of the placement. Deteriorated HCC often exhibits oozing silica gels or the dehydrated and carbonated remains of silica gels. (See chapter 10.)

Amorphous: Not crystalline; without a regular arrangement of the component atoms into a crystal structure.

Analyzer: In a petrographic microscope, a device (located above the objective) that polarizes the light after it has passed through the specimen.

Anhedral: Without bounding crystal faces (see **Euhedral** and **Subhedral**).

Anisotropic: The property of not being the same in all directions. Used especially in reference to mineral substances and usually implies that the substance is at least slightly birefringent.

Basic (mafic)-igneous rocks: Igneous rocks rich in the sodium-calcium feldspars, with little or no quartz; often abundant olivine and pyroxenes. Examples are basalts and diorites. These rocks are often very dark colored and fine-grained.

Becke line: In the microscopical test for the relative index of refraction, a bright line that is most visible while in motion as the focus is changed. It is the projection of the boundary of two substances of different indices of refraction. If the match between the indices is close, the line may be refracted into rainbow colors (unless monochromatic light is used). As the objective lens is raised from the subject, the Becke line appears to move toward the center of the substance with a higher index of refraction. If the line is refracted into colors, the position (movement) of the rusty red color is taken as the true position.

Beneficiation: The process of improving the chemical properties, physical properties, or both, of an ore or other earth material for use in a manufacturing process or as a construction material.

Bertrand lens: A removable plano-convex lens on a slide located in the tube of a petrographic microscope above the upper nicol (analyzer); used with convergent light from the condenser to form interference figures and thus determine the number of optical axes and the optical sign. The focusable, diaphragmed Bertrand lenses are the most convenient.

Binocular: Pertaining to optical equipment. Allowing the use of both eyes together, either to permit the sensation of relative distance (when two objective lenses are furnished) or to provide a more natural method of viewing the subject. In modern petrographic microscopes, binocular viewing is present to relieve eye strain and cannot provide a sensation of depth. In many microscopes, the prisms necessary to split the image for use by both eyes may make determinations of the properties of the optical axis figures nearly impossible.

Biotite: A dark-colored mineral of the mica group that exhibits excellent platy cleavage; in thin section, a bird's eye texture and a birefringence of 0.033.

Birefringence: The numerical difference in the index of refraction between two rays of light separated from one light source by the properties of the substance. Birefringence can be observed when a nonisotropic substance is placed between crossed nicols. The diffraction colors seen are a product of the birefringence of the substance and its thickness. Also called *double refraction*. Low birefringence is gray though pale white, 0.005; moderate birefringence includes the first order colors up to 0.030; all above 0.030 is high to very high.

Birefringent: The property of having at least minimal birefringence.

Bleed water: The water produced by bleeding (the rising of water in the concrete – see the definition below for “bleeding”). The water can be seen as a wet sheen on the surface of the concrete. When abundant, it can form puddles.

Bleeding: In fresh concrete, a process whereby the solids of the HCC, including the cement and other fine particles, settle and water rises to the top.

Calcite: Calcium carbonate (CaCO_3), a common mineral and a major ingredient of limestones and certain other sedimentary rocks. Often occurs as a vein mineral. Calcite is colorless or white when pure, crystallizes in the rhombohedral class, has a hardness of 3 on the Mohs scale, and dissolves with the effervescence of carbon dioxide in dilute HCl. The transparent forms of calcite exhibit excellent double refraction that can be observed in thick slices without lenses or polarizers. The carbonates have very high birefringence (calcite = 0.172). (See **Dolomite**.)

Carbonation: The process in portland cement concrete and in other HCCs where the calcium ions in solution or in the calcium silicate hydrates react with the carbon dioxide of the atmosphere in the presence of moderate humidity to form calcium carbonate with impurities such as amorphous silica. On the surface of HCC, the production of calcium carbonate by this method can provide a tough surface. In the interior, it can indicate weakness; passageways for water, air,

and CO₂ to enter the paste; and lowered pH of the paste, thus making the steel more susceptible to corrosion. (See **Depassivation**.) (Not to be confused with the carbonation of soda water or the coalification of organic materials.)

Coldjoint: A joining between two adjacent placements of HCC material where the earlier placement had hardened when the second was placed. May indicate little or no bond between the two concretes.

Collimate: When pertaining to light rays, to make parallel.

Conchoidal: Said of a fracture surface that is made up of smoothly curved, shelllike surfaces. True of quartz and obsidian and other massive glasses.

Conoscopic lenses: The lenses used to form interference figures. (See **Bertrand lens**.)

Core: When pertaining to concrete testing, a specimen cut from a hardened placement or a large block of concrete with a diamond-core drill for use as a portion of the material for various testing procedures. It is preferred that the core drill have an internal diameter of at least 100 mm. The core should be as deep as the placement is thick so that the entire thickness of the placement is sampled. When coring bridge decks, a small thickness of concrete is often left in the bottom of the drill hole to prevent the core from falling through the bridge and to provide a bottom for the patching material. A core can be distinguished from a cylinder by the diamond-cut exterior curved surface on which cut aggregate particles will normally be exposed.

Crazing: A fine, very shallow cracking that occurs in the exposed surface of concrete. It may be caused by shallow freezing or minor curing flaws. Crazing often has a very fine pattern, like pattern cracking, except that the individual uncracked central portions are usually less than 50 mm across. Crazing may develop to the point where the surface flakes off to a depth of about 3 mm.

Crossed nicols (polars): The microscopical condition of having the analyzer and the polarizer in the system with their vibration directions at 90 degrees to each other.

Crystallite: A tiny crystal, often acicular, and sometimes too small to exhibit birefringence.

Cubic: Used with reference to the crystal structure of a substance to indicate three crystallographic axes of equal length and mutually perpendicular. Often referred to as an *isometric crystal structure*.

Cylinder: When pertaining to concrete testing, a specially cast cylindrically shaped specimen of the concrete being fabricated to provide portions of the concrete for various testing procedures. Standard cylinders have a height two times the diameter. In Virginia, the cylinder is usually 100 mm in diameter and 203 mm in height. A cylinder may be distinguished from a core by the fact that the curved surface was cast in a mold with a smooth surface and may show marks of the seams of the mold.

De-dolomitization: Any of several processes in which the dolomite is removed or replaced from within a solid rock; it may take place through movement of ionic solutions in the interior of the aggregate particles or be particularly active on the rock surface. Especially used for the replacement of dolomite by calcite and brucite.

Depassivate: The process of neutralizing or removing the passivation (protection from active corrosion) on the surface of a metal. In concrete, usually used to mean the lowering of the pH of the material or the presence of aggressive chemical species (e.g., Cl) surrounding the reinforcing bars so that the passivating (protective) effect of the high pH of the paste is no longer present.

Design of the mixture: The specified proportioning of the ingredients of the concrete mixture; the document giving this information. The document should indicate the source of each of the ingredients approved for the concrete in question.

Diffraction: The process of bending light as it passes from one medium to another. Examples are the opponent bending of a straight object at the water line and the bending of light by a prism.

Diffraction colors: Those colors caused by the fact that the different colors of light bend at different angles. Examples are rainbow colors and the colors produced by a prism.

Dolomite: Calcium-magnesium carbonate ($\text{CaMg}(\text{CO}_3)_2$), a common mineral in sedimentary rocks such as limestones and dolostones. Much like calcite, but slightly harder and less soluble in acid. The chemical composition grades toward ankerite, with a substitution of iron and manganese for part of the magnesium. The carbonates have very high birefringence (dolomite = 0.185). (See **Calcite** and **Dolostone**.) Dolomite is sometimes used to mean a rock composed predominantly of the mineral dolomite.

Dolostone: A rock much like limestone in appearance, but composed mainly of the mineral dolomite. Frequently, the rock is called *dolomite*.

Effervesce: To bubble, splatter, etc., by the emission of a gas resulting from a chemical action. An example is CaCO_3 when acted on by acid.

Efflorescence: A surface encrustation caused by the evaporation of solutions seeping out onto the surface of rock or concrete.

Euhedral: Completely bounded by its own regularly developed crystal faces. (See **Anhedral** and **Subhedral**.)

Exudation: Something oozed out, usually a fluid solution.

Feldspar: A mineral of one of the two major feldspar groups: the potassium-sodium group and the sodium-calcium (plagioclase) group. The feldspars are aluminum silicates and are common in low-temperature veins and in types of igneous rocks. They are monoclinic or triclinic, have two optical axes, and range in color from colorless through various pastels to dark gray. They

have nearly perfect cleavage in at least two directions at close to 90 degrees to each other. They are often euhedral or subhedral, even when intergrown with other minerals and each other. The birefringence is moderate, generally between 0.006 and 0.011. They can be recognized by their cleavage and intergrowths.

Grading: Said of an aggregate and used to describe the distribution of the sizes of the particles therein. *Well-graded* aggregate has a large variety of particle sizes and fills a space well. *Poorly graded aggregate* or *gap-graded aggregate*, has particular sizes missing. When used by a geologist, *good grading* indicates a definite sorting of grain sizes and *excellent grading* indicates that the various grain sizes are well separated and deposited in different portions of the sediment.

Greenschist facies or **Greenstone facies:** The stage of metamorphism in which greenstones occur. The rock is rich in chlorite, actinolite, epidote, or all three, occasionally with significant quantities of feldspars and quartz. (See **Greenstone**.)

Greenstone: A compact rock formed by the metamorphism of basic to ultrabasic igneous (sometimes volcanic) rock. The metamorphism has proceeded to the greenschist facies.

Groundmass: The phase of a rock that is so fine-grained that individual minerals cannot be identified. Commonly said of the interstitial material surrounding the larger crystals in an igneous rock or of the unidentifiable mudlike matrix of a sedimentary rock.

Hexagonal: Used with reference to the crystal structure of a substance to indicate three crystallographic axes: of equal length, at 120 degrees to each other, and all perpendicular to a fourth axis.

Hornblende: A dark-colored mineral of the amphibole group of monoclinic silicates, all of which exhibit cleavage parallel with the long axis at about 56 and 124 degrees. Birefringence is about 0.023. Occurs in acid-igneous rocks.

Igneous: Used to indicate rock that has formed by cooling or the escape of fluids from molten portions of the earth's crust either at or near the surface or at great depth. Examples are granites, lavas, and diorites. They occur in massive formations, flows, veins, dikes, and sills. The term includes those vein rocks that are formed from hydrothermal, ion-rich fluids and that produce a large variety of minerals and often gigantic crystal sizes (i.e., pegmatites). On occasion, used to indicate rock (which may be truly metamorphic) that seems to have the characteristics of igneous rock.

Index of refraction: The ratio of the speed of light in a vacuum to the speed of light in the substance under consideration.

Index of refraction oil: Immersion oil used as a standard medium to which to compare subject substances. Prepared sets of such oils are commercially available. Because the index of refraction of these oils may change with time, they should be periodically checked using a refractometer or solid standards.

Insoluble impurities: The substances found in the interstices of a carbonate rock material that cannot be dissolved by warm, dilute HCl. These substances may include clay, quartz, micas, feldspars, and pyrites.

Interference color: The highest order of color seen in a mineral when viewed with the petrographic microscope with crossed nicols. The highest colors will be seen when the two crystallographic axes that have the greatest difference in refractive power are parallel with the stage and when the axes are at 45 degrees to the nicols. The interference color is a product of the birefringence and the thickness of the substance. Charts of the interference colors are available in most books on the use of the petrographic microscope. These charts show 0.000 birefringence as black, increasing to gray, white, yellow, and orange, through the spectrum. When the spectrum starts to repeat, the light is more brilliant and the color bands are increasingly blurred. At about the sixth repeat (the sixth order), the light is a brilliant white in which no specific color can be distinguished. This is the typical appearance of the carbonate minerals at 30 mm in thickness. In a random view of any mineral, the interference colors seen will depend on the thickness, angle of viewing, and angle to the polarization of the nicols. Some particles will be banded from very low to the highest color produced by the substance. Other particles of the same substance when viewed with only equivalent crystallographic axes parallel with the stage will show almost no interference and will be seen as nearly black.

Interference figure: A pattern of light and shadow, and bands of interference colors produced on the back lens of the objective in the petrographic microscope by the use of the accessory convergent lens in the condenser. The figure can be viewed as projected on the back lens surface or with the Bertrand lens. The interference figure provides data concerning the crystal structure and the spread of the optical axes. With the gypsum plate or quartz wedge accessories, the optical sign of the mineral can be determined.

Isometric: The crystallographic or optical property of a substance having three crystallographic axes of equal length at mutual right angles. An isometric mineral has no birefringence unless it has been distorted or subjected to stress.

Isotropic: The property of being crystallographically the same in all directions. Includes isometric and amorphous.

Laitance: A layer of weak material containing cement, calcium hydroxide, and aggregate fines brought to the surface of concrete by bleed water. The amount is increased by a high water-cement ratio, overworking, or improper finishing (see ACI 116).

Lapping: The process of producing a smooth surface by grinding away projecting portions.

Limestone: A common sedimentary rock mainly composed of the mineral calcite (CaCO_3). Includes the lithified chemically deposited benthonic (deep water, bottom) type, as well as the indurated collections of shells and fragments of shells. Usually restricted to meaning only oceanic rocks, but can include the fresh-water limestone, travertine, as well. May be restricted to rocks mainly composed of calcite, but is sometimes used to include the other carbonate rocks, especially dolostones.

Lithology: Rock type, including mineralogy, structure-intrinsic parting, fissibility, and grain size.

Macrocrack: Cracks that can be seen with the unaided eye (often large enough to be seen when one is riding over a pavement or bridge).

Metabasalt: A basaltic, fine-grained, basic igneous rock, often extrusive (volcanic lavas, near surface sills, and dikes, etc.) that has undergone metamorphism. Will frequently include beds of metamorphosed volcanic debris such as ash, lapilli (pebble sized), and bombs. (See **Greenstone**.)

Metamorphic: Pertaining to a rock formed by the processes of metamorphism. The source rock material may be sedimentary, igneous, or earlier metamorphic.

Metamorphism: A natural process that, over the stretch of geologic time, can transform a rock from one appearance, crystal structure, and composition to another. The process can include the stresses of the folding and faulting crust, subduction at the edges of crust plates, pressures of burial at depth, and recrystallization and chemical changes caused by the various solutions and temperatures found in the earth's crust. The word *metamorphism* includes the low-grade, low-temperature processes by which fluids can rearrange the ions, atoms, and minerals of a rock to form new minerals and recrystallize minerals in new forms.

Micrite: The very fine-grained crystalline component of limestones that is thought to have been deposited as a chemical precipitate (calcium carbonate) and is considered to be a lithified ooze. The individual particles are completely anhedral and generally less than 4 μm in diameter.

Microcrack: Cracks that cannot be clearly seen or measured without magnification. They exist on all concrete surfaces, but are extremely difficult to see on rough surfaces.

Modal (from classical petrology): Used with *analysis* or *determination* to indicate the data collection and calculations necessary to make a mathematical determination of the relative abundance of the various component solids or discrete substances that make up the whole. There is no implication of the determination of the three-dimensional spatial arrangement, shape, and size of the individual portions of the phases. When the determination is made optically, from points, chords, or areas on a plane through the substance, the results will be in percentage by volume.

Monoclinic: Used with reference to the crystal structure of a material to indicate three crystallographic axes of not necessarily equal length: two are mutually perpendicular and the third is not.

Monocular: Pertaining to optical equipment. Allowing the use of the equipment by one eye only.

Nicol or **Nicol prism:** In a petrographic microscope, a device that polarizes light. The lower nicol (located in the substage) polarizes the light before it reaches the specimen. The upper nicol (located above the objective) polarizes the light after it has gone through the specimen. (Also known as **Polar** or **Polarizer**.)

Nonisotropic: (See **Anisotropic**.)

Ocular: Pertaining to optical equipment. The lens assembly nearest the eye.

Optical sign: An optical property of birefringent crystal substances. It is one of the properties by which substances can be classified and identified. (See **Interference figure**.)

Orthorhombic: Used with reference to the crystal structure of a substance to indicate three crystallographic axes of unequal length and mutually perpendicular.

Passivate: To render the surface of a metal chemically inactive, usually by the formation of an oxide film. In concrete, passivation of the surface of the steel reinforcing bars is produced by the high pH of the cement paste.

Paste: The portion of a concrete that is not aggregate, consisting of hardened cement hydration products, residual unhydrated cementitious materials, and air voids.

Phase (as used in chemistry): A distinct, mechanically separate component of a heterogeneous whole. The term may or may not refer to the physical state of the component (i.e., gas, liquid, or solid). Also used with *analysis* or *determination* in the same sense as *modal*.

Phenocrysts: The relatively large conspicuous crystals, surrounded by groundmass, finer crystals, or natural glass (such as obsidian). Found in particular igneous rocks.

Pleochroic properties: The property of a mineral such that it exhibits different colors when viewed at different angles, particularly in plane polarized light. A useful identifying property particularly well exhibited in the minerals biotite, hornblende, and tourmaline.

Polarizer: In a petrographic microscope, a device (located in the substage) for polarizing the light before it reaches the specimen. (Also known as **Nichol**.)

Pozzolanic materials: Materials that combine with the lime or alkali hydroxides in cement paste to produce cementitious silicate hydrates, includes natural pozzolans, fly ash, silica fume, and ground granulated blast-furnace slag.

Pyrite: A stable, common mineral of the pyrites group, iron sulphide (FeS₂). It is opaque, with a golden metallic color and conchoidal fracture. Crystallizes in the cubic system with striated faces; common habits are the cube and pyritohedron. Common in all metamorphic rocks, even those of very low-grade metamorphism. (See **Pyrites**.)

Pyrites or Pyrite group: A group of common, opaque, iron sulphide minerals; stability and metallic color depend on the ratio of iron to sulphur. Black in color when occurring in an extremely finely divided state. The group includes pyrite, pyrrolite, and marcasite. The black variety is common in very dark-colored limestones, shales, and slates. (See **Pyrite**.)

Quartz: A common mineral, silicon dioxide (SiO₂), crystallographically rhombohedral, colorless when pure, a major constituent of the rocks of the earth's crust. On the Mohs hardness scale, it is number 7. Occurs in six-sided prisms with pyramidal terminations in veins and in anhedral masses in almost all acidic rocks. A major constituent of most beach and river sands. Cleavage is usually visible only in very thin sections. The birefringence is moderate (0.009).

Refraction: The change in a light wave as it passes into a substance of different density or with different optical properties. Related to diffraction, but includes the splitting of a light wave into two components that travel at different speeds and whose vibration directions are at right angles to each other. Examples are the apparent bending of a straight object at the water line, the bending of a light wave by a prism, and the double refraction of crystals of substances such as calcite. (See **Index of refraction.**)

Relief: The optical property of the degree of contrast microscopically observed, caused by the difference in the index of refraction between a substance and the medium with which it is surrounded. High relief appears as a rough surface; low relief appears as a smooth surface that is hard to distinguish from the background.

Rhombohedral: Used with reference to the crystal structure of a crystalline substance to indicate a subset of the hexagonal crystal system in which the symmetry is incomplete. The two end terminations may differ, and alternate (thus opposing) prism faces may have different textural characteristics.

Screeding: The process of leveling and smoothing concrete to prepare it for the final surface texture. Often combined with vibration as part of the consolidation process.

Sedimentary: Used to indicate rock that has formed by the collection and usually the induration of materials in solution and particles derived from other rocks by the forces of weathering, gravity, running water, etc. The induration may be purely chemical and can take place on the surface or may be caused by compression and solutions at depth. (See **Siltstone.**)

Siltstone: A very fine-grained consolidated rock, the particles of which are predominantly between 0.06 and 0.004 mm across and have been removed from other rocks and transported by wind or water to the place of consolidation.

Stalactite: A cylindrical or conical deposit of solids caused by the evaporation of solutions dripping from an overhead structure such as a cave roof or bridge.

Subconchoidal: Said of a fracture surface that is nearly, but less than perfectly, like a conchoidal surface. (See **Conchoidal.**)

Subhedral: Incompletely bounded by its own regularly developed crystal faces. (See **Anhedral** and **Euhedral.**)

Tetragonal: Used with reference to the crystal structure of a substance to indicate three crystallographic, mutually perpendicular axes, two of which are of equal length.

Tourmaline: A mineral of a complex silicate group that contains boron and is crystallographically rhombohedral. They occur in striated columnar crystals in many different colors. They may be found in acid-igneous rocks and veins. The birefringence of the minerals of the tourmaline group is about 0.020.

Triclinic: Used with reference to the crystal structure of a substance to indicate three crystallographic axes with unequal interaxial angles.

Ultraviolet light: Radiation beyond the visible light in the violet end of the spectrum. Wavelengths are shorter than those of visible light and longer than x rays.

Vitreous: Having the luster of broken glass or quartz, glassy.

Vitrified: Converted into a glassy substance by heat and fusion.

Volcanic: Extrusive igneous rocks that are glassy or very fine-grained because of rapid cooling.

Zeolite: A group of hydrous alumino-silicates of Na, Ca, Sr, Ba, and K characterized by easy gain or loss of water of hydration. Also noted for their base exchange capacity.

ACKNOWLEDGMENTS

Federal Highway Administration would like to thank the following individuals and organizations for their support and efforts in preparing and reviewing this document:

D. Stephen Lane, Virginia Transportation Research Council, and
Paul Stutzman, National Institute of Standards and Technology,
the authors of this revision

The FHWA would also like to thank the following people for their help in the review and production of the revised manual:

Doug Hurcomb, U.S. Bureau of Reclamation
Karl Krill, U.S. Bureau of Reclamation
Celik Ozyildirim, Virginia Transportation Research Council
Bobby Marshall, Virginia Transportation Research Council
Ed Deasy, Virginia Transportation Research Council
Randy Combs, Virginia Transportation Research Council
Linda Evans, Virginia Transportation Research Council

REFERENCES

- American Concrete Institute. ACI 201.1R: Guide for Making a Condition Survey of Concrete in Service, *ACI Manual of Concrete Practice: Part 1, Materials and General Properties of Concrete*. Farmington Hills, MI.
- American Concrete Institute. ACI 201.2R: Guide to Durable Concrete, *ACI Manual of Concrete Practice: Part 1, Materials and General Properties of Concrete*. Farmington Hills, MI.
- American Concrete Institute. ACI 211.1: Standard Practice for Selecting Proportions for Normal, Heavyweight, and Mass Concrete, *ACI Manual of Concrete Practice: Part 1, Materials and General Properties of Concrete*. Farmington Hills, MI.
- American Concrete Institute. ACI 211.2: Standard Practice for Selecting Proportions for Structural Lightweight Concrete, *ACI Manual of Concrete Practice: Part 1, Materials and General Properties of Concrete*. Farmington Hills, MI.
- American Concrete Institute. ACI 211.3: Guide for Selecting Proportions for No-Slump Concrete, *ACI Manual of Concrete Practice: Part 1, Materials and General Properties of Concrete*. Farmington Hills, MI.
- American Concrete Institute. ACI 221R: Guide for Use of Normal Weight and Heavyweight Aggregates in Concrete, *ACI Manual of Concrete Practice: Part 1, Materials and General Properties of Concrete*. Farmington Hills, MI.
- American Concrete Institute. ACI 221.1R-98: State-of-the-Art Report on Alkali-Aggregate Reactivity, *ACI Manual of Concrete Practice: Part 1, Materials and General Properties of Concrete*. Farmington Hills, MI.
- American Concrete Institute. ACI 224R: Control of Cracking in Concrete Structures, *ACI Manual of Concrete Practice: Part 2, Construction Practices and Inspection*. Farmington Hills, MI.
- American Concrete Institute. ACI 224.1R: Causes, Evaluation, and Repair of Cracks in Concrete Structures, *ACI Manual of Concrete Practice: Part 2, Construction Practices and Inspection*. Farmington Hills, MI.
- American Concrete Institute. ACI 226.1R: Use of Fly Ash in Concrete, *ACI Manual of Concrete Practice: Part 2, Construction Practices and Inspection*. Farmington Hills, MI.
- American Concrete Institute. ACI 232.1R: Use of Natural Pozzolans in Concrete *ACI Manual of Concrete Practice: Part 2, Construction Practices and Inspection*. Farmington Hills, MI.
- American Concrete Institute. ACI 233R: Ground Granulated Blast-Furnace Slag as a Cementitious Constituent in Concrete, *ACI Manual of Concrete Practice: Part 2, Construction Practices and Inspection*. Farmington Hills, MI.

American Concrete Institute. ACI 234R: Guide for Use of Silica Fume in Concrete, *ACI Manual of Concrete Practice: Part 2, Construction Practices and Inspection*. Farmington Hills, MI.

American Society for Testing and Materials. ASTM C 29: Standard Test Method for Bulk Density (Unit Weight) and Voids in Aggregate, *Annual Book of ASTM Standards: Volume 04.02, Concrete and Aggregates*. West Conshohocken, PA.

American Society for Testing and Materials. ASTM C 138: Standard Test Method for Density (Unit Weight), Yield, and Air Content (Gravimetric) of Concrete, *Annual Book of ASTM Standards: Volume 04.02, Concrete and Aggregates*. West Conshohocken, PA.

American Society for Testing and Materials. ASTM C 173: Standard Test Method for Air Content of Freshly Mixed Concrete by the Volumetric Method, *Annual Book of ASTM Standards: Volume 04.02, Concrete and Aggregates*. West Conshohocken, PA.

American Society for Testing and Materials. ASTM C 227: Standard Test Method for Potential Alkali Reactivity of Cement Aggregate Combinations (Mortar-Bar Method), *Annual Book of ASTM Standards: Volume 04.02, Concrete and Aggregates*. West Conshohocken, PA.

American Society for Testing and Materials. ASTM C 231: Standard Test Method for Air Content of Freshly Mixed Concrete by the Pressure Method, *Annual Book of ASTM Standards: Volume 04.02, Concrete and Aggregates*. West Conshohocken, PA.

American Society for Testing and Materials. ASTM C 457: Standard Test Method for Microscopical Determination of Parameters of the Air-Void System in Hardened Concrete, *Annual Book of ASTM Standards: Volume 04.02, Concrete and Aggregates*. West Conshohocken, PA.

American Society for Testing and Materials. ASTM C 586: Standard Test Method for Potential Alkali Reactivity of Carbonate Rocks for Concrete Aggregates (Rock Cylinder Method), *Annual Book of ASTM Standards: Volume 04.02, Concrete and Aggregates*. West Conshohocken, PA.

American Society for Testing and Materials. ASTM C 595: Standard Specification for Blended Hydraulic Cements, *Annual Book of ASTM Standards: Volume 04.01, Cement, Lime, Gypsum*. West Conshohocken, PA.

American Society for Testing and Materials. ASTM C 618: Standard Specification for Coal Fly Ash and Raw or Calcined Natural Pozzolan for Use as a Mineral Admixture in Concrete, *Annual Book of ASTM Standards: Volume 04.02, Concrete and Aggregates*. West Conshohocken, PA.

American Society for Testing and Materials. ASTM C 666: Standard Test Method for Resistance of Concrete to Rapid Freezing and Thawing, *Annual Book of ASTM Standards: Volume 04.02, Concrete and Aggregates*. West Conshohocken, PA.

American Society for Testing and Materials. ASTM C 702: Standard Practice for Reducing Samples of Aggregate to Testing Size, *Annual Book of ASTM Standards: Volume 04.02, Concrete and Aggregates*. West Conshohocken, PA.

American Society for Testing and Materials. ASTM C 823: Standard Practice for Examination and Sampling of Hardened Concrete in Constructions, *Annual Book of ASTM Standards: Volume 04.02, Concrete and Aggregates*. West Conshohocken, PA.

American Society for Testing and Materials. ASTM C 856: Standard Practice for Petrographic Examination of Hardened Concrete, *Annual Book of ASTM Standards: Volume 04.02, Concrete and Aggregates*. West Conshohocken, PA.

American Society for Testing and Materials. ASTM C 989: Standard Specification for Ground Granulated Blast-Furnace Slag for Use in Concrete and Mortars, *Annual Book of ASTM Standards: Volume 04.02, Concrete and Aggregates*. West Conshohocken, PA.

American Society for Testing and Materials. ASTM C 1084: Standard Test Method for Portland Cement Content of Hardened Hydraulic-Cement Concrete, *Annual Book of ASTM Standards: Volume 04.02, Concrete and Aggregates*. West Conshohocken, PA.

American Society for Testing and Materials. ASTM C 1105: Standard Test Method for Length Change of Concrete Due to Alkali-Carbonate Rock Reaction, *Annual Book of ASTM Standards: Volume 04.02, Concrete and Aggregates*. West Conshohocken, PA.

American Society for Testing and Materials. ASTM C 1157: Standard Performance Specification for Hydraulic Cement, *Annual Book of ASTM Standards: Volume 04.01, Cement, Lime, Gypsum*. West Conshohocken, PA.

American Society for Testing and Materials. ASTM C 1202: Standard Test Method for Electrical Indication of Concrete's Ability to Resist Chloride Ion Penetration, *Annual Book of ASTM Standards: Volume 04.02, Concrete and Aggregates*. West Conshohocken, PA.

American Society for Testing and Materials. ASTM C 1240: Standard Specification for Use of Silica Fume for Use as a Mineral Admixture in Hydraulic Cement Concrete, Mortar, and Grout, *Annual Book of ASTM Standards: Volume 04.02, Concrete and Aggregates*. West Conshohocken, PA.

American Society for Testing and Materials. ASTM C 1252: Standard Test Methods for Uncompacted Void Content of Fine Aggregate (as Influenced by Particle Shape, Surface Texture, and Grading), *Annual Book of ASTM Standards: Volume 04.02, Concrete and Aggregates*. West Conshohocken, PA.

American Society for Testing and Materials. ASTM C 1260: Standard Test Method for Potential Alkali Reactivity of Aggregates (Mortar-Bar Method), *Annual Book of ASTM Standards: Volume 04.02, Concrete and Aggregates*. West Conshohocken, PA.

American Society for Testing and Materials. ASTM C 1293: Standard Test Method for Determination of Length Change of Concrete Due to Alkali-Silica Reaction, *Annual Book of ASTM Standards: Volume 04.02, Concrete and Aggregates*. West Conshohocken, PA.

American Society for Testing and Materials. ASTM D 75: Standard Practice for Sampling Aggregates, *Annual Book of ASTM Standards: Volume 04.03, Road and Paving Materials*. West Conshohocken, PA.

American Society for Testing and Materials. ASTM E 11: Standard Specification for Wire Cloth and Sieves for Testing Purposes, *Annual Book of ASTM Standards: Volume 04.02, Concrete and Aggregates*. West Conshohocken, PA.

American Society for Testing and Materials. 1988. *Carbonate Additions to Cement*, Report No. ASTM STP 1064, P. Kleiger and R.D. Hooton, Eds. West Conshohocken, PA.

Andrews, L.E. 1953. "Record of Experimental Air-Entrained Concrete 10 to 14 Years After Construction," *Highway Research Board Bulletin 70*. Highway Research Board, Washington, DC.

Attiogbe, E.K. 1993. "Mean Spacing of Air Voids in Hardened Concrete," *ACI Materials Journal*, pp. 174–181.

Badger, S.R.; Clark, B.A.; Sahu, S.; Thaulow, N.; and Lee, R.J. 2001. "Backscattered Electron Imaging to Determine Water-to-Cement Ratio of Hardened Concrete," *Transportation Research Record 1775*. Transportation Research Board, Washington, DC, pp. 17–20.

Bartel, F.F. 1978. "Air Content and Unit Weight," *Significance of Tests and Properties of Concrete and Concrete-Making Materials*. Report No. ASTM STP 169B. American Society for Testing and Materials, West Conshohocken, PA, pp. 122–131.

Beauchamp, R.H., and Williford, J.F. 1974. "Metallographic Methods Applied to Ultrathinning Lunar Rocks, Meteorites, Fossils, and Other Brittle Materials for Optical Microscopy," *Metallographic Specimen Preparation: Optical and Electron Microscopy*, J.L. McCall and W.M. Muller, Eds. Plenum Press, New York, NY, pp. 233-250.

Beauchamp, R.H.; Williford, J.F.; and Gafford, E.L. 1972. *Exploratory Development and Services for Preparing and Examining Ultrathin Polished Sections of Lunar Rocks and Particulates*. NASA 9-11993, 211b00862: Final Report, Parts I and II. Revision 1 to NASA Manned Spacecraft Center, Houston, Texas. Pacific Northwest Laboratories, A Division of Battelle Memorial Institute, Richland, WA.

Bentz, D.P., and Stutzman, P.E. 1993. "SEM Analysis and Computer Modeling of Hydration of Portland Cement Particles," *Petrography of Cementitious Materials*, S. DeHayes and D. Stark, Eds., Report No. ASTM STP 1215. American Society for Testing and Materials, West Conshohocken, PA, pp. 60–73.

- Bloss, F.D. 1961. *An Introduction to the Methods of Optical Crystallography*. Holt Rinehart and Winston, New York, NY.
- British Cement Association. 1992. *The Diagnosis of Alkali-Silica Reaction*, second edition. Crowthorne, Berks, UK.
- Brown, L.S. 1959. "Petrography of Cement and Concrete," *Journal of Research and Development Laboratories, Volume 1*, pp. 23–34.
- Cady, P.D. 1978. "Corrosion of Reinforcing Steel," *Significance of Tests and Properties of Concrete and Concrete-Making Materials*, Report No. ASTM STP 169B. American Society for Testing and Materials, West Conshohocken, PA, pp. 275–299.
- Campbell, D.C. 1999. *Microscopical Examination and Interpretation of Portland Cement and Clinker*, second edition. Portland Cement Association, Skokie, IL.
- Chayes, F. 1956. *Petrographic Modal Analysis*. John Wiley and Sons, New York, NY.
- Clemeña, G.G. 1972. *Determination of the Cement Content of Hardened Concrete by Selective Solution*. Virginia Transportation Research Council, Charlottesville VA.
- Clemeña, G.G.; Lane, S.; Freeman, T.; and Lozev, M. 2000. *Evaluation of Nondestructive Evaluation Methods for Application in Early Detection of Deterioration in Concrete Pavements*, Report No. VTRC 00-R13. Virginia Transportation Research Council, Charlottesville, VA.
- CSA International. 2000. *A864-00: Guide to Evaluation and Management of Concrete Structures Affected by Alkali-Aggregate Reaction*. Toronto, Ontario, Canada.
- Dakhil, F.H.; Cady, P.D.; and Carrier, R.E. 1975. "Cracking of Concrete as Related to Reinforcement," *Journal of the American Concrete Institute, Volume 72, No. 8*, pp. 421–428.
- Deer, W.A.; Howie, R.A.; and Zussman, J. 1962–1963. *Rock Forming Minerals, Volumes 1–5*. Longman, Green, and Co., Ltd., London, England.
- Deer, W.A.; Howie, R.A.; and Zussman, J. 1966, 1975, 1992. *An Introduction to the Rock-Forming Minerals*. Longman, Green, and Co., Ltd., London, England.
- Diamond, S. 1978. "Chemical Reactions Other Than Carbonate Reactions," *Significance of Tests and Properties of Concrete and Concrete-Making Materials*, Report No. ASTM STP 169B. American Society for Testing and Materials, West Conshohocken, PA, pp. 708–722.
- DePuy, G.W. 1990. "Petrographic Examinations of Concrete and Concrete Aggregates at the Bureau of Reclamation," *Petrography Applied to Concrete and Aggregates*, Report No. ASTM STP 1061. American Society for Testing and Materials, West Conshohocken, PA, pp. 32–46.

Dolar-Mantuani, L. 1983. *Handbook of Concrete Aggregates*. Noyes Publications, Park Ridge, NJ.

Erlin, B. 1966. "Methods Used in Petrographic Studies of Concrete," *Analytical Techniques as Applied to Hydraulic Cements and Concrete*, Report No. ASTM STP 395. American Society for Testing and Materials, West Conshohocken, PA, pp. 3–17.

Erlin, B. 1994a. "Embedded Metals and Other Materials Other Than Reinforcing Steel," *Significance of Tests and Properties of Concrete and Concrete-Making Materials*, P. Klieger and J.F. Lamond, Eds., Report No. ASTM STP 169C. American Society for Testing and Materials, West Conshohocken, PA, pp. 173–181.

Erlin, B. 1994b. "Petrographic Examination," *Significance of Tests and Properties of Concrete and Concrete-Making Materials*, P. Klieger and J.F. Lamond, Eds., Report No. ASTM STP 169C. American Society for Testing and Materials, West Conshohocken, PA, pp. 210–218.

Erlin, B. 1999. "So You Want To Be a Concrete Petrographer!," *Concrete International*, December, pp. 49–51.

Erlin, B., 2002. "A Citation Too Far," Letters, *Concrete International*, Volume 24, No. 9, pp. 14–16.

Federal Highway Administration. 1991. *Rock and Mineral Identification for Engineers*, Report No. FHWA-HI-91-025, Washington, DC.

Federal Highway Administration. 2003. HIPERPAV software (<http://www.tfhrc.gov/pavement/pccp/hipermain.htm>).

Feigl, F. 1939. *Qualitative Analysis by Spot Tests*. Elsevier, New York, NY.

Forster, S.W. 1994. "Soundness, Deleterious Substances, and Coatings," *Significance of Tests and Properties of Concrete and Concrete-Making Materials*, P. Klieger and J.F. Lamond, Eds., Report No. ASTM STP 169C. American Society for Testing and Materials, West Conshohocken, PA, pp. 411–420.

Frohnsdorff, G.; Clifton, J.R.; and Brown, P.W. 1978. "History and Status of Standards Relating to Alkalis in Hydraulic Cements," *Cement Standards: Evolution and Trends*, P.K. Mehta, Ed., Report No. ASTM STP 663. American Society for Testing and Materials, West Conshohocken, PA, pp. 16–34.

Gaynor, R.D., and Mullarky, J.I. 1975. *Mixing Concrete in a Truck Mixer*, Publication No. 148. National Ready Mixed Concrete Association, Silver Spring, MD.

Gebhardt, R.F. 1995. "Survey of North American Portland Cements: 1994," *Cement, Concrete & Aggregates*, Volume 17, No. 2, pp. 145–189.

Goldstein, J.I.; Newbury, D.E.; Echlin, P.; Joy, D.C.; Fiori, C.; and Lifshin, E. 1992. *Scanning Electron Microscopy and X-Ray Microanalysis*. Plenum Press, New York, NY.

- Grattan-Bellew, P. 1995. "Evaluation of Alkali-Silica Reaction in Concrete From Saunders Generating Station," *ACI Materials Journal*, Volume 92, No. 2, pp. 126–134.
- Gress, D. 1997. *Early Distress of Concrete Pavements*, Report No. FHWA-SA-97-045. Federal Highway Administration, Washington, DC.
- Guthrie, G.D., and Carey, J.W. 1997. "A Simple, Environmentally Friendly, and Chemically Specific Method for the Identification and Evaluation of the Alkali-Silica Reaction," *Cement and Concrete Research*, Volume 27, No. 9, pp. 1407–1417.
- Guthrie, G.D., and Carey, J.W. 1999. "Geochemical Method for Identifying Alkali-Silica-Reaction Gel," *Transportation Research Record 1668*. Transportation Research Board, Washington, DC, pp. 68–71.
- Hearn, N.; Hooton, R.D.; and Mills, R.H. 1994. "Pore Structure and Permeability," *Significance of Tests and Properties of Concrete and Concrete-Making Materials*, P. Klieger and J.F. Lamond, Eds., Report No. ASTM STP 169C. American Society for Testing and Materials, West Conshohocken, PA, pp. 240–262.
- Heinrich, E.W. 1965. *Microscopic Identification of Minerals*. McGraw-Hill, New York, NY.
- Helms, S.B. 1978. "Air Content and Unit Weight," *Significance of Tests and Properties of Concrete and Concrete-Making Materials*, Report No. ASTM STP 169B. American Society for Testing and Materials, West Conshohocken, PA, pp. 435–461.
- Hilton, M.H. 1974. "Expansion of Reactive Carbonate Rocks Under Restraint," *Transportation Research Record 525*. Transportation Research Board, Washington, DC.
- Hilton, M.H. 1990. *A Brief State-of-the-Art of Pneumatically Applied Concrete or Mortar (Shotcrete)*, Report No. VTRC 90-TAR 5. Virginia Transportation Research Council, Charlottesville, VA.
- Hime, W.G. 1978. "Cement Content," *Significance of Tests and Properties of Concrete and Concrete-Making Materials*, Report No. ASTM STP 169B. American Society for Testing and Materials, West Conshohocken, PA, pp. 462–470.
- Hofmänner, F. 1975. *Microstructure of Portland Cement Clinker*. Rheintaler Druckerei und Verlag, Heerbrugg, Switzerland.
- Holley, J.J.; Thomas, M.D.A.; Hopkins, D.S.; Cail, K.M.; and Lanctot, M.-C. 1999. "Custom HPC Mixtures for Challenging Bridge Design," *Concrete International*, Volume 21, No. 9, pp. 43–48.
- Hooton, R.D., and Rogers, C.A. 1995. "Determination of Slag and Fly Ash Content in Hardened Concrete," *Cement, Concrete & Aggregates*, Volume 17, No. 1, pp. 55–60.

- Houston, B.W. 1969. *Effects of Axial Restraint on Length Change of Expanding Mortar Bars*, Technical Report C-69-8. U.S. Army Corps of Engineers Waterways Experiment Station, Vicksburg, MS.
- Hover, K. 1994. "Air Content and Unit Weight of Concrete," *Significance of Tests and Properties of Concrete and Concrete-Making Materials*, P. Klieger and J.F. Lamond, Eds., Report No. ASTM STP 169C. American Society for Testing and Materials, West Conshohocken, PA, pp. 296–314.
- Insley, H., and Frechette, V.D. 1955. *Microscopy of Ceramics and Cements*. Academic Press, New York, NY.
- Jakobsen, U.H.; Laugesen, P.; and Thaulow, N. 2000. "Determination of Water-Cement Ratio in Hardened Concrete by Optical Fluorescence Microscopy," *Water-Cement Ratio and Other Durability Parameters: Techniques for Determination*, Report No. ACI SP-191. American Concrete Institute, Farmington Hills, MI, pp. 27–41.
- Jakobsen, U.H.; Laugesen, P.; and Thaulow, N. 2002. "Authors' Response," *Letters, Concrete International, Volume 24, No. 9*, pp. 16–18.
- Johannsen, A. 1968. *Manual of Petrographic Methods* (facsimile of the second edition, 1918). Hafner, New York, NY.
- Jungreis, E. 1997. *Spot Test Analysis*. John Wiley and Sons, New York, NY.
- Kaderbek, S.L.; Tracy, S.L.; and Krauss, P.D. 2002. "HPC for Chicago's Wacker Drive," *HPC Bridge Views, No. 19*, pp. 3–4.
- Kammer, H.A., and Carlson, R.W. 1941. "Investigation of Causes of Delayed Expansion of Concrete in Buck Hydroelectric Plant," *Journal of the American Concrete Institute, Volume 37*, pp. 665–671.
- Kerr, P.F. 1959. *Optical Mineralogy*, third edition. McGraw-Hill, New York, NY.
- Lane, D.S. 1994. "Thermal Properties of Aggregates," *Significance of Tests and Properties of Concrete and Concrete-Making Materials*, P. Klieger and J.F. Lamond, Eds, Report No. ASTM STP 169C. American Society for Testing and Materials, West Conshohocken, PA, pp. 438–445.
- Lane, D.S. 2001. "Assessing Alkali-Silica Reactivity of Aggregates From Field Performance," *Proceedings of the 9th Annual Symposium*. International Center for Aggregates Research, Austin, TX.
- Larsen, E.S., and Berman, H. 1964. "Microscopical Determination of the Non-Opaque Minerals," *Geological Survey Bulletin 848*. U.S. Government Printing Office, Washington, DC.

Legatski, L.A. 1994. "Cellular Concrete," *Significance of Tests and Properties of Concrete and Concrete-Making Materials*, P. Klieger and J.F. Lamond, Eds., Report No. ASTM STP 169C. American Society for Testing and Materials, West Conshohocken, PA, pp. 533–539.

Lerch, W. 1957. "Plastic Shrinkage," *Journal of the American Concrete Institute, Volume 28, Proceedings 53*, pp. 797–802.

Liu, J.J., and Khan, M. 2000. "Comparison of Known and Determined Water-Cement Ratios Using Petrography," *Water-Cement Ratio and Other Durability Parameters: Techniques for Determination*, Report No. ACI SP-191. American Concrete Institute, Farmington Hills, MI, pp. 11–25.

Lord, G.W., and Willis, T.F. 1951. "Calculation of Air Bubble Size Distribution From Results of a Rosiwal Traverse of Aerated Concrete," *ASTM Bulletin No. 177*. American Society for Testing and Materials, West Conshohocken, PA.

Lutz, L.A. 1978. "Bond With Reinforcing Steel," *Significance of Tests and Properties of Concrete and Concrete-Making Materials*, Report No. ASTM STP 169B. American Society for Testing and Materials, West Conshohocken, PA, pp. 320–331.

Lutz, L.A. 1994. "Bond With Reinforcing Steel," *Significance of Tests and Properties of Concrete and Concrete-Making Materials*, Report No. ASTM STP 169C. American Society for Testing and Materials, West Conshohocken, PA, pp. 202–209.

Mather, B. 1957. "Laboratory Tests of Portland Blast-Furnace Slag Cements," *Journal of the American Concrete Institute, Volume 20, Proceedings 54*, pp. 205–232.

Mather, B. August 30, 1989. Letter to Kathy Greene, ASTM, Philadelphia, PA.

Mather, K. 1966. "Petrographic Examination of Hardened Concrete," *Significance of Tests and Properties of Concrete and Concrete-Making Materials*. American Society for Testing and Materials, West Conshohocken, PA, pp. 125–143.

Mather, K. 1978. "Petrographic Examination," *Significance of Tests and Properties of Concrete and Concrete-Making Materials*, Report No. ASTM STP 169B. American Society for Testing and Materials, West Conshohocken, PA, pp. 132–145.

Mather, K.; Buck, A.; and Luke, W. 1964. Alkali-Silica and Alkali-Carbonate Reactivity of Some Aggregates From South Dakota, Kansas, and Missouri, *Highway Research Record 45*. Highway Research Board, Washington, DC, pp. 72–109.

Mather, K., and Mather, B. 1991. "Aggregates," *Centennial Special, Volume 3*. Geological Society of America, pp. 323–332.

Mielenz, R.C. 1956. "Petrographic Examination of Concrete Aggregates," *Significance of Tests and Properties of Concrete and Concrete-Making Materials*, Report No. ASTM STP 169A. American Society for Testing and Materials, West Conshohocken, PA, pp. 253–273.

Mielenz, R.C. 1962. "Petrography Applied to Portland Cement Concrete," *Reviews in Engineering Geology, Volume 1*, pp. 1–38.

Mielenz, R.C. 1994. "Petrographic Evaluation of Concrete Aggregates," *Significance of Tests and Properties of Concrete and Concrete-Making Materials*, P. Klieger and J.F. Lamond, Eds., Report No. ASTM STP 169C. American Society for Testing and Materials, West Conshohocken, PA, pp. 341–364.

Missouri DOT, Research Development and Technology Division. 2000. *Automated Imaging System for Concrete Analysis*, Research Investigation RI 98-006. St. Paul, MO.

Mullen, W.G. 1978. "Weight, Density, Absorption and Surface Moisture," *Significance of Tests and Properties of Concrete and Concrete-Making Materials*, Report No. ASTM STP B. American Society for Testing and Materials, West Conshohocken, PA, pp. 629–645.

Newlon, H., Jr. 1978. "Resistance to Weathering," *Significance of Tests and Properties of Concrete and Concrete-Making Materials*, Report No. ASTM STP 169B. American Society for Testing and Materials, West Conshohocken, PA, pp. 351–368.

Newlon, H., and Mitchell, T. 1994. "Freezing and Thawing," *Significance of Tests and Properties of Concrete and Concrete-Making Materials*, P. Klieger and J.F. Lamond, Eds., Report No. ASTM STP 169C. American Society for Testing and Materials, West Conshohocken, PA, pp. 153–163.

Newlon, H., and Ozol, M.A. 1969. *Concrete Case Study No. 20: Delayed Expansion of Concrete Delivered by Pumping Through Aluminum Pipeline*. Virginia Transportation Research Council, Charlottesville, VA.

Newlon, H., and Sherwood, W.C. 1962. "An Occurrence of Alkali-Reactive Carbonate Rock in Virginia," *Highway Research Bulletin 355*. Highway Research Board, Washington, DC.

Newlon, H.H.; Sherwood, W.C.; and Ozol, M.A. 1972. *Potentially Reactive Carbonate Rocks: A Strategy for Use and Control of Potentially Reactive Carbonate Rocks (Including an Annotated Bibliography of Virginia Research): Progress Report No. 8*, Report No. VTRC 71-R41. Virginia Transportation Research Council, Charlottesville, VA.

Ozol, M. 1994. "Alkali-Carbonate Rock Reaction," *Significance of Tests and Properties of Concrete and Concrete-Making Materials*, P. Klieger and J.F. Lamond, Eds., Report No. ASTM STP 169C. American Society for Testing and Materials, West Conshohocken, PA, pp. 372–387.

Ozyildirim, H.C. 1991. "Comparison of the Air Void Contents in Freshly Mixed and Hardened Concretes," *Cement, Concrete & Aggregates, Volume 13, No. 1*, pp. 11–17.

Palache, C.; Berman, H.; and Frondel, C. 1951–1963. *Dana's System of Mineralogy, Volumes I–III*. Wiley and Sons, New York, NY.

Perenchio, W.F. “Corrosion of Reinforcing Steel,” *Significance of Tests and Properties of Concrete and Concrete-Making Materials*, P. Klieger and J.F. Lamond, Eds., Report No. ASTM STP 169C. American Society for Testing and Materials, West Conshohocken, PA, pp. 164–172.

Peterson, K.W.; Swartz, R.A.; Sutter, L.L.; and Van Dam, T.J. 2001. “Hardened Concrete Air Void Analysis With a Flatbed Scanner,” *Transportation Research Record 1775*. Transportation Research Board, Washington, DC, pp. 36–43.

Pettijohn, F.J. 1975. *Sedimentary Rocks*. Harper and Row, New York, NY.

Philleo, R.E. 1983. “A Method for Analyzing Void Distribution in Air-Entrained Concrete,” *Cement, Concrete & Aggregates, Volume 5, No. 2*, pp. 128–130.

Pigeon, M., and Pleau, R. 1995. *Durability of Concrete in Cold Climates*. E & FN Spon, Ltd., London, England.

Pistilli, M.F. 1976. “Cement Content of Hardened Concrete,” presented at the Cement Chemists Seminar. Portland Cement Association, Skokie, IL.

Pleau, R., and Pigeon, M. 1996. “The Use of the Flow Length Concept to Assess the Efficiency of Air Entrainment With Regards to Frost Durability: Part 1, Description of the Test Method,” *Cement, Concrete & Aggregates, Volume 18, No. 1*, pp. 19–29.

Pleau, R.; Pigeon, M.; Laurencot, J.L.; and Gagne, R. 1996. “The Use of the Flow Length Concept to Assess the Efficiency of Air Entrainment With Regards to Frost Durability: Part II, Experimental Results,” *Cement, Concrete & Aggregates, Volume 18, No. 1*, pp. 30–41.

Pleau, R.; Plante, P.; Gagne, R.; and Pigeon, M. 1990. “Practical Considerations Pertaining to the Microscopical Determination of Air-Void Characteristics of Hardened Concrete (ASTM C 457 Standard),” *Cement, Concrete & Aggregates, Volume 12, No. 2*, pp. 3–11.

Poole, A.B.; McLachlan, A.; and Ellis, D.J. 1988. “A Simple Staining Technique for the Identification of Alkali-Silica Gel in Concrete and Aggregates,” *Cement and Concrete Research, Volume 18*, pp. 116–220.

Poole, A.B., and Thomas, A. 1975. “A Staining Technique for the Identification of Sulfates in Aggregates and Concrete,” *Mineralogical Magazine, Volume 40*, pp. 315–316.

Price, W.H. 1982. “Control of Cracking on Concrete During Construction,” *Concrete International, Volume 5, No. 1*, pp. 40–45.

Ray, J. 2000. "Things Petrographic Examination Can and Cannot Do With Concrete: Part Two, Some Basics and Guidelines," *Proceedings of the 22nd International Conference on Cement Microscopy*. International Cement Microscopy Association, Metropolis, IL.

Rhodes, J.A. 1978. "Thermal Properties," *Significance of Tests and Properties of Concrete and Concrete-Making Materials*, Report No. ASTM STP 169B. American Society for Testing and Materials, West Conshohocken, PA, pp. 242–261.

Rivard, P.; Fournier, B.; and Ballivy, G. 2000. "Quantitative Petrographic Technique for Concrete Damage Due to ASR: Experimental and Application," *Cement, Concrete & Aggregates, Volume 22, No. 1*, pp. 63–72.

Roberts, L.R., and Scali, M.J. 1984. "Factors Affecting Image Analysis for Measurement of Air Content," *Proceedings of the Sixth International Conference on Cement Microscopy*. International Cement Microscopy Association, Duncanville, TX.

Rogers, C.A., and Hooton, R.D. 1991. "Reduction in Mortar and Concrete Expansion With Reactive Aggregates Due to Alkali Leaching," *Cement, Concrete & Aggregates, Volume 13, No. 1*, pp. 42–49.

Rogers, A.F., and Kerr, P.F. 1942. *Optical Mineralogy*, second edition. McGraw-Hill, New York, NY.

Roy, D.M.; Grutzeck, M.W.; Scheetz, B.M.; Idorn, G.M.; Thaulow, N.; and Andersen, K.T. 1993. *Concrete Microscopy*. Report No. SHRP-C-662. Transportation Research Board, Washington, DC.

Sahu, S.; Badger, S.R.; Osgood, B.; and Thaulow, N. 2001. "Petrographic Analysis of Concrete Deterioration by Feature Relocation," *Transportation Research Record 1775*. Washington, DC, pp. 21–27.

Scanlon, J.M., and McDonald, J.E. 1994. "Thermal Properties," *Significance of Tests and Properties of Concrete and Concrete-Making Materials*, P. Klieger and J.F. Lamond, Eds., Report No. ASTM STP 169C. American Society for Testing and Materials, West Conshohocken, PA, pp. 229–239.

Schell, H., and Konecny, J. 2003. "Development of an End-Result Specification for Air Void Parameters of Hardened Concrete in Ontario's Highway Structures" (CD-ROM), 2003 Annual Meeting of the Transportation Research Board. Transportation Research Board, Washington, DC.

Schlörholtz, S.M., and Dubberke, W. 1995. "Rapid Determination of the Fly Ash Content of Construction Materials," *Cement, Concrete & Aggregates, Volume 17, No. 1*, pp. 69–75.

Schwartz, D.R. 1987. "D-Cracking of Concrete Pavements," *NCHRP Synthesis No. 134*. Transportation Research Board, Washington, DC.

Scott, M.L.; Lane, D.S.; and Weyers, R.E. 1997. *Preliminary Investigation of the Relationship Between Capillary Pore Pressure and Early Shrinkage Cracking of Concrete*, Report No. VTRC 97-R12. Virginia Transportation Research Council, Charlottesville, VA.

Simon, M.J.; Jenkins, R.B.; and Hover, K.C. 1992. "The Influence of Immersion Vibration on the Void System of Air Entrained Concrete," *Durability of Concrete*, Report No. ACI SP-131. American Concrete Institute, Farmington Hills, MI, pp. 99–126.

Snyder, K. 1997. "Discussion of 'The Use of the Flow Length Concept to Assess the Efficiency of Air Entrainment With Regards to Frost Durability: Part I, Description of the Test Method'," *Cement, Concrete & Aggregates, Volume 19, No. 2*, pp. 116–119.

Snyder, K.; Hover, K.; and Natesaiyer, K. 1991. "An Investigation of the Minimum Expected Uncertainty in the Linear Traverse Technique," *Cement, Concrete & Aggregates, Volume 13, No. 1*, pp. 3–10.

Snyder, K.; Natesaiyer, K.; and Hover, K. 2001. "The Stereological and Statistical Properties of Entrained Air Voids in Concrete: A Mathematical Basis for Air Void System Characterization," *Materials Science of Concrete VI*. The American Ceramic Society, Westerville, OH, pp. 129–214.

Soeder, D.J. 1990. "Applications of Fluorescence Microscopy to Study of Pores in Tight Rocks," *The American Association of Petroleum Geologists Bulletin, Volume 74, No. 1*, pp. 30–40.

Sommer, H. 1979. "The Precision of the Microscopical Determination of the Air-Void System in Hardened Concrete," *Cement, Concrete & Aggregates, Volume 1, No. 2*, pp. 49–55.

St. John, D.S.; Poole, A.W.; and Sims, I. 1998. *Concrete Petrography: A Handbook of Investigative Techniques*. Arnold (John Wiley and Sons), New York, NY.

Stanton, T.E. 1940. "Expansion of Concrete Through Reaction Between Cement and Aggregate," *Proceedings of the American Society of Civil Engineers, Volume 66*, pp. 1781–1811 (also published with discussions in 1942 *ASCE Transactions, Volume 107*, pp. 54–126).

Stark, D. 1990. *Handbook for the Identification of Alkali-Silica Reactivity in Highway Structures*, Report No. SHRP C/FR-91-101. Transportation Research Board, Washington, DC.

Stark, D. 1991. "The Moisture Condition of Field Concrete Exhibiting Alkali-Silica Reaction," *Durability of Concrete*, Report No. ACI SP-126. American Concrete Institute, Farmington Hills, MI, pp. 973–987.

Stark, D.; Morgan, B.; Okamoto, P.; and Diamond, S., 1993. *Eliminating or Minimizing Alkali-Silica Reactivity*, Report No. SHRP C-343. Strategic Highway Research Program, Washington, DC.

Steidtmann, E. 1917. "The Origin of Dolomite as Disclosed by Stains and Other Methods," *Bulletin of the American Geological Society*, Volume 2, pp. 431–458.

Strategic Highway Research Program. 1991. *Handbook for the Identification of Alkali-Silica Reactivity in Highway Structures*, Report No. SHRP C/FR-91-101. Transportation Research Board, Washington, DC.

Struble, L., and Stutzman, P.E. 1989. "Epoxy Impregnation of Hardened Cement for Microstructural Characterization," *Journal of Materials Science Letters*, Volume 8, pp. 632–634.

Stutzman, P.E. 1990. *Serial Sectioning of Hardened Cement Paste for Scanning Electron Microscopy*, Report No. NIST IR 90-4235. National Institute for Standards and Technology, Gaithersburg, MD.

Stutzman, P.E. 1991. "Cement Clinker Characterization by Scanning Electron Microscopy," *Cement, Concrete & Aggregates*, Volume 13, No. 2, pp. 109–114.

Stutzman, P.E. 1993. "Applications of Scanning Electron Microscopy in Cement and Concrete Petrography," *Petrography of Cementitious Materials*, S. DeHayes and D. Stark, Eds., Report No. ASTM STP 1215. American Society for Testing and Materials, West Conshohocken, PA, pp. 74–90.

Stutzman, P.E., and Bentz, D.P. 1993. "Imaging of Cement and Image-Based Simulation of Hardened Cement Microstructure," *Proceedings of the 15th International Conference on Cement Microscopy*, International Cement Microscopy Association, Duncanville, TX, pp. 312–323.

Stutzman, P.E., and Clifton, J.R. 1999. "Specimen Preparation for Scanning Electron Microscopy," *Proceedings of the 21st International Conference on Cement Microscopy*. International Cement Microscopy Association, Duncanville, TX, pp. 10–22.

Sutter, L.L.; Peterson, D.R.; Van Dam, T.J.; Smith W.D.; and Wade, M.J. 2002. *Guidelines for Detection, Analysis, and Treatment of Materials-Related Distress in Concrete Pavements, Volume 3: Case Studies*, Report No. FHWA-RD-01-165. Turner-Fairbank Highway Research Center, McLean, VA.

Swenson, E.G. 1957. "A Reactive Aggregate Undetected by ASTM Tests," *ASTM Bulletin No. 226*. American Society for Testing and Materials, West Conshohocken, PA.

Swenson, E.G., and Gillot, J.E. 1960. "Characteristics of Kingston Carbonate Rock Reaction," *Highway Research Board Bulletin 275*. Highway Research Board, Washington, DC.

Transportation Research Board, Committee on Chemical Additions and Admixtures for Concrete. 1990. *Transportation Research Circular 535*. National Research Council, Washington, DC.

Tuthill, L. 1982. "Alkali-Silica Reaction: 40 Years Later," *Concrete International*, April, pp. 32–36.

Van Dam, T.J.; Sutter L.L.; Smith, K.D.; Wade, M.J.; and Peterson, K.R. 2002a. *Guidelines for Detection, Analysis, and Treatment of Materials-Related Distress in Concrete Pavements, Volume 1, Final Report*, Report No. FHWA-RD-01-163. Turner-Fairbank Highway Research Center, McLean, VA.

Van Dam, T.J.; Sutter L.L.; Smith, K.D.; Wade, M.J.; and Peterson, K.R. 2002b. *Guidelines for Detection, Analysis, and Treatment of Materials-Related Distress in Concrete Pavements, Volume 2, Guidelines*, Report No. FHWA-RD-01-164. Turner-Fairbank Highway Research Center, McLean, VA.

Verbeck, G. 1966. "Pore Structure," *Significance of Tests and Properties of Concrete and Concrete-Making Materials*, Report No. ASTM STP 169A. American Society for Testing and Materials, West Conshohocken, PA, pp. 211–219.

Verbeck, G. 1978. "Pore Structure," *Significance of Tests and Properties of Concrete and Concrete-Making Materials*, Report No. ASTM STP 169B. American Society for Testing and Materials, West Conshohocken, PA, pp. 262–274.

Walker, H.N. 1967. *Alkali-Carbonate Reaction Products Found in Mortar Bars and Prisms*. Virginia Transportation Research Council, Charlottesville, VA.

Walker, H.N. 1972. *Void Parameters of 24 Cores of Concrete Removed From a Consolidation Test Study Section of I64*, Report No. VTRC 72-R13. Virginia Transportation Research Council, Charlottesville, VA.

Walker, H.N. 1978. "Chemical Reactions of Carbonate Aggregates in Cement Paste," *Significance of Tests and Properties of Concrete and Concrete-Making Materials*, Report No. ASTM STP 169B. American Society for Testing and Materials, West Conshohocken, PA, pp. 722–743.

Walker, H.N. 1979. *Evaluation and Adaptation of the Dobrolubov and Romer Method of Microscopic Examination of Hardened Concrete*, Report No. VTRC 79-R42. Virginia Transportation Research Council, Charlottesville, VA.

Walker, H.N. 1980. "Formula for Calculating Spacing Factor for Entrained Air Voids," *Cement, Concrete & Aggregates, Volume 2, No. 2*, pp. 63–66.

Walker, H.N. 1981. "Examination of Portland Cement Concrete by Fluorescent Light Microscopy," *Proceedings of the Third International Conference on Cement Microscopy*. International Cement Microscopy Association, Duncanville, TX, pp. 257–278.

Walker, H.N. 1983. *Bias of Air-Void System Data From Fly Ash Concretes*. Report No. VTRC 84-R6. Virginia Transportation Research Council, Charlottesville, VA.

Walker, H.N. 1988. "Detecting Flawed and Non-Standard Concrete," VTRC Videotape No. VT-104. Virginia Transportation Research Council, Charlottesville, VA.

Walker, H.N., and Marshall, B.F. 1979. "Methods and Equipment Used in Preparing and Examining Fluorescent Ultrathin Sections of Portland Cement Concrete," *Cement, Concrete & Aggregates, Volume 1, No. 1*, pp. 3–9.

Walker, R.D. 1978. "Needed Research," *Significance of Tests and Properties of Concrete and Concrete-Making Materials*, Report No. ASTM STP 169B. American Society for Testing and Materials, West Conshohocken, PA, pp. 49–56.

Webb, J.W. 1970. *The Wearing Characteristics of Mineral Aggregates in Highway Pavements*, Report No. VTRC 70-R7. Virginia Transportation Research Council, Charlottesville, VA.

Whiting D.A., and Nagi, M.A. 1998. *Manual on Control of Air Content in Concrete*, PCA Report No. EB116. Portland Cement Association, Skokie, IL.

Whiting, N. 1999. "Capillary Porosity as It Relates to Durability of Pavements Built With Alkali-Silica Reactive Aggregates," *Transportation Research Record 1668*. Transportation Research Board, Washington, DC, pp. 91–96.

Wilk, W.; Dobrolubov, G.; and Romer, B. 1974. "Development in Quality Control of Concrete During Construction," *Transportation Research Record 504*. Transportation Research Board, Washington, DC.

READING LIST

The literature on these subjects is voluminous. It is impossible to include all of the worthwhile works. A few are listed. It is recommended that the reader pursue individual subjects of interest by consulting the bibliographies of the individual entries.

AGGREGATES (ALSO SEE PETROGRAPHIC METHODS)

Bates, R.L., and Jackson, J.A., Eds. 1987. *Glossary of Geology*, third edition. American Geological Institute, Alexandria, VA.

The paperback version, *The Dictionary of Geology*, can be almost as useful. One of these two references should be available to writers and clerical workers in the geological fields.

Deer, W.A.; Howie, R.A.; and Zussman, J. 1962–1963. *Rock Forming Minerals, Volumes 1–5*. Longman, Green, and Co., Ltd., London, England.

This five-volume work should be available to all whose work includes the identification of mineral species. The minerals are grouped according to families (e.g., feldspars together, micas together). The end members of each family group are described, and the variation in chemical composition, indices of refraction, optical properties, etc., between members are identified. Sketches of the crystal orientation and numerous chemical analyses contribute to the usefulness of this work.

Deer, W.A.; Howie, R.A.; and Zussman, J. 1992. *An Introduction to the Rock Forming Minerals*. Longman, Green, and Co., Ltd., London, England.

A condensed version of the previous work, originally published in 1966. The expanded second edition was published in 1992.

DeHoff, R.T., and Rhines, F.N. 1968. *Quantitative Microscopy*. McGraw-Hill, New York, NY.

Dolar-Mantuani, L. 1983. *Handbook of Concrete Aggregates*. Noyes, Park Ridge, NJ.

This is a definitive and very important work that is recommended for study by anyone who has any control over the selection and purchase of aggregates for use in HCC construction.

Federal Highway Administration. 1991. *Rock and Mineral Identification for Engineers*, Report No. FHWA-HI-91-025, Washington, DC.

This guide can help practicing civil engineers in identifying rocks and minerals and understanding their characteristics and properties.

Gaynor, R.D., and Meininger, R.C. 1983. "Evaluating Concrete Sands," *Concrete International*, Volume 5, No. 12, pp. 53–60.

This work details a number of tests for the quality of sands to be used in concrete. Included are grading, sand equivalent, mica content, particle shape, surface texture, void content, and attrition. The reference list is extensive and informative.

Heinrich, E.W. 1965. *Microscopic Identification of Minerals*. McGraw-Hill, New York, NY.

Part 3 of this work has numerous useful tables and charts, including the clearest and most easily understood chart of interference colors we have seen.²⁵

Krumbein, W.C., and Pettijohn, F.J. 1938. *Manual of Sedimentary Petrography*. Appleton-Century-Crofts, New York, NY.

Milner, H.B. 1952. *Sedimentary Petrography*. T. Murby, London, England.

Mullen, W.G. 1978. "Weight, Density, Absorption and Surface Moisture," *Significance of Tests and Properties of Concrete and Concrete-Making Materials*. Report No. ASTM STP 169B. American Society for Testing and Materials, West Conshohocken, PA, pp. 629–645.

Very clearly written with good illustrations clarifying some of the concepts.

Pettijohn, F.J. 1975. *Sedimentary Rocks*. Harper and Row, New York, NY.

Well illustrated with photographs and sketches of thin sections.

Pirsson, L.V. 1953. *Rocks and Rock Minerals*. John Wiley and Sons, revised by A. Knopf, New York, NY.

Williams, H.; Turner, F.J.; and Gilbert, C.M. 1954. *Petrography: An Introduction to the Study of Rocks in Thin Section*. Freeman, San Francisco, CA.

Includes numerous sketches of the appearance of thin sections of rock under the microscope.

AGGREGATE-PASTE REACTIONS

Bensted, J., and Barnes, P., Eds. 2002. *Structure and Performance of Cements*. Spon Press, London, England, and New York, NY.

Berube, M.A.; Fournier, B.; and Durand, B. 2000. "Alkali-Aggregate Reaction in Concrete," *Proceedings, 11th International Conference*. Centre de Recherche Interuniversitaire sur le Béton CRIB [Center for Research of Infrastructure Concrete], Laval University, Ste.-Foy, Canada.

Bredsdorff, P.; Idorn, G.M.; Kjaer, A.; Plum, M.N.; and Poulsen, E. 1962. "Chemical Reactions Involving Aggregate," *Chemistry of Cement: Proceedings of the Fourth International Symposium, Volume 2*. NBS Monograph No. 43. National Bureau of Standards, Washington, DC, pp. 749–806.

Includes a discussion of the paper.

Fournier, B.; Berube, M.A.; and Bergeron, G. 1991. "A Rapid Autoclave Mortar Bar Method to Determine the Potential Alkali-Silica Reactivity of St. Lawrence Lowlands Carbonate Aggregates, Quebec, Canada," *Cement, Concrete & Aggregates, Volume 131*, pp. 58–71.

Grattan-Bellew, P.E., Ed. 1986. "Concrete Alkali-Aggregate Reactions," *Proceedings of the 7th International Conference*. Noyes Publications, Park Ridge, NJ.

Highway Research Board. 1964. "Symposium on Alkali-Carbonate Rock Reactions," *Highway Research Record 45*. Washington, DC.

Hilton, M.H. 1974. "Expansion of Reactive Carbonate Rocks Under Restraint," *Transportation Research Record* 525. Transportation Research Board, Washington, DC.

This is the only experimentation in alkali-carbonate reactions that we have heard of in which the reaction took place under restraint. In field situations, expansive reactions are almost always under the restraint of the surrounding concrete and other portions of the structure. Even small members are usually under some restraint. For a report of an alkali-silica reaction under restraint, see B.W. Houston, *Effects of Axial Restraint on Length Change of Expanding Mortar Bars*, Technical Report C-69-8, U.S. Army Corps of Engineers, Waterways Experiment Station, Vicksburg, MS, 1969.

Lane, D.S. 1994. *Alkali-Silica Reactivity in Virginia*. Report No. VTRC 94-R17. Virginia Transportation Research Council, Charlottesville, VA.

Mather, B. 1974. "Developments in Specification and Control," *Transportation Research Record* 525. Transportation Research Board, Washington, DC.

An excellent summary of the knowledge available at the time.

Newlon, H.H.; Sherwood, W.C.; and Ozol, M.A. 1972. *Potentially Reactive Carbonate Rocks: A Strategy for Use and Control of Potentially Reactive Carbonate Rocks (Including an Annotated Bibliography of Virginia Research): Progress Report No. 8*. Report No. VTRC 71-R41. Virginia Transportation Research Council, Charlottesville, VA.

All of the reports in this series may be found to be useful. This particular report includes an extensive bibliography and is listed to provide a reference and guide to the others of the Series 1 through 7b.

Okada, K.; Nishibayashi, S.; and Kawamura, M. 1989. *Alkali-Aggregate Reaction: 8th International Conference*. Elsevier Applied Science, London, England, and New York, NY.

Rogers, C.A., Ed. 1990. *Canadian Developments in Testing Concrete Aggregates for Alkali-Aggregate Reactivity*. Report No. EM-92. Engineering Materials Office, Ministry of Transportation, Downsview, Ontario, Canada.

Recommended for information concerning the most up-to-date methods of testing for alkali-carbonate, alkali-silica, and alkali-silicate reactivity.

Ryell, J.; Chojnald, B.; Woda, G.; and Koniuszy, Z.D. 1974. "The Uthoff Quarry Alkali-Carbonate Rock Reaction: A Laboratory and Field Performance Study," *Transportation Research Record* 525. Transportation Research Board, Washington, DC.

Shayan, A. 1996. "Alkali-Aggregate Reaction in Concrete," *Proceedings of the 10th International Conference*. Commonwealth Scientific & Industrial Research Organisation (CSIRO), Melbourne, Australia.

Stark, D. 1990. *Handbook for the Identification of Alkali-Silica Reactivity in Highway Structures*. Report No. SHRP-C/FR-91-101. National Research Council, Washington, DC.

This publication is noted for its fine color photographs that illustrate the features described more clearly than would black-and-white photographs.

Swenson, E.G. 1957. "A Reactive Aggregate Undetected by ASTM Tests," *ASTM Bulletin No. 226*. American Society for Testing and Materials, West Conshohocken, PA.

The first recorded instance of deterioration caused by alkali-carbonate-aggregate reactivity. As the title indicates, the ASTM tests available at the time could not detect alkali-carbonate reactivity. These early tests were designed to detect alkali-silica reactivity.

Walker, H.N. 1974. "Reaction Products in Expansion Test Specimens of Carbonate Aggregate," *Transportation Research Record 525*. Transportation Research Board, Washington, DC.

Wang, H., and Gillott, J.E. 1991. "Mechanism of Alkali-Silica Reaction and Significance of Calcium Hydroxide," *Cement and Concrete Research, Volume 21*, pp. 647–654.

AIR-VOIDS

Backstrom, J.E.; Burrows, R.C.; Mielenz, R.C.; and Wolkodoff, V.E. 1958. "Origin, Evolution, and Effects of the Air-Void System in Concrete: Part 2, Influence of Type and Amount of Air Entraining Agent," *Journal of the American Concrete Institute, Volume 30, Proceedings 55*, pp. 261–272.

Backstrom, J.E.; Burrows, R.C.; Mielenz, R.C.; and Wolkodoff, V.E. 1958. "Origin, Evolution, and Effects of the Air-Void System in Concrete: Part 3, Influence of Water-Cement Ratio and Compaction," *Journal of the American Concrete Institute, Volume 30, Proceedings 55*, pp. 359–375.

Hover, K. 1994. "Air Content and Unit Weight of Concrete," *Significance of Tests and Properties of Concrete and Concrete-Making Materials*, P. Klieger and J.F. Lamond, Eds. Report No. ASTM STP 169C. American Society for Testing and Materials, West Conshohocken, PA, pp. 296–314.

Khayat, K.H., and Nasser, K.W. 1991. "Comparison of Air Contents in Fresh and Hardened Concretes Using Different Air Meters," *Cement, Concrete & Aggregates, Volume 131*, pp. 18–24.

Mielenz, R.C.; Wolkodoff, V.E.; Backstrom, J.E.; and Burrows, R.W. 1958. "Origin, Evolution, and Effects of the Air-Void System in Concrete: Part 4, The Air Void System in Job Concrete," *Journal of the American Concrete Institute, Volume 30, Proceedings 55*, pp. 507–517.

Mielenz, R.C.; Wolkodoff, V.E.; Backstrom, J.E.; and Flack, H.L. 1958. "Origin, Evolution, and Effects of the Air-Void System in Concrete: Part 1, Entrained Air in Unhardened Concrete," *Journal of the American Concrete Institute, Volume 30, Proceedings 55*, pp. 95–121.

These four reports were written during the time that air entrainment was beginning to come into widespread use. There was still much resistance to its use, a lack of belief in its efficacy, and fear that air would lower the compressive strength of the concrete below the specified strength.

Pigeon, M., and Pleau, R., 1994. *Durability of Concrete in Cold Climates*. E & FN Spon, Ltd., London, England.

Schell, H., and Konecny, J. 2003. "Development of an End-Result Specification for Air-Void Parameters of Hardened Concrete in Ontario's Highway Structures," 2003 Annual Meeting of the Transportation Research Board, CD-ROM.

ASTM STANDARDS

The ASTM standard methods should be used with care and all applicable precautions taken. They should be conducted by persons who are qualified by education or experience to conduct such tests and use such standards. These are only a few of the test methods under the jurisdiction of Committee C-9 on Concrete and Concrete Aggregates as published in the *Annual Book of ASTM Standards, Volume 04.02, Concrete and Aggregates*. Many of the standards in this volume, in addition to those listed here, will be needed for specialized testing of individual materials such as epoxy rebar coating, fly ash, or ground granulated blast-furnace slag or as they may be referenced in other standards or for testing individual properties or kinds of concrete. The entire volume should be available for reference.

American Society for Testing and Materials. *Annual Book of ASTM Standards, Volume 04.02: Concrete and Aggregates* (published annually). West Conshohocken, PA:

C 33: Standard Specification for Concrete Aggregates

C 39: Standard Test Method for Compressive Strength of Cylindrical Concrete Specimens

C 42: Standard Test Method for Obtaining and Testing Drilled Cores and Sawed Beams of Concrete

C 117: Standard Test Method for Materials Finer Than 75- μm (No. 200) Sieve in Mineral Aggregates by Washing

C 136: Standard Method for Sieve Analysis of Fine and Coarse Aggregates

C 289: Standard Test Method for Potential Alkali-Silica Reactivity of Aggregates (Chemical Method)

C 873: Standard Test Method for Compressive Strength of Concrete Cylinders Cast in Place in Cylindrical Molds

D 2419: Standard Test Method for Sand Equivalent Value of Soils and Fine Aggregate

R 0030: Manual of Aggregate and Concrete Testing-Related Material

CEMENTS

Bensted, J., and Barnes, P. 2002. *Structure and Performance of Cements*. Spon Press, New York, NY.

Campbell, D.H. 1986. *Microscopical Examination and Interpretation of Portland Cement and Clinker*. Portland Cement Association, Skokie, IL.

The best we have seen on cement clinker. Numerous color photomicrographs.

DeHayes, S., and Stark, D., Eds. 1994. *Petrography of Cementitious Materials*. Report No. ASTM STP 1215. American Society for Testing and Materials, West Conshohocken, PA.

Hewlett, P.C., Ed. 1998. *Lea's Chemistry of Cement and Concrete*, fourth edition. John Wiley and Sons, New York, NY.

Insley, H., and Frechette, V.D. 1955. *Microscopy of Ceramics and Cements*. Academic Press, New York, NY.

Lea, F.M., and Desch, C.M. 1956. *The Chemistry of Cement and Concrete*. Edward Arnold, London, England.

Orchard, D.F. 1962. *Concrete Technology: Volume 1, Properties of Materials*. John Wiley and Sons, New York, NY.

Taylor, H.F.W. 1997. *Cement Chemistry*, second edition. Thomas Telford, London, England.

Winchell, A.N., and Winchell, H. 1964. *The Microscopical Characters of Artificial Inorganic Solid Substances: Optical Properties of Artificial Minerals*. Academic Press, New York, NY, and London, England.

D-CRACKING

Schwartz, D.R. 1987. "D-Cracking of Concrete Pavements," *NCHRP Synthesis 134*. Transportation Research Board, Washington, DC.

This is a short, easily absorbed synthesis of the state of the knowledge in 1987 on D-cracking caused by the failure of carbonate aggregate. There has been much written since, but nothing so succinct. For information on D-cracking caused by lack of an air-void system sufficient to protect the paste against freezing and thawing, see L.E. Andrews, "Record of Experimental Air-Entrained Concrete 10 to 14 Years After Construction," *Highway Research Board Bulletin 70*, Highway Research Board, Washington, DC, 1953.

PASTE

Powers, T.C. 1962. "Physical Properties of Cement Paste," *Bulletin No. 154*. Research Laboratories of the Portland Cement Association. Reprinted from "Chemistry of Cement," *Proceedings of the Fourth International Symposium*, Washington, DC, 1960. *Monograph 43, Volume II, Session V, Paper V-1*, pp. 577-609. National Bureau of Standards, Washington, DC.

Powers, T.C., and Brownyard, T.L. 1948. "Studies of the Physical Properties of Hardened Portland Cement Paste," *Bulletin No. 22*. Research Laboratories of the Portland Cement Association. Reprinted from *Journal of the American Concrete Institute*, October 1946–April 1947, *Proceedings 43*, Detroit, MI.

PETROGRAPHIC METHODS

Beauchamp, R.H., and Williford, J.F. 1974. "Metallographic Methods Applied to Ultrathinning Lunar Rocks, Meteorites, Fossils, and Other Brittle Materials for Optical Microscopy," *Metallographic Specimen Preparation: Optical and Electron Microscopy*, J.L. McCall and W.M. Muller, Eds. Plenum Press, New York, NY, pp. 233–250.

Beauchamp, R.H., Williford, J.F., and Gafford, E.L. 1972. *Exploratory Development and Services for Preparing and Examining Ultrathin Polished Sections of Lunar Rocks and Particulates, NASA 9-11993, 211b00862: Final Report, Parts I and II*. Revision 1 to NASA Manned Spacecraft Center, Houston, TX. Pacific Northwest Laboratories, A Division of Battelle Memorial Institute, Richland, WA.

Of these two publications by this team of Beauchamp, et al., the first is more readily available and has some very instructive photographs; however, the second, available only from the authors, has much more detailed information concerning the sample preparation procedures used for fabricating thin sections of lunar rock. Some of these procedures were adapted at VTRC for use in the fabrication of thin sections of concrete (H.N. Walker and B.F. Marshall, "Methods and Equipment Used in Preparing and Examining Fluorescent Ultrathin Sections of Portland Cement Concrete," *Cement, Concrete & Aggregates, Volume 11*, 1979, pp. 3–91).

Bloss, F.D. 1961. *An Introduction to the Methods of Optical Crystallography*. Holt Rinehart and Winston, New York, NY.

This work places more emphasis on cataloging mineral species by means of their birefringence than does any other text on optical crystallography or petrography we have encountered.

DeHoff, R.T., and Rhines, F.N. 1968. *Quantitative Microscopy*. McGraw-Hill, New York, NY.

French, W.J. 1991. "Concrete Petrography: A Review," *Quarterly Journal of Engineering Geology, Volume 24*, pp. 17–48.

Hutchinson, C.S. 1974. *Laboratory Handbook of Petrographic Techniques*. John Wiley and Sons, New York, NY.

Johannsen, A. 1968. *Manual of Petrographic Methods* (facsimile of the second edition, 1918). Hefner, New York, NY.

"The first attempt to give in English a comprehensive review of petrographic methods" (from the dust jacket). It elucidates the optical parameters of crystalline substances and the use of the modern type of petrographic microscope for determining the optical properties of minerals and the principles of light, harmonic motion, lenses, and other related subjects.

Kerr, P.F. 1959. *Optical Mineralogy*, third edition. McGraw-Hill, New York, NY.

Larsen, E.S., and Berman, H. 1964. "Microscopical Determination of the Non-Opaque Minerals," *Geological Survey Bulletin 848*. U.S. Government Printing Office, Washington, DC.

This indispensable work includes chapters on the determination of the optical constants of minerals and, most important, various arrangements of tables of the optical properties. The optical character of the mineral is considered the most important subdivision. Tables are available under each subdivision in order of the indices of refraction of the minerals.

Nicol, W. 1828–1829. "On a Method of So Far Increasing the Divergence of the Two Rays in Calcareous-Spar That Only One Image May Be Seen at a Time," *The Edinburgh New Philosophical Journal, Volume 6*, pp. 83–94 (cited in Johannsen, 1968).

Ray, J.A. 1983. "Things Petrographic Examination Can and Cannot Do With Concrete," *Proceedings of the Fifth International Conference on Cement Microscopy*. International Cement Microscopy Association, Duncanville, TX.

Ray, J.A. 1984. "Preparation of Concrete Samples for Petrographic Studies," *Proceedings of the Sixth International Conference on Cement Microscopy*. International Cement Microscopy Association, Duncanville, TX.

Ray, J.A. 1987. "Concrete Problems Associated With Air Entrainment," *Proceedings of the Ninth International Conference on Cement Microscopy*. International Cement Microscopy Association, Duncanville, TX.

Roy, D.M.; Grutzeck, M.W.; Scheetz, B.M.; Idorn, G.M.; Thaulow, N.; and Andersen, K.T. 1993. *Concrete Microscopy*. Report No. SHRP-C-662. Transportation Research Board, Washington, DC.

St. John, D.S.; Poole, A.W.; and Sims, I. 1998. *Concrete Petrography: A Handbook of Investigative Techniques*. Arnold (John Wiley and Sons), New York, NY.

Wahlstrom, E.E. 1955. *Petrographic Mineralogy*. Wiley, New York, NY.

Notable for its charts on feldspars and igneous rocks.

Wilk, W.; Dobrolubov, G.; and Romer, B. 1974. "Development in Quality Control of Concrete During Construction," *Transportation Research Record 504*. Transportation Research Board, Washington, DC.

This work is the source of the idea of using fluorescent illumination to distinguish true void areas from the areas of the paste that have little or no birefringence. Thus, fluorescence can be used to locate and enhance microcracking and zones of high capillarity. This report contains many other ideas, for example, quick testing for resistance to freezing and thawing and a numerical scale by which to grade each concrete.

REFERENCE COLLECTIONS

American Concrete Institute. *ACI Manual of Concrete Practice, Volumes 1–5*, (revised yearly). Farmington Hills, MI.

This manual is a very important reference and should be available to all concrete technologists.

American Society for Testing and Materials. 1994. *Significance of Tests and Properties of Concrete and Concrete-Making Materials*, P. Klieger and J.F. Lamond, Eds. Report No. ASTM STP 169C. West Conshohocken, PA.

This worthwhile work is a revision and expansion of ASTM STP 169B (1978), and thus of STP 169 (1956) and STP 169A (1966). All volumes of the STP 169 series have the same title. Each of these volumes can be considered to outline the state of the art for the time each was written. Thus, together they detail the recent history of concrete technology. STP 169D is being prepared.

American Society for Testing and Materials, Committee on Performance of Concrete Chemical Aspects, C-9.02.02, Ed. 1965. "A Symposium on Alkali-Carbonate Rock Reactions," *Highway Research Record 45*. Highway Research Board, Washington, DC.

National Bureau of Standards. 1962. *Chemistry of Cement: Proceedings of the Fourth International Symposium, Volumes 1 and 2*. NBS Monograph No. 43. Washington, DC.

This entire monograph is a classic work and includes discussions of many of the papers. Volume 2 is mainly concerned with alkali-silica reactions.

Transportation Research Board. 1974. "Cement Aggregate Reactions," *Transportation Research Record 525*. Transportation Research Board, Washington, DC.

TERMINOLOGY

American Concrete Institute. ACI 116R: Cement and Concrete Terminology, *ACI Manual of Concrete Practice: Part 1, Materials and General Properties of Concrete*. Farmington Hills, MI.

American Society for Testing and Materials. ASTM C 125: Standard Terminology Relating to Concrete and Concrete Aggregates, *Annual Book of ASTM Standards: Volume 04.02, Concrete and Aggregates*. West Conshohocken, PA.

Bates, R.L., and Jackson, J.A., Eds. 1987. *Glossary of Geology*, third edition. American Geological Institute, Alexandria, VA

