

# Applied Biosafety

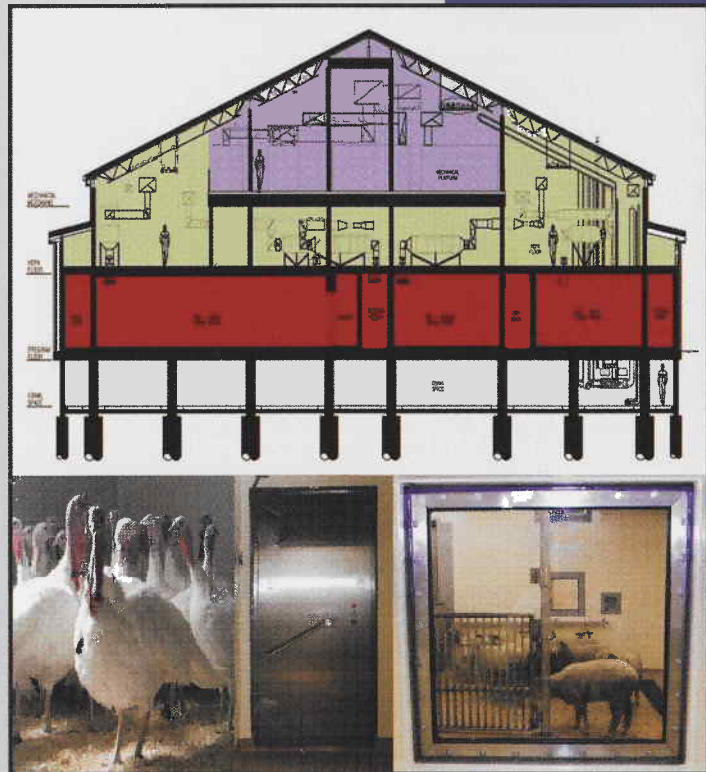

*Journal  
of the  
American  
Biological  
Safety  
Association*



Volume 12, Number 3, 2007

## Energy Efficient Laboratory Design: A Novel Approach to Improve Indoor Air Quality and Thermal Comfort

Farhad Memarzadeh<sup>1</sup>, Andy Manning<sup>2</sup>, and Zheng Jiang<sup>2</sup>

<sup>1</sup>National Institutes of Health, Bethesda, Maryland and <sup>2</sup>Flomerics, Inc., Marlborough, Massachusetts

### Abstract

*The requirements of laboratory facilities differ dramatically from those of other buildings. As we expand our biocontainment needs to Biosafety Levels (BSL) -2, -3, and -4, a clear need exists for an air quality and thermal comfort initiative targeting these facilities. The thermal comfort of occupants in laboratories can be controlled by the choice of ventilation strategy. Added benefits are the realization of a significant energy savings and improved indoor air quality. This study employs an advanced numerical simulation and empirical validation to assess the performance of active chilled beams in a general laboratory layout having some equipment intensive areas. The study examines the removal effectiveness of gases and airborne particles in such a system. Chilled beam performance is also compared to a ceiling diffuser system with and without cooling panels. The results of this study show that chilled beams improve thermal comfort and can be operated at reduced Air Changes per Hour (ACH) while maintaining a comfortable environment in occupied zones expressed as the Predicted Percentage Dissatisfied (PPD). To obtain a similar level of thermal comfort, a higher ACH is required in a ceiling diffuser system with cooling panels and bench exhausts. The chilled beam system also improves the removal effectiveness of gases, or airborne particles because of the inherent better mixing in the room compared with the use of ceiling diffusers. In the cases studied, chilled beams have an insignificant effect on the fume hood containment. As satisfactory thermal comfort and air quality was achieved at a lower flow rate when compared with an all-air ceiling diffuser system, a savings of around 22% is estimated in annual energy costs for cooling and ventilating a typical lab in the Washington, DC area. The methodology and results of this study may be applied to further research for other laboratory types, or climatic conditions than those proposed in this study.*

### Introduction

A large portion of the laboratory space cooling load is from heat producing research equipment located on

benches. Moreover, many chemicals used in laboratories are harmful to occupants' health. Inhalation exposure is a common concern raised by laboratory occupants. The ventilation flow rate required to cool these laboratories and meet local exhaust requirements is usually high. Care needs to be taken in the design of the ventilation system, particularly in instances where a fume hood and/or biosafety cabinet is present. In particular, significant airflow across, or into the face of the fume hood, can dramatically affect the hood containment. A general laboratory uses more energy and water per square foot than the typical office building due to ventilation requirements and other health and safety concerns. Because the requirements of laboratory facilities differ so dramatically from those of other buildings, a clear need exists for an initiative that exclusively targets these facilities. This is especially important as we move to Biosafety Levels (BSL) -2, -3, and -4. The use of chilled beams is not intended to be applicable to all types of laboratories. For example, the use of chilled beams would not be appropriate for BSL-3 or BSL-4 laboratories where the accepted methodologies for control should not be compromised. Further, chilled beams should only be considered for BSL-2 laboratories after extensive consultation with experienced engineers who understand the nature of the work performed in the laboratory. The use of chilled beams should not override the contaminant controls that are appropriate for a containment laboratory, particularly with respect to the use of appropriate biosafety cabinets (BSC), or the handling of hazardous materials on workbenches. Although parts of this study were conducted in the presence of a fume hood rather than biosafety cabinets, the results should be generally applicable to Class I and II biosafety cabinets (BSC). Typical BSC types involve a laminar airflow regime, which serves to protect the scientist from particulates as well as the product in the cabinet. The strict applicability of results from the fume hood cases to BSC scenarios is dependent on the flow profile at the sash and the average face velocity, which should be similar in both scenarios. Developed in the 1980s, chilled beams are a relatively new technology (Virta et al., 1995; Barista, 2005). This type of room air-conditioning has spread rapidly in Europe where it is used to provide comfort cooling in both new and refurbished commercial and industrial

non-laboratory buildings. Chilled beams are flexible, simple to install and maintain, and provide an energy efficient, cost-effective alternative to traditional cooling systems. Chilled beams have not yet been employed in a laboratory setting, but the technology is sufficiently appropriate for BSL-1 and some BSL-2 laboratories.

There are two basic types of chilled beams: active and passive (Building Services Research and Information Association, 2001). Passive beams, which provide only cooling, rely entirely on the natural convection process with chilled water coils and no air supply to the unit. Room air supply is typically provided via floor, or low wall registers similar to displacement ventilation. Active beams with chilled water coils and an air supply connection, offer an increased cooling capacity using a primary air supply to cause induced convection over the water coils. The primary airflow required for fresh air supply is discharged into a mixing zone via nozzles. The induced air is drawn from the room through a water coil. In the mixing section, the induced air is mixed with the primary air and the total discharged into the room via slots as shown in Figure 1. With active chilled beams, the air is cooled by means of cold water, and the supply airflow rate is dimensioned in a way that fulfills the requirement of good air quality. Chilled beams combine the airflow characteristics of ceiling diffusers with the energy benefits of load dissipation using water. Active chilled beams can provide cooling, heating, and ventilation.

In all-air systems, air is used to ventilate the buildings in order to maintain a high level of indoor air quality as well as to provide thermal comfort in the buildings. With chilled beams, the airflow rates of the system need only satisfy the indoor air quality requirements. A cooling capacity, ranging from 90 W/m<sup>2</sup> to 120W/m<sup>2</sup> can be provided by using a water-cooled coil system. The room air temperature can be controlled by regulating the water flow rate of the cooling coil. This is because water cooling can be more energy-efficient than air-based systems (Mumma, 2001); it requires less parasitic energy

(pump and fan energy) to remove heat from a space. Laboratories that are heavily equipped present the most ideal application of chilled beam technology, because they often require many more air changes per hour than is required by code just to offset the heat gain from the lab equipment. By cooling and recirculating the air of the chilled beams, the amount of air changes in a typical lab can be reduced. With fewer air changes needed, ductwork, air-handling units, exhaust fans and chillers can all be downsized to offset the cost of the chilled beam units and infrastructure.

The use of radiant cooling panels or a chilled beam system is an alternative to air/water systems that separate the tasks of ventilation and thermal space conditioning by using the forced air to fulfill ventilation requirements and using radiant cooling panels to provide most of the cooling. In situations where the walls are radiantly cooled, the air temperature can be warmer to achieve the same level of comfort. A warmer air temperature results in lower energy loss to the outdoors. However, the preferred installation of the radiant cooling panel is ceiling mounted as this reduces air stratification and facilitates collection of condensation. This study also assesses the performances and energy costs of the cooling panel system and compares them with those of chilled beams.

## Purpose of This Study

Focusing on active chilled beams, this study investigates and compares different types of ventilation strategies in their performances and annual energy costs. The primary objectives of this study are:

- To assess the performance of active chilled beams in achieving required thermal comfort with minimum ventilation flow rate requirements and compare it with that of a ceiling diffuser system with and without radiant cooling panels.
- To evaluate chilled beams' effectiveness when it comes to removal of gases and airborne particles and

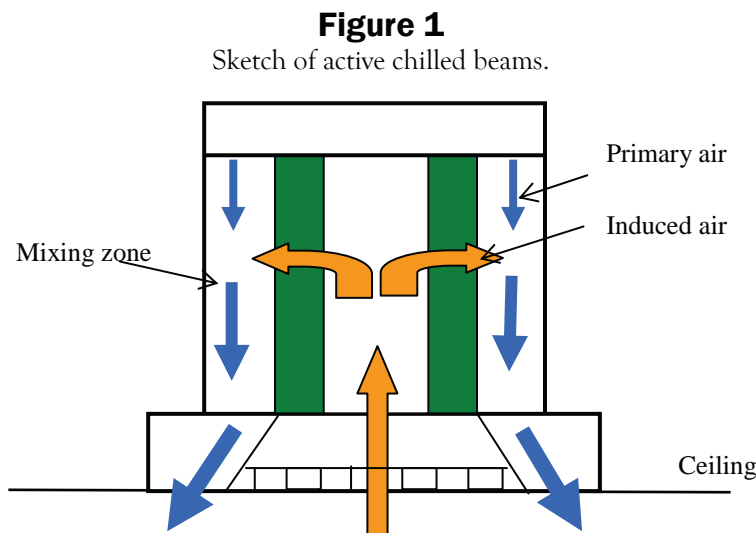

their effects on fume hood containment.

- To evaluate the cost reduction as a result of using chilled beams with reduced ventilation flow rate.

## Methodology and Validation

Computational Fluid Dynamics (CFD) is a very powerful and efficient methodology to study temperature and flow fielding in a room where there are many parameters involved (Memarzadeh, 1998; Jiang et al., 1995; Kang et al., 2001). It solves the set of Navier Stokes equations by superimposing a grid system containing a huge number of cells, which describe the physical geometry heat and contamination sources and air itself. Figure 2 shows a typical laboratory with space discretization subdividing the laboratory into the cells.

In this study, CFD with a finite-volume approach (Flomerics, 1995) was used to consider the discretization and solution of the equations. The simultaneous equations thus formed are solved iteratively for each one of these cells to produce a solution that satisfies the conservation laws for mass momentum and energy. As a result, the flow can then be traced in any part of the room simultaneously coloring the air according to another parameter such as temperature. The airflow in a ventilated laboratory is turbulent. In this study, the turbulence is simulated with the  $k-\epsilon$  model (Wilcox, 1993; Chen, 1995). The  $k-\epsilon$  turbulence model represents the most appropriate choice, because of its extensive use in other research applications such as predicting mixing rate of a jet flow and modeling airflow in urban open space (Gregory-Smith et al., 1996; Palmer et al., 2003). No other turbulence model has been developed that is as universally accepted as the  $k-\epsilon$  turbulence model.

This methodology was used extensively by Memarzadeh (Memarzadeh, 1998) in the "Ventilation Design Handbook on Animal Research Facilities Using Static Microisolators." In order to analyze the ventilation performance of different settings, numerical methods based on CFD were used to create computer simulations of more than 160 different room configurations. The per-

formance of this approach was successfully verified by comparison with an extensive set of experimental measurements. A total of 12.9 million experimental data values were collected to confirm the methodology. The average error between the experimental and computational values was 14.36% for temperature and velocities, while the equivalent value for concentrations was 14.50%.

The Predicted Percentage Dissatisfied (PPD) index produced by Fanger and given in the American Society of Heating, Refrigerating and Air-Conditioning Engineers (ASHRAE) guide (ASHRAE, 1997a) is widely used in assessing thermal comfort (Memarzadeh et al., 2000). This index can be estimated by equations that are based on an empirical investigation of how people react to differing environments. In CFD simulation, PPD can be calculated for each cell in turn and a volume weighted average can be produced for a specific zone. It is well-known that each individual has a different perception of the climate in a building and that any given climate is unlikely to be considered satisfactory by all. In fact, 80% occupant satisfaction is considered good, or a PPD of less than 20%. The PPD is directly related to the Predicted Mean Vote (PMV). While PPD provides the information as to whether or not the environment is likely to be acceptable, PMV tells us what the problem is—whether it is too hot or too cold—when the number dissatisfied is too large. The equations implemented in the analysis shown here are taken from Fanger's equations for PMV and PPD as given in BS EN ISO 7730: 1995.

### Definitions

$$\begin{aligned} \text{PMV} = & (0.303e^{-0.036M} + 0.028)\{(M - W) - 3.05 \times 10^{-3}[5733 - \\ & 6.99(M - W) - p_a] - 0.42[(M - W) - 58.15]1.7 \times 10^{-5} \\ & M(5867 - p_a) - 0.0014M(34 - t_a) - 3.96 \times 10^{-8} f_{cl}[(t_{cl} \\ & + 273)^4 - (t_r + 273)^4] \\ & + f_{cl} h_c (t_{cl} - t_a)\} \end{aligned} \quad (2)$$

where

$$\begin{aligned} t_{cl} = & 35.7 - 0.028(M - W) - I_{cl}\{(3.96 \times 10^{-8} f_{cl}[(t_{cl} + 273)^4 - (t_r + \\ & 273)^4] + f_{cl} h_c (t_{cl} - t_a)\} \\ h_c = & 2.38(t_{cl} - t_a)^{0.25} \quad \text{or} \quad h_c = 12.1v^{0.5} \end{aligned}$$

**Figure 2**

Super-imposed grid of cells for calculation.

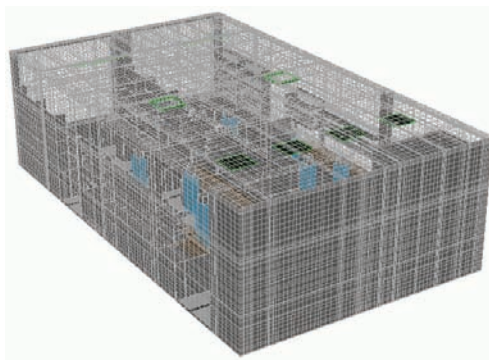



whichever is greater  
 $f_{cl} = 1.00 + 1.29I_{cl}$  for  $I_{cl} \leq 0.078 \text{ m}^2\text{KW}^{-1}$  or  $f_{cl} = 1.05$   
 $+ 0.645I_{cl}$  for  $I_{cl} > 0.078 \text{ m}^2\text{KW}^{-1}$   
 $PPD = 100 - 95e^{-n}$  (3)

where  $n = 0.03353PMV^4 + 0.2179PMV^2$

**List of Symbols**

- PMV= Predicted Mean Vote
- PPD = Predicted Percentage Dissatisfied
- M = Metabolic rate (W/m<sup>2</sup> of the body area)
- W = External work (W/m<sup>2</sup> of the body area [ = 0 in most cases])
- I<sub>cl</sub> = thermal resistance of clothing (m<sup>2</sup>KW-1)
- f<sub>cl</sub> = Ratio of clothed surface area to nude surface area
- t<sub>a</sub> = Air temperature (°C)
- t<sub>r</sub> = Mean radiant temperature (°C)
- v = Air velocity relative to the body (ms-1)
- p<sub>a</sub> = Partial water vapor pressure in Pa
- h<sub>c</sub> = Convective heat transfer coefficient (Wm<sup>2</sup>K)
- t<sub>cl</sub> = Clothing surface Temperature (°C)

**Model Setup**

A generic laboratory that had one island bench, two wall benches, one two-way throw, and two one-way throw chilled beams was developed as the laboratory model for this study as shown in Figure 3. Using the same chilled beams, six cases were studied at different primary supply flow rates and with and without a fume hood fitted, as

listed in Table 1. The supply angle of the beams was 45° from the ceiling for all cases. In Cases 4 through 6, a fume hood was located against the wall opposite the windows. These cases were designed to investigate the effects of the chilled beams on the fume hood containment, as well as the effectiveness of the beams in removing the contaminant from the room if there was a contaminant spill on the bench top.

The induced flow rate of the chilled beams is dependent upon the primary flow rate and the dimension and type of the nozzle through which primary air is supplied to the mixing zone (Figure 1). This study does not take into account geometric details to accurately calculate the pressure in the mixing zone and, therefore, to determine the exact induced airflow rate for each case. In this study, typical ratios of the induced flow rate to the primary flow rate were employed. The temperature drop of the induced flow through a cooling coil was treated in the same way as this parameter could be regulated to the required value by adjusting the cooling water flow rate. The same beam geometry was used for different airflow rates, which makes sense within a narrow range of values. In reality; however, the geometry of the beam and some of the system operating parameters such as air temperature, water temperature, nozzle quantity and type need to be changed to achieve the mix airflow for total load capacity that the room requires.

The following assumptions were made in the model laboratory for this study.

- **Room dimensions:** 6.35m (20' 10") wide, 11m (36')

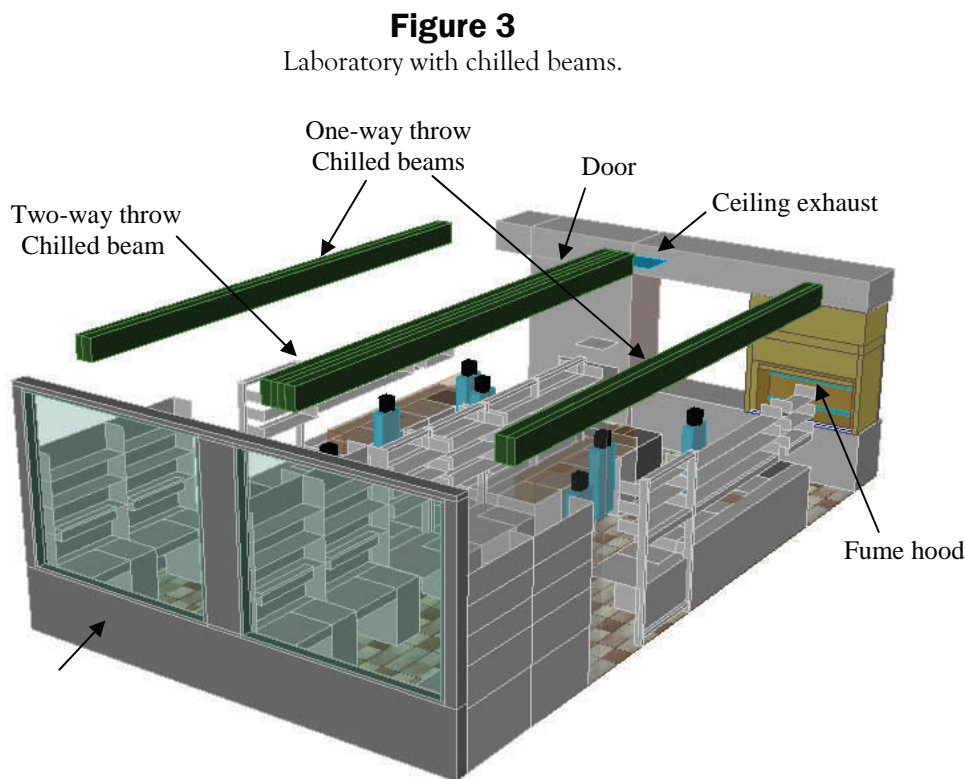

**Table 1**

Chilled beams studied at different flow rate.

	Primary flow rate CFM	Induced Air flow rate CFM	Induced air dT through Coil d°F	Door Gap infiltration CFM	Ceiling exh. flow rate CFM	Hood exh. flow rate CFM
<b>Without fume hood</b>						
Case 1, 8 ACH	970	1746	-7.8	200	-1170	0
Case 2, 6 ACH	730	1971	-8.2	200	-930	0
Case 3, 4 ACH	485	2280	-8.3	200	-685	0
<b>With fume hood</b>						
Case 4, 10 ACH	1210	2299	-5.2	200	-310	-1100
Case 5, 8 ACH	970	1746	-7.8	200	-320	-850
Case 6, 6 ACH	730	1971	-8.2	200	-100	-830

long and 3.2m (12' 6") high.

- **Ventilation system:** Two one-throw chilled beams and one two-throw beam on the ceiling with ceiling exhausts (one or two, depending on the total exhaust flow rate) as shown in Figure 2.
- **Door Gaps:** There was a 200 CFM inflow through the door gaps due to infiltration.
- **Supply temperature of primary air:** Primary air temperature remained at 13.3°C (56°F). After mixing with the induced air from the room, the supply air temperature was in the range of 59.4-62.6°F.
- **Heat sources:** The total heat generation from the bench devices was 5808W. The total lighting heat sources from the ceiling and the workbench was 2083W.
- **Occupants:** Seven occupants each generating 80W sensible heat.
- **Environment:** The external ambient was assumed to be 31.5°C (88.7°F) with an external convective heat transfer coefficient of 6W/m-K. Solar loading from the south-facing windows on the external wall was divided as 1160W transmitted into the room and 1243W absorbed by the glass. Another 30W was conducted through the external wall section. The ceiling, floor and walls were assumed to be adiabatic. Surface-to-surface radiation was not modeled in this study.

For the sake of comparison, this same laboratory with a ceiling diffuser system and ceiling mounted radiant cooling panels was also numerically investigated using 16 different layouts of cooling panels and supply flow rates (see the details of the 16 cases in Table 3 in the results section). The cooling panels were above the bench top and aisle shown in Figure 4. The set mounted above the bench top includes three panels. The central panel is 0.6m (23.5") wide, and the two against the side walls are 0.3m (12") wide. The other set was mounted above the two aisles. These cooling panels were maintained at 13.9°C (57°F) temperature. There were also bench exhausts installed in these 16 cases. The bench exhausts were configured with continuous slots mounted beneath the shelves of the bench and along the length of the benches. The supply temperature was 11.1°C (52°F),

2.2°C lower than that of the chilled beams cases.

Great care was taken with regard to correctly model the chilled beams, fume hood and the numerical grid for CFD. The number of grid cells used in these cases was in the order of 800,000 cells. Grid dependency tests were performed to ensure that the results were appropriate and would not vary upon increasing the grid density. In particular, attention in the tests was directed at areas containing the main flow, or heat sources in the room, for example, the chilled beams and the area close to the glazing, as well as areas of largest flow, or temperature gradients and the flow through the door cracks. Grid was added appropriately in these regions and their surroundings.

## Results

In this section, the air temperature and PPD are discussed in detail since they include the effects of all important parameters on thermal comfort such as metabolic rate, external work, clothing, local air velocity and mean radiant temperature as shown in Equations (2) and (3). Two sets of occupied zone, the walking zone and the bench zone, are defined for evaluating and comparing the performance of different ventilation schemes. The walking zone covers the areas of aisles and the doorways from the floor to 1.8m (71") above floor level and the bench zone includes all benches from the top of the benches to 1.8m (71") above floor level, as highlighted in Figures 5 and 6, respectively. The simulation results are discussed with respect to thermal comfort and air quality.

### Thermal Comfort

The simulation results, mainly the average PPD and temperature in the two occupied zones, are summarized in Tables 2 and 3 for the chilled beam cases and for the ceiling diffuser, with and without cooling panels respectively. The average PPD for the chilled beam cases together with three ceiling diffuser cases without cooling panels is also plotted in Figure 7 to show the trend. The average air temperature in the occupied zones in the chilled beam cases is 1-6°C lower than that of the cases at

the same supply flow rate using ceiling diffusers plus cooling panels, although the primary supply air temperature is 2.2°C higher. The average PPD in occupied zones falls below 15% for all cases with chilled beams even at 4 ACH. The chilled beams appear to work well with variable primary flow rate as the variation of the primary flow rate from 10 ACH to 4 ACH does not have a substantial impact on thermal comfort in the occupied zone. At the lowest flow rate considered, 4 ACH (Case 3), the average PPD with chilled beams is noticeably lower than that of the ceiling diffuser cases of the same flow rate (C-Cases 13 through 16), especially in the bench zone where the average PPD is greatly improved by chilled beams. Bench exhausts were used in the ceiling diffuser cases. The results indicate that with chilled beams, the cooling capacity can be well provided using a water-cooled coil system, and the primary airflow of the system only needs to satisfy the indoor air quality requirements.

Radiant cooling panels rely mainly on the direct cooling of occupants by radiative heat transfer. When cooling panels are used, sensible heat is removed from the room by both ventilation and radiation. Through radiative heat transfer, people in the room emit heat that is absorbed by the radiant cooling panel surface. Therefore, a similar level of thermal comfort can be achieved with higher

average air temperature in the occupied zone than with a chilled beams case, (see Case 3 and C-Case 8). It is noticed that the average PPD in the two occupied zones at 6 ACH drops below 20%, the designed thermal comfort condition, with any one of the three cooling panel arrangements. The results also indicate that the two sets of cooling panels cannot bring the PPD below 20% when the ventilation flow rate is reduced to 4 ACH, the minimum ventilation requirement for laboratories, unless more cooling panels are installed. With chilled beams, very satisfactory PPD (averaging around 10%) in the occupied zones can be achieved at as low as 4 ACH. To obtain a similar level of thermal comfort, 6 ACH is required with two sets of cooling panels and bench exhausts (see C-Case 8 in Table 3).

The temperature and velocity distribution in a vertical plane half way through the length of the room are presented in Figures 8 and 9, respectively, for chilled beams at 8 ACH. The temperature in the room is quite uniform except in the region around the heat sources in the bench top. The temperature stratification from the floor to the ceiling is less than 2°C, which is regarded as one of the benefits of using the chilled beams.

While occupants can be thermally comfortable overall, they may still experience discomfort from drafts on a

**Figure 4**

Two sets of ceiling mounted cooling panels.

Two Aisle Panels, 0.6m (23.5") x 7.3m (24')

Three Aisle Panels  
6.5m (21' 4") long

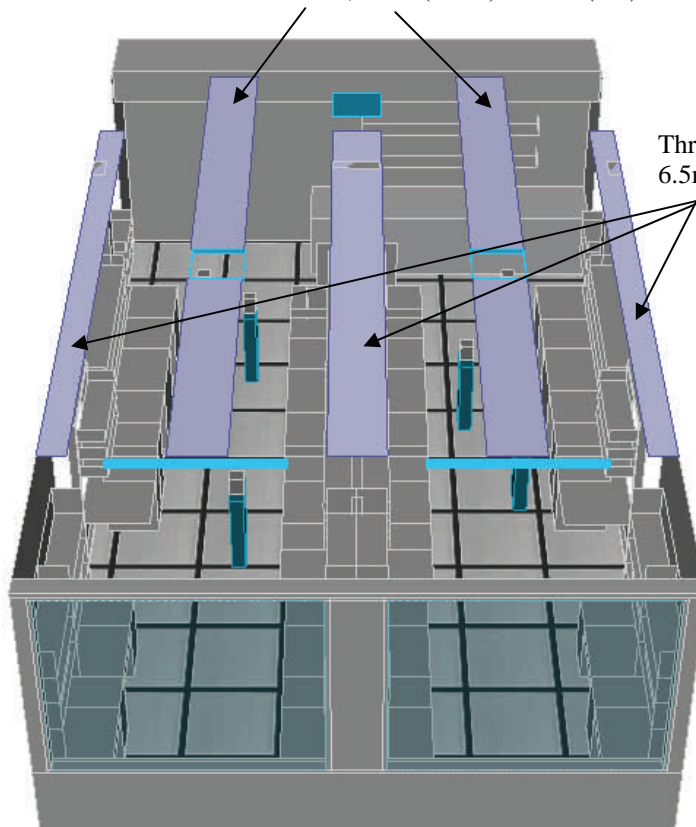

## Figures 5 and 6

**Figure 5:** Walking Zone—Defined as the volume from the floor to 1.8m (71”) above the floor in the five highlighted areas. **Figure 6:** Bench Zone—Defined as the volume above the bench top to 1.8m (71”) above the floor in the four highlighted areas.

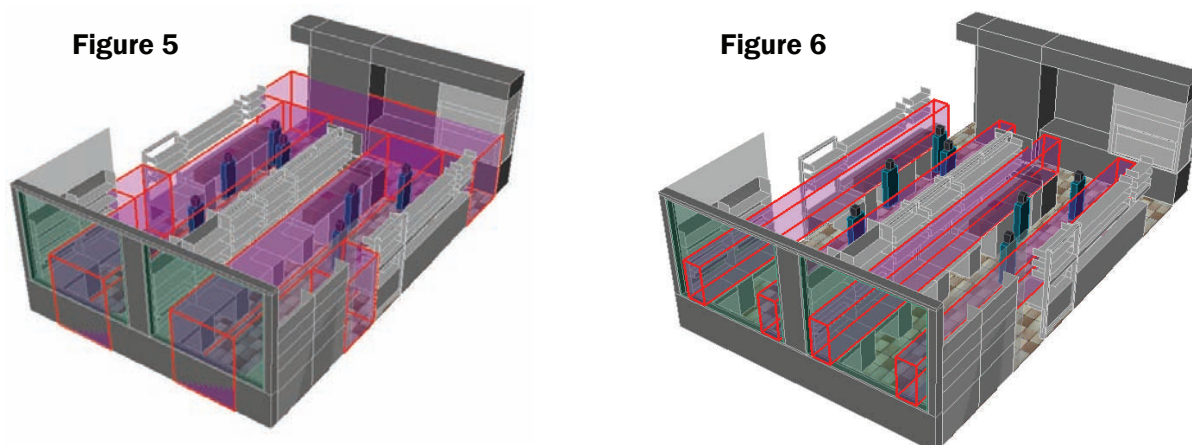

**Table 2**

Chilled Beams—Air temperature and PPD in the occupied zones.

	Primary flow rate CFM	Induced Air flow rate CFM	Supply T °C	Ceiling exh. flow CFM	Hood exh. flow CFM	Average Air T (°C)		Average PPD (%)		Return Air T (°C)	Exh Air T (°C)
						Walk zone	Bench zone	Walk zone	Bench zone		
<b>Without fume hood</b>											
Case 1, 8 ACH	970	1746	15.3	-686	0	21.9	22.7	11.0	13.2	21.8	22.8
Case 2, 6 ACH	730	1971	15.2	-930	0	22.0	23.2	11.3	11.9	21.8	23.6
Case 3, 4 ACH	485	2280	15.4	-685	0	22.5	23.6	9.3	10.2	21.7	23.7
<b>With fume hood</b>											
Case 4, 10 ACH	1210	2299	17.0	-310	-1100	22.2	23.2	10.1	11.4	22.0	23.6
Case 5, 8 ACH	970	1746	15.3	-320	-850	22.2	23.5	10.7	9.5	21.9	23.5
Case 6, 6 ACH	730	1971	15.2	-100	-830	22.3	23.7	10.0	9.2	21.9	23.9

**Table 3**

Sixteen ceiling diffuser cases using different layouts of radiant cooling panels.

	Cooling panels	ACH	Bench exh. CFM	Ceiling exh. CFM	Average Air T (°C)		Average PPD (%)	
					Walking zone	Bench zone	Walking zone	Bench zone
C-Case1	No panel	8	-800	-370	24.0	25.4	7.6	13.0
C-Case2	Bench Panels	8	-800	-370	23.5	24.9	7.3	8.8
C-Case3	Aisle panels	8	-800	-370	23.5	24.9	7.3	8.9
C-Case4	Bench & Aisle	8	-800	-370	23.1	24.6	7.9	7.9
C-Case5	No panel	6	-800	-130	26.4	27.6	12.8	25.1
C-Case6	Bench Panels	6	-800	-130	25.5	26.8	9.1	16.0
C-Case7	Aisle panels	6	-800	-130	25.4	26.6	8.6	14.9
C-Case8	Bench & Aisle	6	-800	-130	24.9	26.2	7.4	12.3
C-Case9	No panel	5	-600	-208	27.4	28.7	16.7	30.0
C-Case10	Bench Panels	5	-600	-208	26.7	28.2	13.4	24.4
C-Case11	Aisle panels	5	-600	-208	26.5	28.0	12.3	23.1
C-Case12	Bench & Aisle	5	-600	-208	26.1	27.5	10.0	18.6
C-Case13	No panel	4	-600	-86	28.8	30.3	28.1	47.4
C-Case14	Bench Panels	4	-600	-86	28.0	29.3	19.5	32.1
C-Case15	Aisle panels	4	-600	-86	27.9	29.2	18.5	31.2
C-Case16	Bench & Aisle	4	-600	-86	27.5	28.8	15.0	26.7



**Figure 7**  
Average PPD in occupied zones.

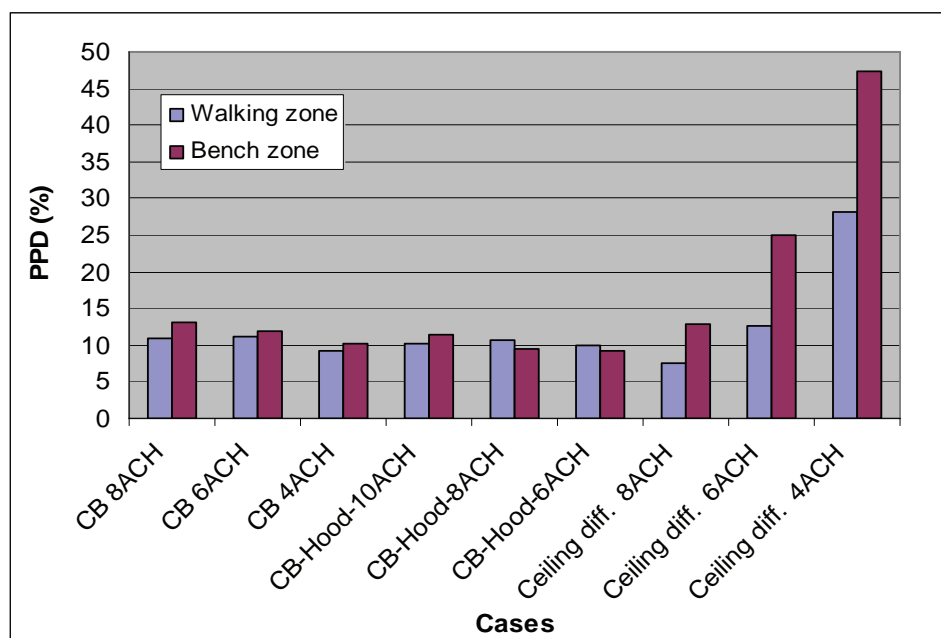

specific part of their body. Occupants' experience of draft depends on air temperature, air velocity, and turbulence intensity. In general, air temperatures within the comfort zone and air velocities below 0.25 m/s (for summer) are considered to meet the thermal comfort requirement (ASHRAE, 1997b). ASHRAE allows for higher air velocities in warm, humid conditions as some research suggests that occupants welcome the cooling effect the higher velocities provide. As chilled beams operate at a high supply flow rate due to the considerably high flow rate of induced air, drafts can become a factor in causing thermal discomfort. At 8 ACH, the average velocity in the occupied zones with chilled beams is 0.24m/s. This is considered to be comfortable for an air temperature between 23-24°C. When the air temperature is lower, this air velocity could be high, particularly at some spots where the local velocity is around 0.34m/s, as shown in Figure 8. The air velocity and local temperature variations are responsible for causing 11% PPD in the walking zone for the case of 8 ACH. The results also indicate that the air temperature at ceiling exhausts is about 1-2°C higher than the recirculation air temperature leaving the room. This is due to the short-circuiting of the induced air, which can be improved by adjusting the supply angle of the diffusers.

### Air Quality and Hood Containment

The discussion in this section focuses on the three chilled beam cases in the presence of a fume, Cases 4 through 6.

### Fume Hood Containment

The fume hood located in the corner opposite to the

windows (Figure 3) is a three-sided enclosure with an adjustable front sash opening. The fume hood is designed to capture and exhaust hazardous fumes generated inside its enclosure by extracting air from the back of the hood to the outside of the building. Since exposure to volatile chemicals constitutes one of the top health and safety hazards to laboratory workers, a fume hood operates as a principle safety device in a laboratory setting. According to the Federal Occupational Safety and Health Administration (OSHA) the face velocity of the hood should be in the range of 0.3m-0.5m/s (60-100 fpm). The sash opening in this study was adjusted to obtain a face velocity of 0.5m/s for all three cases. As the room geometry, ventilation system, diffuser/exhaust locations and operational procedures within a laboratory all affect airflow, it is necessary to assess how chilled beams in the laboratory influence the containment of the hood. In an ideal case, the contaminants generated from a source at the sash opening would be nearly 100% removed by the hood. In reality; however, the contaminants leak backwards into the room due to turbulent diffusion, even if there is no recirculation at the sash opening. The body movements in front of the hood can also increase turbulence and reduce effectiveness of hood containment. The lower the contaminant leakage, the better is the hood containment. Quantitative fume hood containment tests reveal that the concentration of contaminants in the breathing zone can be 300 times higher from a source located at the front of the hood face than from a source placed at least six inches back (National Research Council, 1995). This concentration declines more as the source is moved farther towards the back of the hood.

**Figure 8**

Temperature distribution in vertical plane halfway through the length of the Lab.

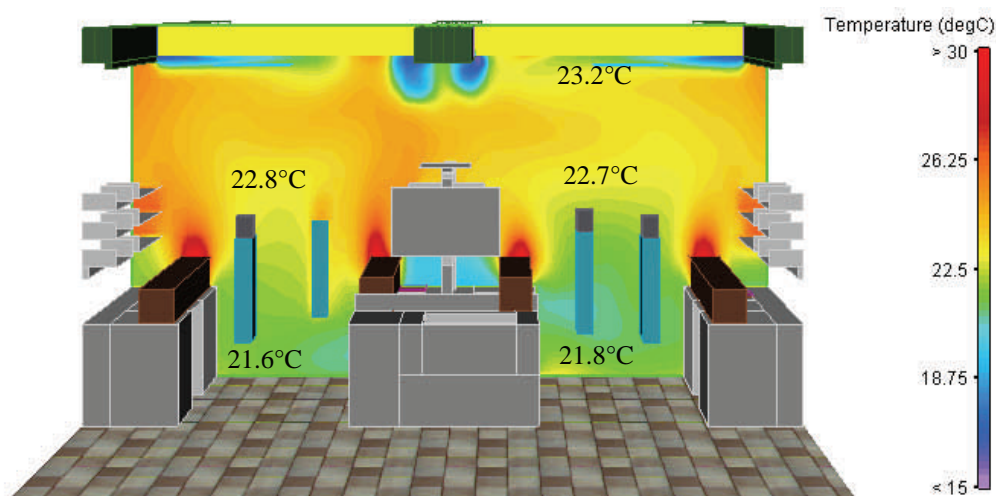
**Figure 9**

Velocity distribution in vertical plane halfway through the length of the Lab.

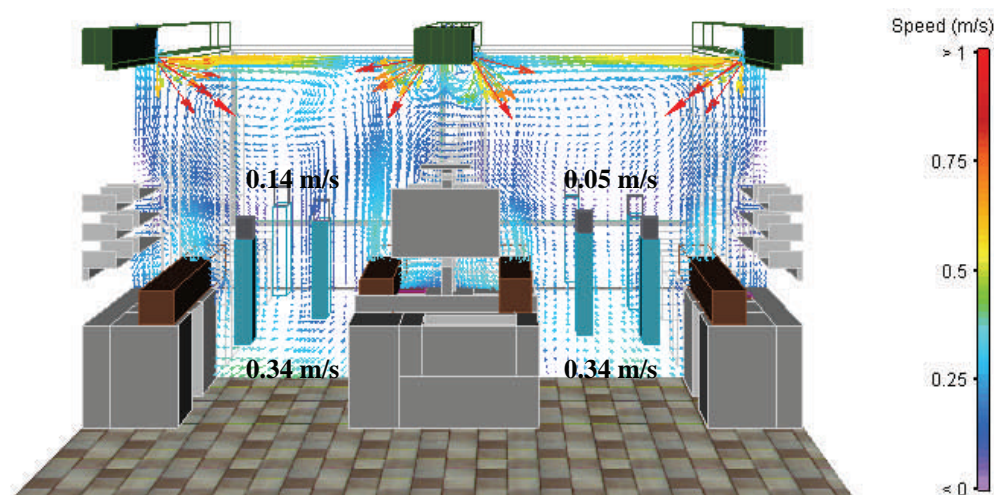

In this study, the sash opening was assumed to be filled with contaminants released towards the inside of the hood to represent a worst-case scenario. The contaminants mass leaking back into the room were represented through an imaginary box that was placed in front of the hood extending 12" outside the sash opening as shown in Figure 10. The total contaminants leaking into the room was the summation of the net leakage at the five faces of the imaginary box. The leakage factor, defined as the fraction of contaminant mass flow rate leaking from the hood to the room against the contaminant mass removed by the hood exhausts, can be used to evaluate the hood containment. This definition has the same meaning as the Box leakage factor outlined by Memarzadeh (Memarzadeh, 1996).

The leakage factor of Cases 4 to 6, shown in Figure 11, varies from 0.00139 to 0.00277. In a concurrent study on hood containment, the leaking factor for a case at 13 ACH with ceiling diffuser was in the range of 0.00183 to 0.00212. The slightly higher leaking factor when chilled beams are operating can be due to the higher turbulence level in the room caused by quite high induction flow rates in addition to the primary flow rates.

#### **Gas and Airborne Particle Removal Effectiveness of a Chilled Beam System with Fume Hood**

In order to examine how the chilled beam system functions in removing contaminants from the room, a chemical spill on the bench top at two locations was considered. The chemical spill was modeled as a source

located at the center of the affected bench, either at Location 1 or at Location 2, as highlighted in Figure 12. The concentration was assumed to be  $1 \times 10^6$  ppm at the top of the contaminants' source. With the existence of the source, the contaminants were dispersed in the room by convection and diffusion and the distribution of the contaminant concentration was computed in the CFD simulations. The removal effectiveness of the chilled beam system was evaluated by the average concentration in the occupied zone as presented in Figure 13. The concentration at the breathing level in front of the four occupants positioned closer to the source, as marked in Figure 12, were also monitored and plotted in Figures 14 and 15 for the two assumed source locations.

Figure 13 shows that the concentration level is lower in the walking zone than in the bench zone for all cases and the average concentration increases when the

primary flow rate decreases. Unlike the average concentration, the local concentrations at the breathing level of the four occupants being monitored are not necessarily increased when primary flow rate decreases. For example, Figure 15 shows that for source Location 2, the case with 6 ACH has the lowest local concentration in front of occupant 4. As the induced flow is relatively high in the chilled beam system, the flow pattern and the resultant concentration distribution can be affected more by induced flow rate change than by the primary flow rate change. Table 4 presents the range of average concentration in the occupied zone for the two source locations when using chilled beams, or a ceiling diffuser system. For both systems, the fume hood is operating. The data indicate that the removal effectiveness of the chilled beams is in the same level of the ceiling diffusers even though the primary flow rate of the chilled beams is

**Figure 10**

Sash opening and the imaginary box in front of the sash opening.

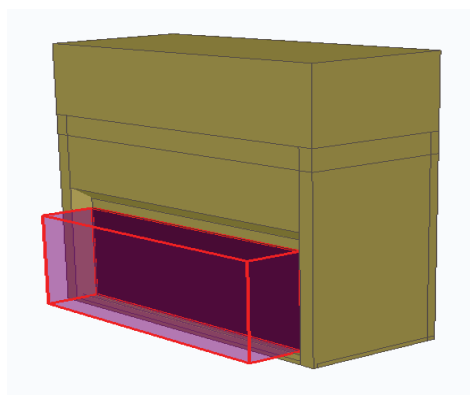

**Figure 11**

Hood leaking factors for Cases 4 through 6.

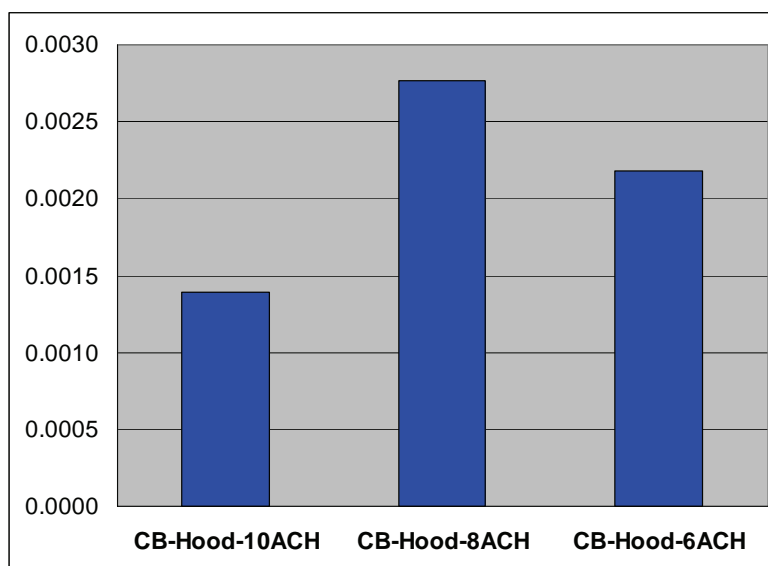

lower. The chilled beam system in the cases studied seems to generate a better mix condition in the room than ceiling diffusers do, which improves the removal effectiveness as a result.

### Operating Cost Reduction

Table 5 presents the annual cooling costs for a typical 70m<sup>2</sup> lab for the chilled beam cases. The following conditions/assumptions are used in this calculation.

- The outdoor temperatures and ambient condition

are taken from weather data in Washington, DC.

- The cooling season is considered to be 4,489 hours annually.
- The percentage of outdoor air is 100% for all cases.
- Supply air temperature is 13.3°C (56°F).
- Cooling load per CFM is considered to be the difference in air enthalpy when entering and leaving the HVAC system. Perfect duct insulation is assumed.
- The ventilation flow rate (CFM) shown in Table 4 is the flow rate required during the peak load of the day. The average cooling load of a day is assumed to be 64.3%

**Figure 12**

Locations of contaminant sources and the four positions being monitored.

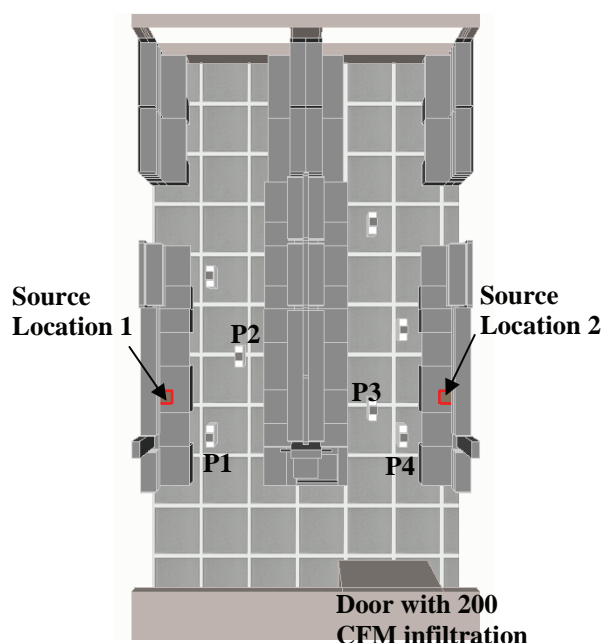

**Figure 13**

Average contaminant concentration in occupied zones with two source locations for cases with fume hood.

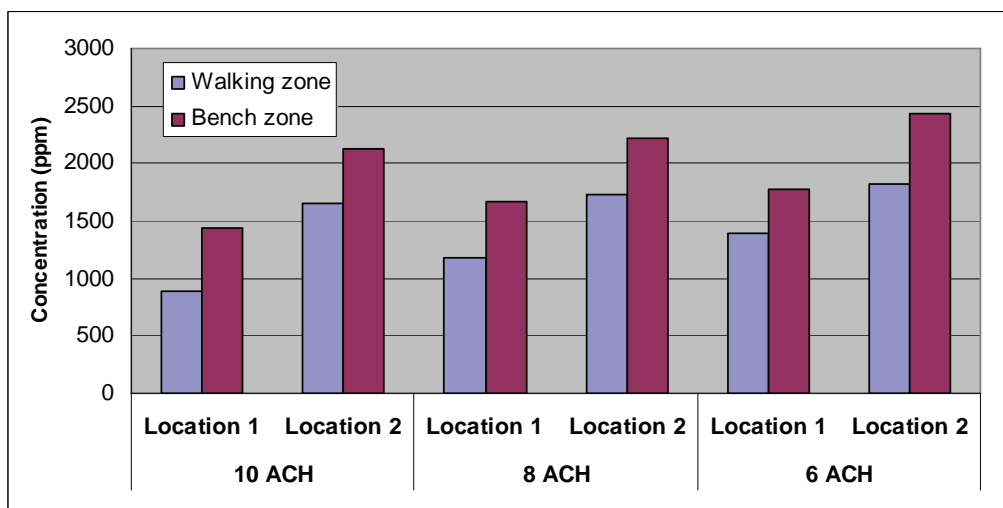



**Figure 14**

Concentration in breathing level of the four occupants for source Location 1.

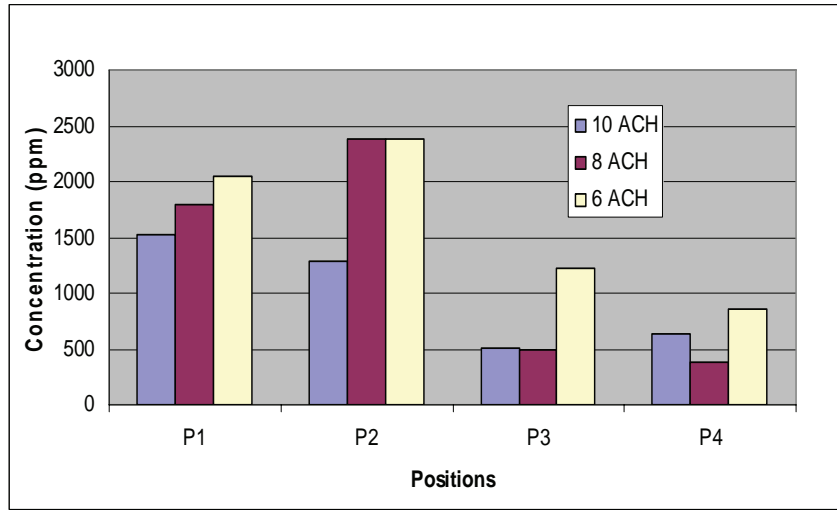

**Figure 15**

Concentration in breathing level of the four occupants for source Location 2.

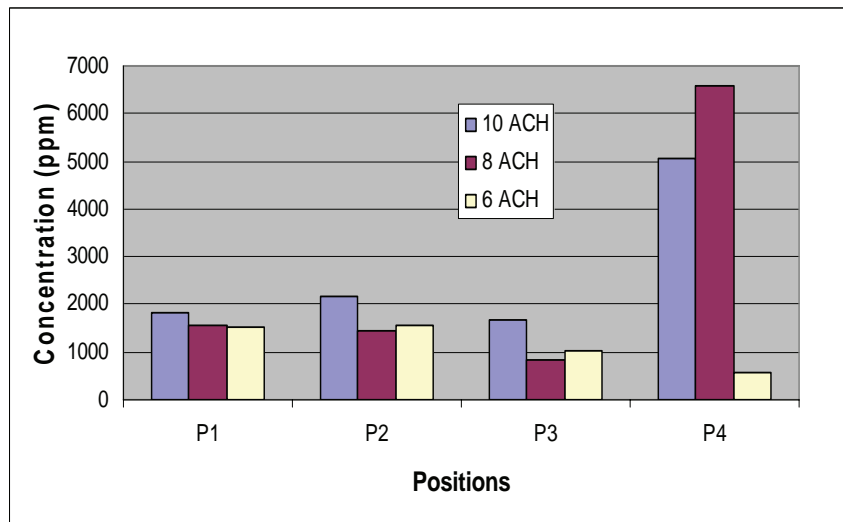

of the day's peak load, as is the ventilation flow rate used in the cost calculation.

- The cost of electricity is 0.1\$/KWH, fuel is 8.0\$/MMBtu; chilled water generation efficiency is 1.0KW/TON; fan efficiency is 68%.

The simulation results demonstrate that with a fume hood, the ventilation flow rate required in chilled beams can be as low as 6 ACH for equipment-intensive laboratories to be thermally comfortable while still meeting the air quality requirement. A concurrent study reveals that when using ceiling diffusers without bench exhausts and cooling panels, the required flow rate to achieve a similar level of thermal comfort and air quality can be as high as 13 ACH. With the reduced ventilation flow rate, a 22.5% saving in annual energy cost for cooling and ventilating a

typical laboratory in the Washington, DC area can be achieved as shown in Figure 16. In this calculation, 70% and 100% of outdoor air are assumed for ceiling diffusers at 13 ACH and chilled beams at 6 ACH. A fume hood is present in both cases.

## Conclusions

The following conclusions can be drawn from this study:

1. Chilled beams improve thermal comfort, and can be operated at as low as 4 ACH (without a fume hood in the laboratory) while maintaining very satisfactory average PPD (around 10%) in the occupied zones. To obtain a similar level of thermal comfort, 6 ACH is required for

**Table 4**

Comparison of Chilled beam system and ceiling diffuser system on average contaminant concentration in occupied zones for cases with fume hood.

	Walking Zone	Bench Zone
Ceiling diffuser at 13 ACH	940- 1580	1470- 2240
Chilled beams at 10-6 ACH	880- 1820	1440- 2430

**Table 5**

Annual energy cost for cooling a typical lab located in Washington, DC.

	Primary flow rate CFM	Induced Air flow rate CFM	Total Air flow rate CFM	Supply T °F	Air Delta-T through Coil d°F	OA %	Energy Cost For Cooling		
							Primary Air	Induced. Air	Total
<b>Without fume hood</b>									
Case 1, 8 ACH	970	1746	2716	59.5	9.9	100	\$2,040	\$483	\$2,523
Case 2, 6 ACH	730	1971	2701	59.4	10.7	100	\$1,536	\$588	\$2,124
Case 3, 4 ACH	485	2280	2765	59.7	10.5	100	\$1,020	\$669	\$1,689
<b>With fume hood</b>									
Case 4, 10 ACH	1210	2299	3509	62.6	5.5	100	\$2,546	\$354	\$2,900
Case 5, 8 ACH	970	1746	2716	59.5	10.0	100	\$2,040	\$488	\$2,528
Case 6, 6 ACH	730	1971	2701	59.4	10.8	100	\$1,536	\$594	\$2,130

**Figure 16**

Saving in annual cooling cost for a typical laboratory in the Washington, DC area.

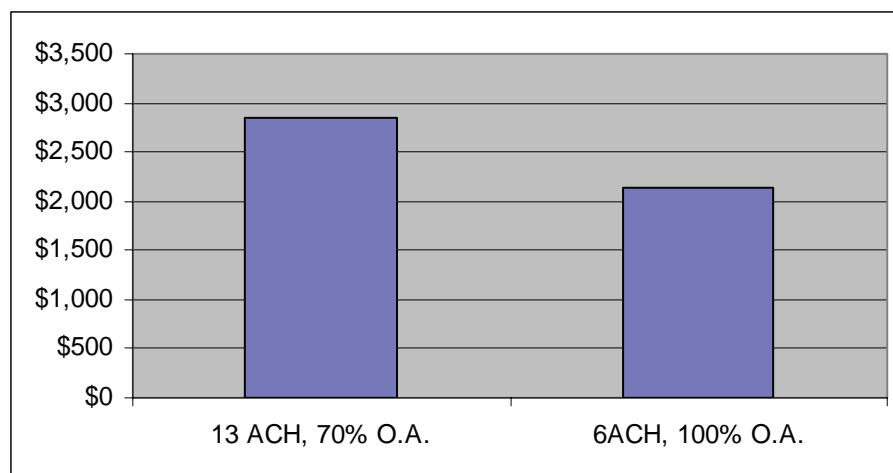

ceiling diffuser system with two sets of cooling panels and bench exhausts.

- The presence of an operational fume hood slightly improves the thermal comfort in the room.
- The average concentration in the occupied zone caused by the bench top spills increases when the primary flow rate decreases, but is not very sensitive to the change of primary air flow rate. The chilled beams improve the removal effectiveness of gases and airborne particles by generating a better mixed condition in the room than ceiling diffusers.
- The chilled beams in the cases studied are seen to have an insignificant effect on the hood containment.

- Using chilled beams with a fume hood, satisfactory thermal comfort and air quality can be achieved at 6 ACH (100% Outside Air) in comparison with an all-air ceiling diffuser ventilation system at 13 ACH (70% Outside Air), which indicates a 22.5% saving in annual energy costs for cooling and ventilating a typical lab in the Washington, DC area.

It should be noted that the use of chilled beams is not intended to be applicable to all types of laboratories and should not override the contaminant controls that are appropriate for this type of laboratory, particularly with respect to the use of appropriate biosafety cabinets (BSCs) and/or fume hoods, and the handling of hazard-

ous materials on the workbenches. Finally, the usefulness of the chilled beam system may not be beneficial from a cost standpoint in scenarios where the room flow rate is already low, and energy costs are relative to other occupied spaces.

## References

- ASHRAE. (1997a). *ASHRAE Handbook*. Fundamentals, chapter 8, Thermal Comfort.
- ASHRAE. (1997b). *ASHRAE Handbook*. Fundamentals, chapter 8, 8.12-8.13.
- Barista, D. (2005). Chill the ceilings and achieve cool energy savings. *Building Design and Construction Magazine*, (November 18).
- Building Services Research and Information Association (BSRIA). (2001). *Climatic ceilings and chilled beams: Applications of low temperature heating and high temperature cooling*. Thermic Project No. DIS/1522/97/FR. New Solution in Energy Utilization. EU-ENERGIE Research Program, ENERGIE publication.
- Chen, Q. (1995). Comparison of different  $k-\epsilon$  models for indoor airflow computations. *Numerical Heat Transfer, Part B: Fundamentals*, 28, 353-369.
- Flomerics. (1995). *FLOVENT Reference Manual*, FLOVENT/RFM/0994/1/1.
- Gregory-Smith, D. G., Smith, A. G., Cutbill, S. C., & Tumelty, M. (1996). Modelling Coanda Effect Flows using PHOENICS. *PHOENICS Journal*, 9(2), 229-252.
- Jiang, Z., Chen, Q., & Haghghat, F. (1995). Airflow and Air Quality in Large Enclosures. *ASME Journal of Solar Energy Engineering*, 117(2), 114-122.
- Kang, Z., Xue, H., & Bong, T. (2001). 3-D WBGT Analysis for Local Thermal Environmental Assessment in an Occupied Building Space. *Proceedings of the 4th International Conference on Indoor Air Quality: Ventilation & Energy Conservation in Buildings*, 3, 1713-1719.
- Memarzadeh, F. (1996). Methodology for optimization of laboratory hood containment. Report Volume 1 of 2, Division of Engineering Services, National Institute of Health.
- Memarzadeh, F. (1998). *Ventilation Design Handbook on Animal Research Facilities Using Static Microisolators*. Bethesda, MD: National Institutes of Health.
- Memarzadeh, F., & Manning, A. (2000). Thermal Comfort, Uniformity and Ventilation Effectiveness in Patient Rooms: Performance Assessment Using Ventilation Indices. *ASHRAE Transactions*, 106(2), MN-00-11-3.
- Mumma, S. A. (2001). Ceiling panel cooling systems. *ASHRAE Journal*, 43(11), 28-32.
- National Research Council. (1995). Guidelines for maximizing fume hood efficiency. *Prudent Practices in the Laboratory: Handling and Disposal of Chemicals*, p. 179. National Academy Press.
- Palmer, G., Vazquez, B., Knapp, G., Wright, N., & Happold, B. (2003). The practical application of CFD to wind engineering problems. *Proceedings of 8th International Conference*, pp. 995-999.
- Virta, M., Butler, D., Gräslund, J., Hogeling, J., Kristiansen, E. L., Reinikainen, M., & Svensson, G. (2004). *Chilled Beam Application Guidebook*, pp. 1-70. Brussels, Belgium: REHVA.
- Wilcox, D. C. (1993). *Turbulence Modeling for CFD*. La Canada, CA: DCW Industries Inc.

---

## Biosafety, Occupational Health and Nanotechnology

Vladimir Murashov and John Howard

National Institute for Occupational Safety and Health, Washington, DC

### Disclaimer

The findings and conclusions in this report are those of the authors and do not necessarily represent the views of the National Institute for Occupational Safety and Health.

### Abstract

*Nanotechnology promises to improve the quality of human life, but it has also provoked concerns about potential adverse health effects on workers, the environment and consumers. Effective risk assessment and risk management of nanotechnology requires: (1) knowing how engineered nanoscale particles (NPs) can gain entry into the human body (routes of exposure); (2) knowing whether engineered NPs*

*can migrate from their point of entry to other locations in the body (translocation); (3) determining what adverse biological effects may occur in response to engineered NP exposure (toxicity); (4) knowing which measurement of exposure and dose correlates best to toxicity (exposure and dose metrics); and (5) knowing how best to monitor exposed populations to detect the occurrence of any adverse health effects (health surveillance). This article reviews what is currently known about potential health risks to workers from exposure to engineered NPs, as well as the best methods to control those risks, in order to ensure that their use in the laboratory and industry conforms to the best principles of occupational health and biosafety.*