

Control of Ammonia Production in Animal Research Facilities Through Ventilation System Design

Farhad Memarzadeh, PhD, PE

Andy Manning, PhD

Associate Member ASHRAE

ABSTRACT

This paper considers the effect of air properties on ammonia levels in the cages and main room space of an animal research facility containing mouse static micro-isolators. The ammonia production from mice is affected by the level of relative humidity (RH) of the air, with higher production rates at elevated RH values. The manipulation of the room supply discharge air, therefore, offers a means of reducing ammonia levels in both the cage and room. This paper outlines a study in which the air properties are considered with regard to ammonia production both experimentally and numerically, in the latter case using the technique of airflow modeling. The paper demonstrates that even relatively modest increases in supply temperature can have major implications with regards to ammonia production, leading to the possibility that it may be possible to increase the time between cage bedding changes.

INTRODUCTION

A study was made on the influence of air properties on ammonia levels in animal cages. This was done in two separate studies, one using experimental measurement techniques and one using the airflow modeling technique of computational fluid dynamics (CFD). In the experimental measurement study, the effect of relative humidity (RH) on ammonia generation rates in cages was considered. In the airflow modeling study, the effect of manipulating the room supply air discharge temperature, and thereby RH, on ammonia levels in the room and the cages was considered.

This study was part of a major research program conducted by the National Institutes of Health in collaboration with the University of Illinois at Champaign-Urbana to produce a ventilation design handbook on laboratory rodent

research facilities using static microisolators. The CFD code used was produced by a company that specializes in software for the calculation of airflow, heat transfer, and contamination distribution in building environments.

EXPERIMENTAL STUDY OF AMMONIA GENERATION IN CAGE

Description of Experimental Setup

The aim of this section of the study was to determine typical mass generation rates of NH_3 of mice in shoebox cages with bedding at two environmental relative humidities (35% and 75%). Measurements to determine CO_2 , H_2O , and NH_3 and consumption of O_2 were also taken at this time but will not be considered here. The cage is shown in Figure 1 and is 7 in. wide \times 11 in. long \times 5 in. high (0.18 m \times 0.28 m \times 0.13 m). The filter top was the high profile type and the filter was specified at 2.1 oz/yd², 12 mils thick. The cage had approximately 0.5 in. (1.3 cm) of hardwood shaving bedding on the floor, a wire rack, water bottle, and simulated feed. To determine the gas generation rates, animals and their cage habitat were placed within enclosed chambers (open-system calorimeters) with precisely controlled fresh air exchange rates.

Outbred mice (female, HSD-ICR, initial age of four weeks) were placed in the shoebox cages for a 13-day period. The bedding type was hardwood (Beta chip) shavings. The cages and accessories were washed and sanitized prior to use under standard procedures for laboratory animal facilities. The number of mice per cage was the maximum allowable for the mouse weight and cage area (five mice per cage). The cages were housed in environmental chambers when not in the calorimeters. The environmental chambers and the chamber in

Farhad Memarzadeh is director of the Division of Policy and Program Assessment, National Institutes of Health, Bethesda, MD. **Andy Manning** is director of Thermal Engineering, Flomerics, Inc., Marlborough, MA.

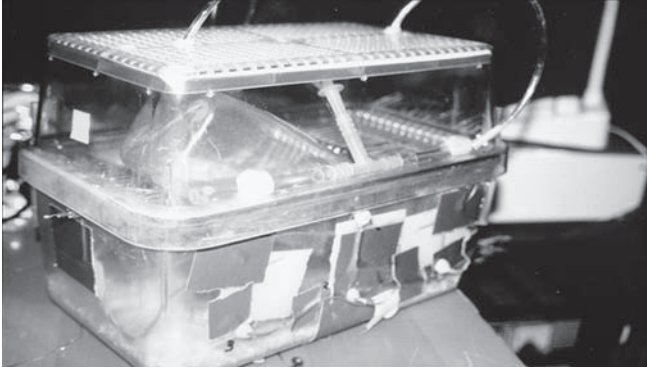

Figure 1 Static microisolator used in study.

which the calorimeters were kept were all approved for housing laboratory animals and were ventilated at 10-15 air changes per hour (ACH). The light period was 12 h light and 12 h dark. A white light and a blue light were on during the light period, and only the blue light was on during the dark period. The light intensities of the dark period ranged from 1 to 6 lux, while those of the light period ranged from 10 to 42 lux. The mice received standard rodent diet and water *ad libitum*.

The first three days after the mice arrived served as an acclimation period to allow the mice to adjust to their new surroundings and cage mates. The cages were kept at static conditions on racks in two environmentally controlled chambers for acclimation. Both environmental chambers were kept at $24 \pm 1.5^\circ\text{C}$, but one was at $35 \pm 10\%$ and the other at $75 \pm 10\%$ relative humidity (RH). The temperature and relative humidity in each chamber were continuously monitored with hygrothermographs. Cage litter was changed after the three-day acclimation period, which was just prior to the ten-day test period.

Three indirect, convective calorimeters were used for this project (see Figure 2). Full details of the calorimeter used can be found in Memarzadeh (1998). Air temperature and velocity and relative humidity were controlled in each calorimeter. The calorimeter boxes were constructed from $\frac{1}{4}$ in. (6.4 mm) thick acrylic plastic and were 14 in. high \times 42.125 in. long \times 23 in. deep (0.356 m \times 1.07 m \times 0.585 m). Clear acrylic plastic was used to allow observation of animals and to allow light into the calorimeter from the environmental chamber.

The entire front panel was removable to allow access of workers and to move mice in and out. The inside edges of the front panel were coated with vacuum grease to form a seal and were clamped on the calorimeter with ten clamps around the perimeter. A recirculation pipe, 200-mm-diameter acrylic plastic tube, exited from one side of the calorimeter box, went up and over the calorimeter, and attached to an in-line fan on the other side of the calorimeter box. This air recirculation

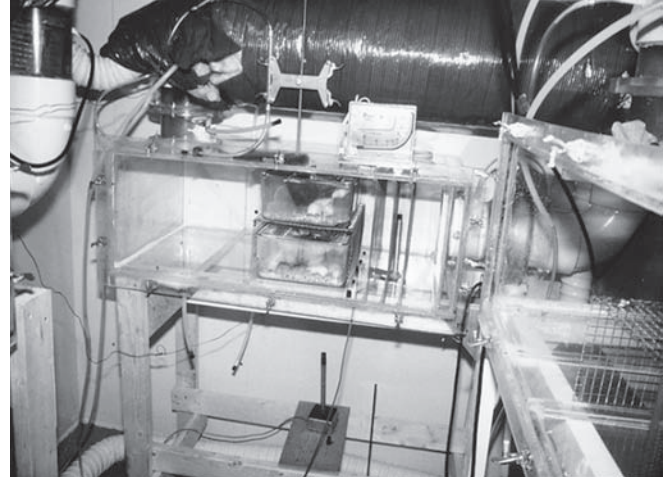

Figure 2 Indirect convective calorimeter.

system allowed for the control of air velocity past the animal without affecting the fresh airflow exchange rate.

Ammonia concentration of the sample air was measured with an ammonia gas detector that was calibrated to ammonia standard gases at 52.7 ppm. Calorimetric tubes were also used as a check for ammonia levels.

Description of Experimental Procedure

There were two environmental relative humidity treatments (low and high relative humidity) and three replications per treatment, so there were six experimental units. Since there were only three calorimeters, this experiment was divided into two tests. During Test 1, ten cages were randomly assigned to the 35% relative humidity treatment and five cages to the 75% relative humidity treatment. During Test 2, ten cages were assigned to the 75% and five cages to the 35% relative humidity treatments.

After the three-day acclimation period, there was a ten-day test period when the mice were placed in the calorimeters for ten hours each day where the measurements were taken. During the rest of the day, the mice were kept in their respective environmental chambers. The same four cages were always randomly assigned to a different calorimeter each day and were an experimental unit. At the morning of every day of the tests, the mice, feed, water, and litter were weighed separately. Four cages with 5 mice each were placed in each calorimeter for a total of 20 mice in each calorimeter. The three calorimeters were operated at the same temperature ($24^\circ\text{C} \pm 1.5^\circ\text{C}$). Data were collected three times during the photophase and three times during the scotophase to determine the effects of the different light levels.

The calorimeters were in the horizontal position so airflow approached the front of the cages (see Figure 3). The four cages were positioned on two levels (as in a cage rack). The calorim-

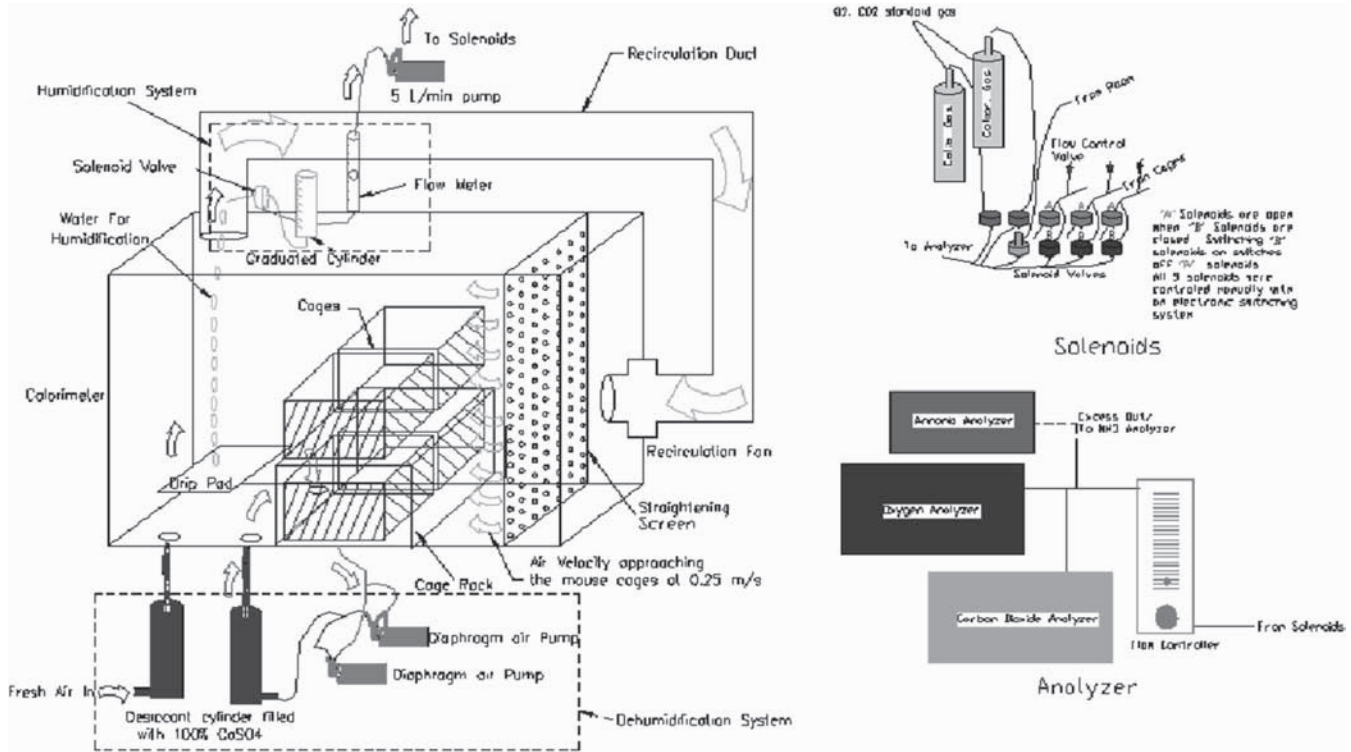
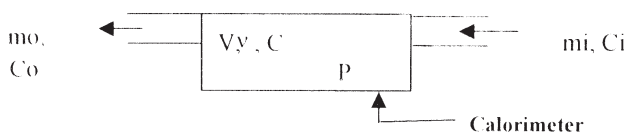

Figure 3 Experimental apparatus for mass generation rates of ammonia in mouse cages at low and high relative humidities.

eter static pressure was kept negative. The fresh air exchange rates for the calorimeters varied from 5 to 9.3 L/min. Fresh airflow rates were increased over the ten-day test period to keep ammonia levels low. After the mice were placed in the calorimeter and also after the lights were turned off, a dehumidification system was manually turned on for approximately one hour for the low humidity calorimeters to reduce the humidity. The dehumidification system was only operated for about one hour, then the gas levels were allowed to stabilize for around two hours before readings were taken.

Mass Generation Rate Calculation

The process in the calorimeter can be regarded as follows:



$$\frac{VdC}{v dt} = miCi + P - moCo \quad (1)$$

where

- mi, mo = fresh air flow rate, kg/s;
- Ci, C, Co = ammonia concentration, mg/kg;
- V = volume of the calorimeter, m^3 ($0.225 m^3$);
- v = specific volume of air, m^3/kg ;
- P = ammonia production rate, mg/s.

Since $mi = mo = m$ and $C = Co$, by solving the above equation we get the following result:

$$C = Ci + \frac{P}{m} \left(1 - e^{-\frac{mv}{V}t} \right) \quad (2)$$

When the time goes to infinity, the calorimeter reaches the stable state, where the concentration is $Ci + P/m$. If we let $\tau = V/mv$, then when $t = 3\tau$, the concentration will reach 95% of the stable state value. We ran our test mostly at 5 L/min flow rate. The volume of the calorimeter is 225 L. So τ is 45 minutes, and after 135 minutes, the concentration will reach 95% of its stable value. We measured the ammonia concentration at the stable state.

So:

$$C = Ci + \frac{P}{m} \quad (3)$$

With rearrangement and unit conversion,

$$P = 4.5588e-3 \times \frac{(C - C_i) \times m}{W_{mice}}, \quad (4)$$

where

- P = ammonia generation rate, g/h/100g of mice;
 $4.5588e-3$ = unit conversion factor;
 C = ammonia concentration in the calorimeter, ppm;
 C_i = ammonia concentration in the chamber, ppm;
 m = fresh air flow rate, L/min;
 W_{mice} = mice weight in one calorimeter, g.

Description of Results

In this experiment, data were collected three times during the photophase and three times during the scotophase every day. The relative humidity sensors in each of the calorimeters and chamber sensed relative humidity every five minutes over the ten-hour test period each day. The average value of relative humidity and temperature in the calorimeters and chamber over the ten-hour test period were used to determine the humidity ratio value of the air (g moisture /kg dry air) from a psychrometric chart.

As shown in Figure 4, the levels of NH_3 were higher for the dark (scotophase) period than they were for the light (photophase) period and are higher for the high RH levels. The generation rate was then input into the CFD model. It should be noted that the average level of cage RH achieved in the desired 30-35% RH experiments was 60.86% (compared with the environmental RH average of around 39%), while the average level of cage RH in the desired 75-80% RH experiments was 79.69%. Therefore, the interpolated value is only wholly accurate between 61% and 80% cage RH.

CFD STUDY OF AMMONIA GENERATION IN ROOM AND CAGES

Airflow Modeling

Airflow modeling based on computational fluid dynamics (CFD) (Flomerics 1994), which solves the fundamental conservation equations for mass momentum and energy in the form of the Navier-Stokes equations, is now well established:

$$\frac{\partial(\rho\phi)}{\partial t} + \text{div}(\rho V\phi - \Gamma_\phi \text{grad}\phi) = S_\phi \quad (5)$$

Transient + Convection – Diffusion = Source

where

- ρ = density
 V = velocity vector
 ϕ = dependent variable
 Γ_ϕ = exchange coefficient (laminar + turbulent)
 S_ϕ = source or sink

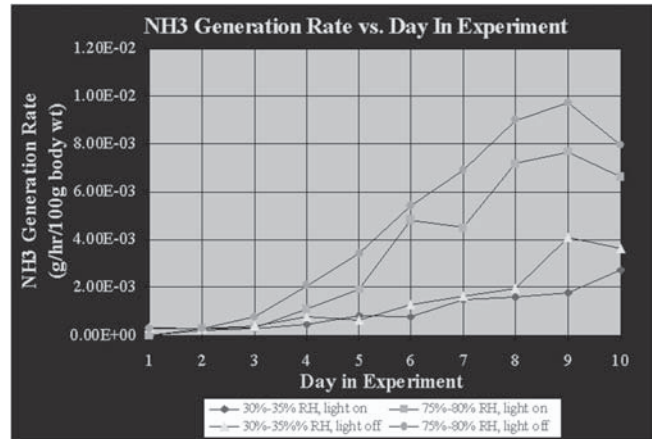

Figure 4 Effect of photoperiod on gaseous ammonia exchange between the mouse cage and the room environment.

How Is It Done?

Airflow modeling solves the set of Navier Stokes equations by superimposing a grid of many tens or even hundreds of thousands of cells that describe the physical geometry of heat and contamination sources and air itself. Figures 5 and 6 show a typical research laboratory and the corresponding space discretization, subdividing the laboratory into the cells. In this study, a finite-volume approach was used to consider the discretization and solution of the equations.

The simultaneous equations thus formed are solved iteratively for each one of these cells to produce a solution that satisfies the conservation laws for mass momentum and energy. As a result, the flow can then be traced in any part of the room, simultaneously coloring the air according to another parameter such as temperature.

The turbulence model used in this study was the k-ε turbulence model. Appropriate grid dependency tests were run to ensure that the results were consistent.

Validation of Airflow Modeling Methodology

The methodology and most of the results generated in this paper have been or are under peer review by numerous entities such as Harvard University. The methodology was also used extensively in a previous publication by Memarzadeh (1998), which concerned a ventilation design handbook on animal research facilities using static microisolators. In order to analyze the ventilation performance of different settings, numerical methods based on computational fluid dynamics were used to create computer simulations of more than 160 different room configurations. The performance of this approach was successfully verified by comparison with an extensive set of experimental measurements. A total of 12.9

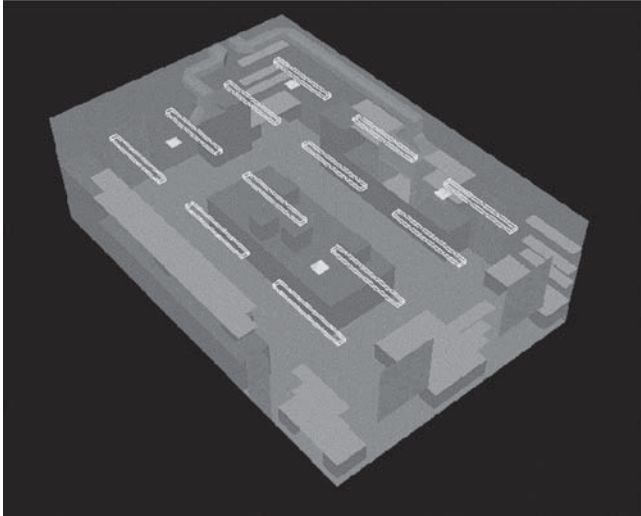

Figure 5 Geometric model of a laboratory.

million experimental data values were collected to confirm the methodology. The average error between the experimental and computational values were 14.36% for temperature and velocities, while the equivalent value for concentrations was 14.50%.

To forward this research, several meetings were held to solicit project input and feedback from the participants. There were more than 55 international experts in all facets of the animal care and use community, including scientists, veterinarians, engineers, animal facility managers, and cage and rack manufacturers. The pre-publication project report underwent peer review by a ten-member panel from the participant group, selected for their expertise in pertinent areas. Their comments were adopted and incorporated in the final report.

The publication was reviewed by the American Society of Heating, Refrigerating and Air-Conditioning Engineers (ASHRAE) technical committee and accepted for inclusion in their 1999 Handbook.

Description of Model Considered

A typical animal research facility in terms of overall size, air change rate, rack layout, mouse population, room pressurization, and other characteristics was modeled as the “baseline” case model for the CFD simulations. The baseline case model can be considered as the initial model in terms of boundary conditions and supply air conditions. The general features of the room are shown in Figure 6 and listed below. The general features of the baseline case model were as follows.

Room:

- 6.10 m long × 3.60 m wide × 4.22 m high (20 ft × 12 ft × 9 ft)

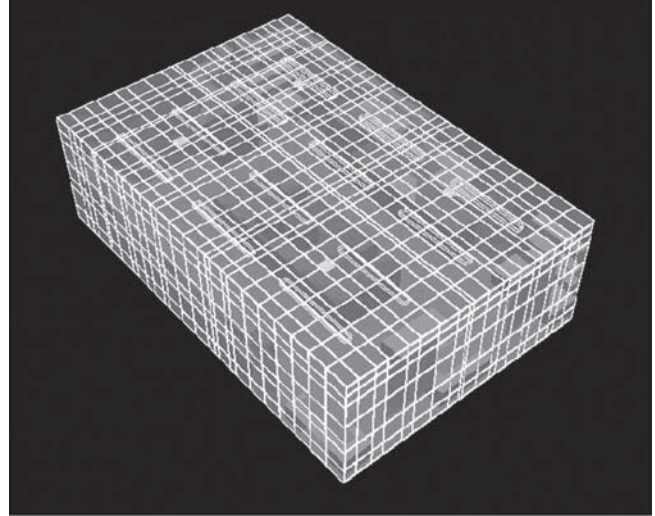

Figure 6 Superimposed grid of cells for calculation on laboratory model.

- Door on short wall
- Sink in corner
- Laminar flow change station
- Five cage racks

Cages:

- Microisolator (with filter top) mouse cage
- Five mice per cage at 20 g/mouse (100 g total body weight per cage)

Rack:

- Static system
- Six shelves per rack
- Seven cages per shelf (42 cages per rack)

Supply:

- Two radial supplies, each providing 0.13 m³/s (270 cfm) for a total of 15 ACH
- Supply discharge temperature, 18.8°C (66°F), set such that the exhaust air temperature was 22.2°C (72.0°F)
- Sixty-one percent relative humidity (to provide 50% RH at 22.2°C (72.0°F))

Exhausts:

- Two ceiling-level exhausts removing 0.1 m³/s (220 cfm) each

Makeup Air:

- 0.047 m³/s (100 cfm) coming from around the door

Overall Geometry

In all the ventilation systems considered in this project, air was introduced through ceiling-mounted diffusers. All devices were mounted flush with the ceiling surface; there was no ductwork present within the upper room volume. The various diffuser types considered in this project were all modeled using a combination of several boundary conditions, which were validated prior to the room parametric study (Memarzadeh 1998). All the air exited through general exhausts. The number and locations of the exhausts were varied. In line with common practice, there was an imbalance between the amount of air supplied to the room and the amount exhausted from the room. This leads to an overall pressurization of the room relative to the rooms or corridors surrounding the room. The makeup air to compensate for the supply/exhaust imbalance was allowed to enter or leave the room through 6.35×10^{-3} m (0.25 in.) gaps on the bottom and two sides of the door.

The rooms considered in this study all contained five animal cage racks, as well as a typical change station. A fuller description of these items is given below. The only other item within the room was a sink that was 0.61 m wide by 0.61 m deep by 0.81 m high ($24 \times 24 \times 32$ in.) located in one corner of the room.

In all cases, the room was considered under scotophase conditions, i.e., the lights were off and produced no additional heat load. Dark period conditions were chosen because early experimental studies for this project indicated that heat, CO_2 , and NH_3 generations were higher in the scotophase compared with the photophase. For CO_2 the generation in the light period was 0.68 (g/h)/100 g BW compared to 0.91 (g/h)/100 g BW for the dark period.

Rack Model

The overall dimensions of the racks were 1.52 m long by 0.61 m deep by 1.83 m high ($60 \times 24 \times 72$ in.) as shown in Figure 7. There were six shelves in the rack. The spacing of the shelves was 0.32 m (12.75 in.) top surface to top surface. The lowest shelf was at a height of 0.21 m (8.25 in.) above the floor. The shelves were modeled as thin rectangular blocks. Details such as the connecting ties between the shelves and the rollers on which the racks move were not modeled, as their effect on the overall flow field and gas concentration distributions was considered insignificant.

Located on the shelves of the racks were representations of the animal cages, shown in Figure 8. The dimensions of the cage were 0.27 m long by 0.16 m wide by 0.21 m high ($10.7 \times 6.38 \times 8.39$ in.), which maintained the volume of the original cage that had sloped sides. The sides of the cage were modeled as thin plates, with the thickness and conductivity of the plates set to those of the physical cage polycarbonate. The water bottle and food normally found in a cage were modeled as a single block in order to reduce the computational overhead. The volume of the block was the same as that of the bottle and food combined. The bedding of the cage was included as a rectangular block 0.27 m long by 0.16 m wide by 1.27×10^{-2} m high ($10.7 \times 6.38 \times 0.5$ in.).

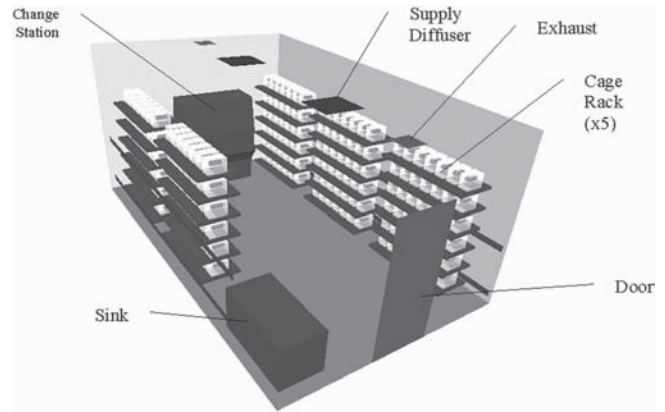

Figure 7 Overall layout of animal room baseline case.



Figure 8 CFD model of cage rack.

The mice were modeled as a block 0.11 m wide by 8.57×10^{-2} m long by 0.22 m high ($4.25 \times 3.38 \times 0.88$ in.). This was the same representation as was used in experimental cage wind tunnel tests (Memarzadeh 1998), which were used to define the CFD cage model, and simulated the effect of “huddling” by the mice. The surface temperature of the block was fixed at 30.0°C (86.0°F), which was agreed to be a typical mouse body surface temperature.

Surrounding this block, a source of concentration was defined at $2.54\text{e-}7$ kg/s (0.91 g/hr) for 100 g of mouse body weight in each cage, which was based on the generation rate obtained for the scotophase in tests on the effect of the photoperiod on the mice (Memarzadeh 1998). The definition of this source allowed the calculation of CO_2 in the room and cages. It also allowed the concentration of other gases, such as NH_3 , to be calculated by scaling, even though it has a different molecular weight than both air and CO_2 . This was possible because the magnitude of the source was very small and the resulting concentrations were so low as to have a negligible effect on the density of the mixture of air, CO_2 , and NH_3 . In effect, the CO_2 and NH_3 are intimately mixed with and flow with the air. The scaling factor for NH_3 was assumed to vary according to two variables: the number of days that passed since the bedding in the cage was changed and the average relative humidity in the cages.

Background levels of CO_2 and NH_3 were assumed to be zero. This means that all values quoted in the CFD section of the report are relative to the background level. If an absolute value for CO_2 is required, an additional amount in the range of 300 ppm to 700 ppm for most locations should be added.

The remaining cage boundary conditions are associated with the transfer mechanisms for air/gases to enter/leave the cage. The cracks at the side of the cage and the top of the cage, which was filtered, were defined using CFD (Flomerics 1994) boundary conditions best suited to model them. The actual specification of the boundary conditions was achieved through extensive validation of the CFD cage model against experimental data obtained during this project (Memarzadeh 1998). This phase of work was very important, as it ensured that values for CO_2 , NH_3 , etc., obtained by the CFD simulation were accurate and also that transfer of air and concentration between the room and the cages and between cages themselves were correctly simulated.

The spacing of the cages on the shelves was dependent on whether the racks were single density (seven cages per shelf) or double density (14 cages per shelf). In the single-density cases, the cages were centrally located in the short dimension and equally spaced in the long dimension. The spacing was $4.88\text{e-}2$ m (1.92 in.) from corner of cage to corner of adjacent cage. In the double-density racks, the cages were equally spaced in both the long and short dimensions. The spacing was $2.20\text{e-}2$ m (0.87 in.) and $4.88\text{e-}2$ m (1.92 in.), respectively.

Change Station Model

The internal structure and flow field within the change station were of no concern in this study. It was only the effect of the station on the room airflow that was of importance.

The design considered in this study is shown in Figure 9 and is based on a change station produced by a major manufacturer. Overall the station was 1.32 m wide by 0.86 m deep by 1.83 m high ($52 \times 34 \times 72$ in.). This design was effectively passive in terms of direct flow field interaction. In particular, the station internally recirculated a flow of $1.65\text{e-}1$ m³/s (350 cfm) with only 10% leakage defined at the sash opening.

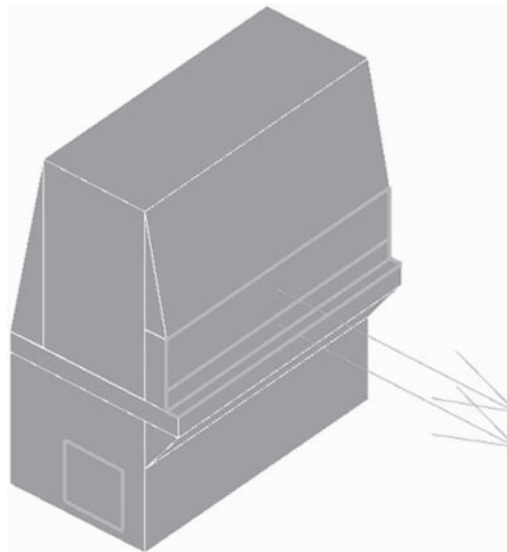

Figure 9 Original change station design.

The makeup air intake for this leakage was mounted at the side of the station. The station dissipated heat that was expected to affect the room's overall flow field. In particular, the station contributed a load of 720 W to the room. This heat was mostly confined to the lower portion of the station where the motor was located.

CASES CONSIDERED

In the original study, over 100 CFD cases were considered. Full details of the cases considered are given in Memarzadeh (1998).

In this paper, two cases are studied: the baseline case outlined above and Case 01, where the supply temperature was raised to 22.2°C (72.0°F). This is summarized in Table 1.

RESULTS AND DISCUSSION

Results

The temperatures in the room and cages for the two cases are shown in Table 2. Case 01 represents an increase of 3.2°C (5.8°F) in the supply temperature and produces an increase of around 2.5°C (4.5°F) in both room and cage temperature.

The concentrations in the room and cages for the two cases are shown in Tables 3 and 4. Case 01 produces an improvement in NH_3 concentration of nearly 50% in the room and 30% percent in the cage.

To further investigate the effect of increasing supply temperature (without re-running all 100+ cases) the results from Memarzadeh (1998) were "post-processed" by adding 3.2°C (5.8°F) to the mean temperature for each cage. This is equivalent to raising the supply temperature by approximately 4.0°C (7.2°F).

Table 1. CFD Animal Room Cases Considered

Case Name	Supply Diffuser Type	Exhaust Location and Number	Change Station (Status)	Rack Orientation	Rack Density	Make-Up Air (m ³ /s) / Pressurization of Room to Corridor	Supply Temperature °C (°F)	Supply ACH
Baseline case	Radial	Ceiling (×2)	ON	Parallel	Single	0.047 / Neg.	18.8 (65.8)	15
Case 01	Radial	Ceiling (×2)	ON	Parallel	Single	0.047 / Neg.	22.2 (72.0)	15

Table 2. Temperatures in Room Breathing Zone and Cages in CFD Cases

Case Name	Room Breathing Zone, °C (°F)	Cage Mean, °C (°F)	Cage Max, °C (°F)
Baseline case	20.3 (68.5)	22.1 (71.8)	23.0 (73.4)
Case 01	23.9 (75.0)	24.8 (76.6)	25.7 (78.3)

Table 3. NH₃ in Room Breathing Zone on Day by Day Basis in CFD Cases

Case Name	Day by Day Room Breathing Zone Average NH ₃ (ppm)									
	1	2	3	4	5	6	7	8	9	10
Baseline case	0.02	0.04	0.06	0.11	0.18	0.26	0.40	0.49	0.59	0.63
Case 01	0.01	0.03	0.04	0.06	0.09	0.12	0.16	0.22	0.29	0.38

Table 4. NH₃ in Cages on Day by Day Basis in CFD Cases

Case Name	Day by Day Cage Average NH ₃ (ppm)									
	1	2	3	4	5	6	7	8	9	10
Baseline case	1.15	2.18	3.37	6.33	10.66	15.82	23.78	29.51	35.35	38.09
Case 01	1.03	2.01	3.10	4.46	6.28	8.70	11.91	16.07	21.34	27.89

Figures 10 and 11 show the resulting bar charts for the day 4 cage and room NH₃ concentrations together with the original data. These charts clearly show the reduction in NH₃ concentrations that can be expected when an increased supply temperature is used. A few of the cases do not show significant improvements. These are cases where the original run is already at the minimum RH (61%) used in the generation rate calculation.

Discussion

In assessing the impact of the NH₃ levels, it is useful to consider the figures of 1 and 25 ppm NH₃. The 1 ppm concentration is a value above which the facility scientists would notice the presence of ammonia (Smyth 1956). The 25 ppm concentration is seen to be problematical to mice. In particular, Schoeb et al. (1982) indicate that NH₃ concentrations above 25 ppm promote the growth of infective agents in the respiratory tract of rats in cages.

The results with increased supply discharge temperature show that the NH₃ levels in the rooms are acceptable by approximately one extra day. Considering the average NH₃

concentration, the rooms are acceptable up to day 7 apart from double-density rack cases that fail on day 6. The maximum NH₃ concentration shows an improvement with many more rooms acceptable on day 5 and with most starting to fail on day 6.

The cages show nearly a two-day improvement, with the average cage going over 25 ppm on day 10, although the worst cages with the maximum NH₃ concentration start to fail in a few rooms on day 8, with most failing on day 9.

The increase in supply discharge temperature is seen to lead generally to a reduction in RH, which results in a lowering of NH₃ concentrations. As a side benefit, the increase in the temperature is also recommended by Gordon et al. (1997) who indicate that the “standard housing temperature of 22.0-24.0°C (72.0-75.0°F) is significantly below the thermoneutral zone of groups of mice suggesting that they are subjected to varying degrees of cold stress under standard housing conditions.”

In reducing the levels of NH₃ using this technique, it is, therefore, possible to increase the time between bed changes by one or possibly two days. The overhead in increasing the

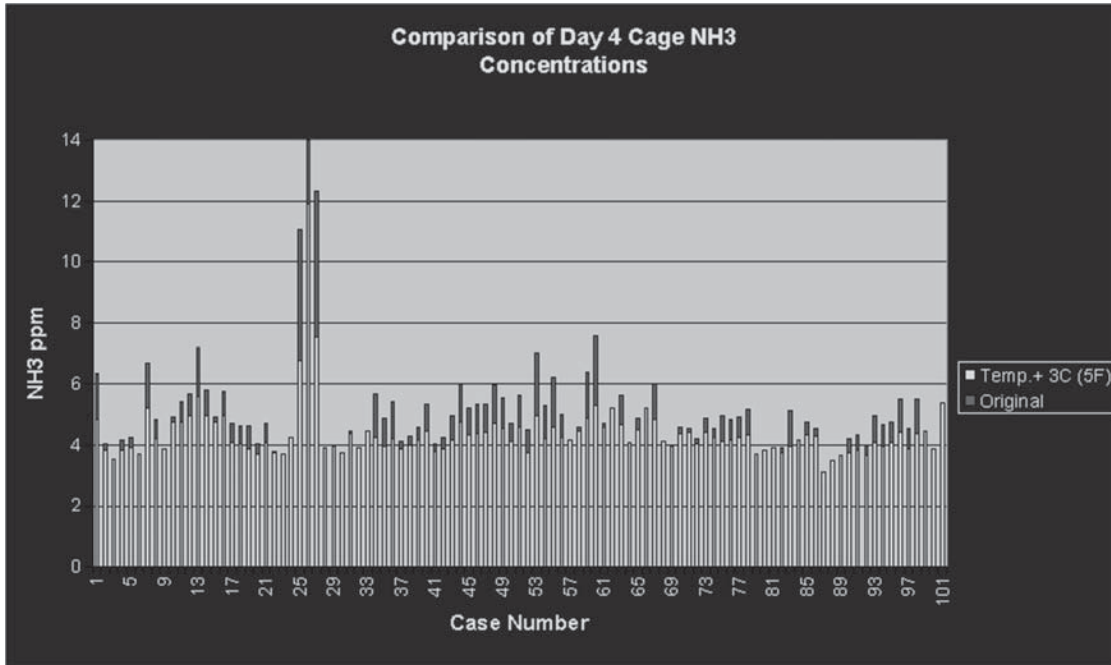

Figure 10 Comparison of cage day 4 NH_3 concentrations on increased supply air discharge temperature (cases taken from Memarzadeh [1986]).

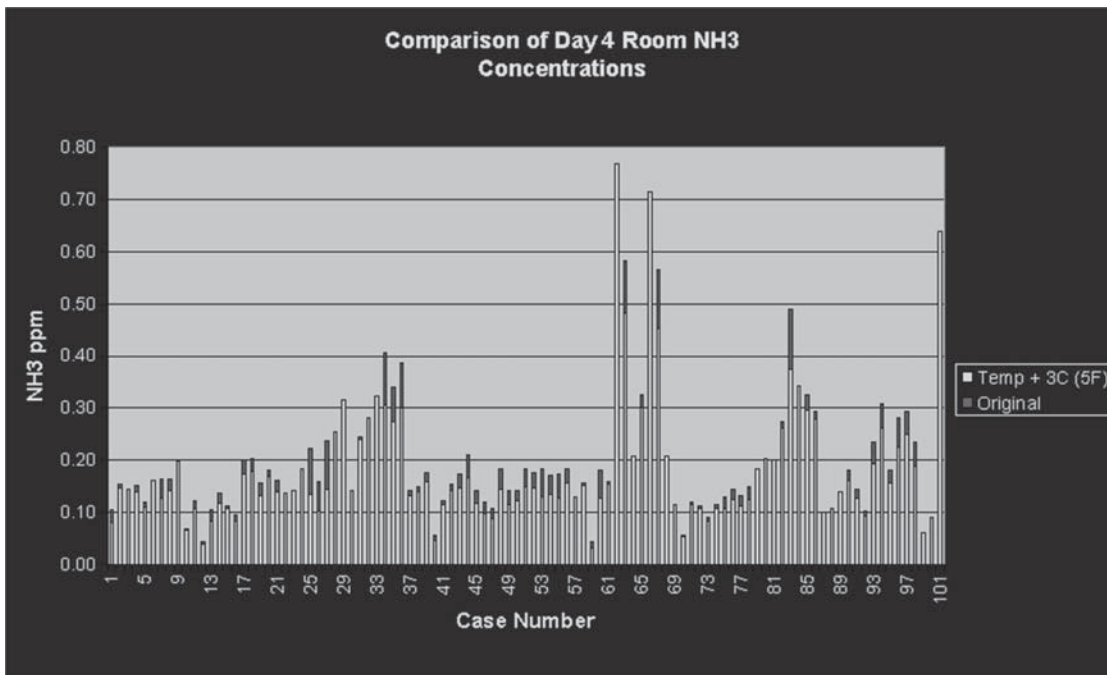

Figure 11 Comparison of room day 4 NH_3 concentrations on increased supply air discharge temperature (cases taken from Memarzadeh [1986]).

supply air temperature by this amount may not be feasible in some regions. However, in regions that can naturally take advantage of this, such a change in bed-change protocol would result in significant savings.

CONCLUSIONS

The main conclusions are:

- An increase in supply discharge temperature is seen to lead generally to a reduction in RH, which results in a lowering of NH₃ concentrations.
- If the supply discharge temperature is increased such that a 3.0°C (5.4°F) rise in temperature is seen in the cages, the time between bed changes can be increased by one to two days.

REFERENCES

- Flomerics. 1994. *FLOVENT[®] Reference Manual*. Document No. FLOVENT[®]/RM/0994/1/0.
- Gordon, C.J., P. Becker, and J.S. Ali. 1997. Behavioral thermoregulatory responses of single and group housed mice. *Physiology and Behavior*, Neurotoxicology Division, National Health and Environmental Effects Research Laboratory, U.S. Environmental Protection Agency, Research Triangle Park, North Carolina.
- Idelchik, I.E. 1989. *Flow Resistance: A Design Guide for Engineers*, E. Fried, ed. New York: Hemisphere Publishing Corp.
- Memarzadeh, F. 1998. *Ventilation Design Handbook on Animal Research Facilities Using Static Microisolators*. Bethesda, MD: National Institutes of Health, Office of the Director.
- Schoeb, T.R., M.K. Davidson, and J.R. Lindsey. Intracage Ammonia Promotes Growth of *Mycoplasma Pulmonis* in the Respiratory Tract of Rats. 1982. *Infect. Immun.* 38:212-217.
- Smyth, H.F., Jr. 1956. Improves communication-hygienic standards for daily inhalation. *Am. Ind. Hyg. Assoc. J.* 17:129-185.