

DOT/FAA/AM-94/19

Office of Aviation Medicine
Washington, D.C. 20591

The Performance of Child Restraint Devices in Transport Airplane Passenger Seats

Van Gowdy
Richard DeWeese

Civil Aeromedical Institute
Federal Aviation Administration
Oklahoma City, Oklahoma 73125

September 1994

Final Report

This document is available to the public
through the National Technical Information
Service, Springfield, Virginia 22161.



U.S. Department
of Transportation
**Federal Aviation
Administration**

NOTICE

This document is disseminated under the sponsorship of the U.S. Department of Transportation in the interest of information exchange. The United States Government assumes no liability for the contents or use thereof.

1. Report Number DOT/FAA/AAM-94/19	2. Government Accession No.	3. Recipients Catalog No.	
4. Title and Subtitle THE PERFORMANCE OF CHILD RESTRAINT DEVICES IN TRANSPORT AIRPLANE PASSENGER SEATS		5. Report Date September 1994	
7. Author(s) Van Gowdy and Richard DeWeese		8. Performing Organization Report Number	
9. Performing Organization Name and Address FAA Civil Aeromedical Institute P.O. Box 25082 Oklahoma City, OK 73125		10. Work Unit No. (TR AIS)	
12. Sponsoring Agency Name and Address Office of Aviation Medicine Federal Aviation Administration 800 Independence Avenue, S.W. Washington, D.C. 20591		11. Contract or Grant Number	
15. Supplementary Notes		13. Type of Report and Period Covered	
16. Abstract <p>The performance of child restraint devices (CRDs) in commercial transport airplane passenger seats was evaluated by a dynamic impact test program. Background information on the policies and regulations related to child restraints is summarized. Tests were conducted at the FAA Civil Aeromedical Institute. Six types (CRDs) certified for use in airplanes were tested. Booster seats, forward facing carriers, aft facing carriers, a harness device, a belly belt, and passenger seat lap belts were evaluated. Impact tests were conducted with CRDs installed on airplane passenger seats. The test severity was 16 Gpk with an impact velocity of 44 ft/sec. Effects of multiple row seats, aft row occupant impact loads, and seat back breakover were part of the project protocol. Four child size anthropomorphic test dummies were utilized. The 6-month and 36-month size ATDs defined in 49 CFR Part 572, the 6-month size CRABI ATD, and a 24-month size experimental ATD identified as CAMIX were used in these tests. An experimental device to measure abdominal pressure was evaluated in the CRABI and CAMIX ATDs. Analyses of the data acquired from the tests and observations related to the performance of the CRDs in airplane seats are presented.</p>		14. Sponsoring Agency Code	
17. Keywords Child Restraints Transport Airplanes Passenger Seats		18. Distribution Statement Document is available to the public through the National Technical Information Service, Springfield, Virginia 22161.	
19. Security Classif. (of this report) Unclassified	20. Security Classif. (of this page) Unclassified	21. No. of Pages 34	22. Price

**This Page
Intentionally
Left Blank**

Table of Contents

	Page
Part I - Issues, Policies, and Standards	1
AVIATION REGULATORY POLICIES	1
AIRCRAFT SEAT REGULATIONS.	2
CHILD RESTRAINTS IN AIRPLANE SEATS - PREVIOUS RESEARCH. ...	2
CHILD RESTRAINTS - CURRENT PERFORMANCE STANDARDS	3
COMPARISON: FMVSS-213 AND FAR 25.562.	4
Part II - Child Restraints - Research Project	5
PERFORMANCE FACTORS	5
CRD TEST SPECIMENS	5
ANTHROPOMORPHIC TEST DUMMIES	7
PASSENGER SEAT SPECIMENS.	9
INSTRUMENTATION	9
TEST FACILITY AND METHODS.	9
TEST SLED CONFIGURATION.	9
TEST VARIABLES	9
Part III - Child Restraints - Performance Tests	10
BOOSTER SEATS	10
FORWARD FACING CONVERTIBLE CARRIERS	14
MODIFIED SEAT BELTS TESTS	16
AFT FACING CARRIERS	17
HARNES RESTRANTS	20
LAP HELD CHILD RESTRAINT (BELLY BELT)	21
NORMAL LAP BELTS	23
Part IV - Conclusions	27
REMARKS.	28
REFERENCES.	29

**This Page
Intentionally
Left Blank**

Acknowledgments

The authors of this report acknowledge the following individuals for their assistance in this project. Frances Holden, Donna Richard, and Bill Taylor of Transport Canada who provided their valuable time and resources during the conduct of the tests. Lisa Sullivan of the National Highway Traffic Safety Administration - Vehicle Research and Test Center assisted by furnishing the 3 year-old test dummies used in this project. Richard Chandler, FAA retired, is acknowledged for his guidance, expertise, and historical perspective in this field.



The Performance of Child Restraint Devices in Transport Airplane Passenger Seats

Part I Issues, Policies, and Standards

Performance standards for child restraint systems sold in the United States are defined by Federal Motor Vehicle Safety Standard 213 (FMVSS-213)(1*). There are important differences between airplane and automobile seats. The methods and fixtures used to certify child restraints may not produce results that effectively measure their performance in an airplane seat. With the advent of dynamic seat performance standards for modern airplane seats, it is important to determine the performance of child restraints in a representative test condition for the airplane environment. As a minimum, the performance criteria of child restraints installed in airplane seats should provide the level of protection implied in the government standards and test procedures by which they are approved. These criteria include protection from serious injury to the head, chest, and legs.

Public awareness of the benefits provided by child restraints has grown during the past decade. The use of child restraints in automobiles has increased with the passage of laws by all 50 states requiring approved restraints for young children. The availability and variety of designs have increased as well. More than 45 models of approved child restraint systems are now produced. The National Highway Traffic Safety Administration (NHTSA) estimates 4.5 million child restraints are sold yearly. Both the increased awareness and use of approved child restraints by the public may escalate the use of child restraints in commercial air transport. Thus, it is important that the standards governing the performance of child restraints result in products that meet the expectations of the users in both automobiles and airplanes.

The term "child restraint system" in FMVSS-213 applies to portable as well as built-in restraints. Indeed, occupant protection must be addressed from a systems approach which includes the vehicle seat, restraints, and surrounding structures. When a portable child restraint is installed on an airplane passenger seat, the child restraint becomes a component in the passenger seat system. An effective assessment of the system performance should include the key components of the system. For the purposes of this report, the term child restraint device (CRD) will be used to distinguish between the portable child restraint and the overall passenger seat system.

AVIATION REGULATORY POLICIES

In 1982, the FAA's first policy that allowed the use of CRDs in airplanes was issued in Technical Standard Order (TSO) C100. Prior to the issuance of this order, the use of passenger furnished child restraints was not allowed during take-off or landing. Voluntary performance standards for child restraints in airplanes had been developed by industry (2,3). However, the FAA's policy, based on FAR 121.311, stated child restraints brought on board an airplane must be treated as carry on baggage.

TSO C100 defined two performance standards for CRDs in airplanes. The first was FMVSS-213 as amended in 1980. The second performance standard was defined in the TSO. An 18 G, 22 ft/sec dynamic test with the CRD installed on a "representative" airplane seat fixture was specified in the TSO. A list of TSO approved CRDs was provided by the FAA.

*Numbers in parentheses indicate references at the end of the report.

At the recommendation of a United States Department of Transportation (DOT) report issued in 1983 (4), TSO C100 was amended in 1985. The dynamic test procedure was deleted from the TSO. FMVSS-213 was also amended to include a roll over test for CRDs in airplane seats, and this NHTSA standard was designated by the DOT as the solitary standard for child restraints. "Approved child restraints" for air carrier operations in the United States were devices certified to meet the requirements of FMVSS-213. A CRD labeled as meeting FMVSS-213 could be allowed, at the discretion of the operator of the airline, as a child restraint.

Changes to the FAR in 1992 (5) expanded the definition of approved child restraints to include any CRD that is labeled to meet United Nations or foreign government standards. The 1992 amendments explicitly removed the discretionary allowance of approved CRDs by the operator. Thus, if any approved CRD is furnished for a child holding a ticket, it must be allowed by the operator.

Simultaneously in 1992, the FAA amended Advisory Circular (AC) 91-62 which defined certain types of CRDs approved per FMVSS-213 that should *not* be used in airplanes. A CRD that positions the child on the lap or chest of an adult seated in a passenger seat should not be used according to the AC. This is despite the fact a CRD of this type may be labeled to meet the requirements of a recognized international standard or foreign regulatory authority. Other limitations for CRDs, such as seat location and proximity to an accompanying adult, were also contained in this Advisory Circular.

Additional policy information was published by the FAA in the form of a Flight Standards Information Bulletin (FSIB Number 92-23) concurrent with the amended FAR and Advisory Circular. This FSIB contained the same information as issued in AC 91-62 .

AIRCRAFT SEAT REGULATIONS.

A separate activity by the FAA in the 1980s resulted in improved performance criteria for aircraft passenger and crew seats (6). Regulations adopted in 1988 defined measurable performance standards for assessing occupant protection from crash injuries as well as structural performance of the seat and restraint system. Dynamic impact test conditions and the pass-fail criteria are specified in the FAR. Two test conditions are specified, a horizontal and a vertical impact orientation. The responses recorded from anthropomorphic test dummies (ATDs) occupying the seats during the

tests must indicate protection from serious injuries to the head, lower spine, femurs, and chest.

Occupant injury due to contact with structures and furnishings surrounding the seat installation must be considered in the certification procedures for the seat. Thus, impact tests for certification of airplane seats often include a representative environment of the seat installation. Performance is measured as a system, rather than an evaluation of the components by separate tests.

The FAR also specify a 50th percentile ATD as the occupant for measuring impact responses. The lap belt restraints on seats certified by the FAR must accommodate a range of occupant size from a 2-year old child to a 99th percentile male. There is no requirement for seats to accommodate CRDs, nor is there an FAA requirement to assess injury protection for occupants in CRDs installed in passenger seats. Thus, new airplane seat performance regulations focus on adult occupant injury protection. Providing additional protection by means of a CRD is the option of the accompanying adult.

CHILD RESTRAINTS IN AIRPLANE SEATS - PREVIOUS RESEARCH

Previous reports on the performance of child restraints in airplane seats have differing results. Most studies have applied the test conditions of existing or proposed automotive standards for CRDs at the time of the studies. Chandler and Trout (7) in 1978 identified difficulties with adapting restraint devices to an airplane seat. They also noted potential hazards due to seat back breakover contact forces on the occupant of a CRD.

In 1983 Naab at Calspan (8) tested 98 CRDs installed on an airplane seat fixture. Based on FMVSS-213 requirements existing in 1983, Naab reported all were successful in meeting the pass/fail criteria. It is important to note that most of the 1983 Calspan tests were conducted at 20 miles-per-hour (22 ft/sec), which is half the impact velocity currently specified in the current FMVSS-213. Also, the vehicle peak acceleration for most of the Calspan tests was approximately 17 G's, whereas, the current FMVSS-213 requirement is a minimum of 24 G's.

A 1993 report (9) by Hardy at the Cranfield Institute in England documented tests with CRDs available in the United Kingdom. Impact tests were performed with CRDs restrained on an airplane seat. Forward facing CRDs were tested at an impact severity of 22 Gpk, and aft facing devices were tested at 16 Gpk. The Cranfield report noted few, if any, of the automotive child restraints built to meet automobile standards would pass the requirements in an airplane seat. Hardy concluded that

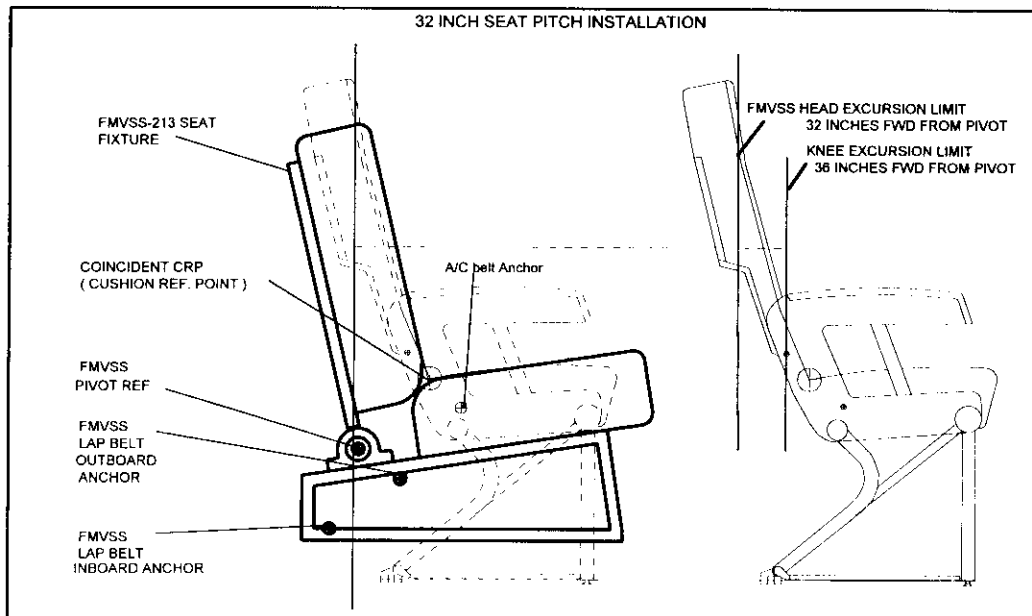

Figure 1.1

some of the CRDs tested in the Cranfield study would perform satisfactorily at a reduced impact severity. He also noted the survivable crash condition associated with transport airplane seats is less severe than automobile standards applied for CRDs.

The Cranfield study also included lap held children with and without supplementary restraints attached to the adult's lap belt. The implications drawn from these tests and noted by Hardy are significant. First, placing unrestrained children on the lap of an adult is "...likely to promote fatalities and injuries to these children in an impact situation." Second, supplementary restraints for lap held children "...may promote other injuries due to the manner in which the restraining forces will be transmitted to the children."

CHILD RESTRAINTS - CURRENT PERFORMANCE STANDARDS

The approval method in FMVSS-213 strictly specifies the test fixtures, procedures, impact conditions, and pass-fail criteria. For portable child restraints, there is no allowance to address the performance of the CRD in a vehicle environment other than the defined test method. The fixtures used to certify CRDs are not representative of the installation of a CRD in an airplane passenger seat. FMVSS-213 test fixtures are designed to represent an automobile seat with the lap belts and shoulder strap anchored geometrically at locations typical in automobiles. There is no allowance to include structures which represent the vehicle's interior

environment in front of the CRD, such as a dash panel or front seat.

Significant differences exist between the test fixture specified in FMVSS-213 and the typical transport airplane passenger seat. Figure 1.1 illustrates some of these differences. These dissimilarities can affect the overall performance of a CRD when dynamically tested. Some of the most notable differences are:

1. Lap belts on the FMVSS-213 fixture are attached at locations that are geometrically different from a typical airplane passenger seat. The inboard and outboard belt anchor points on the automotive test fixture are at different heights. A line passing through the belt anchor points is not parallel to the lateral line defined by the seat back pivot axis. The lap belts on an airplane seat are usually located near a horizontal lateral line passing through the cushion reference point (CRP). This difference results in a more vertical lap belt path over the CRD in the airplane seat.

2. The seat back on the FMVSS-213 test fixture does not rotate forward in a manner representative of airplane passenger seats during the impact. It is common for passenger seats to have breakover seat backs as a convenience feature. On seats with breakover backs, the seat back can be rotated forward to a horizontal position by pushing on the seat back, nominally with 30 pounds of force applied at the top of the back. (Regulations prohibit the installation of seats with breakover backs at certain locations in the cabin). The combined ef-

fects of breakover seat backs and aft row occupant impact forces transferred through the seat back are not evaluated by FMVSS-213.

3. A specific restraint system is not prescribed by FMVSS-213. Modern automobile restraints use a short fixed-length strap on one side. The tension of the belts and shoulder straps is automatically adjusted by the retractor mechanism in the inertia reel. Typically, an automobile buckle is positioned to the inboard side of the occupant when in use. Airplane passenger seat belts are manually adjusted, and the range of adjustment is limited. The buckle on an airplane passenger seat is centered over the lower abdomen when adjusted by an adult occupant.

4. The buckle release mechanisms differ. Modern automobile buckles are smaller and have a push button release. Airplane buckles are usually as wide as the two inch webbing of the belts and have a lift-latch type release. Space above the buckle is required to lift the release plate when removing the belts.

5. The available lateral space for the installation of a CRD on airplane seats is limited to the distance between the arm rests. Typically, this distance is 16.5 to 17.5 inches on economy class seats. On most economy class seats the arm rests can be raised to a stowed position which provides additional space. However, seats in some rows have non-stowable arm rests which may prohibit some CRDs' installation. The FMVSS-213 fixture has no arm rests and provides a wide unobstructed cushion for CRD installation.

Foreign standards for child restraints differ from FMVSS-213. Canada and Australia require a tether strap to secure the CRD to a fixed point on the vehicle. The requirement for a tether strap will prohibit the installation of these devices on transport passenger seats unless the device has been approved for airplane use without the tether by the responsible authorities. Test fixtures and impact severity are also different among the foreign standards. However, foreign approval methods rely on automobile test procedures as the means of measuring performance. Thus, the effects of differences between automobile and airplane seats apply to foreign approved CRDs as well those approved in the US.

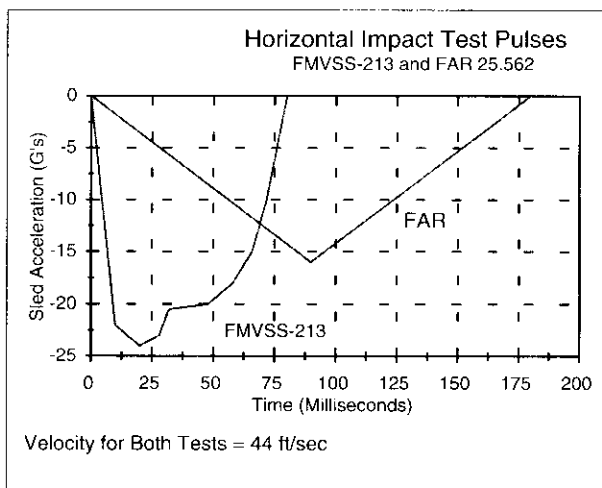

Figure 1.2

COMPARISON: FMVSS-213 AND FAR 25.562.

There are similarities between the pass-fail criteria in FMVSS-213 and FAR 25.562. Both have requirements for structural integrity. Head injury protection, measured by the Head Injury Criteria (HIC), is specified in both regulations. The HIC is determined from a numerical computation performed on head acceleration data. If the value resulting from the HIC computation exceeds 1000, which is considered as an indication of the onset of serious injury, the criteria in the regulations is not met. The HIC is applied only in cases of head contact with surrounding structures in the FAR. Certification of airplane seats often includes representative structures and furnishings in the proximity of the seat installation. HIC is also computed from the FMVSS-213 test procedure. However, there is no structure placed in front of the CRD in the automotive standard. The only potential head strike structures are the CRD and the padded seat fixture. A maximum head forward excursion limit of 32 inches from the seat back pivot axis is specified in FMVSS-213. This forward excursion distance is representative of the clearance for a CRD installed on the front passenger seat in an automobile (10).

The impact severity for the horizontal test condition in FAR 25.562 is significantly less than the required test in FMVSS-213. Shown in Figure 1.2, the peak deceleration in FMVSS-213 is a minimum of 24 G's. The minimum peak acceleration in FAR 25.562 is 16 G's. The FAR requires a second test condition that is a vertical impact orientation. For transport category aircraft, the vertical impact severity is less than the horizontal test severity. Its main purpose is to insure occupant

spinal loads do not exceed a specified criterion of 1500 pounds.

Another important difference exists in the pass-fail criteria of the two regulations. Any evidence that the lower torso restraints load the abdominal region above the pelvis are cause for rejection by the FAR. FMVSS-213 does not prohibit abdominal loading. In fact, the primary load path for some CRDs is directly into the upper abdominal region.

Part II Child Restraints - Research Project

A project was initiated by the FAA Civil Aeromedical Institute (CAMI) Biodynamics Research Section to evaluate approved CRDs currently used in commercial air transport operations. There were no specific "pass/fail" criteria for the CRDs tested by the conditions of this project. Rather, the objective was to evaluate performance factors such as installation difficulties, physical interface with the airplane seat, retention of occupant, and analysis of injury potential by biomechanical responses from the ATDs. Representation of the physical environment surrounding the seat-restraint installation in a transport airplane was included in the test protocol.

PERFORMANCE FACTORS

The three performance factors examined by dynamic impact sled tests with CRDs were as follows:

Factor 1: Fit and adjustment. The physical interface between the CRD and a passenger seat was addressed by this factor. This factor included an assessment of lap belt interface and proper adjustment of the CRD installed in a passenger seat. Ergonomic considerations as well as observations concerning potential misuse or incorrect installation were also considered.

Factor 2: Dynamic performance. This factor was based on an evaluation of observations and measurements from impact tests with the CRD installed in an airplane passenger seat. The dynamic test condition was the 16 Gpk, 44 ft/sec impact pulse as defined in FAR 25.562. The evaluation included dynamic displacement, interaction with breakover seat backs, and compatibility with

the lap belts. Occupant head excursion was included in this factor.

Factor 3: Occupant protection. Occupant protection was assessed from biomechanical responses acquired from the child ATDs. Included were head and chest accelerations required for approval as defined by FMVSS-213. The pass/fail criterion in the automotive regulation require that the resultant chest acceleration not exceed 60 G's for over three milliseconds. Potential head injury was assessed by the HIC. Head acceleration data were acquired only in tests where head contact on structures occurred. An experimental method to measure abdominal forces induced by the CRD was also evaluated.

The test conditions and devices for the series of tests in this project were not selected for the purpose of validating the CRDs' performance per the requirements of FMVSS-213. Rather, the goal of the protocol was to investigate the above factors under the impact conditions considered survivable in modern transport category airplane seats.

CRD TEST SPECIMENS

Table 2.1 lists the models of child restraints evaluated in this test program. The CRDs provided for this dynamic test project were classified into five types, and normal passenger seat lap belts were included as the sixth type of restraint system. Figure 2.1 displays the weight ranges for the types of child restraints tested in this project. The six types of CRDs are described by the following:

1. Booster Seats. Booster seats are designed for children who weigh in the range of 30 to 60 pounds. These seats are a raised platform base on which the child sits. A front shield, over which the lap belts are routed, covers the abdominal area of the occupant. Booster seats do not have a back or side shell. There are no integral belts to restrain the child. Depending on the model, some booster seats can be used without the front shield if a shoulder strap is available. Four booster seats were tested in this project. All were labeled as meeting FMVSS-213 and certified for use in airplanes.

2. Forward Facing Convertible Carriers. These devices are designed to be installed forward facing in the vehicle seat for children weighing more than 20 pounds. For children who weigh less than 20 pounds, the convertible carrier CRD is installed facing aft. Many have a maximum occupant weight restriction of 40 pounds. All convertible carriers provide shoulder straps as part

CHILD RESTRAINT IDENTIFIER	MODEL	TYPE	OCCUPANT WEIGHT RANGE (LBS)
A	CENTURY COMMANDER	BOOSTER	30 TO 60
B	KOLCRAFT TOT-RIDER QUICKSTEP	BOOSTER	
C	CENTURY CR-3	BOOSTER	
D	COSCO EXPLORER 1	BOOSTER	
E	BRITAX (UK AUTO SEAT)	CONVERTIBLE	AFT FACING LESS THAN 20
F	KOLCRAFT DIAL-A-FIT II	CONVERTIBLE	
G	FISHER PRICE CAR SEAT	CONVERTIBLE	
H	EVENFLOW ONESTEP 402	CONVERTIBLE	
J	CENTURY3000 STE	CONVERTIBLE	
K	EVENFLOW 7	CONVERTIBLE	
L	CENTURY 2000	CONVERTIBLE	FORWARD FACING 20 TO 40
M	COSCO TLC INFANT CAR SEAT	AFT FACING	LESS THAN 20
N	EVENFLOW JOYRIDE CAR SEAT /	AFT FACING	
P	CENTURY 580 INFANT CAR SEAT	AFT FACING	
Q	CENTURY 4500 INFANT LOVE SEAT	AFT FACING	
R	CENTURY 4560 SDL	AFT FACING	
S	AVIATION FURNISHINGS CARECHAIR 2040-1	FORWARD FACING	6 TO 36 MONTHS
T	LITTLE CARGO	HARNESS	25 TO 40
BELLY BELT	LAP HELD CHILD RESTRAINT		0 TO 24 MONTHS
LAP BELTS	GENERIC - STANDARD LAP BELTS		ANY AGE

Table 2.1

of the CRD. This type of CRD has a back and side protection shell. Not all models of convertible carriers have a rigid front shield. Some have a padded "Y" plate integral to the shoulder straps on the CRD. These devices are usually installed by routing the vehicle lap belts through a path provided on the back of the forward facing CRD. Six FMVSS-213 approved convertible carriers and one U.K. approved (ECE-44) convertible carrier were tested in this project.

One forward facing carrier included in this project was a CRD device designed specifically for use in an airplane passenger seat. CRD S was designed for forward facing installation. The range of occupant size for CRD S was children between the ages of 6 months and 3 years. It includes an integral 5-point restraint with a rotary release buckle. The seat back is hinged to allow the device to fold for storage in an overhead bin. This device met the European Community Standard ECE-44 standard for child restraints.

3. Aft Facing Carriers. These CRDs are only for small children weighing less than 20 pounds. There is no shield over the chest or abdomen of the child. Adjustable shoulder straps are provided integral to the CRD. Typically, an aft facing carrier for small children is installed by tightening the vehicle lap belts through slots on the top side of the CRD. This type of device should not be installed forward or side facing, i.e., the CRDs are *non-convertible*. Five aft facing non-convertible carriers were included in these tests. All five aft facing CRDs were sold in the United States and certified for use in airplanes.

4. Torso Harness. The fourth type of CRD is a torso harness designed for children weighing between 25 and 40 pounds. These are forward facing restraints fabricated with webbing. There is no rigid shell or platform with these harness devices. The CRD attaches to the vehicle's lap belts by passing the belts through a loop sewn on the

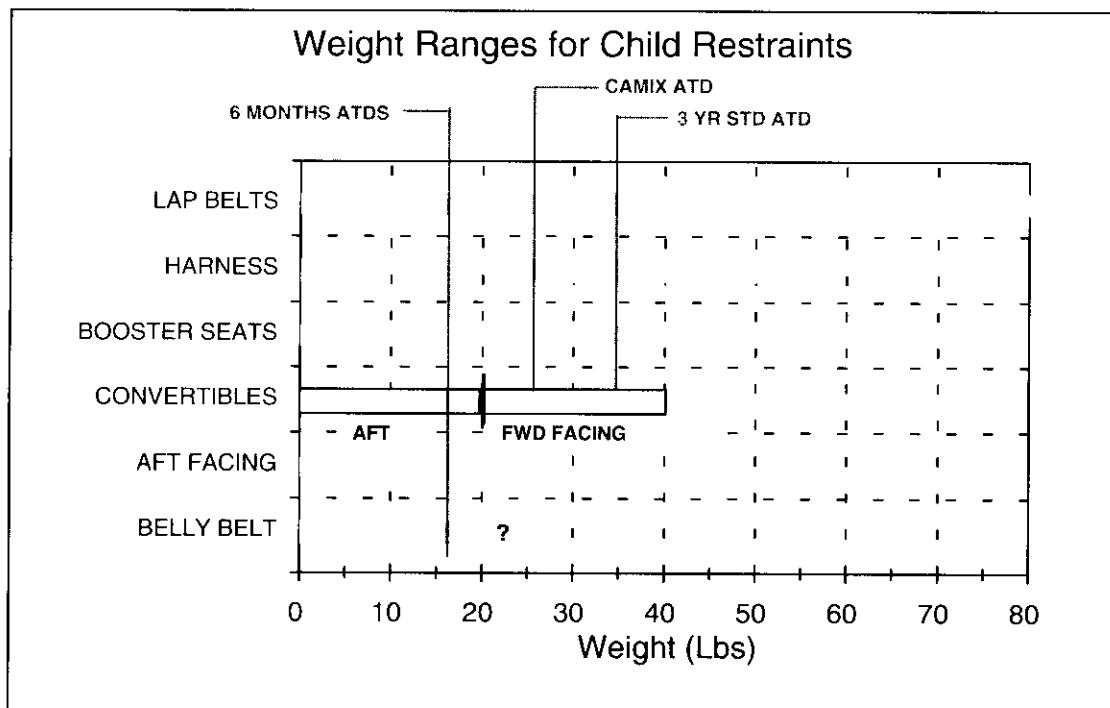

Figure 2.1

back side of the harness. Harness systems are relatively new products. They have the convenience of being lightweight, compact, and easy to install. There are at least three models that currently meet the requirements of FMVSS-213 and certified for use in airplanes.

5. Lap Held Child Restraint. Commonly identified as the "belly belt," this device restrains a small child (less than two years old) on the lap of an adult. Although not approved for use in automobiles by any standards, the belly-belt is certified for use in airplanes by the Civil Aviation Authority of the UK.

6. Passenger Seat Lap Belts. Children of *any age* are allowed to be restrained by the lap belts provided on the passenger seat. Therefore, tests with normal lap belts were conducted for comparison with the add-on devices described in types 1 through 5 above.

ANTHROPOMORPHIC TEST DUMMIES

Four types of child ATDs were utilized in these tests. Two are standard child ATDs as defined in 49 CFR Part 572: the three-year-old Part 572-C with instrumentation, and 6-month old non-instrumented "bean bag" Part 572-D. The third type was an articulated 6-month old identified as

the "Child Restraint and Air Bag Interaction" (CRABI) dummy being developed by the Society of Automotive Engineers (SAE) Infant Dummy Task Group (11). The CRABI dummy has provisions for head and chest instrumentation. The fourth ATD was an experimental 24-month old ATD identified as CAMIX. Table 2.2 lists some of the key anthropomorphic dimensions of these ATDs.

The CAMIX ATD, pictured in Figure 2.2, was developed by Richard Chandler and Joe Young at CAMI for the primary purpose of measuring abdominal pressure loads induced by restraint systems during dynamic tests. The design of the ATD includes articulated limbs, a cast metal pelvis, and an abdominal cavity for fluid pressure instrumentation. The pressure measurement system was comprised of a 500 ml. water-filled intravenous fluid bag. A pressure transducer was attached to the fluid bag by means of a plastic tube. Figure 2.3 shows the system installed in the CAMIX ATD. This was an experimental ATD intended to measure relative differences in abdominal loading from tests with various CRDs. The abdominal pressure instrumentation was also installed in the 6 months old CRABI ATD for selected tests. The water volume in the fluid bag was reduced to 300 ml. when installed in the CRABI ATD. Only one abdominal pressure measurement per test was possible.



Figure 2.2



Figure 2.3

ATD Anthropometry

ATD IDENTIFIER:	PART 572-D 6 MONTH	CRABI	CAMIX	PART 572-C 3-YR OLD	PART 572-B HYBRID II
AGE (MONTHS)	6	6	24	36	ADULT
WEIGHT (LBS)	17.4	17.2	27.2	33.3	170.0
STATURE (INCHES)	26.5	26.3	34.0	38.4	67.0
SITTING HEIGHT (INCHES)	17.5	17.4	20.3	22.5	35.7
WAIST CIRCUMFERENCE (INCHES)	17.3	16.7	18.1	21.0	32.0
HIP BREADTH (INCHES)	6.3	5.9	7.3	7.3	14.7
HEAD CIRCUMFERENCE (INCHES)	16.4	17.4	19.2	19.3	22.5

Table 2.2

There were no established injury criteria for this abdominal pressure measurement. Avoidance of loads in the soft tissues of the abdomen was considered a critical factor in restraint performance. Previous studies to measure abdominal intrusion and pressure in child restraint tests have identified this factor as an important component of restraint performance (12,13). FAR 25.562 requires that lap belt restraints must remain on adult ATD's pelvis during the impact test to certify an

airplane seat. Any indication that the belts move above the prominence of the anterior iliac spine of the test dummy, thus loading the abdomen, is cause for rejection of the seat certification.

A 50th percentile Hybrid II male, specified in 49 CFR Part 572-B, was used in tests to evaluate the lap position belly belt CRD. The 50th percentile ATD was also used to induce aft row occupant impact loads on breakover seat backs.

PASSENGER SEAT SPECIMENS

Economy class triple position transport passenger seats were obtained for this project. The seats are considered typical in construction and dimensions of passenger seats currently in service. These seats were complete assemblies with armrests, backs, tray tables, and cushions. Standard passenger seat lap belts were provided with the seats. All of the seats used in this project were the same model, with the exception of one seat having tray tables in the fixed armrests.

The only modification made to the seats was a seat back breakover lockout plate which was installed on selected tests to inhibit forward rotation of the seat back. For tests with unlocked seat back breakover, the breakover mechanism was adjusted to initiate forward rotation of the seat back with a 30 pound horizontal force applied at the top of the tray table.

INSTRUMENTATION

The biomechanical responses obtained from the tests were dependent on the particular ATDs installed for each test as well as the test configuration. Head impact accelerations were recorded only when there was likelihood of head contact. Thus, head impact responses from forward row ATDs were not recorded. Chest accelerations were recorded if the ATD had provisions for chest instrumentation.

Photometric cameras were positioned on both sides of the impact area to provide accurate coverage of the left and right seating positions when multiple occupants tests were conducted. High speed video recordings were obtained from a "best view" camera perspective for qualitative analysis.

TEST FACILITY AND METHODS

This project was conducted at the CAMI Biodynamics Research Section dynamic impact laboratory. The CAMI impact sled system is a horizontal deceleration facility. Fixtures and test specimens are installed on a ten by five foot sled mounted on a 150 foot long parallel circular rail track. The sled is accelerated gently (<0.4 G) to the impact velocity by means of a falling weight attached through a wire rope and pulley system.

A controlled deceleration pulse is produced with a wire brake mechanism. The moving sled contacts a set of 0.235 inch diameter steel wires placed across the track at the impact site. As the sled moves into the wire pattern, the wires are pulled through rollers anchored to the laboratory floor. The force required to pull the wires through

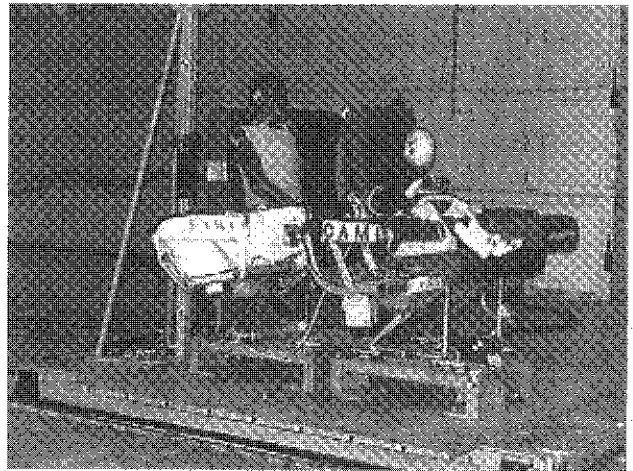

Figure 2.4

the rollers decelerates the sled. Control of the impact pulse shape is determined by the number of wires, placement in the wire pattern, and the lengths of wires.

TEST SLED CONFIGURATION

Figure 2.4 shows the impact sled configuration for the horizontal tests of this project. Dimensions of the double row seat installation represented by the sled test setup are shown in Figure 2.5. Fixtures were installed on the sled to mount the seats in forward orientation. There was no yaw or pitch relative to the impact vector. The fixtures on the sled permitted single row and double row installations of the passenger seats. Double row tests were conducted with 32 inch seat pitch between the seats, which is representative of an economy class cabin. In most tests, more than one CRD was installed in the triple position passenger seats. Vertical impact tests were all single row with the floor for the seat mounted on a 60 degree pitch fixture. Figure 2.6 is a photo of the vertical test setup.

TEST VARIABLES

The primary variable of the tests was the configuration of the passenger seats. Three types of configurations were conducted: 1) single row, 3) double row, and 3) vertical orientation. These configurations are defined as follows:

Single Row Tests. Single row test configurations were conducted to evaluate the CRDs performance without interaction from aft row occupant loads. Important measurements obtained from the single row tests were the maximum excursions of

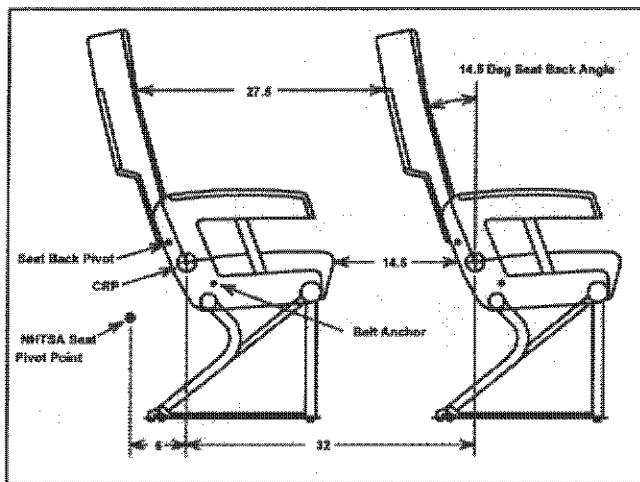

Figure 2.5

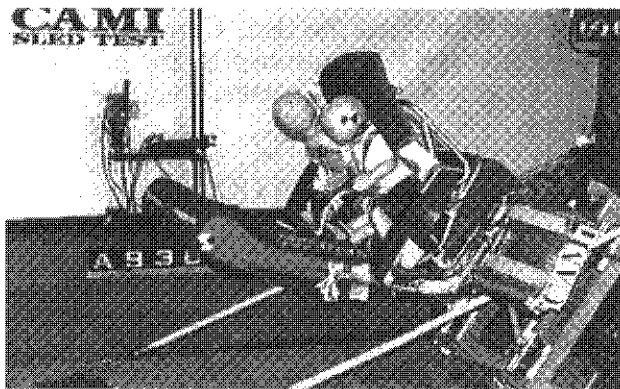

Figure 2.6

the CRD and ATD. Both locked and unlocked seat backs were included in the single row tests. This test configuration is similar to the FMVSS-213 test orientation.

Double Row Tests. A number of different variables were investigated using the double row test setup. With CRDs installed in the forward row seats, it was possible to evaluate the effects of an adult occupant in the aft row impacting the forward seat back and its occupant. Placing the CRDs in the aft row provided head impact responses if the deflection of the CRD resulted in head contact of the child ATD against the forward row seat. The placement of CRDs in the aft row also provided data regarding installation problems, such as contact interference with the forward row seat and cross aisle blockage. Double row tests were also conducted with the belly belt CRD.

Vertical Orientation. The impact orientation for vertical tests was the same as specified in FAR 25.562. This is not a pure vertical impact condition. The impact velocity vector is aligned with

an angle of 30 degrees below the horizontal axis of the vehicle. In this orientation, 86% of the impact momentum vector is parallel with the vertical axis of the seat. Only aft facing CRDs were tested in the vertical orientation.

Part III Child Restraints - Performance Tests

The following results and observations from this series are arranged by the classification of CRDs as presented above. The performance of each class of CRD is summarized in the three previously defined categories of performance factors.

BOOSTER SEATS

Figure 3.1 shows a test setup with booster seats. As shown in Table 3.1, six horizontal tests were conducted with booster seats identified as CRDs A, B, C, and D. The three single row tests provided information pertaining to the physical accommodation and dynamic performance of the CRDs. One of the single row tests was conducted with locked seat backs, and two tests performed with seat back breakover allowed. The three double row tests included an adult ATD placed in the aft row seat. This configuration provided an evaluation of the combined effects of seat back breakover, aft row occupant impact, and the booster seats with no back shell. In four of these tests, one booster seat was occupied with the CAMIX ATD instrumented to measure abdominal pressure. Head path and chest accelerations were acquired from the standard 3-year old ATD. Applying the three per-

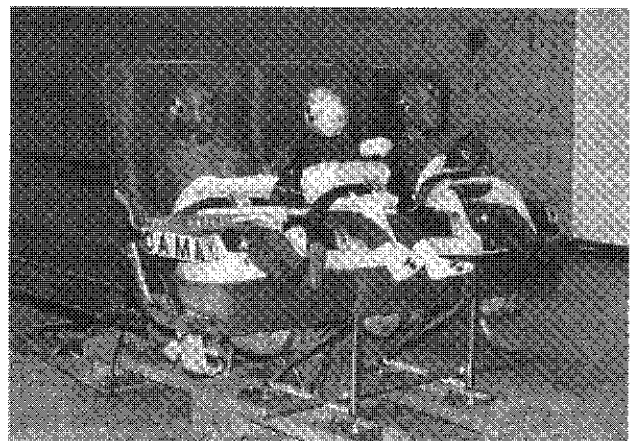

Figure 3.1

BOOSTER SEATS

TEST #	SEAT	POSITION (1)	CRD	ATD	CHEST	ABDOMEN	HEAD FWD
					ACCEL. G's	PRESSURE PSI	EXCURSION INCHES (2)
A93035	SINGLE ROW	RIGHT (L)	A	3 YR-OLD	24.0		
		CENTER (L)	B	CAMIX		20.8	
		LEFT (L)	C	3 YR-OLD	36.1		32.1
A93036	SINGLE ROW	RIGHT (B)	D (2)	3 YR-OLD	31.1		
		CENTER (B)	C	CAMIX		19.5	
		LEFT (B)	B	3 YR-OLD	24.5		35.7
A93037	FWD ROW	CENTER (B)	B	3 YR-OLD	50.4		
		LEFT (L)	C	CAMIX		19.8	
	AFT ROW	CENTER (B)	ADULT 50%				
A93038	FWD ROW	CENTER (B)	C	3 YR-OLD	31.1		
	AFT ROW	CENTER (B)	ADULT 50%				
A93048	FWD ROW	CENTER (B)	C	CAMIX		59.5	
	AFT ROW	CENTER (B)	ADULT 50%				
A93100	SINGLE ROW	CENTER (B)	D (3)	3 YR-OLD	39.3		31.1

(1) L= LOCKED SEAT BACK B = BREAKOVER SEAT BACK

(2) HEAD EXCURSION MEASURED FROM FMVSS-213 SEAT PIVOT LINE

(3) CRD D WAS RE-TESTED ON A93100 TO ACQUIRE HEAD PATH DATA

Table 3.1

three performance factors, the results from the booster seat tests were:

1. Fit and Adjustment. The space between the arm rests on the passenger seats used for this series was 17.25 inches. One booster seat, CRD D, was too wide to be installed in this space without raising one arm rest to a stowed position. Approximately 21 inches of lateral clearance are needed for CRD D. In most transport aircraft there are seat locations with non-stowable armrests. Examples include front row seats, seats aft of cabin walls, and exit row seats. Thus, the correct installation of larger width CRDs can be dependent on location of the passenger seat.

When CRD B was installed and the airplane seat lap belts were tightened over the front shield, the buckle interfered with a webbing retainer on the CRD shield. The webbing retainer could not be used. Figure 3.2 shows position of the webbing retainer relative to the buckle. Bypassing the webbing retainer did not comply with the manufacturer's instructions attached to the CRD.

With CRDs A and C, the seat belt buckle was too wide for the recessed path molded in the shield. This resulted in an angle between the buckle and the correct webbing path over the shield. One effect of the incompatibility between the buckle width and webbing path over the shield is a deviation in the webbing path on the shield. The resulting path of the webbing across the shield is not according to the manufacturer's instructions. Depending on the alternative method the installer chooses for securing the lap belt over the booster, the dynamic performance of the CRD can be compromised (14).

2. Dynamic Performance. The front shield on CRD A failed during a single row test. The shield detached from the plastic tube on the left side of platform of the CRD. This CRD shield snaps on to the plastic tube when in use. Although the shield did not detach on the right side of the platform, the 3-year old ATD in the CRD translated forward and rotated over the unlatched shield. The ATD did not eject from the CRD; however, retention of the occupant was unsatisfactory as

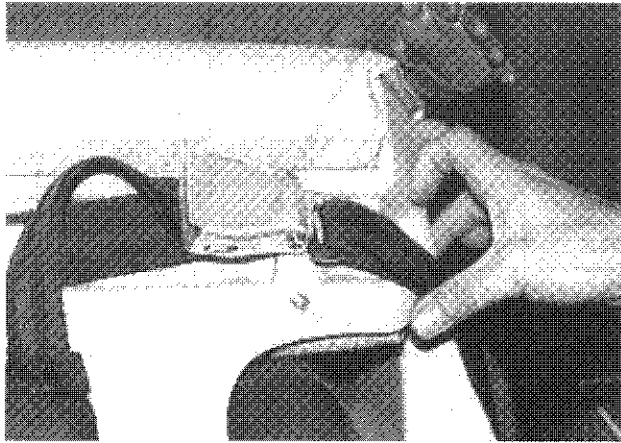

Figure 3.2

viewed from the films of the test. The exact cause of the shield failure was not identified. Post test inspection of the CRD revealed the plastic tube on the left side of the platform had deformed elastically. Discoloration on the plastic tube where deformations occurred were evident. The ATDs were retained in tests with the other three booster seats.

Head excursion paths for booster CRDs B, C, and D are shown in Figure 3.3 and the measured values are indicated in Table 3.1. These data show that head contact will occur if the seat back does not move. Because these data were acquired from single row tests, there were no head impacts recorded. Thus, the HIC was not computed.

Figure 3.3 also illustrates the maximum head excursion for these three booster CRD tests. CRDs B and C exceeded the allowable forward excursion specified in FMVSS-213, though the impact pulse was a lower severity than the automotive standard. These results demonstrate measurable performance differences for CRDs tested in airplane seats versus the approval method in the current standard.

3. Occupant Protection. A key concern for booster seats used in airplane seats is the combined effect of seat back breakover and aft row occupant impact. With no back shell, the typical booster seat does not provide protection from the forces transmitted by the airplane seat back during horizontal impact conditions. Traditionally, restraint systems in airplanes have been designed to avoid loads transmitted to the soft tissues of the abdomen. A child restrained in a booster seat may be forced against the rigid shield of the booster due to the seat back breakover action. For the intended size of children in booster seats, the load path of

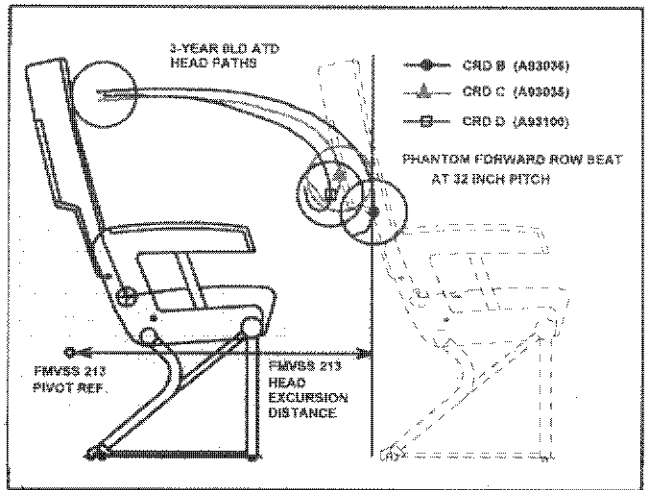

Figure 3.3

these breakover forces may include the abdominal region.

Shown in Table 3.1, the CAMIX ATD with abdominal pressure instrumentation was utilized in four tests with booster seats. The test matrix included abdominal pressure measurement during three different seat back breakover conditions: 1) no seat breakover; 2) normal breakover with no aft row occupant impact; 3) normal breakover combined with an aft row adult occupant impact. These are three common seat locations in transport airplanes.

The quantitative results acquired from the abdominal pressure device can not be applied as an injury criterion. However, compared to the data from single row tests, there was a distinct and significant difference in the abdominal pressure response from the test condition with seat back breakover combined with an aft row adult occupant. Shown in Figure 3.4 are abdominal pressure

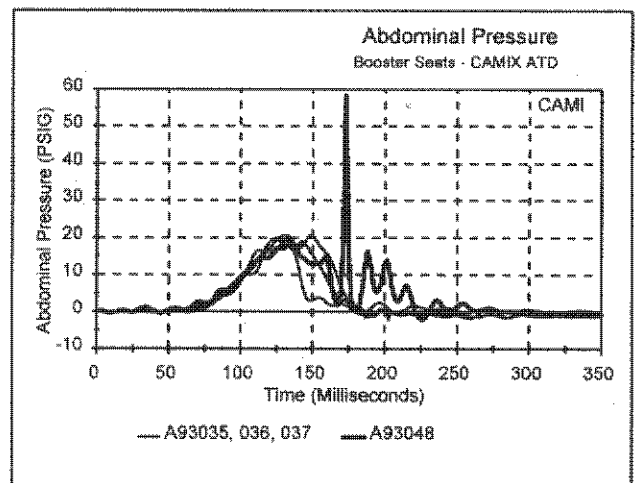

Figure 3.4

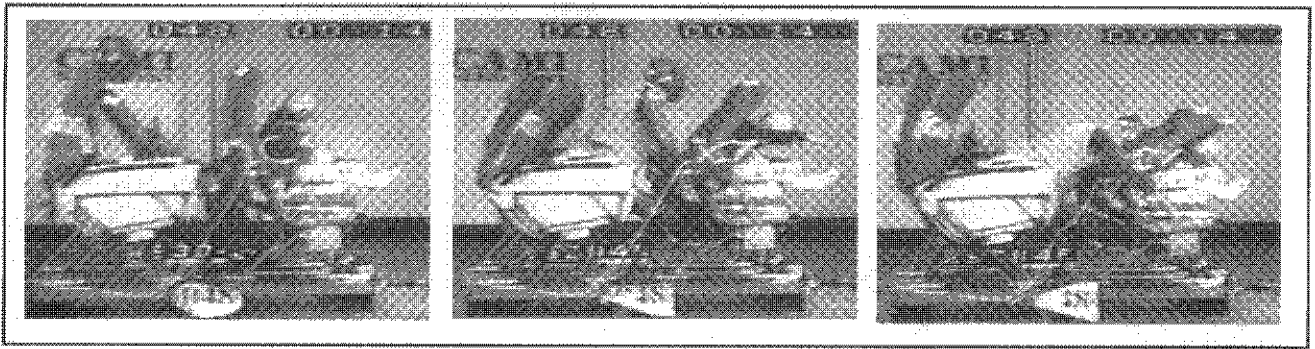

Figure 3.5

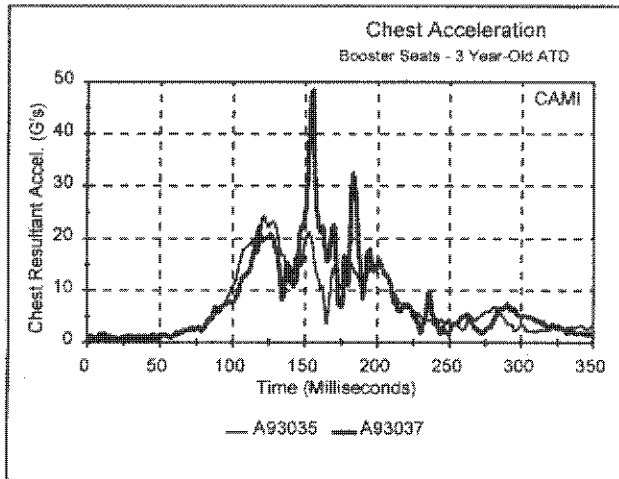

Figure 3.6

response data from four tests. The high-magnitude short-duration abdominal pressure pulse was recorded in test A93048, which included an aft row occupant and seat back breakover. This pressure pulse occurred simultaneously with the aft row adult ATD striking the back of the seat occupied by the CAMIX ATD restrained in a booster seat. Figure 3.5 presents a sequence of three frames extracted from high speed video recorded during test A93048.

There are two important observations to be noted from Figure 3.4. First, the abdominal pressure response before the aft row occupant impacts the seat back during test A93048 is similar to the responses from the other three tests, A93035, -036, and -037. The seat back was locked on tests A93035 and -037. Seat back breakover was allowed on test A93036. These three tests were conducted with no occupant in the aft row seat. Thus, there is no obvious effect on the abdominal pressure measurement due solely to seat back breakover.

Second, the peak magnitude of the pressure pulse at the time of aft row occupant contact is distinct and significantly higher than pressure prior to contact. From the time correlation of film and recorded data, the pressure pulse occurred simultaneously with the aft row occupant impact on the seat back. The peak pressure was 59.5 psig, approximately three times greater than the peaks from the three single row tests.

Chest acceleration measurements acquired from a standard 3-year old ATD in booster seat tests were within the accepted limit specified in FMVSS-213 (60 Gs maximum). Figure 3.6 shows the acceleration results from these tests. The highest chest peak acceleration recorded occurred on test A93037 which was a double row test. The peak chest acceleration occurred coincident with the aft row adult impacting the breakover seat back.

Summary - Booster Seat Tests

With the four booster CRDs tested in this series, three had fit and adjustment problems. Installation difficulties with one CRD were attributed to the limited width between arm rests on the airplane passenger seat. The incompatibility between the buckle and the webbing path molded in the front shield on two booster CRDs altered the web path and buckle position of the tightened lap belts. The resulting variance in the webbing path over the front shield is not in compliance with the manufacturer's instructions, indicating that they can not be correctly installed in an airplane seat.

One of the four booster CRDs failed structurally during the 16 Gpk, 44 ft/sec test. The potential for head impact on a forward row locked seat back at 32 inch pitch was measured from photometric data with 3-year old ATDs tested in the three other booster CRDs. The maximum forward head excursion from tests with two of the CRDs exceeded the distance allowed in FMVSS-213, which has a higher severity impact test condition.

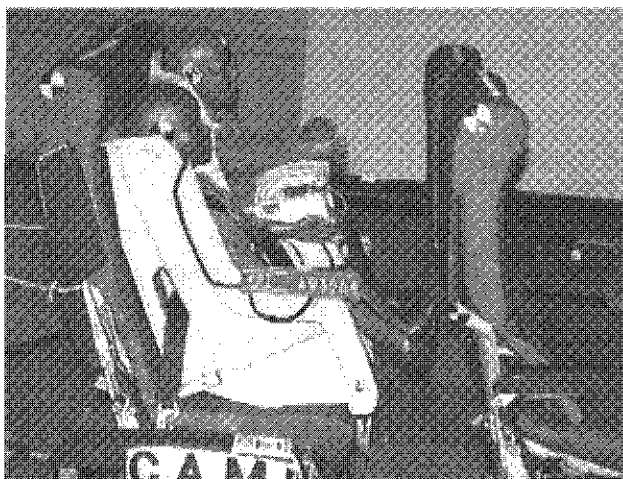

Figure 3.7

The peak abdominal pressure response from the CAMIX ATD was significantly higher in the test with seat back breakover and aft row occupant impact on the seat. The highest peak chest acceleration from a 3-year old ATD was also measured in the same test configuration. Data from tests conducted with no aft row occupant impact did not exhibit a significant effect on abdominal pressure or chest acceleration due solely to seat back breakover.

FORWARD FACING CONVERTIBLE CARRIERS

Figure 3.7 shows a typical double row test with forward facing convertible carriers. Table 3.2 presents the seven tests of this series. Eight models of CRDs were tested, including one foreign device built specifically for use in an airplane passenger seat. The test matrix included five double row tests with the CRDs installed in the rear seat. The forward row seat was unoccupied and the seat backs were locked in the double row tests. All tests of forward facing convertible seats were conducted with the standard 3-year old ATD instrumented to measure head and chest accelerations. The two single row tests were conducted to measure the 3-year old ATD's head excursion with this type of CRD.

The results from the forward facing device tests were:

1. Fit and Adjustment. This type of CRD is the most difficult to install in the confines of a coach class airplane passenger seat environment. Two limiting factors affect the ease of installation and proper adjustment. First, the limited space in front of normal row seats restricts the access of

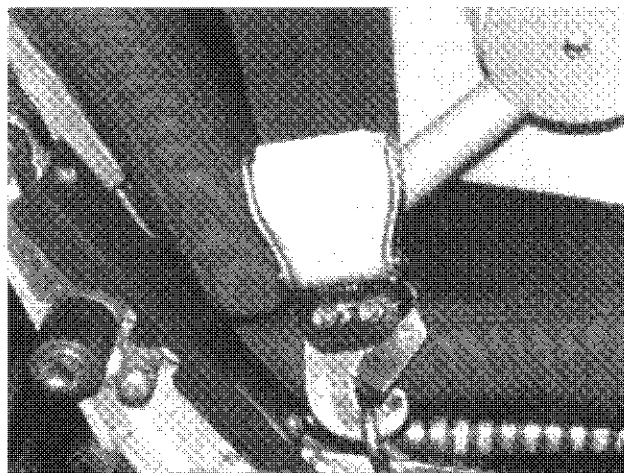

Figure 3.8

the installer to route and adjust the lap belts through the back of the CRD. Second, on seats with non-stowable arm rests, the width of the CRD may inhibit installation or adversely affect proper adjustment.

With the lap belts routed through the backs of CRDs F and J per the manufacturer's instructions, the CRDs were unacceptably loose. This was due to vertical path of the lap belt securing the device to the seat. The CRDs could be moved forward approximately six inches, even with the lap belts adjusted to the minimum length. Dynamic tests with these loosely secured CRDs would obviously result in poor performance. To test CRDs F and J, a modified lap belt was utilized. The photo in Figure 3.8 shows the short fixed-length adaptor used to achieve an acceptable fit with these CRDs. The poor interface with the airplane lap belts resulting in a very loose fit should be considered a misuse condition.

Another characteristic common to this type of CRD was the nearly vertical angle of the airplane lap belts restraining the CRDs. When installed per the manufacturers' instructions, the path angle of the lap belts from the airplane seat attachment to the CRD ranged from 85 to 93 degrees above horizontal. This vertical load path does not produce an effective restraint of forward motion. An angle greater than 90 degrees means the seat belt anchor is forward of the CRD's belt path. During horizontal impact conditions, the CRD must translate forward until the belt path angle is significantly less than 90 degrees for belt tension forces to restrain the CRD. Automotive research has identified similar effects of the belt anchorage location on the performance of child restraints (15).

FORWARD FACING CONVERTIBLES

TEST #	AIRPLANE SEAT	POSITION (1)	CRD	ATD	CHEST ACCEL. G's	HIC
A93044	FWD ROW	EMPTY (L)				
	AFT ROW	CENTER (B)	S	3 Y-OLD	49.8	1131
A93045	SINGLE ROW	CENTER (L)	S	3 Y-OLD	40.9	
A93049	FWD ROW	EMPTY (L)				
	AFT ROW	LEFT (B)	E	3 Y-OLD	50.8	1477
A93052	FWD ROW	EMPTY (L)				
	AFT ROW	LEFT (B)	G	3 Y-OLD	45.8	1246
		CENTER (B)	F	3 Y-OLD	51.1	1145
A93053	FWD ROW	EMPTY (L)				
	AFT ROW	LEFT (B)	J	3 Y-OLD	50.8	1440
		CENTER (B)	H	3 Y-OLD	39	682
A93054	FWD ROW	EMPTY (L)				
	AFT ROW	LEFT (B)	K	3 Y-OLD	54.3	1195
		CENTER (B)	L	3 Y-OLD	50.8	996
A93098	SINGLE ROW	CENTER (B)	F	3 Y-OLD	44.9	

(1) L = LOCKED SEAT BACK B = BREAKOVER SEAT BACK

Table 3.2

CRD S, the device designed specifically for airplane passenger seats, could be installed with minimal effort. The lap belts route over a metal plate structure between the CRD's seat cushion and back. There was no interference with the buckle hardware, and normal length lap belts could be tightened manually to secure the device.

2. Dynamic Performance. Figure 3.9 shows the head excursion measured from single row test A93098 with CRD F. Due to the interface problems with this type of CRD, the forward dynamic excursion was a primary concern. The figure indicates that head contact will occur if the forward row seat back does not rotate forward. Figure 3.10 presents three frames from the high speed film recorded during test A93052 with CRD F. Head excursion was not measured from double row tests, but head contact with the forward row seat back occurred with all seven of the FMVSS-213 certified models tested in this series.

The tests with CRD S, the foreign built device for airplanes, had similar results. Forward excursion of the CRD and head contact with the forward row seat resulted in a HIC of 1131. Another observation from the single row test with CRD S was the ATD submarining or sliding forward beneath the restraints. The 5-point harness prohibited complete release of the ATD.

There were no significant structural failures noted in these tests. The metal insert fitting on the torso restraint integral to CRD G bent during test A93052. This fitting activates an automatic retractor mechanism that adjusts the torso restraints when inserted in the latch on the front of the CRD seat pan. The bent fitting released the tension on the torso restraint and would not re-engage the automatic retractor.

3. Occupant Protection. As noted above, head contact with the forward row seat back occurred with the eight forward facing convertible CRDs tested in the double row configuration.

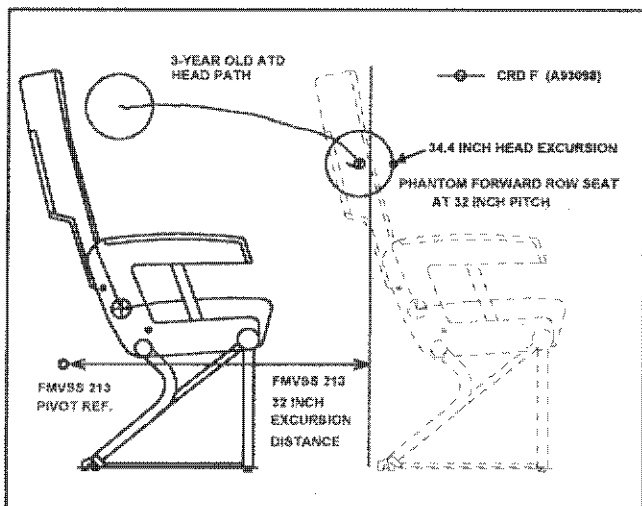

Figure 3.9

Table 3.2 lists the HIC results from these tests. Figure 3.11 shows typical head impact acceleration responses acquired from two of these tests. Six of eight of HIC results exceeded the pass/fail value of 1000. Peak chest acceleration values were all less than the 60 Gpk maximum specified in FMVSS-213.

MODIFIED SEAT BELTS TESTS

To investigate a means of reducing the horizontal dynamic excursion with these CRDs, a modified seat belt location was examined. The objective was to limit forward excursion by moving the lap belt anchor points aft and up from the normal location. The airplane passenger seat was modified to include an alternate lap belt anchor location. This anchor hardware was a common airplane seat belt attachment. The hardware is constructed of a 0.070 inch stainless steel hinged strap with a belt attachment fitting on one end. Figure 3.12 shows a photo of CRD G with the seat belts attached to the modified anchor attachment. Left and right anchors were installed as a replace-

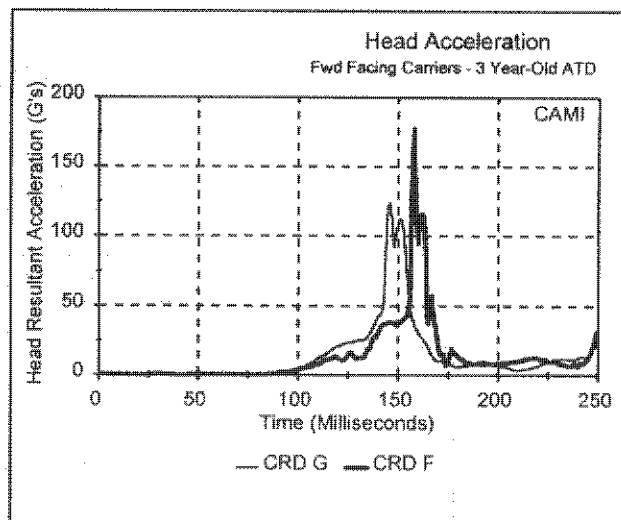

Figure 3.11

ment for two washers on the seat back recline pivot bolt. The anchor locations were part of the existing seat structure. The seat back recline pivot bolt location is common on many coach class seats. It is supported by the structure forming the arm rest attachment.

The anchor point was located 4.5 inches aft and 4.8 inches above the normal seat belt attachment. A shortened lap belt with standard buckle and hardware was installed on these modified anchors. The shortened belts reduced the minimum adjustment length and allowed the belts to be firmly tightened.

Forward facing convertible CRDs E, G, and L were tested with the modified anchor on the rear seat of a double row test. Table 3.3 lists the tests and data acquired. With these three CRDs, the angle of the lap belt path from the anchor point to contact with the CRD was 50, 30, and 65 degrees, respectively, above horizontal. The forward dynamic excursions of the CRDs and the ATDs were significantly reduced. No head contact with the forward row seat back occurred during these tests. ATD head paths from these tests are shown in Fig-

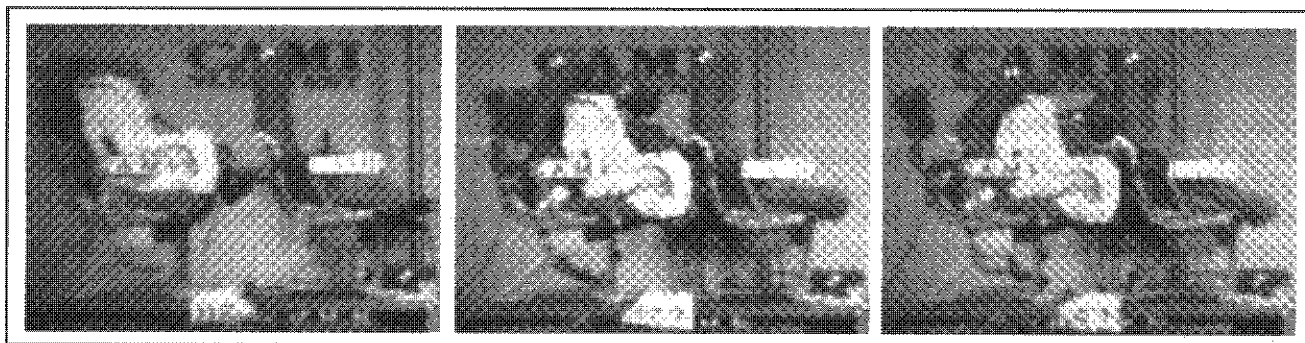

Figure 3.10

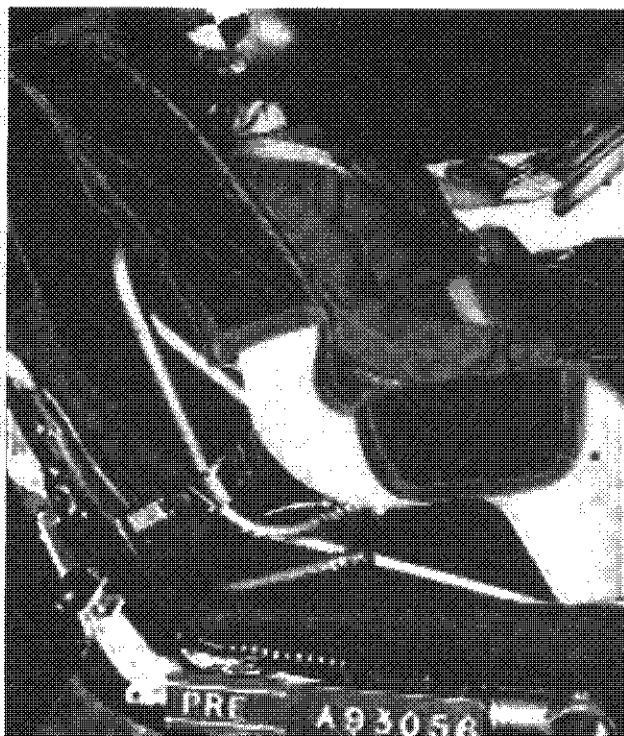

Figure 3.12

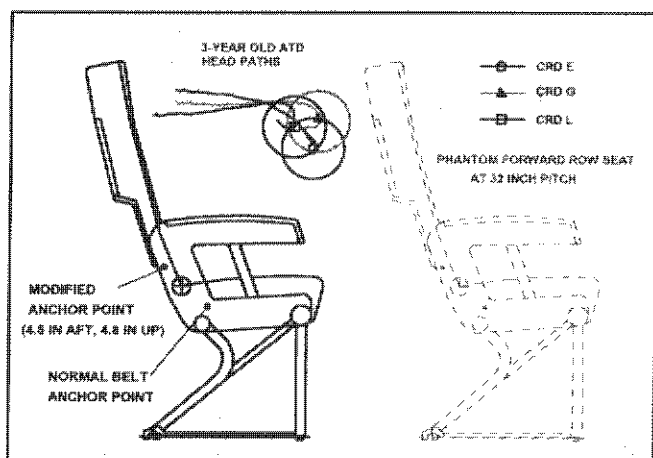

Figure 3.13

MODIFIED SEAT BELT TESTS

TEST #	CRD	ATD	CHEST ACCEL. (G'S)	HEAD EXCURSION (INCHES)
A93055	E	3 YR OLD	26.8	24
A93056	G	3 YR OLD	30	24.6
A93057	L	3 YR OLD	34.6	21.9

EXCURSION MEASURED FROM FMVSS-213 PIVOT REF. CRDS IN AFT ROW, SEAT BACKS WITH BREAKOVER.

Table 3.3

ure 3.13. Peak chest accelerations from the modified belt anchor tests were less than 35 G's for all three CRDs.

Summary - Forward Facing Convertible Carriers

Two of the forward facing convertible CRDs could not be secured satisfactorily in the airplane passenger seat. HIC results were above 1000 in double row tests with six of the eight forward facing convertible CRDs tested in this series. Fit and adjustment problems, particularly with the interface to the airplane seat lap belts, were factors that resulted in forward excursion of the CRDs during dynamic tests. There were no significant structural failures. Peak chest accelerations were less than the maximum of 60 Gpk defined in FMVSS-213.

By moving the seat belt anchor point on the passenger seat aft to the seat back recline pivot bolt, a more effective load path for restraining the CRDs was demonstrated. Head excursions were significantly reduced with the modified anchor point. No head contact resulted for all three CRDs tested with the new anchor point. This modified belt installation also reduced the difficulties of installing a CRD in the confined space of a passenger seat.

AFT FACING CARRIERS

Figure 3.14 is a photo of a test of aft facing CRDs in this series. Table 3.4 shows the matrix of tests with aft facing devices. Eight aft facing CRDs were tested in this project. Note that two tests with aft facing CRDs were performed in the vertical orientation. The vertical tests were conducted per the impact conditions specified in FAR 25.562, i.e., 14 Gpk with a velocity of 35 ft/sec. A photo of the vertical impact test setup is shown in Figure 2.6.

There were two types of aft facing CRDs. The first type was the non-convertible "aft-facing-only" CRD. The second type was the convertible carrier CRD installed aft facing in the airplane passenger seat. Three horizontal tests in this series were double row with one aft facing CRD in the forward row and one in the aft. The seat back on the forward row was locked. Seat back break-over was allowed to occur on the aft row. A standard 6-month old ATD was placed in the forward row CRD, and the CRABI ATD was restrained in the aft row. Four single row tests with the CRABI ATD completed the horizontal test matrix.

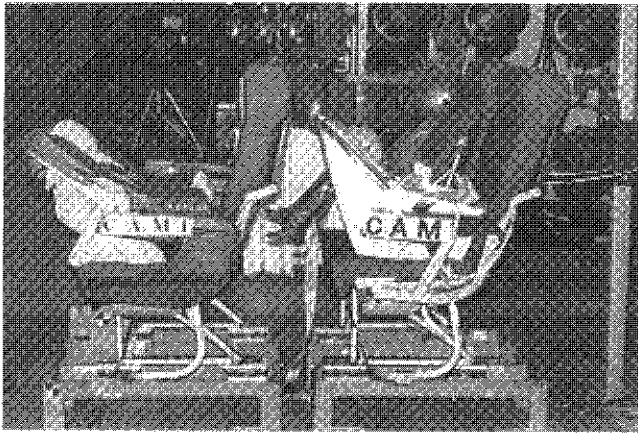

Figure 3.14

The following results apply to these tests:

1. Fit and Adjustment. The non-convertible aft-facing-only CRDs M, N, P, Q, and R could be installed with minimal effort and secured tightly with the airplane lap belts. These devices fit within the available space between the arm rests. Verification of proper installation and adjustment could be confirmed by visual inspection. Quick release of the airplane lap belts and removal of the CRD were considered positive features. One characteristic common to these CRDs was the overhang into the space between seat rows. The extent of the overhang can block the movement of passengers past the CRD and inhibit the forward row passenger from reclining the seat back.

Convertible carriers J and G were tested aft facing with 6-month old ATDs. With these two CRDs, the lap belts are routed over the front of the CRD in a fashion similar to the non-convertible devices. Installation, adjustment, verification, and removal are easily performed. The overhang into the space between seat rows, as noted with the non-convertible aft-facing CRDs, results in the same inconvenience to other passengers.

Two factors which affected the fit and adjustment of the convertible carriers when installed aft facing were the length and attachment location of the fixed-length belt. If the insert fitting on the fixed-length belt was situated in the guide slot formed in the shell of the CRD, the lap belts could not be buckled. If the insert was positioned against a rounded surface on the CRD where the belt path transitions from horizontal to vertical, the buckle pivoted upward when lap belt tension was adjusted. As the buckle pivoted, the internal grip on the webbing was released. Thus, a secure installation could not be achieved. A longer fixed-length belt

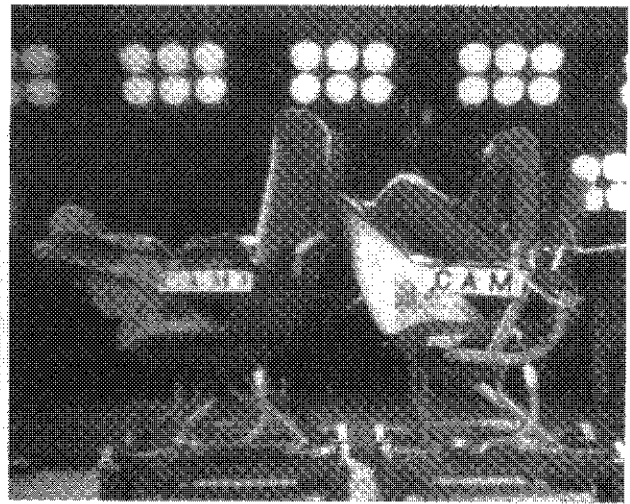

Figure 3.15

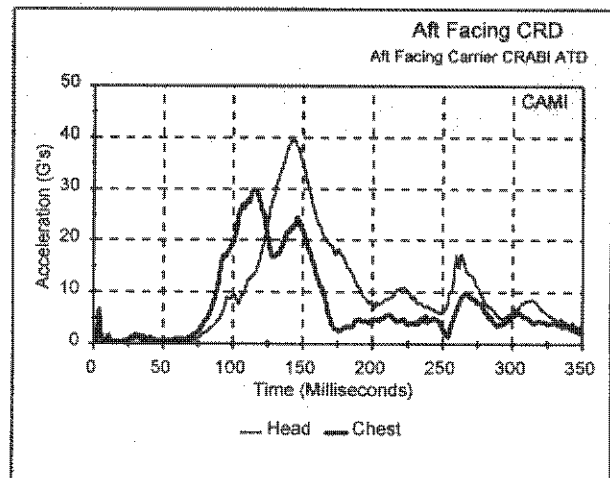

Figure 3.16

was used when these physical interference problems occurred.

2. Dynamic Performance. There were no major problems noted with the eight aft facing CRDs. Forward dynamic excursions were minimal during the horizontal tests, particularly with the aft row installations. The front overhang of the CRDs contacted the seat back of the forward row seat which prevented further horizontal movement. A significant rebound motion and contact with the breakover seat back was noted with the non-convertible CRDs. Figure 3.15 shows the maximum observed excursion of CRDs P and Q in test A93056.

Examination of the films from the vertical tests showed satisfactory retention of the CRDs in the airplane seat. Forward displacement and rotation

AFT FACING DEVICES - HORIZONTAL AND VERTICAL TESTS

6-MONTHS OLD ATDs

TEST #	SEAT	POSITION (1)	CRD	ATD (2)	CRD TYPE	
A93055	FWD ROW	LEFT (L)	M	STD	NON-CONVERTIBLE AFT FACING ONLY	H O R I Z O N T A L
	AFT ROW	LEFT (B)	N	CRABI		
A93056	FWD ROW	LEFT (L)	P	STD		
	AFT ROW	LEFT (B)	Q	CRABI		
A93057	FWD ROW	LEFT (L)	J	STD	CONVERTIBLE AFT FACING	
	AFT ROW	LEFT (B)	G	CRABI		
A93097	SINGLE ROW	LEFT (B)	N	CRABI	NON-CONVERTIBLE AFT FACING ONLY	
A93098	SINGLE ROW	LEFT (B)	R	CRABI		
A93099	SINGLE ROW	LEFT (B)	P	CRABI		
A93100	SINGLE ROW	LEFT (B)	Q	CRABI		
A93065	SINGLE ROW	LEFT (L)	N	STD	NON-CONVERTIBLE	V E R T I C A L
		CENTER (L)	G	CRABI	CONVERTIBLE	
A93066	SINGLE ROW	LEFT (L)	Q	STD	NON-CONVERTIBLE	
		CENTER (L)	F	CRABI	CONVERTIBLE	

(1) L = LOCKED SEAT BACK B = BREAKOVER SEAT BACK

(2) STD = FMVSS-213 STANDARD 6 MONTHS ATD

Table 3.4

tion of the CRDs were minimal. Restraint of the aft facing ATDs was considered acceptable.

3. Occupant Protection. The data acquired with the CRABI ATD in these tests were reduced in magnitude compared to the 3 year-old ATD data from the forward facing tests. An example of head and chest accelerations from the CRABI ATD in test A93056 is shown in Figure 3.16. Admittedly, injury criteria based on head and chest accelerations for 6-month old children are not widely recognized. There are no head or chest acceleration criteria for aft facing CRDs in FMVSS-213. Head and chest acceleration data acquired with the CRABI ATD were considered benign.

Summary - Aft Facing CRDs

Applying the three performance factors of this project, the five non-convertible aft facing CRDs tested in this series performed well. This is the easiest type of CRD to install in an airplane passenger seat. Some of the convertible CRDs could not be secured aft facing in the airplane seat if the

insert fitting on the fixed-length belt was situated in the guide slot on the CRD. The interference prohibited buckling of the belts on some CRDs, and prevented the webbing lock mechanism internal to the lap belt buckle from engaging on others. Both types of aft facing CRDs overhang the airplane seat cushion, and passage in the space between seat rows was blocked by the CRD. These CRDs' overhang may also interfere with the forward row seat back recline motion.

The dynamic performance and occupant protection for both types of aft facing CRDs were equivalent to the results expected in FMVSS-213. Also, retention of the CRD in the airplane seat and restraint of the ATD were considered acceptable from the vertical tests with these devices.

The effects of seat back breakover combined with an aft row adult ATD impact forces were not investigated in this matrix of tests. All of the aft facing devices had rigid side walls which should inhibit seat back intrusion on the occupant. The limited instrumentation in the 6-month size ATDs used in these tests might not provide an adequate assessment of the forces resulting from this test



Figure 3.17

condition. Tests with an aft row adult ATD impacting the seat with an aft facing CRD were proposed as a future project with additional instrumentation in the ATD.

HARNESS RESTRAINTS

One harness type restraint device, CRD T, was tested in this project. Shown in Figure 3.17, this particular model was designed for children in the weight range of 25 to 40 pounds. The CRD was constructed as a torso harness with padded adjustable straps over the shoulders and around the waist. A Gz strap (crotch strap) was included on this CRD. The shoulder and abdomen straps were attached to a rectangular metal plate, approximately 10 x 9 inches wide, positioned on the back of the ATD. The airplane seat lap belts were routed through a loop of webbing attached to the metal back plate on the CRD per the manufacturer's instructions.

Two single row tests with this device were performed. The following observations were noted from two dynamic tests:

1. Fit and Adjustment. Ease of installation and adjustment on the 3 year-old ATD were positive features with this CRD. Placement of the device on the child may be performed before the child sits. There were no interference problems with the seat dimension, and routing of the lap belts to secure the device was simple. However, the short path of the airplane seat lap belts through the back of the harness results in a loose restraint between the occupant and seat. With the lap belts adjusted to the minimum length, the ATD could be moved forward approximately 7 inches before tension was developed in the belts. This was considered unsatisfactory for testing.

At the manufacturer's suggestion, the test was conducted with a small air mattress placed between the ATD and the seat back. The purpose of the mattress was to move the occupant forward approximately 3 inches to reduce the slack in the restraint as well as improve the angle of the lap belt path. The air mattress was not sold with this CRD, and the FMVSS-213 approval tests of the CRD did not include the mattress.

2. Dynamic Performance. Gross ATD excursion was observed on the films from the first test with CRD T. The ATD moved forward and over the front edge of the seat cushion and proceeded to submarine toward the floor. Elasticity in the webbing of the harness and the lap belts then heaved the ATD rearward. The force pulling the ATD back into the seat appeared to be applied by the Gz strap directly through the pubic symphysis of the pelvic bone. Three high speed video frames from a frontal view of test A93041, shown in Figure 3.18, illustrate the excursion and submarining of the ATD. The excessive excursion and vertical displacement of the ATD were obviously unsatisfactory.

A modified installation method was attempted on the second test with this harness. Plastic trim on the side of the seat below the arm rests was removed. The airplane lap belts were wrapped around the tubular frame of the seat exposed by

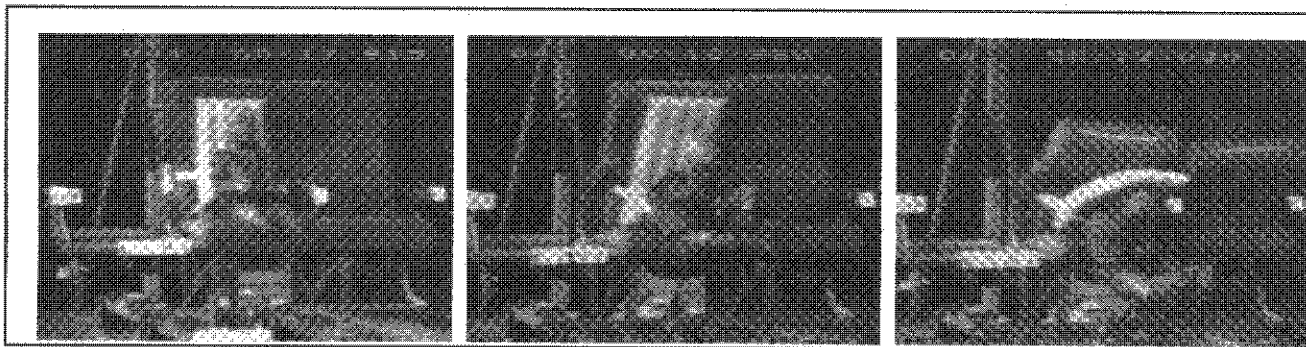

Figure 3.18

removing the plastic trim. This effectively shortened the lap belts and in effect moved the belt anchor point by approximately 5 inches aft and up. The lap belt webbing was twisted numerous times in an attempt to stiffen and further shorten the belts. This modified belt arrangement was used to secure the harness for the second test. The observed motion of the ATD during the second test was reduced compared to the first test. No submarining or gross forward excursion of the ATD were observed.

3. Occupant Protection. There were no injury criteria data acquired from these two tests. The observed motion of the ATD in the first test was considered unsatisfactory restraint of the occupant. A subjective assessment of poor performance in overall protection of the occupant was concluded from the films of the first test. The results of second test were considered successful in reducing the occupant excursion.

Summary - Torso Harness CRD

Due to the limited adjustment range and anchor location of the airplane seat lap belts, the harness restraint could not satisfactorily restrain the motion of the 3 year-old ATD. When installed per the manufacturer's instructions, the loose tension of the lap belts did not provide a secure restraint. The experiment with an air mattress as a spacer between the ATD and the seat back on these tests did not significantly affect the poor interface between the harness and lap belts. Gross displacements, forward and down, were observed from the first test. Modifying the seat and rigging the lap belts through an elaborate wrap-and-twist procedure produced improved results on the second test. However, the modified installation method would not be practical or even possible with most airplane seats.

LAP HELD CHILD RESTRAINT (BELLY BELT)

One device approved by the Civil Aviation Authority of England for the restraint of lap held children less than 2 years-old in airplanes is called the "belly belt." This is a short loop of webbing with standard buckle hardware installed on the ends. The belt is buckled around the child's abdomen. It is secured to the adult's belts by routing the seat belts through a small loop of webbing sewn on the belly belt. Thus, the child is restrained by an abdominal belt attached to the adult's lap belt.

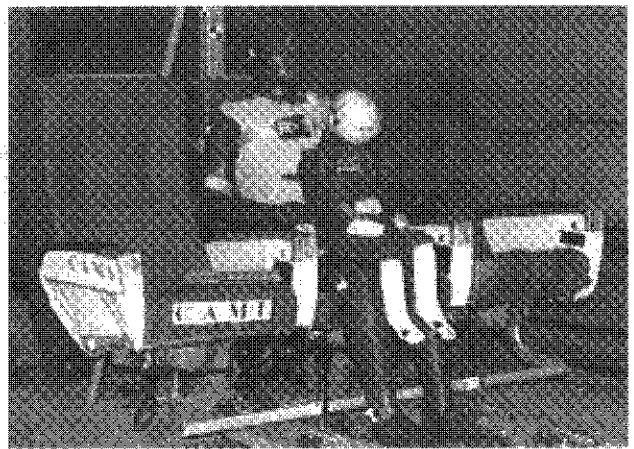

Figure 3.19

The belly belt is not certified under any automotive standard. In fact, carrying a child on the lap in a moving automobile is illegal in the United States. Some belly belts are labeled as meeting the requirements of FAA TSO C22, basically a static strength standard for aviation restraints. There are no known performance standards for the belly belt.

A pretest photograph of the belly belt installed on the CAMIX ATD is shown in Figure 3.19. The four tests conducted with the belly belt are listed in Table 3.5. Two key effects of the belly belt restraint were investigated in these tests. First, the ATDs were instrumented to measure abdominal pressure resulting from restraint loads concentrated on the abdomen. Second, tests were conducted to observe and measure potentially injurious contact forces on the lap held child created by the adult flailing and impacting the forward row seat. The effects of aft row occupant impact combined with seat back breakover were included in the fourth test, A94165.

The results of the belly belt tests were:

1. Fit and Adjustment. This factor is not an issue for the belly belt. The simplicity of the device makes it the easiest to install and adjust. Unfortunately, the installed device is fitted and adjusted directly across the abdomen of the child.

2. Dynamic Performance. The forward translation and rotational flailing of both the adult and lap held ATDs resulted in severe body impacts against the forward row seat during the double row tests, A93040 and A93050. In both tests, the child ATD moved forward to impact the forward row seat back, followed by the adult ATD torso striking the child ATD. The rotational motion of the adult ATD torso continued after contact with the child ATD, crushing the child ATD against the seat

LAP HELD CHILD RESTRAINT
(BELLY BELT)

TEST #	AIRPLANE SEAT	POSITION (1)	ATD	ABDOMINAL PRESSURE (PSI)	HIC
A93039	SINGLE ROW	CENTER (B)	CAMIX	30.5	
A93040	FWD ROW	EMPTY (B)			
	AFT ROW	CENTER (B)	CRABI	44.4	1913
A93050	FWD ROW	EMPTY (L)			
	AFT ROW	CENTER (B)	CAMIX	29.7	
A94165	FWD ROW	CENTER (B)	CAMIX	25.1	
	AFT ROW	CENTER (L)	ADULT		

(1) L = LOCKED SEAT BACK B = BREAKOVER SEAT BACK

Table 3.5

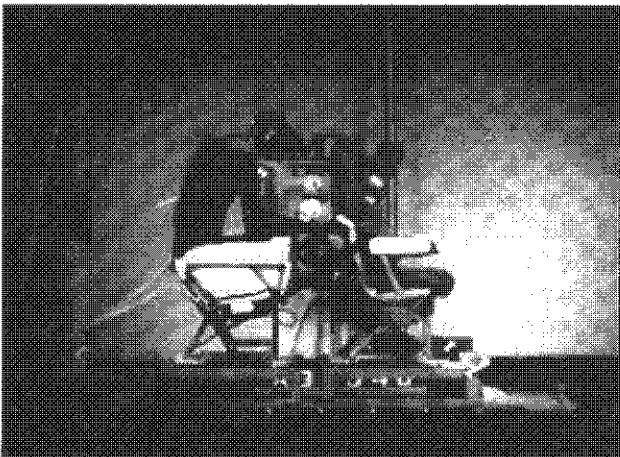

Figure 3.20

back. Figure 3.20 is a film frame showing the adult and child ATD positions immediately prior to contact on the forward row seat back.

3. Occupant Protection. One single row test, A93039, was performed with the CAMIX ATD restrained in a belly belt while sitting on the lap of a 50th percentile male ATD. To prevent forward flail of the adult ATD, its upper torso was tied with cord to a test fixture. The purpose of this protocol was to measure abdominal pressure due solely to the belly belt on the child ATD. The abdominal response from this test is shown in Figure 3.21. Compared to abdominal responses from booster seat tests with no aft row occupant, the peak abdominal pressure from test A93039 was 50% higher (30 psig).

A second test with the CAMIX ATD, A93050, was a double row test with the adult/child combination in the aft row. The adult ATD's upper torso was not restrained in this test. The abdominal response from this test is also shown on Figure 3.21. Peak abdominal pressure from the double row test was not significantly different from the single row test result. The third test of the same adult/child combination was tested in the forward row of double row test A94165. An adult size ATD occupied the aft row seat. The forward row seat, occupied by the CAMIX on an adult ATD, had a breakover seat back. The peak abdominal pressure response from this test, presented as the third data trace in Figure 3.21, occurred coincident with the aft row adult ATD striking the breakover seat back. As noted in the discussion of the booster seat tests, there was evidence from this data of a causal relationship between abdominal loads and aft row occupant impact.

The abdominal pressure transducer was installed in the CRABI ATD for test A93040. A pressure of 44 psig was recorded in this double row test with the lap held CRABI ATD in the aft row. Figures 3.22 and 3.23 show the abdominal pressure response and the resultant head acceleration from the CRABI ATD in this test. The obvious peaks on both data traces identify the time of contact from the adult ATD against the back of the child ATD. The HIC result from the CRABI ATD was 1913.

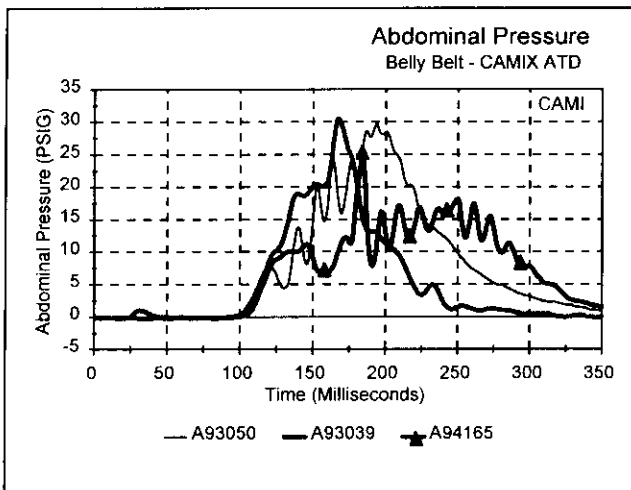

Figure 3.21

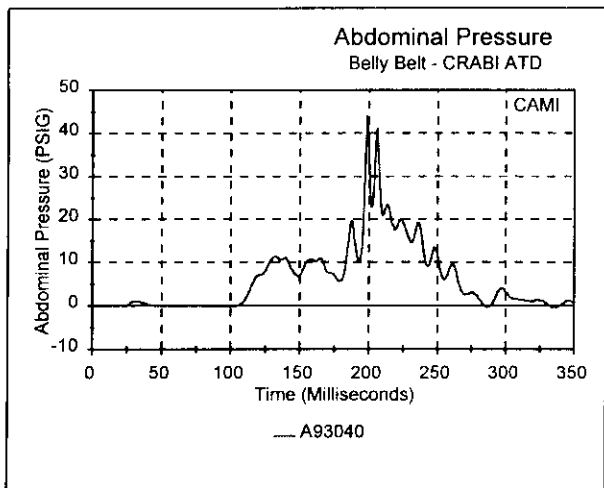

Figure 3.22

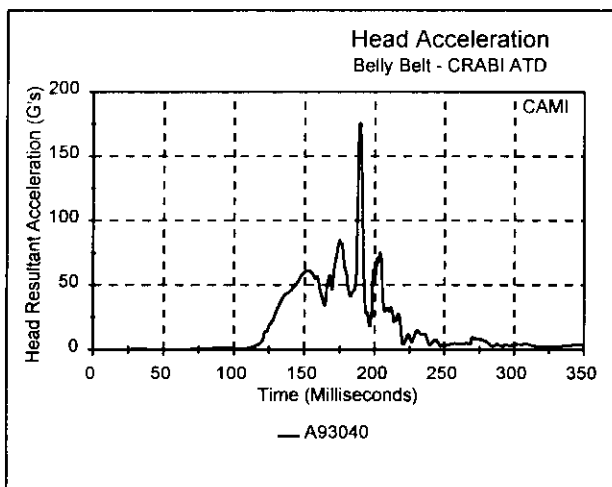

Figure 3.23

Summary - Lap Held Child Restraint

The data and observations from the four tests with the belly belt did not produce any favorable results. The impossibility of protecting a small child, by any means, sitting on the lap of an adult restrained by seat belts was confirmed in these tests. Severe contact with the forward row seat back was observed during double row tests. The recorded head impact of the 6-month old CRABI ATD resulted in a HIC above 1900. Abdominal pressures from the CAMIX ATD were 50% greater than data from booster seat tests under similar conditions. Aft row occupant impact on the breakover seat back resulted in a definitive peak in the abdominal pressure data. Based on biomechanical data as well as observations of the films from these tests, the belly belt should not be construed as means of protecting small children.

NORMAL LAP BELTS

Table 3.6 describes the tests conducted with normal airplane seat lap belts. The first test was conducted with the 24 month-old CAMIX ATD restrained by lap belts. Seat back breakover and aft row occupant impact forces were not included on the first test. The second test had 3-year old ATDs restrained by the normal lap belts in the forward and aft row of a double row test. A third test had an adult ATD in the aft row with a lap belt restrained 3-year old in the forward row. The final test with normal lap belts included the CAMIX restrained in a seat with a breakover back in the forward row, and an adult size ATD in the aft row.

The 6 month-old size test dummies were too small for the minimum adjustment range of the lap belts. Also, it is universally acknowledged that children weighing less than 20 pounds can not be safely restrained in a forward facing restraint. Methods of adapting the lap belts over a 6 month-old size ATD, such as adding pillows or blankets around the occupant, were not investigated.

Results and observations from tests with lap belts were:

1. Fit and Adjustment. The conventional definition of proper seat belt accommodation is a tight fit of the belt when routed and adjusted over the pelvis of the occupant. With the 24 month CAMIX ATD, the fit and path of the lap belts were marginal by this definition. Although the lap belts were not slack when adjusted to the minimum length, the ATD was not tightly coupled to the seat. A longer fixed-length strap on the lap belts would prevent acceptable tension adjustment. The path

NORMAL LAP BELTS

TEST #	AIRPLANE SEAT POSITION (1)	ATD	ABDOMINAL PRESSURE (PSI)	HIC	MAXIMUM HEAD EXCURSION (INCHES) (2)
A93038	FWD ROW	LEFT (L)	CAMIX	9.5	37.4
	AFT ROW	LEFT	unoccupied		
A93046	FWD ROW	CENTER (L)	3 YR OLD		31.6
	AFT ROW	CENTER (B)	3 YR OLD	822	31.8
A93047	FWD ROW	CENTER (B)	3 YR OLD	1002	30.7
	AFT ROW	CENTER (B)	ADULT		
A94164	FWD ROW	CENTER (B)	CAMIX	37.6	
	AFT ROW	CENTER (B)	ADULT		

(1) L = LOCKED SEAT BACK B = BREAKOVER SEAT BACK

(2) HEAD EXCURSION MEASURED FROM FMVSS-213 SEAT PIVOT REFERENCE POINT.

Table 3.6

prevent acceptable tension adjustment. The path of the belts across the ATD was low across the pelvis.

The accommodation of the seat belts was considered acceptable for the 3 year-old ATDs used in these tests. A tight fit could be attained by normal manual adjustment, although the adjusted length was near the minimum for these lap belts. The path angle of approximately 80 degrees above horizontal was measured from the belt anchor to pelvic contact on the ATD. This angle exceeded the recommended belt angle (45-55 degrees) for adults. However, the path of the belts was below the iliac crests of the pelvic bone, and belt intrusion onto the abdomen was not likely with this path.

The minimum size of occupant that could be accommodated by the airplane seat lap belts was not addressed in this project. Lap belts for an occupant with a smaller pelvic breadth than the 3 year-old ATD may not provide a tight fit due to the limited adjustment range. The sitting posture

of a smaller occupant and size of the pelvis also will affect the lap belt accommodation geometry.

2. Dynamic Performance. Figure 3.24 presents three film frames showing the aft row 3 year-old ATD head flail from test A93046. The aft row ATD's head did not strike the forward row seat. Film analysis of the test revealed elastic deflection of the forward row seat provided clearance for the head to miss the seat back. Head movement continued in a curved downward path. Both ATDs' heads hit the front frame of the seat it occupied. Retention of the occupant, while maintaining the restraint loads across the pelvis, was observed in the films.

The head paths from tests with the CAMIX and 3 year-old ATDs restrained in lap belts are shown in Figure 3.25. One explanation of the greater head excursion for the CAMIX ATD was the marginal fit and path of the lap belts on the smaller ATD. The relatively loose fit of the belts

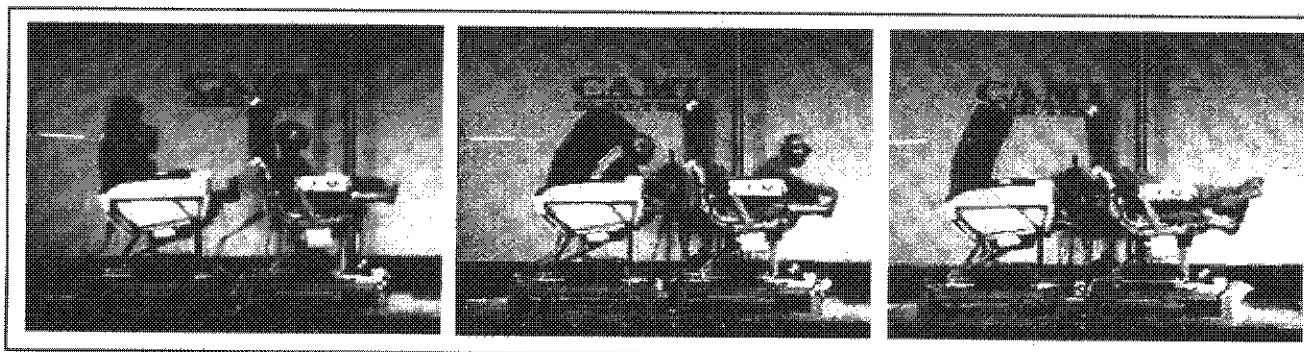

Figure 3.24

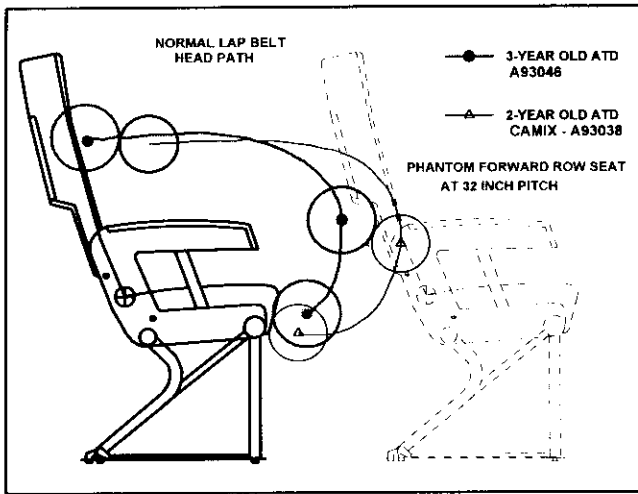

Figure 3.25

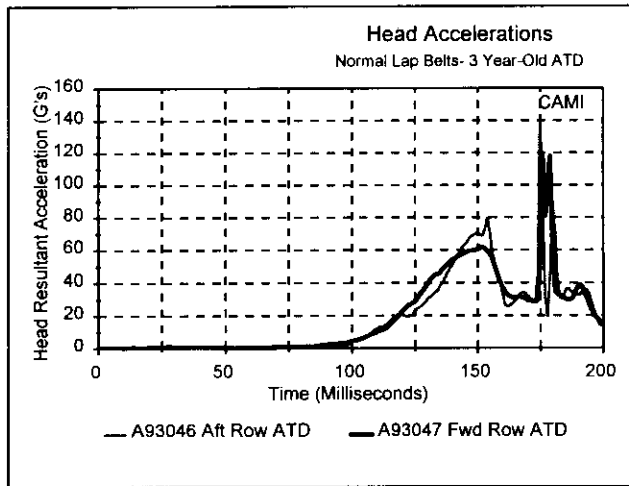

Figure 3.26

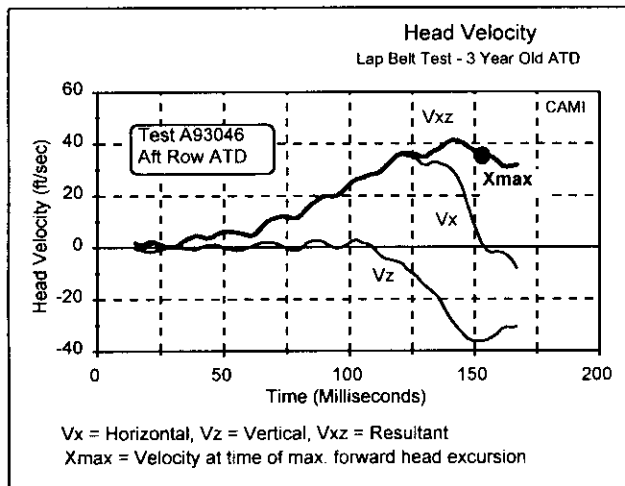

Figure 3.27

allowed the ATD to move forward further than the 3 year-old ATD. There was no indication of submarining or roll out with the CAMIX in lap belts. After the maximum forward excursion, downward and aft motion continued and the CAMIX ATD's head struck the front spreader tube of the seat in which it occupied.

An adult ATD was placed in the aft row seat for the third test, A93047. The forward row seat, which had normal seat back breakover, was occupied by a 3 year-old ATD. During the impact, the adult ATD impacted the forward row seat back, forcing the seat back to collapse on the child ATD in the front seat. The flail motion of the child ATD in the front seat was not notably different from that of the aft row ATD in the first test. As noted on the previous test, the 3-year old ATD's head contacted structure on the front of the seat it occupied.

3. Occupant Protection. Head impact accelerations of the aft row ATD in test A93046 and the front row ATD of test A93047 are shown in Figure 3.26. HIC results from these tests were 822 and 1002 respectively. Chest acceleration from these tests both peaked near 35 G's.

Head velocity, derived from motion analysis of the head path of the aft row child ATD, is shown in Figure 3.27. The velocity of the head as it passed within 1.2 inches of the forward row tray table was 38 ft/sec. Variables such as shorter seat pitch and a greater seat back stiffness would increase the potential for high velocity head strike on the forward row seat back. These tests did not evaluate the effects of a "brace-for-impact" position with child ATDs. A reduction in the head excursion distance and velocity would be expected with a braced occupant.

Abdominal pressure from the double row test A94164 with the CAMIX in the forward row seat with a breakover back are presented in Figure 3.28. The data in this figure are overlaid with the abdominal pressure from test A93038, which was conducted with a locked seat back and no aft row occupant. These data indicate an increased abdominal pressure due to seat back breakover combined with aft row occupant impact. An examination of the film from test A94164 showed the lap belts remained across the pelvis of the CAMIX ATD during the impact. The stimulus for the higher abdominal pressure was apparently due to the abdomen bearing on the thighs and seat cushion. It did not appear to be due to the lap belts loading the abdomen.

A comparison of CAMIX abdominal loads from booster seat test A93048 and lap belt test A94164 are shown in Figure 3.29. Both tests were conducted with breakover seat backs and an aft

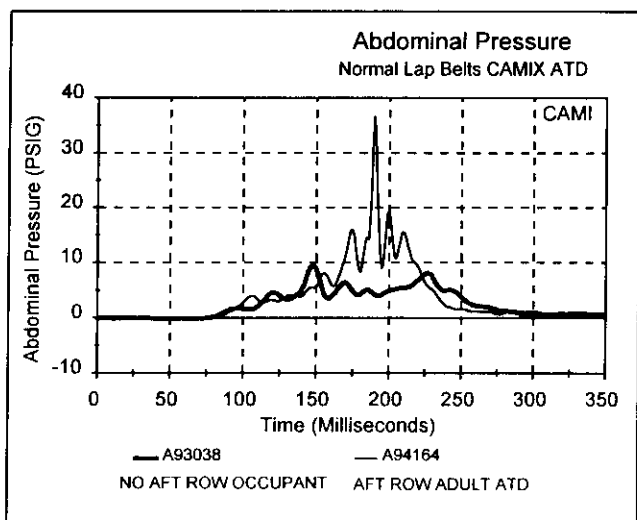

Figure 3.28

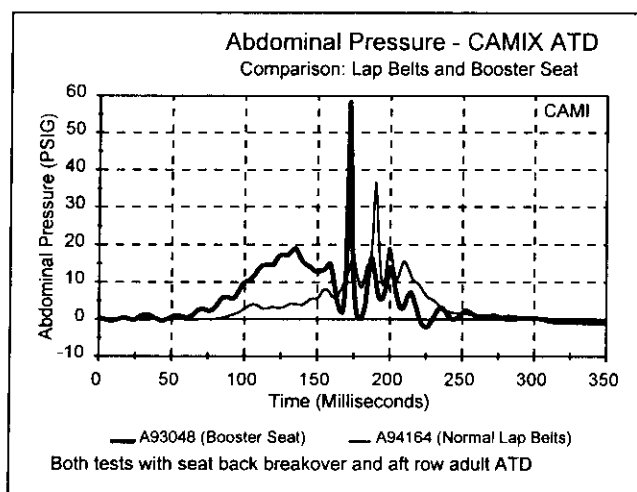

Figure 3.29

row adult ATD. The peaks on both data sets occurred coincident with aft row occupant impact. Higher abdominal loads from the booster seat test were attributed to the rigid shield of the CRD bearing on the abdomen.

Summary -Normal Lap Belts

The fit and adjustment of airplane seat lap belts used to restrain the 3 year-old ATDs was satisfactory, although the lap belts were near the minimum adjustable length with this size occupant. Results and observations from dynamic tests with lap belt restrained 3-year old ATDs indicated the basic performance of lap belts with 3 year-old 33 pound occupants was marginal by existing standards. Other potential injury mechanisms associated with

lap belts were not addressed in this project. The minimum age or size of occupant that would be accommodated properly, as defined by fit and adjustment of the belts, was not determined.

Accommodation of the CAMIX ATD in lap belts was considered marginal. A tight fit was not achieved with the minimum length adjusted belts. The relatively loose fit of the belts and the smaller size pelvis of the CAMIX resulted in a greater head excursion than observed with the 3-year old ATDs.

A head strike against seat structure in the seat which a 3-year old ATD occupied was recorded during two tests. The HIC result calculated from one of the head strikes was 1002, which is unacceptable by the criteria in both FAA and NHTSA regulations. Slight variations in the seat pitch or dynamic deflection of the seats could result in head contact with the forward row seat. Motion analysis of the 3-year old ATD's head path during these tests revealed the potential for high velocity head impact on the forward row seat. If the seat pitch was reduced or the seat back did not move during the impact, the ATD's head would impact the tray table with a relative velocity of approximately 38 ft/sec.

Abdominal loads measured with the CAMIX ATD restrained in lap belts were affected by seat back breakover and aft row occupant impact. The lap belts remained across the pelvis throughout the impact and did not appear to directly load the abdomen. However, a significant peak was noted in the abdominal response coincident with the aft row occupant striking the seat back.

Caution should be exercised when comparing the performance of lap belts versus automotive CRDs presented in this report. The restraint load distribution for lap belts is concentrated across the two-inch wide path across the pelvis. These loads are usually distributed over multiple load paths with wider surfaces in automotive CRDs. Thus, the local contact forces are lower with automobile CRDs. Also, there are injury mechanisms, other than head and chest accelerations, that should be considered for lap belt restrained children (16). Automobile accident studies have identified potential injuries to the abdomen and spine associated with belt restrained children.

Part IV Conclusions

Based on the results from the series of impact tests conducted in this project, there is sufficient evidence to conclude the following: The performance of certain types of child restraint devices does not enhance the level of safety for children in transport airplane passenger seats. The expectation of equivalent protection for children restrained in certain types of CRDs traveling by automobile can not be met in an airplane seat. A level of safety, as defined in FAR 25.562, equal to that provided for adult passengers can not be demonstrated with some CRDs when tested in transport airplane seats. In fact, these tests demonstrated some types of CRDs should not be recommended for use in airplane passenger seats.

Various reasons exist for the unsatisfactory performance of some types of CRDs in airplanes. The main reason is that CRDs are designed to meet an automotive requirement, FMVSS-213, and do not necessarily adapt properly to an airplane seat. Test fixtures, restraints, and pass/fail criteria strictly specified in the automotive standard do not serve as a representative test for a CRD in an airplane seat. In particular, the restraints on airplane seats differ significantly from the test apparatus in the automotive standard. Airplane seat belts differ in anchor point geometry, tension adjustment, and buckle hardware. These differences can adversely affect the performance of a CRD designed primarily for the automobile interior.

In addition to the performance of CRDs exposed to impact test conditions, the accommodation of some CRDs is not satisfactory in airplane passenger seats. Models that require 17 inches or more of lateral space for installation may not fit in seats with fixed arm rests. Forward overhang of aft facing devices can block the passage of adjacent passengers and interfere with the seat back recline motion of the forward row seat. Depending on the specified path for routing the lap belts to secure the CRD to the seat, interference with lap belt buckle hardware can prohibit proper installation.

The airplane seat structure and close seat pitch placement in the economy class cabin are additional reasons for unsatisfactory performance with some CRDs. In the FMVSS-213 test procedure for forward facing seats, the excursion limit for the ATDs head exceeds the distance to the forward row seat back in typical economy class cabin seats. Also, the consequences of seat back breakover on airplane passenger seats, combined with aft row

occupant impact on the seat back, are not considered in the automotive test procedure.

For the six types of child restraints tested in this project, the following conclusions are presented:

- **Booster Seats** may expose the child occupant to potential abdominal injury due to the combined effects of forces imparted from the aft row occupant and seat back breakover. A peak abdominal pressure of 60 psig was acquired during a test with an aft row adult occupant striking a forward seat with an occupied booster seat. By comparison, the peak pressure was 20 psig from booster seat tests without aft row occupant interaction.

The method of measuring abdominal pressure presented in this report was experimental, and no basis was claimed for either the biofidelity of the method or the assessment of potential injury. However, the comparative difference in abdominal pressure due to aft row occupant impact was significant. Avoidance of abdominal loads due to the pelvic restraints is mandatory for the certification of modern aircraft seats. This criterion should not be neglected with child restraints. Further research should be conducted to establish the limits for abdominal loads in children.

Head excursions measured from impact tests of two approved booster seats installed on airplane passenger seats exceeded the distance allowed by FMVSS-213. The head paths of three booster seats indicated head impact on the forward row locked seat back can occur. It should be emphasized that the impact severity of all these tests was lower than the test condition of FMVSS-213.

A child large enough for a booster seat can also be accommodated in the normal passenger seat lap belts. The performance of lap belts, as measured by abdominal pressure and head excursion from these tests, was favorable compared to booster seat test data.

- **Forward Facing Carriers** are difficult to install and adjust properly in economy class passenger seats. The size of some larger carriers inhibits installation in seats with fixed arm rests. Airplane lap belts can not suitably secure some forward facing carriers in an airplane seat. The lap belt anchor point geometry on airplane seats does not afford effective restraint of forward excursion of the occupant with this type of child restraint.

In double row tests with 3 year-old ATDs restrained by forward facing carriers, all eight resulted in head impact on the forward row seat. Six HIC results were above 1000. The rigid shell and integral restraints with these carriers certainly provide protection not afforded by normal lap belts.

However, the assumption that a child restrained in a forward facing carrier traveling in an airplane is protected to the same level of safety as in an automobile can not be supported by the results of this project.

An alternate lap belt installation for child restraints was demonstrated as a means of reducing forward excursion of these carriers. The alternative installation tests were performed to measure the effects of improved restraint geometry. The modification to the airplane seat and the particular hardware used in the alternative method were not intended as a formal recommendation to the aviation community.

- **Aft Facing Carriers**, convertible as well as non-convertible models, installed in airplane seats are a definite safety benefit for children weighing less than 20 pounds. Installation and adjustment are simple and visually verifiable. The airplane seat lap belts can easily be tightened over the carrier to secure attachment of the carrier. Two factors affect passenger convenience with these devices. The forward overhang interferes with passage between the seat rows and the recline motion of a forward row seat.

Performance of aft facing carriers observed in horizontal as well as vertical dynamic tests was satisfactory. Considering the other method for traveling with small children, i.e. on the lap of an adult, the use of this type of child restraint is the only available means of providing adequate protection that can be recommended.

- **Harness Systems** do not interface with the airplane seat lap belts in a manner which adequately restrains forward motion. The lap belts length and anchor points geometry on airplane passenger seats can not provide a firm attachment for the type of harness tested in this project. Unacceptable forward excursion of the child ATD completely off the front of the seat cushion was observed in a horizontal impact test. Only one model of a harness device was tested in this project, but the means of installing the harness was typical of other products on the market. A modified procedure of routing and twisting the lap belts around the arm rest structure resulted in improved performance. This modified procedure was not a practical alternative for the user or the airline operator.

- **A Lap Held Child Restraint, or Belly Belt**, should not be considered a means of protecting a child from injury during an accident.

- **Normal Lap Belts** can provide acceptable restraint for children of a size represented by the 3 year-old ATD used in this project. The factors

which define proper seat belt accommodation are satisfied with the 50th percentile 3 year-old. These factors include an adjustable tight fit, a belt path over the pelvic bone, and no indication of submarining or roll out during dynamic tests. The adjusted lap belt was near minimum length with the 3 year-old ATD.

Accommodation of a 24-month old child in lap belts, based on tests with the CAMIX ATD, was marginal. The lap belt tension was not considered to be a snug fit when adjusted to the minimum length. However, there were no indications of submarining or roll out during dynamic tests, and the belt path remained across the pelvis. Measured abdominal pressure was increased due to the effects of an aft row adult ATD striking the breakover seat back, but they were less than the pressure acquired from the booster seat in the same test mode.

Head impacts against the seat structure occupied by the lap belt restrained ATD occurred during tests in this project. The HIC value from one of the head impacts of a lap belt restrained 3 year-old ATD was 1002, which is an indication of head injury. These results are cause for concern. However, lap belts are not the type of restraint which inhibit upper torso flail. Head impacts were not a consequence of poor fit or adjustment with a child occupant. The performance of the lap belts with the 3 year-old ATD was considered consistent with protection afforded adult passengers in airplanes with type certificates dated prior to 1988. The HIC results above 1000 would not be consistent with adult protection criteria mandated for new airplanes.

REMARKS

These conclusions should not be construed as an indication that a dangerous condition exists for children traveling in commercial transport airplanes. The accident rate for commercial operations in 1991 was 0.32 per 100,000 departures (17), which affirms the fact that commercial aviation is a very safe mode of transportation. Rather, this information is presented to identify a particular component of passenger safety, child restraints, which may not meet the expected levels of performance in an accident. The data and observations in this report are provided to the aviation community, restraint manufacturers, and government agencies to further enhance the safety for children traveling in airplanes.

REFERENCES

1. Title 49 United States Code of Federal Regulations, Part 571 Section 213. Child restraint systems.
2. Society of Automotive Engineers, Aerospace Recommended Practice: ARP 766A, "Restraint Device for Small Children," SAE, Warrendale, PA, 1967.
3. Society of Automotive Engineers, Aerospace Recommended Practice: ARP 1469, "Restraint Device for Infants," SAE, Warrendale, PA, 1978.
4. "An Assessment of the FAA and NHTSA Child Restraint Standards to Determine the Feasibility of Having a Common Standard," Transportation Systems Center, US Dept. of Transportation, Cambridge, MA, March, 1983.
5. Title 14 United States Code of Federal Regulations, Parts 91, 121, 125, and 135, Amendments 91-231, 121-230, 125-17, and 135-44, Effective October, 1992.
6. Soltis, S.J., Nissley, W.J., "The Development of Dynamic Performance Standards for Civil Aircraft Seats," National Institute of Aviation Research, 1990 Aircraft Interiors Conference, Wichita State University, KS, April, 1990.
7. Chandler, R.F., Trout, E. M., "Child Restraint Systems for Civil Aircraft," report number FAA-AM-78-12, FAA Office of Aviation Medicine, Washington, DC, March, 1978.
8. Naab, K., "Performance Evaluation of Child Restraint Systems for Civil Aircraft," report number DOT-HS-806-183, United States Dept. of Transportation, Washington, DC, October, 1982.
9. Hardy, R.N., "The Restraint of Infants and Young Children in Aircraft," Civil Aviation Authority of the UK paper number 92020, CAA, Greville House, 37 Graton Road, Cheltenham, England, 1992.
10. Sullivan, L.K., Mouchahoir, G., Stucki, L., et al., "Assessment of Dynamic Testing Environment of Child Restraint Systems," Proceedings of 1993 Child Occupant Protection Symposium (SP-986), Society of Automotive Engineers paper 933134, SAE, Warrendale, PA, November, 1993.
11. Society of Automotive Engineers Committee Infant Dummy Task Group of the Mechanical Simulation Subcommittee, SAE, Warrendale, PA.
12. Melvin, J.W., Weber, K., "Abdominal Intrusion Sensor for Evaluating Child Restraint Systems," Society of Automotive Engineers paper 860370, SAE, Warrendale, PA, 1986.
13. Biard, R., Alonzo, F., et al., "Child Abdominal Protection: Presentation of a New Transducer for Child Dummies," Proceeding of 1993 Child Restraint Protection Symposium (SP-986), Society of Automotive Engineers paper 933106, SAE, Warrendale, PA, 1993.
14. Ciccone, M.A., Jones, E.N., "Vehicle Crash Tests of Properly and Improperly Used Child Safety Seats," Proceeding of 31st Stapp Car Crash Conference (SP-202), Society of Automotive Engineers paper 872209, SAE, Warrendale, PA, 1987.
15. Weber, K., Radovich, V., "Performance Evaluation of Child Restraints Relative to Vehicle Lap-Belt Anchorage Location," Society of Automotive Engineers paper 870324, SAE, Warrendale, PA, 1987.
16. Lane, J.C., "The Seat Belt Syndrome in Children," Proceedings of 1993 Child Occupant Protection Symposium (SP-986), Society of Automotive Engineers paper 933098, SAE, Warrendale, PA, November, 1993.
17. "Annual Review of Aircraft Accident Data, U.S. Carrier Operations, Calendar Year 1991," report number NTSB/ARC-94/01, National Transportation Safety Board, Washington, DC, April, 1994.