

**TOXICOLOGICAL PROFILE FOR
BROMOFORM AND DIBROMOCHLOROMETHANE**

U.S. DEPARTMENT OF HEALTH AND HUMAN SERVICES
Public Health Service
Agency for Toxic Substances and Disease Registry

August 2005

DISCLAIMER

The use of company or product name(s) is for identification only and does not imply endorsement by the Agency for Toxic Substances and Disease Registry.

UPDATE STATEMENT

A Toxicological Profile for Bromoform and Dibromochloromethane, Draft for Public Comment was released in September 2003. This edition supersedes any previously released draft or final profile.

Toxicological profiles are revised and republished as necessary. For information regarding the update status of previously released profiles, contact ATSDR at:

Agency for Toxic Substances and Disease Registry
Division of Toxicology/Toxicology Information Branch
1600 Clifton Road NE
Mailstop F-32
Atlanta, Georgia 30333

FOREWORD

This toxicological profile is prepared in accordance with guidelines* developed by the Agency for Toxic Substances and Disease Registry (ATSDR) and the Environmental Protection Agency (EPA). The original guidelines were published in the *Federal Register* on April 17, 1987. Each profile will be revised and republished as necessary.

The ATSDR toxicological profile succinctly characterizes the toxicologic and adverse health effects information for the hazardous substance described therein. Each peer-reviewed profile identifies and reviews the key literature that describes a hazardous substance's toxicologic properties. Other pertinent literature is also presented, but is described in less detail than the key studies. The profile is not intended to be an exhaustive document; however, more comprehensive sources of specialty information are referenced.

The focus of the profiles is on health and toxicologic information; therefore, each toxicological profile begins with a public health statement that describes, in nontechnical language, a substance's relevant toxicological properties. Following the public health statement is information concerning levels of significant human exposure and, where known, significant health effects. The adequacy of information to determine a substance's health effects is described in a health effects summary. Data needs that are of significance to protection of public health are identified by ATSDR and EPA.

Each profile includes the following:

- (A) The examination, summary, and interpretation of available toxicologic information and epidemiologic evaluations on a hazardous substance to ascertain the levels of significant human exposure for the substance and the associated acute, subacute, and chronic health effects;
- (B) A determination of whether adequate information on the health effects of each substance is available or in the process of development to determine levels of exposure that present a significant risk to human health of acute, subacute, and chronic health effects; and
- (C) Where appropriate, identification of toxicologic testing needed to identify the types or levels of exposure that may present significant risk of adverse health effects in humans.

The principal audiences for the toxicological profiles are health professionals at the Federal, State, and local levels; interested private sector organizations and groups; and members of the public.

This profile reflects ATSDR's assessment of all relevant toxicologic testing and information that has been peer-reviewed. Staff of the Centers for Disease Control and Prevention and other Federal scientists have also reviewed the profile. In addition, this profile has been peer-reviewed by a nongovernmental panel and was made available for public review. Final responsibility for the contents and views expressed in this toxicological profile resides with ATSDR.

Julie Louise Gerberding, M.D., M.P.H.
Administrator
Agency for Toxic Substances and
Disease Registry

*Legislative Background

The toxicological profiles are developed in response to the Superfund Amendments and Reauthorization Act (SARA) of 1986 (Public Law 99-499) which amended the Comprehensive Environmental Response, Compensation, and Liability Act of 1980 (CERCLA or Superfund). This public law directed ATSDR to prepare toxicological profiles for hazardous substances most commonly found at facilities on the CERCLA National Priorities List and that pose the most significant potential threat to human health, as determined by ATSDR and the EPA. The availability of the revised priority list of 275 hazardous substances was announced in the *Federal Register* on November 7, 2003 (68 FR 63098). For prior versions of the list of substances, see *Federal Register* notices dated April 17, 1987 (52 FR 12866); October 20, 1988 (53 FR 41280); October 26, 1989 (54 FR 43619); October 17, 1990 (55 FR 42067); October 17, 1991 (56 FR 52166); October 28, 1992 (57 FR 48801); February 28, 1994 (59 FR 9486); April 29, 1996 (61 FR 18744); November 17, 1997 (62 FR 61332); October 21, 1999 (64 FR 56792) and October 25, 2001 (66 FR 54014). Section 104(i)(3) of CERCLA, as amended, directs the Administrator of ATSDR to prepare a toxicological profile for each substance on the list.

QUICK REFERENCE FOR HEALTH CARE PROVIDERS

Toxicological Profiles are a unique compilation of toxicological information on a given hazardous substance. Each profile reflects a comprehensive and extensive evaluation, summary, and interpretation of available toxicologic and epidemiologic information on a substance. Health care providers treating patients potentially exposed to hazardous substances will find the following information helpful for fast answers to often-asked questions.

Primary Chapters/Sections of Interest

Chapter 1: Public Health Statement: The Public Health Statement can be a useful tool for educating patients about possible exposure to a hazardous substance. It explains a substance's relevant toxicologic properties in a nontechnical, question-and-answer format, and it includes a review of the general health effects observed following exposure.

Chapter 2: Relevance to Public Health: The Relevance to Public Health Section evaluates, interprets, and assesses the significance of toxicity data to human health.

Chapter 3: Health Effects: Specific health effects of a given hazardous compound are reported by type of health effect (death, systemic, immunologic, reproductive), by route of exposure, and by length of exposure (acute, intermediate, and chronic). In addition, both human and animal studies are reported in this section.

NOTE: Not all health effects reported in this section are necessarily observed in the clinical setting. Please refer to the Public Health Statement to identify general health effects observed following exposure.

Pediatrics: Four new sections have been added to each Toxicological Profile to address child health issues:

Section 1.6	How Can (Chemical X) Affect Children?
Section 1.7	How Can Families Reduce the Risk of Exposure to (Chemical X)?
Section 3.7	Children's Susceptibility
Section 6.6	Exposures of Children

Other Sections of Interest:

Section 3.8	Biomarkers of Exposure and Effect
Section 3.11	Methods for Reducing Toxic Effects

ATSDR Information Center

Phone: 1-888-42-ATSDR or (404) 498-0110	Fax: (770) 488-4178
E-mail: atsdric@cdc.gov	Internet: http://www.atsdr.cdc.gov

The following additional material can be ordered through the ATSDR Information Center:

Case Studies in Environmental Medicine: Taking an Exposure History—The importance of taking an exposure history and how to conduct one are described, and an example of a thorough exposure history is provided. Other case studies of interest include *Reproductive and Developmental*

Hazards; Skin Lesions and Environmental Exposures; Cholinesterase-Inhibiting Pesticide Toxicity; and numerous chemical-specific case studies.

Managing Hazardous Materials Incidents is a three-volume set of recommendations for on-scene (prehospital) and hospital medical management of patients exposed during a hazardous materials incident. Volumes I and II are planning guides to assist first responders and hospital emergency department personnel in planning for incidents that involve hazardous materials. Volume III—*Medical Management Guidelines for Acute Chemical Exposures*—is a guide for health care professionals treating patients exposed to hazardous materials.

Fact Sheets (ToxFAQs) provide answers to frequently asked questions about toxic substances.

Other Agencies and Organizations

The National Center for Environmental Health (NCEH) focuses on preventing or controlling disease, injury, and disability related to the interactions between people and their environment outside the workplace. Contact: NCEH, Mailstop F-29, 4770 Buford Highway, NE, Atlanta, GA 30341-3724 • Phone: 770-488-7000 • FAX: 770-488-7015.

The National Institute for Occupational Safety and Health (NIOSH) conducts research on occupational diseases and injuries, responds to requests for assistance by investigating problems of health and safety in the workplace, recommends standards to the Occupational Safety and Health Administration (OSHA) and the Mine Safety and Health Administration (MSHA), and trains professionals in occupational safety and health. Contact: NIOSH, 200 Independence Avenue, SW, Washington, DC 20201 • Phone: 800-356-4674 or NIOSH Technical Information Branch, Robert A. Taft Laboratory, Mailstop C-19, 4676 Columbia Parkway, Cincinnati, OH 45226-1998 • Phone: 800-35-NIOSH.

The National Institute of Environmental Health Sciences (NIEHS) is the principal federal agency for biomedical research on the effects of chemical, physical, and biologic environmental agents on human health and well-being. Contact: NIEHS, PO Box 12233, 104 T.W. Alexander Drive, Research Triangle Park, NC 27709 • Phone: 919-541-3212.

Referrals

The Association of Occupational and Environmental Clinics (AOEC) has developed a network of clinics in the United States to provide expertise in occupational and environmental issues. Contact: AOEC, 1010 Vermont Avenue, NW, #513, Washington, DC 20005 • Phone: 202-347-4976 • FAX: 202-347-4950 • e-mail: AOEC@AOEC.ORG • Web Page: <http://www.aoec.org/>.

The American College of Occupational and Environmental Medicine (ACOEM) is an association of physicians and other health care providers specializing in the field of occupational and environmental medicine. Contact: ACOEM, 25 Northwest Point Boulevard, Suite 700, Elk Grove Village, IL 60007-1030 • Phone: 847-818-1800 • FAX: 847-818-9266.

CONTRIBUTORS

CHEMICAL MANAGER(S)/AUTHOR(S):

John Risher, Ph.D.
Dennis Jones, D.V.M.
ATSDR, Division of Toxicology, Atlanta, Georgia

Michael H. Lumpkin, Ph.D.
Lisa Ingerman, Ph.D., DABT
Daniel Plewak, M.S.
Lori Moilanen, Ph.D., DABT
Dolores Beblo, Ph.D.
Jennifer Walters, M.S., M.P.A.
Syracuse Research Corporation, North Syracuse, New York

THE PROFILE HAS UNDERGONE THE FOLLOWING ATSDR INTERNAL REVIEWS:

1. Health Effects Review. The Health Effects Review Committee examines the health effects chapter of each profile for consistency and accuracy in interpreting health effects and classifying end points.
2. Minimal Risk Level Review. The Minimal Risk Level Workgroup considers issues relevant to substance-specific Minimal Risk Levels (MRLs), reviews the health effects database of each profile, and makes recommendations for derivation of MRLs.
3. Data Needs Review. The Research Implementation Branch reviews data needs sections to assure consistency across profiles and adherence to instructions in the Guidance.
4. Green Border Review. Green Border review assures the consistency with ATSDR policy.

PEER REVIEW

A peer review panel was assembled for bromoform and dibromochloromethane. The panel consisted of the following members:

1. Bruce Jarnot, Ph.D., DABT, Senior Toxicologist, American Petroleum Institute, Washington DC;
2. Kannan Krishnan, Ph.D., Professor, Human Toxicology Research Group, University of Montreal Montreal Canada; and
3. Clint Skinner, Ph.D., Consultant, Skinner Associates, Creston California

These experts collectively have knowledge of bromoform and dibromochloromethane's physical and chemical properties, toxicokinetics, key health end points, mechanisms of action, human and animal exposure, and quantification of risk to humans. All reviewers were selected in conformity with the conditions for peer review specified in Section 104(I)(13) of the Comprehensive Environmental Response, Compensation, and Liability Act, as amended.

Scientists from the Agency for Toxic Substances and Disease Registry (ATSDR) have reviewed the peer reviewers' comments and determined which comments will be included in the profile. A listing of the peer reviewers' comments not incorporated in the profile, with a brief explanation of the rationale for their exclusion, exists as part of the administrative record for this compound.

The citation of the peer review panel should not be understood to imply its approval of the profile's final content. The responsibility for the content of this profile lies with the ATSDR.

CONTENTS

DISCLAIMER	ii
UPDATE STATEMENT	iii
FOREWORD	v
QUICK REFERENCE FOR HEALTH CARE PROVIDERS.....	vii
CONTRIBUTORS	ix
PEER REVIEW	xi
CONTENTS.....	xiii
LIST OF FIGURES	xvii
LIST OF TABLES	xix
1. PUBLIC HEALTH STATEMENT.....	1
1.1 WHAT ARE BROMOFORM AND DIBROMOCHLOROMETHANE?.....	1
1.2 WHAT HAPPENS TO BROMOFORM AND DIBROMOCHLOROMETHANE WHEN THEY ENTER THE ENVIRONMENT?.....	3
1.3 HOW MIGHT I BE EXPOSED TO BROMOFORM AND DIBROMOCHLOROMETHANE?.....	3
1.4 HOW CAN BROMOFORM AND DIBROMOCHLOROMETHANE ENTER AND LEAVE MY BODY?	4
1.5 HOW CAN BROMOFORM AND DIBROMOCHLOROMETHANE AFFECT MY HEALTH?	4
1.6 HOW CAN BROMOFORM AND DIBROMOCHLOROMETHANE AFFECT CHILDREN?	6
1.7 HOW CAN FAMILIES REDUCE THE RISK OF EXPOSURE TO BROMOFORM AND DIBROMOCHLOROMETHANE?.....	6
1.8 IS THERE A MEDICAL TEST TO DETERMINE WHETHER I HAVE BEEN EXPOSED TO BROMOFORM AND DIBROMOCHLOROMETHANE?.....	7
1.9 WHAT RECOMMENDATIONS HAS THE FEDERAL GOVERNMENT MADE TO PROTECT HUMAN HEALTH?.....	7
1.10 WHERE CAN I GET MORE INFORMATION?	8
2. RELEVANCE TO PUBLIC HEALTH	11
2.1 BACKGROUND AND ENVIRONMENTAL EXPOSURES TO BROMOFORM AND DIBROMOCHLOROMETHANE IN THE UNITED STATES	11
2.2 SUMMARY OF HEALTH EFFECTS	11
2.3 MINIMAL RISK LEVELS (MRLs)	15
3. HEALTH EFFECTS	21
3.1 INTRODUCTION	21
3.2 DISCUSSION OF HEALTH EFFECTS BY ROUTE OF EXPOSURE	21
3.2.1 Inhalation Exposure	22
3.2.1.1 Death	22
3.2.1.2 Systemic Effects	23
3.2.1.3 Immunological and Lymphoreticular Effects	23
3.2.1.4 Neurological Effects	24
3.2.1.5 Reproductive Effects	24
3.2.1.6 Developmental Effects	24
3.2.1.7 Cancer.....	24

3.2.2	Oral Exposure.....	24
3.2.2.1	Death	24
3.2.2.2	Systemic Effects	56
3.2.2.3	Immunological and Lymphoreticular Effects	63
3.2.2.4	Neurological Effects	63
3.2.2.5	Reproductive Effects	65
3.2.2.6	Developmental Effects	67
3.2.2.7	Cancer	68
3.2.3	Dermal Exposure.....	69
3.2.3.1	Death	69
3.2.3.2	Systemic Effects	69
3.2.3.3	Immunological and Lymphoreticular Effects	69
3.2.3.4	Neurological Effects	69
3.2.3.5	Reproductive Effects	70
3.2.3.6	Developmental Effects	70
3.2.3.7	Cancer.....	70
3.3	GENOTOXICITY	70
3.4	TOXICOKINETICS	78
3.4.1	Absorption.....	78
3.4.1.1	Inhalation Exposure.....	78
3.4.1.2	Oral Exposure.....	79
3.4.1.3	Dermal Exposure.....	79
3.4.2	Distribution	81
3.4.2.1	Inhalation Exposure.....	81
3.4.2.2	Oral Exposure.....	81
3.4.2.3	Dermal Exposure.....	82
3.4.3	Metabolism.....	82
3.4.4	Elimination and Excretion.....	87
3.4.4.1	Inhalation Exposure.....	87
3.4.4.2	Oral Exposure.....	87
3.4.4.3	Dermal Exposure.....	88
3.4.5	Physiologically Based Pharmacokinetic (PBPK)/Pharmacodynamic (PD) Models	88
3.5	MECHANISMS OF ACTION	91
3.5.1	Pharmacokinetic Mechanisms.....	91
3.5.2	Mechanisms of Toxicity.....	91
3.5.3	Animal-to-Human Extrapolations	94
3.6	TOXICITIES MEDIATED THROUGH THE NEUROENDOCRINE AXIS	94
3.7	CHILDREN'S SUSCEPTIBILITY.....	95
3.8	BIOMARKERS OF EXPOSURE AND EFFECT	98
3.8.1	Biomarkers Used to Identify or Quantify Exposure to Bromoform and Dibromochloromethane.....	99
3.8.2	Biomarkers Used to Characterize Effects Caused by Bromoform and Dibromochloromethane.....	100
3.9	INTERACTIONS WITH OTHER CHEMICALS	100
3.10	POPULATIONS THAT ARE UNUSUALLY SUSCEPTIBLE.....	102
3.11	METHODS FOR REDUCING TOXIC EFFECTS.....	102
3.11.1	Reducing Peak Absorption Following Exposure	103
3.11.2	Reducing Body Burden.....	103
3.11.3	Interfering with the Mechanism of Action for Toxic Effects	103
3.12	ADEQUACY OF THE DATABASE.....	104
3.12.1	Existing Information on Health Effects of Bromoform and Dibromochloromethane	104

3.12.2	Identification of Data Needs	107
3.12.3	Ongoing Studies.....	115
4.	CHEMICAL AND PHYSICAL INFORMATION.....	117
4.1	CHEMICAL IDENTITY.....	117
4.2	PHYSICAL AND CHEMICAL PROPERTIES.....	117
5.	PRODUCTION, IMPORT/EXPORT, USE, AND DISPOSAL.....	121
5.1	PRODUCTION	121
5.2	IMPORT/EXPORT	122
5.3	USE.....	122
5.4	DISPOSAL.....	122
6.	POTENTIAL FOR HUMAN EXPOSURE	125
6.1	OVERVIEW	125
6.2	RELEASES TO THE ENVIRONMENT	125
6.2.1	Air	128
6.2.2	Water.....	130
6.2.3	Soil	133
6.3	ENVIRONMENTAL FATE.....	134
6.3.1	Transport and Partitioning.....	134
6.3.2	Transformation and Degradation	135
6.3.2.1	Air.....	135
6.3.2.2	Water	135
6.3.2.3	Sediment and Soil.....	136
6.3.2.4	Other Media.....	137
6.4	LEVELS MONITORED OR ESTIMATED IN THE ENVIRONMENT	137
6.4.1	Air	137
6.4.2	Water.....	139
6.4.3	Sediment and Soil	145
6.4.4	Other Environmental Media.....	145
6.5	GENERAL POPULATION AND OCCUPATIONAL EXPOSURE	146
6.6	EXPOSURES OF CHILDREN	149
6.7	POPULATIONS WITH POTENTIALLY HIGH EXPOSURES	150
6.8	ADEQUACY OF THE DATABASE.....	151
6.8.1	Identification of Data Needs	151
6.8.2	Ongoing Studies	154
7.	ANALYTICAL METHODS	157
7.1	BIOLOGICAL MATERIALS	157
7.2	ENVIRONMENTAL SAMPLES.....	158
7.3	ADEQUACY OF THE DATABASE.....	160
7.3.1	Identification of Data Needs	160
7.3.2	Ongoing Studies	163
8.	REGULATIONS AND ADVISORIES	165
9.	REFERENCES	171
10.	GLOSSARY	217

APPENDICES

A. ATSDR MINIMAL RISK LEVELS AND WORKSHEETSA-1

B. USER'S GUIDEB-1

C. ACRONYMS, ABBREVIATIONS, AND SYMBOLS..... C-1

D. INDEXD-1

LIST OF FIGURES

3-1. Levels of Significant Exposure to Bromoform—Oral.....	35
3-2. Levels of Significant Exposure to Dibromochloromethane—Oral	51
3-3. Proposed Pathway of Trihalomethane Metabolism in Rats.....	83
3-4. Proposed Pathway of Trihalomethyl-radical-mediated Lipid Peroxidation	85
3-5. Conceptual Representation of a Physiologically Based Pharmacokinetic (PBPK) Model for a Hypothetical Chemical Substance	90
3-6. Existing Information on Health Effects of Bromoform.....	105
3-7. Existing Information on Health Effects of Dibromochloromethane.....	106
6-1. Frequency of NPL Sites with Bromoform Contamination	126
6-2. Frequency of NPL Sites with Dibromochloromethane Contamination.....	127

LIST OF TABLES

3-1. Levels of Significant Exposure to Bromoform—Oral.....	25
3-2. Levels of Significant Exposure to Dibromochloromethane—Oral	39
3-3. Genotoxicity of Bromoform <i>In Vivo</i>	71
3-4. Genotoxicity of Bromoform <i>In Vitro</i>	72
3-5. Genotoxicity of Dibromochloromethane <i>In Vivo</i>	75
3-6. Genotoxicity of Dibromochloromethane <i>In Vitro</i>	76
3-7. Partition Coefficients for Bromoform and Dibromochloromethane.....	80
4-1. Chemical Identity of Bromoform and Dibromochloromethane.....	118
4-2. Physical and Chemical Properties of Bromoform and Dibromochloromethane.....	119
5-1. Facilities that Produce, Process, or Use Bromoform	123
6-1. Releases to the Environment from Facilities that Produce, Process, or Use Bromoform.....	129
6-2. Occurrence of Bromoform and Dibromochloromethane in Finished Drinking Water.....	140
6-3. Summary of Typical Human Exposure to Bromoform and Dibromochloromethane.....	147
6-4. Ongoing Studies on the Potential for Human Exposure to Bromoform	155
7-1. Analytical Methods for Determining Bromoform and Dibromochloromethane in Biological Materials	159
7-2. Analytical Methods for Determining Bromoform and Dibromochloromethane in Environmental Samples.....	161
8-1. Regulations and Guidelines Applicable to Bromoform and Dibromochloromethane	167

1. PUBLIC HEALTH STATEMENT

This public health statement tells you about bromoform and dibromochloromethane and the effects of exposure to them.

The Environmental Protection Agency (EPA) identifies the most serious hazardous waste sites in the nation. These sites are then placed on the National Priorities List (NPL) and are targeted for long-term federal clean-up activities. Bromoform and dibromochloromethane has been found in at least 140 and 174 of the 1,662 current or former NPL sites. Although the total number of NPL sites evaluated for these substances is not known, the possibility exists that the number of sites at which bromoform and dibromochloromethane is found may increase in the future as more sites are evaluated. This information is important because these sites may be sources of exposure and exposure to these substances may harm you.

When a substance is released either from a large area, such as an industrial plant, or from a container, such as a drum or bottle, it enters the environment. Such a release does not always lead to exposure. You can be exposed to a substance only when you come in contact with it. You may be exposed by breathing, eating, or drinking the substance, or by skin contact.

If you are exposed to bromoform or dichlorobromomethane, many factors will determine whether you will be harmed. These factors include the dose (how much), the duration (how long), and how you come in contact with them. You must also consider any other chemicals you are exposed to and your age, sex, diet, family traits, lifestyle, and state of health.

1.1 WHAT ARE BROMOFORM AND DIBROMOCHLOROMETHANE?

Bromoform (also known as tribromomethane) and dibromochloromethane are colorless to yellow, heavy, nonburnable liquids with a sweetish odor. These chemicals are possible contaminants of drinking water that has been chlorinated to kill bacteria and viruses that could cause serious waterborne infectious diseases. Bromoform and dibromochloromethane may form

1. PUBLIC HEALTH STATEMENT

when chlorine reacts with other naturally occurring substances in water, such as decomposing plant material. Plants in the ocean also produce small amounts of these chemicals.

These chemicals are found mainly in water that originally came from surface sources, such as rivers and lakes. Springs and deep drilled wells usually contain very little of the substances that react with chlorine to form these chemicals; therefore, well and spring water is less likely a source of bromoform and dibromochloromethane than water from a reservoir (artificial lake). The amount of bromoform and dibromochloromethane in drinking water can change considerably from day to day, depending on the source, temperature, amount of plant material in the water, amount of chlorine added, and a variety of other factors.

In the past, bromoform was used by industry to dissolve dirt and grease and to make other chemicals. It was also used in the early part of this century as a medicine to help children with whooping cough get to sleep. Currently, bromoform is only produced in small amounts for use in laboratories and in geological and electronics testing. Dibromochloromethane was used in the past to make other chemicals such as fire extinguisher fluids, spray can propellants, refrigerator fluid, and pesticides. It is now only used on a small scale in laboratories.

In the environment, bromoform and dibromochloromethane are not found as pure liquids, but instead, they are found either dissolved in water or evaporated into air as a gas. Both bromoform and dibromochloromethane are relatively stable in the air, but reactions with other chemicals in the air cause them to break down slowly (about 50% in 1 or 2 months). Bromoform and dibromochloromethane in water or soil may also be broken down by bacteria, but the speed of this process is not known.

Further information on the properties, uses, and chemical identity of bromoform and dibromochloromethane in the environment may be found in Chapters 4, 5, and 6.

1. PUBLIC HEALTH STATEMENT

1.2 WHAT HAPPENS TO BROMOFORM AND DIBROMOCHLOROMETHANE WHEN THEY ENTER THE ENVIRONMENT?

Bromoform and dibromochloromethane enter the environment through the disposal of water that has been disinfected with chlorine or as vapors emitted from chlorinated water. These chemicals are also made naturally by plant-like organisms called algae that are found in the oceans. Some part of bromoform and dibromochloromethane that enters the air is removed by rain. What is left in the air takes about 1–2 months for half of it to degrade. In water, bromoform and dibromochloromethane are slowly broken down at the water surface where oxygen is available, but break down much faster in deep water and in water that is underground where there is a lot less oxygen. Bromoform and dibromochloromethane are mobile in soils and may seep into groundwater. Bromoform and dibromochloromethane do not appear to concentrate in fish.

1.3 HOW MIGHT I BE EXPOSED TO BROMOFORM AND DIBROMOCHLOROMETHANE?

You are most likely to be exposed to bromoform and dibromochloromethane by drinking water that has been treated with chlorine. Usually, the levels in chlorinated drinking water are between 1 and 10 parts of bromoform and dibromochloromethane per billion parts of water (ppb). These are levels that are known to be without adverse health effects. Bromoform and dibromochloromethane have also been detected in chlorinated swimming pools. Exposure can occur at a swimming pool, by breathing bromoform or dibromochloromethane that has evaporated into the air, or by uptake from the water through the skin. Neither dibromochloromethane nor bromoform are likely to be found in food.

If you live near a factory or laboratory that makes or uses dibromochloromethane or bromoform, you might be exposed to dibromochloromethane or bromoform in the air. Currently, bromoform is only used for geological and electronics testing. Dibromochloromethane is used on a small-scale in laboratories. Since neither dibromochloromethane nor bromoform have widespread use in this country, they are usually present in outside air at very low levels (less than 0.01 ppb).

Therefore, exposure to bromoform or dibromochloromethane in the air is a minor route.

Exposure may occur if you come into contact with water or soil at a chemical waste site where

1. PUBLIC HEALTH STATEMENT

dibromochloromethane or bromoform has been disposed. Further information on how you might be exposed to these chemicals is given in Chapter 6.

1.4 HOW CAN BROMOFORM AND DIBROMOCHLOROMETHANE ENTER AND LEAVE MY BODY?

Studies in animals or humans indicate that both bromoform and dibromochloromethane can easily enter your body after swallowing them in water or breathing them in air. They can also enter your body through your skin (for example, by washing or showering in water containing these chemicals). Some portion of bromoform and dibromochloromethane entering your body may be broken down to other compounds. Bromoform, dibromochloromethane, and their breakdown products can be removed from the body by being exhaled from the lungs. These chemicals leave the body fairly rapidly. Bromoform and dibromochloromethane do not tend to build up in the body, 50–90% of the amount that enters the body is removed within 8 hours. Further information on how bromoform and dibromochloromethane enter and leave your body is given in Chapter 3.

1.5 HOW CAN BROMOFORM AND DIBROMOCHLOROMETHANE AFFECT MY HEALTH?

Scientists use many tests to protect the public from harmful effects of toxic chemicals and to find ways for treating persons who have been harmed.

One way to learn whether a chemical will harm people is to determine how the body absorbs, uses, and releases the chemical. For some chemicals, animal testing may be necessary. Animal testing may also help identify health effects such as cancer or birth defects. Without laboratory animals, scientists would lose a basic method for getting information needed to make wise decisions that protect public health. Scientists have the responsibility to treat research animals with care and compassion. Scientists must comply with strict animal care guidelines because laws today protect the welfare of research animals.

1. PUBLIC HEALTH STATEMENT

The effects of bromoform and dibromochloromethane on your health depend largely on the amount you take into your body and the duration of exposure. In general, the more you take in, the greater the chance that an effect will occur. The main effect of swallowing or breathing large amounts of bromoform is a slowing of normal brain activities, resulting in sleepiness or sedation occurring quickly after the chemicals enter your body. In humans, these effects tend to disappear within a day. Exposures capable of producing these effects include swallowing 1–4 drops of liquid bromoform, an amount much greater than is usually found in a glass of drinking water. At much higher amounts, a person may become unconsciousness or die. The amount of dibromochloromethane taken by mouth that would affect humans is not known, but is probably similar to bromoform.

Some studies in animals indicate that exposure to high doses of bromoform or dibromochloromethane may also lead to liver and the kidney injury within a short period of time. Exposure to low levels of bromoform or dibromochloromethane do not appear to seriously affect the brain, liver, or kidneys. Other animal studies suggest that typical bromoform or dibromochloromethane exposures do not pose a high risk of affecting the chance of becoming pregnant or harming an unborn baby. However, studies in animals indicate that long-term intake of either bromoform or dibromochloromethane can cause liver and kidney cancer. Although cancer in humans cannot be definitely attributed to these chemicals, it is an effect of special concern, since many people are exposed to low levels of bromoform and dibromochloromethane in chlorinated drinking water.

The International Agency for Research on Cancer (IARC) concluded that bromoform and dibromochloromethane are not classifiable as to human carcinogenicity. The EPA classified bromoform as a probable human carcinogen and dibromochloromethane as a possible human carcinogen.

Further information on how bromoform and dibromochloromethane can affect the health of humans and animals is presented in Chapter 3.

1. PUBLIC HEALTH STATEMENT

1.6 HOW CAN BROMOFORM AND DIBROMOCHLOROMETHANE AFFECT CHILDREN?

This section discusses potential health effects in humans from exposures during the period from conception to maturity at 18 years of age.

In the early 1900s, bromoform was given to children suffering from whooping cough, resulting in several deaths when children were accidentally overdosed. Children appeared drowsy, then lifeless, just before dying.

There are no studies in humans or laboratory animals that examine whether the effects of bromoform and dibromochloromethane change with age. Based on current knowledge of body function, and metabolism in the body, there is no indication that children will be affected more than adults.

1.7 HOW CAN FAMILIES REDUCE THE RISK OF EXPOSURE TO BROMOFORM AND DIBROMOCHLOROMETHANE?

If your doctor finds that you have been exposed to substantial amounts of bromoform and/or dibromochloromethane, ask whether your children might also have been exposed. Your doctor might need to ask your state health department to investigate.

The chance of consuming bromoform or dibromochloromethane in chlorinated public drinking water varies with season, water temperature, water chemistry, disinfection method, and other factors. However, the health risks associated with drinking non-disinfected water when there is evidence of disease-causing contamination (i.e., bacteria, viruses, etc.) are much greater than the risk of adverse health effects from exposure to bromoform or dibromochloromethane.

There are water treatment methods that people can be used in the home to reduce exposure to bromoform and dibromochloromethane from chlorinated tap water. These include simple do-it-yourself methods such as connecting solid carbon black filters to faucets and shower taps. Homeowners may discuss other home water treatment methods, including filtering, aeration or

1. PUBLIC HEALTH STATEMENT

boiling, distillation, and/or activated charcoal, with a professional plumber or water well contractor. The chance of exposure to bromoform and dibromochloromethane may be reduced by minimizing contact with water expected to have higher levels of these chemicals, such as chlorinated swimming pool water. When bathing or showering some portion of dibromochloromethane and/or bromoform may evaporate into the air. Opening bathroom windows, and taking shorter baths and showers may reduce the amount of chemical vapor that is inhaled or absorbed through the skin.

1.8 IS THERE A MEDICAL TEST TO DETERMINE WHETHER I HAVE BEEN EXPOSED TO BROMOFORM AND DIBROMOCHLOROMETHANE?

If you are exposed to bromoform or dibromochloromethane, measurable levels of the chemicals can sometimes be detected in samples of your blood, breath, or fat. However, there is not enough information at present to use the results of such tests to estimate the level of exposure or to predict the nature or the severity of any health effects that might result. Since special equipment is needed, these tests are not routinely performed in doctors' offices. Because bromoform and dibromochloromethane are quickly eliminated from the body, these special laboratory tests are only effective in detecting recent exposures (within 1 or 2 days). Further information on how bromoform and dibromochloromethane can be measured in exposed humans is presented in Chapters 3 and 7.

1.9 WHAT RECOMMENDATIONS HAS THE FEDERAL GOVERNMENT MADE TO PROTECT HUMAN HEALTH?

The federal government develops regulations and recommendations to protect public health. Regulations *can* be enforced by law. The EPA, the Occupational Safety and Health Administration (OSHA), and the Food and Drug Administration (FDA) are some federal agencies that develop regulations for toxic substances. Recommendations provide valuable guidelines to protect public health, but *cannot* be enforced by law. The Agency for Toxic Substances and Disease Registry (ATSDR) and the National Institute for Occupational Safety

1. PUBLIC HEALTH STATEMENT

and Health (NIOSH) are two federal organizations that develop recommendations for toxic substances.

Regulations and recommendations can be expressed as “not-to-exceed” levels, that is, levels of a toxic substance in air, water, soil, or food that do not exceed a critical value that is usually based on levels that affect animals; they are then adjusted to levels that will help protect humans. Sometimes these not-to-exceed levels differ among federal organizations because they used different exposure times (an 8-hour workday or a 24-hour day), different animal studies, or other factors.

Recommendations and regulations are also updated periodically as more information becomes available. For the most current information, check with the federal agency or organization that provides it. Some regulations and recommendations for bromoform and dibromochloromethane include the following:

OSHA has set a legally enforceable limit of 0.5 ppm for bromoform in workroom air to protect workers during an 8-hour shift over a 40-hour work week.

EPA recommends that drinking water levels for bromoform should not be more than 0.7 parts per million (ppm) for bromoform and 0.7 ppm for dibromochloromethane.

1.10 WHERE CAN I GET MORE INFORMATION?

If you have any more questions or concerns, please contact your community or state health or environmental quality department, or contact ATSDR at the address and phone number below.

ATSDR can also tell you the location of occupational and environmental health clinics. These clinics specialize in recognizing, evaluating, and treating illnesses that result from exposure to hazardous substances.

1. PUBLIC HEALTH STATEMENT

Toxicological profiles are also available on-line at www.atsdr.cdc.gov and on CD-ROM. You may request a copy of the ATSDR ToxProfiles™ CD-ROM by calling the toll-free information and technical assistance number at 1-888-42ATSDR (1-888-422-8737), by e-mail at atsdric@cdc.gov, or by writing to:

Agency for Toxic Substances and Disease Registry
Division of Toxicology
1600 Clifton Road NE
Mailstop F-32
Atlanta, GA 30333
Fax: 1-770-488-4178

Organizations for-profit may request copies of final Toxicological Profiles from the following:

National Technical Information Service (NTIS)
5285 Port Royal Road
Springfield, VA 22161
Phone: 1-800-553-6847 or 1-703-605-6000
Web site: <http://www.ntis.gov/>

2. RELEVANCE TO PUBLIC HEALTH

2.1 BACKGROUND AND ENVIRONMENTAL EXPOSURES TO BROMOFORM AND DIBROMOCHLOROMETHANE IN THE UNITED STATES

Bromoform (CHBr_3 ; CAS Number 75-25-2), also known as tribromomethane, and dibromochloromethane (CHClBr_2 ; CAS Number 124-48-1) belong to a group of chemicals referred to as trihalomethanes; the other two chemicals in this group are chloroform (also known as trichloromethane) and dichlorobromomethane. Trihalomethanes are formed when raw source water is disinfected by chlorination. In the United States, over 280 million people are served by public water systems that apply chlorine or some of its compounds as disinfectants to water in order to provide protection against microbial contaminants that otherwise might cause serious water-borne diseases. While these chlorine-containing disinfectants are effective in controlling many microorganisms, they react with natural organic or carbon-containing matter in the water to form disinfection byproducts. Therefore, the principal source of human exposure to bromoform and dibromochloromethane is chlorinated water supplied to homes, work, and public places. Bromoform and dibromochloromethane concentrations in public supply or tap water are in the low microgram/L range. Dibromochloromethane is often found more frequently than bromoform in samples from chlorinated water systems.

In the past, it was thought that most of the human exposure to bromoform and dibromochloromethane occurred through consumption of chlorinated drinking water. However, because of their physical properties (see Henry's law constants in Chapter 4), some bromoform and dibromochloromethane volatilize into the air from normal household use of water containing these chemicals. Recent models for residential exposure predict that exposure by the inhalation and dermal routes may be significant. Dermal exposure is expected from showering or bathing. Total administered doses of bromoform or dibromochloromethane for residential tap water having low microgram/L concentrations are predicted to be on the order of 10^{-4} mg/kg/day.

2.2 SUMMARY OF HEALTH EFFECTS

The general population is primarily exposed to bromoform and dibromochloromethane via tap water. The primary routes of exposure are ingestion and inhalation (from volatilized compounds) and dermal exposure during showering and bathing. Bromoform and dibromochloromethane are readily absorbed from the

2. RELEVANCE TO PUBLIC HEALTH

gastrointestinal tract and may be absorbed through the respiratory tract and skin. They are rapidly distributed throughout the body. In the liver, bromoform and dibromochloromethane are metabolized by the cytochrome P-450 mixed function oxidase system to a highly reactive metabolite, which is ultimately metabolized to carbon dioxide or carbon monoxide.

Studies in animals, combined with limited observations in humans, indicate that the principal adverse health effects associated with inhalation or oral exposure to bromoform or dibromochloromethane are central nervous system depression and liver and kidney damage. Although limited dermal data were located, it is likely that similar adverse health effects would occur from dermal exposure. Based on the no-observed-adverse-effect level (NOAEL) and lowest-observed-adverse-effect level (LOAEL) values identified in animal studies, the liver appears to be the most sensitive target organ. Two types of liver effects have been observed in laboratory animals: lipidoses and hepatocellular necrosis. Lipidosis is an accumulation of lipids in the hepatocytes resulting in cellular vacuolization and swelling. Hepatocellular necrosis is observed at higher doses. It is not known if these effects represent a continuum of liver damage or are due to separate modes of action. Kidney effects are typically observed at higher doses than the hepatic effects; tubular cell degeneration and nephrosis are the most commonly reported effects in laboratory animals. Central nervous system depression, as evidenced by lethargy, ataxia, and shallow breathing, is typically observed at very high, often lethal, doses. High-dose exposure is also associated with decreases in body weight gain. There are limited data on the immunotoxicity of bromoform and dibromochloromethane. Impaired humoral and cell-mediated (only observed with dibromochloromethane) immunity were observed in a study of mice administered bromoform or dibromochloromethane via gavage for 14 days. For bromoform, the immune and liver effects occurred at the same dose level; for dibromochloromethane, the immune effects occurred at a lower dose than liver effects.

The available data on the potential of bromoform and dibromochloromethane to induce reproductive and/or developmental effects are inconclusive. Human data primarily come from epidemiological studies of pregnancy outcomes in women exposed to trihalomethanes in drinking water. These studies involved mixed exposures to the trihalomethane compounds (chloroform, dichlorobromomethane, bromoform, and dibromochloromethane), and many did not analyze for possible risks associated with bromoform or dibromochloromethane water concentrations. These data are inadequate for establishing a causal relationship between trihalomethane exposure and reproductive and/or developmental toxicity. The animal data suggest that exposure to bromoform or dibromochloromethane does not cause histological damage to reproductive organs or impair reproductive function; although high-dose exposure may result in reduced fertility. The available developmental toxicity data suggest that bromoform and

2. RELEVANCE TO PUBLIC HEALTH

dibromochloromethane may be toxic to the developing fetus, but these data are inadequate to establish firm conclusions.

The carcinogenicity of bromoform and dibromochloromethane has been studied in both humans and laboratory animals. The human data consist of studies of trihalomethane exposure via tap water. As with the reproductive and developmental toxicity studies, these data are inconclusive and do not establish causal relationships. Carcinogenic effects have been observed in animals exposed to bromoform and dibromochloromethane. Chronic oral exposure to bromoform resulted in increases in the occurrence of intestinal tumors in female rats. Dibromochloromethane induced liver tumors in male and female mice. The Department of Health and Human Services (DHHS) has not categorized the human carcinogenic potential of bromoform or dibromochloromethane. The International Agency for Research on Cancer (IARC) concluded that there were inadequate human data and limited animal data and assigned bromoform and dibromochloromethane to weight of evidence category 3, not classifiable as to carcinogenicity in humans. EPA classified bromoform as a probable human carcinogen, group B2 and dibromochloromethane as a possible human carcinogen, group C.

The primary targets of bromoform and dibromochloromethane toxicity—liver, kidney, and central nervous system—are discussed in greater detail below. The reader is referred to Section 3.2, Discussion of Health Effects by Route of Exposure, for additional information on other health effects.

Liver Effects. Acute, intermediate-, and chronic-duration studies in laboratory animals provide strong evidence that the liver is the critical target of bromoform and dibromochloromethane toxicity. There are very limited human data on the toxicity of these two compounds; data for other trihalomethanes, particularly chloroform, suggest that the liver would also be a target of toxicity in humans.

There is strong evidence that the hepatotoxicity of bromoform and dibromochloromethane is due to their metabolism to reactive intermediates and highly reactive trihalomethyl free radicals. At lower doses, the hepatotoxicity of bromoform and dibromochloromethane is characterized by fatty infiltration, cellular vacuolization and swelling, and increases in liver weight. Consistent with the accumulation of lipids is the observed decrease in serum triglyceride levels and alterations in serum cholesterol levels. At higher doses, focal centrilobular necrosis and increases in SGOT and SGPT levels have been observed. For bromoform, the LOAEL is 50 mg/kg (5 days/week; 36 mg/kg/day) for fatty changes observed in rats administered bromoform in corn oil via gavage for 13 weeks. Necrosis was observed in rats receiving gavage doses of 200 mg/kg (143 mg/kg/day), 5 days/week for 2 years, but not after 13 weeks of dosing.

2. RELEVANCE TO PUBLIC HEALTH

For dibromochloromethane, the LOAEL is 40 mg/kg (5 days/week; 28 mg/kg/day) for fatty liver changes in rats receiving gavage doses of dibromochloromethane in corn oil for 2 years. Necrosis was observed at 173 mg/kg/day in rats exposed via the diet for 1 month.

Species and possible gender differences in the hepatotoxicity of bromoform and dibromochloromethane have been identified. Rats appear to be more sensitive than mice to the liver effects. Under similar exposures scenarios, respective NOAEL and LOAEL values of 25 and 50 mg/kg (5 days/week) for fatty changes were identified in rats exposed to bromoform for 13 weeks; the NOAEL and LOAEL values in mice were 100 and 200 mg/kg (5 days/week), respectively. For dibromochloromethane, the NOAEL and LOAEL values for fatty changes following a 13-week gavage exposure (5 days/week) were 30 and 60 mg/kg for rats and 125 and 250 mg/kg for mice.

Kidney Effects. Renal effects have not been consistently found in studies of laboratory animals, particularly in the case of bromoform exposure. One study reported mesangial nephrosis in mice exposed to 145 mg/kg/day bromoform via gavage for 14 days and identified a NOAEL of 37 mg/kg/day. Comprehensive intermediate- and chronic-duration studies in rats and mice did not find significant renal effects at doses as high as 400 mg/kg (5 days/week; 286 mg/kg/day). In contrast, exposure to dibromochloromethane resulted in mesangial hyperplasia in mice exposed to ≥ 37 mg/kg/day via gavage for 14 days. Toxic nephropathy was observed in rats and mice exposed to 250 mg/kg (179 mg/kg/day) for 13 weeks and in mice receiving gavage doses of 100 mg/kg (71 mg/kg/day) for 2 years.

Central Nervous System Depression. In children, oral doses of around 60 mg/kg/day of bromoform typically produced only mild sleepiness, while doses of 150 mg/kg sometimes produced stupor or deep narcosis, usually accompanied by depressed respiration and erratic heartbeat. The onset of sedation after ingestion is rapid, reportedly minutes in children and about an hour in mice. In intermediate and chronic oral studies in animals, doses of bromoform ≥ 100 mg/kg (5 days/week; 71 mg/kg/day) caused lethargy. Airborne concentrations of bromoform leading to central nervous system depression in humans are not known, but brief exposures of laboratory animals to high concentrations (7,000 ppm) leads to deep sedation within minutes. Central nervous system effects were also observed in laboratory animals at a concentration of 240 ppm in a short-term, repeated dose study. These depressant effects on the nervous system appear to be fully reversible both in animals and humans, but it is difficult to rule out the possibility of subtle, but enduring, neurological changes following narcotizing doses.

2. RELEVANCE TO PUBLIC HEALTH

2.3 MINIMAL RISK LEVELS (MRLs)

Estimates of exposure levels posing minimal risk to humans (MRLs) have been made for bromoform and dibromochloromethane. An MRL is defined as an estimate of daily human exposure to a substance that is likely to be without an appreciable risk of adverse effects (noncarcinogenic) over a specified duration of exposure. MRLs are derived when reliable and sufficient data exist to identify the target organ(s) of effect or the most sensitive health effect(s) for a specific duration within a given route of exposure. MRLs are based on noncancerous health effects only and do not consider carcinogenic effects. MRLs can be derived for acute, intermediate, and chronic duration exposures for inhalation and oral routes. Appropriate methodology does not exist to develop MRLs for dermal exposure.

Although methods have been established to derive these levels (Barnes and Dourson 1988; EPA 1990), uncertainties are associated with these techniques. Furthermore, ATSDR acknowledges additional uncertainties inherent in the application of the procedures to derive less than lifetime MRLs. As an example, acute inhalation MRLs may not be protective for health effects that are delayed in development or are acquired following repeated acute insults, such as hypersensitivity reactions, asthma, or chronic bronchitis. As these kinds of health effects data become available and methods to assess levels of significant human exposure improve, these MRLs will be revised.

The details regarding calculations of the MRLs for bromoform and dibromochloromethane are described in Appendix A.

Inhalation MRLs

MRLs for acute- (≤ 14 days), intermediate- (15–364 days), and chronic-duration (≥ 364 days) inhalation exposure to bromoform or dibromochloromethane have not been derived because quantitative data were not available to determine NOAELs or LOAELs.

Information on the toxicity of bromoform or dibromochloromethane in humans following inhalation exposure was not available. Brief summaries of adverse effects in laboratory animals following inhalation exposure to bromoform, reported in abstract form, do not provide sufficient basis for MRL derivation. No studies were located regarding effects of dibromochloromethane in animals exposed via inhalation. Therefore, inhalation MRLs were not derived for either bromoform or dibromochloromethane.

2. RELEVANCE TO PUBLIC HEALTH

*Oral MRLs***Bromoform**

- An MRL of 0.7 mg/kg/day has been derived for acute-duration oral exposure (14 days or less) to bromoform.

The acute toxicity of bromoform has been investigated in a number of animal studies. These studies have identified several targets of toxicity. The available data suggest that the liver is the most sensitive target. The threshold for liver effects appears to be between 50 and 125 mg/kg/day. Increases in absolute and relative liver weights were observed in mice exposed to 125 mg/kg/day bromoform in emulphor in water for 14 days (Munson et al. 1982). Centrilobular pallor, considered to be indicative of hepatocellular degeneration, was observed at 145 mg/kg/day in mice receiving gavage doses of bromoform in corn oil for 14 days (Condie et al. 1983). Hepatocellular vacuolization and/or swelling was observed at 200 mg/kg (9 days/11 days) and higher (Coffin et al. 2000). Other effects observed in acute-duration animal studies include mesangial nephrosis in mice exposed to 145 mg/kg/day via gavage for 14 days (Condie et al. 1983), central nervous system depression, as evidenced by lethargy, labored and shallow breathing, and ataxia in rats and mice at ≥ 600 mg/kg/day for 1–14 days (Balster and Borzelleca 1982; Bowman et al. 1978; NTP 1989a), and developmental effects (increases in the occurrence of skeletal anomalies) in the offspring of rats exposed to 200 mg/kg/day on gestational days 6–15 (Ruddick et al. 1983).

The Condie et al. (1983) and Munson et al. (1982) studies identify the lowest LOAELs for liver effects. The Condie et al. (1983) study identified a NOAEL of 72 mg/kg/day and LOAEL of 145 mg/kg/day for centrilobular pallor in mice receiving daily gavage doses of bromoform in corn oil for 14 days. Focal inflammation and increase in SGPT levels were observed at 280 mg/kg/day. The Munson et al. (1982) study identified a NOAEL of 50 mg/kg/day and LOAEL of 125 mg/kg/day for increases in absolute and relative liver weights in mice receiving daily gavage doses of bromoform in a 10% emulphor/de-ionized water solution for 14 days. At 250 mg/kg/day, increases in SGOT and SGPT levels were also observed. The Condie et al. (1983) study was selected as the basis of the MRL because it identified a higher NOAEL for liver effects than the Munson et al. (1982) study and included histopathological examination of the liver which was not included in the Munson et al. (1982) study. The NOAEL of 72 mg/kg/day was divided by an uncertainty factor of 100 (10 for extrapolation from animals to humans and 10 for human variability) to yield an acute-duration oral MRL of 0.7 mg/kg/day.

2. RELEVANCE TO PUBLIC HEALTH

- An MRL of 0.2 mg/kg/day has been derived for intermediate-duration oral exposure (15–364 days) to bromoform.

The oral toxicity database in animals provides strong evidence that the liver is the most sensitive target of bromoform toxicity. Several intermediate-duration studies have reported liver effects, typically at the lowest dose level. At lower doses, fatty changes, characterized as hepatocellular vacuolization and swelling, were observed in rats and mice. Focal necrosis was observed at higher oral doses. The lowest LOAEL for liver effects identified in an intermediate-duration study is 50 mg/kg in rats receiving gavage doses of bromoform in corn oil 5 days/week for 13 weeks (NTP 1989a); this study identified a NOAEL of 25 mg/kg. The intermediate-duration oral MRL of 0.2 mg/kg/day for bromoform was derived by applying an uncertainty factor of 100 (10 for extrapolation from animals to humans and 10 for human variability) to the duration-adjusted NOAEL of 18 mg/kg/day.

- An MRL of 0.02 mg/kg/day has been derived for chronic-duration oral exposure (365 days or more) to bromoform.

Three studies have examined the chronic toxicity of bromoform in animals. Rat and mouse studies conducted by NTP (1989a) are comprehensive studies that found fatty liver changes (hepatocellular vacuolization) at the lowest dose tested, 100 mg/kg (5 days/week; 71 mg/kg/day). The third study (Tobe et al. 1982) identified a similar LOAEL (140 mg/kg/day) in rats exposed to bromoform in the diet for 2 years; this study also identified a NOAEL of 35 mg/kg/day. At 140 mg/kg/day, yellowing of the liver and increased absolute and relative liver weights were observed. The NTP (1989a) rat study was selected as the basis of the chronic-duration oral MRL for bromoform. Even though the Tobe et al. (1982) study identified a NOAEL for liver effects, this study was not selected as the critical study because no histological examination of the liver was conducted and the results were poorly reported. The duration-adjusted LOAEL of 71 mg/kg/day was divided by an uncertainty factor of 300 (3 for use of a minimal LOAEL, 10 for animal to human extrapolation, and 10 for human variability) and a modifying factor of 10 to account for the identification of a lower LOAEL in a 13-week study (NTP 1989a) resulting in an MRL of 0.02 mg/kg/day.

Dibromochloromethane

- An MRL of 0.1 mg/kg/day has been derived for acute-duration oral exposure (14 days or less) to dibromochloromethane.

2. RELEVANCE TO PUBLIC HEALTH

The available data on the oral toxicity of dibromochloromethane in animals strongly suggest that the liver is the most sensitive target of toxicity. In most studies, liver effects are observed at lower doses than kidney effects (the next most sensitive end point). The study of Condie et al. (1983) was selected as the basis for the acute-duration oral MRL for dibromochloromethane because it showed dose-related incidences of liver and kidney lesions and identified the lowest LOAEL for liver effects among the available studies. A LOAEL of 37 mg/kg/day, the lowest dose tested, was identified for liver damage (hepatocellular vacuolization) in mice administered dibromochloromethane in corn oil for 14 consecutive days. A reliable NOAEL for liver or kidney effects could not be determined from the available acute data. Applying an uncertainty factor of 300 (3 for use of a minimal LOAEL, 10 for extrapolation from animals to humans, and 10 for human variability) to the LOAEL of 37 mg/kg/day yields an acute-duration oral MRL of 0.1 mg/kg/day for dibromochloromethane.

No data were located regarding the toxicity of dibromochloromethane following intermediate-duration oral exposure in humans. A number of intermediate-duration studies of rats and mice were located. The liver was identified as the most sensitive target. Hepatocellular vacuolization was observed at 43 mg/kg/day (60 mg/kg, 5 days/week) and higher (Aida et al. 1992; Daniel et al. 1990; NTP 1985); the highest NOAEL for liver effects is 21 mg/kg/day (30 mg/kg, 5 days/week) (NTP 1985). At higher doses (≥ 100 mg/kg/day), proximal tubular degeneration and nephropathy were observed (Daniel et al. 1990; NTP 1985). Impaired humoral immune function was observed in mice administered 125 mg/kg/day via gavage for 14 days (Munson et al. 1982). Several animal studies also reported neurological effects: decreases in brain weight and decreases in operant behavior at ≥ 100 mg/kg/day (Balster and Borzelleca 1982; Daniel et al. 1990). Borzelleca and Carchman (1982) found decreases in fertility at high dibromochloromethane doses (685 mg/kg/day).

Derivation of an intermediate-duration oral MRL for dibromochloromethane based on the NTP (1985) rat study, which identified NOAEL and LOAEL values of 21 and 43 mg/kg/day, was considered. However, the resultant MRL would be higher than the acute-duration oral MRL.

- An MRL of 0.09 mg/kg/day has been derived for chronic-duration oral exposure (365 days or less) to dibromochloromethane.

Studies of dibromochloromethane consistently indicate that the liver is a target organ. The NTP (1985) study, in which rats received gavage doses of 0, 40, or 80 mg/kg of dibromochloromethane in corn oil, 5 days/week, for 104 weeks, was selected as the basis for the chronic-duration oral MRL. This study (NTP 1985) was selected because it showed dose-related incidences of microscopic hepatic lesions and

2. RELEVANCE TO PUBLIC HEALTH

also identified the lowest LOAEL of 40 mg/kg (duration-adjusted LOAEL of 28 mg/kg/day) for hepatic effects in chronic studies (NTP 1985; Tobe et al. 1982) of dibromochloromethane toxicity. A chronic-duration oral MRL of 0.09 mg/kg/day was derived by applying an uncertainty factor of 300 (3 for use of a minimal LOAEL, 10 for extrapolation from animals to humans, and 10 for human variability) to the LOAEL of 28 mg/kg/day.

3. HEALTH EFFECTS

3.1 INTRODUCTION

The primary purpose of this chapter is to provide public health officials, physicians, toxicologists, and other interested individuals and groups with an overall perspective on the toxicology of bromoform and dibromochloromethane. It contains descriptions and evaluations of toxicological studies and epidemiological investigations and provides conclusions, where possible, on the relevance of toxicity and toxicokinetic data to public health.

A glossary and list of acronyms, abbreviations, and symbols can be found at the end of this profile.

3.2 DISCUSSION OF HEALTH EFFECTS BY ROUTE OF EXPOSURE

To help public health professionals and others address the needs of persons living or working near hazardous waste sites, the information in this section is organized first by route of exposure (inhalation, oral, and dermal) and then by health effect (death, systemic, immunological, neurological, reproductive, developmental, genotoxic, and carcinogenic effects). These data are discussed in terms of three exposure periods: acute (14 days or less), intermediate (15–364 days), and chronic (365 days or more).

Levels of significant exposure for each route and duration are presented in tables and illustrated in figures. The points in the figures showing no-observed-adverse-effect levels (NOAELs) or lowest-observed-adverse-effect levels (LOAELs) reflect the actual doses (levels of exposure) used in the studies. LOAELs have been classified into "less serious" or "serious" effects. "Serious" effects are those that evoke failure in a biological system and can lead to morbidity or mortality (e.g., acute respiratory distress or death). "Less serious" effects are those that are not expected to cause significant dysfunction or death, or those whose significance to the organism is not entirely clear. ATSDR acknowledges that a considerable amount of judgment may be required in establishing whether an end point should be classified as a NOAEL, "less serious" LOAEL, or "serious" LOAEL, and that in some cases, there will be insufficient data to decide whether the effect is indicative of significant dysfunction. However, the Agency has established guidelines and policies that are used to classify these end points. ATSDR believes that there is sufficient merit in this approach to warrant an attempt at distinguishing between

3. HEALTH EFFECTS

"less serious" and "serious" effects. The distinction between "less serious" effects and "serious" effects is considered to be important because it helps the users of the profiles to identify levels of exposure at which major health effects start to appear. LOAELs or NOAELs should also help in determining whether or not the effects vary with dose and/or duration, and place into perspective the possible significance of these effects to human health.

The significance of the exposure levels shown in the Levels of Significant Exposure (LSE) tables and figures may differ depending on the user's perspective. Public health officials and others concerned with appropriate actions to take at hazardous waste sites may want information on levels of exposure associated with more subtle effects in humans or animals (LOAELs) or exposure levels below which no adverse effects (NOAELs) have been observed. Estimates of levels posing minimal risk to humans (Minimal Risk Levels or MRLs) may be of interest to health professionals and citizens alike.

Levels of exposure associated with carcinogenic effects (Cancer Effect Levels, CELs) of bromoform or dibromochloromethane are indicated in Tables 3-1 and 3-2 and Figures 3-1 and 3-2. Because cancer effects could occur at lower exposure levels, Figures 3-1 and 3-2 also shows a range for the upper bound of estimated excess risks, ranging from a risk of 1 in 10,000 to 1 in 10,000,000 (10^{-4} to 10^{-7}), as developed by EPA.

A User's Guide has been provided at the end of this profile (see Appendix B). This guide should aid in the interpretation of the tables and figures for Levels of Significant Exposure and the MRLs.

3.2.1 Inhalation Exposure

No studies were located regarding health effects of bromoform or dibromochloromethane in humans following inhalation exposure. In animals, there are limited data from several older studies on the effects of inhalation exposure to bromoform; no studies were located regarding effects of dibromochloromethane.

3.2.1.1 Death

Inhalation of very high concentrations (56,000 or 84,000 ppm) of bromoform vapor for 1 hour has been reported to cause death in dogs (Merzbach 1928). The chief symptoms noted were initial excitation

3. HEALTH EFFECTS

followed by deep sedation. This indicates that central nervous system depression is probably the chief cause of death in such acute exposures. Because only two animals were used (one animal per dose) and only high doses were administered, these data do not provide a reliable estimate of the minimum lethal concentration in dogs or other animal species.

3.2.1.2 Systemic Effects

No studies were located regarding respiratory, cardiovascular, gastrointestinal, hematological, musculoskeletal, endocrine, dermal, ocular, or body weight effects in animals or humans following inhalation exposure to bromoform or dibromochloromethane.

Hepatic Effects. Two studies (Dykan 1962, 1964; published in Russian and available only as the English abstract) indicate that inhalation exposure of animals to high concentrations of bromoform leads to hepatic injury. Exposure of rats to 240 ppm of bromoform for 10 days resulted in dystrophic and vascular changes in the liver, with altered hepatic metabolism (Dykan 1964). Longer-term exposure (2 months) to concentrations of 24 ppm also led to hepatic changes (decreased blood clotting and impaired glycogenesis) (Dykan 1962). No significant alterations were observed after exposure to 4.8 ppm (Dykan 1964). These changes appear to resemble the changes produced after oral exposure to bromoform (see Section 3.2.2.2), suggesting that the hepatotoxicity of bromoform is not route-specific.

Renal Effects. Similar to the hepatic effects, exposure to 240 ppm bromoform for 10 days resulted in dystrophic and vascular changes in the kidney with altered renal filtration (Dykan 1964). A 2-month exposure to 24 ppm resulted in proteinuria and decreased creatinine clearance (Dykan 1962). A concentration of 4.8 ppm was estimated to be without significant effects on the kidney (Dykan 1964). These changes appear to resemble the changes produced after oral exposure to bromoform (see Section 3.2.2.2).

3.2.1.3 Immunological and Lymphoreticular Effects

No studies were located regarding immunological effects in humans or animals after inhalation exposure to bromoform or dibromochloromethane.

3. HEALTH EFFECTS

3.2.1.4 Neurological Effects

Inhalation exposure to high levels (29,000 ppm or above) of bromoform has been observed to lead to rapid and profound depression of the central nervous system in dogs (Graham 1915; Merzbach 1928). This is presumably due to a nonspecific anesthetic effect similar to that produced by various other volatile halocarbons. Obvious clinical signs included deep relaxation and sedation (Merzbach 1928). Clinical signs of nervous system depression appeared quickly (within minutes), and tended to disappear within a day after exposure ceased (Graham 1915).

No studies were located regarding the following effects in humans or animals after inhalation exposure to bromoform or dibromochloromethane:

3.2.1.5 Reproductive Effects**3.2.1.6 Developmental Effects****3.2.1.7 Cancer****3.2.2 Oral Exposure**

Most information on the health effects of bromoform and dibromochloromethane comes from studies in animals (rats and mice) exposed by the oral route. For bromoform, there are some observations in humans stemming from the past use of bromoform as a sedative, but no studies were located on the effect of dibromochloromethane in humans. Summaries of studies that provide reliable quantitative toxicity data are presented in Table 3-1 and Figure 3-1 for bromoform and in Table 3-2 and Figure 3-2 for dibromochloromethane. The main conclusions from these studies are discussed below.

3.2.2.1 Death

Bromoform. In the early part of this century, bromoform was often given as a sedative to children suffering from whooping cough, and several deaths due to accidental overdoses have been described (Dwelle 1903; Kobert 1906; Roth 1904 as cited in von Oettingen 1955). The principal clinical signs in fatal cases were those of severe central nervous system depression (unconsciousness, stupor, and loss of reflexes), and death was generally the result of respiratory failure (von Oettingen 1955). If death could be averted, recovery was generally complete within several days (Benson et al. 1907; Burton-Fanning 1901;

Table 3-1 Levels of Significant Exposure to Bromoform - Oral

Key to Figure ^a	Species (Strain)	Exposure/ Duration/ Frequency (Route)	System	NOAEL (mg/kg/day)	LOAEL		Reference Chemical Form
					Less Serious (mg/kg/day)	Serious (mg/kg/day)	
ACUTE EXPOSURE							
Death							
1	Human	1 d				445 F (single child died due to overdose)	Dwelle 1903
2	Rat (Sprague-Dawley)	1 day (GO)				1147 F (LD50)	Chu et al 1982a
3	Rat (Sprague-Dawley)	(G)				1388 M (LD50) 1147 ^b F (LD50)	Chu et al. 1980
4	Rat (Fischer- 344)	1 d (GO)				933 (LD50)	NTP 1989a
5	Rat (Fischer- 344)	14 d 1x/d (GO)				600 (100% mortality)	NTP 1989a
6	Mouse (ICR)	1 d (GW)				1400 ^b M (LD50) 1550 F (LD50)	Bowman et al 1978
7	Mouse (B6C3F1)	1 d (GO)				707 ^b M (LD50) 1072 F (LD50)	NTP 1989a

Table 3-1 Levels of Significant Exposure to Bromoform - Oral

(continued)

Key to Figure	Species (Strain)	Exposure/Duration/Frequency (Route)	System	NOAEL (mg/kg/day)	LOAEL		Reference Chemical Form
					Less Serious (mg/kg/day)	Serious (mg/kg/day)	
Systemic							
8	Rat (Fischer- 344)	14 d 1x/d (GO)	Endocr	600	800	(enlarged thyroid gland)	NTP 1989a
			Bd Wt	200 M	400 M	(14% decreased body weight gain)	
9	Rat	1 d (G)	Hepatic	1440			Plaa and Hewitt 1982a
10	Rat (Fischer- 344)	7 d (GW)	Endocr	190 M	380 M	(decreased serum testosterone)	Potter et al 1996
			Bd Wt	380 M			
11	Mouse (B6C3F1)	9 doses in 11 days (GO)	Hepatic		200 F	(hepatocellular ballooning and proliferation)	Coffin et al 2000
12	Mouse (B6C3F1)	11 days (W)	Hepatic		300 F	(hepatocellular ballooning)	Coffin et al 2000
13	Mouse (CD-1)	14 d 1x/d (GO)	Hepatic	72 M	145 M	(centrilobular pallor)	Condie et al 1983
			Renal	72 M	145 M	(mesangial nephrosis)	
			Bd Wt	289 M			

Table 3-1 Levels of Significant Exposure to Bromoform - Oral

(continued)

Key to Figure	Species ^a (Strain)	Exposure/ Duration/ Frequency (Route)	System	NOAEL (mg/kg/day)	LOAEL		Reference Chemical Form
					Less Serious (mg/kg/day)	Serious (mg/kg/day)	
14	Mouse (CD-1)	14 d 1x/d (GW)	Hepatic	50 M	125 M (increased absolute and relative liver weights)		Munson et al 1982
15	Mouse (B6C3F1)	14 d 1x/d (GO)	Gastro	200 M	400 M (stomach nodules)		NTP 1989a
Immuno/ Lymphoret							
16	Mouse (CD-1)	14 d 1x/d (GW)		125 M	250 M (impaired humoral immune function)		Munson et al 1982
Neurological							
17	Rat (Fischer- 344)	14 d 1x/d (GO)		400	600 (lethargy, labored and swallowing breathing, ataxia)		NTP 1989a
18	Rat (Fischer- 344)	1 d (GO)		500	1000 (shallow breathing)		NTP 1989a
19	Mouse (ICR)	14 days daily (GW)		9.7 M			Balster and Borzelleca 1982 Bromoform
20	Mouse (ICR)	1 d (GW)			431 M (ED50 for impaired motor performance)		Balster and Borzelleca 1982

Table 3-1 Levels of Significant Exposure to Bromoform - Oral

(continued)

Key to Figure	Species (Strain)	Exposure/Duration/Frequency (Route)	System	NOAEL (mg/kg/day)	LOAEL		Reference Chemical Form
					Less Serious (mg/kg/day)	Serious (mg/kg/day)	
21	Mouse (ICR)	1 d (GW)				1000 (ataxia, sedation, anesthesia)	Bowman et al 1978
22	Mouse (B6C3F1)	14 d 1x/d (GO)		400		600 (lethargy and ataxia)	NTP 1989a
Developmental							
23	Rat (Sprague-Dawley)	9 d Gd 6-15 (GO)		100		200 (skeletal anom.)	Ruddick et al 1983
INTERMEDIATE EXPOSURE							
Systemic							
24	Rat (Wistar)	30 d (F)	Hepatic		56.4 F (hepatocellular vacuolization and swelling)		Aida et al 1992
			Bd Wt	187.2 M		617.9 M (24% decreased body weight)	
25	Rat (Sprague-Dawley)	28 d (W)	Hemato	14 M			Chu et al 1982a
			Hepatic	14 M			
			Renal	14 M			
			Bd Wt	14 M			

Table 3-1 Levels of Significant Exposure to Bromoform - Oral

(continued)

Key to Figure ^a	Species (Strain)	Exposure/Duration/Frequency (Route)	System	LOAEL			Reference Chemical Form
				NOAEL (mg/kg/day)	Less Serious (mg/kg/day)	Serious (mg/kg/day)	
26	Rat (Fischer-344)	13 wk 5d/wk (GO)	Resp	200			NTP 1989a
			Cardio	200			
			Gastro	200			
			Hepatic	25 ^d M	50 M (hepatocellular vacuolization)		
			Renal	200			
			Endocr	200			
			Dermal	200			
			Bd Wt	200			
27	Mouse (B6C3F1)	3 wk 5 d/wk (GO)	Hepatic	200 F	500 F (hepatocyte hydropic degeneration; increased SGPT and sorbitol dehydrogenase)		Melnick et al 1998
			Bd Wt	500 F			

Table 3-1 Levels of Significant Exposure to Bromoform - Oral

(continued)

Key to Figure ^a	Species (Strain)	Exposure/ Duration/ Frequency (Route)	System	LOAEL			Reference Chemical Form
				NOAEL (mg/kg/day)	Less Serious (mg/kg/day)	Serious (mg/kg/day)	
28	Mouse (B6C3F1)	13 wk 5d/wk (GO)	Resp	400			NTP 1989a
			Cardio	400			
			Hepatic	100 M	200 M (minimal to moderate heptocellular vacuoles)		
			Renal	400			
			Endocr	400			
			Dermal	400			
			Bd Wt	400			
29	Mouse (Swiss)	102 d 1x/d (GO)	Resp	200			NTP 1989b
			Hepatic		200 (hepatocellular vacuoles)		
			Renal	200			
			Endocr	200			
Neurological							
30	Rat (Fischer- 344)	13 wk 5d/wk (GO)		50 M	100 M (lethargy)		NTP 1989a
31	Mouse (ICR)	90 d 1x/d (GW)		0.9 M	9.2 M (decreased exploratory activity)		Balster and Borzelleca 1982 Bromoform

Table 3-1 Levels of Significant Exposure to Bromoform - Oral

(continued)

Key to Figure	Species (Strain)	Exposure/Duration/Frequency (Route)	System	LOAEL		Reference Chemical Form
				NOAEL (mg/kg/day)	Less Serious (mg/kg/day)	
32	Mouse (ICR)	60 d 1x/d (GW)			100 M (decreased response rate in operant behavior test)	Balster and Borzelleca 1982 Bromoform
33	Mouse (ICR)	30d 1x/d (GW)		100 M		Balster and Borzelleca 1982
Reproductive						
34	Rat (Fischer- 344)	13 wk 5d/wk (GO)		200		NTP 1989a
35	Mouse (B6C3F1)	13 wk 5d/wk (GO)		400		NTP 1989a
36	Mouse (Swiss)	105 d 1x/d (GO)		200		NTP 1989b
CHRONIC EXPOSURE						
Death						
37	Rat (Fischer- 344)	103 wk 5d/wk (GO)			200 M (decreased survival)	NTP 1989a

Table 3-1 Levels of Significant Exposure to Bromoform - Oral

(continued)

Key to Figure	Species (Strain)	Exposure/ Duration/ Frequency (Route)	System	NOAEL (mg/kg/day)	LOAEL		Reference Chemical Form
					Less Serious (mg/kg/day)	Serious (mg/kg/day)	
Systemic							
38	Rat (Fischer- 344)	103 wk 5d/wk (GO)	Cardio	200			NTP 1989a
			Gastro	100 M	200 M (forestomach ulcer)		
			Hemato	100 F	200 F (spleen pigmentation)		
			Hepatic		100 ^e (hepatocellular vacuolization)		
			Renal	200			
			Endocr		100 M (pituitary gland hyperplasia)		
			Dermal	200			
Bd Wt	100	200 (>10% decrease in body weight gain)					
39	Rat (Wistar)	2 year (F)	Hepatic	35 F	140 F (yellowing of liver; increased absolute and relative liver weight)		Tobe et al 1982
			Bd Wt	90 M		590 M (40% decrease in body weight gain)	

Table 3-1 Levels of Significant Exposure to Bromoform - Oral

(continued)

Key to Figure ^a	Species (Strain)	Exposure/Duration/Frequency (Route)	System	NOAEL (mg/kg/day)	LOAEL		Reference Chemical Form
					Less Serious (mg/kg/day)	Serious (mg/kg/day)	
40	Mouse (B6C3F1)	103 wk 5d/wk (GO)	Resp	100 M			NTP 1989a
			Cardio	100 M			
			Gastro	50 M	100 M (hyperplasia in glandular stomach)		
			Musc/skel	100 M			
			Hepatic		100 F (hepatocellular vacuolization)		
			Renal	100 M			
			Endocr	100 F	200 F (follicular cell hyperplasia in thyroid)		
			Dermal	100 M			
		Bd Wt	100 M				
Neurological							
41	Rat (Fischer-344)	103 wk 5d/wk (GO)			100	(lethargy)	NTP 1989a
Reproductive							
42	Rat (Fischer-344)	103 wk 5d/wk (GO)		100 M ^b 200 F	200 M	(squamous metaplasia in prostate)	NTP 1989a

Table 3-1 Levels of Significant Exposure to Bromoform - Oral

(continued)

Key to Figure ^a	Species (Strain)	Exposure/ Duration/ Frequency (Route)	System	LOAEL		Reference Chemical Form
				NOAEL (mg/kg/day)	Less Serious (mg/kg/day)	
43	Mouse (B6C3F1)	103 wk 5d/wk (GO)		100 M ^b 200 F		NTP 1989a
Cancer						
44	Rat (Fischer- 344)	103 wk 5d/wk (GO)			200 F (CEL: adenomatous polyps and adenocarcinoma in large intestine)	NTP 1989a

a The number corresponds to entries in Figure 3-1.

b Differences in levels of health effects and cancer effects between male and females are not indicated in Figure 3-1. Where such differences exist, only the levels of effect for the most sensitive gender are presented.

c Used to derive an acute-duration oral MRL of 0.7 mg/kg/day; dose divided by an uncertainty factory of 100 (10 for extrapolation from animals to humans and 10 for human variability).

d Used to derive an intermediate-duration oral MRL of 0.2 mg/kg/day; dose adjusted for intermittent exposure and divided by an uncertainty factor of 100 (10 for extrapolation from animals to humans, and 10 for human variability).

e Used to derive a chronic-duration oral MRL of 0.02 mg/kg/day; dose adjusted for intermittent exposure and divided by an uncertainty factory of 300 (3 for extrapolation from a minimal LOAEL, 10 for extrapolation from animals to humans, and 10 for human variability) and a modifying factor of 10 to account for the identification of a lower LOAEL in a subchronic study (NTP 1989a).

d = day(s); F = female; (F) = food; (G) = gavage; Gastro = gastrointestinal; LD50 = lethal dose, 50% kill; LOAEL = lowest-observed-adverse-effect level; M = male; NOAEL = no-observed-adverse-effect level; (W) = water; wk = week(s); x = time(s)

Figure 3-1. Levels of Significant Exposure to Bromoform - Oral
Acute (≤14 days)

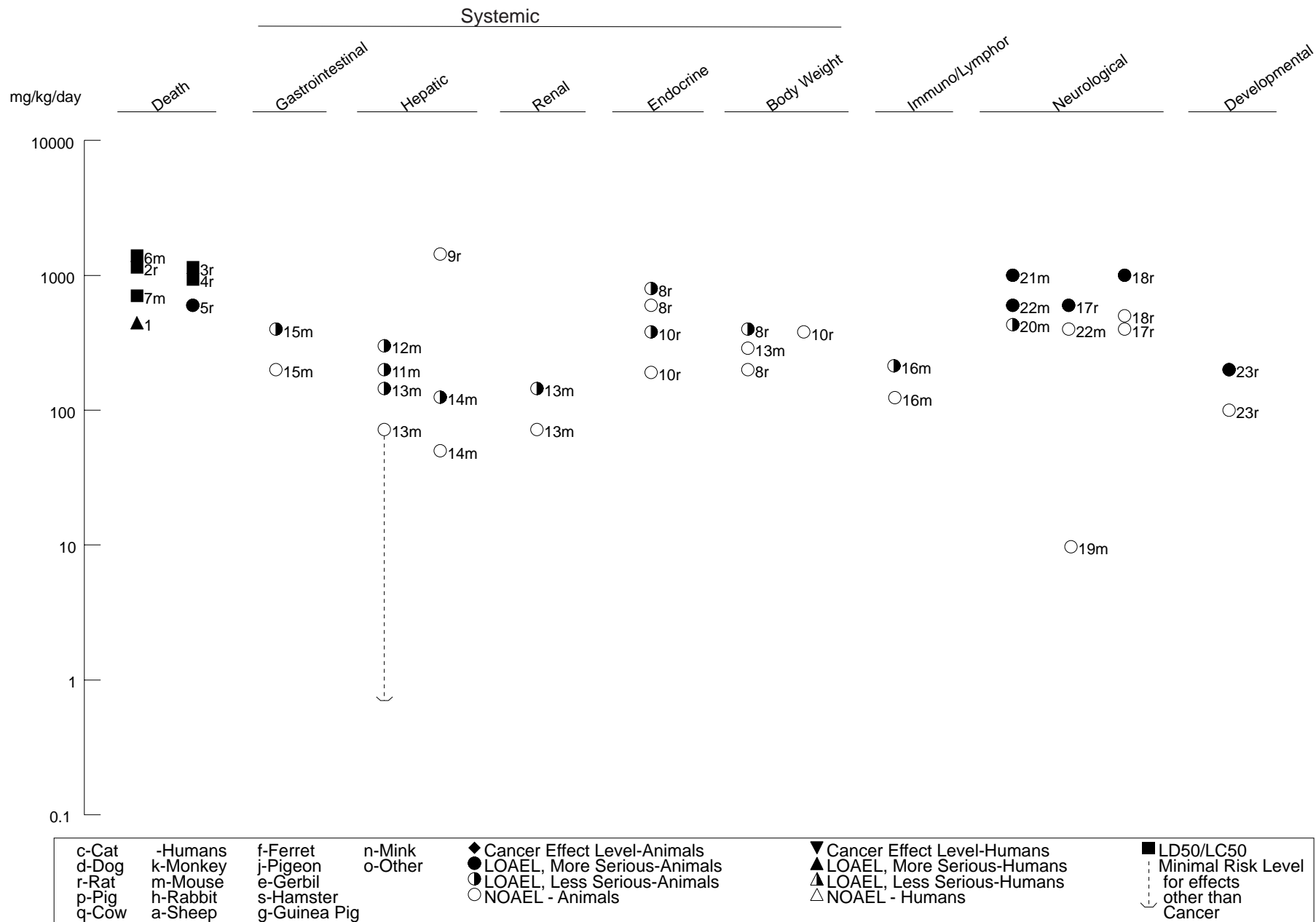

Figure 3-1. Levels of Significant Exposure to Bromoform - Oral (*Continued*)

Intermediate (15-364 days)

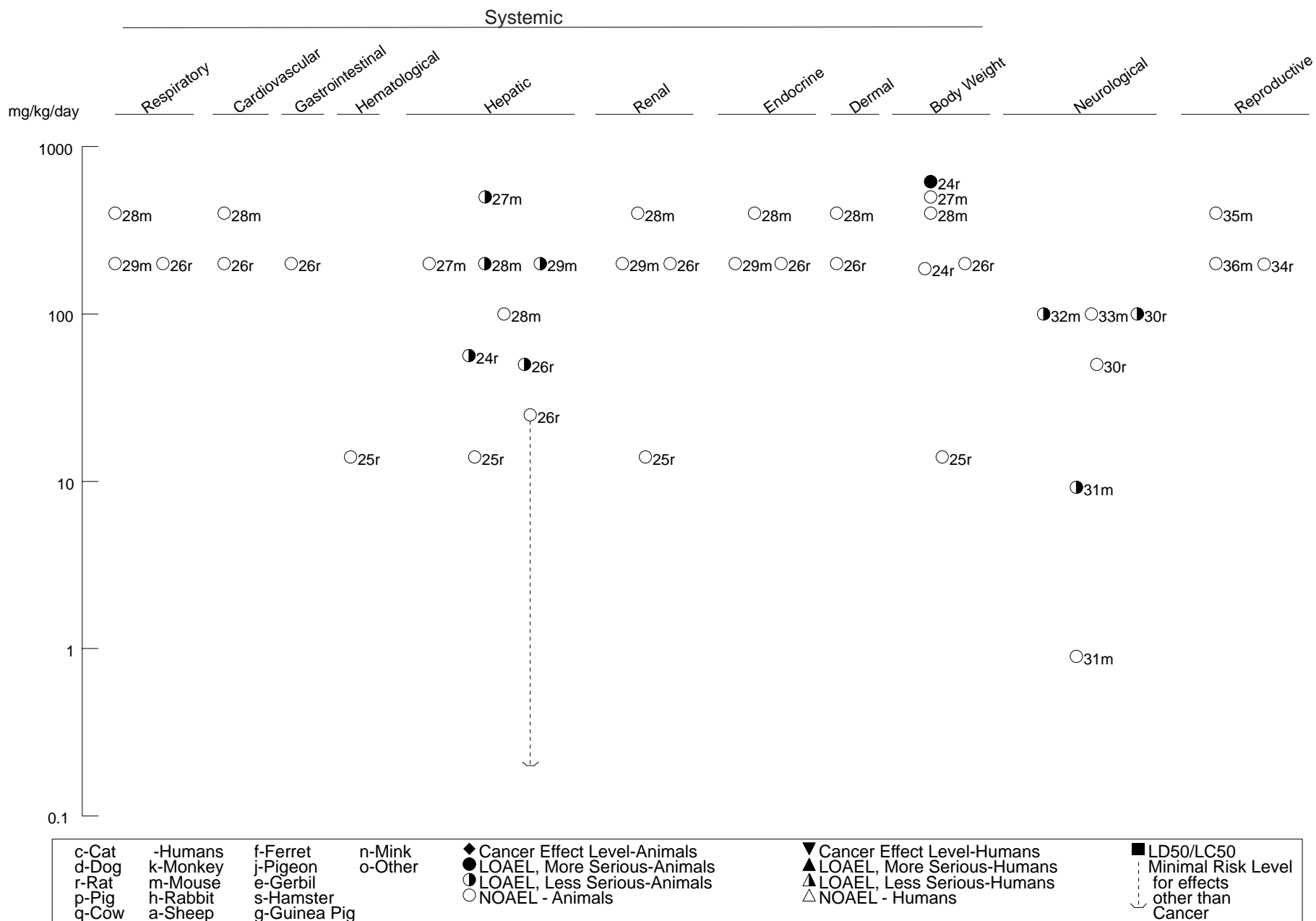
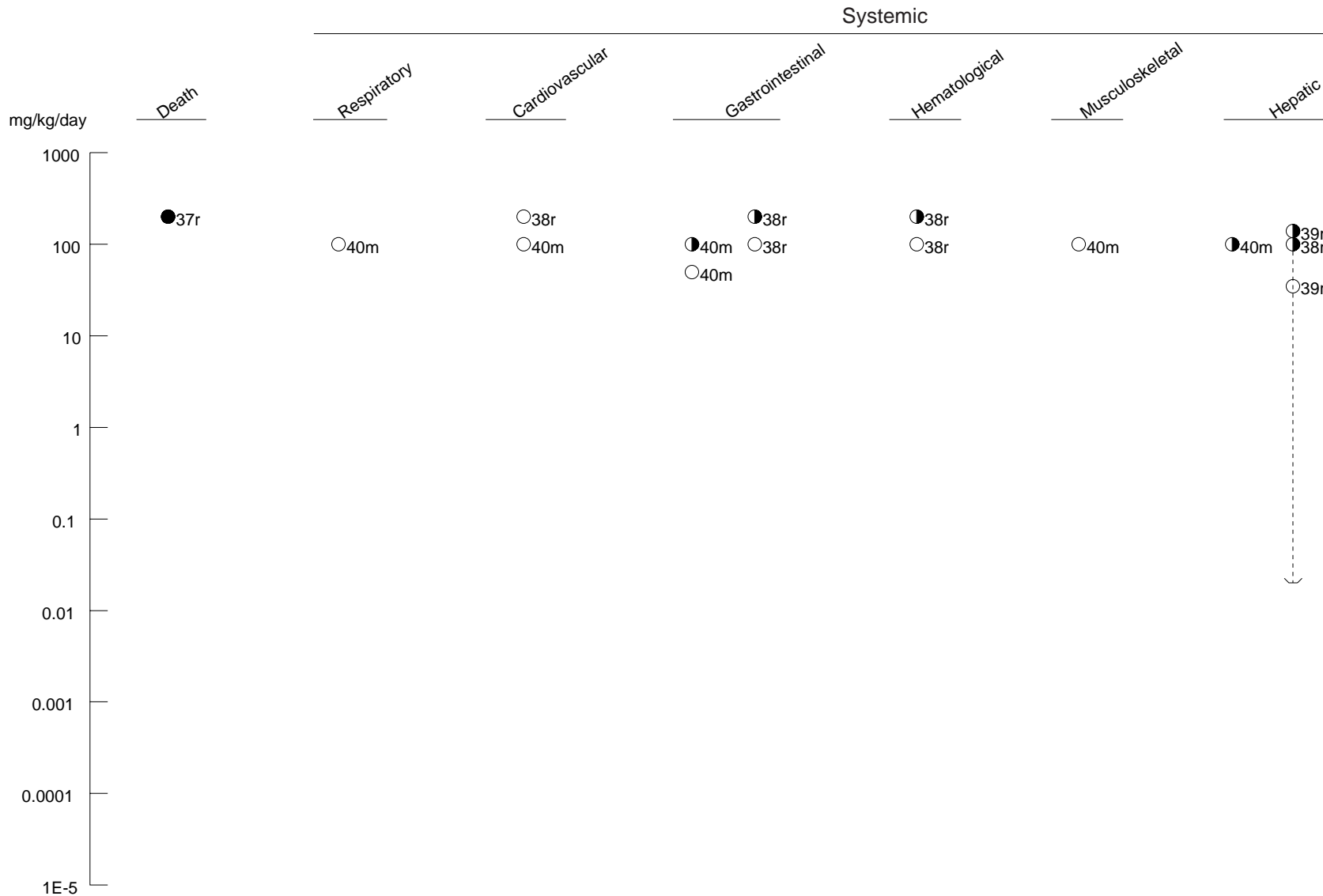

Figure 3-1 Levels of Significant Exposure to Bromoform - Oral
Chronic (≥365 days)



c-Cat	-Humans	f-Ferret	n-Mink	◆ Cancer Effect Level-Animals	▼ Cancer Effect Level-Humans	■ LD50/LC50
d-Dog	k-Monkey	j-Pigeon	o-Other	● LOAEL, More Serious-Animals	▲ LOAEL, More Serious-Humans	⋮ Minimal Risk Level
r-Rat	m-Mouse	e-Gerbil		◐ LOAEL, Less Serious-Animals	△ LOAEL, Less Serious-Humans	for effects
p-Pig	h-Rabbit	s-Hamster		○ NOAEL - Animals	△ NOAEL - Humans	other than
q-Cow	a-Sheep	g-Guinea Pig				Cancer

Figure 3-1 Levels of Significant Exposure to Bromoform - Oral
Chronic (≥365 days)

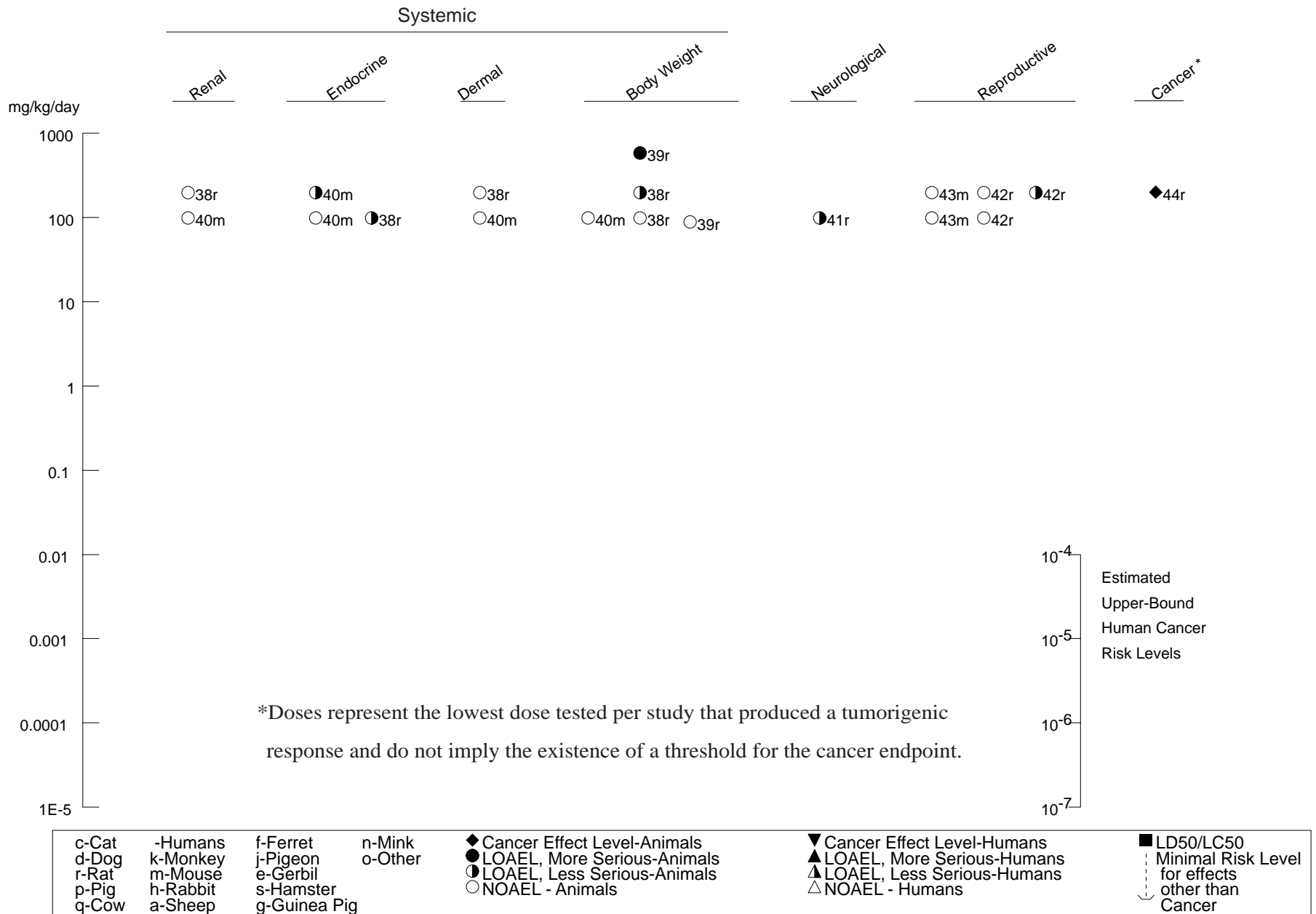

Table 3-2 Levels of Significant Exposure to Dibromochloromethane - Oral

Key to Figure ^a	Species (Strain)	Exposure/Duration/Frequency (Route)	System	NOAEL (mg/kg/day)	LOAEL		Reference Chemical Form
					Less Serious (mg/kg/day)	Serious (mg/kg/day)	
ACUTE EXPOSURE							
Death							
1	Rat (Sprague-Dawley)	1 d (GO)				848 F (LD50)	Chu et al 1982a
2	Rat (Sprague-Dawley)	(G)				1186 M (LD50) 848 F (LD50) ^b	Chu et al. 1980
3	Rat (Sprague-Dawley)	1 d (GO)				3700 M (100% mortality)	Hewitt et al 1983
4	Rat (Fischer- 344)	1 d (GO)				1250 M (4/5 died)	NTP 1985
5	Rat (Fischer- 344)	14 d 1x/d (GO)				500 (8 of 10 died)	NTP 1985
6	Mouse (ICR)	1 d (GW)				800 M (LD50) ^b 1200 F (LD50)	Bowman et al 1978
7	Mouse (B6C3F1)	1 d (GO)				630 M (3/5 died)	NTP 1985
8	Mouse (B6C3F1)	14 d 1x/d (G)				500 (7 of 10 died)	NTP 1985

Table 3-2 Levels of Significant Exposure to Dibromochloromethane - Oral

(continued)

Key to Figure ^a	Species (Strain)	Exposure/ Duration/ Frequency (Route)	System	NOAEL (mg/kg/day)	LOAEL		Reference Chemical Form
					Less Serious (mg/kg/day)	Serious (mg/kg/day)	
9	Hamster (Golden Syrian)	1 d (G)				145 M (LD50)	Korz and Gatterman 1997
Systemic							
10	Rat (Sprague- Dawley)	1 d (GO)	Hepatic		2500 M (increased SGPT and OCT levels)		Hewitt et al 1983
			Renal	2500 M			
11	Rat (Fischer- 344)	14 d 1x/d (GO)	Hepatic	250	500 (mottled liver)		NTP 1985
			Renal	250	500 (darkened renal medullae)		
			Bd Wt	125 M	250 M (45% decrease body weight gain)		
12	Rat	1 d (G)	Hepatic	1220			Plaa and Hewitt 1982a
13	Rat (Fischer- 344)	7 d (GW)	Endocr	160 M	310 M (decreased serum testosterone)		Potter et al 1996
			Bd Wt	160 M	310 M (14% decrease in body weight)		

Table 3-2 Levels of Significant Exposure to Dibromochloromethane - Oral

(continued)

Key to Figure ^a	Species (Strain)	Exposure/Duration/Frequency (Route)	System	NOAEL (mg/kg/day)	LOAEL		Reference Chemical Form
					Less Serious (mg/kg/day)	Serious (mg/kg/day)	
14	Mouse (B6C3F1)	9 doses in 11 day period (GO)	Hepatic		100 F (hepatocellular ballooning and proliferation)		Coffin et al 2000
15	Mouse (B6C3F1)	11 days (W)	Hepatic		170 F (hepatocellular ballooning)		Coffin et al 2000
16	Mouse (CD-1)	14 d 1x/d (GO)	Hepatic		37 ^C M (hepatocellular vacuolization)		Condie et al 1983
			Renal		37 M (mesangial hyperplasia)		
			Bd Wt	147 M			
17	Mouse (CD-1)	14 d 1x/d (GW)	Hepatic	125 F	250 F (increased relative and absolute liver weight, decreased serum glucose, and increased SGPT and SGOT)		Munson et al 1982
18	Mouse (B6C3F1)	14 d 1x/d (GO)	Renal	250	500 (reddened renal medullae)		NTP 1985
Immuno/ Lymphoret							
19	Mouse (CD-1)	14 d 1x/d (GW)		50 F	125 F (impaired humoral immunity)		Munson et al 1982

Table 3-2 Levels of Significant Exposure to Dibromochloromethane - Oral

(continued)

Key to Figure ^a	Species (Strain)	Exposure/Duration/Frequency (Route)	System	NOAEL (mg/kg/day)	LOAEL		Reference Chemical Form
					Less Serious (mg/kg/day)	Serious (mg/kg/day)	
Neurological							
20	Rat (Fischer-344)	14 d 1x/d (GO)		250		500 (lethargy, ataxia)	NTP 1985
21	Rat (Fischer-344)	1 d (GO)		160	310 (lethargy)		NTP 1985
22	Mouse (ICR)	14 days daily (GW)		10 M			Balster and Borzelleca 1982
23	Mouse (ICR)	1 d (GW)			454 M (ED50 for impaired motor performance)		Balster and Borzelleca 1982 Chlorodibromomethane
24	Mouse (ICR)	1 d (GW)				500 (sedation, anesthesia)	Bowman et al 1978
25	Mouse (B6C3F1)	14 d 1x/d (GO)		250		500 (lethargy, ataxia, and labored breathing)	NTP 1985
Developmental							
26	Rat (Sprague-Dawley)	9 d Gd 6-15 (GO)		200			Ruddick et al 1983
INTERMEDIATE EXPOSURE							
Death							
27	Rat (Fischer-344)	13 wk 5d/wk (G)				250 (18/20 died)	NTP 1985

Table 3-2 Levels of Significant Exposure to Dibromochloromethane - Oral

(continued)

Key to Figure ^a	Species (Strain)	Exposure/ Duration/ Frequency (Route)	System	NOAEL (mg/kg/day)	LOAEL		Reference Chemical Form
					Less Serious (mg/kg/day)	Serious (mg/kg/day)	
Systemic							
28	Rat (Wistar)	30 d (F)	Hepatic	18.3 M	56.2 M (heptocellular vacuolation)		Aida et al 1992
			Bd Wt	173.3 M			
29	Rat (Sprague- Dawley)	28 d (W)	Hemato	12 M			Chu et al 1982a
			Hepatic	12 M			
			Renal	12 M			
			Bd Wt	12 M			

Table 3-2 Levels of Significant Exposure to Dibromochloromethane - Oral

(continued)

Key to Figure ^a	Species (Strain)	Exposure/ Duration/ Frequency (Route)	System	NOAEL (mg/kg/day)	LOAEL		Reference Chemical Form
					Less Serious (mg/kg/day)	Serious (mg/kg/day)	
30	Rat (Sprague- Dawley)	90 d (GO)	Resp	200			Daniel et al. 1990
			Cardio	200			
			Gastro	200			
			Hemato	200			
			Hepatic		50 (hepatocellular vacuolization)		
			Renal	50	100 (tubular degeneration)		
			Endocr	200			
			Dermal	200			
			Ocular	200			
Bd Wt	50		200 (55% decrease in body weight gain)				

Table 3-2 Levels of Significant Exposure to Dibromochloromethane - Oral

(continued)

Key to Figure	Species (Strain)	Exposure/ Duration/ Frequency (Route)	System	NOAEL (mg/kg/day)	LOAEL		Reference Chemical Form
					Less Serious (mg/kg/day)	Serious (mg/kg/day)	
31	Rat (Fischer- 344)	13 wk 5d/wk (GO)	Resp	250			NTP 1985
			Cardio	250			
			Gastro	250			
			Musc/skel	250			
			Hepatic	30 M	60 M (hepatocellular vacuolization)		
			Renal	125	250 (toxic nephropathy)		
			Endocr	250			
			Dermal	250			
			Bd Wt	125 M		250 M (47% decreased body weight gain)	
			Other		250 (salivary gland hyperplasia)		
32	Mouse (B6C3F1)	3 wk 5 d/wk (GO)	Hepatic	50 F	192 F (hepatocyte hydropic degeneration)		Melnick et al 1998
					^b 100 F (increased relative liver weight)		
			Bd Wt	417 F			

Table 3-2 Levels of Significant Exposure to Dibromochloromethane - Oral

(continued)

Key to Figure ^a	Species (Strain)	Exposure/ Duration/ Frequency (Route)	System	NOAEL (mg/kg/day)	LOAEL		Reference Chemical Form
					Less Serious (mg/kg/day)	Serious (mg/kg/day)	
33	Mouse (B6C3F1)	13 wk 5d/wk (GO)	Resp	250			NTP 1985
			Gastro	250			
			Hepatic	125 M	250 M (hepatocellular vacuolization)		
			Renal	125 M	250 M (toxic nephropathy)		
			Endocr	250			
			Dermal	250			
			Bd Wt	250			
Immuno/ Lymphoret							
34	Rat (Sprague- Dawley)	90 d (GO)		100	200 (34-40% decr. in thymus wt.)		Daniel et al. 1990
Neurological							
35	Rat (Sprague- Dawley)	90 d (GO)		50 F	100 F (decreased absolute brain weight)		Daniel et al. 1990
36	Mouse (ICR)	60 d 1x/d (GW)		100 M	400 M (decreased response rate in operant behavior test)		Balster and Borzelleca 1982
37	Mouse (ICR)	30d 1x/d (GW)		100 M			Balster and Borzelleca 1982 Chlorodibromomethane

Table 3-2 Levels of Significant Exposure to Dibromochloromethane - Oral

(continued)

Key to Figure ^a	Species (Strain)	Exposure/ Duration/ Frequency (Route)	System	NOAEL (mg/kg/day)	LOAEL		Reference Chemical Form
					Less Serious (mg/kg/day)	Serious (mg/kg/day)	
Reproductive							
38	Rat (Sprague- Dawley)	90 d (GO)		100			Daniel et al. 1990
39	Rat (Fischer- 344)	13 wk 5d/wk (GO)		250			NTP 1985
40	Rat (Sprague- Dawley)	15 d (W)		47.8 F			NTP 1996
41	Rat (Sprague- Dawley)	28-34 d (W)		28.2 M 46 F			NTP 1996
42	Mouse (ICR)	2 generations (continuous) (W)		170 F		685 F (decreased fertility)	Borzelleca and Carchman 1982
43	Mouse (B6C3F1)	13 wk 5d/wk (GO)		250			NTP 1985
Developmental							
44	Mouse (ICR)	2 generations (continuous) (W)		685			Borzelleca and Carchman 1982

Table 3-2 Levels of Significant Exposure to Dibromochloromethane - Oral

(continued)

Key to Figure ^a	Species (Strain)	Exposure/ Duration/ Frequency (Route)	System	NOAEL (mg/kg/day)	LOAEL		Reference Chemical Form
					Less Serious (mg/kg/day)	Serious (mg/kg/day)	
CHRONIC EXPOSURE							
Death							
45	Mouse (B6C3F1)	105 wk 5d/wk (GO)				100 M (decreased survival)	NTP 1985
Systemic							
46	Rat (Fischer- 344)	2 yr 5d/wk (GO)	Resp	80			NTP 1985
			Cardio	80			
			Gastro	80			
			Musc/skel	80			
			Hepatic		40 ^d (fatty change)		
			Endocr	80			
			Dermal	80			
			Bd Wt	80			
47	Rat (Wistar)	2 year (F)	Hepatic	20 M	85 M (yellowing of liver; hypertrophy)		Tobe et al 1982
			Bd Wt	20 M	85 M (10% decrease in body weight gain)	540 M (marked decrease in body weight gain)	

Table 3-2 Levels of Significant Exposure to Dibromochloromethane - Oral

(continued)

Key to Figure ^a	Species (Strain)	Exposure/ Duration/ Frequency (Route)	System	NOAEL (mg/kg/day)	LOAEL		Reference Chemical Form
					Less Serious (mg/kg/day)	Serious (mg/kg/day)	
48	Mouse (B6C3F1)	105 wk 5d/wk (GO)	Resp	100			NTP 1985
			Cardio	100			
			Gastro	100			
			Musc/skel	100			
			Hepatic		50 F (fatty metamorphosis)		
			Renal		100 M (nephrosis)		
			Endocr		50 F (thyroid follicular cell hyperplasia)		
			Dermal	100			
			Bd Wt	50	100 (14-17% decreased terminal body weight)		
Reproductive							
49	Rat (Fischer- 344)	2 yr 5d/wk (GO)		80			NTP 1985
50	Mouse (B6C3F1)	105 wk 5d/wk (GO)		100			NTP 1985

Table 3-2 Levels of Significant Exposure to Dibromochloromethane - Oral

(continued)

Key to Figure	Species (Strain)	Exposure/Duration/Frequency (Route)	System	NOAEL (mg/kg/day)	LOAEL		Reference Chemical Form
					Less Serious (mg/kg/day)	Serious (mg/kg/day)	
Cancer							
51	Mouse (B6C3F1)	105 wk 5d/wk (GO)				100	(CEL: hepatocellular adenoma or carcinoma) NTP 1985

a The number corresponds to entries in Figure 3-2.

b Differences in levels of health effects and cancer effects between male and females are not indicated in Figure 3-2. Where such differences exist, only the levels of effect for the most sensitive gender are presented.

c Used to derive an acute-duration oral MRL of 0.1 mg/kg/day; dose divided by an uncertainty factory of 300 (3 for use of a minimal LOAEL, 10 for extrapolation from animals to humans, and 10 for human variability).

d Used to derive a chronic-duration oral MRL of 0.09 mg/kg/day; dose adjusted for intermittent exposure and divided by an uncertainty factory of 300 (3 for use of a minimal LOAEL, 10 for extrapolation from animals to humans, and 10 for human variability).

Bd Wt = body weight; CNS = central nervous system; d = day(s); F = female; (F) = food; (G) = gavage; Gd = gestation day; Gastro = gastrointestinal; LD50 = lethal dose, 50% kill; LOAEL = lowest-observed-adverse-effect level; M = male; NOAEL = no-observed-adverse-effect level; (W) = water; wk = week(s); x = time(s)

Figure 3-2. Levels of Significant Exposure to Dibromochloromethane - Oral
Acute (≤ 14 days)

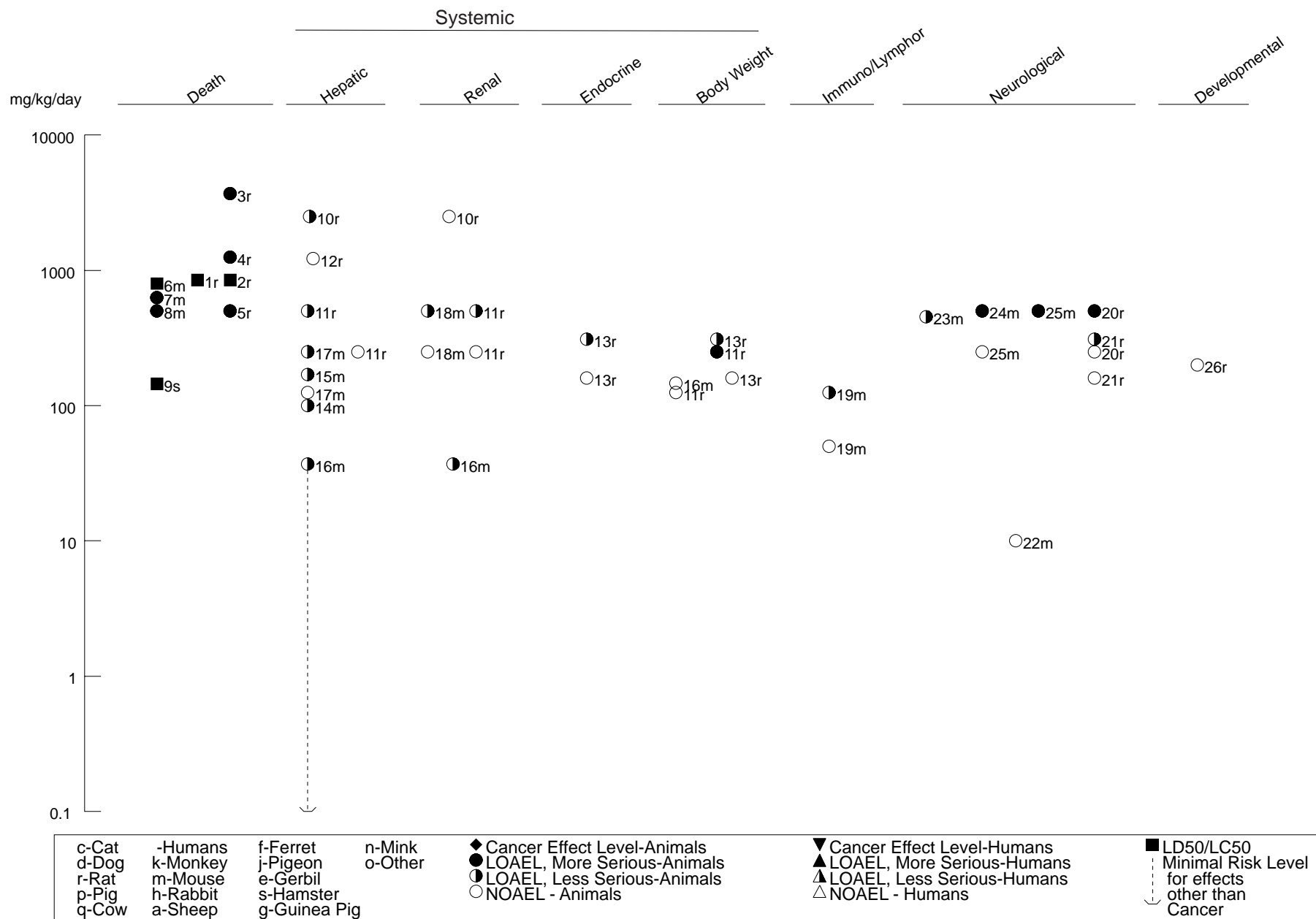

Figure 3-2. Levels of Significant Exposure to Dibromochloromethane - Oral (*Continued*)

Intermediate (15-364 days)

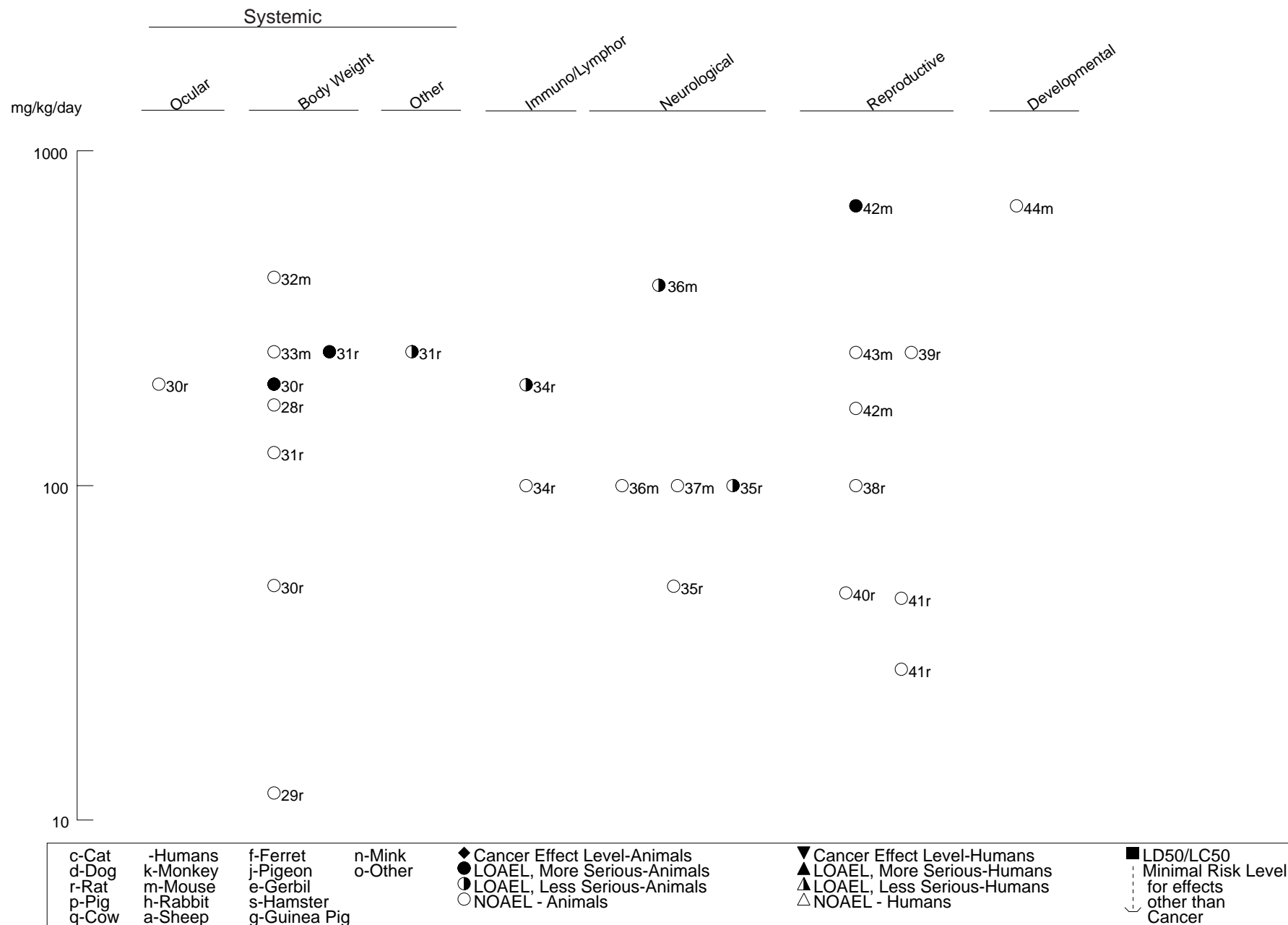
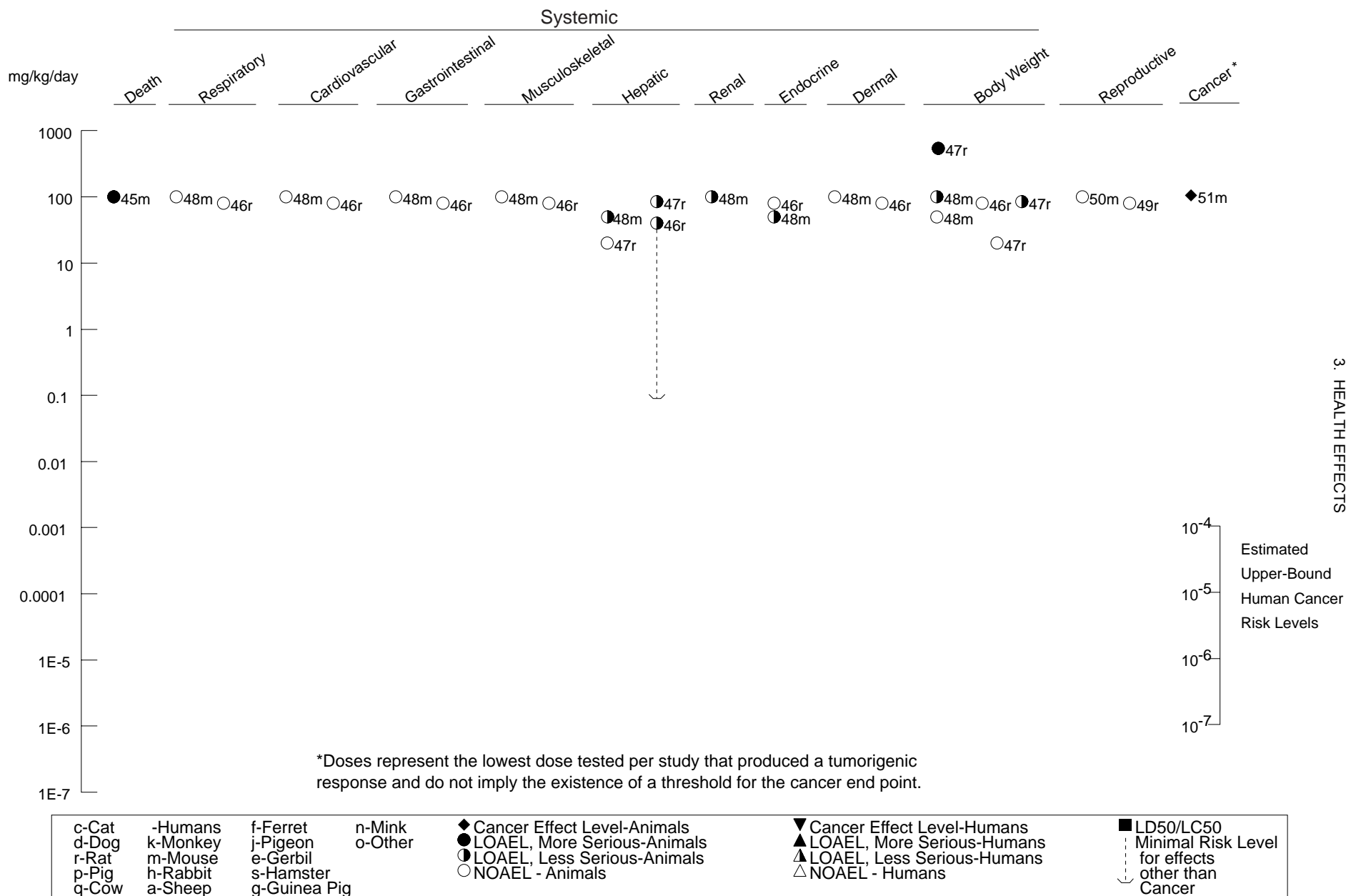

Figure 3-2. Levels of Significant Exposure to Dibromochloromethane - Oral (Continued)

Chronic (≥365 days)



3. HEALTH EFFECTS

Kobert 1906). The dose needed to cause death in children is not known with certainty, but both Dwelle (1903) and Roth (1904) estimated that a dose of about 5 g had been fatal. For a 10–20-kg child, this corresponds to an approximate dose of 250–300 mg/kg.

In animal studies, estimates of the acute oral LD₅₀ for bromoform typically range between 707 and 1,550 mg/kg (Bowman et al. 1978; Chu et al. 1982a; NTP 1989a). There does not appear to be much difference in the doses that cause death across species or between sexes. The LD₅₀ values for a 1-day exposure to bromoform ranged from 933 to 1,388 mg/kg in rats (Chu et al. 1980; NTP 1989a) and from 707 to 1,550 mg/kg in mice (Bowman et al. 1978; NTP 1989a). LD₅₀ values ranged from 1,072 to 1,550 for females and from 707 to 1,388 for males exposed to bromoform for 1 day (Bowman et al. 1978; Chu et al. 1980, 1982a; NTP 1989a). Acute, repeated oral exposure to 600 mg/kg/day resulted in 100% mortality in rats (NTP 1989a). However, only 2/10 mice died from exposure to 800 mg/kg/day (NTP 1989a). No deaths were observed in rats and mice administered 200 or 400 mg/kg (5 days/week) via gavage for 90 days (NTP 1989a). However, significant reductions in survival were observed in rats administered 200 mg/kg via gavage (5 days/week) for 2 years (NTP 1989a).

In animals, the cause of death following acute oral exposure to bromoform has not been thoroughly investigated. Prominent clinical signs include central nervous system depression (Bowman et al. 1978). While central nervous system depression is probably an important factor in rapid lethality, some studies report death occurring several days after an acute exposure (Bowman et al. 1978; NTP 1989a). This suggests that other effects (e.g., hepatic and/or renal injury) may also be important.

Dibromochloromethane. No studies were located regarding death in humans after oral exposure to dibromochloromethane. The acute lethality of dibromochloromethane has been evaluated by several animal studies in rats and mice, with LD₅₀ estimates ranging between 800 and 2,650 mg/kg (Bowman et al. 1978; Chu et al. 1980, 1982a; Hewitt et al. 1983; NTP 1985). Korz and Gatterman (1997) reported an LD₅₀ of 145 mg/kg for a Golden Syrian hamster; however, the experimental details were not reported to validate the data. Deaths in animals have been reported from single oral doses as low 300–600 mg/kg (NTP 1985).

In intermediate and chronic oral exposure studies, significant increases in mortality have been observed in mice and rats at 250 mg/kg (5 days/week) for exposures of 14–90 days (Chu et al. 1982a; Condie et al. 1983; Daniel et al. 1990; NTP 1985) and in rats at 100 mg/kg (5 days/week) for exposures up to 2 years (NTP 1985).

3. HEALTH EFFECTS

Gender-related differences in mortality have been observed in rats and mice acutely exposed to dibromochloromethane. In rats, females appear to be more sensitive than males; increases in mortality were observed at 848 mg/kg in females compared to 1,186 mg/kg in males (Chu et al. 1982a). In contrast, increases in mortality were observed at lower doses in males (800 mg/kg) than females (1,200 mg/kg) (Bowman et al. 1978).

The cause of death following oral exposure of animals to dibromochloromethane has not been thoroughly investigated. Some of the chief clinical signs observed are those of central nervous system depression and other effects, such as hepatic and/or renal injury (Bowman et al. 1978; NTP 1985).

3.2.2.2 Systemic Effects

Respiratory Effects. Labored breathing has been observed in animals exposed to lethal doses of bromoform and dibromochloromethane (NTP 1985, 1989a); this is likely due to central nervous system depression rather than impaired lung function.

Bromoform. No studies were located regarding respiratory effects in humans after oral exposure to bromoform. NTP (1989a) examined the respiratory tract of rats and mice receiving gavage doses of bromoform for 90 days or 2 years. No histological alterations were observed in the intermediate-duration studies or in female rats and male and female mice in the chronic-duration study. An increased incidence of chronic inflammation of the lungs was observed in male rats exposed to 100 or 200 mg/kg (5 days/week). This inflammation was similar in appearance to that caused by a sialodacryoadenitis (SDA) virus infection, and antibodies to rat SDA virus were detected in study animals. Thus, the inflammation observed was probably secondary to the infection and was not a direct result of bromoform. However, the absence of symptoms in control animals suggested that bromoform-treated rats may have been more susceptible to infection by the virus or slower to recover (NTP 1989a).

Dibromochloromethane. No studies were located regarding respiratory effects in humans after oral exposure to dibromochloromethane. No histological alterations in the respiratory tract were observed in rats and mice administered gavage doses of up to 250 mg/kg (days/week) for 90 days or 80–100 mg/kg (5 days/week) (NTP 1985).

3. HEALTH EFFECTS

Cardiovascular Effects.

Bromoform. No studies were located regarding cardiovascular effects in humans after oral exposure to bromoform. Histological examination of rats and mice exposed to up to 100–200 mg/kg (5 days/week) bromoform by gavage for up to 2 years revealed no evidence of adverse effects upon the heart (NTP 1989a). While this indicates that cardiac tissue is not directly injured by bromoform, indirect effects on cardiovascular functions might occur as a consequence of the central nervous system depressant activity of these compounds.

Dibromochloromethane. No studies were located regarding cardiovascular effects in humans after oral exposure to dibromochloromethane. Decreased heart rates and increased blood pressure were observed in male rats following the administration of a single gavage dose (83–667 mg/kg) of dibromochloromethane (Müller et al. 1997). However, a dose-related trend was not exhibited for these. While this suggests that cardiac function may be impaired by dibromochloromethane exposure, it is unclear if effects are caused by the direct action on cardiac function or if they are indirectly caused as a result of central nervous system depression. No histological alterations to cardiac tissue were observed in intermediate- and chronic-duration studies of dibromochloromethane administered to rats and mice via gavage (NTP 1985).

Gastrointestinal Effects.

Bromoform. No studies were located regarding gastrointestinal effects in humans after oral exposure to bromoform. NTP (1989a) examined the esophagus, stomach, and intestines of rats and mice orally exposed to bromoform. Stomach nodules were observed in male and female mice following 14 days of exposure to 400 and 600 mg/kg/day, respectively (NTP 1989a). The biological significance of these nodules is not certain, but it is likely that they are a response to a direct irritant effect of bromoform on the gastric mucosa. In chronic-duration studies, histological alterations were observed in male rats and male mice. Forestomach ulcers were observed in male rats at 200 mg/kg (5 days/week) (NTP 1989a) and hyperplasia of the glandular stomach was observed in male mice at 100 mg/kg (5 days/week) (NTP 1989a). No stomach lesions were observed in female rats or mice exposed to bromoform at doses up to 200 mg/kg. The histological observations in NTP (1989a) suggest that males may be more sensitive to gastrointestinal effects from acute and chronic bromoform exposures than females. In acute studies, the onset of stomach nodules occurred at a lower dose level in males (400 mg/kg) than in females (600 mg/kg). In chronic studies, gastrointestinal effects were only observed in males. While these

3. HEALTH EFFECTS

observations clearly indicate that the stomach may be affected by bromoform, it is possible that the exposure regimen (bolus administration) leads to irritant effects in the stomach that might not occur if exposure were continuous at lower concentrations in food or drinking water.

Dibromochloromethane. No studies were located regarding gastrointestinal effects in humans after oral exposure to dibromochloromethane. No histological changes of the esophagus, stomach, or intestines were observed in mice or rats administered dibromochloromethane via gavage at doses up to 100 mg/kg (5 days/week) for up to 2 years (NTP 1985).

Hematological Effects. Several studies (Chu et al. 1982a, 1982b; Munson et al. 1982; Tobe et al. 1982) have investigated the hematological effects of oral exposure of rats and mice to bromoform and dibromochloromethane. With the exceptions of some minor fluctuations in lymphocyte count following exposure to bromoform (Chu et al. 1982a, 1982b), none of these studies detected any significant effects of bromoform or dibromochloromethane on hemoglobin, hematocrit, red blood cells, or white blood cells.

Musculoskeletal Effects. No studies regarding musculoskeletal effects in humans or animals after oral exposure to bromoform or dibromochloromethane.

Hepatic Effects. The liver is the primary target organ for bromoform and dibromochloromethane-induced toxicity. Oral exposure to these compounds results in an accumulation of fat in the liver, manifested as increased liver weight, appearance of hepatocyte vacuoles, alterations in serum cholesterol levels, and decreases in serum triglyceride levels. In addition to fatty liver changes, exposure to bromoform and dibromochloromethane results in focal hepatocellular necrosis. The necrosis is typically observed at higher doses than the fatty liver. The toxicity of both compounds is greater following gavage administration compared to exposure via the diet or drinking water. This is probably due to the large bolus dose overwhelming the liver's ability to detoxify reactive metabolites and the oil vehicle, which likely increases absorption.

Bromoform. Several animal studies have examined the hepatotoxicity of bromoform in rats and mice following gavage, drinking water, or dietary exposure. The most sensitive hepatic end point appears to be fatty degeneration as indicated by centrilobular pallor observed in mice at 145 mg/kg/day for 14 days (Condie et al. 1983) and hepatocellular vacuolization and/or swelling, which has been observed following acute gavage exposure to 200 mg/kg (9 days in an 11-day period) (Coffin et al. 2000), acute drinking water exposure to 300 mg/kg/day (Coffin et al. 2000), intermediate-duration gavage exposure to 50 mg/kg

3. HEALTH EFFECTS

(5 days/week) (NTP 1989a), dietary exposure to 56.4 mg/kg/day (Aida et al. 1992), and chronic gavage exposure to 100 mg/kg (5 days/week) (NTP 1989a). Increases in relative and/or absolute liver weights, although not always consistently found, occur at similar doses (Munson et al. 1982; Tobe et al. 1982). Alterations in clinical chemistry parameters associated with the fatty changes (alterations in serum triglyceride and cholesterol levels) are typically observed at higher doses. Decreases in serum triglyceride levels were observed at 207.5 and 590 mg/kg/day in rats exposed via the diet for 1 or 24 months, respectively (Aida et al. 1992; Tobe et al. 1982); the no effect levels for this end point are 56.4 and 90 mg/kg/day, respectively. An increase in serum total cholesterol was observed in rats exposed to ≥ 187.2 mg/kg/day in the diet for 1 month (Aida et al. 1992) and a decrease was found in rats exposed to 590 mg/kg/day in the diet for 24 months (Tobe et al. 1982). The data are inadequate to assess whether the difference in the direction of change was related to exposure duration or was an inconsistent finding.

Higher doses of bromoform result in hepatocellular necrosis. Necrosis was observed in rats exposed to 200 mg/kg (5 days/week) for 2 years (NTP 1989a); focal inflammation has also been observed in mice receiving gavage doses of 280 mg/kg for 14 days (Condie et al. 1983). Significant increases in SGPT and/or SGOT, which is indicative of hepatocellular damage, were observed in mice at 250–289 mg/kg/day for 14 days (Condie et al. 1983; Munson et al. 1982), mice at 500 mg/kg (5 days/week) for 3 weeks (Melnick et al. 1998), and rats at 720 mg/kg/day for 24 months (Tobe et al. 1982). A decrease in serum glucose levels observed in rats exposed to ≥ 61.9 mg/kg/day for 1 month (Aida et al. 1992) or ≥ 40 mg/kg/day for 24 months (Tobe et al. 1982) and an increase in hexobarbital sleep time observed in mice at 125 mg/kg/day for 14 days (Munson et al. 1982) are also indicative of liver damage.

There are limited data to assess species differences. The results of the NTP intermediate-duration study (NTP 1989a) suggest that rats may be more sensitive to the hepatotoxicity of bromoform than mice. The NOAEL and LOAEL values for hepatocellular vacuolization were 25 and 50 mg/kg (5 days/week) in rats and 100 and 200 mg/kg in mice. Liver damage was the critical end point used for the derivation of acute-, intermediate-, and chronic-duration oral MRLs for bromoform, as described in the footnotes for Table 3-1 and in Appendix A.

Dibromochloromethane. A variety of hepatic effects have been observed in rats and mice orally exposed to dibromochloromethane. Hepatocellular vacuolization and/or swelling were observed at the lowest adverse effect levels. The LOAEL values for this end point are ≥ 37 mg/kg in acutely exposed mice (Coffin et al. 2000; Condie et al. 1983), ≥ 50 mg/kg in rats and mice exposed for an intermediate duration (Aida et al. 1992; Daniel et al. 1990; NTP 1985), and ≥ 40 mg/kg in rats and mice following

3. HEALTH EFFECTS

chronic exposure (NTP 1985). Clinical chemistry alterations, which are associated with the fatty changes in the liver, include increases in serum cholesterol after a single gavage dose of 1,500 mg/kg (Chu et al. 1982a) or after a 1-month dietary exposure to 56.2 mg/kg/day (Aida et al. 1992), decreases in serum cholesterol at 540 mg/kg/day after a 24-month dietary exposure (Tobe et al. 1982), and decreases in serum triglycerides at 173.3 and 20 mg/kg/day following 1- or 24-month dietary exposures, respectively (Aida et al. 1992; Tobe et al. 1982). Additionally, increases in liver weight were observed in mice administered gavage doses of 250 mg/kg/day for 14 days (Munson et al. 1982) or 100 mg/kg (5 days/week) for 3 weeks (Melnick et al. 1998). The increased incidences of hepatocellular vacuoles observed at 37 mg/kg/day following acute exposure and 40 mg/kg following chronic exposure (NTP 1985) were used to derive acute- and chronic-duration oral MRLs for dibromochloromethane, as described in the footnotes to Table 3-2 and in Appendix A.

At higher doses, oral exposure to dibromochloromethane resulted in hepatocellular necrosis. Necrosis was found in rats and mice exposed to ≥ 100 mg/kg (Aida et al. 1992; Daniel et al. 1990; NTP 1985) for intermediate durations. Necrosis was not reported following acute-duration exposure; however, increases in SGOT and/or SGPT (indicative of hepatocellular damage) were found in rats and mice exposed to ≥ 145 mg/kg (Condie et al. 2000; Hewitt et al. 1983; Munson et al. 1982). Necrosis was not found following chronic exposure in rats and mice exposed to 80 or 100 mg/kg (5 days/week), respectively (NTP 1985). Other liver effects include bile duct hyperplasia in rats exposed to 250 mg/kg (5 days/week) for 13 weeks (NTP 1985), hepatocyte hydropic degeneration in mice exposed to 192 mg/kg (5 days/week) for 3 weeks (Melnick et al. 1998), and decreased serum glucose levels in rats exposed to 540 mg/kg/day for 24 months (Tobe et al. 1982).

Renal Effects.

Bromoform. There is some evidence that oral exposure to bromoform can induce kidney damage. Condie et al. (1983) noted minimal to slight nephrosis and mesangial hypertrophy in male mice exposed to repeated oral doses of 145–289 mg/kg/day of bromoform. In contrast, no significant histopathological alterations were detected by NTP (1989a) in rats or mice receiving gavage of 200 mg/kg (5 days/week) of bromoform for 2 years.

Dibromochloromethane. Histological studies performed by NTP (1985) indicate that oral exposure to dibromochloromethane can cause kidney injury in both rats and mice. The medullae appear to be reddened in both males and females after a single oral dose of 500 mg/kg, but this dose was so high that

3. HEALTH EFFECTS

7 of 10 animals died. Of greater toxicological concern were effects on the nephron that develop after intermediate or chronic exposure to doses of 50–250 mg/kg/day (NTP 1985). These effects were usually much more apparent in males than females, and were characterized by tubular degeneration and mineralization leading to nephrosis (NTP 1985). These histological findings of nephrotoxicity are supported by the kidney function studies of Condie et al. (1983), which found that ingestion of dibromochloromethane tended to impair uptake of para-amino hippuric acid in renal slices prepared from male mice exposed to 37–147 mg/kg/day for 2 weeks.

Endocrine Effects.

Bromoform. Several endocrine effects have been observed in animals exposed to bromoform; however, none of the effects were consistently found. The observed endocrine effects included enlarged thyroid gland in rats administered a lethal dose of 800 mg/kg/day for 14 days (NTP 1989a), decreased thyroid follicular size and colloid density 90 days after termination of exposure to 360 mg/kg/day (Chu et al. 1982b), thyroid follicular cell hyperplasia in mice administered 200 mg/kg (5 days/week) for 2 years (NTP 1989a), pituitary gland hyperplasia in rats administered 100 mg/kg (5 days/week), but not 200 mg/kg (NTP 1989a), and decreased serum testosterone levels in rats exposed to 380 mg/kg/day for 7 days (Potter et al. 1996).

Dibromochloromethane. Several studies have examined the potential of dibromochloromethane to induce histological alterations in endocrine glands following longer-term exposure. No alterations in endocrine glands were observed following intermediate-duration exposure of rats to 200 or 256 mg/kg/day (Chu et al. 1982b; Daniel et al. 1990) or rats or mice to 250 mg/kg for 5 days/week (NTP 1985). Administration of dibromochloromethane via gavage for 2 years resulted in thyroid follicular cell hyperplasia in mice exposed to 50 or 100 mg/kg (5 days/week). No effects were observed in rats administered 40 or 80 mg/kg (5 days/week) (NTP 1985). No effects on serum testosterone levels were observed in rats given gavage doses of 160 mg/kg/day for 7 days. However, a decrease in levels resulted from doses of 310 mg/kg/day (Potter et al. 1996).

Dermal Effects. No histological alterations were found in the skin of rats and mice exposed to bromoform or dibromochloromethane by gavage for up to 2 years (NTP 1985, 1989a).

Ocular Effects. No histological alterations were found in the eyes of rats and mice exposed to bromoform or dibromochloromethane by gavage for up to 2 years (NTP 1985, 1989a).

3. HEALTH EFFECTS

Body Weight Effects.

Bromoform. In animals, treatment with bromoform is associated with significant decrements in body weight, without concurrent reductions in food intake. The threshold for body weight effects appears to be duration-related, as generally observed in the oral exposure studies. In acute repeated-dose oral gavage studies (Condie et al. 1983; Munson et al. 1982, NTP 1989a), 4 and 14% decreases in body weight were observed in female and male rats, respectively, given 400 mg/kg. No significant, consistently-observed effects on body weight were seen in mice administered up to 800 mg/kg. Intermediate-duration studies of bromoform appear to present a similar dose-response relationship for body weight effects as the acute studies. Body weights of rats were unaffected by bromoform doses of ≤ 200 mg/kg administered by gavage, in feed, or in drinking water (Aida et al. 1992; Chu et al. 1982a; NTP 1989a). Body weights of mice treated with 400 mg/kg of bromoform by gavage were slightly (8%) reduced (NTP 1989a). Lower adverse effect levels were observed in chronic studies. Body weights were decreased by 4–10% in rats and female mice treated with 100 mg/kg of bromoform by gavage, whereas 16–25% decreases in body weight gain were noted at 200 mg/kg (NTP 1989a). A chronic feeding study in rats (Tobe et al. 1982) showed a dose-response similar to the gavage studies. Body weight reductions of 15% were observed at 90–150 mg/kg, while reductions of 30–40% were observed at doses above 365 mg/kg.

Dibromochloromethane. Treatment with dibromochloromethane is also associated with decreased body weight gain in animals. Rats appear to be more sensitive than mice to body weight effects. The dose-response relationship seemed to be sensitive to exposure duration, but was similar for various administration routes (gavage, feed, drinking water). The greater sensitivity of rats to dibromochloromethane compared with mice was apparent in both acute and intermediate duration exposures (Chu et al. 1980; Condie et al. 1983; Daniel et al. 1990; Munson et al. 1982; NTP 1985). Rats experienced 20% (400 mg/kg/day) and 47% (250 mg/kg/day) decreases in body weight gain from acute and intermediate gavage exposures, respectively. In contrast, no effect was seen in mice for these dose levels and durations. Duration-related changes to the dose-response were indicated in both species for body weight gain decreases of 10% or more. These effects on body weight gain occurred in the range of 250–500 mg/kg (acute), 200–250 mg/kg (intermediate), and 70–200 mg/kg (chronic) (Aida et al. 1992; Daniel et al. 1990; NTP 1985; Tobe et al. 1982). In chronic exposure studies (NTP 1985; Tobe et al. 1982), neither species nor administration route seemed to affect the dose response.

3. HEALTH EFFECTS

3.2.2.3 Immunological and Lymphoreticular Effects

There are limited data on the immune and lymphoreticular system toxicity of bromoform and dibromochloromethane. Munson et al. (1982) examined immune function following exposure to both compounds. Other studies (Daniel et al. 1990; NTP 1985, 1989a) monitored organ weights or examined tissues for histological damage.

Bromoform. Impaired humoral immune function, as indicated by the response to sheep red blood cells, was observed in rats and mice exposed to 125 or 250 mg/kg/day bromoform for 14 days (Munson et al. 1982), though no adverse effect on cell-mediated immunity was noted. Additionally, male rats exposed to bromoform for 2 years appeared to have decreased resistance to a common viral infection (NTP 1989a), suggesting functional impairment of the immune system. No histological alterations were observed in tissues of the immune or lymphoreticular systems in rats and mice exposed to 200 and 400 mg/kg (5 days/week), respectively, for 90 days (NTP 1985) or 100–200 or 200 mg/kg (5 days/week), respectively, for 2 years (NTP 1985).

Dibromochloromethane. Exposure of mice to doses of 125 or 250 mg/kg/day of dibromochloromethane for 14 days resulted in impaired humoral immunity (splenic IgM response to sheep red blood cells) (Munson et al. 1982). Impaired cellular immunity (popliteal lymph node response to sheep red blood cells) was also observed at 250 mg/kg/day. A significant decrease in thymus weight was observed in rats exposed to 300 mg/kg/day for 90 days (Daniel et al. 1990). No histological alterations were observed in immune or lymphoreticular tissues of rats and mice following intermediate or chronic duration to 250 or 80–100 mg/kg (days/week), respectively (NTP 1985).

3.2.2.4 Neurological Effects

Bromoform. Bromoform, like other volatile halogenated hydrocarbons, can lead to marked central nervous system depression. Because of this property, bromoform was used as a sedative in the early 1900s and was commonly administered to children for relief from whooping cough. Several poisonings and a few deaths resulted from accidental overdoses or separation of the emulsion (Benson 1907; Burton-Fanning 1901; Dwelle 1903; Stokes 1900; von Oettingen 1955). In mild cases of accidental overdose, clinical signs included rapid breathing, constricted pupils, and tremors; more severe cases were accompanied by a drunken-like stupor, cyanosis, shallow breathing, and erratic heart rate (Benson 1907; Kobert 1906). Actual doses associated with these neurological symptoms are not known with certainty.

3. HEALTH EFFECTS

Based on experiences with seven cases of accidental bromoform poisonings in children with whooping cough, Burton-Fanning (1901) advised initial treatment volumes of 0.03 mL for children under 1 year, 0.06 mL for those 1–4 years old, and 0.13 mL for children 4–8 years of age, or approximately 25–60 mg/kg. Dwelle (1903) reported the case of a 33-month-old girl who was prescribed bromoform for relief of whooping cough-induced coughing and vomiting. It is estimated that the girl ingested approximately 700 mg bromoform (60 mg/kg/day) and slept undisturbed that night, suggesting the occurrence of sedative effects.

As with humans, high doses of bromoform result in central nervous system depression in animals. Impaired performance on neurobehavioral tests is observed at lower doses,. The severity of the central nervous system depression is dose-related, with anesthesia and shallow breathing occurring at very high, often lethal, doses and ataxia, lethargy, and sedation at lower doses. In rats, lethargy, shallow breathing, and ataxia were observed at 600 and 1,000 mg/kg/day (NTP 1989a) following acute exposure. Lethargy was also observed at 100 mg/kg (5 days/week) during a 13-week or 2-year exposure (NTP 1989a). In mice, anesthesia, ataxia, and sedation were observed following a single dose of 1,000 mg/kg (Bowman et al. 1978) and lethargy and ataxia were observed following doses of 600 mg/kg/day for 14 days (NTP 1989a). No overt signs of neurotoxicity were observed at 100 or 400 mg/kg following gavage administration, 5 days/week, for 13 weeks or 2 years (NTP 1989a).

A series of experiments conducted by Balster and Borzelleca (1982) assessed neurobehavioral performance in mice following acute- or intermediate-duration exposures. The ED₅₀ for impaired motor performance was 431 mg/kg following a single dose. A decrease in exploratory behavior was observed following 9.2 mg/kg/day for 90 days and a decrease in response rate in an operant behavior test following doses of 100 mg/kg/day for 60 days. No effect on swimming endurance was observed (9.7 mg/kg/day for 14 days) or on passive-avoidance learning (100 mg/kg/day for 30 days).

Dibromochloromethane. No human data on the neurotoxicity of dibromochloromethane were located. In animals, central nervous system depression occurs at relatively high doses, as evidenced by lethargy, ataxia, and sedation. An acute exposure to 500 mg/kg/day resulted in lethargy, ataxia, sedation, and shallow breathing in rats and mice (Bowman et al. 1978; NTP 1985). Lethargy was also observed in rats receiving a single gavage dose of 310 mg/kg (NTP 1985). No overt signs of neurotoxicity were observed following intermediate-duration exposure to 250 mg/kg (5 days/week) or chronic exposure to 80–100 mg/kg (5 days/week) (NTP 1985). Daniel et al. (1990) found a significant decrease in brain weights in rats exposed to 100 or 200 mg/kg/day for 90 days. However, no alterations in brain weight or

3. HEALTH EFFECTS

histopathology were observed at doses as high as 250 mg/kg (5 days/week) for 13 weeks (NTP 1985) or 80 mg/kg (5 days/week) for 2 years (NTP 1985).

Some alterations in neurobehavioral performance were observed in mice (Balster and Borzelleca 1982). An ED₅₀ of 454 mg/kg was calculated for impaired motor performance following a single dose exposure and a decrease in response rate in operant behavior test during a 60-day exposure to 400 mg/kg/day. No alterations were observed in swimming endurance (10 mg/kg/day for 14 days), exploratory behavior (10 mg/kg/day for 90 days), or passive avoidance learning tests (100 mg/kg/day for 30 days).

3.2.2.5 Reproductive Effects

The reproductive toxicity of bromoform and dibromochloromethane has been assessed in a small number of human and animal studies. A number of studies have examined the potential association between adverse reproductive outcomes (spontaneous abortions, stillbirths, and preterm delivery) and consumption of municipal drinking water containing trihalomethanes (bromoform, dibromochloromethane, dichloromethane, and chloroform) (Bove et al. 1992, 1995, 2002; Dodds et al. 1999; Kramer et al. 1992; Mills et al. 1998; Nieuwenhuijsen et al. 2000; Savitz et al. 1995; Waller et al. 1999). These studies involved mixed exposures to trihalomethane compounds and most did not provide bromoform or dibromochloromethane exposure data. Two pregnancy outcome studies (Kramer et al. 1992; Waller et al. 1999) have examined risks associated with levels of bromoform or dibromochloromethane in drinking water. A third study (Windham et al. 2003) examined the association of altered menstrual cycle function in women exposed to trihalomethanes in drinking water. Collectively, the studies provide insufficient evidence for establishing a causal relationship between exposure to trihalomethane compounds and adverse reproductive outcome.

The Kramer et al. (1992) study is a population case-control study of pregnant white, non-Hispanic women living in communities in Iowa where all drinking water was supplied from a single source. No significant associations were found between bromoform or dibromochloromethane levels in the drinking water and the risk of prematurity. The odds ratios were 1.1 (95% confidence limit of 0.8–1.4) for communities with bromoform levels of 1 µg/L and higher and 1.1 (95% confidence limit of 0.7–1.4) for communities with dibromochloromethane levels of 1–3 µg/L. No cases were found in communities with dibromochloromethane levels of 4 µg/L and higher. Similar results were found in the Waller et al. (1999) study. In this study, pregnancy health outcomes were examined in pregnant women living in communities with groundwater, surface water, or mixed sources of drinking water. The risk of spontaneous abortion was

3. HEALTH EFFECTS

not significantly associated with bromoform or dibromochloromethane water levels; the percentage of pregnancies ending with spontaneous abortions were 9.2, 9.8, and 10.3% in communities with bromoform drinking water levels of 0, 1–15, and ≥ 16 $\mu\text{g/L}$, respectively, and 9.7, 9.6, and 10.4% for dibromochloromethane levels of 0, 1–30, and ≥ 31 $\mu\text{g/L}$, respectively.

Windham et al. (2003) examined the possible association between trihalomethanes in drinking water and menstrual cycle function. Menstrual parameter values in premenopausal women were determined based on hormone levels in urine collected during an average of 5.6 menstrual cycles ($n=403$). Estimates of bromoform and dibromochloromethane levels for each cycle were based on residential data (individual trihalomethane concentrations measured within a relatively narrow time period around the menstrual cycle start date) and utility measurements (quarterly measurements made by water utilities during a 90-day period beginning 60 days before the cycle start date). Significant associations were found between exposure to the top quartile of bromoform (≥ 12 $\mu\text{g/L}$) and decreasing menstrual cycle and follicular phase length. The age, race, body mass index, income, pregnancy history, and caffeine and alcohol consumption-adjusted differences were -0.79 days (95% confidence interval [CI] of -1.4 to -0.14) for cycle length and -0.78 days (95% CI -1.4 to -0.14) for follicular phase length. For dibromochloromethane, the differences for the 2–3 quartile (level not reported) and highest quartile (≥ 20 $\mu\text{g/L}$) were -0.69 days (95% CI of -1.4 to -0.02) and -1.21 days (95% CI of -2.0 to -0.38), respectively, for menstrual cycle length and -0.62 days (95% CI of -1.3 to 0.05) and -1.1 days (95% CI of -1.9 to -0.25), respectively, for follicular phase length. No associations between bromoform or dibromochloromethane concentration and luteal phase length, menses length, or cycle variability were found. Interpretation of the study results is limited due to coexposure to other trihalomethanes.

Bromoform. Data on the reproductive toxicity of bromoform in humans are limited to the trihalomethane studies described above. Animal studies have examined the potential of bromoform to induce histological alterations (NTP 1989a) and impair reproductive function (NTP 1989b). No histological alterations were observed in rats and mice exposed to 200 or 400 mg/kg, respectively, 5 days/week for 13 weeks (NTP 1989a). Dose related incidences of squamous metaplasia of the prostate gland were observed in male rats exposed to 200 mg/kg (5 days/week) for 2 years (NTP 1989a). This lesion may represent a chemical effect associated with concurrent inflammatory lesions in this gland, which occurred at similar rates in all groups of male rats tested, including vehicle controls. Chronic exposure of mice to 200 mg/kg (5 days/week) resulted in no detectable noncancerous histological effects in male reproductive tissues (testes, prostate, and seminal vesicles) (NTP 1989a). No nonneoplastic histological alterations were observed in female rats or mice receiving gavage doses of 200 mg/kg (5 days/week) for 2 years (NTP

3. HEALTH EFFECTS

1989a). No adverse effects on reproductive performance or fertility were observed in male and female mice receiving gavage doses of 200 mg/kg/day (NTP 1989b).

Dibromochloromethane. Human data on the reproductive toxicity of dibromochloromethane are limited to the trihalomethane studies described above. No histological alterations (testes, prostate, seminal vesicles, ovaries, uterus, and mammary gland examined) were observed in rats or mice receiving gavage doses of up to 250 mg/kg 5 days/week for 13 weeks (Daniel et al. 1990; NTP 1985) or 80 or 100 mg/kg, respectively, 5 days/week for 2 years (NTP 1985). In contrast to these negative findings, female mice exposed to dibromochloromethane in drinking water at a high dose (685 mg/kg/day) experienced a marked reduction in fertility, with significant decreases in litter size, gestational survival, postnatal survival, and postnatal body weight (Borzelleca and Carchman 1982). These effects may have been due to marked maternal toxicity, as evidenced by decreased weight gain, enlarged and discolored livers, and decreased survival. Exposure to lower doses (17 or 170 mg/kg/day) resulted in occasional decreases in one or more of the reproductive parameters monitored, but the effects were not large and were not clearly dose-related. These data are not sufficient to draw firm conclusions about the effects of dibromochloromethane on reproduction, but it appears that reproductive tissues and functions are not markedly impaired at doses that do not cause frank maternal toxicity. This is supported by a reproductive toxicity study conducted by NTP (1996). No alterations in reproductive or fertility indices were observed in female rats exposed to 40.3 mg/kg/day dibromochloromethane in drinking water for 35 days (13 days prior to mating, during mating, and gestation).

3.2.2.6 Developmental Effects

There are limited data on the developmental toxicity of bromoform or dibromochloromethane in humans and animals. Several human studies have examined the potential association between exposure to trihalomethanes in drinking water and birth outcomes (Dodds et al. 1999; Kramer et al. 1992; Savitz et al. 1995). However, only one study (Kramer et al. 1992) examined the exposure to individual trihalomethanes. In this population-based case control of pregnant white, non-Hispanic women living in communities in Iowa where all drinking water was supplied from a single source, no significant association between exposure to ≥ 1 $\mu\text{g/L}$ of bromoform or ≥ 4 $\mu\text{g/L}$ of dibromochloromethane in tap water and increased risk of low birth weight babies and intrauterine growth retardation were found. Interpretation of this study is limited by the co-exposure to other trihalomethane compounds.

3. HEALTH EFFECTS

Bromoform. Human data on the developmental toxicity of bromoform are limited to the trihalomethane studies discussed above. One animal study (Ruddick et al. 1983) was identified. No significant alterations in the number of resorption sites, fetuses per litter, fetal body weights, fetal malformations, or visceral anomalies were observed in the offspring of rats administered up to 200 mg/kg/day bromoform in corn oil on gestational days 6–15. Increases in several skeletal anomalies were found in the offspring of rats exposed to bromoform, including the presence of a 14th rib, wavy ribs, interparietal deviations, and sternebra aberrations. The study authors did not conduct a statistical analysis of the data. However, an independent analysis of the data using Fisher Exact test revealed a significant increase in the incidence (per fetus and number of affected litters) in sternebra aberrations.

Dibromochloromethane. Human data on the developmental toxicity of dibromochloromethane are limited to the trihalomethane studies discussed above. Two animal studies examined the potential of dibromochloromethane to induce developmental effects. In a study by Ruddick et al. (1983) of rats receiving gavage doses of up to 200 mg/kg/day on gestational days 6–15, no alterations in the number of resorption sites, fetuses per litter, fetal body weights, fetal gross malformations, or skeletal or visceral anomalies were found. Borzelleca and Carchman (1982) exposed mice to 685 mg/kg/day of dibromochloromethane in drinking water for several generations and detected no significant effect on the incidence of gross, skeletal, or soft-tissue anomalies.

3.2.2.7 Cancer

No studies were located regarding carcinogenic effects in humans following oral exposure to bromoform or dibromochloromethane. There are a number of epidemiological studies that indicate that there may be an association between chronic ingestion of chlorinated drinking water (which typically contains trihalomethanes including bromoform and dibromochloromethane) and increased risk of rectal, bladder, or colon cancer in humans (Cantor et al. 1987; Crump 1983; Kanarek and Young 1982; Marienfeld et al. 1986), but these studies cannot provide information on whether any effects observed are due to bromoform, dibromochloromethane, or to one or more of the hundreds of other byproducts that are also present in chlorinated water.

Bromoform. A significant increase in the incidence of adenomatous polyps or adenocarcinomas was observed in female rats receiving gavage dose of 200 mg/kg, 5 days/week for 2 years (NTP 1989a); a nonstatistically significant increase was observed in male rats. The incidences of this relatively rare tumor (combined incidences of adenomatous polyps and adenocarcinoma) were 0/50, 0/50, and 3/50 for

3. HEALTH EFFECTS

males administered 0, 100, or 200 mg/kg and 0/50, 1/50, and 8/50 for females. No significant alterations in neoplastic lesions were observed in mice administered up to 100 (males) or 200 (females) mg/kg, 5 days/week for 2 years (NTP 1989a). The International Agency for Research on Cancer (IARC) concluded that there were inadequate human data and limited animal data and assigned bromoform to weight of evidence category 3, not classifiable as to carcinogenicity in humans (IARC 1991a, 1999a) and EPA classified bromoform as a probable human carcinogen, group B2 (IRIS 2004a). Based on the increased occurrence of neoplastic lesions in the large intestines of female rats, EPA derived an oral slope factor of $7.9 \times 10^{-3} \text{ (mg/kg/day)}^{-1}$ (IRIS 2004a).

Dibromochloromethane. In mice administered gavage doses of 100 mg/kg, 5 days/week for 2 years, increases in the incidences of hepatocellular adenomas and carcinomas were observed (NTP 1985). The incidence was significantly elevated for hepatocellular adenomas in females (2/50, 4/49, and 11/50 for 0, 50, and 100 mg/kg), hepatocellular carcinoma in males (10/50 and 19/50 for 0 and 100 mg/kg) and combined incidences for hepatocellular adenoma or carcinoma (23/50 and 27/50 for males at 0 and 100 mg/kg and 6/50, 10/49, and 19/50 for females at 0, 50, and 100 mg/kg). No significant alterations in the incidence of neoplastic lesion were observed in male or female rats administered up to 80 mg/kg 5 days/week for 2 years (NTP 1985). The IARC considered the available data on dibromochloromethane carcinogenicity to be not classifiable as to carcinogenicity in humans (group 3) (IARC 1991b, 1999b). EPA classified dibromochloromethane as a possible human carcinogen, group C (IRIS 2004b). Based on the increased combined incidence of hepatocellular adenoma or carcinoma in female mice, EPA derived an oral slope factor of $8.4 \times 10^{-2} \text{ (mg/kg/day)}^{-1}$ (IRIS 2004b).

3.2.3 Dermal Exposure

No studies were located regarding the following health effects in humans or animals after dermal exposure to bromoform or dibromochloromethane:

3.2.3.1 Death

3.2.3.2 Systemic Effects

3.2.3.3 Immunological and Lymphoreticular Effects

3.2.3.4 Neurological Effects

3. HEALTH EFFECTS

3.2.3.5 Reproductive Effects**3.2.3.6 Developmental Effects****3.2.3.7 Cancer****3.3 GENOTOXICITY**

Bromoform. The *in vivo* and *in vitro* genotoxicities of bromoform are examined in numerous studies, the results of which are summarized in Tables 3-3 and 3-4, respectively.

The potential of bromoform to induce gene mutations have reported have shown mixed results in *in vitro* assays. Increases (LeCurieux et al. 1995; Simmon and Tardiff 1978; Simmon et al. 1977) and no effect (Kubo et al. 2002; NTP 1989a; Rapson et al. 1980; Varma et al. 1988) on the occurrence of reverse mutations have been found in *Salmonella typhimurium*; an increase in forward mutations was also found in *S. typhimurium* (Roldan-Arjona and Pueyo 1993). The clastogenic activity of bromoform has been tested in one study (Galloway et al. 1985; NTP 1989a) that found no significant alterations with S9 metabolic activation and negative and weakly positive results without metabolic alteration. A significant alteration in mitotic aneuploidy was observed in *Aspergillus nidulans* (Benigni et al. 1993). Other tests of genotoxicity included an increase in sister chromatid exchange in human lymphocytes (Morimoto and Koizumi 1983) and rat erythroblastic leukemia K₃D cells (Fujie et al. 1993), but not in Chinese hamster ovary cells (Galloway et al. 1985; NTP 1989a) or oyster toadfish leukocytes (Maddock and Kelly 1980); SOS induction in *Escherichia coli* (Lecurieux et al. 1995); trifluorotymidine resistance in mouse lymphoma cells (NTP 1989a). DNA strand breaks were observed in human lymphocytes (Landi et al. 1999) and lymphoblastic leukemia cells, but not in primary rat hepatocytes (Geter et al. 2003a).

The potential for bromoform to induce chromosome aberrations, micronuclei, sister chromatid exchange, and DNA damage was investigated in several *in vivo* studies, often with conflicting results. An increase in chromosome aberrations, in particular chromatid and chromosome breaks, was observed in rats receiving five daily gavage doses of 253 mg/kg/day or a single intraperitoneal dose of 25.3 or 253 mg/kg (Fujie et al. 1990), but not in mice administered up to 800 mg/kg via intraperitoneal injection (NTP 1989a). A significant increase in sister chromatid exchange was observed in the bone marrow cells of mice receiving 25 mg/kg/day gavage doses for 4 days (Morimoto and Koizumi 1983) and mice receiving

3. HEALTH EFFECTS

Table 3-3. Genotoxicity of Bromoform *In Vivo*

End point	Species (test system)	Exposure route	Results	Reference
Nonmammalian systems:				
Sex-linked recessive lethal	<i>Drosophila melanogaster</i>	Feeding	+	Woodruff et al. 1985; NTP 1989a
		Injection	-	
Reciprocal translocation	<i>D. melanogaster</i>	Feeding	-	Woodruff et al. 1985; NTP 1989a
Micronuclei	<i>Pleurodeleswalti larvae</i>		+	LeCurieux et al. 1995
Mammalian systems:				
Sister chromatid exchange	Mouse (bone marrow cell)	IP	+	NTP 1989a
	Mouse (bone marrow cell)	oral	+	Morimoto and Koizumi 1983
Chromosomal aberrations	Mouse (bone marrow cell)	IP	-	NTP 1989a
	Rat (bone marrow cell)	IP	+	Fujie et al. 1990
	Rat (bone marrow cell)	Oral	+	Fujie et al. 1990
Micronuclei	Mouse (bone marrow cell)	IP	+	NTP 1989a
	Mouse (bone marrow cell)	Oral	-	Stocker et al. 1996
	Mouse (bone marrow cell)	IP	-	Hayashi et al. 1988
Repairable DNA damage	Rat (liver cells)	Oral	-	Stocker et al. 1996
DNA strand breaks	Rat (kidney cells)	Oral	-	Potter et al. 1996
	Rat (liver, kidney, duodenum)	Oral	-	Geter et al. 2003a

+ = positive result; - = negative result; IP = intraperitoneal

3. HEALTH EFFECTS

Table 3-4. Genotoxicity of Bromoform *In Vitro*

End point	Species (test system)	Results ^a		Reference
		With activation	Without activation	
Prokaryotic organisms:				
Reverse gene mutation	<i>Salmonella typhimurium</i>			Simmon and Tardiff 1978; Simmon et al. 1977
	TA100	No data	+	
	TA1535	No data	+	
	<i>S. typhimurium</i>			LeCurieux et al. 1995
	TA100	–	+	
	<i>S. typhimurium</i>	–	–	Kubo et al. 2002
	TA100			
	TA98	–	–	
	<i>S. typhimurium</i>			Varma et al. 1988
	TA98	–	–	
	TA100	–	(+)	
	TA1535	–	–	
	TA1537	–	–	
	<i>S. typhimurium</i>			Rapson et al. 1980
	TA100	No data	–	
	<i>S. typhimurium</i> (preincubation assay)			
	TA97	(+)	–	NTP 1989a
	TA98	–, –, (+)	–, –, –	
	TA100	–, –, –	(+), –, –	
	TA1535	–, –, –	–, –, –	
	TA1537	–, –, –	–, –, –	
Forward gene mutation	<i>S. typhimurium</i>	No data	(+)	Roldan-Arjona and Pueyo 1993
SOS induction	<i>Escherichia coli</i>	+	+	LeCurieux et al. 1995
Eukaryotic organisms:				
Fungi:				
Mitotic aneuploidy	<i>Aspergillus nidulans</i>	No data	+	Benigni et al. 1993
Fish:				
Sister-chromatid exchange	Oyster toadfish leukocytes	No data	–	Maddock and Kelly 1980
Mammalian cells:				
Sister-chromatid exchange	Human lymphocytes	No data	+	Morimoto and Koizumi 1983
	Chinese hamster ovary cells	–, –	–, (+)	Galloway et al. 1985; NTP 1989a

3. HEALTH EFFECTS

Table 3-4. Genotoxicity of Bromoform *In Vitro*

End point	Species (test system)	Results ^a		Reference
		With activation	Without activation	
	Rat erythroblastic leukemia K ₃ D cells	+	+	Fujie et al. 1993
Chromosomal aberrations	Chinese hamster ovary cells	-, -	-, (+)	Galloway et al. 1985; NTP 1989a
Trifluorothymidine resistance	Mouse lymphoma cells	+	+	NTP 1989a
DNA strand breaks	Human lymphocytes	No data	+	Landi et al. 1999
	Human lymphoblastic leukemia cells	+	+	Geter et al. 2003a
	Primary rat hepatocyte	-	-	Geter et al. 2003a

^aResults from two or more different contract laboratories are separated by commas
 + = positive result; - = negative result; (+) = marginally positive result

3. HEALTH EFFECTS

intraperitoneal doses of 800 mg/kg (NTP 1989a). Increases in micronuclei induction were observed in mice exposed to 800 mg/kg via intraperitoneal injection (NTP 1989a) and newt larvae following a 6-day exposure to 2.5 mg/L (LeCurieux et al. 1995), but not in mice receiving a single intraperitoneal dose of 175–1,400 mg/kg (Hayashi et al. 1988) or 250–1,000 mg/kg via gavage (Stocker et al. 1997). No alterations in unscheduled DNA synthesis were observed in mice administered 324 or 1,080 mg/kg via gavage (Stocker et al. 1997). No alterations in DNA strand breaks were observed in the kidneys of rats administered 380 mg/kg for 1 day via gavage (Potter et al. 1996) or in the liver, kidney, or duodenum of rats administered 152 mg/kg either as a single oral bolus or on drinking water for 2 weeks (Geter et al. 2003a). An increase in sex-linked recessive mutations was observed in *Drosophila melanogaster* following feeding, but not injection exposure (NTP 1989a); no effect on reciprocal translocations was found.

Dibromochloromethane. The genotoxicity of dibromochloromethane has been assessed in a number of *in vivo* and *in vitro* assays. The results of these studies are presented in Tables 3-5 and 3-6, respectively.

Mixed results were found in *in vitro* bacterial assays for reverse gene mutations, with some studies finding significant alterations (Landi et al. 1999; Simmon and Tardiff 1978; Simmon et al. 1977; Varma et al. 1988) and others not finding an effect (Kubo et al. 2002; LeCurieux et al. 1995; NTP 1985; Zeiger et al. 1987). A significant increase in forward gene mutations was found in mouse lymphoma cells (McGregor et al. 1991). An increase in gene conversion, but not gene reversion, was observed in *Saccharomyces cerevisiae* (Nestman and Lee 1985). An increase in mitotic aneuploidy was observed in *A. nidulans* and sister chromatid exchange was observed in human lymphocytes (Morimoto and Koizumi 1983; Sobti 1984), rat liver cells (Sobti 1984), and rat erythroblastic leukemia K₃D cells (Fujie et al. 1993). DNA strand breaks were observed in human lymphoblastic leukemia cells, but not in primary rat hepatocytes (Geter et al. 2003a). Additionally, increases in chromosomal aberrations were observed in mouse lymphoma cells (Sofuni et al. 1996) and Chinese hamster lung cells (Matsuoka et al. 1996).

In vivo, oral exposure to 25–200 mg/kg/day for 4 days resulted in dose-related increases in the frequency of sister chromatid exchanges in mouse bone marrow cells (Morimoto and Koizumi 1983). An increase in the occurrence of chromosomal aberrations was also observed in bone marrow cells of rats receiving a single intraperitoneal injection of 20.8 mg/kg (Fujie et al. 1990); a weak positive response was observed following gavage administration of 10.5–1,041.5 mg/kg/day for 5 days (Fujie et al. 1990). No significant alterations in micronuclei induction (Hayashi et al. 1988), repairable DNA damage (Stocker et al. 1996),

3. HEALTH EFFECTS

Table 3-5. Genotoxicity of Dibromochloromethane *In Vivo*

End point	Species (test system)	Exposure route	Results	Reference
Nonmammalian systems:				
Micronuclei	<i>Pleurodeleswalti larvae</i>		–	LeCurieux et al. 1995
Mammalian systems:				
Sister chromatid exchange	Mouse (bone marrow cell)	Oral	+	Morimoto and Koizumi 1983
Chromosomal aberrations	Rat (bone marrow cell)	IP	+	Fujie et al. 1990
	Rat (bone marrow cell)	Oral	(+)	Fujie et al. 1990
Micronuclei	Mouse (bone marrow cell)	IP	–	Hayashi et al. 1988
Repairable DNA damage	Rat (liver cells)	Oral	–	Stocker et al. 1996
DNA strand breaks	Rat (kidney cells)	Oral	–	Potter et al. 1996
	Rat (liver, kidney, duodenum)	Oral	–	Geter et al. 2003a

+ = positive result; – = negative result; (+) = weak positive; IP = intraperitoneal

3. HEALTH EFFECTS

Table 3-6. Genotoxicity of Dibromochloromethane *In Vitro*

End point	Species (test system)	Results ^a		Reference
		With activation	Without activation	
Prokaryotic organisms:				
Reverse gene mutation	<i>Salmonella typhimurium</i> (desiccator system)			Simmon and Tardiff 1978; Simmon et al. 1977
	TA100	No data	+	
	<i>S. typhimurium</i>			LeCurieux et al. 1995
	TA100	-	-	
	<i>S. typhimurium</i>			Kubo et al. 2002
	TA100	-	-	
	TA98	-	-	
	<i>S. typhimurium</i> (plate incorporation assay)			Varma et al. 1988
	TA98	+	-	
	TA100	+	-	
	TA1535	+	+	
	TA1537	+	+	
	<i>S. typhimurium</i> (preincubation assay)			NTP 1985; Zeiger et al. 1987
	TA98	-	-	
	TA100	-	-	
	TA1535	-	-	
	TA1537	-	-	
	<i>S. typhimurium</i>			Landi et al. 1999
	TPT100	+	+	
	RSJ100	-	-	
Eukaryotic organisms:				
Fungi:				
Mitotic aneuploidy	<i>Aspergillus nidulans</i>	No data	+	Benigni et al. 1993
Gene conversion	<i>Saccharomyces cerevisiae</i>	-	+	Nestman and Lee 1985
Gene reversion	<i>S. cerevisiae</i>	-	-	Nestman and Lee 1985
Mammalian cells:				
Forward gene mutation	Mouse L5178Y lymphoma cells	No data	+	McGregor et al. 1991
Sister-chromatid exchange	Human lymphocytes	No data	+	Morimoto and Koizumi 1983
	Human lymphocytes	No data	+	Sobti 1984
	Rat liver cells	No data	(+)	Sobti 1984
	Rat erythroblastic leukemia K ₃ D cells	+	+	Fujie et al. 1993

3. HEALTH EFFECTS

Table 3-6. Genotoxicity of Dibromochloromethane *In Vitro*

End point	Species (test system)	Results ^a		Reference
		With activation	Without activation	
Chromosomal aberrations	Mouse L5178Y lymphoma cells	+,+	(+),-	Sofuni et al. 1996
	Chinese hamster lung cells	No data	+	Matsuoka et al. 1996
DNA single strand breaks	Human lymphoblastic leukemia cells	+	+	Geter et al. 2003a
	Primary rat hepatocyte	-	-	Geter et al. 2003a

^aResults from two or more different contract laboratories are separated by commas

+ = positive result; - = negative result; (+) = marginally positive result

3. HEALTH EFFECTS

or DNA strand breaks (Potter et al. 1996) were observed in mouse bone marrow cells (intraperitoneal injection of 62.5–1,000 mg/kg), rat liver cells (gavage dose of 135 or 450 mg/kg), or rat kidney cells (gavage dose of 310 mg/kg), respectively. Likewise, no DNA strand breaks were observed in the liver, kidney, or duodenum of rats administered 125 mg/kg either as a single oral bolus or on drinking water for 2 weeks (Geter et al. 2003a).

3.4 TOXICOKINETICS

3.4.1 Absorption

3.4.1.1 Inhalation Exposure

There are limited data on inhalation absorption of bromoform or dibromochloromethane. Based on the physical-chemical properties of these compounds, and by analogy with other related halomethanes such as chloroform (Agency for Toxic Substances and Disease Registry 1997), it is expected that bromoform and dibromochloromethane would be well-absorbed across the lung. The occurrence of systemic and neurological effects following inhalation exposure of animals to bromoform (see Section 3.2.1) supports this view. Aggazzotti et al. (1998) examined the uptake of trihalomethanes in five swimmers exposed to trihalomethanes via chlorinated pool water. Although bromoform was detected in the pool water, it was only detected in one of four indoor air samples. Dibromochloromethane was detected in the pool water (0.8 µg/L) and in air samples before swimming (5.2 µg/m³) and after swimming (11.4 µg/m³). After sitting near the pool for 1 hour, the mean alveolar air level was 0.8 µg/m³. After swimming, alveolar air levels were 1.4 µg/m³; however, oral and percutaneous exposure also influenced this level. Estimated dibromochloromethane uptake during the 1 hour of sitting near the pool ranged from 1.5 to 2.0 µg/hour; after 1 hour of swimming, the estimated uptake rate ranged from 14 to 22 µg/hour.

Several studies have examined the impact of showering with water contaminated with trihalomethanes on the absorption of individual trihalomethane compounds. Showering involves inhalation exposure to volatilized trihalomethanes, percutaneous exposure, and possibly oral exposure. Several studies have found elevated blood bromoform and/or dibromochloromethane levels following showering (Backer et al. 2000; Lynberg et al. 2001; Miles et al. 2002). A comparative study by Backer et al. (2000) found the highest blood levels of dibromochloromethane after a 10-minute shower, compared to bathing for 10 minutes or drinking 1 L of water in 10 minutes. This difference may be due to differences in total exposure levels, metabolism, or excretion rather than differences in absorption efficiencies.

3. HEALTH EFFECTS

Several studies have estimated the blood:air partition coefficients for bromoform and dibromochloromethane in humans and rats, these values are summarized in Table 3-7.

3.4.1.2 Oral Exposure

There are limited data on the absorption of bromoform and dibromochloromethane following oral exposure. Most of the available data (Backer et al. 2000; da Silva et al. 1999; Mink et al. 1986) involved exposure to a mixture of trihalomethanes. Elevated blood concentrations of dibromochloromethane were also observed in humans ingesting drinking water containing trihalomethanes (Backer et al. 2000). da Silva et al. (1999) examined bromoform and dibromochloromethane absorption in rats following a single gavage dose. Both compounds were rapidly absorbed with peak plasma levels occurring <1 hour postexposure. Oral absorption constants of 0.412 and 0.55 per hour were reported for bromoform and dibromochloromethane, respectively. A nonlinear relationship between dose (0.25 and 0.50 mmol/kg; 63 and 126 mg/kg bromoform and 52 and 104 mg/kg dibromochloromethane) and areas under the blood concentration versus time curves (AUCs) were found, suggesting metabolism saturation. The AUCs (20–360 minutes postexposure) for 63 and 126 mg/kg bromoform were 48.6 and 190.4 $\mu\text{M}/\text{hour}$; for 52 and 104 mg/kg dibromochloromethane, the AUCs (20–360 minutes) were 31.2 and 85.6 $\mu\text{M}/\text{hour}$. When bromoform and dibromochloromethane were administered along with chloroform and dichlorobromomethane (0.25 mmol/kg of each trihalomethane), the AUC was significantly higher than when administered singly.

Mink et al. (1986) found that 60–90% of the bromoform and dibromochloromethane administered in a mixture of trihalomethanes in corn oil to rats (100 mg trihalomethane/kg) or mice (150 mg trihalomethane/kg) were recovered in expired air, urine, or in internal organs. This indicates that gastrointestinal absorption was at least 60–90% complete. This is consistent with the ready gastrointestinal absorption observed for other halomethanes such as chloroform (Agency for Toxic Substances and Disease Registry 1997). As noted by Withey et al. (1983), the rate of halocarbon uptake from the gastrointestinal tract may be slower when compounds are given in oil than when they are given in water.

3.4.1.3 Dermal Exposure

No studies were located regarding dermal absorption of bromoform. A single study was found to quantitatively demonstrate dermal absorption of dibromochloromethane in human volunteers exposed for

3. HEALTH EFFECTS

Table 3-7. Partition Coefficients for Bromoform and Dibromochloromethane

	Chemical	Partition coefficient	Species	Reference
Blood:Air	Bromoform	102.3	Human	Batterman et al. 2002
		161	Rat	Beliveau and Krishnan 2000
		187	Rat	Beliveau et al. 2000b
		198.1	Rat	da Silva et al. 1999
	Dibromochloromethane	52.7	Human	Gargas et al. 1989
		49.2	Human	Batterman et al. 2002
		116	Rat	Gargas et al. 1989
		97.5	Rat	Beliveau et al. 2000b
Fat:Air	Bromoform	4,129	Rat	da Silva et al. 1999
	Dibromochloromethane	1,919	Rat	Gargas et al. 1989
Liver:Air	Bromoform	210.3	Rat	da Silva et al. 1999
	Dibromochloromethane	126	Rat	Gargas et al. 1989
Muscle:Air	Bromoform	115.1	Rat	da Silva et al. 1999
	Dibromochloromethane	55.6	Rat	Gargas et al. 1989

3. HEALTH EFFECTS

60 minutes to tap water having a temperature similar to that of bathing water (Prah et al. 2002). The sealed exposure apparatus was designed to permit the exposure of a single hand and lower arm by immersion while preventing an inhalation exposure. The mean tap water concentration of dibromochloromethane was 1.4 ng/mL. Dibromochloromethane levels in the blood increased constantly from the start to 5 minutes after the end of the exposure. At 15 minutes after cessation of exposure, blood levels appeared to fall slightly slower than the rate of appearance. These data have limited use since rates of dermal absorption or appearance in the blood were not reported.

As discussed under Inhalation Exposure, showering, which involves both inhalation and dermal exposure with water contaminated with trihalomethanes, can result in significantly elevated blood bromoform and dibromochloromethane levels. Xu et al. (2002) reported dermal absorption coefficients of 0.21 and 0.20 cm/hour for aqueous solutions of bromoform and dibromochloromethane, respectively. These values were determined *in vitro* using excess breast skin tissues at two temperature settings (20 and 25 °C).

3.4.2 Distribution

Several studies have estimated the tissue:air partition coefficients for bromoform and dibromochloromethane in humans and rats; these values are summarized in Table 3-7. *In vitro* data, suggest that hemoglobin is the primary ligand for bromoform, and presumably dibromochloromethane, in the blood (Béliveau and Krishnan 2000b).

3.4.2.1 Inhalation Exposure

No studies were located regarding the distribution of bromoform or dibromochloromethane in humans or animals following inhalation exposure. However, adverse effects involving several organs (liver, kidney, central nervous system) indicate distribution to these sites.

3.4.2.2 Oral Exposure

The distribution of bromoform and dibromochloromethane in tissues following oral exposure has not been thoroughly investigated. Analysis of bromoform levels in the organs of a child who died after an accidental overdose revealed concentrations of 10–40 mg/kg tissue in intestine, liver, kidney, and brain,

3. HEALTH EFFECTS

with somewhat higher levels in lung (90 mg/kg) and stomach (130 mg/kg) (Roth 1904, as cited in von Oettingen 1955). This suggests that bromoform is distributed fairly evenly from the stomach to other tissues.

In animals, Mink et al. (1986) found that only about 1–2% of a single oral dose of ¹⁴C-labeled dibromochloromethane or bromoform as part of a trihalomethane mixture was retained in the soft tissues of rats 8 hours after dosing. The tissues which contained measurable amounts of the radiolabel were the brain, kidney, liver, lungs, muscle, pancreas, stomach (excluding contents), thymus, and urinary bladder. The relative amount of radiolabel in each tissue was not mentioned. Similar results were noted in mice, except that blood also contained a significant fraction of the total dose (10% in the case of bromoform). The chemical form of the material in the tissues (parent, metabolite, or adduct) was not reported. The form in blood also was not determined, but studies by Anders et al. (1978) suggest that some or all may have been carbon monoxide bound to hemoglobin (see Section 3.4.3).

3.4.2.3 Dermal Exposure

No studies were located regarding the distribution of bromoform or dibromochloromethane in humans or animals following dermal exposure.

3.4.3 Metabolism

The metabolism of bromoform, dibromochloromethane, and other trihalomethanes has been investigated by Anders and colleagues (Ahmed et al. 1977; Anders et al. 1978; Stevens and Anders 1979, 1981). The main reactions, which are not believed to be route-dependent, are shown in Figure 3-3. The first step in the metabolism of trihalomethanes is oxidation by the cytochrome P-450 mixed function oxidase system of liver. This has been demonstrated *in vitro* using isolated rat liver microsomes (Ahmed et al. 1977), and *in vivo*, where the rate of metabolism is increased by cytochrome P-450 inducers (phenobarbital) and decreased by cytochrome P-450 inhibitors (SKF-525A) (Anders et al. 1978). The product of this reaction is presumed to be trihalomethanol, which then decomposes by loss of hydrogen and halide ions to yield the dihalocarbonyl. Although this intermediate has not been isolated, its formation has been inferred by the detection of 2-oxothiazolidine-4-carboxylic acid (OZT) in an *in vitro* microsomal system metabolizing bromoform in the presence of cysteine (Stevens and Anders 1979). The dihalocarbonyl molecule (an

3. HEALTH EFFECTS

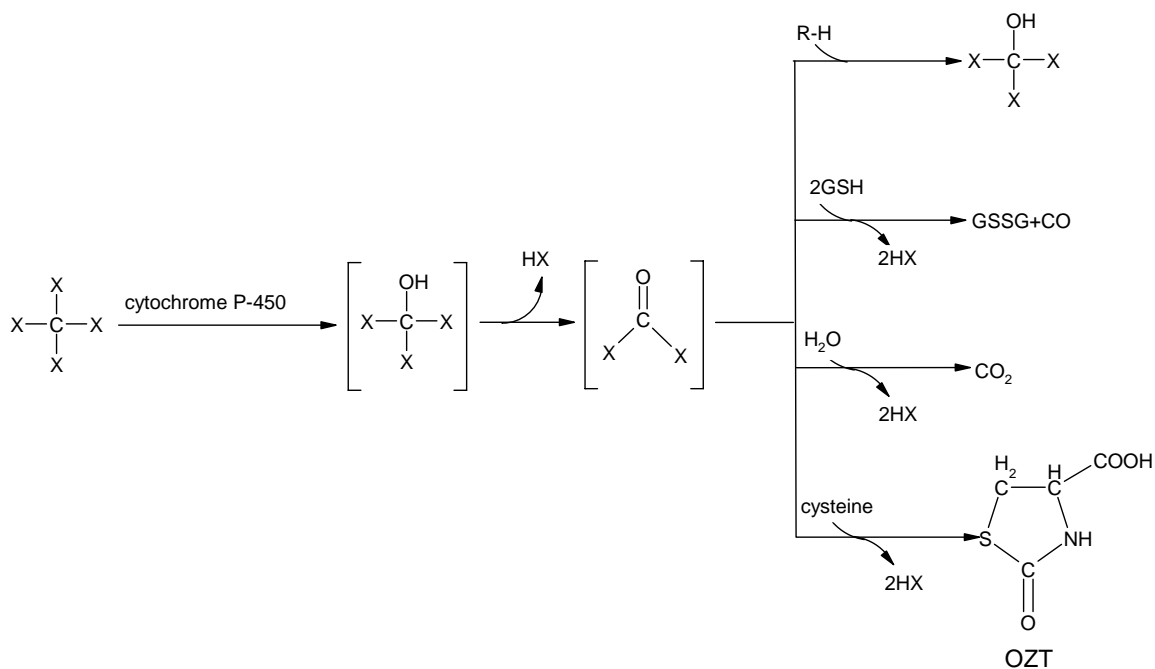
Figure 3-3. Proposed Pathway of Trihalomethane Metabolism in Rats*

*Adapted from Stevens and Anders 1981

X = halogen atom (chlorine, bromine); R = cellular nucleophile (protein, nucleic acid); GSH = reduced glutathione; GSSG = oxidized glutathione; OZT = oxothiazolidine carboxylic acid

3. HEALTH EFFECTS

analogue of phosgene) is highly reactive, and may undergo a number of reactions, including: (a) direct reaction with cellular nucleophiles to yield covalent adducts; (b) reaction with two moles of glutathione (GSH) to yield carbon monoxide and oxidized glutathione (GSSG); and (c) hydrolysis to yield CO₂. The amount of trihalomethane metabolized by each of these pathways has not been studied in detail, but it appears that conversion to CO₂ is the main route. However, this depends on the species, the trihalomethane being metabolized, and metabolic conditions (cellular glutathione levels). Mink et al. (1986) found that mice oxidized 72% of an oral dose of dibromochloromethane and 40% of an oral dose of bromoform to CO₂. In contrast, rats oxidized only 18% of dibromochloromethane and 4% of bromoform to CO₂. The fraction of the dose converted to carbon monoxide has not been quantified, but dramatically increased levels of carboxyhemoglobin have been reported following oral exposure of rats to bromoform (Anders et al. 1978; Stevens and Anders 1981). Mink et al. (1986) reported that about 10% of a dose of bromoform was present in blood in mice; the form of the label was not investigated, but it may have been carboxyhemoglobin.

Metabolism of trihalomethanes by cytochrome P-450 can also lead to the production of highly reactive trihalomethyl free radicals, especially under hypoxic conditions (O'Brien 1988). Radical formation from bromoform has been observed both in isolated hepatocytes incubated with bromoform *in vitro* and in the liver of rats exposed to bromoform *in vivo* (Tomasi et al. 1985). Although it has not been studied, it seems likely that this pathway would also generate trihalomethyl radicals from dibromochloromethane. While metabolism to free radicals is a minor pathway in the sense that only a small fraction of the total dose is converted, it might be an important component of the toxic and carcinogenic mechanism of dibromochloromethane and bromoform. Figure 3-4 shows how free radical generation can lead to an autocatalytic peroxidation of polyunsaturated fatty acids (PLJFAs) in cellular phospholipids (O'Brien 1988). Peroxidation of cellular lipids has been observed in rat kidney slices incubated with bromoform *in vitro*, although lipid peroxidation was not detectable in liver slices (Fraga et al. 1987). Lipid peroxidation is considered to be a likely cause of cell injury for other halogenated compounds such as carbon tetrachloride (Agency for Toxicological Substances and Disease Registry 1994), but the significance of this pathway in the toxicity of dibromochloromethane and bromoform remains to be determined.

Development of the general metabolic scheme for trihalomethanes shown in Figure 3-3 relied primarily on the use of chloroform and bromoform as model substrates. However, some metabolic data specific to dibromochloromethane are available from a series of experiments conducted in rats by Pankow et al. (1997). Increased levels of the metabolites bromide (in plasma) and carbon monoxide (as detected by

3. HEALTH EFFECTS

Figure 3-4. Proposed Pathway of Trihalomethyl-radical-mediated Lipid Peroxidation*

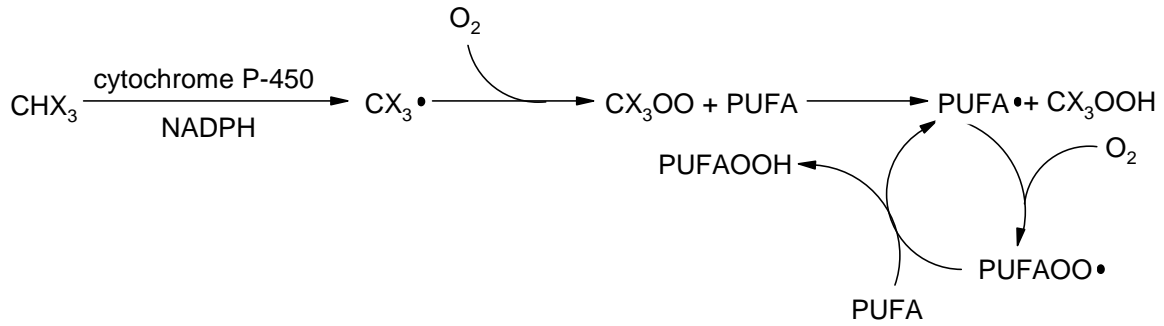

*Adapted from O'Brien 1988

X = halogen atom (chlorine, bromine, iodine); PUFA = polyunsaturated fatty acid

3. HEALTH EFFECTS

formation of carboxyhemoglobin in blood) and dependence of their rate of production on hepatic GSH concentration in rats treated with dibromochloromethane are consistent with the metabolic scheme for the oxidative pathway shown in Figure 3-3. Observation of increased hepatic levels of GSSG in dosed rats by Pankow et al. (1997) is also consistent with the proposed scheme. The observation of (1) partial inhibition of bromide and carboxyhemoglobin production in dosed rats co-administered diethyldithiocarbamate (a potent inhibitor of P-450 isoform CYP2E1) and (2) stimulation of production in rats pretreated with isoniazid (a potent inducer of CYP2E1) indicates that cytochrome P-450 isoform CYP2E1 is at least partially responsible for oxidative metabolism of dibromochloromethane. Pretreatment with phenobarbital (an inducer of CYP2B1/2 in the rat) increased the concentration of bromide in plasma, suggesting that CYP2B1/2, as well as CYP2E1, catalyzes metabolism of dibromochloromethane in the rat.

Recent studies suggest that brominated trihalomethanes, including bromoform and dibromochloromethane, may be metabolized by one or more pathways dependent on glutathione conjugation catalyzed by glutathione S-transferase (De Marini et al. 1997; Pegram et al. 1977) in addition to the oxidative and reductive pathways described above. Transfection of *Salmonella typhimurium* test strain TA1535 with the gene for rat glutathione S-transferase theta 1-1 increased the mutagenicity of bromoform and dibromochloromethane (by 95- and 85-fold, respectively) in reverse mutation assays when compared to mutagenicity in TA1535 transfected with a nonfunctional form of the gene (De Marini et al. 1997). The mutational spectra and site specificity for bromoform, dibromochloromethane, and bromodichloromethane (a structurally-related brominated trihalomethane) were closely similar, suggesting bioactivation of all three compounds via common metabolic intermediates. The mutagenic metabolites were not identified in this study, but S-(1-halomethyl)glutathione, S-(1,1-dihalomethyl) glutathione, or their further metabolites were presumed on the basis of data reported for other halomethanes to be capable of reacting with DNA to produce the observed mutations (De Marini et al. 1997).

The formation of reactive metabolites by conjugation of bromoform or dibromochloromethane via glutathione S-transferase theta-mediated pathways has not been examined in mammalian test systems. However, the metabolism of bromodichloromethane via glutathione conjugation has been investigated *in vitro* using cytosols prepared from human, rat, and mouse liver (Ross and Pegram 2003). Conjugation of bromodichloromethane with glutathione in mouse liver cytosol was time- and protein-dependent, was not affected by an inhibitor of alpha-, mu-, and pi-class glutathione S-transferases, and was correlated with activity toward 1,2-epoxy-3-(4'-nitrophenoxy)propane (a substrate specific for theta-class glutathione S-transferases). Conjugation activity toward bromodichloromethane in hepatic cytosols isolated from

3. HEALTH EFFECTS

different species followed the rank order mouse, followed by rat, then human. The initial conjugate formed was S-chloromethyl glutathione. This compound was unstable and degraded to multiple metabolites including S-hydroxymethyl glutathione, S-formyl glutathione, and formic acid. These data demonstrate that glutathione conjugation of bromodichloromethane occurs in mammalian liver cytosols and is likely catalyzed by glutathione S-transferase theta. These findings are significant because production of reactive glutathione conjugates from bromodichloromethane may result in formation of DNA adducts and thus cause genotoxicity. Because there is structural similarity among the brominated trihalomethanes and evidence for common pathways of bioactivation (De Marini et al. 1997), the findings of Ross and Pegram (2003) support the idea that glutathione conjugation of bromoform and dibromochloromethane leading to formation of reactive metabolites also occurs in the liver of rodents and humans.

Comparison of catalytic efficiencies for recombinant rat CYP2E1 and glutathione S-transferase theta 1-1 using bromodichloromethane as a substrate (data on bromoform or dibromochloromethane are not available) suggest that glutathione conjugation is likely to be a quantitatively minor hepatic pathway *in vivo* (Ross and Pegram 2003). Although metabolism via this pathway may be minor from the standpoint that only a small fraction of the total dose is converted, it might be an important component of the mechanism for dibromochloromethane and/or bromoform toxicity in extrahepatic tissues where GSTT1-1 is expressed in conjunction with lower levels of CYP2E1.

3.4.4 Elimination and Excretion

3.4.4.1 Inhalation Exposure

No studies were located regarding excretion of bromoform or dibromochloromethane by humans or animals following inhalation exposure.

3.4.4.2 Oral Exposure

In rats and mice given a single oral dose of ¹⁴C-labeled bromoform or dibromochloromethane as part of a trihalomethane mixture (100 mg/kg in rats and 150 mg/kg in mice), excretion occurred primarily by exhalation of bromoform or dibromochloromethane or of CO₂ (Mink et al. 1986). In mice, 39.68 and 71.58% of the administered radiolabelled bromoform and dibromochloromethane, respectively, were exhaled as CO₂ and 7.18 and 12.31% as unmetabolized compound, respectively. In contrast, 4.3 and

3. HEALTH EFFECTS

18.2% of bromoform and dibromochloromethane were exhaled as CO₂ in rats and 66.9 and 48.1% of parent compound. Only 1–5% of the dose was excreted in urine (the chemical form in urine was not determined). The elimination half-times of bromoform and dibromochloromethane were 0.8 and 1.2 hours, respectively, in rats at 8 or 2.5 hours, respectively, in mice.

3.4.4.3 Dermal Exposure

No studies were located regarding excretion of bromoform or dibromochloromethane by humans or animals following dermal exposure.

3.4.5 Physiologically Based Pharmacokinetic (PBPK)/Pharmacodynamic (PD) Models

Physiologically based pharmacokinetic (PBPK) models use mathematical descriptions of the uptake and disposition of chemical substances to quantitatively describe the relationships among critical biological processes (Krishnan et al. 1994). PBPK models are also called biologically based tissue dosimetry models. PBPK models are increasingly used in risk assessments, primarily to predict the concentration of potentially toxic moieties of a chemical that will be delivered to any given target tissue following various combinations of route, dose level, and test species (Clewell and Andersen 1985). Physiologically based pharmacodynamic (PBPD) models use mathematical descriptions of the dose-response function to quantitatively describe the relationship between target tissue dose and toxic end points.

PBPK/PD models refine our understanding of complex quantitative dose behaviors by helping to delineate and characterize the relationships between: (1) the external/exposure concentration and target tissue dose of the toxic moiety, and (2) the target tissue dose and observed responses (Andersen et al. 1987; Andersen and Krishnan 1994). These models are biologically and mechanistically based and can be used to extrapolate the pharmacokinetic behavior of chemical substances from high to low dose, from route to route, between species, and between subpopulations within a species. The biological basis of PBPK models results in more meaningful extrapolations than those generated with the more conventional use of uncertainty factors.

The PBPK model for a chemical substance is developed in four interconnected steps: (1) model representation, (2) model parametrization, (3) model simulation, and (4) model validation (Krishnan and Andersen 1994). In the early 1990s, validated PBPK models were developed for a number of

3. HEALTH EFFECTS

toxicologically important chemical substances, both volatile and nonvolatile (Krishnan and Andersen 1994; Leung 1993). PBPK models for a particular substance require estimates of the chemical substance-specific physicochemical parameters, and species-specific physiological and biological parameters. The numerical estimates of these model parameters are incorporated within a set of differential and algebraic equations that describe the pharmacokinetic processes. Solving these differential and algebraic equations provides the predictions of tissue dose. Computers then provide process simulations based on these solutions.

The structure and mathematical expressions used in PBPK models significantly simplify the true complexities of biological systems. If the uptake and disposition of the chemical substance(s) are adequately described, however, this simplification is desirable because data are often unavailable for many biological processes. A simplified scheme reduces the magnitude of cumulative uncertainty. The adequacy of the model is, therefore, of great importance, and model validation is essential to the use of PBPK models in risk assessment.

PBPK models improve the pharmacokinetic extrapolations used in risk assessments that identify the maximal (i.e., the safe) levels for human exposure to chemical substances (Andersen and Krishnan 1994). PBPK models provide a scientifically sound means to predict the target tissue dose of chemicals in humans who are exposed to environmental levels (for example, levels that might occur at hazardous waste sites) based on the results of studies where doses were higher or were administered in different species. Figure 3-5 shows a conceptualized representation of a PBPK model.

PBPK models have not been developed for bromoform or dibromochloromethane. da Silva et al. (1999) developed a model to simulate the venous blood concentration of each trihalomethane after simultaneous exposure to the four trihalomethanes. This model, which simulates competitive inhibition of hepatic metabolism, is discussed in Section 3.9. Although da Silva et al. (1999) also described models in rats following single administration of bromoform or dibromochloromethane, these models involved optimizing metabolic parameters across the dose range used in the study and were not developed as stand-alone models.

3. HEALTH EFFECTS

Figure 3-5. Conceptual Representation of a Physiologically Based Pharmacokinetic (PBPK) Model for a Hypothetical Chemical Substance

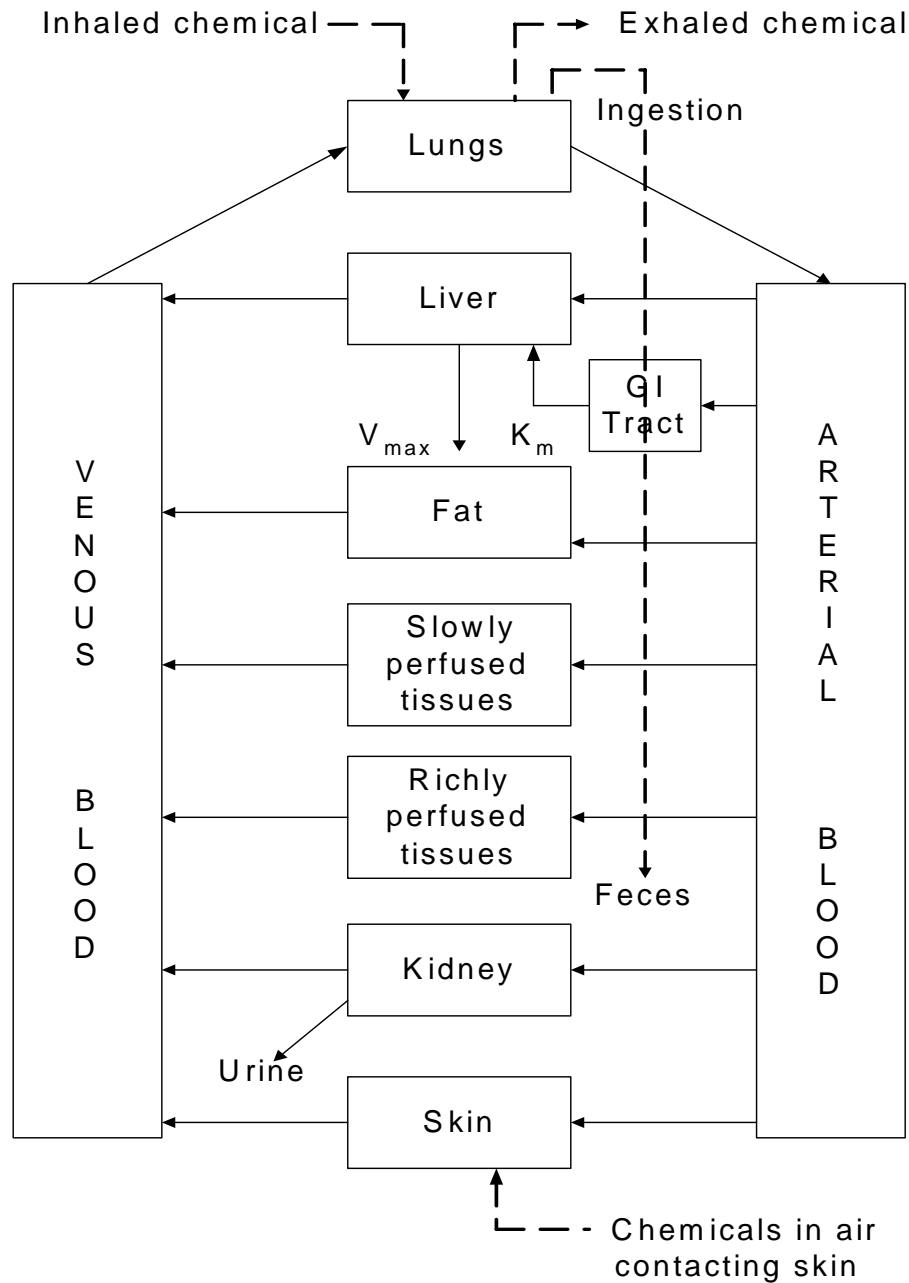

Source: adapted from Krishnan et al. 1994

Note: This is a conceptual representation of a physiologically based pharmacokinetic (PBPK) model for a hypothetical chemical substance. The chemical substance is shown to be absorbed via the skin, by inhalation, or by ingestion, metabolized in the liver, and excreted in the urine or by exhalation.

3. HEALTH EFFECTS

3.5 MECHANISMS OF ACTION**3.5.1 Pharmacokinetic Mechanisms**

Bromoform and dibromochloromethane can be absorbed by inhalation (Graham 1915; Merzbach 1928), ingestion (Backer et al. 2000; Mink et al. 1986), and dermal (Backer et al. 2000; Xu et al. 2002) routes of exposure. In humans and laboratory animals, bromoform and dibromochloromethane are generally absorbed quickly (Backer et al. 2000). Although bromoform and dibromochloromethane are lipophilic, they do not appear to accumulate in adipose tissue (Stanley 1986). Bromoform and dibromochloromethane are thought to be metabolized by at least two route-independent pathways: oxidation by cytochrome P-450 mixed function oxidase system (Ahmed et al. 1977; Anders et al. 1978) and conjugation via glutathione S-transferase (DeMarini et al. 1997; Pegram et al. 1977). Bromoform and dibromochloromethane are primarily excreted via exhalation as the parent compound or carbon dioxide (Mink et al. 1986).

3.5.2 Mechanisms of Toxicity

The mechanisms by which bromoform and dibromochloromethane cause damage in target tissues is not fully understood, but there is strong evidence that metabolism to reactive intermediates is a prerequisite for toxicity. Subsequent interaction of the reactive intermediates with key cellular molecules leads to impaired function and/or cell death.

Several mechanisms for cell injury by trihalomethanes have been proposed based on the combined experimental database for chloroform and the brominated trihalomethanes. These include: (1) oxidative metabolism by CYP2E1 to produce dihalocarbonyls, which deplete glutathione content, and alkylate cellular macromolecules to produce necrosis; (2) reductive dehalogenation under conditions of low physiological oxygen tension to produce highly reactive dihalomethyl free radicals that covalently bind to proteins or lipids; and (3) glutathione-dependent metabolism to DNA-reactive intermediates, which results in adduct formation and mutation. Toxicity of bromoform and dibromochloromethane may result from metabolism by one or more of these pathways. Bromine is generally a better leaving group than chlorine, suggesting that the degree of bromine substitution will influence the rate of metabolism among chlorinated and brominated trihalomethanes and the flux through specific pathways.

3. HEALTH EFFECTS

Although mechanistic data on bromoform and dibromochloromethane are lacking, the requirement for metabolism of these compounds to toxic intermediates is supported by studies of chloroform and bromodichloromethane. In a representative study, Ilett et al. (1973) observed covalent binding of radiolabeled material to proteins in the liver and kidney following administration of [^{14}C]chloroform to mice. The amount of binding was correlated with the extent of renal and hepatic necrosis both in normal animals and in male mice pretreated with an inhibitor or inducer of microsomal enzymes. Autoradiograms showed that the bound radioactivity was located mainly in necrotic lesions. In other studies, Brown et al. (1974) reported that pretreatment of rats with phenobarbital (a cytochrome P-450 inducer) resulted in increased formation of covalent adducts and increased hepatic toxicity following chloroform exposure. Pohl et al. (1980) reported that the level of covalent binding correlated directly with injury to the liver tissue and concluded that phosgene was the metabolite responsible for the covalent binding to liver macromolecules. Tyson et al. (1983) confirmed that covalent binding to proteins in rats was more prevalent in areas of necrosis than in less damaged areas. More recently, Constan et al. (1999) evaluated toxicity in male B6C3F₁, SV/129 wild-type (CYP2E1 +/+), and SV/129 null (CYP2E1 -/-) mice exposed to chloroform by inhalation. Parallel groups of control and treated mice (B6C3F₁ and wild-type SV/129) were also treated with an irreversible cytochrome P-450 inhibitor. Extensive hepatic and renal necrosis occurred in B6C3F₁ and SV/129 mice exposed to chloroform. Chloroform-exposed animals that received the inhibitor were completely protected against hepatic and renal toxicity and pathological changes were absent in null mice, demonstrating that metabolism is necessary for toxicity.

The data linking metabolism of brominated trihalomethanes to toxicity are less extensive than those for chloroform. No data were located specifically for bromoform or dibromochloromethane. Pretreatment of female rats and mice with inhibitors of CYP2E1 metabolism reduced the acute renal and hepatic toxicity of bromodichloromethane (Thornton-Manning et al. 1994). Depletion of glutathione by pretreatment of male F344 rats with butathione sulfoximine (BSO) increased the incidence and severity of hepatic and renal lesions (Gao et al. 1996). Addition of glutathione to hepatic microsomal and S9 preparations and renal microsomes under aerobic conditions decreased covalent binding of [^{14}C]bromodichloromethane to proteins. Addition of glutathione to hepatic or renal microsomes under anaerobic conditions decreased binding of [^{14}C]bromodichloromethane to lipids (Gao et al. 1996). These data demonstrate a protective role of glutathione that is consistent with metabolism of bromodichloromethane to one or more reactive species.

Studies in animals indicate that bromoform and dibromochloromethane have carcinogenic potential (NTP 1985, 1989a). The mechanism of action for tumor induction by these chemicals is unknown and may

3. HEALTH EFFECTS

involve contributions from more than one of the proposed pathways described above. Pathway 1 (oxidative metabolism to dihalocarbonyl) may not be directly genotoxic, but may lead to increased risk of cancer as a result of cytotoxicity and subsequent regenerative hyperplasia, as observed for chloroform (ILSI 1997). Pathways 2 (reductive metabolism) and 3 (glutathione-dependent metabolism) may lead to direct DNA damage *in vivo*. The relative contribution of these pathways to the carcinogenic potential of bromoform and dibromochloromethane has not been determined.

Three studies have examined cytotoxicity and regenerative hyperplasia in the liver of female B6C3F₁ mice (Coffin et al. 2000; Melnick et al. 1998) or the kidney of male F344 rats (Potter et al. 1996) following exposure to bromoform or dibromochloromethane. These studies are of limited use for understanding the mechanism of bromoform carcinogenesis because they do not address cytotoxicity or regeneration in the large intestine, the target tissue for tumor induction. Dibromochloromethane induced cytotoxicity and cell proliferation in the liver of female B6C3F₁ mice, but the LOAEL values reported by Melnick et al. (1998) and Coffin et al. (2000) were inconsistent (400 vs. 100 mg/kg/day). Therefore, a threshold for induction of cellular proliferation cannot be clearly identified for comparison with the liver tumor incidence data in female B6C3F₁ mice (NTP 1985). The reason for the discrepancy between studies is unknown, but might be related to the use of different techniques or different time points for measurement of labeling index (a method for estimating cell proliferation). These data do not allow a conclusion regarding the role of cytotoxicity and regenerative cell proliferation in the development of hepatic tumors in mice exposed to dibromochloromethane. Melnick et al. (1998) modeled dose response data for cell proliferation and serum enzyme activity (as a composite) and for tumor induction in the liver of B6C3F₁ mice using an empirical Hill equation model. The dose-response curves for these processes had different shapes, suggesting that they were not causally associated.

Positive results for mutagenicity and cytogenetic damage have been observed in some standard assays (see Section 3.3), suggesting that some metabolites of bromoform and dibromochloromethane interact directly with DNA. Reductive metabolism (Melnick et al. 1998) and glutathione conjugation of brominated trihalomethanes have been proposed as a source of DNA reactive intermediates (De Marini et al. 1997; Ross and Pegram 2003), but the available data are too limited to fully evaluate the contribution of these pathways to the genotoxicity and carcinogenicity of bromoform and dibromochloromethane. Studies of bromodichloromethane metabolism in hepatic cytosols prepared from rat, mouse, and liver microsomes suggest that metabolism of brominated trihalomethanes via a glutathione-dependent pathway is likely to be a minor pathway in the liver (Ross and Pegram 2003). It is unknown whether the small amounts formed in the liver are toxicologically significant. It is possible that glutathione-dependent

3. HEALTH EFFECTS

pathways are of greater toxicological significance in extrahepatic tissues where concentrations of CYP2E1 are lower, such as the distal large intestine (Ross and Pegram 2003).

3.5.3 Animal-to-Human Extrapolations

Most of the available data on the toxicity and toxicokinetic properties of bromoform and dibromochloromethane come from studies in rats and mice. There are very limited human data, and the only end point that has been examined is neurotoxicity; high doses of bromoform result in central nervous system depression in humans and laboratory animals. Data from other trihalomethanes, particularly chloroform (Agency for Toxic Substances and Disease Registry 1997), suggest that the available laboratory animal toxicity and toxicokinetic data for bromoform and dibromochloromethane would also be applicable for humans. A potential difference between species is quantitative and qualitative differences in Phase I metabolism of trihalomethanes. In rats, trihalomethanes are substrates of cytochrome P-450 enzyme isoforms CYP2E1, CYP2B1, CYP2B2, and CYP1A2 (Allis et al. 2001; Pankow et al. 1997). CYP2E1 and CYP1A2 are also expressed in human tissues; however, the relevance of metabolism by CYP2B1/2 to human health is presently uncertain, since these isoforms have not been reported in human adult or fetal tissues (Juchau et al. 1998; Nelson et al. 1996). CYP2B6 is the only active member of the CYP2B subfamily in man, although the CYP2B7 gene has also been found in the genome (Czerwinski et al. 1994).

3.6 TOXICITIES MEDIATED THROUGH THE NEUROENDOCRINE AXIS

Recently, attention has focused on the potential hazardous effects of certain chemicals on the endocrine system because of the ability of these chemicals to mimic or block endogenous hormones. Chemicals with this type of activity are most commonly referred to as *endocrine disruptors*. However, appropriate terminology to describe such effects remains controversial. The terminology *endocrine disruptors*, initially used by Colborn and Clement (1992), was also used in 1996 when Congress mandated the EPA to develop a screening program for "...certain substances [which] may have an effect produced by a naturally occurring estrogen, or other such endocrine effect[s]...". To meet this mandate, EPA convened a panel called the Endocrine Disruptors Screening and Testing Advisory Committee (EDSTAC), and in 1998, the EDSTAC completed its deliberations and made recommendations to EPA concerning *endocrine disruptors*. In 1999, the National Academy of Sciences released a report that referred to these same types of chemicals as *hormonally active agents*. The terminology *endocrine modulators* has also been used to

3. HEALTH EFFECTS

convey the fact that effects caused by such chemicals may not necessarily be adverse. Many scientists agree that chemicals with the ability to disrupt or modulate the endocrine system are a potential threat to the health of humans, aquatic animals, and wildlife. However, others think that endocrine-active chemicals do not pose a significant health risk, particularly in view of the fact that hormone mimics exist in the natural environment. Examples of natural hormone mimics are the isoflavonoid phytoestrogens (Adlercreutz 1995; Livingston 1978; Mayr et al. 1992). These chemicals are derived from plants and are similar in structure and action to endogenous estrogen. Although the public health significance and descriptive terminology of substances capable of affecting the endocrine system remains controversial, scientists agree that these chemicals may affect the synthesis, secretion, transport, binding, action, or elimination of natural hormones in the body responsible for maintaining homeostasis, reproduction, development, and/or behavior (EPA 1997). Stated differently, such compounds may cause toxicities that are mediated through the neuroendocrine axis. As a result, these chemicals may play a role in altering, for example, metabolic, sexual, immune, and neurobehavioral function. Such chemicals are also thought to be involved in inducing breast, testicular, and prostate cancers, as well as endometriosis (Berger 1994; Giwercman et al. 1993; Hoel et al. 1992).

No *in vitro* studies were located regarding endocrine disruption of bromoform and dibromochloromethane.

There is little evidence to suggest that bromoform or dibromochloromethane has the potential to disrupt the normal functioning of the neuroendocrine axis. There are some suggestive data that these chemicals have the potential to alter reproductive hormone levels. An ecological study found significant correlations between bromoform and dibromochloromethane concentrations in drinking water and alterations in menstrual cycle length (Windham et al. 2003); however, the women were exposed to a number of other potentially toxic compounds in the drinking water and the data are inadequate for establishing causality. In rats administered 310–380 mg/kg/day bromoform or dibromochloromethane, significant decreases in serum testosterone levels were observed (Potter 1996).

3.7 CHILDREN'S SUSCEPTIBILITY

This section discusses potential health effects from exposures during the period from conception to maturity at 18 years of age in humans, when all biological systems will have fully developed. Potential effects on offspring resulting from exposures of parental germ cells are considered, as well as any indirect

3. HEALTH EFFECTS

effects on the fetus and neonate resulting from maternal exposure during gestation and lactation.

Relevant animal and *in vitro* models are also discussed.

Children are not small adults. They differ from adults in their exposures and may differ in their susceptibility to hazardous chemicals. Children's unique physiology and behavior can influence the extent of their exposure. Exposures of children are discussed in Section 6.6, Exposures of Children.

Children sometimes differ from adults in their susceptibility to hazardous chemicals, but whether there is a difference depends on the chemical (Guzelian et al. 1992; NRC 1993). Children may be more or less susceptible than adults to health effects, and the relationship may change with developmental age (Guzelian et al. 1992; NRC 1993). Vulnerability often depends on developmental stage. There are critical periods of structural and functional development during both prenatal and postnatal life and a particular structure or function will be most sensitive to disruption during its critical period(s). Damage may not be evident until a later stage of development. There are often differences in pharmacokinetics and metabolism between children and adults. For example, absorption may be different in neonates because of the immaturity of their gastrointestinal tract and their larger skin surface area in proportion to body weight (Morselli et al. 1980; NRC 1993); the gastrointestinal absorption of lead is greatest in infants and young children (Ziegler et al. 1978). Distribution of xenobiotics may be different; for example, infants have a larger proportion of their bodies as extracellular water and their brains and livers are proportionately larger (Altman and Dittmer 1974; Fomon 1966; Fomon et al. 1982; Owen and Brozek 1966; Widdowson and Dickerson 1964). The infant also has an immature blood-brain barrier (Adinolfi 1985; Johanson 1980) and probably an immature blood-testis barrier (Setchell and Waites 1975). Many xenobiotic metabolizing enzymes have distinctive developmental patterns. At various stages of growth and development, levels of particular enzymes may be higher or lower than those of adults, and sometimes unique enzymes may exist at particular developmental stages (Komori et al. 1990; Leeder and Kearns 1997; NRC 1993; Vieira et al. 1996). Whether differences in xenobiotic metabolism make the child more or less susceptible also depends on whether the relevant enzymes are involved in activation of the parent compound to its toxic form or in detoxification. There may also be differences in excretion, particularly in newborns who all have a low glomerular filtration rate and have not developed efficient tubular secretion and resorption capacities (Altman and Dittmer 1974; NRC 1993; West et al. 1948). Children and adults may differ in their capacity to repair damage from chemical insults. Children also have a longer remaining lifetime in which to express damage from chemicals; this potential is particularly relevant to cancer.

3. HEALTH EFFECTS

Certain characteristics of the developing human may increase exposure or susceptibility, whereas others may decrease susceptibility to the same chemical. For example, although infants breathe more air per kilogram of body weight than adults breathe, this difference might be somewhat counterbalanced by their alveoli being less developed, which results in a disproportionately smaller surface area for alveolar absorption (NRC 1993).

There are limited data on the toxicity of bromoform and dibromochloromethane. In the early 1900s, bromoform was used as a sedative for the treatment of whooping cough (Benson 1907; Burton-Fanning 1901; Dwelle 1903; Stokes 1900; von Oettingen 1955). Sedation was observed at the prescribed dosage; higher doses often resulted in central nervous system depression. Central nervous system depression has also been observed in adult animals following oral exposure to bromoform (Bowman et al. 1978; NTP 1989a) or dibromochloromethane (Bowman et al. 1978; NTP 1985). There is no indication that children are more susceptible than adults to this effect.

Animal data provide strong evidence that the liver is the critical target of bromoform and dibromochloromethane toxicity (Aida et al. 1992; Coffin et al. 2000; Condie et al. 1983; NTP 1985, 1989a; Tobe et al. 1982). These animal studies were conducted in adults and no animal studies using juveniles were located. The available data suggest that the hepatotoxicity of bromoform and dibromochloromethane is due to tissue damage from reactive intermediates that are generated during metabolism. In rats, trihalomethanes are substrates for several cytochrome P-450 enzyme isoforms, including CYP2E1, CYP2B1, CYP2B2, and CYP1A2 (Allis et al. 2001; Pankow et al. 1997) in Phase I reactions and glutathione S-transferase theta (GSTT) (DeMarini et al. 1997; Pegram et al. 1987; Ross and Pegram 2003) in Phase II reactions. As discussed in EPA (2001a), CYP2E1 levels increase rapidly during the first 24 hours after birth and levels in children between 1 and 10 years of age are similar to those in adults. Similarly, GSTT levels in children older than 1 year are similar to adults. These data provide some suggestive evidence that exposure during early childhood would result in the formation of similar reactive intermediates and metabolites as in adults.

The potential of bromoform and dibromochloromethane to induce developmental effects cannot be conclusively established from the existing database. A significant alteration in the occurrence of sternebra aberrations were observed in the offspring of rats administered 200 mg/kg/day bromoform in corn oil during gestation (Ruddick et al. 1983). A similar exposure to dibromochloromethane did not result in any significant alterations. Similarly, no developmental alterations were observed in mouse

3. HEALTH EFFECTS

offspring exposed to 685 mg/kg/day dibromochloromethane in drinking water for several generations (Borzelleca and Carchman 1982).

There are no specific biomarkers of exposure or effect for bromoform or dibromochloromethane that have been validated in children or adults exposed as children. No studies were located regarding interactions of bromoform or dibromochloromethane with other chemicals in children. Additionally, there are no pediatric-specific methods of reducing peak absorption or reducing body burden following exposure to bromoform or dibromochloromethane. In the absence of these data, it is assumed that there are no age-related differences in biomarkers, interactions, or mitigation of effects.

3.8 BIOMARKERS OF EXPOSURE AND EFFECT

Biomarkers are broadly defined as indicators signaling events in biologic systems or samples. They have been classified as markers of exposure, markers of effect, and markers of susceptibility (NAS/NRC 1989).

Due to a nascent understanding of the use and interpretation of biomarkers, implementation of biomarkers as tools of exposure in the general population is very limited. A biomarker of exposure is a xenobiotic substance or its metabolite(s) or the product of an interaction between a xenobiotic agent and some target molecule(s) or cell(s) that is measured within a compartment of an organism (NAS/NRC 1989). The preferred biomarkers of exposure are generally the substance itself or substance-specific metabolites in readily obtainable body fluid(s) or excreta. However, several factors can confound the use and interpretation of biomarkers of exposure. The body burden of a substance may be the result of exposures from more than one source. The substance being measured may be a metabolite of another xenobiotic substance (e.g., high urinary levels of phenol can result from exposure to several different aromatic compounds). Depending on the properties of the substance (e.g., biologic half-life) and environmental conditions (e.g., duration and route of exposure), the substance and all of its metabolites may have left the body by the time samples can be taken. It may be difficult to identify individuals exposed to hazardous substances that are commonly found in body tissues and fluids (e.g., essential mineral nutrients such as copper, zinc, and selenium). Biomarkers of exposure to bromoform and dibromochloromethane are discussed in Section 3.8.1.

Biomarkers of effect are defined as any measurable biochemical, physiologic, or other alteration within an organism that, depending on magnitude, can be recognized as an established or potential health

3. HEALTH EFFECTS

impairment or disease (NAS/NRC 1989). This definition encompasses biochemical or cellular signals of tissue dysfunction (e.g., increased liver enzyme activity or pathologic changes in female genital epithelial cells), as well as physiologic signs of dysfunction such as increased blood pressure or decreased lung capacity. Note that these markers are not often substance specific. They also may not be directly adverse, but can indicate potential health impairment (e.g., DNA adducts). Biomarkers of effects caused by bromoform and dibromochloromethane are discussed in Section 3.8.2.

A biomarker of susceptibility is an indicator of an inherent or acquired limitation of an organism's ability to respond to the challenge of exposure to a specific xenobiotic substance. It can be an intrinsic genetic or other characteristic or a preexisting disease that results in an increase in absorbed dose, a decrease in the biologically effective dose, or a target tissue response. If biomarkers of susceptibility exist, they are discussed in Section 3.10 "Populations that are Unusually Susceptible."

3.8.1 Biomarkers Used to Identify or Quantify Exposure to Bromoform and Dibromochloromethane

The most straightforward means of identifying exposure to bromoform or dibromochloromethane in a person is measurement of parent compound in blood or expired air. Sensitive and specific gas chromatographic-mass spectrophotometric methods available for this purpose are described in Section 7.1. Quantification of exposure is complicated by the relatively rapid clearance rate of these compounds from the body, both by exhalation and metabolic breakdown. Data are not available on clearance rates in humans, but in animals, clearance of parent is nearly complete within 8 hours (see Section 3.4.4). Consequently, this approach is best suited for detecting recent exposures (within 1–2 days).

No data are available on blood or breath levels of bromoform or dibromochloromethane in acutely exposed individuals. However, studies involving exposure to trihalomethanes in water have found elevated alveolar air levels of dibromochloromethane following a 1-hour exposure to volatilized trihalomethanes from swimming pool water (Aggazzotti et al. 1998) and elevated blood bromoform and dibromochloromethane levels following a 10-minute shower or 10-minute bath (Backer et al. 2000). Background concentrations in people not exposed to bromoform or dibromochloromethane except through chlorinated drinking water are about 0.6 ppb (Antoine et al. 1986), while levels in expired breath are undetectable (Wallace et al. 1986a, 1986b). In a study of blood trihalomethane concentrations in women living in areas with trihalomethane in tap water (Miles et al. 2002), a simple linear relationship

3. HEALTH EFFECTS

between blood levels and tap water levels of trihalomethanes was not found. For bromoform and dibromochloromethane, no significant correlations were found between tap water levels of these compounds and blood levels before showering. After showering, a significant correlation between bromoform levels in the tap water and blood levels were found; however, the correlation coefficient (0.450) is relatively low, suggesting that a number of variables affected blood bromoform levels. Although bromoform and dibromochloromethane are lipophilic, they do not appear to accumulate in adipose tissue (Stanley 1986), so measurement of parent levels in this tissue is not likely to be valuable as a biomarker of exposure.

The principal metabolites of bromoform and dibromochloromethane are CO_2 , CO , Cl^- , and Br^- . None of these metabolites are sufficiently specific to be useful as a biomarker of exposure. It is suspected that reactive intermediates formed during metabolism may produce covalent adducts with proteins or other cellular macromolecules (see Section 3.4.3), but these putative adducts have not been identified nor has any means for their quantification been developed.

3.8.2 Biomarkers Used to Characterize Effects Caused by Bromoform and Dibromochloromethane

There are limited data on the toxicity of bromoform and dibromochloromethane in humans. Exposure to bromoform can result in sedation; it is likely that the same is true for dibromochloromethane. However, generalized central nervous system depression is too nonspecific to be useful as a biomarker of effects from bromoform or dibromochloromethane exposure. Studies in animals indicate the liver and the kidneys are also affected, resulting in fatty liver, increased serum enzyme levels, and nephrosis. Effects on liver and kidney can be evaluated using a variety of laboratory and clinical tests (CDC/ATSDR 1990), but these are also too nonspecific to be valuable in recognizing early effects caused by low level exposure to these two chemicals.

3.9 INTERACTIONS WITH OTHER CHEMICALS

It is well-known that exposure to alcohols, ketones, and a variety of other substances can dramatically increase the acute toxicity of halomethanes such as carbon tetrachloride (Agency for Toxic Substances and Disease Registry 1994) and chloroform (Agency for Toxic Substances and Disease Registry 1997).

3. HEALTH EFFECTS

Several studies have been performed to determine if the toxic effects of bromoform and dibromochloromethane are similarly affected by these agents.

Hewitt et al. (1983) found that pretreatment of rats with a single oral dose of acetone resulted in a 10–40-fold potentiation of the hepatotoxic effects of a single oral dose of dibromochloromethane given 18 hours later. Similarly, pretreatment of rats for one to three days with chlordecone resulted in a 7–60-fold potentiation of the hepatotoxic effects of a single oral dose of dibromochloromethane (Plaa and Hewitt 1982a, 1982b). In contrast, chlordecone pretreatment had relatively little potentiating effect on the hepatotoxicity of bromoform (Agarwal and Mehendale 1983; Plaa and Hewitt 1982a).

The mechanism by which chemicals such as acetone and chlordecone potentiate halomethane toxicity is not known, but it is generally considered that at least some of the effect is due to stimulation of metabolic pathways that yield toxic intermediates. If so, the findings above support the hypothesis that the toxicity of dibromochloromethane is mediated at least in part by metabolic generation of reactive intermediates, but that metabolism is relatively less important in bromoform toxicity.

Harris et al. (1982) found that exposure of rats to a combination of bromoform and carbon tetrachloride resulted in more liver injury (judged by release of hepatic enzymes into serum) than would be predicted by the effects of each chemical acting alone. The mechanism of this interaction is not certain, but may be related to dihalocarbonyl formation and lipid peroxidation (Harris et al. 1982).

A PBPK model has been developed by da Silva et al. (1999) that examined the influence of exposure to a mixture of trihalomethanes (bromoform, dibromochloromethane, dichlorobromomethane, and chloroform) on the kinetics of individual compounds. When all four trihalomethanes were administered together (1.0 mmol/kg), the area under the blood concentration versus time curve was significantly higher as compared to the AUC after administration of a single compound (0.25 mmol/kg). For bromoform and dibromochloromethane, the AUCs after the single 0.25 mmol/kg dose were 48.6 and 31.2 $\mu\text{M}/\text{hour}$ and after the 1.0 mmol/kg mixture of trihalomethanes, the AUCs were 127.3 and 128.6 $\mu\text{M}/\text{hour}$. These data suggest that there is metabolic interaction between the trihalomethanes; likely competitive inhibition of hepatic metabolism.

3. HEALTH EFFECTS

3.10 POPULATIONS THAT ARE UNUSUALLY SUSCEPTIBLE

A susceptible population will exhibit a different or enhanced response to bromoform or dibromochloromethane than will most persons exposed to the same level of bromoform or dibromochloromethane in the environment. Reasons may include genetic makeup, age, health and nutritional status, and exposure to other toxic substances (e.g., cigarette smoke). These parameters result in reduced detoxification or excretion of bromoform or dibromochloromethane, or compromised function of organs affected by bromoform or dibromochloromethane. Populations who are at greater risk due to their unusually high exposure to bromoform or dibromochloromethane are discussed in Section 6.7, Populations with Potentially High Exposures.

Studies of bromoform and dibromochloromethane toxicity in animals suggest that there may be some quantitative and qualitative differences in susceptibility between sexes and between species (see Section 3.2). The mechanistic basis for these differences is not known, but one likely factor is sex and species-dependent differences in metabolism (see Section 3.4.3). Thus, it is reasonable to assume that differences in susceptibility could exist between humans as a function of sex, age, or other metabolism-influencing factors. Studies in animals (discussed in Section 3.9) also suggest that humans exposed to alcohols, ketones, or other drugs (e.g., barbiturates, anticoagulants) that influence halomethane metabolism might be more susceptible to the toxic effect of dibromochloromethane and perhaps bromoform as well. Persons with existing renal or hepatic disease might also be more susceptible, since these organs are adversely affected by exposure to bromoform and dibromochloromethane. The elderly may represent an unusually susceptible population because they may have age-related deficiencies of liver and kidney function. They may also be frequently exposed to metabolism-influencing medications.

3.11 METHODS FOR REDUCING TOXIC EFFECTS

This section will describe clinical practice and research concerning methods for reducing toxic effects of exposure to bromoform or dibromochloromethane. However, because some of the treatments discussed may be experimental and unproven, this section should not be used as a guide for treatment of exposures to bromoform or dibromochloromethane. When specific exposures have occurred, poison control centers and medical toxicologists should be consulted for medical advice. The following texts provide specific information about treatment following exposures to bromoform or dibromochloromethane:

3. HEALTH EFFECTS

Haddad LM, Shannon MW, Winchester JF, eds. 1998. *Clinical management of poisoning and drug overdose*. Philadelphia, PA: W.B. Saunders Co., 913-939, 992-1000.

Viccellio P, ed. 1998. *Emergency toxicology*. Philadelphia, PA: Lippincott-Raven Publishers, 925-932.

3.11.1 Reducing Peak Absorption Following Exposure

Human exposure to bromoform or dibromochloromethane may occur by inhalation, ingestion, or dermal contact. General recommendations for reducing absorption of these chemicals include removing the exposed individual from the contaminated area and removing the contaminated clothing. If the eyes and skin were exposed, they should be flushed with water. In order to reduce absorption of ingested bromoform and dibromochloromethane, emesis may be considered unless the patient is comatose, is convulsing, or has lost the gag reflex. Controversy exists concerning use of emesis because of the rapid onset of central nervous system depression, the risk of aspiration of stomach contents into the lungs, and the relative ineffectiveness of this method. In comatose patients with absent gag reflexes, an endotracheal intubation may be performed in advance to reduce the risk of aspiration pneumonia. Gastric lavage may also be used.

3.11.2 Reducing Body Burden

Trihalomethanes levels in human blood have a short half-life of approximately 0.5 hours (Lynberg et al. 2001). Bromoform or dibromochloromethane were not stored to any appreciable extent in the rat and were mostly metabolized to CO₂ (see Section 3.4). The elimination half-life of bromoform was reported to be 0.8 hours in the rat and 8 hours in the mouse (Mink et al. 1986). The half-lives of dibromochloromethane were 1.2 and 2.5 hours in rats and mice, respectively (Mink et al. 1986). Despite an expected relatively fast clearance of from the body, toxic effects may develop in exposed individuals. No method is commonly practiced to enhance the elimination of the absorbed dose of bromoform or dibromochloromethane.

3.11.3 Interfering with the Mechanism of Action for Toxic Effects

The primary targets of bromoform and dibromochloromethane are the liver, kidneys, and central nervous system. It is believed that the mechanism of bromoform and dibromochloromethane toxicity to the liver and kidneys involves metabolism to reactive intermediates. No methods for interfering with the

3. HEALTH EFFECTS

mechanism of action have been developed for these compounds. Studies using two other trihalomethanes (chloroform and dichlorobromomethane) provide suggestive evidence that administration of agents which inhibit cytochrome P-450 decreases hepatotoxicity. Co-administration of chloroform and 1-aminobenzotriazole (an irreversible cytochrome P-450 inhibitor) (Constan et al. 1999) or dibromochloromethane and a CYP2E1 inhibitor (Thornton-Manning et al. 1994) resulted a reduction of acute hepatic and renal toxicity.

3.12 ADEQUACY OF THE DATABASE

Section 104(i)(5) of CERCLA, as amended, directs the Administrator of ATSDR (in consultation with the Administrator of EPA and agencies and programs of the Public Health Service) to assess whether adequate information on the health effects of bromoform or dibromochloromethane is available. Where adequate information is not available, ATSDR, in conjunction with the National Toxicology Program (NTP), is required to assure the initiation of a program of research designed to determine the health effects (and techniques for developing methods to determine such health effects) of bromoform or dibromochloromethane.

The following categories of possible data needs have been identified by a joint team of scientists from ATSDR, NTP, and EPA. They are defined as substance-specific informational needs that if met would reduce the uncertainties of human health assessment. This definition should not be interpreted to mean that all data needs discussed in this section must be filled. In the future, the identified data needs will be evaluated and prioritized, and a substance-specific research agenda will be proposed.

3.12.1 Existing Information on Health Effects of Bromoform and Dibromochloromethane

The existing data on health effects of inhalation, oral, and dermal exposure of humans and animals to bromoform and dibromochloromethane are summarized in Figures 3-6 and 3-7, respectively. The purpose of this figure is to illustrate the existing information concerning the health effects of bromoform or dibromochloromethane. Each dot in the figure indicates that one or more studies provide information associated with that particular effect. The dot does not necessarily imply anything about the quality of the study or studies, nor should missing information in this figure be interpreted as a "data need". A data need, as defined in ATSDR's Decision Guide for Identifying Substance-Specific Data Needs Related to Toxicological Profiles (Agency for Toxic Substances and Disease Registry 1989), is substance-specific

3. HEALTH EFFECTS

Figure 3-6. Existing Information on Health Effects of Bromoform

		Systemic									
		Death	Acute	Intermediate	Chronic	Immunologic/Lymphoretic	Neurologic	Reproductive	Developmental	Genotoxic	Cancer
Inhalation											
Oral	●					●					
Dermal											

Human

		Systemic									
		Death	Acute	Intermediate	Chronic	Immunologic/Lymphoretic	Neurologic	Reproductive	Developmental	Genotoxic	Cancer
Inhalation	●	●	●			●					
Oral	●	●	●	●	●	●	●	●	●	●	●
Dermal											

Animal

● Existing Studies

3. HEALTH EFFECTS

Figure 3-7. Existing Information on Health Effects of Dibromochloromethane

	Systemic									
	Death	Acute	Intermediate	Chronic	Immunologic/Lymphoretic	Neurologic	Reproductive	Developmental	Genotoxic	Cancer
Inhalation										
Oral										
Dermal										

Human

	Systemic									
	Death	Acute	Intermediate	Chronic	Immunologic/Lymphoretic	Neurologic	Reproductive	Developmental	Genotoxic	Cancer
Inhalation										
Oral	●	●	●	●	●	●	●	●	●	●
Dermal										

Animal

● Existing Studies

3. HEALTH EFFECTS

information necessary to conduct comprehensive public health assessments. Generally, ATSDR defines a data gap more broadly as any substance-specific information missing from the scientific literature.

As shown in Figure 3-6, there are limited data on the toxicity of bromoform following inhalation exposure. No human data were located and laboratory animal studies are limited to lethality studies, which found central nervous system depression, and acute and intermediate duration studies, which are only available as abstracts. Human data on the oral toxicity of bromoform are limited to reports of children taking bromoform for the treatment of whooping cough; effects are limited to death and central nervous system depression and the exposure levels are poorly characterized. A number of laboratory animal studies have examined the oral toxicity of bromoform, and data are available for all end points. However, in many cases, the available data for a particular end point are limited to a single study or use a route of administration (e.g., gavage) that may not be relevant to human environmental exposure to bromoform. The dermal toxicity of bromoform has not been studied in humans or animals.

As shown in Figure 3-7, there are no human toxicity data for dibromochloromethane following inhalation, oral, or dermal exposure. Additionally, there are no laboratory animal data on dibromochloromethane following inhalation or dermal exposure. For the oral route of exposure, data are available for all end points. As noted for bromoform, information on a particular end point comes from a single study, and most studies used a gavage in oil administration route, which may not be relevant for human environmental exposure to dibromochloromethane.

3.12.2 Identification of Data Needs

Acute-Duration Exposure. The available data on the acute toxicity of bromoform in humans are limited to reports of children prescribed bromoform for the treatment of whooping cough. Following ingestion, the children were said to sleep undisturbed through the night, suggestive of sedation (Dwelle 1903); accidental overdoses resulted in symptoms of central nervous system depression (Benson 1907; Burton-Fanning 1901; Dwelle 1903; Stokes 1900; von Oettingen 1955). No human data were located discussing human toxicity following inhalation or dermal exposure to bromoform or after inhalation, oral, or dermal exposure to dibromochloromethane. Inhalation and oral exposure animal studies confirm that high oral doses of bromoform (Balster and Borzelleca 1982; Bowman et al. 1978; Graham 1915; Mertzbach 1928; NTP 1989a) or dibromochloromethane (Balster and Borzelleca 1982; NTP 1985) can result in central nervous system depression. At lower doses, the liver and possibly the kidney appear to be the primary targets of toxicity for both compounds. Nonlethal animal inhalation data are limited to a

3. HEALTH EFFECTS

study published in Russian that found liver and kidney effects in rats (Dykan 1964). The inhalation data are inadequate to define the threshold for these effects or identify the critical target of toxicity; additional inhalation studies that examine a wide range of end points and exposure concentrations would be useful for establishing the critical targets of toxicity of bromoform and dibromochloromethane following inhalation exposure and establishing concentration-response relationships. There is a more extensive database following oral exposure, which allows for the derivation of acute-duration oral MRLs for bromoform and dibromochloromethane. Following oral exposure to bromoform, increases in liver weight (Munson et al. 1982), centrilobular pallor (Condie et al. 1983), and hepatocellular vacuolization and/or swelling (Coffin et al. 2000) have been observed. Other effects of bromoform observed in acute-duration animal studies include mesangial nephrosis (Condie et al. 1983), impaired humoral immune function (Munson et al. 1982), and developmental effects (Ruddick et al. 1983). As with bromoform, the most sensitive effects of dibromochloromethane following acute oral exposure are liver and kidney damage; the liver effects consisted of mottled liver, hepatocellular vacuolization and/or swelling, and increases in SGPT and SGOT levels (Coffin et al. 2000; Condie et al. 1983; Munson et al. 1982; NTP 1985) and kidney effects included mesangial hyperplasia and darkened renal medullae (Condie et al. 1983; NTP 1985). At higher doses, impaired humoral immunity (Munson et al. 1982), decreased body weight gain (NTP 1985; Potter et al. 1996), and decreased serum testosterone levels (Potter et al. 1996) were observed.

No data are available in humans or animals following dermal exposure to bromoform or dibromochloromethane. Contact with concentrated solutions of these chemicals might be expected to produce effects similar to those following ingestion or inhalation, and might also result in skin or eye irritation. Studies on this would be useful, although contact with concentrated bromoform or dibromochloromethane is considered extremely unlikely for members of the general population or residents near waste sites. Studies on the effects of dermal contact with lower levels of the compounds in water or soil would be valuable, since people might be exposed by these routes near waste sites.

Intermediate-Duration Exposure. No human data are available on the intermediate-duration toxicity of bromoform or dibromochloromethane following inhalation, oral, or dermal exposure. Animal data are limited to a study reporting liver and kidney effects in rats exposed to bromoform for 2 months (Dykan 1962); however, this study is currently only available as an abstract. No intermediate-duration animal inhalation exposure data are available for dibromochloromethane. Further studies on the intermediate-duration inhalation toxicity of these compounds would be valuable in assessing human health risks from airborne exposures near waste sites, although available data suggest that exposures in air

3. HEALTH EFFECTS

near such sites are likely to be low. The available intermediate-duration oral exposure animal studies strongly identify the liver as the most sensitive target for bromoform and dibromochloromethane. Hepatocellular vacuolization and/or swelling have been observed at the lowest adverse effect levels (Aida et al. 1992; Daniel et al. 1990; NTP 1985, 1989a). Other effects observed in animals exposed to higher doses of bromoform include lethargy (NTP 1989a), impaired performance on neurobehavioral tests (Balster and Borzelleca 1982), and decreased body weight gain (Aida et al. 1992). Exposure to higher doses of dibromochloromethane also resulted in kidney damage (tubular degeneration and nephropathy) (Daniel et al. 1990; NTP 1985), impaired performance on neurobehavioral tests (Balster and Borzelleca 1982), and impaired fertility (Borzelleca and Carchman 1982). These animal data were considered adequate for derivation of an intermediate MRL for bromoform. An MRL was not derived for dibromochloromethane because the resultant MRL would be higher than the MRL for acute duration exposure. Additional studies using a number of dose levels would provide additional information on the threshold of hepatic toxicity and possible allow for the derivation of an intermediate-duration MRL for dibromochloromethane. There are no data on dermal exposure, and studies on intermediate-duration dermal exposure to the compounds in water or soil would be useful in evaluating human health risk at waste sites

Chronic-Duration Exposure and Cancer. No human studies examining the chronic toxicity of bromoform or dibromochloromethane were located, although a number of studies examining health outcomes in areas with elevated trihalomethanes in tap water have been located. Chronic animal inhalation data are not available for either chemical, and would be useful, especially for dibromochloromethane, since it is significantly more volatile (vapor pressure=76 mmHg) than bromoform (vapor pressure=5 mmHg). Chronic-duration studies that identify the critical targets of toxicity and establish concentration-response relationships would be useful for deriving chronic-duration inhalation MRLs for bromoform and dibromochloromethane. In the absence of such data, extrapolation of observations from the oral route might be possible using appropriate toxicokinetic models. The chronic oral toxicity of bromoform (NTP 1989a; Tobe et al. 1982) and dibromochloromethane (NTP 1985; Tobe et al. 1982) has been investigated in several studies, and the data are sufficient to identify hepatotoxicity as the most sensitive end point and to derive MRL values for both chemicals. However, in both cases, chronic oral MRLs are based on LOAELs for hepatotoxicity, so further studies to define the NOAELs would be helpful in reducing uncertainty in the MRL calculations. No data exist for dermal exposure, and further studies (focusing on exposure in water or soil) would be valuable.

3. HEALTH EFFECTS

The carcinogenic effects of chronic oral exposure to bromoform (NTP 1989a) and dibromochloromethane (NTP 1985) have been investigated in well designed studies in both rats and mice, and the data suggest that both chemicals have carcinogenic potential. However, effects were limited or equivocal in some cases, so additional studies to strengthen the weight of evidence would be valuable. Of particular interest would be studies of the carcinogenic effects when exposure is via drinking water rather than by gavage, since drinking water is the most likely route of human exposure, and exposure by gavage (especially using oil as a medium) may not be a good model for this. Also of value would be studies on the mechanism of carcinogenicity and on the identity of carcinogenic metabolites. For example, studies on methylene chloride and other volatile halocarbons indicate that metabolism via a glutathione pathway may be important in carcinogenicity (e.g., Anderson et al. 1987; Reitz et al. 1989). Studies to determine if dibromochloromethane or bromoform are metabolized by a similar pathway would be helpful in evaluating carcinogenic mechanism and risk.

Genotoxicity. There have been a number of studies that indicate bromoform and dibromochloromethane are genotoxic, both in prokaryotic (LeCurieux et al. 1995; Roldan-Arjona and Pueyo 1993; Simmon and Tardiff 1978; Simmon et al. 1977; Varma et al. 1988) and eukaryotic (Benigni et al. 1993; Fujie et al. 1993; Landi et al. 1999; Matsuoka et al. 1996; McGregor et al. 1991; Morimoto and Koizumi 1983; Nestman and Lee 1985; Sobti 1984; Sofuni et al. 1996) organisms. However, a number of other studies have failed to detect significant genotoxic potential for these compounds (Maddock and Kelly 1980; NTP 1985, 1989a). The basis for this inconsistency is not entirely obvious, but might be related to the efficacy of the test system to activate the parent compound to genotoxic metabolites. Several *in vivo* studies have also found genotoxic effects following exposure to bromoform (Fujie et al. 1990; Morimoto and Koizumi 1983; NTP 1989a) or dibromochloromethane (Fujie et al. 1990; Morimoto and Koizumi 1983), although other studies have not found effects (Hayashi et al. 1988; Potter et al. 1996; Stocker et al. 1996). Further studies to define conditions under which these compounds are and are not genotoxic *in vitro* and *in vivo* may help clarify both the mechanism of genotoxicity and the relevance of this to human health risk. Studies on the genotoxic effects of bromoform and dibromochloromethane on germ cells (sperm or ova) would also be valuable.

Reproductive Toxicity. A number of ecological studies have examined the reproductive toxicity to women ingesting drinking water contaminated with trihalomethanes (Bove et al. 1992, 1995; Dodds et al. 1999; Kramer et al. 1992; Mills et al. 1998; Nieuwenhuijsen et al. 2000; Savitz et al. 1995; Waller et al. 1999). Three of these studies (Kramer et al. 1992; Waller et al. 1999; Windham et al. 2003) measured bromoform and dibromochloromethane levels; however, the contribution of the other trihalomethanes to

3. HEALTH EFFECTS

the observed effects cannot be determined from the existing data. Collectively, the trihalomethane studies provide insufficient evidence to establish a causal relationship between exposure to trihalomethanes and adverse reproductive outcome. Animal data are limited to several studies that examined reproductive tissues for histological alterations or examined reproductive function following oral exposure to either compound. No histological alterations were observed in reproductive tissues following chronic exposure to bromoform (NTP 1989a) or dibromochloromethane (NTP 1985). No significant alterations in reproductive performance or fertility were observed in males or females exposed to bromoform (NTP 1989b). For dibromochloromethane, one study found a marked reduction in fertility at a maternally toxic dose level (Borzelleca and Carchman 1982), but no effects on reproductive performance or fertility were observed at lower doses (NTP 1986). Multigeneration studies involving oral exposure to bromoform and dibromochloromethane would provide useful data on the reproductive potential of these chemicals. Based on the oral studies, it does not seem likely that effects would occur following inhalation or dermal exposure except at very high levels, but inhalation and dermal exposure studies to confirm this important point would be valuable.

Developmental Toxicity. Several ecological studies have examined the relationship between exposure to trihalomethanes in tap water and the birth outcomes (Dodds et al. 1999; Kramer et al. 1992; Savitz et al. 1995). The Kramer et al. (1992) study reported levels for individual trihalomethanes, but this study, as well as the other studies, does not provide sufficient evidence for establishing a relationship between trihalomethane exposure and adverse birth outcomes. No other human studies were located for bromoform or dibromochloromethane. No inhalation or dermal exposure animal developmental toxicity studies were located. There are limited data on the developmental toxicity of bromoform and dibromochloromethane following oral exposure in animals. A minor skeletal abnormality was observed in the offspring of rats exposed to bromoform during gestation (Ruddick et al. 1983). No developmental effects were observed in studies of rat and mouse offspring exposed to dibromochloromethane (Borzelleca and Carchman 1982; Ruddick et al. 1983). Additional oral studies on the developmental effects of both bromoform and dibromochloromethane in animals would be valuable to determine whether these skeletal abnormalities are produced consistently, and whether they lead to significant adverse effects in the neonate. If so, then similar studies by the inhalation and dermal routes would also be valuable to define safe inhalation levels for developmental effects.

Immunotoxicity. The immunotoxic effects of bromoform and dibromochloromethane have been investigated in one 14-day oral study (Munson et al. 1982). That study indicated that both chemicals can lead to changes in several immune cell-types in mice. Similar studies in other species would be valuable

3. HEALTH EFFECTS

in determining if this is a common response. In addition, longer duration studies and tests of the functional consequence of these changes (e.g., resistance to infectious disease) would be especially valuable in assessing the biological significance of these effects. If these studies indicate the immune system is a target, then similar studies by inhalation and dermal exposure routes would also be valuable.

Neurotoxicity. Numerous studies, both in humans and animals, reveal that central nervous system depression is a rapid effect following either oral or inhalation exposure to bromoform; more limited data indicate that dibromochloromethane also causes this effect. While central nervous system depression appears to be reversible within a short time after exposure ceases, the possibility of permanent neurological damage from high doses has not been thoroughly studied. Histological studies by NTP indicate that sub-depressant doses of bromoform (NTP 1989a) and dibromochloromethane (NTP 1985) do not lead to detectable histological changes in the brain, but similar data are not available following narcotizing doses. In addition to histological studies, functional studies capable of detecting lasting neurological changes would be valuable. One study of this sort (Balster and Borzelleca 1982) indicates that both bromoform and dibromochloromethane can cause some behavioral changes (impaired motor performance, decreased exploratory behavior [bromoform only], and decreased response rate in tests of operant behavior) at high doses. Further studies along these lines, perhaps employing more sensitive tests of electrophysiological or neurobehavioral changes, would be helpful in determining if this is an effect of concern to exposed humans.

Epidemiological and Human Dosimetry Studies. No epidemiological or human dosimetry studies are currently available for bromoform or dibromochloromethane. Since only very small quantities of these chemicals are produced or used in this country (see Chapter 5), it does not seem likely that a sufficiently large subpopulation of exposed workers exists to serve as the basis for a meaningful epidemiological study. Epidemiological studies of populations exposed to low levels of bromoform and dibromochloromethane in chlorinated drinking water cannot provide specific data on the human health risks of dibromochloromethane or bromoform, since chlorinated drinking water contains hundreds of different contaminants.

Biomarkers of Exposure and Effect.

Exposure. The only known biomarker of exposure to bromoform or dibromochloromethane is the level of parent compound in blood or in expired air. However, data on blood or breath levels in humans following acute exposure are lacking, due to the rarity of such events. Since both bromoform and

3. HEALTH EFFECTS

dibromochloromethane are rapidly cleared from the body by exhalation or metabolism, measurements of parent compounds in blood or breath are likely to be useful only for a short time (1–2 days) after an exposure. Monitoring of humans continuously exposed to the trace levels normally present in chlorinated water reveal very low to nondetectable levels in blood or expired air. The main metabolites of these compounds (CO_2 , CO , Cl^- , Br^-) are not sufficiently specific to be useful for biomonitoring of exposure. Identification of stable and specific biomarkers of exposure (e.g., halomethyl adducts) would be valuable in evaluating the exposure history of people around waste sites and other sources where above-average levels might be encountered.

Effect. No specific biomarkers of bromoform- or dibromochloromethane-induced effect are known. Neurological, hepatic, and renal effects caused by these chemicals can be detected by standard clinical or biochemical tests, but abnormal function in these tissues can be produced by a number of common diseases in humans, so detection of abnormal function is not proof that the effect was caused by bromoform or dibromochloromethane. Efforts to identify more specific and sensitive biomarkers of bromoform and dibromochloromethane-induced effects would be useful, especially biomarkers (e.g., specific DNA adducts) that might be predictive of carcinogenic risk.

Absorption, Distribution, Metabolism, Excretion. Limited data indicate that bromoform and dibromochloromethane are rapidly and efficiently taken up from the gastrointestinal tract, but further studies to confirm and refine available estimates would be valuable. Toxicokinetic studies to date have generally employed exposure by gavage in corn oil, so studies involving exposure via an aqueous vehicle would be especially valuable. No toxicokinetic data exist for inhalation exposure, so quantitative estimates of the inhalation absorption fraction, tissue distribution, and excretion rate would be beneficial. Also, data on dermal absorption would be helpful, especially from soil or from dilute aqueous solutions, since this is how humans are most likely to experience dermal contact near waste sites.

The pathways of bromoform and dibromochloromethane metabolism have been investigated in several laboratories, but quantitative data on the amount of chemical passing through each pathway are limited, and the chemical identity of products appearing in urine has not been studied. Of particular interest would be studies that seek to clarify the role of metabolism in toxicity, the mechanism by which metabolites and adducts lead to toxic effects, and the importance of protective mechanisms such as cellular antioxidants. This would include careful dose-response studies to determine if either activating or protective pathways are saturable.

3. HEALTH EFFECTS

Comparative Toxicokinetics. Available toxicity data indicate that target tissues of bromoform and dibromochloromethane are similar in humans, rats, and mice. Limited data suggest that effect levels are generally similar across species, but some distinctions are apparent. Toxicokinetic studies have revealed differences between rats and mice regarding metabolic patterns and clearance rates and these might underlie the differences in toxicity between tissues, sexes, and species. Additional comparative studies in animals, with special emphasis on differences in metabolism, would be useful in understanding these differences, and in improving inter-species extrapolation. In addition, *in vitro* studies of metabolism by human liver cells would be valuable in determining which animal species has the most similar pattern of metabolism and is the most appropriate model for human toxicity. Data from studies of this sort could then be used to support physiologically-based toxicokinetic models.

Methods for Reducing Toxic Effects. Further research is needed to determine strategies designed to selectively inhibit the specific P-450 isozymes involved in the metabolism of bromoform or dibromochloromethane to reactive intermediates, and thus reduce the toxic effects. Because bromoform or dibromochloromethane are thought to be metabolized by glutathione conjugation (DeMarini et al. 1997; Pegram et al. 1977; Ross and Pegram 2003), further research is needed to determine if administration of sulfhydryl compounds, such as L-cysteine, reduced GSH or N-acetylcysteine, as glutathione surrogates might provide protection against nephrotoxicity or hepatotoxicity induced due to depleted glutathione stores. Research on using dietary supplements for mitigating adverse effects of chronic exposure to bromoform or dibromochloromethane would be helpful, especially in the case of chronic exposure from chlorinated drinking water.

Children's Susceptibility. Data needs relating to both prenatal and childhood exposures, and developmental effects expressed either prenatally or during childhood, are discussed in detail in the Developmental Toxicity subsection above.

The available human data for bromoform are mostly from case reports of accidental orally-administered overdose in children. No data exist on the toxicity of dibromochloromethane following oral administration in children, or of bromoform or dibromochloromethane following inhalation or dermal exposure in children. The developmental effects of oral exposure to bromoform and dibromochloromethane have not been extensively investigated, but limited data suggest that these chemicals have relatively low toxicity on the developing fetus (Borzelleca and Carchman 1982; Ruddick et al. 1983). However, these studies did not examine neurodevelopmental end points that may be a sensitive target. Additional animal studies assessing the neurodevelopmental toxicity of bromoform and dibromochloro-

3. HEALTH EFFECTS

methane would be useful. Toxicokinetic studies examining how aging can influence absorption rates would be useful in assessing children's susceptibility to the toxicity of bromoform or dibromochloromethane.

Child health data needs relating to exposure are discussed in Section 6.8.1, Identification of Data Needs: Exposures of Children.

3.12.3 Ongoing Studies

No ongoing studies on the health effects of bromoform or dibromochloromethane were listed in the Federal Research in Progress database (FEDRIP 2004).

4. CHEMICAL AND PHYSICAL INFORMATION

4.1 CHEMICAL IDENTITY

Information regarding the chemical identity of bromoform and dibromochloromethane is located in Table 4-1.

4.2 PHYSICAL AND CHEMICAL PROPERTIES

Information regarding the physical and chemical properties of bromoform and dibromochloromethane is located in Table 4-2.

4. CHEMICAL AND PHYSICAL INFORMATION

Table 4-1. Chemical Identity of Bromoform and Dibromochloromethane

Characteristic	Bromoform	Dibromochloromethane	Reference
Synonyms	Tribromomethane; methenyltribromide; methane, tribromo-	Chlorodibromomethane dibromochloromethane; methane, dibromochloro-; methane, chlorodibromo-	HSDB 2004a, 2004b
Registered trade name(s)	No data	No data	
Chemical formula	CHBr ₃	CHBr ₂ Cl	O'Neil et al. 2001
Chemical structure	$\begin{array}{c} \text{Br} \\ \\ \text{Br}-\text{C}-\text{Br} \\ \\ \text{H} \end{array}$	$\begin{array}{c} \text{Br} \\ \\ \text{Cl}-\text{C}-\text{Br} \\ \\ \text{H} \end{array}$	
Identification numbers:			
CAS registry	75-25-2	124-48-1	O'Neil et al. 2001
NIOSH RTECS	PB5600000	PA6360000	RTECS 2003
EPA hazardous waste	U225	No data	RTECS 2003
OHM/TADS	No data	No data	HSDB 2004a, 2004b
DOT/UN/NA/IMCO shipping	UN2515; IMCO 6.1	No data	HSDB 2004a, 2004b
HSDB	2517	2763	HSDB 2004a, 2004b
NCI	C55130	C55254	RTECS 2003
Beilstein reference number	1731048	1731046	RTECS 2003
Beilstein handbook reference	4-01-00-00082	4-01-00-0081	RTECS 2003
Wisesser line notation	EYEE	GYEE	RTECS 2003

CAS = Chemical Abstracts Service; DOT/UN/NA/IMCO = Department of Transportation/United Nations/North America/International Maritime Dangerous Goods Code; EPA = Environmental Protection Agency; HSDB = Hazardous Substances Data Bank; NCI = National Cancer Institute; NIOSH = National Institute for Occupational Safety and Health; OHM/TADS = Oil and Hazardous Materials/Technical Assistance Data System; RTECS = Registry of Toxic Effects of Chemical Substances

4. CHEMICAL AND PHYSICAL INFORMATION

Table 4-2. Physical and Chemical Properties of Bromoform and Dibromochloromethane

Property	Bromoform	Dibromochloromethane	Reference
Molecular weight	252.73	208.28	O'Neil et al. 2001
Color	Colorless	Colorless to pale yellow	Verschueren 2001
Physical state	Liquid	Liquid	Verschueren 2001
Melting point	8.0 °C	-20 °C	Lide 2000
Boiling point	149.1 °C	120 °C	Lide 2000
Density at 20 °C	2.899	2.451	Lide 2000
Odor	Sweet, similar to chloroform	No data	Verschueren 2001
Taste	Similar to chloroform	No data	Lewis 1997
Odor threshold:			
Water	0.51 mg/L	No data	Amoore and Hautala 1983
Air	13.45 mg/m ³	No data	Amoore and Hautala 1983
Solubility:			
Water	3.10x10 ³ mg/L (25 °C)	2.7x10 ³ mg/L (20 °C)	Horvath 1982; Heikes 1987
Organic solvents	Miscible in ethanol, benzene, petroleum ether, acetone, oils	Soluble in ethanol, ether, acetone	Lide 2000
Corrosivity	Will attack some forms of plastics, rubber, and coatings.	No data	HSDB 2004a
Partition coefficients:			
Log octanol/water	2.4	2.16	CITI 1992; Sangster 1994
Log K _{oc}	2.06	1.92	Mabey et al. 1982
Vapor pressure at 20 °C	5 mmHg	76 mmHg	Mabey et al. 1982
Vapor density	8.7 (air=1)	No data	IARC 1991a, 1991b
Henry's law constant	5.6x10 ⁻⁴ atm-m ³ /mol	9.9x10 ⁻⁴ atm-m ³ /mol	Mabey et al. 1982
Surface tension	41.53 dynes/cm	No data	Lewis 1997
Heat of vaporization	46.05 KJ/mol (25 °C)	No data	Lide 2000
Autoignition temperature	No data	No data	
Flashpoint	No data	No data	
Flammability limits	Non-flammable	Non-flammable	HSDB 2004a, 2004b
Conversion factor	1 ppm = 10.34 mg/m ³ 1 mg/m ³ = 0.097 ppm	1 ppm = 8.52 mg/m ³ 1 mg/m ³ = 0.12 ppm	IARC 1999a, 1999b

5. PRODUCTION, IMPORT/EXPORT, USE, AND DISPOSAL

5.1 PRODUCTION

Bromoform may be prepared from acetone and sodium hypobromite, by treating chloroform with aluminum bromide, or by electrolysis of potassium bromide in ethyl alcohol (HSDB 2004a; Stenger 1978).

Bromoform is currently produced by Geoliquids, Inc., Prospect Heights, Illinois and Sigma-Aldrich Fine Chemicals (SRI 2004). Bromoform was produced formerly by Dow Chemical Company, Midland, Michigan. In 1975, production of bromoform in the United States was estimated to be <500 metric tons (<1 million pounds) and the 1977 production was estimated at 50–500 metric tons (100,000–1 million pounds) (NTP 1989a; Orrell and Mackie 1988; Perwak et al. 1980). The production volume of bromoform reported by manufacturers in 1990, 1994, and 1998 was within the range of 10,000–500,000 pounds (5–230 metric tons) (IUR 2002). Production volume data were not listed for reporting year 2002.

Dibromochloromethane can be prepared by the addition of dibromochloroacetone to 5N sodium hydroxide (IARC 1991b). It can also be prepared by reaction of a mixture of chloroform and bromoform with triethylbenzylammonium chloride and sodium hydroxide (IARC 1991a). Available information indicates that dibromochloromethane is no longer produced commercially in the United States (SRI 2004).

Both bromoform and dibromochloromethane are inadvertently generated during water chlorination when chlorine reacts with endogenous organic materials such as humic and fulvic acid (Rook 1977). When chlorine is added to water, hypochlorous acid is formed (Wallace 1997). Hypochlorous acid reacts with humic or fulvic acids in the water to produce chloroform or it can oxidize any bromide ion that is present to form hypobromous acid, which leads to the formation of bromoform, dibromochloromethane, or bromodichloromethane. It is estimated that 17 kkg of bromoform and 204 kkg of dibromochloromethane were generated in this way in 1978 (Perwak et al. 1980). According to a model generated by Clark et al. (1996), higher bromide to chloride ratios promote the bromine substitution reaction over the chlorine substitution reaction with organic matter in chlorinated water. At higher bromide concentrations, levels of chloroform decreased, while levels of bromoform increased. Dibromochloromethane was found to

5. PRODUCTION, IMPORT/EXPORT, USE, AND DISPOSAL

increase to a maximum level for bromide concentrations of 2.5 mg/L and then decline with increasing bromide concentration (Clark et al. 1996).

Table 5-1 summarizes information on companies that reported the production, import, or use of bromoform for the Toxics Release Inventory in 2002 (TRI02 2004). The TRI data should be used with caution since only certain types of facilities are required to report. This is not an exhaustive list.

5.2 IMPORT/EXPORT

Orrell and Mackie (1988) estimated that 6–9 kkg of bromoform were imported by Freeman Industries in the late 1980s. No current information was located on the import of bromoform and dibromochloromethane, but it is likely that little, if any, is imported.

5.3 USE

Bromoform is used in geological assaying as a heavy liquid for mineral ore separations based on differences in specific gravity (Verschuere 2001). It is used in the electronics industry in quality assurance programs (Orrell and Mackie 1988). Bromoform has been used as a catalyst, initiator, or sensitizer in polymer reactions and in the vulcanization of rubber (HSDB 2004a). As a solvent, bromoform has been used for waxes, greases, and oils as well as for liquid-solvent extractions and nuclear magnetic resonance (NMR) studies (Lewis 1997; NTP 1989a). Former uses of bromoform include a fire-resistant chemical ingredient, a gauge fluid ingredient, an intermediate in chemical syntheses, and a sedative and antitussive agent (HSDB 2004a; Perwak et al. 1980).

Dibromochloromethane is used in laboratory quantities only and there is no current commercial use for this compound (Perwak et al. 1980). Dibromochloromethane was used formerly as a chemical intermediate in the production of fire extinguishing agents, aerosol propellants, refrigerants, and pesticides (IARC 1991b).

5.4 DISPOSAL

Because bromoform and dibromochloromethane are listed as hazardous substances, land disposal of wastes containing these compounds is controlled by a number of federal regulations (see Chapter 8).

5. PRODUCTION, IMPORT/EXPORT, USE, AND DISPOSAL

Table 5-1. Facilities that Produce, Process, or Use Bromoform

State ^a	Number of facilities	Minimum amount on site in pounds ^b	Maximum amount on site in pounds ^b	Activities and uses ^c
AR	5	0	999,999	1, 2, 4, 9, 12, 13
CA	1	100	999	12
LA	2	0	999	1, 5, 13
MS	1	0	99	12
NE	1	10,000	99,999	12
OH	1	1,000	9,999	12
TX	2	1,000	999,999	12

Source: TRI02 2004 (Data are from 2002)

^aPost office state abbreviations used

^bAmounts on site reported by facilities in each state

^cActivities/Uses:

- | | | |
|--------------------------|--------------------------|-----------------------------|
| 1. Produce | 6. Impurity | 11. Chemical Processing Aid |
| 2. Import | 7. Reactant | 12. Manufacturing Aid |
| 3. Onsite use/processing | 8. Formulation Component | 13. Ancillary/Other Uses |
| 4. Sale/Distribution | 9. Article Component | 14. Process Impurity |
| 5. Byproduct | 10. Repackaging | |

5. PRODUCTION, IMPORT/EXPORT, USE, AND DISPOSAL

Wastes containing dibromochloromethane or bromoform may be incinerated by rotary kiln, liquid injection, or fluidized bed methods. CERCLA reportable quantities for bromoform and dibromochloromethane released to the environment are those quantities ≥ 100 pounds or 45.4 kg.

The amount of bromoform and dibromochloromethane released or disposed of through industrial and/or laboratory use of these chemicals is not known, but is considered to be insignificant compared to the amount inadvertently generated by water chlorination processes (EPA 1987c; HSDB 2004a; Perwak et al. 1980).

6. POTENTIAL FOR HUMAN EXPOSURE

6.1 OVERVIEW

Bromoform has been identified in at least 140 sites while dibromochloromethane has been identified in at least 174 sites of the 1,662 hazardous waste sites that have been proposed for inclusion on the EPA National Priorities List (NPL) (HazDat 2005). However, the number of sites evaluated for bromoform and dibromochloromethane is not known. The frequency of these sites can be seen in Figures 6-1 and 6-2, respectively. Of these sites, 137 of the 140 bromoform sites are located within the United States, 1 is located in the Virgin Islands (not shown), and 2 are located in the Commonwealth of Puerto Rico (not shown). For dibromochloromethane, 172 of the 174 sites are located within the United States, 1 is located in the Virgin Islands, and 1 is located in the Commonwealth of Puerto Rico.

The principal route of human exposure to dibromochloromethane and bromoform is from the consumption of chlorinated drinking water. These chemicals are thought to form in the water as by-products from the reaction of chlorine with dissolved organic matter and bromide ions. Dibromochloromethane and bromoform concentrations in water are quite variable, but average levels are usually $<5 \mu\text{g/L}$.

Most dibromochloromethane and bromoform tend to volatilize from water when exposed to the air. The fate of these chemicals in air has not been investigated, but it is likely they are relatively stable, with half-lives of about 1–2 months. Most measurements of the concentration of these chemicals in air indicate that levels are quite low ($<10 \text{ ppt}$).

Neither chemical is strongly adsorbed from water by soil materials, and it is likely that both readily migrate in groundwater. Neither chemical appears to be easily biodegradable under aerobic conditions, but they may readily biodegrade under anaerobic conditions.

6.2 RELEASES TO THE ENVIRONMENT

The TRI data should be used with caution because only certain types of facilities are required to report (EPA 1997). This is not an exhaustive list. Manufacturing and processing facilities are required to report

6. POTENTIAL FOR HUMAN EXPOSURE

Figure 6-1. Frequency of NPL Sites with Bromoform Contamination

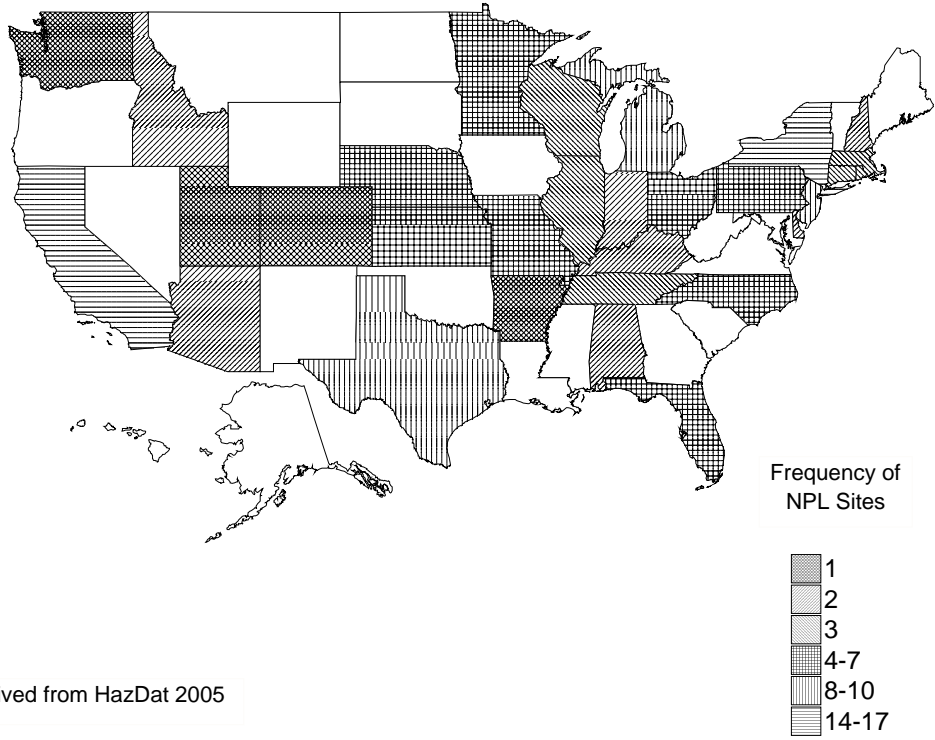

Derived from HazDat 2005

6. POTENTIAL FOR HUMAN EXPOSURE

Figure 6-2. Frequency of NPL Sites with Dibromochloromethane Contamination

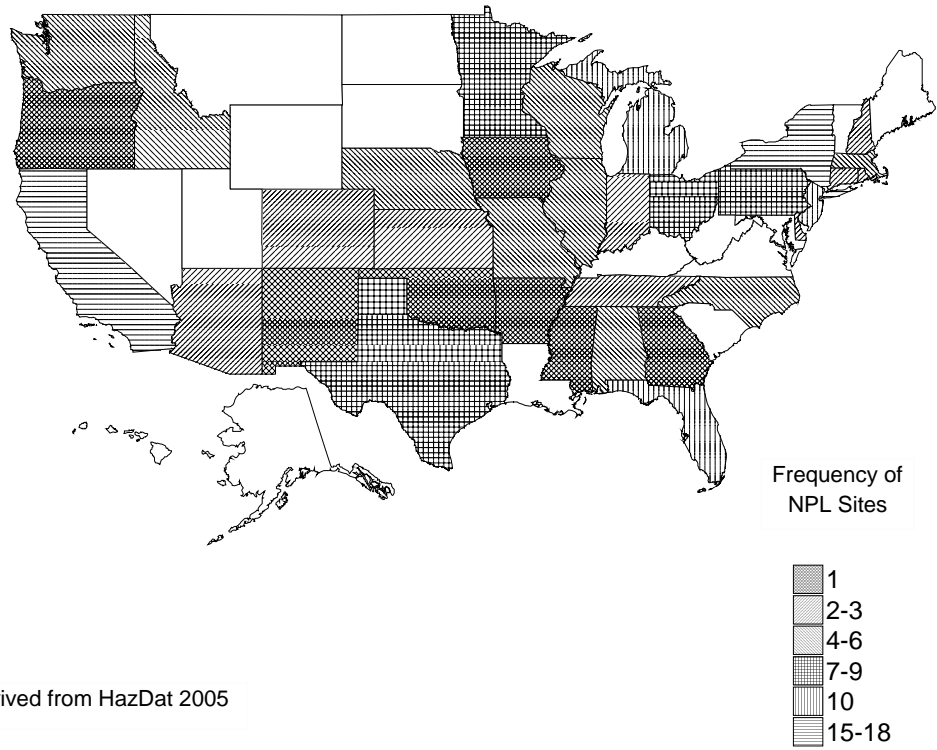

Derived from HazDat 2005

6. POTENTIAL FOR HUMAN EXPOSURE

information to the Toxics Release Inventory only if they employ 10 or more full-time employees; if their facility is classified under Standard Industrial Classification (SIC) codes 20–39; and if their facility produces, imports, or processes $\geq 25,000$ pounds of any TRI chemical or otherwise uses $>10,000$ pounds of a TRI chemical in a calendar year (EPA 1997).

Bromoform and dibromochloromethane have been identified in a variety of environmental media (air, surface water, groundwater, soil, and sediment) collected at 140 and 174 of the 1,662 NPL hazardous waste sites, respectively (HazDat 2005).

6.2.1 Air

Estimated releases of 12 pounds (0.01 metric tons) of bromoform to the atmosphere from 3 domestic manufacturing and processing facilities in 2002, accounted for about 3% of the estimated total environmental releases (TRI02 2004). These releases are summarized in Table 6-1.

Bromoform has been identified in air samples collected at 7 of the 140 NPL hazardous waste sites where it was detected in some environmental media (HazDat 2005). Dibromochloromethane has been identified in air samples collected at 1 of the 174 NPL hazardous waste sites where it was detected in some environmental media.

The average concentration of dibromochloromethane in uncontrolled emissions from 40 medical waste incinerators in the United States and Canada was $0.96 \mu\text{g}/\text{kg}$ waste (Walker and Cooper 1992). The average concentration in controlled emissions was $536 \mu\text{g}/\text{kg}$ waste.

Quack and Wallace (2003) estimated that the annual global flux of bromoform of 3–22 Gmol/year with the main source being sea-to-air emissions from macroalgal and planktonic bromoform production. Estimated anthropogenic emission rates for bromoform are 34 Mmol/year from coastal power plants, 4 Mmol/year from inland nuclear power plants, 280 Mmol/year from coastal fossil fuel plants, 14 Mmol/year from inland fossil fuel plants, 2 Mmol/year from desalination power plants, 12 Mmol/year from water disinfection processes giving a total of 346 Mmol/year from all anthropogenic sources (Quack and Wallace 2003). Emissions of bromoform from a commercial rice paddy in Houston, Texas were reported to range from 0.012 to $0.032 \mu\text{g}/\text{m}^2/\text{hour}$ with a median emission rate of $0.021 \mu\text{g}/\text{m}^2/\text{hour}$ (Redeker et al. 2003). The mean annual concentrations of bromoform in air extracted from deep firn air

6. POTENTIAL FOR HUMAN EXPOSURE

Table 6-1. Releases to the Environment from Facilities that Produce, Process, or Use Bromoform^a

State ^c	RF ^d	Reported amounts released in pounds per year ^b							Total release		
		Air ^e	Water ^f	UI ^g	Land ^h	Other ⁱ	On-site ^j	Off-site ^k	On- and off-site		
		AR	1	7	0	0	0	0	7	0	7
LA	1	0	456	0	0	0	456	0	456		
NE	1	5	0	0	0	0	5	0	5		
Total	3	12	456	0	0	0	468	0	468		

Source: TRI02 2004 (Data are from 2002)

^aThe TRI data should be used with caution since only certain types of facilities are required to report. This is not an exhaustive list. Data are rounded to nearest whole number.

^bData in TRI are maximum amounts released by each facility.

^cPost office state abbreviations are used.

^dNumber of reporting facilities.

^eThe sum of fugitive and point source releases are included in releases to air by a given facility.

^fSurface water discharges, waste water treatment-(metals only), and publicly owned treatment works (POTWs) (metal and metal compounds).

^gClass I wells, Class II-V wells, and underground injection.

^hResource Conservation and Recovery Act (RCRA) subtitle C landfills; other on-site landfills, land treatment, surface impoundments, other land disposal, other landfills.

ⁱStorage only, solidification/stabilization (metals only), other off-site management, transfers to waste broker for disposal, unknown

^jThe sum of all releases of the chemical to air, land, water, and underground injection wells.

^kTotal amount of chemical transferred off-site, including to POTWs.

RF = reporting facilities; UI = underground injection

6. POTENTIAL FOR HUMAN EXPOSURE

were 1.35 and 0.20 ppt at two Antarctic locations (Sturges et al. 2001). Mean annual concentrations of dibromochloromethane were 0.20 and 0.14 ppt.

No other studies were located regarding the amount of bromoform and dibromochloromethane released into the atmosphere from laboratories, chemical plants, or chemical waste sites. However, since neither compound is produced or used in large quantities (Perwak et al. 1980), atmospheric emissions from these sources are probably small.

6.2.2 Water

Estimated releases of 456 pounds (0.21 metric tons) of bromoform to surface water and publicly owned treatment works from three domestic manufacturing and processing facilities in 2002, accounted for about 97% of the estimated total environmental releases (TRI02 2004). These releases are summarized in Table 6-1.

Bromoform has been identified in surface water samples and groundwater samples collected at 14 and 103 of the 140 hazardous waste sites, respectively, where it was detected in some environmental media. Dibromochloromethane has been identified in surface water samples and groundwater samples collected at 15 and 146 of the 174 hazardous waste sites, respectively, where it was detected in some environmental media (HazDat 2005).

The principal anthropogenic source of bromoform and dibromochloromethane in the environment is chlorination of water containing organic materials (Bellar et al. 1974; EPA 1980a; Peters et al. 1994; Rook 1977; Rodriguez et al. 2004; Symons et al. 1975, 1993). It has been estimated that the total amounts of bromoform and dibromochloromethane generated by chlorinating U.S. drinking water in 1978 were 17 and 204 kkg, respectively (Perwak et al. 1980). Bromoform and dibromochloromethane were detected in the distribution systems of three water treatment plants that each use different methods of water chlorination (LeBel et al. 1997). Mean monthly concentrations of dibromochloromethane were 0.2 µg/L in samples from the chlorine-chloramine treatment plant, 0.3 µg/L in samples from the chlorine-chlorine treatment plant, and 0.1 µg/L in samples from the ozone-chlorine treatment plant. Mean monthly bromoform concentrations were <0.1 µg/L in samples from all three plants.

Unlike the chlorination of low-bromide fresh water where chloroform is the trihalomethane produced in the largest amounts, bromoform is the trihalomethane usually produced in the largest amounts during the

6. POTENTIAL FOR HUMAN EXPOSURE

chlorination of sea water or high-bromide fresh water (Khalanski 2003; Richardson et al. 2003). The concentrations of bromoform in the chlorinated cooling water at three European marine power stations on the English Channel were 25.16, 11.4, and 18.23 $\mu\text{g/L}$ (Khalanski 2003). Richardson et al. (2003) measured bromoform concentrations of 23.3, 57, 59, 44, and 55 $\mu\text{g/L}$ in high-bromide water from the Sea of Galilee in Israel after a pre-chlorination step during the months of December, May, September, November, and July, respectively. Concentrations of dibromochloromethane in these samples were reported only for the months of May, September, and July (9.39, 1.9, and 3.7 $\mu\text{g/L}$, respectively).

Ozonation of water containing bromide ion has also been shown to be a source of bromoform in the environment (Glaze et al. 1989; Huang et al. 2003). Bromoform levels were 1.4, 3.7, and 2.1 mg/L in California State Project Water samples after ozonation at the Los Angeles Aqueduct Filtration Plant in 1987 at ozone doses of 1.0, 2.0, and 4.0 mg/L , respectively (Glaze et al. 1989). Huang et al. (2004) reported that bromoform generation is greater in waters with higher organic matter content.

Release of dibromochloromethane and bromoform into groundwater has been shown to occur as a consequence of the yearly aquifer storage and recovery (ASR) in the Las Vegas Valley. As an example, it is estimated that up to $16.3 \times 10^6 \text{ m}^3$ water was injected into the underlying aquifer during the winter months of 1995–1996, when demand for water by neighboring Las Vegas was low (Thomas et al. 2000). Because the recharge water is chlorinated before injection, byproducts of this disinfection process are introduced into the groundwater at concentrations measured during the 1995–1996 ASR recharge seasons of 18 $\mu\text{g/L}$ for dibromochloromethane and 2.6 $\mu\text{g/L}$ for bromoform in the recharge water. During the water recovery phase beginning in the spring of 1996, initial concentrations of dibromochloromethane and bromoform in water recovered from one recharge well (#14) in the spring of 1996 were below detection limits (0.5 $\mu\text{g/L}$) but were much higher, 15 and 2.4 $\mu\text{g/L}$, respectively, in a second well (#51). Dibromochloromethane and bromoform levels in water recovered from the second well fell during the remaining spring and summer months decreasing to concentrations of 1.5 and 0.6 $\mu\text{g/L}$, respectively, in September of 1996. The differences in the concentrations of dibromochloromethane and bromoform between wells 14 and 51, and the decrease in concentrations observed in water recovered from well 51 during the spring and summer recovery months of 1996, were attributed to both dilution of the recharge water in the aquifer with natural water from the surrounding aquifer basin and biotransformation of the trihalomethanes within the aquifer.

Dibromochloromethane and bromoform may also occur as a consequence of chlorinating industrial waste waters (Perry et al. 1979). Staples et al. (1985) reported that bromoform was detected in 60 of

6. POTENTIAL FOR HUMAN EXPOSURE

1,346 samples of industrial waste effluent, at a median concentration of $<5 \mu\text{g/L}$, and dibromochloromethane was detected in 84 of 1,298 samples at a median concentration of $<2.4 \mu\text{g/L}$. These values are not significantly higher than those for typical chlorinated water (see Section 5.4.2), suggesting that industrial discharge may not be a major source of release.

Bromoform and dibromochloromethane were detected in New York City municipal waste water samples taken from 1989 to 1993 (Stubin et al. 1996). Influent concentrations ranged from 7 to $40 \mu\text{g/L}$ for bromoform with a frequency of detection of 4% and $9 \mu\text{g/L}$ for dibromochloromethane with a frequency of detection of 1%. Effluent concentrations ranged from 3 to $11 \mu\text{g/L}$ for bromoform with a frequency of detection of 11% and from 2 to $15 \mu\text{g/L}$ for dibromochloromethane with a frequency of detection of 8%. Moschandreas et al. (1997) studied samples from 14 New York City waste water pollution control plants to determine the organic compound concentrations in the waste water at each of the plants. Bromoform was detected with concentrations of $0.4\text{--}10 \mu\text{g/L}$ in raw influent samples, $2.0\text{--}9.0 \mu\text{g/L}$ in primary influent samples, $1.0\text{--}10 \mu\text{g/L}$ in primary effluent samples, $0.3\text{--}11 \mu\text{g/L}$ in aeration tank samples, $0.4\text{--}12 \mu\text{g/L}$ in superficial of return activated sludge samples, and $0.2\text{--}12 \mu\text{g/L}$ in plant effluent samples. Only the plant effluent concentration range ($0.3\text{--}5.0 \mu\text{g/L}$) was reported for dibromochloromethane.

Although most raw water samples collected from different points of the Great Lakes in 1990 contained trihalomethanes at concentrations $<2 \mu\text{g/L}$, mean concentrations in treated water samples from four of the six locations were above $25 \mu\text{g/L}$ (Henshaw et al. 1993). The low trihalomethane concentrations of the other two locations are attributed to the use of alternative methods of water treatment such as ammonia addition and potassium permanganate disinfection.

The average concentration of dibromochloromethane in sewage treatment effluents in England and Wales in 1995 was $0.2007 \mu\text{g/L}$ with a frequency of detection of 30.4% (Stangroom et al. 1998a). The average concentration of dibromochloromethane in trade effluents in England and Wales in 1995 was $7.91 \mu\text{g/L}$ with a frequency of detection of 63%.

Mean dibromochloromethane concentrations were determined to be 2 ng/L in water and sediment samples taken from the anoxic fjord Idefjorden between Norway and Sweden near the city of Halden, Norway (Abrahamsson and Klick 1989). Dibromochloromethane was detected in effluent water from a nearby paper pulp mill.

6. POTENTIAL FOR HUMAN EXPOSURE

Class et al. (1986) observed trace levels of dibromochloromethane and bromoform and other halogenated methanes in sea water (0.1–6 ng/L) and in the air (0.1–20 ppt) at several locations in the Atlantic. Other studies have reported atmospheric bromoform concentration ranges of 1.0–22.7 pptv off the coast of Galway, Ireland, 0.7–8.0 pptv off the coast of northwestern Tasmania, 0.28–2.9 pptv in the West Pacific Islands, 0.32–7.1 pptv in the Asian Seas, and 1.0–37.4 pptv off the Antarctic Peninsula (Carpenter et al. 1999, 2003). Dibromochloromethane was also detected off the coasts of Galway, Ireland and northwestern Tasmania with atmospheric concentrations of 0.13–1.8 and 0.1–1.4 pptv, respectively. The presence of these compounds can be attributed to biosynthesis and release of bromochloromethanes by macroalgae (Carpenter et al. 1999; Class et al. 1986; Gschwend et al. 1985; Marshall et al. 2003; Quack and Wallace 2003). Gschwend et al. (1985) estimated that marine algae could be a major global source of volatile organobromides. More recently, Carpenter and Liss (2000) estimated that macroalgae produce around 70% of the world's bromoform, which is greater than what was previously estimated due to updated seaweed biomass estimates. However, Class et al. (1986) states that this source accounts for <1% of the anthropogenic burden of total organohalogens in the atmosphere.

6.2.3 Soil

There were no releases to the ground either through soil or underground injection from three domestic manufacturing and processing facilities in 2002 (TRI02 2004). This information is summarized in Table 6-1.

Bromoform has been identified in soil and sediment samples collected at 26 and 3 of the 140 NPL hazardous waste sites, respectively, where it was detected in some environmental media. Dibromochloromethane has been identified in soil and sediment samples collected at 21 and 4 of the 174 NPL hazardous waste sites, respectively, where it was detected in some environmental media (HazDat 2005).

Soils and other unconsolidated surficial materials may become contaminated with bromoform and dibromochloromethane by chemical spills, the landfilling of halomethane-containing solid wastes, or the discharge of chlorinated water. However, no data were located to suggest that land releases are a significant source of the chemicals in the environment.

6. POTENTIAL FOR HUMAN EXPOSURE

6.3 ENVIRONMENTAL FATE**6.3.1 Transport and Partitioning**

Bromoform and dibromochloromethane are slightly volatile liquids, and tend to exist primarily as vapors in the atmosphere. The vapor pressure of bromoform is 0.007 atm at 20 °C (Mabey et al. 1982), and the vapor pressure of dibromochloromethane at 20 °C is approximately 0.1 atm (Mabey et al. 1982). The half-time of evaporation from flowing, aerated water (e.g., rivers and streams) has been estimated to range from 1 to 581 hours for bromoform and from 0.7 to 398 hours for dibromochloromethane (Kaczmar et al. 1984; Mackay et al. 1982).

Both dibromochloromethane and bromoform are moderately soluble in water (Callahan et al. 1979; Heikes 1987), and so each may be removed from the air by being dissolved into clouds or raindrops. Estimates of the Henry's law constant (H) (the tendency of a chemical to partition between its vapor phase and water) for bromoform range from 4.3 to 5.6×10^{-4} atm-m³/mole, and from 8.7 to 9.9×10^{-4} atm-m³/mole for dibromochloromethane (Mabey et al. 1982; Mackay and Shiu 1981; Munz and Roberts 1987; Nicholson et al. 1984). The magnitude of these values suggest that the two halomethanes will tend to partition to both water and air.

It is not known if either compound can be adsorbed by airborne particulate matter that is subject to atmospheric dispersion, gravitational settling, or wash-out by rain. Particle adsorption is probably not an important transport mechanism because these chemicals occur at such low concentrations in the atmosphere.

Bromoform and dibromochloromethane have a minor tendency to be adsorbed by soils and sediments. Calculated and measured values of K_{oc} (the organic carbon/water partition coefficient, an index of the relative mobility of a material in water-soil systems) for bromoform range from 62 to 126 (Hassett et al. 1983; Hutzler et al. 1986; Mabey et al. 1982). These relatively low values imply that bromoform will exhibit only a minor affinity for soil materials and will tend to be highly mobile (Roy and Griffin 1985). This low tendency for adsorption to soil has been confirmed in laboratory studies by Curtis et al. (1986) and in field studies by Roberts et al. (1986).

A similar K_{oc} value of 57 has been estimated for dibromochloromethane, based on its measured water solubility (Heikes 1987). No studies were located on the adsorption of dibromochloromethane by soils or

6. POTENTIAL FOR HUMAN EXPOSURE

soil materials, but it is likely that dibromochloromethane will have properties generally similar to those of bromoform.

Bromoform and dibromochloromethane may be slightly bioconcentrated by aquatic organisms. The octanol/water partition coefficient (K_{ow}) (an index of the partitioning of a compound between octanol and water) is approximately 240 for bromoform and 170 for dibromochloromethane (Mabey et al. 1982). The magnitudes of these values suggest that the chemicals will tend to partition to fat tissues of aquatic organisms. No studies were located regarding the bioconcentration factor (BCF) for dibromochloromethane or bromoform, but based on measured BCFs for similar compounds (Kenaga 1980), the BCF of dibromochloromethane and bromoform may be on the order of 2–10. It is not known if these chemicals can be transferred through food chains to higher trophic levels, but this seems unlikely to be of major concern.

The percent removal of dibromochloromethane measured at the outlet of a waste-water-dependent constructed wetland near Phoenix, Arizona was 86.5% (Keefe et al. 2004). The authors concluded that volatilization was the primary removal mechanism.

6.3.2 Transformation and Degradation

6.3.2.1 Air

Based on the behavior of similar compounds, it seems likely that bromoform and dibromochloromethane may be degraded by photooxidative interactions with atmospheric OH radicals. Radding et al. (1977) proposed that the atmospheric half-life of bromoform and dibromochloromethane is approximately 1–2 months, but this has not been confirmed by direct experimental measurements.

6.3.2.2 Water

Both dibromochloromethane and bromoform are relatively stable in water, with estimated hydrolytic rate constants of $3.2 \times 10^{-11} \text{ sec}^{-1}$ and $8 \times 10^{-11} \text{ sec}^{-1}$ (Mabey and Mill 1978). These rate constants correspond to hydrolytic half-lives of 686 and 274 years for bromoform and dibromochloromethane, respectively.

No information was located on oxidation or photolysis of these chemicals in water, but it is not expected that either is a significant degradative pathway.

6. POTENTIAL FOR HUMAN EXPOSURE

It has been found that dibromochloromethane and bromoform undergo only limited biodegradation (10–25%) under aerobic conditions, although the rate may increase somewhat after microbial adaptation (Bouwer et al. 1981; Tabak et al. 1981a). Bromoform, at initial concentrations ranging from 132 to 177 µg/L, underwent >99% reduction in a continuous-flow biofilm column seeded with primary settled sewage with 1.5 hours packed-bed detention time (Cobb and Bouwer 1991). Under anaerobic conditions, dibromochloromethane and bromoform have been found to be readily biodegraded in the presence of methane-producing bacteria (Bouwer and McCarty 1983a; Bouwer et al. 1981), and under denitrifying and sulfate-reducing conditions in batch and column experiments (Bouwer and McCarty 1983b; Bouwer and Wright 1986). There is also some field evidence that trihalomethanes degrade in anaerobic groundwater (Bouwer et al. 1981), with half-lives estimated to be between 21 and 42 days (Bouwer and McCarty 1984). Increased degradation rates were observed for bromoform and dibromochloromethane under conditions similar to those found inside ferrogenic aquifers, especially at higher pH (Kenneke et al. 2003; Pecher et al. 2002). Bouwer and Wright (1986) reported that one degradation product of bromoform was dibromomethane, but there was no additional information on the identity or fate of environmental degradation by-products. Bromoform was not degraded in enriched sea water cultures taken from beds of the giant kelp, *M. pyrifera* off the coast of California after 40 days (Goodwin et al. 1997).

The concentration of bromoform decreased from 58 µg/L to <1 µg/L in water stored in an aquifer 7 days after recharge with chlorinated water (Nicholson et al. 2002). The concentration of dibromochloromethane decreased from 46 to 3 µg/L 28 days after recharge. The authors stated that the main attenuation processes were most likely adsorption and degradation under methanogenic conditions. McQuarrie and Carlson (2003) suggest that aquifer storage may be a potential method for the removal of disinfection byproducts such as bromoform and dibromochloromethane from treated water.

6.3.2.3 Sediment and Soil

No studies were located regarding the biodegradation of dibromochloromethane or bromoform in soil. It is expected that observations regarding biodegradation rates in aerobic and anaerobic aqueous media (above) will be generally applicable to degradation rates in moist soils.

6. POTENTIAL FOR HUMAN EXPOSURE

6.3.2.4 Other Media

No information was located on the transformation and degradation of bromoform or dibromochloromethane in other media.

6.4 LEVELS MONITORED OR ESTIMATED IN THE ENVIRONMENT

Reliable evaluation of the potential for human exposure to bromoform and dibromochloromethane depends in part on the reliability of supporting analytical data from environmental samples and biological specimens. Concentrations of bromoform and dibromochloromethane in unpolluted atmospheres and in pristine surface waters are often so low as to be near the limits of current analytical methods. In reviewing data on bromoform and dibromochloromethane levels monitored or estimated in the environment, it should also be noted that the amount of chemical identified analytically is not necessarily equivalent to the amount that is bioavailable. The analytical methods available for monitoring bromoform and dibromochloromethane in a variety of environmental media are detailed in Chapter 7.

6.4.1 Air

Dibromochloromethane and bromoform are usually found in air only at very low concentrations. Brodinsky and Singh (1983) tabulated data on dibromochloromethane and bromoform levels in ambient air from five urban locations across the United States. For dibromochloromethane, 63 of 89 samples were below the detection limit, the mean value was 3.8 ppt (32 ng/m³), and the highest value was 27 ppt (230 ng/m³). For bromoform, 60 of 78 samples were below the detection limit, the mean value was 3.6 ppt (37 ng/m³) and the highest value was 71 ppt (730 ng/m³). Forty-six air samples collected near four chemical plants in Arkansas contained a mean bromoform concentration of 0.9 ppt (9 ng/m³) (Pellizzari 1978). The mean dibromochloromethane concentration was 0.08 ppt (0.8 ng/m³), but 54 of 56 measurements were <0.05 ppt (0.5 ng/m³).

Fischer et al. (2000) found a nearly constant mixing ratio of bromoform at 0.5 parts per trillion by volume (pptv) in the marine troposphere of the Atlantic across 30 °W longitude. In the coastal region of South America, bromoform concentrations were 2.4 pptv. A high concentration of bromoform (2.0 pptv) was found in an air sample taken near Cape Verde Island. Air mixing ratios for bromoform in samples taken above the waters of the equatorial Pacific during the third joint Soviet-American Gases and Aerosols

6. POTENTIAL FOR HUMAN EXPOSURE

(SAGA 3) experiment ranged from 0.68 to 3.28 pptv using the charcoal or Tenax adsorption method and from 0.5 to 6.7 pptv using the canister collection method (Atlas et al. 1993). Air mixing ratios for dibromochloromethane ranged from 0.09 to 0.49 pptv using the charcoal or Tenax adsorption method. Dibromochloromethane was not measured with the canister collection method. The mean concentration of bromoform in ambient air samples collected in the Arctic Circle was 5.1 ppt (53 ng/m^3) (Berg et al. 1984).

During the Urban Air Toxics Monitoring Program, concentrations of bromoform and dibromochloromethane at 13 air monitoring sites located in Vermont, New Jersey, Louisiana, and Texas were <1 parts per billion by volume (ppbv) (no detection limit given) (Mohamed et al. 2002). Bromoform was not detected in air samples from three permanent sites in Arizona (Tucson, Payson, and Casa Grande) during the Arizona Hazardous Air Pollutants Monitoring Program, though the detection limit was not specified (Zielinska et al. 1998). Bromoform was detected at a fourth permanent site in Phoenix with a maximum concentration of 0.02 ppbv, although the average bromoform concentration at this site was below the detection limit. Bromoform was not detected (detection limit unspecified) in air samples collected from 13 semi-rural to urban locations in Maine, Massachusetts, New Jersey, Pennsylvania, Ohio, Illinois, Louisiana, and California (Pankow et al. 2003). However, dibromochloromethane was detected at Kettering, Ohio at a concentration of 0.007 ppbV. This concentration was below the lowest daily standard of 0.057 ppbV. Neither bromoform nor dibromochloromethane were detected (detection limit not specified) in air samples from 13 locations in Texas, Louisiana, New Jersey, and Vermont (Mohamed et al. 2002).

The mean, minimum, and maximum concentrations of dibromochloromethane in air samples taken during the Southern California Ozone Study in 1997 were 0.02 ppbv (210 ng/m^3), 0.04 ppbv (420 ng/m^3), and 0.01 ppbv (105 ng/m^3), respectively at a residential/industrial site in Mexicali, Mexico (Zielinska et al. 2001). Dibromochloromethane was not detected at a residential site in Rosarito, Mexico (no detection limit given). Dibromochloromethane was detected at 24 ppb (0.210 mg/m^3) in Finnish industrial air samples medical industry preparing solutions and at 1.6 ppb ($0.014 \text{ } \mu\text{g/m}^3$) in suburban air from Turku, Finland (Kroneld 1989a, 1989b). Dibromochloromethane was not detected in countryside air samples taken from the Islands of Inio at the southwest coast of Finland. Mean concentrations of bromoform detected in air samples collected at two locations in the city of Kaohsiung, Taiwan during the spring of 2002 were 0.25 and $1.00 \text{ } \mu\text{g/m}^3$ (Lai et al. 2004).

6. POTENTIAL FOR HUMAN EXPOSURE

Bromoform was detected with an occurrence rate of 54% in indoor air samples taken from 26 houses, although actual concentrations were not given (Kostiainen 1995). Air from 13 houses in Katusushika Ward, Tokyo, Japan were sampled during a survey of indoor pollution by volatile organohalogen compounds in February 1995 (Amagai et al. 1999). Thirty houses were sampled in July 1995. Bromoform was detected in all 13 houses during the February survey. In July, it was detected in 22 out of 30 houses. Dibromochloromethane was detected in all houses during both the February and July surveys. Mean concentrations of dibromochloromethane in February 1995 were $0.016 \mu\text{g}/\text{m}^3$ in outdoor air, $0.095 \mu\text{g}/\text{m}^3$ in living room air, $0.122 \mu\text{g}/\text{m}^3$ in kitchen air, $0.096 \mu\text{g}/\text{m}^3$ in bedroom air, and $0.701 \mu\text{g}/\text{m}^3$ in bathroom air. Mean concentrations of dibromochloromethane in July 1995 were $0.007 \mu\text{g}/\text{m}^3$ in outdoor air, $0.050 \mu\text{g}/\text{m}^3$ in living room air, $0.065 \mu\text{g}/\text{m}^3$ in kitchen air, $0.042 \mu\text{g}/\text{m}^3$ in bedroom air, and $0.372 \mu\text{g}/\text{m}^3$ in bathroom air. Mean concentrations of bromoform in February 1995 were $0.009 \mu\text{g}/\text{m}^3$ in outdoor air, $0.016 \mu\text{g}/\text{m}^3$ in living room air, $0.018 \mu\text{g}/\text{m}^3$ in kitchen air, $0.015 \mu\text{g}/\text{m}^3$ in bedroom air, and $0.091 \mu\text{g}/\text{m}^3$ in bathroom air. Mean concentrations of bromoform in July 1995 were $0.010 \mu\text{g}/\text{m}^3$ in outdoor air, $0.013 \mu\text{g}/\text{m}^3$ in living room air, $0.013 \mu\text{g}/\text{m}^3$ in kitchen air, $0.012 \mu\text{g}/\text{m}^3$ in bedroom air, and $0.034 \mu\text{g}/\text{m}^3$ in bathroom air.

Kerger et al. (2000) evaluated airborne concentrations of common trihalomethane compounds in bathrooms during showering and bathing in three urban homes supplied with chlorinated tap water. Samples were collected prior to, during, and after the water-use event for 16 shower and 7 bath events. The increases in average airborne concentration of dibromochloromethane were $0.5 \mu\text{g}/\text{m}^3$ per $\mu\text{g}/\text{L}$ during showers and $0.15 \mu\text{g}/\text{m}^3$ per $\mu\text{g}/\text{L}$ during baths.

No studies were located regarding atmospheric concentrations of bromoform or dibromochloromethane in the workplace. Dibromochloromethane was detected in air samples at two hazardous waste sites, but the amounts were not quantified (LaRegina et al. 1986).

6.4.2 Water

Dibromochloromethane and bromoform are rarely measurable in nonchlorinated water (Cech et al. 1981; Staples et al. 1985; Varma et al. 1984), but both are very frequently found in chlorinated water. The levels of bromoform and dibromochloromethane in finished (chlorinated) drinking water have been investigated in several studies (see Table 6-2). Except for a few cases, the concentrations of bromoform and dibromochloromethane in drinking water were $<100 \mu\text{g}/\text{L}$, with mean concentrations generally $<10 \mu\text{g}/\text{L}$.

6. POTENTIAL FOR HUMAN EXPOSURE

Table 6-2. Occurrence of Bromoform and Dibromochloromethane in Finished Drinking Water

Frequency of detection percent	Concentration ($\mu\text{g/L}$)		Location	Reference
	Range	Mean		
Bromoform				
10	ND-92	≈ 0.4	National	Symons et al. 1975
27	ND-3.0	≈ 0.5	13 Cities	Keith et al. 1976
34	NR	12	National	Brass et al. 1977
67	NR-4.4	0.4	Midwest	ORVWSC 1979
NR	ND-258	≈ 7	Texas	Glaze and Rawley 1979
100	4-17	9	Texas	Smith et al. 1980
26	NR-110	NR	National	Westrick et al. 1984
NR	1-10	NR	Iowa	Kelley et al. 1985
8	ND-1.6	0.1	Michigan	Furlong and D'Itri 1986
NR	NR	0.8-8	California	Wallace et al. 1986b
Dibromochloromethane				
86	<0.1-2	0.9	Ohio	Bellar et al. 1974
NR	3-32	NR	5 Cities	Coleman et al. 1975
37	ND-110	2.7	National	Symons et al. 1975
85	ND-15.0	≈ 0.4	13 Cities	Keith et al. 1976
65	ND-9.0	2.9	Iowa	Morris and Johnson 1976
86	NR	14	National	Brass et al. 1977
99	NR-33	5.6	Midwest	ORVWSC 1979
NR	ND-128	≈ 20	Texas	Glaze and Rawley 1979
100	11-31	20	Texas	Smith et al. 1980
42	NR-63	NR	National	Westrick et al. 1984
NR	1-28	NR	Iowa	Kelley et al. 1985
75	ND-40	4.1	Michigan	Furlong and D'Itri 1986
NR	NR	1-2	New Jersey	Wallace et al. 1986a
NR	NR	8-28	California	Wallace et al. 1986b

μg = microgram; L = liter; ND = not detected; NR = not reported

6. POTENTIAL FOR HUMAN EXPOSURE

Bromoform and dibromochloromethane were detected in approximately 90% of samples from 5,320 wells in 21 states from 1985 to 1995 according to data collected by the United States Geological Survey (USGS) National Water-Quality Assessment Program, although actual concentrations were not given (Lapham et al. 2000). Bromoform and dibromochloromethane were detected in 27 and 39 out of 7,712 California drinking water wells, respectively, during monitoring studies conducted from 1984 to 1990 (Lam et al. 1994). Maximum concentrations were 78 µg/L for bromoform and 30 µg/L for dibromochloromethane. Dibromochloromethane was detected in 5 out of 6 samples from 178 active public supply wells in the Los Angeles physiographic basin, California above the laboratory reporting limit of 0.18 µg/L in August through September 2000 (Shelton et al. 2001). Bromoform was detected in four out of four samples above the laboratory reporting limit of 0.06 µg/L. Clark et al. (1994) collected drinking water samples from different points along the North Marin Water District, which serves the greater Novato area in California. Bromoform and dibromochloromethane were detected in the samples with concentrations ranging from 2.4 to 11.4 µg/L and from <0.1 to 7.5 µg/L, respectively. The concentrations of bromoform and dibromochloromethane were below their detection limits of 0.06 and 0.18 µg/L, respectively, in samples collected from 30 groundwater monitoring wells in Wichita, Kansas (USGS 2002). The wells were located in areas of recent residential and commercial development.

The State of California's Water Quality Monitoring Database contains data for public drinking water systems that use either groundwater or surface water sources (Storm 1994). Analysis of these data shows that bromoform was detected in 145 out of 11,765 samples (1.2%) and dibromochloromethane was detected in 171 out of 11,782 samples (1.5%). Mean concentrations in samples with detected dibromochloromethane and bromoform were 8.95 and 7.63 µg/L, respectively. Occurrence data from approximately 22,000 public water systems (source water: 88% groundwater and 12% surface water) from a cross-section of 24 states were selected from the Unregulated Contaminant Information System database (Round 1 monitoring data) (EPA 2001a). Dibromochloromethane and bromoform were detected in these systems with 99th percentile values of 12.7 and 7.3 µg/L, respectively. Occurrence data from approximately 27,000 public water systems (source water: 89% groundwater and 11% surface water) from a cross-section of 22 states were selected from the Safe Drinking Water Information System database (Round 2 monitoring data). Dibromochloromethane and bromoform were detected in these systems with 99th percentile values of 9.7 and 6.5 µg/L, respectively.

It is usually found that halomethanes occur at higher concentrations in drinking water derived from surface sources than those from groundwater supplies because the former tends to contain more dissolved

6. POTENTIAL FOR HUMAN EXPOSURE

organic matter (Bellar et al. 1974; Cech et al. 1981; Glaze and Rawley 1979; Page 1981). The total trihalomethane content of finished water from a given facility can be extremely variable as a function of time (Arguello et al. 1979; Smith et al. 1980), with lower levels of halomethanes usually occurring during the winter.

The mean concentration of dibromochloromethane was 0.74 µg/L in cold season samples from the Elizabethtown, New Jersey water distribution system (Chen and Weisel 1998). Dibromochloromethane levels rose to 1.7 µg/L in warm season samples. Bromoform was not found above the detection limit (0.10 µg/L) in cold season samples from the distribution system, but it was detected in warm season samples with a mean concentration of 0.27 µg/L. Summer concentration ranges in treated water immediately prior to distribution in a 1993 national Canadian survey conducted by Health Canada were <0.1–19.8 µg/L for dibromochloromethane and <0.1–4.2 µg/L for bromoform (Ritter et al. 2002). Winter concentration ranges were <0.1–9.0 µg/L for dibromochloromethane and <0.1–3.3 µg/L for bromoform. Bromoform was detected in the influent, treated, and distribution stages from 47 municipal water treatment plants in Ontario, Canada at concentrations of 0.5, 0–7.0, and 0.2–8.5 µg/L, respectively.

Dibromochloromethane was detected in samples from plant effluents of 35 Finnish waterworks with concentrations ranging from <0.05 to 3 µg/L (Nissinen et al. 2002). One exception was a comparatively high concentration of 43 µg/L measured at one of the plants. Bromoform concentrations were <0.05 µg/L in samples from all plants except for three (0.48, 0.31, and 27 µg/L). Concentrations of bromoform and dibromochloromethane in samples from two Finnish waterworks rose in the spring, changed little over summer and fall, and then dropped during winter. Campillo et al. (2004) detected bromoform in tap water samples collected in Spanish cities at concentrations ranging from 1.8 to 24.7 µg/L (mean=13.5 µg/L). The concentrations of dibromochloromethane in these samples ranged from 2.0 to 66.5 µg/L (mean=30 µg/L). Mean concentrations of dibromochloromethane and bromoform were 0.5 µg/L and below the detection limit (0.3 µg/L), respectively, in tap water from the city of Cherepovets, Russia (Egorov et al. 2003). Dibromochloromethane was detected in tap water samples collected from the 19 districts of Hong Kong at concentrations ranging from 0.830 to 4.15 µg/L (Lee et al. 2004b). Bromoform was detected (detection limit 0.03 µg/L) in tap water samples from only 4 of the 19 districts at concentrations ranging from 0.040 to 0.920 µg/L.

Bromoform and dibromochloromethane were detected in water samples from seven out of nine household residences in the Lower Rio Grande Valley during the spring of 1993 with concentrations ranging from 1.0 to 14.1 µg/L and from 3.3 to 17.3 µg/L, respectively (Berry et al. 1997). These compounds were

6. POTENTIAL FOR HUMAN EXPOSURE

detected in water samples from five out of nine residences in the same region during the summer of 1993 with concentrations ranging from 1.6 to 31.7 $\mu\text{g/L}$ and from 1.8 to 49.9 $\mu\text{g/L}$, respectively.

In order to reduce trihalomethane and related disinfection byproduct concentrations in treated water, communities have begun employing treatment methods that remove disinfection byproduct precursors such as natural organic carbon from the water prior to chlorination (Dey et al. 2001; Peltier et al. 2002; Shetty and Chellam 2003; Weiss et al. 2003; Westerhoff et al. 2004). Some processes employ a coagulation step to aid in filtration or adsorption (Dey et al. 2001; Drikas et al. 2003). Disinfection byproduct removal was studied in the two trains of the Mery-sur-Oise treatment plant, which feeds the northern Parisian Suburbs (Peltier et al. 2002). The newer train uses nanofiltration technology while the older train employs conventional treatment. Trihalomethane concentrations in water treated by the nanofiltration train were 50% less than trihalomethane concentrations in water treated by the conventional train. Weiss et al. (2002, 2003) observed that levels of total organic carbon and dissolved organic carbon in water from the Ohio, Wabash, and Missouri Rivers were reduced by 35–67% after riverbank filtration. However, the brominated trihalomethane precursors were not removed as efficiently as the chlorinated trihalomethane precursors (<40% compared to 80%). This was attributed to the increase in the bromide to total organic carbon ratio as the water traveled from the rivers to the collection wells.

Trihalomethanes may also form in chlorinated swimming pools (Beech et al. 1980). For fresh water pools, chloroform and dichlorobromomethane were usually the predominant THM species present, with dibromochloromethane and bromoform averaging 3–15 and 1–2 $\mu\text{g/L}$, respectively. However, in saline pools (which have a higher bromide ion content than fresh water pools), bromoform was the major THM present (average concentration of 650 $\mu\text{g/L}$), with lower concentrations (5–27 $\mu\text{g/L}$) of dibromochloromethane, bromodichloromethane, and chloroform. Concentrations of bromoform and dibromochloromethane were 1.8–2.9 and 3.5–17 $\mu\text{g/L}$, respectively, in samples taken from three chlorinated sandy bottom swimming areas in September (Mansour et al. 1999). The concentrations of dibromochloromethane were below 40 $\mu\text{g/L}$ in water samples from eight swimming pools in Nagpur, India (Thacker and Nitnaware 2003). Bromoform was detected in samples from only one of the pools at a concentration below 10 $\mu\text{g/L}$.

Dibromochloromethane and bromoform have also been detected in water near hazardous waste sites, although this is not common. Data from the Contract Laboratory Program (CLP) Statistical Data Base (CLPSD 1988) indicated that bromoform was detected in surface water at 2 of 862 hazardous-waste sites; the median concentration was 7 $\mu\text{g/L}$. Dibromochloromethane was detected in only one sample

6. POTENTIAL FOR HUMAN EXPOSURE

(45 µg/L). Bromoform was detected in groundwater samples collected at four sites; the median concentration was 26 µg/L. Based on monitoring data from 479 disposal site groundwater investigations that were conducted across the United States, bromoform was detected in groundwater samples from 10 hazardous waste disposal sites and dibromochloromethane has been detected in groundwater samples from 8 hazardous waste disposal sites (Plumb 1991). Actual concentrations of bromoform and dibromochloromethane were not given.

In a random survey of 954 community water systems, bromoform and dibromochloromethane were detected (minimum reporting limit of 0.2 µg/L) in 3.4 and 5.5%, respectively, of source water samples (Delzer and Ivahnenko 2003). Both bromoform and dibromochloromethane were detected more frequently in groundwater sources than surface water sources. Concentrations of bromoform in groundwater ranged from 0.19 to 2.61 µg/L with a median value of 0.26 µg/L; in surface water, the concentrations ranged from 0.03 to 0.06 µg/L with a median value of 0.05 µg/L. For dibromochloromethane, concentrations in groundwater ranged from 0.02 to 2.43 µg/L with a median value of 0.04 µg/L; in surface water, the concentrations ranged from 0.02 to 0.15 µg/L with a median value of 0.03 µg/L. In a study of over 21 cities throughout the United States conducted between 1991–1995, dibromochloromethane was detected (minimum reporting limit of 0.2 µg/L) in 3.4% of storm water and 0.5% of shallow groundwater samples (Lopes and Bender 1998). The presence of dibromochloromethane in these samples was attributed to the irrigation of lawns, gardens, and parks with chlorinated water, the draining of swimming pools, and uses of chlorinated water that result in its introduction to storm water catchments.

Dibromochloromethane has been detected at concentrations ranging from 1.1 to 36.3 ng/L in the Scheldt River estuary, Germany during May 1998; from 0.2 to 22.7 ng/L in Scheldt River estuary, Germany during October 1998; from below the detection limit to 39.0 ng/L in the Thames River estuary, England during February 1999; from below the detection limit to 7.7 ng/L in the Loire River estuary, France during September 1998; and from below the detection limit to 9.8 ng/L in the Rhine River estuary, Germany during November 1997 (Christof et al. 2002). Bromoform and dibromochloromethane were detected in water samples from the Southampton Water estuary at concentrations of 10–2,597 and 10–2,200 ng/L, respectively (Bianchi et al. 1991).

Bromoform was not found above a detection limit of 0.08 µg/L in 644 samples from 46 surface water locations, including sea, estuarine, river, and industrial effluent, throughout Portugal (Martinez et al. 2002). Concentrations of bromoform in the Belaya River, Russia were <0.0001 mg/L above an industrial zone and <0.0004 mg/L below the industrial zone (Safarova et al. 2004). The concentration of

6. POTENTIAL FOR HUMAN EXPOSURE

bromoform in the waste water flowing into this river was measured as 0.0021 mg/L. The concentrations of bromoform and dibromochloromethane in finished water from the city of Hanoi, Vietnam ranged from 1.2 to 8.5 µg/L (average, 6.6 µg/L) and from 0.3 to 22.3 µg/L (average, 6.3 µg/L), respectively, in high bromide finished water and from <0.2 to 3.7 µg/L (average, 0.5 µg/L) and from <0.2 to 3.8 µg/L (average, 1.8 µg/L), respectively, in low bromide finished water (Duong et al. 2003). In high bromide finished water that also had high ammonia content, dibromochloromethane was detected at concentrations ranging from <0.2 to 3.7 µg/L (average, 0.3 µg/L), while the concentration of bromoform was <0.2 µg/L. Bromoform and dibromochloromethane have been detected in the Marta River, Italy at concentrations of 2.39–3.35 and 0.04–0.11 µg/L, respectively (Russo et al. 2003). The concentrations of bromoform and dibromochloromethane in the Tiber River, Italy were 0.82–1.82 and <16–0.11 µg/L, respectively.

6.4.3 Sediment and Soil

Staples et al. (1985) reported that bromoform was not detected in any of 353 sediment samples analyzed. No data were available for dibromochloromethane. Data from the Contract Laboratory Program Statistic Data Base (CLPSD 1988) indicated dibromochloromethane and bromoform were detected in soils in only 2 of 862 hazardous waste sites; the median concentrations were 17 µg/kg (bromoform) and 15 µg/kg (dibromochloromethane). Bromoform and dibromochloromethane were detected in sediment samples from the Southampton Water estuary at concentrations ranging from 75 to 62,609 and from 150 to 27,350 ng/kg, respectively (Bianchi et al. 1991). During a monitoring study of volatile halogenated organic compounds in the Klosterhede State Forest District in Jutland, Denmark, bromoform was the only brominated compound detected in soil air samples and only in the upper soil layer with a concentration of 0.25 ng/L (Laternus et al. 2000b).

6.4.4 Other Environmental Media

The use of chlorinated water in the manufacture of commercially bottled drinks has raised concern over the presence of trihalomethanes in these drinks (McNeal et al. 1995). Levels of dibromochloromethane in bottled water and in carbonated soft drinks ranged from 0.5 to 2 ng/g in a survey of soft drinks, juices, beers, bottled water, and canned foods purchased from Washington, DC markets in 1991–1992. Bromoform was not found in any of the samples above a detection limit of 0.1 ng/g. Campillo et al. (2004) detected bromoform in pineapple juice, apple juice, and forest fruits juice at concentrations of 4.2,

6. POTENTIAL FOR HUMAN EXPOSURE

3.5, and 2.5 µg/L, respectively. Dibromochloromethane was found in pasteurized milk from a suburban area of Turku, Finland (Kroneld and Reunanen 1990).

Neither bromoform nor dibromochloromethane were detected in oyster, clam, or sediment samples from the Ariho and Yoshingaga Rivers in Japan (Gotoh et al. 1992). No detection limit was given. The mean concentrations of bromoform and dibromochloromethane in daily dietary samples collected from housewives in Nogoya and Yokohama, Japan were 0.2–0.6 and <0.1–0.2 ng/g, respectively (Toyoda et al. 1990).

6.5 GENERAL POPULATION AND OCCUPATIONAL EXPOSURE

Because of the variability of dibromochloromethane and bromoform concentrations in water and air, it is not possible to derive precise estimates of typical human exposure levels. However, based on the typical ranges of dibromochloromethane and bromoform concentrations measured in water and air, it is likely that most individuals will be exposed to average doses of <1 µg/kg/day (Table 6-3), nearly all of which is from water. Limited data suggest that exposure levels around chemical factories or waste sites are not likely to be much higher, but this can only be evaluated on a site-by-site basis.

The range of dibromochloromethane concentrations in tap water, in blood samples before showering, and in blood samples after showering in Cobb County, Georgia were <1–4, 0.001–0.003, and 0.003–0.029 µg/L, respectively (Miles et al. 2002). Concentrations in tap water, in blood samples before showering, and in blood samples after showering samples from Corpus Christi, Texas were 5–20, 0.002–0.031, and 0.011–>0.093 µg/L, respectively. Bromoform was detected in the Cobb County, Georgia samples at concentrations of <1 µg/L in tap water, 0.001–0.0052 µg/L in blood before showering, and 0.0001–0.0059 µg/L in blood after showering. Concentrations of dibromochloromethane in tap water, in blood samples before showering, and in blood samples after showering from Corpus Christi, Texas ranged from 2–17, 0.001–0.02, and 0.006–0.064 µg/L, respectively. Breath samples of individuals taken within 5 minutes after a shower with high dibromochloromethane and bromoform water concentrations contained dibromochloromethane at a mean concentration of 4.8 µg/m³ and bromoform at a mean concentration of 2.3 µg/m³ (Weisel 1999). Breath samples taken 5–20 minutes after a shower with high water concentration contained dibromochloromethane at a mean concentration of 2.8 µg/m³ and bromoform at a mean concentration of 1.2 µg/m³. Breath samples taken >20 minutes after a shower with high water concentration contained dibromochloromethane at a mean concentration of 1 µg/m³ and bromoform at a mean concentration of 0.6 µg/m³. Breath samples from individuals after a shower with

6. POTENTIAL FOR HUMAN EXPOSURE

Table 6-3. Summary of Typical Human Exposure to Bromoform and Dibromochloromethane

Parameter	Exposure medium	
	Water	Air
Typical concentration in medium	1–20 µg/L	0–0.1 µg/m ³
Assumed intake of medium by 70-kg adult	2 L/day	20 m ³ /day
Assumed absorption fraction	1.0	0.5
Estimated dose to 70-kg adult	0.03–0.6 µg/kg/day	0.0–0.01 µg/kg/day

µg = microgram; kg = kilogram; L = liter; m³ = cubic meters

6. POTENTIAL FOR HUMAN EXPOSURE

low water concentration contained dibromochloromethane with a mean concentration of $1 \mu\text{g}/\text{m}^3$ at different collection times and bromoform with a mean concentration of $0.6 \mu\text{g}/\text{m}^3$ at different collection times.

Blood samples taken from 16 individuals in the Lower Rio Grande Valley during the spring of 1993 had a maximum dibromochloromethane concentration of $0.05 \mu\text{g}/\text{L}$ (38% frequency of detection) and a maximum bromoform concentration of $0.07 \mu\text{g}/\text{L}$ (19% frequency of detection) (Buckley et al. 1997). Blood samples taken during the Third National Health and Nutrition Examination Survey, which included over 1,000 individuals, had a maximum dibromochloromethane concentration of $0.024 \mu\text{g}/\text{L}$ (14.5% frequency of detection) and a maximum bromoform concentration of $0.034 \mu\text{g}/\text{L}$ (9.9% frequency of detection) (Buckley et al. 1997; Needham et al. 1995).

Dibromochloromethane was found in human kidney and lung tissue at 0.6 and $0.06 \mu\text{g}/\text{kg}$, respectively, in samples taken in the city of Turku, Finland in 1987 (Kroneld 1989a). It was also detected in air samples from that region at a concentration of $0.31 \text{ mg}/\text{m}^3$. Polkowska et al. (2003) studied the relationship between concentrations of volatile organic halogens in drinking water and the concentrations of these substances in the urine of individuals living in Gdansk-Sopot-Gdynia Tri City area of Poland. Concentrations of dibromochloromethane in drinking water from three locations were $0.015\text{--}0.159$, $0.912\text{--}1.125$, and $0.953\text{--}0.987 \mu\text{g}/\text{L}$ with corresponding urine concentrations ranging from not detected to $0.003 \mu\text{g}/\text{L}$, from 0.001 to $0.012 \mu\text{g}/\text{L}$, and from not detected to $0.005 \mu\text{g}/\text{L}$, respectively. Bromoform was only detected in drinking water from two locations at concentrations of $0.018\text{--}0.032$ and $0.018\text{--}0.045 \mu\text{g}/\text{L}$. It was not detected in any of the urine samples. Detection limits were not provided in this study.

The mean concentrations of bromoform and dibromochloromethane in daily dietary samples collected from housewives in Nogoya and Yokohama, Japan were $0.2\text{--}0.6$ and $<1\text{--}0.2 \text{ ng}/\text{g}$, respectively (Toyoda et al. 1990). Based on these concentrations, the mean daily dietary intakes for housewives in these cities were calculated to be $0.5\text{--}1.2 \mu\text{g}$ for bromoform and $0\text{--}0.5 \mu\text{g}$ for dibromochloromethane.

Exposure to dibromochloromethane and bromoform may be above average for persons who swim in chlorinated swimming pools. Beech (1980) estimated that the total dose for a 6-year-old boy who swam for 3 hours in a pool containing $500 \mu\text{g}/\text{L}$ of trihalomethanes could be as high as 2.8 mg ($130 \mu\text{g}/\text{kg}$). About 60% of this dose was attributed to dermal absorption, with about 30% resulting from inhalation. In fresh water pools, only a small fraction of this would be dibromochloromethane or bromoform, but in a

6. POTENTIAL FOR HUMAN EXPOSURE

salt water pool, a large fraction would be expected to be bromoform (Beech et al. 1980). Aggazzotti et al. (1998) studied the exposure of competitive indoor swimmers to trihalomethanes. The mean concentrations of dibromochloromethane were 0.8 µg/L in the pool water, 5.2 µg/m³ in the pool air prior to swimming, and 11.4 µg/m³ in pool air during swimming. The mean concentration of bromoform was 0.1 µg/L in the pool water. Bromoform was detected above 0.1 µg/m³ in only one air sample. Mean concentrations of dibromochloromethane in the alveolar air sampled from five swimmers were 0.8 µg/m³ before swimming and 1.4 µg/m³ after 1 hour of swimming. Bromoform was not quantified in any of the alveolar air samples. Calculated dibromochloromethane intakes for the five swimmers were 1.5–1.9 µg/hour before swimming and 14–22 µg/hour after 1 hour of swimming.

Individuals who work at indoor pool facilities are expected to be at risk for occupational exposure to trihalomethanes (Fantuzzi et al. 2001). Dibromochloromethane was detected in 24 out of 32 alveolar air samples collected from individuals who work at selected indoor swimming pools in Modena, Italy (Fantuzzi et al. 2001). The mean concentration was 0.5 µg/m³. Bromoform was not detected in any of the alveolar air samples above the detection limit of 0.1 µg/m³. The authors reported that the concentration of trihalomethanes in the alveolar air of poolside attendants was double that in alveolar air collected from employees working in the engine room and reception area (25.1 vs. 14.8 µg/m³). Mean concentrations of dibromochloromethane measured in this study were 1.9 µg/L in pool water, 3.1 µg/m³ in poolside ambient air, 1.5 µg/m³ in reception area ambient air, and 1.6 µg/m³ in engine room ambient air. The mean concentration of bromoform was 0.4 µg/L in pool water. It was only detected in one ambient air sample (poolside) at a concentration of 0.8 µg/m³.

6.6 EXPOSURES OF CHILDREN

This section focuses on exposures from conception to maturity at 18 years in humans. Differences from adults in susceptibility to hazardous substances are discussed in Section 3.7, Children's Susceptibility.

Children are not small adults. A child's exposure may differ from an adult's exposure in many ways. Children drink more fluids, eat more food, breathe more air per kilogram of body weight, and have a larger skin surface in proportion to their body volume. A child's diet often differs from that of adults. The developing human's source of nutrition changes with age: from placental nourishment to breast milk or formula to the diet of older children who eat more of certain types of foods than adults. A child's behavior and lifestyle also influence exposure. Children crawl on the floor, put things in their mouths,

6. POTENTIAL FOR HUMAN EXPOSURE

sometimes eat inappropriate things (such as dirt or paint chips), and spend more time outdoors. Children also are closer to the ground, and they do not use the judgment of adults to avoid hazards (NRC 1993).

No information was located regarding the exposures of children to bromoform or dibromochloromethane. Exposures of children to bromoform and dibromochloromethane through inhalation are expected to vary depending on the length of time a child spends indoors and the concentrations of these compounds in indoor air. The concentrations of bromoform and dibromochloromethane will depend on the source of household water, exchange rate of indoor and outdoor air, frequency and duration of showers, and emission rates of these compounds from other household sources (e.g., dishwasher, washing machines, etc.). Dermal exposures of children to bromoform and dibromochloromethane are expected to be lower than, or similar to, those found for adults, depending on frequency and duration of bathing or showering. However, the primary routes of exposure to bromoform and dibromochloromethane are expected to be through drinking water or consumption of beverage or food products that contain water that has been disinfected through chlorination. It is expected that a child's exposure to bromoform and dibromochloromethane will depend predominantly on the source and amount of drinking water consumed per day. Exposure of newborns and infants to bromoform and dibromochloromethane, whose diets are supplemented with human breast milk, cow's milk, or infant formulas, is not known, since measurements of these compounds are not available in these media. Swimming is expected to provide an additional source of exposure for children who spend time in chlorinated swimming pools (Beech et al. 1980).

6.7 POPULATIONS WITH POTENTIALLY HIGH EXPOSURES

The environmental medium most likely to be contaminated with bromoform and dibromochloromethane is chlorinated water. Therefore, any person who is in frequent contact with such water could have above average exposures. This includes individuals who drink large quantities of water, such as workers in hot climates, or individuals with swimming pools or saunas, where contact could occur by inhalation or by dermal contact. Since bromoform and dibromochloromethane levels in water depend on the organic content of the source water before chlorination, individuals whose water source is high in organics are likely to have finished water with higher-than-average bromoform and dibromochloromethane levels.

Workers in chemical production facilities or laboratories where bromoform and dibromochloromethane is made or used would also have potentially high exposures to the chemicals, most likely by inhalation or dermal exposure. Persons living near hazardous-waste sites may have potentially high exposures to bromoform and dibromochloromethane, but this can only be evaluated on a case-by-case basis.

6. POTENTIAL FOR HUMAN EXPOSURE

6.8 ADEQUACY OF THE DATABASE

Section 104(i)(5) of CERCLA, as amended, directs the Administrator of ATSDR (in consultation with the Administrator of EPA and agencies and programs of the Public Health Service) to assess whether adequate information on the health effects of bromoform and dibromochloromethane is available. Where adequate information is not available, ATSDR, in conjunction with the National Toxicology Program (NTP), is required to assure the initiation of a program of research designed to determine the health effects (and techniques for developing methods to determine such health effects) of bromoform and dibromochloromethane.

The following categories of possible data needs have been identified by a joint team of scientists from ATSDR, NTP, and EPA. They are defined as substance-specific informational needs that if met would reduce the uncertainties of human health assessment. This definition should not be interpreted to mean that all data needs discussed in this section must be filled. In the future, the identified data needs will be evaluated and prioritized, and a substance-specific research agenda will be proposed.

6.8.1 Identification of Data Needs

Physical and Chemical Properties. The physical and chemical properties of dibromochloromethane and bromoform have been well studied, and reliable values for key parameters are available for use in environmental fate and transport models. On this basis, it does not appear that further studies of the physical-chemical properties of dibromochloromethane and bromoform are essential.

Production, Import/Export, Use, Release, and Disposal. According to the Emergency Planning and Community Right-to-Know Act of 1986, 42 U.S.C. Section 11023, industries are required to submit substance release and off-site transfer information to the EPA. The TRI, which contains this information for 2002, became available in May of 2004. This database is updated yearly and should provide a list of industrial production facilities and emissions.

Available data indicate that neither bromoform nor dibromochloromethane is produced or used in significant quantities in the United States. Nevertheless, a listing of laboratories or industries that use small amounts in research or testing would be valuable in identifying locations where the potential for

6. POTENTIAL FOR HUMAN EXPOSURE

environmental releases or human exposure exists. Also, information on the means of disposal of waste chemicals would be valuable in identifying environmental media likely to be affected at such sites. Federal regulations do restrict disposal of dibromochloromethane and bromoform to land or in industrial effluents.

Environmental Fate. The fate of dibromochloromethane and bromoform in the environment has not been thoroughly studied, although the physical-chemical properties indicate that both are likely to partition to air and water. Volatilization rates have been calculated for flowing rivers and streams, but direct measurements of half-times of volatilization would be useful, both for surface waters and for household water (showers, baths, cooking, etc.). Adsorption of these compounds to soils and sediments has been studied and does not appear to be a significant factor. Consequently, transport in surface or groundwater are likely to be important. Studies to confirm these expectations and provide more precise descriptions of the environmental behavior of these compounds would be valuable in assessing human exposure near specific sources of release.

Degradation of dibromochloromethane and bromoform in air has not been studied, but is expected to occur by reaction with hydroxyl radicals. Studies to measure the atmospheric half-times of these compounds would be valuable in estimating long-term trends in atmospheric levels, but such studies are probably not essential in estimating exposure near specific sources. Neither chemical undergoes chemical degradation in water, but both are subject to microbial breakdown in water (especially anaerobic groundwater) or moist soils. Further data on the rate of microbial degradation of dibromochloromethane and bromoform in water and soil would be valuable, with special attention to how these rates depend on environmental conditions (oxygen level, pH, etc.).

Bioavailability from Environmental Media. Both dibromochloromethane and bromoform are known to be absorbed following oral and inhalation exposure. No data are available regarding dermal absorption, but it seems likely that uptake across the skin may occur. No data were located regarding the relative bioavailability of dibromochloromethane and bromoform in water, soil or air. Because of their physical and chemical properties, it is expected that the bioavailability of dibromochloromethane and bromoform are not significantly reduced by environmental media, but studies to substantiate this presumption would be helpful.

Food Chain Bioaccumulation. There are few data on bioconcentration of dibromochloromethane or bromoform by plants or aquatic organisms, and no data were located on the bioaccumulation of

6. POTENTIAL FOR HUMAN EXPOSURE

bromoform and dibromochloromethane in the food chain. This lack of data may not be a major limitation because the general levels of the chemicals in water and soil appear to be quite low, and based on the K_{oc} of these chemicals, there appears to be a low likelihood of food chain buildup.

Exposure Levels in Environmental Media. Reliable monitoring data for the levels of bromoform and dibromochloromethane in contaminated media at hazardous waste sites are needed so that the information obtained on levels of bromoform and dibromochloromethane in the environment can be used in combination with the known body burden of bromoform and dibromochloromethane to assess the potential risk of adverse health effects in populations living in the vicinity of hazardous waste sites.

There are several studies on the atmospheric concentrations of bromoform and dibromochloromethane in urban and rural environments, but many of the samples did not have detectable levels. No data on levels in air near waste sites were located. More research in this area using more sensitive analytical methods would be helpful, although it is anticipated that typical atmospheric levels will usually be low enough that air is not the principal route of exposure. Data are available on dibromochloromethane and bromoform in a number of chlorinated drinking water systems, and these compounds have been detected in surface water and groundwater near a few hazardous waste sites. Further studies on the levels of these compounds in water and soil around waste sites would be valuable in evaluating the risk to human health posed by these contaminants.

Exposure Levels in Humans. There are no data on levels of dibromochloromethane or bromoform in blood, breath or other tissues from humans residing near waste sites. Low levels of bromoform have been detected in blood of humans, presumably as the result of exposure through ingestion of chlorinated drinking water. Levels in expired breath and in adipose tissue appear to be too low to measure reliably for the general population. Direct measurement of typical human intake from water and air (especially indoor air) would be helpful in obtaining more accurate estimates of typical human dose levels. Similar data on inhalation and dermal doses would be useful for bromoform and dibromochloromethane in and around swimming pools (especially indoor pools).

This information is necessary for assessing the need to conduct health studies on these populations.

Exposures of Children. No formal studies of children's inhalation, dermal, or oral exposures to bromoform and dibromochloromethane were located in the literature. Based on the concentrations of bromoform and dibromochloromethane measured in indoor air and in drinking water that has been

6. POTENTIAL FOR HUMAN EXPOSURE

disinfected by chlorination, studies are needed to assess the inhalation, dermal, and oral exposures of children to these and other disinfection by-products. Data on inhalation and dermal doses would be useful for bromoform and dibromochloromethane in and around swimming pools (especially indoor pools).

Child health data needs relating to susceptibility are discussed in Section 3.12.2, Identification of Data Needs: Children's Susceptibility.

Exposure Registries. No exposure registries for bromoform and dibromochloromethane were located. These compounds are not currently one of the compounds for which a sub-registry has been established in the National Exposure Registry. These compounds will be considered in the future when chemical selection is made for sub-registries to be established. The information that is amassed in the National Exposure Registry facilitates the epidemiological research needed to assess adverse health outcomes that may be related to exposure to this substance.

6.8.2 Ongoing Studies

The Federal Research in Progress (FEDRIP 2004) database provides additional information obtainable from a few ongoing studies that may fill in some of the data needs identified in Section 6.8.1. These studies are summarized in Table 6-4.

6. POTENTIAL FOR HUMAN EXPOSURE

Table 6-4. Ongoing Studies on the Potential for Human Exposure to Bromoform^a

Investigator	Affiliation	Research description	Sponsor
Harrington, J; Simpson WR	Pennsylvania State University, University Park, Pennsylvania; University of Alaska Fairbanks Campus, Fairbanks, Alaska	Development and testing of a radiation-transfer model for snow photochemistry. This will help quantify the extent of photochemical processing of trace compounds within snow and will help in interpreting ice core climate records and understanding atmospheric chemistry in snow-covered regions. The study will include measurements of photolysis rates for bromoform.	National Science Foundation
Meyer GJ	Johns Hopkins University, Baltimore, Maryland	Development of new reductive and oxidative dehalogenation chemistries and the elucidation of their fundamental mechanisms; application of these new findings to the sensing, remediation, and determination of the environmental fate of organohalide pollutants. The study will provide a pedagogical platform that informs and educates the next generation of environmental chemists.	National Science Foundation
Saltzman E	University of California-Irvine	The degradation of natural halogenated compounds in coastal seawater will be studied. Measurements will be used to revise estimates for the uptake of atmospheric halocarbons by the oceans, the extent to which the oceans can buffer atmospheric halocarbon concentrations, and the production rate for these gases in the surface oceans.	National Science Foundation

^aSource: CRIS 2003; FEDRIP 2003, 2004

7. ANALYTICAL METHODS

The purpose of this chapter is to describe the analytical methods that are available for detecting, measuring, and/or monitoring bromoform and dibromochloromethane, its metabolites, and other biomarkers of exposure and effect to bromoform and dibromochloromethane. The intent is not to provide an exhaustive list of analytical methods. Rather, the intention is to identify well-established methods that are used as the standard methods of analysis. Many of the analytical methods used for environmental samples are the methods approved by federal agencies and organizations such as EPA and the National Institute for Occupational Safety and Health (NIOSH). Other methods presented in this chapter are those that are approved by groups such as the Association of Official Analytical Chemists (AOAC) and the American Public Health Association (APHA). Additionally, analytical methods are included that modify previously used methods to obtain lower detection limits and/or to improve accuracy and precision.

As is true for most volatile organic compounds, the preferred analytical technique for dibromochloromethane and bromoform is gas chromatography (GC) (Ashley et al. 1996; Djozan and Assadi 1995; Fishbein 1985). A number of devices are suitable for detection and quantification of dibromochloromethane and bromoform as they emerge from the GC, including flame ionization detection (GC/FID), halogen-sensitive detection (GC/HSD) or electron-capture detection (GC/ECD). In general, HSD or ECD are preferable because of their high sensitivity for halogenated compounds. When absolute confidence in compound identity is required, mass spectrometry (GC/MS) is the method of choice.

The most variable aspect of analyses of this sort is the sample preparation procedure used to separate dibromochloromethane and bromoform from the test medium in order to prepare a sample suitable for GC analysis. As volatile organic compounds of relatively low water solubility, both dibromochloromethane and bromoform are easily lost from biological and environmental samples, so appropriate care must be exercised in handling and storing such samples for chemical analysis. Brief summaries of the methods available for extraction and detection of these compounds in biological and environmental samples are provided below.

7.1 BIOLOGICAL MATERIALS

Separation of dibromochloromethane and bromoform from biological samples is most often achieved by headspace analysis, purge-and-trap collection, solvent extraction, or direct collection on adsorbent resins.

7. ANALYTICAL METHODS

Headspace analysis offers speed, simplicity, and good reproducibility, but partitioning of the analyte between the headspace and the sample matrix is dependent upon the nature of the matrix and must be determined separately for each different kind of matrix (Walters 1986).

Purge-and-trap collection is well suited to biological samples such as blood or urine that are readily soluble in water (Ashley et al. 1996; Peoples et al. 1979). This method consists of bubbling an inert gas through a small volume of the sample and collecting the vapor in a trap packed with sorbent. The analytes are then removed from the trap by heating it and backflushing the analytes onto a gas chromatographic column. The two materials most widely used for adsorption and thermal desorption of volatile organic compounds collected by the purge and trap technique are Carbotrap[®], consisting of graphitized carbon black, and Tenax[®], a porous polymer of 2,6-diphenyl-p-phenylene oxide (Fabbri et al. 1987).

For water-insoluble materials such as fat or other tissues, the most common separation procedure is extraction with an organic solvent such as diethyl ether (Zlatkis and Kim 1976). Homogenization of tissue with the extractant and lysing of cells usually improves solvent extraction efficiency.

Analytical methods for the determination of bromoform and dibromochloromethane in biological materials are summarized in Table 7-1.

7.2 ENVIRONMENTAL SAMPLES

Dibromochloromethane and bromoform may be isolated from environmental samples using the same methods and principles as those used for biological materials, followed by gas chromatographic analysis. The most convenient procedure for most liquid and solid samples is the purge-and-trap method. Arthur et al. (1992) used solid phase micro extraction to separate volatile halogenated compounds from water samples. The organic analytes partition between the water sample and the stationary phase coating of a fused silica fiber before they are thermally desorbed in a GC injector. Djozan and Assadi (1995) introduced a gas stripping cryogenic trapping technique for separating volatile halogenated compounds from drinking water samples. In this method, a purified gas passes through the water sample in a stripping column where it removes volatile compounds from a water sample. The effluent from the column is dried, trapped in a cold trapping coil, and then released to the GC system by warming. Membrane inlet mass spectrometry (MIMS) is another technique for separating organohalogen compounds from drinking water (Bocchini et al. 1999). With this method, volatile organic compounds

7. ANALYTICAL METHODS

Table 7-1. Analytical Methods for Determining Bromoform and Dibromochloromethane in Biological Materials

Sample matrix	Preparation method	Analytical method	Sample detection limit	Accuracy (percent recovery)	Reference
Adipose tissue	Extraction, bulk lipid removal, Florisil fractionation	HRGC/MS	0.1 µg/g	NR	Mack and Stanley 1985
Adipose tissue	Heated dynamic headspace purge-and-trap	HRGC/MS	1 ng/g (DBCM) 2 ng/g (TBM)	NR	Stanley 1986
Adipose tissue	Purge from liquified fat at 115 °C, trap on Tenax/silica gel, thermal desorption	GC/HSD	<2 µg/L	83–107 (TBM) 90–118 (DBCM)	Peoples et al. 1979
Blood	Purge from blood onto Tenax, thermal desorption onto column maintained at -20 °C	GC/MS	≈0.1 ng/mL	NR	Antoine et al. 1986
Blood	Extract with n-pentane	HRGC/ECD	0.1 µg/L (DBCM)	NR	Kroneld 1985
Blood	Purge from blood at 30 °C, trap onto Tenax, thermal desorption	GC/MS	0.021µg/L (TBM)	102–108 (TBM)	Ashley et al. 1992
Blood	Purge from blood at 30 °C, trap onto Tenax, thermal desorption	GC/MS	0.017µg/L (DBCM)	91–104 (DBCM)	Ashley et al. 1992
Blood, tissue	Macerate tissue in water, warm blood or tissue, pass inert gas through, trap on Tenax, thermal desorption	GC/MS	3 ng/mL (blood) 6 ng/g (tissue)	NR	Pellizzari et al. 1985b
Blood serum	Purge from water-serum mixture containing antifoam reagent at 115 °C, trap on Tenax/silica gel, thermal desorption	GS/HSD	<2 µg/L	79–100 (TBM) 78–100 (DBCM)	Peoples et al. 1979
Breath	Trap on Tenax, dry over calcium sulfate, thermal desorption	GC/MS	1–5 µg/m ³	92±15 (TBM) 93±13 (DBCM)	Wallace et al. 1986b

µg = microgram; DBCM = dibromochloromethane; ECD = electron capture detector; g = gram; GC = gas chromatography; HRGC = high resolution gas chromatography; HSD = halide specific detector; L = liter; m³ = cubic meters; mg = milligram; mL = milliliter; MS = mass spectrometry; ng = nanogram; NR = not reported; TBM = bromoform

7. ANALYTICAL METHODS

from the drinking water sample diffuse through a hollow-fiber membrane into a mass spectrometer. The advantages of this method are that sample pre-treatment is not required, response times are fast, and trace analysis of the pollutants can be performed on-line. Halocarbons can also be removed from water by adsorption on synthetic polymers contained in cartridges, followed by thermal desorption of the analyte (Pankow et al. 1988). Among the products used for this purpose are Tenax-GC[®] and Tenax-TA[®]. A similar procedure is used for air, in which the air is passed through an adsorbent canister, followed by thermal desorption (Pankow et al. 1998).

Analytical methods for the determination of dibromochloromethane and bromoform in environmental samples are given in Table 7-2.

7.3 ADEQUACY OF THE DATABASE

Section 104(i)(5) of CERCLA, as amended, directs the Administrator of ATSDR (in consultation with the Administrator of EPA and agencies and programs of the Public Health Service) to assess whether adequate information on the health effects of bromoform and dibromochloromethane is available. Where adequate information is not available, ATSDR, in conjunction with the National Toxicology Program (NTP), is required to assure the initiation of a program of research designed to determine the health effects (and techniques for developing methods to determine such health effects) of bromoform and dibromochloromethane.

The following categories of possible data needs have been identified by a joint team of scientists from ATSDR, NTP, and EPA. They are defined as substance-specific informational needs that if met would reduce the uncertainties of human health assessment. This definition should not be interpreted to mean that all data needs discussed in this section must be filled. In the future, the identified data needs will be evaluated and prioritized, and a substance-specific research agenda will be proposed.

7.3.1 Identification of Data Needs

Methods for Determining Biomarkers of Exposure and Effect.

Exposure. Sensitive and specific methods exist for the determination of dibromochloromethane and bromoform in blood, expired air, and adipose tissue. These methods are presumably sensitive enough to

7. ANALYTICAL METHODS

Table 7-2. Analytical Methods for Determining Bromoform and Dibromochloromethane in Environmental Samples

Sample matrix	Preparation method	Analytical method	Sample detection limit	Accuracy (percent recovery)	Reference
Drinking water	Solvent extraction with pentane, direct injection of extract	HRGC/ECD	<0.5 µg/L	NR	Fayad and Iqbal 1985
Drinking water	Gas stripping and cryogenic trapping system	GC/FID	0.05 µg/L (DBCM)	75±7.7 (DBCM)	Djozan and Assadi 1995
Drinking water	Adsorption to and diffusion through a polymeric hollow-fiber membrane	MIMS	0.5 µg/L (TBM)	NR	Bocchini et al. 1999
Drinking water	Adsorption to and diffusion through a polymeric hollow-fiber membrane	MIMS	0.5 µg/L (DBCM)	NR	Bocchini et al. 1999
Drinking water	Purge and trap, thermal desorption	GC/MS	0.1µg/L	89–90 (TBM)	Eichelberger et al. 1990
Drinking water	Purge and trap, thermal desorption	GC/MS	0.1µg/L	95–100 (TBM)	Eichelberger et al. 1990
Air	Coconut shell charcoal sorption, carbon disulfide desorption	GC/FID	10 µg/sample (TBM)	14.0 (TBM)	NIOSH 1994
Air	Carbotrap/Carboxen filled glass cartridge adsorption/thermal desorption	GC/MS	0.02 ppbv (TBM)	95–102 (TBM)	Pankow et al. 1998
Air	Carbotrap/Carboxen filled glass cartridge adsorption/thermal desorption	GC/MS	0.04 ppbv (DBCM)	96–99 (DBCM)	Pankow et al. 1998
Water	Purge and trap	GC/MS	10 µg/L	NR	EPA 1980b
Water	Purge and trap	GC/HSD	0.20 µg/L (TBM)	89±9 (TBM)	EPA 1982a
			0.09 µg/L (DBCM)	98±7 (DBCM)	
Water	Purge and trap	GC/MS	4.7 µg/L (TBM)	105±16 (TBM)	EPA 1982b
			3.1 µg/L (DBCM)	104±14 (DBCM)	
Water	Purge and trap	GC/HSD	0.5 µg/L	97 (DBCM)	APHA 1985a
				101 (DBCM)	
Water	Purge and trap	GC/MS	<2 µg/L	82 (TBM)	APHA 1985b
Water	Solvent extraction (isooctane)	GC/ECD	2 µg/L	NR	ASTM 1988
Water	Solid phase micro extraction	GC/MS	4.7 µg/L (TBM)		Arthur et al. 1992

7. ANALYTICAL METHODS

Table 7-2. Analytical Methods for Determining Bromoform and Dibromochloromethane in Environmental Samples

Sample matrix	Preparation method	Analytical method	Sample detection limit	Accuracy (percent recovery)	Reference
Water	Solid phase micro extraction	GC/MS	3.1 µg/L (DBCM)		Arthur et al. 1992
Contaminated soil	Purge and trap	GC/HSD	2 µg/kg (TBM) 0.9 µg/kg (DBCM)	96 ^b (TBM) 94 ^b (DBCM)	EPA 1986a
Wastes, nonwater miscible	Purge and trap	GC/HSD	250 µg/kg (TBM) 113 µg/kg (DBCM)	96 ^b (TBM) 94 ^b (DBCM)	EPA 1986a
Solid waste	Purge and trap	GC/MS	5 µg/kg	118 ^b (TBM) 101 ^b (DBCM)	EPA 1986b

^aValue refers to both DBCM and TBM unless noted otherwise.

^bThis recovery is typical at concentrations of around 100 µg/L or higher. Recoveries may deviate at lower concentrations.

µg = microgram; DBCM = dibromochloromethane; ECD = electron capture detector; FID = flame ionization detector; g = gram; GC = gas chromatography; HRGC = high resolution gas chromatography; HSD = halide specific detector; kg = kilogram; L = liter; MS = mass spectrometry; NR = not reported; TBM = bromoform

7. ANALYTICAL METHODS

measure levels in humans exposed to doses of the chemicals that produce sedation or cause injury to liver and kidney. However, data on this are lacking due to absence of cases. The methods are also suitable for measuring background levels in the general population, although increased sensitivity would be useful for analysis of expired air and adipose tissue. The major limitation to these methods is that only recent exposures can be detected, so work to identify and quantify a more stable biomarker of exposure (e.g., a halomethyl adduct) would be valuable.

Effect. No chemical or biochemical biomarkers of effect are recognized, aside from nonspecific indices of hepatic or renal dysfunction. Efforts to identify a specific biomarker of effect (in particular, an effect such as alkylation of DNA that may be related to cancer risk) would be valuable in evaluating potential health risk to exposed humans.

Methods for Determining Parent Compounds and Degradation Products in Environmental Media. Reliable and specific methods exist for measuring parent dibromochloromethane and bromoform in air, water, soil and solid wastes. Humans could be exposed to these compounds by contact with any of these media, although ingestion of or dermal contact with contaminated water appears to be the most likely route near a chemical waste site. Existing methods are readily able to detect concentration values in environmental media that are likely to lead to significant noncancer health effects, but might not be sensitive enough to measure levels that pose low levels of cancer risks. However, since no chemical-specific cancer potency values are available for these components, this is not certain.

7.3.2 Ongoing Studies

No ongoing studies on analytical methods were identified in a search of the Federal Research in Progress database (FEDRIP 2004).

8. REGULATIONS AND ADVISORIES

The international, national, and state regulations and guidelines regarding bromoform and dibromochloromethane in air, water, and other media are summarized in Table 8-1.

An acute-duration oral MRL of 0.7 mg/kg/day has been derived for bromoform. This MRL is based on a NOAEL of 72 mg/kg/day and a LOAEL of 145 mg/kg/day for centrilobular pallor in mice receiving gavage doses of bromoform for 14 days (Condie et al. 1983). The MRL was derived by dividing the NOAEL by an uncertainty factor of 100 (10 for animal to human extrapolation and 10 for human variability).

An intermediate-duration oral MRL of 0.2 mg/kg/day has been derived for bromoform. This MRL is based on a NOAEL of 50 mg/kg for hepatocellular vacuolization in rats administered gavage doses of bromoform in corn oil 5 days/week for 13 weeks (NTP 1989a). The MRL was derived by dividing the duration adjusted NOAEL of 18 mg/kg/day by an uncertainty factor of 100 (10 for animal to human extrapolation and 10 for human variability).

A chronic-duration oral MRL of 0.02 mg/kg/day has been derived for bromoform. This MRL is based on a LOAEL of 100 mg/kg for hepatocellular vacuolization in rats administered gavage doses of bromoform in corn oil 5 days/week for 2 years (NTP 1989a). The MRL was derived by dividing the duration adjusted LOAEL of 71 mg/kg/day by an uncertainty factor of 300 (3 for use of a minimal LOAEL, 10 for animal to human extrapolation, and 10 for human variability) and a modifying factor of 10 to account for the identification of a lower LOAEL in a 13-week study (NTP 1989a).

An acute-duration oral MRL of 0.1 mg/kg/day has been derived for dibromochloromethane. This MRL is based on a LOAEL of 37 mg/kg for hepatocellular vacuolization in mice administered gavage doses of dibromochloromethane in corn oil for 14 days (Condie et al. 1983). The MRL was derived by dividing the LOAEL by an uncertainty factor of 300 (3 for use of a minimal LOAEL, 10 for animal to human extrapolation, and 10 for human variability).

A chronic-duration oral MRL of 0.09 mg/kg/day has been derived for dibromochloromethane. This MRL is based on a LOAEL of 40 mg/kg for fatty changes in the liver of rats administered gavage doses of dibromochloromethane in corn oil for 2 years (NTP 1985). The MRL was derived by dividing the

8. REGULATIONS AND ADVISORIES

duration-adjusted LOAEL of 28 mg/kg/day by an uncertainty factor of 300 (3 for use of a minimal LOAEL, 10 for animal to human extrapolation, and 10 for human variability).

8. REGULATIONS AND ADVISORIES

Table 8-1. Regulations and Guidelines Applicable to Bromoform and Dibromochloromethane

Agency	Description	Information	Reference
INTERNATIONAL			
Guidelines:			
IARC	Carcinogenicity classification Bromoform Dibromochloromethane	Group 3 ^a Group 3 ^a	IARC 1999a, 1999b
WHO	Drinking water guideline Bromoform Dibromochloromethane	100 mg/L 100 mg/L	WHO 1996
NATIONAL			
Regulations and Guidelines:			
a. Air:			
ACGIH	TLV (8-hour TWA) Bromoform ^b	0.5 ppm	ACGIH 2003
NIOSH	REL (10-hour TWA) Bromoform ^c IDLH	0.5 ppm 850 ppm	NIOSH 2003
OSHA	PEL (8-hour TWA) for general industry Bromoform ^d	0.5 ppm	OSHA 2003a 29 CFR 1910.1000, Table Z-1
	PEL (8-hour TWA) for construction industry Bromoform ^d	0.5 ppm	OSHA 2003c 29 CFR 1926.55, Appendix A
	PEL (8-hour TWA) for shipyard industry Bromoform ^d	0.5 ppm	OSHA 2003b 29 CFR 1915.1000
USC	Hazardous air pollutant	Bromoform	USC 2003
b. Water			
EPA	Drinking water health advisories Bromoform		EPA 2002a, 2002b
	1-day (10-kg child)	5.0 mg/L	
	10-day (10-kg child)	2.0 mg/L	
	DWEL ^e	0.7 mg/L	
	10 ⁻⁴ Cancer risk ^f	0.4 mg/L	
	Dibromochloromethane		
	1-day (10-kg child)	6.0 mg/L	
	10-day (10-kg child)	6.0 mg/L	
	DWEL ^e	0.7 mg/L	
	Lifetime ^g	0.06 mg/L	
10 ⁻⁴ Cancer risk ^f	0.04 mg/L		
	Effluent guidelines and standards; toxic pollutants pursuant to Section 307 (a)(1) of the Clean Water Act	Bromoform	EPA 2003c 40 CFR 401.15

8. REGULATIONS AND ADVISORIES

Table 8-1. Regulations and Guidelines Applicable to Bromoform and Dibromochloromethane

Agency	Description	Information	Reference
NATIONAL (cont.)			
EPA	National primary drinking water regulations MCL for total trihalomethanes ^h	0.10 mg/L	EPA 2003f 40 CFR 141.12
	Pollutants of initial focus in the Great Lakes Water Quality Initiative	Bromoform and dibromochloromethane	EPA 2003m 40 CFR 132, Table 6
c. Food			
FDA	Bottled drinking water allowable concentrations for total trihalomethanes ⁱ	0.10 mg/L	FDA 2003 21 CFR 165.110
d. Other			
ACGIH	Carcinogenicity classification	A3 ^j	ACGIH 2003
EPA	Carcinogenicity classification Bromoform Dibromochloromethane	B2 ^k C ^l	IRIS 2004a, 2004b
	RfC	No data	IRIS 2004a, 2004b
	RfD Bromoform Dibromochloromethane	2.0x10 ⁻² mg/kg/day 2.0x10 ⁻² mg/kg/day	IRIS 2004a, 2004b
	Community right-to-know; release report; effective date of reporting Bromoform	01/01/87	EPA 2003i 40 CFR 372.65
	Identification and listing of hazardous waste; hazardous waste number Bromoform	U225	EPA 2003d 40 CFR 261, Appendix VIII
	Land disposal restrictions; universal treatment standards Bromoform Dibromochloromethane	Waste water (mg/L) 0.63 0.57	Non-waste water (mg/kg) 15 15
	Municipal solid waste landfills; hazardous constituents Bromoform	Suggested method 8010 8021 8260	PQL (µg/L) 2 15 5
		Dibromochloromethane 8010 8021 8260	1 0.3 5
	Reportable quantity of hazardous substance in accordance with Section 307 (a) of the Clean Water Act, Section 112 of RCRA, and Section 112 of the Clean Air Act Bromoform	100 pounds	EPA 2003b 40 CFR 302.4

8. REGULATIONS AND ADVISORIES

Table 8-1. Regulations and Guidelines Applicable to Bromoform and Dibromochloromethane

Agency	Description	Information	Reference
<u>NATIONAL (cont.)</u>			
EPA	Reportable quantity of hazardous substance in accordance with Section 112 of RCRA		EPA 2003b 40 CFR 302.4
	Dibromochloromethane	100 pounds	
	Standards for the management of specific hazardous waste and types of hazardous waste management facilities		EPA 2003g 40 CFR 266, Appendix V
	Bromoform	<u>Risk specific doses</u> $7.0 \times 10^{-1} \mu\text{g}/\text{m}^3$	
	Standards for owners or operators of hazardous waste TSD facilities; maximum concentration for groundwater protection		EPA 2003h 40 CFR 264, Appendix IX
	Bromoform	Suggested <u>method</u> <u>PQL ($\mu\text{g}/\text{L}$)</u>	
		8010 2	
		8240 5	
	Dibromochloromethane	8010 1	
		8240 5	
	TSCA; chemical information rules	Effective Sunset <u>date</u> <u>date</u>	EPA 2003k 40 CFR 712.30
	Bromoform	03/11/94 05/10/94	
TSCA; health and safety data reporting	Effective Sunset <u>date</u> <u>date</u>	EPA 2003j 40 CFR 716.120	
Bromoform	06/01/87 06/01/97		
Dibromochloromethane	06/01/87 06/01/87		
TSCA; identification of specific chemical substance and mixture testing requirements for		EPA 2003i 40 CFR 799.5055	
Bromoform	Hydrolysis testing		
<u>STATE</u>			
a. Air	No data		
b. Water			
Arizona	Drinking water guideline		HSDB 2004a, 2004b
	Bromoform	0.19 $\mu\text{g}/\text{L}$	
	Dibromochloromethane	0.19 $\mu\text{g}/\text{L}$	
Florida	Drinking water guideline		HSDB 2004a, 2004b
	Bromoform	4.0 $\mu\text{g}/\text{L}$	
	Dibromochloromethane	1.0 $\mu\text{g}/\text{L}$	
Minnesota	Drinking water guideline		HSDB 2004a, 2004b
	Bromoform	40 $\mu\text{g}/\text{L}$	
	Dibromochloromethane	10 $\mu\text{g}/\text{L}$	
New Hampshire	Drinking water guideline		HSDB 2004a
	Bromoform	4.0 $\mu\text{g}/\text{L}$	
Wisconsin	Drinking water guideline		HSDB 2004a, 2004b
	Bromoform	4.4 $\mu\text{g}/\text{L}$	
	Dibromochloromethane	60 $\mu\text{g}/\text{L}$	

8. REGULATIONS AND ADVISORIES

Table 8-1. Regulations and Guidelines Applicable to Bromoform and Dibromochloromethane

Agency	Description	Information	Reference
<u>STATE</u> (<i>cont.</i>)			
c. Food	No data		
d. Other	No data		

^aGroup 3: not classifiable as to its carcinogenicity to humans

^bSkin notation: refers to the potential significant contribution to the overall exposure by the cutaneous route, including mucous membranes and the eyes, either by contact with vapors or, of probable greater significance, by direct skin contact with the substance.

^cSkin designation: indicates the potential for dermal absorption; skin exposure should be prevented as necessary through the use of good work practices and gloves, coveralls, goggles, and other appropriate equipment.

^dSkin designation

^eDWEL: a lifetime exposure concentration protection of adverse, non-cancer health effects, that assumes all of the exposure to a contaminant is from drinking water.

^f10⁻² Cancer risk: the concentration of a chemical in drinking water corresponding to an excess estimated lifetime cancer risk of 1 in 10,000.

^gLifetime: the concentration of a chemical in drinking water that is not expected to cause any adverse noncarcinogenic effects for a lifetime of exposure. The Lifetime HA is based on exposure of a 70-kg adult consuming 2 L water/day.

^hTotal trihalomethanes (the sum of the concentrations of bromoform, dibromochloromethane, bromodichloromethane, and chloroform) applies to subpart H community water systems which serve a population of 10,000 people or more until December 31, 2001. This level applies to community water systems that use only groundwater not under the direct influence of surface water and serves a population of 10,000 people or more until December 31, 2003. Compliance with the MCL for total trihalomethanes is calculated pursuant to 40 CFR 141.30. After December 31, 2003, this section no longer applies.

ⁱTotal trihalomethanes: sum of the concentration in mg/L of the trihalomethane compounds (bromoform, dibromochloromethane, bromodichloromethane, and chloroform), rounded to two significant figures.

^jA3: confirmed animal carcinogen with unknown relevance to humans

^kB2: probable human carcinogen

^lC: possible human carcinogen

ACGIH = American Conference of Governmental Industrial Hygienists; CFR = Code of Federal Regulations; DWEL = drinking water equivalent level; EPA = Environmental Protection Agency; FDA = Food and Drug Administration; HSDB = Hazardous Substances Data Bank; IARC = International Agency for Research on Cancer; IDLH = immediately dangerous to life or health; IRIS = Integrated Risk Information System; MCL = maximum contaminant level; NIOSH = National Institute for Occupational Safety and Health; OSHA = Occupational Safety and Health Administration; PEL = permissible exposure limit; PQL = practical quantitation level; RCRA = Resource Conservation and Recovery Act; REL = recommended exposure limit; RfC = inhalation reference concentration; RfD = oral reference dose; TLV = threshold limit values; TSCA = Toxic Substances Control Act; TSD = treatment, storage, and disposal; TWA = time-weighted average; USC = United States Code; WHO = World Health Organization

9. REFERENCES

- *Abrahamsson K, Klick S. 1989. Distribution and fate of halogenated organic substances in an anoxic marine environment. *Chemosphere* 18:2247-2256.
- ACGIH. 1986. Documentation of the threshold limit values and biological exposure indices. 5th ed. Cincinnati, OH: American Conference of Governmental Industrial Hygienists.
- ACGIH. 2001. Threshold limit values for chemical substances and physical agents & biological exposure indices. Cincinnati, OH: American Conference of Governmental Industrial Hygienists.
- *ACGIH. 2003. Bromoform. Threshold limit values for chemical substances and physical agents and biological exposure indices. Cincinnati, OH: American Conference of Governmental Industrial Hygienists.
- *Adinolfi M. 1985. The development of the human blood-CSF-brain barrier. *Dev Med Child Neurol* 27:532-537.
- *Adlercreutz H. 1995. Phytoestrogens: Epidemiology and a possible role in cancer protection. *Environ Health Perspect Suppl* 103(7):103-112.
- *Agarwal AK, Mehendale HM. 1983. Absence of potentiation of bromoform hepatotoxicity and lethality by chlordecone. *Toxicol Lett* 15:251-257.
- Agency for Toxic Substances and Disease Registry. 1989a. Toxicological profile for chloroform. Atlanta, GA: ATSDR, January 1989.
- Agency for Toxic Substances and Disease Registry. 1989b. Toxicological profile for carbon tetrachloride. Atlanta, GA: Agency for Toxic Substances and Disease Registry. December 1989.
- *Agency for Toxic Substances and Disease Registry. 1989c. Decision guide for identifying substance-specific data needs related to toxicological profiles; Notice. *Fed Regist* 54(174):37618-37634.
- Agency for Toxic Substances and Disease Registry. 1990a. Biomarkers of organ damage or dysfunction for the renal, hepatobiliary, and immune systems. Subcommittee on Biomarkers of Organ Damage and Dysfunction. Atlanta, GA: Agency for Toxic Substances and Disease Registry.
- Agency for Toxic Substances and Disease Registry. 1990b. Toxicological profile for bromoform and chlorodibromomethane. PB91180323. <http://www.atsdr.cdc.gov/toxprofiles/tp130.pdf>.
- *Agency for Toxic Substances and Disease Registry. 1997. Toxicological profile for chloroform. Atlanta, GA: U.S. Department of Health and Human Services, Agency for Toxic Substances and Disease Registry.

* Cited in text

9. REFERENCES

- *Agency for Toxic Substances and Disease Registry. 1994. Toxicological profile for chlorodibenzofurans. U.S. Department of Health and Human Services, Public Health Service. Atlanta, GA: Agency for Toxic Substances and Disease Registry.
- *Aggazzotti G, Fantuzzi G, Righi E, et al. 1998. Blood and breath analyses as biological indicators of exposure to trihalomethanes in indoor swimming pools. *Sci Total Environ* 30(1-2):155-163.
- *Ahmed AE, Kubic VL, Anders MW. 1977. Metabolism of haloforms to carbon monoxide: I. *In vitro* studies. *Drug Metab Dispos* 5:198-204.
- Ahmed AE, Kubic VL, Stevens JL, et al. 1980. Halogenated methanes: Metabolism and toxicity. *Fed Proc* 39:3150-3155.
- Aida Y, Takada K, Momma J, et al. 1987. Acute and subacute toxicities of three trihalomethanes in rats I. *J Toxicol Sci* 12:585.
- *Aida Y, Takada K, Uchida O, et al. 1992. Toxicities of microencapsulated tribromomethane, dibromochloromethane and bromodichloromethane administered in the diet to Wistar rats for one month. *J Toxicol Sci* 17(3):119-133.
- Air Resources Board. 1993. Toxic air contaminant identification list. December 1999. California Air Resources Board. State of California. <http://www.arb.ca.gov/toxics/catable.htm>.
- Aizawa T, Magara Y, Musashi M. 1989. Effect of bromide ions on trihalomethane (THM) formation in water. *Aqua* 38:165-175.
- Akland GG, Schwab M, Zenick H, et al. 1997. An interagency partnership applied to the study of environmental health in the Lower Rio Grande Valley of Texas. *Environ Int* 23(5):595-609.
- Aldrich TE, Peoples AJ. 1982. Malignant melanoma and drinking water contamination. *Bull Environ Contam Toxicol* 28:519-523.
- Allis JW, Zhao G. 2002. Quantification evaluation of bromodichloromethane metabolism by recombinant rat and human cytochrome P450s. *Chem Biol Interact* 140:137-153.
- Allis JW, Anderson BP, Ross TM, et al. 2002. Evidence for the involvement of CYP1A2 in the metabolism of bromodichloromethane. *Toxicology* 176:25-37.
- *Allis JW, Brown BL, Zhao G, et al. 2001. The effects of inhalation exposure to bromodichloromethane on specific rat CYP isoenzymes. *Toxicology* 161(1-2):67-77.
- *Altman PL, Dittmer DS. 1974. Biological handbooks: Biology data book. Vol. III. 2nd ed. Bethesda, MD: Federation of American Societies for Experimental Biology, 1987-2008, 2041.
- Alvanja M, Goldstein I, Susser M. 1978. A case-control study of gastrointestinal and urinary tract cancer mortality and drinking water chlorination. In: Jolley RL, Bull RJ, Cotruvo JA, et al., eds. *Water chlorination: Environmental impact and health effects*. Ann Arbor, MI: Ann Arbor Science Publishers, 395-409.
- *Amagai T, Olansandan, Matsushita H, et al. 1999. A survey of indoor pollution by volatile organohalogen compounds in Katsushika, Tokyo, Japan. *Indoor Built Environ* 8:255-268.

9. REFERENCES

- *Amoore JE, Hautala E. 1983. Odor as an aid to chemical safety: Odor thresholds compared with threshold limit values and volatilities for 214 industrial chemicals in air and water dilution. *J Appl Toxicol* 3:272-290.
- *Anders MW, Stevens JL, Sprague RW, et al. 1978. Metabolism of haloforms to carbon monoxide: II. *In vivo* studies. *Drug Metab Dispos* 6:556-560.
- *Andersen ME, Krishnan K. 1994. Relating *in vitro* to *in vivo* exposures with physiologically based tissue dosimetry and tissue response models. In: Salem H, ed. *Animal test alternatives: Refinement, reduction, replacement*. New York: Marcel Dekker, Inc., 9-25.
- *Andersen ME, Clewell HJ III, Gargas ML, et al. 1987. Physiologically based pharmacokinetics and the risk assessment process for methylene chloride. *Toxicol Appl Pharmacol* 87:185-205.
- Anderson BE, Zeiger E, Shelby MD, et al. 1990. Chromosome aberration and sister chromatid exchange test results with 42 chemicals. *Environ Mol Mutagen* 16(Suppl 18):55-137.
- Anonymous. 1985. Chlorodibromomethane. *Dangerous Properties of Industrial Materials Reports* 5:61-63.
- *Antoine SR, DeLeon IR, O'Dell-Smith RM. 1986. Environmentally significant volatile organic pollutants in human blood. *Bull Environ Contam Toxicol* 36:364-371.
- *APHA. 1985a. Halogenated methanes and ethanes by purge and trap-method 514. In: Greenberg AF, Trussell RR, Clesceri LS, eds. *Standard methods for the examination of water and wastewater*. 16th ed. Washington, DC: American Public Health Association, 591-602.
- *APHA. 1985b. Organic contaminants, gas chromatographic/mass spectrometric method - method 516. In: Greenberg AF, Trussell RR, Clesceri LS, eds. *Standard methods for the examination of water and wastewater*, 16th ed. Washington, DC: American Public Health Association, 612-619.
- Aremu DA, Olawuyi JF, Meshitsuka S, et al. 2002. Heavy metal analysis of groundwater from Warri, Nigeria. *Int J Environ Health Res* 12:261-267.
- Arena JM, Drew RH, eds. 1986. *Poisoning: Toxicology-symptoms treatments*. 5th ed. Springfield, IL: Charles C. Thomas, 522, 652.
- *Arguello MD, Chriswell CD, Fritz JS, et al. 1979. Trihalomethanes in water: A report on the occurrence, seasonal variation in concentrations, and precursors of trihalomethanes. *JAWWA* 71:504-508.
- Ariyoshi T, Yamaguchi M, Miyazaki Y, et al. 1993. Trihalomethane induced alterations in the content of metallothionein and in the activities of heme metabolizing enzymes in rats. *Bull Environ Contam Toxicol* 50(5):772-778.
- Arlett CF, Cole J. 1988. The role of mammalian cell mutation assays in mutagenicity and carcinogenicity testing. *Mutagenesis* 3(6):455-458.
- *Arthur CL, et al. 1992. Environmental analysis of organic compounds in water using solid phase micro extraction. *J High Resolut Chromatogr* 15:741-744.

9. REFERENCES

- Aschengrau A, Zierler S, Cohen A. 1993. Quality of community drinking water and the occurrence of late adverse pregnancy outcomes. *Arch Environ Health* 48(2):105-113.
- Ashby J, Tennant RW. 1988. Chemical structure, Salmonella mutagenicity, and extent of carcinogenicity as indicators of genotoxic carcinogenesis among 222 chemicals tested in rodents by the U.S. NCI/NTP. *Mutat Res* 204:17-115.
- *Ashley DL, Bonin MA, Cardinali FL, et al. 1992. Determining volatile organic compounds in human blood from a large sample population by using purge and trap gas chromatography/mass spectrometry. *Anal Chem* 64:1021-1029.
- *Ashley DL, Bonin MA, Cardinali FL, et al. 1996. Measurement of volatile organic compounds in human blood. *Environ Health Perspect Suppl* 104(5):871-877.
- Asoh M, Tateishi T, Kumai T, et al. 1999. Induction of CYP2B in fetal and postnatal rats after maternal administration of phenobarbital. *Pharmacol Toxicol* 84:18-23.
- *ASTM. 1988. Low molecular weight halogenated hydrocarbons in water method D 3978-85. In: 1988 Annual book of ASTM standards: Water and environmental technology. Vol. 11.02. Water (II). Philadelphia, PA: American Society for Testing and Materials, 141-145.
- *Atlas E, Pollock W, Greenburg J, et al. 1993. Alkyl nitrates, nonmethane hydrocarbons, and halocarbon gases over the equatorial Pacific Ocean during saga 3. *J Geophys Res* 98(D9):16933-16947.
- Axelson O. 1985. Halogenated alkanes and alkenes and cancer: Epidemiological aspects. In: Fishbein L, O'Neill IK, eds. Environmental carcinogens selected methods of analysis. Vol. 7. Some volatile halogenated hydrocarbons. Lyon, France: International Agency for Research on Cancer, 5-20.
- Backer LC, Ashley DL, Bonin MA, et al. 2000. Household exposures to drinking water disinfection by-products: Whole blood trihalomethane level. *J Expo Anal Environ Epidemiol* 10(4):321-326.
- *Balster RL, Borzelleca JF. 1982. Behavioral toxicity of trihalomethane contaminants of drinking water in mice. *Environ Health Perspect* 46:127-136.
- Baltussen E, Sandra P, David F, et al. 1999. Stir bar sorptive extraction (SBSE), a novel extraction technique for aqueous sample: Theory and principles. *J Microcolumn Sep* 11(10):737-747.
- Banerji AP, Fernandes AO. 1996. Field bean protease inhibitor mitigates the sister-chromatid exchanges induced by bromoform and depresses the spontaneous sister-chromatid exchanges frequency of human lymphocytes in vitro. *Mutat Res* 360(1):29-35.
- Barbante C, Boutron C, Moreau A-L, et al. 2002. Seasonal variations in nickel and vanadium in Mont Blanc snow and ice dated from the 1960's and 1990's. *J Environ Monitor* 4:960-966.
- Barkley J, Bunch J, Bursey JT, et al. 1980. Gas chromatography/mass spectrometry computer analysis of volatile halogenated hydrocarbons in man and his environment - A multimedia environmental study. *Biomed Mass Spectrom* 7:139-147.

9. REFERENCES

- Barnes D, Bellin J, DeRosa C, et al. 1987. Reference dose (RfD): Description and use in health risk assessments. Vol. I, Appendix A: Integrated risk information system supportive documentation. Washington, DC: U.S. Environmental Protection Agency, Office of Health and Environmental Assessment. EPA600886032a.
- *Barnes DG, Dourson M. 1988. Reference dose (RfD): Description and use in health risk assessments. *Regul Toxicol Pharmacol* 8:471-486.
- Bartnicki EW, Castro CE. 1994. Biodehalogenation: Rapid oxidative metabolism of mono- and polyhalomethanes by *Methylosinus trichosporium* OB-3b. *Environ Toxicol Chem* 13(2):241-245.
- Bassford MR, Simmonds PG, Nickless G. 1998. An automated system for near-real-time monitoring of trace atmospheric halocarbons. *Anal Chem* 70(5):958-965.
- Bathija AT. 2003. Health risk to fetuses, infants and children from stage 1 disinfectants and disinfectant by-products (D/DBPs). *Toxicologist* 72(S-1):28.
- Batjer K, Gabel B, Koschorrek M, et al. 1980. Drinking water in Bremen: Trihalomethanes and social costs: A case study of bromoform formation during chlorination of river water highly contaminated with bromide ions. *Sci Total Environ* 14:287-291.
- *Batterman S, Zhang L, Wang S, et al. 2002. Partition coefficients for the trihalomethanes among blood, urine, water, milk and air. *Sci Total Environ* 284(1-3):237-247.
- Bedding ND, McIntyre AE, Perry R, et al. 1982. Organic contaminants in the aquatic environment: I. Sources and occurrence. *Sci Total Environ* 25:143-167.
- *Beech JA. 1980. Estimated worst case trihalomethane body burden of a child using a swimming pool. *Med Hypothesis* 6:303-307.
- *Beech JA, Diaz R, Ordaz CO, et al. 1980. Nitrates, chlorates and trihalomethanes in swimming pool water. *Am J Public Health* 70:79-82.
- Beissner RS, Guilford WJ, Coates RM, et al. 1981. Synthesis of brominated heptanones and bromoform by a bromoperoxidase of marine origin. *Biochemistry* 20:3724-3731.
- Beliveau M, Krishnan K. 2000a. Concentration dependency of rat blood: Air partition coefficients of some volatile organic chemicals. *J Toxicol Environ Health A* 60(6):377-389.
- *Beliveau M, Krishnan K. 2000b. Estimation of rat blood:air partition coefficients of volatile chemicals using reconstructed mixtures of blood components. *Toxicol Lett* 116(3):183-188.
- Beliveau M, Charest-Tardif G, Krishnan K. 2001. Blood:air partition coefficients of individual and mixtures of trihalomethanes. *Chemosphere* 44(3):377-381.
- Belkin S, Smulski DR, Dadon S, et al. 1997. A panel of stress-positive luminous bacteria for the detection of selected classes of toxicants. *Water Res* 31(12):3009-3016.
- *Bellar TA, Lichtenberg JJ, Kroner RC. 1974. The occurrence of organohalides in chlorinated drinking waters. *JAWWA* 66:703-706.

9. REFERENCES

Benfenati E, Facchini G, Pierucci P, et al. 1996. Identification of organic contaminants in leachates from industrial waste landfills. *TrAC Trends Anal Chem* 15(8):305-310.

Benigni R. 1989. A bootstrap analysis of four in vitro short-term test performances. *Mutat Res* 216(2):127-136.

*Benigni R, Andeoli C, Conti L et al. 1993. Quantitative structure activity relationship models correctly predict the toxic and aneuplodizing properties of six halogenated methanes in *Aspergillus nidulans*. *Mutagenesis* 8:301-305.

*Benson M, Brux MD. 1907. Poisoning by bromoform. *Br Med J* July 27:204.

*Berg WW, Heidt LE, Pollock W, et al. 1984. Brominated organic species in the Arctic atmosphere. *Geophysical Research Letters* 11:429-432.

*Berger GS. 1994. Epidemiology of endometriosis. In: Berger GS, ed. *Endometriosis: Advanced management and surgical techniques*. New York, NY: Springer-Verlag.

*Berry MR, Johnson LS, Brenner KP, et al. 1997. Dietary characterizations in a study of human exposures in the lower Rio Grande Valley: II. Household waters. *Environ Int* 23(5):693-703.

Betterton EA, Arnold RG, Kuhler RJ, et al. 1995. Reductive dehalogenation of bromoform in aqueous solution. *Environ Health Perspect Suppl* (103):89-91.

*Bianchi AP, Varney MS, Phillips J. 1991. Analysis of volatile organic compounds in estuarine sediments using dynamic headspace and gas chromatography-mass spectrometry. *J Chromatogr* 542:413-450.

Bielmeier SR, Best DS, Guidici DL, et al. 2002. Pregnancy loss in the rat caused by bromodichloromethane. *Toxicol Sci* 59:309-315.

Binz C. 1891. [The conversion of bromoform in warm-blooded animals.] *Archiv F Experiment Path u Pharmakol* 28:201-205. (German)

Biziuk M, Namiesnik J, Czerwinski J, et al. 1996. Occurrence and determination of organic pollutants in tap and surface waters of the Gdansk district. *J Chromatogr A* 733(1-2):171-183.

Blair A, Burg J, Foran J, et al. 1995. Guidelines for application of meta-analysis in environmental epidemiology. *Regul Toxicol Pharmacol* 22:189-197.

Board AS, Fuelberg HE, Gregory GL, et al. 1999. Chemical characteristics of air from differing source regions during the Pacific Exploratory Mission-Tropics A. *J Meteorol* 104(D13):16181-16196.

*Bocchini P, Pozzi R, Andalo C, et al. 1999. Membrane inlet mass spectrometry of volatile organohalogen compounds in drinking water. *Rapid Commun Mass Spectrom* 13(20):2049-2053.

Bonanno LJ, Freeman NCG, Greenburg M, et al. 2001. Multivariate analysis on levels of selected metals, particulate matter, VOC, and household characteristics and activities from the Midwestern states NHEXAS. *Appl Occup Environ Hyg* 16(9):859-874.

9. REFERENCES

- Bonome M. 1884. *Über die physiologische Wirkung des Bromoform, des Bromäthyl und des Bromäthylens*. *Centralblatt für Chirurgie* 36:593-594.
- Boorman GA, Dellarco V, Dunnick JK, et al. 1999. Drinking water disinfection byproducts: Review and approach to toxicity evaluation. *Environ Health Perspect Suppl* 107(1):207-217.
- Borzelleca JF. 1983. A review of volatile organic contaminant data. Proceedings - American Water Works Association Water Quality Technology Conference.
- *Borzelleca JF, Carchman RA. 1982. Effects of selected organic drinking water contaminants on male reproduction. Research Triangle Park, NC: U.S. Environmental Protection Agency, Office of Research and Development. EPA600/1-82/009. PB82259847.
- Bourquin AW, Gibson DT. 1980. Microbial degradation of halogenated hydrocarbons. In: Jolley RL, Gorchev H, Hamilton, DH, Jr., eds. *Water chlorination: Environmental impact and health effects*. Vol. 2. Ann Arbor, MI: Ann Arbor Science Publishers, Inc., 253-264.
- *Bouwer EJ, McCarty PL. 1983a. Transformation of 1- and 2-carbon halogenated aliphatic organic compounds under methanogenic conditions. *Appl Environ Microbiol* 45:1286-1294.
- *Bouwer EJ, McCarty PL. 1983b. Transformation of halogenated organic compounds under denitrification conditions. *Appl Environ Microbiol* 45:1295-1299.
- *Bouwer EJ, McCarty PL. 1984. Modeling of trace organics biotransformation in the subsurface. *Ground Water* 22:433-440.
- *Bouwer EJ, Wright JP. 1986. Anoxic transformations of trace halogenated aliphatics [Abstract]. *American Chemical Society: Environmental Chemistry Section* 26:42-45.
- *Bouwer EJ, Rittman BE, McCarty PL. 1981. Anaerobic degradation of halogenated 1- and 2-carbon organic compounds. *Environ Sci Technol* 15:596-599.
- *Bove F, Shim Y, Zeitz P. 2002. Drinking water contaminants and adverse pregnancy outcomes: A review. *Environ Health Perspect* 110(Suppl 1):61-74.
- *Bove FJ, Fulcomer M, Klotz JB, et al. 1992. Population-based surveillance and etiological research of adverse reproductive outcomes and toxic wastes. Report on phase 1V-B: Public drinking water contamination and birthweight, and selected birth defects. A case control study. New Jersey: New Jersey Department of Health.
- *Bove FJ, Fulcomer MC, Klotz JB, et al. 1995. Public drinking water contamination and birth outcomes. *Am J Epidemiol* 141(9):850-862.
- *Bowman FJ, Borzelleca JF, Munson AE. 1978. The toxicity of some halomethanes in mice. *Toxicol Appl Pharmacol* 44:213-215.
- *Brass HF, Feige MA, Halloran T, et al. 1977. The national organic monitoring survey: Samplings and analyses for purgeable organic compounds. In: Pojasek RB, ed. *Drinking water quality enhancement through source protection*. Ann Arbor, MI: Ann Arbor Science Publishers, 393-416.

9. REFERENCES

- Brenniman GR, Vasilomanolakis-Lagos J, Amsel J, et al. 1980. Case-control study of cancer deaths in Illinois communities served by chlorinated or non-chlorinated water. In: Jolley RL, Brungs WA, Cummings RB, et al., eds. Water chlorination: Environmental impact and health effects. Ann Arbor, MI: Ann Arbor Science Publishers, 1043-1057.
- Brett RW, Calverley RA. 1979. A one-year survey of trihalomethane concentration changes within a distribution system. *JAWWA* 71:515-520.
- *Brodzinsky R, Singh HB. 1983. Volatile organic chemicals in the atmosphere: An assessment of available data. Research Triangle Park, NC: U.S. Environmental Protection Agency, Office of Research and Development. EPA600/383027(A).
- Brooks BO, Aldrich FD, Utter GM, et al. 1990. Immune responses to pollutant mixtures from indoor sources. *Ann N Y Acad Sci* 641:199-214.
- *Brown BR, Sipes IG, Sagalyn MA. 1974. Mechanisms of acute hepatic toxicity: Chloroform, haloform and glutathione. *Anesthesiology* 41:554-561.
- Brzezinski MR, Boutelet-Bochan H, Person RE, et al. 1999. Catalytic activity and quantitation of cytochrome P-450 2E1 in prenatal human brain. *J Pharmacol Exp Ther* 289:1648-1653.
- *Buckley TJ, Liddle J, Ashley DL, et al. 1997. Environmental and biomarker measurements in nine homes in the lower Rio Grande valley: Multimedia results for pesticides, metals, PAHs, and VOCs. *Environ Int* 23(5):705-732.
- Bull RJ, Birnbaum LS, Cantor KP, et al. 1995. Water chlorination: Essential process or cancer hazard? *Fundam Appl Toxicol* 28(2):155-166.
- *Burton-Fanning FW. 1901. Poisoning by bromoform. *Br Med J* May 18:1202-1203.
- Butterworth BE, Conolly RB, Morgan KT. 1995. A strategy for establishing mode of action of chemical carcinogenesis as a guide for approaches to risk assessments. *Cancer Lett* 93:129-146.
- Cailleux A, Subra JF, Riberi P, et al. 1989. Uptake of trihalomethanes by patients during hemodialysis. *Clin Chim Acta* 181(1):75-80.
- *Callahan MA, Slimak MW, Gabel NW, et al. 1979. Water-related environmental fate of 129 priority pollutants: Vol. I: Introduction and technical background, metals and inorganics, pesticides and PCB. Washington, DC: U.S. Environmental Protection Agency, Office of Water Planning and Standards. EPA440/479029a. PB80204373.
- Callahan MA, Slimak MW, Gabel NW, et al. 1980. Epidemiologic studies of chlorination by-products in drinking water: An overview. In: Jolley RL, Brungs WA, Cotruvo JA, et al., eds. Water chlorination: Environmental impact and health effects. Environment, health, and risk. Ann Arbor, MI: Ann Arbor Science Publishers.
- Cammann K, Hubner K. 1995. Trihalomethane concentrations in swimmers' and bath attendants' blood and urine after swimming or working in indoor swimming pools. *Arch Environ Health* 50(1):61-65.

9. REFERENCES

- *Campillo N, Viñas P, López-García N, et al. 2004. Purge-and-trap capillary gas chromatography with atomic emission detection for volatile halogenated organic compounds determination in waters and beverages. *J Chromatogr A* 1035(1):1-8.
- Cantor KP. 1983. Epidemiologic studies of chlorination by-products in drinking water: An overview. In: Jolley RL, Brungs WA, Cotruvo JA, et al., eds. *Water chlorination: Environmental impact and health effects*. Vol. 4, Book 2. Environment, health, and risk. Ann Arbor, MI: Ann Arbor Science Publishers, 1381-1398.
- Cantor KP, Hoover R, Hartge P, et al. 1985. Drinking water source and risk of bladder cancer: A case-control study. In: Jolley RL, Bull RJ, Cotruvo JA, eds. *Water chlorination. Environmental impact and health effects*. Ann Arbor, MI: Ann Arbor Science Publishers, 143-150.
- *Cantor KP, Hoover R, Hartge P, et al. 1987. Bladder cancer, drinking water source, and tap water consumption: A case-control study. *J Natl Cancer Inst* 79:1269-1279.
- Cantor KP, Hoover R, Mason TJ, et al. 1978. Associations of cancer mortality with halomethanes in drinking water. *J Natl Cancer Inst* 61:979-985.
- *Carpenter LJ, Liss PS. 2000. On template sources of bromoform and other reactive bromine gases. *J Geophys Res* 105(D16):20539-20547.
- Carpenter LJ, Liss PS, Penkett SA. 2003. Marine organohalogenes in the atmosphere over the Atlantic and Southern Oceans. *J Geophys Res* 108 (D9):ACH 1-1-ACH1-13.
- Carpenter LJ, Malin G, Liss PS, et al. 2000. Novel biogenic iodine-containing trihalomethanes and other short-lived halocarbons in the coastal East Atlantic. *Global Biogeochem Cycles* 14(4):1191-1204.
- *Carpenter LJ, Sturges WT, Penkett SA, et al. 1999. Short-lived alkyl iodines and bromides at Mace Head, Ireland: Links to biogenic sources and halogen oxide production. *J Geophys Res* 104(D1):1679-1689.
- Carpenter SP, Lasker JM, Raucy JL. 1996. Expression, induction, and catalytic activity of the ethanol-inducible cytochrome P450 (CYP2E1) in human fetal liver and hepatocytes. *Mol Pharmacol* 49(2):260-268.
- CCTTE. 1988. Computerized listing of chemicals being tested for toxic effects. United Nations Environment Programme, International Programme on Chemical Safety, International Register of Potentially Toxic Chemicals. Geneva, Switzerland. June 1988.
- *CDC/ATSDR. 1990. Biomarkers of organ damage or dysfunction for the renal, hepatobiliary and immune systems. Atlanta, GA: Centers for Disease Control and Prevention/Agency for Toxic Substances and Disease Registry (CDC/ATSDR). August 1990.
- *Cech I, Smith V, Henry J. 1981. Spatial and seasonal variations in concentration of trihalomethanes in drinking water. In: Albaiges J, ed. *Analytical techniques in environmental chemistry II*. New York, NY: Pergamon Press Ltd., 19-38.
- Chapin R, Gulati D, Hope E, et al. 1997. Bromoform. *Environ Health Perspect Suppl* 105(1):277-278.

9. REFERENCES

- *Chen WJ, Weisel CP. 1998. Halogenated DBP concentrations in a distribution system. *J Am Water Works Assoc* 90(4):151-163.
- Chenoweth MB, Hake CL. 1962. The smaller halogenated aliphatic hydrocarbons. *Annual Review of Pharmacology* 2:363-398.
- *Christof O, Seifert R, Michaelis W. 2002. Volatile halogenated organic compound in European estuaries. *Biogeochem* 59(1-2):143-160.
- *Chu I, Secours V, Marino I, et al. 1980. The acute toxicity of four trihalomethanes in male and female rats. *Toxicol Appl Pharmacol* 52:351-353.
- *Chu I, Villeneuve DC, Secours VE, et al. 1982a. Toxicity of trihalomethanes: I. The acute and subacute toxicity of chloroform, bromodichloromethane, chlorodibromomethane and bromoform in rats. *J Environ Sci Health [B]* 17:205-224.
- *Chu I, Villeneuve DC, Secours VE, et al. 1982b. Trihalomethanes: II. Reversibility of toxicological changes produced by chloroform, bromodichloromethane, chlorodibromomethane and bromoform in rats. *J Environ Sci Health [B]* 17:225-240.
- *CITI. 1992. Biodegradation and bioaccumulation data of existing chemicals based on the CSCL Japan. Japan: Japan Chemical Industry Ecology-Toxicology and Information Center. Chemicals Inspection and Testing Institute.
- Clansky KB, ed. 1986. Chemical guide to the OSHA hazard communication standard. Burlingame, CA: Roytech Publications Inc., 653-655.
- *Clark RM, Pourmoghaddas H, Wymer LJ, et al. 1996. Modelling the kinetics of chlorination by-product formation: The effects of bromide. *Aqua (Oxford)* 45(3):112-119.
- *Clark RM, Smalley G, Goodrich JA, et al. 1994. Managing water quality in distribution systems: Simulating TTHM and chlorine residual propagation. *Aqua (Oxford)* 43(4):182-191.
- *Class T, Kohnle R, Ballschmiter K. 1986. Chemistry of organic traces in air VII: Bromo- and bromochloromethanes in air over the Atlantic Ocean. *Chemosphere* 15:429-436.
- Clayton GD, Clayton FE, eds. 1981. *Patty's industrial hygiene and toxicology*. 3rd ed. New York, NY: John Wiley and Sons, 3469-3470.
- *Clewell HJ III, Andersen ME. 1985. Risk assessment extrapolations and physiological modeling. *Toxicol Ind Health* 1(4):111-131.
- CLC. 1988. Coordinated list of chemicals. Washington, DC: U.S. Environmental Protection Agency, Office of Research and Development.
- *CLPSD. 1988. Contract Laboratory Program Statistical Database. Alexandria, VA: Viar and Company, Management Services Division. December, 1988.
- *Cobb GD, Bouwer EJ. 1991. Effects of electron acceptors on halogenated organic compound biotransformations in a biofilm column. *Environ Sci Technol* 25:1068-1074.

9. REFERENCES

- *Cocchioni M, Pellegrini MG, Nacciarriti L, et al. 1996. Presenza di organo-alogenati alifatici nelle bevande del commercio. *Ig Mod* 106:287-293.
- *Coffin JC, Ge R, Yang S, et al. 2000. Effect of trihalomethanes on cell proliferation and demethylation in female B6C3F1 mouse liver. *Toxicol Sci* 58:243-252.
- *Colborn T, Clement C. 1992. Chemically induced alterations in sexual and functional development. The wildlife/human connection. In: *Advances in modern environmental toxicology*. Volume XXI. Princeton, NJ: Princeton Scientific Publishing Co.
- Cole RH, Frederick RE, Healy RP, et al. 1984. Preliminary findings of the priority pollutant monitoring project of the nationwide urban runoff program. *J Water Pollut Control Fed* 56:898-908.
- *Coleman WE, Lingg RD, Melton RG, et al. 1975. The occurrence of volatile organics in five drinking water supplies using gas chromatography/mass spectrometry. In: Keith IH, ed. *Identification and analysis of organic pollutants in water*. Ann Arbor Science Publishers, Inc., 305-327.
- *Condie LW, Smallwood CL, Laurie RD. 1983. Comparative renal and hepatotoxicity of halomethanes: Bromodichloromethane, bromoform, chloroform, dibromochloromethane and methylene chloride. *Drug Chem Toxicol* 6:563-578.
- *Constan AA, Sprankle CS, Peters JM, et al. 1999. Metabolism of chloroform by cytochrome P450 2E1 is required for induction of toxicity in the liver, kidney, and nose of male mice. *Toxicol Appl Pharmacol* 160(2):120-126.
- Cragle DL, Shy CM, Struba RJ, et al. 1985. A case-control study of colon cancer and water chlorination in North Carolina. *Water chlorination: environmental impact and health effects*. Ann Arbor, Michigan: Ann Arbor Science Publishers, 153-159.
- Crebelli R, Andreoli C, Carere A, et al. 1995. Toxicology of halogenated aliphatic hydrocarbons: Structural and molecular determinants for the disturbance of chromosome segregation and the induction of lipid peroxidation. *Chem Bio Interact* 98(2):113-129.
- Cresteil T, Beaune C, Celier C, et al. 1986. Cytochrome P450 isoenzyme content and monooxygenase activities in rat liver: Effect of ontogenesis and pretreatment by phenobarbital and 3-methylcholanthrene. *J Pharmacol Exp Ther* 236:269-276.
- Cresteil T, Beaune P, Kremers P, et al. 1985. Immunooquantitation in of epoxide hydroxylase and cytochrome P450 isozymes in fetal and adult liver microsomes. *Eur J Biochem* 151:345-350.
- *CRIS. 2003. CRIS database. Current Research Information System. <http://cristel.csrees.usda.gov/star/system.html>.
- *Crump KS. 1983. Chlorinated drinking water and cancer: The strength of the epidemiologic evidence. In: Jolley RL, Brungs WA, Cotruvo JA, et al., eds. *Water chlorination: Environmental impact and health effects*. Vol. 4, Book 2. Environment, health, and risk. Ann Arbor, MI: Ann Arbor Science Publishers, 1481-1491.
- *Curtis GP, Robert PV, Reinhard M. 1986. A natural gradient experiment on solute transport in a sand aquifer. 4. Sorption of organic solutes and its influence on mobility. *Water Resour Res* 22:2059-2067.

9. REFERENCES

- *Czerwinski M, McLemore T, Gelboin H, et al. 1994. Quantification of CYP2B7, CY4B1, and CYPOR messenger RNAs in normal lung and lung tumors. *Cancer Res* 54:1085-1091.
- *Daniel FB, Robinson M, Condie LW, et al. 1990. Ninety-day oral toxicity study of chloral hydrate in Sprague-Dawley rats. *Drug Chem Toxicol* 13(2&3):135-154.
- Daniel FB, Robinson M, Condie LW, et al. 1992. Ninety-day oral toxicity study of dibromochloromethane in Sprague-Dawley rats. *Drug Chem Toxicol* 15(3):217-232.
- *Da Silva ML, Charest-Tardif G, Krishnan K, et al. 1999. Influence of oral administration of a quaternary mixture of trihalomethanes on their blood kinetics in the rat. *Toxicol Lett* 106(1):49-57.
- Da Silva ML, Charest-Tardif G, Krishnan K, et al. 2000. Evaluation of the pharmacokinetic interactions between orally administered trihalomethanes in the rat. *J Toxicol Environ Health A* 60:343-353.
- DeAngelo AB, Geter DR, Rosenberg OW, et al. 2002. The induction of aberrant crypt foci (ACF) in the colons of rats by trihalomethanes administered in the drinking water. *Cancer Lett* 187(1-2):25-31.
- DeCarlo VJ. 1979. Studies on brominated chemicals in the environment. *Ann NY Acad Sci* 320:678-681.
- DeGreef E, Morris JC, Van Kreijl CF, et al. 1980. Health effects in the chemical oxidation of polluted waters. In: Jolley RL, Brungs WA, Cumming RB, et al., eds. *Water chlorination: Environmental impact and health effects*. Vol. 3. Ann Arbor, MI: Ann Arbor Science Publishers, Inc., 913-924.
- Delaney JC, Wolfe GW, Kaiser L, et al. 1997. Short term reproductive development effects of chlorodibromomethane in S-D rats when administered in the drinking water. *Toxicologist* 36(1Pt2):257.
- *Delzer GC, Ivahnenko T. Occurrence and temporal variability of methyl *tert*-butyl ether (MTBE) and other volatile organic compounds in select sources of drinking water: Results of the focused survey. United States Geological Survey. Oregon Health & Science University and the American Water Works Association Research Foundation, 1-65.
- *DeMarini DM, Shelton ML, Warren SH, et al. 1997. Glutathione S-transferase-mediated induction of GC→AT transitions by halomethanes in *Salmonella*. *Environ Mol Mutagen* 30(4):440-447.
- Department of Health Services. 2000. Monitoring B unregulated contaminants. California code of regulations. 22 CCR 64450.1. Sacramento, CA: California Department of Health Services.
- Department of Health Services. 2002. Drinking water standards. Primary maximum contaminant levels (MCLs) and lead and copper action levels. California code of regulations. 22 CCR 64439. Sacramento, CA: California Department of Health Services.
- *Dey A, Gareth T, Arun K, et al. 2001. The effect of SFR on the removal of THMs from municipal water by GAC filter. *Ultrapure Water* 18(3):40-42, 44, 46, 48-50, 53-54.
- Dilling WL. 1977. Interphase transfer processes. II. Evaporation rates of chloro methanes, ethanes, ethylenes, propanes, and propylenes from dilute aqueous solutions. Comparisons with theoretical predictions. *Environ Sci Technol* 11:405-409.

9. REFERENCES

- *Djozan D, Assadi Y. 1995. Optimization of the gas chromatographic analysis of traces of volatile halogenated compounds in drinking water. *J Chromatogr A* 697(1-2):525-532.
- Docks EL, Krishna G. 1976. The role of glutathione in chloroform induced hepatotoxicity. *Exp Mol Pathol* 24:13-22.
- Dodds L, King WD. 2001. Relations between trichloromethane compounds and birth defects. *Occup Environ Med* 58(7):443-446.
- *Dodds L, King W, Woolcott C, et al. 1999. Trihalomethanes in public water supplies and adverse birth outcomes. *Epidemiology* 10(3):233-237.
- Dowty B, Carlisle D, Laseter JL. 1975. Halogenated hydrocarbons in New Orleans drinking water and blood plasma. *Science* 187:75-77.
- Doyle TJ, Zheng W, Cerhan JR, et al. 1997. The association of drinking water source and chlorination by-products with cancer incidence among postmenopausal women in Iowa: A prospective cohort study. *Am J Public Health* 87(7):1168-1176.
- *Drikas M, Chow CWK, Cook D. 2003. The impact of recalcitrant organic character on disinfection stability, trihalomethane formation and bacterial regrowth: An evaluation of magnetic ion exchange resin (MIEX) and alum coagulation. *J Water Suppl Res Technol-AQUA* 52(7):475-487.
- Dunnick JK, Haseman JK, Lilja HS, et al. 1985. Toxicity and carcinogenicity of chlorodibromomethane in Fischer 344/N rats and B63CF₁ mice. *Fundam Appl Toxicol* 5:1128-1136.
- *Duong HA, Berg M, Hoang MH, et al. 2003. Trihalomethane formation by chlorination of ammonium- and bromide-containing groundwater in water supplies of Hanoi, Vietnam. *Water Res* 37(13):3242-3252.
- *Dwelle EH. 1903. Fatal bromoform poisoning. *JAMA* 41:1540.
- *Dykan VA. 1962. Changes in liver and kidney functions due to methylene bromide and bromoform. *Nauchn Tr Ukr Nauchn-Issled Inst Gigeny Truda i Profzabolevanii* 29:82-90.
- *Dykan VA. 1964. Problems on toxicology, clinical practice, and work hygiene in the production of bromine-organic compounds. *Gigiena* 5b:100-103.
- *Egorov AI, Tereschenko AA, Altshul LM, et al. 2003. Exposures to drinking water chlorination by-products in a Russian city. *Int J Hyg Environ Health* 206(6):539-551.
- *Eichelberger JW, Bellar TA, Donnelly JP, et al. 1990. Determination of volatile organics in drinking water with USEPA method 524.2 and the ion trap detector. *J Chromatogr Sci* 28:460-467.
- El-Dib MA, Ali RK. 1994. Mixed algal population and *Scenedesmus* sp. as trihalomethane precursors. *Bull Environ Contam Toxicol* 52(5):712-717.
- Elmore E, Fitzgerald MP. 1990. Evaluation of the bioluminescence assays as screen for genotoxic chemicals. *Biol Res* 340:379-388.
- Environment Canada. 1995. Guidelines for Canadian drinking water quality. Canada Water Act. Ottawa, Ontario: Environment Canada.

9. REFERENCES

- *EPA. 1980a. Ambient water quality criteria for halomethanes. Washington, DC: U.S. Environmental Protection Agency, Office of Water Regulations and Standards. EPA440580051.
- *EPA. 1980b. Volatile organic compounds isotope dilution GC-MS - method 1624. Washington, DC: U.S. Environmental Protection Agency.
- *EPA. 1980c. U.S. Environmental Protection Agency. Fed Regist 45:33133.
- *EPA. 1982a. Test method: Purgeable halocarbons - method 601. In: Longbottom JE, Lichtenberg JJ, eds. Test methods: Methods for organic chemical analysis of municipal and industrial wastewater. Cincinnati, OH: U.S. Environmental Protection Agency, Office of Research and Development. EPA600482057.
- *EPA. 1982b. Test method: Purgeables - method 624. In: Longbottom JE, Lichtenberg JJ, eds. Test methods: Methods for organic chemical analysis of municipal and industrial wastewater. Cincinnati, OH: U.S. Environmental Protection Agency, Office of Research and Development. EPA600482057.
- EPA. 1983a. Reportable quantity document for chlorodibromomethane (dibromochloromethane). Cincinnati, OH: U.S. Environmental Protection Agency, Office of Environmental Criteria and Assessment.
- EPA. 1983b. Reportable quantity document for tribromomethane (bromoform). Cincinnati, OH: U.S. Environmental Protection Agency, Office of Environmental Criteria and Assessment.
- EPA. 1983c. Treatability manual. Vol. I. Treatability data. Washington, DC: U.S. Environmental Protection Agency, Office of Research and Development. EPA600282001a.
- EPA. 1985. U.S. Environmental Protection Agency: Part II. Fed Regist 50:13456-13522.
- *EPA. 1986a. Halogenated volatile organics - method 8010. In: Test methods for evaluating solid waste. 3rd ed. SW-846. Washington, DC: U.S. Environmental Protection Agency, Office of Solid Waste and Emergency Response.
- *EPA. 1986b. Gas chromatography/mass spectrometry for volatile organics, method 8240. In: Test methods for evaluating solid waste. 3rd ed. SW-846. Washington, DC: U.S. Environmental Protection Agency, Office of Solid Waste and Emergency Response.
- EPA. 1986c. External review draft for the drinking water criteria document on trihalomethanes. Washington, DC: U.S. Environmental Protection Agency, Office of Drinking Water.
- EPA. 1987a. U.S. Environmental Protection Agency: Part II. Fed Regist 52:25690-25717.
- EPA. 1987b. U.S. Environmental Protection Agency: Part II. Fed Regist. 52:25942-25953.
- *EPA. 1987c. Land disposal restrictions for certain "California List" hazardous wastes and modifications to the framework; Final rule. Part V. U.S. Environmental Protection Agency. Fed Regist 52(130):25760-25792.
- EPA. 1988a. U.S. Environmental Protection Agency: Part V. Fed Regist 53:38642-38654.

9. REFERENCES

- EPA. 1988b. Toxic chemical release reporting: Community right-to-know. U.S. Environmental Protection Agency. Part II. Fed Regist 53(30):4500-4554.
- EPA. 1988c. U.S. Environmental Protection Agency. Part II. Fed Regist 53:31138-31222.
- EPA. 1989. Interim methods for development of inhalation reference doses. Washington, DC: U.S. Environmental Protection Agency, Office of Health and Environmental Assessment. EPA600888066F. Exichem Data Base, 1989.
- *EPA. 1990. Interim methods for development of inhalation reference concentrations. Washington, DC: U.S. Environmental Protection Agency, Office of Health and Environmental Assessment, Office of Research and Development, Environmental Criteria and Assessment Office. EPA600890066A.
- *EPA. 1997a. Automated Form R for Windows: User's guide (RY97). Washington, DC: U.S. Environmental Protection Agency, Office of Pollution Prevention and Toxics.
- *EPA. 1997b. Special report on environmental endocrine disruption: An effects assessment and analysis. Washington, DC: U.S. Environmental Protection Agency, Risk Assessment Forum. EPA630R96012.
- EPA. 1998a. MCLG for bromoform. Washington, DC: U.S. Environmental Protection Agency, Fed Regist 63(241):69402.
- *EPA. 2001a. Occurrence of unregulated contaminants in public water systems - A national summary. U.S. Environmental Protection Agency.
- *EPA. 2001b. Exploration of perinatal pharmacokinetic issues. Risk assessment forum. Washington, DC: U.S. Environmental Protection Agency. EPA630R01004. <http://cfpub.epa.gov/ncea/raf/recordisplay.cfm?deid=29420>.
- *EPA. 2002a. EPA public drinking water systems: Facts and figures. <http://www.epa.gov/safewater/pws/factoids.html>.
- *EPA. 2002b. 2002 Edition of the drinking water standards and health advisories. Summer 2002. Washington, DC: U.S. Environmental Protection Agency, Office of Water. EPA822R038. <http://www.epa.gov/waterscience/drinking/standards/dwstandards.pdf>.
- *EPA. 2003a. Criteria for municipal solid waste landfills. List of hazardous inorganic and organic constituents. Washington, DC: U.S. Environmental Protection Agency. 40 CFR 258, Appendix II.
- *EPA. 2003b. Designation, reportable quantities, and notification. Designation of hazardous substances. Washington, DC: U.S. Environmental Protection Agency. 40 CFR 302.4. <http://www.epa.gov/epahome/cfr40.htm>.
- *EPA. 2003c. Effluent guidelines and standards. General provisions. Toxic pollutants. Washington, DC: U.S. Environmental Protection Agency. 40 CFR 401.15. <http://www.epa.gov/epahome/cfr40.htm>.
- *EPA. 2003d. Identification and listing of hazardous waste. Hazardous constituents. Washington, DC: U.S. Environmental Protection Agency. 40 CFR 261, Appendix VIII. <http://www.epa.gov/epahome/cfr40.m>.

9. REFERENCES

- *EPA. 2003e. Land disposal restrictions. Universal treatment standards. Washington, DC: U.S. Environmental Protection Agency. 40 CFR 268.48. <http://www.epa.gov/epahome/cfr40.htm>.
- *EPA. 2003f. National primary drinking water regulations. Maximum contaminant levels for trihalomethanes. Washington, DC: U.S. Environmental Protection Agency. 40 CFR 141.12. <http://www.epa.gov/epahome/cfr40.htm>.
- *EPA. 2003g. Standards for the management of specific hazardous wastes and specific types of hazardous waste management facilities. Washington, DC: U.S. Environmental Protection Agency. 40 CFR 266, Appendix V. <http://www.epa.gov/epahome/cfr40.htm>.
- *EPA. 2003h. Standards for owners and operators of hazardous waste treatment, storage, and disposal facilities. Ground-water monitoring list. Washington, DC: U.S. Environmental Protection Agency. 40 CFR 264, Appendix IX. <http://www.epa.gov/epahome/cfr40.htm>.
- *EPA. 2003i. Toxic chemical release reporting: Community right-to-know. Chemicals and chemical categories to which this part applies. Washington, DC: U.S. Environmental Protection Agency. 40 CFR 372.65. <http://www.epa.gov/epahome/cfr40.htm>.
- *EPA. 2003j. Toxic Substances Control Act. Health and safety data reporting. Substances and listed mixtures to which this subpart applies. Washington, DC: U.S. Environmental Protection Agency. 40 CFR 716.120. <http://www.epa.gov/epahome/cfr40.htm>.
- *EPA. 2003k. Toxic Substances Control Act. Chemical information rules. Chemical lists and reporting periods. Washington, DC: U.S. Environmental Protection Agency. 40 CFR 712.30. <http://www.epa.gov/epahome/cfr40.htm>.
- *EPA. 2003l. Toxic Substances Control Act. Identification of specific chemical substance and mixture testing requirements. Washington, DC: U.S. Environmental Protection Agency. 40 CFR 799.5055. <http://www.epa.gov/epahome/cfr40.htm>.
- *EPA. 2003m. Water quality guidance for the Great Lakes system. Pollutants of initial focus in the Great Lakes water quality initiative. Washington, DC: U.S. Environmental Protection Agency. 40 CFR 132, Table 6. <http://www.epa.gov/epahome/cfr40.htm>.
- European Union. 1998. Council Directive No. 98/83/EC on the quality of water intended for human consumption. <http://europa.eu.int/comm/energy/nuclear/pdf/ec98-83en.pdf>.
- *Fabbri A, Crescentini G, Mangani F, et al. 1987. Advances in the determination of volatile organic solvents and other organic pollutants by gas chromatography with thermal desorption sampling and injection. *Chromatographia* 23:856-860.
- *Fantuzzi G, Righi E, Predieri G, et al. 2001. Occupational exposure to trihalomethanes in indoor swimming pools. *Sci Total Environ* 17(3):257-265.
- Farant J-P, Baldwin M, de Repentigny F, et al. 1992. Environmental conditions in a recently constructed office building before and after the implementation of energy conservation measures. *Appl Occup Environ Hyg* 7(2):93-100.
- Faust SD. 1977. Chemical mechanisms affecting the fate of organic pollutants in natural aquatic environments. *Adv Environ Sci Technol* 8:317-365.

9. REFERENCES

- Fawell J. 2000. Risk assessment case study-chloroform and related substances. *Food Chem Toxicol* 38(Suppl 1):S91-S95.
- Fawell JK, Fielding M. 1985. Identification and assessment of hazardous compounds in drinking water. *Sci Total Environ* 47:317-341.
- *Fayad NM, Iqbal S. 1985. Analysis of drinking water for the detection of trihalomethanes. *Bull Environ Contam Toxicol* 35:576-582.
- *FDA. 2003. Beverages. Bottled water. Washington, DC: U.S. Food and Drug Administration. 21 CFR 165.110. <http://www.access.gpo.gov/cgi-bin/cfrassemble.cgi?title=200321>.
- *FEDRIP. 2004. Dialog Information Systems, Inc., Palo Alto, CA: Federal Research in Progress.
- Ferek RJ, Reid JS, Hobbs PV, et al. 1998. Emission factors of hydrocarbons, halocarbons, trace gases and particles from biomass burning in Brazil. *J Geophys Res* 103(D24):32107-32118.
- Fernandez M, L'Hariodion J, Gauthier L, et al. 1993. Amphibian micronucleus test(s): A simple and reliable method for evaluating in vivo genotoxic effects of freshwater pollutants and radiations: Initial assessment. *Mutat Res* 292(1):83-99.
- Fernández-Martínez G, López-Vilarino JM, López-Mahía P, et al. 2001. Determination of volatile organic compounds in emissions by coal-fired power stations from Spain. *Environ Technol* 22:567-575.
- Finley BL, Scott P, Paustenbach DJ. 1993. Evaluating the adequacy of maximum contaminant levels as health-protective cleanup goals: An analysis based on Monte Carlo techniques. *Regul Toxicol Pharmacol* 18(3):438-455.
- *Fischer RG, Kastler J, Ballschmiter K. 2000. Levels and patterns of alkyl nitrates, multifunctional alkyl nitrates, and halocarbons in the air over the Atlantic Ocean. *J Geophys Res* 105(D11):14473-14494.
- *Fishbein L. 1985. A survey of the analysis of halogenated alkanes and alkenes in biological samples. In: Fishbein L, O'Neill IK, eds. *Environmental carcinogens selected methods of analysis*. Vol. 7 - Some volatile halogenated hydrocarbons. Publication No. 68. Lyon, France: International Agency for Research on Cancer, 141-168.
- Flocke F, Herman RL, Salawitch RJ, et al. 1999. An examination of chemistry and transport processes in the tropical lower stratosphere using observations of long-lived and short-lived compounds obtained during STRAT and POLARIS. *J Geophys Res* 104(D21):26625-26642.
- *Fomon SJ. 1966. Body composition of the infant: Part I: The male "reference infant". In: Falkner F, ed. *Human development*. Philadelphia, PA: WB Saunders, 239-246.
- *Fomon SJ, Haschke F, Ziegler EE, et al. 1982. Body composition of reference children from birth to age 10 years. *Am J Clin Nutr* 35:1169-1175.
- Fourman P, Mason JM, Valencia R, et al. 1994. Chemical mutagenesis testing in *Drosophila*. X. Results of 70 coded chemicals tested for the National Toxicology Program. *Environ Mol Mutagen* 23(3):208-227.

9. REFERENCES

- *Fraga CG, Leibovitz BE, Tappel AL. 1987. Halogenated compounds as inducers of lipid peroxidation in tissue slices. *Free Radic Biol Med* 3:119-123.
- Fraga CG, Zamora R, Tappel AL. 1989. Damage to protein synthesis concurrent with lipid peroxidation in rat liver slices: Effect of halogenated compounds, peroxides, and vitamin E1. *Arch Biochem Biophys* 270:84-91.
- Francois C, Mestres R, Causse C. 1979. Volatilization rates of some halogen pollutants in water. *Trav Soc Pharm Montpellier* 39:49-58.
- Franks NP, Jenkins A, Conti E, et al. 1998. Structural basis for the inhibition of firefly luciferase by a general anesthetic. *Biophys J* 75(5):2205-2211.
- FSTRAC. 1988. Summary of state and federal drinking water standards and guidelines. Washington, DC: Federal-State Toxicology and Regulatory Alliance Committee.
- Fujie K, Aoki T. 1991a. Acute and subacute cytogenetic effects of the trihalomethanes on rat bone marrow cells *in vivo*. *Mutat Res* 252(1):85-86.
- Fujie K, Aoki T. 1991b. Four major trihalomethanes as inducers of sister-chromatid exchanges *in vitro*. *Mutat Res* 253(3):245.
- Fujie K, Aoki T, Ito Y, et al. 1993. Sister-chromatid exchanges induced by trihalomethanes in rat erythroblastic cells and their suppression by crude catechin extracted from green tea. *Mutat Res* 300(3-4):241-246.
- *Fujie K, Aoki T, Wada M. 1990. Acute and subacute cytogenetic effects of the trihalomethanes on rat marrow cells *in vivo*. *Mutat Res* 242(2):111-119.
- *Furlong EA, D'Itri FM. 1986. Trihalomethane levels in chlorinated Michigan drinking water. *Ecol Modell* 32:215-225.
- Gagne M, Beauchamp M, Seguin J-Y. 1996. Fifteen years experience in ozonation for drinking water in Montreal. *Ozone Sci Eng* 18:299-310.
- Gallagher MD, Nuckols JR, Stallones L, et al. 1998. Exposure to trihalomethanes and adverse pregnancy outcomes. *Epidemiology* 9(5):484-489.
- *Galloway SM, Bloom AD, Resnick M, et al. 1985. Development of a standard protocol for *in vitro* cytogenetic testing with Chinese hamster ovary cells: Comparison of results for 22 compounds in two laboratories. *Environ Mutagen* 7:1-51.
- *Gao P, Pegram RA. 1996. *In vitro* microsomal lipid and protein binding by metabolically activated bromodichloromethane [Abstract]. *Toxicologist* 12:421.
- *Gao P, Thortan-Manning JR, Warren SH, et al. 1996. Protective effects of glutathione on bromodichloromethane *in vivo* toxicity and *in vitro* macromolecular binding in Fischer 344 rats. *J Toxicol Environ Health* 49:145-159.
- *Gargas ML, Burgess RJ, Voisard DE, et al. 1989. Partition coefficients of low-molecular-weight volatile chemicals in various liquids and tissues. *Toxicol Appl Pharmacol* 98:87-99.

9. REFERENCES

- Gargas ML, Clewell HJ, Andersen ME. 1986. Metabolism of inhaled dihalomethanes *in vivo*: Differentiation of kinetic constants for two independent pathways. *Toxicol Appl Pharmacol* 82:211-223.
- Gebremichael A, Chang A-M, Buckpitt AR, et al. 1995. Postnatal development of cytochrome P4501A1 and 2B1 in rat lung and liver: Effect of aged and diluted sidestream cigarette smoke. *Toxicol Appl Pharmacol* 135:246-253.
- Geiss KT, Frazier JM. 2001. Assessment of oxidative stress in primary rat hepatocytes following exposures to volatile halogenated methanes [Abstract]. *Toxicol Lett* 123:18.
- *Gemma S, Vittozzi L, Testai E. 2003. Metabolism of chloroform in the human liver and identification of the competent p450s. *Drug Metab Dispos* 31(3):266-274.
- Geter D, Chang L, Granville C, et al. 2002. Analysis of *in vitro* and *in vivo* DNA strand breaks induced by trihalomethanes (THMs) [Abstract]. *Environ Mol Mutagen* 39:27
- *Geter DR, Chang LW, Hanley NM, et al. 2004a. Analysis of *in vivo* and *in vitro* DNA strand breaks from trihalomethane exposure. *J Carcinog* 3(1):2-10.
- Geter DR, George MH, Moore TM, et al. 2004b. The effects of high animal fat diet on the induction of aberrant crypt foci in the colons of male F344/N rats exposed to trihalomethanes in the drinking water. *Toxicol Lett* 147(3):245-252.
- Geter DR, George H, Moore TM, et al. 2004c. Vehicle and mode of administration effects on the induction of aberrant crypt foci in the colons of male F344/N rats exposed to bromodichloromethane. *J Toxicol Environ Health A* 67(1):23-29.
- Ghess MJ, Wilbourn J, Tossavainen A, et al. 1986. Information bulletin on the survey of chemicals being tested for carcinogenicity. No. 12. Lyon, France: International Agency for Research on Cancer, 98, 212, 226.
- *Giwerzman A, Carlsen E, Keiding N, et al. 1993. Evidence for increasing incidence of abnormalities of the human testis: A review. *Environ Health Perspect Suppl* 101(2):65-71.
- *Glaze WH, Rawley R. 1979. A preliminary survey of trihalomethane levels in selected East Texas water supplies. *JAWWA* 71:509-515.
- *Glaze WH, Koga M, Cancilla D, et al. 1989. Evaluation of ozonation by-products from two California surface waters. *JAWWA* 81:66-73.
- Golderman L, Gellert J, Teschke R. 1983. Quantitative assessment of carbon tetrachloride levels in human blood by head-space gas chromatography: Application in a case of suicidal carbon tetrachloride intoxication. *Intensive Care Med* 9:131-135.
- *Goodwin KD, Lidstrom ME, Oremland RS. 1997. Marine bacterial degradation of brominated methanes. *Environ Sci Technol* 31:3188-3192.
- *Gotoh M, Sikitani Y, Aramaki T, et al. 1992. Pollution due to volatile halocarbon compound in biota. *Bull Environ Contam Toxicol* 49:186-191.

9. REFERENCES

- Gottlieb MS, Carr JK, Clarkson JR. 1982. Drinking water and cancer in Louisiana: A retrospective mortality study. *Am J Epidemiol* 116:652-667.
- Gowda TPH, Asce AM, Lock JD. 1985. Volatilization rates of organic chemicals of public health concern. *J Environ Eng* 3:755-776.
- *Graham EA. 1915. Late poisoning with chloroform and other alkyl halides in relationship to the halogen acids formed by their chemical dissociation. *J Exp Med* 221:48-75.
- Grant WM. 1974. *Toxicology of the eye: Drugs, chemicals, plants, venoms*. 2nd ed. Springfield, IL: Charles C. Thomas, 203.
- Gribble GW. 1992. Naturally occurring organohalogen compounds: A survey. *J Nat Prod* 55(10):1353-1395.
- Gross PM, Saylor JH. 1931. The solubilities of certain slightly soluble organic compounds in water. *J Am Chem Soc* 53:1744-1751.
- *Gschwend PM, MacFarlane JK, Newman KA. 1985. Volatile halogenated organic compounds released to seawater from temperate marine macroalgae. *Science* 227:1033-1035.
- Gschwend PM, Zafiriou OC, Mantoura RFC, et al. 1982. Volatile organic compounds at a coastal site. 1. Seasonal variations. *Environ Sci Technol* 16:31-38.
- *Guasp E, Wei R. 2003. Dehalogenation of trihalomethanes in drinking water on Pd-Fe bimetallic surface. *J Chem Technol Biotechnol* 78(6):654-658.
- *Guzelian PS, Henry CJ, Olin SS, eds. 1992. *Similarities and differences between children and adults: Implications for risk assessment*. Washington, DC: International Life Sciences Institute Press.
- Hakkola J, Pasanen M, Hukkanen J, et al. 1996a. Expression of xenobiotic-metabolizing cytochrome P450 forms in human full-term placenta. *Pharmacology* 51:403-411.
- Hakkola J, Raunio H, Purkunen R, et al. 1996b. Detection of cytochrome P450 gene expression in human placenta in first trimester of pregnancy. *Biochem Pharmacol* 52(2):379-383.
- Hakkola J, Tanaka E, Pelkonen O. 1998. Developmental expression of cytochrome P450 enzymes in human liver. *Pharmacol Toxicol* 82(5):209-217.
- Hardin BD, Schuler RL, Burg JR, et al. 1987. Evaluation of 60 chemicals in a preliminary developmental toxicity test. *Teratog Carcinogen Mutagen* 7:29-48.
- Harris MA, Chapin RE, Lockhart AC, et al. 1992. Assessment of short-term reproductive and developmental toxicity screen. *Fundam Appl Toxicol* 19(2):186-196.
- *Harris RN, Ratnayake JH, Garry VF, et al. 1982. Interactive hepatotoxicity of chloroform and carbon tetrachloride. *Tox Appl Pharmacol* 63:281-291.
- Haseman JK, Lockhardt A. 1994. The relationship between use of maximum tolerated dose and study sensitivity for detecting rodent carcinogenicity. *Fundam Appl Toxicol* 22(3):382-391.

9. REFERENCES

- *Hassett JJ, Banwart WL, Griffin RA. 1983. Chapter 15: Correlation of compound properties with sorption characteristics of nonpolar compounds by soils and sediments: Concepts and limitations. In: Francis CW, Averbach SI, eds. Environment and solid wastes: Characterization, treatment, and disposal. Ann Arbor, MI: Ann Arbor Science Publishers, Inc., 161-176.
- Haworth S, Lawlor T, Mortelmans K, et al. 1983. Salmonella mutagenicity test results for 250 chemicals. Environ Mutagen Suppl 1:3-142.
- Hawthorne B. 1988. Workshop on supercritical fluid chromatography. American Laboratory (August 1988):6-8.
- *Hayashi M, Kishi M, Sofuni T, et al. 1988. Micronucleus tests in mice on 39 food additives and eight miscellaneous chemicals. Food Chem Toxicol 26(6):487-500.
- *HazDat. 2005. HazDat database. ATSDR's Hazardous Substance Release and Health Effects Database. Atlanta, GA: Agency for Toxic Substances and Disease Registry. <http://www.atsdr.cdc.gov/hazdat.html>.
- *Heikes DI. 1987. Pesticide and industrial chemical residues: Purge and trap method for determination of volatile halocarbons and carbon disulfide in table-ready foods. J Assoc Off Anal Chem 70:215-226.
- Hekmati M, Bradley RL Jr, Sunde ML. 1983. Use of a fertile egg injection technique to assess toxicity of chlorinated compounds found in drinking water. J Food Prot 46:690-692.
- Helmig D, Pollock W, Greenburg J, et al. 1996. Gas chromatography mass spectrometry analysis of volatile organic trace gases at Mauna Loa Observatory, Hawaii. J Geophys Res 101(D9):14697-14710.
- Henderson VE. 1930. Anaesthetic toxicity. Arch Int Pharmacodyn Ther 38:150-165.
- *Henshaw PF, Bewtra JK, Biswas N. 1993. Occurrence of aluminum, lead, and trihalomethanes in drinking water from the Great Lakes. J Great Lakes Res 19:521-532.
- Herren-Freund SL, Pereira MA. 1986. Carcinogenicity of by-products of disinfection in mouse and rat liver. Environ Health Perspect 69:59-65.
- *Hewitt WR, Brown EM, Plaa GL. 1983. Acetone-induced potentiation of trihalomethane toxicity in male rats. Toxicol Lett 16:285-296.
- *Hoel DG, Davis DL, Miller AB, et al. 1992. Trends in cancer mortality in 15 industrialized countries, 1969-1986. J Natl Cancer Inst 84(5):313-320.
- Honma M, Hayashi M, Shimada H, et al. 1999. Evaluation of the mouse lymphoma tk assay (microwell method) as an alternative to the *in vitro* chromosomal aberration test. Mutagenesis 14(1):5-22.
- Hopkins RM, Krantz JC Jr. 1968. Anesthesia LXXV: Relative effects of haloforms and epinephrine on cardiac automaticity. Anesth Analg 47:57-67.
- *Horvath AL. 1982. Halogenated hydrocarbons: Solubility-miscibility with water. New York, NY: Marcel Dekker, Inc.

9. REFERENCES

- *HSDB. 2004a. Bromoform. Environmental standards and regulations. Bethesda, MD: Hazardous Substances Data Bank. <http://toxnet.nlm.nih.gov/cgi-bin/sis/htmlgen?HSDB.htm>.
- *HSDB. 2004b. Dibromochloromethane. Bethesda, MD: Hazardous Substances Data Bank. National Library of Medicine, National Toxicology Information Program. <http://toxnet.nlm.nih.gov/cgi-bin/sis/htmlgen?HSDB.htm>.
- *Huang W-J, Chen L-Y, Peng H-S. 2004. Effect of NOM characteristics on brominated organics formation by ozonation. *Environ Int* 29(8):1049-1055.
- Huang Q, Wang X, Liao Y, et al. 1995. Discriminant analysis of the relationship between genotoxicity and molecular structure of organochlorine compounds. *Bull Environ Contam Toxicol* 55(6):796-801.
- *Hutzler NJ, Crittenden JC, Gierke JS. 1986. Transport of organic compounds with saturated groundwater flow: Experimental results. *Water Resour Res* 22:285-295.
- *IARC. 1991a. Bromoform. In: IARC monographs on the on the evaluation of carcinogenic risks to humans: Chlorinated drinking water; chlorination by-products; some other halogenated compounds; cobalt and cobalt compounds. Volume 52. Lyon, France: World Health Organization (WHO), International Agency for Research on Cancer, 213-242.
- *IARC. 1991b. Dibromochloromethane. In: IARC monographs on the on the evaluation of carcinogenic risks to humans: Chlorinated drinking water; chlorination by-products; some other halogenated compounds; cobalt and cobalt compounds. Volume 52. Lyon, France: World Health Organization (WHO), International Agency for Research on Cancer, 243-268.
- *IARC. 1999a. Bromoform. In: IARC monographs on the evaluation of carcinogenic risks to humans: Re-evaluation of some organic chemicals, hydrazine and hydrogen peroxide. Volume 71, part three. Lyon, France: World Health Organization (WHO), International Agency for Research on Cancer, 1309-1316.
- *IARC. 1999b. Chlorodibromomethane. In: IARC monographs on the evaluation of carcinogenic risks to humans: Re-evaluation of some organic chemicals, hydrazine and hydrogen peroxide. Volume 71, Part Three. Lyon, France: World Health Organization, International Agency for Research on Cancer, 1331-1338.
- ICRP. 1981. Limits for intakes of radionuclides by workers. International Commission on Radiological Protection. 93-95.
- *Illet, KF, Reid WD, Sipes I., et al. 1973. Chloroform toxicity in mice: Correlation of renal and hepatic necrosis with covalent binding of metabolites to tissue macromolecules. *Exp Mol Pathol* 19:215-229.
- *ILSI. 1997. An evaluation of EPA's proposed guidelines for carcinogen risk assessment using chloroform and dichloroacetate as case studies: Report of an expert panel. International Life Sciences Institute, Health and Environmental Sciences Institute. November 1997.
- *Imaeda K, Yamamoto D, Watanabe T, et al. 1994. Formation of trihalomethanes during production of bean-curd. *Jpn J Toxicol Environ Health* 40(6):527-533.
- *IRIS. 2004a. Bromoform. Integrated Risk Information System. Washington, DC: U.S. Environmental Protection Agency. <http://www.epa.gov/iris/subst/0214.htm>.

9. REFERENCES

- *IRIS. 2004b. Dibromochloromethane. Integrated Risk Information System. Washington, DC: U.S. Environmental Protection Agency. <http://www.epa.gov/iris/subst/0222.htm>.
- Irish DD. 1962. Aliphatic halogenated hydrocarbons. In: Patty FA, ed. Industrial hygiene and toxicology. 2nd ed. Vol. II. Toxicology. New York, NY: Interscience Publishers, 1262-1263.
- IRPTC. 1989. IRPTC data profile: Bromoform. Geneva, Switzerland: International Register of Potentially Toxic Chemicals. United Nations Environment Programme. January 1989.
- Isacson P, Bean JA, Lynch C. 1981. Relationship of cancer incidence rates in Iowa municipalities to chlorination status of drinking water. In: Jolley RL, Brungs WA, Cotruvo JA, et al., eds. Water chlorination: Environmental impact on health effects. Vol. 4, Part 2. Ann Arbor, MI: Ann Arbor Science Publishers, 1353-1364.
- *IUR. 2002. Inventory Update Rule. Toxic Substances Control Act (TSCA) Inventory Update Database. Washington, DC: U.S. Environmental Protection Agency. <http://www.epa.gov/oppt/iuru/iur02/index.htm>.
- Jackson RE, Patterson RJ. 1989. A remedial investigation of an organically polluted outwash aquifer. *Ground Water Monit Rev* 119-125.
- Jenkins TF, Leggett DC, Parker LV, et al. 1985. Toxic organics removal kinetics in overland flow land treatment. *Water Res* 19:707-718.
- Jenner HA, Taylor CJL, van Donk M, et al. 1996. Chlorination byproducts in chlorinated cooling water of some European coastal stations. *Mar Environ Res* 43(4):279-293.
- Jerpe J, Davis A. 1987. Ambient capillary chromatography of volatile organics with a portable gas chromatograph. *J Chromatogr Sci* 25:154-157.
- Jo WK, Weisel CP, Lioy PJ. 1990. Chloroform exposure and the health risk associated with multiple uses of chlorinated tap water. *Risk Anal* 10(4):581-585.
- *Johanson CE. 1980. Permeability and vascularity of the developing brain: Cerebellum vs. cerebral cortex. *Brain Res* 190:3-16.
- Johnson TL, Scherer MM, Tratnyek PG. 1996. Kinetics of halogenated organic compound degradation by iron metal. *Environ Sci Technol* 30:2634-2640.
- Jorgenson TA, Meierhenry EF, Rushbrook CJ, et al. 1985. Carcinogenicity of chloroform in drinking water to male Osborne-Mendel rats and female B6C3F1 mice. *Fundam Appl Toxicol* 5:760-769.
- *Juchau MR, Boutelet-Bouchan H, Huang Y. 1998. Cytochrome-P-450-dependent biotransformation of xenobiotics in human and rodent embryonic tissues. *Drug Metab Rev* 30(3):541-568.
- Jury WA, Winer AM, Spencer WF, et al. 1987. Transport and transformations of organic chemicals in the soil-air-water ecosystem. *Rev Environ Contam Toxicol* 99:120-164.
- *Kaczmar SW, D'Itri FM, Zabik MJ. 1984. Vitalization rates of selected haloforms from aqueous environments. *Environ Toxicol Chem* 3:31-35.

9. REFERENCES

- *Kanarek MS, Young TB. 1982. Drinking water treatment and risk of cancer death in Wisconsin. *Environ Health Perspect* 46:179-186.
- Kanitz S, Franco Y, Patrone V, et al. 1996. Association between drinking water disinfection and somatic parameters at birth. *Environ Health Perspect* 104(5):516-520.
- Kargalioglu Y, McMillian BJ, Minear RA, et al. 2002. Analysis of the cytotoxicity and mutagenicity of drinking water disinfection by-products in *Salmonella typhimurium*. *Teratog Carcinog Mutagen* 22(2):113-128.
- Karimi AA, Singer PC. 1991. Trihalomethane formation in open reservoirs. *AWWJ* 83(3):84-88.
- Kash TL, Jenkins A, Harrison NL. 2003. Molecular volume determines the activity of the halogenated alkane bromoform at wild-type and mutant GABA_A receptors. *Brain Res* 960(1-2):36-41.
- Kavlock R, Chernoff N, Carver B, et al. 1979. Teratology studies in mice exposed to municipal drinking-water concentrates during organogenesis. *Food Cosmet Toxicol* 17:343-347.
- *Keefe SH, Barber LB, Runkel RL, et al. 2004. Fate of volatile organic compounds in constructed wastewater treatment wetlands. *Environ Sci Technol* 38(7):2209-2216.
- *Keith LH, Garrison AW, Allen FR, et al. 1976. Identification of organic compounds in drinking water from thirteen U.S. cities. In: Keith LH, ed. *Identification and analysis of organic pollutants in water*. Ann Arbor, MI: Ann Arbor Science Publishers, Inc., 329-373.
- *Kelley RD. 1985. Synthetic organic compound sampling survey of public water supplies. Des Moines, IA: Iowa Department of Water, Air and Waste Management. PB85214427.
- *Kenaga EE. 1980. Predicted bioconcentration factors and soil sorption coefficients of pesticides and other chemicals. *Ecotoxicol Environ Safety* 4:26-38.
- *Kenneke JF, Weber EJ. 2003. Reductive dehalogenation of halomethanes in iron- and sulfate-reducing sediments. 1. Reactivity pattern analysis. *Environ Sci Technol* 37(4):713-720.
- *Kerger BD, Schmidt CE, Paustenbach DJ. 2000. Assessment of airborne exposure to trihalomethanes from tap water in residential showers and baths. *Risk Anal* 20(5):637-651.
- *Khalanski M. 2003. Organic by-products generated by the chlorination of cooling water at marine power stations. *Tribune de l'Eau* 55/56(619-621):24-39.
- Khristov K, Bratanova Z. 1986. Content of trichloromethane in drinking water and determination of toxicological parameters of some of them in acute experiment [Abstract]. *Khig Zoraveopaz* 5:39.
- Kim JW, Lee CG, Park YG, et al. 2000. Combined analysis of germline polymorphisms of p53, GSTM1, GSTT1, CYP1A1, and CYP2E1: Relation to the incidence rate of cervical carcinoma. *Cancer* 88(9):2082-2091.
- Kim WJ, Kim H, Kim CH, et al. 2002. GSTT1-null genotype is a protective factor against bladder cancer. *Urology* 60(5):913-918.

9. REFERENCES

- King WD, Dodds L, Allen AC. 2000. Relation between stillbirth and specific chlorination by-products in public water supplies. *Environ Health Perspect* 108(9):883-886.
- Klingensmith JS, Mehendale HM. 1981. Potentiation of brominated halomethane hepatotoxicity by chlordecone in the male rat. *Toxicol Appl Pharmacol* 61:378-384.
- Klotz JB, Pynch LA. 1999. Neural tube defects and drinking water disinfection by-products. *Epidemiology* 10(4):383-390.
- Knecht KT, Mason RP. 1991. The detection of halocarbon-derived radical adducts in bile and liver of rats. *Drug Metab Dispos* 19(2):325-331.
- Kobayashi H, Rittmann BE. 1982. Microbial removal of hazardous organic compounds. *Environ Sci Technol* 16:170A-183A.
- *Kobert R. 1906. *Lehrbuch der Intoxikationen. II band. Spezieller teil.* Stuttgart: Verlag Von Ferdinand Enke, 914-916.
- Komori M, Nishio K, Fujitani T, et al. 1989. Isolation of a new human fetal liver cytochrome P450 cDNA clone: Evidence for expression of a limited number of forms of cytochrome P450 in human livers. *Arch Biochem Biophys* 272(1):219-225.
- *Komori M, Nishio K, Kitada M, et al. 1990. Fetus-specific expression of a form of cytochrome P-450 in human livers. *Biochemistry* 29:4430-4433.
- Komulainen H. 2004. Experimental cancer studies of chlorinated by-products. *Toxicology* 198 (1-3):239-248.
- Kool HF, Van Kreijl CF, Van Kranen HJ, et al. 1981. Toxicity assessment of organic compounds in drinking water in the Netherlands. *Sci Total Environ* 18:135-153.
- Kopfler FC, Melton RG. 1977. Human exposure to water pollutants. In: Suffet IH, ed. *Advances in environmental science and technology. Vol. 8. Fate of pollutants in the air and water environments. Part 2. Chemical and biological fate of pollutants in the environment.* New York, NY: John Wiley and Sons, 419-433.
- Korolev AA, Donchenko AI. 1985. Toxicological characteristics of halomethanes: Dichlorobromomethane and dibromochloromethane formed in water chlorination. *Gig Sanit* 4:80-82.
- *Korz V, Gatterman R. 1997. Behavioral alterations in male golden hamsters exposed to chlorobromomethane. *Pharmacol Biochem Behav* 58(3):643-647.
- *Kostiainen R. 1995. Volatile organic compounds in the indoor air of normal and sick houses. *Atmos Environ* 29(6):693-702.
- Koyama Y, Nakazawa Y. 1986. Comparison of the effect of trihalomethanes on lipid metabolism in rat liver slice. *Toxicol Lett* 31:37-44.
- *Kramer MD, Lynch CF, Isacson P, et al. 1992. The association of waterborne chloroform with intrauterine growth retardation. *Epidemiology* 3:407-413.

9. REFERENCES

- Kraybill HF. 1980. Evaluation of public health aspects of carcinogenic/mutagenic biorefractories in drinking water. *Prev Med* 9:212-218.
- Krewski D, Thomas RD. 1992. Carcinogenic mixtures. *Risk Anal* 12(1):105-113.
- *Krishnan K, Andersen ME. 1994. Physiologically based pharmacokinetic modeling in toxicology. In: Hayes AW, ed. *Principles and methods of toxicology*. 3rd ed. New York, NY: Raven Press, Ltd., 149-188.
- *Krishnan K, Andersen ME, Clewell HJ III, et al. 1994. Physiologically based pharmacokinetic modeling of chemical mixtures. In: Yang RSH, ed. *Toxicology of chemical mixtures: Case studies, mechanisms, and novel approaches*. San Diego, CA: Academic Press, 399-437.
- Kroll RB, Robinson GD, Chung JH. 1994a. Characterization of trihalomethane (THM)-induced renal dysfunction in the rat. I. Effects of THM on glomerular filtration and renal concentrating ability. *Arch Environ Contam Toxicol* 27(1):1-4.
- Kroll RB, Robinson GD, Chung JH. 1994b. Characterization of trihalomethane (THM)-induced renal dysfunction in the rat. II. Relative potency of THMs in promoting renal dysfunction. *Arch Environ Contam Toxicol* 27(1):5-7.
- *Kroneld R. 1985. Recovery and reproducibility in determination of volatile halocarbons in water and blood. *Bull Environ Contam Toxicol* 34:486-496.
- Kroneld R. 1986. Volatile halocarbons in water. *Bull Environ Contam Toxicol* 37:677-685.
- Kroneld R. 1987. Effect of volatile halocarbons on lymphocytes and cells of the urinary tract. *Bull Environ Contam Toxicol* 38:856-861.
- *Kroneld R. 1989a. Volatile pollutants in suburban and industrial air. *Bull Environ Contam Toxicol* 42:868-872.
- *Kroneld R. 1989b. Volatile pollutants in the environment and human tissues. *Bull Environ Contam Toxicol* 42:873-877.
- *Kroneld R, Reunanen M. 1990. Determination of volatile pollutants in human and animal milk. *Bull Environ Contam Toxicol* 44(6):917-923.
- *Kubo T, Urano K, Utsumi H. 2002. Mutagenicity characteristics of 255 environmental chemicals. *J Health Sci* 48(6):545-554.
- Kudchadker AP, Kudchadker SA, Shukla RP, et al. 1979. Vapor pressures and boiling points of selected halomethanes. *J Phys Chem Ref Data* 8:499-517.
- Kutob SD, Plaa GL. 1962. A procedure for estimating the hepatotoxic potential of certain industrial solvents. *Toxicol Appl Pharmacol* 4:354-361.
- Kuzma RJ, Kuzma CM, Buncher CR. 1977. Ohio drinking water source and cancer rates. *Am J Public Health* 77:725-729.

9. REFERENCES

- Lahl U, Cetinkaya M, Duszeln JV, et al. 1982. Health risks for infants caused by trihalomethane generation during chemical disinfection of feeding utensils. *Ecol Food Nutr* 12:7-17.
- *Lai CH, Chen KS, Ho YT. 2004. Characteristics of C₂-C₁₅ hydrocarbons in the air of urban Kaohsiung, Taiwan. *Atmos Environ* 38(13):1997-2011.
- *Lam RHF, Brown JP, Fan AM, et al. 1994. Chemicals in California drinking water: Source contaminants, risk assessment, risk management, and regulatory standards. *J Hazard Mater* 39:173-192.
- Lander RE, Kinefelter GR, Strafer LF, et al. 1994. Acute spermatogenic effects of bromoacetic acids. *Fundam Appl Toxicol* 22:422-430.
- Landi S. 2000. Mammalian class theta GST and susceptibility to carcinogens: A review. *Mutat Res* 463(3):247-283.
- *Landi S, Hanley NM, Kligerman AD, et al. 1999. Induction of sister chromatid exchanges in human peripheral blood lymphocytes by bromoform: Investigation of the role of GSTT1-1 polymorphism. *Mutat Res* 429(2):261-267.
- *Lapham WW, Moran MJ, Zogorski JS. 2000. Enhancement of nonpoint source monitoring of volatile organic compounds in ground water. *J Am Water Resour Assoc* 36(6):1321-1334.
- *LaRegina J, Bozzelli JW, Harkov R, et al. 1986. Volatile organic compounds at hazardous waste sites and a sanitary landfill in New Jersey. *Environ Prog* 5:18-27.
- Laternus F. 1996. Volatile halocarbons released from Arctic macroalgae. *Mar Chem* 55:359-366.
- Laternus F, Giese B, Wiencke C, et al. 2000a. Low-molecular-weight organoiodine and organobromine compounds released by polar macroalgae-the influence of abiotic factors. *Fresenius Environ Bull* 368(2-3):297-302.
- *Laternus F, Lauritsen FR, Gron C. 2000b. Chloroform in a pristine aquifer system: Toward an evidence of biogenic origin. *Water Resour Res* 36(10):2999-3009.
- Lawrence CE, Taylor PR, Track BJ, et al. 1984. Trihalomethanes in drinking water and human colorectal cancer. *J Natl Cancer Inst* 72:563-568.
- *Lebel GL, Benoit FM, Williams DT. 1997. A one-year survey of halogenated disinfection by-products in the distribution system of treatment plants using three different disinfection processes. *Chemosphere* 34:2301-2317.
- *LeCurieux F, Gauthier L, Erb F, et al. 1995. Use of the SOS chromotest, the Ames-fluctuation test, and the newt micronucleus test to study the genotoxicity of four trihalomethanes. *Mutagenesis* 10(4):333-341.
- Lee J-F, Liao P-M, Lee C-K, et al. 2004a. Clay-catalyzed reactions of coagulant polymers during water chlorination. *J Colloid Interface Sci* 270(2):381-387.
- *Lee SC, Guo H, Lam SM, et al. 2004b. Multipathway risk assessment on disinfection by-products of drinking water in Hong Kong. *Environ Res* 94(1):47-56.

9. REFERENCES

- *Leeder JS, Kearns GL. 1997. Pharmacogenetics in pediatrics: Implications for practice. *Pediatr Clin North Am* 44(1):55-77.
- *Leung H-W. 1993. Physiologically-based pharmacokinetic modelling. In: Ballentine B, Marro T, Turner P, eds. *General and applied toxicology*. Vol. 1. New York, NY: Stockton Press, 153-164.
- Leuze E. 1922. Zur theorie der narkose: Die veteilung der inhalationsnarkotika im tierkorper. *Archiv F Experiment Path u Pharmakol* 95:145-165.
- *Lewis RJ. 1997. *Hawley's condensed chemical dictionary*. 13th ed. New York, NY: John Wiley & Sons, Inc., 354.
- *Lide DR. 2000. Bromoform. In: *CRC handbook and chemistry and physics*. 81st ed. Boca Raton, FL: CRC Press LLC, 3-207.
- Lieber L. 1997. Cytochrome P-4502E1: Its physiological and pathological role. *Physiol Rev* 77(2):517-544.
- Ligocki MP, Pankow JF. 1985. Assessment of adsorption/solvent extraction with polyurethane foam and adsorption/thermal desorption with Tenax gas chromatography for the collection and analysis of ambient organic vapors. *Anal Chem* 57:1138-1144.
- Ligocki MP, Leuenberger C, Pankow JF. 1985. Trace organic compounds in rain-II. Gas scavenging of neutral organic compounds. *Atmos Environ* 19:1609-1617.
- *Livingston, AL. 1978. Forage plant estrogens. *J Toxicol Environ Health* 4:301-324.
- *Lopes TJ, Bender DA. 1998. Nonpoint sources of volatile organic compounds in urban areas – relative importance of land surfaces and air. *Environ Pollut* 101:221-230.
- Loveday KS, Anderson BE, Resnick BE, et al. 1990. Chromosome aberration and sister chromatid exchange tests in Chinese hamster ovary cells in vitro: V. Results with 46 chemicals. *Environ Mol Mutagen* 16(4):272-303.
- *Low JC, Wang NY, Williams J, et al. 2003. Measurements of ambient atmospheric C₂H₅Cl and other ethyl and methyl halides at coastal California sites and over the Pacific Ocean. *J Geophys Res* 108(D19):ACH 7-1-ACH 7-13.
- Lucas GHW. 1928. A study of the fate and toxicity of bromine and chlorine containing anesthetics. *J Pharmacol* 34:223-237.
- Luciene da Silva M, Charest-Tardif G, Krishnan K, et al. 1999. Influence of oral administration of a quaternary mixture of trihalomethanes on their blood kinetics in the rat. *Toxicol Lett* 106:49-57.
- *Lynberg M, Nuckols JR, Langlois P, et al. 2001. Assessing exposure to disinfection by-products in women of reproductive age living in Corpus Christi, Texas, and Cobb County, Georgia: Descriptive results and methods. *Environ Health Perspect* 109:597-604.
- *Mabey W, Mill T. 1978. Critical review of hydrolysis of organic compounds in water under environmental conditions. *J Phys Chem Ref Data* 7:383-409.

9. REFERENCES

- *Mabey WR, Smith JH, Podoll RT, et al. 1982. Aquatic fate process data for organic priority pollutants. Washington, DC: U.S. Environment Protection Agency, Office of Water Regulations and Standards. EPA440481014.
- *Mack GA, Stanley J. 1985. The national human adipose tissue survey. Washington, DC: U.S. Environmental Protection Agency, Office of Pesticides and Toxic Substances.
- *Mackay D, Shiu WY. 1981. A critical review of Henry's law constants for chemicals of environmental interest. *J Phys Chem Ref Data* 10:1175-1199.
- *Mackay D, Bobra A, Chan D, et al. 1982. Vapor pressure correlations for low-volatility environmental chemicals. *Environ Sci Technol* 16:645-649.
- Mackay DM, Ball WP, Durant MG. 1986a. Variability of aquifer sorption properties in a field experiment on groundwater transport of organic solutes: Methods and preliminary results. *J Contam Hydrol* 1:119-132.
- Mackay DM, Freyberg DL, Goltz MN, et al. 1983. A field experiment on ground water transport of halogenated organic solutes. *American Chemical Society: Division of Environmental Chemistry* 23:368-371.
- Mackay DM, Freyberg DL, Roberts PV, et al. 1986b. A natural gradient experiment on solute transport in a sand aquifer: 1. Approach and overview of plume movement. *Water Resource Research* 22:2017-2029.
- *Maddock MB, Kelly JJ. 1980. A sister chromatid exchange assay for detecting genetic damage to marine fish exposed to mutagens and carcinogens. In: Jolley RL, Qrungs WA, Cumming RB, et al., eds. *Water chlorination: Environmental impact and health effects*. Vol. 3. Ann Arbor, MI: Ann Arbor Science Publishers, Inc., 835-844.
- *Mansour H, Robson M, Meyer R, et al. 1999. Potential impact of chlorination of sandy bottom swimming areas on drinking water sources. *Int J Environ Stud* 56(5):653-665.
- Maresova Z, Mach O, Friedberger V, et al. 1957. The dissolution of gallstones with bromoform [Abstract]. *Casopis Lekarů Ceskych* 96:179-182.
- *Marienfeld CJ, Collins M, Wright H, et al. 1986. Cancer mortality and the method of chlorination of public drinking water: St. Louis City and St. Louis County, Missouri. *J Environ Pathol Toxicol Oncol* 7:141-158.
- *Marshall RA, Hamilton JT, Dring MJ, et al. 2003. Do vesicle cells of the red alga *Asparagopsis* (*Falkenbergia* stage) play a role in bromoform production? *Chemosphere* 52(2):471-475.
- *Martinez E, Llobet I, Lacorte S, et al. 2002. Patterns and levels of halogenated volatile compounds in Portuguese surface waters. *J Environ Monit* 4:253-257.
- Mathews JM, Troxler PS, Jeffcoat AR. 1990. Metabolism and distribution of bromodichloromethane in rats after single and multiple oral doses. *J Toxicol Environ Health* 30:15-22.
- Matsuoka A, Yamakage K, Kusakabe H, et al. 1996. Re-evaluation of chromosomal aberration induction on nine mouse lymphoma assay 'unique positive' NTP carcinogens. *Mutat Res* 369(3-4):243-252.

9. REFERENCES

- *Mayr U, Butsch A, Schneider S. 1992. Validation of two *in vitro* test systems for estrogenic activities with zearalenone, phytoestrogens and cereal extracts. *Toxicology* 74:135-149.
- McGeehin MA, Reif JS, Becher J, et al. 1993. A case-control study of bladder cancer and water disinfection in Colorado. *Am J Epidemiol* 138:492-501.
- *McGregor DB, Brown AG, Howgate S, et al. 1991. Responses of the L5178Y mouse lymphoma cell forward mutation assay. V. 27 coded chemicals. *Environ Mol Mutagen* 17(3):196-219.
- *McNeal TP, Hollifield HC, Diachenko GW. 1995. Survey of trihalomethanes and other volatile chemical contaminants in processed foods by purge-and-trap capillary gas chromatography with mass selective detection. *J AOAC Int* 78:391-397.
- *McQuarrie JP, Carlson K. 2003. Secondary benefits of aquifer storage and recovery: Disinfection by-product control. *J Environ Eng* 129(5):412-418.
- *Melnick RL, Kohn MC, Dunnick JK, et al. 1998. Regenerative hyperplasia is not required for liver tumor induction in female B6C3F1 mice exposed to trihalomethanes. *Toxicol Appl Pharmacol* 148(1):137-147.
- Mera N, Ohmori S, Itahashi S, et al. 1994. Immunochemical evidence for the occurrence of Mu class glutathione S-transferase in human fetal livers. *J Biochem* 116:315-320.
- Mersch-Sundermann V. 1989. [Examination of mutagenicity of organic microconcentrations of the environment. II. Communication: The mutagenicity of halogenated aliphatic hydrocarbons with the Salmonella-Microsome-Test (Ames-Test) as to contamination of ground – and drinking water]. *Abl Bakt Hyg B* 187:230-243. (German)
- *Merzbach L. 1928. [The pharmacology of methyl bromide and related compounds.] *Z Gesamte Ep Med* 63:383-392. (German)
- Michael LC, Pellizzari ED, Wiseman RW. 1988. Development and evaluation of a procedure for determining volatile organics in water. *Environ Sci Technol* 22:565-570.
- *Milanovich FP. 1986. Detecting chloroorganics in groundwater. *Environ Sci Technol* 20:441-442.
- *Miles AM, Singer PC, Ashley DL. 2002. Comparison of trihalomethanes in tap water and blood. *Environ Sci Technol* 36:1692-1698.
- Mill T, Winterle JS, Davenport JE, et al. 1982. Validation of estimation techniques for predicting environmental transformation of chemicals. Washington, DC: U.S. Environmental Protection Agency, Office of Pesticides and Toxic Substances.
- *Mills WB, Lew CS, Loh JY. 1998. Predictions of potential human health and ecological risks from power plant discharges of total residual chlorine and chloroform into rivers. *Environ Sci Technol* 32:2162-2171.
- *Mink FL, Brown JT, Rickabaugh J. 1986. Absorption, distribution, and excretion of ¹⁴C-trihalomethanes in mice and rats. *Bull Environ Contam Toxicol* 37:752-758.

9. REFERENCES

- *Miyagawa M, Takasawa H, Sugiyama A, et al. 1995. The *in vivo-in vitro* replicative DNA synthesis (RDS) test with hepatocytes prepared from male B6C3F1 mice as an early prediction assay for putative nongenotoxic (Ames-negative) mouse hepatocarcinogens. *Mutat Res* 343:157-183.
- Mochida K, Yamasaki M. 1984. Toxicity of halomethanes to cultured human and monkey cells. *Bull Environ Contam Toxicol* 33:253-256.
- *Mohamed MF, Kang D, Aneja VP. 2002. Volatile organic compounds in some urban locations in United States. *Chemosphere* 47:863-882.
- Moody DA, Smuckler EA. 1986. Disturbances in hepatic heme metabolism in rats administered alkyl halides. *Toxicol Lett* 32:209-214.
- Moody DE, James JL, Clawson GA, et al. 1981. Correlations among the changes in hepatic microsomal components after intoxication with alkyl halides and other hepatotoxins. *Mol Pharmacol* 20:685-693.
- *Morimoto K, Koizumi A. 1983. Trihalomethanes induce sister chromatid exchanges in human lymphocytes *in vitro* and mouse bone marrow cells *in vivo*. *Environ Res* 32:72-79.
- *Morris RL, Johnson LG. 1976. Agricultural runoff as a source of halomethanes in drinking water. *JAWWA* 68:492-494.
- Morris RS, Audet AM, Angelillo IF, et al. 1993a. Chlorination, chlorination by-products, and cancer: A meta-analysis. *Am J Public Health* 82(7):955-963.
- Morris RS, Audet AM, Angelillo IF, et al. 1993b. Chlorination, chlorination by-products, and cancer: A meta-analysis. Erratum. *Am J Public Health* 83(9):1257.
- Morris RS, Audet AM, Angelillo IF, et al. 1993c. Chlorination, chlorination by-products, and cancer: A meta-analysis. *Am J Public Health* 83(9):1347-1348.
- *Morselli PL, Franco-Morselli R, Bossi L. 1980. Clinical pharmacokinetics in newborns and infants: Age-related differences and therapeutic implications. *Clin Pharmacokin* 5:485-527.
- *Moschandreas D, Cha D, Kao SN. 1997. Organic compound concentrations in wastewater of water control plants. *Chimika Chronika* 26(3):345-378.
- *Müller SP, Wolna P, Wunscher U, et al. 1997. Cardiotoxicity of chlorodibromomethane and trichloromethane in rats and isolated rat cardiac myocytes. *Arch Toxicol* 71(12):766-777.
- *Munson AE, Sain LE, Sanders VM, et al. 1982. Toxicology of organic drinking water contaminants: Trichloromethane, bromodichloromethane, dibromochloromethane, and tribromomethane. *Environ Health Perspect* 46:117-126.
- *Munz C, Roberts PV. 1987. Air-water phase equilibria of volatile organic solutes. *JAWWA* 79:62-69.
- Nakajima T, Elovaara E, Okino T, et al. 1995. Different contributions of cytochrome P450 2E1 and P450 2B1/2 to chloroform hepatotoxicity in rat. *Toxicol Appl Pharmacol* 133:215-222.
- Narotsky MG, Best DS, Rogers EH, et al. 2001. Developmental effects of disinfectant by-products bromoform, bromodichloroacetic acid, and bromochloroacetic acid in mice. *Teratology* 63(6):279.

9. REFERENCES

- Narotsky MG, Brownie CF, Kavlock RJ. 1997. Critical period of carbon tetrachloride-induced pregnancy loss in Fischer-344 rats, with insights into the detection of resorption sites by ammonium sulfide staining. *Teratology* 56:252-261.
- Nartosky MG, Hamby BT, Mitchell DS, et al. 1993. Full-litter resorptions caused by low-molecular-weight halocarbons in F-344 rats. *Teratology* 472-473.
- Nartosky MG, Pegram RA, Kavlock RJ. 1997. Effect of dosing vehicle on the development toxicity of bromodichloromethane and carbon tetrachloride in rats. *Fundam Appl Toxicol* 30:30-36.
- NAS. 1977. Drinking water and health. Washington, DC: National Academy of Sciences, 695-697.
- NAS. 1980. Drinking water and health: Vol. 3. Washington, DC: National Academy of Sciences, 189, 205-206.
- NAS. 1987. Drinking water and health: Disinfectants and disinfectant byproducts. Vol. 7. Washington, DC: National Academy of Sciences, 111-112.
- *NAS/NRC. 1989. Biologic markers in reproductive toxicology. National Academy of Sciences/National Research Council. Washington, DC: National Academy Press, 15-35.
- NATICH. 1988. National air toxics information clearing house: NATICH data base report on state, local and EPA air toxics activities: Final. Austin, TX: Radian Corporation. EPA450588007.
- *Needham LL, Hill RHJ, Ashley DL, et al. 1995. The priority toxicant reference range study: Interim report. *Environ Health Perspect Suppl* 103(3):89-94.
- *Nelson DR, Koymans L, Kamataki T, et al. 1996. P450 superfamily: Update on new sequences, gene mapping, accession numbers and nomenclature. *Pharmacogenetics* 6:1-42.
- *Nestman ER, Lee EG-H. 1985. Genetic activity in *Saccharomyces cerevisiae* of compounds found in effluents of pulp and paper mills. *Mutat Res* 155:53-60.
- Newsom JM. 1985. Transport of organic compounds dissolved in ground water. *Ground Water Monit Rev* 51:28-36.
- *Nicholson BC, Maguire BP, Bursill DB. 1984. Henry's law constants for the trihalomethanes: Effects of water composition and temperature. *Environ Sci Technol* 18:518-521.
- *Nieuwenhuijsen MJ, Toledano MB, Eaton N, et al. 2000. Chlorination disinfection byproducts in water and their association with adverse reproductive outcomes: A review. *Occup Environ Med* 57(2):73-85.
- NIOSH. 1988. National Occupational Hazard Survey Printout. Cincinnati, OH: National Institute of Occupational Safety and Health. December 1988.
- *NIOSH. 1994. Hydrocarbons, halogenated - method 1003. In: Eller PM, ed. NIOSH manual of analytical methods. 3rd ed. Vol. 2. Cincinnati, OH: U.S. Department of Health and Human Services, Public Health Service, Centers for Disease Control, National Institute for Occupational Safety and Health. DHHS (NIOSH) Publication No. 84-100.

9. REFERENCES

- *NIOSH. 2003. NIOSH pocket guide to chemical hazards. Bromoform. Washington, DC: National Institute for Occupational Safety and Health. <http://www.cdc.gov/niosh/npg/npg.html>.
- *Nirmalakhandan N, Arulgnanendran V, Moshin M, et al. 1994. Toxicity of mixtures of organic chemicals to microorganisms. *Water Res* 28(3):543-551.
- *Nissinen TK, Miettinen IT, Martikainen PJ, et al. 2002. Disinfection by-products in Finnish drinking waters. *Chemosphere* 48:9-20.
- NLM. 1988. National Library of Medicine CHEMLINE database. Bethesda, MD: National Library of Medicine. December 1988.
- Norin H, Renberg L. 1980. Determination of trihalomethanes in water using high efficiency solvent extraction. *Water Res* 14:1397-1402.
- *NRC. 1993. Pesticides in the diets of infants and children. Washington, DC: National Research Council. National Academy Press.
- *NTP. 1985. Toxicology and carcinogenesis studies of chlorodibromomethane (CAS No. 124-48-1) in F344/N rats and B6C3F₁ mice (gavage studies). Technical report series no. 282. Research Triangle Park, NC: U.S. Department of Health and Human Services, Public Health Service, National Institutes of Health, National Toxicology Program. NIH Publication No. 88-2538.
- *NTP. 1989a. Toxicology and carcinogenesis studies of tribromomethane (bromoform) (CAS No. 75-25-2) in F344/N rats and B6C3F₁ mice (gavage studies). Technical report series no. 350. Research Triangle Park, NC: U.S. Department of Health and Human Services, Public Health Service, National Institute of Health, National Toxicology Program. NIH Publication No. 88-2805.
- *NTP. 1989b. Bromoform: Reproduction and fertility assessment in Swiss CD-1 mice when administered by gavage. Research Triangle Park, NC: National Toxicology Program. NTP-89-068. PB89169254.
- *NTP. 1996. Short-term reproductive & developmental toxicity of chlorodibromomethane (CAS No. 124-48-1) administered in drinking water to Sprague-Dawley rats. NTP Study No. RDGT94003.
- Nygren O. 2002. New approaches for assessment of occupational exposure to metals using on-site measurements. *J Environ Monit* 4:623-627.
- *O'Brien PJ. 1988. Radical formation during the peroxidase catalyzed metabolism of carcinogens and xenobiotics: The reactivity of these radicals with GSH, DNA, and unsaturated lipid. *Free Radic Biol Med* 4:169-184.
- Odland JO, Nieboer E, Romanova N, et al. 2003. Intercommunity and temporal variation of eleven essential and five toxic elements in human placentas from deliveries in thirteen arctic and sub-chronic areas of Russia and Norway. *J Environ Monit* 5:166-174.
- Omiencinski CJ, Hassett C, Costa P. 1990. Developmental expression and *in situ* localization of the phenobarbital-inducible rat hepatic mRNAs for cytochromes CYP2B1, CYP2B2, CYP2C6, and CYP3A1. *Mol Pharmacol* 38(2):462-470.

9. REFERENCES

- *O'Neil NJ, Smith A, Heckelman PE, eds. 2001. The Merck index. An encyclopedia of chemicals, drugs, and biologicals, 11th edition. Whitehouse Station, NJ: Merck & Co., Inc., 1410.
- Ono Y, Somiya I, Kawamura M. 1991. Genotoxicity of the by-products produced in chlorination and ozonation processes. *Mutat Res* 252:102.
- *Oppenheimer JA, Jacangelo JG, Laine J-M, et al. 1997. Testing the equivalency of ultraviolet light and chlorine for disinfection of wastewater to reclamation standards. *Water Environ Res* 69(1):14-24.
- *Orrell JK, Mackie M. 1988. Economic impact analysis of final test rule for 33 solid waste chemicals. Washington, DC: U.S. Environmental Protection Agency, Office of Toxic Substances, Economics and Technology Division, 23-24.
- *ORVWSC. 1979. Water treatment process modifications for trihalomethane control and organic substances in the Ohio River. Cincinnati, OH: Ohio River Valley Water Sanitation Commission.
- *OSHA. 1989. Department of Labor, Occupational Safety and Health Administration: Part III. *Fed Regist.* 54:2332-2983.
- *OSHA. 2003a. Occupational safety and health standards. Limits for air contaminants. Washington, DC: Occupational Safety and Health Administration. 29 CFR 1910.1000. Table Z-1. <http://www.osha.gov/comp-links.html>.
- *OSHA. 2003b. Occupational safety and health standards for shipyard employment. Air contaminants. Washington, DC: Occupational Safety and Health Administration. 29 CFR 1915.1000. <http://www.osha.gov/comp-links.html>.
- *OSHA. 2003c. Safety and health regulations for construction. Gases, vapors, fumes, dusts, and mists. Washington, DC: Occupational Safety and Health Administration. 29 CFR 1926.55, Appendix A.
- OTA. 1990. Neurotoxicity: Identifying and controlling poisons of the nervous system. Washington, DC: Office of Technology Assessment. OTA-BA-438.
- Otson R, Williams DT, Bothwell PD. 1982. Volatile organic compounds in water at thirty Canadian potable water treatment facilities. *J Assoc Off Anal Chem* 65:1370-1374.
- *Owen GM, Brozek J. 1966. Influence of age, sex and nutrition on body composition during childhood and adolescence. In: Falkner F, ed. *Human development*. Philadelphia, PA: WB Saunders, 222-238.
- *Page GW. 1981. Comparison of groundwater and surface water for patterns and levels of contamination by toxic substances. *Environ Sci Technol* 15:1475-1481.
- *Pankow D, Damme B, Wunscher U, et al. 1997. Chlorodibromomethane metabolism to bromide and carbon monoxide in rats. *Arch Toxicol* 71(4):203-210.
- Pankow JF, Isabelle LM, Asher WE. 1984. Trace organic compounds in rain. 1. Sampler design and analysis by adsorption/thermal desorption (ATD). *Environ Sci Technol* 18:310-318.
- *Pankow JF, Ligocki MP, Rosen ME, et al. 1988. Adsorption/thermal desorption with small cartridges for the determination of trace aqueous semivolatile organic compounds. *Anal Chem* 60:40-47.

9. REFERENCES

- *Pankow JF, Luo W, Bender DA, et al. 2003. Concentrations and co-occurrence correlations of 88 volatile organic compounds (VOCs) in the ambient air of 13 semi-rural to urban locations in the United States. *Atmos Environ* 37(36):5023-5046.
- *Pankow JF, Luo W, Isabells LM, et al. 1998. Determination of a wide range of volatile compounds in ambient air using multisorbent adsorption/thermal desorption and gas chromatography/mass spectrometry. *Anal Chem* 70(24):5213-5221.
- Pasanen M. 1994. The expression and environmental regulation of P450 enzymes in human placenta. *Crit Rev Toxicol* 24:211-229.
- *Pecher K, Hederlein SB, Schwarzenbach RP. 2002. Retention of polyhalogenated methanes by surface-bound Fe (II) in aqueous suspensions of iron oxides. *Environ Sci Technol* 36(8):1734-1741.
- *Pegram RA, Andersen ME, Areen SH, et al. 1977. Glutathione S-transferase-mediated mutagenicity of trihalomethanes in *Salmonella typhimurium*: Contrasting results with bromodichloromethane and chloroform. *Toxicol Appl Pharmacol* 144(1):183-188.
- *Pellizzari ED. 1978. Environmental monitoring near industrial sites: Brominated chemicals. Part I. Washington, DC: U.S. Environmental Protection Agency, Office of Toxic Substances. EPA560678002. PB286484.
- Pellizzari ED, Harwell TD, Harris BS, et al. 1982. Purgeable organic compounds in mother's milk. *Bull Environ Contam Toxicol* 28:322-328.
- Pellizzari ED, Sheldon LS, Bursley JT. 1985a. GC/MS determination of volatile halocarbons in blood and tissue. In: Fishbein L, O'Neill IK, eds. *Environmental carcinogens selected methods of analysis*. Vol. 7. Lyon, France: International Agency for Research on Cancer, 435-444.
- *Pellizzari ED, Zweidinger RA, Sheldon LS. 1985b. Method 24: GC/MS determination of volatile hydrocarbons in breath samples. In: Fishbein L, O'Neill IK, eds. *Environmental carcinogens selected methods of analysis*. Vol. 7. Lyon, France: International Agency For Research on Cancer, 413-431.
- *Peltier S, Benezet M, Gatel D, et al. 2002. Effects of nanofiltration on water quality in the distribution system. *J Water Supply Res Technol-AQUA* 51(5):253-262.
- *Peoples AJ, Pfaffenberger CD, Shafik TM. 1979. Determination of volatile purgeable halogenated hydrocarbons in human adipose tissue and blood serum. *Bull Environ Contam Toxicol* 23:244-249.
- Pereira MA. 1983. Carcinogenicity of chlorination byproducts: Trihalomethanes. In: Jolley RL, Brungs WA, Cotruvo JA, et al., eds. *Water chlorination: Environmental impact and health effects*. Vol. 4, Book 2. Environment, health and risk. Ann Arbor, MI: Ann Arbor Science Publishers, 1165-1176.
- Pereira MA, Herren SL, Britt AL, et al. 1982a. Initiation/promotion bioassay in rat liver: Use of gamma glutamyltranspeptidase-positive foci to indicate carcinogenic activity. *Toxicol Pathol* 10:11-18.
- Pereira MA, Lin L-HC, Lippitt JM, et al. 1982b. Trihalomethanes as initiators and promoters of carcinogenesis. *Environ Health Perspect* 46:151-156.

9. REFERENCES

- *Perry DL, Chuang CC, Jungclaus, et al. 1979. Identification of organic compounds in industrial effluent discharges. Athens, GA: U.S. Environmental Protection Agency, Office of Research and Development.
- *Perwak J, Goyer M, Harris J, et al. 1980. An exposure and risk assessment for trihalomethanes. Washington, DC: U.S. Environmental Protection Agency, Office of Water Regulations and Standards.
- *Peters R JB, De Leer E WB, Versteegh J FM. 1994. Identification of halogenated compounds produced by chlorination of humic acid in the presence of bromide. *J Chromatogr A* 686(2):253-261.
- PHRED. 1988. Public Health Risk Evaluation Database. Washington, DC: U.S. Environmental Protection Agency. December 1988.
- Piet GJ, Morra CHF, Kruijf DE. 1981. The behavior of organic micropollutants during passage through the soil. *Stud Environ Sci* 17:557-564.
- Plaa GL. 1988. Experimental evaluation of haloalkanes and liver injury. *Fundam Appl Toxicol* 10:563-570.
- *Plaa GL, Hewitt WR. 1982a. Methodological approaches for interaction studies: Potentiation of haloalkane-induced hepatotoxicity. National Research Council of Canada. Workshop on the Combined Effects of Xenobiotics, 67-96.
- *Plaa GL, Hewitt WR. 1982b. Potentiation of liver and kidney injury of ketones and ketogenic substances. *Adv Pharmacol Ther Proc Int Cong* 5:65-75.
- *Plumb RH Jr. 1991. The occurrence of Appendix IX organic constituents in disposal site ground water. *Ground Water Monit Rev* 11:157-164.
- *Pohl LR, Martin JL, George JW. 1980. Mechanism of metabolic activation of chloroform by rat liver microsomes. *Biochem Pharmacol* 29:3271-3276.
- *Polkowska Z, Kozłowska K, Mazerska Z, et al. 2003. Relationship between volatile organohalogen compounds in drinking water and human urine in Poland. *Chemosphere* 53(8):899-909.
- *Potter CL, Chang LW, DeAngelo AB, et al. 1996. Effects of four trihalomethanes on DNA strand breaks, renal hyaline droplet formation, and serum testosterone in male F-344 rats. *Cancer Lett* 106:235-242.
- *Prah JD, Blount B, Cardinali FL, et al. 2002. The development and testing of a dermal exposure system for pharmacokinetic studies of administered and ambient water contaminants. *J Pharmacol Toxicol Methods* 47(3):189-195.
- Premble S, Schroeder KR, Spencer SR, et al. 1994. Human glutathione S-transferase theta (GSTT1): cDNA cloning and the characterization of a genetic polymorphism. *Biochem J* 300:271-276.
- *Quack B, Wallace DWR. 2003. Air-sea flux of bromoform: Controls, rates, and implications. *Global Biogeochem Cycles* 17(1):23-1-23-27.

9. REFERENCES

- *Radding SB, Liu DH, Johnson HL, et al. 1977. Review of the environmental fate of selected chemicals. Washington, DC: U.S. Environmental Protection Agency, Office of Toxic Substances. EPA560577003, 69-72.
- *Rapson WH, Nazar MA, Butsky W. 1980. Mutagenicity produced by aqueous chlorination of organic compounds. *Bull Environ Contam Toxicol* 24:590-596.
- Raucy JL. 1995. Risk assessment: Toxicity from chemical exposure resulting from enhanced expression of CYP2E1. *Toxicology* 105:217-223.
- Rebhun M, Heller-Grossman L, Manka J. 1997. Formation of disinfection byproducts during chlorination of secondary effluent and renovated water. *Water Environ Res* 69(6):1154-1162.
- *Redeker KR, Meinardi S, Blake D. 2003. Gaseous emissions from flooded rice paddy agriculture. *J Geophys Res* 108(D113):ACH 3-1-ACH 3-13.
- Reif JS, Hatch MC, Bracken M, et al. 1996. Reproductive and developmental effects of disinfection by-products in drinking water. *Environ Health Perspect* 104(10):1056-1061.
- *Reitz RH, Mendrala AL, Guengerich FP. 1989. *In vitro* metabolism of methylene chloride in human and animal tissues: Use in physiologically based pharmacokinetic models. *Toxicol Appl Pharmacol* 97:230-246.
- *Richardson SD, Thruston AD Jr. 2003. Tribromopyrrole, brominated acids, and other disinfection byproducts produced by disinfection of drinking water rich in bromide. *Environ Sci Technol* 37(17):3782-3793.
- *Ritter L, Solomon K, Sibley P, et al. 2002. Sources, pathways, and relative risks of contaminants in surface water and ground water: A perspective prepared for the Walkerton inquiry. *J Toxicol Environ Health A* 65:1-142.
- Rittmann BE, McCarty PL, Roberts PV. 1980. Trace-organics biodegradation in aquifer recharge. *Ground Water* 18:236-243.
- *Roberts PV, Goltz MN, Mackay DM. 1986. A natural gradient experiment on solute transport in a sand aquifer. 3. Retardation estimates and mass balances for organic solutes. *Water Resour Res* 22:2047-2058.
- *Rodriguez MJ, Huard M, Serodes JB. 2004. Experimental study of the formation of chlorination by products in potable water of Quebec City, Canada. *Bull Environ Contam Toxicol* 72(1):211-218.
- Rodriguez MJ, Yannick V, Serodes J-B, et al. 2003. Trihalomethanes in drinking water of greater Quebec region (Canada): Occurrence, variations and modelling. *Environ Monit Assess* 89(1):69-93.
- *Roldan-Arjona T, Pucyo C. 1993. Mutagenic and lethal effects of halogenated methanes in the Ara test of *Salmonella typhimurium*: Quantitative relationship with chemical reactivity. *Mutagenesis* 8(2):127-131.
- *Rook JJ. 1977. Chlorination reactions of fulvic acids in natural waters. *Environ Sci Technol* 11:478-482.

9. REFERENCES

- Rosenkranz HS, Ennever FK. 1990. An association between mutagenicity and carcinogenic potency. *Mutat Res* 244(1):61-66.
- Rosenkranz HS, Klopman G. 1990. The structural basis of the mutagenicity of chemicals in *Salmonella typhimurium*: The National Toxicology Program data base. *Mutat Res* 228(1):51-80.
- Rosenkranz HS, Klopman G. 1993. Structural relationships between mutagenicity, maximum tolerated dose, and carcinogenicity in rodents. *Environ Mol Mutagen* 21(2):193-206.
- *Ross MK, Pegram RA. 2003. Glutathione transferase theta 1-1-dependent metabolism of the water disinfection byproduct bromodichloromethane. *Chem Res Toxicol* 16:216-226.
- *Roth O. 1904. *Zeitschr f Medizinalbeamte* 17:233.
- *Roy WR, Griffen RA. 1985. Mobility of organic solvents in water- saturated soil materials. *Environ Geol Water Sci* 7:241-247.
- *RTECS. 2003. Registry of Toxic Effects of Chemical Substances. National Library of Medicine, Bethesda, MD: National Toxicology Information Program. February 2000.
- *Ruddick JA, Villeneuve DC, Chu I, et al. 1983. A teratological assessment of four trihalomethanes in the rat. *Environ Sci Health B*18:333-349.
- *Russo MV, Campanella L, Avino P. 2003. Identification of halocarbons in the Tiber and Marta rivers by static headspace and liquid-liquid extraction analysis. *J Sep Sci* 26(5):376-380.
- *Sangster J. 1994. LOGKOW databank. Sangster Research Laboratory, Montreal, Quebec.
- *Sarafova VI, Sapelinikova SV, Djazhenko EV, et al. 2004. Gas-chromatography-mass spectrometry with headspace for the analysis of volatile organic compounds in waste water. *J Chromatogr B Biomed Sci Appl* 800(1-2):325-330.
- *Savitz DA, Andrews KW, Pastore LM. 1995. Drinking water and pregnancy outcome in central North Carolina: Source, amount, and trihalomethane levels. *Environ Health Perspect* 103(6):592-596.
- Sax NI. 1984. Dangerous properties of industrial materials. 6th ed. New York, NY: Van Nostrand Reinhold Company, 529-530.
- Sax NI, Lewis RJ, eds. 1987. *Hawley's condensed chemical dictionary*. 11th ed. New York, NY: Van Nostrand Reinhold Company.
- Schall C, Laturnus F, Heumann KG. 1994. Biogenic volatile organochloride and organobromine compounds released from polar macroalgae. *Chemosphere* 28(7):1315-1324.
- Schwander P. 1936. Uber die diffusion halogenisierter kohlenwasserstoffe durch die haut. *Arch Gewerbepath Gewerbehg* 7:109-116.
- Scott DR. 1987. Classification and identification of hazardous organic compounds in ambient air by pattern recognition of mass spectral data. *Environ Sci Technol* 21:891-897.
- Sekihashi K, Yamamoto A, Matsumura Y, et al. 2002. Comparative investigation of multiple organs of mice and rats in the comet assay. *Mutat Res* 517(1-2):53-75.

9. REFERENCES

- *Setchell BP, Waites GMH. 1975. The blood-testis barrier. In: Creep RO, Astwood EB, Geiger SR, eds. *Handbook of physiology: Endocrinology V*. Washington, DC: American Physiological Society.
- *Shelton JJ, Burow KR, Belitz K, et al. 2001. Low-level volatile organic compounds in active public supply wells as ground-water tracers in the Los Angeles physiographic basin, California, 2000. *Water-resources investigations report*. Sacramento, CA: United States Geological Survey, 1029.
- *Shetty G, Chellam S. 2003. Predicting contaminant removal during nanofiltration using artificial neural networks. *Maximizing the resources: Solutions for pure and plentiful water*. Atlanta, GA: Membrane Technology Conference Proceedings. March 2-5, 2003.
- Shen TT. 1982. Estimation of organic compound emissions from waste lagoons. *J Air Pollut Control Assoc* 32:79-82.
- Simmon VF. 1977. Structural correlations of carcinogenic and mutagenic alkyl halides. In: *Structural correlates of carcinogenesis and mutagenesis: A guide to testing priorities*. Washington, DC: U.S. Food and Drug Administration, 163-171.
- *Simmon VF, Tardiff RG. 1978. The mutagenic activity of halogenated compounds found in chlorinated drinking water. In: Jolley RL, Gorchev H, Hamilton DH Jr, et al., eds. *Water chlorination: Environmental impact and health effects*. Vol. 2. Ann Arbor, MI: Ann Arbor Science Publishers, Inc., 417-431.
- *Simmon VF, Kauhanen K, Tardiff RG. 1977. Mutagenic activity of chemicals identified in drinking water. *Dev Toxicol Environ Sci* 2:249-258.
- Simmons JE. 1994. Nephrotoxicity resulting from multiple chemical exposures and chemical interactions. In: Yang RSH, ed. *Toxicology of chemical mixtures: Case studies, mechanisms, and novel approaches*. San Diego, CA: Academic Press, Inc., 335-360.
- Singer PC, Obolensky A, Greiner A. 1995. DBPs in chlorinated North Carolina drinking waters. *AWWA* 832-892.
- Sistrunk C, DeAngelo T. 2001. The induction of colorectal neoplasia in male F344/N rats exposed to a mixture high in brominated trihalomethanes (THMs) in the drinking water. *Int J Toxicol* 20(6):408-409.
- Sittig M. 1985a. Bromoform. In: *Handbook of toxic and hazardous chemicals and compounds*. Park Ridge, NJ: Noyes Publications, 149-150.
- Sittig M. 1985b. Dibromochloromethane. In: *Handbook of toxic and hazardous chemicals and compounds*. Park Ridge, NJ: Noyes Publications, 306.
- *Smith VL, Cech I, Brown JH, et al. 1980. Temporal variations in trihalomethane content of drinking water. *Environ Sci Technol* 14:190-196.
- So B-J, Bull RJ. 1995. Dibromoacetate (DBA) acts as a promoter of abnormal crypt foci in the colon of F344 rats. *Toxicologist* 15:1242.
- *Sobti RC. 1984. Sister chromatid exchange induction potential of the halogenated hydrocarbons produced during water chlorination. *CIS Chromosome Inf Serv* 37:17-19.

9. REFERENCES

- *Sofuni T, Honma M, Hayashi M, et al. 1996. Detection of *in vitro* clastogens and spindle poisons by the mouse lymphoma assay using the microwell method: Interim report of an international collaborative study. *Mutagenesis* 11(4):349-355.
- Sonoyama N, Seike S, Sueoka T, et al. 2003. Electrochemical decomposition of ppb level trihalomethane in tap water. *J Appl Electrochem* 33(11):1049-1055.
- SRI. 1985. Directory of chemical producers: United States of America. Palo Alto, CA. SRI International, 457.
- SRI. 1986. Directory of chemical producers: United States of America. Palo Alto, CA. SRI International, 512.
- SRI. 1987. Directory of chemical producers: United States of America. Palo Alto, CA. SRI International, 495.
- SRI. 1988. Directory of chemical producers: United States of America. Palo Alto, CA. SRI International, 490.
- SRI. 2002. Directory of chemical producers: United States of America. Palo Alto, CA. SRI International, 490.
- *SRI. 2004. Directory of chemical producers. United States of America. Palo Alto, CA. SRI International.
- *Stangroom SJ, Collins CD, Lester JN. 1998. Sources of organic micropollutants to lowland rivers. *Environ Technol* 19:643-666.
- *Stanley JS. 1986. Broad scan analysis of human adipose tissue: Vol. 1: Executive summary. Washington, DC: U.S. Environmental Protection Agency, Office of Toxic Substances. EPA560586035.
- *Staples CA, Werner AF, Hoogheem TJ. 1985. Assessment of priority pollutant concentrations in the United States using STORET database. *Environ Toxicol Chem* 4:131-142.
- *Stenger VA. 1978. Bromine compounds: Organic. In: Kirk-Othmer's encyclopedia of chemical technology, 3rd ed., Vol. 4. New York, NY: John Wiley and Sons, 243-263.
- *Stevens JL, Anders MW. 1979. Metabolism of haloforms to carbon monoxide-III: Studies on the mechanism of the reaction. *Biochem Pharmacol* 28:3189-3194.
- *Stevens JL, Anders MW. 1981. Metabolism of haloforms to carbon monoxide. IV. Studies on the reaction mechanism *in vivo*. *Chem Biol Interact* 37:365-374.
- Stevens RH, Cole DA, Lindholm PT, et al. 1984. Identification of carcinogens by measurement of cell-mediated immunity v. antitumor immunity in rats to halogen-containing organic compounds. In: Jolley RL, Bull RJ, Davis WP, et al., eds. *Water chlorination: Chemistry, environmental impact, and health effects*. Vol. 5. Chelsea, MI: Lewis Publishers, Inc., 251-264.

9. REFERENCES

- *Stocker KJ, Statham J, Howard WR, et al. 1997. Assessment of the potential *in vivo* genotoxicity of three trihalomethanes: Chlorodibromomethane, bromodichloromethane and bromoform. *Mutagenesis* 12(3):169-173.
- *Stokes CE. 1900. Memoranda: Medical, surgical, obstetrical, therapeutical, pathological, etc. Two cases of bromoform poisoning: Recovery. *Br Med J* May 26, 1900.
- Stoltz C, Vachon E, Trottier E, et al. 1998. The CYP2B2 phenobarbital response unit contains an accessory factor element and a putative glucocorticoid response element essential for conferring maximal Phenobarbital responsiveness. *J Biol Chem* 273:8528-8536.
- *Storm DL. 1994. Chemical monitoring of California's public drinking water sources: Public exposures and health impacts. In: Wang RGM, ed. *Water contamination and health: Integration of exposure assessment, toxicology, and risk assessment*. New York, NY: Marcel Dekker, Inc., 67-124.
- *Stubin AI, Brosnan TM, Porter KD, et al. 1996. Organic priority pollutants in New York City municipal wastewaters: 1989-1993. *Water Environ Res* 68:1037-1044.
- Sturges WT, Harrison RM. 1986. Bromine in marine aerosols and the origin, nature and quantity of natural atmospheric bromine. *Atmos Environ* 20:1485-1496.
- Sturges WT, Cota GF, Buckley PT. 1992. Bromoform emission from Arctic ice algae. *Nature* 358:660-662.
- *Sturges WT, McIntyre HP, Penkett SA, et al. 2001. Methyl bromide, other brominated methanes, and methyl iodine in polar firn air. *J Geophys Res* 106(D2):1595-1606.
- Suitheimer C, Bost R, Sunshine I. 1982. Volatiles by headspace chromatography. In: Sunshine I, Jatlow PI, eds. *Methodology for analytical technology*. Vol. II. Boca Raton, FL: CRC Press, 1-9.
- *Symons JM, Bellar TA, Carswell JK, et al. 1975. National organics reconnaissance survey for halogenated organics. *JAWWA* 67:634-647.
- *Symons JM, Krasner SW, Simms LA, et al. 1993. Measurement of THM and precursor concentrations revisited: The effect of bromide ion. *JAWWA* 85(1):51-62.
- *Tabak HH, Quaze SA, Mashni CI, et al. 1981. Biodegradability studies with organic priority pollutant compounds. *J Water Pollut Control Fed* 53:1503-1518.
- Tardiff RG, Carlson GP, Simmon V. 1975. Halogenated organics in tap water. In: Jolley RL, ed. *Water chlorination: Environmental impact and health effects*. Vol. 1. Ann Arbor, MI: Ann Arbor Science Publishers, Inc., 195-209.
- Tennant RW, Ashby J. 1991. Classification according to chemical structure, mutagenicity to *Salmonella* and level of carcinogenicity by the U.S. National Toxicology Program. *Mutat Res* 257(3):209-228.
- Tennant RW, Elwell R, Spalding JW, et al. 1991. Evidence that toxic injury is not always associated with induction of chemical carcinogenesis. *Mol Carcinog* 4:420-440.
- *Thacker NP, Nitaware V. 2003. Factors influencing formation of trihalomethanes in swimming pool water. *Bull Environ Contam Toxicol* 71:633-640.

9. REFERENCES

- Their R, Taylor JB, Pemble SE, et al. 1993. Expressions of mammalian glutathione S-transferase 5-5 in *Salmonella typhimurium* tester strains to study the activation/detoxification of mutagenic compounds: Studies with halogenated compounds, aromatic amines, and aflatoxin B1. *Proc Natl Acad Sci USA* 90(18):8576-8580.
- Theiss JC, Stoner GD, Shimkin MB, et al. 1977. Test for carcinogenicity of organic contaminants of United States drinking waters by pulmonary tumor response in strain A mice. *Cancer Res* 37:2717-2720.
- Thiyagarajah A, Teuschler LK, Lipscomb JC, et al. 2000. Chronic pathological effects from exposure of Japanese medaka (*Oryzias latipes*) embryos to bromoform [Abstract]. *Toxicologist* 54(1):185.
- *Thomas JM, McKay WA, Cole E, et al. 2000. The fate of haloacetic acids and trihalomethanes in an aquifer storage and recovery program, Las Vegas, Nevada. *Ground Water* 38(4):605-614.
- *Thornton-Manning JR, Seely JC, Pegram RA. 1994. Toxicity of bromodichloromethane in female rats and mice after repeated oral dosing. *Toxicology* 94(1-3):3-18.
- *Tobe M, Suzuki Y, Aida K, et al. 1982. Studies on the chronic oral toxicity of tribromomethane, dibromochloromethane, and bromodichloromethane. National Institute of Hygienic Sciences, Division of Toxicology, Biological Safety Research Center, 8-43.
- *Todoya M, Takagi K, Tsurumizu A, et al. 1990. Estimation of daily intake of four kinds of trihalomethane by Japanese housewives. *J Food Saf* 10:191-200.
- *Tomasi A, Albano E, Biasi F, et al. 1985. Activation of chloroform and related trihalomethanes to free radical intermediates in isolated hepatocytes and in the rat in vivo as detected by the ESR-spin trapping technique. *Chem Biol Interact* 55:303-316.
- TPCDB. 1988. Testing Priority Committee Data Base. Washington, DC: U.S. Environmental Protection Agency, Office of Toxic Substances.
- *TRI02. 2004. TRI explorer: Providing access to EPA's toxics release inventory data. Washington, DC: Office of Information Analysis and Access. Office of Environmental Information. U.S. Environmental Protection Agency. Toxic Release Inventory. <http://www.epa.gov/triexplorer/>.
- Trussell RR, Umphres MD. 1978. The formation of trihalomethanes. *JAWWA* 70:604-612.
- *Tyson CA, Prather KH, Story DL, et al. 1983. Correlation of *in vitro* and *in vivo* hepatotoxicity for five haloalkanes. *Toxicol Appl Pharmacol* 70:289-302.
- Uhler AD, Means JC. 1985. Reaction of dissolved chlorine with surficial sediment: Oxidant demand and production of trihalomethanes. *Environ Sci Technol* 19:340-344.
- Urhahn T, Ballschmiter K. 2000. Analysis of halogenated C1/C2-trace compounds in marine atmosphere. *Fresenius J Anal Chem* 366(4):365-367.
- *USC. 2003. Hazardous air pollutants. Washington, DC: United States Code. 42 USC 7412. <http://www4.law.cornell.edu/uscode>.
- Van Winkle MR, Scheff PA. 2001. Volatile organic compounds, polycyclic aromatic hydrocarbons, and elements in the air of ten urban homes. *Indoor Air* 11(1):49-64.

9. REFERENCES

- *Varma MM, Ampy FR, Verma K, et al. 1988. *In vitro* mutagenicity of water contaminants in complex mixtures. *J Appl Toxicol* 8:243-248.
- *Varma MM, Balram A, Katz HM. 1984. Trihalomethanes in ground water systems. *J Environ Syst* 14:115-126.
- Veenstra JN, Schnoor JL. 1980. Seasonal variations in trihalomethane levels in an Iowa river water supply. *JAWWA* 72:583-590.
- *Verschueren K. 2001. Handbook of environmental data on organic chemicals. 2nd ed. New York, NY: Van Nostrand Reinhold Company.
- Vieira I, Pasanen M, Raunio H, et al. 1998. Expression of CYP2E1 in human lung and kidney during development and in full-term placenta: A differential methylation of the gene is involved in the regulation process. *Pharmacol Toxicol* 83:183-187.
- *Vieira I, Sonnier M, Cresteil T. 1996. Developmental expression of *CYP2E1* in the human liver: Hypermethylation control of gene expression during the neonatal period. *Eur J Biochem* 238:476-483.
- VIEW Database. 1989. Atlanta, GA: Agency for Toxic Substances and Disease Registry (ATSDR), Office of External Affairs, Exposure and Disease Registry Branch.
- Villanueva CM, Fernandez F, Malats N, et al. 2003. Meta-analysis of studies on individual consumption of chlorinated drinking water and bladder cancer. *J Epidemiol Commun Health* 57(3):166-173.
- Vogel TM, Criddle CS, McCarty PL. 1987. Transformations of halogenated aliphatic compounds. *Environ Sci Technol* 21:722-736.
- Vogt C, Regli S. 1981. Controlling trihalomethanes while attaining disinfection. *JAWWA* 73:33-40.
- *Von Oettingen WF. 1955. The halogenated aliphatic, olefinic, cyclic, aromatic, and aliphatic-aromatic hydrocarbons including the halogenated insecticides, their toxicity and potential dangers. Washington, DC: U.S. Department of Health, Education and Welfare, Public Health Service, 65-67.
- Voronin VM, Donchenko AI, Korolev AA. 1987. An experimental study of the carcinogenicity of dichlorobromomethane and dibromochloromethane released during the water chlorination process. *Gig Sanit* 0:19-21.
- Wackett LP, Logan MSP, Blocki FA, et al. 1992. A mechanical perspective on bacterial metabolism of chlorinated methanes. *Biodegradation* 3:19-36.
- *Walker BL, Cooper CD. 1992. Air pollution emission factors for medical waste incinerators. *J Air Waste Manage Assoc* 42:784-791.
- *Wallace LA. 1997. Human exposure and body burden for chloroform and other trihalomethanes. *Crit Rev Environ Sci* 27:113-194.
- *Wallace LA, Pellizzari ED, Harwell TD, et al. 1986a. Total exposure assessment methodology (TEAM) study: Personal exposures, indoor/outdoor relationships, and breath levels of volatile organic compounds in New Jersey. *Environ Int* 12:369-387.

9. REFERENCES

- Wallace LA, Pellizzari ED, Hartwell TD, et al. 1987. The TEAM study: Personal exposures to toxic substances in air, drinking water, and breath of 400 residents of New Jersey, North Carolina, and North Dakota. *Environ Res* 43:290-307.
- *Wallace LA, Pellizzari ED, Sheldon L, et al. 1986b. The total exposure assessment methodology (TEAM) study: Direct measurement of personal exposures through air and water for 600 residents of several U.S. cities. In: Cohen Y, ed. *Pollutants in a multimedia environment*. New York, NY: Plenum Publishing Corporation, 289-315.
- *Waller K, Swan SH, Delorenze G, et al. 1999. Trihalomethanes in drinking water and spontaneous abortion. *Epidemiology* 10(2):203-204.
- *Walters SM. 1986. Cleanup of samples. In: Zweig G, Sherma J, eds. *Analytical methods for pesticides and plant growth regulators*. Vol. 15: Principles, statistics, and applications. New York, NY: Academic Press Inc., 67-110.
- Wang PY, Kaneko T, Tsukada H, et al. 1994. Dose and route dependency of metabolism and toxicity on chloroform in ethanol-treated rats. *Arch Toxicol* 69(1):18-23.
- Washall JW, Wampler TP. 1988. Purge and trap analysis of aqueous samples with cryofocusing. *American Laboratory* (July 1988):70-74.
- Washington JW. 1996. Gas portioning of dissolved volatile organic compounds in the vadose zone: Principles, temperature effect, and literature review. *Ground Water* 34(4):709-717.
- Weast RC, ed. 1985. *CRC handbook of chemistry and physics*. 66th ed. Boca Raton, FL: CRC Press, Inc.
- *Weisel CP, Kim H, Haltmeier P, et al. 1999. Exposure estimates to disinfection by-products of chlorinated drinking water. *Environ Health Perspect* 107:103-110.
- *Weiss WJ, Bouwer EJ, Ball EJ, et al. 2003. Riverbank filtration- fate of DCP precursors and selected microorganisms. *J Am Water Works Assoc* 95(10):68-81.
- *West JR, Smith HW, Chasis H. 1948. Glomerular filtration rate, effective renal blood flow, and maximal tubular excretory capacity in infancy. *J Pediatr* 32:10-18.
- *Westerhoff P, Chao P, Mash H. 2004. Reactivity of natural organic matter with aqueous chlorine and bromine. *Water Res* 38(6):1502-1513.
- *Westrick JJ, Mellow JW, Thomas RF. 1984. The groundwater supply survey. *JAWWA* 76:52-59.
- Wever R, Tromp MGM, Krenn BE, et al. 1991. Brominating activity of the seaweed *Ascophyllum nodosum*: Impact on the biosphere. *Environ Sci Technol* 25(3):446-449.
- WHO. 1984. *Guidelines for drinking-water quality*. Vol. 2: Health criteria and other supporting information. Geneva, Switzerland: World Health Organization, 240-246.
- *WHO. 1996. *Guidelines for drinking water quality*. Geneva, Switzerland: World Health Organization. <http://www.who.int/en/>.

9. REFERENCES

- *Widdowson EM, Dickerson JWT. 1964. Chemical composition of the body. In: Comar CL, Bronner F, eds. Mineral metabolism: An advanced treatise. Volume II: The elements Part A. New York: Academic Press.
- Wilkins JR, Comstock GW. 1981. Source of drinking water at home and site-specific cancer incidence in Washington County, Maryland. *Am J Epidemiol* 114:178-190.
- Williams DT, Benoit FM, Lebel GL. 1998. Trends in levels of disinfection by-products. *Environmetrics* 9:555-563.
- Williams DT, Nestman ER, LeBel GL, et al. 1982. Determination of mutagenic potential and organic contaminants of Great Lakes drinking water. *Chemosphere* 11:263-276.
- *Windham GC, Waller K, Anderson M, et al. 2003. Chlorination by-products in drinking water and menstrual cycle function. *Environ Health Perspect* 111(7):935-941.
- Withey JR, Karpinski K. 1985. The fetal distribution of some aliphatic chlorinated hydrocarbons in the rat after vapor phase exposure. *Biol Res Pregnancy* 6:79-88.
- *Withey JR, Collins BT, Collins PG. 1983. Effect of vehicle on the pharmacokinetics and uptake of four halogenated hydrocarbons from the gastrointestinal tract of the rat. *J Appl Toxicol* 3:249-253.
- *Woodruff RC, Mason JM, Valencia R, et al. 1985. Chemical mutagenesis testing in *Drosophila*. V. Results of 53 coded compounds tested for the National Toxicology Program. *Environ Mutagen* 7:677-702.
- *Xu X, Mariano TM, Laskin JD, et al. 2002. Percutaneous absorption of trihalomethanes, haloacetic acids, and halo ketones. *Toxicol Appl Pharmacol* 184(1):19-26.
- Yamazaki H, Yamaguchi T, Yamauchi A, et al. 1992. Effect of halogenated and styrene on thrombin and calcium ionophore induced activation of rabbit platelets. *Chemosphere* 25(5):665-673.
- Yoshikawa K. 1996. Anomalous nonidentity between *Salmonella* genotoxicants and rodent carcinogens and genotoxic noncarcinogens. *Environ Health Perspect* 104(1):40-46.
- Young TB. 1981. Epidemiologic study of drinking water chlorination and Wisconsin female cancer mortality. *J Natl Cancer Inst* 67:1191-1198.
- Young TB, Wolf DA, Kanarek MS. 1987. Case-control study of colon cancer and drinking water trihalomethanes in Wisconsin. *Int J Epidemiol* 16(2):190-197.
- Zakhari S, Aviado DM. 1982. Cardiovascular toxicology of aerosol propellants, refrigerants, and related solvents. In: Van Stee EW, ed. Cardiovascular toxicology. New York, NY: Raven Press, 281-326.
- *Zeiger E, Anderson B, Haworth S, et al. 1987. *Salmonella* mutagenicity tests: III. Results from the testing of 255 chemicals. *Environ Mutagen* 9(Suppl 9):1-110.
- *Ziegler EE, Edwards BB, Jensen RL, et al. 1978. Absorption and retention of lead by infants. *Pediatr Res* 12:29-34.

9. REFERENCES

- *Zielinska B, Fujita E, Sagebiel J, et al. 1998. Arizona hazardous air pollutants monitoring program. *J Air Waste Manage Assoc* 48:1038-1050.
- *Zielinska B, Sagebiel J, Hashfield G, et al. 2001. Volatile organic compound measurements in the California/Mexico border region during SCOS97. *Sci Total Environ* 26(1-3):19-31.
- Zierler S, Danley RA, Feingold L. 1986. Type of disinfectant in drinking water and patterns of mortality in Massachusetts. *Environ Health Perspect* 69:275-279.
- Zierler S, Feingold RA, Danley RA, et al. 1988. Bladder cancer in Massachusetts related to chlorinated and chloraminated drinking water: A case-control study. *Arch Environ Health* 43(2):195-200.
- *Zlatkis A, Kim K. 1976. Column elution and concentration of volatile compounds in biological fluids. *J Chromatogr* 126:475-485.
- Zoeteman CJ, DeGreef E, Brinkman FJJ. 1981. Persistency of organic contaminants in groundwater, lessons from soil pollution incidents in The Netherlands. *Sci Total Environ* 21:187-202.

10. GLOSSARY

Absorption—The taking up of liquids by solids, or of gases by solids or liquids.

Acute Exposure—Exposure to a chemical for a duration of 14 days or less, as specified in the Toxicological Profiles.

Adsorption—The adhesion in an extremely thin layer of molecules (as of gases, solutes, or liquids) to the surfaces of solid bodies or liquids with which they are in contact.

Adsorption Coefficient (K_{oc})—The ratio of the amount of a chemical adsorbed per unit weight of organic carbon in the soil or sediment to the concentration of the chemical in solution at equilibrium.

Adsorption Ratio (Kd)—The amount of a chemical adsorbed by sediment or soil (i.e., the solid phase) divided by the amount of chemical in the solution phase, which is in equilibrium with the solid phase, at a fixed solid/solution ratio. It is generally expressed in micrograms of chemical sorbed per gram of soil or sediment.

Benchmark Dose (BMD)—Usually defined as the lower confidence limit on the dose that produces a specified magnitude of changes in a specified adverse response. For example, a BMD_{10} would be the dose at the 95% lower confidence limit on a 10% response, and the benchmark response (BMR) would be 10%. The BMD is determined by modeling the dose response curve in the region of the dose response relationship where biologically observable data are feasible.

Benchmark Dose Model—A statistical dose-response model applied to either experimental toxicological or epidemiological data to calculate a BMD.

Bioconcentration Factor (BCF)—The quotient of the concentration of a chemical in aquatic organisms at a specific time or during a discrete time period of exposure divided by the concentration in the surrounding water at the same time or during the same period.

Biomarkers—Broadly defined as indicators signaling events in biologic systems or samples. They have been classified as markers of exposure, markers of effect, and markers of susceptibility.

Cancer Effect Level (CEL)—The lowest dose of chemical in a study, or group of studies, that produces significant increases in the incidence of cancer (or tumors) between the exposed population and its appropriate control.

Carcinogen—A chemical capable of inducing cancer.

Case-Control Study—A type of epidemiological study that examines the relationship between a particular outcome (disease or condition) and a variety of potential causative agents (such as toxic chemicals). In a case-controlled study, a group of people with a specified and well-defined outcome is identified and compared to a similar group of people without outcome.

Case Report—Describes a single individual with a particular disease or exposure. These may suggest some potential topics for scientific research, but are not actual research studies.

10. GLOSSARY

Case Series—Describes the experience of a small number of individuals with the same disease or exposure. These may suggest potential topics for scientific research, but are not actual research studies.

Ceiling Value—A concentration of a substance that should not be exceeded, even instantaneously.

Chronic Exposure—Exposure to a chemical for 365 days or more, as specified in the Toxicological Profiles.

Cohort Study—A type of epidemiological study of a specific group or groups of people who have had a common insult (e.g., exposure to an agent suspected of causing disease or a common disease) and are followed forward from exposure to outcome. At least one exposed group is compared to one unexposed group.

Cross-sectional Study—A type of epidemiological study of a group or groups of people that examines the relationship between exposure and outcome to a chemical or to chemicals at one point in time.

Data Needs—Substance-specific informational needs that if met would reduce the uncertainties of human health assessment.

Developmental Toxicity—The occurrence of adverse effects on the developing organism that may result from exposure to a chemical prior to conception (either parent), during prenatal development, or postnatally to the time of sexual maturation. Adverse developmental effects may be detected at any point in the life span of the organism.

Dose-Response Relationship—The quantitative relationship between the amount of exposure to a toxicant and the incidence of the adverse effects.

Embryotoxicity and Fetotoxicity—Any toxic effect on the conceptus as a result of prenatal exposure to a chemical; the distinguishing feature between the two terms is the stage of development during which the insult occurs. The terms, as used here, include malformations and variations, altered growth, and *in utero* death.

Environmental Protection Agency (EPA) Health Advisory—An estimate of acceptable drinking water levels for a chemical substance based on health effects information. A health advisory is not a legally enforceable federal standard, but serves as technical guidance to assist federal, state, and local officials.

Epidemiology—Refers to the investigation of factors that determine the frequency and distribution of disease or other health-related conditions within a defined human population during a specified period.

Genotoxicity—A specific adverse effect on the genome of living cells that, upon the duplication of affected cells, can be expressed as a mutagenic, clastogenic, or carcinogenic event because of specific alteration of the molecular structure of the genome.

Half-life—A measure of rate for the time required to eliminate one half of a quantity of a chemical from the body or environmental media.

Immediately Dangerous to Life or Health (IDLH)—The maximum environmental concentration of a contaminant from which one could escape within 30 minutes without any escape-impairing symptoms or irreversible health effects.

10. GLOSSARY

Immunologic Toxicity—The occurrence of adverse effects on the immune system that may result from exposure to environmental agents such as chemicals.

Immunological Effects—Functional changes in the immune response.

Incidence—The ratio of individuals in a population who develop a specified condition to the total number of individuals in that population who could have developed that condition in a specified time period.

Intermediate Exposure—Exposure to a chemical for a duration of 15–364 days, as specified in the Toxicological Profiles.

In Vitro—Isolated from the living organism and artificially maintained, as in a test tube.

In Vivo—Occurring within the living organism.

Lethal Concentration_(LO) (LC_{LO})—The lowest concentration of a chemical in air that has been reported to have caused death in humans or animals.

Lethal Concentration₍₅₀₎ (LC₅₀)—A calculated concentration of a chemical in air to which exposure for a specific length of time is expected to cause death in 50% of a defined experimental animal population.

Lethal Dose_(LO) (LD_{LO})—The lowest dose of a chemical introduced by a route other than inhalation that has been reported to have caused death in humans or animals.

Lethal Dose₍₅₀₎ (LD₅₀)—The dose of a chemical that has been calculated to cause death in 50% of a defined experimental animal population.

Lethal Time₍₅₀₎ (LT₅₀)—A calculated period of time within which a specific concentration of a chemical is expected to cause death in 50% of a defined experimental animal population.

Lowest-Observed-Adverse-Effect Level (LOAEL)—The lowest exposure level of chemical in a study, or group of studies, that produces statistically or biologically significant increases in frequency or severity of adverse effects between the exposed population and its appropriate control.

Lymphoreticular Effects—Represent morphological effects involving lymphatic tissues such as the lymph nodes, spleen, and thymus.

Malformations—Permanent structural changes that may adversely affect survival, development, or function.

Minimal Risk Level (MRL)—An estimate of daily human exposure to a hazardous substance that is likely to be without an appreciable risk of adverse noncancer health effects over a specified route and duration of exposure.

Modifying Factor (MF)—A value (greater than zero) that is applied to the derivation of a Minimal Risk Level (MRL) to reflect additional concerns about the database that are not covered by the uncertainty factors. The default value for a MF is 1.

Morbidity—State of being diseased; morbidity rate is the incidence or prevalence of disease in a specific population.

10. GLOSSARY

Mortality—Death; mortality rate is a measure of the number of deaths in a population during a specified interval of time.

Mutagen—A substance that causes mutations. A mutation is a change in the DNA sequence of a cell's DNA. Mutations can lead to birth defects, miscarriages, or cancer.

Necropsy—The gross examination of the organs and tissues of a dead body to determine the cause of death or pathological conditions.

Neurotoxicity—The occurrence of adverse effects on the nervous system following exposure to a chemical.

No-Observed-Adverse-Effect Level (NOAEL)—The dose of a chemical at which there were no statistically or biologically significant increases in frequency or severity of adverse effects seen between the exposed population and its appropriate control. Effects may be produced at this dose, but they are not considered to be adverse.

Octanol-Water Partition Coefficient (K_{ow})—The equilibrium ratio of the concentrations of a chemical in *n*-octanol and water, in dilute solution.

Odds Ratio (OR)—A means of measuring the association between an exposure (such as toxic substances and a disease or condition) that represents the best estimate of relative risk (risk as a ratio of the incidence among subjects exposed to a particular risk factor divided by the incidence among subjects who were not exposed to the risk factor). An OR of greater than 1 is considered to indicate greater risk of disease in the exposed group compared to the unexposed group.

Organophosphate or Organophosphorus Compound—A phosphorus-containing organic compound and especially a pesticide that acts by inhibiting cholinesterase.

Permissible Exposure Limit (PEL)—An Occupational Safety and Health Administration (OSHA) allowable exposure level in workplace air averaged over an 8-hour shift of a 40-hour workweek.

Pesticide—General classification of chemicals specifically developed and produced for use in the control of agricultural and public health pests.

Pharmacokinetics—The dynamic behavior of a material in the body, used to predict the fate (disposition) of an exogenous substance in an organism. Utilizing computational techniques, it provides the means of studying the absorption, distribution, metabolism, and excretion of chemicals by the body.

Pharmacokinetic Model—A set of equations that can be used to describe the time course of a parent chemical or metabolite in an animal system. There are two types of pharmacokinetic models: data-based and physiologically-based. A data-based model divides the animal system into a series of compartments, which, in general, do not represent real, identifiable anatomic regions of the body, whereas the physiologically-based model compartments represent real anatomic regions of the body.

Physiologically Based Pharmacodynamic (PBPD) Model—A type of physiologically based dose-response model that quantitatively describes the relationship between target tissue dose and toxic end points. These models advance the importance of physiologically based models in that they clearly describe the biological effect (response) produced by the system following exposure to an exogenous substance.

10. GLOSSARY

Physiologically Based Pharmacokinetic (PBPK) Model—Comprised of a series of compartments representing organs or tissue groups with realistic weights and blood flows. These models require a variety of physiological information: tissue volumes, blood flow rates to tissues, cardiac output, alveolar ventilation rates, and possibly membrane permeabilities. The models also utilize biochemical information, such as air/blood partition coefficients, and metabolic parameters. PBPK models are also called biologically based tissue dosimetry models.

Prevalence—The number of cases of a disease or condition in a population at one point in time.

Prospective Study—A type of cohort study in which the pertinent observations are made on events occurring after the start of the study. A group is followed over time.

q_1^* —The upper-bound estimate of the low-dose slope of the dose-response curve as determined by the multistage procedure. The q_1^* can be used to calculate an estimate of carcinogenic potency, the incremental excess cancer risk per unit of exposure (usually $\mu\text{g/L}$ for water, mg/kg/day for food, and $\mu\text{g/m}^3$ for air).

Recommended Exposure Limit (REL)—A National Institute for Occupational Safety and Health (NIOSH) time-weighted average (TWA) concentration for up to a 10-hour workday during a 40-hour workweek.

Reference Concentration (RfC)—An estimate (with uncertainty spanning perhaps an order of magnitude) of a continuous inhalation exposure to the human population (including sensitive subgroups) that is likely to be without an appreciable risk of deleterious noncancer health effects during a lifetime. The inhalation reference concentration is for continuous inhalation exposures and is appropriately expressed in units of mg/m^3 or ppm.

Reference Dose (RfD)—An estimate (with uncertainty spanning perhaps an order of magnitude) of the daily exposure of the human population to a potential hazard that is likely to be without risk of deleterious effects during a lifetime. The RfD is operationally derived from the no-observed-adverse-effect level (NOAEL, from animal and human studies) by a consistent application of uncertainty factors that reflect various types of data used to estimate RfDs and an additional modifying factor, which is based on a professional judgment of the entire database on the chemical. The RfDs are not applicable to nonthreshold effects such as cancer.

Reportable Quantity (RQ)—The quantity of a hazardous substance that is considered reportable under the Comprehensive Environmental Response, Compensation, and Liability Act (CERCLA). Reportable quantities are (1) 1 pound or greater or (2) for selected substances, an amount established by regulation either under CERCLA or under Section 311 of the Clean Water Act. Quantities are measured over a 24-hour period.

Reproductive Toxicity—The occurrence of adverse effects on the reproductive system that may result from exposure to a chemical. The toxicity may be directed to the reproductive organs and/or the related endocrine system. The manifestation of such toxicity may be noted as alterations in sexual behavior, fertility, pregnancy outcomes, or modifications in other functions that are dependent on the integrity of this system.

10. GLOSSARY

Retrospective Study—A type of cohort study based on a group of persons known to have been exposed at some time in the past. Data are collected from routinely recorded events, up to the time the study is undertaken. Retrospective studies are limited to causal factors that can be ascertained from existing records and/or examining survivors of the cohort.

Risk—The possibility or chance that some adverse effect will result from a given exposure to a chemical.

Risk Factor—An aspect of personal behavior or lifestyle, an environmental exposure, or an inborn or inherited characteristic that is associated with an increased occurrence of disease or other health-related event or condition.

Risk Ratio—The ratio of the risk among persons with specific risk factors compared to the risk among persons without risk factors. A risk ratio greater than 1 indicates greater risk of disease in the exposed group compared to the unexposed group.

Short-Term Exposure Limit (STEL)—The American Conference of Governmental Industrial Hygienists (ACGIH) maximum concentration to which workers can be exposed for up to 15 minutes continually. No more than four excursions are allowed per day, and there must be at least 60 minutes between exposure periods. The daily Threshold Limit Value-Time Weighted Average (TLV-TWA) may not be exceeded.

Standardized Mortality Ratio (SMR)—A ratio of the observed number of deaths and the expected number of deaths in a specific standard population.

Target Organ Toxicity—This term covers a broad range of adverse effects on target organs or physiological systems (e.g., renal, cardiovascular) extending from those arising through a single limited exposure to those assumed over a lifetime of exposure to a chemical.

Teratogen—A chemical that causes structural defects that affect the development of an organism.

Threshold Limit Value (TLV)—An American Conference of Governmental Industrial Hygienists (ACGIH) concentration of a substance to which most workers can be exposed without adverse effect. The TLV may be expressed as a Time Weighted Average (TWA), as a Short-Term Exposure Limit (STEL), or as a ceiling limit (CL).

Time-Weighted Average (TWA)—An allowable exposure concentration averaged over a normal 8-hour workday or 40-hour workweek.

Toxic Dose₍₅₀₎ (TD₅₀)—A calculated dose of a chemical, introduced by a route other than inhalation, which is expected to cause a specific toxic effect in 50% of a defined experimental animal population.

Toxicokinetic—The absorption, distribution, and elimination of toxic compounds in the living organism.

10. GLOSSARY

Uncertainty Factor (UF)—A factor used in operationally deriving the Minimal Risk Level (MRL) or Reference Dose (RfD) or Reference Concentration (RfC) from experimental data. UFs are intended to account for (1) the variation in sensitivity among the members of the human population, (2) the uncertainty in extrapolating animal data to the case of human, (3) the uncertainty in extrapolating from data obtained in a study that is of less than lifetime exposure, and (4) the uncertainty in using lowest-observed-adverse-effect level (LOAEL) data rather than no-observed-adverse-effect level (NOAEL) data. A default for each individual UF is 10; if complete certainty in data exists, a value of 1 can be used; however, a reduced UF of 3 may be used on a case-by-case basis, 3 being the approximate logarithmic average of 10 and 1.

Xenobiotic—Any chemical that is foreign to the biological system.

APPENDIX A. ATSDR MINIMAL RISK LEVELS AND WORKSHEETS

The Comprehensive Environmental Response, Compensation, and Liability Act (CERCLA) [42 U.S.C. 9601 et seq.], as amended by the Superfund Amendments and Reauthorization Act (SARA) [Pub. L. 99–499], requires that the Agency for Toxic Substances and Disease Registry (ATSDR) develop jointly with the U.S. Environmental Protection Agency (EPA), in order of priority, a list of hazardous substances most commonly found at facilities on the CERCLA National Priorities List (NPL); prepare toxicological profiles for each substance included on the priority list of hazardous substances; and assure the initiation of a research program to fill identified data needs associated with the substances.

The toxicological profiles include an examination, summary, and interpretation of available toxicological information and epidemiologic evaluations of a hazardous substance. During the development of toxicological profiles, Minimal Risk Levels (MRLs) are derived when reliable and sufficient data exist to identify the target organ(s) of effect or the most sensitive health effect(s) for a specific duration for a given route of exposure. An MRL is an estimate of the daily human exposure to a hazardous substance that is likely to be without appreciable risk of adverse noncancer health effects over a specified duration of exposure. MRLs are based on noncancer health effects only and are not based on a consideration of cancer effects. These substance-specific estimates, which are intended to serve as screening levels, are used by ATSDR health assessors to identify contaminants and potential health effects that may be of concern at hazardous waste sites. It is important to note that MRLs are not intended to define clean-up or action levels.

MRLs are derived for hazardous substances using the no-observed-adverse-effect level/uncertainty factor approach. They are below levels that might cause adverse health effects in the people most sensitive to such chemical-induced effects. MRLs are derived for acute (1–14 days), intermediate (15–364 days), and chronic (365 days and longer) durations and for the oral and inhalation routes of exposure. Currently, MRLs for the dermal route of exposure are not derived because ATSDR has not yet identified a method suitable for this route of exposure. MRLs are generally based on the most sensitive chemical-induced end point considered to be of relevance to humans. Serious health effects (such as irreparable damage to the liver or kidneys, or birth defects) are not used as a basis for establishing MRLs. Exposure to a level above the MRL does not mean that adverse health effects will occur.

APPENDIX A

MRLs are intended only to serve as a screening tool to help public health professionals decide where to look more closely. They may also be viewed as a mechanism to identify those hazardous waste sites that are not expected to cause adverse health effects. Most MRLs contain a degree of uncertainty because of the lack of precise toxicological information on the people who might be most sensitive (e.g., infants, elderly, nutritionally or immunologically compromised) to the effects of hazardous substances. ATSDR uses a conservative (i.e., protective) approach to address this uncertainty consistent with the public health principle of prevention. Although human data are preferred, MRLs often must be based on animal studies because relevant human studies are lacking. In the absence of evidence to the contrary, ATSDR assumes that humans are more sensitive to the effects of hazardous substance than animals and that certain persons may be particularly sensitive. Thus, the resulting MRL may be as much as 100-fold below levels that have been shown to be nontoxic in laboratory animals.

Proposed MRLs undergo a rigorous review process: Health Effects/MRL Workgroup reviews within the Division of Toxicology, expert panel peer reviews, and agency-wide MRL Workgroup reviews, with participation from other federal agencies and comments from the public. They are subject to change as new information becomes available concomitant with updating the toxicological profiles. Thus, MRLs in the most recent toxicological profiles supersede previously published levels. For additional information regarding MRLs, please contact the Division of Toxicology, Agency for Toxic Substances and Disease Registry, 1600 Clifton Road NE, Mailstop F-32, Atlanta, Georgia 30333.

APPENDIX A

MINIMAL RISK LEVEL (MRL) WORKSHEET

Chemical Name: Bromoform
CAS Number: 75-25-2
Date: August 2005
Profile Status: Final Draft of Post-Public Comment Toxicological Profile
Route: Inhalation Oral
Duration: Acute Intermediate Chronic
Key to Figure: 13
Species: Mice

Minimal Risk Level: 0.7 mg/kg/day mg/m³

Reference: Condie LW, Smallwood CL, Laurie RD. 1983. Comparative renal and hepatotoxicity of halomethanes: Bromodichloromethane, bromoform, chloroform, dibromochloromethane and methylene chloride. Drug Chem Toxicol 6:563-578.

Experimental design:

Groups of 5–16 male CD-1 mice received daily gavage doses of 0, 72, 145, or 289 mg/kg/day bromoform in corn oil for 14 days. Body weight was measured on days 1 and 14. Blood was collected for clinical chemistry at study termination. Renal cortical slices of kidney tissue were collected for measurement of para-aminohippurate (PAH) uptake, and samples of liver and kidney tissue were collected for histopathological examination.

Effects noted in study and corresponding concentrations:

No significant alterations in body weight gain were observed. PAH uptake by kidney slices was decreased by 30% in the 289 mg/kg/day group; a significant increase in SGPT was also observed at this dose. Minimal to moderate liver and kidney histological alterations were observed. Liver effects included centrilobular pallor at 145 and 289 mg/kg/day and focal inflammation at 289 mg/kg/day. Kidney effects consisted of epithelial hyperplasia at 289 mg/kg/day and mesangial nephrosis at 145 and 289 mg/kg/day.

Concentration and end point used for MRL derivation:

The MRL is based on a NOAEL of 72 mg/kg/day and a LOAEL of 145 mg/kg/day for hepatic centrilobular pallor in mice.

NOAEL LOAEL

Uncertainty Factors used in MRL derivation:

10 for extrapolation from animals to humans
 10 for human variability

Was a conversion factor used from ppm in food or water to a mg/body weight dose? No.

If an inhalation study in animals, list conversion factors used in determining human equivalent concentration: NA

APPENDIX A

Was a conversion used from intermittent to continuous exposure? No.

Other additional studies or pertinent information that lend support to this MRL:

Several acute-duration studies support the identification of the liver as the most sensitive target of bromoform toxicity. The observed effects include hepatocellular vacuolization and swelling (Chu et al. 1982a; Coffin et al. 2000), centrilobular pallor (Condie et al. 1983), increased absolute and relative liver weights (Munson et al. 1982), alterations in serum chemistry enzymes such as SGPT (Munson et al. 1982), and impaired liver function (Munson et al. 1982). The highest NOAEL for liver effects is 72 mg/kg/day in mice (Condie et al. 1983); in this study, centrilobular pallor (Condie et al. 1983), which was considered to be indicative of liver degeneration, was observed at 145 mg/kg/day. At 125 mg/kg/day, increases in liver weight were observed (Munson et al. 1982) and hepatocellular vacuolization and swelling were observed at 200 mg/kg (164 mg/kg/day) (Coffin et al. 2000). Other adverse effects that have been observed at similar or higher dose levels include mesangial nephrosis at 145 mg/kg/day (NOAEL of 72 mg/kg/day) (Condie et al. 1983), impaired immune function at 125 mg/kg/day (NOAEL of 50 mg/kg/day) (Munson et al. 1982), skeletal anomalies in the offspring of rats exposed to 200 mg/kg/day (NOAEL of 100 mg/kg/day) (Ruddick et al. 1983), and central nervous system depression at ≥ 600 mg/kg (Balster and Borzelleca 1982; Bowman et al. 1978; NTP 1989a). Although several adverse effects have been reported at 100–200 mg/kg/day, the liver was selected as the critical target because the adverse liver effects are consistently observed in animals following acute-, intermediate-, and chronic-duration exposure.

Agency Contact (Chemical Managers): John Risher, Dennis Jones

APPENDIX A

MINIMAL RISK LEVEL (MRL) WORKSHEET

Chemical Name: Bromoform
CAS Number: 75-25-2
Date: August 2005
Profile Status: Final Draft of Post-Public Comment Toxicological Profile
Route: Inhalation Oral
Duration: Acute Intermediate Chronic
Key to Figure: 26
Species: Rat

Minimal Risk Level: 0.2 mg/kg/day mg/m³

Reference: NTP. 1989a. Toxicology and carcinogenesis studies of tribromomethane (bromoform) in F344/N rats and B6C3F1 mice (gavage studies). National Toxicology Program. Technical Report Series No. 350. Research Triangle Park, NC: U.S. Department of Health and Human Services.

Experimental design:

Groups of F344/N male and female F344/N rats (10/sex/group) received gavage doses of 0, 12, 25, 50, 100, or 200 mg/kg bromoform in corn oil 5 days/week for 13 weeks. The rats were observed twice per day and weighed weekly. At sacrifice, all animals were necropsied and tissues from the vehicle control and high dose groups were examined histologically.

Effects noted in study and corresponding concentrations:

None of the rats died before the end of the study. Final mean body weights were similar in dosed and control groups. Lethargy was observed in all male rats exposed to 100 or 200 mg/kg and in all females exposed to 200 mg/kg. Hepatocellular vacuolization was observed in male rats (3/10, 6/10, 5/10, 8/10, 8/10, and 10/10 in the 0, 12, 25, 50, 100, and 200 mg/kg groups, respectively); the response reached statistical significance (Fisher exact one-tailed p-value of 0.03) at 50 mg/kg/day. Severity data were not reported for this lesion, but the study authors noted that vacuoles were more numerous in the 200 mg/kg group. Corresponding hepatic effects were not observed in females.

Concentration and end point used for MRL derivation:

The MRL is based on a NOAEL of 25 mg/kg (duration-adjusted to 18 mg/kg/day) and a LOAEL of 50 mg/kg (duration-adjusted to 36 mg/kg/day) for hepatic lesions (hepatocellular vacuolization).

NOAEL LOAEL

Uncertainty Factors used in MRL derivation:

10 for extrapolation from animals to humans
 10 for human variability

Was a conversion factor used from ppm in food or water to a mg/body weight dose? No.

If an inhalation study in animals, list conversion factors used in determining human equivalent concentration: NA

APPENDIX A

Was a conversion used from intermittent to continuous exposure?

The NOAEL was adjusted for intermittent exposure: $25 \text{ mg/kg} \times 5 \text{ days}/7 \text{ days} = 18 \text{ mg/kg/day}$

Other additional studies or pertinent information that lend support to this MRL:

A number of animal studies have identified the liver as the critical target of bromoform oral toxicity. An intermediate-duration study in rats (Aida et al. 1992) supports the identification of 50 mg/kg as the critical dose. In this study, a LOAEL of 56.4 mg/kg/day was identified for hepatocellular vacuolization and swelling in rats exposed to bromoform in the diet for 1 month. At a higher dose (207.5 mg/kg/day), a decrease in serum triglycerides and an increase in serum cholesterol levels were found; these findings are consistent with the liver histological alterations. Mice appear to be less sensitive to the toxicity of bromoform than rats. NOAEL and LOAEL values of 100 and 200 mg/kg (5 days/week) for hepatocellular vacuolization were identified in the intermediate-duration mouse NTP study (NTP 1989a). Melnick et al. (1998) found hydropic degeneration and increases in SGPT and sorbitol dehydrogenase levels in mice receiving gavage doses of 500 mg/kg, 5 days/week for 3 weeks. Acute- and chronic-duration studies have also identified the liver as the most sensitive target of toxicity.

Agency Contact (Chemical Managers): John Risher, Dennis Jones

APPENDIX A

MINIMAL RISK LEVEL (MRL) WORKSHEET

Chemical Name: Bromoform
CAS Number: 75-25-2
Date: September 2005
Profile Status: Final Draft of Post-Public Comment Toxicological Profile
Route: Inhalation Oral
Duration: Acute Intermediate Chronic
Key to Figure: 38
Species: Rat

Minimal Risk Level: 0.02 mg/kg/day mg/m³

Reference: NTP. 1989a. Toxicology and carcinogenesis studies of tribromomethane (bromoform) in F344/N rats and B6C3F1 mice (gavage studies). National Toxicology Program. Technical Report Series No. 350. Research Triangle Park, NC: U.S. Department of Health and Human Services.

Experimental design:

Groups of male and female F344/N rats (50/sex/group) were administered via gavage 0, 100, or 200 mg/kg bromoform in corn oil 5 days/week for 103 weeks. Animals were observed for clinical signs throughout the study. Body weights were measured weekly for 12 weeks and monthly thereafter. At termination, all study animals were necropsied. Full histopathological examination was performed on all control and high dose animals and on low dose males. Selected tissues including esophagus, gross lesions, kidney, liver, lymph nodes, mammary gland, pancreas, pituitary gland, salivary glands, thyroid gland, trachea, and uterus were examined in low-dose females.

Effects noted in study and corresponding concentrations:

Significantly increased mortality was observed in male rats exposed to 200 mg/kg after week 91 (36–78% vs. 26–32%). Survival was comparable to vehicle controls in males exposed to 100 mg/kg and in females exposed to 100 or 200 mg/kg. Bromoform-related clinical signs included lethargy in both sexes and aggressiveness in males. After 15 weeks, the difference between control body weights and body weights of males exposed to 200 mg/kg males was consistently $\geq 10\%$; terminal body weights were 21% lower than controls. In the females exposed to 200 mg/kg, the difference in body weights was $\geq 10\%$ after week 41; terminal body weights were 25% lower than controls. Body weights in the 100 mg/kg groups were typically within 10% of controls. Bromoform-related hepatic lesions included fatty change (characterized as hepatocellular vacuolization) in 23/50, 49/50, and 50/50 males exposed to 0, 100, or 200 mg/kg, respectively, and 19/50, 39/49, and 46/50 females; chronic active inflammation (male: 0/50, 29/50, and 23/50; female: 9/50, 8/49, and 27/50); and necrosis (male: 7/50, 3/50, and 20/50; female: 11/50, 3/49, and 2/50). Other lesions with significantly increased incidences included salivary gland duct squamous metaplasia at 100 and 200 mg/kg (males: 0/50, 15/50, and 31/48; females: 0/49, 10/49, and 16/50) and chronic active inflammation (male: 0/50, 14/50, and 22/48; female: 0/49, 9/49, and 18/50); ulcers of the forestomach in males at 200 mg/kg (1/49, 5/50, and 10/50); chronic active inflammation in the lungs in males at 100 and 200 mg/kg (1/50, 7/50, and 15/50); squamous metaplasia in the prostate gland at 200 mg/kg (2/49, 6/46, and 12/50); hyperplasia of the anterior lobe of the pituitary gland in males at 100 mg/kg (9/48, 26/50, and 15/50); and spleen pigmentation in females at 200 mg/kg (7/49, 6/28, and 29/50), which was characteristic of hemosiderin. The occurrence of ulcers in the forestomach may have resulted from gavage bolus dose delivery. Lesions observed in the lungs and salivary glands were reported to be consistent with infection by sialodacryoadenitis (SDA) virus. However, since the

APPENDIX A

occurrence of these lesions was clearly dose-related, the study authors concluded that they were likely to represent a combination of viral and chemical-related effects.

It should be noted that the study authors did not report statistical analysis data for nonneoplastic lesions. An independent statistical analysis was conducted; statistical significance was determined using a Fisher exact test, one tailed $p < 0.05$).

Concentration and end point used for MRL derivation:

The MRL is based on a LOAEL of 100 mg/kg (duration-adjusted to 71 mg/kg/day) for histopathological changes (vacuolization) in the liver.

NOAEL LOAEL

Uncertainty Factors used in MRL derivation:

- 3 for use of a minimal LOAEL
- 10 for extrapolation from animals to humans
- 10 for human variability

Modifying Factors used in MRL derivation:

- 10 to account for the identification of a lower LOAEL in the 13-week NTP (1989a) study.

Was a conversion factor used from ppm in food or water to a mg/body weight dose? No.

If an inhalation study in animals, list conversion factors used in determining human equivalent concentration: NA

Was a conversion used from intermittent to continuous exposure? Yes.

The LOAEL was adjusted for intermittent exposure: $100 \text{ mg/kg} \times 5 \text{ days/7 days} = 71 \text{ mg/kg/day}$

Other additional studies or pertinent information that lend support to this MRL:

Two studies have examined the chronic toxicity of bromoform (NTP 1989a; Tobe et al. 1982). Both studies identified the liver as the most sensitive target of toxicity. Both the NTP (1989a) rat and mouse studies identified LOAEL values of 100 mg/kg (5 days/week) for hepatocellular vacuolization. The rat study was selected over the mouse study because the effects were observed in both sexes. This study is supported by a 2-year dietary study conducted by Tobe et al. (1982). Yellowing of the liver and increases in absolute and liver weights were observed in female rats exposed to 140 mg/kg/day; histological examinations were not conducted. Alterations in several clinical chemistry parameters are also indicative of liver damage. Increases in SGOT and SGPT and decreases in serum triglycerides and cholesterol were observed at 590–720 mg/kg/day. A number of intermediate-duration studies (Aida et al. 1992; Chu et al. 1982b; Melnick et al. 1998; NTP 1989a) support the identification of the liver as the critical target of bromoform toxicity.

Agency Contact (Chemical Managers): John Risher, Dennis Jones

APPENDIX A

MINIMAL RISK LEVEL (MRL) WORKSHEET

Chemical Name: Dibromochloromethane
CAS Number: 124-48-1
Date: August 2005
Profile Status: Final Draft of Post-Public Comment Toxicological Profile
Route: Inhalation Oral
Duration: Acute Intermediate Chronic
Key to Figure: 16
Species: Mouse

Minimal Risk Level: 0.1 mg/kg/day mg/m³

Reference: Condie LW, Smallwood CL, Laurie RD. 1983. Comparative renal and hepatotoxicity of halomethanes: Bromodichloromethane, bromoform, chloroform, dibromochloromethane and methylene chloride. Drug Chem Toxicol 6:563-578.

Experimental design:

Groups of 5–16 male CD-1 mice received daily gavage doses of 0, 37, 74, or 147 mg/kg/day dibromochloromethane in corn oil for 14 days. Body weight was measured on days 1 and 14. Blood was collected for clinical chemistry at study termination. Renal cortical slices of kidney tissue were collected for measurement of para-aminohippurate uptake, and samples of liver and kidney tissue were histopathological examination.

Effects noted in study and corresponding concentrations:

No deaths or treatment-related clinical signs were reported. No significant alterations in body weight gain were observed. Para-aminohippurate uptake by kidney slices was decreased by approximately 30% in the 147 mg/kg/day group; a significant increase in SGPT was also observed at this dose. Minimal to moderate liver and kidney histological alterations were observed. Liver effects included hepatocellular vacuolization at 37 mg/kg/day and higher (1/16, 3/5, 4/10, and 8/10 in the 0, 37, 74, and 147 mg/kg/day groups, respectively) and mitotic figures at 147 mg/kg/day (0/16, 0/5, 2/10, and 4/10). Kidney effects consisted of mesangial hypertrophy was observed at 37 mg/kg/day and higher (0/16, 4/5, 7/10, and 7/10).

Concentration and end point used for MRL derivation:

The MRL is based on a LOAEL of 37 mg/kg/day for hepatocellular vacuolization (Condie et al. 1983).

NOAEL LOAEL

Uncertainty Factors used in MRL derivation:

- 3 for use of a minimal LOAEL
- 10 for extrapolation from animals to humans
- 10 for human variability

Was a conversion factor used from ppm in food or water to a mg/body weight dose? No.

APPENDIX A

If an inhalation study in animals, list conversion factors used in determining human equivalent concentration: NA

Was a conversion used from intermittent to continuous exposure? No.

Other additional studies or pertinent information that lend support to this MRL:

There are numerous studies that support the identification of the liver as the critical target of dibromochloromethane toxicity. Hepatocellular vacuolization and/or swelling were observed in mice exposed to 100 and 300 mg/kg (9 doses in an 11-day period) (Coffin et al. 2000), at ≥ 50 mg/kg in rats and mice exposed to dibromochloromethane for an intermediate duration (Aida et al. 1992; Daniel et al. 1990; NTP 1985) and in rats and mice exposed to ≥ 40 for 2 years (NTP 1985). At higher doses, hepatocellular necrosis is observed (Aida et al. 1993; Daniel et al. 1990; NTP 1985) in rats and mice exposed to ≥ 100 mg/kg for intermediate durations.

The Condie et al. study (1983) also identified the 37 mg/kg/day dose as a LOAEL for kidney effects, mesangial cell hyperplasia. Other animal studies have also found kidney lesions following oral exposure to dibromochloromethane. Nephropathy, characterized by tubular cell degeneration and tubular cast formation was noted in 80% of male rats and 100% of female rats, but was not found in the controls or other dose groups exposed to dibromochloromethane in corn oil for 13 weeks (NTP 1985). The liver was selected as the critical target because the results of other studies suggest that it may be the more sensitive target of toxicity.

Agency Contact (Chemical Managers): John Risher, Dennis Jones

APPENDIX A

MINIMAL RISK LEVEL (MRL) WORKSHEET

Chemical Name: Dibromochloromethane
CAS Number: 124-48-1
Date: August 2005
Profile Status: Final Draft of Post-Public Comment Toxicological Profile
Route: Inhalation Oral
Duration: Acute Intermediate Chronic
Key to Figure: 46
Species: Rat

Minimal Risk Level: 0.09 mg/kg/day mg/m³

Reference: NTP. 1985. Toxicology and carcinogenesis studies of dibromochloromethane in F344/N rats and B6C3F1 mice (gavage studies). National Toxicology Program. Technical Report Series No. 282. Research Triangle Park, NC: U.S. Department of Health and Human Services.

Experimental design:

Groups of 50 male and 50 female F344/N rats received 0, 40, or 80 mg/kg gavage doses of dibromochloromethane in corn oil 5 days/week for 2 years. Clinical signs were recorded weekly. Body weights were recorded weekly for the first twelve weeks of the study and monthly thereafter. Necropsy was performed on all animals. Histopathological examination was conducted on tissues from all dose groups.

Effects noted in study and corresponding concentrations:

Survival was comparable in all study groups. Body weight gain was within 10% of controls throughout the study. In the liver, fatty change (male: 27/50, 47/50, and 49/50; female: 12/50, 23/50, and 50/50) and "ground glass" cytoplasmic changes (male: 8/50, 22/50, and 34/50; female: 0/50, 1/50, and 12/50) were observed. A dose-related increase in nephrosis was observed in female rats (7/50, 11/50, and 14/50); however, the incidences in exposed rats was not statistically higher than in vehicle controls assessed using the Fisher exact test.

It should be noted that the study authors did not report statistical analysis data for nonneoplastic lesions. An independent statistical analysis was conducted; statistical significance was determined using a Fisher exact test, one tailed $p < 0.05$.

Concentration and end point used for MRL derivation:

The MRL is based on a LOAEL of 40 mg/kg (duration-adjusted to 28 mg/kg/day) for liver histopathology (fatty change) (NTP 1985).

NOAEL LOAEL

Uncertainty Factors used in MRL derivation:

- 3 for use of a minimal LOAEL
- 10 for extrapolation from animals to humans
- 10 for human variability

APPENDIX A

Was a conversion factor used from ppm in food or water to a mg/body weight dose? No.

If an inhalation study in animals, list conversion factors used in determining human equivalent concentration: NA

Was a conversion used from intermittent to continuous exposure?

The LOAEL was adjusted for intermittent exposure: $40 \text{ mg/kg} \times 5 \text{ days}/7 \text{ days} = 28 \text{ mg/kg/day}$

Other additional studies or pertinent information that lend support to this MRL:

The identification of the liver as the critical target is supported by numerous acute-duration studies in rats and mice exposed to $\geq 37 \text{ mg/kg}$ (Chu et al. 1982a; Coffin et al. 2000; Condie et al. 1983; Hewitt et al. 1983; Munson et al. 198; NTP 1985), 50 mg/kg for intermediate durations (Aida et al. 1992; Daniel et al. 1990; Melnick et al. 1998; NTP 1985), and 40 mg/kg for chronic durations (NTP 1985; Tobe et al. 1982). The identification of the LOAEL of 40 mg/kg for fatty changes in the liver is supported by the NTP (1985) mouse study and a rat study by Tobe et al. (1982). Fatty metamorphosis was found in mice receiving gavage doses of 50 mg/kg , 5 days/week for 2 years (NTP 1985). Necrosis was observed at 100 mg/kg . In the Tobe et al. (1982) study, groups of rats were exposed to dibromochloromethane in diet for 2 years. No histological examinations were conducted; however, hypertrophy and yellowing of the liver was found at 85 mg/kg/day . Alterations in a number of clinical chemistry parameters, which are indicative of liver damage, were also observed. Decreases in serum triglycerides were observed at 20 mg/kg/day and decreases in serum cholesterol were observed at 540 mg/kg/day .

Agency Contact (Chemical Managers): John Risher, Dennis Jones

APPENDIX B. USER'S GUIDE

Chapter 1

Public Health Statement

This chapter of the profile is a health effects summary written in non-technical language. Its intended audience is the general public, especially people living in the vicinity of a hazardous waste site or chemical release. If the Public Health Statement were removed from the rest of the document, it would still communicate to the lay public essential information about the chemical.

The major headings in the Public Health Statement are useful to find specific topics of concern. The topics are written in a question and answer format. The answer to each question includes a sentence that will direct the reader to chapters in the profile that will provide more information on the given topic.

Chapter 2

Relevance to Public Health

This chapter provides a health effects summary based on evaluations of existing toxicologic, epidemiologic, and toxicokinetic information. This summary is designed to present interpretive, weight-of-evidence discussions for human health end points by addressing the following questions:

1. What effects are known to occur in humans?
2. What effects observed in animals are likely to be of concern to humans?
3. What exposure conditions are likely to be of concern to humans, especially around hazardous waste sites?

The chapter covers end points in the same order that they appear within the Discussion of Health Effects by Route of Exposure section, by route (inhalation, oral, and dermal) and within route by effect. Human data are presented first, then animal data. Both are organized by duration (acute, intermediate, chronic). *In vitro* data and data from parenteral routes (intramuscular, intravenous, subcutaneous, etc.) are also considered in this chapter.

The carcinogenic potential of the profiled substance is qualitatively evaluated, when appropriate, using existing toxicokinetic, genotoxic, and carcinogenic data. ATSDR does not currently assess cancer potency or perform cancer risk assessments. Minimal Risk Levels (MRLs) for noncancer end points (if derived) and the end points from which they were derived are indicated and discussed.

Limitations to existing scientific literature that prevent a satisfactory evaluation of the relevance to public health are identified in the Chapter 3 Data Needs section.

Interpretation of Minimal Risk Levels

Where sufficient toxicologic information is available, ATSDR has derived MRLs for inhalation and oral routes of entry at each duration of exposure (acute, intermediate, and chronic). These MRLs are not

APPENDIX B

meant to support regulatory action, but to acquaint health professionals with exposure levels at which adverse health effects are not expected to occur in humans.

MRLs should help physicians and public health officials determine the safety of a community living near a chemical emission, given the concentration of a contaminant in air or the estimated daily dose in water. MRLs are based largely on toxicological studies in animals and on reports of human occupational exposure.

MRL users should be familiar with the toxicologic information on which the number is based. Chapter 2, "Relevance to Public Health," contains basic information known about the substance. Other sections such as Chapter 3 Section 3.9, "Interactions with Other Substances," and Section 3.10, "Populations that are Unusually Susceptible" provide important supplemental information.

MRL users should also understand the MRL derivation methodology. MRLs are derived using a modified version of the risk assessment methodology that the Environmental Protection Agency (EPA) provides (Barnes and Dourson 1988) to determine reference doses (RfDs) for lifetime exposure.

To derive an MRL, ATSDR generally selects the most sensitive end point which, in its best judgement, represents the most sensitive human health effect for a given exposure route and duration. ATSDR cannot make this judgement or derive an MRL unless information (quantitative or qualitative) is available for all potential systemic, neurological, and developmental effects. If this information and reliable quantitative data on the chosen end point are available, ATSDR derives an MRL using the most sensitive species (when information from multiple species is available) with the highest no-observed-adverse-effect level (NOAEL) that does not exceed any adverse effect levels. When a NOAEL is not available, a lowest-observed-adverse-effect level (LOAEL) can be used to derive an MRL, and an uncertainty factor (UF) of 10 must be employed. Additional uncertainty factors of 10 must be used both for human variability to protect sensitive subpopulations (people who are most susceptible to the health effects caused by the substance) and for interspecies variability (extrapolation from animals to humans). In deriving an MRL, these individual uncertainty factors are multiplied together. The product is then divided into the inhalation concentration or oral dosage selected from the study. Uncertainty factors used in developing a substance-specific MRL are provided in the footnotes of the levels of significant exposure (LSE) tables.

Chapter 3

Health Effects

Tables and Figures for Levels of Significant Exposure (LSE)

Tables and figures are used to summarize health effects and illustrate graphically levels of exposure associated with those effects. These levels cover health effects observed at increasing dose concentrations and durations, differences in response by species, MRLs to humans for noncancer end points, and EPA's estimated range associated with an upper-bound individual lifetime cancer risk of 1 in 10,000 to 1 in 10,000,000. Use the LSE tables and figures for a quick review of the health effects and to locate data for a specific exposure scenario. The LSE tables and figures should always be used in conjunction with the text. All entries in these tables and figures represent studies that provide reliable, quantitative estimates of NOAELs, LOAELs, or Cancer Effect Levels (CELs).

The legends presented below demonstrate the application of these tables and figures. Representative examples of LSE Table 3-1 and Figure 3-1 are shown. The numbers in the left column of the legends correspond to the numbers in the example table and figure.

APPENDIX B

LEGEND**See Sample LSE Table 3-1 (page B-6)**

- (1) Route of Exposure. One of the first considerations when reviewing the toxicity of a substance using these tables and figures should be the relevant and appropriate route of exposure. Typically when sufficient data exist, three LSE tables and two LSE figures are presented in the document. The three LSE tables present data on the three principal routes of exposure, i.e., inhalation, oral, and dermal (LSE Tables 3-1, 3-2, and 3-3, respectively). LSE figures are limited to the inhalation (LSE Figure 3-1) and oral (LSE Figure 3-2) routes. Not all substances will have data on each route of exposure and will not, therefore, have all five of the tables and figures.
- (2) Exposure Period. Three exposure periods—acute (less than 15 days), intermediate (15–364 days), and chronic (365 days or more)—are presented within each relevant route of exposure. In this example, an inhalation study of intermediate exposure duration is reported. For quick reference to health effects occurring from a known length of exposure, locate the applicable exposure period within the LSE table and figure.
- (3) Health Effect. The major categories of health effects included in LSE tables and figures are death, systemic, immunological, neurological, developmental, reproductive, and cancer. NOAELs and LOAELs can be reported in the tables and figures for all effects but cancer. Systemic effects are further defined in the "System" column of the LSE table (see key number 18).
- (4) Key to Figure. Each key number in the LSE table links study information to one or more data points using the same key number in the corresponding LSE figure. In this example, the study represented by key number 18 has been used to derive a NOAEL and a Less Serious LOAEL (also see the two "18r" data points in sample Figure 3-1).
- (5) Species. The test species, whether animal or human, are identified in this column. Chapter 2, "Relevance to Public Health," covers the relevance of animal data to human toxicity and Section 3.4, "Toxicokinetics," contains any available information on comparative toxicokinetics. Although NOAELs and LOAELs are species specific, the levels are extrapolated to equivalent human doses to derive an MRL.
- (6) Exposure Frequency/Duration. The duration of the study and the weekly and daily exposure regimens are provided in this column. This permits comparison of NOAELs and LOAELs from different studies. In this case (key number 18), rats were exposed to "Chemical x" via inhalation for 6 hours/day, 5 days/week, for 13 weeks. For a more complete review of the dosing regimen, refer to the appropriate sections of the text or the original reference paper (i.e., Nitschke et al. 1981).
- (7) System. This column further defines the systemic effects. These systems include respiratory, cardiovascular, gastrointestinal, hematological, musculoskeletal, hepatic, renal, and dermal/ocular. "Other" refers to any systemic effect (e.g., a decrease in body weight) not covered in these systems. In the example of key number 18, one systemic effect (respiratory) was investigated.

APPENDIX B

- (8) NOAEL. A NOAEL is the highest exposure level at which no harmful effects were seen in the organ system studied. Key number 18 reports a NOAEL of 3 ppm for the respiratory system, which was used to derive an intermediate exposure, inhalation MRL of 0.005 ppm (see footnote "b").
- (9) LOAEL. A LOAEL is the lowest dose used in the study that caused a harmful health effect. LOAELs have been classified into "Less Serious" and "Serious" effects. These distinctions help readers identify the levels of exposure at which adverse health effects first appear and the gradation of effects with increasing dose. A brief description of the specific end point used to quantify the adverse effect accompanies the LOAEL. The respiratory effect reported in key number 18 (hyperplasia) is a Less Serious LOAEL of 10 ppm. MRLs are not derived from Serious LOAELs.
- (10) Reference. The complete reference citation is given in Chapter 9 of the profile.
- (11) CEL. A CEL is the lowest exposure level associated with the onset of carcinogenesis in experimental or epidemiologic studies. CELs are always considered serious effects. The LSE tables and figures do not contain NOAELs for cancer, but the text may report doses not causing measurable cancer increases.
- (12) Footnotes. Explanations of abbreviations or reference notes for data in the LSE tables are found in the footnotes. Footnote "b" indicates that the NOAEL of 3 ppm in key number 18 was used to derive an MRL of 0.005 ppm.

LEGEND

See Sample Figure 3-1 (page B-7)

LSE figures graphically illustrate the data presented in the corresponding LSE tables. Figures help the reader quickly compare health effects according to exposure concentrations for particular exposure periods.

- (13) Exposure Period. The same exposure periods appear as in the LSE table. In this example, health effects observed within the acute and intermediate exposure periods are illustrated.
- (14) Health Effect. These are the categories of health effects for which reliable quantitative data exists. The same health effects appear in the LSE table.
- (15) Levels of Exposure. Concentrations or doses for each health effect in the LSE tables are graphically displayed in the LSE figures. Exposure concentration or dose is measured on the log scale "y" axis. Inhalation exposure is reported in mg/m³ or ppm and oral exposure is reported in mg/kg/day.
- (16) NOAEL. In this example, the open circle designated 18r identifies a NOAEL critical end point in the rat upon which an intermediate inhalation exposure MRL is based. The key number 18 corresponds to the entry in the LSE table. The dashed descending arrow indicates the extrapolation from the exposure level of 3 ppm (see entry 18 in the table) to the MRL of 0.005 ppm (see footnote "b" in the LSE table).

APPENDIX B

- (17) CEL. Key number 38m is one of three studies for which CELs were derived. The diamond symbol refers to a CEL for the test species-mouse. The number 38 corresponds to the entry in the LSE table.
- (18) Estimated Upper-Bound Human Cancer Risk Levels. This is the range associated with the upper-bound for lifetime cancer risk of 1 in 10,000 to 1 in 10,000,000. These risk levels are derived from the EPA's Human Health Assessment Group's upper-bound estimates of the slope of the cancer dose response curve at low dose levels (q_1^*).
- (19) Key to LSE Figure. The Key explains the abbreviations and symbols used in the figure.

SAMPLE

1 → **Table 3-1. Levels of Significant Exposure to [Chemical x] – Inhalation**

Key to figure ^a	Species	Exposure frequency/ duration	System	NOAEL (ppm)	LOAEL (effect)		Reference
					Less serious (ppm)	Serious (ppm)	
2 →	INTERMEDIATE EXPOSURE						
3 →	Systemic	↓	↓	↓	↓	↓	↓
4 →	18	Rat	13 wk 5 d/wk 6 hr/d	Resp	3 ^b	10 (hyperplasia)	Nitschke et al. 1981
	CHRONIC EXPOSURE						
	Cancer					11	
					↓		
	38	Rat	18 mo 5 d/wk 7 hr/d			20	(CEL, multiple organs) Wong et al. 1982
	39	Rat	89–104 wk 5 d/wk 6 hr/d			10	(CEL, lung tumors, nasal tumors) NTP 1982
	40	Mouse	79–103 wk 5 d/wk 6 hr/d			10	(CEL, lung tumors, hemangiosarcomas) NTP 1982

12 → ^a The number corresponds to entries in Figure 3-1.

^b Used to derive an intermediate inhalation Minimal Risk Level (MRL) of 5×10^{-3} ppm; dose adjusted for intermittent exposure and divided by an uncertainty factor of 100 (10 for extrapolation from animal to humans, 10 for human variability).

SAMPLE

Figure 3-1. Levels of Significant Exposure to [Chemical X] - Inhalation

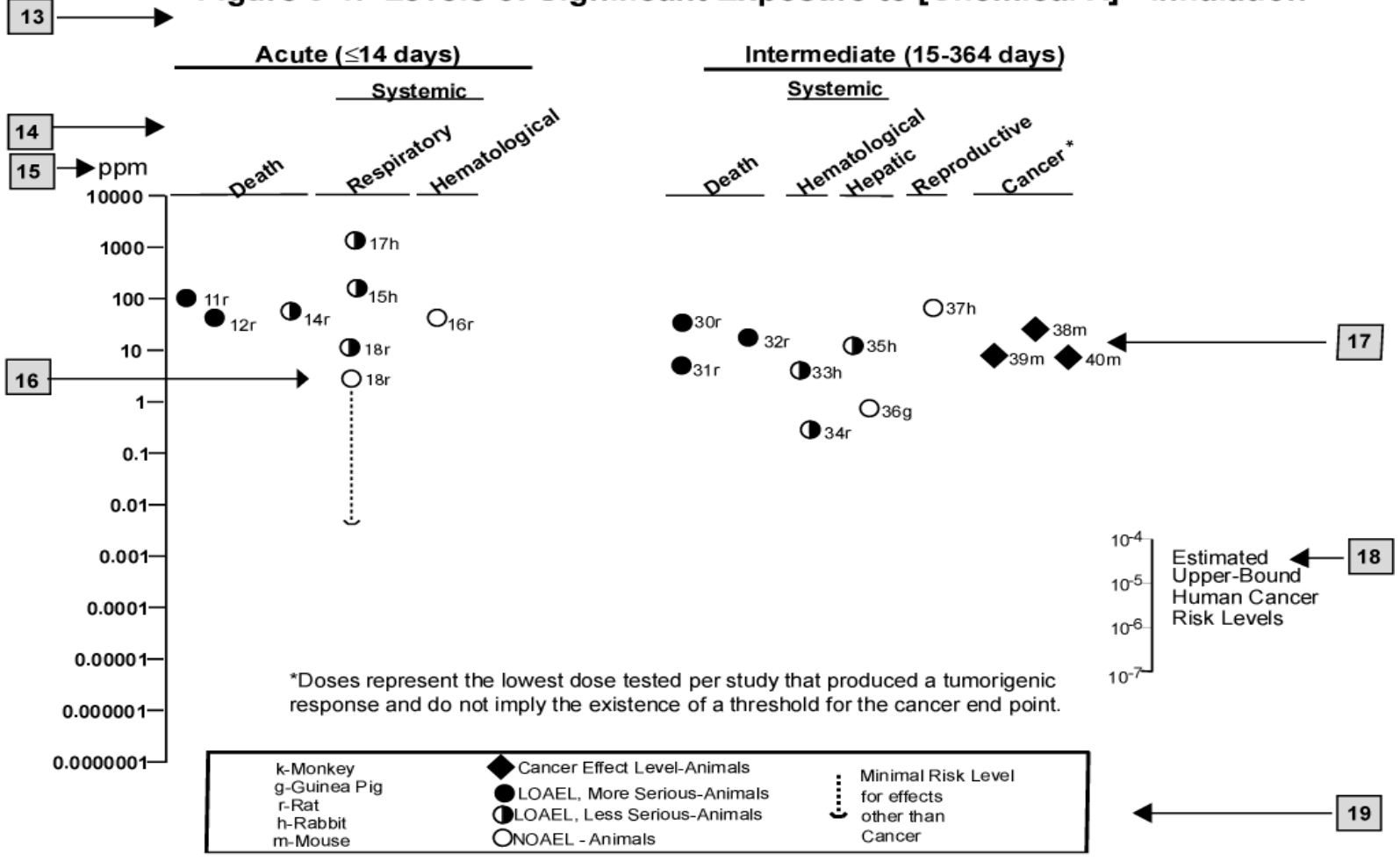

APPENDIX C. ACRONYMS, ABBREVIATIONS, AND SYMBOLS

ACGIH	American Conference of Governmental Industrial Hygienists
ACOEM	American College of Occupational and Environmental Medicine
ADI	acceptable daily intake
ADME	absorption, distribution, metabolism, and excretion
AED	atomic emission detection
AFID	alkali flame ionization detector
AFOSH	Air Force Office of Safety and Health
ALT	alanine aminotransferase (also known as SGPT)
AML	acute myeloid leukemia
AOAC	Association of Official Analytical Chemists
AOEC	Association of Occupational and Environmental Clinics
AP	alkaline phosphatase
APHA	American Public Health Association
AST	aspartate aminotransferase (also known as SGOT)
atm	atmosphere
ATSDR	Agency for Toxic Substances and Disease Registry
AWQC	Ambient Water Quality Criteria
BAT	best available technology
BCF	bioconcentration factor
BEI	Biological Exposure Index
BMD	benchmark dose
BMR	benchmark response
BSC	Board of Scientific Counselors
C	centigrade
CAA	Clean Air Act
CAG	Cancer Assessment Group of the U.S. Environmental Protection Agency
CAS	Chemical Abstract Services
CDC	Centers for Disease Control and Prevention
CEL	cancer effect level
CELDS	Computer-Environmental Legislative Data System
CERCLA	Comprehensive Environmental Response, Compensation, and Liability Act
CFR	Code of Federal Regulations
Ci	curie
CI	confidence interval
CL	ceiling limit value
CLP	Contract Laboratory Program
cm	centimeter
CML	chronic myeloid leukemia
CPSC	Consumer Products Safety Commission
CWA	Clean Water Act
DHEW	Department of Health, Education, and Welfare
DHHS	Department of Health and Human Services
DNA	deoxyribonucleic acid
DOD	Department of Defense
DOE	Department of Energy
DOL	Department of Labor

APPENDIX C

DOT	Department of Transportation
DOT/UN/ NA/IMCO	Department of Transportation/United Nations/ North America/International Maritime Dangerous Goods Code
DWEL	drinking water exposure level
ECD	electron capture detection
ECG/EKG	electrocardiogram
EEG	electroencephalogram
EEGL	Emergency Exposure Guidance Level
EPA	Environmental Protection Agency
F	Fahrenheit
F ₁	first-filial generation
FAO	Food and Agricultural Organization of the United Nations
FDA	Food and Drug Administration
FEMA	Federal Emergency Management Agency
FIFRA	Federal Insecticide, Fungicide, and Rodenticide Act
FPD	flame photometric detection
fpm	feet per minute
FR	Federal Register
FSH	follicle stimulating hormone
g	gram
GC	gas chromatography
gd	gestational day
GLC	gas liquid chromatography
GPC	gel permeation chromatography
HPLC	high-performance liquid chromatography
HRGC	high resolution gas chromatography
HSDB	Hazardous Substance Data Bank
IARC	International Agency for Research on Cancer
IDLH	immediately dangerous to life and health
ILO	International Labor Organization
IRIS	Integrated Risk Information System
K _d	adsorption ratio
kg	kilogram
kkg	metric ton
K _{oc}	organic carbon partition coefficient
K _{ow}	octanol-water partition coefficient
L	liter
LC	liquid chromatography
LC ₅₀	lethal concentration, 50% kill
LC _{Lo}	lethal concentration, low
LD ₅₀	lethal dose, 50% kill
LD _{Lo}	lethal dose, low
LDH	lactic dehydrogenase
LH	luteinizing hormone
LOAEL	lowest-observed-adverse-effect level
LSE	Levels of Significant Exposure
LT ₅₀	lethal time, 50% kill
m	meter
MA	<i>trans,trans</i> -muconic acid
MAL	maximum allowable level
mCi	millicurie

APPENDIX C

MCL	maximum contaminant level
MCLG	maximum contaminant level goal
MF	modifying factor
MFO	mixed function oxidase
mg	milligram
mL	milliliter
mm	millimeter
mmHg	millimeters of mercury
mmol	millimole
mppcf	millions of particles per cubic foot
MRL	Minimal Risk Level
MS	mass spectrometry
NAAQS	National Ambient Air Quality Standard
NAS	National Academy of Science
NATICH	National Air Toxics Information Clearinghouse
NATO	North Atlantic Treaty Organization
NCE	normochromatic erythrocytes
NCEH	National Center for Environmental Health
NCI	National Cancer Institute
ND	not detected
NFPA	National Fire Protection Association
ng	nanogram
NHANES	National Health and Nutrition Examination Survey
NIEHS	National Institute of Environmental Health Sciences
NIOSH	National Institute for Occupational Safety and Health
NIOSHTIC	NIOSH's Computerized Information Retrieval System
NLM	National Library of Medicine
nm	nanometer
nmol	nanomole
NOAEL	no-observed-adverse-effect level
NOES	National Occupational Exposure Survey
NOHS	National Occupational Hazard Survey
NPD	nitrogen phosphorus detection
NPDES	National Pollutant Discharge Elimination System
NPL	National Priorities List
NR	not reported
NRC	National Research Council
NS	not specified
NSPS	New Source Performance Standards
NTIS	National Technical Information Service
NTP	National Toxicology Program
ODW	Office of Drinking Water, EPA
OERR	Office of Emergency and Remedial Response, EPA
OHM/TADS	Oil and Hazardous Materials/Technical Assistance Data System
OPP	Office of Pesticide Programs, EPA
OPPT	Office of Pollution Prevention and Toxics, EPA
OPPTS	Office of Prevention, Pesticides and Toxic Substances, EPA
OR	odds ratio
OSHA	Occupational Safety and Health Administration
OSW	Office of Solid Waste, EPA
OTS	Office of Toxic Substances

APPENDIX C

OW	Office of Water
OWRS	Office of Water Regulations and Standards, EPA
PAH	polycyclic aromatic hydrocarbon
PBPD	physiologically based pharmacodynamic
PBPK	physiologically based pharmacokinetic
PCE	polychromatic erythrocytes
PEL	permissible exposure limit
pg	picogram
PHS	Public Health Service
PID	photo ionization detector
pmol	picomole
PMR	proportionate mortality ratio
ppb	parts per billion
ppm	parts per million
ppt	parts per trillion
PSNS	pretreatment standards for new sources
RBC	red blood cell
REL	recommended exposure level/limit
RfC	reference concentration
RfD	reference dose
RNA	ribonucleic acid
RQ	reportable quantity
RTECS	Registry of Toxic Effects of Chemical Substances
SARA	Superfund Amendments and Reauthorization Act
SCE	sister chromatid exchange
SGOT	serum glutamic oxaloacetic transaminase (also known as AST)
SGPT	serum glutamic pyruvic transaminase (also known as ALT)
SIC	standard industrial classification
SIM	selected ion monitoring
SMCL	secondary maximum contaminant level
SMR	standardized mortality ratio
SNARL	suggested no adverse response level
SPEGL	Short-Term Public Emergency Guidance Level
STEL	short term exposure limit
STORET	Storage and Retrieval
TD ₅₀	toxic dose, 50% specific toxic effect
TLV	threshold limit value
TOC	total organic carbon
TPQ	threshold planning quantity
TRI	Toxics Release Inventory
TSCA	Toxic Substances Control Act
TWA	time-weighted average
UF	uncertainty factor
U.S.	United States
USDA	United States Department of Agriculture
USGS	United States Geological Survey
VOC	volatile organic compound
WBC	white blood cell
WHO	World Health Organization

APPENDIX C

>	greater than
≥	greater than or equal to
=	equal to
<	less than
≤	less than or equal to
%	percent
α	alpha
β	beta
γ	gamma
δ	delta
μm	micrometer
μg	microgram
q ₁ *	cancer slope factor
-	negative
+	positive
(+)	weakly positive result
(-)	weakly negative result

APPENDIX D. INDEX

absorbed dose	99, 103
adenocarcinoma	68
adenocarcinomas	68
adipose tissue	91, 100, 153, 160, 163
adsorbed	125, 134
adsorption	134, 136, 138, 143, 158, 160, 161
aerobic	92, 125, 136
ambient air	137, 138, 149
anaerobic	92, 125, 136, 152
bath	99, 139
bioaccumulation	152
bioavailability	152
bioconcentration factor	135
biodegradation	136
biomarker	98, 99, 100, 112, 163
biomarkers	98, 99, 113, 157, 163
body weight effects	23, 62
breast milk	149, 150
cancer	4, 5, 22, 68, 93, 96, 163, 170
carcinogen	13, 69, 170
carcinogenic	13, 15, 21, 22, 68, 84, 92, 110, 113
carcinogenicity	13, 69, 93, 110, 170
carcinoma	69
carcinomas	69
cardiovascular	23, 57
cardiovascular effects	57
chromatid exchange	70, 71, 72, 74, 75, 76
chromosomal aberrations	74
clearance	23, 99, 103, 114
CYP2E1	86, 87, 91, 92, 94, 97, 104
cytochrome	12, 82, 84, 86, 91, 92, 94, 97, 104
death	21, 22, 24, 55, 56, 91, 107
dermal effects	61
dermal exposure	11, 12, 15, 69, 81, 82, 88, 104, 107, 108, 109, 111, 112, 114, 150
DNA	70, 71, 73, 74, 75, 77, 78, 86, 87, 91, 93, 99, 113, 163
duodenum	71, 74, 75, 78
elderly	102
elimination half-time	88
endocrine	23, 61, 94, 95
endocrine effects	61
fetal tissue	94
fetus	13, 68, 96, 114
gastrointestinal effects	57, 58
general population	11, 98, 108, 153, 163
genotoxic	21, 93, 110
genotoxicity	70, 74, 87, 93, 110
glutathione	83, 84, 86, 87, 91, 92, 93, 97, 110, 114
groundwater	3, 65, 125, 128, 130, 131, 136, 141, 144, 152, 153, 169, 170
growth retardation	67
half-life	98, 103, 135

APPENDIX D

hematological effects	58
hepatic effects	12, 19, 23, 58, 59
hydrolysis	84
hydroxyl radical	152
immune system	63, 112
immunological	21, 23
immunological effects	23
K_{ow}	135
LD_{50}	55
leukemia	70, 73, 74, 76, 77
lymphoreticular	63
menstrual	65, 66, 95
micronuclei	70, 74
milk	146, 150
musculoskeletal effects	58
neoplastic	69
neurobehavioral	64, 65, 95, 109, 112
neurodevelopmental	114
nuclear	122, 128
odds ratio	65
oxidative metabolism	86, 91, 93
P-450	12, 82, 84, 86, 91, 92, 94, 97, 104, 114
partition coefficients	79, 81
PBPK model	88, 89, 101
pharmacodynamic	88
pharmacokinetic	88, 89, 90
pharmacokinetics	96
photolysis	135, 155
potentiation	101
rate constant	135
rate constants	135
renal effects	14, 23, 60, 113
SGOT	13, 16, 59, 60, 108
shower	4, 6, 11, 78, 81, 99, 139, 146, 150
solubility	134, 157
swimming	3, 6, 64, 65, 78, 99, 143, 144, 148, 149, 150, 153, 154
tap water	6, 11, 13, 67, 81, 99, 109, 111, 139, 142, 146
testosterone	61, 95, 108
thyroid	61
toxicokinetic	21, 94, 109, 113, 114
tremors	63
tumors	13, 93
vapor phase	134
vapor pressure	109, 134
volatilization	135, 152
whooping cough	2, 6, 24, 63, 97, 107

