

TOXICOLOGICAL PROFILE FOR CARBON TETRACHLORIDE

U.S. DEPARTMENT OF HEALTH AND HUMAN SERVICES
Public Health Service
Agency for Toxic Substances and Disease Registry

August 2005

DISCLAIMER

The use of company or product name(s) is for identification only and does not imply endorsement by the Agency for Toxic Substances and Disease Registry.

UPDATE STATEMENT

A Toxicological Profile for Carbon Tetrachloride, Draft for Public Comment was released in September 2003. This edition supersedes any previously released draft or final profile.

Toxicological profiles are revised and republished as necessary. For information regarding the update status of previously released profiles, contact ATSDR at:

Agency for Toxic Substances and Disease Registry
Division of Toxicology/Toxicology Information Branch
1600 Clifton Road NE
Mailstop F-32
Atlanta, Georgia 30333

FOREWORD

This toxicological profile is prepared in accordance with guidelines* developed by the Agency for Toxic Substances and Disease Registry (ATSDR) and the Environmental Protection Agency (EPA). The original guidelines were published in the *Federal Register* on April 17, 1987. Each profile will be revised and republished as necessary.

The ATSDR toxicological profile succinctly characterizes the toxicologic and adverse health effects information for the hazardous substance described therein. Each peer-reviewed profile identifies and reviews the key literature that describes a hazardous substance's toxicologic properties. Other pertinent literature is also presented, but is described in less detail than the key studies. The profile is not intended to be an exhaustive document; however, more comprehensive sources of specialty information are referenced.

The focus of the profiles is on health and toxicologic information; therefore, each toxicological profile begins with a public health statement that describes, in nontechnical language, a substance's relevant toxicological properties. Following the public health statement is information concerning levels of significant human exposure and, where known, significant health effects. The adequacy of information to determine a substance's health effects is described in a health effects summary. Data needs that are of significance to protection of public health are identified by ATSDR and EPA.

Each profile includes the following:

- (A) The examination, summary, and interpretation of available toxicologic information and epidemiologic evaluations on a hazardous substance to ascertain the levels of significant human exposure for the substance and the associated acute, subacute, and chronic health effects;
- (B) A determination of whether adequate information on the health effects of each substance is available or in the process of development to determine levels of exposure that present a significant risk to human health of acute, subacute, and chronic health effects; and
- (C) Where appropriate, identification of toxicologic testing needed to identify the types or levels of exposure that may present significant risk of adverse health effects in humans.

The principal audiences for the toxicological profiles are health professionals at the Federal, State, and local levels; interested private sector organizations and groups; and members of the public.

This profile reflects ATSDR's assessment of all relevant toxicologic testing and information that has been peer-reviewed. Staff of the Centers for Disease Control and Prevention and other Federal scientists have also reviewed the profile. In addition, this profile has been peer-reviewed by a nongovernmental panel and was made available for public review. Final responsibility for the contents and views expressed in this toxicological profile resides with ATSDR.

Julie Louise Gerberding, M.D., M.P.H.
Administrator
Agency for Toxic Substances and
Disease Registry

*Legislative Background

The toxicological profiles are developed in response to the Superfund Amendments and Reauthorization Act (SARA) of 1986 (Public Law 99-499) which amended the Comprehensive Environmental Response, Compensation, and Liability Act of 1980 (CERCLA or Superfund). This public law directed ATSDR to prepare toxicological profiles for hazardous substances most commonly found at facilities on the CERCLA National Priorities List and that pose the most significant potential threat to human health, as determined by ATSDR and the EPA. The availability of the revised priority list of 275 hazardous substances was announced in the *Federal Register* on November 7, 2003 (68 FR 63098). For prior versions of the list of substances, see *Federal Register* notices dated April 17, 1987 (52 FR 12866); October 20, 1988 (53 FR 41280); October 26, 1989 (54 FR 43619); October 17, 1990 (55 FR 42067); October 17, 1991 (56 FR 52166); October 28, 1992 (57 FR 48801); February 28, 1994 (59 FR 9486); April 29, 1996 (61 FR 18744); November 17, 1997 (62 FR 61332); October 21, 1999 (64 FR 56792) and October 25, 2001 (66 FR 54014). Section 104(i)(3) of CERCLA, as amended, directs the Administrator of ATSDR to prepare a toxicological profile for each substance on the list.

QUICK REFERENCE FOR HEALTH CARE PROVIDERS

Toxicological Profiles are a unique compilation of toxicological information on a given hazardous substance. Each profile reflects a comprehensive and extensive evaluation, summary, and interpretation of available toxicologic and epidemiologic information on a substance. Health care providers treating patients potentially exposed to hazardous substances will find the following information helpful for fast answers to often-asked questions.

Primary Chapters/Sections of Interest

Chapter 1: Public Health Statement: The Public Health Statement can be a useful tool for educating patients about possible exposure to a hazardous substance. It explains a substance's relevant toxicologic properties in a nontechnical, question-and-answer format, and it includes a review of the general health effects observed following exposure.

Chapter 2: Relevance to Public Health: The Relevance to Public Health Section evaluates, interprets, and assesses the significance of toxicity data to human health.

Chapter 3: Health Effects: Specific health effects of a given hazardous compound are reported by type of health effect (death, systemic, immunologic, reproductive), by route of exposure, and by length of exposure (acute, intermediate, and chronic). In addition, both human and animal studies are reported in this section.

NOTE: Not all health effects reported in this section are necessarily observed in the clinical setting. Please refer to the Public Health Statement to identify general health effects observed following exposure.

Pediatrics: Four new sections have been added to each Toxicological Profile to address child health issues:

Section 1.6	How Can (Chemical X) Affect Children?
Section 1.7	How Can Families Reduce the Risk of Exposure to (Chemical X)?
Section 3.7	Children's Susceptibility
Section 6.6	Exposures of Children

Other Sections of Interest:

Section 3.8	Biomarkers of Exposure and Effect
Section 3.11	Methods for Reducing Toxic Effects

ATSDR Information Center

Phone: 1-888-42-ATSDR or (404) 498-0110	Fax: (770) 488-4178
E-mail: atsdric@cdc.gov	Internet: http://www.atsdr.cdc.gov

The following additional material can be ordered through the ATSDR Information Center:

Case Studies in Environmental Medicine: Taking an Exposure History—The importance of taking an exposure history and how to conduct one are described, and an example of a thorough exposure history is provided. Other case studies of interest include *Reproductive and Developmental*

Hazards; Skin Lesions and Environmental Exposures; Cholinesterase-Inhibiting Pesticide Toxicity; and numerous chemical-specific case studies.

Managing Hazardous Materials Incidents is a three-volume set of recommendations for on-scene (prehospital) and hospital medical management of patients exposed during a hazardous materials incident. Volumes I and II are planning guides to assist first responders and hospital emergency department personnel in planning for incidents that involve hazardous materials. Volume III—*Medical Management Guidelines for Acute Chemical Exposures*—is a guide for health care professionals treating patients exposed to hazardous materials.

Fact Sheets (ToxFAQs) provide answers to frequently asked questions about toxic substances.

Other Agencies and Organizations

The National Center for Environmental Health (NCEH) focuses on preventing or controlling disease, injury, and disability related to the interactions between people and their environment outside the workplace. Contact: NCEH, Mailstop F-29, 4770 Buford Highway, NE, Atlanta, GA 30341-3724 • Phone: 770-488-7000 • FAX: 770-488-7015.

The National Institute for Occupational Safety and Health (NIOSH) conducts research on occupational diseases and injuries, responds to requests for assistance by investigating problems of health and safety in the workplace, recommends standards to the Occupational Safety and Health Administration (OSHA) and the Mine Safety and Health Administration (MSHA), and trains professionals in occupational safety and health. Contact: NIOSH, 200 Independence Avenue, SW, Washington, DC 20201 • Phone: 800-356-4674 or NIOSH Technical Information Branch, Robert A. Taft Laboratory, Mailstop C-19, 4676 Columbia Parkway, Cincinnati, OH 45226-1998 • Phone: 800-35-NIOSH.

The National Institute of Environmental Health Sciences (NIEHS) is the principal federal agency for biomedical research on the effects of chemical, physical, and biologic environmental agents on human health and well-being. Contact: NIEHS, PO Box 12233, 104 T.W. Alexander Drive, Research Triangle Park, NC 27709 • Phone: 919-541-3212.

Referrals

The Association of Occupational and Environmental Clinics (AOEC) has developed a network of clinics in the United States to provide expertise in occupational and environmental issues. Contact: AOEC, 1010 Vermont Avenue, NW, #513, Washington, DC 20005 • Phone: 202-347-4976 • FAX: 202-347-4950 • e-mail: AOEC@AOEC.ORG • Web Page: <http://www.aoec.org/>.

The American College of Occupational and Environmental Medicine (ACOEM) is an association of physicians and other health care providers specializing in the field of occupational and environmental medicine. Contact: ACOEM, 25 Northwest Point Boulevard, Suite 700, Elk Grove Village, IL 60007-1030 • Phone: 847-818-1800 • FAX: 847-818-9266.

CONTRIBUTORS

CHEMICAL MANAGER(S)/AUTHOR(S):

Obaid Faroon, Ph.D.
Jessilynn Taylor, M.S.
Nicolette Roney, M.P.H.
ATSDR, Division of Toxicology, Atlanta, GA

Margaret E. Fransen, Ph.D.
Suzanne Bogaczyk, Ph.D.
Gary Diamond, Ph.D.
Syracuse Research Corporation, Syracuse, NY

THE PROFILE HAS UNDERGONE THE FOLLOWING ATSDR INTERNAL REVIEWS:

1. Health Effects Review. The Health Effects Review Committee examines the health effects chapter of each profile for consistency and accuracy in interpreting health effects and classifying end points.
2. Minimal Risk Level Review. The Minimal Risk Level Workgroup considers issues relevant to substance-specific Minimal Risk Levels (MRLs), reviews the health effects database of each profile, and makes recommendations for derivation of MRLs.
3. Data Needs Review. The Research Implementation Branch reviews data needs sections to assure consistency across profiles and adherence to instructions in the Guidance.
4. Green Border Review. Green Border review assures the consistency with ATSDR policy.

PEER REVIEW

A peer review panel was assembled for CARBON TETRACHLORIDE. The panel consisted of the following members:

1. Finis Cavender, Ph.D., DABT, Consultant in Toxicology, CEI, Greer, South Carolina;
2. Lisa Kamendulis, Ph.D., Assistant Scientist, Department of Pharmacology and Toxicology, Indiana University School of Medicine; Associate Director, Indiana State Department of Toxicology, Indianapolis, Indiana; and
3. Julie Stickney, Ph.D., Principal Scientist, ARCADIS G&M, Inc., Portland, Maine.

These experts collectively have knowledge of carbon tetrachloride's physical and chemical properties, toxicokinetics, key health end points, mechanisms of action, human and animal exposure, and quantification of risk to humans. All reviewers were selected in conformity with the conditions for peer review specified in Section 104(I)(13) of the Comprehensive Environmental Response, Compensation, and Liability Act, as amended.

Scientists from the Agency for Toxic Substances and Disease Registry (ATSDR) have reviewed the peer reviewers' comments and determined which comments will be included in the profile. A listing of the peer reviewers' comments not incorporated in the profile, with a brief explanation of the rationale for their exclusion, exists as part of the administrative record for this compound.

The citation of the peer review panel should not be understood to imply its approval of the profile's final content. The responsibility for the content of this profile lies with the ATSDR.

CONTENTS

DISCLAIMER	ii
UPDATE STATEMENT	iii
FOREWORD	v
QUICK REFERENCE FOR HEALTH CARE PROVIDERS.....	vii
CONTRIBUTORS	ix
PEER REVIEW	xi
CONTENTS.....	xiii
LIST OF FIGURES	xvii
LIST OF TABLES	xix
1. PUBLIC HEALTH STATEMENT.....	1
1.1 WHAT IS CARBON TETRACHLORIDE?	1
1.2 WHAT HAPPENS TO CARBON TETRACHLORIDE WHEN IT ENTERS THE ENVIRONMENT?	2
1.3 HOW MIGHT I BE EXPOSED TO CARBON TETRACHLORIDE?	3
1.4 HOW CAN CARBON TETRACHLORIDE ENTER AND LEAVE MY BODY?.....	4
1.5 HOW CAN CARBON TETRACHLORIDE AFFECT MY HEALTH?.....	4
1.6 HOW CAN CARBON TETRACHLORIDE AFFECT CHILDREN?.....	7
1.7 HOW CAN FAMILIES REDUCE THE RISK OF EXPOSURE TO CARBON TETRACHLORIDE?	8
1.8 IS THERE A MEDICAL TEST TO DETERMINE WHETHER I HAVE BEEN EXPOSED TO CARBON TETRACHLORIDE?	8
1.9 WHAT RECOMMENDATIONS HAS THE FEDERAL GOVERNMENT MADE TO PROTECT HUMAN HEALTH?.....	9
1.10 WHERE CAN I GET MORE INFORMATION?	10
2. RELEVANCE TO PUBLIC HEALTH	13
2.1 BACKGROUND AND ENVIRONMENTAL EXPOSURES TO CARBON TETRACHLORIDE IN THE UNITED STATES.....	13
2.2 SUMMARY OF HEALTH EFFECTS	14
2.3 MINIMAL RISK LEVELS	19
3. HEALTH EFFECTS	27
3.1 INTRODUCTION	27
3.2 DISCUSSION OF HEALTH EFFECTS BY ROUTE OF EXPOSURE	27
3.2.1 Inhalation Exposure	28
3.2.1.1 Death	28
3.2.1.2 Systemic Effects	45
3.2.1.3 Immunological and Lymphoreticular Effects	54
3.2.1.4 Neurological Effects	54
3.2.1.5 Reproductive Effects	55
3.2.1.6 Developmental Effects	56
3.2.1.7 Cancer	56
3.2.2 Oral Exposure.....	59
3.2.2.1 Death	59
3.2.2.2 Systemic Effects	76

3.2.2.3	Immunological and Lymphoreticular Effects.....	83
3.2.2.4	Neurological Effects.....	83
3.2.2.5	Reproductive Effects.....	84
3.2.2.6	Developmental Effects.....	85
3.2.2.7	Cancer.....	86
3.2.3	Dermal Exposure.....	87
3.2.3.1	Death.....	90
3.2.3.2	Systemic Effects.....	90
3.2.3.3	Immunological and Lymphoreticular Effects.....	92
3.2.3.4	Neurological Effects.....	92
3.2.3.5	Reproductive Effects.....	92
3.2.3.6	Developmental Effects.....	92
3.2.3.7	Cancer.....	93
3.3	GENOTOXICITY.....	93
3.4	TOXICOKINETICS.....	102
3.4.1	Absorption.....	103
3.4.1.1	Inhalation Exposure.....	103
3.4.1.2	Oral Exposure.....	103
3.4.1.3	Dermal Exposure.....	104
3.4.2	Distribution.....	105
3.4.2.1	Inhalation Exposure.....	105
3.4.2.2	Oral Exposure.....	106
3.4.2.3	Dermal Exposure.....	107
3.4.3	Metabolism.....	107
3.4.4	Elimination and Excretion.....	111
3.4.4.1	Inhalation Exposure.....	111
3.4.4.2	Oral Exposure.....	113
3.4.4.3	Dermal Exposure.....	113
3.4.4.4	Other Routes of Exposure.....	114
3.4.5	Physiologically Based Pharmacokinetic (PBPK)/Pharmacodynamic (PD) Models.....	115
3.5	MECHANISMS OF ACTION.....	121
3.5.1	Pharmacokinetic Mechanisms.....	121
3.5.2	Mechanisms of Toxicity.....	122
3.5.3	Animal-to-Human Extrapolations.....	130
3.6	TOXICITIES MEDIATED THROUGH THE NEUROENDOCRINE AXIS.....	130
3.7	CHILDREN'S SUSCEPTIBILITY.....	132
3.8	BIOMARKERS OF EXPOSURE AND EFFECT.....	135
3.8.1	Biomarkers Used to Identify or Quantify Exposure to Carbon Tetrachloride.....	136
3.8.2	Biomarkers Used to Characterize Effects Caused by Carbon Tetrachloride.....	137
3.9	INTERACTIONS WITH OTHER CHEMICALS.....	140
3.10	POPULATIONS THAT ARE UNUSUALLY SUSCEPTIBLE.....	147
3.11	METHODS FOR REDUCING TOXIC EFFECTS.....	150
3.11.1	Reducing Peak Absorption Following Exposure.....	151
3.11.2	Reducing Body Burden.....	151
3.11.3	Interfering with the Mechanism of Action for Toxic Effects.....	152
3.12	ADEQUACY OF THE DATABASE.....	158
3.12.1	Existing Information on Health Effects of Carbon Tetrachloride.....	158
3.12.2	Identification of Data Needs.....	160
3.12.3	Ongoing Studies.....	167

4. CHEMICAL AND PHYSICAL INFORMATION.....	171
4.1 CHEMICAL IDENTITY.....	171
4.2 PHYSICAL AND CHEMICAL PROPERTIES.....	171
5. PRODUCTION, IMPORT/EXPORT, USE, AND DISPOSAL.....	175
5.1 PRODUCTION.....	175
5.2 IMPORT/EXPORT.....	175
5.3 USE.....	176
5.4 DISPOSAL.....	176
6. POTENTIAL FOR HUMAN EXPOSURE.....	179
6.1 OVERVIEW.....	179
6.2 RELEASES TO THE ENVIRONMENT.....	179
6.2.1 Air.....	181
6.2.2 Water.....	181
6.2.3 Soil.....	183
6.3 ENVIRONMENTAL FATE.....	184
6.3.1 Transport and Partitioning.....	184
6.3.2 Transformation and Degradation.....	185
6.3.2.1 Air.....	185
6.3.2.2 Water.....	186
6.3.2.3 Sediment and Soil.....	187
6.4 LEVELS MONITORED OR ESTIMATED IN THE ENVIRONMENT.....	187
6.4.1 Air.....	187
6.4.2 Water.....	189
6.4.3 Sediment and Soil.....	189
6.4.4 Other Environmental Media.....	190
6.5 GENERAL POPULATION AND OCCUPATIONAL EXPOSURE.....	190
6.6 EXPOSURES OF CHILDREN.....	192
6.7 POPULATIONS WITH POTENTIALLY HIGH EXPOSURES.....	193
6.8 ADEQUACY OF THE DATABASE.....	194
6.8.1 Identification of Data Needs.....	194
6.8.2 Ongoing Studies.....	198
7. ANALYTICAL METHODS.....	199
7.1 BIOLOGICAL MATERIALS.....	199
7.2 ENVIRONMENTAL SAMPLES.....	200
7.3 ADEQUACY OF THE DATABASE.....	202
7.3.1 Identification of Data Needs.....	204
7.3.2 Ongoing Studies.....	205
8. REGULATIONS AND ADVISORIES.....	207
9. REFERENCES.....	213
10. GLOSSARY.....	303

APPENDICES

A. ATSDR MINIMAL RISK LEVELS AND WORKSHEETS A-1

B. USER’S GUIDE..... B-1

C. ACRONYMS, ABBREVIATIONS, AND SYMBOLS..... C-1

D. INDEX D-1

LIST OF FIGURES

3-1.	Levels of Significant Exposure to Carbon Tetrachloride - Inhalation	41
3-2.	Levels of Significant Exposure to Carbon Tetrachloride – Oral.....	72
3-3.	Pathways of Carbon Tetrachloride Metabolism.....	108
3-4.	Conceptual Representation of a Physiologically Based Pharmacokinetic (PBPK) Model for a Hypothetical Chemical Substance	117
3-5.	Physiologically Based Pharmacokinetic Model for Inhaled Carbon Tetrachloride	118
3-6.	Existing Information on Health Effects of Carbon Tetrachloride.....	159
6-1.	Frequency of NPL Sites with Carbon Tetrachloride Contamination	180

LIST OF TABLES

3-1.	Levels of Significant Exposure to Carbon Tetrachloride - Inhalation	29
3-2.	Levels of Significant Exposure to Carbon Tetrachloride - Oral	60
3-3.	Summary of Carcinogenic Unit Risk Calculations for Oral Exposure to Carbon Tetrachloride ...	88
3-4.	Levels of Significant Exposure to Carbon Tetrachloride - Dermal	89
3-5.	Genotoxicity of Carbon Tetrachloride <i>In Vivo</i>	94
3-6.	Genotoxicity of Carbon Tetrachloride <i>In Vitro</i>	96
3-7.	Parameters in PBPK Models for Carbon tetrachloride	119
3-8.	Ongoing Studies on the Health Effects of Carbon Tetrachloride	168
4-1.	Chemical Identity of Carbon Tetrachloride	172
4-2.	Physical and Chemical Properties of Carbon Tetrachloride	173
5-1.	Facilities that Produce, Process, or Use Carbon Tetrachloride.....	177
6-1.	Releases to the Environment from Facilities that Produce, Process, or Use Carbon Tetrachloride.....	182
7-1.	Analytical Methods for Determining Carbon Tetrachloride in Biological Materials	201
7-2.	Analytical Methods for Determining Carbon Tetrachloride in Environmental Samples.....	203
8-1.	Regulations and Guidelines Applicable to Carbon Tetrachloride.....	208

1. PUBLIC HEALTH STATEMENT

This public health statement tells you about carbon tetrachloride and the effects of exposure to it.

The Environmental Protection Agency (EPA) identifies the most serious hazardous waste sites in the nation. These sites are then placed on the National Priorities List (NPL) and are targeted for long-term federal clean-up activities. Carbon tetrachloride has been found in at least 430 of the 1,662 current or former NPL sites. Although the total number of NPL sites evaluated for this substance is not known, the possibility exists that the number of sites at which carbon tetrachloride is found may increase in the future as more sites are evaluated. This information is important because these sites may be sources of exposure and exposure to this substance may harm you.

When a substance is released either from a large area, such as an industrial plant, or from a container, such as a drum or bottle, it enters the environment. Such a release does not always lead to exposure. You can be exposed to a substance only when you come in contact with it. You may be exposed by breathing, eating, or drinking the substance, or by skin contact.

If you are exposed to carbon tetrachloride, many factors will determine whether you will be harmed. These factors include the dose (how much), the duration (how long), and how you come in contact with it. You must also consider any other chemicals you are exposed to and your age, sex, diet, family traits, lifestyle, and state of health.

1.1 WHAT IS CARBON TETRACHLORIDE?

Carbon tetrachloride is a clear liquid that evaporates very easily. Most carbon tetrachloride that escapes to the environment is therefore found as a gas. Carbon tetrachloride does not easily burn. Carbon tetrachloride has a sweet odor, and most people can begin to smell it in air when the concentration reaches 10 parts carbon tetrachloride per million parts of air (ppm). It is not

1. PUBLIC HEALTH STATEMENT

known whether people can taste it or, if they can, at what level. Carbon tetrachloride is a manufactured chemical and does not occur naturally in the environment,

Carbon tetrachloride has been produced in large quantities to make refrigeration fluid and propellants for aerosol cans. Since many refrigerants and aerosol propellants have been found to affect the earth's ozone layer, the production of these chemicals is being phased out. Consequently, the manufacture and use of carbon tetrachloride has declined a great deal.

In the past, carbon tetrachloride was widely used as a cleaning fluid (in industry and dry cleaning establishments as a degreasing agent, and in households as a spot remover for clothing, furniture, and carpeting). Carbon tetrachloride was also used in fire extinguishers and as a fumigant to kill insects in grain. Most of these uses were discontinued in the mid-1960s. Until recently, carbon tetrachloride was used as a pesticide, but this was stopped in 1986.

Further information on the properties and uses of carbon tetrachloride can be found in Chapters 4, 5, and 6.

1.2 WHAT HAPPENS TO CARBON TETRACHLORIDE WHEN IT ENTERS THE ENVIRONMENT?

Because carbon tetrachloride evaporates easily, most of the compound released to the environment during its production and use reaches the air, where it is found mainly as a gas. It can remain in air for several years before it is broken down to other chemicals. Small amounts of carbon tetrachloride are found in surface water. Because it evaporates easily, much of it will move from surface water to the air within a few days or weeks. However, it may be trapped in groundwater for longer periods. Carbon tetrachloride is not expected to stick to soil particles. If spilled onto the ground, much of it will evaporate to the air. Some of it may also go into groundwater, where it can remain for months before it is broken down to other chemicals. It is not expected to build up in fish. We do not know if it builds up in plants.

1. PUBLIC HEALTH STATEMENT

Further information on what happens to carbon tetrachloride in the environment may be found in Chapters 5 and 6.

1.3 HOW MIGHT I BE EXPOSED TO CARBON TETRACHLORIDE?

Very low background levels of carbon tetrachloride are found in air, water, and soil because of past and present releases. Concentrations in air of 0.1 part carbon tetrachloride per billion parts of air (ppb) are common around the world, with somewhat higher levels often found (0.2–0.6 ppb) in cities. Carbon tetrachloride is also found in some drinking water supplies, usually at concentrations less than 0.5 ppb. Exposure to levels of carbon tetrachloride higher than these typical "background" levels is likely to occur only at specific industrial locations where carbon tetrachloride is still used or near chemical waste sites where emissions into air, water, or soil are not properly controlled. Exposure at such sites could occur by breathing carbon tetrachloride present in the air, by drinking water contaminated with carbon tetrachloride, or by getting soil contaminated with carbon tetrachloride on the skin. Young children may also be exposed if they eat soil that contains carbon tetrachloride. Carbon tetrachloride has been found in water or soil at about 26% of the waste sites investigated under Superfund, at concentrations ranging from less than 50 to over 1,000 ppb.

People who work with carbon tetrachloride are likely to receive the greatest exposure to the compound. The National Institute for Occupational Safety and Health (NIOSH) estimates that 58,208 workers are potentially exposed to carbon tetrachloride in the United States. The average daily intake of carbon tetrachloride for the general population is estimated to be 0.1 microgram (μg per kg of body weight). The estimated average daily amount that the general population may drink in water is 0.01 μg per kg of body weight.

Further information on the ways that humans can be exposed to carbon tetrachloride is presented in Chapter 6.

1. PUBLIC HEALTH STATEMENT

1.4 HOW CAN CARBON TETRACHLORIDE ENTER AND LEAVE MY BODY?

Carbon tetrachloride can enter your body through your lungs if you breathe air containing carbon tetrachloride, or through your stomach and intestines if you swallow food or water containing carbon tetrachloride. Carbon tetrachloride can also pass through the skin into the body. When you inhale carbon tetrachloride, over 30–40% of what you inhale enters your body, where most of it temporarily accumulates in body fat. Some can enter the kidney, liver, brain, lungs, and skeletal muscle. When you drink water contaminated with carbon tetrachloride, about 85–91% of it can enter your body. Much of the compound that enters your body when you breathe it or drink water contaminated with it leaves your body quickly, and a lot of it can be found in your breath within a few hours. Animal studies have shown that under differing conditions, 34–75% of carbon tetrachloride leaves the body in expired air, 20–62% leaves the body in feces, and only low amounts leave the body in the urine. Animal studies also suggest that it may take weeks for the remainder of the compound in the body to be eliminated, especially that which has entered the body fat. Most of the carbon tetrachloride is eliminated from your body unchanged, but some of it may be changed to other chemicals before removal from the body (for example, chloroform, hexachloroethane, and carbon dioxide). Chloroform and hexachloroethane may themselves cause harmful effects.

Further information on how carbon tetrachloride enters and leaves the body is presented in Chapter 3.

1.5 HOW CAN CARBON TETRACHLORIDE AFFECT MY HEALTH?

Scientists use many tests to protect the public from harmful effects of toxic chemicals and to find ways for treating persons who have been harmed.

One way to learn whether a chemical will harm people is to determine how the body absorbs, uses, and releases the chemical. For some chemicals, animal testing may be necessary. Animal testing may also help identify health effects such as cancer or birth defects. Without laboratory animals, scientists would lose a basic method for getting information needed to make wise

1. PUBLIC HEALTH STATEMENT

decisions that protect public health. Scientists have the responsibility to treat research animals with care and compassion. Scientists must comply with strict animal care guidelines because laws today protect the welfare of research animals.

Most information on the health effects of carbon tetrachloride in humans comes from cases where people have been exposed to relatively high levels of carbon tetrachloride, either only once or for a short period, for example, by accidental poisoning or by working with the chemical in a confined space without ventilation. Experiments have not been performed on the effects of long-term exposure of humans to low levels of carbon tetrachloride, so the human health effects of such exposures are not known.

The liver is especially sensitive to carbon tetrachloride since it contains a large amount of the enzymes that change the form of the chemical. Some of the breakdown products may attack cell proteins, interfering with the functions of the liver cells. Products that attack cell membranes may result in the death of the cells. In mild cases, the liver becomes swollen and tender, and fat builds up inside the organ. In severe cases, liver cells may be damaged or destroyed, leading to a decrease in liver function. Such effects are usually reversible if exposure is not too high or too long.

The kidney is also sensitive to carbon tetrachloride. Less urine may be formed, leading to a buildup of water in the body (especially in the lungs) and buildup of waste products in the blood. Kidney failure often was the main cause of death in people who died after very high exposure to carbon tetrachloride. Long-term breathing exposure to carbon tetrachloride worsened age-related kidney disease in rats.

Fortunately, if injuries to the liver and kidney are not too severe, these effects eventually disappear after exposure stops. This is because both organs can repair damaged cells and replace dead cells. Function usually returns to normal within a few days or a few weeks after the exposure has stopped.

1. PUBLIC HEALTH STATEMENT

After exposure to high levels of carbon tetrachloride, the nervous system, including the brain, is affected. Such exposure can be fatal. The immediate effects are usually signs of intoxication, including headache, dizziness, and sleepiness perhaps accompanied by nausea and vomiting. These effects usually disappear within 1–2 days after exposure stops. In severe cases, stupor or even coma can result, and permanent damage to nerve cells can occur.

Carbon tetrachloride also causes effects on other tissues of the body, but these are not usually as common or important as the effects on the liver, kidney, and brain.

There have been no studies of the effects of carbon tetrachloride on reproduction in humans, but studies in rats showed that long-term inhalation may cause decreased fertility.

Studies in animals have shown that swallowing or breathing carbon tetrachloride over a period of years increases the frequency of liver tumors. Mice breathing carbon tetrachloride also developed tumors of the adrenal gland. Studies have not been performed to determine whether swallowing or breathing carbon tetrachloride causes tumors in humans, but it should be assumed that carbon tetrachloride could produce cancer. The Department of Health and Human Services (DHHS) has determined that carbon tetrachloride may reasonably be anticipated to be a carcinogen (i.e., cause cancer). The International Agency for Research on Cancer (IARC) has classified carbon tetrachloride in Group 2B, possibly carcinogenic to humans. EPA has determined that carbon tetrachloride is a probable human carcinogen.

Many reported cases of carbon tetrachloride toxicity are associated with drinking alcohol. The frequent drinking of alcoholic beverages increases the danger of organ damage from carbon tetrachloride exposure. This enhanced effect has been shown in situations in which a group of workers were exposed to carbon tetrachloride in air, but only those who were heavy consumers of alcohol became ill.

Further information on the health effects of carbon tetrachloride may be found in Chapter 3.

1. PUBLIC HEALTH STATEMENT

1.6 HOW CAN CARBON TETRACHLORIDE AFFECT CHILDREN?

This section discusses potential health effects in humans from exposures during the period from conception to maturity at 18 years of age.

Children and adults may be exposed to low levels of carbon tetrachloride in drinking water. Small children who live near factories that produce or use carbon tetrachloride could accidentally eat some of the chemical by putting dirty hands in their mouths, but the amount of carbon tetrachloride in the soil is thought to be too low to be harmful. Carbon tetrachloride is no longer used in consumer products, but children could breathe in vapors if households are still using old supplies.

It is not known if the way in which carbon tetrachloride is absorbed into and eliminated from the body is different in children than it is in adults, but the processes are likely to be similar. Compared to adults, young children have lower amounts of the enzyme that converts carbon tetrachloride to a harmful chemical. The health effects of carbon tetrachloride have not been studied in children, but they are likely to be similar to those seen in adults exposed to the chemical.

There is no direct evidence that maternal exposure to carbon tetrachloride has a harmful effect on the fetus in humans. A few human survey-type studies suggest that maternal drinking water exposure to carbon tetrachloride might possibly be related to certain birth defects, such as low birthweight and small size at birth. Information from animal studies indicates that carbon tetrachloride may cause early fetal deaths, but does not cause birth defects in babies surviving to term. However, these animal studies did not test for neurological damage in exposed newborn babies.

One study calculated that carbon tetrachloride is likely to pass from the maternal circulation into breast milk. Thus, it is possible that children could be exposed to carbon tetrachloride from breast feeding, but the levels of exposure are likely to be low.

1. PUBLIC HEALTH STATEMENT

Further information on the health effects of carbon tetrachloride in children may be found in Chapter 3.

1.7 HOW CAN FAMILIES REDUCE THE RISK OF EXPOSURE TO CARBON TETRACHLORIDE?

If your doctor finds that you have been exposed to substantial amounts of carbon tetrachloride, ask whether your children might also have been exposed. Your doctor might need to ask your state health department to investigate.

Although most consumer uses of carbon tetrachloride have been banned, children may be exposed to carbon tetrachloride in old consumer household cleaning products. Removing these old containers will reduce your family's risk of exposure to carbon tetrachloride. Household chemicals should be stored out of the reach of children to prevent accidental poisonings and skin burns. Always store household chemicals in their original containers. Never store household chemicals in containers that children would find attractive to eat and drink from, such as old soda bottles. Keep your poison control center's number next to your phone.

Sometimes older children sniff household chemicals in an attempt to get high. Your children may be exposed to carbon tetrachloride by intentionally inhaling products containing it. Talk with your children about the dangers of sniffing chemicals.

Further information on reducing the risk of exposure to carbon tetrachloride can be found in Chapter 3.

1.8 IS THERE A MEDICAL TEST TO DETERMINE WHETHER I HAVE BEEN EXPOSED TO CARBON TETRACHLORIDE?

Several very sensitive and specific tests can detect carbon tetrachloride in exposed persons. The most convenient way is simply to measure carbon tetrachloride in exhaled air, but carbon tetrachloride can also be measured in blood, fat, or other tissues. Because special equipment is

1. PUBLIC HEALTH STATEMENT

needed, these tests are not routinely performed in doctors' offices, but your doctor can refer you to where you can obtain such a test. Although these tests can show that a person has been exposed to carbon tetrachloride, the test results cannot be used to reliably predict whether any bad health effects might result. Because carbon tetrachloride leaves the body fairly quickly, these methods are best suited to detecting exposures that have occurred within the last several days.

Further information on how carbon tetrachloride can be measured in exposed humans is given in Chapter 7.

1.9 WHAT RECOMMENDATIONS HAS THE FEDERAL GOVERNMENT MADE TO PROTECT HUMAN HEALTH?

The federal government develops regulations and recommendations to protect public health. Regulations *can* be enforced by law. The EPA, the Occupational Safety and Health Administration (OSHA), and the Food and Drug Administration (FDA) are some federal agencies that develop regulations for toxic substances. Recommendations provide valuable guidelines to protect public health, but *cannot* be enforced by law. The Agency for Toxic Substances and Disease Registry (ATSDR) and the National Institute for Occupational Safety and Health (NIOSH) are two federal organizations that develop recommendations for toxic substances.

Regulations and recommendations can be expressed as “not-to-exceed” levels, that is, levels of a toxic substance in air, water, soil, or food that do not exceed a critical value that is usually based on levels that affect animals; they are then adjusted to levels that will help protect humans. Sometimes these not-to-exceed levels differ among federal organizations because they used different exposure times (an 8-hour workday or a 24-hour day), different animal studies, or other factors.

Recommendations and regulations are also updated periodically as more information becomes available. For the most current information, check with the federal agency or organization that

1. PUBLIC HEALTH STATEMENT

provides it. Some regulations and recommendations for carbon tetrachloride include the following:

To protect the general public from exposure to carbon tetrachloride, the federal government has limited or banned the use of this compound in most common household products and fire extinguishers, and has discontinued its use as a pesticide. To protect workers who use carbon tetrachloride while on the job, the OSHA has set a maximum concentration limit in workplace air of 10 ppm for an 8-hour workday over a 40-hour work week. EPA has also set limits on how much carbon tetrachloride can be released from an industrial plant into waste water and is preparing to set limits on how much carbon tetrachloride can escape from an industrial plant into outside air. To ensure that drinking water supplies are safe, EPA has set a Maximum Contaminant Level (MCL) for carbon tetrachloride of 5 parts per billion (ppb), based on analytical detection limits in drinking water. Because carbon tetrachloride is possibly carcinogenic to humans, a Maximum Contaminant Level Goal (MCLG) of zero has been proposed. More detailed information on federal and state regulations regarding carbon tetrachloride may be found in Chapter 8.

1.10 WHERE CAN I GET MORE INFORMATION?

If you have any more questions or concerns, please contact your community or state health or environmental quality department, or contact ATSDR at the address and phone number below.

ATSDR can also tell you the location of occupational and environmental health clinics. These clinics specialize in recognizing, evaluating, and treating illnesses that result from exposure to hazardous substances.

Toxicological profiles are also available on-line at www.atsdr.cdc.gov and on CD-ROM. You may request a copy of the ATSDR ToxProfiles™ CD-ROM by calling the toll-free information

1. PUBLIC HEALTH STATEMENT

and technical assistance number at 1-888-42ATSDR (1-888-422-8737), by e-mail at atsdric@cdc.gov, or by writing to:

Agency for Toxic Substances and Disease Registry
Division of Toxicology
1600 Clifton Road NE
Mailstop F-32
Atlanta, GA 30333
Fax: 1-770-488-4178

Organizations for-profit may request copies of final Toxicological Profiles from the following:

National Technical Information Service (NTIS)
5285 Port Royal Road
Springfield, VA 22161
Phone: 1-800-553-6847 or 1-703-605-6000
Web site: <http://www.ntis.gov/>

2. RELEVANCE TO PUBLIC HEALTH

2.1 BACKGROUND AND ENVIRONMENTAL EXPOSURES TO CARBON TETRACHLORIDE IN THE UNITED STATES

Carbon tetrachloride is a solvent that has been used in the past as a cleaning fluid or degreasing agent, as a grain fumigant, and industrially in the synthesis of refrigeration fluid and propellants for aerosol cans. Although most of these uses have been discontinued, the possibility still exists for carbon tetrachloride to be released to the environment, primarily through industrial processes or old bottles of cleaning agents containing carbon tetrachloride that may still be in the home. Degradation of carbon tetrachloride occurs slowly in the environment, which contributes to the accumulation of the chemical in the atmosphere as well as the groundwater. Carbon tetrachloride is widely dispersed and persistent in the environment, but is not detected frequently in foods.

The general population is not likely to be exposed to large amounts of carbon tetrachloride. Populations living within or very near waste sites, or areas of heavy carbon tetrachloride use would have an increased risk of exposure from contaminated media (air, water, or soil). Those likely to receive the highest levels of exposure are those who are involved in the production, formulation, handling, and application of carbon tetrachloride. Inhalation appears to be the major route of exposure for workers and also for the general population, which may be exposed to carbon tetrachloride in ambient air and from volatilization of contaminated water during showering or bathing. Ingestion via contaminated drinking water is an important route of exposure for the general population not living in areas where carbon tetrachloride is extensively used. Dermal contact from showering or bathing has not been shown to be a significant route of exposure to carbon tetrachloride.

Most carbon tetrachloride released to the environment is expected to volatilize rapidly due to its high vapor pressure. Outdoor measurements in several areas of the United States have reported average concentrations of carbon tetrachloride in air between 0.6 and 1.0 $\mu\text{g}/\text{m}^3$ (0.1–0.16 ppb). Typical indoor concentrations in homes in several U.S. cities were about 1.0 $\mu\text{g}/\text{m}^3$ (0.16 ppb), with some values up to 9 $\mu\text{g}/\text{m}^3$ (1.4 ppb). Indoor concentrations in indoor air were thought to be higher than in outdoor air because of the presence of carbon tetrachloride in building materials or household products. The majority of domestic water supplies contain carbon tetrachloride at concentrations below 0.5 $\mu\text{g}/\text{L}$. Children are expected to be exposed to carbon tetrachloride by the same routes that affect adults. Since carbon

2. RELEVANCE TO PUBLIC HEALTH

tetrachloride has a low affinity for adsorption onto soil and dust particles, the risk of exposure for small children from ingesting soil or dust is likely to be low. The average daily intake of carbon tetrachloride for the general population is estimated as 0.1 µg/kg/day from inhalation exposure and 0.01 µg/kg/day from ingesting drinking water containing typical low concentrations of the chemical.

See Chapter 6 for more detailed information regarding concentrations of carbon tetrachloride in environmental media.

2.2 SUMMARY OF HEALTH EFFECTS

As a volatile halogenated alkane, carbon tetrachloride has depressant effects on the central nervous system that are most significant at high exposure levels. Carbon tetrachloride also produces irritant effects on the gastrointestinal tract. Most other toxic effects of absorbed carbon tetrachloride are related to its metabolism by mixed function cytochrome P-450 oxygenases (in humans, primarily CYP2E1, but also CYP3A). The liver is the most sensitive target in exposed humans and animals, independent of the route of administration, because of the abundance of CYP2E1 and other cytochromes. The kidneys are also sensitive targets in humans and animals. There is no conclusive evidence from epidemiological studies of workers or the general population that carbon tetrachloride is carcinogenic in humans. Carbon tetrachloride has been shown to be carcinogenic in animals following chronic inhalation or oral exposure. Alcohol consumption is an important risk factor for the development of serious toxicological effects following exposure to carbon tetrachloride, since alcohol induces CYP2E1, leading to increased production of reactive metabolites. Several case reports demonstrated that when groups of individuals were accidentally exposed to carbon tetrachloride in the workplace, the individuals who were heavy consumers of alcohol developed the most serious adverse effects.

Studies in animals, combined with limited observations in humans, indicate that the principal adverse health effects associated with inhalation exposure to carbon tetrachloride are central nervous system depression, liver damage, and kidney damage. Case reports in humans and studies in animals indicate that the liver, kidney, and central nervous system are also the primary targets of toxicity following oral exposure to carbon tetrachloride; gastrointestinal irritation has been frequently noted following accidental ingestion of high doses in humans. Limited dermal data suggest that carbon tetrachloride absorbed through the skin can cause, in addition to skin irritation, gastrointestinal effects such as nausea and vomiting and neurological effects such as polyneuritis in humans, and liver damage in animals. Based on the no-observed-adverse-effect level (NOAEL) and lowest-observed-adverse-effect level (LOAEL)

2. RELEVANCE TO PUBLIC HEALTH

values identified in the animal studies, the liver appears to be the most sensitive target. Several types of liver effects have been observed in humans and laboratory animals. At lower adverse effect levels, hepatocytes accumulate lipids, resulting in cellular vacuolization and fatty degeneration. At higher exposure levels, hepatocellular necrosis (cell death), fibrosis, and cirrhosis are observed. Hepatic carcinogenicity has been observed in laboratory rodents following chronic-duration inhalation or oral exposure to carbon tetrachloride. In animal studies, kidney effects, such as tubular cell degeneration and fatty accumulation, are typically observed at higher oral doses than hepatic effects. However, in rats with chronic progressive nephropathy, hepatotoxicity and exacerbation of the severity of renal disease occurred at similar effect levels following chronic inhalation exposure. Human case reports indicate that high oral or inhalation exposures sufficient to cause renal failure (progressive uremia and electrolyte retention) may cause delayed secondary damage (edema) to the lungs. Central nervous system effects following inhalation or oral exposure include headache, weakness, lethargy, stupor, blurred vision, and coma; neurological effects are generally observed at exposure levels higher than the thresholds for hepatic or renal toxicity. High-level inhalation or oral exposure is associated with mild hematological effects, primarily anemia in humans and animals, and reduced platelet function (clotting efficiency) in animals. Suppression of immune function (reductions in IgM antibody-forming cell activity, T-cell activity, lymphocyte counts, or host resistance to bacteria) has been observed in animals exposed short-term to oral doses higher than those causing liver effects.

No studies were located regarding reproductive effects in humans after exposure to carbon tetrachloride and the available human data for developmental effects are limited to epidemiological studies of pregnancy outcomes in women exposed to carbon tetrachloride and other halogenated hydrocarbons in drinking water. These data are inadequate for establishing a causal relationship between carbon tetrachloride exposure and developmental toxicity in humans. In animals exposed by inhalation for intermediate durations, reproductive effects included decreased fertility and testicular atrophy. In developmental studies in animals exposed by inhalation or ingestion, no fetal toxicity was observed in the absence of maternal toxicity and morphological defects were not observed in offspring. However, oral doses that produced clear maternal toxicity increased fetal mortality, in some cases, complete litter loss. It is not known whether litter loss is the result of toxicity to the fetus or to the placenta.

The following sections discuss significant effects resulting from exposure to carbon tetrachloride in greater detail: hepatic, renal, neurological, and cancer.

2. RELEVANCE TO PUBLIC HEALTH

Hepatic Effects. Hepatotoxicity is the major effect of exposure to carbon tetrachloride by any route in humans and animals and is the basis for all MRLs derived for that compound. Liver injury is detectable by clinical signs (jaundice, swollen and tender liver), biochemical alterations (elevated levels of hepatic enzymes in the blood, loss of enzymatic activities in the liver), or histological examination (fatty degeneration and necrosis of central hepatocytes, destruction of intracellular organelles, fibrosis, cirrhosis). Elevated levels of serum enzymes (alanine aminotransferase [ALT], aspartate aminotransferase [AST], alkaline phosphatase, and gamma glutamyl transferase) may provide evidence of hepatocellular injury in the absence of clinical signs, as was observed in workers occupationally exposed at intermediate-to-chronic durations at levels between 1.1 and 12 ppm. Degeneration or necrosis of the liver was noted in humans following acute inhalation exposure at 250 ppm or acute oral exposure at ≥ 110 mg/kg. In humans, acute lethal inhalation or oral exposures were associated with massive liver necrosis and steatosis. In rats, centrilobular vacuolization was observed at an acute oral dose of 20 mg/kg/day, whereas necrosis was observed at 80 mg/kg/day. Hepatic necrosis was also observed in guinea pigs following acute dermal exposure at 513 mg/cm². In chronic studies, significant increases in fatty change, fibrosis, and cirrhosis were observed in rats at 25 ppm; in the same study, the major non-neoplastic hepatic lesion in mice was necrosis. These species differences in hepatic effects may be related to the differential involvement of tumor necrosis factor alpha, which may facilitate necrosis, or transforming growth factor beta, which is an initiator of fibrosis.

It is widely agreed that the reason for the special sensitivity of the liver to carbon tetrachloride toxicity is the inherently high rate of metabolism of carbon tetrachloride by this tissue, presumed to be associated with the high abundance of CYP2E1, particularly concentrated in the centrilobular zone. This hypothesis was verified for mice in a study that administered 1,590 mg carbon tetrachloride/kg body weight by intraperitoneal injection to wild-type or CYP2E1 knockout mice (*cyp2e1*^{-/-}). In wild-type mice expressing CYP2E1, hepatotoxicity characterized by elevated serum enzyme levels (ALT and AST) and histopathology (centrilobular parenchymal degeneration and perivenular vacuolation) was observed 24 hours after treatment with carbon tetrachloride. None of these hepatic lesions were observed in CYP2E1 knockout mice treated with the same dose. In humans, CYP2E1 is also the primary enzyme responsible for metabolizing carbon tetrachloride at environmentally relevant concentrations, but others, particularly CYP3A, are also involved at higher concentrations. The reactive metabolites (trichloromethyl free radicals) generated by the oxidation of carbon tetrachloride are believed to trigger a spectrum of hepatocellular damage. Mechanisms that appear to be involved include direct binding of reactive metabolites to cellular proteins, peroxidation of unsaturated membrane lipids, and alterations in intracellular calcium levels. Release of proteolytic enzymes from dying cells has been shown to extend

2. RELEVANCE TO PUBLIC HEALTH

the necrosis of hepatic tissue beyond the initial site exposed to carbon tetrachloride. The outcome of any carbon tetrachloride-induced injury has been demonstrated to depend on several factors, including the induction of P-450 enzymes and the presence of antioxidants and interactions with other chemicals.

Renal Effects. Injury to the kidney is also observed in many reports of carbon tetrachloride toxicity in humans, often at the same exposure levels that cause hepatic injury. The principal clinical signs in severe cases are oliguria or anuria, with resultant azotemia and edema, leading in turn to hypertension and pulmonary edema. Cells of the proximal tubule are most clearly injured by carbon tetrachloride, probably because of high content of cytochrome P-450. Renal injury is observed in animal studies, but usually at higher doses with lesser severity than in humans. In oral exposure studies, the effect levels for kidney toxicity are generally higher than for hepatic toxicity. Some intermediate-duration inhalation bioassays in rats reported the adverse effect level for the kidney to be the same as or higher than that for the liver. In a 2-year inhalation study in F344 rats, exposure to carbon tetrachloride at hepatotoxic levels increased the severity of chronic progressive nephropathy compared to the control group.

There is some evidence that the susceptibility of the kidney to carbon tetrachloride may increase in elderly animals. Both the liver and the kidney exhibit age-related reductions in CYP-450, which would result in relatively lower production of reactive metabolites following exposure, but findings have been qualitatively different in the two organs. Reductions in CYP3A and CYP2E1 activity have been noted in the liver of elderly humans and rats. In the rat kidney, however, one isoform of CYP3A was upregulated by 50% in old (25–26-month) rats, resulting in a net 11% increase (not statistically significant) in total CYP3A in the kidney, possibly contributing to increased renal vulnerability to carbon tetrachloride. In addition to the possibility that the kidney in the elderly generates relatively more reactive metabolites following exposure, reductions in the organ content of antioxidants protecting against reactive metabolites may contribute to sensitivity. Both the liver and the kidney exhibit age-related reductions in glutathione. One study in F344 rats (the same strain used in the chronic inhalation assay) reported a significant decrease in glutathione peroxidase activity in the kidney, but not the liver of 24-month-old rats compared to 6-month-old rats, consistent with a greater sensitivity in the kidney. Although the findings outlined above are suggestive, no study has specifically demonstrated age-related changes in the renal metabolism of carbon tetrachloride.

Neurological Effects. The primary acute toxicological effect of unmetabolized carbon tetrachloride is depression of the central nervous system. Acute-duration inhalation or oral exposures in humans have resulted in neurological effects such as headache, dizziness, and weakness, and, at higher exposures,

2. RELEVANCE TO PUBLIC HEALTH

tremor, blurred vision, drowsiness, seizures, and loss of consciousness. Immediate fatalities occur from suppression of respiratory centers. Following ingestion of single doses, autopsy findings have included neurohistopathology in the cerebellum (demyelination and Purkinje cell damage with widespread hemorrhagic infarcts), but survivors appear not to have lasting cerebellar deficits. Suppression of autonomic respiratory centers is also observed in animals exposed by inhalation. Degeneration of the optic nerve has sometimes been noted in humans and repeated inhalation exposure studies in animals, sometimes at levels lower than those causing overt signs of central nervous system depression. It is likely that the observed neurohistopathology may be related to the generation of reactive metabolites in the neural tissues of exposed animals.

Cancer. There are a few reports of cancer in people who have been exposed to carbon tetrachloride, but these data alone are not sufficient to show that carbon tetrachloride causes cancer in humans. Suggestive data in humans comes from occupational case-control studies that found positive associations between exposure to carbon tetrachloride and mortality from several types of cancer (lymphosarcoma, lymphatic leukemia, non-Hodgkin's lymphoma, or multiple myeloma). There is convincing evidence that exposure to carbon tetrachloride leads to hepatic tumors in rodents exposed by inhalation or dosed orally. The lowest cancer effect levels were observed for mice: 25 ppm by inhalation and 20 mg/kg/day orally.

Two kinds of processes appear to contribute to the carcinogenicity of carbon tetrachloride. Genotoxicity, primarily covalent binding to DNA in the liver, results from the direct binding of reactive carbon tetrachloride metabolites or lipid peroxidation products in animals exposed orally or by intraperitoneal injection. High oral doses have resulted in DNA breakage, detectable by electrophoresis. It is likely that DNA breakage following acute exposures at high levels may be secondary to liver necrosis that is characterized by the release of nucleases and other enzymes from lysosomes of degenerating hepatocytes. There is some evidence that carbon tetrachloride may also cause cancer by a nongenotoxic mechanism involving cellular regeneration. Mild hepatic necrosis stimulates cell division processes; the resulting increase in cell proliferation could result in either the replication of unrepaired DNA damage or the induction of additional errors during the replication process, both of which can produce heritable mutations that may result in an initiated preneoplastic cell.

The U.S. Department of Health and Human Services has determined that carbon tetrachloride may reasonably be anticipated to be a carcinogen. IARC has classified carbon tetrachloride in Group 2B, possibly carcinogenic to humans. EPA has determined that carbon tetrachloride is a probable human

2. RELEVANCE TO PUBLIC HEALTH

carcinogen and derived an oral slope factor of 1.3×10^{-1} per (mg/kg/day). EPA is currently revising the carcinogenicity assessment for carbon tetrachloride.

2.3 MINIMAL RISK LEVELS

Estimates of exposure levels posing minimal risk to humans (MRLs) have been made for carbon tetrachloride. An MRL is defined as an estimate of daily human exposure to a substance that is likely to be without an appreciable risk of adverse effects (noncarcinogenic) over a specified duration of exposure. MRLs are derived when reliable and sufficient data exist to identify the target organ(s) of effect or the most sensitive health effect(s) for a specific duration within a given route of exposure. MRLs are based on noncancerous health effects only and do not consider carcinogenic effects. MRLs can be derived for acute, intermediate, and chronic duration exposures for inhalation and oral routes. Appropriate methodology does not exist to develop MRLs for dermal exposure.

Although methods have been established to derive these levels (Barnes and Dourson 1988; EPA 1990), uncertainties are associated with these techniques. Furthermore, ATSDR acknowledges additional uncertainties inherent in the application of the procedures to derive less than lifetime MRLs. As an example, acute inhalation MRLs may not be protective for health effects that are delayed in development or are acquired following repeated acute insults, such as hypersensitivity reactions, asthma, or chronic bronchitis. As these kinds of health effects data become available and methods to assess levels of significant human exposure improve, these MRLs will be revised.

The liver is the most sensitive target organ for carbon tetrachloride toxicity by the oral and inhalation routes. Adverse effects are also observed in the kidney, which is a significant target in humans acutely exposed at high levels and in animals following chronic inhalation exposure. However, all derived MRLs for carbon tetrachloride are based on nonneoplastic hepatic effects, which occurred at lower exposure levels than effects in other target tissues in studies that quantified exposure. All derived MRLs are based on rat studies since the observed nonneoplastic hepatic effects (fatty degeneration, necrosis, fibrosis, and cirrhosis) in this species are similar to the range of histopathology observed in exposed humans. Conversely, in exposed mice, the most significant nonneoplastic features of hepatic histopathology are fatty degeneration and necrosis, but not fibrosis or cirrhosis. Thus, studies in rats would appear to be preferred as a basis for human health risk assessment for carbon tetrachloride. The MRLs for carbon tetrachloride were based on the lowest available LOAELs or the associated NOAELs (if available) in well-designed studies.

2. RELEVANCE TO PUBLIC HEALTH

Inhalation MRLs

The database for acute-duration inhalation exposure to carbon tetrachloride includes a few studies in humans as well as studies in laboratory animals. No neurological effects were observed in six volunteers exposed to 50 ppm carbon tetrachloride for 1–3 hours, but these individuals exhibited a decrease in serum iron levels that was not observed at 10 ppm (Stewart et al. 1961); the significance of serum iron to hepatic toxicity is not clear. Single exposures of 200 ppm for ≤ 3 hours resulted in hepatic effects (increased serum bilirubin), renal effects (proteinuria), and gastrointestinal effects (nausea) (Barnes and Jones 1967; Norwood et al. 1950). Ethanol consumption increases the severity of carbon tetrachloride toxicity and confounds dose-response assessments from case reports. Whereas two workers experienced only mild neurological effects (headache and dizziness) after 4 hours exposure at 250 ppm, a co-worker who was a heavy consumer of alcohol died from renal insufficiency six days after a 15-minute exposure (Norwood et al. 1950); severe effects in the fatal case were noted in the liver (necrosis), kidney (oliguria, nephrosis), and lung (edema secondary to kidney failure). A NOAEL for hepatic effects was not observed in acute-duration inhalation studies in animals. Effects in rats included slight fatty degeneration of the liver at 10 ppm, increasing in extent and severity at ≥ 25 ppm, cirrhosis at ≥ 200 ppm, and parenchymatous degeneration of renal tubules in female rats treated at 400 ppm following exposure 7 hours/day for 13 days in a 17-day period (Adams et al. 1952). Mild liver effects (altered glycogen distribution, hepatocytic steatosis, hydropic degeneration, and necrosis, and elevated serum alanine aminotransferase) were observed in rats exposed at 50 ppm for 6 hours/day for 4 days (David et al. 1981). Hepatic effects (fatty degeneration and elevated serum sorbitol dehydrogenase) were also reported in rats exposed to 100 ppm 8 hours/day, 5 days/week for 2 weeks (Paustenbach et al. 1986a). Exposure for 15 minutes at 180 ppm resulted in increased alanine aminotransferase and relative liver weight in rats (Sakata et al. 1987). Effects in other organ systems following acute-duration inhalation exposure of rodents include hematological effects (increased coagulation time) at 325 ppm (Vazquez et al. 1990), developmental effects (decreased fetal body weight and crown-rump length) at 330 ppm (Schwetz et al. 1974), and neurological effects (coma, inhibition of response to electrical stimulus) at 180–1,370 ppm (Frantik et al. 1994; Sakata et al. 1987); dogs exposed to 15,000 ppm for 2–10 hours exhibited depression of the central nervous system (Von Oettingen et al. 1949). No renal effects were observed in rats exposed once or repeatedly to 100 ppm (Adams et al. 1952; Paustenbach et al. 1986b). Hepatotoxicity appears to be the critical effect of acute-duration inhalation exposure because it occurs at the lowest LOAELs in laboratory animals. The Adams et al. (1952) study identified the lowest LOAEL of 10 ppm and highest NOAEL of 5 ppm. In this study, male or female Wistar rats (2–30 of one sex/group) were exposed to carbon

2. RELEVANCE TO PUBLIC HEALTH

tetrachloride vapor at concentrations of 0, 5, 10, 25, 50, 100, 200, or 400 ppm, 7 hours/day, 5 days/week for 173–205 days of exposures.

No MRL was established for acute-duration inhalation exposure to carbon tetrachloride because a derivation based on the most suitable data (the minimal LOAEL of 10 ppm in rats reported by Adams et al. 1952) would result in an acute-duration MRL lower than the intermediate-duration MRL. The intermediate-duration inhalation MRL of 0.03 ppm, based on a NOAEL of 5 ppm and a LOAEL of 10 ppm for liver effects (Adams et al. 1952), is expected to be protective for acute-duration inhalation exposure.

- An MRL of 0.03 ppm has been derived for intermediate-duration inhalation exposure to carbon tetrachloride.

Limited human data are available for intermediate-duration inhalation exposure to carbon tetrachloride. Effects in humans exposed intermittently included gastrointestinal effects (nausea, dyspepsia) at 20–50 ppm, depression at 40 ppm, and narcosis at 80 ppm (Elkins 1942; Heiman and Ford 1941; Kazantzis and Bomford 1960). An occupational study of hepatic effects in workers exposed for <1–>5 years indicated that serum levels of hepatic enzymes were significantly elevated only at exposures >1 ppm, but the actual durations of exposure were not reported (Tomenson et al. 1995). Interpretation of this study is also limited by the finding that the group estimated to have had the highest exposure did not show the highest levels of serum enzymes. The liver appears to be the most sensitive target in animals exposed for intermediate durations. Fatty degeneration, sometimes with increased liver weight, was observed at a LOAEL of 10 ppm in rats, mice, and guinea pigs treated 6–8 hours/day, 5 days/week for 12–36 weeks or continuously for 90 days (Adams et al. 1952; DOE 1999; Japan Bioassay Research Center 1998; Prendergast et al. 1967), and 50–100 ppm in monkeys (Adams et al. 1952; Smyth et al. 1936). Increased serum enzymes and necrosis were observed in mice at 20 ppm and hamsters at 100 ppm (DOE 1999). Exposure to higher concentrations resulted in cirrhosis in guinea pigs (25 ppm) and rats (50–270 ppm) (Adams et al. 1952; Japan Bioassay Research Center 1998; Prendergast et al. 1967; Smyth et al. 1936). In studies examining other organs, renal effects (tubular degeneration) were noted at 50–200 ppm in rats (Adams et al. 1952; Smyth et al. 1936), at 90 ppm in rats and mice (Japan Bioassay Research Center 1998), and at 200 ppm in monkeys (Smyth et al. 1936). A neurological effect (injury to sciatic and optical nerves) was noted in rats at 50 ppm (Smyth et al. 1936). Hematological effects (decreased erythrocytes, hemoglobin, hematocrit; hemolysis, increased spleen weight) were observed in rats and mice exposed to 90–270 ppm (Japan Bioassay Research Center 1998; Smyth et al. 1936). Reproductive toxicity (decreased litters, testicular atrophy) was noted at 200 ppm (Adams et al. 1952; Smyth et al.

2. RELEVANCE TO PUBLIC HEALTH

1936). Hepatotoxicity is identified as the critical effect of intermediate-duration inhalation exposure to carbon tetrachloride since it was noted at the lowest LOAELs.

The intermediate-duration inhalation MRL for carbon tetrachloride is based on a NOAEL of 5 ppm and a LOAEL of 10 ppm for liver effects in rats identified in a study by Adams et al. 1952. In this study, Wistar rats (15/sex/group) were exposed to carbon tetrachloride vapor at concentrations of 0, 5, 10, 25, 50, 100, 200, or 400 ppm, 7 hours/day, 5 days/week for periods between 173 and 205 days. Fatty degeneration and increased liver weights were evident at concentrations of ≥ 10 ppm, cirrhosis occurred at ≥ 50 ppm, and necrosis at ≥ 200 ppm. Renal effects (cloudy swelling of the tubular epithelium) were first evident at ≥ 50 ppm, with increased kidney weights and degeneration of renal tubular epithelium evident at ≥ 200 ppm. Testicular atrophy was observed at ≥ 200 ppm. A human equivalent concentration of the identified rat NOAEL of 5 ppm ($\text{NOAEL}_{\text{HEC}}$) was calculated by multiplying the duration-adjusted rat NOAEL ($\text{NOAEL}_{\text{ADJ}}$) by the ratio of the rat and human blood:gas partition coefficients. The $\text{NOAEL}_{\text{ADJ}}$ is 0.9 ppm ($5 \text{ ppm} \times 7 \text{ hours}/24 \text{ hours} \times 5 \text{ days}/7 \text{ days}$) and the blood:gas partition coefficient ratio is 1.7 ($4.52/2.64$). Because the ratio was greater than 1, a default value of 1 was applied, resulting in a $\text{NOAEL}_{\text{HEC}}$ of 0.9 ppm. An uncertainty factor of 30 was applied to the $\text{NOAEL}_{\text{HEC}}$ of 0.9 ppm (3 for extrapolation from animals to humans using a dosimetric adjustment and 10 for human variability).

- An MRL of 0.03 ppm has been derived for chronic-duration inhalation exposure to carbon tetrachloride.

The chronic-duration inhalation database for carbon tetrachloride includes the occupational study by Tomenson et al. (1995) and 2-year bioassays in rats and mice (Japan Bioassay Research Center 1998; Nagano et al. 1998). As discussed under the intermediate-duration MRL, elevated hepatic serum enzymes were observed in workers who had been exposed to concentrations >1 ppm for <1 –5 years, but the actual durations of exposure were not reported (Tomenson et al. 1995). Interpretation of this study is also limited by the finding that the group estimated to have had the highest exposure did not show the highest levels of serum enzymes.

In the 2-year bioassays, groups of F344/DuCrj rats and BDF₁ mice (50/sex) were treated at 0, 5, 25 or 125 ppm, 6 hours/day, 5 days/week for 104 weeks (Japan Bioassay Research Center 1998; Nagano et al. 1998). Male rats exhibited increased hemosiderin deposition in the spleen at 5 ppm and above, but this effect was the result of anemia that was observed at 13 weeks, but not 104 weeks. For most observed effects, the lowest concentration of 5 ppm was a NOAEL and 25 ppm was a LOAEL: hematological

2. RELEVANCE TO PUBLIC HEALTH

(decreased hemoglobin, hematocrit in female rats and increased extramedullary splenic hematopoiesis in mice), body weight (reduced body weight gain), renal (altered clinical chemistry values in both species, chronic progressive glomerulonephrosis in rats, protein casts in mice), and hepatic (increased liver weight and serum enzymes in both species; fibrosis, cirrhosis, severe fatty change and granulation in rats; thrombus, necrosis, and, degeneration in mice). Mice showed increased mortality from hepatic cancer at 25 ppm, rats at 125 ppm. The severity of proteinuria, but not renal histopathology, was elevated in male and female rats treated at ≥ 5 ppm compared to controls; this lesion was not used as the basis for MRL derivation because the severity in control rats was so high (>90% with scores of 3+ or 4+).

Hepatotoxicity is selected as the critical effect of chronic-duration inhalation exposure because the severity of effects at 25 ppm was greater compared to other end points. Furthermore, selection of hepatotoxicity as the critical effect of chronic exposure is consistent with the database for intermediate-duration inhalation exposure.

The chronic-duration inhalation bioassay in rats is selected as the principal study because it provided a NOAEL of 5 ppm and a LOAEL of 25 ppm for hepatic effects (increased serum enzyme levels, liver weight, and liver histopathology) without increased mortality (Japan Bioassay Research Center 1998; Nagano et al. 1998). The duration-adjusted rat NOAEL (NOAEL_{ADJ}) for hepatic effects was multiplied by the ratio of the rat and human blood:gas partition coefficients to derive a human equivalent concentration of the identified chronic rat NOAEL of 5 ppm. The NOAEL_{ADJ} is 0.9 ppm (5 ppm x 6 hours/24 hours x 5 days/7 days) and the blood:gas partition coefficient ratio is 1.7 (4.52/2.64). Using standard procedures, a default value of 1 was applied because the ratio was greater than 1, resulting in a chronic-duration NOAEL_{HEC} of 0.9 ppm. An uncertainty factor of 30 was applied to the NOAEL_{HEC} of 0.9 ppm (3 for extrapolation from animals to humans using dosimetric adjustment and 10 for human variability), resulting in a chronic-duration inhalation MRL of 0.03 ppm.

Oral MRLs

- An MRL of 0.02 mg/kg/day has been derived for acute-duration oral exposure to carbon tetrachloride.

Limited data in humans and several studies in laboratory animals are available for acute-duration oral exposure to carbon tetrachloride. In humans, hepatic toxicity (fatty accumulation, necrosis) has been noted following ingestion of single doses of carbon tetrachloride in the range of 80–180 mg/kg (Docherty and Burgess 1922; Docherty and Nicholls 1923; Phelps and Hu 1924). Single doses of 70 mg/kg had no overt neurological effect, but various neurological symptoms indicative of depression of the central

2. RELEVANCE TO PUBLIC HEALTH

nervous system have been reported at doses between 114 and 10,800 mg/kg (Cohen 1957; Hall 1921; Leach 1922; Stevens and Forster 1953; Stewart et al. 1963). Gastrointestinal effects in humans following ingestion of single doses include nausea at ≥ 100 mg/kg (Ruprah et al. 1985) and vomiting and abdominal pain at 680–910 mg/kg (Hardin 1954; New et al. 1962; Smetana 1939; Umiker and Pearce 1953; von Oettingen 1964). In laboratory animals, mild hepatic effects (cytoplasmic vacuolization and increased serum enzymes) have been reported to occur following treatment with single doses of 40–80 mg/kg or repeated dosing at 5–20 mg/kg/day (Bruckner et al. 1986; Kim et al. 1990b; Korsrud et al. 1972; Smialowicz et al. 1991). No renal effects or positive results in special tests for immunological function were observed in rats following repeated administration at 5–160 mg/kg/day (Bruckner et al. 1986; Smialowicz et al. 1991). Renal effects (fatty degeneration, swelling of convoluted tubules) were observed in dogs given single doses of 3,200–6,400 mg/kg (Chandler and Chopra 1926; Gardner et al. 1925). Hepatic toxicity is selected as the critical effect of acute-duration oral exposure to carbon tetrachloride because effects were observed at the lowest effect level.

The study of Smialowicz et al. (1991) is selected as the principal study because it provides the lowest LOAEL for hepatotoxicity, the critical effect. In this study, groups of 5–6 male Fischer rats were dosed by oral gavage with 0, 5, 10, 20, or 40 mg/kg/day for 10 consecutive days and evaluated for hepatic and renal toxicity (organ weight and serum parameters and histology) as well as some immunological end points. Another set of animals was exposed at 40, 80, or 160 mg/kg/day and evaluated for additional immunological parameters. Liver toxicity was the most sensitive effect observed in this study and was dose related in severity. Centrilobular vacuolar degeneration was barely detectable in all six animals of the 5 mg/kg/day group, whereas no liver effects were observed in any of the six controls. Hepatocellular necrosis was first evident at 10 mg/kg/day. At higher doses, serum levels of ALT and AST became significantly elevated ($p < 0.01$ – 0.05) (20 and 40 mg/kg/day), as did relative liver weight (40 mg/kg/day). No renal effects were observed at the highest dose of 40 mg/kg/day and no immunological effects were observed at doses as high as 160 mg/kg/day. The LOAEL of 5 mg/kg/day is considered to be minimal because the type and degree of hepatic histopathology was relatively mild. A total uncertainty factor of 300 was applied to the minimal LOAEL of 5 mg/kg/day (3 for the use of a minimal LOAEL, 10 for extrapolation between animals to humans, and 10 for human variability).

- An MRL of 0.007 mg/kg/day has been derived for intermediate-duration oral exposure to carbon tetrachloride.

The intermediate-duration oral toxicity database for carbon tetrachloride is somewhat limited in that no human data are available and many studies in laboratory animals restricted analysis to the liver. The

2. RELEVANCE TO PUBLIC HEALTH

incidence and severity of hepatic effects were dose-related in animal studies. A NOAEL of 1 mg/kg and a LOAEL of 10 mg/kg was identified for significantly elevated sorbitol dehydrogenase (SDH) and mild centrilobular vacuolization in rats exposed 5 days/week for 12 weeks (Bruckner et al. 1986); at 33 mg/kg, ALT and ornithine carbamyl transferase activities were increased and cirrhosis was observed. In mice ingesting carbon tetrachloride 5 days/week for 12–13 weeks, no hepatic effects were detected at a dose of 1.2 mg/kg (Condie et al. 1986). Significant elevation in some serum enzymes (ALT, aspartate aminotransferase [AST], lactate dehydrogenase [LDH]), and mild necrosis were seen in mice at doses of 12 mg/kg and higher (Condie et al. 1986; Hayes et al. 1986). More extensive hepatic lesions (fatty accumulation, fibrosis, cirrhosis, necrosis) were noted in rats at doses of 20–25 mg/kg and higher (Allis et al. 1990; Koporec et al. 1995). At 100 mg/kg/day, hepatic effects in rats also included cytomegaly and various types of hyperplasia, which were perhaps adaptive responses to necrosis (Koporec et al. 1995). Effects in other organ systems include reduced body weight gain at doses between 33 and 100 mg/kg/day (Bruckner et al. 1986; Koporec et al. 1995) and neurological effects (increased serotonin synthesis) at 290 mg/kg/day (Bengtsson et al. 1987). No renal effects were observed in rats exposed at 33 mg/kg/day (Bruckner et al. 1986) or mice exposed at 1,200 mg/kg/day (Hayes et al. 1986). Increased mortality was observed in rats exposed at 25 mg/kg/day (Koporec et al. 1995). Cancer (hepatoma) was observed in mice treated with 20 mg/kg/day for 120 days and hamsters treated once weekly with 120 mg/kg/day for 30 weeks (Eschenbrenner and Miller 1946; Della Porta et al. 1961). Hepatotoxicity was selected as the critical effect of intermediate-duration oral exposure to carbon tetrachloride because it occurred at the lowest effect level.

The rat study of Bruckner was selected as the principal study because it provided the lowest LOAEL for the critical effect. In this study, male Sprague-Dawley rats (15–16 per group) were administered 0, 1, 10, or 33 mg/kg carbon tetrachloride by gavage in corn oil 5 days/week for 12 weeks. Blood samples were taken at biweekly intervals throughout the study for analysis of serum parameters related to liver and kidney toxicity and both organs were examined for histopathology at termination. Slightly elevated blood levels of sorbitol dehydrogenase and mild centrilobular vacuolation of the liver were observed at 10 mg/kg, but not at 1 mg/kg. Cirrhosis, extensive degenerative hepatic lesions, and significantly elevated serum enzyme levels (ornithine carbamyl transferase and alanine aminotransferase) were observed at the high dose of 33 mg/kg. No renal effects were observed at any dose. The NOAEL of 1 mg/kg was adjusted for intermittent exposure (5 days/7 days) and divided by a total uncertainty factor of 100 (10 for extrapolation between animals to humans and 10 for human variability).

2. RELEVANCE TO PUBLIC HEALTH

No data were located on the effects of chronic-duration oral exposure in humans. Carbon tetrachloride was employed as a positive control for hepatic cancer in several chronic oral gavage bioassays in rats and mice exposed 5 days/week for 78 weeks (NCI 1976a, 1976b, 1977); serious effects were observed at the lowest tested doses. Exposure at ≥ 47 mg/kg reduced survival by 46% in rats because of severe hepatotoxicity. Portal cirrhosis, bile duct proliferation, and fatty accumulation were observed in more than 55% of treated rats. In the same study, survival in mice treated at doses of $\geq 1,250$ mg/kg was reduced by $\geq 80\%$ compared to controls on account of hepatic carcinogenicity. Since a no-effect level was not identified and ATSDR does not base MRLs on doses at which serious effects occur, a chronic-duration oral MRL was not derived for carbon tetrachloride.

3. HEALTH EFFECTS

3.1 INTRODUCTION

The primary purpose of this chapter is to provide public health officials, physicians, toxicologists, and other interested individuals and groups with an overall perspective on the toxicology of carbon tetrachloride. It contains descriptions and evaluations of toxicological studies and epidemiological investigations and provides conclusions, where possible, on the relevance of toxicity and toxicokinetic data to public health.

A glossary and list of acronyms, abbreviations, and symbols can be found at the end of this profile.

3.2 DISCUSSION OF HEALTH EFFECTS BY ROUTE OF EXPOSURE

To help public health professionals and others address the needs of persons living or working near hazardous waste sites, the information in this section is organized first by route of exposure (inhalation, oral, and dermal) and then by health effect (death, systemic, immunological, neurological, reproductive, developmental, genotoxic, and carcinogenic effects). These data are discussed in terms of three exposure periods: acute (14 days or less), intermediate (15–364 days), and chronic (365 days or more).

Levels of significant exposure for each route and duration are presented in tables and illustrated in figures. The points in the figures showing no-observed-adverse-effect levels (NOAELs) or lowest-observed-adverse-effect levels (LOAELs) reflect the actual doses (levels of exposure) used in the studies. LOAELs have been classified into "less serious" or "serious" effects. "Serious" effects are those that evoke failure in a biological system and can lead to morbidity or mortality (e.g., acute respiratory distress or death). "Less serious" effects are those that are not expected to cause significant dysfunction or death, or those whose significance to the organism is not entirely clear. ATSDR acknowledges that a considerable amount of judgment may be required in establishing whether an end point should be classified as a NOAEL, "less serious" LOAEL, or "serious" LOAEL, and that in some cases, there will be insufficient data to decide whether the effect is indicative of significant dysfunction. However, the Agency has established guidelines and policies that are used to classify these end points. ATSDR believes that there is sufficient merit in this approach to warrant an attempt at distinguishing between

3. HEALTH EFFECTS

"less serious" and "serious" effects. The distinction between "less serious" effects and "serious" effects is considered to be important because it helps the users of the profiles to identify levels of exposure at which major health effects start to appear. LOAELs or NOAELs should also help in determining whether or not the effects vary with dose and/or duration, and place into perspective the possible significance of these effects to human health.

The significance of the exposure levels shown in the Levels of Significant Exposure (LSE) tables and figures may differ depending on the user's perspective. Public health officials and others concerned with appropriate actions to take at hazardous waste sites may want information on levels of exposure associated with more subtle effects in humans or animals (LOAELs) or exposure levels below which no adverse effects (NOAELs) have been observed. Estimates of levels posing minimal risk to humans (Minimal Risk Levels or MRLs) may be of interest to health professionals and citizens alike.

Levels of exposure associated with carcinogenic effects (Cancer Effect Levels, CELs) of carbon tetrachloride are indicated in Tables 3-1 and 3-2 and Figures 3-1 and 3-2. Because cancer effects could occur at lower exposure levels, Figure 3-2 also shows a range for the upper bound of estimated excess risks, ranging from a risk of 1 in 10,000 to 1 in 10,000,000 (10^{-4} to 10^{-7}), as developed by EPA.

A User's Guide has been provided at the end of this profile (see Appendix B). This guide should aid in the interpretation of the tables and figures for Levels of Significant Exposure and the MRLs.

3.2.1 Inhalation Exposure

The highest NOAEL values and all LOAEL values from each reliable study for death, and respiratory, cardiovascular, gastrointestinal, hematological, hepatic, renal, dermal, body weight, neurological, reproductive, and developmental effects in each species and duration category are recorded in Table 3-1 and plotted in Figure 3-1.

3.2.1.1 Death

In the past, when industrial and household use of carbon tetrachloride was still common, inhalation exposure to carbon tetrachloride resulted in a considerable number of deaths in humans (e.g., Forbes

Table 3-1 Levels of Significant Exposure to Carbon Tetrachloride - Inhalation

Key to Figure	Species ^a (Strain)	Exposure/Duration/Frequency (Route)	System	NOAEL (ppm)	LOAEL		Reference Chemical Form
					Less Serious (ppm)	Serious (ppm)	
ACUTE EXPOSURE							
Death							
1	Human	15 min				250 M (1 alcoholic male died)	Norwood et al. 1950
2	Rat	8-10 hr				3000 (1/50)	Adams et al. 1952
3	Mouse	8 hr				9500 (LC50)	Svirbey et al. 1947
Systemic							
4	Human	Up to 3 hr	Hepatic		200 M (increased serum bilirubin)		Barnes and Jones 1967
			Renal		200 M (proteinuria)		
5	Human	15 min	Resp			250 M (edema)	Norwood et al. 1950
			Gastro		250 M (nausea)		
			Hepatic			250 M (severe central necrosis)	
			Renal			250 M (oliguria, nephrosis)	
6	Human	70-180 min	Cardio	50 M			Stewart et al. 1961
			Gastro	50 M			
			Hepatic	10 M	50 M (decreased serum iron)		
			Dermal	50 M			

Table 3-1 Levels of Significant Exposure to Carbon Tetrachloride - Inhalation

(continued)

Key to Figure ^a	Species (Strain)	Exposure/Duration/Frequency (Route)	System	NOAEL (ppm)	LOAEL		Reference Chemical Form
					Less Serious (ppm)	Serious (ppm)	
7	Rat	7 hr	Hepatic	50 M	100 M (fatty degeneration)		Adams et al. 1952
			Renal	100 M			
8	Rat	5-20 d 7 hr/d 5d/wk	Hepatic		10 M (fatty degeneration in 18 M treated 13 times over 17 d)		Adams et al. 1952
9	Rat	1d-15 wk 2d/wk 4hr/d	Hepatic			4800 M (necrosis, fibrosis, cirrhosis, mitogenic and anti-mitogenic activities)	Belyaev et al. 1992
10	Rat	4 d 6hr/d	Hepatic		50 M (steatosis, hydropic degeneration, necrosis, 2x increased alanine aminotransferase)		David et al 1981
11	Rat	2 wk 5d/wk 8hr/d or 11.5hr/d	Hepatic		100 (Fatty degeneration, increased serum sorbitol dehydrogenase)		Paustenbach et al. 1986b
			Renal	100			

Table 3-1 Levels of Significant Exposure to Carbon Tetrachloride - Inhalation

(continued)

Key to Figure ^a	Species (Strain)	Exposure/Duration/Frequency (Route)	System	NOAEL (ppm)	LOAEL		Reference Chemical Form
					Less Serious (ppm)	Serious (ppm)	
12	Rat	15 min	Hepatic		180	(increases 19x in alanine aminotransferase and 23% in relative liver weight)	Sakata et al. 1987
13	Rat	6-10 min/d 8 d	Hemato		325	(increased coagulation time)	Vazquez et al. 1990
Neurological							
14	Human	15 min			250	(dizziness)	Norwood et al. 1950
15	Human	70-180 min		50			Stewart et al. 1961
16	Rat (albino)	4 hr			611 M	(30% inhibition of response to electrical stimulus)	Frantik et al. 1994
17	Rat	15 min				180 (coma)	Sakata et al. 1987
18	Mouse (H)	2 hr			1370 F	(30% inhibition of response to electrical stimulus)	Frantik et al. 1994

Table 3-1 Levels of Significant Exposure to Carbon Tetrachloride - Inhalation

(continued)

Key to Figure ^a	Species (Strain)	Exposure/Duration/Frequency (Route)	System	NOAEL (ppm)	LOAEL		Reference Chemical Form	
					Less Serious (ppm)	Serious (ppm)		
19	Dog	2-10 hr				15000	(depression of central nervous system)	Von Oettingen et al. 1949
Developmental								
20	Rat	9 d Gd 6-15 7hr/d			330		(decreased fetal body weight and crown to rump length)	Schwetz et al. 1974
INTERMEDIATE EXPOSURE								
Death								
21	Monkey	6 wk 5d/wk 8hr/d				80	(1/3)	Prendergast et al. 1967
22	Rat	173-205 d 5d/wk 7hr/d				200	(9/15 male, 6/15 female)	Adams et al. 1952
23	Gn Pig	180-260d 5d/wk 7hr/d				100	(7/8 males, 4/8 females)	Adams et al. 1952
24	Gn Pig	6 wk 5d/wk 8hr/d				80	(3/15)	Prendergast et al. 1967
25	Gn Pig	90 d cont.				10	(3/15)	Prendergast et al. 1967
Systemic								
26	Human	8 hr/d intermit.	Gastro		20		(nausea)	Elkins 1942

Table 3-1 Levels of Significant Exposure to Carbon Tetrachloride - Inhalation

(continued)

Key to Figure ^a	Species (Strain)	Exposure/Duration/Frequency (Route)	System	NOAEL (ppm)	LOAEL		Reference Chemical Form
					Less Serious (ppm)	Serious (ppm)	
27	Human	2 mo 8hr/d 5d/wk	Gastro		50	(dyspepsia, nausea)	Kazantzis and Bomford 1960
28	Monkey	232-277d 5d/wk 7hr/d	Resp	100			Adams et al. 1952
			Cardio	100			
			Gastro	100			
			Hemato	100			
			Musc/skel	100			
			Hepatic	50	100	(slight fatty degeneration)	
			Renal	100			
29	Monkey	10.5 mo 8hr/d 5d/wk	Cardio	200			Smyth et al. 1936
			Hemato	200			
			Hepatic		50	(fatty degeneration)	
			Renal		200	(cloudy swelling of cells in convoluted tubules and loop of Henle)	
30	Rat (Fischer- 344)	12 wk 6 hr/d 5 d/wk	Hepatic	20 M	100 M	(increased serum ALT, SDH; hepatic necrosis)	DOE 1999

Table 3-1 Levels of Significant Exposure to Carbon Tetrachloride - Inhalation

(continued)

Key to Figure ^a	Species (Strain)	Exposure/Duration/Frequency (Route)	System	NOAEL (ppm)	LOAEL		Reference Chemical Form
					Less Serious (ppm)	Serious (ppm)	
31	Rat	173-205 d 5d/wk 7hr/d	Resp	200			Adams et al. 1952
			Cardio	200			
			Hemato	200			
			Hepatic	^b 5	10 (hepatic fatty degeneration and incr liver wt)	50 (cirrhosis)	
			Renal	100	200 (degeneration of tubular epithelium, elevated blood urea nitrogen, and increased organ weight)		
32	Rat (Fischer- 344)	13 wk 6 hr/d 5 d/wk	Hemato	30	90 (decreased hemoglobin and hematocrit; increased spleen wt in F)		Japan Bioassay Research Center 1998
			Hepatic		10 (granulation, fatty change; increased liver wt)	270 (fibrosis, cirrhosis; incr liver wt, serum enzyme incr)	
			Renal		10 M (increased kidney weight)	270 (protein casts in M and vacuolization of tubules in F)	
			Bd Wt	270 M	810 M (decreased bd wt)		

Table 3-1 Levels of Significant Exposure to Carbon Tetrachloride - Inhalation

(continued)

Key to Figure ^a	Species (Strain)	Exposure/Duration/Frequency (Route)	System	NOAEL (ppm)	LOAEL		Reference Chemical Form
					Less Serious (ppm)	Serious (ppm)	
33	Rat	6 wk 5d/wk 8hr/d	Resp	80			Prendergast et al. 1967
			Cardio	80			
			Hemato	80			
			Hepatic		80	(fatty infiltration, cirrhosis)	
			Renal	80			
34	Rat	90 d cont.	Resp	10			Prendergast et al. 1967
			Cardio	10			
			Hemato	10			
			Hepatic	1	10	(fatty degeneration)	
			Renal	10			
35	Rat	10.5 mo 8hr/d 5d/wk	Cardio	400			Smyth et al. 1936
			Hemato	50	100	(hemolysis)	
			Hepatic	50		100 (cirrhosis)	
			Renal		50	(swelling of cells in the convoluted tubules and loop of Henle)	

Table 3-1 Levels of Significant Exposure to Carbon Tetrachloride - Inhalation

(continued)

Key to Figure	Species (Strain)	Exposure/Duration/Frequency (Route)	System	NOAEL (ppm)	LOAEL		Reference Chemical Form
					Less Serious (ppm)	Serious (ppm)	
36	Mouse (B6C3F1)	12 wk 6 hr/d 5 d/wk	Hepatic	5 M	20 M (increased serum ALT, SDH; necrosis)		DOE 1999
37	Mouse	1d-15 wk 2d/wk 4hr/d	Hepatic			4800 (necrosis, fibrosis, cirrhosis, mitogenic and anti-mitogenic activities)	Belyaev et al. 1992
38	Mouse BDF1	13 wk 6 hr/d 5 d/wk	Hemato	90 F	270 F (decr erythrocyte and hemoglobin)		Japan Bioassay Research Center 1998
			Hepatic	10 F	10 M (cytological alterations)	30 (hepatic collapse; proliferative ducts in F)	
			Bd Wt	10 M	30 M		
39	Gn Pig	4-9 mo 5d/wk 7hr/d	Hepatic	5	10 (fatty degeneration)	25 (cirrhosis)	Adams et al. 1952
40	Gn Pig	90 d cont.	Resp	10			Prendergast et al. 1967
			Cardio	10			
			Hemato	10			
			Hepatic	1	10 (fatty degeneration)		
			Renal	10			

Table 3-1 Levels of Significant Exposure to Carbon Tetrachloride - Inhalation

(continued)

Key to Figure	Species (Strain)	Exposure/Duration/Frequency (Route)	System	NOAEL (ppm)	LOAEL		Reference Chemical Form
					Less Serious (ppm)	Serious (ppm)	
41	Hamster (Golden Syrian)	12 wk 6 hr/d 5 d/wk	Hepatic	20 M	100 M (increased serum ALT and SDH; necrosis)		DOE 1999
Neurological							
42	Human	>3 mo 8hr/d 5d/wk				80 (narcosis)	Heimann and Ford 1941
43	Human	2 mo 8hr/d 5d/wk			40 (depression)		Kazantzis and Bomford 1960
44	Monkey	232-277d 5d/wk 7hr/d		100			Adams et al. 1952
45	Rat	10.5 mo 8hr/d 5d/wk				50 (sciatic and optic nerve injury)	Smyth et al. 1936
Reproductive							
46	Rat	10.5 mo 8hr/d 5d/wk		100		200 (decreased litters)	Smyth et al. 1936
CHRONIC EXPOSURE							
Death							
47	Rat (Fischer- 344)	104 wk 6 hr/d 5 d/wk				125 (survival decreased by 86% in M and 97% in F)	Japan Bioassay Res. Ctr. 1998; Nagano et al. 1998

Table 3-1 Levels of Significant Exposure to Carbon Tetrachloride - Inhalation

(continued)

Key to Figure ^a	Species (Strain)	Exposure/Duration/Frequency (Route)	System	NOAEL (ppm)	LOAEL		Reference Chemical Form	
					Less Serious (ppm)	Serious (ppm)		
48	Mouse (BDF1)	104 wk 6 hr/d 5 d/wk				25	(survival decreased by 29% in M and 61% in F)	Japan Bioassay Res. Ctr. 1998; Nagano et al. 1998
Systemic								
49	Rat (Fischer- 344)	104 wk 6 hr/d 5 d/wk	Hemato	5 F	25 F (decreased hemoglobin, hematocrit)			Japan Bioassay Res. Ctr. 1998; Nagano et al. 1998
			Hepatic	^c 5		25	(increased liver wt, fibrosis, cirrhosis and deposition of ceroid; increased severity of fatty change and granulation)	
			Renal	5		25	(incr marked chronic nephropathy)	
			Bd Wt	5	25 (decreased bd wt gain)			

Table 3-1 Levels of Significant Exposure to Carbon Tetrachloride - Inhalation

(continued)

Key to Figure ^a	Species (Strain)	Exposure/ Duration/ Frequency (Route)	System	NOAEL (ppm)	LOAEL		Reference Chemical Form
					Less Serious (ppm)	Serious (ppm)	
50	Mouse (BDF1)	104 wk 6 hr/d 5 d/wk	Hemato	5	25	(increased extramedullary hematopoiesis in spleen)	Japan Bioassay Res. Ctr. 1998; Nagano et al. 1998
			Hepatic	5		25 F (thrombus, necrosis) 25 (increased liver wt, degeneration, cyst, deposit of ceroid, serum enzymes, cholesterol, bilirubin)	
			Renal	5 M	25	(decreased pH and ketone bodies; protein casts, M; increased occult blood and urobilinogen, F)	
			Bd Wt			25 (marked decreased bd wt gain)	

Table 3-1 Levels of Significant Exposure to Carbon Tetrachloride - Inhalation

(continued)

Key to Figure ^a	Species (Strain)	Exposure/Duration/Frequency (Route)	System	NOAEL (ppm)	LOAEL		Reference Chemical Form	
					Less Serious (ppm)	Serious (ppm)		
Cancer								
51	Rat (Fischer-344)	104 wk 6 hr/d 5 d/wk				125	(CEL: hepatocellular adenoma in 21/50 M and 40/50 F; hepatocellular carcinoma in 32/50 M and 15/50 F)	Japan Bioassay Res. Ctr. 1998; Nagano et al. 1998
52	Mouse (BDF1)	104 wk 6 hr/d 5 d/wk				25 M	(CEL: adrenal pheochromocytoma in 16/50 males)	Japan Bioassay Res. Ctr. 1998; Nagano et al. 1998
						125 F	(CEL: adrenal pheochromocytoma in 22/49 females)	
						25	(CEL: hepatocellular adenoma in 27/50 males and 17/50 females; hepatocellular carcinoma in 42/50 males and 33/50 females)	

a The number corresponds to entries in Figure 3-1.

b Used to derive an intermediate-duration inhalation MRL of 0.03 ppm; the NOAEL was adjusted for intermittent exposure (7 hours/24 hours x 5 days/7 days). The duration-adjusted NOAEL of 0.9 ppm would be multiplied by the ratio of the rat and human blood:air partition coefficients (4.52/2.64) under EPA (1994) guidelines. However, as the ratio was greater than one, a default value of one was applied, resulting in a NOAEL-HEC of 0.9 ppm. The NOAEL-HEC was divided by an uncertainty factor of 30 (3 for extrapolation between animals and humans using a dosimetric adjustment and 10 for human variability).

c Used to derive a chronic-duration inhalation MRL of 0.03 ppm; the NOAEL was adjusted for intermittent exposure (6 hours/24 hours x 5 days/7 days). The duration-adjusted NOAEL of 0.9 ppm would be multiplied by the ratio of the rat and human blood:air partition coefficients (4.52/2.64) under EPA (1994) guidelines. However, as the ratio was greater than one, a default value of one was applied, resulting in a NOAEL-HEC of 0.9 ppm. The NOAEL-HEC was divided by an uncertainty factor of 30 (3 for extrapolation between animals and humans using a dosimetric adjustment and 10 for human variability).

d Differences in levels of health effects and cancer effects between male and females are not indicated in Figure 3-1. Where such differences exist, only the levels of effect for the most sensitive gender are presented.

Cardio = cardiovascular; CEL = cancer effect level; cont. = continuous; d = day(s); Derm = dermal; F = female; Gastro = gastrointestinal; gd = gestation day; Gn pig = guinea pig; Hemato = hematological; hr = hour(s); incr = increased; intermit. = intermittent; LC50 = lethal concentration, 50% kill; LOAEL = Lowest-observed-adverse-effect level; M = male; min = minute(s); mo = month(s); musc/skel = musculoskeletal; NOAEL = no-observed-adverse-effect-level; ppm = parts per million; Resp = respiratory; wk = week(s).

Figure 3-1 Levels of Significant Exposure to Carbon Tetrachloride - Inhalation (Continued)
Chronic (≥365 days)

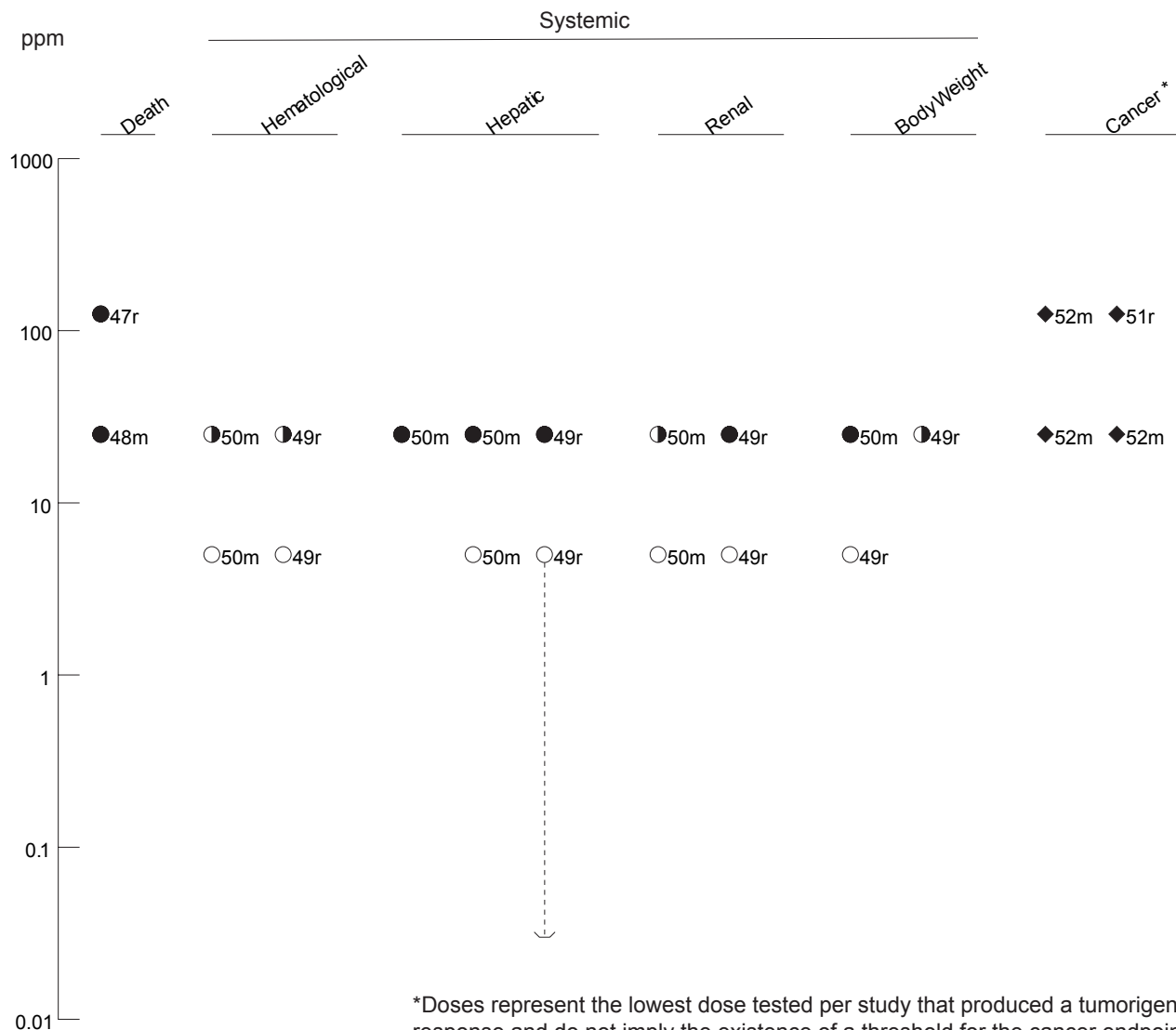

c-Cat	-Humans	f-Ferret	n-Mink	◆ Cancer Effect Level-Animals	▼ Cancer Effect Level-Humans	■ LD50/LC50
d-Dog	k-Monkey	j-Pigeon	o-Other	● LOAEL, More Serious-Animals	▲ LOAEL, More Serious-Humans	⋮ Minimal Risk Level
r-Rat	m-Mouse	e-Gerbil		○ LOAEL, Less Serious-Animals	▲ LOAEL, Less Serious-Humans	⋮ for effects
p-Pig	h-Rabbit	s-Hamster		○ NOAEL - Animals	△ NOAEL - Humans	⋮ other than
q-Cow	a-Sheep	g-Guinea Pig				⋮ Cancer

3. HEALTH EFFECTS

1944; Norwood et al. 1950; Umiker and Pearce 1953). However, quantitative estimates of the exposure levels that caused death are rare; furthermore, cleaning usages often involved concurrent dermal exposure. In one case involving inhalation of carbon tetrachloride by an alcoholic, the lethal exposure level was estimated at only 250 ppm for 15 minutes (Norwood et al. 1950). Other workers (nonalcoholics) were exposed at the same level for 4 hours with no significant clinical signs other than slight headache (Norwood et al. 1950). One of three naval officers who weekly misused a carbon tetrachloride fire-extinguishing fluid as a dry cleaning agent over 3 months died of heart failure that was secondary to nephrosis-induced pulmonary edema (Forbes 1944); the man who died was a heavy consumer of alcohol. The relative exposure by inhalation or through the skin was not known, but about 3 kg carbon tetrachloride was used during 3 months.

Lethal inhalation exposure levels in animals depend on exposure duration and species. In mice, the estimated LC₅₀ for an 8-hour exposure is 9,500 ppm, with no deaths in 20 animals exposed to 6,300 ppm (Svirbely et al. 1947). In rats, exposure to 7,300 ppm caused no deaths after 1.5 hours, about 50% mortality by 4–6 hours, and 100% mortality by 8 hours (Adams et al. 1952). Exposure to 3,000 ppm for 8–10 hours caused death in 1 of 50 animals. Repeated exposure to 200 ppm 7 hours/day led to increased mortality in rats after approximately 190 days (Adams et al. 1952).

All LOAEL values from each reliable study for death in each species and duration category are recorded in Table 3-1 and plotted in Figure 3-1.

3.2.1.2 Systemic Effects

No studies were located regarding musculoskeletal or endocrine effects in humans or animals after inhalation exposure to carbon tetrachloride. Studies have been conducted in both humans and animals to evaluate the respiratory, cardiovascular, hematological, hepatic, and renal effects of inhalation exposure to carbon tetrachloride. Gastrointestinal and dermal/ocular effects have been studied in humans but not in animals. These effects are discussed below. The highest NOAEL values and all LOAEL values from each reliable study for systemic effects in each species and duration category are recorded in Table 3-1 and plotted in Figure 3-1.

Respiratory Effects. Pulmonary edema is a common finding in humans exposed to lethal levels of carbon tetrachloride in air. Thirteen fatal cases were reported following acute inhalation exposure in humans; exposure concentrations were not determined. Marked hemorrhagic congestion and edema were

3. HEALTH EFFECTS

observed in the lungs of all the victims who had been exposed for 1–6 hours (Umiker and Pearce 1953). However, these effects typically did not develop in lung until 8 days after exposure, and appeared to be secondary to severe renal injury rather than to a direct action of carbon tetrachloride on the lung. Lung appearance in the carbon tetrachloride victims was found comparable with that in cases of rapidly developing uremia occasioned by various causes of renal failure. Thus, the progressive uremia, electrolyte retention, and extracellular fluid build-up that accompanies renal failure is a likely principal cause of the observed pulmonary edema. In one fatal case, pulmonary edema secondary to renal malfunction developed following combined inhalation/dermal exposure over 3 months (Forbes 1944).

Lung injury is usually not as prominent an effect in animals exposed to carbon tetrachloride vapors as it is in humans. For example, lung injury was not observed in rats exposed to concentrations of 3,000–19,000 ppm for 7 hours, or in rats and monkeys exposed to 100 ppm for 7 hours/day, 5 days/week for 205 and 232 days, respectively (Adams et al. 1952). As it appears that lung injury is secondary to renal injury, then the absence of lung effects in animals may be because animals are also less susceptible to the renal injury produced by carbon tetrachloride than are humans.

Cardiovascular Effects. Most studies of humans exposed to carbon tetrachloride by inhalation have not detected significant evidence of cardiovascular injury, even at exposure levels sufficient to markedly injure the liver and/or kidney. Changes in blood pressure, heart rate, or right-sided cardiac dilation have sometimes, but not always, been observed (Ashe and Sailer 1942; Guild et al. 1958; Kittleson and Borden 1956; Stewart et al. 1961; Umiker and Pearce 1953), and are probably secondary either to fluid and electrolyte retention resulting from renal toxicity, or to central nervous system effects on the heart or blood vessels. Failure of the left side of the heart was the proximate cause of death in one naval officer who had a combined inhalation/dermal exposure over 3 months (Forbes 1944). The heart effect was secondary to the pulmonary edema that had developed from renal toxicity. Carbon tetrachloride also may have the potential to induce cardiac arrhythmias by sensitizing the heart to epinephrine, as has been reported for various halogenated hydrocarbon propellants (Reinhardt et al. 1971).

Similarly, except for what are likely secondary effects following acute lethal exposures, significant cardiovascular injury has not accompanied hepato- or nephrotoxic inhalation exposure to carbon tetrachloride in a variety of experimental animals (Adams et al. 1952; Prendergast et al. 1967; Smyth et al. 1936; von Oettingen et al. 1949).

3. HEALTH EFFECTS

Gastrointestinal Effects. One of the most common signs of exposure of humans to carbon tetrachloride is dyspepsia, with nausea, vomiting, and gastrointestinal pain (Forbes 1944; Stewart and Witts 1944). This is often one of the first clinical signs to become apparent following acute exposure (Guild et al. 1958; Norwood et al. 1950), but is also common in persons exposed for months to several years to concentrations as low as approximately 20 ppm (Elkins 1942; Smyth et al. 1936). Exposure levels of approximately 50 ppm do not cause significant dyspepsia if exposure is brief (Stewart et al. 1961), but may lead to nausea if exposure extends for several days (Kazantzis and Bomford 1960). Because inhalation exposure is unlikely to be directly irritating to the gastrointestinal tract, it is probable that these effects are secondary to effects on the autonomic nervous system (Stewart and Witts 1944).

Hematological Effects. Significant effects on the hematological system are not usually observed in humans exposed to carbon tetrachloride by inhalation (Heimann and Ford 1941; Norwood et al. 1950; Smyth et al. 1936). In some cases, moderate elevations in white cell counts are observed, perhaps in response to necrosis in the liver or kidneys. In a few cases, mild anemia is observed (Gray 1947), and may occasionally become severe (Straus 1954). A cross-sectional study of hepatic function in workers exposed <1–>5 years to carbon tetrachloride reported small (2.5–3.6%), statistically significant reductions in some hematological parameters compared to non-exposed workers, but without a dose response (Tomenson et al. 1995). At the low (<1 ppm) or medium (1–3 ppm) exposure levels, there were decreases in packed cell volume and in hemoglobin and erythrocyte count for the medium exposure group; no significant changes from controls were noted in the high exposure group (>4 ppm). The mechanism underlying anemia is not known, but it might be secondary to internal hemorrhaging as a result of decreased synthesis of clotting factors by the liver or a direct effect on bone marrow cells (Guild et al. 1958; Stevens and Forster 1953; Straus 1954). Since lipid peroxidation caused by carbon tetrachloride also affects calcium sequestration, clotting functions, which are regulated by calcium sequestration would be expected to be impaired, resulting in a tendency for internal hemorrhaging.

Similar observations have been obtained in inhalation studies in animals. Prothrombin time increased and there was lengthened activated partial thromboplastin time in rats exposed 22–40 times to 325 ppm carbon tetrachloride for 10 minutes/day, 5 days/week, indicating defective coagulation in both the extrinsic and intrinsic clotting pathways (Vazquez et al. 1990). No significant effects on hematology were detected in rats, monkeys, or guinea pigs exposed to concentrations of 10–200 ppm, 7 hours/day for periods of time up to 170 days (Adams et al. 1952; Prendergast et al. 1967). Rats exposed for 10 months to 100 ppm suffered some destruction of red blood cells, but this did not result in anemia (Smyth et al. 1936). No evidence of red blood cell hemolysis was observed at 50 ppm. Decreased hemoglobin and

3. HEALTH EFFECTS

hematocrit levels and increased spleen weight) at ≥ 90 ppm and reduced erythrocyte counts at 810 ppm were observed in male and female rats intermittently exposed to carbon tetrachloride vapor for 13 weeks (Japan Bioassay Research Center 1998); in similarly exposed mice at ≥ 270 ppm, reduced erythrocyte and hemoglobin counts were observed in females, and at 810 ppm, there were reductions in hematocrit in females and in hemoglobin counts in males. Significant reductions in hemoglobin and hematocrit values were observed in female rats exposed to ≥ 25 ppm carbon tetrachloride vapor for 6 hours/day, 5 days/week for 2 years (Japan Bioassay Research Center 1998). Splenic changes related to erythrocyte destruction included increased hemosiderin deposition in male rats at ≥ 5 ppm, a consequence of erythrocyte destruction observed in the 13-week studies, and increased extramedullary hematopoiesis in male and female mice at ≥ 25 ppm.

Hepatic Effects. Carbon tetrachloride has been known for many years to be a powerful hepatotoxic agent in humans and animals. The principal clinical signs of liver injury in humans who inhale carbon tetrachloride are swollen and tender liver, elevated levels of hepatic enzyme (aspartate aminotransferase) in the serum, elevated serum bilirubin levels and the appearance of jaundice, and decreased serum levels of proteins such as albumin and fibrinogen (Ashe and Sailer 1942; McGuire 1932; New et al. 1962; Norwood et al. 1950; Straus 1954). In cases of lethal acute or repeated exposures, autopsy generally reveals marked liver necrosis with pronounced steatosis (Forbes 1944; Jennings 1955; Markham 1967; Smetana 1939), and repeated or chronic exposure leads in some cases to fibrosis and/or cirrhosis (McDermott and Hardy 1963).

Quantitative information on the inhalation exposure levels that cause significant hepatic injury in humans is sparse. Liver necrosis was reported in one fatal case involving an alcoholic who was exposed to 250 ppm carbon tetrachloride for 15 minutes (Norwood et al. 1950). Humans exposed to concentrations of 50 ppm for 70 minutes or 10 ppm for 3 hours showed no measurable change in serum enzyme levels or urinary urobilinogen levels (Stewart et al. 1961). A slight decrease in serum iron levels occurred in two of four subjects exposed to 50 ppm for 1 hour, suggesting to the authors that minimal liver injury had occurred. However, all values were within or close to the normal range of serum iron concentrations, and there were no control subjects. Consequently, it is difficult to judge if the variations observed were treatment-related and whether they were of biological significance. No hepatic effects were observed in humans exposed to average concentrations of 80 ppm for 8 hours/day, 5 days/week for 3 months (Heimann and Ford 1941).

3. HEALTH EFFECTS

Occasional and slight elevations of serum bilirubin levels were seen in workers exposed for 8 hours/day for several months to many years to carbon tetrachloride concentrations ranging from 10 to 100 ppm, but no other clinical signs of injury were detected (Smyth et al. 1936). Similarly, workers exposed for up to 3 hours/day to carbon tetrachloride concentrations averaging about 200 ppm displayed small increases in serum enzyme levels and serum bilirubin levels, indicative of minimal liver damage (Barnes and Jones 1967). More recently, chronic occupational exposure of 35 male workers to <1 ppm (8 hours/day) of chlorinated solvents, primarily carbon tetrachloride and perchlorethylene, was not correlated with any significant changes in standard indicators of liver function (e.g., serum levels of protein, albumin, bilirubin, alanine and aspartate aminotransferase, alkaline phosphatase, γ -glutamyl transpeptidase, and cholesterol) (Driscoll et al. 1992). However, when workers were segregated as to having relatively higher or lower exposure, higher exposure was correlated with significantly ($p < 0.03$ – 0.05) lower fasting serum levels of three bile acids (chenodeoxycholate, taurocholate, and total deoxycholate). This effect was in the opposite direction to what might be expected based upon oral animal data and upon serum bile acid increases reported by the same authors for a companion worker population exposed to hexachlorobutadiene or trichloroethylene. Thus, these results should be viewed with caution, especially in view of the low exposure level to carbon tetrachloride and the variable concurrent exposure to several other solvents.

A cross sectional study of hepatic function (serum enzyme levels) was conducted on 135 workers occupationally exposed to carbon tetrachloride and 276 nonexposed controls who were employed in three plants in northern England (Tomenson et al. 1995). Workers were categorized according to their duration of employment (<1 year, 1–5 years, and >5 years), but the serum enzyme results were not presented by estimated duration of exposure because statistical analysis showed that duration of exposure had no significant effect. Exposures were estimated from historical personal monitoring data for each job category, and exposure groups were categorized as low (≤ 1 ppm), medium (1.1–3.9 ppm), or high (≥ 4.0 –11.9 ppm). Alcohol consumption was equivalent among groups. A comparison of exposed workers and nonexposed controls found no significant difference in blood levels of alkaline phosphatase or gamma glutamyl transferase; however, when the exposed group was subdivided by level of exposure, these values were significantly elevated in the medium exposure group. None of the exposed subjects had hepatic disease that could be attributed to exposure to carbon tetrachloride.

In animals, the hepatic effects of inhalation exposure to carbon tetrachloride are much the same as in humans: elevated serum enzyme levels, steatosis, and centrilobular necrosis progressing to fibrosis. Statistically significant doubling of serum levels of mitochondrial glutamate dehydrogenase and sorbitol

3. HEALTH EFFECTS

dehydrogenase was observed in rats 24 hours after a 4-hour exposure at 530 ppm and of ALT and AST at 1,460 ppm (Brondeau et al. 1983). Following 4-hour exposure at 500–2,500 ppm, fasted rats showed a 2.0–2.5-fold higher level of serum enzymes indicative of hepatic injury than fed rats (Jaeger et al. 1975); the increases in serum enzyme levels were similar in fed and fasted rats at 5,000 ppm. In rats, hypoxia (10–12% oxygen) increased the severity of hepatic injury (serum enzyme levels) compared to normal air (21% oxygen) conditions during 2–3 hour exposures to carbon tetrachloride vapor (Shen et al. 1982; Siegers et al. 1985). In rats, exposure to concentrations of 10–100 ppm, 6–7 hours/day for approximately 2 weeks generally results in mild to moderate signs of liver injury (fatty degeneration), both after short-term (roughly 2 weeks) (Adams et al. 1952; David et al. 1981; Paustenbach et al. 1986a, 1986b). Four days of exposure at 50 ppm caused elevated serum alanine aminotransferase, altered hepatic glycogen distribution (preferential accumulation in the central and pericentral zones, rather than the uniform distribution observed in controls), steatosis, hydropic degeneration, and necrosis (David et al. 1981). Short-term exposure (15 minutes/day, 2 days/week for 8 weeks) caused fibrosis in rats exposed to 180 ppm (Sakata et al. 1987). A 4-hour exposure to 4,800 ppm or higher induced centrilobular necrosis within 24 hours (Belyaev et al. 1992; Magos et al. 1982). In rats exposed for 2 hours, there were significant reductions in hepatic CYP-450 levels at ≥ 100 ppm and significantly elevated serum enzymes (SDH 16-fold and ALT 2-fold) at 1,000 ppm (Sanzgiri et al. 1995); the results indicate an alteration of hepatic cell function at 100 ppm, but leakage from hepatocytes at 1,000 ppm. With continued biweekly exposures at 4,800 ppm for 4 hours/day, necrotic areas were largely replaced by hepatocellular proliferation after 2–3 weeks, and then fibrosis and eventually cirrhosis (Belyaev et al. 1992). Cirrhosis along with fatty degeneration was observed in rats exposed at 200 or 400 ppm (7 hours/day, 5 days/week for 2 weeks) (Adams et al. 1952). No acute MRL was established for inhalation exposure to carbon tetrachloride because the value calculated from the most acceptable data would be the same as or lower than the intermediate-duration MRL (see Section 2.3). The intermediate-duration inhalation MRL is expected to be protective for acute-duration inhalation exposures.

The pattern of hepatic injury following intermediate-duration exposure to carbon tetrachloride is similar to that seen in acute studies. Mild to moderate liver effects (increased liver weight, fatty degeneration) were observed following intermittent exposure (6–7 hours/day, 5 days/week) at 10 ppm for 12 weeks to 6 months (Adams et al. 1952; Bogers et al. 1987; DOE 1999; Japan Bioassay Research Center 1998; Smyth et al. 1936). Similar effects were observed in rats exposed continuously at 10 ppm for 6 weeks (Prendergast et al. 1967). In 12–13-week studies, increased serum enzyme levels (AST and SDH) and necrotic injury is apparent in mice intermittently exposed at 20 ppm (DOE 1999) and in rats exposed at 90 ppm or higher (Belyaev et al. 1992; Japan Bioassay Research Center 1998). Hepatic regeneration and

3. HEALTH EFFECTS

proliferation were evident within 2–3 weeks of treatment at 4,800 ppm (Belyaev et al. 1992). Fibrosis and cirrhosis developed in rats following intermittent (6–7 hours/day, 5 days/week) exposure at 50 ppm for 6 months (Adams et al. 1952) or at ≥ 90 ppm for 12–15 weeks (Belyaev et al. 1992; DOE 1999; Japan Bioassay Research Center 1998). Although hepatic histopathology was similar in rats and mice exposed for 13 weeks, only rats developed fibrosis and cirrhosis and only mice developed collapse of the liver (Japan Bioassay Research Center 1998). Guinea pigs appear to be somewhat more sensitive to carbon tetrachloride inhalation than rats (Prendergast et al. 1967; Smyth et al. 1936), and monkeys appear to be somewhat less sensitive than guinea pigs and rats (Adams et al. 1952; Prendergast et al. 1967). Another study found mice to be more susceptible to hepatic damage (necrosis) than rats or hamsters (DOE 1999). The basis of these species differences is likely related to differences in hepatic metabolism (see Section 3.4.3). Exposure to concentrations of 1–5 ppm, 6–7 hours/day, 5 days/week for periods up to 6 months or 1 ppm continuously for 6 weeks have not been observed to cause any significant changes in liver of rats, monkeys, or guinea pigs (Adams et al. 1952; Prendergast et al. 1967). The NOAEL of 5 ppm (Adams et al. 1952) was selected as the basis for an intermediate-duration MRL for inhalation exposure to carbon tetrachloride, as described in the footnote in Table 3-1.

Plummer et al. (1990) conducted experiments that suggest that the hepatotoxicity of carbon tetrachloride administered by inhalation is proportional to the concentration x time product (Haber's rule). Rats exposed for 4 weeks at equivalent time-weighted average concentrations—either continuously (24 hours/day, 7 days/week except for two 1.5-hour breaks 2 days/week) at 16 ppm or discontinuously (6 hours/day, 5 days/week) at 87 ppm—showed identical severity of liver histopathology.

In 2-year inhalation bioassays, concentration-related hepatic effects were observed in rats and in mice following intermittent exposure (6 hours/day, 5 days/week) to carbon tetrachloride vapor (Japan Bioassay Research Center 1998; Nagano et al. 1998). Alterations in some serum hepatic biomarkers were not statistically significant in rats exposed at 5 ppm. Statistically significant increases in liver weight and serum parameters (ALT, AST, LDH, leucine aminopeptidase and gamma-glutamyl transferase, total bilirubin) were observed at ≥ 25 ppm in rats and mice. Hepatic lesions at ≥ 25 ppm included basophilic, eosinophilic, clear and mixed cell foci, deposition of ceroid, fibrosis and cirrhosis, and increased severity of fatty change and granulation. In the parallel assay in mice, statistically significant decreases in some serum parameters at 5 ppm were not considered by the authors to be biologically significant because the control values for serum chemistry parameters in males were unusually high compared to available historical control values. Hepatic degeneration, thrombus, and deposition of ceroid were evident in both sexes, and hepatic necrosis was found in female mice treated at ≥ 25 ppm. The NOAEL of 5 ppm for

3. HEALTH EFFECTS

hepatic effects in rats (Japan Bioassay Research Center 1998) was selected as the basis for a chronic-duration inhalation MRL for carbon tetrachloride, as described in a footnote in Table 3-1.

Renal Effects. Nephritis and nephrosis are very common effects in humans following inhalation exposure to carbon tetrachloride (Jennings 1955; McGuire 1932; Norwood et al. 1950). The most obvious clinical signs, developing within hours to days after exposure, are oliguria or anuria with resulting edema. In some cases, this leads to generalized uremia, and is frequently accompanied by proteinuria, hemoglobinuria, and glucosuria (Forbes 1944; Guild et al. 1958; New et al. 1962; Smetana 1939; Umiker and Pearce 1953). In fatal cases, histological examination generally reveals relatively mild degeneration of the kidney (Ashe and Sailer 1942; Forbes 1944; Gray 1947; Jennings 1955; Norwood et al. 1950). The mechanism of the injury to the kidney is not known, but Sirota (1949) reported that back-diffusion of glomerular filtrate was important in the early stages of oliguria and decreased renal blood flow contributed in the later stages of oliguria following carbon tetrachloride inhalation in humans.

The exposure levels leading to renal damage in humans have not been well defined. An increased incidence of proteinuria was reported in workers exposed to vapor concentrations of around 200 ppm (Barnes and Jones 1967), while no change was observed in urinary properties following inhalation exposure to 50 ppm for 70 minutes or 10 ppm for 3 hours (Stewart et al. 1961).

Threshold concentrations for renal injury in animals exposed by inhalation to carbon tetrachloride are sometimes higher than those for hepatic effects. Animals appear to be less sensitive to renal injury than humans, possibly because of species differences in carbon tetrachloride metabolism by the kidney. No evidence of kidney damage was observed in rats, cats, monkeys, or guinea pigs exposed for 6–8 hours/day to concentrations of 10–200 ppm for periods of time from 1 to 90 days (Adams et al. 1952; Bogers et al. 1987; Prendergast et al. 1967). In a 13-week study, 10 ppm produced increased absolute and relative kidney weights in male rats; organ weight effects and vacuolization were observed in females at 90 ppm and hyaline degeneration of the glomerulus at 810 ppm (Japan Bioassay Research Center 1998). No renal effects were noted in similarly exposed mice. Slight renal swelling was noted in rats exposed to 50 ppm for 5–10.5 months for 7–8 hours/day, 5 days/week, and in monkeys exposed to 200 ppm for 10.5 months for 7–8 hours/day, 5 days/week (Adams et al. 1952; Smyth et al. 1936). Renal tubular degeneration was apparent following exposure at 200 ppm for 7 hours/day, 5 days/week for 6 months (Adams et al. 1952).

3. HEALTH EFFECTS

Chronic exposure (6 hours/day, 5 days/week for 2 years) to carbon tetrachloride vapor caused renal effects in rodents, with rats being more sensitive than mice (Japan Bioassay Research Center 1998). The most sensitive renal effect in rats was a dose-related enhancement of proteinuria (scores of 4+), having a significantly ($p \leq 0.01$) higher severity in males and females treated at 5 or 25 ppm (too few animals survived at 125 ppm for statistical analysis) compared to controls; however, as the severity in controls was so high (>90% of rats with scores of 3+ or 4+), the statistical difference is not biologically significant and this end point was not used as the basis for the chronic-duration inhalation MRL. Blood urea nitrogen levels and the severity and incidence of chronic progressive nephropathy were elevated at >25 ppm in both sexes. In the parallel study in mice, protein casts in the kidney were observed in male and female mice exposed at ≥ 25 ppm.

Dermal Effects. Very few reports mention any effect of carbon tetrachloride inhalation on the skin. Inhalation exposure to carbon tetrachloride for several days in the workplace caused a blotchy, macular rash in one man (but not in six others) (McGuire 1932). Similarly, a hemorrhagic rash occurred in a woman exposed to carbon tetrachloride vapors for several days in the workplace (Gordon 1944), and black and blue marks were seen in a patient exposed intermittently to carbon tetrachloride vapors for several years (Straus 1954). Because observations of dermal effects are so sporadic, it is difficult to judge whether these effects are related to carbon tetrachloride exposure, or are incidental. Conceivably, they may have been secondary to reduced synthesis of blood coagulation factors resulting from carbon tetrachloride-induced hepatotoxicity. No animal studies evaluated dermal effects following inhalation exposure.

Ocular Effects. Ocular effects following inhalation exposure to carbon tetrachloride are discussed under neurological effects.

Body Weight Effects. No human and very few animal reports mention the effect of carbon tetrachloride inhalation on body weight gain. In rodents intermittently exposed to carbon tetrachloride vapor for 6 hours/day, 5 days/week for 13 weeks, body weight gain was significantly reduced by 20% in male rats exposed at 810 ppm and by 8–15% in male mice exposed at ≥ 30 ppm, but not significantly in female rats or mice exposed at concentrations as high as 810 ppm (Japan Bioassay Research Center 1998). In the companion 2-year study, terminal body weights were depressed by 11% in male and female rats exposed at 25 ppm and by 22–45% at 125 ppm (Japan Bioassay Research Center 1998; Nagano et al. 1998); survival at 125 ppm was too low to determine statistical significance. In mice exposed at 25 ppm

3. HEALTH EFFECTS

for 2 years, body weight gain at termination showed a >30% reduction in males and a >20% reduction in females relative to controls (only single male and female mice survived in the 125 ppm groups).

3.2.1.3 Immunological and Lymphoreticular Effects

No studies were located regarding immunological effects in humans or animals after inhalation exposure to carbon tetrachloride.

3.2.1.4 Neurological Effects

Like many volatile halocarbons and other hydrocarbons, inhalation of carbon tetrachloride leads to rapid depression of the central nervous system. Because of its central nervous system depressant properties, carbon tetrachloride was used briefly as an anesthetic in humans, but its use was discontinued because it was less efficacious and more toxic than other anesthetics available (Hardin 1954; Stevens and Forster 1953). Depending on exposure levels, common signs of central nervous system effects include headache, giddiness, weakness, lethargy, and stupor (Cohen 1957; Stevens and Forster 1953; Stewart and Witts 1944). Effects on vision (restricted peripheral vision, amblyopia) have been observed in some cases (e.g., Forbes 1944; Johnstone 1948; Smyth et al. 1936; Wirtschafter 1933), but not in others (e.g., Stewart and Witts 1944). Sudden severe epileptiform seizure and coma occurred in a subsequently fatal case following weekly combined inhalation/dermal exposure over a period of 3 months (Forbes 1944). In several fatal cases, microscopic examination of brain tissue taken at autopsy revealed focal areas of fatty degeneration and necrosis, usually associated with congestion of cerebral blood vessels (Ashe and Sailer 1942; Cohen 1957; Stevens and Forster 1953).

Exposure levels leading to effects on the central nervous systems of humans are not precisely defined. No symptoms of lightheadedness or nausea were experienced by humans exposed to 50 ppm for 70 minutes or 10 ppm for 3 hours (Stewart et al. 1961), but nausea, headache, and giddiness were found to be common symptoms in workers exposed to carbon tetrachloride for 8 hours/day at concentrations of 20–125 ppm (Elkins 1942; Heimann and Ford 1941; Kazantzis and Bomford 1960). Dizziness has also been reported in humans following short-term exposure (15 minutes) at a higher concentration (250 ppm) (Norwood et al. 1950). This suggests that the threshold for central nervous system effects in humans is, as a conservative estimate, probably in the range of 20–50 ppm for an 8-hour workday.

3. HEALTH EFFECTS

Central nervous system depression is also observed in animals exposed to carbon tetrachloride vapors. Rats reportedly became inactive within 15 minutes after exposure to a concentration of 180 ppm (Sakata et al. 1987), although when compared with other studies, this concentration appears too low to be capable of inducing such an effect. Drowsiness or stupor occurred in rats exposed for 0.1–8.0 hours to 4,600 ppm, with ataxia and unconsciousness at 12,000 ppm, and death (from respiratory failure) at 19,000 ppm (Adams et al. 1952). Similarly, dogs exposed for 2–10 hours to 15,000 ppm experienced profound depression of the autonomic system, as evidenced by decreases in respiration, reflex activity, body temperature, heart rate, and blood pressure (the latter due to marked vasodilation) (von Oettingen et al. 1949). Exposure of rats, monkeys, or guinea pigs to concentrations of carbon tetrachloride up to 400 ppm, 8 hours/day, 5 days/week for over 10 months did not cause any observable effects on activity, alertness, or appetite, indicating that this level did not cause obvious central nervous system depression in animals (Smyth et al. 1936). However, histological examination of sciatic and optic nerves revealed degenerative changes in a number of animals exposed to 200–400 ppm, and in a few animals (rats) after exposure to levels as low as 50 ppm under the same exposure schedule. The changes were apparently not severe enough to impair movement or vision. Exposure to ≥ 5 ppm carbon tetrachloride vapor for 6 hours/day, 5 days/week for 2 years resulted in decreased absolute brain weights in male, but not female, rats, however, this effect was attributed to the overall depression in body weight, since brain weights relative to body weight were increased (Japan Bioassay Research Center 1998). Furthermore, no histopathology was detected in the brain in either sex at any concentration.

The highest NOAEL values and all LOAEL values for each reliable study for neurotoxicity in each species and duration category are recorded in Table 3-1 and plotted in Figure 3-1.

3.2.1.5 Reproductive Effects

No studies were located regarding reproductive effects in humans after inhalation exposure to carbon tetrachloride.

In rats that inhaled carbon tetrachloride vapors for three generations, there was a decrease in fertility in animals exposed to concentrations of 200 ppm or higher for 8 hours/day, 5 days/week for 10.5 months (Smyth et al. 1936). Since both sexes were exposed, it was not possible to determine if this was due to effects on males, females, or both. Moderate to marked degeneration of testicular germinal epithelium has been seen in rats exposed repeatedly (7 hours/day, 5 days/week) to 200 ppm or higher for 192 days (Adams et al. 1952).

3. HEALTH EFFECTS

Deposition of ceroid was observed in the ovaries of mice that were exposed to 125 ppm of carbon tetrachloride vapor, 6 hours/day, 5 days/week for 2 years (Japan Bioassay Research Center 1998). At 25 ppm, absolute and relative testicular weights were elevated in male mice.

All LOAEL values for each reliable study for reproductive effects in each species and duration category are recorded in Table 3-1 and plotted in Figure 3-1.

3.2.1.6 Developmental Effects

No studies were located on developmental effects in humans after known inhalation exposure to carbon tetrachloride. A questionnaire-based study of 3,418 pregnant women in West Germany found no association between probable occupational exposure to carbon tetrachloride (as estimated from a job exposure matrix) and the birth of infants who were small for their gestational age (Seidler et al. 1999).

In rats, inhalation exposure to 330 or 1,000 ppm for 7 hours/day on gestational days 6–15 caused reduced feed intake by dams, maternal weight loss, and clear maternal hepatotoxicity (elevated serum ALT, relative liver weight), but no effect on conception, number of implants, or number of resorptions (Schwetz et al. 1974). There were no gross anomalies, but dose-related statistically significant reductions in fetal body weight and crown-rump length were observed. The incidence of delayed ossification of sternebrae was significantly increased at 1,000 ppm. The lowest exposure level in this study is a LOAEL for both maternal and fetal toxicity.

All LOAEL values for each reliable study for developmental toxicity in each species and duration category are recorded in Table 3-1 and plotted in Figure 3-1.

3.2.1.7 Cancer

Two case reports of liver cancer in humans suggested that previous exposure to carbon tetrachloride vapors might have contributed to the development of the cancer (Tracey and Sherlock 1968; Johnstone 1948). In the first case, a 66-year-old male died of hepatocellular carcinoma 7 years after acute intoxication with carbon tetrachloride sufficient to cause jaundice as well as vomiting and diarrhea (Tracey and Sherlock 1968). As the tumor was too extensive to make a diagnosis of cirrhosis, the report

3. HEALTH EFFECTS

could not rule out the man's history of moderate alcohol consumption as contributory. In the second case, a 30-year-old female died of "liver cancer" after 2–3 years of occupational exposure to carbon tetrachloride that was sufficient to produce signs of central nervous system depression. The evidence of these studies is much too weak to establish a cause-and-effect relationship between exposure to carbon tetrachloride and hepatic cancer in humans.

A number of epidemiological studies have been conducted to evaluate the association of risk of increased mortality from particular types of cancer and occupational exposure to carbon tetrachloride. Both positive and negative associations have been reported, varying with the target organ. IARC (1999) has noted that few of these studies had definitive evidence of exposure to carbon tetrachloride—generally, few positive cases were identified among exposed individuals—and that extensive exposure to other possible carcinogenic chemicals could not be excluded, and in fact, was likely. Thus, the positive associations discussed below are considered suggestive, but are not conclusive.

An analysis of cancer mortality and solvent exposure among a cohort of 6,678 active and retired male workers in the rubber industry found a significant association between age-adjusted exposure to carbon tetrachloride and lymphosarcoma (odds ratio [OR] 4.2, $p < 0.05$; based on six cases) and lymphatic leukemia (OR 15.3, $p < 0.001$; based on eight exposed cases) (Checkoway et al. 1984; Wilcosky et al. 1984). A retrospective cohort mortality study of 14,457 workers employed at an aircraft maintenance facility for at least 1 year during 1952–1956 included 6,737 workers who had ever been exposed to carbon tetrachloride (Blair et al. 1998; Spirtas et al. 1991). In the first study, standard mortality ratios (SMRs) for selected causes of death were calculated for workers exposed to solvents compared to the Utah death rates (Spirtas et al. 1991). A statistically significant association was found in women for deaths from non-Hodgkin's lymphoma and exposure to carbon tetrachloride (SMR 325, 95% confidence interval [CI] 119–708); excess SMRs in men for non-Hodgkin's lymphoma and in both sexes for multiple myeloma following carbon tetrachloride exposure were not statistically significant. In the follow-up study, a Poisson regression analysis was performed on cancer incidence data to evaluate the risk from exposure to carbon tetrachloride (Blair et al. 1998). Among men and women, the relative risk (RR) of mortality from non-Hodgkin's lymphoma or non-Hodgkin's lymphoma following exposure to carbon tetrachloride was not significantly increased. A study of causes of death in a cohort of 5,365 workers exposed to dry-cleaning solvents in St. Louis, Missouri, found statistically significant excesses in deaths from all cancers, esophageal cancer, and cervical cancer compared to the general U.S. population (Blair et al. 1990). The risk of esophageal cancer showed a statistically significant association with estimated cumulative exposure to dry cleaning solvents (SMR = 2.8 for the highest cumulative exposure group), but

3. HEALTH EFFECTS

not with level or duration of exposure. The most heavily exposed workers showed a 4-fold increased risk for cancers of the lymphatic and hematopoietic system, but the number of deaths (five) was small.

No positive association was found between likely occupational exposure to carbon tetrachloride and the risk of increased mortality from pancreatic cancer among residents of 24 states (Kernan et al. 1999), astrocytic brain tumors in workers in the petrochemical industry in three states (Heineman et al. 1994), rectal cancer in Montreal (Dumas et al. 2000), renal carcinoma in Minnesota (Dosemici et al. 1999), lung cancer among men working in a chemical plant in Texas (Bond et al. 1986), or respiratory system tumors in workers in the rubber industry (Checkoway et al. 1984; Wilcosky et al. 1984). No significantly elevated risk of cancer was detected in a cohort of 4,772 Finnish laboratory workers who were exposed to chemicals including carbon tetrachloride, but the duration of exposure was too short (<16 years) to detect cancers with longer latency periods (Kauppinen et al. 2003). A case-control study estimating the occupational exposures to some industrial chemicals among women in 24 states found a weak association between probable high-intensity exposure to carbon tetrachloride and an increased risk (OR ratio 1.21, 95% CI: 1.1–1.3) of breast cancer in Caucasian women (Cantor et al. 1995). However, a retrospective cohort study of workers in an aircraft maintenance facility found no association in woman for exposure to carbon tetrachloride and increased mortality from breast cancer (Blair et al. 1998).

Chronic exposure to carbon tetrachloride vapor induced tumors in rats and mice (Japan Bioassay Research Center 1998; Nagano et al. 1998). Following intermittent exposure for 2 years (6 hours/day, 5 days/week), significant increases in the incidences of hepatocellular adenoma and carcinoma were observed in male and female rats exposed at 125 ppm (22.3 ppm, duration adjusted) and in mice exposed at ≥ 25 ppm (4.5 ppm, duration adjusted). Adrenal pheochromocytomas were also induced in male mice exposed at ≥ 25 ppm and female mice at 125 ppm.

The carcinogenicity of carbon tetrachloride is currently undergoing reassessment by the EPA under the IRIS program, with the final report scheduled for 2006. As chronic inhalation data were not available for the earlier assessment, the EPA extrapolated oral dose-response data on liver tumor risk to yield estimates of the carcinogenic risk from inhalation exposure to carbon tetrachloride (EPA 1984). Based on the assumption that a 70-kg person breathes 20 m³/day of air and that 40% of inhaled carbon tetrachloride is absorbed, the calculated upper-bound unit risk (the upper 95% confidence limit on the excess cancer risk associated with lifetime exposure to carbon tetrachloride at a concentration of 1 $\mu\text{g}/\text{m}^3$) is 1.5×10^{-5} . Based on this, the concentration of carbon tetrachloride in air corresponding to excess cancer risk levels of 10^{-4} ,

3. HEALTH EFFECTS

10^{-5} , 10^{-6} , and 10^{-7} are 0.001, 0.0001, 0.00001, and 0.000001 ppm, respectively. Because these are upper-bound estimates, the true risk could be lower. These values are displayed in Figure 3-1.

3.2.2 Oral Exposure

The highest NOAEL values and all LOAEL values from each reliable study for death and respiratory, cardiovascular, gastrointestinal, hematological, musculoskeletal, hepatic, renal, immunological/lymphoreticular, neurological, reproductive, developmental, and cancer effects in each species and duration category are recorded in Table 3-2 and plotted in Figure 3-2.

3.2.2.1 Death

Ingestion of concentrated solutions of carbon tetrachloride can cause death in humans within hours to days. The principal clinical signs observed in fatal cases include gastrointestinal irritation, central nervous system depression, and cardiovascular disturbances, with death usually resulting from severe injury to kidney and/or liver (Guild et al. 1958; reviewed in von Oettingen 1964).

There is considerable variation in the doses that have been found to cause lethality, with alcohol ingestion leading to markedly increased risk. Twelve fatalities were reported following oral exposure (Umiker and Pearce 1953). In most cases, about 50–150 mL had been ingested, but one case involved only 5.3 mL (about 121 mg/kg). A review of some of the earlier literature found that ingestion of 14–20 mL (320–450 mg/kg) was fatal in the majority of cases (von Oettingen 1964). In other cases, ingestion of 2.5–15 mL (60–340 mg/kg) as a treatment for hookworm produced death in only a very small number of people out of hundreds of thousands treated, although doses as low as 1.5 mL (40 mg/kg) caused death in a few cases (Lamson et al. 1928). Two fatal cases have been reported in humans dosed with approximately 70 mg/kg (Phelps and Hu 1924).

A single dose oral LD₅₀ value of approximately 13,000 mg/kg was reported for mice, and 14 daily doses of 625 mg/kg were lethal for 6 of 20 exposed male mice (Hayes et al. 1986). In rats fed carbon tetrachloride in stock diets or protein-free diets, LD₅₀ values of 10,200 or 23,400 mg/kg, respectively were reported (McLean and McLean 1966). The authors attributed the difference in sensitivity in animals in this study to protein depletion, which has reportedly afforded protection against carbon tetrachloride toxicity. This may result from protein depletion-induced reduction in cytochrome P-450 synthesis, with a

Table 3-2 Levels of Significant Exposure to Carbon Tetrachloride - Oral

Key to Figure ^a	Species (Strain)	Exposure/Duration/Frequency (Route)	System	NOAEL (mg/kg/day)	LOAEL		Reference Chemical Form	
					Less Serious (mg/kg/day)	Serious (mg/kg/day)		
ACUTE EXPOSURE								
Death								
1	Human	Once (C)				40	(lowest quantifiable dose producing death out of 6 cases)	Lamson et al. 1928
2	Human	Once				70	(death in 2/2)	Phelps and Hu 1924
3	Human	Once				120 M	(lowest quantifiable dose producing death out of 12 cases)	Umiker and Pearce 1953
4	Rat	Once (G)				10200	(LD50)	McLean and McLean 1966
5	Rat (Sprague-Dawley)	Once (G)				7500	(LD50)	Pound et al. 1973
6	Rat (Sprague-Dawley)	1 d 1-2x/d (GO)				8000	(death in 17/20)	Thakore and Mehendale 1991
7	Mouse	Once (G)				13000	(LD50)	Hayes et al. 1986
8	Mouse	14 d (G)				625 M	(death in 6/20 males)	Hayes et al. 1986

Table 3-2 Levels of Significant Exposure to Carbon Tetrachloride - Oral

(continued)

Key to Figure	Species (Strain)	Exposure/Duration/Frequency (Route)	System	NOAEL (mg/kg/day)	LOAEL		Reference Chemical Form
					Less Serious (mg/kg/day)	Serious (mg/kg/day)	
9	Cat	Once (G)				400 (death in 25/36)	Chandler and Chopra 1926
Systemic							
10	Human	Once	Cardio	2500	(sinus bradycardia and arrhythmia, auricoventricular nodal rhythm, auricular fibrillation)		Conaway and Hoven 1946
			Renal	2500	(increased blood urea nitrogen)		
11	Human	Once (W)	Hepatic	110	(degeneration of hepatocytes)		Docherty and Burgess 1922
			Renal	180	(swelling of proximal convoluted tubules)		
12	Human	Once (W)	Hepatic	90	(slight fatty infiltration)		Docherty and Nicholls 1923
			Renal	90			
13	Human	Once	Renal			2700 (acute tubular necrosis, increased blood urea nitrogen, anuria, proteinuria)	Guild et al. 1958

Table 3-2 Levels of Significant Exposure to Carbon Tetrachloride - Oral

(continued)

Key to Figure ^a	Species (Strain)	Exposure/ Duration/ Frequency (Route)	System	NOAEL (mg/kg/day)	LOAEL		Reference Chemical Form	
					Less Serious (mg/kg/day)	Serious (mg/kg/day)		
14	Human	Once	Hepatic			670	(severe necrosis; fatty deposits)	MacMahon and Weiss 1929
			Renal			670	(mild proteinuria, elevated blood urea nitrogen; kidneys swollen, fatty degeneration)	
15	Human	Once	Gastro		100	(nausea)		Ruprah et al. 1985
16	Human	1-6 d	Resp			120	(substantial hemorrhagic edema of the lung)	Umiker and Pearce 1953
17	Rat (Fischer- 344)	8-10 d 1x/d (GO)	Hepatic			280	(centrilobular necrosis, increased alkaline phosphatase and 5-nucleotidase)	Blair et al. 1991

Table 3-2 Levels of Significant Exposure to Carbon Tetrachloride - Oral

(continued)

Key to Figure ^a	Species (Strain)	Exposure/ Duration/ Frequency (Route)	System	NOAEL (mg/kg/day)	LOAEL		Reference Chemical Form
					Less Serious (mg/kg/day)	Serious (mg/kg/day)	
18	Rat (Sprague- Dawley)	Once (G)	Hepatic	40 M	80 M (slight vacuolization of some centrilobular hepatocytes)	160 M (increased centrilobular vacuolization with significant necrosis, substantially elevated ornithine carbamyl transferase, sorbitol dehydrogenase and alanine aminotranferase)	Bruckner et al. 1986
			Renal	160 M			
19	Rat (Sprague- Dawley)	11 d 9 doses (G)	Hepatic		20 M (limited centrilobular vacuolization, moderately elevated sorbitol dehydrogenase, alanine aminotranferase, ornithine carbamyl transferase)	80 M (increased centrilobular vacuolization with some limited necrosis, greatly elevated ornithine carbamyl transferase, sorbitol dehydrogenase, alanine aminotranferase)	Bruckner et al. 1986
			Renal	160 M			
20	Rat (Sprague- Dawley)	Once (GW)	Hepatic		10 (increased alanine aminotranferase, sorbitol dehydrogenase, ornithine carbamyl transferase; hepatic centrilobular vacuolization)		Kim et al 1990b
21	Rat	Once (F)	Hepatic		20 M (cytoplasmic vacuolization of hepatocytes)		Korsrud et al. 1972

Table 3-2 Levels of Significant Exposure to Carbon Tetrachloride - Oral

(continued)

Key to Figure ^a	Species (Strain)	Exposure/ Duration/ Frequency (Route)	System	NOAEL (mg/kg/day)	LOAEL		Reference Chemical Form
					Less Serious (mg/kg/day)	Serious (mg/kg/day)	
22	Rat	Once (G)	Hepatic		80 M (decreased P-450)	1600 M (centrilobular necrosis)	Matsubara et al. 1983
23	Rat (Fischer- 344)	10 d 1x/d (GO)	Hepatic		^b 5 M (slight vacuolation)		Smialowicz et al. 1991
			Renal	40 M			
24	Rat (Fischer- 344)	once (GW)	Hepatic			80 M (necrosis; increased serum alanine aminotransferase, sorbitol dehydrogenase)	Steup et al. 1993
25	Rat (Sprague- Dawley)	Once (G)	Renal		4000 M (mitochondrial swelling in cells of proximal tubules)		Striker et al. 1968

Table 3-2 Levels of Significant Exposure to Carbon Tetrachloride - Oral

(continued)

Key to Figure ^a	Species (Strain)	Exposure/Duration/Frequency (Route)	System	NOAEL (mg/kg/day)	LOAEL		Reference Chemical Form	
					Less Serious (mg/kg/day)	Serious (mg/kg/day)		
26	Rat (Sprague-Dawley)	1 d 1-2x/d (GO)	Hepatic				480 M (necrosis, vacuolation; elevated serum levels of aspartate transaminase, alanine transaminase, sorbitol dehydrogenase, decreased liver microsomal cytochrome P-450, aminopyrine demethylase, aniline hydroxylase)	Thakore and Mehendale 1991
27	Rat	Once (GO)	Hepatic	800	1600 (elevated urinary taurine)	3200 (lipid vacuoles, 96 hours post-treatment)	(48 hours post-treatment: necrosis lipid vacuolation, inflammation, elevated serum taurine, elevated serum alanine and aspartate amino-transferases, reduced liver taurine)	Waterfield et al. 1991
28	Mouse	Once (G)	Hepatic	10	40 (necrosis)			Eschenbrenner and Miller 1946
29	Mouse (B6C3F1)	14 d 1x/d (GO)	Hepatic		50 F (increased relative organ weight and SGPT)			Guo et al. 2000
			Bd Wt	1000 F				

Table 3-2 Levels of Significant Exposure to Carbon Tetrachloride - Oral

(continued)

Key to Figure ^a	Species (Strain)	Exposure/ Duration/ Frequency (Route)	System	NOAEL (mg/kg/day)	LOAEL		Reference Chemical Form
					Less Serious (mg/kg/day)	Serious (mg/kg/day)	
30	Mouse (CD-1)	14 d (G)	Hemato	625	(decreased fibrinogen and lymphocyte levels)		Hayes et al. 1986
			Hepatic		(increased liver weight, elevated lactate dehydrogenase, alanine aminotransferase, aspartate aminotransferase)		
			Renal		2500		
31	Dog	Once (G)	Hepatic	3200	(centrilobular necrosis)		Chandler and Chopra 1926
			Renal		(fatty degeneration)		
32	Dog	Once (G)	Hepatic	160	400 (centrilobular necrosis)		Gardner et al. 1925
			Renal		6400 (fatty accumulation in cortical tubules)		
Immuno/ 33	Lymphoret Rat	10 d 1x/d (GO)		160			Smialowicz et al. 1991

Table 3-2 Levels of Significant Exposure to Carbon Tetrachloride - Oral

(continued)

Key to Figure	Species (Strain)	Exposure/Duration/Frequency (Route)	System	NOAEL (mg/kg/day)	LOAEL		Reference Chemical Form
					Less Serious (mg/kg/day)	Serious (mg/kg/day)	
34	Mouse (BALB/c)	7 d 1x/d (GO)			500 F (suppressed T-cell activity)		Delaney et al. 1994
35	Mouse (B6C3F1)	14 d 1x/d (GO)			50 F (decreased: IgM antibody-forming cell activity per spleen and host resistance to <i>Listeria monocytogenes</i>)		Guo et al. 2000
Neurological							
36	Human	Once (C)		70			Hall 1921
37	Human	Once (C)		120	300 (drowsiness)		Leach 1922
38	Human	Once				4800 (narcosis)	Stevens and Forster 1953
Developmental							
39	Rat (Fischer-344)	Gd 6-15 1x/d (GO)		25 F		50 F (total litter resorption in 5/12)	Narotsky et al. 1997a
40	Rat (Fischer-344)	Gd 6-15 1x/d (G)		25 F	50 F (maternal piloerection and reduced body wt gain)	50 F (total litter resorption in 2/14)	Narotsky et al. 1997a

Table 3-2 Levels of Significant Exposure to Carbon Tetrachloride - Oral

(continued)

Key to Figure	Species (Strain)	Exposure/Duration/Frequency (Route)	System	NOAEL (mg/kg/day)	LOAEL		Reference Chemical Form
					Less Serious (mg/kg/day)	Serious (mg/kg/day)	
41	Rat	2-3 d (G)				1400 (total litter resorption in 11/29)	Wilson 1954
42	Mouse (B6D2F1)	Gd 1-5 or GD 6-10 or Gd 11-1: 1x/d (GO)		826 F			Hamlin et al. 1993
INTERMEDIATE EXPOSURE							
Death							
43	Rat (Sprague-Dawley)	13 wk 5 d/wk (GO)				25 M (10% mortality)	Koprec et al. 1995
44	Rat (Sprague-Dawley)	13 wk 5 d/wk (GW)				25 M (25% mortality)	Koprec et al. 1995
Systemic							
45	Rat	12 wk (GO)	Hepatic			20 (increased serum enzymes; necrosis; cirrhosis)	Allis et al. 1990

Table 3-2 Levels of Significant Exposure to Carbon Tetrachloride - Oral

(continued)

Key to Figure	Species (Strain)	Exposure/Duration/Frequency (Route)	System	NOAEL (mg/kg/day)	LOAEL		Reference Chemical Form		
					Less Serious (mg/kg/day)	Serious (mg/kg/day)			
46	Rat	12 wk 5d/wk 1x/d (G)	Hepatic	^c 1	10	(substantially elevated sorbitol dehydrogenase, mild centrilobular vacuolization)	33	(substantially elevated sorbitol dehydrogenase, ornithine carbamyl transferase, alanine aminotransferase, cirrhosis)	Bruckner et al. 1986
			Renal	33					
			Bd Wt	10	33	(Bd wt gain reduced by 16%)			
47	Rat (Sprague-Dawley)	13 wk 5 d/wk (GO)	Hepatic		25 M	(increases 2x in serum ALT and 10x in SDH; minimal-to-slight vacuolization, minimal fibrosis)	100 M	(necrosis, hyperplasia)	Koporec et al. 1995
			Bd Wt	25 M			100 M	(Bd wt decreased 25%)	
48	Rat (Sprague-Dawley)	13 wk 5 d/wk (GW)	Hepatic		25 M	(increases 2 x in serum ALT and 10 x in SDH; vacuolation, fibrosis)	100 M	(necrosis, hyperplasia)	Koporec et al. 1995
			Bd Wt	25 M			100 M	(Bd wt decr 25%)	
49	Mouse	90 d 5d/wk (G)	Hepatic	1.2	12	(elevated alanine aminotransferase, aspartate aminotransferase, lactate dehydrogenase; mild necrosis)			Condie et al. 1986

Table 3-2 Levels of Significant Exposure to Carbon Tetrachloride - Oral

(continued)

Key to Figure ^a	Species (Strain)	Exposure/Duration/Frequency (Route)	System	NOAEL (mg/kg/day)	LOAEL		Reference Chemical Form
					Less Serious (mg/kg/day)	Serious (mg/kg/day)	
50	Mouse	120 d (G)	Hepatic	80			Eschenbrenner and Miller 1946
51	Mouse	90 d (G)	Hemato	1200			Hayes et al. 1986
			Hepatic		12	(centrilobular necrosis, elevated lactate dehydrogenase, alanine aminotransferase, aspartate aminotransferase, and alkaline phosphatase)	
			Renal	1200			
52	Dog (Beagle)	28 d 1 x/d (C)	Hepatic		797	(incr serum ALT and OCT; vacuolization, single-cell necrosis)	Litchfield and Gartland 1974
53	Dog (Beagle)	8 wk 1 x/d (C)	Hepatic	32 F			Litchfield and Gartland 1974
Neurological							
54	Rat	1x/wk 10 wk (G)			290 M	(increased serotonin synthesis)	Bengtsson et al. 1987
Cancer							
55	Mouse	120 d (G)				20 (CEL: hepatoma)	Eschenbrenner and Miller 1946

Table 3-2 Levels of Significant Exposure to Carbon Tetrachloride - Oral

(continued)

Key to Figure ^a	Species (Strain)	Exposure/Duration/Frequency (Route)	System	NOAEL (mg/kg/day)	LOAEL		Reference Chemical Form
					Less Serious (mg/kg/day)	Serious (mg/kg/day)	
56	Hamster	30 wk 1x/wk (GO)				120 (CEL: hepatoma)	Della Porta et al. 1961
CHRONIC EXPOSURE							
Death							
57	Rat (Osborne-Mendel)	78 wk 5d/wk (G)				94 M (survival at 110 wks decr by 46%)	NCI 1976
58	Mouse	78 wk 5d/wk (G)				1250 (survival decr by 80%)	NCI 1976
Systemic							
59	Rat (Osborne-Mendel)	78 wk 5d/wk (G)	Hepatic			47 M (cirrhosis, bile duct proliferation, fatty accumulation)	NCI 1976
Cancer							
60	Rat	78 wk 5d/wk (G)				47 M (CEL: hepatocellular carcinomas)	NCI 1976
61	Mouse (B6C3F1)	78 wk 5d/wk (G)				1250 (CEL: 100% with hepatic carcinoma)	NCI 1976

a The number corresponds to entries in Figure 3-2.

b Used to derive an acute-duration oral MRL of 0.02 mg/kg/day; the minimal LOAEL was divided by an uncertainty factor of 300 (3 for the use of a minimal LOAEL, 10 for extrapolation from animals to humans, and 10 for human variability).

c Used to derive an intermediate-duration oral MRL of 0.007 mg/kg/day; the NOAEL was first adjusted for intermittent exposure (5 days/7 days) and divided by an uncertainty factor of 100 (10 for extrapolation from animals to humans and 10 for human variability).

(C) = capsule; Cardio = cardiovascular; CEL = cancer effect level; d = day(s); F = female; (F) = feed; (G) = gavage; (GO) = gavage in oil; Gastro = gastrointestinal; (GW) = gavage in water; Hemato = hematological; LD50 = lethal dose, 50% kill; LOAEL = lowest-observed-adverse-effect level; M = male; mg/kg/day = milligrams per kilograms per day; NOAEL = no-observed-adverse-effect level; Resp = respiratory; (W) = water; wk = week(s); x = time(s); yr = year(s)

Figure 3-2 Levels of Significant Exposure to Carbon Tetrachloride - Oral

Acute (≤ 14 days)

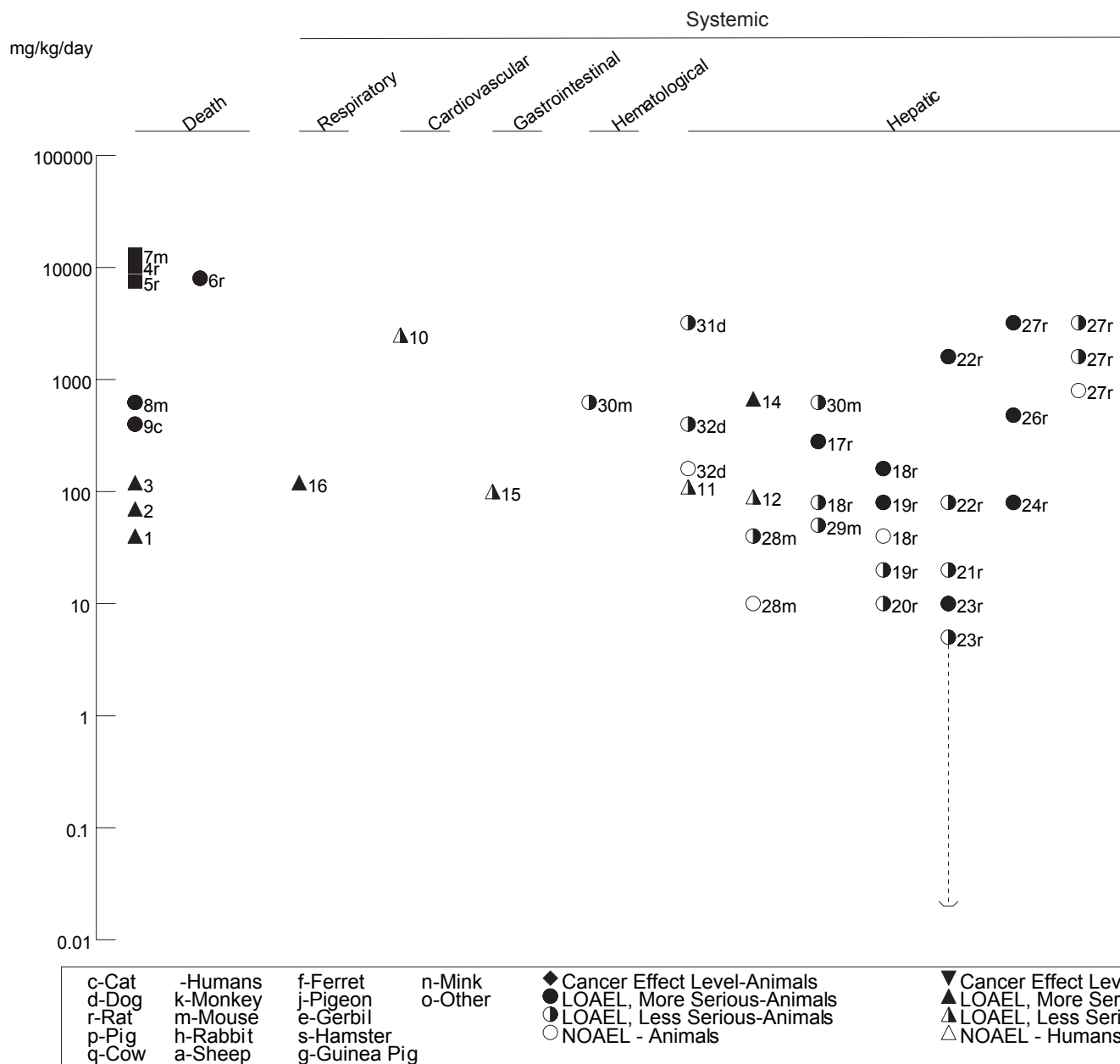

Figure 3-2 Levels of Significant Exposure to Carbon Tetrachloride - Oral (*Continued*)

Acute (≤ 14 days)

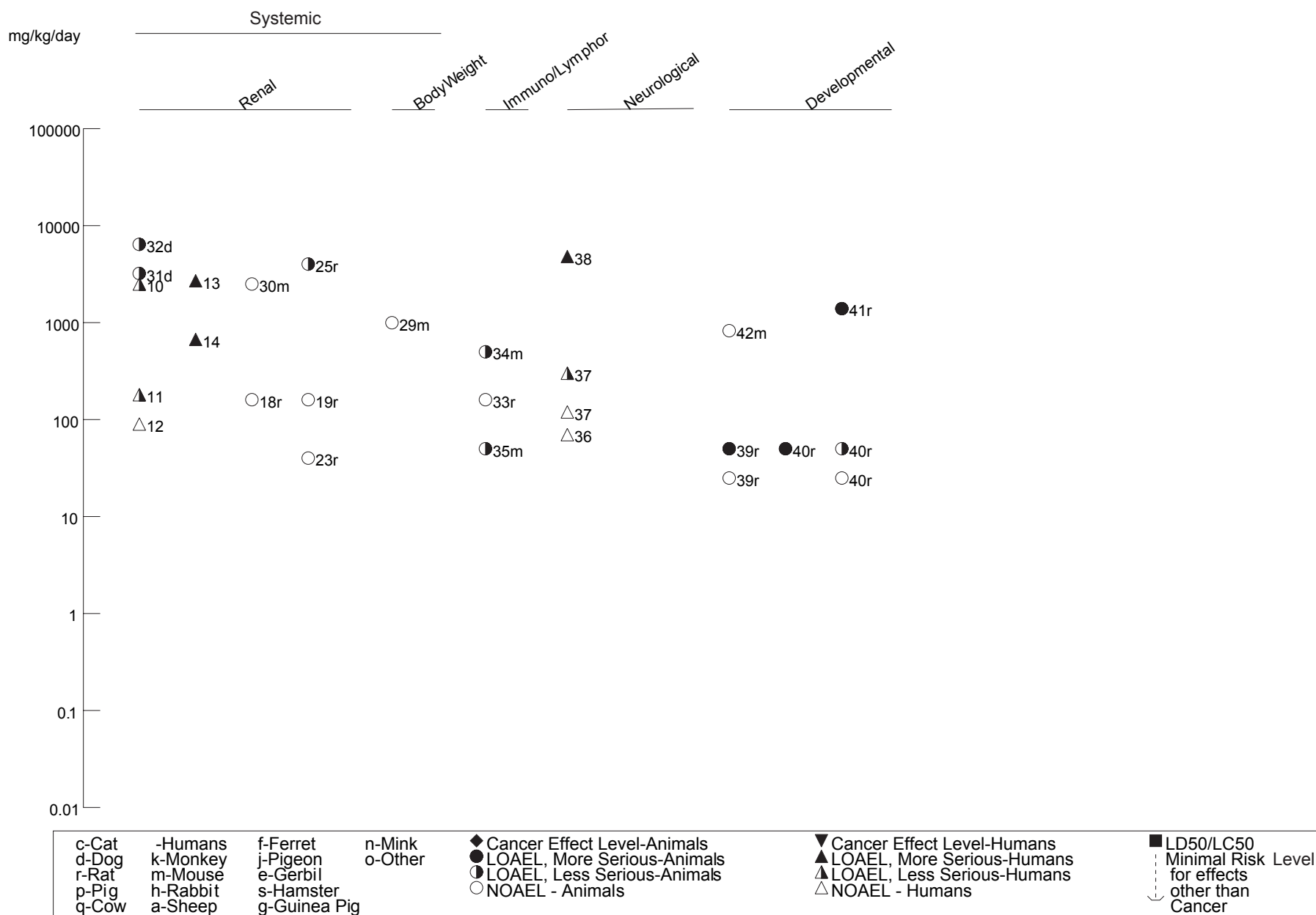

Figure 3-2 Levels of Significant Exposure to Carbon Tetrachloride - Oral (Continued)
Intermediate (15-364 days)

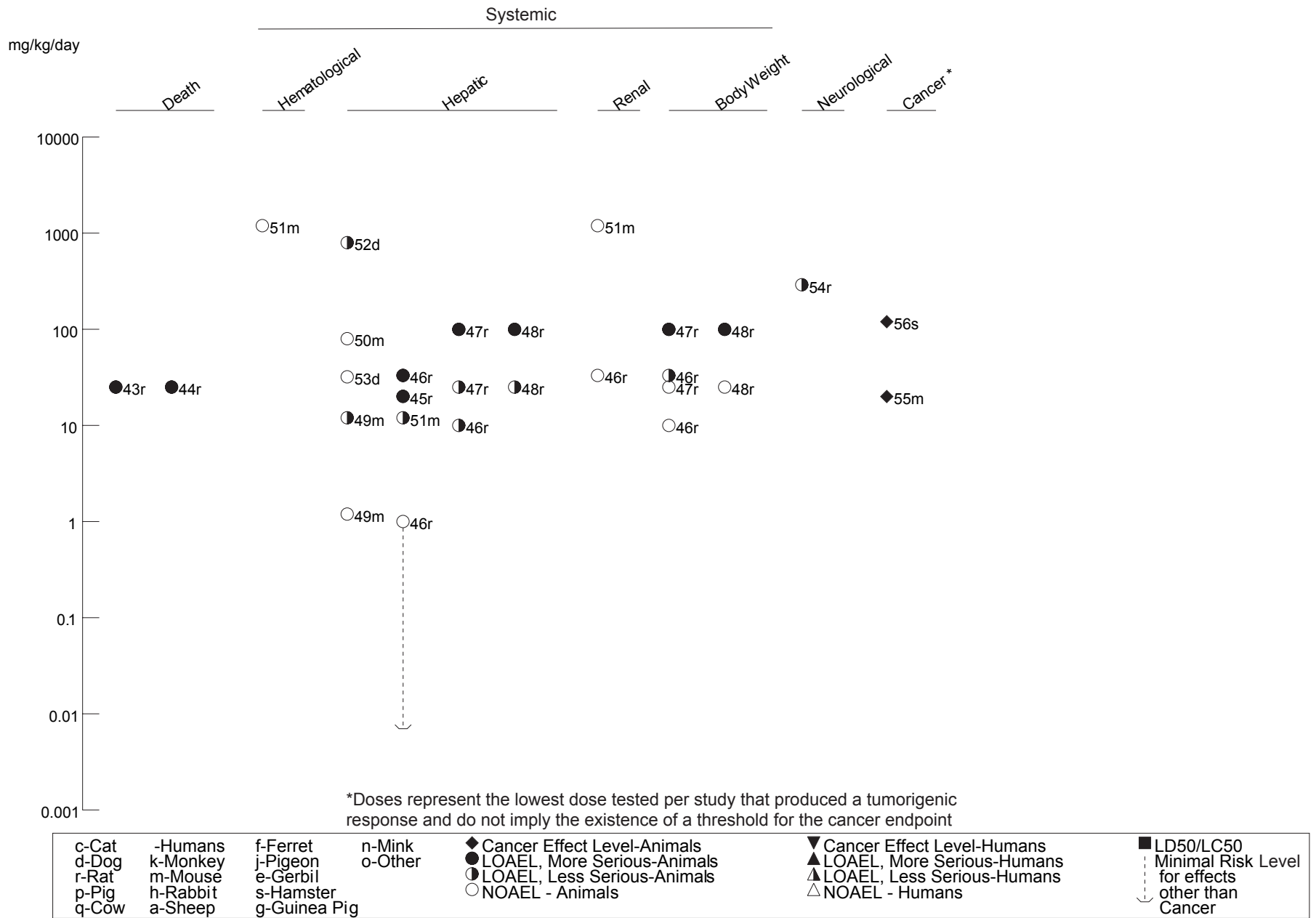
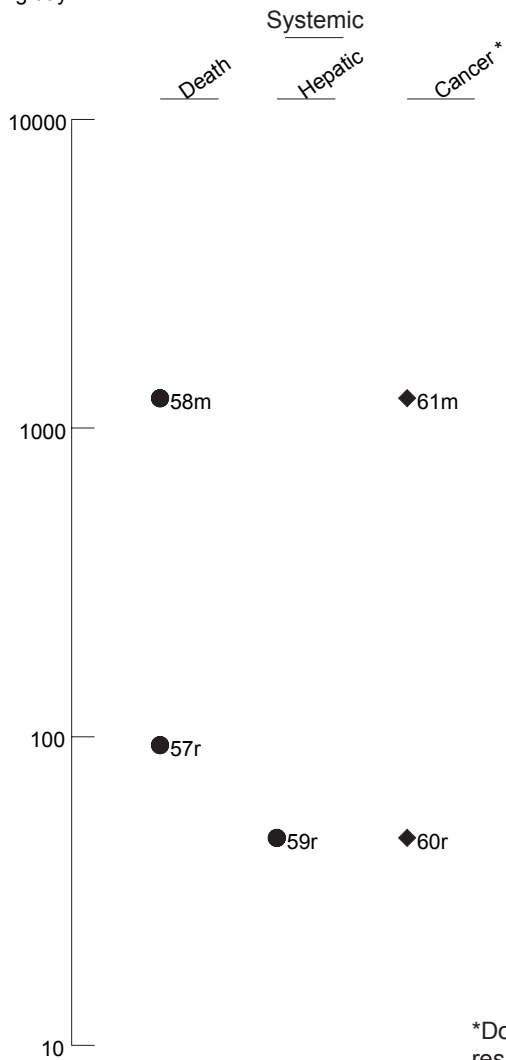

Figure 3-2 Levels of Significant Exposure to Carbon Tetrachloride - Oral (Continued)

Chronic (≥365 days)

mg/kg/day



*Doses represent the lowest dose tested per study that produced a tumorigenic response and do not imply the existence of a threshold for the cancer endpoint

c-Cat	-Humans	f-Ferret	n-Mink	◆ Cancer Effect Level-Animals	▼ Cancer Effect Level-Humans	■ LD50/LC50
d-Dog	k-Monkey	j-Pigeon	o-Other	● LOAEL, More Serious-Animals	▲ LOAEL, More Serious-Humans	⋯ Minimal Risk Level
r-Rat	m-Mouse	e-Gerbil		○ LOAEL, Less Serious-Animals	▲ LOAEL, Less Serious-Humans	⋯ for effects other than Cancer
p-Pig	h-Rabbit	s-Hamster		○ NOAEL - Animals	△ NOAEL - Humans	
q-Cow	a-Sheep	g-Guinea Pig				

3. HEALTH EFFECTS

consequent diminished metabolic activation of carbon tetrachloride to toxic metabolites. In other studies using rats, an LD₅₀ value of approximately 7,500 mg/kg was reported (Pound et al. 1973), while 17/20 animals were killed within 14 days of a single oral gavage exposure to 8,000 mg/kg (Thakore and Mehendale 1991). Doses as low as 400 mg/kg have resulted in the death of cats (Chandler and Chopra 1926).

One study reported a vehicle effect on mortality in rats repeatedly dosed on weekdays with carbon tetrachloride for 13 weeks (Koporec et al. 1995). When the vehicle was corn oil, mortality was 45% at the high dose of 100 mg/kg/day (average daily dose of 17.8 mg/kg/day) and 10% at the low dose of 25 mg/kg/day (average daily dose of 17.8 mg/kg/day); there were no deaths in the control group. When administration was as an aqueous emulsion in 1% Emulphor, the respective mortalities were 75 and 25%. As hepatic effects were the same for the equivalent dose groups, it is not known whether effects on other organ systems (not evaluated) were associated with the vehicle effects on mortality.

In rats exposed to ≥ 47 mg/kg of carbon tetrachloride 5 days/week for 78 weeks and observed for an additional period, survival at 110 weeks was reduced by 46% compared to controls because of hepatotoxicity (NCI 1976a, 1976b). In the same study, survival in mice treated at doses of $\geq 1,250$ mg/kg was reduced by $\geq 80\%$ compared to controls on account of hepatic carcinogenicity.

All LOAEL values for each reliable study for death in each species and duration category are recorded in Table 3-2 and plotted in Figure 3-2.

3.2.2.2 Systemic Effects

No studies were located regarding endocrine, dermal, ocular, or metabolic effects in humans or animals after oral exposure to carbon tetrachloride. Studies have been conducted in humans and animals to evaluate the respiratory, cardiovascular, hematological, or hepatic effects. Gastrointestinal and renal effects have been evaluated in humans, and musculoskeletal effects have been noted in animals. These effects are discussed below. The highest NOAEL values and all LOAEL values for each reliable study for systemic effects in each species and duration category are recorded in Table 3-2 and plotted in Figure 3-2.

Respiratory Effects. A number of human fatalities have been reported following ingestion of carbon tetrachloride (Umiker and Pearce 1953). Edema and hemorrhage of the lung were common autopsy

3. HEALTH EFFECTS

findings. Injury to the lung usually did not become apparent until 8 days or longer after poisoning, and the effects on the lung were essentially the same as observed in cases of uremia due to other causes. This suggests that the late-developing edema and hemorrhagic injury to lung is secondary to severe kidney injury.

In animals, acute oral exposure to doses of 4,000 mg/kg has been observed to cause respiratory edema, atelectasis, and hemorrhage (Gould and Smuckler 1971). This is accompanied by marked disruption of subcellular structure in most pulmonary cell types, including granular pneumocytes, capillary endothelial cells, and Clara cells (Boyd et al. 1980; Gould and Smuckler 1971; Hollinger 1982). It has been shown that Clara cells were most severely injured because they are the most active in metabolic activation of carbon tetrachloride. Injury to capillary endothelial cells is dose-dependent, with increased release of cellular enzymes occurring at doses as low as 160 mg/kg (Hollinger 1982). No studies of respiratory effects following longer-term oral exposure were located.

Cardiovascular Effects. Effects of carbon tetrachloride ingestion on the cardiovascular system have not been the subject of extensive investigation. Most studies in humans have not detected significant gross or histopathological changes in heart tissue at dose levels that cause marked hepatic and renal damage (Leach 1922; MacMahon and Weiss 1929). Electrocardiographic changes (sinus arrhythmia, QRS complex splintering, elevated S-T₄ and P-R intervals) suggestive of myocardial injury were seen in a man who ingested several mouthfuls of carbon tetrachloride, but these appeared to be fully reversible (Conaway and Hoven 1946).

The few animal studies located appear to be in general agreement with the human findings (Gardner et al. 1925; Korsrud et al. 1972). Effects of carbon tetrachloride ingestion on blood pressure are sometimes observed, but these are likely secondary to effects on the central nervous system, or to effects on fluid and electrolyte balance following renal injury.

Gastrointestinal Effects. Humans who ingest oral doses in excess of 30 or 40 mL (680–910 mg/kg) frequently experience nausea, vomiting, and abdominal pain (Hardin 1954; New et al. 1962; Smetana 1939; Umiker and Pearce 1953; von Oettingen 1964). Nausea has been reported after an oral dose of as little as 100 mg/kg (Ruprah et al. 1985). These effects could be the direct result of irritation of the gastrointestinal tract caused by the high dose or secondary to effects on the central nervous system. Oral doses of 3–5 mL (70–110 mg/kg) were widely used in the past for the treatment of hookworms with only mild gastrointestinal distress (Hall 1921; Leach 1922).

3. HEALTH EFFECTS

No studies were located regarding gastrointestinal effects in animals after oral exposure to carbon tetrachloride.

Hematological Effects. Oral exposure to carbon tetrachloride has not been reported to have substantial direct hematological effects in humans or animals. Focal hemorrhagic lesions and mild anemia are sometimes observed in humans who have ingested carbon tetrachloride (Guild et al. 1958; Stewart et al. 1963), but this is likely due to decreased hepatic synthesis and/or secretion of clotting factors.

Only one study was identified that examined the hematological effects of carbon tetrachloride in animals. Intermediate oral exposure of mice to carbon tetrachloride did not result in any consistently significant hematological changes (Hayes et al. 1986).

Musculoskeletal Effects. No studies were located regarding musculoskeletal effects in humans after oral exposure to carbon tetrachloride.

Only a single animal oral study was located that described effects on skeletal muscles, but as it employed co-treatment with phenobarbital to enhance the development of hepatotoxicity (inflammation, necrosis and fibrosis), it is omitted from the LSE table. Male rats were exposed once per week by gavage to carbon tetrachloride doses of approximately 260–1,300 mg/kg/day, for either 3 or 10 weeks (Weber et al. 1992). Histological examination of various muscle tissues revealed no evidence of necrosis or inflammation, a finding supported by normal plasma levels of albumin, creatinine, creatinine phosphokinase, and urea nitrogen. However, muscle atrophy was observed that was apparently selective for fast glycolytic fibers, but not fast or slow oxidative fibers. This was shown to result from increased protein catabolism, and not from decreased protein synthesis. Although the mechanisms are not clearly understood, this muscle effect may be secondary to induced hepatic damage. This conclusion was partially inferred from the observed complete lack of myocyte necrosis, the fiber selectivity of the effect, the absence of enhanced catabolism in muscle exposed directly *in vitro* to 10-fold higher concentrations of carbon tetrachloride, the elimination of disuse atrophy as a factor, and the correlation of this effect with only liver inflammation and necrosis, not cirrhosis (a condition which has been associated in humans with a negative nitrogen balance).

3. HEALTH EFFECTS

Hepatic Effects. Ingestion of carbon tetrachloride can lead to marked hepatotoxicity. In most reports involving humans, exposure has involved ingestion of several mouthfuls or more (probably 500 mg/kg or higher). Typical clinical signs of hepatic damage in such patients include a swollen liver, along with elevated serum levels of hepatic enzymes and decreased serum levels of liver-synthesized proteins (e.g., albumin, fibrinogen). In cases of death (usually occurring within 1–15 days), typical histological findings include fat accumulation, hepatic degeneration, and moderate to severe centrilobular necrosis; hepatitis was also diagnosed (Ashe and Sailer 1942; Jennings 1955; MacMahon and Weiss 1929; Umiker and Pearce 1953).

Single oral doses of 3–5 mL (70–110 mg/kg) were widely used in the past for treatment of hookworm, and ingestion of this dose resulted in clinical signs of liver injury in only a small number of cases (Hardin 1954; Lamson et al. 1928). Single doses of 4–8 mL (90–180 mg/kg) were found to result in fat accumulation in liver in several individuals (Docherty and Burgess 1922; Docherty and Nicholls 1923), and doses of only 1 mL (child) and 3 mL (adult) (approximately 80 mg/kg) have resulted in hepatic necrosis and death in a few cases (Phelps and Hu 1924). These results are indicative of differential susceptibility to carbon tetrachloride in humans. Certain confounding variables (age) may have been contributing factors to lethality at lower dose levels. One of the two cases involved a 5-year-old child, while the second report involved an adult; however, factors that may have increased susceptibility to the compound in this case could not be determined (Phelps and Hu 1924). No studies were located regarding the effects of longer-term or chronic oral exposure in humans to carbon tetrachloride.

The hepatotoxic effects of carbon tetrachloride have been widely studied in animals. Indeed, carbon tetrachloride is used as a model chemical in many laboratory investigations of the basic mechanism of action of hepatotoxic chemicals. Oral exposure to carbon tetrachloride has been observed to result in a wide spectrum of adverse effects on the liver, the most prominent of which are destruction of the smooth and rough endoplasmic reticulum and its associated enzyme activities (Reynolds and Yee 1968), inhibition of protein synthesis (Lutz and Shires 1978), impaired secretion of triglycerides with resultant fat accumulation (Recknagel and Ghoshal 1966; Recknagel and Glende 1973; Waterfield et al. 1991), centrilobular necrosis (Blair et al. 1991; Reynolds and Yee 1968; Waterfield et al. 1991), and eventually fibrosis and cirrhosis (Allis et al. 1990; Bruckner et al. 1986;). Hepatic injury, as indicated by regenerative proliferation following carbon tetrachloride ingestion, initially affects the peri-portal zone and spreads in a dose-dependent fashion to the perivenous-to-midlobular zones over time (Lee et al. 1998). In rats treated with 7,970 mg/kg, peak increases were observed in serum levels of ALT at 24 hours and AST at 48 hours and increased activity of DNA-synthesizing enzymes (thymidine kinase and

3. HEALTH EFFECTS

thymidylate synthetase) was observed at 48–72 hours (Nakata et al. 1975). These results reflect the initial leakage of enzymes from damaged hepatocytes followed by cell regeneration. Similar observations have been seen in dosed mice, in which hepatic necrosis was observed during the first 24 hours after dosing and hepatic mitotic activity was noted by 48 hours (Eschenbrenner and Miller 1946).

Although the occurrence of these effects has been confirmed in a very large number of studies, only a few investigations have focused on the dose-dependency of hepatic injury. After a single oral dose of 1,600 mg/kg to rats, urinary taurine levels were significantly increased ($p < 0.01$ – 0.05) within 24 hours and liver weight was reduced (Waterfield et al. 1991). During the first 48 hours after a higher dose (3,200 mg/kg), first liver, then serum, and finally urinary levels of taurine were elevated. Similar effects, as well as reduced hepatic microsome levels of cytochrome P-450, aminopyrine demethylase, and aniline hydroxylase, were observed in rats after a single oral dose of 480 mg/kg/day (Thakore and Mehendale 1991). These effects were much more severe after 8,000 mg/kg, a dose found to be lethal within 14 days for most animals. Additionally, the liver evidenced necrosis, lipid vacuolation, and inflammation, and serum alanine and aspartate amino transferase levels were elevated. Strain differences in sensitivity have been identified (Magos et al. 1982). Twenty hours after a single dose, slight centrilobular damage was observed at 600 mg/kg in Fisher rats, but at 1,200 mg/kg in Porton-Wistar rats; the dose required to elevate serum ALT 10-fold over background was 610 mg/kg for Fisher rats, but 2,000 mg/kg for Porton-Wistar rats. These results were consistent with the higher background levels of serum ALT in Fisher rats, twice that of Porton-Wistar rats (Magos et al. 1982); this study is omitted from the LSE table because exact group sizes were not reported. Single oral doses of only 40–80 mg/kg have also been observed to produce liver injury in rats and mice (Bruckner et al. 1986; Eschenbrenner and Miller 1946; Steup et al. 1993). In rats receiving 80 mg/kg, elevated serum ALT and SDH were observed as early as 3 hours after administration and histopathology (glycogen depletion and focal necrosis) by 6 hours (Steup et al. 1993); recovery was largely complete by 72 hours. When exposures are continued for 10–11 days, doses of 5–40 mg/kg/day produced mild signs of liver change, while 80 mg/kg/day caused clear hepatic injury (Bruckner et al. 1986; Smialowicz et al. 1991). The LOAEL of 5 mg/kg/day from the study by Smialowicz et al. (1991) has been employed to calculate an acute-duration oral MRL of 0.02 mg/kg/day, as described in the footnote on Table 3-2. At this dose, the earliest sign (vacuolar degeneration) of hepatocyte toxicity was just detectable. The severity of this hepatocellular injury with accompanying necrosis increased in a dose-related manner from 10 to 40 mg/kg/day.

The incidence and severity of hepatic effects were dose-related in intermediate-duration oral exposure studies in animals. In rodents ingesting carbon tetrachloride 5 days/week for 12–13 weeks, no hepatic

3. HEALTH EFFECTS

effects were detected at doses of 1–1.2 mg/kg (Bruckner et al. 1986; Condie et al. 1986). At 10 mg/kg, mild centrilobular vacuolization and elevated serum levels of sorbitol dehydrogenase were observed in rats (Bruckner et al. 1986). Significant elevation in some serum enzymes (ALT, AST, lactate dehydrogenase) and mild necrosis were seen in mice at doses of 12 mg/kg and higher (Condie et al. 1986; Hayes et al. 1986). More extensive hepatic lesions (fatty accumulation, fibrosis, cirrhosis, necrosis) were noted in rats at doses of 20–33 mg/kg (Allis et al. 1990; Bruckner et al. 1986; Koporec et al. 1995). At 100 mg/kg/day, hepatic effects in rats also included cytomegaly and various types of hyperplasia (Koporec et al. 1995). The vehicle used to administer carbon tetrachloride modifies the observed effect levels. The incidence and severity of hepatic lesions was increased when carbon tetrachloride was administered in an aqueous emulsion (in 1% Emulphor) compared to administration in corn oil (Koporec et al. 1995). Dogs appear to be less vulnerable to the hepatic effects of carbon tetrachloride than rodents. In female dogs given 32 mg/kg/day for 8 weeks, there was no liver histopathology and no significant increase in serum enzymes (Litchfield and Gartland 1974). Male and female dogs that received 797 mg/kg/day for 4 weeks exhibited liver histopathology (centrilobular fatty vacuolization sometimes with single cell necrosis); the severity of hepatic lesions in individual dogs was correlated with the level of increases in serum enzyme levels (ALT and ornithine carbamyl transferase). Based on the NOAEL of 1 mg/kg in rats that was reported by Bruckner et al. (1986), an intermediate oral MRL of 0.007 mg/kg/day was calculated as described in the footnote in Table 3-2.

A no-effect level for hepatic effects has not been determined in chronic-duration oral exposure studies in animals. Alumot et al. (1976) reported no significant effects on serum enzyme levels or hepatic fat content of rats exposed to nominal doses of approximately 11–14 mg/kg/day for 2 years. However, the doses in this study cannot be reliably estimated because of uncertainty regarding the method of exposure; diets were fumigated with carbon tetrachloride vapor for 2 days prior to use and the degree of loss from evaporation is not known. Although the gradual intake from the diet would be expected to result in less hepatic toxicity than the same daily amount delivered as a single oral bolus (see, for example, Bruckner et al. 1986 discussed above), this study does not provide definitive information on threshold levels for oral exposure to carbon tetrachloride. The only other chronic-duration oral information comes from chronic gavage bioassays by the NCI (1976a, 1976b) on chloroform and trichloroethylene in which carbon tetrachloride was employed as a positive control for hepatic carcinogenicity. Rats treated with doses as low as 47 mg/kg, 5 days/week for 78 weeks exhibited severe hepatotoxicity, the most prominent effects being portal cirrhosis in 58%, bile duct proliferation in 62%, and fatty accumulation in 58% of treated animals; fibrosis, necrosis, and regenerating nodules were observed less frequently. The main hepatic effect in mice was carcinogenicity, discussed in Section 3.2.2.7. No chronic-duration oral MRL was

3. HEALTH EFFECTS

derived for carbon tetrachloride because the lowest tested doses in well-conducted bioassays caused severe hepatic toxicity. Under ATSDR guidance, MRLs are not derived on dose levels causing severe effects.

Renal Effects. Nephritis is a common finding in fatal cases of carbon tetrachloride ingestion in humans (Umiker and Pearce 1953), and renal failure may contribute to death in many cases (Gosselin et al. 1976; von Oettingen 1964). Typically, clinical signs of renal dysfunction (oliguria or anuria, albuminuria, proteinuria, elevated blood urea nitrogen edema, hypertension) tend to develop within 1–6 days after exposure, somewhat later than the appearance of hepatic injury (Conaway and Hoven 1946; Guild et al. 1958; Kluwe 1981; MacMahon and Weiss 1929; Smetana 1939; Umiker and Pearce 1953). In nonfatal cases, renal function usually returns to normal within several weeks (Guild et al. 1958; Kluwe 1981; Smetana 1939). Histological changes in the kidney are observed primarily in the proximal tubular epithelium, where cells become swollen and granular, with moderate to severe necrosis (Docherty and Burgess 1922; Guild et al. 1958; MacMahon and Weiss 1929; Smetana 1939).

Studies in animals confirm that the kidney is a target tissue for carbon tetrachloride, although in rodents, the kidney is much less sensitive than the liver to carbon tetrachloride. Doses of 4,000 mg/kg resulted in swollen and pale kidneys in rats within 2 days, with morphological changes present primarily in proximal tubular epithelial cells. All histological and functional signs of renal injury were fully reversible within 5 days (Striker et al. 1968). Fatty degeneration of the kidney has been observed in dogs after a single dose of 3,200 mg/kg (Chandler and Chopra 1926) and swelling of the convoluted tubules after 6,400 mg/kg (Gardner et al. 1925). Exposure of rats to 160 mg/kg/day for about 10 days did not induce adverse renal effects (Bruckner et al. 1986; Smialowicz et al. 1991), nor did 12 weeks exposure to 33 mg/kg/day, 5 days/week (Bruckner et al. 1986). Only marginal indication of kidney injury was detected in mice exposed to doses of 2,500 mg/kg/day for 14 days or 1,200 mg/kg/day for 90 days (Hayes et al. 1986). It should be recalled that these doses result in marked hepatotoxicity.

Body Weight Effects. Reduced body weight gain has been observed in rats orally dosed with carbon tetrachloride 5 days/week for 90 days. Terminal body weights were 16% lower than controls in rats dosed with 33 mg/kg (Bruckner et al. 1986) and 25% lower in rats dosed with 100 mg/kg (Koporec et al. 1995).

3. HEALTH EFFECTS

3.2.2.3 Immunological and Lymphoreticular Effects

No studies were located regarding immunological effects in humans after oral exposure to carbon tetrachloride.

Studies in rodents have shown significant suppression of immune function following exposure to carbon tetrachloride. Exposure of female mice to carbon tetrachloride at 500 mg/kg/day for 7 consecutive days suppressed the T-cell-dependent humoral responses to sheep red blood cells (SRBC) (Delaney et al. 1994). The effect was mediated by an increase in serum levels of transforming growth factor beta-1 (TGF-beta-1), which occurred 24–48 hours after exposure in single-dose experiments (at 250–500 mg/kg, but not 50 mg/kg). Exposure of rats to carbon tetrachloride (up to 160 mg/kg/day for 10 days) by gavage did not alter the primary antibody response to SRBC, lymphoproliferative responses to mitogen or mixed leukocytes, natural killer cell activity, or cytotoxic T-lymphocyte responses; also, spleen and thymus weights were comparable to controls (Smialowicz et al. 1991). In female mice that were given daily gavage doses between 50 and 500 mg/kg/day for 14 days (sufficient for hepatotoxicity), the T-cell-dependent humoral response to SRBC was suppressed at ≥ 50 mg/kg/day, serum anti-SRBC IgM titers were reduced at 100 mg/kg/day, and the absolute number and percentage of CD4⁺CD8⁻ T-cells per spleen was reduced at 500 mg/kg/day (Guo et al. 2000). Exposure had no effect on the mixed leukocyte response to allogenic spleen cells, or the activities of cytotoxic T-lymphocytes or natural killer (NK) cells. In this study, exposure to carbon tetrachloride also decreased host resistance to *Streptococcus pneumoniae* and *Listeria monocytogenes*, with the effective dose dependent on the magnitude of the challenge. In rats exposed twice weekly for 4–12 weeks to 3,688 mg/kg/day, there was histologic evidence of hemorrhage, hemosiderin deposition, and lymphocyte depletion in the pancreaticoduodenal lymph node (Doi et al. 1991), an effect that may be secondary to induced hepatic damage.

The highest NOAEL values and all LOAEL values for each reliable study of immunological and lymphoreticular effects in each species and duration category are recorded in Table 3-2 and plotted in Figure 3-2.

3.2.2.4 Neurological Effects

Ingestion of carbon tetrachloride frequently results in marked depression of the central nervous system. Neurological signs in humans include headache, vertigo, weakness, blurred vision, lethargy, and coma, sometimes accompanied by tremor and paresthesias. Mental confusion and disorientation tend to appear

3. HEALTH EFFECTS

later. These symptoms have been reported in people who ingested single oral doses of carbon tetrachloride ranging from 5 to 473 mL (approximately 114–10,800 mg/kg) (Cohen 1957; Leach 1922; Stevens and Forster 1953; Stewart et al. 1963). The onset of initial effects is very rapid, and is likely the result of direct narcotic action on the central nervous system, similar to other anesthetic halocarbons. Recovery from the depressant effects generally appears to be complete (Stevens and Forster 1953; Stewart et al. 1963), although in some fatal cases, histological examination of the brain has revealed patchy pontine necrosis, demyelination, and Purkinje cell damage, with widespread hemorrhagic infarcts (Cohen 1957). Single oral doses of 70 or 120 mg/kg have been reported to be without significant neurological effect (Hall 1921; Leach 1922).

Only one animal study was located that specifically reported neurological effects other than those that typically attend acute high-dose exposure (e.g., lethargy, coma, related cardiac effects of arrhythmia, and blood pressure changes). When rats pretreated with phenobarbital received weekly doses of carbon tetrachloride for 10 weeks (initially 289 mg/kg/day, increasing to a maximum of approximately 1,600 mg/kg/day according to body weight gain), a condition of diffuse micronodular liver cirrhosis was induced (Bengtsson et al. 1987). This was accompanied by significantly increased synthesis of the neurotransmitter serotonin in all six areas of the brain that were monitored. Serotonin levels were not, however, reliably correlated with any abnormal open-field behavior, which was used as an indicator of the possible portal-systemic encephalopathy that may accompany liver failure.

The highest NOAEL values and all LOAEL values for each reliable study for neurological effects in each species and duration category are recorded in Table 3-2 and plotted in Figure 3-2.

3.2.2.5 Reproductive Effects

No studies were located regarding reproductive effects in humans after oral exposure to carbon tetrachloride.

Rats (males and females) ingested carbon tetrachloride in their food for 5–6 weeks (Alumot et al. 1976). No effects were noted on most reproductive parameters monitored (percent conception, percent with litters, mean litter size, mean body weight of offspring at birth and at weaning). An increase in neonatal mortality was observed in the low dose group (about 6 mg/kg/day), but not in the high dose group (about 15 mg/kg/day). The authors concluded that this response was not treatment related, and that these doses of carbon tetrachloride had no adverse effect on reproduction.

3. HEALTH EFFECTS

The highest NOAEL values for reproductive effects in rats after chronic exposure are recorded in Table 3-2 and plotted in Figure 3-2.

3.2.2.6 Developmental Effects

An epidemiological study was conducted using birth outcome and drinking water exposure databases from a four-county area in northern New Jersey (Bove et al. 1992a, 1992b, 1995). The cross-sectional study of data from 75 out of 146 towns spanned the period 1985–1988 and evaluated the entire study population of 80,938 singleton live births and 599 singleton fetal deaths. Estimated carbon tetrachloride concentrations in the drinking water of >1 ppb were associated with the following adverse developmental outcomes (odds ratio, 95% confidence interval, significance): full-term birth weight <2,500 g (2.26, 1.41–3.6, $p<0.001$), small for gestational age (1.35, 1.03–1.8, $p<0.03$), and neural tube defects (5.39, 1.31–22.2, $p<0.025$). However, the weight/size effects were also associated with trihalomethanes that were present in the drinking water at larger concentrations than carbon tetrachloride and the neural tube defects were based on a total of two cases in the group exposed to carbon tetrachloride. Methodological limitations of the study may have resulted in chance, missed, or under- or overestimated associations. As acknowledged by the authors, inhalation and/or dermal exposure through bathing and showering could be at least as significant as the oral exposure. Although these studies suggest a causative role for carbon tetrachloride in the generation of certain adverse developmental outcomes, issues that could beneficially be addressed in the future include better-defined exposure levels (these levels appear to be rather low for a causative agent) and the potential for such effects to be the result of complex mixture exposure.

A case-control study of selected congenital malformations and maternal residential proximity to NPL sites in California between 1989 and 1991 did not find an increased risk of conotruncal heart defects or oral cleft defects associated with sites containing carbon tetrachloride (Croen et al. 1997).

No teratogenic effects (morphological anomalies) were reported in rats following maternal oral exposure to carbon tetrachloride, but total resorption of fetuses was reported at maternally toxic doses. Doses of 1,400 mg/kg/day during gestation caused marked maternal toxicity in rats, and total resorption of fetuses in some animals, but no adverse effects in surviving litters (Wilson 1954). In rats treated with carbon tetrachloride by gavage in corn oil or an aqueous vehicle (Emulphor EL-620) on gestational days 6–15, no maternal or developmental toxicity occurred at a dose of 25 mg/kg/day (Narotsky et al. 1997a). Total loss of some litters and clinical signs of toxicity (piloerection and reduced body weight gain) occurred in

3. HEALTH EFFECTS

dams treated with ≥ 50 mg/kg/day. Effects were slightly more severe when the vehicle was corn oil (5/12 litters resorbed) than when an aqueous vehicle was used (2/24 litters resorbed).

Temporal variations during gestation in sensitivity to carbon tetrachloride were reported in rats. When pregnant rats were given a single dose of 150 mg/kg carbon tetrachloride on gestational day 6, 7, 8, 10, or 12, the incidences of full litter loss ranged between 36 and 72% during gestation days 6–10 (maximal day 8) and 0% on day 12 compared to 4% for the controls (Narotsky et al. 1997b). The authors concluded that gestational days 6–10 represented a critical period of vulnerability to carbon tetrachloride in rats. Dams later found to have had full litter resorption exhibited bloody vaginal discharges within 24 hours of dosing. No additional developmental toxicity was reported in surviving litters. Offspring were not evaluated for possible neurobehavioral deficits.

Mice appear to be less vulnerable than rats to carbon tetrachloride. When pregnant mice were given oral doses as high as 826 mg/kg/day on five consecutive days (the preimplantation period [gestation days 1–5], or organogenesis periods [gestation days 6–10 or 11–15]), there were no overt signs of maternal toxicity and no adverse effects on survival, growth or development during the fetal and postnatal stages (Hamlin et al. 1993).

The highest NOAEL value for developmental effects in rats after acute exposure is recorded in Table 3-2 and plotted in Figure 3-2.

3.2.2.7 Cancer

No studies were located regarding carcinogenic effects in humans after oral exposure to carbon tetrachloride.

Studies in animals (rats, hamsters, and several strains of mice) provide convincing evidence that ingestion of carbon tetrachloride increases the risk of liver cancer (Andervont 1958; Della Porta et al. 1961; Edwards 1941; Edwards and Dalton 1942; Edwards et al. 1942; Eschenbrenner and Miller 1944, 1946; NCI 1976a). In general, carbon tetrachloride-induced liver tumors were either hepatomas or hepatocellular carcinomas that appeared after exposure periods of only 10–30 weeks (Edwards 1941; Eschenbrenner and Miller 1944; NCI 1976a). For example, daily oral doses as low as 20 mg/kg produced hepatic tumors in mice exposed for 120 days (Eschenbrenner and Miller 1946). In most cases, the incidence of hepatic tumors was very high (75–100%) in exposed animals. In each of these studies, the

3. HEALTH EFFECTS

carbon tetrachloride was administered daily by single bolus gavage. As noted in the discussion of oral hepatic effects, such a dosing regimen may exacerbate cancer effects relative to those that might be observed under conditions of food or drinking water exposure. Based on these studies, both IARC (1987) and EPA (IRIS 1993) have concluded there is sufficient evidence that carbon tetrachloride is carcinogenic in experimental animals, and that it is possibly or probably carcinogenic in humans.

The EPA (1984) reviewed the available information on the carcinogenic effects of carbon tetrachloride following oral exposure, and concluded that the studies by Della Porta et al. (1961) in hamsters, Edwards et al. (1942) in mice, and NCI (1976a, 1976b, 1977; Weisburger 1977) in rats and mice had adequate dose-response data to allow quantitative estimation of the unit cancer risk (the excess risk of cancer associated with lifetime ingestion of water containing 1 µg/L, assuming intake of 2 L/day by a 70-kg person). Since each study was judged to have some limitations, no one study was selected as the basis for the risk calculation. Rather, calculations were performed for all four data sets, and the geometric mean of these estimates was taken to be the most appropriate value. These calculations are summarized in Table 3-3. Because of the uncertainty in the data and in the calculations, the EPA identified the geometric mean of the upper 95% confidence limit (3.7×10^{-6}) as the preferred estimate of unit cancer risk.

Based on this value, the upper-bound lifetime risk from ingestion of 1 µg/kg/day of carbon tetrachloride is 1.3×10^{-4} , and the daily intake levels associated with lifetime risks of 10^{-4} , 10^{-5} , 10^{-6} , and 10^{-7} are 0.77, 0.077, 0.0077, and 0.00077 µg/kg/day, respectively.

Because these are based on upper-bound estimates, the true risk could be lower. These values, along with doses of carbon tetrachloride that have been observed to cause cancer in animals, are presented in Figure 3-2.

3.2.3 Dermal Exposure

The highest NOAEL values and all LOAEL values from each reliable study for death and hepatic and dermal effects in each species and duration category are recorded in Table 3-4.

3. HEALTH EFFECTS

Table 3-3. Summary of Carcinogenic Unit Risk Calculations for Oral Exposure to Carbon Tetrachloride^a

Reference	Species	Unit cancer risk ^b	
		Best estimate	Upper 95% confidence limit
Della Porta et al. (1961)	Hamster	2.5×10^{-5}	3.4×10^{-5}
Edwards et al. (1942)	Mouse	7.1×10^{-6}	9.4×10^{-6}
NCI (1976)	Mouse	1.4×10^{-6}	1.8×10^{-6}
NCI (1976)	Rat	1.9×10^{-7}	3.1×10^{-7}
	Geometric Mean	2.5×10^{-6}	3.7×10^{-6}

^aSource: EPA 1984

^bThe estimated probability of cancer in a 70-kg person ingesting 2 L/day of water containing 1 µg/L of carbon tetrachloride for a lifetime

Table 3-4 Levels of Significant Exposure to Carbon Tetrachloride - Dermal

Species (Strain)	Exposure/ Duration/ Frequency (Route)	System	LOAEL		Reference Chemical Form
			NOAEL	Less Serious	
ACUTE EXPOSURE					
Death					
Gn Pig	Once 24 hr			15000 mg/kg	(LD50, 24 hours) Roudabush et al. 1965
Gn Pig	Once contact for 5 d			260 mg/cm ²	(5/20) Wahlberg and Boman 1979
Rabbit	Once 24 hr			15000 mg/kg	(LD50, 24 hours) Roudabush et al. 1965
Systemic					
Gn Pig	Once 15 min-16 hr	Hepatic	513 mg/cm ²	(hydropic changes, slight necrosis)	Kronevi et al. 1979
		Dermal	513 mg/cm ²	(karyopynosis, spongiosis, perinuclear edema)	
Gn Pig	Once 24 hr	Dermal	120 mg/kg/day	(primary irritation)	Roudabush et al. 1965
Rabbit	Once 24 hr	Dermal	120 mg/kg/day	(primary irritation)	Roudabush et al. 1965

cm = centimeters; d = day(s); Derm = dermal; Gn pig = Guinea pig; hr = hour(s); LD50 = lethal dose, 50% kill; LOAEL = lowest-observed-adverse-effect level; mg/kg/day = milligrams per kilograms per day; NOAEL = no-observed-adverse-effect level

3. HEALTH EFFECTS

3.2.3.1 Death

One of three naval officers who weekly misused a carbon tetrachloride fire-extinguishing fluid as a dry cleaning agent over 3 months died of heart failure that was secondary to nephrosis-induced pulmonary edema (Forbes 1944); the man who died was a heavy consumer of alcohol. It is likely that the individual was exposed by inhalation as well as dermally, but the actual intakes were not known; 4 pints of the fluid (equivalent to 3 kg carbon tetrachloride) were used during the time period.

3.2.3.2 Systemic Effects

No studies were located regarding hematological, musculoskeletal, endocrine, or ocular effects after dermal exposure of humans or animals to carbon tetrachloride. Respiratory, cardiovascular, gastrointestinal, hepatic, renal, ocular, and dermal effects were reported in humans. Hepatic and dermal effects were also seen in animals. These effects are discussed below. The LOAEL values from each reliable study for systemic effects in each species and duration category are recorded in Table 3-4.

Respiratory Effects. Pulmonary edema that developed in one fatal case of combined weekly inhalation/dermal exposure over 3 months appeared to be secondary to renal malfunction (Forbes 1944).

Cardiovascular Effects. Failure of the left side of the heart was the proximate cause of death in one case repeatedly exposed dermally and by inhalation over 3 months (Forbes 1944). The heart effect developed secondary to nephrosis-induced pulmonary edema.

Gastrointestinal Effects. There are case reports of three humans who experienced gastrointestinal symptoms, including nausea and vomiting, after dermal application of carbon tetrachloride-based lotion (Perez et al. 1987). No quantitative estimate of the amount of carbon tetrachloride applied or absorbed was provided. Three individuals who were repeatedly exposed dermally and by inhalation over 3 months experiences anorexia and vomiting (Forbes 1944).

No studies were located regarding gastrointestinal effects in animals after dermal exposure to carbon tetrachloride.

3. HEALTH EFFECTS

Hepatic Effects. Liver injury, characterized by an elevated serum enzyme (alanine aminotransferase level), was described in case reports of three humans after dermal application of carbon tetrachloride (Perez et al. 1987). In the absence of quantitative estimates of the amount of carbon tetrachloride applied or absorbed, NOAEL and LOAEL values cannot be determined. Severe centrilobular necrosis was found at autopsy following the death of one of three naval officers who were exposed by inhalation and dermally over 3 months (Forbes 1944); none of the exposed men exhibited jaundice. Actual exposure levels could not be determined.

Hydropic changes and isolated necrotic areas were reported in the liver of guinea pigs 16 hours after dermal contact with 513 mg/cm² of carbon tetrachloride (1.0 mL placed in a sealed enclosure covering a sealed enclosure covering a 3.1 cm² area of clipped skin) (Kronevi et al. 1979).

Renal Effects. Acute renal failure, as evident by anuria and azoturia, was reported in three case reports of humans after dermal application of carbon tetrachloride-based lotion (Perez et al. 1987). The usefulness of this finding is limited by the lack of data concerning the amount of carbon tetrachloride applied or absorbed. Albuminuria and uremia developed in three naval officers exposed weekly by inhalation and dermally to an unknown amount of carbon tetrachloride over 3 months (Forbes 1944). The one fatality, an alcoholic, showed signs of albuminous degeneration of the convoluted tubules and Bowman's capsule and granular casts in the distal convoluted tubules.

No studies were located regarding renal effects in animals after dermal exposure to carbon tetrachloride.

Dermal Effects. In humans, direct dermal contact with undiluted carbon tetrachloride causes a mild burning sensation with mild erythema (Stewart and Dodd 1964). Some individuals appear to be hypersensitive, developing marked swelling, itching, and blisters following dermal contact (Taylor 1925).

Similar effects of dermal contact with carbon tetrachloride have been described in animals. A dose of 124 mg/cm² carbon tetrachloride produced moderate primary irritation within 24 hours when applied occluded to the intact or abraded skin of rabbits or guinea pigs, with irritation scores of 2.2–4.1 on skin (Roudabush et al. 1965). Direct dermal contact of guinea pigs with liquid carbon tetrachloride (occluded; 513 mg/cm²) caused degenerative changes in epidermal cells and marked intercellular edema or spongiosis (Kronevi et al. 1979). These effects became apparent within 15 minutes, and progressed in severity over the course of several hours. These effects require direct dermal contact because similar effects on the skin are not observed following inhalation or oral exposure.

3. HEALTH EFFECTS

Ocular Effects. Double-vision was reported in an individual exposed dermally and by inhalation from weekly use of carbon tetrachloride fire-extinguishing fluid as a dry-cleaning agent over a period of 3 months (Forbes 1944).

No data were located for ocular effects in animals exposed dermally.

3.2.3.3 Immunological and Lymphoreticular Effects

No studies were located regarding immunological effects in humans or animals after dermal exposure to carbon tetrachloride

3.2.3.4 Neurological Effects

A case of polyneuritis was reported in a man who had repeated dermal contact 8 hours/day with carbon tetrachloride using it as a degreasing agent (Farrell and Senseman 1944). Sudden severe epileptiform seizure and coma occurred in a subsequently fatal case following weekly combined inhalation/dermal exposure (Forbes 1944). The individual, an alcoholic, was one of three men who misused a carbon tetrachloride fire-extinguishing fluid as a dry-cleaning agent over a period of 3 months (Forbes 1944).

No studies were located regarding neurological effects in animals after dermal exposure to carbon tetrachloride.

3.2.3.5 Reproductive Effects

No studies were located regarding reproductive effects in humans or animals after dermal exposure to carbon tetrachloride.

3.2.3.6 Developmental Effects

No studies were located exclusively regarding developmental effects in humans or animals after dermal exposure to carbon tetrachloride. However, note the epidemiological studies discussed in Section 3.2.2.6,

3. HEALTH EFFECTS

which almost certainly involved significant dermal and inhalation exposures in addition to the emphasized oral exposure.

3.2.3.7 Cancer

No studies were located regarding carcinogenic effects in humans or animals following dermal exposure to carbon tetrachloride.

3.3 GENOTOXICITY

The genotoxic potential of carbon tetrachloride has been evaluated *in vivo* (Table 3-5) and *in vitro* (Table 3-6).

Inhalation Exposure. No studies were located on genetic effects in humans or animals after inhalation exposure to carbon tetrachloride.

Oral Exposure. No studies were located regarding genetic effects in humans after oral exposure to carbon tetrachloride.

Results of *in vivo* tests in animals orally exposed to carbon tetrachloride suggest that genotoxic effects only occur at doses high enough to cause hepatic toxicity. No sex-linked recessive mutations were induced in *Drosophila melanogaster* exposed dietarily (Fouremant et al. 1994). In oral gavage studies, there were no increases in the frequencies of chromosomal aberration, sister chromatid exchange, or micronucleus formation in the liver of rats or in the frequency of micronucleus formation in bone marrow of mice (Sawada et al. 1991; Suzuki et al. 1997). Some studies reported negative results in the liver for unscheduled DNA synthesis in rats (Mirsalis and Butterworth 1980; Mirsalis et al. 1982). However, authors of one study attributed increased DNA synthesis in rats exposed at a high dose not to unscheduled DNA synthesis *per se*, but to the increased tissue regeneration following hepatic necrosis (Craddock and

3. HEALTH EFFECTS

Table 3-5. Genotoxicity of Carbon Tetrachloride *In Vivo*

Species (test system)	End point	Results	Reference
Oral route:			
<i>Drosophila melanogaster</i> ^a	Sex-linked recessive mutation	–	Foureman et al. 1994
Rat hepatocytes ^b	Chromosomal aberrations	–	Sawada et al. 1991
Rat hepatocytes ^b	Sister chromatid exchange	–	Sawada et al. 1991
Rat hepatocytes ^b	Micronuclei	–	Sawada et al. 1991
Rat hepatocytes ^c	Unscheduled DNA synthesis	–	Mirsalis and Butterworth 1980
Rat hepatocytes ^d	Unscheduled DNA synthesis	–	Mirsalis et al. 1982
Rat hepatocytes ^e	Unscheduled DNA synthesis	–	Craddock and Henderson 1978
Rat hepatocytes ^f	Unscheduled DNA synthesis	[+]	Craddock and Henderson 1978
Rat hepatocytes ^g	DNA damage	–	Bermudez et al. 1982
Rat liver ^h	DNA adducts (lipid peroxidation)	+	Chaudhary et al. 1994
Rat liver (partially hepatectomized) ⁱ	Caffeine elutable (single-stranded) DNA	–	Stewart 1981
Hamster liver and kidney ^j	DNA adducts (lipid peroxidation)	+	Wang and Liehr 1995
Mouse liver, stomach, kidney, bladder, lung, brain, bone marrow ^k	DNA damage (comet assay) after 3 hours	–	Sasaki et al. 1998
Mouse stomach, kidney, bladder, lung, brain, bone marrow ^l	DNA damage (comet assay) after 24 hours	–	Sasaki et al. 1998
Mouse liver ^m	DNA damage (comet assay) after 24 hours	[+]	Sasaki et al. 1998
Mouse liver ⁿ	DNA damage (alkaline elution) after 4 hours	–	Schwartz et al. 1979
Mouse bone marrow ^o	Micronuclei after 24–72 hours	–	Suzuki et al. 1997
Intraperitoneal injection:			
<i>D. melanogaster</i> ^p	Sex-linked recessive mutation	–	Foureman et al. 1994
Rat forestomach, liver, lung, colon, kidney ^q	DNA adducts (lipid peroxidation)	[+]	Wacker et al. 2001
Rat liver ^r	DNA adducts (lipid peroxidation)	[+]	Chung et al. 2001
Rat liver ^s	Covalent binding to DNA	+	Castro et al. 1989
Hamster liver ^s	Covalent binding to DNA	+	Castro et al. 1989
Mouse liver ^s	Covalent binding to DNA	+	Castro et al. 1989
Mouse peripheral reticulocytes ^t	Micronuclei	–	Suzuki et al. 1997
Mouse bone marrow ^u	Micronuclei after 24 or 48 hours	–	Crebelli et al. 1999

3. HEALTH EFFECTS

Table 3-5. Genotoxicity of Carbon Tetrachloride *In Vivo*

Species (test system)	End point	Results	Reference
Oral route:			
Rat liver ^v	DNA damage (reduced viscosity) after 2 hours	–	Brambilla et al. 1983
Rat liver ^w	DNA damage (alkaline elution) after 4 hours	–	Barbin et al. 1983

^aMales exposed to dietary concentration of 25,000 ppm for 72 hours prior to mating with untreated females.

^bMale F344 rats exposed to 1,600 mg/kg carbon tetrachloride by oral gavage in corn oil 4–72 hours prior to sacrifice.

^cMale F344 rats exposed to 100 mg/kg carbon tetrachloride by oral gavage in corn oil.

^dMale F344 rats exposed to 400 mg/kg carbon tetrachloride by oral gavage in corn oil.

^eFemale Wistar rats exposed to 4,000 mg/kg carbon tetrachloride by oral gavage in liquid paraffin; injected with hydroxyurea to stop *de novo* DNA synthesis and tritiated thymidine two hours after dosing.

^fFemale Wistar rats exposed to 4,000 mg/kg carbon tetrachloride by oral gavage in liquid paraffin; injected with hydroxyurea to stop *de novo* DNA synthesis and tritiated thymidine 17 hours after dosing. Increase in DNA synthesis associated with increased tissue regeneration, but no unscheduled DNA synthesis.

^gMale Fischer 344 rats exposed to 400 mg/kg carbon tetrachloride by oral gavage in corn oil; nuclei of hepatocytes isolated 2, 12, or 24 hours after dosing were analyzed by alkaline elution.

^hSprague-Dawley rats (sex not specified) exposed to 0.1 mg/kg carbon tetrachloride by oral gavage 4 days before sacrifice.

ⁱFemale Wistar rats, 3 weeks after partial hepatectomy and treatment with tritiated thymidine, exposed to 200–800 mg/kg carbon tetrachloride by oral gavage in corn oil 4 or 24 hours before sacrifice.

^jFemale Syrian golden hamsters exposed to 160 or 1,600 mg/kg carbon tetrachloride by oral gavage in corn oil 4 days prior to sacrifice.

^kMale CD-1 mice, exposed to 2,000 mg/kg carbon tetrachloride by oral gavage in corn oil.

^lMale CD-1 mice, exposed to 500, 1,000, or 2,000 mg/kg carbon tetrachloride by oral gavage in corn oil.

^mMale CD-1 mice, exposed to hepatotoxic doses of 1,000 or 2,000 mg/kg carbon tetrachloride by oral gavage in corn oil; no effect observed at 500 mg/kg.

ⁿMale and female NMRI mice exposed to 4,000 mg/kg carbon tetrachloride by oral gavage in corn oil 4 hours before sacrifice.

^oMale BDF₁ mice exposed to 500, 1,000, or 2,000 mg/kg carbon tetrachloride by oral gavage in olive oil 24 hours before sacrifice.

^pMales injected with 0.7% NaCl containing 2,000 ppm carbon tetrachloride in ethanol 24 hours before mating.

^qFemale F344 rats injected with 500 mg/kg carbon tetrachloride 4–24 hours before sacrifice.

^rMale F344 rats injected with 3,200 mg/kg carbon tetrachloride in olive oil.

^sAnimals injected with 770 mg/kg radiolabeled carbon tetrachloride 6 hours before sacrifice.

^tMale BDF₁ mice injected with 2,000 or 3,000 mg/kg carbon tetrachloride 24–72 hours before sacrifice.

^uMale or female CD-1 mice injected with 1,500 or 3,000 mg/kg carbon tetrachloride 24–48 hours before sacrifice.

^vMale Sprague-Dawley rats injected with 200 mg/kg carbon tetrachloride.

^wMale BD-V1 rats injected with 4,000 mg/kg carbon tetrachloride.

– = negative result; + = positive result; [+] = hepatotoxicity was evident; DNA = deoxyribonucleic acid

3. HEALTH EFFECTS

Table 3-6. Genotoxicity of Carbon Tetrachloride *In Vitro*

Test system Species (concentration) ^a	End point	Results		Reference
		With activation	Without activation	
Prokaryotic organisms:				
<i>Escherichia coli</i> K-12 343/113 (15.4 mg/mL)	Differential DNA repair	–	–	Hellmer and Bolcsfoldi 1992
<i>E. coli</i> WP2, WP67, CM871; liquid micromethod, sealed (12.5 µg)	Differential DNA repair	+	+	De Flora et al. 1984
<i>E. coli</i> WP2, WP67, CM871; 2-hour preincubation, sealed	Differential DNA repair	–	+	De Flora et al. 1984
<i>E. coli</i> WP2, WP67, CM871; spot test	Differential DNA repair	NT	–	De Flora et al. 1984
<i>E. coli</i> PQ37 (1540 µg/mL)	SOS induction (DNA repair)	–	–	Brams et al. 1987
<i>E. coli</i> WP2/pKM101; WPuvrA/pKM101 (1,000 ppm; enclosed gas atmosphere 24 hours)	Reversion frequency	+	+	Araki et al. 2004
<i>E. coli</i> WPuvrA/pKM101 (10,000 ppm; enclosed gas atmosphere 24 hours)	Reversion frequency	+/-	+/-	Araki et al. 2004
<i>Salmonella typhimurium</i> TA98 (10,000 ppm; enclosed gas atmosphere 24 hours)	Reversion frequency	–	+/-	Araki et al. 2004
<i>S. typhimurium</i> TA100, TA1535, TA1537 (50,000 ppm)	Reversion frequency	–	–	Araki et al. 2004
<i>S. typhimurium</i> TA100, TA1535 (10 mg/plate)	Reversion frequency	–	–	McCann et al. 1975
<i>S. typhimurium</i> TA1535, TA1538 (1,230 µg/mL)	Reversion frequency	–	No data	Uehleke et al. 1977
<i>S. typhimurium</i> TA98, TA100, TA1535, TA1537, TA1538	Reversion frequency	No data	–	Simmon et al. 1977
<i>S. typhimurium</i> TA1535, TA98, TA100 (2,830 µg/plate)	Reversion frequency	–	–	Barber et al. 1981
<i>S. typhimurium</i> TA98, TA100, TA1535, TA1537, TA1538 (10 mg/plate)	Reversion frequency	–	–	De Flora 1981, De Flora et al. 1984
<i>S. typhimurium</i> TA1537, TA100 (2,450 µg/plate)	Reversion frequency	+ ^b	+ ^b	Varma et al. 1988
<i>S. typhimurium</i> TA98 (2,450 µg/plate)	Reversion frequency	NT	+ ^b	Varma et al. 1988
<i>S. typhimurium</i> TA1535 (2,450 µg/plate)	Reversion frequency	NT	–	Varma et al. 1988
<i>S. typhimurium</i> TA1535/pSK1002 (5.3 mg/plate)	SOS induction (<i>umu</i> expression)	–	–	Nakamura et al. 1987

3. HEALTH EFFECTS

Table 3-6. Genotoxicity of Carbon Tetrachloride *In Vitro*

Test system Species (concentration) ^a	End point	Results		Reference
		With activation	Without activation	
<i>S. typhimurium</i> BA13 and BAL13; sealed (1,230 µg/plate)	Forward mutation (Ara ^R test)	–	–	Roldan-Arjona et al. 1991
Eukaryotic organisms:				
<i>Aspergillus nidulans</i> P1 (diploid) (0.5%)	Somatic segregation, crossovers, non-disjunction frequency	NT	+ (CT)	Gualandi 1984
<i>A. nidulans</i> P1 (diploid) (0.0275%)	Somatic segregation	NT	+ (CT)	Benigni et al. 1993
<i>A. nidulans</i> 35 (haploid); (growth mediated) (0.5%)	Forward mutation (su meth G1)	NT	+ (CT)	Gualandi 1984
<i>A. nidulans</i> 35 (haploid); plate incorporation (0.5%)	Forward mutation (su meth G1)	NT	–	Gualandi 1984
<i>Saccharomyces cerevisiae</i> D7 (5230 µg/mL)	Frequency of convertants recombinants, revertants	No data	+	Callen et al. 1980
<i>S. cerevisiae</i> RS112 (diploid) (4 mg/mL)	DEL (intrachromosomal recombinant HIS ⁺)	NT	+ (CT)	Schiestl et al. 1989; Brennan and Schiestl 1998
<i>S. cerevisiae</i> RS112 (diploid) (4 mg/mL)	Interchromosomal recombinant (ADE ⁺)	NT	–	Schiestl et al. 1989
<i>S. cerevisiae</i> RS112 (diploid) (4 mg/mL)	DEL (intrachromosomal recombinant HIS ⁺)	NT	+/- (see text)	Galli and Schiestl 1998
<i>S. cerevisiae</i> RS112 (diploid); arrested in G1 (5 mg/mL)	Interchromosomal recombinant (ADE ⁺)	NT	+ (CT)	Galli and Schiestl 1996
<i>S. cerevisiae</i> RS112 (diploid); arrested in G1 (8 mg/mL)	DEL (intrachromosomal recombinant HIS ⁺)	NT	+ (CT)	Galli and Schiestl 1996
<i>S. cerevisiae</i> AGY3 (arrested in G2) (8 mg/mL)	DEL (intrachromosomal recombinant HIS ⁺)	NT	+ (CT)	Galli and Schiestl 1995
<i>S. cerevisiae</i> D61.M (6.4 mg/mL)	Aneuploidy	NT	–	Whittaker et al. 1989
Mammalian cells:				
Rat liver cell line (RL ₁) (0.02 µg/mL)	Chromatid gaps, deletions or aberrations	No data	–	Dean and Hodson-Walker 1979
Rat hepatocytes (Wistar) (154 µg/mL)	DNA strand breaks, adducts	NT	+	Beddowes et al. 2003
Rat hepatocytes (460 µg/mL)	DNA damage	NT	+(CT)	Sina et al. 1983
Rat hepatocytes (CD) (154 µg/mL)	Unscheduled DNA synthesis	NT	–	Selden et al. 1994
Human/peripheral lymphocytes (48 µg/mL)	Sister chromatid exchange	–	–	Garry et al. 1990
Human/peripheral lymphocytes (76 µg/mL)	Chromosomal aberration	–	–	Garry et al. 1990
Human/ peripheral lymphocytes (1,540 µg/mL)	Micronuclei	+ ^c	+ ^c	Tafazoli et al. 1998

3. HEALTH EFFECTS

Table 3-6. Genotoxicity of Carbon Tetrachloride *In Vitro*

Test system Species (concentration) ^a	End point	Results		Reference
		With activation	Without activation	
Human/ peripheral lymphocytes (3,080 µg/mL)	DNA damage (comet assay)	–	–	Tafazoli et al. 1998
Human/peripheral lymphocytes (16 mg/mL)	Unscheduled DNA synthesis	+/- (CT)	–	Perocco and Prodi 1981
Human lymphoblastoid cells AHH-1 (1,540 µg/mL)	Micronucleus formation	NT	–	Doherty et al. 1996
Human lymphoblastoid cells h2E1, MCL-5 (308 µg/mL)	Micronucleus formation	NT	+	Doherty et al. 1996
Lamb (<i>Ovis aries</i>)/peripheral lymphocytes (16 µg/mL)	Chromosomal aberration	NT	–	Sivikova et al. 2001
Lamb (<i>Ovis aries</i>)/peripheral lymphocytes (4 µg/mL)	Micronucleus formation	+	+	Sivikova et al. 2001
Chinese hamster ovary cells (1,490 µg/mL)	Sister chromatid exchange	–	–	Loveday et al. 1990
Chinese hamster ovary cells (3,000 µg/mL)	Chromosomal aberration	–	–	Loveday et al. 1990
Chinese hamster ovary cells (8 mg/mL)	Chromosomal aberration at anaphase	NT	+	Coutino 1979
Chinese hamster V79 cells (246 µg/mL)	Aneuploidy	NT	+	Onfelt 1987
Chinese hamster V79 cells	Spindle disturbances (c-mitosis)	NT	+ (CT)	Onfelt 1987
Syrian hamster embryo cells (3 µg/mL)	Clonal transformation	NT	+/-	Amacher and Zelljadt 1983
Calf thymus DNA (308 µg/mL)	Covalent binding	+	NT	DiRenzo et al. 1982

^aConcentrations are the highest tested in negative studies and the lowest tested in negative studies.

^bEffect not dose-related but cytotoxicity not evaluated.

^cEffect not dose-related, seen only in cells from one of two subjects.

– = negative result; + = positive result; +/- = weak positive; CT = increase with cytotoxicity; NT = not tested; plate = plate incorporation assay; sealed = assay vessel sealed to prevent evaporation

3. HEALTH EFFECTS

Henderson 1978). Single high doses of carbon tetrachloride resulted in DNA breakage in the liver (but not other tissues) that was detectable electrophoretically (comet assay) in mice, but only 24 hours after dosing (Sasaki et al. 1998). No increase in DNA breakage was detected in mice assayed only 3 or 4 hours after receiving a high dose (Sasaki et al. 1998; Schwarz et al. 1979) or in rats exposed at a lower dose (Bermudez et al. 1982). Stewart (1981) found no increase in the generation of DNA repair intermediates (with accessible single-strand regions) in the livers of partially hepatectomized female Wistar rats given doses insufficient to cause overt hepatic necrosis 24 hours after exposure. The results of these studies suggest that DNA breakage resulting from oral exposure to carbon tetrachloride is related to hepatic cytotoxicity.

Some genotoxicity of carbon tetrachloride following oral exposure is related to the lipid peroxidation activity of its metabolites. Increases in endogenous lipid peroxidation adducts of DNA, such as malondialdehyde deoxyguanosine, were noted in the liver and kidney of hamsters and the liver of rats dosed with carbon tetrachloride (Chaudhary et al. 1994; Wang and Liehr 1995).

Dermal Exposure. No studies were located regarding genotoxic effects in humans or animals after dermal exposure to carbon tetrachloride.

Other Routes of Exposure In Vivo. Results of genotoxicity assays in which carbon tetrachloride was administered by intraperitoneal injection were similar to results from oral gavage assays. Carbon tetrachloride caused no increase in frequencies of sex-linked recessive mutations in *D. melanogaster* (Fouremant et al. 1994) or micronucleus formation in mice (Crebelli et al. 1999; Suzuki et al. 1997). Hepatic DNA damage was not detectable electrophoretically in rats assayed 2–4 hours after exposure (Barbin et al. 1983; Brambilla et al. 1983).

Two kinds of DNA adducts related to carbon tetrachloride metabolism have been detected in injection studies. Covalent binding of metabolites of radiolabeled carbon tetrachloride was detected in the hepatic DNA of rats, hamsters, and mice 6 hours after injection (Castro et al. 1989); the level of binding to DNA was similar in the three species, whereas binding to nuclear proteins was 3 times higher in mice and hamsters than in rats. In other rat studies, carbon tetrachloride significantly increased the level of an endogenous lipid peroxidation product, *trans*-4-hydroxy-2-nonenal, and its deoxyguanosine adduct, 1,*N*²-propanodeoxyguanosine (Chung et al. 2000; Wacker et al. 2001). The affected tissues included the liver and forestomach, and to a lesser degree the lung, colon, and kidney (Chung et al. 2000; Wacker et al. 2001). Hepatic increases in adduct formation were about 2-fold following a dose of 500 mg/kg and ~37-

3. HEALTH EFFECTS

fold following a dose of 3,200 mg/kg (Chung et al. 2000). *In vivo* genotoxicity studies are summarized in Table 3-5.

In Vitro. The genotoxicity of carbon tetrachloride has been studied in prokaryotic and eukaryotic cells *in vitro* (Table 3-6).

The majority of mutagenicity assays for bacteria exposed to carbon tetrachloride have been negative with or without metabolic activation, but volatilization of the chemical in standard plate incorporation methods using unsealed plates may have contributed to some negative findings. In *Salmonella typhimurium*, negative results were reported for a preincubation forward mutation assay in strains BA13 and BAL13 using sealed plates (Roldan-Arioina et al. 1991), for an SOS induction assay in strain TA1535/pSK1002 (Nakamura et al. 1987), and for reverse mutation assays in several strains (Araki et al. 2004; Barber et al. 1981; De Flora 1981, De Flora et al. 1984; McCann et al. 1975; Simmon et al. 1977; Uehleke et al. 1977; Varma et al. 1988). Increases in reverse mutation frequency were observed in plate incorporation assays for strains TA1537 and TA100 with or without activation and TA98 without activation, but the responses were not dose-related and cytotoxicity was not examined (Varma et al. 1988). Weak positive results for mutagenicity were also reported for strain TA98 exposed to 10,000 ppm carbon tetrachloride vapor in an enclosed system (Araki et al. 2004). In the same gas-phase system, weakly increased reversion frequencies with or without metabolic activation were reported for *Escherichia coli* strain WPuvrA/pKM101 and stronger increases for strain WP2/pKM101, which is repair-proficient. Negative results were reported for an SOS induction assay in *E. coli* strain PQ37 (Brams et al. 1987) and a differential DNA repair assays in strains K-12 343/113 (Hellmer and Bolcsfoldi 1992). Induction of differential DNA repair was observed in strains WP2, WP67, and CM871 when assays were conducted in sealed vessels, but not when conducted as spot tests (De Flora et al. 1984).

Assays for the genotoxicity (somatic segregation, non-disjunction frequency, forward mutation) of carbon tetrachloride in the mold *Aspergillus nidulans* were negative or positive only with cytotoxicity (Benigni et al. 1993; Gualandi 1984). Carbon tetrachloride did not induce aneuploidy in the yeast *Saccharomyces cerevisiae* strain D61.M (Whittaker et al. 1989). Similarly, cytotoxicity was generally observed at concentrations at which positive or weak positive results were reported for genotoxicity (interchromosomal recombination or reversion) in *S. cerevisiae* (Brennan and Schiestl 1998; Callen et al. 1980; Galli and Schiestl 1996). Galli and Schiestl (1998) observed that carbon tetrachloride induced intrachromosomal recombination in dividing cells or cells arrested in G1 or G2 phase, but not cells in S-phase. These authors suggested that chemical-induced cytotoxicity prematurely pushed G1 cells into

3. HEALTH EFFECTS

S-phase, indicating that genotoxicity might result from the failure to completely repair DNA before replication, resulting in DNA strand breaks.

In vitro genotoxicity assays in mammalian cells treated with carbon tetrachloride gave results consistent with *in vivo* bioassays. Carbon tetrachloride yielded weak positive results (1 out of 2,003 clones counted) in a clonal transformation assay in hamster embryo cells exposed without activation (Amacher and Zelljadt 1983). No increase in unscheduled DNA synthesis was observed in rat hepatocytes or human peripheral lymphocytes treated without metabolic activation, although weak positive results were observed in human lymphocytes treated with activation at cytotoxic concentrations (Perocco and Prodi 1981; Selden et al. 1994). Negative results in standard chromosomal aberration assays were reported for exposed rat hepatocytes, human peripheral lymphocytes, lamb lymphocytes, and Chinese hamster ovary cells (Dean and Hodson Walker 1979; Garry et al. 1990; Loveday et al. 1990; Sivikova et al. 2001). However, one study that examined Chinese hamster ovary cells for chromosomal aberrations at anaphase rather than metaphase reported 6-fold increases in lag chromosomes (indicative of centromere or microtubule malfunction) and multipolar spindles (Coutino 1979). Aneuploidy was induced in treated Chinese hamster V9 lung cells, but a 10% increase in spindle aberrations (c-mitosis) only occurred at a concentration at which 50% cytotoxicity was observed (Onfelt 1987). The frequency of sister chromatid exchanges was not elevated in human peripheral lymphocytes or Chinese hamster ovary cells treated with or without metabolic activation (Garry et al. 1990; Loveday et al. 1990). Micronucleus formation was induced in treated peripheral lymphocytes taken from one of two human donors (Tafazoli et al. 1998). In micronucleus assays in cultured human lymphoblastoid cells, negative results were reported for a cell line (AHH-1) with a low native level of CYP1A1 activity, but positive results for derivative cell lines expressing cDNA for one or more human microsomal enzymes (CYP2E1 in line h2E1 and CYP 1A2, 2A6, 3A4, and 2E1 and epoxide hydrolase in line MCL-5) (Doherty et al. 1996). These results demonstrate that biotransformation of carbon tetrachloride is needed for micronucleus induction. Increases in single-strand DNA breaks were observed in rat hepatocytes exposed to cytotoxic concentrations of carbon tetrachloride, but not in exposed human lymphocytes (Beddowes et al. 2003; Sina et al. 1983; Tafazoli et al. 1998)

As reported for *in vivo* studies, DNA adducts have been detected in mammalian cells following exposure to carbon tetrachloride *in vitro*. Covalent binding of radiolabeled carbon tetrachloride to DNA and protein was detected in hepatic nuclear preparations from male Sprague-Dawley rats, Syrian Golden hamsters, and C3H mice (Castro et al. 1989). When NADPH was added to the reaction mixtures, the level of covalent binding to DNA was enhanced for hamsters and mice, but not rats. Direct covalent

3. HEALTH EFFECTS

binding of carbon tetrachloride to calf thymus DNA was detected following microsomal bioactivation (DiRenzo et al. 1983); the degree of binding was increased 2.2-fold when the DNA samples were pre-treated with pronase, suggesting that reactive metabolites of carbon tetrachloride react with both DNA and protein. Carbon tetrachloride treatment of rat hepatocytes or hepatic microsomes also increased the frequency of DNA adducts generated as by-products of lipid peroxidation (Beddowes et al. 2003; Castro et al. 1997). In treated hepatocytes, there were statistically significant increases (compared to background levels) in malondialdehyde deoxyguanosine adducts (Beddowes et al. 2003). Increases in 8-oxodeoxyguanosine adducts were observed at the threshold of, and concomitant with, cytotoxicity. A biochemical study using DNA bases and liver microsomes from male Sprague-Dawley rats demonstrated that the bioactivation of carbon tetrachloride resulted in the formation of adducts to guanine (2,6-diamino-4-hydroxy-5-formamidopyrimidine), cytosine (5-hydroxycytosine), and thymidine (5-hydroxymethyluracil), but not to adenine (Castro et al. 1997). The authors attributed formation of these adducts to reactive metabolites (trichloromethyl or trichloromethylperoxyl free radicals) or to reactive aldehydes, such as malondialdehyde, which are generated by lipid peroxidation. *In vitro* genotoxicity studies are summarized in Table 3-6.

3.4 TOXICOKINETICS

Carbon tetrachloride is absorbed readily from the gastrointestinal and respiratory tracts, and more slowly through the skin. It is distributed to all major organs, with highest concentrations in the fat, liver, bone marrow, adrenals, blood, brain, spinal cord, and kidney (Bergman 1983; Dambrauskas and Cornish 1970; McCollister et al. 1951; Paustenbach et al. 1986a, 1986b). Once carbon tetrachloride is absorbed, it is metabolized by cytochrome P-450 enzymes, with the production of the trichloromethyl radical (Lai et al. 1979; Poyer et al. 1978). Aerobically, metabolism of the trichloromethyl radical can eventually form phosgene (Shah et al. 1979). Anaerobically, the radical can undergo reactions to form chloroform (Glende et al. 1976; Uehleke et al. 1973), hexachloroethane (Fowler 1969; Uehleke et al. 1973), or carbon monoxide (Wolf et al. 1977), as well as bind directly to lipids, proteins, and deoxyribonucleic acid (DNA) (Rao and Recknagel 1969). Carbon tetrachloride is excreted primarily in exhaled air (initial elimination half-life of 1–3 hours) and in the feces, while relatively minimal amounts are excreted in the urine (McCollister et al. 1951; Paustenbach et al. 1986a; Stewart and Dodd 1964; Stewart et al. 1961, 1963, 1965; Young and Mehendale 1989).

3. HEALTH EFFECTS

3.4.1 Absorption**3.4.1.1 Inhalation Exposure**

Although there are many cases of human overexposure to carbon tetrachloride vapor, there are few quantitative studies of pulmonary absorption of carbon tetrachloride in humans. Based on the difference in carbon tetrachloride concentration in inhaled and exhaled air, absorption across the lung was estimated to be about 60% in humans (Lehmann and Schmidt-Kehl 1936). Monkeys exposed to 50 ppm absorbed an average of 30.4% of the total amount of carbon tetrachloride inhaled, at an average absorption rate of 0.022 mg carbon tetrachloride/kg/minute (McCollister et al. 1951). The concentration of carbon tetrachloride in the blood increased steadily in monkeys, but did not reach a steady-state within 344 minutes of exposure. In rats exposed to 100 or 1,000 ppm for 2 hours, the total absorbed dose of carbon tetrachloride was 17.5 or 179 mg/kg of body weight, respectively (Sanzgiri et al. 1995). (These results were used to establish dose levels for parallel oral-route studies described in Section 3.4.1.2.) Carbon tetrachloride was rapidly absorbed from the lungs as indicated by the near peak levels that were measured in arterial blood at the earliest timepoint (5 minutes). A near steady-state was achieved within 10 or 15 minutes and was maintained for the duration of the 2-hour exposures. In rats, mice, and hamsters exposed to 20 ppm ¹⁴C-labeled carbon tetrachloride vapor for 4 hours, the initial body burdens of carbon tetrachloride equivalents (CE) immediately following exposure were 12.1, 1.97, and 3.65 μmol, respectively (Benson et al. 2001).

3.4.1.2 Oral Exposure

No studies were located regarding absorption in humans after oral exposure to carbon tetrachloride. It would be anticipated, however, that carbon tetrachloride is well absorbed from the gastrointestinal tract of humans, since carbon tetrachloride is readily absorbed from the gastrointestinal tract of animals (see below), and there are many accounts of human poisonings resulting from ingestion of carbon tetrachloride (e.g., Ashe and Sailer 1942; Conway and Hoven 1946; Gosselin et al. 1976; Guild et al. 1958; Kluwe 1981; Lamson et al. 1928; Phelps and Hu 1924; Ruprah et al. 1985; Stewart et al. 1963; Umiker and Pearce 1953; von Oettingen 1964).

Results from several animal studies indicate that carbon tetrachloride is rapidly and extensively absorbed from the gastrointestinal tract. Typically, 80–85% of an oral dose may be recovered in expired air, indicating that gastrointestinal absorption is at least 85% (Marchand et al. 1970; Paul and Rubinstein

3. HEALTH EFFECTS

1963). The time course of absorption depends on exposure conditions, with peak blood levels occurring as early as 3–6 minutes after dosing (Kim et al. 1990a). While oral absorption from water or other aqueous vehicles is very rapid and extensive, when carbon tetrachloride is administered using corn oil as the vehicle, absorption is slowed and diminished (Gillespie et al. 1990; Kim et al. 1990a). Similar findings were reported by Withey et al. (1983) for several other halogenated hydrocarbons. The absorption rate and, therefore, peak blood levels will be inversely proportional to the volume of corn oil employed in oral dosing.

Sanzgiri et al. (1995) compared pharmacokinetics of carbon tetrachloride administered to fasted rats as a single bolus by gavage or by infusion over 2 hours. The doses, 17.5 and 179 mg/kg, were established by uptake measured in a 2-hour inhalation experiment (see Section 3.4.1.1). Carbon tetrachloride was rapidly absorbed in the gastrointestinal tract. Peak arterial blood concentrations were reached within 15 minutes of bolus administration and then declined, whereas infusion caused a steady increase over the 2-hour period. The peak concentrations were higher for the bolus group than for the infusion group.

3.4.1.3 Dermal Exposure

Carbon tetrachloride is significantly absorbed through the skin of humans, though less readily than from the lung or gastrointestinal tract. When volunteers immersed their thumbs in undiluted carbon tetrachloride for 30 minutes, carbon tetrachloride was detected in the alveolar air of each subject within 10 minutes, indicating relatively rapid percutaneous absorption (Stewart and Dodd 1964). The alveolar concentration of carbon tetrachloride rose steadily thereafter and peaked by about 30 minutes postexposure. The authors estimated that immersion of both hands in liquid carbon tetrachloride for 30 minutes would yield an exposure equivalent to breathing 100–500 ppm for 30 minutes. The investigators noted that the amount of carbon tetrachloride that can penetrate human skin appeared to be related to the method of application, the duration and area of skin exposure, and the type of skin exposed.

Studies in animals confirm that liquid carbon tetrachloride is absorbed through the skin (Jakobson et al. 1982; Morgan et al. 1991; Tsuruta 1975). The rate of uptake is high enough (54 nmol/min/cm² in mice) that absorbed doses may be comparable to the doses absorbed from relatively high levels of carbon tetrachloride in air (Tsuruta 1975). Uptake kinetics are linear only for a short time (about 30 minutes), after which blood levels tend to decrease (Jakobson et al. 1982; Morgan et al. 1991). This is probably due to local vasoconstriction in the exposed skin area. During the course of a 24-hour exposure (2 mL/3.1 cm² skin), rats absorbed 27% (0.54 mL) of the applied neat solution, whereas >99% of the

3. HEALTH EFFECTS

carbon tetrachloride in 110–648 µg/mL aqueous solutions (approximately one-third to completely saturated) was absorbed (Morgan et al. 1991). Rather broad peak blood concentrations of approximately 8–70 ng/mL were observed 2–8 hours into the exposure period. In monkeys, the dermal absorption of radioactive carbon tetrachloride vapor at concentrations of 485 or 1,150 ppm over a period of 240 or 270 minutes, respectively, was negligible, as measured in samples of blood and expired air (McCollister et al. 1951).

3.4.2 Distribution

3.4.2.1 Inhalation Exposure

No studies were located regarding distribution in humans after inhalation exposure to carbon tetrachloride.

Inhalation studies in monkeys (McCollister et al. 1951), rats (Benson et al. 2001; Dambrauskas and Cornish 1970; Paustenbach et al. 1986a, 1986b; Sanzgiri et al. 1997), and hamsters and mice (Benson et al. 2001) reveal that the highest carbon tetrachloride concentrations occur in fat, and in organs or tissues with high fat content such as bone marrow, liver, brain, and kidney. In rats exposed to 1,000 ppm for 2 hours (receiving a dose of 179 mg/kg), the maximal concentration of carbon tetrachloride was reached within 30 minutes (the earliest timepoint) in the liver, kidney, lung, brain, heart, muscle, spleen, and gastrointestinal tract, and by 240 minutes in fat (Sanzgiri et al. 1997). The maximal concentration of carbon tetrachloride (µg/g tissue) achieved in the kidney was 1.25 times higher than the liver. The area under the tissue concentration versus time curve (AUC) for the first 30 minutes of exposure was 322, 409, 460, and 710 µg per minute/mL, respectively, for the liver, kidney, brain, and fat. The half-life of clearance from different organs (evaluated over 24 hours) ranged from 204 minutes for the kidney, 249 minutes for the liver to 665 minutes for fat. Through the use of a low temperature whole-body autoradiographic technique, Bergman (1983) observed a particularly high uptake of ¹⁴C-carbon tetrachloride into the white matter of brain, spinal cord, and spinal nerves in mice exposed by inhalation. Considerably lower levels were found in the kidney, lung, spleen, muscle, and blood.

Immediately following exposure to 20 ppm ¹⁴C-labeled carbon tetrachloride vapor for 4 hours, the proportion of the initial body burden as carbon tetrachloride equivalents (CE) present in the major tissues was 30% for rats and hamsters and 40% for mice (Benson et al. 2001). The CE concentrations at that

3. HEALTH EFFECTS

time were highest in the liver of mice and hamsters but were highest in fat for rats; 48 hours later, CE concentrations in all three species were highest in the liver.

3.4.2.2 Oral Exposure

No studies were located regarding distribution in humans after oral exposure to carbon tetrachloride.

Studies of the time-course of tissue distribution in male rats given oral doses of carbon tetrachloride reported that concentrations in the blood, striated muscle, brain, and liver were maximal 2 hours after dosing (Marchand et al. 1970). The peak concentrations in the liver and brain were significantly higher than in the muscle and blood. Peak levels in the fat were not reached until 5.5 hours post dosing, at which time they were more than 50-fold greater than peak blood levels. A similar time-course of tissue deposition of carbon tetrachloride has been observed in female rats (Teschke et al. 1983) and rabbits (Fowler 1969) dosed orally with carbon tetrachloride. Higher carbon tetrachloride levels were found consistently in the liver than in the brain of rats dosed orally (Marchand et al. 1970; Watanabe et al. 1986). This may be because carbon tetrachloride absorbed from the gastrointestinal tract enters the portal circulation, which initially passes through the liver. A significant proportion of the carbon tetrachloride is likely taken up from the portal blood during the first pass, resulting in the high liver levels following ingestion. One week after exposure to ¹⁴C-carbon tetrachloride, the concentrations of radiolabel (expressed as mmol carbon tetrachloride/g tissue) were about 1.5 in plasma, 5–6.5 in soleus and white vastus lateralis muscle, 8 in liver, 10 in kidney and diaphragm, and 13 in adipose tissue (Weber et al. 1992). It is interesting to note that phenobarbital pretreatment, often used to hasten or intensify the toxic effects of carbon tetrachloride exposure, was found not only to nearly double the amount of radiolabel retained in the examined tissues, but also to significantly alter its distribution. Liver, kidney, and plasma concentrations were elevated to 600, 350, and 150% of their respective control (carbon tetrachloride alone) levels, while the muscle, diaphragm, and adipose levels were reduced to 40–70%. This observation is consistent with higher levels of the administered dose being metabolized (largely in the liver) and subsequently entering the carbon pool.

Sanzgiri et al. (1997) exposed rats by bolus dosing or gastric infusion over 2 hours to a dose of carbon tetrachloride that was equivalent to the amount absorbed during a 2-hour exposure at 1,000 ppm. In rats receiving a dose of 179 mg/kg by infusion over 2 hours, the maximal concentration of carbon tetrachloride was reached by 120 minutes in the liver, kidney, and heart, 150 minutes in the brain, muscle, and spleen, 180 minutes in lung, and by 360 minutes in fat (Sanzgiri et al. 1997). The AUC for the first

3. HEALTH EFFECTS

30 minutes of exposure was 3, 4, 28, and 157 μg per minute/mL, respectively, for the liver, kidney, brain, and fat in infused rats. Absorption of carbon tetrachloride was more rapid and organ concentrations of carbon were higher in rats that received the same dose as a single bolus by gavage. The maximal concentration was reached by 1 minute in the liver, 5 minutes in the kidney, heart, and spleen, 15 minutes in lung and brain, 60 minutes in muscle, and 120 minutes in fat. The AUC for the first 30 minutes was 680, 380, 423, and 306 μg per minute/mL, respectively, for the liver, kidney, brain, and fat in the bolus-treated rats. The authors indicated that the bolus-delivery resulted in high 30-minute AUC values because the capacity of first-pass hepatic and pulmonary elimination was exceeded. The half-life of clearance from different organs (based on the AUC over 24 hours) ranged from 190 minutes for the kidney and 269 minutes for the liver to 358 minutes for fat in the infused rats, and from 278 minutes for the kidney and 323 minutes for the liver to 780 minutes for fat in the bolus-treated rats. The maximum tissue concentrations ($\mu\text{g}/\text{g}$ tissue) achieved in the kidney were 24% of the value for the liver following bolus dosing, but 8 times higher than the liver following gastric infusion.

3.4.2.3 Dermal Exposure

No studies were located regarding distribution in humans or animals after dermal exposure to carbon tetrachloride.

3.4.3 Metabolism

The metabolism of carbon tetrachloride in humans has not been investigated, but a great deal of information is available from studies in animals. Pathways of carbon tetrachloride metabolism are illustrated in Figure 3-3, and metabolites that have been identified are underlined. Bioactivation of carbon tetrachloride proceeds by cytochrome P-450-dependent reductive dehalogenation (Sipes et al. 1977). Ethanol inducible CYP2E1 is the primary enzyme responsible for metabolizing carbon tetrachloride in humans at environmentally relevant concentrations, but others, particularly CYP3A, are also involved at higher concentrations (Castillo et al. 1992; Zangar et al. 2000). Studies with CYP2E1 genetic knockout mice (*cyp2e1*^{-/-}) demonstrated that hepatic toxicity of carbon tetrachloride in mice is entirely dependent on CYP2E1 (Wong et al. 1998). A large body of experimental data indicates that the first step involves homolytic cleavage of one carbon chlorine bond in carbon tetrachloride to yield chloride ion and the trichloromethyl radical (Lai et al. 1979; Poyer et al. 1978). Anaerobically, the

3. HEALTH EFFECTS

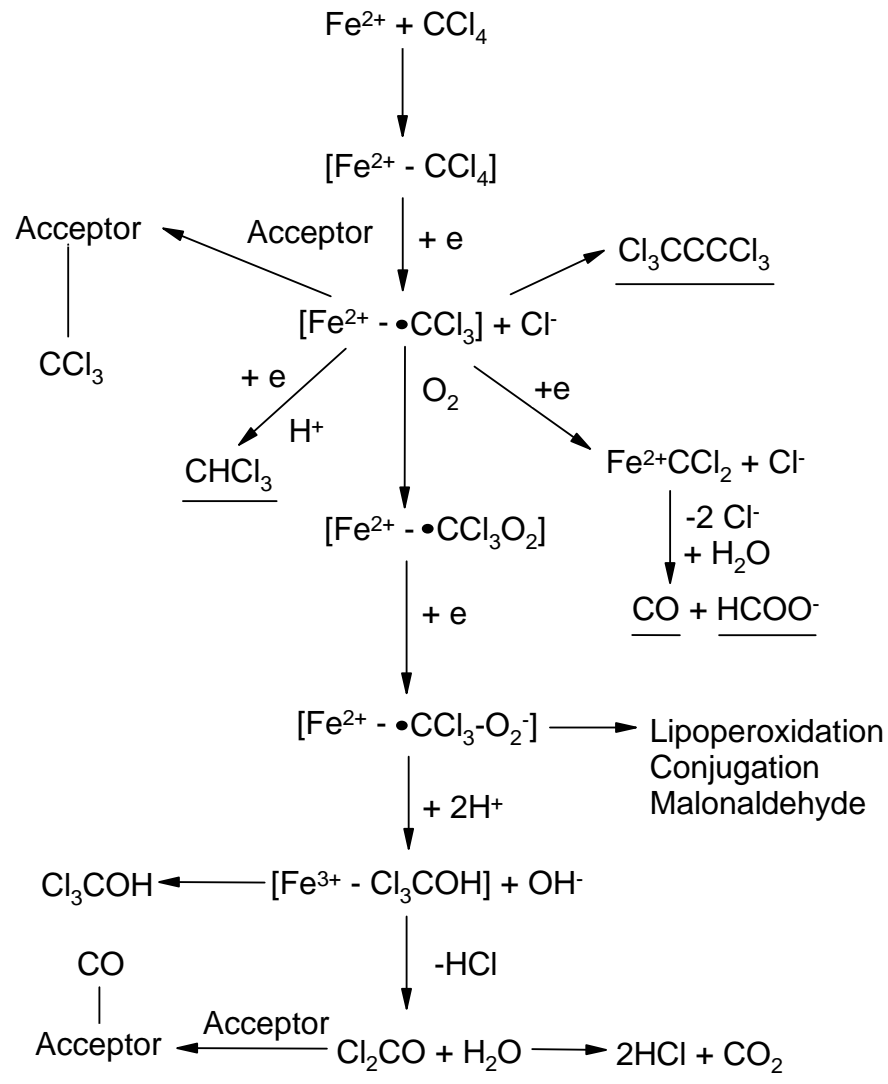
Figure 3-3. Pathways of Carbon Tetrachloride Metabolism*

*Adapted from Shah et al. 1979. Fe^{2+} and Fe^{3+} denote the reduced and oxidized forms of cytochrome P-450, and brackets indicate an enzyme substrate complex. Electrons are donated from NADPH or NADH.

3. HEALTH EFFECTS

trichloromethyl radical may undergo several reactions, including (1) direct binding to microsomal lipids and proteins (Ansari et al. 1982; Gordis 1969; Rao and Recknagel 1969; Villarruel et al. 1977); (2) addition of a proton and an electron to form chloroform (Glende et al. 1976; Uehleke et al. 1973); (3) dimerization to form hexachloroethane (Fowler 1969; Uehleke et al. 1973); and (4) further reductive dechlorination to form carbon monoxide (Wolf et al. 1977). Aerobically, trichloromethyl radical ($\text{CCl}_3\bullet$) may be trapped by oxygen to form trichloromethylperoxy radical ($\text{CCl}_3\text{OO}\bullet$), which decomposes to phosgene (COCl_2) (Pohl et al. 1984). Hydrolytic cleavage of phosgene is likely the major pathway by which carbon dioxide is formed from carbon tetrachloride (Shah et al. 1979). The trichloromethylperoxy radical is more reactive than the trichloromethyl radical towards amino acids (Packer et al. 1978).

Metabolism of carbon tetrachloride by CYP2E1 may result in the destruction of the enzyme during the metabolic process (Noguchi et al. 1982a, 1982b). CYP2E1 may be lost by either a direct attack (i.e., covalent binding) of radicals on the cytochrome(s) (Manno et al. 1992; Vittozzi and Nastainczyk 1987), or highly localized lipid peroxidation resulting in detachment of P-450 proteins from the microsomal membranes. Cytochrome P-450 mediated homolytic cleavage of the carbon-chlorine bond in carbon tetrachloride is thought to be followed by hydrogen abstraction by the trichloromethyl radical at a methylene group of polyenic fatty acids in the microsomal lipids, thus forming organic free radicals. These organic free radicals then rapidly react with molecular oxygen, leading to the formation of organic peroxy free radicals and eventually organic peroxides (Rao and Recknagel 1969; Recknagel 1967; Recknagel and Glende 1973; Recknagel et al. 1977). The unstable organic peroxides cleave homolytically to form new free radicals, which attack methylene groups of neighboring polyenic lipids in the membrane. This autocatalytic process occurs very rapidly; hepatic microsomal lipid peroxidation is more than half of its maximum value at 5 minutes, and is complete within 15 minutes after oral administration of carbon tetrachloride to fasted rats (Rao and Recknagel 1968). Lipid peroxidation can contribute to breakdown of membrane structure and loss of organelle and cell functions. Connor et al. (1986) conducted a study in which they detected the trichloromethyl radical and a second free radical, the carbon dioxide anion radical, by electron spin resonance spectroscopy in liver perfusate and in urine of female rats. Adducts of both radicals have also been detected in blood of male rats (Reinke and Janzen 1991).

Cytochrome P-450 from rat or human liver microsome preparations is inactivated when incubated anaerobically with carbon tetrachloride in the presence of NADPH and an oxygen-scavenging system (Manno et al. 1988, 1992). Inactivation involved destruction of the heme tetrapyrrolic structure, and followed pseudo first-order kinetics with fast and slow half-lives of 4.0 and 29.8 minutes. When

3. HEALTH EFFECTS

compared with rat liver microsomes, the human preparations were 6–7 times faster at metabolizing carbon tetrachloride and only about one-eighth as susceptible to self-destructing ("suicidal") inactivation (about 1 enzyme molecule lost for every 196 carbon tetrachloride molecules metabolized).

The rate of carbon tetrachloride metabolism *in vivo* has been estimated primarily by indirect methods. Male rats were exposed to carbon tetrachloride vapor in a desiccator jar with a recirculating atmosphere. The decline in the chamber concentration was monitored over time as the index of carbon tetrachloride uptake into the animals (Gargas et al. 1986). The shapes of the uptake curves were a function of tissue partition coefficients and the metabolism of carbon tetrachloride. The uptake kinetics of carbon tetrachloride were accurately described by a physiological pharmacokinetic model with a single, saturable metabolic pathway. The maximum rate of reaction (V_{max}) was calculated to be 0.14 mg/hour (0.62 mg/kg/hour), while the half-maximum rate concentration of carbon tetrachloride (K_m , the Michaelis-Menten constant) was calculated to be 1.62 μ M (0.25 mg/L). Carbon tetrachloride was metabolized more slowly than other halocarbons studied (methyl chloroform, 1,1-dichloroethylene, bromochloromethane). Another indirect method was evaluated for estimating the rate of carbon tetrachloride metabolism in male rats, based on arterial blood:inhaled air concentration ratios (Uemitsu 1986). Results of this study suggest that carbon tetrachloride metabolism was limited by the rate of blood perfusion of the liver at concentrations below 100 ppm, and was saturated at concentrations above 100 ppm. The estimated V_{max} was 2.8 mg/kg/hour. The rate of metabolism gradually decreased during the exposure period, apparently the result of carbon tetrachloride-induced loss of cytochrome P-450.

Based on comparative PBPK modeling, which incorporated *in vivo* gas uptake data and *in vitro* data, Thrall et al. (2000) calculated that the rates of metabolism (V_{max}/K_m) by milligrams of liver protein differed across species, with hamster > mouse > rat > human. The human *in vivo* metabolic rates for carbon tetrachloride were estimated as 1.49 mg/hour/kg body weight (V_{max}) and 0.25 mg/L for K_m .

The extent of metabolism of 14 C-carbon tetrachloride in rats was assessed by measuring the amounts of unchanged carbon tetrachloride, carbon dioxide, and chloroform exhaled in the breath, 14 C-metabolite excreted in urine and feces, and 14 C-metabolite bound to liver macromolecules within a 24-hour period post oral dosing (Reynolds et al. 1984). The major metabolite in this study was carbon dioxide at all dose levels, ranging from 85% of total metabolites recovered at 15 mg/kg to 63% at 4,000 mg/kg. The modest 22% (from 85 down to 63%) reduction in carbon dioxide production when the dose was increased 28-fold (15 versus 4,000 mg/kg) suggests that excess amounts of P-450 are available in the liver for metabolism of carbon tetrachloride. Intermediate amounts of nonvolatile 14 C-labeled material were recovered from

3. HEALTH EFFECTS

the urine and feces, although none of the metabolites were identified by these investigators. About 2–4% of the label was found covalently bound to liver macromolecules. The relative amount of chloroform formed depended on dose, with chloroform being the least abundant metabolite formed at the lowest dose, but the second most abundant metabolite at the highest dose. As the dose of carbon tetrachloride increased, the fraction of the dose recovered decreased for each metabolite except chloroform. A major change in the overall extent of carbon tetrachloride metabolism occurred as the dose was increased from 15 to 46 mg/kg, the nature of which suggests that the oxidative metabolism of carbon tetrachloride was saturated and/or impaired by destruction of cytochrome P-450 in this dosage range. The fraction recovered in the expired air as unchanged carbon tetrachloride increased from 20 to 80% of the administered dose, and the peak carbon tetrachloride exhalation rate increased 40-fold. Thus, this study indicated that when oxidative metabolism of carbon tetrachloride was saturated or inhibited, more of the parent chemical was exhaled and increased amounts of chloroform were formed by a reductive pathway. Low levels of carbon tetrachloride metabolism to CO₂ were also indicated by other studies showing that 6 hours after intraperitoneal injection of 128–159 mg/kg carbon tetrachloride to rats or gerbils, <1% (approximately 0.2% for rats, and 0.7% for gerbils) of the dose had been expired as CO₂, while approximately 80–90% had been expired as unchanged carbon tetrachloride (Cai and Mehendale 1990; Mehendale and Klingensmith 1988; Young and Mehendale 1989).

3.4.4 Elimination and Excretion

3.4.4.1 Inhalation Exposure

Little quantitative information was located regarding the amount or fraction of absorbed carbon tetrachloride that is subsequently excreted in air, urine, or feces in humans exposed by inhalation. Studies of the rate of excretion of carbon tetrachloride in the expired air indicate that samples taken immediately after exposure may be contaminated with environmental carbon tetrachloride, but realistic values may be obtained by 15 minutes (Stewart et al. 1961). Among volunteers who breathed 10–49 ppm carbon tetrachloride for 1–3 hours, expired air concentrations in the range of 1–3 ppm were detectable within 15–25 minutes, steadily declining to about 0.3 ppm 5 hours after exposure (Stewart et al. 1961). No carbon tetrachloride was detected in blood or urine of the subjects where the limit of detection was 5 ppm. In subjects who inhaled 2.5 mg radiochlorinated carbon tetrachloride vapor in a single breath (subsequently held for 20 seconds to maximize absorption), 33% of the administered dose was exhaled within 1 hour (Morgan et al. 1970). The urinary excretion rate during the first hour was less than 0.01% of the administered dose per minute.

3. HEALTH EFFECTS

Studies in animals indicate about 30–40% of an inhaled dose of carbon tetrachloride is excreted in expired air and about 32–62% is excreted in feces (McCollister et al. 1951; Paustenbach et al. 1986a). Relatively low amounts are excreted in urine. Nearly all of the material in expired air is parent carbon tetrachloride, with only small amounts of carbon dioxide. The identity of the nonvolatile metabolites in feces and urine was not determined.

During the 48 hours following nose-only inhalation exposure to 20 ppm ^{14}C -labeled carbon tetrachloride vapor for 4 hours, rats, mice and hamsters eliminated 65–83% of the initial body burden of ^{14}C activity as CO_2 or volatile organic compounds in exhaled breath (Benson et al. 2001). Elimination in expired air was described as a single-order negative exponential function. Elimination half-times for carbon tetrachloride equivalents (CEs) in exhaled breath were 4.3, 0.8, and 3.6 hours for volatile organic compounds and 7.4, 8.8, and 5.3 hours for CO_2 for rats, mice, and hamsters, respectively. The fraction of the initial body burden of CEs eliminated in urine and feces combined was <10% in rats and >20% in mice and hamsters. Clearance of CEs from various tissues was characterized as being best described by single- or two-component negative exponential functions (Benson et al. 2001). Clearance of CEs from the blood was complete within 48 hours and was described by a single-component function for all three species. The half-life for clearance ($T_{1/2}$) from blood was shortest for rats (1.8 hours) and longest for hamsters (23 hours). Clearance of CEs from the lung was also described by a single-component function for all three species, but was only about 80% complete after 48 hours; the $T_{1/2}$ ranged from 7 hours for rats to 17 hours for mice. Clearance of CEs from the liver in hamsters was complete and best described by a single-component function; the $T_{1/2}$ was 33 hours. In rats and mice, clearance from the liver was best described by a two-component function; a large fraction was cleared with a $T_{1/2}$ of 3 hours and the remainder cleared with a $T_{1/2}$ of 35 hours. Clearance of CEs from the kidney in rats was complete and best described by a two-component function. In mice and hamsters, the $T_{1/2}$ for clearance from the kidney for the largest fraction (70–80%) of carbon tetrachloride was <10 hours, but no additional clearance occurred up to 48 hours.

As in humans, the rate of carbon tetrachloride excretion in rats appears to be biphasic, with an initial half-life value of 7–10 hours (Paustenbach et al. 1986a). The rapid phase was judged to reflect clearance from blood, while the slower phase was related to clearance from fatty tissue and metabolic turnover of covalent adducts (Paustenbach et al. 1988). In support of this, exposure for longer periods of time led to higher concentrations of carbon tetrachloride in fat and a decreased rate of clearance (Paustenbach et al. 1986a, 1986b, 1988).

3. HEALTH EFFECTS

3.4.4.2 Oral Exposure

The concentration of carbon tetrachloride was measured in the expired air of a person who swallowed a large amount of carbon tetrachloride (Stewart et al. 1963). Excretion in expired air was found to decrease exponentially in a biphasic or multiphasic fashion, but no quantitative estimate of the elimination half-life of carbon tetrachloride or of the fraction of the dose excreted by this pathway was provided. Visual inspection of their graphed data suggests very approximate half-lives of less than several hours initially, 40 hours (75–150 hours post exposure), and 85 hours (300–400 hours post exposure).

A detailed investigation of carbon tetrachloride excretion was performed in rats exposed by gavage to a range of doses (Reynolds et al. 1984). At doses of 50 mg/kg or higher, most of the dose (70–90%) was recovered in expired air as unchanged carbon tetrachloride. Lower amounts were recovered as expired carbon dioxide or chloroform, or as nonvolatile metabolites in feces or urine. As would be expected for a saturable or self-destructing metabolic system, the proportion of each dose recovered as metabolites tended to decrease as the dose increased. For example, 12% of the lowest dose (15 mg/kg) was recovered as carbon dioxide, while only 0.7% of the highest dose (4,000 mg/kg) was recovered as carbon dioxide. The time-course of excretion also depended on dose, tending to become slower as doses increased. For example, the half-life for exhalation of carbon tetrachloride was 1.3 hours at a dose of 50 mg/kg, but was 6.3 hours at a dose of 4,000 mg/kg. This is consistent with the concept that an increased proportion of a dose enters fat as the dose level increases, with clearance from fat being slower than from blood and other tissues. Increased hepatotoxicity in the form of greater cytochrome P-450 destruction (and thus reduced carbon tetrachloride metabolism) may also be a significant factor. Studies evaluating the rate of excretion over the first 12 hours described a one-compartment model, but did not deduce that a two-compartment model was inappropriate (Reynolds et al. 1984). Approximately 24 hours after receiving an oral dose of 3,985 mg/kg, rats were observed to excrete elevated levels of various lipid peroxidation products (formaldehyde, acetaldehyde, malondialdehyde, and acetone) in their urine, presumably as a result of carbon tetrachloride-induced oxidative stress (Shara et al. 1992).

3.4.4.3 Dermal Exposure

Carbon tetrachloride was rapidly excreted in expired air of volunteers who immersed their thumbs in liquid carbon tetrachloride (Stewart and Dodd 1964). The half-life of expiration was about 30 minutes,

3. HEALTH EFFECTS

but no quantitative estimate of the fraction of the absorbed dose excreted in air was performed. No studies were located regarding excretion in animals after dermal exposure to carbon tetrachloride.

3.4.4.4 Other Routes of Exposure

After what was described as either intragastric or intraduodenal administration of carbon tetrachloride to rats under various conditions, evidence from electron paramagnetic resonance experiments using phenyl-N-t-butyl nitron as a spin trap suggested that trichloromethyl free-radical adducts are secreted into the bile without being concentrated, and in concentrations which reflect those concurrently found in the liver (Knecht and Mason 1991). Expressed in arbitrary concentration units, spin-trap-bound adduct quantities found in the liver, in the bile, and liver/bile concentration ratios under the various experimental conditions were as follows: carbon tetrachloride alone (93, 28, 3.4 ratio), carbon tetrachloride plus hypoxia (161, 50, 3.2 ratio), carbon tetrachloride with phenobarbital pretreatment (118, 69, 1.7 ratio), and carbon tetrachloride with intravascular infusion of the bile salt dehydrocholate to double the bile flow rate (85, 13, 6.8 ratio). Taken together, these results from conditions that vary bile flow or reductive metabolic generation of free radical seem to indicate that carbon tetrachloride free-radical adducts are secreted rather than merely diffused into bile, and in amounts proportional to their generation in the liver. The drop in liver/bile ratio observed with phenobarbital pretreatment (from 3.4 to 1.7) was attributed to the liver's phenobarbital-enhanced ability to destroy many of the induced free-radical adducts. These results are supported by findings in bile duct-cannulated rats and in perfused rat liver systems, where spin-trapped free-radical adducts were observed in bile, but not in blood or urine (Hughes et al. 1991).

As noted above, within 6 hours of intraperitoneally injecting rats or gerbils with 128–159 mg/kg of carbon tetrachloride, 80–90% of the administered dose was expired as unchanged carbon tetrachloride, while less than 1% was expired as CO₂ (Cai and Mehendale 1990; Mehendale and Klingensmith 1988; Young and Mehendale 1989). After rats were injected intraperitoneally with 3 mL carbon tetrachloride per kg body weight, volatile carbonyl compounds released into expired air over 24 hours were evaluated by gas chromatography (Dennis et al. 1993). Injected rats exhaled significantly higher levels of acetone and a compound tentatively identified as formyl chloride than control rats; the amounts of acetaldehyde and formaldehyde were not significantly different in the two groups.

3. HEALTH EFFECTS

3.4.5 Physiologically Based Pharmacokinetic (PBPK)/Pharmacodynamic (PD) Models

Physiologically based pharmacokinetic (PBPK) models use mathematical descriptions of the uptake and disposition of chemical substances to quantitatively describe the relationships among critical biological processes (Krishnan et al. 1994). PBPK models are also called biologically based tissue dosimetry models. PBPK models are increasingly used in risk assessments, primarily to predict the concentration of potentially toxic moieties of a chemical that will be delivered to any given target tissue following various combinations of route, dose level, and test species (Clewell and Andersen 1985). Physiologically based pharmacodynamic (PBPD) models use mathematical descriptions of the dose-response function to quantitatively describe the relationship between target tissue dose and toxic end points.

PBPK/PD models refine our understanding of complex quantitative dose behaviors by helping to delineate and characterize the relationships between: (1) the external/exposure concentration and target tissue dose of the toxic moiety, and (2) the target tissue dose and observed responses (Andersen et al. 1987; Andersen and Krishnan 1994). These models are biologically and mechanistically based and can be used to extrapolate the pharmacokinetic behavior of chemical substances from high to low dose, from route to route, between species, and between subpopulations within a species. The biological basis of PBPK models results in more meaningful extrapolations than those generated with the more conventional use of uncertainty factors.

The PBPK model for a chemical substance is developed in four interconnected steps: (1) model representation, (2) model parameterization, (3) model simulation, and (4) model validation (Krishnan and Andersen 1994). In the early 1990s, validated PBPK models were developed for a number of toxicologically important chemical substances, both volatile and nonvolatile (Krishnan and Andersen 1994; Leung 1993). PBPK models for a particular substance require estimates of the chemical substance-specific physicochemical parameters, and species-specific physiological and biological parameters. The numerical estimates of these model parameters are incorporated within a set of differential and algebraic equations that describe the pharmacokinetic processes. Solving these differential and algebraic equations provides the predictions of tissue dose. Computers then provide process simulations based on these solutions.

The structure and mathematical expressions used in PBPK models significantly simplify the true complexities of biological systems. If the uptake and disposition of the chemical substance(s) are adequately described, however, this simplification is desirable because data are often unavailable for

3. HEALTH EFFECTS

many biological processes. A simplified scheme reduces the magnitude of cumulative uncertainty. The adequacy of the model is, therefore, of great importance, and model validation is essential to the use of PBPK models in risk assessment.

PBPK models improve the pharmacokinetic extrapolations used in risk assessments that identify the maximal (i.e., the safe) levels for human exposure to chemical substances (Andersen and Krishnan 1994). PBPK models provide a scientifically sound means to predict the target tissue dose of chemicals in humans who are exposed to environmental levels (for example, levels that might occur at hazardous waste sites) based on the results of studies where doses were higher or were administered in different species. Figure 3-4 shows a conceptualized representation of a PBPK model.

If PBPK models for carbon tetrachloride exist, the overall results and individual models are discussed in this section in terms of their use in risk assessment, tissue dosimetry, and dose, route, and species extrapolations.

A detailed physiologically based pharmacokinetic model (Figure 3-5) has been developed that describes the metabolism of carbon tetrachloride following inhalation exposure (Paustenbach et al. 1988). The model was based on and validated against a previous study in rats in which 1–2 weeks of inhalation exposure to 100 ppm ^{14}C -labeled carbon tetrachloride for 8–11.5 hours/day, 4–5 days/week apparently resulted in 40–60% of the absorbed dose being metabolized (Paustenbach et al. 1986a). The model incorporated partition characteristics of carbon tetrachloride (blood:air and tissue:blood partition coefficients), anatomical and physiological parameters of the test species (body weight, organ weights, ventilation rates, blood flows), and biochemical constants (V_{max} and K_m) for carbon tetrachloride metabolism. Rat and human parameters used in the model are listed in Table 3-7. The model accurately predicted the behavior of carbon tetrachloride and its metabolites, both the exhaled unmetabolized parent compound and $^{14}\text{CO}_2$ and the elimination of radioactivity in urine and feces. In agreement with other studies (Gargas et al. 1986; Uemitsu 1986), Paustenbach et al. (1988) found that metabolism was best described as a single saturable pathway, with a V_{max} of 0.65 mg/kg/hour and a K_m of 0.25 mg/L. Metabolites were partitioned in the model to three compartments: the amounts to be excreted in the breath (as $^{14}\text{CO}_2$), urine, and feces. Of total carbon tetrachloride metabolites, 6.5% was excreted as CO_2 , 9.5% was excreted in urine, and 84.0% was excreted in feces. Based on this model, the authors estimated that about 4% of initially metabolized carbon tetrachloride is converted directly to carbon dioxide and is promptly excreted, while the remainder forms adducts with proteins and other cellular molecules. These adducts are then degraded with a half-life of about 24 hours, and the products are excreted mainly in the

3. HEALTH EFFECTS

Figure 3-4. Conceptual Representation of a Physiologically Based Pharmacokinetic (PBPK) Model for a Hypothetical Chemical Substance

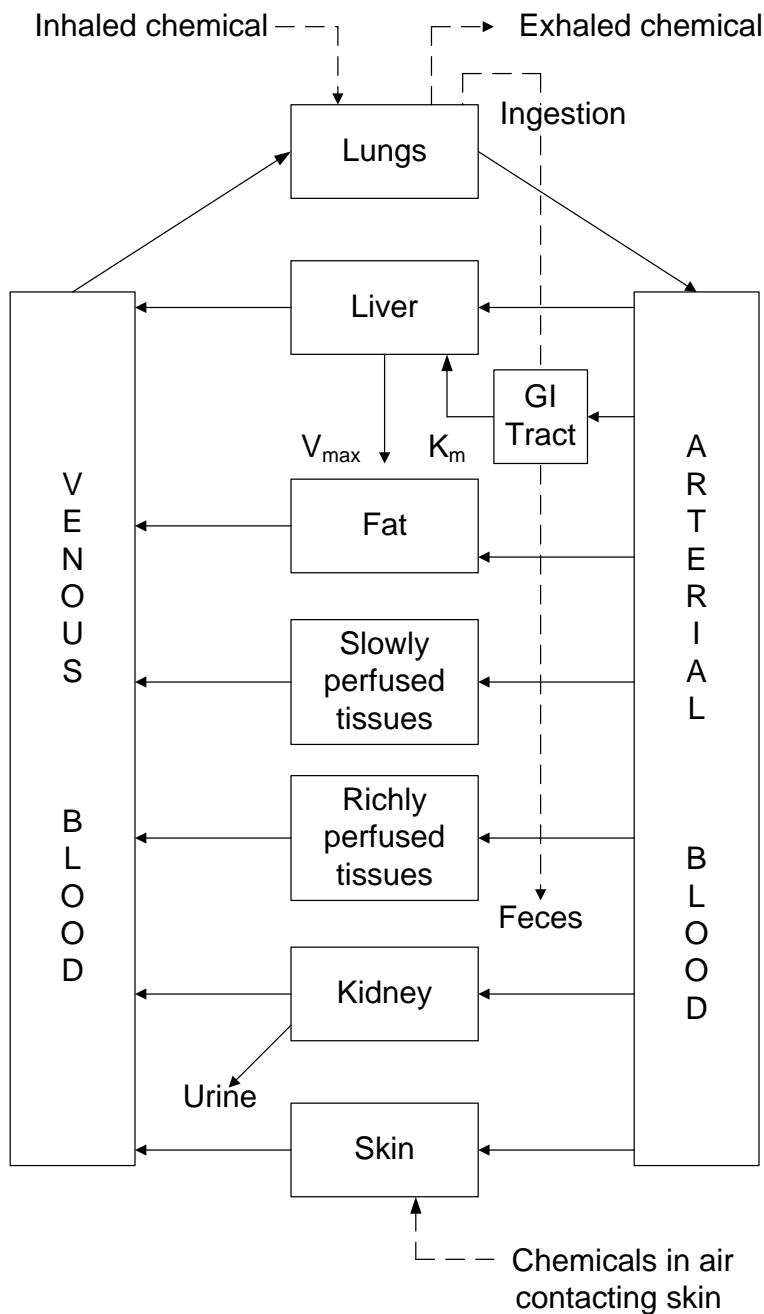

Source: adapted from Krishnan et al. 1994

Note: This is a conceptual representation of a physiologically based pharmacokinetic (PBPK) model for a hypothetical chemical substance. The chemical substance is shown to be absorbed via the skin, by inhalation, or by ingestion, metabolized in the liver, and excreted in the urine or by exhalation.

3. HEALTH EFFECTS

Figure 3-5. Physiologically Based Pharmacokinetic Model for Inhaled Carbon Tetrachloride*

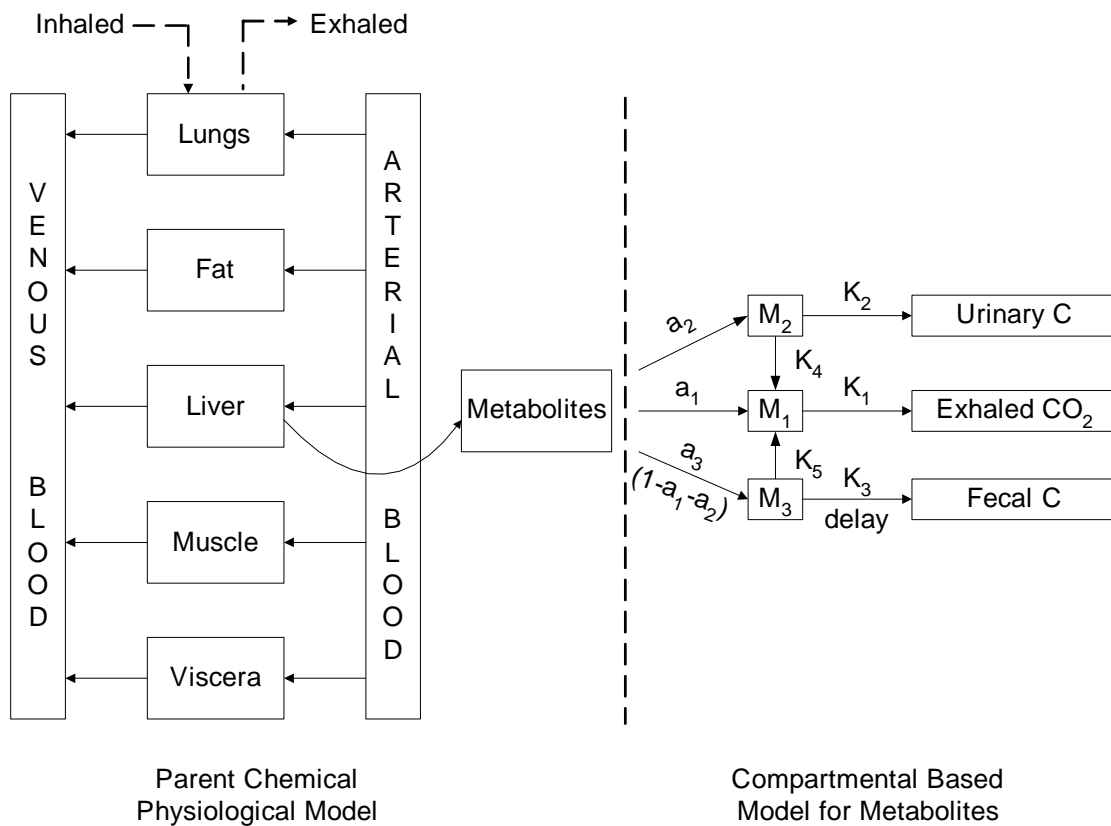

*Adapted from Paustenbach et al. 1988

3. HEALTH EFFECTS

Table 3-7. Parameters in PBPK Models for Carbon tetrachloride

Parameter	Rat	Human
Physiological parameters (as per Paustenbach et al. 1988)		
Body weight (kg)	0.42	70
Percentages of body weight		
Liver	4	4 ^a
Fat	8	10
Rapidly perfused	5	5
Slowly perfused	74	62
Flows (L/hour)		
Cardiac output (QC)	8.15	348
Alveolar ventilation (QP)	7.91	254
Blood flow (percentages of cardiac output)		
Liver	25	25 ^a
Fat	4	6
Rapidly perfused	51	51 ^a
Slowly perfused	20	18
Partition coefficients		
Blood:air	4.52	2.64
Liver:blood	3.14 ^b	3.14 ^a
Fat:blood	79.4	79.4 ^a
Rapidly perfused:blood	3.14 ^c	3.14 ^a
Slowly perfused:blood	1	1 ^a
Metabolism		
V _{max} (mg/hour)	0.35	12.72 ^d
K _m (mg/L)	0.25	0.25 ^a

^aHuman value set equal to rat value

^bGargas et al. 1986

^cRapidly perfused blood: set equivalent to liver blood

^dHuman value scaled up using allometric equation $V_{max} = V_{maxc} \times (\text{body weight})^{0.7}$ using V_{maxc} for rat = (maximum rate of metabolism of 0.65 mg/hour-kg body weight) and human body weight of 70 kg

3. HEALTH EFFECTS

urine and feces, with small amounts eliminated as carbon dioxide. The amount of carbon tetrachloride metabolized is limited by the saturable enzyme system, with high exposures (e.g., 100 ppm) leading to saturation within a short time. Following cessation of exposure, considerable metabolism may occur as carbon tetrachloride emerges from fatty tissue. The model successfully described elimination using a V_{\max} of 0.65 mg/kg/hour and a K_m of 0.25 mg/L. The model was scaled up to predict the expected behavior of carbon tetrachloride in monkeys and humans. The results were consistent with data collected by McCollister et al. (1951) and Stewart et al. (1961). The earlier study by Paustenbach et al. (1986) showed that rats did not have significant day-to-day accumulations in the blood or fat following repeated exposure to 100 ppm for 8 or 11.5 hours/day; this was accurately described in the model. In contrast, humans exposed to 5 ppm for 8 hours/day would be expected to show day-to-day increases in fat because of physiological differences.

Thrall et al. (2000) adapted the model of Paustenbach et al. (1988) to compare the metabolism of carbon tetrachloride in male rats, mice, and hamsters exposed to 40–1,800 ppm in a recirculating closed-chamber gas-uptake system. For each species, an optimal fit of the uptake curves was obtained by adjusting the metabolic constants V_{\max} (capacity) and K_m (affinity) using the model. The mouse had a slightly higher capacity and lower affinity for metabolizing carbon tetrachloride than the rat, whereas the hamster had a higher capacity and lower affinity than either the rat or mouse. A comparison of V_{\max}/K_m normalized for milligrams of liver protein (L/hour/mg) indicated that hamsters metabolize more carbon tetrachloride than rats or mice. The species comparisons were evaluated against toxicokinetic studies conducted in animals exposed by nose-only inhalation to 20 ppm ^{14}C -labeled carbon tetrachloride for four hours. Rats eliminated a lower fraction of the dose as metabolites and more as parent compound compared to mice or hamsters. The use of the model was expanded to include *in vitro* constants using liver microsomes from rat, mouse, hamster, and human in order to estimate *in vivo* metabolic rates for humans: a V_{\max} of 1.49 mg/hour/kg body weight and a K_m of 0.25 mg/L. Normalizing the rate of metabolism (V_{\max}/K_m), the rate of metabolism differed across species, with hamster > mouse > rat > human.

Yoshida et al. (1999) estimated rates of absorption of carbon tetrachloride and three trihalomethanes in low-level inhalation exposures by rats using a pharmacokinetic analysis. A three-compartment model, consisting of a tank with barium chloride to trap the chemical, the exposure chamber, and the rat, was employed for carbon tetrachloride, which was injected into the chamber. The model estimated that the amounts of carbon tetrachloride metabolized by rats in $\mu\text{mol}/\text{hour}/\text{kg}$ were 0.000053, 0.0053, and 0.53 for exposures at 1 ppb, 10 ppb, and 10 ppm, respectively.

3. HEALTH EFFECTS

Semino et al. (1997) adapted the model of Paustenbach et al. (1988) to develop a PBPK model to describe the oral uptake of carbon tetrachloride administered to male Fischer 344 rats in corn oil or 0.25% Emulphor, an aqueous vehicle. The gastrointestinal model used a series of subcompartments with an absorption constant (K_a , L/hour), a bioavailability term (A , unitless), and a compartment emptying time (T , hours). The model was optimized by varying the values of the constants for the experimental data. Higher values of K_a and A were needed to fit data from aqueous gavage compared to that for corn oil. The model provided precise fits of multiphase blood and exhaled breath carbon tetrachloride concentration-time profiles. A pulsatile pattern noted following corn oil gavage was attributed to discontinuous emptying of the stomach into the small intestine. Initial absorption of the bolus occurs rapidly in the stomach, especially for aqueous vehicles; subsequently, stomach absorption slows and uptake from the small intestine determines the absorption profile.

Gallo et al. (1993) developed a PBPK model for blood concentration of carbon tetrachloride in rats following intravenous delivery in aqueous polyethylene glycol 400. Subsequently, absorption input functions were added to the model to describe blood concentration profiles resulting from administration of 25 mg carbon tetrachloride per kg body weight alone, in aqueous vehicles (water or 0.25% Emulphor emulsion), or in corn oil. Absorption was 91.9% for administration in water, 85.4% in Emulphor, 62.8% for the pure compound, and 93.1% for administration in corn oil. A pulsatile pattern was obtained for absorption in corn oil.

Andersen et al. (1996) developed a pharmacokinetic model to calculate the concentration of carbon tetrachloride in microsomal suspensions from male Fischer 344 rats under anaerobic conditions. Dose-response curves revealed a nonlinear, biphasic appearance of trichloromethane. One experiment compared microsomes from fasted or unfasted rats; fasting did not alter the shape of the dose-response curve, but increased the production of trichloromethane in microsomes.

3.5 MECHANISMS OF ACTION

3.5.1 Pharmacokinetic Mechanisms

Absorption. As a small volatile haloalkane, carbon tetrachloride diffuses passively across cell membranes, leading to rapid absorption from the lungs and gastrointestinal tract into the circulatory system (Sanzgiri et al. 1995, 1997). Pulmonary absorption is ventilation limited.

3. HEALTH EFFECTS

Distribution. Being somewhat lipophilic, absorbed carbon tetrachloride diffuses from the blood to the liver, kidney, brain, and other organs and accumulates in adipose tissue. Following absorption by the gastrointestinal tract, a first-pass effect is apparent through the liver, where carbon tetrachloride is biotransformed and adducts are formed from reactive metabolites binding to cell macromolecules. Clearance of unmetabolized carbon tetrachloride is limited by passive diffusion; the rate of clearance is slowest for adipose tissue compared to internal organs (Benson et al. 2001; Sanzgiri et al. 1997). Quantitative differences between maximal tissue concentrations of carbon tetrachloride in the kidney or liver occur following administration of equivalent absorbed doses (179 mg/kg) by inhalation, oral bolus dosing, or gradual gastric infusion (Sanzgiri et al. 1997). Inhalation exposure resulted in similar values for kidney (25 µg/g) and liver (20 µg/g). Delivery of carbon tetrachloride as a single bolus can exceed first-pass hepatic and pulmonary elimination, resulting in higher blood levels and more severe hepatic injury compared to gradual delivery of the same dose over a longer period of time (Sanzgiri et al. 1997); bolus delivery resulted in a maximal tissue concentration for the kidney (14 µg/g) that is only 24% of the hepatic value (58 µg/g). Gastric infusion of the equivalent dose over 2 hours resulted in much lower tissue concentrations, with the kidney value (4 µg/g) 8 times higher than the value for the liver (0.5 µg/g). These results suggest that gradual oral intakes, such as might occur from contaminated drinking water, might result in less hepatotoxicity than equivalent exposure by bolus dosing or inhalation.

Metabolism. Carbon tetrachloride is primarily metabolized in tissues that express CYP2E1. The metabolic pathways are described in detail in Section 3.4.3 and depicted in Figure 3-3.

Excretion. In humans and animals, carbon tetrachloride is eliminated by passive diffusion primarily through exhaled breath, with a smaller fraction eliminated in urine and feces (Benson et al. 2001; Thrall et al. 2000).

3.5.2 Mechanisms of Toxicity

Unmetabolized carbon tetrachloride, as a volatile halogenated alkane, depresses the central nervous system. All other toxic effects of carbon tetrachloride are related to its biotransformation catalyzed by cytochrome P-450 dependent monooxygenase, specifically CYP2E1 (Azri et al. 1991; Hughes et al. 1991; Lindros et al. 1990; Raucy et al. 1993; Wong et al. 1998; Zangar et al. 2000). The liver and kidney (especially in humans) are especially vulnerable because of the abundance of CYP2E1, which is also present in the respiratory and nervous systems, and various isoforms of CYP3A (Haehner et al. 1996; Koch et al. 2002; Martin et al. 2003; Warrington et al. 2004; Wauthier et al. 2004). Considerable data

3. HEALTH EFFECTS

are available for hepatic toxicity, but similar cellular damage would be expected in other tissues with a high abundance of CYP2E1. There is considerable evidence that hepatic injury produced by carbon tetrachloride is mediated by two major processes resulting from bioactivation in the endoplasmic reticulum and mitochondria of centrilobular hepatocytes, which have the highest concentration of CYP2E1 (Buhler et al. 1992; Raucy et al. 1993): haloalkylation of cellular macromolecules by reactive metabolites such as trichloromethyl free radical or trichloromethyl peroxy free radical (Link et al 1984; Mico and Pohl 1983; Poyer et al. 1980; Recknagel et al. 1977; Slater et al. 1986) and lipid peroxidation, which impairs cellular functions dependent on membrane integrity (Benedetti et al. 1982; Comporti 1985; Lee et al. 1982; Slater 1981; Slater and Sawyer 1970; Tribble et al. 1987; Weber et al. 2003). Both haloalkylation and lipid peroxidation contribute to loss of cellular functions and subsequent cell death as discussed in greater detail in the following paragraphs. In response to parenchymal cell damage, perisinusoidal cells may be stimulated to release extracellular matrix proteins (type-I collagen) that contribute to hepatic fibrogenesis, which is largely mediated by hepatic macrophages (Kupffer cells) (Belyaev et al. 1992; Ishiki et al. 1992; Johnson et al. 1992; Luckey and Petersen 2001; Muriel and Escobar 2003). Kupffer cells activated by carbon tetrachloride release tumor necrosis factor- α (TNF- α), nitric oxide, transforming growth factor- β (TGF- β) (Date et al. 1998), and interleukins (IL)-1, -6, and -10 (Weber et al. 2003). TNF- α elicits an inflammatory response and may generate apoptosis or contribute to the development of steatosis in hepatocytes (Morio et al. 2000); however, impaired secretion of lipoproteins, possibly because of lipid peroxidation, has also been proposed as a mechanism for steatosis (Boll et al. 2001c). TNF- α may also stimulate genes involved in hepatic mitogenesis (Bruccoleri et al. 1997). TNF- α is also responsible for the activity of hepatocyte nuclear factor 1 (HNF-1) in down-regulating genes for organic anion transporters (*Ntcp*, *Oatp1*, and *Oatp2*) that operate in the basolateral domain of parenchymal cells following carbon tetrachloride treatment (Geier et al. 2003). Nitric oxide modulates intra-hepatic vascular tone in normal rats (Loureiro-Silva et al. 2003) and generally protects against apoptotic tissue damage (Muriel 1998), but it can also react with the O_2^- radical (formed during carbon tetrachloride-induced oxidative stress) to form an aggressive peroxynitrite radical, resulting in more severe hepatic injury (Morio et al. 2001; Weber et al. 2003). Inhibition of Kupffer cell activation with gadolinium prevented hepatic lipid peroxidation and histopathology produced by carbon tetrachloride (Muriel et al. 2001). Interleukin-6 pathways that use the signal transducer gp130 have been proposed as protective against the progression of carbon tetrachloride-induced fibrosis (Streetz et al. 2003). As shown by the results of experiments with IL-10 knockout mice, IL-10 reduces neutrophilic infiltration (inflammation) following injury with carbon tetrachloride and limits the proliferative response of hepatocytes and the development of fibrosis during the recovery phase (Louis et al. 1998). TGF- β 1 promotes hepatic fibrogenesis following carbon tetrachloride treatment, as shown

3. HEALTH EFFECTS

by the inhibition of fibrosis by peptides that block the cytokine's Type III receptor (Ezquerro et al. 2003). Lipid peroxidation may be at least partially independent of cytochrome P-450, as iron-dependent peroxidation occurred in cultured mammalian cells even in the presence of P-450 inhibitors (Dickens 1991). While carbon tetrachloride-induced liver damage was mitigated by treatment with allopurinol, an inhibitor of xanthine oxidase (a free radical-generating enzyme), prolonged administration of the free radical scavenger superoxide dismutase actually aggravated hepatocellular damage (Dashti et al. 1992). Some inflammatory processes in the liver following carbon tetrachloride treatment appear to be mediated by the activation of prothrombin by the prothrombinase complex (Mizuguchi et al. 2002). In acute injury from carbon tetrachloride, hydrolytic enzymes such as calpain are released from dying hepatocytes and are activated by the higher calcium levels in the extracellular space (Limaye et al. 2003). As a result, the activated proteases begin to hydrolyze proteins in neighboring cells, leading to a progression of the lesion. Necrotic responses in the liver to carbon tetrachloride are apparently mediated by the Cdk inhibitor p21, as shown by an absence of necrosis in p21-knockout mice treated with the chemical (Kwon et al. 2003).

Overall responses of different organs to carbon tetrachloride will be mediated, in part, by variations in gene expression patterns. DNA array studies in rodents demonstrated slightly different and dose-related patterns of gene expression/repression in the liver and kidney; activated genes involved heat shock proteins, oxidative stress, and DNA damage responses (Bartosiewicz et al. 2001; Fountoulakis et al. 2002; Jessen et al. 2003; Kier et al. 2004). In human hepatoma G2 cells, treatment with carbon tetrachloride increased expression and activity of interleukin-8 (IL-8), which *in vivo* directs the migration of neutrophils, resulting in release of reactive oxygen species (Holden et al. 2000). Injection of carbon tetrachloride into rats activated the expression of c-fos and c-jun within 30 minutes and also increased in hepatic nuclei the levels of the transcription factor NF- κ B, which regulates transcription related to inflammation, apoptosis, and regenerative processes (Gruebele et al. 1996). Suppression of CYP3A1 and activation of multiple drug resistance gene1 (MDR1) were observed in livers of Sprague-Dawley rats following acute exposure (Kier et al. 2004). Gene expression changes associated with fibrosis (see below) may persist for weeks after cessation of treatment (Jiang et al. 2004).

Hepatic microsomal lipid peroxidation damages cellular functions by disturbing the integrity and hence the function of membranes and by covalent binding of reactive intermediates. The trichloromethyl radical is sufficiently reactive to bind covalently to CYP2E1, a process sometimes referred to as the "suicidal inactivation" of CYP2E1 (De Groot and Haas, 1981; Fernandez et al. 1982; Fujii 1997; Manno et al. 1988, 1992). It is also possible that reactive intermediates formed during the process of lipid peroxidation contribute to the loss of CYP2E1, but some *in vitro* studies have indicated that carbon tetrachloride-

3. HEALTH EFFECTS

induced lipid peroxidation is not required for the inactivation of CYP2E1 (Dai and Cederbaum 1995; De Groot and Haas 1980). Nevertheless, it is still not clear how these initial events are related to subsequent triglyceride accumulation, polyribosomal disaggregation, depression of protein synthesis, cell membrane breakdown and eventual death of the hepatocytes. Carbon tetrachloride can inhibit triglyceride secretion from hepatocytes in the absence of lipid peroxidation, and polyribosomal dissociation and decreased protein synthesis can occur when no ^{14}C -labelled carbon tetrachloride has been incorporated into ribosomal fractions (Waller et al. 1983). When rats were pretreated with a chemical that reduced lipid peroxidation by 85%, only small recoveries from carbon tetrachloride-induced decreases in hepatocellular viability, cytochrome P-450 content, aniline hydroxylase activity, and carbon tetrachloride metabolism capacities were observed (Kostyuk and Potapovich 1991). This suggests that free radical binding to critical cellular macromolecules (e.g., microsomal oxidation system enzymes) may be more critical for these effects than lipid peroxidation. On the other hand, inhalation exposure to carbon tetrachloride produced a direct correlation between lipid peroxidation and proline hydroxylase (a collagen biosynthetic enzyme) in rats, and dietary zinc supplementation was associated with decreases in lipid peroxidation, collagen deposition, and proline hydroxylase activity, together with an increase in collagenase activity (Camps et al. 1992). Carbon tetrachloride-induced lipid peroxidation apparently requires the presence of Fe^{2+} ions, as demonstrated by the inhibitory effect of the iron-chelating agent deferoxamine on lipid peroxidation and hepatotoxicity in rats (Younes and Siegers 1985). One product of lipid peroxidation, 4-hydroxynonenal, has been shown to act as a pro-fibrogenic stimulus following acute hepatic injury from carbon tetrachloride (Zamara et al. 2004).

Intrinsic tissue levels of antioxidants such as glutathione influence the degree to which oxidative damage progresses following exposure to carbon tetrachloride. In 11 selected human cells types, steady-state levels of oxidative DNA base modifications (e.g., 8-hydroxyguanine) were inversely proportional to intrinsic glutathione levels (Will et al. 1999). An age-related decline in the activity of nuclear factor erythroid2-related factor (Nrf2), the factor regulating the transcription of gamma-glutamylcysteine ligase (GGCL), is the ultimate cause of the age-related decline in hepatic glutathione levels in rats (Suh et al. 2004). The hepatic activity of GGCL, which synthesizes gamma-glutamylcysteine, a precursor to glutathione, is 54.8% lower in old (24-month) rats compared to young (3-month) rats, resulting in a 35% decline in glutathione content in older rats. Agents such as buthionine sulphoximine, which inhibit GGCL, also deplete glutathione levels (Edgren and Revesz 1987). Conversely, S-adenosylmethionine (SAM), which is required for the synthesis of precursors to glutathione (homocysteine and cysteine), is also depleted by liver injury and its loss is exacerbated by the concomitant inactivation of SAM synthetase (Gasso et al. 1996). Exogenous administration of SAM or cysteine reduced carbon

3. HEALTH EFFECTS

tetrachloride-induced liver injury by the increase in glutathione levels (De Ferreyra et al. 1974; Gasso et al. 1996). Reduced glutathione levels concomitant with renal histopathology have also been demonstrated in the kidney of rats injected with carbon tetrachloride (Dogukan et al. 2003; Ozturk et al. 2003).

Another factor that may be of importance in carbon tetrachloride-induced hepatotoxicity is the perturbation of normal cellular calcium homeostasis following exposure. A number of studies have reported data that suggest carbon tetrachloride exposure inhibits the capacity of the hepatocyte endoplasmic reticulum or microsomal fraction to sequester (or keep sequestered) calcium, under either *in vivo* (Kodavanti et al. 1993; Long and Moore 1986a; Long et al. 1989; Lowrey et al. 1981b; Moore 1980; Moore et al. 1976) or *in vitro* (Long and Moore 1987; Long et al. 1989; Lowrey et al. 1981a; Srivastava et al. 1990; Waller et al. 1983) exposure conditions. This inhibition of sequestration capacity is considered to be a key contributor to the rise in cytosolic calcium concentration that is generally observed following carbon tetrachloride exposure (e.g., Kodavanti et al. 1990b, 1993; Long and Moore 1987), and that is postulated to play a central role in the induced cytotoxicity. The suppression of calcium uptake by microsomes occurred in the liver, (but not the kidney) of rats receiving a single oral dose of 2,500 mg/kg carbon tetrachloride (Moore et al. 1976). While some *in vivo* (Long and Moore 1986a) and *in vitro* (Srivastava et al. 1990) data suggest that carbon tetrachloride intoxication actually promotes the release of calcium to the cytosol from the endoplasmic reticulum or microsomes, other *in vivo* studies with carbon tetrachloride alone (Yamamoto 1990b) or in conjunction with chlordecone (Agarwal and Mehendale 1984a, 1984b, 1986) indicate that microsomal calcium content in fact rises, though generally to a lesser extent than cytosolic or total calcium content. Such microsomal increases presumably occur despite diminished calcium sequestration capacity. In isolated hepatocytes, immediate (<1 minute) alterations in calcium sequestration following treatment have been attributed to the solvent effect of unmetabolized carbon tetrachloride (Hemmings et al. 2002). It should be noted that another *in vitro* study found that membrane effects (membrane fusion) only occurred at concentrations that are unlikely to be achieved during inhalation exposure, but might occur following bolus gavage dosing at high levels (Johnston and Kroening 1998).

Studies have indicated that increased intracellular calcium may mediate cytotoxicity by activating phospholipase A2 (Chiarotto et al. 1990; Glende and Recknagel 1991, 1992; Simon et al. 1986; van den Bosch et al. 1990), which might contribute to irreversible plasma membrane damage. Lipid damage from phospholipase A2 may result from increased lipid hydrolysis and from the initiation of the arachidonic acid cascade that generates toxic prostanoids (Basu 2003; Glende and Pushpendran 1986). Elevated

3. HEALTH EFFECTS

phospholipase A2 activity has been detected in the renal cortex and medulla of rats with carbon tetrachloride/phenobarbital-induced hepatic cirrhosis (Niederberger et al. 1998). Elevated intracellular calcium may also be associated with elevated levels of phosphorylase and altered intracellular levels and distribution of calmodulin (Kodavanti et al. 1990), but was reported not to result in any DNA degradation—a potential result of calcium-activation of endonuclease activity (Long et al. 1989).

The finding that carbon tetrachloride is converted to reactive metabolites that bind to nuclear protein, lipids, and DNA may be relevant to the understanding of carbon tetrachloride carcinogenicity. Binding of radiolabel to liver cytoplasmic and nuclear proteins was found in Wistar rats and Swiss mice dosed with ^{14}C -carbon tetrachloride (Rocchi et al. 1973). Pretreatment of the animals with 3-methylcholanthrene (an inducer of cytochrome P-450 IA [P-448]) resulted in ^{14}C binding to hepatic DNA of mice, but not rats. Similarly, Diaz Gomez and Castro (1980a) found significantly greater ^{14}C binding to the liver DNA of A/J mice than to that of Sprague-Dawley rats given a tracer dose of ^{14}C -carbon tetrachloride. A/J mice are among the most susceptible of strains tested with respect to liver tumor induction by carbon tetrachloride. Administration of a high dose (3,200 mg/kg) of ^{14}C -carbon tetrachloride, having the same total radioactivity as the tracer dose, resulted in much more intensive binding to hepatic DNA. Presumably, the fewer reactive metabolites formed from the tracer dose react primarily with microsomal lipids and proteins in close proximity to their formation. With the higher dose, more ^{14}C -carbon tetrachloride can apparently reach the nucleus and be metabolically activated there, subsequently reacting with nuclear lipids, proteins, and DNA. This scenario receives support from the finding that highly purified rat liver nuclear preparations were able to anaerobically activate ^{14}C -carbon tetrachloride in the presence of an NADPH generating system (Diaz Gomez and Castro 1980b). Under microsome-mediated aerobic conditions, it was observed that ^{14}C -carbon tetrachloride bound more to histone than to nonhistone chromosomal proteins from livers of B6C3F₁ mice (Oruambo and Van Duuren 1987). These findings may be relevant to the understanding of carbon tetrachloride hepatocarcinogenicity, since reactive metabolites of carbon tetrachloride appear capable of binding to targets of putative relevance to cancer induction (chromosomal DNA and nucleosome proteins), and may even be generated within the nucleus itself. Since lipid peroxidation products such as malonaldehyde also have the ability to form adducts with DNA (Chaudhary et al. 1994; Chung et al. 2001; Wacker et al. 2001), it is possible that the genotoxic effect of carbon tetrachloride is partly indirect. Malonaldehyde-initiated tumors have been reported in Swiss mice (Shamberger et al. 1974). It is also worth noting that data from a variety of congenic mouse strains suggest that both the toxicity of, and recovery from, carbon tetrachloride exposure are under genetic control (an Ah gene, and H-2 genes) (Bhathal et al. 1983; Biesel et al. 1984).

3. HEALTH EFFECTS

Results of chronic bioassays in rats and mice exposed orally or by inhalation indicate that hepatocellular carcinomas are induced at hepatotoxic doses, suggesting that there may be a threshold for carcinogenicity of carbon tetrachloride (Japan Bioassay Research Centre 1998; NCI 1976a, 1976b, 1977). The results of these chronic rodent studies are consistent with the idea that hepatic carcinogenicity directly related to the increase in cellular replication that occurs in response to hepatocyte lethality. Enhanced cellular replication increases the possibility that unrepaired DNA errors will become fixed mutations, possibly resulting in an initiated preneoplastic cell. Exposures at levels lower than those eliciting hepatic regeneration would not be expected to result in hepatic carcinogenicity.

Interesting data from other studies illustrate that the hepatotoxic effects of carbon tetrachloride (or carbon tetrachloride plus chlordecone) depend not merely on its metabolic activation, but also to a substantial degree on the liver's hepatocellular regenerative capacity (e.g., Mehendale 1990, 1991, 1992). For example, the auto protection conferred by a low nontoxic dose of carbon tetrachloride against the toxic effects of a subsequent high dose seem not to be completely accounted for by mere destruction of cytochrome P-450 activation capacity, but appear also to involve the early (2–6 hours after pretreatment) stimulation of hepatocellular regeneration (Rao and Mehendale 1991; Thakore and Mehendale 1991). This early, low-dose stimulation, which leads to much greater hepatocellular regenerative activity (DNA-synthesis and mitosis) following the high-dose exposure, and the autoprotection phenomenon are both inhibited by a colchicine-induced mitotic block (Rao and Mehendale 1991, 1993). It has been hypothesized that the low dose of carbon tetrachloride and/or the resulting minimal injury induces hepatocytes into the cell cycle from an arrested G₂ state (Calabrese et al. 1993). Further, partial hepatectomy in rats has been shown to confer resistance to carbon tetrachloride-induced hepatotoxicity, presumably via enhanced regenerative capacity, as hepatic uptake and metabolism of carbon tetrachloride was not significantly altered (Young and Mehendale 1989). The particular sensitivity of gerbils to carbon tetrachloride-induced hepatotoxicity appeared related not only to extensive bioactivation, but also to a sluggish hepatocellular regenerative and tissue repair response, and was mitigated by partial hepatectomy that stimulated this response in the absence of any significant effect on carbon tetrachloride bioactivation or induced lipid peroxidation (Cai and Mehendale 1990, 1991a, 1991b). Finally, in rats, pretreatment with nontoxic levels of chlordecone has been shown to substantially potentiate the hepatotoxicity of low doses of carbon tetrachloride without affecting its hepatic metabolism to a similarly significant degree, whereas phenobarbital pretreatment induced greater bioactivation, but less hepatotoxicity (Mehendale and Klingensmith 1988; Young and Mehendale 1989). This chlordecone potentiation phenomenon has been attributed to its inhibitory effect on the level of hepatocellular regeneration and tissue repair normally induced by low-dose carbon tetrachloride, with death resulting from hepatic failure and hepatic

3. HEALTH EFFECTS

encephalopathy (renal toxicity was not affected) (Kodavanti et al. 1992; Soni and Mehendale 1993). Where chlordecone cannot inhibit this regenerative response, as in cultured rat hepatocytes (Mehendale et al. 1991) or gerbils (Cai and Mehendale 1990), it does not potentiate cellular or hepatic toxicity.

The signaling factor leptin apparently plays a role in the initiation of hepatic regenerative processes following acute injury by a sublethal dose of carbon tetrachloride (Leclercq et al. 2003). Hepatic changes occurring in mice treated with carbon tetrachloride (in temporal order) include induction of nuclear factor kappaB (NF- κ B) and interleukin-6 (IL-6) at the time of G1/S transition, increased DNA binding by STAT3 (signal transducer and activator of transcription), induction of cyclin D1 expression consistent with an increase in mitosis, and a time-dependent increase in tumor necrosis factor (TNF) consistent with the appearance of necrosis. NF- κ B also regulates genes involved in inflammation, apoptosis, proliferation, and regeneration in the liver (Gruebele et al. 1996). Mice (*ob/ob*) transgenic for the loss of expression of leptin and treated with carbon tetrachloride had an exaggerated expression of STAT3 and NF- κ B, impaired activation of TNF and IL-6 release, failure of induction of cyclin D1, and reduced hepatocyte proliferation. Exogenous leptin restored the regenerative capacity of *ob/ob* mice. Hepatic regeneration following acute injury by carbon tetrachloride is mediated by the type 1 TNF receptor, but not the type 2 receptor, in mice (Yamada and Fausto 1998).

Fibrotic processes in the liver following carbon tetrachloride treatment are modulated by the adipocytokine adiponectin (Kamada et al. 2003). Repeated (twice weekly) intraperitoneal dosing with 1,594 mg/kg but not 478 mg/kg carbon tetrachloride significantly reduced plasma concentrations of adiponectin. Although showing the same degree of initial hepatic injury (serum ALT, inflammation) as wild type mice following injection with carbon tetrachloride, adiponectin-knockout mice showed more extensive liver fibrosis (hydroxyproline content) and enhanced expression of TGF- β 1 and connective tissue growth factor (CTGF) compared to wild type mice. Replacement dosing with adiponectin reduced hepatic fibrosis. The effect of adiponectin on cultured hepatic stellate cells stimulated with platelet-derived growth factor-BB (PDGF-BB) was to inhibit proliferation and migration and counteract the TGF- β 1-induced activation of TGF- β 1 and CTGF genes by interfering with the nuclear translocation of Smad2. Overall, a reduction of adiponectin levels following carbon tetrachloride treatment would be expected to foster fibrotic processes in the liver.

Telomere shortening resulting in chromosomal instability has been associated with hepatocellular carcinoma in humans, with loss of regenerative capacity in chronic liver injury. Intraperitoneal injection of carbon tetrachloride into wild type mice increased the initiation of hepatic foci and the development of

3. HEALTH EFFECTS

hepatocellular carcinoma (Farazi et al. 2003). The number and size of hepatic nodules were significantly lower in treated mice that were transgenic for aberrant telomerase. The authors suggest that telomere dysfunction impedes the progression to malignancy. Estradiol protected against telomere shortening, fibrosis, and senescence in hepatocytes of rats injected intramuscularly with carbon tetrachloride (Sato et al. 2004). The authors attributed the protective effect of estradiol on its transactivation of the telomerase gene.

3.5.3 Animal-to-Human Extrapolations

Patterns of toxicity and metabolism of carbon tetrachloride in laboratory animals are very similar in humans and animals. In both, similar effects are observed in the major target organs, the liver and kidney, as well as in the nervous system during acute inhalation exposures. There are some minor species differences in metabolic parameters following exposure to carbon tetrachloride. Benson et al. (2001) reported that the fraction of carbon tetrachloride (equivalents following inhalation of radiolabeled carbon tetrachloride) partitioning to the liver after a 4-hour inhalation exposure was higher in hamsters and mice than in rats, which show an immediate accumulation in fat. Rats eliminated less radioactivity associated with metabolism and more associated with the parent compound in exhaled air than mice or hamsters. Thrall et al. (2000) estimated that humans at low inhalation concentrations metabolized less of the dose than rats, and would be less sensitive than rats at equivalent exposures; the rate of metabolism was highest in mice, followed by rat, and then humans. In humans, rats, and mice, CYP2E1 is the major enzyme responsible for bioactivation of carbon tetrachloride; thus, similar effects of reactive metabolites could be expected in rodents and humans.

3.6 TOXICITIES MEDIATED THROUGH THE NEUROENDOCRINE AXIS

Recently, attention has focused on the potential hazardous effects of certain chemicals on the endocrine system because of the ability of these chemicals to mimic or block endogenous hormones. Chemicals with this type of activity are most commonly referred to as *endocrine disruptors*. However, appropriate terminology to describe such effects remains controversial. The terminology *endocrine disruptors*, initially used by Colborn and Clement (1992), was also used in 1996 when Congress mandated the EPA to develop a screening program for "...certain substances [which] may have an effect produced by a naturally occurring estrogen, or other such endocrine effect[s]...". To meet this mandate, EPA convened a panel called the Endocrine Disruptors Screening and Testing Advisory Committee (EDSTAC), and in

3. HEALTH EFFECTS

1998, the EDSTAC completed its deliberations and made recommendations to EPA concerning *endocrine disruptors*. In 1999, the National Academy of Sciences released a report that referred to these same types of chemicals as *hormonally active agents*. The terminology *endocrine modulators* has also been used to convey the fact that effects caused by such chemicals may not necessarily be adverse. Many scientists agree that chemicals with the ability to disrupt or modulate the endocrine system are a potential threat to the health of humans, aquatic animals, and wildlife. However, others think that endocrine-active chemicals do not pose a significant health risk, particularly in view of the fact that hormone mimics exist in the natural environment. Examples of natural hormone mimics are the isoflavonoid phytoestrogens (Adlercreutz 1995; Livingston 1978; Mayr et al. 1992). These chemicals are derived from plants and are similar in structure and action to endogenous estrogen. Although the public health significance and descriptive terminology of substances capable of affecting the endocrine system remains controversial, scientists agree that these chemicals may affect the synthesis, secretion, transport, binding, action, or elimination of natural hormones in the body responsible for maintaining homeostasis, reproduction, development, and/or behavior (EPA 1997). Stated differently, such compounds may cause toxicities that are mediated through the neuroendocrine axis. As a result, these chemicals may play a role in altering, for example, metabolic, sexual, immune, and neurobehavioral function. Such chemicals are also thought to be involved in inducing breast, testicular, and prostate cancers, as well as endometriosis (Berger 1994; Giwercman et al. 1993; Hoel et al. 1992).

There is no reported direct effect of carbon tetrachloride on hormones in humans or animals. Fertility was reduced in an inhalation bioassay in rats, but it is not known whether the cause was hormonal disruption or a necrotic effect on the gonads (Smyth et al. 1936). Testicular degeneration, possibly resulting from necrosis, was observed in rats exposed by inhalation (Adams et al. 1952). Adrenal pheochromocytomas were induced in mice exposed to carbon tetrachloride vapor for 2 years (Japan Bioassay Research Center 1998). It is possible that catecholamine balances were affected in these animals (Landsberg and Young 1998).

It is possible that the loss of hepatic function caused by carbon tetrachloride could indirectly impair hormone metabolic processes that are regulated by the liver. Functions that could be affected by reduced liver function include inactivation of some hormones (e.g., insulin and glucagon) by proteolysis or deamination, deiodination of thyroxine and triiodothyronine, inactivation of steroid hormones (e.g., glucocorticoids and aldosterone) followed by glucuronidation, metabolism of testosterone to 17-ketosteroids and sulfonation, conversion of estrogens to estriol and estrone followed by conjugation to glucuronic acid or sulfate, and removal of circulating vasoactive substances such as epinephrine and

3. HEALTH EFFECTS

bradykinin (Podolsky and Isselbacher 1998). In humans, chronic liver disease not caused by carbon tetrachloride is known to result in signs of hormonal imbalance such as testicular atrophy (Podolsky and Isselbacher 1998). The development of ascites in chronic liver disease may be facilitated by the elevated levels of epinephrine (Podolsky and Isselbacher 1998).

No *in vitro* studies were located regarding endocrine disruption of carbon tetrachloride.

3.7 CHILDREN'S SUSCEPTIBILITY

This section discusses potential health effects from exposures during the period from conception to maturity at 18 years of age in humans, when all biological systems will have fully developed. Potential effects on offspring resulting from exposures of parental germ cells are considered, as well as any indirect effects on the fetus and neonate resulting from maternal exposure during gestation and lactation. Relevant animal and *in vitro* models are also discussed.

Children are not small adults. They differ from adults in their exposures and may differ in their susceptibility to hazardous chemicals. Children's unique physiology and behavior can influence the extent of their exposure. Exposures of children are discussed in Section 6.6, Exposures of Children.

Children sometimes differ from adults in their susceptibility to hazardous chemicals, but whether there is a difference depends on the chemical (Guzelian et al. 1992; NRC 1993). Children may be more or less susceptible than adults to health effects, and the relationship may change with developmental age (Guzelian et al. 1992; NRC 1993). Vulnerability often depends on developmental stage. There are critical periods of structural and functional development during both prenatal and postnatal life and a particular structure or function will be most sensitive to disruption during its critical period(s). Damage may not be evident until a later stage of development. There are often differences in pharmacokinetics and metabolism between children and adults. For example, absorption may be different in neonates because of the immaturity of their gastrointestinal tract and their larger skin surface area in proportion to body weight (Morselli et al. 1980; NRC 1993); the gastrointestinal absorption of lead is greatest in infants and young children (Ziegler et al. 1978). Distribution of xenobiotics may be different; for example, infants have a larger proportion of their bodies as extracellular water and their brains and livers are proportionately larger (Altman and Dittmer 1974; Fomon 1966; Fomon et al. 1982; Owen and Brozek 1966; Widdowson and Dickerson 1964). The infant also has an immature blood-brain barrier (Adinolfi 1985; Johanson 1980) and probably an immature blood-testis barrier (Setchell and Waites 1975). Many

3. HEALTH EFFECTS

xenobiotic metabolizing enzymes have distinctive developmental patterns. At various stages of growth and development, levels of particular enzymes may be higher or lower than those of adults, and sometimes unique enzymes may exist at particular developmental stages (Komori et al. 1990; Leeder and Kearns 1997; NRC 1993; Vieira et al. 1996). Whether differences in xenobiotic metabolism make the child more or less susceptible also depends on whether the relevant enzymes are involved in activation of the parent compound to its toxic form or in detoxification. There may also be differences in excretion, particularly in newborns who all have a low glomerular filtration rate and have not developed efficient tubular secretion and resorption capacities (Altman and Dittmer 1974; NRC 1993; West et al. 1948). Children and adults may differ in their capacity to repair damage from chemical insults. Children also have a longer remaining lifetime in which to express damage from chemicals; this potential is particularly relevant to cancer.

Certain characteristics of the developing human may increase exposure or susceptibility, whereas others may decrease susceptibility to the same chemical. For example, although infants breathe more air per kilogram of body weight than adults breathe, this difference might be somewhat counterbalanced by their alveoli being less developed, which results in a disproportionately smaller surface area for alveolar absorption (NRC 1993).

One epidemiological study reported associations between maternal exposure to carbon tetrachloride at levels higher than 1 ppb in drinking water and adverse developmental outcomes (low full-term birth weight and small for gestational age) in humans (Bove et al. 1992a, 1992b, 1995). However, the same effects were associated with exposure to trihalomethanes, which occurred at higher concentrations in drinking water. Associations between exposure and incidences of central nervous system defects, cleft-lip or cleft-palate, or heart conotruncal defects were not statistically significant (Bove et al. 1992a, 1992b, 1995; Croen et al. 1997). In general, exposure to other chemicals by the study population raises uncertainty as to the causative role of carbon tetrachloride in the observed adverse developmental effects. Animal studies did not report adverse developmental effects in the absence of maternal toxicity. No teratogenic effects (morphological anomalies) were observed in rats exposed to carbon tetrachloride by inhalation (Gilman 1971; Schwetz et al. 1974) or in rats or mice exposed by ingestion (Hamlin et al. 1993; Wilson 1954). Complete litter loss occurred in some rats given oral doses that produced clear maternal toxicity (Narotsky et al. 1997a, 1997b; Wilson 1954). It is not known whether litter loss is the result of toxicity to the fetus or to the placenta, but the critical site of injury is likely related to the abundance of cytochrome proteins that metabolize carbon tetrachloride.

3. HEALTH EFFECTS

An *in vitro* fertilization assay in mice reported significant adverse effects on fertilization at concentrations ≥ 1 mM (154 $\mu\text{g/mL}$), but not ≤ 0.5 mM (77 $\mu\text{g/mL}$) (Hamlin et al. 1993). These levels are significantly higher than those encountered by the general population (see Section 6.5). An assay in mice intraperitoneally injected with carbon tetrachloride found no increase in sperm head abnormalities at doses as high as 3,180 mg/kg (Topham 1990).

Fetal tissues and the placenta appear to have the capacity for bioactivating carbon tetrachloride, although the levels of cytochrome enzymes are lower than in neonates or adults (EPA 2001). Total fetal liver CYP content is a relatively constant 30% of the adult level from the end of the first trimester of gestation up to 1 year of age (EPA 2001). mRNA for CYP2E1 has been detected in human first-trimester placentas (Hakkola et al. 1996). Low levels of CYP2E1 protein have been detected in human fetal brain as early as gestational day 46, substantially increasing around day 50 (Boutelet-Bochan et al. 1997; Brzezinski et al. 1999). In the fetal liver, CYP2E1 protein was not detectable at 10 weeks of gestation, but was present at 16 weeks (Carpenter et al. 1996). Therefore, it would appear that there is a period early in gestation during which the fetal brain might be more vulnerable than the liver to the effects of carbon tetrachloride. However, no developmental studies are available that specifically examined neurological or neurobehavioral effects of exposure to carbon tetrachloride during gestation. Additionally, there is some evidence that maternal alcohol consumption induces placental CYP2E1 in humans (Rasheed et al. 1997b). If maternal alcohol exposure also increases levels of CYP2E1 in fetal tissues, the likelihood of fetal injury from exposure to carbon tetrachloride would be increased. Induction of fetal hepatic CYP2E1 by maternal ethanol consumption has been confirmed in rats (Carpenter et al. 1997). Transcription of the CYP2E1 gene in human placenta and fetal lung and kidney is regulated in part by hypermethylation of dinucleotide CG residues within the promoter (Viera et al. 1998).

Hepatic levels of CYP2E1 mRNA increase significantly during the first 24 hours after birth, largely resulting from demethylation that allows transcription to proceed (Viera et al. 1996). Major accumulations of CYP2E1 occur between 1 and 3 months of age and values comparable to those of adults are achieved sometime between 1 and 10 years of age (EPA 2001; Viera et al. 1996). Thus, children exposed to carbon tetrachloride would be expected to experience similar effects as in adults.

Fisher et al. (1997) have calculated that maternal exposure to carbon tetrachloride is likely to result in its transfer to breast milk, which would be a possible means of exposure for nursing infants.

3. HEALTH EFFECTS

Effects of metabolism of carbon tetrachloride on late (day 20) rat fetal hepatic microsomes have been measured *in vitro* (Cambron-Gros 1986). Fetal microsomes had the ability to metabolize the compound as evidenced by inhibition of cytochrome P-450 (to a greater degree than maternal microsomes), inhibition of calcium uptake (similar to maternal microsomes), and the increased amount of carbon tetrachloride bound to protein (less than maternal microsomes). The production of trichloromethyl radicals by fetal microsomes did not induce the membrane phospholipid peroxidation observed with maternal microsomes. The absence of lipid peroxidation in fetal liver would be expected to result in a qualitatively different pattern of hepatic toxicity following exposure to carbon tetrachloride compared to adults. The authors suggest that necrotic effects would be less in fetuses than in adults. The basis for the lack of lipid peroxidation by fetal microsomes was not determined in that study.

3.8 BIOMARKERS OF EXPOSURE AND EFFECT

Biomarkers are broadly defined as indicators signaling events in biologic systems or samples. They have been classified as markers of exposure, markers of effect, and markers of susceptibility (NAS/NRC 1989).

Due to a nascent understanding of the use and interpretation of biomarkers, implementation of biomarkers as tools of exposure in the general population is very limited. A biomarker of exposure is a xenobiotic substance or its metabolite(s) or the product of an interaction between a xenobiotic agent and some target molecule(s) or cell(s) that is measured within a compartment of an organism (NAS/NRC 1989). The preferred biomarkers of exposure are generally the substance itself or substance-specific metabolites in readily obtainable body fluid(s) or excreta. However, several factors can confound the use and interpretation of biomarkers of exposure. The body burden of a substance may be the result of exposures from more than one source. The substance being measured may be a metabolite of another xenobiotic substance (e.g., high urinary levels of phenol can result from exposure to several different aromatic compounds). Depending on the properties of the substance (e.g., biologic half-life) and environmental conditions (e.g., duration and route of exposure), the substance and all of its metabolites may have left the body by the time samples can be taken. It may be difficult to identify individuals exposed to hazardous substances that are commonly found in body tissues and fluids (e.g., essential mineral nutrients such as copper, zinc, and selenium). Biomarkers of exposure to carbon tetrachloride are discussed in Section 3.8.1.

3. HEALTH EFFECTS

Biomarkers of effect are defined as any measurable biochemical, physiologic, or other alteration within an organism that, depending on magnitude, can be recognized as an established or potential health impairment or disease (NAS/NRC 1989). This definition encompasses biochemical or cellular signals of tissue dysfunction (e.g., increased liver enzyme activity or pathologic changes in female genital epithelial cells), as well as physiologic signs of dysfunction such as increased blood pressure or decreased lung capacity. Note that these markers are not often substance specific. They also may not be directly adverse, but can indicate potential health impairment (e.g., DNA adducts). Biomarkers of effects caused by carbon tetrachloride are discussed in Section 3.8.2.

A biomarker of susceptibility is an indicator of an inherent or acquired limitation of an organism's ability to respond to the challenge of exposure to a specific xenobiotic substance. It can be an intrinsic genetic or other characteristic or a preexisting disease that results in an increase in absorbed dose, a decrease in the biologically effective dose, or a target tissue response. If biomarkers of susceptibility exist, they are discussed in Section 3.10 "Populations that are Unusually Susceptible."

3.8.1 Biomarkers Used to Identify or Quantify Exposure to Carbon Tetrachloride

Measurement of parent carbon tetrachloride and its metabolites in expired air has been the most convenient way to determine exposure. Levels of 9.5 ppm carbon tetrachloride were detected in expired air of one worker who had been exposed to carbon tetrachloride vapors for several minutes (Stewart et al. 1965). In another case, expired air levels were over 2,000 ppm in a person exposed by ingestion to a pint of carbon tetrachloride mixed with methanol (Stewart et al. 1963). Levels fell below 2 ppm after 16 days. Depending on dose and length and route of exposure, the half-life of carbon tetrachloride in expired air initially appears to range from 1 to several hours, later lengthening to 40–85 hours. Measurement of carbon tetrachloride in blood has also been used as an indicator of exposure.

Covalent adducts between reactive carbon tetrachloride metabolites (trichloromethyl radical) and cellular protein, lipids, and nucleic acids are known to occur. Although measurements of such adducts may provide data on past exposure, the method's overall usefulness in assessing exposure in the general population is severely limited since it requires the use of radiolabeled carbon tetrachloride. Further, metabolite compounds and their adducts may originate in ways other than from carbon tetrachloride, or they may undergo reduction and thus require some reoxidation procedure prior to being detectable by *in vivo* spin trapping techniques (Sentjure and Mason 1992).

3. HEALTH EFFECTS

3.8.2 Biomarkers Used to Characterize Effects Caused by Carbon Tetrachloride

As discussed in Section 3.2, the effects that are most often observed in humans exposed to carbon tetrachloride are liver and kidney injury and central nervous system depression. Exposure levels leading to these effects in humans are not well-defined. The threshold for central nervous system effects following exposures of 8 hours or more is probably in the range of 20–50 ppm (Elkins 1942; Heimann and Ford 1941; Kazantzis and Bomford 1960). On the other hand, kidney and liver effects can occur following exposure (15 minutes to 3 hours) to vapor concentrations of 200 and 250 ppm, respectively (Barnes and Jones 1967; Norwood et al. 1950). These exposures correspond to an absorbed dose of approximately 100–200 mg/kg.

Detection of liver injury has commonly been associated with alterations in serum levels of certain hepatic enzymes and proteins. Elevation in bilirubin levels following exposure (Barnes and Jones 1967) has been detected in humans, as have decreased serum levels of secreted liver proteins (e.g., albumin and fibrinogen) (Ashe and Sailer 1942; McGuire 1932; New et al. 1962; Norwood et al. 1950; Straus 1954). Elevations in serum levels of enzymes (alkaline phosphatase and gamma-glutamyltransferase) released from damaged hepatocytes have been reported in occupational exposures above 1 ppm lasting months to years (Tomenson et al. 1995). Similar enzyme elevations were observed following acute-, intermediate-, and chronic-duration exposures to carbon tetrachloride in animals (Bruckner et al. 1986; Hayes et al. 1986; Japan Bioassay Research Center 1998; Sakata et al. 1987). Typically, ALT, AST, alkaline phosphatase, and LDH have been monitored, but these are also produced in nonhepatic tissues. Ikemoto et al. (2001) investigated serum levels of several urea-cycle enzymes that are more exclusively found in the liver: liver-type arginase (ARG), ornithine carbamoyltransferase (OCT), and arginosuccinate synthase (AS). After rats were injected with carbon tetrachloride, serum ARG levels were immediately elevated at the first 15-minute timepoint and within 30 minutes, were about 45-fold higher than normal; after 300 minutes, the increase in serum ARG levels had not reached a plateau. All other enzymes (AST, ALT, OCT, and AS) measured had maximally 10-fold increases. The authors propose that ARG is a sensitive biomarker for acute exposure to carbon tetrachloride and attribute its pattern of appearance in serum to the fact that it is a cytosolic enzyme (having only the plasma membrane as a barrier to the extracellular compartment) and to its smaller molecular mass compared to the other enzyme biomarkers.

Yamaguchi et al. (2002) proposed that serum concentrations of regucalcin, a Ca^{2+} -binding protein that is especially abundant in the liver but not abundant in the kidney, heart, or brain of rats, would be a sensitive measure of hepatitis following exposure to carbon tetrachloride. In rats that received 5 doses of

3. HEALTH EFFECTS

15,940 mg/kg at 3-day intervals, standard serum markers for AST and ALT were significantly elevated compared to controls in samples taken during the first week of exposure, but not later, whereas significant elevations in serum regucalcin were detectable both during the first week and, at lower levels, 18 and 30 days after the first exposure.

In rats acutely treated with 1,275 mg/kg carbon tetrachloride, histological evaluations of the liver showed peak scores for necrosis at 24–36 hours and for inflammation at 48 hours, with resolution largely evident by 60 hours and 4 days, respectively (Giffen et al. 2003). Detection of serum markers for necrosis and inflammation demonstrated a pattern consistent with the histological results. Serum markers of hepatic damage (AST, ALT, glutamate dehydrogenase) showed peak elevations at 36 hours and a subsequent decline. Serum haptoglobin, a marker for inflammation, peaked at 48 hours (400% over control), and after declining, was significantly elevated at 4 days but not later. The authors suggest that haptoglobin would be a sensitive marker for hepatic inflammation, since that protein is primarily synthesized by centrilobular hepatocytes, which are vulnerable to injury by carbon tetrachloride.

In the rat, carbon tetrachloride-induced liver cytolysis has been associated with elevated serum activities of glutamate dehydrogenase, sorbitol dehydrogenase, and glucose-6-phosphatase (microsomal glucose-6-phosphatase activity was decreased) (Brondeau et al. 1991, 1993), while serum procollagen III peptide was demonstrated to be a valuable indicator of liver fibrogenesis, and serum prolidase was shown to be a limited signal of accelerated liver collagen metabolism (Jiang et al. 1992). Serum immunoassay for the 7S fragment of type IV collagen may be an even more sensitive indicator of hepatic fibrosis in man (Ala-Kokko et al. 1992). Another sensitive (but nonspecific) indicator of liver injury is the serum levels of individual bile acids (Bai et al. 1992). Lipid peroxidation, increased erythrocyte membrane cholesterol/phospholipid ratio, and decreased erythrocyte ATPase activity were all associated with the onset of carbon tetrachloride-induced liver cirrhosis (Mourelle and Franco 1991). Also, lipid peroxidation accompanying carbon tetrachloride-induced hepatotoxicity has been monitored by quantitating hepatic levels of hydroperoxy- and hydroxy-eicosatetraenoic acids (Guido et al. 1993).

Renal injury has been associated with acute exposure of humans to carbon tetrachloride. Impaired renal function as evidenced by oliguria and anuria have been reported (Barnes and Jones 1967; Norwood et al. 1950). Proteinuria, hemoglobinuria, and glycosuria have also been reported in other cases involving acute exposure of humans to the compound (Forbes 1944; Guild et al. 1958; New et al. 1962; Smetana 1939; Umiker and Pearce 1953). Although acute renal failure induced in rats by carbon tetrachloride apparently did not involve activation of the circulating active renin-angiotensin system, increased

3. HEALTH EFFECTS

prorenin levels were associated with decreased renal function (Cruz et al. 1993). Long-term inhalation exposure to carbon tetrachloride increased the incidence and severity of chronic nephropathy in the rat, and significantly increased proteinuria levels and serum biomarkers such as blood nitrogen (Japan Bioassay Research Center 1998). These renal effects can occur following exposure to chemicals other than carbon tetrachloride.

Neurotoxicity, as evidenced by central nervous system depression, has been associated with acute exposure to carbon tetrachloride in humans. Clinical signs and symptoms that may be monitored include headache, dizziness, fatigue, and coma (Cohen 1957; Stevens and Forster 1953; Stewart et al. 1961). Impaired visual functions have also been observed (Johnstone 1948; Smyth et al. 1936; Wirtschafter 1933). It should be noted that central nervous system effects disappear rapidly as carbon tetrachloride is eliminated from the body. Therefore, they will be detectable for only relatively short periods after exposure. The neural effects are not specific to carbon tetrachloride exposure and may occur following exposure to other chemicals.

Lipid peroxidation products appearing in urine following exposure to carbon tetrachloride offer the possibility of noninvasive monitoring for hepatic damage (de Zwart et al. 1998). As measured by gas chromatography, the urinary levels in rats of the following lipid peroxidation products showed statistically significant increases over normal values within 12 hours of an intraperitoneal injection with 0.5 or 1.0 mL/kg carbon tetrachloride: formaldehyde, acetaldehyde, propanal, butanal, pentanal, hexanal, and malondialdehyde (MDA). The 0.25 mL/kg dose elicited significant increases only in acetaldehyde. The level of MDA returned to normal after 48 hours, at which time the levels of the other chemicals remained elevated. The same study found that neither coproporphyrin III nor 8-hydroxy-2'-deoxyguanosine were suitable urinary biomarkers for exposure to carbon tetrachloride.

Metabonomics is a new technology combining high resolution nuclear magnetic resonance (NMR) and pattern recognition technology that is starting to be applied to the evaluation of *in vivo* toxicology. Robertson et al. (2000) treated rats with single intraperitoneal or oral doses of carbon tetrachloride and evaluated the changes in NMR spectra of urine as displayed by principal component analysis (PCA), a statistical method that reduces multidimensional data to a two- or three-dimensional pattern. The PCA pattern was most altered compared to the pretreatment state on the first and second days after treatment, but had returned to normal within 10 days. PCA patterns were detectable in rats treated with 0.5 mg/kg, but not in rats treated with 0.1 mg/kg.

3. HEALTH EFFECTS

Additional information concerning biomarkers for effects on the immune, renal, and hepatic systems can be found in the CDC/ATSDR Subcommittee Report on Biological Indicators of Organ Damage (CDC/ATSDR 1990), and on the neurological system in the Office of Technology Assessment Report on Identifying and Controlling Poisons of the Nervous System (OTA 1990).

3.9 INTERACTIONS WITH OTHER CHEMICALS

There is substantial evidence that the toxicity of carbon tetrachloride is dramatically increased by alcohols, ketones and a variety of other chemicals. Many of these might be found at hazardous waste sites also containing carbon tetrachloride. Although the precise mechanisms for this marked potentiation are not always known, it is likely that most potentiators act, at least in part, by increasing the metabolic activation of carbon tetrachloride to its toxic intermediates and metabolites, thus increasing the induced injury. Other agents may affect the toxic outcome by altering cellular regenerative and tissue repair capacities. The extent to which either or both of these mechanisms are involved in the interaction will substantially affect the relationships among induced injury, duration of toxic damage, and animal survival. Interactions with agents enhancing lipid peroxidation would be expected to increase the severity of cell injury due to increased permeability of cell membranes.

Ethanol. Alcohol (ethanol) ingestion has often been associated with potentiation of carbon tetrachloride-induced hepatic and renal injury in humans (Manno et al. 1996). In two cases in which men cleaned furniture and draperies with carbon tetrachloride, one man, a heavy drinker, became ill and died, whereas his coworker, a nondrinker, suffered a headache and nausea, but recovered quickly after breathing fresh air (Smetana 1939). Both men were subjected to the same carbon tetrachloride exposure, as they had been working in the same room for the same amount of time. In 19 cases of acute renal failure due to carbon tetrachloride inhalation or ingestion, 17 of 19 patients had been drinking alcoholic beverages at about the time of their carbon tetrachloride exposure (New et al. 1962). Many other cases of carbon tetrachloride-induced hepatic and/or renal injury associated with ethanol ingestion have been described in the medical literature (Durden and Chipman 1967; Guild et al. 1958; Jennings 1955; Lamson et al. 1928; Markham 1967; Tracey and Sherlock 1968). These clinical reports establish that occasional or frequent ingestion of alcoholic beverages can increase the danger from exposure to carbon tetrachloride at levels that otherwise do not result in significant toxicity. As ethanol is known to induce microsomal mixed-function oxidase activity in man (Rubin and Lieber 1968), the mechanism of potentiation may involve ethanol-induced enhancement of the metabolic activation of carbon tetrachloride.

3. HEALTH EFFECTS

Numerous studies in animals confirm that ethanol is a strong potentiator of carbon tetrachloride-induced hepatotoxicity (Ikatsu et al. 1991; Kniepert et al. 1991; Reinke et al. 1988; Sato and Nakajima 1985; Strubelt 1984; Teschke et al. 1984; Wang et al. 1997a). Ethanol administration 16–18 hours before carbon tetrachloride exposure potentiated hepatotoxicity (Cornish and Adefuin 1966; Towner et al. 1991); however, enhancement was less when ethanol was given 2 hours before carbon tetrachloride (Cornish and Adefuin 1966). This is consistent with the idea that ethanol increases carbon tetrachloride toxicity by inducing the synthesis of one or more enzymes, such as cytochrome P-450 2E1 (Castillo et al. 1992), that are involved in the metabolic activation of carbon tetrachloride; or by acting as a competitive inhibitor of carbon tetrachloride metabolism during concurrent exposure. Thus, the precise timing of exposure to each agent is likely to critically influence the observed effects. For example, a single dose of ethanol 18 hours prior to intraperitoneal administration of 1,275 mg/kg carbon tetrachloride in rats did not increase either trichloromethyl free-radical adducts or p-nitrophenol hydroxylase activity, whereas 2 weeks of dietary exposure to ethanol significantly increased the generation of trichloromethyl radicals (Reinke et al. 1988, 1992). Threshold levels also appear involved, as 14 days of 0.05–0.5 mL/kg/day ethanol did not result in a statistically significant increase in any effects of a subtoxic 20 mg/kg/day dose of carbon tetrachloride (Berman et al. 1992). Ethanol exposure intensified carbon tetrachloride toxicity in pregnant rats and caused decreased postnatal survival of offspring (Gilman 1971). For the most part, these studies involved short-term exposures to ethanol. Inhalation studies involving longer-term pretreatment exposures to ethanol (5–10 weeks) prior to carbon tetrachloride exposure raised the possibility of increased susceptibility to chronic liver injury at low doses of carbon tetrachloride that have not been shown to cause significant liver damage (Hall et al. 1990). On the other hand, when ethanol pretreatments increased in duration (30 or 52 weeks), there was a decrease in ethanol potentiation of carbon tetrachloride toxicity (Kniepert et al. 1990). Factors contributing to this diminished potentiation were not determined. It has also been reported that despite substantial potentiation of carbon tetrachloride-induced hepatotoxicity in ethanol pretreated rats, no increase in lethality was observed (Ray and Mehendale 1990). The authors speculated that this result occurred due to the treatment's concomitant stimulation of hepatic regenerative capacity—to a degree sufficient to overcome the induced injury. In addition to enhanced hepatotoxicity pretreatments with ethanol have been reported to enhance certain immunosuppressive effects of carbon tetrachloride (Kaminski et al. 1990).

Other Alcohols and Ketones. Secondary alcohols can also potentiate carbon tetrachloride hepatorenal toxicity in humans. Eighteen workers in an isopropyl alcohol packaging plant became ill after inhalation of carbon tetrachloride (Folland et al. 1976). Four of these people were hospitalized; one with liver injury, one with kidney damage, and the other two with both kidney and liver injury. Air samples taken

3. HEALTH EFFECTS

at the plant during a subsequent investigation revealed relatively high concentrations of isopropanol and acetone, and these were thought to play a major role in potentiation of toxicity. Potentiation of carbon tetrachloride hepatotoxicity in mice by isopropanol far exceeded that caused by an equal dose of ethanol, though both exerted their maximum effect when given 18 hours before carbon tetrachloride (Traiger and Plaa 1971). In rats, isopropanol potentiated hepatic injury caused by carbon tetrachloride, but lethality was not increased because of the augmentation of hepatic tissue repair mechanisms (Rao et al. 1996). Methanol co-treatment in rats potentiated the hepatotoxicity of carbon tetrachloride by inducing CYP2E1 in rat liver (Allis et al. 1996). Methanol was found to be markedly less effective on an equimolar basis than either isopropanol or tertiary-butanol in enhancing carbon tetrachloride-induced hepatotoxicity in rats (Harris and Anders 1980). These differences likely reflect the substantially longer half-lives of the secondary and tertiary compounds (relative to their primary congeners), which makes them more potent and persistent inducers of cytochrome P-450 activities. Methanol, ethanol, isopropanol, or decanol in combination with carbon tetrachloride caused massive liver damage, but failed to increase carbon tetrachloride induced lethality. On the other hand, tert-butanol, pentanol, hexanol, and octanol not only potentiated liver damage when administered prior to carbon tetrachloride, but also significantly increased the lethal effects of carbon tetrachloride (Ray and Mehendale 1990). Thus, potentiated hepatotoxicity, as measured by various endpoints, may not be a very reliable predictor of the eventual survival outcome. Other experiments in rats demonstrated that both isopropanol and acetone (the major metabolite of isopropanol) are apparently responsible for the marked enhancement of carbon tetrachloride hepatotoxicity (Plaa and Traiger 1972). Similarly, the metabolism of 2-butanol to 2-butanone contributed to the marked ability of this alcohol to potentiate carbon tetrachloride hepatotoxicity in rats (Traiger and Bruckner 1976).

Investigations in rats indicate that ketosis, caused either by diabetes or administration of ketones, can potentiate carbon tetrachloride hepatotoxicity. Pre-treatment with methyl isobutyl ketone, acetone, or methyl ethyl ketone increased hepatotoxicity in rats treated with a single dose of carbon tetrachloride, essentially reducing the ED₅₀ for carbon tetrachloride by 80, 73, or 89%, respectively (Raymond and Plaa 1995). Hepatotoxicity (fibrosis and cirrhosis) and nephrotoxicity were increased in rats exposed to both acetone and carbon tetrachloride (Charbonneau et al. 1986). Carbon tetrachloride hepatotoxicity increased in diabetic rats (Hanasono et al. 1975), while 1,3-butanediol induced ketosis and potentiated carbon tetrachloride hepatotoxicity (Pilon et al. 1986). In both studies, ketosis was a better index for prediction of liver injury than glycemic status. Interestingly, the same specific form of cytochrome P-450 was reported to be induced in rats by chronic ethanol administration (Joly et al. 1977) and by diabetes (Past and Cook 1982). The bulk of available evidence suggests that elevated levels of ketone bodies

3. HEALTH EFFECTS

induce the enzyme system responsible for biotransformation of carbon tetrachloride to its reactive metabolites (Pilon et al. 1986). Methyl isobutyl ketone significantly increased total levels of cytochrome P-450 in rat liver microsomes (Raymond and Plaa 1995).

Phenobarbital, Metamphetamine, DDT, PBB, Chlordecone. Phenobarbital (PB) has been shown to produce a marked increase in carbon tetrachloride hepatotoxicity in rats and it is widely used to provide experimental animal models of carbon tetrachloride-induced cirrhosis (Abraham et al. 1999; Cornish et al. 1973; Garner and McLean 1969; Hoche et al. 1996; Sundari et al. 1997). This is not surprising, in that cytochrome P-450 PB-B (CYP2B1), the isozyme that can be induced at least 50-fold in rats by PB, participates in the metabolic activation of carbon tetrachloride (Vittozzi and Nastainczyk 1987). Lethal effects of carbon tetrachloride are not potentiated by even large doses of phenobarbital in spite of increased liver injury. Thus, as with the alcohols, manifestations of bioactivation capacity or hepatic injury do not appear to reliably predict the eventual survival outcome. The mechanism underlying this phenomenon appears to be the stimulation of hepatic regeneration and tissue repair. Although the early phase of hepatic regeneration was postponed from 6 to 24 hours, it was greatly increased at 24 and 48 hours. Therefore, in spite of remarkably increased liver injury, the animals are able to overcome injury and survive the potentiated liver toxicity (Kodavanti et al. 1992; Mehendale 1990, 1991, 1992). Some data suggest that the PB-induced P-450 isozyme(s) are more rapidly inactivated by carbon tetrachloride, and that PB pretreatment may alter the target lipids and/or the initiating metabolites involved in lipid peroxidation and diene conjugate formation (Moody 1992). DDT increased the sensitivity of rats to carbon tetrachloride poisoning (McLean and McLean 1966), and mice fed 100 ppm polybrominated biphenyls (PBBs) or 200 ppm polychlorinated biphenyls (PCBs) in their diet for 28 days experienced increased carbon tetrachloride hepatotoxicity (Kluwe et al. 1979). Potentiation of renal dysfunction was also found in the PBB-pretreated mice. All of these compounds are broad-spectrum mixed-function oxidase (MFO) inducers.

Concurrent treatment with methamphetamine at doses between 5 and 15 mg/kg increased hepatotoxicity in rats treated with carbon tetrachloride (Roberts et al. 1994). No potentiation occurred when methamphetamine was administered several hours before or after administration of carbon tetrachloride.

Low dietary doses (10 ppm) of the insecticides chlordecone or mirex (a structural analog of chlordecone) have been demonstrated to potentiate carbon tetrachloride hepatotoxicity. Chlordecone greatly enhanced the hepatotoxicity of carbon tetrachloride in rats, producing cholestasis as well as hepatocellular damage (Curtis et al. 1979). The investigators conclude that there is the likelihood of severe liver damage

3. HEALTH EFFECTS

resulting from interaction of carbon tetrachloride and chlordecone at exposure levels which may independently be nontoxic. Chlordecone has been reported not to potentiate the renal toxicity in rats (Kodavanti et al. 1992) or neurotoxicity in gerbils (Desaiah et al. 1991) of carbon tetrachloride, so its enhancing effects may be liver-specific. Chlordecone potentiation of carbon tetrachloride hepatotoxicity and lethality appears due to incapacitation of hepatocytes to regenerate and initiate the early phase of tissue repair. The authors also suggest that this is due to a precipitous depletion of cellular ATP that results from increased intracellular accumulation of Ca^{2+} , which in turn leads to a depletion of glycogen (Bell and Mehendale 1987; Mehendale 1990, 1991, 1992; Soni and Mehendale 1993). Mirex pretreatment of carbon tetrachloride-dosed rats was found not to produce cholestasis, but to produce a relatively modest increase in carbon tetrachloride hepatotoxicity (Bell and Mehendale 1985). Pretreatment of carbon tetrachloride-dosed rats with both mirex and chlordecone did not increase hepatotoxicity above that seen with chlordecone alone, indicating that chlordecone influenced susceptibility to carbon tetrachloride in a way independent of that of mirex. As proposed for phenobarbital, the mechanism underlying only limited and low-grade potentiation of carbon tetrachloride by mirex may involve a stimulation of hepatic regeneration and tissue repair that offsets cytochrome P-450 induction (Mehendale 1990, 1991, 1992). A single oral dose of chlordecone enhanced the oxidative metabolism of carbon tetrachloride in rats, but to a lesser degree than PB, which was in inverse relationship to these agents' effects on potentiation of the lethal and hepatotoxic effects of carbon tetrachloride (Mehendale and Klingensmith 1988). The investigators suggested the involvement as of yet unidentified factors, in addition to the modest enhancement of carbon tetrachloride metabolism, in chlordecone's unusually strong potentiating capacity. As discussed above, subsequent studies have suggested that chlordecone potentiates carbon tetrachloride-induced hepatotoxicity by depleting cellular energy stores, and consequently by inhibiting hepatocellular regeneration and liver tissue repair (e.g., Kodavanti et al. 1992; Mehendale 1991, 1992; Soni and Mehendale 1993).

Haloalkanes. Certain haloalkanes and haloalkane-containing mixtures have been demonstrated to potentiate carbon tetrachloride hepatotoxicity. Pretreatment of rats with trichloroethylene (TCE) enhanced carbon tetrachloride-induced hepatotoxicity, and a mixture of nontoxic doses of TCE and carbon tetrachloride elicited moderate to severe liver injury (Pessayre et al. 1982). The researchers believed that the interaction was mediated by TCE itself rather than its metabolites. TCE can also potentiate hepatic damage produced by low (10 ppm) concentrations of carbon tetrachloride in ethanol pretreated rats (Ikatsu and Nakajima 1992). Acetone was a more potent potentiator of carbon tetrachloride hepatotoxicity than was TCE, and acetone pretreatment also enhanced the hepatotoxic response of rats to a TCE-carbon tetrachloride mixture (Charbonneau et al. 1986). The potentiating

3. HEALTH EFFECTS

action of acetone may involve not only increased metabolic activation of TCE and/or carbon tetrachloride, but also possible alteration of the integrity of organelle membranes. Carbon tetrachloride-induced liver necrosis and lipid peroxidation in the rat have been reported to be potentiated by 1,2-dichloroethane in an interaction that does not involve depletion of reduced liver glutathione, and that is prevented by vitamin E (Aragno et al. 1992; Danni et al. 1992). Dichloromethane potentiated the hepatotoxicity of carbon tetrachloride in rats by increasing the covalent binding of carbon tetrachloride metabolites to hepatic microsomal lipids (Kim 1997). Several anesthetics (isoflurane, enflurane, halothane, and sevoflurane) enhanced the dechlorination of carbon tetrachloride by guinea pig microsomes by stimulating the reduction of cytochrome P-450 (Fujii 1996; Fujii et al. 1996).

Nicotine. Treatment of rats for 10 days with nicotine in drinking water increased liver histopathology (fatty change, necrosis, and dark-cell change) caused by an injection of carbon tetrachloride (Yuen et al. 1995). It was proposed that the increased hepatotoxicity might have resulted from a synergistic effect of the lipid peroxidation induced by both agents. Pregnant rats showed less severe effects than nonpregnant rats, possibly because of the differential hormonal status or differential expression of CYP-450 enzymes.

Carbon Disulfide and Other Alkyl Sulfides. Just as chemicals that serve to stimulate the metabolism of carbon tetrachloride lead to increased toxicity, chemicals that impair carbon tetrachloride metabolism lead to decreased toxicity. Rats dosed with carbon disulfide together with carbon tetrachloride displayed effects on the liver that resembled those due to carbon disulfide alone, rather than those caused by carbon tetrachloride alone (Seawright et al. 1980). This was judged to be due to destruction of the hepatic P-450 metabolizing system by carbon disulfide, such that activation of carbon tetrachloride was much reduced. Similar results have been reported in workers exposed to "80/20" (a mixture of carbon tetrachloride and carbon disulfide used to fumigate grain) (Peters et al. 1987). The neurological effects observed in these individuals resembled those caused by carbon disulfide alone, and there was no evidence of hepatotoxic effects characteristic of carbon tetrachloride exposure.

Other sulfides administered as pretreatments had different effects on carbon tetrachloride hepatotoxicity as measured by plasma ALT levels (Kim et al. 1996). The increase in plasma ALT levels induced by carbon tetrachloride was blocked by pretreatment with allyl sulfide or allyl disulfide and increased by pretreatment with propyl disulfide and butyl sulfide.

Dietary Status. Because carbon tetrachloride causes injury through oxidative pathways, depletion of cellular antioxidants such as glutathione, vitamin E, and methionine tend to increase the toxicity of carbon

3. HEALTH EFFECTS

tetrachloride. For example, feeding rats a diet low in vitamin E, selenium (a required cofactor for glutathione reductase), and methionine led to increased lipid peroxidation, while feeding a diet supplemented with one or more of these antioxidants tended to decrease lipid peroxidation (Hafeman and Hoekstra 1977) and oxidative liver damage (Parola et al. 1992). Similar results have been obtained by Taylor and Tappel (1976) and Sagai and Tappel (1978). In mice, retinoic acid or retinol inhibited the carbon tetrachloride-induced increase in serum alanine transaminase activity and liver histopathology, suggesting a protective effect of vitamin A in mice (Kohno et al. 1992; Rosengren et al. 1995). However, pretreatment with retinol increased hepatocyte injury in rats exposed to carbon tetrachloride (Badger et al. 1996; ElSisi et al. 1993a, 1993b).

Food deprivation has also been shown to have a substantial effect on carbon tetrachloride hepatotoxicity. A 24-hour fast significantly depressed hepatic glutathione (GSH) levels and enhanced carbon tetrachloride hepatotoxicity in rats (Harris and Anders 1980; Sato and Nakajima 1985), and promoted lipid peroxidation as measured by malondialdehyde formation (Ikatsu et al. 1991). A 1-day fast also increased hepatic injury as measured by increases in serum enzymes 2–2.5-fold compared to fed rats following 4-hour exposures at 500–2,500 ppm (Jaeger et al. 1982); the dietary status had no effect at 5,000 ppm. Diurnal decreases in hepatic GSH levels were found to coincide with periods of maximal susceptibility to carbon tetrachloride hepatotoxicity (Bruckner et al. 1984; Harris and Anders 1980). Even though the role of GSH in carbon tetrachloride cytotoxicity is poorly understood, it appears that more than GSH depletion is involved in fasting-induced enhancement of carbon tetrachloride hepatotoxicity. A 1-day fast stimulates the capacity of liver microsomes from male and female rats to metabolize carbon tetrachloride, although fasting did not produce a significant increase in hepatic microsomal protein or cytochrome P-450 levels (Nakajima and Sato 1979). Thus, short-term food deprivation may enhance the biotransformation of carbon tetrachloride to cytotoxic metabolites. Another factor in fasted animals was demonstrated in mice fasted for 24 hours that showed an 8-fold increase in hepatic triglycerides (steatosis) compared to untreated mice (Pentz and Strubelt 1983); it is likely that the increase in lipid content in the livers of fasted mice was responsible for their greater hepatic accumulation of injected carbon tetrachloride compared to fed mice. It should be recognized that food deprivation or consumption of a protein-free diet for several days diminishes MFO activity and makes rats more resistant to carbon tetrachloride (McLean and McLean 1966; Seawright and McLean 1967). Food restriction (25 or 50% lower caloric than control intake) for 30 days prior to administration of carbon tetrachloride and increased the carbon-tetrachloride-induced elevations in some serum enzymes in carbon-tetrachloride-treated rats. (Ramkumar et al. 2003; Seki et al. 2000). For example, the chemical-induced increase in serum AST was elevated 11-fold in female rats fed *ad libitum* but 27-fold in those on

3. HEALTH EFFECTS

a restricted diet (-25%) compared to controls. Food restriction (reduced by 25%) also increased the severity of lesions of the liver (hepatic cellular degeneration and fibrosis) and kidney (proximal tubular vacuolation and glomerular sclerosis) in treated rats compared to those fed *ad libitum* (Seki et al. 2000).

Metals. Pre-exposure to single doses of various metals (hexavalent chromium, mercuric chloride or silver) had no synergistic effect on lipid peroxidation in rats treated with carbon tetrachloride (Rungby and Ernst 1992). In mice fed a diet augmented with 3% carbonyl iron and intraperitoneally injected with carbon tetrachloride for 12 weeks, there were significant increases in parameters of hepatic injury (serum ALT, absolute and relative liver weight, severity of necrosis) compared to controls that were numerically larger than for groups treated with iron or carbon tetrachloride alone (Arezzini et al. 2003). Rats fed a low-copper diet were reported to be more sensitive to hepatic plasma membrane injury 24 hours following an intraperitoneal injection of carbon tetrachloride, possibly due to reduced Cu-Zn superoxide dismutase activities (DiSilvestro and Medeiros 1992). Rats fed a diet mildly deficient in zinc showed elevated levels of hepatocyte injury, as assessed by serum sorbitol dehydrogenase activity (DiSilvestro and Carlson 1994). In rats injected with lead nitrate and then carbon tetrachloride, hepatotoxicity, as measured by serum ALT and AST, was lower than in rats injected with carbon tetrachloride alone (Calabrese et al. 1995); the authors attributed this effect to the ability of lead to inhibit cytochrome P-450.

3.10 POPULATIONS THAT ARE UNUSUALLY SUSCEPTIBLE

A susceptible population will exhibit a different or enhanced response to carbon tetrachloride than will most persons exposed to the same level of carbon tetrachloride in the environment. Reasons may include genetic makeup, age, health and nutritional status, and exposure to other toxic substances (e.g., cigarette smoke). These parameters result in reduced detoxification or excretion of carbon tetrachloride, or compromised function of organs affected by carbon tetrachloride. Populations who are at greater risk due to their unusually high exposure to carbon tetrachloride are discussed in Section 6.7, Populations with Potentially High Exposures.

Section 3.9 discusses several types of compounds that can exacerbate the toxicity of carbon tetrachloride. Individuals exposed to these compounds may, therefore, be more sensitive to carbon tetrachloride exposure. As noted above, persons who are moderate to heavy drinkers are at significantly increased risk of liver and/or kidney injury following ingestion or inhalation of carbon tetrachloride (Manno et al. 1996). Occupational exposure to isopropanol has also been reported to markedly potentiate the hepatic or renal toxicity of carbon tetrachloride in men and women (Folland et al. 1976). This report and numerous

3. HEALTH EFFECTS

animal studies indicate that primary, secondary, and tertiary alcohols, as well as their ketone analogues, can substantially enhance the toxic potency of carbon tetrachloride. Substantial exposures to alcohols and ketones may occur in occupational settings or in certain instances in the use of household products containing these chemicals.

Drugs and other chemicals that significantly induce microsomal MFO activity can significantly increase the toxicity of carbon tetrachloride by enhancing its biotransformation to reactive, cytotoxic metabolites. A number of drugs such as phenobarbital, pentobarbital, and phenylbutazone are MFO inducers in animals and humans. Thus, individuals taking such medications may be at substantially greater risk of carbon tetrachloride toxicity. Other unusually susceptible individuals are those who have had significant exposures to insecticides such as DDT, chlordecone, or mirex, or to industrial chemicals such as PCBs or PBBs. All of these chemicals are potent MFO inducers and have been shown to markedly potentiate the hepatotoxicity of carbon tetrachloride in animals. Exposures to these chemicals can occur in industrial and agricultural settings, as well as in the general population via environmental media (i.e., contaminated water, food, air, and soil). Other widely used chemicals such as TCE have been found to enhance carbon tetrachloride toxicity in animals. Thus, persons with substantial exposure to TCE and other haloalkanes may be at greater risk of carbon tetrachloride toxicity.

Nutritional status can also influence the toxic potency of carbon tetrachloride. Animal studies have clearly demonstrated that brief fasting or consumption of diets low in antioxidants (vitamin E, selenium, methionine) can lead to increased carbon tetrachloride hepatotoxicity. The same may be true for humans, although this is not known for certain. Another aspect of nutritional status affecting carbon tetrachloride toxicity is hepatic energy status. Hepatic ATP levels might influence the ultimate outcome of toxicity (low levels may inhibit recovery mechanisms).

A variety of conditions may predispose certain segments of the population to carbon tetrachloride toxicity. Persons with alcoholic cirrhosis, or other liver diseases that have significantly diminished the functional reserve of the liver, have a reduced capacity to tolerate carbon tetrachloride-induced hepatotoxicity. The same is true for carbon tetrachloride-induced nephrotoxicity in people with significant renal dysfunction from other causes. Diabetics may be particularly susceptible to carbon tetrachloride poisoning, in light of animal studies that indicate elevated levels of ketone bodies induce the MFO system, which converts carbon tetrachloride to reactive, cytotoxic metabolites. Animal models for diabetes suggest different outcomes from exposure to carbon tetrachloride, depending on whether the disease is type 1 or type 2 (Sawant et al. 2004). Mice with type 1 diabetes, induced by intraperitoneal

3. HEALTH EFFECTS

injection with 200 mg/kg streptozotocin, showed no mortality after receiving a dose of carbon tetrachloride (1,594 mg/kg) that was lethal to half of non-diabetic mice (Shankar et al. 2003). Conversely, rats with type 2 diabetes, induced by administration of a high-fat diet and 45 mg/kg streptozotocin, showed 100% lethality at a dose of 3,188 mg/kg carbon tetrachloride that was not lethal to untreated controls or rats receiving a high-fat diet or streptozotocin alone (Sawant et al. 2004). The type 2 diabetic group had more severe hepatic necrosis between hours 12 and 36, greater depletion of hepatic glutathione at 6 hours, and a significant delay in the stimulation and progression of the S-phase of the cell division cycle compared to the other groups; CYP2E1 levels and rates of lipid peroxidation were not affected by type 2 diabetes in this animal model. Individuals with genetically-determined high MFO activity may be more susceptible to carbon tetrachloride toxicity, as may be persons with habits (e.g., smoking, consumption of smoked meats) that can produce increased MFO activity.

The organ-content of microsomal enzymes responsible for metabolizing carbon tetrachloride may change during different stages of the life cycle, indicating a potential for differing age-related susceptibilities following exposure. A number of studies on drug metabolism reported declines in hepatic activities of CYP2E1 and CYP3A3/4 in the elderly (>65 years) compared with earlier adult stages (as reviewed in Tanaka 1998). *In vitro* studies of human microsomes indicated that total immunoreactive CYP3A (the sum of CYP3A4 and CYP3A5) was significantly higher in livers from individuals aged 21–40 years compared to those aged 14–20 or 61–72 years (Patki et al. 2004). The observed lower rates of biotransformation of triazolam in the adolescent and elderly microsomal preparations was consistent with the reduced CYP3A content. In 18-month-old rats, no statistically significant reduction was observed in the mRNA or protein content for CYP2E1, but enzyme activity was reduced by 46% compared to 8-month-old rats (Wauthier et al. 2004). The reduced activity was attributed to inactivation of the enzyme over time by reactive metabolites. Reduced hepatic CYP3A content was noted in microsomes from 2-year-old CD-1 mice compared to 1-year-old mice (Warrington et al. 2000). Total CYP3A protein was also reduced in the liver of 25–26-month old F344 rats compared to younger animals, but was elevated by 11% in the kidney, largely because of a 50% upregulation of one isoform (Warrington et al. 2004). These results suggest that in F344 rats, ability of the kidney to generate reactive metabolites increases in the elderly.

Age-related reductions in antioxidant content would also tend to increase vulnerability to reactive metabolites of carbon tetrachloride in the elderly. Reductions in glutathione in old rats compared to younger animals have been noted in the liver and are associated with an age-related reduction in the transcription factor nuclear factor erythroid2-related factor (NrF2) that induces gammaglutamylcysteine

3. HEALTH EFFECTS

ligase, significantly involved with the synthesis of glutathione (Suh et al. 2004). In Wistar rats, both the liver and kidney of 22-month-old rats had significant decreases in glutathione and glutathione peroxidase, but increases in biomarkers of lipid peroxidation compared to 10-week-old rats (Martin et al. 2003). In F344 rats, glutathione peroxidase activity was significantly reduced in the kidney but not the liver of 24-month-old rats compared to 6-month-old rats (Tian et al. 1998); these results suggest a possible basis for the increasing sensitivity of the kidney in rats exposed to carbon tetrachloride by inhalation for 2 years (Japan Bioassay Research Center 1998). No study, however, has directly measured age-related differences in carbon tetrachloride metabolism in the kidney.

Genetic polymorphisms may confer differing susceptibilities to the effects of carbon tetrachloride exposure. In rat liver, two different forms of glutathione S-transferase 3-3 have been identified (Mayama et al. 2003). Hirosaki hairless rats are homozygous for the NC type gene (encoding Asn¹⁹⁸-Cys¹⁹⁹) and Sprague-Dawley rats are homozygous for the KS type gene (encoding Lys¹⁹⁸-Ser¹⁹⁹). When the two strains of rat were given an oral gavage dose of carbon tetrachloride, hepatic glutathione activity 0.5 hours later was reduced more significantly in NC rats compared to KS rats. Electrophoretic and chromatographic studies showed that the polymorphism affected the ability of the two kinds of enzyme to bind to heat shock protein 90-beta. The authors conclude that heat shock protein-beta protects the KS type of enzyme from inactivation by carbon tetrachloride.

3.11 METHODS FOR REDUCING TOXIC EFFECTS

This section will describe clinical practice and research concerning methods for reducing toxic effects of exposure to carbon tetrachloride. However, because some of the treatments discussed may be experimental and unproven, this section should not be used as a guide for treatment of exposures to carbon tetrachloride. When specific exposures have occurred, poison control centers and medical toxicologists should be consulted for medical advice. The following texts provide specific information about treatment following exposures to carbon tetrachloride:

Ellenhorn MJ. 1997. *Ellenhorn's medical toxicology: Diagnosis and treatment of human poisoning*. 2nd ed. New York, NY: Elsevier, 1422-1429.

Leikin JB, Paloucek FP. 2002. *Poisoning and toxicology handbook*. 3rd ed. Hudson, OH: Lexi-Comp, Inc., 334.

Shih RD. 1998. Hydrocarbons. In: Goldfrank LR, Flomenbaum NE, Lewin NA, et al., eds *Goldfrank's toxicologic emergencies*. 6th ed. Stamford, CT: Appleton & Lange, 1383-1398.

3. HEALTH EFFECTS

3.11.1 Reducing Peak Absorption Following Exposure

Human exposure to carbon tetrachloride may occur by inhalation, ingestion, or dermal contact. Inhalation or oral exposure to carbon tetrachloride may cause hepatic, renal, and neurological effects. There is evidence, though limited, that dermal contact causes a similar pattern of effects.

If carbon tetrachloride has been inhaled, movement to fresh air is recommended. Humidified supplemental oxygen (100%) may be administered as required.

Ingestion of carbon tetrachloride should be considered a toxic emergency in which treatment should begin immediately. Treatment currently involves gastric emptying, either by gastric lavage (with a small bore nasogastric tube) or by induction of vomiting, preferably within minutes of exposure (Shih 1998). The patient needs to have a gag reflex and should not show signs of seizure, lethargy, or coma because of the risk of pneumonitis from pulmonary aspiration. In infants and young children, the induction of vomiting may induce severe fluid loss. Supportive therapy should be followed in all instances of treatment. A cathartic may be administered to speed fecal excretion (Ellenhorn 1997). Administration of activated charcoal is unlikely to be effective (Ellenhorn 1997). Animal studies revealed peak blood levels of carbon tetrachloride within 3–6 minutes after oral exposure when carbon tetrachloride was ingested undiluted or in aqueous vehicles by fasted rats (Kim et al. 1990a). Chemicals that induce P-450, such as ethanol and phenobarbital, should not be given. The administration of epinephrine is avoided, due to the possibility of inducing ventricular arrhythmias. In order to minimize absorption through the skin, all contaminated clothing should be removed and the skin should be washed with soap and water. In cases where the compound has been splashed into the eyes, irrigation with copious amounts of tepid water for 15 minutes has been recommended. Medical treatment is required if irritation, pain, swelling, lacrimation, or photophobia persist.

3.11.2 Reducing Body Burden

Hemodialysis may be employed in order to lower plasma carbon tetrachloride at the onset of renal failure (Ellenhorn 1997). Although this method is not very effective in removing lipophilic compounds from the blood, it is effective in controlling extracellular fluid composition if renal failure occurs (Ellenhorn 1997; EPA 1989b;). Because a substantial portion of absorbed carbon tetrachloride is exhaled within the first

3. HEALTH EFFECTS

hour, maintenance of a good tidal volume is recommended; hyperventilation may also be of value (Ellenhorn 1997). Administration of hyperbaric oxygen is an experimental treatment that is also available. Hyperbaric oxygen has been used in treating overdoses of carbon tetrachloride in humans (Larcán and Lorbet 1981; Truss and Killenberg 1982; Zearbaugh et al. 1988). Administration of hyperbaric oxygen following exposure to carbon tetrachloride improved survival from 31 to 96% in rats (Ellenhorn and Barceloux 1988). Hyperbaric oxygen has also been used in treating overdoses of carbon tetrachloride in humans and may correct regional tissue hypoxia and damage, as well as inhibit the P-450-dependent reductive dehalogenation of carbon tetrachloride to the metabolically active trichloromethyl radical in the liver. However, the effectiveness of this method has not been established in humans (Burkhart et al. 1991; Ellenhorn and Barceloux 1988).

3.11.3 Interfering with the Mechanism of Action for Toxic Effects

Information is limited in humans regarding compounds that interfere with the mechanism of action of carbon tetrachloride. However, there is evidence that liver toxicity associated with exposure to carbon tetrachloride is mediated by reactive metabolites that bind to hepatocytes and initiate lipid peroxidation, thus resulting in loss of cell function. N-acetylcysteine has been suggested to bind the toxic metabolite phosgene and to serve as a precursor for the formation of glutathione (Ellenhorn and Barceloux 1988), and was protective against hepatotoxicity in carbon tetrachloride-exposed rats (Simko et al. 1992; Wong et al. 2003). Glutathione, a cellular antioxidant, tends to decrease lipid peroxidation due to carbon tetrachloride ingestion in rats (Arosio et al. 1997; Hafeman and Hoekstra 1977). Prior oral treatment with glutathione protected against hepatic necrosis, but did not modify lipid peroxidation or prevent covalent binding of carbon tetrachloride metabolites to hepatic microsomes in rats exposed intraperitoneally (Gorla et al. 1983). Agents that foster the maintenance of hepatic reduced glutathione levels have a similar protective effect against carbon tetrachloride: cysteine, a precursor to glutathione (De Ferreyra et al. 1974), taurine (Dincer et al. 2002; Vohra and Hui 2001; Waterfield et al. 1993), constituents of garlic oil such as diallyl trisulfide (Fukao et al. 2004), gamma-glutamylcysteinylethyl ester (Nishida et al. 1998), metformin, a dimethyl biguanide anti-hypoglycemic agent (Poon et al. 2003), and clofibrate (Manautou et al. 1998). Administration of 16,16-dimethyl prostaglandin E2 to block the accumulation of intracellular lipids has also been suggested (Haddad and Winchester 1990; Rush et al. 1986). Administration of fructose 1,6-diphosphate to rats has been shown to decrease carbon tetrachloride liver toxicity by increasing hepatocyte levels of ATP. The ATP thus generated is thought to promote hepatocellular regeneration and tissue repair (Rao and Mehendale 1989). Shertzer and Sainsbury (1991) reported that indole antioxidants 4b,5,9b,10-tetrahydroindeno[1,2-b]indole (THII) and 5,10-dihydroindeno-

3. HEALTH EFFECTS

[1,2-b]indole (DHII) inhibited carbon tetrachloride initiation of lipid peroxidation in rat liver microsomes, and protected against hepatotoxicity in rats when administered prior to carbon tetrachloride treatment. The authors suggested that these compounds may be suitable candidates for further development as potential chemoprotective and therapeutic agents for use in human disorders that involve free-radicals. Colchicine and trimethylcolchicinic acid, an analog that does not bind tubulin, prevented decreases in Ca^{2+} -ATP-ase activity, and reduced increases in gamma-glutamyl transpeptidase, alanine aminotransferase, and alkaline phosphatase in hepatocyte plasma membranes in rats treated with carbon tetrachloride (Cedillo et al. 1996; Martinez et al. 1995).

Oxygen supplementation improved ratios of ATP/ADP, inorganic phosphate/ATP, and lactate/pyruvate that had been altered in cirrhotic livers of rats previously treated with carbon tetrachloride (Harvey et al. 2000). These results were consistent with the hypothesis that hepatocyte damage in cirrhotic livers is exacerbated by a reduced oxygen supply and may partly explain the efficacy of hyperbaric oxygen therapy as described in Section 3.11.2).

Compounds that suppress the activity or expression of CYP2E1 have been shown to reduce the hepatic necrosis caused by the bioactivation of carbon tetrachloride. Pretreatment with 100–400 $\mu\text{mol/kg}$ (subcutaneous) oleanolic acid, a triterpenoid compound, reduced hepatotoxicity in rats and mice injected with carbon tetrachloride (Liu et al. 1998); the protective effect occurred 12–72 hours after pretreatment and was found to be unrelated to metallothionein levels. In mice, the protective effect of oleanolic acid was associated with inhibition of expression and activity of CYP2E1 (Jeong 1999). Another triterpenoid, alpha-hederin similarly reduced expression of CYP2E1 and hepatic injury in mice treated with carbon tetrachloride (Jeong and Park 1998). Methylenedioxybenzenes such as isosafrole, dihydrosafrole, and benzodioxole, administered 1 hour before carbon tetrachloride, prevented increases in plasma AST and ALT in mice (Zhao and O'Brien 1996). Isosafrole co-treatment also prevented the development of liver necrosis. Safrole was partially hepatoprotective, whereas piperonyl butoxide, eugenol, isoeugenol, sesamol, and curcumin were ineffective. Other similar compounds that prevented increases in plasma AST and ALT in rats included tetrahydro-5-methyl bis[1,3]benzodioxole [4,5-C: 5',6]-azecin-13 (5*H*)-one (protopine) (Janbaz et al. 1998) and 2-methylaminoethyl-4,4'-dimethoxy-5,6,5',6'-dimethylenedioxy-biphenyl-2-carboxylic acid-2'-carboxylate monohydrochloride (DBB-S) (Oh et al. 2000). A synthetic agent, 2-(allylthio)pyrazine, suppressed constitutive and inducible CYP2E1 expression and also blocked carbon tetrachloride-induced hepatotoxicity in mice (Kim et al. 1997); the compound also elevated hepatic GSH levels.

3. HEALTH EFFECTS

Tumor necrosis factor alpha (TNF-alpha) has been implicated in the process of hepatocellular injury following exposure to carbon tetrachloride. Co-treatment of rats with the soluble receptor to TNF-alpha reduced hepatocellular necrosis and the elevation in serum enzyme levels caused by carbon tetrachloride (Czaja et al. 1995). Mortality was 16% in the rats co-treated with the soluble receptor and 60% in rats co-treated with IgG.

A number of agents have been shown to reduce the severity of fibrosis induced in animals following intermediate-duration exposure to carbon tetrachloride. A weak but significant reduction in the area of carbon tetrachloride-induced hepatic fibrosis was measured by image analysis in rats co-treated with interferon alpha2a over a period of 9 weeks (Fort et al. 1998). There were concomitant reductions in several biochemical markers of fibrosis (hyaluronate, hydroxyproline, and the mRNAs for procollagen and fibronectin). In mice transgenic for the alpha(2)(I) collagen gene (COL1A2) promoter sequence and receiving a single intraperitoneal injection of carbon tetrachloride, interferon-alpha antagonized the transcription of COL1A2 that is stimulated by transforming growth factor-beta and the coactivator Smad3 (Inagaki et al. 2003); the progression of hepatic fibrosis was also prevented in interferon-treated mice. Administration of interferon-alpha2b also reduced the severity of fibrosis in the kidneys of rats subcutaneously injected with carbon tetrachloride over 7 weeks (Dogukan et al. 2003). Histopathology analysis revealed reductions in necrosis, dilatation and atrophy of renal tubules, hypercellularity of glomeruli, and obliteration of renal capillaries in rats co-treated with interferon compared to placebo-co-treated rats; the level of interstitial fibrosis was also reduced by interferon, although the difference was not statistically significant from the placebo co-treatment group. The kidneys of rats co-treated with interferon had more interstitial inflammation than the rats in the control group or in the placebo-co-treatment group. Pirfenidone (5 methyl-1-phenyl-2-(1H)-pyridone), an anti-fibrotic drug approved by the U.S. FDA for Phase II trials against pulmonary and renal fibrosis, reduced both the number of activated hepatic stellate cells and the severity of hepatic fibrosis when administered to rats with carbon tetrachloride-induced hepatic cirrhosis (Garcia et al. 2002); according to the authors, the anti-fibrotic effect of pirfenidone involves suppression of collagen gene transcription and possibly an inhibition of proline hydroxylase levels that would be expected to reduce the availability of hydroxyproline required for collagen synthesis.

Administration of liver growth factor to rats with hepatic cirrhosis following intraperitoneal injections of carbon tetrachloride for 10 weeks significantly improved the structure and function of the liver (Diaz-Gil et al. 1999). Significant decreases were observed in the levels of serum enzymes, the hepatic collagen content, and microscopic findings of fibrosis, necrosis, and inflammatory infiltration of the liver. In

3. HEALTH EFFECTS

addition, hepatic hemodynamic measures were improved in rats treated with liver growth factor compared to cirrhotic rats: reduced portal pressure and portosystemic shunting, reduced ascites, and increased mean arterial pressure and systemic vascular resistance. Implantation of rat fibroblasts genetically modified to express hepatic growth factor into the spleens of syngeneic rats significantly reduced hepatic injury (serum enzymes, histopathology) resulting from an intraperitoneal injection of carbon tetrachloride (Kaido et al. 1997). Gene therapy using an adenoviral vector bearing cDNA for a nonsecreted form of human urokinase plasminogen activator (Ad- Δ huPA) reduced hepatic fibrosis in rats that became cirrhotic following treatment with carbon tetrachloride for 6–8 weeks (Salgado et al. 2000). The beneficial effect of enhanced uPA expression was partly attributed to its induction of hepatocyte growth factor.

Treatment of insulin-like growth factor-I (IGF-I) to rats during the last 3 weeks of exposure to carbon tetrachloride/phenobarbitol partially normalized the expression of 8 of 16 genes that were either up- or down-regulated in the cirrhotic liver (Mirpuri et al. 2002). Three of the genes affected by IGF-I are for protease inhibitors; restoration of the expression of these genes would be expected to protect against necrosis. IGF-I treatment also partially restored the expression of growth hormone receptor and the levels of global genomic DNA methylation, which are reduced during the development of cirrhosis (Mirpuri et al. 2002). Evaluation of hepatic effects following IGF-I administration to cirrhotic rats on the same protocol resulted in reductions in lipid peroxidation, fibrosis, and plasma AST and ALT, and increases in mitochondrial transmembrane potential (a measure of mitochondrial membrane integrity) (Castilla-Cortazar et al. 1997).

Several agents have been shown to ameliorate the effect of carbon tetrachloride on hepatic membranes. When co-administered with carbon tetrachloride, betaine, a mitochondrial metabolite of choline, reduced the extent of centrilobular steatosis and minimized the loss of hepatocyte organelle membranes (rough endoplasmic reticulum) in treated rats (Junnila et al. 2000); the effect was attributed to the enhancement of phospholipid synthesis necessary for maintaining the integrity of cell membranes. Hydroxychalcones, which have a 3,4-dihydroxycinnamoyl structure and inhibit lipoxygenases and cyclooxygenases, were potent inhibitors of lipid peroxidation in cultured rat hepatocytes (Sogawa et al. 1994). Polyenylphosphatidyl choline also reduced hepatic fibrosis induced by carbon tetrachloride in rats and accelerated the regression of existing fibrosis (Ma et al. 1996).

One effect of lipid injury following exposure to carbon tetrachloride is the release of hydrolytic enzymes such as calpain from lysosomes into the extracellular space where activation by calcium occurs (Limaye et al. 2003). As a result, cell necrosis progresses to neighboring cells, extending the hepatic lesion.

3. HEALTH EFFECTS

Administration of the calpain inhibitor *N*-CBZ-Val-Phe-methyl ester (CBZ) or the cell-impermeable inhibitor E64 1 hour after a toxic, nonlethal intraperitoneal dose of carbon tetrachloride protected against calpain-specific breakdown of alpha-fodrin, a cytoskeletal protein, and reduced the increase in serum ALT. Administration of CBZ 1 hour after a lethal dose (3 g/kg) increased survival from 25 to 75%. The calpain inhibitors have no effect on the metabolism of carbon tetrachloride by CYP2E1 or the generation of metabolites that bind to liver tissue.

As vitamin A (retinol) shows species-specific variations on carbon tetrachloride-related hepatotoxicity, it is not possible to predict whether it would be useful as a therapeutic agent in exposed humans.

Pretreatment of male mice with vitamin A for 7 days prior to a single exposure to carbon tetrachloride reduced the elevations in plasma ALT levels as well as the extent of hepatic degeneration (Hooser et al. 1994). Some strain variations were evident in the protective effect of vitamin A, with no hepatocyte damage visible in C3H/He or athymic nude mice and only minimal hepatocyte damage visible near the central vein in Swiss-Webster or Balb/C mice. Conversely, pretreatment with vitamin A increased the hepatotoxicity (plasma ALT levels) of carbon tetrachloride 10-fold in male and female Sprague-Dawley rats, and male nude and Fischer-344 rats. The underlying basis for the species and strain differences is not known, but the possible involvement of Kupffer cells or polymorphonuclear neutrophils is under investigation. Inder et al. (1999) determined that the effect of vitamin A in Swiss-Webster mice does not involve alteration of the constitutive or inducible expression of CYP2E1.

Avid retention of Na^+ is a feature of liver cirrhosis. Icatibant (HOE 140), an antagonist to the bradykinin B_2 receptor, normalized Na^+ retention and reduced the hyperactivity of the renin-angiotensin-aldosterone system in rats that had become cirrhotic following treatment with carbon tetrachloride (Wirth et al. 1997).

Malnutrition is a common result of cirrhosis. Survival was improved in rats with carbon tetrachloride-induced cirrhosis by the dietary administration of branched-chain amino acids in addition to a casein diet (Kajiwara et al. 1998). Supplementation with branched-chain amino acids significantly preserved plasma albumin concentration and inhibited the occurrence of ascites and hyperammonemia without altering liver histopathology. The authors hypothesize that administration of branched-chain amino acids may suppress muscular protein catabolism and aid in detoxifying excess serum ammonia levels, which are characteristic of cirrhotic patients.

The protective effects of gadolinium a rare earth metal (lanthanide) and glycine against carbon tetrachloride injury operate via inactivation of Kupffer cells, which are hepatic macrophages (Rivera et al.

3. HEALTH EFFECTS

2001). When either compound was administered to rats with carbon tetrachloride-induced cirrhosis, the livers showed reductions in fibrosis, collagen protein, and transforming growth factor-beta-1 caused by carbon tetrachloride (Rivera et al. 2001). The inactivation of Kupffer cells by glycine is suspected to be related to the inhibition of calcium signaling via glycine-gated chloride channels (Rivera et al. 2001). Gadolinium chloride also prevented liver injury and increased hepatocyte proliferation (as measured by immunostaining for the hepatocyte proliferating cell nuclear antigen) in rats when administered prior to treatment with carbon tetrachloride (Ishiyama et al. 1995). Gadolinium chloride inhibited CYP2E1 activity in cultured hepatocytes, reducing the loss of plasma membrane integrity caused by carbon tetrachloride (Badger et al. 1997).

Other substances that have been demonstrated to be protective against the toxic effects of carbon tetrachloride in animals include disulfiram (Brady et al. 1991), enprostil, an analog of prostaglandin E₂ (Bang et al. 1992), bosentan, and TAK-044, antagonists to the endothelin receptor (Hochoer et al. 1995; Thirunavukkarasu et al. 2004), the xanthine oxidase inhibitor allopurinol (Dashti et al. 1992), the prolyl 4-hydroxylase inhibitors S 0885 and HOE 077 (Bickel et al. 1991), pyridoxol L,2-pyrrolidon-5 carboxylate (metadoxine) (Annoni et al. 1992), cyclosporine A (Farghali et al. 1996), the calcium antagonist nifedipine (Cutrin et al. 1992, 1994), alpha-tocopherol and derivatives (Hsiao et al. 2001; Liu et al. 1995), polyamines (Wu et al. 1997), adenosine (Hernandez-Munoz et al. 1992), various phenolic compounds (mostly flavinoids) (Adaramoye and Akinloye 2000; Cholbi et al. 1991; Pavanato et al. 2003), zinc (Camps et al. 1992), and chromium III (but not chromium IV) (Rungby and Ernst 1992; Tezuka et al. 1991a, 1991b). Supplementation with sodium tungstate for 7 weeks significantly reduced lipid peroxidation and necrosis produced by carbon tetrachloride in rats (Pawa and Ali 2004). A combination treatment with hyaluronic acid and chondroitin-4-sulfate (but not either agent alone) partly reduced the effects of carbon tetrachloride treatment (Camp et al. 2004); the therapy reduced hepatic necrosis and the increases in hepatic malondialdehyde, plasma TNF-alpha, and neutrophil-mediated myeloperoxidase and reversed the reduction in glutathione. Exercise has been shown to protect subsequently isolated rat hepatocyte from carbon tetrachloride cytotoxicity, probably by affecting cytochrome P-450-2E1 activity, and perhaps also by stimulating intracellular levels of free radical scavengers and antioxidants (Day and Weiner 1991). Food restriction (25 or 50% lower caloric than control intake) for 30 days prior to administration of carbon tetrachloride reduced the magnitude of blood lipid peroxidation and of increases in serum enzymes in carbon-tetrachloride treated rats (Ramkumar et al. 2003).

3. HEALTH EFFECTS

3.12 ADEQUACY OF THE DATABASE

Section 104(i)(5) of CERCLA, as amended, directs the Administrator of ATSDR (in consultation with the Administrator of EPA and agencies and programs of the Public Health Service) to assess whether adequate information on the health effects of carbon tetrachloride is available. Where adequate information is not available, ATSDR, in conjunction with the National Toxicology Program (NTP), is required to assure the initiation of a program of research designed to determine the health effects (and techniques for developing methods to determine such health effects) of carbon tetrachloride.

The following categories of possible data needs have been identified by a joint team of scientists from ATSDR, NTP, and EPA. They are defined as substance-specific informational needs that if met would reduce the uncertainties of human health assessment. This definition should not be interpreted to mean that all data needs discussed in this section must be filled. In the future, the identified data needs will be evaluated and prioritized, and a substance-specific research agenda will be proposed.

3.12.1 Existing Information on Health Effects of Carbon Tetrachloride

The existing data on health effects of inhalation, oral, and dermal exposure of humans and animals to carbon tetrachloride are summarized in Figure 3-6. The purpose of this figure is to illustrate the existing information concerning the health effects of carbon tetrachloride. Each dot in the figure indicates that one or more studies provide information associated with that particular effect. The dot does not necessarily imply anything about the quality of the study or studies, nor should missing information in this figure be interpreted as a “data need”. A data need, as defined in ATSDR’s Decision Guide for Identifying Substance-Specific Data Needs Related to Toxicological Profiles (Agency for Toxic Substances and Disease Registry 1989), is substance-specific information necessary to conduct comprehensive public health assessments. Generally, ATSDR defines a data gap more broadly as any substance-specific information missing from the scientific literature.

As shown in Figure 3-6, there is a considerable body of data on the health effects of carbon tetrachloride in humans, especially following acute oral or inhalation exposures. Although many of the available reports lack quantitative information on exposure levels, the data are sufficient to derive approximate values for safe exposure levels. There is limited information on the effects of intermediate or chronic inhalation exposure in the workplace, but there are essentially no data on longer-term oral exposure of humans to carbon tetrachloride. Most toxicity studies have focused on the main systemic effects of

3. HEALTH EFFECTS

Figure 3-6. Existing Information on Health Effects of Carbon Tetrachloride

	Systemic									
	Death	Acute	Intermediate	Chronic	Immunologic/Lymphoretic	Neurologic	Reproductive	Developmental	Genotoxic	Cancer
Inhalation	●	●	●	●		●				●
Oral	●	●				●	●			
Dermal	●	●								

Human

	Systemic									
	Death	Acute	Intermediate	Chronic	Immunologic/Lymphoretic	Neurologic	Reproductive	Developmental	Genotoxic	Cancer
Inhalation	●	●	●	●		●	●	●	●	●
Oral	●	●	●	●	●	●	●	●	●	●
Dermal	●	●								

Animal

● Existing Studies

3. HEALTH EFFECTS

obvious clinical significance (hepatotoxicity, renal toxicity, central nervous system depression). There are data on the effects of carbon tetrachloride on the immune system, but there are no reports that establish whether or not developmental, reproductive, genotoxic, or carcinogenic effects occur in humans exposed to carbon tetrachloride.

The toxicity of carbon tetrachloride has been extensively investigated in animals, both by oral and inhalation exposure. While the majority of existing studies in animals have focused on systemic toxicity (hepatic and renal injury), several studies have examined the neurologic, developmental, and reproductive effects of carbon tetrachloride. Effects of carbon tetrachloride on the immune system have been studied following oral, but not after inhalation or dermal exposure. The carcinogenicity of carbon tetrachloride has been studied in animals following inhalation or oral exposure.

3.12.2 Identification of Data Needs

Despite the phase-out of carbon tetrachloride manufacture and use in many areas of the world, its environmental persistence may support the continued practical relevance of many of the data needs identified below.

Acute-Duration Exposure. A large number of studies are available regarding the effects of single exposures to carbon tetrachloride, both in animals and humans. Available data indicate that the central nervous system, liver, and kidneys are primary target organs for carbon tetrachloride. Many of these studies involved exposure to only one dose level (usually high enough to cause clear effects), and the minimum dose needed to produce the characteristic effects of carbon tetrachloride toxicity is not defined with certainty. Although human studies exist, data were not suitable for derivation of an acute inhalation MRL. An acute inhalation MRL was not derived because calculations based on the most suitable data (exposure of rats at 10 ppm, 7 hours/day for 13 exposures over 17 days in the study by Adams et al. 1952), would result in a value (0.02 ppm) lower than the intermediate-duration inhalation MRL. Another assay by Adams et al. (1952) in which rats were exposed for 7 hours on a single day used too small group sizes. The intermediate-duration inhalation MRL of 0.03 ppm is expected to be protective for acute-duration inhalation exposures. An acute-duration oral MRL of 0.02 mg/kg/day was derived based on a LOAEL of 5 mg/kg/day in rats exposed on 10 consecutive days (Smialowicz et al. 1991). Further studies in animals, involving a range of exposure levels and employing sensitive histological and biochemical measurements of injury to liver and kidney, would be helpful in defining the thresholds for acute hepatic

3. HEALTH EFFECTS

and renal toxicity. Studies on the time-course of changes in the most sensitive parameters would be valuable. Most studies are conducted 18–24 hours after exposure. Because carbon tetrachloride is so rapidly absorbed and distributed to target tissues, significant biochemical and histological changes may occur within minutes. These changes may not be evident 18–24 hours later (e.g., Mehendale 1991, 1992). Data for all exposure routes would be valuable, but further information on inhalation and dermal dose-response relationships would be particularly helpful. In addition, dose-response studies of the effects of acute exposures on other tissues and systems (e.g., nervous, immune, reproductive, developmental) would be useful in determining whether other tissues are injured, especially at doses near the thresholds for injury to the liver and kidney. Furthermore, for purposes of enhancing toxicity and risk assessments related to carbon tetrachloride exposure, dose-response studies in species other than rats and gerbils on induced compensatory mechanisms (e.g., hepatocellular regeneration and tissue repair; see, for example, Calabrese et al. 1993; Kodavanti et al. 1992; Mehendale 1990, 1991, 1992; Rao and Mehendale 1991, 1993) might also prove useful.

Intermediate-Duration Exposure. The effects of repeated exposure to carbon tetrachloride have been investigated in a relatively small number of studies. Similar target organs were reported as those for acute-duration exposure. An intermediate-duration inhalation MRL of 0.03 ppm was derived for liver effects based on a NOAEL of 5 ppm in rats (Adams et al. 1952). An intermediate-duration oral MRL of 0.007 mg/kg/day was derived based on a NOAEL of 1 mg/kg/day in animals (Bruckner et al. 1986). There are a number of areas where further studies would be useful. Most oral studies of carbon tetrachloride toxicity in animals have involved administration of carbon tetrachloride by gavage in corn oil (Condie et al. 1986; Kim et al. 1990b). Since a bolus dose in oil may produce effects somewhat different from those following intermittent exposure in water (e.g., greater hepatotoxicity when administered in oil, Condie et al. 1986), studies involving exposure in drinking water would be valuable, especially since this is a likely exposure pathway for residents using private wells near hazardous waste sites. More information on the adverse effect levels and mechanism of toxicity in tissues other than the liver (e.g., the kidney and nervous system) would be useful; since many oral exposure studies examined only the liver, adverse effect levels for other organ systems are not well characterized.

Chronic-Duration Exposure and Cancer. No definitive studies were located in humans on the noncarcinogenic effects of carbon tetrachloride after chronic-duration exposure. An occupational study by Tomenson et al. (1995) evaluated liver function, as indicated by the levels of hepatic enzymes in serum, in a cross-sectional study of individuals occupationally exposed to carbon tetrachloride. Although the exposed workers were categorized by their length of time on the job (<1, 1–5, and >5 years), this

3. HEALTH EFFECTS

information was not included in the exposure-response analysis, so the effect of exposure duration is uncertain. A chronic inhalation MRL of 0.03 ppm was derived based on a NOAEL of 5 ppm and a LOAEL of 25 ppm for hepatic effects in rats exposed 6 hours/day, 5 days/week for 2 years (Japan Bioassay Research Center 1998; Nagano et al. 1998). Increased incidence of chronic progressive nephropathy in rats occurred at the same NOAEL and LOAEL; significantly elevated proteinuria (4+) was observed at a LOAEL of 5 ppm, but was not used for derivation of the MRL because intrinsic levels in controls were so high (>90% scoring 3+ or 4+). At the doses used in chronic oral bioassays, increases in the incidence and severity of non-neoplastic hepatic lesions in rats, the incidence of hepatic cancer in mice, and mortality in both sexes were too high to provide a basis for a chronic oral MRL. A study is needed to determine no-effect levels for hepatotoxicity following chronic-duration oral dosing with carbon tetrachloride.

The carcinogenicity of carbon tetrachloride was evaluated in rats and mice exposed intermittently by inhalation for 2 years (Japan Bioassay Research Center 1998; Nagano et al. 1998). These assays provided sufficient data for hepatic carcinogenicity in both sexes, and some evidence for a threshold effect in both species. The adrenal gland in mice was the only other tissue that had an increased tumor incidence. There is ample evidence that oral (Andervont 1958; Della Porta et al. 1961; Edwards 1941; Edwards et al. 1942; Eschenbrenner and Miller 1944, 1946; NCI 1976a) and parenteral (Della Porta et al. 1961; Reuber and Glover 1967b, 1970) exposure to carbon tetrachloride can lead to increased tumor frequency in animals, but there is currently no dose-response information for carcinogenicity at more relevant oral exposure levels. Results of oral gavage studies could be used to plan dose levels for studies in which the chemical is administered in drinking water, as more relevant to actual human exposure scenarios. Current oral data was derived from animals dosed by corn oil bolus gavage, a method of dosing that does not reflect human exposure calculations, and may overestimate the risk as has been suggested by studies of other chlorinated methane and ethane compounds (Jorgenson et al. 1985; Kleming et al. 1986). While the carcinogenic risks of chronic dermal exposure have not been studied, chronic dermal exposure to carbon tetrachloride is not likely for most individuals.

Genotoxicity. Although it is evident that carbon tetrachloride exposure can increase the incidence of tumors in animals, it is not certain whether carbon tetrachloride is acting via a genotoxic mechanism, as a promoter, or some other process. Nearly all studies to date have failed to demonstrate any genotoxicity of unmetabolized carbon tetrachloride, although reactive metabolites and lipid peroxidation products are genotoxic, forming adducts with DNA (Castro et al. 1989; Chaudhary et al. 1994; Chung et al. 2000; Wacker et al. 2001). Since it is believed that carbon tetrachloride toxicity is mediated at least in part

3. HEALTH EFFECTS

through highly reactive and short-lived metabolites, further studies should focus particular attention on the issue of metabolic activation (especially anaerobic, reductive reactions), with *in vivo* or intact eukaryotic cell systems capable of activation *in situ* being preferred over systems relying on exogenous activation.

Reproductive Toxicity. The effects of carbon tetrachloride on reproduction have not been well investigated. Inhalation of carbon tetrachloride caused testicular degeneration (Adams et al. 1952) and reduced fertility (Smyth et al. 1936) in rats, but at doses higher than the adverse effect level for hepatotoxicity. Oral exposure to carbon tetrachloride did not adversely affect reproduction in one study in rats, but there is uncertainty as to the actual doses administered in this study (Alumot et al. 1976). Additional studies in animals using modern techniques and protocols would be useful to evaluate dose-response relationships for functional reproductive parameters in males and females.

Developmental Toxicity. Epidemiological studies have been published on the developmental effects of carbon tetrachloride in humans (Bove et al. 1992a, 1992b, 1995; Croen et al. 1997). Limited data suggest that carbon tetrachloride has a low potential for developmental toxicity in animals. Fetal size was reduced and viability and lactation indices were decreased following inhalation exposures at or above 250 ppm (Gilman 1971; Schwetz et al. 1974). Fetotoxicity and teratogenicity were not seen in offspring coming to term, but total resorption of fetuses occurred in pregnant rats following oral exposure (Narotsky et al. 1997a, 1997b; Wilson 1954). Metabolic studies suggest that the fetuses of several rodent species, including the rat, lack the enzymes needed for activation of carbon tetrachloride, and that this may explain the low developmental toxicity. However, this phenomenon may not apply to humans, where some drug metabolizing activity takes place *in utero*, especially in the fetal brain (Brezinski et al. 1999). It would be useful to find nonrodent animal models, possibly primates, in which the MFO system also develops *in utero*, and use these to study the developmental toxicity of carbon tetrachloride. Studies are needed to evaluate the possible neurological or neurobehavioral effects of gestational exposure to carbon tetrachloride; parallel groups to evaluate the effect of maternal exposure to ethanol, which induces CYP2E1 would also be relevant to humans.

Immunotoxicity. There are a number of reports that parenteral exposure of animals to carbon tetrachloride can affect the immune system (Kaminski et al. 1989, 1990; Tajima et al. 1985). The effects of carbon tetrachloride on the immune system have been investigated following oral dosing (Smialowicz et al. 1991), but no immunotoxicity was observed at doses much higher than those causing hepatic toxicity. Intermediate- and chronic-duration inhalation bioassays in rodents reported increased spleen

3. HEALTH EFFECTS

weights, but, as indicated by hemosiderin deposition, this effect appears to be secondary to erythrocyte toxicity and not an immunological effect *per se* (Japan Bioassay Research Center 1998). Although some older reports suggested that dermal exposure to carbon tetrachloride may result in a hypersensitization reaction (McGuire 1932; Taylor 1925), additional dermal exposure studies do not appear to be of high priority.

Neurotoxicity. Available data make it clear that the central nervous system is a target organ for carbon tetrachloride, with the most obvious acute effects being central nervous system depression (Cohen 1957; Stevens and Forster 1953; Stewart et al. 1963). Although our understanding of this important aspect of carbon tetrachloride toxicity might benefit from further study of animals and accidentally exposed humans, of greater concern are the scattered reports that carbon tetrachloride exposure causes focal injury and degeneration of peripheral neurons. Additional studies by inhalation and oral routes would be helpful in defining the dose-response dependency of nerve cell injury, and in determining whether these effects are primary or are secondary to effects on the liver or kidneys.

Epidemiological and Human Dosimetry Studies. Several epidemiological studies have been conducted on the health effects of intermittent workplace exposure to carbon tetrachloride, primarily evaluating the effects on the central nervous system (Elkins 1942; Heimann and Ford 1941; Kazantzis and Bomford 1960), hepatic (Barnes and Jones 1967; Smyth et al. 1936; Tomenson et al. 1995), and renal (Barnes and Jones 1967) function in relatively small groups of workers. Cancer epidemiological studies have been conducted on significantly larger subject groups (Blair et al. 1998; Bond et al. 1986; Cantor et al. 1985; Checkoway et al. 1984; Dumas et al. 2000; Heineman et al. 1994; Kernan et al. 1999; Wilcosky et al. 1984). Epidemiological studies evaluated developmental effects (Bove et al. 1992a, 1992b, 1995; Croen et al. 1997) in populations exposed to carbon tetrachloride in drinking water, which is a route of exposure that may be of concern near hazardous waste sites. A common problem in epidemiological studies is the acquisition of reliable dosimetry data on the exposed populations. For this reason, efforts to improve estimates of past exposures and to define more accurately current exposure levels to carbon tetrachloride would be valuable.

Biomarkers of Exposure and Effect.

Exposure. The presence of carbon tetrachloride in expired air is the most commonly used biomarker of exposure. The rate of excretion in humans appears to be biphasic, with an initial elimination half-life of less than 1 hour, and a second phase of about 30–40 hours. The compound can be detected in expired air

3. HEALTH EFFECTS

within hours to weeks after exposure. Research on additional biomarkers of exposure would be of value, perhaps in areas such as detection of DNA adducts.

Effect. There are a number of clinical and biochemical tests available that can detect early signs of hepatic and renal injury in humans. However, these tests are not specific for carbon tetrachloride-induced effects. For this reason, studies to identify and measure effects more diagnostic of carbon tetrachloride-specific injury would be helpful. Also, improvements in the sensitivity of these tests, such as accomplished by Ikemoto et al. (2001), would be valuable in evaluating the health status of individuals who have been exposed to low levels of carbon tetrachloride.

Absorption, Distribution, Metabolism, and Excretion. There is relatively little quantitative information on the systemic absorption of inhaled carbon tetrachloride in animals and humans, with estimates ranging from 30 to 60% (Lehmann and Schmidt-Kehl 1936; McCollister et al. 1951). Sanzgiri et al. (1995, 1997) have compared uptake, distribution, and elimination of carbon tetrachloride administered to rats over 2 hours by inhalation or gastric infusion or as a single bolus by gavage and correlated the results with the severity of hepatic injury. This study provides information pertinent to a route-to-route extrapolation.

Although dermal absorption of carbon tetrachloride is relatively modest compared to absorption by the oral or inhalation routes, it would be helpful to quantify the rate and extent of percutaneous absorption of carbon tetrachloride from water. This information would be useful in determining the contribution of dermal exposure to the total dose received by persons using carbon tetrachloride-contaminated drinking water for bathing or showering, or to those who contact carbon tetrachloride-contaminated water near chemical waste sites.

Animal studies reveal that carbon tetrachloride is distributed to tissues according to their rate of blood perfusion and lipid content. Adipose tissue accumulates much higher concentrations of carbon tetrachloride than other tissues, due to the high oil:water partition coefficient of carbon tetrachloride. The animal tissue distribution data are limited, in that carbon tetrachloride levels in tissues in rats have been determined at only a few time-points after a single, high oral dose (Marchand et al. 1970; Teschke et al. 1983). Paustenbach et al. (1986a, 1986b) have measured ^{14}C -carbon tetrachloride levels in tissues of rats at just one time-point following repeated inhalation exposure regimens.

3. HEALTH EFFECTS

Although numerous studies have investigated the metabolism of carbon tetrachloride in the liver, there is little information about rates of metabolism or relevant CYP-450 proteins in the kidney, to which a substantial proportion of absorbed carbon tetrachloride is distributed under gradual exposures such as inhalation or gastric infusion (Sanzgiri et al. 1997). Investigation of these processes would provide a basis for understanding the increased prominence of renal toxicity in rats under intermediate- and chronic-duration inhalation exposures (Japan Bioassay Research Center 1998).

Comparative Toxicokinetics. Metabolic pathways and mechanisms of hepatotoxicity of carbon tetrachloride have been the subject of many studies in intact animals and *in vitro*, and are therefore better understood than for many other chemicals. However, there are apparently little data on metabolism of carbon tetrachloride in humans. It would be valuable to conduct *in vitro* experiments with human liver samples and hepatocytes to determine whether metabolic pathways and toxic metabolites are similar to those found in animals. It would also be beneficial to identify an animal model in which MFO systems develop in utero as they do in the human fetus.

PBPK models have been developed for a number of drugs and chemicals, in order to better understand and simulate the dynamics of those compounds in the body. Advances made to date indicate that valid PBPK models can accurately predict the concentration of chemicals over time in the blood and specific tissues. Blood and tissue concentration versus time profiles, as well as excretion patterns from animals have been used to validate and adjust PBPK models for carbon tetrachloride (Gallo et al. 1993; Paustenbach et al. 1988). Addition of parameter values for humans has been used to scale-up the PBPK model to predict target tissue uptake, metabolism, and elimination of carbon tetrachloride in humans (Thrall et al. 2000). One limitation of using current models for deriving human equivalent concentrations from animal data for the purposes of MRL derivation is that there is insufficient information on the rates of metabolism for carbon tetrachloride for the general population. Thrall et al. (2000) estimated the *in vivo* metabolic rate (V_{\max}) in humans from animal *in vivo* rates and *in vitro* results for animal and human hepatic microsomes. However, the *in vivo* rate derived for humans was based on microsomes pooled from only three individuals (Zangar et al. 2000) and without additional studies, it is not known whether the rate is typical of the general population. Additional studies to characterize the variability of metabolic rates in humans would help to reduce the uncertainty associated with the application of the PBPK model. Quantitative relationships between carbon tetrachloride levels in target organs and organ damage in animals could be used to establish toxicodynamic models. Accurate prediction of ultimate toxicological outcomes will likely also have to account for base-line and inducible levels of compensatory repair

3. HEALTH EFFECTS

mechanisms. Combined PBPK-toxicodynamic models might then be scaled up and used to predict target organ concentrations and toxicity of carbon tetrachloride in man.

Methods for Reducing Toxic Effects. The usefulness of methods and treatments for reducing peak absorption and reducing the body burden of carbon tetrachloride is rather limited due to the chemical's rapid rates of absorption and tissue disposition. On the other hand, investigations of antidotal therapy based on the mechanism of action have been limited to a few studies involving the administration of compounds to reduce free radical injury. Additional studies would be useful to better establish the effectiveness of both acute and prolonged antidotal therapy, since carbon tetrachloride is persistent in the body.

Children's Susceptibility. Data needs relating to both prenatal and childhood exposures, and developmental effects expressed either prenatally or during childhood, are discussed in detail in the Developmental Toxicity subsection above.

The difference between the toxicity of carbon tetrachloride in children and adults is likely to be dependent on the relative expression of microsomal enzymes, such as CYP2E1. Viera et al. (1996) determined that hepatic levels of CYP2E1 in children reach adult levels sometime between the ages of 1 and 10. Additional studies are needed to obtain a precise chronology of the increase. Furthermore, additional studies are needed to clarify fetal expression of CYP2E1 to determine the sensitivity of different fetal tissues and the placenta during gestation.

Child health data needs relating to exposure are discussed in Section 6.8.1, Identification of Data Needs: Exposures of Children.

3.12.3 Ongoing Studies

Numerous current publications on carbon tetrachloride have addressed the efficacy of various agents for reducing or eliminating the toxic effects of exposure; these are mentioned in Section 3.11.3. Additional research programs are focusing on potential therapeutic agents, interacting factors, or mechanisms of toxicity following exposure to carbon tetrachloride. These studies are listed in Table 3-8.

3. HEALTH EFFECTS

Table 3-8. Ongoing Studies on the Health Effects of Carbon Tetrachloride

Investigator	Affiliation	Research description	Sponsor
Alpini GD	Texas A&M University	Role of protein kinase C in regulating biliary damage from carbon tetrachloride.	NIH-NIDDKD
Anania FA	University of Maryland	Role of leptin in liver fibrogenesis.	NIH-NIDDKD
Bacon BR	St. Louis University	Signaling pathways in hepatic fibrogenesis.	NIH-NIDDKD
Carrasquillo JA	NIH Clinical Center	Development and use of Tc-99m, a radiopharmaceutical as a hepatobiliary agent to visualize effects of carbon tetrachloride <i>in vivo</i> .	NIH
Devilliers WJ	University of Kentucky	Role of CD36, a class B scavenger receptor, on activation of hepatic stellate cells and hepatic fibrosis.	NIH-NIAAA
Dranoff JA	DVA, Medical Center, West Haven, Connecticut	Effects of liver injury on nucleotide receptors.	DVA
Gandhi CR	University of Pittsburgh	Endothelin receptor involvement in development of hepatic cirrhosis following exposure to carbon tetrachloride.	NIH- NIDDKD
Kavanagh TJ	University of Washington	Role of glutamate-cysteine ligase in antioxidant defense against hepatic injury.	NIH-NIEHS
Lambris JD	University of Pennsylvania	Role of complement in liver regeneration	NIH-NIDDKD
Lu SC	University of Southern California	Support research on cultured hepatic parenchymal and non-parenchymal cells as models of hepatic injury from carbon tetrachloride and other hepatotoxins.	NIH-NIDDKD
Manautou JE	University of Connecticut	Evaluation of upregulation of canalicular ATP-dependent efflux pump (cMRP or C MOAT) for organic ions and hepatocellular regeneration after carbon tetrachloride exposure.	NIH-NIEHS
Mason R	NIEHS	Role of nitric oxide in metabolism of toxic chemicals.	NIH-NIEHS
Mason R	NIEHS	Biomarkers of oxidative stress in carbon tetrachloride -induced hepatotoxicity.	NIEHS
Mehendale HM	University of Louisiana at Monroe	Investigate factors associated with resiliency in aged rats to hepatotoxicity from chlordecone and carbon tetrachloride.	NIH-NIA

3. HEALTH EFFECTS

Table 3-8. Ongoing Studies on the Health Effects of Carbon Tetrachloride

Petersen BE	University of Florida	Study subpopulations of oval cells derived from bone marrow for therapeutic purposes following carbon tetrachloride hepatotoxicity.	NIH-NIDDKD
Song BJ	NIAAA	Regulation and role of CYP2E1 in mechanism of hepatic injury.	NIH-NIAAA
Tyner AL	University Illinois at Chicago	Role of cyclin kinase inhibitors p21 and p27 in carbon tetrachloride -induced hepatotoxicity.	NIH-NIDDKD

Sources: CRISP 2004; FEDRIP 2004

CRISP = Computer Retrieval of Information on Scientific Projects; DVA = Department of Veterans Affairs; FEDRIP = Federal Research in Progress database; NIAAA = National Institute on Alcohol Abuse and Alcoholism; NIDDKD = National Institute of Diabetes and Digestive and Kidney Diseases; NIEHS = National Institute of Environmental Health Services; NIH = National Institute of Health

4. CHEMICAL AND PHYSICAL INFORMATION

4.1 CHEMICAL IDENTITY

Information regarding the chemical identity of carbon tetrachloride is located in Table 4-1.

4.2 PHYSICAL AND CHEMICAL PROPERTIES

Information regarding the physical and chemical properties of carbon tetrachloride is located in Table 4-2.

4. CHEMICAL AND PHYSICAL INFORMATION

Table 4-1. Chemical Identity of Carbon Tetrachloride

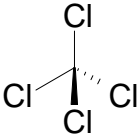
Characteristic	Information	Reference
Chemical name	Carbon tetrachloride	IARC 1979
Synonym(s)	Carbona; carbon chloride; carbon tet; methane tetrachloride; perchloromethane; tetrachloromethane; benzinoform	HSDB 2004
Registered trade name(s)	Benzinoform; Fasciolin; Flukoids; Freon 10; Halon 104; Tetraform; Tetrasol	IARC 1979
Chemical formula	CCl ₄	IARC 1979
Chemical structure		IARC 1979
Identification numbers:		
CAS registry	56-23-5	NLM 1988
NIOSH RTECS	FG4900000	HSDB 2004
EPA hazardous waste	U211; D019	HSDB 2004
OHM/TADS	7216634	HSDB 2004
DOT/UN/NA/IMCO shipping	UN1846; IMCO 6.1	HSDB 2004
HSDB	53	HSDB 2004
NCI	No data	

CAS = Chemical Abstracts Service; DOT/UN/NA/IMCO = Department of Transportation/United Nations/North America/International Maritime Dangerous Goods Code; EPA = Environmental Protection Agency; HSDB = Hazardous Substances Data Bank; NCI = National Cancer Institute; NIOSH = National Institute for Occupational Safety and Health; OHM/TADS = Oil and Hazardous Materials/Technical Assistance Data System; RTECS = Registry of Toxic Effects of Chemical Substances

4. CHEMICAL AND PHYSICAL INFORMATION

Table 4-2. Physical and Chemical Properties of Carbon Tetrachloride

Property	Information	Reference
Molecular weight	153.82	Lide 1993
Color	Colorless	Verschueren 1983
Physical state	Liquid	Verschueren 1983
Melting point	-23 °C	Lide 1992
Boiling point	76.5 °C	Lide 1992
Density	1.594 g/mL	Lide 1992
Odor	Aromatic, sweet	HSDB 2004
Odor threshold:		
Water	0.52 mg/L	IRIS 2004
Air	10–71,000 mg/m ³ 96 ppm (600 mg/m ³) 60–1,500 mg/m ³	Verschueren 1983 Amoore and Hautala 1983 Ruth 1986
Solubility:		
Water at 20 °C	800 mg/L	Verschueren 1983
Organic solvent(s)	Miscible	HSDB 2004
Partition coefficients:		
Log K _{ow}	2.64	EPA 1984
Log K _{oc}	2.04	Kenaga 1980
Vapor pressure at 20 °C	90 mmHg	Verschueren 1983
Henry's law constant:		
at 25 °C	2.94x10 ⁻² atm-m ³ /mol	Yaws et al. 1991
at 24.8 °C	3.04x10 ⁻² atm-m ³ /mol	HSDB 2004
at 20 °C	2.04x10 ⁻² atm-m ³ /mol	Tse et al. 1992
at 30 °C	3.37x10 ⁻² atm-m ³ /mol	Tse et al. 1992
Autoignition temperature	Nonflammable	HSDB 2004
Flashpoint	Nonflammable	HSDB 2004
Flammability limits	Nonflammable	HSDB 2004
Conversion factors		
ppm (v/v) to mg/m ³ in air (25 °C)	1 ppm=6.39 mg/m ³	HSDB 2004
mg/m ³ to ppm (v/v) in air (25 °C)	1 mg/m ³ =0.16 ppm	Verschueren 1983
Explosive limits	No data	

5. PRODUCTION, IMPORT/EXPORT, USE, AND DISPOSAL

5.1 PRODUCTION

Carbon tetrachloride is produced by exhaustive chlorination of a variety of low molecular weight hydrocarbons such as carbon disulfide, methane, ethane, propane, and ethylene dichloride (HSDB 2004). It is also produced by thermal chlorination of methyl chloride (HSDB 2004). Carbon tetrachloride is a feedstock for chlorofluorocarbon gases, such as dichlorodifluoromethane (F-12) and trichlorofluoromethane (F-11), which were used as aerosol propellants in the 1950s and 1960s (Holbrook 1991). Following this, the growth rate for the production of carbon tetrachloride averaged 10.7% per year from 1960 to 1970 (Holbrook 1991). This rate slowed to 7.2% per year from 1970 to 1974, when the production of this chemical was at its peak, as other forms of propellants became commercially available (Anonymous 1981; Holbrook 1991). The FDA banned the sale of carbon tetrachloride in any product used in the home and the EPA regulated the use of chlorofluorocarbon gases as aerosols or propellants. Since then, production of carbon tetrachloride has declined at approximately 8% a year from 1974 to 1994 (Anonymous 1995; Holbrook 1991). Carbon tetrachloride is currently manufactured in the United States by Vulcan Materials Company at two plants: Geismar, Louisiana and Wichita, Kansas, with a combined 130 million pound capacity (HSDB 2004; SRI 2004). It should be noted, however, that these capacities are flexible, since other chlorinated solvents are made using the same equipment (SRI 2004).

This recent decline in production is due to the adoption of an international agreement (the Montreal Protocol) to reduce environmental concentrations of ozone-depleting chemicals (including carbon tetrachloride), and to the provisions of Title VI of the Clean Air Act Amendments of 1990 addressing these chemicals. The regulation called for reduction to 15% of 1989 production levels by 1995 and a complete phase-out of carbon tetrachloride production for nonfeedstock uses by 2000. The EPA allocated a baseline production allowance of about 138 million pounds (63,000 metric tons) of carbon tetrachloride, apportioned among the eight U.S. companies producing the chemical in 1989 (EPA 1991a).

5.2 IMPORT/EXPORT

The trend in recent years has shown a drop off in both imports and exports for carbon tetrachloride. (Anonymous 1983, 1995). Current import or export quantities show that for the year 2002, the United

5. PRODUCTION, IMPORT/EXPORT, USE, AND DISPOSAL

States exported 11,880,074 kg (1,880 metric tons), and for 2003 through April, the United States exported 3,714,817 kg (3,715 metric tons) (USITC 2003). Imports for both years were reported at <50 kg.

Table 5-1 summarizes information on U.S. companies that reported the production, import, or use of carbon tetrachloride for the Toxics Release Inventory (TRI) in 2002 (TRI02 2004). The TRI data should be used with caution since only certain types of facilities are required to report. This is not an exhaustive list.

5.3 USE

The major use of carbon tetrachloride has historically been for the production of chlorofluorocarbons, such as dichlorodifluoromethane (F-12) and trichlorofluoromethane (F-11), which are used primarily as refrigerants as mentioned in section 5.1 (Holbrook 1991; HSDB 2004). Carbon tetrachloride found a variety of other uses in the past in industry, in medicine, and in the home. In the early part of this century, carbon tetrachloride was taken by mouth as a treatment for intestinal worms (Hall 1921), and it was also used briefly as an anesthetic (Hardin 1954). Because carbon tetrachloride is a solvent, it has been widely used as a cleaning fluid in the home and as a degreaser in industry. Because it is nonflammable, it was also used in fire extinguishers. Until recently, it was used as solvent in some household products and as a fumigant to kill insects in grain. It has been estimated that 28 million pounds of carbon tetrachloride were used as a fumigant in 1978 (Daft 1991). Because of the toxicity of carbon tetrachloride, consumer and fumigant uses have been discontinued, and only industrial uses remain (HSDB 2004).

Since production of carbon tetrachloride for most remaining uses has been phased-out due to Clean Air Act legislation (see Section 5.1), the chemical is only available for those uses for which no effective substitute has been found.

5.4 DISPOSAL

EPA classifies carbon tetrachloride and waste containing carbon tetrachloride as hazardous wastes. Generators of waste containing this contaminant must conform to EPA regulations for treatment, storage, and disposal (see Chapter 8). Rotary kiln or fluidized bed incineration methods are acceptable disposal methods for these wastes (HSDB 2004). According to the TRI, 2,893 pounds of carbon tetrachloride were transferred to landfills and/or other treatment/disposal facilities and 617,050 pounds were sent to publicly owned treatment works in 2002 (TRI02 2004) (see Section 6.2).

5. PRODUCTION, IMPORT/EXPORT, USE, AND DISPOSAL

Table 5-1. Facilities that Produce, Process, or Use Carbon Tetrachloride

State ^a	Number of facilities	Minimum amount on site in pounds ^b	Maximum amount on site in pounds ^b	Activities and uses ^c
AL	10	0	49,999,999	1, 3, 4, 5, 10, 11, 12, 13
AR	10	100	999,999	6, 7, 10, 11, 12
CA	25	0	49,999,999	1, 2, 3, 4, 5, 6, 7, 8, 10, 11, 12
CO	8	1,000	999,999	1, 2, 5, 6, 10, 11, 12, 13
CT	2	10,000	999,999	6, 10
DE	2	100,000	999,999	6, 10
FL	1	10,000	99,999	12
GA	4	0	9,999,999	7, 8, 10, 11
ID	1	0	99	2, 3, 10, 11
IL	14	0	9,999,999	1, 3, 4, 5, 6, 7, 9, 10, 12
IN	13	0	9,999,999	1, 2, 3, 5, 10, 11, 12, 13, 14
KS	14	0	9,999,999	1, 3, 4, 6, 7, 10, 11, 12, 13
KY	12	1,000	49,999,999	1, 3, 5, 6, 9, 10, 12
LA	60	0	49,999,999	1, 2, 3, 4, 5, 6, 7, 9, 10, 11, 12, 13
MD	5	10,000	999,999	2, 3, 6, 7
MI	10	0	9,999,999	5, 6, 7, 10, 12
MN	4	100	99,999	7, 10, 11, 12
MO	5	100	99,999	7, 12
MS	6	0	999,999	8, 9, 10, 12
MT	2	100	99,999	10
NC	2	0	9,999	1, 7, 13
ND	2	1,000	99,999	10
NE	2	10,000	999,999	12
NH	1	0	99	12
NJ	16	0	9,999,999	1, 2, 3, 5, 6, 7, 8, 9, 10, 11, 12
NY	6	1,000	999,999	9, 10, 12, 13
OH	18	1,000	999,999	1, 4, 5, 9, 10, 11, 12, 13
OK	2	10,000	999,999	10
PA	10	1,000	9,999,999	6, 7, 10, 11, 12
PR	1	10,000	99,999	12
SC	7	1,000	9,999,999	6, 7, 8, 12
TN	14	0	999,999	1, 2, 3, 6, 7, 9, 10, 11, 12, 13, 14
TX	52	0	99,999,999	1, 2, 3, 4, 5, 6, 7, 8, 9, 10, 11, 12, 13
UT	1	10,000	99,999	12
VA	4	0	99,999	12
VI	3	10,000	9,999,999	10
WA	3	1,000	99,999	10, 11, 12
WI	2	1,000	9,999	9, 10

5. PRODUCTION, IMPORT/EXPORT, USE, AND DISPOSAL

Table 5-1. Facilities that Produce, Process, or Use Carbon Tetrachloride

State ^a	Number of facilities	Minimum amount on site in pounds ^b	Maximum amount on site in pounds ^b	Activities and uses ^c
WV	11	0	9,999,999	1, 4, 5, 9, 11, 12, 13
WY	4	0	99,999	2, 3, 10

Source: TRI02 2004 (Data are from 2002)

^aPost office state abbreviations used

^bAmounts on site reported by facilities in each state

^cActivities/Uses:

- | | | |
|--------------------------|--------------------------|-----------------------------|
| 1. Produce | 6. Impurity | 11. Chemical Processing Aid |
| 2. Import | 7. Reactant | 12. Manufacturing Aid |
| 3. Onsite use/processing | 8. Formulation Component | 13. Ancillary/Other Uses |
| 4. Sale/Distribution | 9. Article Component | 14. Process Impurity |
| 5. Byproduct | 10. Repackaging | |

6. POTENTIAL FOR HUMAN EXPOSURE

6.1 OVERVIEW

Carbon tetrachloride has been identified in at least 430 of the 1,662 hazardous waste sites that have been proposed for inclusion on the EPA National Priorities List (NPL) (HazDat 2005). However, the number of sites evaluated for carbon tetrachloride is not known. The frequency of these sites can be seen in Figure 6-1. Of these sites, 425 are located within the United States, 1 is located in Guam, 2 are located in the Virgin Islands, and 2 are located in the Commonwealth of Puerto Rico (not shown).

Carbon tetrachloride is a stable chemical that is degraded very slowly, so there has been a gradual accumulation of carbon tetrachloride in the environment as a consequence of releases from human activities. Until 1986, the largest source of release was from the use of carbon tetrachloride as a grain fumigant, but this practice has now been stopped. Other releases of carbon tetrachloride may occur during carbon tetrachloride production or during the use of carbon tetrachloride in the manufacture of chlorofluorocarbons and other chemical products.

Because carbon tetrachloride is volatile at ambient temperature, most carbon tetrachloride in the environment exists in the air. Typical levels in rural areas are about $1 \mu\text{g}/\text{m}^3$, with somewhat higher values in urban areas and near industrial sources (Brodzinski and Singh 1983; Simmonds et al. 1983; Wallace et al. 1986). Low levels of carbon tetrachloride have been detected in many water systems (particularly surface water systems), with typical values of $<0.5 \mu\text{g}/\text{L}$ (Letkiewicz et al. 1983). Less than 1% of all groundwater-derived drinking water systems has levels of carbon tetrachloride $>0.5 \mu\text{g}/\text{L}$ and $<0.2\%$ have levels $>5 \text{ mg}/\text{L}$ (EPA 1987a).

6.2 RELEASES TO THE ENVIRONMENT

The TRI data should be used with caution because only certain types of facilities are required to report (EPA 1997). This is not an exhaustive list. Manufacturing and processing facilities are required to report information to the Toxics Release Inventory only if they employ 10 or more full-time employees; if their facility is classified under Standard Industrial Classification (SIC) codes 20–39; and if their facility

6. POTENTIAL FOR HUMAN EXPOSURE

Figure 6-1. Frequency of NPL Sites with Carbon Tetrachloride Contamination

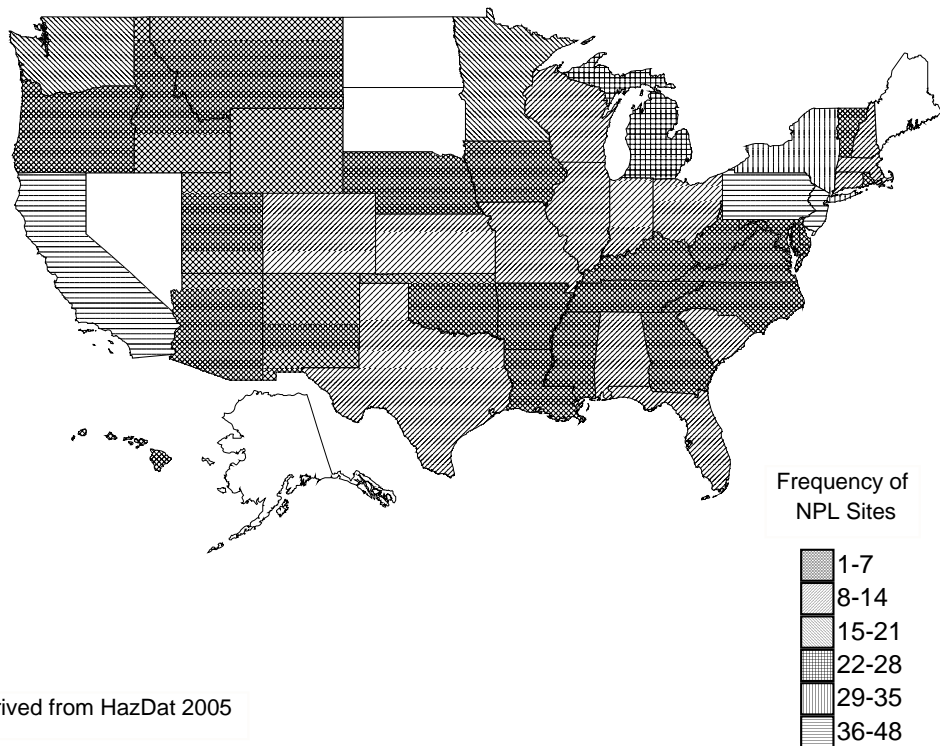

6. POTENTIAL FOR HUMAN EXPOSURE

produces, imports, or processes $\geq 25,000$ pounds of any TRI chemical or otherwise uses $>10,000$ pounds of a TRI chemical in a calendar year (EPA 1997).

6.2.1 Air

Estimated releases of 4.44 million pounds (202 metric tons) of carbon tetrachloride to the atmosphere from 55 domestic manufacturing and processing facilities in 2002, accounted for about 71% of the estimated total environmental releases from facilities required to report to the TRI (TRI02 2004). These releases are summarized in Table 6-1.

Although sources of carbon tetrachloride including marine algae, oceans, volcanoes, and drill wells have been cited (Gribble 1994), the majority of carbon tetrachloride in the environment is due to direct release to the atmosphere during production, disposal, or use of the compound. The estimated annual global release of carbon tetrachloride was about 60,000–80,000 metric tons/year during the period 1965–1977 (Singh et al. 1979a). Based on measurements of the rate of change of carbon tetrachloride levels in air around the globe, the calculated total atmospheric releases of carbon tetrachloride during the period 1978–1985 were around 90,000 metric tons/year (Simmonds et al. 1988). Some carbon tetrachloride may also be formed in air by photochemical decomposition of perchloroethylene (Singh et al. 1975) or by incomplete combustion of this chemical during waste incineration (Katami et al. 1992), although the magnitude of this contribution is difficult to estimate (Singh et al. 1979a).

Releases of carbon tetrachloride to air in the United States from manufacturing and processing ranged from 3.7 to 4.6 million pounds during 1987–1989, but were substantially reduced in 1990 and years after (EPA 1990, 1991b; TRI02 2004). According to the TRI02 (2004), an estimated total of 444,436 pounds (202 metric tons) of carbon tetrachloride, amounting to 71% of the total environmental release, was discharged to the air from manufacturing and processing facilities in the United States in 2001 (TRI02 2004) (see Table 6-1). The TRI data should be used with caution since only certain types of facilities are required to report. This is not an exhaustive list.

6.2.2 Water

Estimated releases of 320 pounds (0.145 metric tons) of carbon tetrachloride to surface water from 55 domestic manufacturing and processing facilities in 2002, accounted for about $<1\%$ of the estimated

6. POTENTIAL FOR HUMAN EXPOSURE

Table 6-1. Releases to the Environment from Facilities that Produce, Process, or Use Carbon Tetrachloride^a

State ^c	RF ^d	Reported amounts released in pounds per year ^b							
		Air ^e	Water ^f	UI ^g	Land ^h	Other ⁱ	Total release		On- and off-site
							On-site ^j	Off-site ^k	
AL	1	10	0	0	0	0	0	10	10
AR	3	4,031	0	0	0	0	0	4,031	4,031
CA	1	1,000	0	0	0	0	0	1,000	1,000
IL	1	11	0	0	215	168	383	11	394
IN	2	500	250	0	5	0	0	755	755
KS	1	12,239	0	32,922	0	0	0	45,161	45,161
KY	2	854	0	0	5	0	5	854	859
LA	12	304,984	55	139,323	45	38	44	444,401	444,445
MD	1	119	0	0	0	0	0	119	119
MI	1	250	0	0	0	0	0	250	250
MS	1	500	0	0	0	0	0	500	500
NC	1	41	0	0	0	0	0	41	41
NE	1	255	0	0	0	0	0	255	255
OH	4	4,530	5	2	255	61	316	4,537	4,853
PA	2	6,983	0	0	500	1,564	2,064	6,983	9,047
TN	2	21	0	0	0	0	0	21	21
TX	15	107,605	10	5,568	8	28	5,604	107,618	113,223
UT	1	65	0	0	0	0	0	65	65
WV	2	438	0	0	0	0	0	438	438
WY	1	No data	No data	No data	No data	No data	No data	No data	No data
Total	55	444,436	320	177,815	1,033	1,860	8,417	617,050	625,467

Source: TRI02 2004 (Data are from 2002)

^aThe TRI data should be used with caution since only certain types of facilities are required to report. This is not an exhaustive list. Data are rounded to nearest whole number.

^bData in TRI are maximum amounts released by each facility.

^cPost office state abbreviations are used.

^dNumber of reporting facilities.

^eThe sum of fugitive and point source releases are included in releases to air by a given facility.

^fSurface water discharges, waste water treatment-(metals only), and publicly owned treatment works (POTWs) (metal and metal compounds).

^gClass I wells, Class II-V wells, and underground injection.

^hResource Conservation and Recovery Act (RCRA) subtitle C landfills; other on-site landfills, land treatment, surface impoundments, other land disposal, other landfills.

ⁱStorage only, solidification/stabilization (metals only), other off-site management, transfers to waste broker for disposal, unknown

^jThe sum of all releases of the chemical to air, land, water, and underground injection wells.

^kTotal amount of chemical transferred off-site, including to POTWs.

RF = reporting facilities; UI = underground injection

6. POTENTIAL FOR HUMAN EXPOSURE

total environmental releases from facilities required to report to the TRI (TRI02 2004). These releases are summarized in Table 6-1.

Relatively small amounts of carbon tetrachloride are released to water. The total in 1978 was estimated to be 2.5 metric tons, due almost entirely to discharges from carbon tetrachloride production facilities (Rams et al. 1979). Analysis of data from EPA's Storage and Retrieval (STORET) database for the early 1980s indicate that carbon tetrachloride was detectable in 5.5% of 1,343 industrial effluent samples (Staples et al. 1985). The median concentration of all samples was <5 µg/L. Carbon tetrachloride was also detected in leachates from industrial landfills at concentrations ranging from <10 to 92 µg/L (Brown and Donnelly 1988).

In 1989, approximately 320 pounds (0.145 metric tons) of carbon tetrachloride was released in the United States to surface waters (EPA 1991b). An estimated total of 178,135 pounds (81 metric tons) of carbon tetrachloride, amounting to about 28% of the total environmental release, was discharged to the water and underground injection (potential groundwater release) from manufacturing and processing facilities in the United States in 2002 (TRI02 2004, see Table 6-1).

6.2.3 Soil

Estimated releases of 1,033 pounds (0.47 metric tons) of carbon tetrachloride to soils from 55 domestic manufacturing and processing facilities in 2002, accounted for about 0.0016% of the estimated total environmental releases from facilities required to report to the TRI (TRI02 2004). An additional 1.78 million pounds (81 metric tons), constituting about 28% of the total environmental emissions, were released via underground injection (TRI02 2004). These releases are summarized in Table 6-1.

Release of carbon tetrachloride to soil during carbon tetrachloride production was estimated to be 200,000 pounds (92 metric tons) in 1978 (Letkiewicz et al. 1983). Other sources of carbon tetrachloride discharged to soil include wastes associated with production and use of chlorofluorocarbons, metal cleaning compounds, adhesives, paints and other products. Total emissions to soil were estimated to be 2.6 million pounds (1,200 metric tons) in 1978 (Letkiewicz et al. 1983). In 1989, approximately 1,800 pounds (0.8 metric tons) of carbon tetrachloride were released in the United States to land (EPA 1991b). An estimated total of 1,033 pounds (0.47 metric tons) of carbon tetrachloride, amounting to <1%

6. POTENTIAL FOR HUMAN EXPOSURE

of the total environmental release, was discharged to the soil from manufacturing and processing facilities in the United States in 2002 (TRI02 2004).

6.3 ENVIRONMENTAL FATE

6.3.1 Transport and Partitioning

Nearly all carbon tetrachloride released to the environment exists in the atmosphere (73% is released to the atmosphere directly). Most of the carbon tetrachloride released to soil and water evaporates within a few days (EPA 1991b). Because carbon tetrachloride does not degrade readily in the atmosphere, significant global transport is expected. Although carbon tetrachloride is moderately soluble in water (800 mg/L at 20 °C) (Verschuere 1983), only about 1% of the total carbon tetrachloride in the environment exists dissolved in surface waters and oceans (Galbally 1976). This is attributable to the relatively high rate of volatilization of low molecular weight chlorinated hydrocarbons from water (Dilling 1977; Dilling et al. 1975). Because of this, carbon tetrachloride also tends to volatilize from tap water used for showering, bathing, cooking, and other household uses inside a home (McKone 1987; Tancrede et al. 1992).

Most carbon tetrachloride released to soil is expected to volatilize rapidly due to its high vapor pressure (91.3 mmHg at 20 °C) (Howard 1990; IARC 1979). A fraction of the carbon tetrachloride remaining in the soil may adsorb to the soil organic matter, based on a calculated soil sorption coefficient of 110 (log K_{oc} of 2.04) (Kenaga 1980). Nevertheless, carbon tetrachloride is expected to be moderately mobile in most soils, depending on the organic carbon content, and leaching to groundwater is possible (Howard 1990). Marine sediments high in organic matter tended to have higher concentrations of carbon tetrachloride than did sediments with lower organic matter (McConnell et al. 1975). The composition of the soil organic matter and the water content of the soil may also affect sorption of carbon tetrachloride (Rutherford and Chiou 1992; Rutherford et al. 1992). Experimentally determined K_{oc} values for sorption of carbon tetrachloride on soils with organic carbon contents of 1.49 and 0.66% were 143.6 and 48.89 (log K_{oc} = 2.16 and 1.69), respectively (Walton et al. 1992). The retardation factor of carbon tetrachloride in breakthrough sampling in groundwater ranged from 1.4 to 1.7, indicating that soil adsorption is a relatively minor fate process (Mackay et al. 1983). Retardation factors for carbon tetrachloride measured in a flow-through system studying sorption of organics to aquifer materials with very low organic carbon (0.07–0.025%) ranged from 1.10 to 1.46 (Larsen et al. 1992), confirming this conclusion.

6. POTENTIAL FOR HUMAN EXPOSURE

There is little tendency for carbon tetrachloride to bioconcentrate in aquatic or marine organisms. Reported log bioconcentration factors (BCFs) were 1.24 and 1.48 in trout and bluegill sunfish, respectively (HSDB 2004; Neely et al. 1974; Pearson and McConnell 1975). However, the log octanol/water partition coefficient ($\log K_{ow}$) of 2.64 for carbon tetrachloride (EPA 1984) suggests that bioaccumulation is at least possible under conditions of constant exposure and may occur in occupational settings or in people living at or near hazardous waste sites. No data were located on the biomagnification of carbon tetrachloride. However, since most animals readily metabolize and excrete carbon tetrachloride following exposure (see Section 3.4.3), biomagnification is not expected.

6.3.2 Transformation and Degradation

6.3.2.1 Air

Carbon tetrachloride is very stable in the troposphere (Cox et al. 1976; Lillian et al. 1975; Singh et al. 1980). This is primarily because carbon tetrachloride does not react with hydroxyl radicals that initiate breakdown and transformation reactions of other volatile hydrocarbons. In addition, carbon tetrachloride does not photodissociate in the troposphere because, in the vapor state, it has no chromophores that absorb light in those visible or near ultraviolet regions of the electromagnetic spectrum, which prevail in the troposphere (Davis et al. 1975). The rate of oxidation of carbon tetrachloride is thought to be so slow that its estimated tropospheric half-life exceeds 330 years (Cox et al. 1976). Ultimately, carbon tetrachloride that is not removed from the troposphere by rainfall (Pearson and McConnell 1975) diffuses upward into the stratosphere where it may be photodegraded by shorter wavelength ultraviolet light (185–225 nm) more prevalent in this region of the atmosphere to form the trichloromethyl radical and chlorine atoms (Molina and Rowland 1974). The rate of photodissociation begins to become important at altitudes >20 km, and increases as altitude increases (Molina and Rowland 1974). Estimates of the atmospheric lifetime (the overall persistence of carbon tetrachloride in the troposphere and the stratosphere combined) are variable, but most values range from 30 to 100 years (EPA 1991b; Molina and Rowland 1974; Simmonds et al. 1983, 1988; Singh et al. 1979a), with 50 years generally being accepted as the most reasonable value.

Chlorine atoms and other chlorine species formed by photodecomposition of carbon tetrachloride in the stratosphere can catalyze reactions that destroy ozone. As the manufacture of carbon tetrachloride for use

6. POTENTIAL FOR HUMAN EXPOSURE

in chlorofluorocarbons is phased out according to an international agreement (EPA 1987e), the impact of carbon tetrachloride on atmospheric ozone is likely to decrease.

6.3.2.2 Water

Carbon tetrachloride dissolved in water does not photodegrade or oxidize in any measurable amounts (Howard et al. 1991). The rate of hydrolysis in water is second order with respect to carbon tetrachloride, but is extremely slow, with a calculated half-life of 7,000 years at a concentration of 1 ppm (Mabey and Mill 1978). The reported aqueous hydrolysis rate calculated from gas phase measurements was $<2 \times 10^{-6} \text{M}^{-1} \text{s}^{-1}$ (Haag and Yao 1992), 1–2 orders of magnitude less than other chlorinated alkanes. Others have suggested that hydrolysis may be the cause of decreasing carbon tetrachloride concentrations with depth in the ocean (Lovelock et al. 1973). However, this observation might also be explained by the biodegradation of carbon tetrachloride, which occurs much more rapidly than hydrolysis, particularly under anaerobic conditions. Biodegradation may occur within 16 days under anaerobic conditions (Tabak et al. 1981). Based upon acclimated aerobic screening test data, the aqueous aerobic half-life of carbon tetrachloride was estimated to be 6–12 months (Howard et al. 1991). Based upon unacclimated anaerobic screening test data and acclimated aerobic sediment/aquifer grab sample data, the aqueous anaerobic half-life of carbon tetrachloride was estimated to be 7–28 days (Howard et al. 1991).

The carbon atom in carbon tetrachloride is in its most oxidized state, therefore it is much more likely to undergo reductive degradation, as opposed to oxidative degradation (McCarty 1996a; McCarty and Reinhart 1993; McCarty and Semprini 1994; McCarty et al. 1996b). Carbon tetrachloride may undergo reductive dechlorination in aquatic systems in the presence of free sulfide and ferrous ions, or naturally occurring minerals providing those ions (Kriegman-King and Reinhard 1991). The transformation rate of carbon tetrachloride to chloroform and other products under simulated groundwater conditions at 50 °C was evaluated for the chemical alone, with minerals (biotite and vermiculite) providing ferrous ions and free sulfide ions, and with natural iron sulfides (pyrite and marcasite). Reported half-lives for carbon tetrachloride were 380 days for carbon tetrachloride alone, 2.9–4.5 days with minerals and sulfide ion present, and 0.44–0.85 days in the presence of natural iron sulfides. The effects noted with free ferrous or free sulfide ions were two orders of magnitude less than with natural minerals. Another recent study found degradation of 84% of the carbon tetrachloride present in aqueous solution containing ferrous ions 33 days, but no effect with sulfide ions (Doong and Wu 1992). Additional studies indicated that the abiotic reductive dechlorination of carbon tetrachloride could involve microbial cofactors or metabolites. Reductive dechlorination also occurs by anaerobic microbial transformation (Edwards et al. 1942).

6. POTENTIAL FOR HUMAN EXPOSURE

Carbon tetrachloride removal via reductive dechlorination has also been observed under sulfate reducing conditions in an anaerobic system (de Best et al. 1998). Complete removal of carbon tetrachloride was observed, with chloroform and dichloromethane as the main transformation products; however, some unknown degradation products were also observed.

6.3.2.3 Sediment and Soil

No studies were located on the degradation of carbon tetrachloride in soil or sediment. Based on the estimated aqueous aerobic biodegradation half-life of carbon tetrachloride, the half-life of carbon tetrachloride in soil is estimated to be 6–12 months (Howard et al. 1991).

6.4 LEVELS MONITORED OR ESTIMATED IN THE ENVIRONMENT

Reliable evaluation of the potential for human exposure to carbon tetrachloride depends in part on the reliability of supporting analytical data from environmental samples and biological specimens. Concentrations of carbon tetrachloride in unpolluted atmospheres and in pristine surface waters are often so low as to be near the limits of current analytical methods. In reviewing data on carbon tetrachloride levels monitored or estimated in the environment, it should also be noted that the amount of chemical identified analytically is not necessarily equivalent to the amount that is bioavailable. The analytical methods available for monitoring carbon tetrachloride in a variety of environmental media are detailed in Chapter 7.

6.4.1 Air

Carbon tetrachloride appears to be ubiquitous in ambient air. Based on analysis of 4,913 ambient air samples reported in the National Ambient Volatile Organic Compounds Database (including remote, rural, suburban, urban, and source dominated sites in the United States), the average concentration of carbon tetrachloride was 0.168 ppb ($1.1 \mu\text{g}/\text{m}^3$) (Shah and Heyerdahl 1988). Carbon tetrachloride was detected in air at 76 NPL hazardous waste sites (HazDat 2005). Average values reported in four U.S. cities ranged from 0.144 to 0.291 ppb (Singh et al. 1992). Similar results were reported by Simmonds et al. (1983), who found average concentrations of 0.6–0.8 $\mu\text{g}/\text{m}^3$ (0.10–0.13 ppb) at five coastal monitoring stations around the world, and Kelly et al. (1994), who reported a median ambient

6. POTENTIAL FOR HUMAN EXPOSURE

concentration of $0.8 \mu\text{g}/\text{m}^3$ based on a compilation of ambient data from 1964 through 1992. Continued monitoring studies by Simmonds et al. (1988) reveal that global atmospheric levels of carbon tetrachloride have been steadily increasing by about 1.3% per year, reaching 0.12–0.14 ppb by 1985. Similar concentrations of carbon tetrachloride were also reported in air at five hazardous waste sites and one landfill in New Jersey, where average values ranged from 0.02 to 0.12 ppb (LaRegina et al. 1986). A study done involving the Toxic Air Monitoring System (TAMS) network showed concentrations of carbon tetrachloride in urban locations in Boston, Chicago, Houston, and the Seattle/Tacoma area (Evans et al. 1992). The median 24-hour concentrations were 0.12, 0.13, and 0.13 ppb at the three Boston sites, 0.12, 0.12, and 0.13 ppb at the three Chicago sites, 0.15, 0.13, and 0.12 ppb at the three Houston sites, and 0.12 ppb at the Seattle/Tacoma site. Sweet and Vermette (1990, 1992) have shown that carbon tetrachloride is present in areas of urban Illinois including southeast Chicago and east St. Louis at average concentrations of $0.7\text{--}1.0 \mu\text{g}/\text{m}^3$ (0.11–0.16 ppb). It was determined in this study that point sources of carbon tetrachloride from industry and wind direction are responsible for localized increases in concentration. The Arizona hazardous air pollutants monitoring program has demonstrated average concentrations of carbon tetrachloride ranging from 0.7 to $0.75 \mu\text{g}/\text{m}^3$ (0.11–0.12 ppb) (Zielinska et al. 1998). A study on air toxics in Minnesota has shown a carbon tetrachloride median concentration of $0.77 \mu\text{g}/\text{m}^3$ (0.12 ppb). This concentration exceeded health benchmark values in 88% of monitoring sites (Pratt et al. 2000). A study monitoring levels of carbon tetrachloride in 13 urban areas of the United States during September 1996 to August 1997 provided a mean concentration of 0.072–0.09 ppbv throughout the areas (Mohamed et al. 2002). The more recent studies demonstrate a decrease in levels of carbon tetrachloride in the ambient air, which could be a reflection of the current drop in production; however, the resistance to atmospheric degradation allows for levels to remain somewhat constant. Ambient air concentrations of carbon tetrachloride were unaffected by changes in temperature and season (Mohamed et al. 2002), or day of the week (Austin 2003).

Studies have revealed that carbon tetrachloride is also a common contaminant of indoor air. Typical concentrations in homes in several U.S. cities were about $1 \mu\text{g}/\text{m}^3$ (0.16 ppb), with some values up to $9 \mu\text{g}/\text{m}^3$ (1.4 ppb) (Wallace et al. 1986). Concentrations in indoor air were usually higher than in outdoor air, indicating that the source of the carbon tetrachloride was building materials or products (pesticides, cleaning agents) inside the home (Wallace et al. 1986, 1987). Based on 2,120 indoor air samples in the United States, the average concentration of carbon tetrachloride was 0.4 ppb ($2.6 \mu\text{g}/\text{m}^3$) (Shah and Heyerdahl 1988). However, the median value was 0 ppb, indicating that carbon tetrachloride was not detected in more than half of the samples. A later study determined backyard outdoor air concentrations of carbon tetrachloride taken from 175 home sites in 6 urban areas to be $0.6 \mu\text{g}/\text{m}^3$ (Wallace 1991). In

6. POTENTIAL FOR HUMAN EXPOSURE

this same study, 24-hour average exposures of 750 people in 6 urban areas were determined to be $1 \mu\text{g}/\text{m}^3$ (0.16 ppb). This indicates that for carbon tetrachloride, outdoor sources account for a majority of the airborne risk; however, indoor sources are still a concern (Acquavella et al. 1994; Wallace 1991). These data may reflect the effects of the discontinuation of the use of carbon tetrachloride in consumer products.

6.4.2 Water

There have been a number of surveys performed by the federal government to define typical levels of carbon tetrachloride in water supplies in this country. The results of these studies reveal that about 99% of all groundwater supplies and about 95% of all surface water supplies contain $<0.5 \mu\text{g}/\text{L}$ of carbon tetrachloride (Letkiewicz et al. 1983). Carbon tetrachloride was detected in groundwater at 310 NPL hazardous waste sites, and in surface water at 53 NPL hazardous waste sites (HazDat 2005). Analysis of 945 drinking water samples from cities around the United States found detectable levels ($>0.2 \mu\text{g}/\text{L}$) in 30 (3.2%) of the samples (Westrick et al. 1984). The highest value reported was $16 \mu\text{g}/\text{L}$, and the median value of the positive samples ranged from 0.3 to $0.7 \mu\text{g}/\text{L}$ in different sample groups. Carbon tetrachloride has also been detected in some private drinking water wells, at levels ranging from 1 to $720 \mu\text{g}/\text{L}$ (RIDOH 1989). Based on a survey of groundwater monitoring data from 479 waste sites, carbon tetrachloride was also detectable in groundwater (concentration not reported) at 32 sites in 9 EPA regions (Plumb 1991, 1992). A U.S. Geological Survey study of pesticide compounds present in well water around the United States showed the presence of carbon tetrachloride in $<5\%$ of the wells, but no concentration data were provided (Kolpin et al. 1997). A study on chemicals in California drinking water from 1984 to 1990 showed organic pollutants in 921 of 7,712 wells sampled (Lam et al. 1994). Of these contaminated wells, 45 were contaminated with carbon tetrachloride, at a maximum concentration of $29 \mu\text{g}/\text{L}$ (Lam et al. 1994). A survey of data by the National Academy of Sciences (NAS 1978) reported a range of carbon tetrachloride concentrations in seawaters of 0.2– $0.7 \text{ ng}/\text{L}$. Based on analysis of data from the STORET database, carbon tetrachloride was detectable in 12% of 8,858 ambient water samples (Staples et al. 1985). The median concentration in all samples was $0.1 \mu\text{g}/\text{L}$.

6.4.3 Sediment and Soil

Because carbon tetrachloride is ubiquitous in air, it is likely that trace levels of carbon tetrachloride are present in surface soils around the globe. Carbon tetrachloride was detected in soil at 103 NPL hazardous waste sites, and in sediment at 23 NPL hazardous waste sites (HazDat 2005). Based on information from

6. POTENTIAL FOR HUMAN EXPOSURE

the STORET database, carbon tetrachloride was detected in 0.8% of sediment samples across the United States (Staples et al. 1985). The median concentration of all samples was <5 mg/kg dry weight.

6.4.4 Other Environmental Media

Until 1986, one of the major uses of carbon tetrachloride was as a fumigant for grain, and consequently, low levels of carbon tetrachloride occurred in grain or food products derived from such grain. Estimates of carbon tetrachloride residue levels in treated grain varied as a function of fumigation conditions and the amount of aeration after fumigation, but values of 1–100 mg/kg were typical (Deer et al. 1987; Letkiewicz et al. 1983; Lynn and Vorches 1957; McMahan 1971). Levels in finished food prepared from fumigated grains were considerably lower, with typical concentrations below 0.1 mg/kg (Berck 1974). Carbon tetrachloride was detected in 44 of 549 food items at an average concentration of 0.031 mg/kg in a Food and Drug Administration (FDA) survey (Daft 1991). However, carbon tetrachloride is no longer used for this purpose in the United States, so exposure from this source is no longer of concern, but certain foods may absorb small amounts of carbon tetrachloride from the air during processing (Daft 1991). Carbon tetrachloride does not appear to occur in significant quantities in most other foods (Letkiewicz et al. 1983; McConnell et al. 1975).

Carbon tetrachloride was detected in 11 of 1,159 household cleaning and related products in a survey conducted during the late 1980s (Sack et al. 1992). Since this chemical is no longer used in consumer products, exposure from this source is not likely to be of concern.

6.5 GENERAL POPULATION AND OCCUPATIONAL EXPOSURE

Members of the general population are most likely to be exposed to carbon tetrachloride through ambient air and drinking water. Despite being banned from consumer products, the long lifetime of carbon tetrachloride in the atmosphere contributes to the background level to which the general population is exposed (Wallace 1991). Assuming inhalation of 20 m³/day by a 70-kg adult and 40% absorption of carbon tetrachloride across the lung (IRIS 2003), typical levels of carbon tetrachloride in ambient air (about 1 µg/m³) yield systemically absorbed doses of about 0.1 µg/kg/day. Somewhat higher exposures could occur near point sources such as industries that produce or use carbon tetrachloride or hazardous waste sites contaminated with carbon tetrachloride. Estimates of daily intake from air and water range from 12 to 511 µg/day and from 0.2 to 60 µg/day, respectively, based on average concentrations of 0.1–

6. POTENTIAL FOR HUMAN EXPOSURE

4 ppb ($0.64\text{--}25.6\ \mu\text{g}/\text{m}^3$) in air and $0.1\text{--}30\ \mu\text{g}/\text{L}$ in water (Howard 1990). For water, consumption of 2 L/day by a 70-kg adult containing a typical carbon tetrachloride concentration of $0.5\ \mu\text{g}/\text{L}$ yields a typical daily intake of about $0.01\ \mu\text{g}/\text{kg}/\text{day}$.

A study by Hartwell et al. (1992) analyzed the levels of carbon tetrachloride breath, personal air, and fixed indoor and outdoor sites in the Los Angeles area of California. The percentages of samples in which carbon tetrachloride was detected overnight, during the winter season were 2.13% in breath, 81.4% in personal air, 90.5% in kitchen, and 91.3% in outdoor air. Based on these results, carbon tetrachloride is considered often found, but not at relatively high concentrations in the winter season, and therefore, concentrations were not provided. Similar results were determined for daytime and summer months.

Exposure to carbon tetrachloride may also occur by dermal and inhalation routes while using tap water for bathing and other household purposes (McKone 1987; Tancrede et al. 1992).

Exposure to carbon tetrachloride via food is not likely to be of significance, since levels in most foods are below analytical detection limits. Ingestion of bread or other products made with carbon tetrachloride-fumigated grain may have contributed to dietary exposure in the past, but this route of exposure is no longer believed to be of significance.

In the workplace, the most likely route of exposure is by inhalation. Air concentrations at a number of locations where fumigated grain was stored were well below 5 ppm, while some samples contained over 60 ppm (Deer et al. 1987). The average exposure of workers in the grain facilities ranged from 0.002 to 0.1 ppm, depending on job activity. For a worker exposed to 0.1 ppm ($630\ \mu\text{g}/\text{m}^3$), the intake during an 8-hour day corresponds to a dose of about $35\ \mu\text{g}/\text{kg}/\text{day}$. Based on results of the National Occupational Exposure Survey (NOES) conducted during 1981–1983, the National Institute for Occupational Safety and Health (NIOSH) estimated that 58,208 workers were potentially exposed to carbon tetrachloride in the United States at that time (HSDB 2004). A study showing the baseline for potential emissions in the extrusion of polycarbonate resin at $304\ ^\circ\text{C}$ showed that carbon tetrachloride was either undetectable or present at very low levels (Rhodes et al. 2002).

6. POTENTIAL FOR HUMAN EXPOSURE

6.6 EXPOSURES OF CHILDREN

This section focuses on exposures from conception to maturity at 18 years in humans. Differences from adults in susceptibility to hazardous substances are discussed in Section 3.7, Children's Susceptibility.

Children are not small adults. A child's exposure may differ from an adult's exposure in many ways. Children drink more fluids, eat more food, breathe more air per kilogram of body weight, and have a larger skin surface in proportion to their body volume. A child's diet often differs from that of adults. The developing human's source of nutrition changes with age: from placental nourishment to breast milk or formula to the diet of older children who eat more of certain types of foods than adults. A child's behavior and lifestyle also influence exposure. Children crawl on the floor, put things in their mouths, sometimes eat inappropriate things (such as dirt or paint chips), and spend more time outdoors. Children also are closer to the ground, and they do not use the judgment of adults to avoid hazards (NRC 1993).

Young children often play close to the ground and frequently play in the dirt, which increases their dermal exposure to toxicants in dust and soil. They also tend to ingest soil, either intentionally through pica, or unintentionally through hand-to-mouth activity. Children, thus, may be orally dosed and dermally exposed to carbon tetrachloride present as a contaminant in soil and dust. It has been demonstrated that carbon tetrachloride vapors are absorbed by the skin slowly (HSDB 2004). In addition, carbon tetrachloride has a log K_{oc} value (organic carbon-water partition coefficient) of 2.04 (Kenaga 1980) indicating that it is not expected to adsorb to soil and sediment (HSDB 2004). Most of the carbon tetrachloride in the upper layers of the soil will be rapidly volatilized to air (vapor pressure=90 mmHg at 20 °C). Loss of carbon tetrachloride from the soil decreases the potential of dermal and oral exposure to children, but its rapid volatilization results in inhalation being the most likely route of exposure during play on the ground.

Children breathe in more air per kilogram of body weight than adults. Therefore, a child in the same micro-environment as an adult is likely to be exposed to a higher dosage of carbon tetrachloride from ambient air. Young children are closer to the ground or floor because of their height. The carbon tetrachloride vapors being heavier than air (vapor density=5.32, air=1, HSDB 2004) tend to concentrate near the ground. Children are therefore at a greater risk of exposure than adults during accidental spills or through indoor use of carbon tetrachloride in an unventilated area.

6. POTENTIAL FOR HUMAN EXPOSURE

Exposures of the embryo or fetus to volatile organic compounds such as carbon tetrachloride may occur if the expectant mother is exposed. A newborn infant may be exposed by breathing contaminated air and by ingestion of mother's milk, which can contain small amounts of carbon tetrachloride. Children may be exposed through accidental ingestion of products containing carbon tetrachloride. Because of the toxicity of carbon tetrachloride, consumer uses have been discontinued, and only industrial uses remain (Section 5.3); therefore, the occurrence of products containing carbon tetrachloride being in the home should be low. Older children and adolescents may be exposed to carbon tetrachloride in their jobs or hobbies, or through deliberate solvent abuse by "sniffing." Inhalant abuse during pregnancy poses significant risks to the pregnancy and endangers both the mother and the fetus. Solvent abuse of carbon tetrachloride for euphoric effects would result in exposure levels that exceed those producing adverse effects in animals.

A study has been done in the Kanawha Valley in West Virginia observing children from 74 elementary schools in the this area (Ware et al. 1993). The Kanawha Valley region is one of the largest areas of chemical manufacturing in the United States. Concentrations of 5 petroleum-related compounds and 10 compounds more specific to industrially related processes, including carbon tetrachloride, were determined at the different schools in groups based on proximity to industry. It was determined that the mean concentration values of both the petroleum-related compounds and the process-related compounds for schools in the valley, near the chemical companies, were higher than for schools in the valley further away from the chemical companies, as well as schools out of the valley, both near and further away from the chemical companies. These values ($19.71 \mu\text{g}/\text{m}^3$ for the petroleum-related compounds and $5 \mu\text{g}/\text{m}^3$ for the process-related compounds) are also higher than normally found in outdoor air around the country. A correlation was drawn between these higher concentrations of chemicals and an increased incidence of respiratory symptoms, including asthma, wheeze-related symptoms, and symptoms characteristic of reactive airway disease. It should be noted, however, that these data are for mixtures of volatile organic compounds and are not specific to carbon tetrachloride. Also, the observed data do not show direct causation of the observed symptoms; therefore, a need exists for further investigation of the effects of carbon tetrachloride on children (Donnelly et al. 1995).

6.7 POPULATIONS WITH POTENTIALLY HIGH EXPOSURES

Workers involved in the manufacture or use of carbon tetrachloride are the population most likely to have exposures to carbon tetrachloride significantly higher than members of the general public. Workers exposed to concentrations in air ranging from 20 to 125 ppm for intermediate durations have experienced

6. POTENTIAL FOR HUMAN EXPOSURE

a variety of neurological effects (see Section 3.2.1.4). Current regulations restrict the acceptable concentration of carbon tetrachloride in workplace air to 2 ppm, but this is still much higher than commonly encountered in the ambient environment. Fugitive emissions of carbon tetrachloride from chemical plants may expose area residents to elevated levels of this halocarbon, although concentrations outside the plant are typically much lower than in the chemical plant itself. Other populations that might have above average exposure include persons living near hazardous waste sites contaminated with carbon tetrachloride.

6.8 ADEQUACY OF THE DATABASE

Section 104(i)(5) of CERCLA, as amended, directs the Administrator of ATSDR (in consultation with the Administrator of EPA and agencies and programs of the Public Health Service) to assess whether adequate information on the health effects of carbon tetrachloride is available. Where adequate information is not available, ATSDR, in conjunction with NTP, is required to assure the initiation of a program of research designed to determine the health effects (and techniques for developing methods to determine such health effects) of carbon tetrachloride.

The following categories of possible data needs have been identified by a joint team of scientists from ATSDR, NTP, and EPA. They are defined as substance-specific informational needs that if met would reduce the uncertainties of human health assessment. This definition should not be interpreted to mean that all data needs discussed in this section must be filled. In the future, the identified data needs will be evaluated and prioritized, and a substance-specific research agenda will be proposed.

6.8.1 Identification of Data Needs

Physical and Chemical Properties. The physical and chemical properties of carbon tetrachloride have been well studied, and reliable values for key parameters are available for use in environmental fate and transport models. On this basis, it does not appear that further studies of the physical-chemical properties of carbon tetrachloride are essential.

Production, Import/Export, Use, Release, and Disposal. According to the Emergency Planning and Community Right-to-Know Act of 1986, 42 U.S.C. Section 11023, industries are required to submit substance release and off-site transfer information to the EPA. The TRI, which contains this information

6. POTENTIAL FOR HUMAN EXPOSURE

for 2002, became available in May of 2004. This database is updated yearly and should provide a list of industrial production facilities and emissions.

Although the production of carbon tetrachloride has been declining, humans are at risk of exposure to the compound at specific industrial locations where the compound is used or near chemical waste sites where emission to the environment may occur. Available data indicate that most carbon tetrachloride manufactured in this country is consumed in the synthesis of chlorofluorocarbons, but current quantitative data on the amounts of carbon tetrachloride imported and exported into and from the United States are sparse (HSDB 2004; USITC 2003). According to the Emergency Planning and Community Right-to-Know Act of 1986, 43 U.S.C. Section 11023, Industries are required to submit substance release and off-site transfer information to the EPA. TRI, which contains this information for 2002, became available in 2004. This database is updated yearly and should provide a list of industrial production facilities and emissions.

In 2002, the United States released approximately 414,000 pounds (188 metric tons) of carbon tetrachloride to the environment from manufacturing and processing facilities, most of which (70%) was released directly to the atmosphere (TRIO2 2004). Carbon tetrachloride is considered a hazardous waste and is subject to disposal regulations. Information on current disposal practices for used containers, sludges, and soils containing carbon tetrachloride waste are lacking. Because carbon tetrachloride is so stable in the environment, collection of this information on production, use, release, and disposal are needed to evaluate the effect of current industrial practices on local and global levels of carbon tetrachloride. Further, this information would be useful in the overall evaluation of human health risk of carbon tetrachloride.

Environmental Fate. The environmental fate of carbon tetrachloride has been investigated by a number of workers, and available data are adequate to conclude that one main fate process is volatilization followed by photodecomposition in the stratosphere (Pearson and McConnell 1975). However, there is some uncertainty in available estimates of atmospheric lifetime, and more detailed studies of the rate of carbon tetrachloride decomposition, and how this depends on altitude, geographic location, and other atmospheric components, are needed to refine models predicting global and local trends in carbon tetrachloride levels. Although only a small fraction of environmental carbon tetrachloride is thought to exist in surface waters, the possibility exists that hydrolysis, bioaccumulation, or adsorption, while slow, could compete with the slow photodecomposition occurring in the atmosphere. Estimates on the aerobic and anaerobic biodegradation half-lives of carbon tetrachloride in water have

6. POTENTIAL FOR HUMAN EXPOSURE

been made based on limited data. For this reason, additional studies on carbon tetrachloride flux rates into and out of surface water, as well as refined quantitative estimates of aquatic fate processes would be valuable. The chemical is expected to evaporate rapidly from soil due to its high vapor pressure and may migrate into groundwater due to its low soil adsorption coefficient. No data are available on biodegradation in soil. Additional studies to determine degradation rates and the extent to which adsorption has occurred are needed. These data are also useful in evaluating the impact of carbon tetrachloride leaching from hazardous waste sites.

Bioavailability from Environmental Media. Carbon tetrachloride can be absorbed following oral dosing and inhalation, or dermal exposure. No data were located regarding the potential effects of environmental media (air, water, soil) on the absorption of carbon tetrachloride. However, since soil adsorption is considered to be relatively low for carbon tetrachloride, it seems unlikely that soil would have a significant effect on its bioavailability. Additional studies are needed to determine the extent of bioavailability from contaminated air, drinking water, and soil at hazardous waste sites.

Food Chain Bioaccumulation. Limited data indicate that carbon tetrachloride has a low tendency to bioconcentrate in the food chain, even though it is a lipophilic compound (Neely et al. 1974; Pearson and McConnell 1975). The lack of bioconcentration is mainly due to the volatility of carbon tetrachloride, which facilitates clearance from exposed organisms. Nevertheless, carbon tetrachloride does tend to become concentrated in fatty tissues, and further studies on the levels of carbon tetrachloride in the fat of fish would help evaluate the risk of carbon tetrachloride exposure by this pathway. No data are available on the bioconcentration in plants. Additional studies would be useful in assessing potential for human exposure from ingestion of plant foodstuff. Data are also needed on the biomagnification of the compound in the aquatic and terrestrial food chain. These data would be useful in assessing food chain bioaccumulation as a potential human exposure pathway.

Exposure Levels in Environmental Media. Reliable monitoring data for the levels of carbon tetrachloride in contaminated media at hazardous waste sites are needed so that the information obtained on levels of carbon tetrachloride in the environment can be used in combination with the known body burden of carbon tetrachloride to assess the potential risk of adverse health effects in populations living in the vicinity of hazardous waste sites.

Levels of carbon tetrachloride in air, water, and sediments have been measured at numerous locations in the United States, and typical or average exposure levels in ambient air and drinking water are fairly well

6. POTENTIAL FOR HUMAN EXPOSURE

defined (Letkiewicz et al. 1983; Shah and Heyerdahl 1988; Singh et al. 1992; Westrick et al. 1984). There is considerable local variation, with higher-than-average levels occurring in some industrial areas and near some waste sites. However, much of this information is no longer current. Consequently, further monitoring of carbon tetrachloride in the workplace and in ambient water and air near known or potential sources of carbon tetrachloride would be valuable in identifying locations where human exposure could be elevated.

Reliable monitoring data for the levels of carbon tetrachloride in contaminated media at hazardous waste sites are needed so that the information obtained on levels of carbon tetrachloride in the environment can be used in combination with the known body burden of carbon tetrachloride to assess the potential risk of adverse health effects in populations living in the vicinity of hazardous waste sites.

Exposure Levels in Humans. Detection of carbon tetrachloride in blood, urine, and expired air has been used as an indicator of exposure to the compound in occupational settings. Similar information on the general population, particularly in the vicinity of hazardous waste sites, are needed to estimate levels of the compound to which the general population has been exposed and perhaps some correlation of these levels with levels of carbon tetrachloride in contaminated air, drinking water, and soil.

This information is necessary for assessing the need to conduct health studies on these populations.

Exposures of Children. There are very limited data on the effects of carbon tetrachloride exposure on children. As stated earlier (Section 6.6), adult data cannot simply be extrapolated to children for a variety of different reasons. Data on children's exposure are needed.

Child health data needs relating to susceptibility are discussed in Section 3.12.2, Identification of Data Needs: Children's Susceptibility.

Exposure Registries. No exposure registries for carbon tetrachloride were located. This substance is not currently one of the compounds for which a sub-registry has been established in the National Exposure Registry. The substance will be considered in the future when chemical selection is made for sub-registries to be established. The information that is amassed in the National Exposure Registry facilitates the epidemiological research needed to assess adverse health outcomes that may be related to exposure to this substance.

6. POTENTIAL FOR HUMAN EXPOSURE

6.8.2 Ongoing Studies

As part of the Third National Health and Nutrition Evaluation Survey (NHANES III), the Environmental Health Laboratory Sciences Division of the National Center for Environmental Health, Centers for Disease Control and Prevention, will be analyzing human blood samples for carbon tetrachloride and other volatile organic compounds. These data will give an indication of the frequency of occurrence and background levels of these compounds in the general population.

The Federal Research in Progress (FEDRIP 2004) database provides additional information obtainable from a few ongoing studies that may fill in some of the data needs identified in Section 6.8.2. These studies that include one which deals with the phytoremediation of toxic waste sites using poplar trees to remove toxic solvents from influent waters. Over a 4-year period, 98–99% of trichloroethylene was removed, with similar results shown for carbon tetrachloride and perchloroethylene. Further study is being done using this methodology to determine the fate of the carbon from these chemicals.

7. ANALYTICAL METHODS

The purpose of this chapter is to describe the analytical methods that are available for detecting, measuring, and/or monitoring carbon tetrachloride, its metabolites, and other biomarkers of exposure and effect to carbon tetrachloride. The intent is not to provide an exhaustive list of analytical methods. Rather, the intention is to identify well-established methods that are used as the standard methods of analysis. Many of the analytical methods used for environmental samples are the methods approved by federal agencies and organizations such as EPA and the National Institute for Occupational Safety and Health (NIOSH). Other methods presented in this chapter are those that are approved by groups such as the Association of Official Analytical Chemists (AOAC) and the American Public Health Association (APHA). Additionally, analytical methods are included that modify previously used methods to obtain lower detection limits and/or to improve accuracy and precision.

As is true for most volatile organic compounds, the preferred analytical technique for carbon tetrachloride is gas chromatography (GC). A number of devices are suitable for detection of carbon tetrachloride as it emerges from the GC, including flame ionization detector (FID), halogen-sensitive detector (HSD), or electron-capture detector (ECD). In general, HSD or ECD are preferable because of their high sensitivity for halogenated compounds. When absolute confidence in compound identity is required, gas chromatography/mass spectrometry (GC/MS) is the method of choice.

The most variable aspect of carbon tetrachloride analysis is the procedure used to extract carbon tetrachloride from the medium and prepare a sample suitable for GC analysis. As a volatile organic compound of relatively low water solubility, carbon tetrachloride is easily lost from biological and environmental samples, so appropriate care must be exercised in handling and storing such samples for chemical analysis. Brief summaries of the methods available for extraction and detection of carbon tetrachloride in biological and environmental samples are provided below.

7.1 BIOLOGICAL MATERIALS

Separation of carbon tetrachloride from biological samples may be achieved by headspace analysis, purge-and-trap collection from aqueous solution or slurry samples, solvent extraction, or direct collection on resins. Headspace analysis offers speed, simplicity, and good reproducibility, but partitioning of the

7. ANALYTICAL METHODS

analyte between the headspace and the sample matrix is dependent upon the nature of the matrix and must be determined separately for each different kind of matrix (Walters 1986).

Purge-and-trap collection is well adapted to biological samples such as blood or urine that are soluble in water (Pellizzari et al. 1985a; Peoples et al. 1979), and is readily adapted from techniques that have been developed for the analysis of carbon tetrachloride in water and waste water. For water-insoluble materials, the purge-trap approach is complicated by uncertainty of partitioning the analyte between sample slurry particles and water.

Historically, diethyl ether has been a widely used solvent for the extraction of volatile components from biological fluids (Zlatkis and Kim 1976). Homogenization of tissue with the extractant and lysing of cells improves extraction efficiency. When, as is often the case, multiple analytes are being determined using solvent extraction, selective extraction and loss of low-boiling compounds can cause errors. Highly purified solvents have largely eliminated problems with solvent impurities, although high costs, solvent toxicities, and restrictions on spent solvent disposal must be considered. Supercritical fluid extraction using pure carbon dioxide or carbon dioxide with additives offers some potential for the extraction of organic analytes such as carbon tetrachloride from biological samples (Hawthorne 1988).

Analytical methods for the determination of carbon tetrachloride in biological samples are summarized in Table 7-1.

7.2 ENVIRONMENTAL SAMPLES

The basic method for collection of carbon tetrachloride from the ambient atmosphere is adsorption on a solid phase, followed by removal by thermal or solvent elution for subsequent analysis. One of the most common adsorbents for carbon tetrachloride is Tenax[®] GC. Using Tenax[®] adsorbent, standard air containing 1.15 ppb by gas volume of carbon tetrachloride was determined with biases of -23.0, -34.7, -50.0, and -69.2% at collection volumes of 10, 20, 38, and 76 L of air, respectively (Crist and Mitchell 1986). Citing these large negative biases even when the sampled volume was less than 10% of the breakthrough volume, these authors conclude that Tenax[®] is not suitable for quantitative sampling for carbon tetrachloride (Crist and Mitchell 1986). For occupational monitoring of carbon tetrachloride in air, NIOSH (1984) recommends samplers containing activated carbon. The adsorbed carbon tetrachloride is extracted from the activated carbon with carbon disulfide, then determined by GC/FID. Studies have been conducted to improve analytical methods for detection of low-level volatile organic compounds.

7. ANALYTICAL METHODS

Table 7-1. Analytical Methods for Determining Carbon Tetrachloride in Biological Materials

Sample matrix	Preparation method	Analytical method	Sample detection limit	Percent recovery	Reference
Alveolar air	Collect on Tenax-TA [®] ; desorb thermally; inject by cryotrap	Capillary column GC/FID	No data	No data	Clair et al. 1991
Breath	Collect on Tenax-GC [®] ; desorb thermally	Capillary column GC/MS	No data	No data	Pellizzari et al. 1985b
Adipose tissue	Purge from liquefied fat at 115 °C, trap on Tenax [®] /silica gel, thermal desorption	GC/HSD	<1.3 µg/L	96 (90–100)	Peoples et al. 1979
Adipose tissue	Macerate in water; purge with inert gas; trap on Tenax-GC [®] ; desorb thermally	Capillary column GC/MS	≈6 ng/g	≈50	Pellizzari et al. 1985a
Blood serum	Purge from water-serum mixture containing antifoam reagent at 115 °C, trap on Tenax [®] /silica gel, thermal desorption	GC/HSD	<1.3 µg/L	112 (108–124)	Peoples et al. 1979
Blood	Purge with inert gas, trap on Tenax-GC [®] ; desorb thermally	Capillary column GC/MS	≈3 ng/mL	89.4	Pellizzari et al. 1985a
Biofluids	Dilute with water, sealed vial; collect headspace vapors	GC/FID	NR	No data	Suitheimer et al. 1982

FID = flame ionization detector; GC = gas chromatography; HSD = halogen-selective detector; MS = mass spectrometry; NR = not reported

7. ANALYTICAL METHODS

Methods have been evaluated that do not require the use of sorbents, thereby reducing associated uncertainties due to their adsorption/desorption efficiencies. The use of cryogenic preconcentration techniques to increase the sample content of trace volatile toxic organic compounds in a gas matrix for analysis by GC has been evaluated (Rhoderick and Miller 1990). The authors revealed that a linear multipoint calibration range from 1 to 15 ppb can be obtained by using a single standard, cryogenic trapping, a constant flow rate and varied trapping timer. Acceptable methods for the determination of carbon tetrachloride in ambient air are detailed in EPA Compendium Method TO-14A (EPA 1999).

Purge and trap methods are standard for the determination of carbon tetrachloride in water, with analyte measurement by GC using halogen-specific detection, electron-capture detection, or mass-spectrometry (APHA 1992a, 1992b; ASTM 1987; Bellar 1989; Eichelberger and Buddle 1989a, 1989b; EPA 1982a, 1982b; Ho 1989). The APHA (1992a, 1992b) methods for carbon tetrachloride have been accepted by EPA as equivalent to EPA-developed methods. Analyte measurement using an ion trap detector that functions as a mass spectrometer has also been evaluated (Eichelberger et al. 1990). This method is sufficiently sensitive to measure the analytes below the regulatory levels. Headspace sampling, coupled with whole column cryotrapping chromatography and mass spectrometry, have been used in the analysis of volatile priority pollutants in water and waste water (Gryder-Boutlet and Kennish 1988). The advantage of headspace sampling over other methods of analysis include minimal sample preparation, injection of a larger sample preparation and, and shorter analysis timer, because all of the compounds being analyzed are volatile. Carbon tetrachloride can also be determined in solid wastes by purge and trap collection followed by GC (EPA 1986a, 1986b). A modified open-loop dynamic headspace technique has been applied for stripping and trapping volatile organic compounds from estuarine sediments (Bianchi et al. 1991). This method is capable of quantifying volatile organic compounds at detection limits between 10 and 100 ng/kg.

Analytical methods for the determination of carbon tetrachloride in environmental samples are summarized in Table 7-2.

7.3 ADEQUACY OF THE DATABASE

Section 104(i)(5) of CERCLA, as amended, directs the Administrator of ATSDR (in consultation with the Administrator of EPA and agencies and programs of the Public Health Service) to assess whether adequate information on the health effects of carbon tetrachloride is available. Where adequate

7. ANALYTICAL METHODS

Table 7-2. Analytical Methods for Determining Carbon Tetrachloride in Environmental Samples

Sample matrix	Preparation method	Analytical method	Sample detection limit	Percent recovery	Reference
Air	Coconut shell carbon sorption, carbon disulfide desorption	GC/FID	10 µg/sample	No data	NIOSH 1984
Air	Adsorption on Tenax [®] GC, thermal desorption	GC/MS	<1.15 ppb ^a	23–77	Crist and Mitchell 1986
Air	Sorption	GC/CLMD	0.003 ng/sample	No data	Yamada et al. 1982
Air	Charcoal sorption, carbon disulfide desorption	GC/HSD	No data	No data	ASTM 1987
Water	Purge and trap	GC/MS	No data	No data	ASTM 1987
Water	Extract with n-pentane	GC/ECD	0.4 µg/L	No data	Garcia et al. 1992
Water	Purge and trap	GC/HSD	0.12 µg/L	82.5	EPA 1982a
Water	Purge and trap	GC/MS	2.8 µg/L	102	EPA 1982b
Drinking water	Purge with inert gas; trap on sorbent tube; desorb thermally	Capillary column GC/HSD	0.01 µg/L	92	Ho 1989
Drinking water	Purge with inert gas; trap on sorbent tube; desorb thermally	Packed column GC/HSD	0.003 µg/L	90	Bellar 1989
Drinking water	Purge with inert gas; trap on sorbent tube; desorb thermally	Capillary column GC/HSD	0.08 µg/L	92	EPA 1989b
Drinking water	Purge with inert gas; trap on sorbent tube; desorb thermally	Packed column GC/HSD	0.3 µg/L	88	EPA 1989b
Water	Purge and trap	GC/ITD	0.1 µg/L	No data	Eichelberger et al. 1990
Water	Solvent extraction (isooctane)	GC/ECD	1 µg/L ^b	No data	ASTM 1988
Soil	Purge and trap	GC/HSD	1.2 µg/kg	43–143	EPA 1986b
Wastes, non-water miscible	Purge and trap	GC/HSD	150 µg/kg	43–143	EPA 1986b
Solid waste	Purge and trap	GC/MS	5 µg/kg	70–140	EPA 1986a
Grain	Extract with acetone/water (5/1); dry; inject acetone solution	GC/ECD	NR	No data	AOAC 1984

^aPersistent negative bias in recovery suggests Tenax[®] sorption is not suitable for collection of carbon tetrachloride.

^bApproximate detection limit

CLMD = chemiluminescence detection; ECD = electron capture detector; FID = flame ionization detector; GC = gas chromatography; HSD = halogen-selective detector; ITD = ion trap detector; MS = mass spectrometry; NR = not reported

7. ANALYTICAL METHODS

information is not available, ATSDR, in conjunction with NTP, is required to assure the initiation of a program of research designed to determine the health effects (and techniques for developing methods to determine such health effects) of carbon tetrachloride.

The following categories of possible data needs have been identified by a joint team of scientists from ATSDR, NTP, and EPA. They are defined as substance-specific informational needs that if met would reduce the uncertainties of human health assessment. This definition should not be interpreted to mean that all data needs discussed in this section must be filled. In the future, the identified data needs will be evaluated and prioritized, and a substance-specific research agenda will be proposed.

7.3.1 Identification of Data Needs

Methods for Determining Biomarkers of Exposure and Effect. Covalent adducts between reactive carbon tetrachloride metabolites (e.g., the trichloromethyl radical) and cellular proteins, lipids and nucleic acids are known to occur, but at present these can only be measured using radiolabeled carbon tetrachloride. Development of immunological or other methods to detect such adducts in humans exposed to carbon tetrachloride could be of value in estimating past exposures to carbon tetrachloride.

Methods for Determining Parent Compounds and Degradation Products in Environmental Media. Analytical methods are available for measuring carbon tetrachloride in air, water, soil, and solid waste, and most of these methods have good sensitivity and specificity (APHA 1992a, 1992b; ASTM 1987; Bellar 1989; Eichelberger and Buddle 1989a, 1989b; EPA 1982a, 1982b; Ho 1989). However, the estimated 10⁻⁶ cancer risk levels for carbon tetrachloride are quite low (0.01 ppb in air and 0.3 ppb in drinking water) (IRIS 2003), so improvements in sensitivity would be valuable. It is desirable to have means to measure organohalides such as carbon tetrachloride *in situ* in water and other environmental media. One approach to doing this has been demonstrated by the *in situ* analysis of chloroform-contaminated well water using remote fiber fluorimetry (RFF) and fiber optic chemical sensors (FOCS) (Milanovich 1986). With this approach, fluorescence of basic pyridine in the presence of an organohalide (Fujiwara reaction) is measured from a chemical sensor immersed in the water at the end of an optical fiber. Carbon tetrachloride undergoes a Fujiwara reaction, so its determination might be amenable to this approach. Another *in situ* method for field monitoring of carbon tetrachloride has been described by Kirtland et al. (2003); this method uses isotopic labeling and detection of metabolites by gas chromatography.

7. ANALYTICAL METHODS

7.3.2 Ongoing Studies

The EPA is funding on-going research to develop a "Master Analytical Scheme" for organic compounds in water (Michael et al. 1988), which includes carbon tetrachloride as an analyte. The overall goal is to detect organic compounds at 0.1 µg/L in drinking water, 1 µg/L in surface water, and 10 µg/L in effluent waters. Analytes are to include numerous semivolatile compounds and some compounds that are only "semisoluble" in water, as well as volatile compounds. A comprehensive review of the literature leading up to these efforts has been published (Pellizzari et al. 1985a).

Improvements in analytical technology to identify groundwater contaminants revealed that soil gas analysis may enhance the effectiveness of traditional sampling and analysis (Kerfoot 1990). Carbon tetrachloride has properties that make it amenable to detection by soil gas analysis.

Researchers have coupled two GC capillary columns with different lengths and polarities in series to optimize separation of complex mixtures of volatile organics in air samples (Clair et al. 1991). Atomic emission detectors (AEDs) and mass selective detectors (MSDs) are also being used to enhance selectivity and sensitivity for air analyses (Yamashita et al. 1992).

The Environmental Health Laboratory Sciences Division of the Center for Environmental Health and Injury Control, Centers for Disease Control, is developing methods for the analysis of carbon tetrachloride and other volatile organic compounds in blood (Ashley et al. 1992). These methods use purge and trap methodology, high resolution gas chromatography, and magnetic mass spectrometry which gives detection limits in the low parts per trillion (ppt) range. Also useful is the ability to test for carbon tetrachloride and other volatile organic compounds in expired air (Wallace 1996).

8. REGULATIONS AND ADVISORIES

Because of its potential to cause adverse health effects in exposed people, a number of regulations and advisory values have been established for carbon tetrachloride by various international, national, and state agencies. These values are summarized in Table 8-1.

ATSDR has calculated an intermediate inhalation MRL of 0.03 ppm based on a NOAEL of 5 ppm and a LOAEL of 10 ppm for liver effects in an intermediate-duration (187–192 days) inhalation study in rats exposed 7 hours/day, 5 days/week (Adams et al. 1952). The intermediate-duration MRL is expected to be protective also for acute-duration inhalation exposures. ATSDR has also calculated a chronic inhalation MRL of 0.03 ppm based on a NOAEL of 5 ppm and a LOAEL of 25 ppm for hepatic effects (increased liver weight, serum enzymes, and liver histopathology) in rats exposed for 6 hours/day, 5 days/week for 2 years (Japan Bioassay Research Center 1998; Nagano et al. 1998). ATSDR has also calculated an acute oral MRL of 0.02 mg/kg/day based on a LOAEL of 5 mg/kg/day over 10 days for minimal liver effects (vacuolar degeneration) in the rat (Smialowicz et al. 1991), and an intermediate oral MRL of 0.007 mg/kg/day based on a NOAEL of 1 mg/kg/day (0.71 mg/kg/day adjusted for intermittent exposure) and a LOAEL of 10 mg/kg/day for liver effects in rats dosed 5 days/week over 12 weeks (Bruckner et al. 1986). More information about the derivation of MRLs is found in Section 2.3 and Appendix A.

EPA has calculated a chronic oral reference dose (RfD) of 7×10^{-4} mg/kg/day for carbon tetrachloride based on a NOAEL of 1 mg/kg/day (converted to 0.71 mg/kg/day based on intermittent exposure) for rats in a 12-week study (Bruckner et al. 1986; IRIS 2003). The critical effect was liver toxicity. A subchronic oral RfD of 7×10^{-3} mg/kg/day was also calculated based on the same NOAEL used for the chronic RfD (EPA 1989b). It should be noted that EPA is currently developing new assessments for carbon tetrachloride that have not yet been released for public review.

8. REGULATIONS AND ADVISORIES

Table 8-1. Regulations and Guidelines Applicable to Carbon Tetrachloride

Agency	Description	Information	Reference
<u>INTERNATIONAL</u>			
Guidelines:			
IARC	Carcinogenicity classification	Group 2B ^a	IARC 1999
WHO	Guideline value or tolerable concentration for air quality	6.1 µg/m ³	WHO 2000
	Guideline for drinking water	2 µg/L	WHO 1993
<u>NATIONAL</u>			
Regulations and Guidelines:			
a. Air			
ACGIH	TLV (8-hour TWA) ^b	5 ppm	ACGIH 2003
	TLV-STEL (15-minute TWA)	10 ppm	
EPA	Hazardous air pollutant pursuant to Section 112 of the Clean Air Act	Yes	EPA 2003e 40 CFR 61.01
	Protection of stratospheric ozone; listed as a ozone-depleting chemical	Group IV	EPA 2003h 40 CFR 82, Subpart A, Appendix F
NIOSH	STEL (60-minute TWA)	2 ppm	NIOSH 2003
	IDLH	200 ppm	
	Potential occupational carcinogen	Yes	
OSHA	PEL (8-hour TWA) for general industry	2 mg/m ³	OSHA 2003c 29 CFR 1910.1000, Table Z-1
	PEL (8-hour TWA)	10 ppm	OSHA 2003e
	Acceptable ceiling concentration	25 ppm	29 CFR 1910.1000, Table Z-2
	Acceptable maximum peak above the acceptable ceiling concentration for an 8-hour shift	200 ppm (maximum duration for 5 minutes in any 4 hours)	
	PEL (8-hour TWA) for construction industry ^c	10 ppm	OSHA 2003f 29 CFR 1926.55, Appendix A
	PEL (8-hour TWA) for shipyard industry ^c	10 ppm	OSHA 2003a 29 CFR 1915.1000
USC	Hazardous air pollutant	Yes	USC 2003 42 USC 7412
b. Water			
EPA	Drinking water health advisories		EPA 2002
	1-day (10-kg child)	4 mg/L	
	10-day (10-kg child)	0.2 mg/L	
	DWEL ^d	0.03 mg/L	
	10 ⁻⁴ Cancer risk ^e	0.03 mg/L	
	Effluent guidelines and standards; toxic pollutants pursuant to Section 307(a)(1) of the Clean Water Act	Yes	EPA 2003c 40 CFR 401.15
	Hazardous substance in accordance with Section 311 of the Clean Water Act	Yes	EPA 2003n 40 CFR 116.4

8. REGULATIONS AND ADVISORIES

Table 8-1. Regulations and Guidelines Applicable to Carbon Tetrachloride

Agency	Description	Information	Reference
	National primary drinking water regulations—MCL	5 µg/L	EPA 2003g 40 CFR 141.61
NATIONAL (cont.)			
EPA	National primary drinking water regulations—MCLG	0 µg/L	EPA 2003f 40 CFR 141.50
	Pollutant of initial focus in the Great Lakes Water Quality Initiative	Yes	EPA 2003o 40 CFR 132, Table 6
	Reportable quantity of hazardous substances designated pursuant to Section 311 of the Clean Water Act	10 pounds	EPA 2003i 40 CFR 117.3
c. Food			
FDA	Bottled drinking water allowable level	5 µg/L	FDA 2003a 21 CFR 165.110
	Indirect food additive; adhesives	Yes	FDA 2003b 21 CFR 175.105(c)(5)
	Indirect food additive; paper and paperboard components; anti-offset substances	Yes	FDA 2003c 21 CFR 176.130(c)
	Indirect food additive; components of paper and paperboard in contact with dry food	Yes	FDA 2003d 21 CFR 176.180(b)(2)
	Labeling; warning statements for prescription and restricted device products containing or manufactured with chlorofluorocarbons or other ozone-depleting substances	Yes	FDA 2003f 21 CFR 801.433
	Labeling; medical devices; warning statements for devices containing or manufactured with chlorofluorocarbons and other class I ozone-depleting substances	Yes	FDA 2003e 21 CFR 801.63
d. Other			
ACGIH	Carcinogenicity classification	A2 ^f	ACGIH 2003
EPA	Carcinogenicity classification	B2 ^g	IRIS 2003
	RfC	No data	IRIS 2003
	RfD (chronic oral)	7x10 ⁻⁴ mg/kg/day	IRIS 2003
	Community right-to-know; release reporting; effective date of reporting	01/01/87	EPA 2003m 40 CFR 372.65
	Criteria for municipal solid waste landfills; hazardous constituent	Yes	EPA 2003a 40 CFR 258, Appendix II
	Identification and listing of hazardous waste; regulatory level of the maximum concentration of contaminants for the toxicity characteristic	0.5 mg/L	EPA 2003d 40 CFR 261.24

8. REGULATIONS AND ADVISORIES

Table 8-1. Regulations and Guidelines Applicable to Carbon Tetrachloride

Agency	Description	Information	Reference
<u>NATIONAL (cont.)</u>			
EPA	Reportable quantity; designated as a hazardous substances pursuant to Section 307 and 311 of the Clean Water Act, Section 112 of the Clean Air Act, and Section 3001 of RCRA	10 pounds	EPA 2003b 40 CFR 302.4
	Standards for owners and operators of hazardous waste TSD facilities; groundwater monitoring	Suggested Method 8010 8240 5x10 ⁻³ mg/kg	EPA 2003l 40 CFR 264, Appendix IX
	Standards for owners and operators of hazardous waste TSD facilities; health-based limits for exclusion of waste-derived residues; residue concentration limit		EPA 2003k 40 CFR 266, Appendix VII
	Standards for the management of specific hazardous waste and hazardous waste management facilities; risk specific dose	6.7x10 ⁻¹ µg/m ³	EPA 2003j 40 CFR 266, Appendix V
NTP	Carcinogenicity classification	Reasonably anticipated to be a human carcinogen	NTP 2002
<u>STATE</u>			
a. Air	No data		
b. Water			
Arizona	Drinking water guideline	0.27 µg/L	
California	Drinking water standard	0.5 µg/L	HSDB 2003
Connecticut	Drinking water guideline	5 µg/L	HSDB 2003
Florida	Drinking water standard	3 µg/L	HSDB 2003
Maine	Drinking water guideline	2.7 µg/L	HSDB 2003
Minnesota	Drinking water guideline	3 µg/L	HSDB 2003
New Jersey	Drinking water standard	2 µg/L	HSDB 2003
c. Food	No data		

8. REGULATIONS AND ADVISORIES

Table 8-1. Regulations and Guidelines Applicable to Carbon Tetrachloride

Agency	Description	Information	Reference
<u>STATE (cont.)</u>			
d. Other	No data		

^aGroup 2B: possibly carcinogenic to humans

^bSkin notation: refers to the potential significant contribution to the overall exposure by the cutaneous route, including mucous membranes and the eyes, either by contact with vapors or, of probable greater significance, by direct skin contact with the substance.

^cSkin designation

^dDWEL: a lifetime exposure concentration protection of adverse, non-cancer health effects, that assumes all of the exposure to a contaminant is from drinking water.

^e10⁻² Cancer risk: the concentration of a chemical in drinking water corresponding to an excess estimated lifetime cancer risk of 1 in 10,000.

^fA2: suspected human carcinogen

^gB2: probable human carcinogen

ACGIH = American Conference of Governmental Industrial Hygienists; CFR = Code of Federal Regulations; DWEL = drinking water equivalent level; EPA = Environmental Protection Agency; FDA = Food and Drug Administration; HSDB = Hazardous Substances Data Bank; IARC = International Agency for Research on Cancer; IDLH = immediately dangerous to life or health; IRIS = Integrated Risk Information System; MCL = maximum contaminant level; MCLG = maximum contaminant level goal; NIOSH = National Institute for Occupational Safety and Health; NTP = National Toxicology Program; PQL = practical quantitation limit; OSHA = Occupational Safety and Health Administration; PEL = permissible exposure limit; RCRA = Resource Conservation and Recovery Act; RfC = inhalation reference concentration; RfD = oral reference dose; STEL = short-term exposure limit; TLV = threshold limit values; TSD = treatment, storage, and disposal; TWA = time-weighted average; USC = United States Codes; WHO = World Health Organization

9. REFERENCES

- *Abraham P, Wilfred G, Catherine SP, et al. 1999. Oxidative damage to the lipids and proteins of the lungs, testis and kidney of rats during carbon tetrachloride intoxication. *Clin Chim Acta* 289(1-2):177-179.
- *ACGIH. 1986. Documentation of the threshold limit values and biological exposure indices. 5th edition. Cincinnati, OH: American Conference of Government Industrial Hygienists Inc., 109-110.
- *ACGIH. 2003. Carbon tetrachloride. Threshold limit values for chemical substances and physical agents and biological exposure indices. Cincinnati, OH: American Conference of Governmental Industrial Hygienists.
- *Acquavella JF, Friedlander BR, Ireland BK. 1994. Interpretation of low to moderate relative risks in environmental epidemiologic studies. *Annu Rev Public Health* 15:179-201.
- *Adams EM, Spencer HC, Rowe VK, et al. 1952. Vapor toxicity of carbon tetrachloride determined by experiments on laboratory animals. *AMA Arch Ind Hyg Occup Med* 6:50-66.
- Adamson DT, Parkin GF. 1999. Biotransformation of mixtures of chlorinated aliphatic hydrocarbons by an acetate-grown methanogenic enrichment culture. *Water Res* 33:1482-1494.
- *Adaramoye OA, Akinloye O. 2000. Possible protective effect of kolaviron on CCl₄-induced erythrocyte damage in rats. *Biosci Rep* 20:4.
- *Adinolfi M. 1985. The development of the human blood-CSF-brain barrier. *Dev Med Child Neurol* 27:532-537.
- *Adlercreutz H. 1995. Phytoestrogens: Epidemiology and a possible role in cancer protection. *Environ Health Perspect Suppl* 103(7):103-112.
- *Agarwal AK, Mehendale HM. 1984a. CCl₄-induced alterations in Ca⁺⁺ homeostasis in chlordecone and phenobarbital pretreated animals. *Life Sci* 34:141-148.
- *Agarwal AK, Mehendale HM. 1984b. Excessive hepatic accumulation of intracellular Ca²⁺ in chlordecone potentiated CCl₄ toxicity. *Toxicology* 30:17-24.
- *Agarwal AK, Mehendale HM. 1986. Effect of chlordecone on carbon tetrachloride-induced increase in calcium uptake in isolated perfused rat liver. *Toxicol Appl Pharmacol* 83:342-348.
- Agency for Toxic Substances and Disease Registry. 1988. VIEW database. Atlanta, GA: Agency for Toxic Substances and Disease Registry Office of External Affairs, Exposure and Disease Registry Branch, October 1988.
- *Agency for Toxic Substances and Disease Registry. 1989. Decision guide for identifying substance-specific data needs related to toxicological profiles; Notice. *Fed Regist* 54(174):37618-37634.

* Cited in text

9. REFERENCES

- *Agency for Toxic Substances and Disease Registry. 1990. Biomarkers of organ damage or dysfunction for the renal, hepatobiliary, and immune systems. Subcommittee on Biomarkers of Organ Damage and Dysfunction. Atlanta, GA: Agency for Toxic Substances and Disease Registry.
- Agrawal HC, Agrawal D. 1989. Tumor promoters accentuate phosphorylation of PO: Evidence for the presence of protein kinase C in purified PNS myelin. *Neurochem Res* 14:409-413.
- Ahmad FF, Cowan DL, Sun AY. 1987. Detection of free radical formation in various tissues after acute carbon tetrachloride administration in gerbil. *Life Sci* 40:2469-2475.
- Ahmadizadeh M, Echt R, Heusner WW, et al. 1990. Effect of carbon tetrachloride on hamster tracheal epithelial cells. *J Toxicol Environ Health* 30:273-285.
- *Ala-Kokko L, Gunzler V, Hoek JB, et al. 1992. Hepatic fibrosis in rats produced by carbon tetrachloride and dimethylnitrosamine: Observations suggesting immunoassays of serum for the 7S fragment of type IV collagen are a more sensitive index of liver damage than immunoassays for the NH₂-terminal propeptide of type III procollagen. *Hepatology* 16:167-172.
- Ala-Kokko L, Stenback F, Ryhanen L. 1987. Preventive effect of malotilate on carbon tetrachloride-induced liver damage and collagen accumulation in the rat. *Biochem J* 246:503-509.
- Albano E, Carini R, Parola M, et al. 1989. Effects of carbon tetrachloride on calcium homeostasis. *Biochem Pharmacol* 38:2719-2725.
- *Allis JW, Brown BL, Simmons JE, et al. 1996. Methanol potentiation of carbon tetrachloride hepatotoxicity: The central role of cytochrome P450. *Toxicology* 112(2):131-140.
- *Allis JW, Ward TR, Seely JC, et al. 1990. Assessment of hepatic indicators of subchronic carbon tetrachloride injury and recovery in rats. *Fundam Appl Toxicol* 15:558-570.
- Alric L, Orfila C, Carrere N, et al. 2000. Reactive oxygen intermediates and eicosanoid production by Kupffer cells and infiltrated macrophages in acute and chronic liver injury induced in rats by CCl₄. *Inflamm Res* 49:700-707.
- *Altman PL, Dittmer DS. 1974. Biological handbooks: Biology data book. Vol III. 2nd ed. Bethesda, MD: Federation of American Societies for Experimental Biology, 1987-2008, 2041.
- *Alumot E, Nachtomi E, Mandel E, et al. 1976. Tolerance and acceptable daily intake of chlorinated fumigants in the rat diet. *Food Cosmet Toxicol* 14:105-110.
- *Amacher DE, Zelljadt I. 1983. The morphological transformation of Syrian hamster embryo cells by chemicals reportedly nonmutagenic to Salmonella typhimurium. *Carcinogenesis* 4(3):291-296.
- *Amoore JE, Hautala E. 1983. Odor as an aid to chemical safety: Odor thresholds compared with threshold limit values and volatilities for 214 industrial chemicals in air and water dilution. *J Appl Toxicol* 3(6):272-290.
- *Andersen ME, Krishnan K. 1994. Relating in vitro to in vivo exposures with physiologically based tissue dosimetry and tissue response models. In: Salem H, ed. *Animal test alternatives: Refinement, reduction, replacement*. New York: Marcel Dekker, Inc., 9-25.

9. REFERENCES

- *Andersen ME, Clewell HJ III, Gargas ML, et al. 1987. Physiologically based pharmacokinetics and the risk assessment process for methylene chloride. *Toxicol Appl Pharmacol* 87:185-205.
- Andersen NJ, Waller CL, Adamovic JB, et al. 1996. A pharmacokinetic model of anaerobic in vitro carbon tetrachloride metabolism. *Chem Biol Interact* 101:13-31.
- *Andervont HB. 1958. Induction of hepatomas in strain C3H mice with 4-o-tolylazo-o-toluidine and carbon tetrachloride. *J Natl Cancer Inst* 20:431-438.
- Andrabi K, Kaul N, Gangly NK, et al. 1989. Altered calcium homeostasis in carbon tetrachloride exposed rat hepatocytes. *Biochem International* 18:1287-1295.
- Aniya Y, Anders MW. 1985. Alteration of hepatic glutathione S-transferases and release into serum after treatment with bromobenzene, carbon tetrachloride, or N-nitrosodimethylamine. *Biochem Pharmacol* 34:4239-4244.
- *Annoni G, Contu L, Tronci MA, et al. 1992. Pyridoxol L,2-pyrrolidon-5 carboxylate prevents active fibroplasia in CCl₄-treated rats. *Pharmacol Res* 25:87-93.
- *Anonymous. 1981. Chemical profile: Carbon tetrachloride. *Chem Mark Rep*. October 12, 1981.
- *Anonymous. 1983. Chemical profile: Carbon tetrachloride. *Chem Mark Rep*. May 21, 1983.
- Anonymous. 1992. Carbon tetrachloride toxicity. *Am Fam Phys* 46:1199-1207.
- *Anonymous. 1995. Chemical profile: Carbon tetrachloride. *Chem Mark Rep*. February 20, 1995.
- *Ansari GAS, Moslen MT, Reynolds ES. 1982. Evidence of in vivo covalent binding of CCl₃ derived from CCl₄ to cholesterol of rat liver. *Biochem Pharmacol* 31(21):3509-3510.
- Anttinen H, Oikarinen A, Puistola U, et al. 1985. Prevention by zinc of rat lung collagen accumulation in carbon tetrachloride injury. *Am Rev Respir Dis* 132:536-540.
- *AOAC. 1984. Fumigant residues. Volatile fumigants in grain. Gas chromatographic method. Section 29.071. In: *Official methods of analysis of The Association of Official Analytical Chemists*. 14th ed. Arlington, VA: Association of Official Analytical Chemists Inc., 547-548.
- *APHA. 1985. Halogenated methanes and ethanes by purge and trap - method 514. In: *Standard methods for the examination of water and wastewater*. 16th ed. Washington, DC: American Public Health Association, 591-602.
- *APHA. 1992a. Methos 6230A. Volatile halocarbons. In: *Standard methods for the examination of water and wastewater*. 18th ed. Washington, DC. American Public Health Association, 46-57.
- *APHA. 1992b. Methos 6040C. Purge and trap technique. In: *Standard methods for the examination of water and wastewater*. 18th ed. Washington, DC. American Public Health Association, 17-36.
- Aragno M, Danni O, Ugazio G. 1989. In vivo studies on halogen compound interactions. II. Effects of carbon tetrachloride plus 1,2-dibromomethane on relative liver weight and hepatic steatosis. *Res Comm Chem Pathol Pharmacol* 66:105-116.

9. REFERENCES

- *Aragno M, Tamagno E, Boccuzzi G, et al. 1993. Dehydroepiandrosterone pretreatment protects rats against the pro-oxidant and necrogenic effects of carbon tetrachloride. *Biochem Pharmacol* 46(10):1689-1694.
- *Aragno M, Tamagno E, Danni O, et al. 1992. *In vivo* studies on halogen compound interactions. III. Effect of carbon tetrachloride plus 1,2-dichloroethane on liver necrosis and fatty accumulation. *Res Comm Chem Pathol Pharmacol* 76:341-354.
- *Araki A, Kamigaito N, Sasaki T, et al. 2004. Mutagenicity of carbon tetrachloride and chloroform in *Salmonella typhimurium* TA98, TA100, TA1535, and TA1537, and *Escherichia coli* WP2/pKM101, using a gas exposure method. *Environ Mol Mutagen* 43:128-133.
- *Arezzini B, Lunghi B, Lungarella G, et al. 2003. Iron overload enhances the development of experimental liver cirrhosis in mice. *Int J Biochem Cell Biol* 35:486-495.
- Arii S, Monden K, Itai S, et al. 1990. Depressed function of Kupffer cells in rats with CCl₄-induced liver cirrhosis. *Res Exp Med* 190:173-182.
- *Ariosto F, Riggio O, Cantafora A, et al. 1989. Carbon tetrachloride-induced experimental cirrhosis in the rat: A reappraisal of the model. *Eur Surg Res* 21:280-286.
- Armendariz-Borunda J, Katai H, Jones CM, et al. 1993. Transforming growth factor β gene expression is transiently enhanced at a critical stage during liver regeneration after CCl₄ treatment. *Lab Invest* 69(3):283-294.
- Arosio B, Santambrogio D, Gagliano N, et al. 1997. Glutathione pretreatment lessens the acute liver injury induced by carbon tetrachloride. *Pharmacol Toxicol* 81(4):164-168.
- Asakura S, Sawada S, Daimon H, et al. 1994. Effects of dietary restriction on induction of unscheduled DNA synthesis (UDS) and replicative DNA synthesis (RDS) in rat liver. *Mutat Res* 322:257-264.
- *Ashe WF, Sailer S. 1942. Fatal uremia following single exposure to carbon tetrachloride fumes. *Ohio State Med J* 38:553-555.
- *Ashley DL, Bonin MA, Cardinali FL, et al. 1992. Determining volatile organic compounds in human blood from a large sample population by using purge and trap gas chromatography/mass spectrometry. *Anal Chem* 64:1021-1029.
- Ashley DL, Bonin MA, Cardinali FL, et al. 1994. Blood concentrations of volatile organic compounds in a nonoccupationally exposed US population and in groups with suspected exposure. *Clin Chem* 40(7):1401-1404.
- Assmuth TW, Strandberg T. 1993. Groundwater contamination at Finnish landfills. *Water Air Soil Pollut* 69:179-199.
- *ASTM. 1987. Sampling workplace atmospheres to collect organic gases or vapors with activated charcoal diffusional samplers - method D 4597-87. In: 1987 Annual book of ASTM standards. Volume 11.03. Atmospheric analysis; occupational health and safety. Philadelphia, PA: American Society for Testing and Materials, 490-494.

9. REFERENCES

- *ASTM. 1988. Low molecular weight halogenated hydrocarbons in water - method D 3973-85. 1988 Annual book of ASTM standards. Volume 11.02. Water and environmental technology. Philadelphia, PA: American Society for Testing Materials, 141-145.
- Atkinson R. 1989. Kinetics and mechanisms of the gas-phase reactions of the hydroxyl radical with organic compounds. *J Phys Chem Ref Data Monograph* 1:66.
- Atucha NM, Cegarra M, Ramirez A, et al. 1993. Pressure diuresis and naturiruresis in cirrhotic rats. *Am J Physiol* 265(6 pt 1):G1045-1049.
- *Austin J. 2003. Day-of-week patterns in toxic air contaminants in southern California. *J Air Waste Manage Assoc* 53:889-896.
- Axelsson G, Rylander R. 1989. Outcome of pregnancy in women engaged in laboratory work at a petrochemical plant. *Am J Ind Med* 16:539-545.
- Ayub-Ayala M, Flores-Alvarado LJ, Bueno Topete MR, et al. 1993. Effect of short-term carbon tetrachloride administration on blood lactic acid levels. *Gen Pharmacol* 24(3):627-630.
- *Azri S, Mata HP, Gandolfi AJ, Brendel K. 1991. CCl₄-induced cytochrome P-450 loss and lipid peroxidation in rat liver slices. *Biol Reactive Intermediates* 669-674.
- Bachem MG, Meyer D, Melchior R, et al. 1992. Activation of rat liver perisinusoidal lipocytes by transforming growth factors derived from myofibroblastlike cells. *J Clin Invest* 89:19-27.
- Badger DA, Kuester RK, Sauer J-M, et al. 1997. Gadolinium chloride reduces cytochrome P450: Relevance to chemical-induced hepatotoxicity. *Toxicology* 121:143-153.
- Badger DA, Sauer J-M, Hoglen NC, et al. 1996. The role of inflammatory cells and cytochrome P450 in the potentiation of CCl₄-induced liver injury by a single dose of retinol. *Toxicol Appl Pharmacol* 141:507-519.
- Baehr AL, Stackelberg PE, Baker RJ. 1999. Evaluation of the atmosphere as a source of volatile organic compounds in shallow groundwater. *Water Resour Res* 35:127-136.
- Bagchi D, Bagchi M, Hassoun E, et al. 1993. Carbon-tetrachloride-induced urinary excretion of formaldehyde, malondialdehyde, acetaldehyde and acetone in rats. *Pharmacology* 47:209-216.
- *Bai CL, Canfield PJ, Stacey NH. 1992. Individual serum bile acids as early indicators of carbon tetrachloride- and chloroform-induced liver injury. *Toxicology* 75:221-234.
- Bailey RE. 2001. Global hexachlorobenzene emissions. *Chemosphere* 43:167-182.
- Bakale G, McCreary RD. 1990. Response of the k_e test to NCI/NTP-screened chemicals. I. Nongenotoxic carcinogens and genotoxic noncarcinogens. *Carcinogenesis* 11:1811-1818.
- *Baker EL. 1994. A review of recent research on health effects of human occupational exposure to organic solvents. *J Occup Med* 36(10):1079-1092.
- Balint GA. 1998. Possible role of endogenous prostacyclin in the maintenance of hepatic integrity in rat. *Exp Toxicol Pathol* 50(1):9-11.

9. REFERENCES

- Ban M, Hettich D, Bonnet P. 2003. Effect of inhaled industrial chemicals on systemic and local immune response. *Toxicology* 184:41-50.
- Bandi ZL, Ansari GA. 1989. Isolation of hydroxy fatty acids from livers of carbon tetrachloride-treated rats by thin-layer chromatography. *J Chromatogr* 475:461-466.
- Bang S, Myren J, Linnestad P, et al. 1992. Effect of the prostaglandin E2 analogue enprostil on the carbon tetrachloride-induced necrosis of liver cells in mice. *APMIS* 100(11):936-966.
- Barbee GC. 1994. Fate of chlorinated aliphatic hydrocarbons in the vadose zone and ground water. *Ground Water Monit Remed* 14:129-140.
- *Barber ED, Donish WH, Mueller KR. 1981. A procedure for the quantitative measurement of the mutagenicity of volatile liquids in the Ames Salmonella/microsome assay. *Mutat Res* 90:31-48.
- Barber LB, Thurman EM, Takahashi Y, et al. 1992. Comparison of purge and trap GC/MS and purgeable organic chloride analysis for monitoring volatile chlorinated hydrocarbons. *Ground Water* 30:836-842.
- *Barbin A, Bereziat J-C, Bartsch H. 1983. Evaluation of DNA damage by the alkaline elution technique in liver, kidneys and lungs of rats and hamsters treated with N-nitrosodialkylamines. *Carcinogenesis* 4(5):541-545.
- Barkley J, Bunch J, Bursey JT, et al. 1980. Computer analysis of volatile halogenated hydrocarbons in man and his environment -- a multimedia environmental study. *Biomed Mass Spectrom* 7:139-147.
- *Barnes DG, Dourson M. 1988. Reference dose (RfD): Description and use in health risk assessments. *Regul Toxicol Pharmacol* 8:471-486.
- *Barnes R, Jones RC. 1967. Carbon tetrachloride poisoning. *Am Ind Hyg Assoc J* 28:557-560.
- Barrow L, Tanner MS. 1989. The effect of carbon tetrachloride on the copper-laden rat liver. *Br J Exp Pathol* 70:9-19.
- *Bartosiewicz MJ, Jenkins D, Penn S, et al. 2001. Unique gene expression patterns in liver and kidney associated with exposure to chemical toxicants. *J Pharmacol Exp Ther* 297(3):895-905.
- Bascom R, Bromberg PA, Costa DA, et al. 1996. Health effects of outdoor air pollution. *Am J Respir Crit Care Med* 153(1):1996.
- Bastien M-C, Leblond F, Pichette V, et al. 2000. Differential alteration of cytochrome P450 isoenzymes in two experimental models of cirrhosis. *Can J Physiol Pharmacol* 78:912-919.
- Basu S. 1999. Oxidative injury induced cyclooxygenase activation in experimental hepatotoxicity. *Biochem Biophys Res Commun* 254(3):764-767.
- *Basu S. 2003. Carbon tetrachloride-induced lipid peroxidation: Eicosanoid formation and their regulation by antioxidant nutrients. *Toxicology* 189:113-127.

9. REFERENCES

- Batusic DS, Armbrust T, Saile B, et al. 2004. Induction of Mx-2 in rat liver by toxic injury. *J Hepatol* 40:446-453.
- Baumann M, Berauer M. 1985. Comparative study on the sensitivity of several serum enzymes in detecting hepatic damage in rats. *Arch Toxicol* 8 (Suppl.):370-372.
- Becker E, Messner B, Berndt J. 1987. Two mechanisms of CCl₄-induced fatty liver: Lipid peroxidation or covalent binding studied in cultured rat hepatocytes. *Free Rad Res Commun* 3:299-308.
- Beckonert O, Bollard ME, Ebbels TMD, et al. 2003. NMR-based metabonomic toxicity classification: Hierarchical cluster analysis and k-nearest-neighbour approaches. *Anal Chim Acta* 490:3-15.
- *Beddowes EJ, Faux SP, Chipman JK. 2003. Chloroform, carbon tetrachloride and glutathione depletion induce secondary genotoxicity in liver cells via oxidative stress. *Toxicology* 187:101-115.
- Bedossa P, Houghlum K, Trautwein C, et al. 1994. Stimulation of collagen α_1 (I) gene expression is associated with lipid peroxidation in hepatocellular injury: A link to tissue fibrosis. *Hepatology* 19:1262-1271.
- Beliveau M, Tardif R, Krishnan K. 2003. Quantitative structure-property relationships for physiologically based pharmacokinetic modeling of volatile organic chemicals in rats. *Toxicol Appl Pharmacol* 189(3):221-232.
- *Bell AN, Mehendale HM. 1985. The effect of dietary exposure to a mirex plus chlordane combination on CCl₄ hepatotoxicity. *Fundam Appl Toxicol* 5:679-687.
- *Bell AN, Mehendale HM. 1987. Comparative changes in hepatic DNA, RNA, protein, lipid, and glycogen induced by a subtoxic dose of CCl₄ in chlordane, mirex, and phenobarbital pretreated rats. *Toxicol Lett* 35:191-200.
- Bell J, Melcer H, Monteith H, et al. 1993. Stripping of volatile organic compounds at full-scale municipal wastewater treatment plants. *Water Environ Res* 65:708-716.
- *Bellar TA. 1989. Method 502.1. Volatile halogenated organic compounds in water by purge and trap gas chromatography. Cincinnati, OH: U.S. Environmental Protection Agency, Office of Research and Development.
- *Belyaev ND, Budker VC, Deriy LV, et al. 1992. Liver plasma membrane-associated fibroblast growth: Stimulatory and inhibitory activities during experimental cirrhosis. *Hepatology* 15:525-531.
- Bender AP, Parker DL, Johnson RA, et al. 1989. Minnesota highway maintenance worker study: Cancer mortality. *Am J Ind Med* 15:545-556.
- *Benedetti A, Fulceri R, Ferrali M, et al. 1982. Detection of carbonyl functions in phospholipids of liver microsomes in CCl₄- and BrCCl₃-poisoned rats. *Biochim Biophys Acta* 712:628-638.
- *Bengtsson F, Bugge M, Vagianos C, et al. 1987. Brain serotonin metabolism and behavior in rats with carbon tetrachloride-induced liver cirrhosis. *Res Exp Med* 187:429-438.

9. REFERENCES

- *Benigni R, Andreoli C, Conti L, et al. 1993. Quantitative structure–activity relationship models correctly predict the toxic and aneuploidizing properties of six halogenated methanes in *Aspergillus nidulans*. *Mutagenesis* 8(4):301-305.
- *Benson JM, Tibbetts BM, Thrall KD, et al. 2001. Uptake, tissue distribution, and fate of inhaled carbon tetrachloride: Comparison of rat, mouse, and hamster. *Inhal Toxicol* 13:207-217.
- *Berck B. 1974. Fumigant residues of carbon tetrachloride, ethylene dichloride, and ethylene dibromide in wheat, flour, bran, middlings, and bread. *J Agric Food Chem* 22:977-985.
- *Berger GS. 1994. Epidemiology of endometriosis. In: Berger GS, ed. *Endometriosis: Advanced management and surgical techniques*. New York, NY: Springer-Verlag.
- Berger ML, Sozen T. 1987. Rapid halogenated hydrocarbon toxicity in isolated hepatocytes is mediated by direct solvent effects. *Toxicology* 45:319-330.
- *Bergman K. 1983. Application and results of whole-body autoradiography in distribution studies of organic solvents. *CRC Crit Rev Toxicol* 12:59-118.
- *Berman E, House DE, Allis JW, et al. 1992. Hepatotoxic interactions of ethanol with allyl alcohol or carbon tetrachloride in rats. *J Toxicol Environ Health* 37:161-176.
- *Bermudez E, Mirsalis JC, Eales HC. 1982. Detection of DNA damage in primary cultures of rat hepatocytes following in vivo and in vitro exposure to genotoxic agents. *Environ Mutagen* 4:667-679.
- Bernacchi AS, Fernandez G, Villarruel MC, et al. 1988. Further studies on the late preventive effects of the anticarcinogen trifluoperazine on carbon tetrachloride-induced liver necrosis. *Exp Mol Pathol* 48:286-300.
- Bertelli A, Giovannini L, Bertelli AA, et al. 1986. Tissue concentrations of coenzyme Q in liver of rats intoxicated by carbon tetrachloride. *Int J Tissue React* 8:343-346.
- Bezerra JA, Laney DW, Degan SJF. 1994. Increased expression of mRNA for hepatocyte growth factor-like protein during liver regeneration and inflammation. *Biochem Biophys Res Commun* 203(1):666-673.
- *Bhathal PS, Rose NR, Mackay IR, et al. 1983. Strain differences in mice in carbon tetrachloride-induced liver injury. *Br J Exp Pathol* 64:524-533.
- *Bhattacharyya K. 1965. Foetal and neonatal responses to hepatotoxic agents. *J Path Bact* 90:151-161.
- *Bianchi AP, Varney MS, Phillips J. 1991. Analysis of volatile organic compounds in estuarine sediments using dynamic headspace and gas chromatography-mass spectrometry. *J Chromatogr* 542:413-450.
- Biasi F, Albano E, Chiarpotto E, et al. 1991. *In vivo* and *in vitro* evidence concerning the role of lipid peroxidation in the mechanism of hepatocyte death due to carbon tetrachloride. *Cell Biochem Func* 9:111-118.
- *Bickel M, Baader E, Brocks DG, et al. 1991. Beneficial effects of inhibitors of prolyl 4-hydroxylase in CCl₄-induced fibrosis of the liver in rats. *J Hepatology* 13:S26-S34.

9. REFERENCES

- *Biesel KW, Ehrinpreis MN, Bhathal PS, et al. 1984. Genetics of carbon tetrachloride-induced liver injury in mice. II. Multigenic regulation. *Br J Exp Pathol* 65:125-131.
- Blain RB, Reeves R, Ewald KA, et al. 1999. Susceptibility to chlordecone-carbon tetrachloride induced hepatotoxicity and lethality is both age and sex dependent. *Toxicol Sci* 50:280-286.
- Blair A, Decoufle P, Grauman D. 1979. Causes of death among laundry and dry cleaning workers. *Am J Public Health* 69:508-511.
- *Blair A, Hartge P, Stewart PA, et al. 1998. Mortality and cancer incidence of aircraft maintenance workers exposed to trichloroethylene and other organic solvents and chemicals: Extended follow up. *Occup Environ Med* 55:161-171.
- *Blair A, Stewart PA, Tolbert PE, et al. 1990. Cancer and other causes of death among a cohort of dry cleaners. *Br J Ind Med* 47:162-168.
- *Blair PC, Thompson MB, Wilson RE, et al. 1991. Correlation of changes in serum analytes and hepatic histopathology in rats exposed to carbon tetrachloride. *Toxicol Lett* 55:149-159.
- Blum DJW, Speece RE. 1991a. A database of chemical toxicity to environmental bacteria and its use in interspecies comparisons and correlations. *Res J Water Pollut Control Fed* 63:198-207.
- Blum DJW, Speece RE. 1991b. Quantitative structure-activity relationships for chemical toxicity to environmental bacteria. *Ecotoxicol Environ Saf* 22:198-224.
- Bogen KT. 1990. Risk extrapolation for chlorinated methanes as promoters vs initiators of multistage carcinogenesis. *Fundam Appl Toxicol* 15:536-557.
- *Bogers M, Appelman LM, Feron VJ, et al. 1987. Effects of the exposure profile on the inhalation toxicity of carbon tetrachloride in male rats. *J Appl Toxicol* 7:185-191.
- Boll M, Weber LWD, Becker E, et al. 2001a. Hepatocyte damage induced by carbon tetrachloride: Inhibited lipoprotein secretion and changed lipoprotein composition. *Z Naturforsch C* 56(3-4):283-290.
- Boll M, Weber LWD, Becker E, et al. 2001b. Mechanism of carbon tetrachloride-induced hepatotoxicity. Hepatocellular damage by reactive carbon tetrachloride metabolites. *Z Naturforsch C* 56:649-659.
- Boll M, Weber LWD, Becker E, et al. 2001c. Pathogenesis of carbon tetrachloride-induced hepatocyte injury: Bioactivation of CCL₄ by cytochrome P450 and effects on lipid homeostasis. *Z Naturforsch C* 56(1-2):111-121.
- *Bond GG, Flores GH, Shellenberger RJ, et al. 1986. Nested case-control study of lung cancer among chemical workers. *Am J Epidemiol* 124(1):53-66.
- Bond GG, McLaren EA, Sabel FL, et al. 1990. Liver and biliary tract cancer among chemical workers. *Am J Ind Med* 18:19-24.

9. REFERENCES

- Borzelleca JF, O'Hara TM, Gennings C, et al. 1990. Interactions of water contaminants. I. Plasma enzyme activity and response surface methodology following gavage administration of CCl₄ and CHCl₃ or TCE singly and in combination in the rat. *Fundam Appl Toxicol* 14:447-490.
- Bosch-Marce M, Morales-Ruiz M, Jimenez W, et al. 1998. Increased renal expression of nitric oxide synthase type III in cirrhotic rats with ascites. *Hepatology* 27(5):1191-1199.
- Bosma A, Brouwer A, Seifert WF, et al. 1988. Synergism between ethanol and carbon tetrachloride in the generation of liver fibrosis. *J Pathol* 156:15-21.
- Botta D, Dancelli E, Mantica E. 1994. A case history of contamination by polychloro-1,3-butadiene congeners. *Environ Sci Technol* 30:453-462.
- Boublik T, Fried V, Hala E. 1984. Untitled section. The vapour pressures of pure substances. Selected values of the temperature dependence of the vapour pressure of some pure substances in the normal and low pressure region, Vol. 17. 2nd revised ed. Amsterdam, The Netherlands: Elsevier, 111-112.
- Boucquey J-B, Renard P, Amerlynck P, et al. 1995. High-rate continuous biodegradation of concentrated chlorinated aliphatics by a durable enrichment of methanogenic origin carrier-dependent conditions. *Biotechnol Bioeng* 47(3):298-307.
- *Boutelet-Bochan H, Huang Y, Juchau MR. 1997. Expression of CYP2E1 during embryogenesis and fetogenesis in human cephalic tissues: Implications for the fetal alcohol syndrome. *Biochem Biophys Res Commun* 238(2):443-447.
- *Bove FJ, Fulcomer MC, Klotz JB, et al. 1992a. Population-based surveillance and etiological research of adverse reproductive outcomes and toxic wastes. Report on Phase IV-A: Public drinking water contamination and birthweight, fetal deaths, and birth defects. A cross-sectional study. New Jersey Department of Health.
- *Bove FJ, Fulcomer MC, Klotz JB, et al. 1992b. Population-based surveillance and etiologic research of adverse reproductive outcomes and toxic wastes. Report on Phase IV-B: Public drinking water contamination and birthweight, fetal deaths, and birth defects. A case-control study. New Jersey Department of Health.
- *Bove FJ, Fulcomer MC, Klotz JB, et al. 1995. Public drinking water contamination and birth outcomes. *Am J Epidemiol* 141(9):850-862.
- *Boyd MR, Statham CN, Longo NS. 1980. The pulmonary Clara cell as a target for toxic chemicals requiring metabolic activation; studies with carbon tetrachloride. *J Pharmacol Exp Ther* 212:109-114.
- Bozzelli J, Kebbekus BB. 1982. A study of some aromatic and halocarbon vapors in the ambient atmosphere of New Jersey. *J Environ Sci Technol* 9:833-838.
- Brady JF, Li D, Ishizaki H, et al. 1989. Induction of cytochromes P450IIE1 and P450IIB1 by secondary ketones and the role of P450IIE1 in chloroform metabolism. *Toxicol Appl Pharmacol* 100:342-349.
- *Brady JF, Xiao F, Wang M-H, et al. 1991. Effects of disulfiran on hepatic P450IIE1, other microsomal enzymes, and hepatotoxicity in rats. *Toxicol Appl Pharmacol* 108:366-373.

9. REFERENCES

- *Brambilla G, Carlo P, Finollo R, et al. 1983. Viscometric detection of liver DNA fragmentation in rats treated with minimal doses of chemical carcinogens. *Cancer Res* 43:202-209.
- *Brams A, Buchet JP, Crutzen-Fayt MC, et al. 1987. A comparative study, with 40 chemicals, of the efficiency of the Salmonella assay and the SOS chromotest (kit procedure). *Toxicol Lett* 38:123-133.
- Brandom WF, McGavran L, Bistline RW, et al. 1990. Sister chromatid exchanges and chromosome aberration frequencies in plutonium workers. *Int J Radiat Biol* 58:195-207.
- Brattin WJ, Glende EA Jr., Recknagel RD. 1985. Pathological mechanisms in carbon tetrachloride hepatotoxicity. *J Free Radical Biol Med* 1:27-38.
- Brattin WJ, Pencil SD, Waller RL, et al. 1984. Assessment of the role of calcium ion in halocarbon hepatotoxicity. *Environ Health Perspect* 57:321-323.
- *Brennan RJ, Schiestl RH. 1998. Chloroform and carbon tetrachloride induce intrachromosomal recombination and oxidative free radicals in *Saccharomyces cerevisiae*. *Mutat Res* 397:271-278.
- Brent JA, Rumack BH. 1993. Role of free radicals in toxic hepatic injury II. Are free radicals the cause of toxin-induced liver injury? *Clin Toxicol* 31:173-196.
- Briggs GG. 1973. A simple relationship between soil adsorption of organic chemicals and their octanol/water partition coefficients. *Proceedings of the 7th British Insecticide Fungicide Conference*, 83-86.
- Brittebo EB, Brandt I. 1989. Metabolic activation of carbon tetrachloride by the cervico-vaginal epithelium in rodents. *Pharmacol Toxicol* 65:336-342.
- *Brittebo EB, Eriksson C, Brandt I. 1990. Metabolic activation of halogenated hydrocarbons in the conjunctival epithelium and excretory ducts of the intraorbital lacrimal gland in mice. *New York, NY: Academic Press*, 245-252.
- *Brodzinski R, Singh HB. 1983. Volatile organic chemicals in the atmosphere: An assessment of available data. Research Triangle Park, NC: U.S. Environmental Protection Agency, Office of Research and Development. EPA600/3-83/027(A).
- *Brondeau MT, Bonnet P, Guenier JP, et al. 1983. Short-term inhalation test for evaluating industrial hepatotoxicants in rats. *Toxicol Lett* 19:139-146.
- *Brondeau MT, Coulais C, de Ceaurriz J. 1991. Difference in liver and serum malathion carboxylesterase and glucose-6-phosphatase in detecting carbon tetrachloride-induced liver damage in rats. *J Appl Toxicol* 11:433-435.
- *Brown KW, Donnelly KC. 1988. An estimation of risk associated with the organic constituents of hazardous and municipal waste landfill leachates. *Hazardous Waste and Hazardous Materials* 5(1):1-30.
- Brown SK, Sim MR, Abramson, et al. 1994. Concentrations of volatile organic compounds in indoor air- A review. *Indoor Air* 4:123-134.

9. REFERENCES

- *Bruccoleri A, Gallucci R, Germolec DR, et al. 1997. Induction of early-immediate genes by tumor necrosis factor alpha contribute to liver repair following chemical-induced hepatotoxicity. *Hepatology* 25(1):133-141.
- *Bruckner JV, Kim HJ, Muralidhara S, et al. 1990. Influence of route and pattern exposure on the pharmacokinetics and hepatotoxicity of carbon tetrachloride. In: Gerrity TR, Henry CJ, eds. *Principle of route to route extrapolation for risk assessment*. New York, NY: Elsevier Science Publishing Co., Inc., 271-284.
- *Bruckner JV, Luthra R, Kyle GM, et al. 1984. Influence of time of exposure to carbon tetrachloride on toxic liver injury. *Ann Rev Chronopharmacol* 1:373-376.
- *Bruckner JV, MacKenzie WF, Muralidhara S, et al. 1986. Oral toxicity of carbon tetrachloride: Acute, subacute and subchronic studies in rats. *Fundam Appl Toxicol* 6:16-34.
- Bruckner JV, Ramanathan R, Lee KM, et al. 2002. Mechanisms of circadian rhythmicity of carbon tetrachloride hepatotoxicity. *J Pharmacol Exp Ther* 300(1):273-281.
- Brunke EG, Allen RJ. 1988. Tropospheric background measurements of CFCl_3 , CH_3CCl_3 , and CCl_4 at Cape Point, South Africa, and their long-term trends. *South African J Sci* 84:266-270.
- *Brzezinski MR, Boutelet-Bochan H, Person RE, et al. 1999. Catalytic activity and quantitation cytochrome P-450 2E1 in prenatal human brain. *J Pharmacol Exp Ther* 289:1648-1653.
- *Buhler R, Lindros KO, Nordling A, et al. 1992. Zonation of cytochrome P450 isozyme expression and induction in rat liver. *Eur J Biochem* 204(1):407-412.
- Bull RJ, Sasser LB, Lei XC. 2004. Interactions in the tumor-promoting activity of carbon tetrachloride, trichloroacetate, and dichloroacetate in the liver of male B6C3F1 mice. *Toxicology* 199:169-183.
- Bullister JL, Wesegarver DP. 1998. The solubility of carbon tetrachloride in water and seawater. 45:1285-1302.
- Burk RF, Reiter R, Lane JM. 1986. Hyperbaric oxygen protection against carbon tetrachloride hepatotoxicity in the rat. Association with altered metabolism. *Gastroenterol* 90:812-818.
- *Burkhart KK, Hall AH, Gerace R, et al. 1991. Hyperbaric oxygen treatment for carbon tetrachloride poisoning. *Drug Safety* 6:332-338.
- Butler TC. 1961. Reduction of carbon tetrachloride *in vivo* and reduction of carbon tetrachloride and chloroform *in vitro* by tissues and tissue constituents. *J Pharmacol Exper Therap* 134:311-319.
- *C&EN. 1992. Production by the U.S. Chemical Industry. *Chemical and Engineering News*, June 29, 1992, 36.
- *C&EN. 1993. Production by the U.S. Chemical Industry. *Chemical and Engineering News*, June 28, 1993.
- Cabre M, Camps J, Paternain JL, et al. 2000. Time-course of changes in hepatic lipid peroxidation and glutathione metabolism in rats with carbon tetrachloride-induced cirrhosis. *Clin Exp Pharmacol Physiol* 27:694-699.

9. REFERENCES

- *Cagen SZ, Klaassen CD. 1979. Hepatotoxicity of carbon tetrachloride in developing rats. *Toxicol Appl Pharmacol* 50:347-354.
- *Cai Z, Mehendale HM. 1990. Lethal effects of CCl₄ and its metabolism by Mongolian gerbils pretreated with chlordecone, phenobarbital, or mirex. *Toxicol Appl Pharmacol* 104:511-520.
- *Cai Z, Mehendale HM. 1991a. Hepatotoxicity and lethality of halomethanes in Mongolian gerbils pretreated with chlordecone, phenobarbital or mirex. *Arch Toxicol* 65:204-212.
- *Cai Z, Mehendale HM. 1991b. Prestimulation of hepatocellular regeneration by partial hepatectomy decreases toxicity of carbon tetrachloride in gerbils. *Biochem Pharmacol* 42:633-644.
- *Cai Z, Mehendale HM. 1993. Resiliency to amplification of carbon tetrachloride hepatotoxicity by chlordecone during postnatal development in rats. *Pediatr Res* 33:225-232.
- *Calabrese EJ, Baldwin LA, Leonard DA, et al. 1995. Decrease in hepatotoxicity by lead exposure is not explained by its mitogenic response. *J Appl Toxicol* 15(2):129-132.
- *Calabrese EJ, Baldwin LA, Mehendale HM. 1993. Contemporary issues in toxicology. G₂ subpopulation in rat liver induced into mitosis by low-level exposure to carbon tetrachloride: An adaptive response. *Toxicol Appl Pharmacol* 121:1-7.
- Calleja MC, Geladi P, Persoone G, et al. 1994. Modelling of human acute toxicity from physicochemical properties and non-vertebrate acute toxicity of the 38 organic chemicals of the MEIC priority list by PLS regression and neural network. *Food Chem Toxicol* 32(10):923-941.
- *Callen DF, Wolf CR, Philpot RM. 1980. Cytochrome P-450 mediated genetic activity and cytotoxicity of seven halogenated aliphatic hydrocarbons in *Saccharomyces cerevisiae*. *Mutat Res* 77:55-63.
- *Cambron-Gros C, Deltour P, Boigegrain R-A, et al. 1986. Radical activation of carbon tetrachloride in foetal and maternal rat liver microsomes. *Biochem Pharmacol* 35(12):2041-2044.
- *Campo GM, Avenoso A, Campo S, et al. 2004. Hyaluronic acid and chondroitin-4-sulphate treatment reduces damage in carbon tetrachloride-induced acute rat liver injury. *Life Sci* 74:1289-1305.
- *Camps J, Bargallo T, Gimenez A, et al. 1992. Relationship between hepatic lipid peroxidation and fibrogenesis in carbon tetrachloride-treated rats: Effect of zinc administration. *Clin Sci* 83:695-700.
- *Cantor KP, Stewart PA, Brinton LA, et al. 1995. Occupational exposures and female breast cancer mortality in the United States. *J Occup Environ Med* 37(3):336-348.
- Capurro PU. 1979. Cancer in a community subject to air pollution by solvent vapors. *Clin Toxicol* 14:285-294.
- Carakostas MC, Gossett KA, Church GE, et al. 1986. Evaluating toxin-induced hepatic injury in rats by laboratory results and discriminant analysis. *Vet Pathol* 23:264-269.
- Carlson GP. 1989. Effect of ethanol, carbon tetrachloride, and methyl ethyl ketone on butanol oxidase activity in rat lung and liver. *J Toxicol Environ Health* 27:255-261.

9. REFERENCES

Carpenter AV, Flanders WD, Frome EL, et al. 1988. Chemical exposures and central nervous system cancers: A case-control study among workers at two nuclear facilities. *Am J Ind Med* 13:351-362.

*Carpenter SP, Lasker JM, Raucy JL. 1996. Expression, induction, and catalytic activity of the ethanol-inducible cytochrome P450 (CYP2E1) in human fetal liver and hepatocytes. *Mol Pharmacol* 49:260-268.

Carpenter SP, Savage DD, Schultz ED, et al. 1997. Ethanol-mediated transplacental induction of CYP2E1 in fetal rat liver. *J Pharmacol Exp Ther* 282:1028-1036.

*Castilla-Cortazar I, Garcia M, Mugerza B, et al. 1997. Hepatoprotective effects of insulin-like growth factor I in rats with carbon tetrachloride-induced cirrhosis. *Gastroenterology* 113(5):1682-1691.

*Castillo T, Koop DR, Kamimura S, et al. 1992. Role of cytochrome P-450 2E1 in ethanol-, carbon tetrachloride- and iron-dependent microsomal lipid peroxidation. *Hepatology* 16(4):992-996.

Castro JA, Diaz-Gomez MI. 1972. Studies on the irreversible binding of ¹⁴C-Carbon tetrachloride to microsomal lipids in rats under varying experimental conditions. *Toxicol Appl Pharmacol* 23:541-552.

*Castro GD, Diaz Gomez MI, Castro JA. 1989. Species differences in the interaction between CCl₄ reactive metabolites and liver DNA or nuclear protein fractions. *Carcinogenesis* 10(2):289-294.

Castro GD, Diaz-Gomez MI, Castro JA. 1990. Biotransformation of carbon tetrachloride and lipid peroxidation promotion by liver nuclear preparations from different animal species. *Cancer Lett* 53:9-15.

*Castro GD, Diaz Gomez MI, Castro JA. 1997. DNA bases attack by reactive metabolites produced during carbon tetrachloride biotransformation and promotion of liver microsomal lipid peroxidation. *Res Commun Mol Pathol Pharmacol* 95(3):253-258.

Castro GD, López AJ, Petricio AR, et al. 1986. Effect of the pretreatment with pyrazole, cystamine or diphenyl-P-phenylenediamine (DPPD) on the CCl₄-promoted pentane evolution in rats. *Res Commun Chem Pathol Pharmacol* 52:137-140.

Castro GD, Simpson JT, Castro JA. 1994. Interaction of trichloromethyl free radicals with thymine in a model system: A mass spectrometric study. *Chem Biol Interact* 90:13-22.

*Castro JA, de Ferreyra EC, de Castro CR, et al. 1973. Studies on the mechanism of cystamine prevention of several liver structural and biochemical alterations caused by carbon tetrachloride. *Toxicol Appl Pharmacol* 24:1-19.

*CDC/ATSDR. 1990. Biomarkers of organ damage or dysfunction for the renal, hepatobiliary and immune systems. Atlanta, GA: CDC/ATSDR Subcommittee on Biomarkers of Organ Damage and Dysfunction, Centers for Disease Control, Agency for Toxic Substances and Disease Registry. Summary report, August 27, 1990.

CDHS. 1988. Notice of proposed rulemaking. June 23. Sacramento, CA: California Department of Health Services.

*Cedillo A, Mourelle M, Muriel P. 1996. Effect of colchicine and trimethylcolchicinic acid on CCl₄-induced cirrhosis in the rat. *Pharmacol Toxicol* 79(5):241-246.

9. REFERENCES

- *CEH. 1985. CEH product review. Chlorinated methanes. Chemical economic handbook-SRI International, 635.2020A-635.2022B.
- Cessi C, Colombini C, Mameli L. 1966. The reaction of liver proteins with a metabolite of carbon tetrachloride. *Biochem J* 101:46c-47c.
- Chadwick RW, Copeland MF, Carlson GP, et al. 1988. Comparison of *in vivo* and *in vitro* methods for assessing the effects of carbon tetrachloride on the hepatic drug-metabolizing enzyme system. *Toxicol Lett* 42:309-316.
- Chamuleau RA, Creighton JH, De Nie I, et al. 1988. Is the magnetic resonance imaging proton spin-lattice relaxation time a reliable noninvasive parameter of developing liver fibrosis. *Hepatology* 8:217-221.
- Chamultirat W, Jordan SJ, Mason RP. 1994. Nitric oxide production during endotoxic shock in carbon tetrachloride-treated rats. *Mol Pharmacol* 46(2):391-397.
- *Chandler FA. 1936. The use of carbon tetrachloride in the removal of adhesive tape. Report of a near fatal case. *J Am Med Assoc* 107:2121.
- *Chandler AC, Chopra RN. 1926. Effects of the administration of sugar, magnesium sulfate, sodium citrate and dilute acid on the liver damage done by carbon tetrachloride. *Ind J Med Res* 14:219-226.
- Chang IM. 1998. Liver-protective activities of aucubin derived from traditional oriental medicine. *Res Commun Mol Pathol Pharmacol* 102(2):189-204.
- *Chapman K, Prabhudesai M, Erdman JW. 1992. Effects of ethanol and carbon tetrachloride upon vitamin A status of rats. *Alcoholism: Clinical and Experimental Research* 16:764-768.
- Charbonneau M, Couture J, Plaa GL. 1991. Inhalation versus oral administration of acetone: Effect of the vehicle on the potentiation of CCl₄-induced liver injury. *Toxicol Lett* 57:47-54.
- *Charbonneau M, Oleskevich S, Brodeur J, et al. 1986. Acetone potentiation of rat liver injury induced by trichloroethylene-carbon tetrachloride mixtures. *Fundam Appl Toxicol* 6:654-661.
- Charbonneau M, Tuchweber B, Plaa GL. 1986. Acetone potentiation of chronic liver injury induced by repetitive administration of carbon tetrachloride. *Hepatology* 6(4):694-700.
- *Chatterjee A. 1966. Testicular degeneration in rats by carbon tetrachloride intoxication. *Experientia* 226:395-396.
- *Chaudhary AK, Nokubo M, Reddy GR, et al. 1994. Detection of endogenous malondialdehyde-deoxyguanosine adducts in human liver. *Science* 265(5178):1580-1582.
- Chaudhury S, Mehendale HM. 1991. Amplification of CCl₄ toxicity by chlordecone: Destruction of rat hepatic microsomal cytochrome P-450 subpopulation. *J Toxicol Environ Health* 32:277-294.
- *Checkoway H, Wilcosky T, Wolf P, et al. 1984. An evaluation of the associations of leukemia and rubber industry solvent exposures. *Am J Ind Med* 5(3):239-249.

9. REFERENCES

- Chen JD, Wang JD, Jang JP, et al. 1991. Exposure to mixtures of solvents among paint workers and biochemical alterations of liver function. *Br J Ind Med* 48:696-701.
- Chen WJ, Chi EY, Smuckler EA. 1977. Carbon tetrachloride-induced changes in mixed function oxidases and microsomal cytochromes in the rat lung. *Lab Invest* 36:388-394.
- *Chiarpotto E, Biasi F, Comoglio A, et al. 1990. CCl₄-induced increase of hepatocyte free arachidonate level: Pathogenesis and contribution to cell death. *Chem Biol Interact* 74:195-206.
- *Chiu PY, Tang MH, Mak DHF, et al. 2003. Hepatoprotective mechanism of schisandrin B: Role of mitochondrial glutathione antioxidant status and heat shock proteins. *Free Radic Biol Med* 35(4):368-380.
- Choi-Miura N-H, Otsuyama K, Sano Y, et al. 2001. Hepatic injury-specific conversion of mouse plasma hyaluronan binding protein to the active hetero-dimer form. *Biol Pharm Bull* 24(8):892-896.
- *Cholbi MR, Paya M, Alearaz MJ. 1991. Inhibitory effects of phenolic compounds on CCl₄-induced microsomal lipid peroxidation. *Research Articles* 47:195-199.
- Christenson WR, Davis ME, Berndt WO. 1989. Effect in the rat of the interaction of dichloromaleic acid and carbon tetrachloride on renal and hepatic function. *Fundam Appl Toxicol* 13:493-499.
- *Chung F-L, Nath RG, Ocando J, et al. 2000. Deoxyguanosine adducts of t-4-hydroxy-2-nonal are endogenous DNA lesions in rodents and humans: Detection and potential sources. *Cancer Res* 60:1507-1511.
- *Clair P, Tua M, Simian H. 1991. Capillary columns in series for GC analysis of volatile organic pollutants in atmospheric and alveolar air. *J High Resolut Chromatogr* 14:383-387.
- Clawson GA. 1989. Mechanisms of carbon tetrachloride hepatotoxicity. *Pathol Immunopathol Res* 8:104-112.
- Clawson GA, Blankenship LJ, Rhame JG, et al. 1992. Nuclear enlargement induced by hepatocarcinogens alters ploidy. *Cancer Res* 52:1304-1308.
- Clawson GA, MacDonald JR, Woo CH. 1987. Early hypomethylation of 2'-O-ribose moieties in hepatocyte cytoplasmic ribosomal RNA underlies the protein synthetic defect produced by CCl₄. *J Cell Biol* 105:705-711.
- *Clewell HJ III, Andersen ME. 1985. Risk assessment extrapolations and physiological modeling. *Toxicol Ind Health* 1(4):111-131
- *Cohen MM. 1957. Central nervous system in carbon tetrachloride intoxication. *Neurology* 7:238-244.
- Cohen MA, Ryan PB, Spengler JD. 1991. Source-receptor study of volatile organic compounds and particulate matter in the Kanawha Valley, WV—II. Analysis of factors contributing to VOC and particle exposures. *Atmos Environ* 25B:95-107.
- Cohen MA, Ryan PB, Yanagisawa Y, et al. 1989. Indoor/outdoor measurements of volatile organic compounds in the Kanawha Valley of West Virginia. *JAPCA* 39:1086-1093.

9. REFERENCES

- Cohen S, Svrjcek A, Durborrow T, et al. 1999. Ground water quality Water quality impacts by golf courses. *J Environ Qual* 28:798-809.
- *Colborn T, Clement C. 1992. Chemically induced alterations in sexual and functional development. The Wildlife/Human Connection. In: *Advances in modern environmental toxicology*. Volume XXI. Princeton, NJ: Princeton Scientific Publishing Co.
- Colby HD, Purcell H, Kominami S, et al. 1994. Adrenal activation of carbon tetrachloride: Role of microsomal P450 isozymes. *Toxicology* 94:31-40.
- Coleman JB, Condie LW, Lamb RG. 1988. The role of CCl₄ biotransformation in the activation of hepatocyte phospholipase C *in vivo* and *in vitro*. *Toxicol Appl Pharmacol* 95:208-219.
- Columbano A, Ledda-Columbano GM, Ennas MG, et al. 1990. Cell proliferation and promotion of rat liver carcinogenesis: Different effect of hepatic regeneration and mitogen induced hyperplasia on the development of enzyme-altered foci. *Carcinogenesis* 11:771-776.
- Columbano A, Rajalakshmi S, Sarma DSR. 1981. Requirement of cell proliferation for the initiation of liver carcinogenesis as assayed by three different procedures. *Cancer Res* 41:2079-2083.
- *Comporti M. 1985. Biology of disease: Lipid peroxidation and cellular damage in toxic liver injury. *Lab Invest* 53(6):599-623.
- Comporti M. 1989. Three models of free radical-induced cell injury. *Chem Biol Interact* 72:1-56.
- *Conaway HB, Hoven F. 1946. Electrocardiographic changes in carbon tetrachloride poisoning. *U.S. Navy Med Bull* 46:593-595.
- *Condie LW, Laurie RD, Mills T, et al. 1986. Effect of gavage vehicle on hepatotoxicity of carbon tetrachloride in CD-1 mice: corn oil versus Tween-60 aqueous emulsion. *Fundam Appl Toxicol* 7:199-206.
- Connor HD, Lacagnin LB, Knecht KT, et al. 1989. Reaction of glutathione with a free radical metabolite of carbon tetrachloride. *Mol Pharmacol* 37:443-451.
- Connor HD, Thurman RG, Chen G, et al. 1998. Clarification of the relationship between free radical spin trapping and carbon tetrachloride metabolism in microsomal systems. *Free Radic Biol Med* 24(9):1364-1368.
- *Connor HD, Thurman RG, Galizi MD, et al. 1986. The formation of a novel free radical metabolite from CCl₄ in the perfused rat liver and *in vivo*. *J Biol Chem* 261:4542-4548.
- *Cornish HH, Adefuin J. 1966. Ethanol potentiation of halogenated aliphatic solvent toxicity. *Am Ind Hyg Assoc J* 27:57-61.
- *Cornish HH, Ling BP, Barth ML. 1973. Phenobarbital and organic solvent toxicity. *Am Ind Hyg Assoc J* 34:487-492.
- Corsi RL, Chang DP, Schroeder ED, et al. 1987. Emissions of volatile and potentially toxic organic compounds from municipal wastewater treatment plants. Presented at the 80th annual meeting of the APCA. New York, NY: Air Pollution Control Association.

9. REFERENCES

- Cotrim HP, Andrade ZA, Parana R, et al. 1999. Nonalcoholic steatohepatitis: A toxic liver disease in industrial workers. *Liver* 19:299-304.
- Cotson R, Williams T. 1982. Headspace chromatographic determination of water pollutants. *Anal Chem* 54:942.
- *Coutino RR. 1979. Analysis of anaphase in cell culture: An adequate test system for the distinction between compounds which selectively alter the chromosome structure or the mitotic apparatus. *Environ Health Perspect* 31:131-136.
- *Cox RA, Derwent RG, Eggleton AEJ. 1976. Photochemical oxidation of halocarbons in the troposphere. *Atmos Environ* 10:305-308.
- *Craddock VM, Henderson AR. 1978. De novo and repair replication of DNA in liver of carcinogen-treated animals. *Cancer Res* 38:2135-2143.
- *Crebelli R, Carere A, Leopardi P, et al. 1999. Evaluation of 10 aliphatic halogenated hydrocarbons in the mouse bone marrow micronucleus test. *Mutagenesis* 14(2):207-215.
- Criddle CS, McCarty PL. 1991. Electrolytic model system for reductive dehalogenation in aqueous environments. *Environ Sci Technol* 25:973-978.
- Criddle CS, DeWitt JT, Grbic-Galic D, et al. 1990. Transformation of carbon tetrachloride by *pseudomonas sp.* strain KC under denitrification conditions. *Appl Environ Microbiol* 56:3240-3246.
- *CRISP. 1993. Computer Retrieval of Information on Scientific Projects. National Institutes of Health, Division of Research Grants. Bethesda, MD: May 15, 1993.
- *Crist HL, Mitchell WJ. 1986. Field audit results with organic gas standards on volatile organic ambient air samplers equipped with Texas GC. *Environ Sci Technol* 20:1260-1262.
- *Croen LA, Shaw GM, Sanbonmatsu L, et al. 1997. Maternal residential proximity to hazardous waste sites and risk for selected congenital malformations. *Epidemiology* 8:347-354.
- *Cruz C, Ibarra-Rubio ME, Pedraza-Chaverri J. 1993. Circulating levels of active, total and inactive renin (prorenin), angiotensin-I and angiotensinogen in carbon tetrachloride-treated rats. *Clin Exp Pharmacol Physiol* 30:83-88.
- Cunnane SC. 1987. Hepatic triacylglycerol accumulation induced by ethanol and carbon tetrachloride: Interactions with essential fatty acids and prostaglandins. *Alcoholism Clin Exp Res* 11:25-31.
- Currier AR, Sabla G, Locaputo S, et al. 2003. Plasminogen directs the pleiotropic effects of uPA in liver injury and repair. *Am J Physiol* 284:G508-G515.
- *Curtis GP, Reinhard M. 1992. Reductive dehalogenation of hexachlorethane, carbon tetrachloride and bromoform by anthrahydroquinone disulfonate and humic acid. *Abstr Pap Am Chem Soc* 203:91.
- *Curtis LR, Williams WL, Mehendale HM. 1979. Potentiation of the hepatotoxicity of carbon tetrachloride following preexposure to chlordecone (kepone) in the male rat. *Toxicol Appl Pharmacol* 51:283-293.

9. REFERENCES

- Cutrin C, Menino J, Carballo C, et al. 1994. Nifedipine in rat liver cirrhosis. *Vet Hum Toxicol* 36(1):13-17.
- Cutrin C, Menino MJ, Otero X, et al. 1992. Effect of nifedipine and S-adenosylmethionine in the liver of rats treated with CCl₄ and ethanol for one month. *Life Sci* 51:113-118.
- *Czaja MJ, Xu J, Alt E. 1995. Prevention of carbon tetrachloride-induced rat liver injury by soluble tumor necrosis factor receptor. *Gastroenterology* 108(6):1849-1854.
- Dabeva MD, Alpini G, Hurston E, et al. 1993. Models of hepatic progenitor cell activation. *Proc Soc Exp Biol Med* 204(3):242-252.
- *Dai Y, Cederbaum AI. 1995. Inactivation and degradation of human cytochrome P4502E1 by CCl₄ in a transfected HepG2 cell line. *J Pharmacol Exp Ther* 275:1614-1622.
- Daft JL. 1989. Determination of fumigants and related chemicals in fatty and nonfatty foods. *J Agric Food Chem* 37:560-564.
- *Daft JL. 1991. Fumigants and related chemicals in foods: Review of residue findings, contamination sources and analytical methods. *Sci Total Environ* 100:501-518.
- Dalu A, Mehendale HM. 1996. Efficient tissue repair underlies the resiliency of postnatally developing rats to chlordecone + CCL₄ hepatotoxicity. *Toxicology* 111(1-3):29-42.
- Dalu A, Rao PS, Mehendale HM. 1998. Colchicine antimitosis abolishes resiliency of postnatally developing rats to chlorecone-amplified carbon tetrachloride hepatotoxicity and lethality. *Environ Health Perspect* 106(9):597-606.
- Dalu A, Warbritton A, Bucci TJ, et al. 1995. Age-related susceptibility to chlordecone-potentiated carbon tetrachloride hepatotoxicity and lethality is due to hepatic quiescence. *Pediatr Res* 38(2):140-148.
- *Dambrauskas T, Cornish HH. 1970. Effect of pretreatment of rats with carbon tetrachloride on tolerance development. *Toxicol Appl Pharmacol* 17:83-97.
- *Danni O, Aragno M, Tamagno E, et al. 1992. In vivo studies on halogen compound interactions. IV. Interaction among different halogen derivatives with and without synergistic action on liver toxicity. *Res Commun Chem Pathol Pharmacol* 76(3):355-366.
- Danni O, Aragno M, Ugazio G. 1988. *In vivo* studies on halogen compound interactions. *Res Commun Chem Pathol Pharmacol* 61:377-390.
- *Dashti HM, Al-Sayer H, Behbehani A, et al. 1992. Liver cirrhosis induced by carbon tetrachloride and the effects of superoxide dismutase and xanthine oxidase inhibitor treatment. *J R Coll Surg Edinb* 37:23-28.
- da Silva Augusto LG, Lieber SR, Ruiz MA, et al. 1997. Micronucleus monitoring to assess human occupational exposure to organochlorides. *Environ Mol Mutagen* 29:46-52.

9. REFERENCES

- *Date M, Matsuzaki K, Matsushita M, et al. 1998. Differential expression of transforming growth factor-beta and its receptors in hepatocytes and nonparenchymal cells of rat liver after CCl₄ administration. *J Hepatol* 28(4):572-581.
- *David A, Frantik E, Holusa R, et al. 1981. Role of time and concentration on carbon tetrachloride toxicity in rats. *Int Arch Occup Environ Health* 48:49-60.
- *Davis DD, Schmidt JF, Neeley CM, et al. 1975. Effect of wavelength in the gas-phase photolysis of carbon tetrachloride at 253.7, 184.9, 147, and 106.7 nm. *J Phys Chem* 79:11-17.
- *Dawkins MJR. 1963. Carbon tetrachloride poisoning in the liver of the new-born rat. *J Pathol Bact* 85:189-196.
- *Day WW, Weiner M. 1991. Short communications: Inhibition of hepatic drug metabolism and carbon tetrachloride toxicity in Fischer-344 rats by exercise. *Biochem Pharmacol* 42:181-184.
- *Dean BJ, Hodson-Walker G. 1979. An *in vitro* chromosome assay using cultured rat-liver cells. *Mutat Res* 64:329-337.
- *de Best JH, Salminen E, Doddema HJ, et al. 1998. Transformation of carbon tetrachloride under sulfate reducing conditions. *Biodegradation* 8(6):429-436
- De Bleser PJ, Scott CD, Niki T, et al. 1996. Insulin-like growth factor II/mannose 6-phosphate-receptor expression in liver and serum during acute CCl₄ intoxication in the rat. *Hepatology* 23(6):1530-1537.
- De Bleser PJ, Xu G, Rombouts K, et al. 1999. Glutathione levels discriminate between oxidative stress and transforming growth factor-B signaling in activated rat hepatic stellate cells. *J Biol Chem* 274(48):33881-33887.
- *De Castro CR, Bernacchi AS, De Ferreyra EC, et al. 1978. Carbon tetrachloride induced ultrastructural alterations in pancreatic acinar cells and in the hepatocytes. Similarities and differences. *Toxicology* 11:289-296.
- DeCicco LA, Rikans LE, Tutor CG, et al. 1998. Serum and liver concentrations of tumor necrosis factor alpha and interleukin-1beta following the administration of carbon tetrachloride to male rats. *Toxicol Lett* 98(1-2):115-121.
- *Deer HM, McJilton CE, Harein PK. 1987. Respiratory exposure to grain inspection workers to carbon tetrachloride fumigant. *Am Ind Hyg Assoc J* 48:586-593.
- *de Ferreyra EC, Castro JA, Diaz Gomez MI. 1974. Prevention and treatment of carbon tetrachloride hepatotoxicity by cysteine: Studies about its mechanism. *Toxicol Appl Pharmacol* 27:558-568.
- *De Flora S. 1981. Study of 106 organic and inorganic compounds in the *salmonella*/microsome test. *Carcinogenesis* 2(4):283-298.
- *De Flora S, Znacchi P, Camoirano A, et al. 1984. Genotoxic activity and potency of 135 compounds in the Ames reversion test and in a bacterial DNA-repair test. *Mutat Res* 133:161-198.
- *De Groot H, Haas W. 1980. O₂-independent damage of cytochrome P450 by CCl₄-metabolites in hepatic microsomes. *FEBS Lett* 115(2):253-265.

9. REFERENCES

- *De Groot H, Haas W. 1981. Self-catalysed, O₂-independent inactivation of NADPH- or dithionite-reduced microsomal cytochrome P-450 by carbon tetrachloride. *Biochem Pharmacol* 30(16):2343-2347.
- DeGroot H, Noll T. 1989. Halomethane hepatotoxicity: Induction of lipid peroxidation and inactivation of cytochrome P-450 in rat liver microsomes under low oxygen partial pressures. *Toxicol Appl Pharmacol* 97:530-537.
- Delaney B, Kaminski NE. 1993. Induction of serum-borne immunomodulatory factors in B6C3F1 mice by carbon tetrachloride. I. Carbon tetrachloride-induced suppression of helper T-lymphocyte function is mediated by a serum borne factor. *Toxicology* 85:67-84.
- *Delaney B, Strom SC, Collins S, et al. 1994. Carbon tetrachloride suppresses T-cell-dependent immune responses by induction of transforming growth factor- β 1. *Toxicol Appl Pharmacol* 126:98-107.
- DeLeon IR, Overton EB, Raschke CK, et al. 1980. Rapid gas chromatographic method for the determination of volatile and semivolatile organochlorine compounds in soil and chemical waste disposal site samples. *J Chromatogr Sci* 18:85-88.
- Delic JJ, Lilly PD, MacDonald AJ, et al. 2000. The utility of PBPK in the safety assessment of chloroform and carbon tetrachloride. *Regul Toxicol Pharmacol* 32:144-155.
- Deliconstantinos G, Mykoniatis M, Papadimitriou D. 1986. Carbon tetrachloride modulates the rat hepatic microsomal UDP-glucuronyl transferase activity and membrane fluidity. *Experientia* 42:181-183.
- *Della Porta GD, Terracini B, Shubik P. 1961. Induction with carbon tetrachloride of liver cell carcinomas in hamsters. *J Natl Cancer Inst* 26:855-863.
- DeLorey DC, Cronn DR, Farmer JC. 1988. Tropospheric latitudinal distributions of CF₂Cl₂, CFCl₃, N₂O, CH₃CCl₃, and CCl₄ over the remote Pacific Ocean. *Atmos Environ* 22:1481-1494.
- Deng JF, Wang JD, Shih TS, et al. 1987. Outbreak of carbon tetrachloride poisoning in a color printing factory related to the use of isopropyl alcohol and air conditioning systems in Taiwan. *Am J Ind Med* 12:11-19.
- *Dennis KJ, Ichinose T, Miller M. 1993. Gas chromatographic determination of vapor-phase biomarkers formed from rats dosed with CCl₄. *J Appl Toxicol* 13(4):301-303.
- *Desaiah D, Pentyala SN, Trotman CH, et al. 1991. Combined effects of carbon tetrachloride and chlordecone on calmodulin activity in gerbil brain. *J Toxicol Environ Health* 34:219-228.
- *De Toranzo EG, Diaz Gomez MI, Castro JA. 1978a. Carbon tetrachloride activation, lipid peroxidation and liver necrosis in different strains of mice. *Res Commun Chem Pathol Pharmacol* 19:347-352.
- *De Toranzo EG, Villarruel MC, Castro JA. 1978b. Early destruction of cytochrome P-450 in testis of carbon tetrachloride poisoned rats. *Toxicology* 10:39-44.
- DeWulf J, Vanlangenhove H. 1997. Chlorinated c1 and c2-hydrocarbons and monocyclic aromatic hydrocarbons in marine waters: An overview on fate processes, sampling, analysis and measurements. *Water Res* 31:1825-1838.

9. REFERENCES

- de Zwart LL, Hermans RCA, Meerman JHN, et al. 1998. Evaluation of urinary biomarkers for radical-induced liver damage in rats treated with carbon tetrachloride. *Toxicol Appl Pharmacol* 148(1):71-82.
- *De Zwart LL, Venhorst J, Groot M, et al. 1997. Simultaneous determination of eight lipid peroxidation degradation products in urine of rats treated with carbon tetrachloride using gas chromatography with electron-capture detection. *J Chromatogr B Biomed Sci Appl* 694(2):277-287.
- *Diaz-Gil JJ, Munoz J, Albillos A, et al. 1999. Improvement in liver fibrosis, functionally and hemodynamics in CCL4-cirrhotic rats after injection of the liver growth factor. *J Hepatol* 30(6):1065-1072.
- *Diaz Gomez MI, Castro JA. 1980a. Covalent binding of carbon tetrachloride metabolites to liver nuclear DNA, proteins and lipids. *Toxicol Appl Pharmacol* 56:199-206.
- *Diaz Gomez MI, Castro JA. 1980b. Nuclear activation of carbon tetrachloride and chloroform. *Res Commun Chem Pathol Pharmacol* 27:191-193.
- *Diaz Gomez MI, De Castro CR, D'Acosta N, et al. 1975. Species differences in carbon tetrachloride - induced hepatotoxicity: The role of CCl₄ activation and of lipid peroxidation. *Toxicol Appl Pharmacol* 34:102-114.
- Diaz-Munoz M, Tapia R. 1988. Glutamate decarboxylase inhibition and vitamin B₆ metabolism in brain of cirrhotic rats chronically treated with carbon tetrachloride. *J Neurosci Res* 20:376-382.
- Dich J, Zahm SH, Hanberg A, et al. 1997. Pesticides and cancer. *Cancer Causes Control* 8:420-443.
- *Dickens BF. 1991. Free radical mechanisms of xenobiotic mammalian cytotoxicities. Washington, DC: The George Washington University Medical Center.
- *Dilling WL. 1977. Interphase transfer processes. II. Evaporation of chloromethanes, ethanes, propanes and polypropylenes from dilute aqueous solutions. Comparisons with theoretical predictions. *Environ Sci Technol* 11:405-409.
- *Dilling WL, Tefertiller NB, Kallos GJ. 1975. Evaporation rates and reactivities of methylene chloride, chloroform, 1,1,1-trichloroethane, trichloroethylene, tetrachloroethylene, and other chlorinated compounds in aqueous solutions. *Environ Sci Technol* 9:833-838.
- Dincer S, Ozenirler S, Oz E, et al. 2002. The protective effect of taurine pretreatment on carbon tetrachloride-induced hepatic damage - A light and electron microscopic study. *Amino Acids* 22:417-426.
- *DiRenzo AB, Gandolfi AJ, Sipes IG. 1982. Microsomal bioactivation and covalent binding of aliphatic halides to DNA. *Toxicol Lett* 11:243-252.
- DiSilvestro RA, Carlson GP. 1990. Effects of moderate copper deficiency on carbon tetrachloride-induced hepatotoxicity in rats. *Proc Soc Exp Biol Med* 197(1): 32-35.
- *DiSilvestro RA, Carlson GP. 1994. Effects of mild zinc deficiency, plus or minus acute phase response, on CCl₄ hepatotoxicity. *Free Radic Biol Med* 16:57-61.

9. REFERENCES

- *DiSilvestro RA, Medeiros DM. 1992. Low and marginal copper intake by postweaning rats: Effects on copper status and resistance to carbon tetrachloride hepatotoxicity. *Metabolism* 41:1122-1124.
- Dittman EC, Etschenberg E. 1973. Endoanesthetic and narcotic activity of halogenated methane derivatives. *Eur J Pharmacol* 24:389-398.
- *Docherty JF, Burgess E. 1922. The action of carbon tetrachloride on the liver. *Br Med J* 2:907-908.
- *Docherty JF, Nicholls L. 1923. Report of three autopsies following carbon tetrachloride treatment. *Br Med J* 2:753.
- DOE. 1999. Improved risk estimates for carbon tetrachloride. Final Report. New Mexico: U.S. Department of Energy. http://emsp.em.doe.gov/EMSPprojects1996_2003/completed/54940.pdf. February 17, 2005.
- Dogterom P, Nagelkerke JF, van Steveninck J, et al. 1988. Inhibition of lipid peroxidation by disulfiram and diethyldithiocarbamate does not prevent hepatotoxin-induced cell death in isolated rat hepatocytes. A study with allyl alcohol, tert-butyl hydroperoxide, diethyl maleate, bromoisovalerylurea and carbon tetrachloride. *Chem Biol Interact* 66:251-265.
- Dogukan A, Akpolat N, Ceiler H, et al. 2003. Protective effect of interferon-a on carbon tetrachloride-induced nephrotoxicity. *J Nephrol* 16:81-84.
- *Doherty AT, Ellard S, Parry EM, et al. 1996. An investigation into the activation and deactivation of chlorinated hydrocarbons to genotoxins in metabolically competent human cells. *Mutagenesis* 11(3):247-274.
- *Doi K, Kurabe S, Shimazu N, et al. 1991. Systemic histopathology of rats with CCl₄-induced hepatic cirrhosis. *Lab Anim* 25:21-25.
- Dolak JA, Britton RS, Glende EA, et al. 1987. Chlordecone does not interfere with hepatic repair after carbon tetrachloride or partial hepatectomy. *J Biochem Toxicol* 2:57-66.
- Dolak JA, Waller RL, Glende EA, et al. 1988. Liver cell calcium homeostasis in carbon tetrachloride liver cell injury: New data with Fura2. *J Biochem Toxicol* 3:329-342.
- Dolfing J, van den Wijngaard AJ, Janssen DB. 1993. Microbiological aspects of the removal of chlorinated hydrocarbons from air. *Biodegradation* 4:261-282
- *Donnelly CA. 1995. The spatial analysis of covariates in a study of environmental epidemiology. *Stat Med* 14:2393-2409.
- Doolittle DJ, Muller G, Scribner HE. 1987. Relationship between hepatotoxicity and induction of replicative DNA synthesis following single or multiple doses of carbon tetrachloride. *J Toxicol Environ Health* 22:63-78.
- *Doong RA, Wu SC. 1992. Reductive dechlorination of chlorinated hydrocarbons in aqueous solutions containing ferrous and sulfide ions. *Chemosphere* 24:1063-1075.
- *Dosemeci M, Cocco P, Chow W-H. 1999. Gender differences in risk of renal cell carcinoma and occupational exposures to chlorinated aliphatic hydrocarbons. *Am J Ind Med* 36(1):54-59.

9. REFERENCES

- Dowty DC, Laseter JL, Storer J. 1975. Halogenated hydrocarbons in New Orleans drinking water and blood plasma. *Science* 187:75-77.
- *Dragiani TA, Manenti G, Porta GD. 1986. Enhancing effects of carbon tetrachloride in mouse hepatocarcinogenesis. *Cancer Lett* 31:171-179.
- *Drill VA, Ivy AC. 1944. Comparative value of bromsulphalein, serum phosphatase, prothrombin time, and intravenous galactose tolerance tests in detecting hepatic damage produced by carbon tetrachloride. *J Clin Invest* 23:209-216.
- *Driscoll TR, Hamdan HH, Wang G, et al. 1992. Concentrations of individual serum or plasma bile acids in workers exposed to chlorinated aliphatic hydrocarbons. *Br J Ind Med* 49:700-705.
- Drotman RB, Lawhorn GT. 1978. Serum enzymes as indicators of chemically induced liver damage. *Drug Chem Toxicol* 1:163-171.
- Dufour J-F, Luthi M, Forestier M, et al. 1999. Expression of inositol 1,4,5-trisphosphate receptor isoforms in rat cirrhosis. *Hepatology* 30:1018-1026.
- *Dumas S, Parent ME, Siemiatycki J, et al. 2000. Rectal cancer and occupational risk factors: A hypothesis-generating, exposure-based case-control study. *Int J Cancer* 87(6):874-879.
- *Durden WD Jr., Chipman DW. 1967. Gasoline sniffing complicated by acute carbon tetrachloride poisoning. *Arch Intern Med* 119:371-374.
- Durk H, Klessen C, Frank H. 1987. Tetrachloromethane metabolism in vivo under normoxia and hypoxia: Biochemical and histopathological effects relative to alkane exhalation. *Arch Toxicol* 60:115-121.
- Edgerton SA, Holdren MW, Smith DL, et al. 1989. Inter-urban comparison of ambient volatile organic compound concentrations in U.S. cities. *JAPCA* 39:729-732.
- *Edgren M, Revesz L. 1987. Compartmentalised depletion of glutathione in cells treated with buthionine sulphoximine. *Br J Radiol* 60:723-724.
- Eduardo S, Limbert B, Betts B. 1994. Biodegradation of trace levels of a complex organic pollutant mixture. *Microbios* 78(317):237-243.
- *Edwards JE. 1941. Hepatomas in mice induced with carbon tetrachloride. *J Natl Cancer Inst* 2:197-199.
- *Edwards JE, Dalton AJ. 1942. Induction of cirrhosis of the liver and of hepatomas in mice with carbon tetrachloride. *J Natl Cancer Inst* 3:19-41.
- Edwards EA, Liang LN, Grbic-Galic D. 1993. Anaerobic microbial transformation of aromatic hydrocarbons and mixtures of aromatic hydrocarbons and halogenated solvents. Stanford, CA: Environmental Engineering and Science program, Department of Civil Engineering.
- *Edwards J, Heston WE, Dalton AJ. 1942. Induction of the carbon tetrachloride hepatoma in strain L mice. *J Natl Cancer Inst* 3:297-301.

9. REFERENCES

- Edwards M, Keller BJ, Kauffman FC, et al. 119. The involvement of Kupffer cells in carbon tetrachloride toxicity. *Toxicol Appl Pharmacol* 119(2):275-279.
- Egli C, Tschan T, Scholtz R, et al. 1988. Transformation of tetrachloromethane to dichloromethane and carbon dioxide by *Acetobacterium woodii*. *Appl Environ Microbiol* 54:2819-2824.
- *Eichelberger JW, Bellar TA, Donnelly JP, et al. 1990. Determination of volatile organics in drinking water with USEPA method 524.2 and the ion trap detector. *J Chromatog Sci* 28:460-467.
- Eisenberg JNS, McKone TE. 1998. Decision tree method for the classification of chemical pollutants: Incorporation of across-chemical pollutants: Incorporation of across-chemical variability and within-chemical uncertainty. *Environ Sci Technol* 32:3396-3404.
- *Elkins HB. 1942. Maximal allowable concentrations. II. Carbon tetrachloride. *J Ind Hyg Toxicol* 24:233-235.
- *Ellenhorn MJ. 1997. *Ellenhorn's medical toxicology: Diagnosis and treatment of human poisoning*. New York, NY: Elsevier, 1422.
- El-Masri HA, Thomas RS, Benjamin SA, et al. 1995. Physiologically based pharmacokinetic/pharmacodynamic modeling of chemical mixtures and possible applications in risk assessment. *Toxicology* 105:275-282.
- El-Masri HA, Thomas RS, Sabados GR, et al. 1996. Physiologically based pharmacokinetic/pharmacodynamic modeling of the toxicologic interaction between carbon tetrachloride and kepone. *Arch Toxicol* 70:704-713.
- ElSisi AD, Earnest DL, Sipes IG. 1993a. Vitamin A potentiation of carbon tetrachloride hepatotoxicity: Role of liver macrophages and active oxygen species. *Toxicol Appl Pharmacol* 119:295-301.
- ElSisi AD, Hall P, Sim W-L W, et al. 1993b. Characterization of vitamin A potentiation of carbon tetrachloride-induced liver injury. *Toxicol Appl Pharmacol* 119:280-288.
- *Endou H, Koseki C, Hasmura S, et al. 1982. Renal cytochrome P-450: Its localization along a single nephron and its induction. In: Morel F, ed. *Biochemistry of kidney functions*. INSERM Symposium No. 21. Elsevier Biomedical Press B.V., 319-327.
- EPA. 1975. Preliminary assessment of suspected carcinogens in drinking water: Interim report to the Congress. Washington, DC: U.S. Environmental Protection Agency.
- EPA. 1980a. Human exposure to atmospheric concentrations of selected chemicals. Volume I. Carbon tetrachloride. Research Triangle Park, NC: U.S. Environmental Protection Agency, Office of Air Quality Planning and Standards. PB81-193252.
- EPA. 1980b. U.S. Environmental Protection Agency. *Fed Regist* 45:33084-33133.
- EPA. 1980c. U.S. Environmental Protection Agency. *Fed Regist* 45:79318.
- EPA. 1980d. U.S. Environmental Protection Agency. *Fed Regist* 45:79347-79357.

9. REFERENCES

- EPA. 1980e. Volatile organic compounds by purge and trap isotope dilution GC-MS method 1624. Washington, DC: U.S. Environmental Protection Agency.
- EPA. 1981a. Carbon tetrachloride. Washington, DC: U.S. Environmental Protection Agency, Office of Drinking Water. September 11, 1981.
- EPA. 1981b. Treatability Manual. Washington, DC: U.S. Environmental Protection Agency, Office of Research and Development. EPA600282001A.
- *EPA. 1982a. Test method: Purgeable halocarbons - method 601. Test methods: Methods for organic chemical analysis of municipal and industrial wastewater. Cincinnati, OH: U.S. Environmental Protection Agency, Office of Research and Development. EPA600482057.
- *EPA. 1982b. Test method: Purgeables - method 624. Test methods: Methods for organic chemical analysis of municipal and industrial wastewater. Cincinnati, OH: U.S. Environmental Protection Agency, Office of Research and Development. EPA600482057.
- EPA 1982c. Aquatic fate process data for organic priority pollutants. Washington, DC: U.S. Environmental Protection Agency, Office of Water Regulations and Standards. EPA440481014. PB87169090.
- EPA. 1983. Carbon tetrachloride; occurrence in drinking water, food and air. Washington, DC: U.S. Environmental Protection Agency, Office of Drinking Water.
- *EPA. 1984. Health assessment document for carbon tetrachloride. Cincinnati, OH: U.S. Environmental Protection Agency, Office of Research and Development. EPA600882001F.
- *EPA. 1985a. Assessment of the mutagenic potential of carbon disulfide, carbon tetrachloride, dichloromethane, ethylene dichloride and methyl bromide: A comparative analysis in relation to ethylene dibromide. Washington, DC: U.S. Environmental Protection Agency, Office of Health and Environmental Assessment. EPA600685001.
- EPA. 1985b. U.S. Environmental Protection Agency. Fed Regist 50:32621-32627.
- EPA. 1985c. U.S. Environmental Protection Agency. Part II. Fed Regist 50:13456-13522.
- EPA. 1985d. Final draft criteria document for carbon tetrachloride. Washington, DC: U.S. Environmental Protection Agency, Office of Drinking Water.
- EPA. 1985e. U.S. Environmental Protection Agency. Part III. Fed Regist 50:46880-46901.
- EPA. 1985f. Survey of carbon tetrachloride emission sources. Research Triangle Park, NC: U.S. Environmental Protection Agency, Office of Air Quality Planning and Standards. EPA450385018.
- *EPA. 1986a. Gas chromatography/mass spectrometry for volatile organics-method-8240. Test methods for evaluating solid waste. SW-846. Washington, DC: U.S. Environmental Protection Agency, Office of Solid Waste and Emergency Response, 8240-1 to 8240-40.
- *EPA. 1986b. Halogenated volatile organics-method 8010. Test methods for evaluating solid waste. SW-846. Washington, DC: U.S. Environmental Protection Agency, Office of Solid Waste and Emergency Response, 8010-1 to 8010-13.

9. REFERENCES

- EPA. 1986c. U.S. Environmental Protection Agency. Fed Regist 51:41004.
- EPA. 1986d. Reference values for risk assessment. Cincinnati, OH: U.S. Environmental Protection Agency, Environmental Criteria and Assessment Office. ECAO-CIN-477.
- *EPA. 1987a. U.S. Environmental Protection Agency. Fed Regist 50:8140.
- EPA. 1987b. Health advisory for carbon tetrachloride. Washington DC: U.S. Environmental Protection Agency, Office of Drinking Water. March 31.
- EPA. 1987c. U.S. Environmental Protection Agency. Part II. Fed Regist 52:25942-25953.
- EPA. 1987d. U.S. Environmental Protection Agency. Part II. Fed Regist 52:25690-25717.
- *EPA. 1987e. U.S. Environmental Protection Agency. Part II. Fed Regist 52:47495-47519.
- EPA. 1987f. Reference dose (RfD): Description and use in health risk assessments. Volume I, Appendix A: Integrated risk information system supportive documentation. Washington, DC: U.S. Environmental Protection Agency, Office of Health and Environmental Assessment. EPA600886032a.
- EPA. 1987g. Household solvent products: A "shelf" survey with laboratory analysis. Washington, DC: U.S. Environmental Protection Agency, Office of Toxic Substances. EPAOTS560587006.
- EPA. 1987h. National primary drinking water regulations; synthetic organic chemicals; monitoring for unregulated contaminants. U.S. Environmental Protection Agency: Part II. Fed Regist 52(130):25690-25717. 40 CFR Parts 141 and 142.
- EPA. 1988a. Evaluation of the potential carcinogenicity of carbon tetrachloride (56-23-5). Final Report. Washington, DC: U.S. Environmental Protection Agency, Office of Health and Environmental Assessment. OHEA-C-073-50.
- EPA. 1988b. Toxic chemical release reporting: Community right-to-know. Fed Regist 53(30):4500-4554.
- *EPA. 1989a. Interim methods for development of inhalation reference doses. Washington, DC: U.S. Environmental Protection Agency, Office of Health and Environmental Assessment. EPA600888066F.
- *EPA. 1989b. Health effects assessment for carbon tetrachloride. Cincinnati, OH: U.S. Environmental Protection Agency, Office of Research and Development, EPA600889088.
- *EPA. 1989c. Method 524.1. Measurement of purgeable organic compounds in water by packed column gas chromatography/mass spectrometry. Cincinnati, OH: U.S. Environmental Protection Agency, Office of Research and Development.
- EPA. 1989d. U.S. Environmental Protection Agency. Fed Regist 54(155):33418, 33453.
- EPA. 1990a. Interim methods for development of inhalation reference concentrations. Washington, DC: U.S. Environmental Protection Agency, Office of Health and Environmental Assessment, Office of Research and Development, Environmental Criteria and Assessment Office. EPA600890066A.

9. REFERENCES

- *EPA. 1990b. Toxics in the community. 1988 National and local perspectives. Washington, DC: U.S. Environmental Protection Agency, Office of Toxic Substances Economics and Technology Division.
- EPA. 1991a. *In-situ* biotransformation of carbon tetrachloride under anoxic conditions. Ada, OK: U.S. Environmental Protection Agency, Robert S. Kerr Environmental Research Laboratory, EPA600290060.
- *EPA. 1991b. Toxics in the community. National and local perspectives. Washington, DC: U.S. Environmental Protection Agency, Office of Toxic Substances. EPA560491014.
- EPA. 1993. Reference guide to odor thresholds for hazardous air pollutants listed in the clean air act amendments of 1990. Washington DC: U.S. Environmental Protection Agency, Environmental Criteria and Assessment Office. EPA600R92047. PB922395163.
- *EPA. 1997. Special report on environmental endocrine disruption: An effects assessment and analysis. Washington, DC: U.S. Environmental Protection Agency, Risk Assessment Forum. EPA630R96012.
- *EPA. 1999. Compendium Method TO-14A: Determination of volatile organic compounds (VOCs) in ambient air using specially prepared canisters with subsequent analysis by gas chromatography. Compendium of methods for the determination of toxic organic compounds in ambient air. Cincinnati, OH: U.S. Environmental Protection Agency, Center for Environmental Research Information, Office of Research and Development. EPA625R96010b. <http://www.epa.gov/ttn/amtic/files/ambient/airtox/to-14ar.pdf>. January 06, 2005.
- *EPA 2001. Exploration of perinatal pharmacokinetic issues. Washington, DC: U.S. Environmental Protection Agency, Risk Assessment Forum. EPA630R-01004. <http://cfpub.epa.gov/ncea/raf/recordisplay.cfm?deid=29420>. May 2001.
- *EPA. 2002. 2002 Edition of the drinking water standards and health advisories. Washington, DC: U.S. Environmental Protection Agency. EPA822R02038. <http://www.epa.gov/waterscience>. June 6, 2003.
- *EPA. 2003a. Criteria for municipal solid waste landfills. List of hazardous inorganic and organic constituents. Washington, DC: U.S. Environmental Protection Agency. 40 CFR 258, Appendix II. <http://www.epa.gov/epahome/cfr40.htm>. June 6, 2003.
- *EPA. 2003b. Designation, reportable quantities, and notification. Designation of hazardous substance. Washington, DC: U.S. Environmental Protection Agency. 40 CFR 302.4. <http://www.epa.gov/epahome/cfr40.htm>. June 6, 2003.
- *EPA. 2003c. Effluent guidelines and standards. General provisions. Toxic pollutants. Washington, DC: U.S. Environmental Protection Agency. 40 CFR 401.15. <http://www.epa.gov/epahome/cfr40.htm>. June 6, 2003.
- *EPA. 2003d. Identification and listing of hazardous waste. Toxicity characteristic. Washington, DC: U.S. Environmental Protection Agency. 40 CFR 261.24. <http://www.epa.gov/epahome/cfr40.htm>. June 6, 2003.
- *EPA. 2003e. National emission standards for hazardous air pollutants. List of pollutants. Washington, DC: U.S. Environmental Protection Agency. 40 CFR 61.01. <http://www.epa.gov/epahome/cfr40.htm>. June 6, 2003.

9. REFERENCES

- *EPA. 2003f. National primary drinking water regulations. Maximum contaminant level goals for organic contaminants. Washington, DC: U.S. Environmental Protection Agency. 40 CFR 141.50. <http://www.epa.gov/epahome/cfr40.htm>. June 6, 2003.
- *EPA. 2003g. National primary drinking water regulations. Maximum contaminant levels for organic contaminants. Washington, DC: U.S. Environmental Protection Agency. 40 CFR 141.61. <http://www.epa.gov/epahome/cfr40.htm>. June 6, 2003.
- *EPA. 2003h. Protection of stratospheric ozone. Listing of ozone-depleting chemicals. Washington, DC: U.S. Environmental Protection Agency. 40 CFR 82, Subpart A, Appendix F. <http://www.epa.gov/epahome/cfr40.htm>. June 6, 2003.
- *EPA. 2003i. Reportable quantities of hazardous substances designated pursuant to Section 311 of the Clean Water Act. Washington, DC: U.S. Environmental Protection Agency. 40 CFR 117.3. <http://www.epa.gov/epahome/cfr40.htm>. June 6, 2003.
- *EPA. 2003j. Standards for the management of specific hazardous wastes and specific types of hazardous waste management facilities. Washington, DC: U.S. Environmental Protection Agency. 40 CFR 266, Appendix V. <http://www.epa.gov/epahome/cfr40.htm>. June 6, 2003.
- *EPA. 2003k. Standards for the management of specific hazardous wastes and specific types of hazardous waste management facilities. Health-based limits for exclusion of waste-derived residues. Washington, DC: U.S. Environmental Protection Agency. 40 CFR 266, Appendix VII. <http://www.epa.gov/epahome/cfr40.htm>. June 6, 2003.
- *EPA. 2003l. Standards for owners and operators of hazardous waste treatment, storage, and disposal facilities. Ground-water monitoring list. Washington, DC: U.S. Environmental Protection Agency. 40 CFR 264, Appendix IX. <http://www.epa.gov/epahome/cfr40.htm>. June 6, 2003.
- *EPA. 2003m. Toxic chemical release reporting: Community right-to-know. Chemicals and chemical categories to which this part applies. Washington, DC: U.S. Environmental Protection Agency. 40 CFR 372.65. <http://www.epa.gov/epahome/cfr40.htm>. June 6, 2003.
- *EPA. 2003n. Water programs. Designation of hazardous substances. Washington, DC: U.S. Environmental Protection Agency. 40 CFR 116.4. <http://www.epa.gov/epahome/cfr40.htm>. June 6, 2003.
- *EPA. 2003o. Water quality guidance for the Great Lakes system. Pollutants of initial focus in the Great Lakes water quality initiative. Washington, DC: U.S. Environmental Protection Agency. 40 CFR 132, Table 6. <http://www.epa.gov/epahome/cfr40.htm>. June 6, 2003.
- *Eschenbrenner AB, Miller E. 1944. Studies on hepatomas -- Size and spacing of multiple doses in the induction of carbon tetrachloride hepatomas. *J Natl Cancer Inst* 4:385-388.
- *Eschenbrenner AB, Miller E. 1946. Liver necrosis and the induction of carbon tetrachloride hepatomas in strain A mice. *J Natl Cancer Inst* 6:325-341.
- Esparza RJ, Mahmood RJ, Sedman RM. 1991. Hazardous waste incineration: A correlation of operating parameters with risk and emission rates. *Waste Management* 11:163-170.

9. REFERENCES

- Esterbauer H, Schaur RJ, Zollner H. 1991. Chemistry and biochemistry of 4-hydroxynonenal, malonaldehyde and related aldehydes. *Free Radic Biol Med* 11:81-128.
- Evans MV, Simmons JE. 1996. Physiologically based pharmacokinetic estimated metabolic constants and hepatotoxicity of carbon tetrachloride after methanol pretreatment in rats. *Toxicol Appl Pharmacol* 140(2):245-253.
- *Evans GF, Lumpkin TA, Smith DL, et al. 1992. Measurements of VOCs from the Tams network. *J Air Waste Manage Assoc* 42:1319-1323.
- Evans MV, Crank WD, Yang H-M, et al. 1994. Applications of sensitivity analysis to a physiologically based pharmacokinetic model for carbon tetrachloride in rats. *Toxicol Appl Pharmacol* 128:36-44.
- *Ezquerro I-J, Lasarte J-J, Dotor J, et al. 2003. A synthetic peptide from transforming growth factor beta type III receptor inhibits liver fibrogenesis in rats with carbon tetrachloride liver injury. *Cytokine* 22:12-20.
- Fanelli SL, Castro JA. 1995. Covalent binding of carbon tetrachloride reactive metabolites to liver microsomal and nuclear lipid and phospholipid classes from Sprague Dawley and Osborne Mendel male rats. *Teratog Carcinog Mutagen* 15:155-166.
- Fanelli SL, Castro GD, Castro JA, et al. 1995. Cholesterol interaction with free radicals. *Chem Biol Interact* 98(3):223-236.
- Fanelli SL, Castro GD, de Toranzo EGD, et al. 1998. Mechanisms of the preventive properties of some garlic components in the carbon tetrachloride-promoted oxidative stress. Diallyl sulfide; diallyl disulfide; allyl mercaptan and allyl methyl sulfide. *Res Commun Mol Pathol Pharmacol* 102(2):163-174.
- *Farazi PA, Glickman J, Jiang S, et al. 2003. Differential impact of telomere dysfunction on initiation and progression of hepatocellular carcinoma. *Cancer Res* 63:5021-5027.
- Farber JL. 1981. Minireview: The role of calcium in cell death. *Life Sci* 29:1289-1295.
- Farghali H, Martinek J, Kamenikova L, et al. 1996. Amelioration of chemically induced hepatocyte injury by cyclosporine A. *Pharmacol Res* 34(5-6):211-218.
- *Farrell CL, Senseman LA. 1944. Carbon tetrachloride polyneuritis. A case report. *RI Med J* 27:334, 346.
- FDA. 1970. Food and Drug Administration. Part 191-Hazardous substances: Definitions and procedural and interpretive regulations. Carbon tetrachloride: Findings of fact and conclusions and final order regarding classification as banned hazardous substance. *Fed Regist* 35:13198-13205.
- *FDA. 2003a. Beverages. Bottled water. Washington, DC: U.S. Food and Drug Administration. 21 CFR 165.110. <http://www.access.gpo.gov/cgi-bin/cfrassemble.cgi?title=200321>. June 6, 2003.
- *FDA. 2003b. Indirect food additives: Adhesives and components of coatings. Washington, DC: U.S. Food and Drug Administration. 21 CFR 175.105(c)(5). <http://www.access.gpo.gov/cgi-bin/cfrassemble.cgi?title=200321>. June 6, 2003.

9. REFERENCES

- *FDA. 2003c. Indirect food additives: Paper and paperboard components. Anti-offset substances. Washington, DC: U.S. Food and Drug Administration. 21 CFR 176.130(c). <http://www.access.gpo.gov/cgi-bin/cfrassemble.cgi?title=200321>. June 6, 2003.
- *FDA. 2003d. Indirect food additives: Paper and paperboard components. Components of paper and paperboard in contact with dry food. Washington, DC: U.S. Food and Drug Administration. 21 CFR 176.180(b)(2). <http://www.access.gpo.gov/cgi-bin/cfrassemble.cgi?title=200321>. June 6, 2003.
- *FDA. 2003e. Labeling. Medical devices; warning statements for devices containing or manufactured with chlorofluorocarbons and other class I ozone-depleting substances. Washington, DC: U.S. Food and Drug Administration. 21 CFR 801.63. <http://www.access.gpo.gov/cgi-bin/cfrassemble.cgi?title=200321>. June 6, 2003.
- *FDA. 2003f. Labeling. Warning statements for prescription and restricted device products containing or manufactured with chlorofluorocarbons or other ozone-depleting substances. Washington, DC: U.S. Food and Drug Administration. 21 CFR 801.433. <http://www.access.gpo.gov/cgi-bin/cfrassemble.cgi?title=200321>. June 6, 2003.
- *FEDRIP. 2004. Carbon Tetrachloride. Federal Research in Progress database. Springfield, VA: National Technical Information Service.
- *Fernandez G, Villarruel MC, de Toranzo EGD, et al. 1982. Covalent binding of carbon tetrachloride metabolites to the heme moiety of cytochrome P-450 and its degradation products. *Res Commun Chem Pathol Pharmacol* 35(2):283-290.
- *Fischer-Nielsen A, Poulsen HE, Hansen BA, et al. 1991. CCl₄ cirrhosis in rats: Irreversible histological changes and differentiated functional impairment. *J Hepatol* 12:110-117.
- Fiserova-Bergerova V, Pierce JT, Droz PO. 1990. Dermal absorption potential of industrial chemicals: Criteria for skin notation. *Am J Ind Med* 17:617-635.
- Fisher J, Lumpkin M, Boyd D, et al. 2004. PBPK modeling of the metabolic interactions of carbon tetrachloride and tetrachloroethylene in B6C3F1 mice. *Environ Toxicol Pharmacol* 16:93-105.
- *Fisher J, Mahle D, Bankston L, et al. 1997. Lactational transfer of volatile chemicals in breast milk. *Am Ind Hyg Assoc J* 58(6):425-431.
- *Folland DS, Schaffner W, Ginn EH, et al. 1976. Carbon tetrachloride toxicity potentiated by isopropyl alcohol. *J Am Med Assoc* 236:1853-1856.
- *Fomon SJ. 1966. Body composition of the infant: Part I: The male "reference infant." In: Falkner F, ed. *Human development*. Philadelphia, PA: WB Saunders, 239-246.
- *Fomon SJ, Haschke F, Ziegler EE, et al. 1982. Body composition of reference children from birth to age 10 years. *Am J Clin Nutr* 35:1169-1175.
- *Forbes JR. 1944. Carbon tetrachloride nephrosis. *Lancet* 247:590-592.
- *Fort J, Pilette C, Veal N, et al. 1998. Effects of long-term administration of interferon alpha in two models of liver fibrosis in rats. *J Hepatol* 29:263-270.

9. REFERENCES

- Foster P, Laffond M, Bausasnd P, et al. 1991. Measurements of volatile organic compounds (VOC) in the Grenoble area and study of benzaldehyde behavior in a simulation chamber. *Pollut Atmos* 19:175-191.
- Fountoulakis M, de Vera M-C, Cramer F, et al. 2002. Modulation of gene and protein expression by carbon tetrachloride in the rat liver. *Toxicol Appl Pharmacol* 183:71-80.
- *Fouremant P, Mason JM, Valencia R, et al. 1994. Chemical mutagenesis testing in *Drosophila*. X. Results of 70 coded chemicals tested for the national toxicology program. *Environ Mol Mutagen* 23(3):208-227.
- *Fowler JSL. 1969. Carbon tetrachloride metabolism in the rabbit. *Br J Pharmacol* 37:733-737.
- Foxell AWH. 1951. Three cases of carbon tetrachloride poisoning with one fatality. *Br Med J* 1:397.
- Frank H, Frank W. 1988. Quantitative determination of airborne C₁- and C₂-halocarbons by GC/ECD. *J High Resolut Chromatogr Chromatogr Comm* 11:51-56.
- *Frantik R, Hornychova M, Horvath M. 1994. Relative acute neurotoxicity of solvents: Isoeffective air concentrations of 48 compounds evaluated in rats and mice. *Environ Res* 66:173-185.
- Frezza EE, Gerunda GE, Farinati F, et al. 1994. CCl₄-induced liver cirrhosis and hepatocellular carcinoma in rats: Relationship to plasma zinc, copper and estradiol. *Hepatogastroenterology* 41:367-369.
- FSTRAC. 1990. Summary of state and federal drinking water standards and guidelines. Federal-State Toxicology and Regulatory Alliance Committee. March, 1988.
- *Fujii K. 1996. Stimulatory effect of anesthetics on dechlorination of carbon tetrachloride in guinea-pig liver microsomes. *Toxicology* 114(2):147-153.
- *Fujii K. 1997. Preventive effect of isoflurane on destruction of cytochrome P450 during reductive dehalogenation of carbon tetrachloride in guinea-pig liver microsomes. *Drug Metabol Drug Interact* 14(2):99-107.
- *Fujii K, Rahman M, Yuge O, et al. 1996. Isoflurane enhances dechlorination of carbon tetrachloride in guinea-pig liver microsomes. *J Appl Toxicol* 16(3):249-253.
- Fukai F, Nishizawa S, Kurano M, et al. 1989. Carbon tetrachloride-induced alteration of glutathione S-transferase in rat liver cytosol and plasma. *J Clin Biochem Nutr* 6:175-185.
- Fukao T, Hosano T, Misawa S, et al. 2004. The effects of allyl sulfides on the induction of phase II detoxification enzymes and liver injury by carbon tetrachloride. *Food Chem Toxicol* 42:743-749.
- Gagliano N, Arosio B, Grizzi F, et al. 2002. Acute liver CCl₄ intoxication causes low HSP70 gene expression and a delayed transition through the cell cycle in aged rats. *Exp Gerontol* 37:791-801.
- *Galbally IE. 1976. Man-made carbon tetrachloride in the atmosphere. *Science* 193:573-576.

9. REFERENCES

- Galelli ME, Castro JA. 1998. Effect of trichloromethyl and trichloromethyl peroxy free radicals on protein sulfhydryl content studies in model and enzymatic carbon tetrachloride activation systems. *Res Commun Mol Pathol Pharmacol* 100(2):227-238.
- Galelli M, Gomez D, Castro JA. 1994. Decreased incorporation of ¹⁴C-leucine in different liver nuclear protein fractions at early stages of carbon tetrachloride poisoning in the rat. *Arch Toxicol* 68(3):206-209.
- *Galli A, Schiestl RH. 1995. Salmonella test positive and negative carcinogens show different effects of intrachromosomal recombination in G2 cell cycle arrested yeast cells. *Carcinogenesis* 16(3):659-663.
- *Galli A, Schiestl RH. 1996. Effects of Salmonella assay negative and positive carcinogens on intrachromosomal recombination in G1-arrested yeast cells. *Mutat Res* 370:209-221.
- *Galli A, Schiestl RH. 1998. Effect of Salmonella assay negative and positive carcinogens on intrachromosomal recombination in S-phase arrested yeast cells. *Mutat Res* 419:53-68.
- Galli R, McCarty PL. 1989. Biotransformation of 1,1,1-trichloroethane, trichloromethane, and tetrachloromethane by a *Clostridium* sp. *Appl Environ Microbiol* 55:837-844.
- Gallo JM, Cheung LL, Kim JJ, et al. 1993. A physiological and system analysis hybrid pharmacokinetic model to characterize carbon tetrachloride blood concentrations following administration in different oral vehicles. *J Pharmacokinet Biopharm* 21(5):551-567.
- Gandhi CR, Sproat LA, Subbotin VM. 1996. Increased hepatic endothelin-1 levels and endothelin receptor density in cirrhotic rats. *Life Sci* 58(1):55-62.
- Gans JH, Korson R. 1984. Liver nuclear DNA synthesis in mice following carbon tetrachloride administration or partial hepatectomy. *Proc Soc Exp Biol Med* 175:237-242.
- Gao L, Zackert WE, Hasford JJ, et al. 2003. Formation of prostaglandins E2 and D2 via the isoprostane pathway: A mechanism for the generation of bioactive prostaglandins independent of cyclooxygenase. *J Biol Chem* 278(31):28479-28489.
- Garcia C, Tiedra G, Ruano A, et al. 1992. Evaluation of the liquid-liquid extraction technique and application to the determination of volatile halo-organic compounds in chlorinated water. *J Chromatogr* 605:251-255.
- Garcia L, Hernandez I, Sandoval A, et al. 2002. Pirfenidone effectively reverses experimental liver fibrosis. *J Hepatol* 37:797-805.
- *Gardner GH, Gove RC, Gustafson RK, et al. 1925. Studies on the pathological histology of experimental carbon tetrachloride poisoning. *Bulletin of Johns Hopkins Hospital* 36:107-133.
- *Gargas ML, Andersen ME, Clewell III HJ. 1986. A physiologically based simulation approach for determining metabolic constants from gas uptake data. *Toxicol Appl Pharmacol* 86:341-352.
- Gargas ML, Burgess RJ, Voisard DE, et al. 1989. Partition coefficients of low-molecular-weight volatile chemicals in various liquids and tissues. *Toxicol Appl Pharmacol* 98:87-99.
- *Garner RC, McLean AEM. 1969. Increased susceptibility to carbon tetrachloride poisoning in the rat after pretreatment with oral phenobarbitone. *Biochem Pharmacol* 18:645-650.

9. REFERENCES

- *Garry VF, Nelson RL, Griffith J, et al. 1990. Preparation for human study of pesticide applicators: Sister chromatid exchanges and chromosome aberrations in cultured human lymphocytes exposed to selected fumigants. *Teratog Carcinog Mutagen* 10:21-29.
- *Gasso M, Rubio M, Varela G, et al. 1996. Effects of S-adenosylmethionine on lipid peroxidation and liver fibrogenesis in carbon tetrachloride-induced cirrhosis. *J Hepatol* 25:200-205.
- Gee DL, Bechtold MM, Tappel AL. 1981. Carbon tetrachloride-induced lipid peroxidation: Simultaneous in vivo measurements of pentane and chloroform exhaled by the rat. *Toxicology* 8:299-306.
- *Geier A, Dietrich CG, Voigt S, et al. 2003. Effects of proinflammatory cytokines on rat organic anion transporters during toxic liver injury and cholestasis. *Hepatology* 38(2):345-354.
- Genoni GP. 1997. Influence of the energy relationships of organic compounds on their specificity toward aquatic organisms. *Ecotoxicol Environ Saf* 36:99-108.
- Germolec DR, Yang RS, Ackermann MF, et al. 1989. Toxicology studies of a chemical mixture of 25 groundwater contaminants. II. Immunosuppression in B6C3F₁ mice. *Fundam Appl Toxicol* 13:377-387.
- Giffen PS, Turton J, Andrews CM, et al. 2003. Markers of experimental acute inflammation in the Wistar Han rat with particular reference to haptoglobin and C-reactive protein. *Arch Toxicol* 77:392-402.
- *Gillespie WR, Cheung LL, Kim HJ, et al. 1990. Application of system analysis to toxicology: Characterization of carbon tetrachloride oral absorption kinetics. In: Gentry TR, Henry CJ, eds. *Principles of route-to-route extrapolations for risk assessment*. New York, NY: Elsevier Science Publishing Company.
- *Gilman MR. 1971. A preliminary study of the teratogenic effects of inhaled carbon tetrachloride and ethyl alcohol consumption in the rat. Dissertation. Philadelphia, PA: Drexel University.
- *Giwerzman A, Carlsen E, Keiding N, et al. 1993. Evidence for increasing incidence of abnormalities of the human testis: A review. *Environ Health Perspect Suppl* 101(2):65-71.
- *Glende EA. 1972. Carbon tetrachloride-induced protection against carbon tetrachloride toxicity. The role of the liver microsomal drug-metabolizing system. *Biochem Pharmacol* 21:1697-1702.
- Glende EA, Pushpendran CK. 1986. Activation of phospholipase A₂ by carbon tetrachloride in isolated rat hepatocytes. *Biochem Pharmacol* 35:3301-3307.
- *Glende EA, Recknagel RO. 1991. An indirect method demonstrating that CCl₄-dependent hepatocyte injury is linked to a rise in intracellular calcium ion concentration. *Res Commun Chem Pathol Pharmacol* 73:41-52.
- *Glende EA, Recknagel RO. 1992. Phospholipase A₂ activation and cell injury in isolated rat hepatocytes exposed to bromotrichloromethane, chloroform, and 1,1-dichloroethylene as compared to effects of carbon tetrachloride. *Toxicol Appl Pharmacol* 113:159-162.

9. REFERENCES

- *Glende EA Jr., Hruszkewycz AM, Recknagel RO. 1976. Critical role of lipid peroxidation in carbon tetrachloride-induced loss of aminopyrine demethylase, cytochrome P-450 and glucose 6-phosphatase. *Biochem Pharmacol* 25:2163-2170.
- Goerz G, Vizethum W, Bolsen K, et al. 1978. [Hexachlorobenzene (HCB) induced porphyria in rats. Influence of HCB-metabolites on the biosynthesis of heme.] *Arch Dermatol Res* 263:189-196. (German)
- Golderman L, Gellert J, Teschke R. 1983. Methods and Devices. Quantitative assessment of carbon tetrachloride levels in human blood by head-space gas chromatography: Application in a case of suicidal carbon tetrachloride intoxication. *Intensive Care Medicine* 9:131-135.
- Goldsmith LB, Friberg SE, Wahlberg JE. 1988. The effect of solvent extraction on the lipids of the stratum corneum in relation to observed immediate whitening of the skin. *Contact Dermatitis* 19:348-350.
- Gomez MR, Cocco P, Dosemeci M, et al. 1994. Occupational exposure to chlorinated aliphatic hydrocarbons: Job exposure matrix. *Am J Ind Med* 26(2):171-183.
- *Gordis E. 1969. Lipid metabolites of carbon tetrachloride. *J Clin Invest* 48:203-209.
- *Gordon AJ. 1944. Uremia following inhalation of carbon tetrachloride. *J Mt Sinai Hosp NY* 10:792-795.
- *Gorla N, de Ferreyra EC, Villarruel MC, et al. 1983. Studies on the mechanism of glutathione prevention of carbon tetrachloride-induced liver injury. *Br J Exp Pathol* 64:388-395.
- *Gosselin RE, Hodge HC, Smith RP, et al. 1976. Clinical toxicology of commercial products. Acute poisoning. 4th ed., Baltimore, MD: The Williams and Wilkins Co., 13, 92-97, 110.
- Gotoh M, Sikitani Y, Aramaki T, et al. 1992. Pollution due to volatile halocarbon compound in biota. *Bull Environ Contam Toxicol* 49:186-191.
- *Gould VE, Smuckler EA. 1971. Alveolar injury in acute carbon tetrachloride intoxication. *Arch Intern Med* 128:109-117.
- Grant WB, Kagann RH, McClenny WA. 1992. Optical remote measurement of toxic gases. *J Air Waste Manage Assoc* 42:18-30.
- *Gray I. 1947. Carbon tetrachloride poisoning -- Report of seven cases with two deaths. *NY State J Med* 47:2311-2315.
- *Gribble GW. 1994. The natural production of chlorinated compounds. *Environ Sci Technol* 28(7):310A-319A.
- Gruebele A, Zawaski K, Kaplan D. 1996. Effects on signal transduction as demonstrated by altered immediate-early (c-Fos and c-Jun) gene expression and nuclear AP-1 and NK- κ B transcription factor levels. *Drug Metab Dispos* 24(1):15-22.
- *Gryder-Boutlet DE, Kennish JM. 1988. Using headspace sampling with capillary column GC-MS to analyze trace volatile organics in water and wastewater. *J Am Water Works Assoc* 80:52-55.

9. REFERENCES

- *Gualandi G. 1984. Genotoxicity of the free-radical producers of CCl₄ and lipoperoxide in *Aspergillus nidulans*. *Mutat Res* 136:109-114.
- Gubskii IuI, Kurskii MD, Zadorina OV, et al. 1990. Calcium transport in endoplasmic reticulum of the rat liver during lipid peroxidation. *Biokhimiia* 55(1):12-22.
- Guengerich FP, Kim DH, Iwasaki M. 1991. Role of human cytochrome P-450 IIE1 in the oxidation of many low molecular weight cancer suspects. *Chem Res Toxicol* 5:168-179.
- *Guido DM, McKenna R, Mathews WR. 1993. Quantitation of hydroperoxy-eicosatetraenoic acids and hydroxy-eicosatetraenoic acids as indicators of lipid peroxidation using gas chromatography-mass spectrometry. *Anal Biochem* 209:123-129.
- Guidotti M, Onorati B, Lucarelli E, et al. 2001. Determination of chlorinated solvents in exhaled air, urine, and blood of subjects exposed in the workplace using SPME and GC-MS. *Am Clin Lab* 20(4):23-26.
- *Guild WR, Young JV, Merrill JP. 1958. Anuria due to carbon tetrachloride intoxication. *Ann Intern Med* 48:1221-1227.
- *Guo TL, McCay JA, Brown RD, et al. 2000. Carbon tetrachloride is immunosuppressive and decreases host resistance to *Listeria monocytogenes* and *Streptococcus pneumoniae* in female B6C3F1 mice. *Toxicology* 154:85-101.
- Gupta TK, Toruner M, Chung MK, et al. 1998. Endothelial dysfunction and decreased production of nitric oxide in the intrahepatic microcirculation of cirrhotic rats. *Hepatology* 28:926-931.
- *Guzelian PS, Henry CJ, Olin SS, eds. 1992. Similarities and differences between children and adults: Implications for risk assessment. Washington, DC: International Life Sciences Institute Press.
- *Haag WR, Yao CCD. 1992. Rate constants for reaction of hydroxyl radicals with several drinking water contaminants. *Environ Sci Technol* 26:1005-1013.
- *Haddad LM, Winchester JF. 1990. Clinical management of poisoning and drug overdose. 2nd ed. Philadelphia, PA: W.B. Saunders Company, 1218-1219, 1257-1259.
- *Haehner BD, Gorski JC, Vandenbranden M, et al. 1996. Bimodal distribution of renal cytochrome P450 3A activity in humans. *Mol Pharmacol* 50:52-59.
- *Hafeman DG, Hoekstra WG. 1977. Protection against carbon tetrachloride-induced lipid peroxidation in the rat by dietary vitamin E, selenium and methionine as measured by ethane evolution. *J Nutr* 107:656-665.
- *Hakkola J, Raunio H, Purkunen R, et al. 1996. Detection of cytochrome P450 gene expression in human placenta in first trimester of pregnancy. *Biochem Pharmacol* 52(2):379-383.
- *Hall MC. 1921. The use of carbon tetrachloride for the removal of hookworms. *J Am Med Assoc* 77:1641-1643.
- *Hall P de la M, Plummer JL, Ilesley AH, et al. 1990. Hepatic fibrosis and cirrhosis after chronic administration of alcohol and "low-dose" carbon tetrachloride vapor in the rat. *Hepatology* 13:815-819.

9. REFERENCES

- *Hamlin GP, Kholkute SD, Dukelow WR. 1993. Toxicology of maternally ingested carbon tetrachloride (CCl₄) on embryonal and fetal development and in vitro fertilization in mice. *Zoolog Sci* 10:111-116.
- Hammock BD, Gee SJ, Cheung PYK, et al. 1987. Utility of immunoassay in pesticide trace analysis. In: Greenhalgh R, Roberts TR, eds. *Pesticide science and biotechnology*. New York, NY: Blackwell Scientific Publications.
- *Hanasono GK, Cote MG, Plaa GL. 1975. Potentiation of carbon tetrachloride-induced hepatotoxicity in alloxan- or streptozotocin-diabetic rats. *J Pharmacol Exp Therap* 192:592-604.
- Hansch C, Leo A. 1979. Substituent constants for correlation analysis in chemistry and biology. New York, NY: John Wiley & Sons, 25-26, 171-180.
- Hansen H, De Rosa CT, Pohl H, et al. 1998. Public health challenges posed by chemical mixtures. *Environ Health Perspect* 106(Suppl. 6):1271-1280.
- Hanst PL. 1978. Part II: Halogenated pollutants. Noxious trace gases in the air. *Chemistry* 51:6-12.
- Happell JD, Wallace DWR. 1998. Removal of atmospheric CCl₄ under bulk aerobic conditions in groundwater and soils. *Environ Sci Technol* 32:1244-1252.
- Hardell L, Eriksson M, Lenner P, et al. 1981. Malignant lymphoma and exposure to chemicals especially organic solvents, chlorophenols and phenoxy acids: A case-control study. *Br J Cancer* 43:169-176.
- *Hardin BL. 1954. Carbon tetrachloride poisoning. A review. *Ind Med Surg* 23:93-105.
- Harms MS, Peterson RE, Fujimoto JM, et al. 1976. Increased "bile duct--pancreatic fluid" flow in chlorinated hydrocarbon-treated rats. *Toxicol Appl Pharmacol* 35:41-49.
- *Harris RN, Anders MW. 1980. Effect of fasting, diethyl maleate and alcohols on carbon tetrachloride-induced hepatotoxicity. *Toxicol Appl Pharmacol* 56:191-198.
- Harris L, Morris LE, Farber E. 1989. Protective value of a liver initiation-promotion regimen against the lethal effect of carbon tetrachloride in rats. *Lab Invest* 61:467-470.
- Harris RN, Ratnayake JH, Garry VF, et al. 1982. Interactive hepatotoxicity of chloroform and carbon tetrachloride. *Toxicol Appl Pharmacol* 63:281-291.
- Hartley DP, Kolaja KL, Reichard J, et al. 1999. 4-Hydroxynonenal and malondialdehyde hepatic protein adducts in rats treated with carbon tetrachloride: Immunochemical detection and lobular localization. *Toxicol Appl Pharmacol* 161:23-33.
- *Hartwell TD, Perritt RL, Pelizzari ED, et al. 1992. Results from the 1987 total exposure assessment methodology (team) study in Southern California. *Atmos Environ* 26a:1519-1527.
- Harvey PJ, Gready JE, Hickey HM, et al. 1999. ³¹P and ¹H NMR spectroscopic studies of liver extracts of carbon tetrachloride-treated rats. *NMR Biomed* 12(6):395-401.
- *Harvey PJ, Gready JE, Yin Z, et al. 2000. Acute oxygen supplementation restores markers of hepatocyte energy status and hypoxia in cirrhotic rats. *J Pharmacol Exp Ther* 293(2):641-645.

9. REFERENCES

- Haselmann KF, Laturus F, Sevensmark B, et al. 2000. Formation of chloroform in spruce forest soil - results from laboratory incubation studies. *Chemosphere* 41:1769-1774.
- Hatch GE, Santrock J, Slade R, et al. 1988. Detection of CCl₄-induced oxidation of hepatic tissue *in vivo* by oxygen-18 tracing. *Toxicol Appl Pharmacol* 93:81-88.
- *Hawthorne SB. 1988. Workshop on supercritical fluid chromatography. *Am Lab* 88:6-8.
- *Hayes JR, Condie LW, Borzelleca JF. 1986. Acute, 14-day repeated dosing, and 90-day subchronic toxicity studies of carbon tetrachloride in CD-1 mice. *Fundam Appl Toxicol* 7:454-463.
- *HazDat. 2005. Atlanta, GA: Agency for Toxic Substances and Disease Registry (ATSDR). April 28, 2005.
- Hazle JD, Narayana PA, Dunsford HA. 1991. *In vivo* NMR, biochemical, and histologic evaluation of alcohol-induced fatty liver in rat and a comparison with CCl₄ hepatotoxicity. *Magn Reson Med* 19:124-135.
- *Heimann H, Ford CA. 1941. Low concentration of carbon tetrachloride capable of causing mild narcosis. *Ind Bull* 20, July-August.
- *Heineman EF, Cocco P, Gomez MR, et al. 1994. Occupational exposure to chlorinated aliphatic hydrocarbons and risk of astrocytic brain cancer. *Am J Ind Med* 26:155-169.
- Hellemans K, Rombouts K, Quartier E, et al. 2003. PPARbeta regulates vitamin A metabolism-related gene expression in hepatic stellate cells undergoing activation. *J Lipid Res* 44(2):280-295.
- Hellerbrand C, Stefanovic B, Giordano F, et al. 1999. The role of TGFbeta1 in initiating hepatic stellate cell activation *in vivo*. *J Hepatol* 30:77087.
- *Hellmer L, Bolcsfoldi G. 1992. An evaluation of the *E. coli* K-12 *uvrB/recA* DNA repair host-mediated assay. I. *In vitro* sensitivity of the bacteria to 61 compounds. *Mutat Res* 272:145-160.
- Helmig D, Arey J. 1992. Organic chemicals in the air at Whitaker's Forest/Sierra Nevada Mountains, California. *Sci Total Environ* 112:233-250.
- Hemmings SJ, Pulga VB, Tran ST et al. 2002. Differential inhibitory effects of carbon tetrachloride on the hepatic plasma membrane, mitochondrial and endoplasmic reticular calcium transport systems: Implications to hepatotoxicity. *Cell Biochem Funct* 20:47-59
- Hendler AH, Crow WL. 1992. Preliminary results of the Chemical Manufacturers Association urban baseline VOC measurement program. *Proc Annu Meet Air Waste Manage Assoc* 2b:1-17.
- Henschler D, Elsasser H, Romen W, et al. 1984. Carcinogenicity study of trichloroethylene with and without epoxide stabilizers, in mice. *J Cancer Res Clin Oncol* 107:149-156.
- Herbarth O, Rehwagen M, Ronco AE. 1997. The influence of localized emittants on the concentration of volatile organic compounds in the ambient air measured close to ground level. *Environ Toxicol Water Qual* 12:31-37.

9. REFERENCES

- *Hernandez-Munoz R, Diaz-Munoz M, Chagoya de Sanchez V. 1992. Effects of adenosine administration on the function and membrane composition of liver mitochondria in carbon tetrachloride-induced cirrhosis. *Arch Biochem Biophys* 294:160-167.
- Hernberg S, Kauppinen T, Riala R, et al. 1988. Increased risk for primary liver cancer among women exposed to solvents. *Scand J Work Environ Health* 14:356-365.
- Herzfeld D, van der Gun K, Louw R. 1988. Quantitative determination of volatile organochlorine compounds in water by GC-headspace analysis with dibromomethane as an internal standard. *Chemosphere* 14(8):1425-1430.
- *Ho JS. 1989. Method 502.2. Volatile organic compounds in water by purge and trap capillary column gas chromatography with photoionization and electrolytic conductivity detectors in series. Cincinnati, OH: U.S. Environmental Protection Agency, Office of Research and Development.
- Hocher B, Zart R, Diekmann F, et al. 1995a. Protective effects of the mixed endothelin receptor antagonist bosentan in rats with CCL4-induced liver injury. *J Cardiovasc Pharmacol* 26(Suppl. 3):S130-131.
- Hocher B, Zart R, Diekmann F, et al. 1995b. Role of the paracrine liver endothelin system in the pathogenesis of CCL4-induced liver injury. *Eur J Pharmacol* 293(4):361-368.
- *Hocher B, Zart R, Diekmann F, et al. 1996. Paracrine renal endothelin system in rats with liver cirrhosis. *Br J Pharmacol* 118:220-227.
- Hoekstra EJ, Deleer EWB, Brinkman UAT. 2001. Findings supporting the natural formation of trichloroacetic acid in soil. *Chemosphere* 38:2875-2883.
- Hoekstra EJ, Duyzer JH, Deleer EWB, et al. 2001. Chloroform-concentration gradients in soil air and atmospheric air and emission fluxes from soil. *Atmos Environ* 35:61-70.
- *Hoel DG, Davis DL, Miller AB, et al. 1992. Trends in cancer mortality in 15 industrialized countries, 1969-1986. *J Natl Cancer Inst* 84(5):313-320.
- *Holbrook HT. 1991. Carbon tetrachloride. In: Kroschwitz JI, Howe-Grant M, eds. *Kirk-Othmer encyclopedia of chemical technology*. Vol 5. 4th edition. New York: John Wiley & Sons, 1062-1072.
- Holden PR, James NH, Brooks AN. 2000. Identification of a possible association between carbon tetrachloride-induced hepatotoxicity and interleukin-8 expression. *J Biochem Mol Toxicol* 14(5):283-290.
- Holecek M, Skalska H, Mraz J. 1999. Plasma amino acid levels after carbon tetrachloride induced acute liver damage. A dose-response and time-response study in rats. *Amino Acids* 16:1-11.
- Holecek M, Tilser I, Skopec F, et al. 1996. Leucine metabolism in rats with cirrhosis. *J Hepatol* 24(2):209-216.
- *Hollinger MA. 1982. Biochemical evidence for pulmonary endothelial cell injury after carbon tetrachloride administration in mice. *J Pharmacol Exp Therap* 222:641-644.

9. REFERENCES

- Hooper K, LaDou J, Rosenbaum JS, et al. 1992. Regulation of priority carcinogens and reproductive or development toxicants. *Am J Ind Med* 22:793-808.
- *Hooser SB, Rosengren RJ, Hill DA. 1994. Vitamin A modulation of xenobiotic-induced hepatotoxicity in rodents. *Environ Health Perspect* 102(Suppl 9):39-43.
- *Horn TL, O'Brein TD, Schook LB, et al. 2000. Acute hepatotoxicant exposure induces TNFR-mediated hepatic injury and cytokin/apoptotic gene expression. *Toxicol Sci* 54:262-273.
- Horvath AL. 1982. Tabulated data. Halogenated hydrocarbons: Solubility–miscibility with water. New York, NY: Marcel Dekker, Inc., 484-572.
- Hosoda A, Yamada S, Kawasaki H, et al. 1993. Effects of carbon tetrachloride-induced chronic liver damage on glutathione-dependent enzymes in rat gastric mucosa. *Res Commun Chem Pathol Pharmacol* 81(2):209-220.
- Hotz P. 1994. Occupational hydrocarbon exposure and chronic nephropathy. *Toxicology* 90:163-283.
- *Howard PH, ed. 1990. Handbook of environmental fate and exposure data. Vol II. Chelsea, MI: Lewis Publishers, Inc., 85-91.
- *Howard PH, Boethling RS, Jarvis WF, et al, eds. 1991. Handbook of environmental degradation rates. Chelsea, MI: Lewis Publishers, Inc., 34-35.
- *HSDB. 2004. Carbon tetrachloride. Environmental standards and regulations. Bethesda, MD: Hazardous Substances Data Bank. <http://toxnet.nlm.nih.gov/cgi-bin/sis/htmlgen?HSDB.htm>. December 30, 2004.
- Huang YS, Deng JF, Wang JD, et al. 1987. [Clinical manifestations and laboratory findings of cases in an outbreak of carbon tetrachloride-induced hepatic injury at a printing factory.] [Abstract] 86:743-749. (Japanese)
- Huang Z-H, Murakami T, Okochi A, et al. 2001. Expression and function of p-glycoprotein in rats with carbon tetrachloride-induced acute hepatic failure. *J Pharm Pharmacol* 53:873-881.
- Huber M, Estermann G, Bonn G. 1988. Analysis of volatile halogenated hydrocarbons on the ppq scale. *Fresenius Z Anal Chem* 331:486-489.
- *Hughes CS. 1985. Chlorinated methanes. In: Chemical economics handbook. Menlo Park, CA: SRI International.
- *Hughes HM, George IM, Evans JC, et al. 1991. The role of the liver in the production of free radicals during halothane anaesthesia in the rat. *Biochem J* 277:795-800.
- *IARC. 1979. Evaluation of the carcinogenic risk of chemicals to humans. Lyon, France: International Agency for Research on Cancer, October 1979, 20:371-399.
- *IARC. 1987. IARC Monographs on the evaluation of carcinogenic risks to humans. Overall evaluations of carcinogenicity: An updating of IARC Monographs volumes 1 to 42, Supplement 7. Lyon, France: International Agency for Research on Cancer.

9. REFERENCES

- *IARC. 1999. IARC monographs programme on the evaluation of carcinogenic risks to humans. Carbon tetrachloride. Lyon, France: International Agency for Research on Cancer. <http://monographs.iarc.fr/>. June 6, 2003.
- Ichinose T, Miller MG, Shibamoto T. 1994. Determination of free malonaldehyde formed in liver microsomes upon CCL4 oxidation. *J Appl Toxicol* 14(6):453-455.
- Ideura T, Yoshimura A, Shirai M, et al. 1993. Endotoxin-induced acute tubular necrosis in cirrhotic rats. *Scand J Urol Nephrol* 27:433-439.
- *Ikatsu H, Nakajima T. 1992. Hepatotoxic interaction between carbon tetrachloride and chloroform in ethanol treated rats. *Arch Toxicol* 66:580-586.
- *Ikatsu H, Okino T, Nakajima T. 1991. Ethanol and food deprivation induced enhancement of hepatotoxicity in rats given carbon tetrachloride at low concentration. *Br J Ind Med* 48:636-642.
- Ikemoto M, Tsunekawa S, Toda Y, et al. 2001. Liver-type arginase in a highly sensitive marker for hepatocellular damage in rats. *Clin Chem* 47(5):946-948.
- Inagaki Y, Nemoto T, Kushida M, et al. 2003. Interferon alfa down-regulates collagen gene transcription and suppresses experimental hepatic fibrosis in mice. *Hepatology* 38(4):890-899.
- *Inder RE, Bray BJ, Sipes IG, et al. 1999. Role of cytochrome P4502E1 in retinol's attenuation of carbon tetrachloride-induced hepatotoxicity in the Swiss Webster mouse. *Toxicol Sci* 52(1):130-139.
- Infante FI, Marlow PB. 1980. Evidence for the carcinogenicity of selected halogenated hydrocarbons included ethylene dichloride. *Banbury Rep* 5:287-308.
- Ingall A, Lott KAK, Slater TF. 1978. Metabolic activation of carbon tetrachloride to a free-radical product study using a spin trap. *Biochem Soc Trans* 6:962-964.
- Iredale JP, Benyon RC, McCullen M, et al. 1998. Mechanisms of spontaneous resolution of rat liver fibrosis. *J Clin Invest* 102(3):538-549.
- *IRIS. 2003. Carbon tetrachloride. Washington, DC: Integrated Risk Information System. <http://www.epa.gov/iris/>. June 6, 2003.
- Ishigami T, Fujita T, Simbula G, et al. 2001. Regulatory effects of senescence marker protein 30 on the proliferation of hepatocytes. *Pathol Int* 51(7):491-497.
- Ishikawa K, Michida S, Mashiba S, et al. 1999. Expressions of vascular endothelial growth factor in nonparenchymal as well as parenchymal cells in rat liver after necrosis. *Biochem Biophys Res Commun* 254:587-593.
- *Ishiki Y, Ohnishi H, Muto Y, et al. 1992. Direct evidence that hepatocyte growth factor is a hepatotrophic factor for liver regeneration and has a potent antihepatitis effect *in vivo*. *Hepatology* 16:1227-1235.
- Ishiyama H, Sato M, Matsumura K, et al. 1995. Proliferation of hepatocytes and attenuation from carbon tetrachloride hepatotoxicity by gadolinium chloride in rats. *Pharmacol Toxicol* 77(4):293-298.

9. REFERENCES

- Isono M, Soda M, Inoue A, et al. 2003. Reverse transformation of hepatic myofibroblast-like cells by TGF β 1/LAP. *Biochem Biophys Res Commun* 311:959-965.
- Itoh H, Koyata H, Takahara T, et al. 1992. Prostacyclin administration suppresses the increase in hepatic levels of COL1A(I) and glyceraldehyde-3-phosphate dehydrogenase mRNAs in the rat treated with carbon tetrachloride. *Biochem Biophys Res Commun* 185(3):981-986.
- *Itoh S, Yamaba Y, Matsuo S, et al. 1985. Early changes in the levels of serum triiodothyronine (T3), thyroxine (T4), T3/T4 ratio and microsomal carboxylesterase activity in rats following treatment with CCl₄. *Res Commun Chem Pathol Pharmacol* 49:447-450.
- Iwai S, Karim R, Kitano M, et al. 2002. Role of oxidative DNA damage caused by carbon tetrachloride-induced liver injury -enhancement of MeIQ-induced glutathione S-transferase placental form-positive foci in rats. *Cancer Lett* 179:15-24.
- Iwamoto K, Watanaba J, Araki K, et al. 1985. Reduced hepatic clearance of propranolol induced by chronic carbon tetrachloride treatment in rats. *J Pharmacol Exp Ther* 234:470-475.
- *Jaeger RJ, Conolly RB, Murphy SD. 1975. Short-term inhalation toxicity of halogenated hydrocarbons. *Arch Environ Health* 30:26-31.
- Jaeschke H, Gores GJ, Cederbaum AI, et al. 2002. Mechanisms of hepatotoxicity. *Toxicol Sci* 65:166-176.
- *Jakobson I, Wahlberg JE, Holmberg B, et al. 1982. Uptake via the blood and elimination of 10 organic solvents following epicutaneous exposure of anesthetized guinea pigs. *Toxicol Appl Pharmacol* 63:181-187.
- James KJ, Stack MA. 1997. The impact of leachate collection on air quality in landfills. *Chemosphere* 34:1713-1721.
- Janakat S, Al-Merie H. 2002. Optimization of the dose and route of injection, and characterisation of the time course of carbon tetrachloride-induced hepatotoxicity in the rat. *J Pharmacol Toxicol Methods* 48:41-44.
- Janbaz KH, Gilani AH. 1999. Potentiation of paracetamol and carbon tetrachloride-induced hepatotoxicity in rodents by the food additive vanillin. *Food Chem Toxicol* 37(6):603-607.
- *Janbaz KH, Saeed SA, Gilani AH, et al. 1998. An assessment of the potential of protopine to inhibit microsomal drug metabolising enzymes and prevent chemical-induced hepatotoxicity in rodents. *Pharmacol Res* 38(3):215-219.
- Janzen EG, Poyer JL, West MS, et al. 1994. Study of reproducibility of spin trapping results in the use of C phenyl-N-tert-butyl nitron (PBN) for trichloromethyl radical detection in CCl₄ metabolism by rat liver microsomal dispersions Biological spin trapping I. *J Biochem Biophys Meth* 29:189-205.
- Janzen EG, Towner RA, Brauer M. 1988. Factors influencing the formation of the carbon dioxide radical anion (CO₂⁻) spin adduct of PBN in the rat liver metabolism of halocarbons. *Free Radic Res Commun* 4:359-369.

9. REFERENCES

- Janzen EG, Towner RA, Haire DL. 1987. Detection of free radicals generated from the in vitro metabolism of carbon tetrachloride using improved EPR spin trapping techniques. *Free Radic Res Commun* 3:357-364.
- *Japan Bioassay Research Center. 1998. Subchronic inhalation toxicity and carcinogenicity studies of carbon tetrachloride in F344 rats and B6F1 mice (Studies Nos. 0020, 0021, 0043, and 0044). Kanagawa, Japan Industrial Safety and Health Association, Japan Bioassay Research Center (Unpublished report to the Ministry of Labor). Hirasawa Hadano Kanagawa, 257 Japan.
- Javier Perez A, Courel M, Sobrado J, et al. 1987. Acute renal failure after topical application of carbon tetrachloride. *Lancet* 515-516.
- Jeffers PM, Ward LM, Woytowitch LM, et al. 1989. Homogeneous hydrolysis rate constants for selected chlorinated methanes, ethanes, ethenes, and propane. *Environ Sci Technol* 23:965-969.
- *Jennings RB. 1955. Fatal fulminant acute carbon tetrachloride poisoning. *Arch Pathol* 59:269-284.
- Jennings RB, Kearns WM. 1953. Necrotizing nephrosis in the rat following administration of carbon tetrachloride. *Arch Pathol* 56:348-359.
- Jeon TI, Hwang SG, Park NG, et al. 2003. Antioxidative effects of chitosan on chronic carbon tetrachloride induced hepatic injury in rats. *Toxicology* 187:67-73.
- Jeon YJ, Han SH, Yang KH, et al. 1997. Induction of liver-associated transforming growth factor beta1 (TGF-beta1) mRNA expression by carbon tetrachloride leads to the inhibition of T helper 2 cell-associated lymphokines. *Toxicol Appl Pharmacol* 144:27-35.
- *Jeong HG. 1999. Inhibition of cytochrome P450 2E1 expression by oleanolic acid hepatoprotective effects against carbon tetrachloride induced hepatic injury. *Toxicol Lett* 105(3):215-222.
- *Jeong HG, Park HY. 1998. The prevention of carbon tetrachloride-induced hepatotoxicity in mice by alpha-hederin: Inhibition of cytochrome P450 2E1 expression. *Biochem Mol Biol Int* 45(1):163-170.
- Jeong W-I, Lee C-S, Park S-J, et al. 2002. Kinetics of macrophages, myofibroblasts and mast cells in carbon tetrachloride-induced rat liver cirrhosis. *Anticancer Res* 2A:869-877.
- *Jiang Y, Liu J, Waalkes M, et al. 2004. Changes in the gene expression associated with carbon tetrachloride-induced liver fibrosis persist after cessation of dosing in mice. *Toxicol Sci* 79:404-410.
- *Jiang Z, You Dy, Chen XC, et al. 1992. Monitoring of serum markers for fibrosis during CCl₄-induced liver damage. *J Hepatol* 16:282-289.
- Jimenez-Jativa S, Nunez de Castro I, Morata P, et al. 1992. Rat serum fructose 1,6 biphosphatase: Modifications in different experimental conditions. *Biochem Int* 27(5):923-929.
- *Johanson CE. 1980. Permeability and vascularity of the developing brain: Cerebellum vs cerebral cortex. *Brain Res* 190:3-16.
- Johns R. 1976. Air pollution assessment of carbon tetrachloride. Mitre Technical Report No. MTR-7144, McLean, VA: Mitre Corp.

9. REFERENCES

- *Johnson SJ, Hines JE, Burt AD. 1992. Macrophage and perisinusoidal cell kinetics in acute liver injury. *J Pathol* 166:351-358.
- Johnston DE, Kroening C. 1998. Mechanism of early carbon tetrachloride toxicity in cultured rat hepatocytes. *Pharmacol Toxicol* 83:231-239.
- *Johnstone RT. 1948. Occupational medicine and industrial hygiene. St. Louis, MO: CV Mosby Co., 148-158.
- *Joly JG, Villeneuve JP, Marier P. 1977. Chronic ethanol administration induced a form of cytochrome P-450 with specific spectral and catalytic properties. *Alcoholism* 1:17-25.
- Jordan A, Harnisch J, Borchers R, et al. 2000. Volcanogenic halocarbons. *Environ Sci Technol* 34:1122-1124.
- *Jorgenson TA, Meierhenry EF, Rushbrook CJ, et al. 1985. Carcinogenicity of chloroform in drinking water to male Osborne-Mendel rats and female B6C3F1 mice. *Fundam Appl Toxicol* 5:760-769.
- Joron GE, Hollenberg CH, Bensley EH. 1957. Carbon tetrachloride -- an underrated hazard. *Can Med Assoc J* 763:173-175.
- Junnila M, Rahko T, Sukura A, et al. 2000. Reduction of carbon tetrachloride-induced hepatotoxic effects by oral administration of betaine in male Han-Wistar rats: A morphometric histological study. *Vet Pathol* 37:231-238.
- Kaido T, Yamaoka S, Seto S-Funaki N, et al. 1997. Continuous hepatocyte growth factor supply prevents lipopolysaccharide-induced liver injury in rats. *FEBS Lett* 411:378-382.
- Kajiwara K, Okuno M, Kobayashi T, et al. 1998. Oral supplementation with branched-chain amino acids improves survival rate of rats with carbon tetrachloride-induced liver cirrhosis. *Dig Dis Sci* 43(7):1572-1579.
- Kalf GF, Post GB, Snyder R. 1987. Solvent toxicology: Recent advances in the toxicology of benzene, the glycol ethers and carbon tetrachloride. *Ann Rev Pharmacol Toxicol* 27:399-427.
- *Kalla NR, Bansal MP. 1975. Effect of carbon tetrachloride on gonadal physiology in male rats. *Acta Anat* 91:380-385.
- *Kamada Y, Tamura S, Kiso S, et al. 2003. Enhanced carbon tetrachloride-induced liver fibrosis in mice lacking adiponectin. *Gastroenterology* 125:1796-1807.
- *Kaminski NE, Stevens WD. 1992. The role of metabolism in carbon tetrachloride-mediated immunosuppression. *In vitro* studies. *Toxicology* 75:175-188.
- *Kaminski NE, Barnes DW, Jordan SD, et al. 1990. The role of metabolism in carbon tetrachloride-mediated immunosuppression: *In vivo* studies. *Toxicol Appl Pharmacol* 102:9-20.
- *Kaminski NE, Jordan SD, Holsapple MP. 1989. Suppression of humoral and cell-mediated immune responses by carbon tetrachloride. *Fundam Appl Toxicol* 12:117-128.

9. REFERENCES

- Kanada M, Miyagawa M, Sato M, et al. 1994. Neurochemical profile of effects of 28 neurotoxic chemicals on the central nervous system in rats. Effects of oral administration on brain contents of biogenic amines and metabolites. *Ind Health* 32:145-164.
- Kanno K, Tazuma S, Chayama K. 2003. AT1A-deficient mice show less severe progression of liver fibrosis induced by CCl₄. *Biochem Biophys Res Commun* 308:177-183.
- Kanta J, Kvasnickova E, Bartos F. 1992. Prolonged reduction of hepatocyte proliferative ability in rats after a single treatment with carbon tetrachloride. *Int J Exp Path* 73:21-26.
- Kaphalia BS, Ansari GA. 1989. Covalent modification of hepatic microsomal lipids of rats by carbon tetrachloride. *Mol Toxicol* 2:199-213.
- *Katami T, Nisikawa H, Yasuhara A. 1992. Emission of chlorinated compounds by combustion of waste dry-cleaning materials. *Chemosphere* 24:343-349.
- Kato H, Nakazawa Y. 1987. The effect of carbon tetrachloride on the enzymatic hydrolysis of cellular triacylglycerol in adult rat hepatocytes in primary monolayer culture. *Biochem Pharmacol* 36:1807-1814.
- Kato K, Kawai T, Fujii M, et al. 1985. Enhancing effect of preadministration of carbon tetrachloride on methylazoxymethanol acetate-induced intestinal carcinogenesis. *J Toxicol Sci* 10:289-293.
- Kato T, Miyamoto M, Date T, et al. 2003. Repeated hepatocyte injury promotes hepatic tumorigenesis in hepatitis C virus transgenic mice. *Cancer Sci* 94(8):679-85.
- Katz RM, Jowett D. 1981. Female laundry and dry cleaning workers in Wisconsin: A mortality analysis. *Am J Public Health* 71:305-307.
- Kauppinen T, Partanen T, Degerth R, et al. 1995. Pancreatic cancer and occupational exposures. *Epidemiology* 6(5):498-502.
- *Kauppinen T, Pukkala E, Saalo A, et al. 2003. Exposure to chemical carcinogens and risk of cancer among Finnish laboratory workers. *Am J Ind Med* 44:343-350.
- Kauschke SG, Knorr A, Heke M. 1999. Two assays for measuring fibrosis: Reverse transcriptase-polymerase chain reaction of collagen alpha1 (III) mRNA is an early predictor of subsequent collagen deposition while a novel serum N-terminal procollagen (III) propeptide assay reflects manifest fibrosis in carbon tetrachloride-treated rats. *Anal Biochem* 275(2):131-140.
- *Kazantzis G, Bomford RR. 1960. Dyspepsia due to inhalation of carbon tetrachloride vapor. *Lancet*, February 13, 360-362.
- Kefalas V, Stacey NH. 1989. Potentiation of carbon tetrachloride-induced lipid peroxidation by trichloroethylene in isolated rat hepatocytes: No role in enhanced toxicity. *Toxicol Appl Pharmacol* 101:158-169.
- Kefalas V, Stacey NH. 1991. Potentiating effects of chlorinated hydrocarbons on carbon tetrachloride toxicity in isolated rat hepatocytes and plasma membranes. *Toxicol Appl Pharmacol* 109:171-179.
- *Kelly TJ, Mukund R, Spicer CW, et al. 1994. Concentrations and transformations of hazardous air pollutants. *Environ Sci Technol* 28:378-387.

9. REFERENCES

- *Kenaga EE. 1980. Predicted bioconcentration factors and soil sorption coefficients of pesticides and other chemicals. *Ecotoxicol Environ Safety* 4:26-38.
- Kenel MF, Kulkarni AP. 1985a. Ethanol potentiation of carbon tetrachloride hepatotoxicity: Possible role for the *in vivo* inhibition of aldehyde dehydrogenase. *Gen Pharmacol* 16:355-360.
- Kenel MF, Kulkarni AP. 1985b. Inhibition of hepatic aldehyde dehydrogenase by carbon tetrachloride: An *in vitro* study. *Int J Biochem* 17:605-610.
- Kennedy GL, Graepel GJ. 1991. Acute toxicity in the rat following either oral or inhalation exposure. *Toxicol Lett* 56:317-326.
- *Kerfoot HB. 1990. Soil-gas surveys for detection and delineation of groundwater contamination. *Trends Anal Chem* 9:157-163.
- *Kernan GJ, Ji B-T, Dosemeci M, et al. 1999. Occupational risk factors for pancreatic cancer: A case-control study based on death certificates from 24 U.S. states. *Am J Ind Med* 36:260-270.
- *Kier LD, Neft R, Tang L, et al. 2004. Applications of microarrays with toxicology relevant genes (tox genes) for the evaluation of chemical toxicants in Sprague Dawley rats *in vivo* and human hepatocytes *in vitro*. *Mutat Res* 549:101-113.
- *Kim YC. 1997. Dichloromethane potentiation of carbon tetrachloride hepatotoxicity in rats. *Fundam Appl Toxicol* 35:138-141.
- Kim YK. 1988. Hypogonadism in hepatic failure. *Nishinohon J Urology* 50:1-6.
- *Kim HJ, Bruckner JV, Dallas CE, et al. 1990a. Effect of dosing vehicles on the pharmacokinetics of orally administered carbon tetrachloride in rats. *Toxicol Appl Pharmacol* 102:50-60.
- *Kim HJ, Odendhal S, Bruckner JV. 1990b. Effect of oral dosing vehicles on the acute hepatotoxicity of carbon tetrachloride in rats. *Toxicol Appl Pharmacol* 102:34-49.
- Kim JY, Park JK, Emmons B, et al. 1995. Survey of volatile organic compounds at a municipal solid waste cocomposing facility. *Water Environ Res* 67(7):1044-1051.
- *Kim ND, Kwak MK, Kim SG. 1997. Inhibition of cytochrome P450 2E1 expression by 2-(allylthio)pyrazine, a potential chemoprotective agent: Hepatoprotective effects. *Biochem Pharmacol* 53(3):261-269.
- *Kim SG, Chung HC, Cho JY. 1996. Molecular mechanism for alkyl sulfide-modulated carbon tetrachloride-induced hepatotoxicity: The role of cytochrome P450 2E1, P450 2B and glutathione S-transferase expression. *J Pharmacol Exp Ther* 277(2):1058-1066.
- Kiplinger GF, Kensler CJ. 1963. Failure of phenoxybenzamine to prevent formation of hepatomas after chronic carbon tetrachloride administration. *J Natl Cancer Inst* 30:837-843.
- Kirman CR, Sweeney LM, Meek ME, et al. 2003. Assessing the dose-dependency of allometric scaling performance using physiologically based pharmacokinetic modeling. *Regul Toxicol Pharmacol* 38:345-367.

9. REFERENCES

- *Kirtland BC, Aelion CM, Stone PA, et al. 2003. Isotopic and geochemical assessment of in situ biodegradation of chlorinated hydrocarbons. *Environ Sci Technol* 37:4205-4212.
- *Kittleson KD, Borden CW. 1956. Acute renal failure due to carbon tetrachloride poisoning. *Northwestern University Medical School Magazine* 30:117-123.
- Klaassen CD, Liu J. 1998. Induction of metallothionein as an adaptive mechanism affecting the magnitude and progression of toxicological injury. *Environ Health Perspect* 106(Suppl 1):297-300.
- Klaassen CD, Plaa GL. 1966. Relative effects of various chlorinated hydrocarbons on liver and kidney function in mice. *Toxicol Appl Pharmacol* 9:139-151.
- Klaassen CD, Plaa GL. 1967. Relative effects of various chlorinated hydrocarbons on liver and kidney function in dogs. *Toxicol Appl Pharmacol* 10:119-131.
- Klaunig JE, Ruch RJ, Pereira MA. 1986. Carcinogenicity of chlorinated methane and ethane compounds administered in drinking water to mice. *Environ Health Perspect* 69:89-95.
- Kliest J, Fast T, Boley JS. 1989. The relationship between soil contaminated with volatile organic compounds and indoor air pollution. *Environ Int* 15:419-425.
- *Kluwe WM. 1981. The nephrotoxicity of low molecular weight halogenated alkane solvents, pesticides and chemical intermediates. *Toxicol Kidney* 179-226.
- *Kluwe WM, Herrmann CL, Hook JB. 1979. Effects of dietary polychlorinated biphenyls and polybrominated biphenyls on the renal and hepatic toxicities of several chlorinated hydrocarbon solvents in mice. *J Toxicol Environ Health* 5:605-615.
- Knecht KT, Mason RP. 1988. *In vivo* radical trapping and biliary secretion of radical adducts of carbon tetrachloride-derived free radical metabolites. *Drug Metab Dispos* 16:813-817.
- *Knecht KT, Mason RP. 1991. The detection of halocarbon-derived radical adducts in bile and liver of rats. *Drug Metab Dispos* 19:325-331.
- *Kniepert E, Siegemund A, Gorisch V. 1990. Influence of ethanol pretreatment of differing duration on toxic effects of carbon tetrachloride in rats. *Biomed Biochim Acta* 49:1097-1102.
- *Kniepert E, Siegemund A, Rosenkranz M, et al. 1991. Toxic effects of carbon tetrachloride during short and long term ethanol intake in rats. *Arch Toxicol Suppl* 14:263-265.
- Kobayashi K, Mutai M, Goto K, et al. 1997. Effects of carbon tetrachloride administration on initiation of liver cell foci by the non-hepatocarcinogens N-methyl-N'-nitro-N-nitrosoguanidine (MNNG) and benzo(a)pyrene (B(a)P). *Cancer Lett* 118:55-60.
- *Koch I, Weil R, Wolbold R, et al. 2002. Interindividual variability and tissue-specificity in the expression of cytochrome P450 3A mRNA. *Drug Metab Dispos* 30(10):1108-1114.
- Kodavanti PR, Joshi UM, Mehendale HM. 1989a. Chlordecone (kepone)-potentiated carbon tetrachloride hepatotoxicity in partially hepatectomized rats—a histomorphometric study. *J Appl Toxicol* 9:367-375.

9. REFERENCES

- Kodavanti PR, Joshi UM, Young RA, et al. 1989b. Protection of hepatotoxic and lethal effects of CCl₄ by partial hepatectomy. *Toxicol Pathol* 17:494-505.
- Kodavanti PR, Joshi UM, Young RA, et al. 1989c. Role of hepatocellular regeneration in chlordecone potentiated hepatotoxicity of carbon tetrachloride. *Arch Toxicol* 63:367-375.
- *Kodavanti PR, Kodavanti UP, Faroon OM, et al. 1992. Pivotal role of hepatocellular regeneration in the ultimate hepatotoxicity of CCl₄ in chlordecone-, mirex, or phenobarbital-pretreated rats. *Toxicol Pathol* 20:556-569.
- Kodavanti PR, Kodavanti UP, Mehendale HM. 1990a. Altered hepatic energy status in chlordecone (Kepone)-potentiated CCl₄ hepatotoxicity. *Biochem Pharmacol* 40:859-866.
- *Kodavanti PR, Kodavanti UP, Mehendale HM. 1990b. Carbon tetrachloride-induced alterations of hepatic calmodulin and free calcium levels in rats pretreated with chlordecone. *Hepatology* 9:230-238.
- *Kodavanti PR, Rao VC, Mehendale HM. 1993. Loss of calcium homeostasis leads to progressive phase of chlordecone-potentiated carbon tetrachloride hepatotoxicity. *Toxicol Appl Pharmacol* 122:77-87.
- *Kohno H, Hoshino Y, Katoh S, et al. 1992. Effect of retinoic acid on liver transglutaminase activity and carbon tetrachloride-induced liver damage in mice. *Experientia* 48:386-388.
- *Kolpin DW, Squillace PJ, Zogorski JS, et al. 1997. Pesticides and volatile organic compounds in shallow urban groundwater of the United States. In: *Groundwater urban environment proceedings, IAH Congress, 27th*. Chilton J, ed. Balkema: Rotterdam, Netherlands, 69-74.
- *Komori M, Nishio K, Kitada M, et al. 1990. Fetus-specific expression of a form of cytochrome P-450 in human livers. *Biochemistry* 29:4430-4433.
- *Koporec KP, Kim HJ, MacKenzie WF, et al. 1995. Effect of oral dosing vehicles on the subchronic hepatotoxicity of carbon tetrachloride in the rat. *J Toxicol Environ Health* 44:13-27.
- Koptagel E, Bulut HE. 1998. Effects of short-term hydrocarbon inhalation on rat tracheal mucosa. *Okajimas Fol Anat Jpn* 75(2-3):71-86.
- *Korsrud GO, Grice HC, McLaughlan JM. 1972. Sensitivity of several serum enzymes in detecting carbon tetrachloride-induced liver damage in rats. *Toxicol Appl Pharmacol* 22:474-483.
- *Kostyuk VA, Potapovich AI. 1991. Damage of rat liver microsomal mixed function oxidase system by carbon tetrachloride *in vivo* study with selective inhibitor of lipid peroxidation. *Biochem Int* 25:349-353.
- Kourounakis PN. 1994. Effect of spironolactone on dimethyl mercury toxicity: A possible molecular mechanism. *Arzneim Forsch* 44(10):1150-1153.
- Kovalovich K, DeAngelis RA, Li W. 2000. Increased toxin-induced liver injury and fibrosis in interleukin-6-deficient mice. *Hepatology* 31:149-159.
- Krähenbühl L, Ledermann M, Lang C, et al. 2000. Relationship between hepatic mitochondrial functions *in vivo* and *in vitro* in rats with carbon tetrachloride-induced liver cirrhosis. *J Hepatol* 33:216-223.

9. REFERENCES

- Krapotkina MA. 1981. Clinical and experimental estimation of toxic effects of and derivation of maximum permissible concentration for adipic acid in the air of a work environment. *Gig Tr Prof Zabol* 0(5):46-47.
- Kravetz D, Bosch J, Arderiu M, et al. 1989. Hemodynamic effects of blood volume restitution following a hemorrhage in rats with portal hypertension due to cirrhosis of the liver: Influence of the extent of portal-systemic shunting. *Hepatology* 9:808-814.
- *Kriegman-King MR, Reinhard M. 1991. Abiotic transformation of carbon tetrachloride in the presence of sulfide and mineral surfaces. *Amer Chem Soc, Div Environ Chem. Preprint, 203rd ACS National Meeting* 32:495-498.
- *Krishnan K, Andersen ME. 1994. Physiologically based pharmacokinetic modeling in toxicology. In: Hayes AW, ed. *Principles and methods of toxicology*. 3rd ed. New York, NY: Raven Press, Ltd., 149-188.
- *Krishnan K, Anderson ME, Clewell HJ III, et al. 1994. Physiologically based pharmacokinetic modeling of chemical mixtures. *Toxicology of Chemical Mixtures* 399-437.
- Kristensen DB, Kawada K, Imamura K, et al. 2000. Proteome analysis of rat hepatic stellate cells. *Hepatology* 32(2):268-277.
- Kroneld R, Reunanen M. 1990. Determination of volatile pollutants in human and animal milk by GC-MS. *Bull Environ Contam Toxicol* 44:917-923.
- *Kronevi T, Wahlberg J, Holmberg B. 1979. Histopathology of skin, liver, and kidney after epicutaneous administration of five industrial solvents to guinea pigs. *Environ Res* 19:56-69.
- Kubic VL, Anders MW. 1980. Metabolism of carbon tetrachloride to phosgene. *Life Sci* 26:2151-2155.
- Kulcsar-Gergely J, Kulcsar A. 1992. Metoprolol and propranolol treatment in carbon tetrachloride-induced hepatic injury. *Arzneim Forsch* 42(10):1192-1195.
- *Kwon YH, Jovanovic A, Serfas MS, et al. 2004. The Cdk inhibitor p21 is required for necrosis, but it inhibits apoptosis following toxin-induced liver injury. *J Biol Chem* 278(32):30348-30355.
- LaCagnin LB, Connor HD, Mason RP, et al. 1987. The carbon dioxide anion radical adduct in the perfused rat liver: Relationship to halocarbon-induced toxicity. *Mol Pharmacol* 33:351-257.
- Lachnit V, Pietschmann H. 1960. Activity of serum glutamic-oxaloacetic transaminase and aldolase in workers exposed to halogenated hydrocarbons. *Ind Med Surg* 29:523-526.
- *Lai EK, McCay PB, Noguchi T, et al. 1979. *In vivo* spin-trapping of trichloromethyl radicals formed from carbon tetrachloride. *Biochem Pharmacol* 28:2231-2235.
- *Lam RHF, Brown JP, Fan AM. 1994. Chemicals in California drinking water: Source of contamination, risk assessment, and drinking water standards. In: Wang RGM, ed. *Water contamination and health*. New York, NY: Marcel Dekker, Inc., 15-44.
- Lamb RG, Borzelleca JF, Condie LW, et al. 1989. Toxic interactions between carbon tetrachloride and chloroform in cultured rat hepatocytes. *Toxicol Appl Pharmacol* 101:106-113.

9. REFERENCES

- *Lamson PD, Minot AS, Robbins BH. 1928. The prevention and treatment of carbon tetrachloride intoxication. *J Am Med Assoc* 90:345-346.
- *Landsberg, L, Young JB 1998. Pheochromocytoma. In: Fauci AS, Martin JB, Braunwald E, et al., eds. *Harrison's principles of internal medicine*, 14th ed. New York: McGraw-Hill, 2057-2060.
- *LaRegina J, Bozzelli JW, Harkov R, et al. 1986. Volatile organic compounds at hazardous waste sites and a sanitary landfill in New Jersey. *Environmental Progress* 5:18-27.
- *Larsen T, Kjeldsen P, Christensen TH. 1992. Sorption of hydrophobic hydrocarbons on three aquifer materials in a flow through system. *Chemosphere* 24:439-451.
- Lasierra J, Barrao F, Cena G, et al. 1992. Changes in the fibrinolytic system in liver dysfunction: Role of portal hypertension. *Thromb Res* 67(1):15-21.
- *Leach CN. 1922. Carbon tetrachloride in the treatment of hookworm disease. *J Am Med Assoc* 78:1789-1790.
- *Leclercq IA, Field J, Farrell GC. 2003. Leptin-specific mechanisms for impaired liver regeneration in ob/ob mice after toxic injury. *Gastroenterology* 124:1451-1464.
- Ledda-Columbano GM, Columbano A, Coni P, et al. 1987. Liver cell proliferation induced by the mitogen ethylene dibromide, unlike compensatory cell proliferation, does not achieve initiation of rat liver carcinogenesis by diethylnitrosamine. *Cancer Lett* 36:247-252.
- Lee SY, Ku YS. 2000. Pharmacokinetics and hepatoprotective effects of 2-methylaminoethyl-4,4'-dimethoxy-5,6,5',6'-dimethylenedioxybiphenyl-2-carboxylic acid -2'-carboxylate monohydrochloride in rats with CCl₄-induced acute hepatic failure. *J Pharm Pharmacol* 52:1099-1103.
- Lee KJ, Woo E-R, Choi CY, et al. 2004. Protective effect of acteoside on carbon tetrachloride-induced hepatotoxicity. *Life Sci* 74:1051-1064.
- *Lee PY, McCay PB, Hornbrook KR. 1982. Evidence for carbon tetrachloride-induced lipid peroxidation in mouse liver. *Biochem Pharmacol* 31(3):405-409.
- *Lee VM, Cameron RG, Archer MC. 1998. Zonal location of compensatory hepatocyte proliferation following chemically induced hepatotoxicity in rats and humans. *Toxicol Pathol* 26(5):621-627.
- *Leeder JS, Kearns GL. 1997. Pharmacogenetics in pediatrics: Implications for practice. *Pediatr Clin North Am* 44(1):55-77.
- *Lehmann KB, Schmidt-Kehl L. 1936. The thirteen most important chlorinated aliphatic hydrocarbons from the standpoint of industrial hygiene. *Arch Hygiene* 116:132-200.
- Leighton DT Jr, Calo JM. 1981. Distribution coefficients of chlorinated hydrocarbons in dilute air-water systems for groundwater contamination applications. *J Chem Eng Data* 26:382-385.
- LeSage GD, Glaser SS, Marucci L, et al. 1999. Acute carbon tetrachloride feeding induces damage of large but not small cholangiocytes from BDL rat liver. *Am J Physiol* 39:G1289-G1302.

9. REFERENCES

- *Letkiewicz, F. 1983. Occurrence of carbon tetrachloride in drinking water, food and air. McLean, Virginia: JRB Associates, Inc. PB95183174.
- Leung HW. 1991. Development and utilization of physiologically based pharmacokinetic models for toxicological applications. *J Toxicol Environ Health* 32:247-267.
- *Leung H-W. 1993. Physiologically-based pharmacokinetic modelling. In: Ballentine B, Marro T, Turner P, eds. *General and applied toxicology*. Vol. 1. New York, NY: Stockton Press, 153-164.
- Levine D, Rockey DC, Milner TA, et al. 2000. Expression of the integrin $\alpha 8 \beta 1$ during pulmonary and hepatic fibrosis. *Am J Pathol* 156(6):1927-1935.
- Levy BSB, Meyer CB. 1977. Health hazard evaluation determination report number 76-1-388, Bohn Aluminum & Brass Corporation, Danville, Illinois. Cincinnati, OH: National Institute for Occupational Safety and Health. PB273733.
- Lide DR. 1993. *CRC handbook of chemistry and physics*. 73rd ed. CRC Press, Inc.
- *Lillian D, Singh HB, Appleby A, et al. 1975. Atmospheric fates of halogenated compounds. *Environ Sci Technol* 9:1042-1048.
- *Limaye PB, Apte UM, Shankar K, et al. 2003. Calpain released from dying hepatocytes mediates progression of acute liver injury induced by model hepatotoxicants. *Toxicol Appl Pharmacol* 191:211-226.
- *Lindros KO, Cai Y, Penttila KE. 1990. Role of ethanol-inducible cytochrome P-450 IIE1 in carbon tetrachloride-induced damage to centrilobular hepatocytes from ethanol-treated rats. *Hepatology* 12(5):1092-1097.
- Lindros PM, Zarnegar R, Michalopoulos GK. 1990. Hepatocyte growth factor (hepatopoietin A) rapidly increases in plasma before DNA synthesis and liver regeneration stimulated by partial hepatectomy and carbon tetrachloride administration. *Hepatology* 13:743-750.
- *Link B, Durk H, Thiel D, et al. 1984. Binding of trichloromethyl radicals to lipids of the hepatic endoplasmic reticulum during tetrachloromethane metabolism. *Biochem J* 223:577-586.
- *Litchfield MH, Gartland CJ. 1974. Plasma enzyme activity and hepatocellular changes in the Beagle dog after single or repeated administration of carbon tetrachloride. *Toxicol Appl Pharmacol* 30:117-128.
- Litterst CL, Farber TM, Van Loon EJ. 1973. Potentiation of carbon tetrachloride-induced hepatotoxicity in the dog by chronic exposure to phenobarbital. *Toxicol Appl Pharmacol* 24:354-362.
- Liu P, Kawada N, Mizoguchi Y, et al. 1992. Arachidonate metabolism in D-galactosamine or CCl_4 -induced acute and chronic liver injuries in rats. *Gastroenterol Jpn* 27(5):624-632.
- Liu S-L, Esposti SD, Yao T, et al. 1995. Vitamin E therapy of acute CCl_4 -induced hepatic injury in mice is associated with inhibition of nuclear factor kappa B binding. *Hepatology* 22:1474-1481.
- Liu Y, Hartley DP, Liu J. 1998. Protection against carbon tetrachloride hepatotoxicity by oleanolic acid is not mediated through metallothionein. *Toxicol Lett* 95:77-85.

9. REFERENCES

- *Livingston, AL. 1978. Forage plant estrogens. *J Toxicol Environ Health* 4:301-324.
- Lloyd SA, Franklin MR. 1991. Modulation of carbon tetrachloride hepatotoxicity and xenobiotic-metabolizing enzymes by corticosterone pretreatment, adrenalectomy and sham surgery. *Toxicol Lett* 55:65-75.
- Lombardi B, Ove P, Reddy TV. 1985. Endogenous hepatic growth-modulating factors and effects of a choline-devoid diet and of phenobarbital on hepatocarcinogenesis in the rat. *Nutr Cancer* 7:145-154.
- *Long RM, Moore L. 1986a. Elevated cytosolic calcium in rat hepatocytes exposed to carbon tetrachloride. *J Pharmacol Exp Ther* 238:186-191.
- *Long RM, Moore L. 1986b. Inhibition of liver endoplasmic reticulum calcium pump by CCl₄ and release of a sequestered calcium pool. *Biochem Pharmacol* 35:4131-4137.
- Long RM, Moore L. 1987. Cytosolic calcium after carbon tetrachloride, 1,1-dichloroethylene, and phenylephrine exposure. Studies in rat hepatocytes with phosphorylase and quin2. *Biochem Pharmacol* 36:1215-1221.
- Long RM, Moore L. 1988. Biochemical evaluation of rat hepatocyte primary cultures as a model for carbon tetrachloride in rats based on arterial blood: Inhaled air concentration ratios. *Toxicol Appl Pharmacol* 92:295-306.
- *Long RM, Moore L, Schoenberg DR. 1989. Halocarbon hepatotoxicity is not initiated by Ca²⁺-stimulated endonuclease activation. *Toxicol Appl Pharmacol* 97:350-359.
- Lopez del Pino V, Bolt HM. 1977. [Effects of hepatotoxic agents on hepatic microsomal metabolism of estrogens in the rat.] *Drug Res* 27:2117-2120. (German)
- Lopez-Lirola A, Gonzalez-Reimers E, Olivera RM, et al. 2003. Protein deficiency and muscle damage in carbon tetrachloride induced liver cirrhosis. *Food Chem Toxicol* 41:1789-1797.
- *Louis H, Van Laethem J-L, Wu W, et al. 1998. Interleukin-10 controls neutrophilic infiltration, hepatocyte proliferation, and liver fibrosis induced by carbon tetrachloride in mice. *Hepatology* 28(6):1607-1615.
- *Loureiro-Silva MR, Cadelina GW, Iwakiri Y, et al. 2003. A liver-specific nitric oxide donor improves the intra-hepatic vascular response to both portal blood flow increase and methoxamine in cirrhotic rats. *J Hepatol* 39:940-946.
- *Loveday KS, Anderson BE, Resnick MA, et al. 1990. Chromosome aberration and sister chromatid exchange tests in Chinese hamster ovary cells *in vitro*. V: Results with 46 chemicals. *Environ Mol Mutagen* 16:272-303.
- *Lovelock JE, Maggs RJ, Wade WJ. 1973. Halogenated hydrocarbons in and over the Atlantic. *Nature* 241:194-196.
- Lowrey K, Glende EA, Recknagel RO. 1981a. Destruction of liver microsomal calcium pump activity by carbon tetrachloride and bromotrichloromethane. *Biochem Pharmacol* 30:135-140.

9. REFERENCES

- Lowrey K, Glende EA, Recknagel RO. 1981b. Rapid depression of rat liver microsomal calcium pump activity after administration of carbon tetrachloride or bromotrachloromethane and lack of effect after ethanol. *Toxicol Appl Pharmacol* 59:389-394.
- Loyke HF. 1986. Hematological and blood pressure studies in cell treated rats. *J Environ Pathol Toxicol Oncol* 7:1-8.
- Loyke HF, Maksem JA. 1992. Hepatocellular injury induced by chronic low-dose CCl₄ in spontaneous and renal hypertensive rats: A correlation to the reversal of experimental rat hypertensive models. *J Environ Pathol Toxicol Oncol* 11:38-42.
- Lu PC. 1992. A health hazard assessment in school arts and crafts. *J Environ Pathol Toxicol Oncol* 11:12-17.
- *Luckey SW, Petersen DR. 2001. Activation of Kupffer cells during the course of carbon tetrachloride-induced liver injury and fibrosis in rats. *Exp Mol Pathol* 71:226-240.
- Lukita-Atmadja W, Sato T, Wake K. 1993. Granuloma formation in the liver of Balb/c mice intoxicated with carbon tetrachloride. *Virchows Arch B* 64(4):247-257.
- Lundh HAB. 1964. Sequence comparison between kidney and liver lesions in the rat following carbon tetrachloride poisoning. *J Occup Med* 6:123-128.
- *Luster MI, Munson AE, Thomas PT, et al. 1988. Development of a testing battery to assess chemical-induced immunotoxicity: National Toxicology Program's guidelines for immunotoxicity evaluation in mice. *Fundam Appl Toxicol* 10:2-19.
- Luster MI, Simeonova PP, Gallucci RM, et al. 2000. The role of tumor necrosis factor α in chemical-induced hepatotoxicity. *Ann N Y Acad Sci* 919:214-220.
- *Lutz RW, Shires TK. 1978. Polysomal changes in rats treated with lethal doses of carbon tetrachloride. *Toxicol Appl Pharmacol* 45:653-663.
- Lynge E, Anttila A, Hemminki K, et al. 1997. Organic solvents and cancer. *Cancer Causes Control* 8(3):406-419.
- *Lynn GE, Vorhes FA. 1957. Residues in foods and feeds resulting from fumigation of grains with the commoner liquid formulations of carbon disulfide, carbon tetrachloride, ethylene dichloride and ethylene dibromide. *J Assoc Off Agric Chem* 40:163-165.
- Ma LY, LaCagnin LB, Bowman L, et al. 1989. Carbon tetrachloride inhibits synthesis of pulmonary surfactant disaturated phosphatidylcholines and ATP production in alveolar type II cells. *Acta Biochem Biophys* 1003:136-144.
- Ma X, Zhao J, Lieber CS. 1996. Polyenylphosphatidylcholine attenuates non-alcoholic hepatic fibrosis and accelerates its regression. *J Hepatol* 24(5):604-613.
- *Mabey W, Mill T. 1978. Critical review of hydrolysis of organic compounds in water under environmental conditions. *J Phys Chem* 7:383-415.

9. REFERENCES

- *Mackay DM, Freyberg DL, Goltz MN, et al. 1983. A field experiment of ground water transport of halogenated organic solutes (Preprint Extended Abstract). American Chemical Society 196th National Meeting of Division of Environmental Chemists 23:368-371.
- *MacMahon HE, Weiss S. 1929. Carbon tetrachloride poisoning with microscopic fat in the pulmonary artery. *Am J Pathol* 5:623-630.
- *Magos L, Snowden R, White INH, et al. 1982. Isotoxic oral and inhalation exposure of carbon tetrachloride in Porton-Wistar and Fischer rats. *J Appl Toxicol* 2(5):238-240.
- Manautou JE, Silva VM, Henning GE, et al. 1998. Repeated dosing with the peroxisome proliferator clofibrate decreases the toxicity of model hepatotoxic agents in male mice. *Toxicology* 127:1-10.
- *Mannering GJ. 1985. Drug metabolism in the newborn. *Fed Proc* 44:2302-2308.
- *Manno M, deMatteis F, King LJ. 1988. The mechanism of the suicidal, reductive inactivation of microsomal cytochrome P-450 by carbon tetrachloride. *Biochem Pharmacol* 37:1981-1990.
- *Manno M, Ferrara R, Cazzaro S, et al. 1992. Suicidal inactivation of human cytochrome P-450 by carbon tetrachloride and halothane *in vitro*. *Pharmacol Toxicol* 70:13-18.
- Manno M, Rezzadore M, Cazzaro S. 1991. Suicidal inactivation of cytochrome P-450 by halothane and carbon tetrachloride. Padova, Italy: Institut Occup Med, 329-331.
- *Manno M, Rezzadore M, Grossi M, et al. 1996. Potentiation of occupational carbon tetrachloride toxicity by ethanol abuse. *Hum Exp Toxicol* 15:294-300.
- Manno M, Tolando R, Ferrara R, et al. 1995. Suicidal inactivation of haemoproteins by reductive metabolites of halomethanes: A structure-activity relationship study. *Toxicology* 100:175-183.
- Marathe GK, Harrison KA, Roberts LJ, et al. 2001. Identification of platelet-activating factor as the inflammatory lipid mediator in CCl₄-metabolizing rat liver. *J Lipid Res* 42:587-596.
- *Marchand C, McLean S, Plaa GL. 1970. The effect of SKF 525A on the distribution of carbon tetrachloride in rats. *J Pharmacol Exp Therap* 714:232-238.
- *Markham TN. 1967. Renal failure due to carbon tetrachloride. *J Occup Med* 9:16-17.
- *Martin C, Dutertre-Catella H, Radionoff M, et al. 2003. Effect of age and photoperiodic conditions on metabolism and oxidative stress related markers at different circadian stages in rat liver and kidney. *Life Sci* 73(3):327-335.
- Martin CJ, Le CXC, Guidotti TL, et al. 1999. Zinc exposure in Chinese foundry workers. *Am J Ind Med* 35:574-580.
- *Martinez M, Mourelle M, Muriel P. 1995. Protective effect of colchicine on acute liver damage induced by CCl₄. Role of cytochrome P-450. *J Appl Toxicol* 15(1):49-52.
- Masuda Y, Nakamura Y. 1990. Effects of oxygen deficiency and calcium omission on carbon tetrachloride hepatotoxicity in isolated perfused livers from phenobarbital-pretreated rats. *Biochem Pharmacol* 40:1865-1876.

9. REFERENCES

- Mathur AK, Gupta BN. 1998. Dermal toxicity of linear alkylbenzene sulfonate, chromium, and nickel in guinea pigs. *J Toxicol Cutaneous Ocul Toxicol* 17(4):191-196.
- Matkovics B, Novak R, Szabo L, et al. 1978. Effect of acute carbon tetrachloride intoxication on the lipid peroxidation and the enzymes of the peroxide metabolism of rat tissues. *Gen Pharmacol* 9:329-332.
- *Matsubara T, Mori S, Touchi A, et al. 1983. Carbon tetrachloride-induced hepatotoxicity in rats: Evidence for different susceptibilities of rat liver lobes. *Japan J Pharmacol* 33:435-445.
- Matwichuk C, Daniel G, DeNovo R et al. 2000. Evaluation of plasma time-activity curves of technetium-99m-mebrofenin for measurement of hepatic function in dogs. *Vet Radiol Ultrasound* 41(1):78-84.
- *Mayama J, Kumano T, Hayakari M, et al. 2003. Polymorphic glutathione S-transferase subunit 3 of rat liver exhibits different susceptibilities to carbon tetrachloride: Differences in their interactions with heat-shock protein 90. *Biochem J* 372:611-616.
- *Mayr U, Butsch A, Schneider S. 1992. Validation of two in vitro test systems for estrogenic activities with zearalenone, phytoestrogens and cereal extracts. *Toxicology* 74:135-149.
- *McCann J, Choi E, Yamasaki E, et al. 1975. Detection of carcinogens as mutagens in the *Salmonella*/microsome test: Assay of 300 chemicals. *Proc Nat Acad Sci* 72:5135-5139.
- *McCarty PL. 1996. Biotic and abiotic transformations of chlorinated solvents in ground water. EPA540r96509. Symp. Nat. Atten. Chlorin. Org. Groundwater. Washington, DC: U.S. Environmental Protection Agency, Office of Resource Development, 5-9.
- *McCarty PL, Reinhard M. 1993. Biological and chemical transformations of halogenated aliphatic compounds in aquatic and terrestrial environments. In: Oremland RS, ed. *The biochemistry of global change: Radiative trace gases*. New York, NY: Chapman & Hall, 839-852.
- *McCarty PL, Semprini L. 1994. Ground-water treatment for chlorinated solvents. In: Norris RD, et al., eds. *Handbook of bioremediation*. Boca Raton, FL: Lewis Publishers, 87-116.
- McCarty LP, Flannagan DC, Randall SA, et al. 1992. Acute toxicity in rats of chlorinated hydrocarbons given via the intratracheal route. *Human Exp Toxicol* 11:173-177.
- *McCarty PL, Goltz MN, Hopkins GD, et al. 1996. In-situ biodegradation of chlorinated solvent contaminants in groundwater. In: Proc-WEFTEC. Annual Conference Expo., 69th, Vol. 3, 217-223.
- McClenny WA, Pleil JD, Lumpkin TA, et al. 1987. Toxic monitoring with canister-based systems. *Proceedings of the APCA Annual Meeting* 80:87/62.3.
- *McCollister DD, Beamer WH, Atchison GJ, et al. 1951. The absorption, distribution and elimination of radioactive carbon tetrachloride by monkeys upon exposure to low vapor concentrations. *J Pharmacol Exp Therap* 102:112-124.
- *McConnell G, Ferguson DM, Peason CR. 1975. Chlorinated hydrocarbons and the environment. *Endeavour* 34:13-18.

9. REFERENCES

- *McDermott WV, Hardy HL. 1963. Cirrhosis of the liver following chronic exposure to carbon tetrachloride. *J Occup Med* 5:249-251.
- McGregor D, Lang M. 1996. Carbon tetrachloride: Genetic effects and other modes of action. *Mutat Res* 366:181-195.
- *McGuire LW. 1932. Carbon tetrachloride poisoning. *J Am Med Assoc* 99:988-989.
- McKinney JD, Maurer RR, Hass JR, et al. 1975. Possible factors in the drinking water of laboratory animals causing reproductive failure. In: Keith LH, ed. Identification and analysis of organic pollutants in water. Ann Arbor, MI: Ann Arbor Science Publishers Inc., 417-432.
- *McKone TE. 1987. Human exposure to volatile organic compounds in household tap water: The indoor inhalation pathway. *Environ Sci Technol* 21:1194-1201.
- McKone TE. 1989. Household exposure models. *Toxicol Lett* 49:321-339.
- *McLean AEM, McLean EK. 1966. The effect of diet and 1,1,1-trichloro-2,2-bis-(p-chlorophenyl)ethane (DDT) on microsomal hydroxylating enzymes and on sensitivity of rats to carbon tetrachloride poisoning. *Biochem J* 100:564-571.
- *McMahon BM. 1971. Analysis of commercially fumigated grains for residues of organic fumigants. *J Assoc Off Anal Chem* 51:964-965.
- *Mehendale HM. 1990. Potentiation of halomethane hepatotoxicity by chlordecone: A hypothesis for the mechanism. *Med Hypotheses* 33:289-299.
- *Mehendale HM. 1991. Commentary: Role of hepatocellular regeneration and hepatolobular healing in the final outcome of liver injury. A two-stage model of toxicity. *Biochem Pharmacol* 42:1155-1162.
- *Mehendale HM. 1992. Biochemical mechanisms of biphasic dose-response relationships: Role of hormesis. In: Calabrese EJ, ed. Biological effects of low level exposures to chemicals and radiation. Chelsea, MI: Lewis Publishers, 59-94.
- Mehendale HM. 1994. Amplified interactive toxicity of chemicals at nontoxic levels: Mechanistic considerations and implications to public health. *Environ Health Perspect* 102(Suppl. 9):139-149.
- *Mehendale HM, Klingensmith JS. 1988. *In vitro* metabolism of carbon tetrachloride by rats pretreated with chlordecone, mirex, or phenobarbital. *Toxicol Appl Pharmacol* 93:247-256.
- *Mehendale HM, Ray SD, Cai Z. 1991. Paradoxical toxicity of CCl₄ in isolated hepatocytes from chlordecone, phenobarbital and mirex pretreated rats. *In Vitro Toxicol* 4:187-196.
- Melin A-M, Perromat A, Deleris G. 2001. The *in vivo* toxicity of carbon tetrachloride and carrageenan on heart microsomes: Analysis by fourier transform infrared spectroscopy. *Can J Physiol Pharmacol* 79(9):799-804.
- Michael LC, Pellizzari ED, Perritt RL, et al. 1990. Comparison of indoor, backyard, and centralized air monitoring strategies for assessing personal exposure to volatile organic compounds. *Environ Sci Technol* 24:996-1003.

9. REFERENCES

- *Michael LC, Pellizzari ED, Wiseman RW. 1988. Development and evaluation of a procedure for determining volatile organics in water. *Environ Sci Technol* 22:565-570.
- *Mico BA, Pohl LR. 1983. Reductive oxygenation of carbon tetrachloride: Trichloromethylperoxyl radical as a possible intermediate in the conversion of carbon tetrachloride to electrophilic chlorine. *Arch Biochem Biophys* 225:596-609.
- Mikhail TH, Awadallah R, El-Dessoukey EA. 1978. Effect of AMP on serum minerals in carbon-tetrachloride hepatotoxicity. *Z Ernahrungswiss* 17:47-51.
- *Milanovich FP. 1986. Detecting chloroorganics in groundwater. *Environ Sci Technol* 20:441-442.
- *Mirpuri E, Garcia-Trevijano ER, Castilla-Cortazar, et al. 2002. Altered liver gene expression in CCl₄-cirrhotic rats is partially normalized by insulin-like growth factor-I. *Int J Biochem Cell Biol* 34(3):242-252.
- *Mirsalis JC, Butterworth BE. 1980. Detection of unscheduled DNA synthesis in hepatocytes isolated from rats treated with genotoxic agents: An *in vivo-in vitro* assay for potential carcinogens and mutagens. *Carcinogenesis* 1:621-625.
- Mirsalis JC, Steinmetz KL. 1990. The role of hyperplasia in liver carcinogenesis. In: *Mouse liver carcinogenesis: Mechanisms and species comparisons*. Alan R. Liss, Inc., 149-161.
- *Mirsalis JC, Tyson CK, Butterworth BE. 1982. Detection of genotoxic carcinogens in the *in vivo-in vitro* hepatocyte DNA repair assay. *Environ Mutagen* 4:553-562.
- *Mizuguchi H, Yamazaki Y, Shikamoto Y, et al. 2002. Prothrombin activation during carbon tetrachloride-induced acute liver injury in mice. *Thromb Res* 106:257-261.
- Mizumoto M, Arai S, Furutani M, et al. 1997. NO as an indicator of portal hemodynamics and the role of iNOS in increased NO production in CCl₄-induced liver cirrhosis. *J Surg Res* 70:124-133.
- Moghaddam AP, Eggers JS, Calabrese EJ. 1998. Evaluation of sex difference in tissue repair following acute carbon tetrachloride toxicity in male and female Sprague-Dawley rats. *Toxicology* 130(2-2):95-105.
- *Mohamed MF, Kang D, Aneja VP. 2002. Volatile organic compounds in some urban locations in United States. *Chemosphere* 47:863-882.
- Mokuda O, Ubukata E, Sakamoto Y. 1995. Impaired glucose uptake and intact gluconeogenesis in perfused rat liver after carbon tetrachloride injury. *Biochem Mol Med* 54(1):38-42.
- *Molina MJ, Rowland FS. 1974. Predicted present stratospheric abundances of chlorine species from photodissociation of carbon tetrachloride. *Geophys Res Lett* 1:309-312.
- Montalto de Mecca M, Castro GD, Diaz Gomez MI. 1995. Dithiothreitol inhibitory effects on carbon tetrachloride-promoted naph-dependent lipid peroxidation in liver microsomal suspensions. *Res Commun Mol Pathol Pharmacol* 88(28):205-213.
- *Moody DA. 1992. Effect of phenobarbital treatment on carbon tetrachloride-mediated cytochrome P-450 loss and diene conjugate formation. *Toxicol Lett* 61:213-224.

9. REFERENCES

- Moody DE, James JL, Smuckler EA. 1990. Phenobarbital pretreatment alters the localization of CCl₄-induced changes in rat liver microsomal fatty acids. *Toxicol Appl Pharmacol* 103:16-27.
- *Moore L. 1980. Inhibition of liver-microsome calcium pump by in vivo administration of CCl₄, CHCl₃, and 1,1-dichloroethylene (vinylidene chloride). *Biochem Pharmacol* 29:2505-2511.
- *Moore L, Davenport GR, Landon EJ. 1976. Calcium uptake of a rat liver microsomal subcellular fraction in response to in vivo administration of carbon tetrachloride. *J Biol Chem* 251(4):1197-1201.
- Moore L, Schoenberg DR, Long RM. 1990. Impact of halogenated compounds on calcium homeostasis in hepatocytes. *Environ Health Perspect* 84:149-153.
- *Morgan A, Black A, Belcher DR. 1970. The excretion in breath of some aliphatic halogenated hydrocarbons following administration by inhalation. *Ann Occup Hyg* 13:219-233.
- *Morgan DL, Copper SW, Carlock DL, et al. 1991. Dermal absorption of neat and aqueous volatile organic chemicals in the Fischer 344 rat. *Environ Res* 55:51-63.
- Morio LA, Chiu H, Sprowles KA, et al. 2001. Distinct roles of tumor necrosis factor- α and nitric oxide in acute liver injury induced by carbon tetrachloride in mice. *Toxicol Appl Pharmacol* 172:44-51.
- *Morselli PL, Franco-Morselli R, Bossi L. 1980. Clinical pharmacokinetics in newborns and infants: Age-related differences and therapeutic implications. *Clin Pharmacokin* 5:485-527.
- *Mourelle M, Franco MT. 1991. Erythrocyte defects precede the onset of CCl₄-induced liver cirrhosis protection by silymarin. *Life Sci* 48:1083-1090.
- Mourelle M, Meza M. 1990. CCl₄-induced lipoperoxidation triggers a lethal defect in the liver plasma membranes. *J Appl Toxicol* 10:23-27.
- Murakami T, Nagamura Y, Hirano K. 1998. The effect of ethanolamine on acute carbon tetrachloride intoxication. *Biol Pharm Bull* 21(1):84-86.
- Muriel P. 1993. S-adenosyl-L-methionine prevents and reverses erythrocyte membrane alterations in cirrhosis. *J Appl Toxicol* 13(3):179-182
- *Muriel P. 1998. Nitric oxide protection of rat liver from lipid peroxidation, collagen accumulation, and liver damage induced by carbon tetrachloride. *Biochem Pharmacol* 56:773-779.
- *Muriel P, Escobar Y. 2003. Kupffer cells are responsible for liver cirrhosis induced by carbon tetrachloride. *J Appl Toxicol* 23:103-108.
- Muriel P, Mourelle M. 1990. Prevention by Silymarin of membrane alterations in acute CCl₄ liver damage. *J Appl Toxicol* 10:275-279.
- *Muriel P, Alba N, Perez-Alvarez VM, et al. 2001. Kupffer cells inhibition prevents hepatic lipid peroxidation and damage induced by carbon tetrachloride. *Comp Biochem Physiol C* 130:219-226.
- *Muro H, Shirasawa H, Kosugi I, et al. 1990. Defect of sinusoidal Fc receptors and immune complex uptake in CCl₄-induced liver cirrhosis in rats. *Gastroenterology* 99:200-210.

9. REFERENCES

- Murphy SD, Malley S. 1969. Effect of carbon tetrachloride on induction of liver enzymes by acute stress or corticosterone. *Toxicol Appl Pharmacol* 15:117-130.
- Murray M, Farrell GC. 1984. Different effects of carbon tetrachloride toxicity and cirrhosis on substrate binding to rat hepatic microsomal cytochrome P-450. *Biochem Pharmacol* 33:687-689.
- Murray M, Zaluzny L, Farrell GC. 1987. Impaired androgen 16 α -hydroxylation in hepatic microsomes from carbon tetrachloride-cirrhotic male rats. *Gastroenterology* 93:141-147.
- Nagai H, Shimazawa T, Yakuo I, et al. 1989a. Role of peptide-leukotrienes in liver injury in mice. *Inflammation* 13:673-680.
- Nagai H, Shimazawa T, Yakuo I, et al. 1989b. The role of thromboxane A₂ [TxA₂] in liver injury in mice. *Prostaglandins* 38:439-446.
- Nagano K, Katagiri T, Aiso S, et al. 1997. Spontaneous lesions of nasal cavity in aging F344 rats and BDF1 mice. *Exp Toxicol Pathol* 49:97-104.
- *Nagano K, Nishizawa T, Yamamoto S, et al. 1998. Inhalation carcinogenesis studies of six halogenated hydrocarbons in rats and mice. In: Chiyotani K, Hosoda Y, Aizawa Y, eds. *Advances in the prevention of occupational respiratory diseases*. Elsevier Science B.V., 741-746.
- Nakahira K, Takahashi T, Shimizu H, et al. 2003. Protective role of heme oxygenase-1 induction in carbon tetrachloride-induced hepatotoxicity. *Biochem Pharmacol* 66:1091-1105.
- *Nakajima T, Sato A. 1979. Enhanced activity of liver drug-metabolizing enzymes for aromatic and chlorinated hydrocarbons following food deprivation. *Toxicol Appl Pharmacol* 50:549-556.
- *Nakamura S, Oda Y, Shimada T, et al. 1987. SOS-inducing activity of chemical carcinogens and mutagens in *Salmonella typhimurium* TA1535/pSK1002: Examination with 151 chemicals. *Mutat Res* 192:239-246.
- Nakamura T, Arii S, Monden K, et al. 1998. Expression of the Na⁺/Ca²⁺ exchanger emerges in hepatic stellate cells after activation in association with liver fibrosis. *Proc Natl Acad Sci U S A* 95(9):5389-5394.
- *Nakata R, Tsukamoto I, Miyoshi M, et al. 1975. Liver regeneration after carbon tetrachloride intoxication in the rat. *Biochem Pharmacol* 34:586-588.
- Nardacci R, Lacono OL, Ciccocanti F, et al. 2003. Transglutaminase type II plays a protective role in hepatic injury. *Am J Pathol* 162(4):1293-1303.
- Narotsky MG, Kavlock RJ. 1995. A multidisciplinary approach to toxicological screening: II. Developmental toxicity. *J Toxicol Environ Health* 45:145-171.
- *Narotsky MG, Brownie CF, Kavlock RJ, et al. 1997a. Critical period of carbon tetrachloride-induced pregnancy loss in Fischer-344 rats, with insights into the detection of resorption sites by ammonium sulfide staining. *Teratology* 56(4):252-261.

9. REFERENCES

- Narotsky MG, Hamby BT, Best DS, et al. 1995. Carbon tetrachloride (CCl₄)-induced pregnancy loss in F-344 rats: Leutenizing hormone (LH) levels and rescue by human chorionic gonadotropin (hCG). *Biol Reprod* 52:172.
- Narotsky MG, Hamby BT, Mitchell DS, et al. 1992. Full-litter resorptions caused by low molecular weight halocarbons in F-344 rats. *Teratology Society Abstracts*, 472-473.
- Narotsky MG, Hamby BT, Mitchell DS, et al. 1994. Effect of vehicle on the developmental toxicity of bromodichloromethane (BDCM) and carbon tetrachloride. *Teratology* 49(5):395.
- *Narotsky MG, Pegram RA, Kavlock RJ. 1997b. Effect of dosing vehicle on the developmental toxicity of bromodichloromethane and carbon tetrachloride in rats. *Fundam Appl Toxicol* 40:30-36.
- NAS. 1977. *Drinking water and health*. Washington, DC: National Academy of Sciences, 703-707.
- *NAS. 1978. *Chloroform, carbon tetrachloride, and other halomethanes: An environmental assessment*. Washington, DC: National Academy of Sciences.
- NAS. 1980. *Drinking water and health, Volume 3*. Washington, DC: National Academy of Sciences.
- NAS. 1984. *Causes and effects of changes in stratospheric ozone: Update 1983*. Washington DC: National Academy of Sciences.
- *NAS/NRC. 1989. *Biologic markers in reproductive toxicology*. Washington, DC: National Academy of Sciences, National Research Council, National Academy Press.
- Nath RG, Li D, Randerath K. 1990. Acute and long-term effects of carbon tetrachloride on DNA modifications (I-compounds) in male mouse liver. *Chem Biol Interactions* 76:343-357.
- NATICH. 1991. *NATICH data base report on state, local and EPA air toxics activities*. Research Triangle Park, NC: U.S. Environmental Protection Agency, Office of Air Quality Planning and Standards. National Air Toxics Information Clearinghouse.
- *NCI. 1976a. *Report on carcinogenesis bioassay of chloroform*. Bethesda, MD: National Cancer Institute, March 1, 1976.
- *NCI. 1976b. *Carcinogenesis bioassay of trichloroethylene*. National Cancer Institute Technical Report Series, No. 2. Bethesda, MD: National Cancer Institute. PB264122. NCICGTR2.
- *NCI. 1977. *Bioassay of 1,1,1-trichloroethane for possible carcinogenicity*. National Cancer Institute Carcinogenesis Technical Report Series No. 3. U.S. Department of Health, Education, and Welfare. PB265082.
- *Neely WB. 1977. Material balance analysis of trichlorofluoromethane and carbon tetrachloride in the atmosphere. *Sci Total Environ* 8:267-274.
- *Neely WB, Branson DR, Blau GE. 1974. Partition coefficient to measure bioconcentrations potential of organic chemicals in fish. *Environ Sci Technol* 8:1113-1115.
- Nelson EDP, Shikiya D, Liu CS. 1987. Multiple air toxics exposure and risk assessment in the South Coast Air Basin. *Proceedings of the APCA Annual Meeting* 89:87/97.4.

9. REFERENCES

- Neubauer K, Knittel T, Aurisch S, et al. 1996. Glial fibrillary acidic protein -a cell type specific marker for Ito cells in vivo and in vitro. *J Hepatol* 24(6):719-730.
- *New PS, Lubash GD, Scherr L, et al. 1962. Acute renal failure associated with carbon tetrachloride intoxication. *J Am Med Assoc* 181:903-906.
- Nhongsang J, Toskulkao C, Glinsukon T. 1990. Potentiation of the mechanism of carbon tetrachloride induced hepatotoxicity by thinner inhalation. *Res Commun Subst Abuse* 11:73-76.
- *Niederberger M, Gines P, Martin P-Y, et al. 1998. Increased renal and vascular cytosolic phospholipase A2 activity in rats with cirrhosis and ascites. *Hepatology* 27(1):42-47.
- Nielsen VK, Larsen J. 1965. Acute renal failure due to carbon tetrachloride poisoning. *Acta Med Scand* 178:363.
- NIOSH. 1975. Occupational exposure to carbon tetrachloride. Washington, DC: National Institute for Occupational Safety and Health, Department of Health, Education, and Welfare.
- *NIOSH. 1984. Hydrocarbons, halogenated-method 1003. NIOSH Manual of Analytical Methods. 3rd ed. (2nd supplement). Cincinnati, OH: National Institute for Occupational Safety and Health, 1003-1 to 1003-9.
- NIOSH. 1986. NIOSH recommendations for occupational safety and health standards. Atlanta, GA: U.S. Department of Health and Human Services, National Institute for Occupational Safety and Health, September, 1986.
- NIOSH. 1992. Recommendation for occupational safety, health, compendium of policy documents and statements. Cincinnati, OH: U.S. Department of Health and Human Services, Centers for Disease Control.
- *NIOSH. 2003. NIOSH pocket guide to chemical hazards. Carbon tetrachloride. Washington, DC: National Institute for Occupational Safety and Health. <http://www.cdc.gov/niosh/npg/npg.html>. June 6, 2003.
- *Nirmalakhandan NN, Speece RE. 1988. Prediction of aqueous solubility of organic chemicals based on molecular structure. *Environ Sci Technol* 22:328-338.
- Nishida K, Ohta Y, Ishiguro I. 1998a. Glutamylcysteinethyl ester attenuates progression of carbon tetrachloride-induced acute liver injury in mice. *Toxicology* 126:55-63.
- Nishida K, Ohta Y, Ishiguro I. 1998b. Preventive effect of γ -glutamylcysteinylethyl ester on carbon tetrachloride-induced hepatic triglyceride accumulation in mice. *Toxicol Lett* 95:141-146.
- Nishida K, Ohta Y, Kongo M, et al. 1996. Response of endogenous reduced glutathione through hepatic glutathione redox cycle to enhancement of hepatic lipid peroxidation with the development of acute liver injury in mice intoxicated with carbon tetrachloride. *Res Commun Mol Pathol Pharmacol* 93(2):198-218.
- NJDEP. 1988. STAL for carbon tetrachloride. Trenton, NJ: New Jersey Department of Environmental Protection.

9. REFERENCES

- *NLM. 1988. CAS registry. National Library of Medicine.
- Noda T, Morita S, Baba A. 1994. Enhanced teratogenic activity of di-n-butyltin diacetate by carbon tetrachloride pretreatment in rats. *Food Chem Toxicol* 32(4):321-327.
- *Noguchi T, Fong K-L, Lai EK, et al. 1982a. Specificity of a phenobarbital-induced cytochrome P-450 for metabolism of carbon tetrachloride to the trichloromethyl radical. *Biochem Pharmacol* 31:615-624.
- *Noguchi T, Fong K-L, Lai EK, et al. 1982b. Selective early loss of polypeptides in liver microsomes of CCl₄-treated rats. Relationship to cytochrome P-450 content. *Biochem Pharmacol* 31:609-614.
- Noll T, Hugo-Wisseman D, Littauer A, et al. 1987. The decisive pO₂-levels in haloalkane-mediated liver cell injury. *Free Radic Res Commun* 3:293-298.
- *Norwood WD, Fuqua PA, Scudder BC. 1950. Carbon tetrachloride poisoning. *Arch Ind Hyg Occup Med* 1:90-100.
- *NRC. 1993. National Research Council. Pesticides in the diets of infants and children. Washington, DC: National Academy Press.
- NTP. 1985. Fourth annual report on carcinogens (summary). Washington, DC: U.S. Department of Health and Human Services, NTP 85-002, 50-2.
- NTP. 1990. Sixth annual report on carcinogens. Summary report to the National Institute of Environmental Health Sciences, Research Triangle Park, NC, by Technical Resources, Inc., Rockville, MD.
- *NTP. 2002. Report on carcinogens. Research Triangle Park, NC: National Toxicology Program. <http://eph.niehs.nih.gov/roc/tox10.html>. June 6, 2003.
- Oakley F, Trim N, Constandinou CM, et al. 2003. Hepatocytes express nerve growth factor during liver injury: Evidence for paracrine regulation of hepatic stellate cell apoptosis. *Am J Pathol* 163(5):1849-1858.
- Ochi Y, Yumori Y, Morioka A, et al. 1990. Effect of α -blockade on liver regeneration after carbon tetrachloride intoxication in the rat. *Biochem Pharmacol* 39:2065-2066.
- Ogawa M, Mori T, Mori Y, et al. 1992. Study on chronic renal injuries induced by carbon tetrachloride: Selective inhibition of the nephrotoxicity by irradiation. *Nephron* 60:68-73.
- O'Hara TM, Sheppard MA, Clarke EC, et al. 1991. A CCl₄/CHCl₃ interaction study in isolated hepatocytes: Non-induced and phenobarbital-pretreated cells. *J Appl Toxicol* 11:147-154.
- *Ohta Y, Sahashi D, Sasaki E, et al. 1999. Alleviation of carbon tetrachloride-induced chronic liver injury and related dysfunction by L-tryptophan in rats. *Ann Clin Biochem* 36:504-510.
- Okada K, Ueshima S, Imano M, et al. 2004. The regulation of liver regeneration by the plasmin/ α_2 -antiplasmin system. *J Hepatol* 40:110-116.
- Omura M, Katsumata T, Misawa H, et al. 1999. Decrease in protein kinase and phosphatase activities in the liver nuclei of rats exposed to carbon tetrachloride. *Toxicol Appl Pharmacol* 160:192-197.

9. REFERENCES

- O'Neil MJ, Smith A, Heckelman PE, et al., eds. 2001. Carbon tetrachloride. The Merck index. An encyclopedia of chemicals, drugs, and biologicals. 13th ed. Whitehouse Station, NJ: Merck & Co., Inc., 305-306.
- *Onfelt A. 1987. Spindle disturbances in mammalian cells. III. Toxicity, c-mitosis and aneuploidy with 22 different compounds. Specific and unspecific mechanisms. *Mutat Res* 182(3):135-154.
- Onori P, Morini S, Franchitto A, et al. 2000. Hepatic microvascular features in experimental cirrhosis: A structural and morphometrical study in CCl₄-treated rats. *J Hepatol* 33(4):555-563.
- *Oraumbo IF, Van Duuren BL. 1987. Time-related binding of the hepatocarcinogen carbon tetrachloride to hepatic chromatin proteins *in vitro*. *Carcinogenesis* 8:855-856.
- Oraumbo IF, Van Duuren BL. 1989. Evidence for the covalent interaction of carbon tetrachloride with mouse liver chromatin DNA *in vitro*. Laboratory of Organic Chemistry and Carcinogenesis, Report No. L231.13-18.
- Orfila C, Lepert JC, Alric L, et al. 1999. Expression of TNF-alpha and immunohistochemical distribution of hepatic macrophage surface markers in carbon tetrachloride-induced chronic liver injury in rats. *Histochem J* 31:677-685.
- *OSHA. 1989. Occupational Safety and Health Administration. Part III. Fed Regist 2679-2681.
- OSHA. 1993. Occupational Safety and Health Administration: Part V. Fed Regist 58:35338-35351.
- *OSHA. 2003a. Occupational safety and health standards for shipyard employment. Air contaminants. Washington, DC: Occupational Safety and Health Administration. 29 CFR 1915.1000. <http://www.osha.gov/comp-links.html>. June 6, 2003.
- OSHA. 2003b. Occupational safety and health standards. Health hazards definitions. Washington, DC: Occupational Safety and Health Administration. 29 CFR 1910.1200, Appendix A. <http://www.osha.gov/comp-links.html>. June 6, 2003.
- *OSHA. 2003c. Occupational safety and health standards. Limits for air contaminants. Washington, DC: Occupational Safety and Health Administration. 29 CFR 1910.1000, Table Z-1. <http://www.osha.gov/comp-links.html>. June 6, 2003.
- OSHA. 2003d. Occupational safety and health standards. National Research Council recommendations concerning chemical hygiene in laboratories. Washington, DC: Occupational Safety and Health Administration. 29 CFR 1910.1450, Appendix A. <http://www.osha.gov/comp-links.html>. June 6, 2003.
- *OSHA. 2003e. Occupational safety and health standards. Toxic and hazardous substances. Washington, DC: Occupational Safety and Health Administration. 29 CFR 1910.1000, Table Z-2. <http://www.osha.gov/comp-links.html>. June 6, 2003.
- *OSHA. 2003f. Safety and health regulations for construction. Gases, vapors, fumes, dusts, and mists. Washington, DC: Occupational Safety and Health Administration. 29 CFR 1926.55, Appendix A. <http://www.osha.gov/comp-links.html>. June 6, 2003.

9. REFERENCES

- *OTA. 1990. Neurotoxicity: Identifying and controlling poisons of the nervous system. Washington, DC: Office of Technology Assessment, U.S. Congress. OTA-BA-436.
- *Owen GM, Brozek J. 1966. Influence of age, sex and nutrition on body composition during childhood and adolescence. In: Falkner F, ed. Human development. Philadelphia, PA: WB Saunders, 222-238.
- Ozturk F, Ucar M, Ozturk IC, et al. 2003. Carbon tetrachloride-induced nephrotoxicity and protective effect of betaine in Sprague-Dawley rats. *Urology* 62(2):353-356.
- Paakko P, Anttila S, Sormunen R, et al. 1996. Biochemical and morphological characterization of carbon tetrachloride-induced lung fibrosis in rats. *Arch Toxicol* 70:540-552.
- *Packer JE, Slater TF, Willson RL. 1978. Reactions of the carbon tetrachloride-related peroxy free radical (CCL3O2) with amino acids: Pulse radiolysis evidence. *Life Sci* 23:2617-2620.
- Paddle GM. 1983. Incidence of liver cancer and trichloroethylene manufacture: Joint study by industry and a cancer registry. *Br Med J* 286:846.
- Page DA, Carlson GP. 1993. The role of the intestinal tract in the elimination of carbon tetrachloride. *Toxicol Appl Pharmacol* 124(2):268-274.
- Paradis V, Dargere D, Vidaud M, et al. 1999. Expression of connective tissue growth factor in experimental rat and human liver fibrosis. *Hepatology* 30:968-976.
- Parker KJ, Tuthil TA. 1986. Carbon tetrachloride- induced changes in ultrasonic properties of liver. *IEEE Trans Biomed Eng* 33:453-460.
- *Parola M, Leonarduzzi G, Biasi F, et al. 1992. Vitamin E dietary supplementation protects against carbon tetrachloride-induced chronic liver damage and cirrhosis. *Hepatology* 16:1014-1021.
- Paronetto F, Popper H. 1964. Enhanced antibody formation in experimental acute and chronic liver injury produced by carbon tetrachloride or allyl alcohol. *Proc Soc Exp Bio Med* 116:1060-1064.
- *Past MR, Cook DE. 1982. Effect of diabetes on rat liver cytochrome P-450: Evidence for a unique diabetes-dependent rat liver cytochrome P-450. *Biochem Pharmacol* 31:3329-3334.
- *Patki KC, von Moltke LL, Harmatz JS, et al. 2004. Effect of age on in vitro triazolam biotransformation in male human liver microsomes. *J Pharmacol Exp Ther* 308(3):874-879.
- *Paul BB, Rubinstein D. 1963. Metabolism of carbon tetrachloride and chloroform by the rat. *J Pharmacol Exp Ther* 141:141-148.
- *Paustenbach DJ, Carlson GP, Christian JE, et al. 1986a. A comparative study of the pharmacokinetics of carbon tetrachloride in the rat following repeated inhalation exposures of eight and 11.5 hr/day. *Fundam Appl Toxicol* 6:484-497.
- *Paustenbach DJ, Christian JE, Carlson GP, et al. 1986b. The effect of an 11.5-hr/day exposure schedule on the distribution and toxicity of inhaled carbon tetrachloride in the rat. *Fundam Appl Toxicol* 6:472-483.

9. REFERENCES

- Paustenbach DJ, Clewell HJ III, Gargas ML, et al. 1987. Development of a physiologically based pharmacokinetic model for multiday inhalation of carbon tetrachloride. *Pharmacokinetics in risk assessment*. Washington DC: National Academy Press, 312-326.
- *Paustenbach DJ, Clewell HJ, Gargas ML, et al. 1988. A physiologically based pharmacokinetic model for inhaled carbon tetrachloride. *Toxicol Appl Pharmacol* 96:191-211.
- Pavanato A, Tunon MJ, Sanchez-Campos S, et al. 2003. Effects of quercetin on liver damage in rats with carbon tetrachloride-induced cirrhosis. *Dig Dis Sci* 48(4):824-829.
- *Pawa S, Ali S. 2004. Liver necrosis and fulminant hepatic failure in rats: Protection by oxyanionic form of tungsten. *Biochim Biophys Acta* 1688:210-222.
- *Pearson CR, McConnell G. 1975. Chlorinated Cl and C2 hydrocarbons in the marine environment. *Proc R Soc Lond [Biol]* 189:305-332.
- *Pellizzari ED, Sheldon LS, Bursley JT, et al. 1985a. Master scheme for the analysis of organic compounds in water, state-of-the-art review of analytical operations. Washington, DC: U.S. Environmental Protection Agency.
- Pellizzari ED, Sheldon LS, Bursley JT. 1985b. GC/MS determination of volatile halocarbons in blood and tissue. In: Fishbein L, O'Neill IK, eds. *Environmental carcinogens selected methods of analysis*. Vol. 7. International Agency for Research on Cancer, 435-444.
- Pellizzari ED, Zweidinger RA, Sheldon LS. 1985c. GC/MS determination of volatile hydrocarbons in breath samples. In: Fishbein L, O'Neill IK, eds. *Environmental carcinogens selected methods of analysis*. Vol. 7. International Agency for Research on Cancer, 413-431.
- *Pentz R, Strubelt O. 1983. Fasting increases the concentrations of carbon tetrachloride and of its metabolite chloroform in the liver of mice. *Toxicol Lett* 16:231-234.
- *Peoples AJ, Pfaffenberger CD, Shafik TM, et al. 1979. Determination of volatile purgeable halogenated hydrocarbons in human adipose tissue and blood serum. *Bull Environ Contam Toxicol* 23:244-249.
- *Perez AJ, Courel M, Sobrado J, et al. 1987. Acute renal failure after topical application of carbon tetrachloride. Letter to editor. *Lancet*: February: 515-516.
- Permutt TJ, Moezzi M, Hudischewskyj AB, et al. 1987. Statistical analysis of concentrations of toxic air pollutants in California and Louisiana. *Proceedings of the APCA Annual Meeting* 80:87/66.1.
- *Perocco P, Prodi G. 1981. DNA damage by haloalkanes in human lymphocytes cultured in vitro. *Cancer Lett* 13:213-218.
- *Pessayre D, Colbert B, Descatoire V, et al. 1982. Hepatotoxicity of trichloroethylene-carbon tetrachloride mixtures in rats. *Gastroenterology* 83:761-772.
- *Peters HA, Levine RL, Matthews CG, et al. 1987. Synergistic neurotoxicity of carbon tetrachloride/carbon disulfide (80/20 fumigants) and other pesticides in grain storage workers. *Acta Pharmacol Toxicol (Copenhagen)* 59:535-546.

9. REFERENCES

- Peterson RE, Fujimoto JM. 1976. Increased "bile duct-pancreatic fluid" flow in rats pretreated with carbon tetrachloride. *Toxicol Appl Pharmacol* 35:29-39.
- *Phelps BM, Hu CH. 1924. Carbon tetrachloride poisoning. Report of two fatal cases and a series of animal experiments. *J Am Med Assoc* 82:1254-1256.
- *Pilon D, Brodeur J, Plaa GL. 1986. 1,3-Butanediol-induced increases in ketone bodies and potentiation of CCl₄ hepatotoxicity. *Toxicology* 40:165-180.
- Pilon D, Brodeur J, Plaa GL. 1988. Potentiation of CCl₄-induced liver injury by ketonic and ketogenic compounds: Role of the CCl₄ dose. *Toxicol Appl Pharmacol* 94:183-190.
- Piscaglia F, Knittel T, Kobold D, et al. 1999. Cellular localization of hepatic cytochrome 1B1 expression and its regulation by aromatic hydrocarbons and inflammatory cytokines. *Biochem Pharmacol* 58:157-165.
- Plaa GL. 1997. A four-decade adventure in experimental liver injury. *Drug Metab Rev* 29(1&2):1-37.
- Plaa GL. 2000. Chlorinated methanes and liver injury: Highlights of the past 50 years. *Annu Rev Pharmacol Toxicol* 40:43-65.
- Plaa GL, Larson RE. 1964. Relative nephrotoxic properties of chlorinated methane, ethane and ethylene derivatives in mice. *Toxicol Appl Pharmacol* 7:37-44.
- *Plaa GL, Traiger GJ. 1972. Mechanism of potentiation of CCl₄-induced hepatotoxicity. *Proceedings of the 5th International Congress of Pharmacologists* 2:100-113.
- Pleil JD, Oliver KD, McClenny WA. 1988. Ambient air analyses using nonspecific flame ionization and electron capture detection compared to specific detection by mass spectroscopy. *JAPCA* 38:1006-1010.
- *Plumb RH. 1991. The occurrence of appendix IX organic constituents in disposal site ground water. *Ground Water Monitoring Review* XI:157-164.
- *Plumb RH Jr. 1992. The importance of volatile organic compounds as a disposal site monitoring parameter. *Environ Sci Pollut Control Ser.*, 4(Groundwater contamination and analysis at hazardous waste sites):173-197.
- *Plummer JL, de la M Hall P, Ilsley AH, et al. 1990. Influence of enzyme induction and exposure profile on liver injury due to chlorinated hydrocarbon inhalation. *Pharmacol Toxicol* 67:329-335.
- *Plummer JL, de la M Hall P, Ilsley AH, et al. 1994. Dose-response relationships in hepatic injury produced by alcohol and carbon tetrachloride. *Alcohol Clin Exp Res* 18(6):1523-1526.
- *Podolsky DK, Isselbacher KJ. 1998. Derangements of hepatic metabolism. In: Fauci SS, Martin JB, Braunwald E, et al., eds. *Harrison's principles of internal medicine*, 14th ed., 1667-1672.
- *Pohl LR, Schulick RD, Highet RJ, et al. 1984. Reductive-oxygenation mechanism of metabolism of carbon tetrachloride to phosgene by cytochrome P-450. *Mol Pharmacol* 25:318-321.

9. REFERENCES

- Poli G, Cheeseman KH, Biasi F, et al. 1989. Promethazine inhibits the formation of aldehydic products of lipid peroxidation but not covalent binding resulting from the exposure of rat liver fractions to CCl₄. *Biochem J* 264:527-532.
- *Poon MKT, Chiu P-Y, Mak DHF, et al. 2003. Metformin protects against carbon tetrachloride hepatotoxicity in mice. *J Pharm Sci* 93:501-504.
- *Pound AW, Horn L, Lawson TA. 1973. Decreased toxicity of dimethylnitrosamine in rats after treatment with carbon tetrachloride. *Pathology* 5:233-242.
- *Poyer JL, Floyd RA, McCay PB, et al. 1978. Spin-trapping of the trichloromethyl radical produced during enzymic NADPH oxidation in the presence of carbon tetrachloride or bromotrichloromethane. *Biochim Biophys Acta* 539:402-409.
- *Poyer JL, McCay PB, Lai EK, et al. 1980. Confirmation of assignment of the trichloromethyl radical spin adduct detected by spin trapping during ¹³C-carbon tetrachloride metabolism in vitro and in vivo. *Biochem Biophys Res Commun* 94(4):1154-1160.
- Pratt GC, McCourtney M, Wu CY, et al. 1998. Measurement and source apportionment of human exposures to toxic air pollutants in the Minneapolis-St. Paul metropolitan area. Measurement of toxic and related air pollutants. Sewickley, PA: Air and Waste Management Association, 64-72.
- *Pratt GC, Palmer K, Wu CY, et al. 2000. An assessment of air toxics in Minnesota. *Environ Health Perspect* 108:815-825.
- *Prendergast JA, Jones RA, Jenkins LJ, et al. 1967. Effects on experimental animals of long-term inhalation of trichloroethylene, carbon tetrachloride, 1,1,1-trichloroethane, dichlorofluoromethane, and 1,1-dichloroethylene. *Toxicol Appl Pharmacol* 10:270-289.
- Pronzato MA, Domenicotti C, Biasi F, et al. 1990. Inactivation of hepatocyte protein kinase C by carbon tetrachloride: Involvement of drug's metabolic activation and prooxidant effect. *Biochem Biophys Res Commun* 171:1353-1360.
- Ptacek CJ, Gillham RW. 1992. Laboratory and field measurements of nonequilibrium transport in the Borden aquifer, Ontario, Canada. *J Contam Hydrol* 10:119-158.
- Ramkumar KN, Rajesh MR, Anuradha CV. 2003. Food restriction attenuates blood lipid peroxidation in carbon tetrachloride-intoxicated rats. *Nutrition* 19:358-362.
- *Rams JM, Pilgrim M, Rauth S, et al. 1979. Level II materials balance: Carbon tetrachloride (draft report). Washington, DC: U.S. Environmental Protection Agency, Office of Pesticides and Toxic Substances.
- Ramsey JC, Andersen ME. 1984. A physiologically based description of the inhalation pharmacokinetics of styrene in rats and humans. *Toxicol Appl Pharmacol* 73:159-175.
- *Rao KS, Recknagel RO. 1968. Early onset of lipoperoxidation in rat liver after carbon tetrachloride administration. *Exp Mol Pathol* 9:271-278.
- *Rao KS, Recknagel RO. 1969. Early incorporation of carbon-labeled carbon tetrachloride into rat liver particulate lipids and proteins. *Exp Mol Pathol* 10:219-228.

9. REFERENCES

- *Rao SB, Mehendale HM. 1989. Protective role of fructose 1,6-bisphosphate during carbon tetrachloride hepatotoxicity in rats. *Biochem J* 262:721-725.
- *Rao VC, Mehendale HM. 1991. Colchicine antimetabolism abolishes CCl₄ autoprotection. *Toxicol Pathol* 19:179-606.
- *Rao VC, Mehendale HM. 1993. Effect of antimetabolic agent colchicine on carbon tetrachloride toxicity. *Arch Toxicol* 67:392-400.
- *Rao PS, Dalu A, Kulkarni SG, et al. 1996. Stimulated tissue repair prevents lethality in isopropanol-induced potentiation of carbon tetrachloride hepatotoxicity. *Toxicol Appl Pharmacol* 140:235-244.
- Rao PS, Mangipudy RS, Mehendale HM. 1997. Tissue injury and repair as parallel and opposing responses to CCl₄ hepatotoxicity: A novel dose-response. *Toxicology* 118:181-193.
- Rao SB, Young RA, Mehendale HM. 1990. Perturbations in polyamines and related enzymes following chloroform-potentiated bromotrichloromethane hepatotoxicity. *J Biochem Toxicol* 5:23-32.
- *Rasheed A, Hines RN, McCarver-May DG. 1997. Variation in induction of human placental CYP2E1: Possible role in susceptibility to fetal alcohol syndrome? *Toxicol Appl Pharmacol* 144:396-400.
- *Raucy JL, Kraner JC, Lasker JM. 1993. Bioactivation of halogenated hydrocarbons by cytochrome P450E1. *Crit Rev Toxicol* 23(1):1-20.
- Ray P, Moore L. 1986. Carbon tetrachloride-induced release of calcium from isolated hepatocytes. *Toxicology* 41:205-212.
- *Ray SD, Mehendale HM. 1990. Potentiation of CCl₄ and CHCl₃ hepatotoxicity and lethality by various alcohols. *Fundam Appl Toxicol* 15:429-440.
- Raymer JH, Thomas KW, Cooper SD, et al. 1990. A device for sampling of human alveolar breath for the measurement of expired volatile organic compounds. *J Anal Toxicol* 14:337-344.
- Raymond P, Plaa G. 1995a. Ketone potentiation of haloalkane-induced hepato- and nephrotoxicity. II. Implication of monooxygenases. *J Toxicol Environ Health* 46:317-328.
- *Raymond P, Plaa GL. 1995b. Ketone potentiation of haloalkane-induced hepato- and nephrotoxicity. I. Dose-response relationships. *J Toxicol Environ Health* 45:465-480.
- Raymond P, Plaa GL. 1997. Effect of dosing vehicle on the hepatotoxicity of CCl₄ and hepatotoxicity of CHCl₃ in rats. *J Toxicol Environ Health* 51(5):463-476.
- *Recknagel RO. 1967. Carbon tetrachloride hepatotoxicity. *Pharmacol Rev* 19:145-208.
- *Recknagel RO, Ghoshal AK. 1966. Lipoperoxidation as a vector in carbon tetrachloride hepatotoxicity. *Lab Invest* 15:132-145.
- *Recknagel RO, Glende EA. 1973. Carbon tetrachloride hepatotoxicity: An example of lethal cleavage. *CRC Crit Rev Toxicol* 2:263-297.

9. REFERENCES

- Recknagel RO, Glende EA, Dolak JA, et al. 1989. Mechanisms of carbon tetrachloride toxicity. *Pharmacol Ther* 43:139-154.
- *Recknagel RO, Glende EA, Hriszkewycz AM. 1977. Chemical mechanisms in carbon tetrachloride toxicity. In: Pryor WA, ed. *Free radicals in biology*. Volume III. New York, NY: Academic Press, Inc.:97-132.
- *Reinhardt CF, Azer A, Maxfield ME, et al. 1971. Cardiac arrhythmias and aerosol sniffing. *Arch Environ Health* 22:265-279.
- *Reinke LA, Janzen EG. 1991. Detection of spin adducts in blood after administration of carbon tetrachloride to rats. *Chem Biol Interact* 78:155-165.
- *Reinke LA, Lai EK, McCay PB. 1988. Ethanol feeding stimulates trichloromethyl radical formation from carbon tetrachloride in liver. *Xenobiotica* 18(11):1311-1318.
- *Reinke LA, Towner RA, Janzen EG. 1992. Spin trapping of free radical metabolites of carbon tetrachloride *in vitro* and *in vivo*: Effect of acute ethanol administration. *Toxicol Appl Pharmacol* 112:17-23.
- Reiter R, Burk RF. 1988. Formation of glutathione adducts of carbon tetrachloride metabolites in a rat liver microsomal incubation system. *Biochem Pharmacol* 37:327-331.
- Reitz RH, Gargas ML, Mendrala AL, et al. 1996. In vivo and in vitro studies of perchloroethylene metabolism for physiologically based pharmacokinetic modeling in rats, mice, and humans. *Toxicol Appl Pharmacol* 136:289-306.
- Reuber MD, Glover EL. 1967a. Cholangiofibrosis in the liver of buffalo strain rats injected with carbon tetrachloride. *Br J Exp Pathol* 48(3):319-322.
- *Reuber MD, Glover EL. 1967b. Hyperplastic and early neoplastic lesions of the liver in buffalo strain rats of various ages given subcutaneous carbon tetrachloride. *J Natl Cancer Inst* 38:891-899.
- *Reuber MD, Glover EL. 1970. Cirrhosis and carcinoma of the liver in male rats given subcutaneous carbon tetrachloride. *J Natl Cancer Inst* 44:419-427.
- Reviere R, Schneider S, Woolbright K. 1995. Associations between disease and occupation: Hypothesis generated from the national mortality followback survey. *Am J Ind Med* 27(2):195-205.
- Reynolds ES. 1967. Liver parenchymal cell injury. IV. Pattern of incorporation of carbon and chlorine from carbon tetrachloride into chemical constituents of liver *in vivo*. *J Pharmacol Exp Therap* 155:117-126.
- *Reynolds ES, Yee AG. 1968. Liver parenchymal cell injury. Part VI. Significance of early glucose-6-phosphatase suppression and transient calcium influx following poisoning. *Lab Invest* 19:273-281.
- *Reynolds ES, Treinen RJ, Farrish HH. 1984. Metabolism of [¹⁴C]carbon tetrachloride to exhaled, excreted and bound metabolites. *Biochem Pharmacol* 33:3363-3374.

9. REFERENCES

- *Rhoderick GC, Miller WR. 1990. Multipoint calibration of a gas chromatograph using cryogenic preconcentration of a single gas standard containing volatile organic compounds. *Anal Chem* 62:810-815.
- *Rhodes VL, Kriek G, Lazear N, et al. 2002. Development of emission factors for polycarbonate processing. *J Air Waste Manage Assoc* 52:781-788.
- *RIDOH. 1989. Rhode Island Department of Health. Letter with accompanying data, from Bela T. Matyas (Chief, Office of Environmental Health Risk Assessment) to James Gibson (ATSDR), dated 3 March, 1989.
- Rikans LE, DeCicco LA, Hornbrook KR, et al. 1999. Effect of age and carbon tetrachloride on cytokine concentrations in rat liver. *Mech Ageing Dev* 108:173-182.
- Rinkus SJ, Legator MS. 1979. Chemical characterization of 465 known or suspected carcinogens and their correlation with mutagenic activity in the *Salmonella typhimurium* system. *Cancer Res* 39:3289-3318.
- Rivera CA, Bradford BU, Hunt KJ, et al. 2001. Attenuation of CCl₄-induced hepatic fibrosis by GdCl₃ treatment or dietary glycine. *Am J Physiol Gastrointest Liver Physiol* 281(1):G200-207.
- *Roberts SM, Harbison RD, James RC, et al. 1994. Methamphetamine potentiation of carbon tetrachloride hepatotoxicity in mice. *J Pharmacol Exp Ther* 271(2):1051-1057.
- *Roberts SM, Harbison RD, James RC, et al. 1995. Mechanistic studies on the potentiation of carbon tetrachloride hepatotoxicity by methamphetamine. *Toxicology* 97(1-3):49-57.
- *Robertson DG, Reily MD, Sigler RE, et al. 2000. Metabonomics: Evaluation of nuclear magnetic resonance (NMR) and pattern recognition technology for rapid *in vivo* screening of liver and kidney toxicants. *Toxicol Sci* 57(2):326-337.
- *Rocchi P, Prodi G, Grilli S, et al. 1973. *In vivo* and *in vitro* binding of carbon tetrachloride with nucleic acids and proteins in rat and mouse liver. *Int J Cancer* 11:419-425.
- Rockey DC, Chung JJ. 1997. Regulation of inducible nitric oxide synthase and nitric oxide during hepatic injury and fibrogenesis. *Am J Physiol* 273(1):G124-130.
- Rockey DC, Weisiger RA. 1996. Endothelin induced contractility of stellate cells from normal and cirrhotic rat liver: Implications for regulation of portal pressure and resistance. *Hepatology* 24:233-240.
- Roghani M, Da Silva C, Castagna M. 1987. Tumor promoter chloroform is a potent protein kinase C activator. *Biochem Biophys Res Commun* 142:738-744.
- *Roldan-Arjona T, Garcia-Pedrajas MD, Luque-Romero FL, et al. 1991. An association between mutagenicity of the Ara test of *Salmonella typhimurium* and carcinogenicity in rodents for 16 halogenated aliphatic hydrocarbons. *Mutagenesis* 6:199-205.
- Rood AS, McGavran PD, Aanenson JW, et al. 2001. Stochastic estimates of exposure and cancer risk from carbon tetrachloride released to the air from the Rocky Flats Plant. *Risk Anal* 21(4):675-695.

9. REFERENCES

- Rosengren RJ, Sauer J-M, Hooser SB, et al. 1995. The interactions between retinol and five different hepatotoxicants in the Swiss Webster Mouse. *Fundam Appl Toxicol* 25(281-292)
- *Roudabush RL, Terhaar CJ, Fassett DW, et al. 1965. Comparative acute effects of some chemicals on the skin of rabbits and guinea pigs. *Toxicol Appl Pharmacol* 7:559-565.
- *Rubin E, Lieber CS. 1968. Hepatic microsomal enzymes in man and rat: Induction and inhibition by ethanol. *Science* 162:690-691.
- *Rungby J, Ernst E. 1992. Experimentally induced lipid peroxidation after exposure to chromium, mercury or silver: Interactions with carbon tetrachloride. *Pharmacol Toxicol* 70:205-207.
- *Ruprah M, Mant TGK, Flanagan RJ. 1985. Acute carbon tetrachloride poisoning in 19 patients: Implications for diagnosis and treatment. *Lancet* I:1027:1029.
- *Rush B, Merritt MV, Kaluzny M, et al. 1986. Studies on the mechanism of the protective action of 16,16-dimethyl PGE₂ in carbon tetrachloride induced acute hepatic injury in the rat. *Prostaglandins* 32:439-455.
- *Ruth JH. 1986. Odor thresholds and irritation levels of several chemical substances: A review. *Am Ind Hyg Assoc J* 47:142-151.
- *Rutherford DW, Chiou CT. 1992. Effect of water saturation in soil organic matter on the partition of organic compounds. *Environ Sci Technol* 965-970.
- *Rutherford DW, Chiou CT, Kile DE. 1992. Influence of soil organic matter composition on the partition of organic compounds. *Environ Sci Technol* 26:336-340.
- *Sack TM, Steele DH, Hammerstrom K, et al. 1992. A survey of household products for volatile organic compounds. *Atmos Environ* 6:1063-1070.
- Saez JC, Bennett VL, Spray DC. 1987. Carbon tetrachloride at hepatotoxic levels blocks reversibly gap junctions between rat hepatocytes. *Science* 236:967-969.
- *Sagai M, Tappel AL. 1978. Effect of vitamin E on carbon tetrachloride-induced lipid peroxidation as demonstrated by in vivo pentane production. *Toxicol Lett* 2:149-155.
- Sakai H, Tsukamoto T, Yamamoto M, et al. 2000. Summation of initiation activities of low doses of the non-hepatocarcinogen 1,2-dimethylhydrazine in the liver after carbon tetrachloride administration. *Cancer Lett* 148:59-63.
- *Sakata T, Watanabe A, Hobara N, et al. 1987. Chronic liver injury in rats by carbon tetrachloride inhalation. *Bull Environ Contam Toxicol* 38:959-961.
- *Salgado S, Garcia J, Vera J, et al. 2000. Liver cirrhosis is reverted by Urokinase-type plasminogen activator gene therapy. *Mol Ther* 2(6):545-551.
- Salie B, Matthes N, Knittel T, et al. 1999. Transforming growth factor β and tumor necrosis factor α inhibit both apoptosis and proliferation of activated rat hepatic stellate cells. *Hepatology* 30:196-202.

9. REFERENCES

- *Sanzgiri UY, Bruckner JV. 1997. Effect of emulphor, an emulsifier, on the pharmacokinetics and hepatotoxicity of oral carbon tetrachloride in the rat. *Fundam Appl Toxicol* 36(1):54-61.
- *Sanzgiri UY, Kim HJ, Muralidhara S, et al. 1995. Effect of route and pattern of exposure on the pharmacokinetics and acute hepatotoxicity of carbon tetrachloride. *Toxicol Appl Pharmacol* 134:148-154.
- Sanzgiri UY, Muralidhara S, Bruckner JV. 1992. Correlation of tissue distribution and hepatotoxicity of carbon tetrachloride (CCl₄) following ingestion. *Toxicologist* 12:423.
- *Sanzgiri UY, Srivattsan V, Muralidhara S, et al. 1997. Uptake, distribution, and elimination of carbon tetrachloride in rat tissue following inhalation and ingestion exposures. *Toxicol Appl Pharmacol* 143:120-129.
- *Sasaki YF, Saga A, Akasaka M, et al. 1998. Detection of in vivo genotoxicity of haloalkanes and haloalkenes carcinogenic to rodents by the alkaline single cell gel electrophoresis (comet) assay in multiple mouse organs. *Mutat Res* 419:13-20.
- *Sato A, Nakajima T. 1985. Enhanced metabolism of volatile hydrocarbons in rat liver following food deprivation, restricted carbohydrate intake, and administration of ethanol, phenobarbital, polychlorinated biphenyl and 3-methylcholanthrene: A comparative study. *Xenobiotica* 15(1):67-75.
- Sato A, Nakajima T. 1987. Pharmacokinetics of organic solvent vapors in relation to their toxicity. *Scand J Work Environ Health* 13:81-93.
- *Sato R, Maesawa C, Fujisawa K, et al. 2004. Prevention of critical telomere shortening by oestradiol in human normal hepatic cultured cells and carbon tetrachloride induced rat liver fibrosis. *Gut* 53(7):1001-1009.
- Sato Y, Yoneda M, Nakamura K, et al. 2003. Protective effect of central thyrotropin-releasing hormone on carbon tetrachloride-induced acute hepatocellular necrosis in rats. *J Hepatol* 39:47-54.
- Sawada S, Asakura S, Daimon H, et al. 1995. Comparison of autoradiography, liquid scintillation counting and immunoenzymatic staining of 5-bromo-2'-deoxyuridine for measurement of unscheduled DNA synthesis and replicative DNA synthesis in rat liver. *Mutat Res* 344:109-116.
- *Sawada S, Yamanaka T, Yamatsu K, et al. 1991. Chromosome aberrations, micronuclei and sister-chromatid exchanges (SCEs) in rat liver induced in vivo by hepatocarcinogens including heterocyclic amines. *Mutat Res* 251:59-69.
- *Sawant SP, Dnyanmote AV, Shankar K, et al. 2004. Potentiation of carbon tetrachloride hepatotoxicity and lethality in type 2 diabetic rats. *J Pharmacol Exp Ther* 308(2):694-704.
- Scharf J-G, Dombrowski F, Novosyadlyy R, et al. 2004. Insulin-like growth factor (IGF)-binding protein-1 is highly induced during acute carbon tetrachloride liver injury and potentiates the IGF-I-stimulated activation of rat hepatic stellate cells. *Endocrinology* 145(7):3463-3472.
- *Schiestl RH, Gietz RD, Mehta RD, et al. 1989. Carcinogens induce intrachromosomal recombination in yeast. *Carcinogenesis* 10:1445-1446.

9. REFERENCES

- Schoeffner DJ, Warren DA, Muralidhara S, et al. 1999. Organ weights and fat volume in rats as a function of strain and age. *J Toxicol Environ Health A* 56:449-462.
- Schuetzle D, Crittenden AJ, Charison RJ. 1973. Application of computer controlled high resolution mass spectrometry to the analysis of air pollutants. *J Air Pollut Control Assoc* 23:704-709.
- Schultz VD, Esposti SD, Panzica MA, et al. 1997. Expression of TA1, a rat oncofetal cDNA with homology to transport-associated genes, in carbon-tetrachloride-induced liver injury. *Pathobiology* 65:14-25.
- *Schwarz M, Hummel J, Appel KE, et al. 1979. DNA damage induced in vivo evaluated with a non-radioactive alkaline elution technique. *Cancer Lett* 6:221-226.
- *Schwetz BA, Ledwig BKJ, Gehring PJ. 1974a. Embryo- and fetotoxicity of inhaled chloroform in rats. *Toxicol Appl Pharmacol* 28:442-451.
- *Schwetz BA, Leong BKJ, Gehring PJ. 1974b. Embryo- and fetotoxicity of inhaled carbon tetrachloride, 1,1-dichloroethane and methyl ethyl ketone in rats. *Toxicol Appl Pharmacol* 28:452-64.
- *Seawright AA, McLean AEM. 1967. The effect of diet on carbon tetrachloride metabolism. *Biochem J* 105:1055-1060.
- *Seawright AA, Wilkie IW, Costigan P, et al. 1980. The effect of an equimolar mixture of carbon tetrachloride and carbon disulphide on the liver of the rat. *Biochem Pharmacol* 29:1007-1014.
- *Seidler A, Raum E, Arabin B, et al. 1999. Maternal occupational exposure to chemical substances and the risk of infants small-for-gestational-age. *Am J Ind Med* 36(1):213-222.
- Sein KT, Chu N. 1979. Liver and kidney glucose-6-phosphatase levels in carbon tetrachloride- and PDT- administered mice. *Enzyme* 24:72-74.
- *Seki M, Kasama K, Imai K. 2000. Effect of food restriction on hepatotoxicity of carbon tetrachloride in rats. *J Toxicol Sci* 25(1):33-40.
- Selan FM, Evans MA. 1987. The role of microtubules in chlorinated alkane-induced fatty liver. *Toxicol Lett* 36:117-127.
- *Selden JR, Dolbeare F, Miller JE, et al. 1994. Validation of a flow cytometric in vitro DNA repair (UDS) assay in rat hepatocytes. *Mutat Res* 315(2):147-167.
- Semino G, Lilly P, Andersen ME. 1997. A pharmacokinetic model describing pulsatile uptake of orally-administered carbon tetrachloride. *Toxicology* 117:25-33.
- Semprini L. 1995. In situ bioremediation of chlorinated solvents. *Environ Health Perspect Suppl* 103:101-105.
- *Sentjurs M, Mason RP. 1992. Inhibition of radical adduct reduction and reoxidation of the corresponding hydroxylamines in *in vivo* spin trapping of carbon tetrachloride-derived radicals. *Free Radical Biology Medicine* 13:151-160.

9. REFERENCES

- *Setchell BP, Waites GMH. 1975. The blood-testis barrier. In: Creep RO, Astwood EB, Geiger SR, eds. Handbook of physiology: Endocrinology V. Washington, DC: American Physiological Society.
- *Shah JJ, Heyerdahl EK. 1988. National ambient volatile organic compounds (VOCs) data base update. Research Triangle Park, NC: U.S. Environmental Protection Agency, Office of Research and Development. PB88-195631.
- *Shah JJ, Singh HB. 1988. Distribution of volatile organic chemicals in outdoor and indoor air. Environ Sci Technol 22:1381-1388.
- *Shah H, Hartman SP, Weinhouse S. 1979. Formation of carbonyl chloride in carbon tetrachloride metabolism by rat liver *in vitro*. Cancer Res 39:3942-3947.
- *Shamberger RJ, Andreone TL, Willis CE. 1974. Antioxidants and cancer. IV. Initiating activity of malonaldehyde as a carcinogen. J Natl Cancer Inst 53:1771-1773.
- *Shankar K, Vaidya VS, Apte UM, et al. 2003. Type 1 diabetic mice are protected from acetaminophen hepatotoxicity. Toxicol Sci 73:220-234.
- *Shara MA, Dickson PH, Bagchi D, et al. 1992. Excretion of formaldehyde, malondialdehyde, acetaldehyde and acetone in the urine of rats in response to 2,3,7,8-tetrachlorodibenzo-*p*-dioxin, paraquat, endrin and carbon tetrachloride. J Chromatogr Biomed Appl 576:221-233.
- *Shen ES, Garry VF, Anders MW. 1982. Effect of hypoxia on carbon tetrachloride hepatotoxicity. Biochem Pharmacol 31(23):3787-3793.
- *Shertzer HG, Sainsbury M. 1991. Chemoprotective and hepatic enzyme induction properties of indole and indenoindole antioxidants in rats. Food Chem Toxicol 29:391-400.
- Shertzer HG, Niemi MP, Reitman FA, et al. 1987. Protection against carbon tetrachloride hepatotoxicity by pre-treatment with indo1-3-carbinol. Exper Mol Pathol 46:180-189.
- Shertzer HG, Reitman FA, Tabor MW. 1988. Influence of diet on the expression of hepatotoxicity from carbon tetrachloride in ICR mice. Drug Nutr Interact 5:275-282.
- Shi J, Aisaki K, Ikawa Y, et al. 1998. Evidence of hepatocyte apoptosis in rat liver after the administration of carbon tetrachloride. Am J Pathol 153(2):515-525.
- Shibayama Y. 1988. On the pathogenesis of portal hypertension in cirrhosis of the liver. Liver 8:95-99.
- Shimizu Y, Nagase C, Kawai K. 1973. Accumulation and toxicity of carbon tetrachloride after repeated inhalation in rats. Ind Health 11:48-54.
- Shimizu H, Uetsuka K, Nakayama H, et al. 2001. Carbon tetrachloride-induced acute liver injury in Mini and Wistar rats. Exp Toxicol Pathol 53(1):11-17.
- Shindell S, Ulrich S. 1985. A cohort study of employees of a manufacturing plant using trichloroethylene. J Occup Med 27:577-579.
- *Short CL, Kinden DA, Stith R. 1976. Fetal and neonatal development of the microsomal monooxygenase system. Drug Metab Rev 5:1-42.

9. REFERENCES

- Siegers CP, Horn W, Younes M. 1985. Effect of hypoxia on the metabolism and hepatotoxicity of carbon tetrachloride and vinylidene chloride in rats. *Acta Pharmacol Toxicol* 56:81-86.
- Simeonova PP, Gallucci RM, Hulderman T, et al. 2001. The role of tumor necrosis factor- α in liver toxicity, inflammation, and fibrosis induced by carbon tetrachloride. *Toxicol Appl Pharmacol* 177:112-120.
- *Simko V, Michael S, Katz J, et al. 1992. Protective effect of oral acetylcysteine against the hepatorenal toxicity of carbon tetrachloride potentiated by ethyl alcohol. *Alcohol Clin Exp Res* 16:795-799.
- *Simmon VF, Kavhanen K, Tardiff RG. 1977. Mutagenic activity of chemicals identified in drinking water. In: Scott D, Bridges BA, Sobesl FH, eds. *Progress in genetic toxicology*. New York: Elsevier/North-Holland Biomedical Press, 249-258.
- *Simmonds PG, Alyea FN, Cardelino CA, et al. 1983. The atmospheric lifetime experiment. 6. Results for carbon tetrachloride based on 3 years data. *J Geophys Res* 88:8427-8441.
- *Simmonds PG, Cunnold DM, Alyea FN, et al. 1988. Carbon tetrachloride lifetimes and emissions determined from daily global measurements during 1978-1985. *J Atmospheric Chem* 7:35-58.
- *Simon M-F, Chap H, Douste-Blazy L. 1986. Selective inhibition of human platelet phospholipase A₂ by buffering cytoplasmic calcium with the fluorescent indicator quin 2. Evidence for different calcium sensitive of phospholipases A₂ and C. *Biochim Biophys Acta* 875:157-164.
- *Sina JF, Bean CL, Dysart GR, et al. 1983. Evaluation of the alkaline elution/rat hepatocyte assay as a predictor of carcinogenic/mutagenic potential. *Mutat Res* 113:357-391.
- Singh HB, Fowler DP, Peyton TO. 1976. Atmospheric carbon tetrachloride: Another man-made pollutant. *Science* 192:1231-1234.
- *Singh HB, Lillian D, Appleby A, et al. 1975. Atmospheric formation of carbon tetrachloride from tetrachloroethylene. *Environ Lett* 10:253-256.
- *Singh HB, Salas LJ, Cavanagh LA. 1977. Distribution, sources and sinks of atmospheric halogenated compounds. *Air Pollut Cont* 27:332-338.
- *Singh HB, Salas LJ, Shigeishi H, et al. 1979a. Atmospheric distributions, sources and sinks of selected halocarbons, hydrocarbons, SF₆ and N₂O. Draft final report. Research Triangle Park, NC: U.S. Environmental Protection Agency, Office of Research and Development.
- Singh HB, Salas LJ, Smith A, et al. 1979b. Atmospheric measurements of selected toxic organic chemicals. Research Triangle Park, NC: U.S. Environmental Protection Agency, Atmospheric Chemistry and Physics Department, Environmental Sciences Research Laboratory.
- *Singh HB, Salas LJ, Smith A, et al. 1980. Measurements of some potentially hazardous organic chemicals in urban environments. *Atmos Environ* 15:601-612.
- *Singh HB, Salas L, Viezee W, et al. 1992. Measurement of volatile organic chemicals at selected sites in California. *Atmos Environ* 16:2929-2946.

9. REFERENCES

Sipes IG, El Sisi AE, Sim WW, et al. 1991. Reactive oxygen species in the progression of CCl₄-induced liver injury. In: *Biol Reactive Intermediates IV*. New York, NY: Plenum Press, 489-497.

*Sipes IG, Krishna G, Gillette JR. 1977. Bioactivation of carbon tetrachloride, chloroform and bromotrichloromethane: Role of cytochrome P-450. *Life Sci* 20:1541-1548.

*Sirota JH. 1949. Carbon tetrachloride poisoning in man. I. The mechanism of renal failure and recovery. *J Clin Invest* 28:1412-1422.

*Sivikova K, Piesova E, Dianovsky J. 2001. The protection of vitamin E and selenium against carbon tetrachloride-induced genotoxicity in ovine peripheral blood lymphocytes. *Mutat Res* 494:135-142.

Skrzypinska-Gawrysiak M, Piotrowski JK, Sporny S. 2000. Circadian variations in hepatotoxicity of carbon tetrachloride in mice. *Int J Occup Med Environ Health* 13(2):165-173.

*Slater TF. 1981. Free radicals as reactive intermediates in tissue injury. *Adv Exp Med Biol* 136(Part A):575-589.

Slater TF. 1982. Activation of carbon tetrachloride: Chemical principles and biological significance. In: Slater TF, McBrien DCH, eds. *Free radicals, lipid peroxidation and cancer*. New York: Academy Press, 243-274.

Slater RW, Ho JS. 1989. Method 502.2. Volatile organic compounds in water by purge and trap capillary column gas chromatography with photoionization and electrolytic conductivity detectors in series. Cincinnati, OH: U.S. Environmental Protection Agency, Office of Research and Development.

*Slater TF, Sawyer BC. 1970. The hepatotoxic action of carbon tetrachloride stimulatory effect of carbon tetrachloride on lipid peroxidation in microsomal suspensions. *FEBS Lett* 11(2):132-136.

*Slater TF, Cheeseman KH, Davies MJ, et al. 1987. Symposium on 'Nutritional Aspects of Free Radicals': Free radical mechanisms in relation to tissue injury. *Proc Nutr Soc* 46:1-12.

Slater TF, Cheeseman KH, Ingold KU. 1985. Carbon tetrachloride toxicity as a model for studying free-radical mediated liver injury. *Philos Trans R Soc Lond [Biol]* 311:633-645.

*Smetana J. 1939. Nephrosis due to carbon tetrachloride. *Arch Intern Med* 63:760-777.

*Smialowicz RJ, Simmons JE, Luebke RW, et al. 1991. Immunotoxicologic assessment of subacute exposure of rats to carbon tetrachloride with comparison to hepatotoxicity and nephrotoxicity. *Fundam Appl Toxicol* 17:186-196.

Smyth HF. 1935. Carbon tetrachloride in industry-the present status and plans for further necessary studies. *Ind Med* 4:12-15.

*Smyth HF, Smyth HF Jr., Carpenter CP. 1936. The chronic toxicity of carbon tetrachloride; animal exposure and field studies. *J Ind Hyg Toxicol* 18:277-298.

Sogawa S, Nihro Y, Ueda H, et al. 1994. Protective effects of hydroxychalcones on free radical-induced cell damage. *Biol Pharm Bull* 17(2):251-256.

9. REFERENCES

- Song I-M, Lee Y-M, Chung S-J, et al. 2003. Multiple alterations on canalicular membrane transport activities in rats with CCL4-induced hepatic injury. *Drug Metab Dispos* 31(4):482-490.
- Soni MG, Mehendale HM. 1991. Protection from chlordecone-amplified carbon tetrachloride toxicity by cyanidanol: Biochemical and histological studies. *Toxicol Appl Pharmacol* 108:46-57.
- *Soni MG, Mehendale HM. 1993. Hepatic failure leads to lethality of chlordecone-amplified hepatotoxicity of carbon tetrachloride. *Fundam Appl Toxicol* 21:442-450.
- Sonich C, Kraemer DF, Lucas JB. 1980. An epidemiologic study of acute effects of a low level exposure to carbon tetrachloride (CCl₄). *Am J Epidemiol* 112(3):445.
- Spicer CW, Buxton BE, Holdren MW, et al. 1996. Variability of hazardous air pollutants in an urban area. *Atmos Environ* 30(20):3443-3456.
- *Spirtas R, Stewart PA, Lee JS, et al. 1991. Retrospective cohort mortality study of workers at an aircraft maintenance facility. I. Epidemiological results. *Br J Ind Med* 48:515-530.
- *SRI. 2004. Directory of chemical producers. Menlo Park, CA: SRI Consulting, 408, 409, 501.
- *Srivastava SP, Chen NQ, Holtzman JL. 1990. The *in vitro* NADPH-dependent inhibition by CCl₄ of the ATP-dependent calcium uptake of hepatic microsomes from male rats. *J Biol Chem* 265:8392-8399.
- *Staples CA, Werner F, Hooghem TJ. 1985. Assessment of priority pollutant concentrations in the United States using STORET database. *Environ Toxicol Chem* 4:131-142.
- *Steup DR, Hall P, McMillan DA, et al. 1993. Time course of hepatic injury and recovery following coadministration of carbon tetrachloride and trichloroethylene in Fischer-344 Rats. *Toxicol Pathol* 21:327-334.
- Steup DR, Wiersma D, McMillan DA, et al. 1991. Pretreatment with drinking water solutions containing trichloroethylene or chloroform enhances the hepatotoxicity of carbon tetrachloride in Fischer 344 rats. *Fundam Appl Toxicol* 16:798-809.
- *Stevens H, Forster FM. 1953. Effect of carbon tetrachloride on the nervous system. *Arch Neurol Psychiat* 70:635-649.
- *Stewart BW. 1981. Generation and persistence of carcinogen-induced repair intermediates in rat liver DNA *in vivo*. *Cancer Res* 41:3238-3243.
- *Stewart A, Witts LJ. 1944. Chronic carbon tetrachloride intoxication. *Br J Ind Med* 1:11-19.
- Stewart PA, Lee JS, Marano DE, et al. 1991. Retrospective cohort mortality study of workers at an aircraft maintenance facility. II. Exposures and their assessment. *Br J Ind Med* 48:531-537.
- *Stewart RD, Dodd HC. 1964. Absorption of carbon tetrachloride, trichloroethylene, tetrachloroethylene, methylene chloride and 1,1,1-trichloroethane through the human skin. *Am Ind Hyg Assoc J* 25:439-446.
- *Stewart RD, Boettner EA, Southworth RR, et al. 1963. Acute carbon tetrachloride intoxication. *J Am Med Assoc* 183:94-97.

9. REFERENCES

- *Stewart RD, Dodd HC, Erley DS, et al. 1965. Diagnosis of solvent poisoning. *J Am Med Assoc* 193:115-118.
- *Stewart, RD, Gay HH, Erley DS, et al. 1961. Human exposure to carbon tetrachloride vapor. *J Occup Expos* 3:586-590.
- Stoyanovsky DA, Cederbaum AI. 1996. Thiol oxidation and cytochrome P450-dependent metabolism of CCl₄ triggers Ca²⁺ release from liver microsomes. *Biochemistry* 35(49):15839-15845.
- Stoyanovsky DA, Cederbaum AI. 1999. Metabolism of carbon tetrachloride to trichloromethyl radical: An ESR and HPLC-EC study. *Chem Res Toxicol* 12:730-736.
- *Straus B. 1954. Aplastic anemia following exposure to carbon tetrachloride. *J Am Med Assoc* 155:737-739.
- *Streetz KL, Tacke F, Leifeld L, et al. 2003. Interleukin 6/gp130-dependent pathways are protective during chronic liver diseases. *Hepatology* 38(1):218-229.
- *Striker GE, Smuckler EA, Kohnen PW, et al. 1968. Structural and functional changes in rat kidney during CCl₄ intoxication. *Am J Pathol* 53:769-789.
- *Strubelt O. 1984. Alcohol potentiation of liver injury. *Fundam Appl Toxicol* 4:144-151.
- Suda H, Masui T, Ikawa E, et al. 1987. Compared promoting potential of D-galactosamine, carbon tetrachloride and partial hepatectomy in rapid induction of preneoplastic liver lesions in the rat. *Cancer Lett* 37:163-171.
- *Suh JH, Shenvi SV, Dixon BM, et al. 2004. Decline in transcriptional activity of Nrf2 causes age-related loss of glutathione synthesis, which is reversible with lipoic acid. *Proc Natl Acad Sci U S A* 101(10):3381-3386.
- *Sutheimer C, Bost R, Sunshine I. 1982. Volatiles by headspace chromatography. In: Sunshine I, Jatlow PI, eds. *Methodology for analytical technology*. Volume II. Boca Raton, FL: CRC Press Inc., 1-9.
- Summerhays J. 1991. Evaluation of risks from urban air pollutants in the Southeast Chicago area. *J Air Waste Manage Assoc* 41:844-850.
- *Sundari PN, Wilfred G, Ramakrishna B. 1997. Does oxidative protein damage play a role in the pathogenesis of carbon tetrachloride-induced liver injury in the rat? *Biochim Biophys Acta* 1362(2-3):169-176.
- Suntres ZE, Lui EM. 1990. Biochemical mechanism of metallothionein-carbon tetrachloride interaction *in vitro*. *Biochem Pharmacol* 39:833-840.
- *Suzuki H, Hirano N, Watanabe C, et al. 1997. Carbon tetrachloride does not induce micronucleus in either mouse bone marrow or peripheral blood. *Mutat Res* 394(1-3):77-80.

9. REFERENCES

- *Svirbely JL, Highman B, Alford WC, et al. 1947. The toxicity and narcotic action of monochloromonobromomethane with special reference to inorganic and volatile bromide in blood, urine and brain. *J Indust Hyg* 29:382-389.
- *Sweet CW, Vermette SJ. 1990. Monitoring toxic VOCs in urban air in Illinois. U.S. Environmental Protection Agency. Research Triangle Institute; Proceedings of the 1990 EPA/AWMA International Symposium. EPA600990026. PB91120279, 536-540
- *Sweet CW, Vermette SJ. 1992. Toxic volatile organic compounds in urban air in Illinois. *Environ Sci Technol* 26:165-173.
- Symons JM, Bellar TA, Carswell JK, et al. 1975. National organics reconnaissance survey for halogenated organics. *J Am Water Works Assoc* 67:634-647.
- *Tabak HH, Quave SA, Mashni CI, et al. 1981. Biodegradability studies with organic priority pollutant compounds. *J Water Pollut Control Fed* 53:1503-1518.
- *Tafazoli M, Baeten A, Geerlings P, et al. 1998. In vitro mutagenicity and genotoxicity study of a number of short-chain chlorinated hydrocarbons using the micronucleus test and the alkaline single cell gel electrophoresis technique (Comet assay) in human lymphocytes: A structure-activity relationship (QSAR) analysis of the genotoxic and cytotoxic potential. *Mutagenesis* 13(2):115-126.
- *Tajima S, Nishimura N, Ito K. 1985. Suppression of delayed-type hypersensitivity mediated by macrophage-like cells in mice with experimental liver injury. *Immunology* 54:57-64.
- Takei N, Watanabe A, Sakata T, et al. 1983. Brain tyrosine hydroxylase activity and calculated amount of brain dopa synthesized in carbon tetrachloride-intoxicated rats. *Gastroenterol Jpn* 18(1):11-14.
- *Takizawa S, Watanabe H, Naito Y, et al. 1975. Preparative action of carbon tetrachloride in liver tumorigenesis by a single application of n-butylnitrosourea in male ICR/JCL strain mice. *Gann* 66:603-614.
- Tanaka E. 1997. Short communication: Simultaneous determination of carbamazepine and its metabolites in plasma from carbon tetrachloride-intoxicated rats using a new reversed-phase chromatographic column of 2-um porous microspherical silica gel. *J Chromatogr B Biomed Sci Appl* 688(1):155-160.
- *Tanaka E. 1998. In vivo age-related changes in hepatic drug-oxidizing capacity in humans. *J Clin Pharm Ther* 23:247-255.
- Tanaka E, Sakamoto N, Inubushi M, et al. 1995. Short communication simultaneous determination of plasma phenytoin and its primary hydroxylated metabolites in carbon tetrachloride-intoxicated rats by high-performance liquid chromatography. *J Chromatogr B Biomed Appl* 673(1):147-151.
- Tanaka S, Tsurukami H, Sakai A, et al. 2003. Effects of 1,25(OH)₂D₃ on turnover, mineralization, and strength of bone in growing rats with liver cirrhosis induced by administration of carbon tetrachloride. *Bone* 32:275-283.
- *Tancrede M, Yanagisawa Y, Wilson R. 1992. Volatilization of volatile organic compounds from showers - I. Analytical method and quantitative assessment. *Atmos Environ* 26a:1103-1111.

9. REFERENCES

- Tang N. 1987. DDT and ethanol potentiation of the hepatotoxicity of carbon tetrachloride. *Chin J Prev Med* 21:196-198.
- Tanka E. 2001. Chlorzoxazone: A probe drug the metabolism of which can be used to monitor one-point blood sampling in the carbon tetrachloride -intoxicated rat. *Hum Exp Toxicol* 20:381-385.
- *Taylor HF. 1925. A case of hypersensitiveness to carbon tetrachloride. *J Am Med Assoc* 84:280.
- *Taylor SL, Tappel AL. 1976. Effect of dietary antioxidants and phenobarbital pretreatment on microsomal lipid peroxidation and activation by carbon tetrachloride. *J Life Sci* 19:1151-1160.
- *Teschke R, Vierke W, Goldermann L. 1983. Carbon tetrachloride (CCl₄) levels and serum activities of liver enzymes following activities CCl₄ intoxication. *Toxicol Lett* 17:175-180.
- Teschke R, Vierke W, Gellert J. 1984. Effect of ethanol on carbon tetrachloride levels and hepatotoxicity after acute carbon tetrachloride poisoning. *Arch Toxicol* 56:78-82.
- Teta MJ, Ott MG. 1988. A mortality study of a research, engineering, and metal fabrication facility in Western New York State. *Am J Epidemiol* 127:540-551.
- *Tezuka M, Ishii S, Okada S. 1991a. Chromium (III) decreases carbon tetrachloride-originated trichloromethyl radical in mice. *J Inorganic Biochem* 44:261-265.
- *Tezuka M, Momiyama K, Edano T, et al. 1991b. Protective effect of chromium(III) on acute lethal toxicity of carbon tetrachloride in rats and mice. *J Inorganic Biochem* 42:1-8.
- *Thakore KN, Mehendale HM. 1991. Role of hepatocellular regeneration in CCl₄ autoprotection. *Toxicol Pathol* 19:47-58.
- Theocharis SE, Kanelli H, Margeli AP. 2000. Metallothionein and heat shock protein expression during acute liver injury and regeneration in rats. *Clin Chem Lab Med* 38(11):1137-1140.
- Theocharis SE, Margeli AP, Skaltsas SD, et al. 2001. Induction of metallothionein in the liver of carbon tetrachloride intoxicated rats: An immunohistochemical study. *Toxicology* 161:129-138.
- *Thirunavukkarasu C, Yang Y, Subbotin VM, et al. 2004. Endothelin receptor antagonist TAK-044 arrests and reverses the development of carbon tetrachloride induced cirrhosis in rats. *Gut* 53:1010-1019.
- Thomas MJ. 1995. The role of free radicals and antioxidants: How do we know that they are working? *Crit Rev Food Sci Nutr* 35:21-39.
- Thomas CE, Aust SD. 1986. Free radicals and environmental toxins. *Ann Emerg Med* 15:1075-1083.
- Thomas KW, Pellizzari ED, Cooper SD. 1991. A canister-based method for collection and GC/MS analysis of volatile organic compounds in human breath. *J Anal Toxicol* 15:54-59.
- Thrall KD, Kenny DV. 1996. Evaluation of a carbon tetrachloride physiologically based pharmacokinetic model using real-time breath-analysis monitoring of the rat. *Inhal Toxicol* 8:251-261.
- *Thrall KD, Vucelick ME, Gies RA, et al. 2000. Comparative metabolism of carbon tetrachloride in rats, mice, and hamsters using gas uptake and PBPK modeling. *J Toxicol Environ Health A* 60:531-548.

9. REFERENCES

- *Tian L, Cai Q, Wei H. 1998. Alterations of antioxidant enzymes and oxidative damage to macromolecules in different organs of rats during aging. *Free Radic Biol Med* 24(9):1477-1484.
- Tomasi A, Albano E, Banni S, et al. 1987. Free-radical metabolism of carbon tetrachloride in rat liver mitochondria. A study of the mechanism of action. *Biochem J* 246:313-317.
- *Tomenson JA, Baron CE, O'Sullivan J, et al. 1995. Hepatic function in workers occupationally exposed to carbon tetrachloride. *Occup Environ Med* 52:508-514.
- *Topham JC. 1980. Do induced sperm-head abnormalities in mice specifically identify mammalian mutagens rather than carcinogens? *Mutat Res* 74:379-387.
- Tortoriello PJ, Riebow JF, Advani S, et al. 1991. The anomaly of pyridine nucleotide synergism in carbon tetrachloride metabolism. *Free Radic Biol Med* 10:387-396.
- *Towner RA, Reinke LA, Janzen EG, et al. 1991. Enhancement of carbon tetrachloride-induced liver injury by a single dose of ethanol: Proton magnetic resonance imaging (MRI) studies *in vivo*. *Acta Biochem Biophys* 1096:222-230.
- Towner RA, Reinke LA, Janzen EG, et al. 1994. In vivo magnetic resonance imaging study of Kupffer cell involvement in CCl₄-induced hepatotoxicity. *Can J Physiol Pharmacol* 72(5):441-446.
- *Tracey JP, Sherlock P. 1968. Hepatoma following carbon tetrachloride poisoning. *NYJ Med* 68:2202-2204.
- *Traiger GJ, Bruckner JV. 1976. The participation of 2-butanone in 2-butanol-induced potentiation of carbon tetrachloride hepatotoxicity. *J Pharmacol Exp Therap* 196:493-500.
- *Traiger GJ, Plaa GL. 1971. Differences in the potentiation of carbon tetrachloride in rats by ethanol and isopropanol pretreatment. *Toxicol Appl Pharmacol* 20:105-112.
- Traiger GJ, Bruckner JV, Jiang WD, et al. 1989. Effect of 2-butanol and 2-butanone on rat hepatic ultrastructure and drug metabolizing enzyme activity. *J Toxicol Environ Health* 28:235-248.
- *Tribble DL, Aw TY, Jones DP. 1987. The pathophysiological significance of lipid peroxidation in oxidative cell injury. *Hepatology* 7(2):377-387.
- TRI02. 2004. TRI explorer: Providing access to EPA's toxics release inventory data. Washington, DC: Office of Information Analysis and Access. Office of Environmental Information. U.S. Environmental Protection Agency. Toxics Release Inventory. <http://www.epa.gov/triexplorer/>. December 23, 2004.
- Triger DR, Wright R. 1973. Studies on hepatic uptake of antigen. II. The effect of hepatotoxins on the immune response. *Immunology* 25:951-956.
- *Tsuda H, Masui T, Ikawa E, et al. 1987. Compared promoting potential of d-galactosamine, carbon tetrachloride and partial hepatectomy in rapid induction of preneoplastic liver lesions in the rat. *Cancer Lett* 37:163-171.
- *Tsuruta H. 1975. Percutaneous absorption of organic solvents. Comparative study of the *in vivo* percutaneous absorption of chlorinated solvents in mice. *Industrial Health* 13:227-236.

9. REFERENCES

- *Uehleke H, Hellmer KH, Tabarelli S. 1973. Binding of ¹⁴C-carbon tetrachloride to microsomal proteins *in vitro* and formation of CHC13 by reduced liver microsomes. *Xenobiotica* 3:1-11.
- *Uehleke H, Werner T, Greim H, et al. 1977. Metabolic activation of haloalkanes and tests *in vitro* for mutagenicity. *Xenobiotica* 7:393-400.
- *Uemitsu N. 1986. Inhalation pharmacokinetics of carbon tetrachloride in rats based on arterial blood: Inhaled air concentration ratios. *Toxicol Appl Pharmacol* 83:20-29.
- Uemitsu N, Nishimura C, Nakayoshi H. 1986. Evaluation of liver weight changes following repeated administration of carbon tetrachloride in rats and body-liver weight relationship. *Toxicology* 40:181-190.
- *Umiker W, Pearce J. 1953. Nature and genesis of pulmonary alterations in carbon tetrachloride poisoning. *Arch Pathol* 55:203-217.
- Uryvaeva IV, Delone GV. 1995. An improved method of mouse liver micronucleus analysis: An application to age-related genetic alteration and polyploidy study. *Mutat Res* 334(1):71-80.
- *USC. 2003. Hazardous air pollutants. Washington, DC: United States Code. 42 USC 7412. <http://www4.law.cornell.edu/uscode/>. June 6, 2003.
- *USITC. 1986. Synthetic organic chemicals. United States production and sales. 1986. Washington, DC: U.S. International Trade Commission, publication 2009, 212.
- *USITC. 1991. Synthetic organic chemicals. United States production and sales. 1990. Washington, DC: U.S. International Trade Commission, publication 2470, 15-8, 15-30.
- *USITC. 2002. Synthetic organic chemicals. United States production and sales. Washington, DC: U.S. International Trade Commission.
- *USITC. 2003. Synthetic organic chemicals. United States production and sales. Washington, DC: U.S. International Trade Commission.
- Valdivia E, Sonnad J. 1966. Fatty change of the granular pneumocyte in carbon tetrachloride intoxication. *Arch Pathol* 81:514-519.
- Van de Casteele M, van Pelt JF, Nevens F, et al. 2003. Low NO bioavailability in CCl₄ cirrhotic rat livers might result from low NO synthesis combined with decreased superoxide dismutase activity allowing superoxide-mediated NO breakdown: A comparison of two portal hypertensive rat models with healthy controls. *Comp Hepatol* 2(1):2.
- *van den Bosch H, Aarsman AJ, van Schaik RHN, et al. 1990. Structural and enzymological properties of cellular phospholipases A₂. *Biochem Soc Trans* 18:781-785.
- van Kuijk FJGM, Sevanian A, Handelman GJ, et al. 1987. A new role for phospholipase A₂: Protection of membranes from lipid peroxidation damage. *Trends Biochem Sci* 12:31-34.
- Vannelli T, Logan M, Arciero DM, et al. 1990. Degradation of halogenated aliphatic compounds by the ammonia-oxidizing bacterium *nitrosomonas europaea*. *Appl Environ Microbiol* 56:1169-1171.

9. REFERENCES

- Van Stee EW, Boorman GA, Moorman MP, et al. 1982. Time-varying concentration profile as a determinant of the inhalation toxicity of carbon tetrachloride. *J Toxicol Environ Health* 10:785-795.
- *Varma MM, Ampy FR, Verma K, et al. 1988. In vitro mutagenicity of water contaminants in complex mixtures. *J Appl Toxicol* 8(4):243-248.
- *Vazquez C, Bujan J, Vallejo D. 1990. Blood coagulation variations induced by carbon tetrachloride inhalation in Wistar rats. *Toxicol Appl Pharmacol* 103:206-213.
- Veng-Pedersen P, Paustenback DJ, Carlson GP, et al. 1987. A linear systems approach to analyzing the pharmacokinetics of carbon tetrachloride in the rat following repeated exposures of 8 and 11.5 h/day. *Arch Toxicol* 60:355-364.
- *Verschuere K. 1983. Handbook of environmental data on organic chemicals. New York: Van Nostrand Reinhold Company.
- *Vieira I, Sonnier M, Cresteil T. 1996. Developmental expression of *CYP2E1* in the human liver: Hypermethylation control of gene expression during the neonatal period. *Eur J Biochem* 238:476-483.
- *Villarruel MdC, de Toranzo EGD, Castro JA. 1977. Carbon tetrachloride activation, lipid peroxidation, and the mixed function oxygenase activity of various rat tissues. *Toxicol Appl Pharmacol* 41:337-344.
- Villarruel MC, Fernandez G, Aguilar EG, et al. 1987. Early biochemical alternations in liver mitochondria from carbon tetrachloride poisoned rats. *J Appl Toxicol* 7:173-177.
- *Vittozzi L, Nastainczyk W. 1987. Binding of reactive metabolites of CCl₄ to specific microsomal proteins. *Biochem Pharmacol* 36:1401-1406.
- Vohra BPS, Hui X. 2001. Taurine protects against carbon tetrachloride toxicity in the cultured neurons and *in vivo* *Arch Physiol Biochem* 109(1):90-94.
- *Volkering F, Breure AM, Rulkens WH, et al. 1998. Microbiological aspects of surfactant use for biological soil remediation. *Biodegradation* 8(6):410-417.
- *von Oettingen WF. 1964. The halogenated hydrocarbons of industrial and toxicological importance. In: Browning E, ed. Elsevier monographs on toxic agents. New York, NY: Elsevier Publishing Co.
- *von Oettingen WF, Powell CC, Sharpless NE, et al. 1949. Relation between the toxic action of chlorinated methanes and their chemical and physicochemical properties. *National Inst Health Bull No.* 191.
- von Oettingen WF, Powell CC, Sharpless NE, et al. 1950. Comparative studies of the toxicity and pharmacodynamic action of chlorinated methanes with special reference to their physical and chemical characteristics. *Arch Int Pharmacodyn* 81:17-34.
- *Wacker M, Wanek P, Eder E. 2001. Detection of 1, N²-propanodeoxyguanosine adducts of *trans*-4-hydroxy-2-nonenal after gavage of *trans*-4-hydroxy-2-nonenal or induction of lipid peroxidation with carbon tetrachloride in F344 rats. *Chem Biol Interact* 137:269-283.
- Wackett LP, Logan M, Blocki F et al. 1992. A mechanistic perspective on bacterial metabolism of chlorinated methanes. *Biodegradation* 3:19-36.

9. REFERENCES

- *Wahlberg JE, Boman A. 1979. Comparative percutaneous toxicity of ten industrial solvents in the guinea pig. *Scand J Work Environ Health* 5:345-351.
- Walker BL, Cooper CD. 1992. Air pollution emission factors for medical waste incinerators. *J Air Waste Manage Assoc* 42:784-791.
- *Wallace LA. 1986. Personal exposures, indoor and outdoor air concentrations and exhaled breath concentrations of selected volatile organic compounds measured for 600 residents of New Jersey, North Dakota, North Carolina and California. *Toxicol Environ Chem* 12:215-236.
- *Wallace LA. 1991. Comparison of risks from outdoor and indoor exposure to toxic chemicals. *Environ Health Perspect* 95:7-13.
- *Wallace L, Buckley T, Pellizzari IE, et al. 1996. Breath measurements as volatile organic compounds biomarkers. *Environ Health Perspect* 104:861-869.
- Wallace LA, Pellizzari ED, Hartwell TD, et al. 1989. The influence of personal activities on exposure to volatile organic compounds. *Environ Res* 50:37-55.
- *Wallace LA, Pellizzari ED, Leaderer B, et al. 1987. Emissions of volatile organic compounds from building materials and consumer products. *Atmos Environ* 21:385-393.
- *Waller RL, Glende EA Jr., Recknagel RO. 1983. Carbon tetrachloride and bromotrichloromethane toxicity. *Biochem Pharmacol* 32:1613-1617.
- *Walters SM. 1986. Cleanup of samples. In: Zweig G, Shema J, eds. *Analytical methods for pesticides and plant growth regulators*. New York, NY: Academic Press, 67-110.
- *Walton BT, Hendricks MS, Anderson TA, et al. 1992. Soil sorption of volatile and semivolatile organic compounds in a mixture. *J Environ Qual* 21:552-558.
- Wang B, Gao Z, Zou Q et al. 2003. Quantitative diagnosis of fatty liver with dual-energy CT. *Acta Radiol* 44:92-97
- Wang D-H, Ishii K, Zhen L-X, et al. 1996. Enhanced liver injury in acatalasemic mice following exposure to carbon tetrachloride. *Arch Toxicol* 70:189-194.
- *Wang M-Y, Liehr JG. 1995. Lipid hydroperoxide-induced endogenous DNA adducts in hamsters: Possible mechanism of lipid hydroperoxide-mediated carcinogenesis. *Arch Biochem Biophys* 316(1):38-46.
- *Wang P-Y, Kaneko T, Tsukada H, et al. 1997a. Dose- and route-dependent alterations in metabolism and toxicity of chemical compounds in ethanol-treated rats: Difference between highly (chloroform) and poorly (carbon tetrachloride) metabolized hepatotoxic compounds. *Toxicol Appl Pharmacol* 142:13-21.
- Wang P-Y, Kaneko T, Tsukada H, et al. 1997b. Time courses of hepatic injuries induced by chloroform and by carbon tetrachloride: Comparison of biochemical and histopathological changes. *Arch Toxicol* 71:638-645.

9. REFERENCES

- *Ware JH, Spengler JD, Neas LM, et al. 1993. Respiratory and irritant health effects of ambient volatile organic compounds. *Am J Epidemiol* 137:1287-1301.
- Waring JF, Jolly RA, Ciurlionis R, et al. 2001. Clustering of hepatotoxins based on mechanism of toxicity using gene expression profiles. *Toxicol Appl Pharmacol* 175(1):28-42.
- *Warrington JS, Greenblatt DJ, von Moltke LL. 2004. Age-related differences in CYP3A expression and activity in the rat liver, intestine, and kidney. *J Pharmacol Exp Ther* 309(2):720-729.
- Washall JW, Wampler TP. 1988. Purge and trap analysis of aqueous samples with cryofocusing. *Am Lab July*:70-74.
- *Watanabe A, Shiota T, Takei N, et al. 1986. Blood to brain transfer of carbon tetrachloride and lipoperoxidation in rat brain. *Res Comm Chem Path Pharmacol* 51:137-140.
- Watanabe T, Niioka M, Hozawa S, et al. 2000. Gene expression of interstitial collagenase in both progressive and recovery phase of rat liver fibrosis induced by carbon tetrachloride. *J Hepatol* 33(2):224-235.
- Waterfield CJ, Mesquita M, Parnham P, et al. 1993. Taurine protects against the cytotoxicity of hydrazine, 1,4-naphthoquinone and carbon tetrachloride in isolated rat hepatocytes. *Biochem Pharmacol* 46(4):589-595.
- *Waterfield CJ, Turton JA, Scales MD, et al. 1991. Taurine, a possible urinary marker of liver damage: A study of taurine excretion in carbon tetrachloride-treated rats. *Arch Toxicol* 65:548-555.
- *Wauthier V, Verbeeck RK, Calderon PB. 2004. Age-related changes in the protein and mRNA levels of CYP2E1 and CYP3A isoforms as well as in their hepatic activities in Wistar rats. What role for oxidative stress? *Arch Toxicol* 78:131-138.
- Weast RC. 1985. *CRC handbook of chemistry and physics: A ready-reference book of chemical and physical data*. Boca Raton, FL: CRC Press, Inc., C-349, C-350.
- Weaver VM, Buckley TJ, Groopman JD. 1998. Approaches to environmental exposure assessment in children. *Environ Health Perspect* 106 (Suppl 3):827-832.
- *Weber FL, Macechko PT, Kelson SR, et al. 1992. Increased muscle protein catabolism caused by carbon tetrachloride hepatic injury in rats. *Gastroenterology* 102:1700-1706.
- *Weber LWD, Boll M, Stampfl A. 2003. Hepatotoxicity and mechanism of action of haloalkanes: Carbon tetrachloride as a toxicological model. *Crit Rev Toxicol* 33(2):105-136.
- Weiner FR, Giambone M-A, Czaja MJ, et al. 1990. Ito-cell gene expression and collagen regulation. *Hepatology* 11:111-117.
- *Weisburger EK. 1977. Carcinogenicity studies on halogenated hydrocarbons. *Environ Health Perspect* 21:7-16.
- *West JR, Smith HW, Chasis H. 1948. Glomerular filtration rate, effective renal blood flow, and maximal tubular excretory capacity in infancy. *J Pediatr* 32:10-18.

9. REFERENCES

- *Westrick JJ, Mello JW, Thomas RF. 1984. The groundwater supply survey. *J Am Water Works Assoc* 76:52-59.
- *Whittaker SG, Zimmerman FK, Dicus B, et al. 1989. Detection of induced mitotic chromosome loss in *Saccharomyces cerevisiae*- an interlaboratory study. *Mutat Res* 224:31-78.
- WHO. 1984. Guidelines for drinking-water quality. Volume 1. Recommendations. Geneva: World Health Organization.
- *WHO. 1993. Guidelines for drinking water quality. Carbon tetrachloride. Geneva, Switzerland: World Health Organization. <http://www.who.int/en/>. June 6, 2003.
- *WHO. 2000. Air quality guidelines. Geneva, Switzerland: World Health Organization. <http://www.who.int/en/>. June 6, 2003.
- *Widdowson EM, Dickerson JWT. 1964. Chemical composition of the body. In: Comar CL, Bronner F, eds. *Mineral metabolism: An advanced treatise. Volume II: The elements Part A.* New York: Academic Press.
- *Wilcosky TC, Checkoway H, Marshall EG, et al. 1984. Cancer mortality and solvent exposures in the rubber industry. *Am Ind Hyg Assoc J* 45(12):809-811.
- *Will O, Mahler H-C, Arrigo A-P, et al. 1999. Influence of glutathione levels and heat-shock on the steady-state levels of oxidative DNA base modifications in mammalian cells. *Carcinogenesis* 20(2):333-337.
- Williams CA, Jones HD, Freeman RW, et al. 1994. The EPC approach to estimating safety from exposure to environmental chemicals. *Regul Toxicol Pharmacol* 20(3 part 1):259-280.
- *Wilson JG. 1954. Influence of the offspring of altered physiologic states during pregnancy in the rat. *Ann NY Acad Sci* 57:517-525.
- *Wirth KJ, Bickel M, Hropot M, et al. 1997. The bradykinin B₂ receptor antagonist Icatibant (HOE 140) corrects avid Na⁺ retention in rats with CCl₄-induced liver cirrhosis: Possible role of enhanced microvascular leakage. *Eur J Pharmacol* 337(1):45-53.
- *Wirtschafter ZT. 1933. Toxic amblyopia and accompanying physiological disturbances in carbon tetrachloride intoxication. *Am J Public Health* 22:1035-1038.
- Wirtschafter ZT, DeMeritt MG. 1959. Reticuloendothelial response to carbon tetrachloride. *Arch Pathol* 67:146-158.
- *Withey JR, Collins BT, Collins PG. 1983. Effects of vehicle on the pharmacokinetics and uptake of four halogenated hydrocarbons from the gastrointestinal tract of rat. *J Appl Toxicol* 3:249-253.
- *Wolf CR, Mansuy D, Nastainczyk W, et al. 1977. The reduction of polyhalogenated methanes by liver microsomal cytochrome P-450. *Mol Pharmacol* 13:698-705.
- Wolff MS, Weston A. 1997. Breast cancer risk and environmental exposures. *Environ Health Perspect Suppl* 105(4):891-896.

9. REFERENCES

- Wolfgang GH, Donarski WJ, Petry TW. 1990. Effects of novel antioxidants on carbon tetrachloride-induced lipid peroxidation and toxicity in precision-cut rat liver slices. *Toxicol Appl Pharmacol* 106:63-70.
- Wong LCK, DiStefano V. 1966. Rapid accumulation of renal fat in cats after single inhalations of carbon tetrachloride. *Toxicol Appl Pharmacol* 9:485-494.
- Wong CK, Ooi VEC, Wong CK. 2003. Protective effects of N-acetylcysteine against carbon tetrachloride- and trichloroethylene-induced poisoning in rats. *Environ Toxicol Pharmacol* 14:109-116.
- *Wong FWY, Chan WY, Lee SST. 1998. Resistance to carbon tetrachloride-induced hepatotoxicity in mice which lack CYP2E1 expression. *Toxicol Appl Pharmacol* 153(1):109-118.
- Woodruff TJ, Axelrad DA, Caldwell J, et al. 1998. Public health implications of 1990 air toxics concentrations across the United States. *Environ Health Perspect* 106:245-251.
- Wright PB, Moore L. 1991. Potentiation of the toxicity of model hepatotoxicants by acetaminophen. *Toxicol Appl Pharmacol* 109:327-335.
- Wu C, Miyagawa C, Kennedy DO, et al. 1997. Involvement of polyamines in the protection of taurine against the cytotoxicity of hydrazine or carbon tetrachloride in isolated rat hepatocytes. *Chem Biol Interact* 103(3):213-224.
- Wynder E, Goldsmith R. 1977. The epidemiology of bladder cancer: A second look. *Cancer* 40:1246-1268.
- Wyrebowska J, Jerykowski T. 1980. Some properties of aminopropanol dehydrogenase in rat serum studied in normal conditions and in acute carbon tetrachloride poisoning. *J Toxicol Environ Health* 6:613-620.
- Xu R-J, Cranwell PD. 1990. Development of gastric acid secretion in pigs from birth to thirty six days of age: The response to pentagastrin. *J Dev Physiol* 13:315-326.
- *Yamada Y, Fausto N. 1998. Deficient liver regeneration after carbon tetrachloride injury in mice lacking type 1 but not type 2 tumor necrosis factor receptor. *Am J Pathol* 152(6):1577-1589.
- *Yamada M, Ishiwada A, Hobo T, et al. 1982. Novel chemiluminescence detector for determination of volatile polyhalogenated hydrocarbons by gas chromatography. *J Chromatogr* 238:347-356.
- Yamagishi F, Komoda T, Ohnishi K, et al. 1994. Correlation between various ratios of serum thyroid hormones and liver cytochrome P-450 in CCl₄ treated and untreated rats. *Res Commun Chem Pathol Pharmacol* 83(2):237-240.
- *Yamaguchi M, Tsurusaki Y, Misawa H, et al. 2002. Potential role of regucalcin as a specific biochemical marker of chronic liver injury with carbon tetrachloride administration in rats. *Mol Cell Biochem* 241:61-67.
- *Yamamoto HA. 1990a. Brain phenylalanine and tyrosine levels and hepatic encephalopathy induced by CCl₄ in rats. *Toxicology* 61:241-247.

9. REFERENCES

- *Yamamoto HA. 1990b. Relation of Ca^{++} accumulation and lipid peroxidation with CCl_4 -induced toxicity in the rat liver. *Pharmacol Toxicol* 66:213-216.
- Yamamoto H, Sugihara N. 1987. Blood ammonia levels and hepatic encephalopathy induced by CCl_4 in rats. *Toxicol Appl Pharmacol* 91:461-468.
- *Yamashita S, Ozawa R, Yamaguchi K, et al. 1992. Analysis of volatile organic compounds in air by gas chromatography with thermal desorption cold-trap injection and atomic emission and mass selective detection. *J High Resolut Chromatogr* 15:549-551.
- Yang Y, Harvey SAK, Gandhi CR. 2003. Kupffer cells are a major source of increased platelet activating factor in the CCl_4 -induced cirrhotic liver. *J Hepatol* 39:200-207.
- Yano T, Shibagaki T, Kitamura H, et al. 1988. The mechanism of carbon tetrachloride induced pulmonary clara cell damage: Biochemical and morphologic studies. *Res Commun Chem Pathol Pharmacol* 62:483-493.
- Yata Y, Takahara T, Furui K, et al. 1999. Expression of matrix metalloproteinase-13 and tissue inhibitor of metalloproteinase-1 in acute liver injury. *J Hepatol* 30:419-424.
- *Yaws C, Yang H-C, Pan X. 1991. Henry's law constants for 362 organic compounds in water. *Chem Eng* 179-185.
- Yokogawa K, Watanabe M, Takeshita H, et al. 2004. Serum aminotransferase activity as a predictor of clearance of drugs metabolized by CYP isoforms in rats with acute hepatic failure induced by carbon tetrachloride. *Int J Pharm* 269:479-789.
- Yoneda M, Sato Y, Nakamura K, et al. 2003. Involvement of calcitonin gene-related peptide and capsaicin-sensitive afferents in central thyrotropin-releasing hormone-induced hepatic cytoprotection. *Eur J Pharmacol* 478:173-177.
- Yoshida T, Adachi E, Nigi H, et al. 1999. Changes of sinusoidal basement membrane collagens in early hepatic fibrosis induced with CCl_4 in cynomolgus monkeys. *Pathology* 31:29-35.
- Yoshida T, Andoh K, Fukuhara M. 1999. Estimation of absorption of trihalomethanes and carbon tetrachloride in low-level exposure by inhalation pharmacokinetic analysis in rats. *Arch Environ Contam Toxicol* 36:347-354.
- *Younes M, Siegers C-P. 1985. The role of iron in the paracetamol- and CCl_4 -induced lipid peroxidation and hepatotoxicity. *Chem Biol Interact* 55:327-334.
- *Young RA, Mehendale HM. 1989. Carbon tetrachloride metabolism in partially hepatectomized and sham-operated rats pre-exposed to chlordecone (kepone). *J Biochem Toxicol* 4:211-219.
- Yu C, Wang F, Jin C, et al. 2003. Animal model: Role of fibroblast growth factor type 1 and 2 in carbon tetrachloride-induced hepatic injury and fibrogenesis. *Am J Pathol* 163(4):1653-1662.
- *Yuen ST, Gogo AR, Luk ISC, et al. 1995. The effect of nicotine and its interaction with carbon tetrachloride in the rat liver. *Pharmacol Toxicol* 77:225-230.

9. REFERENCES

Zalatnai A, Sarosi I, Rot A, et al. 1991. Inhibitory and promoting effects of carbon tetrachloride-induced liver cirrhosis on the diethylnitrosamine hepatocarcinogenesis in rats. *Cancer Lett* 57:67-73.

*Zamara E, Novo E, Marra F, et al. 2004. 4-Hydroxynonenal as a selective pro-fibrogenic stimulus for activated human hepatic stellate cells. *J Hepatol* 40:60-68.

*Zangar RC, Benson JM, Burnett VL, et al. 2000. Cytochrome P450 2E1 is the primary enzyme responsible for low-dose carbon tetrachloride metabolism in human liver microsomes. *Chem Biol Interact* 125:233-243.

Zanovello A, Ferrara R, Manno M. 2003. Reductive activation of HCFC-123 by methaemalbumin. *Toxicol Lett* 144:127-136.

*Zhang C, Valsaraj KT, Constant WD, et al. 1998. Nutrient and surfactant enhancement for the biodegradation of chlorinated hydrocarbons in the wastewater from a Louisiana superfund site. *J Hazard Mater* 62:41-58.

*Zhao ZS, O'Brien PJ. 1996. The prevention of CCl₄-induced liver necrosis in mice by naturally occurring methylenedioxybenzenes. *Toxicol Appl Pharmacol* 140(2):411-421.

Zhu W, Fung PCW. 2000. The roles played by crucial free radicals like lipid free radicals, nitric oxide, and enzymes NOS and NADPH in CCl₄-induced acute liver injury of mice. *Free Radic Biol Med* 29(9):870-880.

*Ziegler EE, Edwards BB, Jensen RL, et al. 1978. Absorption and retention of lead by infants. *Pediatr Res* 12:29-34.

*Zielinska AB, Fujita E, Sagebiel J, et al. 1998. Arizona hazardous air pollutants monitoring program. *J Air Waste Manage Assoc* 48:1038-1050.

*Zlatkis A, Kim K. 1976. Column elution and concentration of volatile compounds in biological fluids. *J Chromatogr* 126:475-485.

10. GLOSSARY

Absorption—The taking up of liquids by solids, or of gases by solids or liquids.

Acute Exposure—Exposure to a chemical for a duration of 14 days or less, as specified in the Toxicological Profiles.

Adsorption—The adhesion in an extremely thin layer of molecules (as of gases, solutes, or liquids) to the surfaces of solid bodies or liquids with which they are in contact.

Adsorption Coefficient (K_{oc})—The ratio of the amount of a chemical adsorbed per unit weight of organic carbon in the soil or sediment to the concentration of the chemical in solution at equilibrium.

Adsorption Ratio (Kd)—The amount of a chemical adsorbed by sediment or soil (i.e., the solid phase) divided by the amount of chemical in the solution phase, which is in equilibrium with the solid phase, at a fixed solid/solution ratio. It is generally expressed in micrograms of chemical sorbed per gram of soil or sediment.

Benchmark Dose (BMD_{10})—Usually defined as the lower confidence limit on the dose that produces a specified magnitude of changes in a specified adverse response. For example, a BMD_{10} would be the dose at the 95% lower confidence limit on a 10% response, and the benchmark response (BMR) would be 10%. The BMD is determined by modeling the dose response curve in the region of the dose response relationship where biologically observable data are feasible.

Benchmark Dose Model—A statistical dose-response model applied to either experimental toxicological or epidemiological data to calculate a BMD.

Bioconcentration Factor (BCF)—The quotient of the concentration of a chemical in aquatic organisms at a specific time or during a discrete time period of exposure divided by the concentration in the surrounding water at the same time or during the same period.

Biomarkers—Broadly defined as indicators signaling events in biologic systems or samples. They have been classified as markers of exposure, markers of effect, and markers of susceptibility.

Cancer Effect Level (CEL)—The lowest dose of chemical in a study, or group of studies, that produces significant increases in the incidence of cancer (or tumors) between the exposed population and its appropriate control.

Carcinogen—A chemical capable of inducing cancer.

Case-Control Study—A type of epidemiological study that examines the relationship between a particular outcome (disease or condition) and a variety of potential causative agents (such as toxic chemicals). In a case-controlled study, a group of people with a specified and well-defined outcome is identified and compared to a similar group of people without outcome.

Case Report—Describes a single individual with a particular disease or exposure. These may suggest some potential topics for scientific research, but are not actual research studies.

10. GLOSSARY

Case Series—Describes the experience of a small number of individuals with the same disease or exposure. These may suggest potential topics for scientific research, but are not actual research studies.

Ceiling Value—A concentration of a substance that should not be exceeded, even instantaneously.

Chronic Exposure—Exposure to a chemical for 365 days or more, as specified in the Toxicological Profiles.

Cohort Study—A type of epidemiological study of a specific group or groups of people who have had a common insult (e.g., exposure to an agent suspected of causing disease or a common disease) and are followed forward from exposure to outcome. At least one exposed group is compared to one unexposed group.

Cross-sectional Study—A type of epidemiological study of a group or groups of people that examines the relationship between exposure and outcome to a chemical or to chemicals at one point in time.

Data Needs—Substance-specific informational needs that if met would reduce the uncertainties of human health assessment.

Developmental Toxicity—The occurrence of adverse effects on the developing organism that may result from exposure to a chemical prior to conception (either parent), during prenatal development, or postnatally to the time of sexual maturation. Adverse developmental effects may be detected at any point in the life span of the organism.

Dose-Response Relationship—The quantitative relationship between the amount of exposure to a toxicant and the incidence of the adverse effects.

Embryotoxicity and Fetotoxicity—Any toxic effect on the conceptus as a result of prenatal exposure to a chemical; the distinguishing feature between the two terms is the stage of development during which the insult occurs. The terms, as used here, include malformations and variations, altered growth, and *in utero* death.

Environmental Protection Agency (EPA) Health Advisory—An estimate of acceptable drinking water levels for a chemical substance based on health effects information. A health advisory is not a legally enforceable federal standard, but serves as technical guidance to assist federal, state, and local officials.

Epidemiology—Refers to the investigation of factors that determine the frequency and distribution of disease or other health-related conditions within a defined human population during a specified period.

Genotoxicity—A specific adverse effect on the genome of living cells that, upon the duplication of affected cells, can be expressed as a mutagenic, clastogenic, or carcinogenic event because of specific alteration of the molecular structure of the genome.

Half-life—A measure of rate for the time required to eliminate one half of a quantity of a chemical from the body or environmental media.

Immediately Dangerous to Life or Health (IDLH)—The maximum environmental concentration of a contaminant from which one could escape within 30 minutes without any escape-impairing symptoms or irreversible health effects.

10. GLOSSARY

Immunologic Toxicity—The occurrence of adverse effects on the immune system that may result from exposure to environmental agents such as chemicals.

Immunological Effects—Functional changes in the immune response.

Incidence—The ratio of individuals in a population who develop a specified condition to the total number of individuals in that population who could have developed that condition in a specified time period.

Intermediate Exposure—Exposure to a chemical for a duration of 15–364 days, as specified in the Toxicological Profiles.

In Vitro—Isolated from the living organism and artificially maintained, as in a test tube.

In Vivo—Occurring within the living organism.

Lethal Concentration(Lo) (LC_{Lo})—The lowest concentration of a chemical in air that has been reported to have caused death in humans or animals.

Lethal Concentration(50) (LC₅₀)—A calculated concentration of a chemical in air to which exposure for a specific length of time is expected to cause death in 50% of a defined experimental animal population.

Lethal Dose(Lo) (LD_{Lo})—The lowest dose of a chemical introduced by a route other than inhalation that has been reported to have caused death in humans or animals.

Lethal Dose(50) (LD₅₀)—The dose of a chemical that has been calculated to cause death in 50% of a defined experimental animal population.

Lethal Time(50) (LT₅₀)—A calculated period of time within which a specific concentration of a chemical is expected to cause death in 50% of a defined experimental animal population.

Lowest-Observed-Adverse-Effect Level (LOAEL)—The lowest exposure level of chemical in a study, or group of studies, that produces statistically or biologically significant increases in frequency or severity of adverse effects between the exposed population and its appropriate control.

Lymphoreticular Effects—Represent morphological effects involving lymphatic tissues such as the lymph nodes, spleen, and thymus.

Malformations—Permanent structural changes that may adversely affect survival, development, or function.

Minimal Risk Level (MRL)—An estimate of daily human exposure to a hazardous substance that is likely to be without an appreciable risk of adverse noncancer health effects over a specified route and duration of exposure.

Modifying Factor (MF)—A value (greater than zero) that is applied to the derivation of a Minimal Risk Level (MRL) to reflect additional concerns about the database that are not covered by the uncertainty factors. The default value for a MF is 1.

Morbidity—State of being diseased; morbidity rate is the incidence or prevalence of disease in a specific population.

10. GLOSSARY

Mortality—Death; mortality rate is a measure of the number of deaths in a population during a specified interval of time.

Mutagen—A substance that causes mutations. A mutation is a change in the DNA sequence of a cell's DNA. Mutations can lead to birth defects, miscarriages, or cancer.

Necropsy—The gross examination of the organs and tissues of a dead body to determine the cause of death or pathological conditions.

Neurotoxicity—The occurrence of adverse effects on the nervous system following exposure to a chemical.

No-Observed-Adverse-Effect Level (NOAEL)—The dose of a chemical at which there were no statistically or biologically significant increases in frequency or severity of adverse effects seen between the exposed population and its appropriate control. Effects may be produced at this dose, but they are not considered to be adverse.

Octanol-Water Partition Coefficient (K_{ow})—The equilibrium ratio of the concentrations of a chemical in *n*-octanol and water, in dilute solution.

Odds Ratio (OR)—A means of measuring the association between an exposure (such as toxic substances and a disease or condition) that represents the best estimate of relative risk (risk as a ratio of the incidence among subjects exposed to a particular risk factor divided by the incidence among subjects who were not exposed to the risk factor). An OR of greater than 1 is considered to indicate greater risk of disease in the exposed group compared to the unexposed group.

Organophosphate or Organophosphorus Compound—A phosphorus-containing organic compound and especially a pesticide that acts by inhibiting cholinesterase.

Permissible Exposure Limit (PEL)—An Occupational Safety and Health Administration (OSHA) allowable exposure level in workplace air averaged over an 8-hour shift of a 40-hour workweek.

Pesticide—General classification of chemicals specifically developed and produced for use in the control of agricultural and public health pests.

Pharmacokinetics—The dynamic behavior of a material in the body, used to predict the fate (disposition) of an exogenous substance in an organism. Utilizing computational techniques, it provides the means of studying the absorption, distribution, metabolism, and excretion of chemicals by the body.

Pharmacokinetic Model—A set of equations that can be used to describe the time course of a parent chemical or metabolite in an animal system. There are two types of pharmacokinetic models: data-based and physiologically-based. A data-based model divides the animal system into a series of compartments, which, in general, do not represent real, identifiable anatomic regions of the body, whereas the physiologically-based model compartments represent real anatomic regions of the body.

Physiologically Based Pharmacodynamic (PBPD) Model—A type of physiologically based dose-response model that quantitatively describes the relationship between target tissue dose and toxic end points. These models advance the importance of physiologically based models in that they clearly describe the biological effect (response) produced by the system following exposure to an exogenous substance.

10. GLOSSARY

Physiologically Based Pharmacokinetic (PBPK) Model—Comprised of a series of compartments representing organs or tissue groups with realistic weights and blood flows. These models require a variety of physiological information: tissue volumes, blood flow rates to tissues, cardiac output, alveolar ventilation rates, and possibly membrane permeabilities. The models also utilize biochemical information, such as air/blood partition coefficients, and metabolic parameters. PBPK models are also called biologically based tissue dosimetry models.

Prevalence—The number of cases of a disease or condition in a population at one point in time.

Prospective Study—A type of cohort study in which the pertinent observations are made on events occurring after the start of the study. A group is followed over time.

q_1^* —The upper-bound estimate of the low-dose slope of the dose-response curve as determined by the multistage procedure. The q_1^* can be used to calculate an estimate of carcinogenic potency, the incremental excess cancer risk per unit of exposure (usually $\mu\text{g/L}$ for water, mg/kg/day for food, and $\mu\text{g/m}^3$ for air).

Recommended Exposure Limit (REL)—A National Institute for Occupational Safety and Health (NIOSH) time-weighted average (TWA) concentration for up to a 10-hour workday during a 40-hour workweek.

Reference Concentration (RfC)—An estimate (with uncertainty spanning perhaps an order of magnitude) of a continuous inhalation exposure to the human population (including sensitive subgroups) that is likely to be without an appreciable risk of deleterious noncancer health effects during a lifetime. The inhalation reference concentration is for continuous inhalation exposures and is appropriately expressed in units of mg/m^3 or ppm.

Reference Dose (RfD)—An estimate (with uncertainty spanning perhaps an order of magnitude) of the daily exposure of the human population to a potential hazard that is likely to be without risk of deleterious effects during a lifetime. The RfD is operationally derived from the no-observed-adverse-effect level (NOAEL, from animal and human studies) by a consistent application of uncertainty factors that reflect various types of data used to estimate RfDs and an additional modifying factor, which is based on a professional judgment of the entire database on the chemical. The RfDs are not applicable to nonthreshold effects such as cancer.

Reportable Quantity (RQ)—The quantity of a hazardous substance that is considered reportable under the Comprehensive Environmental Response, Compensation, and Liability Act (CERCLA). Reportable quantities are (1) 1 pound or greater or (2) for selected substances, an amount established by regulation either under CERCLA or under Section 311 of the Clean Water Act. Quantities are measured over a 24-hour period.

Reproductive Toxicity—The occurrence of adverse effects on the reproductive system that may result from exposure to a chemical. The toxicity may be directed to the reproductive organs and/or the related endocrine system. The manifestation of such toxicity may be noted as alterations in sexual behavior, fertility, pregnancy outcomes, or modifications in other functions that are dependent on the integrity of this system.

10. GLOSSARY

Retrospective Study—A type of cohort study based on a group of persons known to have been exposed at some time in the past. Data are collected from routinely recorded events, up to the time the study is undertaken. Retrospective studies are limited to causal factors that can be ascertained from existing records and/or examining survivors of the cohort.

Risk—The possibility or chance that some adverse effect will result from a given exposure to a chemical.

Risk Factor—An aspect of personal behavior or lifestyle, an environmental exposure, or an inborn or inherited characteristic that is associated with an increased occurrence of disease or other health-related event or condition.

Risk Ratio—The ratio of the risk among persons with specific risk factors compared to the risk among persons without risk factors. A risk ratio greater than 1 indicates greater risk of disease in the exposed group compared to the unexposed group.

Short-Term Exposure Limit (STEL)—The American Conference of Governmental Industrial Hygienists (ACGIH) maximum concentration to which workers can be exposed for up to 15 minutes continually. No more than four excursions are allowed per day, and there must be at least 60 minutes between exposure periods. The daily Threshold Limit Value-Time Weighted Average (TLV-TWA) may not be exceeded.

Standardized Mortality Ratio (SMR)—A ratio of the observed number of deaths and the expected number of deaths in a specific standard population.

Target Organ Toxicity—This term covers a broad range of adverse effects on target organs or physiological systems (e.g., renal, cardiovascular) extending from those arising through a single limited exposure to those assumed over a lifetime of exposure to a chemical.

Teratogen—A chemical that causes structural defects that affect the development of an organism.

Threshold Limit Value (TLV)—An American Conference of Governmental Industrial Hygienists (ACGIH) concentration of a substance to which most workers can be exposed without adverse effect. The TLV may be expressed as a Time Weighted Average (TWA), as a Short-Term Exposure Limit (STEL), or as a ceiling limit (CL).

Time-Weighted Average (TWA)—An allowable exposure concentration averaged over a normal 8-hour workday or 40-hour workweek.

Toxic Dose₍₅₀₎ (TD₅₀)—A calculated dose of a chemical, introduced by a route other than inhalation, which is expected to cause a specific toxic effect in 50% of a defined experimental animal population.

Toxicokinetic—The absorption, distribution, and elimination of toxic compounds in the living organism.

10. GLOSSARY

Uncertainty Factor (UF)—A factor used in operationally deriving the Minimal Risk Level (MRL) or Reference Dose (RfD) or Reference Concentration (RfC) from experimental data. UFs are intended to account for (1) the variation in sensitivity among the members of the human population, (2) the uncertainty in extrapolating animal data to the case of human, (3) the uncertainty in extrapolating from data obtained in a study that is of less than lifetime exposure, and (4) the uncertainty in using lowest-observed-adverse-effect level (LOAEL) data rather than no-observed-adverse-effect level (NOAEL) data. A default for each individual UF is 10; if complete certainty in data exists, a value of 1 can be used; however, a reduced UF of 3 may be used on a case-by-case basis, 3 being the approximate logarithmic average of 10 and 1.

Xenobiotic—Any chemical that is foreign to the biological system.

APPENDIX A. ATSDR MINIMAL RISK LEVELS AND WORKSHEETS

The Comprehensive Environmental Response, Compensation, and Liability Act (CERCLA) [42 U.S.C. 9601 et seq.], as amended by the Superfund Amendments and Reauthorization Act (SARA) [Pub. L. 99–499], requires that the Agency for Toxic Substances and Disease Registry (ATSDR) develop jointly with the U.S. Environmental Protection Agency (EPA), in order of priority, a list of hazardous substances most commonly found at facilities on the CERCLA National Priorities List (NPL); prepare toxicological profiles for each substance included on the priority list of hazardous substances; and assure the initiation of a research program to fill identified data needs associated with the substances.

The toxicological profiles include an examination, summary, and interpretation of available toxicological information and epidemiologic evaluations of a hazardous substance. During the development of toxicological profiles, Minimal Risk Levels (MRLs) are derived when reliable and sufficient data exist to identify the target organ(s) of effect or the most sensitive health effect(s) for a specific duration for a given route of exposure. An MRL is an estimate of the daily human exposure to a hazardous substance that is likely to be without appreciable risk of adverse noncancer health effects over a specified duration of exposure. MRLs are based on noncancer health effects only and are not based on a consideration of cancer effects. These substance-specific estimates, which are intended to serve as screening levels, are used by ATSDR health assessors to identify contaminants and potential health effects that may be of concern at hazardous waste sites. It is important to note that MRLs are not intended to define clean-up or action levels.

MRLs are derived for hazardous substances using the no-observed-adverse-effect level/uncertainty factor approach. They are below levels that might cause adverse health effects in the people most sensitive to such chemical-induced effects. MRLs are derived for acute (1–14 days), intermediate (15–364 days), and chronic (365 days and longer) durations and for the oral and inhalation routes of exposure. Currently, MRLs for the dermal route of exposure are not derived because ATSDR has not yet identified a method suitable for this route of exposure. MRLs are generally based on the most sensitive chemical-induced end point considered to be of relevance to humans. Serious health effects (such as irreparable damage to the liver or kidneys, or birth defects) are not used as a basis for establishing MRLs. Exposure to a level above the MRL does not mean that adverse health effects will occur.

APPENDIX A

MRLs are intended only to serve as a screening tool to help public health professionals decide where to look more closely. They may also be viewed as a mechanism to identify those hazardous waste sites that are not expected to cause adverse health effects. Most MRLs contain a degree of uncertainty because of the lack of precise toxicological information on the people who might be most sensitive (e.g., infants, elderly, nutritionally or immunologically compromised) to the effects of hazardous substances. ATSDR uses a conservative (i.e., protective) approach to address this uncertainty consistent with the public health principle of prevention. Although human data are preferred, MRLs often must be based on animal studies because relevant human studies are lacking. In the absence of evidence to the contrary, ATSDR assumes that humans are more sensitive to the effects of hazardous substance than animals and that certain persons may be particularly sensitive. Thus, the resulting MRL may be as much as 100-fold below levels that have been shown to be nontoxic in laboratory animals.

Proposed MRLs undergo a rigorous review process: Health Effects/MRL Workgroup reviews within the Division of Toxicology, expert panel peer reviews, and agency-wide MRL Workgroup reviews, with participation from other federal agencies and comments from the public. They are subject to change as new information becomes available concomitant with updating the toxicological profiles. Thus, MRLs in the most recent toxicological profiles supersede previously published levels. For additional information regarding MRLs, please contact the Division of Toxicology, Agency for Toxic Substances and Disease Registry, 1600 Clifton Road NE, Mailstop F-32, Atlanta, Georgia 30333.

APPENDIX A

MINIMAL RISK LEVEL (MRL) WORKSHEET

Chemical Name: Carbon Tetrachloride
CAS Number: 56-23-5
Date: June 2005
Profile Status: Final Post-Public Comment Draft
Route: Inhalation Oral
Duration: Acute Intermediate Chronic
Graph Key: 30
Species: Rat

Minimal Risk Level: 0.03 mg/kg/day ppm

Reference: Adams EM, Spencer HC, Rowe VK, et al. 1952. Vapor toxicity of carbon tetrachloride determined by experiments on laboratory animals. Arch Ind Hyg Occup Med 6:50-66.

Experimental design: Groups of Wistar rats (15–25 males, 15–23 females) were exposed to vapors of carbon tetrachloride (5, 10, 25, 50, 100, 200, and 400 ppm) for 173–205 days (5 days/week, 7 hours/day). Two kinds of control groups were used: ‘unexposed controls’ that were maintained in the animal quarters and ‘air-exposed controls’ that were exposed to room air while in exposure chambers at equivalent frequency and duration as compound-exposed animals. Animals were weighed twice weekly and observed frequently for clinical signs. Food consumption was monitored. Hematological (prothrombin time) and biochemical indices (blood urea nitrogen, phospholipid, esterified cholesterol) were monitored in selected groups. Gross necropsy was performed and organ weights were determined for lung, heart liver, kidneys, spleen, and testes. Histopathological examination was performed on these and 11 other organs.

Effects noted in study and corresponding doses: No effects were observed in the 5 ppm exposure groups for any of the parameters measured. In rats, fatty degeneration of the liver and increased liver weight were evident at concentrations of ≥ 10 ppm and hepatic cirrhosis and pathology of the renal tubular epithelium (moderate cloudy swelling) occurred at ≥ 50 ppm. At ≥ 200 ppm, hepatic necrosis, increased kidney weight, degeneration of the renal tubular epithelium, and some testicular atrophy were observed. The severity of effects increased with exposure level.

Dose and end point used for MRL derivation: The MRL was based on a NOAEL of 5 ppm and a LOAEL of 10 ppm for fatty degeneration and increased liver weights.

NOAEL LOAEL

Uncertainty Factors used in MRL derivation:

- 10 for use of a LOAEL
- 3 for extrapolation from animals to humans using a dosimetric adjustment
- 10 for human variability

Was a conversion used from ppm in food or water to a mg/body weight dose? Not applicable.

If so, explain:

APPENDIX A

If an inhalation study in animals, list the conversion factors used in determining human equivalent dose:

A human equivalent concentration was calculated from the rat NOAEL of 5 ppm in the principal study for an extrarespiratory effect of a type 3 gas, as recommended by EPA (1994) guidance for derivation of inhalation reference concentrations. A human equivalent concentration of the identified rat NOAEL of 5 ppm (NOAEL_{HEC}) was calculated by multiplying the duration-adjusted rat NOAEL (NOAEL_{ADJ}) by the ratio of the rat and human blood:gas partition coefficients. The NOAEL_{ADJ} is 0.9 ppm (5 ppm x 7 hours/24 hours x 5 days/7 days) and the blood:gas partition coefficient ratio is 1.7 (4.52/2.64). Because the ratio was greater than 1, a default value of 1 was applied, resulting in a NOAEL_{HEC} of 0.9 ppm. An uncertainty factor of 30 was applied to the NOAEL_{HEC} of 0.9 ppm (3 for extrapolation from animals to humans using a dosimetric adjustment and 10 for human variability).

Other additional studies or pertinent information which lend support to this MRL: Limited human data are available for intermediate-duration inhalation exposure to carbon tetrachloride. Effects in humans exposed intermittently included gastrointestinal effects (nausea, dyspepsia) at 20–50 ppm, central nervous system depression at 40 ppm, and narcosis at 80 ppm (Elkins 1942; Heiman and Ford 1941; Kazantzis and Bomford 1960). An occupational study of hepatic effects in workers exposed from <1 to >5 years indicated that serum levels of hepatic enzymes were significantly elevated only at exposures >1 ppm, but the actual durations of exposure were not reported (Tomenson et al. 1995). Interpretation of this study is also limited by the finding that the group estimated to have had the highest exposure did not show the highest levels of serum enzymes. The liver appears to be the most sensitive target in animals exposed for intermediate durations. Fatty degeneration, sometimes with increased liver weight, was observed at a LOAEL of 10 ppm in rats, mice, and guinea pigs treated 6–8 hours/day, 5 days/week for 12–36 weeks or continuously for 90 days (Adams et al. 1952; DOE 1999; Japan Bioassay Research Center 1998; Prendergast et al. 1967), and 50–100 ppm in monkeys (Adams et al. 1952; Smyth et al. 1936). Increased serum enzymes and necrosis were observed in mice at 20 ppm and hamsters at 100 ppm (DOE 1999). Exposure to higher concentrations resulted in cirrhosis in guinea pigs (25 ppm) and rats (50–270 ppm) (Adams et al. 1952; Japan Bioassay Research Center 1998; Prendergast et al. 1967; Smyth et al. 1936). In studies examining other organs, renal effects (tubular degeneration) were noted at 50–200 ppm in rats (Adams et al. 1952; Smyth et al. 1936), at 90 ppm in rats and mice (Japan Bioassay Research Center 1998), and at 200 ppm in monkeys (Smyth et al. 1936). Injury to sciatic and optical nerves was noted in rats at 50 ppm (Smyth et al. 1936); hematological effects (decreased erythrocytes, hemoglobin, hematocrit; hemolysis, increased spleen weight) were observed in rats and mice exposed to 90–270 ppm (Japan Bioassay Research Center 1998; Smyth et al. 1936), and reproductive toxicity (decreased litters, testicular atrophy) was noted at 200 ppm (Adams et al. 1952; Smyth et al. 1936). Hepatotoxicity is identified as the critical effect of intermediate-duration inhalation exposure to carbon tetrachloride since it was noted at the lowest LOAELs. The study by Adams et al. (1952) is selected as the principal study because it identified the lowest LOAEL and the highest NOAEL for the critical effect.

Agency Contacts (Chemical Managers): Obaid Faroon, Ph.D.; Jessilynn Taylor, M.S.; Nickolette Roney, M.P.H.

APPENDIX A

MINIMAL RISK LEVEL (MRL) WORKSHEET

Chemical Name: Carbon Tetrachloride
CAS Number: 56-23-5
Date: June 2005
Profile Status: Final Post-Public Comment Draft
Route: Inhalation Oral
Duration: Acute Intermediate Chronic
Graph Key: 50
Species: Rat

Minimal Risk Level: 0.03 mg/kg/day ppm

References: Japan Bioassay Research Center. 1998. Subchronic inhalation toxicity and carcinogenicity studies of carbon tetrachloride in F344 rats and BDF1 mice (Studies Nos. 0020, 0021, 0043, and 0044). Kanagawa, Japan Industrial Safety and Health Association, Japan Bioassay Research Center (Unpublished report to the Ministry of Labor). Hirasawa Hadano Kanagawa, 257 Japan. (In 2001, T. Matsushima provided to SRC organ weight data tables for these studies.)

(Methods published in: Nagano K, Nishizawa T, Yamamoto S, et al. 1998. Inhalation carcinogenesis studies of six halogenated hydrocarbons in rats and mice. In: Chiyotani K, Hosoda Y, Aizawa Y, eds. Advances in the prevention of occupational respiratory diseases. Elsevier Science B.V., 741-746.)

Experimental design: Groups of 50 male and 50 female F344/DuCrj rats were exposed (whole-body) to vapors of carbon tetrachloride (>99% pure) at concentrations of 0, 5, 25, or 125 ppm, 6 hours/day, 5 days/week for 104 weeks. Rats were observed daily for clinical signs, behavioral changes, and mortality. Body weights were measured weekly for the first 13 weeks and every 4 weeks thereafter. Urinalysis was performed at the end of the dosing period. Hematology and serum chemistry were measured in blood samples taken during final euthanization after overnight fasting. All organs and tissues were examined for gross lesions, weighed, and fixed for histopathological analysis.

Effects noted in study and corresponding concentrations: Male rats at ≥ 5 ppm exhibited enhanced hemosiderin deposition in the spleen; this was apparently a residual effect of anemia that was observed in the 13-week study, but not at 104 weeks. No significant hepatic effects were noted at 5 ppm. At ≥ 25 ppm, significant hepatic effects were observed: statistically significant elevations relative liver weights, serum parameters (total bilirubin, ALT, AST), and increased incidences of liver histopathology (fatty change, granulation, foci in the liver, deposition of ceroid, and serious effects such as fibrosis and cirrhosis). Chronic nephropathy was observed in all groups, including controls, but at greater severity at 25 ppm and above; significant proteinuria (dipstick values of 3+ or 4+) was also observed in all groups (in >90% of controls), but at higher severity in males treated at 5 ppm and females at 25 ppm and above. At 25 ppm, females had significant hematological changes (decreased hemoglobin, hematocrit, and lymphocyte counts and increased leukocyte and segmented neutrophil counts). At 125 ppm, body weights were decreased and there was increased mortality from chronic nephrosis and tumors.

The tumors observed at 125 ppm included: hepatocellular adenomas in 21/50 males and 40/50 females and hepatocellular carcinomas in 32/50 males and 15/50 females. At 25 ppm, females had significant hematological changes (decreased hemoglobin, hematocrit, and lymphocyte counts and increased leukocyte and segmented neutrophil counts).

APPENDIX A

Dose and end point used for MRL derivation: A NOAEL of 5 ppm LOAEL of 25 ppm for increased liver weight, serum enzymes, and liver histopathology (fatty change, granulation, foci, deposition of ceroid, fibrosis, and cirrhosis).

NOAEL LOAEL

Uncertainty Factors used in MRL derivation:

10 for use of a LOAEL

3 for extrapolation from animals to humans using dosimetric adjustment

10 for human variability

Was a conversion used from ppm in food or water to a mg/body weight dose? Not applicable.

If so, explain:

If an inhalation study in animals, list the conversion factors used in determining human equivalent concentration: A human equivalent concentration was calculated from the rat NOAEL of 5 ppm in the principal study for an extrapulmonary effect of a type 3 gas, as recommended by EPA (1994) guidance for derivation of inhalation reference concentrations. A human equivalent concentration of the identified rat NOAEL of 5 ppm for hepatic effects (Japan Bioassay Research Center 1998) was calculated by multiplying the duration-adjusted rat NOAEL (NOAEL_{ADJ}) by the ratio of the rat and human blood:gas partition coefficients. The NOAEL_{ADJ} is 0.9 ppm (5 ppm x 6 hours/24 hours x 5 days/7 days) and the blood:gas partition coefficient ratio is 1.7 (4.52/2.64). Because the ratio was greater than 1, a default value of 1 was applied, resulting in a NOAEL_{HEC} of 0.9 ppm. An uncertainty factor of 30 was applied to the NOAEL_{HEC} to derive the chronic-duration inhalation MRL.

Other additional studies or pertinent information which lend support to this MRL: The chronic-duration inhalation database for carbon tetrachloride includes the occupational study by Tomenson et al. (1995) and 2-year bioassays in rats and mice (Japan Bioassay Research Center 1998; Nagano et al. 1998). As discussed under the intermediate-duration MRL, elevated hepatic serum enzymes were observed in workers who had been exposed to concentrations >1 ppm for <1-5> years, but the actual durations of exposure were not reported (Tomenson et al. 1995). Interpretation of this study is also limited by the finding that the group estimated to have had the highest exposure did not show the highest levels of serum enzymes. In the 2-year bioassay in BDF₁ mice, groups of 50/sex were treated at 0, 5, 25, or 125 ppm, 6 hours/day, 5 days/week for 104 weeks (Japan Bioassay Research Center 1998; Nagano et al. 1998). No effects were noted at the lowest concentration of 5 ppm. In mice, 25 ppm was a LOAEL for most observed effects: hematological (increased extramedullary hematopoiesis in spleen associated with recovery from anemia), body weight (reduced body weight gain), renal (protein casts and altered clinical chemistry values), and hepatic (increased liver weights, degeneration, cyst, deposition of ceroid, increased serum enzymes, cholesterol, bilirubin in both sexes, and thrombus and necrosis in females). Mice at ≥25 ppm also exhibited significant increases in the incidences of hepatic adenoma and carcinoma with increased mortality.

One effect in rat was noted at 5 ppm, but was not selected as the critical effect of chronic-duration inhalation exposure. The severity of proteinuria, but not renal histopathology, was elevated in male and female rats treated at 5 ppm compared to controls; however, as the severity in control rats was so high (>90% with scores of 3+ or 4+), this lesion was not used as the basis for MRL derivation. Hepatotoxicity is selected as the critical effect of chronic-duration inhalation exposure because the severity of effects at 25 ppm was greater compared to other end points. Furthermore, selection of hepatotoxicity as the critical effect of chronic exposure is consistent with the database for intermediate-duration inhalation exposure. The 2-year bioassay in rats is selected as the principal study for the chronic-duration inhalation MRL.

APPENDIX A

since it provided a NOAEL of 5 ppm and a LOAEL of 25 ppm for hepatic effects without increased mortality.

Agency Contacts (Chemical Managers): Obaid Faroon, Ph.D.; Jessilynn Taylor, M.S.; Nickolette Roney, M.P.H.

APPENDIX A

MINIMAL RISK LEVEL (MRL) WORKSHEET

Chemical Name: Carbon Tetrachloride
CAS Number: 56-23-5
Date: June 2005
Profile Status: Final Post-Public Comment Draft
Route: Inhalation Oral
Duration: Acute Intermediate Chronic
Graph Key: 23
Species: Rat

Minimal Risk Level: 0.02 mg/kg/day ppm

Reference: Smialowicz RJ, Simmons JE, Luebke RW, et al. 1991. Immunotoxicologic assessment of subacute exposure of rats to carbon tetrachloride with comparison to hepatotoxicity and nephrotoxicity. *Fundam Appl Toxicol* 17:186-196.

Experimental design: Groups of 5–6 male Fischer 344 rats were dosed by gavage for 10 consecutive days with 0, 5, 10, 20, or 40 mg/kg/day of carbon tetrachloride in corn oil. Serum chemistry profiles, hepatic cytochrome P-450 content and activity, and kidney and liver organ weight and histopathology were assessed. Various immune function parameters were also examined in these animals, and in another set exposed to 40, 80, or 160 mg/kg/day. Immune function end points included relative spleen and thymus weights; natural killer cell activity; lymphoproliferative response to concanavalin A, phytohemagglutinin, pokeweed mitogen, and *Salmonella typhimurium* mitogen; allogeneic cytotoxic T lymphocyte reaction; and primary antibody response to sheep red blood cells.

Effects noted in study and corresponding doses: No hepatic effects were observed in controls. Minimal centrilobular vacuolar degeneration was detectable in all rats at 5 mg/kg/day; degeneration was mild in all rats treated at 10 and 20 mg/kg/day and 5/6 rats at 40 mg/kg/day and moderate in one high-dose rat. Hepatocellular necrosis was minimal in 3/6 rats at 10 mg/kg/day, 5/6 rats at 20 mg/kg/day, and 5/6 rats at 40 mg/kg/day, and mild in one high-dose rat. Serum ALT and AST levels were significantly elevated 1.5–5.4-fold compared to controls at doses of 20 and 40 mg/kg/day. Mean relative liver weight was significantly ($p < 0.01$) increased by 17.7% compared to controls at 40 mg/kg/day. Treatment with carbon tetrachloride had no significant effect compared to controls on body weight, absolute liver weight, or renal parameters at doses from 5 to 40 mg/kg/day. However, when three separate 40 mg/kg/day groups and their controls were analyzed by two-way ANOVA with carbon tetrachloride and replicates as factors, a significant decrease in weight gain was detected. Body weight gain was significantly reduced at 80 mg/kg/day and higher, as determined by comparison of the slopes of weight gains over the dosing period. There were no adverse effects on immunological parameters at doses up to 160 mg/kg/day.

Dose and end point used for MRL derivation: LOAEL of 5 mg/kg/day for minimal vacuolar degeneration of centrilobular hepatocytes.

NOAEL LOAEL

Uncertainty Factors used in MRL derivation:

- 3 for use of a minimal LOAEL
- 10 for extrapolation from animals to humans
- 10 for human variability

APPENDIX A

Was a conversion used from ppm in food or water to a mg/body weight dose? Not applicable.

If so, explain:

If an inhalation study in animals, list the conversion factors used in determining human equivalent dose:

Not applicable.

Other additional studies or pertinent information which lend support to this MRL: In humans, hepatic toxicity (fatty accumulation, necrosis) has been noted following ingestion of single doses of carbon tetrachloride in the range of 80–180 mg/kg (Docherty and Burgess 1922; Docherty and Nicholls 1923; Phelps and Hu 1924). Single doses of 70 mg/kg had no overt neurological effect, but various neurological symptoms indicative of depression of the central nervous system have been reported at doses between 114 and 10,800 mg/kg (Cohen 1957; Hall 1921; Leach 1922; Stevens and Forster 1953; Stewart et al. 1963). Gastrointestinal effects in humans following ingestion of single doses include nausea at ≥ 100 mg/kg (Ruprah et al. 1985) and vomiting and abdominal pain at 680–910 mg/kg (Hardin 1954; New et al. 1962; Smetana 1939; Umiker and Pearce 1953; von Oettingen 1964). In laboratory animals, mild hepatic effects (cytoplasmic vacuolization and increased serum enzymes) have been reported to occur following treatment with single doses of 40–80 mg/kg or repeated dosing at 5–20 mg/kg/day (Bruckner et al. 1986; Kim et al. 1990b; Korsrud et al. 1972; Smialowicz et al. 1991). No renal effects or positive results in special tests for immunological function were observed in rats following repeated administration at 5–160 mg/kg/day (Bruckner et al. 1986; Smialowicz et al. 1991). Renal effects (fatty degeneration, swelling of convoluted tubules) were observed in dogs given single doses of 3,200–6,400 mg/kg (Chandler and Chopra 1926; Gardner et al. 1925). Hepatic toxicity is selected as the critical effect of acute-duration oral exposure to carbon tetrachloride because effects were observed at the lowest effect level. The study of Smialowicz et al. (1991) is selected as the principal study because it provides the lowest LOAEL of 5 mg/kg/day for the critical effect.

Agency Contacts (Chemical Managers): Obaid Faroon, Ph.D.; Jessilynn Taylor, M.S.; Nickolette Roney, M.P.H.

APPENDIX A

MINIMAL RISK LEVEL (MRL) WORKSHEET

Chemical Name: Carbon Tetrachloride
CAS Number: 56-23-5
Date: June 2005
Profile Status: Final Post-Public Comment Draft
Route: Inhalation Oral
Duration: Acute Intermediate Chronic
Graph Key: 46
Species: Rat

Minimal Risk Level: 0.007 mg/kg/day ppm

Reference: Bruckner JV, MacKenzi WF, Muralidhara S, et al. 1986. Oral toxicity of carbon tetrachloride: Acute, subacute and subchronic studies in rats. *Fundam Appl Toxicol* 6:16–34.

Experimental design: Male Sprague-Dawley rats (15–16/dose) were administered carbon tetrachloride (0, 1, 10, or 33 mg/kg) in corn oil by gavage 5 days/week for 12 weeks. Body weight was monitored twice weekly. Blood samples were collected from five rats per group just before dosing at 2, 4, 6, 8, 10, and 12 weeks for measurement of serum levels of sorbitol dehydrogenase (SDH), ornithine carbamyl transferase (OCT), alanine aminotransferase (ALT), and blood urea nitrogen (BUN). Each rat served as a blood donor twice during the study at 6-week intervals. At the end of the 12-week period, 7–9 rats per group were sacrificed and the remaining were maintained for 13 days without dosing before sacrifice. Histopathological examination of the liver and kidneys was performed.

Effects noted in study and corresponding doses: No adverse effects were noted at 1 mg/kg. Body weight gain was reduced in the 33 mg/kg group by 17% compared to controls after 90 days ($p < 0.05$). At 10 mg/kg, there were statistically significant increases in serum SDH activity, 2-fold higher than controls, observed as early as 10 weeks; a statistically significant 35% elevation in serum ALT was observed in this group at 12 weeks. Elevations in these serum parameters returned to control levels during the recovery period. Mild centrilobular vacuolization was observed in the liver of all animals treated at 10 mg/kg/day for 12 weeks. Substantial liver toxicity was observed at 33 mg/kg as early as 2 weeks. At 2 weeks, serum ALT was elevated 5-fold, OCT 6-fold, and SDH 38-fold compared to controls; after 12 weeks, serum ALT was elevated 20-fold, OCT 5-fold, and SDH 45-fold compared to controls. Only the serum ALT elevation (2-fold) was still statistically different from controls after 2 weeks of recovery. The liver:body weight ratio was significantly elevated by 46% in the 33 mg/kg group compared to controls. Extensive hepatic lesions observed in the 33 mg/kg group after 12 weeks included vacuolization, periportal fibrosis, bile duct hyperplasia, hyperplastic nodules, and single-cell necrosis. Treatment with carbon tetrachloride had no significant effect on kidney:body weight ratios, a kidney-related serum parameter (BUN) or on the incidence of kidney lesions.

Dose and end point used for MRL derivation: The NOAEL of 1 mg/kg for mild centrilobular vacuolization and increased serum SDH was used to derive the MRL. The NOAEL was adjusted for intermittent exposure (5 days/7 days), resulting in a duration-adjusted NOAEL of 0.71 mg/kg/day.

NOAEL LOAEL

APPENDIX A

Uncertainty Factors used in MRL derivation:

- 10 for use of a LOAEL
- 10 for extrapolation from animals to humans
- 10 for human variability

Was a conversion used from ppm in food or water to a mg/body weight dose? Not applicable.

If so, explain:

If an inhalation study in animals, list the conversion factors used in determining human equivalent dose:
Not applicable.

Other additional studies or pertinent information which lend support to this MRL: The intermediate-duration oral toxicity database for carbon tetrachloride is somewhat limited in that no human data are available and many studies in laboratory animals restricted analysis to the liver or to the liver and kidney. The incidence and severity of hepatic effects were dose-related in animal studies. Whereas no hepatic effects were noted at 1 mg/kg, significantly elevated sorbitol dehydrogenase (SDH) and mild centrilobular vacuolization were noted in rats exposed at 10 mg/kg 5 days/week for 12 weeks (Bruckner et al. 1986). In mice ingesting carbon tetrachloride 5 days/week for 12–13 weeks, no hepatic effects were detected at a dose of 1.2 mg/kg (Condie et al. 1986). Significant elevation in some serum enzymes (ALT, aspartate aminotransferase [AST], lactate dehydrogenase [LDH]), and mild necrosis were seen in mice at doses of 12 mg/kg and higher (Condie et al. 1986; Hayes et al. 1986). More extensive hepatic lesions (fatty accumulation, fibrosis, cirrhosis, necrosis) were noted in rats at doses of 20–25 mg/kg and higher (Allis et al. 1990; Bruckner et al. 1986; Koporec et al. 1995). At 100 mg/kg/day, hepatic effects in rats also included cytomegaly and various types of hyperplasia, which were perhaps adaptive responses to necrosis (Koporec et al. 1995). Effects in other organ systems include reduced body weight gain at doses between 33 and 100 mg/kg/day (Bruckner et al. 1986; Koporec et al. 1995) and neurological effects (increased serotonin synthesis) at 290 mg/kg/day (Bengtsson et al. 1987). No renal effects were observed in mice exposed at 1,200 mg/kg/day despite hepatic effects at lower levels (Hayes et al. 1986). Increased mortality was observed in rats exposed at 25 mg/kg/day (Koporec et al. 1995) and cancer (hepatoma) in mice treated with 20 mg/kg/day for 120 days and hamsters treated once weekly with 120 mg/kg/day for 30 weeks (Eschenbrenner and Miller 1946; Della Porta et al. 1961). Hepatic effects were selected as the critical effects of intermediate-duration oral exposure to carbon tetrachloride because they occurred at the lowest effect level. The rat study of Bruckner was selected as the principal study because it provided the lowest LOAEL for the critical effect.

Agency Contacts (Chemical Managers): Obaid Faroon, Ph.D.; Jessilynn Taylor, M.S.; Nickolette Roney, M.P.H.

APPENDIX B. USER'S GUIDE

Chapter 1

Public Health Statement

This chapter of the profile is a health effects summary written in non-technical language. Its intended audience is the general public, especially people living in the vicinity of a hazardous waste site or chemical release. If the Public Health Statement were removed from the rest of the document, it would still communicate to the lay public essential information about the chemical.

The major headings in the Public Health Statement are useful to find specific topics of concern. The topics are written in a question and answer format. The answer to each question includes a sentence that will direct the reader to chapters in the profile that will provide more information on the given topic.

Chapter 2

Relevance to Public Health

This chapter provides a health effects summary based on evaluations of existing toxicologic, epidemiologic, and toxicokinetic information. This summary is designed to present interpretive, weight-of-evidence discussions for human health end points by addressing the following questions:

1. What effects are known to occur in humans?
2. What effects observed in animals are likely to be of concern to humans?
3. What exposure conditions are likely to be of concern to humans, especially around hazardous waste sites?

The chapter covers end points in the same order that they appear within the Discussion of Health Effects by Route of Exposure section, by route (inhalation, oral, and dermal) and within route by effect. Human data are presented first, then animal data. Both are organized by duration (acute, intermediate, chronic). *In vitro* data and data from parenteral routes (intramuscular, intravenous, subcutaneous, etc.) are also considered in this chapter.

The carcinogenic potential of the profiled substance is qualitatively evaluated, when appropriate, using existing toxicokinetic, genotoxic, and carcinogenic data. ATSDR does not currently assess cancer potency or perform cancer risk assessments. Minimal Risk Levels (MRLs) for noncancer end points (if derived) and the end points from which they were derived are indicated and discussed.

Limitations to existing scientific literature that prevent a satisfactory evaluation of the relevance to public health are identified in the Chapter 3 Data Needs section.

Interpretation of Minimal Risk Levels

Where sufficient toxicologic information is available, ATSDR has derived MRLs for inhalation and oral routes of entry at each duration of exposure (acute, intermediate, and chronic). These MRLs are not meant to support regulatory action, but to acquaint health professionals with exposure levels at which adverse health effects are not expected to occur in humans.

APPENDIX B

MRLs should help physicians and public health officials determine the safety of a community living near a chemical emission, given the concentration of a contaminant in air or the estimated daily dose in water. MRLs are based largely on toxicological studies in animals and on reports of human occupational exposure.

MRL users should be familiar with the toxicologic information on which the number is based. Chapter 2, "Relevance to Public Health," contains basic information known about the substance. Other sections such as Chapter 3 Section 3.9, "Interactions with Other Substances," and Section 3.10, "Populations that are Unusually Susceptible" provide important supplemental information.

MRL users should also understand the MRL derivation methodology. MRLs are derived using a modified version of the risk assessment methodology that the Environmental Protection Agency (EPA) provides (Barnes and Dourson 1988) to determine reference doses (RfDs) for lifetime exposure.

To derive an MRL, ATSDR generally selects the most sensitive end point which, in its best judgement, represents the most sensitive human health effect for a given exposure route and duration. ATSDR cannot make this judgement or derive an MRL unless information (quantitative or qualitative) is available for all potential systemic, neurological, and developmental effects. If this information and reliable quantitative data on the chosen end point are available, ATSDR derives an MRL using the most sensitive species (when information from multiple species is available) with the highest no-observed-adverse-effect level (NOAEL) that does not exceed any adverse effect levels. When a NOAEL is not available, a lowest-observed-adverse-effect level (LOAEL) can be used to derive an MRL, and an uncertainty factor (UF) of 10 must be employed. Additional uncertainty factors of 10 must be used both for human variability to protect sensitive subpopulations (people who are most susceptible to the health effects caused by the substance) and for interspecies variability (extrapolation from animals to humans). In deriving an MRL, these individual uncertainty factors are multiplied together. The product is then divided into the inhalation concentration or oral dosage selected from the study. Uncertainty factors used in developing a substance-specific MRL are provided in the footnotes of the levels of significant exposure (LSE) tables.

Chapter 3

Health Effects

Tables and Figures for Levels of Significant Exposure (LSE)

Tables and figures are used to summarize health effects and illustrate graphically levels of exposure associated with those effects. These levels cover health effects observed at increasing dose concentrations and durations, differences in response by species, MRLs to humans for noncancer end points, and EPA's estimated range associated with an upper-bound individual lifetime cancer risk of 1 in 10,000 to 1 in 10,000,000. Use the LSE tables and figures for a quick review of the health effects and to locate data for a specific exposure scenario. The LSE tables and figures should always be used in conjunction with the text. All entries in these tables and figures represent studies that provide reliable, quantitative estimates of NOAELs, LOAELs, or Cancer Effect Levels (CELs).

The legends presented below demonstrate the application of these tables and figures. Representative examples of LSE Table 3-1 and Figure 3-1 are shown. The numbers in the left column of the legends correspond to the numbers in the example table and figure.

APPENDIX B

LEGEND**See Sample LSE Table 3-1 (page B-6)**

- (1) **Route of Exposure.** One of the first considerations when reviewing the toxicity of a substance using these tables and figures should be the relevant and appropriate route of exposure. Typically when sufficient data exist, three LSE tables and two LSE figures are presented in the document. The three LSE tables present data on the three principal routes of exposure, i.e., inhalation, oral, and dermal (LSE Tables 3-1, 3-2, and 3-3, respectively). LSE figures are limited to the inhalation (LSE Figure 3-1) and oral (LSE Figure 3-2) routes. Not all substances will have data on each route of exposure and will not, therefore, have all five of the tables and figures.
- (2) **Exposure Period.** Three exposure periods—acute (less than 15 days), intermediate (15–364 days), and chronic (365 days or more)—are presented within each relevant route of exposure. In this example, an inhalation study of intermediate exposure duration is reported. For quick reference to health effects occurring from a known length of exposure, locate the applicable exposure period within the LSE table and figure.
- (3) **Health Effect.** The major categories of health effects included in LSE tables and figures are death, systemic, immunological, neurological, developmental, reproductive, and cancer. NOAELs and LOAELs can be reported in the tables and figures for all effects but cancer. Systemic effects are further defined in the "System" column of the LSE table (see key number 18).
- (4) **Key to Figure.** Each key number in the LSE table links study information to one or more data points using the same key number in the corresponding LSE figure. In this example, the study represented by key number 18 has been used to derive a NOAEL and a Less Serious LOAEL (also see the two "18r" data points in sample Figure 3-1).
- (5) **Species.** The test species, whether animal or human, are identified in this column. Chapter 2, "Relevance to Public Health," covers the relevance of animal data to human toxicity and Section 3.4, "Toxicokinetics," contains any available information on comparative toxicokinetics. Although NOAELs and LOAELs are species specific, the levels are extrapolated to equivalent human doses to derive an MRL.
- (6) **Exposure Frequency/Duration.** The duration of the study and the weekly and daily exposure regimens are provided in this column. This permits comparison of NOAELs and LOAELs from different studies. In this case (key number 18), rats were exposed to "Chemical x" via inhalation for 6 hours/day, 5 days/week, for 13 weeks. For a more complete review of the dosing regimen, refer to the appropriate sections of the text or the original reference paper (i.e., Nitschke et al. 1981).
- (7) **System.** This column further defines the systemic effects. These systems include respiratory, cardiovascular, gastrointestinal, hematological, musculoskeletal, hepatic, renal, and dermal/ocular. "Other" refers to any systemic effect (e.g., a decrease in body weight) not covered in these systems. In the example of key number 18, one systemic effect (respiratory) was investigated.
- (8) **NOAEL.** A NOAEL is the highest exposure level at which no harmful effects were seen in the organ system studied. Key number 18 reports a NOAEL of 3 ppm for the respiratory system, which was used to derive an intermediate exposure, inhalation MRL of 0.005 ppm (see footnote "b").

APPENDIX B

- (9) LOAEL. A LOAEL is the lowest dose used in the study that caused a harmful health effect. LOAELs have been classified into "Less Serious" and "Serious" effects. These distinctions help readers identify the levels of exposure at which adverse health effects first appear and the gradation of effects with increasing dose. A brief description of the specific end point used to quantify the adverse effect accompanies the LOAEL. The respiratory effect reported in key number 18 (hyperplasia) is a Less Serious LOAEL of 10 ppm. MRLs are not derived from Serious LOAELs.
- (10) Reference. The complete reference citation is given in Chapter 9 of the profile.
- (11) CEL. A CEL is the lowest exposure level associated with the onset of carcinogenesis in experimental or epidemiologic studies. CELs are always considered serious effects. The LSE tables and figures do not contain NOAELs for cancer, but the text may report doses not causing measurable cancer increases.
- (12) Footnotes. Explanations of abbreviations or reference notes for data in the LSE tables are found in the footnotes. Footnote "b" indicates that the NOAEL of 3 ppm in key number 18 was used to derive an MRL of 0.005 ppm.

LEGEND**See Sample Figure 3-1 (page B-7)**

LSE figures graphically illustrate the data presented in the corresponding LSE tables. Figures help the reader quickly compare health effects according to exposure concentrations for particular exposure periods.

- (13) Exposure Period. The same exposure periods appear as in the LSE table. In this example, health effects observed within the acute and intermediate exposure periods are illustrated.
- (14) Health Effect. These are the categories of health effects for which reliable quantitative data exists. The same health effects appear in the LSE table.
- (15) Levels of Exposure. Concentrations or doses for each health effect in the LSE tables are graphically displayed in the LSE figures. Exposure concentration or dose is measured on the log scale "y" axis. Inhalation exposure is reported in mg/m³ or ppm and oral exposure is reported in mg/kg/day.
- (16) NOAEL. In this example, the open circle designated 18r identifies a NOAEL critical end point in the rat upon which an intermediate inhalation exposure MRL is based. The key number 18 corresponds to the entry in the LSE table. The dashed descending arrow indicates the extrapolation from the exposure level of 3 ppm (see entry 18 in the table) to the MRL of 0.005 ppm (see footnote "b" in the LSE table).
- (17) CEL. Key number 38m is one of three studies for which CELs were derived. The diamond symbol refers to a CEL for the test species-mouse. The number 38 corresponds to the entry in the LSE table.

APPENDIX B

- (18) Estimated Upper-Bound Human Cancer Risk Levels. This is the range associated with the upper-bound for lifetime cancer risk of 1 in 10,000 to 1 in 10,000,000. These risk levels are derived from the EPA's Human Health Assessment Group's upper-bound estimates of the slope of the cancer dose response curve at low dose levels (q_1^*).
- (19) Key to LSE Figure. The Key explains the abbreviations and symbols used in the figure.

SAMPLE

1 →

Table 3-1. Levels of Significant Exposure to [Chemical x] – Inhalation

Key to figure ^a	Species	Exposure frequency/ duration	System	NOAEL (ppm)	LOAEL (effect)		Reference
					Less serious (ppm)	Serious (ppm)	
INTERMEDIATE EXPOSURE							
	5	6	7	8	9		10
3 →	Systemic	↓	↓	↓	↓	↓	↓
4 →	18	Rat	13 wk 5 d/wk 6 hr/d	Resp	3 ^b	10 (hyperplasia)	Nitschke et al. 1981
CHRONIC EXPOSURE							
	Cancer					11	
					↓		
	38	Rat	18 mo 5 d/wk 7 hr/d			20	(CEL, multiple organs) Wong et al. 1982
	39	Rat	89–104 wk 5 d/wk 6 hr/d			10	(CEL, lung tumors, nasal tumors) NTP 1982
	40	Mouse	79–103 wk 5 d/wk 6 hr/d			10	(CEL, lung tumors, hemangiosarcomas) NTP 1982

12 →

^a The number corresponds to entries in Figure 3-1.

^b Used to derive an intermediate inhalation Minimal Risk Level (MRL) of 5×10^{-3} ppm; dose adjusted for intermittent exposure and divided by an uncertainty factor of 100 (10 for extrapolation from animal to humans, 10 for human variability).

SAMPLE

Figure 3-1. Levels of Significant Exposure to [Chemical X] - Inhalation

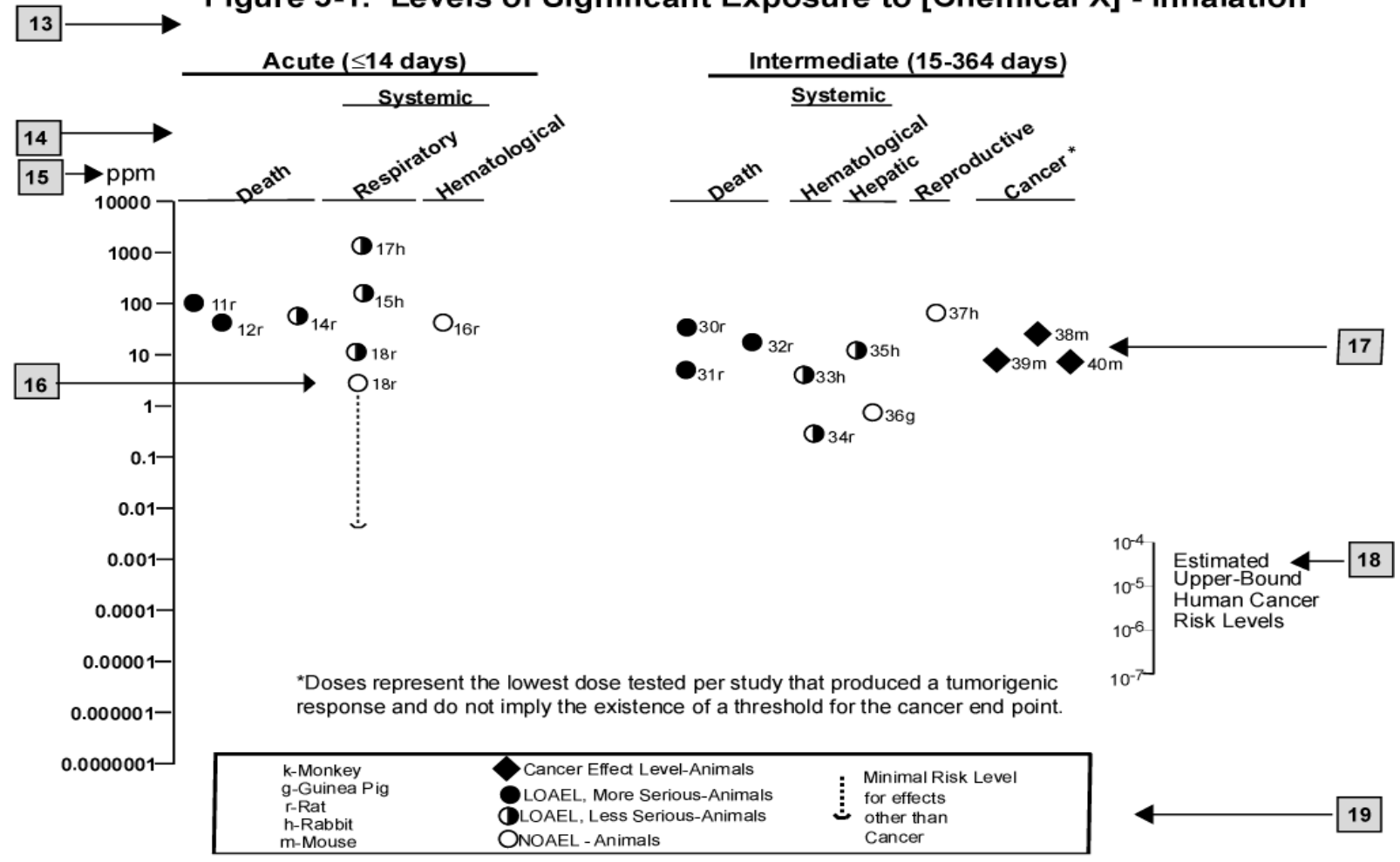

13

14

15

16

17

18

19

APPENDIX C. ACRONYMS, ABBREVIATIONS, AND SYMBOLS

ACGIH	American Conference of Governmental Industrial Hygienists
ACOEM	American College of Occupational and Environmental Medicine
ADI	acceptable daily intake
ADME	absorption, distribution, metabolism, and excretion
AED	atomic emission detection
AFID	alkali flame ionization detector
AFOSH	Air Force Office of Safety and Health
ALT	alanine aminotransferase
AML	acute myeloid leukemia
AOAC	Association of Official Analytical Chemists
AOEC	Association of Occupational and Environmental Clinics
AP	alkaline phosphatase
APHA	American Public Health Association
AST	aspartate aminotransferase
atm	atmosphere
ATSDR	Agency for Toxic Substances and Disease Registry
AWQC	Ambient Water Quality Criteria
BAT	best available technology
BCF	bioconcentration factor
BEI	Biological Exposure Index
BMD	benchmark dose
BMR	benchmark response
BSC	Board of Scientific Counselors
C	centigrade
CAA	Clean Air Act
CAG	Cancer Assessment Group of the U.S. Environmental Protection Agency
CAS	Chemical Abstract Services
CDC	Centers for Disease Control and Prevention
CEL	cancer effect level
CELDS	Computer-Environmental Legislative Data System
CERCLA	Comprehensive Environmental Response, Compensation, and Liability Act
CFR	Code of Federal Regulations
Ci	curie
CI	confidence interval
CL	ceiling limit value
CLP	Contract Laboratory Program
cm	centimeter
CML	chronic myeloid leukemia
CPSC	Consumer Products Safety Commission
CWA	Clean Water Act
DHEW	Department of Health, Education, and Welfare
DHHS	Department of Health and Human Services
DNA	deoxyribonucleic acid
DOD	Department of Defense
DOE	Department of Energy
DOL	Department of Labor
DOT	Department of Transportation

APPENDIX C

DOT/UN/ NA/IMCO	Department of Transportation/United Nations/ North America/International Maritime Dangerous Goods Code
DWEL	drinking water exposure level
ECD	electron capture detection
ECG/EKG	electrocardiogram
EEG	electroencephalogram
EEGL	Emergency Exposure Guidance Level
EPA	Environmental Protection Agency
F	Fahrenheit
F ₁	first-filial generation
FAO	Food and Agricultural Organization of the United Nations
FDA	Food and Drug Administration
FEMA	Federal Emergency Management Agency
FIFRA	Federal Insecticide, Fungicide, and Rodenticide Act
FPD	flame photometric detection
fpm	feet per minute
FR	Federal Register
FSH	follicle stimulating hormone
g	gram
GC	gas chromatography
gd	gestational day
GLC	gas liquid chromatography
GPC	gel permeation chromatography
HPLC	high-performance liquid chromatography
HRGC	high resolution gas chromatography
HSDB	Hazardous Substance Data Bank
IARC	International Agency for Research on Cancer
IDLH	immediately dangerous to life and health
ILO	International Labor Organization
IRIS	Integrated Risk Information System
K _d	adsorption ratio
kg	kilogram
kgg	metric ton
K _{oc}	organic carbon partition coefficient
K _{ow}	octanol-water partition coefficient
L	liter
LC	liquid chromatography
LC ₅₀	lethal concentration, 50% kill
LC _{Lo}	lethal concentration, low
LD ₅₀	lethal dose, 50% kill
LD _{Lo}	lethal dose, low
LDH	lactic dehydrogenase
LH	lutinizing hormone
LOAEL	lowest-observed-adverse-effect level
LSE	Levels of Significant Exposure
LT ₅₀	lethal time, 50% kill
m	meter
MA	<i>trans,trans</i> -muconic acid
MAL	maximum allowable level
mCi	millicurie
MCL	maximum contaminant level

APPENDIX C

MCLG	maximum contaminant level goal
MF	modifying factor
MFO	mixed function oxidase
mg	milligram
mL	milliliter
mm	millimeter
mmHg	millimeters of mercury
mmol	millimole
mppcf	millions of particles per cubic foot
MRL	Minimal Risk Level
MS	mass spectrometry
NAAQS	National Ambient Air Quality Standard
NAS	National Academy of Science
NATICH	National Air Toxics Information Clearinghouse
NATO	North Atlantic Treaty Organization
NCE	normochromatic erythrocytes
NCEH	National Center for Environmental Health
NCI	National Cancer Institute
ND	not detected
NFPA	National Fire Protection Association
ng	nanogram
NHANES	National Health and Nutrition Examination Survey
NIEHS	National Institute of Environmental Health Sciences
NIOSH	National Institute for Occupational Safety and Health
NIOSHTIC	NIOSH's Computerized Information Retrieval System
NLM	National Library of Medicine
nm	nanometer
nmol	nanomole
NOAEL	no-observed-adverse-effect level
NOES	National Occupational Exposure Survey
NOHS	National Occupational Hazard Survey
NPD	nitrogen phosphorus detection
NPDES	National Pollutant Discharge Elimination System
NPL	National Priorities List
NR	not reported
NRC	National Research Council
NS	not specified
NSPS	New Source Performance Standards
NTIS	National Technical Information Service
NTP	National Toxicology Program
ODW	Office of Drinking Water, EPA
OERR	Office of Emergency and Remedial Response, EPA
OHM/TADS	Oil and Hazardous Materials/Technical Assistance Data System
OPP	Office of Pesticide Programs, EPA
OPPT	Office of Pollution Prevention and Toxics, EPA
OPPTS	Office of Prevention, Pesticides and Toxic Substances, EPA
OR	odds ratio
OSHA	Occupational Safety and Health Administration
OSW	Office of Solid Waste, EPA
OTS	Office of Toxic Substances
OW	Office of Water

APPENDIX C

OWRS	Office of Water Regulations and Standards, EPA
PAH	polycyclic aromatic hydrocarbon
PBPD	physiologically based pharmacodynamic
PBPK	physiologically based pharmacokinetic
PCE	polychromatic erythrocytes
PEL	permissible exposure limit
pg	picogram
PHS	Public Health Service
PID	photo ionization detector
pmol	picomole
PMR	proportionate mortality ratio
ppb	parts per billion
ppm	parts per million
ppt	parts per trillion
PSNS	pretreatment standards for new sources
RBC	red blood cell
REL	recommended exposure level/limit
RfC	reference concentration
RfD	reference dose
RNA	ribonucleic acid
RQ	reportable quantity
RTECS	Registry of Toxic Effects of Chemical Substances
SARA	Superfund Amendments and Reauthorization Act
SCE	sister chromatid exchange
SGOT	serum glutamic oxaloacetic transaminase
SGPT	serum glutamic pyruvic transaminase
SIC	standard industrial classification
SIM	selected ion monitoring
SMCL	secondary maximum contaminant level
SMR	standardized mortality ratio
SNARL	suggested no adverse response level
SPEGL	Short-Term Public Emergency Guidance Level
STEL	short term exposure limit
STORET	Storage and Retrieval
TD ₅₀	toxic dose, 50% specific toxic effect
TLV	threshold limit value
TOC	total organic carbon
TPQ	threshold planning quantity
TRI	Toxics Release Inventory
TSCA	Toxic Substances Control Act
TWA	time-weighted average
UF	uncertainty factor
U.S.	United States
USDA	United States Department of Agriculture
USGS	United States Geological Survey
VOC	volatile organic compound
WBC	white blood cell
WHO	World Health Organization

APPENDIX C

>	greater than
≥	greater than or equal to
=	equal to
<	less than
≤	less than or equal to
%	percent
α	alpha
β	beta
γ	gamma
δ	delta
μm	micrometer
μg	microgram
q ₁ *	cancer slope factor
-	negative
+	positive
(+)	weakly positive result
(-)	weakly negative result

APPENDIX D. INDEX

absorbed dose	103, 104, 114, 116, 122, 136, 137, 190
adducts	94, 97, 99, 101, 112, 114, 116, 122, 127, 136, 141, 162, 165, 204
adipose tissue	106, 122
adrenal gland	6, 162
adrenals	102
adsorbed	200
adsorption	14, 184, 195, 196, 200, 202
aerobic	127, 186, 187, 195
alanine aminotransferase (see ALT)	16, 20, 25, 50, 91, 153
ALT (see alanine aminotransferase)	16, 24, 25, 50, 51, 56, 79, 80, 81, 129, 137, 138, 145, 147, 153, 155, 156
ambient air	13, 187, 190, 192, 196, 202
anaerobic	163, 186, 187, 195
anemia	15, 22, 47, 78
aspartate aminotransferase (see AST)	16, 25, 48, 49
AST (see aspartate aminotransferase)	16, 24, 25, 50, 51, 79, 81, 137, 138, 146, 147, 153, 155
bioaccumulation	185, 195, 196
bioavailability	121, 196
bioconcentration factor	185
biodegradation	186, 187, 195
biomarker	51, 135, 136, 137, 139, 140, 150, 164, 165, 199
Body Weight Effects	53, 82
breast milk	7, 134, 192
calcium	16, 47, 124, 126, 135, 155, 157
cancer	4, 6, 15, 18, 23, 25, 28, 56, 57, 58, 59, 86, 87, 88, 127, 133, 162, 204, 210
carcinogen	6, 18, 207, 209, 210
carcinogenic	6, 10, 14, 18, 19, 27, 28, 57, 58, 86, 87, 93, 160, 162, 210
carcinogenicity	15, 18, 19, 26, 58, 76, 81, 127, 128, 160, 162
carcinoma	56, 58, 86, 128, 129
cardiac arrhythmia	46
cardiovascular	28, 45, 46, 59, 76, 77, 90
Cardiovascular Effects	46, 77, 90
chromosomal aberrations	101
cirrhosis	15, 16, 19, 20, 21, 22, 23, 25, 26, 48, 50, 51, 56, 78, 79, 81, 84, 127, 138, 142, 143, 148, 154, 155, 156, 157, 168
Clara cells	77
clearance	105, 107, 112, 113, 122, 196
CYP2E1	14, 16, 17, 101, 107, 109, 122, 124, 130, 134, 142, 149, 153, 156, 157, 163, 167, 169
death	5, 15, 27, 28, 45, 46, 55, 57, 59, 76, 79, 82, 87, 90, 91, 123, 125, 128
deoxyribonucleic acid (see DNA)	95, 102
dermal effects	53, 87, 90, 91
DNA (see deoxyribonucleic acid)	18, 79, 93, 94, 95, 96, 97, 98, 99, 100, 101, 102, 124, 125, 127, 128, 129, 136, 155, 162, 165
endocrine	45, 76, 90, 130, 132
endocrine effects	45
erythema	91
ethanol	95, 134, 140, 141, 142, 144, 151, 163
fetal tissue	134, 167
fetus	7, 15, 132, 133, 166, 193
fibrosis	15, 16, 19, 23, 25, 48, 49, 51, 78, 79, 81, 123, 124, 129, 130, 138, 142, 147, 154, 155, 157, 168
gastrointestinal effects	14, 20, 21, 47, 77, 78, 90
general population	3, 13, 14, 134, 135, 136, 148, 166, 190, 197, 198
genotoxic	27, 93, 99, 127, 160, 162

APPENDIX D

genotoxicity	99, 100, 101, 102, 162
germinal epithelium	55
groundwater	2, 13, 179, 183, 184, 186, 189, 196, 205, 209
half-life	102, 105, 107, 112, 113, 116, 135, 136, 164, 185, 186, 187
hematological effects	15, 20, 47, 78
hematopoietic	58
hepatic effects	15, 16, 19, 20, 21, 23, 24, 48, 49, 51, 52, 76, 79, 80, 81, 87, 91, 155, 162, 206
hydrolysis	126, 186, 195
hydroxyl radical	185
immune system	160, 163
immunological	24, 27, 54, 59, 83, 92, 164, 204
immunological effects	24, 54, 83, 92
K_{ow}	173, 185
Kupffer cells	123, 156
LD ₅₀	59, 76
leukemia	18, 57
lipid peroxidation	18, 47, 94, 99, 102, 109, 113, 123, 124, 127, 128, 135, 138, 139, 140, 143, 145, 146, 147, 149, 150, 152, 155, 157, 162
lymphatic	18, 57
lymphoreticular	59, 83
metabolic effects	76
milk	193
musculoskeletal effects	76, 78
necrosis	15, 16, 17, 18, 19, 20, 21, 22, 23, 24, 25, 47, 48, 49, 51, 54, 78, 79, 80, 81, 82, 84, 91, 93, 99, 124, 129, 131, 138, 145, 147, 149, 152, 153, 154, 155, 157
neonatal	84
neoplastic	16, 162
neurobehavioral	86, 131, 134, 163
neurotransmitter	84
nitric oxide	123, 168
non-Hodgkin's lymphoma	18
nuclear	99, 101, 123, 125, 127, 129, 139, 149, 157
ocular effects	45, 90, 92
odds ratio	57, 85
partition coefficients	22, 23, 110, 116
pharmacodynamic	115
pharmacokinetic	104, 110, 115, 116, 117, 120, 121, 132
phosgene	102, 109, 152
phospholipase A2	126
placenta	15, 133, 134, 167
renal effects	17, 20, 21, 24, 25, 45, 52, 53, 76, 82, 91, 139
retention	15, 46, 156
sequestered	126
solubility	199
T4	77
thyroxine	131
TNF-alpha	123, 154, 157
toxicokinetic	27, 120
triiodothyronine	131
tumor necrosis factor-alpha	123
tumors	6, 18, 58, 86, 127, 162
vapor pressure	13, 184, 192, 196
volatility	196
volatilization	13, 100, 184, 192, 195

