

**COMPUTER TESTING  
SUPPLEMENT  
FOR  
SPORT PILOT**

**2005**

**U.S. DEPARTMENT OF TRANSPORTATION  
FEDERAL AVIATION ADMINISTRATION  
Flight Standards Service**



## PREFACE

This computer testing supplement is designed by the Flight Standards Service of the Federal Aviation Administration (FAA) for use by computer testing designees (CTDs) in the administration of computer-assisted airman knowledge tests in the following knowledge areas:

Sport Pilot—Airplane (ASEL and ASES)  
Sport Pilot—Gyroplane  
Sport Pilot—Glider  
Sport Pilot—Airship (LTA)  
Sport Pilot—Balloon (LTA)  
Sport Pilot—Weight Shift Controlled (WSCS and WSCL)  
Sport Pilot—Powered Parachute (PPL and PPS)  
Sport Pilot—Flight Instructor

SIA Flight Instructor - Sport Pilot - Airplane  
SIB Flight Instructor - Sport Pilot - Balloon  
SIG Flight Instructor - Sport Pilot - Glider  
SIL Flight Instructor - Sport Pilot - Lighter-Than-Air (Airship)  
SIP Flight Instructor - Sport Pilot - Powered Parachute  
SIR Flight Instructor - Sport Pilot - Gyroplane  
SIW Flight Instructor - Sport Pilot - Weight Shift Control

SEA Pilot Examiner - Sport Pilot - Airplane  
SEB Pilot Examiner - Sport Pilot - Balloon  
SEG Pilot Examiner - Sport Pilot - Glider  
SEL Pilot Examiner - Sport Pilot - Lighter-Than-Air (Airship)  
SEP Pilot Examiner - Sport Pilot - Powered Parachute  
SER Pilot Examiner - Sport Pilot - Gyroplane  
SEW Pilot Examiner - Sport Pilot - Weight Shift Control

FAA-CT-8080-10A supercedes FAA-CT-8080-10, Computer Testing Supplement for Sport Pilot, Sport Pilot Instructor, and Sport Pilot Examiner, dated 2004.

Comments regarding this supplement should be sent to:

U.S. Department of Transportation  
Federal Aviation Administration  
Flight Standards Service  
Airman Testing Standards Branch, AFS-630  
P.O. Box 25082  
Oklahoma City, OK 73125



# CONTENTS

Preface .....	iii
Contents .....	v

## APPENDIX 1

Legend 1.—Sectional Aeronautical Chart .....	1
--	---

## APPENDIX 2

Figure 1.—Lesson Plan .....	1
Figure 2.—Pseudo-Adiabatic Chart .....	2
Figure 3.—Aviation Routine Weather Reports (METAR) .....	3
Figure 4.—Pilot Weather Report .....	3
Figure 5.—Terminal Aerodrome Forecasts (TAF) .....	3
Figure 6.—Aviation Area Forecast (FA) .....	4
Figure 7.—Winds and Temperatures Aloft Forecast (FD) .....	5
Figure 8.—Surface Analysis Chart Symbol .....	5
Figure 9.—Surface Analysis Chart Symbols .....	5
Figure 10.—Weather Depiction Chart Symbol .....	5
Figure 11.—Weather Depiction Chart Symbol .....	5
Figure 12.—Weather Depiction Chart .....	6
Figure 13.—Radar Summary Chart .....	7
Figure 14.—Significant Weather Prognostic Chart .....	8
Figure 15.—Severe Weather Outlook Chart .....	9
Figure 16.—Stability Chart .....	10
Figure 17.—Velocity/Load Factor Chart .....	10
Figure 18.—Load Factor/Stall Speed Chart .....	11
Figure 19.—Angle-of-Attack Chart .....	11
Figure 20.—Drag Chart .....	12
Figure 21.—Aspect Ratio .....	12
Figure 22.—Force Vectors .....	12
Figure 23.—Wing Flap Diagrams .....	13
Figure 24.—Density Altitude Chart .....	13
Figure 25.—Airspeed Calibration/Stall Speeds Chart .....	14
Figure 26.—Takeoff Data Chart .....	14
Figure 27.—Maximum Climb Chart .....	15
Figure 28.—Short-Field Takeoff Distance Chart .....	16
Figure 29.—Glide Distance Chart .....	17
Figure 30.—Wind Component Chart .....	18
Figure 31.—Landing Distance Chart .....	19
Figure 32.—Weight and Balance Diagram .....	20
Figure 33.—Weight and Balance Diagram .....	20
Figure 34.—Weight and Balance Diagram .....	20
Figure 35.—Weight and Balance Diagram .....	20
Figure 36.—Weight and Balance Chart .....	21

Figure 37.—Rotor Blade Positions .....	22
Figure 38.—Glider Cross-Country .....	22
Figure 39.—Balloon Performance Graph .....	22
Figure 40.—Wind Triangle .....	23
Figure 41.—Area Forecast .....	24
Figure 42.—Terminal Aerodrome Forecasts (TAF) .....	25
Figure 43.—Winds and Temperatures Aloft Forecast .....	25
Figure 44.—Sectional Chart Excerpt .....	26
Figure 45.—Sectional Chart Excerpt .....	27
Figure 46.—Sectional Chart Excerpt .....	28
Figure 47.—Class C Airspace Diagram .....	29
Figure 48.—Rectangular Course .....	29
Figure 49.—Ground Track Diagram .....	30
Figure 50.—S-Turn Diagram .....	30
Figure 51.—S-Turn Diagram .....	30
Figure 52.—Pilot Weather Report .....	30
Figure 52A.—Pilot Weather Report .....	30
Figure 53.—Aviation Routine Weather Reports (METAR) .....	31
Figure 54.—Traffic Pattern Indicator .....	31
Figure 55.—Airport/Facility Directory .....	32
Figure 56.—Sectional Chart .....	33
Figure 57.—Sectional Chart Excerpt .....	34
Figure 58.—Sectional Chart Excerpt .....	35
Figure 59.—Sectional Chart .....	36
Figure 60.—Sectional Chart Excerpt .....	37
Figure 61.—Sectional Chart Excerpt .....	38
Figure 62.—Airport Diagram .....	39
Figure 63.—Airport Diagram .....	39
Figure 64.—Airport Landing Indicator .....	39
Figure 65.—VASI Illustrations .....	40
Figure 66.—Sectional Chart Excerpt .....	41
Figure 67.—Airport/Facility Directory Excerpt .....	42
Figure 68.—Velocity vs. G-Loads .....	42
Figure 69.—Sectional Chart Excerpt .....	43
Figure 70.—Sectional Chart Excerpt .....	44
Figure 71.—U.S. Airport Signs .....	45
Figure 72.—Airport Markings .....	46
Figure 73.—Sectional Chart .....	47

# APPENDIX 1





# SECTIONAL AERONAUTICAL CHART SCALE 1:500,000

## LEGEND

Airports having Control Towers are shown in blue, all others in Magenta. Consult Airport/Facility Directory (AFD) for details involving airport lighting, navigation aids, and services. For additional symbol information refer to the Chart User's Guide.

### AIRPORTS

- Other than hard-surfaced runways
- Scopelone Base
- Hard-surfaced runways 1500 ft. in length
- Hard-surfaced runways greater than 8069 ft., or some multiple runways less than 8069 ft.

Open dot within hard-surfaced runway configuration indicates approximate VOR, VOR-DME, or VORTAC location. All recognizable hard-surfaced runways, including those closed, are shown for visual identification. Airports may be public or private.

### ADDITIONAL AIRPORT INFORMATION

- Private "Pvt" - Non-public use having emergency or landmark value.
- Military - Other than hard-surfaced. All military airports are identified by abbreviations AFB, NAS, AAF, etc. For complete airport information consult DOD FUP.
- Unverified
- Abandoned - paved having landmark value, 3000 ft. or greater
- Heliport Selected
- Lighted Flight Path Selected

Services-fee available and field tended during normal working hours depicted by use of fields around basic airport symbol. (Normal working hours are Mon thru Fri 10:00 A.M. to 4:00 P.M. local time.) Consult A/FD for service availability at airports with hard-surfaced runways greater than 8069 ft.

\* Rotating airport beacon in operation Sunset to Sunrise.

### RADIO AIDS TO NAVIGATION AND COMMUNICATION BOXES

VHF OMNI RANGE (VOR)

VORTAC

VOR-DME

Non-Directional Radiobeacon (NDB)

NDB-DME

Other facilities, i.e., Commercial Broadcast Stations, FSS Outlets-RCO, etc.

### AIRPORT DATA

Box indicates F.A.R. 93 Special Air Traffic Rules & Airport Traffic Patterns

F.A.R. 91 Location Identifier

FSS (NAME) (N/A/M)

NO SVFR

CT - 118.3 \* ATIS 123.8

285 L 72 122.95

VFR Advy 125.0

UNICOM

Airport of Entry

FSS - Flight Service Station

NO SVFR - Fixed-wing special VFR flight is prohibited.

CT - 118.3 - Central Tower (CT) - primary frequency

NFCI - Non-Federal Control Tower

\* - Star indicates operation part-time (see tower frequencies tabulation for hours of operation).

Ⓢ - Indicates Common Traffic Advisory Frequencies (CTAF)

ATIS 123.8 - Automatic Terminal Information Service

ASOS/AWOS 135.42 - Automated Surface Weather Observing System. NDBs broadcasting ASOS/AWOS data may not be located at the airport.

UNICOM - Aeronautical advisory station

VFR Advy - VFR Advisory Service shown where ATIS not available and frequency is other than primary CT frequency

285 - Elevation in feet

L - Lighting limitations exist, refer to Airport/Facility Directory.

72 - Length of longest runway in hundreds of feet; usable length may be less.

When facility or information is lacking, the respective character is replaced by a dash. All lighting codes refer to runway lights. Lighted runway may not be the longest or lighted full length. All times are local.

### CHICAGO CHI 122.1R

Heavy line box indicates Flight Service Station (FSS). Freqs. 121.5, 122.2, 243.0, and 255.4 (Canada - 121.5, 126.7 and 243.0) are normally available at all FSSs and are not shown above boxes. All other freqs. are shown. For Local Airport Advisory use FSS freq. 123.6.

Frequencies above thin line box are removed to NAVDAD site. Other frequencies at FSS providing voice communication may be available. Consult Airport/Facility Directory for complete information.

CONTOUR INTERVAL 500 feet

HIGHEST TERRAIN elevation is 3818 feet located at 34°52'N - 101°59'W

Spot elevation..... \* 4254

Approximate elevation..... x 3200

Doubtful locations are indicated by omission of the point locator (dot or "x")

### AIRPORT TRAFFIC SERVICE AND AIRSPACE INFORMATION

- Only the controlled and reserved airspace effective below 18,000 ft. MSL are shown on this chart. All times are local.
- Class B Airspace
- Class C Airspace (Mode C See F.A.R. 91.215/AUM)
- Class D Airspace
- Class E Airspace with floor 1200 ft. or greater above surface that abuts Class G Airspace.
- Class E Airspace (Class E (Hc) Airspace) Airspace greater than 700 ft. above surface
- Class E Airspace low altitude Federal Airways
- Class G Airspace

Obstructions 1000 ft and higher AGL below 1000 ft. AGL

Obstruction with high-intensity lights May operate part-time

2049 - Elevation of the top above mean sea level (1149)

UC - Height above ground

Under construction or reported; position and elevation unverified

NOTICE: Guy wires may extend outward from structures.

MISCELLANEOUS

- 10 E - Magnetic Line (1995 VALUE)
- Flashing Light
- Ultralight Activity
- Hang Glider Activity
- Glider Operations
- NAME (Magenta, Blue, or Black)
- Visual Check Point
- Parachute Jumping Area (See Airport/Facility Directory.)

### TOPOGRAPHIC INFORMATION

- Roads
- Road Markers
- Railroad
- Bridges And Viaducts
- Power Transmission Lines
- Aerial Cable
- Landmark Feature - stadium, factory, school, golf course, etc.
- Outdoor Theatre
- Lookout Tower P-17 (Site Number) 818 (Elevation Base of Tower)
- US Coast Guard Station
- Race Track
- Tank-water, oil or gas
- Oil Well
- Water Well
- Mines And Quarries
- Mountain Pass
- 1823 (Elevation of Pass)

Dams

Perennial Lake

Non-Perennial Lake

MILITARY TRAINING ROUTES (MTRs)

All IR and VR MTRs are shown, and may extend from the surface upwards. Only the route centerline, direction of flight along the route and the route designator are depicted - route widths and altitudes are not shown.

Since these routes are subject to change every 36 days, and the charts are reissued every 6 months, you are cautioned and advised to contact the nearest FSS for route dimensions and current status for those routes affecting your flight.

Routes with a change in the alignment of the charted route centerline will be indicated in the Aeronautical Chart Bulletin of the Airport/Facility Directory.

Military Pilots refer to Area Planning AP/1B Military Training Route North and South America for current routes.

ATTENTION

THIS CHART CONTAINS MAXIMUM ELEVATION FIGURES (MEF). The Maximum Elevation Figures shown in quadrangles bounded by ticked lines of latitude and longitude are represented in THOUSANDS and HUNDREDS of feet above mean sea level. The MEF is based on information available concerning the highest known feature in each quadrangle, including terrain and obstructions (trees, towers, antennas, etc.).

Example: 12,500 feet

125

LEGEND 1.—SECTIONAL AERONAUTICAL CHART.



# APPENDIX 2



LESSON	GROUND REFERENCE MANEUVERS	STUDENT _____	DATE _____
A _____		TO DEVELOP THE STUDENT'S SKILL IN PLANNING AND FOLLOWING A PATTERN OVER THE GROUND COMPENSATING FOR WIND DRIFT AT VARYING ANGLES.	
B _____		USE OF GROUND REFERENCES TO CONTROL PATH. OBSERVATION AND CONTROL OF WIND EFFECT. CONTROL OF AIRPLANE ATTITUDE, ALTITUDE, AND HEADING.	
C _____		PREFLIGHT DISCUSSION.	: 10
		INSTRUCTOR DEMONSTRATIONS.	: 25
		STUDENT PRACTICE.	: 45
		POSTFLIGHT CRITIQUE.	: 10
D _____		CHALKBOARD FOR PREFLIGHT DISCUSSION. IFR VISOR FOR MANEUVERS REVIEWED.	
E _____		PREFLIGHT – DISCUSS LESSON OBJECTIVE. DIAGRAM "S" TURNS, EIGHTS ALONG A ROAD, AND RECTANGULAR COURSE ON A CHALKBOARD.	
		INFLIGHT – DEMONSTRATE ELEMENTS. DEMONSTRATE FOLLOWING A ROAD, "S" TURNS, EIGHTS ALONG A ROAD, AND RECTANGULAR COURSE. COACH STUDENT PRACTICE.	
		POSTFLIGHT – CRITIQUE STUDENT PERFORMANCE AND MAKE STUDY ASSIGNMENT.	
F _____		PREFLIGHT – DISCUSS LESSON OBJECTIVE AND RESOLVE QUESTIONS.	
		INFLIGHT – REVIEW PREVIOUS MANEUVERS INCLUDING POWER-OFF STALLS AND FLIGHT AT MINIMUM CONTROLLABLE AIRSPEED. PERFORM EACH NEW MANEUVER AS DIRECTED.	
		POSTFLIGHT – ASK PERTINENT QUESTIONS.	
G _____		STUDENT SHOULD DEMONSTRATE COMPETENCY IN MAINTAINING ORIENTATION, AIRSPEED WITHIN 10 KNOTS, ALTITUDE WITHIN 100 FEET, AND HEADINGS WITHIN 10 DEGREES, AND IN MAKING PROPER CORRECTION FOR WIND DRIFT.	

FIGURE 1.—Lesson Plan.

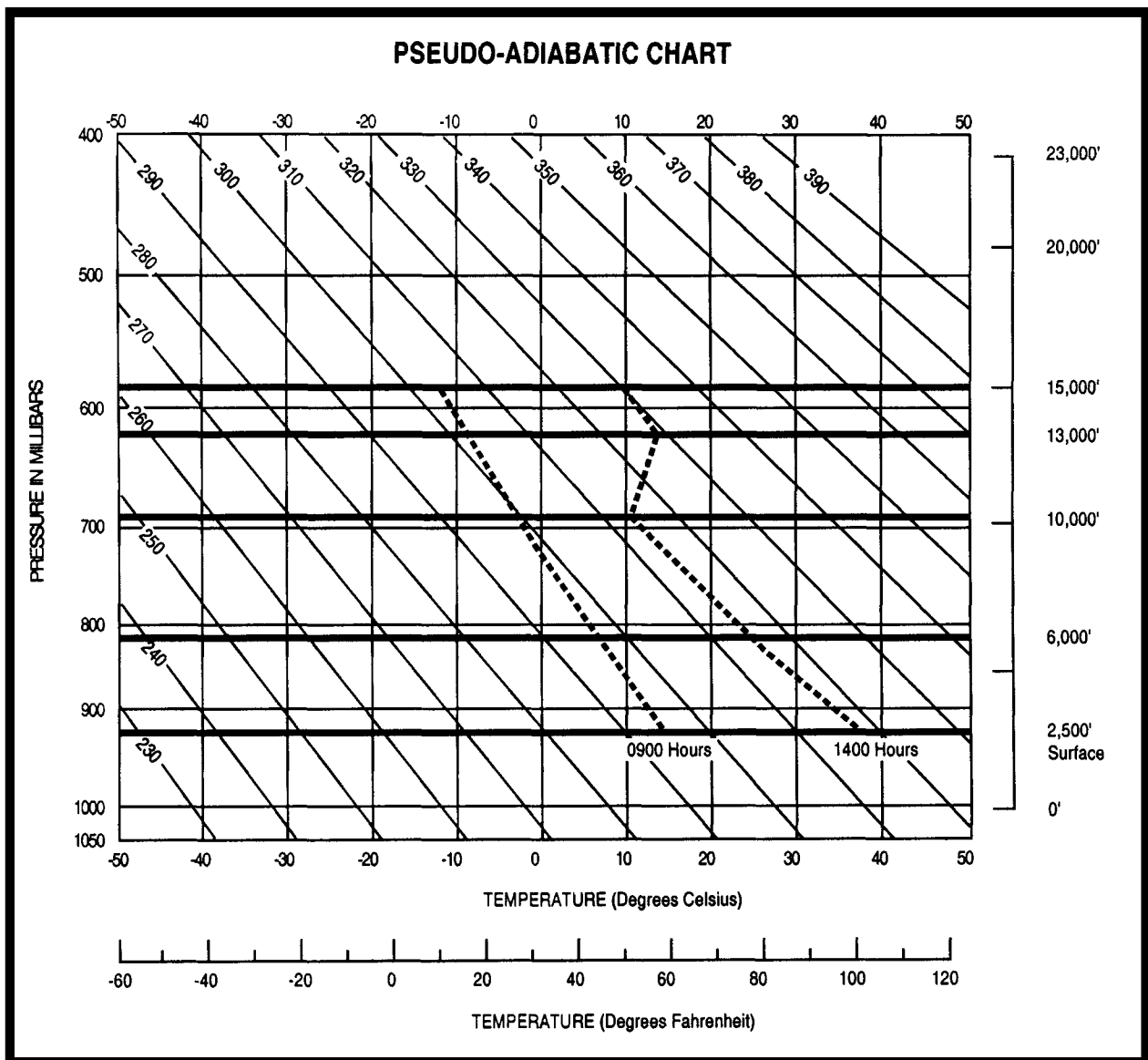

FIGURE 2.—Pseudo-Adiabatic Chart.

METAR KAMA 301651Z 05016KT 5/8SM R04/3000FT BR OVC007 11/9 A3013  
 RMK DZB26DZE40

METAR KAUS 301651Z 12008KT 4SM -RAHZ BKN010 BKN023 OVC160 21/17  
 A3005 RMK RAB25

METAR KBRO 301655Z 15015G20KT 7SM SCT020 SCT130 TCU OVC250 29/19  
 A2997 RMK RAB19RAE25

METAR KDAL 301649Z 00000KT 3SM BRHZ OVC009 22/17 A3010

METAR KFTW 301654Z 09004KT 1/2SM HZFU VV006 21/17 A3010

METAR KTYR 301650Z AUTO 08004KT 3SM BR SCT015 24/19 A2999

FIGURE 3.—Aviation Routine Weather Reports (METAR).

UA/OV KOKC-KTUL/TM 1800/FL120/TP BE90//SK BKN018-TOP055/OVC072-  
 TOP089/CLR ABV/TA M7/WV 08021/TB LGT 055-072/IC LGT-MOD RIME 072-089

FIGURE 4.—Pilot Weather Report.

TAF

KMEM 121720Z 121818 20012KT 5SM HZ BKN030 PROB40 2022 1SM TSRA OVC008CB  
 FM2200 33015G20KT P6SM BKN015 OVC025 PROB40 2202 3SM SHRA  
 FM0200 35012KT OVC008 PROB40 0205 2SM -RASN BECMG 0608 02008KT BKN012  
 BECMG 1012 00000KT 3SM BR SKC TEMPO 1214 1/2SM FG  
 FM1600 VRB06KT P6SM SKC=

KOKC 051130Z 051212 14008KT 5SM BR BKN030 TEMPO 1316 1 1/2SM BR  
 FM1600 18010KT P6SM SKC BECMG 2224 20013G20KT 4SM SHRA OVC020  
 PROB40 0006 2SM TSRA OVC008CB BECMG 0608 21015KT P6SM SCT040=

FIGURE 5.—Terminal Aerodrome Forecasts (TAF).

BOSC FA 241845  
 SYNOPSIS AND VFR CLDS/WX  
 SYNOPSIS VALID UNTIL 251300  
 CLDS/WX VALID UNTIL 250700...OTLK VALID 250700-251300  
 ME NH VT MA RI CT NY LO NJ PA OH LE WV MD DC DE VA AND CSTL WTRS

.  
 SEE AIRMET SIERRA FOR IFR CONDS AND MTN OBSCN.  
 TS IMPLY SEV OR GTR TURB SEV ICE LLWS AND IFR CONDS.  
 NON MSL HGTS DENOTED BY AGL OR CIG.

.  
 SYNOPSIS...19Z CDFNT ALG A 160NE ACK-ENE LN...CONTG AS A QSTNRY  
 FNT ALG AN END-50SW MSS LN. BY 13Z...CDFNT ALG A 140ESE ACK-HTO  
 LN...CONTG AS A QSTNRY FNT ALG A HTO-SYR-YYZ LN. TROF ACRS CNTRL  
 PA INTO NRN VA. ...REYNOLDS...

.  
 OH LE  
 NRN HLF OH LE...SCT-BKN025 OVC045. CLDS LYRD 150. SCT SHRA. WDLY  
 SCT TSRA. CB TOPS FL350. 23-01Z OVC020-030. VIS 3SM BR. OCNL -  
 RA. OTLK...IFR CIG BR FG.  
 SWRN QTR OH...BKN050-060 TOPS 100. OTLK...MVFR BR.  
 SERN QTR OH...SCT-BKN040 BKN070 TOPS 120. WDLY SCT -TSRA. 00Z  
 SCT-BKN030 OVC050. WDLY SCT -TSRA. CB TOPS FL350. OTLK...VFR  
 SHRA.

.  
 CHIC FA 241945  
 SYNOPSIS AND VFR CLDS/WX  
 SYNOPSIS VALID UNTIL 251400  
 CLDS/WX VALID UNTIL 250800...OTLK VALID 250800-251400  
 ND SD NE KS MN IA MO WI LM LS MI LH IL IN KY

.  
 SEE AIRMET SIERRA FOR IFR CONDS AND MTN OBSCN.  
 TS IMPLY SEV OR GTR TURB SEV ICE LLWS AND IFR CONDS.  
 NON MSL HGTS DENOTED BY AGL OR CIG.

.  
 SYNOPSIS...LOW PRES AREA 20Z CNTRD OVR SERN WI FCST MOV NEWD INTO  
 LH BY 12Z AND WKN. LOW PRES FCST DEEPEN OVR ERN CO DURG PD AND  
 MOV NR WRN KS BORDER BY 14Z. DVLPG CDFNT WL MOV EWD INTO S CNTRL  
 NE-CNTRL KS BY 14Z. ..SMITH..

.  
 UPR MI LS  
 WRN PTNS...AGL SCT030 SCT-BKN050. TOPS 080. 02-05Z BECMG CIG  
 OVC010 VIS 3-5SM BR. OTLK...IFR CIG BR.  
 ERN PTNS...CIG BKN020 OVC040. OCNL VIS 3-5SM -RA BR. TOPS FL200.  
 23Z CIG OVC010 VIS 3-5SM -RA BR. OTLK...IFR CIG BR.

.  
 LWR MI LM LH  
 CNTRL/NRN PTNS...CIG OVC010 VIS 3-5SM -RA BR. TOPS FL200.  
 OTLK...IFR CIG BR.

.  
 SRN THIRD...CIG OVC015-025. SCT -SHRA. TOPS 150. 00-02Z BECMG CIG  
 OVC010 VIS 3-5SM BR. TOPS 060. OTLK...IFR CIG BR.

.  
 IN  
 NRN HALF...CIG BKN035 BKN080. TOPS FL200. SCT -SHRA. 00Z CIG  
 BKN-SCT040 BKN-SCT080. TOPS 120. 06Z AGL SCT-BKN030. TOPS 080.  
 OCNL VIS 3-5SM BR. OTLK...MVFR CIG BR.  
 SRN HALF...AGL SCT050 SCT-BKN100. TOPS 120. 07Z AGL SCT 030  
 SCT100. OTLK...VFR.

FIGURE 6.—Aviation Area Forecast (FA).



FD WBC 151745									
DATA BASED ON 151200Z									
VALID 1600Z FOR USE 1800-0300Z. TEMPS NEG ABV 24000									
FT	3000	6000	9000	12000	18000	24000	30000	34000	39000
ALS			2420	2635-08	2535-18	2444-30	245945	246755	246862
AMA		2714	2725+00	2625-04	2531-15	2542-27	265842	256352	256762
DEN			2321-04	2532-08	2434-19	2441-31	235347	236056	236262
HLC		1707-01	2113-03	2219-07	2330-17	2435-30	244145	244854	245561
MKC	0507	2006+03	2215-01	2322-06	2338-17	2348-29	236143	237252	238160
STL	2113	2325+07	2332+02	2339-04	2356-16	2373-27	239440	730649	731960

FIGURE 7.—Winds and Temperatures Aloft Forecast (FD).

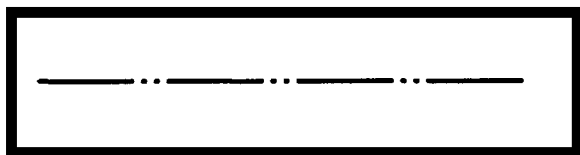

FIGURE 8.—Surface Analysis Chart Symbol.

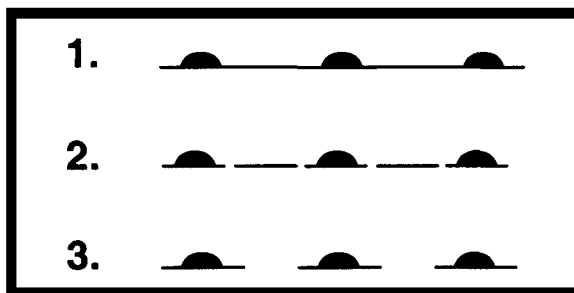

FIGURE 9.—Surface Analysis Chart Symbols.

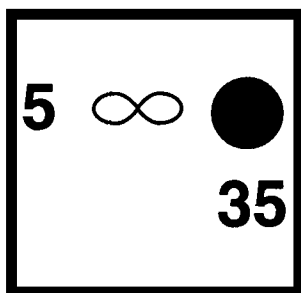

FIGURE 10.—Weather Depiction Chart Symbol.

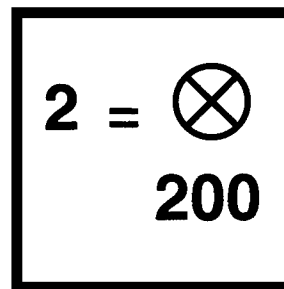

FIGURE 11.—Weather Depiction Chart Symbol.

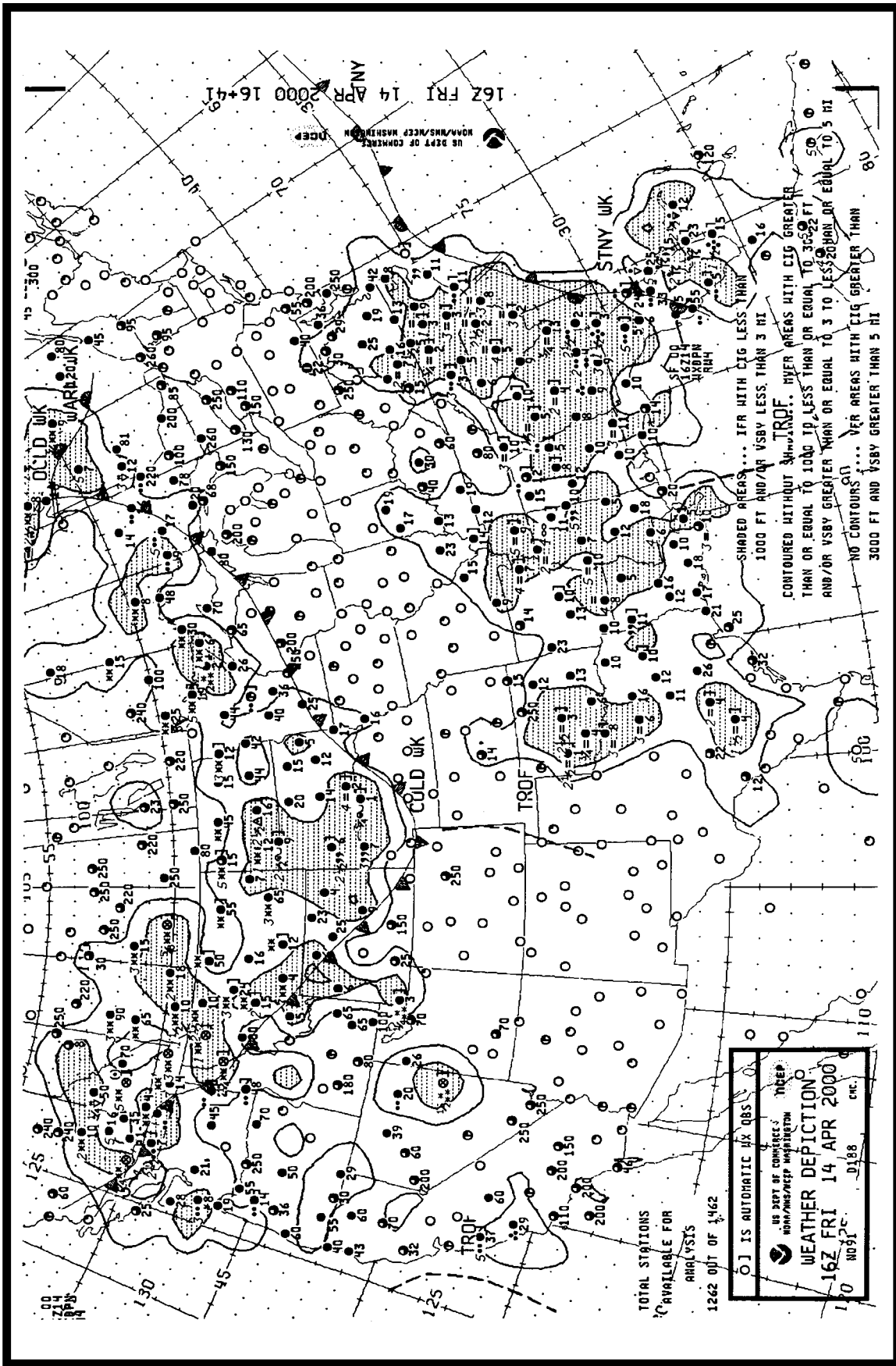

Figure 12.—Weather Depiction Chart.

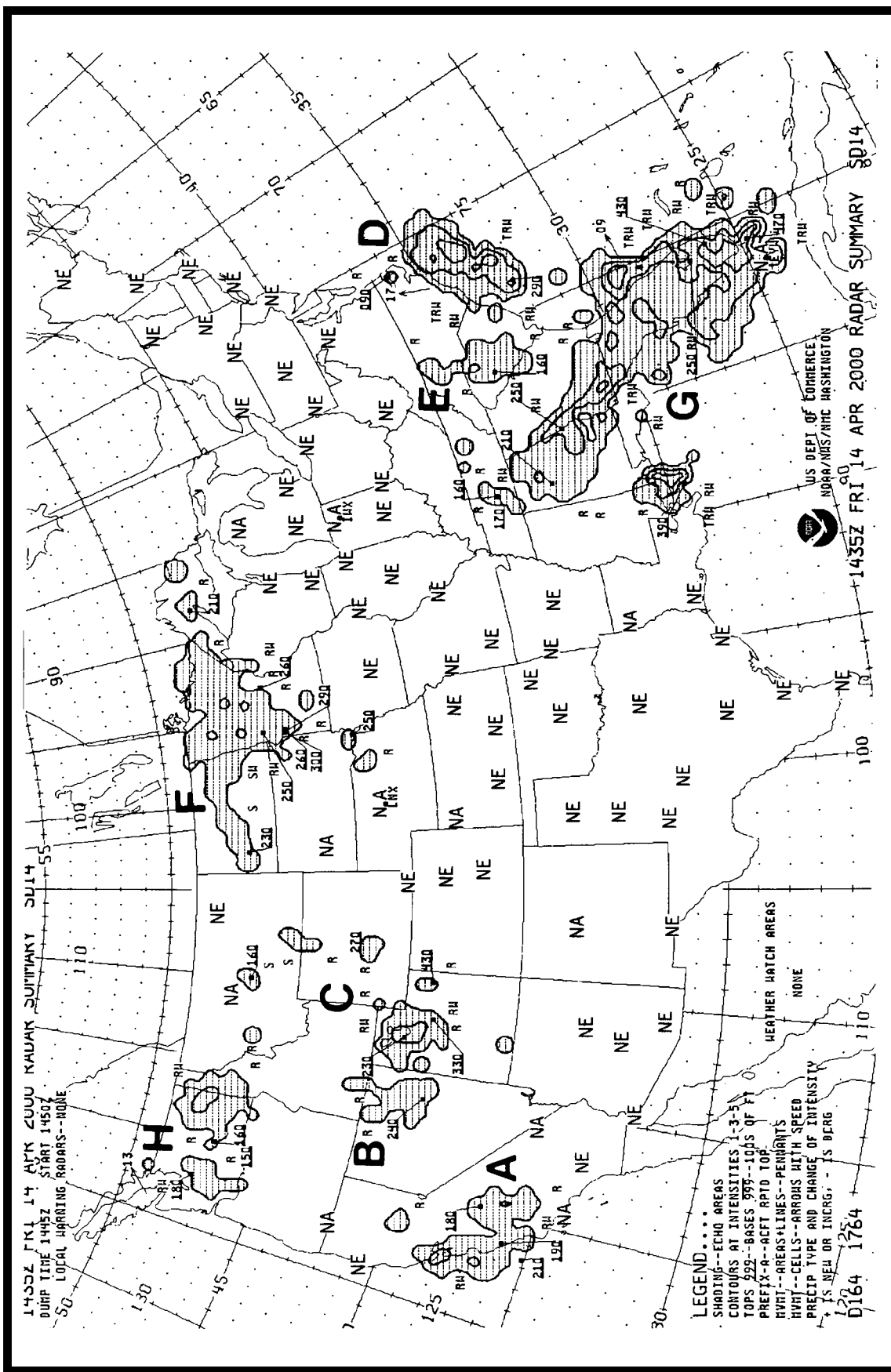

Figure 13.—Radar Summary Chart.

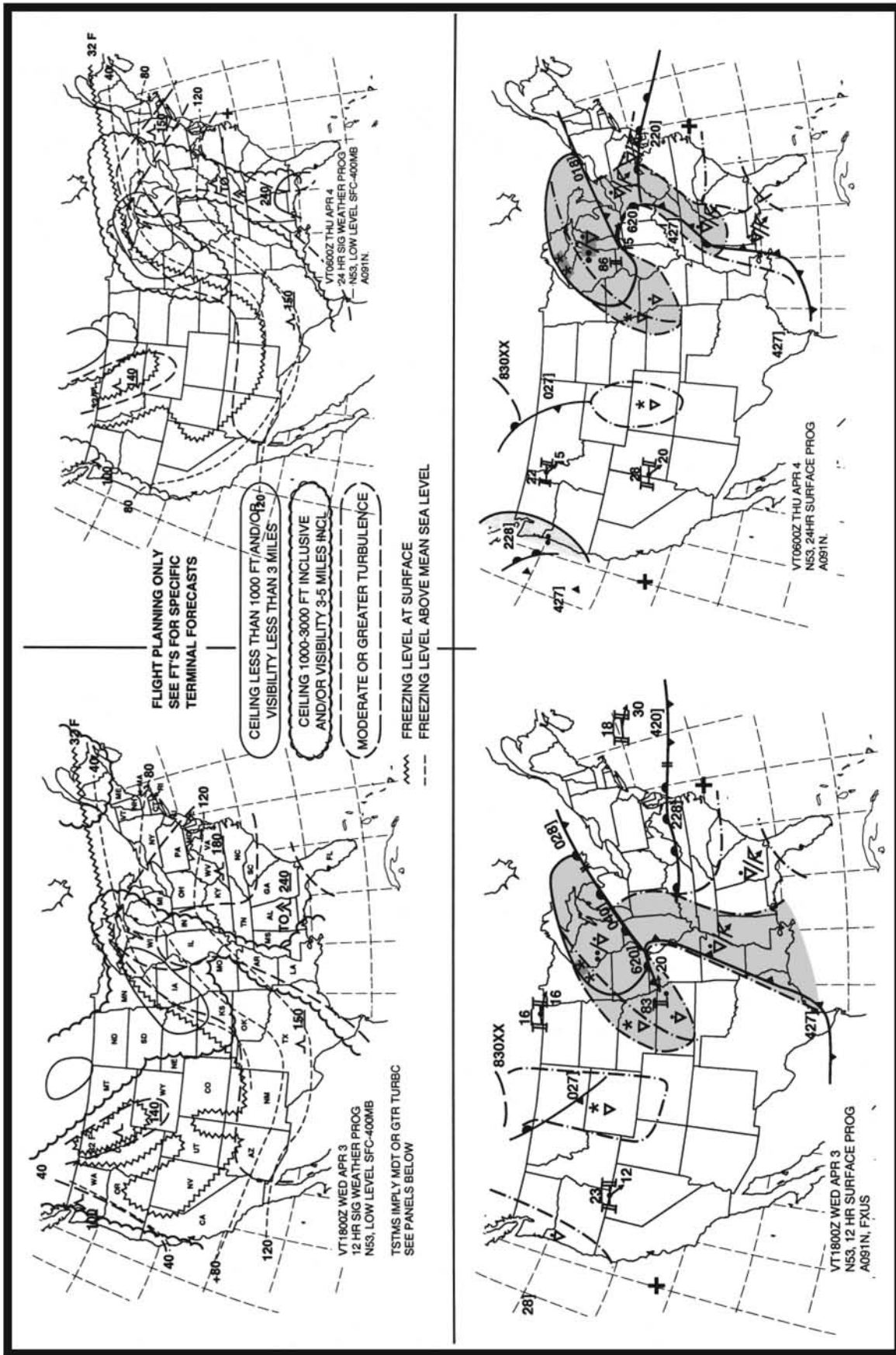

FIGURE 14.—Significant Weather Prognostic Chart.

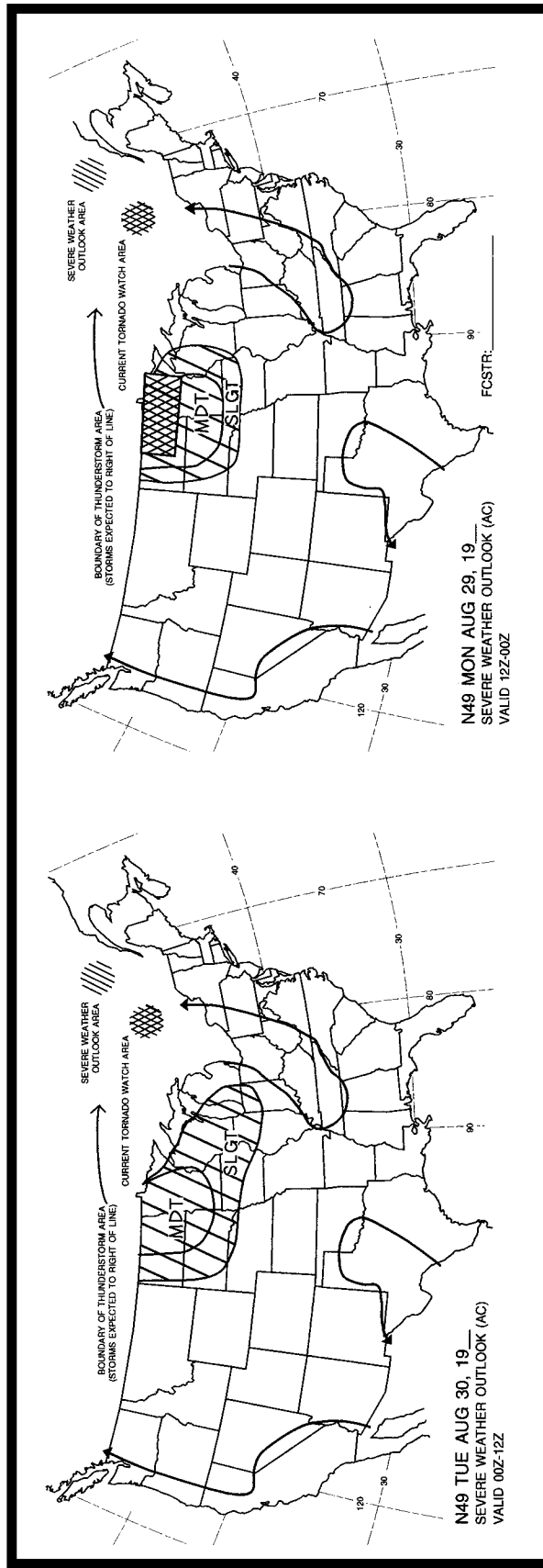

FIGURE 15.—Severe Weather Outlook Chart.

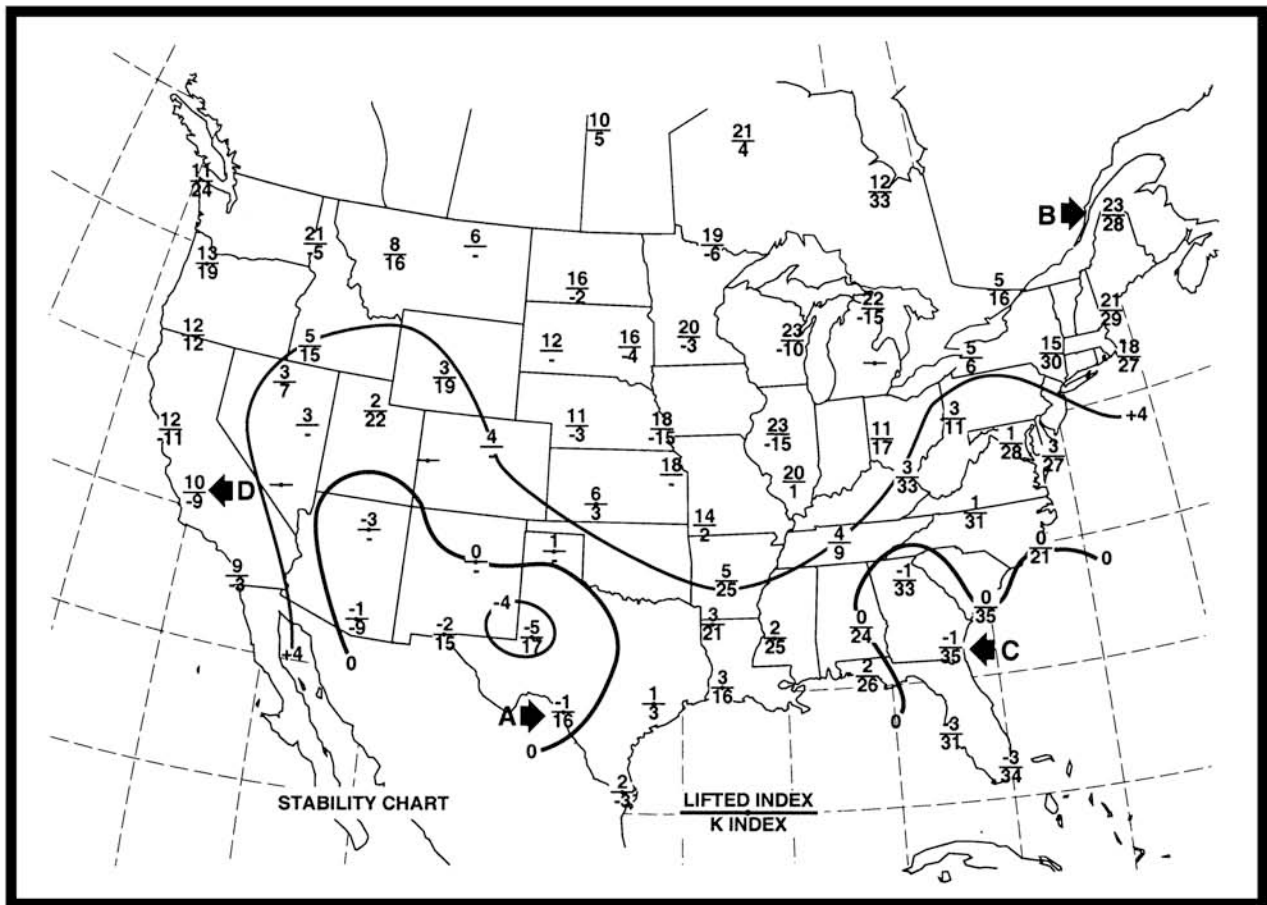

FIGURE 16.—Stability Chart.

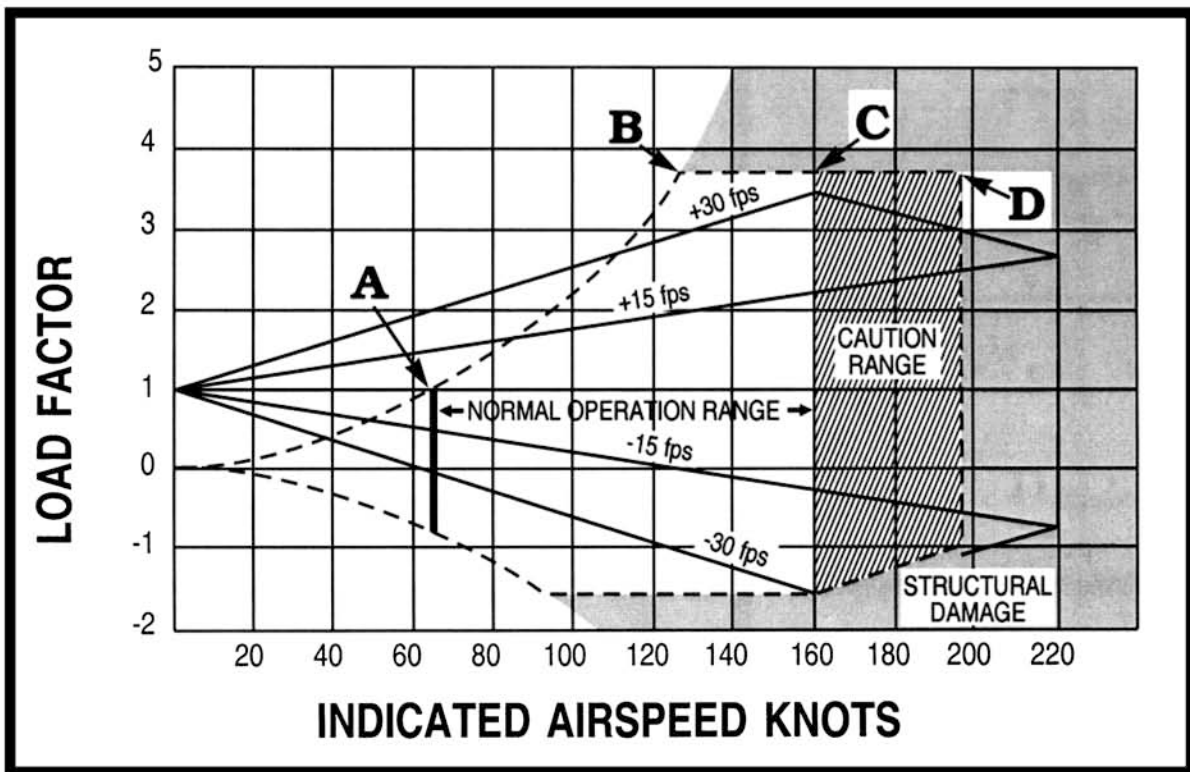

FIGURE 17.—Velocity/Load Factor Chart.

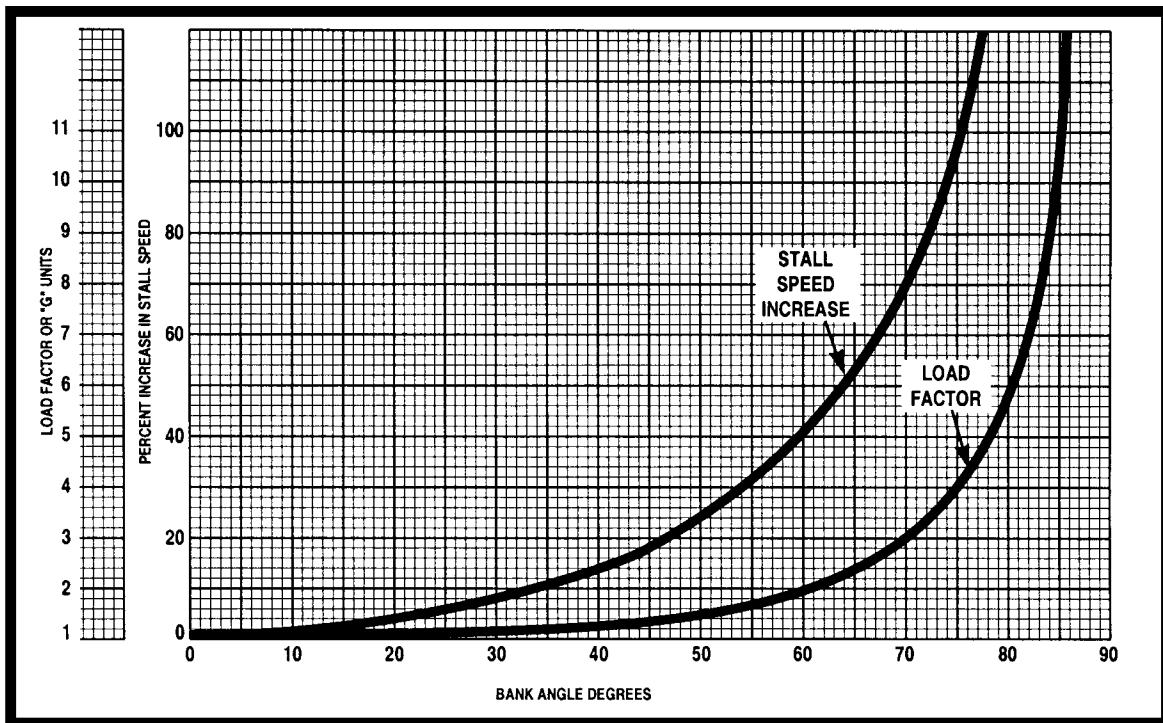

FIGURE 18.—Load Factor/Stall Speed Chart.

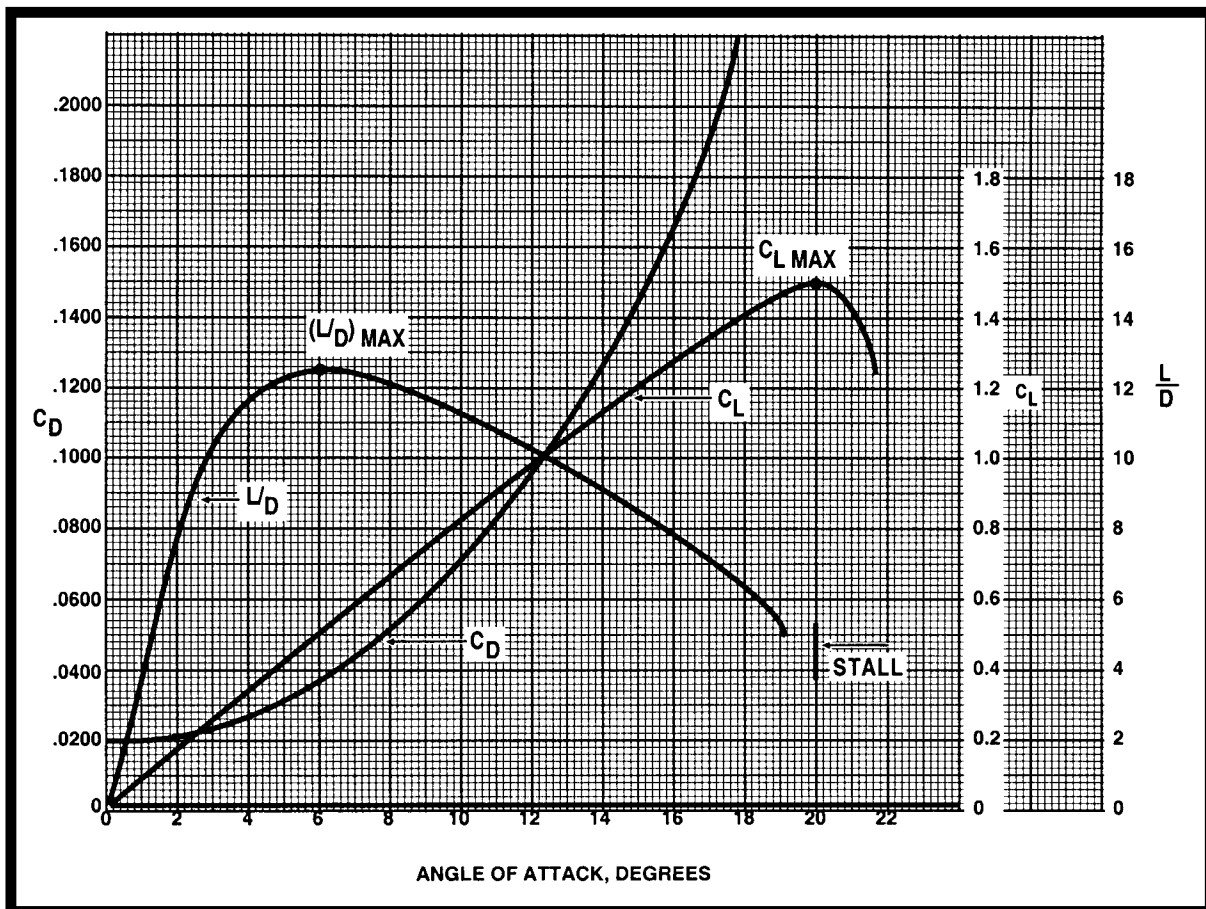

FIGURE 19.—Angle-of-Attack Chart.

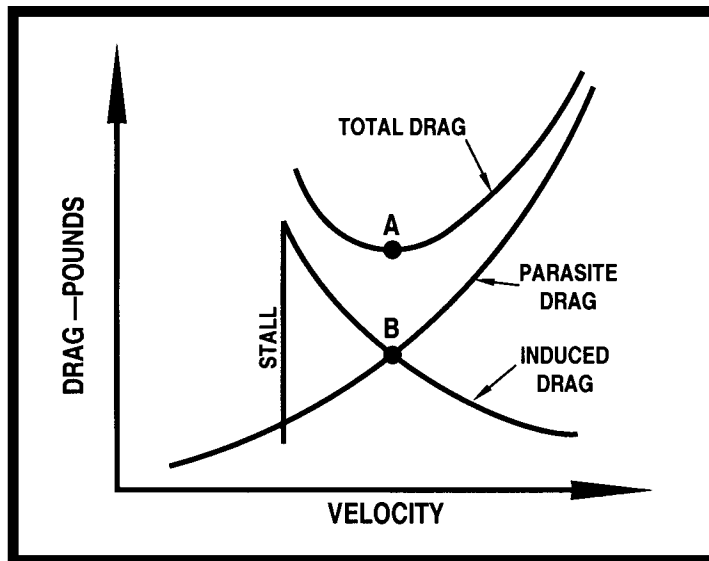

FIGURE 20.—Drag Chart.

AIRCRAFT	1	2	3	4
WING SPAN	40'	35'	48'	30'
AVERAGE WING CHORD	6'	5'	6'	6'

FIGURE 21.—Aspect Ratio.

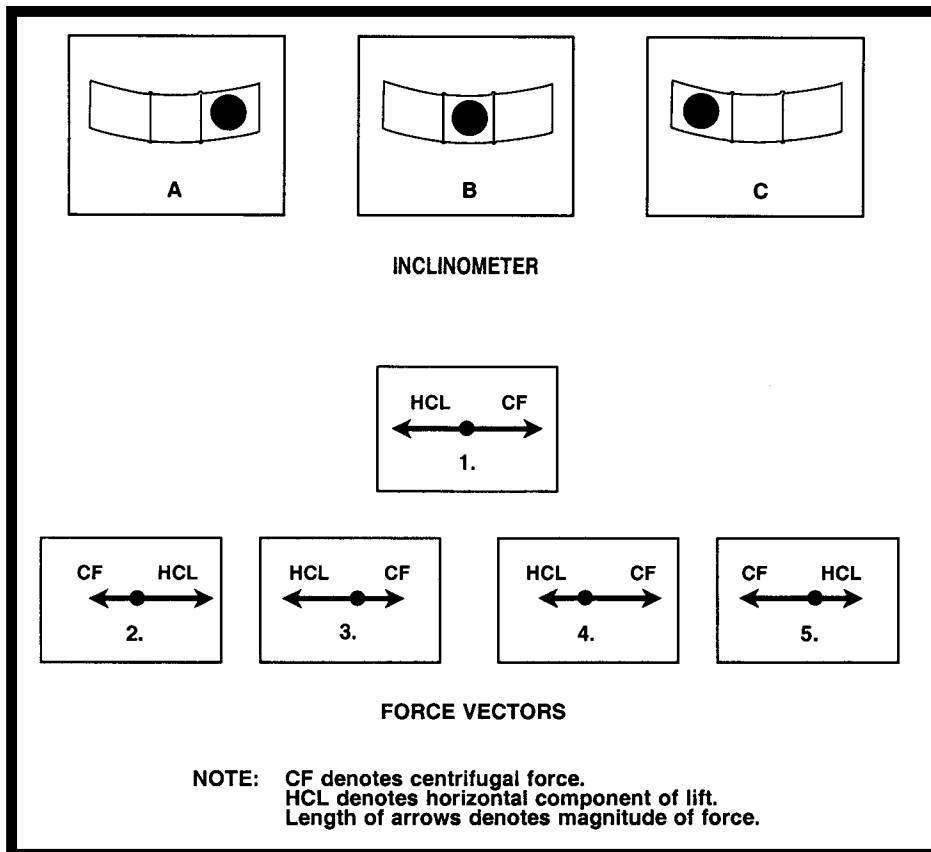

FIGURE 22.—Force Vectors.



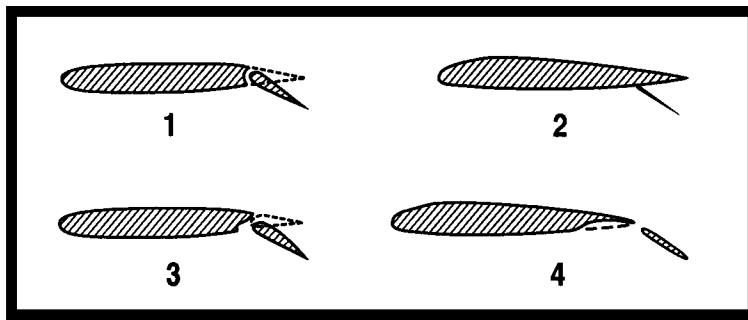

FIGURE 23.—Wing Flap Diagrams.

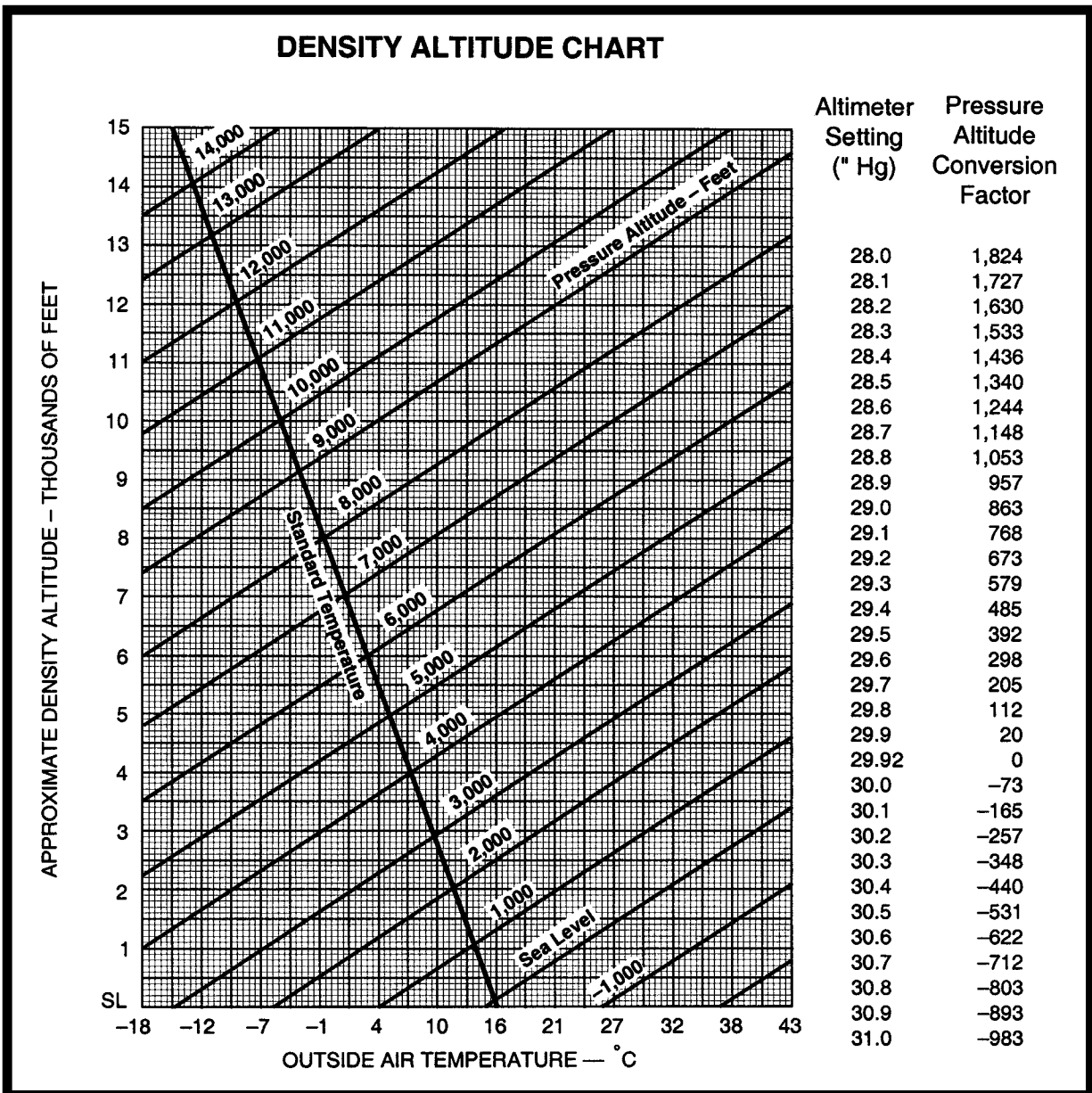

FIGURE 24.—Density Altitude Chart.

<b>AIRSPEED CALIBRATION — NORMAL SYSTEM</b>					
Flaps 0°		Flaps 15°		Flaps 45°	
CIAS	KCAS	CIAS	KCAS	CIAS	KCAS
80	84	70	79	70	76
100	102	80	86	80	84
120	122	90	94	90	93
140	141	100	103	100	102
160	161	110	112	110	111
180	181	120	121	120	120
200	201	130	131	130	129
220	221	140	141	140	138
240	242	150	151		

CIAS — INDICATED AIRSPEED IN KNOTS  
 KCAS — CALIBRATED AIRSPEED IN KNOTS

<b>STALL SPEEDS — KCAS</b>				
4600 LB GROSS WEIGHT				
CONFIGURATION	ANGLE OF BANK			
	0°	20°	40°	60°
Gear and Flaps Up	84	87	97	119
Gear Down and Flaps 15°	80	83	92	113
Gear Down and Flaps 45°	76	79	87	108

FIGURE 25.—Airspeed Calibration/Stall Speeds Chart.

<b>TAKEOFF DATA</b>										
TAKEOFF DISTANCE WITH 10° FLAPS FROM HARD-SURFACED RUNWAY										
GROSS WEIGHT LB	CIAS AT 50 FT	HEAD WIND KTS	AT SEA LEVEL & 15° C		AT 2500 FT & 10° C		AT 5000 FT & 5° C		AT 7500 FT & 0° C	
			GROUND ROLL	TOTAL TO CLEAR 50' OBS	GROUND ROLL	TOTAL TO CLEAR 50' OBS	GROUND ROLL	TOTAL TO CLEAR 50' OBS	GROUND ROLL	TOTAL TO CLEAR 50' OBS
2200	55	0	345	680	405	770	480	885	580	1040
		15	205	460	245	525	295	615	365	725
		30	100	275	120	320	155	380	195	460
2600	60	0	500	915	585	1045	705	1230	855	1470
		15	310	635	370	735	455	870	560	1055
		30	165	395	200	465	255	565	325	695
3000	64	0	695	1210	820	1405	990	1675	1205	2045
		15	450	855	535	1005	660	1215	815	1505
		30	250	555	310	665	390	820	500	1030

NOTE: INCREASE DISTANCES 10% FOR EACH 14° C ABOVE STANDARD TEMPERATURE FOR PARTICULAR ALTITUDE.

FIGURE 26.—Takeoff Data Chart.

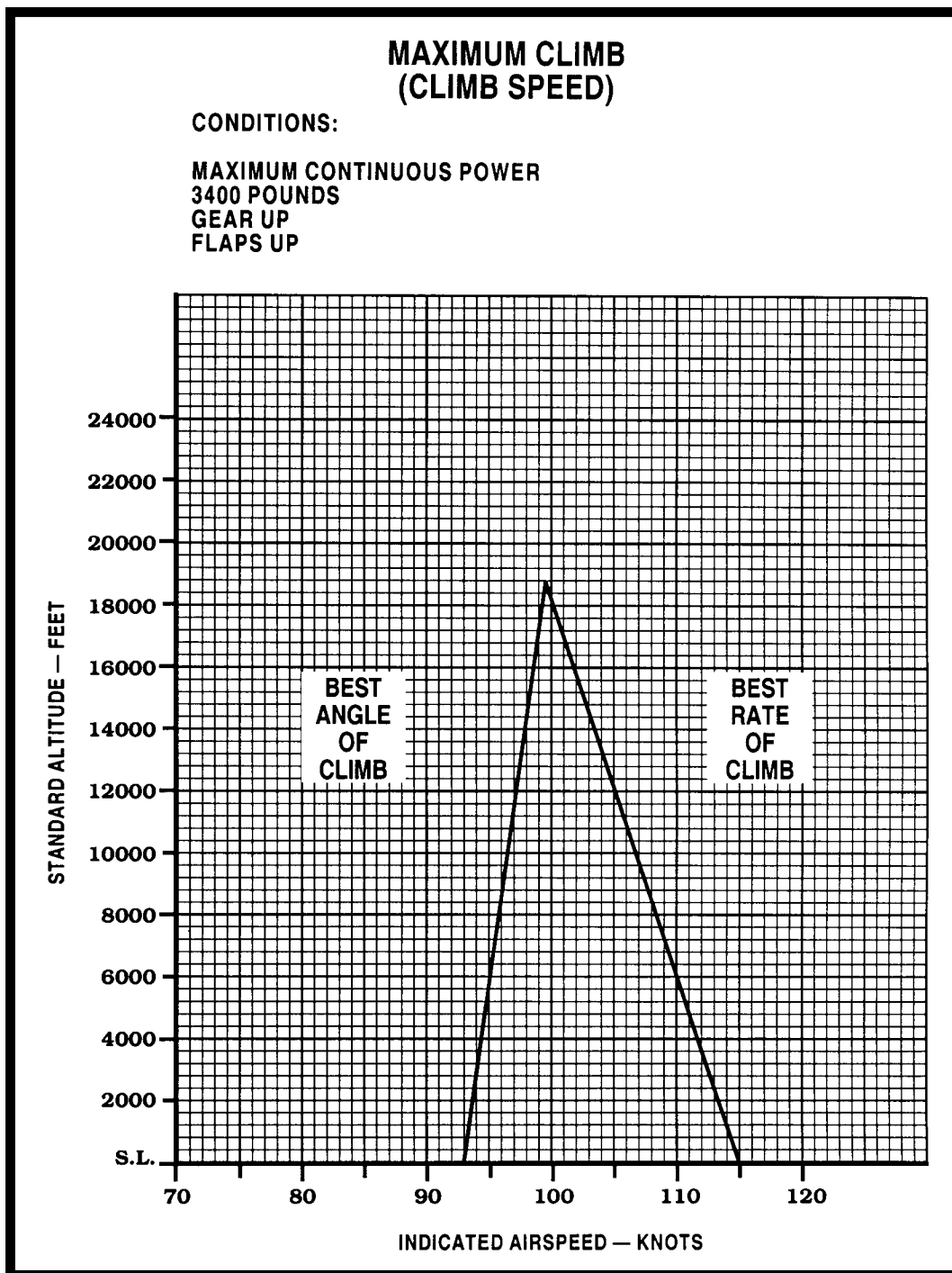

FIGURE 27.—Maximum Climb Chart.

SHORT-FIELD TAKEOFF DISTANCE								
CONDITIONS:			NOTE:					
1. Power - FULL THROTTLE and 2700 RPM before releasing brakes.			1. Increase total distance 8 percent for operation on dry, sod runway.					
2. Mixtures - LEAN for field elevation.			2. Decrease total distance 7 percent for each 10 knots of headwind.					
3. Cowl flaps - OPEN.			3. Increase total distance 5 percent for each 2 knots of tailwind.					
4. Wing flaps - UP.								
5. Level, dry, hard-surface runway.								
WEIGHT-POUNDS	TAKEOFF TO 50-FOOT OBSTACLE SPEED-KIAS	PRESSURE ALTITUDE- FEET	20 C		30 C		40 C	
			GROUND ROLL - FEET	TOTAL DISTANCE TO CLEAR 50' OBS	GROUND ROLL - FEET	TOTAL DISTANCE TO CLEAR 50' OBS	GROUND ROLL - FEET	TOTAL DISTANCE TO CLEAR 50' OBS
5500	82	Sea Level	1390	1760	1490	1890	1590	2020
		1000	1530	1950	1640	2080	1760	2230
		2000	1680	2150	1810	2300	1940	2470
		3000	1860	2380	2000	2550	2150	2750
		4000	2060	2650	2220	2850	2380	3070
		5000	2280	2950	2460	3190	2640	3450
		6000	2530	3310	2730	3590	2950	3900
		7000	2830	3750	3160	4190	3410	4570
		8000	3280	4420	3540	4840	3830	5330
		9000	3690	5170	4000	5730	4330	6420
		10,000	4150	6140	4500	6980	4880	8130
5100	78	Sea Level	1160	1470	1240	1570	1330	1680
		1000	1280	1620	1370	1730	1470	1850
		2000	1400	1780	1500	1910	1610	2040
		3000	1550	1960	1660	2100	1780	2280
		4000	1710	2180	1840	2340	1970	2510
		5000	1890	2410	2030	2590	2180	2790
		6000	2090	2690	2250	2890	2420	3120
		7000	2330	3010	2510	3250	2700	3520
		8000	2600	3400	2800	3690	3030	4010
		9000	2920	3890	3270	4360	3530	4760
		10,000	3390	4580	3660	5030	3960	5560
4700	75	Sea Level	960	1220	1020	1300	1090	1380
		1000	1050	1340	1120	1430	1200	1520
		2000	1150	1460	1230	1560	1320	1670
		3000	1270	1610	1360	1720	1460	1840
		4000	1400	1770	1500	1900	1610	2030
		5000	1540	1960	1650	2100	1780	2250
		6000	1700	2170	1830	2330	1970	2500
		7000	1890	2410	2030	2590	2190	2790
		8000	2100	2700	2260	2910	2440	3140
		9000	2350	3040	2540	3290	2730	3570
		10,000	2620	3430	2830	3730	3060	4060

FIGURE 28.—Short-Field Takeoff Distance Chart.

# GLIDE DISTANCE

**CONDITIONS:**

GEAR	UP
FLAPS	UP
COWL FLAPS	CLOSED
PROPELLER	FULL HIGH PITCH (LOW RPM)
GLIDE SPEED	122 KIAS

- NOTES:**
1. INCREASE GLIDE DISTANCE APPROXIMATELY 10% FOR EACH 10 KNOTS OF TAILWIND.
  2. DECREASE GLIDE DISTANCE APPROXIMATELY 10% FOR EACH 10 KNOTS OF HEADWIND.

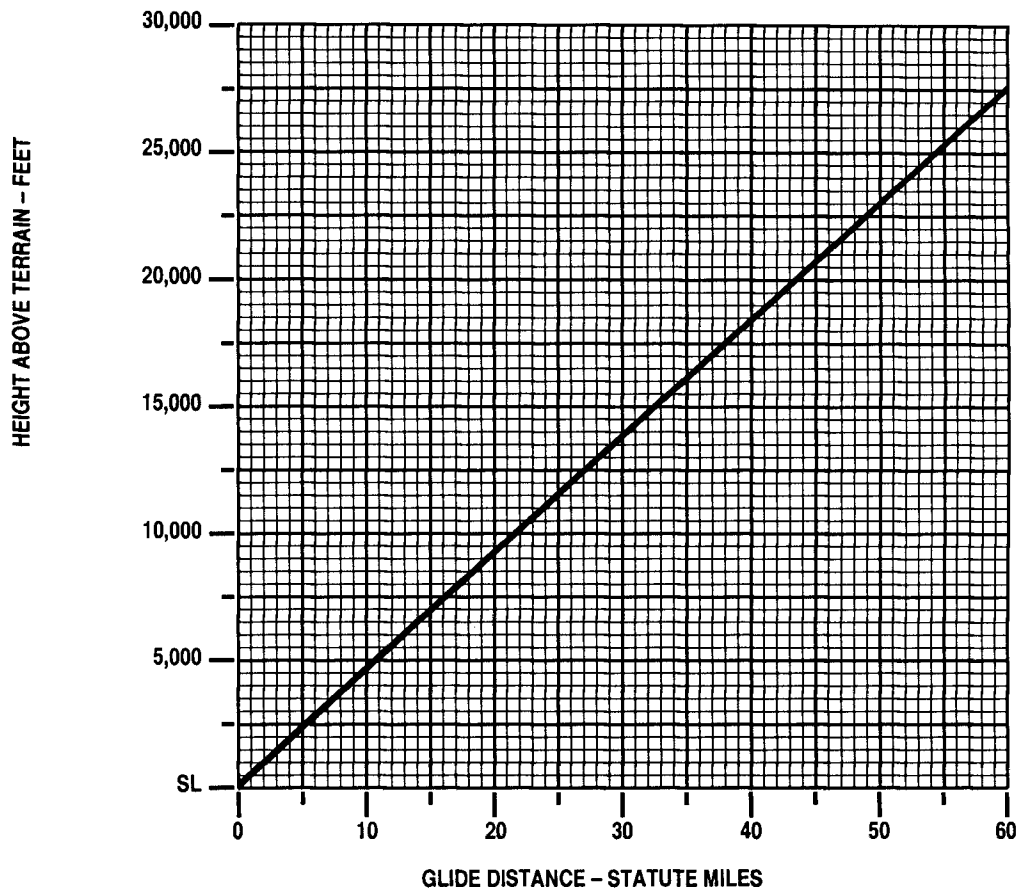

FIGURE 29.—Glide Distance Chart.

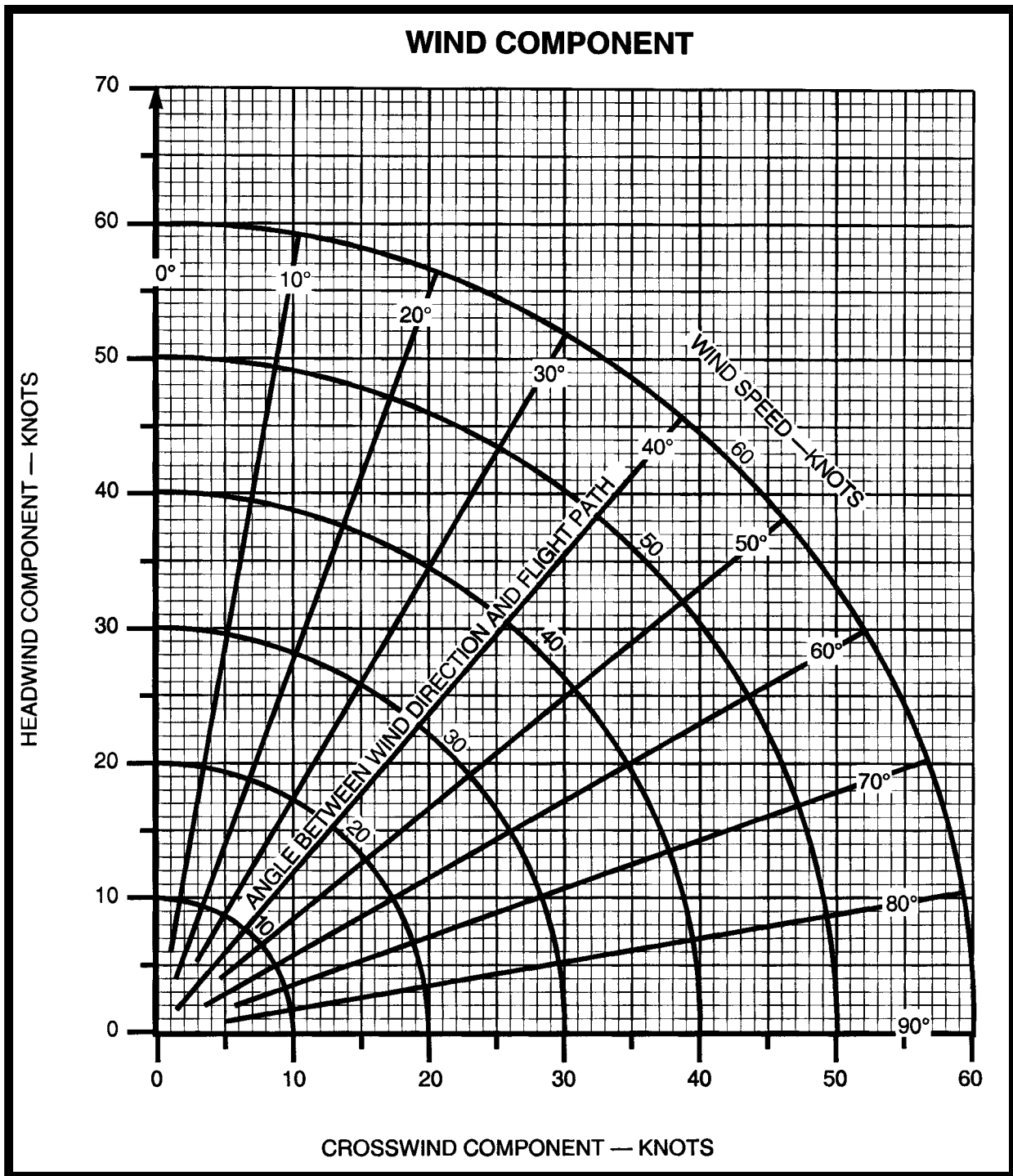

FIGURE 30.—Wind Component Chart.

### LANDING DISTANCE

**CONDITIONS:**

POWER AS REQUIRED TO MAINTAIN 800 FT/MIN DESCENT ON APPROACH  
 FLAPS DOWN  
 RUNWAY PAVED, LEVEL, DRY SURFACE  
 APPROACH SPEED IAS AS TABULATED

**EXAMPLE:**

OAT 27 °C  
 PRESSURE ALTITUDE 4000 FT  
 LANDING WEIGHT 3200 LB  
 HEADWIND 10 KTS  

---

 TOTAL LANDING DISTANCE OVER A 50 FT OBSTACLE 1475 FT  
 GROUND ROLL (53% OF 1475) 782 FT  
 IAS APPROACH SPEED 87 MPH IAS

NOTE: GROUND ROLL IS APPROX. 53% OF TOTAL LANDING DISTANCE OVER A 50 FT OBSTACLE.

WEIGHT POUNDS	IAS APPROACH SPEED (ASSUMES ZERO INSTR. ERROR)	
	MPH	KNOTS
3400	90	78
3200	87	76
3000	84	73
2800	81	70
2600	78	68
2400	75	65

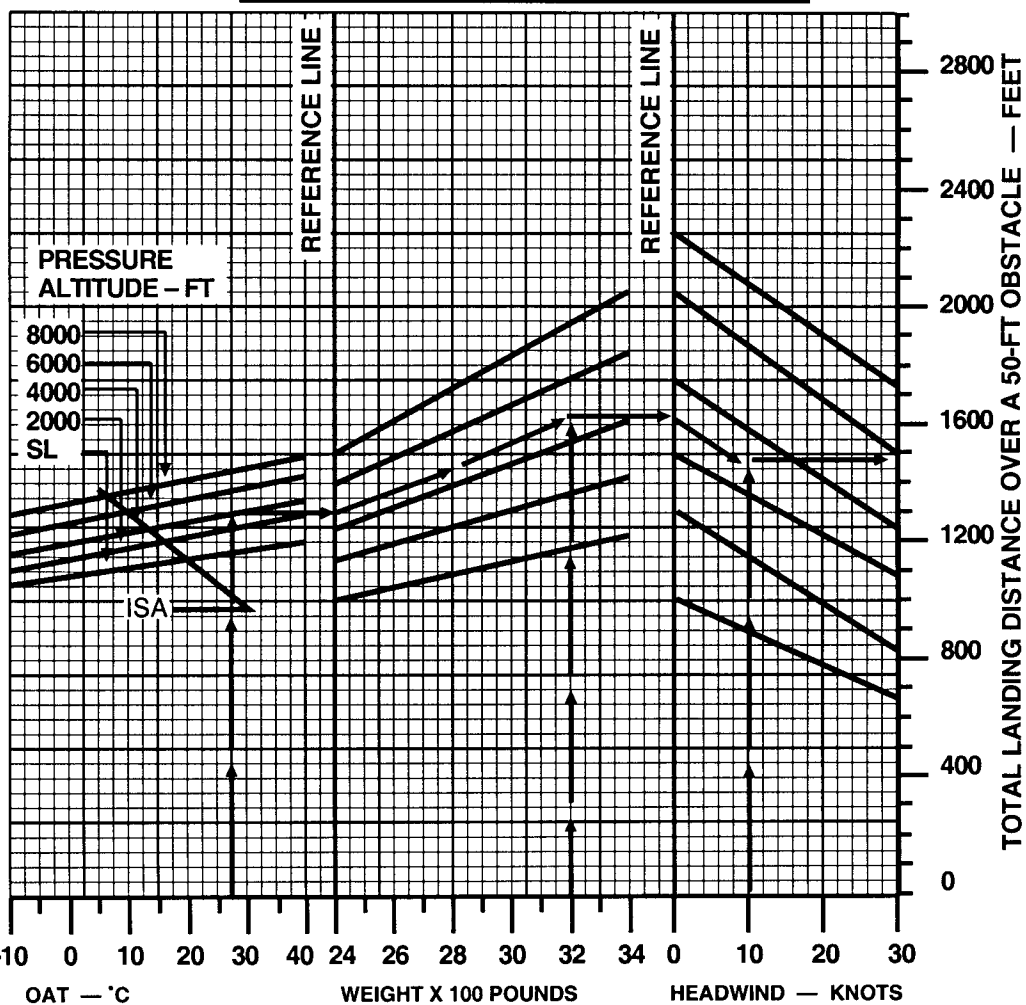

FIGURE 31.—Landing Distance Chart.

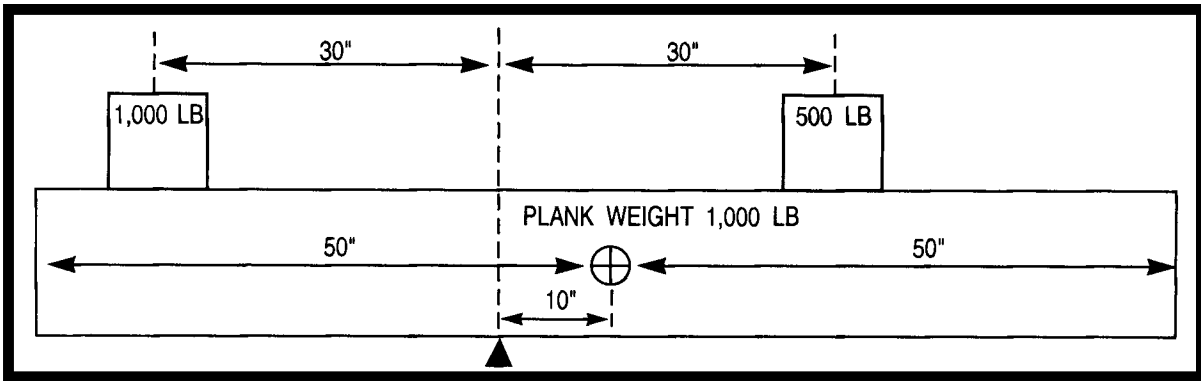

FIGURE 32.—Weight and Balance Diagram.

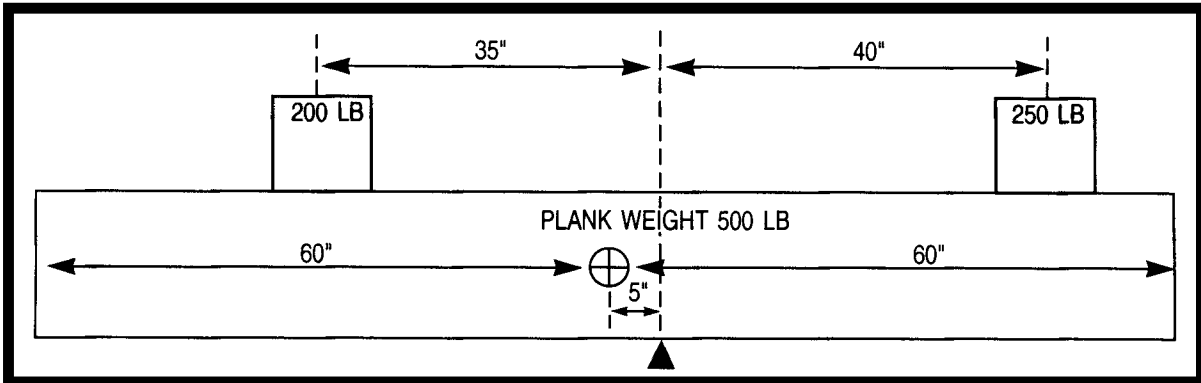

FIGURE 33.—Weight and Balance Diagram.

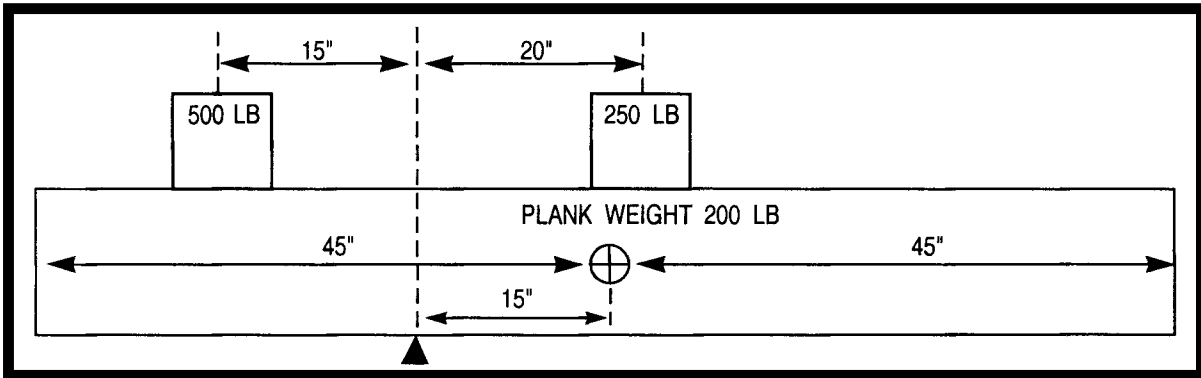

FIGURE 34.—Weight and Balance Diagram.

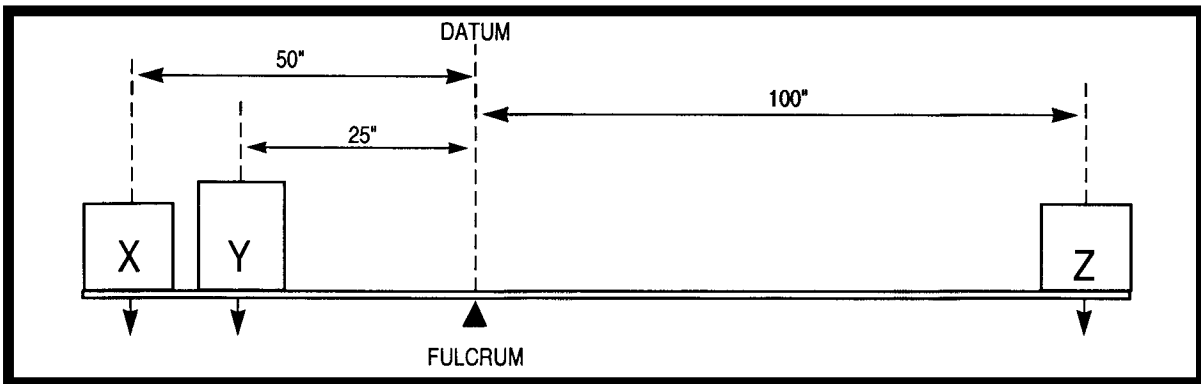

FIGURE 35.—Weight and Balance Diagram.



### USEFUL LOAD WEIGHTS AND MOMENTS

EMPTY WEIGHT DATA		
*Oil is included in empty weight	Empty Weight (Lb.)	Empty Weight Moment (/100)
	Certificated Weight	2110      1652

OCCUPANTS				
Front Seats		Rear Seats		
ARM 85			Fwd Position ARM 111	Aft Position ARM 136
Weight	Moment	Weight	Moment	Moment
120	102	120	145	163
130	111	130	157	177
140	119	140	169	190
150	128	150	182	204
160	136	160	194	218
170	145	170	206	231
180	153	180	218	245
190	162	190	230	258
200	170	200	242	273

FUEL					
ARM 75					
Gallons	Weight	Moment	Gallons	Weight	Moment
5	30	23	45	270	203
10	60	45	49	294	221
15	90	68	55	330	248
20	120	90	60	360	270
25	150	113	65	390	293
30	180	135	70	420	315
35	210	158	75	450	338
40	240	180	80	480	360

BAGGAGE	
ARM 150	
Weight	Moment
10	15
20	30
30	45
40	60
50	75
60	90
70	105
80	120
90	135
100	150
110	165
120	180
130	195
140	210
150	225
160	240
170	255
180	270
190	285
200	300
210	315
220	330
230	345
240	360
250	375
260	390
270	405

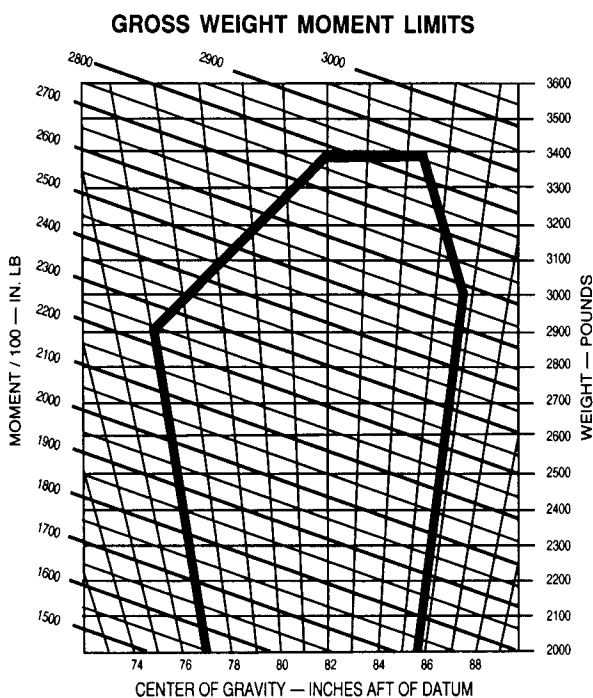

NOTE: All moments are equal to  

$$\frac{\text{weight} \times \text{arm}}{100}$$

FIGURE 36.—Weight and Balance Chart.

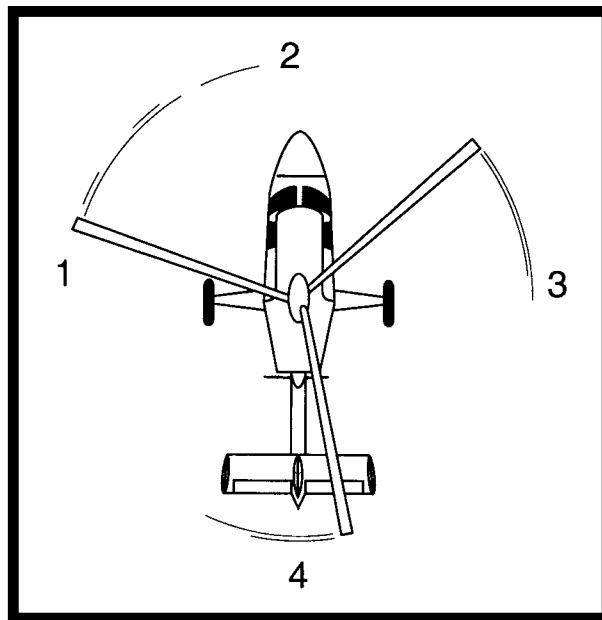

FIGURE 37.—Rotor Blade Positions.

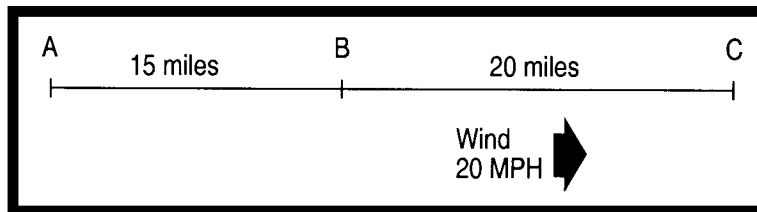

FIGURE 38.—Glider Cross-Country.

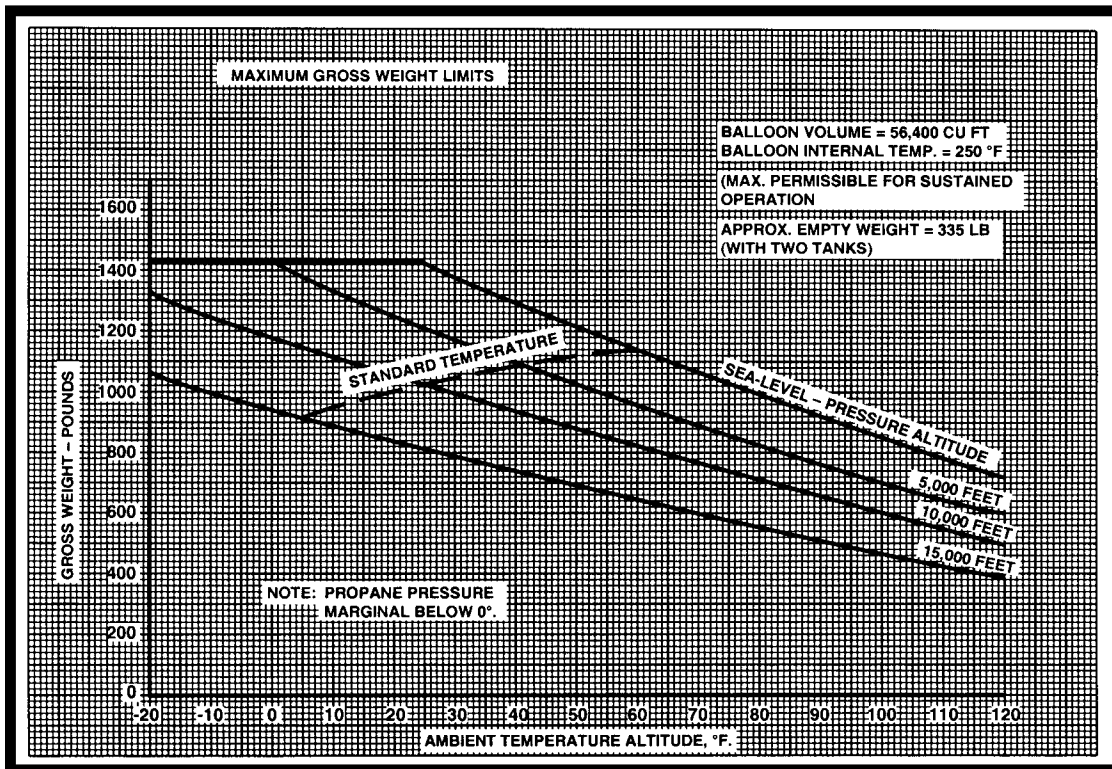

FIGURE 39.—Balloon Performance Graph.

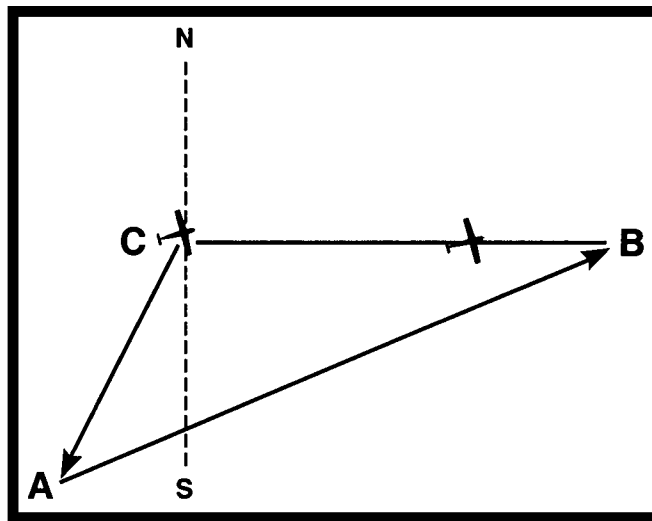

FIGURE 40.—Wind Triangle.

BOSC FA 241845  
 SYNOPSIS AND VFR CLDS/WX  
 SYNOPSIS VALID UNTIL 251300  
 CLDS/WX VALID UNTIL 250700...OTLK VALID 250700-251300  
 ME NH VT MA RI CT NY LO NJ PA OH LE WV MD DC DE VA AND CSTL WTRS  
 .  
 SEE AIRMET SIERRA FOR IFR CONDS AND MTN OBSCN.  
 TS IMPLY SEV OR GTR TURB SEV ICE LLWS AND IFR CONDS.  
 NON MSL HGTS DENOTED BY AGL OR CIG.  
 .  
 SYNOPSIS...19Z CDFNT ALG A 160NE ACK-ENE LN...CONTG AS A QSTNRY  
 FNT ALG AN END-50SW MSS LN. BY 13Z...CDFNT ALG A 140ESE ACK-HTO  
 LN...CONTG AS A QSTNRY FNT ALG A HTO-SYR-YYZ LN. TROF ACRS CNTRL  
 PA INTO NRN VA. ...REYNOLDS...  
 .  
 OH LE  
 NRN HLF OH LE...SCT-BKN025 OVC045. CLDS LYRD 150. SCT SHRA. WDLY  
 SCT TSRA. CB TOPS FL350. 23-01Z OVC020-030. VIS 3SM BR. OCNL -  
 RA. OTLK...IFR CIG BR FG.  
 SWRN QTR OH...BKN050-060 TOPS 100. OTLK...MVFR BR.  
 SERN QTR OH...SCT-BKN040 BKN070 TOPS 120. WDLY SCT -TSRA. 00Z  
 SCT-BKN030 OVC050. WDLY SCT -TSRA. CB TOPS FL350. OTLK...VFR  
 SHRA.  
 .  
 CHIC FA 241945  
 SYNOPSIS AND VFR CLDS/WX  
 SYNOPSIS VALID UNTIL 251400  
 CLDS/WX VALID UNTIL 250800...OTLK VALID 250800-251400  
 ND SD NE KS MN IA MO WI LM LS MI LH IL IN KY  
 .  
 SEE AIRMET SIERRA FOR IFR CONDS AND MTN OBSCN.  
 TS IMPLY SEV OR GTR TURB SEV ICE LLWS AND IFR CONDS.  
 NON MSL HGTS DENOTED BY AGL OR CIG.  
 .  
 SYNOPSIS...LOW PRES AREA 20Z CNTRD OVR SERN WI FCST MOV NEWD INTO  
 LH BY 12Z AND WKN. LOW PRES FCST DEEPEN OVR ERN CO DURG PD AND  
 MOV NR WRN KS BORDER BY 14Z. DVLPG CDFNT WL MOV EWD INTO S CNTRL  
 NE-CNTRL KS BY 14Z. ..SMITH..  
 .  
 UPR MI LS  
 WRN PTNS...AGL SCT030 SCT-BKN050. TOPS 080. 02-05Z BECMG CIG  
 OVC010 VIS 3-5SM BR. OTLK...IFR CIG BR.  
 ERN PTNS...CIG BKN020 OVC040. OCNL VIS 3-5SM -RA BR. TOPS FL200.  
 23Z CIG OVC010 VIS 3-5SM -RA BR. OTLK...IFR CIG BR.  
 .  
 LWR MI LM LH  
 CNTRL/NRN PTNS...CIG OVC010 VIS 3-5SM -RA BR. TOPS FL200.  
 OTLK...IFR CIG BR.  
 .  
 SRN THIRD...CIG OVC015-025. SCT -SHRA. TOPS 150. 00-02Z BECMG CIG  
 OVC010 VIS 3-5SM BR. TOPS 060. OTLK...IFR CIG BR.  
 .  
 IN  
 NRN HALF...CIG BKN035 BKN080. TOPS FL200. SCT -SHRA. 00Z CIG  
 BKN-SCT040 BKN-SCT080. TOPS 120. 06Z AGL SCT-BKN030. TOPS 080.  
 OCNL VIS 3-5SM BR. OTLK...MVFR CIG BR.  
 SRN HALF...AGL SCT050 SCT-BKN100. TOPS 120. 07Z AGL SCT 030  
 SCT100. OTLK...VFR.

FIGURE 41.—Area Forecast.

## TAF

KMEM 121720Z 121818 20012KT 5SM HZ BKN030 PROB40 2022 1SM TSRA OVC008CB  
 FM2200 33015G20KT P6SM BKN015 OVC025 PROB40 2202 3SM SHRA  
 FM0200 35012KT OVC008 PROB40 0205 2SM -RASN BECMG 0608 02008KT NSW BKN012  
 BECMG 1012 00000KT 3SM BR SKC TEMPO 1214 1/2SM FG  
 FM1600 VRB04KT P6SM NSW SKC=

KOKC 051130Z 051212 14008KT 5SM BR BKN030 TEMPO 1316 1 1/2SM BR  
 FM1600 16010KT P6SM NSW SKC BECMG 2224 20013G20KT 4SM SHRA OVC020  
 PROB40 0006 2SM TSRA OVC008CB BECMG 0608 21015KT P6SM NSW SCT040=

FIGURE 42.—Terminal Aerodrome Forecasts (TAF).

FD WBC 151745

BASED ON 151200Z DATA

VALID 1600Z FOR USE 1800-0300Z. TEMPS NEG ABV 24000

FT	3000	6000	9000	12000	18000	24000	30000	34000	39000
ALS			2420	2635-08	2535-18	2444-30	245945	246755	246862
AMA		2714	2725+00	2625-04	2531-15	2542-27	265842	256352	256762
DEN			2321-04	2532-08	2434-19	2441-31	235347	236056	236262
HLC		1707-01	2113-03	2219-07	2330-17	2435-30	244145	244854	245561
MKC	0507	2006+03	2215-01	2322-06	2338-17	2348-29	236143	237252	238160
STL	2113	2325+07	2332+02	2339-04	2356-16	2373-27	239440	730649	731960

FIGURE 43.—Winds and Temperatures Aloft Forecast.



FIGURE 44.—Sectional Chart Excerpt.



FIGURE 45.—Sectional Chart Excerpt.



FIGURE 46.—Sectional Chart Excerpt.



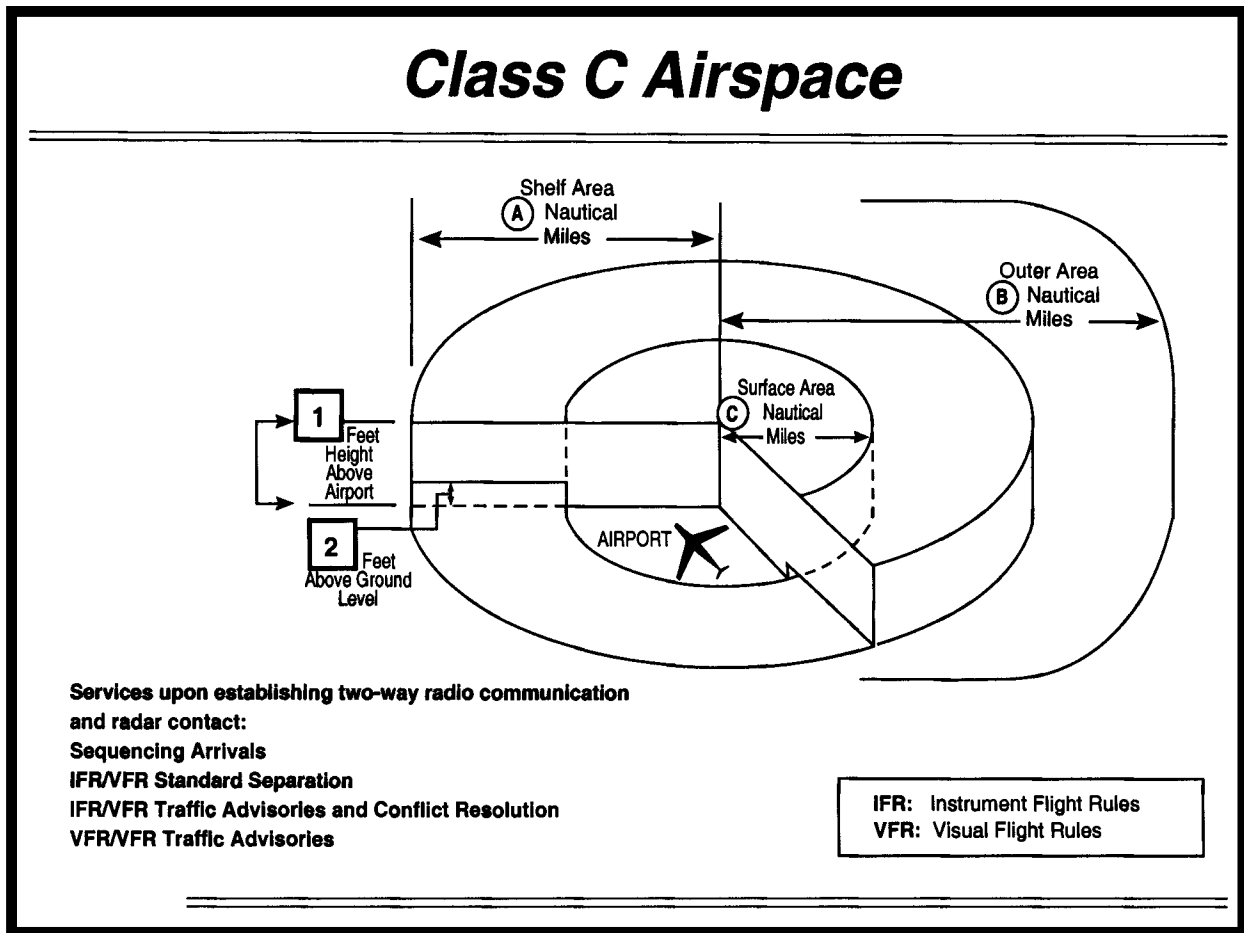

FIGURE 47.—Class C Airspace Diagram.

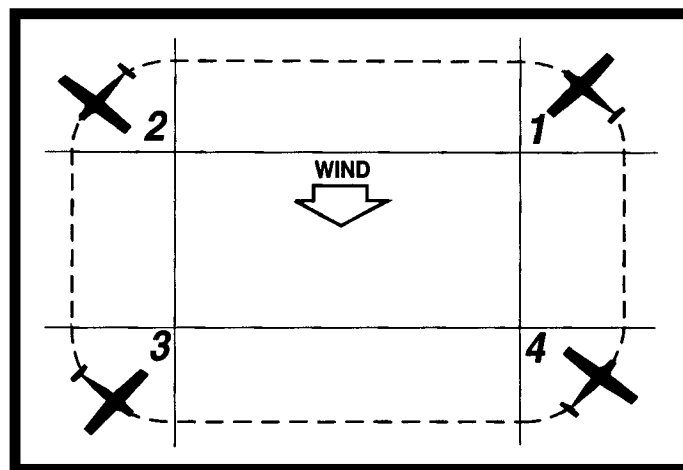

FIGURE 48.—Rectangular Course.

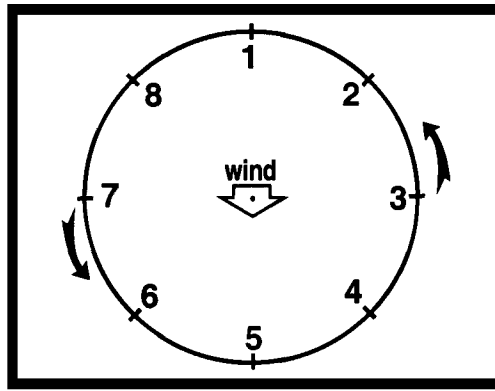

FIGURE 49.—Ground Track Diagram.

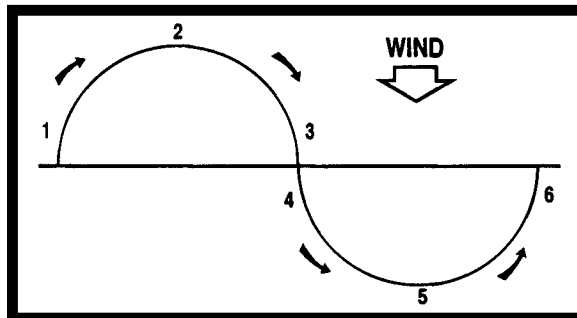

FIGURE 50.—S-Turn Diagram.

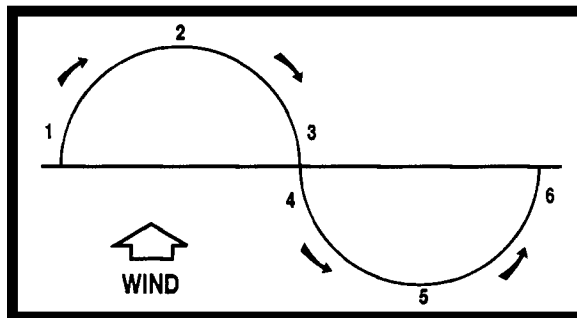

FIGURE 51.—S-Turn Diagram.

UA /OV OKC-TUL /TM 1800 /FL 120 /TP BE90 /SK 018 BKN 055 /  
 /072 OVC 089 /CLR ABV /TA -9/WV 0921/TB MDT 055-072 /IC LGT-MDT  
 CLR 072-089.

FIGURE 52.—Pilot Weather Report.

UA/OV KOKC-KTUL/TM 1800/FL120/TP BE90//SK BKN018-TOP055/OVC072-  
 TOP089/CLR ABV/TA M7/WV 08021/TB LGT 055-072/IC LGT-MOD RIME 072-089

FIGURE 52A.—Pilot Weather Report.

METAR KINK 121845Z 11012G18KT 15SM SKC 25/17 A3000  
 METAR KBOI 121854Z 13004KT 30SM SCT150 17/6 A3015  
 METAR KLAX 121852Z 25004KT 6SM BR SCT007 SCT250 16/15 A2991  
 SPECI KMDW 121856Z 32005KT 1 1/2SM RA OVC007 17/16 A2980 RMK RAB35  
 SPECI KJFK 121853Z 18004KT 1/2SM FG R04/2200 OVC005 20/18 A3006

FIGURE 53.—Aviation Routine Weather Reports (METAR).

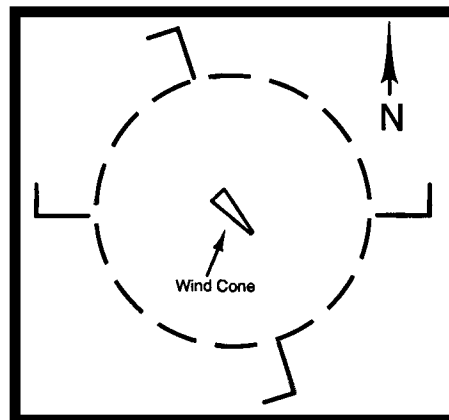

FIGURE 54.—Traffic Pattern Indicator.

<b>TEXAS</b>		<b>156</b>
<b>DALLAS LOVE FLD (DAL) 5 NW UTC-6(-5DT) N32°50.83' W96°51.11'</b> 487 B S4 FUEL 100LL, JET A OX 1, 2, 3, 4 LRA ARFF Index B RWY 13R-31L: H8800X150 (CONC) S-100, D-200, DT-350 HIRL,CL RWY 13R: VASI(V4L)—GA 3.0' TCH 53'. Thld dsplcd 490'. Tree. Rgt ttc. RWY 31L: MALS. TDZ. Building.		<b>DALLAS-FT. WORTH</b> H-2E, 4F, 5B, L-13C, A IAP
RWY 13L-31R: H7753X150 (CONC-GRVD) S-100, D-200, DT-350 HIRL, CL RWY 13L: MALS. TDZ. Tree. <b>RWY 31R: MALS. VASI(V4L)—GA 3.0' TCH 38'. Pole. Rgt ttc.</b>		
RWY 18-36: H6149X150 (ASPH) S-50, D-74, DT-138 HIRL RWY 18: VASI(V4L)—GA 3.0' TCH 52'. Rgt ttc. <b>RWY 36: VASI(V4L)—GA 3.0' TCH 52'. REIL. Tree. Rgt ttc.</b>		
<b>RUNWAY DECLARED DISTANCE INFORMATION</b>		
RWY 13L:	TORA-7753 TORA-7753 ASDA-7753 LDA-7753	
RWY 31R:	TORA-7753 TORA-7753 ASDA-7753 LDA-7753	
RWY 13R:	TORA-8800 TORA-8800 ASDA-8800 LDA-8310	
RWY 31L:	TORA-8800 TORA-8800 ASDA-8800 LDA-8800	
RWY 18:	TORA-6149 TORA-6149 ASDA-6149 LDA-6149	
RWY 36:	TORA-6149 TORA-6149 ASDA-6149 LDA-6149	
<b>AIRPORT REMARKS:</b> Attended continuously. Birds on and in/ovt arpt. 260' AGL crane 1 mile south AER 3 1L SR-SS. 180' marked crane 4000' south AER 31L daltg hours. Ldg Rwy 18 & takeoff Rwy 36 not authorized to aircraft over 60,000 lbs gross weight unless crosswind NW-SE rwys exceed acft safe operating capability. Noise sensitive areas all quadrants, noise abatement procedures in effect for fixed and rotary wing ttc, for information call arpt ops 214-670-6610. Private pilot certificate or better required to takeoff or land, no student solo flights permitted. Rwy 36 VASI OTS indef. Rwy 31R VASI OTS indef. Twy B7 clsd indef. Twy A has a 500' lgtd barricade 3600' apch end Rwy 13L. Twy M edge lgts out of svc between Twy B and Rwy 18, reflectors in place. Twy K clsd thru traffic. Flight Notification Service (ADCUS) available. NOTE: See Land and Hold Short Operations Section.		
<b>COMMUNICATIONS:</b> ATIS 120.15 UNICOM 122.95 FORT WORTH FSS (FTW) TF 1-800-WX-BRIEF. NOTAM FILE DAL. DALLAS RCO 122.3 (FORT WORTH FSS)		
Ⓞ REGIONAL APP CON 125.2 (South) 124.3 (North) LOVE TOWER 118.7 GND CON 121.75 CLNC DEL 127.9		
Ⓞ REGIONAL DEP CON 118.55		
<b>RADIO AIDS TO NAVIGATION:</b> NOTAM FILE DAL.		
DALLAS - FT WORTH (H) VORTACW 117.0 DFW Chan 117 N32°51.96' W97°01.68' 089° 9.0 NM to fld. 560/8E		
CONIS NDB (LOM) 275 LV N32°46.48' W96°46.51' 311° 5.8 NM to fld.		
ILS/DME 111.5 I-DAL Chan 52 Rwy 13L.		
ILS/DME 111.1 I-DPX Chan 48 Rwy 13R. LOC unusable beyond 25' right side of course.		
ILS/DME 111.1 I-LVF Chan 48 Rwy 31L. LOM CONIS NDB. BC unusable.		
ILS/DME 111.5 I-OVW Chan 52 Rwy 31R.		
<b>ASR</b>		
<b>REDBIRD (RBD) 6 SW UTC-6(-5DT) N32°40.85' W96°52.09'</b> 660 B S4 FUEL 100LL, JET A OX 1, 2 RWY 13-31: H6451X150 (CONC) S-35, D-60, DT-110 MIRL 0.3% up NW RWY 13: REIL. VASI(V4L)—GA 3.0' TCH 50'. Trees. RWY 31: LDIN. VASI(V4L)—GA 3.0' TCH 47'. Road.		<b>DALLAS-FT. WORTH</b> COPTER H-2E, 4F, 5B, L-13C, 17A, A IAP
RWY 17-35: H3801X150 (CONC) S-35, D-60, DT-110 MIRL RWY 17: REIL. PAPI (P4R)—GA 3.0' TCH 43'. <b>RWY 35: REIL.</b>		
<b>AIRPORT REMARKS:</b> Attended 1400-0300Z. Birds on and in vicinity of arpt. When twr closed ACTIVATE LDIN Rwy 31 VASI Rwy 13 and PAPI RWY 17—120.3. NOTE: See Land and Hold Short Operations Section.		
<b>WEATHER DATA SOURCES:</b> ASOS 126.925 (214) 330-5317. LAWRS.		
<b>COMMUNICATIONS:</b> CTAF 120.3 ATIS 126.35 UNICOM 122.95 FORT WORTH FSS (FTW) TF 1-800-WX-BRIEF. NOTAM FILE RBD.		
Ⓞ REGIONAL APP/DEP CON 125.2 TOWER 120.3 (1400-0300z) GND CON 121.7 CLNC DEL 125.45		
<b>AIRSPACE:</b> CLASS D svc effective 1400-0300Z other times CLASS G.		
<b>RADIO AIDS TO NAVIGATION:</b> NOTAM FILE DFW.		
DALLAS-FT WORTH (H) VORTACW 117.0 DFW Chan 117 N32°51.96' W97°01.68' 136°13.7 NM to fld. 560/08E.		
NDB (HW) 287 RBD N32°40.62' W96°52.27' at fld. NOTAM FILE RBD.		
ILS 108.5 I-RBD Rwy 31. Unmonitored when tower closed.		
<hr/> <b>DAN E. RICHARDS MUNI (See PADUCAH)</b>		
<b>DAVID HOOKS N30°07.53' W95°33.96' NOTAM FILE DWH.</b> NDB (MHW) 521 DWH 164° 3.9 NM to David Wayne Hooks Mem. Unmonitored.		<b>HOUSTON</b> L-17B
<hr/> <b>DAVID WAYNE HOOKS MEM (See HOUSTON)</b>		

FIGURE 55.—Airport/Facility Directory.

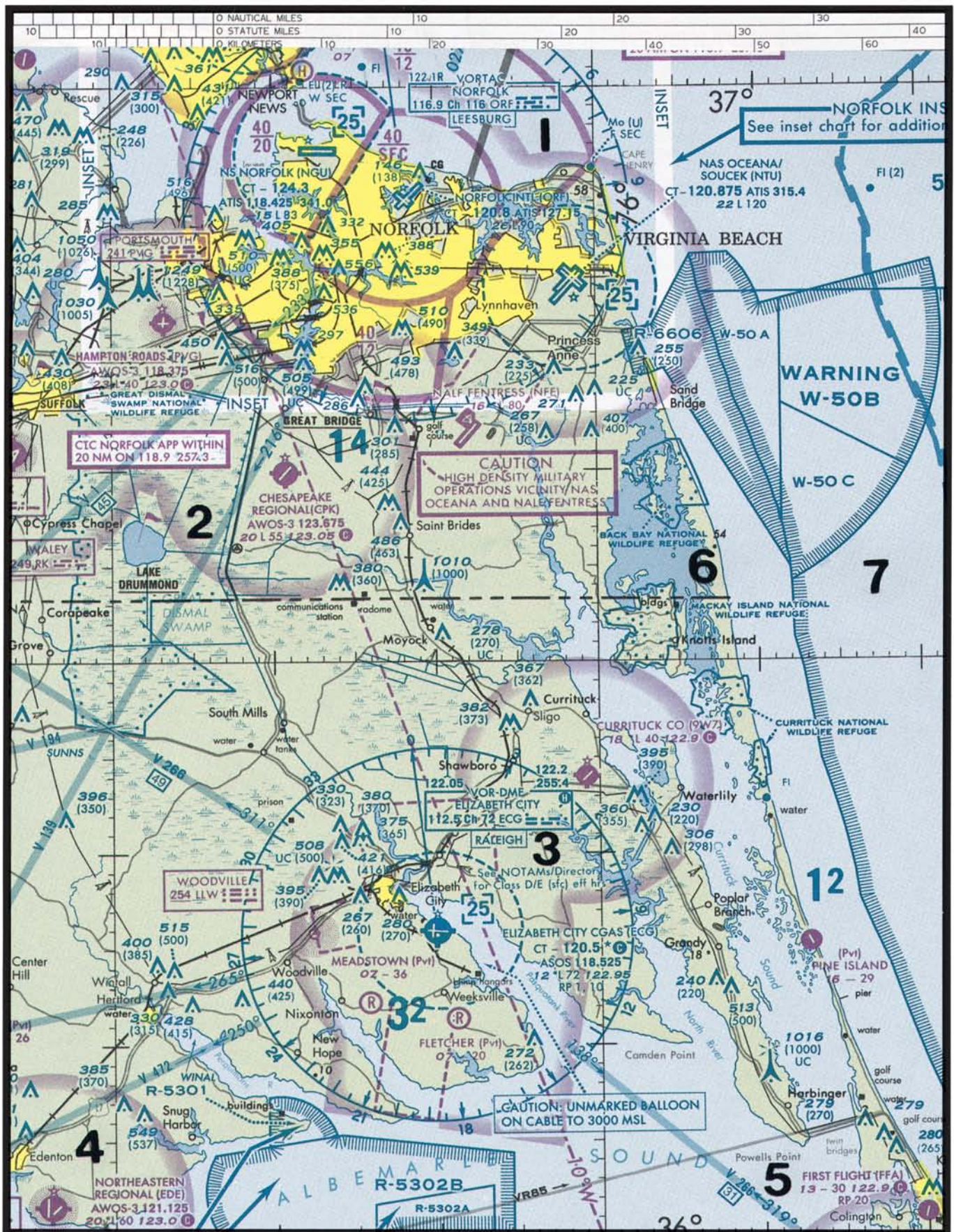

FIGURE 56.—Sectional Chart.

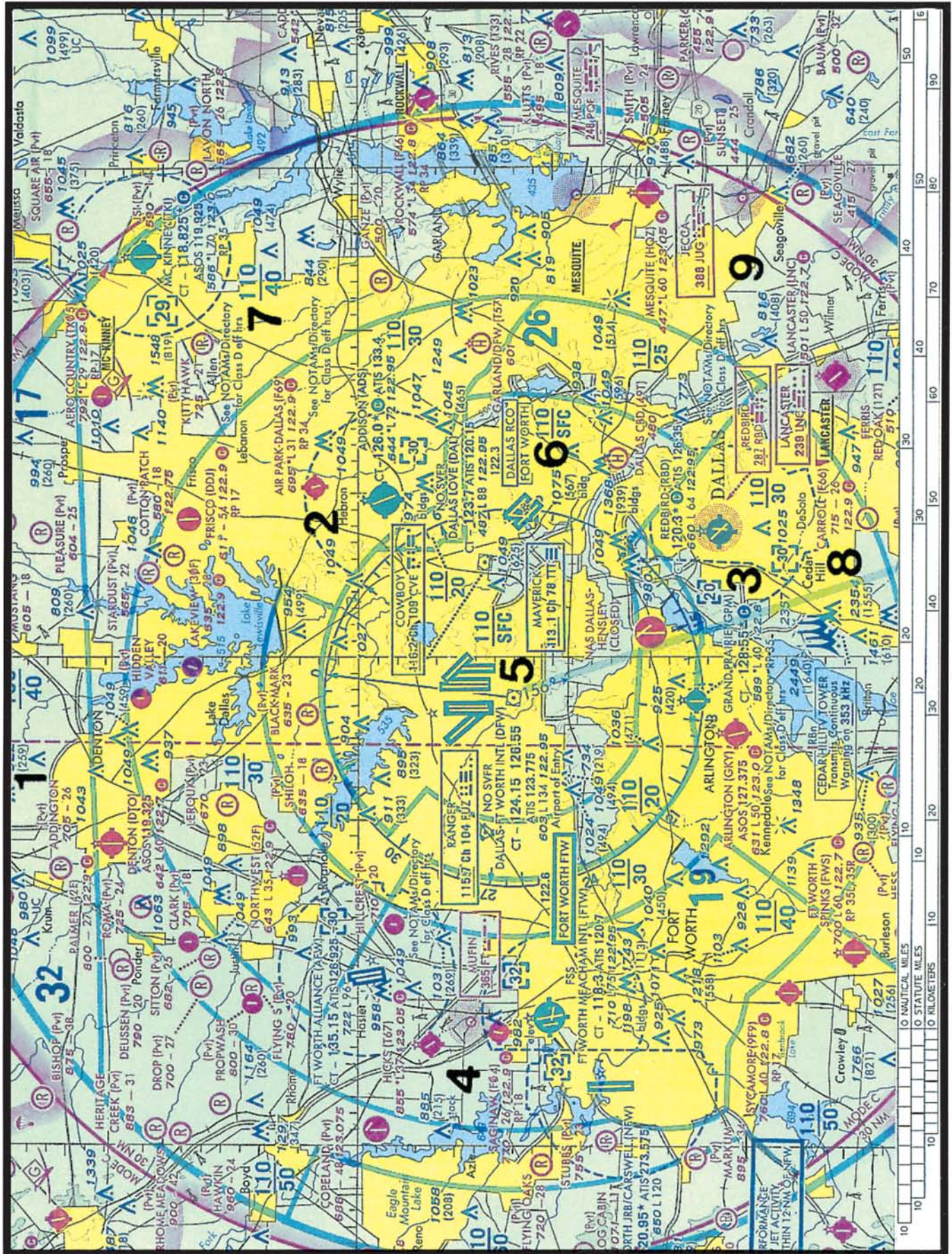

Figure 57.—Sectional Chart Excerpt.

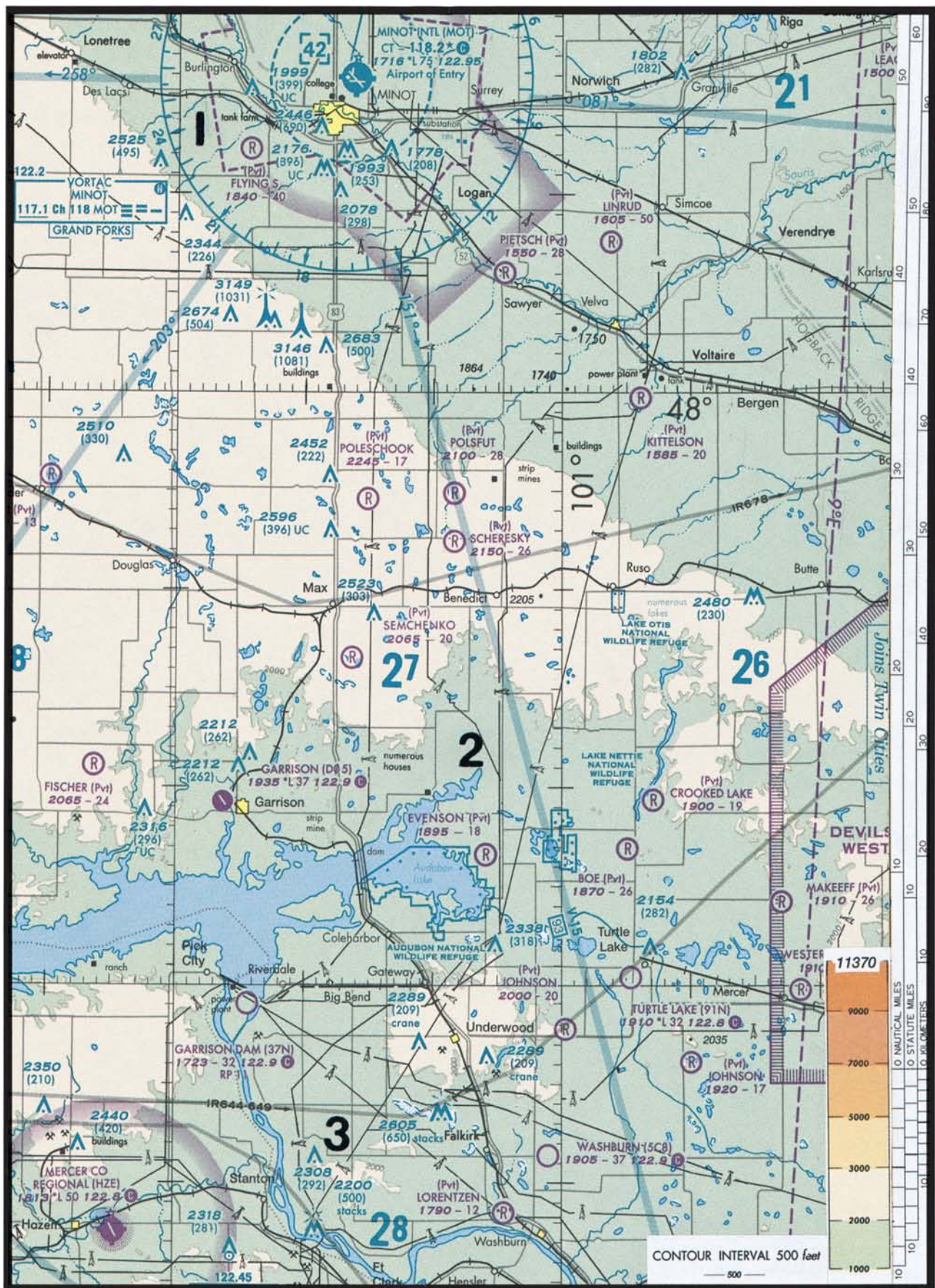

FIGURE 58.—Sectional Chart Excerpt.

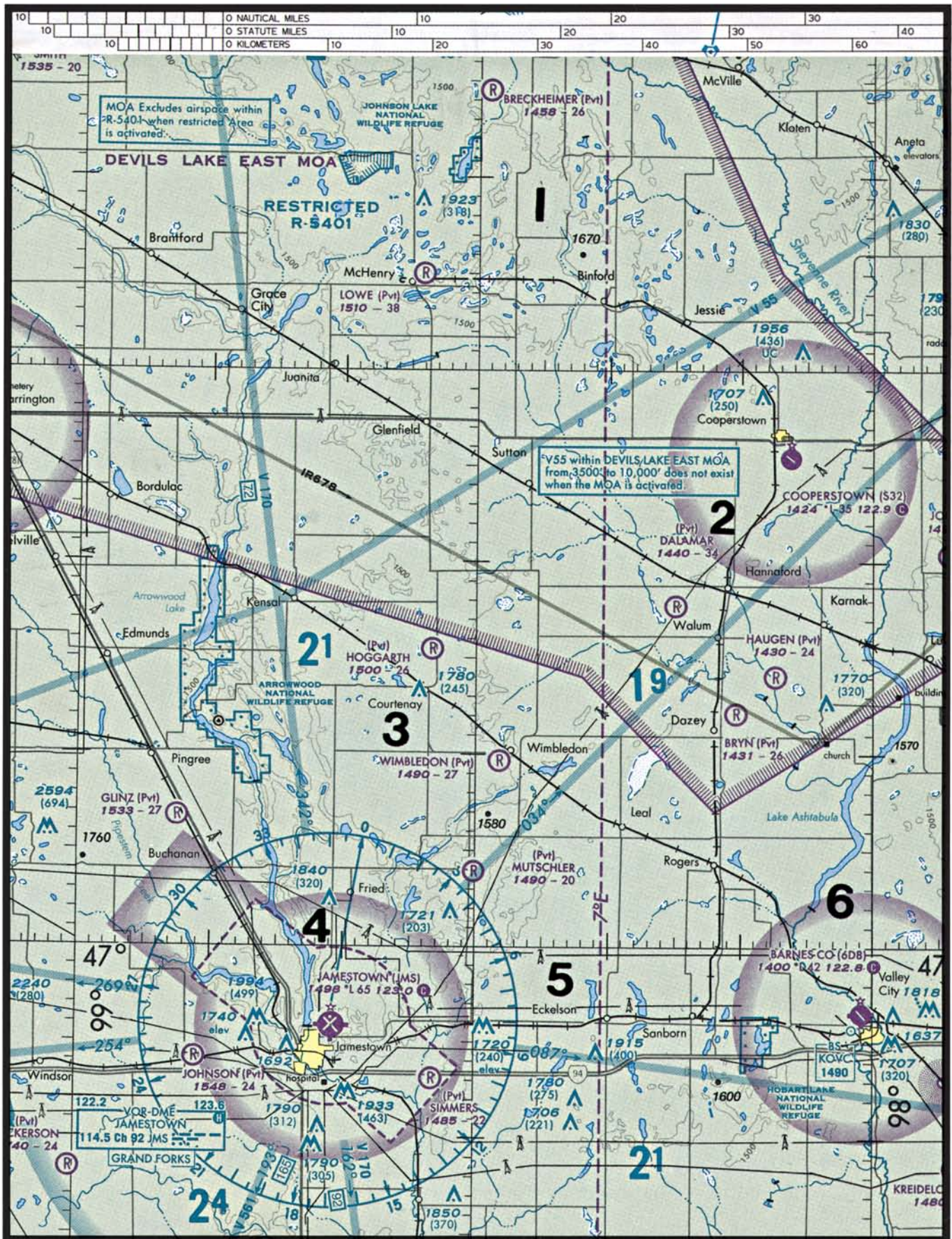

FIGURE 59.—Sectional Chart Excerpt.—Sectional Chart Excerpt.



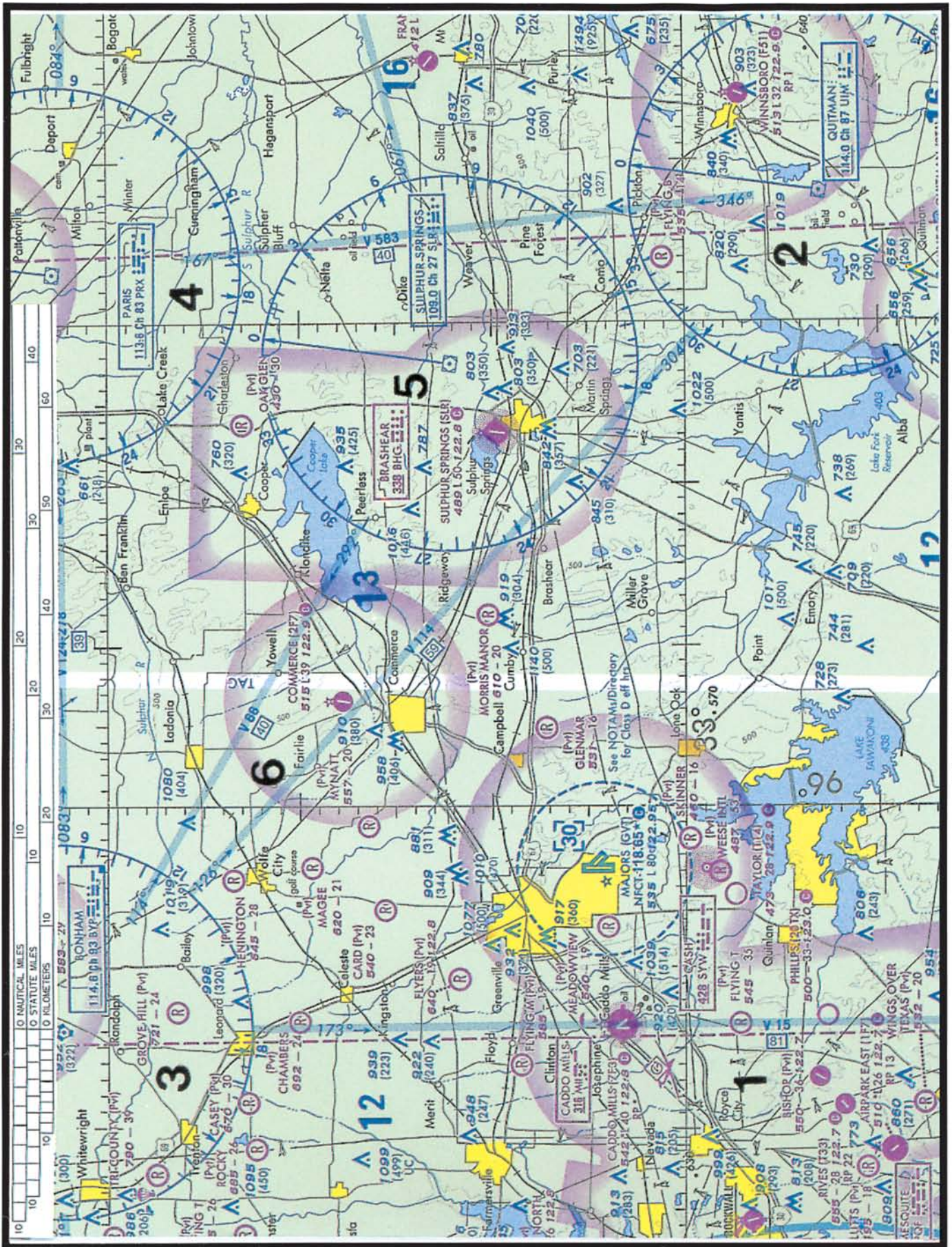

FIGURE 60.—Sectional Chart Excerpt.



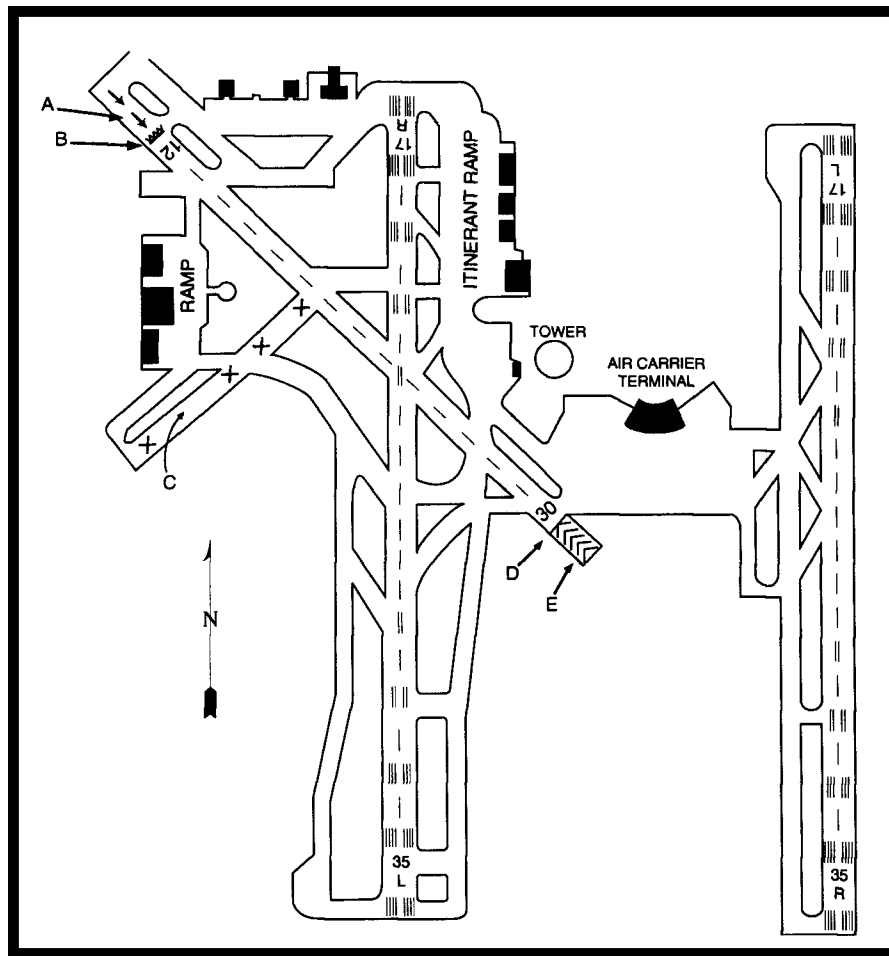

FIGURE 62.—Airport Diagram.

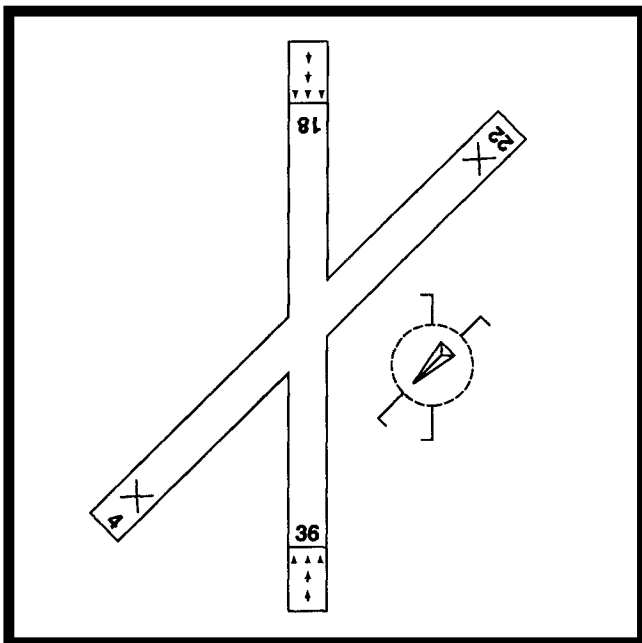

FIGURE 63.—Airport Diagram.

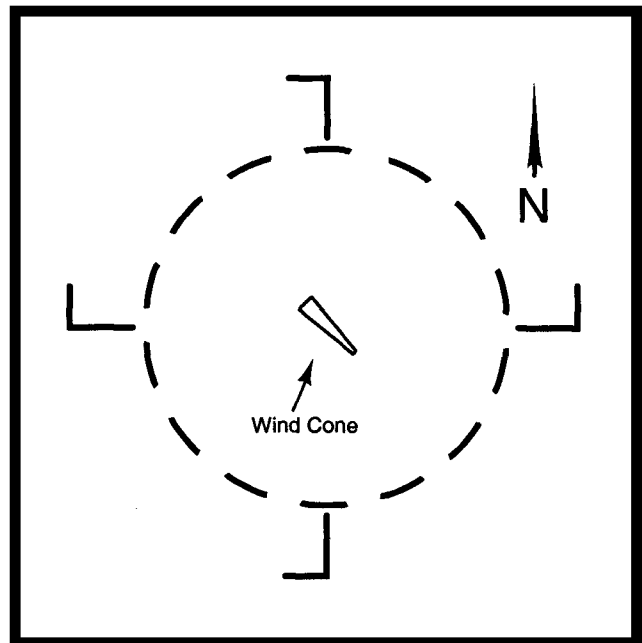

FIGURE 64.—Airport Landing Indicator.

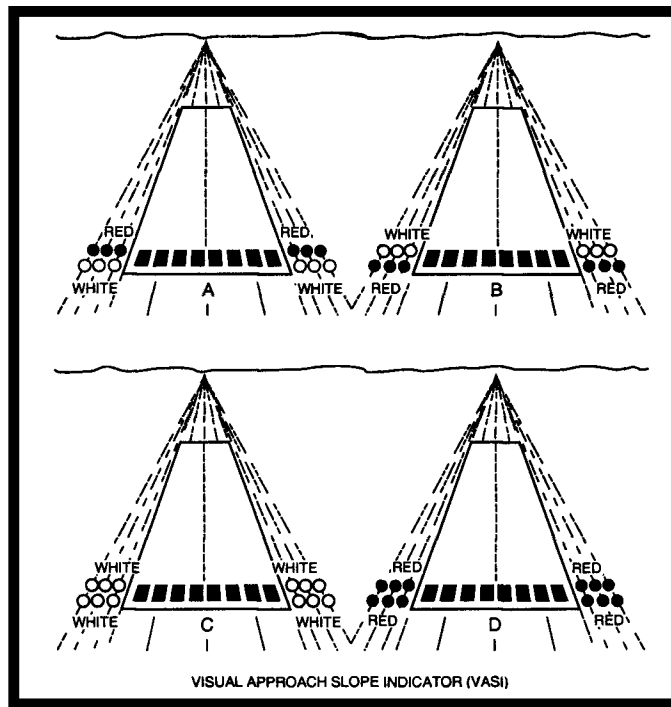

FIGURE 65.—VASI Illustrations.

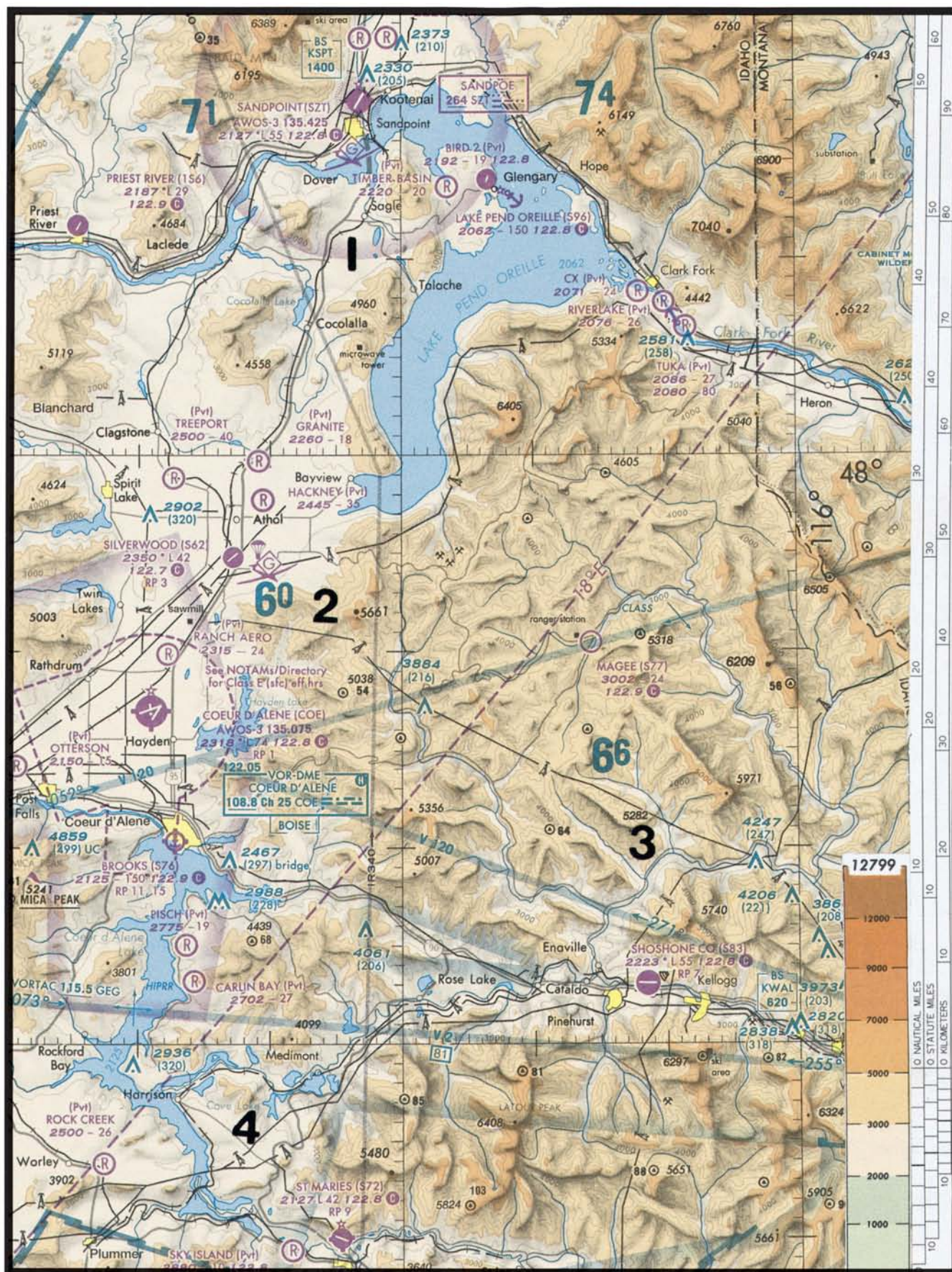

FIGURE 66.—Sectional Chart Excerpt.

**18** **IDAHO**

---

**COEUR D'ALENE AIR TERMINAL** (COE) 9 NW UTC-8(-7DT) N47°46.46' W116°49.17' **GREAT FALLS**  
 2318 B S4 FUEL 80, 100, JET A OX 1, 2 **H-1B, L-9A**  
**RWY 05-23:** H7400X140 (ASPH-GRVD) S-57, D-95, DT-165 HIRL 0.7%up NE **IAP**  
**RWY 05:** MALSR. **RWY 23:** REIL. VASI(V4L)—GA 3.0° TCH 39'.  
**RWY 01-19:** H5400X75 (ASPH) S-50, D-83, DT-150 MIRL  
**RWY 01:** REIL. Rgt tfc.

**AIRPORT REMARKS:** Attended Mon-Fri 1500-0100Z+. Rwy 05-23 potential standing water and/or ice on center 3000' of rwy. Arpt conditions avbl on UNICOM. Rwy 19 is designated calm wind rwy. ACTIVATE MIRL Rwy 01-19, HIRL Rwy 05-23 and MALSR Rwy 05—CTAF. REIL Rwy 23 opr only when HIRL on high ints.

**WEATHER DATA SOURCES:** AWOS-3 135.075 (208) 772-8215.  
**COMMUNICATIONS:** CTAF/UNICOM 122.8  
**BOISE FSS (BOI)** TF 1-800-WX-BRIEF. NOTAM FILE COE.  
**RCO 122.05 (BOISE FSS)**  
 ® **SPOKANE APP/DEP COM 132.1**  
**RADIO AIDS TO NAVIGATION:** NOTAM FILE COE.  
 (T) **VORW/DME 108.8 COE** Chan 25 N47°46.42' W116°49.24' at fld. 2290/19E.  
 DME portion unusable 280°-350° byd 15 NM blo 11000' 220°-240° byd 15 NM.  
**LEENY NDB (LOM) 347 CO** N47°44.57' W116°57.66' 053° 6.0 NM to fld.  
**ILS 110.7 I-COE Rwy 05 LOM LEENY NDB.** ILS localizer/glide slope unmonitored.

---

FIGURE 67.—Airport/Facility Directory Excerpt.

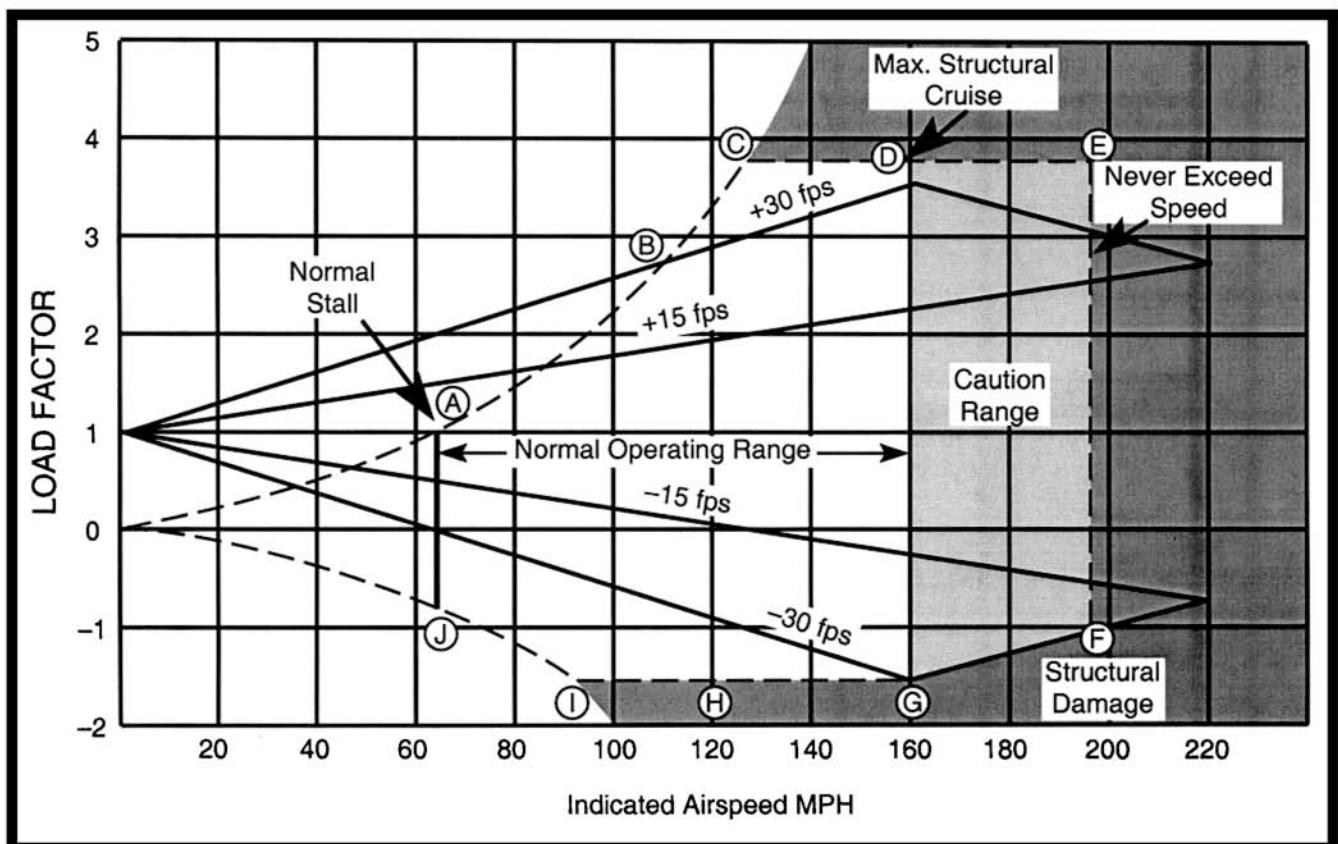

FIGURE 68.—Velocity vs. G-Loads.

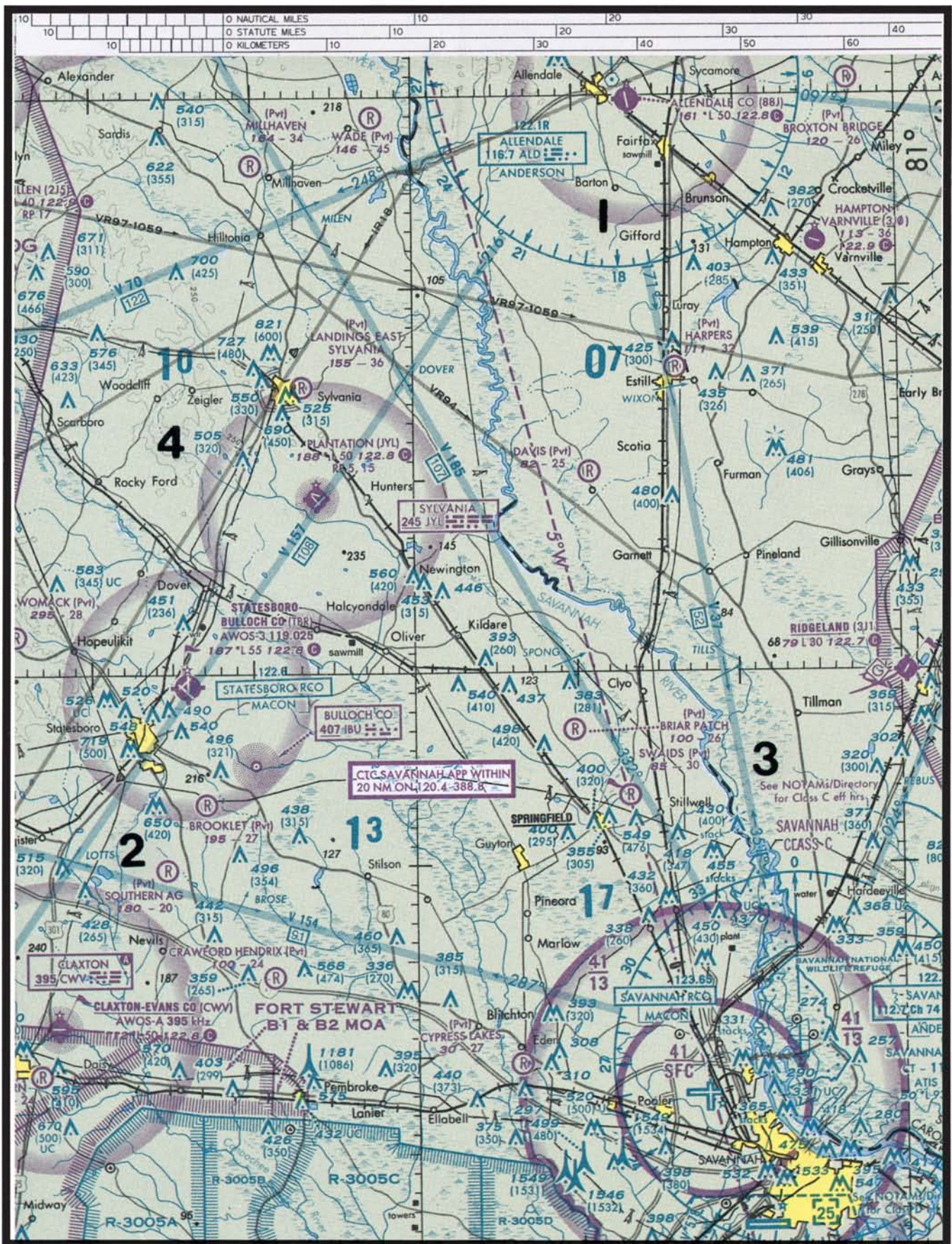

FIGURE 69.—Sectional Chart Excerpt.

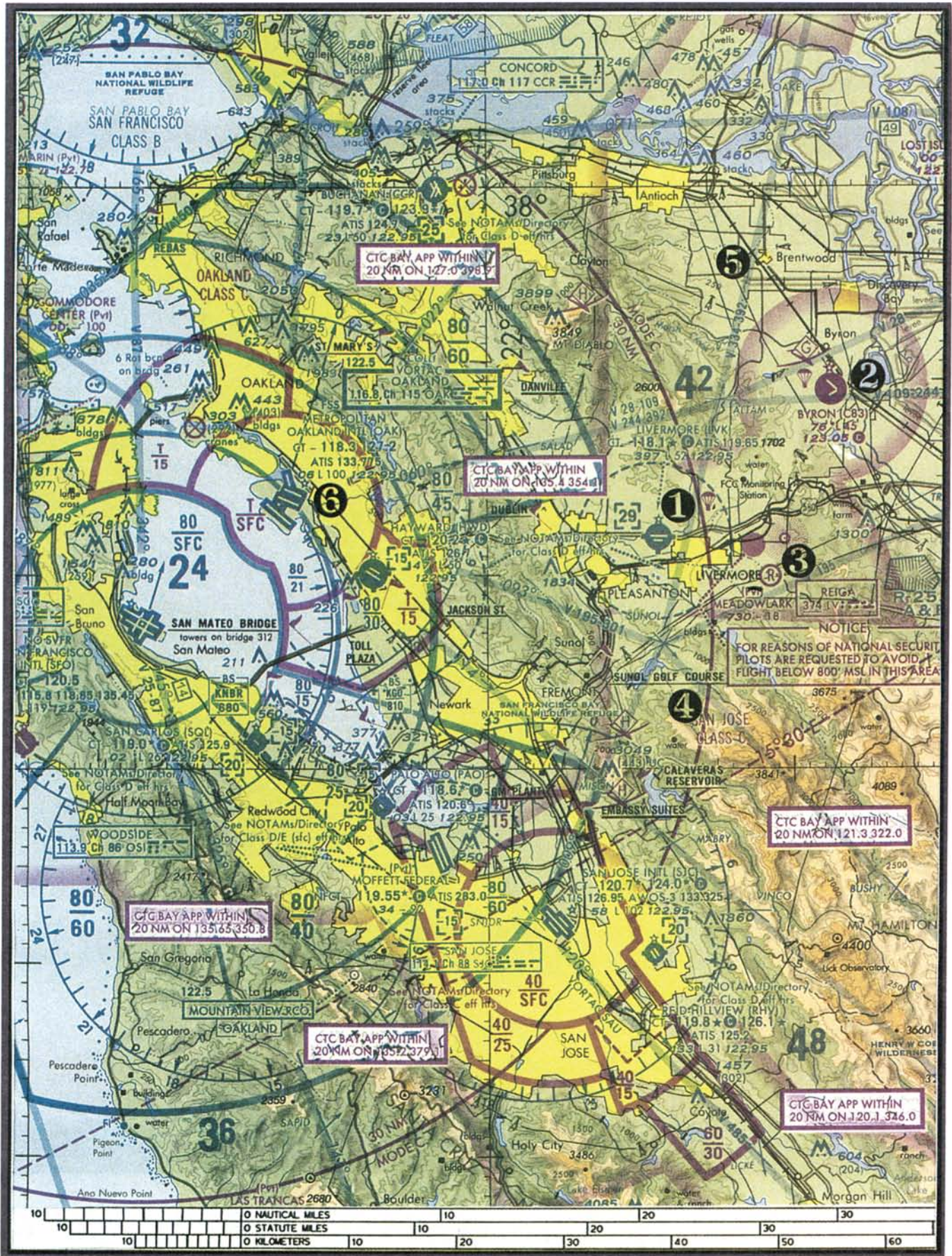

FIGURE 70.—Sectional Chart Excerpt.



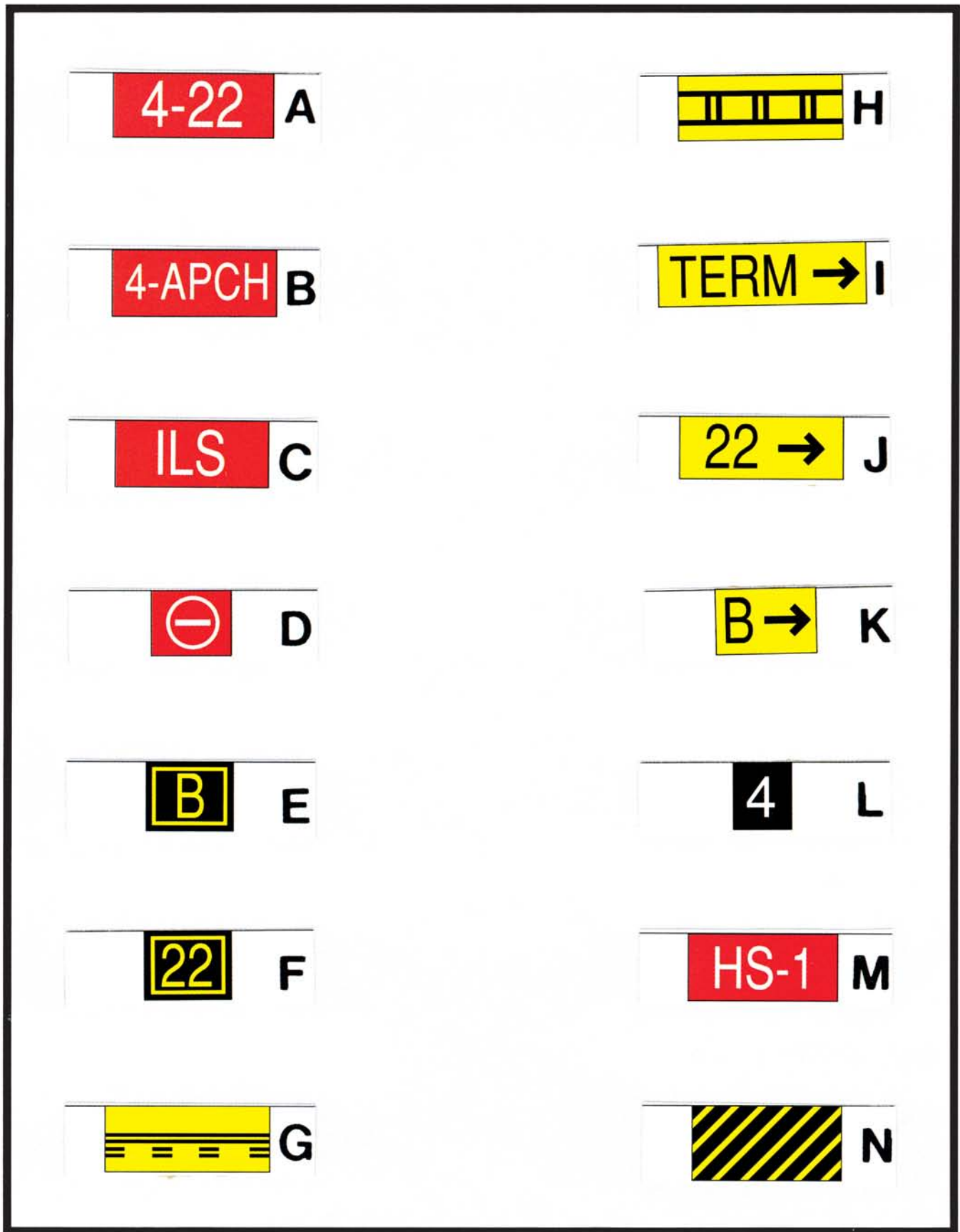

FIGURE 71.—U.S. Airport Signs.

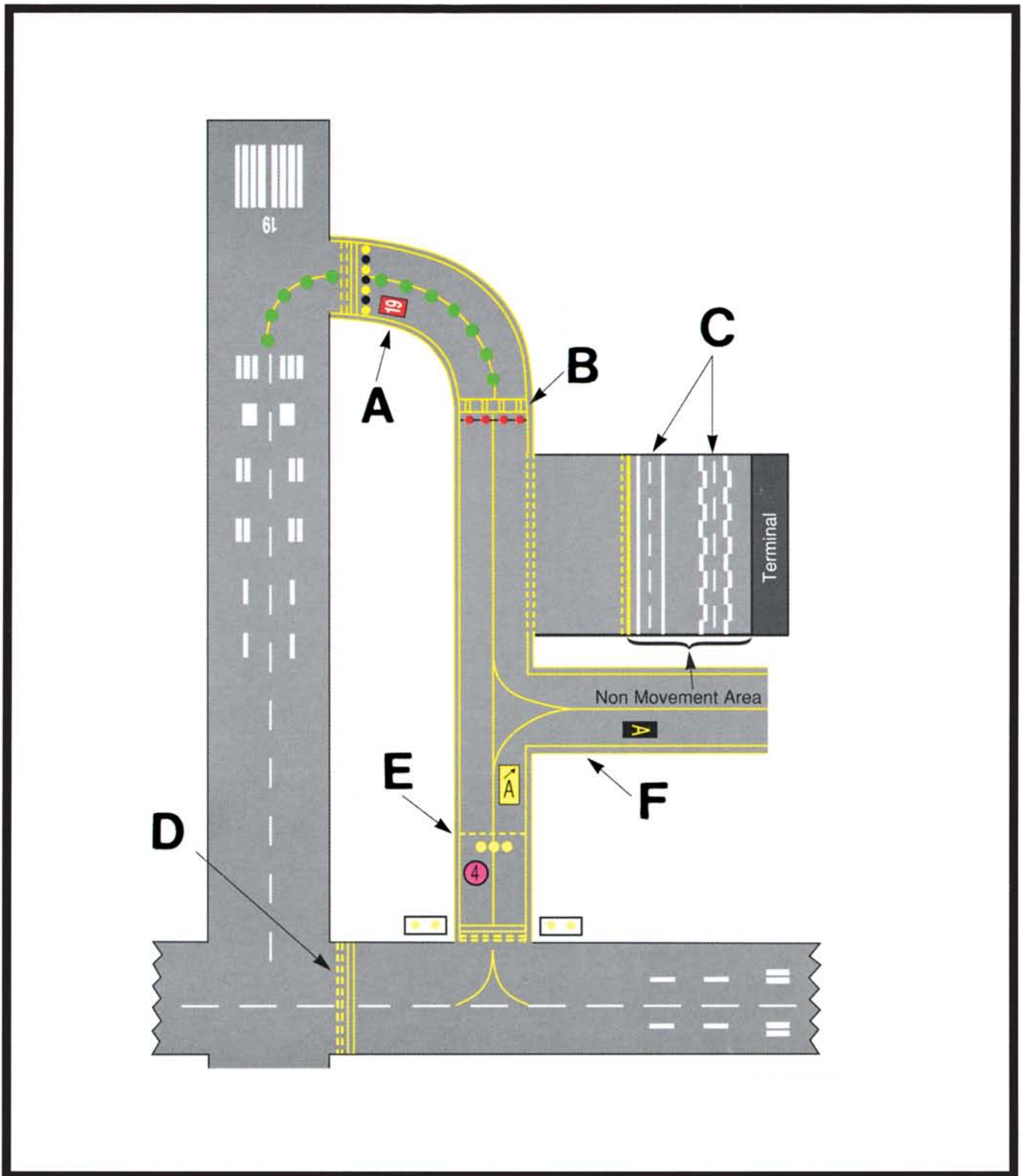

FIGURE 72.—Airport Markings.

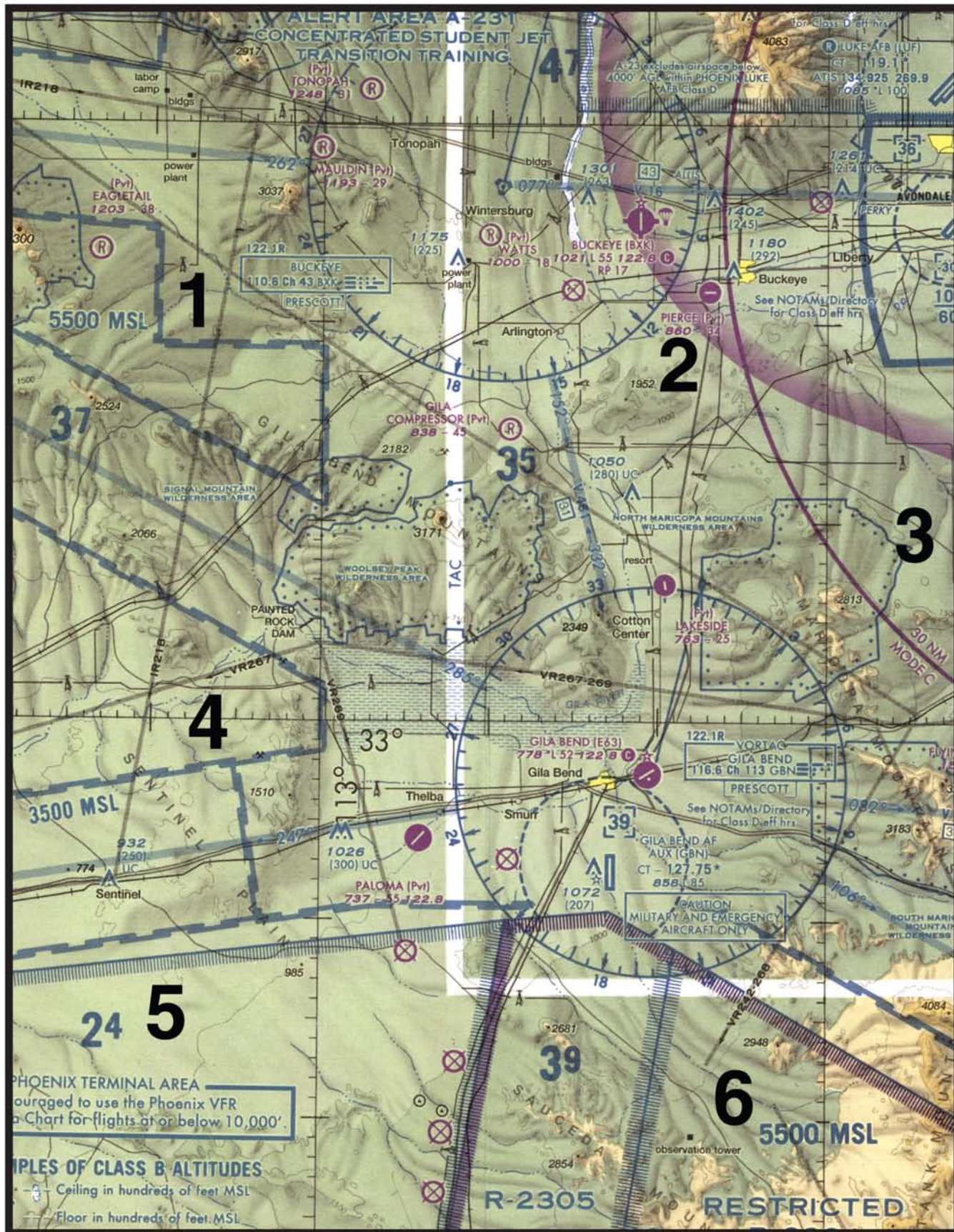

FIGURE 73.—Sectional Chart.