

**LAKE PONTCHARTRAIN, LA.
AND VICINITY
LAKE PONTCHARTRAIN
HIGH LEVEL PLAN**

**DESIGN MEMORANDUM NO. 19
GENERAL DESIGN**

**ORLEANS AVENUE
OUTFALL CANAL**

**IN THREE VOLUMES
VOLUME III**

**DEPARTMENT OF THE ARMY
NEW ORLEANS DISTRICT, CORPS OF ENGINEERS**

NEW ORLEANS, LOUISIANA

AUGUST 1988

SERIAL NO. 60



**US Army Corps
of Engineers**
New Orleans District

TC7
.P6
dm19
1988
v.3



US Army Corps
of Engineers

TECHNICAL REPORT HL-87-

HURRICANE PROTECTION STRUCTURE FOR LONDON AVENUE OUTFALL CANAL
LAKE PONTCHARTRAIN, NEW ORLEANS, LOUISIANA

Hydraulic Model Investigation

by

James R. Leech

Hydraulics Laboratory

DEPARTMENT OF THE ARMY
Waterways Experiment Station, Corps of Engineers
PO Box 631, Vicksburg, Mississippi 39180-0631

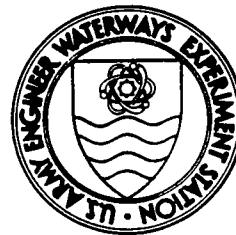

November 1987

Final Report

Approved For Public Release; Distribution Unlimited

HYDRAULICS

LABORATORY

Prepared for US Army Engineer District, New Orleans
New Orleans, Louisiana 70160-0267

**Destroy this report when no longer needed. Do not return
it to the originator.**

**The findings in this report are not to be construed as an official
Department of the Army position unless so designated
by other authorized documents.**

**The contents of this report are not to be used for
advertising, publication, or promotional purposes.
Citation of trade names does not constitute an
official endorsement or approval of the use of
such commercial products.**

Unclassified

SECURITY CLASSIFICATION OF THIS PAGE

REPORT DOCUMENTATION PAGE				Form Approved OMB No. 0704-0188	
1a. REPORT SECURITY CLASSIFICATION Unclassified		1b. RESTRICTIVE MARKINGS			
2a. SECURITY CLASSIFICATION AUTHORITY		3. DISTRIBUTION/AVAILABILITY OF REPORT			
2b. DECLASSIFICATION/DOWNGRADING SCHEDULE		Approved for public release; distribution unlimited			
4. PERFORMING ORGANIZATION REPORT NUMBER(S) Technical Report HL-87		5. MONITORING ORGANIZATION REPORT NUMBER(S)			
6a. NAME OF PERFORMING ORGANIZATION USAEWES Hydraulics Laboratory		6b. OFFICE SYMBOL (if applicable) WESHS-S	7a. NAME OF MONITORING ORGANIZATION		
6c. ADDRESS (City, State, and ZIP Code) PO Box 631 Vicksburg, MS 39180-0631		7b. ADDRESS (City, State, and ZIP Code)			
8a. NAME OF FUNDING / SPONSORING ORGANIZATION USAED, New Orleans		8b. OFFICE SYMBOL (if applicable) TMNED-H	9. PROCUREMENT INSTRUMENT IDENTIFICATION NUMBER		
8c. ADDRESS (City, State, and ZIP Code) PO Box 60267 New Orleans, LA 70160-0267		10. SOURCE OF FUNDING NUMBERS			
		PROGRAM ELEMENT NO.	PROJECT NO.	TASK NO.	WORK UNIT ACCESSION NO.
11. TITLE (Include Security Classification) Hurricane Protection Structure for London Avenue Outfall Canal, Lake Pontchartrain, New Orleans, Louisiana					
12. PERSONAL AUTHOR(S) Leech, James R.					
13a. TYPE OF REPORT Final report		13b. TIME COVERED FROM 1984 TO 1986	14. DATE OF REPORT (Year, Month, Day) November 1987		15. PAGE COUNT 161
16. SUPPLEMENTARY NOTATION Available from National Technical Information Service, 5285 Port Royal Road, Springfield, VA 22161.					
17. COSATI CODES			18. SUBJECT TERMS (Continue on reverse if necessary and identify by block number)		
FIELD	GROUP	SUB-GROUP	Alignment	Gates	Similitude Waves
			Canal	Head loss	Surge
			Drainage	Pumps	Torque
19. ABSTRACT (Continue on reverse if necessary and identify by block number) The 1:20-scale physical model investigation was conducted to give a three-dimensional analysis of the hydraulic performance of the unique vertical butterfly-gated structure, measure the torque on each gate shaft due to incoming and outgoing flows, and evaluate the effects of wave action on the gates. The model was also used to align the canal to provide a more uniform flow distribution through the structure and measure the water-surface differentials across the structure. Model tests indicated that the original design did not perform as intended; therefore, a solution was obtained by modifying the geometry of the canal and gates by trial and error. The recommended crescent gate design performed satisfactorily for anticipated incoming and outgoing flows. Storm waves were measured along the reach of the canal from the lake to the structure to determine the maximum wave heights propagating in the canal. The model also					
(Continued)					
20. DISTRIBUTION/AVAILABILITY OF ABSTRACT <input checked="" type="checkbox"/> UNCLASSIFIED/UNLIMITED <input type="checkbox"/> SAME AS RPT. <input type="checkbox"/> DTIC USERS			21. ABSTRACT SECURITY CLASSIFICATION Unclassified		
22a. NAME OF RESPONSIBLE INDIVIDUAL		22b. TELEPHONE (Include Area Code)		22c. OFFICE SYMBOL	

Unclassified

SECURITY CLASSIFICATION OF THIS PAGE

19. ABSTRACT (Continued).

indicated that the torque on each gate shaft decreased with waves superimposed during pumping operations and increased with waves superimposed during storm surges.

The results of the torque measurements are presented in Appendix A to give design information for sizing the dampening device which operates as a shock absorber, the vertical shafts, operating machinery, and structural components.

Unclassified

SECURITY CLASSIFICATION OF THIS PAGE

PREFACE

The model investigation reported herein was authorized by the Office, Chief of Engineers, US Army, on 15 May 1984 at the request of the US Army Engineer District, New Orleans (LMN).

The study was conducted during the period May 1984 to January 1986 in the Hydraulics Laboratory (HL) and the Coastal Engineering Research Center (CERC) of the US Army Engineer Waterways Experiment Station (WES), under the direction of Mr. F. A. Herrmann, Jr., Chief, HL, and under the general supervision of Messrs. J. L. Grace, Jr., Chief, Hydraulic Structures Division, G. A. Pickering, Acting Chief, Hydraulic Structures Division, and N. R. Oswalt, Chief, Spillways and Channels Branch (SCB). The project engineer for the model study was Mr. J. R. Leech, assisted by Mr. S. T. Maynard, SCB. This report was prepared by Mr. Leech and edited by Mrs. Nancy Johnson, Information Products Division, under the Inter-Agency Personnel Agreement Act. Mr. Bobby P. Fletcher, SCB, provided valuable guidance during model design and operation.

During the course of the investigation, Messrs. L. Cook, R. Louque, E. Walker, and F. Weaver, US Army Engineer Division, Lower Mississippi Valley, and COL Eugene S. Witherspoon, Messrs. F. Chatry, C. Soileau, R. Guizerix, V. Stutts, J. Combe, T. Hassenboehler, and D. Strecker, and Ms. J. Hote, LMN, visited WES to discuss the program and results of model tests, observe the model in operation, and correlate these results with design studies.

COL Dwayne G. Lee, CE, is the Commander and Director of WES.
Dr. Robert W. Whalin is the Technical Director.

CONTENTS

	<u>Page</u>
PREFACE.....	1
CONVERSION FACTORS, NON-SI TO SI (METRIC) UNITS OF MEASUREMENT.....	3
PART I: INTRODUCTION.....	5
Prototype.....	5
Purpose and Scope of Model Study.....	6
PART II: MODEL.....	8
Description.....	8
Scale Relations.....	9
PART III: TESTS AND RESULTS.....	10
Canal.....	10
Gates.....	10
PART IV: CONCLUSIONS AND RECOMMENDATIONS.....	25
TABLES 1-3	
PHOTOS 1-4	
PLATES 1-62	
APPENDIX A: TORQUE MEASUREMENTS ON BUTTERFLY GATES, TYPE 33 DESIGN.....	A1

CONVERSION FACTORS, NON-SI TO SI (METRIC)
UNITS OF MEASUREMENT

Non-SI units of measurement used in this report can be converted to SI (metric) units as follows:

<u>Multiply</u>	<u>By</u>	<u>To Obtain</u>
acres	4,046.873	square metres
cubic feet	0.02831685	cubic metres
degrees (angle)	0.01745329	radians
feet	0.3048	metres
foot-kips	1.355818	metre-kilonewtons
gallons	3.785412	cubic decimetres
inches	2.54	centimetres
miles (US statute)	1.609344	kilometres
pounds (mass)	0.4535924	kilograms
square miles (US statute)	2.589998	square kilometres

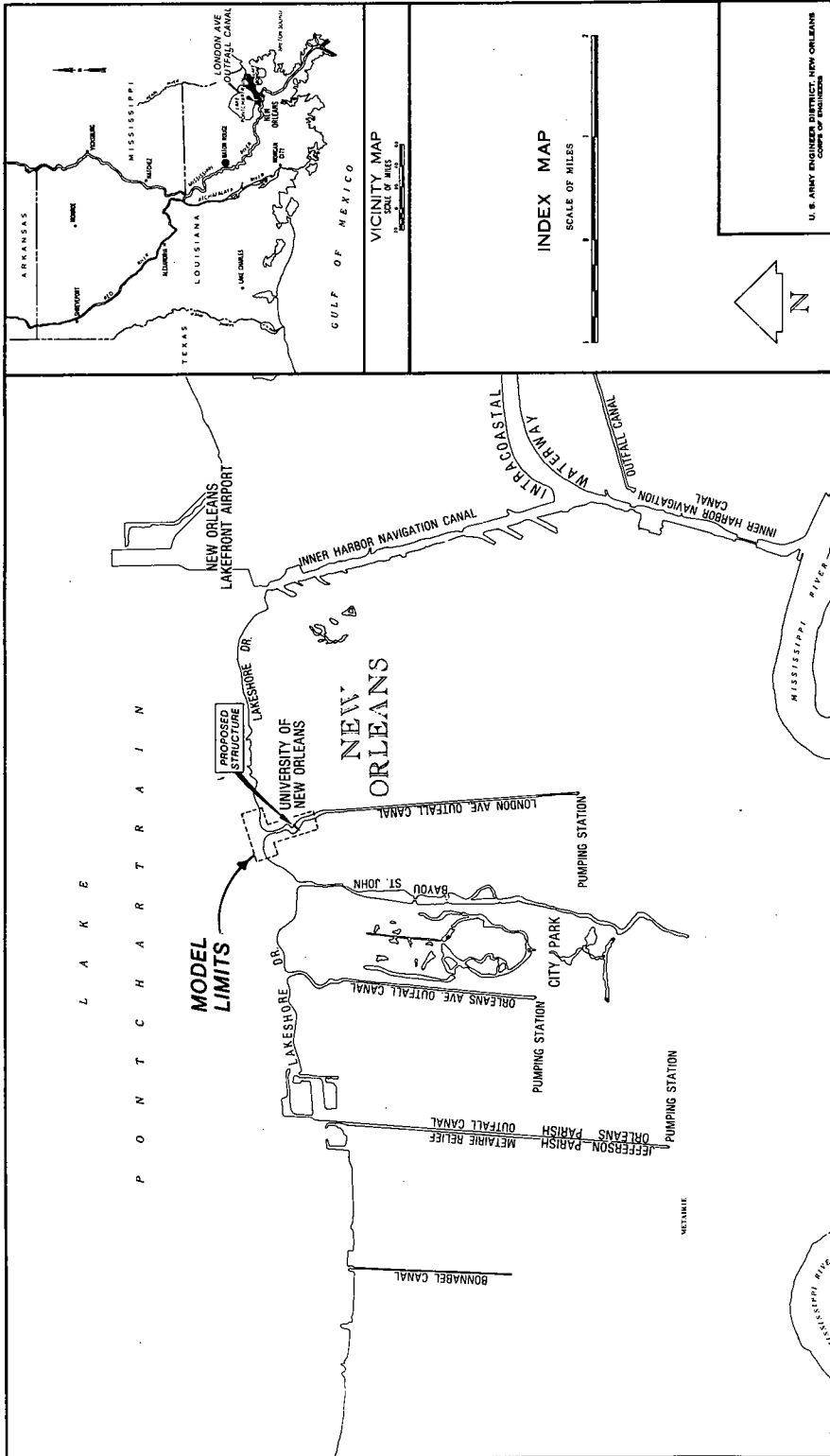

Figure 1. Vicinity and location map

HURRICANE PROTECTION STRUCTURE FOR LONDON AVENUE OUTFALL CANAL
LAKE PONTCHARTRAIN, NEW ORLEANS, LOUISIANA

Hydraulic Model Investigation

PART I: INTRODUCTION

Prototype

1. The city of New Orleans, Louisiana, has a unique drainage system that removes rainwater and storm water during frequent deluges. Eighteen pumping stations on the east bank of the Mississippi River and two on the west bank have a combined capacity of 25 billion gal per day*--enough to empty a lake with an area of 10 square miles and a depth of 11 ft in 24 hr. The city's average annual rainfall of 58.12 in. is exceeded by only two other metropolitan areas: Miami, Florida, and Mobile, Alabama. The area to be drained consists of approximately 55,085 acres in the developed portion of the city and 2,640 acres in adjoining Jefferson Parish.

2. The small amount of water reaching the drainage pumping stations in dry weather is diverted to sewage pumping stations for discharge into the river. During heavy rains the large drainage pumps go into operation discharging storm water into lake-level open channels leading to Lake Pontchartrain or Lake Borgne via Bayou Bienvenue.

3. The London Avenue Outfall Canal is one of three canals on the south side of Lake Pontchartrain being considered for hurricane surge protection (Figure 1). The outfall canal's primary purpose is to transport the interior drainage from part of the city to Lake Pontchartrain. A pumping station with a capacity of 8,000 cfs used to pump the interior drainage into the outfall canal is at the origin of the canal approximately 3 miles south of the lakefront. The elevation of the parallel levees from the lakefront to the pumping station is +10.0** and along the lakefront, +15.0.

* A table of factors for converting non-SI units of measurement to SI (metric) units is presented on page 3.

** All elevations (el) cited herein are in feet referred to the National Geodetic Vertical Datum (NGVD).

4. The existing levee system does not have sufficient elevation to protect the city from a 100-year hurricane storm surge. Therefore, a plan to provide hurricane protection for New Orleans consists of raising the levees to an elevation of +18 along the lakefront and tapering the levees from el +18 to el +14 along the canal approximately 1,000 ft to the proposed gated structure. The proposed structure was based on the theory of a self-opening and -closing, vertical, eccentrically pinned, butterfly-gated structure. The butterfly gates would remain open during pumping of the interior drainage to the lake as long as the water level in the outfall canal exceeded that on the lakeside of the structure (Figure 2). The gates would close only when an incoming surge

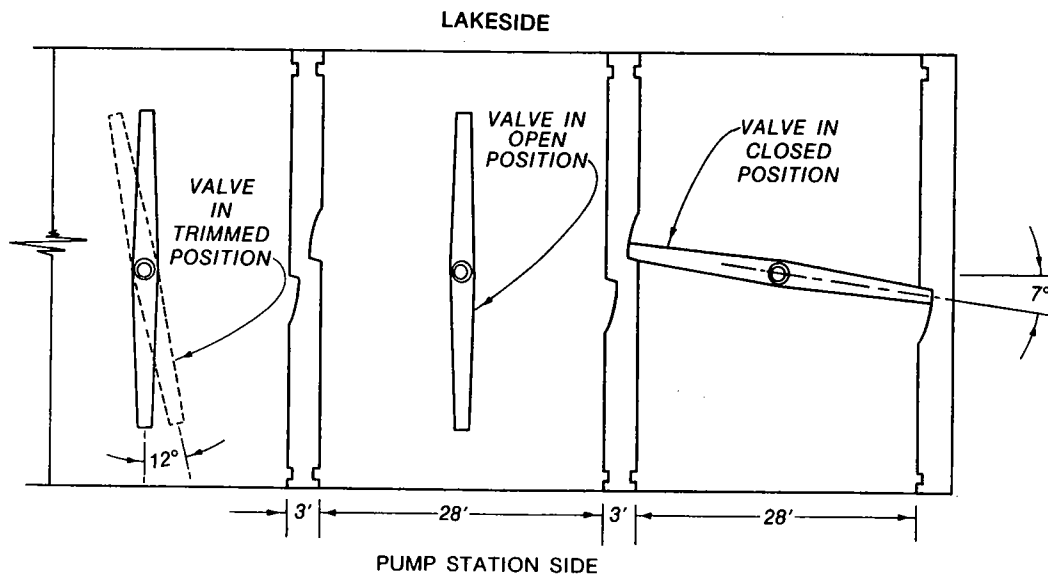

Figure 2. Partial plan view, typical valve positions

created a water level greater than that in the outfall canal on the pumping station side of the structure. This would permit operating the pumping station for as long as possible before closing the gates during a hurricane and automatically reopening the gates as soon as the water level in the outfall canal downstream of the pumping station exceeded that on the lakeside of the control structure. In the open (trimmed) position, the axis of each gate would be 12 deg from the center line of each gate bay (Figure 2). During a surge flow, the eccentricity of the pin and the 12-deg offset (trim) would induce closing of the gates.

Purpose and Scope of Model Study

5. The primary purpose of the hydraulic model study was to establish

whether or not the conceptual designs for the proposed butterfly valve structure would permit automatic flow-induced opening or closing of the valve when subjected, respectively, to pumped flows or hurricane surges. Other information to be derived from the model study included proper canal configuration to ensure uniform flow for both inlet and exit conditions; magnitude of torques on valve trunnions, when subjected to various flows, wave conditions, and gate openings; and head differential across the proposed structure for one final recommended gate design. The determination of the proper gate shape, trunnion location, and amount of eccentricity proved to be a significant part of the overall study effort.

PART II: MODEL

Description

6. The 1:20-scale model (Figure 3 and Photo 1) reproduced discharge from the pumping plant; about 3,000 ft of London Avenue Canal; the gated control structure; a 1,000-ft width of approach out into Lake Pontchartrain; and 2,000 ft of shoreline. The eight 30-ft-wide butterfly gates of the control structure reproduced in the model (Photo 2) were fabricated of brass to accurately simulate the weight of each gate. A calibrated wave generator was strategically placed in the modeled portion of Lake Pontchartrain to simulate expected prototype wave action. The seawall along the lakefront and the Lakeshore Drive Bridge (Photo 3) were reproduced in the model also. A fiber wave absorber was installed around the inside perimeter of the lake portion of the model to damp any wave energy that might otherwise be reflected from the model walls.

7. Water used in the operation of the model was supplied by pumps (Photo 4), and discharge was measured with an orifice plate. The valves were arranged to simulate either pumping interior drainage from the outfall canal to the lake or the reversed flow induced by a hurricane surge from the lake. Hydraulic forces on each gate shaft were measured by torque meters and

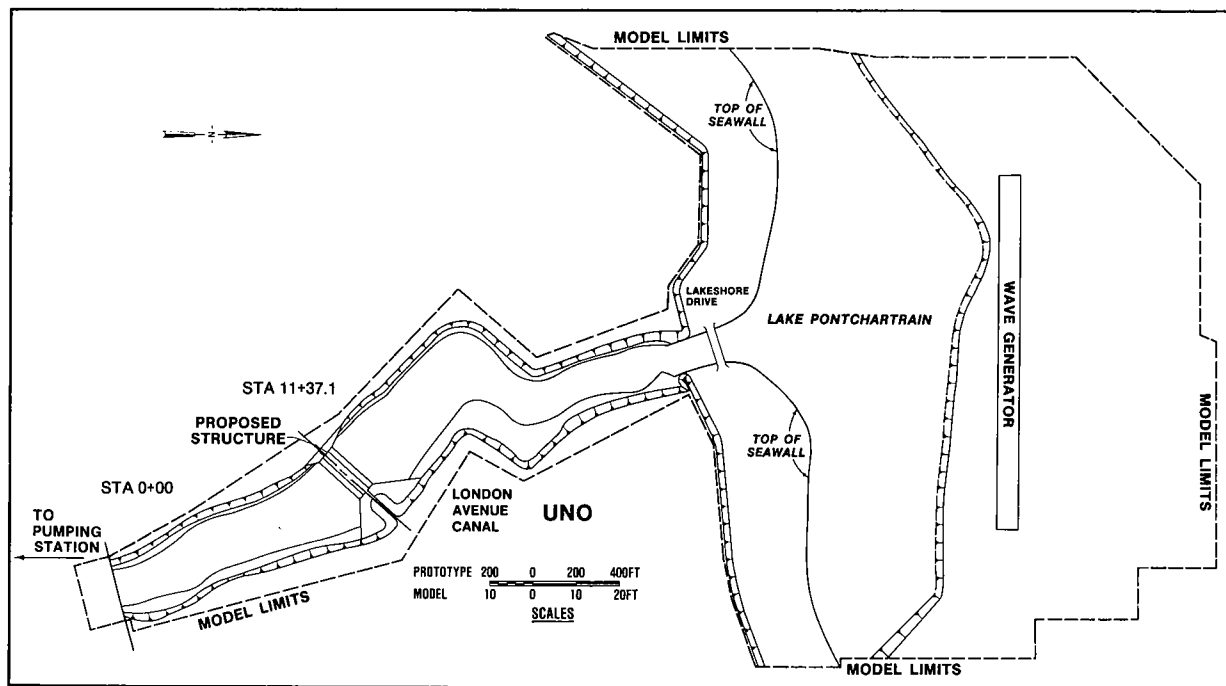

Figure 3. Plan view of 1:20-scale model

recorded and analyzed by a computer. Water-surface elevations were measured with point gages. Wave heights and periods were obtained with computerized wave gages. Pumped and surge flows were observed by injecting dye and confetti into the flow.

Scale Relations

8. The accepted equations of hydraulic similitude, based upon Froudian criteria, were used to express mathematical relations between the dimensions and hydraulic quantities of the model and prototype. General relations expressed in terms of the model scale or length ratio L_r are presented as follows:

<u>Dimension*</u>	<u>Ratio</u>	<u>Scale Relations Model:Prototype</u>
Length	L_r	1:20
Area	$A_r = L_r^2$	1:400
Discharge	$Q_r = L_r^{5/2}$	1:1,788.84
Torque	$T_r = L_r^4$	1:160,000

* Dimensions are in terms of length.

PART III: TESTS AND RESULTS

Canal

9. The original canal alignment (Figure 4) was tested by locking the gates in the 12-deg trimmed position (Figure 2), and injecting dye and confetti into the flow. Flow patterns through the structure were asymmetric for all anticipated pumped flows and water-surface elevations. Tests indicated that for the gates to function properly, the canal would have to be realigned to provide more even flow distribution through the structure. Figure 5 shows an eddy that generated reverse flow conditions through gate bays 7 and 8. The gates were numbered as shown in Figure 5.

10. The adverse flow conditions through the structure were attributed to poor entry conditions resulting from siting the structure in an existing bend in the canal (Figure 4). Flow distribution in the canal approach to the structure was improved by moving the levee on the west side of the canal westward 40 ft for a distance along the levee of 220 ft upstream and 540 ft downstream from the structure while maintaining the existing canal side slopes (Figures 6 and 7). Flow contractions induced by flow along the west wing wall (Figure 4) on the pump station side of the structure were eliminated for all pumped flow conditions by streamlining the wing wall with a 60-ft radius as shown in Figures 6 and 7. Flow distribution along the east side of the canal was improved by the addition of a spur dike. Flow distribution through the structure was also improved by excavating upstream and downstream from the structure (Figure 6). Acceptable flow conditions through the structure were achieved by the recommended canal design shown in Figures 6 and 7.

11. Figure 8 shows the recommended canal design with a more uniform flow distribution in the approach and through the structure. For some pumped flow conditions, an eddy continued along the west levee; however, it had no adverse effect on flow through the structure.

Gates

Gate design

12. Observations during operation of the model with the recommended canal design indicated that the type 1 vertical butterfly gates (Figure 9)

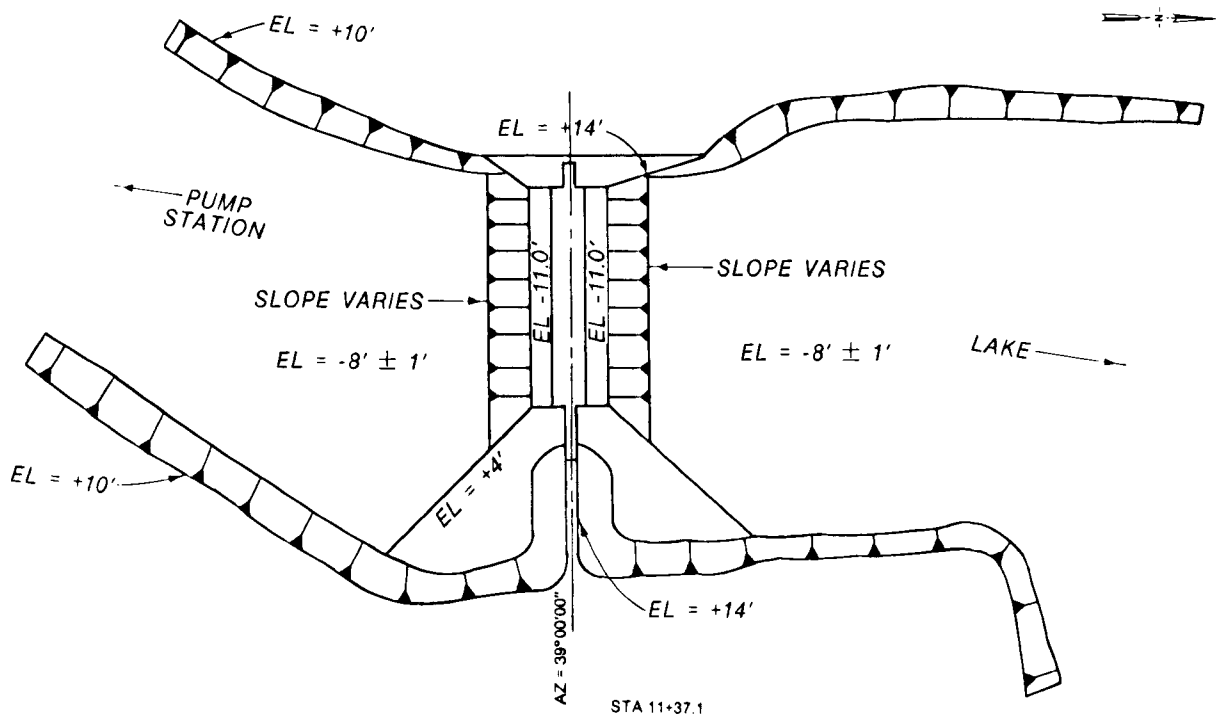

Figure 4. Area of original design upstream and downstream of the structure

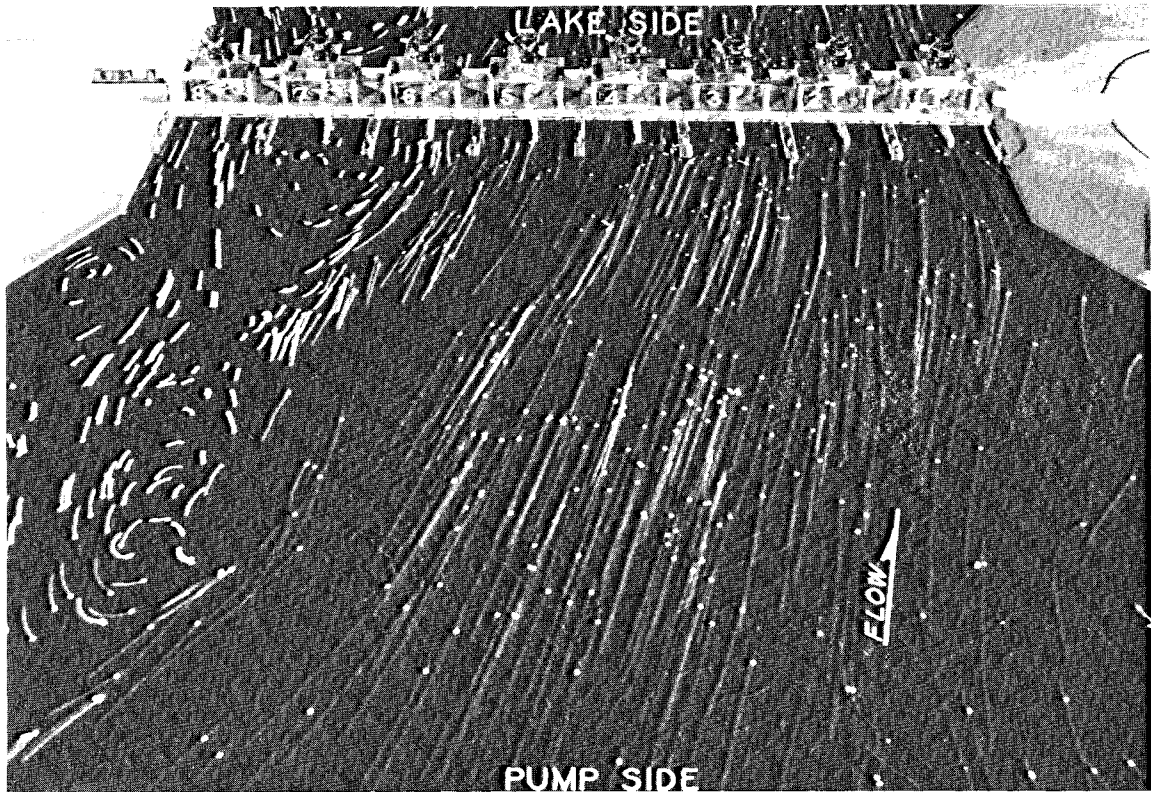

Figure 5. Flow toward the lake with a discharge of 8,000 cfs and a lake elevation of +4 ft

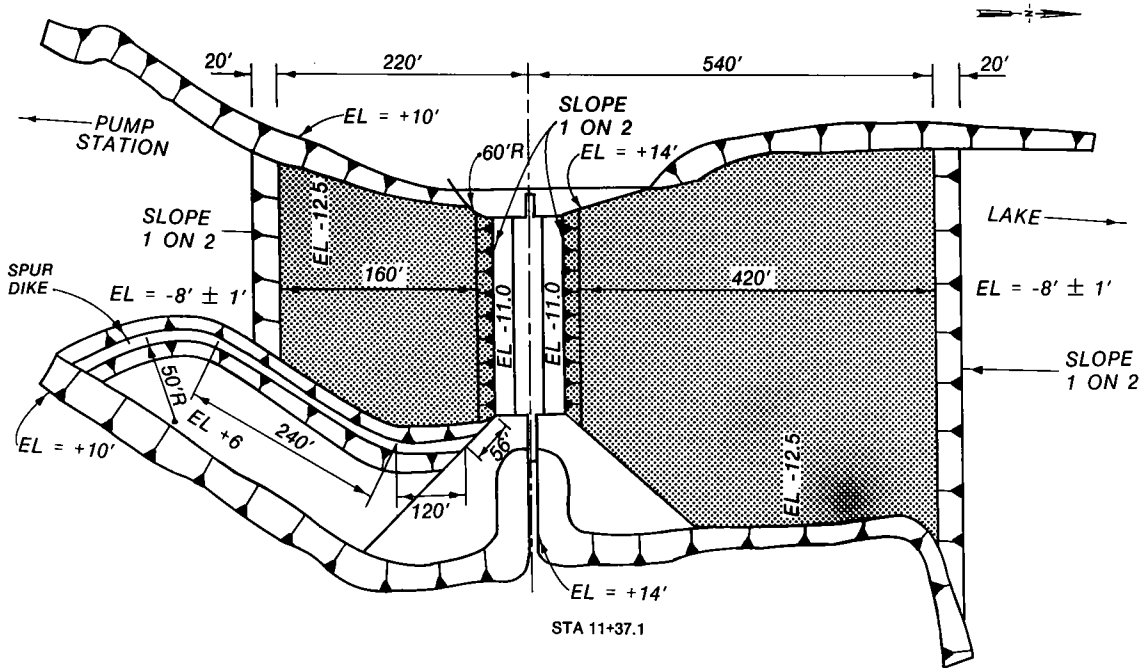

Figure 6. Recommended canal alignment and excavation upstream and downstream of the structure

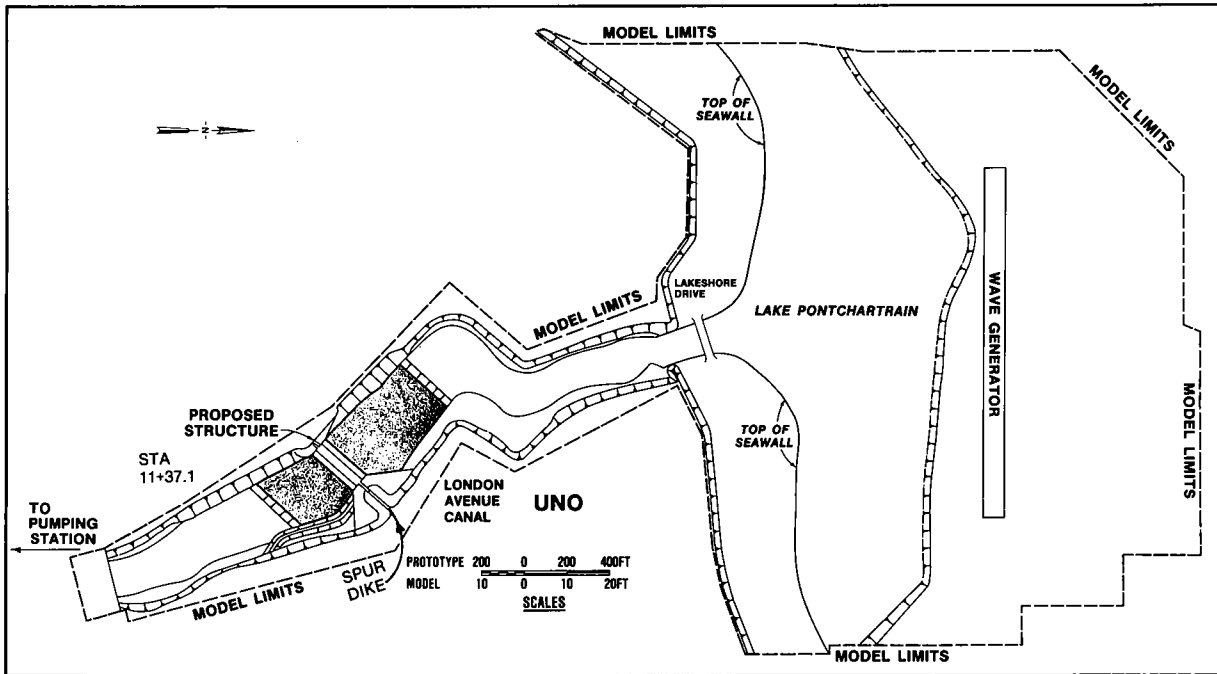

Figure 7. Plan view of model with the recommended canal alignment

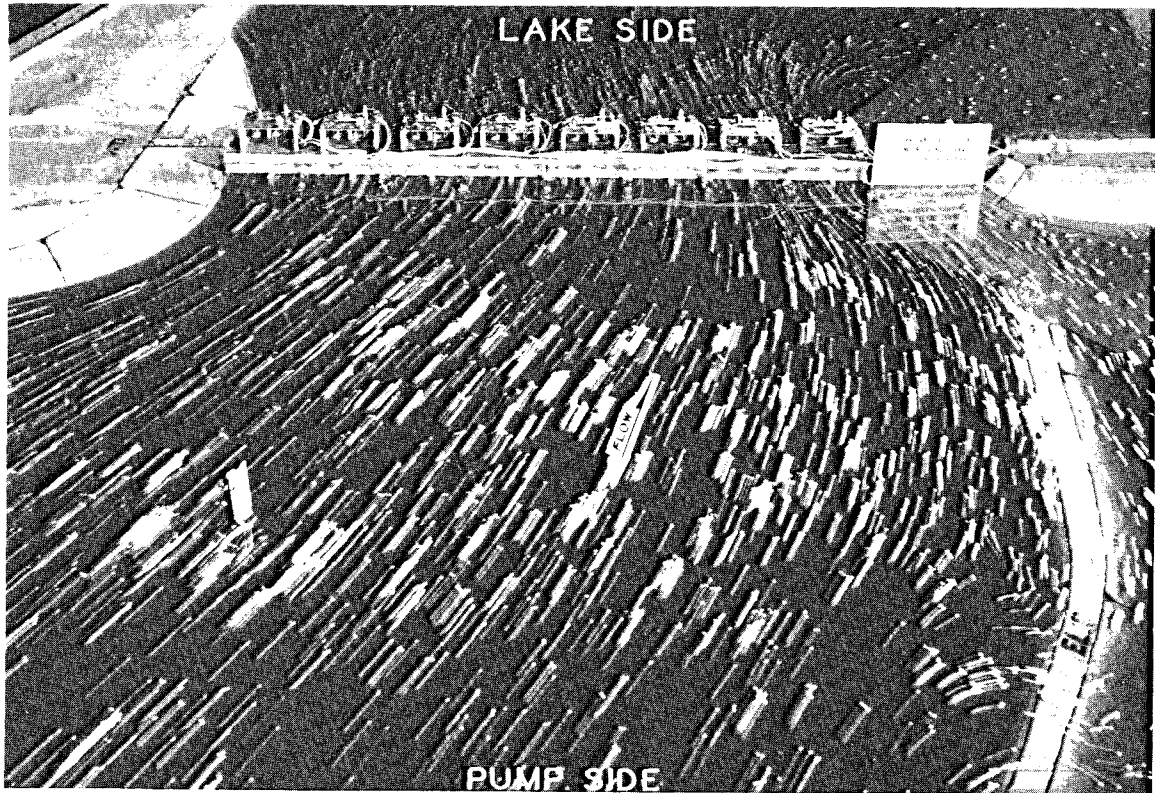

Figure 8. Flow toward the lake with a discharge of 8,000 cfs and a lake elevation of +7 ft

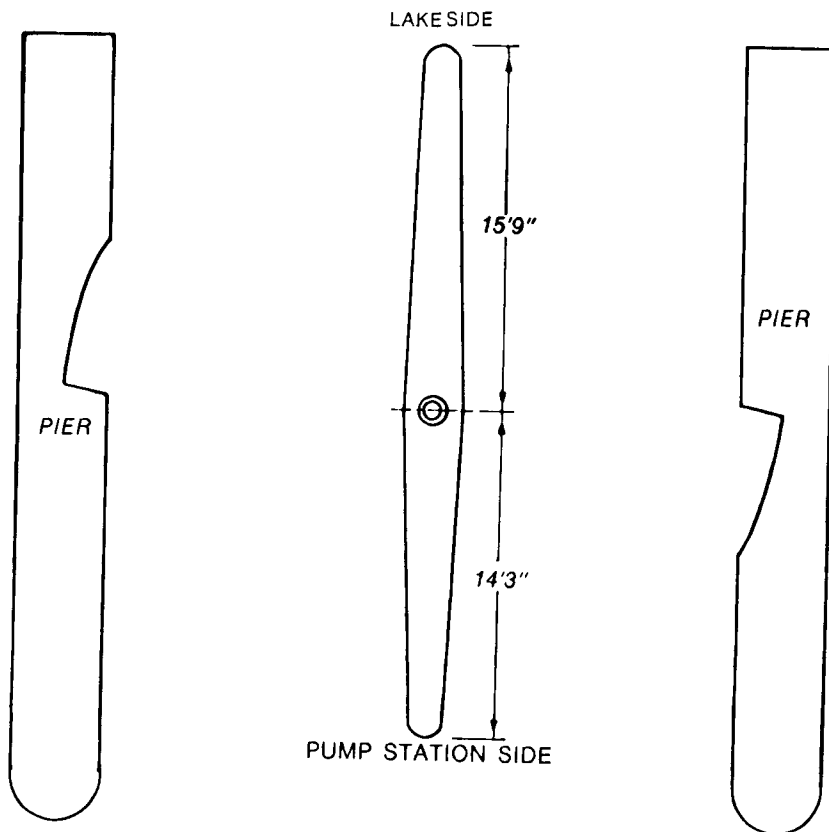

Figure 9. Type 1 gate design

were not performing properly during pumping. The gates closed as designed (Figure 2) during the simulated hurricane surge. However, during pumped flows, the type 1 gate design did not open to the trimmed position (Figure 2) but remained almost closed (Figure 10). This reduced the cross-sectional area and caused noticeable head differential at the control structure. The type 1 gate design was tested with a lake elevation of +5.0 and pumped flows ranging from 4,000 to 8,000 cfs. The type 4 gate design (Figure 11) was equipped with a 20-in. scoop that improved the gate performance by causing the gate to oscillate through a larger opening (Figure 12). Other designs (types 2, 3, 5, and 6, Plates 1-4, respectively) with spoilers were tested by varying the location and size of the scoop or spoilers to evaluate their effectiveness. The 20-in. scoop, located 1 ft from the long end of the gate (Figure 11, type 4 gate design), was the most effective in improving the performance of the gate.

13. The type 1 gate was removed from the structure and held in the open channel upstream of the structure. The long axis of the gate was held parallel to the flow and then released to permit rotation about the shaft. Also the piers were streamlined by adding a semicircular nose with a radius of 1.5 ft to allow a smooth transition of flow around the nose and reduce head loss. The gate established a position normal to the flow (Figure 13) which indicated that the structure (piers) was not having an adverse effect on gate performance.

14. Tests were conducted to determine the effect of changing the eccentricity of the gate shaft. The eccentricity tests ranged from a 9- to a 36-in. offset (types 7-13), and the gate performance improved by increasing the opening as the eccentricity increased. However, due to the separation of flow at the nose of the gate, the gate began to oscillate at a random frequency from the trimmed to the half-opened position with an eccentricity of 2 ft 9 in. The types 14-17 gate designs (Figure 14 and Plates 5-7) consisted of modifying the pier and installing a gate and/or a pier or wall scoop that permitted pumped flow to be deflected from the side of the pier, forcing the gate to open to the trimmed position. The type 16 gate design was slow to open against pumped flow ranging from 1,500 to 3,000 cfs (Plate 7). By increasing the eccentricity to 3 ft, the type 17 gate design (Figure 14) performed favorably by opening to the trimmed position with low pumped flows to the lake and by closing during any anticipated hurricane surge (Figure 15).

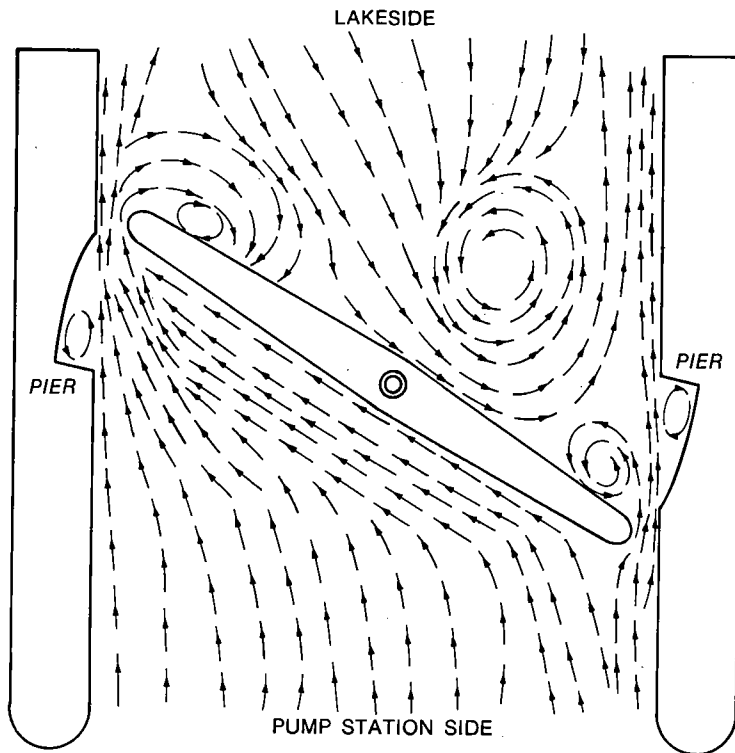

Figure 10. Plan view of type 1 gate design during pumped flow

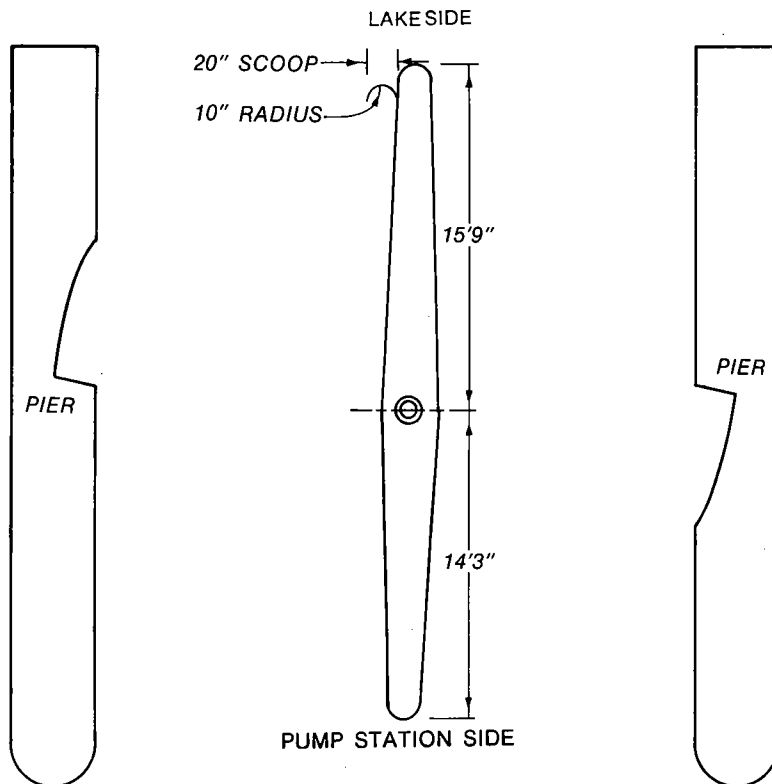

Figure 11. Plan view of type 4 gate design

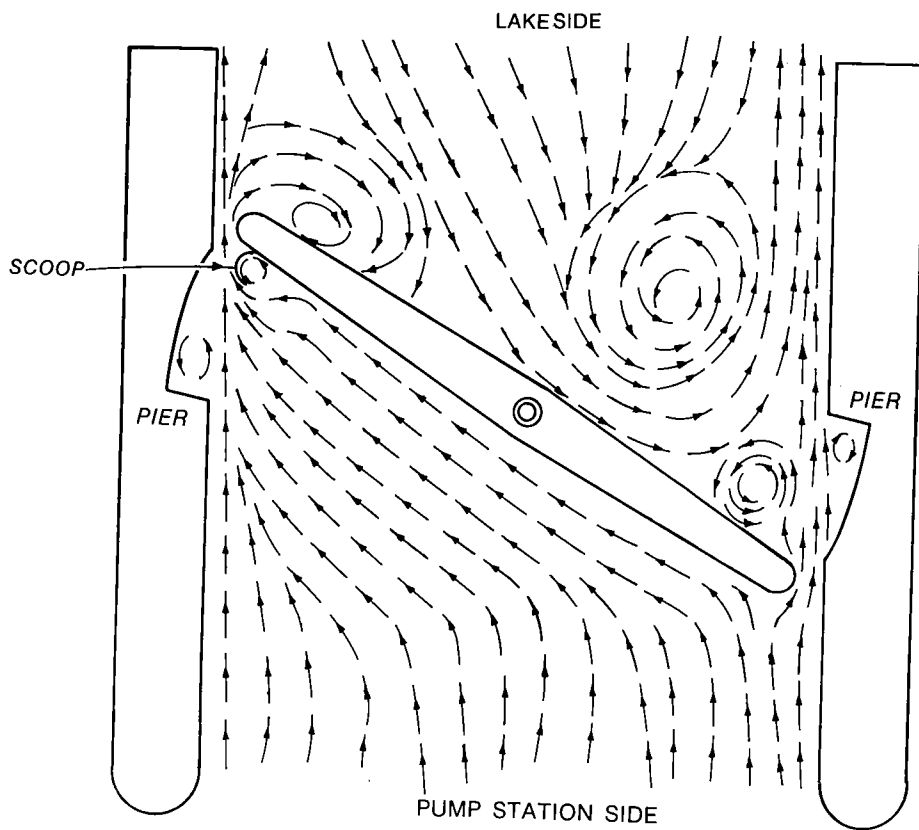

Figure 12. Plan view of type 4 gate design during pumped flow

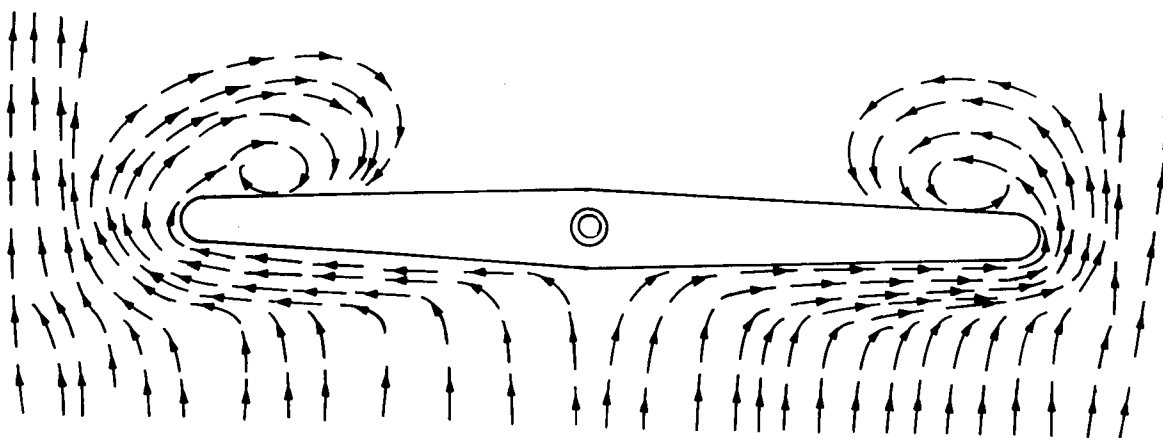

Figure 13. Plan view of type 1 design with flow in an open channel

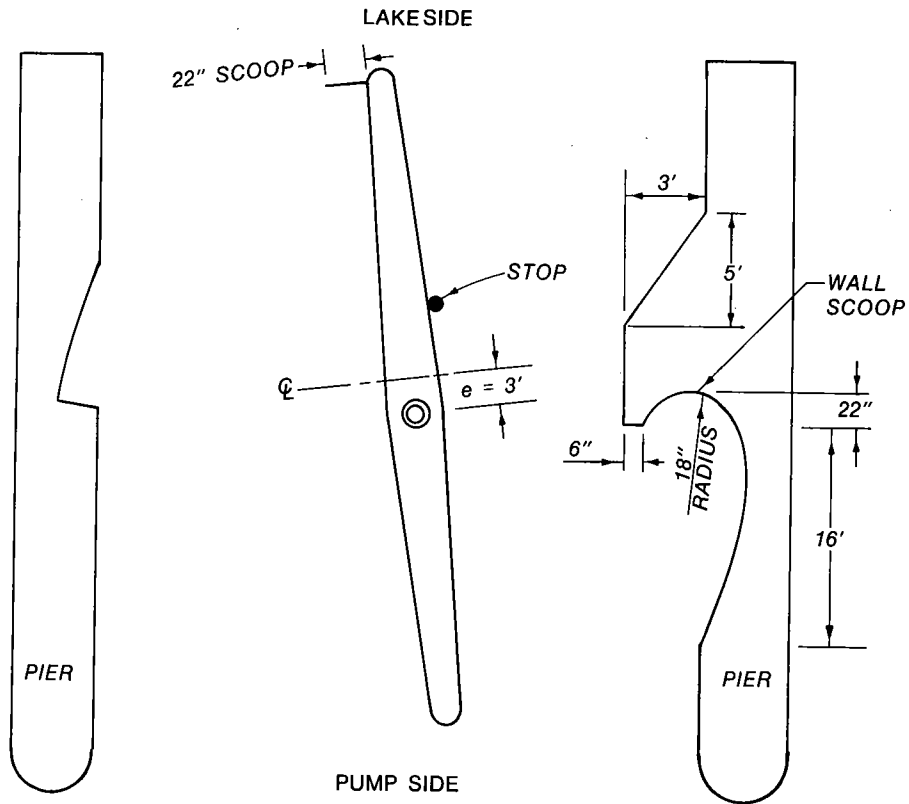

Figure 14. Plan view of type 17 gate design

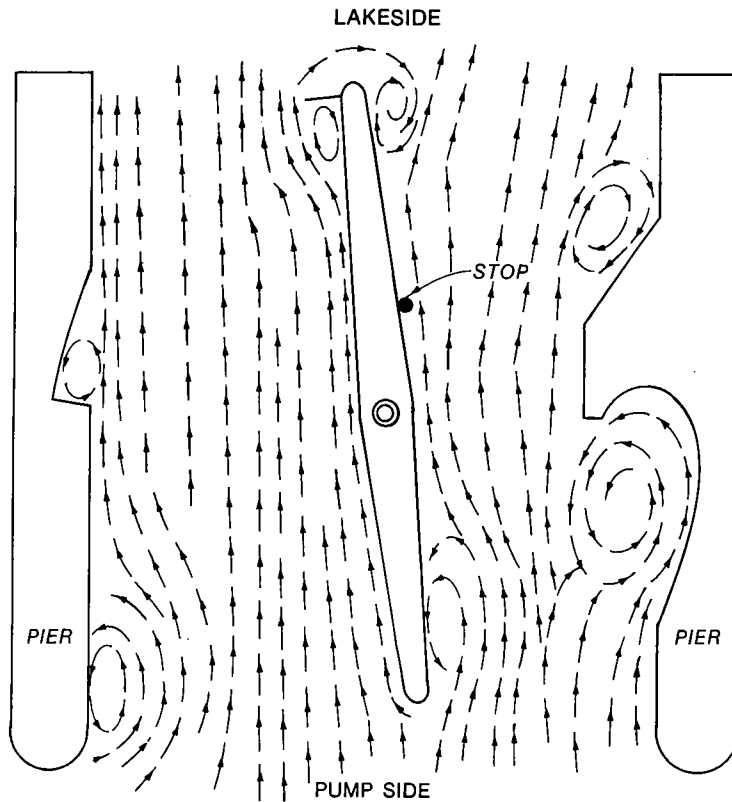

Figure 15. Plan view of type 17 gate design during flow

However, this design was undesirable due to the increased head loss through the structure caused by the pier scoop in the pier wall. Integrated testing of the shape of the gate scoops or spoilers indicated the rounded and/or straight forms performed identically.

15. Tests to determine the effects of changing the shape of the gate were then conducted. Types 18-20 gate designs were ineffective in increasing the performance of the gate. These designs were variations of the type 18 gate design (Plate 8). The crescent-shaped gate (Figure 16) was developed from numerous tests that consisted of changing the variables α , β , e , and x (types 24-33). The α and β angles were varied from 6 to 12 deg (Table 1), the eccentricity, e , ranged from 0.75 to 3 ft, and the scoop size x was varied from 1.0 to 1.83 ft, as shown in Plates 9 and 10. The model study produced the type 33 gate design (Figure 17), which performed very satisfactorily by responding quickly to changes in flow direction and remaining in the trim position during pumped flows (Figure 18). A discharge of 8,000 cfs and a lake elevation of +5 ft produced a head loss across the structure of 0.02 ft with the type 33 gate design installed. The maximum permissible head loss across the structure was specified to be 0.5 ft. The type 33 gate design allowed all eight gates to open in unison (even with the lower range of pumped flows) and close in rapid sequence with storm surges. The type 33 crescent-shaped gate design (Figure 17) was recommended based on the gate's satisfactory performance in closing against a lakeside surge, in opening satisfactorily during essential pumped flows, and in creating only a minimal head loss across the structure.

Wave tests

16. Wave tests in the model were conducted by the Wave Dynamics Division of the Coastal Engineering Research Center (CERC), US Army Engineer Waterways Experiment Station. Results of these tests are detailed in Bottin and Mize (1987).*

Force measurements

17. The magnitude and direction of the minimum, average, and maximum torque on each vertical shaft of the type 33 gate (recommended design) were

* R. R. Bottin, Jr., and M. G. Mize. 1987 (Aug). "Effects of Wave Action on a Hurricane Protection Structure for London Avenue Outfall Canal in Lake Pontchartrain, New Orleans, Louisiana," Miscellaneous Paper CERC-87-14, US Army Engineer Waterways Experiment Station, Vicksburg, Miss.

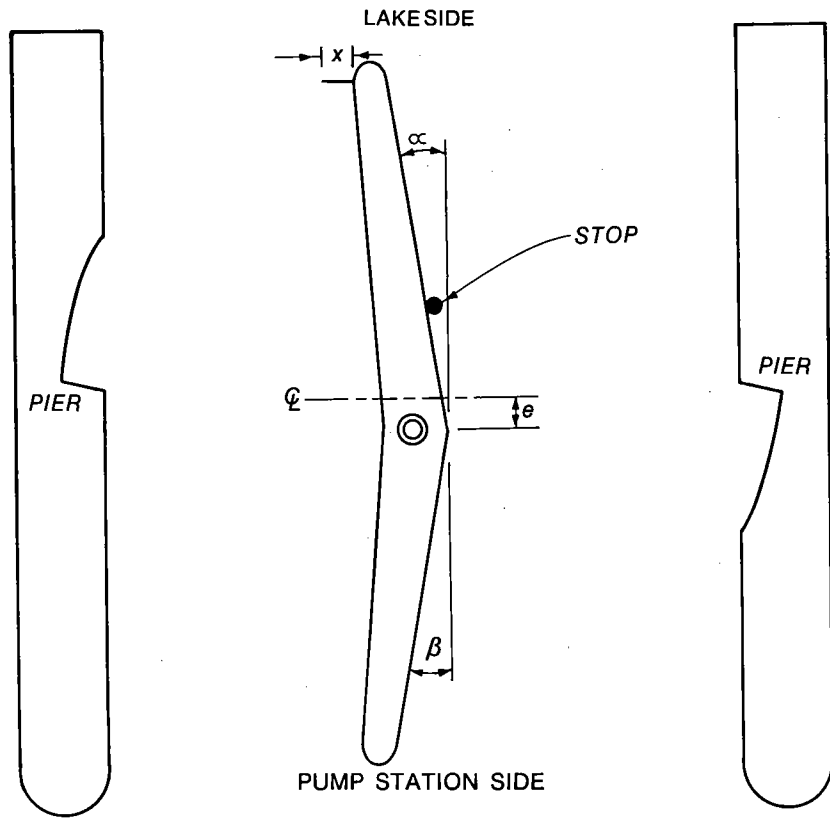

Figure 16. Plan view of crescent-shaped gate

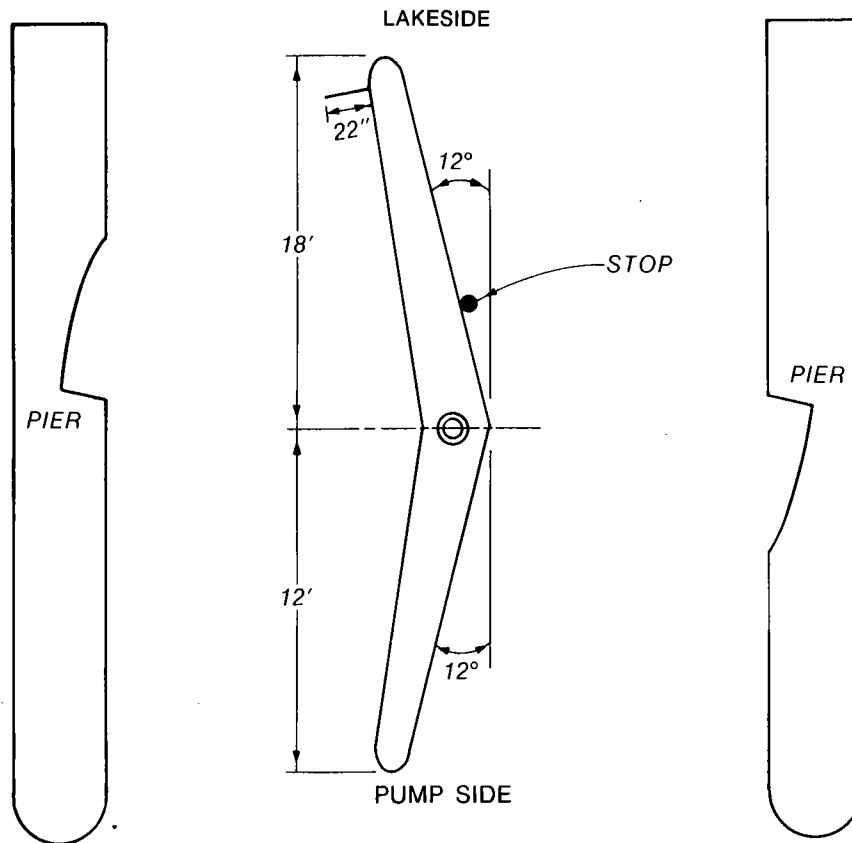

Figure 17. Plan view of type 33 (recommended) gate design

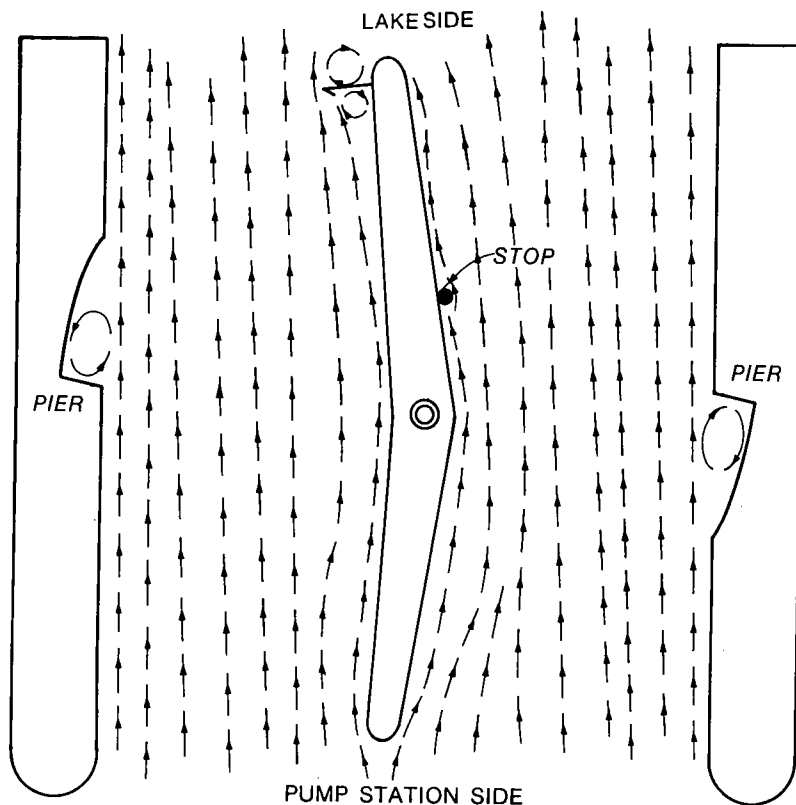

Figure 18. Plan view of type 33 (recommended) gate design during pumped flow

simultaneously measured on eight gates by independent torque meters and recorded by a computer. The test included measurement of torque with static heads on the closed gates, pumped flows with variable gate openings, and surge flows with the gates in the trim position and variable gate openings. The tests were conducted with and without waves superimposed, fixed gate openings, various stable flow rates, and lake elevations. Counterclockwise torque values (Figure 19) are positive and relate to a surge flow condition driving the gate closed. Conversely the clockwise torque values represent a negative torque and indicate a pumped flow condition driving the gate open against the stop. Appendix A is a tabulation of all the basic torque data obtained from the model and shows the maximum, minimum, and average value of prototype torque for a test period that consisted of taking 13 samples per second for 4.5 min (prototype). Maximum and minimum torques are the peak torque values in a test period. The average torque value is the average of all torques measured in a test period.

18. Torque measurements on all eight gate trunnions with all gates in the closed position and a head differential of 1 ft between the outfall canal

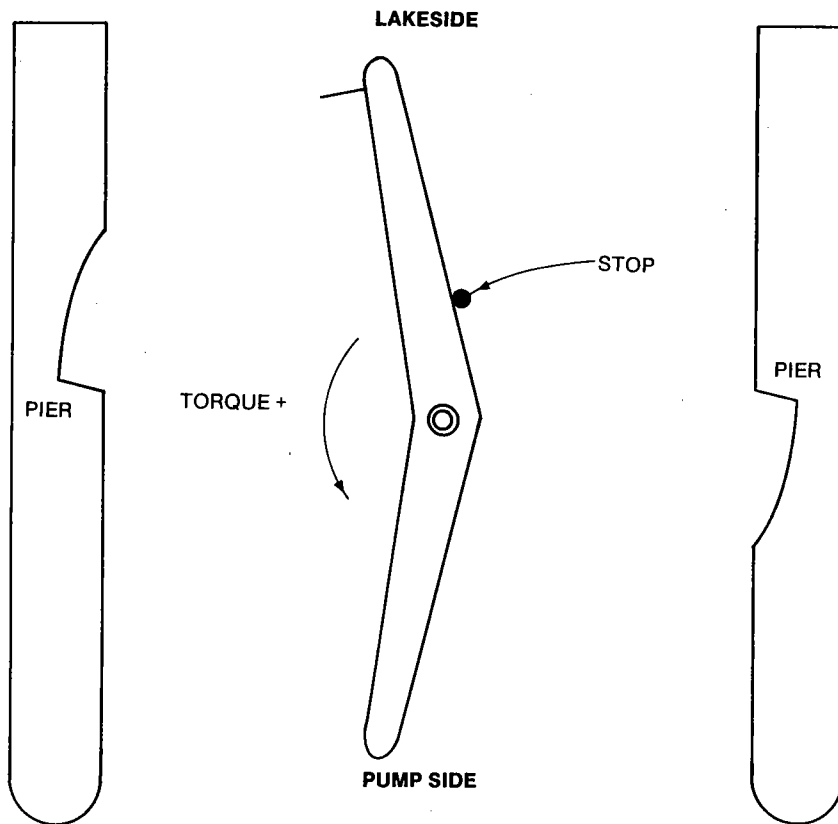

Figure 19. Sign convention. Counterclockwise is positive. Note: Angle of closure is measured from the stop

and the lake were obtained simultaneously for water levels in the canal of el +7 and el +9. This test determined the amount of torque developed with 1 ft of head differential and was essential in the design of a dampening device. Torques were obtained without waves and with waves having a period of 7.3 sec and a height of 7.8 ft from the north-northwest direction. Plates 11-18 show the maximum torques (clockwise direction) measured on each of the eight trunnions during these four test conditions.

19. Results of tests to measure torque (counterclockwise direction) versus head differential ΔH with flow from the lake to the canal, a lake elevation of +11.5 ft, and a 1-ft gate opening (measured from the side of the pier to the side of the gate) are presented in Plates 19-26. These tests simulated the amount of torque to be absorbed by the dampening device with the gates in a stationary position; however, the effects of the dynamic forces developed as the gates slammed into the closed position are not included in the data. A least squares fit of the data presented in the plots indicates a linear relation between torque and head differential. Plates 27-34 present

results of similar test conditions with 7.3-sec-period and 7.8-ft-high waves generated from the north-northwest. Waves from this direction had more impact on the structure than the other directions tested. Wave test results are published in Bottin and Mize (1987).*

20. Results of tests to measure torque (clockwise direction) versus head differential with flow from the canal to the lake, a canal elevation of 11.5 ft, and a 1-ft gate opening are presented as plots with a least squares fit in Plates 35-42. Plates 43-50 present results of similar test conditions with 7.3-sec, 7.8-ft-high waves generated from the north-northwest.

21. Results of tests to measure torque (clockwise direction) without and with waves, variable gate openings, an 8,000-cfs pumped outfall canal discharge (flow toward the lake), and a lake stage of +5 ft are shown in Plates 51 and 52. Plate 51 is a plot of maximum instantaneous torque versus angle of closure for each gate without waves, and Plate 52 presents results with waves. The angle of closure is illustrated in Figure 19 and is equal to 0 deg. Results of tests with lake stages of +3 ft and +1 ft without waves are presented in Plates 53 and 54, respectively. Plates 51-54 indicate that the torques are greatest with the gate in the nearly closed position (72-deg angle of closure). Thus, the dampening system could be subjected to the greatest loadings when pumped outfall canal discharges initiate reopening of the gates closed previously by a surge from the lake. Torques on the gates in the open or trimmed position (12-deg angle of closure) induced by pumped outfall canal discharges are significantly less and should not subject the stops and fenders or shock absorbers to large forces.

22. Results of model tests to determine the torque (counterclockwise direction) on the gate trunnions with the gates held against the stops (12-deg trimmed position), with surge flows of 500, 1,000, 1,500, and 2,000 cfs from the lake, without waves, and with +1- and +6-ft lake stages are provided in Appendix A, tests 34-41. Again the maximum torques on the gates in the open or trimmed position are relatively small (1-4 ft-kips) but sufficient to initiate closure of the model gates by surges from the lake.

23. The results of tests 71-114 to measure torque (counterclockwise direction) on the gate trunnions versus angle of closure with a lake elevation of +7 ft and surge flow rates from the lake to the canal of 500, 1,000, 1,500,

* Bottin and Mize, op. cit.

and 2,000 cfs are provided in Plates 55-58. Similar results obtained from tests 115-158 conducted with 7.8-ft-high and 7.3-sec-period waves generated from the north-northwest direction, a lake elevation of +7 ft, and surge flow rates of 500, 1,000, 1,500, and 2,000 cfs are provided in Plates 59-62. The curves in Plates 55-62 indicate that the 45-deg angle of closure is where the torque measurement makes a dramatic increase in magnitude due to the shape of the gate.

24. Torque values of 4 and 7 ft-kips were induced on gates 1 and 8, respectively, when they were positioned 24 deg from the stop, and the other six gates were positioned against the stop during tests 159-162 (see Appendix A). Values of torque on gates 2-6 with gates 1 and 8 closed are shown in Appendix A as tests 163-166. Tests 167-170 were conducted with gates 7 and 8 positioned 24 deg from the stop with the other gates against the stop. A torque of about 7 ft-kips was created on gate 8. Torques on gates 1-6 were not increased significantly with gates 7 and 8 closed (see tests 171-174 of Appendix A). Torques of about 3 and 4 ft-kips were created on gates 4 and 5, respectively, when they were positioned 24 deg from the stop with the other gates positioned against their stops (tests 175-178), and only 1 and 2 ft-kips, respectively, were measured when the gates were closed (tests 179-182).

25. Results of torque measurements with a lake elevation of +1 ft and surge flows of 500, 1,000, 1,500, and 2,000 cfs with all gates open 6 deg from the stop are presented in Appendix A, tests 183-186. Similar results with all gates open 12 deg from their stops are presented in Appendix A, tests 187-190.

Water-surface differential through structure

26. Results of model tests to measure the differential at the structure between the water surfaces on the pumping station and the lakesides of the structure with a pumped canal discharge of 8,000 cfs and a lake elevation of +7 ft are presented in Table 2. Various combinations of gate positions were used to measure the water-surface differentials. The objective was to see which combinations of gate positions created a differential in excess of 0.5 ft. Excessive water-surface differentials occurred when gate bays carrying a higher percentage of flow were restricted.

27. Results of model tests to determine water-surface elevations upstream and downstream of the proposed London Avenue structure are presented in Table 3. Tests included measuring the water-surface elevation with lake

stages of +11.5 and +7.0 ft and a discharge of 8,000 cfs simulating pumping to the lake. Horizontal distances upstream and downstream of the structure were measured from the pier nose on their respective sides.

PART IV: CONCLUSIONS AND RECOMMENDATIONS

28. The recommended canal alignment was obtained by observing flow patterns in the 1:20-scale physical model and modifying the canal to achieve acceptable hydraulic performance. Tests conducted to evaluate the canal alignment indicated that a uniform approach flow was necessary for flow-induced opening and closing of the gates.

29. The type 33 gate design consisted of 3-ft eccentricity, 22-in. gate scoop, and a 24-deg angle (Figure 17). The gate design performed satisfactorily in the model over the full range of expected prototype conditions by closing with the incoming hurricane surge and opening with pump flow. The geometry of the type 33 gate design was derived for the anticipated flow conditions at this site-specific study. Any variation on the hydraulic conditions or the gate geometry will affect the performance of the gate and should be investigated further.

30. Torque measurements were obtained without and with waves superimposed on pumped and surge flows. Test results were affected by wave action; increasing the torque up to 25 percent for a surge condition and decreasing the torque by as much as 10 percent for a low pumped flow condition.

31. Torque measurements were collected for a wide range of conditions for design purposes to include sizing the vertical shaft, mechanical components, dampening device, and structural components. Test conditions with the gates fully opened or closed yielded the values of torque that will allow comparison to the amount of torque necessary to overcome the dampening device and internal friction. The dampening device, which was not a physical component of this study, will be a vital link in the system to absorb most of the dynamic forces, therefore preventing the gate from slamming, and regulate the speed of opening and closing. It is recommended that these dynamic forces be investigated further in a larger scale model prior to prototype design.

32. For other applications of this gate design, consideration should be given to the concentration of suspended load at the proposed location. The crescent-gated structure would be subjected to silting in or being blocked open if heavy debris were present in the system. However, this site-specific application is located downstream of a pumping station where a large percentage of debris is filtered out by the trashracks of the pumping plant, and the water has a very low suspended load concentration. In the prototype 9 in. of

clearance will be provided between the bottom of the gate and the basic slab in an attempt to prevent debris or silt from jamming the gate.

Table 1
Crescent-Gate Designs

Design Type Number	Angle, deg			Eccentricity e , ft	Scoop Size x , ft	Performance
	α	β	$\alpha + \beta$			
21	6	6	12	0.75	1.250	Would not reopen
22	6	6	12	0.75	1.833	Would not stay against stop
23	6	6	12	1.75	1.833	Would not stay against stop
24	12	6	18	0.75	1.833	Would not stay against stop
25	12	6	18	1.75	1.250	Gate was slow to reopen
26	12	6	18	1.75	1.833	Oscillated before resting on stop
27	12	6	18	1.75	1.833*	The angle the scoop made with the gate was varied. The gate performed slower as the angle was increased
28	12	12	24	1.75	1.000	Slow to reopen
29	12	12	24	1.75	1.250	Slow to reopen
30	12	12	24	1.75	1.417	Oscillated before resting on stop
31	12	12	24	1.75	1.833	Oscillated before resting on stop
32	12	12	24	**	1.833	Oscillated before resting on stop
33	12	12	24	3	1.833	Performed very satisfactorily. No hesitations

* See Plate 9.

** Pin was eccentric in two directions: e_x and e_y . $e_x = 9.6$ in., $e_y = 1$ ft 9 in. (see Plate 10).

Table 2
Head Loss Across the Structure

Lake El	Pumped Flow Q, cfs	Water-Surface Differential ft	Gate Angle from Stop, deg, for Gate Number								
			1	2	3	4	5	6	7	8	
+7	8,000	0.48	24	0	0	0	0	0	0	0	24
		0.52	*	0	0	0	0	0	0	0	*
		0.48	0	0	0	0	0	0	0	24	24
		0.50	0	0	0	0	0	0	0	*	*
		0.60	0	0	0	24	24	0	0	0	0
		0.62	0	0	0	*	*	0	0	0	0

* Closed.

Table 3
Water-Surface Elevations
Discharge 8,000 cfs

Lake Stage ft	Location, ft		Water-Surface Elevation ft
	Upstream	Downstream	
11.5	400	--	11.76
	200	--	11.68
	100	--	11.65
	50	--	11.64
	--	50	11.60
	--	150	11.60
7.0	400	--	7.40
	200	--	7.39
	100	--	7.38
	50	--	7.36
	--	50	7.28
	--	150	7.26

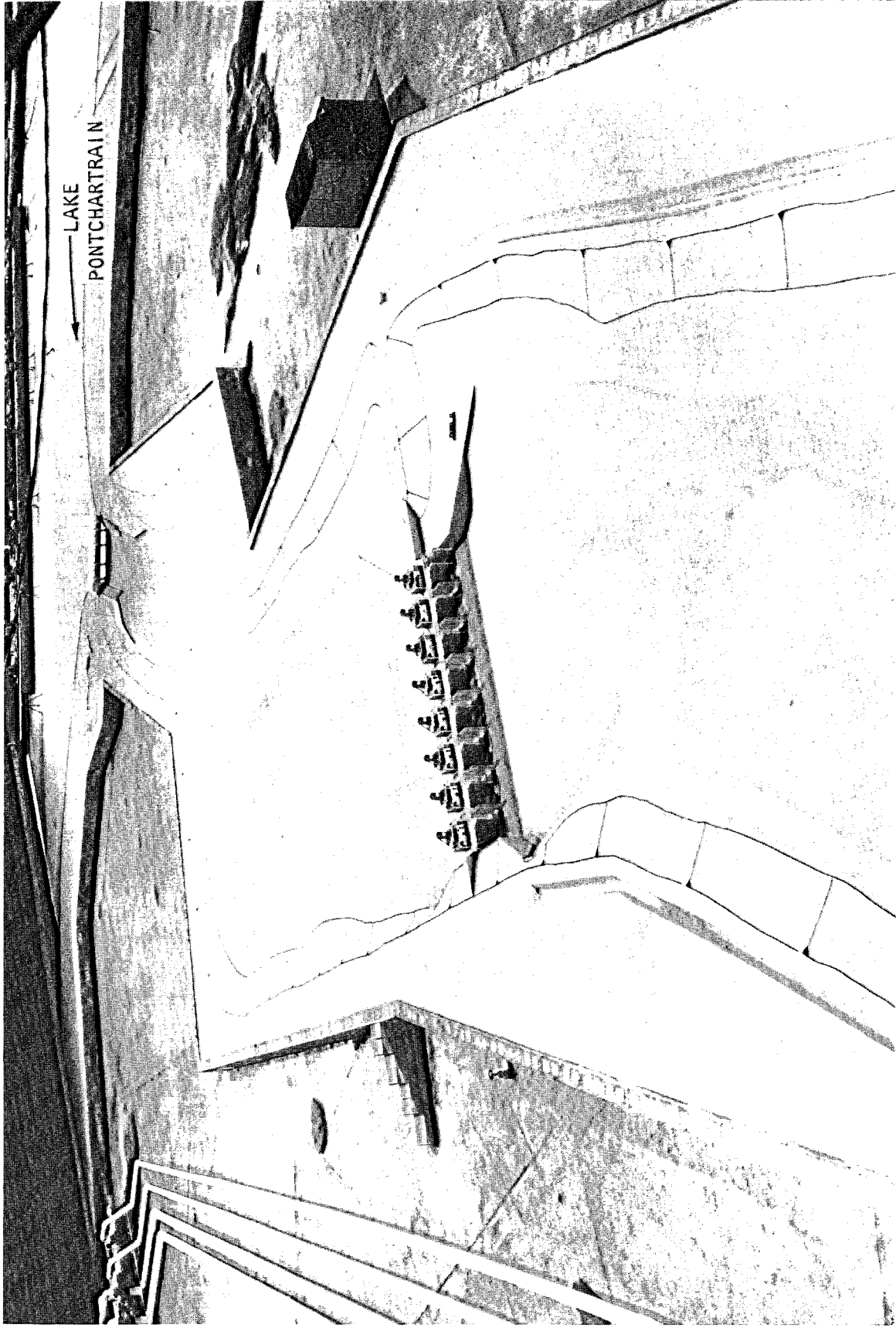

Photo 1. Dry bed of original design channel

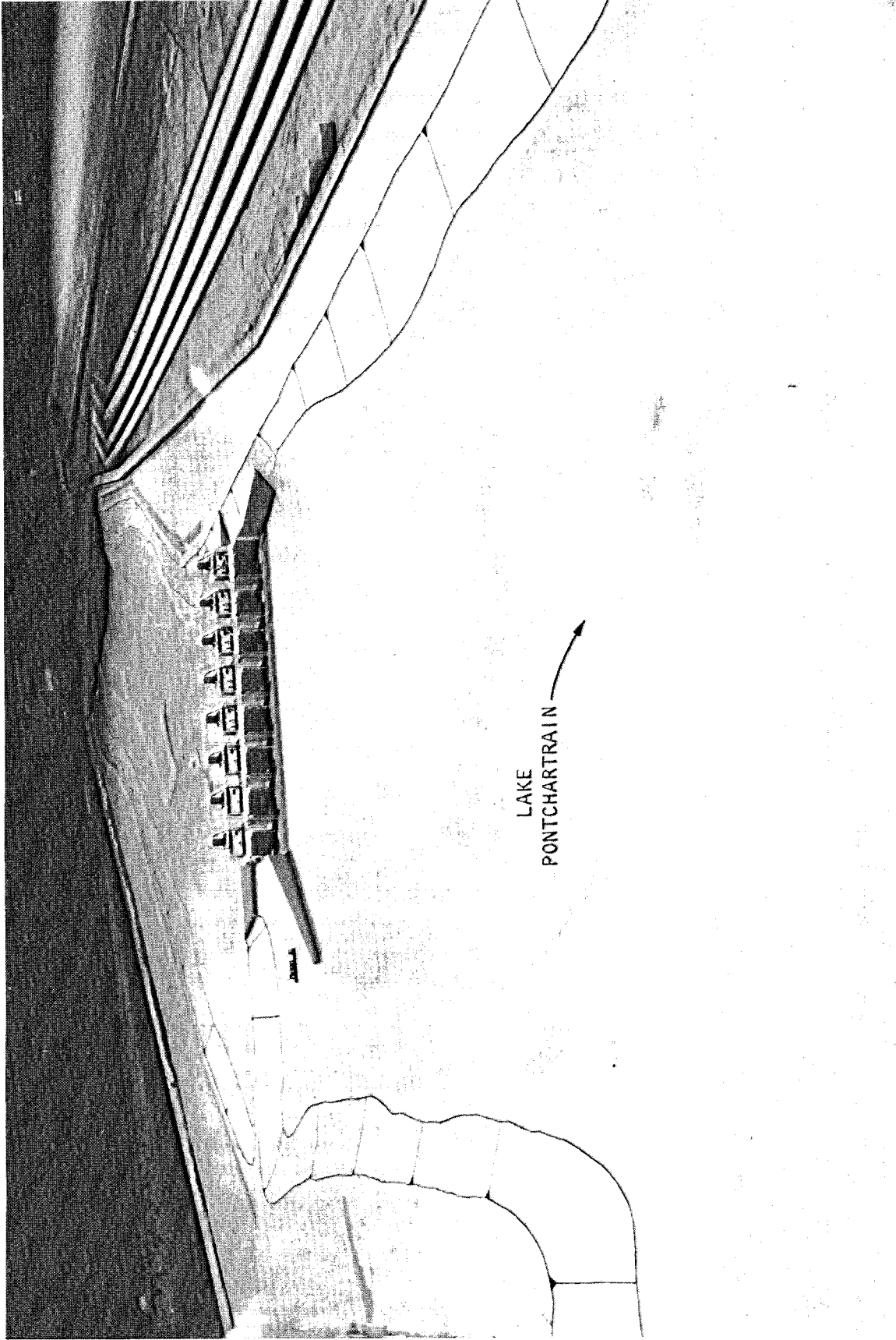

Photo 2. Dry bed of control structure

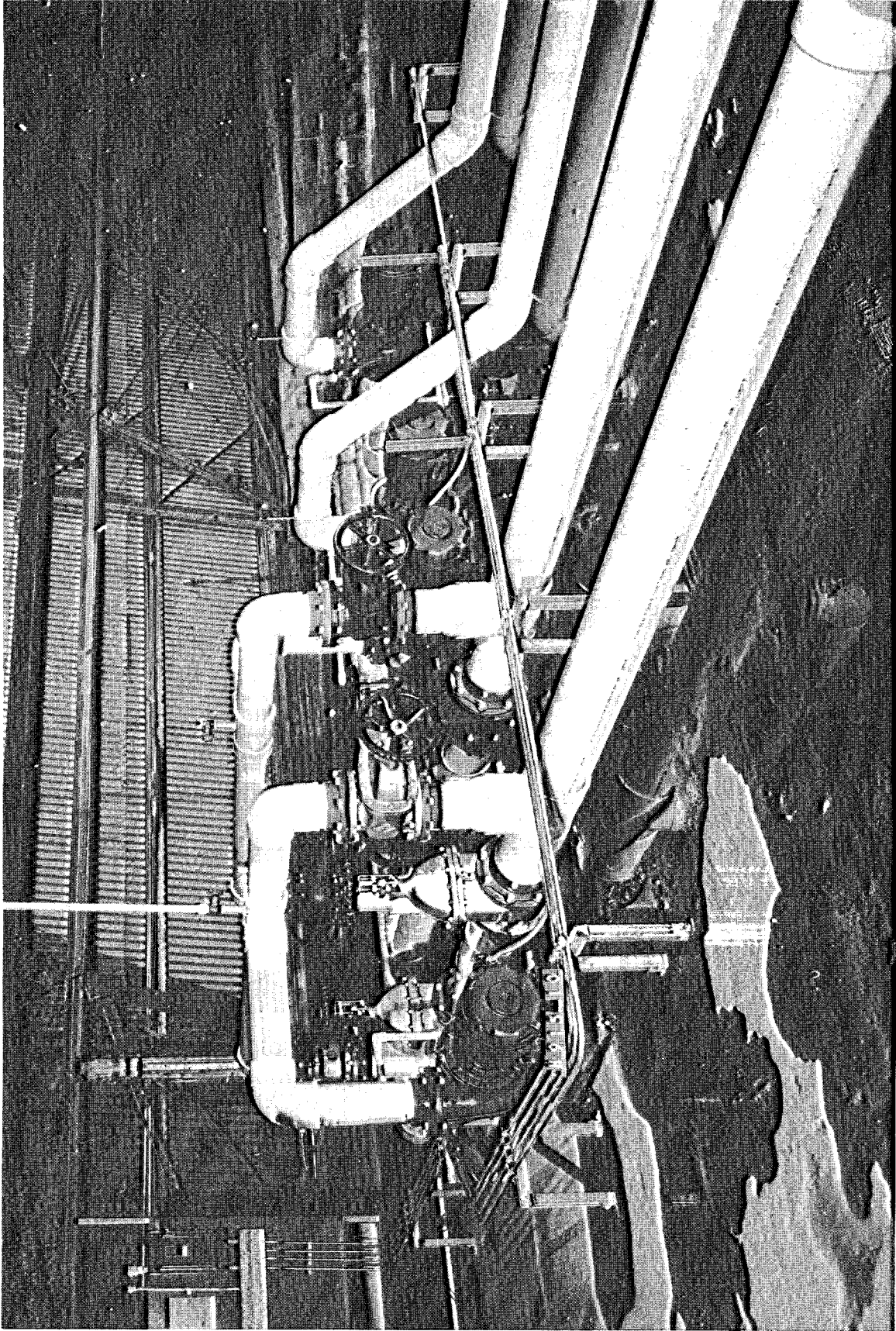
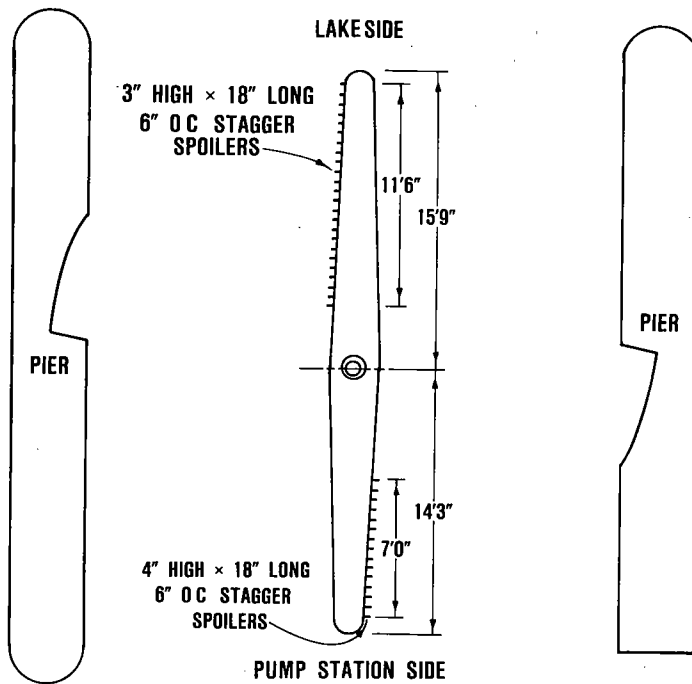

Photo 3. Lakeshore Drive Bridge



Photo 4. Pump configuration



PUMP STATION SIDE
a. TYPE 2 GATE DESIGN

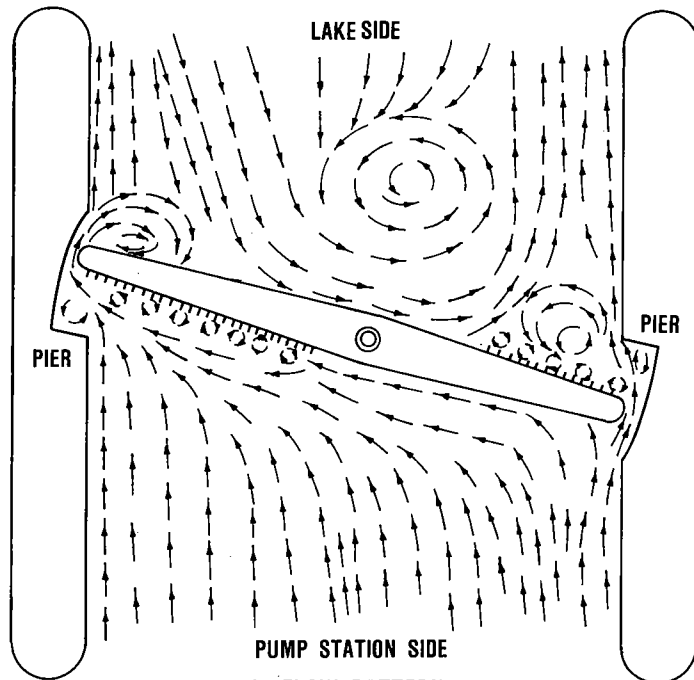

PUMP STATION SIDE
b. FLOW PATTERN

FLOW PATTERN WITH TYPE 2 GATE DESIGN

DISCHARGE $Q = 4,000$ CFS

LAKE EL = + 5 FT

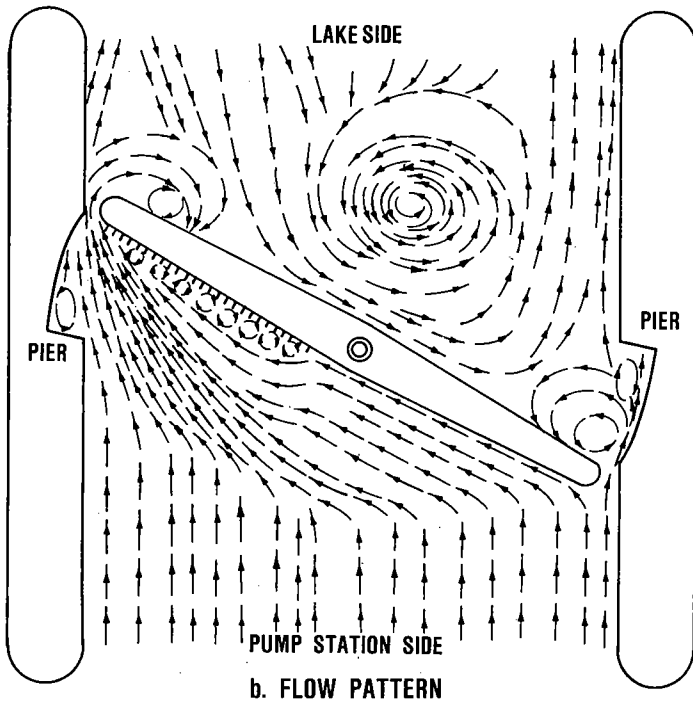
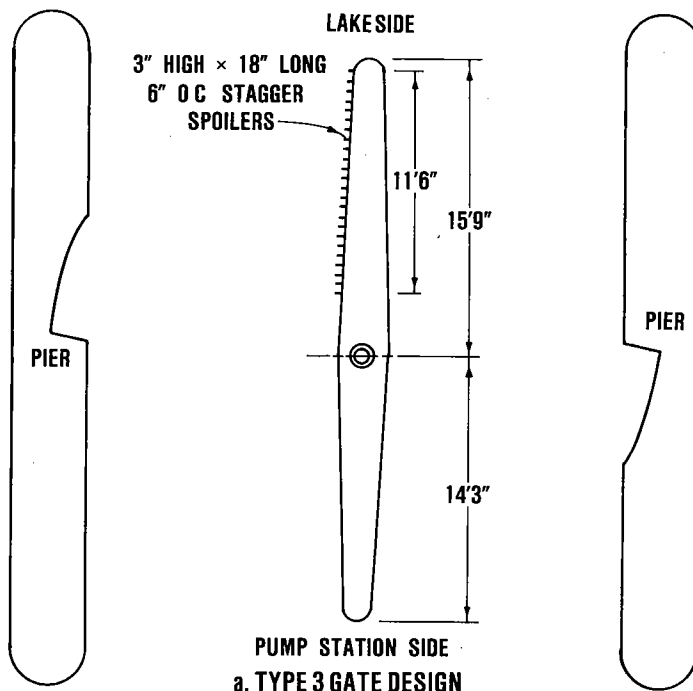

FLOW PATTERN WITH TYPE 3 GATE DESIGN

DISCHARGE $Q = 4,000$ CFS

LAKE EL = + 5 FT

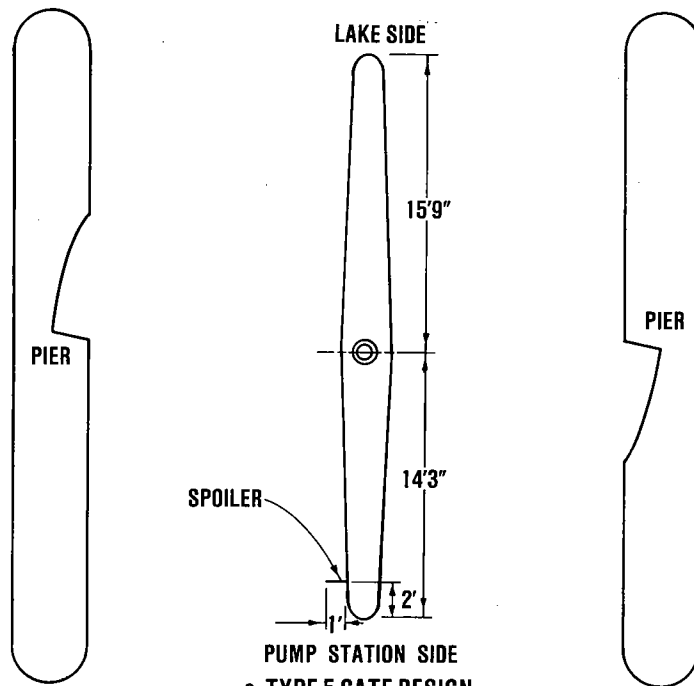

a. TYPE 5 GATE DESIGN

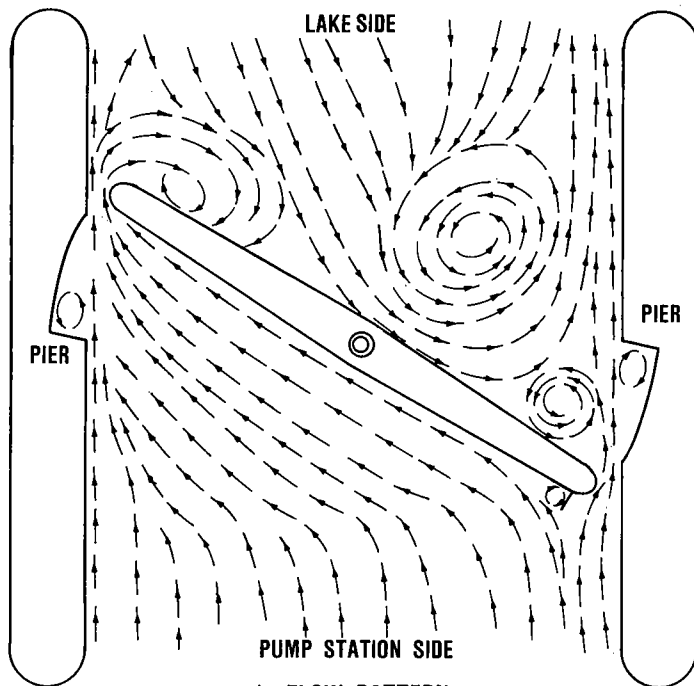

b. FLOW PATTERN

FLOW PATTERN WITH TYPE 5 GATE DESIGN
 DISCHARGE $Q = 4,000$ CFS
 LAKE EL = + 5 FT

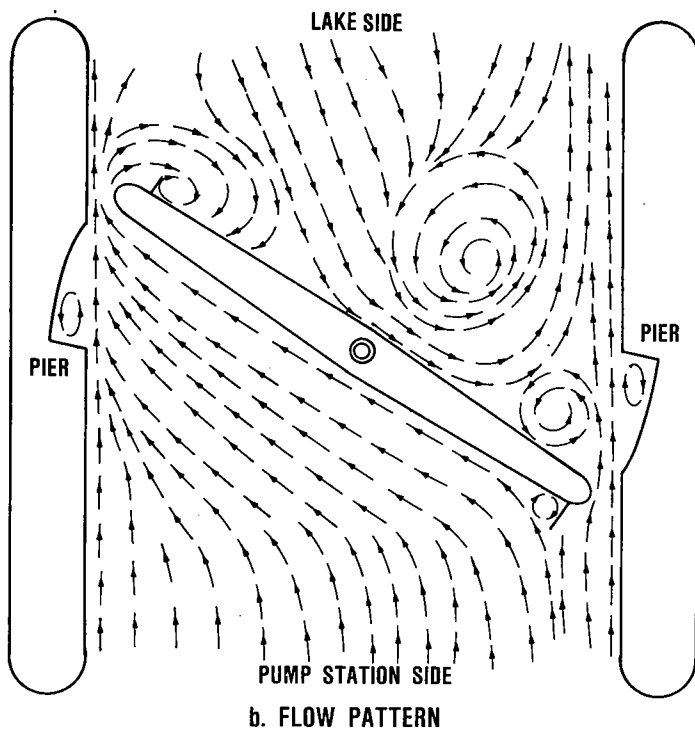
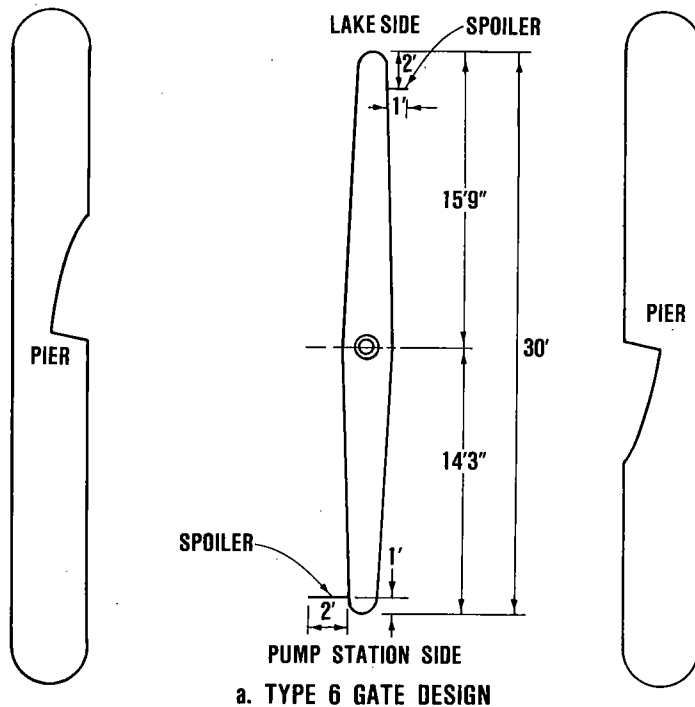

FLOW PATTERN WITH TYPE 6 GATE DESIGN

DISCHARGE $Q = 4,000$ CFS

LAKE EL = + 5 FT

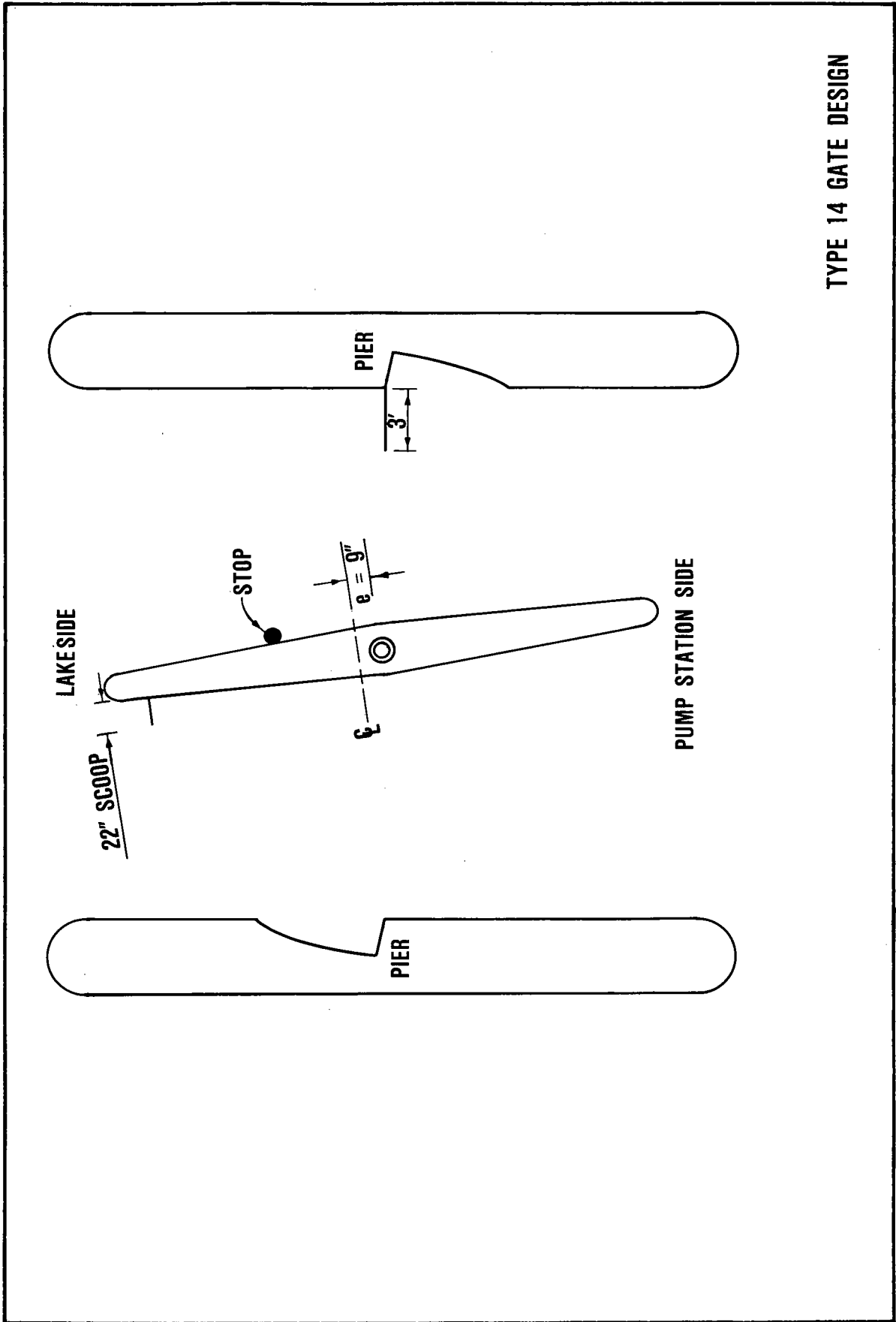

TYPE 14 GATE DESIGN

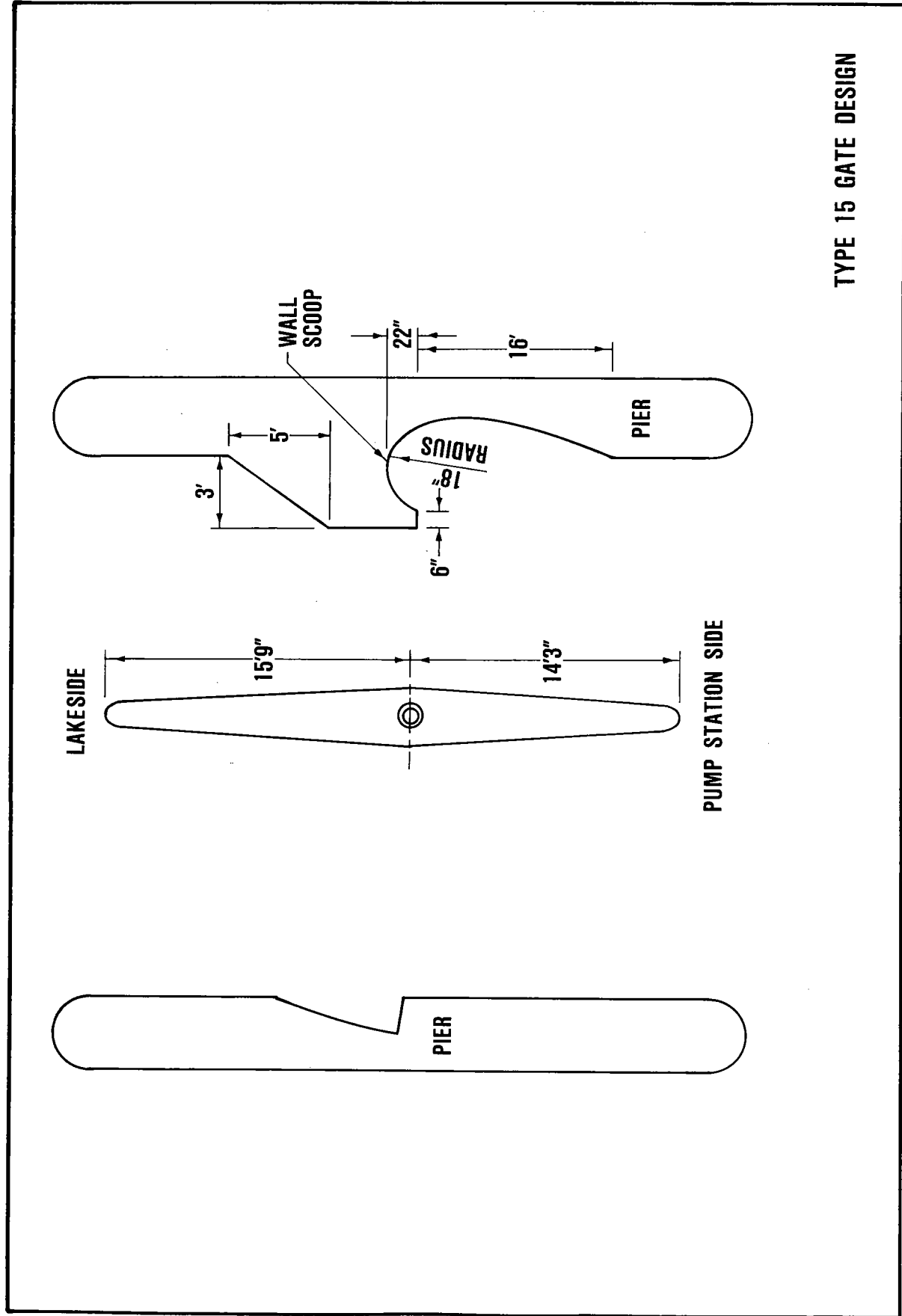

TYPE 15 GATE DESIGN

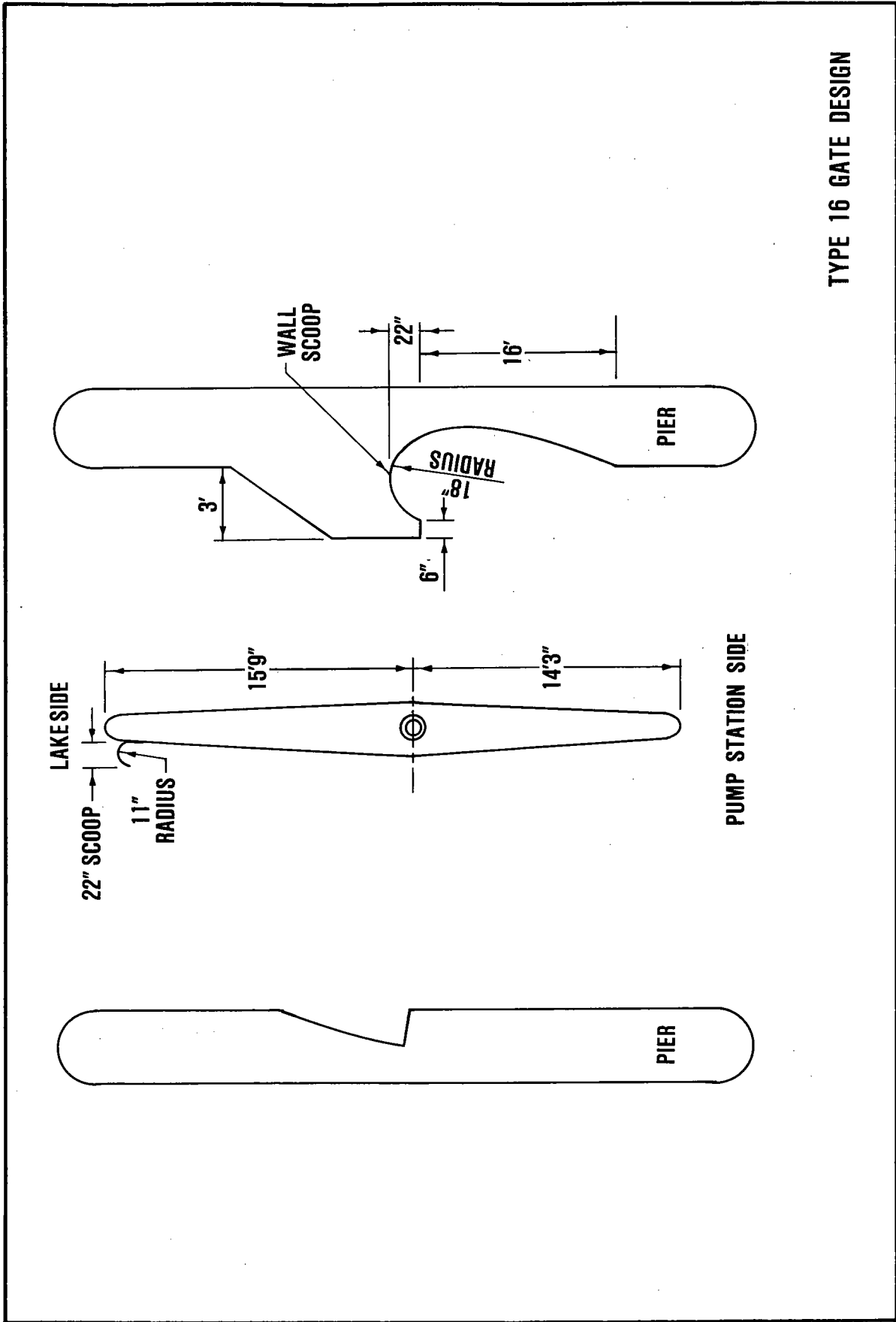

TYPE 16 GATE DESIGN

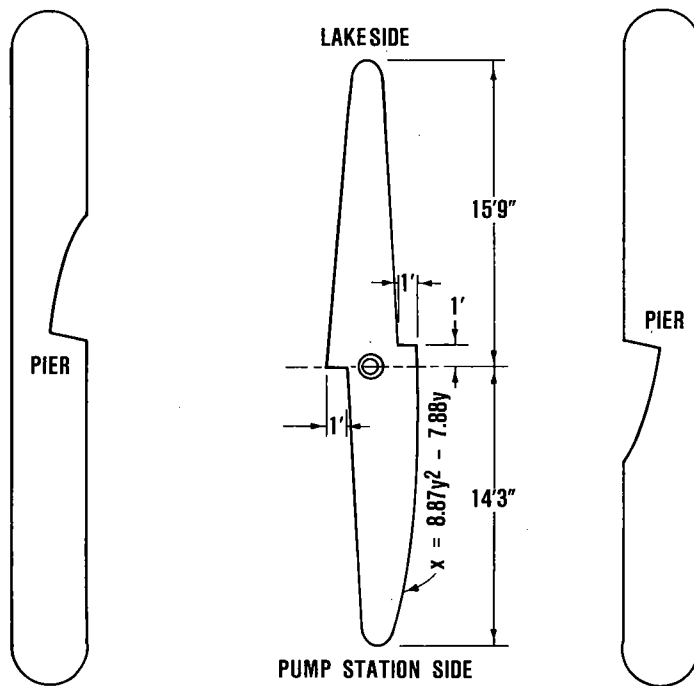

a. TYPE 18 GATE DESIGN

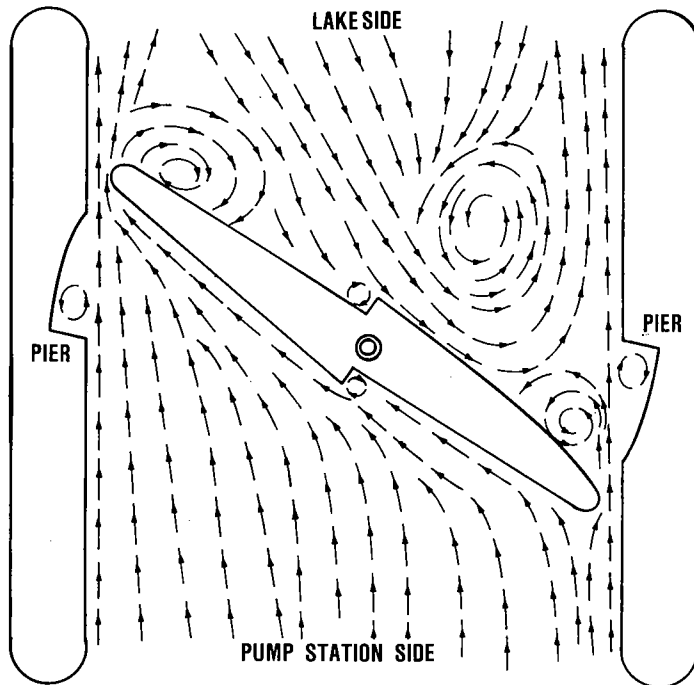

b. FLOW PATTERN

FLOW PATTERN WITH TYPE 18 GATE DESIGN

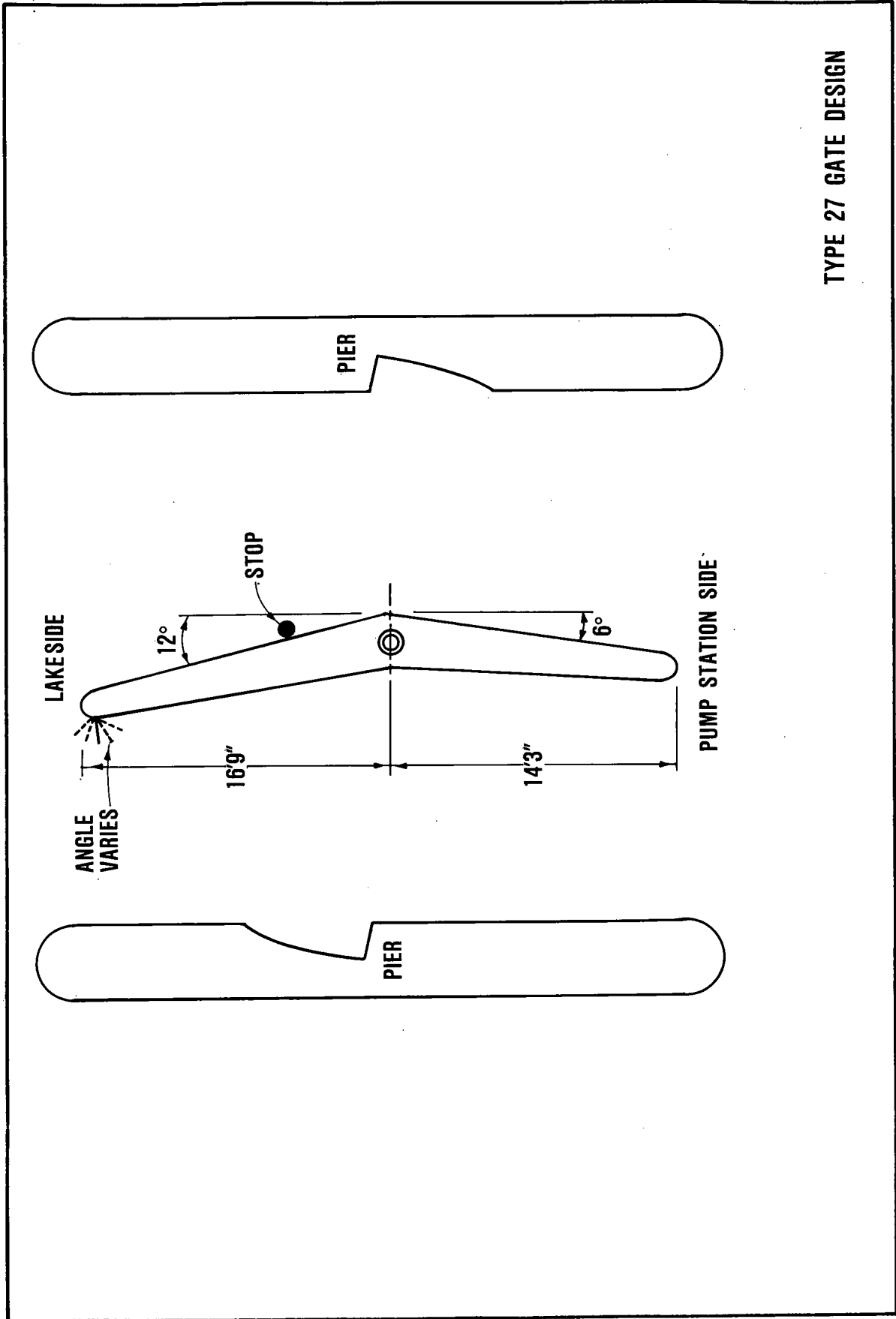

TYPE 27 GATE DESIGN

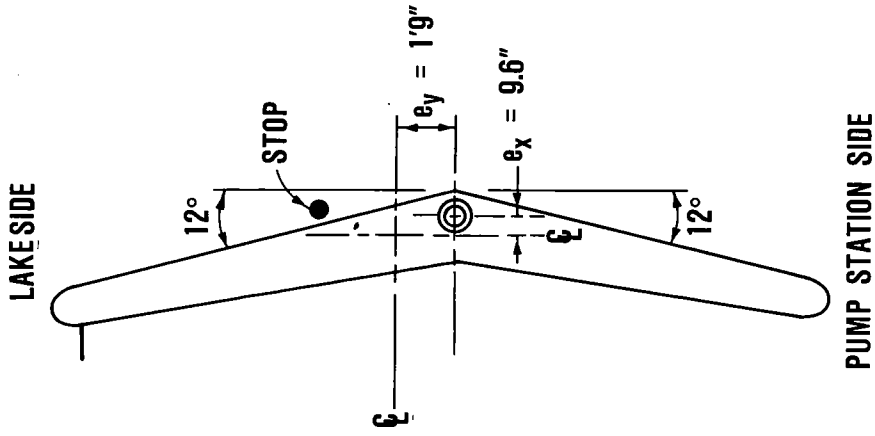

TYPE 32 GATE DESIGN

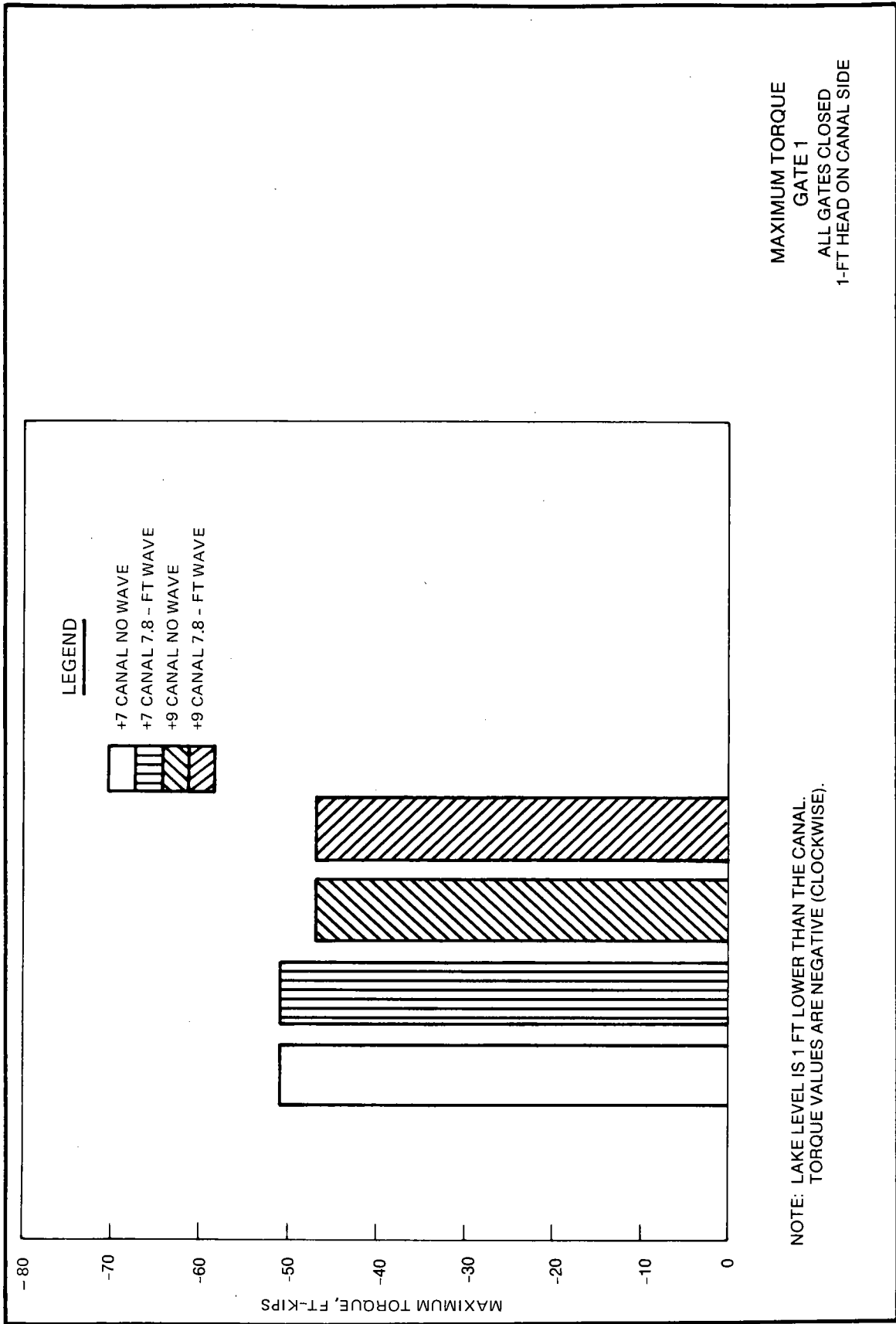

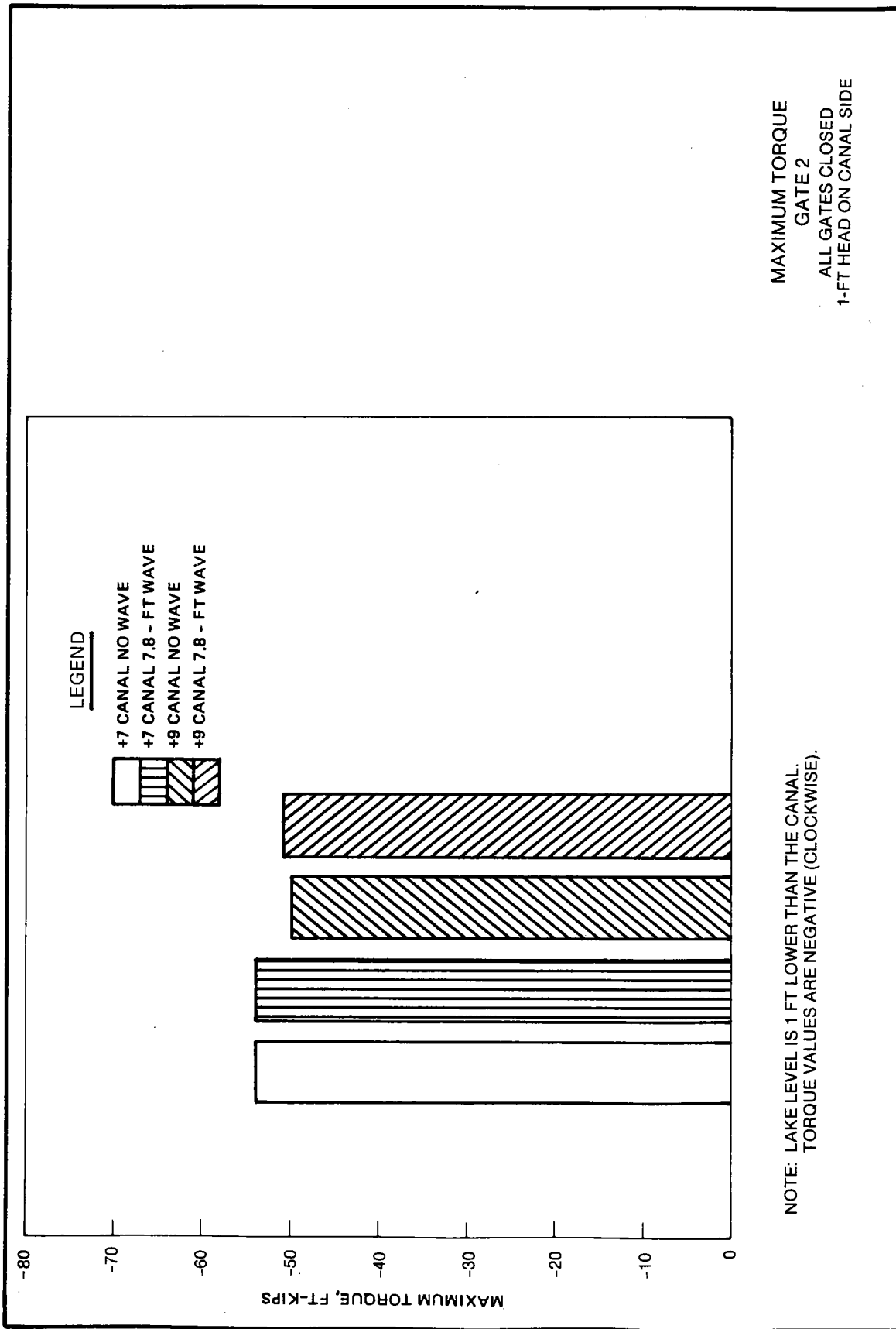

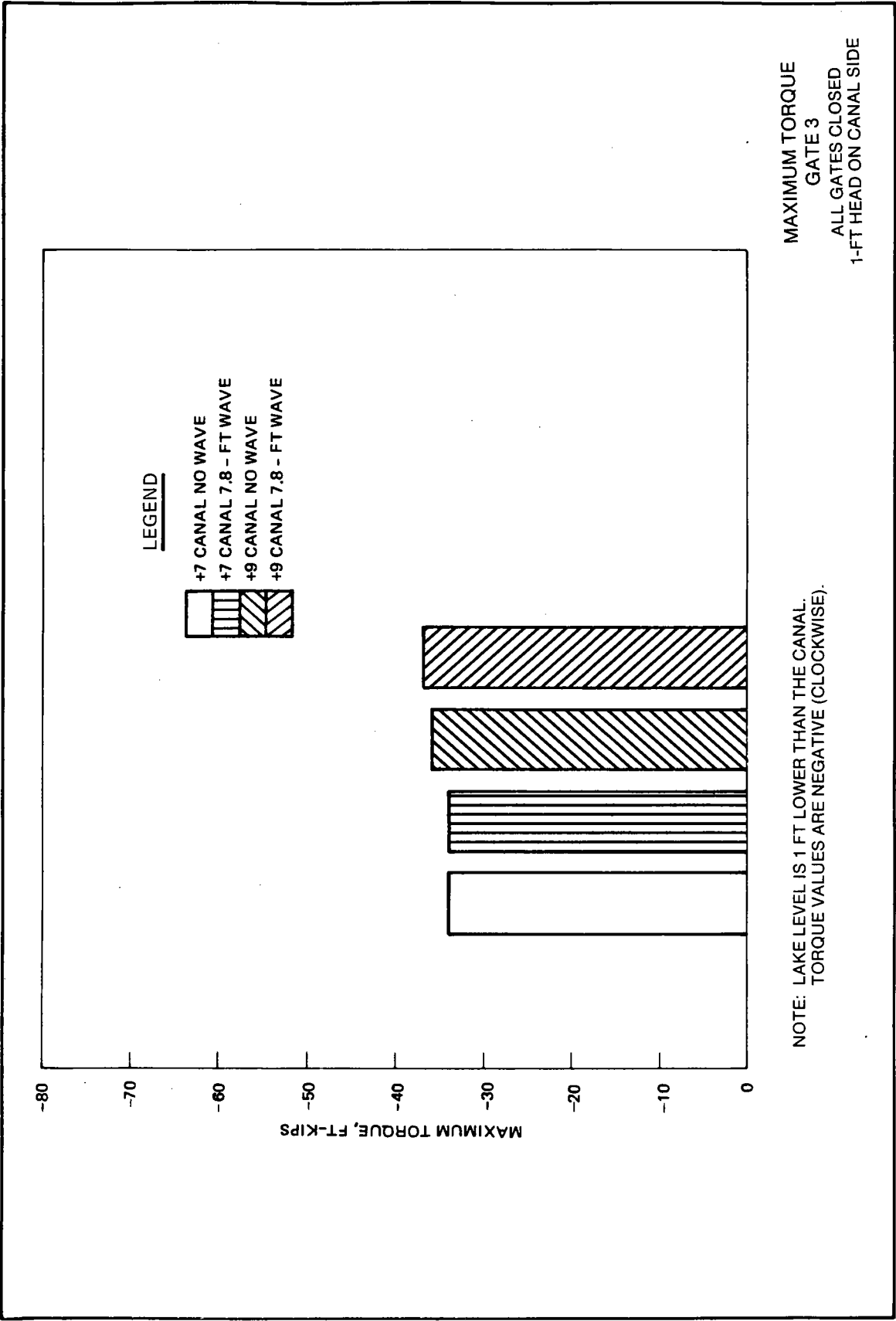

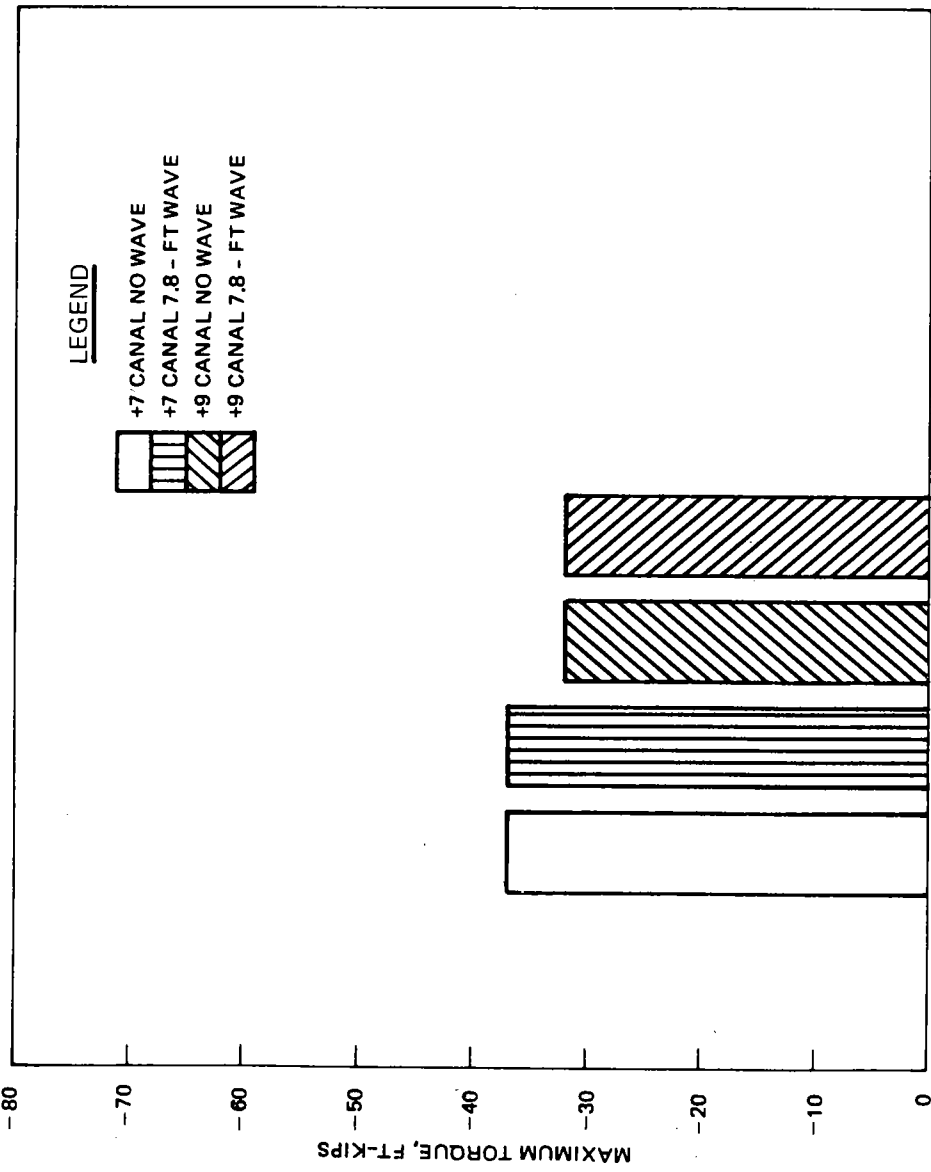

MAXIMUM TORQUE
GATE 4
ALL GATES CLOSED
1-FT HEAD ON CANAL SIDE

NOTE: LAKE LEVEL IS 1 FT LOWER THAN THE CANAL.
TORQUE VALUES ARE NEGATIVE (CLOCKWISE).

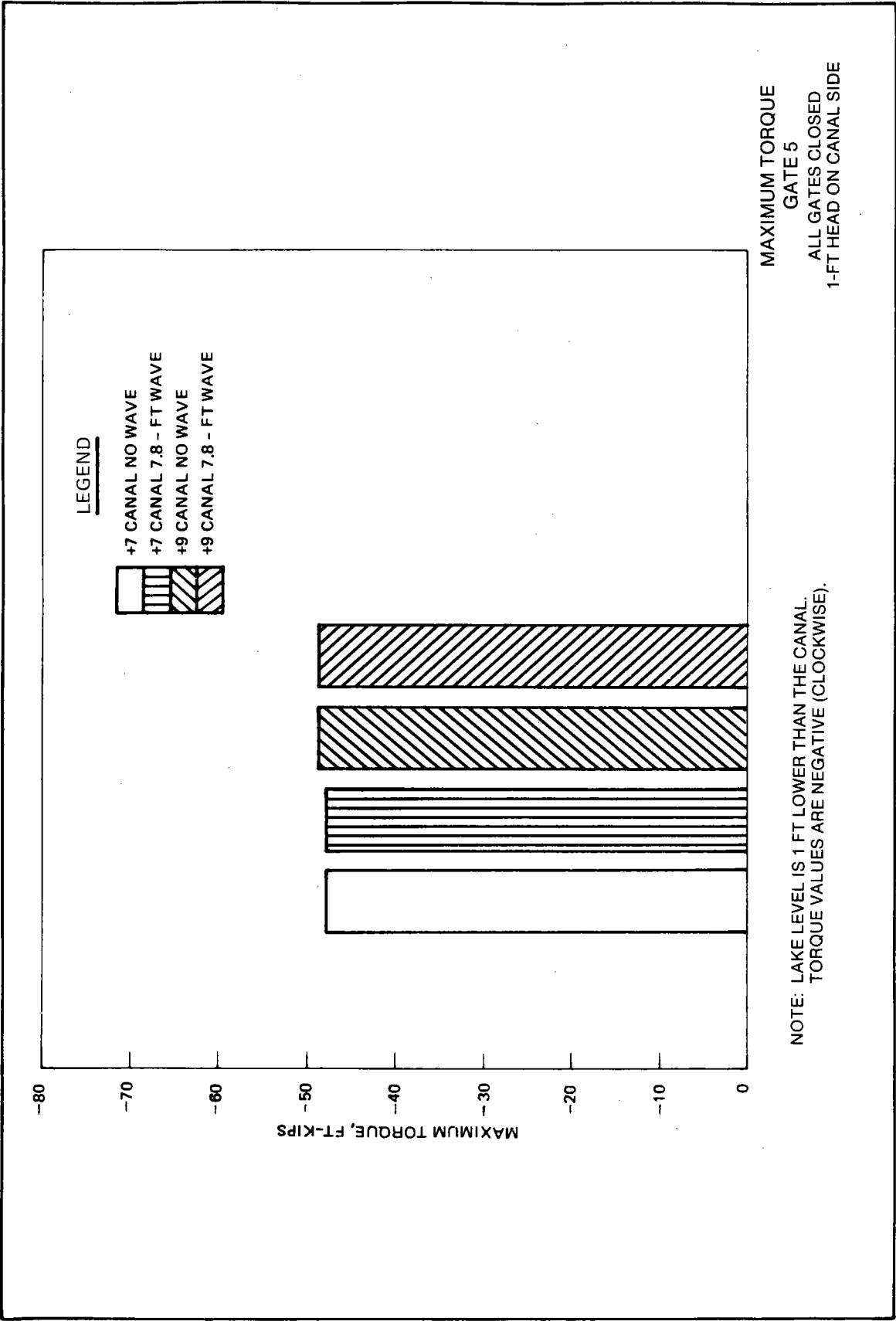

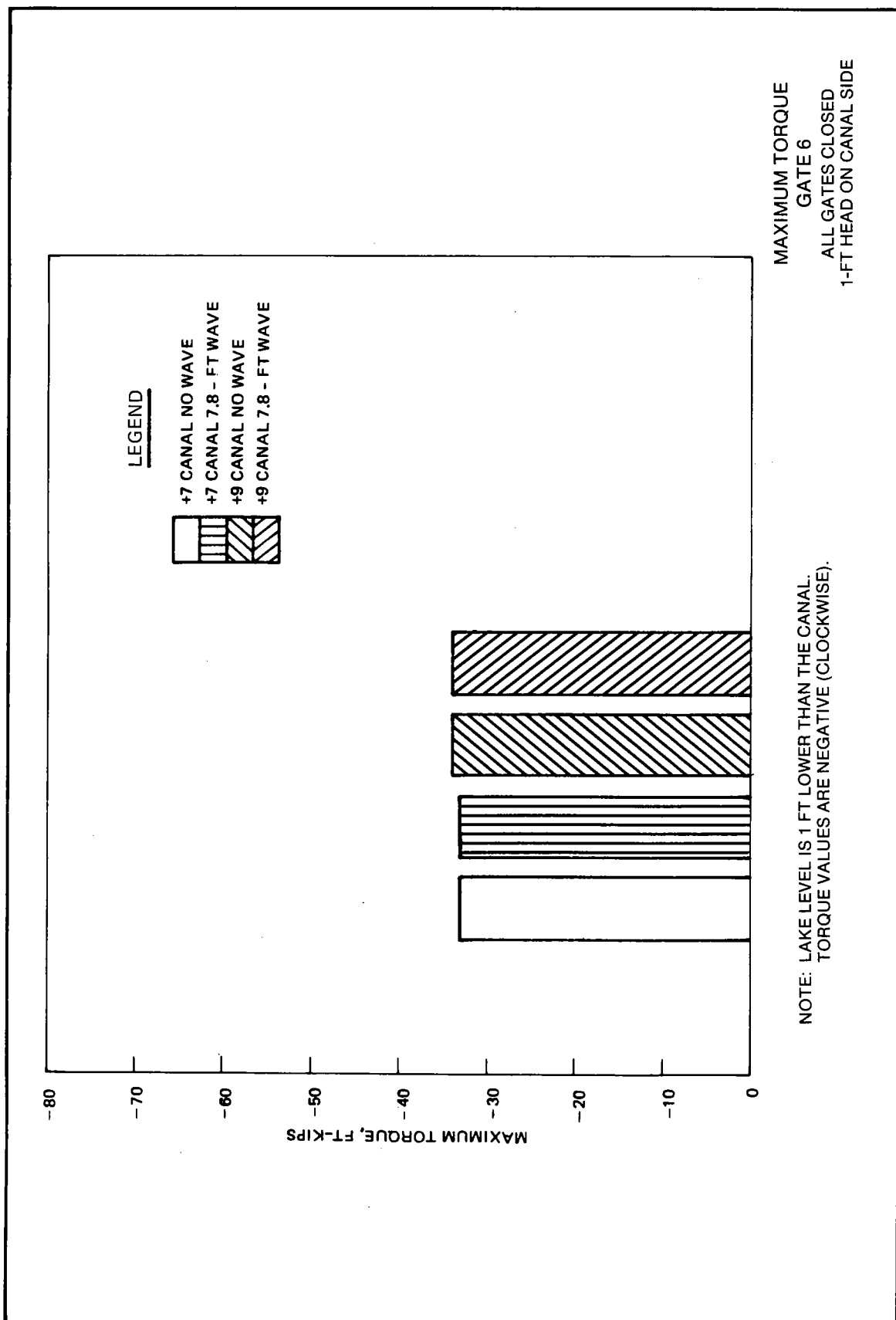

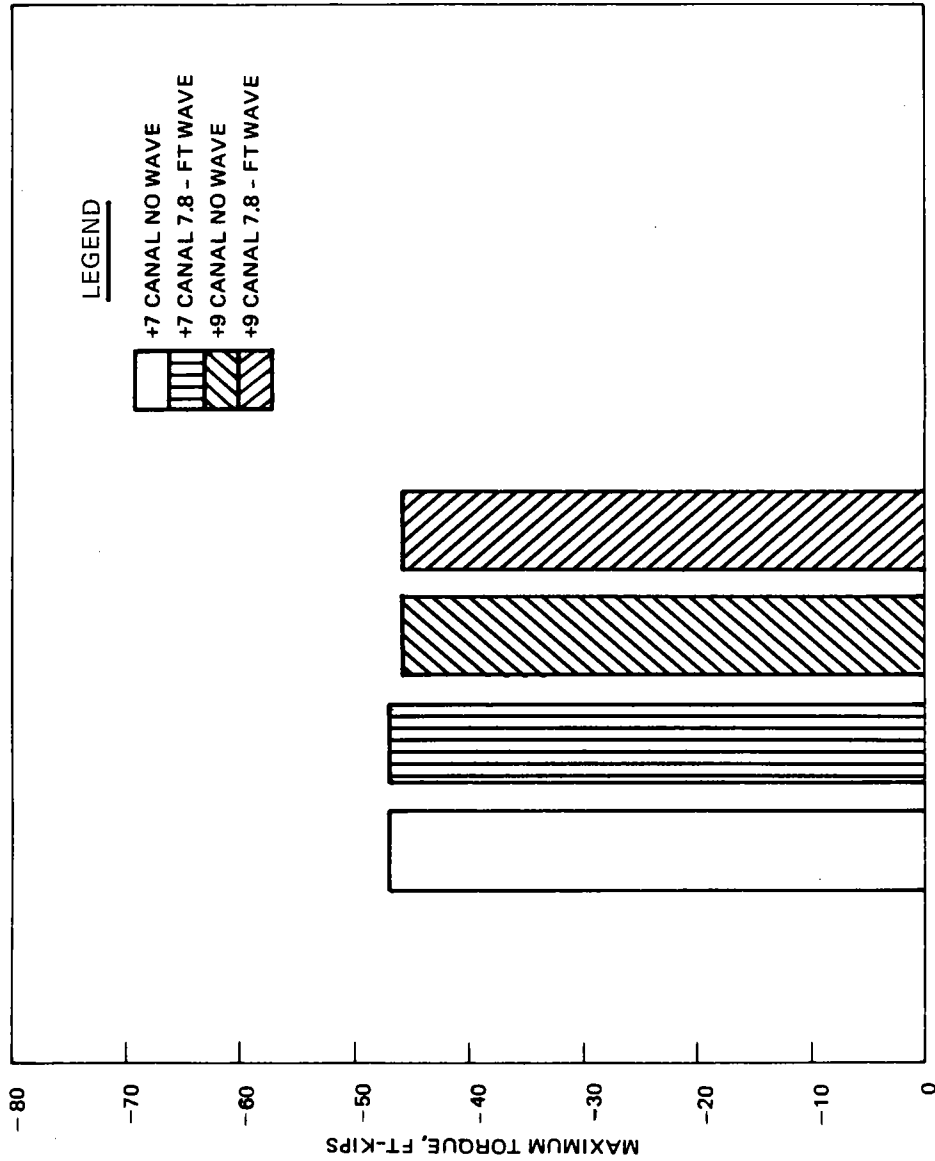

MAXIMUM TORQUE
GATE 7
ALL GATES CLOSED
1-FT HEAD ON CANAL SIDE

NOTE: LAKE LEVEL IS 1 FT LOWER THAN THE CANAL.
TORQUE VALUES ARE NEGATIVE (CLOCKWISE).

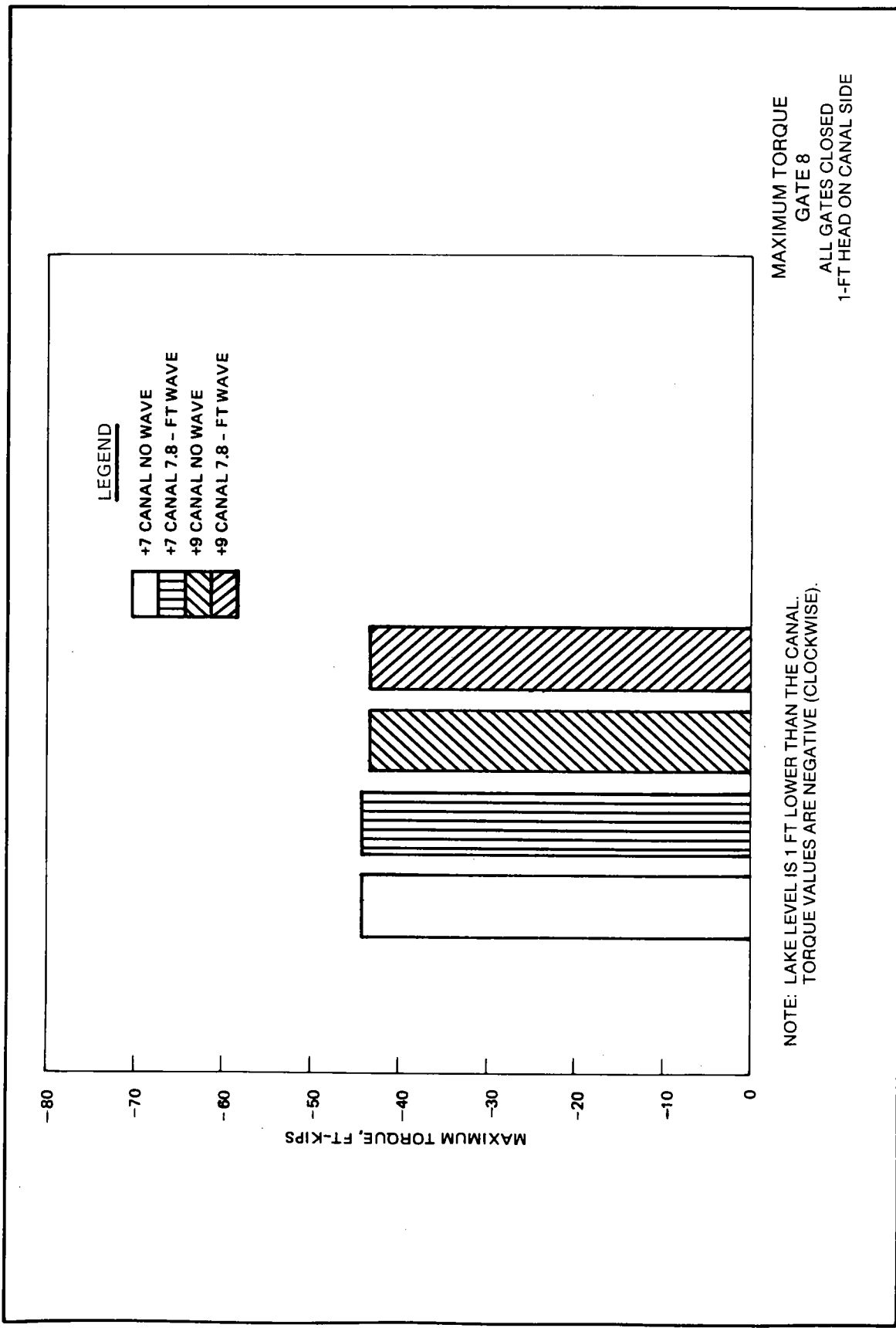

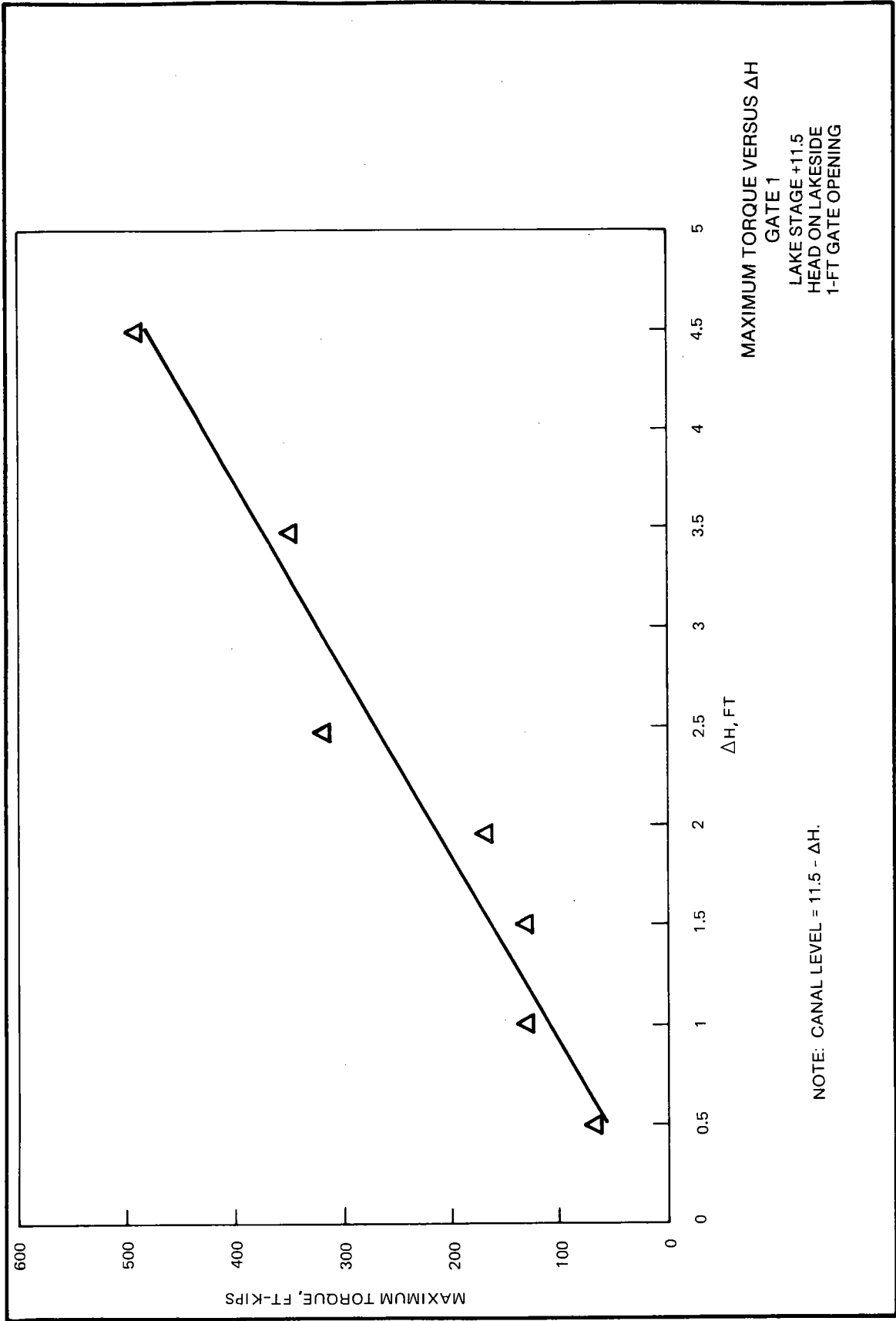

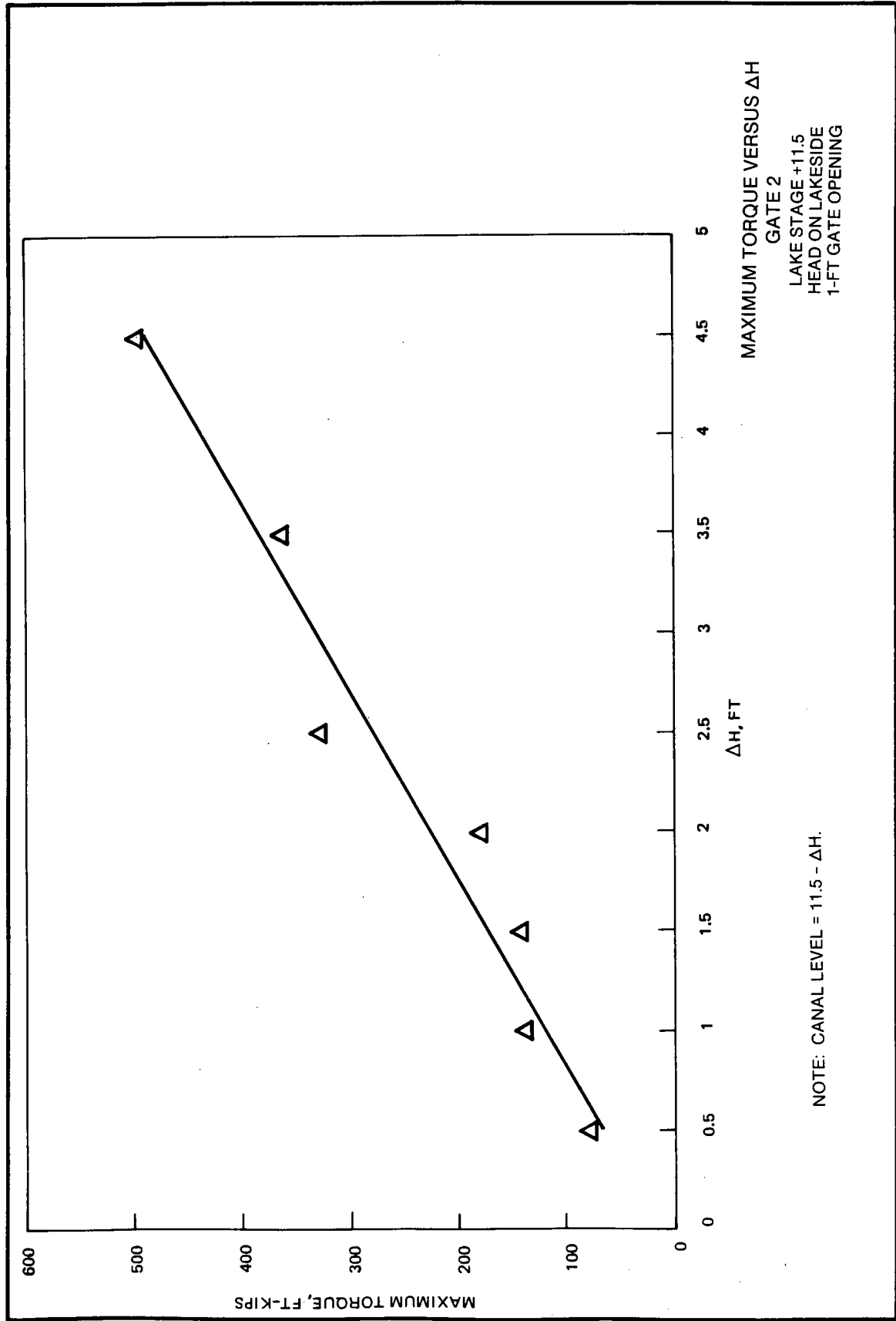
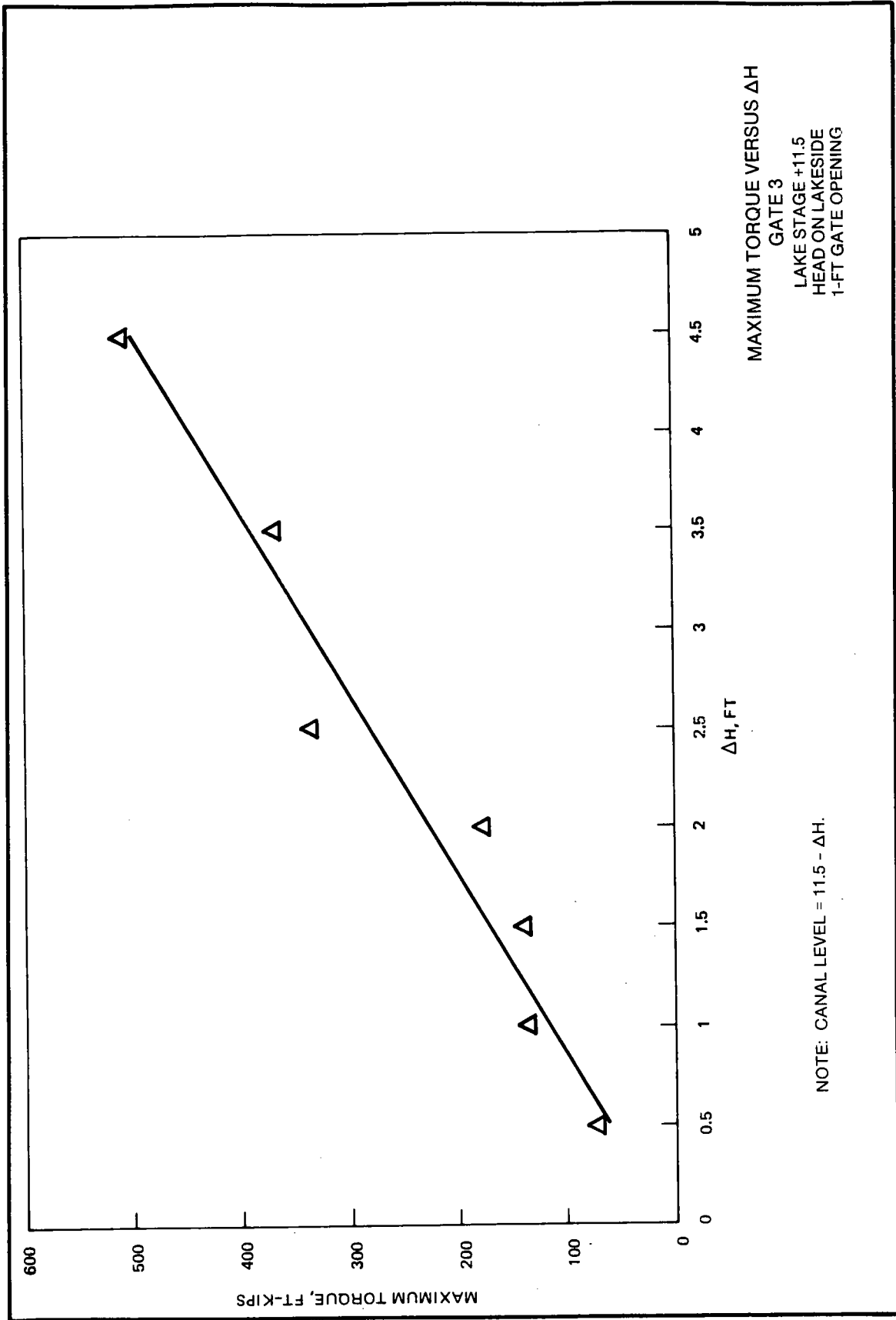

PLATE 20



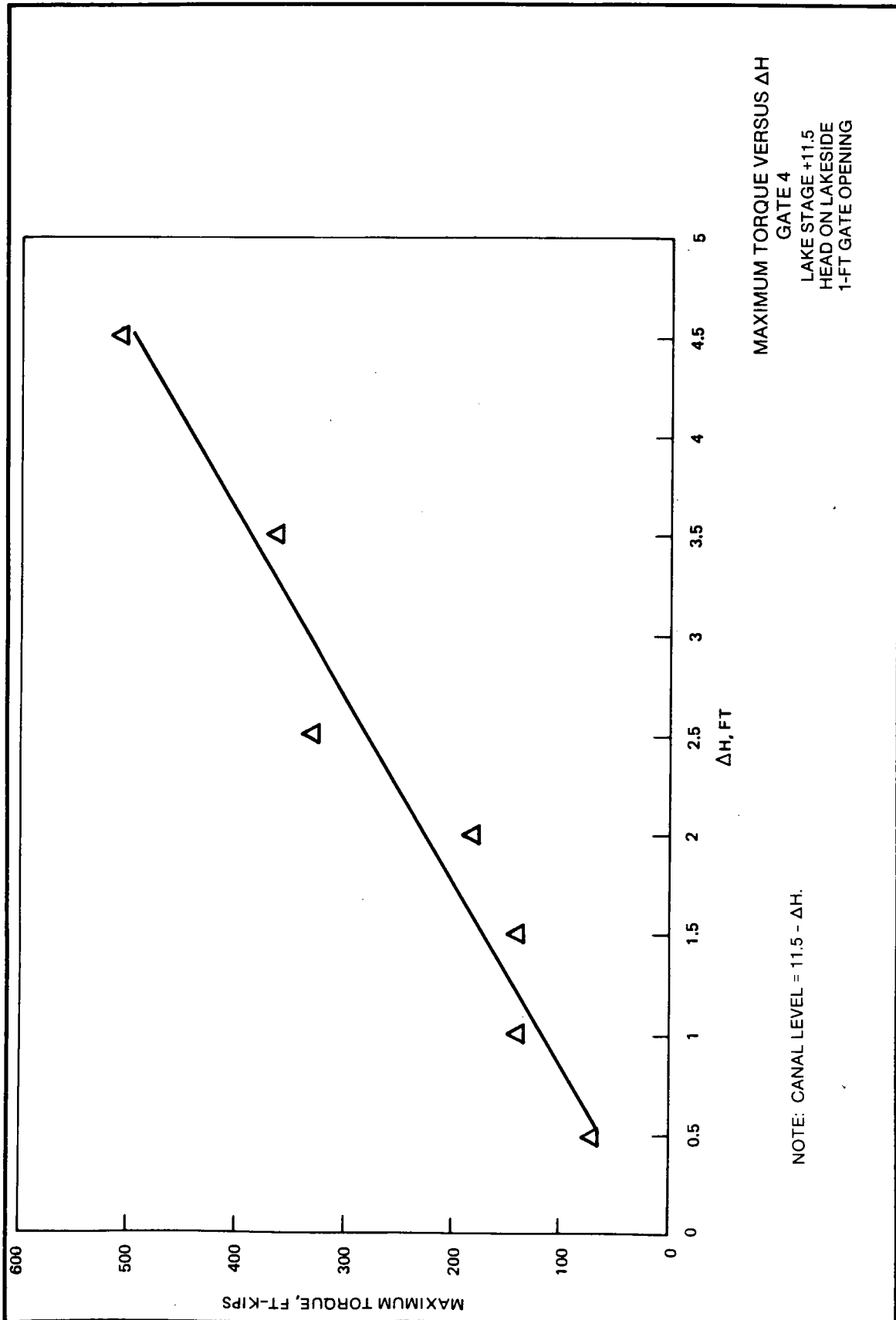
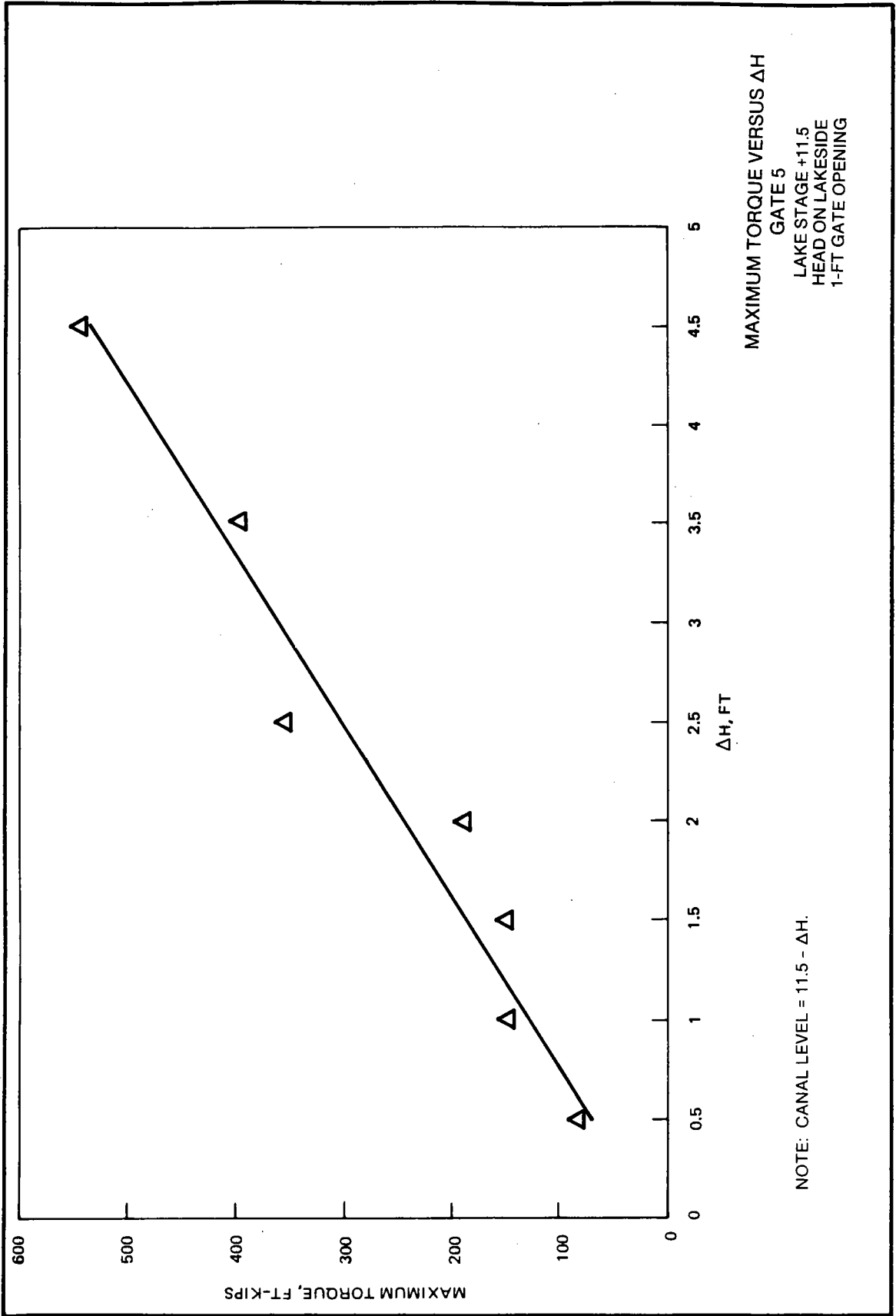

PLATE 22



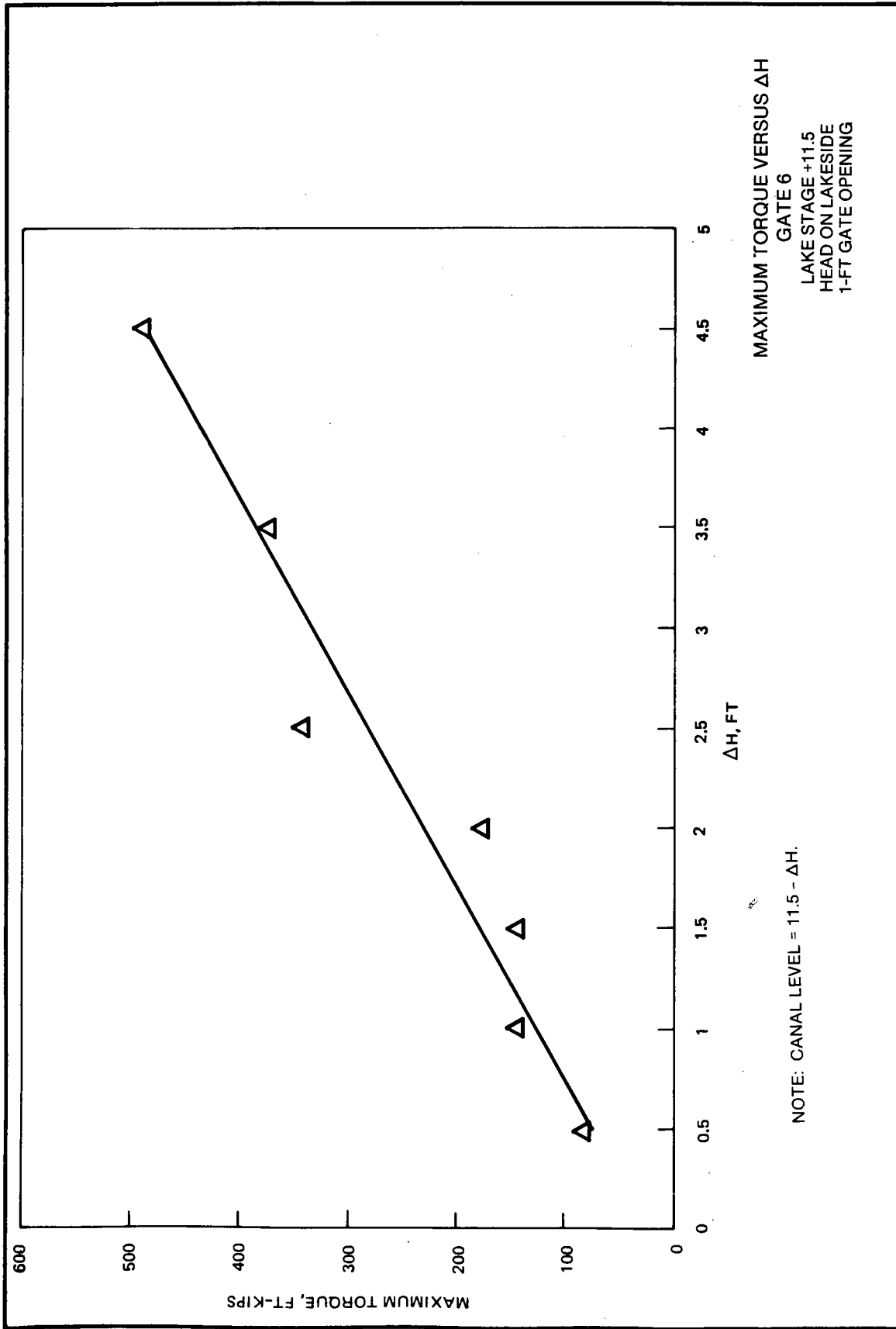
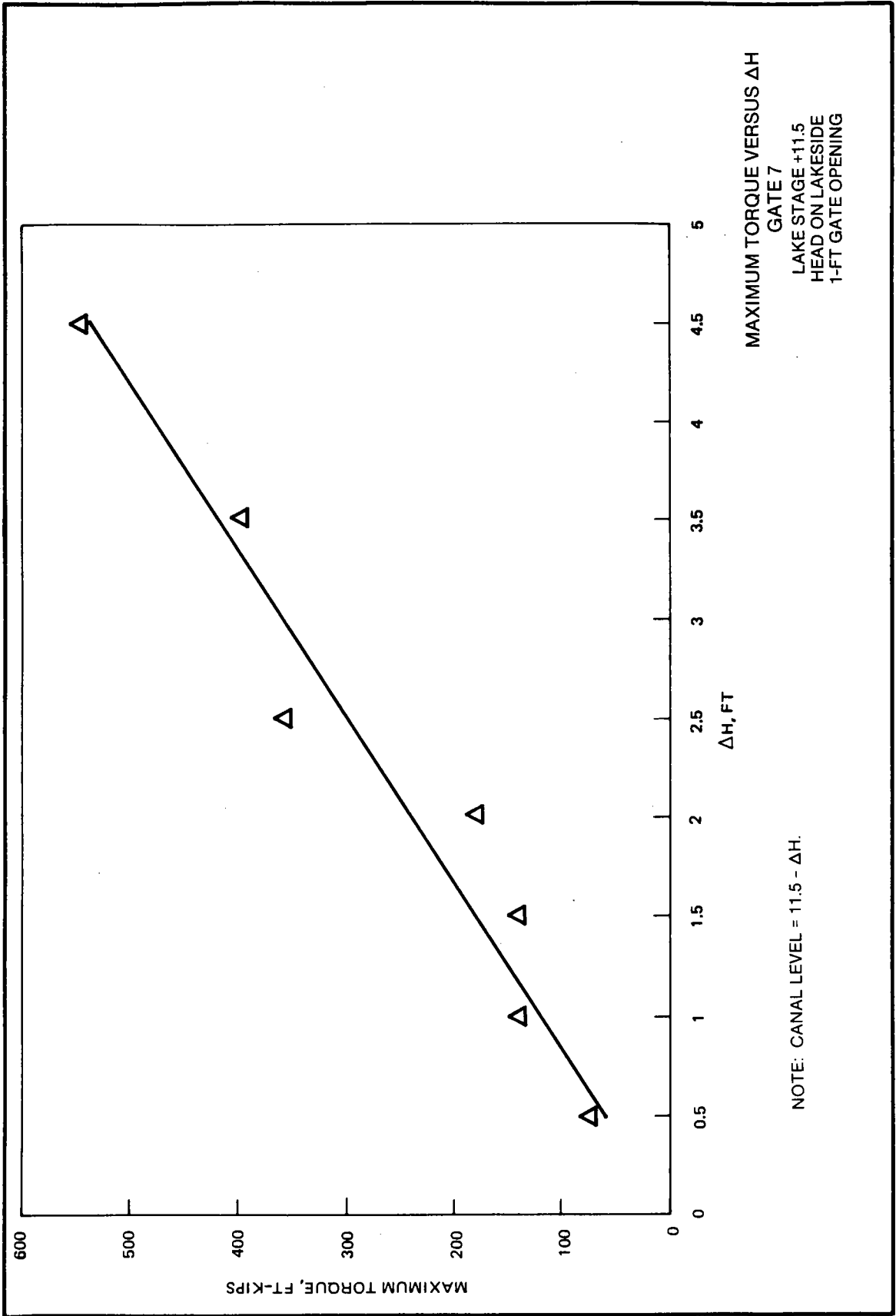

PLATE 24.



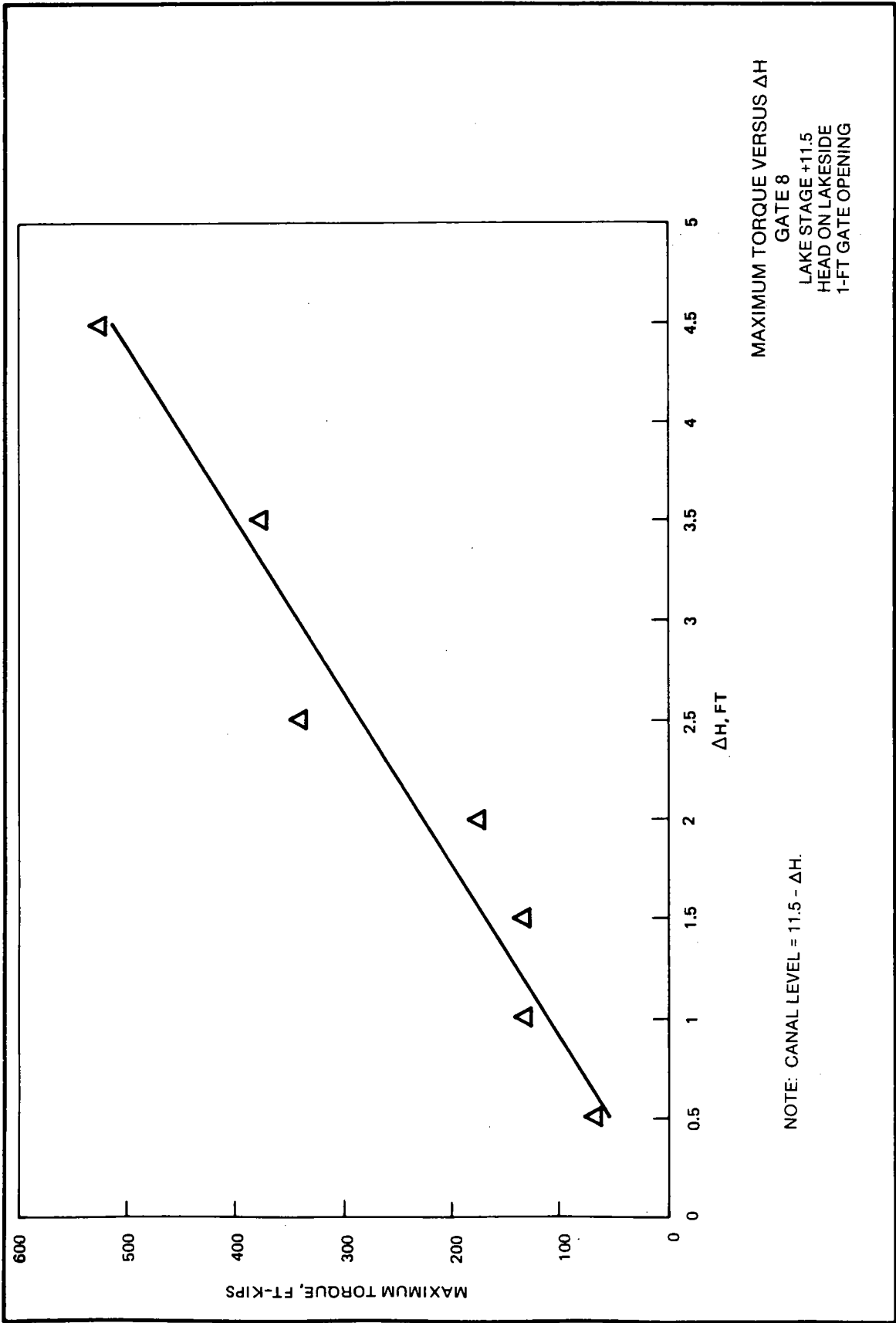
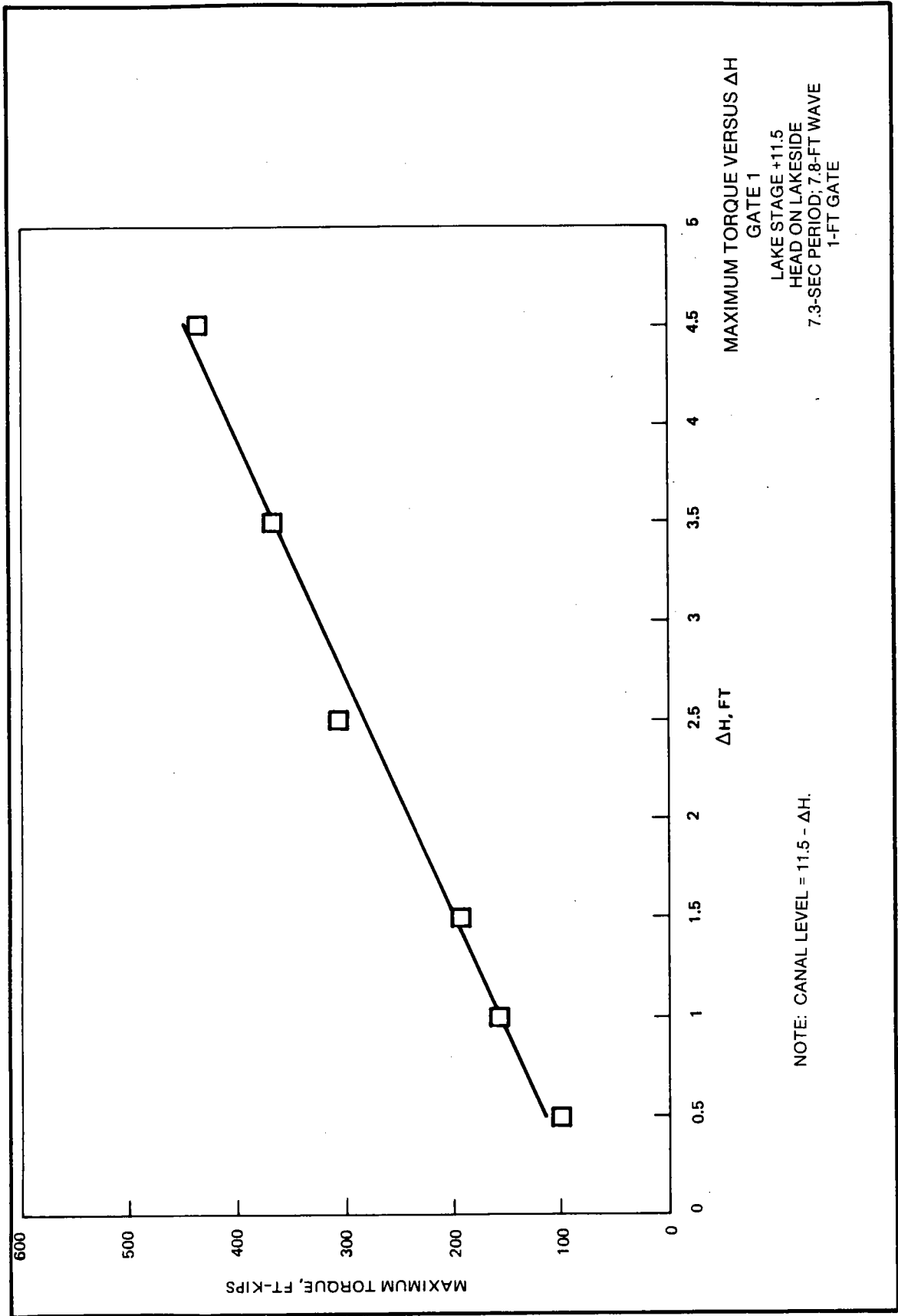
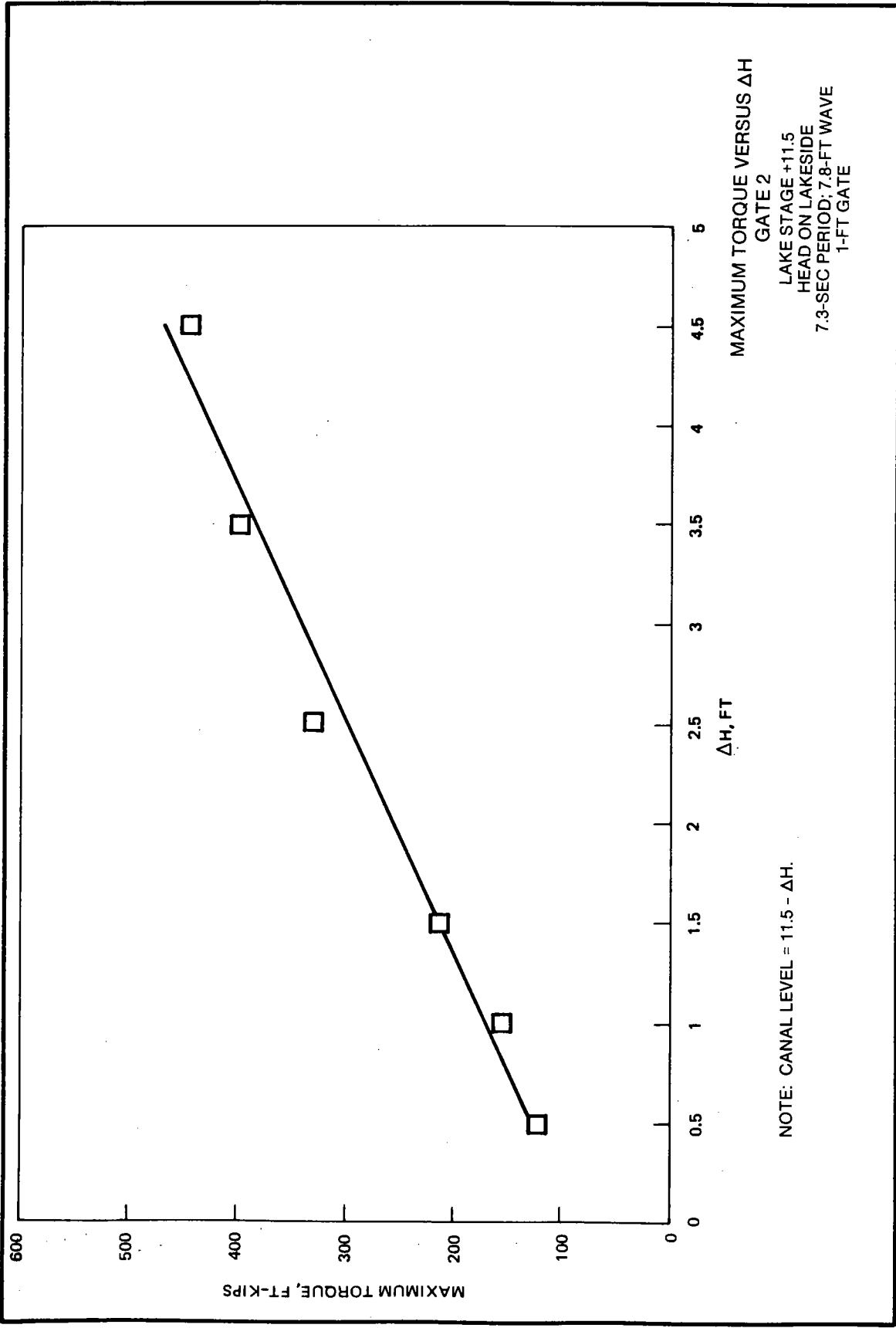
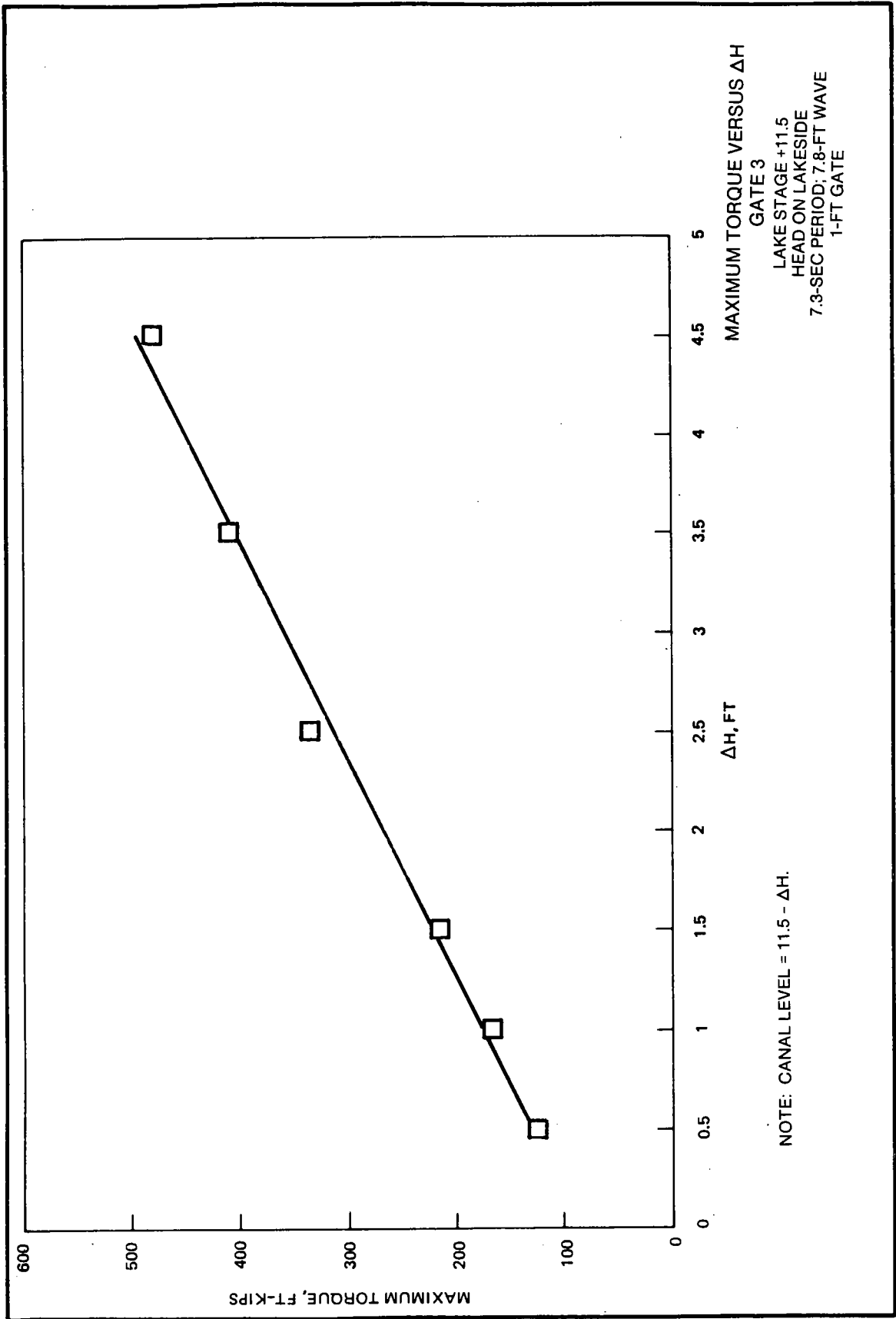

PLATE 26.







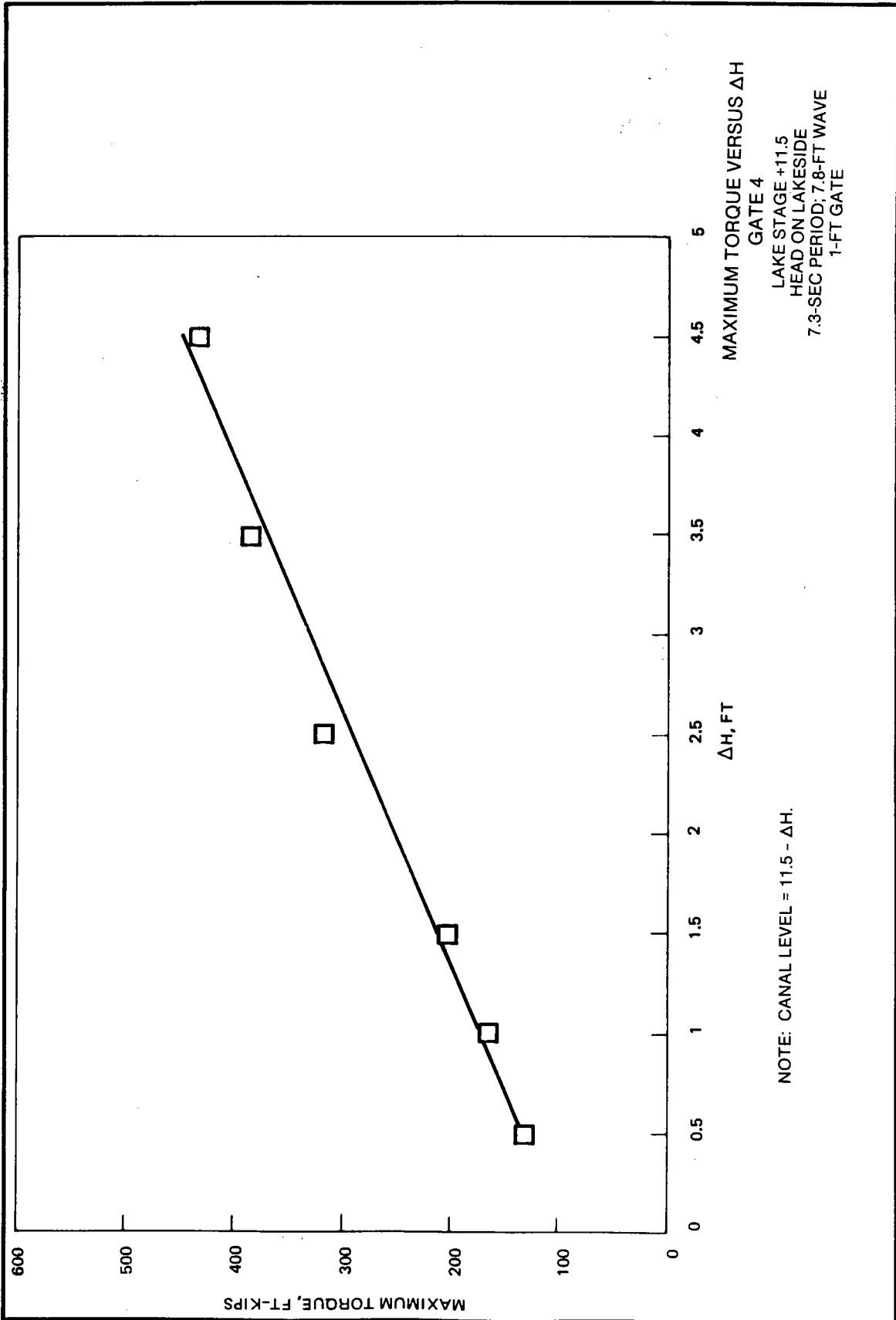
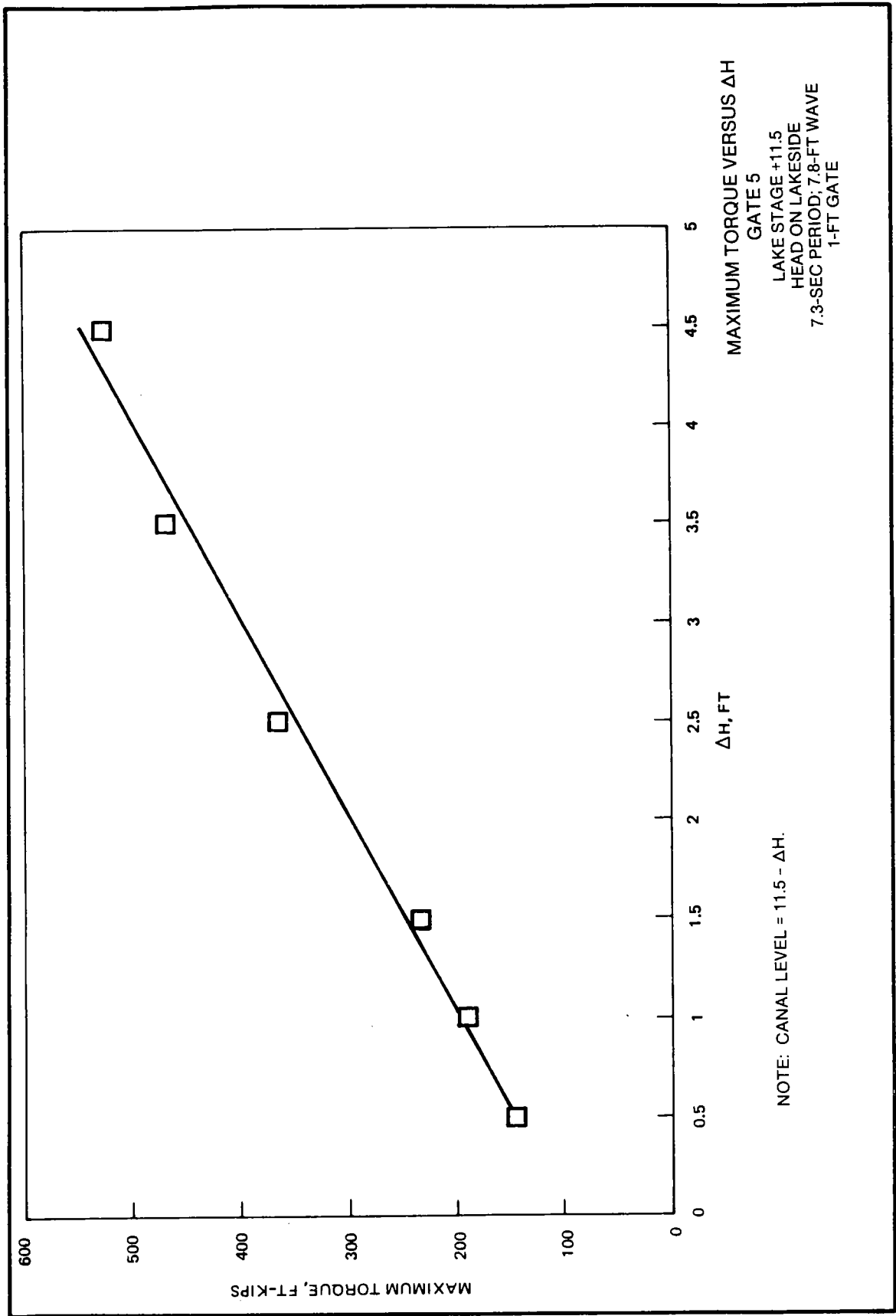

PLATE 30



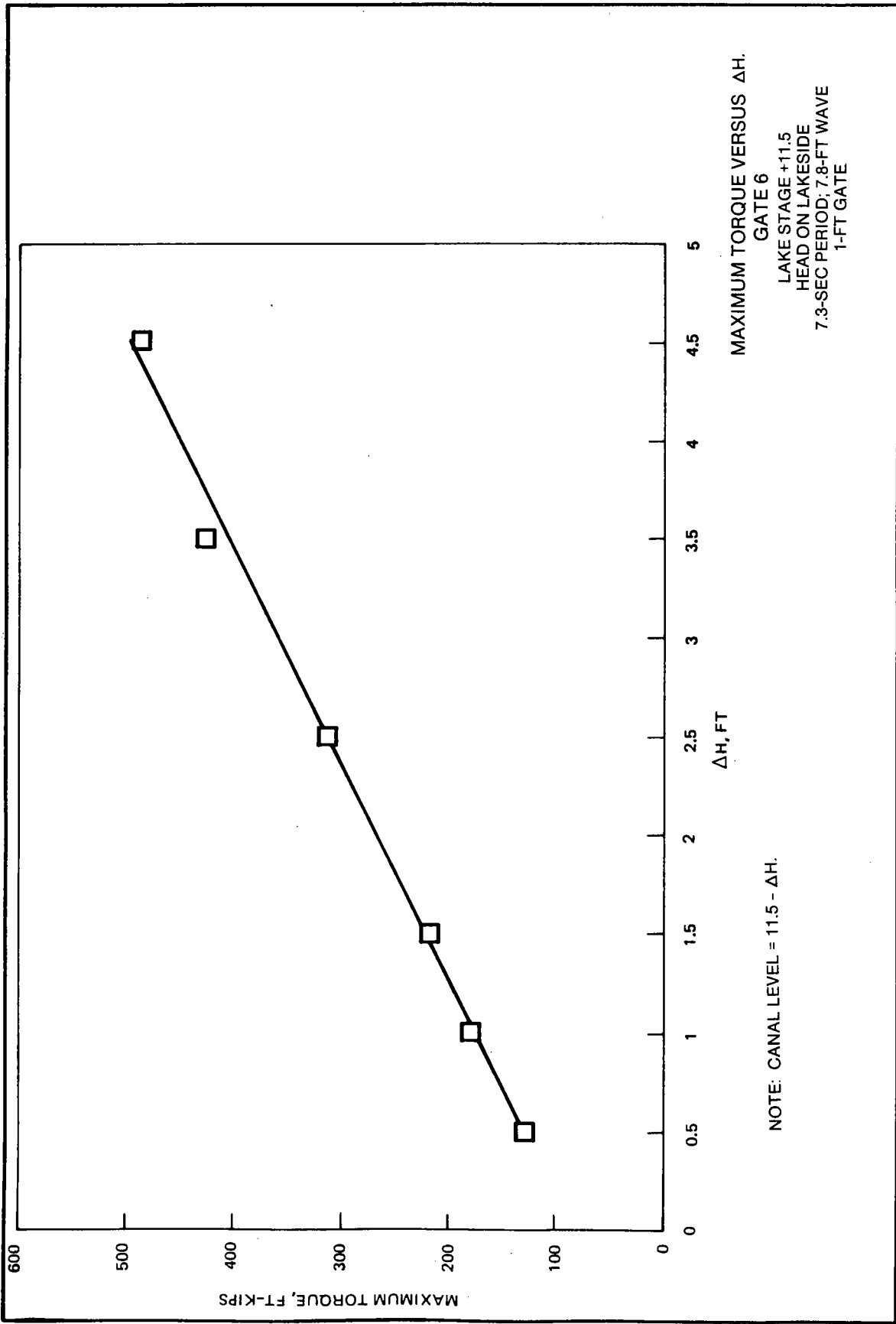
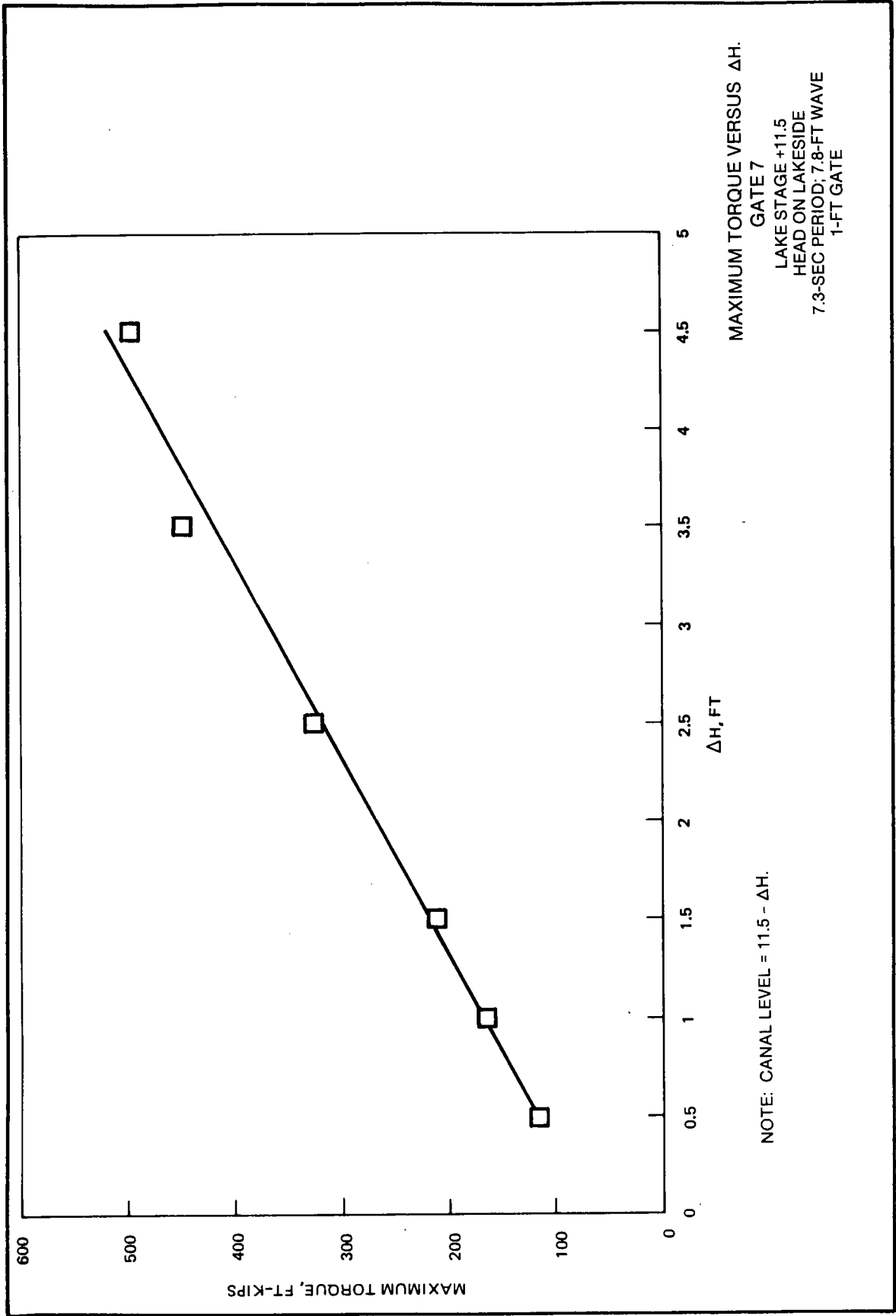

PLATE 32



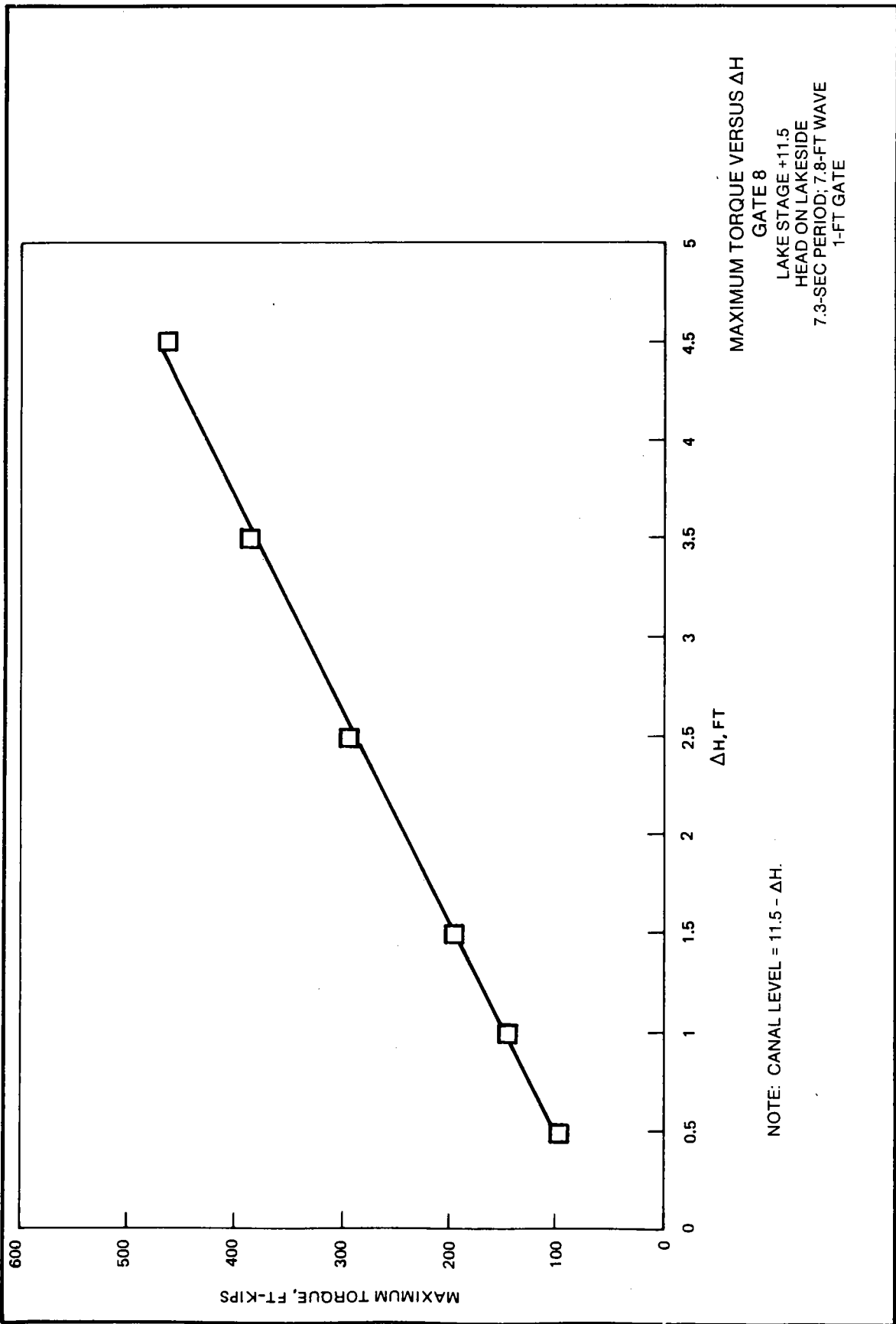
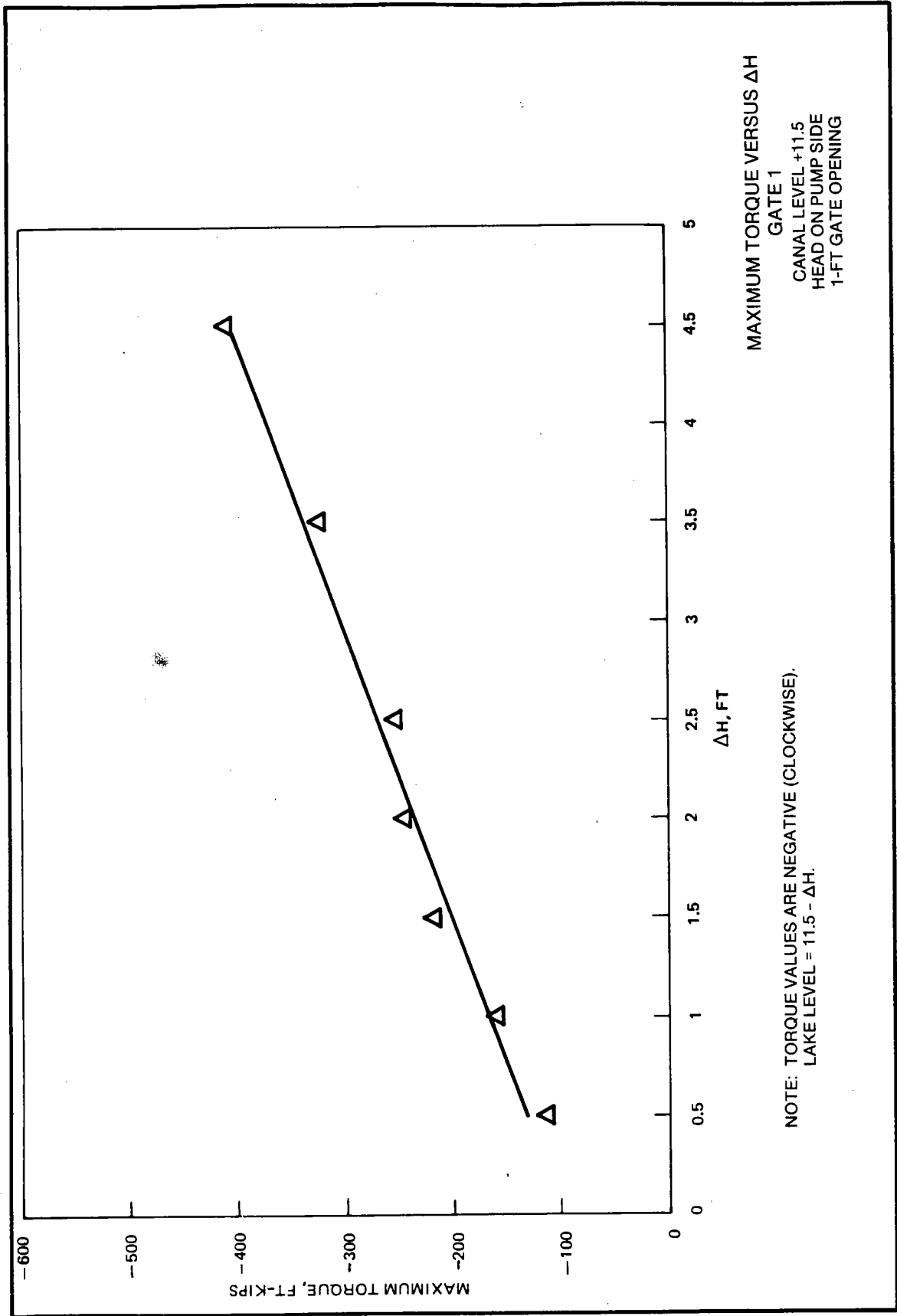

PLATE 34.



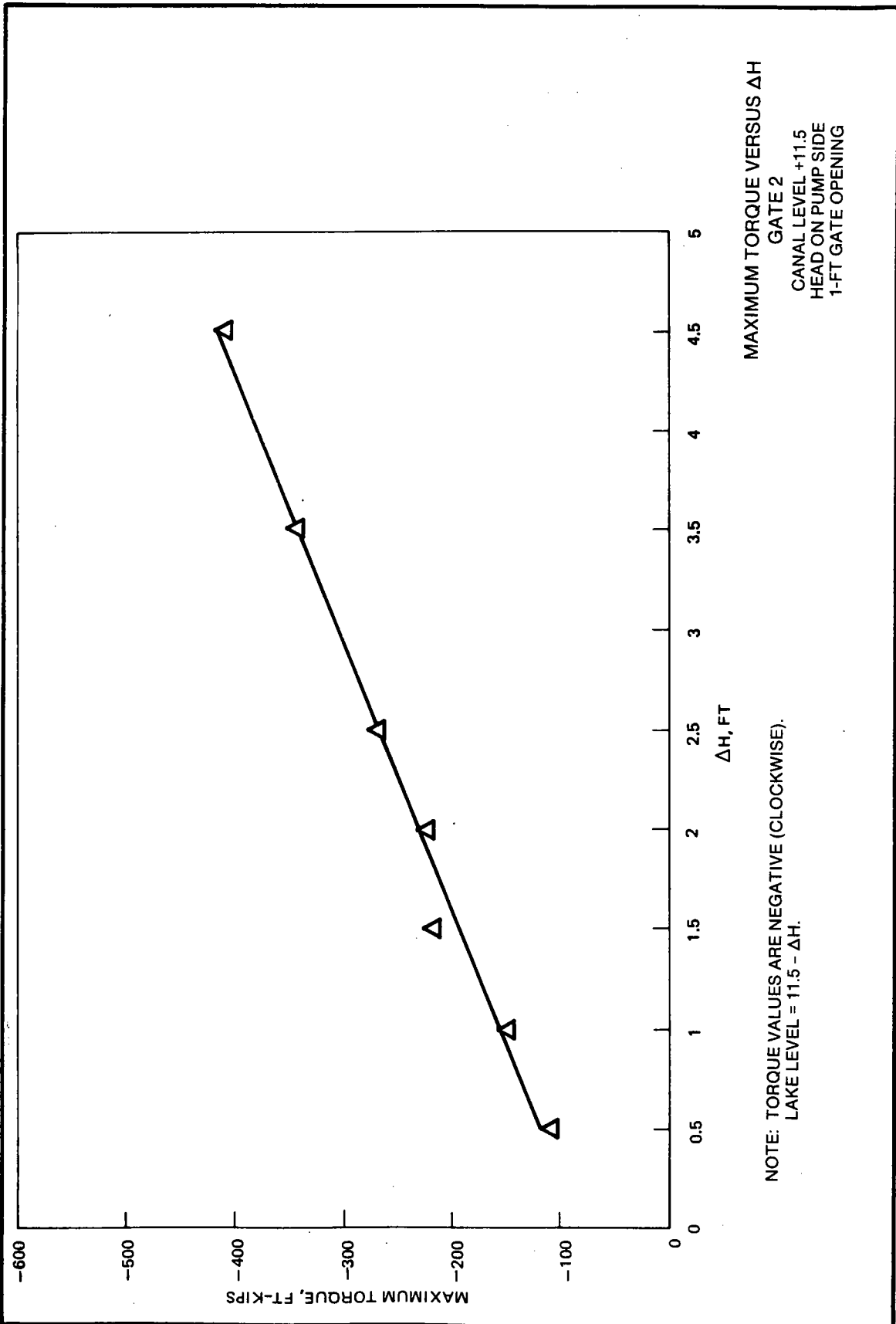
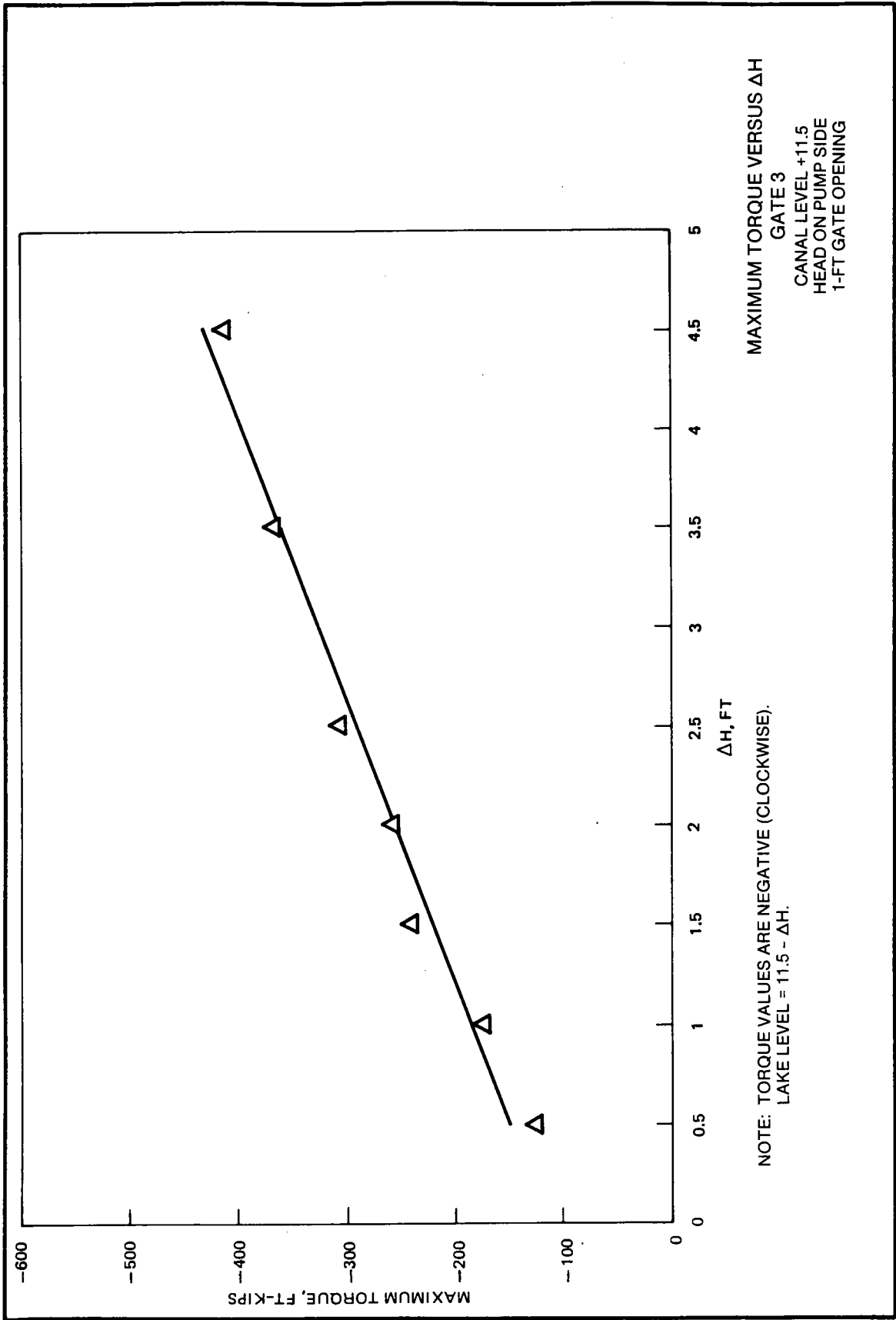

PLATE 36



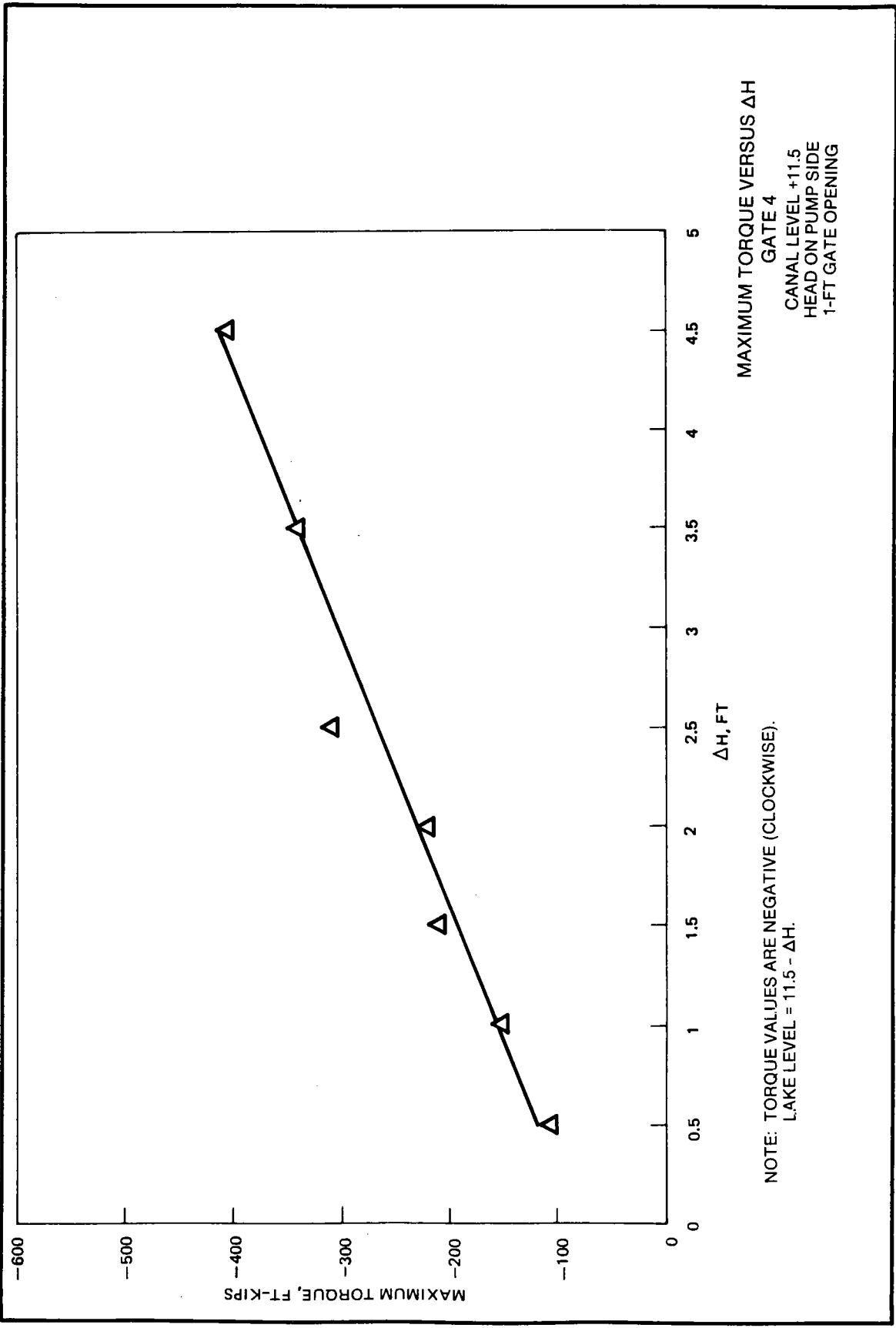
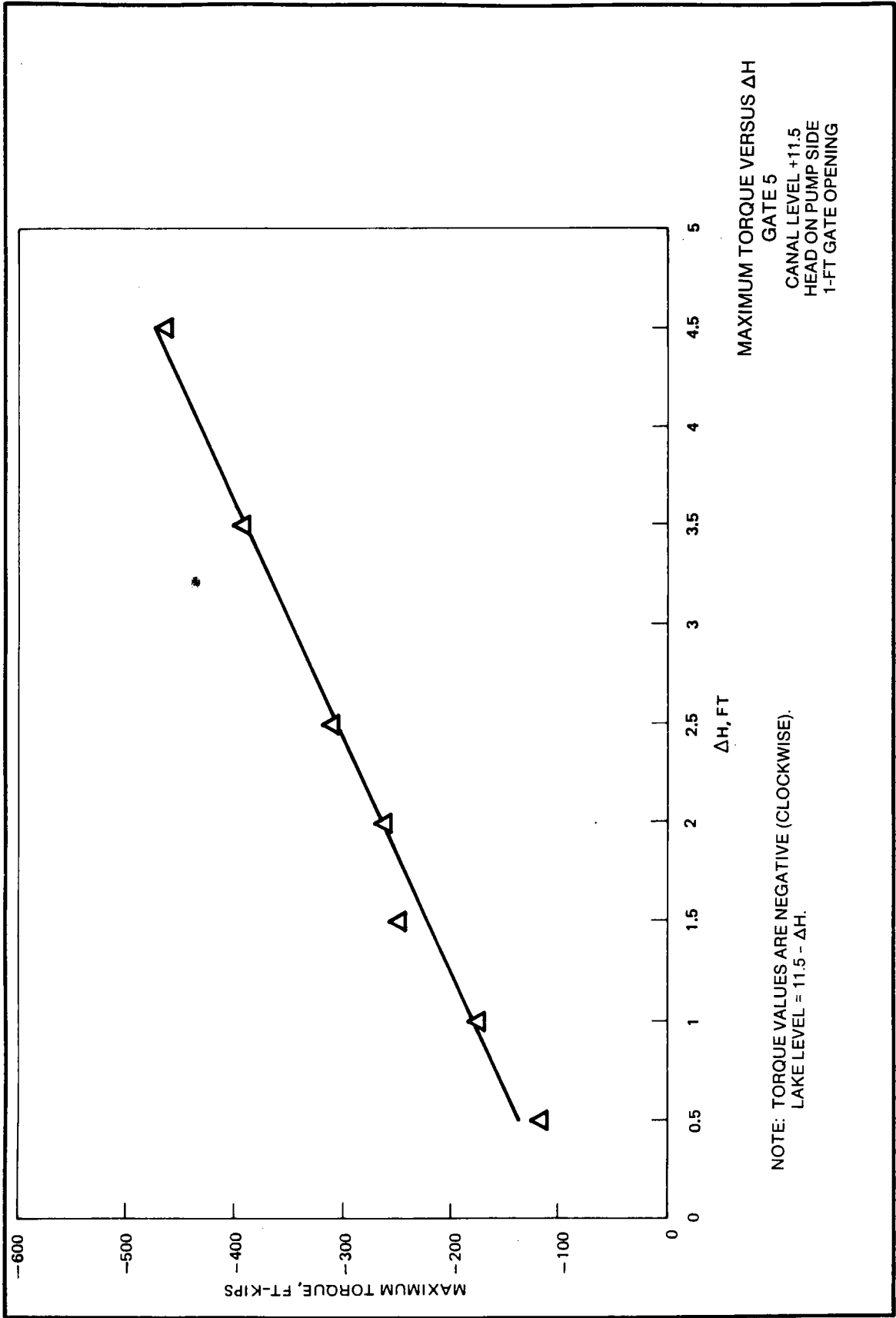

PLATE 38



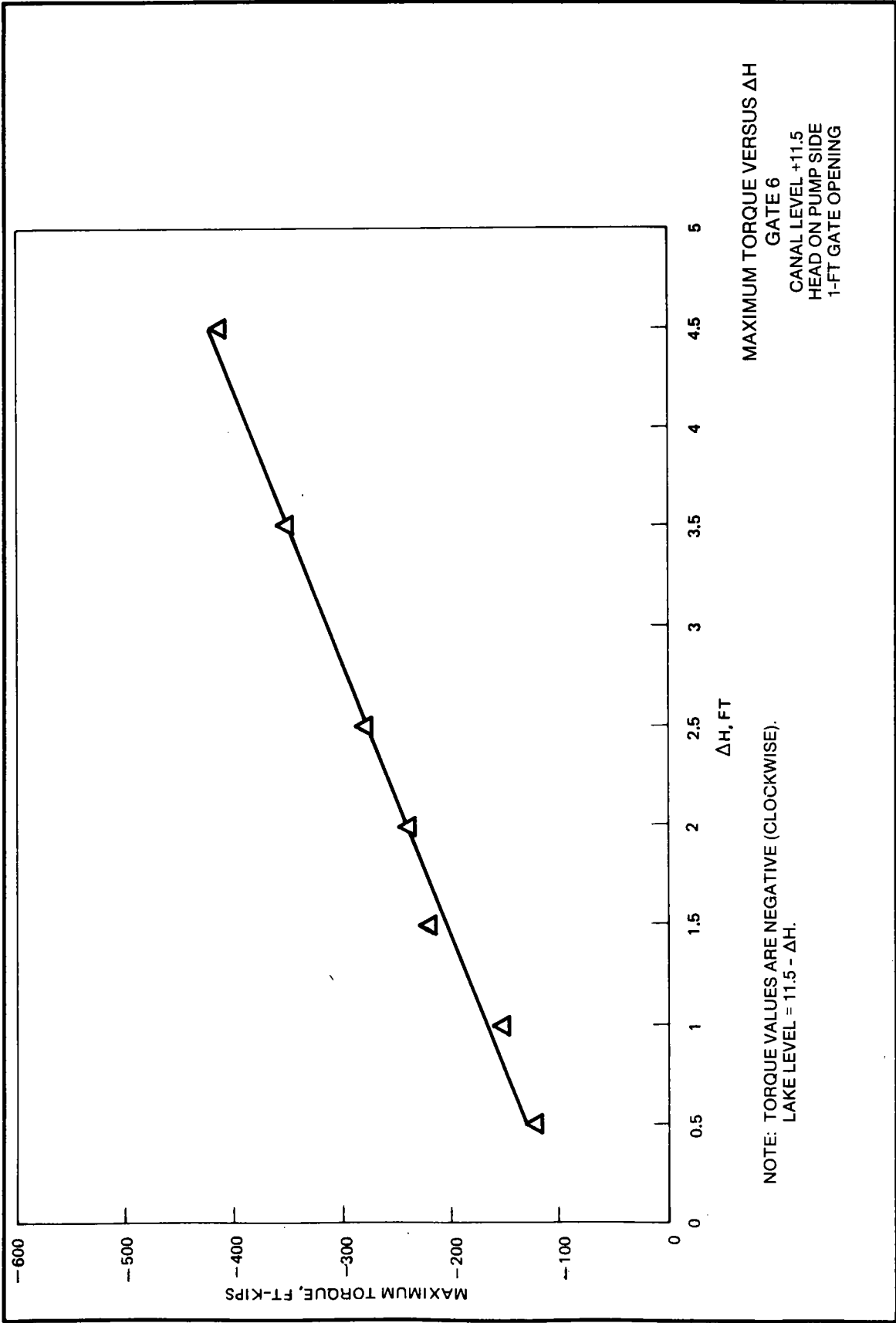
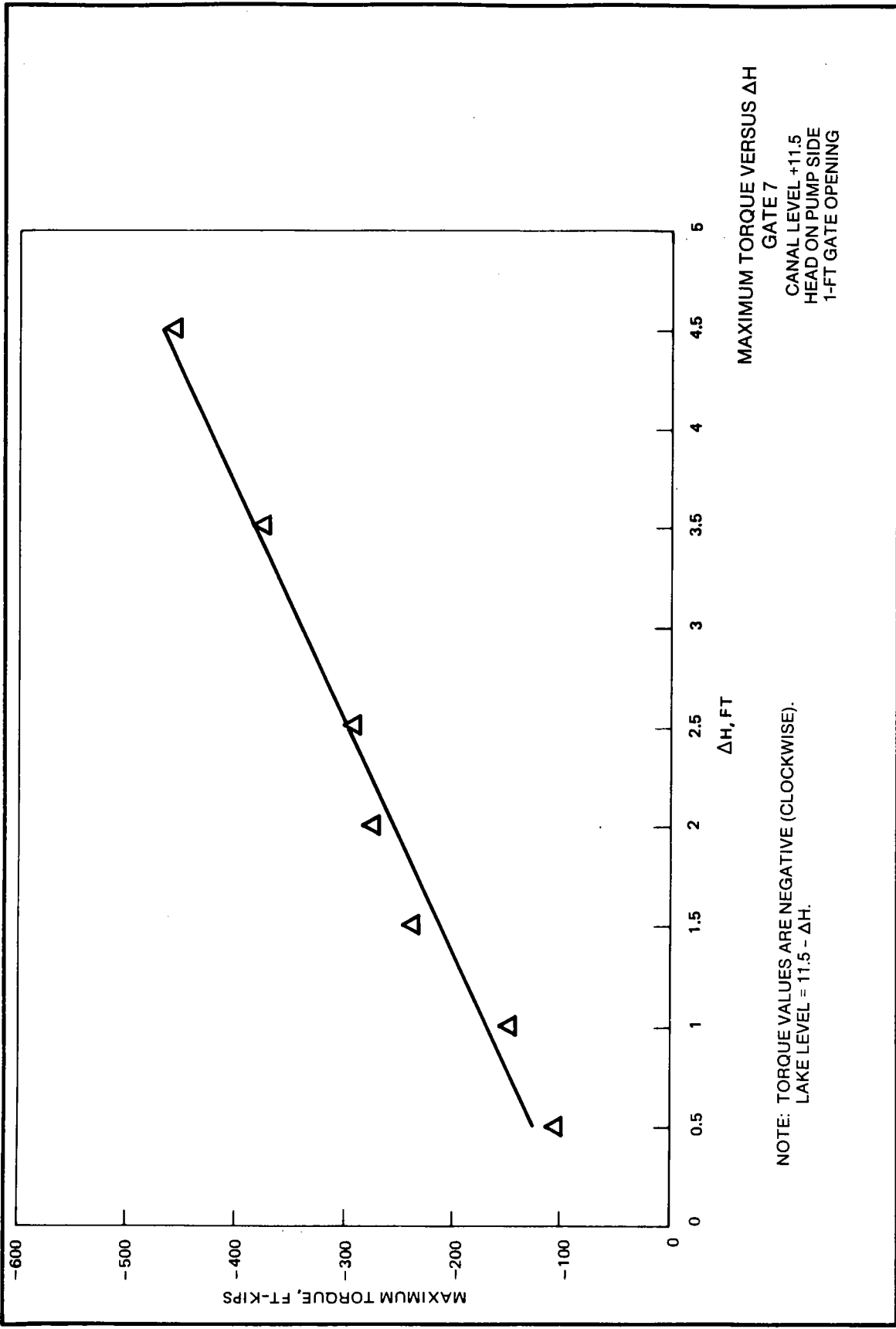
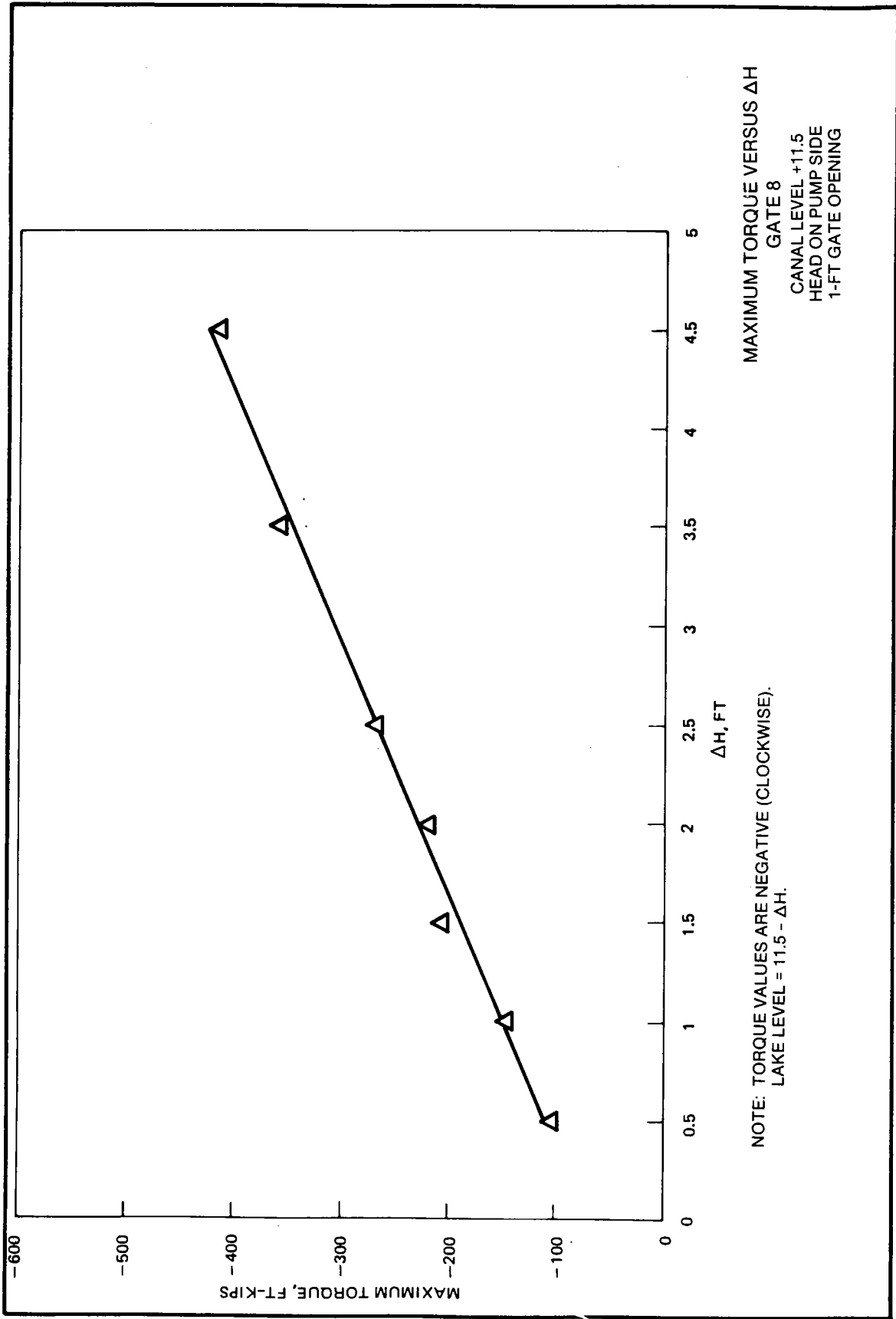
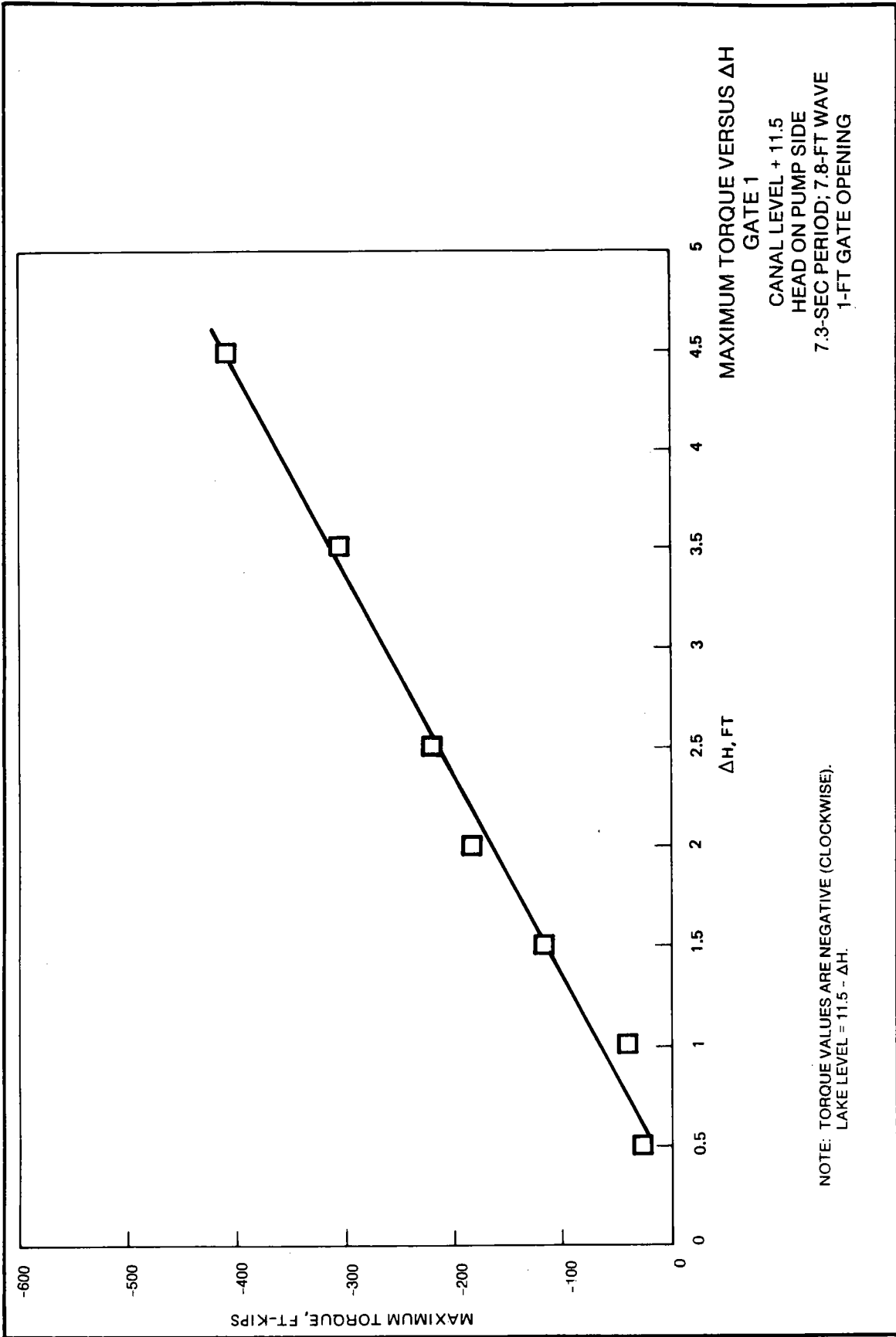

PLATE 40







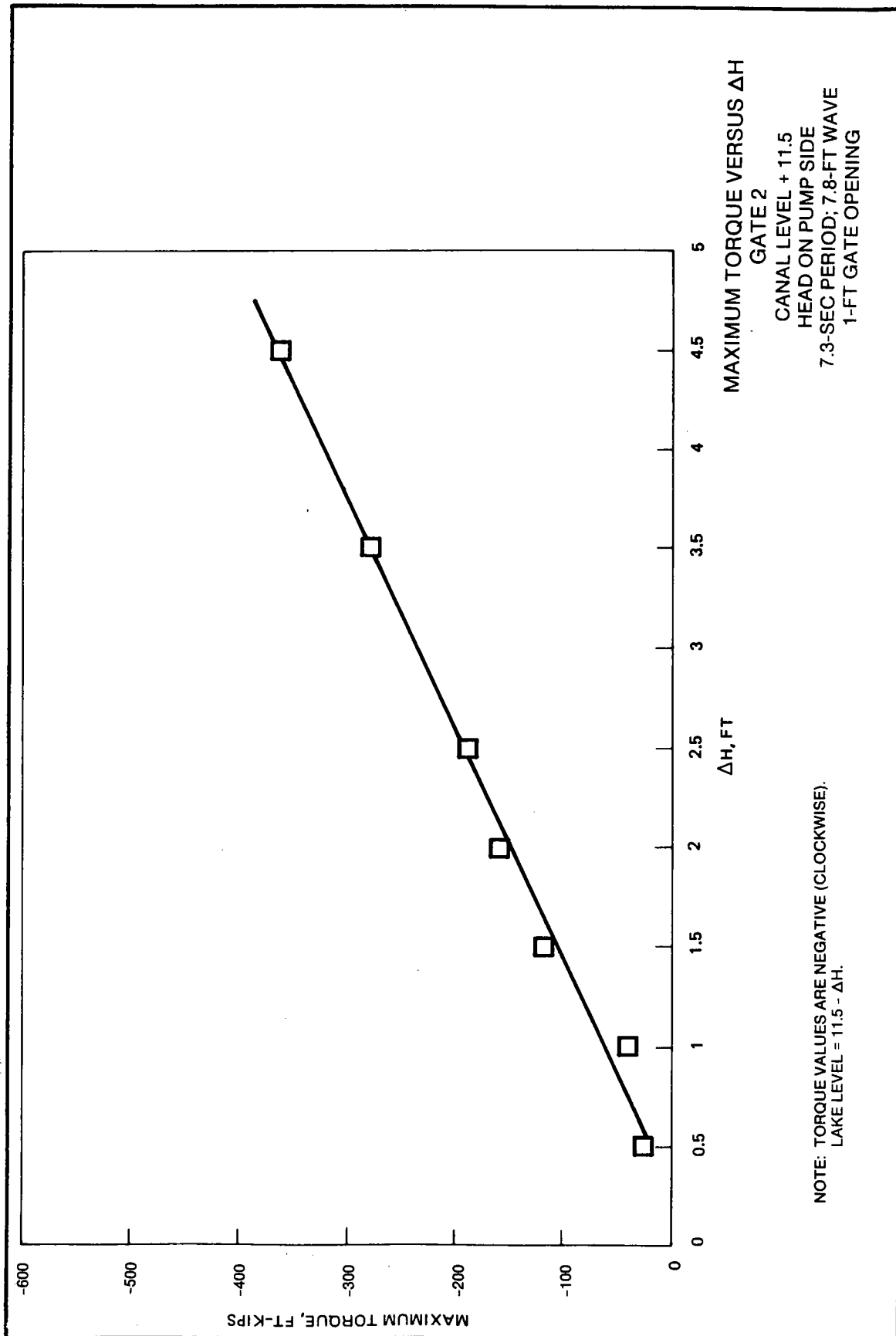
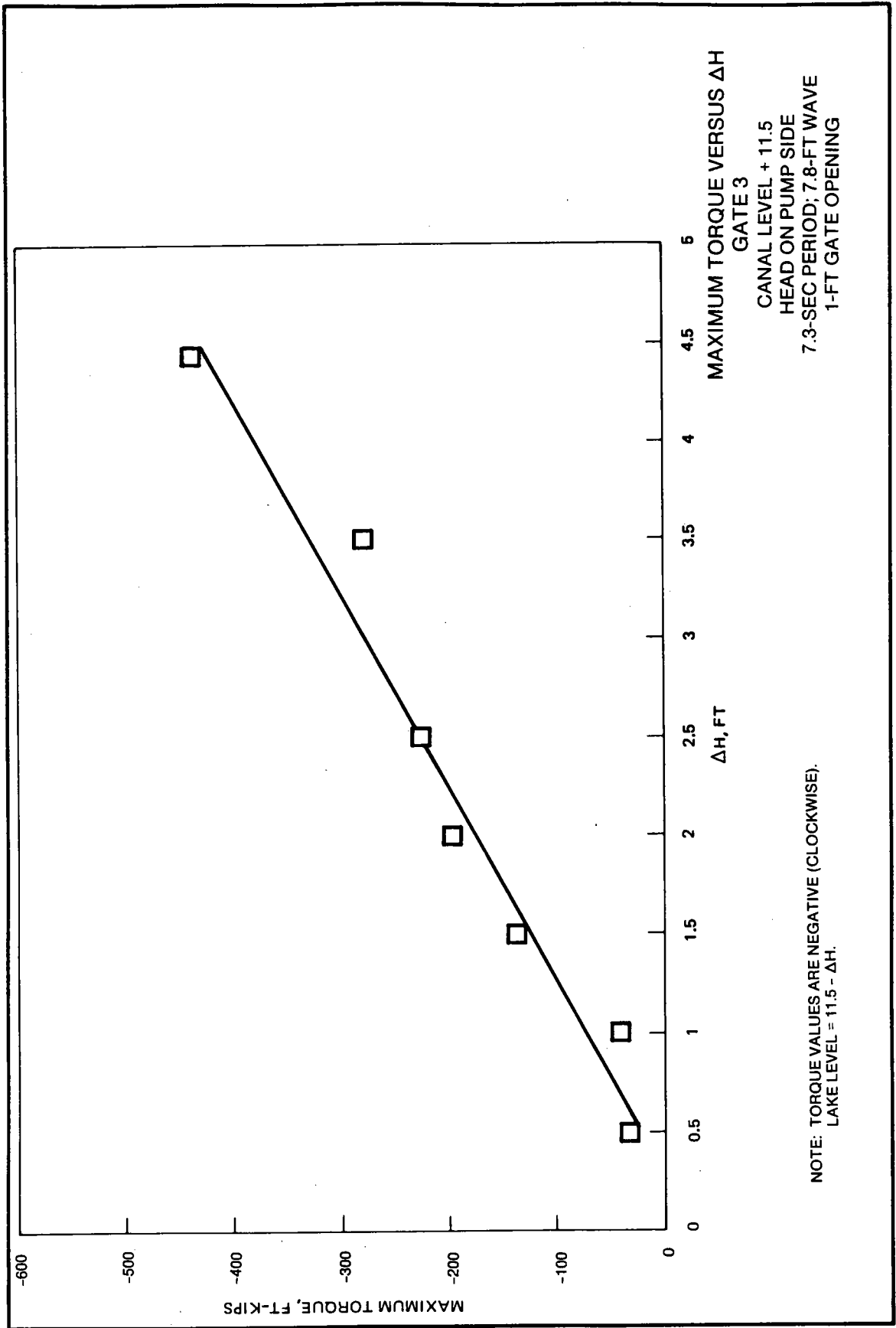

PLATE 44



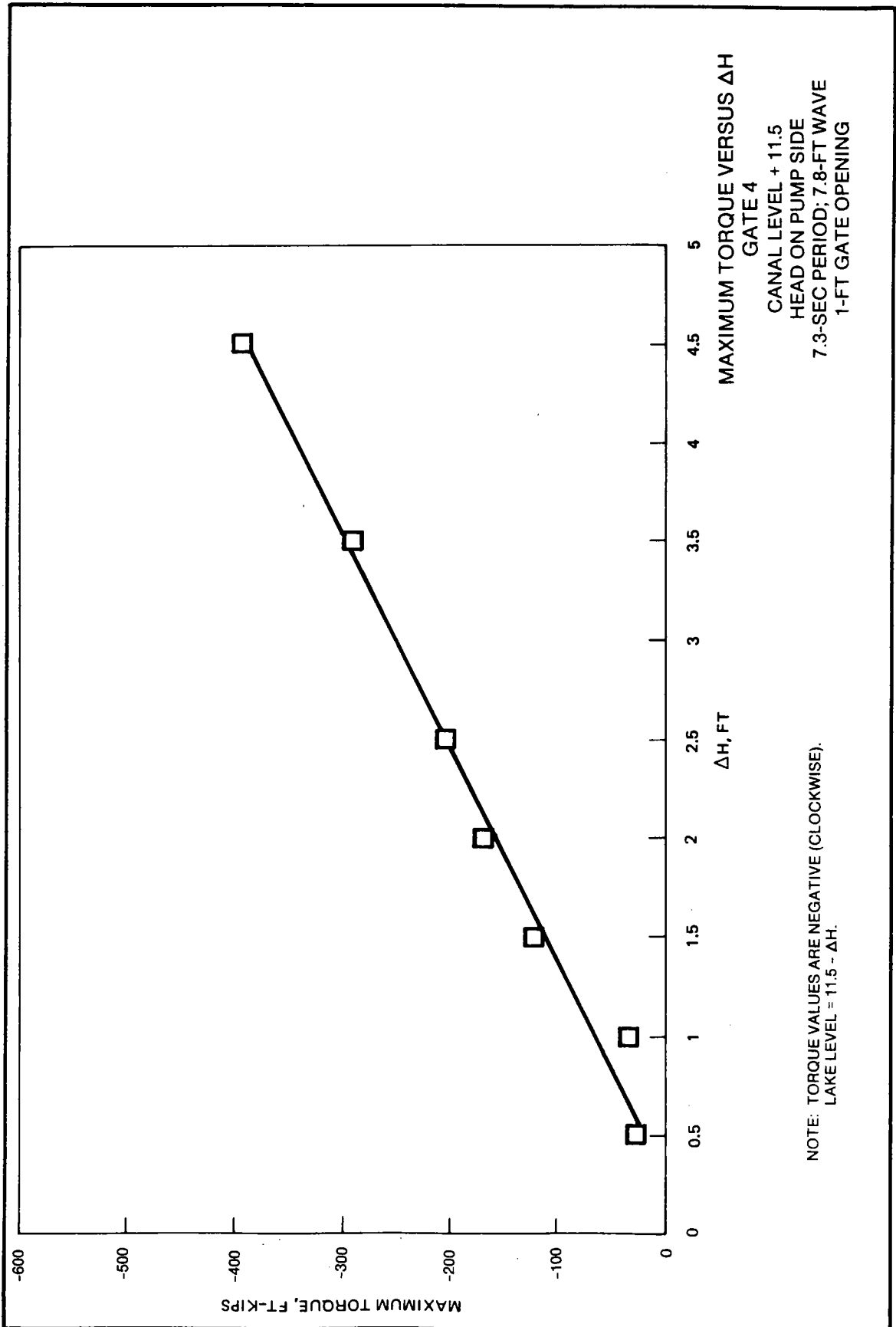
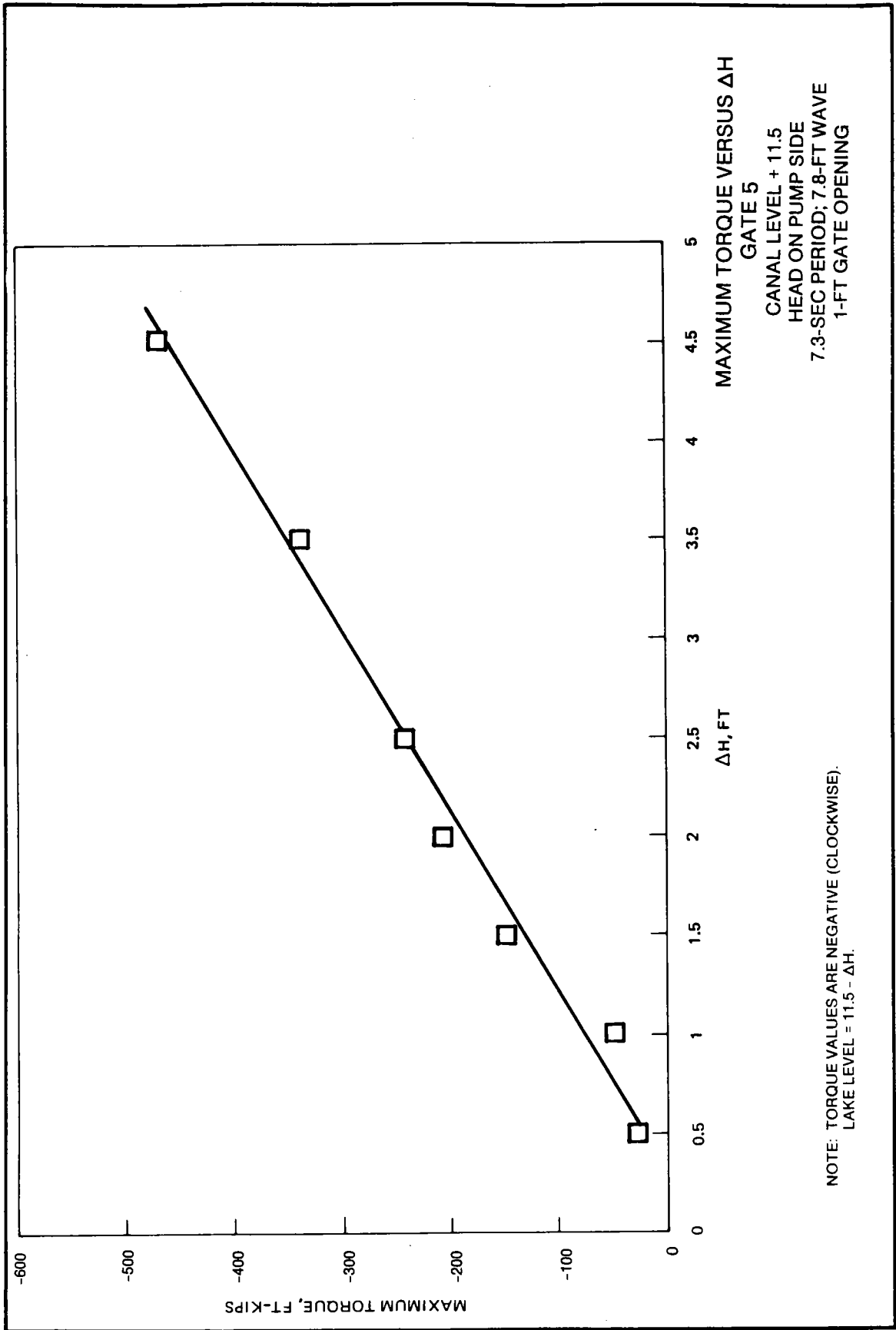
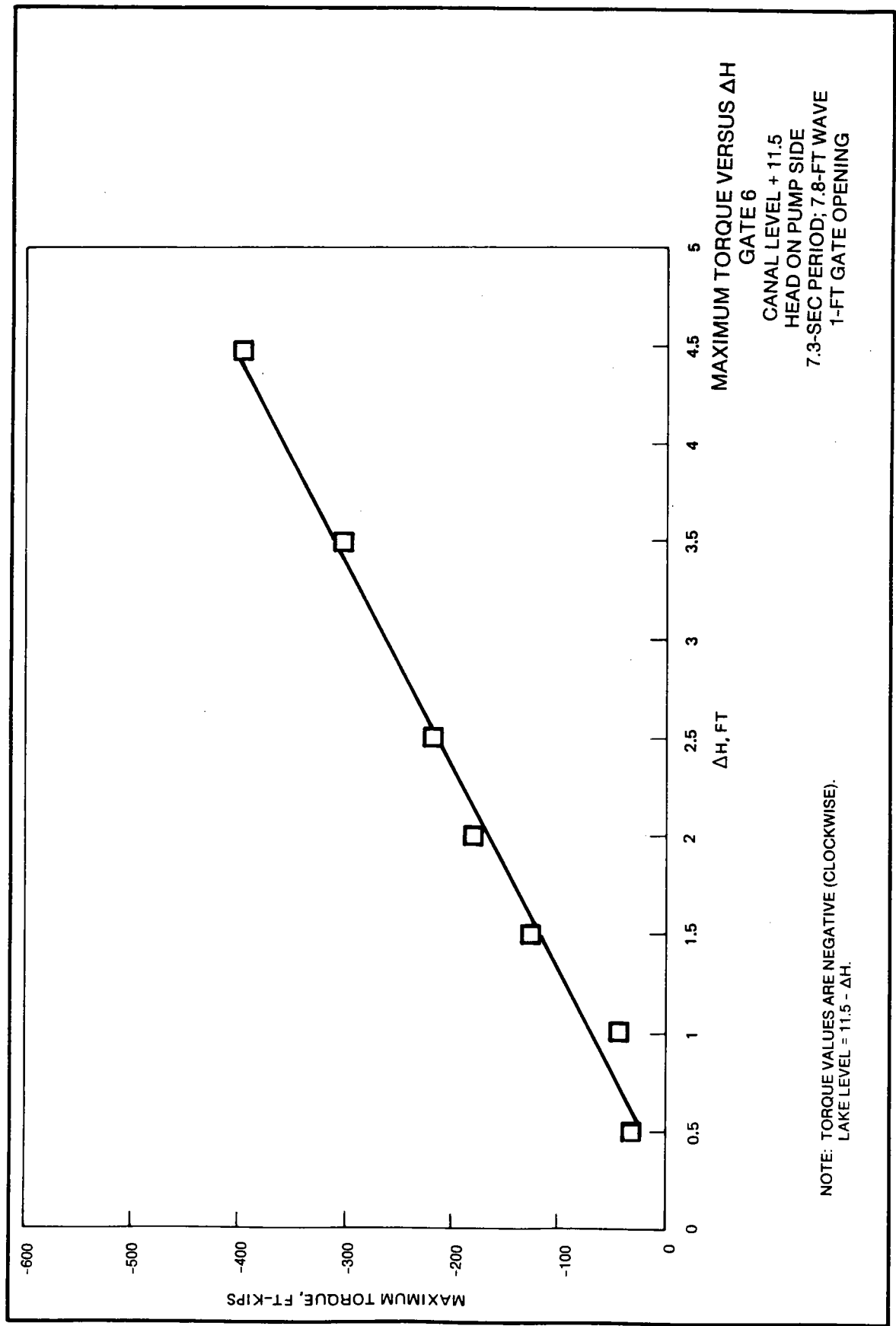
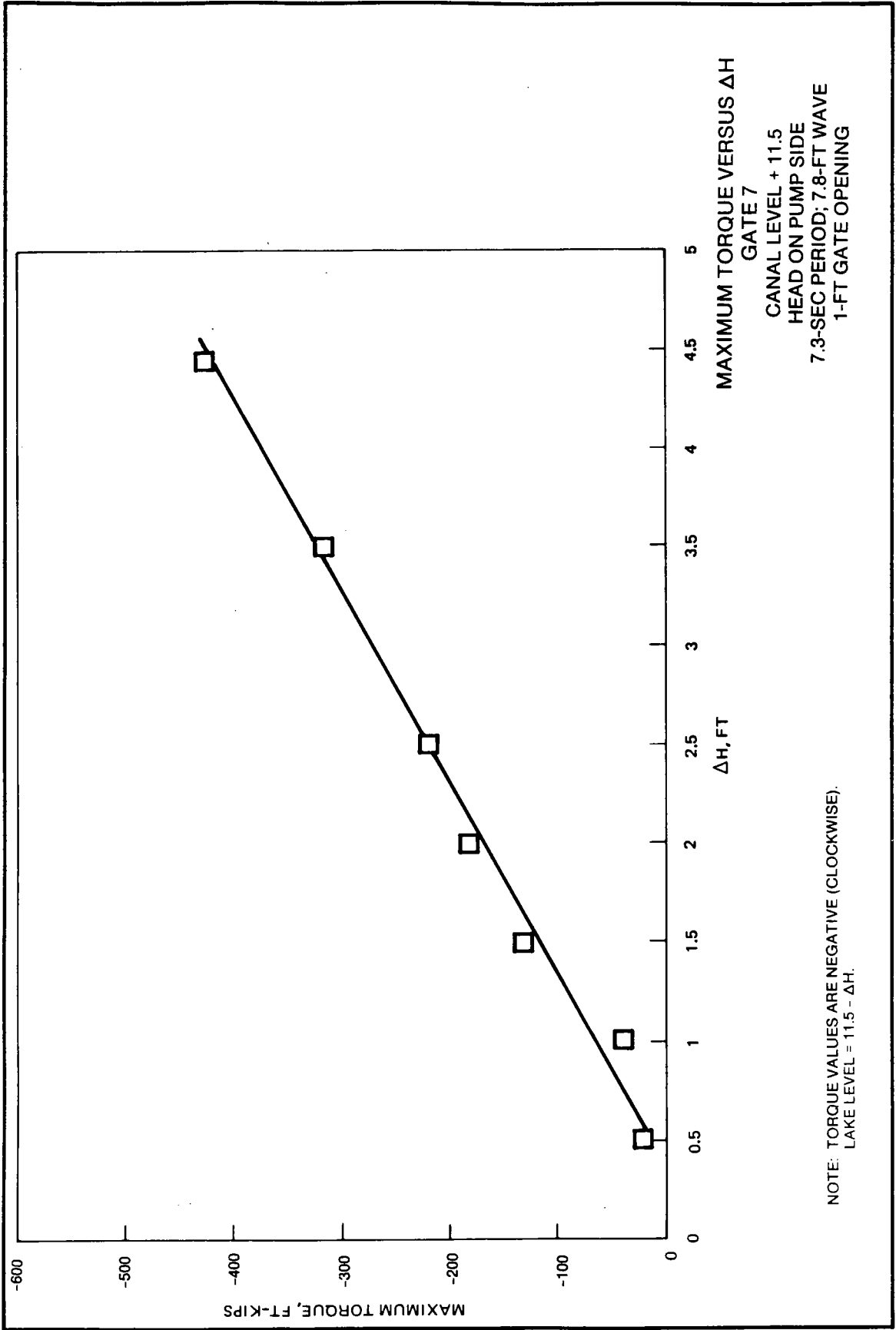
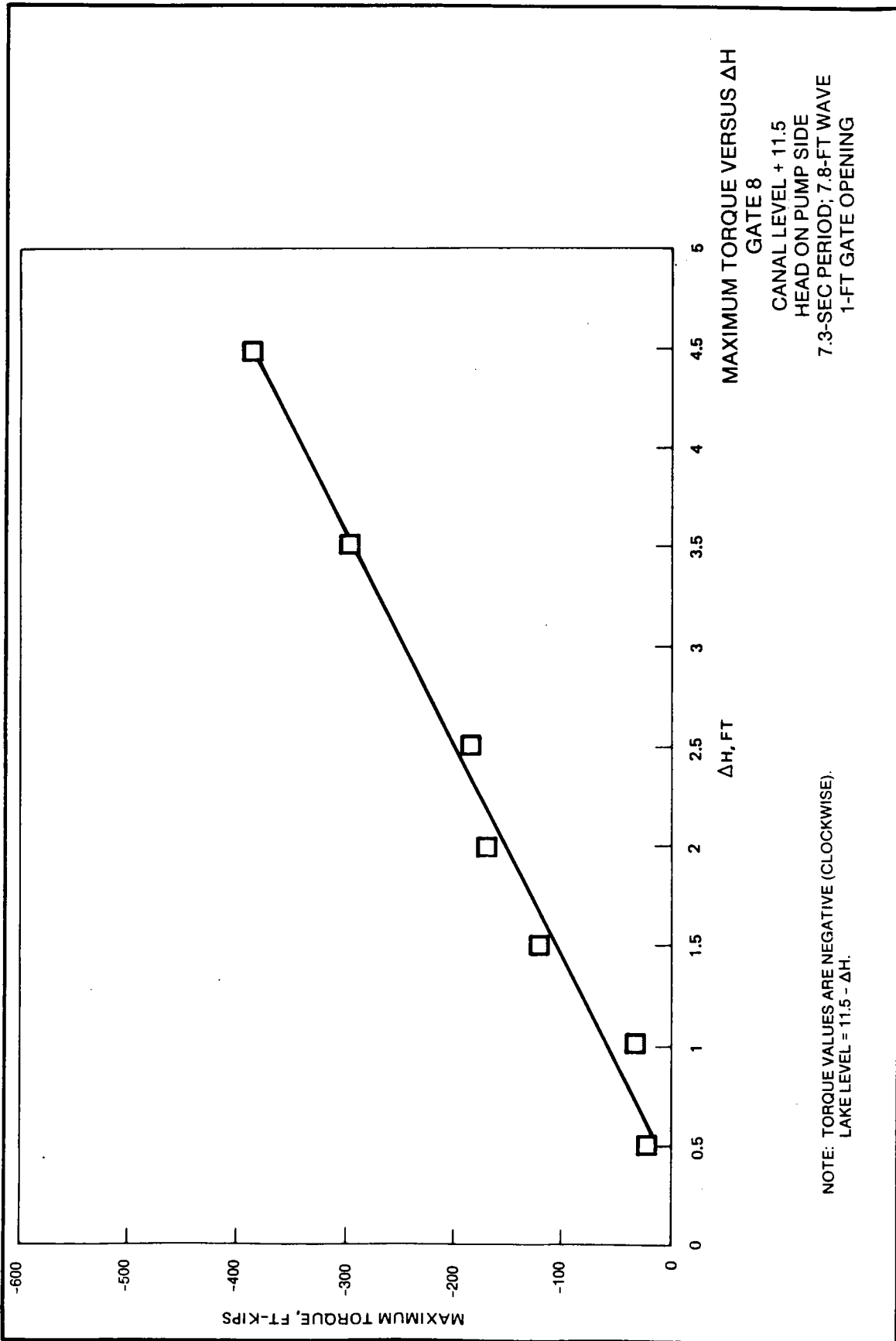

PLATE 46









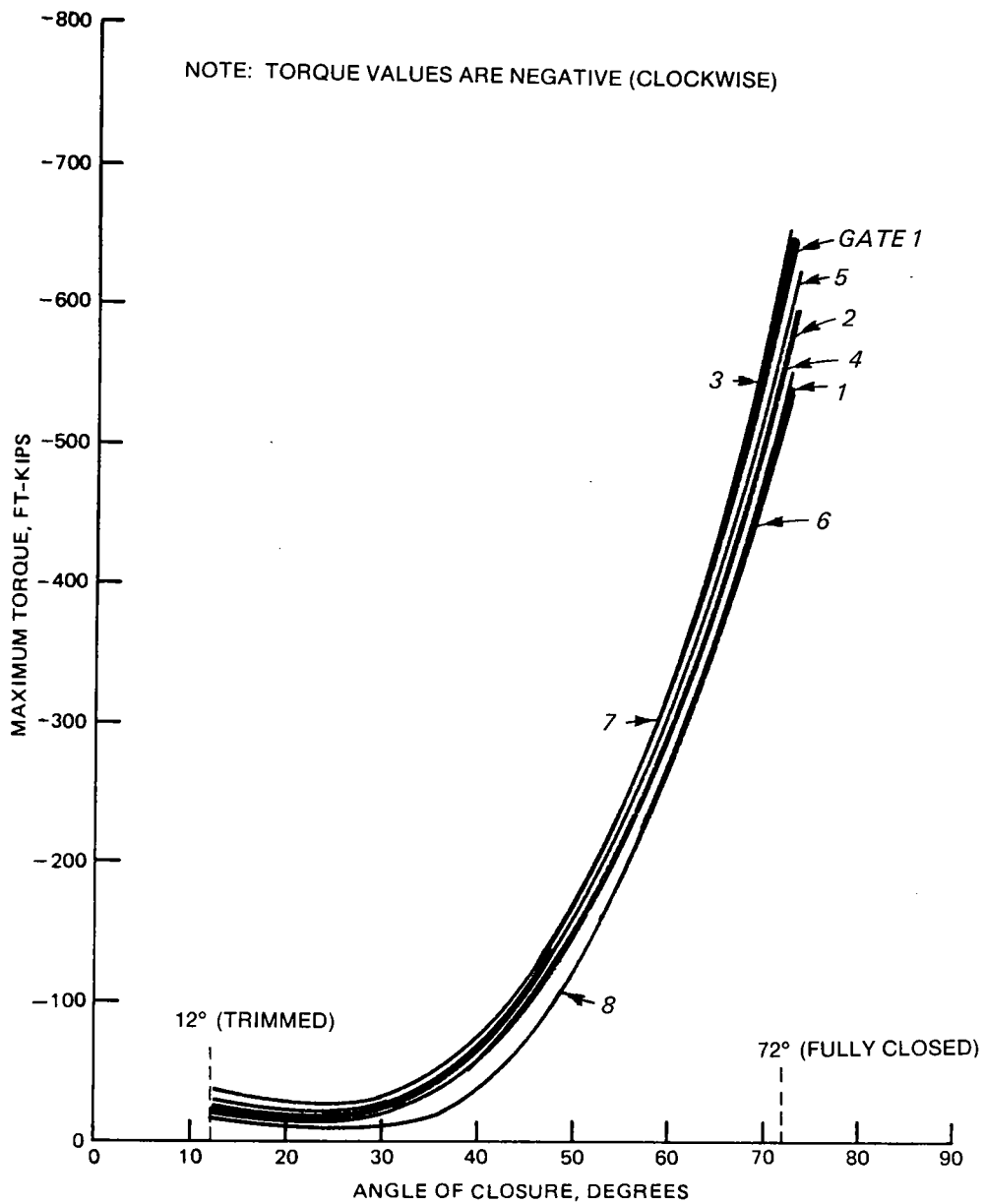

TORQUE VERSUS ANGLE OF CLOSURE
DISCHARGE = 8,000 CFS TO THE LAKE
LAKE ELEVATION = +5 FT

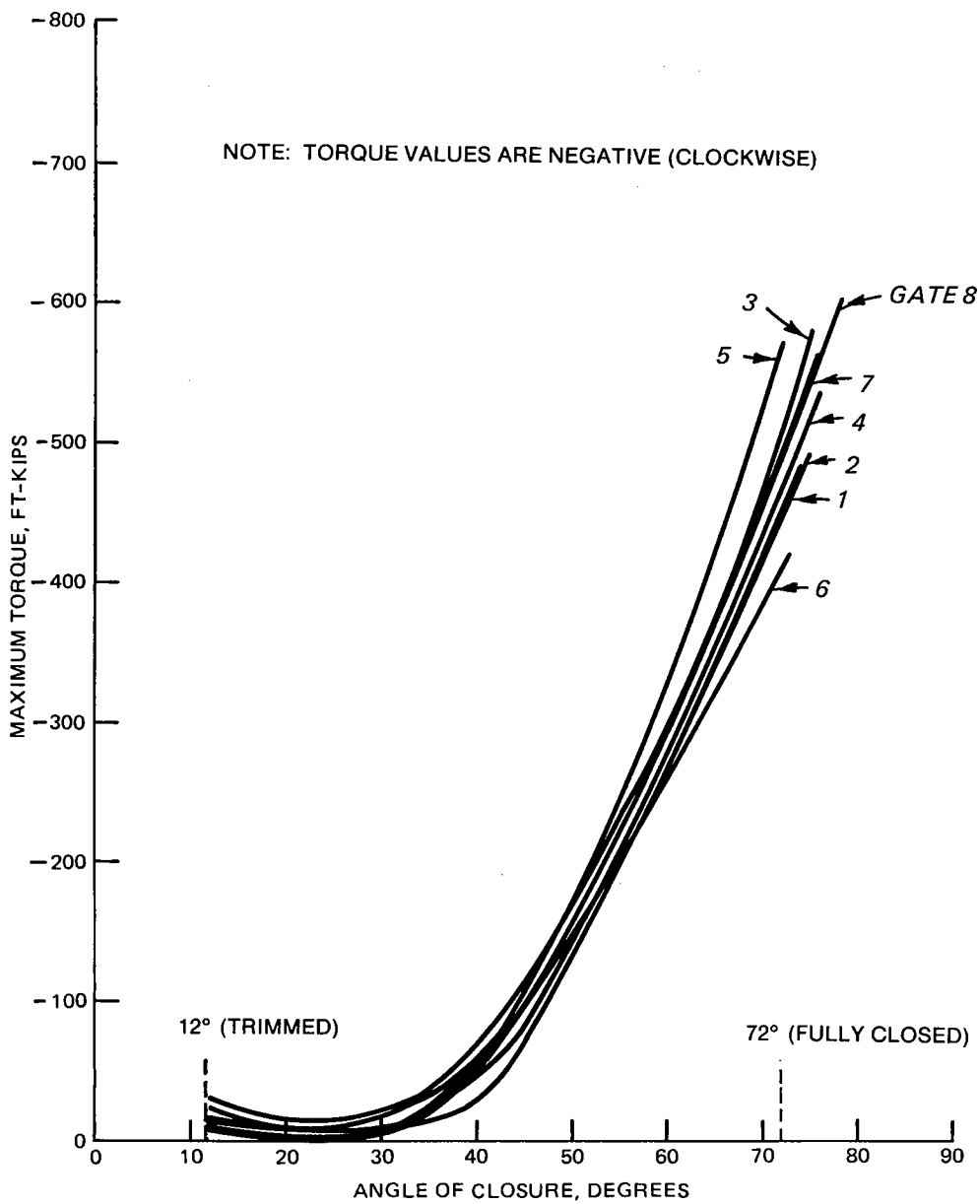

TORQUE VERSUS ANGLE OF CLOSURE

DISCHARGE = 8,000 CFS TO THE LAKE

LAKE ELEVATION = +5 FT

WAVE HEIGHT = 7.8 FT

WAVE PERIOD = 7.3 SEC

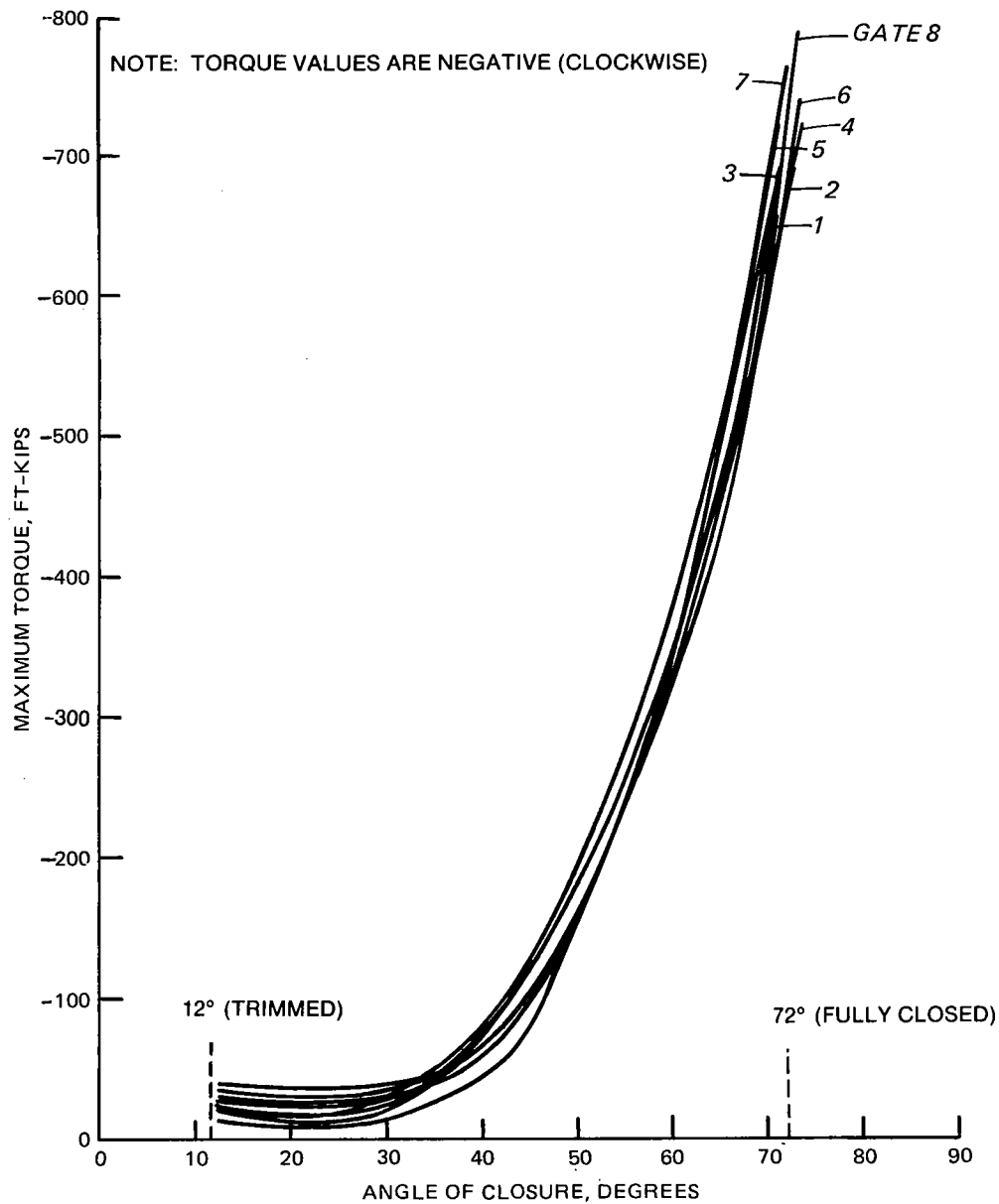

TORQUE VERSUS ANGLE OF CLOSURE
 DISCHARGE = 8,000 CFS TO THE LAKE
 LAKE ELEVATION = +3 FT
 NO WAVES

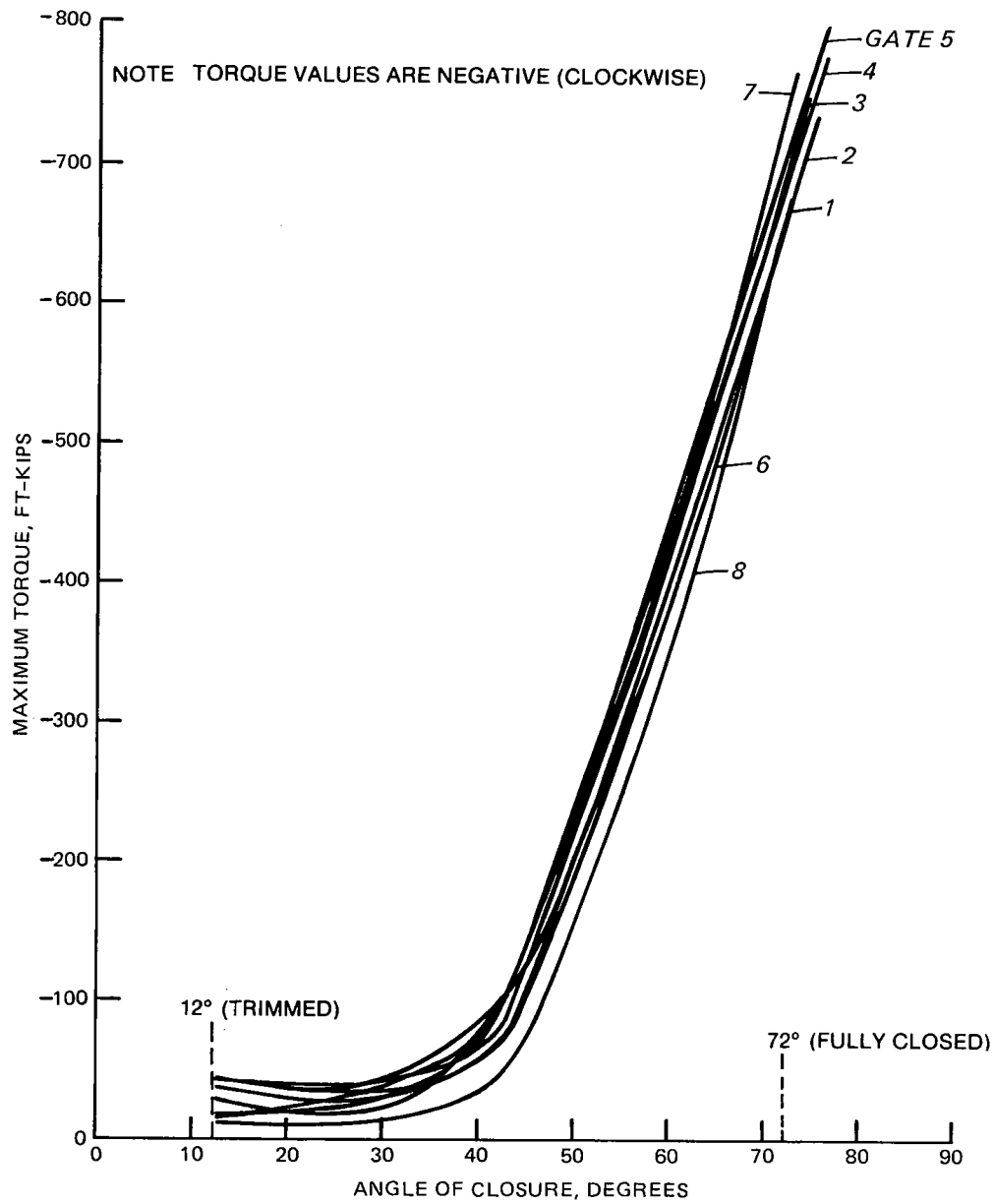

TORQUE VERSUS ANGLE OF CLOSURE
DISCHARGE = 8,000 CFS TO THE LAKE
LAKE ELEVATION = + 1 FT
NO WAVES

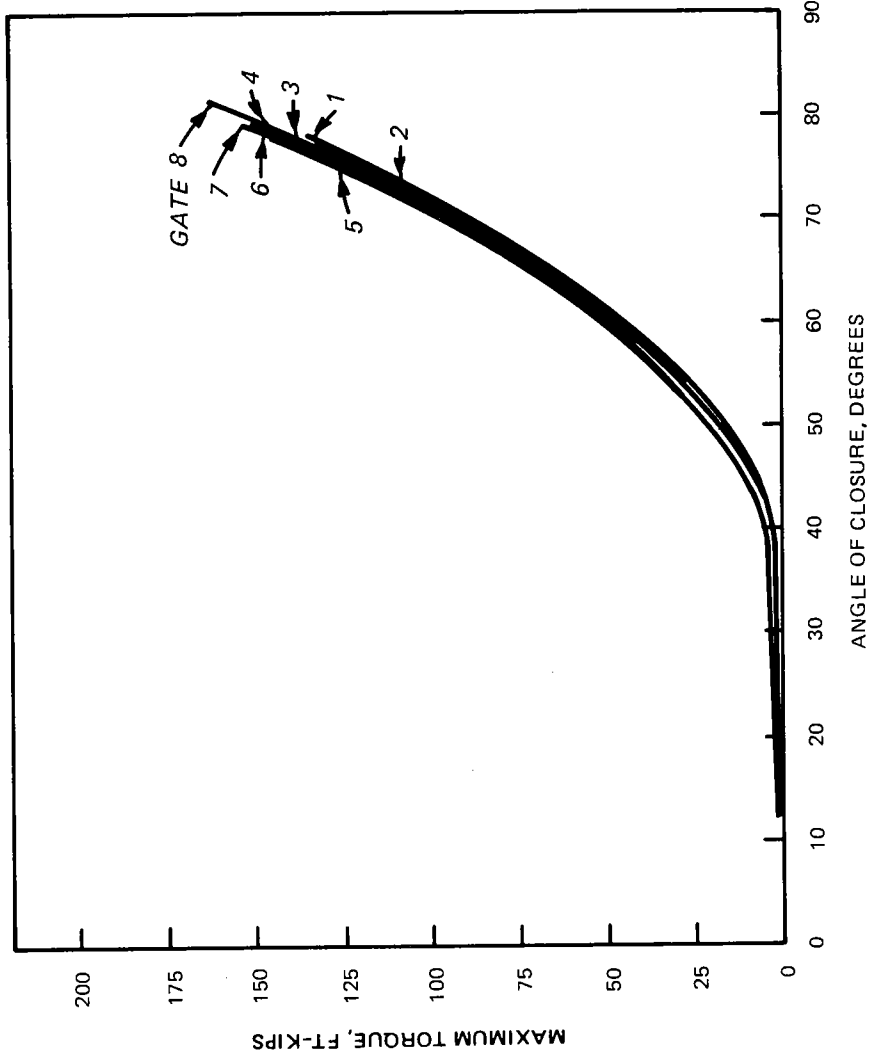

TORQUE VERSUS ANGLE OF CLOSURE
 SURGE FLOW 500 CFS
 LAKE ELEVATION +7
 CANAL LEVEL VARIES

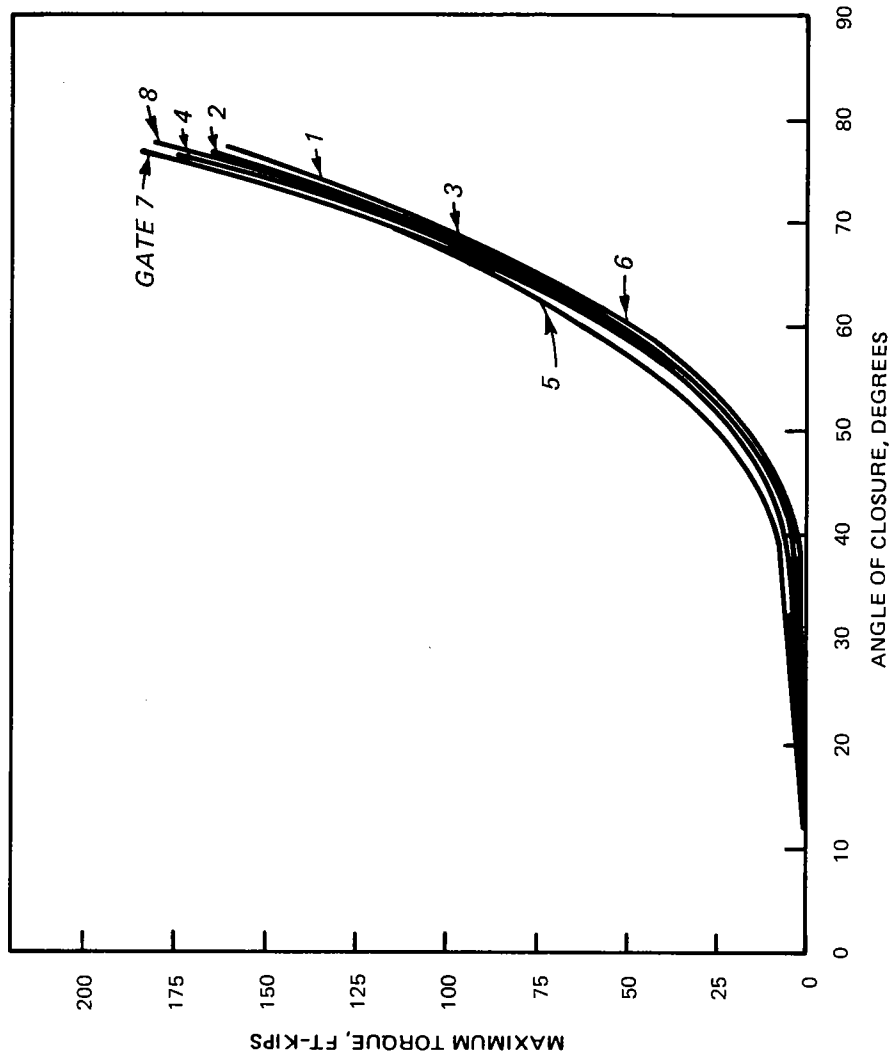

TORQUE VERSUS ANGLE OF CLOSURE
 SURGE FLOW 1,000 CFS
 LAKE ELEVATION +7
 CANAL LEVEL VARIES

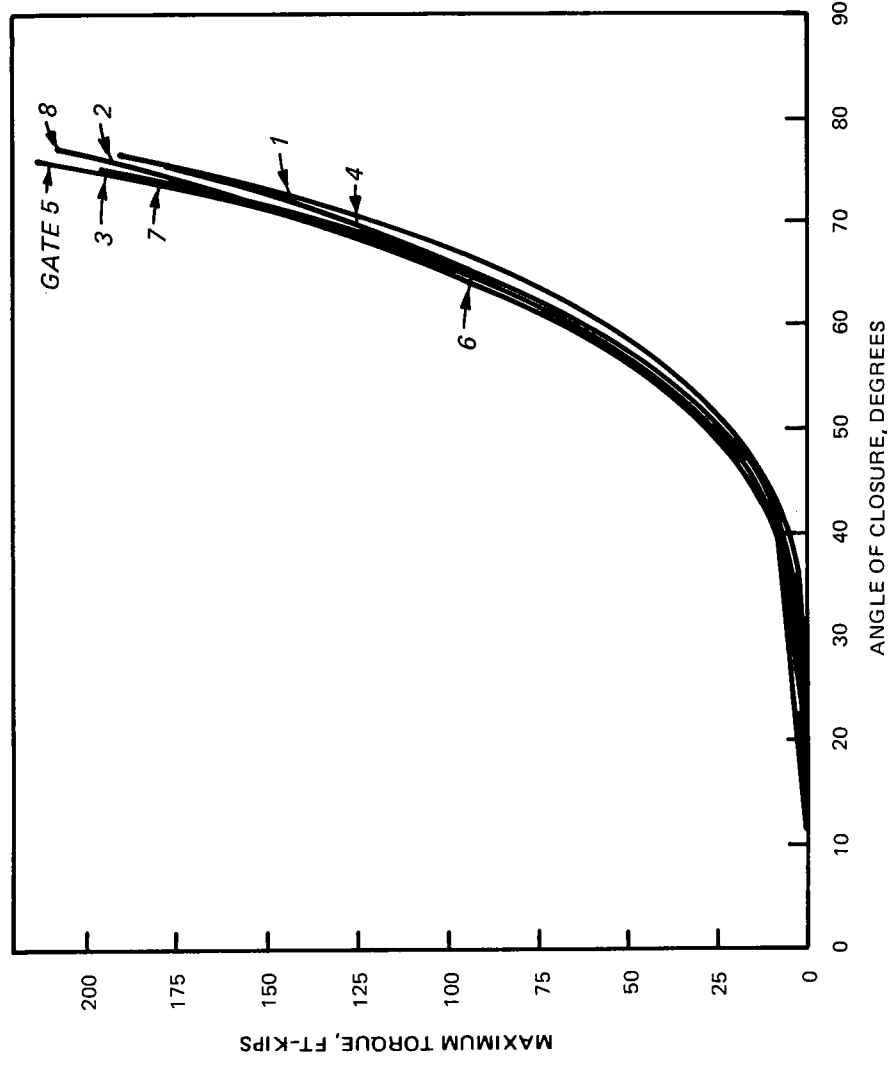

TORQUE VERSUS ANGLE OF CLOSURE
 SURGE FLOW 1,500 CFS
 LAKE ELEVATION +7
 CANAL LEVEL VARIES

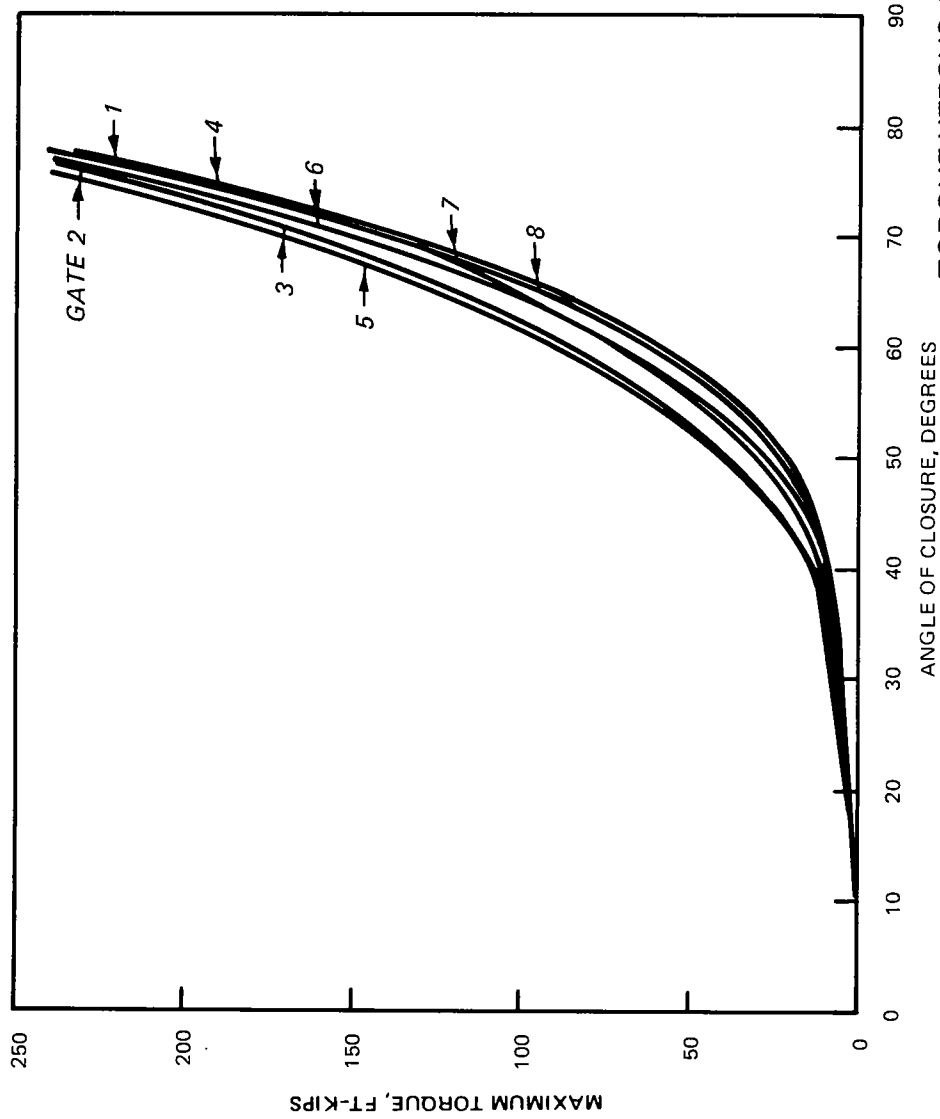

TORQUE VERSUS ANGLE OF CLOSURE
 SURGE FLOW 2,000 CFS
 LAKE ELEVATION +7
 CANAL LEVEL VARIES

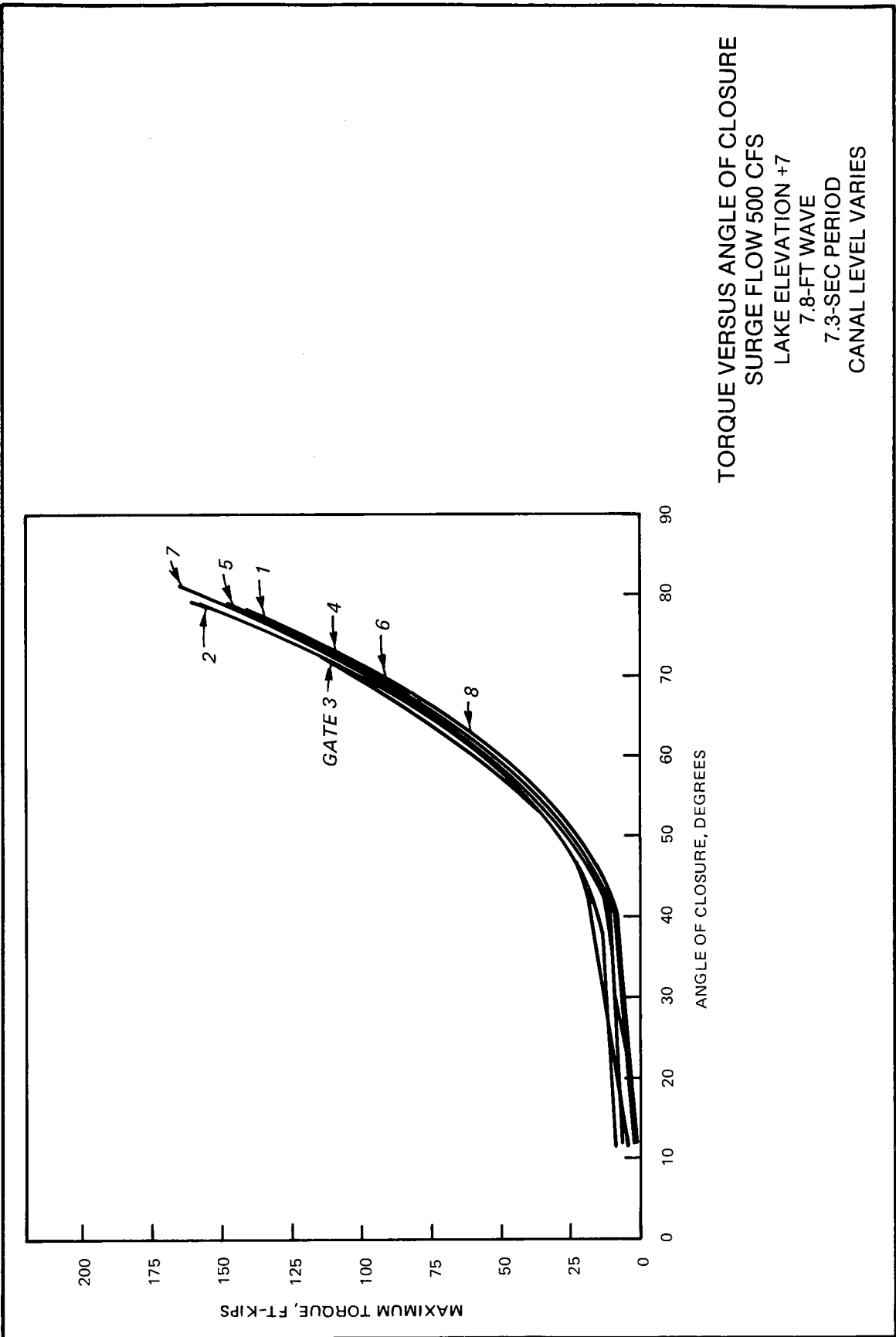

TORQUE VERSUS ANGLE OF CLOSURE
 SURGE FLOW 500 CFS
 LAKE ELEVATION +7
 7.8-FT WAVE
 7.3-SEC PERIOD
 CANAL LEVEL VARIES

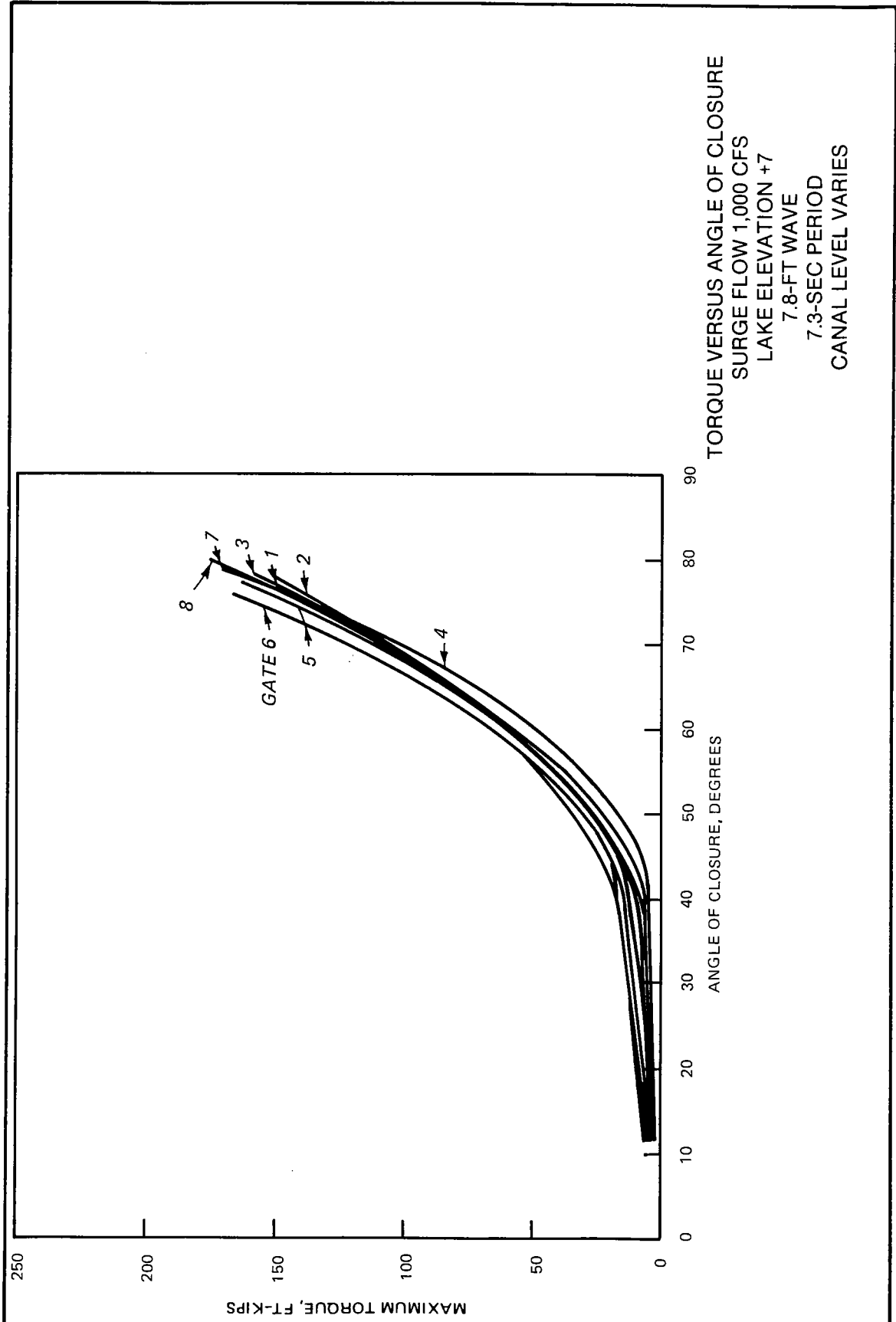
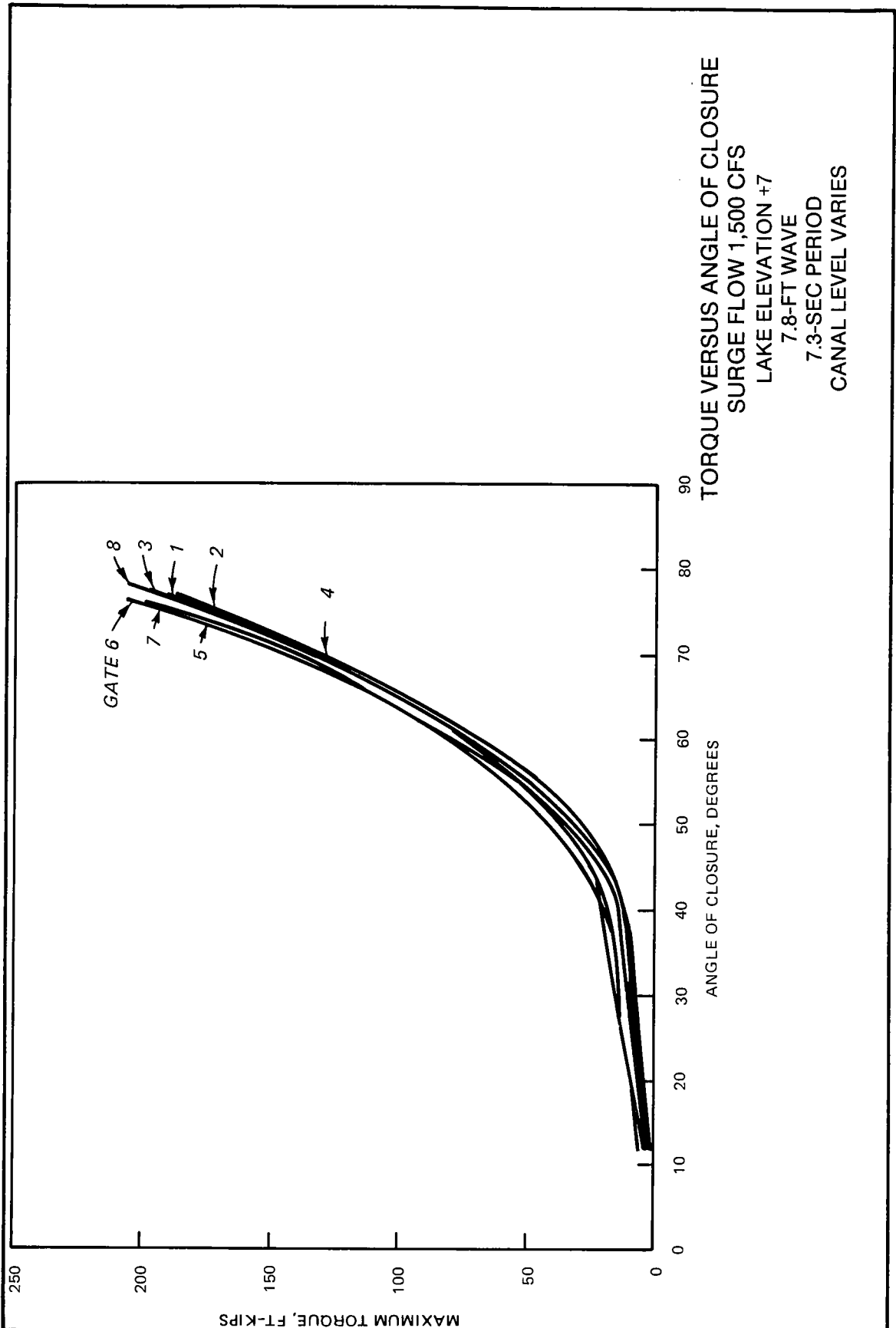
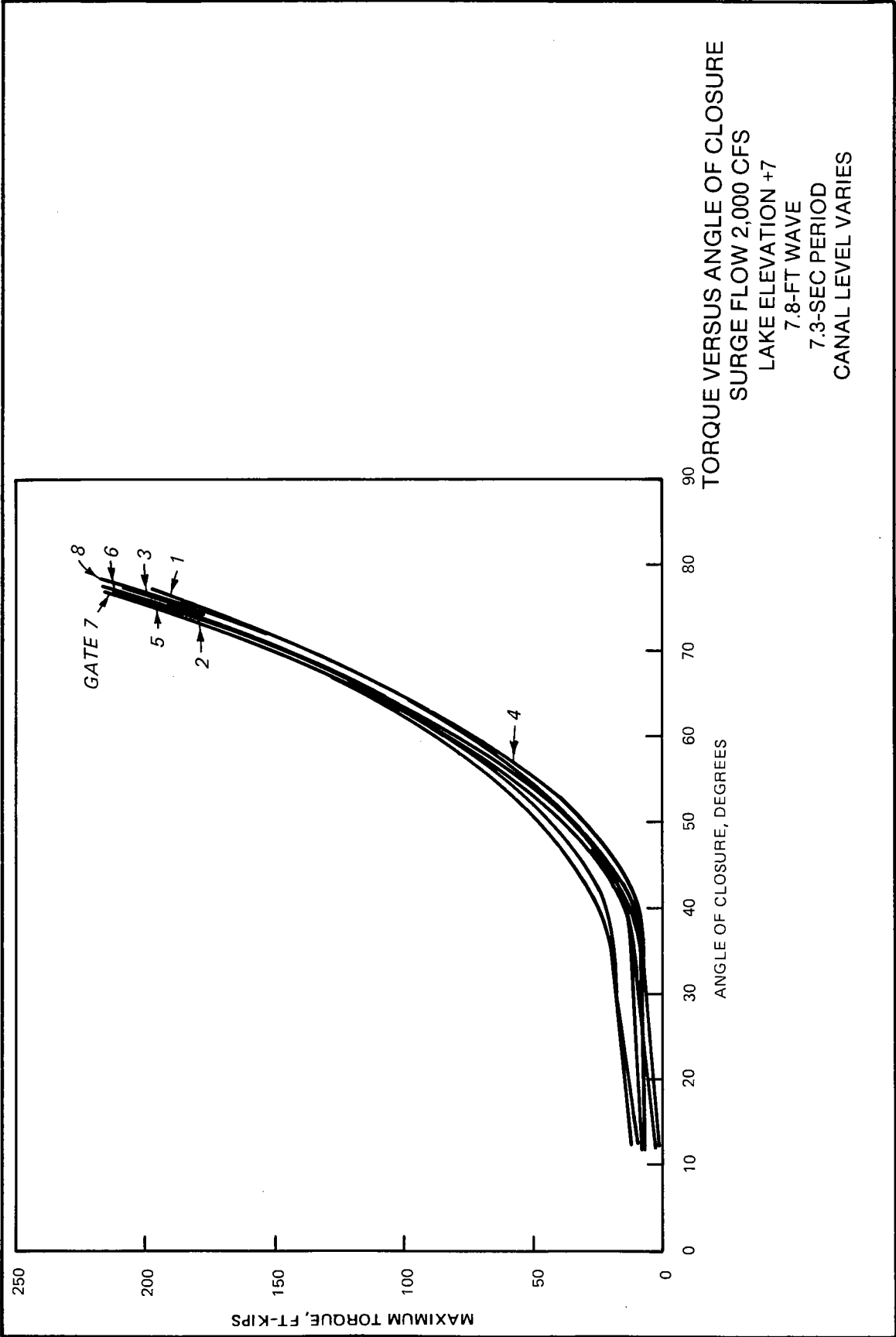

PLATE 60





APPENDIX A: TORQUE MEASUREMENTS ON BUTTERFLY GATES
TYPE 33 DESIGN

Table A1
Torque Measurements on Butterfly Gates
Type 33 Design

Test No.	Gate Angle from Stop deg*	Gate No.	Canal El	Lake El	Wave Period sec	Wave Height ft	Surge Flow cfs	Pumped Flow cfs	Torque, ft-kips		
									Max	Min	Avg
1	0	1	7.0	+6	7.3	7.8			-51	-49	-50
		2							-54	-52	-53
		3							-34	-31	-33
		4							-37	-35	-36
		5							-48	-46	-47
		6							-33	-31	-32
		7							-47	-46	-46
		8							-44	-42	-44
2	0	1	9.0	+8	7.3	7.8			-47	-45	-46
		2							-51	-43	-49
		3							-37	-18	-34
		4							-32	-30	-31
		5							-49	-45	-48
		6							-34	-31	-32
		7							-46	-44	-45
		8							-43	-40	-42
3	67	1	11.5	+7					-413	-317	-362
		2							-411	-321	-366
		3							-416	-325	-375
		4							-409	-320	-365
		5							-469	-359	-414
		6							-416	-313	-370
		7							-462	-351	-403
		8							-418	-325	-372

(Continued)

* Stop is at 12-deg angle.

Table A1 (Continued)

Test No.	Gate Angle from Stop deg	Gate No.	Canal El	Lake El	Wave Period sec	Wave Height ft	Surge Flow cfs	Pumped Flow cfs	Torque, ft-kips		
									Max	Min	Avg
4	67	1	11.5	+8.0					-326	-250	-292
		2							-345	-265	-307
		3							-370	-265	-318
		4							-343	-263	-305
		5							-395	-301	-354
		6							-354	-270	-315
		7							-379	-292	-339
		8							-359	-271	-314
5	67	1	11.5	+9.0					-256	-191	-222
		2							-269	-207	-236
		3							-310	-235	-270
		4							-272	-205	-238
		5							-312	-236	-273
		6							-281	-214	-245
		7							-296	-239	-262
		8							-269	-199	-241
6	67	1	11.5	+9.5					-248	-168	-200
		2							-223	-144	-184
		3							-262	-187	-217
		4							-224	-159	-201
		5							-266	-167	-219
		6							-240	-176	-208
		7							-277	-177	-206
		8							-220	-169	-202

(Continued)

Table A1 (Continued)

Test No.	Gate Angle from Stop deg	Gate No.	Canal El	Lake El	Wave Period sec	Wave Height ft	Surge Flow cfs	Pumped Flow cfs	Torque, ft-kips		
									Max	Min	Avg
7	67	1	11.5	+10.0					-222	-140	-182
		2							-218	-112	-168
		3							-243	-147	-197
		4							-211	-135	-174
		5							-250	-142	-199
		6							-222	-124	-176
		7							-240	-163	-203
		8							-208	-135	-174
8	67	1	11.5	+10.5					-164	-98	-127
		2							-149	-96	-121
		3							-177	-110	-142
		4							-155	-104	-129
		5							-178	-115	-142
		6							-154	-103	-126
		7							-150	-112	-128
		8							-147	-114	-128
9	67	1	11.5	+11.0					-116	-49	-75
		2							-110	-45	-71
		3							-130	-56	-84
		4							-107	-50	-74
		5							-119	-57	-82
		6							-124	-46	-78
		7							-108	-51	-74
		8							-105	-49	-72

(Continued)

Table A1 (Continued)

Test No.	Gate Angle from Stop deg	Gate No.	Canal El	Lake El	Wave Period sec	Wave Height ft	Surge Flow cfs	Pumped Flow cfs	Torque, ft-kips		
									Max	Min	Avg
10	0	1		+5				8,000	-22	-21	-22
	15								-19	-13	-15
	22								-36	-25	-30
	30								-77	-55	-66
	45								-243	-218	-232
58	-508	-453	-484								
11	0	2		+5				8,000	-29	-18	-25
	15								-25	-5	-14
	22								-41	-17	-28
	30								-83	-46	-61
	45								-234	-194	-214
58	-520	-471	-495								
12	0	3		+5				8,000	-32	-15	-25
	15								-27	-7	-15
	22								-47	-10	-32
	30								-77	-48	-61
	45								-243	-198	-222
58	-552	-448	-507								
13	0	4		+5				8,000	-23	-22	-22
	15								-18	-11	-14
	22								-40	-26	-32
	30								-94	-73	-85
	45								-239	-205	-221
58	-528	-452	-501								

(Continued)

(Sheet 4 of 62)

Table A1 (Continued)

Test No.	Gate Angle from Stop deg	Gate No.	Canal El	Lake El	Wave Period sec	Wave Height ft	Surge Flow cfs	Pumped Flow cfs	Torque, ft-kips		
									Max	Min	Avg
14	0	5		+5				8,000	-21	-19	-20
	15								-15	-13	-14
	22								-50	-29	-42
	30								-98	-73	-84
	45								-245	-221	-234
58	-592	-526	-559								
15	0	6		+5				8,000	-19	-16	-17
	15								-11	-8	-10
	22								-31	-24	-27
	30								-70	-41	-54
	45								-247	-213	-228
58	-500	-431	-459								
16	0	7		+5				8,000	-11	-10	-11
	15								-12	-9	-11
	22								-40	-32	-36
	30								-92	-72	-81
	45								-267	-252	-259
58	-578	-524	-554								
17	0	8		+5				8,000	-18	-17	-17
	15								-6	-4	-5
	22								-19	-16	-18
	30								-54	-34	-42
	45								-221	-191	-205
58	-530	-470	-503								

(Continued)

(Sheet 5 of 62)

Table A1 (Continued)

Test No.	Gate Angle from Stop deg	Gate No.	Canal El	Lake El	Wave Period sec	Wave Height ft	Surge Flow cfs	Pumped Flow cfs	Torque, ft-kips		
									Max	Min	Avg
18	0	1		+3				8,000	-17	-16	-17
	15								-22	-12	-17
	22								-45	-28	-33
	30								-71	-46	-57
	45								-291	-239	-267
58	-612	-567	-591								
19	0	2		+3				8,000	-34	-20	-28
	15								-31	-3	-17
	22								-44	-16	-28
	30								-101	-55	-78
	45								-281	-232	-257
58	-614	-573	-594								
20	0	3		+3				8,000	-39	-17	-28
	15								-40	-4	-17
	22								-43	-13	-30
	30								-83	-44	-63
	45								-312	-236	-281
58	-653	-573	-608								
21	0	4		+3				8,000	-30	-24	-27
	15								-26	-11	-19
	22								-41	-29	-34
	30								-98	-67	-84
	45								-282	-243	-264
58	-620	-573	-601								

(Continued)

(Sheet 6 of 62)

Table A1 (Continued)

Test No.	Gate Angle from Stop deg	Gate No.	Canal El	Lake El	Wave Period sec	Wave Height ft	Surge Flow cfs	Pumped Flow cfs	Torque, ft-kips		
									Max	Min	Avg
22	0	5	+3					8,000	-26	-23	-24
	15								-19	-6	-14
	22								-54	-29	-40
	30								-100	-67	-84
	45								-325	-288	-308
	58								-690	-655	-673
23	0	6	+3					8,000	-21	-16	-18
	15								-11	-4	-8
	22								-37	-23	-31
	30								-78	-46	-60
	45								-276	-240	-257
	58								-603	-551	-573
24	0	7	+3					8,000	-14	-9	-10
	15								-12	-7	-9
	22								-54	-34	-47
	30								-85	-49	-67
	45								-312	-268	-287
	58								-685	-649	-666
25	0	8	+3					8,000	-11	-9	-10
	15								-6	-4	-5
	22								-27	-18	-21
	30								-57	-40	-48
	45								-280	-222	-253
	58								-622	-577	-601

(Continued)

(Sheet 7 of 62)

Table A1 (Continued)

Test No.	Gate Angle from Stop deg	Gate No.	Canal El	Lake El	Wave Period sec	Wave Height ft	Surge Flow cfs	Pumped Flow cfs	Torque, ft-kips		
									Max	Min	Avg
26	0	1		+1				8,000	-17	-6	-12
	15								-20	-1	-13
	22								-47	-20	-32
	30								-70	-40	-57
	45								-351	-312	-331
58	-626	-567	-596								
27	0	2		+1				8,000	-42	-23	-31
	15								-32	-2	-18
	22								-38	-16	-26
	30								-69	-36	-52
	45								-362	-306	-335
58	-626	-571	-602								
28	0	3		+1				8,000	-42	-21	-32
	15								-39	-7	-22
	22								-49	-14	-31
	30								-80	-41	-60
	45								-379	-297	-349
58	-641	-581	-614								
29	0	4		+1				8,000	-36	-27	-32
	15								-28	-13	-21
	22								-45	-22	-31
	30								-95	-61	-80
	45								-377	-327	-350
58	-621	-580	-602								

(Continued)

Table A1 (Continued)

Test No.	Gate Angle from Stop deg	Gate No.	Canal El	Lake El	Wave Period sec	Wave Height ft	Surge Flow cfs	Pumped Flow cfs	Torque, ft-kips		
									Max	Min	Avg
30	0	5		+1				8,000	-35	-32	-33
	15								-20	-8	-15
	22								-63	-33	-45
	30								-83	-51	65
	45								-396	-327	-368
	58								-664	-608	-635
31	0	6		+1				8,000	-25	-22	-24
	15								-20	-8	-13
	22								-46	-23	-34
	30								-83	-51	-65
	45								-332	-271	-309
	58								-619	-577	-595
32	0	7		+1				8,000	-13	-12	-12
	15								-18	-14	-15
	22								-52	-30	-40
	30								-103	-72	-87
	45								-381	-327	-354
	58								-696	-638	-667
33	0	8		+1				8,000	-10	-9	-9
	15								-15	-9	-11
	22								-22	-16	-19
	30								-46	-24	-36
	45								-306	-258	-285
	58								-633	-595	-613

(Continued)

Table A1 (Continued)

Test No.	Gate Angle from Stop deg	Gate No.	Canal El	Lake El	Wave Period sec	Wave Height ft	Surge Flow cfs	Pumped Flow cfs	Torque, ft-kips		
									Max	Min	Avg
34	0	1		+1				500	-1	0	0
		2							-1	0	0
		3							-1	0	-1
		4							-1	0	0
		5							-1	0	0
		6							-1	0	0
		7							-1	0	0
		8							-1	0	0
35	0	1		+1				1,000	-1	0	0
		2							-1	0	-1
		3							-2	0	-1
		4							-2	-1	-1
		5							-2	-1	-2
		6							-1	0	0
		7							-1	0	0
		8							-2	1	-2
36	0	1		+1				1,500	-2	-1	-2
		2							-1	0	-1
		3							-2	0	-1
		4							-2	-1	-1
		5							-2	-1	-2
		6							-1	0	0
		7							-1	0	-1
		8							-2	-1	-2

(Continued)

Table A1 (Continued)

Test No.	Gate Angle from Stop deg	Gate No.	Canal El	Lake El	Wave Period sec	Wave Height ft	Surge Flow cfs	Pumped Flow cfs	Torque, ft-kips		
									Max	Min	Avg
37	0	1		+1				2,000	-1	0	-1
		2							-2	-1	-1
		3							-4	-3	-1
		4							-3	-1	-2
		5							-3	-1	-2
		6							-4	-1	-3
		7							-4	-3	-4
		8							-3	-2	-2
38	0	1		+6				500	-1	0	0
		2							-1	0	0
		3							-1	0	0
		4							-1	0	0
		5							-1	0	0
		6							-1	0	0
		7							-1	0	0
		8							-2	-1	-1
39	0	1		+6				1,000	-1	0	0
		2							-1	0	0
		3							-1	0	-1
		4							-2	-1	-1
		5							-1	0	0
		6							-2	0	-1
		7							-2	-1	-1
		8							-1	0	0

(Continued)

Table A1 (Continued)

Test No.	Gate Angle from Stop deg	Gate No.	Canal El	Lake El	Wave Period sec	Wave Height ft	Surge Flow cfs	Pumped Flow cfs	Torque, ft-kips		
									Max	Min	Avg
40	0	1	+6.0					1,500	-1	0	0
		2							-1	0	0
		3							-2	-1	-1
		4							-3	-2	-2
		5							-1	0	-1
		6							-1	0	-1
		7							-1	0	-1
		8							-1	0	-1
41	0	1	+6.0					2,000	-1	-1	-1
		2							-2	-1	-1
		3							-3	0	-1
		4							-1	0	-1
		5							-1	0	-1
		6							-1	0	-1
		7							-1	0	-1
		8							-1	0	-1
42	67	1	7.0	+11.5					496	420	451
		2							500	423	561
		3							510	431	472
		4							511	432	469
		5							550	462	508
		6							490	427	464
		7							550	469	510
		8							525	438	481

(Continued)

Table A1 (Continued)

Test No.	Gate Angle from Stop deg	Gate No.	Canal El	Lake El	Wave Period sec	Wave Height ft	Surge Flow cfs	Pumped Flow cfs	Torque, ft-kips		
									Max	Min	AVG
43	67	1	8.0	+11.5					355	312	336
		2							365	316	344
		3							369	322	347
		4							365	325	348
		5							396	353	378
		6							375	323	351
		7							396	350	377
		8							375	331	357
44	67	1	9.0	+11.5					322	238	290
		2							330	246	299
		3							335	247	300
		4							331	250	301
		5							359	271	326
		6							344	250	303
		7							359	267	325
		8							340	253	309
45	67	1	9.5	+11.5					169	105	128
		2							180	113	134
		3							178	108	135
		4							182	110	134
		5							190	117	145
		6							178	96	130
		7							180	109	137
		8							175	101	128

(Continued)

Table A1 (Continued)

Test No.	Gate Angle from Stop deg	Gate No.	Canal El	Lake El	Wave Period sec	Wave Height ft	Surge Flow cfs	Pumped Flow cfs	Torque, ft-kips		
									Max	Min	Avg
46	67	1	10.0	+11.5					133	102	119
		2							144	109	127
		3							140	103	123
		4							141	111	126
		5							152	120	138
		6							144	99	124
		7							142	115	130
		8							133	105	121
47	67	1	10.5	+11.5					132	68	85
		2							140	76	94
		3							136	64	84
		4							141	72	91
		5							151	83	103
		6							145	73	92
		7							142	79	97
		8							133	72	88
48	67	1	11.0	+11.5					68	27	53
		2							80	36	62
		3							73	25	51
		4							73	36	60
		5							86	42	70
		6							84	29	61
		7							77	38	62
		8							70	31	54

(Continued)

Table A1 (Continued)

Test No.	Gate Angle from Stop deg	Gate No.	Canal El	Lake El	Wave Period sec	Wave Height ft	Surge Flow cfs	Pumped Flow cfs	Torque, ft-kips		
									Max	Min	Avg
49	67	1	7	+11.5	7.3	7.8			438	375	406
		2							447	373	406
		3							482	393	428
		4							433	366	394
		5							528	449	481
		6							487	431	456
		7							498	442	467
		8							466	401	428
50	67	1	8	+11.5	7.3	7.8			368	252	313
		2							399	258	323
		3							411	241	324
		4							385	230	305
		5							469	280	374
		6							426	279	340
		7							449	307	360
		8							388	285	333
51	67	1	9	+11.5	7.3	7.8			308	200	242
		2							330	190	245
		3							338	171	240
		4							318	173	234
		5							365	228	285
		6							312	232	263
		7							326	244	279
		8							295	224	257

(Continued)

Table A1 (Continued)

Test No.	Gate Angle from Stop deg	Gate No.	Canal El	Lake El	Wave Period sec	Wave Height ft	Surge Flow cfs	Pumped Flow cfs	Torque, ft-kips		
									Max	Min	Avg
52	67	1	9.5	+11.5	7.3	7.8			240	182	221
		2							266	201	242
		3							273	222	251
		4							253	196	230
		5							301	256	275
		6							263	200	231
		7							272	211	245
		8							255	191	222
53	67	1	10.0	+11.5	7.3	7.8			194	139	164
		2							213	133	165
		3							216	115	162
		4							204	124	159
		5							232	164	197
		6							217	161	183
		7							211	163	187
		8							195	153	171
54	67	1	10.5	+11.5	7.3	7.8			159	59	101
		2							156	49	101
		3							167	34	94
		4							167	42	99
		5							189	61	124
		6							179	70	117
		7							165	69	118
		8							146	62	102

(Continued)

Table A1 (Continued)

Test No.	Gate Angle from Stop deg	Gate No.	Canal El	Lake El	Wave Period sec	Wave Height ft	Surge Flow cfs	Pumped Flow cfs	Torque, ft-kips		
									Max	Min	Avg
55	67	1	11.0	+11.5	7.3	7.8			101	10	59
		2							122	10	64
		3							126	10	56
		4							133	12	63
		5							145	31	79
		6							128	26	71
		7							116	21	70
		8							98	10	57
56	67	1	11.5	+7.0	7.3	7.8			-410	-256	-321
		2							-371	-248	-286
		3							-419	-264	-329
		4							-387	-259	-301
		5							-460	-304	-370
		6							-397	-362	-308
		7							-412	-259	-324
		8							-387	-242	-303
57	67	1	11.5	+8.0	7.3	7.8			-306	-175	-242
		2							-278	-161	-226
		3							-324	-182	-258
		4							-292	-161	-236
		5							-339	-191	-269
		6							-303	-167	-238
		7							-317	-191	-260
		8							-297	-165	-239

(Continued)

Table A1 (Continued)

Test No.	Gate Angle from Stop deg	Gate No.	Canal El	Lake El	Wave Period sec	Wave Height ft	Surge Flow cfs	Pumped Flow cfs	Torque, ft-kips		
									Max	Min	Avg
58	67	1	11.5	+9.0	7.3	7.8			-221	-90	-136
		2							-189	-88	-122
		3							-225	-103	-149
		4							-205	-96	-132
		5							-241	-106	-153
		6							-218	-88	-143
		7							-220	-105	-143
		8							-185	-100	-132
59	67	1	11.5	+9.5	7.3	7.8			-183	-67	-120
		2							-158	-64	-113
		3							-197	-73	-130
		4							-170	-66	-116
		5							-206	-79	-132
		6							-181	-70	-125
		7							-182	-74	-125
		8							-170	-72	-118
60	67	1	11.5	+10.0	7.3	7.8			-116	-42	-73
		2							-117	-46	-79
		3							-137	-51	-92
		4							-123	-49	-82
		5							-146	-49	-92
		6							-125	-41	-82
		7							-131	-47	-89
		8							-121	-42	-84

(Continued)

Table A1 (Continued)

Test No.	Gate Angle from Stop deg	Gate No.	Canal El	Lake El	Wave Period sec	Wave Height ft	Surge Flow cfs	Pumped Flow cfs	Torque, ft-kips			
									Max	Min	Avg	
61	67	1	11.5	+10.5	7.3	7.8			-40	-3	-20	
		2							-41	-4	-22	
		3							-41	-2	-25	
		4							-36	-4	-21	
		5							-47	-5	-24	
		6							-42	-1	-23	
		7							-40	-10	-24	
		8							-33	-10	-22	
62	67	1	11.5	+11.0	7.3	7.8			-27	8	-5	
		2							-25	11	-6	
		3							-33	12	-8	
		4							-28	3	-9	
		5							-26	8	-7	
		6							-31	17	-4	
		7							-21	10	-4	
		8							-23	2	-10	
63	0 15 22 30 45 58	1		+5.0	7.3	7.8		8,000	-19	-8	-13	
									-12	-0	-6	
										-31	-11	-20
										-80	-55	-66
										-271	-247	-258
										-450	-419	-436

(Continued)

Table A1 (Continued)

Test No.	Gate Angle from Stop deg	Gate No.	Canal El	Lake El	Wave Period sec	Wave Height ft	Surge Flow cfs	Pumped Flow cfs	Torque, ft-kips		
									Max	Min	Avg
64	0	2		+5	7.3	7.8		8,000	-25	-8	-16
	15								-17	7	-7
	22								-37	-10	-23
	30								-107	-55	-87
	45								-243	-208	-228
58	-454	-417	-438								
65	0	3		+5	7.3	7.8		8,000	-35	-20	-28
	15								-17	3	-8
	22								-36	-8	-21
	30								-74	-39	-58
	45								-260	-215	-234
58	-492	-429	-457								
66	0	4		+5	7.3	7.8		8,000	-19	-12	-15
	15								-2	13	6
	22								-27	-12	-18
	30								-93	-67	-83
	45								-278	-250	-267
58	-472	-442	-457								
67	0	5		+5	7.3	7.8		8,000	-10	-2	-6
	15								-10	0	-4
	22								-51	-26	-40
	30								-104	-77	-92
	45								-270	-242	-255
58	-537	-495	-510								

(Continued)

Table A1 (Continued)

Test No.	Gate Angle from Stop deg	Gate No.	Canal El	Lake El	Wave Period sec	Wave Height ft	Surge Flow cfs	Pumped Flow cfs	Torque, ft-kips		
									Max	Min	Avg
68	0	6	+5	7.3	7.8	8,000	-4	5	0		
	15						-8	4	-2		
	22						-29	-16	-23		
	30						-81	-42	-61		
	45						-250	-213	-231		
	58						-396	-340	-370		
69	0	7	+5	7.3	7.8	8,000	-8	-1	-4		
	15						-12	-2	-7		
	22						-29	-18	-25		
	30						-100	-83	-90		
	45						-268	-239	-253		
	58						-504	-472	-486		
70	0	8	+5	7.3	7.8	8,000	-17	-11	-14		
	15						-7	0	-3		
	22						-19	-10	-15		
	30						-57	-41	-48		
	45						-249	-222	-237		
	58						-475	-433	-455		
71	0	1	+7	500	0	0	0				
	15				1	0	1				
	22				2	0	1				
	30				1	0	1				
	45				1	0	1				
	58				1	0	1				
					1	0	1				
					1	0	1				

(Continued)

(Sheet 21 of 62)

Table A1 (Continued)

Test No.	Gate Angle from Stop deg	Gate No.	Canal El	Lake El	Wave Period sec	Wave Height ft	Surge Flow cfs	Pumped Flow cfs	Torque, ft-kips		
									Max	Min	Avg
72	0	1		+7			1,000		0	0	0
		2							1	0	1
		3							2	0	1
		4							1	1	1
		5							1	0	1
		6							1	0	1
		7							1	0	1
		8							1	1	1
73	0	1		+7			1,500		0	0	0
		2							1	0	1
		3							1	0	1
		4							1	1	1
		5							1	0	0
		6							1	0	1
		7							1	0	1
		8							1	1	1
74	0	1		+7			2,000		0	0	0
		2							1	0	0
		3							1	1	1
		4							1	1	1
		5							1	0	1
		6							1	0	1
		7							1	1	1
		8							1	1	1

(Continued)

Table A1 (Continued)

Test No.	Gate Angle from Stop deg	Gate No.	Canal El	Lake El	Wave Period sec	Wave Height ft	Surge Flow cfs	Pumped Flow cfs	Torque, ft-kips		
									Max	Min	Avg
75	6	1	+7				500		1	0	0
		2							1	1	
		3							0	1	
		4							0	1	
		5							0	1	
		6							1	1	
		7							1	1	
		8							0	1	
76	6	1	+7			1,000		1	0	0	
		2						1	1		
		3						1	1		
		4						0	1		
		5						0	1		
		6						1	1		
		7						1	1		
		8						1	1		
77	6	1	+7			1,500		1	0	0	
		2						1	1		
		3						1	1		
		4						1	1		
		5						1	1		
		6						1	1		
		7						1	2		
		8						1	1		

(Continued)

Table A1 (Continued)

Test No.	Gate Angle from Stop deg	Gate No.	Canal El	Lake El	Wave Period sec	Wave Height ft	Surge Flow cfs	Pumped Flow cfs	Torque, ft-kips		
									Max	Min	Avg
78	6	1		+7			2,000		1	0	0
		2							1	1	1
		3							2	1	2
		4							1	1	1
		5							1	1	1
		6							3	2	2
		7							2	1	1
		8							2	1	1
79	12	1		+7			500		1	0	0
		2							1	0	1
		3							3	0	1
		4							1	0	0
		5							1	0	0
		6							1	0	0
		7							1	0	0
		8							1	0	0
80	12	1		+7			1,000		1	0	0
		2							1	1	1
		3							3	1	2
		4							1	0	0
		5							1	0	1
		6							1	0	1
		7							1	0	0
		8							1	0	1

(Continued)

Table A1 (Continued)

Test No.	Gate Angle from Stop deg	Gate No.	Canal El	Lake El	Wave Period sec	Wave Height ft	Surge Flow cfs	Pumped Flow cfs	Torque, ft-kips		
									Max	Min	Avg
81	12	1		+7			1,500		1	0	0
		2							1	1	1
		3							3	1	2
		4							1	0	1
		5							1	0	1
		6							2	0	1
		7							1	0	1
		8							2	1	1
82	12	1		+7			2,000		1	0	0
		2							1	1	1
		3							3	1	2
		4							1	1	1
		5							1	1	1
		6							1	1	1
		7							1	1	1
		8							2	1	2
83	15	1		+7			500		1	1	1
		2							3	1	2
		3							4	1	3
		4							2	1	2
		5							2	1	2
		6							2	1	2
		7							2	1	1
		8							3	2	2

(Continued)

Table A1 (Continued)

Test No.	Gate Angle from Stop deg	Gate No.	Canal El	Lake El	Wave Period sec	Wave Height ft	Surge Flow cfs	Pumped Flow cfs	Torque, ft-kips		
									Max	Min	Avg
84	15	1		+7			1,000		1	1	1
		2							2	2	2
		3							2	1	2
		4							4	3	3
		5							3	2	3
		6							3	2	3
		7							2	1	2
		8							3	3	3
85	15	1		+7			1,500		1	1	1
		2							2	2	2
		3							3	2	1
		4							2	2	2
		5							3	2	3
		6							2	2	2
		7							2	2	2
		8							3	3	3
86	15	1		+7			2,000		1	1	1
		2							3	2	2
		3							4	2	3
		4							5	4	4
		5							3	3	3
		6							5	3	4
		7							3	2	3
		8							4	4	4

(Continued)

Table A1 (Continued)

Test No.	Gate Angle from Stop deg	Gate No.	Canal El	Lake El	Wave Period sec	Wave Height ft	Surge Flow cfs	Pumped Flow cfs	Torque, ft-kips		
									Max	Min	Avg
87	18	1		+7			500		2	1	1
		2							5	3	4
		3							6	2	4
		4							5	4	4
		5							4	3	4
		6							4	3	4
		7							3	2	2
		8							6	5	5
88	18	1		+7			1,000		2	1	1
		2							3	3	3
		3							3	2	3
		4							5	4	4
		5							4	3	4
		6							4	3	4
		7							3	2	3
		8							5	5	5
89	18	1		+7			1,500		1	1	1
		2							3	3	3
		3							4	3	4
		4							5	4	5
		5							4	4	4
		6							4	4	4
		7							3	3	3
		8							5	5	5

(Continued)

Table A1 (Continued)

Test No.	Gate Angle from Stop deg	Gate No.	Canal El	Lake El	Wave Period sec	Wave Height ft	Surge Flow cfs	Pumped Flow cfs	Torque, ft-kips		
									Max	Min	Avg
90	18	1		+7			2,000		1	1	1
		2							4	3	3
		3							5	3	4
		4							5	4	5
		5							4	4	4
		6							5	4	4
		7							3	3	3
		8							6	5	5
91	22	1		+7			500		2	2	2
		2							5	3	3
		3							6	2	4
		4							4	3	3
		5							6	4	5
		6							4	3	4
		7							4	3	4
		8							6	5	5
92	22	1		+7			1,000		3	1	2
		2							4	3	4
		3							5	3	3
		4							3	3	3
		5							5	5	5
		6							4	3	4
		7							4	2	3
		8							4	4	4

(Continued)

Table A1 (Continued)

Test No.	Gate Angle from Stop deg	Gate No.	Canal El	Lake El	Wave Period sec	Wave Height ft	Surge Flow cfs	Pumped Flow cfs	Torque, ft-kips		
									Max	Min	Avg
93	22	1		+7			1,500		4	3	4
		2							5	4	4
		3							6	5	5
		4							3	3	3
		5							6	5	6
		6							6	5	6
		7							7	6	7
		8							9	8	8
94	22	1		+7			2,000		4	3	4
		2							6	6	6
		3							7	7	7
		4							4	4	4
		5							7	6	7
		6							7	6	7
		7							8	7	8
		8							9	8	9
95	24	1		+7			500		3	2	2
		2							5	3	3
		3							7	2	4
		4							4	3	3
		5							6	5	5
		6							4	3	4
		7							4	3	4
		8							6	5	5

(Continued)

Table A1 (Continued)

Test No.	Gate Angle from Stop deg	Gate No.	Canal El	Lake El	Wave Period sec	Wave Height ft	Surge Flow cfs	Pumped Flow cfs	Torque, ft-kips		
									Max	Min	Avg
96	24	1		+7			1,000		3	2	2
		2							4	3	4
		3							5	3	4
		4							3	3	3
		5							5	5	5
		6							4	3	4
		7							4	3	4
		8							5	5	5
97	24	1		+7			1,500		4	4	4
		2							5	4	5
		3							6	5	5
		4							3	3	3
		5							6	6	6
		6							6	6	6
		7							7	7	7
		8							9	9	9
98	24	1		+7			2,000		4	4	4
		2							6	5	6
		3							8	7	7
		4							4	3	4
		5							7	7	7
		6							7	6	7
		7							8	8	8
		8							10	9	10

(Continued)

Table A1 (Continued)

Test No.	Gate Angle from Stop deg	Gate No.	Canal El	Lake El	Wave Period sec	Wave Height ft	Surge Flow cfs	Pumped Flow cfs	Torque, ft-kips		
									Max	Min	Avg
99	30	1		+7			500		6	5	6
		2							5	4	4
		3							7	4	6
		4							8	8	8
		5							10	10	10
		6							8	8	8
		7							8	8	8
		8							9	8	8
100	30	1		+7			1,000		8	7	7
		2							6	4	5
		3							8	3	6
		4							12	11	11
		5							13	13	13
		6							11	9	9
		7							13	13	13
		8							12	10	11
101	30	1		+7			1,500		13	6	8
		2							16	4	9
		3							18	5	12
		4							12	10	11
		5							14	11	12
		6							12	8	10
		7							14	12	13
		8							12	9	10

(Continued)

Table A1 (Continued)

Test No.	Gate Angle from Stop deg	Gate No.	Canal El	Lake El	Wave Period sec	Wave Height ft	Surge Flow cfs	Pumped Flow cfs	Torque, ft-kips		
									Max	Min	Avg
102	30	1		+7			2,000		16	13	15
		2							20	14	18
		3							23	16	21
		4							16	14	16
		5							19	14	18
		6							16	14	15
		7							25	25	25
		8							20	17	19
103	45	1		+7			500		31	23	27
		2							38	26	32
		3							33	21	27
		4							31	22	26
		5							40	30	25
		6							34	27	30
		7							35	25	30
		8							34	26	30
104	45	1		+7			1,000		36	31	33
		2							42	34	38
		3							38	27	33
		4							38	31	34
		5							47	39	43
		6							41	33	37
		7							40	33	36
		8							40	33	37

(Continued)

Table A1 (Continued)

Test No.	Gate Angle from Stop deg	Gate No.	Canal El	Lake El	Wave Period sec	Wave Height ft	Surge Flow cfs	Pumped Flow cfs	Torque, ft-kips		
									Max	Min	Avg
105	45	1		+7			1,500		42	36	40
		2							53	45	49
		3							47	38	42
		4							48	42	44
		5							55	47	51
		6							48	40	44
		7							51	44	47
		8							52	46	49
106	45	1		+7			2,000		72	42	56
		2							79	47	60
		3							85	43	61
		4							75	46	60
		5							90	57	73
		6							75	45	60
		7							82	50	65
		8							81	49	64
107	58	1		+7			500		90	84	87
		2							99	90	94
		3							96	84	90
		4							98	92	94
		5							109	101	105
		6							107	98	103
		7							103	96	100
		8							98	90	94

(Continued)

Table A1 (Continued)

Test No.	Gate Angle from Stop deg	Gate No.	Canal El	Lake El	Wave Period sec	Wave Height ft	Surge Flow cfs	Pumped Flow cfs	Torque, ft-kips		
									Max	Min	Avg
108	58	1		+7			1,000		111	105	108
		2							120	113	116
		3							116	105	110
		4							120	114	117
		5							135	127	131
		6							131	121	126
		7							128	120	124
		8							122	114	118
109	58	1		+7			1,500		141	137	138
		2							150	140	145
		3							154	140	148
		4							148	142	146
		5							167	160	164
		6							163	151	157
		7							158	151	154
		8							151	144	148
110	58	1		+7			2,000		140	129	135
		2							150	135	144
		3							156	142	149
		4							140	128	136
		5							167	156	161
		6							141	127	135
		7							110	101	106
		8							129	142	137

(Continued)

Table A1 (Continued)

Test No.	Gate Angle from Stop deg	Gate No.	Canal El	Lake El	Wave Period sec	Wave Height ft	Surge Flow cfs	Pumped Flow cfs	Torque, ft-kips		
									Max	Min	Avg
111	64	1		+7			500		113	101	107
		2							118	106	113
		3							117	98	108
		4							116	107	112
		5							127	114	121
		6							135	120	128
		7							134	122	129
		8							128	117	122
112	64	1		+7			1,000		150	135	141
		2							157	140	148
		3							153	137	145
		4							156	142	148
		5							170	156	162
		6							174	157	165
		7							176	161	167
		8							167	152	158
113	64	1		+7			1,500		183	175	179
		2							191	181	187
		3							198	185	192
		4							181	174	178
		5							213	202	208
		6							214	204	208
		7							213	205	209
		8							203	194	198

(Continued)

Table A1 (Continued)

Test No.	Gate Angle from Stop deg	Gate No.	Canal El	Lake El	Wave Period sec	Wave Height ft	Surge Flow cfs	Pumped Flow cfs	Torque, ft-kips		
									Max	Min	Avg
114	64	1		+7			2,000		221	216	219
		2							229	219	224
		3							234	221	228
		4							225	217	221
		5							241	225	232
		6							240	223	233
		7							239	220	227
		8							229	218	224
115	0	1		+7	7.3	7.8	500		2	-3	-1
		2							9	-9	0
		3							6	-10	-1
		4							4	-11	-2
		5							2	-1	0
		6							6	-2	1
		7							7	2	4
		8							2	0	1
116	0	1		+7	7.3	7.8	1,000		1	-3	-1
		2							6	-9	-1
		3							6	-10	-2
		4							3	-4	-1
		5							1	-1	0
		6							3	-1	1
		7							5	2	4
		8							2	0	1

(Continued)

Table A1 (Continued)

Test No.	Gate Angle from Stop deg	Gate No.	Canal El	Lake El	Wave Period sec	Wave Height ft	Surge Flow cfs	Pumped Flow cfs	Torque, ft-kips		
									Max	Min	Avg
117	0	1		+7	7.3	7.8	1,500		2	-3	-1
		2							7	-8	-1
		3							7	-11	-2
		4							1	-6	-3
		5							1	-2	-1
		6							4	-4	-1
		7							6	2	4
		8							2	-1	1
118	0	1		+7	7.3	7.8	2,000		3	-1	1
		2							12	-10	2
		3							13	-8	3
		4							4	-1	1
		5							2	-1	1
		6							13	-5	2
		7							6	1	3
		8							2	-1	1
119	6	1		+7	7.3	7.8	500		3	-2	0
		2							9	-8	0
		3							10	-10	-1
		4							2	-2	0
		5							1	-1	0
		6							6	1	4
		7							4	1	2
		8							4	2	3

(Continued)

Table A1 (Continued)

Test No.	Gate Angle from Stop deg	Gate No.	Canal El	Lake El	Wave Period sec	Wave Height ft	Surge Flow cfs	Pumped Flow cfs	Torque, ft-kips		
									Max	Min	Avg
120	6	1		+7	7.3	7.8	1,000		3	-3	0
		2						10	-11	1	
		3						11	-11	-2	
		4						8	-1	2	
		5						2	0	1	
		6						10	3	5	
		7						6	0	3	
		8						4	-1	3	
121	6	1		+7	7.3	7.8	1,500		2	-1	0
		2						7	-7	0	
		3						10	-7	0	
		4						3	-1	1	
		5						2	-1	1	
		6						7	1	5	
		7						5	2	4	
		8						5	3	4	
122	6	1		+7	7.3	7.8	2,000		7	-7	2
		2						14	-11	2	
		3						21	-11	2	
		4						11	-6	3	
		5						4	0	2	
		6						15	-3	5	
		7						5	2	3	
		8						5	2	4	

(Continued)

Table A1 (Continued)

Test No.	Gate Angle from Stop deg	Gate No.	Canal El	Lake El	Wave Period sec	Wave Height ft	Surge Flow cfs	Pumped Flow cfs	Torque, ft-kips		
									Max	Min	Avg
123	12	1		+7	7.3	7.8	500		6	-5	0
		2							14	-12	-1
		3							14	-14	-1
		4							3	-4	0
		5							3	2	2
		6							13	-2	4
		7							7	5	6
		8							6	1	4
124	12	1		+7	7.3	7.8	1,000		8	-12	1
		2							13	-13	-1
		3							11	-16	-1
		4							4	-6	1
		5							4	2	3
		6							16	-7	5
		7							7	5	6
		8							6	1	4
125	12	1		+7	7.3	7.8	1,500		9	-9	1
		2							16	-12	0
		3							11	-17	0
		4							5	-1	2
		5							5	3	4
		6							7	1	5
		7							10	3	6
		8							7	4	5

(Continued)

Table A1 (Continued)

Test No.	Gate Angle from Stop deg	Gate No.	Canal El	Lake El	Wave Period sec	Wave Height ft	Surge Flow cfs	Pumped Flow cfs	Torque, ft-kips		
									Max	Min	Avg
126	12	1		+7	7.3	7.8	2,000		6	-5	2
		2							11	-8	2
		3							18	-13	3
		4							8	-3	3
		5							5	3	4
		6							7	2	5
		7							9	6	7
		8							12	1	5
127	15	1		+7	7.3	7.8	500		8	0	3
		2							18	-13	2
		3							17	-12	2
		4							5	2	3
		5							8	3	5
		6							15	-7	4
		7							8	1	5
		8							8	0	5
128	15	1		+7	7.3	7.8	1,000		8	-3	2
		2							20	-18	1
		3							18	-18	1
		4							4	1	2
		5							7	4	5
		6							12	1	5
		7							8	3	6
		8							9	6	7

(Continued)

Table A1 (Continued)

Test No.	Gate Angle from Stop deg	Gate No.	Canal El	Lake El	Wave Period sec	Wave Height ft	Surge Flow cfs	Pumped Flow cfs	Torque, ft-kips		
									Max	Min	Avg
129	15	1		+7	7.3	7.8	1,500		8	-5	2
		2							16	-13	3
		3							18	-13	4
		4							7	1	4
		5							8	5	6
		6							17	-5	5
		7							9	4	5
		8							8	0	5
130	15	1		+7	7.3	7.8	2,000		14	-2	5
		2							14	-3	5
		3							21	-9	6
		4							6	1	3
		5							6	1	3
		6							15	-2	6
		7							9	2	5
		8							8	4	5
131	18	1		+7	7.3	7.8	500		5	-4	1
		2							11	-12	0
		3							11	-15	0
		4							8	-1	3
		5							4	3	3
		6							10	-2	4
		7							6	5	5
		8							8	6	7

(Continued)

Table A1 (Continued)

Test No.	Gate Angle from Stop deg	Gate No.	Canal El	Lake El	Wave Period sec	Wave Height ft	Surge Flow cfs	Pumped Flow cfs	Torque, ft-kips		
									Max	Min	Avg
132	18	1		+7	7.3	7.8	1,000		10	-9	1
		2							22	-16	1
		3							12	-12	0
		4							6	-2	2
		5							7	1	4
		6							10	0	6
		7							7	5	6
		8							8	6	7
133	18	1		+7	7.3	7.8	1,500		13	-7	3
		2							16	-12	2
		3							16	-15	1
		4							6	3	4
		5							9	5	7
		6							11	4	7
		7							7	4	6
		8							8	5	7
134	18	1		+7	7.3	7.8	2,000		8	1	3
		2							12	-4	3
		3							13	-6	3
		4							7	4	5
		5							7	6	6
		6							6	3	4
		7							7	6	6
		8							9	6	7

(Continued)

BLANK

Table A1 (Continued)

Test No.	Gate Angle from Stop deg	Gate No.	Canal El	Lake El	Wave Period sec	Wave Height ft	Surge Flow cfs	Pumped Flow cfs	Torque, ft-kips		
									Max	Min	Avg
138	22	1		+7	7.3	7.8	2,000		13	-1	5
		2							22	-12	4
		3							17	-9	5
		4							19	6	7
		5							10	7	9
		6							22	2	11
		7							13	10	11
		8							14	6	11
139	24	1		+7	7.3	7.8	500		12	-3	4
		2							12	-14	2
		3							18	-16	2
		4							11	-3	4
		5							7	-1	4
		6							14	-7	5
		7							12	8	10
		8							11	3	7
140	24	1		+7	7.3	7.8	1,000		14	-10	4
		2							20	-15	2
		3							21	-14	2
		4							13	-3	5
		5							9	2	5
		6							12	-1	5
		7							11	9	10
		8							9	7	8

(Continued)

Table A1 (Continued)

Test No.	Gate Angle from Stop deg	Gate No.	Canal E1	Lake E1	Wave Period sec	Wave Height ft	Surge Flow cfs	Pumped Flow cfs	Torque, ft-kips		
									Max	Min	Avg
141	24	1		+7	7.3	7.8	1,500		13	-2	5
		2							19	-12	3
		3							17	-14	4
		4							9	2	6
		5							8	3	5
		6							12	3	6
		7							11	10	10
		8							9	6	7
142	24	1		+7	7.3	7.8	2,000		15	-1	8
		2							19	-7	7
		3							25	-6	7
		4							11	5	9
		5							10	5	7
		6							15	1	8
		7							12	9	11
		8							12	6	10
143	30	1		+7	7.3	7.8	500		16	-12	5
		2							16	-5	5
		3							21	-9	6
		4							8	3	6
		5							9	5	7
		6							12	-1	7
		7							10	4	7
		8							16	-2	7

(Continued)

Table A1 (Continued)

Test No.	Gate Angle from Stop deg	Gate No.	Canal El	Lake El	Wave Period sec	Wave Height ft	Surge Flow cfs	Pumped Flow cfs	Torque, ft-kips		
									Max	Min	Avg
144	30	1		+7	7.3	7.8	1,000		15	-5	6
		2							18	-7	6
		3							24	-10	7
		4							9	6	7
		5							15	5	9
		6							17	4	8
		7							11	7	9
		8							10	2	7
145	30	1		+7	7.3	7.8	1,500		25	-1	7
		2							29	-3	8
		3							29	-7	9
		4							21	6	10
		5							21	8	11
		6							23	4	9
		7							17	6	9
		8							25	2	9
146	30	1		+7	7.3	7.8	2,000		22	-5	9
		2							33	-9	10
		3							35	-14	11
		4							13	6	10
		5							15	8	12
		6							28	-1	12
		7							15	5	12
		8							15	9	12

(Continued)

Table A1 (Continued)

Test No.	Gate Angle from Stop deg	Gate No.	Canal El	Lake El	Wave Period sec	Wave Height ft	Surge Flow cfs	Pumped Flow cfs	Torque, ft-kips		
									Max	Min	Avg
147	45	1		+7	7.3	7.8	500		44	14	27
		2							43	21	32
		3							47	4	27
		4							42	16	28
		5							47	21	34
		6							45	13	29
		7							42	16	29
		8							47	12	29
148	45	1		+7	7.3	7.8	1,000		42	15	26
		2							44	13	29
		3							47	7	27
		4							36	10	24
		5							52	16	31
		6							50	10	28
		7							47	16	29
		8							53	7	28
149	45	1		+7	7.3	7.8	1,500		53	27	39
		2							60	35	46
		3							62	21	40
		4							59	28	43
		5							63	31	51
		6							54	26	42
		7							57	30	45
		8							61	28	46

(Continued)

Table A1 (Continued)

Test No.	Gate Angle from Stop deg	Gate No.	Canal El	Lake El	Wave Period sec	Wave Height ft	Surge Flow cfs	Pumped Flow cfs	Torque, ft-kips		
									Max	Min	Avg
150	45	1		+7	7.3	7.8	2,000		59	41	50
		2							75	42	60
		3							72	40	54
		4							63	46	55
		5							77	55	67
		6							63	45	55
		7							66	52	60
		8							66	52	59
151	58	1		+7	7.3	7.8	500		95	63	80
		2							102	72	87
		3							102	63	85
		4							101	74	86
		5							105	83	95
		6							103	75	92
		7							103	75	88
		8							98	69	83
152	58	1		+7	7.3	7.8	1,000		112	83	96
		2							120	94	105
		3							116	81	101
		4							114	91	104
		5							127	101	115
		6							133	96	112
		7							114	94	106
		8							112	89	101

(Continued)

Table A1 (Continued)

Test No.	Gate Angle from Stop deg	Gate No.	Canal El	Lake El	Wave Period sec	Wave Height ft	Surge Flow cfs	Pumped Flow cfs	Torque, ft-kips		
									Max	Min	Avg
153	58	1		+7	7.3	7.8	1,000		140	112	126
		2							150	117	136
		3							154	116	135
		4							141	125	133
		5							163	141	151
		6							159	131	145
		7							150	133	141
		8							139	125	132
154	58	1		+7	7.3	7.8	2,000		151	115	134
		2							150	124	136
		3							159	124	143
		4							151	128	141
		5							161	137	151
		6							163	133	150
		7							164	138	153
		8							149	126	139
155	64	1		+7	7.3	7.8	500		94	67	84
		2							103	77	91
		3							110	70	91
		4							98	83	91
		5							115	88	100
		6							116	90	102
		7							116	88	101
		8							112	75	95

(Continued)

Table A1 (Continued)

Test No.	Gate Angle from Stop deg	Gate No.	Canal El	Lake El	Wave Period sec	Wave Height ft	Surge Flow cfs	Pumped Flow cfs	Torque, ft-kips		
									Max	Min	Avg
156	64	1		+7	7.3	7.8	1,000		133	103	117
		2							137	115	126
		3							140	106	124
		4							136	115	125
		5							148	118	135
		6							154	127	139
		7							149	129	138
		8							144	109	129
157	64	1		+7	7.3	7.8	1,500		175	139	159
		2							180	154	168
		3							180	153	165
		4							169	155	163
		5							188	174	182
		6							195	172	185
		7							198	179	187
		8							184	165	174
158	64	1		+7	7.3	7.8	2,000		182	148	166
		2							188	155	172
		3							196	159	179
		4							180	152	167
		5							200	176	190
		6							207	170	190
		7							202	174	190
		8							194	164	179

(Continued)

Table A1 (Continued)

Test No.	Gate Angle from Stop deg	Gate No.	Canal E1	Lake E1	Wave Period sec	Wave Height ft	Surge Flow cfs	Pumped Flow cfs	Torque, ft-kips		
									Max	Min	Avg
159	24	1		+7			500		4	4	4
	0	2						1	0	0	0
	0	3						1	-1	0	0
	0	4						1	0	1	1
	0	5						1	0	0	0
	0	6						1	0	1	1
	0	7						1	1	1	1
	24	8						7	7	7	7
160	24	1		+7			1,000		4	4	4
	0	2						1	1	1	1
	0	3						1	0	0	0
	0	4						1	0	1	1
	0	5						1	0	1	1
	0	6						1	1	1	1
	0	7						1	1	1	1
	24	8						7	7	7	7
161	24	1		+7			1,500		4	4	4
	0	2						1	1	1	1
	0	3						1	0	0	0
	0	4						1	1	1	1
	0	5						1	0	1	1
	0	6						1	1	1	1
	0	7						1	1	1	1
	24	8						7	7	7	7

(Continued)

Table A1 (Continued)

Test No.	Gate Angle from Stop deg*	Gate No.	Canal El	Lake El	Wave Period sec	Wave Height ft	Surge Flow cfs	Pumped Flow cfs	Torque, ft-kips		
									Max	Min	Avg
162	24	1		+7			2,000		4	4	4
	0	2						1	1	1	1
	0	3						1	0	0	0
	0	4						1	1	1	1
	0	5						1	0	1	1
	0	6						1	1	1	1
	0	7						1	1	1	1
	24	8						7	7	7	7
163	Closed	1		+7			500		0	0	0
	0	2						1	1	1	1
	0	3						2	1	1	2
	0	4						2	2	2	2
	0	5						1	0	1	1
	0	6						3	3	3	3
	0	7						1	1	1	1
	Closed	8						0	0	0	0
164	Closed	1		+7			1,000		3	2	2
	0	2						4	3	3	3
	0	3						3	2	2	3
	0	4						3	2	2	2
	0	5						1	0	1	1
	0	6						4	3	3	3
	0	7						1	1	1	1
	Closed	8						0	0	0	0

(Continued)

Table A1 (Continued)

Test No.	Gate Angle from Stop deg	Gate No.	Canal El	Lake El	Wave Period sec	Wave Height ft	Surge Flow cfs	Pumped Flow cfs	Torque, ft-kips		
									Max	Min	Avg
165	Closed	1		+7			1,500		3	2	2
	0	2						3	3	2	2
	0	3						3	3	2	3
	0	4						2	2	2	2
	0	5						1	0	1	1
	0	6						3	3	3	3
	0	7						1	1	1	1
	Closed	8						0	0	0	0
166	Closed	1		+7			2,000		2	2	2
	0	2						2	2	1	2
	0	3						1	1	1	1
	0	4						3	2	2	2
	0	5						1	1	1	1
	0	6						3	3	3	3
	0	7						1	1	1	1
	Closed	8						1	0	0	0
167	0	1		+7			500		3	3	3
	0	2						2	1	2	2
	0	3						2	2	2	2
	0	4						1	0	1	1
	0	5						1	0	0	0
	0	6						1	0	1	1
	24	7						2	1	2	2
	24	8						7	6	7	7

(Continued)

Table A1 (Continued)

Test No.	Gate Angle from Stop deg	Gate No.	Canal El	Lake El	Wave Period sec	Wave Height ft	Surge Flow cfs	Pumped Flow cfs	Torque, ft-kips		
									Max	Min	Avg
168	0	1		+7			1,000		3	2	3
	0	2							2	1	2
	0	3							2	1	2
	0	4							1	1	1
	0	5							1	0	1
	0	6							1	0	1
	24	7							2	1	1
	24	8							7	6	7
169	0	1		+7			1,500		3	3	3
	0	2							2	1	1
	0	3							2	1	1
	0	4							1	1	1
	0	5							1	0	1
	0	6							1	0	1
	24	7							2	2	2
	24	8							7	6	7
170	0	1		+7			2,000		3	3	3
	0	2							1	1	1
	0	3							1	0	1
	0	4							1	1	1
	0	5							1	0	1
	0	6							1	1	1
	24	7							1	1	1
	24	8							3	2	2

(Continued)

Table A1 (Continued)

Test No.	Gate Angle from Stop deg	Gate No.	Canal El	Lake El	Wave Period sec	Wave Height ft	Surge Flow cfs	Pumped Flow cfs	Torque, ft-kips		
									Max	Min	Avg
171	0	1		+7			500		1	1	1
	0	2							3	1	2
	0	3							3	1	2
	0	4							1	1	1
	0	5							1	0	1
	0	6							0	0	0
	Closed	7							0	0	0
	Closed	8							0	0	0
172	0	1		+7			1,000		1	1	1
	0	2							2	1	2
	0	3							2	2	2
	0	4							1	1	1
	0	5							1	1	1
	0	6							0	0	0
	Closed	7							0	0	0
	Closed	8							0	0	0
173	0	1		+7			1,500		1	1	1
	0	2							2	2	2
	0	3							2	2	2
	0	4							1	1	1
	0	5							1	1	1
	0	6							0	0	0
	Closed	7							0	0	0
	Closed	8							0	0	0

(Continued)

Table A1 (Continued)

Test No.	Gate Angle from Stop deg	Gate No.	Canal El	Lake El	Wave Period sec	Wave Height ft	Surge Flow cfs	Pumped Flow cfs	Torque, ft-kips		
									Max	Min	Avg
174	0	1		+7					1	1	1
	0	2				2,000		1	1	1	
	0	3						1	1	1	
	0	4						1	1	1	
	0	5						1	1	1	
	0	6						1	1	1	
	Closed	7						0	0	0	
	Closed	8						0	0	0	
175	0	1		+7			500		1	1	1
	0	2						3	2	2	
	0	3						3	2	2	
	24	4						3	3	3	
	24	5						5	4	4	
	0	6						1	1	1	
	0	7						1	1	1	
	0	8						1	1	1	
176	0	1		+7			1,000		1	1	1
	0	2						2	1	1	
	0	3						2	1	1	
	24	4						3	3	3	
	24	5						4	4	4	
	0	6						1	1	1	
	0	7						1	1	1	
	0	8						1	1	0	

(Continued)

Table A1 (Continued)

Test No.	Gate Angle from Stop deg	Gate No.	Canal El	Lake El	Wave Period sec	Wave Height ft	Surge Flow cfs	Pumped Flow cfs	Torque, ft-kips		
									Max	Min	Avg
177	0	1		+7			1,500		1	1	1
	0	2							1	0	0
	0	3							0	0	0
	24	4							3	2	3
	24	5							5	4	4
	0	6							2	0	1
	0	7							1	1	1
	0	8							1	0	0
178	0	1		+7			2,000		1	1	1
	0	2							0	0	0
	0	3							0	0	0
	24	4							3	3	3
	24	5							5	4	4
	0	6							1	1	1
	0	7							1	1	1
	0	8							1	0	0
179	0	1		+7			500		0	0	0
	0	2							2	1	1
	0	3							1	1	1
	Closed	4							1	1	1
	Closed	5							2	1	2
	0	6							1	0	1
	0	7							1	1	1
	0	8							1	0	1

(Continued)

Table A1 (Continued)

Test No.	Gate Angle from Stop deg	Gate No.	Canal El	Lake El	Wave Period sec	Wave Height ft	Surge Flow cfs	Pumped Flow cfs	Torque, ft-kips		
									Max	Min	Avg
180	0	1		+7			1,000		0	0	0
	0	2							2	1	2
	0	3							1	0	1
	Closed	4							1	1	1
	Closed	5							2	2	2
	0	6							1	1	1
	0	7							1	1	1
	0	8							1	1	1
181	0	1		+7			1,500		0	0	0
	0	2							0	0	0
	0	3							0	0	0
	Closed	4							1	1	1
	Closed	5							2	2	2
	0	6							1	1	1
	0	7							1	1	1
	0	8							1	1	1
182	0	1		+7			2,000		0	0	0
	0	2							0	0	0
	0	3							0	0	0
	Closed	4							1	1	1
	Closed	5							2	2	2
	0	6							1	1	1
	0	7							2	2	2
	0	8							1	1	1

(Continued)

Table A1 (Continued)

Test No.	Gate Angle from Stop deg	Gate No.	Canal E1	Lake E1	Wave Period sec	Wave Height ft	Surge Flow cfs	Pumped Flow cfs	Torque, ft-kips		
									Max	Min	Avg
183	6	1		+1			500		2	1	2
		2							1	0	0
		3							1	0	0
		4							4	4	4
		5							2	1	1
		6							2	2	2
		7							2	1	2
		8							6	5	5
184	6	1		+1			1,000		2	2	2
		2							1	0	1
		3							2	0	1
		4							5	4	4
		5							2	1	2
		6							3	2	2
		7							2	2	2
		8							6	6	6
185	6	1		+1			1,500		2	2	2
		2							1	0	1
		3							4	0	1
		4							5	5	5
		5							2	2	2
		6							3	2	2
		7							2	2	2
		8							6	6	6

(Continued)

Table A1 (Continued)

Test No.	Gate Angle from Stop deg	Gate No.	Canal El	Lake El	Wave Period sec	Wave Height ft	Surge Flow cfs	Pumped Flow cfs	Torque, ft-kips		
									Max	Min	Avg
186	6	1		+1			2,000		3	2	3
		2							6	5	5
		3							7	5	6
		4							3	3	3
		5							2	1	2
		6							3	2	2
		7							2	2	2
		8							7	6	6
187	12	1		+1			500		1	0	1
		2							1	0	1
		3							1	0	1
		4							1	0	1
		5							1	0	1
		6							1	0	1
		7							1	0	1
		8							1	0	1
188	12	1		+1			1,000		1	1	1
		2							2	1	2
		3							4	3	4
		4							1	1	1
		5							1	1	1
		6							1	1	1
		7							1	1	1
		8							1	1	1

(Continued)

Table A1 (Continued)

Test No.	Gate Angle from Stop deg	Gate No.	Canal El	Lake El	Wave Period sec	Wave Height ft	Surge Flow cfs	Pumped Flow cfs	Torque, ft-kips		
									Max	Min	Avg
189	12	1		+1			1,500		1	1	1
		2							6	3	5
		3							9	4	7
		4							2	1	2
		5							1	1	1
		6							2	1	1
		7							1	1	1
		8							1	1	1
190	12	1		+1			2,000		1	1	1
		2							1	1	1
		3							2	2	2
		4							2	1	1
		5							2	1	1
		6							3	1	2
		7							3	1	2
		8							4	2	3
191	0	1		+6					-51	-49	-50
		2							-54	-52	-53
		3							-34	-31	-33
		4							-37	-35	-36
		5							-48	-46	-47
		6							-33	-31	-32
		7							-47	-46	-47
		8							-44	-42	-43

(Continued)

Table A1 (Concluded)

Test No.	Gate Angle from Stop deg	Gate No.	Canal El	Lake El	Wave Period sec	Wave Height ft	Surge Flow cfs	Pumped Flow cfs	Torque, ft-kips		
									Max	Min	Avg
192	0	1	9	+8					-47	-45	-46
		2							-50	-47	-49
		3							-36	-31	-35
		4							-32	-30	-31
		5							-49	-48	-49
		6							-34	-30	-33
		7							-46	-44	-45
		8							-43	-41	-43