

# MISSISSIPPI RIVER LEVEES AND BANKS

## MILE 66 TO MILE 10

### SOIL REPORT - PART I

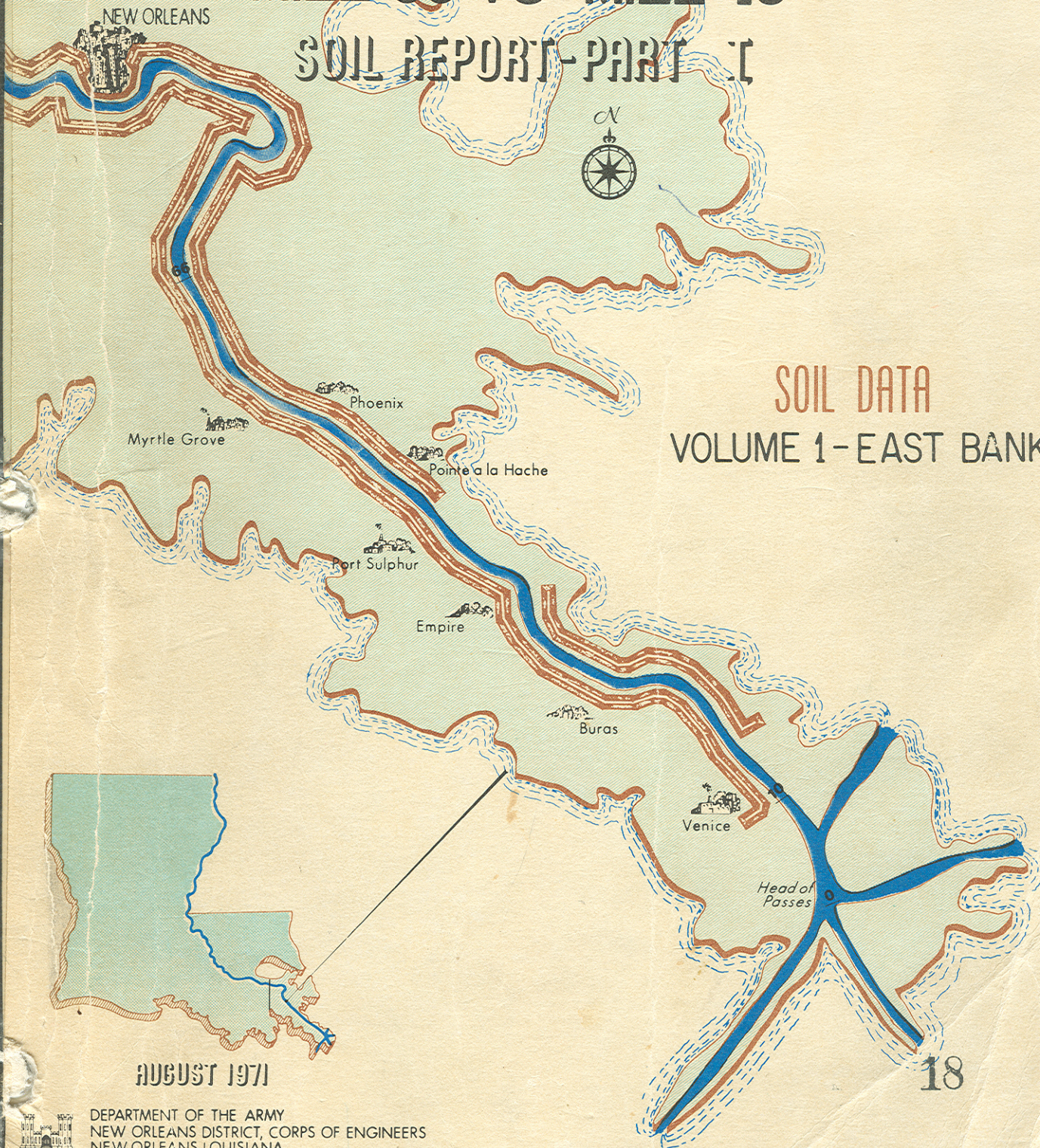

SOIL DATA  
VOLUME 1 - EAST BANK

AUGUST 1971

18



DEPARTMENT OF THE ARMY  
NEW ORLEANS DISTRICT, CORPS OF ENGINEERS  
NEW ORLEANS, LOUISIANA



MISSISSIPPI RIVER LEVEES AND BANKS

MILE 66 TO MILE 10

SOIL REPORT-PART I

SOIL DATA  
VOLUME 1 - EAST BANK

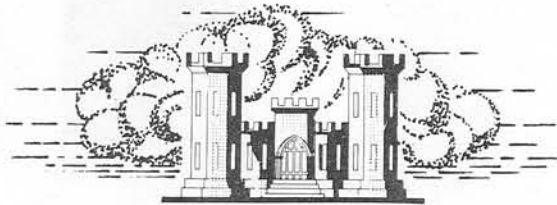

DEPARTMENT OF THE ARMY  
NEW ORLEANS DISTRICT, CORPS OF ENGINEERS  
NEW ORLEANS, LOUISIANA

MISSISSIPPI RIVER LEVEES AND BANKS

MILE 66 TO MILE 10

SOIL REPORT

PART INDEX

PART

I

SOIL DATA

Volume 1 - East Bank

Volume 2 - West Bank

Appendix A - Detailed Shear Test Data

II

LEVEE STABILITY ANALYSES

Volume 1 - East Bank

Volume 2 - West Bank

III

BANK STABILITY ANALYSES

Volume 1 - East Bank

Volume 2 - West Bank

## PREFACE

This report presents a compilation of available geology and soil data for the east bank of the Mississippi River from Belair, Louisiana, to a point opposite Venice, Louisiana, a distance of 56 river miles. The data presented include soil boring logs; results of laboratory tests; soil profiles; and soil stratification and shear strengths selected for design.

The design soil stratification and shear strengths presented in this report were selected by personnel of the New Orleans District and were reviewed and approved by representatives of the Mississippi River Commission.

The soil borings were made by field personnel of the New Orleans District under the supervision of Messrs. Roy V. Bankston (now retired) and Wayne W. Weiser, Field Investigations Section.

This report was prepared in the Structures Foundation Section by Mr. Rodney P. Picciola under the direction of Messrs. Herman A. Huesmann and Krum J. Cannon, Foundations and Materials Branch, New Orleans District. Geologic data presented were prepared by Mr. E. Burton Kemp III, Geologic Section.

District Engineer during the preparation of this report was Colonel Herbert R. Haar, Jr., CE. Chief of Engineering Division was Mr. Jerome C. Baehr.



TABLE OF CONTENTS

	<u>Page</u>
PREFACE	v
I - INTRODUCTION	1
II - GEOLOGY	2
Physiography	2
General Geology	2
Subsidence and Erosion	3
Mineral Resources	4
III - SOIL DATA	5
Borings	5
Boring Numbers	6
Boring Logs	6
Laboratory Tests	6
Foundation Conditions	7
Soil Profiles	7
Soil Stratification	9
Shear Strength Data	9
Clay Strengths	10
Silt Strength	10
Sand Strength	10

TABLES

<u>No.</u>	<u>Title</u>	
1	Soil Boring Locations	11
2	Design Shear Strengths and Soil Stratification	19

PLATES

1	Area Map	
2-15	Boring Location Map	
16-25	General Type Borings	
26	Borings, Bohemia Spillway and Bayou Lamoque Structures	
27	Borings, Ostrica Lock	
28	Borings, Freshwater Culvert, Vicinity Mile 18.2 AHP	
29-67	Undisturbed Boring Data	
68-75	Borrow Borings, Pointe-a-la Hache Relief Outlet	
76-77	Bank Borrow Borings, Vicinity Mile 36.0 AHP	
78	Soil and Geologic Profile, Mile 66.2 to Mile 37.5 AHP	
79	Soil and Geologic Profile, Mile 37.5 to Mile 10.0 AHP	
A	Soil Boring Legend	

TABLE OF CONTENTS (cont'd)

<u>No.</u>	<u>Title</u>
	Undisturbed Borings
29	Boring R-65.6-LU
30	Boring R-62.6-LU
31	Borings 25-MHUL and 25-MHULT
32	Boring R-60.3-UL
33	Boring R-58.0-LU
34	Borings 56-UE and 56-UET
35	Boring 19-MHUL
36	Boring 19-MHULT
37	Borings 15-MHUL and 15-MHULT
38	Boring R-51.7-LU
39	Borings 10-MHUL and 10-MHULT
40	Boring 1-U (Station 2296+25)
41	Borings 47-UE and 47-UET
42	Boring R-46.95-LU
43	Boring 2-MHULT
44	Boring 61-MHUL, Bohemia Spillway Freshwater Diversion Structure
45	Boring R-41.8-LU
46	Boring 5-BU
47	Boring 32-MHUL
48	Boring 36-MHUL
49	Boring R-34.4-UL
50	Boring 38-MHUL
51	Boring 39-MHUL
52	Boring 64-MHUL, Bayou Lamoque Freshwater Structure
53	Boring R-32.3-UL
54	Boring 43-MHUL
55	Boring 47-MHUL
56	Boring 50-MHUL
57	Boring 66-MHUL, Ostrica Lock
58	Boring 68-MHUL, Ostrica Lock
59	Boring R-24.0-LU
60	Boring 52-MHUL
61	Boring R-20.0-LU
62	Boring 73-MHUL, Freshwater Culvert, Vicinity Mile 18.2 AHP
63	Boring 53-MHUL
64	Boring R-15.9-LU
65	Boring 54-MHUL
66	Boring R-11.6-LU
67	Boring 58-MHUL



## I - INTRODUCTION

1. Through the years, a voluminous amount of geologic and soil data has been collected from borings made on the banks of the Mississippi River below New Orleans, Louisiana, for revetment, levee, and various miscellaneous projects. In recent years, additional borings and soil data were obtained for use in study of hurricane protection projects.

2. This report presents a compilation of all available geologic and soil data for the east (left descending) bank of the Mississippi River between about river miles 10 and 66 AHP<sup>1</sup>. This data was used in design of the Mississippi River and Tributaries Project (MR&T) levees; the New Orleans to Venice, Louisiana, Mississippi River Hurricane Protection Project levees; and bank revetments required within this stretch of the Mississippi River.

---

<sup>1</sup>All mileages in this report are those above Head of Passes of the Mississippi River.

## II - GEOLOGY

### Physiography

3. The study area is located within the Central Gulf Coastal Plain. Specifically, the area is located on the modern subdelta which projects gulfward from the deltaic plain of the Mississippi River. It is a region of extremely low relief. Dominant physiographic features are the natural levees of the Mississippi River and abandoned distributaries, and the marshlands and inland bodies of water that lie between the natural levee ridges. Elevations range from a maximum of about 5 feet along the crests of the natural levees to a minimum of sea level or slightly lower in the marshlands between the natural levee ridges. The numerous inland bodies of water vary in depth from 1 to 6 feet. The Mississippi River channel varies in depth from 65 to 190 feet below sea level.

### General Geology

4. Only the geologic history since the end of the Pleistocene Epoch is significant for this project. At that time, with sea level about 450 feet below its present level, the Mississippi River began to aggrade the final entrenchment which it had cut to the west of the project area during the last glacial period. Initial alluvial sedimentation was confined to the central portion of the alluvial valley. This sedimentation was accompanied by downwarping of the Pleistocene Prairie surface and some faulting resulting in a gulfward dip of the Prairie surface averaging about 3 feet per mile and increasing towards the coastline. Only minor amounts of dissection occurred on the Pleistocene as a result of estuaries and small streams. Sedimentation was insignificant in the study area prior to the time sea level reached about 200 feet below its present elevation. Most of the study area stood above sea level and only coarse fluvial materials were deposited in the deep entrenchment to the



west of the study area. The continued rise in sea level resulted in the reworking and redepositing of minor amounts of fluvial sediments in the study area. When sea level reached within tens of feet of its present level, the first marine and fluvial marine sediments of any significance were carried into the study area. Deltaic marine sediments were first introduced into the study area about 3,500 years ago when the Mississippi occupied the Teche course to the west of the study area. The first major advance of sediments occurred approximately 2,800 years ago when the Mississippi River shifted eastward and began to develop the La Loutre-St. Bernard Delta. About 1500 years ago, the Mississippi River shifted westward to the Lafourche course and for a period of several hundred years the study area was subjected to only minor amounts of sedimentation and deltaic deterioration and subsidence became important. When the river again shifted eastward about 1,200 years ago and began to occupy the present Plaquemine course, sedimentation again became the predominant process in the study area. With the construction of levees along the Mississippi River, floodwaters have been eliminated from most of the area and at present only a small amount of sediments is being introduced into the area. The land mass along the edges of the study area is decreasing as a result of subsidence and erosion by wave action.

#### Subsidence and Erosion

5. Progressive subsidence and downwarping have been occurring in the study area since the end of the Pleistocene Epoch. The surface of the Pleistocene deposits have been downwarped toward the south and west to a maximum of about 500 feet at the edge of the continental shelf, which is 15 to 25 miles south of Venice, Louisiana. At present, the rate of subsidence in the study area varies between 0.5 and 1.0 foot per century.

6. As a result of subsidence and wave erosion, the seaward facing edges of the shoreline and the shorelines of the canals, ponds, lakes, and bays within the marshlands are retreating. Because of prevailing winds and littoral drift, the marshland area east of

the Mississippi River, below Bohemia to the vicinity of Baptiste Collette Bayou, has been subjected to strong wave attacks and erosion, resulting in a more rapid retreat and destruction of the marshlands than elsewhere in this region.

#### Mineral Resources

7. Extensive oil, gas, and sulphur production are found in the general vicinity of the study area. Exploration and production of these mineral resources will not adversely affect the levee and bank stabilization projects, nor will the projects adversely affect exploration and production of these resources.



### III - SOIL DATA

8. Considerable soil and related data were obtained from the east bank of the Mississippi River between river miles 10 and 66 AHP to determine the characteristics of the subsurface materials for use in levee and bank revetment design. Undisturbed soil borings were made at numerous locations and were supplemented with general type borings. Samples from the undisturbed borings were subjected to various laboratory tests to determine the consolidation and strength characteristics of the subsurface soils. The methods used and the tests performed in the field and laboratory for collection of the soil data are discussed in the following paragraphs.

#### Borings

9. A total of 143 general type and undisturbed soil borings have been made on the east bank of the Mississippi River between miles 10 AHP and 66 AHP for the various levee and revetment projects. The type of project for which the soil data was required determined the depth to which each boring was made. Depths ranged down from the surface of the ground to about elevation -50 to -130 feet mean sea level<sup>2</sup> for borings made for levee projects, and down to about -80 to -210 for revetment projects. The undisturbed borings were made with a 5-inch diameter steel tube piston-type sampler and the general type borings with a 1-7/8 inch I.D. core barrel sampler. In addition to the 143 soil borings mentioned above, 251 auger borings to depths of 10 to 15 feet were made in the Pointe-a-la Hache Relief Outlet for investigation of this area as a possible source of borrow material for use in levee construction. The borrow borings were made by hand with a 4-inch diameter post hole auger. The locations of all the borings presented in this report are shown in plan on plates 2 to 15. In addition, a tabulated list of the locations of the general type and undisturbed

---

<sup>2</sup>Hereinafter, all elevations stated refer to feet mean sea level.

borings is presented in Table 1. Tabulation of the borrow boring locations is not presented.

#### Boring Numbers

10. Through the years, various numbering systems were used to identify the borings for the various projects. As a guide in identifying the different borings included within this report, the following should prove helpful:

- a. All undisturbed borings are identified by the letter "U." (Example: 1-U or 25-MHUL). Boring numbers without the letter "U" indicate general type borings or auger borings.
- b. The letters "MH" indicate borings made for the Mississippi River Hurricane Project. (Example: 19-MHUL).
- c. The letter "R" as a prefix to the boring number indicates the boring was made for a revetment project. (Example: R-32.3-LU).
- d. As a suffix, the letter "E" or "L" indicates that the boring was made on the east (left descending) bank. (Example: 56-UE, 53-MHUL, or R-65.6-LU). The letter "T" indicates a boring made at the levee toe. (Example: 25-MHULT).
- e. The letter "B" indicates a borrow boring. (Example: 4-B or B-7).

#### Boring Logs

11. The borings made on the east bank consisted of 99 general type, 44 undisturbed, and 251 auger borings. The detailed logs of the general type borings are shown on plates 16 to 28; the undisturbed borings on plates 29 to 67; and the auger type borrow borings on plates 68 to 77.

#### Laboratory Tests

12. Visual classifications and water content determinations were made on all samples from the borings. Unconfined-compression (UC) shear tests were made on typical clay samples. Unconsolidated-undrained (Q) and consolidated-undrained (R) triaxial compression tests, consolidated-drained (S) direct shear tests, and consolidation tests were performed on selected samples from the undisturbed borings. In addition, Atterberg limit determinations were performed on each sample

subjected to a shear or consolidation test. Results of all laboratory tests performed are shown on the boring logs, plates 16 through 77. Detailed laboratory test data sheets for the (Q), (R), and (S) shear tests are shown in appendix A to this report.

### Foundation Conditions

#### Soil Profiles

13. Generalized profiles of the subsurface soils and geologic deposits along the east bank of the river in the study area are shown on plates 78 and 79. It was impossible to show all available borings used in determining the profile in some areas because of the necessity for confining the horizontal scale; therefore, the profiles are based on the results of selected levee and revetment borings. The boring number of each boring used is shown on the profiles.

14. The subsurface on the east bank, as shown on plates 78 and 79, consists of Recent deposits varying in thickness from 100 feet at the upstream end of the project (mile 66 AHP) to 252 feet at the downstream end of the project (mile 10 AHP). The Recent deposits are underlain by Pleistocene materials. Generally, the Recent consists of a surface layer of soft to stiff natural levee clays with layers and lenses of silt, varying in thickness from a maximum of about 18 feet in the vicinity of station 1400+00 (mile 65.6) and station 2100+00 (mile 52.5), to a minimum of 4 to 8 feet between station 240+00 (mile 20.0) and station 880+00 (mile 10.1). In the vicinity of stations 1410+00 (mile 65.6); 190+00 through 235+00 (mile 40.5-39.8); 435+00 through 125+00 (mile 34.7-33.6); and 150+00 through 240+00 (mile 33.2-31.6), the natural levee deposits are underlain by a discontinuous layer of very soft marsh clays with peat and organic matter. The marsh deposits vary in thickness from 2 feet between stations 190+00 and 235+50 (mile 40.5-39.8) to 6 feet in the vicinity of stations 200+00 (mile 32.3) and 240+00 (mile 31.6). Between stations 1380+00 (mile 66.2) and 1530+00 (mile 63.2); 1590+00 (mile 62.1) and 1767+00

(mile 58.6); 1790+00 (mile 58.3) and 1900+00 (mile 56.1); 2086+00 (mile 52.6) and 2280+00 (mile 49.3); 2332+00 (mile 48.4) and 2455+00 (mile 46.0); 60+00 (mile 34.6) and 85+00 (mile 34.2); 165+00 (mile 33.0) and 252+00 (mile 31.4); 25+00 (mile 24.4) and 40+00 (mile 24.2); 240+00 (mile 20.4) and 590+00 (mile 14.1); and 740+00 (mile 11.5) and 879+00 (mile 10.1), the natural levee and marsh deposits are underlain by soft, alternating layers of intradelta clays and silts with layers of silty sand and sand. The thickness of the intradelta deposits varies from a minimum of 10 feet in the vicinity of station 2100+00 (mile 52.5) to a maximum of 87 feet in the general vicinity of station 850+00 (mile 10.8). The remaining reaches of natural levee and marsh deposits are underlain by point bar silts, silty sands, and sands with layers of clay, varying in thickness from 90 feet between stations 1530+00 (mile 63.2) and 590+00 (mile 62.1), where the deposits extend down to elevation -95, to 187 feet between stations 40+00 (mile 24.2) and 240+00 (mile 20.4), where these deposits extend down to elevation -197. Exceptions to this occur in the general vicinity of station 1767+00 (mile 58.6) to 1790+00 (mile 58.3), 226+00 (mile 40.0) to 232+00 (mile 39.7), and 85+00 (mile 34.2) to 165+00 (mile 33.0), where abandoned distributary silty sands and sands with clay layers are found with thicknesses of 55 feet (to elev. -65.0), 72 feet (to elev. -79.5), and 119 feet (to elev. -121.0), respectively, between stations 55+00 (mile 43.2) and 226+00 (mile 40.0) where a 38 to 65 foot zone of very soft to soft interdistributary clay with lenses and layers of silt and silty sand directly underlies natural levee and marsh deposits; and between stations 590+00 (mile 14.1) and 740+00 (mile 11.5) where accretionary silts, silty sands, and sands 60 feet thick underlie the natural levee deposits to an elev. of -64.5. The accretionary materials are underlain by a 12 to 20 foot wedge of intradelta deposits. The intradelta, interdistributary, point bar, and abandoned distributary deposits are underlain along the entire levee alignment by medium to stiff prodelta clays, except between stations 1530+00 (mile 63.2) and 1590+00 (mile 62.1), and stations 1900+00 (mile 56.1) and 2086+00 (mile 52.6) where

point bar deposits lie directly over Pleistocene clays and nearshore sands. The thickness of the prodelta clays vary from a minimum of 55 feet (to elev. -115.0) between stations 2100+00 (mile 52.5) and 2280+00 (mile 49.3) to a maximum of 135-140 feet (to elevations -205.0 and -225.0) between stations 240+00 (mile 20.4) and 879+00 (mile 10.1). Between stations 1590+00 (mile 62.1) and 2544+90 (mile 44.2), and stations 200+00 (mile 40.5) and 879+00 (mile 10.1), nearshore sands with shell and shell fragments underlie the prodelta at elevations varying between -100 in the vicinity of station 1590+00 (mile 62.1) to -225 at station 879+00 (mile 10.1). Elsewhere, the prodelta lies directly over the stiff to very stiff Pleistocene clays. The nearshore deposits between stations 1590+00 (mile 62.1) and 2544+90 (mile 44.2) vary in thickness from 2 to 25 feet, and between stations 200+00 (mile 40.5) and 879+00 (mile 10.1) thicken as a wedge in a downstream direction from a thin veneer to a maximum of 27 feet. Underlying the entire sequence of Recent deposits, at elevations varying from -93 at station 1380+00 (mile 66.2) to -252 at station 879+00 (mile 10.1), are stiff to very stiff Pleistocene clays.

#### Soil Stratification

15. To facilitate levee and bank revetment designs, the bank of the river was divided into soil reaches. The extent of each reach was determined from the soil profiles and was based on the stratification and types of subsurface soils, and the concept that each reach was generally uniform in composition and stratification. The reaches selected are shown on the soil profiles, plates 78 and 79.

#### Shear Strength Data

16. The results of all laboratory shear tests performed are shown on the boring logs. The shear strengths selected for use in levee and bank revetment design are shown on the undisturbed boring logs, plates 29 to 67. Also, the design shear strengths, together with the soil stratification selected for each soil reach, are shown tabulated in



Table 2. The design shear strengths and soil stratification for groups of reaches were reviewed and approved by representatives of the Mississippi River Commission, progressively as developed.

#### Clay Strengths

17. The shear strengths for clay soils selected for use in levee and bank revetment designs were based on the results of the unconsolidated-undrained (Q) triaxial compression shear tests. The preconsolidation pressures shown on the undisturbed boring logs agree closely with the overburden pressure, thus indicating that the clay soils are normally consolidated. It was determined that the undrained (Q) shear strengths of the normally consolidated clays above elevation -10 to -40 are essentially constant and range between 0.20 and 0.40 ton per sq ft beneath existing levee fill, and between 0.05 and 0.30 ton per sq ft beyond the influence of levee fill. Below these elevations, the shear strength increases with depth according to the relation defined by the ratio  $c/\bar{p}=0.25$ , where  $c$  is the undrained shear strength in tons per sq ft and  $\bar{p}$  is the effective overburden pressure in tons per sq ft. Based on the above  $c/\bar{p}$  ratio and the results of the (Q) shear tests, it was determined that with few exceptions, the undrained shear strength of the Recent clay soils below elevation -10 to -40 increases at a rate of 0.005 ton per sq ft per ft of depth.

#### Silt Strength

18. A shear strength value of  $\phi=15^\circ$ ,  $c=0.10$  ton per sq ft, was selected for silt (ML). This value is based on the results of the unconsolidated-undrained (R) shear tests. In determining the shear strength, the strength envelopes used were based on the deviator stresses at maximum positive pore pressures.

#### Sand Strength

19. The shear strength selected for silty sand (SM) and sand (SP) was based on the results of the consolidated-drained (S) shear tests. A value of  $\phi=30^\circ$ ,  $c=0$ , was selected for levee and bank revetment designs.

## **NOTE**

**The back of all pages in the paper copy of the report from page 10 through 102 were intentionally left blank, but were included in the page numbering. There are no even numbered pages in the paper copy of the report after page 10.**

TABLE 1  
SOIL BORING LOCATIONS

MISSISSIPPI RIVER LEVEES AND BANKS  
MILE 66 TO MILE 10  
EAST BANK

SOIL BORING LOCATIONS

SOIL BORING NO.	LEVEE B/L		SOIL BORING NO.	LEVEE B/L	
	STATION	LOCATION		STATION	LOCATION
R-65.6LU	1409+00	170'R.S.C/L	R-52.0	2130+50	28' R.S.C/L
R-62.6LU	1564+00	140'R.S.C/L	15-MHUL	2140+00	C/L Levee
R-62.0L	1600+00	110'R.S.C/L	15-MHULT	2140+00	41'L.S.C/L
26-MHL	1607+00	56'L.S.C/L	R-51.7 LU	2148+50	60'R.S.C/L
25-MHUL	1632+00	C/L Levee	14-MHL	2174+00	C/L Levee
25-MHULT	1632+00	L.S. Toe	13-MHL	2199+00	33'R.S.C/L
MS-28	1666+50	600'L.S.C/L	R-50.5L	2209+50	160'R.S.C/L
R-60.7-L	1670+00	210'R.S.C/L	12-MHL	2224+00	48'L.S.C/L
R-60.3LU	1695+00	152'R.S.C/L	R-49.7L	2251+00	285'R.S.C/L
30-MHL	1724+00	C/L	11-MHL	2259+00	38'R.S.C/L
29-MHL	1751+00	60'R.S.C/L	10-MHUL	2284+00	C/L Levee
28-MHL	1775+00	C/L	10-MHULT	2284+00	44'L.S.C/L
R-58.0LU	1800+00	100'R.S.C/L	3-W	2293+85	95'R.S.C/L
27-MHL	1826+00	50'R.S.C/L	4-W	2295+83	108'L.S.C/L
24-MHL	1857+00	C/L Levee	1-U	2296+25	122'R.S.C/L
23-MHL	1882+00	48'R.S.C/L	2-W	2298+50	125'R.S.C/L
56-UE	1907+00	C/L Levee	9-MHL	2327+00	40'L.S.C/L
56-UET	1907+50	88'L.S.C/L	8-MHL	2352+00	C/L Levee
22-MHL	1940+00	37'L.S.C/L	7-MHL	2377+00	52'R.S.C/L
21-MHL	1965+00	C/L Levee	47-UE	2402+40	C/L Levee
20-MHL	1990+00	45'L.S.C/L	47-UET	2402+40	57'L.S.
19-MHUL	2015+00	C/L Levee	R-46.95LU	2402+40	185'R.S.C/L
19-MHULT	2015+00	70'R.S.C/L	6-MHL	2418+00	C/L Levee
18-MHL	2053+00	43'L.S.C/L	5-MHL	2443+00	63'L.S.C/L
17-MHL	2078+00	41'R.S.C/L	4-MHL	2468+00	36'R.S.C/L
R-52.6L	2087+00	110'R.S.C/L	3-MHL	2493+00	C/L Levee
16-MHL	2103+00	C/L Levee	2-MHULT	2518+00	40'R.S.C/L

MISSISSIPPI RIVER LEVEES AND BANKS  
MILE 66 TO MILE 10  
EAST BANK

SOIL BORING LOCATIONS

SOIL BORING NO.	LEVEE B/L		SOIL BORING NO.	LEVEE B/L	
	STATION	LOCATION		STATION	LOCATION
1-MHL	2543+00	C/L Levee	R-32.3LU	204+80	90'R.S.
			R-32.0L	223+70	25'R.S.
R-44.2 L	0+00	125' R.S.	R-31.6L	241+30	50'R.S.
R-43.7 L	18+00	225'R.S.	40-MHL	258+00	85'R.S.
R-43.2 L	60+00	370'R.S.	41-MHL	285+00	220'R.S.
R-42.5 L	99+00	345'R.S.	42-MHL	310+00	465'R.S.
R-41.8LU	137+00	300'R.S.	43-MHUL	330+00	525'R.S.
R-41.2L	170+00	253'R.S.	44-MHL	355+00	65'R.S.
R-40.5 L	195+00	100'R.S.	45-MHL	380+00	115'R.S.
R-39.8 L	235+00	360'R.S.	46-MHL	410+00	230'R.S.
5-BU	263+50	178'L.S.B/L	47-MHUL	430+00	60' R.S.
31-MHL	270+00	on B/L	48-MHL	455+00	150'R.S.
32-MHUL	297+00	80'L.S.	49-MHL	479+76	89'R.S.
33-MHL	324+00	20'L.S.	R-26.2 L	500+00	300'R.S.
34-MHL	351+00	47'L.S.	50-MHUL	533+75	365'L.S.
35-MHL	378+00	50'R.S.	R-25.6L	544+66	780'R.S.
36-MHUL	405+00	110'L.S.	51-MHL	558+12	187'R.S.
37-MHL	435+70	32'L.S.	R-24.8L	6+73	234'R.S.
R-35.1L	27+80	50'R.S.	R-24.0LU	53+00	125'R.S.
R-34.7L	48+80	100'R.S.	R-23.4L	82+50	190'R.S.
R-34.4LU	70+10	240'R.S.	R-22.8 L	118+50	178'R.S.
38-MHUL	75+00	152'L.S.	52-MHUL	140+00	30'L.S. C/L
R-34.0L	92+35	200'R.S.	R-21.9 L	155+50	186'R.S.
R-33.6L	118+00	90'R.S.	R-21.2L	181+50	400'R.S.
39-MHUL	135+00	357'L.S.	R-20.6L	210+00	67'R.S.
R-33.2L	148+20	150'R.S.	R-20.0 LU	255+50	20'R.S.
R-32.8L	179+00	40'L.S.	R-19.5 L	294+60	210'R.S.



MISSISSIPPI RIVER LEVEES AND BANKS  
MILE 66 TO MILE 10  
EAST BANK

SOIL BORING LOCATIONS

SOIL BORING NO.	LEEVE B/L		SOIL BORING NO.	LEEVE B/L	
	STATION	LOCATION		STATION	LOCATION
R-18.9L	329+50	125'R.S.			
R-18.4L	366+85	130'R.S.	Bohemia Freshwater Structure (La. DPW)		
R-17.7L	391+50	215'R.S.	60-MHL	34+93	on B/L
53-MHUL	411+00	50'R.S.	61-MHUL	36+84	on B/L
R-17.0 L	430+50	265'R.S.	62-MHL	38+93	on B/L
R-16.4L	468+00	110'R.S.			
R-15.9 LU	487+00	175'R.S.	Bayou Lamoque Structure		
R-15.3L	531+50	375'R.S.	63-MHL	160+00	330' L.S.
54-MHUL	545+50	50'L.S.	64-MHUL	160+36	350' L.S.
R-14.7L	562+00	394'R.S.	65-MHL	163+00	330' L.S.
R-14.0L	602+00	52'R.S.			
R-13.4 L	633+50	250'R.S.	Ostrica Lock		
R-12.8L	666+00	13'L.S.	66-MHUL	553+00	360' L.S.
R-12.2L	693+00	375'R.S.	67-MHL	553+00	600' L.S.
R-11.6LU	734+00	340'R.S.	68-MHUL	554+00	475' L.S.
55-MHL	750+60	21'L.S.	69-MHL	555+35	380' L.S.
56-MHL	800+00	on B/L	70-MHL	555+35	600' L.S.
57-MHL	814+00	on B/L			
58-MHUL	843+00	200'R.S.	Freshwater Culvert,		
59-MHL	872+00	on B/L	Vicinity Mile 18.2 A.H.P.		
			71-MHL	368+10	225' L.S.
			72-MHL	371+00	140' L.S.
			73-MHUL	371+00	275' L.S.
			74-MHL	371+20	420' L.S.
			75-MHL	372+50	250' L.S.

TABLE 2  
DESIGN SHEAR STRENGTHS  
AND  
SOIL STRATIFICATION  
(SOIL REACHES AE-1 THROUGH ZE)

EASTLEVEEREACH NO. AE-1LOCATION STA 1380+00 to 1525+00UNDIST. BORING NO.25-MHULUNDIST. BORING NO.65.6-LU

BENEATH C/L OF LEVEE						BENEATH TOE OF LEVEE					
SOIL TYPE	* ELEV. (M.S.L.)	STRENGTH PARAMETERS				SOIL TYPE	* ELEV. (M.S.L.)	STRENGTH PARAMETERS			
		$\sigma$ (P.C.F.)	C (P.S.F.)		$\phi$			$\sigma$ (P.C.F.)	C (P.S.F.)		$\phi$
			AVG.	BASE					AVG,	BASE	
CL-CH	3.0	110	600	500	0						
CH	0.0	110	500	-	0	CH	0.0	110	500	-	0
CH	-6.0	48	500	-	0	CH	-6.0	48	500	-	0
CHO	-13.0	38	500	500	0	CHO	-13.0	30	500	500	0
ML	-19.0	55	200	600	15	ML	-19.0	55	200	600	15
CHO	-25.0	40	600	600	0	CHO	-25.0	40	600	600	0
ML	-30.0	55	200	600	15	ML	-30.0	55	200	600	15
CH	-35.0	48	600	600	0	CH	-35.0	48	600	600	0
CH	-50.0	48	675	750	0	CH	-50.0	48	600	600	0
CH	-94.0	43	970	1190	0	CH	-94.0	43	820	1040	0
PLEIST	-	60	1200	-	0	PLEIST.	-	60	1200	-	0

\*Elevations denote bottom of each soil strata.

EAST

LEVEE

REACH NO.

AE-2

LOCATION

STA. 1525+00 to 1590+00

UNDIST. BORING NO.

25-MHUL

UNDIST. BORING NO.

25-MHULT

BENEATH C/L OF LEVEE						BENEATH TOE OF LEVEE					
SOIL TYPE	ELEV. (M.S.L.)	STRENGTH PARAMETERS				SOIL TYPE	ELEV. (M.S.L.)	STRENGTH PARAMETERS			
		$\bar{\sigma}$ (P.C.F.)	C (P.S.F.)		$\phi$			$\bar{\sigma}$ (P.C.F.)	C (P.S.F.)		$\phi$
			AVG.	BASE					AVG.	BASE	
CL-CH	5.0	110	600	500	0						
CL	0.0	110	500	-	0	CL	0.0	110	400	-	0
CL	-2.0	48	500	500	0	CL	-2.0	48	400	400	0
ML	-8.0	55	200	600	15	ML	-8.0	55	200	500	15
CL	-12.0	43	600	600	0	CL	-12.0	43	500	500	0
ML	-20.0	55	200	600	15	ML	-20.0	55	200	500	15
CH	-23.0	48	600	600	0	CH	-23.0	48	500	500	0
ML	-27.0	55	200	600	15	ML	-27.0	55	200	520	15
CH	-35.0	48	600	600	0	CH	-35.0	43	560	600	0
CH	-40.0	48	625	650	0	CH	-40.0	48	625	650	0
ML	-57.0	55	200	820	15	ML	-57.0	55	200	820	15
CH	-65.0	43	860	900	0	CH	-65.0	43	860	900	0
SP-F	-97.0	60	0	1220	30	SP-F	-97.0	60	0	1220	30
PLEIST.	-	60	1220	-	0	PLEIST.	-	60	1220	-	0

EAST LEVEE

REACH NO. AE-3

LOCATION STA. 1590+00 to 1685+00

UNDIST. BORING NO.

25-MHUL

UNDIST. BORING NO. 25-MHULT

BENEATH C/L OF LEVEE						BENEATH TOE OF LEVEE					
SOIL TYPE	ELEV. (M.S.L.)	STRENGTH PARAMETERS				SOIL TYPE	ELEV. (M.S.L.)	STRENGTH PARAMETERS			
		$\bar{\sigma}$ (P.C.F.)	C (P.S.F.)		$\phi$			$\bar{\sigma}$ (P.C.F.)	C (P.S.F.)		$\phi$
			AVG.	BASE					AVG.	BASE	
CL-CH	5.0	110	600	500	0						
CH	0.0	110	500	-	0	CH	0.0	110	400	-	0
CH	-5.0	48	500	-	0	CH	-5.0	48	400	-	0
CHO	-10.0	38	500	500	0	CHO	-10.0	28	400	400	0
CH	-25.0	48	600	600	0	CH	-25.0	43	500	500	0
ML	-33.0	55	200	-	15	ML	-33.0	55	200	-	15
SP-F	-38.0	60	0	630	30	SP-F	-38.0	60	0	630	30
CH	-60.0	48	740	850	0	CH	-60.0	48	740	850	0
CH	-101.0	43	1055	1260	0	CH	-101.0	43	1055	1260	0
SM	-110.0	60	0	1350	30	SM	-110.0	60	0	1350	30
PLEIST.	-	60	1350	-	0	PLEIST	-	60	1350	-	0

25



EAST LEVEE

REACH NO. AE-4

LOCATION STA. 1685+00 to 1815+00

UNDIST. BORING NO.

25-MHUL

UNDIST. BORING NO.

25-MHULT

BENEATH C/L OF LEVEE						BENEATH TOE OF LEVEE					
SOIL TYPE	ELEV. (M.S.L.)	STRENGTH PARAMETERS				SOIL TYPE	ELEV. (M.S.L.)	STRENGTH PARAMETERS			
		$\bar{\sigma}$ (P.C.F.)	C (P.S.F.)		$\phi$			$\bar{\sigma}$ (P.C.F.)	C (P.S.F.)		$\phi$
		AVG.	BASE				AVG,	BASE			
CH-ML	5.0	110	600	500	0						
CH-CL	0.0	110	500	-	0	CH-CL	0.0	110	400	-	0
CH-CL	-10.0	48	500	500	0	CH-CL	-10.0	48	400	400	0
ML	-20.0	55	200	600	15	ML	-20.0	55	200	500	15
CH	-25.0	48	600	600	0	CH	-25.0	43	500	500	0
SP-F	-30.0	60	0	600	30	SP-F	-30.0	60	0	550	30
CH	-35.0	48	600	600	0	CH	-35.0	43	575	600	0
SM-SP	-45.0	60	0	700	30	SM-SP	-45.0	60	0	700	30
CH	-60.0	48	775	850	0	CH	-60.0	48	775	850	0
CH	-107.0	43	1085	1320	0	CH	-107.0	43	1085	1320	0
SM	-112.0	60	0	1370	30	SM	-112.0	60	0	1370	30
PLEIST.	-	60	1370	-	0	PLEIST.	-	60	1370	-	0

27

EAST

LEVEE

REACH NO. AE-5

LOCATION STA. 1815+00 to 1893+00

UNDIST. BORING NO.

25-MHUL

UNDIST. BORING NO.

25-MHULT

BENEATH C/L OF LEVEE						BENEATH TOE OF LEVEE					
SOIL TYPE	ELEV. (M.S.L.)	STRENGTH PARAMETERS				SOIL TYPE	ELEV. (M.S.L.)	STRENGTH PARAMETERS			
		$\bar{\sigma}$ (P.C.F.)	(P.S.F.)		$\phi$			$\bar{\sigma}$ (P.C.F.)	(P.S.F.)		$\phi$
			AVG.	BASE					AVG.	BASE	
CH-ML	4.0	110	600	500	0						
CH-CL	0.0	110	500	-	0	CH-CL	0.0	110	400	-	0
CH-CL	-7.0	48	500	400	0	CH-CL	-7.0	48	400	-	0
CHO	-10.0	38	400	400	0	CHO	-10.0	28	400	400	0
ML	-16.0	55	200	600	15	ML	-16.0	55	200	500	15
CH	-21.0	48	600	600	0	CH	-21.0	43	500	500	0
SP-F	-31.0	60	0	600	30	SP-F	-31.0	60	0	560	30
CH	-35.0	48	600	600	0	CH	-35.0	43	580	600	0
CH	-60.0	48	725	850	0	CH	-60.0	48	725	850	0
CH	-110.0	43	1,100	1,350	0	CH	-110.0	43	1,100	1,350	0
SM	-114.0	60	0	1390	30	SM	-114.0	60	0	1390	30
PLEIST.	-	60	1,390	-	0	PLEIST	-	60	1,390	-	0

EAST LEVEE

REACH NO. BE

LOCATION Sta. 1893+00 to 1978+00

UNDIST. BORING NO.

56-UE

UNDIST. BORING NO.

56-UET; 88' L.S.

BENEATH C/L OF LEVEE						BENEATH TOE OF LEVEE					
SOIL TYPE	ELEV. (M.S.L.)	STRENGTH PARAMETERS				SOIL TYPE	ELEV. (M.S.L.)	STRENGTH PARAMETERS			
		$\bar{\sigma}$ (P.C.F.)	C (P.S.F.)		$\phi$			$\bar{\sigma}$ (P.C.F.)	C (P.S.F.)		$\phi$
			AVG.	BASE					AVG.	BASE	
CL	3.0	112	800	400	0						
CH	0.0	112	400	-	0	CH	0.0	112	350	-	0
CH	-5.0	50	400	400	0	CH	-5.0	50	350	350	0
ML	-13.0	55	200	400	15	ML	-13.0	55	200	400	15
CH	-17.0	50	400	400	0	CH	-17.0	50	400	400	0
ML	-46.0	55	200	-	15	ML	-46.0	55	200	-	15
SM	-60.0	60	0	-	30	SM	-60.0	60	0	-	30
ML	-70.0	55	200	-	15	ML	-70.0	55	200	-	15
SM-SP	-78.0	60	0	780	30	SM-SP	-78.0	60	0	780	30
CH	-112.0	50	950	1120	0	CH	-112.0	50	950	1120	0
SP-F	-116.0	60	0	1500	30	SP-F	-116.0	60	0	1500	30
PLEIST.	-	60	1500	-	0	PLEIST.	-	60	1500	-	0

31

EAST

LEVEE

REACH NO.

CE

LOCATION

STA. 1978+00 to 2087+00

UNDIST. BORING NO.

19-MHUL

UNDIST. BORING NO.

19-MHULT

BENEATH C/L OF LEVEE						BENEATH TOE OF LEVEE					
SOIL TYPE	ELEV. (M.S.L.)	STRENGTH PARAMETERS				SOIL TYPE	ELEV. (M.S.L.)	STRENGTH PARAMETERS			
		$\bar{\sigma}$ (P.C.F.)	C (P.S.F.)		$\phi$			$\bar{\sigma}$ (P.C.F.)	C (P.S.F.)		$\phi$
			AVG.	BASE					AVG,	BASE	
CH-CL	4.0	110	800	600	0						
CH-CL	0.0	110	600	-	0	CH-CL	0.0	110	500	-	0
CH-CL	-15.0	48	600	500	0	CH-CL	-15.0	48	500	300	0
CH	-30.0	43	500	500	0	CH	-30.0	43	300	300	0
SP-F	-118.0	60	0	1500	30	SP-F	-118.0	60	0	1500	30
PLEIST	-	60	1500	-	0	PLEIST.	-	60	1500	-	0

EAST

LEVEE

REACH NO.

DE

LOCATION

STA. 2087+00 TO 2274+00

UNDIST. BORING NO.

15-MHUL

UNDIST. BORING NO.

15-MHULT; 74' L.S.

BENEATH C/L OF LEVEE						BENEATH TOE OF LEVEE					
SOIL TYPE	ELEV. (M.S.L.)	STRENGTH PARAMETERS				SOIL TYPE	ELEV. (M.S.L.)	STRENGTH PARAMETERS			
		$\bar{\sigma}$ (P.C.F.)	C (P.S.F.)		$\phi$			$\bar{\sigma}$ (P.C.F.)	C (P.S.F.)		$\phi$
			AVG.	BASE					AVG.	BASE	
CH	0.0	110	800	-	0	CH	0.0	108	400	-	0
CH	-6.0	48	800	600	0	CH	-6.0	46	400	-	0
CHO	-14.0	43	600	600	0	CHO	-14.0	38	400	400	0
ML	-20.0	55	200	600	15	ML	-20.0	55	200	400	15
CH	-40.0	48	600	-	0	CH	-40.0	43	400	400	0
CH	-50.0	48	600	600	0	CH	-50.0	48	450	500	0
CH	-130.0	48	920	1240	0	CH	-130.0	48	820	1140	0
Pleist.	-	60	1500	-	0	Pleist.	-	60	1500	-	0

35



EAST

LEVEE

REACH NO.

EE

LOCATION

STA. 2274+00 TO 2312+00

UNDIST. BORING NO.

10-MHUL

UNDIST. BORING NO.

10-MHULT; 44' L.S.

BENEATH C/L OF LEVEE						BENEATH TOE OF LEVEE					
SOIL TYPE	ELEV. (M.S.L.)	STRENGTH PARAMETERS				SOIL TYPE	ELEV. (M.S.L.)	STRENGTH PARAMETERS			
		$\sigma$ (P.C.F.)	C (P.S.F.)		$\phi$			$\sigma$ (P.C.F.)	C (P.S.F.)		$\phi$
			AVG.	BASE					AVG.	BASE	
CH	0.0	114	800	-	0	CH	0.0	110	600	-	0
CH	-2.0	52	800	500	0	CH	-2.0	48	600	400	0
CL	-10.0	48	500	500	0	CL	-10.0	48	400	400	0
CL	-16.0	43	530	560	0	CL	-16.0	43	430	460	0
ML	-19.0	55	200	625	15	ML	-19.0	55	200	525	15
CH	-26.0	43	625	660	0	CH	-26.0	43	525	560	0
SM	-33.0	60	0	770	30	SM	-33.0	60	0	670	30
CH	-41.0	48	770	810	0	CH	-41.0	43	670	710	0
SM	-44.0	60	0	840	30	SM	-44.0	60	0	740	30
CH	-49.0	48	865	890	0	CH	-49.0	43	765	790	0
SM-SP	-104.0	60	0	1440	30	SM-SP	-104.0	60	0	1340	30
CH	-119.0	48	1515	1590	0	CH	-119.0	43	1415	1490	0
SP-F	-142.0	60	0	1720	30	SP-F	-142.0	60	0	1720	30
Pleist.	-	60	1720	-	0	Pleist.	-	60	1720	-	0

EAST

LEVEE

REACH NO. FE

LOCATION

STA 2312+00 TO 2454+00

UNDIST. BORING NO.

47-UE

UNDIST. BORING NO.

47 UET: 57' L.S.

BENEATH C/L OF LEVEE						BENEATH TOE OF LEVEE					
SOIL TYPE	ELEV. (M.S.L.)	STRENGTH PARAMETERS				SOIL TYPE	ELEV. (M.S.L.)	STRENGTH PARAMETERS			
		$\sigma$ (P.C.F.)	C (P.S.F.)		$\phi$			$\sigma$ (P.C.F.)	C (P.S.F.)		$\phi$
			AVG.	BASE					AVG.	BASE	
CL & CH	4.0	110	600	-	0						
CH	0.0	102	600	-	0	CH	0.0	102	400	-	0
CH	-5.0	40	600	400	0	CH	-5.0	40	400	400	0
CHO	-15.0	33	400	400	0	CHO	-15.0	28	400	400	0
ML	-20.0	55	200	600	15	ML	-20.0	55	200	500	15
CH	-35.0	48	600	600	0	CH	-35.0	48	500	500	0
ML	-40.0	55	200	600	15	ML	-40.0	55	200	500	15
CH	-50.0	48	600	600	0	CH	-50.0	48	550	600	0
CH	-120.0	48	950	1300	0	CH	-120.0	48	950	1300	0
SP-F	-138.0	60	0	1480	30	SP-F	-138.0	60	0	1480	30
Pleist	-	60	1480	-	0	Pleist	-	60	1480	-	0

LME Form 983 (O/T)

Oct 69

EAST

LEVEE

REACH NO. GE-1

LOCATION

STA. 2454+00 TO 2500+00

UNDIST. BORING NO.

2-MHULT: 40' L.S.

UNDIST. BORING NO.

2-MHULT; 40' L.S.

BENEATH C/L OF LEVEE						BENEATH TOE OF LEVEE					
SOIL TYPE	ELEV. (M.S.L.)	STRENGTH PARAMETERS				SOIL TYPE	ELEV. (M.S.L.)	STRENGTH PARAMETERS			
		$\sigma$ (P.C.F.)	C (P.S.F.)		$\phi$			$\sigma$ (P.C.F.)	C (P.S.F.)		$\phi$
			AVG.	BASE					AVG.	BASE	
CH	0.0	112	750	-	0	CH	0.0	112	750	-	0
CH	-4.0	50	750	750	0	CH	-4.0	50	750	750	0
ML	-9.0	55	200	-	15	ML	-9.0	55	200	-	15
SM-SP	-16.0	60	0	400	30	SM-SP	-16.0	60	0	400	30
CH	-22.0	50	400	400	0	CH	-22.0	50	400	400	0
SP-SM	-30.0	60	0	400	30	SM-SP	-30.0	60	0	400	30
CH	-36.0	48	400	400	0	CH	-36.0	48	400	400	0
SP-SM	-60.0	60	0	-	30	SM-SP	-60.0	60	0	-	30
ML	-65.0	55	200	650	15	ML	-65.0	55	200	650	15
CH-CL	-84.0	48	745	840	0	CH	-84.0	48	45	40	0
SP-F	-91.0	60	0	910	30	SP-F	-91.0	60	0	910	30
CH	-120.0	50	975	1140	0	CH	-120.0	0	975	1140	0
SP-F	-134.0	60	0	1340	30	SP-F	-134.0	60	0	1340	30
Pleist	-	60	1340	-	0	Pleist	-	60	1340	-	0

LMM Form 983 (0/T)

Oct 69

EAST

LEVEE

REACH NO. GE-2

LOCATION

STA. 2500+00 TO 2544+90= 0+00 to 10+00

UNDIST. BORING NO.

2-MHULT; 40' L.S.

UNDIST. BORING NO.

2-MHULT; 40' L.S.

BENEATH C/L OF LEVEE						BENEATH TOE OF LEVEE					
SOIL TYPE	ELEV. (M.S.L.)	STRENGTH PARAMETERS				SOIL TYPE	ELEV. (M.S.L.)	STRENGTH PARAMETERS			
		$\bar{\sigma}$ (P.C.F.)	C (P.S.F.)		$\phi$			$\bar{\sigma}$ (P.C.F.)	C (P.S.F.)		$\phi$
			AVG.	BASE					AVG.	BASE	
CH	0.0	112	750	-	0	CH	0.0	112	750	-	0
CH	-5.0	50	750	550	0	CH	-5.0	50	750	550	0
CH	-10.0	50	550	550	0	CH	-10.0	50	550	550	0
ML	-15.0	55	200	400	15	ML	-15.0	55	200	400	15
CL	-21.0	50	400	400	0	CL	-21.0	50	400	400	0
ML	-35.0	55	200	-	15	ML	-35.0	55	200	-	15
SM	-48.0	60	0	-	30	SM	-48.0	60	0	-	30
ML	-65.0	55	200	650	15	ML	-65.0	55	200	650	15
CH	-84.0	48	745	840	0	CH	-84.0	48	745	840	0
SP-F	-91.0	60	0	910	30	SP-F	-91.0	60	0	910	30
CH	-124.0	50	1075	1240	0	CH	-124.0	50	1075		0
SP-F	-136.0	60	0	1360	30	SP-F	-136.0	60	0	1360	30
Pleist.	-	60	1360	-	0	Pleist.	-	60	1360	-	0

13

EAST

LEVEE

REACH NO. HE-1

LOCATION STA. 10+00 to 120+00

UNDIST. BORING NO.

No existing levee

UNDIST. BORING NO.

R-41.8LU

BENEATH C/L OF LEVEE					BENEATH TOE OF LEVEE						
SOIL TYPE	ELEV. (M.S.L.)	STRENGTH PARAMETERS				SOIL TYPE	ELEV. (M.S.L.)	STRENGTH PARAMETERS			
		$\delta$ (P.C.F.)	C (P.S.F.)		$\phi$			$\delta$ (P.C.F.)	C (P.S.F.)		$\phi$
			AVG.	BASE					AVG.	BASE	
					ML	2.0	117	200	700	15	
					CH	0.0	110	700	-	0	
					CH	-3.0	48	700	400	0	
					CH	-15.0	38	400	400	0	
					SM	-19.0	60	0	440	30	
					CH	-45.0	43	570	700	0	
					ML	-49.0	55	200	740	15	
					CH	-52.0	48	755	770	0	
					SM	-57.0	60	0	820	30	
					CH	-90.0	48	985	1150	0	
					CH	-110.0	53	1250	1350	0	
					CH	-130.0	48	1450	1550	0	
					PLEIST.	-	60	1550	-	0	

54



EAST

LEVEE

REACH NO. HE-3

LOCATION STA. 155+00 to 217+00

UNDIST. BORING NO.

No existing levee

UNDIST. BORING NO.

R-41.8 LU

BENEATH C/L OF LEVEE						BENEATH TOE OF LEVEE					
SOIL TYPE	ELEV. (M.S.L.)	STRENGTH PARAMETERS				SOIL TYPE	ELEV. (M.S.L.)	STRENGTH PARAMETERS			
		$\bar{\sigma}$ (P.C.F.)	C (P.S.F.)		$\phi$			$\bar{\sigma}$ (P.C.F.)	C (P.S.F.)		$\phi$
			AVG.	BASE					AVG.	BASE	
					ML	2.0	117	200	700	15	
					CL	0.0	110	700	-	0	
					CL	-3.0	48	700	400	0	
					CH	-15.0	38	400	400	0	
					CH	-37.0	43	510	620	0	
					SP-F	-43.0	60	0	680	30	
					CH	-90.0	48	915	1150	0	
					CH	-110.0	53	1250	1350	0	
					CH	-137.0	48	1485	1620	0	
					PLEIST.	-	60	1620	-	0	

EAST LEVEE REACH NO. HE-4 LOCATION STA. 217+00 to 255+00

UNDIST. BORING NO. No existing levee UNDIST. BORING NO. R-41.8LU

BENEATH C/L OF LEVEE					BENEATH TOE OF LEVEE					
SOIL TYPE	ELEV. (M.S.L.)	STRENGTH PARAMETERS			φ	SOIL TYPE	ELEV. (M.S.L.)	STRENGTH PARAMETERS		
		σ (P.C.F.)	C (P.S.F.)					σ (P.C.F.)	C (P.S.F.)	
			AVG.	BASE			AVG,	BASE		
					CH	0.0	110	700	700	0
					ML	-3.0	55	200	400	15
					CH	-15.0	38	400	400	0
					CH	-28.0	43	465	530	0
					SP-F	-80.0	60	0	1050	30
					CH	-90.0	48	1100	1150	0
					CH	-110.0	53	1250	1350	0
					CH	-140.0	48	1500	1650	0
					PLEIST.	-	60	1650	-	0

51



EAST

LEVEE

REACH NO.

IE

LOCATION

STA. 255+00 TO 360+00

UNDIST. BORING NO.

NO EXISTING LEVEE

UNDIST. BORING NO.

32-MHUL

BENEATH C/L OF LEVEE					BENEATH TOE OF LEVEE					
SOIL TYPE	ELEV. (M.S.L.)	STRENGTH PARAMETERS			SOIL TYPE	ELEV. (M.S.L.)	STRENGTH PARAMETERS			
		$\sigma$ (P.C.F.)	C (P.S.F.)				$\phi$	$\sigma$ (P.C.F.)	C (P.S.F.)	
			AVG.	BASE			AVG.	BASE		
					ML	2.0	117	200	300	15
					CH&CL	0.0	110	300	-	0
					CH&CL	-5.0	48	300	300	0
					ML	-10.0	55	200	350	15
					CL	-20.0	48	350	400	0
					ML	-24.0	55	200	440	15
					CH	-35.0	48	495	550	0
					SP-F	-58.0	60	0	780	30
					CH	-64.0	48	810	840	0
					SP-F	-72.0	60	0	920	30
					CH	-88.0	48	1005	1080	0
					SP-F	-115.0	60	0	1350	30
					CH	-137.0	48	1460	1570	0
					SP-F	-145.0	60	0	1650	30
					PLEIST	-	60	1650	-	0

53

STA. 360+00 to 444+70 = 0+00

EAST LEVEE

REACH NO. JE

LOCATION

STA. 0+00 to 10+00

UNDIST. BORING NO.

NO EXISTING LEVEE

UNDIST. BORING NO.

36-MHUT

BENEATH C/L OF LEVEE						BENEATH TOE OF LEVEE					
SOIL TYPE	ELEV. (M.S.L.)	STRENGTH PARAMETERS				SOIL TYPE	ELEV. (M.S.L.)	STRENGTH PARAMETERS			
		$\sigma$ (P.C.F.)	C (P.S.F.)		$\phi$			$\sigma$ (P.C.F.)	C (P.S.F.)		$\phi$
			AVG.	BASE					AVG,	BASE	
					CH	0.0	110	350	350	0	
					CL&CH	-19.0	48	445	540	0	
					ML	-28.0	55	200	630	15	
					CL	-33.0	48	655	680	0	
					ML	-69.0	55	200	-	15	
					SM	-115.0	60	0	1500	30	
					CH	-142.0	48	1635	1770	0	
					SP-F	-150.0	60	0	1850	30	
					PLEIST	-	60	1850	-	0	

55

EAST

LEVEE

REACH NO. KE

LOCATION STA. 10+00 to 73+00

UNDIST. BORING NO.

NO EXISTING LEVEE

UNDIST. BORING NO.

R-34.4 LU

BENEATH C/L OF LEVEE					BENEATH TOE OF LEVEE					
SOIL TYPE	ELEV. (M.S.L.)	STRENGTH PARAMETERS			SOIL TYPE	ELEV. (M.S.L.)	STRENGTH PARAMETERS			
		$\bar{\sigma}$ (P.C.F.)	C (P.S.F.) AVG.	BASE			$\phi$	$\bar{\sigma}$ (P.C.F.)	C (P.S.F.) AVG.	BASE
					ML	0.0	117	200	500	15
					CL	-6.0	38	500	250	0
					CHO	-12.0	28	250	250	0
					CH	-34.0	38	400	400	0
					ML	-66.0	55	200	660	15
					CH	-125.0	58	955	1250	0
					CH	-145.0	48	1350	1450	0
					SP-F	-155.0	60	0	1550	30
					PLEIST	-	60	1550	-	0

EAST

LEVEE

REACH NO.

LE

LOCATION

STA. 73+00 to 130+00

UNDIST. BORING NO.

No existing levee

UNDIST. BORING NO. 38-MHUL

BENEATH C/L OF LEVEE					BENEATH TOE OF LEVEE					
SOIL TYPE	ELEV. (M.S.L.)	STRENGTH PARAMETERS			SOIL TYPE	ELEV. (M.S.L.)	STRENGTH PARAMETERS			
		$\delta$ (P.C.F.)	C (P.S.F.)				$\phi$	$\delta$ (P.C.F.)	C (P.S.F.)	
AVG.	BASE		AVG.	BASE						
					CH	2.0	100	500	500	0
					ML	0.0	117	200	-	15
					ML	-2.0	55	200	-	15
					CH	-5.0	38	500	250	0
					CHO	-10.0	28	250	250	0
					CH	-20.0	38	400	400	0
					SM	-24.0	60	0	400	30
					CH	-30.0	38	400	400	0
					SP-F	-57.0	60	0	-	30
					ML	-91.0	55	200	910	15
					CH	-145.0	48	1180	1450	0
					SP-F	-160.0	60	0	1600	30
					PLEIST.	-	60	1600	-	0

EAST

LEVEE

REACH NO. ME

LOCATION

STA. 130+00 to 165+00

UNDIST. BORING NO.

NO EXISTING LEVEE

UNDIST. BORING NO.

39-MHUL

BENEATH C/L OF LEVEE						BENEATH TOE OF LEVEE					
SOIL TYPE	ELEV. (M.S.L.)	STRENGTH PARAMETERS				SOIL TYPE	ELEV. (M.S.L.)	STRENGTH PARAMETERS			
		$\sigma$ (P.C.F.)	C (P.S.F.)		$\phi$			$\sigma$ (P.C.F.)	C (P.S.F.)		$\phi$
			AVG.	BASE					AVG,	BASE	
					ML	0.0	117	200	400	15	
					CH	-4.0	38	400	250	0	
					CHO	-10.0	33	250	250	0	
					ML	-16.0	55	200	350	15	
					CH	-30.0	38	350	350	0	
					ML	-59.0	55	200	590	15	
					CH	-64.0	43	615	640	0	
					SP-F	-90.0	60	0	900	30	
					CH	-162.0	53	1260	1620	0	
					PLEIST	-	60	1620	-	0	

EAST

LEVEE

REACH NO. NE

LOCATION STA. 165+00 to 255+00

UNDIST. BORING NO.

No Existing Levee

UNDIST. BORING NO.

R-32.3 LU

BENEATH C/L OF LEVEE						BENEATH TOE OF LEVEE					
SOIL TYPE	ELEV. (M.S.L.)	STRENGTH PARAMETERS				SOIL TYPE	ELEV. (M.S.L.)	STRENGTH PARAMETERS			
		$\sigma$ (P.C.F.)	C (P.S.F.)		$\phi$			$\sigma$ (P.C.F.)	C (P.S.F.)		$\phi$
			AVG.	BASE					AVG,	BASE	
					CH	0.0	115	600	600	0	
					CH	-4.0	53	600	250	0	
					CHO	-10.0	23	250	250	0	
					CH	-13.0	38	350	350	0	
					ML	-20.0	55	200	350	15	
					CH	-30.0	38	350	350	0	
					CH	-46.0	43	500	500	0	
					ML	-56.0	55	200	560	15	
					CH	-80.0	53	680	800	0	
					CH	-105.0	58	925	1050	0	
					CH	-157.0	53	1310	1570	0	
					PLEIST.	-	60	1570	-	0	

EAST

LEVEE

REACH NO. OE-1

LOCATION STA. 255+00 to 320+00

UNDIST. BORING NO.

NO EXISTING LEVEE

UNDIST. BORING NO.

43-MHUL

BENEATH C/L OF LEVEE					BENEATH TOE OF LEVEE						
SOIL TYPE	ELEV. (M.S.L.)	STRENGTH PARAMETERS				SOIL TYPE	ELEV. (M.S.L.)	STRENGTH PARAMETERS			
		$\delta$ (P.C.F.)	C (P.S.F.)		$\phi$			$\delta$ (P.C.F.)	C (P.S.F.)		$\phi$
			AVG.	BASE					AVG,	BASE	
					CH	0.0	115	400	250	0	
					CL&CH	-6.0	38	250	250	0	
					ML	-20.0	55	200	-	15	
					SP-F	-120.0	60	0	1200	30	
					CH	-160.0	48	1400	1600	0	
					PLEIST	-	60	1600	-	0	

65

EAST

LEVEE

REACH NO. OE-2

LOCATION STA. 320+00 TO 390+00

UNDIST. BORING NO.

NO EXISTING LEVEE

UNDIST. BORING NO.

43-MHUL

BENEATH C/L OF LEVEE					BENEATH TOE OF LEVEE						
SOIL TYPE	ELEV. (M.S.L.)	STRENGTH PARAMETERS				SOIL TYPE	ELEV. (M.S.L.)	STRENGTH PARAMETERS			
		$\sigma$ (P.C.F.)	C (P.S.F.)		$\phi$			$\sigma$ (P.C.F.)	C (P.S.F.)		$\phi$
			AVG.	BASE				AVG,	BASE		
					CH	0.0	115	400	250	0	
					CH&CL	-10.0	38	250	250	0	
					ML	-15.0	55	200	300	15	
					CH&CL	-19.0	38	300	300	0	
					ML	-22.0	55	200	300	15	
					CH	-31.0	38	300	300	0	
					SP-F	-128.0	60	0	1280	30	
					CH	-166.0	48	1470	1660	0	
					SP-F	-170.0	60	0	1700	30	
					PLEIST	-	60	1700	-	0	



EAST

LEVEE

REACH NO. PE-1

LOCATION STA. 390+00 to 460+00

UNDIST. BORING NO.

NO EXISTING LEVEE

UNDIST. BORING NO.

47-MHUL

BENEATH C/L OF LEVEE						BENEATH TOE OF LEVEE					
SOIL TYPE	ELEV. (M.S.L.)	STRENGTH PARAMETERS				SOIL TYPE	ELEV. (M.S.L.)	STRENGTH PARAMETERS			
		$\sigma$ (P.C.F.)	C (P.S.F.)		$\phi$			$\sigma$ (P.C.F.)	C (P.S.F.)		$\phi$
			AVG.	BASE					AVG,	BASE	
					ML	2.0	117	200	250	15	
					CL&CH	0.0	100	250	-	0	
					CL&CH	-12.0	38	250	250	0	
					ML	-17.0	55	200	250	15	
					CH	-20.0	38	250	250	0	
					SM	-25.0	60	0	300	30	
					CH	-30.0	38	325	350	0	
					SP-F	-78.0	60	0	830	30	
					CH	-164.0	45	1260	1690	0	
					SP-F	-174.0	60	0	1790	30	
					PLEIST	-	60	1790	-	0	

EAST

LEVEE

REACH NO. PE-2

LOCATION STA. 460+00 to 515+00

UNDIST. BORING NO.

NO EXISTING LEVEE

UNDIST. BORING NO.

47-MHUL

BENEATH C/L OF LEVEE						BENEATH TOE OF LEVEE					
SOIL TYPE	ELEV. (M.S.L.)	STRENGTH PARAMETERS				SOIL TYPE	ELEV. (M.S.L.)	STRENGTH PARAMETERS			
		$\sigma$ (P.C.F.)	C (P.S.F.)		$\phi$			$\sigma$ (P.C.F.)	C (P.S.F.)		$\phi$
			AVG.	BASE					AVG,	BASE	
					CH	0.0	115	400	250	0	
					CH&CL	-12.0	38	250	250	0	
					ML	-22.0	55	200	250	15	
					CH	-33.0	38	250	250	0	
					SP-F	-37.0	60	0	420	30	
					CH&CL	-42.0	45	495	470	0	
					SP-F	-47.0	60	0	520	30	
					CH	-51.0	45	540	560	0	
					SP-F	-73.0	60	0	780	30	
					CH	-78.0	45	805	830	0	
					SP-F	-98.0	60	0	1030	30	
					CH	-180.0	45	1440	1850	0	
					SP-F	-195.0	60	0	2000	30	
					PLEIST	-	60	2000	-	0	
							60				

TL

EAST

LEVEE

REACH NO. QE-1

LOCATION STA. 515+00 to 555+00

UNDIST. BORING NO.

No Existing Levee

UNDIST. BORING NO. 50-MHUL

BENEATH C/L OF LEVEE						BENEATH TOE OF LEVEE					
SOIL TYPE	ELEV. (M.S.L.)	STRENGTH PARAMETERS				SOIL TYPE	ELEV. (M.S.L.)	STRENGTH PARAMETERS			
		$\sigma$ (P.C.F.)	C (P.S.F.)		$\phi$			$\sigma$ (P.C.F.)	C (P.S.F.)		$\phi$
			AVG.	BASE					AVG,	BASE	
					ML	0.0	117	200	400	15	
					CH	-8.0	43	400	400	0	
					CL	-24.0	48	400	400	0	
					ML	-68.0	55	200	680	15	
					CH	-110.0	43	895	1100	0	
					CH	-184.0	48	1470	1840	0	
					SP-F	-208.0	60	0	2080	30	
					Pleist	-	60	2080	-	0	

73

EAST

LEVEE

REACH NO. QE-2

LOCATION STA. 555+00 to 559+81.93 =0+00 to 19+06.01=0+00 to 30+00

UNDIST. BORING NO.

No Existing Levee

UNDIST. BORING NO.

50-MHUL

BENEATH C/L OF LEVEE					BENEATH TOE OF LEVEE					
SOIL TYPE	ELEV. (M.S.L.)	STRENGTH PARAMETERS			$\phi$	SOIL TYPE	ELEV. (M.S.L.)	STRENGTH PARAMETERS		
		$\sigma$ (P.C.F.)	C (P.S.F.)					$\sigma$ (P.C.F.)	C (P.S.F.)	$\phi$
			AVG.	BASE			AVG.	BASE		
					ML	0.0	117	200	400	15
					CH	-22.0	43	400	400	0
					ML	-29.0	55	200	400	15
					CL	-32.0	48	400	400	0
					ML	-43.0	55	200	-	15
					SM	-47.0	60	0	470	30
					CH	-110.0	43	790	1100	0
					CH	-189.0	48	1495	1890	0
					SP-F	-209.0	60	0	2090	30
					PLEIST.	-	60	2090	-	0

75

EAST

LEVEE

REACH NO. RE-1

LOCATION STA. 30+00 to 65+00

UNDIST. BORING NO.

No Existing Levee

UNDIST. BORING NO.

R-24.0-LU

BENEATH C/L OF LEVEE					BENEATH TOE OF LEVEE					
SOIL TYPE	ELEV. (M.S.L.)	STRENGTH PARAMETERS			SOIL TYPE	ELEV. (M.S.L.)	STRENGTH PARAMETERS			
		$\sigma$ (P.C.F.)	C (P.S.F.)				$\phi$	$\sigma$ (P.C.F.)	C (P.S.F.)	
			AVG.	BASE			AVG.	BASE		
					CH	0.0	115	300	300	0
					ML	-3.0	55	200	300	15
					CHO	-10.0	33	300	300	0
					CH	-15.0	38	300	300	0
					CH	-21.0	38	330	360	0
					SM	-35.0	60	0	500	30
					CH	-55.0	43	600	700	0
					SP-F	-95.0	60	0	1100	30
					CH	-192.0	48	1585	2070	0
					SP-F	-209.0	60	0	2240	30
					Pleist	-	60	2240	-	0

EAST

LEVEE

REACH NO. RE-2

LOCATION STA. 65+00 to 100+00

UNDIST. BORING NO.

No Existing Levee

UNDIST. BORING NO.

R-24.0-LU

BENEATH C/L OF LEVEE						BENEATH TOE OF LEVEE					
SOIL TYPE	ELEV. (M.S.L.)	STRENGTH PARAMETERS				SOIL TYPE	ELEV. (M.S.L.)	STRENGTH PARAMETERS			
		$\bar{\sigma}$ (P.C.F.)	C (P.S.F.)		$\phi$			$\bar{\sigma}$ (P.C.F.)	C (P.S.F.)		$\phi$
			AVG.	BASE					AVG,	BASE	
						ML	0.0	117	200	300	15
						CHO	-5.0	33	300	300	0
						ML	-13.0	55	200	-	15
						SM	-19.0	60	0	340	30
						CH	-23.0	38	360	380	0
						SP-F	-28.0	60	0	430	30
						CH	-31.0	43	445	460	0
						SM	-39.0	60	0	540	30
						CL&CH	-58.0	43	635	730	0
						SP-F	-64.0	60	0	790	30
						CL&CH	-197.0	48	1455	2120	0
						SP-F	-208.0	60	0	2230	30
						PLEIST	-	60	2230	-	0

67

EAST LEVEE

REACH NO. SE-1

LOCATION

STA. 100+00 TO 130+00

UNDIST. BORING NO.

NO EXISTING LEVEE

UNDIST. BORING NO.

52-MHUL

BENEATH C/L OF LEVEE						BENEATH TOE OF LEVEE					
SOIL TYPE	ELEV. (M.S.L.)	STRENGTH PARAMETERS				SOIL TYPE	ELEV. (M.S.L.)	STRENGTH PARAMETERS			
		$\bar{\sigma}$ (P.C.F.)	C (P.S.F.)		$\phi$			$\bar{\sigma}$ (P.C.F.)	C (P.S.F.)		$\phi$
			AVG.	BASE					AVG,	BASE	
					ML	0.0	117	200	250	15	
					CH	-7.0	38	250	250	0	
					ML	-14.0	55	200	-	15	
					SM	-18.0	60	0	330	30	
					CH	-23.0	38	355	380	0	
					SP-F	-34.0	60	0	490	30	
					CH	-38.0	48	510	530	0	
					SP-F	-83.0	60	0	980	30	
					CH	-93.0	48	1030	1080	0	
					SP-F	-115.0	60	0	-	30	
					ML	-121.0	55	200	-	15	
					SP-F	-207.0	60	0	2220	30	
					PLEIST	-	60	2220	-	0	

EAST

LEVEE

REACH NO. SE-2

LOCATION STA. 130+00 to 155+00

UNDIST. BORING NO.

NO EXISTING LEVEE

UNDIST. BORING NO.

52-MHUL

BENEATH C/L OF LEVEE						BENEATH TOE OF LEVEE					
SOIL TYPE	ELEV. (M.S.L.)	STRENGTH PARAMETERS				SOIL TYPE	ELEV. (M.S.L.)	STRENGTH PARAMETERS			
		$\bar{\sigma}$ (P.C.F.)	C (P.S.F.)		$\phi$			$\bar{\sigma}$ (P.C.F.)	C (P.S.F.)		$\phi$
			AVG.	BASE					AVG,	BASE	
					CH	0.0	100	250	-	0	
					CH	-10.0	38	250	250	0	
					CH	-14.0	38	270	290	0	
					ML	-30.0	55	200	450	15	
					CL	-34.0	48	470	490	0	
					ML	-111.0	55	200	-	15	
					SP-F	-125.0	60	0	1400	30	
					CH	-128.0	48	1415	1430	0	
					SP-F	-149.0	60	0	1640	30	
					CH	-153.0	48	1660	1680	0	
					SP-F	-197.0	60	0	2120	30	
					CH	-205.0	48	2160	2200	0	
					SP-F	-208.0	60	0	2230	30	
					PLEIST	-	60	2230	-	0	



EAST

LEVEE

REACH NO. SE-3

LOCATION

STA. 155+00 to 235+00

UNDIST. BORING NO.

NO EXISTING LEVEE

UNDIST. BORING NO.

52-MHUL

BENEATH C/L OF LEVEE						BENEATH TOE OF LEVEE					
SOIL TYPE	ELEV. (M.S.L.)	STRENGTH PARAMETERS				SOIL TYPE	ELEV. (M.S.L.)	STRENGTH PARAMETERS			
		$\bar{\sigma}$ (P.C.F.)	C (P.S.F.)		$\phi$			$\bar{\sigma}$ (P.C.F.)	C (P.S.F.)		$\phi$
			AVG.	BASE					AVG,	BASE	
					ML	0.0	117	200	-	15	
					ML	-18.0	55	200	330	15	
					CL	-24.0	48	360	390	0	
					ML	-45.0	55	200	600	15	
					CH&CL	-58.0	48	665	730	0	
					ML	-71.0	55	200	860	15	
					CH&CL	-77.0	48	890	920	0	
					ML	-86.0	55	200	1010	15	
					CH	-90.0	48	1030	1050	0	
					SM&SP	-105.0	60	0	1200	30	
					CH&CL	-109.0	48	1220	1240	0	
					SP-F	-197.0	60	0	2120	30	
					CH	-208.0	48	2175	2230	0	
					SP-F	-212.0	60	0	2270	30	
					Pleist	-	60	2270	-	0	

EAST LEVEE

REACH NO. TE-1

LOCATION STA. 235+00 to 315+00

UNDIST. BORING NO.

NO EXISTING LEVEE

UNDIST. BORING NO.

R-20.0 - LU

BENEATH C/L OF LEVEE						BENEATH TOE OF LEVEE					
SOIL TYPE	ELEV. (M.S.L.)	STRENGTH PARAMETERS				SOIL TYPE	ELEV. (M.S.L.)	STRENGTH PARAMETERS			
		$\bar{\sigma}$ (P.C.F.)	C (P.S.F.)		$\phi$			$\bar{\sigma}$ (P.C.F.)	C (P.S.F.)		$\phi$
			AVG.	BASE					AVG.	BASE	
					CH	0.0	105	200	-	0	
					CH	-5.0	43	200	200	0	
					CH	-10.0	43	300	-	0	
					CHO	-15.0	28	300	-	0	
					CH	-25.0	43	300	300	0	
					SM	-42.0	60	0	420	30	
					CH	-130.0	43	860	1300	0	
					CH	-205.0	48	1675	2050	0	
					SP-F	-211.0	60	0	2110	30	
					PLEIST	-	60	2110	-	0	

EAST LEVEE

REACH NO. TE-2

LOCATION STA 315+00 TO 350+00

UNDIST. BORING NO.

NO EXISTING LEVEE

UNDIST. BORING NO.

R-20.0-LU

BENEATH C/L OF LEVEE					BENEATH TOE OF LEVEE						
SOIL TYPE	ELEV. (M.S.L.)	STRENGTH PARAMETERS			SOIL TYPE	ELEV. (M.S.L.)	STRENGTH PARAMETERS				
		$\bar{\sigma}$ (P.C.F.)	C (P.S.F.)				$\phi$	$\bar{\sigma}$ (P.C.F.)	C (P.S.F.)		$\phi$
		AVG.	BASE			AVG,			BASE		
					ML	0.0	117	200	200	15	
					CH	-3.0	43	200	-	0	
					CHO	-7.0	28	200	200	0	
					CL	-10.0	43	300	300	0	
					ML	-13.0	55	200	300	15	
					CHO	-17.0	43	300	300	0	
					ML	-25.0	55	200	300	15	
					CH	-30.0	43	300	300	0	
					CH	-68.0	43	490	680	0	
					ML	-73.0	55	200	730	15	
					CH	-130.0	43	1015	1300	0	
					CH	-203.0	48	1665	2030	0	
					SP-F	-209.0	60	0	2090	30	
					Pleist	-	60	2090	-	0	

68

EAST

LEVEE

REACH NO. UE

LOCATION

STA. 350+00 to STA 420+00

UNDIST. BORING NO.

NO EXISTING LEVEE

UNDIST. BORING NO.

53-MHUL

BENEATH C/L OF LEVEE					BENEATH TOE OF LEVEE					
SOIL TYPE	ELEV. (M.S.L.)	STRENGTH PARAMETERS			SOIL TYPE	ELEV. (M.S.L.)	STRENGTH PARAMETERS			
		$\sigma$ (P.C.F.)	C (P.S.F.)	$\phi$			$\sigma$ (P.C.F.)	C (P.S.F.)	$\phi$	
			AVG.	BASE			AVG,	BASE		
					ML	0.0	117	200	100	15
					CH	-7.0	23	100	100	0
					CHO	-16.0	23	200	200	0
					ML	-30.0	55	200	300	15
					CL	-34.0	43	320	340	0
					ML	-46.0	55	200	460	15
					CH	-70.0	43	580	700	0
					ML	-83.0	55	200	830	15
					CH	-202.0	48	1425	2020	0
					SP-F	-212.0	60	0	2120	30
					PLEIST	-	60	2120	-	0

T6

EAST

LEVEE

REACH NO. VE

LOCATION STA. 420+00 to 525+00

UNDIST. BORING NO.

NO EXISTING LEVEE

UNDIST. BORING NO.

R-15.9-LU

BENEATH C/L OF LEVEE						BENEATH TOE OF LEVEE					
SOIL TYPE	ELEV. (M.S.L.)	STRENGTH PARAMETERS				SOIL TYPE	ELEV. (M.S.L.)	STRENGTH PARAMETERS			
		$\sigma$ (P.C.F.)	C (P.S.F.)		$\phi$			$\sigma$ (P.C.F.)	C (P.S.F.)		$\phi$
			AVG.	BASE					AVG,	BASE	
					ML	0.0	117	200	-	15	
					ML	-2.0	55	200	300	15	
					CH	-8.0	38	300	-	0	
					CHO	-16.0	28	300	300	0	
					ML	-19.0	55	200	-	15	
					SM	-23.0	60	0	-	30	
					ML	-27.0	55	200	-	15	
					SM	-40.0	60	0	-	30	
					ML	-46.0	55	200	610	15	
					CH	-65.0	43	705	800	0	
					CH	-80.0	43	800	800	0	
					CH	-202.0	48	1410	2020	0	
					SP-F	-214.0	60	0	2140	30	
					PLEIST	-	60	2140	-	0	

EAST LEVEE

REACH NO. WE

LOCATION STA 525+00 to 615+00

UNDIST. BORING NO.

NO EXISTING LEVEE

UNDIST. BORING NO.

54-MHITL

BENEATH C/L OF LEVEE						BENEATH TOE OF LEVEE					
SOIL TYPE	ELEV. (M.S.L.)	STRENGTH PARAMETERS				SOIL TYPE	ELEV. (M.S.L.)	STRENGTH PARAMETERS			
		$\sigma$ (P.C.F.)	C (P.S.F.)		$\phi$			$\sigma$ (P.C.F.)	C (P.S.F.)		$\phi$
			AVG.	BASE					AVG,	BASE	
						0.0					
					CH	-14.0	23	150	150	0	
					SM	-29.0	60	0	-	30	
					ML	-32.0	55	200	320	15	
					CH	-49.0	43	405	490	0	
					ML	-52.0	55	200	520	15	
					CH	-70.0	48	610	700	0	
					CH	-85.0	43	775	850	0	
					ML	-89.0	55	200	890	15	
					CH	-202.0	48	1455	2020	0	
					SP-F	-220.0	60	0	2200	30	
					PLEIST.	-	60	2200	-	0	

95

EAST

LEVEE

REACH NO. XE-1

LOCATION Sta. 615+00 to 650+00

UNDIST. BORING NO.

NO EXISTING LEVEE

UNDIST. BORING NO.

R-11.6-LU

BENEATH C/L OF LEVEE						BENEATH TOE OF LEVEE					
SOIL TYPE	ELEV. (M.S.L.)	STRENGTH PARAMETERS				SOIL TYPE	ELEV. (M.S.L.)	STRENGTH PARAMETERS			
		$\bar{\sigma}$ (P.C.F.)	C (P.S.F.)		$\phi$			$\bar{\sigma}$ (P.C.F.)	C (P.S.F.)		$\phi$
			AVG.	BASE					AVG,	BASE	
					ML	0.0	117	200	200	15	
					CH	-5.0	38	200	200	0	
					ML	-22.0	55	200	-	15	
					SP-F	-61.0	60	0	812	30	
					CH	-207.0	48	1688	2564	0	
					SP-F	-227.0	60	0	2804	30	
					PLEIST	-	60	2804	-	0	

EAST

LEVEE

REACH NO.

XE-2

LOCATION

STA.650+00 to 735+00

UNDIST. BORING NO.

NO EXISTING LEVEE

UNDIST. BORING NO.

R-11.6-LU

BENEATH C/L OF LEVEE						BENEATH TOE OF LEVEE					
SOIL TYPE	ELEV. (M.S.L.)	STRENGTH PARAMETERS				SOIL TYPE	ELEV. (M.S.L.)	STRENGTH PARAMETERS			
		$\bar{\sigma}$ (P.C.F.)	C (P.S.F.)		$\phi$			$\bar{\sigma}$ (P.C.F.)	C (P.S.F.)		$\phi$
			AVG.	BASE					AVG,	BASE	
					ML	0.0	117	200	200	15	
					CH	-10.0	33	200	200	0	
					CH	-22.0	33	272	344	0	
					SP-F	-64.0	60	0	848	30	
					CH	-210.0	48	1724	2600	0	
					SP-F	-231.0	60	0	2850	30	
					PLEIST		60	2850	-	0	



EAST

LEVEE

REACH NO.

YE

LOCATION

STA. 735+00 to 811+00

UNDIST. BORING NO.

NO EXISTING LEVEE

UNDIST. BORING NO.

R-11.6-LU

BENEATH C/L OF LEVEE						BENEATH TOE OF LEVEE					
SOIL TYPE	ELEV. (M.S.L.)	STRENGTH PARAMETERS				SOIL TYPE	ELEV. (M.S.L.)	STRENGTH PARAMETERS			
		$\bar{\sigma}$ (P.C.F.)	C (P.S.F.)		$\phi$			$\bar{\sigma}$ (P.C.F.)	C (P.S.F.)		$\phi$
			AVG.	BASE					AVG,	BASE	
					CL-CH	0.0	110	300	-	0	
					CL-CH	-7.0	48	300	200	0	
					CHO	-13.0	28	200	200	0	
					CH-CHO	-31.0	33	290	380	0	
					SM	-34.0	60	0	410	30	
					CH	-217.0	48	1325	2240	0	
					SP-F	-241.0	60	0	2480	30	
					PLEIST	-	60	2480	-	0	

101

EAST

LEVEE

REACH NO. ZE

LOCATION

STA. 811+00 to 879+00

UNDIST. BORING NO.

NO EXISTING LEVEE

UNDIST. BORING NO.

58-MHUT

BENEATH C/L OF LEVEE						BENEATH TOE OF LEVEE					
SOIL TYPE	ELEV. (M.S.L.)	STRENGTH PARAMETERS				SOIL TYPE	ELEV. (M.S.L.)	STRENGTH PARAMETERS			
		$\sigma$ (P.C.F.)	C (P.S.F.)		$\phi$			$\sigma$ (P.C.F.)	C (P.S.F.)		$\phi$
			AVG.	BASE					AVG.	BASE	
					CH	0.0	100	250	250	0	
					ML	-3.0	55	200	250	15	
					CH	-28.0	38	250	250	0	
					ML	-33.0	55	200	-	15	
					SM	-85.0	60	0	-	30	
					ML	-88.0	55	200	630	15	
					CH	-223.0	48	1305	1980	0	
					SP-F	-249.0	50	0	2240	30	
					PLEIST.	-	60	2240	-	0	

103

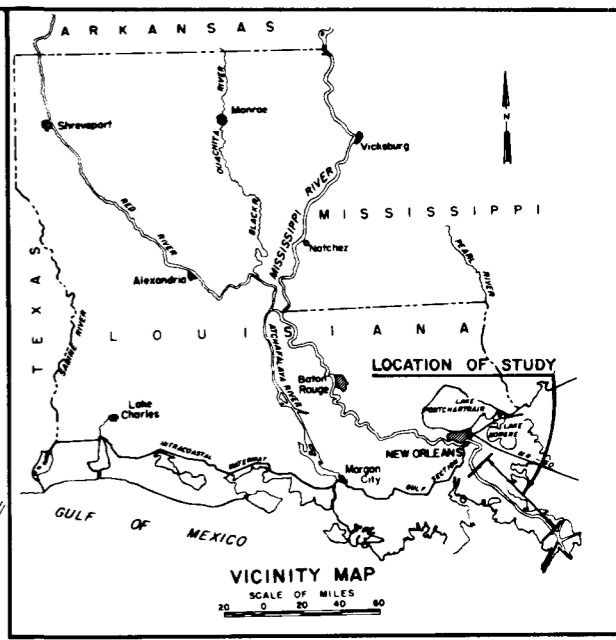
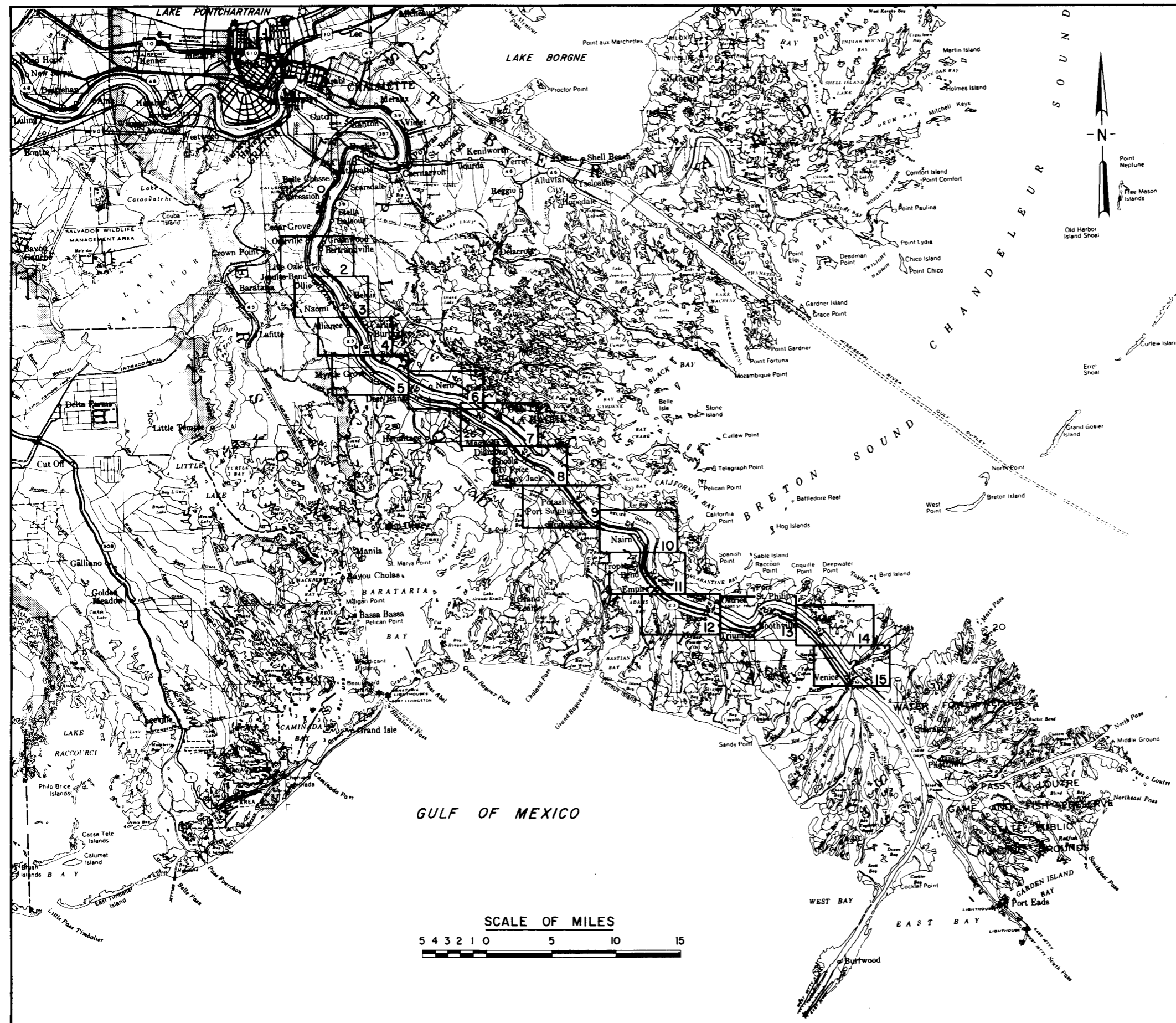

MISSISSIPPI RIVER LEVEES AND BANKS  
 MILE 66 TO MILE 10  
 SOIL REPORT - PART I  
 EAST AND WEST BANKS  
 SOIL BORING DATA  
 GENERAL MAP  
 U. S. ARMY ENGINEER DISTRICT, NEW ORLEANS  
 CORPS OF ENGINEERS

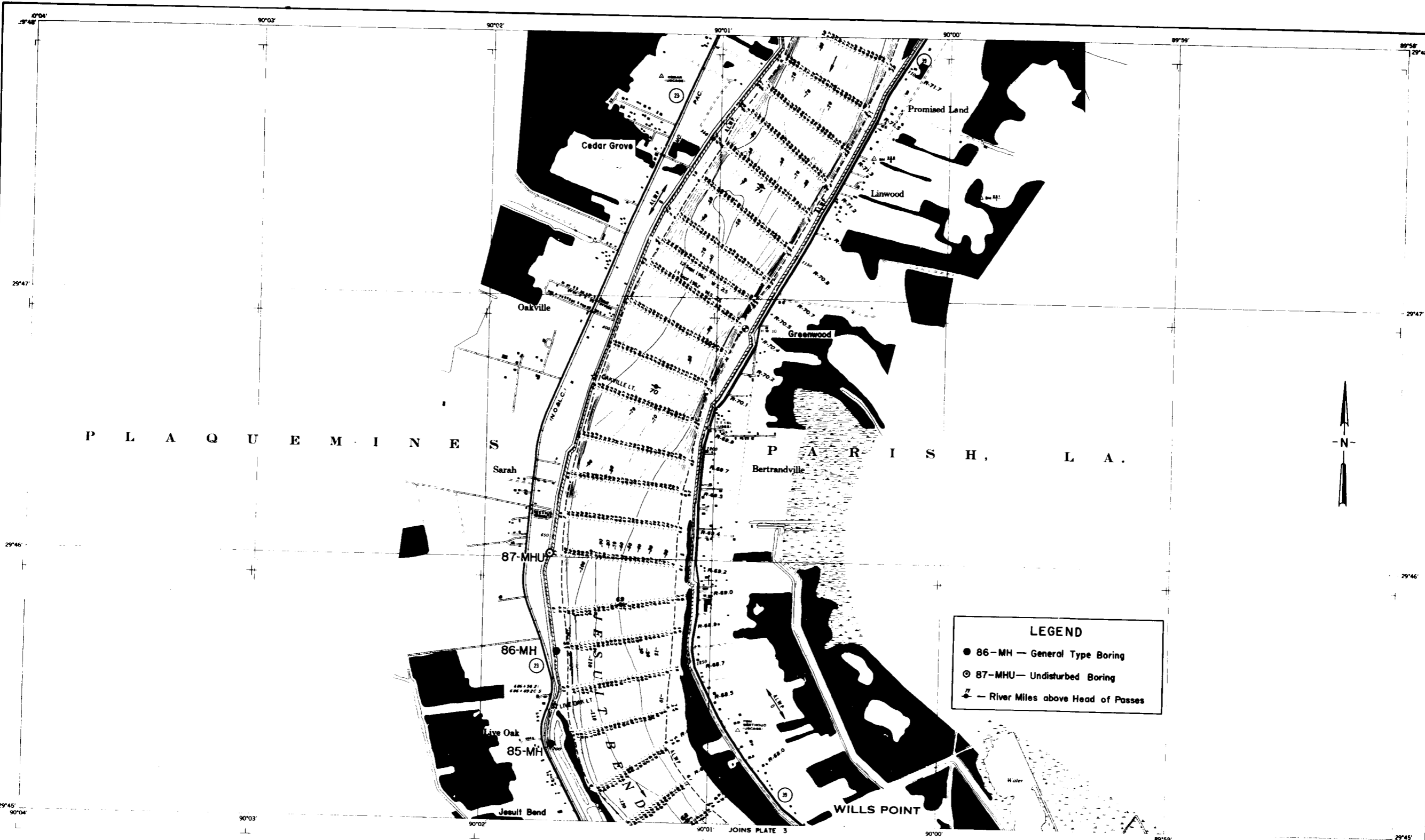

**LEGEND**

- 86-MH — General Type Boring
- ⊙ 87-MHU — Undisturbed Boring
- ↔ — River Miles above Head of Passes

All elevations are expressed in feet and refer to Mean Sea Level.  
 Contours below Average Low Water Plane are expressed in feet at 5 and 10 ft. intervals.  
 Contours above Average Low Water Plane are expressed in feet at 5 ft. intervals.  
 Planimetry from aerial photographs flown November 1962.  
 Distances on Mississippi River above Head of Passes are shown at 1 mile intervals.  
 1962 and 1942 surveys.  
 Polyconic Projection: North American Datum.  
 Polyconic Projection: Gulf Coast Datum is indicated by ticks.  
 A.L.W.P. — Average Low Water Plane.

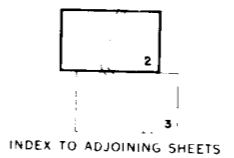
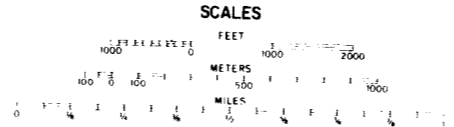

MISSISSIPPI RIVER LEVEES AND BANKS  
 MILE 66 TO MILE 10  
 SOIL REPORT - PART I  
 EAST AND WEST BANKS  
 SOIL BORING DATA  
**BORING LOCATIONS**  
**MILE 71.7 TO MILE 68.0**  
 U.S. ARMY ENGINEER DISTRICT, NEW ORLEANS  
 CORPS OF ENGINEERS  
 AUGUST 1971



P L A Q U E M I S A R I H L A .

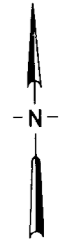

All elevations are expressed in feet and refer to Mean Sea Level.  
 Contour below Average Low Water Plane are expressed in feet at 5-foot intervals.  
 Contour above Average Low Water Plane are expressed in feet at 1-foot intervals.  
 Planimetry from aerial photographs flown November 1962.  
 Elevation of Mississippi River above Mean of Plaque at the town of Lumberville  
 1962 and 1942 surveys.  
 Polygons of ground North American Datum.  
 Polygons of ground South Coast Datum is indicated by ticks.  
 A.L.W.P. Average Low Water Plane.

SCALES

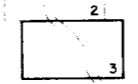
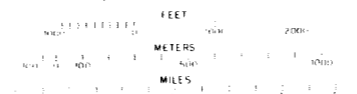

INDEX TO ADJOINING SHEETS

MISSISSIPPI RIVER LEVEES AND BANKS  
 MILE 66 TO MILE 63  
 SOIL REPORT - PART I  
 EAST AND WEST BANKS  
 SOIL BORING DATA  
**BORING LOCATIONS**  
**MILE 68.0 TO MILE 63.7**  
 U.S. ARMY ENGINEER DISTRICT, NEW ORLEANS  
 CORPS OF ENGINEERS  
 AUGUST 1971 FILE NO. H-2-25275

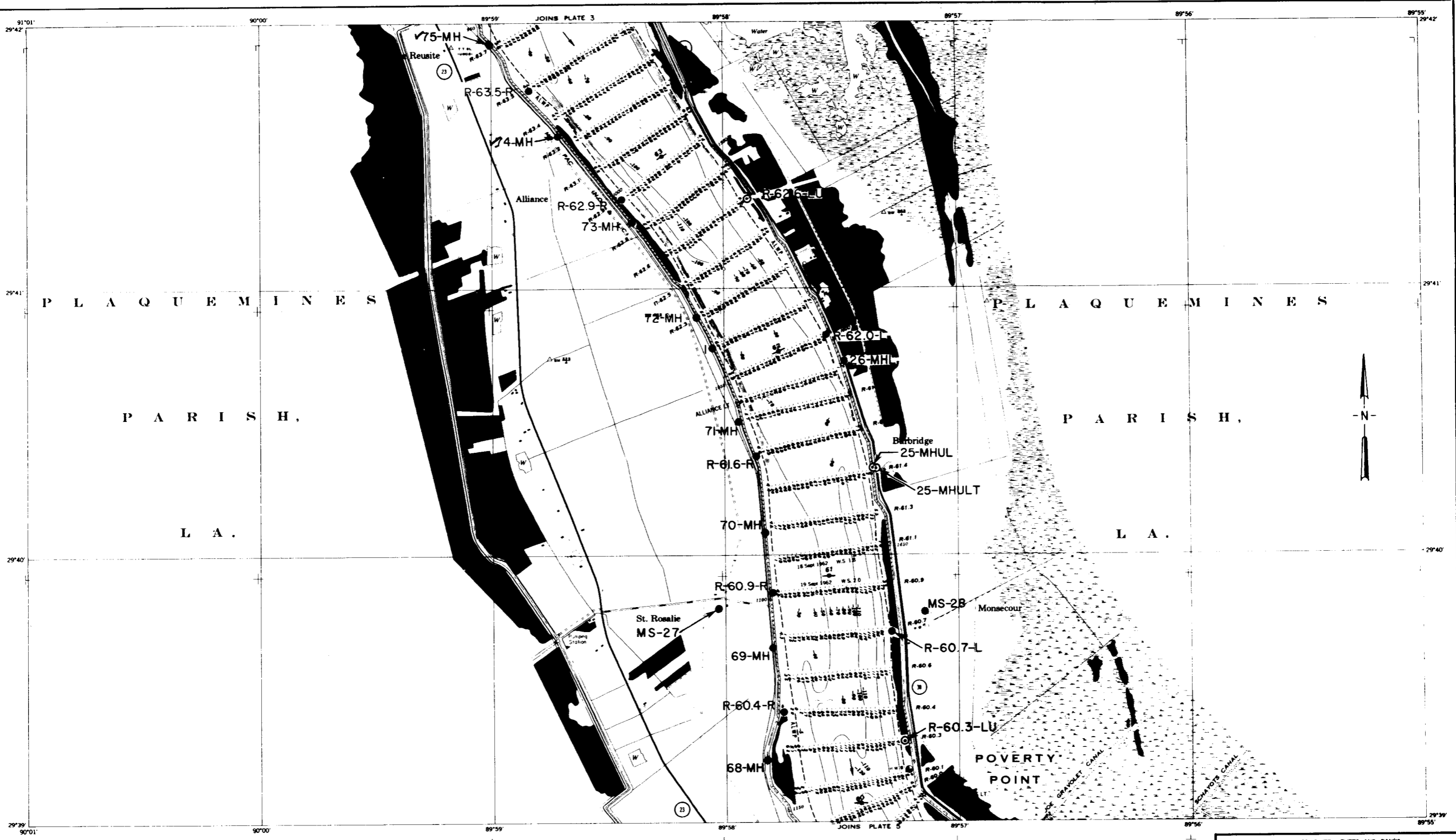

All elevations are expressed in feet and refer to Mean Sea Level.  
 Contours below Average Low Water Plane are expressed in feet at 5 and 10 ft intervals.  
 Contours above Average Low Water Plane are expressed in feet at 5 ft intervals.  
 Planimetry from aerial photographs flown November 1962.  
 Distances on Mississippi River above Head of Passes are shown at 1 mile intervals.  
 1962 and 1942 surveys.  
 Polyconic Projection - North American Datum.  
 Polyconic Projection - Gulf Coast Datum is indicated by ticks.  
 A.L.W.P. - Average Low Water Plane.

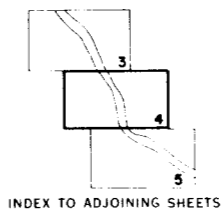
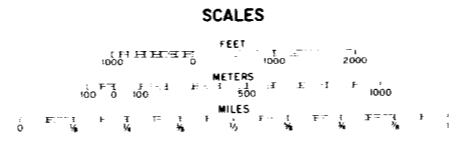

MISSISSIPPI RIVER LEVEES AND BANKS  
 MILE 66 TO MILE 60  
 SOIL REPORT - PART I  
 EAST AND WEST BANKS  
 SOIL BORING DATA  
**BORING LOCATIONS**  
**MILE 63.7 TO MILE 60.0**  
 U.S. ARMY ENGINEER DISTRICT, NEW ORLEANS  
 CORPS OF ENGINEERS  
 AUGUST 1971  
 FILE NO. H-2-25275

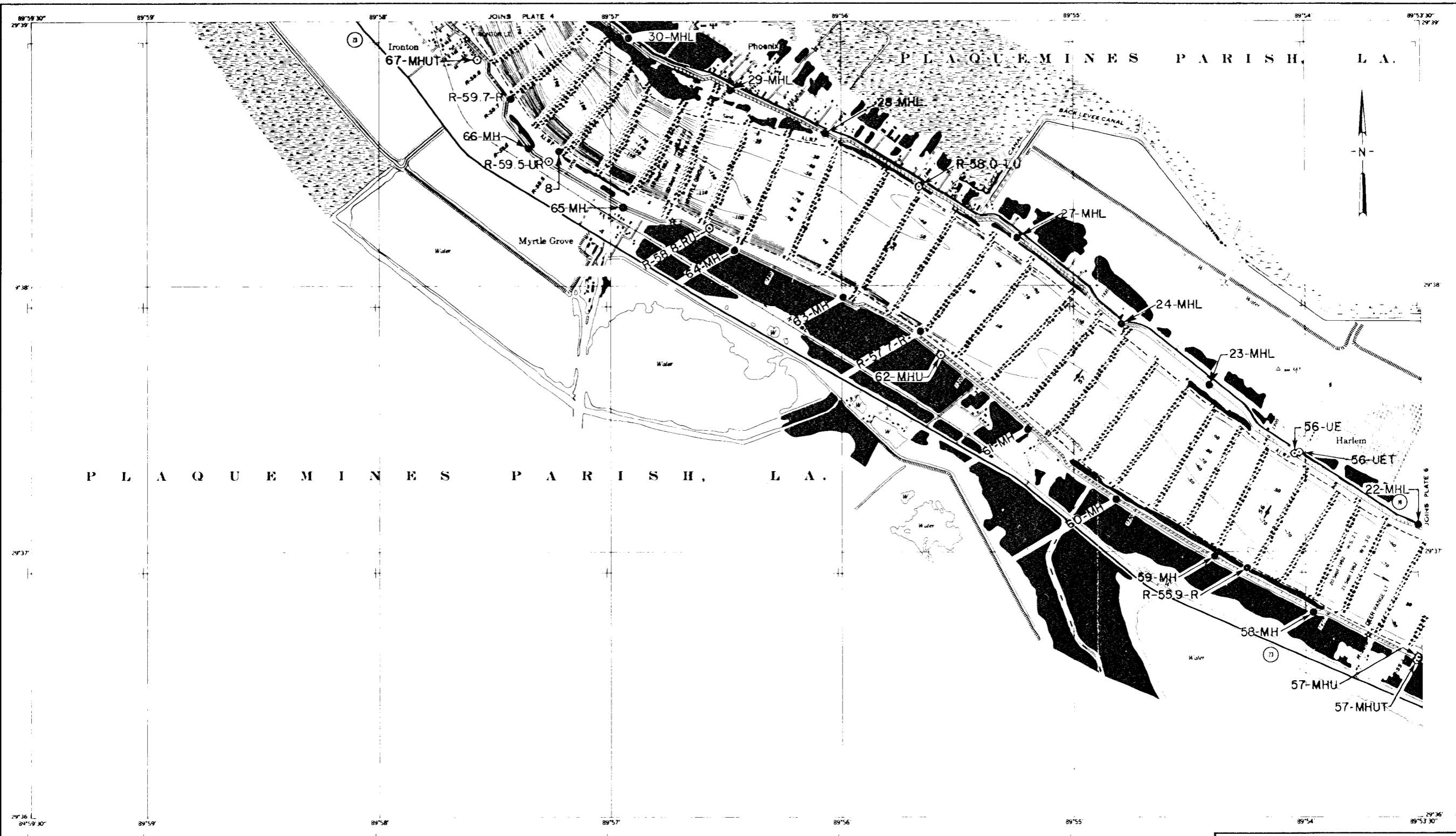

All elevations are expressed in feet and refer to Mean Sea Level.  
 Contours below Average Low Water Plane are expressed in feet at 5 and 10 ft intervals.  
 Contours above Average Low Water Plane are expressed in feet at 5 ft intervals.  
 Planimetry from aerial photographs, June, November, 1962.  
 Distances on Mississippi River above Head of Passes are shown at 1 mile intervals.  
 1962 and 1942 surveys.  
 Polyconic Projection, North American Datum.  
 Polyconic Projection, Gulf Coast Datum is indicated by ticks.  
 A.L.W.P. - Average Low Water Plane.

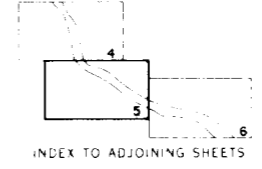
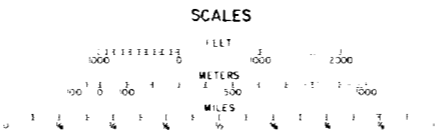

MISSISSIPPI RIVER LEVEES AND BANKS  
 MILE 66 TO MILE 60  
 SOIL REPORT - PART I  
 EAST AND WEST BANKS  
 SOIL BORING DATA  
**BORING LOCATIONS**  
 MILE 60.0 TO MILE 55.2  
 U.S. ARMY ENGINEER DISTRICT, NEW ORLEANS  
 CORPS OF ENGINEERS  
 AUGUST 1971  
 FILE NO. H-2-25275

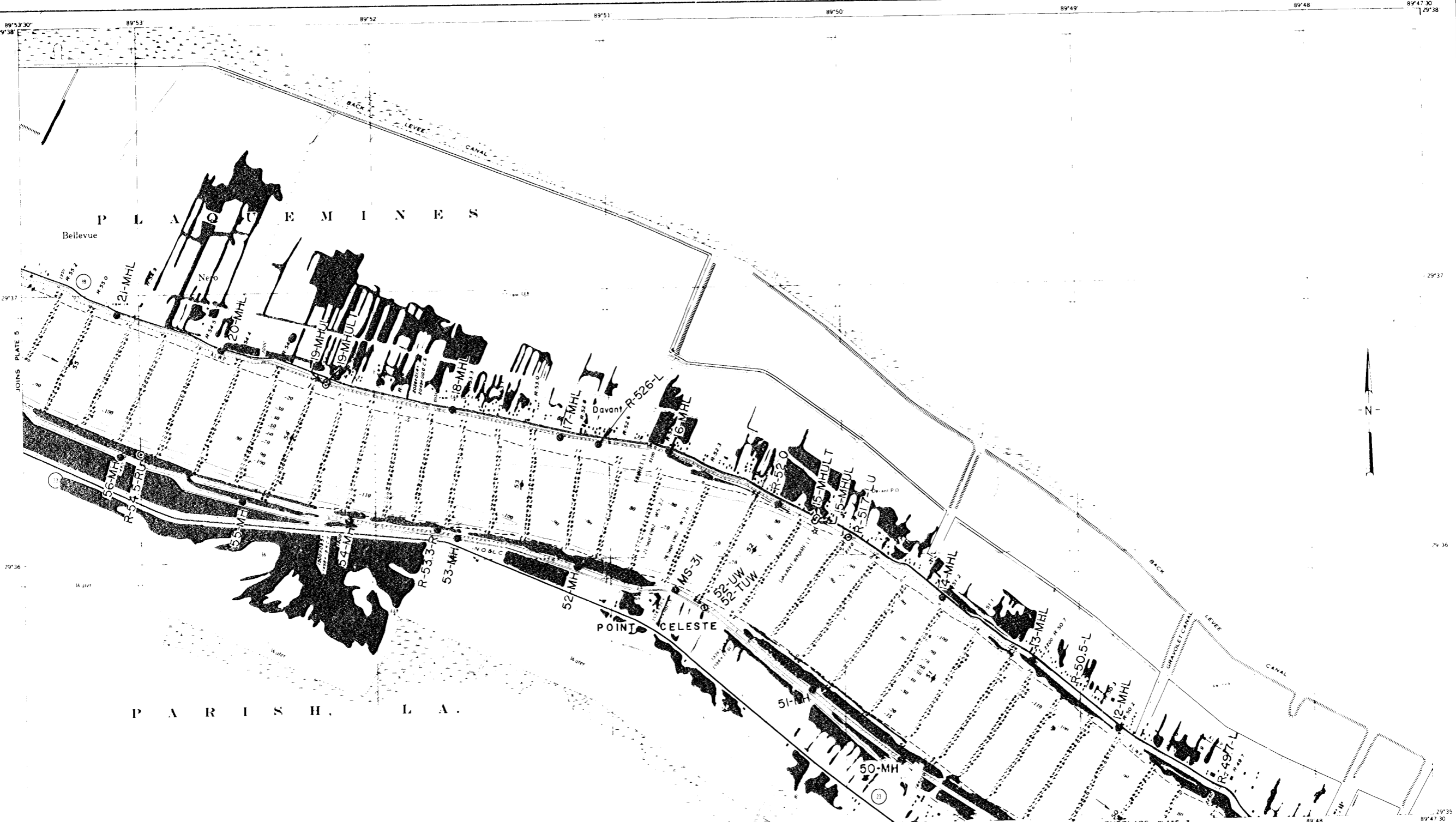

1. Elevations are expressed in feet and refer to Mean Sea Level.  
 2. Elevation above Average Low Water Plane are expressed in feet and refer to  
 the Average High Water Plane are expressed in feet and refer to  
 3. Elevation from sea level photographs taken November 1962.  
 4. Elevations in Mississippi River above head of Pass are given in whole and tenths  
 feet and 1942 surveys.  
 5. Elevation based on North American Datum.  
 6. Elevation in feet on Gulf Coast Datum is indicated by the  
 A. W. P. Average Low Water Plane.

SCALES  
 1:111  
 1:1114  
 1:55

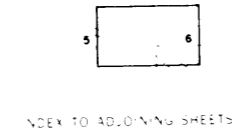

MISSISSIPPI RIVER LEVEES AND BANKS  
 MILE 56 TO MILE 10  
 SOIL REPORT - PART I  
 EAST AND WEST BANKS  
 SOIL BORING DATA  
**BORING LOCATIONS**  
**MILE 55.2 TO MILE 50.0**  
 U.S. ARMY ENGINEER DISTRICT, NEW ORLEANS  
 CORPS OF ENGINEERS  
 AUGUST 1971



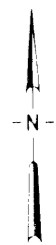
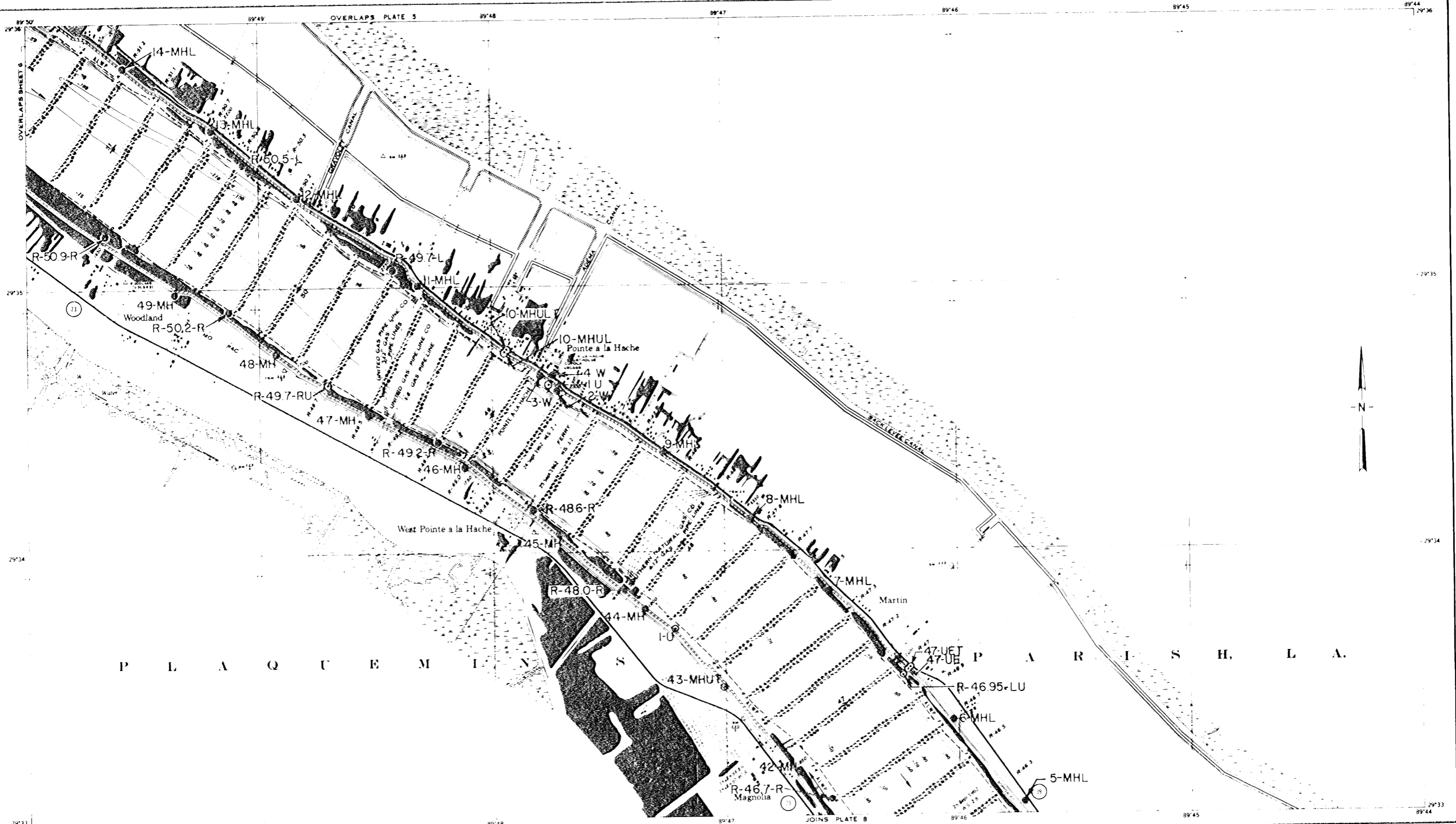

A. Surveyed by...  
 B. Surveyed by...  
 C. Surveyed by...  
 D. Surveyed by...  
 E. Surveyed by...  
 F. Surveyed by...  
 G. Surveyed by...  
 H. Surveyed by...  
 I. Surveyed by...  
 J. Surveyed by...  
 K. Surveyed by...  
 L. Surveyed by...  
 M. Surveyed by...  
 N. Surveyed by...  
 O. Surveyed by...  
 P. Surveyed by...  
 Q. Surveyed by...  
 R. Surveyed by...  
 S. Surveyed by...  
 T. Surveyed by...  
 U. Surveyed by...  
 V. Surveyed by...  
 W. Surveyed by...  
 X. Surveyed by...  
 Y. Surveyed by...  
 Z. Surveyed by...

SCALES  
 FEET  
 METERS  
 MILES

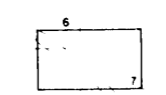

INDEX TO ADJOINING SHEETS

MISSISSIPPI RIVER LEVEES AND BANKS  
 MILE 66 TO MILE 10  
 SOIL REPORT - PART I  
 EAST AND WEST BANKS  
 SOIL BORING DATA  
**BORING LOCATIONS**  
**MILE 51.4 TO MILE 46.3**  
 U.S. ARMY ENGINEER DISTRICT, NEW ORLEANS  
 CORPS OF ENGINEERS  
 AUGUST 1971  
 FILE NO H-2-25275

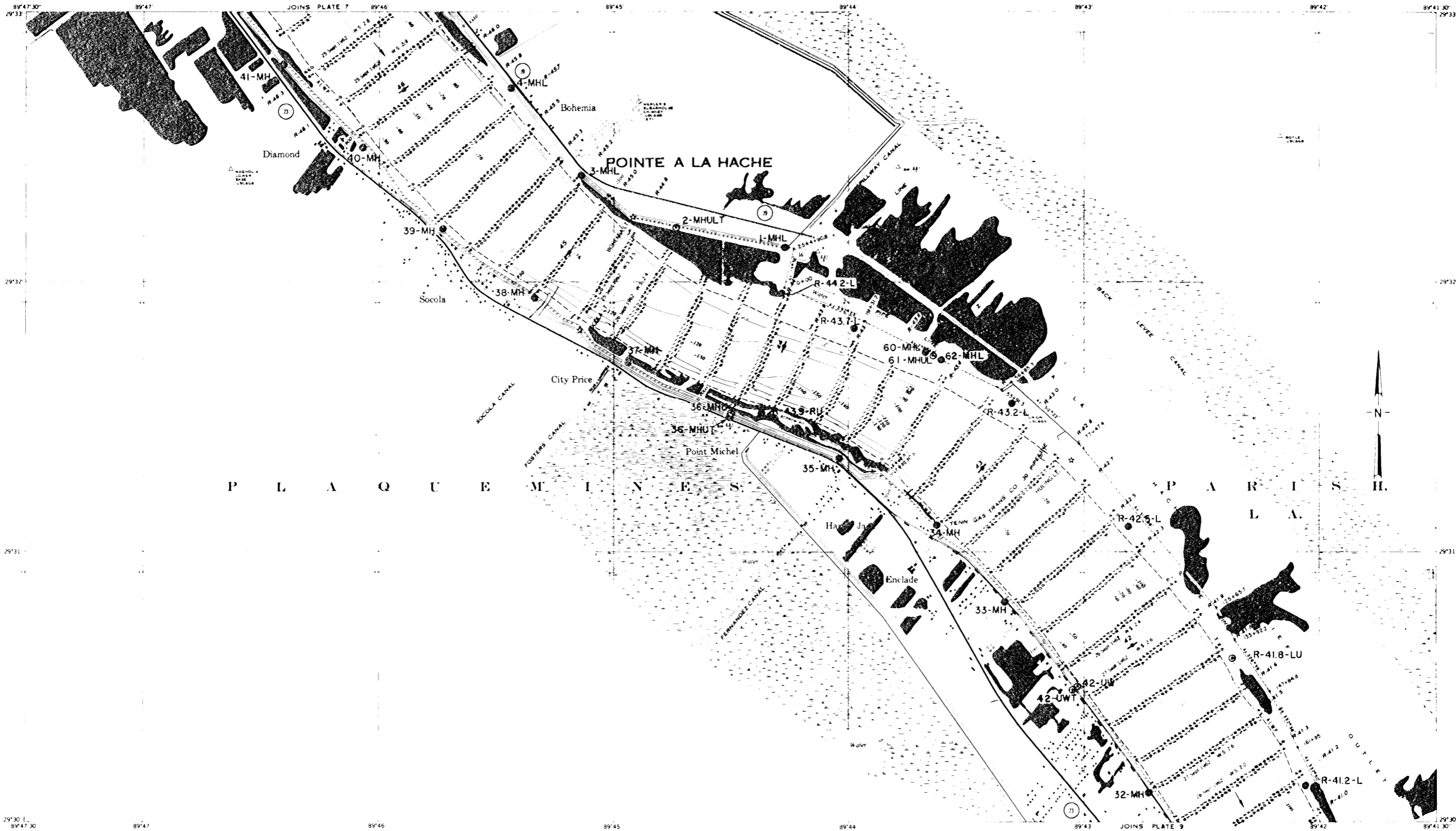

1. Surveyed in place by the U.S. Army Corps of Engineers.  
 2. Surveyed by the U.S. Army Corps of Engineers.  
 3. Surveyed by the U.S. Army Corps of Engineers.  
 4. Surveyed by the U.S. Army Corps of Engineers.  
 5. Surveyed by the U.S. Army Corps of Engineers.  
 6. Surveyed by the U.S. Army Corps of Engineers.  
 7. Surveyed by the U.S. Army Corps of Engineers.  
 8. Surveyed by the U.S. Army Corps of Engineers.  
 9. Surveyed by the U.S. Army Corps of Engineers.  
 10. Surveyed by the U.S. Army Corps of Engineers.

SCALES

FEET 1" = 100'  
 METERS 1" = 300'  
 MILES 1" = 1 MILE

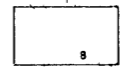

INDEX TO ADJOINING SHEETS

MISSISSIPPI RIVER LEVEES AND BANKS  
 MILE 66 TO MILE 10  
 SOIL REPORT - PART I  
 EAST AND WEST BANKS  
 SOIL BORING DATA  
**BORING LOCATIONS**  
**MILE 46.3 TO MILE 41.2**  
 U.S. ARMY ENGINEER DISTRICT, NEW ORLEANS  
 CORPS OF ENGINEERS  
 AUGUST 1971 FILE NO H-2-25275

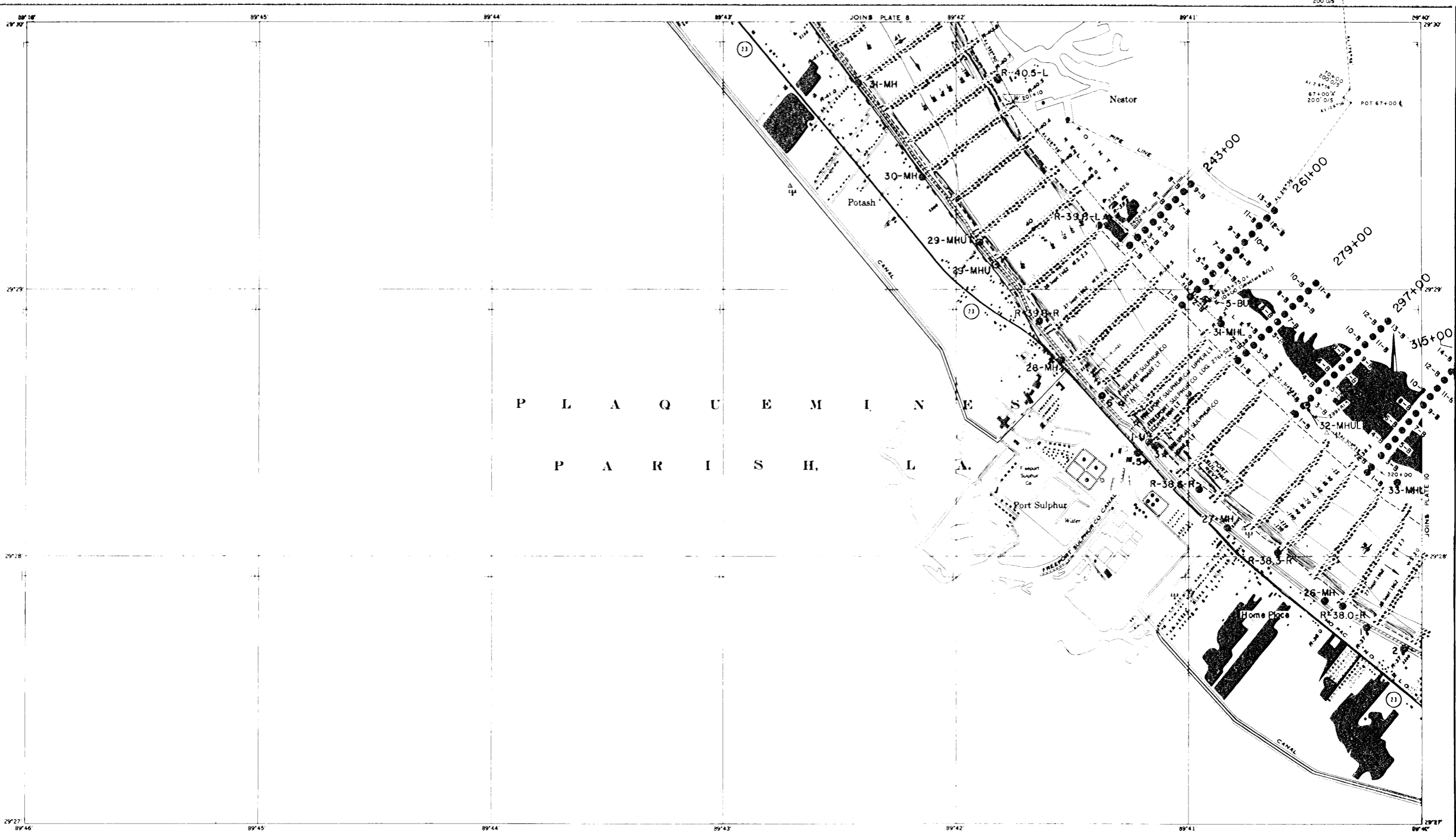

P L A Q U E M I N E  
P A R I S H, L A.

All elevations are expressed in feet and refer to Mean Sea Level.  
Contours below Average Low Water Plane are expressed in feet at 5 and 10 ft. intervals.  
Contours above Average Low Water Plane are expressed in feet at 5 ft. intervals.  
Plan is derived from aerial photographs flown November 1962.  
Distances on Mississippi River above head of Passes are shown at 1 mile intervals.  
Polyconic Projection, North American Datum.  
Polyconic Projection, Gulf Coast Datum is indicated by ticks.  
A.L.W.P. - Average Low Water Plane.

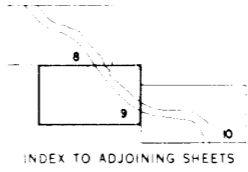
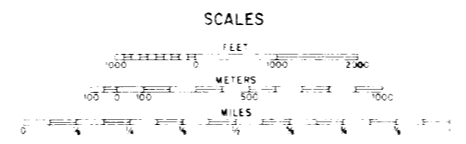

MISSISSIPPI RIVER LEVEES AND BANKS  
MILE 66 TO MILE 10  
SOIL REPORT - PART I  
EAST AND WEST BANKS  
SOIL BORING DATA  
**BORING LOCATIONS**  
MILE 41.2 TO MILE 37.8  
U.S. ARMY ENGINEER DISTRICT, NEW ORLEANS  
CORPS OF ENGINEERS  
AUGUST 1971  
FILE NO. H-2-23275

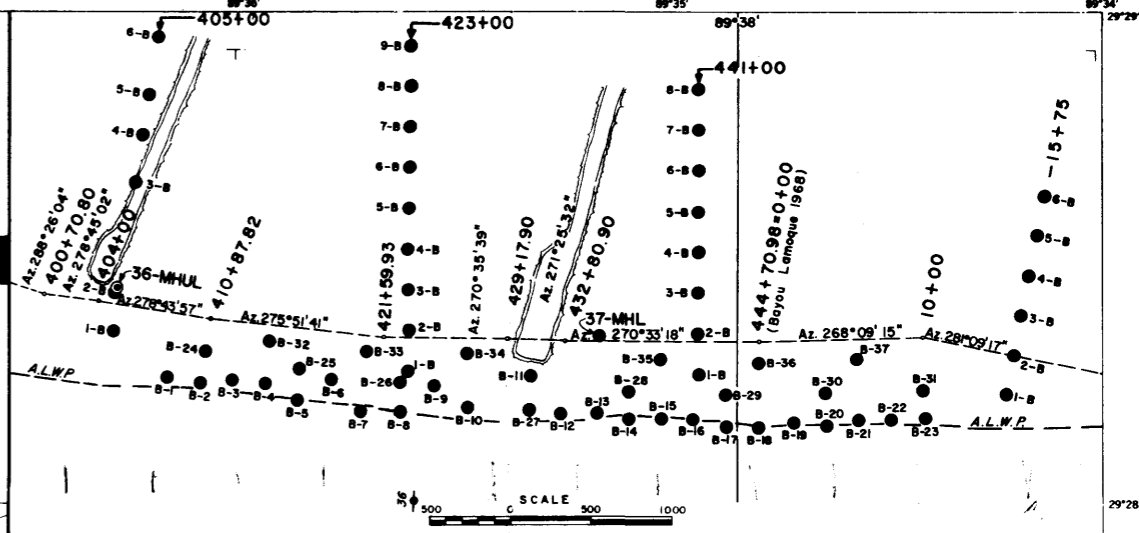
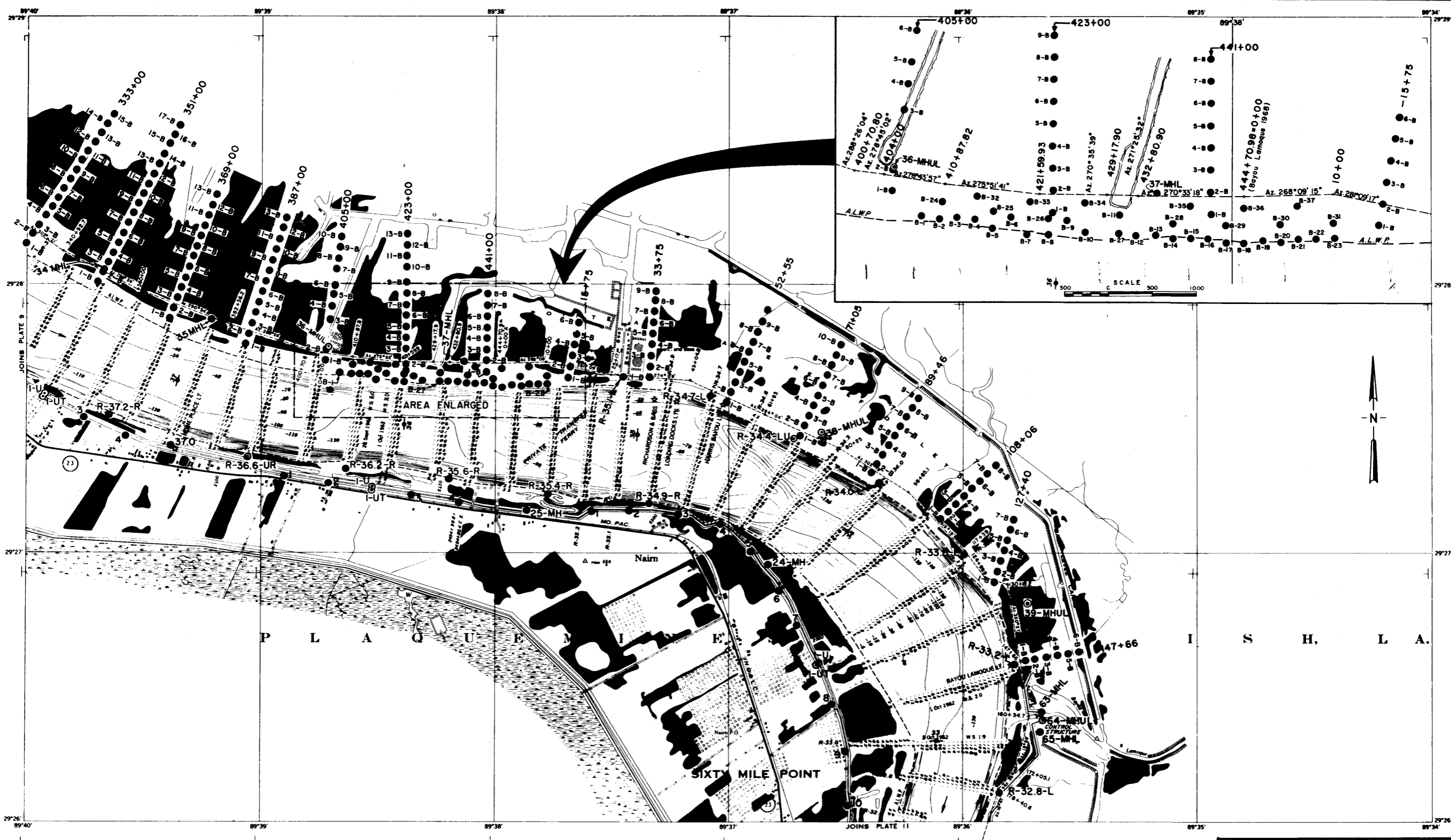

All elevations are expressed in feet and refer to Mean Sea Level  
 Contours below Average Low Water Plane are expressed in feet at 5 and 10 ft. intervals  
 Contours above Average Low Water Plane are expressed in feet at 5 ft. intervals  
 Planimetry from aerial photographs flown November 1962  
 Distances on Mississippi River above Head of Passes are shown at 1 mile intervals  
 1962 and 1942 surveys  
 Polyconic Projection - North American Datum  
 Polyconic Projection - Gulf Coast Datum is indicated by ticks  
 A.L.W.P. - Average Low Water Plane

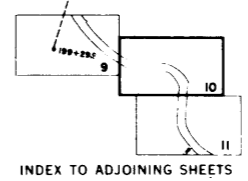
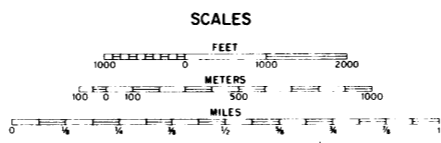

MISSISSIPPI RIVER LEVEES AND BANKS  
 MILE 66 TO MILE 10  
 SOIL REPORT - PART I  
 EAST AND WEST BANKS  
 SOIL BORING DATA  
**BORING LOCATIONS**  
**MILE 37.8 TO MILE 32.6**  
 U.S. ARMY ENGINEER DISTRICT, NEW ORLEANS  
 CORPS OF ENGINEERS  
 AUGUST 1971  
 FILE NO. H-2-25275

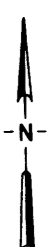

PLAQUEMINES

PARISH, LA.

All elevations are expressed in feet and refer to Mean Sea Level  
 Contours below Average Low Water Plane are expressed in feet at 5 and 10 ft. intervals  
 Contours above Average Low Water Plane are expressed in feet at 5 ft. intervals  
 Planimetry from aerial photographs from November 1962  
 Distances on Mississippi River above Head of Passes are shown at 1 mile intervals  
 1962 and 1942 surveys  
 Polyconic Projection: North American Datum  
 Polyconic Projection: Gulf Coast Datum is indicated by ticks  
 A.L.W.P. - Average Low Water Plane

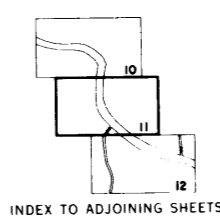
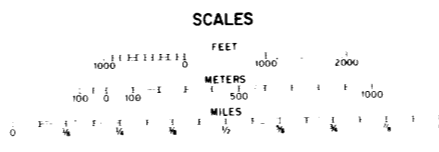

MISSISSIPPI RIVER LEVEES AND BANKS  
 MILE 66 TO MILE 10  
 SOIL REPORT - PART I  
 EAST AND WEST BANKS  
 SOIL BORING DATA  
**BORING LOCATIONS**  
**MILE 32.6 TO MILE 28.5**  
 U.S. ARMY ENGINEER DISTRICT, NEW ORLEANS  
 CORPS OF ENGINEERS  
 AUGUST 1971



All elevations are expressed in feet and refer to Mean Sea Level.  
 Contours below Average Low Water Plane are expressed in feet at 5 and 10 ft intervals.  
 Contours above Average Low Water Plane are expressed in feet at 5 ft intervals.  
 Planimetry from aerial photographs flown November 1962.  
 Distances on Mississippi River above Head of Passes are shown at 1 mile intervals.  
 1962 and 1942 surveys.  
 Polyconic Projection North American Datum.  
 Polyconic Projection Gulf Coast Datum is indicated by ticks.  
 A.L.W.P. Average Low Water Plane.

**SCALES**

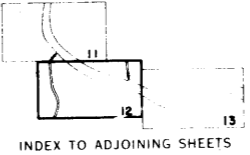

INDEX TO ADJOINING SHEETS

MISSISSIPPI RIVER LEVEES AND BANKS  
 MILE 66 TO MILE 10  
 SOIL REPORT - PART I  
 EAST AND WEST BANKS  
 SOIL BORING DATA  
**BORING LOCATIONS**  
**MILE 28.5 TO MILE 24.2**  
 U.S. ARMY ENGINEER DISTRICT, NEW ORLEANS  
 CORPS OF ENGINEERS  
 AUGUST 1971 FILE NO H-2-25275



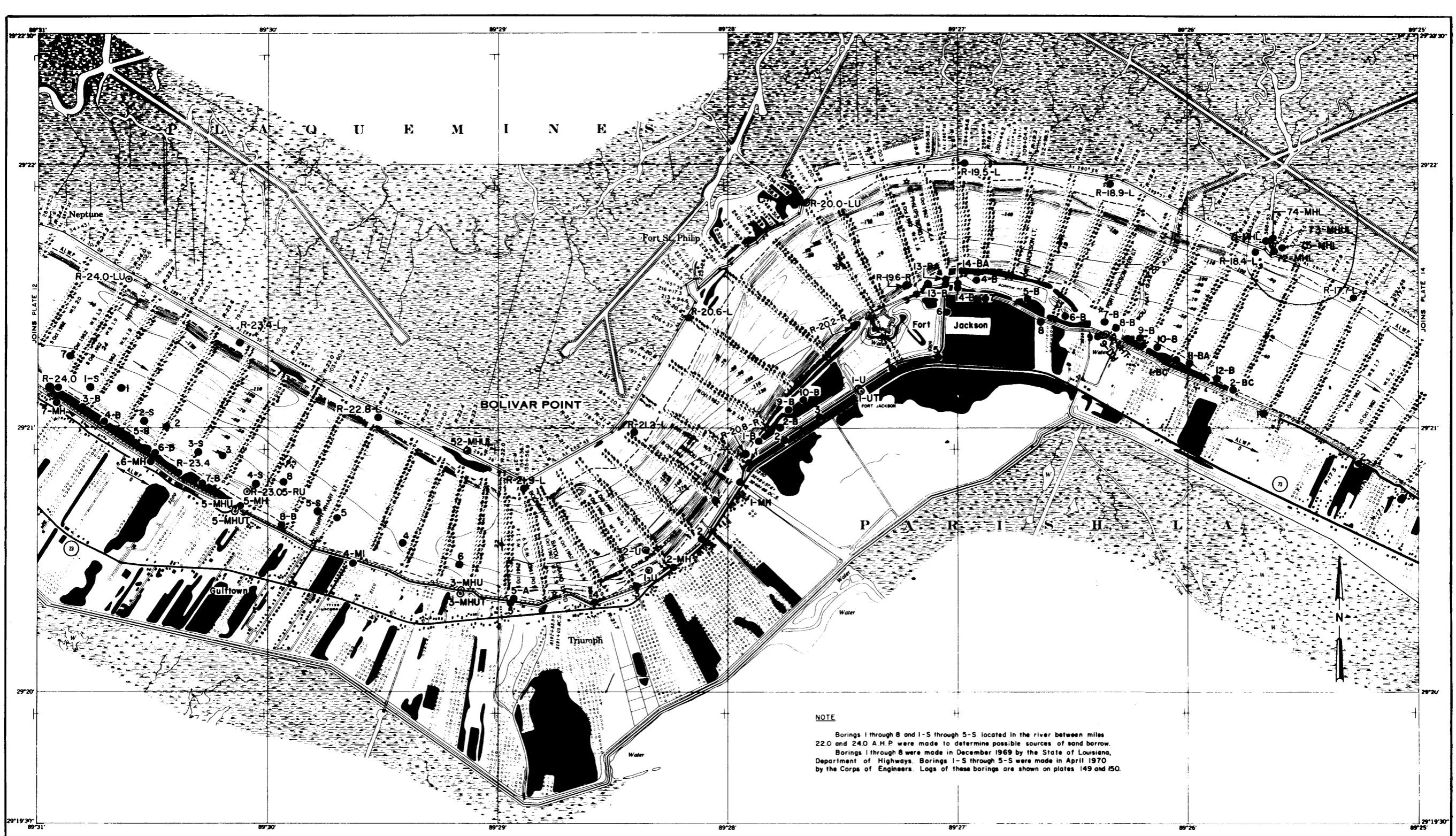

All elevations are expressed in feet and refer to Mean Sea Level.  
 Contours below Average Low Water Plane are expressed in feet at 5 and 10 ft intervals.  
 Contours above Average Low Water Plane are expressed in feet at 5 ft intervals.  
 Planimetry from aerial photographs from November 1962.  
 Distances on Mississippi River above Head of Passes are shown at 1 mile intervals.  
 1962 and 1942 surveys.  
 Polyconic Projection, North American Datum.  
 Polyconic Projection, Gulf Coast Datum is indicated by ticks.  
 A.L.W.P. - Average Low Water Plane.

SCALES

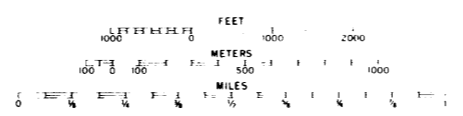

NOTE

Borings 1 through 8 and 1-S through 5-S located in the river between miles 22.0 and 24.0 A.H.P. were made to determine possible sources of sand borrow.  
 Borings 1 through 8 were made in December 1969 by the State of Louisiana, Department of Highways. Borings 1-S through 5-S were made in April 1970 by the Corps of Engineers. Logs of these borings are shown on plates 149 and 150.

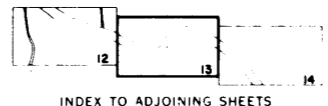

MISSISSIPPI RIVER LEVEES AND BANKS  
 MILE 26 TO MILE 10  
 SOIL REPORT - PART I  
 EAST AND WEST BANKS  
 SOIL BORING DATA  
**BORING LOCATIONS**  
**MILE 24.2 TO MILE 17.1**  
 U.S. ARMY ENGINEER DISTRICT, NEW ORLEANS  
 CORPS OF ENGINEERS  
 AUGUST 1971  
 FILE NO H-2-25275

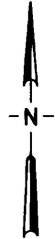
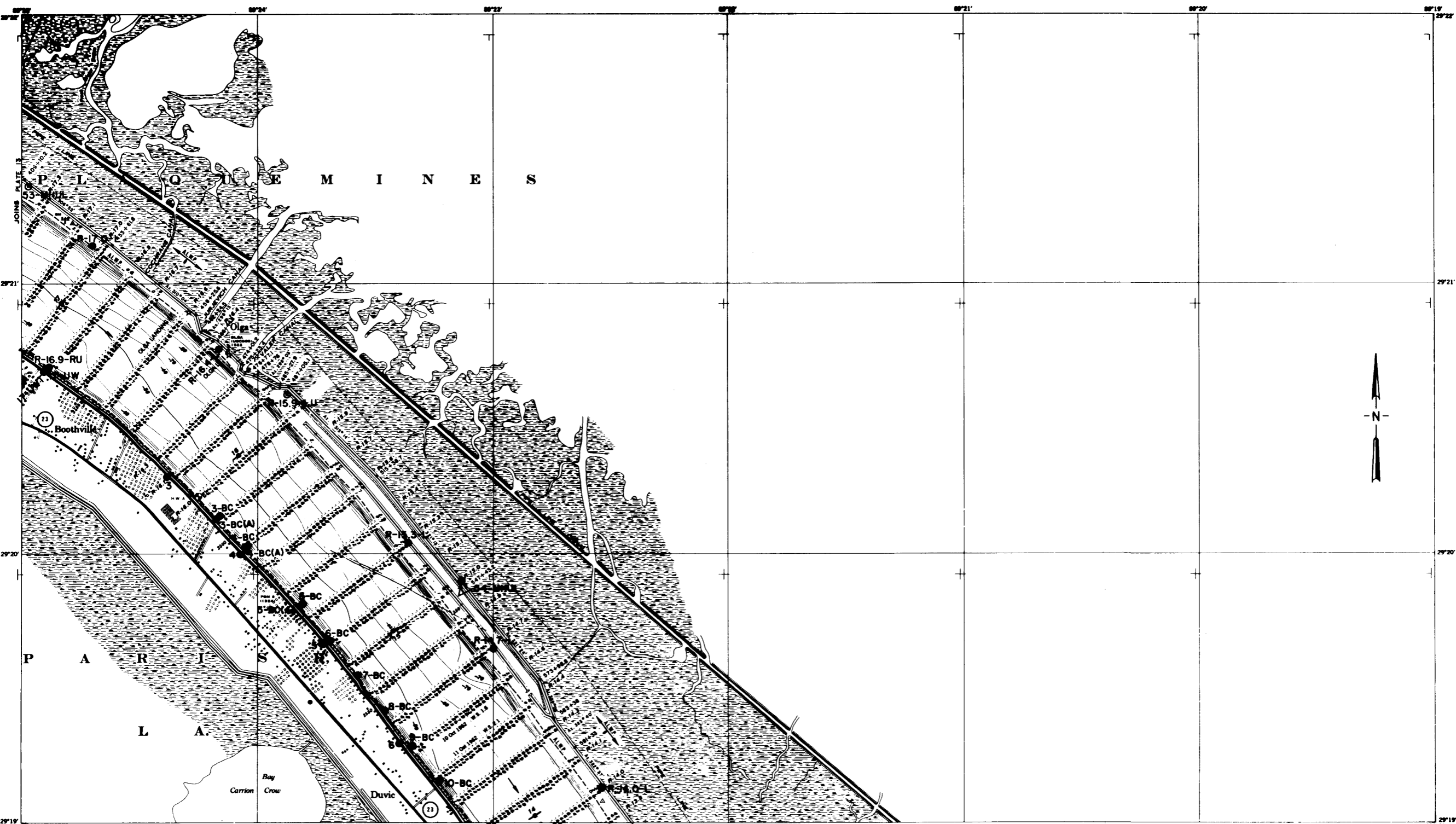

All elevations are expressed in feet and refer to Mean Sea Level.  
 Contours below Average Low Water Plane are expressed in feet at 5 and 10 ft. intervals.  
 Contours above Average Low Water Plane are expressed in feet at 5 ft. intervals.  
 Planimetry from aerial photographs flown February 1963.  
 Distances on Mississippi River above Head of Passes are shown at 1 mile intervals.  
 1962 and 1942 surveys.  
 Polyconic Projection, North American Datum.  
 Polyconic Projection, Gulf Coast Datum is indicated by ticks.  
 A.L.W.P. - Average Low Water Plane.

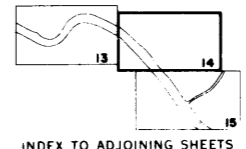
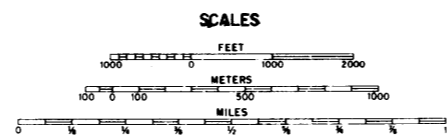

MISSISSIPPI RIVER LEVEES AND BANKS  
 MILE 66 TO MILE 10  
 SOIL REPORT - PART I  
 EAST AND WEST BANKS  
 SOIL BORING DATA  
**BORING LOCATIONS**  
**MILE 17.1 TO MILE 14.0**  
 U.S. ARMY ENGINEER DISTRICT, NEW ORLEANS  
 CORPS OF ENGINEERS  
 AUGUST 1971 FILE NO. H-2-25275



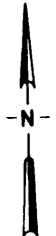
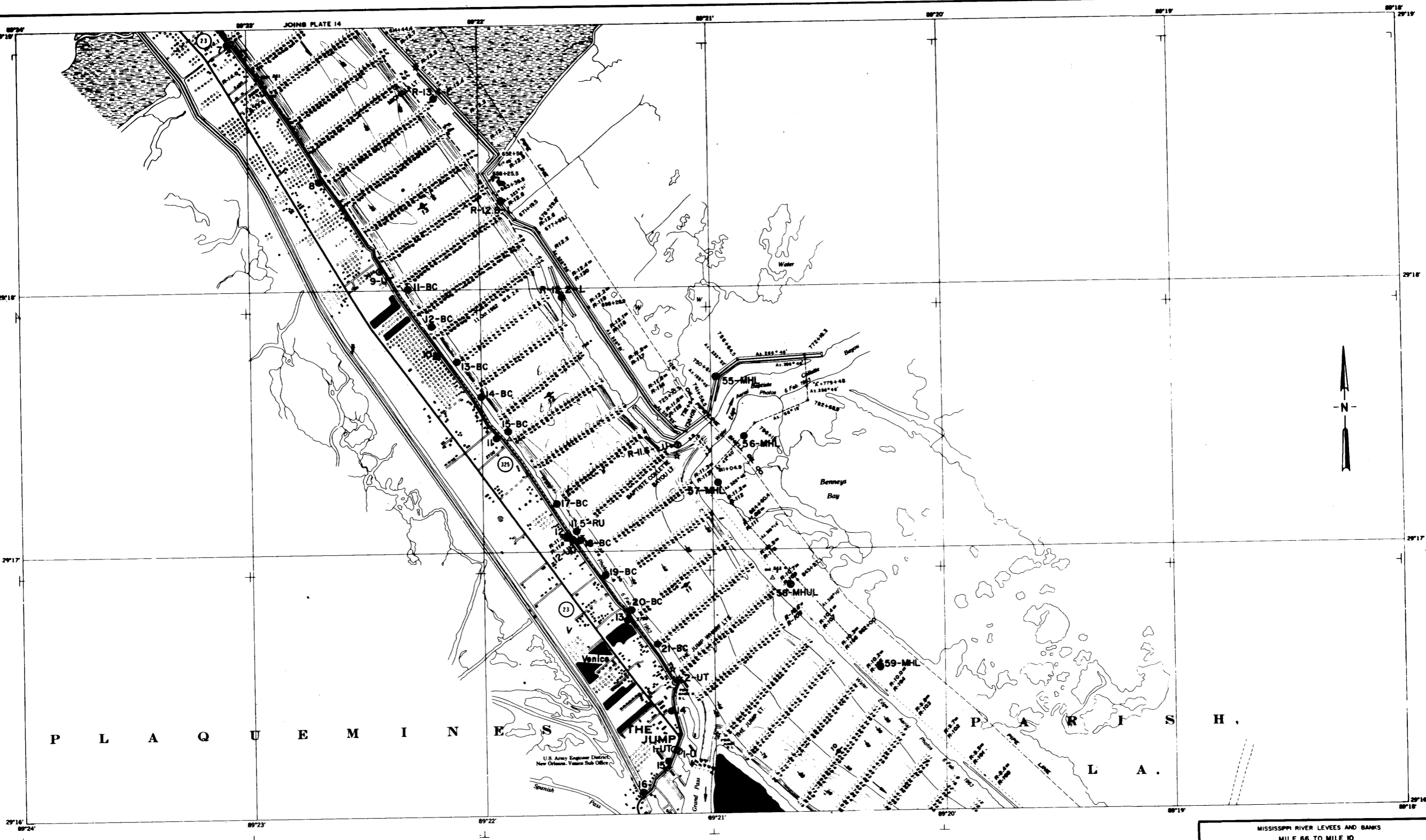

P L A Q U E M I N E S      T H E   J U M P   H U T C H I N S      P A R R I S H      L A .

All elevations are expressed in feet and refer to Mean Sea Level  
 Contours below Average Low Water Plane are expressed in feet at 5 and 10 ft. intervals  
 Contours above Average Low Water Plane are expressed in feet at 5 ft. intervals  
 Planimetry from aerial photographs from February 1963  
 Distances on Mississippi River above Head of Passes are shown at 1 mile intervals  
 1962 and 1942 surveys  
 Polyconic Projection, North American Datum  
 Polyconic Projection, Gulf Coast Datum is indicated by ticks  
 A.L.W.P. - Average Low Water Plane

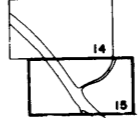
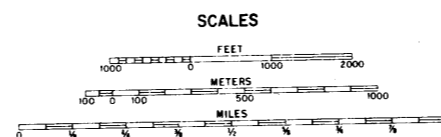

INDEX TO ADJOINING SHEETS

MISSISSIPPI RIVER LEVEES AND BANKS  
 MILE 66 TO MILE 10  
 SOIL REPORT - PART I  
 EAST AND WEST BANKS  
 SOIL BORING DATA  
**BORING LOCATIONS**  
**MILE 14.0 TO MILE 10.0**  
 U.S. ARMY ENGINEER DISTRICT, NEW ORLEANS  
 CORPS OF ENGINEERS  
 AUGUST 1971

R-65.6 LU For log see plate 29  
 R-62.6 LU For log see plate 30  
 25-MHUL ← 61.4 → 25-MHUL For log see plate 31  
 R-60.3 LU For log see plate 32  
 R-58.0 LU For log see plate 33  
 56-UE ← 56.0 → 56-UET For log see plate 34

BOR. R-62.6-L STA. 1600+00 110 FT. R.S. 11-7-68  
 BOR. 28-MHL STA. 1607+00 56 FT. FROM C.L. LEVEE OF TOE 14-15 SEPT. 1967  
 BOR. MS-28 STA. 666+50 600 FT. L.S. C.L. LEVEE 23-24 JUL. 59  
 BOR. R-60.7-L STA. 1670+00 210 FT. R.S. 11-8-68  
 BOR. 30-MHL STA. 1724+00 C.L. LEVEE 13 OCT. 69  
 BOR. 29-MHL STA. 1751+00 60 FT. R.S. 14 OCT. 69  
 BOR. 28-MHL STA. 1775+00 ON C.L. EXISTING LEVEE 15 OCT. 69  
 BOR. 27-MHL STA. 1826+00 50 FT. R.S. 16 OCT. 69  
 BOR. 24-MHL STA. 1857+00 C.L. LEVEE 14 SEPT. 67  
 BOR. 28-MHL STA. 1882+00 48 FT. R.S. TOE 13 SEPT 67

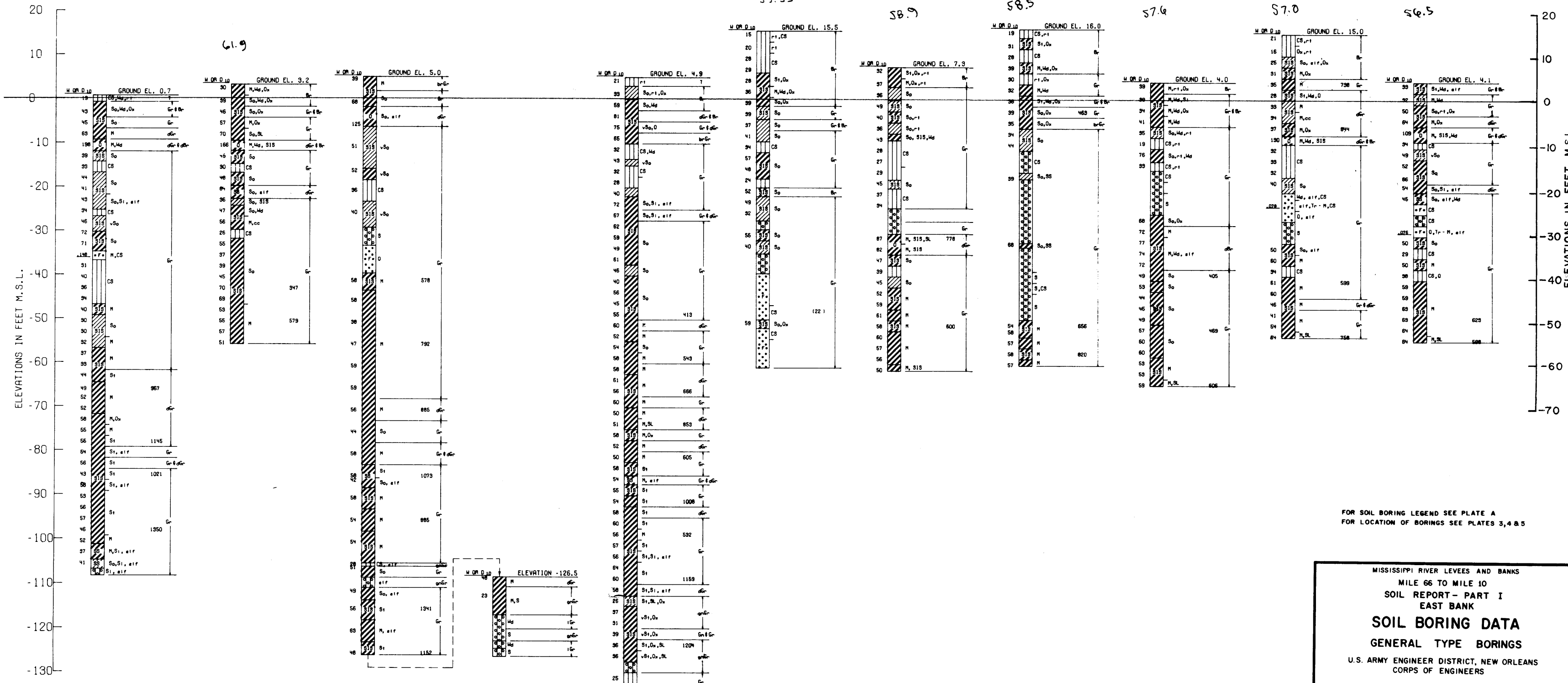

FOR SOIL BORING LEGEND SEE PLATE A  
 FOR LOCATION OF BORINGS SEE PLATES 3, 4 & 5

**MISSISSIPPI RIVER LEVEES AND BANKS**  
**MILE 66 TO MILE 10**  
**SOIL REPORT - PART I**  
**EAST BANK**  
**SOIL BORING DATA**  
**GENERAL TYPE BORINGS**  
 U.S. ARMY ENGINEER DISTRICT, NEW ORLEANS  
 CORPS OF ENGINEERS

AUGUST 1971 FILE NO. H-2-25275

BOR. 22-MHL  
 STA. 1940+00  
 37 FT. L.S. TOE  
 15 SEPT. 67

BOR. 21-MHL  
 STA. 1965+00  
 C.L. LEVEE  
 13 SEPT. 67  
 54.95

19-MHUL 53.9  
 For log see plate 35  
 BOR. 20-MHL  
 STA. 1990+00  
 45 FT. L.S. TOE  
 20 SEPT. 67  
 54.45

19-MHUL  
 For log see plate 36  
 BOR. 18-MHL  
 STA. 2053+00  
 43 FT. L.S. TOE  
 12 SEPT. 67  
 53.4

BOR. 17-MHL  
 STA. 2078+00  
 41 FT. R.S. C.L. LEVEE  
 12 SEPT. 67  
 52.9

BOR. R-52.6-L  
 STA. 2087+00  
 110 FT. R.S. OF LEVEE  
 TOP OF BANK  
 17 JUL 69  
 52.5

BOR. 16-MHL  
 STA. 2103+00  
 C.L. LEVEE  
 11 SEPT. 67  
 51.3

15-MHUL 51.8  
 For log see plate 37  
 BOR. R52.0  
 STA. 2130+50  
 28 FT. R.S. LEVEE C.L.  
 26 JULY 56

15-MHUL  
 For log see plate 37  
 BOR. 14-MHL  
 STA. 2174+00  
 C.L. LEVEE  
 8 SEPT. 67

R-51.7  
 For log see plate 38  
 BOR. 13-MHL  
 STA. 2199+00  
 33 FT. R.S. TOE  
 5 SEPT. 67  
 50.7

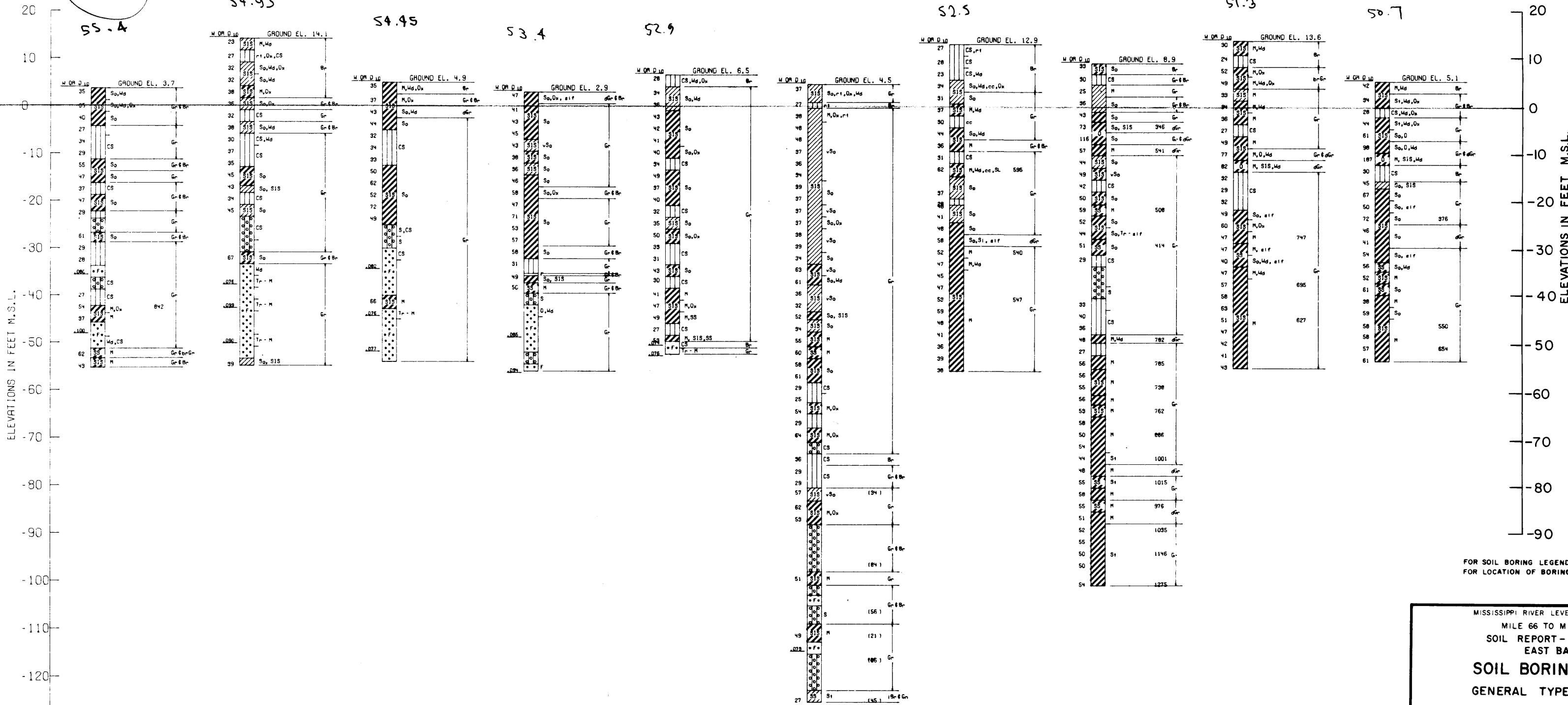

FOR SOIL BORING LEGEND SEE PLATE A  
 FOR LOCATION OF BORINGS SEE PLATES 586

MISSISSIPPI RIVER LEVEES AND BANKS  
 MILE 66 TO MILE 10  
 SOIL REPORT - PART I  
 EAST BANK  
**SOIL BORING DATA**  
 GENERAL TYPE BORINGS  
 U.S. ARMY ENGINEER DISTRICT, NEW ORLEANS  
 CORPS OF ENGINEERS  
 AUGUST 1971

10-MHUL ← 49.1 → 10-MHUL

1-U 48.85

47-UE ← 46.95 → 47-UET

R-4695-LU

For log see plate 39

For log see plate 40

For log see plate 41

For log see plate 41

For log see plate 42

BOR. R-50.5-L STA. 2209+50 160 FT. R.S. OF LEVEE TOP OF BANK 11 JUL 69

BOR. 12-MHL STA. 2224+00 48 FT. L.S. TOE 18 SEPT. 67

BOR. R-49.7-L STA. 2251+00 285 FT. R.S. OF LEVEE TOP OF BANK 15 JUL 69

BOR. 11-MHL STA. 2259+00 38 FT. R.S. TOE 1 SEPT. 67

BOR. 3-W STA. 2293+85 95 FT. R.S. C.A. LEVEE 1-2 OCT. 51

BOR. 4-W STA. 2295+83 108 FT. L.S. C.A. LEVEE 3-4 OCT. 51

BOR. 2-W STA. 2296+50 125 FT. R.S. C.A. LEVEE 27-28 SEP. 51

BOR. 9-MHL STA. 2327+00 40 FT. L.S. TOE 31 AUG. 67 - 1 SEP. 67

BOR. 8-MHL STA. 2352+00 C.L. LEVEE 31 AUG 67

BOR. 7-MHL STA. 2377+00 52 FT. R.S. C.L. LEVEE 30 AUG 67

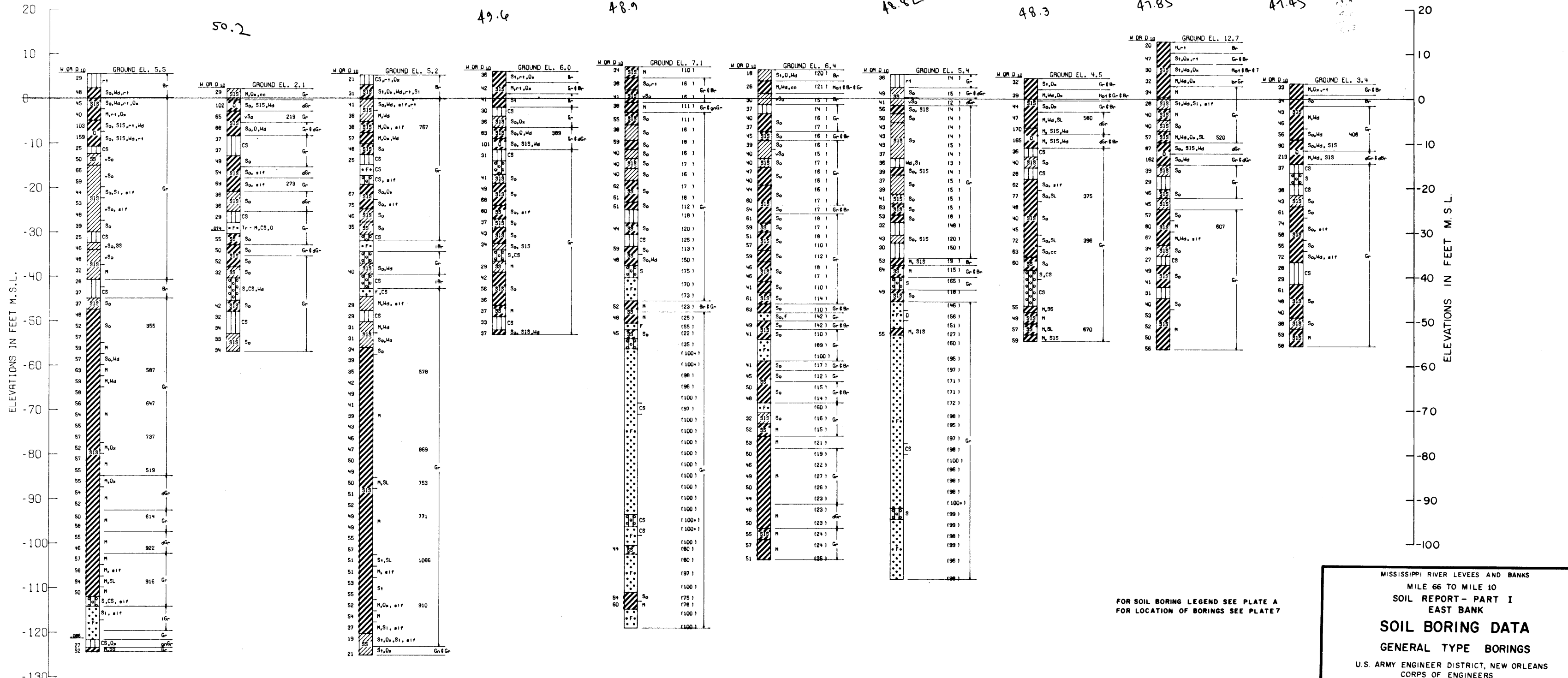

FOR SOIL BORING LEGEND SEE PLATE A  
FOR LOCATION OF BORINGS SEE PLATE 7

MISSISSIPPI RIVER LEVEES AND BANKS  
MILE 66 TO MILE 10  
SOIL REPORT - PART I  
EAST BANK  
**SOIL BORING DATA**  
GENERAL TYPE BORINGS  
U.S. ARMY ENGINEER DISTRICT, NEW ORLEANS  
CORPS OF ENGINEERS

44.5 2-MHUL ← END OF LEVEE

For log see plate 43

61-MHUL ← 43.5 → 62-MHUL

For log see plates 26 & 44

For log see plate 26

BOR. 6-MHL  
STA. 2418+00  
C.L. LEVEE  
21 SEPT 67

BOR. 5-MHL  
STA. 2443+00  
63 FT. L.S. TOE  
19 SEPT 67

BOR. 4-MHL  
STA. 2468+00  
36 FT. R.S. TOE  
29 AUG 67

BOR. 3-MHL  
STA. 2493+00  
C.L. LEVEE  
29 AUG 66

BOR. 1-MHL  
STA. 2543+00  
ON C.A.  
25-28 AUG 1967

BOR. R-44.2-L  
STA. 0+00  
125 FT. R.S. OF B.L.  
17-18 DEC 69

BOR. R-43.7-L  
STA. 18+00  
225 FT. R.S. OF B.L.  
19-23 DEC 69

BOR. R-43.2-L  
STA. 60+00  
370 FT. R.S. OF B.L.  
24-29 DEC 69

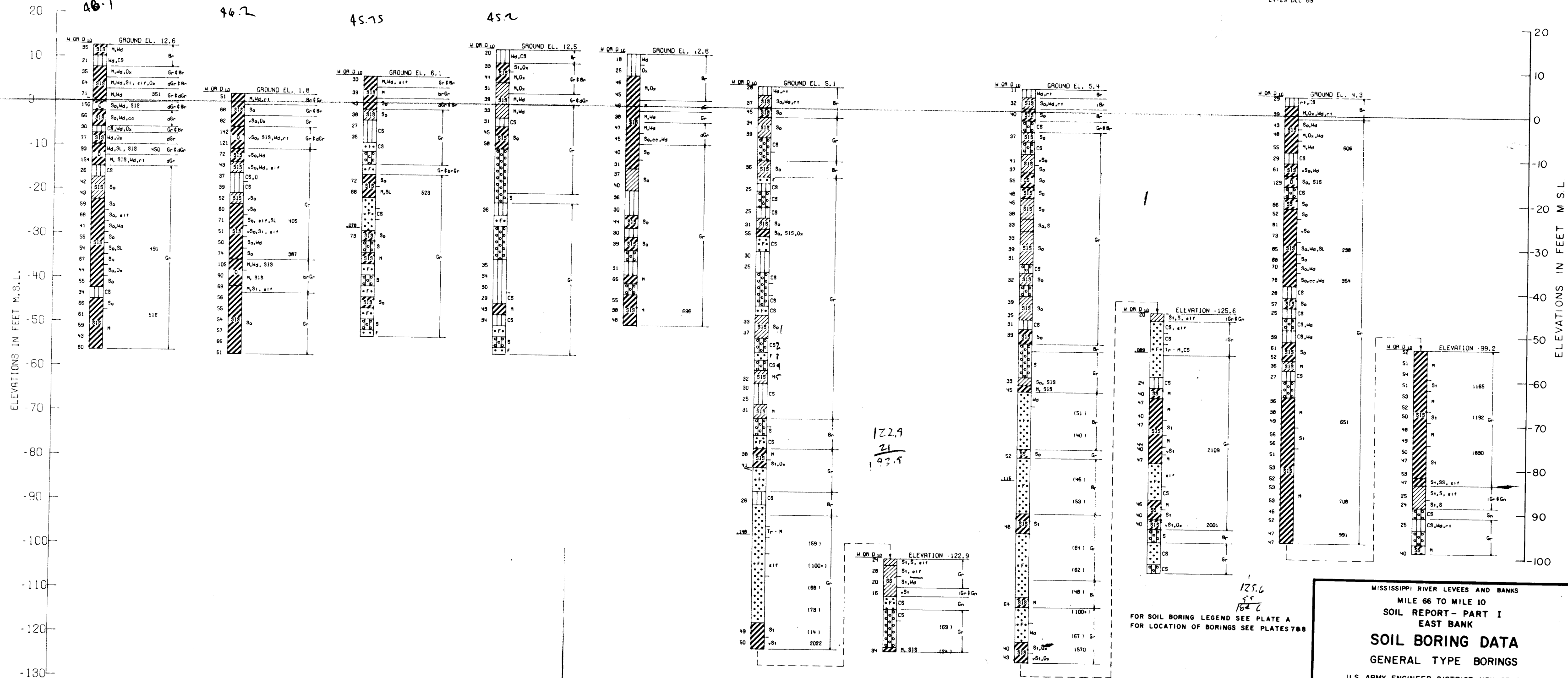

MISSISSIPPI RIVER LEVEES AND BANKS  
 MILE 66 TO MILE 10  
 SOIL REPORT - PART I  
 EAST BANK  
**SOIL BORING DATA**  
 GENERAL TYPE BORINGS  
 U.S. ARMY ENGINEER DISTRICT, NEW ORLEANS  
 CORPS OF ENGINEERS  
 AUGUST 1971  
 FILE NO H-2-25275

R-41.8-LU

For log see plate 45

5-BU 39.3

For log see plate 46

32-MHUL 38.6

For log see plate 47

36-MHUL 38.4

For log see plate 48

BOR. R-42.5-L  
STA. 99+00  
345 FT. R.S. OF B.L.  
30-31 DEC 69

BOR. R-41.2-L  
STA. 170+00  
253 FT. R.S. OF B.L.  
9-13 JAN 70

BOR. R-40.5-L  
STA. 195+00  
100 FT. RIVER SIDE  
13 JAN 1970

BOR. R-39.8-L  
STA. 235+00  
260 FT. R.S.  
15-16 JAN 70

BOR. 31-MHL  
STA. 270+00  
ON C.A. TRAVERSE  
19-20 JAN 70

39.2

BOR. 33-MHL  
STA. 324+00  
20 FT. L.S.  
23 JAN 70

38.1

BOR. 34-MHL  
STA. 351+00  
47 FT. L.S.  
30 JAN 70

37.5

BOR. 35-MHL  
STA. 378+00  
50 FT. R.S.  
3 FEB 70

37.0

BOR. 37-MHL  
STA. 435+70  
32 FT. L.S.  
9 FEB 70

35.7

BOR. R-35.1-L  
STA. 271+80  
50 FT. R.S.  
7 MAR 67

GROUND EL. 11.5

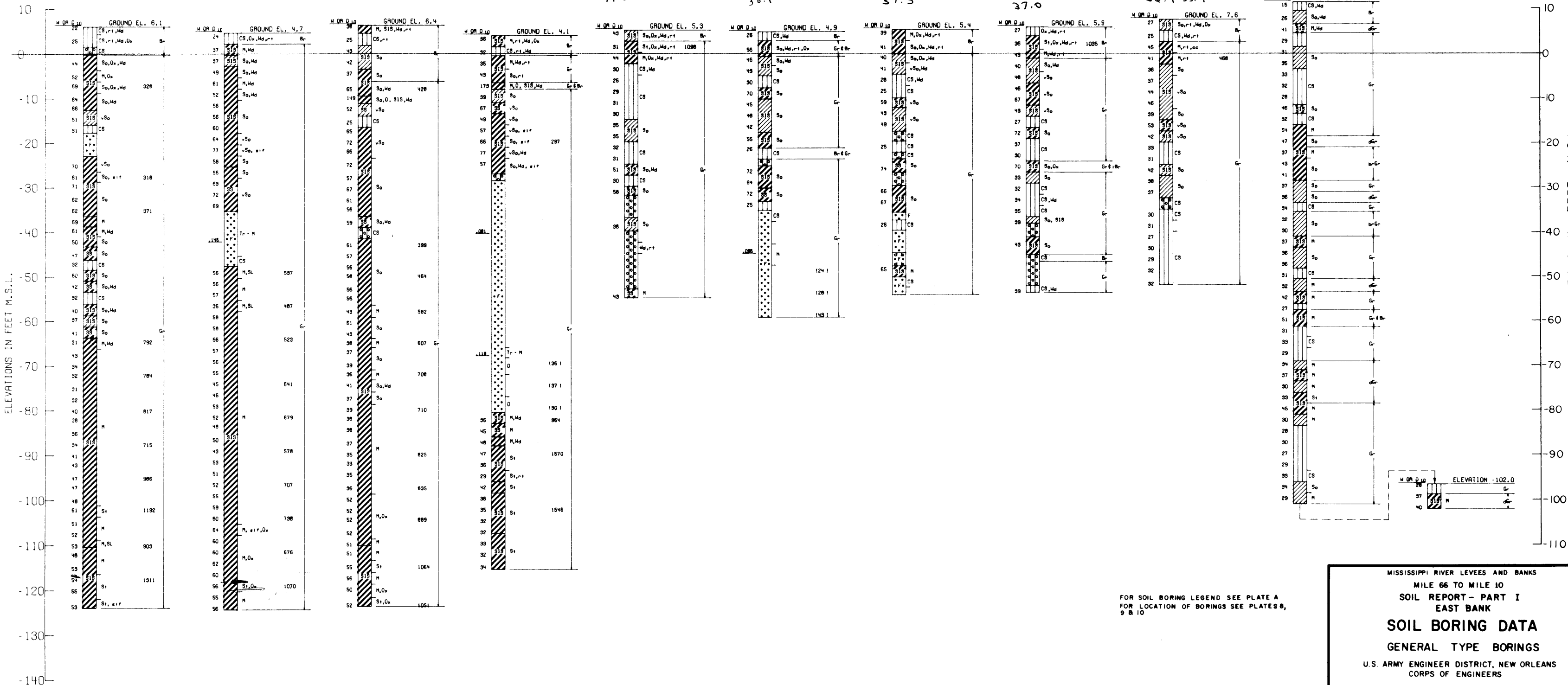

FOR SOIL BORING LEGEND SEE PLATE A  
FOR LOCATION OF BORINGS SEE PLATES 8,  
9 & 10

MISSISSIPPI RIVER LEVEES AND BANKS  
MILE 66 TO MILE 10  
SOIL REPORT - PART I  
EAST BANK  
**SOIL BORING DATA**  
GENERAL TYPE BORINGS  
U.S. ARMY ENGINEER DISTRICT, NEW ORLEANS  
CORPS OF ENGINEERS

R-34.4-LU  
For log see plate 49  
BOR. R-34.7-L  
STA 48+80  
100 FT R S  
10 APR 67

38-MHUL 34.35  
For log see plate 50  
BOR. R-34.0-L  
STA 92+35  
200 FT R S  
11 APR 67

39-MHUL 33.4  
For log see plate 51  
BOR. R-33.6-L  
STA 118+00  
90 FT R S  
13 APR 67

63-MHL 33.1  
For log see plate 26  
BOR. R-33.2-L  
STA 148+20  
150 FT R S  
13 APR 67

64-MHUL 33.05  
For log see plates 26 & 52  
BOR. R-32.8-L  
STA 179+00  
40 FT L S  
12 APR 67

65-MHL 33.08  
For log see plate 26  
BOR. R-32.8-L  
STA 179+00  
40 FT L S  
12 APR 67

R-32.3-LU  
For log see plate 53  
BOR. R-32.0-L  
STA 223+70  
25 FT R S  
14 APR 67

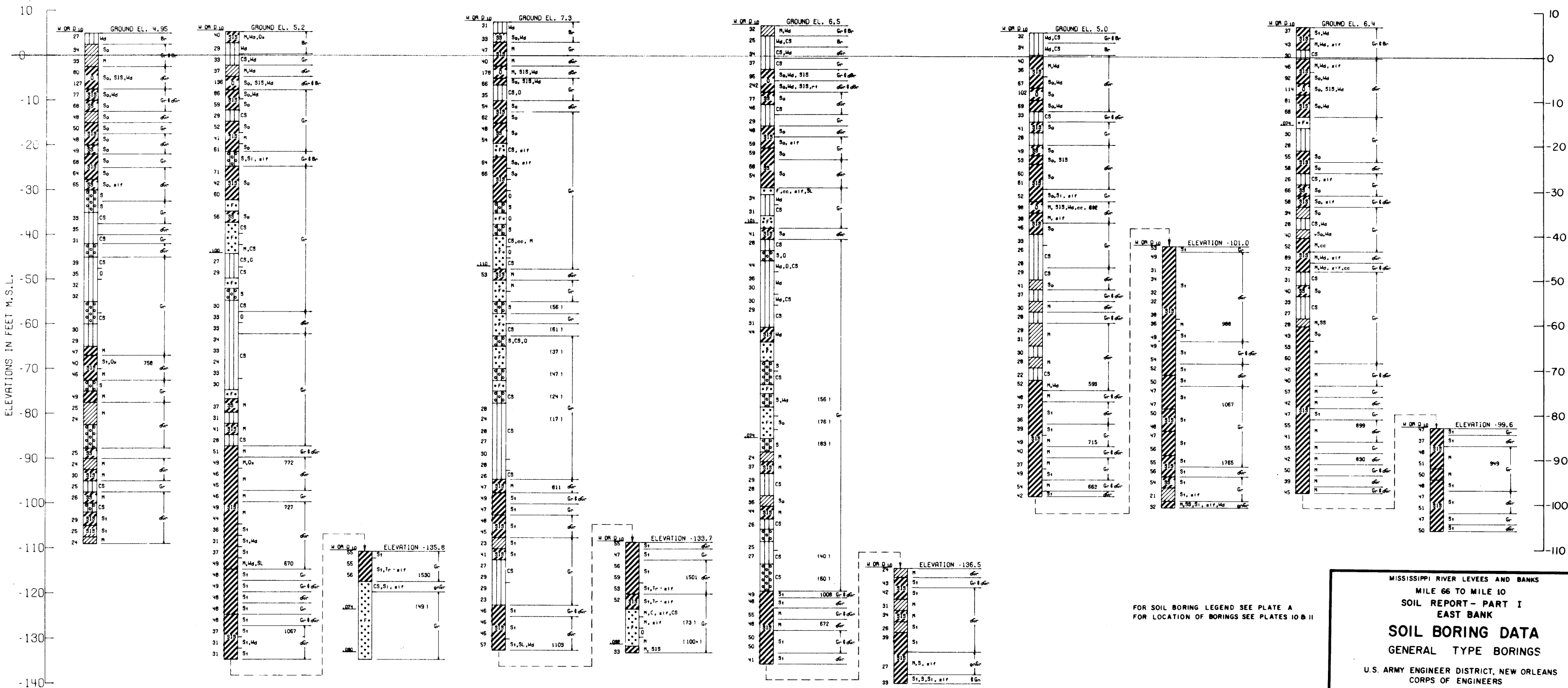

FOR SOIL BORING LEGEND SEE PLATE A  
FOR LOCATION OF BORINGS SEE PLATES 10 & 11

MISSISSIPPI RIVER LEVEES AND BANKS  
MILE 66 TO MILE 10  
SOIL REPORT - PART I  
EAST BANK  
**SOIL BORING DATA**  
GENERAL TYPE BORINGS  
U.S. ARMY ENGINEER DISTRICT, NEW ORLEANS  
CORPS OF ENGINEERS

AUGUST 1971 FILE NO H-2-25275

BOR. R-31.6-L  
STA 241+30  
50 FT R S  
18 APR 67

BOR. 40-MHL  
STA. 258+00  
85 FT. R.S. OF B.L.  
12-13 FEB 70

BOR. 41-MHL  
STA. 285+00  
220 FT. R.S. OF B.L.  
13-18 FEB 70

BOR. 42-MHL  
STA. 310+00  
465 FT. R.S. OF B.L.  
19 FEB 70

BOR. 44 MHL  
STA. 355+00  
65 FT. R.S. OF B.L.  
19 FEB 70

BOR. 45 MHL  
STA. 380+00  
115 FT. R.S. OF B.L.  
20 FEB 70

BOR. 46 MHL  
STA. 410+00  
230 FT. R.S. OF B.L.  
24 FEB 70

BOR. 48 MHL  
STA. 455+00  
150 FT. R.S. OF B.L.  
25 FEB 70

BOR. 49 MHL  
STA. 479+76  
89 FT. R.S. OF B.L.  
26 FEB 70

BOR. R-26.2-L  
STA. 500+00  
300 FT. FROM B.L.  
26-27 FEB 70

43-MHUL 29.65  
For log see plate 54

47-MHUL 27.65  
For log see plate 55

50-MHUL  
For log see plate 56

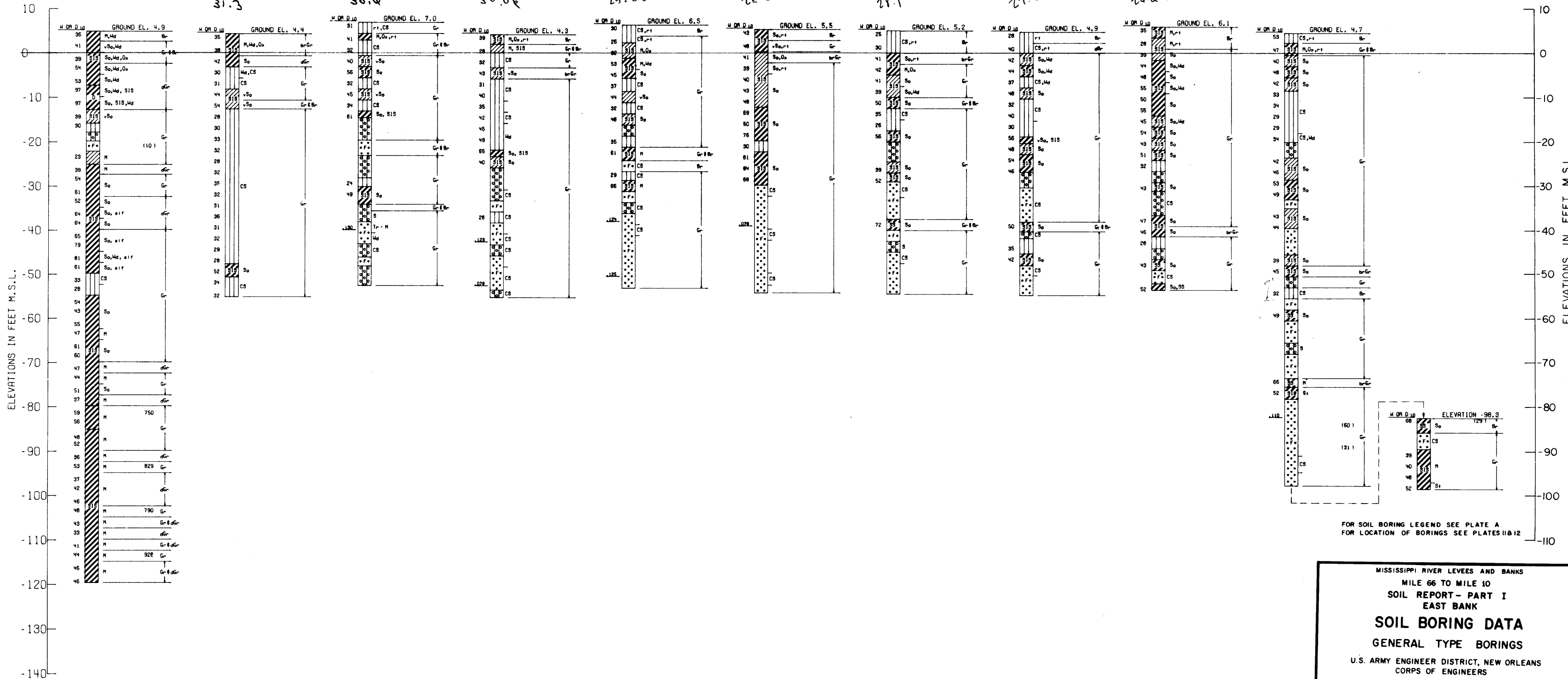

MISSISSIPPI RIVER LEVEES AND BANKS  
MILE 66 TO MILE 10  
SOIL REPORT - PART I  
EAST BANK  
**SOIL BORING DATA**  
GENERAL TYPE BORINGS  
U.S. ARMY ENGINEER DISTRICT, NEW ORLEANS  
CORPS OF ENGINEERS  
AUGUST 1971



66  
MHUL For log see plates 27 & 57  
68  
MHUL For log see plates 27 & 58  
67, 69 & 70  
MHUL For log see plate 70  
R-  
24.0  
LU For log see plate 59

BOR. R-25.6-L STA. 544+66 780 FT. A.S. FROM B.L. 4-5 MAR 70  
 BOR. 51 MHL STA. 556+12 187 FT. A.S. FROM B.L. 6 MAR 70  
 BOR. R-24.8-L STA. 6+73 234 FT. A.S. OF B.L. 10 MAR 70  
 BOR. R-23.4-L STA. 82+50 190 FT. A.S. FROM B.L. 16-17 MAR 70

52  
MHUL 22.3 For log see plate 60

BOR. R-22.8-L STA. 118+50 178 FT. A.S. B.L. 18-20 MAR 70  
 BOR. R-21.9-L STA. 155+50 186 FT. A.S. B.L. 23-25 MAR 70  
 BOR. R-21.2-L STA. 181+50 400 FT. A.S. OF B.L. 26-30 MAR 70

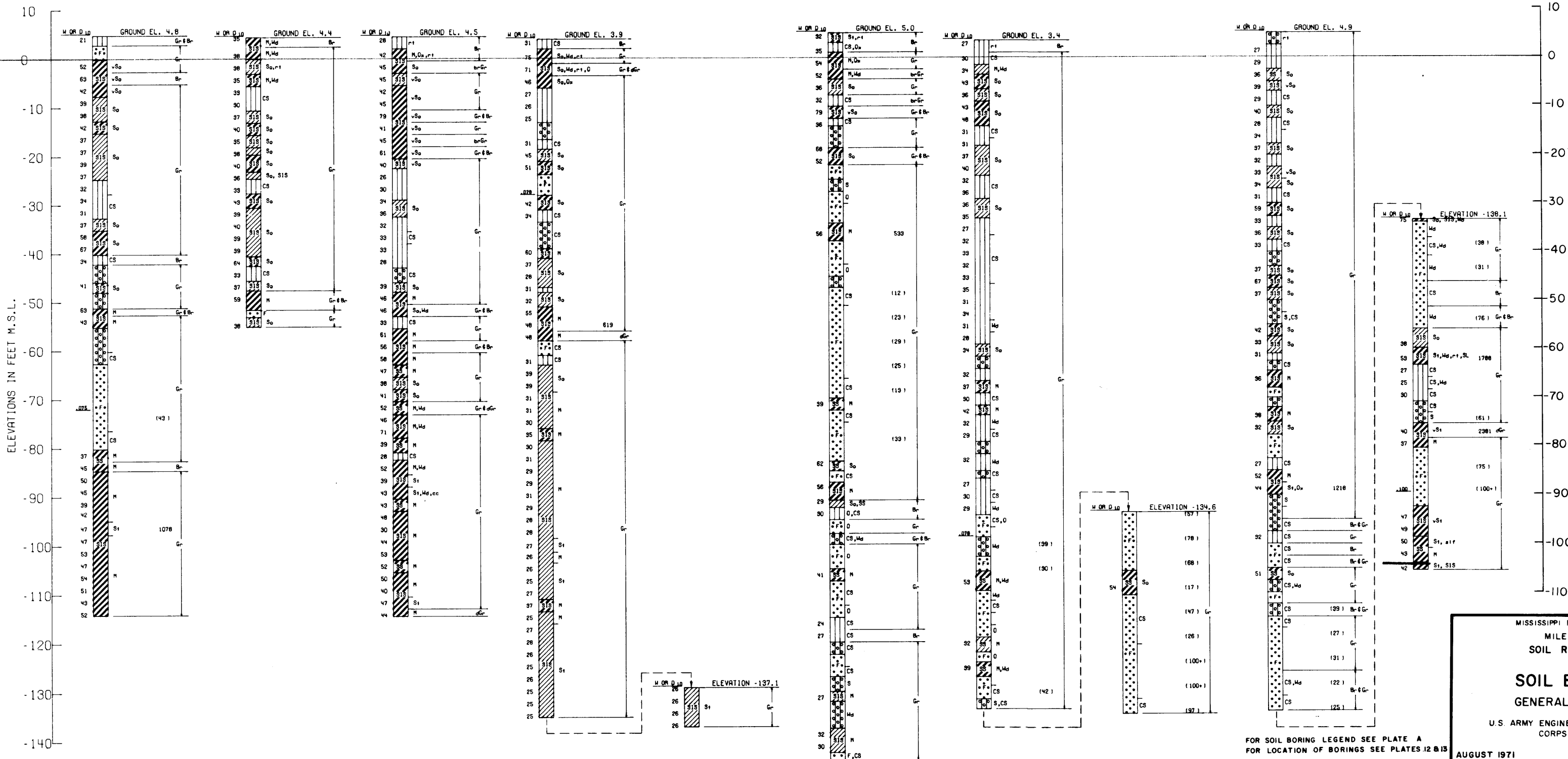

MISSISSIPPI RIVER LEVEES AND BANKS  
 MILE 66 TO MILE 10  
 SOIL REPORT - PART I  
 EAST BANK  
**SOIL BORING DATA**  
 GENERAL TYPE BORINGS  
 U.S. ARMY ENGINEER DISTRICT, NEW ORLEANS  
 CORPS OF ENGINEERS  
 AUGUST 1971  
 FILE NO H-2-25275

R-20.0  
LU.

For log  
see plate 61

BOR. R-20.6-L | BOR. R-19.5-L  
STA. 210+00 | STA. 294+60  
67 FT. A.S. OF B.L. | 210 FT. A.S. OF B.L.  
19-23 MAR 70 | 24 MARCH 70

BOR. R-18.9-L  
STA. 329+50  
125 FT. A.S. OF B.L.  
25 MARCH 70

73  
MHUL

For log  
see plates 28 & 62

71,72,74,75-  
M

For log  
see plate 28

BOR. R-18.4-L  
STA. 366+85  
130 FT. A.S. OF B.L.  
27-31 MAR 70

53  
MHUL

For log  
see plate 63

BOR. R-17.7-L  
STA. 391+50  
215 FT. A.S. OF B.L.  
1 APR 70

BOR. R-17.0-L  
STA. 430+50  
265 FT. A.S. OF B.L.  
2 APR 70

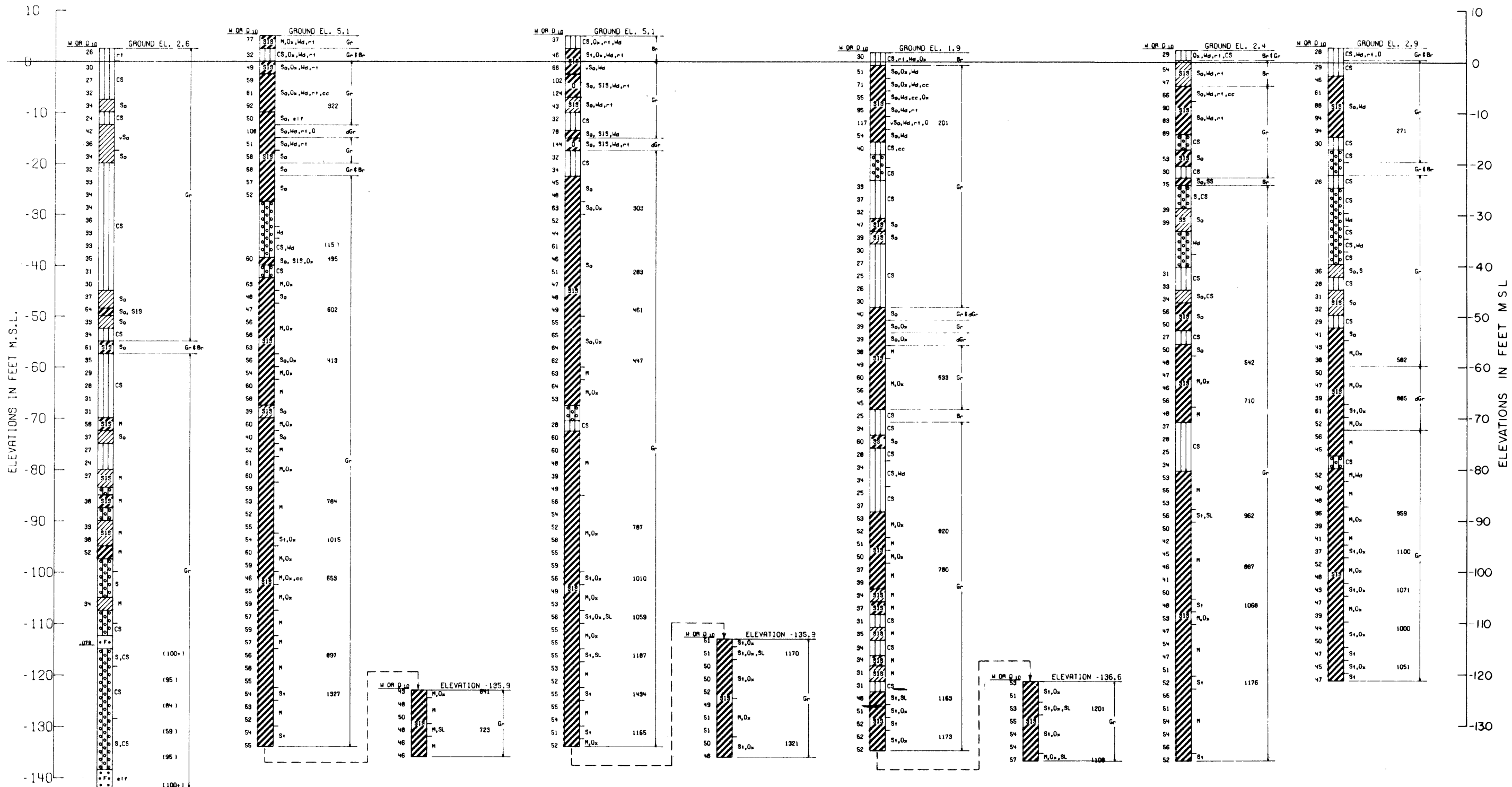

FOR SOIL BORING LEGEND SEE PLATE A  
FOR LOCATION OF BORINGS SEE PLATES 13 & 14

MISSISSIPPI RIVER LEVEES AND BANKS  
MILE 66 TO MILE 10  
SOIL REPORT - PART I  
EAST BANK  
**SOIL BORING DATA**  
GENERAL TYPE BORINGS  
U.S. ARMY ENGINEER DISTRICT, NEW ORLEANS  
CORPS OF ENGINEERS

AUGUST 1971

FILE NO H-2-25275

R-15.9-LU

54-15.0 MHUL

R-11.6-LU

58-MHUL

For log see plate 64

For log see plate 65

For log see plate 66

For log see plate 67

BOR. R-16.4-L

BOR. R-15.3-L

BOR. R-14.7-L

BOR. R-14.0-L

BOR. R-13.4-L

BOR. R-12.8-L

BOR. R-12.2-L

~~BOR. 55 MHL~~

~~BOR. 56 MHL~~

BOR. 57 MHL

BOR. 59 MHL

STA. 468+00

STA. 531+50

STA. 562+00

STA. 602+00

STA. 633+50

STA. 666+00

STA. 693+00

STA. 750+60

~~STA. 800+00~~

STA. 814+00

STA. 872+00

110 FT. R.S. OF B.L.

375 FT. R.S. OF B.L.

394 FT. R.S. OF B.L.

52 FT. R.S. FROM B.L.

250 FT. R.S. FROM B.L.

13 FT. L.S. C.L. LEVEE

375 FT. R.S. OF C.L. LEVEE

~~21 FT. L.S. B.L.~~

~~ON B.L.~~

ON B.L.

ON B.L.

3-6 APR 70

6-7 APR 70

7 APR 70

7 APRIL 70

8 APRIL 70

8 APRIL 70

9-10 APR 70

~~10-13 APR 70~~

~~13 APR 70~~

14 APR 70

14 APR 70

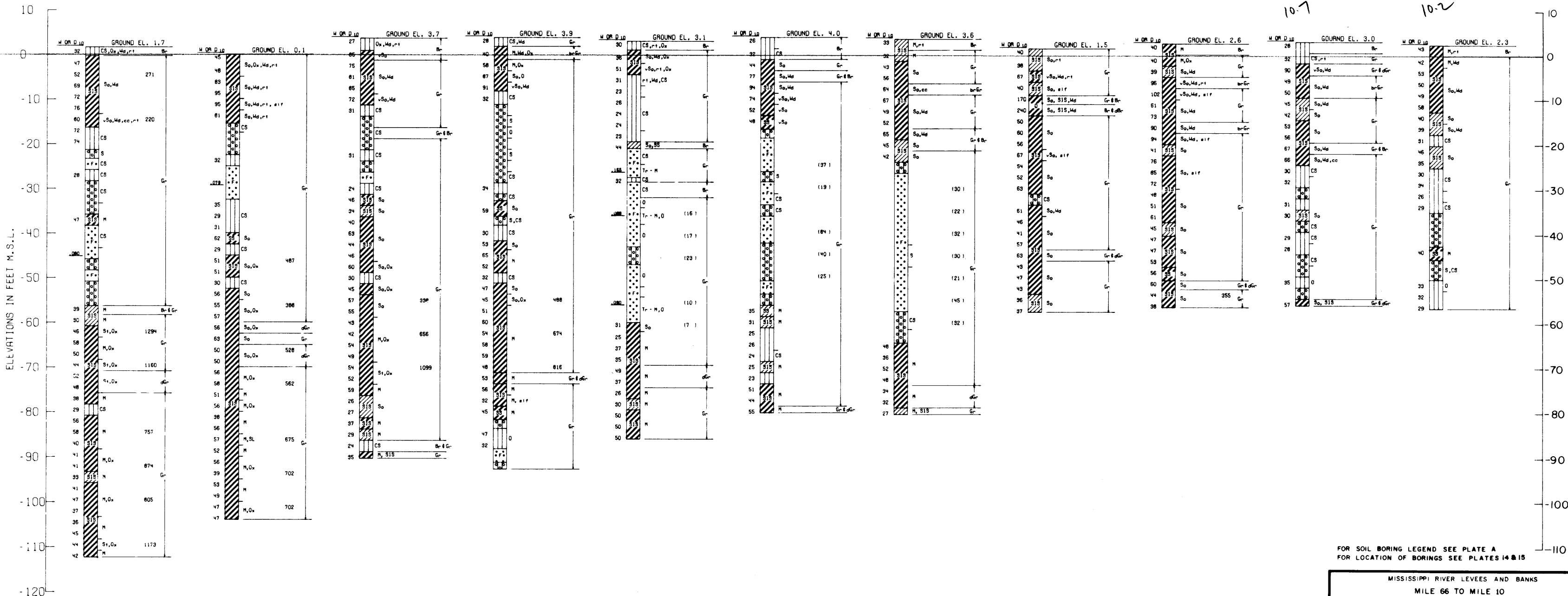

FOR SOIL BORING LEGEND SEE PLATE A  
FOR LOCATION OF BORINGS SEE PLATES 14 & 15

MISSISSIPPI RIVER LEVEES AND BANKS  
 MILE 66 TO MILE 10  
 SOIL REPORT - PART I  
 EAST BANK  
**SOIL BORING DATA**  
 GENERAL TYPE BORINGS  
 U.S. ARMY ENGINEER DISTRICT, NEW ORLEANS  
 CORPS OF ENGINEERS

AUGUST 1971 FILE NO H-2-25275

BOR. 60-MHL  
STA. 34+93  
ON B/L  
21 APR 70

BOR. 61-MHUL  
STA. 36+84  
ON + B.L.  
19-25 JUN 70  
(FOR DETAILED  
DATA, SEE PLATE 44)

BOR. 62-MHL  
STA. 38+93  
ON B/L  
20 APR 70

BOR. 63-MHL  
STA. 160+00  
330 FT. LEFT B/L  
27 APR 70

BOR. 64-MHJL  
STA. 160+36  
350 FT. LEFT OF B.L.  
12-13 MAY 70  
(FOR DETAILED  
DATA, SEE PLATE 52)

BOR. 65 MHL  
STA. 163+00  
330 FT LEFT B/L  
24 APR 70

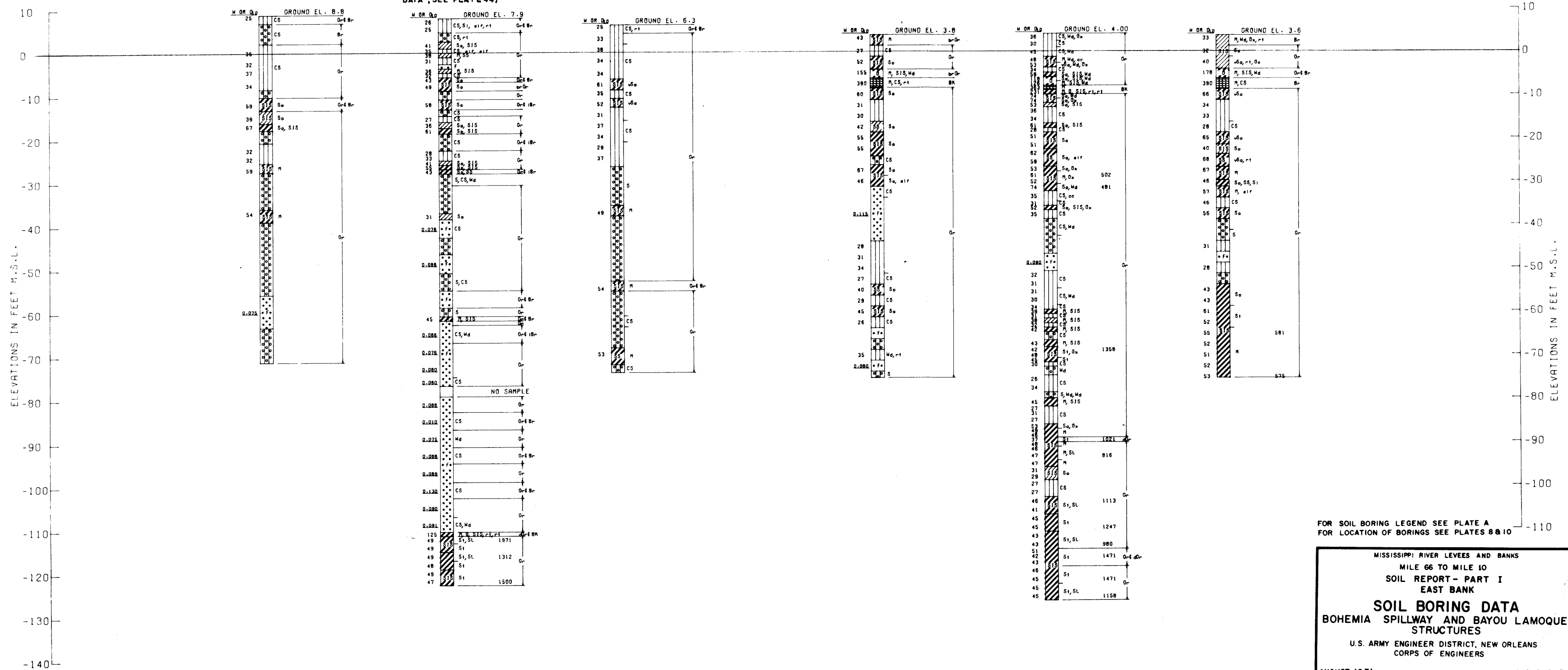

FOR SOIL BORING LEGEND SEE PLATE A  
FOR LOCATION OF BORINGS SEE PLATES 8 & 10

MISSISSIPPI RIVER LEVEES AND BANKS  
MILE 66 TO MILE 10  
SOIL REPORT - PART I  
EAST BANK

**SOIL BORING DATA**  
BOHEMIA SPILLWAY AND BAYOU LAMOQUE  
STRUCTURES

U.S. ARMY ENGINEER DISTRICT, NEW ORLEANS  
CORPS OF ENGINEERS

AUGUST 1971  
FILE NO H-2-25275

**BOR. 66-MHUL**

STA. 553+00  
360 FT. LEFT OF B.L.  
25 MAY 70  
(FOR DETAILED  
DATA, SEE PLATE 57)

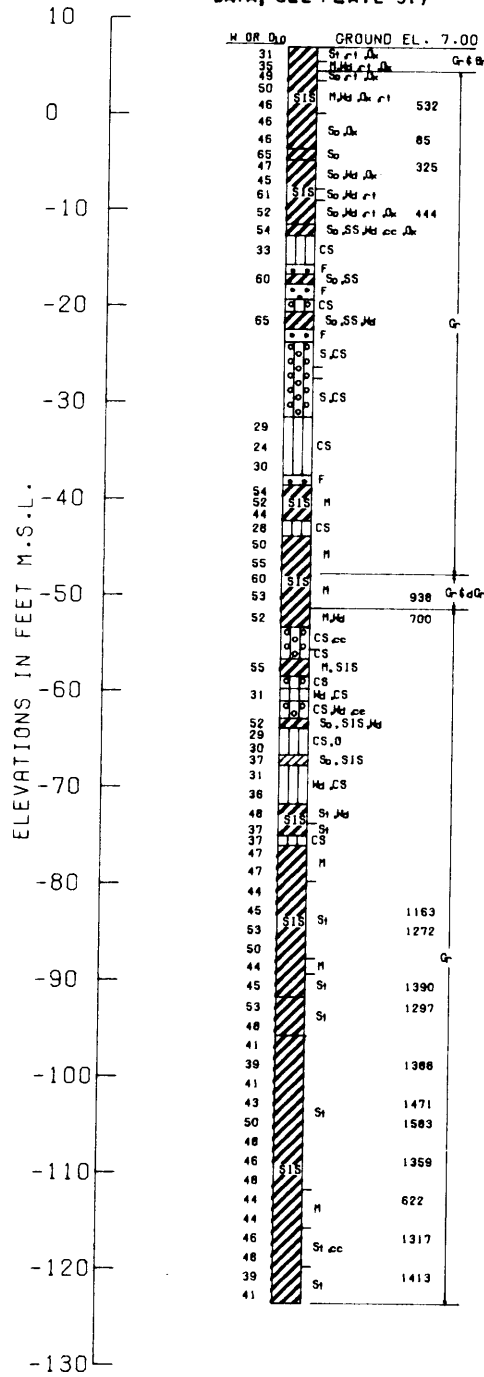

**BOR. 67-MHL**

STA. 553+00  
600 FT. LEFT B/L  
23 APR 70

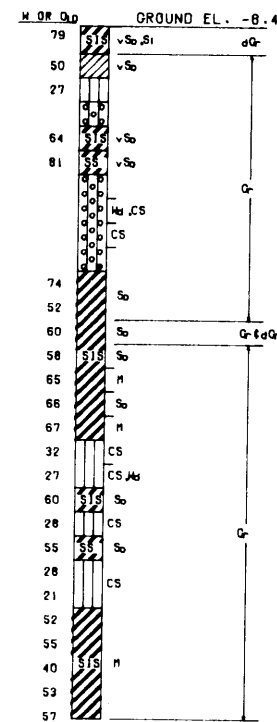

**BOR. 68-MHUL**

STA. 554+00  
475 FT. LEFT OF B.L.  
18-21 MAY 1970  
(FOR DETAILED  
DATA SEE PLATE 58)

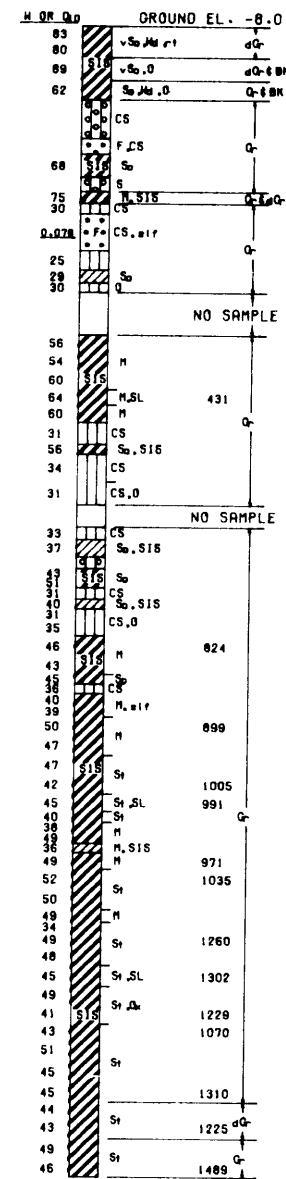

**BOR. 69-MHL**

STA. 555+35  
380 FT. LEFT B/L  
22 APR 70

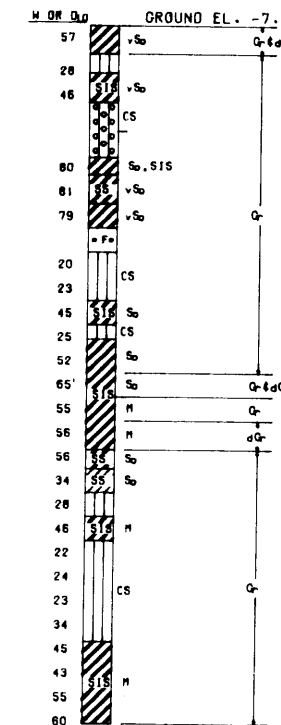

**BOR. 70-MHL**

STA. 555+35  
600 FT. LEFT B/L  
29 APR 70

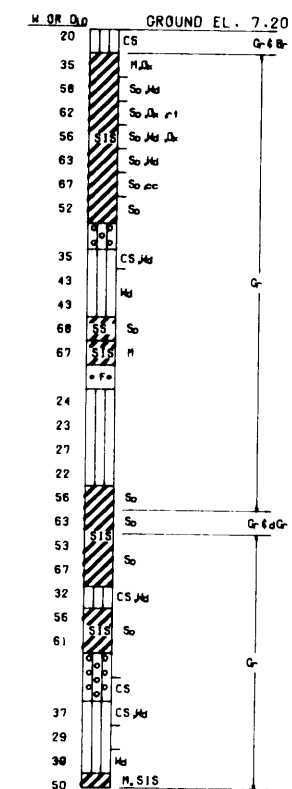

FOR SOIL BORING LEGEND SEE PLATE A  
FOR LOCATION OF BORINGS SEE PLATE I2

MISSISSIPPI RIVER LEVEES AND BANKS  
MILE 66 TO MILE 10  
SOIL REPORT - PART I  
EAST BANK  
**SOIL BORING DATA**  
OSTRICA LOCK  
U.S. ARMY ENGINEER DISTRICT, NEW ORLEANS  
CORPS OF ENGINEERS  
AUGUST 1971

BOR. 71-MHL  
 STA. 368+10  
 225 FT. LEFT B/L  
 5 MAY 70

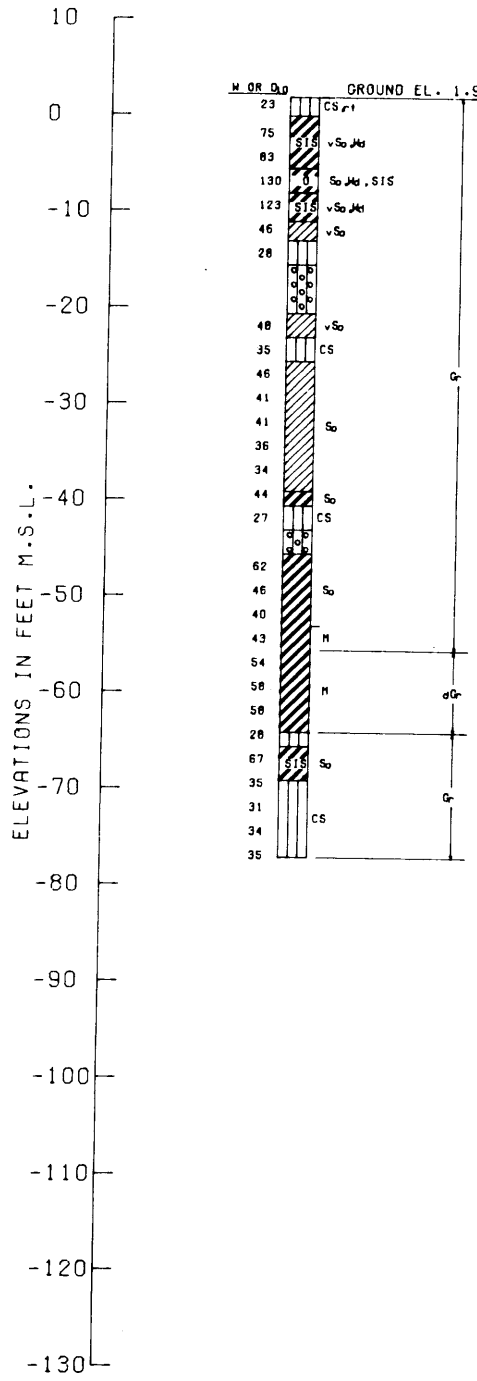

BOR. 72-MHL  
 STA. 371+00  
 140 FT. LEFT B/L  
 30 APR 70

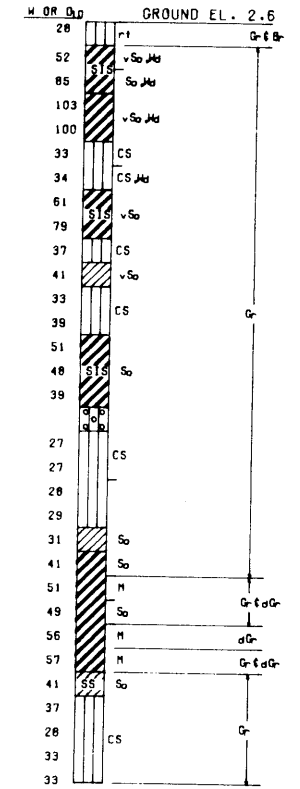

BOR. 73-MHUL  
 STA. 371+00  
 275 FT. LEFT OF B.L.  
 9-10 SEPT 70  
 WATER DEPTH 2.5 FT  
 (FOR DETAILED DATA  
 SEE PLATE 62)

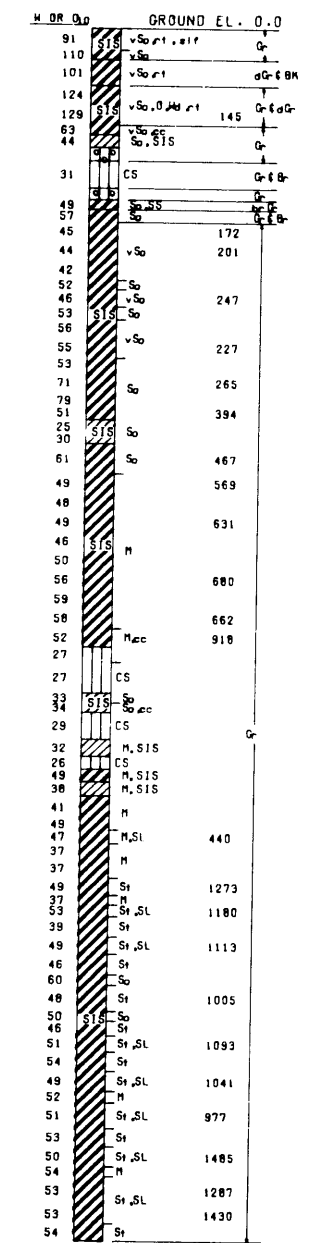

BOR. 74-MHL  
 STA. 371+20  
 420 FT. LEFT B/L  
 1 MAY 70

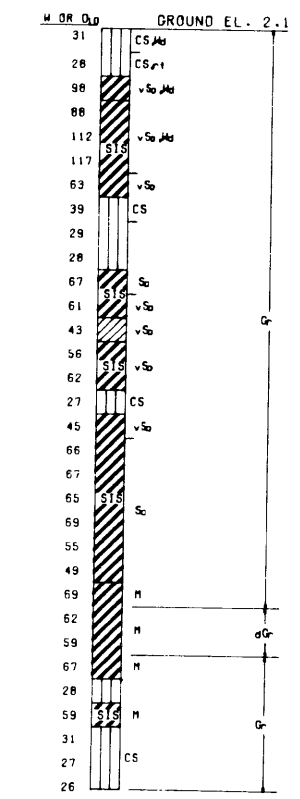

BOR. 75-MHL  
 STA. 372+50  
 250 FT. LEFT B/L  
 4 MAY 70

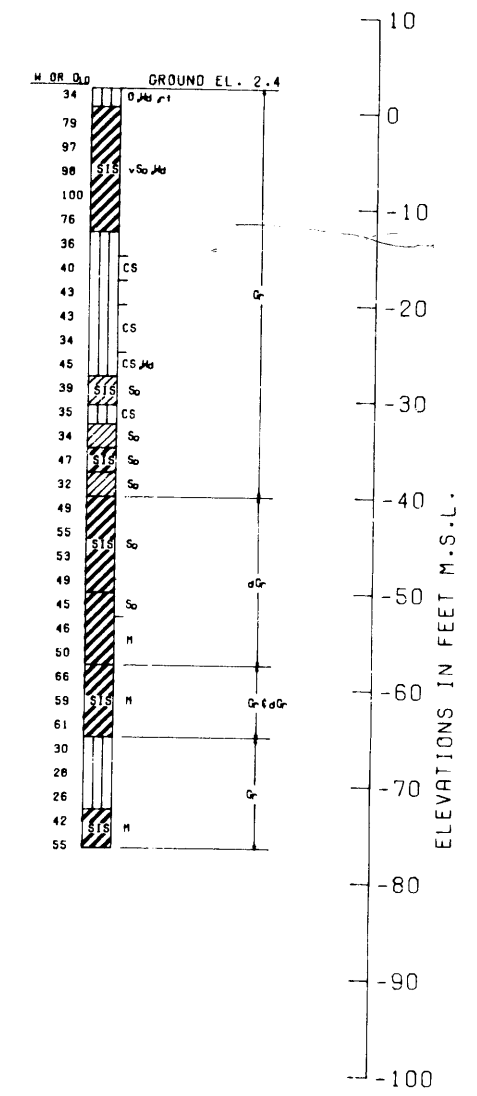

FOR SOIL BORING LEGEND SEE PLATE A  
 FOR LOCATION OF BORINGS SEE PLATE 13

MISSISSIPPI RIVER LEVEES AND BANKS  
 MILE 66 TO MILE 10  
 SOIL REPORT - PART I  
 EAST BANK  
**SOIL BORING DATA**  
 FRESHWATER CULVERT  
 VICINITY MILE 18.2 AHP  
 U.S. ARMY ENGINEER DISTRICT, NEW ORLEANS  
 CORPS OF ENGINEERS  
 AUGUST 1971

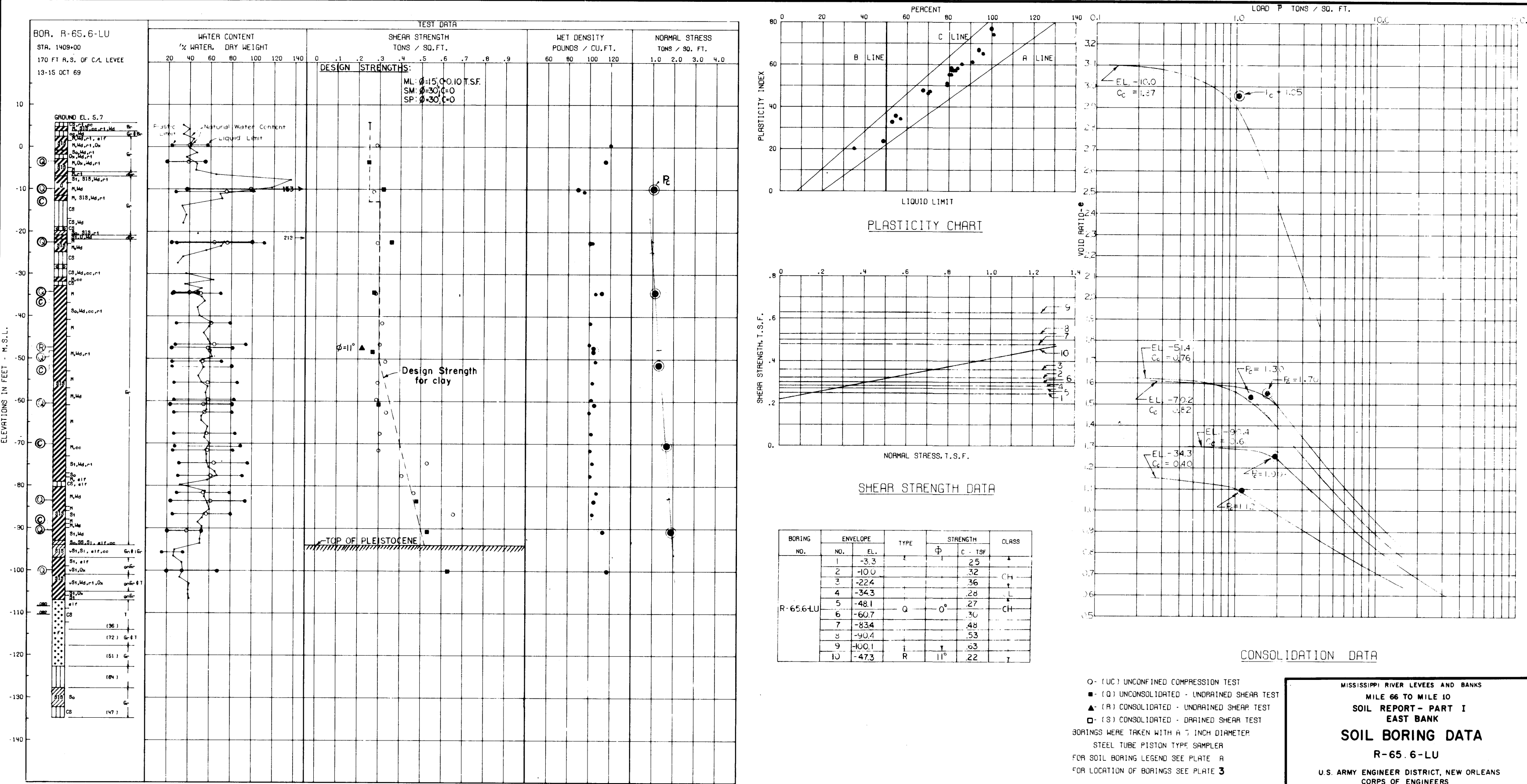

BOR. R-65.6-LU  
STA. 1409+00  
170 FT R.S. OF C.A. LEVEE  
13-15 OCT 69

TEST DATA  
WATER CONTENT % WATER, DRY WEIGHT  
SHEAR STRENGTH TONS / SQ. FT.  
WET DENSITY POUNDS / CU. FT.  
NORMAL STRESS TONS / SQ. FT.

DESIGN STRENGTHS:  
ML: 0-15, C: 0.10 T.S.F.  
SM: 0-30, C: 0  
SP: 0-30, C: 0

PLASTICITY CHART

SHEAR STRENGTH DATA

CONSOLIDATION DATA

BORING NO.	ENVELOPE		TYPE	STRENGTH		CLASS
	NO.	EL.		$\phi$	C - TSF	
R-65.6-LU	1	-3.3			25	
	2	-10.0			32	CH
	3	-22.4			36	CH
	4	-34.3			28	CL
	5	-48.1			27	CH
	6	-60.7		Q	30	CH
	7	-83.4			48	
	8	-90.4			53	
	9	-100.1			63	
	10	-47.3		R	11°	7

O - (UC) UNCONFINED COMPRESSION TEST  
■ - (U) UNCONSOLIDATED - UNDRAINED SHEAR TEST  
▲ - (A) CONSOLIDATED - UNDRAINED SHEAR TEST  
□ - (S) CONSOLIDATED - DRAINED SHEAR TEST  
BORINGS WERE TAKEN WITH A 7 INCH DIAMETER  
STEEL TUBE PISTON TYPE SAMPLER  
FOR SOIL BORING LEGEND SEE PLATE A  
FOR LOCATION OF BORINGS SEE PLATE B

MISSISSIPPI RIVER LEVEES AND BANKS  
MILE 66 TO MILE 10  
SOIL REPORT - PART I  
EAST BANK  
**SOIL BORING DATA**  
R-65.6-LU  
U.S. ARMY ENGINEER DISTRICT, NEW ORLEANS  
CORPS OF ENGINEERS

BOR. NO. R-62.6-LU  
 STA. 1564+00  
 140 FT. R.S. OF C.L. LEVEE  
 8-10 OCT 69

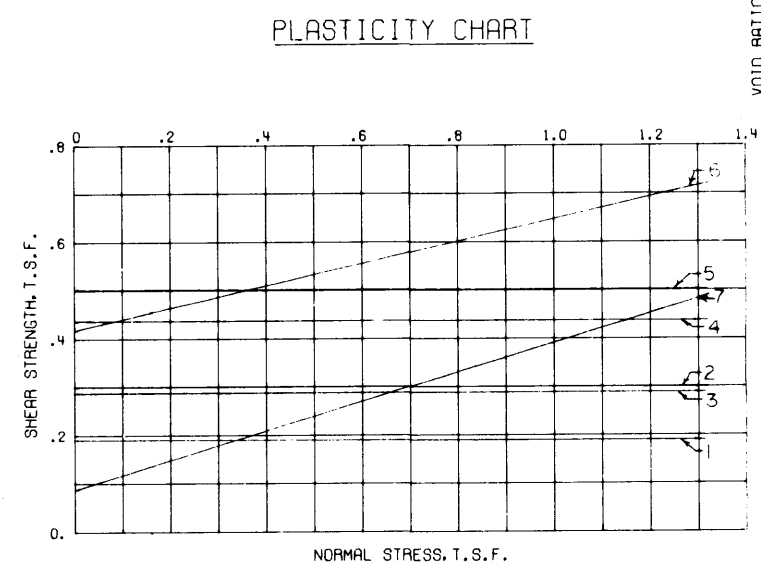
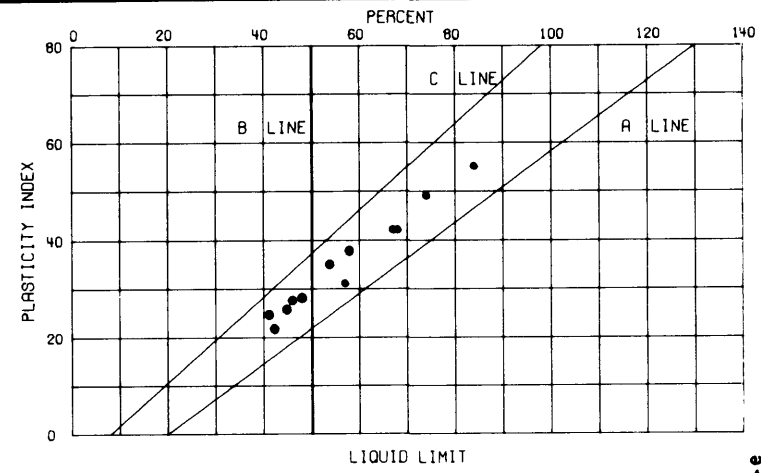
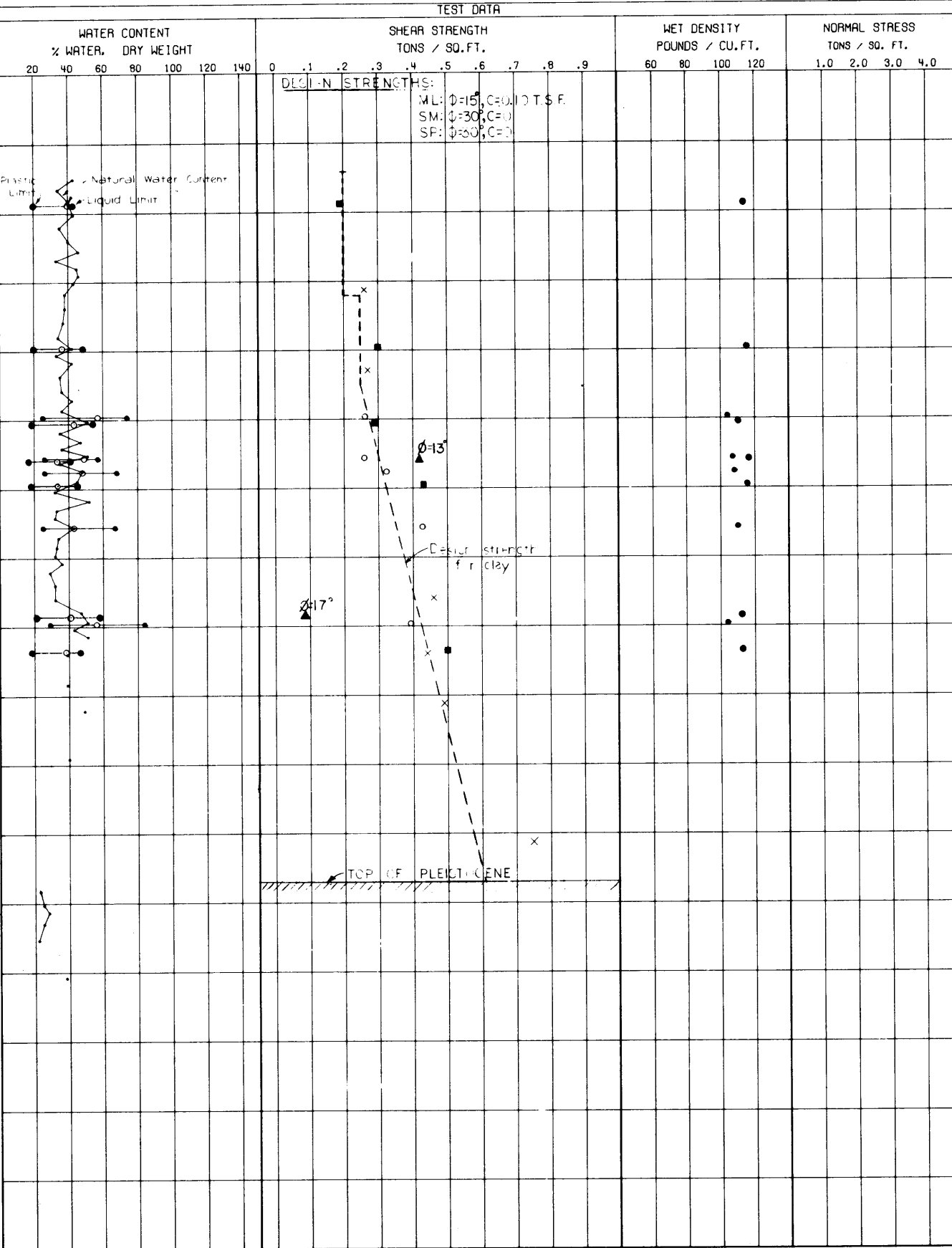
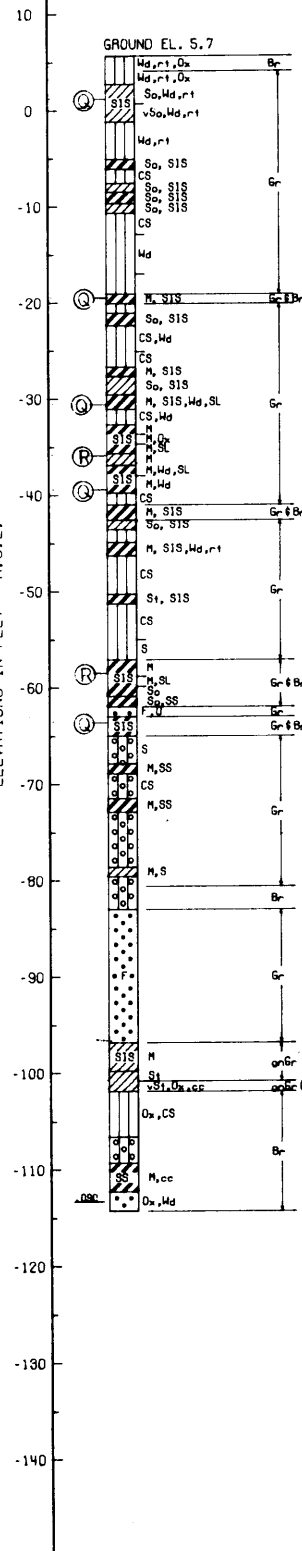

BORING NO.	ENVELOPE		TYPE	STRENGTH		CLASS
	NO.	EL.		$\phi$	C - TSF	
R-62.6-LU	1	+1.2		0°	19	CL
	2	-19.5		0°	30	CL
	3	-30.5	Q	0°	29	CH
	4	-34.3		0°	44	CL
	5	-63.3		0°	50	CL
	6	-35.5		13°	42	CL
	7	-58.3		17°	09	CH

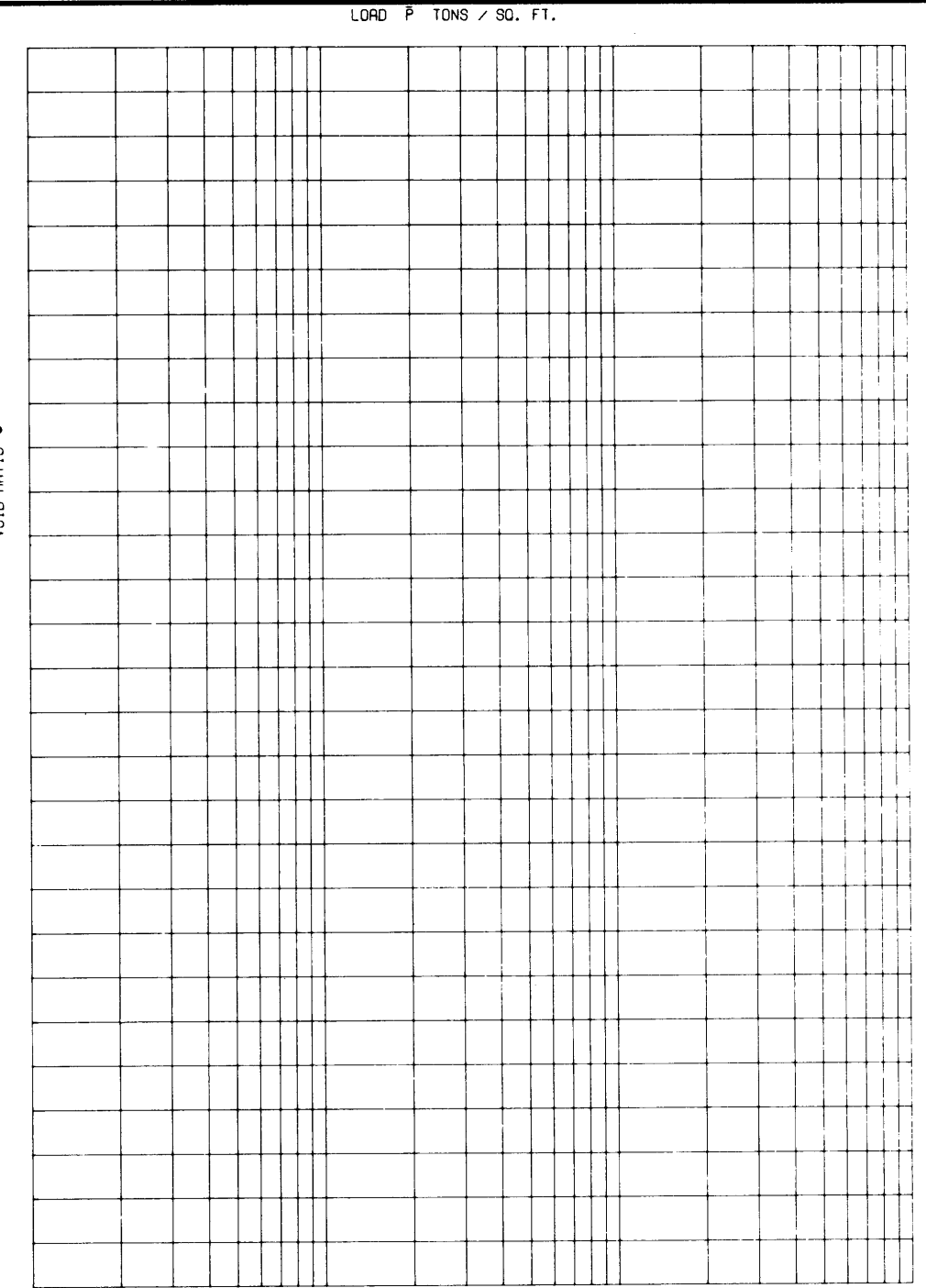

CONSOLIDATION DATA

○ - (UC) UNCONFINED COMPRESSION TEST  
 ■ - (Q) UNCONSOLIDATED - UNDRAINED SHEAR TEST  
 ▲ - (R) CONSOLIDATED - UNDRAINED SHEAR TEST  
 □ - (S) CONSOLIDATED - DRAINED SHEAR TEST

BORINGS WERE TAKEN WITH A 5 INCH DIAMETER  
 STEEL TUBE PISTON TYPE SAMPLER  
 FOR SOIL BORING LEGENDS SEE PLATE A  
 FOR LOCATION OF BORINGS SEE PLATE 4

MISSISSIPPI RIVER LEVEES AND BANKS  
 MILE 66 TO MILE 10  
 SOIL REPORT - PART I  
 EAST BANK  
**SOIL BORING DATA**  
 R-62.6-LU  
 U.S. ARMY ENGINEER DISTRICT, NEW ORLEANS  
 CORPS OF ENGINEERS



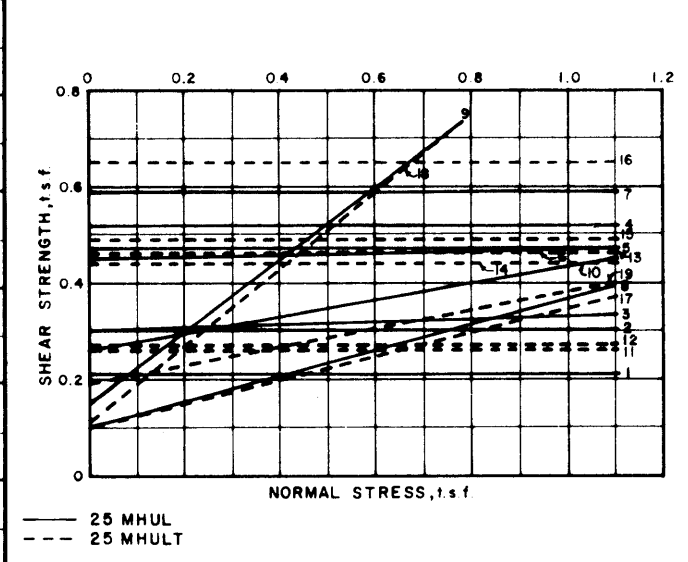
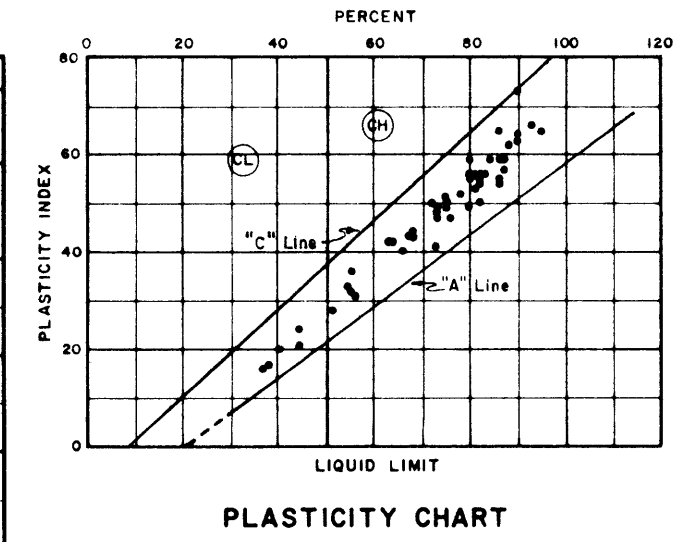
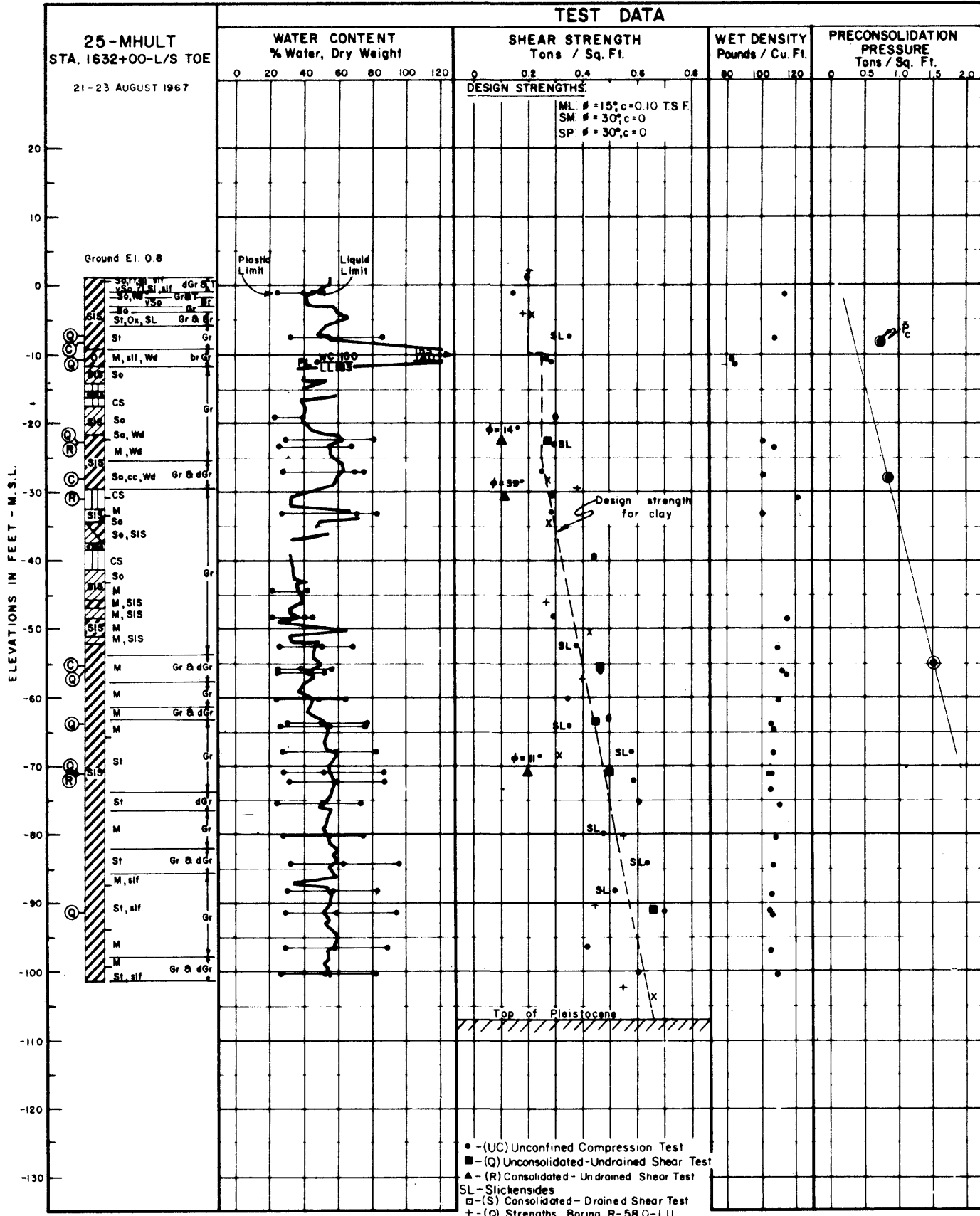
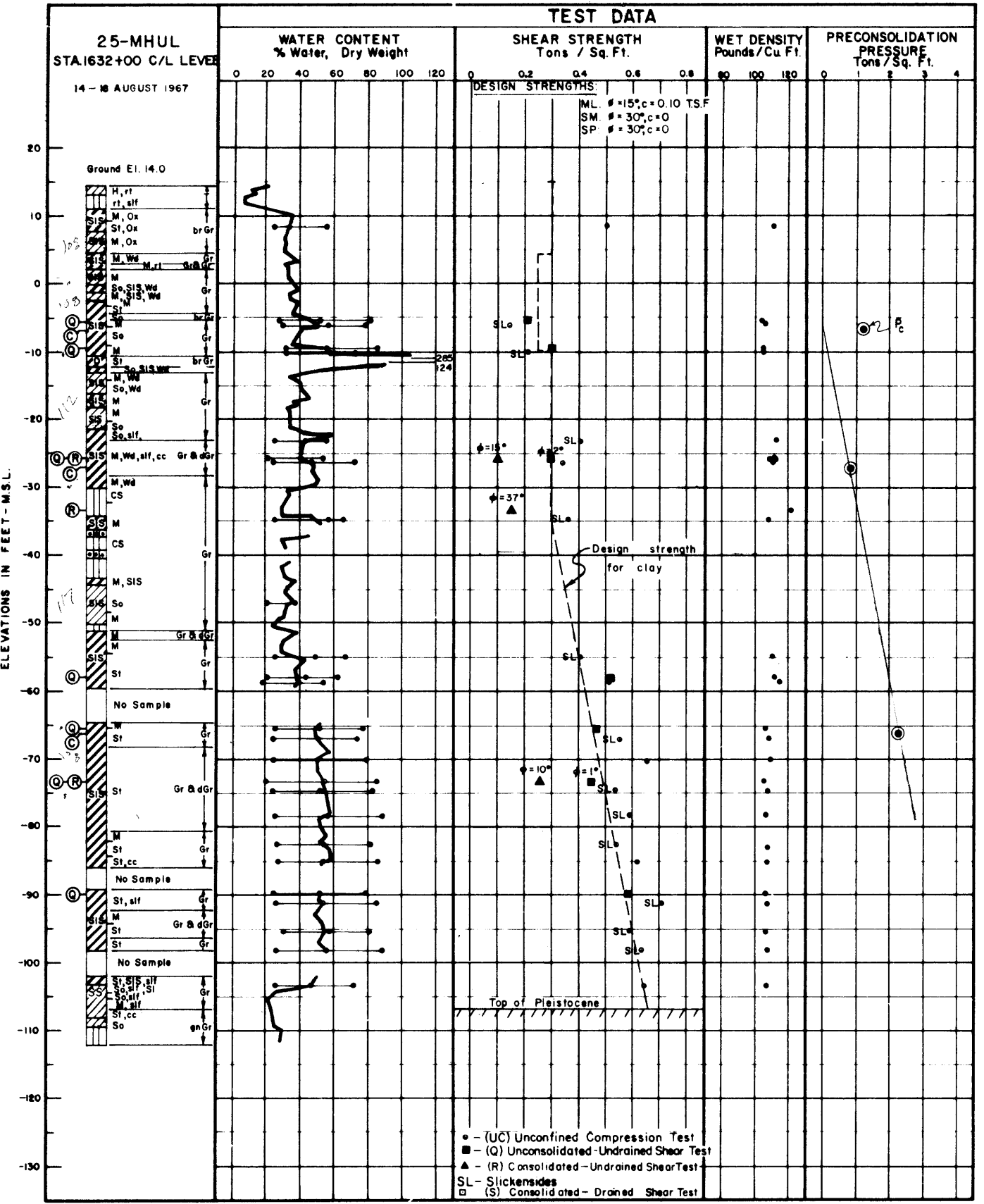

BORING NO	ENVELOPE		TYPE	STRENGTH		CLASS	
	NO	EL		$\phi$	(t.s.f.)		
25 MHUL	1	-59		0	0.21	CH	
	2	-99		0	0.30	CH	
	3	-261		2	0.30	CH	
	4	-583		0	0.52	CH	
	5	-659		0	0.47	CH	
	6	-737		1	0.45	CH	
	7	-901		0	0.59	CH	
8	-261		15	0.10	CH		
9	-337		R	*37	0.15	ML	
10	-737		10	0.26	CH		
25 MHULT	11	-110		0	0.26	CH	
	12	-230		0	0.27	CH	
	13	-561		0	0.46	CH	
	14	-640		0	0.44	CH	
	15	-712		0	0.49	CH	
	16	-913		0	0.65	CH	
	17	-230		14	0.10	CL	
	18	-311		R	*39	0.11	ML
	19	-712		11	0.19	CH	

\* BASED ON DEVIATOR STRESS AT MAXIMUM POSITIVE PORE PRESSURE:  $\beta = 18.8^\circ, c = 0.20$  TS.F.

**SHEAR STRENGTH DATA**

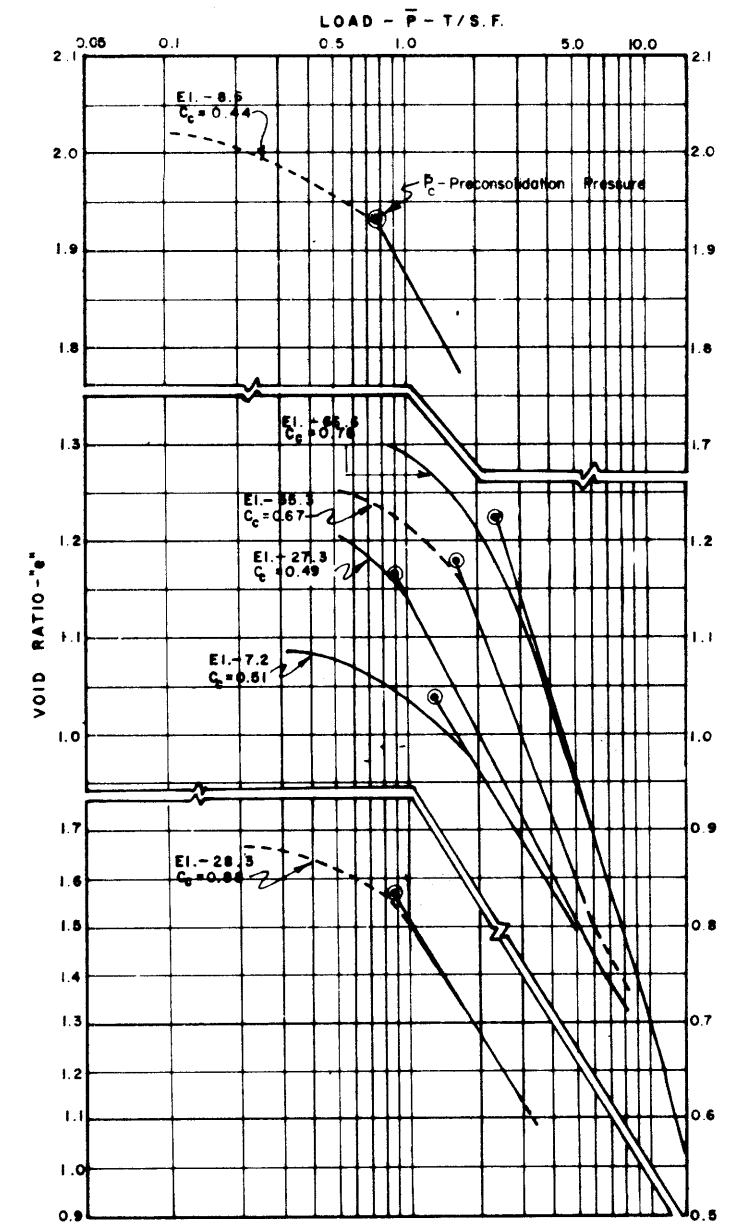

— Boring No. 25 MHUL  
 - - - Boring No. 25 MHULT

For soil boring legend see plate A  
 For location of borings see plate 4

Borings were taken with a 5" diameter steel tube piston type sampler.

MISSISSIPPI RIVER LEVEES AND BANKS  
 MILE 66 TO MILE 10  
 SOIL REPORT - PART I  
 EAST BANK  
**SOIL BORING DATA**  
 25-MHUL AND 25 MHULT  
 STA. 1632 + 00  
 U.S. ARMY ENGINEER DISTRICT, NEW ORLEANS  
 CORPS OF ENGINEERS  
 AUGUST 1971

BOR. R-60.3-UL  
 STA. 1695+00  
 152 FT. R.S. OF C.L. LEVEE  
 9-14 JULY 69

ELEVATIONS IN FEET - M.S.L.

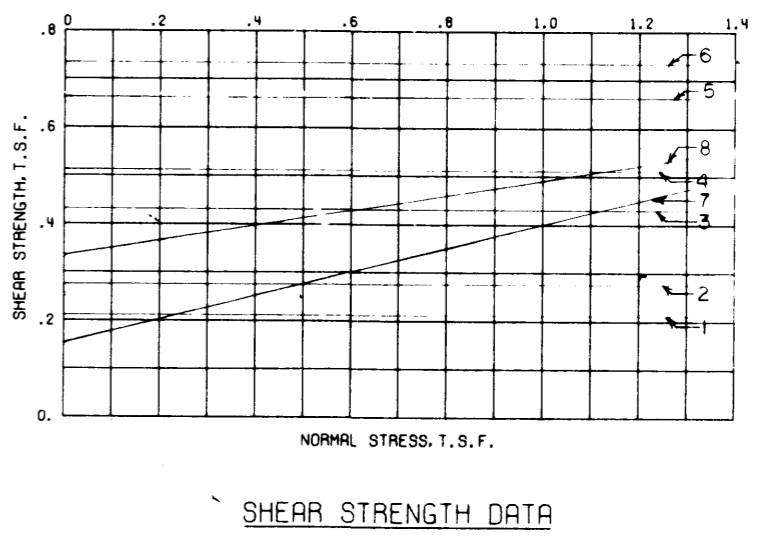
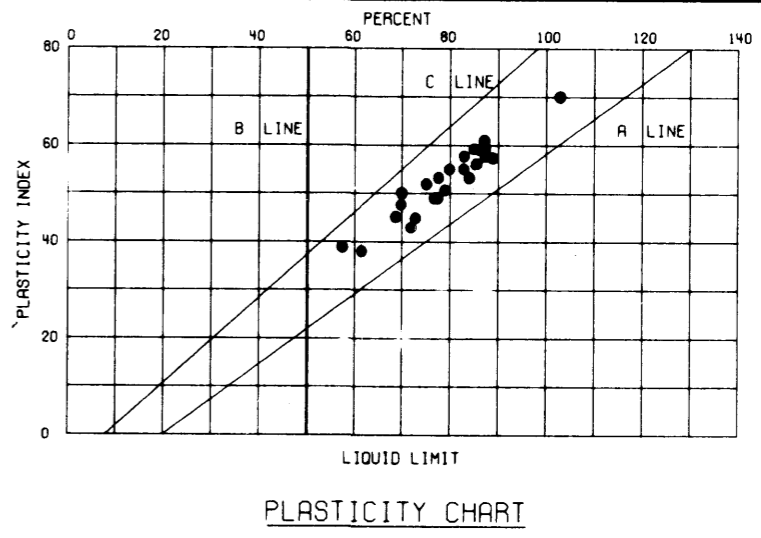
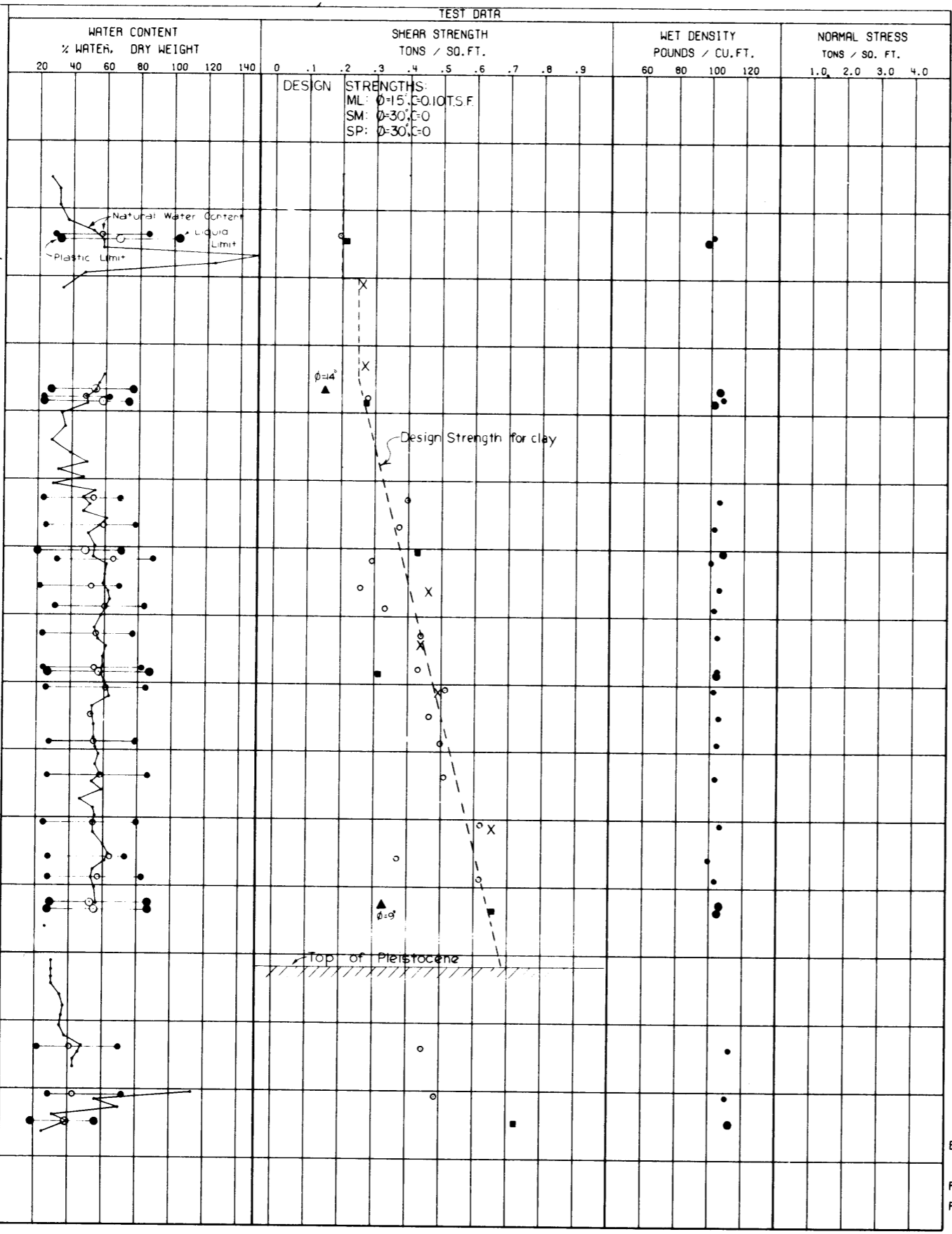
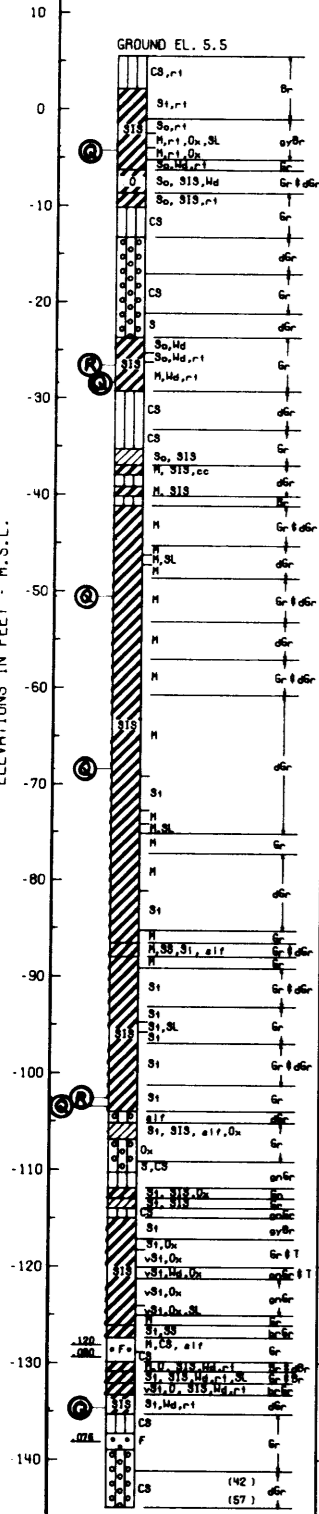

BORING NO.	ENVELOPE		TYPE	STRENGTH		CLASS	
	NO.	EL.		$\phi$	C - TSF		
R-60.3-UL	1	-4.4			.21	CH	
	2	-28.4			.27	CH	
	3	-50.5			.43	CH	
	4	-68.4	Q	0°	.31	CH	
	5	-103.5			.66	CH	
	6	-134.7			.73	CH	
	7	-26.6		R	14	.15	CH
	8	-102.6		R	9	.33	CH

○ - (UC) UNCONFINED COMPRESSION TEST  
 ■ - (Q) UNCONSOLIDATED - UNDRAINED SHEAR TEST  
 ▲ - (R) CONSOLIDATED - UNDRAINED SHEAR TEST  
 □ - (S) CONSOLIDATED - DRAINED SHEAR TEST

BORINGS WERE TAKEN WITH A 5 INCH DIAMETER  
 STEEL TUBE PISTON TYPE SAMPLER  
 FOR SOIL BORING LEGEND SEE PLATE A  
 FOR LOCATION OF BORINGS SEE PLATE 4

MISSISSIPPI RIVER LEVEES AND BANKS  
 MILE 66 TO MILE 10  
 SOIL REPORT - PART I  
 EAST BANK  
**SOIL BORING DATA**  
 R-60.3-UL  
 U.S. ARMY ENGINEER DISTRICT, NEW ORLEANS  
 CORPS OF ENGINEERS

X-(Q) Strengths, Boring 25-MHULT

AUGUST 1971

FILE NO H-2-25275

BOR. R-58.0-LU  
 STA. 1800+00  
 100 FT. R.S. OF C.L. LEV.  
 16 OCT 69

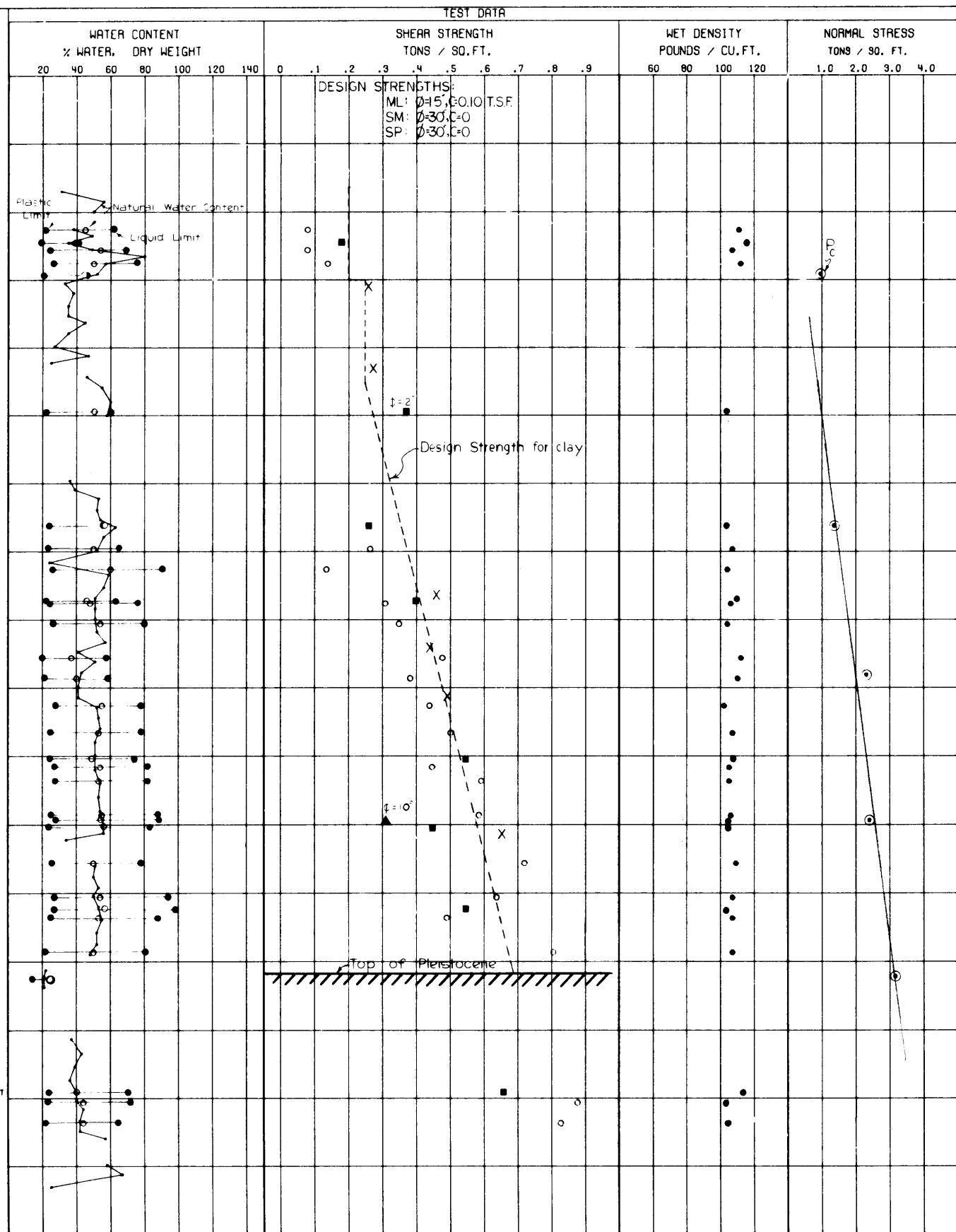
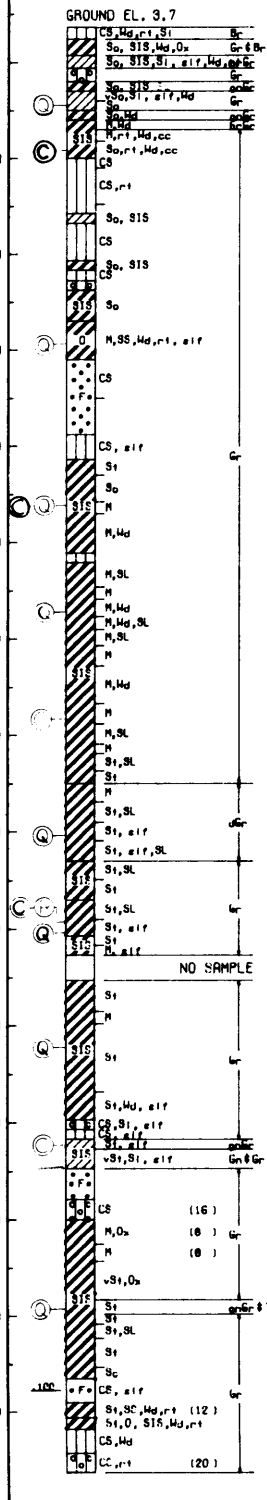

DESIGN STRENGTHS:  
 ML: 0.15, 0.10 T.S.F.  
 SM: 0.30, C=0  
 SP: 0.30, C=0

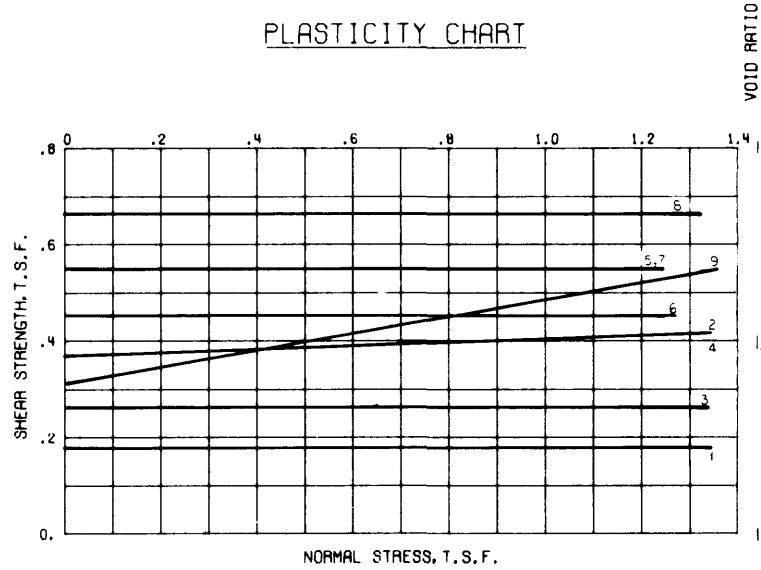
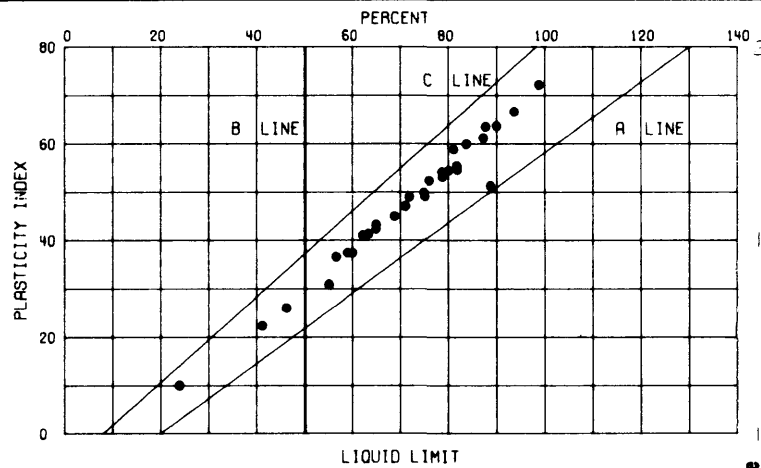

BORING NO.	ENVELOPE		TYPE	STRENGTH		CLASS
	NO.	EL.		$\phi$	C - TSF	
R-58.0-LU	1	-4.4	R	0	.18	CL
	2	-29.4		2	.37	CH
	3	-46.2		0	.26	CH
	4	-57.2		0	.40	CH
	5	-80.4		0	.55	CH
	6	-90.3		0	.45	CH
	7	-102.3		0	.55	CH
	8	-129.2		0	.66	CH
	9	-89.4		10	.31	CH

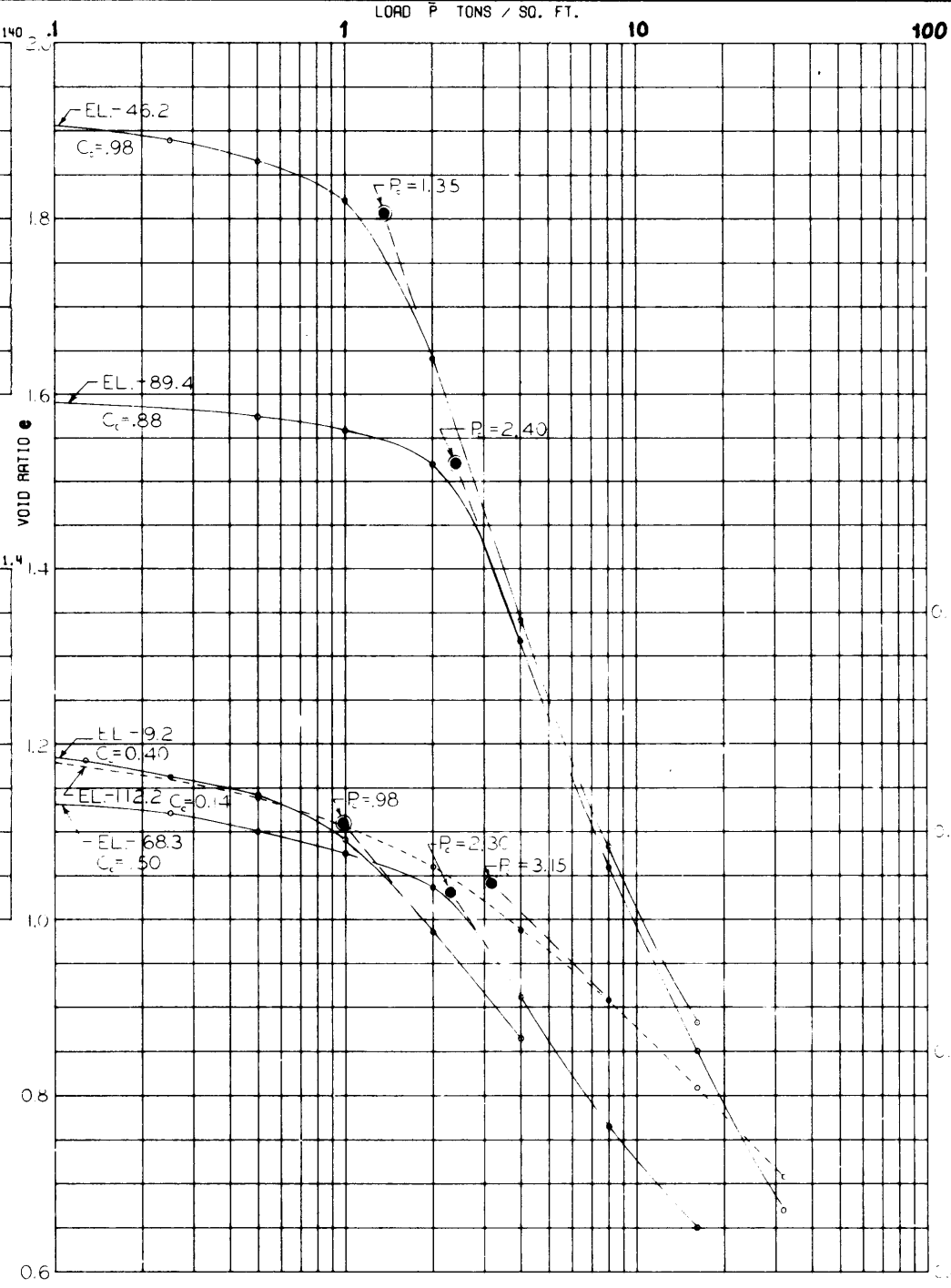

○ - (UC) UNCONFINED COMPRESSION TEST  
 ■ - (Q) UNCONSOLIDATED - UNDRAINED SHEAR TEST  
 ▲ - (R) CONSOLIDATED - UNDRAINED SHEAR TEST  
 □ - (S) CONSOLIDATED - DRAINED SHEAR TEST  
 BORINGS WERE TAKEN WITH A 5 INCH DIAMETER STEEL TUBE PISTON TYPE SAMPLER  
 FOR SOIL BORING LEGEND SEE PLATE A  
 FOR LOCATION OF BORINGS SEE PLATE B

MISSISSIPPI RIVER LEVEES AND BANKS  
 MILE 66 TO MILE 10  
 SOIL REPORT - PART I  
 EAST BANK  
**SOIL BORING DATA**  
 R-58.0-LU  
 U.S. ARMY ENGINEER DISTRICT, NEW ORLEANS  
 CORPS OF ENGINEERS

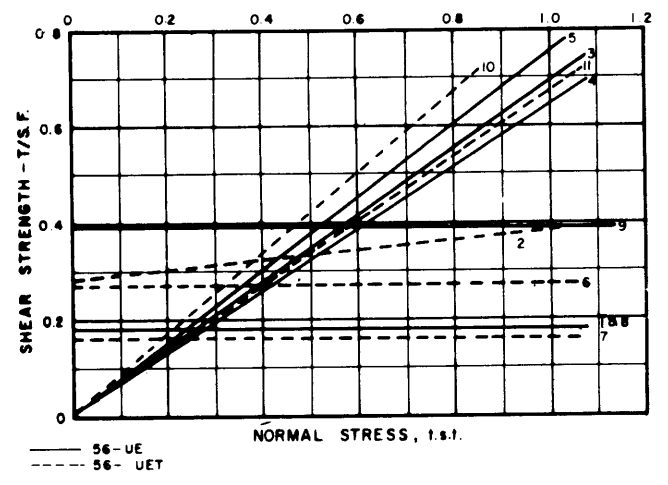
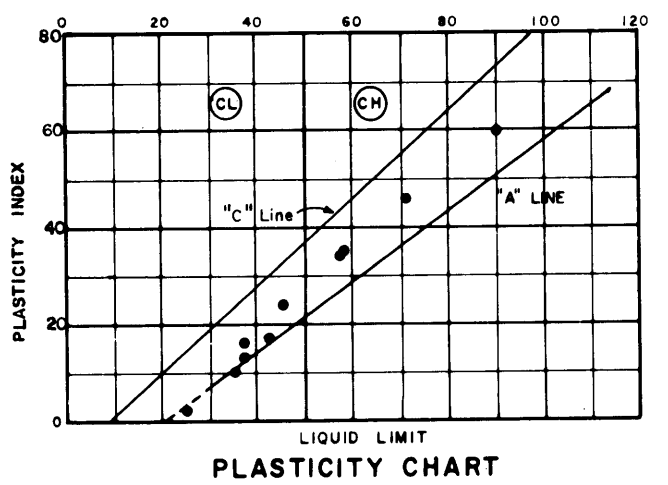
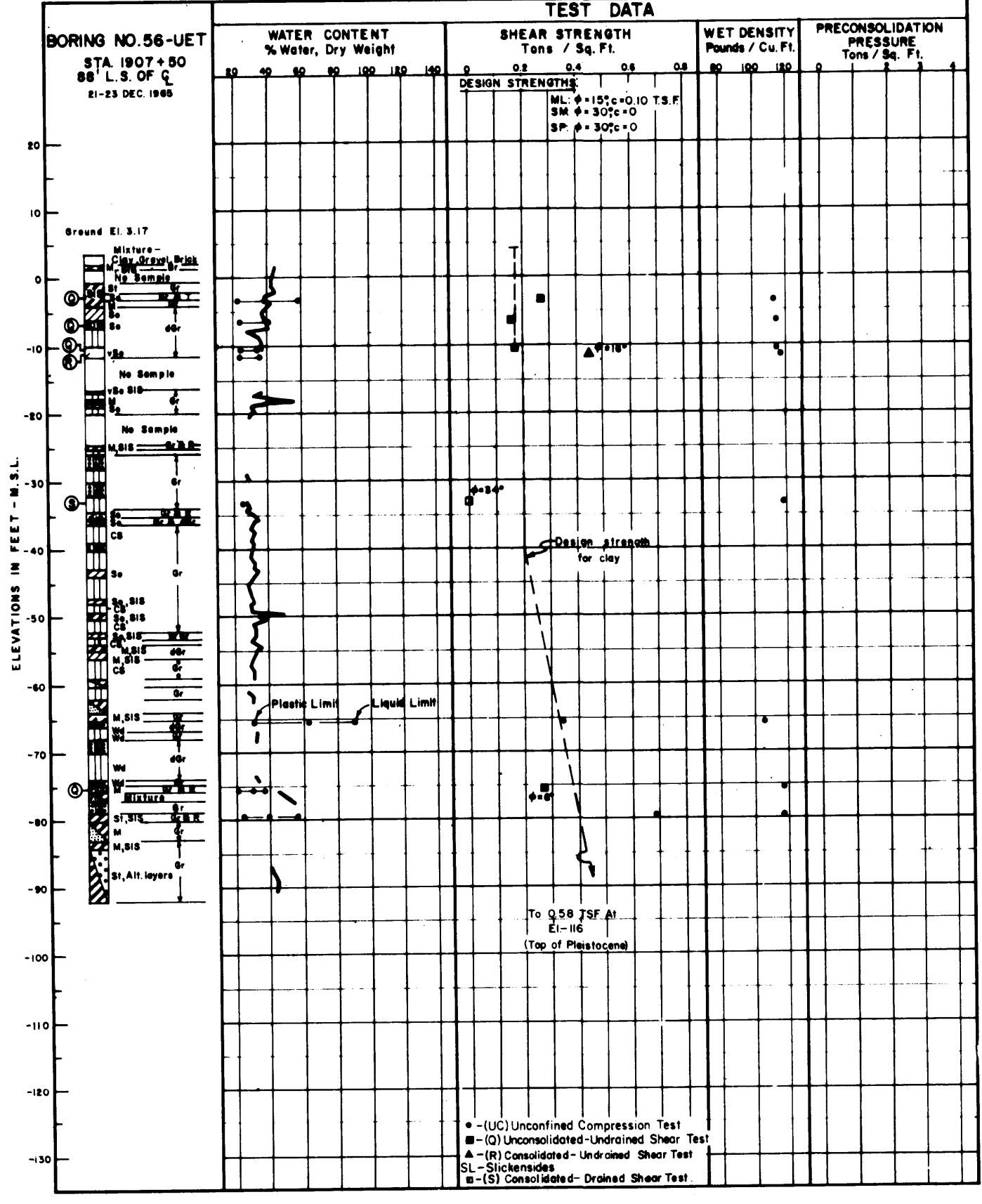
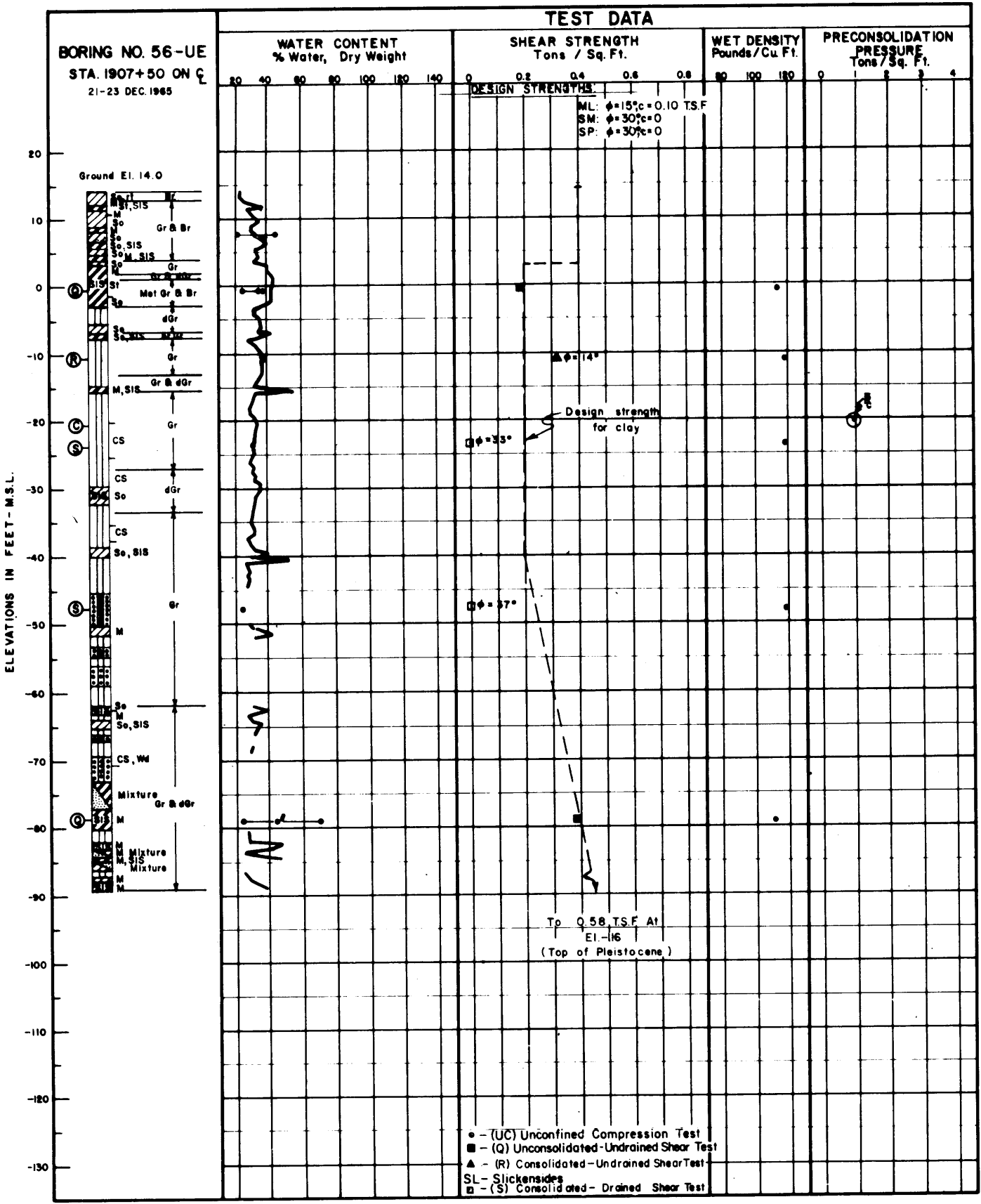

BORING NO.	ENVELOPE NO.	EL.	TYPE	STRENGTH $\phi$	STRENGTH $c$ (T.S.F.)	CLASS
56-UE	1	-0.7	Q	0	0.18	ML
	2	-79.0	Q	0	0.39	CH
	3	-11.1	R*	35	0.00	ML
	4	-23.8	S	35	0.00	ML
	5	-47.9	S	37	0.00	SM
56 UET	6	-3.3	Q	0	0.27	CH
	7	-6.7	Q	0	0.16	CL
	8	-10.6	Q	0	0.18	ML
	9	-75.6	Q	6	0.28	CL
	10	-11.5	R	40	0.00	CL
	11	-33.2	S	34	0.00	ML

\*BASED ON DEVIATOR STRESS AT MAXIMUM POSITIVE PORE PRESSURE:  $\beta=15^\circ, c=0.10$  T.S.F.

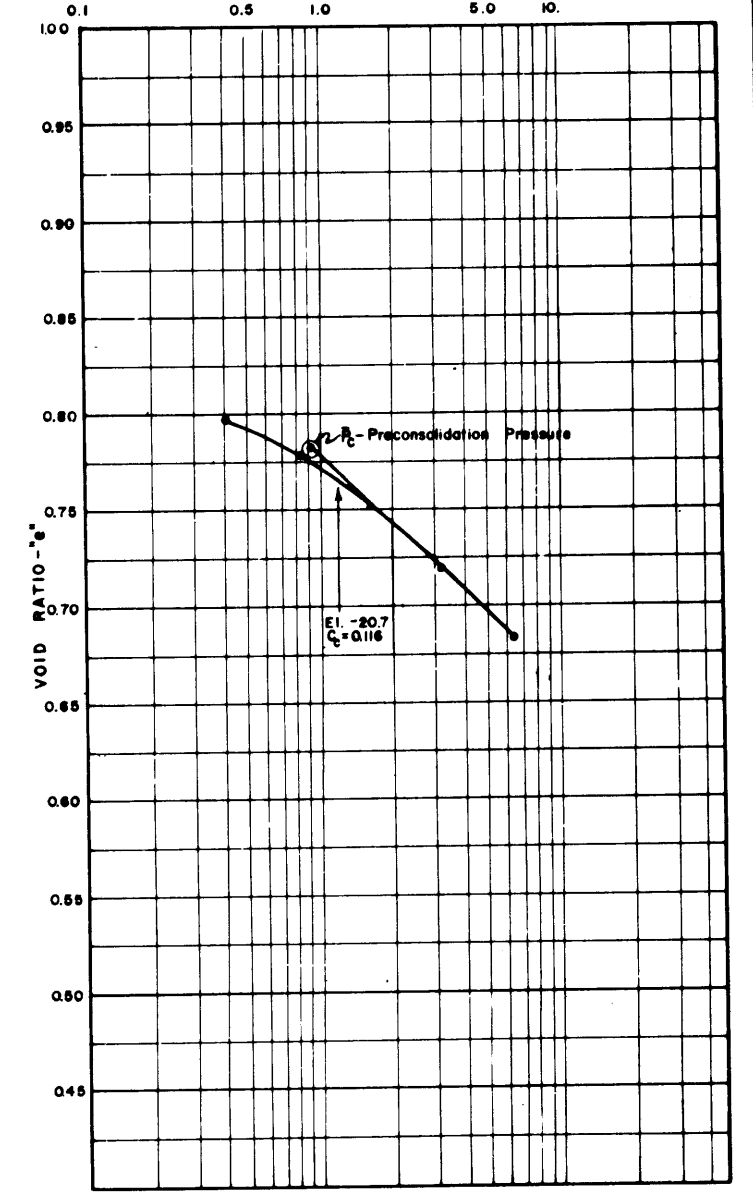

— Boring No. 56-UE  
--- Boring No. 56-UET  
For soil boring legend see plate A  
For location of borings see plate 5

Borings were taken with a 5" diameter steel tube piston type sampler.

MISSISSIPPI RIVER LEVEES AND BANKS  
MILE 66 TO MILE 10  
SOIL REPORT - PART I  
EAST BANK  
**SOIL BORING DATA**  
56-UE AND 56-UET  
STA. 1907+50  
U.S. ARMY ENGINEER DISTRICT, NEW ORLEANS  
CORPS OF ENGINEERS  
AUGUST 1971 FILE NO. H-2-25275

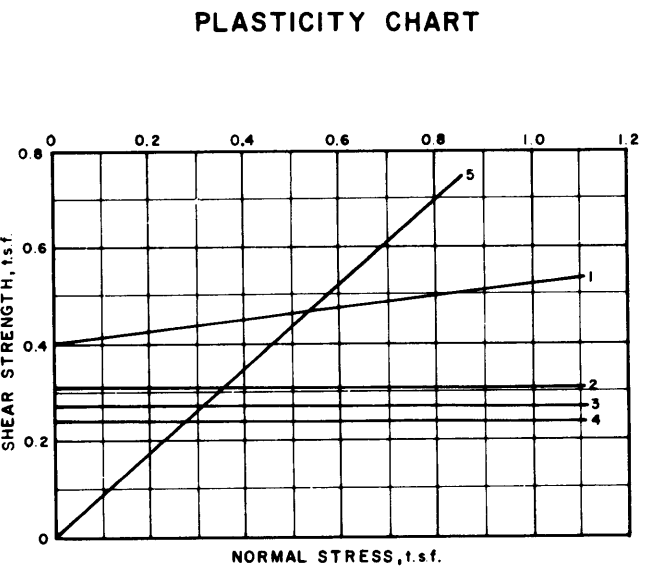
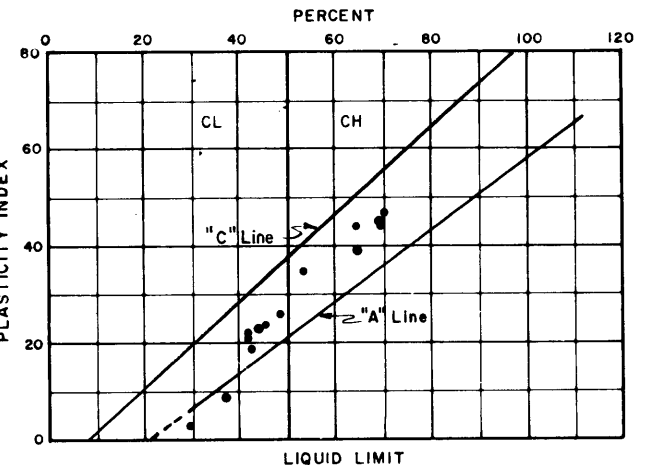
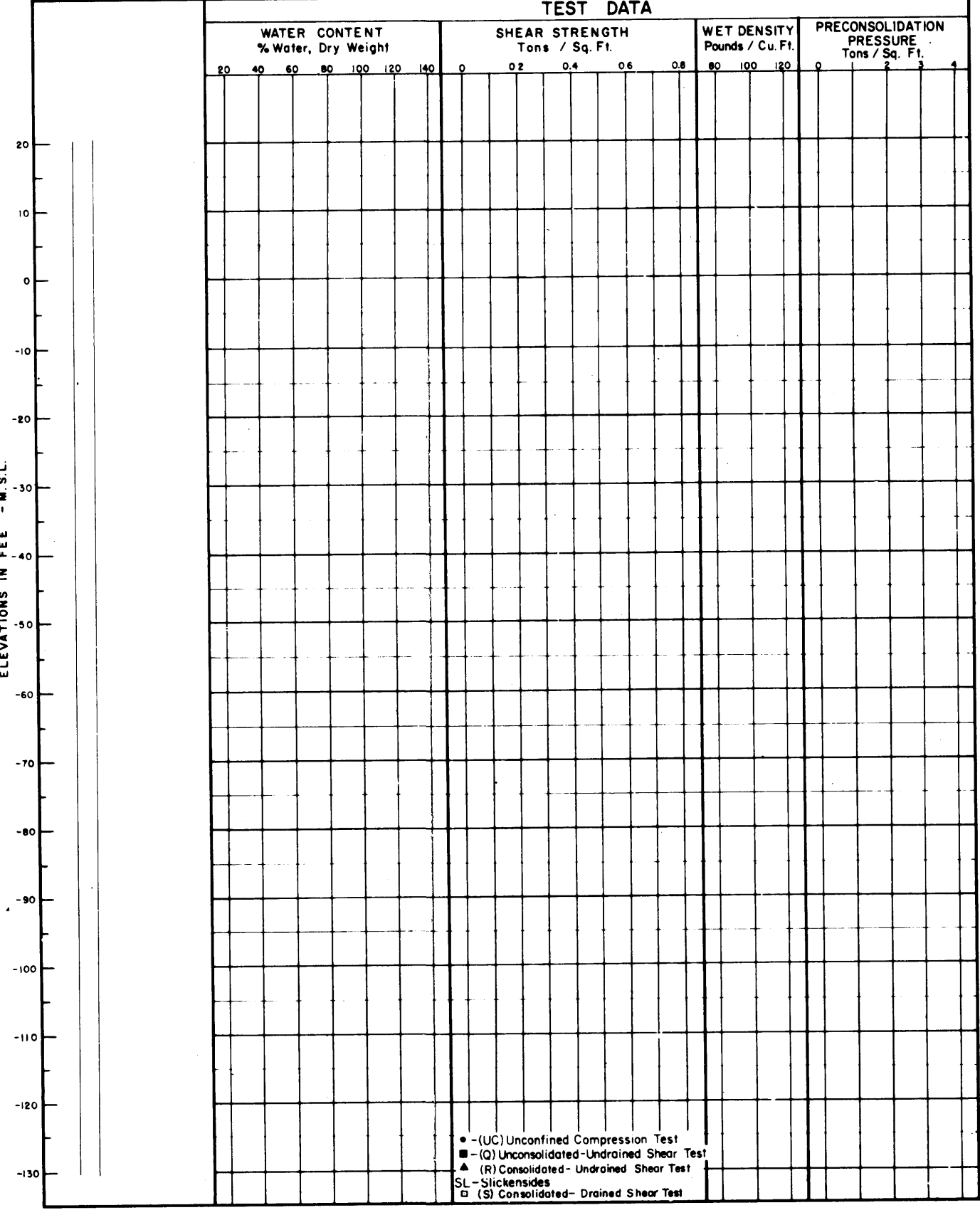
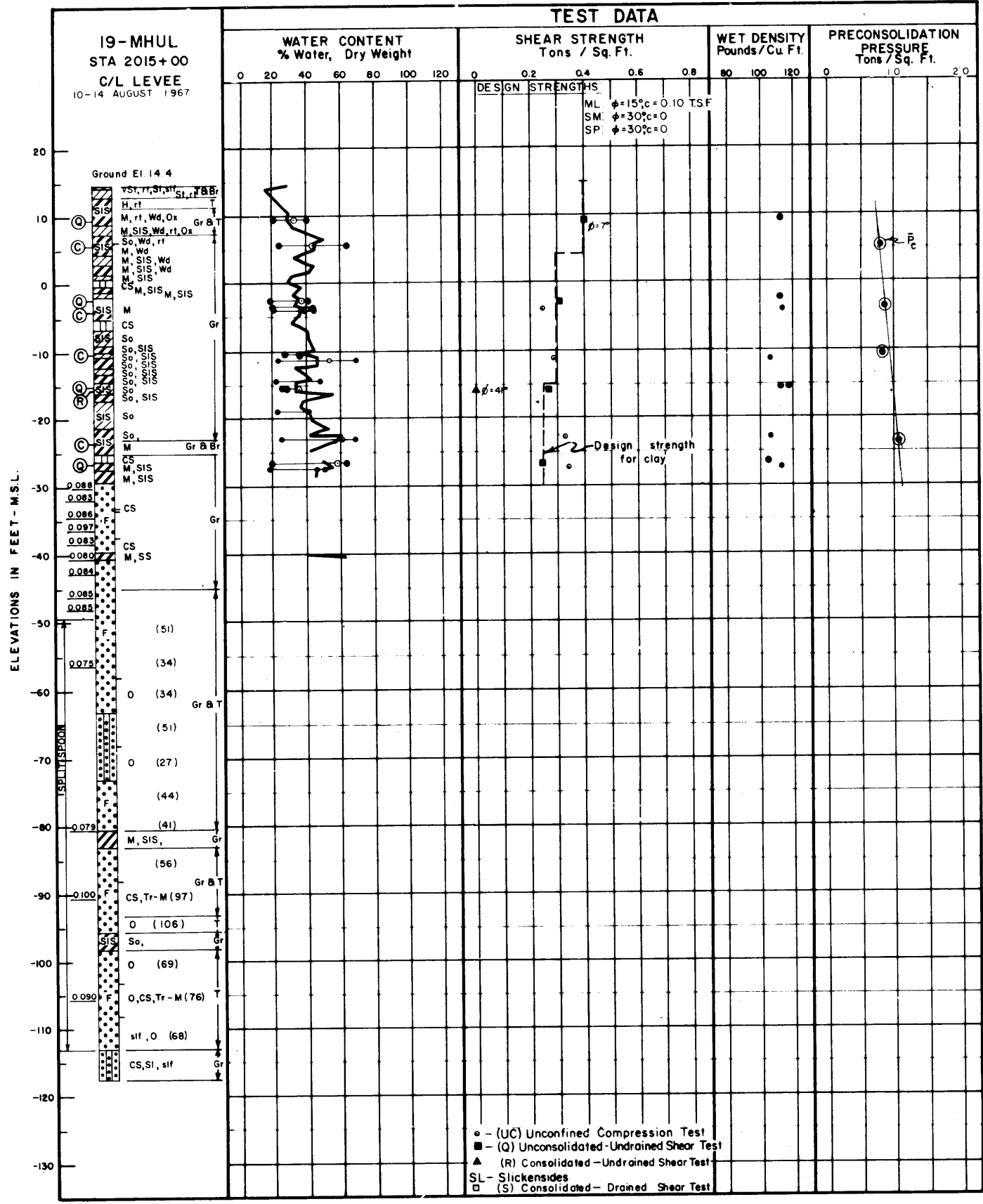

BORING NO.	ENVELOPE		TYPE	STRENGTH		CLASS
	NO.	EL.		$\phi^*$	(t.s.f.)	
19-MHUL	1	+ 9.2	Q	7	0.40	CL
	2	- 2.6		0	0.31	CL
	3	- 15.6		0	0.27	ML
	4	- 26.7		0	0.24	CH
	5	- 15.6		* R	41	0.00

\* BASED ON DEVIATOR STRESS AT MAXIMUM POSITIVE PORE PRESSURE:  $\phi=15.7^\circ, c=0.28$  TSF

**SHEAR STRENGTH DATA**

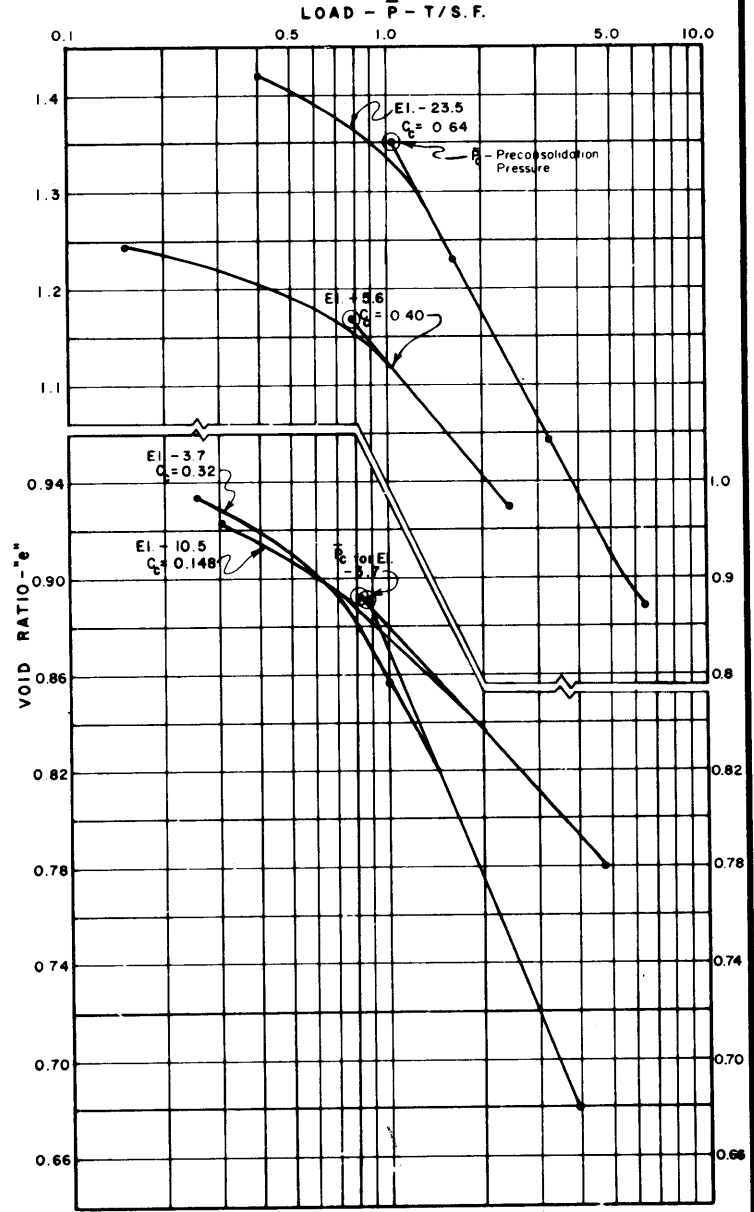

**CONSOLIDATION DATA**

— Boring No. 19 - MHUL  
 - - - Boring No.  
 For soil boring legend see plate A  
 For location of borings see plate 6

Borings were taken with a 5" diameter steel tube piston type sampler.

MISSISSIPPI RIVER LEVEES AND BANKS  
 MILE 66 TO MILE 10  
 SOIL REPORT - PART I  
 EAST BANK  
**SOIL BORING DATA**  
 19-MHUL  
 STA. 2015+00  
 U.S. ARMY ENGINEER DISTRICT, NEW ORLEANS  
 CORPS OF ENGINEERS  
 AUGUST 1971  
 FILE NO. H-2-25275

BOR. 19 MHULT  
 STA. 2015+00  
 70 FT. R.S. OF C.L. LEVEE  
 24 OCT. 69

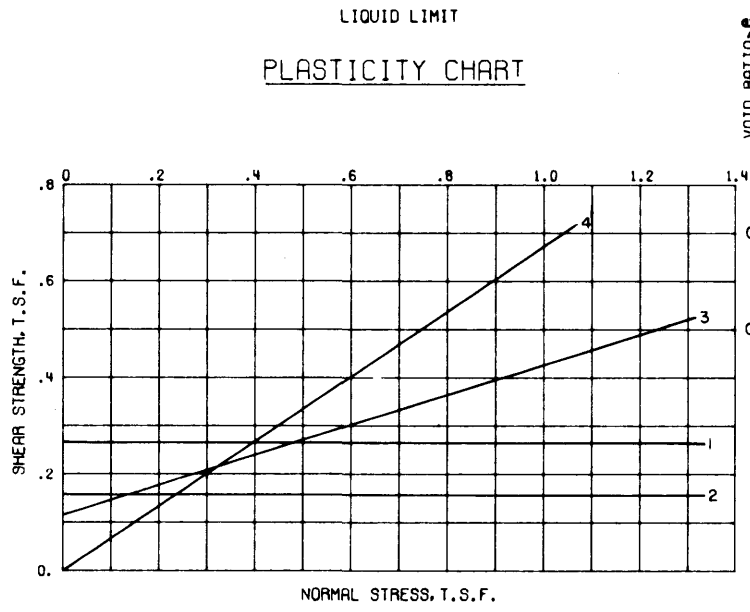
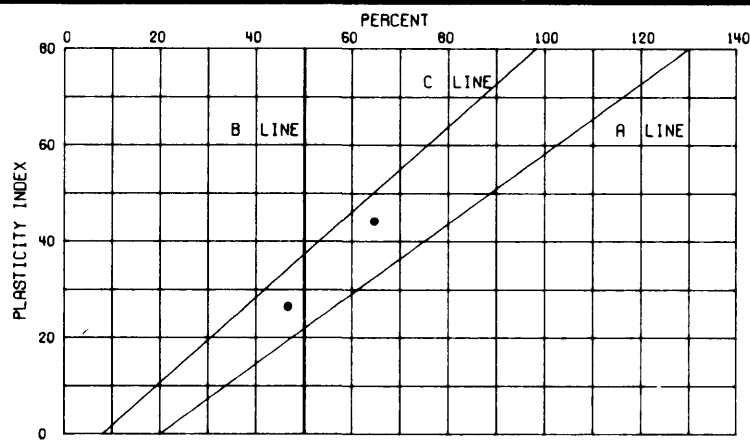
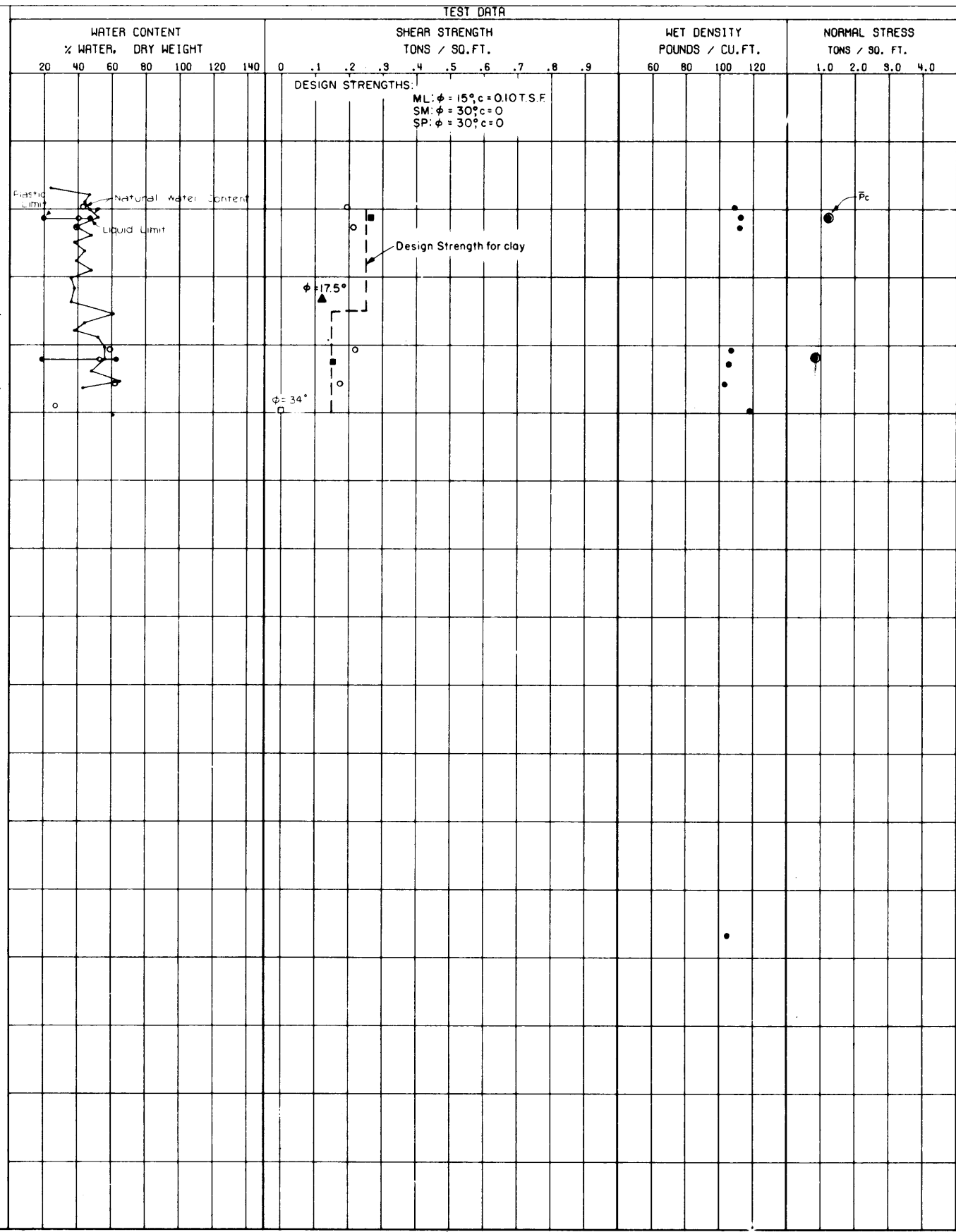
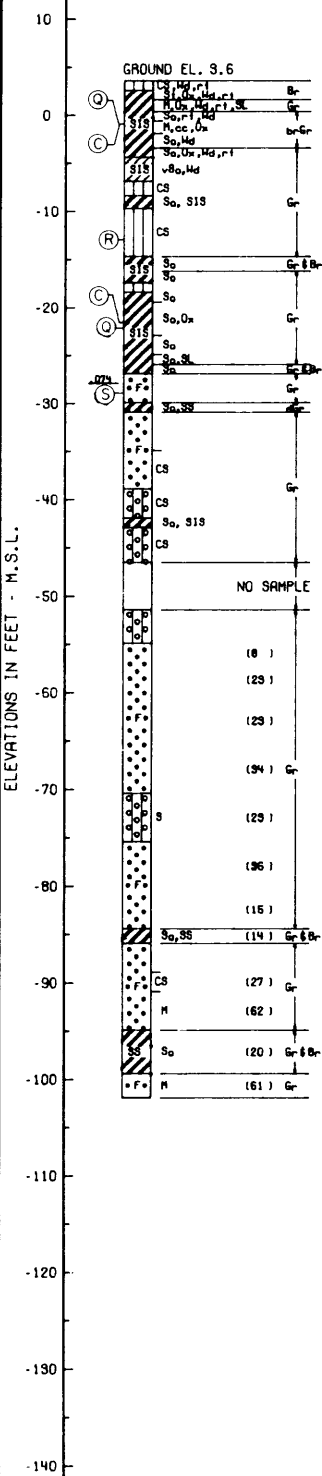

BORING NO.	ENVELOPE		TYPE	STRENGTH		CLASS
	NO.	EL.		Φ	C TSF	
19-MHULT	1	-12	Q	0	0.270	CL
	2	-22.5	Q	0	0.160	CH
	3	-13.3	R*	17.5°	0.120	ML
	4	-29.2	S	34°	0.00	SM

\*BASED ON DEVIATOR STRESS AT MAXIMUM POSITIVE PORE PRESSURE

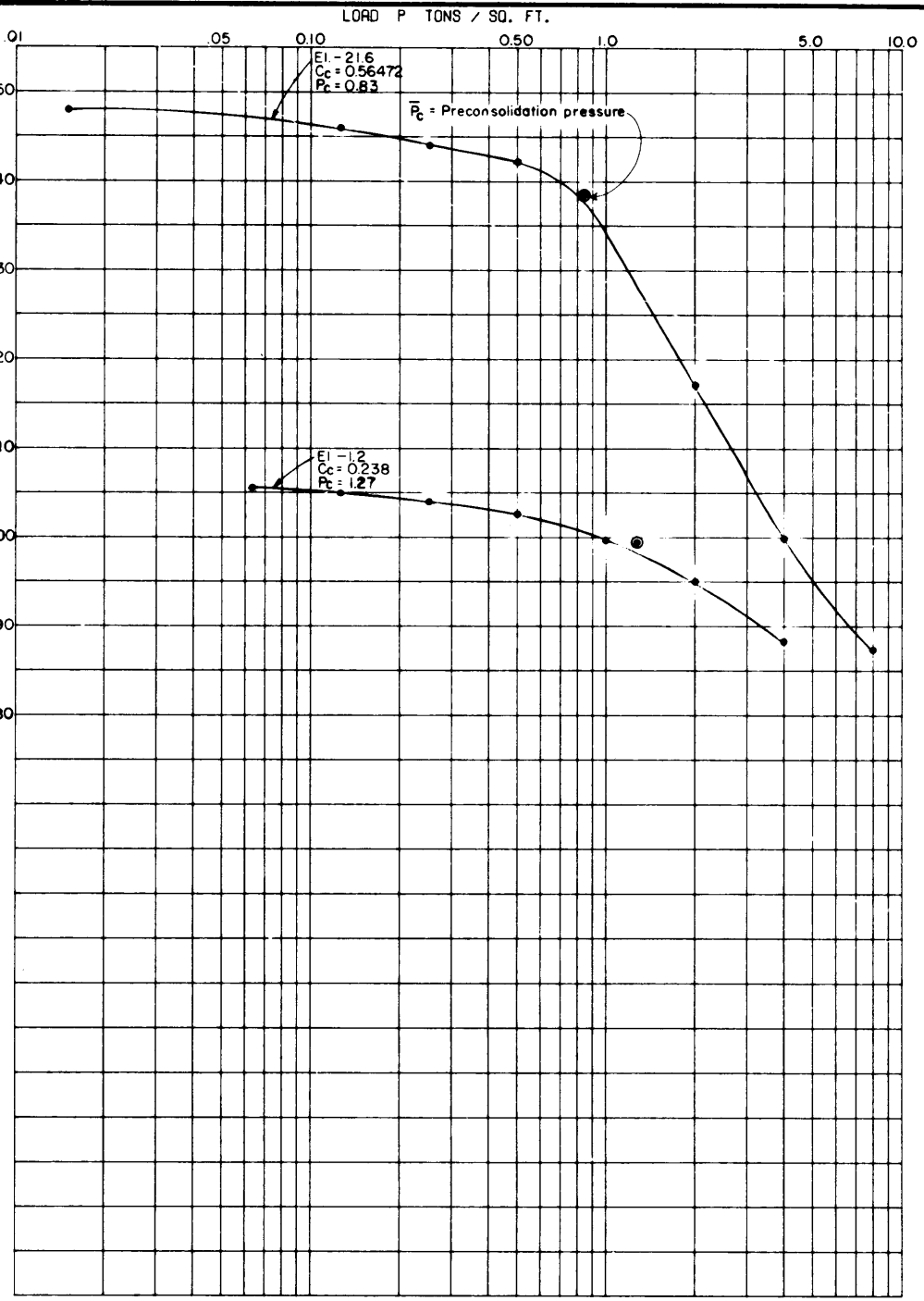

○ - (UC) UNCONFINED COMPRESSION TEST  
 ■ - (Q) UNCONSOLIDATED - UNDRAINED SHEAR TEST  
 ▲ - (R) CONSOLIDATED - UNDRAINED SHEAR TEST  
 □ - (S) CONSOLIDATED - DRAINED SHEAR TEST  
 BORINGS WERE TAKEN WITH A 5 INCH DIAMETER STEEL TUBE PISTON TYPE SAMPLER FOR SOIL BORING LEGEND SEE PLATE A FOR LOCATION OF BORINGS SEE PLATE 6

MISSISSIPPI RIVER LEVEES AND BANKS  
 MILE 66 TO MILE 10  
 SOIL REPORT - PART I  
 EAST BANK  
**SOIL BORING DATA**  
 19-MHULT  
 U.S. ARMY ENGINEER DISTRICT, NEW ORLEANS  
 CORPS OF ENGINEERS  
 AUGUST 1971



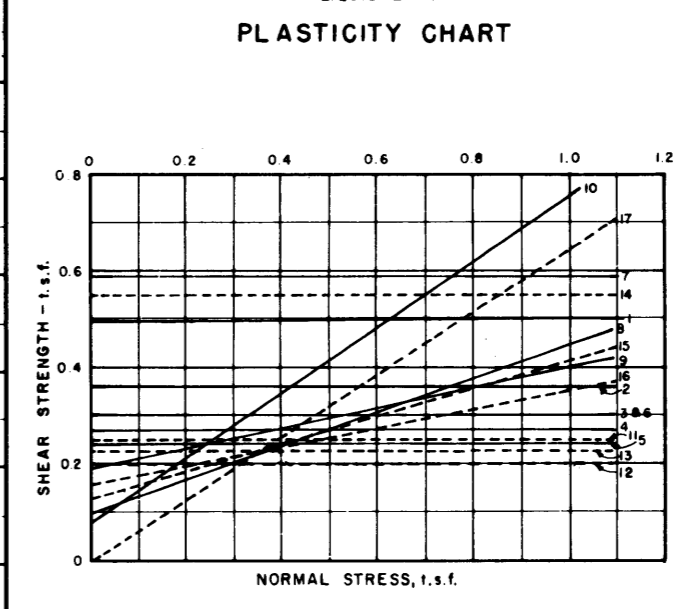
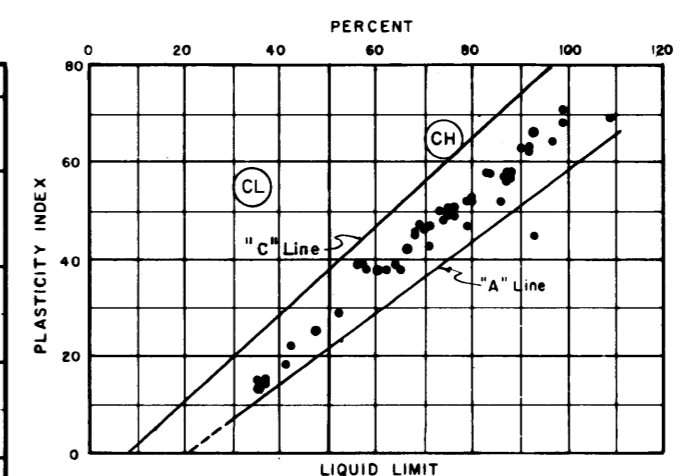
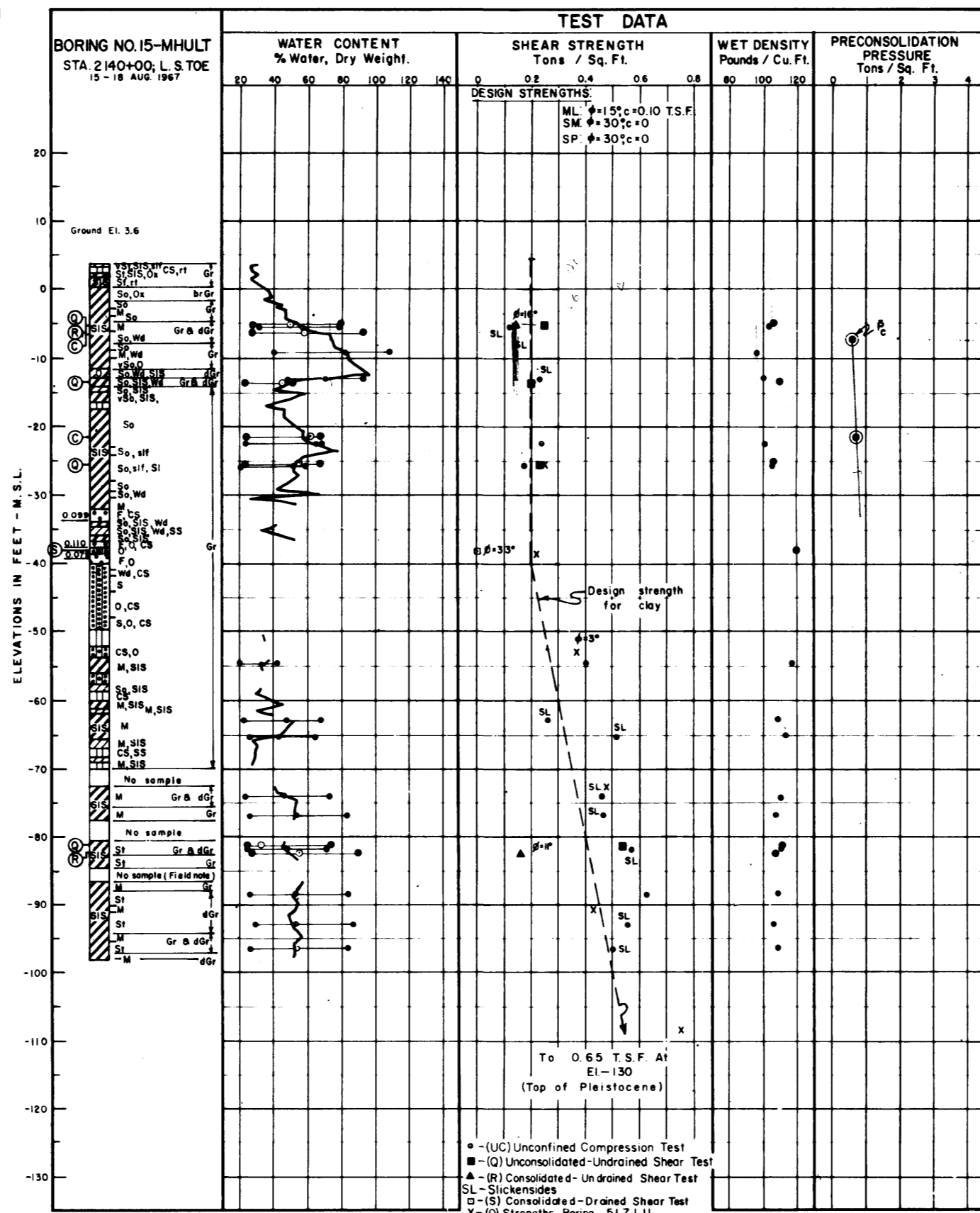
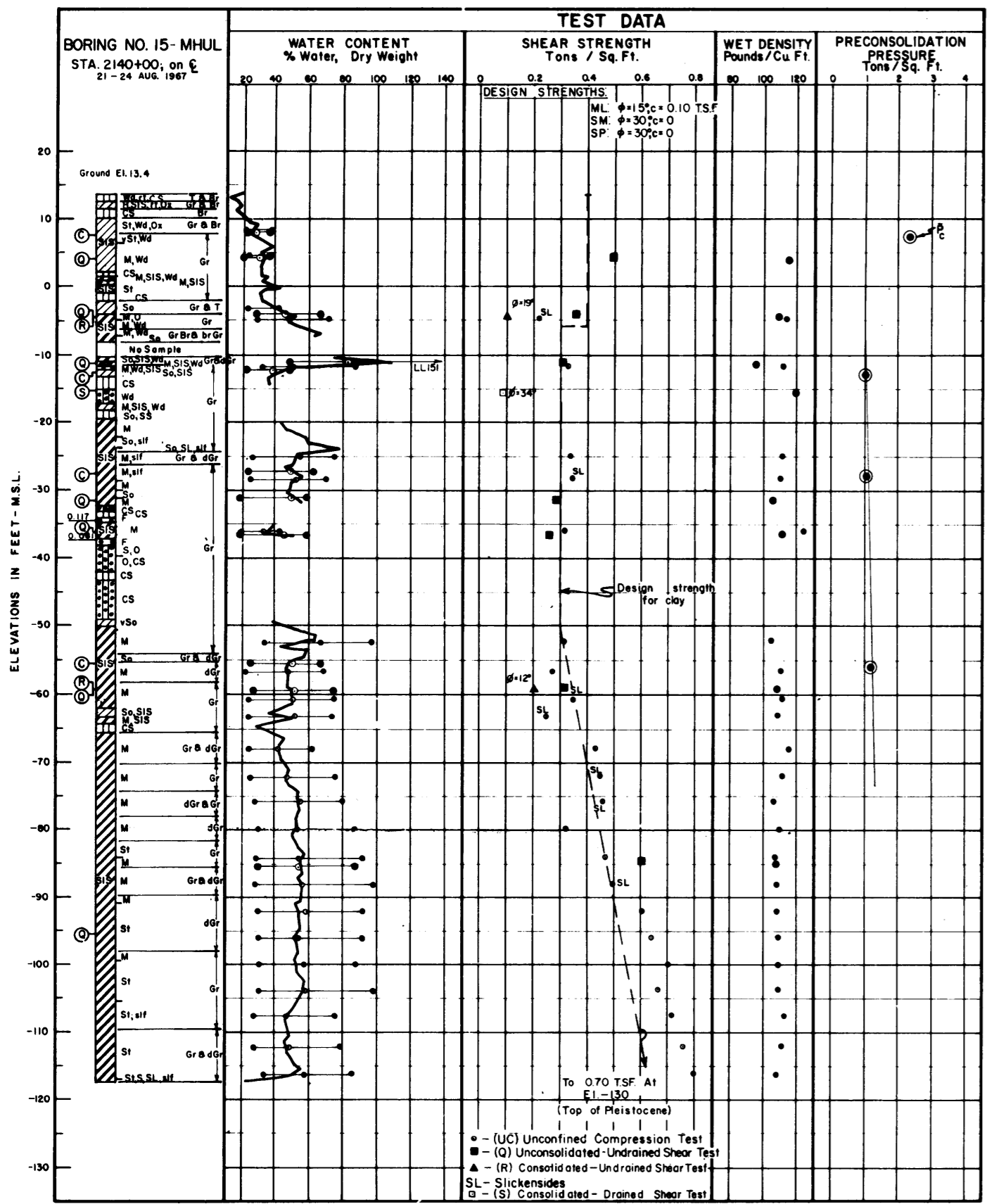

BORING NO.	ENVELOPE NO.	EL.	TYPE	STRENGTH		CLASS
				$\phi$	(t.s.f.)	
15-MHUL	1	3.8		0	0.50	SM
	2	4.6			0.36	CH
	3	11.5			0.30	CH
	4	31.8		Q	0.27	CH
	5	36.7			0.24	CH
	6	59.8			0.30	CH
	7	85.6			0.59	CH
	8	4.6	19		0.10	CH
	9	59.8	12	R	0.19	CH
	10	15.6	34	S	0.08	SM
15-MHULT	11	5.3		0	0.25	CH
	12	13.5		Q	0.20	CH
	13	25.5			0.23	CH
	14	81.1			0.53	CH
	15	5.3	16	R	0.13	CH
	16	82.2	11		0.16	CH
	17	38.3	33	S	0.00	SM

**SHEAR STRENGTH DATA**

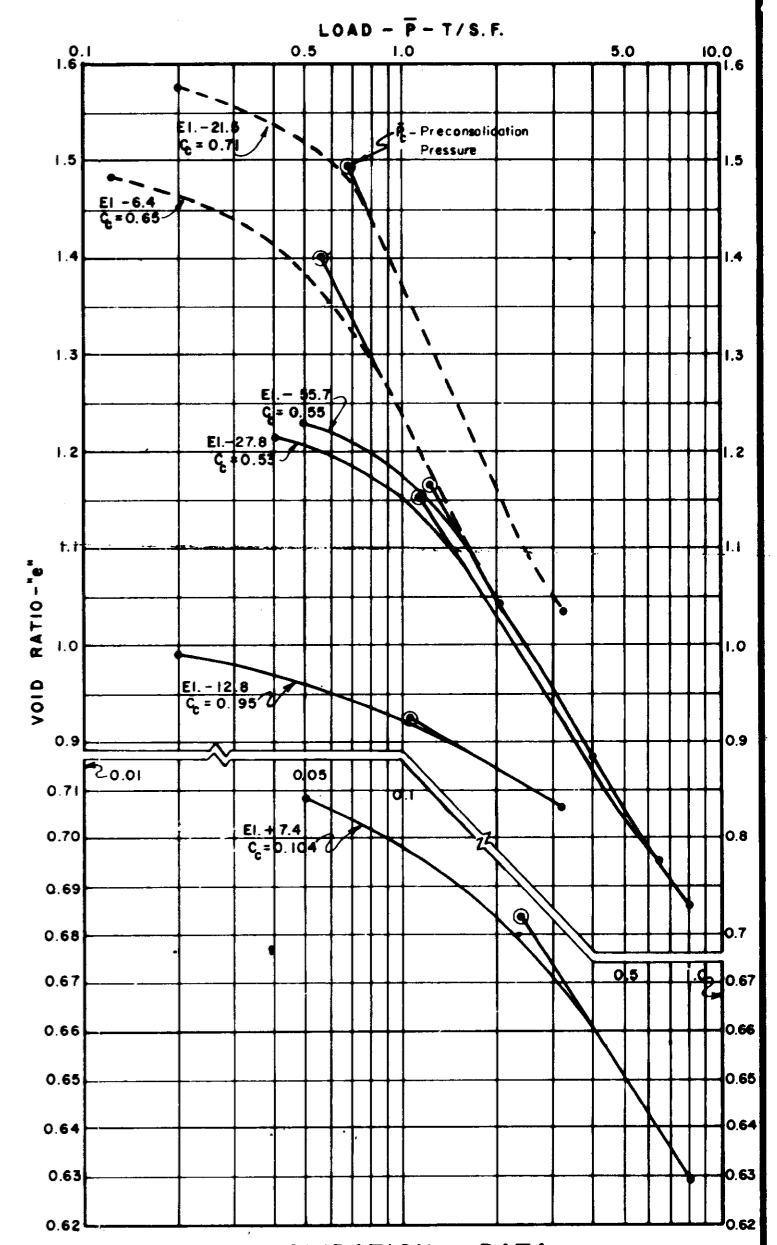

**CONSOLIDATION DATA**

— Boring No. 15-MHUL  
 - - - Boring No. 15-MHULT  
 For soil boring legend see plate A  
 For location of borings see plate 6

Borings were taken with a 5" diameter steel tube piston type sampler.

MISSISSIPPI RIVER LEVEES AND BANKS  
 MILE 66 TO MILE 10  
 SOIL REPORT - PART I  
 EAST BANK  
**SOIL BORING DATA**  
 15-MHUL AND 15-MHULT  
 STA. 2140+00  
 U.S. ARMY ENGINEER DISTRICT, NEW ORLEANS  
 CORPS OF ENGINEERS  
 AUGUST 1971 FILE NO. H-2-25275

BORING NO. R-51.7-LU  
 STA. 2148+50  
 60 FT. R.S. OF LEVEE C/L  
 11-16 DEC 68

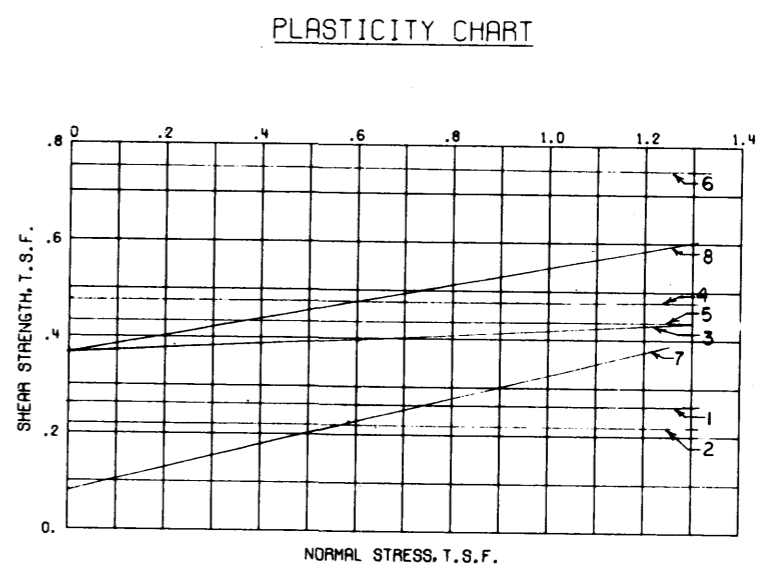
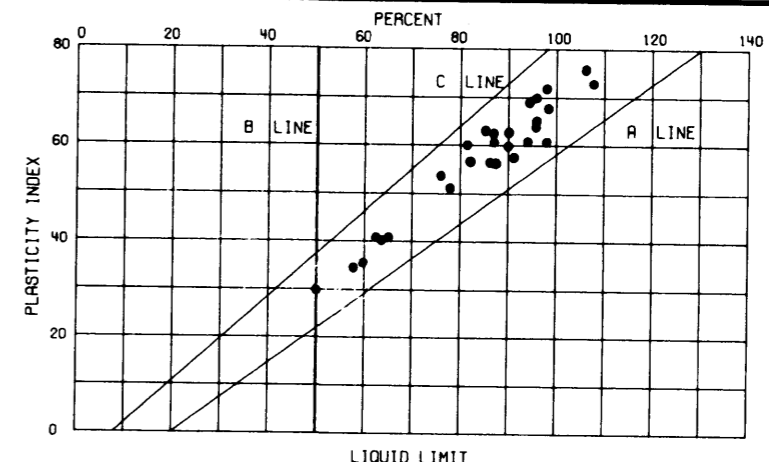
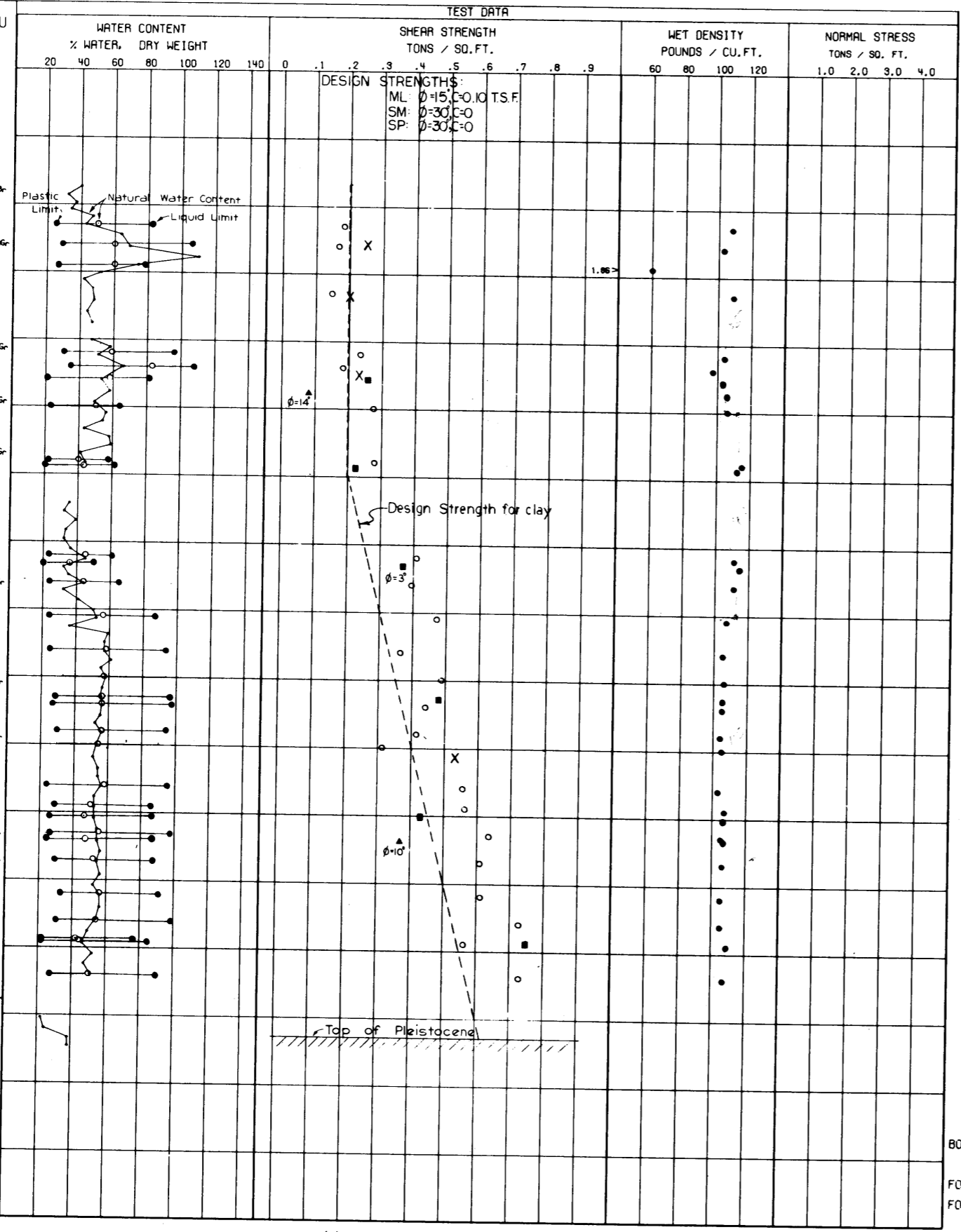
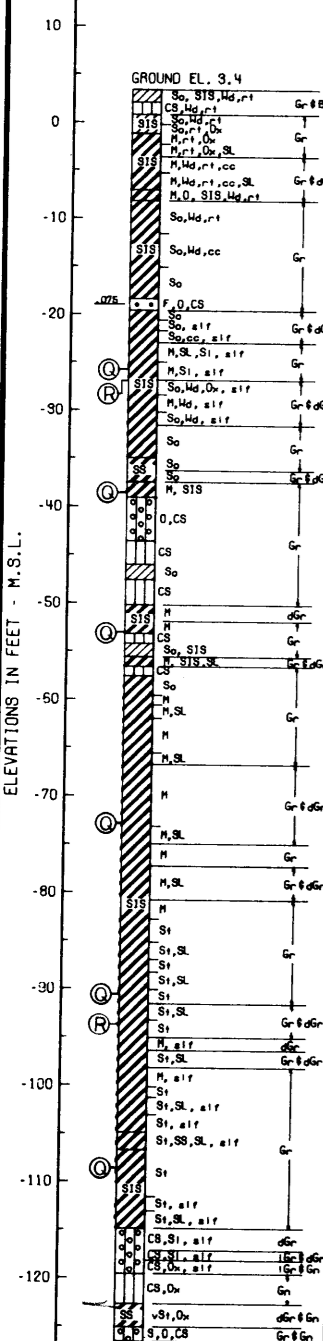

BORING NO.	ENVELOPE		TYPE	STRENGTH		CLASS
	NO.	EL.		$\phi$	C - TSF	
R-51.7-LU	1	-25.5	Q	0°	.26	CH
	2	-38.6		0°	.22	CH
	3	-53.0		3°	.37	CH
	4	-72.7		0°	.48	CH
	5	-90.3	R	0°	.43	CH
	6	-108.8		0°	.75	CH
	7	-26.4		14°	.08	CH
	8	-93.7		10°	.37	CH

○ - (UC) UNCONFINED COMPRESSION TEST  
 ■ - (Q) UNCONSOLIDATED - UNDRAINED SHEAR TEST  
 ▲ - (R) CONSOLIDATED - UNDRAINED SHEAR TEST  
 □ - (S) CONSOLIDATED - DRAINED SHEAR TEST  
 BORINGS WERE TAKEN WITH A 5 INCH DIAMETER STEEL TUBE PISTON TYPE SAMPLER  
 FOR SOIL BORING LEGEND SEE PLATE A  
 FOR LOCATION OF BORINGS SEE PLATE 6

MISSISSIPPI RIVER LEVEES AND BANKS  
 MILE 66 TO MILE 10  
 SOIL REPORT - PART I  
 EAST BANK  
**SOIL BORING DATA**  
 R-51.7-LU  
 U.S. ARMY ENGINEER DISTRICT, NEW ORLEANS  
 CORPS OF ENGINEERS  
 AUGUST 1971

X-(Q) Strengths, Boring 15-MHULT



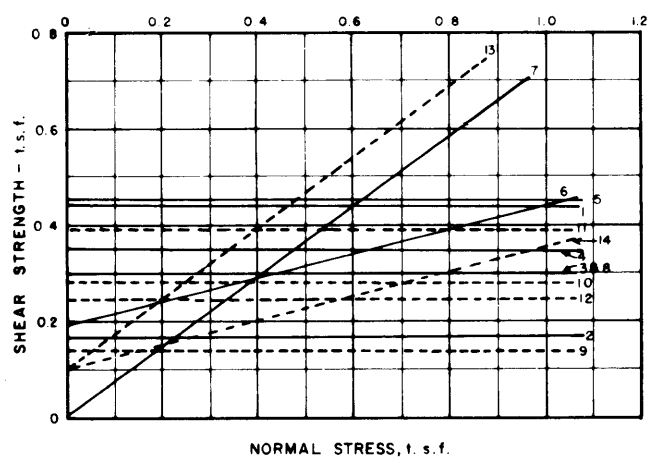
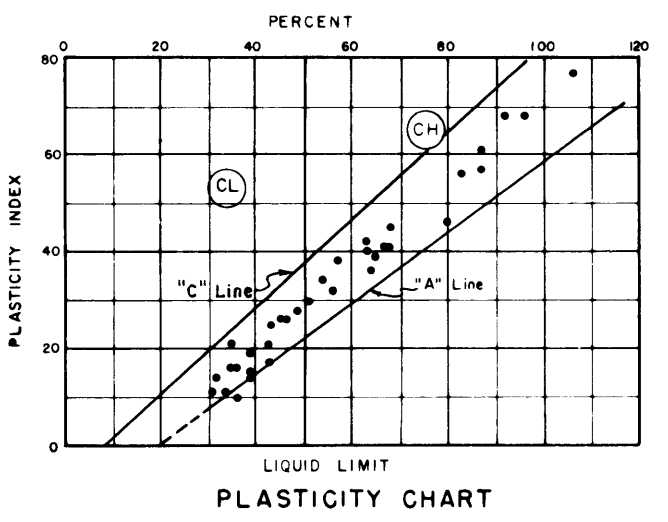
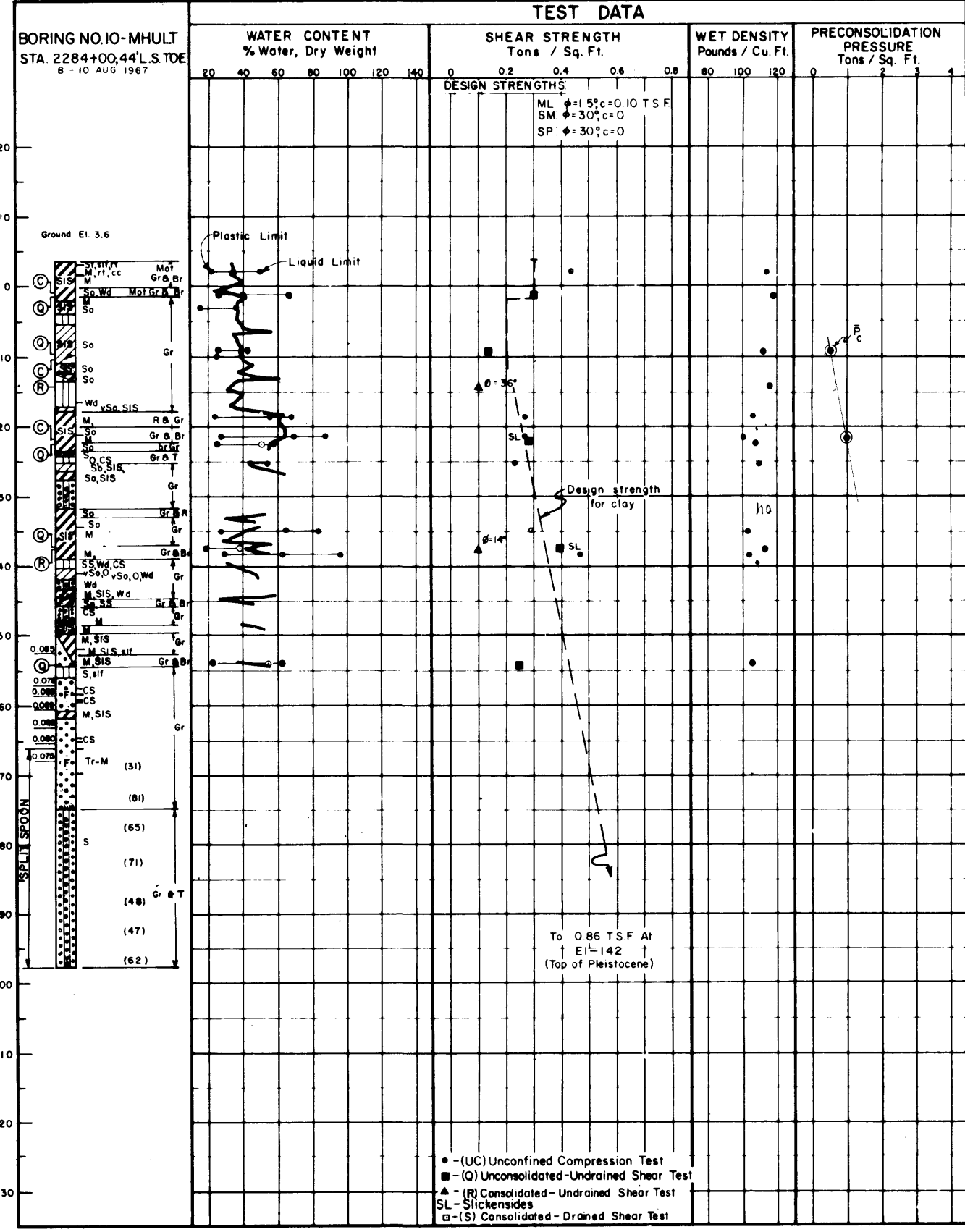
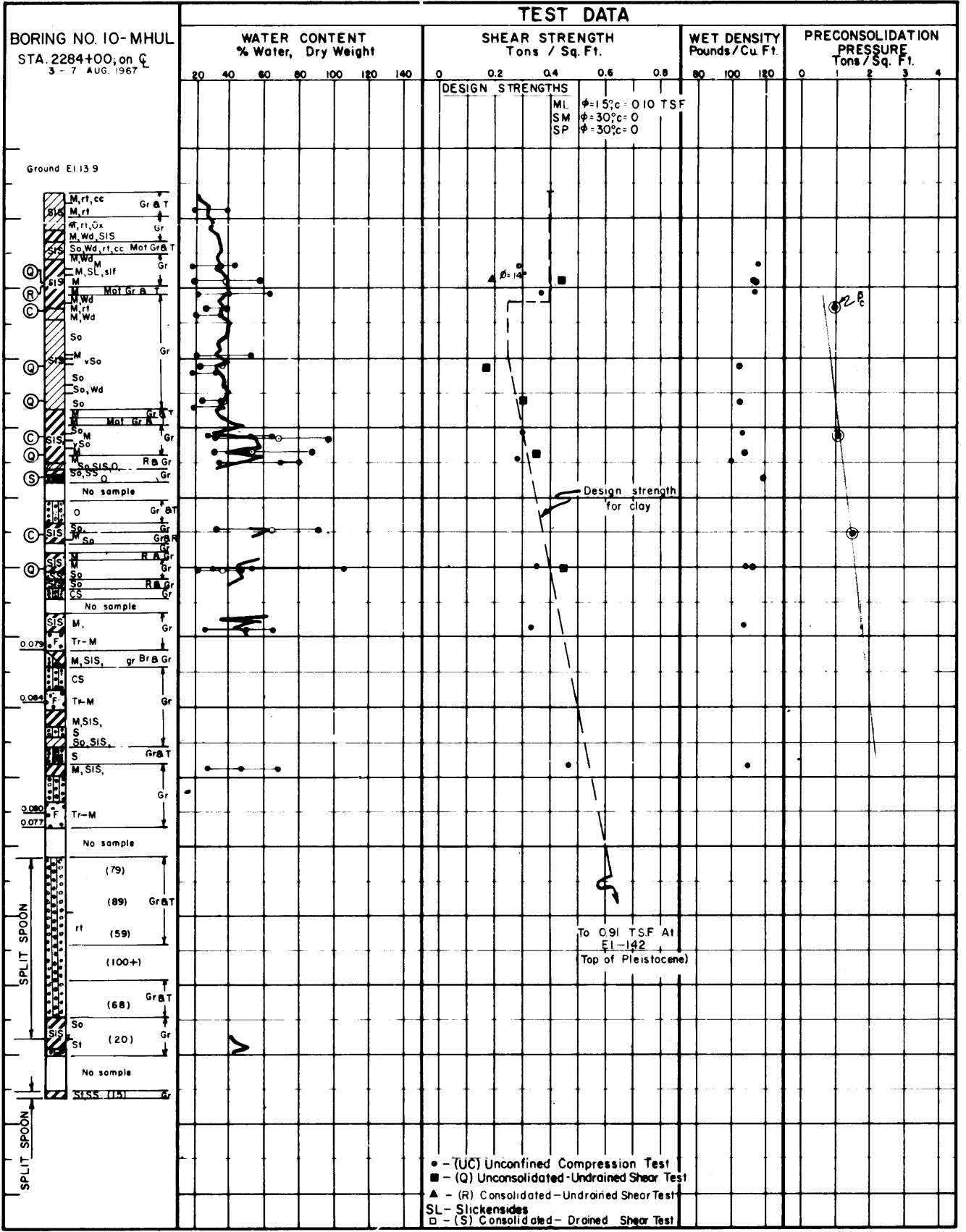

BORING NO.	ENVELOPE		TYPE	STRENGTH		CLASS
	NO.	EL.		$\phi^*$	$c$ (t.s.f.)	
10-MHUL	1	1.0		0	0.44	CH
	2	-11.2		0	0.17	CL
	3	-16.0	Q	0	0.30	CL
	4	-23.7		0	0.35	CH
	5	-40.1		0	0.45	CL, SM
	6	1.0	R	14	0.19	CH
	7	-27.1	S	36	0.00	SM
10-MHULT	8	-1.1		0	0.14	CH
	9	-9.5		0	0.25	CH
	10	-22.5	Q	0	0.28	CH
	11	-37.6		0	0.39	CL
	12	-54.0		0	0.25	CH
	13	-14.3	R	*36	0.10	ML
	14	-37.6		14	0.10	CL

\* BASED ON DEVIATOR STRESS AT MAXIMUM POSITIVE PORE PRESSURE:  $\phi=18^\circ, c=0.08$  TSF

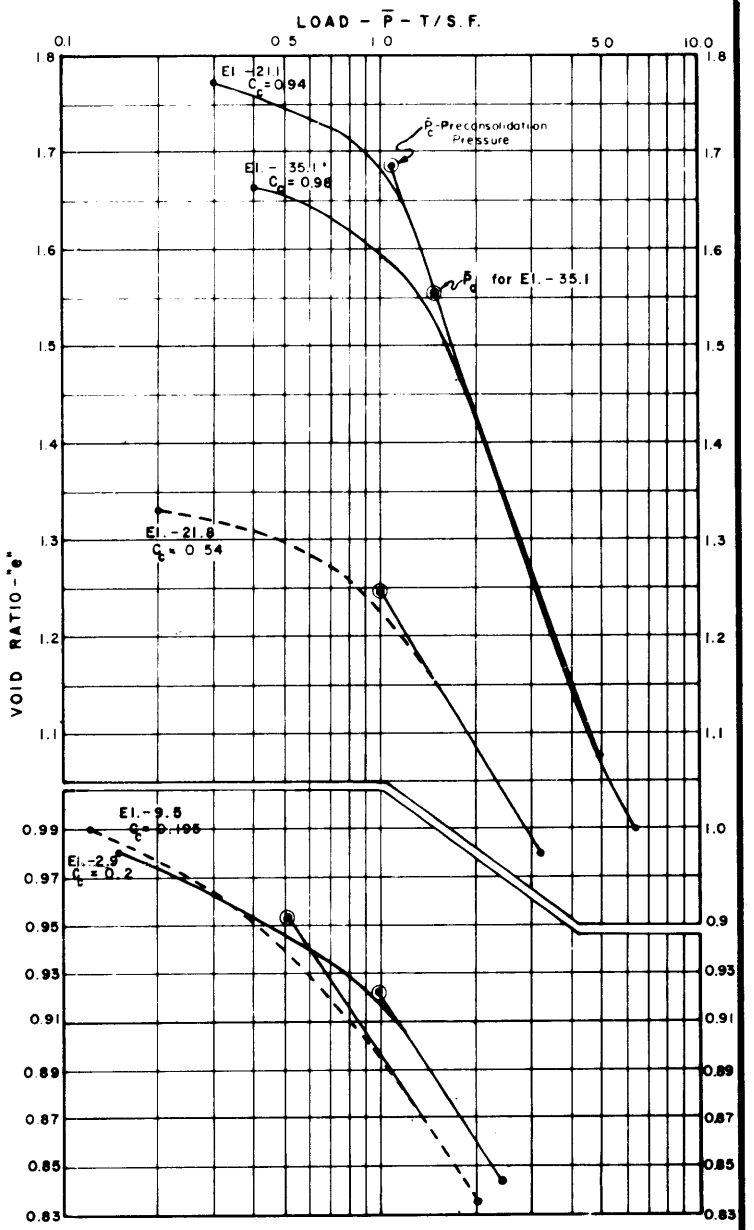

— Boring No. 10-MHUL  
- - - Boring No. 10-MHULT

For soil boring legend see plate A  
For location of borings see plate 7

Borings were taken with a 5" diameter steel tube piston type sampler.

MISSISSIPPI RIVER LEVEES AND BANKS  
MILE 66 TO MILE 10  
SOIL REPORT - PART I  
EAST BANK  
**SOIL BORING DATA**  
10-MHUL AND 10-MHULT  
STA. 2284 + 00  
U.S. ARMY ENGINEER DISTRICT, NEW ORLEANS  
CORPS OF ENGINEERS  
AUGUST 1971  
FILE NO. H-2-25275

BORING NO. 1-U  
 STA. 2296 + 25;  
 122' R. S. Q. LEVEE  
 20-27 JUN. 1951

ELEVATIONS IN FEET - M.S.L.

Ground El. 7.0

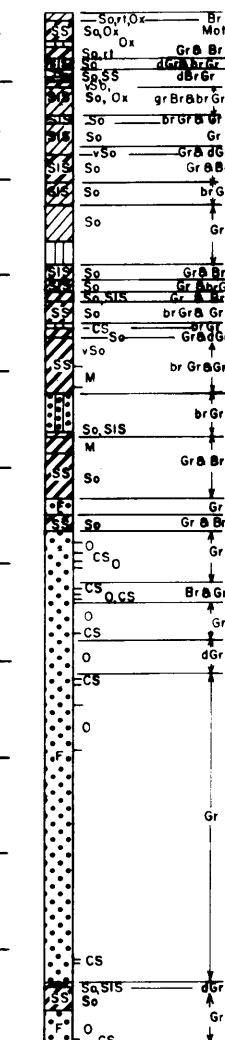

TEST DATA

ELEVATION (FEET - M.S.L.)	WATER CONTENT % Water, Dry Weight				SHEAR STRENGTH Tons / Sq. Ft.				WET DENSITY Pounds / Cu. Ft.				PRECONSOLIDATION PRESSURE Tons / Sq. Ft.			
	20	40	80	100	0	0.2	0.4	0.6	80	100	120	140	0	1	2	3
0																
10																
20																
30																
40																
50																
60																
70																
80																
90																
100																
110																
120																
130																

• - (UC) Unconfined Compression Test  
 ■ - (Q) Unconsolidated - Undrained Shear Test  
 ▲ - (R) Consolidated - Undrained Shear Test  
 SL - Slickensides  
 □ - (S) Consolidated - Drained Shear Test

ELEVATIONS IN FEET - M.S.L.

ELEVATION (FEET - M.S.L.)	WATER CONTENT % Water, Dry Weight				SHEAR STRENGTH Tons / Sq. Ft.				WET DENSITY Pounds / Cu. Ft.				PRECONSOLIDATION PRESSURE Tons / Sq. Ft.			
	20	40	80	100	0	0.2	0.4	0.6	80	100	120	140	0	1	2	3
0																
10																
20																
30																
40																
50																
60																
70																
80																
90																
100																
110																
120																
130																

• - (UC) Unconfined Compression Test  
 ■ - (Q) Unconsolidated - Undrained Shear Test  
 ▲ - (R) Consolidated - Undrained Shear Test  
 SL - Slickensides  
 □ - (S) Consolidated - Drained Shear Test

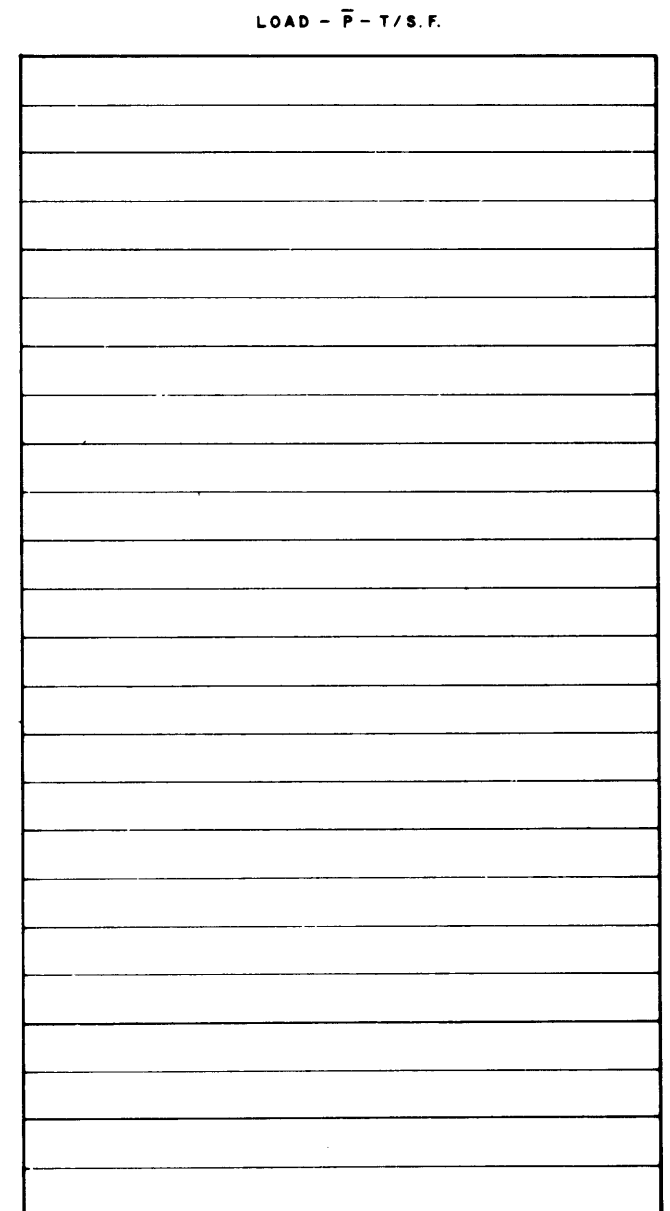
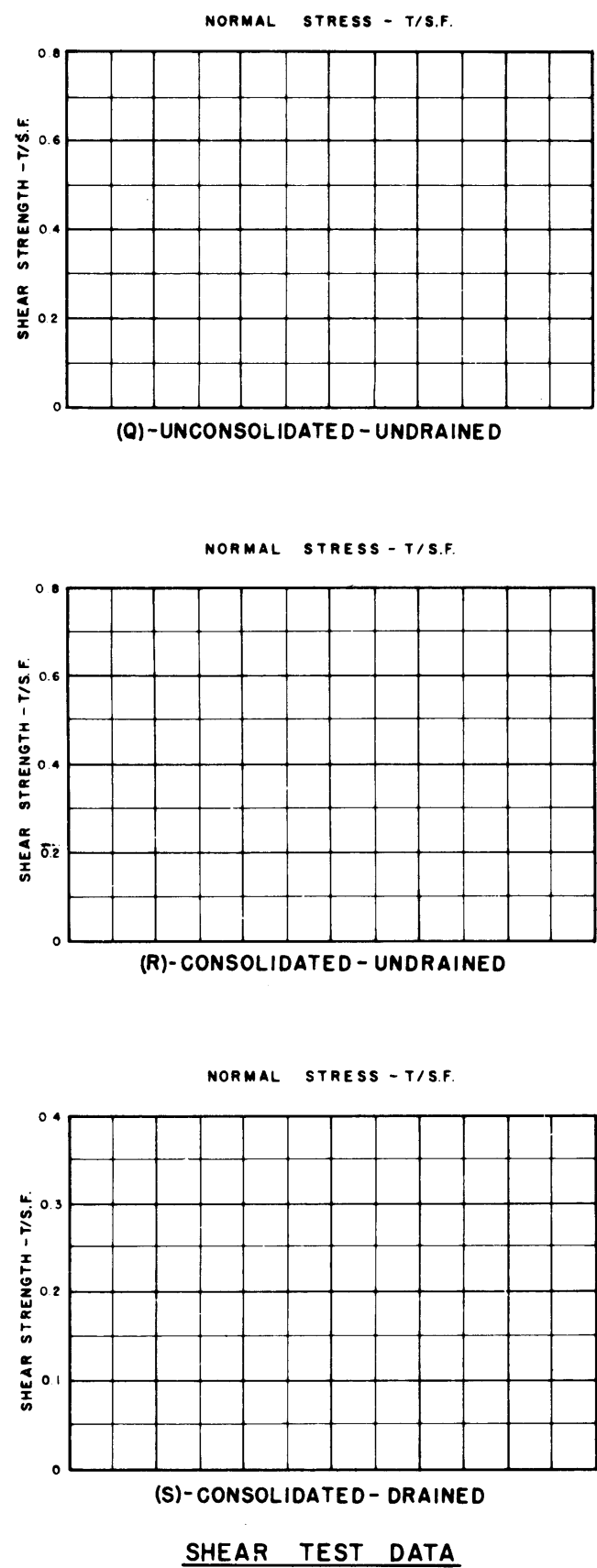

CONSOLIDATION DATA

— Boring No. 1-U  
 - - Boring No.  
 For soil boring legend see plate A  
 For location of borings see plate 7

Borings were taken with a 5" diameter steel tube piston type sampler.

MISSISSIPPI RIVER LEVEES AND BANKS  
 MILE 66 TO MILE 10  
 SOIL REPORT - PART I  
 EAST BANK  
**SOIL BORING DATA**  
 1-U  
 STA. 2296 + 95  
 U.S. ARMY ENGINEER DISTRICT, NEW ORLEANS  
 CORPS OF ENGINEERS  
 AUGUST 1971

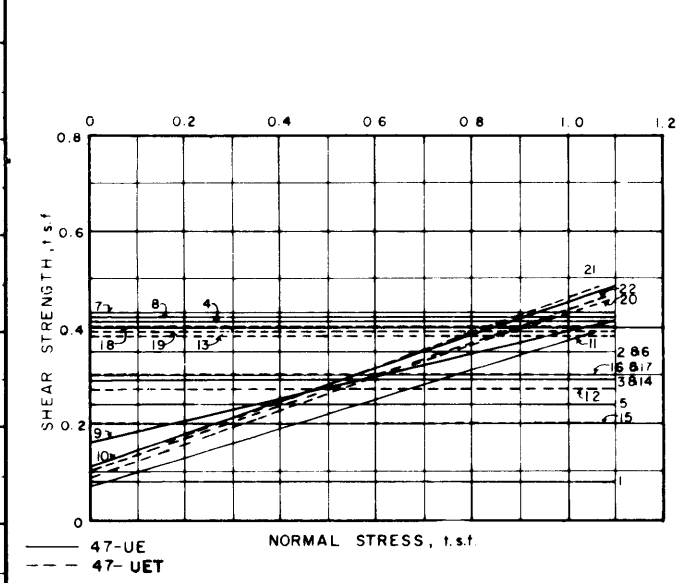
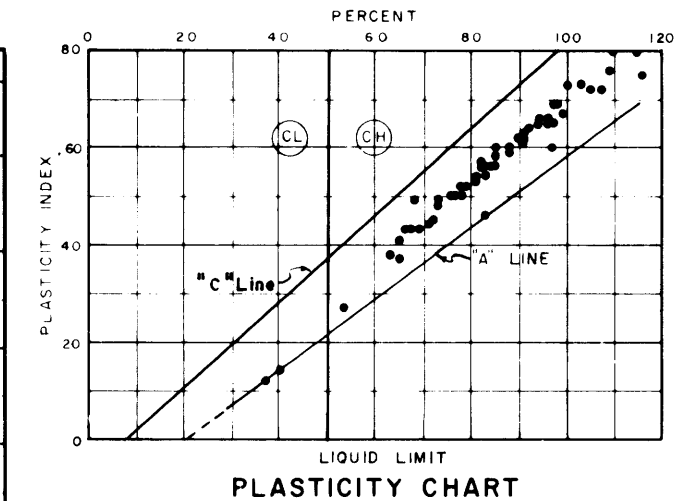
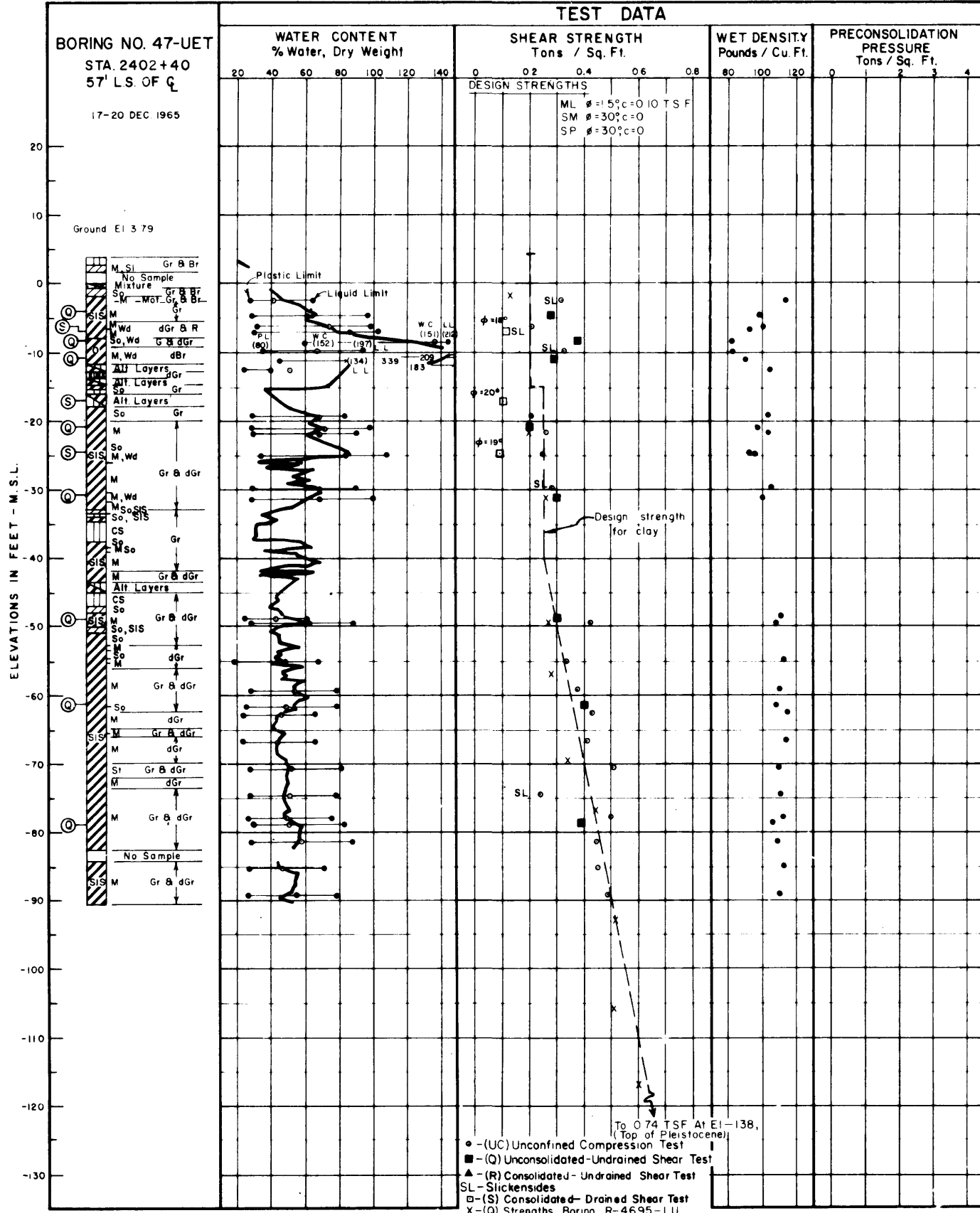
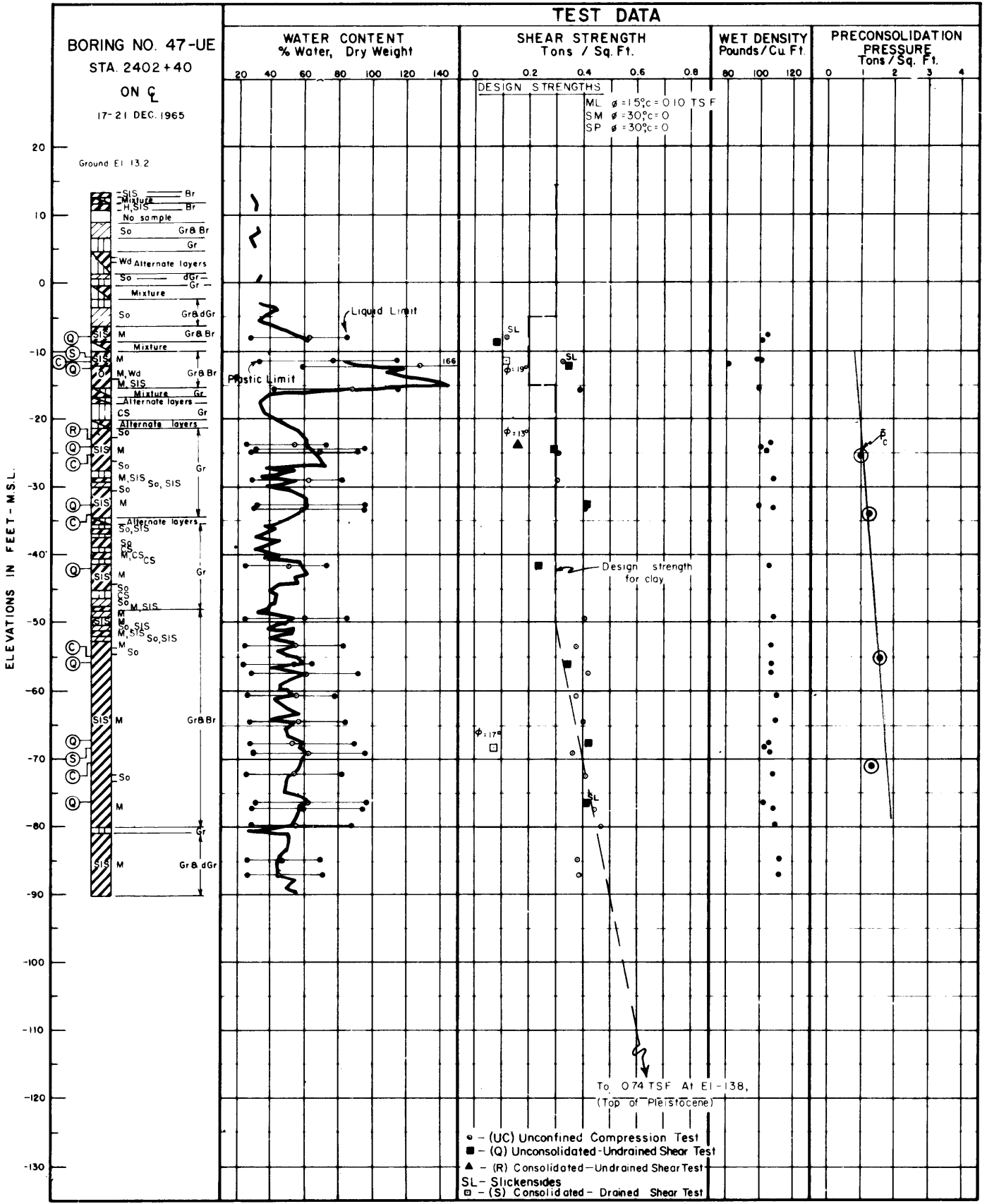

BORING NO.	ENVELOPE NO.	EL.	TYPE	STRENGTH		CLASS
				$\phi$	c (t.s.f.)	
47-UE	1	-8.4		0	0.08	CH
	2	-11.9		0	0.35	CH
	3	-24.1		0	0.29	CH
	4	-32.8		0	0.41	CH
	5	-41.7		0	0.24	CH
	6	-56.0		0	0.35	CH
	7	-67.6		0	0.43	CH
	8	-76.6		0	0.42	CH
	9	-23.3	R	13	0.16	CH
47-UET	10	-11.0	S	19	0.11	CH
	11	-68.3		17	0.07	CH
	12	-4.5		0	0.27	CH
	13	-8.5		0	0.38	CH
	14	-11.0		0	0.29	CH
	15	-20.9		0	0.20	CH
	16	-31.1		0	0.30	CH
	17	-48.5		0	0.30	CH
	18	-61.4		0	0.40	CH
	19	-78.7		0	0.39	CH
	20	-7.0		18	0.11	CH
	21	-17.3	S	20	0.10	CH/ML
	22	-24.6		19	0.09	CH

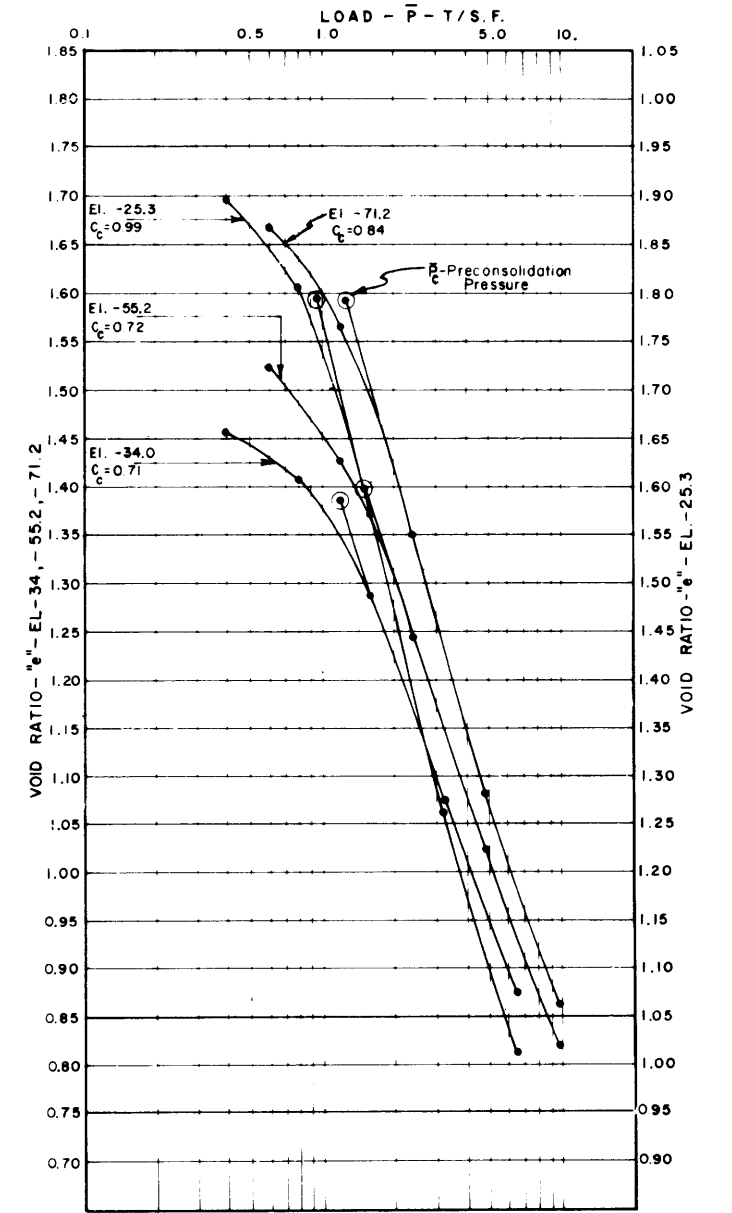

MISSISSIPPI RIVER LEVEES AND BANKS  
MILE 66 TO MILE 10  
SOIL REPORT - PART I  
EAST BANK  
**SOIL BORING DATA**  
47-UE AND 47-UET  
STA. 2402+40  
U.S. ARMY ENGINEER DISTRICT, NEW ORLEANS  
CORPS OF ENGINEERS  
AUGUST 1971  
FILE NO H-2-25275

BOR. R-46.95-LU  
 STA. 2402+40  
 185 FT. R.S. OF C.L. LEVEE  
 29 OCT. 69

ELEVATIONS IN FEET - M.S.L.

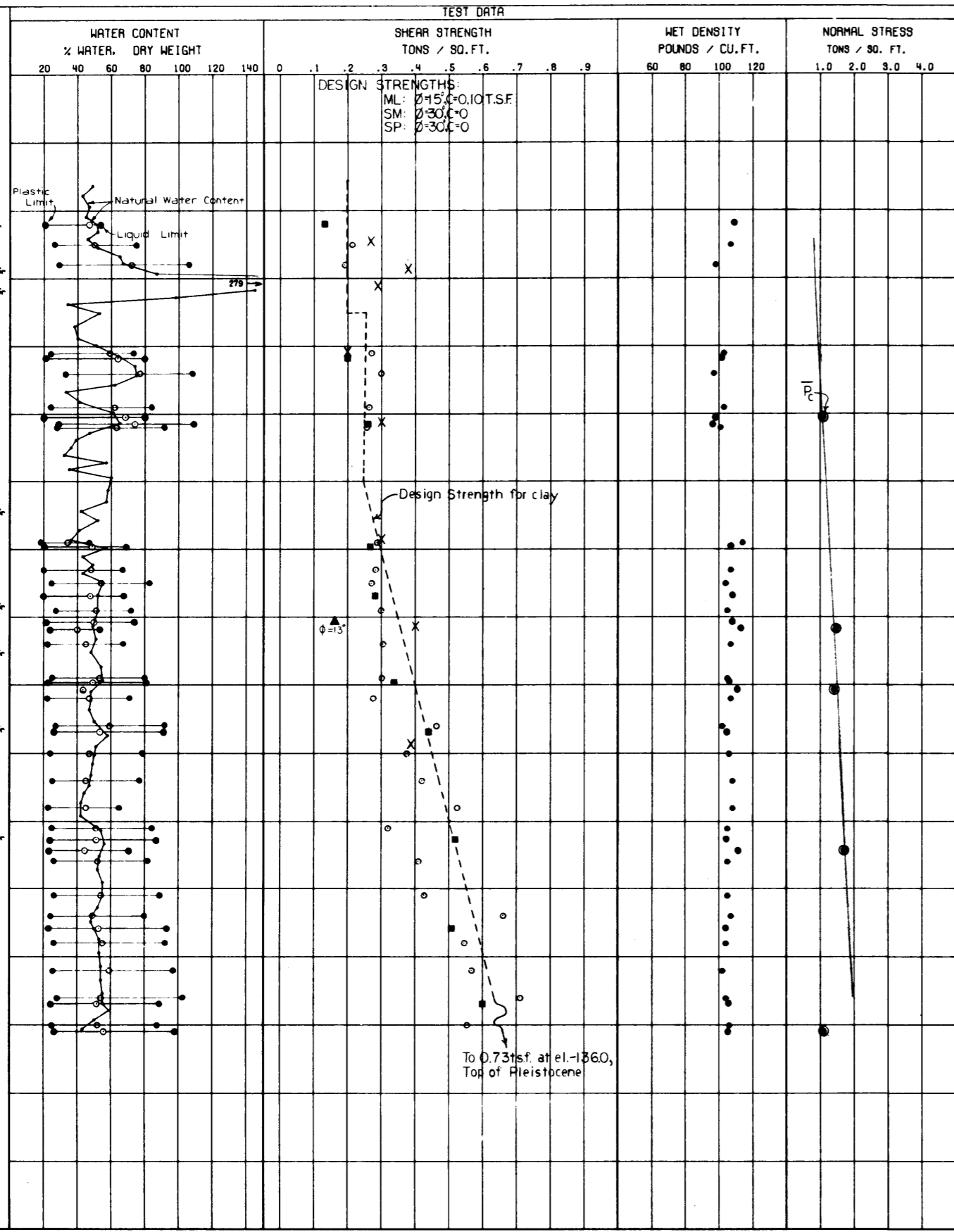
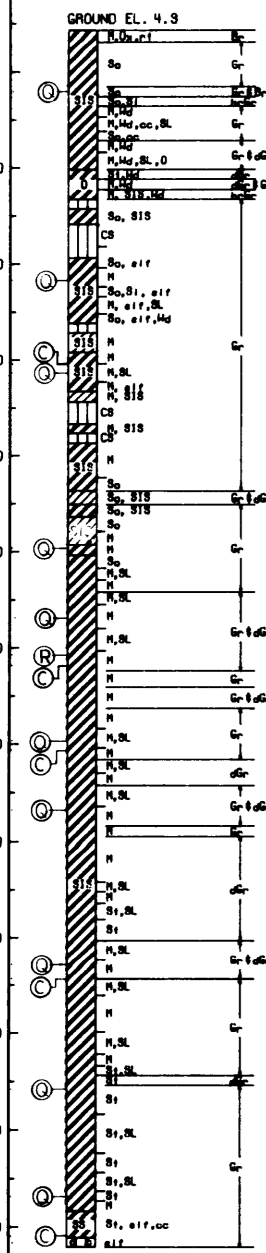

X (Q) Strengths, Boring 47-UET

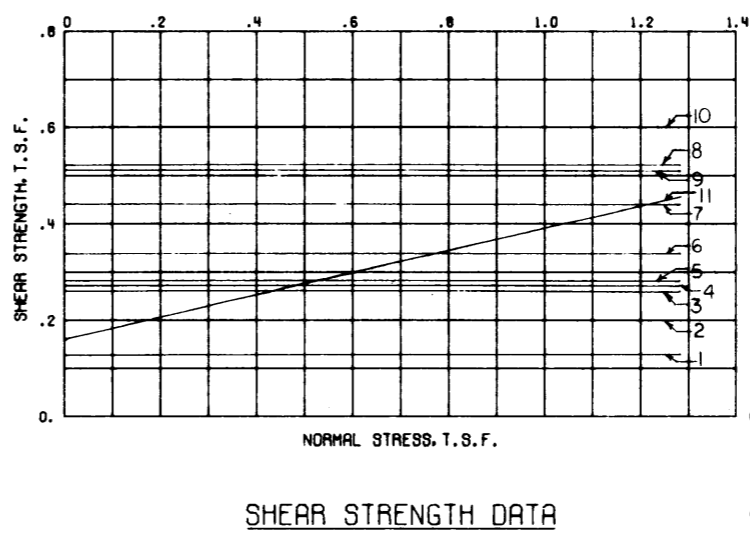
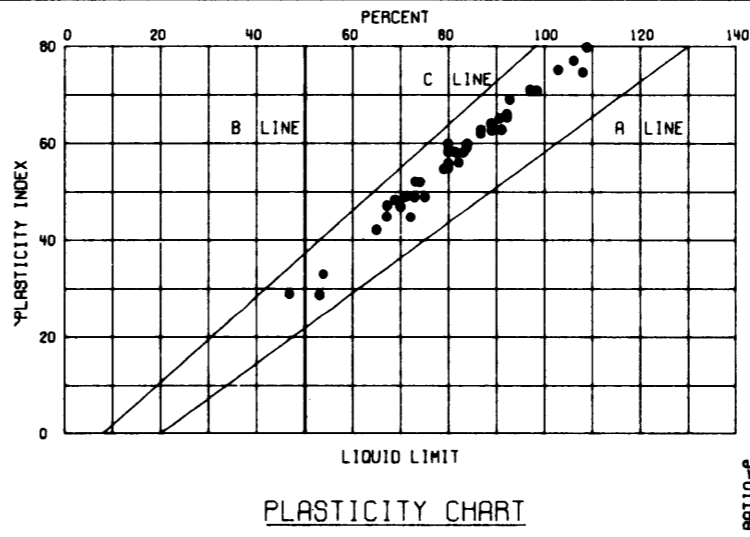

BORING NO.	ENVELOPE		TYPE	STRENGTH		CLASS
	NO.	EL.		$\phi$	C - TSF	
R46.95LU	1	-2.0			.13	CH
	2	-21.7			.20	
	3	-31.2			.26	
	4	-49.6			.27	
	5	-56.8			.28	
	6	-69.7		Q	.34	
	7	-76.8			.44	
	8	-92.9			.52	
	9	-105.7			.51	
	10	-116.7			.60	
	11	-60.7		R	.16	

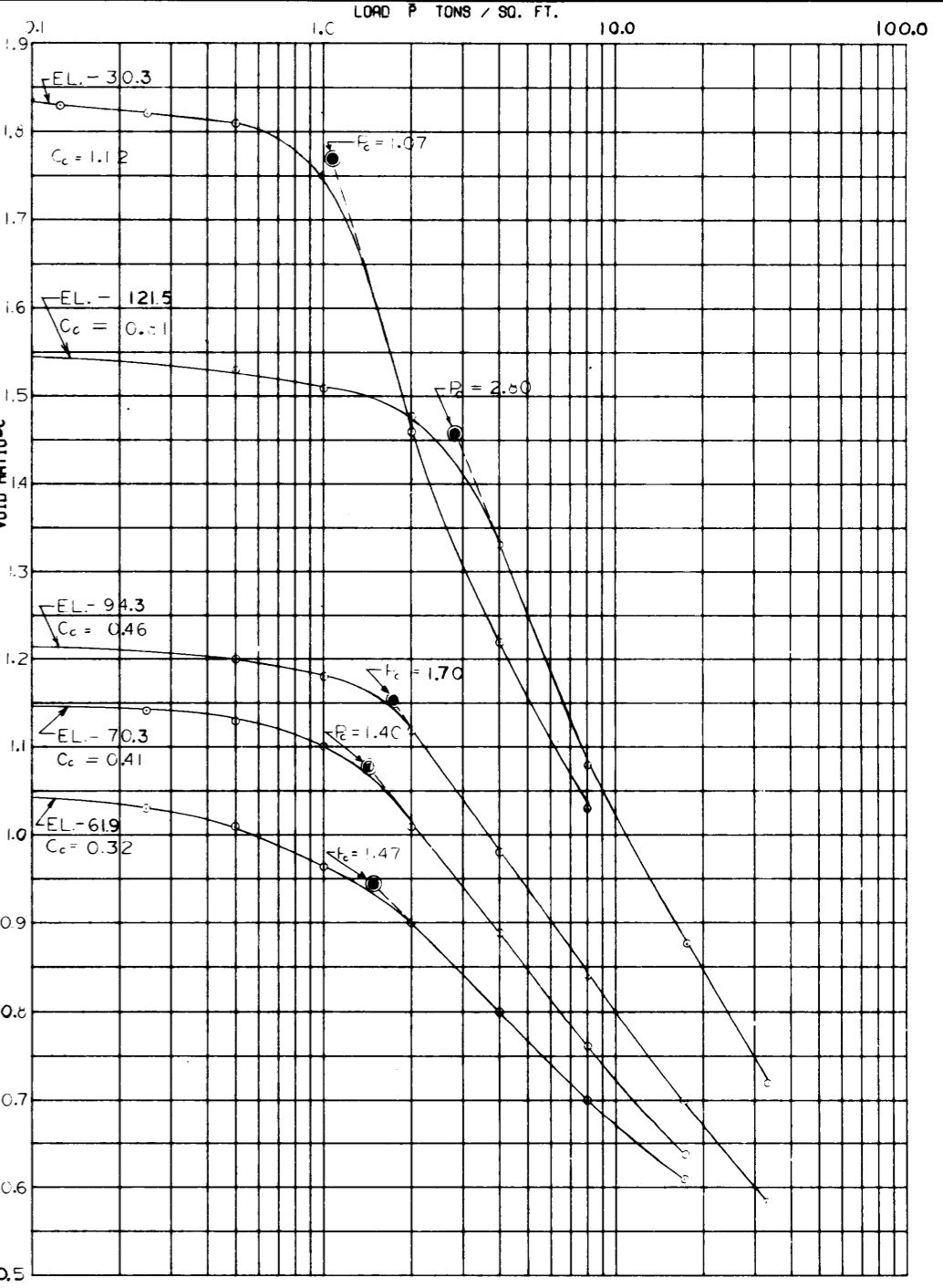

CONSOLIDATION DATA

○ (UC) UNCONFINED COMPRESSION TEST  
 ■ (Q) UNCONSOLIDATED - UNDRAINED SHEAR TEST  
 ▲ (R) CONSOLIDATED - UNDRAINED SHEAR TEST  
 □ (S) CONSOLIDATED - DRAINED SHEAR TEST  
 BORINGS WERE TAKEN WITH A 5 INCH DIAMETER STEEL TUBE PISTON TYPE SAMPLER  
 FOR SOIL BORING LEGEND SEE PLATE A  
 FOR LOCATION OF BORINGS SEE PLATE 7

MISSISSIPPI RIVER LEVEES AND BANKS  
 MILE 66 TO MILE 10  
 SOIL REPORT - PART I  
 EAST BANK  
**SOIL BORING DATA**  
 R-46.95-LU  
 U.S. ARMY ENGINEER DISTRICT, NEW ORLEANS  
 CORPS OF ENGINEERS  
 AUGUST 1971

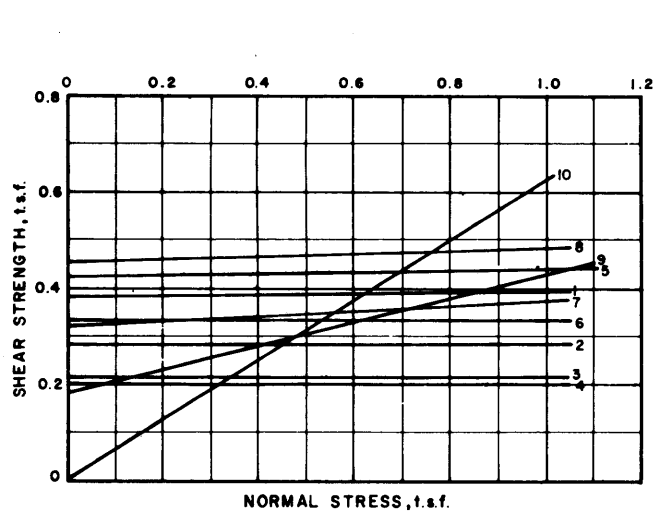
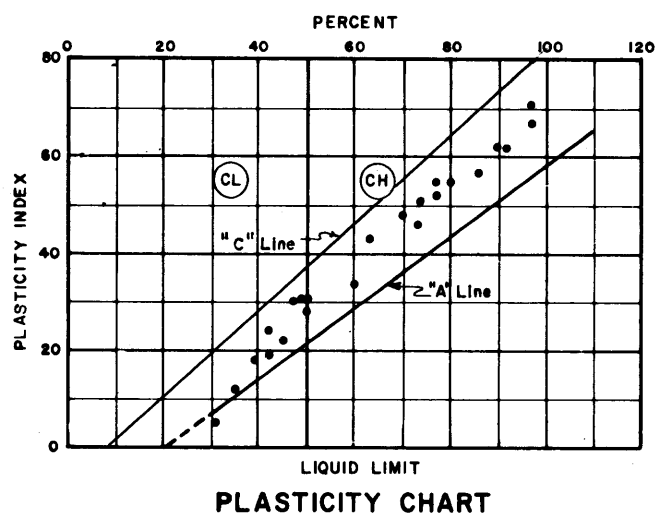
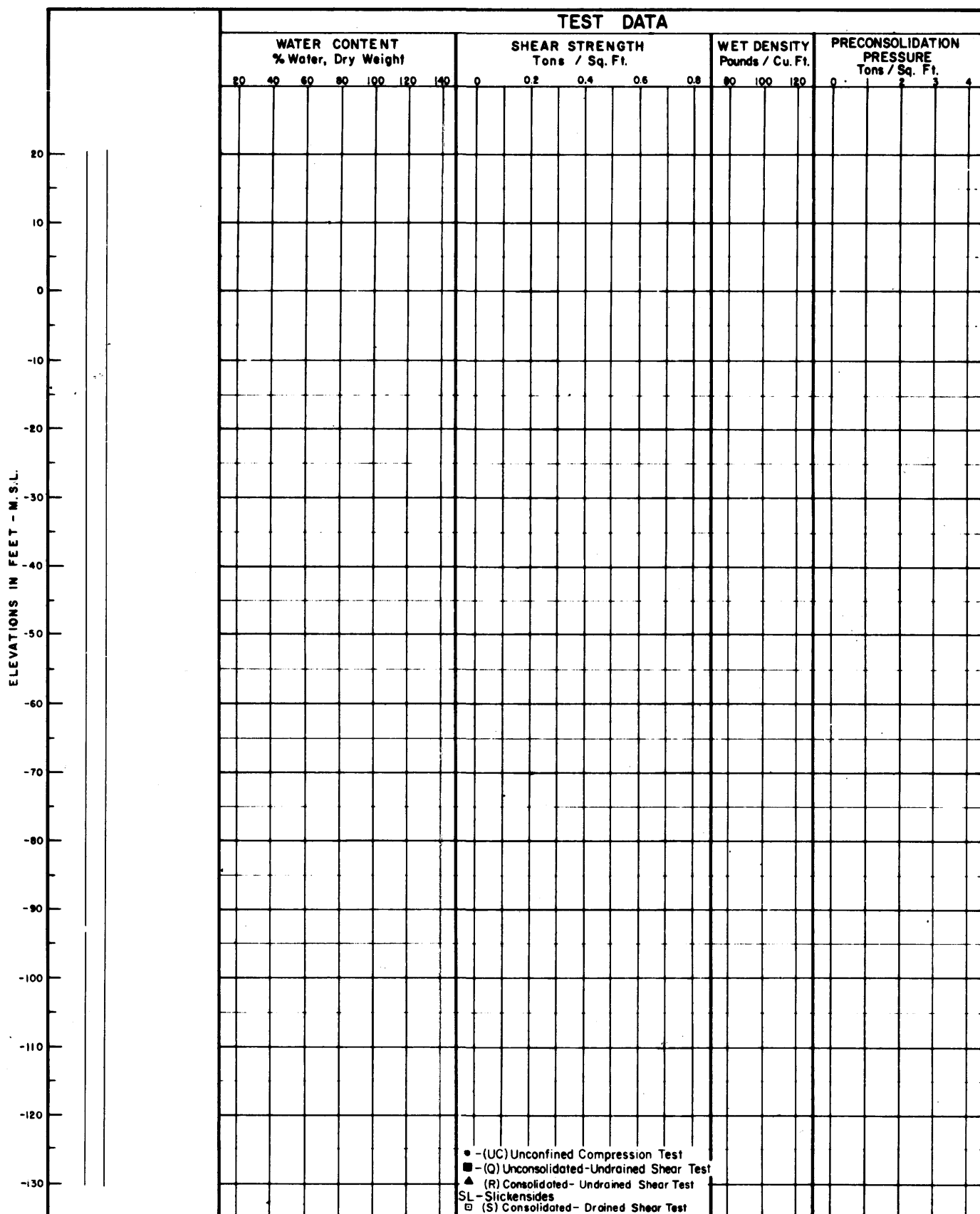
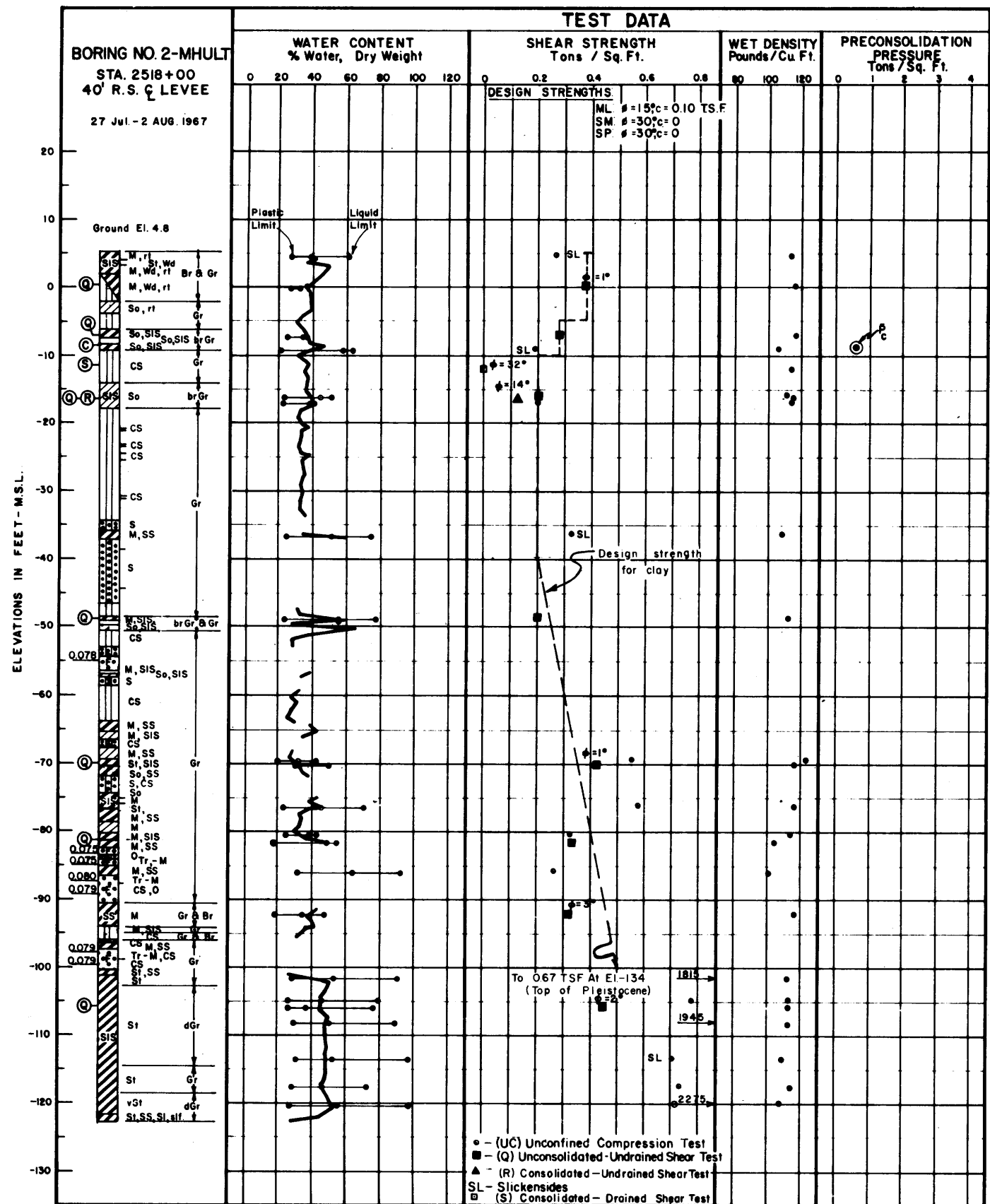

BORING NO.	ENVELOPE NO.	EL.	TYPE	STRENGTH $\phi^\circ$	$c$ (t.s.f.)	CLASS
2 - MHULT	1	- 0.3	Q	1	0.38	ML
	2	- 7.6		0	0.28	CL
	3	- 16.4		0	0.21	CL
	4	- 49.1		0	0.20	CH
	5	- 70.4		1	0.42	CH
	6	- 81.9		0	0.33	CL
	7	- 92.4		3	0.32	CL
	8	- 106.1		2	0.45	CH
	9	- 16.8	R	14	0.18	CL
	10	- 12.4	S	32	0.0	ML

**SHEAR STRENGTH DATA**

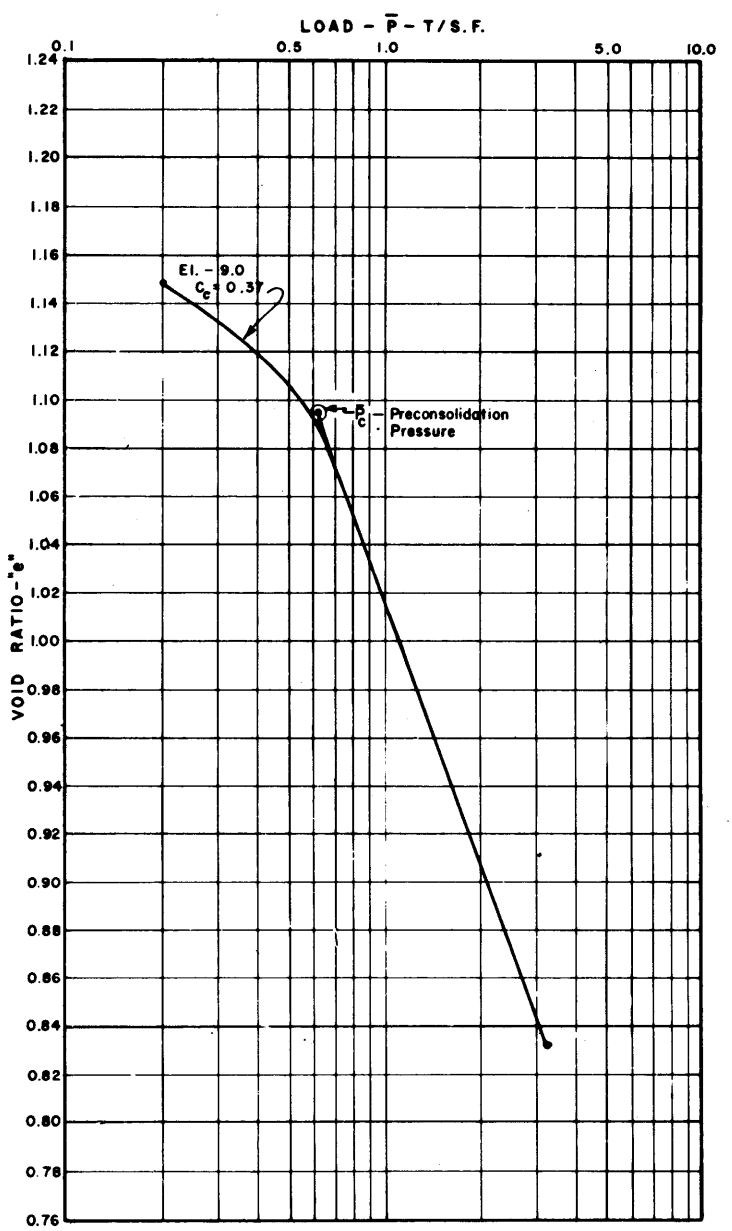

— Boring No. 2-MHULT  
 - - - Boring No.  
 For soil legend see plate A  
 For location of borings see plate B

Borings were taken with a 5" diameter steel tube piston type sampler.

MISSISSIPPI RIVER LEVEES AND BANKS  
 MILE 66 TO MILE 10  
 SOIL REPORT - PART I  
 EAST BANK  
**SOIL BORING DATA**  
 2-MHULT  
 STA. 2518+00  
 U.S. ARMY ENGINEER DISTRICT, NEW ORLEANS  
 CORPS OF ENGINEERS  
 AUGUST 1971

BOR. 61-MHUL  
 STA. 36+84  
 ON + B.L.  
 19-25 JUN 70

ELEVATIONS IN FEET - M.S.L.

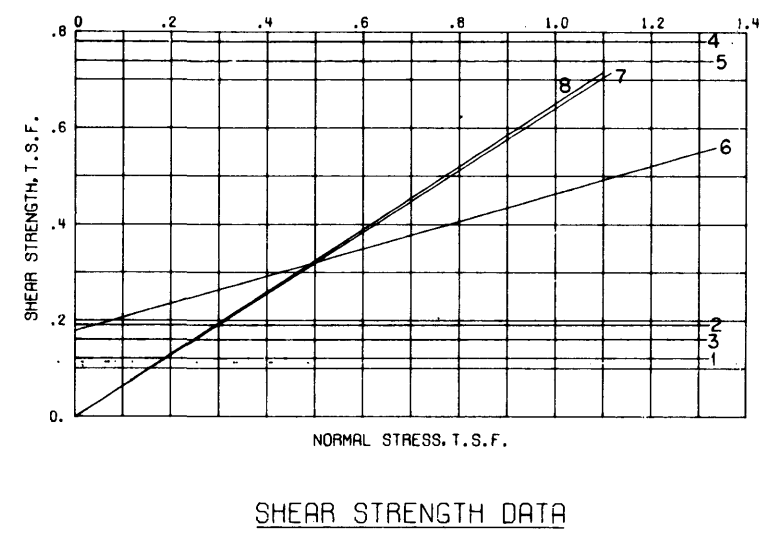
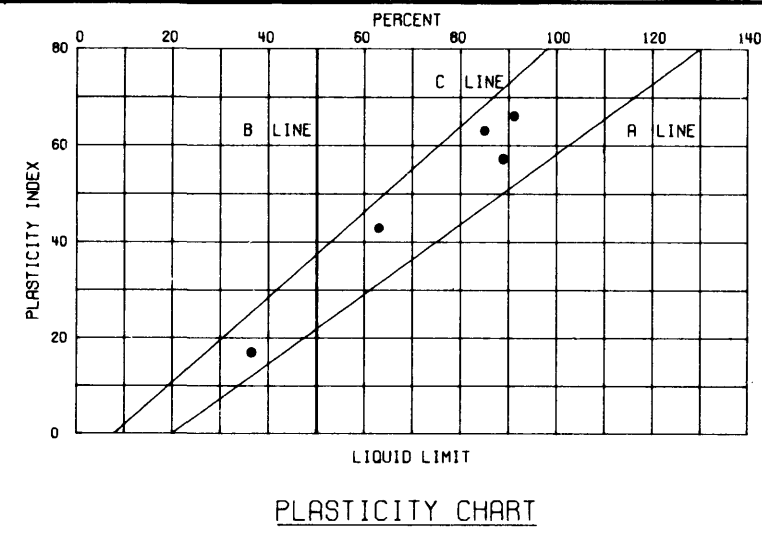
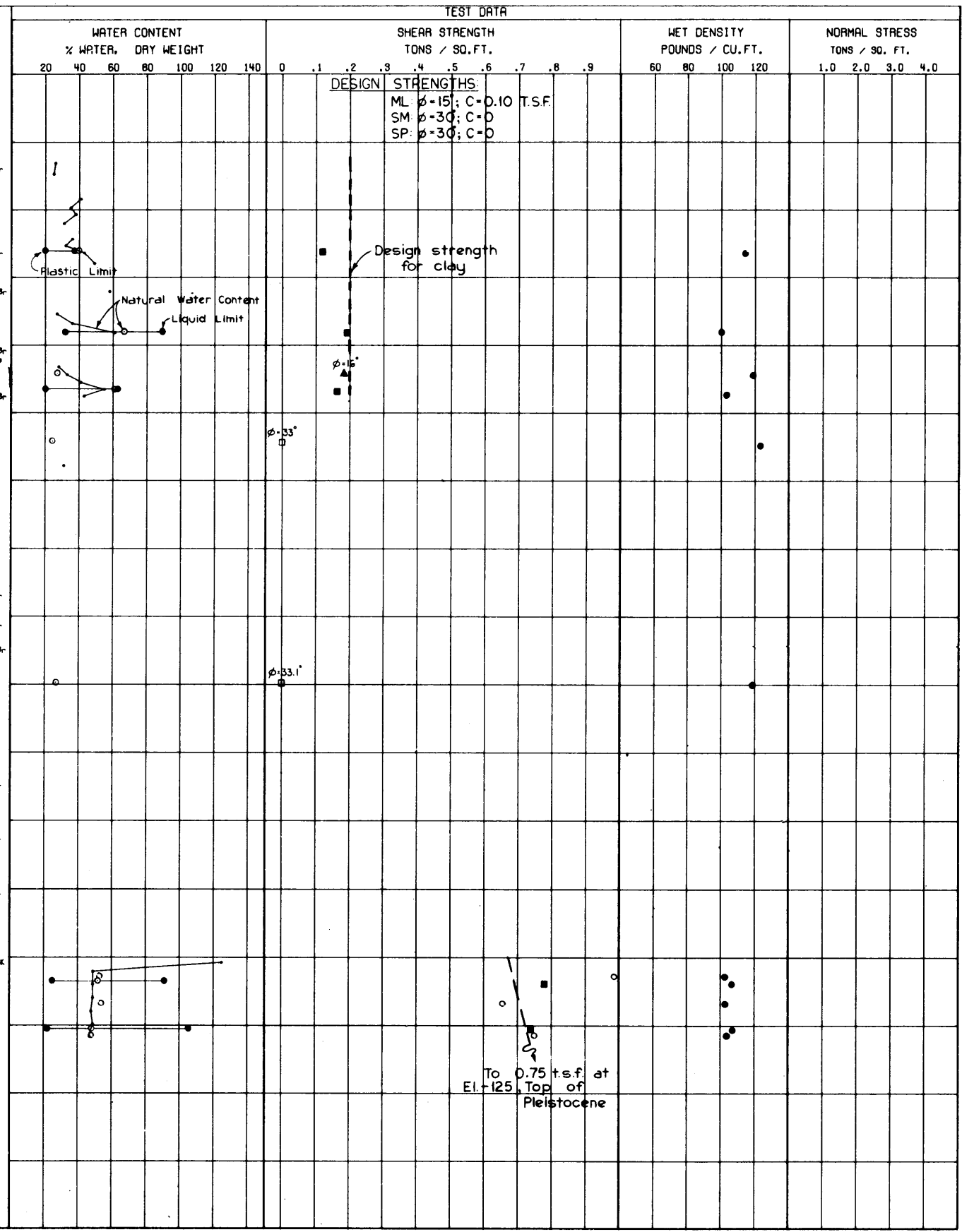
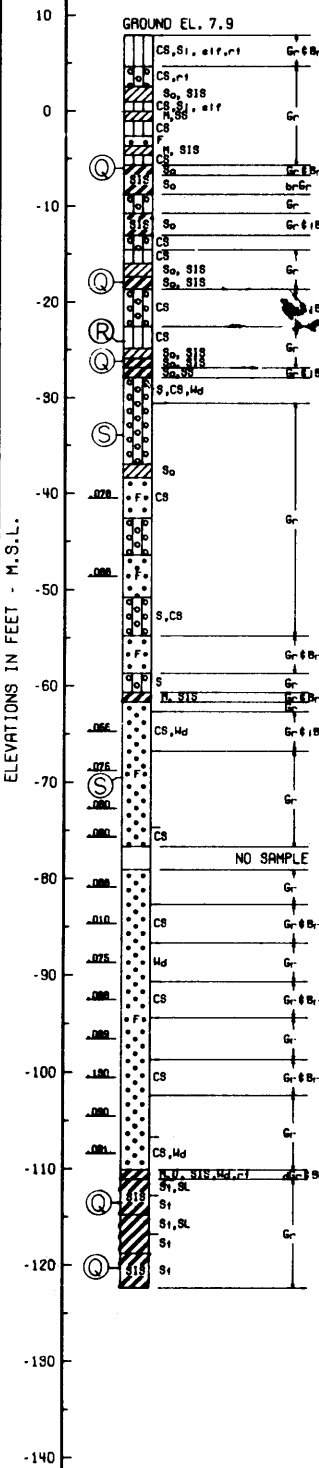

BORING NO.	ENVELOPE		TYPE	STRENGTH		CLASS
	NO.	EL.		$\phi$	C - TSF	
61-MHUL	1	-6.0	Q	0	0.12	CL
	2	-17.7		0	0.19	CH
	3	-26.0		0	0.16	CH
	4	-113.3		0	0.78	CH
	5	-120.2		0	0.74	CH
	6	-24.1	R*	16.0*	0.18	ML
	7	-33.9	S	33.0*	0	SM
	8	-69.9		33.1*	0	SM

VOID RATIO - e

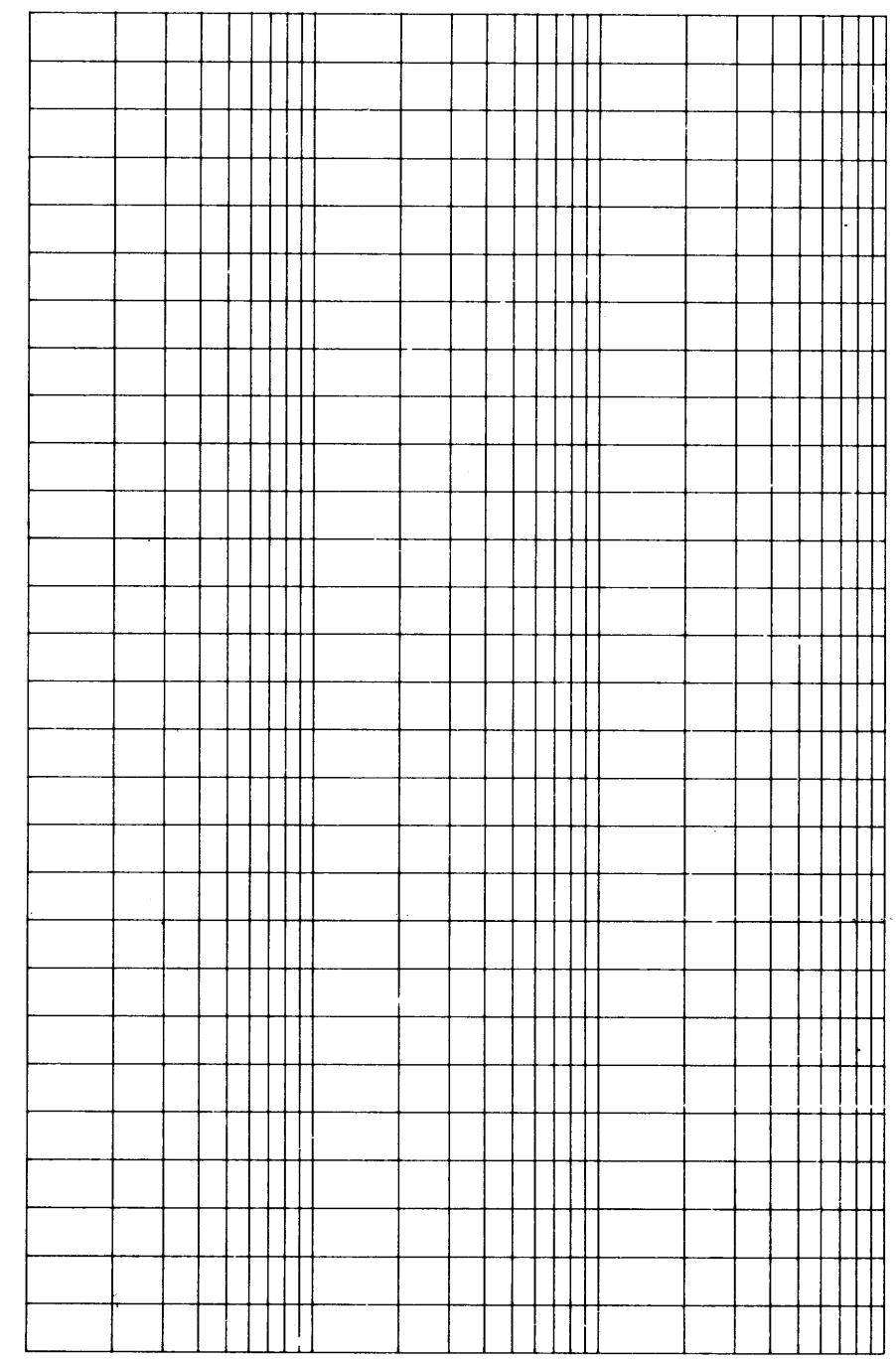

CONSOLIDATION DATA

- - (UC) UNCONFINED COMPRESSION TEST
  - - (O) UNCONSOLIDATED - UNDRAINED SHEAR TEST
  - ▲ - (A) CONSOLIDATED - UNDRAINED SHEAR TEST
  - - (S) CONSOLIDATED - DRAINED SHEAR TEST
- BORINGS WERE TAKEN WITH A 5 INCH DIAMETER STEEL TUBE PISTON TYPE SAMPLER  
 FOR SOIL BORING LEGEND SEE PLATE A  
 FOR LOCATION OF BORINGS SEE PLATE B

MISSISSIPPI RIVER LEVEES AND BANKS  
 MILE 66 TO MILE 10  
**SOIL REPORT - PART I**  
 EAST BANK  
**SOIL BORING DATA**  
 61-MHUL  
 U.S. ARMY ENGINEER DISTRICT, NEW ORLEANS  
 CORPS OF ENGINEERS

AUGUST 1971

FILE NO. H-2-25275



BOR. R-41.8-LU  
 STA. 137+00  
 300 FT. R.S.  
 6-9 JAN 70

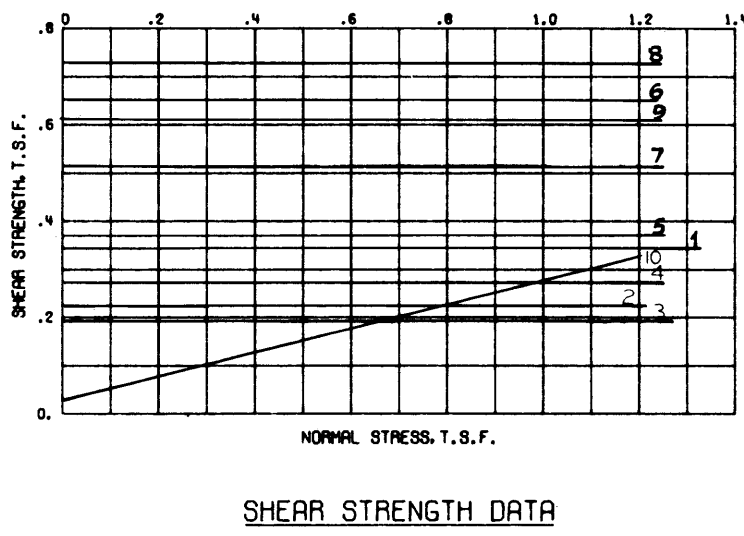
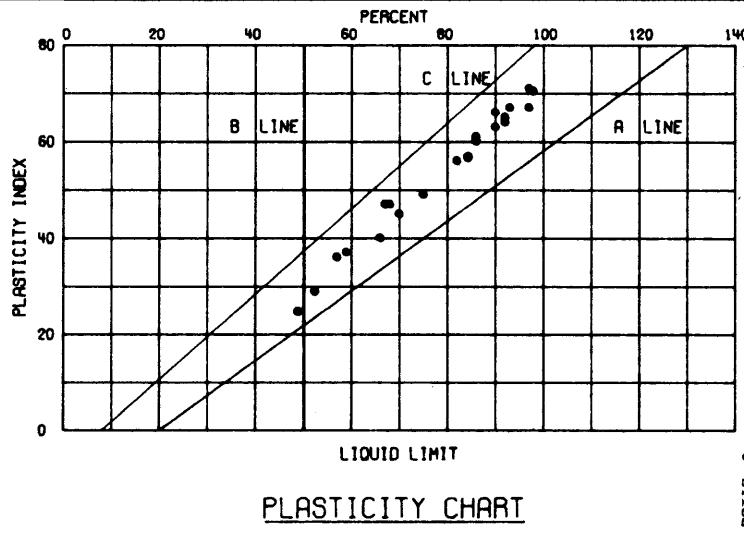
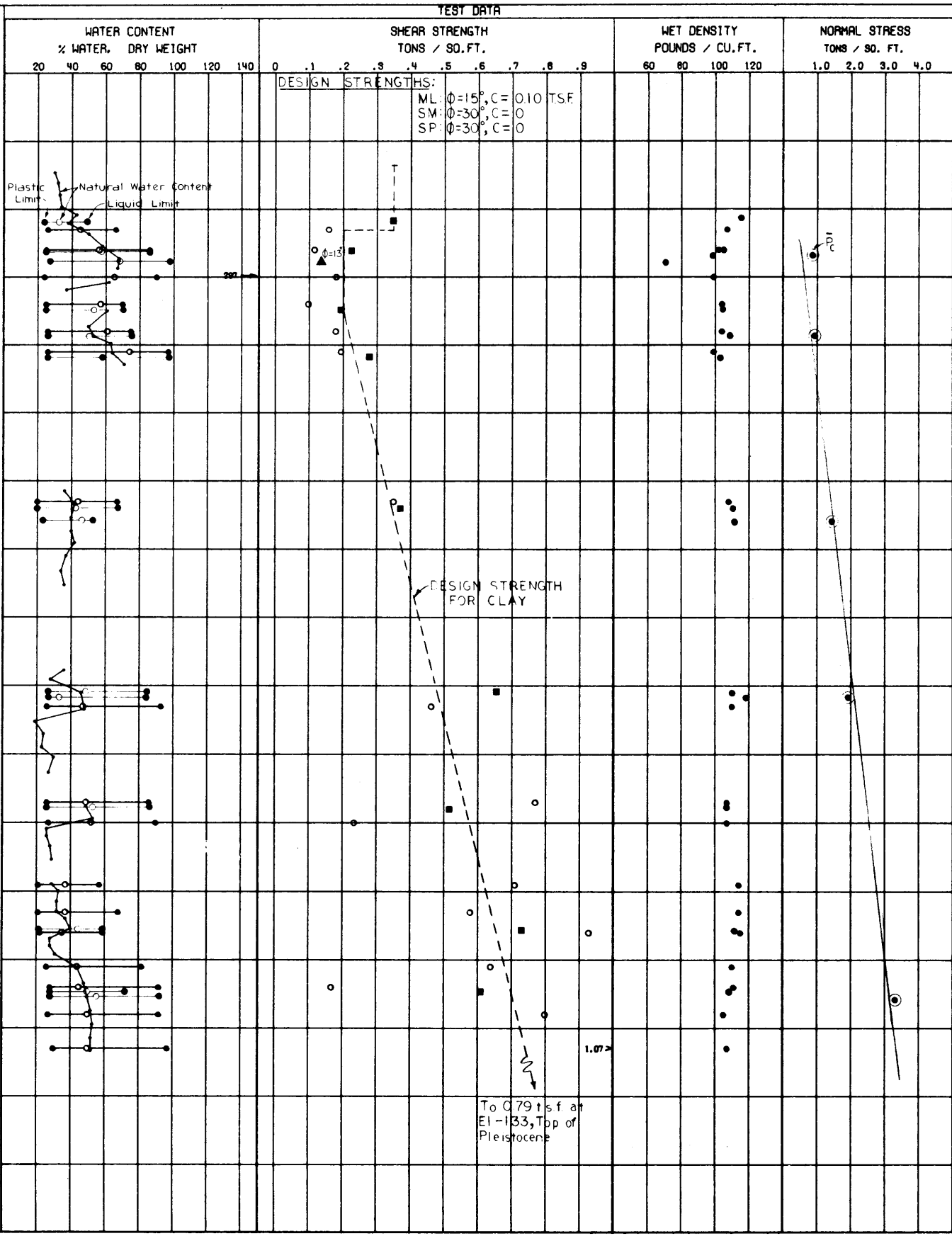
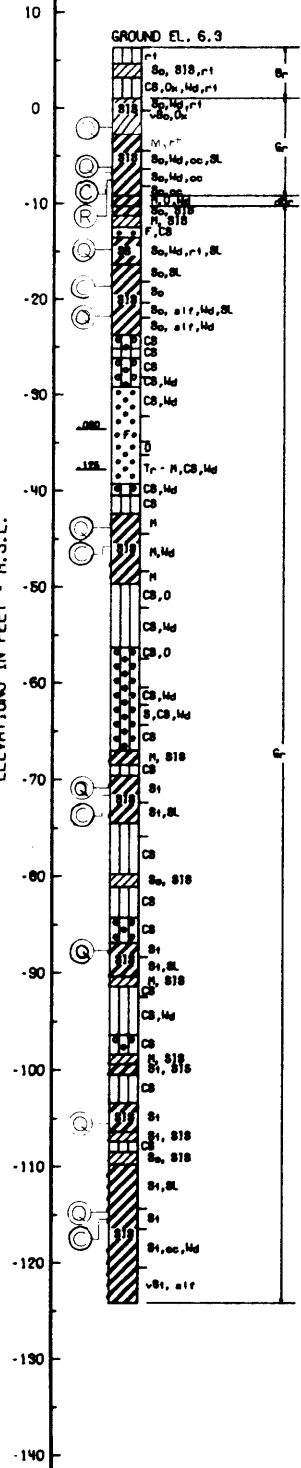

BORING NO.	ENVELOPE		TYPE	STRENGTH		CLASS
	NO.	EL.		$\phi$	C - TSF	
R-41.8-LU	1	-1.9	Q	0.0	.348	CL
	2	-6.1		0.0	.222	CH
	3	-14.9		0.0	.193	CH
	4	-21.7		0.0	.275	CH
	5	-43.9		0.0	.370	CH
	6	-70.8		0.0	.655	CH
	7	-87.6		0.0	.55	CH
	8	-105.8		0.0	.730	CH
	9	-114.8		0.0	.610	CH
	10	-7.7		F	13 <sup>c</sup>	.140

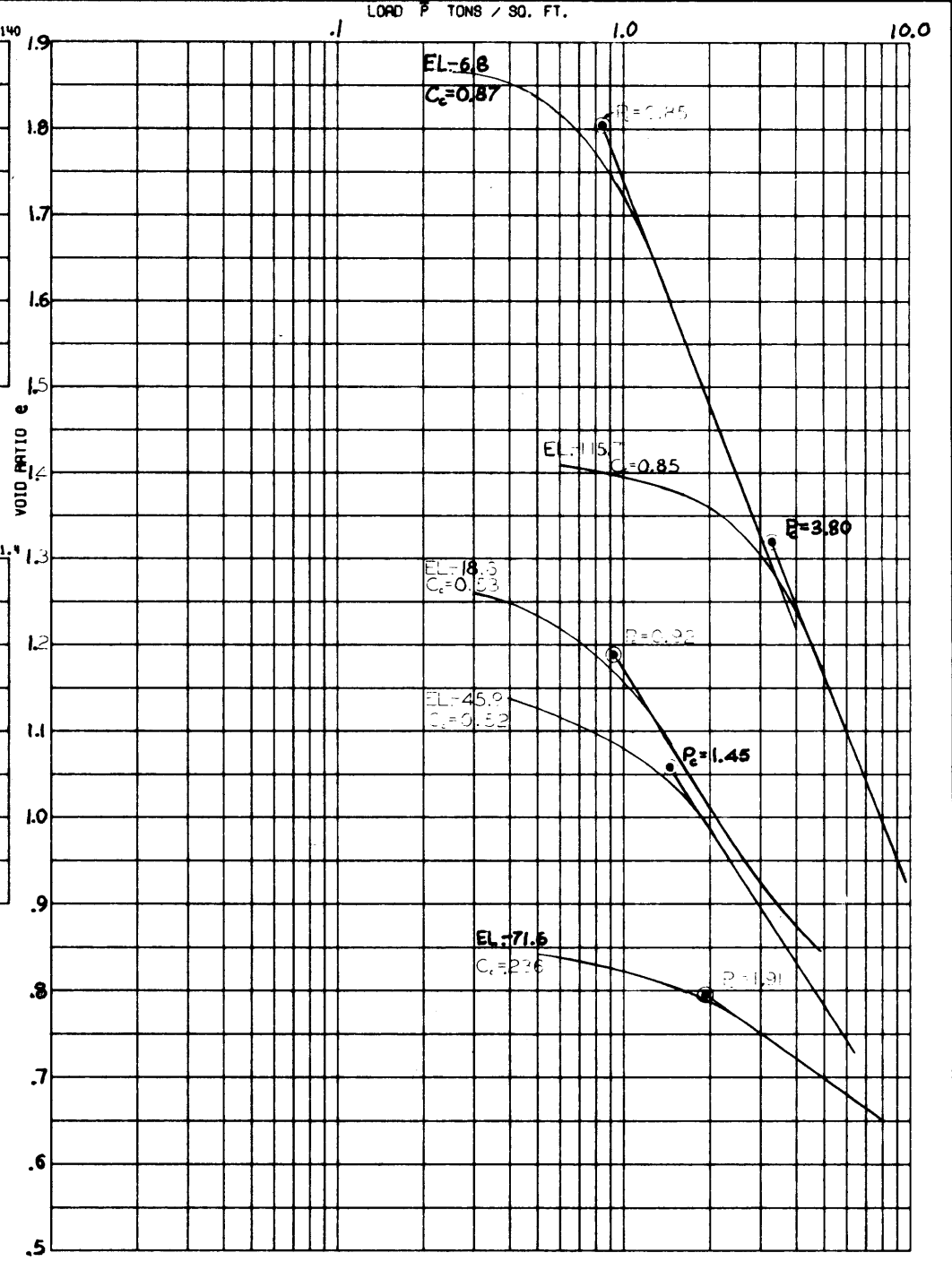

- - (UC) UNCONFINED COMPRESSION TEST
  - - (Q) UNCONSOLIDATED - UNDRAINED SHEAR TEST
  - ▲ - (R) CONSOLIDATED - UNDRAINED SHEAR TEST
  - - (S) CONSOLIDATED - DRAINED SHEAR TEST
- BORINGS WERE TAKEN WITH A 5 INCH DIAMETER STEEL TUBE PISTON TYPE SAMPLER  
 FOR SOIL BORING LEGEND SEE PLATE A  
 FOR LOCATION OF BORINGS SEE PLATE B

MISSISSIPPI RIVER LEVEES AND BANKS  
 MILE 66 TO MILE 10  
 SOIL REPORT - PART I  
 EAST BANK  
**SOIL BORING DATA**  
 R-41.8-LU  
 U.S. ARMY ENGINEER DISTRICT, NEW ORLEANS  
 CORPS OF ENGINEERS

AUGUST 1971

FILE NO. H-2-25275

BOR. 5-BU  
 STA. 11+80 ON C.A.  
 3-9 FEB 70

ELEVATIONS IN FEET - M.S.L.

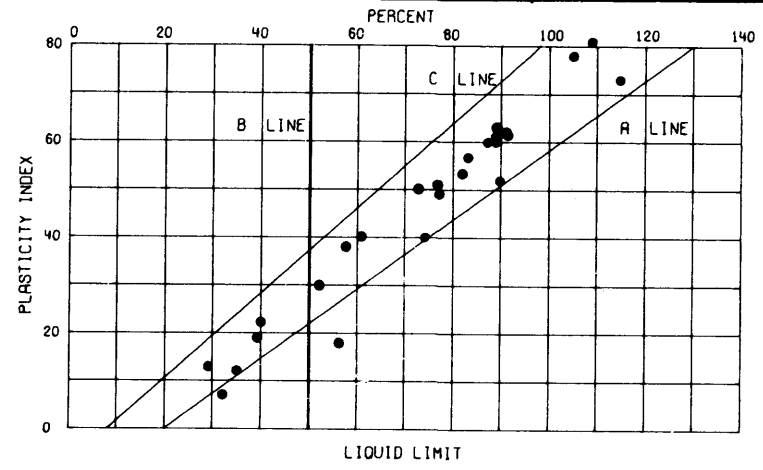
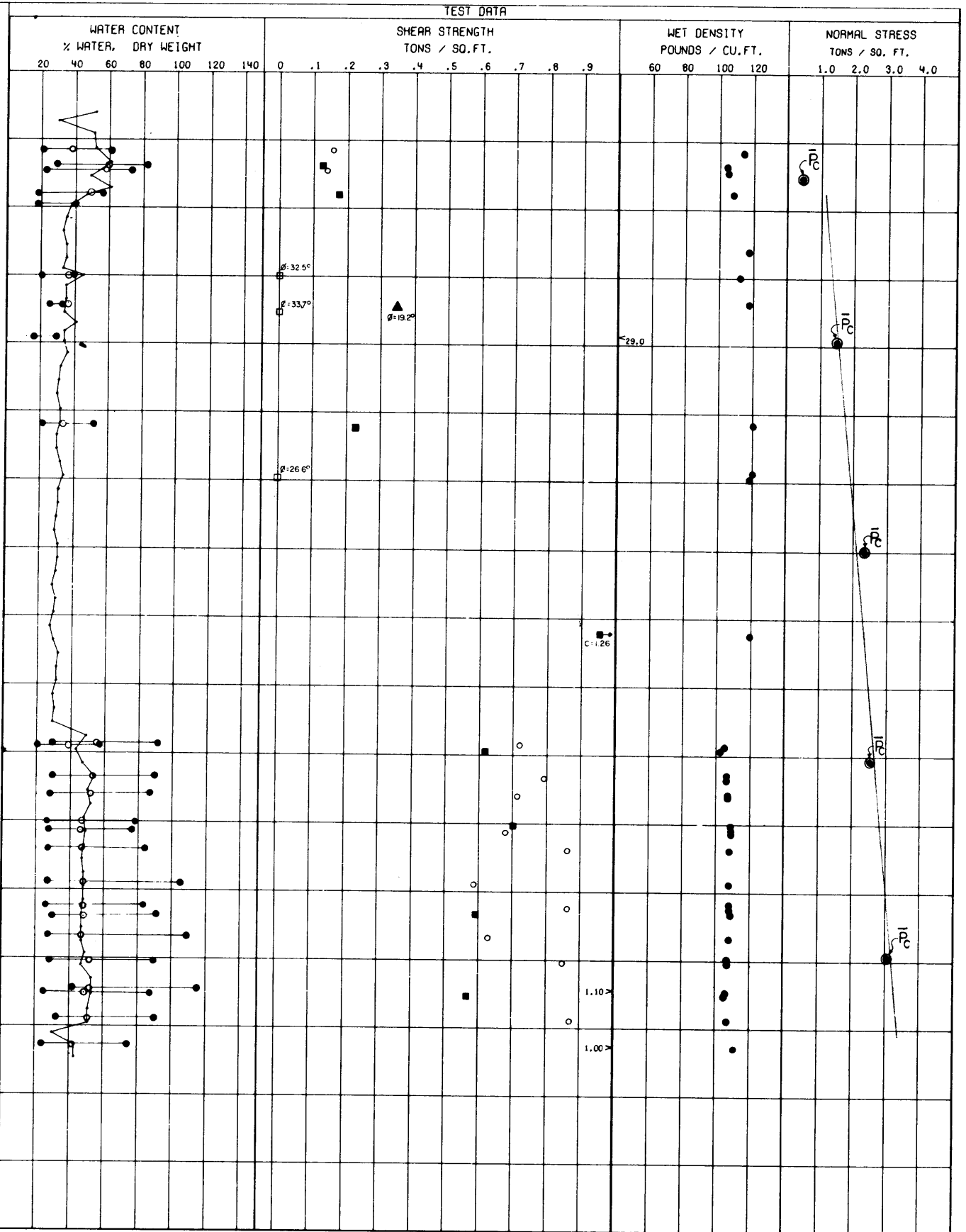
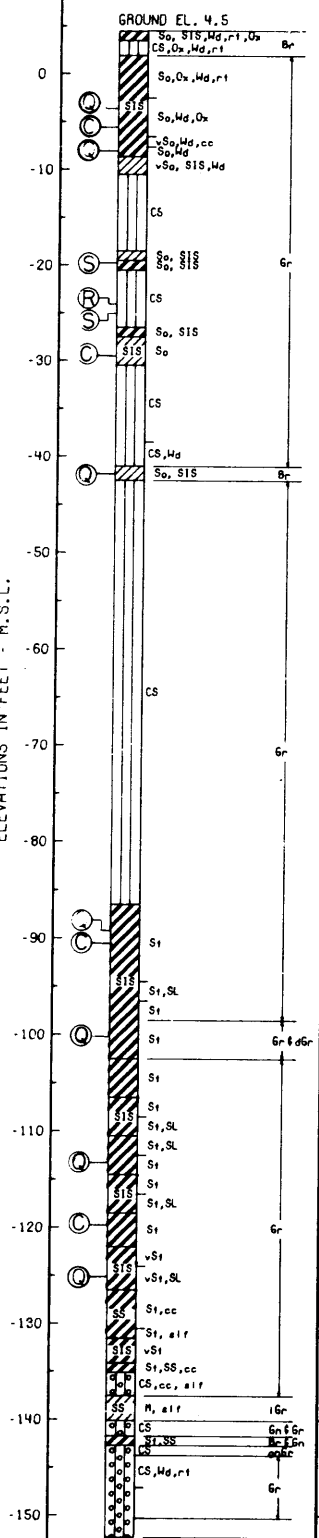

PLASTICITY CHART

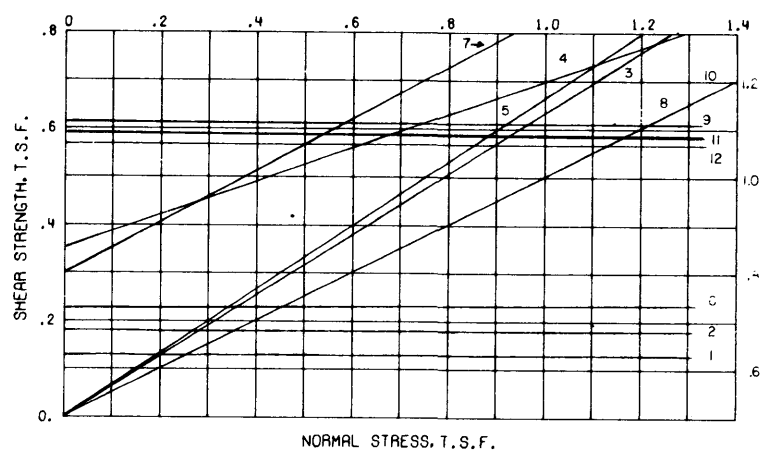

SHEAR STRENGTH DATA

BORING NO.	ENVELOPE		TYPE	STRENGTH		CLASS
	NO.	EL.		$\phi$	C - TSF	
5-BU	1	-3.8	Q	0°	0.130	CH
	2	-8.0	Q	0°	0.180	CH
	3	-20.0	S	32.5°	0	CL
	4	-24.0	R*	19.2°	0.350	ML
	5	-24.9	S	33.7°	0	ML
	6	-41.9	Q	0°	0.230	CL
	7	-48.7	R**	28°	0.800	ML
	8	-49.6	S	26.6°	0	ML
	9	-89.1	Q	0°	0.613	CH
	10	-100.1	Q	0°	0.700	CH
	11	-113.1	Q	0°	0.591	CH
	12	-125.1	Q	0°	0.568	CH

BASED ON DEVIATOR STRESS AT MAXIMUM POSITIVE PORE PRESSURE: \*  $\beta = 15.5^\circ$ , C = 0.18 TSF  
 \*\*  $\beta = 17.2^\circ$ , C = 0.20 TSF

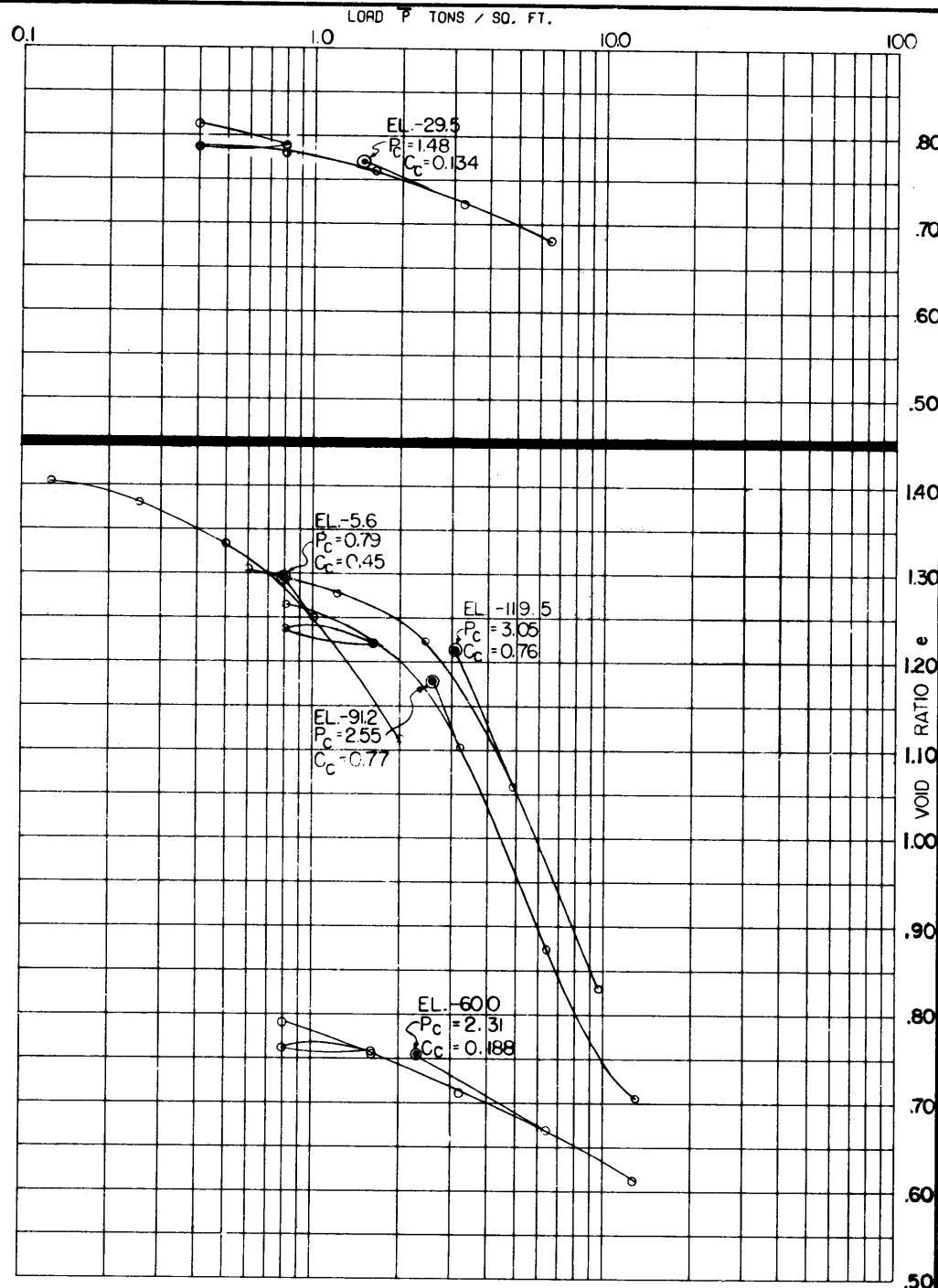

CONSOLIDATION DATA

- - (UC) UNCONFINED COMPRESSION TEST
  - - (Q) UNCONSOLIDATED - UNDRAINED SHEAR TEST
  - ▲ - (R) CONSOLIDATED - UNDRAINED SHEAR TEST
  - - (S) CONSOLIDATED - DRAINED SHEAR TEST
- BORINGS WERE TAKEN WITH A 5 INCH DIAMETER STEEL TUBE PISTON TYPE SAMPLER  
 FOR SOIL BORING LEGEND SEE PLATE A  
 FOR LOCATION OF BORINGS SEE PLATE 9

MISSISSIPPI RIVER LEVEES AND BANKS  
 MILE 66 TO MILE 10  
 SOIL REPORT - PART I  
 EAST BANK  
**SOIL BORING DATA**  
 5-BU  
 U.S. ARMY ENGINEER DISTRICT, NEW ORLEANS  
 CORPS OF ENGINEERS

AUGUST 1971

FILE NO. H-2-25275



BOR. 32-MHUL  
 STA. 297+00  
 80 FT L.S. OF B.L.  
 18 FEB 70

ELEVATIONS IN FEET - M.S.L.

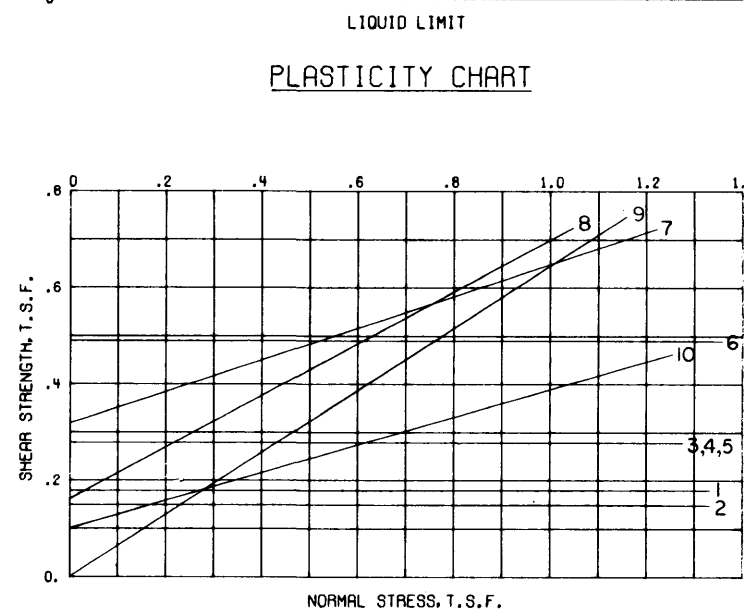
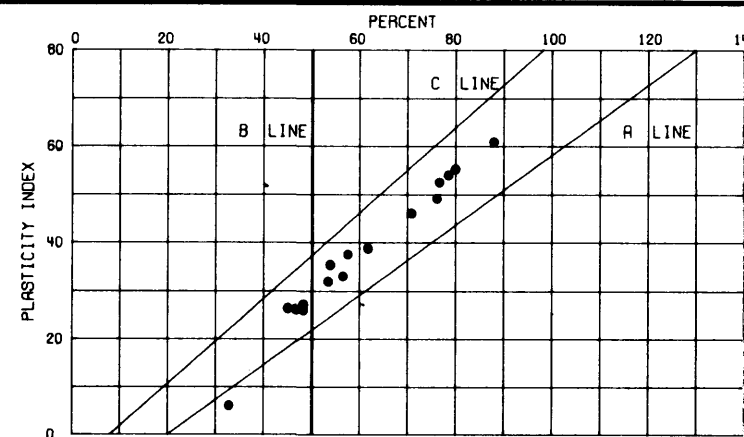
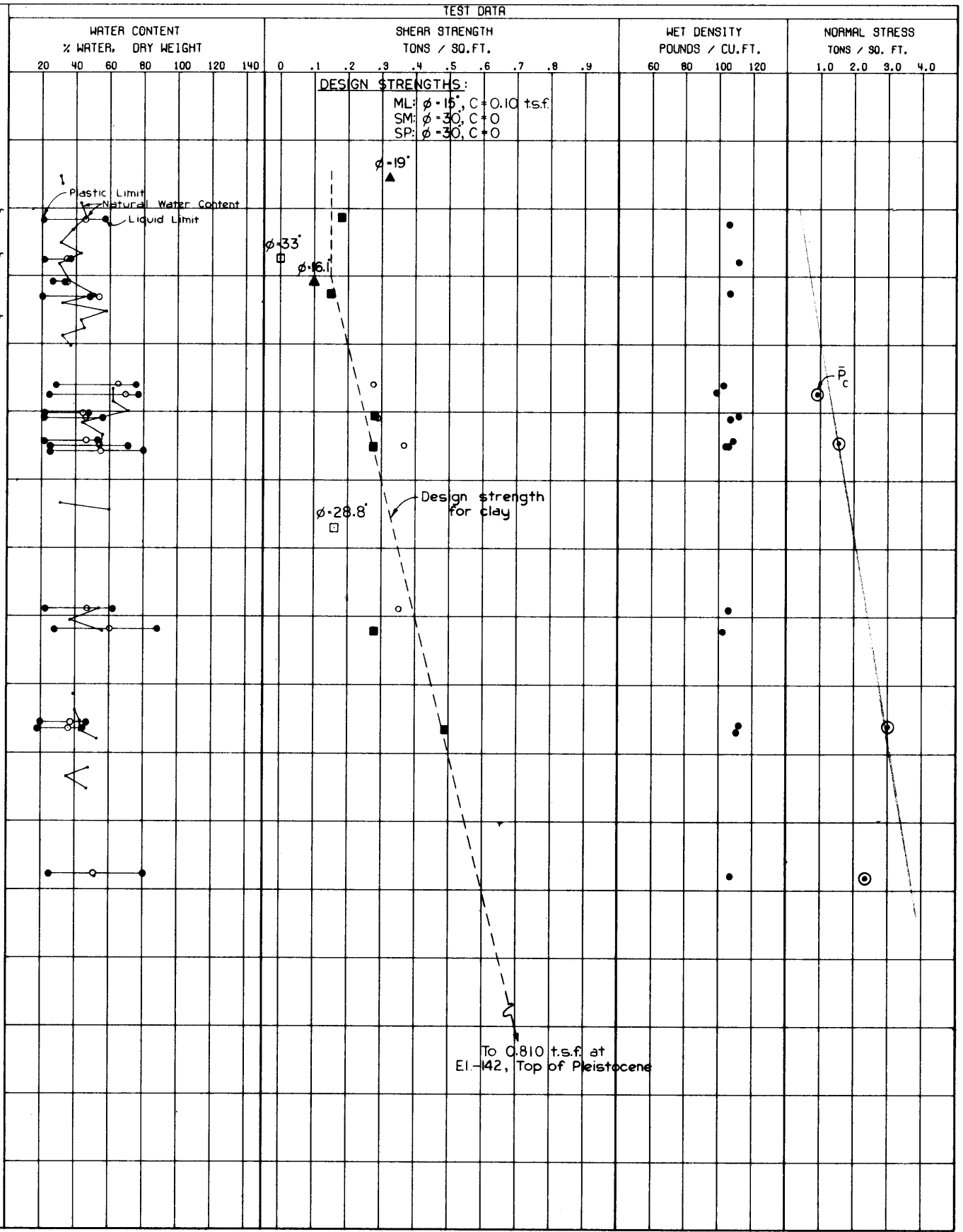
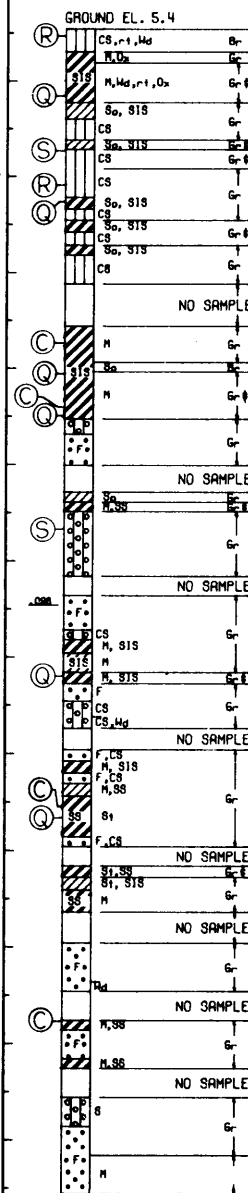

BORING NO.	ENVELOPE		TYPE	STRENGTH		CLASS
	NO.	EL.		$\phi$	C - TSF	
32-MHUL	1	-1.6	Q	0	0.18	CH
	2	-12.6		0	0.15	CH
	3	-30.6		0	0.28	CL
	4	-35.0		0	0.28	CH
	5	-62.0	R*	0	0.28	CH
	6	-76.6		0	0.49	CL
	7	4.7	S	19.0	0.32	ML
	8	-10.8		16.1	0.10	ML
	9	-7.6		33.0	0	CL
	10	-46.7		28.8	0.16	SM

\*BASED ON DEVIATOR STRESS AT MAXIMUM POSITIVE PORE PRESSURE.

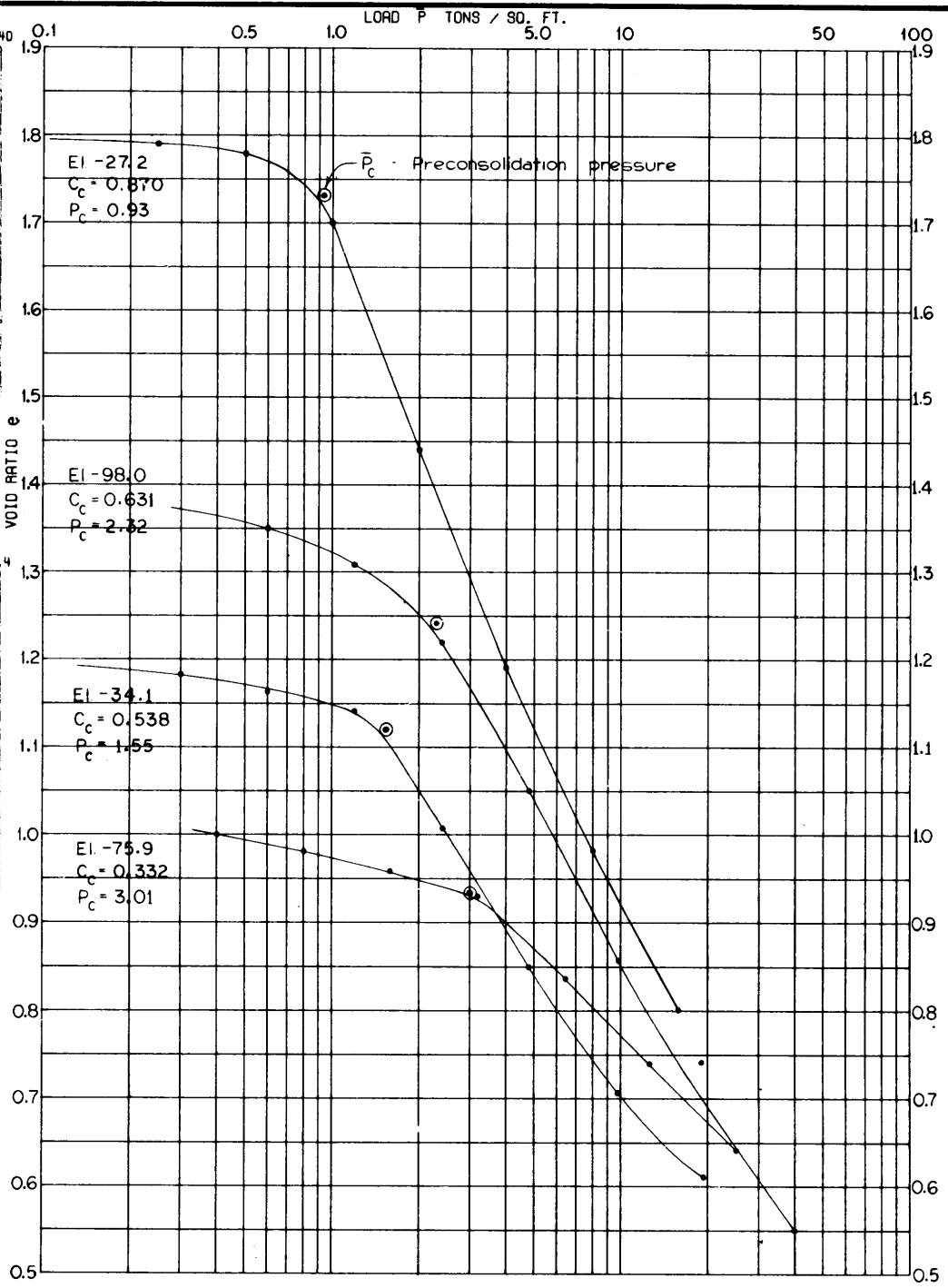

○ - (UC) UNCONFINED COMPRESSION TEST  
 ■ - (Q) UNCONSOLIDATED - UNDRAINED SHEAR TEST  
 ▲ - (R) CONSOLIDATED - UNDRAINED SHEAR TEST  
 □ - (S) CONSOLIDATED - DRAINED SHEAR TEST

BORINGS WERE TAKEN WITH A 5 INCH DIAMETER STEEL TUBE PISTON TYPE SAMPLER  
 FOR SOIL BORING LEGEND SEE PLATE A  
 FOR LOCATION OF BORINGS SEE PLATE 9

MISSISSIPPI RIVER LEVEES AND BANKS  
 MILE 66 TO MILE 10  
 SOIL REPORT - PART I  
 EAST BANK  
**SOIL BORING DATA**  
 32 - MHUL  
 U.S. ARMY ENGINEER DISTRICT, NEW ORLEANS  
 CORPS OF ENGINEERS

AUGUST 1971

FILE NO. H-2-25275

BOR. 36-MHUL  
 STA. 405+00  
 110 FT L.S. OF B.L.  
 2-3 MAR 70

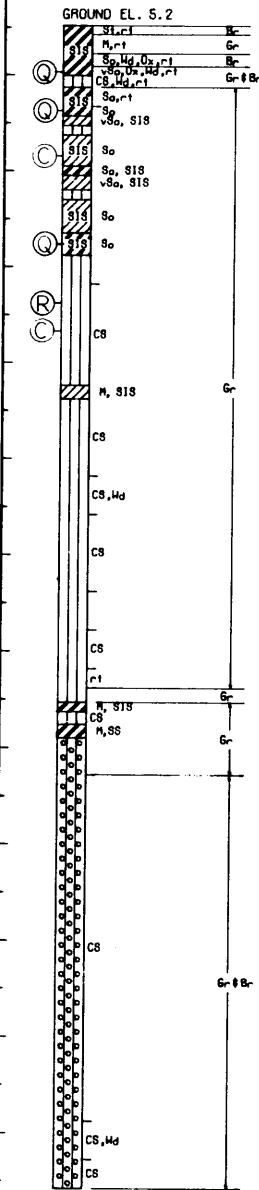

ELEVATIONS IN FEET - M.S.L.

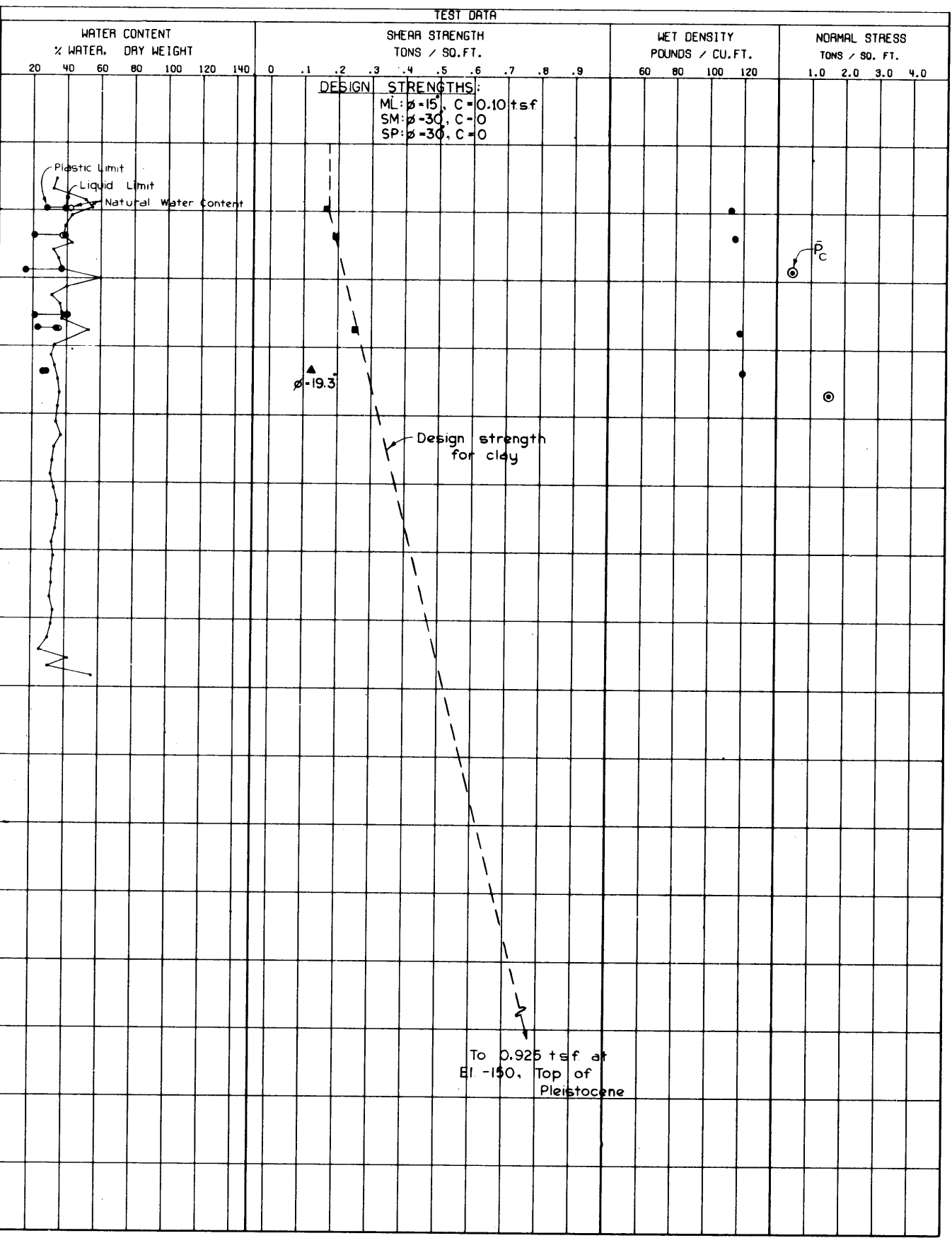

DESIGN STRENGTHS:  
 ML:  $\phi = 15$ ,  $C = 0.10$  tsf  
 SM:  $\phi = 30$ ,  $C = 0$   
 SP:  $\phi = 30$ ,  $C = 0$

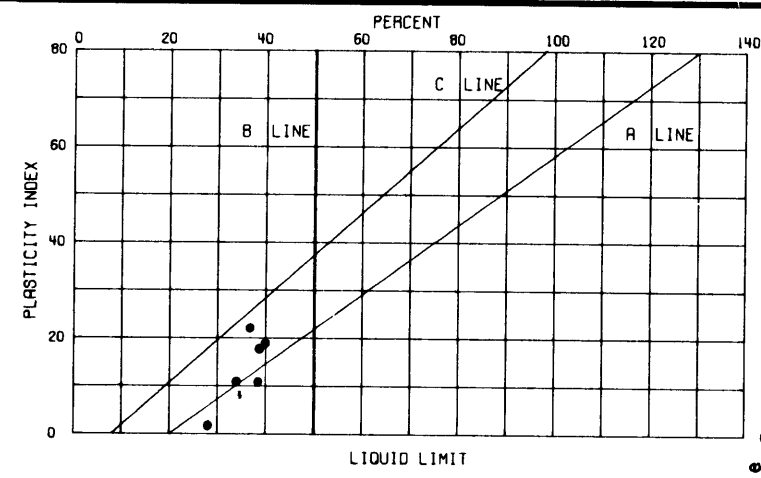

PLASTICITY CHART

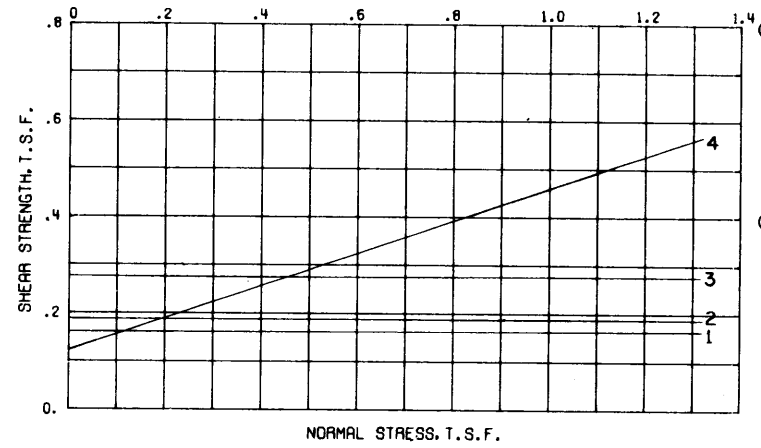

SHEAR STRENGTH DATA

BORING NO.	ENVELOPE		TYPE	STRENGTH		CLASS
	NO.	EL.		$\phi$	C - TSF	
36-MHUL	1	0.2	↑	0	0.16	ML
	2	-3.7	Q	0	0.19	CL
	3	-17.4	↓	0	0.27	CL
	4	-23.4	R*	19.3	0.12	ML

\*BASED ON DEVIATOR STRESS AT MAXIMUM POSITIVE PORE PRESSURE.

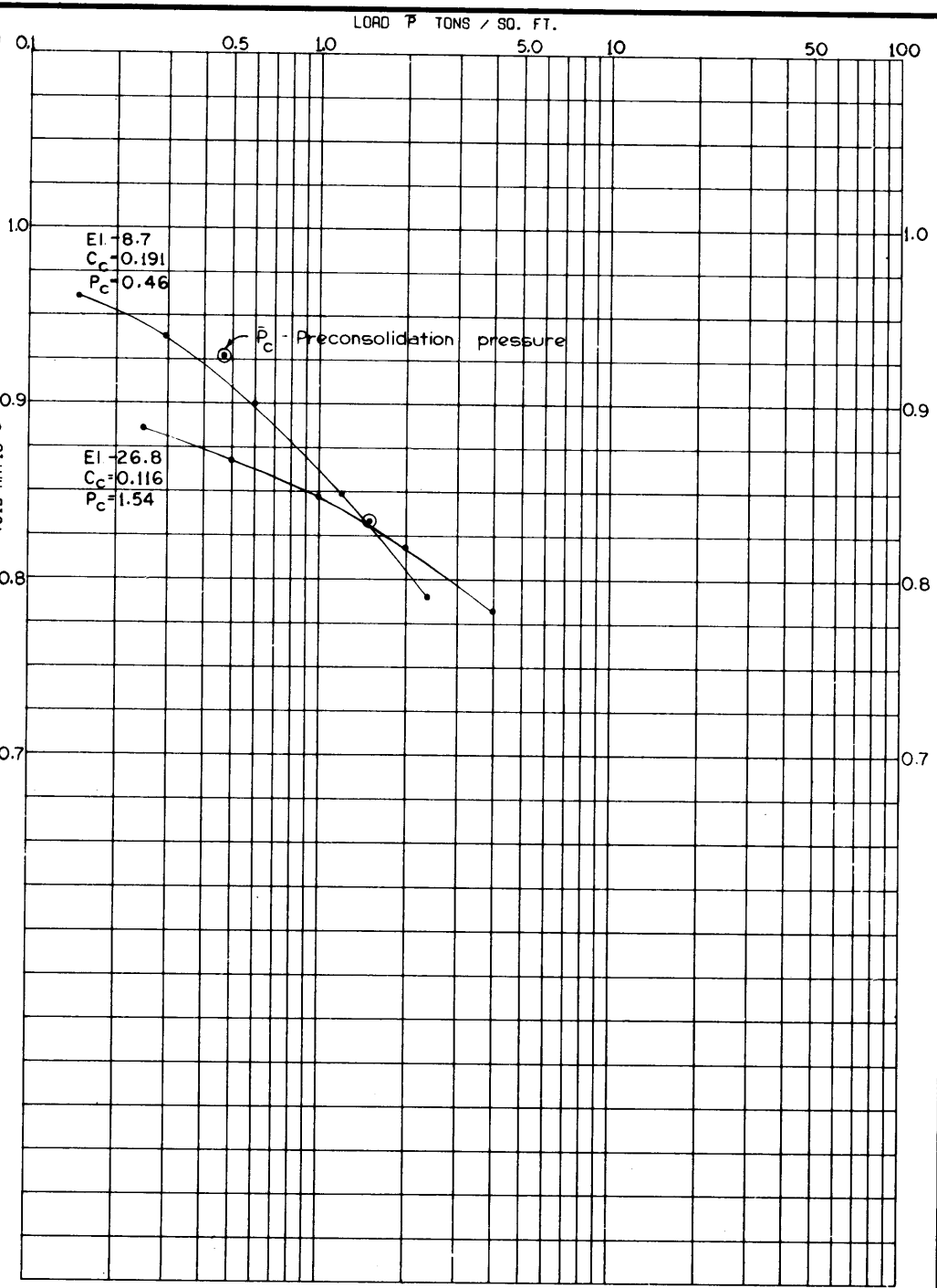

CONSOLIDATION DATA

- - (UC) UNCONFINED COMPRESSION TEST
  - - (Q) UNCONSOLIDATED - UNDRAINED SHEAR TEST
  - ▲ - (R) CONSOLIDATED - UNDRAINED SHEAR TEST
  - - (S) CONSOLIDATED - DRAINED SHEAR TEST
- BORINGS WERE TAKEN WITH A 5 INCH DIAMETER STEEL TUBE PISTON TYPE SAMPLER  
 FOR SOIL BORING LEGEND SEE PLATE A  
 FOR LOCATION OF BORINGS SEE PLATE 10

MISSISSIPPI RIVER LEVEES AND BANKS  
 MILE 66 TO MILE 10  
 SOIL REPORT - PART I  
 EAST BANK  
**SOIL BORING DATA**  
 36 - MHUL  
 U.S. ARMY ENGINEER DISTRICT, NEW ORLEANS  
 CORPS OF ENGINEERS

AUGUST 1971 FILE NO. H-2-25275

BOR. R-34.4-UL  
 STA. 70 + 10  
 24C FT. RS. CF BL  
 4 APRIL 1967

ELEVATIONS IN FEET - M.S.L.

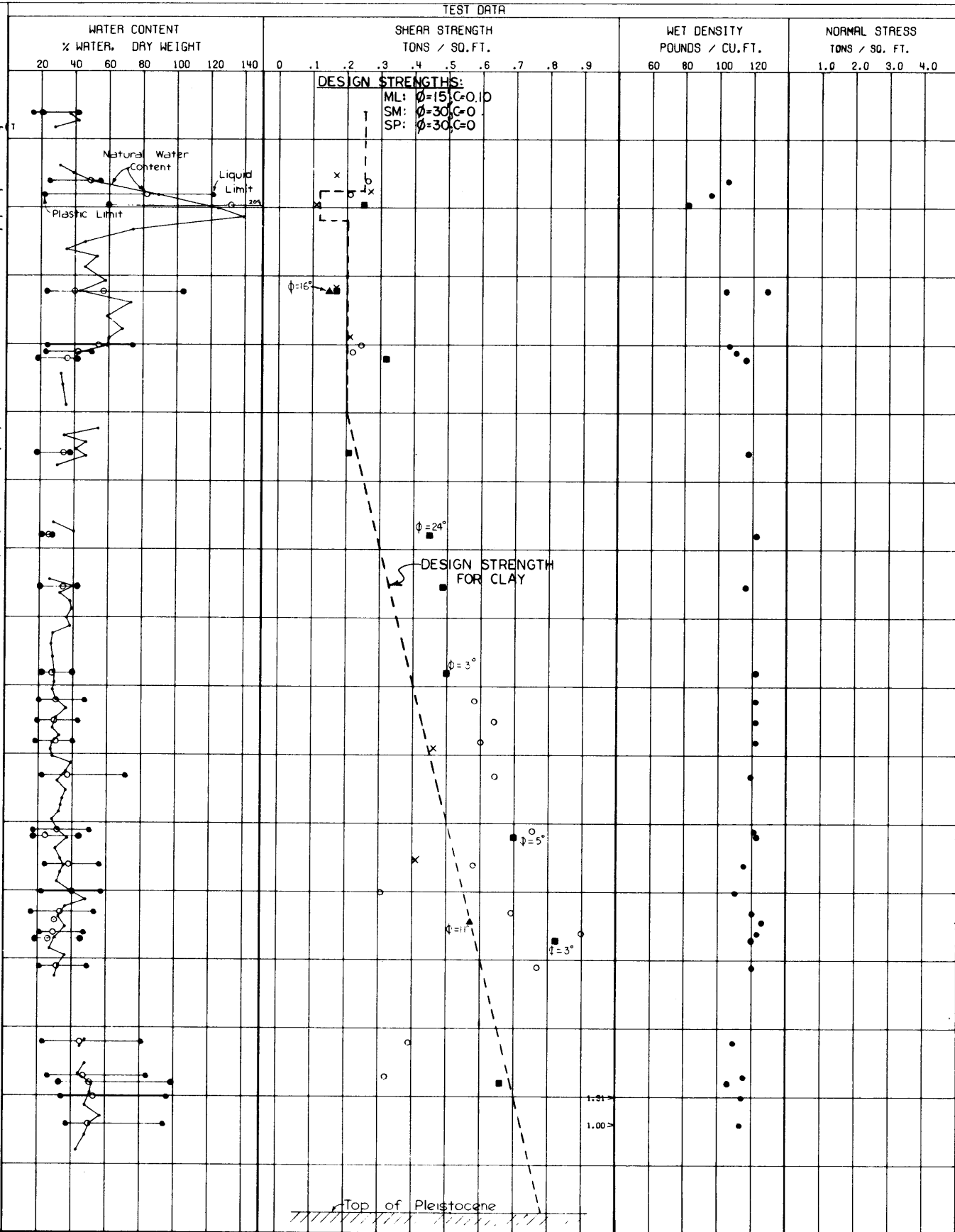
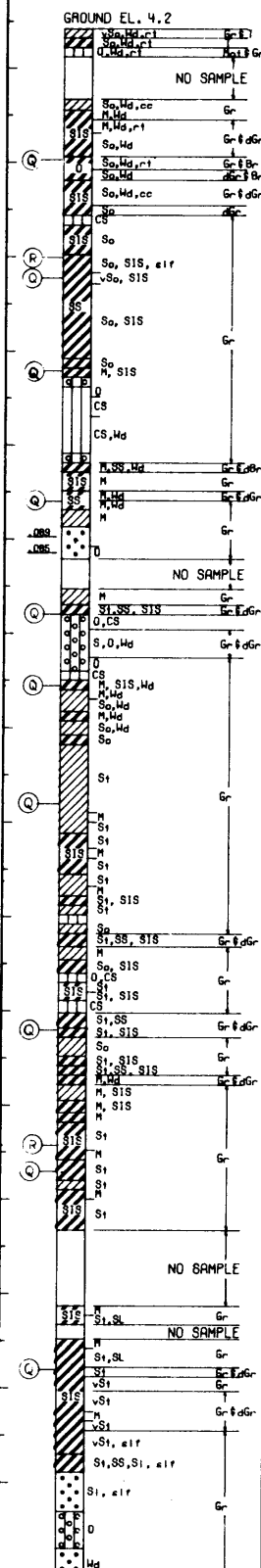

X-(Q) STRENGTH, BORING 38-MHUL

Top of Pleistocene

DESIGN STRENGTHS:  
 ML:  $\phi = 15, C = 0.10$   
 SM:  $\phi = 30, C = 0$   
 SP:  $\phi = 30, C = 0$

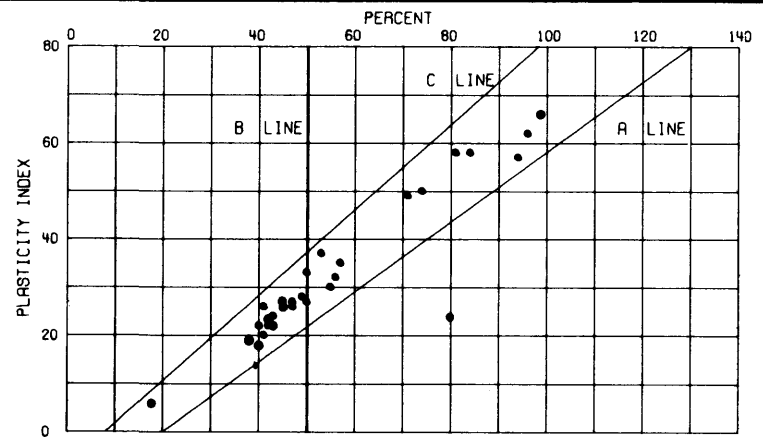

PLASTICITY CHART

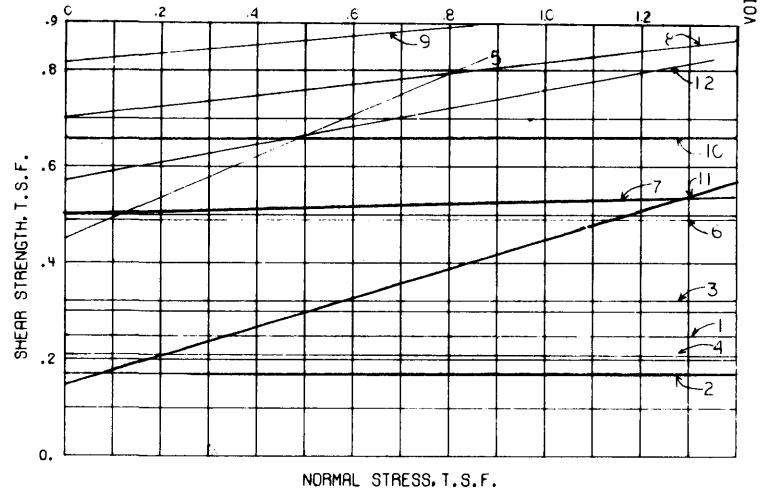

SHEAR STRENGTH DATA

BORING NO.	ENVELOPE		TYPE	STRENGTH		CLASS
	NO.	EL.		$\phi$	C - TSF	
R-34.4UL	1	-9.8	Q	$0^\circ$	0.25	CH
	2	-22.2	Q	$0^\circ$	0.17	CH
	3	-32.1	Q	$0^\circ$	0.32	CL
	4	-46.0	Q	$0^\circ$	0.21	CL
	5	-56.0	Q	$24^\circ$	0.45	SM
	6	-65.6	Q	$0^\circ$	0.45	CL
	7	-76.0	Q	$3^\circ$	0.50	CL
	8	-102.0	Q	$5^\circ$	0.70	CL
	9	-117.3	Q	$3^\circ$	0.82	CL
	10	-136.2	Q	$0^\circ$	0.06	CH
	11	-22.2	R	$16^\circ$	0.15	CH
	12	-114.3	R	$11^\circ$	0.57	CH

- - (UC) UNCONFINED COMPRESSION TEST
  - - (Q) UNCONSOLIDATED - UNDRAINED SHEAR TEST
  - ▲ - (R) CONSOLIDATED - UNDRAINED SHEAR TEST
  - - (S) CONSOLIDATED - DRAINED SHEAR TEST
- BORINGS WERE TAKEN WITH A 5 INCH DIAMETER STEEL TUBE PISTON TYPE SAMPLER  
 FOR SOIL BORING LEGEND SEE PLATE A  
 FOR LOCATION OF BORINGS SEE PLATE 10

CONSOLIDATION DATA

MISSISSIPPI RIVER LEVEES AND BANKS  
 MILE 66 TO MILE 10  
 SOIL REPORT - PART I  
 EAST BANK  
**SOIL BORING DATA**  
 R-34.4-LU  
 U.S. ARMY ENGINEER DISTRICT, NEW ORLEANS  
 CORPS OF ENGINEERS

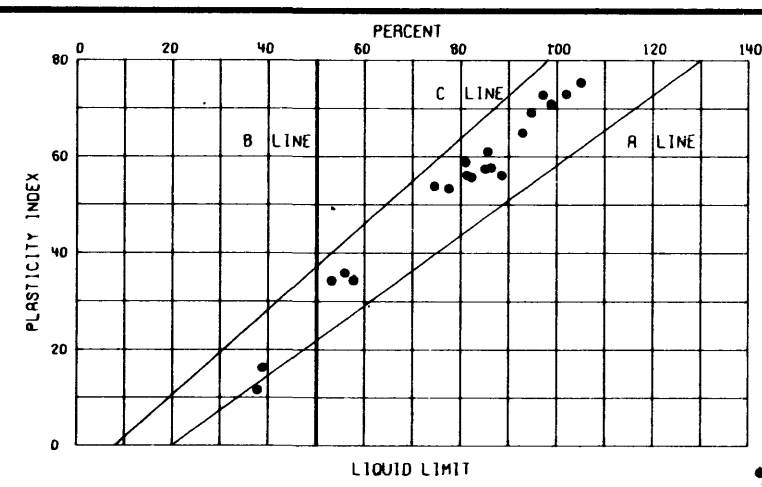
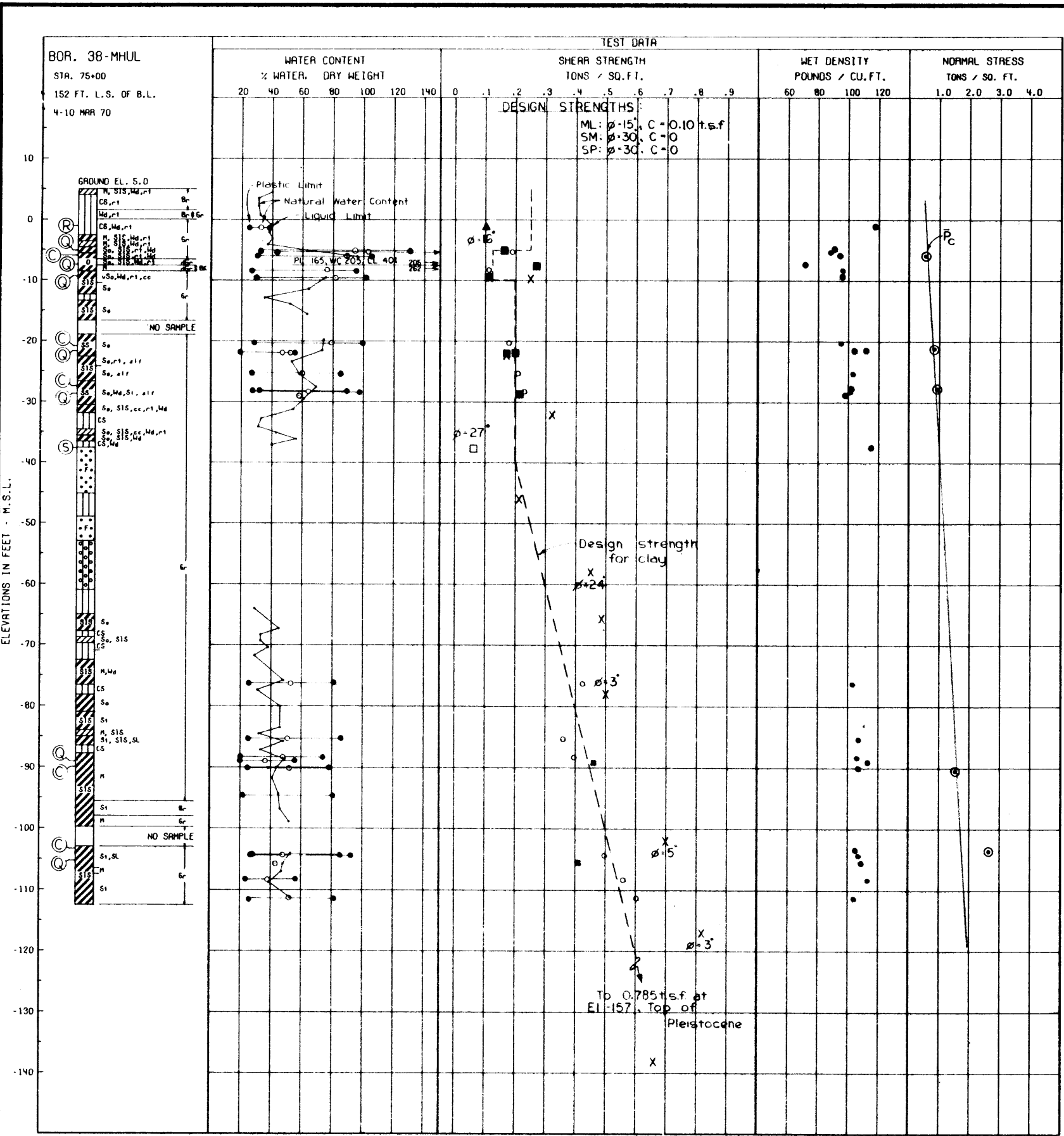

PLASTICITY CHART

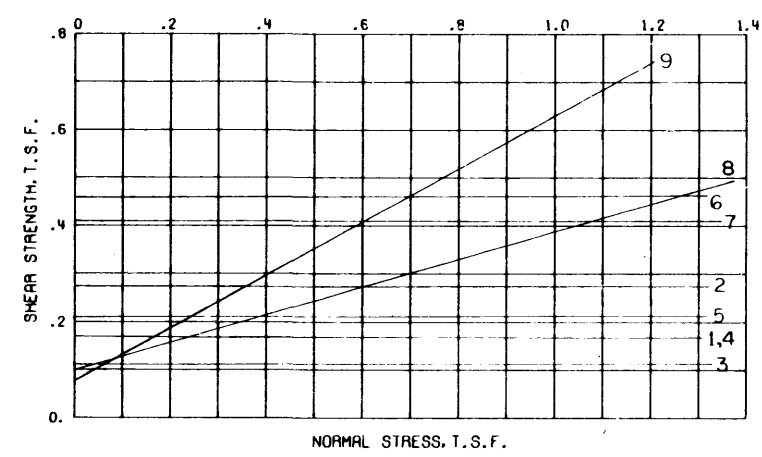

SHEAR STRENGTH DATA

BORING NO.	ENVELOPE		TYPE	STRENGTH		CLASS
	NO.	EL.		$\phi$	C - TSF	
38-MHUL	1	-5.1	Q	0	0.17	CH
	2	-7.5		0	0.27	CH
	3	-9.5		0	0.11	CH
	4	-21.8		0	0.17	CH
	5	-28.8		0	0.21	CH
	6	-89.1		0	0.46	CH
	7	-105.4		0	0.41	CH
	8	-1.1	R*	16.0	0.10	ML
	9	-37.4	S	27.0	0.06	CL

\*BASED ON DEVIATOR STRESS AT MAXIMUM POSITIVE PORE PRESSURE.

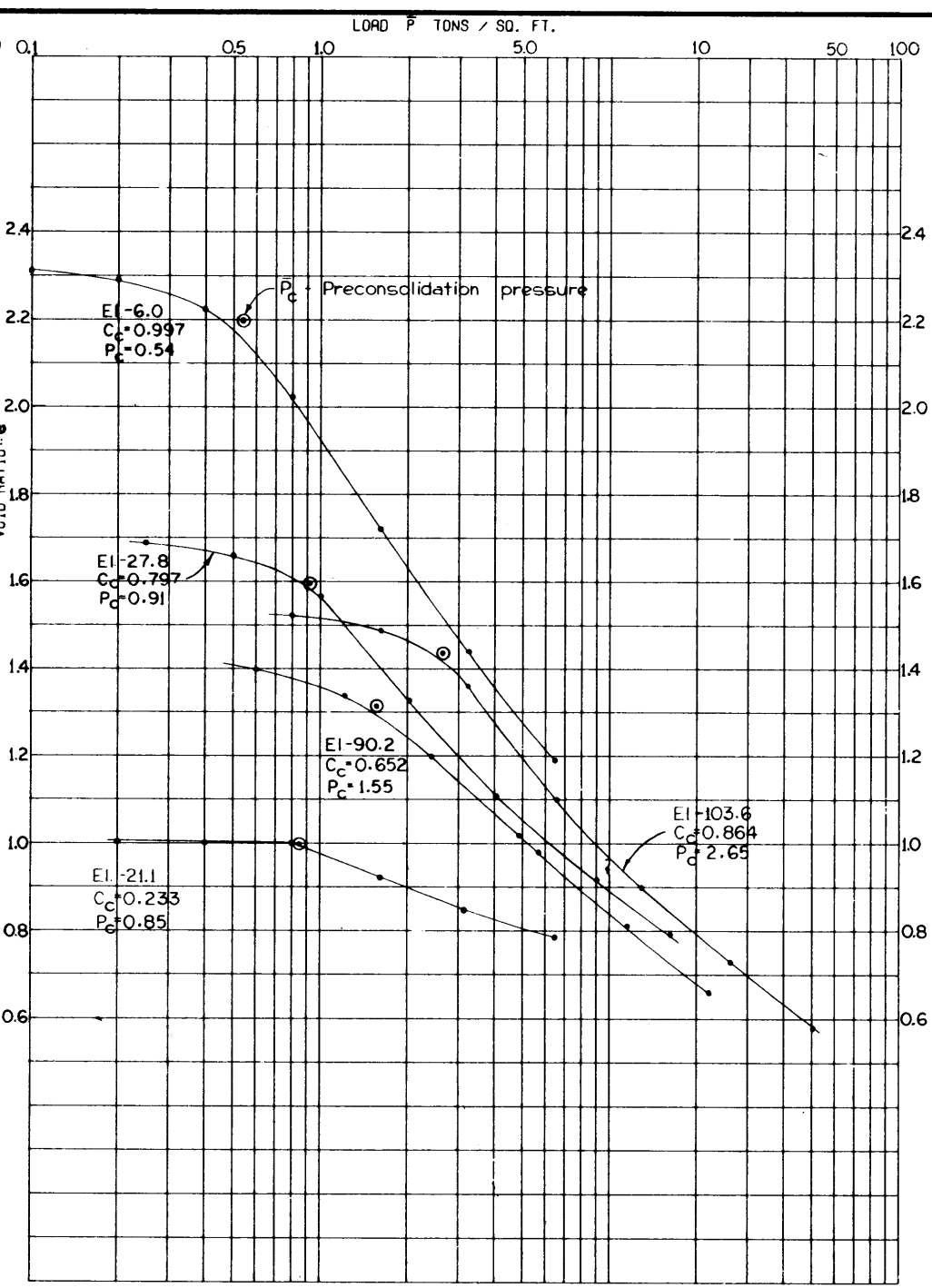

CONSOLIDATION DATA

- - (UC) UNCONFINED COMPRESSION TEST
  - - (O) UNCONSOLIDATED - UNDRAINED SHEAR TEST
  - ▲ - (A) CONSOLIDATED - UNDRAINED SHEAR TEST
  - - (S) CONSOLIDATED - DRAINED SHEAR TEST
- BORINGS WERE TAKEN WITH A 5 INCH DIAMETER STEEL TUBE PISTON TYPE SAMPLER
- FOR SOIL BORING LEGEND SEE PLATE A
- FOR LOCATION OF BORINGS SEE PLATE 10

MISSISSIPPI RIVER LEVEES AND BANKS  
 MILE 66 TO MILE 10  
 SOIL REPORT - PART I  
 EAST BANK  
**SOIL BORING DATA**  
 38-MHUL  
 U.S. ARMY ENGINEER DISTRICT, NEW ORLEANS  
 CORPS OF ENGINEERS

X - (Q) Strengths, Boring R-34.4-LU

BOR. 39-MHUL  
 STA. 135+00  
 357 FT. L.S. OF B.L.  
 13 MAR 70

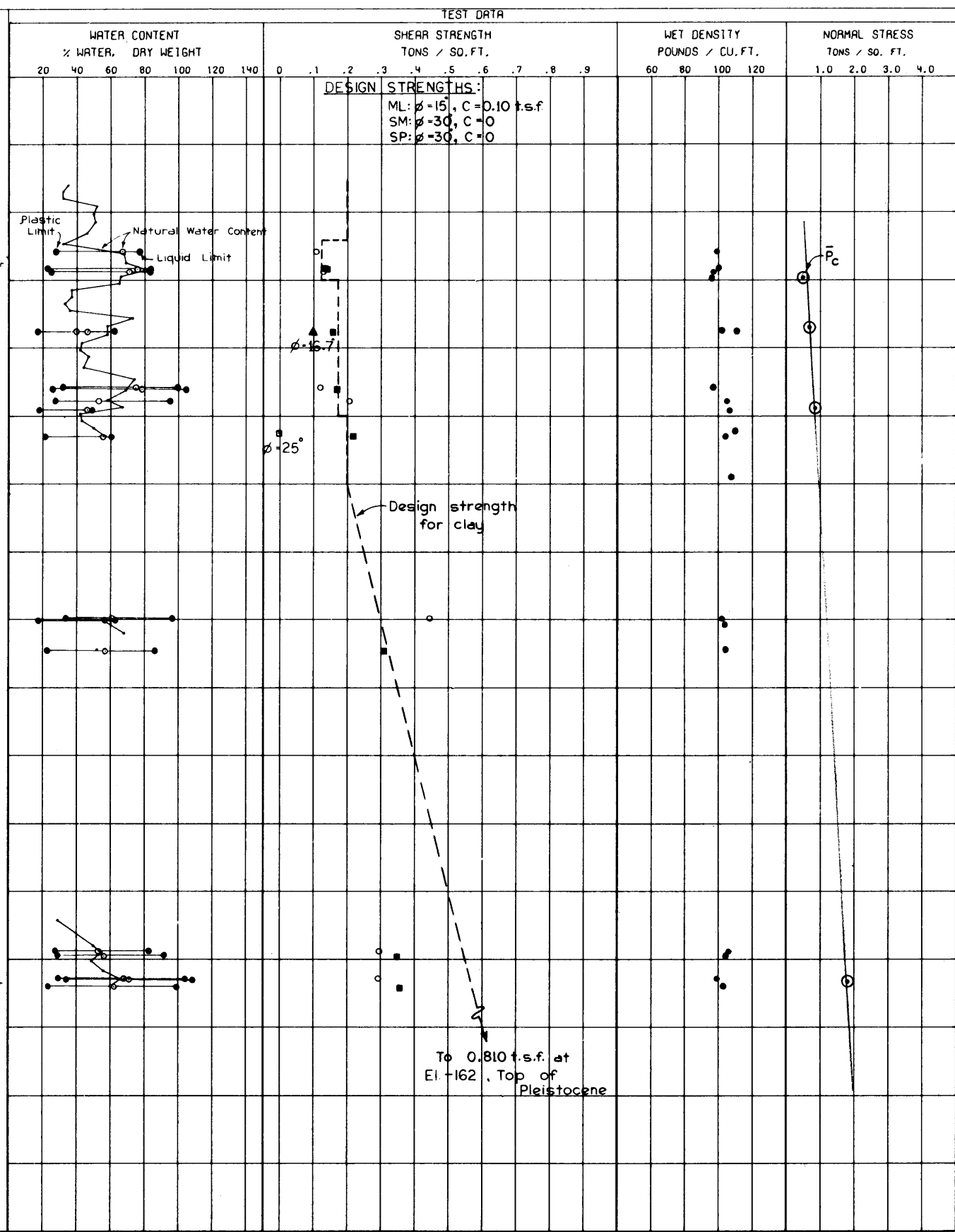
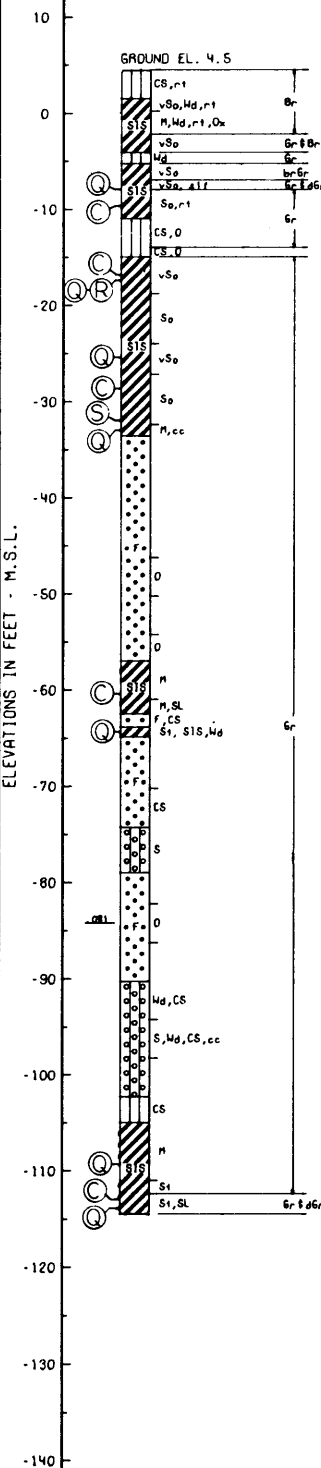

DESIGN STRENGTHS:  
 ML:  $\phi=15^\circ$ ,  $C=0.10$  t.s.f.  
 SM:  $\phi=30^\circ$ ,  $C=0$   
 SP:  $\phi=30^\circ$ ,  $C=0$

To 0.810 t.s.f. at  
 El. -162, Top of  
 Pleistocene

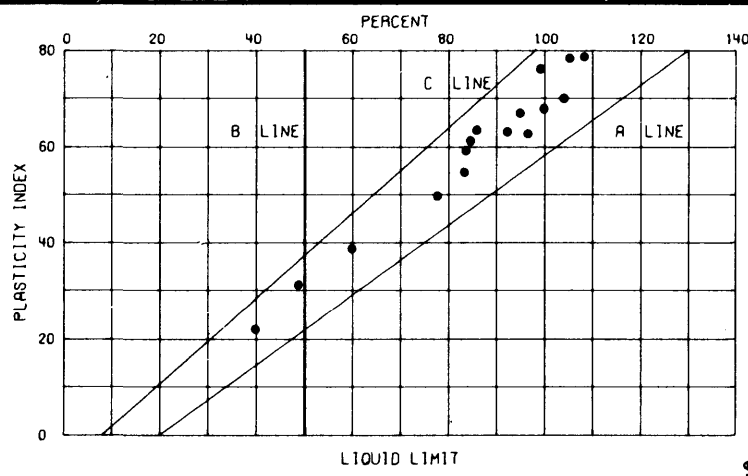

PLASTICITY CHART

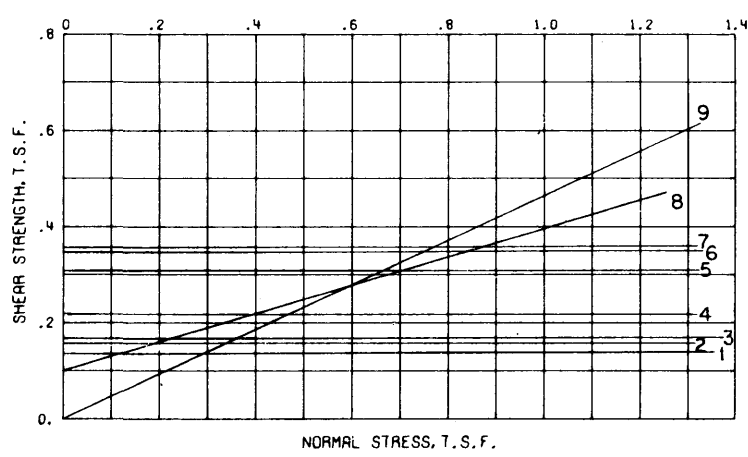

SHEAR STRENGTH DATA

BORING NO.	ENVELOPE		TYPE	STRENGTH		CLASS	
	NO.	EL.		$\phi$	C - TSF		
39-MHUL	1	-8.3	Q	0	0.14	CH	
	2	-17.6		0	0.16	CL	
	3	-25.8		0	0.17	CH	
	4	-33.0		0	0.22	CH	
	5	-64.4		0	0.31	CH	
	6	-109.6		0	0.35	CH	
	7	-114.0		0	0.36	CH	
	8	-17.6		R	16.7	0.10	CL
	9	-32.1		S	25.0	0	CL

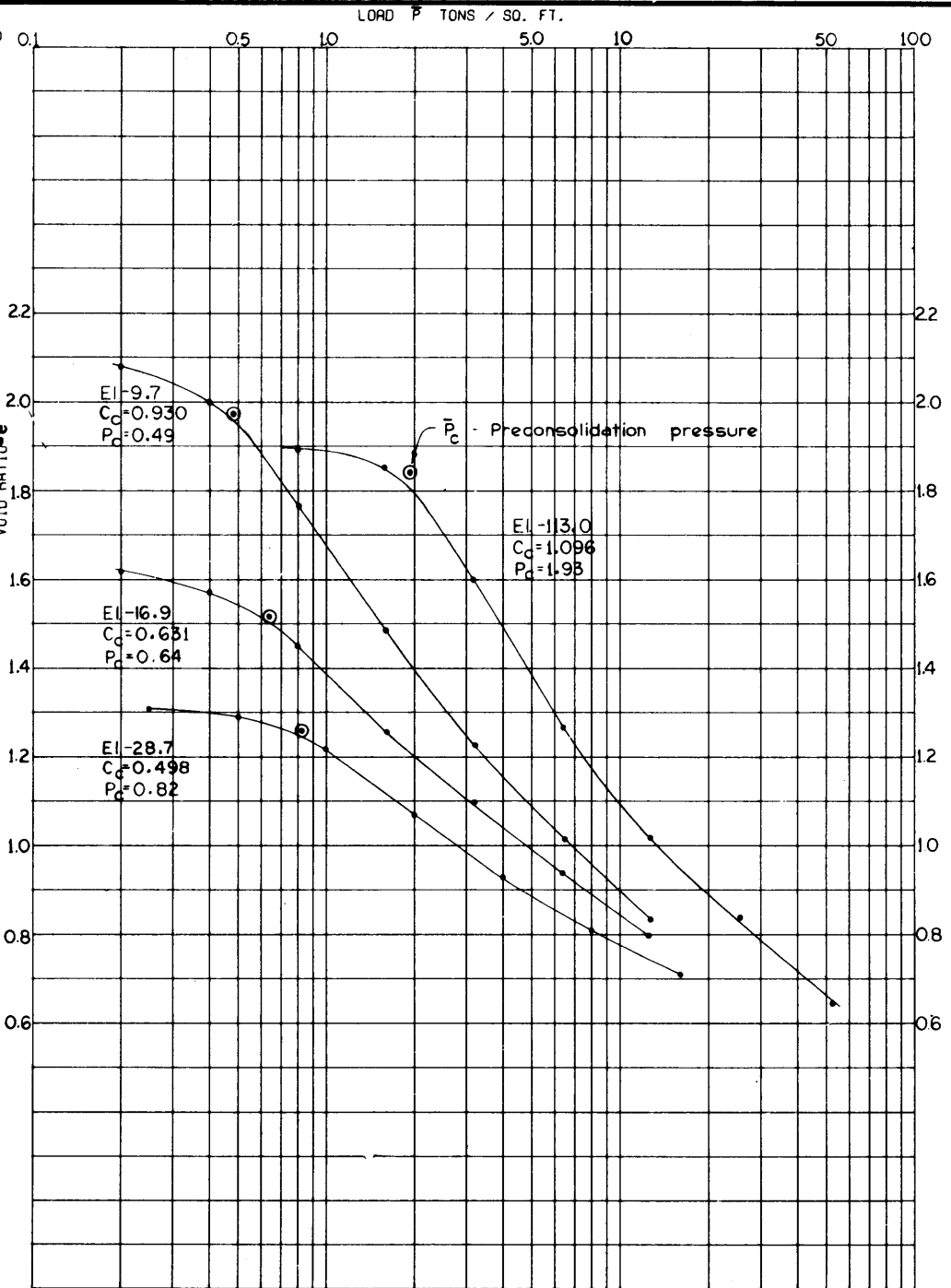

CONSOLIDATION DATA

○ - (UC) UNCONFINED COMPRESSION TEST  
 ■ - (U) UNCONSOLIDATED - UNDRAINED SHEAR TEST  
 ▲ - (R) CONSOLIDATED - UNDRAINED SHEAR TEST  
 □ - (S) CONSOLIDATED - DRAINED SHEAR TEST  
 BORINGS WERE TAKEN WITH A 5 INCH DIAMETER  
 STEEL TUBE PISTON TYPE SAMPLER  
 FOR SOIL BORING LEGEND SEE PLATE A  
 FOR LOCATION OF BORINGS SEE PLATE 10

MISSISSIPPI RIVER LEVEES AND BANKS  
 MILE 66 TO MILE 10  
 SOIL REPORT - PART I  
 EAST BANK  
**SOIL BORING DATA**  
 39-MHUL  
 U.S. ARMY ENGINEER DISTRICT, NEW ORLEANS  
 CORPS OF ENGINEERS  
 AUGUST 1971

BOR. 64-MHUL  
 STA. 160+36  
 350 FT. LEFT OF B.L.  
 12-13 MAY 70

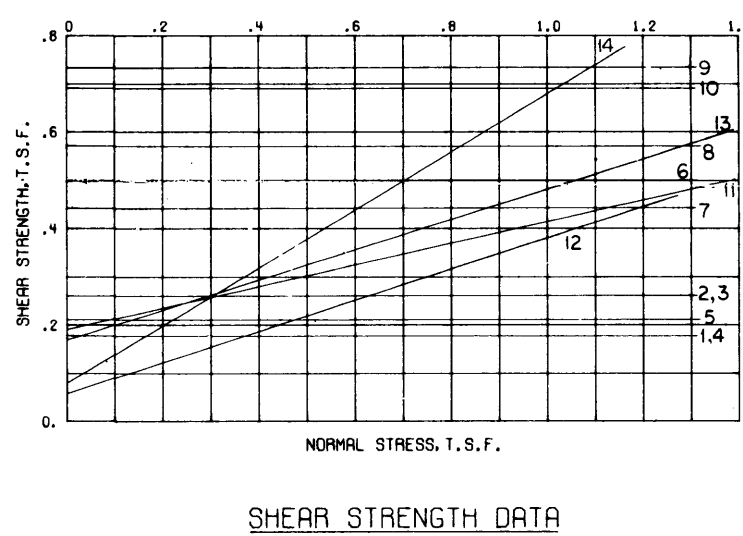
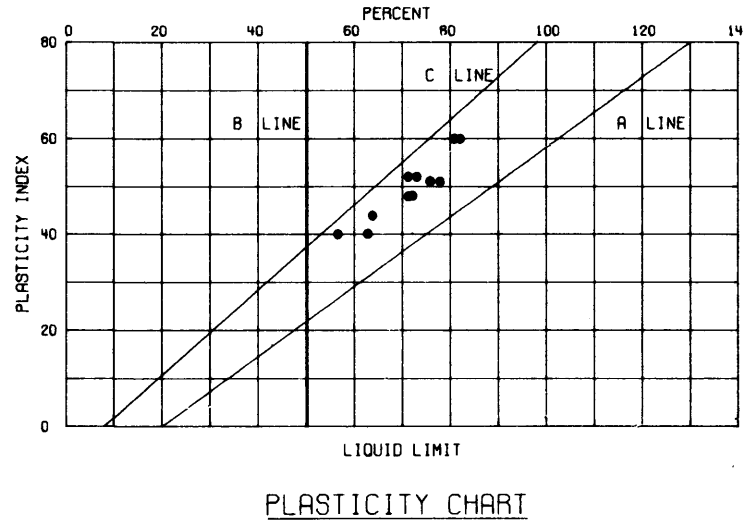
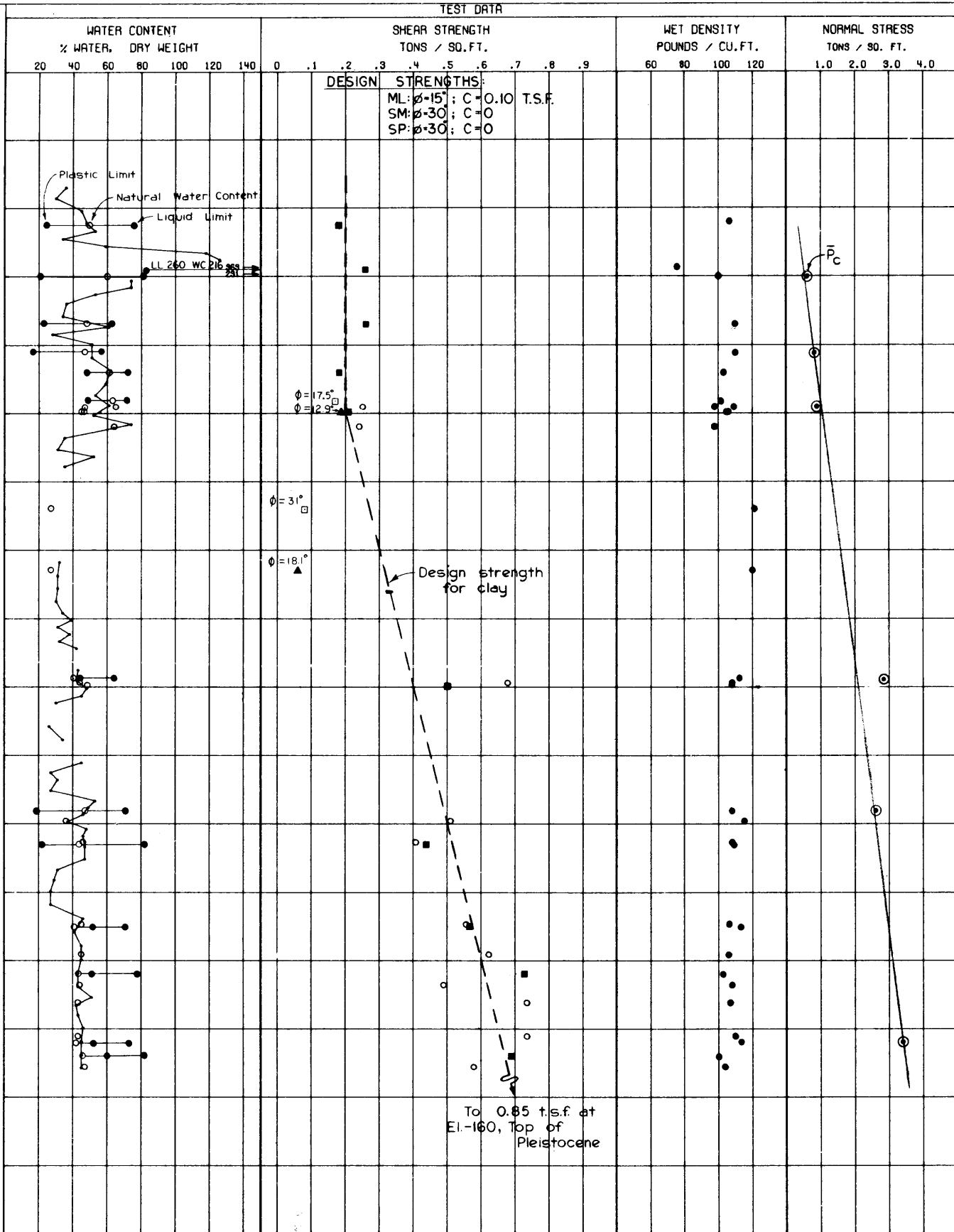
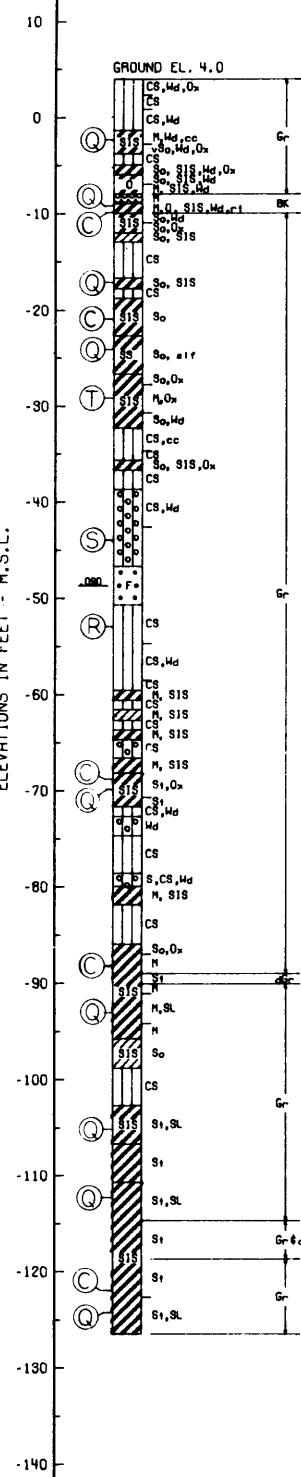

BORING NO.	ENVELOPE		TYPE	STRENGTH		CLASS
	NO.	EL.		$\phi$	C - TSF	
64-MHUL	1	-2.5	Q	0	0.18	CH
	2	-9.1		0	0.26	CH
	3	-17.0		0	0.26	CH
	4	-24.0		0	0.18	CH
	5	-29.8		0	0.21	CH
	6	-69.9		0	0.50	CH
	7	-93.0		0	0.44	CH
	8	-105.0		0	0.57	CH
	9	-112.0		0	0.73	CH
	10	-124.0		0	0.69	CH
	11	-29.8		12.9	0.19	CH
	12	-53.0		18.1	0.06	SP
	13	-28.2		17.5	0.17	CH
	14	-44.0		31.0	0.08	SM

\*BASED ON DEVIATOR STRESS AT MAXIMUM POSITIVE PORE PRESSURE

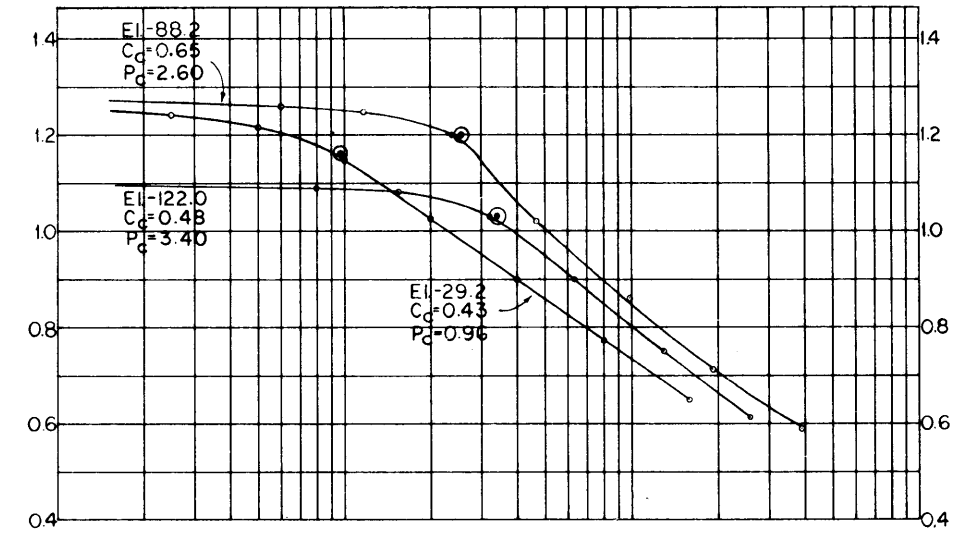
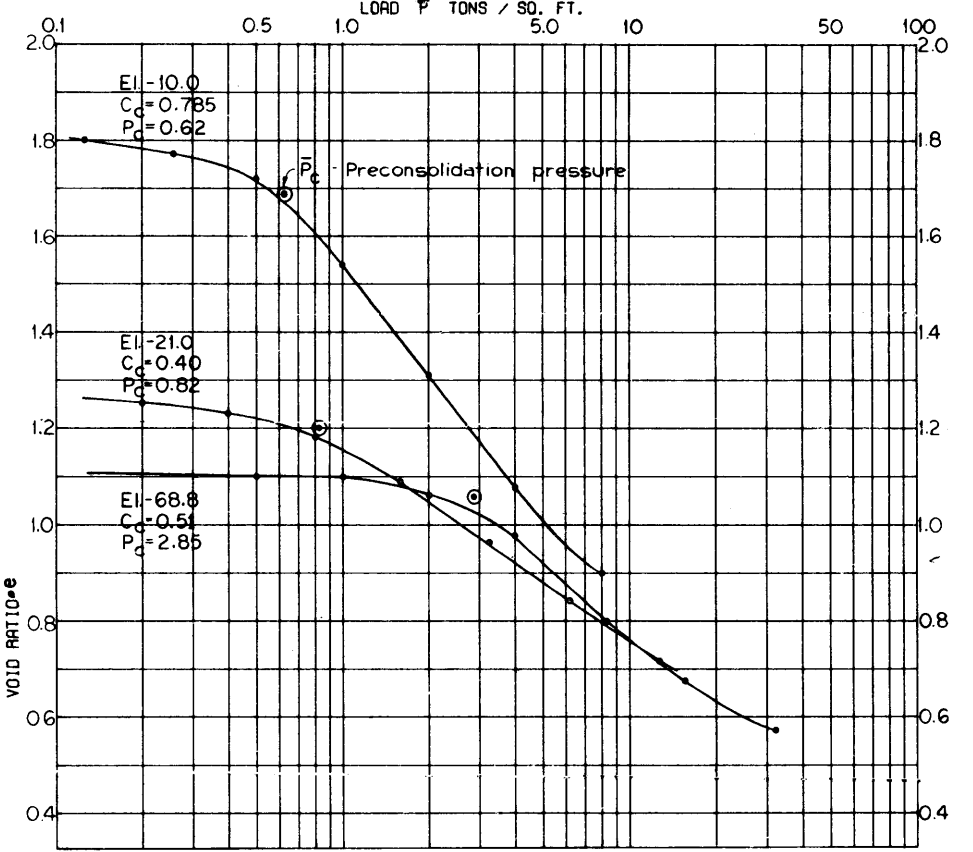

- - (UC) UNCONFINED COMPRESSION TEST
- - (U) UNCONSOLIDATED - UNDRAINED SHEAR TEST
- ▲ - (R) CONSOLIDATED - UNDRAINED SHEAR TEST
- - (S) CONSOLIDATED - DRAINED SHEAR TEST

BORINGS WERE TAKEN WITH A 5 INCH DIAMETER STEEL TUBE PISTON TYPE SAMPLER FOR SOIL BORING LEGEND SEE PLATE A FOR LOCATION OF BORINGS SEE PLATE 10

MISSISSIPPI RIVER LEVEES AND BANKS  
 MILE 66 TO MILE 10  
 SOIL REPORT - PART I  
 EAST BANK  
**SOIL BORING DATA**  
 64-MHUL  
 U.S. ARMY ENGINEER DISTRICT, NEW ORLEANS  
 CORPS OF ENGINEERS

BOR. R-32.3-UL  
 STA. 204+80  
 90 FT. R.S. BL  
 11 APRIL 1967

GROUND EL. 6.7

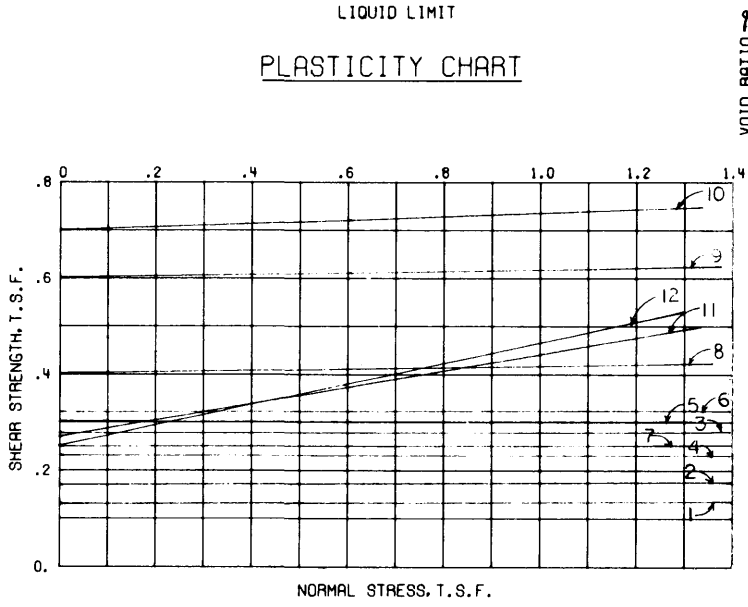
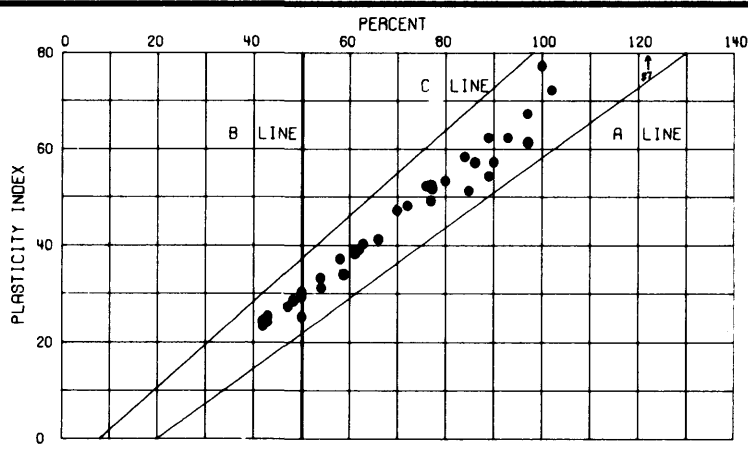
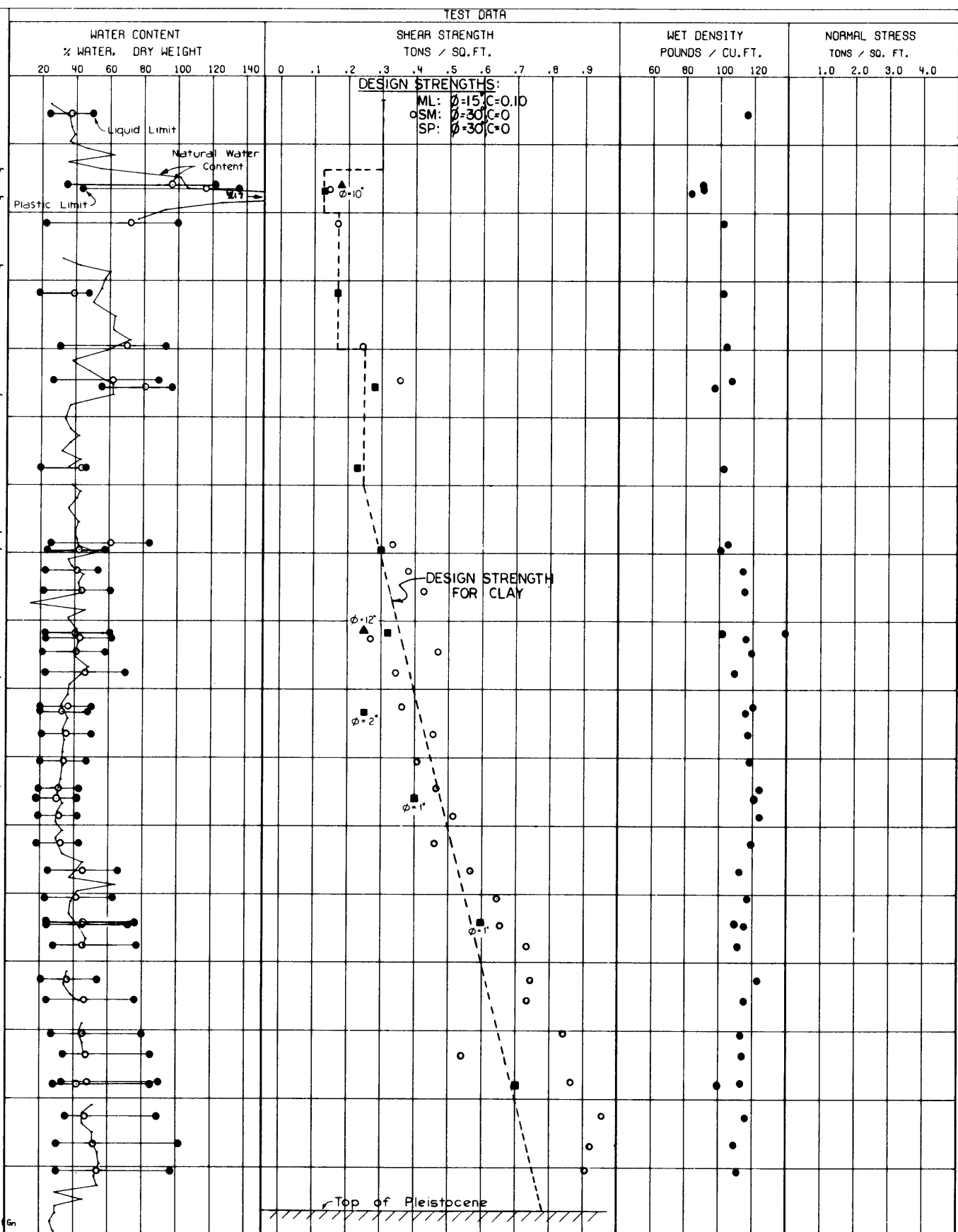
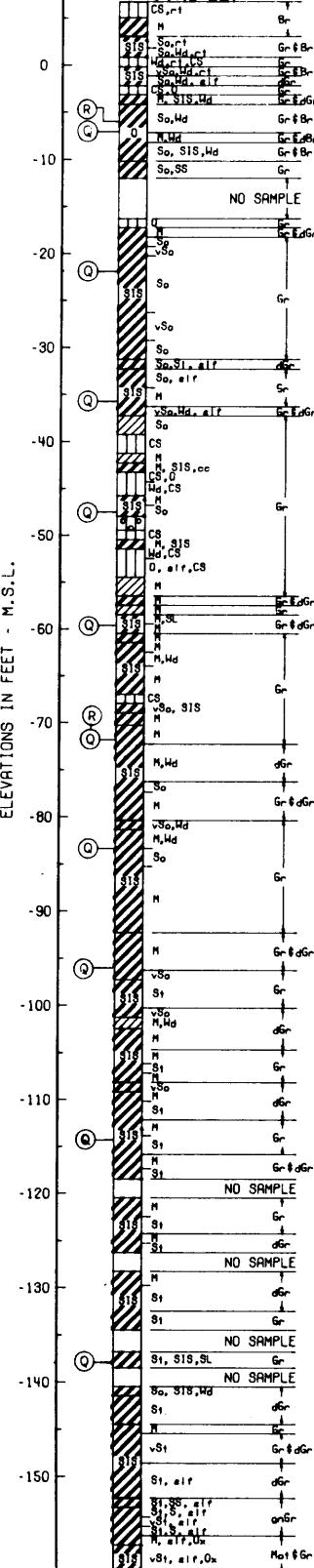

BORING NO.	ENVELOPE		TYPE	STRENGTH		CLASS
	NO.	EL.		$\phi$	C - TSF	
R-32.3-UL	1	-7.0	Q	0°	0.13	CH
	2	-21.9	Q	0°	0.17	CL
	3	-35.7	Q	0°	0.28	CH
	4	-47.5	Q	0°	0.23	CL
	5	-59.7	Q	0°	0.20	CH
	6	-71.8	Q	0°	0.32	CH
	7	-83.3	Q	2°	0.25	CH
	8	-96.0	Q	1°	0.40	CL
	9	-114.3	Q	1°	0.60	CH
	10	-138.0	Q	2°	0.70	CL
	11	-6.0	R	10°	0.27	CH
	12	1.8	R	12°	0.25	CH

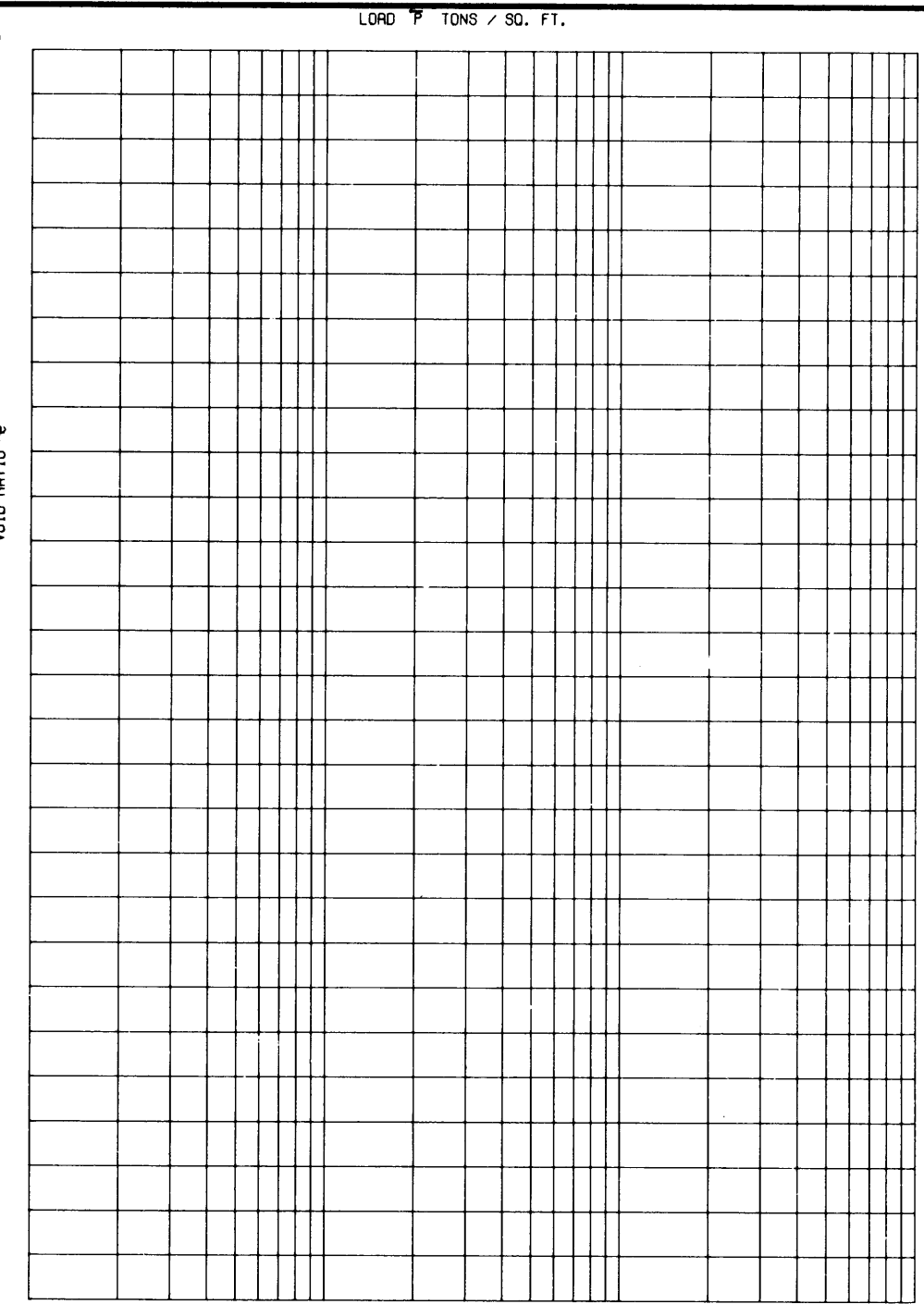

**CONSOLIDATION DATA**

○ - (UC) UNCONFINED COMPRESSION TEST  
 ■ - (Q) UNCONSOLIDATED - UNDRAINED SHEAR TEST  
 ▲ - (R) CONSOLIDATED - UNDRAINED SHEAR TEST  
 □ - (S) CONSOLIDATED - DRAINED SHEAR TEST

BORINGS WERE TAKEN WITH A 5 INCH DIAMETER STEEL TUBE PISTON TYPE SAMPLER  
 FOR SOIL BORING LEGEND SEE PLATE A  
 FOR LOCATION OF BORINGS SEE PLATE II

MISSISSIPPI RIVER LEVEES AND BANKS  
 MILE 66 TO MILE 10  
**SOIL REPORT - PART I**  
 EAST BANK  
**SOIL BORING DATA**  
 R - 32.3-LU  
 U.S. ARMY ENGINEER DISTRICT, NEW ORLEANS  
 CORPS OF ENGINEERS

AUGUST 1971 FILE NO. H-2-25275



BOR. 43-MHUL  
 STA. 330+00  
 525 FT. A.S. B/L  
 16 MARCH 70

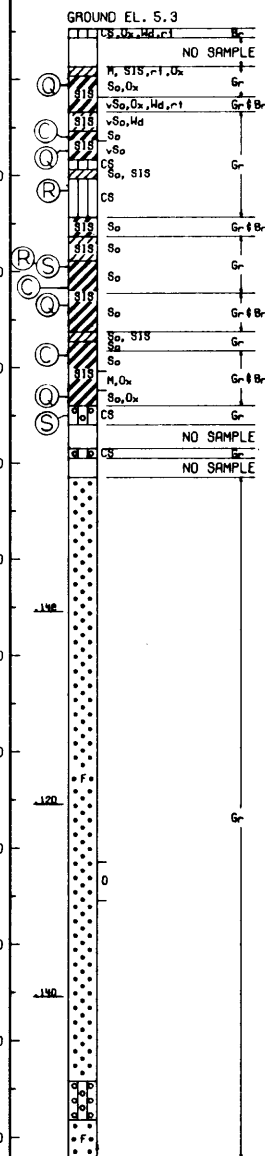

TEST DATA

WATER CONTENT  
 % WATER, DRY WEIGHT

SHEAR STRENGTH  
 TONS / SQ. FT.

WET DENSITY  
 POUNDS / CU. FT.

NORMAL STRESS  
 TONS / SQ. FT.

DESIGN STRENGTHS

ML:  $\phi=15$ , C=0.10 tsf  
 SM:  $\phi=30$ , C=0  
 SP:  $\phi=30$ , C=0

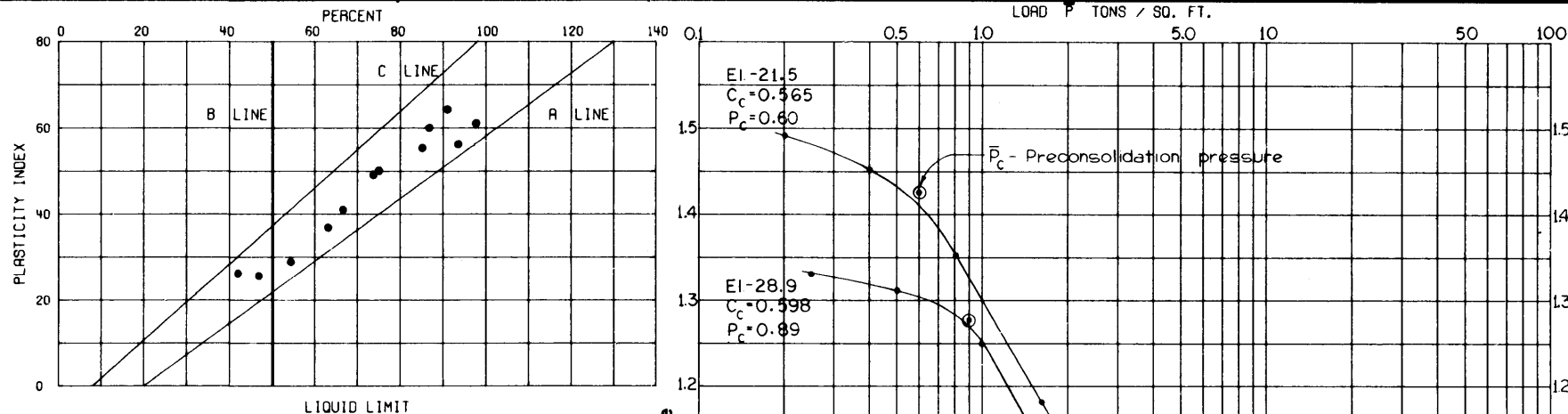
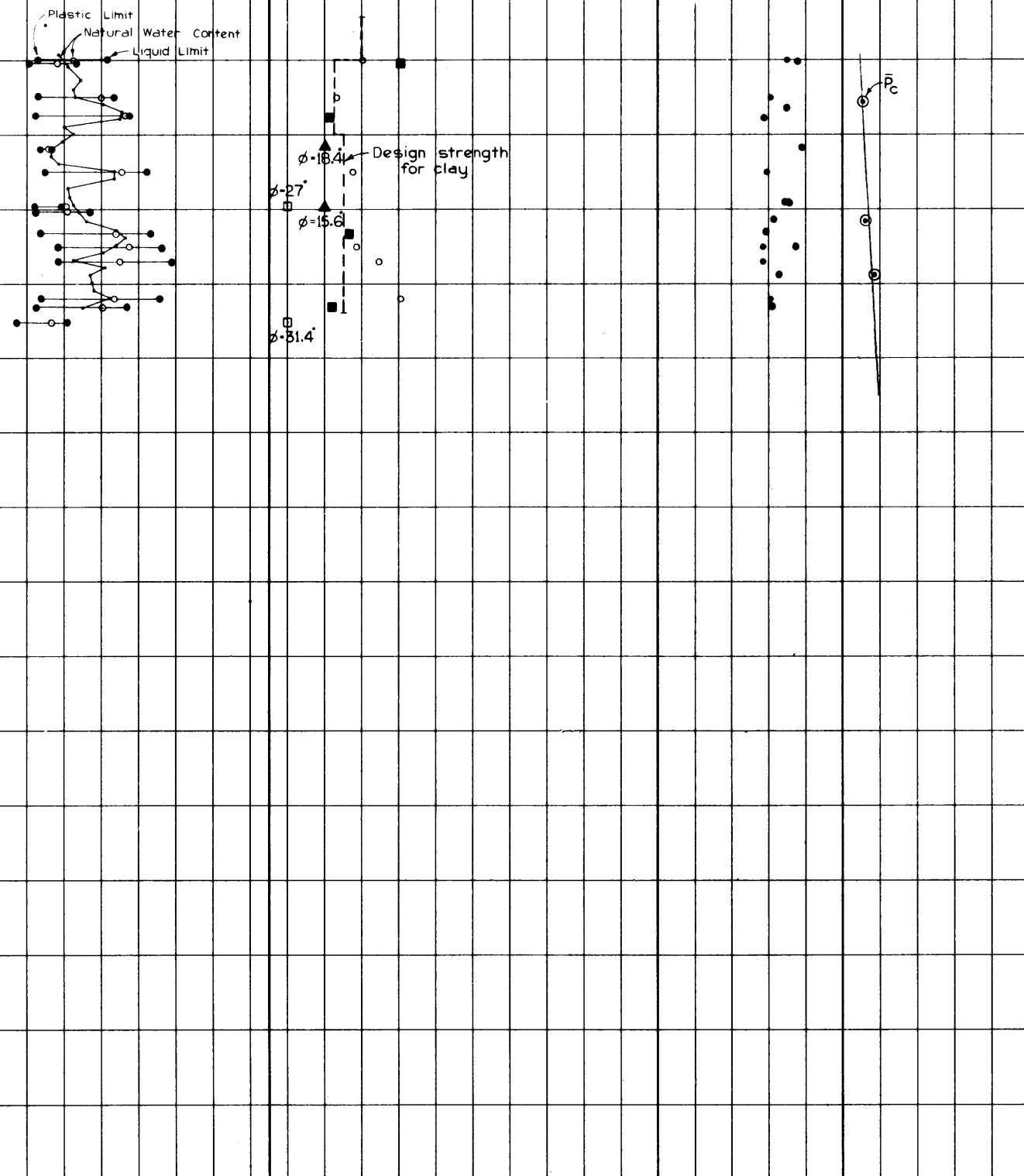

PLASTICITY CHART

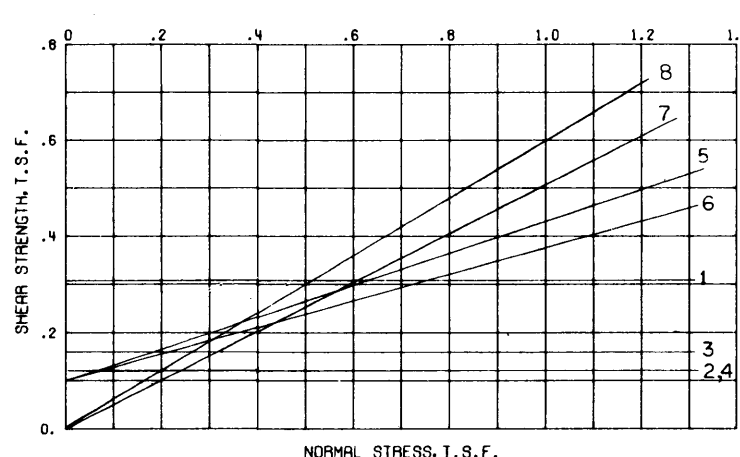

SHEAR STRENGTH DATA

BORING NO.	ENVELOPE		TYPE	STRENGTH		CLASS
	NO.	EL.		$\phi$	C - TSF	
43-MHUL	1	-0.4	Q	0	0.31	CL
	2	-7.6		0	0.12	CH
	3	-23.3		0	0.16	CH
	4	-33.0		0	0.12	CH
	5	-11.5	R	*18.4	0.10	ML
	6	-19.7		15.6	0.10	CL
	7	-19.7		27.0	0	CL
	8	-35.2		31.4	0	CL

\*BASED ON DEVIATOR STRESS AT MAXIMUM POSITIVE PORE PRESSURE.

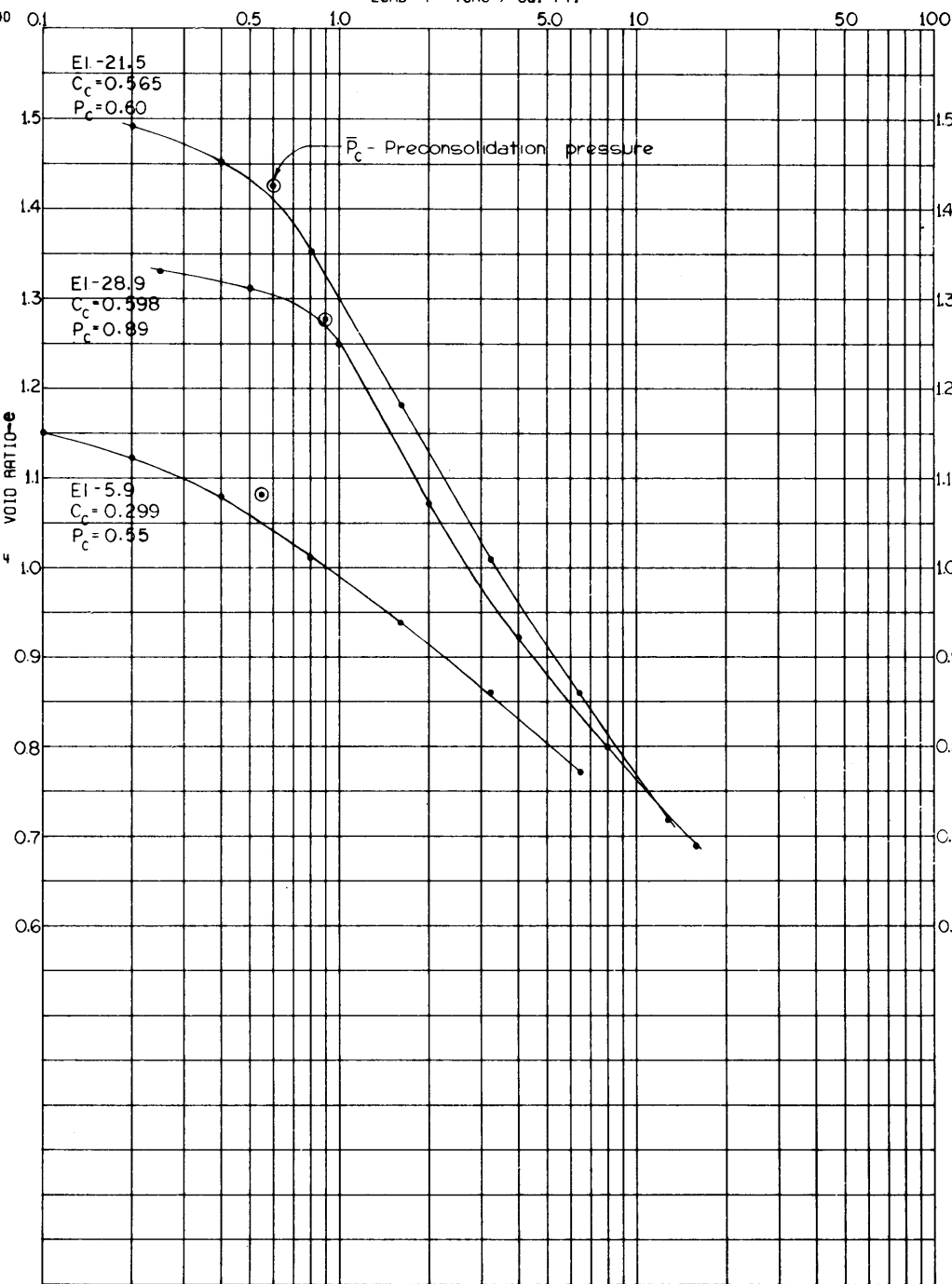

CONSOLIDATION DATA

- - (UC) UNCONFINED COMPRESSION TEST
  - - (Q) UNCONSOLIDATED - UNDRAINED SHEAR TEST
  - ▲ - (R) CONSOLIDATED - UNDRAINED SHEAR TEST
  - - (S) CONSOLIDATED - DRAINED SHEAR TEST
- BORINGS WERE TAKEN WITH A 5 INCH DIAMETER STEEL TUBE PISTON TYPE SAMPLER  
 FOR SOIL BORING LEGEND SEE PLATE A  
 FOR LOCATION OF BORINGS SEE PLATE II

MISSISSIPPI RIVER LEVEES AND BANKS  
 MILE 66 TO MILE 10  
 SOIL REPORT - PART I  
 EAST BANK  
**SOIL BORING DATA**  
 43-MHUL  
 U.S. ARMY ENGINEER DISTRICT, NEW ORLEANS  
 CORPS OF ENGINEERS



BOR. 47-MHUL  
 STA. 430+00  
 60 FEET R.S.B.  
 20-23 MAR 70

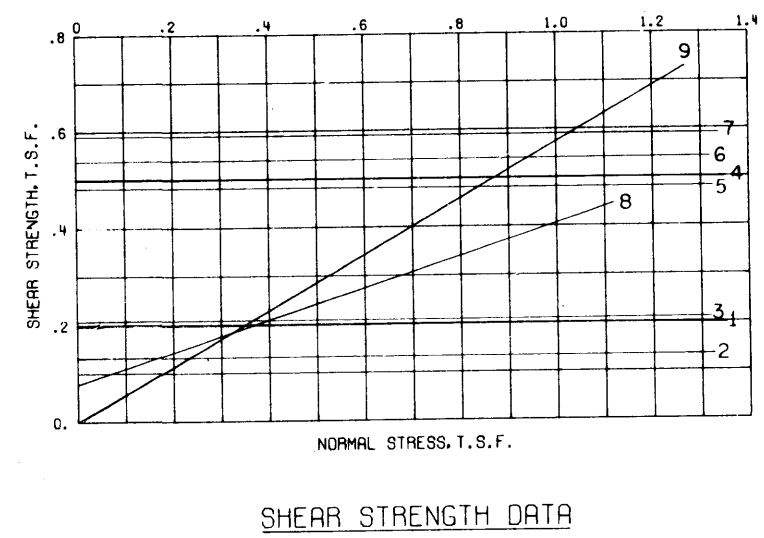
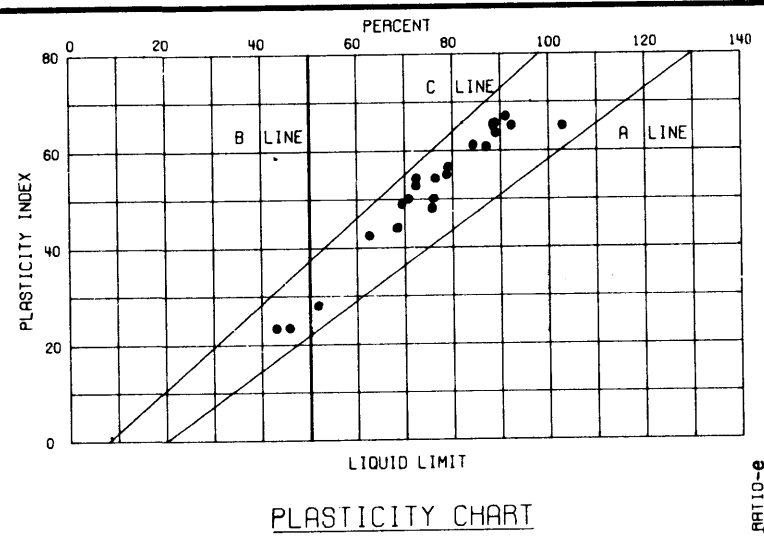
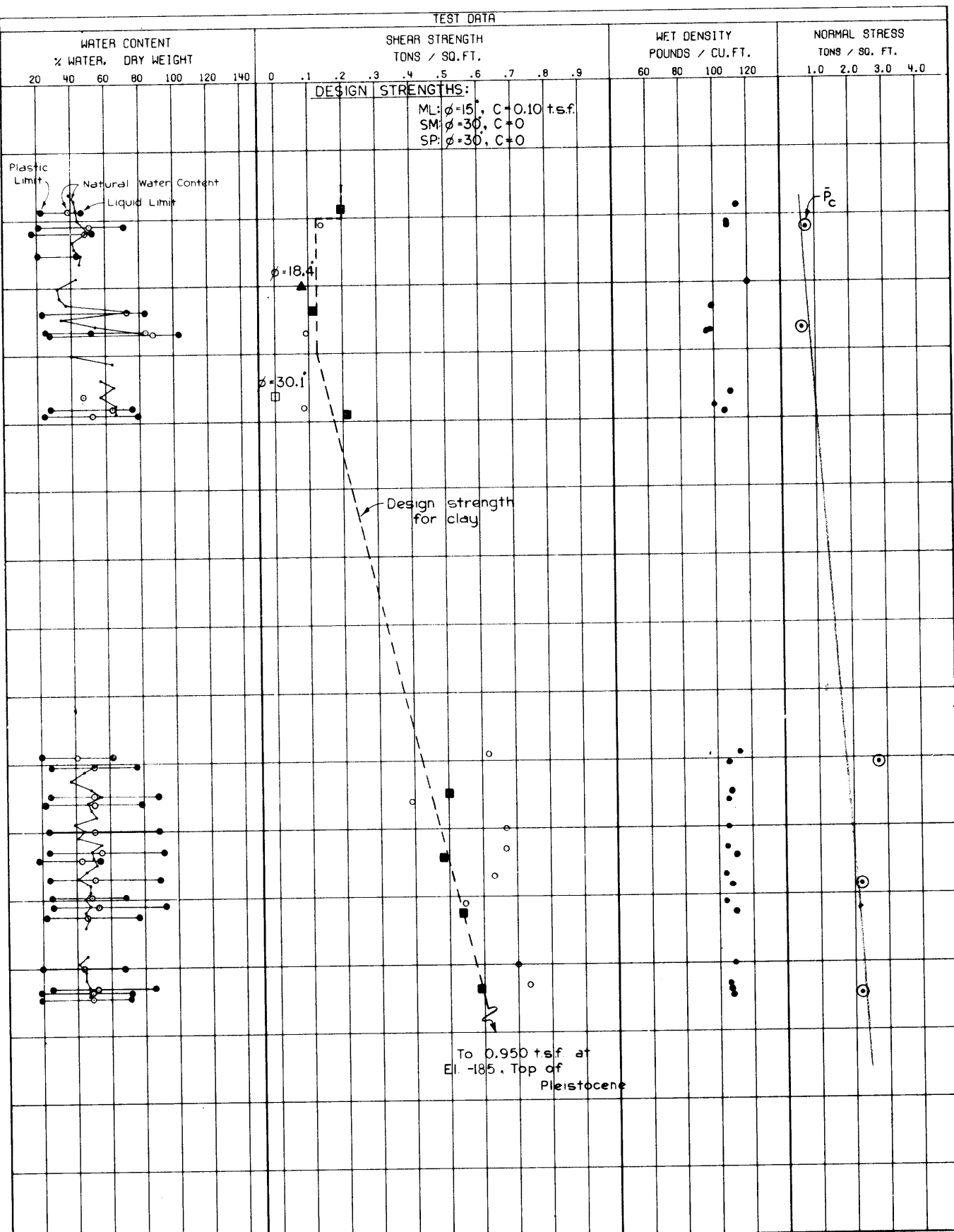
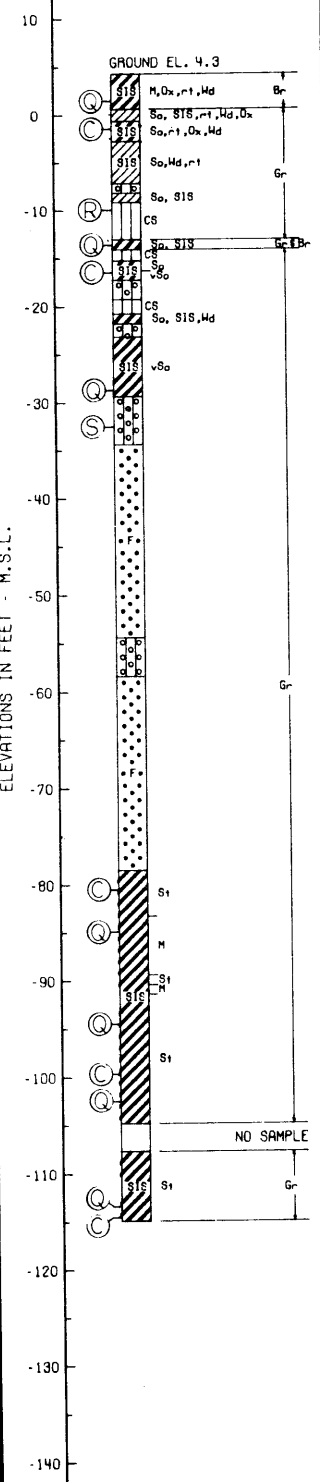

BORING NO.	ENVELOPE		TYPE	STRENGTH		CLASS
	NO.	EL.		$\phi$	C - TSF	
47-MHUL	1	1.5	Q	0	0.21	CL
	2	-13.5		0	0.11	CH
	3	-28.8		0	0.21	CH
	4	-84.8		0	0.50	CH
	5	-94.3	R*	0	0.48	CH
	6	-102.5		0	0.54	CH
	7	-113.5		0	0.59	CH
	8	-10.1		18.4	0.08	ML
	9	-26.1		S	30.1	0

\*BASED ON DEVIATOR STRESS AT MAXIMUM POSITIVE PORE PRESSURE.

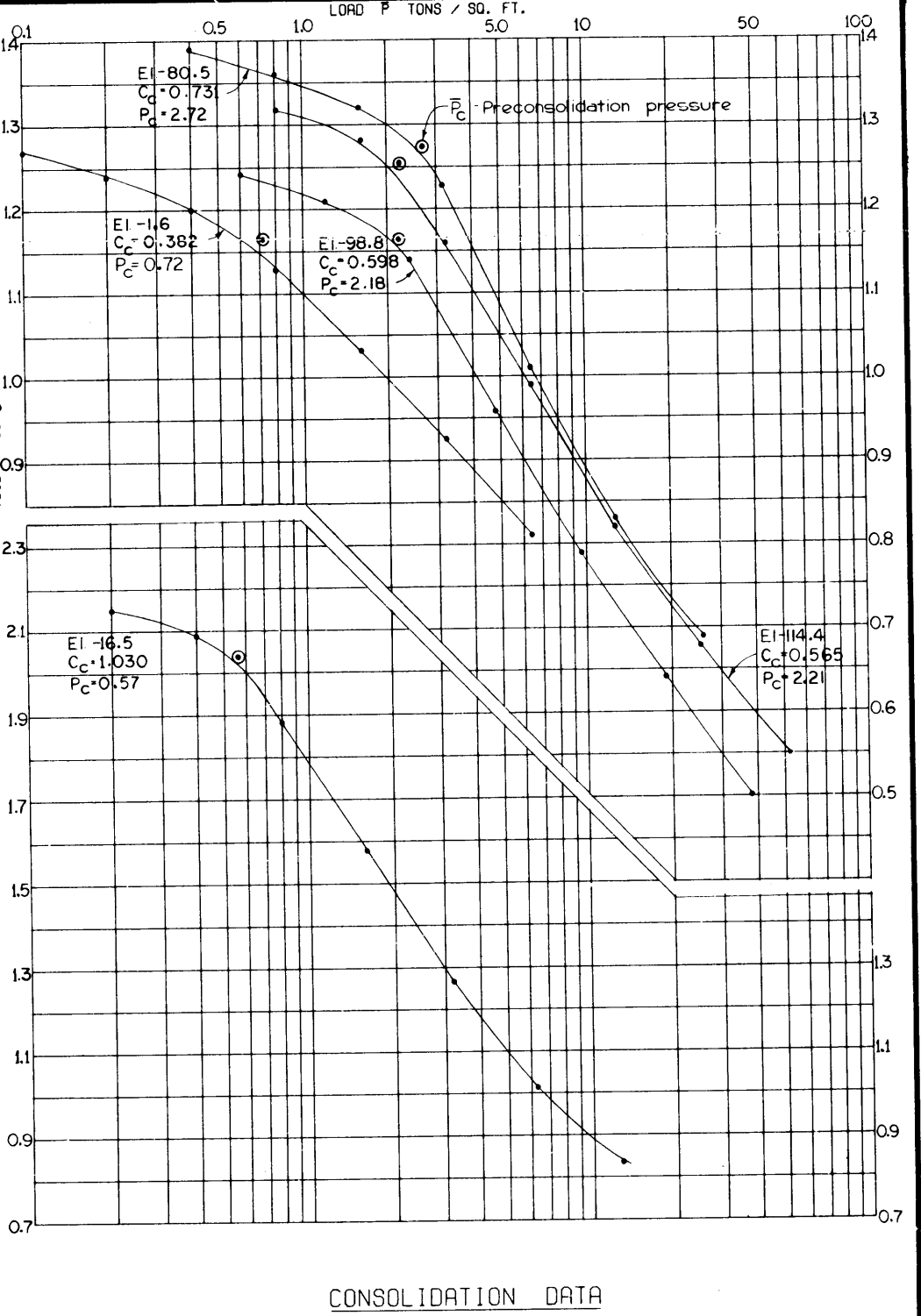

○ - (UC) UNCONFINED COMPRESSION TEST  
 ■ - (Q) UNCONSOLIDATED - UNDRAINED SHEAR TEST  
 ▲ - (R) CONSOLIDATED - UNDRAINED SHEAR TEST  
 □ - (S) CONSOLIDATED - DRAINED SHEAR TEST  
 BORINGS WERE TAKEN WITH A 5 INCH DIAMETER STEEL TUBE PISTON TYPE SAMPLER  
 FOR SOIL BORING LEGEND SEE PLATE A  
 FOR LOCATION OF BORINGS SEE PLATE 12

MISSISSIPPI RIVER LEVEES AND BANKS  
 MILE 66 TO MILE 10  
 SOIL REPORT - PART I  
 EAST BANK  
**SOIL BORING DATA**  
 47-MHUL  
 U.S. ARMY ENGINEER DISTRICT, NEW ORLEANS  
 CORPS OF ENGINEERS  
 AUGUST 1971  
 FILE NO. H-2-25275

BOR. 50-MHUL  
 STA. 533+75  
 365 FT. L.S. OF B.L.  
 24-26 MAR 70

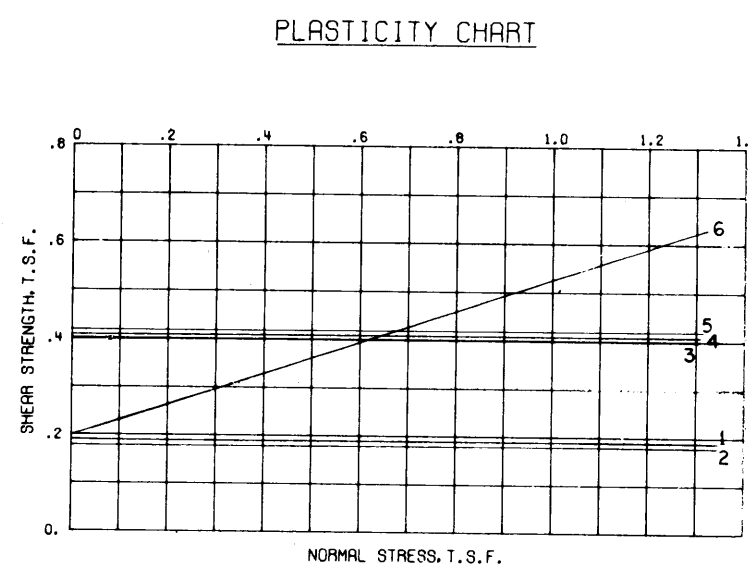
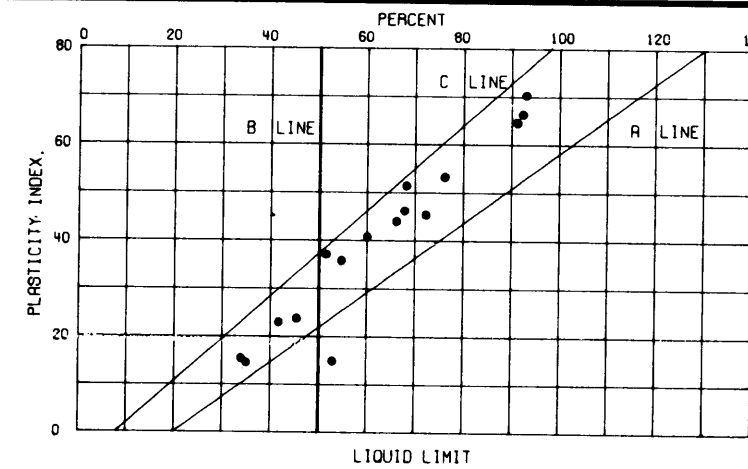
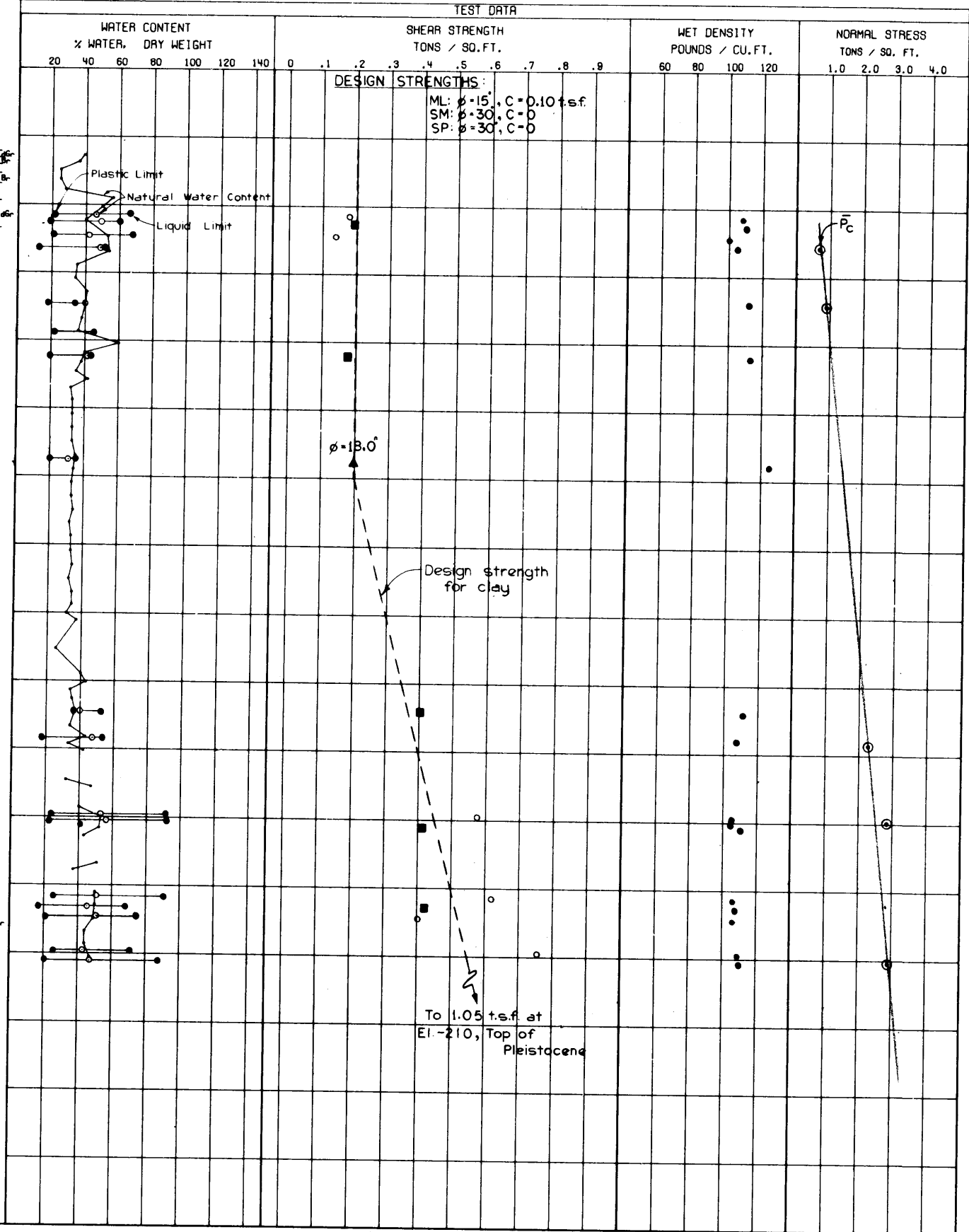
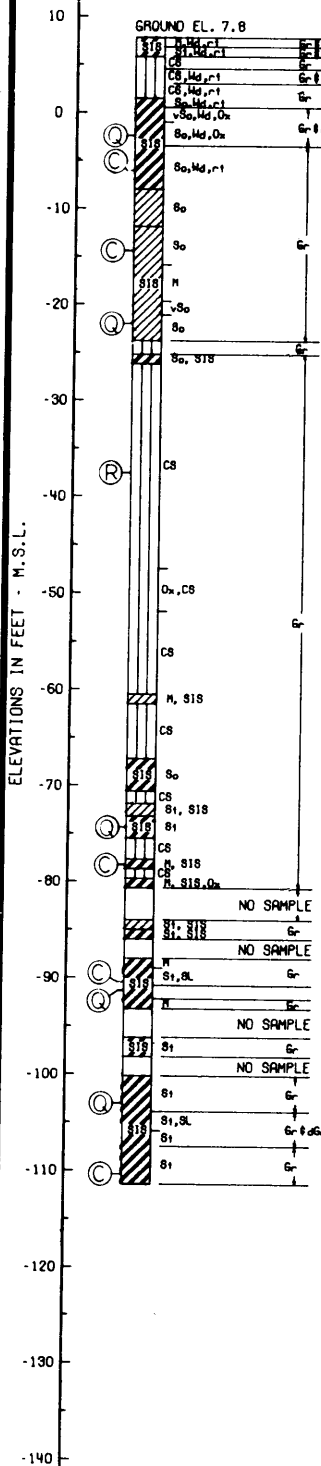

BORING NO.	ENVELOPE		TYPE	STRENGTH		CLASS
	NO.	EL.		$\phi$	C - TSF	
50-MHUL	1	2.3	Q	0	0.19	CH
	2	-22.0		0	0.18	CL
	3	-74.3	0	0.40	CH	
	4	-91.2	0	0.41	CH	
	5	-103.0	0	0.42	CH	
	6	-37.4	R*	18.0	0.20	CL

\*BASED ON DEVIATOR STRESS AT MAXIMUM POSITIVE PORE PRESSURE

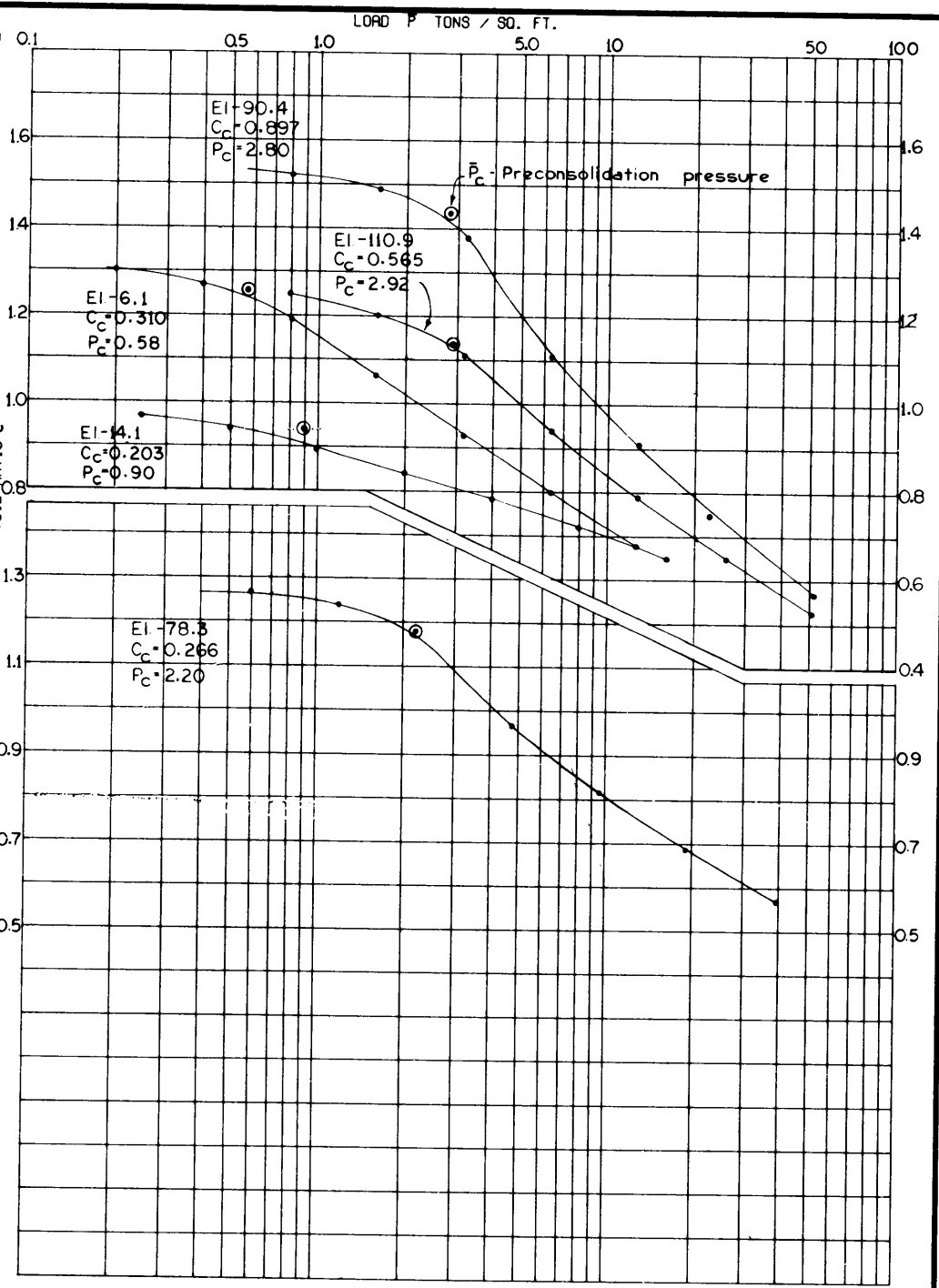

- - (UC) UNCONFINED COMPRESSION TEST
  - - (Q) UNCONSOLIDATED - UNDRAINED SHEAR TEST
  - ▲ - (R) CONSOLIDATED - UNDRAINED SHEAR TEST
  - - (S) CONSOLIDATED - DRAINED SHEAR TEST
- BORINGS WERE TAKEN WITH A 5 INCH DIAMETER STEEL TUBE PISTON TYPE SAMPLER  
 FOR SOIL BORING LEGEND SEE PLATE A  
 FOR LOCATION OF BORINGS SEE PLATE 12

MISSISSIPPI RIVER LEVEES AND BANKS  
 MILE 66 TO MILE 10  
 SOIL REPORT - PART I  
 EAST BANK  
**SOIL BORING DATA**  
 50-MHUL  
 U.S. ARMY ENGINEER DISTRICT, NEW ORLEANS  
 CORPS OF ENGINEERS

BOR. 66-MHUL  
 STA 553+00  
 360 FT. LEFT OF B.L.  
 25 MAY 70

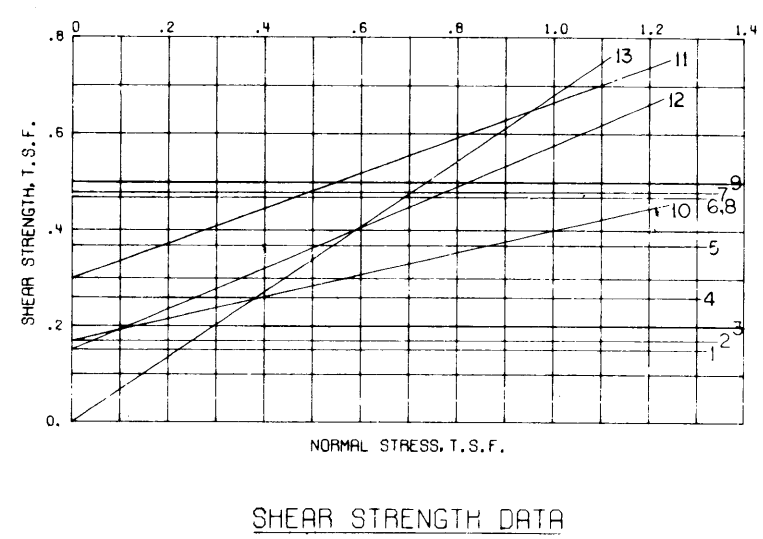
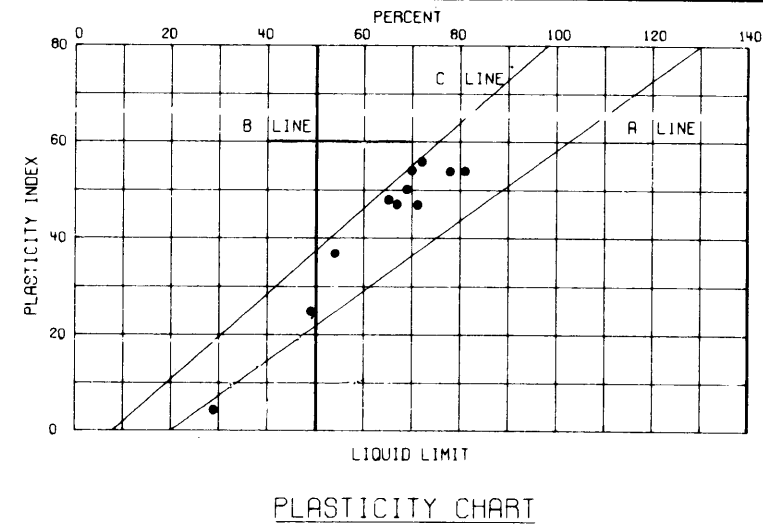
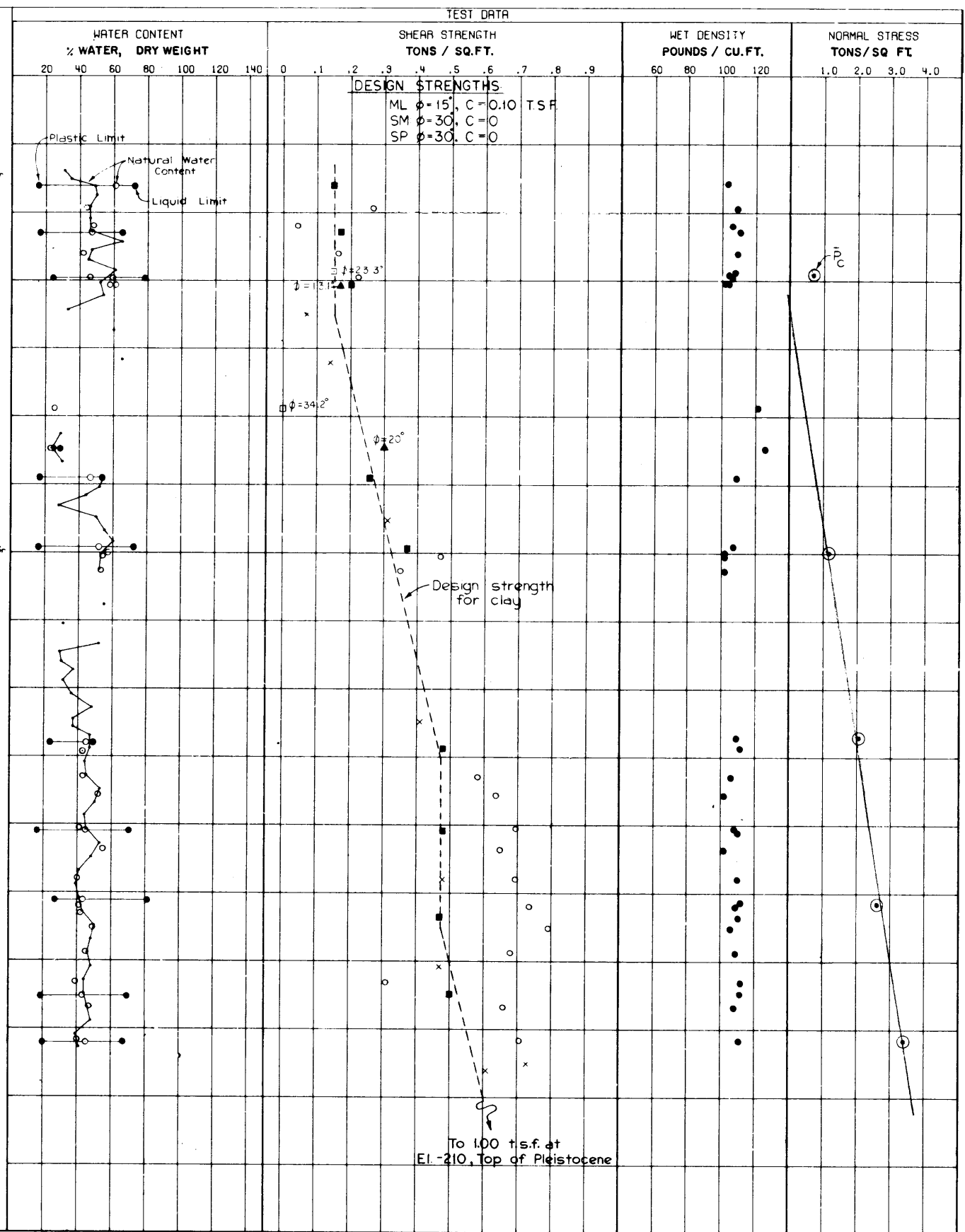
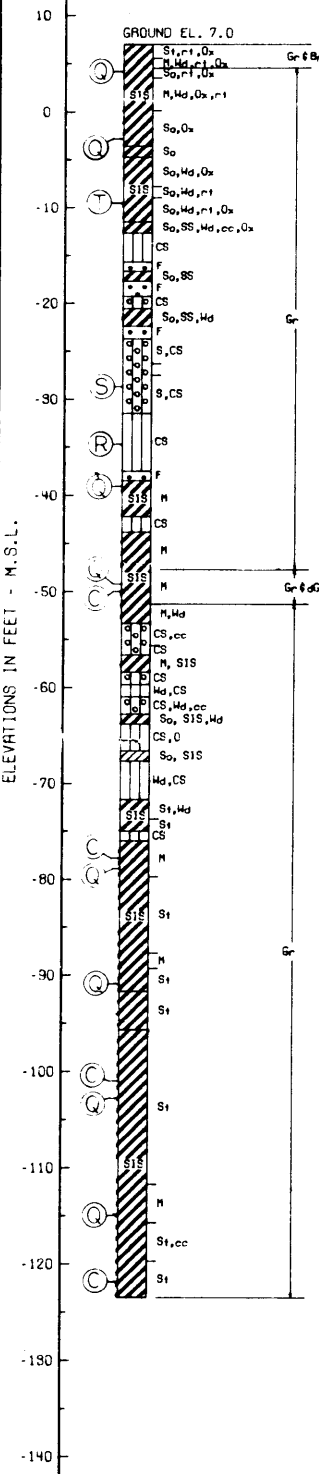

BORING NO.	ENVELOPE		TYPE	STRENGTH		CLASS
	NO.	EL.		$\phi$	C - TSF	
66-MHUL	1	4.1	I	0	0.15	CH
	2	-2.9		0	0.17	CH
	3	-10.5		0	0.20	CH
	4	-38.6		0	0.26	CH
	5	-49.4		Q	0	0.37
	6	-78.9	0		0.47	CH
	7	-91.0	0		0.48	CH
	8	-102.7	0	0.47	CH	
	9	-115.0	I	0	0.50	CH
	10	-10.5		13.1	0.17	CH
	11	-34.5		*20.0	0.30	ML
	12	-8.7	S	23.3	0.15	CH
	13	-28.8		34.2	0	SM

\*BASED ON DEVIATOR STRESS AT MAXIMUM POSITIVE PORE PRESSURE.

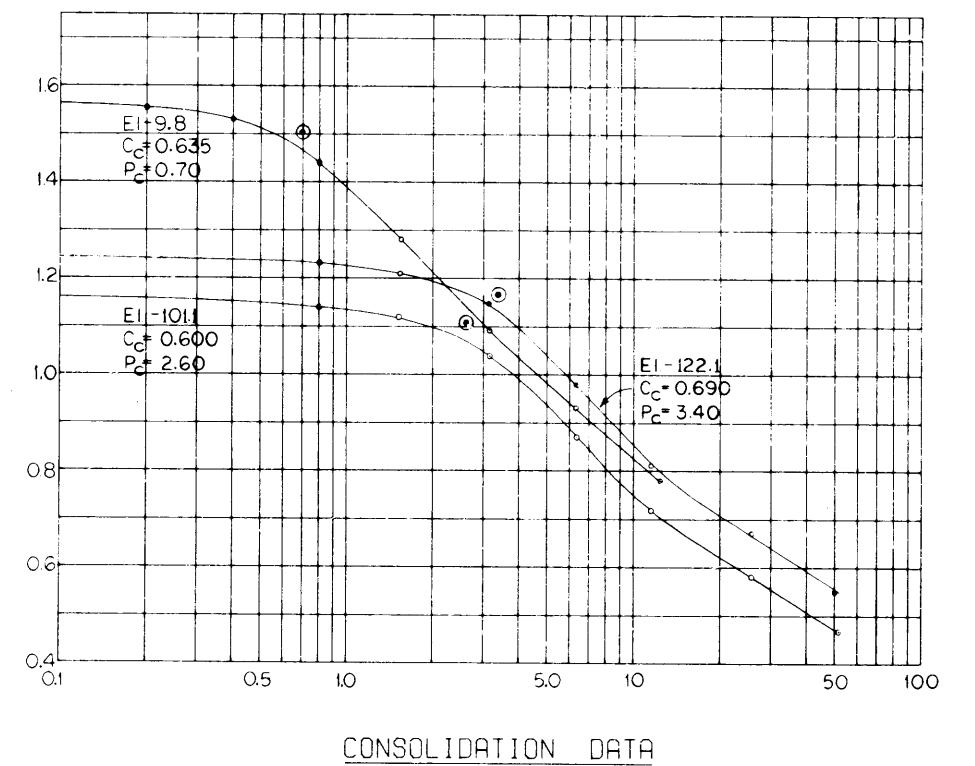
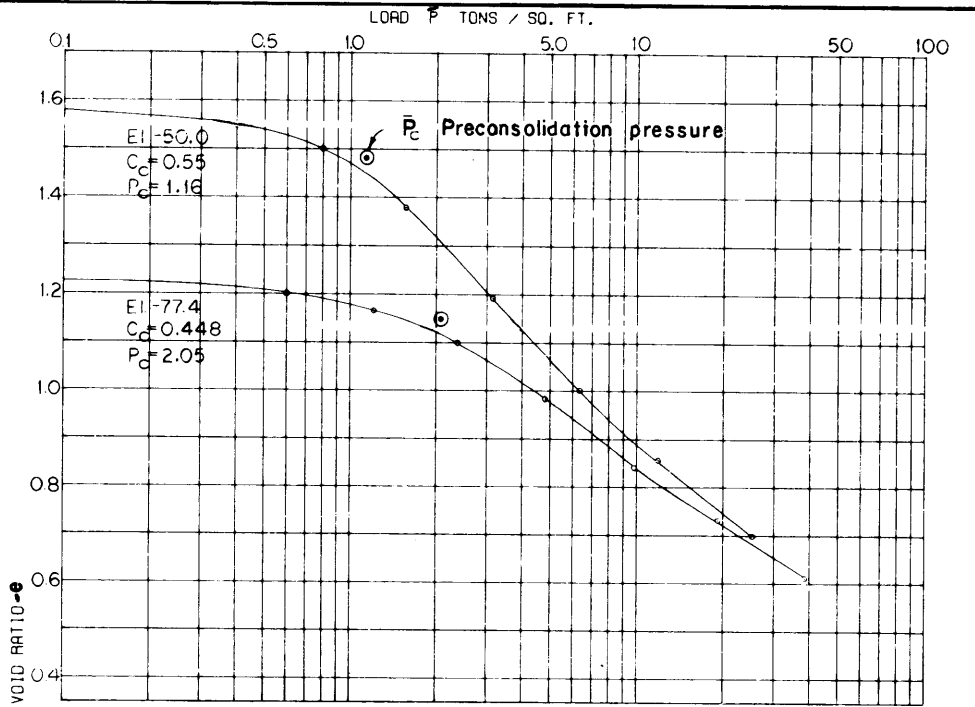

○ - (UC) UNCONFINED COMPRESSION TEST  
 ■ - (Q) UNCONSOLIDATED - UNDRAINED SHEAR TEST  
 ▲ - (R) CONSOLIDATED - UNDRAINED SHEAR TEST  
 □ - (S) CONSOLIDATED - DRAINED SHEAR TEST  
 BORINGS WERE TAKEN WITH A 3 INCH DIAMETER STEEL TUBE PISTON TYPE SAMPLER  
 FOR SOIL BORING LEGEND SEE PLATE A  
 FOR LOCATION OF BORINGS SEE PLATE 12

MISSISSIPPI RIVER LEVEES AND BANKS  
 MILE 66 TO MILE 10  
 SOIL REPORT - PART I  
 EAST BANK  
**SOIL BORING DATA**  
 66-MHUL  
 U.S. ARMY ENGINEER DISTRICT, NEW ORLEANS  
 CORPS OF ENGINEERS

BOR. 68-MHUL  
 STA. 554+00  
 475 FT. LEFT OF B...  
 18-21 MAY 1970

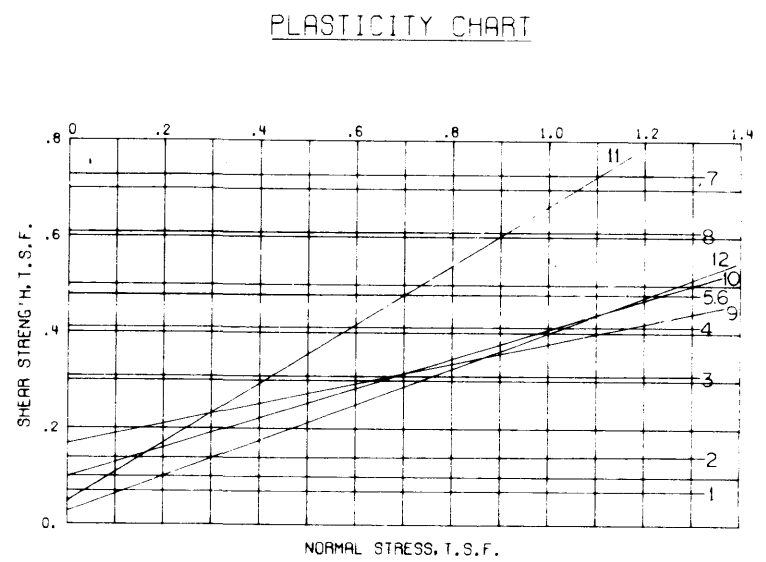
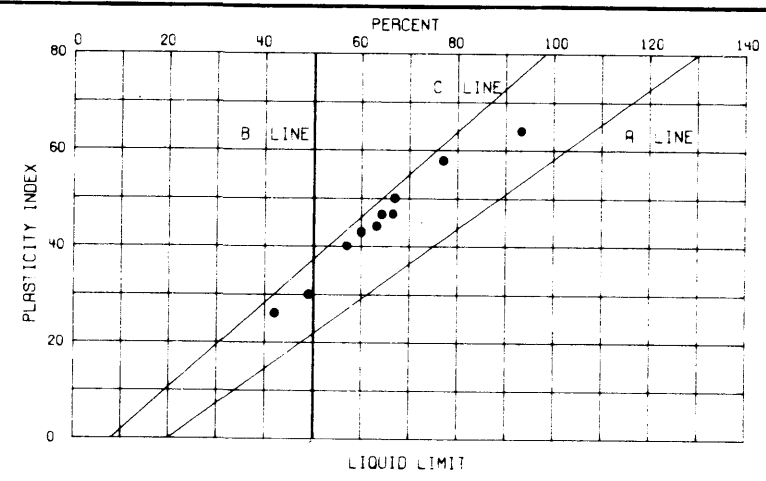
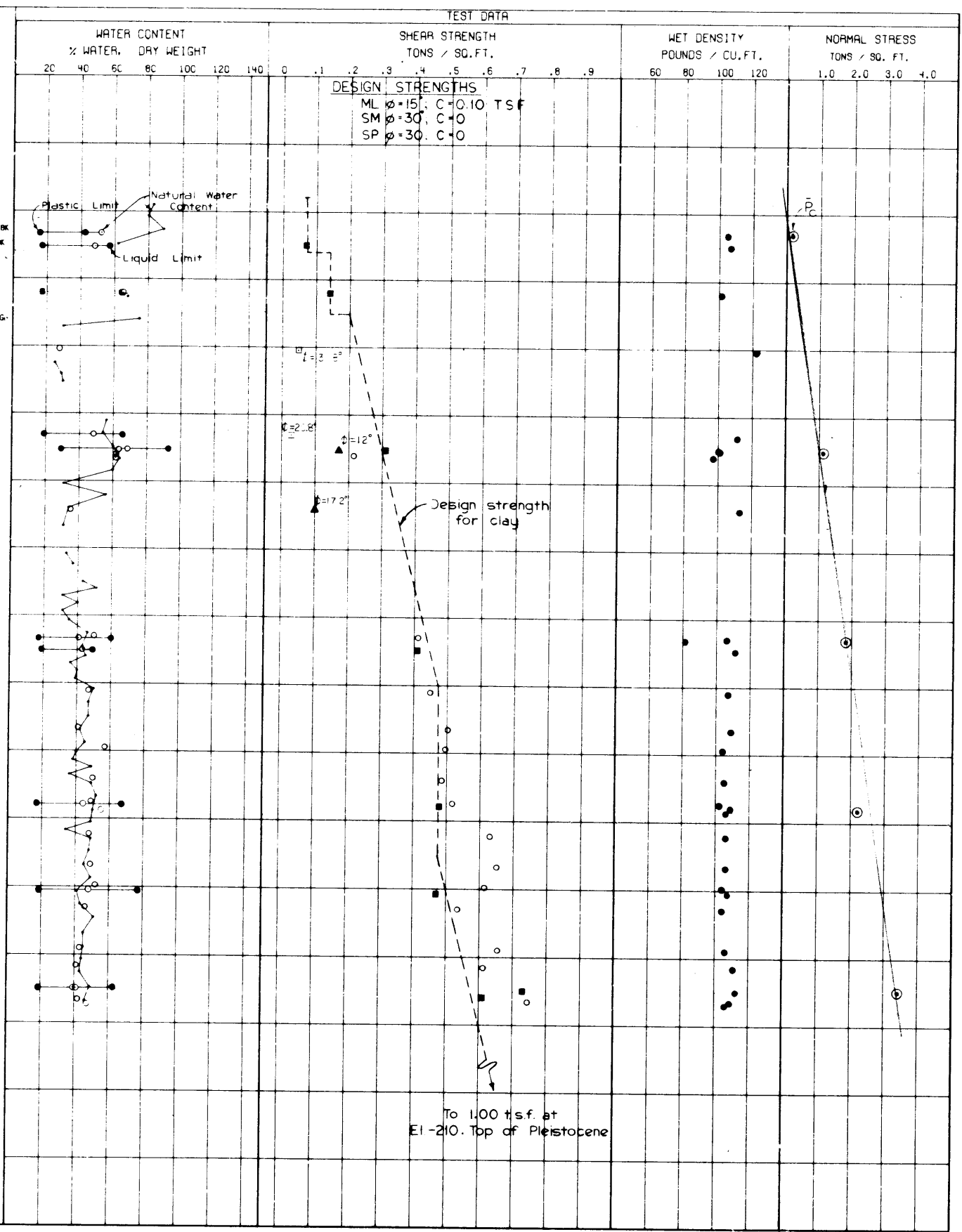
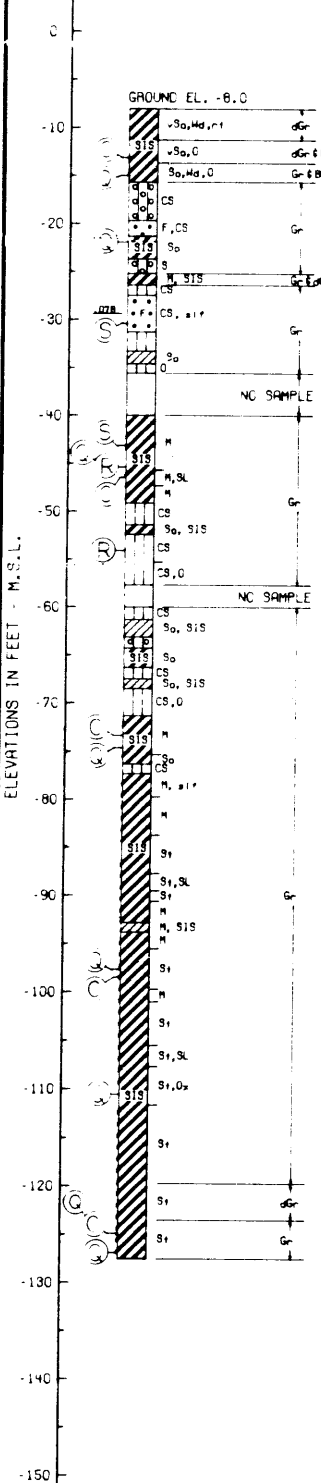

BORING NO.	ENVELOPE		TYPE	STRENGTH		CLASS
	NO.	EL.		$\phi$	C - TSF	
68-MHUL	1	-15.0	Q	0	0.07	CH
	2	-22.0		0	0.14	CH
	3	-45.2		0	0.31	CH
	4	-74.8		0	0.41	CL
	5	-97.9		0	0.48	CH
	6	-110.7		0	0.48	CH
	7	-125.1		0	0.73	CH
	8	-127.0		0	0.61	CH
	9	-45.2	R	12.0	0.17	CH
	10	-54.0		17.2'	0.10	ML
	11	-30.3		31.8'	0.05	ML
	12	-43.1		20.8'	0.03	CH

\*BASED ON DEVIATOR STRESS AT MAXIMUM POSITIVE PORE PRESSURE

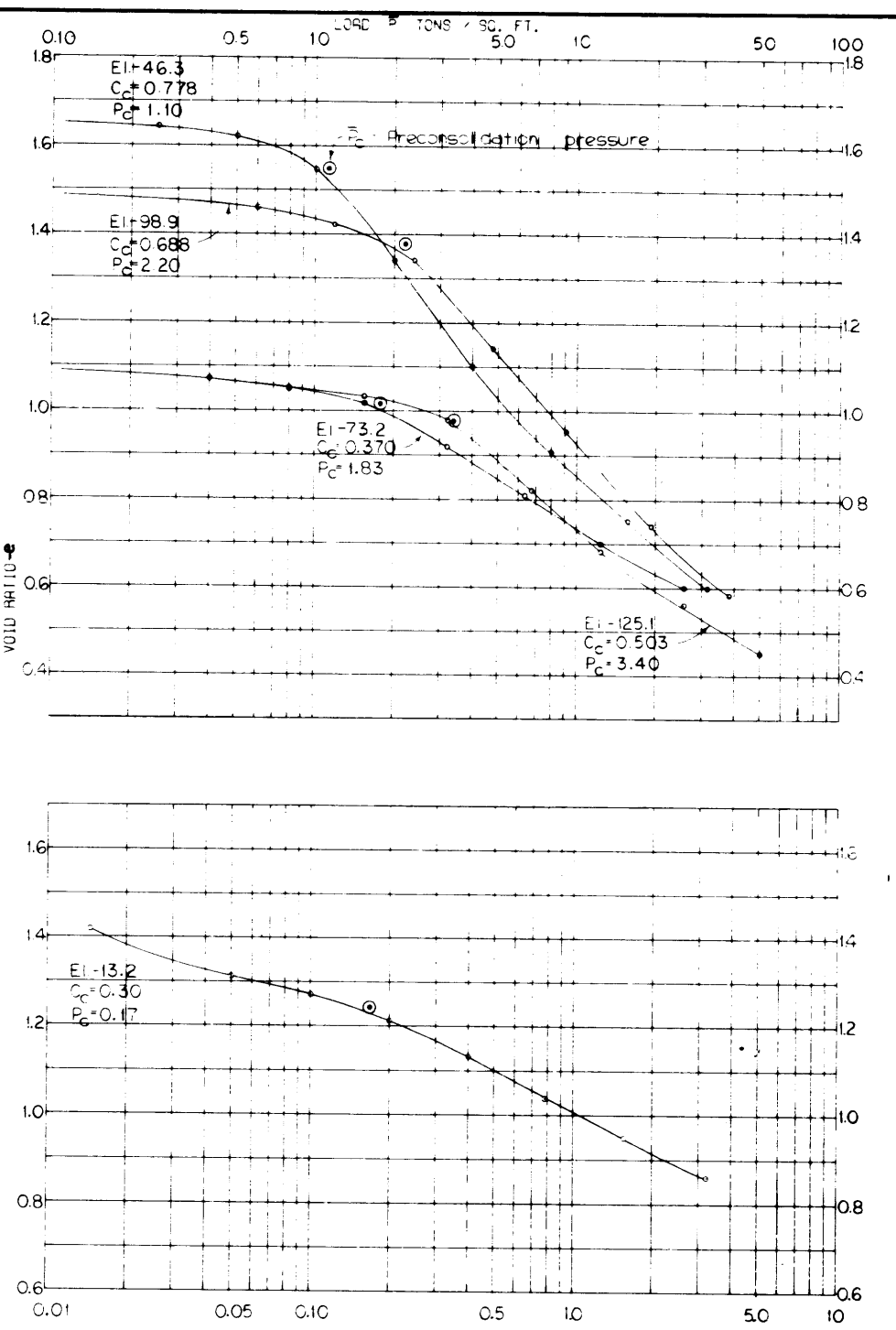

○ (UC) UNCONFINED COMPRESSION TEST  
 ● (Q) UNCONSOLIDATED - UNDRAINED SHEAR TEST  
 ▲ (R) CONSOLIDATED - UNDRAINED SHEAR TEST  
 □ (S) CONSOLIDATED - DRAINED SHEAR TEST

BORINGS WERE TAKEN WITH A 3 INCH DIAMETER STEEL TUBE PISTON TYPE SAMPLER FOR SOIL BORING LEGEND SEE PLATE A FOR LOCATION OF BORINGS SEE PLATE 12

MISSISSIPPI RIVER LEVEES AND BANKS  
 MILE 66 TO MILE 10  
 SOIL REPORT - PART I  
 EAST BANK  
**SOIL BORING DATA**  
 68-MHUL  
 U.S. ARMY ENGINEER DISTRICT, NEW ORLEANS  
 CORPS OF ENGINEERS  
 AUGUST 1971

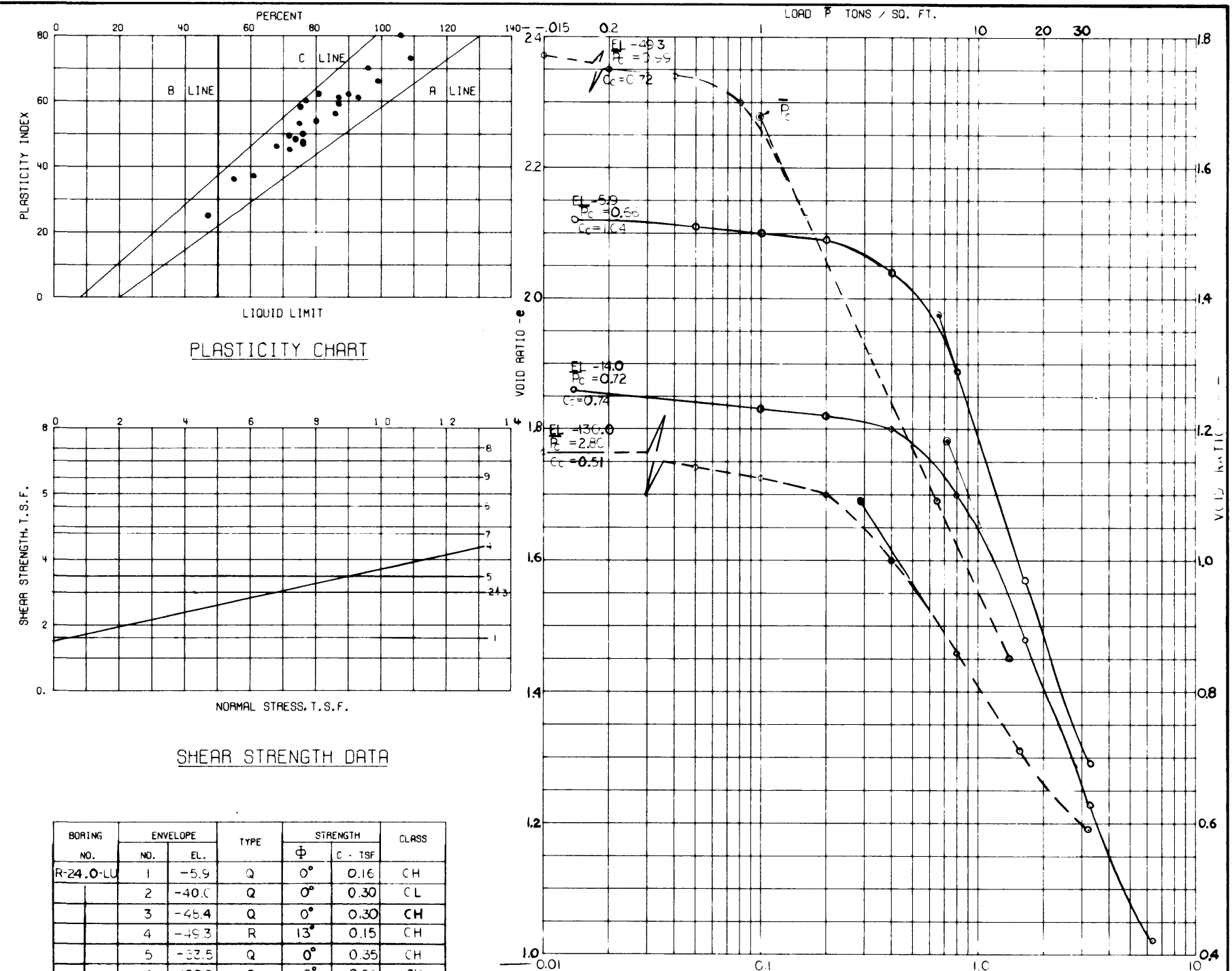
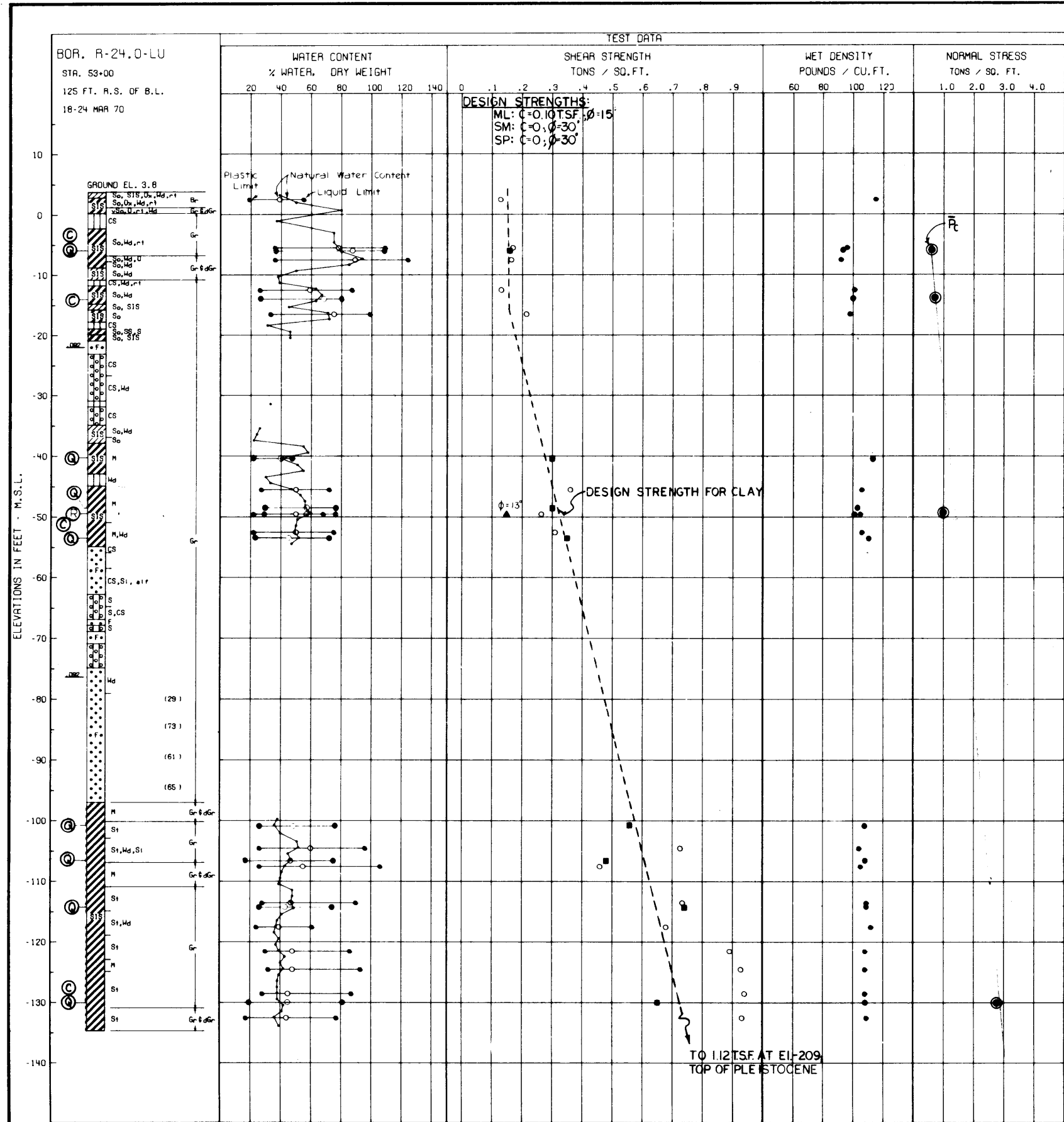

BORING NO.	ENVELOPE		TYPE	STRENGTH		CLASS
	NO.	EL.		$\phi$	C - TSF	
R-24.0-LU	1	-5.9	Q	$0^\circ$	0.16	CH
	2	-40.0	Q	$0^\circ$	0.30	CL
	3	-45.4	Q	$0^\circ$	0.30	CH
	4	-48.3	R	$13^\circ$	0.15	CH
	5	-57.5	Q	$0^\circ$	0.35	CH
	6	-100.9	Q	$0^\circ$	0.56	CH
	7	-106.4	Q	$0^\circ$	0.48	CH
	8	-114.2	Q	$0^\circ$	0.74	CH
	9	-130.0	Q	$0^\circ$	0.65	CH

○ - (UC) UNCONFINED COMPRESSION TEST  
 ■ - (Q) UNCONSOLIDATED - UNDRAINED SHEAR TEST  
 ▲ - (R) CONSOLIDATED - UNDRAINED SHEAR TEST  
 □ - (S) CONSOLIDATED - DRAINED SHEAR TEST

BORINGS WERE TAKEN WITH A 5 INCH DIAMETER  
 STEEL TUBE PISTON TYPE SAMPLER  
 FOR SOIL BORING LEGEND SEE PLATE A  
 FOR LOCATION OF BORINGS SEE PLATE 13

MISSISSIPPI RIVER LEVEES AND BANKS  
 MILE 66 TO MILE 10  
 SOIL REPORT - PART I  
 EAST BANK  
**SOIL BORING DATA**  
 R-24.0-LU  
 U.S. ARMY ENGINEER DISTRICT, NEW ORLEANS  
 CORPS OF ENGINEERS

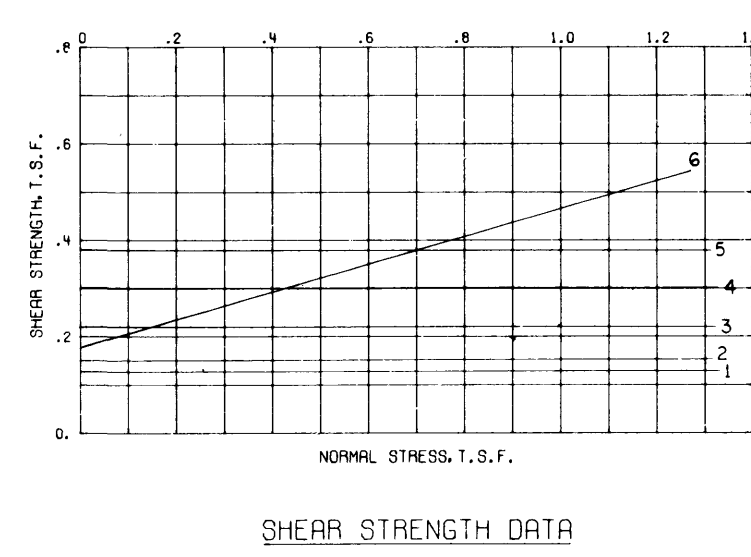
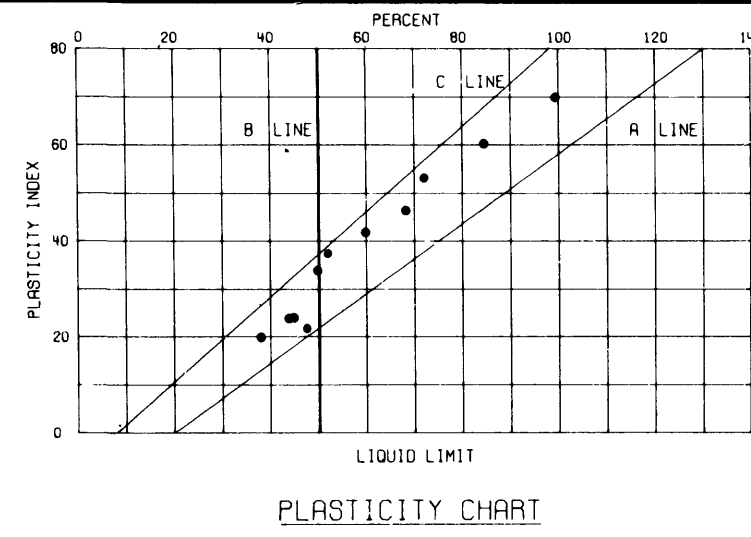
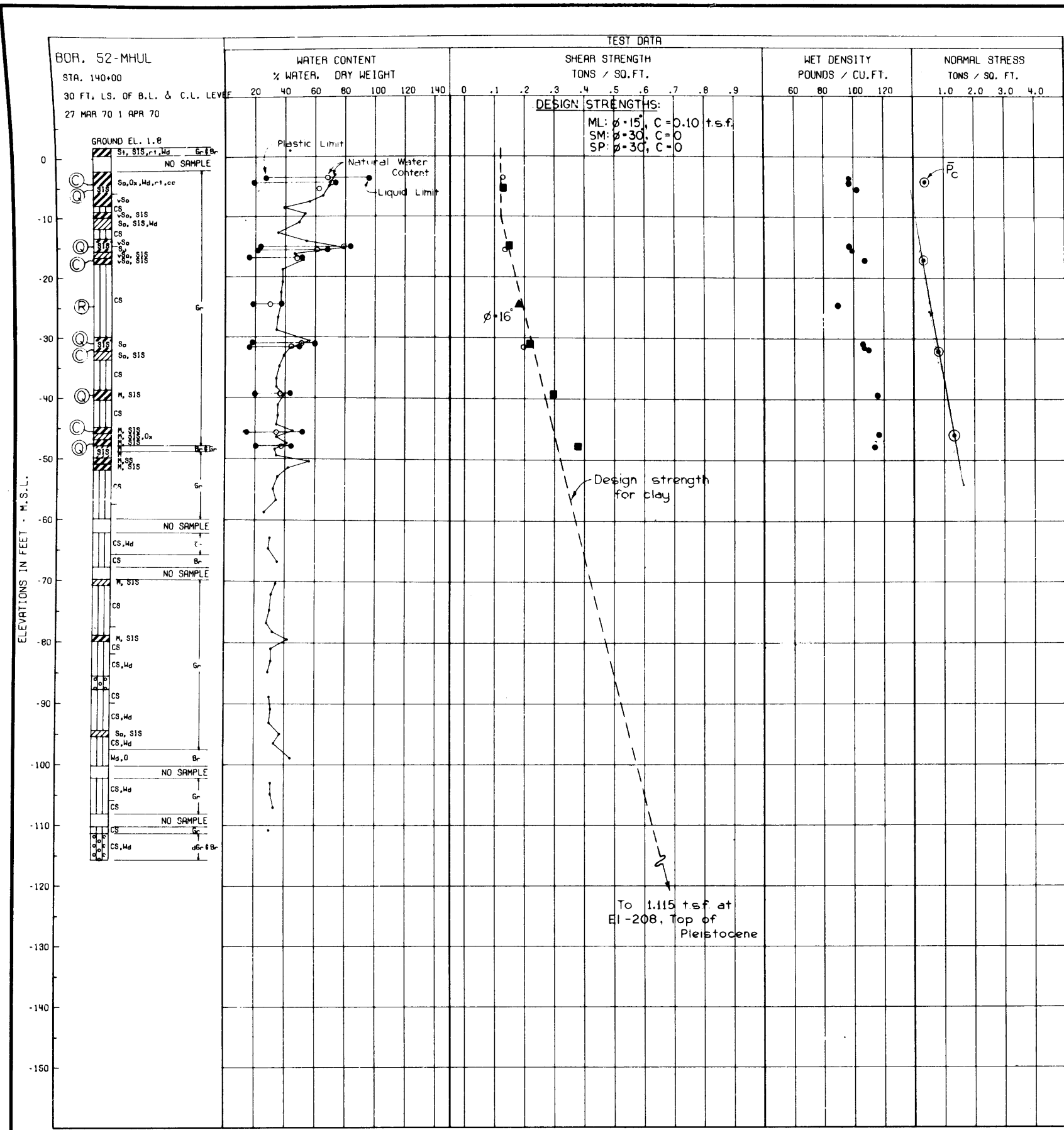

BORING NO.	ENVELOPE		TYPE	STRENGTH		CLASS
	NO.	EL.		$\phi$	C - TSF	
52-MHUL	1	-5.1	Q	0	0.13	CH
	2	-14.6		0	0.15	CH
	3	-30.9		0	0.22	CH
	4	-39.2		0	0.30	CL
	5	-47.4		0	0.38	CL
	6	-24.6		R*	16°	0.18

\*BASED ON DEVIATOR STRESS AT MAXIMUM POSITIVE PORE PRESSURE.

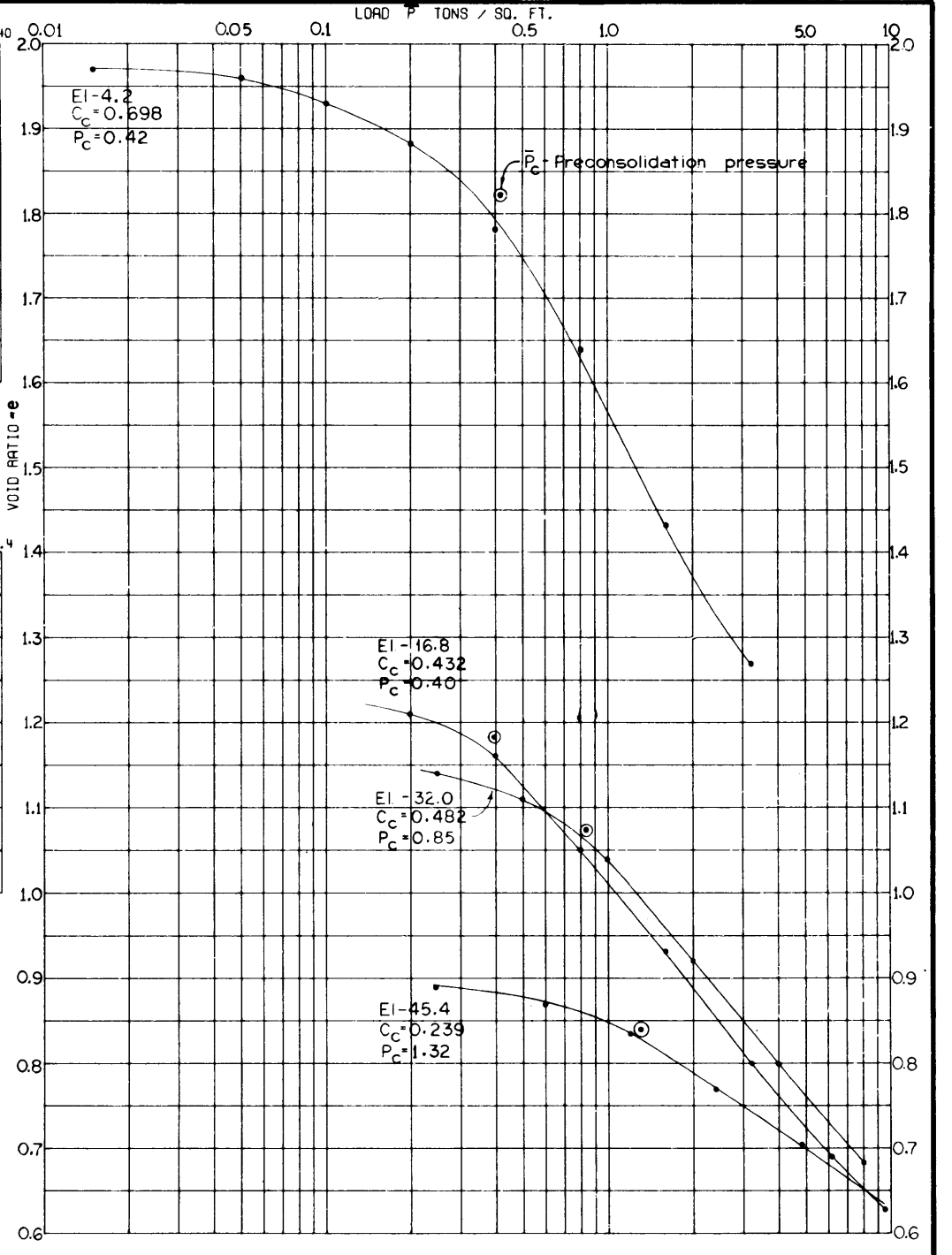

- - (UC) UNCONFINED COMPRESSION TEST
  - - (Q) UNCONSOLIDATED - UNDRAINED SHEAR TEST
  - ▲ - (R) CONSOLIDATED - UNDRAINED SHEAR TEST
  - - (S) CONSOLIDATED - DRAINED SHEAR TEST
- BORINGS WERE TAKEN WITH A 5 INCH DIAMETER STEEL TUBE PISTON TYPE SAMPLER FOR SOIL BORING LEGEND SEE PLATE A FOR LOCATION OF BORINGS SEE PLATE 13

MISSISSIPPI RIVER LEVEES AND BANKS  
 MILE 66 TO MILE 10  
 SOIL REPORT - PART I  
 EAST BANK  
**SOIL BORING DATA**  
 52-MHUL  
 U.S. ARMY ENGINEER DISTRICT, NEW ORLEANS  
 CORPS OF ENGINEERS

AUGUST 1971

FILE NO. H-2-25275



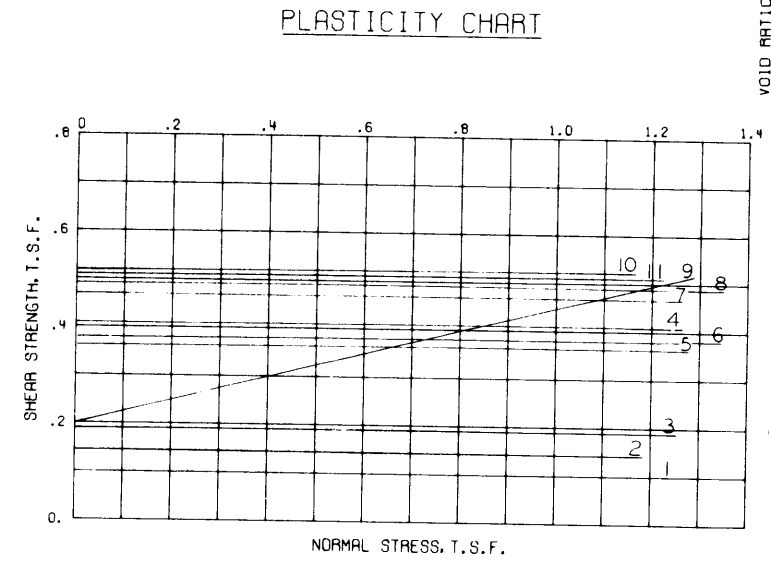
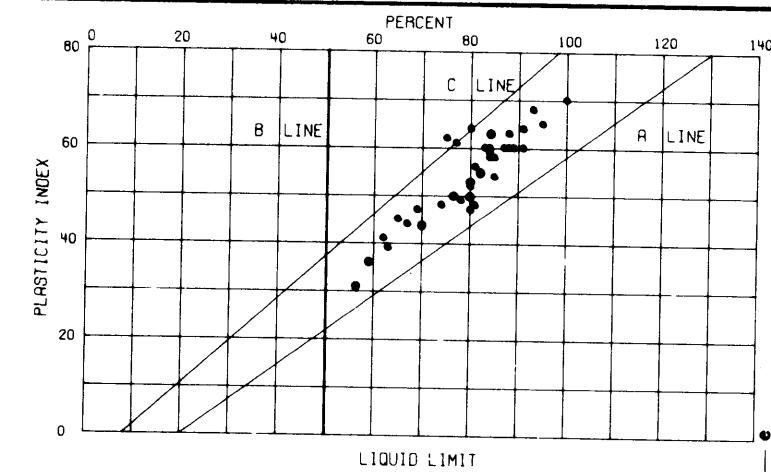
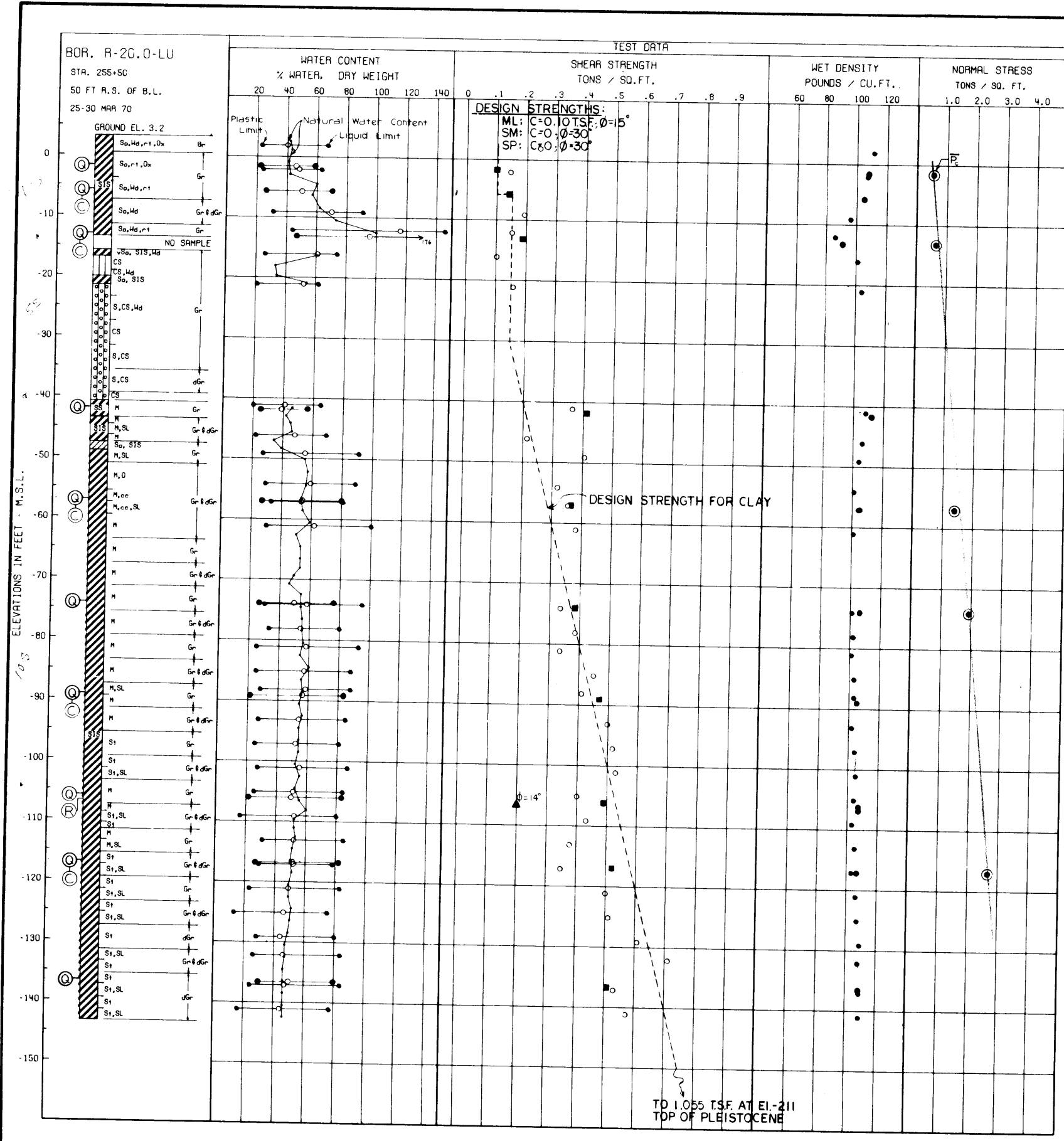

BORING NO.	ENVELOPE		TYPE	STRENGTH		CLASS
	NO.	EL.		$\phi$	C - T.S.F.	
R-200-LU	1	-1.5	Q	0.0	.10	CF
	2	-5.6		0.0	.145	
	3	-13.0		0.0	.19	
	4	-4.8		0.0	.4	
	5	-57.0		0.0	.36	
	6	-74.0		0.0	.38	
	7	89.0		0.0	.47	
	8	-105.9		0.0	.49	
	10	-116.9		0.0	.52	
	11	-136.8		0.0	.51	
9	-106.8	R	14.0	.20		

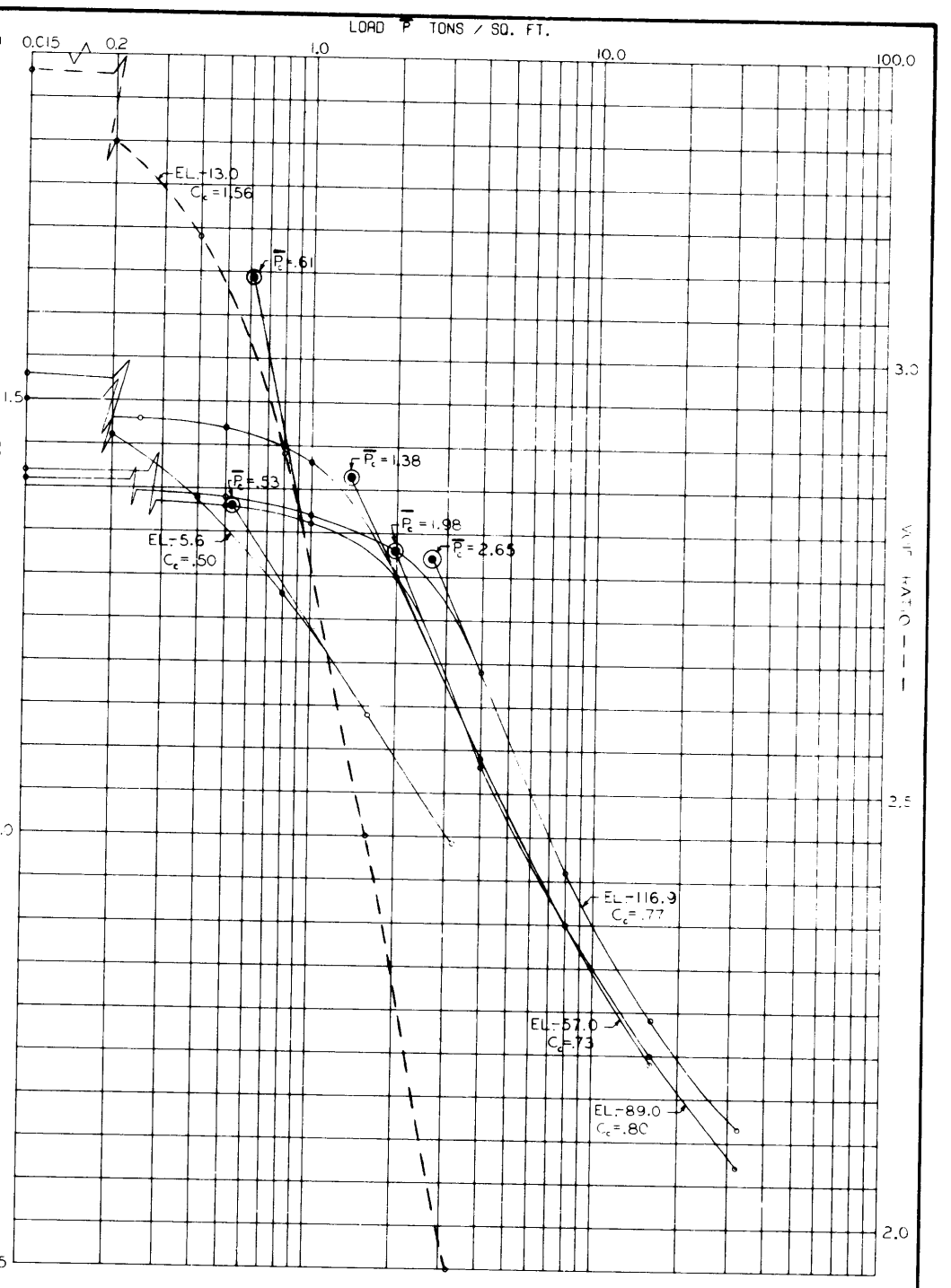

○ - (UC) UNCONFINED COMPRESSION TEST  
 ■ - (Q) UNCONSOLIDATED - UNDRAINED SHEAR TEST  
 ▲ - (R) CONSOLIDATED - UNDRAINED SHEAR TEST  
 ⊖ - (S) CONSOLIDATED - DRAINED SHEAR TEST

BORINGS WERE TAKEN WITH A 5 INCH DIAMETER  
 STEEL TUBE PISTON TYPE SAMPLER

FOR SOIL BORING LEGEND SEE PLATE A  
 FOR LOCATION OF BORINGS SEE PLATE 13

MISSISSIPPI RIVER LEVES AND BANKS  
 MILE 66 TO MILE 10  
**SOIL REPORT - PART I**  
 EAST BANK  
**SOIL BORING DATA**  
 R-20.0-LU  
 U.S. ARMY ENGINEER DISTRICT, NEW ORLEANS  
 CORPS OF ENGINEERS

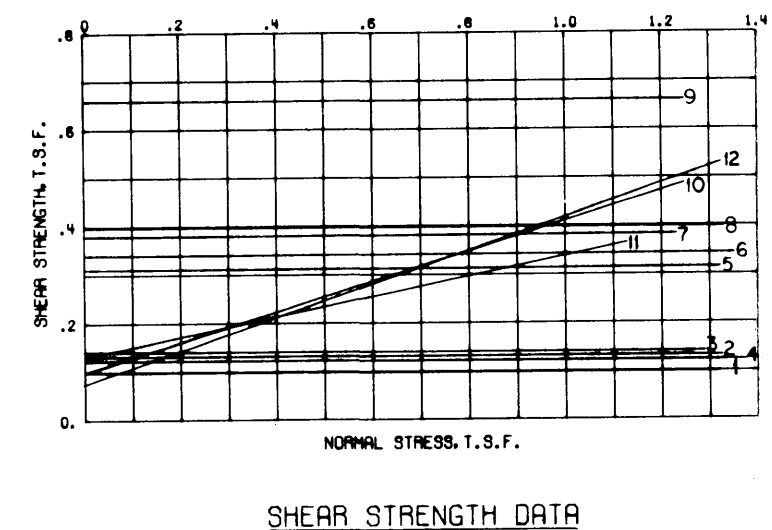
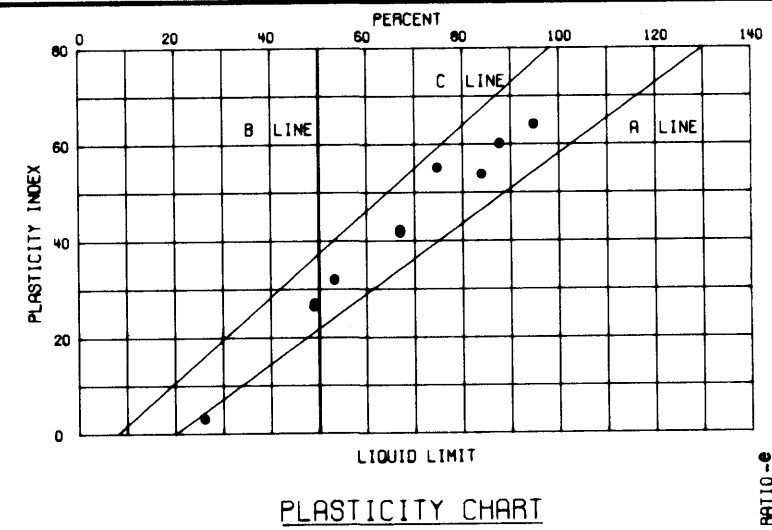
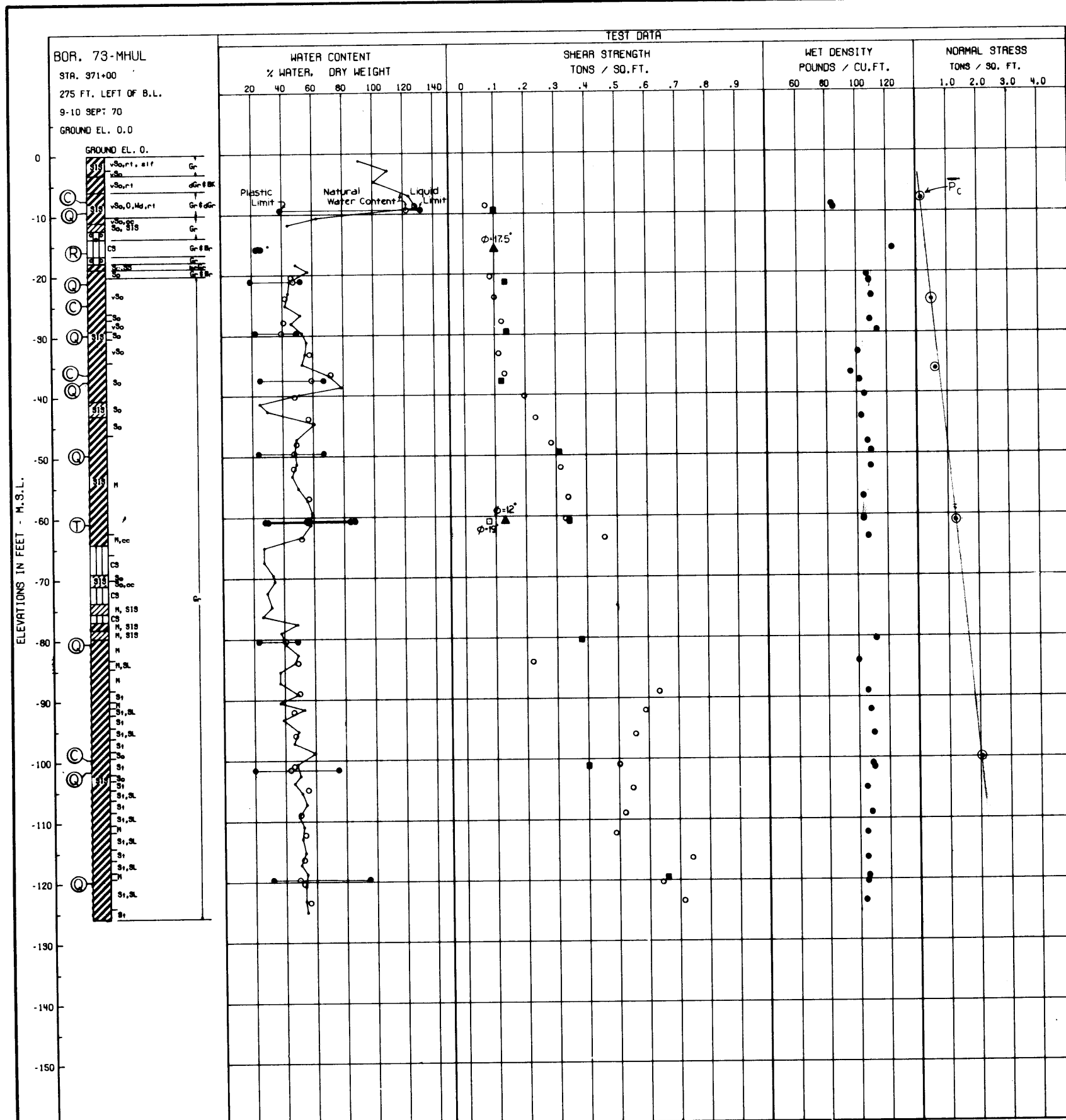

BORING NO.	ENVELOPE		TYPE	STRENGTH		CLASS	
	NO.	EL.		$\phi$	C - TSF		
73-MHUL	1	-9.2	Q	0	0.10	CH	
	2	-21.0		0	0.13	CH	
	3	-29.3		0	0.14	CL	
	4	-37.1		0	0.12	CH	
	5	-49.5		0	0.31	CH	
	6	-59.7		0	0.34	CH	
	7	-80.3		0	0.38	CL	
	8	-101.5		0	0.40	CH	
	9	-119.6		0	0.66	CH	
	10	-16.1		R	*17.5°	0.10	ML
	11	-59.7		R	12.0°	0.13	CH
	12	-61.5		S	19.0°	0.08	CH

\*BASED ON DEVIATOR STRESS AT MAXIMUM PORE PRESSURE

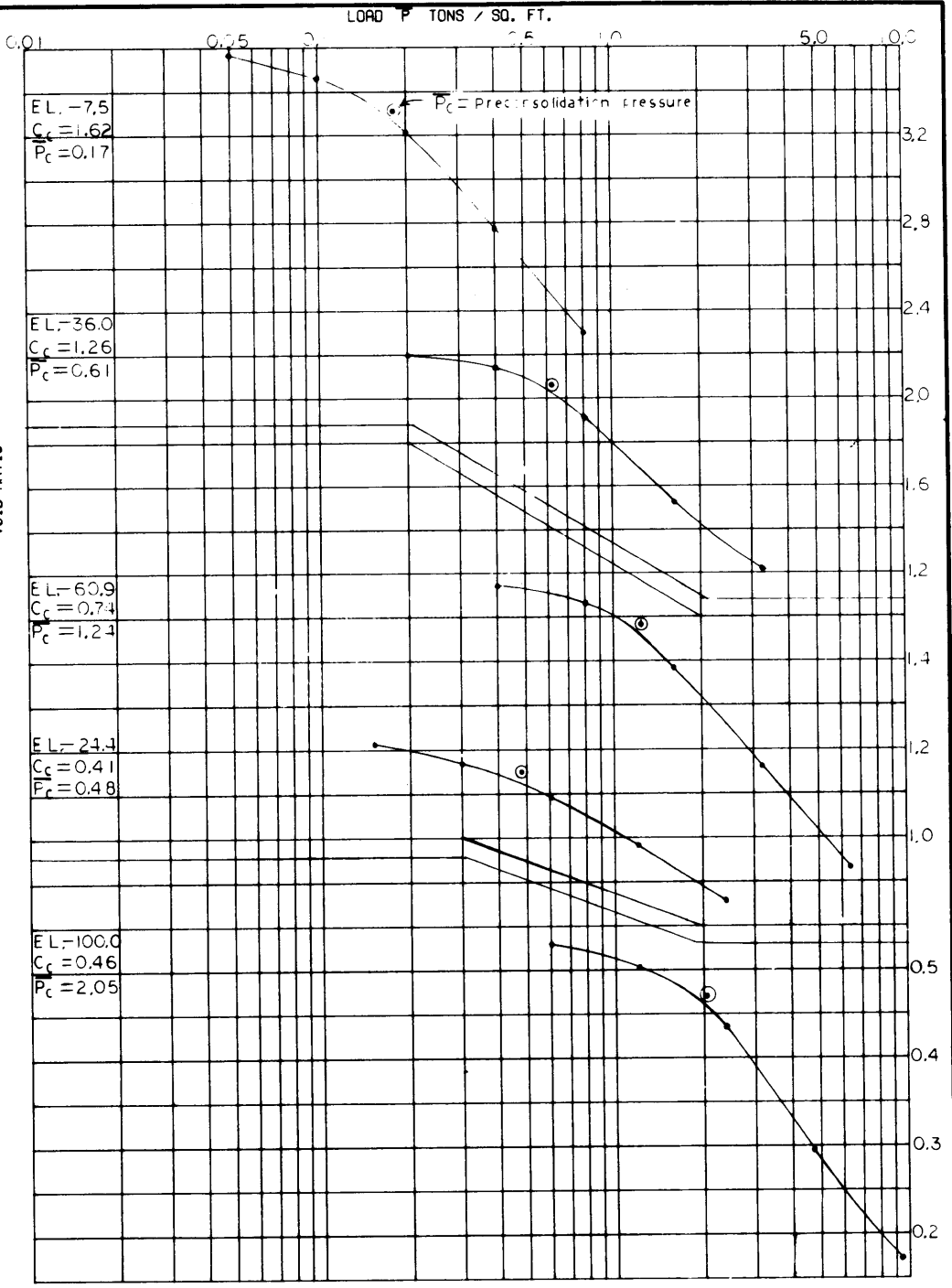

- - (UC) UNCONFINED COMPRESSION TEST
  - - (Q) UNCONSOLIDATED - UNDRAINED SHEAR TEST
  - ▲ - (R) CONSOLIDATED - UNDRAINED SHEAR TEST
  - - (S) CONSOLIDATED - DRAINED SHEAR TEST
- BORINGS WERE TAKEN WITH A 5 INCH DIAMETER STEEL TUBE PISTON TYPE SAMPLER  
 FOR SOIL BORING LEGEND SEE PLATE A  
 FOR LOCATION OF BORINGS SEE PLATE 13

MISSISSIPPI RIVER LEVEES AND BANKS  
 MILE 06 TO MILE 10  
 SOIL REPORT - PART I  
 EAST BANK  
**SOIL BORING DATA**  
**73-MHUL**  
 U.S. ARMY ENGINEER DISTRICT, NEW ORLEANS  
 CORPS OF ENGINEERS  
 AUGUST 1971  
 FILE NO. H-2-25275



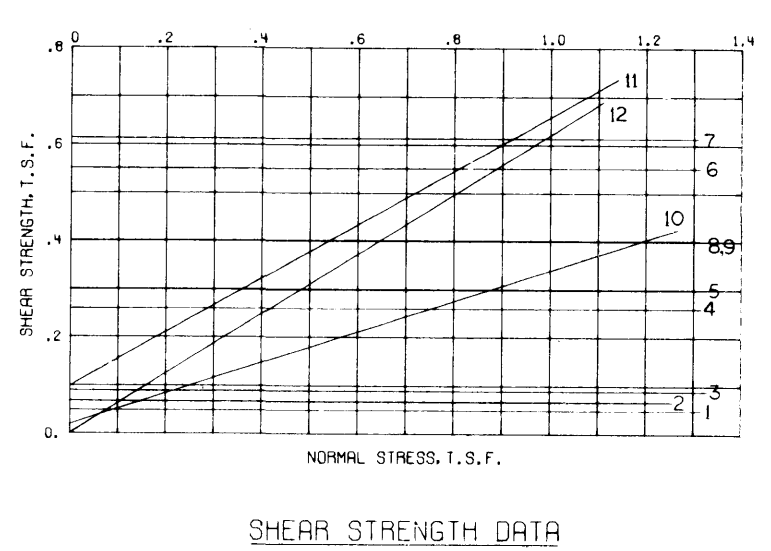
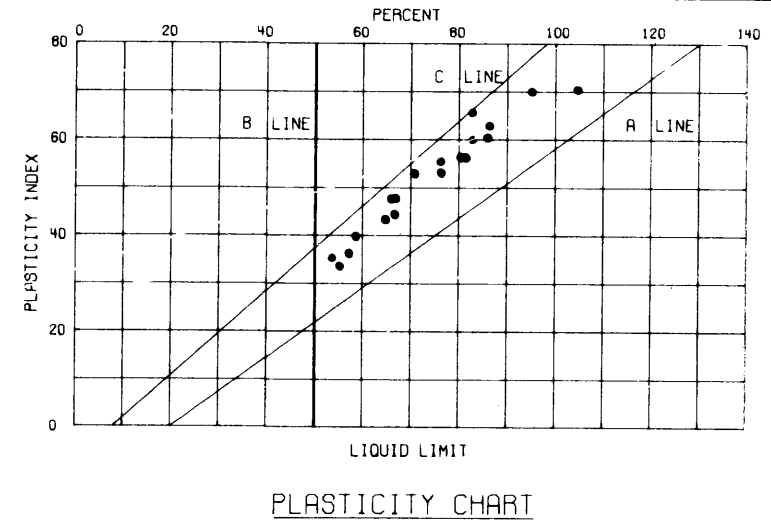
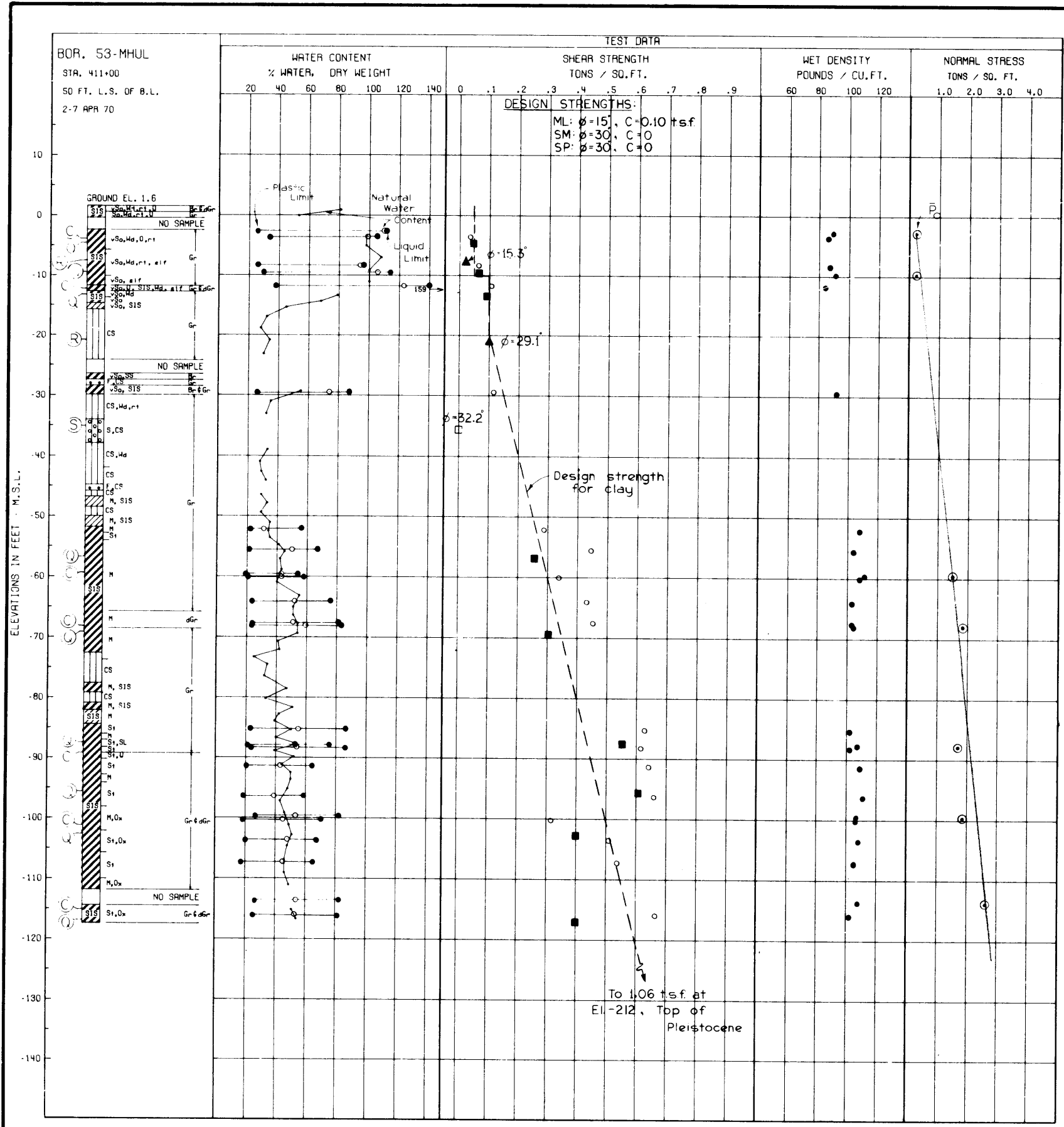

BORING NO.	ENVELOPE		TYPE	STRENGTH		CLASS
	NO.	EL.		$\phi$	C - TSF	
53-MHUL	1	-4.5	I	0	0.05	CH
	2	-9.3		0	0.07	CH
	3	-13.1		0	0.09	CH
	4	-56.5		0	0.26	CH
	5	-68.9	Q	0	0.30	CH
	6	-87.4		0	0.55	CH
	7	-95.5	0	0.61	CH	
	8	-104.5	C	0	0.40	CH
	9	-116.9		0	0.40	CH
	10	-7.5	R	15.3	0.02	CH
	11	-20.8		29.1	0.10	ML
	12	-35.1		32.2	0	SM

\*BASED ON DEVIATOR STRESS AT MAXIMUM POSITIVE PORE PRESSURE

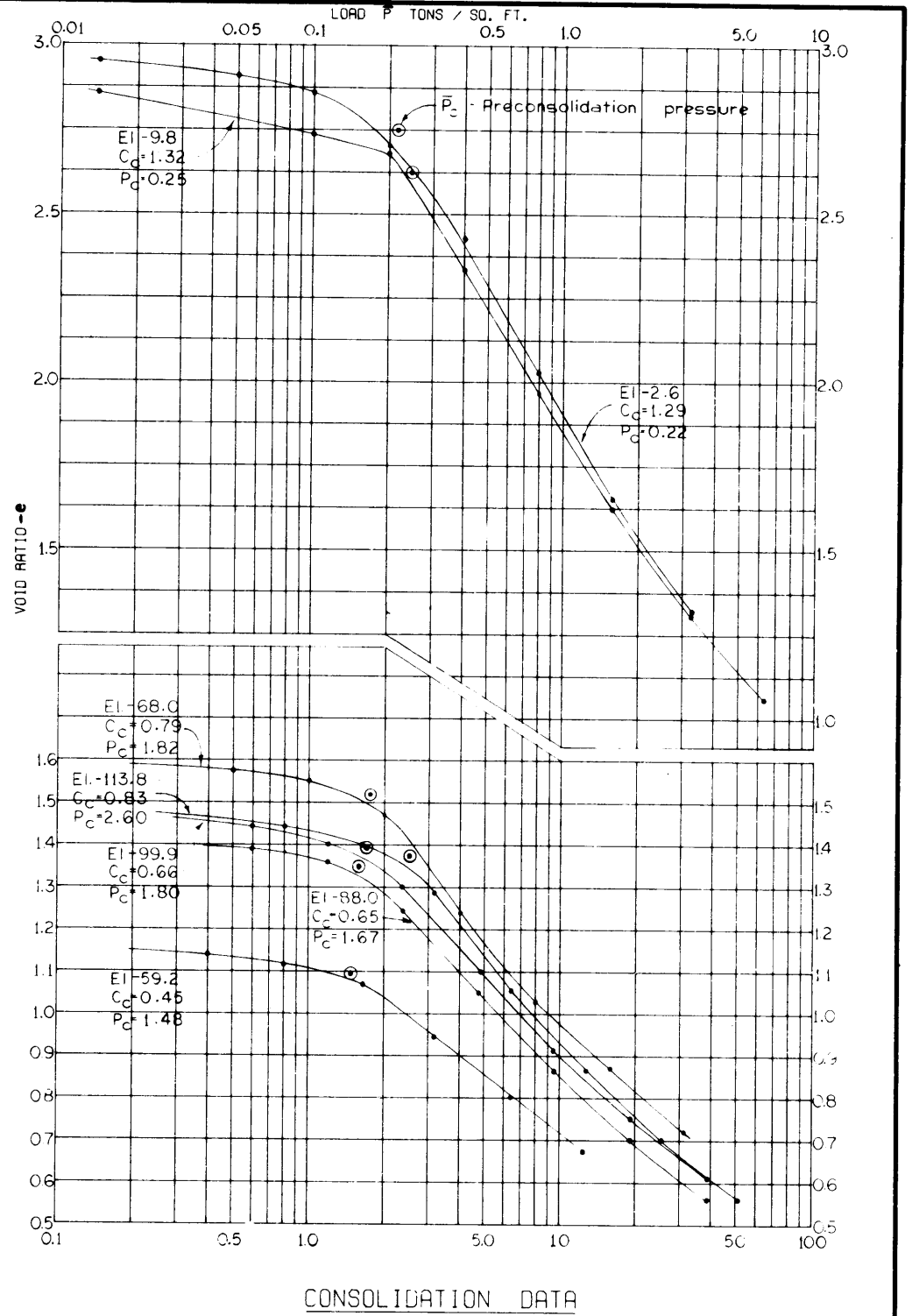

○ - (UC) UNCONFINED COMPRESSION TEST  
 ■ - (U) UNCONSOLIDATED - UNDRAINED SHEAR TEST  
 ▲ - (R) CONSOLIDATED - UNDRAINED SHEAR TEST  
 □ - (S) CONSOLIDATED - DRAINED SHEAR TEST  
 BORINGS WERE TAKEN WITH A 5 INCH DIAMETER STEEL TUBE PISTON TYPE SAMPLER  
 FOR SOIL BORING LEGEND SEE PLATE A  
 FOR LOCATION OF BORINGS SEE PLATE 14

MISSISSIPPI RIVER LEVEES AND BANKS  
 MILE 66 TO MILE 10  
**SOIL REPORT - PART I**  
 EAST BANK  
**SOIL BORING DATA**  
 53-MHUL  
 U.S. ARMY ENGINEER DISTRICT, NEW ORLEANS  
 CORPS OF ENGINEERS

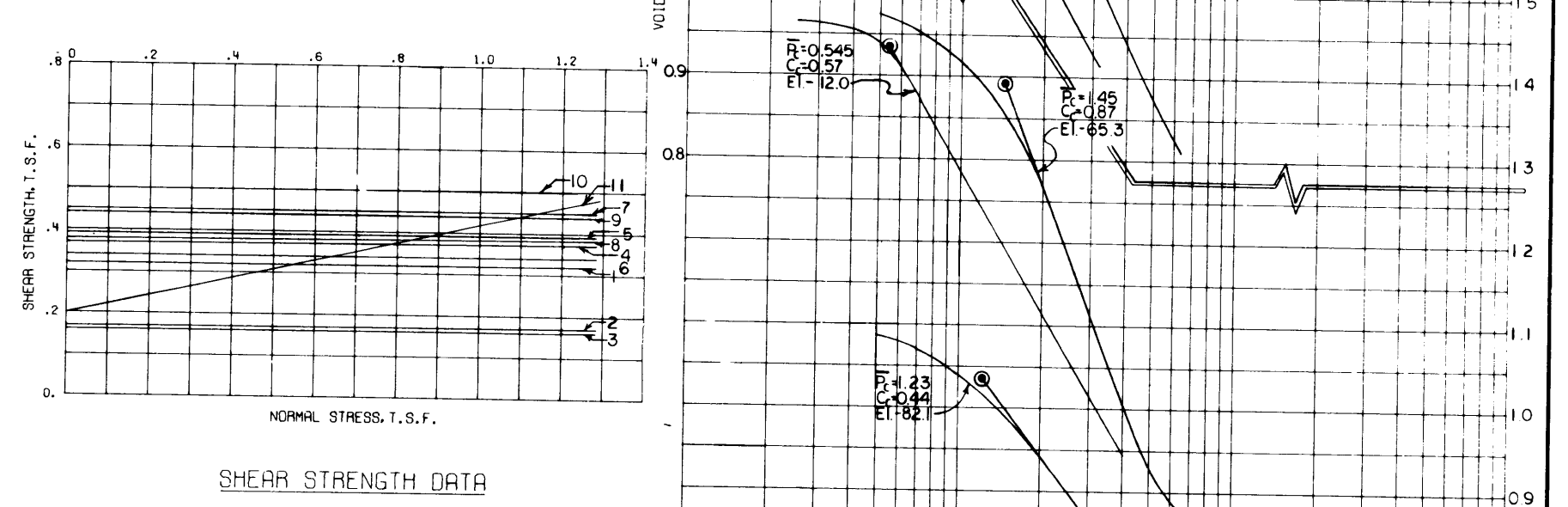
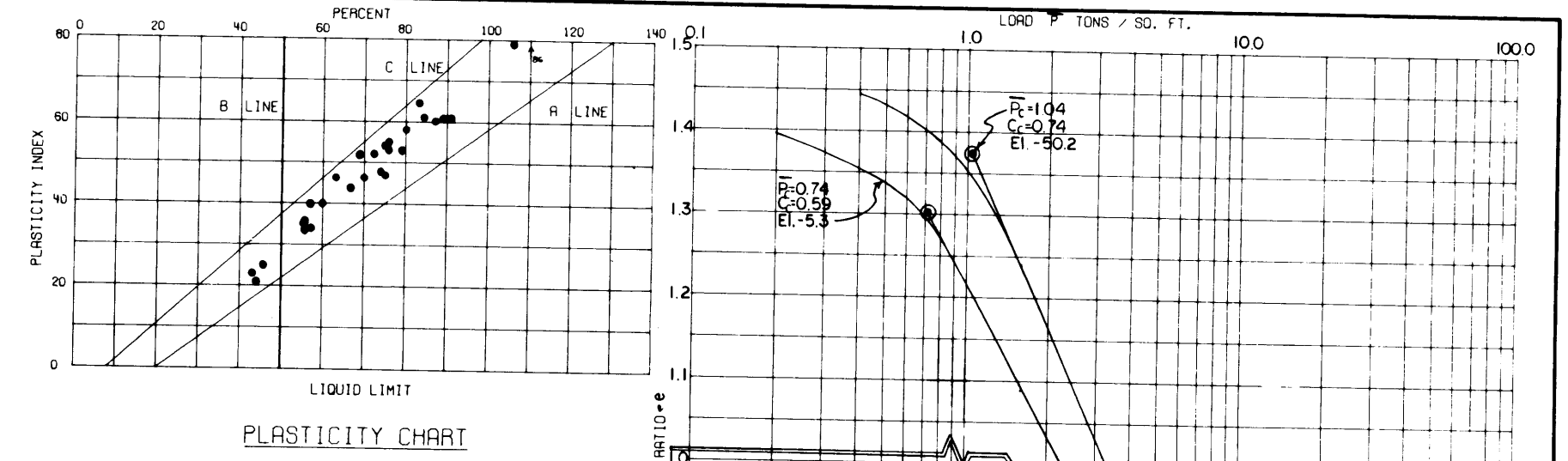
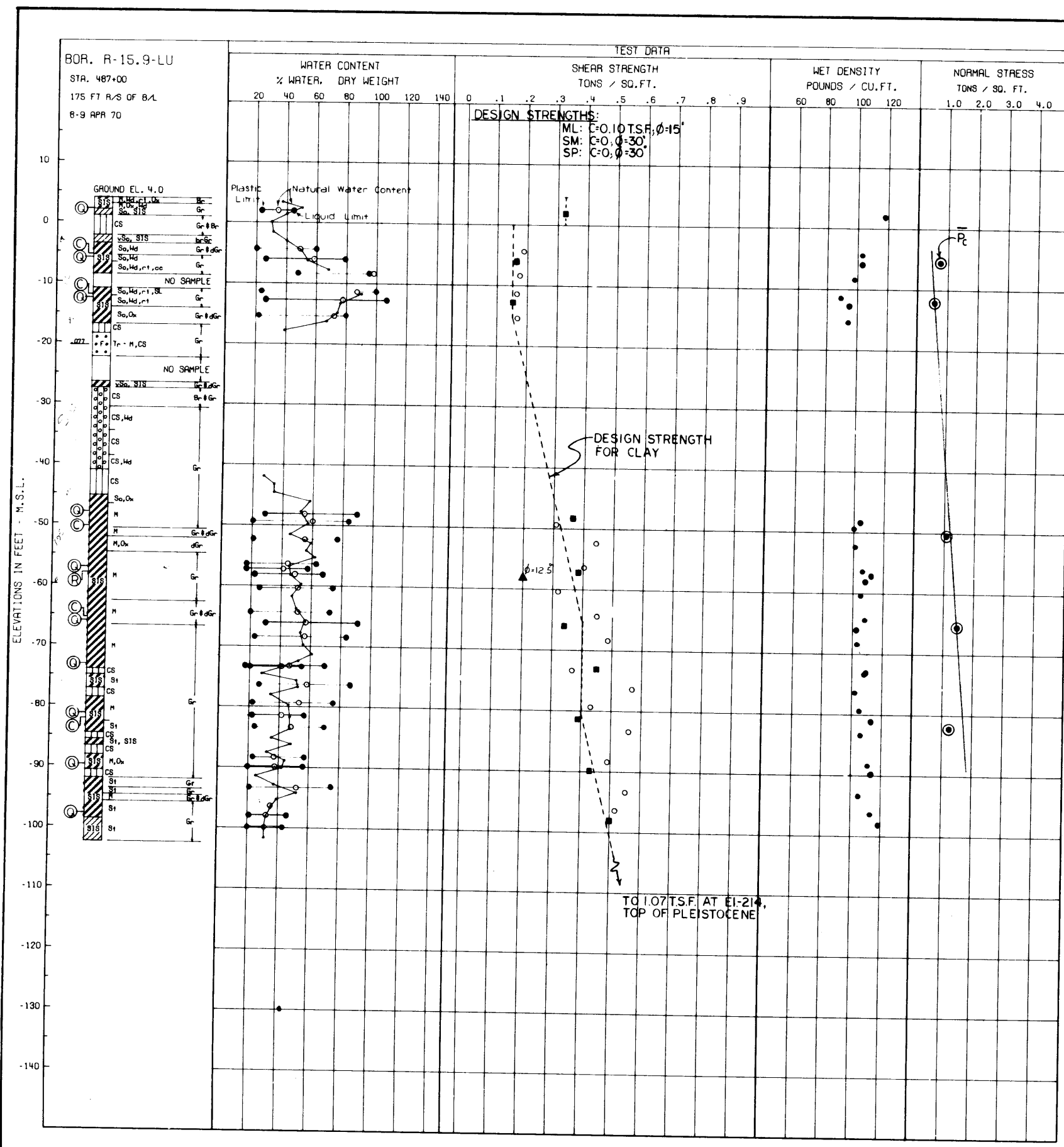

BORING NO.	ENVELOPE		TYPE	STRENGTH		CLASS
	NO.	EL.		$\phi$	C - TSF	
R-15.9-LU	1	+1.9	G	$0^\circ$	.32	CL
	2	-6.0		$0^\circ$	.17	CH
	3	-12.7		$0^\circ$	.16	CH
	4	-48.2		$0^\circ$	.37	CH
	5	-57.1		$0^\circ$	.39	CH
	6	-66.0		$0^\circ$	.34	CH
	7	-73.1		$0^\circ$	.45	CH
	8	-81.2		$0^\circ$	.38	CH
	9	-89.9		$0^\circ$	.44	CH
	10	-98.0		$0^\circ$	.50	CL
	11	-56.0		$12.5^\circ$	.20	CH

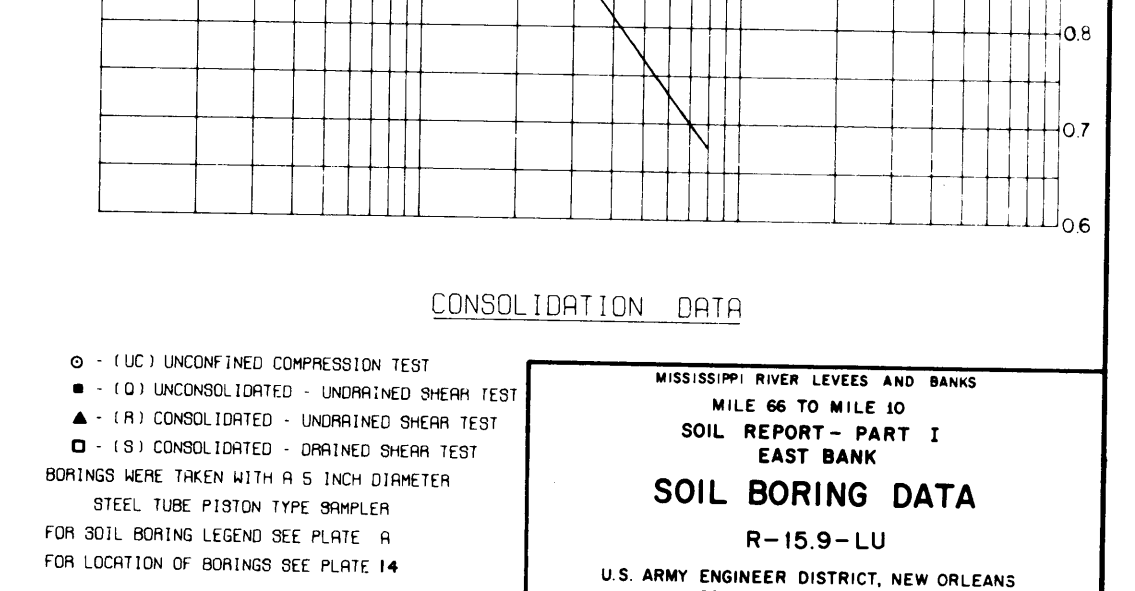

MISSISSIPPI RIVER LEVEES AND BANKS  
 MILE 66 TO MILE 10  
 SOIL REPORT - PART I  
 EAST BANK  
**SOIL BORING DATA**  
 R-15.9-LU  
 U.S. ARMY ENGINEER DISTRICT, NEW ORLEANS  
 CORPS OF ENGINEERS

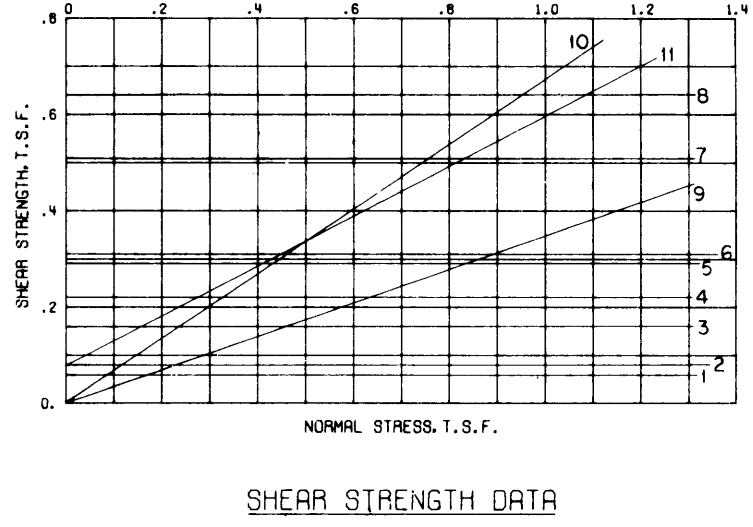
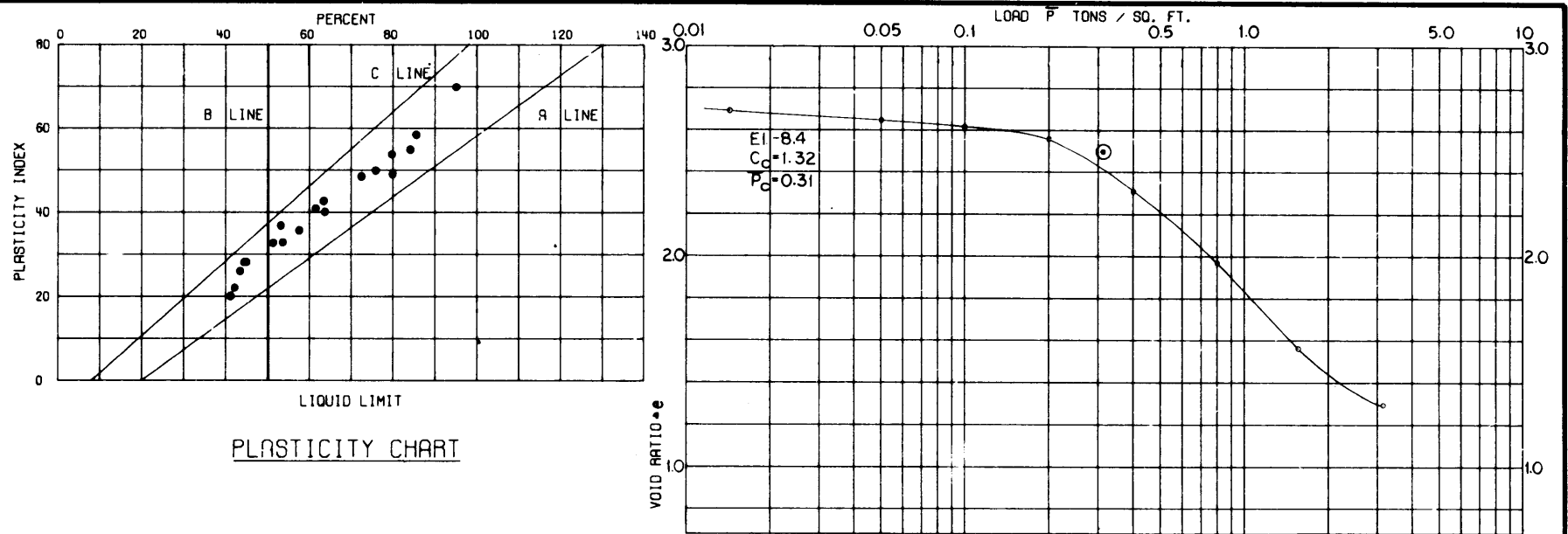
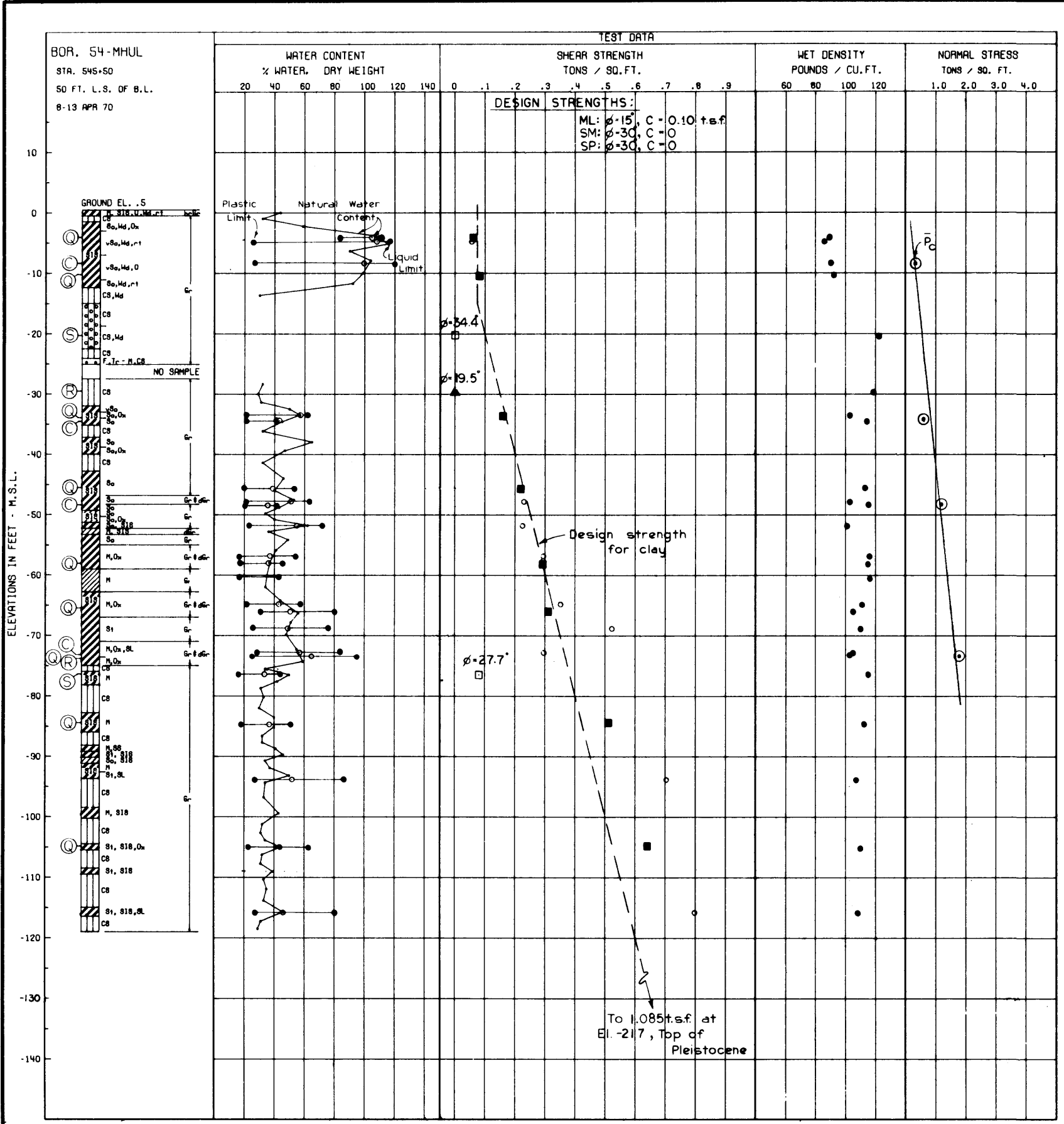

BORING NO.	ENVELOPE		TYPE	STRENGTH		CLASS
	NO.	EL.		$\phi$	C - TSF	
54-MHUL	1	-4.2	Q	0	0.06	CH
	2	-10.3		0	0.08	CH
	3	-33.5		0	0.16	CH
	4	-45.6		0	0.22	CH
	5	-58.1		0	0.29	CL
	6	-66.0		0	0.31	CH
	7	-84.6		0	0.51	CH
	8	-105.0		0	0.64	CH
	9	-29.6	R*	19.5	0	ML
	10	-20.3	S	34.4	0	SM
	11	-76.5	S	27.7	0.08	CL

\*BASED ON DEVIATOR STRESS AT MAXIMUM POSITIVE PORE PRESSURE.

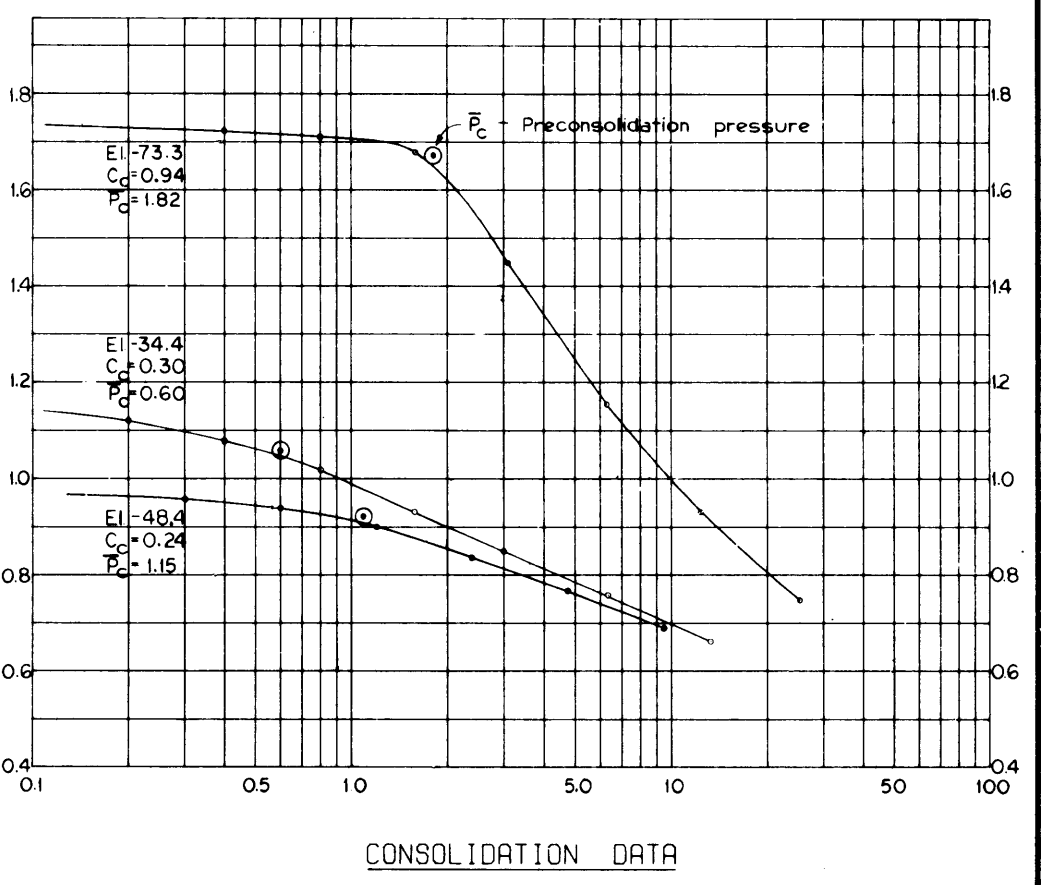
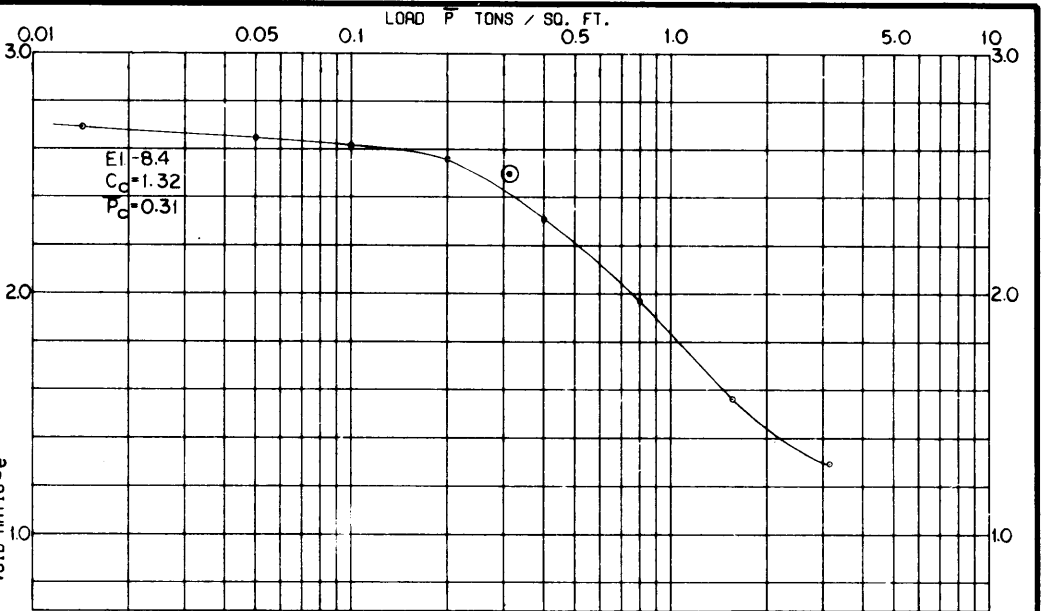

○ - (UC) UNCONFINED COMPRESSION TEST  
 ■ - (Q) UNCONSOLIDATED - UNDRAINED SHEAR TEST  
 ▲ - (R) CONSOLIDATED - UNDRAINED SHEAR TEST  
 □ - (S) CONSOLIDATED - DRAINED SHEAR TEST

BORINGS WERE TAKEN WITH A 5 INCH DIAMETER STEEL TUBE PISTON TYPE SAMPLER FOR SOIL BORING LEGEND SEE PLATE A FOR LOCATION OF BORINGS SEE PLATE 14

MISSISSIPPI RIVER LEVEES AND BANKS  
 MILE 66 TO MILE 10  
 SOIL REPORT - PART I  
 EAST BANK  
**SOIL BORING DATA**  
 54-MHUL  
 U.S. ARMY ENGINEER DISTRICT, NEW ORLEANS  
 CORPS OF ENGINEERS

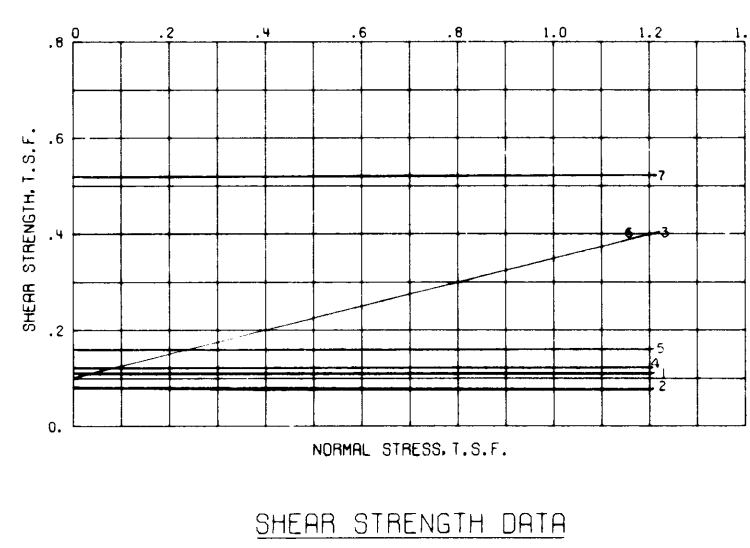
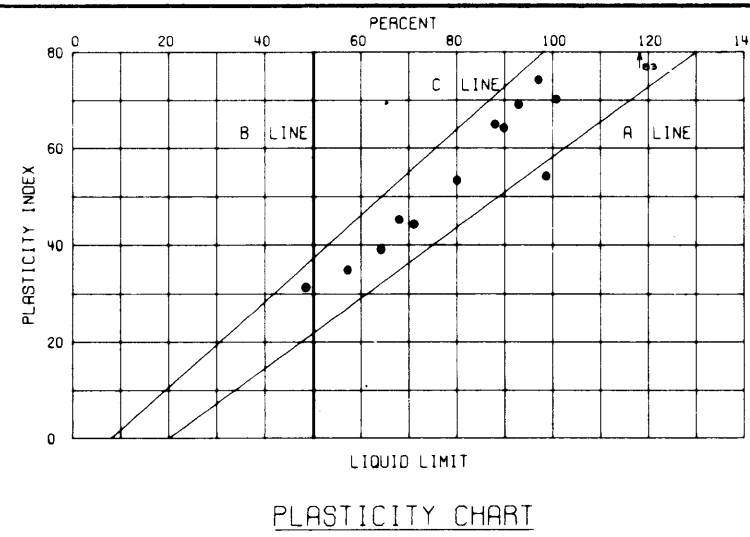
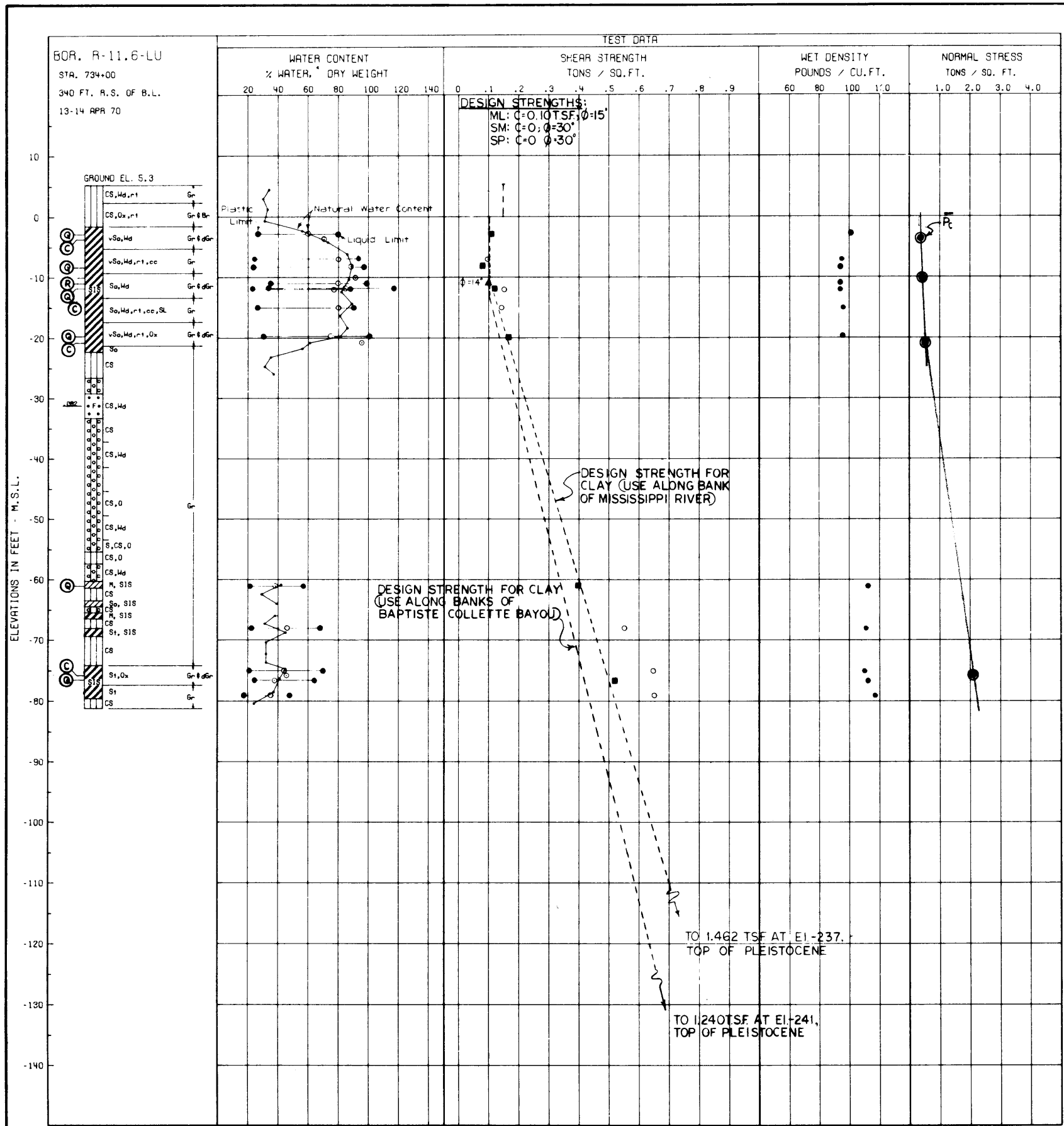

BORING NO.	ENVELOPE NO.	EL.	TYPE	STRENGTH		CLASS
				$\phi$	C - TSF	
R-11.6-LU	1	-2.6	Q	$c^\circ$	0.11	CH
	2	-8.4	Q	$c^\circ$	0.08	CH
	3	-10.9	R	$14^\circ$	0.10	CH
	4	-11.8	G	$c^\circ$	0.12	CH
	5	-19.8	G	$c^\circ$	0.16	CH
	6	-61.0	Q	$c^\circ$	0.40	CH
	7	-76.6	G	$c^\circ$	0.52	CH

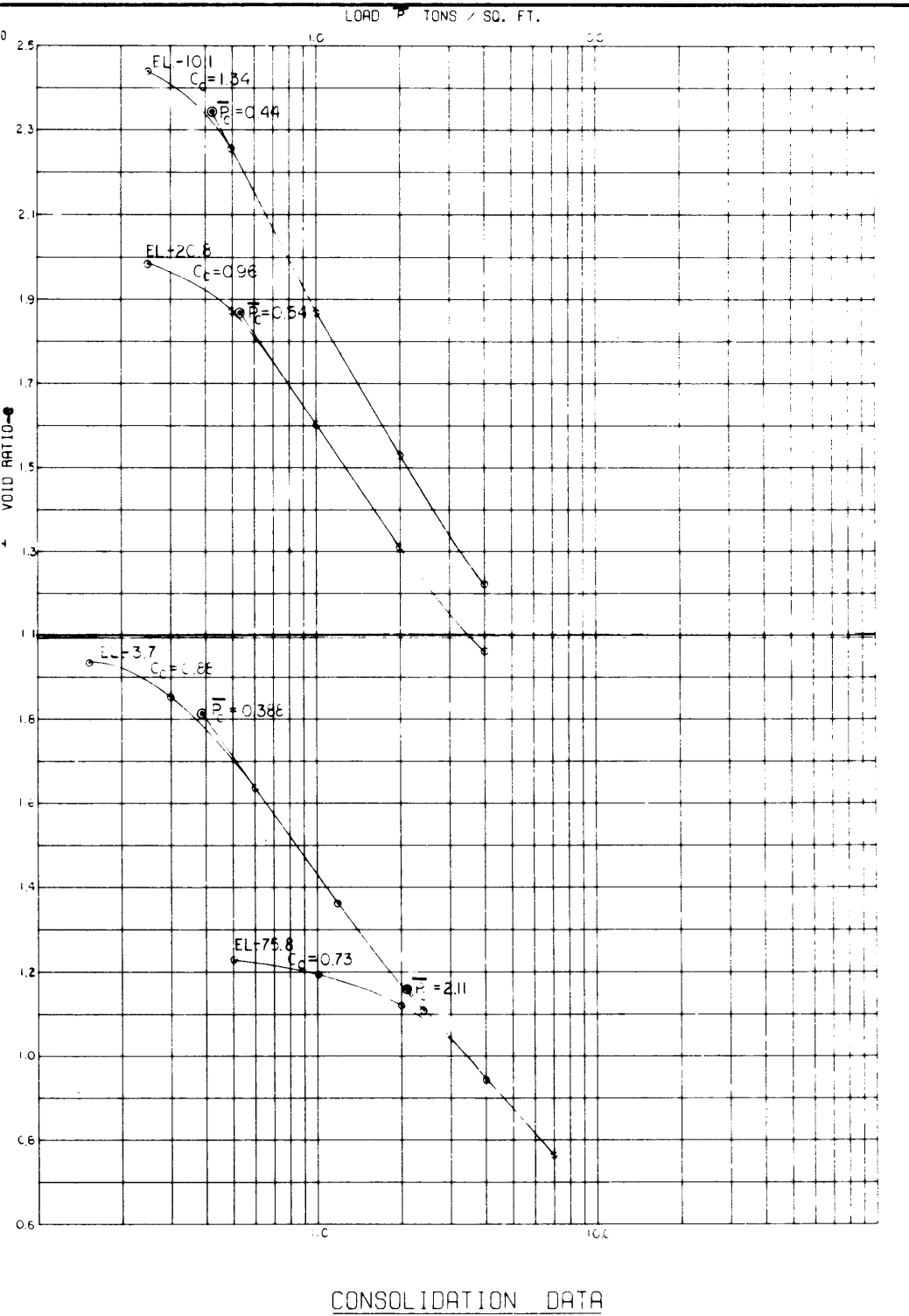

C - (UC) UNCONFINED COMPRESSION TEST  
 ■ - (Q) UNCONSOLIDATED - UNDRAINED SHEAR TEST  
 ▲ - (R) CONSOLIDATED - UNDRAINED SHEAR TEST  
 □ - (S) CONSOLIDATED - DRAINED SHEAR TEST  
 BORINGS WERE TAKEN WITH A 5 INCH DIAMETER  
 STEEL TUBE PISTON TYPE SAMPLER  
 FOR SOIL BORING LEGEND SEE PLATE A  
 FOR LOCATION OF BORINGS SEE PLATE B

MISSISSIPPI RIVER LEVEES AND BANKS  
 MILE 66 TO MILE 10  
 SOIL REPORT - PART I  
 EAST BANK  
**SOIL BORING DATA**  
 R-11.6-LU  
 U.S. ARMY ENGINEER DISTRICT, NEW ORLEANS  
 CORPS OF ENGINEERS  
 AUGUST 1971

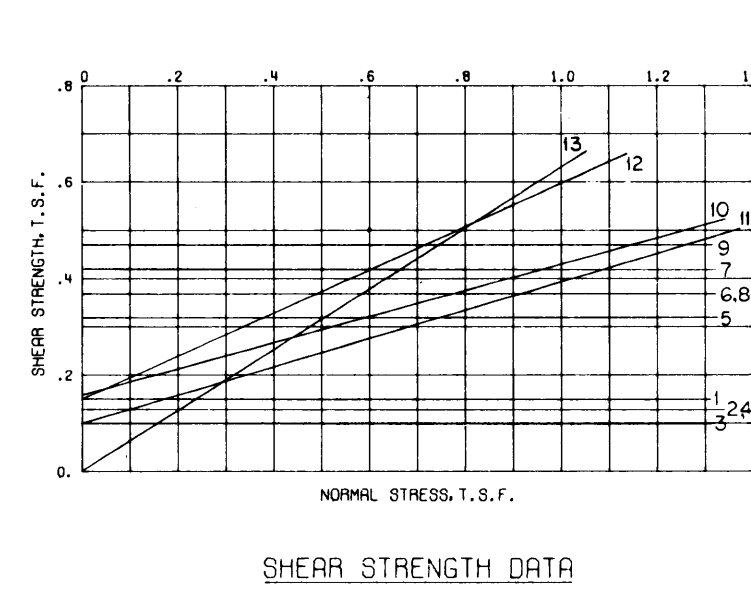
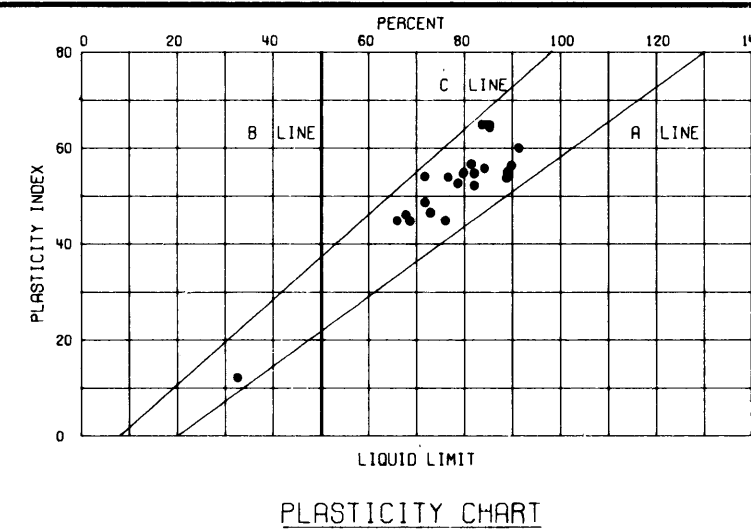
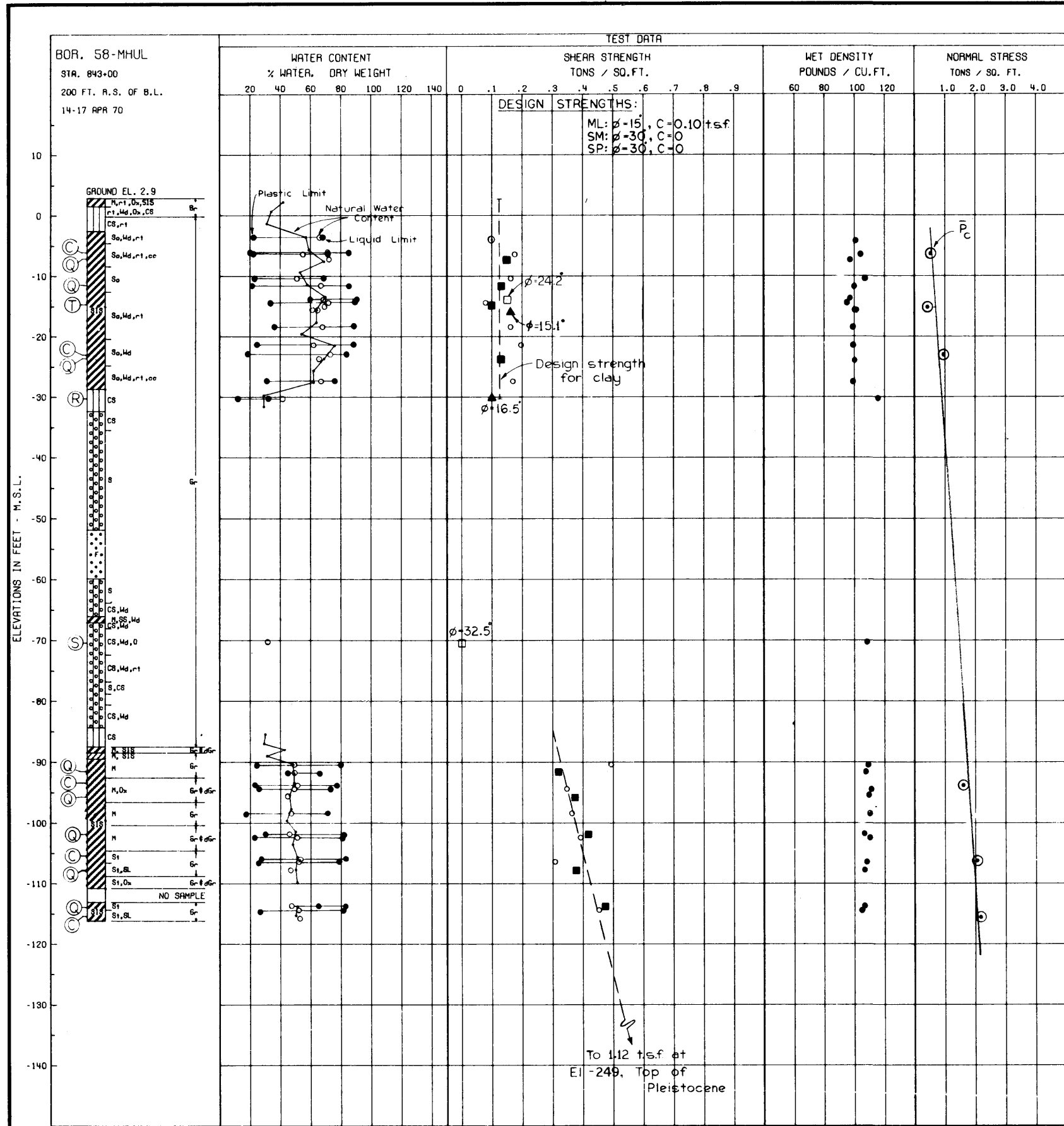

BORING NO.	ENVELOPE		TYPE	STRENGTH		CLASS
	NO.	EL.		$\phi$	C - T.S.F.	
58-MHUL	1	-7.2	Q	0	0.15	CH
	2	-11.6		0	0.13	CH
	3	-15.7		0	0.10	CH
	4	-23.9		0	0.13	CH
	5	-91.6		0	0.32	CH
	6	-95.5		0	0.37	CH
	7	-101.9		0	0.42	CH
	8	-107.9		0	0.37	CH
	9	-113.9		0	0.47	CH
	10	-15.7	R	15.1	0.16	CH
	11	-30.3	R	*16.5	0.10	CL
	12	-13.8	S	24.2	0.15	CH
	13	-70.3	S	32.5	0	SM

\*BASED ON DEVIATOR STRESS AT MAXIMUM PORE PRESSURE.

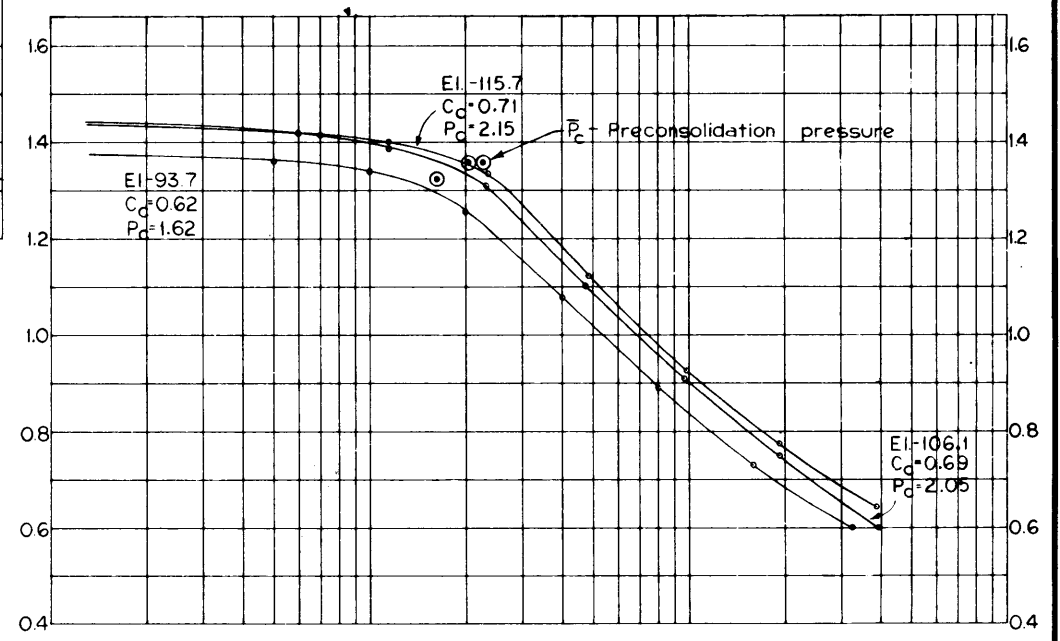
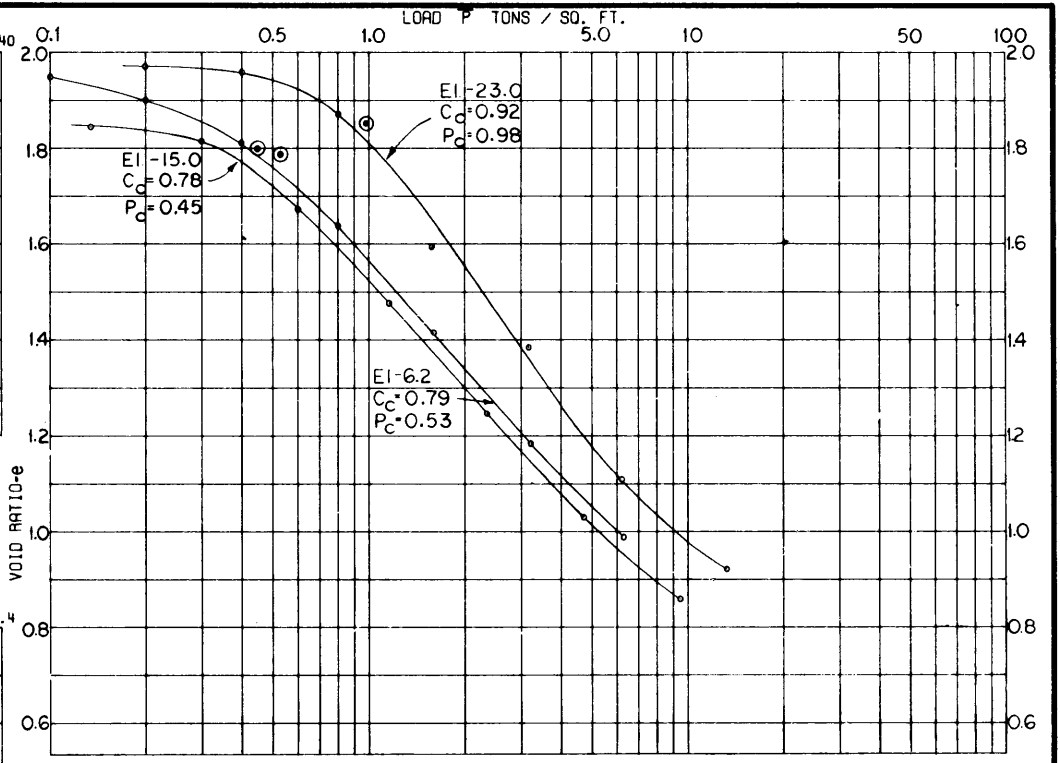

○ - (UC) UNCONFINED COMPRESSION TEST  
 ■ - (Q) UNCONSOLIDATED - UNDRAINED SHEAR TEST  
 ▲ - (R) CONSOLIDATED - UNDRAINED SHEAR TEST  
 □ - (S) CONSOLIDATED - DRAINED SHEAR TEST

BORINGS WERE TAKEN WITH A 5 INCH DIAMETER STEEL TUBE PISTON TYPE SAMPLER FOR SOIL BORING LEGEND SEE PLATE A FOR LOCATION OF BORINGS SEE PLATE 15

MISSISSIPPI RIVER LEVEES AND BANKS  
 MILE 66 TO MILE 10  
**SOIL REPORT - PART I**  
 EAST BANK  
**SOIL BORING DATA**  
 58-MHUL  
 U.S. ARMY ENGINEER DISTRICT, NEW ORLEANS  
 CORPS OF ENGINEERS

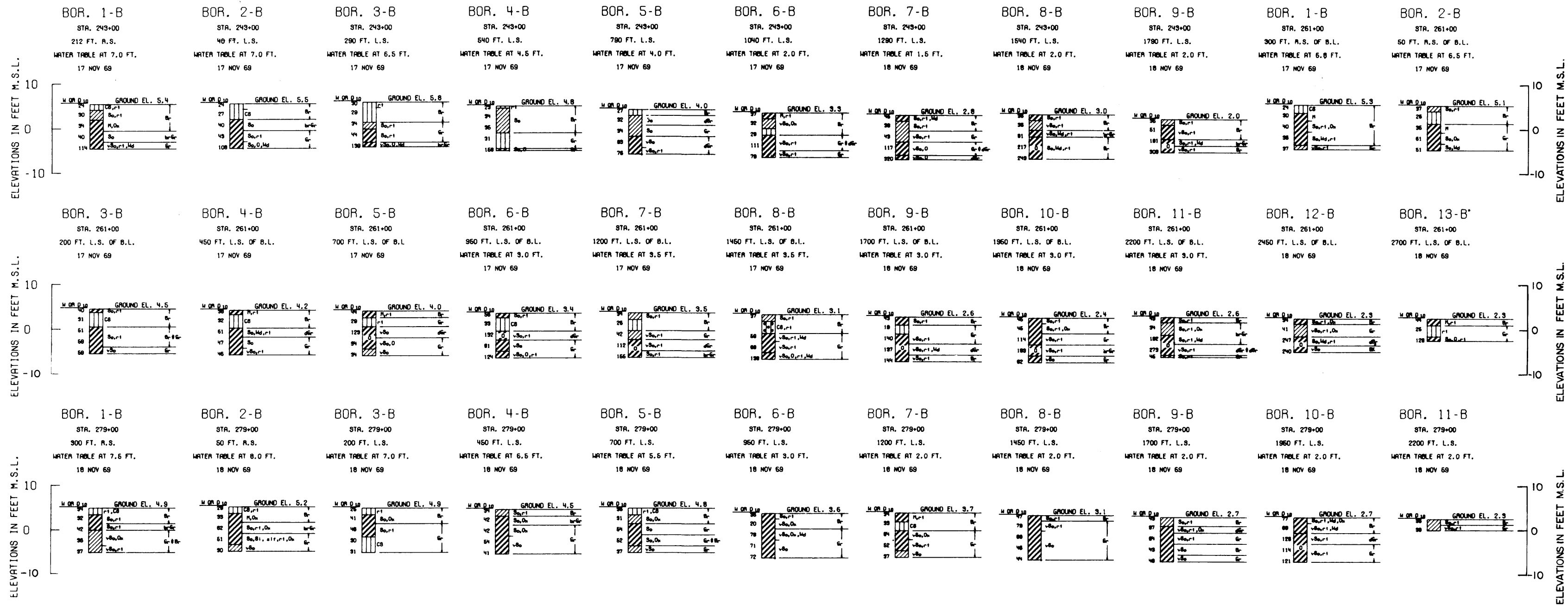

FOR SOIL BORING LEGEND SEE PLATE A  
FOR LOCATION OF BORINGS SEE PLATE 9

MISSISSIPPI RIVER LEVEES AND BANKS  
MILE 66 TO MILE 10  
SOIL REPORT - PART I  
EAST BANK  
**SOIL BORING DATA**  
BORROW BORINGS  
POINTE-A-LA-HACHE-RELIEF OUTLET  
U.S. ARMY ENGINEER DISTRICT, NEW ORLEANS  
CORPS OF ENGINEERS

NOTE: GENERAL TYPE BORING LOGS WERE TAKEN WITH A  
4 INCH DIAMETER POST HOLE AUGER.

AUGUST 1971 FILE NO. H-2-25275

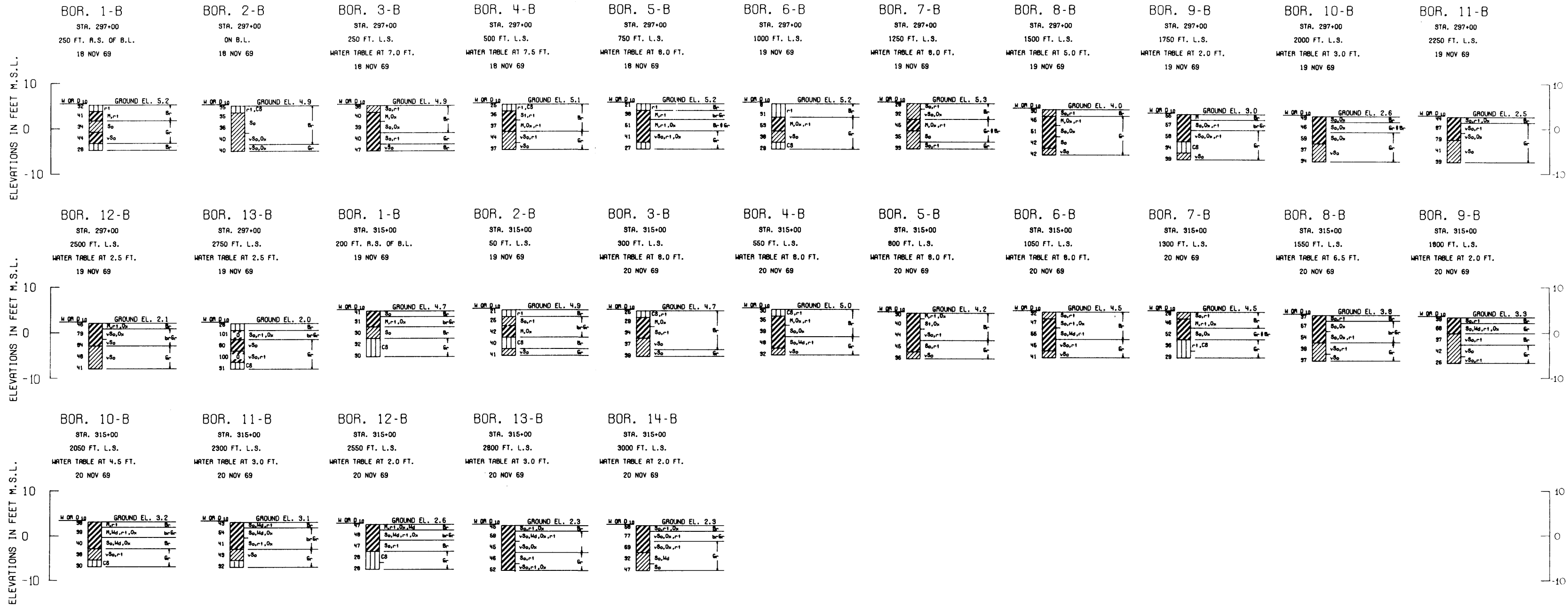

FOR SOIL BORING LEGEND SEE PLATE A  
 FOR LOCATION OF BORINGS SEE PLATE 9

MISSISSIPPI RIVER LEVEES AND BANKS  
 MILE 66 TO MILE 10  
 SOIL REPORT - PART I  
 EAST BANK  
**SOIL BORING DATA**  
 BORROW BORINGS  
 POINTE-A-LA-HACHE-RELIEF OUTLET  
 U.S. ARMY ENGINEER DISTRICT, NEW ORLEANS  
 CORPS OF ENGINEERS

NOTE: GENERAL TYPE BORING LOGS WERE TAKEN WITH A  
 4 INCH DIAMETER POST HOLE AUGER.

AUGUST 1971 FILE NO. H-2-25275



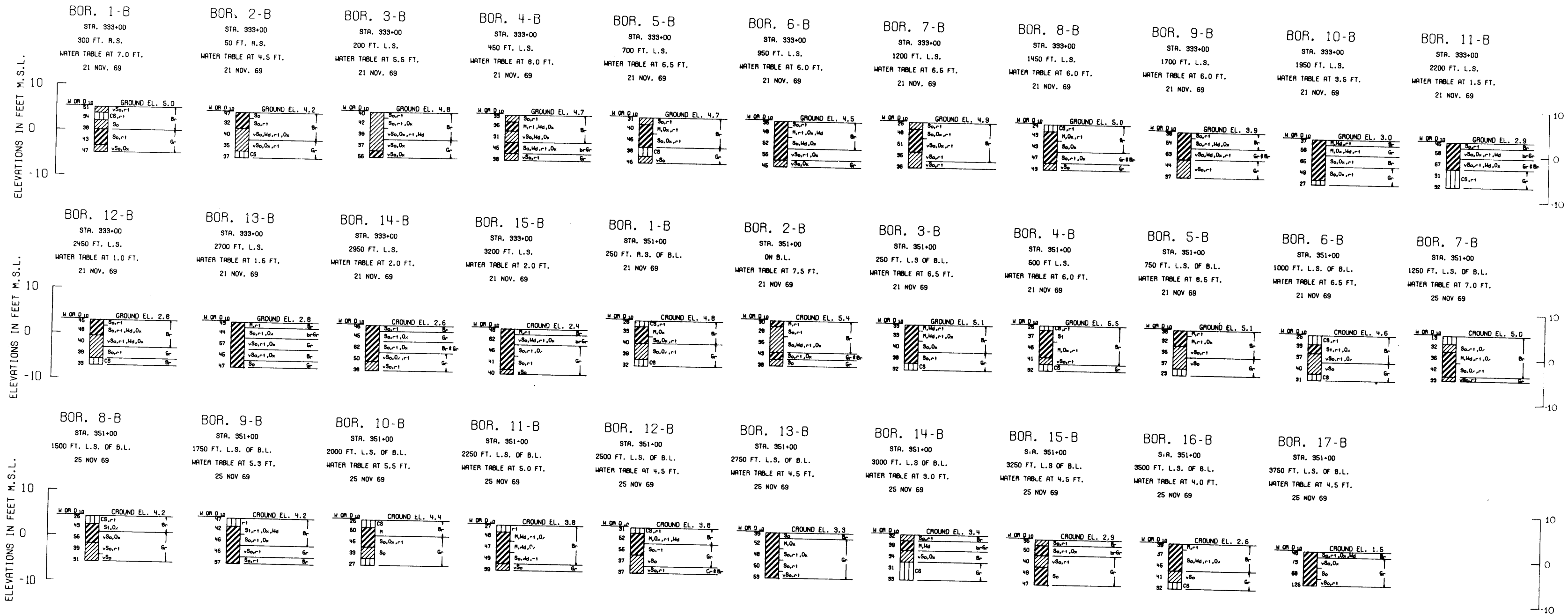

FOR SOIL BORING LEGEND SEE PLATE A  
FOR LOCATION OF BORINGS SEE PLATE IO

MISSISSIPPI RIVER LEVEES AND BANKS  
MILE 66 TO MILE 10  
SOIL REPORT - PART I  
EAST BANK  
**SOIL BORING DATA**  
BORROW BORINGS  
POINTE-A-LA-HACHE - RELIEF OUTLET  
U.S. ARMY ENGINEER DISTRICT, NEW ORLEANS  
CORPS OF ENGINEERS

NOTE: GENERAL TYPE BORING LOGS WERE TAKEN WITH A  
4 INCH DIAMETER POST HOLE AUGER.

AUGUST 1971

FILE NO H-2-25275



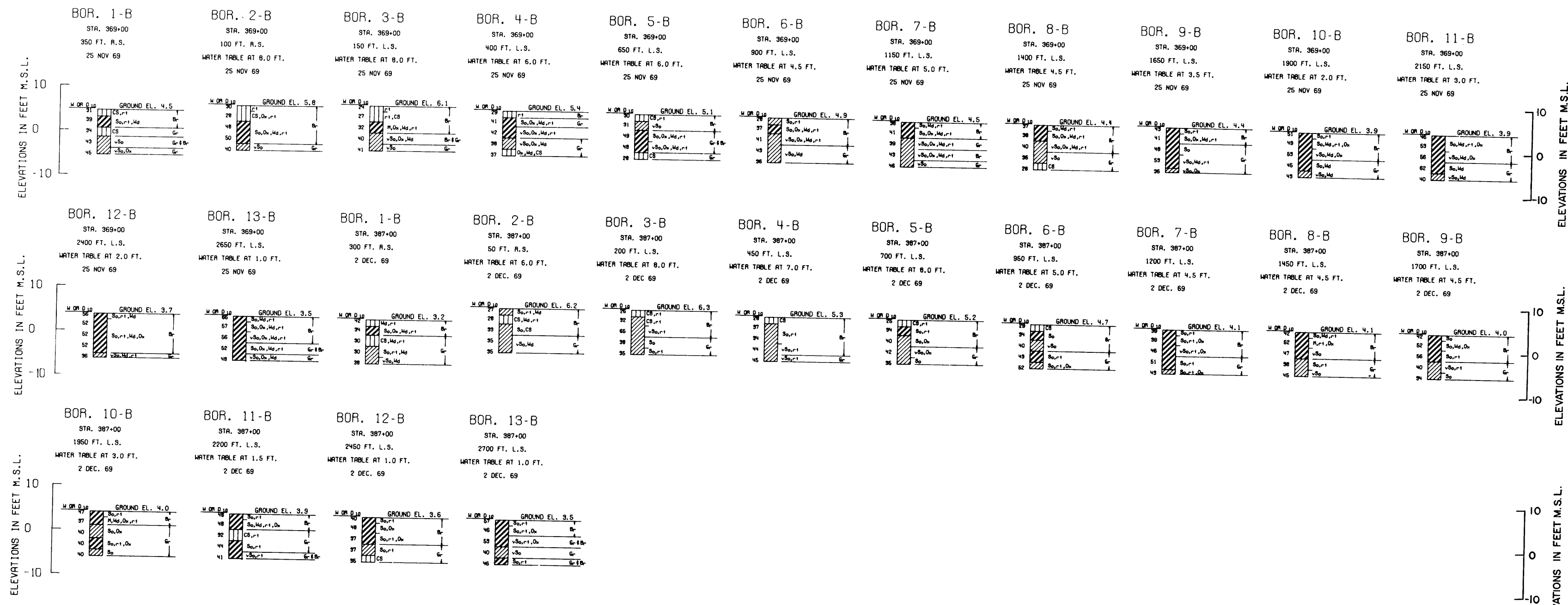

FOR SOIL BORING LEGEND SEE PLATE A  
FOR LOCATION OF BORINGS SEE PLATE IO

MISSISSIPPI RIVER LEVEES AND BANKS  
MILE 66 TO MILE 10  
SOIL REPORT - PART I  
EAST BANK  
**SOIL BORING DATA**  
BORROW BORINGS  
POINTE-A-LA-HACHE-RELIEF OUTLET  
U.S. ARMY ENGINEER DISTRICT, NEW ORLEANS  
CORPS OF ENGINEERS

NOTE: GENERAL TYPE BORING LOGS WERE TAKEN WITH A  
4 INCH DIAMETER POST HOLE AUGER.

AUGUST 1971

FILE NO H-2-25275

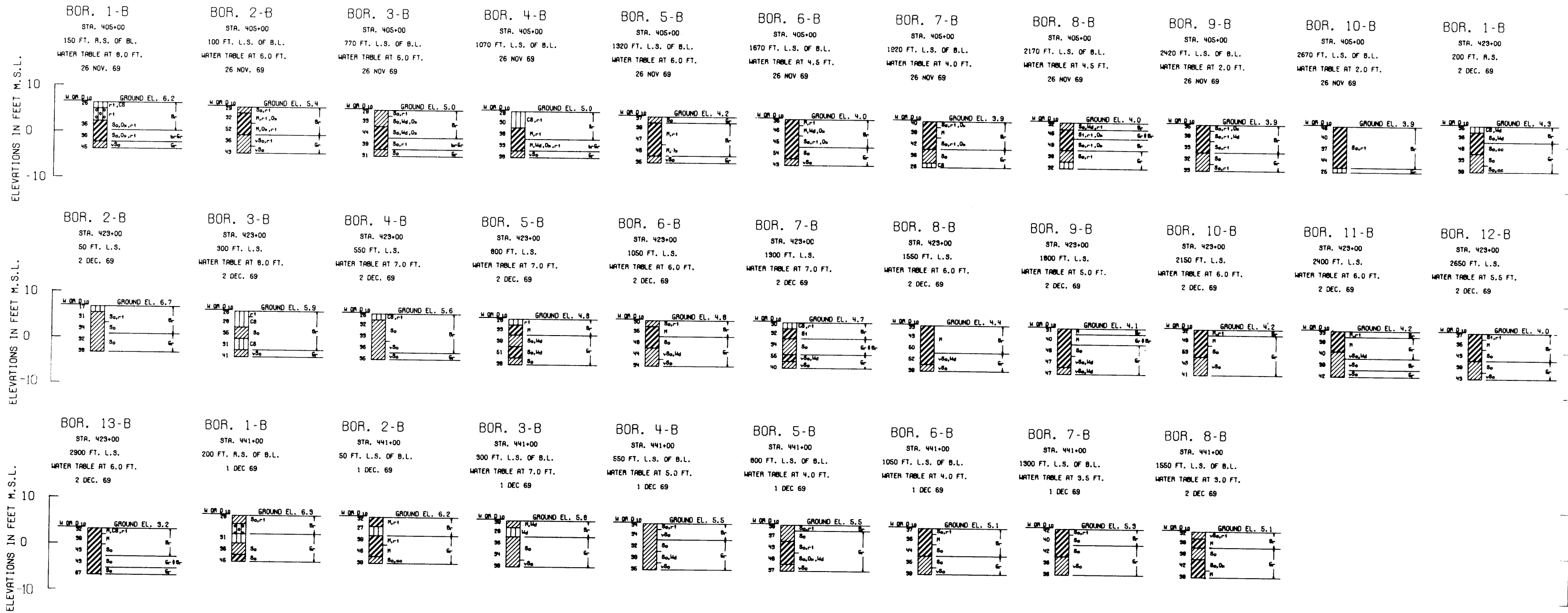

FOR SOIL BORING LEGEND SEE PLATE A  
FOR LOCATION OF BORINGS SEE PLATE 10

MISSISSIPPI RIVER LEVEES AND BANKS  
MILE 66 TO MILE 10  
SOIL REPORT - PART I  
EAST BANK  
**SOIL BORING DATA**  
BORROW BORINGS  
POINTE-A-LA-HACHE - RELIEF OUTLET  
U.S. ARMY ENGINEER DISTRICT, NEW ORLEANS  
CORPS OF ENGINEERS  
AUGUST 1971

NOTE: GENERAL TYPE BORING LOGS WERE TAKEN WITH A  
4 INCH DIAMETER POST HOLE AUGER.

FILE NO H-2-25275

ELEVATIONS IN FEET M.S.L.

BOR. 1-B  
STA. 15+75  
250 FT. R.S.  
WATER TABLE AT 5.5 FT.  
3 DEC. 69

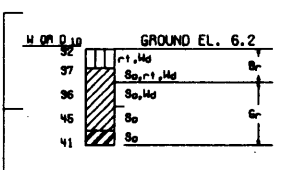

BOR. 2-B  
STA. 15+75  
ON C.L.  
WATER TABLE AT 7.5 FT.  
3 DEC. 69

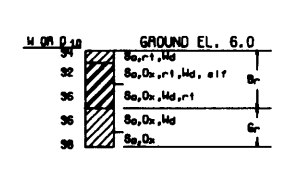

BOR. 3-B  
STA. 15+75  
250 FT. L.S.  
WATER TABLE AT 4.5 FT.  
3 DEC. 69

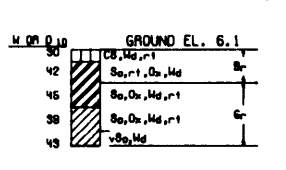

BOR. 4-B  
STA. 15+75  
500 FT. L.S.  
WATER TABLE AT 2.5 FT.  
3 DEC. 69

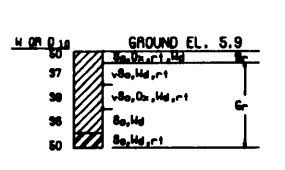

BOR. 5-B  
STA. 15+75  
750 FT. L.S.  
WATER TABLE AT 2.5 FT.  
3 DEC. 69

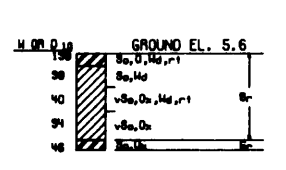

BOR. 6-B  
STA. 15+75  
1000 FT. L.S.  
WATER TABLE AT 2.0 FT.  
3 DEC. 69

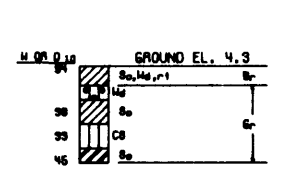

BOR. 1-B  
STA. 33+75  
ON B.L.  
24 NOV 69

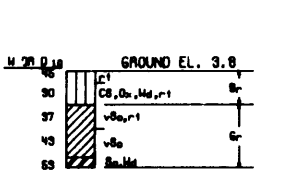

BOR. 2-B  
STA. 33+75  
250 FT. L.S. OF B.L.  
WATER TABLE AT 6.5 FT.  
24 NOV 69

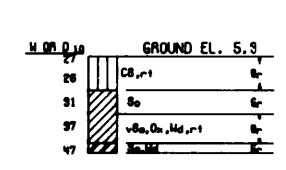

BOR. 3-B  
STA. 33+75  
500 FT. L.S. OF B.L.  
WATER TABLE AT 7.0 FT.  
24 NOV 69

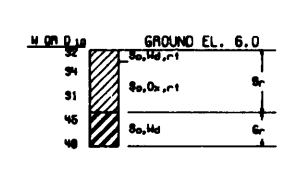

BOR. 4-B  
STA. 33+75  
750 FT. L.S. OF B.L.  
WATER TABLE AT 7.0 FT.  
2 DEC. 69

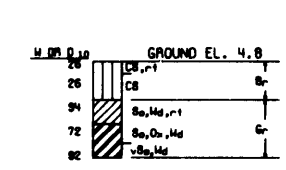

BOR. 5-B  
STA. 33+75  
1000 FT. L.S. OF B.L.  
2 DEC. 69

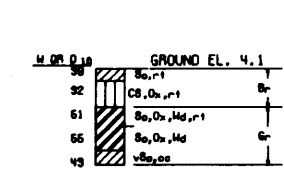

ELEVATIONS IN FEET M.S.L.

ELEVATIONS IN FEET M.S.L.

BOR. 6-B  
STA. 33+75  
1250 FT. L.S. OF B.L.  
WATER TABLE AT 7.0 FT.  
2 DEC. 69

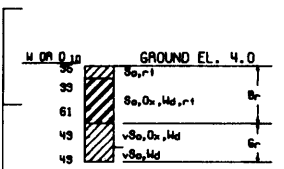

BOR. 7-B  
STA. 33+75  
1500 FT. L.S. OF B.L.  
WATER TABLE AT 3.5 FT.  
2 DEC. 69

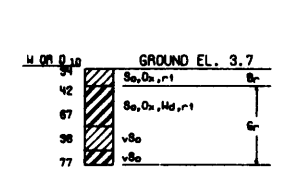

BOR. 8-B  
STA. 33+75  
1750 FT. L.S. OF B.L.  
WATER TABLE AT 2.0 FT.  
2 DEC. 69

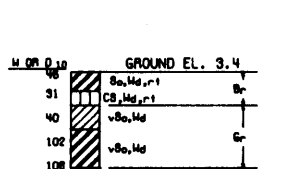

BOR. 9-B  
STA. 33+75  
1950 FT. L.S. OF B.L.  
2 DEC. 69

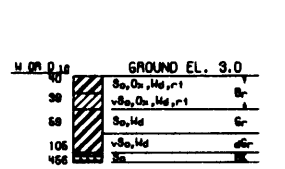

BOR. 1-B  
STA. 52+55  
100 FT. R.S.  
3 DEC 69

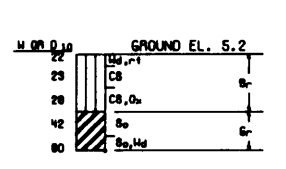

BOR. 2-B  
STA. 52+55  
150 FT. L.S.  
3 DEC. 69

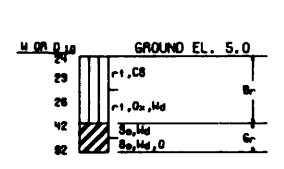

BOR. 3-B  
STA. 52+55  
400 FT. L.S.  
3 DEC. 69

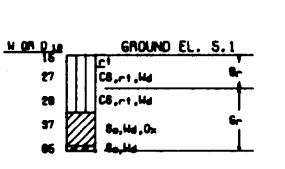

BOR. 4-B  
STA. 52+55  
650 FT. L.S.  
3 DEC. 69

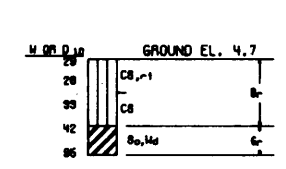

BOR. 5-B  
STA. 52+55  
900 FT. L.S.  
WATER TABLE AT 6.0 FT.  
3 DEC. 69

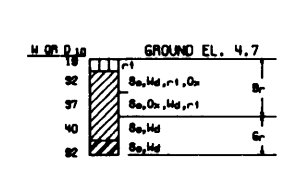

BOR. 6-B  
STA. 52+55  
1150 FT. L.S.  
WATER TABLE AT 2.5 FT.  
3 DEC. 69

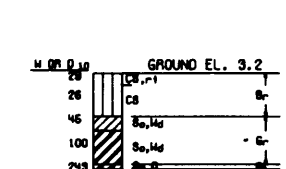

BOR. 7-B  
STA. 52+55  
1400 FT. L.S.  
WATER TABLE AT 6.0 FT.  
3 DEC. 69

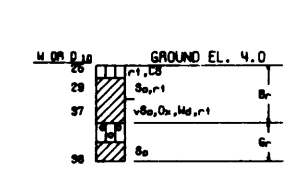

ELEVATIONS IN FEET M.S.L.

ELEVATIONS IN FEET M.S.L.

BOR. 8-B  
STA. 52+55  
1650 FT. L.S.  
WATER TABLE AT 4.0 FT.  
3 DEC. 69

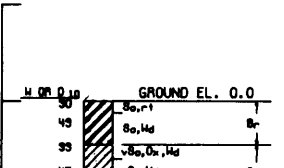

BOR. 9-B  
STA. 52+55  
1900 FT. L.S.  
WATER TABLE AT 2.0 FT.  
3 DEC. 69

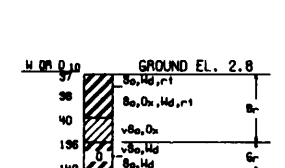

BOR. 10-B  
STA. 52+55  
2150 FT. L.S.  
WATER TABLE AT 2.0 FT.  
3 DEC. 69

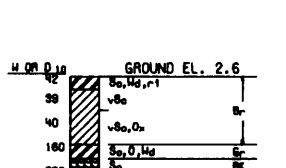

ELEVATIONS IN FEET M.S.L.

FOR SOIL BORING LEGEND SEE PLATE A  
FOR LOCATION OF BORINGS SEE PLATE IO

MISSISSIPPI RIVER LEVEES AND BANKS  
MILE 66 TO MILE 10  
SOIL REPORT - PART I  
EAST BANK  
**SOIL BORING DATA**  
BORROW BORINGS  
POINTE-A-LA-HACHE - RELIEF OUTLET  
U.S. ARMY ENGINEER DISTRICT, NEW ORLEANS  
CORPS OF ENGINEERS  
AUGUST 1971

NOTE: GENERAL TYPE BORING LOGS WERE TAKEN WITH A  
4 INCH DIAMETER POST HOLE AUGER.

FILE NO H-2-25275

ELEVATIONS IN FEET M.S.L.

ELEVATIONS IN FEET M.S.L.

ELEVATIONS IN FEET M.S.L.

BOR. 1-B  
STA. 71+05  
100 FT. R.S. OF B.L.  
2 DEC 69

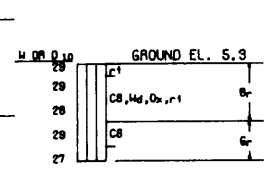

BOR. 2-B  
STA. 71+05  
150 FT. L.S. OF B.L.  
2 DEC 69

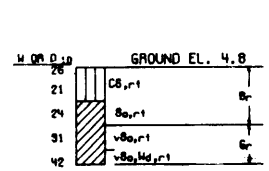

BOR. 3-B  
STA. 71+05  
400 FT. L.S. OF B.L.  
2 DEC 69

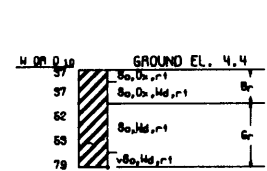

BOR. 4-B  
STA. 71+05  
650 FT. L.S. OF B.L.  
2 DEC 69

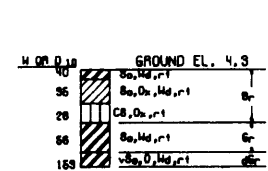

BOR. 5-B  
STA. 71+05  
900 FT. L.S. OF B.L.  
WATER TABLE AT 5.0 FT.  
3 DEC 69

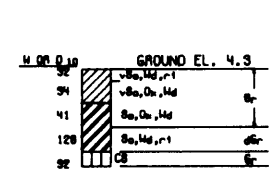

BOR. 6-B  
STA. 71+05  
1150 FT. L.S. OF B.L.  
WATER TABLE AT 4.0 FT.  
3 DEC 69

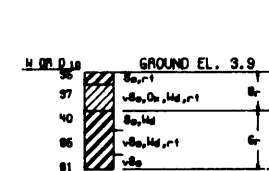

BOR. 7-B  
STA. 71+05  
1400 FT. L.S. OF B.L.  
WATER TABLE AT 3.0 FT.  
3 DEC 69

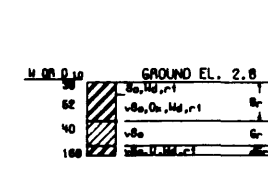

BOR. 8-B  
STA. 71+05  
1650 FT. L.S. OF B.L.  
WATER TABLE AT 2.0 FT.  
3 DEC 69

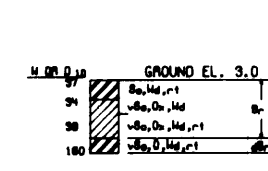

BOR. 9-B  
STA. 71+05  
1900 FT. L.S. OF B.L.  
WATER TABLE AT 2.0 FT.  
3 DEC 69

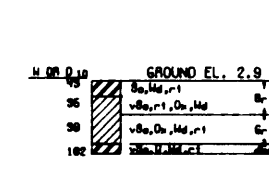

BOR. 10-B  
STA. 71+05  
2150 FT. L.S. OF B.L.  
WATER TABLE AT 2.0 FT.  
3 DEC 69

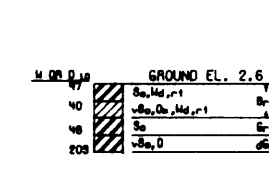

BOR. 1-B  
STA. 89+46  
100 FT. R.S.  
3 DEC 69

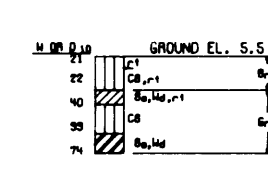

BOR. 2-B  
STA. 89+46  
150 FT. L.S.  
3 DEC 69

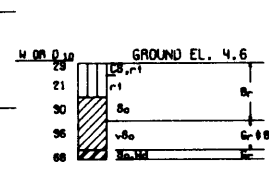

BOR. 3-B  
STA. 89+46  
400 FT. L.S.  
3 DEC 69

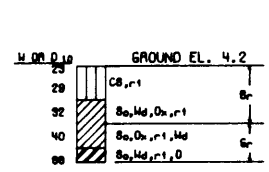

BOR. 4-B  
STA. 89+46  
650 FT. L.S.  
WATER TABLE AT 3.0 FT.  
3 DEC 69

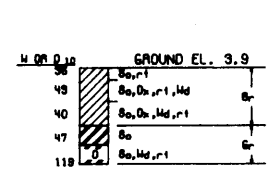

BOR. 5-B  
STA. 89+46  
900 FT. L.S.  
WATER TABLE AT 4.0 FT.  
3 DEC 69

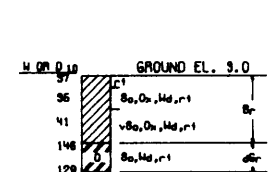

BOR. 6-B  
STA. 89+46  
1150 FT. L.S.  
WATER TABLE AT 2.5 FT.  
3 DEC 69

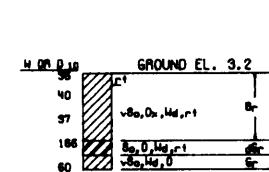

BOR. 7-B  
STA. 89+46  
1400 FT. L.S.  
WATER TABLE AT 1.5 FT.  
3 DEC 69

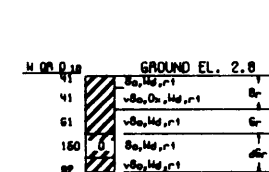

BOR. 8-B  
STA. 89+46  
1650 FT. L.S.  
WATER TABLE AT 2.0 FT.  
3 DEC 69

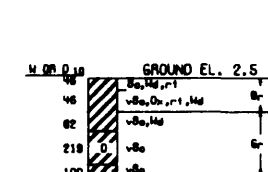

BOR. 9-B  
STA. 89+46  
1900 FT. L.S.  
WATER TABLE AT 1.0 FT.  
3 DEC 69

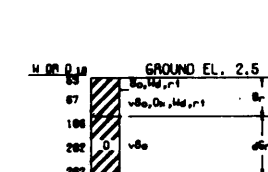

BOR. 1-B  
STA. 108+06  
100 FT. L.S. B.L.  
WATER TABLE AT 4.0 FT.  
3 DEC 69

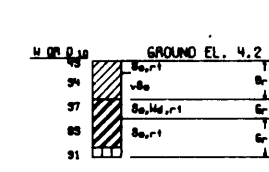

BOR. 2-B  
STA. 108+06  
350 FT. L.S. OF B.L.  
3 DEC 69

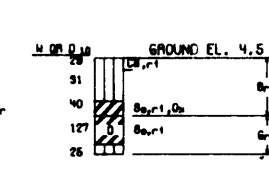

BOR. 3-B  
STA. 108+06  
600 FT. L.S. OF B.L.  
WATER TABLE AT 4.0 FT.  
3 DEC 69

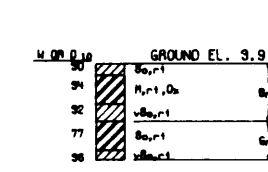

BOR. 4-B  
STA. 108+06  
850 FT. L.S. OF B.L.  
3 DEC 69

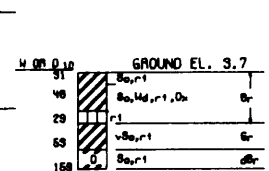

BOR. 5-B  
STA. 108+06  
1100 FT. L.S. OF B.L.  
WATER TABLE AT 2.0 FT.  
4 DEC 69

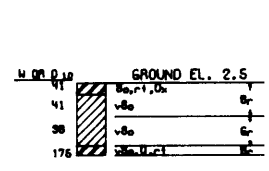

BOR. 6-B  
STA. 108+06  
1350 FT. L.S. OF B.L.  
WATER TABLE AT 2.0 FT.  
4 DEC 69

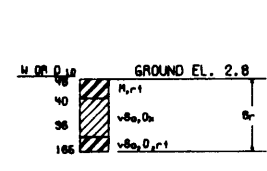

BOR. 7-B  
STA. 108+06  
1600 L.S. OF B.L.  
WATER TABLE AT 1.5 FT.  
4 DEC 69

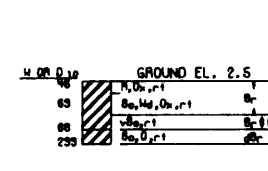

BOR. 8-B  
STA. 108+06  
1850 FT. L.S. OF B.L.  
WATER TABLE AT 1.5 FT.  
4 DEC 69

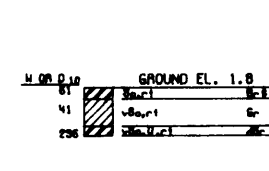

FOR SOIL BORING LEGEND SEE PLATE A  
FOR LOCATION OF BORINGS SEE PLATE 10

MISSISSIPPI RIVER LEVEES AND BANKS  
MILE 66 TO MILE 10  
SOIL REPORT - PART I  
EAST BANK  
**SOIL BORING DATA**  
BORROW BORINGS  
POINTE-A-LA-HACHE-RELIEF OUTLET  
U.S. ARMY ENGINEER DISTRICT, NEW ORLEANS  
CORPS OF ENGINEERS  
AUGUST 1971

NOTE: GENERAL TYPE BORING LOGS WERE TAKEN WITH A  
4 INCH DIAMETER POST HOLE AUGER.

FILE NO H-2-25275

ELEVATIONS IN FEET M.S.L.

ELEVATIONS IN FEET M.S.L.

BOR. 1-B

STA. 127+40  
50 FT. R.S.  
WATER TABLE AT 8.0 FT.  
3 DEC. 69

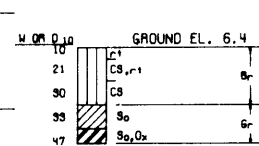

BOR. 2-B

STA. 127+40  
200 FT. L.S.  
WATER TABLE AT 8.0 FT.  
3 DEC. 69

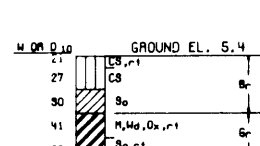

BOR. 3-B

STA. 127+40  
450 FT. L.S.  
WATER TABLE AT 7.0 FT.  
3 DEC. 69

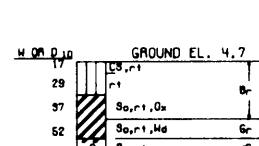

BOR. 4-B

STA. 127+40  
700 FT. L.S.  
WATER TABLE AT 4.0 FT.  
3 DEC. 69

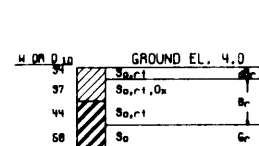

BOR. 5-B

STA. 127+40  
950 FT. L.S.  
WATER TABLE AT 2.5 FT.  
3 DEC. 69

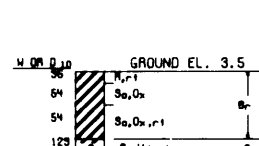

BOR. 6-B

STA. 127+40  
1200 FT. L.S.  
WATER TABLE AT 2.0 FT.  
3 DEC. 69

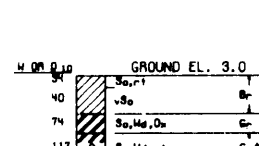

BOR. 7-B

STA. 127+40  
1450 FT. L.S.  
WATER TABLE AT 1.5 FT.  
3 DEC. 69

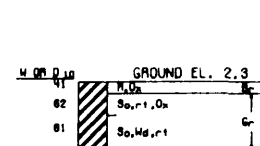

BOR. 1-B

STA. 147+66  
100 FT. L.S. OF B.L.  
WATER TABLE AT 8.0 FT.  
4 DEC. 69

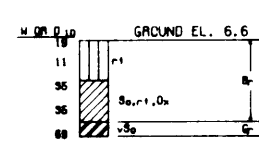

BOR. 2-B

STA. 147+66  
350 FT. L.S. OF B.L.  
WATER TABLE AT 8.0 FT.  
4 DEC. 69

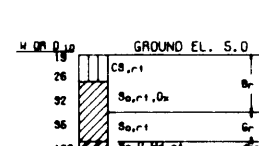

BOR. 3-B

STA. 147+66  
600 FT. L.S. OF B.L.  
WATER TABLE AT 5.0 FT.  
4 DEC. 69

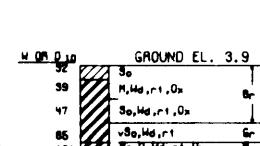

BOR. 4-B

STA. 147+66  
850 FT. L.S. OF B.L.  
WATER TABLE AT 4.0 FT.  
4 DEC. 69

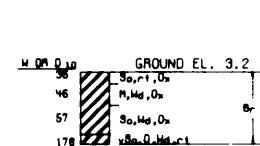

BOR. 5-B

STA. 147+66  
1100 FT. L.S. OF B.L.  
WATER TABLE AT 2.0 FT.  
4 DEC. 69

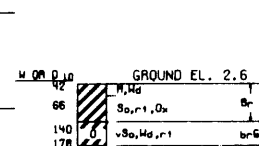

BOR. 6-B

STA. 147+66  
1350 FT. L.S. OF B.L.  
WATER TABLE AT 2.0 FT.  
4 DEC. 69

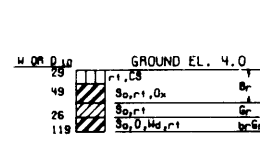

FOR SOIL BORING LEGEND SEE PLATE A  
FOR LOCATION OF BORINGS SEE PLATE 10

MISSISSIPPI RIVER LEVEES AND BANKS  
MILE 66 TO MILE 10  
SOIL REPORT - PART I  
EAST BANK  
**SOIL BORING DATA**  
BORROW BORINGS  
POINTE-A-LA-HACHE-RELIEF OUTLET  
U.S. ARMY ENGINEER DISTRICT, NEW ORLEANS  
CORPS OF ENGINEERS  
AUGUST 1971

NOTE: GENERAL TYPE BORING LOGS WERE TAKEN WITH A  
4 INCH DIAMETER POST HOLE AUGER.

BOR. B-1

STA. 408+88  
400 FT. RT. OF B.L.  
WATER TABLE 4.0 FT.  
15 SEPT 70

BOR. B-2

STA. 410+88  
400 FT. RT. OF B.L.  
WATER TABLE 4.5 FT.  
16 SEPT 70

BOR. B-3

STA. 412+71  
360 FT. RT. OF B.L.  
WATER TABLE 5.0 FT.  
16 SEPT 70

BOR. B-4

STA. 414+71  
360 FT. RT. OF B.L.  
WATER TABLE 2.0 FT.  
16 SEPT 70

BOR. B-5

STA. 416+71  
450 FT. RT. OF B.L.  
WATER TABLE 3.0 FT.  
17 SEPT 70

BOR. B-6

STA. 418+71  
300 FT. RT. OF B.L.  
WATER TABLE 2.0 FT.  
17 SEPT 70

BOR. B-7

STA. 420+70  
470 FT. RT. OF B.L.  
WATER TABLE 1.5 FT.  
17 SEPT 70

BOR. B-8

STA. 422+71  
470 FT. RT. OF B.L.  
WATER TABLE 1.3 FT.  
17 SEPT 70

BOR. B-9

STA. 424+71  
300 FT. RT. OF B.L.  
WATER TABLE 2.0 FT.  
17 SEPT 70

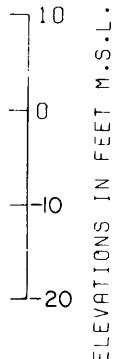
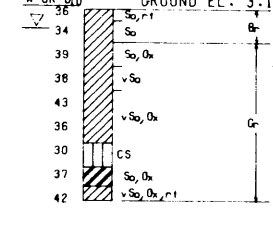
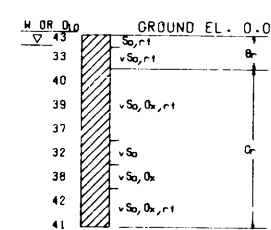
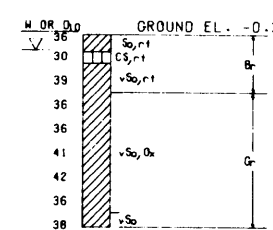
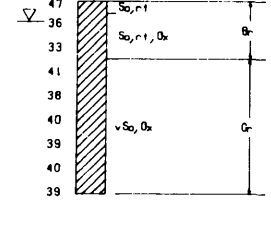
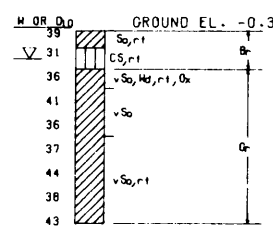
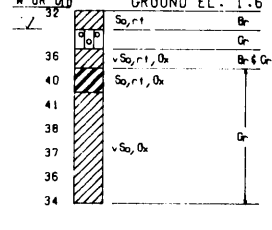
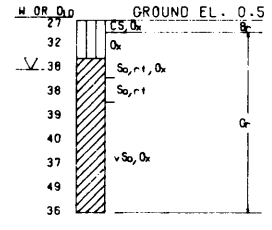
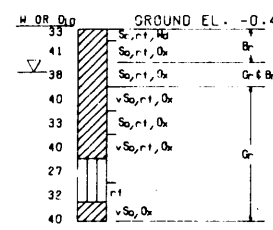
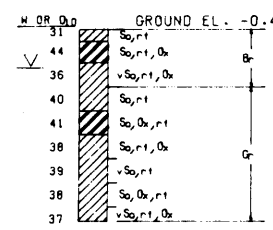
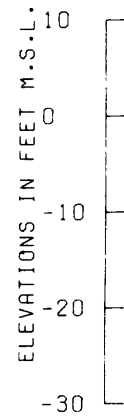

BOR. B-10

STA. 426+71  
430 FT. RT. OF B.L.  
WATER TABLE 2.0 FT.  
17 SEPT 70

BOR. B-11

STA. 430+71  
230 FT. RT. OF B.L.  
WATER TABLE 5.0 FT.  
18 SEPT 70

BOR. B-12

STA. 432+71  
450 FT. RT. OF B.L.  
WATER TABLE 3.5 FT.  
18 SEPT 70

BOR. B-13

STA. 434+71  
450 FT. RT. OF B.L.  
WATER TABLE 3.0 FT.  
18 SEPT 70

BOR. B-14

STA. 436+71  
480 FT. RT. OF B.L.  
WATER TABLE 2.0 FT.  
18 SEPT 70

BOR. B-15

STA. 438+71  
480 FT. RT. OF B.L.  
WATER TABLE 2.0 FT.  
18 SEPT 70

BOR. B-16

STA. 440+71  
480 FT. RT. OF B.L.  
WATER TABLE 2.5 FT.  
18 SEPT 70

BOR. B-17

STA. 442+71  
525 FT. RT. OF B.L.  
WATER TABLE 2.5 FT.  
21 SEPT 70

BOR. B-18

STA. 0+00  
525 FT. RT. OF B.L.  
WATER TABLE 4.0 FT.  
21 SEPT 70

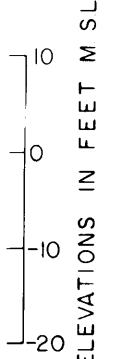
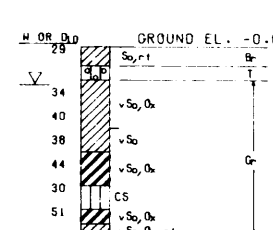
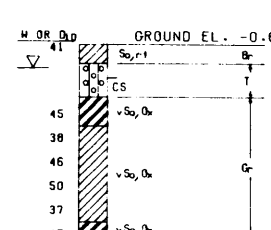
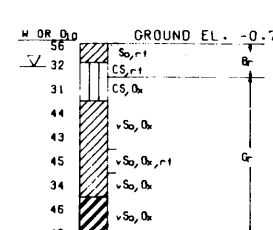
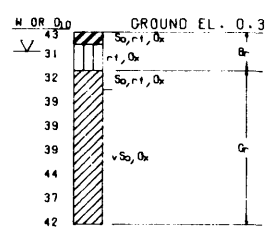
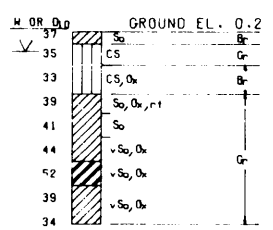
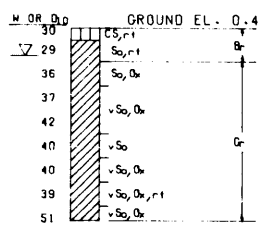
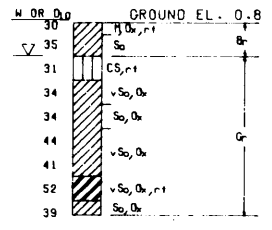
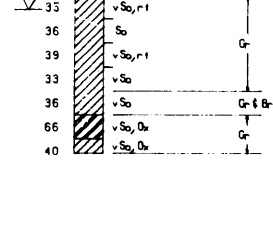
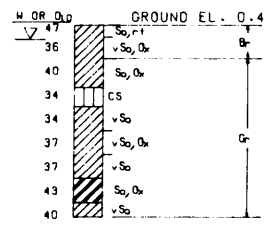
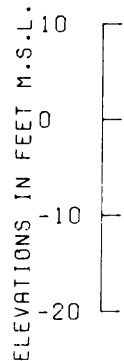

WATER TABLE LOCATION SHOWN ON BORING LOG IS THAT OBSERVED ON DATE BORING WAS MADE

ALL BORINGS SHOWN ON THIS PLATE WERE MADE WITH A 4-IN DIAMETER POST HOLE AUGER

FOR SOIL BORING LEGEND SEE PLATE A FOR LOCATION OF BORINGS SEE PLATE IO

MISSISSIPPI RIVER LEVEES AND BANKS  
MILE 66 TO MILE 10  
SOIL REPORT - PART I  
EAST BANK

**SOIL BORING DATA**  
BANK BORROW BORINGS  
VICINITY MILE 36.0 A.H.P.

U.S. ARMY ENGINEER DISTRICT, NEW ORLEANS  
CORPS OF ENGINEERS

AUGUST 1971

BOR. B-19  
 STA. 2+00  
 500 FT. RT. OF B.L.  
 WATER TABLE 3.9 FT.  
 21 SEPT 70

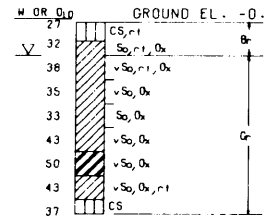

BOR. B-20  
 STA. 4+00  
 525 FT. RT. OF B.L.  
 WATER TABLE 3.0 FT.  
 21 SEPT 70

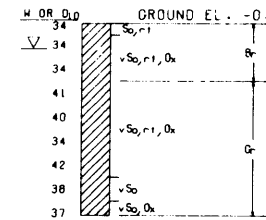

BOR. B-21  
 STA. 6+00  
 500 FT. RT. OF B.L.  
 WATER TABLE 4.0 FT.  
 21 SEPT 70

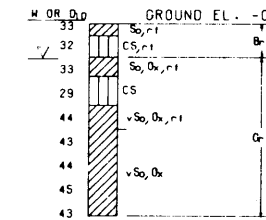

BOR. B-22  
 STA. 8+00  
 500 FT. RT. OF B.L.  
 WATER TABLE 3.1 FT.  
 14 SEPT 70

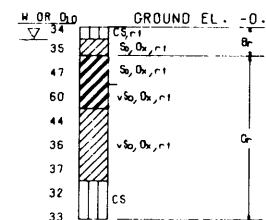

BOR. B-23  
 STA. 10+00  
 500 FT. RT. OF B.L.  
 WATER TABLE 2.3 FT.  
 14 SEP 1970

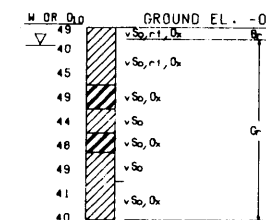

BOR. B-24  
 STA. 410+88  
 200 FT. RT. OF B.L.  
 WATER TABLE 2.5 FT.  
 SEPT 22 1970

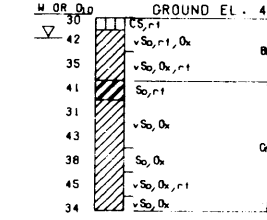

BOR. B-25  
 STA. 416+71  
 250 FT. RT. OF B.L.  
 WATER TABLE 3.0 FT.  
 22 SEPT 70

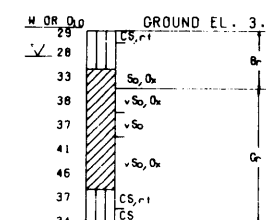

BOR. B-26  
 STA. 422+71  
 270 FT. RT. OF B.L.  
 WATER TABLE 3.0 FT.  
 22 SEPT 70

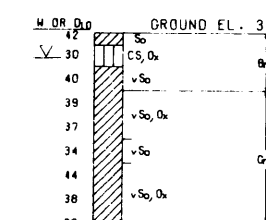

BOR. B-27  
 STA. 430+71  
 430 FT. RT. OF B.L.  
 WATER TABLE 5.0 FT.  
 22 SEPT 70

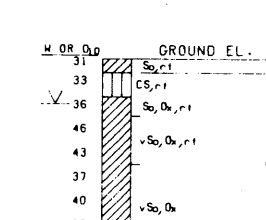

BOR. B-28  
 STA. 436+71  
 310 FT. RT. OF B.L.  
 WATER TABLE 2.5 FT.  
 22 SEPT 70

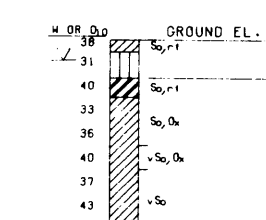

BOR. B-29  
 STA. 442+71  
 325 FT. RT. OF B.L.  
 WATER TABLE 2.5 FT.  
 22 SEPT 70

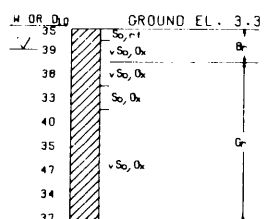

BOR. B-30  
 STA. 4+00  
 325 FT. RT. OF B.L.  
 WATER TABLE 2.0 FT.  
 22 SEPT 70

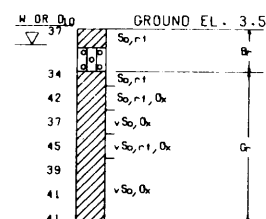

BOR. B-31  
 STA. 10+00  
 325 FT. RT. OF B.L.  
 WATER TABLE 5.0 FT.  
 22 SEPT 70

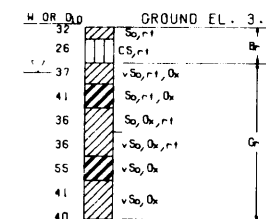

BOR. B-32  
 STA. 414+71  
 100 FT. RT. OF B.L.  
 WATER TABLE 2.5 FT.  
 22 SEPT 70

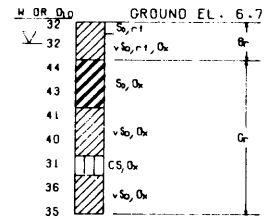

BOR. B-33  
 STA. 420+71  
 100 FT. RT. OF B.L.  
 WATER TABLE 1.0 FT.  
 22 SEPT 70

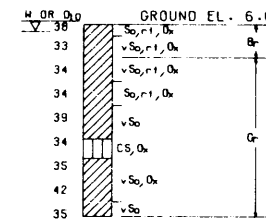

BOR. B-34  
 STA. 426+71  
 100 FT. RT. OF B.L.  
 WATER TABLE 1.0 FT.  
 24 SEPT 70

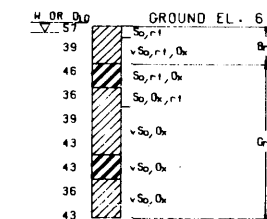

BOR. B-35  
 STA. 438+71  
 110 FT. RT. OF B.L.  
 WATER TABLE 2.5 FT.  
 23 SEPT 70

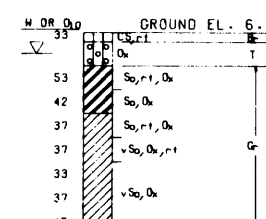

BOR. B-36  
 STA. 0+00  
 125 FT. RT. OF B.L.  
 WATER TABLE 1.5 FT.  
 23 SEPT 70

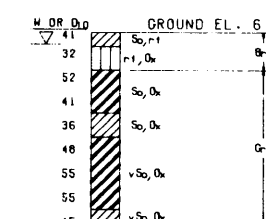

BOR. B-37  
 STA. 6+00  
 125 FT. RT. OF B.L.  
 WATER TABLE 2.5 FT.  
 24 SEPT 70

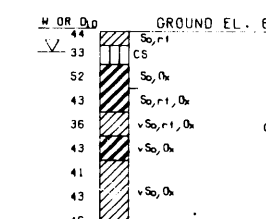

ELEVATIONS IN FEET M.S.L.

ELEVATIONS IN FEET M.S.L.

ELEVATIONS IN FEET M.S.L.

ELEVATIONS IN FEET M.S.L.

WATER TABLE LOCATION SHOWN ON BORING LOG IS THAT OBSERVED ON DATE BORING WAS MADE  
 ALL BORINGS SHOWN ON THIS PLATE WERE MADE WITH A 4-IN DIAMETER POST HOLE AUGER.  
 FOR SOIL BORING LEGEND SEE PLATE A  
 FOR LOCATION OF BORINGS SEE PLATE 10

MISSISSIPPI RIVER LEVEES AND BANKS  
 MILE 66 TO MILE 10  
 SOIL REPORT - PART I  
 EAST BANK  
**SOIL BORING DATA**  
 BANK BORROW BORINGS  
 VICINITY MILE 36.0 A.H.P.  
 U.S. ARMY ENGINEER DISTRICT, NEW ORLEANS  
 CORPS OF ENGINEERS

AUGUST 1971 FILE NO H-2-25275

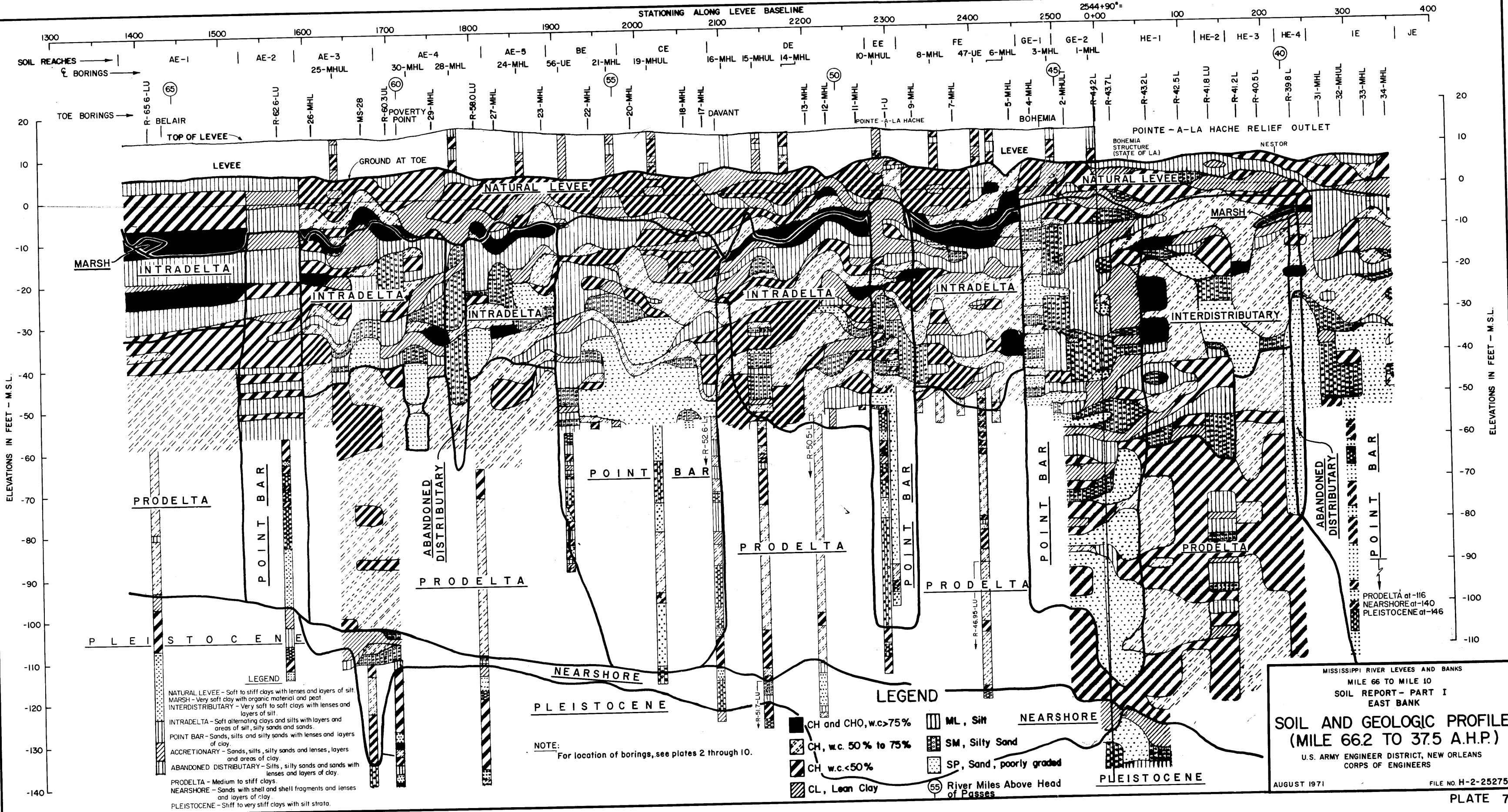

**LEGEND**

NATURAL LEVEE - Soft to stiff clays with lenses and layers of silt.  
 MARSH - Very soft clay with organic material and peat.  
 INTERDISTRIBUTARY - Very soft to soft clays with lenses and layers of silt.  
 INTRADELTA - Soft alternating clays and silts with layers and areas of silt, silty sands and sands.  
 POINT BAR - Sands, silts and silty sands with lenses and layers of clay.  
 ACCRETIONARY - Sands, silts, silty sands and lenses, layers and areas of clay.  
 ABANDONED DISTRIBUTARY - Silts, silty sands and sands with lenses and layers of clay.  
 PRODELTA - Medium to stiff clays.  
 NEARSHORE - Sands with shell and shell fragments and lenses and layers of clay.  
 PLEISTOCENE - Stiff to very stiff clays with silt strata.

**LEGEND**

CH and CH<sub>0</sub>, w.c. > 75%  
 CH, w.c. 50% to 75%  
 CH, w.c. < 50%  
 CL, Lean Clay

ML, Silt  
 SM, Silty Sand  
 SP, Sand, poorly graded

55 River Miles Above Head of Passes

**NOTE:**  
 For location of borings, see plates 2 through 10.

MISSISSIPPI RIVER LEVEES AND BANKS  
 MILE 66 TO MILE 10  
 SOIL REPORT - PART I  
 EAST BANK  
**SOIL AND GEOLOGIC PROFILE**  
**(MILE 66.2 TO 37.5 A.H.P.)**  
 U.S. ARMY ENGINEER DISTRICT, NEW ORLEANS  
 CORPS OF ENGINEERS  
 AUGUST 1971  
 FILE NO. H-2-25275



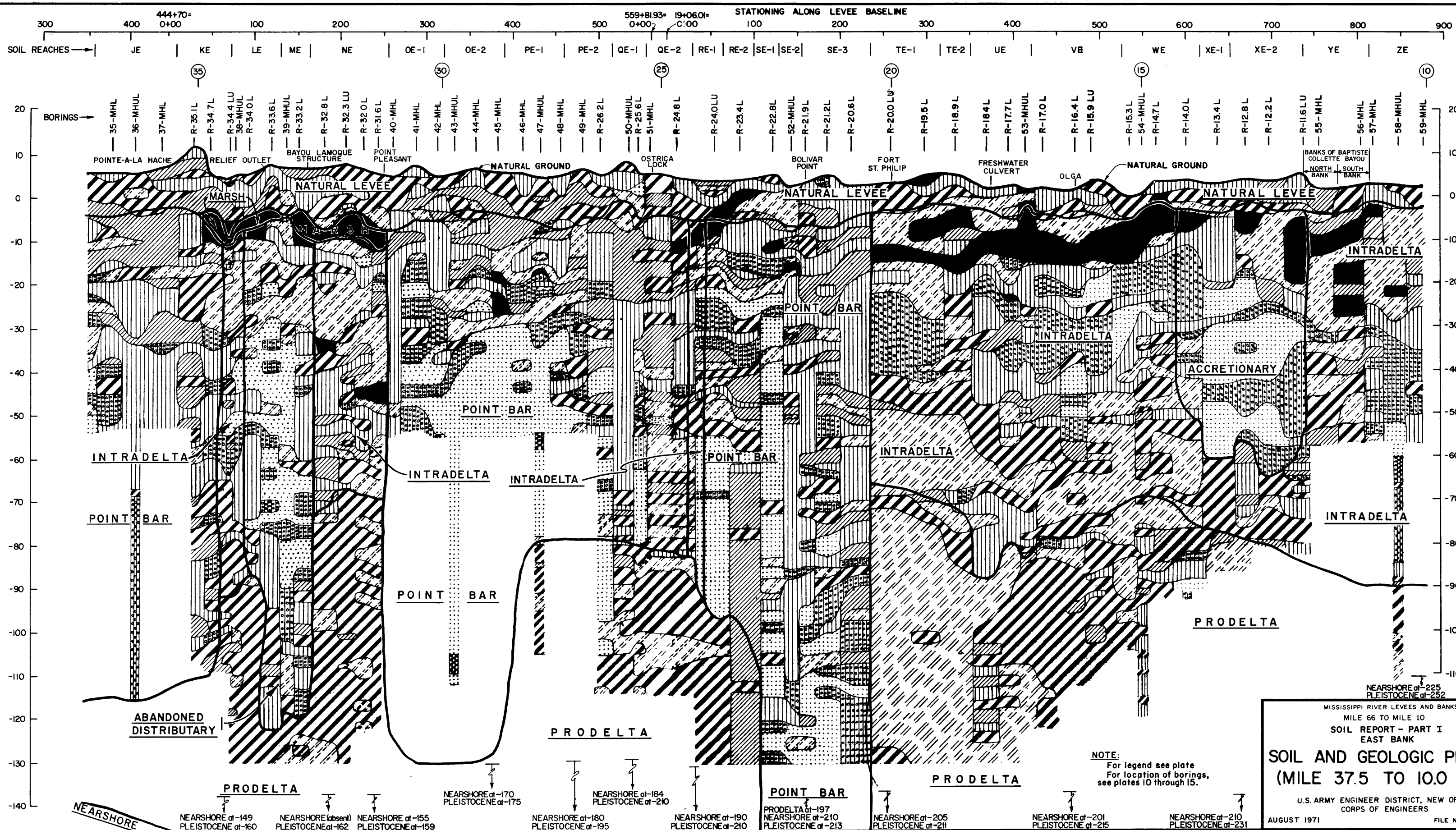

MISSISSIPPI RIVER LEVEES AND BANKS  
 MILE 66 TO MILE 10  
 SOIL REPORT - PART I  
 EAST BANK  
**SOIL AND GEOLOGIC PROFILE**  
**(MILE 37.5 TO 10.0 A.H.P.)**  
 U.S. ARMY ENGINEER DISTRICT, NEW ORLEANS  
 CORPS OF ENGINEERS  
 AUGUST 1971  
 FILE NO. H-2-25275

# UNIFIED SOIL CLASSIFICATION

MAJOR DIVISION	TYPE	LETTER SYMBOL	SYM BOL	TYPICAL NAMES
COARSE - GRAINED SOILS More than half of material is larger than No. 200 sieve size.	GRAVELS More than half of coarse fraction is larger than No. 4 sieve size.	CLEAN GRAVEL (Little or No Fines)	GW	GRAVEL, Well Graded, gravel-sand mixtures, little or no fines
		GRAVEL WITH FINES (Appreciable Amount of Fines)	GP	GRAVEL, Poorly Graded, gravel-sand mixtures, little or no fines
		CLEAN SAND (Little or No Fines)	GM	SILTY GRAVEL, gravel-sand-silt mixtures
		SANDS WITH FINES (Appreciable Amount of Fines)	GC	CLAYEY GRAVEL, gravel-sand-clay mixtures
			SW	SAND, Well-Graded, gravelly sands
	SANDS More than half of coarse fraction is smaller than No. 4 sieve size.		SP	SAND, Poorly-Graded, gravelly sands
			SM	SILTY SAND, sand-silt mixtures
			SC	CLAYEY SAND, sand-clay mixtures
			ML	SILT & very fine sand, silty or clayey fine sand or clayey silt with slight plasticity
			CL	LEAN CLAY; Sandy Clay; Silty Clay; of low to medium plasticity
FINE - GRAINED SOILS More than half the material is smaller than No. 200 sieve size.	SILTS AND CLAYS (Liquid Limit < 50)	OL	ORGANIC SILTS and organic silty clays of low plasticity	
		MH	SILT, fine sandy or silty soil with high plasticity	
		CH	FAT CLAY, inorganic clay of high plasticity	
	SILTS AND CLAYS (Liquid Limit > 50)	OH	ORGANIC CLAYS of medium to high plasticity, organic silts	
HIGHLY ORGANIC SOILS		Pt	PEAT, and other highly organic soil	
WOOD		Wd	WOOD	
SHELLS		Si	SHELLS	
NO SAMPLE				

NOTE: Soils possessing characteristics of two groups are designated by combinations of group symbols

## DESCRIPTIVE SYMBOLS

COLOR		CONSISTENCY FOR COHESIVE SOILS			MODIFICATIONS	
COLOR	SYMBOL	CONSISTENCY	COHESION IN LBS./SQ. FT. FROM UNCONFINED COMPRESSION TEST	SYMBOL	MODIFICATION	SYMBOL
TAN	T	VERY SOFT	< 250	vSo	Traces	Tr-
YELLOW	Y	SOFT	250 - 500	So	Fine	F
RED	R	MEDIUM	500 - 1000	M	Medium	M
BLACK	BK	STIFF	1000 - 2000	St	Coarse	C
GRAY	Gr	VERY STIFF	2000 - 4000	vSt	Concretions	cc
LIGHT GRAY	lGr	HARD	> 4000	H	Rootlets	rt
DARK GRAY	dGr				Lignite fragments	lg
BROWN	Br				Shale fragments	sh
LIGHT BROWN	lBr				Sandstone fragments	sds
DARK BROWN	dBr				Shell fragments	slf
BROWNISH-GRAY	br Gr				Organic matter	O
GRAYISH-BROWN	gyBr				Clay strata or lenses	CS
GREENISH-GRAY	gnGr				Silt strata or lenses	SIS
GRAYISH-GREEN	gyGn				Sand strata or lenses	SS
GREEN	Gn				Sandy	S
BLUE	Bl				Gravelly	G
BLUE-GREEN	BlGn				Boulders	B
WHITE	Wh				Slickensides	SL
MOTTLED	Mot				Wood	Wd
					Oxidized	Ox

**PLASTICITY CHART**  
For classification of fine-grained soils

NOTES:	
<b>FIGURES TO LEFT OF BORING UNDER COLUMN "W OR D<sub>10</sub>"</b>	
Are natural water contents in percent dry weight	
When underlined denotes D <sub>10</sub> size in mm *	
<b>FIGURES TO LEFT OF BORING UNDER COLUMNS "LL" AND "PL"</b>	
Are liquid and plastic limits, respectively	
<b>SYMBOLS TO LEFT OF BORING</b>	
▽ Ground-water surface and date observed	
⊙ Denotes location of consolidation test **	
⊙ Denotes location of consolidated-drained direct shear test **	
⊙ Denotes location of consolidated-undrained triaxial compression test **	
⊙ Denotes location of unconsolidated-undrained triaxial compression test **	
⊙ Denotes location of sample subjected to consolidation test and each of the above three types of shear tests **	
FW Denotes free water encountered in boring or sample	
<b>FIGURES TO RIGHT OF BORING</b>	
Are values of cohesion in lbs./sq. ft. from unconfined compression tests	
In parenthesis are driving resistances in blows per foot determined with a standard split spoon sampler (1 3/8" I.D., 2" O.D.) and a 140 lb. driving hammer with a 30" drop	
Where underlined with a solid line denotes laboratory permeability in centimeters per second of undisturbed sample	
Where underlined with a dashed line denotes laboratory permeability in centimeters per second of sample remoulded to the estimated natural void ratio	

\* The D<sub>10</sub> size of a soil is the grain diameter in millimeters of which 10% of the soil is finer, and 90% coarser than size D<sub>10</sub>.

\*\*Results of these tests are available for inspection in the U.S. Army Engineer District Office, if these symbols appear beside the boring logs on the drawings.

## GENERAL NOTES:

While the borings are representative of subsurface conditions at their respective locations and for their respective vertical reaches, local variations characteristic of the subsurface materials of the region are anticipated and, if encountered, such variations will not be considered as differing materially within the purview of clause 4 of the contract.

Ground-water elevations shown on the boring logs represent ground-water surfaces encountered on the dates shown. Absence of water surface data on certain borings implies that no ground-water data is available, but does not necessarily mean that ground water will not be encountered at the locations or within the vertical reaches of these borings.

Consistency of cohesive soils shown on the boring logs is based on driller's log and visual examination and is approximate, except within those vertical reaches of the borings where shear strengths from unconfined compression tests are shown.

## SOIL BORING LEGEND

REVISION	DATE	DESCRIPTION	BY
3	5-3-71	ADDED UPPER LIMIT LINE (P.I.:0.9(LL-8)) ON PLASTICITY CHART	LMVED-G LETTER DT'D 29 APRIL 1971
2	6-8-64	SYMBOL FW, NOTE REVISED	ORAL FROM LMV.G.G. 5 JUNE 1964
1	9-17-63	1ST. PAR. OF GENERAL NOTES REVISED	L.M.V.D. MULTIPLE LETTER, DATED 5 SEPT, 1963

U.S. ARMY ENGINEER DISTRICT, NEW ORLEANS  
CORPS OF ENGINEERS  
FILE NO. H-2-21800