

FEDERAL EMERGENCY MANAGEMENT AGENCY - EMERGENCY MANAGEMENT INSTITUTE

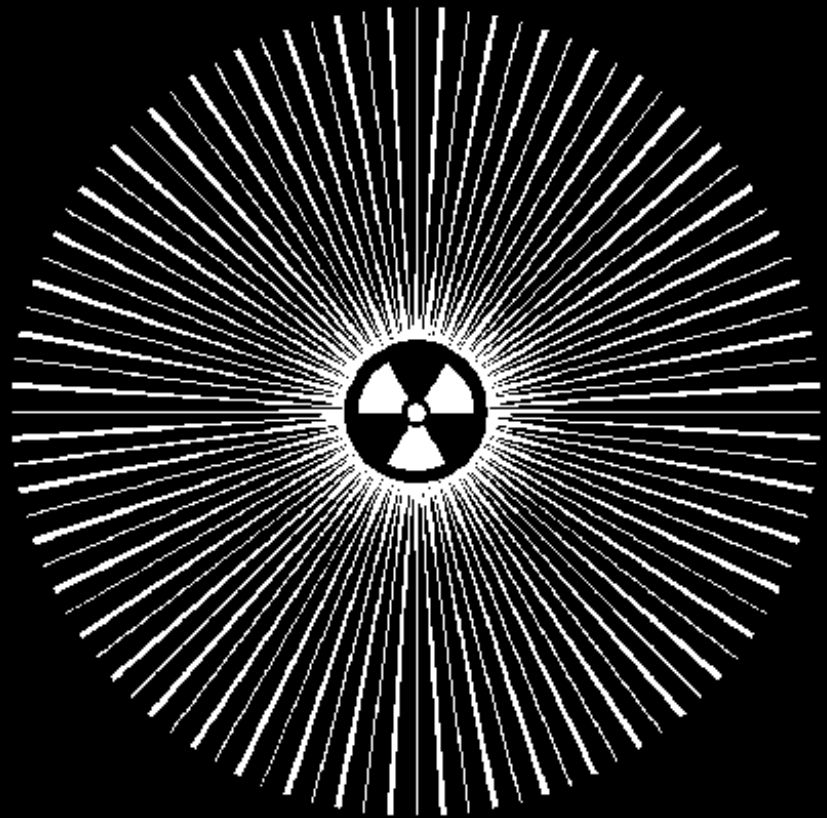

Radiological Emergency Management

Independent Study Course
15-300-0000-0000

Table of Contents

Preface	1
Introduction.....	2
Pretest	4
Unit 1: Fundamental Concepts	1-1
Introduction.....	1-1
Radioactivity.....	1-2
Biological Effects of Radiation	1-11
Exposure Control Techniques	1-17
Emergency Management and the Radiological Protection System	1-20
Unit 1 Review	1-21
Unit 2: Radiological Transportation Accidents.....	2-1
Introduction.....	2-1
Packaging	2-2
Information Sources	2-6
On-scene Accident Response	2-12
Unit 2 Review	2-15
Unit 3: Nuclear Power Plant Accidents.....	3-1
Introduction.....	3-1
Operating Principles of Nuclear Power Plants	3-2
Power Plant Accidents.....	3-11
Offsite Protective Actions	3-17
Unit 3 Review	3-23
Unit 4: Nuclear Threat	4-1
Introduction.....	4-1
Nuclear Detonation	4-2
Protective Measures	4-8
Exposure Rate Determination	4-12
Unit 4 Review	4-17

Unit 5: Other Radiological Hazards

Introduction.....	5-1
Other Radiation Sources.....	5-2
Natural Sources	5-3
Man-made Sources.....	5-5
Unit 5 Review	5-9
Glossary	G-1
Unit Practice Exercise Answer Key	PE-1
Final Examination.....	F-1

FOREWORD

Emergency Management Institute

The Federal Emergency Management Agency (FEMA) provides training and education in emergency management through a nationwide training system. The National Emergency Training Center (NETC) is located on a campus in Emmitsburg, Maryland. The institutions that conduct the Agency's nationwide training program, the National Fire Academy (NFA) and the Emergency Management Institute (EMI), share the facilities.

The goal of EMI is to offer training and education that continuously improves emergency management practices in communities throughout the United States. Training activities consist of courses, workshops, seminars, and conferences offered both at EMI and at locations throughout the U.S., often in cooperation with State emergency management agencies. These training activities are directed primarily to persons with local or State government responsibilities for emergency management.

In addition, EMI presents teleconferences, provides independent or self-directed study courses, and develops instructional materials to promote interest, cooperation, and involvement in emergency management by school children and adults in the general public.

Independent Study Courses

Some of the independent study courses are suitable for both the general public and persons who have local government responsibilities for emergency management. Some courses are targeted for specific audiences such as radiological responders. All courses are available at no charge for either individual or group training. Each course includes a final examination. Persons who score 75% or better on the examination are issued a certificate of completion by EMI.

Radiological Emergency Management

PREFACE

In a radiological emergency, effects caused by radiation may be a significant concern. Throughout this course, the term radiation refers to ionizing or nuclear radiation. Radiological emergency management is a term that describes efforts to prevent, prepare for, respond to and recover from an event that could result in significant radiation-related effects. Efforts to prevent radiological emergencies include actions to stop such events from happening and actions that decrease the harmful effects of such an occurrence. Efforts to prepare for a radiological emergency include learning the warning signs and knowing what to do during an emergency. Responding to a radiological emergency means taking appropriate actions to protect yourself and others from harm. Recovering from a radiological emergency includes actions performed after an emergency to return to normal.

Ionizing radiation cannot normally be seen by the human eye, nor can it be smelled, heard, or otherwise detected by our normal senses. Radiation can only be detected by radiation detection instruments. This characteristic makes radiological emergencies different from other types of emergencies such as floods, hurricanes or explosions. To prepare effectively for radiological emergencies, it is necessary to understand what radiation is, what types of events can cause a radiological emergency, and what harmful effects could result from such an event. This course is designed to familiarize you with:

- ☞ Types of radiological emergencies.
- ☞ Potential effects of radiological emergencies on the public.
- ☞ Fundamental concepts related to how you can best ensure the safety of yourself and others during a radiological emergency.

Too few people understand that, except in a nuclear detonation, exposure to large amounts of radiation is less likely to cause large scale damage, death, and injury than many of the conventional hazards we have faced for years. For example, more than 40,000 people die on our nation's highways each year. More than 6,000 deaths result annually from fires. An even greater number of injuries and deaths are caused by other accidents such as falling down stairs.

Unlike incidents involving radiation exposure, these accidents are familiar and understandable. Most people do not know what can happen if sources of nuclear radiation are released into the environment. Although hazards may exist when radioactive materials are involved in an accident, these risks may be

Radiological Emergency Management Independent Study Course

exaggerated due to the lack of understanding by the general public. Education is the key to understanding the potential risks and dangers involved in all types of radiological emergencies.

This independent study course is intended to provide members of the general public with an overview of several types of radiological emergencies: radiological transportation accidents, nuclear power plant accidents, nuclear terrorism threat, and other radiological hazards. This overview introduces the nature, degree of hazard, and general emergency response strategies associated with each type of emergency. Specific emergency response guidance, such as how to operate radiation detection equipment or how to respond to a radiation incident, is presented in other courses.

INTRODUCTION

How to Complete the Course

For optimal results, study this course carefully at your own pace. The course is self-instructional and contains all of the information you need to increase your knowledge of radiological hazards.

Tests and Review

The course contains a pretest, five units, a final examination and a glossary. You should take the pretest to test your knowledge before you begin studying. You can score the pretest yourself, using the pretest answer key (located after the pretest questions), to determine units requiring additional emphasis.

Within each unit are fill-in-the-blank and true/false practice exercises. The answers to these exercises are located at the end of the text. At the end of each unit, you will find review questions which will test your mastery of the material. You will score the review tests using the answer key provided at the end of each unit.

The final examination, located after the fifth unit, will test the knowledge you have gained from the course. You may test online at <http://training.fema.gov> and follow the links to the specific course. Or an answer sheet can be ordered online at <http://training.fema.gov>, click on FEMA Independent Study and go to Opscan Request. Follow the instructions on the answer sheet to take the final exam and mail it to:

FEMA Independent Study Program
Emergency Management Institute
16825 S. Seton Avenue
Emmitsburg, Maryland 21727

Upon successful completion of the examination a certificate will be mailed or emailed to you.

The glossary, located before the final exam, contains definitions of terms related to radiological hazards. The glossary may be consulted while you are reading the units or may be read separately.

How to Take the Pretest

This pretest is designed to indicate how much you know about radiation hazards and radiological emergency management before you take the course. Read each question carefully and select the one answer you think is best. Circle the letter corresponding to the answer you have chosen. Complete all the questions. Do not look ahead at the course materials. Your pretest score will be a useful measure only if you answer all the questions before reading any of the course materials.

When you have completed the pretest, check your answers against the pretest answer key provided at the end of the pretest. This answer key will also help guide you through the text. Each test item covers information discussed in a specific unit of the text which is identified next to each answer.

The pretest should take you approximately 15 minutes. Find a quiet spot where you will not be interrupted. When you have checked all of your answers, begin reading Unit 1.

PRETEST

1. The program designed to protect the population in the event of disasters and emergencies and to minimize the effects of these on the nation is:
 - a. National security
 - b. Emergency management
 - c. Military defense
 - d. Nuclear defense

2. The three main types of nuclear radiation are:
 - a. Microwave, x-ray, gamma
 - b. Alpha, gamma, neutron
 - c. Beta, gamma, neutron
 - d. Alpha, beta, gamma

3. The amount of radiation absorbed into the body is:
 - a. Charge
 - b. Exposure rate
 - c. Dose
 - d. Contamination

4. A unit used to express radiation exposure is the:
 - a. Roentgen
 - b. Dose
 - c. Ray
 - d. Curie

5. The rate at which an individual is exposed to radiation is:
 - a. Watts per hour
 - b. Roentgens
 - c. Exposure rate
 - d. Dose

6. The most common physical symptoms of early radiation sickness are:
 - a. Nausea, changes in blood cell formation, vomiting
 - b. Diarrhea, nausea, vomiting, headache, fatigue
 - c. Vomiting, changes in blood cell formation, burns
 - d. High fever, changes in blood cell formation, nausea

7. One of the delayed effects of high-level radiation exposure is:
 - a. Increased risk of cancer
 - b. Nausea
 - c. High fever
 - d. Restlessness

8. Most radioactive material shipments in the United States are made for:
 - a. Nuclear power plants
 - b. Nuclear weapon production
 - c. Medical facilities
 - d. Construction sites

9. Type B radioactive material packaging is designed and tested to withstand:
 - a. Normal handling conditions
 - b. Normal and rough handling conditions
 - c. Normal and rough handling, and accident conditions
 - d. Abnormal accident conditions

10. Sources of information about radioactive material shipments which are posted on the exterior of vehicles are:
 - a. Shipping papers
 - b. Placards
 - c. Markings
 - d. Labels

11. The transport index on radioactive material labels indicates the radiation level _____ feet from the surface of the package.
 - a. 1
 - b. 2
 - c. 3
 - d. 4

12. The maximum radiation exposure rate on contact with a package of radioactive material in or on a transport vehicle is:
 - a. 10 mrem/hr or .100 mSv/hr)
 - b. 50 mrem/hr or .500 mSv/hr)
 - c. 100 mrem/hr or 1.0 mSv/hr)
 - d. 1000 mrem/hr or 110 mSv/hr)

13. Commercial nuclear reactors generate heat by a process called:
- a. Fission
 - b. Fusion
 - c. Combustion
 - d. Ignition
14. Which of the following is inserted into the reactor core to reduce reactor power or to shut down the reactor?
- a. Primary coolant
 - b. Secondary coolant
 - c. Control rods
 - d. Cladding
15. A cooling tower is used to cool which of the following?
- a. Primary coolant system
 - b. Reactor core
 - c. Water from condensers
 - d. Control rods
16. Fission is a process in which atoms of uranium:
- a. Split
 - b. Combine
 - c. Fuse together
 - d. Explode

17. The large dome-like structure that is often seen when approaching a nuclear power plant is the:
- Nuclear reactor
 - Cooling tower
 - Containment building
 - Pressure building
18. In the event of a nuclear reactor accident, evacuation of offsite areas should:
- Always be performed regardless of radiation levels and other hazards
 - Sometimes be performed depending on the proximity to the plant and the severity of the release
 - Not be performed due to hazards involved with relocating people
 - Be based on the projected time of the arrival of the plume and radiation levels
19. Radioactivity is the process where unstable atoms disintegrate or decay to stable atoms. The energy released in this process is called:
- The blast effect
 - The shock wave
 - A mushroom cloud
 - Nuclear radiation
20. The type of radiation that is a major hazard due to its relatively high penetrating power is _____ radiation.
- Alpha
 - Microwave
 - Gamma
 - Neutron

21. Dirt drawn up into the mushroom cloud of a nuclear detonation often returns to the earth as:
- a. Neutrons
 - b. Acid rain
 - c. Gamma rays
 - d. Radioactive fallout
22. When radioactive particles from a nuclear detonation land on a surface, the original surface:
- a. Becomes permanently radioactive
 - b. Becomes radioactive for a limited period of time
 - c. Is considered contaminated, but does not become radioactive
 - d. Is unaffected and is safe to walk about
23. Radiation levels naturally decrease due to radioactive:
- a. Decay
 - b. Decontamination
 - c. Equilibrium
 - d. Absorption
24. The radiation exposure rate one week after a nuclear detonation should be approximately _____ the exposure rate in the same area one day after the blast.
- a. 10 times less than
 - b. Equal to
 - c. 10 times more than
 - d. 100 times greater

25. Almost all of the world population's dose from radioactivity comes from _____ sources?
- Radon
 - Natural
 - Nuclear medicine
 - Artificial
26. Taking a long distance trip in a _____ can result in a significant increase in someone's radiation dose:
- Passenger train
 - Family van
 - Airplane
 - Sailboat
27. The source of most of the dose from natural sources of radiation is from what?
- Radon
 - Lead
 - The sun
 - Consumer products
28. The most common medical procedure leading to an individual's collective dose of radiation is what?
- Radiotherapy
 - Filling a cavity
 - Blood pressure check
 - X-ray

29. A person's exposure to cosmic radiation:
- a. Increases with altitude.
 - b. Decreases with altitude.
 - c. Is not possible.
 - d. Can only be received in outer space.
30. The most likely consumer product that may be contributing to your dose of radiation (if you are wearing one) is what?
- a. A diamond bracelet
 - b. A luminous dial wrist watch
 - c. A diamond pendant
 - d. A sterling silver belt buckle

PRETEST ANSWER KEY		
Test Item Number	Correct Answer	If you answered the question incorrectly, study this unit:
1.	b	Unit 1 Fundamental Concepts
2.	d	
3.	c	
4.	a	
5.	c	
6.	b	
7.	a	
8.	c	Unit 2 Radiological Transportation Accidents
9.	c	
10.	b	
11.	c	
12.	d	
13.	a	Unit 3 Nuclear Power Accidents
14.	c	
15.	c	
16.	a	
17.	c	
18.	b	
19.	d	Unit 4 Nuclear Threat
20.	c	
21.	d	
22.	c	
23.	a	
24.	a	
25.	b	Unit 5 Other Radiological Hazards
26.	c	
27.	a	
28.	d	
29.	a	
30.	b	

Unit 1 Fundamental Concepts

In this unit you will learn:

- ☞ Radioactive material emits radiation.
- ☞ Biological effects of radiation.
- ☞ Techniques for reducing exposure.
- ☞ Purposes of the Radiological Protection System (RPS).

INTRODUCTION

This course is designed to help you understand and prepare for an event involving excessive exposures to nuclear radiation. To implement radiological incident management techniques effectively, basic concepts of radiation hazards must be understood. This unit explains the fundamental principles of radioactivity, describes the biological effects of radiation on individuals, and introduces the function of the Radiological Protection System.

It is important to remember that the biological effects to be discussed are "worst case", the result of very large amounts of nuclear radiation received in a very short period of time. The types of radiological emergencies, such as nuclear power plant accidents, transportation accidents, or radiological incidents may result in such amounts of radiation, but only in relatively small areas. "Worst case" amounts would typically be encountered over widespread areas only if we experienced a nuclear weapon detonation.

This unit is divided into four major sections: Radioactivity, Biological Effects of Radiation, Exposure Reduction Techniques, and the Radiological Protection System. Each of these sections contains information that can be used to help you keep yourself and others as safe as possible in the event of a radiological emergency.

The **Radioactivity** section describes the physics of radioactivity and the properties of the different types of nuclear radiation. Familiar radiation sources are also explored.

The **Biological Effects of Radiation** section describes both the immediate and long-term effects from exposure to radiation.

The **Exposure Reduction Techniques** section describes the three methods of reducing one's exposure to radiation: reducing the duration of exposure, increasing one's distance from the radiation source, and increasing the amount of shielding between oneself and the radiation source.

The **Radiological Protection System** section describes the program's design and purposes. The structure of the program and the respective roles of the federal, state and local governments are explained.

RADIOACTIVITY

Although radiation has always been present in our environment, it was not discovered until the late 1800s. To understand nuclear radiation, you need to know how radioactive atoms emit radiation and some of the terms used to express amounts of radiation present.

Elements and Atoms

Elements are simple fundamental substances, commonly referred to as nature's building blocks. Although there are at least 106 known elements, 98% of the planet is made up of only six elements: iron, oxygen, magnesium, silicon, sulfur and nickel. The first 92 are naturally occurring elements; the remainder are man-made and radioactive.

ELEMENT	ELEMENT	ELEMENT	
ENT	ELEMENT	ELEMENT	EL
ELEMENT	ELEMENT	ELEMENT	
ENT	ELEMENT	ELEMENT	EL
ELEMENT	ELEMENT	ELEMENT	

Nature's Building Blocks

The smallest unit of an element is the atom. The atom has all the physical and chemical properties necessary to identify it as a particular element. Atoms are composed of smaller particles including protons, neutrons, and electrons. **Protons** and **neutrons** are heavy particles that are found in the center, or **nucleus**, of the atom. The basic difference between a proton and neutron is their associated electrical charge. Protons have a positive charge and neutrons have no charge. **Electrons** are even smaller, negatively charged particles.

Electrons orbit the nucleus producing what is often described as a "shell" around the atom. The extent of the orbits of the electrons determine the size of an atom. If an atom could be enlarged such that the nucleus would be the size of a baseball, the outer electrons would be tiny specks nearly a mile away.

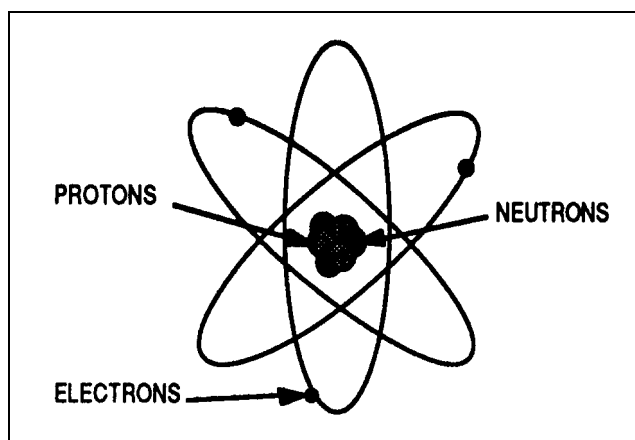

Atom

Radioactivity and Nuclear Radiation

Everything in nature would prefer to be in a relaxed, or stable state. Unstable atoms undergo nuclear processes that cause them to become more stable. One such process involves emitting excess energy from the nucleus. This process is called radioactivity or **radioactive decay**.

The energy released from unstable (radioactive) atoms is called **nuclear radiation**. The terms "radiation" and "radioactive" are often confused. By keeping the following relationship in mind, these two terms can be distinguished: **RADIOACTIVE ATOMS EMIT RADIATION**.

There are three main types of nuclear radiation emitted from radioactive atoms:

- ☞ Alpha.
- ☞ Beta.
- ☞ Gamma.

Alpha and beta radiation consist of actual particles that are electrically charged and are commonly referred to as alpha particles and beta particles. Gamma radiation, however, belongs to a class known as electromagnetic radiation. Electromagnetic radiation consists of energy transmitted in the form of waves. Other types of electromagnetic radiation include television and radio waves, microwaves and visible light. The only differences between gamma rays and these more familiar forms of electromagnetic radiation are that gamma rays are generally higher in energy and that gamma rays originate in the nuclei of atoms.

Alpha

Alpha particles are the heaviest and most highly charged of the nuclear radiations. Without additional energy input, these characteristics make alpha particles less penetrating than beta particles and gamma rays. Their energy is used up before they get very far. Alpha particles cannot travel more than four to seven inches (10 to 18 cm) in air and are completely stopped by an ordinary sheet of paper. Their energy is spent interacting with the charged protons and electrons they meet near any surface they strike.

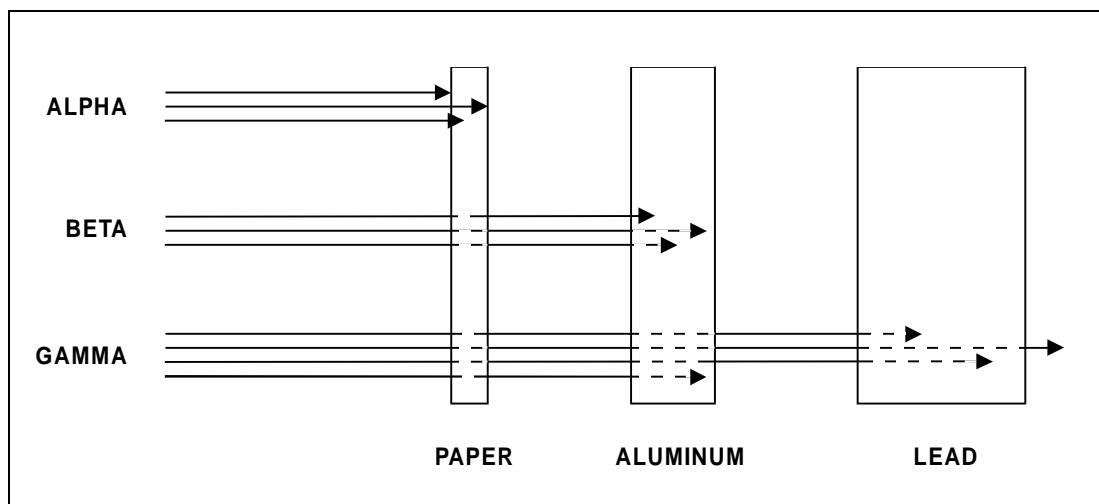

Penetrating Power of Alpha, Beta, and Gamma Radiation

Even the most energetic alpha particle from radioactive decay can be stopped by the outermost layer of dead skin that covers the body. Therefore, exposure to most alpha particles originating outside the body is not a serious hazard. On the other hand, if alpha emitting radioactive materials are taken inside the body, they can be the most damaging source of radiation exposure. The short range of the alpha particle causes the damaging effects of the radiation to be concentrated and in a very localized area.

Beta

Beta particles are smaller and travel much faster than alpha particles. They are physically similar to the electrons discussed earlier in this unit, but they are not in orbit around an atom. Since beta particles travel faster and have less charge than alpha particles, they penetrate further into any material or tissue. Typical beta particles can travel several millimeters through tissue, but they generally do not penetrate far enough to reach the vital inner organs. Beta particles may be a major hazard, however, when emitted by internally deposited radioactive material or when interacting with the lens of the eye.

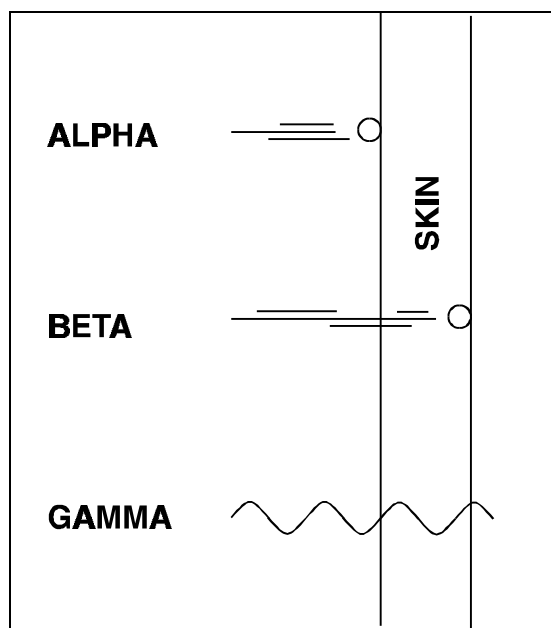

Radiation Penetration Into Skin

Exposure to beta particles from outside the body is normally thought of as a slight hazard. However, if the skin is exposed to large amounts of beta radiation for long periods of time, skin burns similar to heat burns may result. If removed from the skin shortly after exposure, beta-emitting materials will not cause serious burns and will not pose a severe external hazard.

Like alpha particles, beta particles are considered to be an internal hazard if taken into the body by eating food, drinking water, or breathing air containing radioactive material. Beta emitting contamination can also enter the body through unprotected open wounds.

Gamma

Gamma rays are similar to medical x-rays. As discussed earlier, gamma rays are a type of electromagnetic radiation, energy transmitted through space in the form of waves. Physical characteristics of electromagnetic radiation include wavelength and frequency. Different types of electromagnetic radiation have unique wavelengths and frequency. By measuring these characteristics, the type of radiation can be identified. Short wavelength and high frequency are characteristic of radiations, such as gamma and x-rays.

Gamma rays are the most hazardous type of radiation from sources outside the body because they can travel much greater distances through air and all types of material. Gamma rays can travel up to a mile (1.6 km) in open air and may present a significant hazard even at fairly large distances. Since gamma rays penetrate more deeply through the body than alpha or beta particles, all tissues and organs can be damaged by sources outside of the body.

In many cases, some type of dense material is needed to reduce the hazard presented by gamma rays. Any material between the radiation source and the receptor is called **shielding**, because it absorbs some of the gamma ray energy before it can penetrate. For example, 2-1/2 inches (6 cm) of dense concrete will absorb approximately 50 percent of typical gamma rays. Five inches (13 cm) of water is just as effective.

All three types of nuclear radiation can be a hazard if they are emitted by radioactive material inside the body. Such material can get into your body by eating food with radioactive material in or on it, breathing air with radioactive material in it, or drinking water with radioactive material in it. If you keep radioactive material outside your body, you can use your knowledge of some of the radiation characteristics described in this unit to minimize the amount of radiation that penetrates your body.

Neutron

In addition to the three types of nuclear radiation already discussed, there is another type that has much different properties. This type is **neutron radiation**. Neutron radiation consists of neutrons in motion. These are the same as the neutrons you learned about earlier, except they are not contained in the nucleus of an atom. They are traveling through space by themselves and, in open air, neutrons can travel up to 3,000 feet (900 m). Neutrons lose their energy mostly by colliding with protons in the nucleus of hydrogen atoms. When a neutron has lost enough energy, it can be "captured" by a nucleus making the target atom radioactive. The radioactive atoms then emit alpha, beta or gamma radiation in their attempt to become more stable. Certain elements have a high affinity for capturing slowed down neutrons. Such elements are used in control rods in commercial nuclear reactors as will be discussed in Unit 3.

Practice Exercise

1. The type of radiation which is only a hazard if it originates from radioactive material inside the body is _____.
2. The type of radiation which may cause skin burns if it originates from radioactive material located on the skin for extended periods of time is _____.
3. The type of radiation which presents the greatest hazard from radioactive materials outside the body is _____.

Radiation Measurement Terms

Since nuclear radiation affects people, we must be able to measure its presence. We also need to relate the amount of radiation received by the body to its physiological effects. Two terms used to relate the amount of radiation received by the body are **exposure** and **dose**. When you are exposed to radiation, your body absorbs a dose of radiation.

As in most measurement quantities, certain units are used to properly express the measurement.

Roentgen

Roentgen is the unit used to express the amount of gamma radiation exposure an individual receives. In writing exposures, roentgen is usually abbreviated with a capital "R," which follows immediately after the amount of gamma radiation received. An exposure of 50 roentgens would then be written "50 R." Milliroentgen is a subunit of the roentgen (one thousandth of a roentgen), and is abbreviated "mR."

The **roentgen** is independent of the time over which the exposure occurs. For instance, if a man is exposed to 5 R of gamma rays on one occasion, and 6 R on another, the sum of the two, 11 roentgens, is his cumulative gamma radiation exposure.

Rad (radiation absorbed dose)

Different materials that receive the same exposure may not absorb the same amount of energy. The rad was developed to relate the different types of radiation (i.e., alpha, beta, gamma and neutron) to the energy they impart in materials. It is the basic unit of the absorbed dose of radiation. The dose of one rad indicates the absorption of 100 ergs (an erg is a small but measurable amount of energy) per gram of absorbing material. One roentgen of gamma radiation exposure results in about one rad of absorbed dose. To indicate the dose an individual receives in the unit rad, the word "rad" follows immediately after the magnitude, for example, "50 rads." One thousandth of a rad is abbreviated "mrad."

Rem (roentgen equivalent man)

Some types of nuclear radiation produce greater biological effects than others for the same amount of energy imparted. The rem is a unit that relates the dose of any radiation to the biological effect of that dose. Therefore, to relate the absorbed dose of specific types of radiation, a "quality factor" must be multiplied by the dose in rad. To indicate the dose an individual receives in the unit rem, the word "rem" follows immediately after the magnitude, for example, "50 rem." For gamma rays and beta particles, 1 rad of exposure results in 1 rem of dose. For alpha particles, 1 rad of exposure results in approximately 20 rem of dose. For neutrons, 1 rad of exposure results in approximately 10 rem of dose. One thousandth of a rem is abbreviated as "mrem."

Another quantity measured is the rate at which an individual is exposed to radiation. This is often measured on a per-hour basis, and is called the **exposure rate**. Exposure rates are expressed in terms of roentgen or milliroentgen per hour. An exposure rate of sixty roentgen per hour would be written "60 R/hr." "R" stands for Roentgen, a "/" is used in place of "per," and "hr" is used for the word "hour."

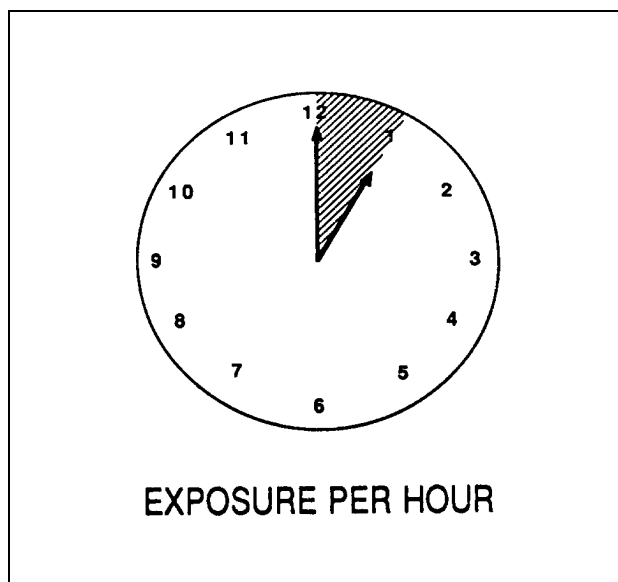

Exposure Rate Usually Expressed “Per Hour”

Standard international (SI) units which may be used in place of the rem and the rad are the sievert (Sv) and the gray (Gy). These units are related as follows:

☞ 1 Sv = 100 rem.

☞ 1 Gy = 100 rad.

SI units must be used on transportation labels. Many radiation meters in use utilize R/hr for measuring dose rate. To convert R/hr to Sv/hr divide by 100. (For example: 60 R/hr ÷ 100 = .6 Sv/hr.)

Radioactivity Measurement Terms

The radioactivity of a given material is a measure of the rate at which the material undergoes radioactive decay. The unit used to measure radioactivity is the curie (Ci) where one curie equals 3.7×10^{10} radioactive disintegrations per second (dps). The SI unit which may be used in place of the curie is the becquerel (Bq). These units are related as follows:

☞ 1 Ci = 3.7×10^{10} dps = 3.7×10^{10} Bq.

☞ 1 Bq = 1 dps.

Another useful quantity is the amount of radioactivity per unit mass. This quantity, called **specific activity**, is typically measured in units of curies per gram (Ci/g).

Natural and Man-made Radiation Sources

Before we discuss the biological effects of nuclear radiation, it is important to remember the many sources of natural and man-made radiation that surround us. Individuals are exposed to minute amounts of radiation from the environment daily. This natural background radiation comes from three main sources:

- ☞ **Cosmic radiation:** Cosmic radiation reaches the earth primarily from the sun. It is composed of a very wide range of penetrating radiations which undergo many types of reactions with the elements they encounter in the atmosphere. The atmosphere acts as a shield and considerably reduces the amount of cosmic radiation reaching the earth's surface. The average dose rate in the U.S. from cosmic radiation is approximately 0.3 mSv/year or 30 mrem/year. Much higher doses (up to 140 mrem/year or 1.4 mSv/year) are received by individuals living in higher elevation areas such as Denver.
- ☞ **Terrestrial sources:** The environment we live in is filled with radioactive materials. For example, the rocks and soil of the earth contain small quantities of the natural radioactive elements uranium and thorium. The concentration of these and other radioactive elements varies considerably depending on the type of rock formation. Thus, the dose rate from this source depends on the geographical location. In the U.S., the dose rate to the body may vary between approximately 15 and 140 mrem/year (0.15 and 1.4 mSv/year). The average is approximately 40 mrem/year (0.4 mSv/year).
- ☞ **Radioactivity in the body:** The human body contains very small quantities of radioactive carbon and potassium. This radioactive material gets incorporated into tissues and organs throughout the body. The radioactive carbon originates in the atmosphere and results in a dose of approximately 1 mrem/year (0.01 mSv/year) in the soft tissue. Radioactive potassium is naturally occurring and contributes approximately 20 mrem/year (0.2 mSv/year) to the testes or ovaries.

In addition to the natural background radiation, there are many sources of man-made radiation which may contribute daily to radiation exposure for humans. These sources include:

- ☞ **Diagnostic radiology:** Diagnostic radiology is the use of radiation (e.g., x-rays) to determine a patient's condition. It has been estimated that 75 to 90 percent of the total exposure of the population from medical uses of radiation comes from the diagnostic use of x-rays.
- ☞ **Therapeutic radiology:** Therapeutic radiology is the use of radiation to treat a patient. The average dose to the overall population from therapeutic radiology is much less than that from diagnostic radiology. Although quite large exposures may be used in certain treatments such as cancer radiotherapy, only a small number of people are involved and exposures are limited to small, precise areas.

**Table 1-1
Annual Whole Body Radiation Dose Rates in the United States***

Source	Average Annual Dose		% of Total
	mSv/year	mrem/year	
Natural background (cosmic, terrestrial, internal)	0.82	82	44.6
Medical radiation	0.77	77	41.8
X-rays			
Radiopharmaceuticals	0.14	14	7.6
Fallout (weapons testing)	0.04-0.05	4-5	2.4
Nuclear industry	<0.01	<1	<0.5
Research	<<0.01	<<1	<<0.5
Consumer products	0.03-0.04	3-4	1.9
Airlines			
Travel	0.005	0.5	0.3
Transport of radiopharmaceuticals	0.0001	0.01	0.005
	1.84	184	100%

*Adapted from BEIR (1980), pp. 66-67.

- ☞ **Fallout from weapons testing:** Some of the radioactive materials created during a nuclear test were injected into the highest region of the atmosphere and carried around the earth several times. They gradually returned to the earth over a period of a few years and consequently gave doses to the population. The dose reached a peak shortly after each weapon test. For some population, minute amounts of radioactive strontium atoms concentrated in the body's skeleton and radioactive cesium atoms were distributed throughout the body.
- ☞ **Occupational exposure:** Occupational exposure is exposure to individuals such as nuclear energy workers, industrial users of radioactive materials, and medical personnel who encounter radioactive materials as part of their jobs. Because the number of these individuals is limited, the dose from all occupational exposure is very small (approximately 0.5 mrem/year or 0.005 mSv/year) when averaged over the entire population.

Practice Exercise

4. Cosmic radiation and radioactive potassium in the body are examples of _____.
5. The roentgen (R) is a unit of _____.
6. The roentgen per hour (R/hr) is a unit of _____.

BIOLOGICAL EFFECTS OF RADIATION

Nuclear radiation is the most-studied environmental hazard in the world. The effects on people caused by exposure to very large amounts of radiation is well known.

In this section, you will learn about the biological effects of very large radiation doses received in a relatively short period of time. An exposure received within a short period of time is called **acute exposure**. Generally, a large acute exposure can result in observable effects, such as radiation sickness or death, shortly after exposure. The severity of these immediate effects depends on the amount of radiation dose. Large acute exposures can also result in effects such as cancer that show up after a number of years. The probability of these delayed effects also depends on the amount of radiation dose.

A continuous or repetitive exposure is called a **chronic exposure**. Natural background radiation, an example of chronic exposure, exposes individuals to relatively small amounts of radiation over a long time. Small chronic exposures, such as exposure to background radiation, have no immediately observable effects, but may result in the same types of delayed effects that are associated with acute exposures.

To understand the types of biological effects resulting from exposure to nuclear radiation, it is important to understand how radiation interacts with the body. Remember, radiation is a form of energy in motion. When alpha, beta and gamma radiation enter the body, some or all of their energy is lost in collisions with the body's atoms. The major characteristic of these atomic interactions is the stripping away of electrons from atoms in the body. This removal of electrons is called **ionization**. For this reason, alpha, beta, and gamma radiation is often called **ionizing radiation**.

The biological effects of radiation are caused by these ionizations and their effects on cells. The body cells depend on individual atoms working together. The body is accustomed to repairing many types of cell damage. Usually, the body is able to handle cell damage through its repair mechanisms. The immediate and delayed biological effects seen from radiation occur when the body either improperly repairs the damage, or when the body has so much repair to perform that it can't overcome the damage quickly enough.

Acute Effects

The body's natural defenses against radiation damage have developed in the naturally radioactive environment we live in. These defenses are overwhelmed by **acute exposures**. For example, if a large group of people received an acute exposure of 450 R (0.12 C/kg), half of them would probably die within a month without medical care. However, if this same group were exposed to 450 R over an extended period of time, far fewer would die as a result. If the exposure was protracted over many years, no radiation sickness would be observed, although the delayed effects might be statistically observable. Therefore, **chronic**

exposures received over an extended period of time can be tolerated by the body with much less biological effect than **acute exposures**.

Biological Factors

Although the effects of exposure to large groups can be predicted, each individual's body differs. These differences can mean that, except at extremely high acute doses, two people exposed to the same amount of nuclear radiation may experience different symptoms. Biological factors which may influence the effect of radiation on an individual include age, sex, diet, body temperature, and health.

Biological Symptoms

The symptoms discussed below are those caused by large short-term (acute) exposures of gamma radiation. We will relate some general symptoms to specific amounts of exposure. These classifications must be general because, as previously stated, radiation effects are somewhat variable among individuals.

Two visible, potential signs of radiation sickness are nausea and vomiting. Since shock or pain can also cause nausea and vomiting, they are not necessarily an indication of radiation sickness. The symptoms must be weighed against the dose received to determine whether they indicate radiation sickness. Another symptom is a high fever. All three of these symptoms resemble those of many common illnesses, including the "flu" and the common cold.

Radiation sickness symptoms may appear shortly after exposure, then disappear for a few days only to reappear in a much more serious form in a week or so. This "latent" period is related to the amount of the exposure. When the symptoms recur, they are sometimes accompanied by swelling in the passages of the nose, mouth, and throat.

Acute Radiation Sickness

As stated, acute radiation doses occur when an individual is exposed to a large amount of radiation within a relatively short period. The effects of acute radiation doses greater than approximately 1 Sv (100 rem) are collectively known as **acute radiation sickness**. Acute radiation sickness symptoms include:

- ☞ Changes in blood cells.
- ☞ Vascular changes (blood vessels).
- ☞ Skin irritation.
- ☞ Gastrointestinal system effects.
- ☞ Radiation sickness (diarrhea, nausea, vomiting, high fever).
- ☞ Hair loss (epilation).
- ☞ Burns.

The severity and course of the acute radiation sickness depends on how much total dose is received, how much of the body is exposed and the radiosensitivity of the exposed individual. The symptoms of acute doses usually appear within the first one or two weeks after the radiation is received. The effects of acute radiation exposure are described below.

Any organism will die if it is exposed to too much radiation. For some people, exposures above .05 C/Kg (200 R) to the whole body may be lethal. At .09 C/Kg (350 R), perhaps 5 percent of the exposed group would die within a month without medical attention. At .12 C/Kg (450 R), as stated earlier, half of the exposed group would probably die without medical attention. At .17 C/Kg (650 R), most would die without intense medical care.

Hair loss results from the destruction of hair follicles in the skin. Hair loss may be temporary or permanent depending on the dose.

Skin irritation is another effect likely to occur from acute exposures to radiation. A tingling sensation of the skin and some reddening may persist for a couple of days after exposure. This response is typical of a sunburn and the dead skin cells are obvious from the peeling of skin after the burn. But unlike sunburn, the irritation will return after some time has passed and persist for about 3 weeks. More severe skin burns and blistering occurs after higher exposures.

Severity Levels

The severity and the time of onset of early radiation sickness after exposure are important indicators in the determination of what the later symptoms of the acute radiation sickness will be, especially if the absorbed dose is not known. Nausea, vomiting, diarrhea and anorexia are common symptoms of early radiation sickness. Later symptoms may include:

- ☞ Malaise (a vague feeling of illness and depression).
- ☞ Fatigue.
- ☞ Drowsiness.
- ☞ Weight loss.
- ☞ Fever.
- ☞ Abdominal pain.
- ☞ Insomnia (sleeplessness).
- ☞ Restlessness.
- ☞ Blisters.

Changes in the formation or production of blood cells may occur when individuals are exposed to large amounts of radiation such as 300 to 500 R. Some smaller (sublethal) doses may generate blood changes detectable in laboratories with no overt patient symptoms. The individual initially suffers from nausea and vomiting and may appear to recover in about three days. At this level of exposure, blood cells essential for fighting infections are greatly reduced in number. In two to three weeks, symptoms including chills, fatigue, and ulceration of the mouth will appear. Susceptibility to secondary infection is greatly increased during this period and may cause death, even with medical care.

If an individual receives over 500 R of acute radiation dose, damage to the stomach lining and/ or intestine may occur. The high doses of radiation may cause structural changes to the gastrointestinal tract

including decreased absorption, ulceration, and dehydration. If the individual suffers from severe infection, fluid loss, blood loss or circulatory collapse, death may occur within 7 days.

Acute doses of over 1000 R cause irreparable damage to the central nervous system cells. Terminal symptoms may include over excitability, lack of coordination, breathing difficulty, and occasional periods of disorientation. At these doses, death occurs within hours to days.

Table 1-2 shows the effects of various large doses in the weeks after exposure.

**Table 1-2
Clinical Symptoms of Acute Radiation Sickness in
Relation to Postexposure Time and Dose**

Time after Exposure	Sublethal Dose (100-250 rem)	Lethal Dose (250-450 rem)	Supralethal Dose (>650 rem)
First Week	Nausea and occasional vomiting within hours	Nausea, vomiting, extreme paleness within a few minutes or hours	Nausea, vomiting, extreme paleness within a few minutes Shock, unconsciousness, diarrhea, abdominal pains and cramps, fever, severe skin irritation, burns or blisters, insomnia, restlessness
Second Week		Weight loss, general malaise, fatigue, stomatitis Fever, anorexia, abdominal pains, severe skin irritation	Death certain (without medical attention) within a few hours to a few days
Third Week	General malaise, anorexia, mild skin irritation, diarrhea, fatigue, drowsiness Hair loss	Hair loss, internal bleeding	
Fourth Week and Later	Recovery probable Changes in blood cells detectable in laboratory	Menstrual irregularities in females 50% chance of death from changes in blood cells if not treated	

Treatments

As discussed, individuals exposed to radiation may suffer from a full range of injuries from invisible blood change effects at low doses to superficial burns caused by beta particles, to serious radiation sickness at high doses. Whatever the injury, a medical doctor should treat the individual. By examining blood microscopically, a medical doctor can diagnose radiation exposure before other effects appear or after an exposure not great enough to cause more severe symptoms. Treatment depends upon the nature and seriousness of injury. Beta burns, for example, may be treated just like any other burn.

Long-term Effects

The probability of experiencing long-term effects increases as the level of exposure increases. However, at occupational exposure levels such as 0.5 R/year, the probability of these effects occurring to an individual is very small.

Cancer

One of the most serious delayed effects of exposure to nuclear radiation is the increased risk of cancer. Although widely thought of as a cause of cancer, acute radiation exposure contributes only a limited increase to cancer risk. For example, of 82,000 Japanese atomic bomb survivors receiving an average of approximately 28 rads (0.28 Gy), only an estimated 185 or 0.2 percent experienced a radiation induced cancer. The danger of cancer caused by acute radiation exposure is clearly less than the danger presented by the short-term acute radiation effects discussed previously in this unit.

Low-level radiation exposure, although also widely thought of as a cause of cancer, is an even less potent cancer causing agent. Measurable increases in cancer rates are not observed but are generally assumed to exist due to the known cancer causing effect of the much higher, acute doses. When responding to radiological accidents such as most transportation accidents or a nuclear power plant accident as severe as that at Three Mile Island, it will be this assumed low-level radiation exposure risk that will be a factor.

Table 1-3 compares the risk of radiation exposure with other common risks.

**Table 1-3
Risk Comparisons**

Condition	Average Lifespan Reduction (Days)
Being an unmarried male	3,500
Cigarette smoking (male)	2,250
Being 30 percent overweight	1,300
Motor vehicle accidents	207
Alcohol (U.S. average)	130
Accidents in the home	95
Accidents on the job (average)	74
Occupational radiation exposure (5 rem/year or 0.05 Sv/year)	32
Illicit drugs (U.S. average)	18
Natural radiation	8
Medical x-rays	6
Occupational radiation exposure (0.5 rem/year or 0.005 Sv/year)	3
Diet drinks	2
Average radiation dose from a nuclear reactor accident	0.2-2

Cataracts

The fibers that comprise the lens of the eye are specialized to transmit light. Damage to these fibers, and particularly to the developing immature cells that give rise to them, can result in dark spots in the lens called cataracts which can interfere with vision. Acute exposure of 200 rads (2 Gy) or more can induce the formation of vision-impairing cataracts. Exposure to 1,000 rads (10 Gy) over a period of months can also cause cataracts.

Life-Shortening

The evidence regarding life-shortening is derived mainly from animal experiments where radiation has been demonstrated to shorten lifespan. The aging process is complex and largely obscure; and the exact mechanisms involved in it are yet uncertain. Irradiated animals in these investigations appear to die of the same diseases as nonirradiated animals, but they do so at an earlier age. How much of the total effect is due to premature aging and how much to an increased incidence of radiation-induced diseases is still unresolved. However, data from the populations of Hiroshima and Nagasaki indicate that, if life-shortening occurs it is very slight, less than 1 year per 100 R.

Table 1-4 shows typical latent periods between exposure and effect.

Table 1-4
Long-Term Effects of Radiation

Effect	Mean Latent Period (years)	Evidence
Leukemia	2-4	Atomic bomb casualties Medical x-ray treatment
Bone cancer	15	Radium luminous dial painters
Thyroid cancer	15-30	Atomic bomb casualties Medical treatment
Lung cancer	10-20	Mine workers
Life-shortening	Not applicable	Experiments with mice
Cataract formation	1-5	Atomic bomb casualties

EXPOSURE CONTROL TECHNIQUES

There are three important factors in protecting individuals from radiation: **time**, **distance**, and **shielding**.

The time factor means that the less time an individual remains in a radiation field, the less exposure that individual will receive. The figure below shows the effect of time spent in a field of 100 mR/hr. If you remain in a 100 mR/hr field of radiation for 1 hour, you will be exposed to 100 mR. If you remain in the same 100 mR/hr field for 3 hours, you will be exposed to 300 mR (3 x 100).

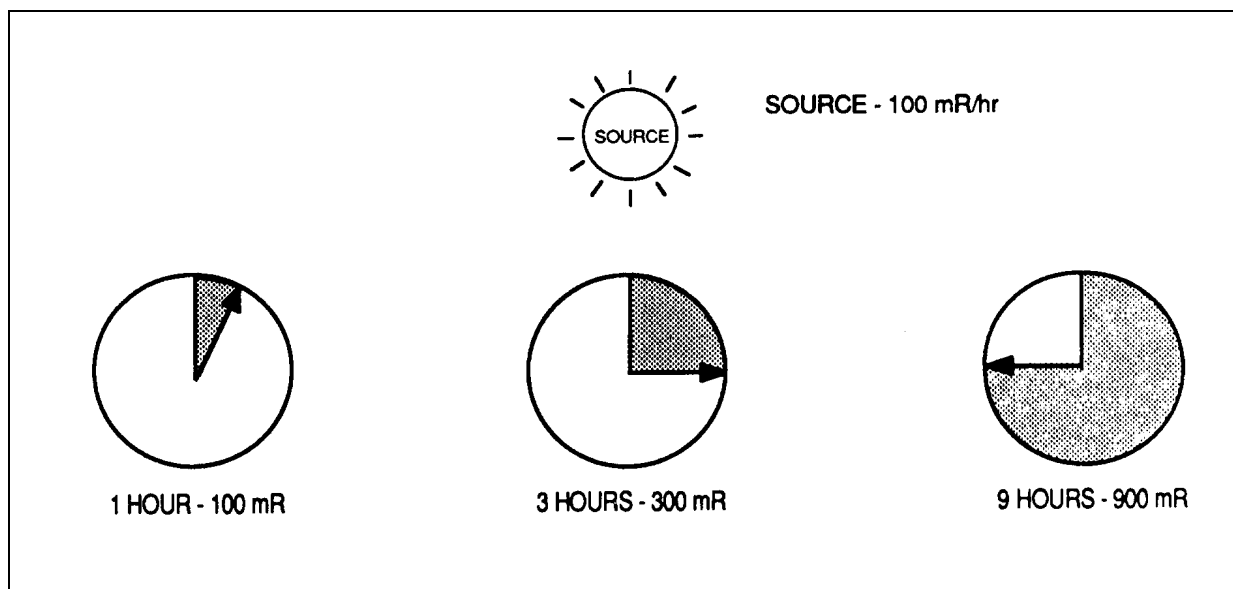

Effect of Exposure Rate and Time On Total Exposure

The **distance** factor means that the further an individual remains from a radiation source, the less exposure that individual will receive. The intensity of a radiation field decreases as the distance from the source increases. The figure below shows the effect of distance on gamma exposure rates. If the exposure rate at one foot (30.5 cm) away from the source is 1,000 mR/hr, the exposure rate at two feet (61 cm) away will be 250 mR/hr. The 250 mR/hr is 1/4 of the exposure rate at one foot.

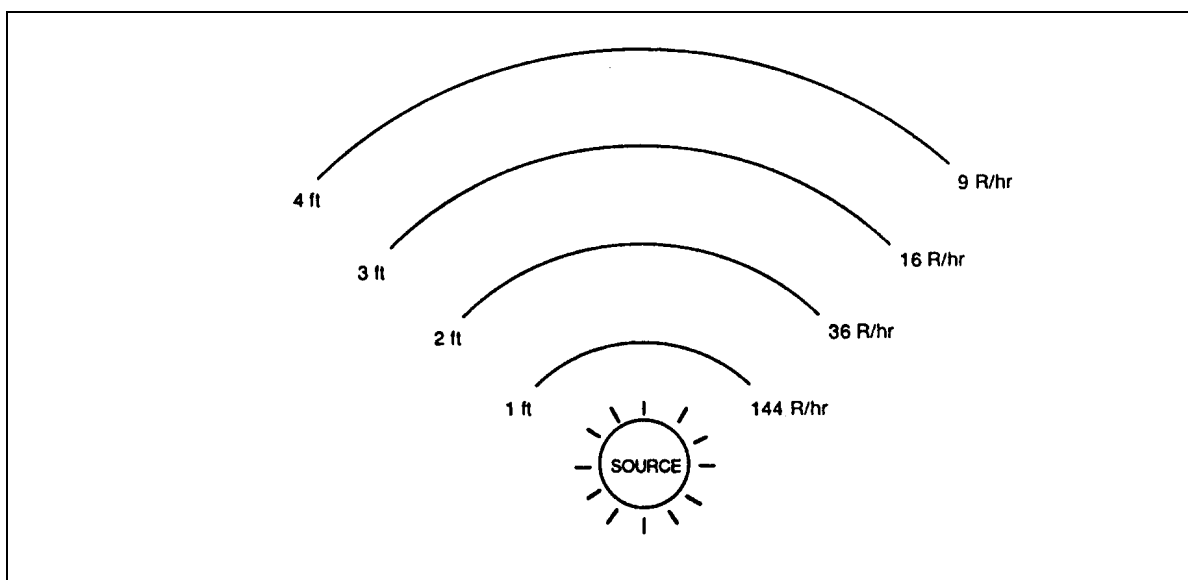

Effect of Gamma Exposure Rate and Distance On Total Exposure

The **shielding factor** means that the more material placed between an individual and a radiation source, the less exposure that individual will receive. The intensity of a radiation beam is reduced by absorption and scattering processes with the material. For gamma radiation, dense material such as lead is most effective as a shield. Beta radiation can be shielded by relatively thin amounts of wood or plastic. Alpha is shielded by virtually any material.

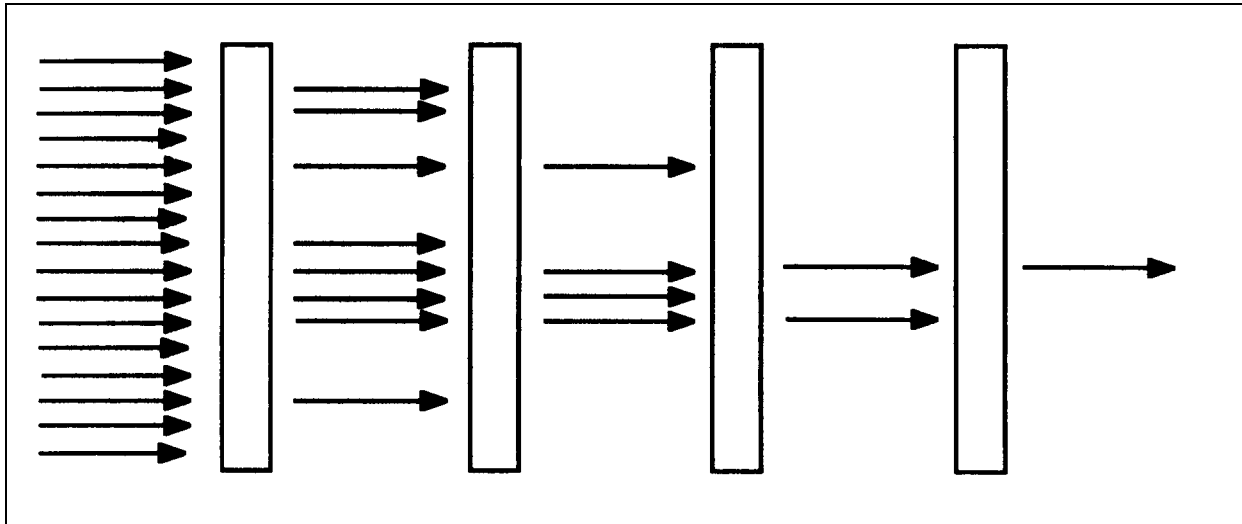

Effect of Shielding Layers On Exposure Rate

All of the above mentioned factors may be accomplished by an adequate shelter. The shelter provides distance away from the radiation located outside. The shelter acts as shielding and can help prevent inhalation of radioactive material.

Practice Exercise

7. Some visible or measurable signs of radiation sickness are _____.
8. The amount of acute radiation exposure which will kill approximately 50% of the individuals exposed (if not medically treated) is _____.
9. The factors which protect an individual from exposure to radiation are, _____, _____, and _____.

EMERGENCY MANAGEMENT AND THE RADIOLOGICAL PROTECTION SYSTEM

In the United States, emergency management at the Federal, state, and local level is designed to minimize the effects of all hazards on the civilian population. The Radiological Protection System (RPS) is one element of emergency management. This system of public protection provides plans and trained personnel to respond to any situation involving the release or potential release of radioactive materials. The RPS may be activated by transportation accidents, problems at nuclear power plants or other fixed facilities, natural disaster damage to facilities that use radioactive materials in industry, research or medicine, or terrorist use of a nuclear weapon or conventional weapon containing nuclear material.

Key elements of emergency management are **preparedness, response, recovery** and **mitigation** measures:

- ☞ Preparedness includes training, exercising, public information programs, and administration of government emergency management programs. The federal government, through the Federal Emergency Management Agency, establishes program guidelines and the establishment of state and local programs.
- ☞ Response includes the implementation of plans and procedures for dealing with any type of hazard. These plans and procedures include the protective measures for both the general public and emergency workers or responders.
- ☞ Recovery is returning the community back to normal as much as possible.
- ☞ Mitigation includes measures taken by both the public and government to lessen the impact and effects of a hazard.

The radiological protection system conducts preparedness, response, recovery and mitigation activities as related to events that could result in public exposure to radiation.

Preparedness: use Federal guidelines for state and local planning and training. Includes maintenance of radiation detection instruments.

Response: to all types of radiation events -- protection for public includes State radiological health, local responders, local and state emergency managers.

Recovery: decontamination, monitoring of food and water supply, returning people to homes.

Mitigation: public education (re: nuclear power plants and general effects of radiation, notification systems, Emergency Planning Zone (EPZ) plans, and evacuation routes).

Practice Exercise

10. The system designed to minimize the effects of a radiological hazard on the population is called _____.

UNIT 1 REVIEW

This unit described Radioactivity, the Biological Effects of Radiation, Techniques for Reducing Exposure, and the RPS.

Radioactive atoms emit radiation. There are three main types of nuclear radiation emitted from radioactive atoms: alpha, beta and gamma. Neutrons are a fourth type of nuclear radiation. When you are exposed to radiation, your body absorbs a dose of radiation. There are both natural and man-made sources of radiation in our environment. Radiation is the most studied environmental hazard in the world.

The biological effects of radiation exposure are dependent on the type of exposure (acute or chronic), the level of exposure, and certain biological factors. The acute biological symptoms due to radiation exposure are not unique except at very high levels of exposure. The long-term effects of high doses of radiation include increased risk of cancer and cataracts with a possibility of life-shortening. Measurable effects of low-level radiation exposure have not been observed but are generally assumed to exist due to the known cancer causing effect of much higher, acute doses.

Protective measures can be used to reduce an individual's radiation exposure. The use of time, distance, and shielding principles are especially important in reducing exposure to radiation.

The Radiological Protection System (RPS), a part of the overall Emergency Management Program, is an organized effort designed to minimize the effects of nuclear radiation (from all sources) on people and their property.

UNIT 1 REVIEW QUESTIONS

Answer the following questions to review your knowledge of the Fundamental Concepts unit. Read each question carefully and circle the correct answer.

1. The greatest hazard from radioactive material outside the body is from:
 - a. Alpha particles
 - b. Beta particles
 - c. Gamma rays
2. The type of radiation totally absorbed by the body when emitted by radioactive material inside the body is:
 - a. Alpha particles
 - b. Gamma rays
 - c. Both gamma rays and beta particles
3. The amount of radiation absorbed per hour is the:
 - a. Dose rate
 - b. Radiation effect
 - c. Exposure rate
4. If a man was exposed to .2 C/Kg of gamma rays on one occasion and .5 C/Kg on another, his total exposure would be:
 - a. 2.5 C/Kg
 - b. .25 C/Kg
 - c. .7 C/Kg

5. Cosmic radiation, terrestrial radiation sources and radioactive potassium in the body are all examples of:
 - a. Radioactive contamination
 - b. Natural background radiation
 - c. Man-made radiation
6. One example of man-made radiation which may contribute to routine human exposure is:
 - a. Therapeutic radiology
 - b. Cosmic radiation
 - c. Terrestrial sources
7. Some visible or measurable signs of radiation sickness are:
 - a. Nausea, vomiting, fever
 - b. Diarrhea, jaundice, nervousness
 - c. Burns, backache, headache
8. Most individuals receiving an acute radiation exposure of 500 R will:
 - a. Probably experience no noticeable effects
 - b. Probably be ill and likely die if medical treatment is not received
 - c. Be certain to die almost immediately
9. One example of a potential long-term effect from chronic low level radiation exposure is:
 - a. Hair loss
 - b. Cataracts
 - c. Nausea
10. Identify the three factors that are important in protecting individuals from radiation exposure of any type.
 - a. Time, shielding and dose rate
 - b. Dose rate, shielding and distance
 - c. Time, distance and shielding

UNIT 1

REVIEW ANSWER KEY

1. c
2. a
3. c
4. c
5. b
6. a
7. a
8. b
9. b
10. c

Unit 2 Radiological Transportation Accidents

In this unit you will learn:

- ☞ Types of radioactive material shipments and associated packaging.
- ☞ Information sources available at the scene of a radioactive material accident that describe the nature of the potential hazard.
- ☞ On-scene accident response actions for the general public.

INTRODUCTION

Millions of packages of radioactive materials are transported in the United States annually. Most shipments consist of medical and industrial products. Other shipments include nuclear power plant fuel, nuclear weapons and weapons material, and radioactive waste generated by hospitals, laboratories, nuclear reactors, and military facilities.

Because of the sheer number of radioactive material shipments, transportation accidents are the most common type of incident involving radioactive materials. Despite their frequency, there have been no known serious nuclear radiation exposures resulting from transportation accidents. This is due largely to the nature of the radioactive materials transported and the use of protective packaging commensurate with the degree of potential hazard of the radioactive material contained.

This unit is divided into three major sections: Packaging, Information Sources, and On-scene Accident Response. Each of these sections contains information that can be used to understand and respond to transportation accidents involving radioactive materials.

The **Packaging** section describes the various degrees of protective packaging used for the various types of radioactive material shipments.

The **Information Sources** section describes sources of information available to a member of the public at an accident scene that describe the hazards which may be present. These sources may include package labels, package markings, vehicle placards, and shipping papers.

The **On-scene Accident Response** section describes actions which should be taken by a member of the public at the scene of a transportation accident involving radioactive materials. These actions include helping injured individuals, notifying the authorities, and isolating the area.

PACKAGING

As we have mentioned, there have been no known serious radiation exposures resulting from transportation accidents in the United States despite the millions of shipments made each year. This excellent safety record is due to the close attention given by the shippers to the proper packaging of radioactive materials.

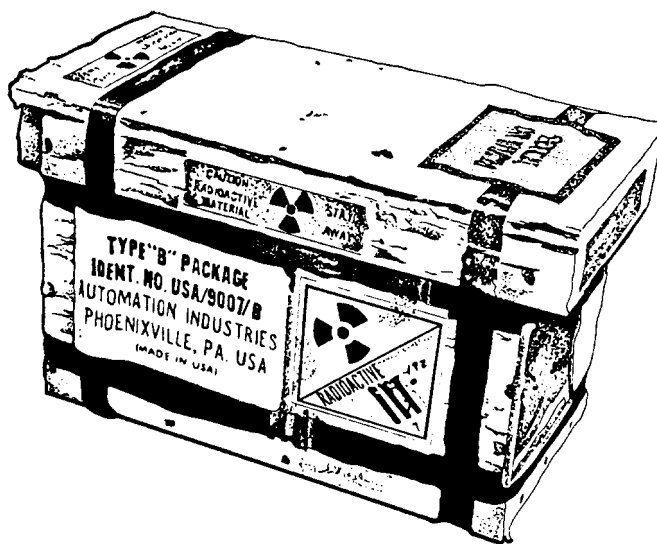

Radioactive Material Package

The types of radioactive material packages addressed in this section, listed in order of increasing potential hazard and therefore, of increasing package integrity, are as follows:

- ☞ Industrial packaging.
- ☞ Type A packaging.
- ☞ Type B packaging.

Industrial Packaging

Industrial packaging is used for shipping low, specific activity, materials and surface contaminated objects. Low specific activity (LSA) materials are generally materials in which radioactivity is essentially uniformly distributed in a large amount of nonradioactive material. Surface Contaminated Objects (SCO) are nonradioactive items with surfaces slightly contaminated with radioactive materials. LSA materials include uranium ore concentrate, low-level waste from hospitals, laboratories and power plants such as contaminated protective clothing and trash and building rubble from cleanup projects. SCO include pieces of equipment used in nuclear power plants that are very slightly contaminated on the surface.

When LSA and SCO materials are transported with other commodities by common carrier, they must be marked, labeled, and contained in industrial packages that meet basic and industrial packaging requirements (as described above). Industrial packaging will be designated as either IP-1, IP-2, or IP-3

depending upon its design and ability to contain the materials inside. However, when they are transported with certain special arrangements between the shipper, carrier and receiver for controlling transport conditions, the packaging need only be "strong tight packages" that will not allow loss of contents under normal transport conditions. These "strong tight packages" will not display the usual required marking and labeling. Instead, they will be marked "RADIOACTIVE-LSA" or "RADIOACTIVE-SCO."

Because the radioactivity in a LSA or SCO shipment is very dilute, the potential radiation hazard is very low. If LSA or SCO packages were involved in an accident, large volumes of low level radioactivity could be dispersed but the risks to public health would be minimal.

Type A Packaging

The majority of radioactive material shipments are made with Type A packaging. Examples of materials shipped in Type A packaging include training sources, radiopharmaceuticals, and research and industrial sources.

The amount of radioactivity allowed in a Type A package is greater than that allowed in limited quantity packages but lower than that of Type B packages (described below). Thus, accidents that may cause damage to Type A packaging would not likely result in serious radiation hazards.

Generally, Type A packaging is designed to withstand the stress of transit under **nonaccident** conditions (including rough handling) and must be labeled as "radioactive." Even though Type A packaging is not designed to prevent the loss of the contents under accident conditions, there have been many accidents involving Type A packaging in which there was no loss. In those accidents where there was loss of contents, no adverse health or environmental effects resulted due to the limited amount of radioactivity allowed in the packaging.

Type B Packaging

Certain shipments of more highly radioactive materials require Type B packaging. Examples of such materials include radiography sources, larger research and industrial sources, and spent nuclear reactor fuel. Most Type B shipments are made by commercial carriers, by tractor trailer or by rail. However, some such as radiography sources which are used to "X-ray" construction welds, may be transported from construction site to construction site in private vehicles. Touching an unshielded radiography source (as shown below) would be extremely hazardous. Such sources are normally carried in a heavily shielded container.

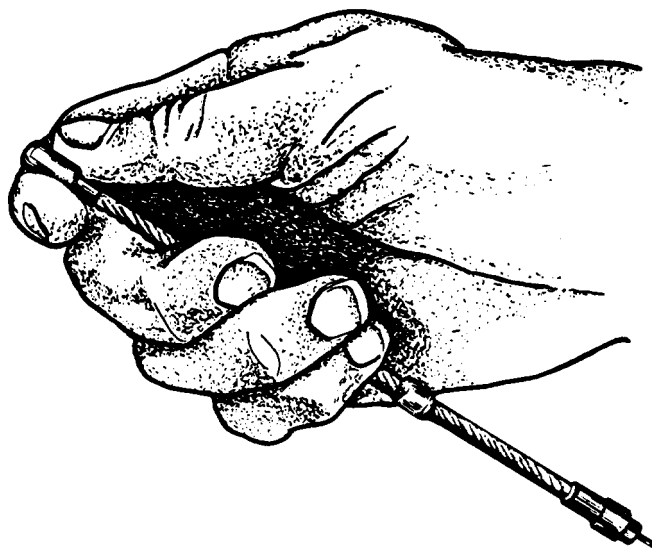

Radiography Source

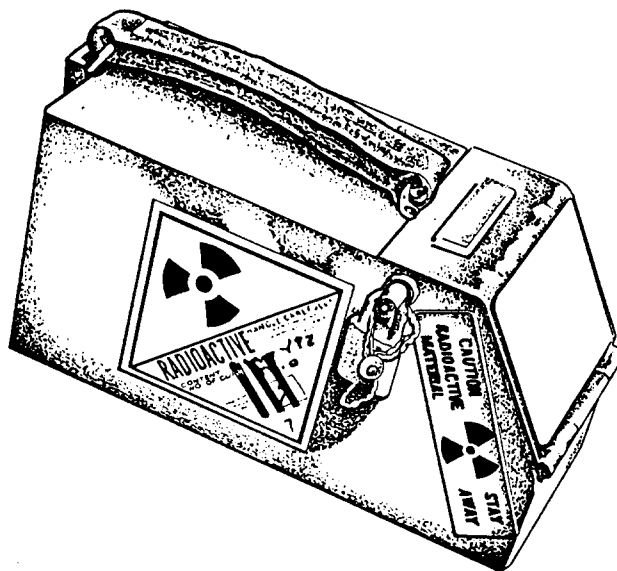

Radiography Source Container

The amount of radioactivity allowed in a Type B package is greater than that allowed in a Type A package. Because certain Type B packages may contain amounts of radioactivity which could be harmful if released to the environment, Type B packages are strictly designed to contain their contents under **accident** as well as nonaccident conditions. In addition to meeting Type A packaging standards, Type B packaging must withstand severe puncture, drop, thermal and water immersion tests simulating transportation accident conditions. Although Type B packages have been involved in actual transportation accidents, no releases have occurred.

Limited Quantity Shipments

Many radioactive shipments involve quantities of radioactivity and levels of surface radiation exposure that are extremely low. Such shipments (called limited quantity shipments) may be shipped in regular packaging materials.

Typical radioactive materials shipped in limited quantities include certain medical diagnostic kits, research and industrial test materials, and radioactive devices such as smoke detectors, luminous watch dials, and special electronic instruments. Such materials are shipped routinely by common carriers. The U.S. Postal Service also transports such packages although the amount of radioactivity allowed per package is one-tenth that permitted for transport by other carriers.

The potential radiation hazard from a limited quantity shipment is very low. However, if packages involved in such shipments were destroyed in an accident, measurable amounts of radioactivity might be found in the debris.

In summary, packaging requirements reflect the degree of hazard associated with the type, quantity and other characteristics of the radioactive materials shipped. Most shipments present minimal potential hazard, even if there is some release. For shipments with significant potential hazards (Type B), the packaging is designed to prevent the release of the contents. To date, no releases have occurred from Type B packages under accident conditions.

Practice Exercise

11. The type of packaging designed to prevent all leakage after a transportation accident is _____ packaging.
12. Items such as smoke detectors and luminous watch dials containing extremely low levels of radioactive materials may be shipped in unlabeled _____ packaging.
13. Packages designed to prevent leakage during normal (nonaccident) transportation conditions are _____ packages.

INFORMATION SOURCES

As we have learned, transportation accidents involving radioactive materials have never resulted in significant radiation exposures due largely to the packaging required. To verify that an accident presents a minimal hazard, however, one must determine certain information about the radioactive material involved. Information sources available at an accident scene before the arrival of trained radiation monitoring personnel include:

- ☞ Package labels.
- ☞ Package marking.
- ☞ Vehicle placards.
- ☞ Shipping papers.

Package Labels

Nearly all packages containing radioactive materials are required to be labeled "RADIOACTIVE." The exception to this requirement, as has been mentioned, is limited quantity packages. These exempted quantities have very little radioactivity associated with them and would present a minimal hazard in the event of an accident.

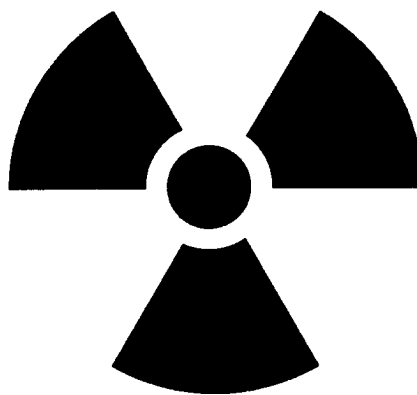

Tri-blade Radiation Symbol

There are three basic labels which are used to identify radioactive materials. All of the labels bear the distinctive tri-blade symbol which is universal for the identification of radioactivity or radiation. By looking at a package's label, one can determine the hazards associated with it without the aid of a radiation monitoring device.

The radioactive White-I label is used on packages with a maximum dose rate of .005 mSv/hr (0.5 mR/hr) on any exterior surface. This measurement is taken "on contact" with the package.

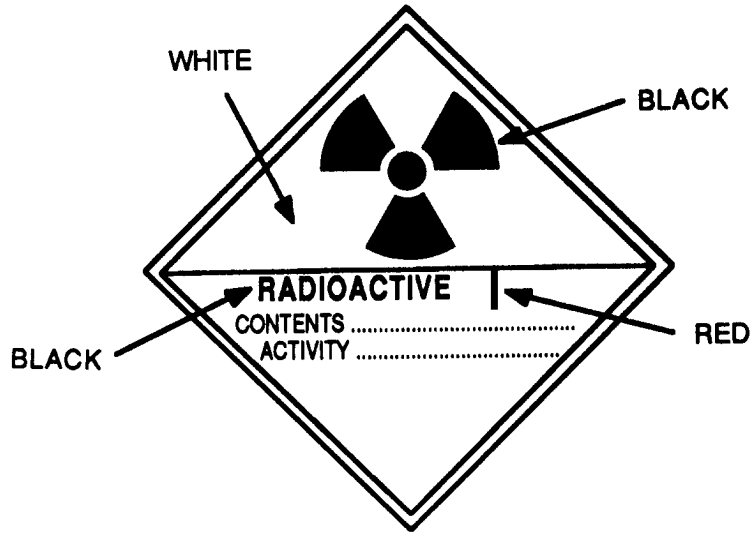

Radioactive White-I Label

The Radioactive Yellow-II label is used on packages which have a maximum dose rate of .5 mSv/hr (50 mR/hr) on any exterior surface. The Radioactive Yellow-III label is used on packages with a maximum dose rate of 2 mSv/hr (200 mRr/hr) on their exterior surfaces.

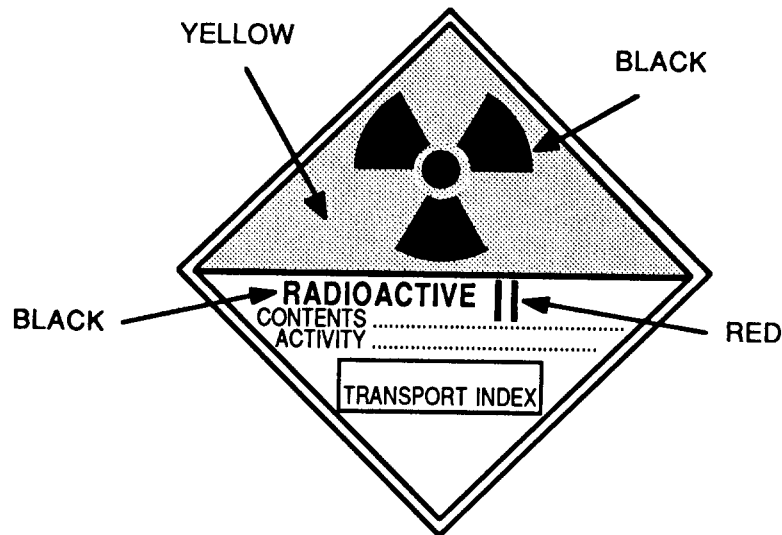

Radioactive Yellow-II Label

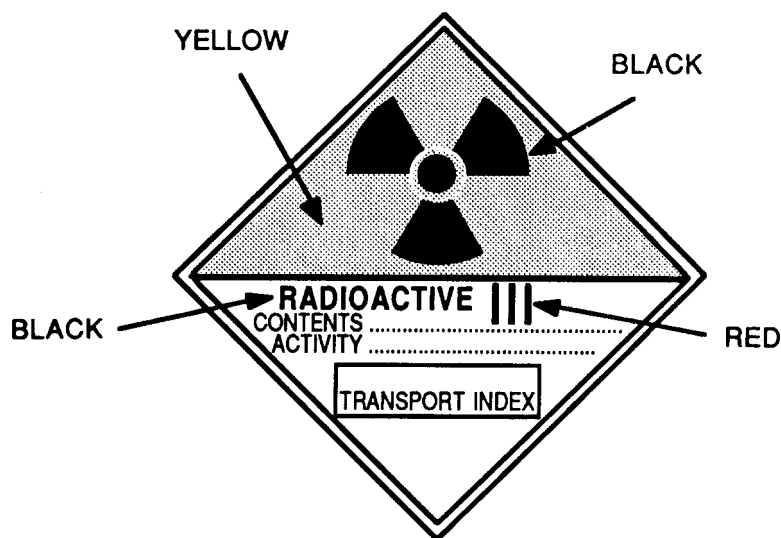

Radioactive Yellow-III Label

The labels are white except for the upper half of the Radioactive Yellow-II and Radioactive Yellow III labels which are yellow. The printing and the radiation symbol are black except for the "I," "II," or "III" numerals which must be red. The type of label quickly indicates to any informed member of the public or to responders the radiation exposure rate near the package (if the package has not broken open). If the package is broken, the hazard **might** be greater due to the loss of shielding provided by the packaging material or due to the possibility of a contamination hazard.

Radioactive package labels also list the type of radioactive nuclide contained and the amount of activity. This additional information is valuable to radiation protection specialists in determining the degree of hazard present if a package breaks releasing radioactive material.

An "exclusive use shipment" can be used to ship a package with a maximum dose rate of 10 mSv/hr (1,000 mR/hr) if special requirements and instructions are followed. Note that in all cases, the radiation exposure rate at the surface of an unbroken package should be no more than 1,000 mR/hr.

Package Marking

Generally, every package labeled as radioactive will also have a marking showing a certain "proper shipping name" and a four digit "U. N. Identification Number." For example, the marking on package might show the words "Radioactive Material, Low Specific Activity" (LSA) and the number "U.N. 2912." With either the proper shipping name or the identification number, emergency responders can determine the proper response actions to be taken.

Actions keyed by a given proper shipping name or U.N. identification number include fire fighting strategies, spill or leak confinement techniques, and first aid considerations. These actions are published in the U.S. Department of Transportation's Emergency Response Guidebook which is used by fire, law enforcement, and other emergency response organizations for dealing with all kinds of hazardous material emergencies.

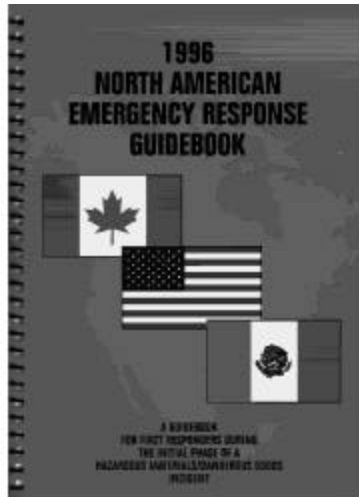

DOT Emergency Response Guidebook

Vehicle Placards

Just as labels and markings are used to show the quantity of radioactivity in a **package**, and to generally indicate the level of radiation emitted, placards are standard signs affixed to the exterior of a **vehicle** or freight container to identify hazards associated with the cargo.

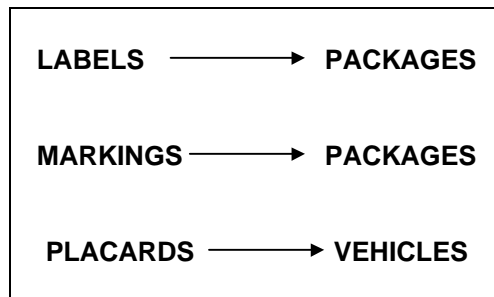

Labels and Placards

Any vehicle carrying a package with a Radioactive Yellow-III label is required to bear the placard shown below. Certain other vehicles, such as those carrying "strong tight" LSA packages, must also be placarded. The RADIOACTIVE placard must be yellow on the top half with the black tri-blade symbol. The bottom half must be white with the word RADIOACTIVE inscribed in black. Vehicle placards can help a great deal following an accident, particularly for a closed vehicle where the packages have remained in the vehicle.



Placard

Highway vehicles transporting larger specified quantities of radioactive materials are required to have the previously described placard placed on a white square as shown below.



Placard On White Square

Placards are used by shippers so that emergency response personnel can determine the appropriate actions to be taken when first arriving at an accident scene. Emergency response actions such as fire fighting strategies, spill or leak confinement techniques, and first aid considerations are keyed by a given hazardous material placard just as they are by the proper shipping name and U.N. identification number found on the package marking.

Shipping Papers

A fourth source of information about a radioactive material shipment available at the scene of a transportation accident is shipping papers. With certain exceptions, shipping papers identifying hazardous materials are required to be kept in:

- ☞ The cab of a motor vehicle within easy access to the driver.
- ☞ The possession of a train crew member.
- ☞ A holder on the bridge of a sailing vessel.
- ☞ An aircraft pilot's possession.

One (1) Box, Thorium Nitrate, Radioactive Material, UN 2976, 15 kg, ThNatural, Solid (Powder), 1.3 mCi, Radioactive White - 1 and Oxidizer Labels, Cargo Aircraft Only

Sample Shipping Paper Entry

Shipping papers list all of the information provided by the package labels and markings. They also provide additional information including the physical and chemical form of the material, the material's hazard class (e.g., "Radioactive Material" or "Flammable Liquid"), and the material's identification number (e.g., "UN 2976" for radioactive thorium nitrate). The material's identification number is used by trained emergency response personnel to quickly determine the appropriate actions to be taken upon arrival at an accident scene.

Practice Exercise

14. The four sources of information about the contents of a radioactive material shipment are _____, _____, _____, and _____.
15. Package labels indicate the maximum amount of radiation present after the package has broken open in a transportation accident. (True or False)
16. The maximum exposure rate permitted at the surface of a radioactive material package during shipping is _____.

ON-SCENE ACCIDENT RESPONSE

Actions which should be taken before the arrival of trained emergency response personnel are **helping** injured personnel, **notifying** the appropriate authorities, and **isolating** the area.

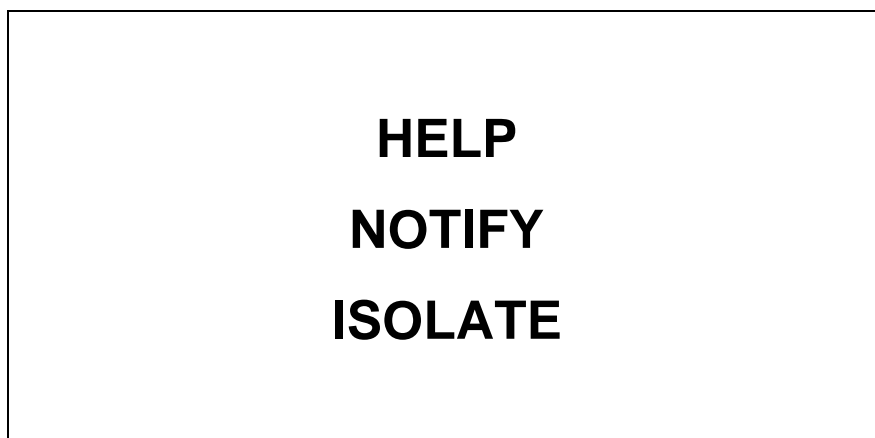

Help, Notify, and Isolate

Help Injured Individuals

As we have learned, the likelihood that nuclear radiation levels at an accident scene would be high enough to cause injury to a responder is extremely remote. Unbroken radioactive material packages never have a surface radiation level exceeding 1000 mR/hr, and packages likely to break under accident conditions are used only for materials low enough in radioactivity to present no immediate hazard if dispersed. Therefore, help for injured individuals should not be delayed out of concern for radiological hazards. The responder should give normal first aid to the extent qualified.

Notify the Authorities

Using any form of communication available, an individual responding to an accident should notify the authorities of the accident. The local 9-1-1 emergency service or the local police or fire departments should be able to respond properly.

It is important to give the greatest amount of detail possible when calling for help. Important information includes:

- ☞ The location and nature of the accident.
- ☞ The cargo (if easily identified by vehicle placards or package labels).
- ☞ Your name and the phone number from where you are calling (if applicable).

- ☞ The number of persons injured and the seriousness of their injuries.
- ☞ The actions being taken at the time of the call.

If at all possible, communications should be maintained until the authorities have arrived. It is important for those first on the scene to wait for the arrival of authorities and give them a full description of the events that occurred before their arrival. This will ensure that all persons involved understand the potential hazards and that all personnel will receive proper medical treatment and be decontaminated as required.

Isolate the Area

Once injured individuals have been helped and the authorities have been notified, the accident scene should be isolated. Two reasons are:

- ☞ To prevent the spread of low-level radioactive contamination.
- ☞ To prevent exposure to high-levels of radiation in the highly unlikely event of a release of highly radioactive materials or a high level sealed source.

Radioactive materials released at an accident scene, even at levels of little consequence, can result in very small but still detectable levels of contamination being spread a great distance. The spread of contamination can be controlled by limiting access to and egress from the accident scene. Although, in some cases, the contamination spread would be of insignificant radiological consequence, any **detectable amount** can prove to be of great concern to the public and news media.

It is important to treat everything that has been near the accident as potentially radioactive and contaminated until it has been verified by qualified radiation protection personnel to be free of radioactive contamination. Individuals who have contacted potentially contaminated materials should remain on-hand until they have been checked by qualified personnel. **Only qualified personnel should attempt to clean up a spill of any hazardous materials--radioactive or not.**

Very severe accidents involving highly radioactive Type B shipments are highly improbable, but not impossible. Such an accident might require an extensive response **if the package were severely damaged and involved a release of a significant fraction of its contents.** Although this has never occurred and is highly unlikely because of the stringent packaging requirements, response plans should be implemented for such an accident, even if only to verify that there is no hazard.

If a radioactive materials package has been badly damaged or if you suspect that it is leaking, do not panic. The steps to take are simple:

- ☞ Stay away from the package and do not touch it.
- ☞ Keep other people away from the package.
- ☞ Tell anyone who may have touched the package to remain on-hand to be checked by radiation protection specialists.
- ☞ If you touched the package or objects near it, wash your hands with lukewarm water.

Practice Exercise

17. The three key actions to be taken before the arrival of trained emergency response personnel at the scene of an accident involving radioactive material are _____, _____, and _____.
18. Safe radiation levels should be verified before providing lifesaving first aid for accident victims. (true or false).
19. Cleanup of a hazardous material spill should be attempted only by _____.

UNIT 2 REVIEW

This unit described the hazards and protective measures associated with a radiological transportation accident. Transportation of radioactive material is highly regulated to minimize the risk of serious hazards in the event of an accident.

Radioactive materials are packaged, marked, labeled and placarded with public safety as the foremost goal. The degree of packaging used is commensurate with the degree of hazard of the contents. Extremely hazardous radioactive materials are shipped in packaging which does not break under accident conditions. Low-level radioactive materials are shipped in less resistant packages and may be dispersed. However, if dispersed, these materials would present only a minimal health risk and would be easily detectable by radiation protection specialists.

The three steps to be taken before the arrival of trained emergency response personnel at an accident scene are to help injured individuals, to notify the authorities, and to isolate the area. Help for injured individuals should not be delayed out of concern for radiological hazards.

UNIT 2 REVIEW QUESTIONS

Answer the following questions to review your knowledge of the Radiological Transportation Accidents unit. Read each question carefully and circle the correct answer.

1. In the United States serious radiation exposures:
 - a. Frequently result from radioactive transportation accidents due to the large number of such shipments
 - b. Have resulted from improper packaging of radioactive material shipments
 - c. Have resulted from improper labeling of radioactive material shipments
 - d. Have not resulted from radiological transportation accidents due largely to the nature of the materials transported and the use of appropriate protective packaging
2. Shipments of limited quantity radioactive materials such as smoke detectors and luminous watch dials require:
 - a. Normal industrial packaging
 - b. Type A packaging
 - c. Type B packaging
 - d. "Strong tight" packaging
3. Type B radioactive material packaging is designed and tested to withstand:
 - a. Normal handling conditions
 - b. Normal and rough handling conditions
 - c. Normal and rough handling, and accident conditions

4. Sources of information about radioactive material shipments which are posted on the exterior of shipment vehicles are:
 - a. Labels
 - b. Markings
 - c. Placards
 - d. Shipping papers
5. The Radioactive Yellow-I, Yellow-II, and Yellow-III package labels indicate:
 - a. The radiation exposure rate near the package if the package has broken open
 - b. The radiation exposure rate near the package if the package has not broken open
 - c. The U.N. identification number
 - d. The proper shipping name
6. The maximum radiation exposure rate at the surface of an unbroken radioactive material package may be at most:
 - a. .5 mSv/hr (50 mR/hr)
 - b. 2 mSv/hr (200 mR/hr)
 - c. 10 mSv/hr (1000 mR/hr)
 - d. 1 Sv/hr (100 R/hr)
7. A member of the public should give lifesaving first aid to injured victims of a radiological transportation accident:
 - a. Immediately after notifying the appropriate authorities
 - b. After isolating the area
 - c. After verifying that no radioactive material packages have been broken open
 - d. Without delay out of concern for radiological hazards (within the extent of their training)

8. The scene of a radiological transportation accident should be isolated to prevent:
 - a. The spread of radioactive contamination away from the accident site
 - b. Exposure to high levels of radiation in the unlikely event of a release of highly radioactive materials or a high level exposed source
 - c. Both A and B
 - d. Neither A nor B

UNIT 2 REVIEW ANSWER KEY

1. d
2. a
3. c
4. c
5. b
6. c
7. d
8. c

Unit 3 Nuclear Power Plant Accidents

In this unit you will learn:

- ☞ Basic operating principles of a nuclear power plant.
- ☞ Types of nuclear power plant accidents and plant safety features.
- ☞ Offsite consequences of nuclear power plant accidents and resultant protective actions.

INTRODUCTION

To many, the term "nuclear power plant accident" brings to mind the accidents that have occurred at the Three Mile Island and Chernobyl sites. The purpose of this unit is to provide information concerning methods used to minimize the possibilities for these accidents and actions to be taken to minimize their effects on the public.

Virtually all commercial nuclear power reactors in the United States are either pressurized water reactors (PWRs) or boiling water reactors (BWRs). These types of reactors are called light water reactors (LWRs) because the reactor core is covered with water to allow the nuclear reaction to take place and to keep the core cool. This unit discusses primarily accidents at light water reactors.

This unit is divided into three major sections: Operating Principles of Nuclear Power Plants, Power Plant Accidents, and Offsite Protective Actions. Each of these sections contains information that can be used to respond appropriately to a nuclear power plant accident.

The **Operating Principles of Nuclear Power Plants** section describes how power plants generate electricity. The major processes and components of U.S. nuclear plants are examined.

The **Power Plant Accidents** section describes the design philosophy used for U.S. nuclear plants, some accidents that have occurred, and the effect on the public of those accidents.

The **Offsite Protective Actions** section describes protective actions detailed in the formal emergency plans required for each commercial nuclear power plant in the U.S. These actions are based on minimizing public exposure from a radioactive "plume" and from ingesting radioactive material into the body.

OPERATING PRINCIPLES OF NUCLEAR POWER PLANTS

A nuclear power plant is a facility at which energy released by the fissioning of atoms is converted to electrical energy under strictly regulated operating conditions. The major processes are the same as those in nonnuclear (conventional) power plants except that the coal or oil fired boiler is replaced by a nuclear reactor.

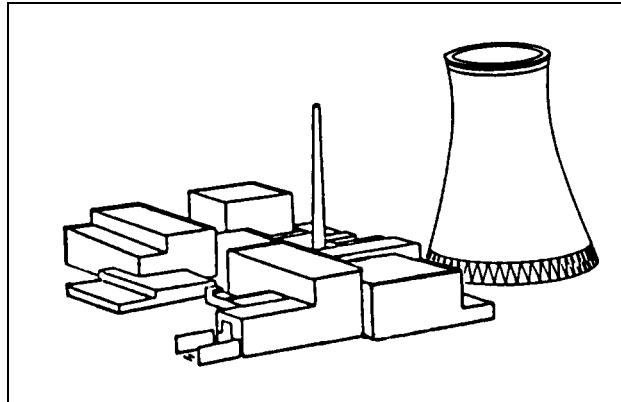

Electric Power Plant

In each plant, whether nuclear or fossil-fueled, the following basic components are present:

- ⌘ **Heat source:** Provides heat to generate steam. In a nuclear power plant, the heat source is the nuclear reactor, often referred to as the reactor core.
- ⌘ **Turbine/generator:** Uses the energy of the steam to turn a turbine/generator that produces electricity.
- ⌘ **Condenser:** Condenses the steam back to water so that it can be returned to the heat source to be heated again.
- ⌘ **Pump:** Provides the force to circulate the water through the system.

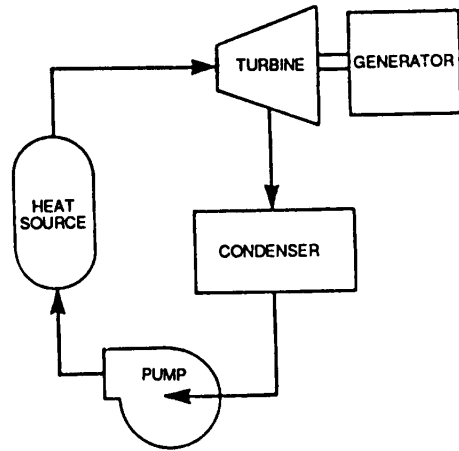

Basic Plant Components and Process

Cooling Water

Just as water vapor condenses on a cool drinking glass on a warm day, a power plant's condenser uses a cool surface to condense the steam from the turbine. This cool surface is provided by cooling water pumped from a nearby water supply such as a river, lake or ocean.

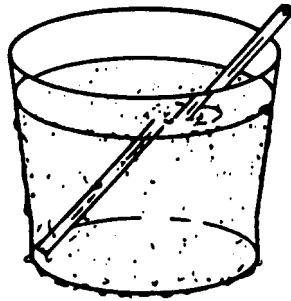

Cold Glass with Condensation

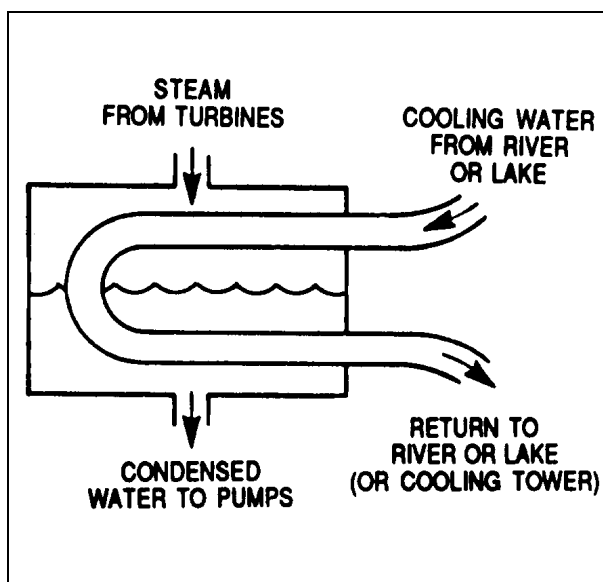

Power Plant Condensation

The water used to cool the condenser is slightly warmer after use. For this reason, a **cooling tower** is sometimes used to prevent a harmful temperature rise in the water supply. A cooling tower is a large heat exchanger. This heat is carried up the stack and is visible as water vapor. Cooling towers are used at many large nuclear as well as non-nuclear power plants. Because cooling towers are part of a nonradioactive system, no radioactive material is released from them.

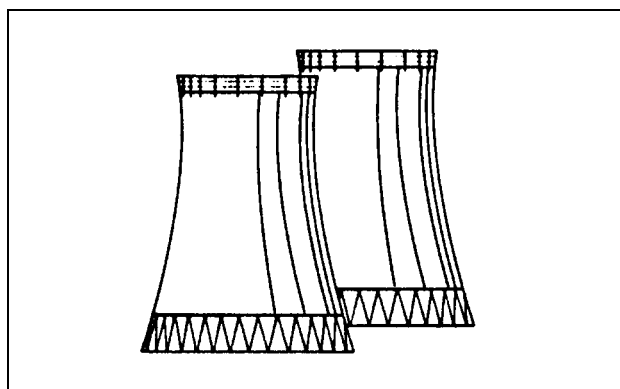

Cooling Towers

Nuclear Reactors

The source of heat in a nuclear power plant is the **reactor core**. A nuclear reactor generates heat through a controlled nuclear reaction. The commercial nuclear reactors used today splits **uranium atoms** to produce heat.

Uranium atoms, like other atoms, consist of neutrons, protons and electrons. As you have learned, protons and neutrons are small particles found in the atom's nucleus. Electrons are even smaller particles which orbit the nucleus.

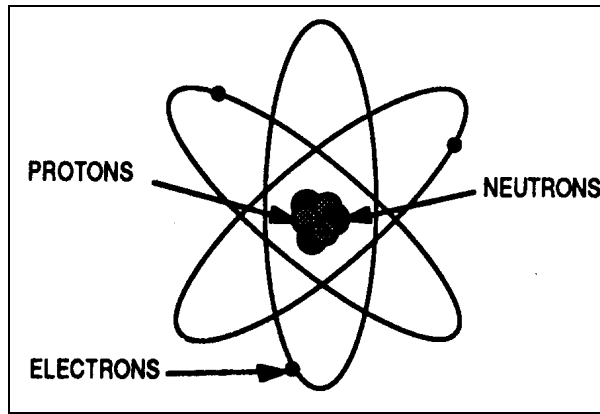

Atom

When a uranium atom is struck by a free neutron, it may split into two or more atoms called "fission products". The process of splitting an atom is called "fission." The fission process is accompanied by the release of energy, including heat and one or more neutrons.

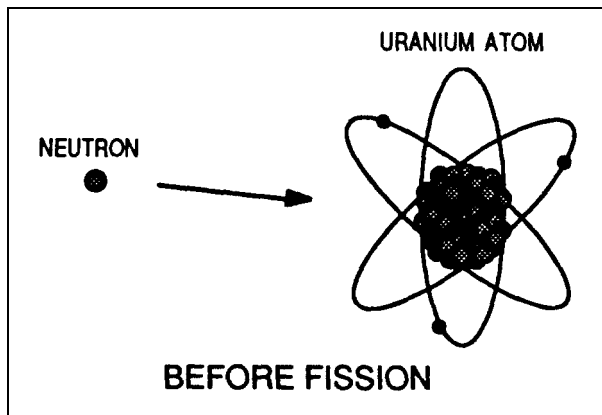

Neutron Approaching a Uranium Atom

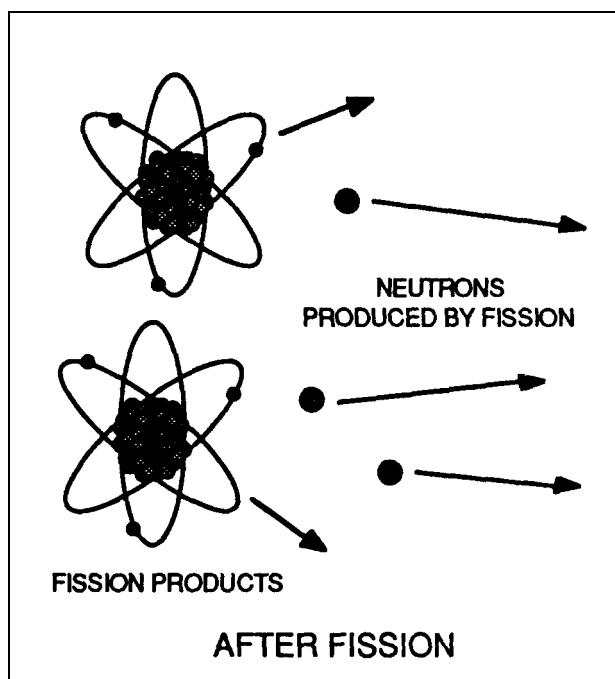

Fission Products and Neutrons

The fission of one atom releases only a very small amount of energy. However, if other uranium atoms are located near a fissioning uranium atom, they may be struck by one or more of the neutrons released by the fission reaction. This may result in a chain reaction involving a tremendous number of fissions and great amounts of energy.

Nuclear weapons and nuclear reactors are designed differently and contain different amounts of fissionable materials. Consequently, a reactor cannot explode like a nuclear bomb.

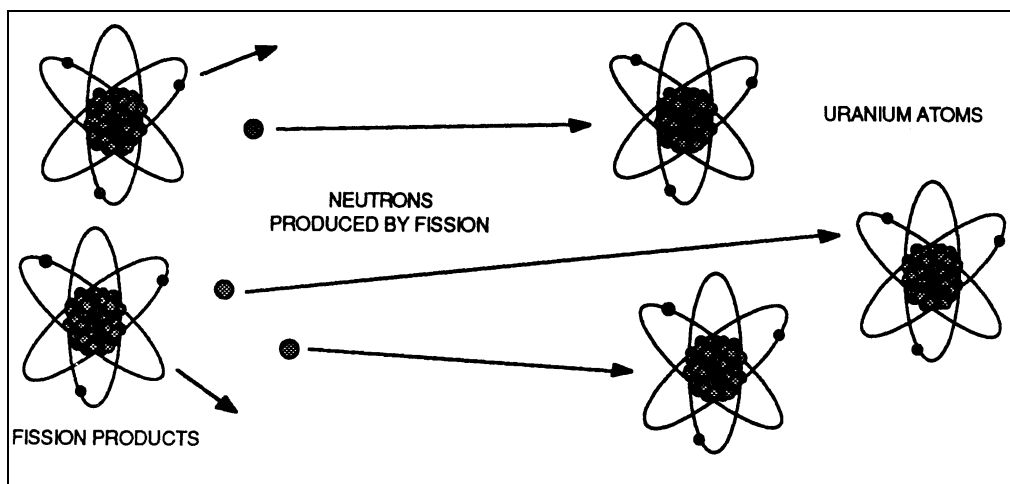

Fission Chain Reaction

The nuclear chain reaction may be controlled using a device called a **control rod**. Control rods are made of materials which absorb neutrons. Thus, when a control rod is inserted into a nuclear reactor it reduces the number of free neutrons available to cause the uranium atoms to fission. When all the control rods are inserted into the reactor, it is called a reactor shutdown. Sometimes all the control rods will be inserted quickly due to a safety or emergency condition. This is known as a **scram**.

The nuclear chain reaction is also affected by the water in the core. All light water reactors (LWR) require the core be covered with water for the chain reaction to be allowed to continue. Therefore if there was an accident that resulted in loss of the water covering the core the reactor would scram.

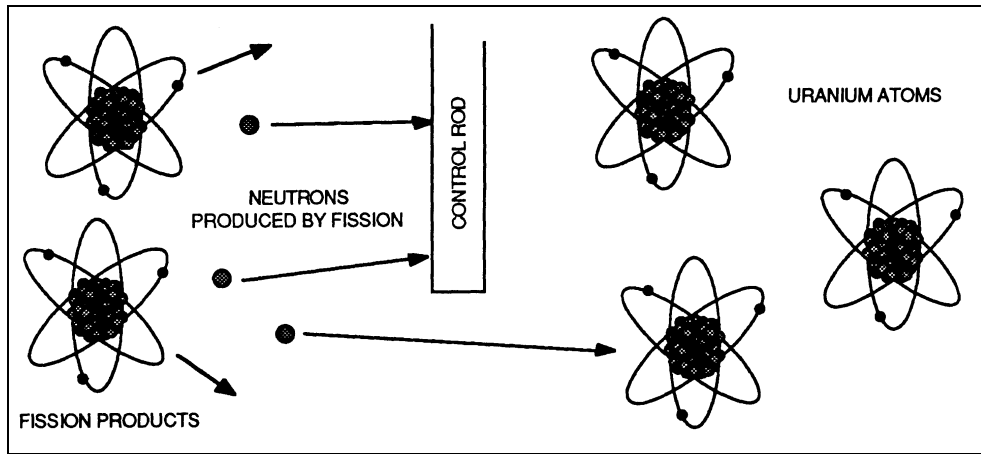

Control Rods Absorb Neutrons to Prevent Fissions

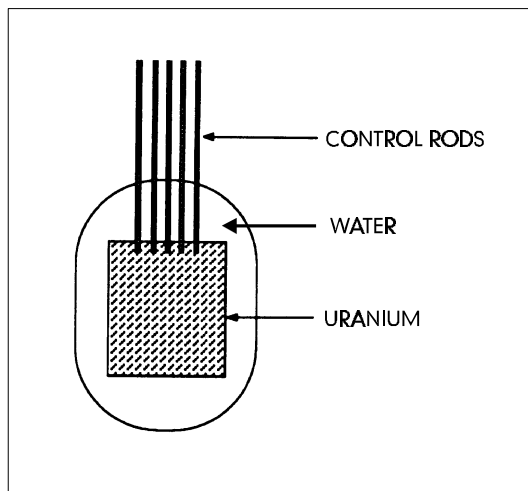

Control Rods Withdrawn

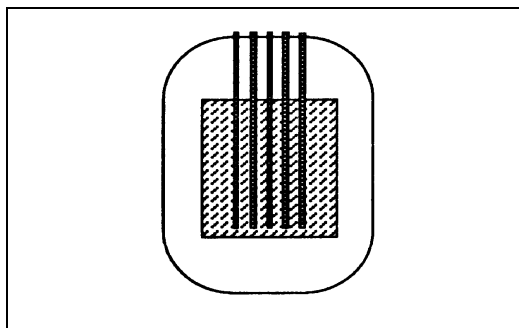

Control Rods Inserted

Fission Products

The smaller atoms produced by nuclear fission are called fission products. Fission products may be of a wide variety of elements. Common fission products include xenon, krypton, iodine, cesium and strontium. Most fission products are highly radioactive and will undergo radioactive decay. Most decay quickly and will be gone within several days. Some, however, remain in the nuclear fuel for many years, and must be contained to prevent injury to the public.

Decay also produces heat, referred to as decay heat, that must be removed even after the reactor is shut down. If the decay heat is not removed, it will result in failures of the barriers designed to contain the fission products and possibly a radioactive release from the plant.

Nuclear Fuel

The nuclear fuel typically used in nuclear power plants consists of uranium in the form of uranium dioxide (UO_2). Uranium dioxide, a ceramic, is used because like all ceramics, it can withstand very high temperatures. The uranium dioxide is fabricated into cylindrical **fuel pellets**, approximately one-half inch long.

Many fuel pellets are stacked end-to-end to form a **fuel rod**. Each fuel rod is approximately 12 feet long and is encased in a metal tube called the **fuel cladding**. The purpose of the cladding is to prevent fission products from escaping from the fuel pellets into the reactor cooling water. Most radioactive fission products remain in the fuel, very close to where they are formed. However, certain fission products such as krypton and xenon gases or iodine atoms are mobile and may move out of the fuel and become trapped in the narrow gaps between the fuel pellets and the fuel cladding.

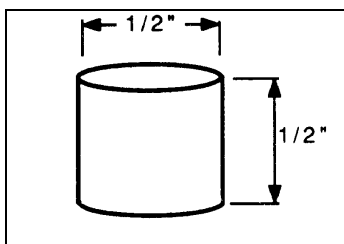

Uranium Fuel Pellet

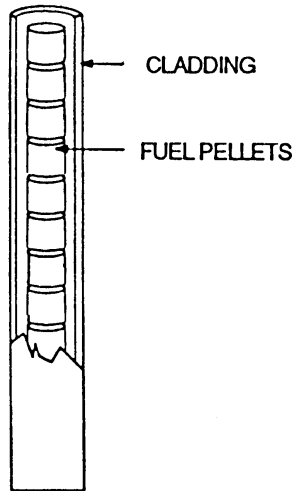

Fuel Rod With Pellets and Cladding

A number of fuel rods are grouped side-by-side to form a **fuel assembly**. A number of fuel assemblies are in turn grouped together to form the nuclear **reactor core**. A large modern nuclear power reactor core is approximately 12 feet (3.7m) long and 12 feet in diameter, with approximately 200 fuel assemblies.

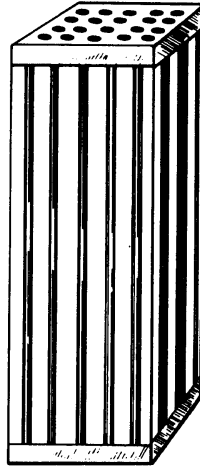

Fuel Assembly

Heat generated in the reactor is removed by **reactor cooling water**. Reactor cooling water is circulated, through the length of the reactor core, between the various fuel rods. The system that contains the reactor cooling water is called the **primary coolant system**.

Types of Reactors

There are two main types of commercial nuclear reactors used in power plants in the United States:

- ☞ Boiling Water Reactors (BWRs).
- ☞ Pressurized Water Reactors (PWRs).

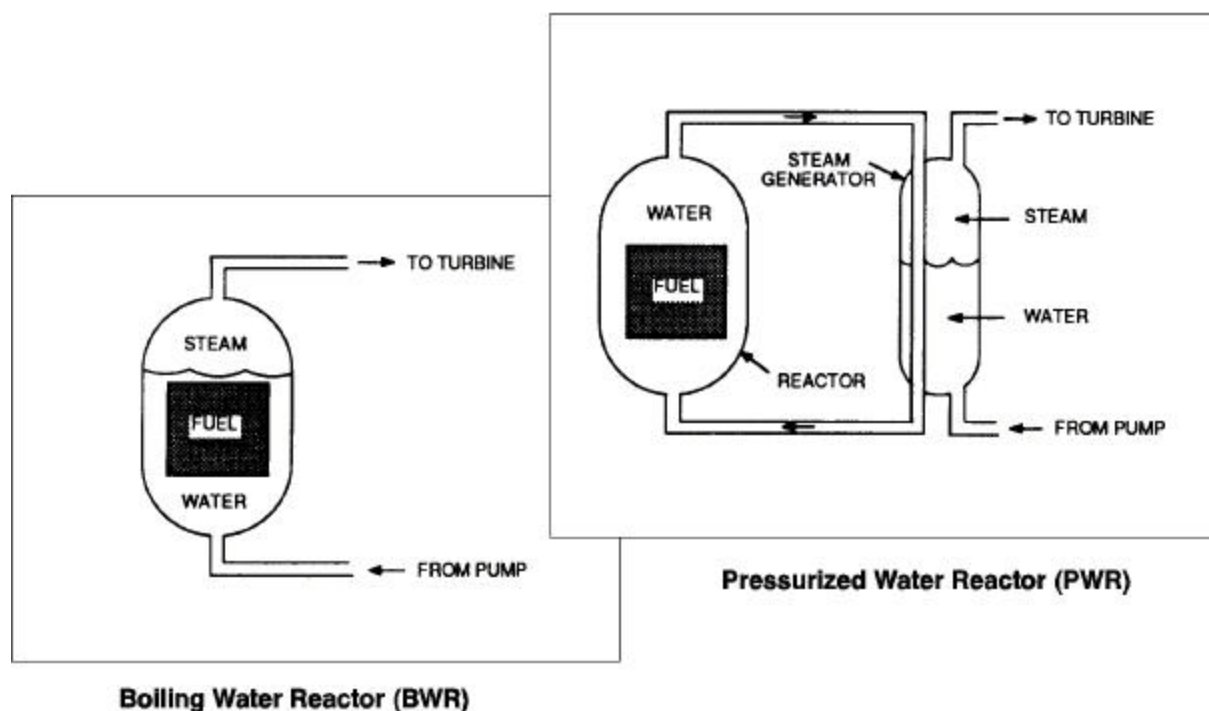

In Boiling Water Reactors (BWRs), water (primary coolant) is allowed to boil directly in the reactor core. The boiling water generates steam which is drawn away from the reactor and used to rotate the turbine, which in turn generates electricity via the generator. Even in non-emergency conditions this water may contain small amounts of radioactive fission products.

In Pressurized Water Reactors (PWRs), the water (primary coolant) in the reactor core is prevented from boiling by being maintained at a much higher pressure. Heat is removed using a **steam generator**. In a steam generator, the primary coolant flows through a series of metal tubes while secondary cooling water flows around the tubes. In this way, heat is transferred from the slightly radioactive primary coolant system to the nonradioactive secondary coolant system. The secondary coolant is maintained at a much lower pressure than the primary coolant.

Thus, as the heat is transferred, the secondary coolant flashes to steam. This steam is then drawn from the steam generator and used to rotate the turbine generating electricity.

In addition to the PWR and BWR systems discussed above, there are several other types of systems in use, or under development, throughout the world. Although stringent regulations govern the operation of all nuclear power plants, there will always be a possibility for some type of accident to occur. The following section of this unit deals with the very real issue of how the public is protected from an accident should one occur at a nuclear power plant.

Practice Exercise

20. Major components which may be found at coal and oil burning power plants as well as nuclear plants include _____, _____, _____, and _____.
21. A structure used to prevent harmful temperature increases in lakes and rivers is a _____.
22. The fuel used at nuclear power plants is made from _____.
23. When an atom of nuclear fuel is struck by a free neutron, it fissions yielding _____, _____, and _____.
24. The number of neutrons available to cause further fissions is governed by _____.
25. The two main types of commercial nuclear reactors used in the United States are _____ and _____.

POWER PLANT ACCIDENTS

Nuclear power plants are designed with two principal safety objectives in mind:

1. To contain fission products to prevent offsite health effects.
2. To ensure that heat generated by the reactor, including heat generated by the decay of fission products after reactor shutdown, is removed.

If the decay heat is not continually removed from the reactor following shutdown, this heat could cause failures of the system designed to contain the fission products. The fission products generated in the reactor core are highly radioactive, thus releasing significant amounts of them to the environment could be quite harmful. Great care has been taken to prevent such a release through the **defense-in-depth** approach used in the design of nuclear power plants.

Defense-in-Depth

The defense-in-depth approach ensures that any release of hazardous amounts of radioactive materials will be extremely unlikely. This approach uses three barriers to prevent the release of fission products from the reactor core to the environment. These consist of:

1. Fuel rods (fuel pellet and fuel cladding).
2. Reactor vessel and primary coolant system.
3. Containment.

The chance of any single barrier failing is unlikely. The chance of all three failing simultaneously is, therefore, extremely remote.

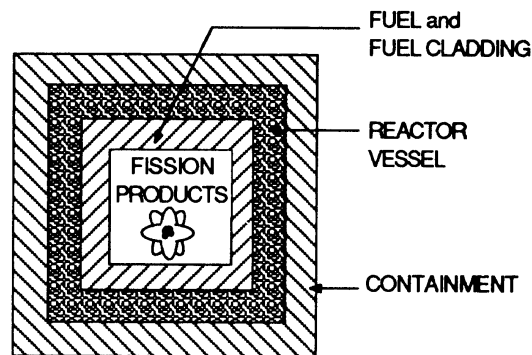

Fission Product Barriers

Fuel Rods

The first barrier designed to prevent an inadvertent release of radioactive material from the reactor core is the nuclear fuel rod itself. During normal operations, about 99 percent of all fission products remain trapped within the fuel's structure very near the point at which they were generated by fission. The fuel cladding which encases the nuclear fuel is designed to contain the remaining 1 percent.

The release of fission products from the fuel rods would require a breakdown of the fuel cladding. If the core is not sufficiently covered with water to provide cooling, it could overheat resulting in a breakdown of the fuel cladding and the release of fission products in a short period of time. Additional overheating could cause the release of some of the 99 percent of the fission products normally trapped in the fuel structure. Still more overheating could cause the fuel to actually melt. This is often referred to as a "meltdown".

It does not require a "meltdown" for sufficient fission products to be released from the fuel to pose a threat. It does require loss of the many redundant systems designed to keep the core covered and cool (by removing the decay heat). These systems are designed to maintain cooling even under severe accident conditions such as a total break in the largest pipe in the system.

As discussed earlier, excess heat is normally removed from the reactor by the primary coolant system. If cooling water flow cannot be maintained, the control rods are automatically inserted into the core to stop the fission process and thus shut down the reactor (called a scram). However, the radioactive fission products remaining in the core would continue to decay. As previously stated, this decay process yields radiation and heat (called **decay heat**). To prevent increased temperatures and damage to the reactor core, the decay heat must continually be removed, even after shutdown. Numerous systems and back-up emergency core cooling systems are provided to ensure that reactor cooling water continues to flow through the reactor core to remove decay heat, even after the reactor has been shut down and the fission process has stopped. Only failure of all of these systems would allow the potential for a "severe core damage accident" or a meltdown.

Reactor Vessel and Primary Cooling System

Even if the fuel cladding (first barrier) fails, there are two more barriers to prevent a release to the atmosphere. The second barrier designed to prevent the inadvertent release of fission products to the environment is the primary coolant system. One part of the primary coolant system, the reactor core, is located within a pressure vessel which has walls of steel up to 10 inches (25 cm) thick. This pressure vessel is called the **reactor vessel**. The primary coolant system contains within its large pipes, reactor cooling water and any radioactive materials which may be present. Failure of the reactor vessel or the associated primary coolant system piping would result in the release to the **containment building** (the third fission product barrier) of any fission products released from the fuel.

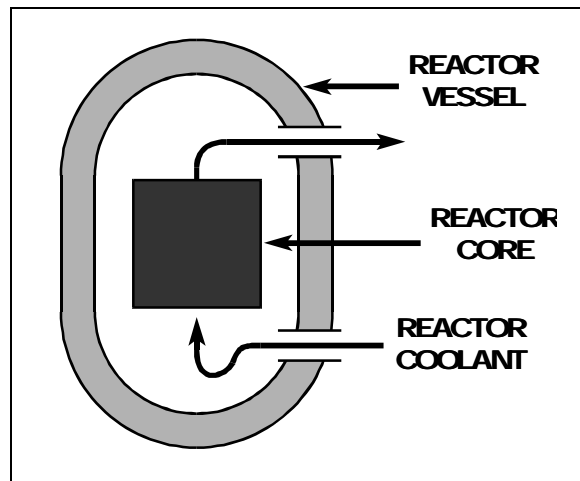

Core, Vessel, and Coolant

Containment Building

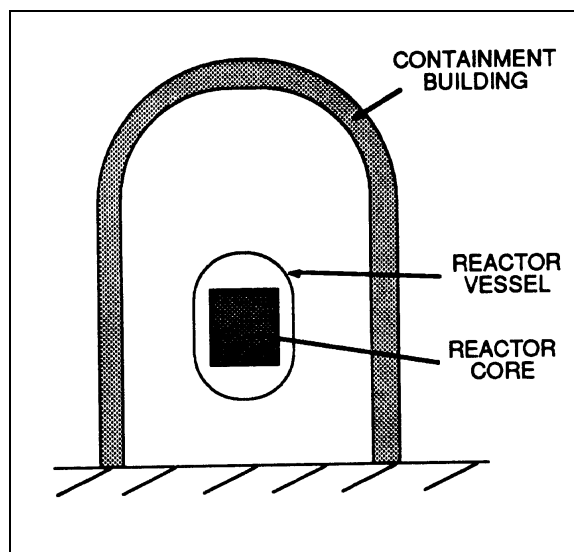

Core, Vessel, and Containment Building

The third barrier between the fission products and the environment is the containment building. The containment building is the familiar large dome-like structure which may be seen when approaching or passing many nuclear power plants. At some plants, the containment is located within a building which serves as yet another fission product barrier.

A containment building generally consists of high density, reinforced concrete as much as 6 feet (1.8 m) thick and is built to withstand not only a severe accident, but also a variety of natural and man-made hazards such as earthquakes, tornadoes, and airplane crashes.

Even if the core is severely damaged or melted (first barrier) and the primary cooling system fails (second barrier), there should be only small releases to the atmosphere because of the last fission product barrier, the containment. During the accident at Three Mile Island, there was severe core damage and some melting of the core and the primary coolant system did fail but only a small amount of fission products were released because of the effectiveness of the containment.

Although all three of these boundaries exist to prevent the inadvertent release of fission products to the environment, like all man-made things, they may fail or partially fail to perform their intended function. The failure of these boundaries may then result in the release of radioactive material to environment.

The History of Nuclear Accidents

Nuclear accidents occasionally occur, making people more concerned about the safety of nuclear power plants. Now that we have learned about the defense-in-depth measures taken in the design of nuclear power plants, we can examine some of the past nuclear power plant accidents. The most well-known nuclear power plant accidents occurred at Three Mile Island and Chernobyl. Both of these accidents involved the release of radioactive material and initiated radiological emergency management efforts. Not every accident at such plants results in public radiation exposure. Even serious accidents could occur without public exposure. Examples of some nuclear accidents which have occurred at nuclear power plants and other nuclear facilities include:

- ☞ Windscale, England (October 7, 1957). A fire at this plutonium production plant released significant amounts of radioactive material. Radioactive iodine contaminated nearby grazing land. Two million liters of milk were kept from the market. Although large amounts of radioactive material were released, no cases of acute radiation sickness occurred.
- ☞ SL-1, Idaho (January 3, 1961). Three workers were killed by an event at this small military test reactor. A control rod was ejected from the core while being manually moved by one of the workers. All three deaths were due to causes other than radiation.
- ☞ Enrico Fermi, Michigan (October 5, 1966). A partial meltdown of this reactor was caused when a component broke loose and blocked the flow of coolant. This serious accident did not result in any release of radioactive material.
- ☞ Browns Ferry, Alabama (March 22, 1975). A fire under this commercial power plant's control room was caused by use of a candle flame to check for air leaks. The fire burned the electrical cables used by plant operators to control plant equipment and to send instructions to emergency cooling equipment. This serious accident did not result in any release of radioactive material.

The worst accident at a U.S. commercial power reactor occurred on March 28, 1979 at Three Mile Island (TMI) Nuclear Station in Pennsylvania. As a result of equipment failures and human operation errors, the water level in the reactor core decreased to the point that the fuel was no longer submerged in water. Without the cooling normally provided by this water, the cladding and some of the fuel pellets melted. Large quantities of radioactive materials were released into the containment building. The containment building performed as it was designed. The radioactive releases to the atmosphere that occurred during the TMI accident were very small and resulted primarily from leaks in systems that were required to operate during the course of the accident. These systems carried water that contained very large amounts of fission products outside the containment and some leaking could not be prevented.

With all of the care and precautions involved in the defense-in-depth design of a nuclear plant, how could the TMI accident happen? At TMI, the defense-in-depth safety systems operated correctly but were shut down by qualified operators who misinterpreted the chain of events. The operators consciously turned off emergency cooling systems because they thought additional water would rupture the cooling system. The operators were convinced a valve was closed because a control panel light showed the valve had been given a signal to close. Although there were other indications that the valve was actually open, the operators continued to act to protect the system from additional water.

After TMI, the nuclear power plants have expanded their operator training programs. Plants have also modified their control room indicators, and have modified some plant equipment to prevent other accidents from occurring.

Another serious commercial power reactor accident occurred at the Chernobyl nuclear power plant in the Soviet Union. At Chernobyl, on April 26, 1986, a nuclear power plant accident released large amounts of radioactive fission products to the environment.

The Chernobyl accident was caused by a combination of errors, deliberate failure to follow procedure and a poor design. The design of the Chernobyl reactor resulted in a very rapid increase in power after the water used to cool the core was lost. As a result, the pressure increased to the point that the reactor was blown apart. Such an accident is impossible at a U.S. PWR or BWR. In PWRs or BWRs, such a loss of water would have shut down the reactor.

Thirty-one people, all of whom were onsite emergency response personnel, died as a result of the accident. Two workers were killed by an explosion. Twenty-nine were killed by acute effects of radiation exposure, and 203 were hospitalized with radiation sickness. More than 36 hours elapsed after the accident before the 135,000 people living within a 20-mile (32 km) radius of the plant were told to evacuate.

Although a very large amount of fission products was released, no one outside the Chernobyl site boundary is reported to have suffered any symptoms of direct radiation sickness. The relatively low radiation doses offsite were the result of the fission products being carried high up into the atmosphere by the explosion and resulting fire.

Practice Exercise

26. The two main safety objects of nuclear power plant design are to contain _____ and to remove _____ generated by the reactor.
27. The three fission product barriers designed into a nuclear power plant are _____, _____, and _____.

OFFSITE PROTECTIVE ACTIONS

Despite the extensive safety measures designed into each nuclear power plant, government emergency preparedness agencies require yet another degree of protection for the public. This extra step, known as "Beyond Defense-in-Depth," is intended to protect the public from the release of hazardous amounts of radioactivity from a nuclear power plant. Plant operators, as well as the federal government and the local states and counties, are required to maintain emergency plans to deal with the following radiological hazards:

- ☞ Direct exposure to radiation from a **plume** of airborne radioactive material or from radioactive material deposited on the ground.
- ☞ Internal or external contamination caused by direct contact with the plume.
- ☞ Ingestion of radioactive material.

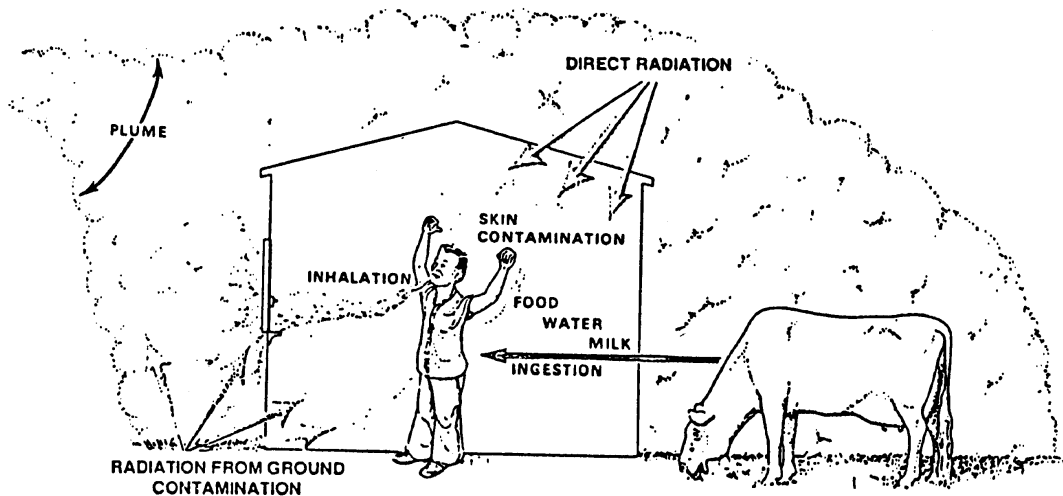

Radiation Dose Pathways

Plume Exposure

A **plume** is an airborne cloud of radioactive gases, particles and/or vapors released from a plant. In many ways, the risk from a radioactive plume is similar to that from any cloud of hazardous materials. Members of the public should avoid being immersed in the hazardous cloud, breathing from the hazardous cloud, and entering areas contaminated by the cloud's passage. Obviously, the major difference is that a plume released as a result of a major reactor accident will be radioactive and not hazardous in other ways (e.g., flammable, corrosive).

The plume could be very hot and rise as it leaves the plant (e.g., as steam rises), as was the case for the Chernobyl accident. If this is the case, the population close to the plant may be spared many of the consequences as the plume passes overhead. The plume could be released continuously over a long period, or it could be released as a very short puff. As the radioactive plume (cloud) moves away from the reactor site, radioactive materials will settle out and deposit on the ground, trees, people, etc. This is called ground contamination.

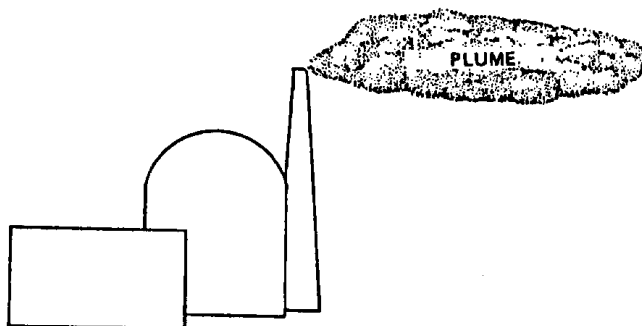

Plume

Extensive communication networks have been established to notify the public near a nuclear power plant accident. Upon notification, members of the public should listen carefully to their Emergency Broadcast System (EBS) radio or television stations to learn of the appropriate actions to be taken.

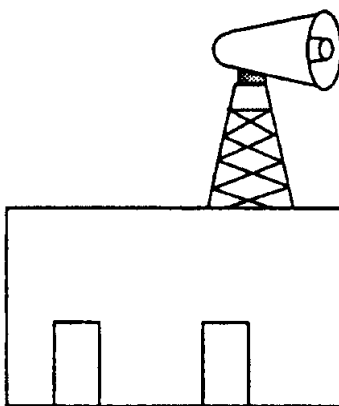

Notification Siren

In areas near operating nuclear power plants, provisions have been made to provide the public with information on what actions they should take in the event of an emergency and how they will be notified. If you live near a plant, you should obtain and study this material which is available through the county emergency planning department.

There are four levels of emergencies covered by the emergency plans at nuclear power plants. Each level requires specific actions to be taken by the plant operator and offsite officials. These levels, in order of increasing severity, are:

- ☞ Unusual Event.
- ☞ Alert.
- ☞ Site Area Emergency.
- ☞ General Emergency.

Unusual Events are events that are uncommon but, do not represent a threat to the plant or public. There are about 200 unusual events a year.

Alerts are the result of events that should be monitored closely. They also do not represent a threat to the public. There are about 10 alerts a year.

Site Area Emergencies are major failures but immediate actions by the public are not needed. At this level of emergency, the public would normally be notified and instructed to stand by for further instructions.

General Emergencies are very severe accidents that call for immediate protective action by the public. In the event of a General Emergency, the actions to be taken have been preplanned. While these events represent a major threat, a major release of radioactive material would not necessarily take place. Actions taken are precautionary. Under current federal regulations, Three Mile Island would have been a general emergency.

It is very important to realize that the emergency plans for each site are unique. The plans were developed to take into consideration local conditions and they must be studied and followed if you live near a plant. If instructions are given to take a protective action, they should be followed **promptly**.

Typical recommended protective actions following a severe nuclear power plant accident (general emergency) would be to:

- ☞ Evacuate areas close (2 to 3 miles or 3 to 5 km) to the plant in all directions and a section downwind out to 10 miles (i.e., a key hole effect).
- ☞ Shelter elsewhere within approximately 10 miles (16 km).

These actions would be recommended, if possible, **before** a major release of radioactive material. After the release, evacuation of additional sectors might be recommended if indicated by radiological monitoring in those areas. If local conditions prevent evacuation, shelter may be advised.

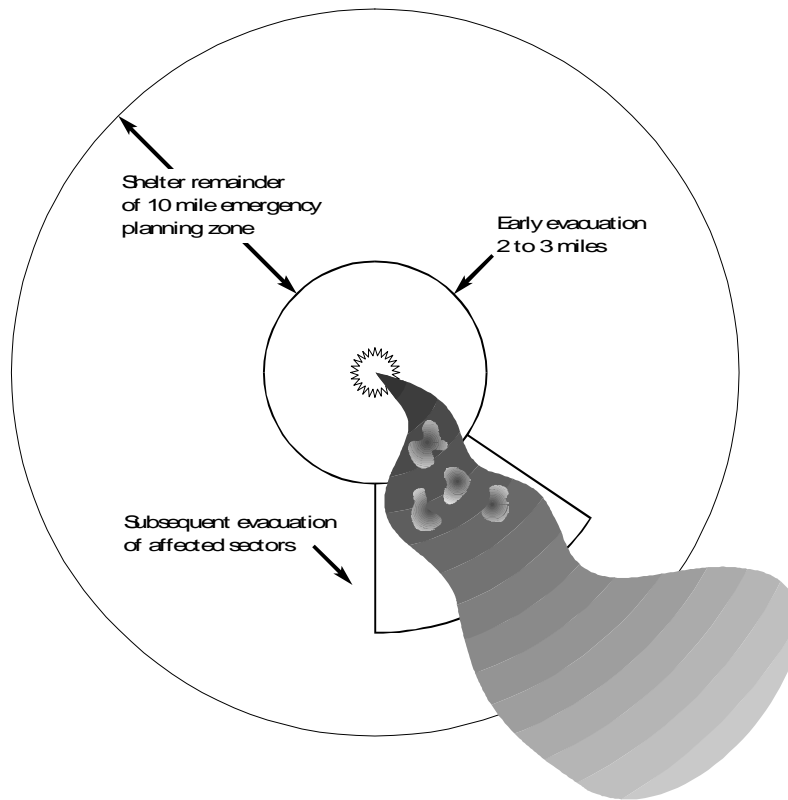

Protective Actions for Severe Nuclear Power Plant Accidents

In rare cases, as an alternative to evacuating, sheltering in a home, office or other building could provide protection just as sheltering following a nuclear detonation by a terrorist attack. As we will learn in Unit 4, a shelter would provide both distance and shielding between individuals and nuclear radiation. A home or building could similarly provide protection from the radioactive plume.

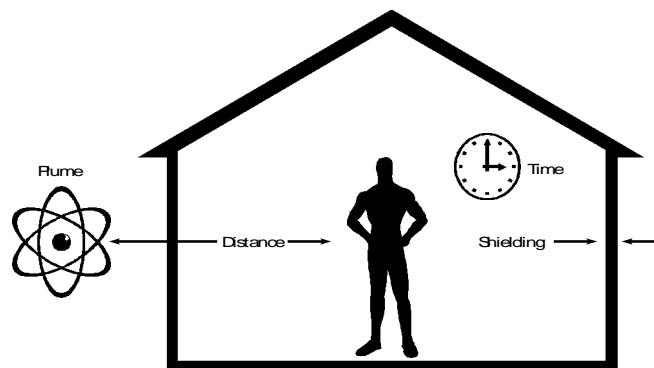

Contamination Exposure

Radioactive fission products can also present a hazard through direct contact with the exposed individuals. Contact with a plume can result in contamination of a person's clothing or skin. Airborne radioactive materials may also present an internal exposure hazard if inhaled by individuals exposed to the passing radioactive plume. Inhaled material, in addition to directly providing a dose, contains certain elements that concentrate in particular organs (e.g., lungs, bones, or thyroid) and thus become a special threat to those organs.

When taking shelter from a radioactive plume, one should take care to prevent unnecessary exposure to airborne radioactive material by closing windows and turning off air conditioners and ventilation fans. Additional protection actions may be recommended by the local authorities.

Ingestion Exposure

Radioactive material from a radioactive plume may be ingested by man from a variety of pathways. For example, radioactive particles deposited on the ground may be eaten by grazing cattle whose meat or milk is consumed by man.

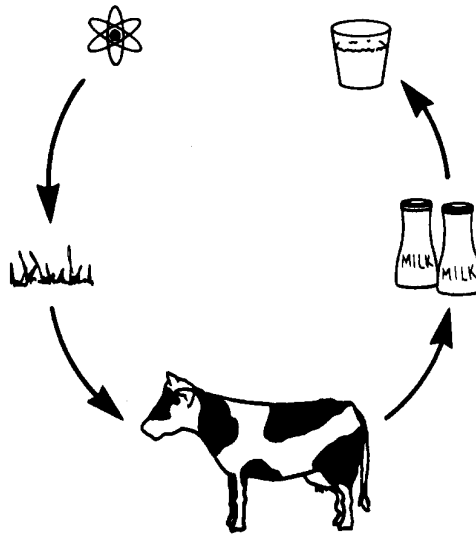

Ingestion Pathway Example: Milk

The public should heed official warnings to prevent this sort of exposure. In addition, state and local officials will conduct tests to determine if there are problems with local food, water or milk supplies.

Special protective actions are available to prevent exposure to radioactive iodine. Iodine is a major fission product which may be released during nuclear power plant accidents. Iodine is of particular interest because it tends to concentrate in the thyroid gland, just as iron concentrates in blood or calcium in bone.

An amount of radiation exposure which would be of little concern if spread throughout the entire body, may become a problem if concentrated in the thyroid. To prevent this exposure, you may be advised to take a **thyroid blocking agent**.

A thyroid blocking agent is a pill, typically containing potassium-iodide. The thyroid blocking agent contains non-radioactive iodine which, when taken before or immediately after exposure to radioactive iodine, saturates the thyroid with non-radioactive iodine. Since additional iodine will not be absorbed by the thyroid, any radioactive iodine subsequently taken up by the body will remain spread throughout the body and will be quickly excreted.

It must be understood that use of a thyroid blocking agent is not an adequate substitute for prompt evacuation or sheltering by the general population near a plant in response to a severe accident. Ingestion of a thyroid blocking agent will serve only to reduce the dose to the thyroid caused by intake of radioactive iodine. The primary risk to the population from a severe accident is whole body dose, not the dose to the thyroid.

Practice Exercise

28. Emergency plans are developed for nuclear power plants to address the following three radiological hazards: _____, _____, and _____.
29. In areas near operating nuclear power plants, information on what actions the public should take following an accident and how they will be notified has been prepared. If you live near a plant, you should obtain and _____ this material.
30. Although events representing a general emergency represent a major threat, a major release of radioactive material would not normally take place. Actions taken are _____.
31. When notified to take protective actions following a nuclear accident, the instructions should be followed _____.
32. In the event if an accident at a nuclear power plant, special protective actions may be taken to prevent exposure to radioactive _____.

UNIT 3 REVIEW

This unit described the hazards and protective measures associated with a nuclear power plant accident. The defense-in-depth approach used in designing U.S. nuclear plants ensures that most accidents will not result in the release of radioactive materials. Even in the accident at Three Mile Island, the vast majority of radioactive material was contained. The accident at Chernobyl released much larger quantities of radioactive material than were released during the Three Mile Island accident.

Each U.S. nuclear plant has an emergency plan as do the Federal government and the state, counties, and local jurisdictions. These plans describe actions to minimize public exposure that could result from a serious accident. The plans address exposure to radioactive plumes and exposure from ingesting radioactive material into the body.

UNIT 3 REVIEW QUESTIONS

Answer the following questions to review your knowledge of this unit. Read each question carefully and circle the correct answer.

1. Which one of the following components distinguishes a nuclear power plant from a coal or oil burning plant?
 - a. Turbine
 - b. Condenser
 - c. Cooling tower
 - d. Pump
 - e. Heat source

2. A power plant's condenser may be cooled through the use of a cooling tower or:
 - a. Water from a nearby lake, river, ocean or man-made reservoir
 - b. Steam exhausted from the turbine
 - c. Refrigeration systems
 - d. Direct evaporation

3. A cooling tower is:
 - a. A large concrete structure built to contain the nuclear reactor and prevent the release of fission products
 - b. A component of nuclear power plants only
 - c. A structure used to prevent harmful temperature increases in lakes and rivers
 - d. A large hollow concrete structure filled with water

4. The fuel used at nuclear power plants is made of:
 - a. Fission products
 - b. Uranium
 - c. Fossil fuels
 - d. Neutrons
5. When an atom of nuclear fuel is struck by a free neutron, it fissions yielding:
 - a. Additional free neutrons, heat, and fission products
 - b. Heat, fission products, and plutonium
 - c. Fission products, radiation, and plutonium
 - d. Plutonium, heat, and additional free neutrons
6. Which of the following is NOT a barrier to the release of fission products?
 - a. Fuel cladding
 - b. Reactor vessel and primary coolant system
 - c. Containment building
 - d. Cooling tower
7. Upon notification of a nuclear power plant accident, individuals should:
 - a. Evacuate immediately
 - b. Seek a shelter
 - c. Call the local emergency program manager for instructions
 - d. Listen to the EAS radio or TV stations to learn of appropriate protective actions

Radiological Emergency Management Independent Study Course

8. If a nuclear power plant accident results in the release of a radioactive plume, an individual 30 miles (48 km) downwind should be concerned about:
 - a. Direct exposure to radiation from the passing plume
 - b. Direct exposure to radiation from fallout
 - c. Contaminated food and water
 - d. The need for sheltering or evacuation
9. Fuel rods are grouped side-by-side to form a:
 - a. Control rod
 - b. Fuel cladding
 - c. Fuel assembly
10. A thyroid blocking agent protects the user from:
 - a. An over-active thyroid
 - b. External radiation sources
 - c. Dispersal of radioactive iodine throughout the body
 - d. Concentration of radioactive iodine in the thyroid

UNIT 3 REVIEW ANSWER KEY

1. e
2. a
3. c
4. b
5. a
6. d
7. d
8. c
9. c
10. d

Unit **4** Nuclear Threat

In this unit you will learn:

- ☞ Nuclear weapon detonation characteristics and effects
- ☞ Protective measures against effects
- ☞ Exposure rate determination after a detonation

INTRODUCTION

The end of the cold war and the dissolution of the Soviet empire has changed, not eliminated, the nuclear threat to the United States. Other countries who previously had the weapons but did not have weapon delivery vehicles able to reach the United States now have the ability to do so. Improvised nuclear devices (IND) or radioactive dispersal devices (RDD) (radioactive material placed inside a conventional explosive device) are becoming increasingly possible. These IND weapons are within a terrorist's ability to employ. The threat of a terrorist using weapons of mass destruction is increasing. A critical priority for the United States is to stem the proliferation of nuclear weapons and their delivery systems. Efforts are being made to account for and control all existing nuclear weapons and radioactive material worldwide. The United States also seeks to prevent additional countries and terrorist groups from acquiring nuclear weapons.

There is no doubt that a nuclear weapon detonation, either from an accident or an attack, would be a catastrophe. This unit is not intended to trivialize the tremendous destructive power represented by nuclear weapons. It is designed to inform you of actions you can take to increase your chance of survival in the event of nuclear detonation.

This unit provides a basic understanding of the potential hazards you may encounter in the event of a nuclear detonation and protective measures required to minimize your exposure to these hazards. Upon completion of this unit, you should be able to recognize the severity of a nuclear detonation and prioritize your actions in order to minimize the potential effect that the situation and hazards may have on you.

This unit is divided into three major sections: Nuclear Detonation, Protective Measures, and Exposure Rate Determination. Each of these sections contains information that can be used to enhance your chances for surviving a nuclear detonation.

The **Nuclear Detonation** section describes the different types of hazards that result from the nuclear explosion. These hazards include the effects from the flash, thermal and blast waves, initial nuclear radiation, and the longer-term hazard from radioactive fallout.

The **Protective Measures** section describes actions you can take to protect yourself and others from the hazards discussed in the Nuclear Detonation section. These measures include actions that can help you survive the immediate thermal and blast hazards, and guidance for minimizing your exposure to radioactive fallout.

The **Exposure Rate Determination** section describes how to predict radiation exposure rates at various time periods after an initial radiation survey is performed. This section describes how to use a radiation survey instrument and presents a simple calculation for projecting exposure rates after a nuclear blast.

NUCLEAR DETONATION

In general terms, a blast or explosion is a rapid release of a large amount of energy within a limited space. There are five basic differences between nuclear and conventional blasts:

- ☞ Nuclear explosions are caused by an unrestrained fission reaction whereas conventional explosions are caused by chemical reactions.
- ☞ Nuclear explosions can be millions of times more powerful than the largest conventional explosions.
- ☞ Nuclear explosions create much higher temperatures and much brighter light flashes than conventional explosions, to the extent that skin burns and fires can occur at considerable distances.
- ☞ Nuclear explosions are accompanied by highly penetrating and harmful radiation
- ☞ Radioactive debris is spread by a nuclear blast, to the extent that lethal exposures can be received long after the explosion occurs.

The power of a nuclear explosion is expressed in terms of its relationship to TNT due to the enormous power possessed by a single nuclear weapon, the explosive energy available is equivalent to thousands of tons (kilotons) or even millions of tons (megatons) of TNT. For example, if a nuclear explosion releases energy equivalent to 7,000 tons (6 million kilograms) of TNT, it is called a 7 kiloton blast.

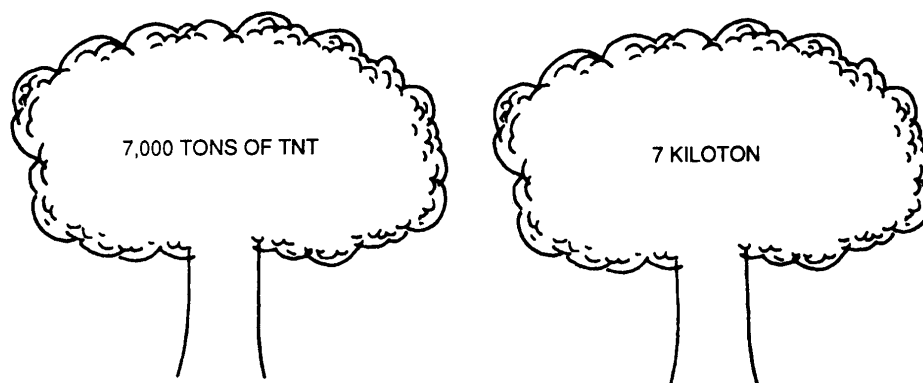

7,000 Tons of TNT = 7 Kiloton Blast

In this section, you will learn about the different types of hazards that result from a nuclear detonation. The energy yielded immediately by a blast presents hazards **from blast or shock effects, thermal radiation effects, and nuclear radiation effects**. You will also learn how longer-term hazards, such as radioactive fallout, could result from a nuclear detonation.

Types of Burst

The destructive forces associated with a nuclear explosion vary with the location of the point of burst in relation to the surface of the earth. The main types are:

- ☞ **High Altitude Burst.** Detonation above 100,000 feet. Destructive forces do not significantly affect the ground.
- ☞ **Air Burst.** The fireball does not touch the ground. Detonation is below 100,000 feet.
- ☞ **Surface Burst.** Detonation occurs at or slightly above the actual surface of the earth. The blast kicks up considerable radioactive debris. “Dirty Bomb”
- ☞ **Sub-surface Burst.** Detonation occurs under ground or under water. Depth determines destructive forces on the surface.

Energy Yield

The total energy released in nuclear explosion is called the weapon's energy yield. The energy yield of a nuclear explosion takes three forms:

- ☞ Thermal radiation (light and heat)
- ☞ Blast or shock effect
- ☞ Nuclear radiation

Thermal Radiation

The energy yield of a nuclear blast also includes tremendous amounts of light and heat, as if an enormous sun lamp was flashed on for a matter of seconds. This flash of light and heat, called **thermal radiation**, travels ahead of the winds and overpressure. The light flash is so intense that it can cause "flashblindness" and even skin burns. When flashblind, people are unable to see what is going on around them or what they are doing. A 6 kiloton blast could cause flashblindness 0.5 miles (0.8 km) away on a clear day, or 20 miles (32 km) away at night. Many people in Hiroshima and Nagasaki were blinded for several minutes. Some cases of flashblindness lasted up to three hours, and one person suffered permanent blindness. A nighttime blast probably would have caused more severe blinding effects due to the degree of pupil enlargement and focusing actions of the eye.

The high intensity of light is strong enough to cause skin burns. A 10 kiloton blast can cause first degree burns 2 miles (3.2 km) away on a clear day. First degree burns are equivalent to a bad sunburn. The same blast can cause second degree burns 1.5 miles (2.4 km) away. Second degree burns over 30 percent of the body will result in serious shock and death without medical attention. Blisters from second degree burns will become infected if untreated. The same blast can cause third degree burns about 1.0 miles (1.6 km) away. Third degree burns destroy skin tissue, to the extent that such burns over 24 percent of the body will cause serious shock and death without specialized medical care.

The temperatures at the center of a nuclear explosion can reach tens of millions of degrees. Although temperatures fall off rapidly with increasing distance, a nuclear blast is capable of causing skin burns and setting fires at considerable distances. There is evidence from data gathered in Japan that temperatures may exceed 3,000°F (1650°C) as far as 3,200 feet (975 meters) away.

In a low yield surface burst, of the type possible in a terrorist attack, the amount of thermal energy reaching a target at a specific distance may be half to three fourths of that from an air burst of the same total energy yield. Thermal energy received at a distance will be affected by:

- ☞ Shielding due to buildings and terrain irregularities
- ☞ Absorption in low layer dust and water vapor
- ☞ Absorption by the heavier air near the earth's surface

Blast or Shock Effect

Nuclear explosions are similar to conventional explosions to the extent that their immediate destructive action is due mainly to **blast or shock**. The rapid release of energy within a small enclosed space causes a considerable increase in temperature and pressure. All materials present within this space are converted into hot, compressed gases. These highly compressed gases expand rapidly, causing a **shock wave** in the surrounding medium (air, water or earth). The shock wave drives air away from the center of the explosion. This action produces sudden changes in air pressure that can crush objects and create high winds that can knock people and structures down. The shock wave is characterized by a sudden increase in air pressure at the front, followed by a gradual decrease.

DIRECT EFFECTS OF 10 KT BLAST (SURFACE BLAST)

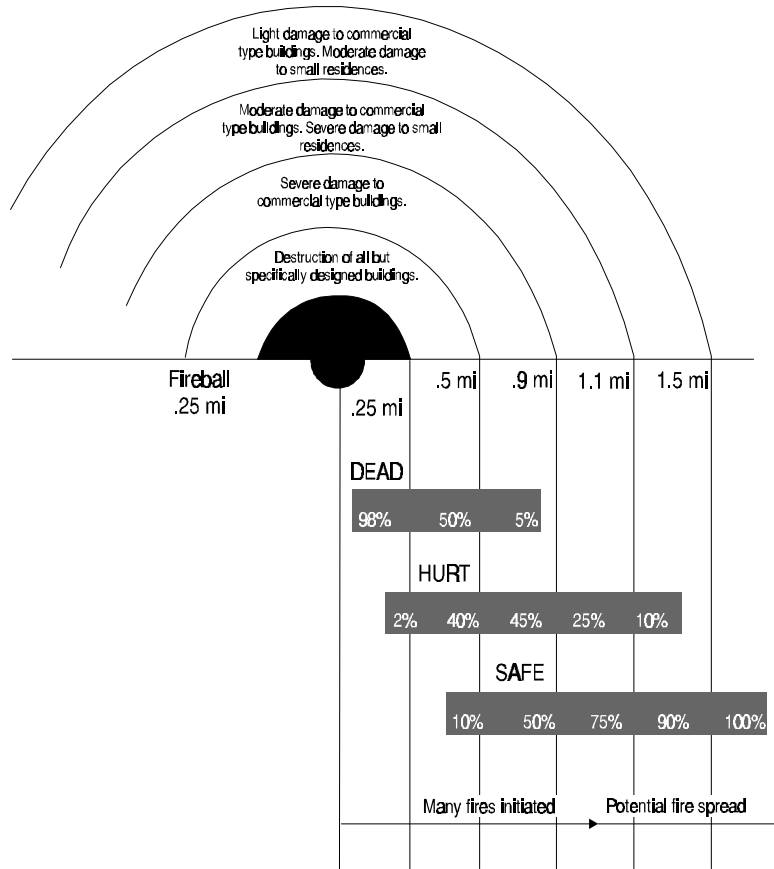

Shock Wave Effects On Air Pressure

The resultant shock wave from a nuclear explosion can destroy buildings and other structures for miles around. For example, .25 miles (0.4 km) away from a 10 kiloton blast, the air pressure could exert an excess force of over 5 pounds per square inch (psi). This 5 psi (0.35 kg/cm²) "overpressure" is the same as a force of over 180 tons (160,000 kg) slamming against the side of a typical two-story house. At the same place, there would be a wind of 160 miles per hour (260 km per hour). Although your body could withstand overpressure up to 30 psi (2.1 kg/cm²), the winds accompanying an overpressure of as little as 2 to 3 psi (0.15 to 0.21 kg/cm²) could blow people out of a typical office building.

Practice Exercise

33. The power of a nuclear explosion is expressed in terms of its relationship to _____.

34. The total effective energy released during a nuclear explosion is called the weapon's _____.

Nuclear Radiation

The third form of energy released by a nuclear blast is **nuclear radiation**. The radiation from a nuclear explosion is subdivided into two categories:

- ☞ Initial nuclear radiation
- ☞ Residual nuclear radiation (radioactive fallout)

Initial nuclear radiation is the radiation emitted within the first minute after a nuclear explosion. The initial radiation consists mainly of gamma rays and neutrons. As discussed earlier, these types of radiation are highly penetrating and travel great distances through air. Although they can neither be seen nor felt, gamma rays and neutrons can produce harmful effects even at a large distance from their source. The large quantity of gamma radiation absorbed by the surrounding air and ground will create a quick pulse of electromagnetic waves. This pulse, called the **electromagnetic pulse (EMP)**, is not considered a biological hazard to people. However, EMP will severely damage electrical components attached to power lines or communication systems.

Residual nuclear radiation arises mainly from the radioactive materials produced during the blast. These radioactive materials, like all radioactive materials, attempt to become stable by emitting gamma rays, alpha particles, and beta particles.

Radioactive Fallout

Even if individuals are not close enough to a nuclear blast to be affected by the energy yield, they may be affected by the resultant radioactive fallout. Any nuclear blast will result in some fallout. Explosions that occur near the earth's surface create much greater amounts of fallout than explosions that occur at high altitudes.

How Fallout is Created

The tremendous heat produced by any conventional or nuclear blast causes an up-draft of air which forms the familiar mushroom cloud. When a nuclear blast occurs near the earth's surface, millions of vaporized dirt particles are also drawn into the cloud. As the heat diminishes, any radioactive materials that have been vaporized condense on the drawn-up dirt particles, which are also condensing.

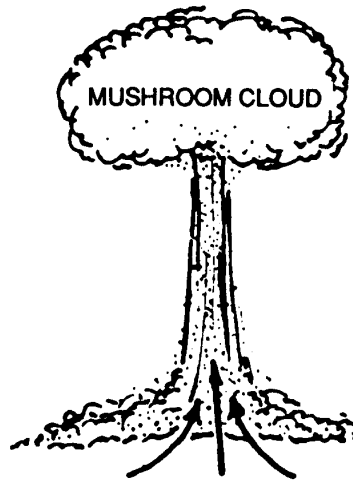

Particles of Earth Drawn Up Into Mushroom Cloud

Eventually these particles fall back to earth. This phenomenon is called **radioactive fallout**. This fallout material decays over a long period of time, and is the main source of the residual nuclear radiation.

Hazards of Fallout

Radioactive fallout emits alpha, beta, and gamma radiation. Alpha particles emitted from fallout on the ground are not considered a serious hazard, since the source is outside the body. However alpha particles are harmful if the alpha-emitting source is taken into the body. The beta radiation which is much less penetrating than gamma radiation, may cause skin burns if the fallout remains on the body surface for a prolonged period of time. Exposure from the gamma radiation is considered the major hazard as a result of fallout.

The extent, nature, and arrival time of fallout are difficult to predict accurately due to variables such as:

- ☞ Energy yield of the weapon--a more powerful bomb will produce more fallout.
- ☞ Height of explosion--a ground level blast will produce more fallout than an elevated blast.

- ☞ Nature of surface beneath explosion--some materials are more likely to become radioactive and to become airborne.
- ☞ Meteorological conditions--wind speed and direction will affect the arrival time of fallout; precipitation may wash out fallout from the atmosphere prematurely.

Distribution of Fallout

The irregularity of the fallout distribution is demonstrated in the figure below, which shows the fallout patterns of two separate Nevada weapons tests. The high altitude winds of the day play a major role in determining the fallout distribution pattern. In Test-1, the winds carried fallout predominately to the north. In Test-2, the winds initially carried fallout to the west, then shifted to the northeast. The numbers associated with each gradient of fallout represents the dose rate (in mRAD/hr) in that area.

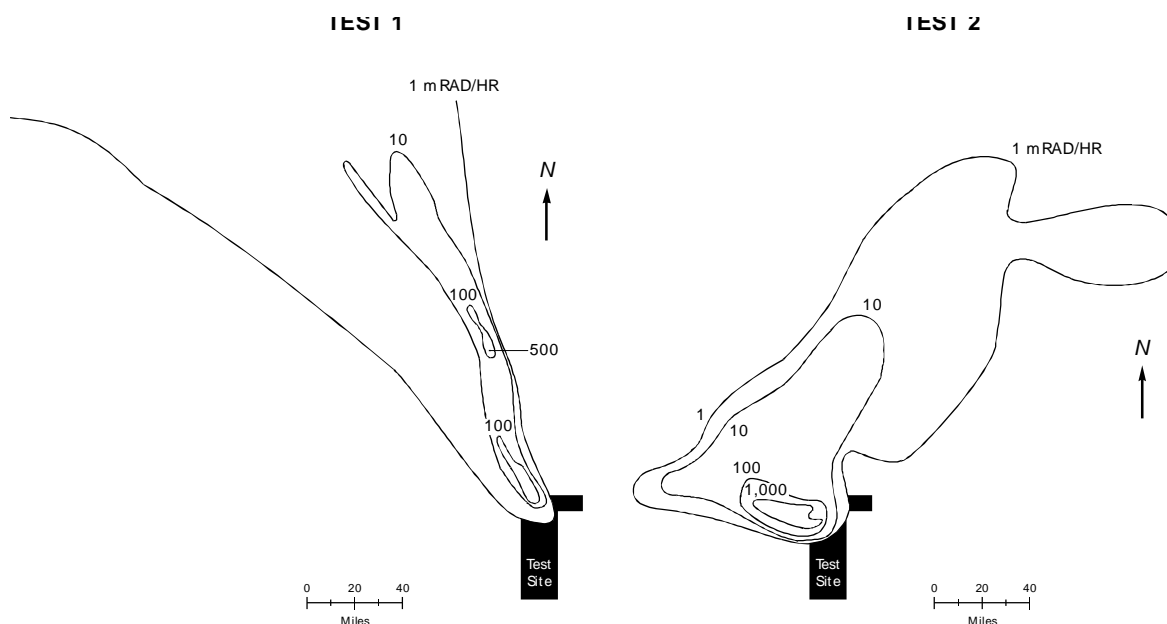

Effect of High-Altitude Winds on Fallout Distribution

Emergency plans state that the expected time of fallout arrival will be announced during an official public warning. However, any notice of an increasing surface buildup of gritty dust and dirt should be a warning of a need for protective measures.

PROTECTIVE MEASURES

The previous section described the different types of hazards from a nuclear detonation. This section describes the types of protective actions one can take to minimize the harmful effects of an explosion. The protective actions against immediate blast hazards are much different than the protective measures against fallout.

Minimizing Immediate Blast Hazards

Within a certain radius of a given blast, total destruction of life and property from the blast and thermal effects is inevitable. High initial neutron and gamma radiation exposures may result in additional casualties. Table 4-1 below shows typical distances associated with certain effects of a 10 kiloton explosion.

Table 4-1
Distances of Effects From a 10 Kiloton Nuclear Bomb

Effect	Range		Area	
	miles	km	square miles	square km
Blast and Thermal Crater (everything is vaporized)	0.25	0.4	0.19	0.5
Destruction of brick structures	0.9	1.4	2.5	6.1
Destruction of wooden structures	1.5	2.4	7	18
Forest fires (dry conditions)	3-6	5-10	28-113	78-314
Nuclear Radiation Immediate death from initial radiation	.5	.8	1	2
Fallout sufficient to kill persons in the open	10	16	314	803

Obviously, the distance away from the blast is very important in determining survival chances. Within the most destructive radius, protection from the blast and thermal pulse is highly unlikely. If warned of an impending nuclear detonation, take shelter in the best protected facility available.

It is also possible to avoid blast effects and exposure to much of the thermal radiation if **evasive action**, such as falling face down behind a substantial object and shielding the eyes, is taken immediately. In certain circumstances it may mean the difference between life and death. Weapons tests suggest that a typical residence will be collapsed by an overpressure of about 5 psi (0.35 kg/cm²). People standing in such a residence have a 50 percent chance of being killed by an overpressure of 3.5 psi (0.25 kg/cm²), but people who are lying down at the moment the blast wave hits have a 50 percent chance of surviving a 7 psi (0.5 kg/cm²) overpressure. This leaves the survivors of the blast with a need for protective measures against the radioactive fallout.

Minimizing Exposure to Fallout

Fallout, as you have learned, is radioactive material. This means that fallout emits radiation. This section describes how to minimize the dose of nuclear radiation one receives from fallout. The section begins by showing the important distinction between radiation and contamination. This section also describes how one can use the three factors of time, distance, and shielding to minimize dose. The section concludes with procedures that can be used enroute to a shelter and while inside a shelter.

Contamination vs. Radiation

Radioactive material deposited in undesired locations is called radioactive contamination. The difference between contamination and radiation is important to understand. You can be exposed to radiation without becoming contaminated. When you are exposed to radiation, the radiation does its damage, expends all its energy, and is gone. If you carry contamination on your clothes or body, the material continues to emit radiation as long as it is radioactive.

Radiation is related to contamination in the same way that odor is related to manure and fertilizer. The following analogy illustrates this point. If you stand next to a freshly fertilized field, you can smell the fertilizer (manure). When you walk away from the field, you leave the odor behind. If you had stepped into the field, you would carry some of the fertilizer (manure) away with you on your shoes, and may be able to smell the odor of fertilizer until you clean your shoes. In the same way, if you stand next to contamination, you will be exposed to radiation. As long as you don't get the contamination on your body or clothes, you can walk away and leave the source of radiation behind. If you get contamination on your body, you will continue to be exposed to radiation until you wash the contamination off of your body. The radioactive material continues to emit radiation, but you are no longer carrying it with you.

Protection from Radioactive Fallout

As discussed in Unit 1, the three important methods of reducing radiation exposure are **time, distance, and shielding**. To minimize exposure to fallout, these methods are implemented by seeking shelter.

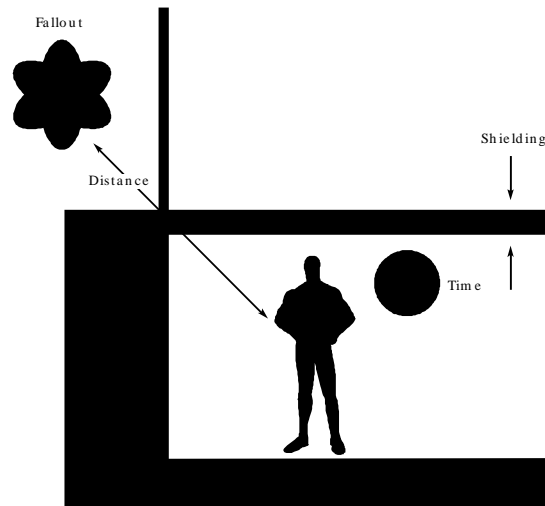

**A Basement Provides Some Protection From Radioactive Fallout
-- Shelter Provides Time, Distance and Shielding**

If a warning is given, or fallout starts to arrive, proceed to shelter that provides the best possible shielding. These include locations such as basements, interior rooms of a house, highway culverts, etc.

Remember that fallout consists of particles of earth, fission products and other materials returning to the earth's surface. If dust like particles are visible in the air or on surfaces, they should be considered a radiation hazard.

If fallout has arrived before reaching shelter, cover as much of the body as possible to keep particles from depositing on the skin. This should include, as a minimum, long sleeves, hat and gloves. If adequate clothing is not available or time not sufficient, make use of any available material such as newspaper to cover the head. Placing hands in the pockets help keep them as fallout free as possible. Remember that fallout particles that remain on the skin for several hours may cause skin burns.

When fallout particles are seen on clothing, brush them off. It is a good idea to minimize the amount of fallout transported into the shelter. Remember, radioactive fallout on a surface does not make the surface itself radioactive. The particles themselves are radioactive, not the surface they come in contact with. The surface can usually be cleaned of any contamination.

It is unlikely that enough fallout particles could be inhaled into the lungs to cause significant harm. However, if it is very dusty, a folded cloth over the nose and mouth may act as a filter. This can prevent some ingestion or inhalation of the fallout particles.

The primary objective at this point is survival. If it becomes necessary to take shelter, the outside exposure rate will be much greater than any fallout an individual could track into a shelter. Do not delay entry into a shelter for the purpose of removing fallout completely from clothing.

Actions Inside Shelter

Once safely in a shelter, secure all unnecessary vents or openings to prevent the wind from blowing fallout particles into the shelter. Unnecessary openings would be doors and windows since they are not necessary for the survival of the occupants. Ventilation passages must be kept open all or most of the time; they are considered vital to the survival of the shelter's occupants.

Contamination of food and water supplies is not a big problem. Public water supplies will generally be safe for use, and any food or water stored in a shelter should be used. Uncontaminated food and water supplies should be used first. Thereafter, contaminated supplies should be used. Do not keep anyone from eating or drinking on the basis that supplies may be contaminated. The remote health risks associated with consuming contaminated food and water are preferable to starvation .

Take every precaution to keep stored food and water from becoming contaminated by fallout particles. Keep water and food covered or in closed containers. Any water or food brought to a shelter from the outside should be carefully inspected for contamination. If contamination is visible or detected, wipe the outside of all containers. Fruit and vegetables should be washed if possible, and peeled or pared where applicable.

If it becomes necessary to perform urgent missions outside of the shelter, take every precaution possible to protect the body from fallout particles. Wear outer clothing that can be removed and disposed of upon return to the shelter. Plan your route and safe travel times in advance, and minimize the time spent outside the shelter. Finally, postpone ventures outside the shelter as long as possible to allow the natural radioactive decay of the fallout to reduce radiation levels.

Generally, the actions and measures that can be taken for protection from radioactive fallout, both inside and outside a shelter, are limited. However, when you take the time to consider the basic protective factors - time, distance and shielding - common sense will be your greatest asset.

Practice Exercise

35. The major hazard to the public resulting from radioactive fallout is exposure due to _____.
36. Radioactively contaminated food in a shelter (should/should not) be consumed if uncontaminated food is unavailable.

EXPOSURE RATE DETERMINATION

At some point after a nuclear detonation, sheltered personnel will find the need to begin performing outside operations (i.e., gathering additional food supplies or medical equipment). Such operations cannot begin until the exposure rate is low enough to support limited outside emergency activities without damaging those who leave the shelter. The proper evaluation of exposure rates and exposures is an integral part of public safety following a nuclear detonation, and the subject of the remainder of this unit.

Fallout particles accumulate on the ground, roofs of buildings, bushes, ledges, and all other surfaces exposed to the environment. As fallout accumulates, the unsheltered exposure rate will increase until most of the particles have fallen. At this point, exposure rates will begin to decrease with time due to **radioactive decay**. The decrease is rapid at first, then gets slower and slower. The exposure rates decrease according to the rate of radioactive decay.

Radiological Survey Instruments

The most effective method for determining exposure rates is with the use of **radiological survey instruments**. These survey instruments typically consist of a chamber in which nuclear radiation interacts, yielding an electric pulse or current, and electronic circuitry which converts the current into a meaningful readout. Most survey instruments maintained for emergency management are powered by standard D cell batteries making them portable and fairly easy to maintain in operational condition.

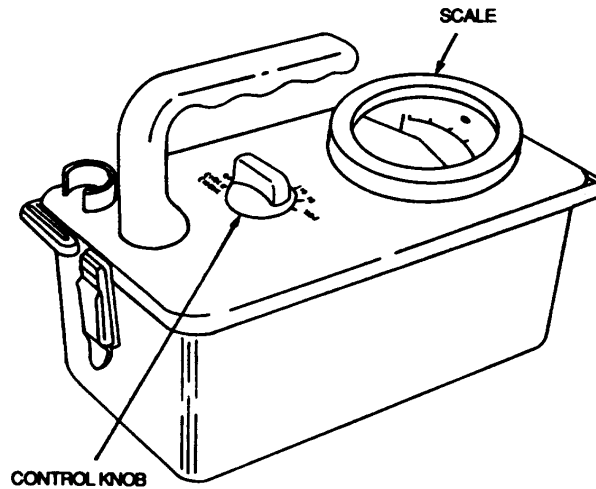

Radiological Survey Instrument

To determine exposure rates with a survey instrument, follow the operating instructions for that instrument. The procedure varies for different detectors.

The 7:10 Rule of Thumb

From the exposure rate determined by a survey instrument, future exposure rates may be predicted from a basic rule known as the "**7:10 Rule of Thumb**." The 7:10 Rule of Thumb states that for every 7-fold increase in time after detonation, there is a 10-fold decrease in the exposure rate, where the rate is the same unit as the time increase; i.e., 7 days, R/day.

Like any rule of thumb, the answers obtained are only approximations. Also, the rule assumes that the time of detonation is known and that fallout from only one detonation is present in relatively significant quantities. For accuracy and reliability, nothing can replace a direct instrument reading. However, depending on circumstances, it may become necessary to apply this general rule to predict when conditions may allow short trips outside a shelter.

Two example problems are worked out step-by-step. A third problem is presented for you to work on your own.

Example Problem 1

If the exposure rate 1 hour after detonation is 1,000 R/hr, what will the exposure rate be 343 hours after detonation?

There are three steps involved in solving this kind of problem. The first step is to determine the number of seven-fold increases in time after detonation between when the initial measurement was obtained and the future time of interest. The second step is to determine the expected magnitude of decrease during the time period of interest. The third step is to calculate the predicted exposure rate.

- ☞ Step 1: Between the initial measurement (taken 1 hour after detonation) and the future time of interest (343 hours after detonation), there are 3 seven-fold increases in time after detonation:

$$(1 \text{ hour}) (7)(7)(7) = 343 \text{ hours}$$

- ☞ Step 2: During three seven-fold increases in time, the magnitude of decrease in exposure rates is 1,000-fold. One thousand was calculated by multiplying 10 by itself three times:

$$(10)(10)(10) = 1,000$$

- ☞ Step 3: The predicted exposure rate is 1 R/hr, which is 1,000 times less than the initial measurement of 1,000 R/hr. The solution for this step was performed as follows:

$$\begin{aligned} \text{Predicted exposure rate} &= \frac{\text{Initial measurement}}{\text{Magnitude of decrease}} \\ &= 1 \text{ R/hr} \end{aligned}$$

For this example, the solution for this step looks as follows:

$$\begin{aligned} \text{Predicted exposure rate} &= \frac{1,000 \text{ R/hr}}{1,000} \\ &= 1 \text{ R/hr} \end{aligned}$$

Example Problem 2

If the exposure rate 5 hours after detonation is 200 R/hr, what will the exposure rate be 35 hours after detonation?

☞ Step 1: There is one seven-fold increase in time after the detonation:

$$(5 \text{ hours})(7) = 35 \text{ hours}$$

☞ Step 2: The expected magnitude of decrease in exposure rates is ten-fold (10 times itself once).

☞ Step 3: The predicted exposure rate is 20 R/hr, which is 10 times less than the initial measurement of 200 R/hr.

$$\begin{aligned} \text{Predicted exposure rate} &= \frac{200 \text{ R/hr}}{10} \\ &= 20 \text{ R/hr} \end{aligned}$$

Example Problem 3

If the exposure rate 1 hour after detonation is 1,000 R/hr, what will the exposure rate be 49 hours after detonation?

☞ Step 1: Number of seven-fold increases in time = _____

☞ Step 2: Magnitude of decrease = _____

☞ Step 3: Predicted exposure rate = _____

The correct answers for each step, and their solutions, are shown below:

Step 1: Number of seven-fold increases in time = 2

$$(1 \text{ hour}) (7) (7) = 49 \text{ hours}$$

Step 2: Magnitude of decrease = One hundred-fold

$$(10) (10) = 100$$

Step 3: Predicted exposure rate = 10 R/hr

$$\frac{1000 \text{ R/hr}}{100} = 10 \text{ R/hr}$$

Practice Exercise

37. After most of the fallout particles have accumulated, radiation levels will begin to decrease due to _____.
38. If the exposure rate due to radioactive fallout is 50 R/hr six hours after detonation, the exposure rate expected after 42 hours is _____.
39. If the exposure rate due to radioactive fallout is 1,000 R/hr one hour after detonation, the exposure rate expected after 49 hours is _____.

UNIT 4 REVIEW

This unit described the hazards and protective measures associated with a nuclear detonation. The energy yield of a nuclear explosion takes the form of blast or shock, thermal radiation and nuclear radiation. Each of these energy forms has distinct hazards. Radioactive fallout presents a potential long term hazard after the immediate energy yield no longer threatens life or health.

Radiological survey instruments provide the most effective way to determine exposure rates. Once an exposure rate is determined, the "7:10 Rule of Thumb" can be used to predict future exposure rates.

UNIT 4 REVIEW QUESTIONS

Answer the following questions to review your knowledge of the Nuclear Threat unit. Read each question carefully and circle the correct answer.

1. Nuclear explosions share one similarity with conventional explosions in that their initial destructive action is mainly due to which of the following effects?
 - a. Blast or shock
 - b. Thermal radiation
 - c. Nuclear radiation
 - d. Fallout

2. The total effective energy released during a nuclear explosion is called the weapon's:
 - a. Thermal release
 - b. Nuclear release
 - c. Yield
 - d. Radioactivity

3. The major hazard to the public resulting from radioactive fallout is exposure due to:
 - a. Alpha particles
 - b. Beta particles
 - c. Gamma rays
 - d. Neutrons

4. Identify which of the following actions should be followed if radioactive fallout begins to arrive before an individual reaches adequate shelter.
 - a. Immediately take the closest shelter available and wait for fallout to cease.
 - b. Adjust clothing to cover as much of the skin as possible and proceed to adequate shelter.
 - c. Stand still to avoid excessive contact with fallout particles and proceed once fallout has ceased.
 - d. No action necessary, since neither alpha nor beta particles can harm people.
5. Which of the following is a true statement concerning food and water supplies in a fallout shelter?
 - a. Consume contaminated food and water first.
 - b. Do not consume any contaminated food or water.
 - c. Do not prevent food or water consumption on the basis that they might be contaminated.
6. The phenomenon which accounts for the decrease in fallout exposure rates over time is called:
 - a. Radioactive decay
 - b. Acid rain
 - c. Spontaneous fission
 - d. Fusion
7. The most accurate and reliable tool for determining exposure rates is:
 - a. Fallout dust color
 - b. 7:10 Rule of Thumb
 - c. Survey instruments
 - d. Exposure probes

Radiological Emergency Management Independent Study Course

8. Most radiological survey instruments are powered by:
 - a. AC line current
 - b. High voltage AC current
 - c. Solar energy cells
 - d. Batteries

9. Using the 7:10 Rule of Thumb, how long will it take an exposure rate of 1,000 R/hr, measured 1-hour after detonation, to decrease to 10 R/hr?
 - a. 7 hours
 - b. 10 hours
 - c. 49 hours
 - d. 100 hours

10. If the exposure rate due to radioactive fallout is 60 R/hr five hours after detonation, the exposure rate expected after 35 hours is:
 - a. 2 R/hr
 - b. 6 R/hr
 - c. 30 R/hr
 - d. 40 R/hr

UNIT 4 REVIEW ANSWER KEY

1. a
2. c
3. c
4. b
5. c
6. a
7. c
8. d
9. c
10. b

Unit 5 Other Radiological Hazards

In this unit you will learn:

- ☞ Sources of non-life threatening radiation that people are exposed to daily.
- ☞ Hazards associated with these sources.
- ☞ Measures used to protect against the hazards.

INTRODUCTION

Many people are unaware that they are exposed to radiation on a continuing basis. By far, the greatest amount of radiation received by the world's population comes from natural sources. There are also man-made sources of radiation that people are exposed to periodically that contribute to their overall dose. This unit introduces you to some of these other radiation sources that people are exposed to and the radiological hazards associated with some of them.

This unit provides an introduction to the major sources of radiological hazards that are non-life threatening and are not associated with any type of emergency situation. This unit provides basic information on the measures that are taken on your behalf or which you can take to protect against some of these hazards. Upon completion of this unit you should be aware of the amount of radiation that you are exposed to on a continuing basis, and the sources of radiation that contribute to this. You should also be aware of man-made sources that contribute to your overall radiation dose on a periodic basis.

This unit is divided into three sections: Other Radiation Sources, Natural Sources, and Man-made Sources.

The **Other Radiation Sources** section describes the every day exposure of people to radiation from many sources. These sources are both natural and artificial and originate from many different places.

The **Natural Sources** section describes the natural sources of radiation that contribute to a person's every day exposure to radiation. The measures that can be taken to provide protection from some of these hazards are explained.

The **Man-made Sources** section describes the man-made sources of radiation that contribute to the every day exposure to radiation and the measures that can be taken to provide protection from some of these hazards.

OTHER RADIATION SOURCES

The attention that large radioactive sources such as nuclear power plants and nuclear devices has received recently has led to a greater understanding of the hazards from these sources of radiation and the need for emergency plans to respond to situations involving an accident or threat associated with them. However, radiation and radioactivity is present all the time, and has existed on the earth long before life emerged. Indeed, they were present in the universe long before the earth itself existed.

Radiation contributed to the formation of the universe, as far as we can tell, and has pervaded the cosmos ever since. Radioactive materials became part of the earth at its very conception. Even man himself is slightly radioactive. However, it has only been a little over one century since man discovered this phenomenon and began to use it for beneficial reasons. Radioactive materials are utilized in a broad array of activities which contribute to the total amount of radiation exposure a typical person receives.

Thus, the presence of radiation in our everyday lives comes from natural process, such as cosmic rays, and decay of uranium in the earth, and from man-made sources such as medical x-rays, industrial gamma rays, and air travel.

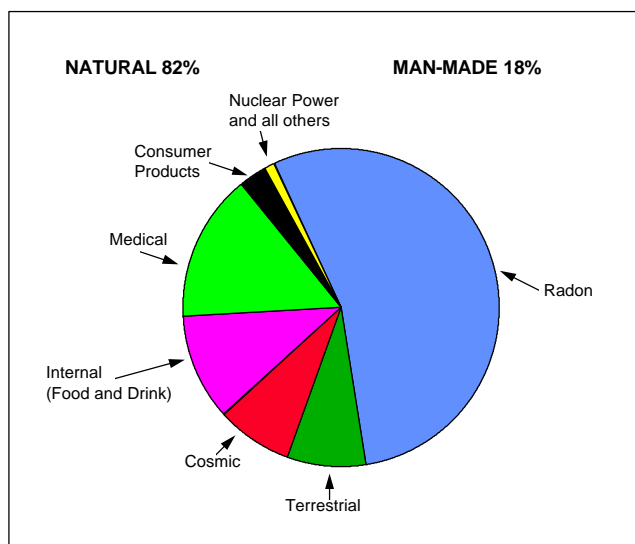

Sources of Radiation

Until very recently, radiation from natural sources was regarded as unremarkable and unalterable, a background phenomenon. It is now recognized that one of the largest sources of natural radiation, radon decay products in the home, can be high and it is fairly easy to reduce their levels in existing homes.

For all intents and purposes, exposure to the other natural sources cannot be controlled, and comprises a basic "background" dose from radiation. Some dose from radon decay products is unavoidable, but extreme exposures can be eliminated. Man-made sources, on the other hand, are more susceptible to control than natural sources, and the potential doses from them are often prevented or easily remedied through controls on their manufacture and distribution.





NATURAL SOURCES

Natural sources of radiation that individuals are exposed to routinely come from either **cosmic radiation** or **terrestrial radiation**.

Cosmic Radiation

Just under half of man's exposure to external natural radiation comes from cosmic rays. Most of these originate deep in interstellar space, however, some are released from the sun during solar flares. They irradiate the earth and interact with the atmosphere to produce further types of radiation and radioactive materials.

This source of radiation is always present. However, it affects some parts of the earth more than others. The poles receive more than the areas of the earth near the equator because the earth's magnetic field diverts the radiation. More importantly, however, the level of exposure to cosmic radiation increases with altitude, since there is less air as altitude increases to act as a shield. Someone living at sea level will, on average, receive a dose of about 300 microsievert of cosmic radiation every year, while an individual living above 2,000 meters will receive several times as much.

	20,000m	13 μ Sv/hr
	12,000m	5 μ Sv/hr
	4,000m	.2 μ Sv/hr
	sea level	.03 μ Sv/hr

Cosmic Radiation Increases with Altitude

A trip from New York to Paris would expose a passenger to about 50 microsievert in addition to whatever cosmic radiation he would be exposed to at home or work. The more frequently an individual flies, especially over long distances, the more additional dose from cosmic radiation he or she is exposed to. For this reason, there are requirements limiting the number of long flights that airline personnel can fly in any year to control the total additional dose these individuals receive from cosmic radiation.

Terrestrial Radiation

Terrestrial radiation accounts for over three-quarters of the overall dose from natural sources of radiation. Three main types of terrestrial radiation account for most of this:

1. Rocks and minerals.
2. Radon and its decay products.
3. Activity in food.

Rocks and Minerals

The main sources of radiation in **rocks** are Potassium-40 and the two series of radioactive elements that come from the decay of Uranium-238 and Thorium-232. Uranium-238 is dispersed throughout the soil at various low levels of concentration. Where the concentration exceeds 1,000 ppm, it may be economic to mine the ore to make fuel for nuclear reactors. Thorium-232 is similarly dispersed in soil. Potassium-40 constitutes a significant part of elemental potassium which makes up 2.4 percent of the earth's crust.

Concentrations of minerals that collect in ash from the burning of coal for energy are sometimes quite high in radioactivity. The vast majority of ash from burning coal remains behind in the furnace, but the lighter portions that “fly” up the stack contribute to the terrestrial portion of an individual's dose. Modern pollution technology has done much to remedy this situation, and the dose contribution is much lower than at times in the past.

Phosphate, when used in fertilizer or in supplements for livestock feed can also contribute a small amount to an individual's dose from natural sources.

The series of radioactive elements, or daughters, that come from the decay of Uranium and Thorium include radon-222 and radon-220, which contribute significantly to man's exposure to radiation from natural sources.

Radon Decay Products

Radon-222 and Radon-220, referred to collectively as radon, seeps out of the earth all over the world. The doses from radon, however, are contributed to by the **radon decay products** (daughters) rather than by the gas itself. The levels of radon in outside air varies markedly from place to place, however, people are mainly exposed to the dose from radon decay products indoors. Radon contributes, on average, about one-half of the dose received by individuals from all natural sources.

Radon concentrates in indoor air when buildings are, by and large, closed spaces. Once the gas gets in, by filtering up through floorboards from the ground or, to a much lesser extent, seeping out of the materials used to construct the building, it cannot get out. Modern construction techniques known for good air-tightness and insulation, make it especially hard for radon to get out. The decay products of the gas are solid, and they attach themselves to dust particles in the air which when inhaled, irradiate the lung.

Radon concentrations in indoor air can be easily controlled using two main methods. Covering walls with plastic materials or thick coats of paint and filling gaps in floors combined with diverting the gas to the open air is an effective control method. Ventilating crawl spaces with fans to remove the radon concentrated air before it gets into living or working spaces in structures is also an effective control method.

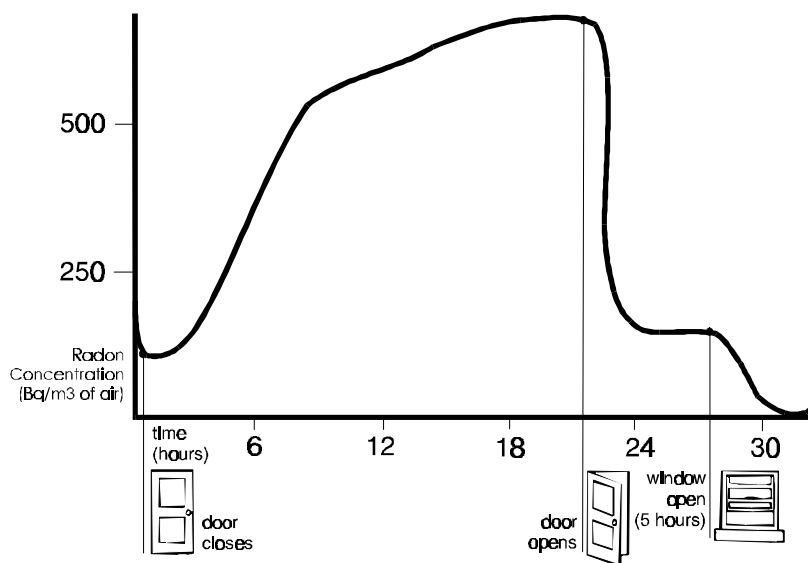

Radon and Ventilation

Activity in Food

Other daughter products from the decay of Uranium and Thorium contribute to an individual's radiation dose from natural sources in **food** that is eaten. Lead-210 and Polonium-210, for example, are concentrated in fish and shellfish. Persons who eat a large amount of seafood are getting a higher dose from this source of natural radiation than those who don't.

Like many of the other situations discussed in this section, some areas of the world have certain foods higher in some radionuclides due to the particular rocks and minerals prevalent in the soil where the crops or livestock are grown.

MAN-MADE SOURCES

Man-made sources of radiation that individuals are routinely exposed to include **medical sources, nuclear fallout, and consumer products.**

Medical Sources

Medical sources of radiation are the greatest source of man-made radiation exposure. Radiation is used both in diagnosing and treating disease.

There are three uses of radiation in the practice of medicine:

1. X-ray examinations.
2. Nuclear medicine.
3. Radiotherapy.

X-ray Examinations

X-ray examinations and nuclear medicine are both techniques used in diagnosing injuries and illnesses. X-rays from an x-ray machine pass through the area of the patients body being examined and are then detected with film. X-rays by far account for most of the exposures from medical uses of radiation. The parts of the body most often x-rayed are the teeth, chest, and limbs, each accounting for about a quarter of the total number of examinations.

Because they are used so frequently and account for most of the man-made radiation exposure, great improvements have been made in x-ray machines and methodologies to try to keep doses at a minimum. Doses from dental x-rays have come down as a result of limiting the x-ray beam more tightly, filtering it further to remove unnecessary radiation, using faster films to capture the beams, and better shielding of patients.

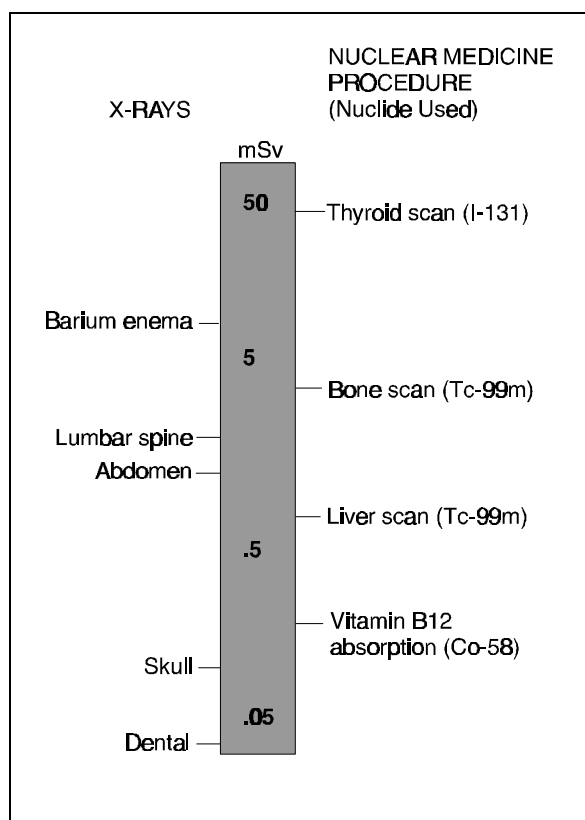

Dose From Typical Diagnostic Procedure

Nuclear Medicine

Nuclear Medicine refers to diagnostic techniques that use the gamma rays from a radioactive substance that is introduced into the patient to allow medical professionals to diagnose certain functions of critical organs. The radioactive material is administered with a drug that is chosen carefully because it is preferentially absorbed by the organ that needs to be diagnosed. The distribution of the drug with the gamma-emitting radioactive material is watched in the organ using a gamma-scanning camera.

The use of nuclear medicine has increased dramatically over the past two decades, but is still used much less frequently than x-rays. The radionuclide used in over 75 percent of nuclear medicine procedures is Technetium-99m because it can be easily obtained, has a convenient half-life of six hours, and it is suitable for incorporating into a wide variety of drugs allowing for examinations of the brain, liver, and kidneys.

Radiotherapy

Radiotherapy is confined almost exclusively to the treatment of malignant cancers with the intention of either curing the disease or alleviating the more distressing symptoms. Beams of high energy X-rays or gamma rays from Cobalt-60 are most commonly used for radiotherapy. High doses are given to the target tissue while the surrounding healthy tissues is spared exposure.

Cancerous tumors require a dose on the order of tens of grays to kill or inactivate the malignant cells. This is a very high dose and thus, radiotherapy is regarded as a severe measure which is used only on those conditions which are extremely serious or which other forms of treatment are not available or have been ineffective. It is important that considerable care is taken to deliver these doses as accurately as possible to avoid ineffective treatment or unacceptable complications.

Nuclear Fallout

For the last 50 years, the world's population has been exposed to radiation from fallout from atmospheric explosions carried out to test nuclear weapons. This testing reached two peaks, the first between 1954 and 1959 and the second in 1961 and 1962.

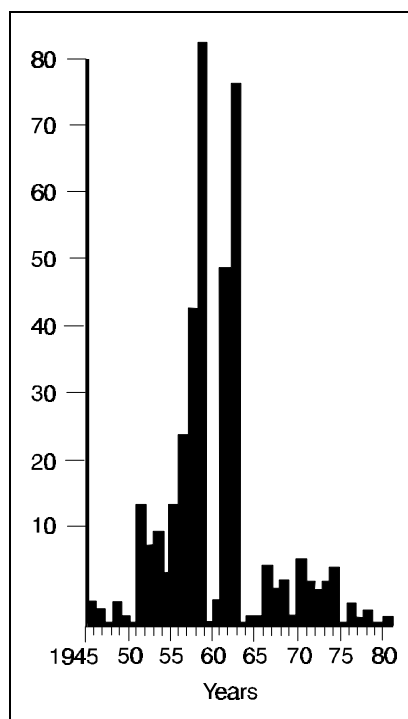

Numbers of Atmospheric Tests

Some of the radioactive debris from an atmospheric nuclear weapon test lands relatively close by. Some stays in the troposphere, the lowest layer of the atmosphere, and is carried by the wind around the world, remaining on average about a month in the air. Most debris is pushed into the stratosphere, the next layer of the atmosphere (from about 10 to 50 kilometers up) where it stays for many months, and whence it slowly descends all over the earth.

These various types of fallout contain several hundred different radionuclides, but only a few contribute to human exposure. Four collectively contribute about 1 percent to the world population dose from nuclear test explosions. These are Carbon-14, Cesium-137, Zirconium-95, and Strontium-90. Like some of the terrestrial sources of natural radiation, the dose from these radionuclides is generally delivered through the ingestion of the radioactivity in some food that has been exposed to the fallout.

Consumer Products

Some common consumer products contain materials or generate radiation which contributes to the dose to individuals, although in an extremely minor way. Luminous watches and clocks contain Tritium or Promethium-147, and by far contribute the most dose from consumer products.

Many smoke detectors use alpha radiation. More than 26 million of them containing Americium-241 had been installed in the United States by the end of the 1980s. X-rays are produced inside color televisions, although modern sets emit only a tiny amount if used normally and serviced appropriately.

Practice Exercise

40. Natural sources of radiation can be grouped into either _____ radiation or _____ radiation.
41. The level of exposure to cosmic radiation increases with _____.
42. Besides the contribution from the radionuclides from the Uranium and Thorium series, rocks containing _____ can contribute a significant dose to humans.
43. The dose contribution from radon actually comes from the radon _____ products.
44. _____ by far account for most of the dose from medical uses of radiation.
45. Like many natural sources of radiation, a dose from radioactive fallout is likely to be delivered through someone's _____.

UNIT 5 REVIEW

This unit reviews the fact that most of our exposure to radiation comes from everyday sources that are not considered life-threatening. This type of radiation comes from natural and artificial sources. The vast majority of this everyday radiation (over 80 percent) comes from natural sources.

Of the natural sources, cosmic radiation accounts for most of our direct exposure. Radon decay products account for most of the dose delivered through inhalation or ingestion. Most of our everyday radiation exposure from artificial sources is due to x-ray.

Mitigation measures can be used to decrease our exposure to almost all of these sources of radiation, although some exposure to background radiation is considered unavoidable.

UNIT 5 REVIEW QUESTIONS

Answer the following questions to review your knowledge of the Other Radiological Hazards unit. Read each question carefully and circle the correct answer.

1. On average, approximately 82 percent of our everyday radiation exposure comes from what sources?
 - a. Uranium
 - b. Radon
 - c. Natural
 - d. Extra-terrestrial
2. Solar flares are one source of this type of radiation.
 - a. Cosmic
 - b. Radon
 - c. Terrestrial
 - d. Artificial
3. Altitude increases exposure to cosmic radiation because there is (are) less _____ to act as a shield.
 - a. Clouds
 - b. Air
 - c. Airplanes
 - d. People
4. Radon dose comes primarily from its _____ products.
 - a. Son
 - b. After
 - c. Follow-on
 - d. Daughter

Radiological Emergency Management Independent Study Course

5. What radionuclide concentrates in seafood?
 - a. Mercury
 - b. Thorium
 - c. Lead
 - d. Iron

6. What two parts of the body are most often x-rayed?
 - a. Limbs and chest
 - b. Chest and liver
 - c. Teeth and spine
 - d. Spine and thyroid

7. What is radiotherapy used almost exclusively in the treatment of?
 - a. Broken bones
 - b. Chest pain
 - c. Cancer
 - d. Migraine headaches

8. Most debris from atmospheric tests of nuclear weapons _____.
 - a. Fell immediately
 - b. Was pushed into the troposphere
 - c. Was pushed into the stratosphere
 - d. Disintegrated

9. Where did most of the dose from atmospheric test of nuclear weapons come from?
 - a. Direct exposure
 - b. Inhalation of dust particles
 - c. Radon decay products
 - d. Ingestion of contaminated food

10. What radionuclide is often used in luminous watches and clocks?
 - a. Tritium
 - b. Carbon-14
 - c. Strontium-90
 - d. Iodine

UNIT 5

REVIEW ANSWER KEY

1. c
2. a
3. b
4. d
5. c
6. a
7. c
8. c
9. d
10. a

RADIOLOGICAL EMERGENCY MANAGEMENT GLOSSARY

Acute Exposure: Radiation exposure of short duration.

ALARA: Acronym for keeping radiation exposure "As Low As Reasonably Achievable."
Radioactive material users apply this concept in minimizing occupational and public exposure.

Alpha Particle: A positively charged particle ejected spontaneously from the nuclei of some radioactive elements. It is equal in mass and charge to a helium nucleus and has low penetrating power and short range. The most energetic alpha particle from radioactive decay will generally fail to penetrate the skin. Alphas are hazardous when an alpha-emitting nuclide is introduced into the body.

Atom: The smallest particle of an element that cannot be divided or broken up by chemical means. It consists of a central core called the nucleus which contains protons and neutrons. Electrons revolve in orbits in the region surrounding the nucleus.

Becquerel (Bq): The radioactivity unit of the international system of units. One becquerel equals one nuclear disintegration per second.

Beta Particle: A charged particle emitted from a nucleus during radioactive decay. The beta particle, with a mass equal to 1/1837 that of a proton, is similar to an electron. Large amounts of beta radiation may cause skin burns, and beta emitters are harmful if they enter the body. Beta particles from radioactive decay are easily stopped by a thin sheet of metal or plastic.

Blast Effect: A pulse of air in which the pressure increases sharply at the front, accompanied by winds, propagated from an explosion.

Boiling Water Reactor (BWR): A type of reactor system which allows water to boil directly in the reactor core to produce steam for the turbine generator.

Central Nervous System: The body's organ system that originates, sends, and receives electrical signals to control movement and action. Acute exposures of over 2,200 R cause death within hours by damage to this organ system.

Charge: The electrical characteristic of atomic particles. Positive charge is the opposite of negative charge. Neutral charge is the absence of charge.

Chronic Exposure: Radiation exposure occurring over long periods of time.

Containment: A structure found at nuclear power plants designed to contain any radioactive materials that may be released from the nuclear reactor fuel and cooling systems.

Contamination: Radioactive material spread on surfaces where it is not supposed to be.

Control Rod: A rod made of neutron absorbing material which, when inserted into a nuclear reactor, reduces the number of free neutrons available to cause the uranium atoms to fission.

Cooling Tower: A heat exchanger used to cool the water used to condense exhaust steam exiting the turbines of a power plant. Cooling towers transfer exhaust heat into the air instead of into a body of water.

Curie (Ci): The unit of radioactivity equal to 3.7×10^{10} disintegrations per second or 3.7×10^{10} becquerel.

Decay Heat: The heat generated by the radioactive decay of fission products.

Defense-in-Depth: The nuclear power plant design basis used to ensure maximum protection of the environment from an inadvertent release of fission products.

Deposition: Physical settling or placing of radioactive material onto a surface. Fallout may be deposited on surfaces. Material ingested or inhaled by an individual may be deposited in the lungs or other organs.

Dose: A general term denoting the quantity of radiation or energy absorbed. Dose may refer to absorbed dose, the amount of energy deposited per unit mass, or to equivalent dose, the absorbed dose adjusted for the relative biological effect of the type of radiation being measured.

Dose Rate: The radiation dose delivered per unit time.

Dosimeter: A portable device that measures total radiation dose received.

Electron: A small, negatively charged particle typically found surrounding an atom's nucleus.

Element: One of the approximately 107 known chemical substance that cannot be broken down further without changing its chemical properties. Some examples include hydrogen, nitrogen, gold, lead and uranium.

Emergency: An event which inflicts or threatens to inflict serious damage to property or people.

Energy Yield: The total effective energy released in a nuclear explosion.

Explosion: The rapid release of a large amount of energy within a limited space.

Exposure: A measurement of the total amount of radiation to which an individual is exposed related to the ionization produced in air by x-ray or gamma radiation. Similar to "dose."

Fallout: See "Radioactive Fallout."

Fission: The splitting of an atom resulting in the release of neutrons, energy, and two or more smaller atoms.

Fission Product: An atom produced through the splitting (fissioning) of a larger atom.

Fuel Assembly: A number of nuclear fuel rods grouped together.

Fuel Cladding: A long metal tube encasing the nuclear fuel rod. Cladding designed to prevent fission products which migrate from the nuclear fuel from escaping to the primary coolant system.

Fuel Pellet: A cylindrical pellet of nuclear fuel typically consisting of uranium dioxide.

Fuel Rod: A stack of cylindrical fuel pellets encased in fuel cladding.

Gamma Rays: High-energy, short wavelength electromagnetic radiation emitted from the nucleus. Gamma radiation frequently accompanies alpha and beta emissions and always accompanies fission. Gamma rays are very penetrating and are best stopped or shielded against by dense materials such as lead or uranium. Gamma rays are similar to X rays, but are usually more energetic .

Gray (Gy): The absorbed radiation dose unit of the international system of units. One gray equals 100 rad.

Half-Life: The time in which half the atoms of a particular radioactive material disintegrate to another nuclear form. Measured half-lives vary from millionths of a second to billions of years. See "Radioactive Decay."

Ingestion: The term used when radioactive materials are taken into the body through the mouth, such as by eating or drinking. Also applies when breathing results in the inhaled materials being swallowed.

Inhalation: The term used when radioactive materials are taken into the lungs by breathing.

Initial Nuclear Radiation: Nuclear radiation emitted from the fireball and the cloud column during the first minute after a nuclear explosion.

Ionization: The process of adding one or more electrons to, or removing one or more electrons from, atoms or molecules, thereby creating ions. High temperatures, electrical discharges, or nuclear radiations are possible causes of ionization.

Kilo: The prefix used to designate one thousand.

Kiloton: An explosive force equivalent to that of 1,000 tons (907,000 kg) of TNT.

Label: A standard device or sign attached to the outside of a package of radioactive materials to identify the radiological hazards associated with it.

Mega: The prefix used to designate one million.

Megaton: An explosive force equivalent to that of 1,000,000 tons (907,000,000 kg) of TNT.

Meltdown: The melting of nuclear fuel.

Micro: The prefix used to designate one one-millionth.

Milli: The prefix used to designate one one-thousandth.

Neutron: A small particle possessing no electrical charge typically found within an atom's nucleus. Neutrons released by fission may strike nuclear fuel atoms causing additional fissions.

Nucleus: That part of an atom where neutrons and protons are located and in which the positive electrical charge and most of its mass is concentrated.

Nuclide: A general term applicable to all atomic forms of the elements. Nuclides are characterized by the number of protons and neutrons in the nucleus. There are 279 stable nuclides and about 500 unstable nuclides.

Particle: As related to nuclear radiation, a particle is a subatomic piece of matter with characteristic mass and charge. See "Alpha Particle," "Beta Particle," and "Neutron."

Placard: A standard device or sign attached to the outside of a vehicle to identify the hazards associated with the cargo.

Plume: An airborne cloud of radioactive gases or particles released from a nuclear power plant.

Pressurized Water Reactor (PWR): A type of reactor system which maintains cooling water at a very high pressure which prevents water from boiling in the reactor core during normal operation. Heat from the reactor is transferred to another system of water in a steam generator to provide steam for generating electricity.

Primary Coolant System: The combination of mechanical and electrical components which work together to maintain control of and cool the reactor.

Proton: A small particle typically found within an atom's nucleus which possesses a positive electrical charge.

Rad: An acronym for Radiation Absorbed Dose.

Radiation: The propagation of energy through space or through matter in the form of waves (e.g., electromagnetic waves) or particles (e.g., alpha, beta, or neutron radiation).

Radiation Absorbed Dose: The basic unit of dose of ionizing radiation. A dose of one rad means the absorption of 100 ergs of radiation energy per gram of absorbing material.

Radiation Sickness: The complex of symptoms resulting from excessive exposure of most of the body to ionizing radiation. The earliest visible symptoms are nausea, fatigue, vomiting, and diarrhea, which may be followed by loss of hair (epilation), hemorrhage, inflammation of the mouth and throat, and general loss of energy. In severe cases, where the radiation exposure has been relatively large, death may occur within two to four weeks. Those who survive 6 weeks after the receipt of a single large dose of radiation will generally recover.

Radiation Survey Instrument: A portable battery-powered device used to detect and measure the dose rate at the spot where the instrument is held.

Radioactive Decay: The decrease in the amount of any radioactive material with the passage of time due to the spontaneous emission of alpha, beta, or gamma radiation from the nucleus.

Radioactive Fallout: Radioactive debris (including fission products) from a nuclear detonation, which is airborne or has been deposited on the earth.

Radioactive Material: Any material which spontaneously emits particulate or electromagnetic ionizing radiation.

Radioactivity: Spontaneous emission of alpha or beta particles or gamma radiation by unstable atoms.

Radionuclide: An unstable (radioactive) nuclide.

Range: As related to nuclear radiation, the typical distance which a type of radiation will travel before all of its energy is absorbed. The range of radiation may vary through different types of materials.

Reactor Cooling Water: The water which circulates through the primary cooling system of a nuclear power plant and provides cooling for the reactor core and core components.

Reactor Core: The heat source of a nuclear power plant consisting of a number of fuel assemblies grouped side-by-side.

Rem: An acronym for Roentgen Equivalent Mammal. The unit of dose of any type of ionizing radiation that produces the same biological effect as a unit of absorbed dose of ordinary X-rays.

Residual Nuclear Radiation: Nuclear radiation emitted from radioactive fallout which persists for some time following a nuclear explosion.

Roentgen (R): A unit of exposure to ionizing gamma radiation in air.

Shielding: Any material between a radiation source and a radiation receptor.

Shock Wave: See "Blast Effect."

Sievert (Sv): The radiation dose unit of the international system of units. One sievert equals 100 rem.

Specific Activity: The amount of radioactivity of a material per unit mass.

Steam Generator: The component used in a pressurized water reactor which transfers the heat generated in the primary system (by the reactor core) to the secondary cooling water and hence to the turbine.

Thermal Radiation: Electromagnetic radiation emitted from an explosion in the form of light and heat.

Thyroid Blocking Agent: A pill or liquid containing non-radioactive iodine which, when taken before or immediately after exposure to radioactive iodine, saturates the thyroid gland to prevent excessive uptake of radioactive iodine.

Time, Distance, Shielding: The three main ways to minimize exposure to radiation.

TNT: The flammable compound, trinitrotoluene, used as a high explosive.

Uranium: A type of atom used to fuel nuclear reactors due to its ability to undergo fission with a free neutron creating a nuclear chain reaction and resulting in heat.

X Rays: Penetrating electromagnetic radiation originating in the electron field of an atom. X-rays are similar in wavelength and frequency to gamma rays, which originate in the nucleus of an atom.

Yield: See "Energy Yield."

RADIOLOGICAL EMERGENCY MANAGEMENT PRACTICE EXERCISE ANSWER KEY

1. Alpha radiation
2. Beta radiation
3. Gamma radiation
4. Natural background radiation
5. Radiation exposure
6. Radiation exposure rate
7. Nausea, vomiting, and fever
8. 450 R
9. Time, distance, and shielding
10. Radiological Protection System (RPS)
11. Type B
12. Limited quantity
13. Type A
14. Labels, markings, placards, and shipping papers
15. False
16. 1,000 mR/hr
17. Helping, notifying, and isolating
18. False
19. Qualified personnel
20. Turbines, condensers, pumps, and cooling towers

Radiological Emergency Management Independent Study Course

21. Cooling tower
22. Uranium
23. Additional free neutrons, heat, and fission products
24. Shutdown (or scram)
25. Boiling water reactors, pressurized water reactors
26. Fission products, heat
27. Fuel rod, primary coolant system, and containment building
28. Direct exposure, contamination, ingestion
29. Study
30. Precautionary
31. Promptly
32. Iodine
33. TNT
34. Yield
35. Gamma rays
36. Should
37. Radioactive decay
38. 5 R/hr
39. 10 R/hr
40. Cosmic, terrestrial
41. Altitude
42. Potassium
43. Decay
44. X-rays
45. Food

RADIOLOGICAL EMERGENCY MANAGEMENT FINAL EXAMINATION

1. A unit used to express the exposure an individual receives is the:
 - a. Rem/hr
 - b. Roentgen
 - c. Curie
 - d. Rad

2. The rem is a unit used to measure:
 - a. Radiation exposure
 - b. Radiation dose in terms of the amount of energy absorbed
 - c. Radiation dose in terms of the amount of the biological effect caused by the amount of energy absorbed
 - d. Radioactivity

3. Because of its low penetrating ability, the type of radiation which is usually only a hazard when inhaled or ingested is:
 - a. Alpha radiation
 - b. Beta radiation
 - c. Gamma radiation
 - d. Neutron radiation

Radiological Emergency Management Independent Study Course

4. Which of the following is an example of proper units for expressing exposure rate?
 - a. Hr/R
 - b. R/hr
 - c. Hr:R
 - d. r:hr

5. Cosmic radiation and radiation from terrestrial sources are examples of:
 - a. Natural background radiation
 - b. Natural man-made radiation
 - c. Industrial sources of radiation
 - d. Radioactive sources used in the medical field

6. An example of a man-made source of radiation is:
 - a. Terrestrial sources
 - b. Cosmic radiation
 - c. Diagnostic radiation
 - d. Potassium-40 in the human body

7. The three factors which are important in protecting individuals from radiation are:
 - a. Time, shielding, and dose rate
 - b. Dose rate, time, and gender
 - c. Time, shielding, and distance
 - d. Distance, time, and dose rate

8. Radiation received by the body over a short period is:
 - a. Chronic exposure
 - b. Sublethal exposure
 - c. Acute exposure
 - d. Supralethal exposure
9. Chronic exposures are:
 - a. Amounts of radiation received over a short period of time
 - b. Amounts of radiation received over a very long period of time
 - c. Acute exposures which affect only critical organs of the body
 - d. Acute exposures which affect all parts of the body
10. Radioactive decay is defined as:
 - a. The decrease in the amount of any radioactive material due to the spontaneous emission of nuclear radiation from the nucleus
 - b. The decomposition of radioactive atoms due to lengthy exposure to direct sunlight
 - c. The gradual decrease in the number of radioactive atoms in radioactive material due to spontaneous fission
 - d. The decline in the strength of a radioactive source due to the combined effects of time, distance, and shielding
11. The key elements of emergency management are _____, Response, Recovery and, Mitigation.
 - a. Removal
 - b. Preparedness
 - c. Measurement
 - d. Employment

12. The majority of radioactive material shipments are made in this type of packaging.
 - a. Type A
 - b. Type B
 - c. Limited Quantity
 - d. Industrial

13. Type B packages must be able to meet Type A requirements and also withstand the effects of _____ conditions?
 - a. Higher radiation
 - b. Accident
 - c. Higher weight
 - d. Faster transportation speed

14. The label required for radioactive material packages with a maximum dose rate of 200 mR/hr at the surface of the package is:
 - a. Radioactive Yellow-II
 - b. Radioactive Yellow III
 - c. Radioactive White I

15. The label required for radioactive material packages in excess of 50 mr/hr but less than 200 mr/hr is:
 - a. Radioactive Yellow-I
 - b. Radioactive Yellow-II
 - c. Radioactive Yellow-III

16. To determine the amount of radioactive material in a package of radioactive materials, you would look at the:
 - a. Placard
 - b. Label
 - c. Package type

17. The distinctive symbol used to identify radioactive materials is the:
- a. Diamond
 - b. Tri-blade
 - c. White square
18. Unbroken radioactive material packages never have a surface radiation dose above this level:
- a. 50 mR/hr
 - b. 100 mR/hr
 - c. 500 mR/hr
 - d. 1,000 mR/hr
19. A member of the public should give lifesaving first aid to injured victims of a radiological transportation accident:
- a. Without delay out of concern for radiological hazards
 - b. After verifying that no radioactive material packages have broken open
 - c. After isolating the area
 - d. Immediately after notifying the appropriate authorities
20. In the United States, serious radiation exposures:
- a. Have not resulted from radiological transportation accidents due largely to the nature of the material transported and the use of appropriate protective packaging
 - b. Have resulted from improper labeling of radioactive material shipments
 - c. Have resulted from improper packaging of radioactive material shipments
 - d. Frequently result from radioactive transportation accidents due to the large number of such shipments
21. In every power plant that generates electricity, the following components are present:
- a. Heat source, steam generator, cooling tower
 - b. Heat source, turbine electricity generator, pump
 - c. Turbine electricity generator, pump, cooling tower
 - d. Pump, steam generator, cooling tower

22. A chain reaction results when a uranium atom is struck by _____ released by a nearby uranium atom undergoing fission.
- Electron
 - Proton
 - Gamma ray
 - Neutron
23. The three main barriers in a nuclear power plant to prevent release of fission products are the fuel rods, the reactor vessel, and the _____.
- Secondary coolant system
 - Contaminant building
 - Condensor
 - Control rods
24. To prevent fuel damage, decay heat must be removed from the reactor core:
- Until the reactor shuts down
 - After the reactor shuts down
 - Until the primary coolant system is activated
25. Control rods are used in a reactor core to:
- Absorb free neutrons
 - Are a source of free neutrons which are used to cause fission
 - Encase the nuclear fuel
26. In a pressurized water- reactor the primary cooling water:
- Boils in the core and is used to turn the turbine
 - Evaporates to the atmosphere using a cooling tower
 - Transfers its heat to the secondary cooling water in a steam generator

27. A large modern nuclear power plant has approximately ____ fuel assemblies in its core.
- a. 100
 - b. 50
 - c. 200
 - d. 500
28. Nuclear power plant emergency plans are required to incorporate actions for which of the following types of radiological hazards?
- a. Direct exposure to radiation from a plume of radioactive material
 - b. Blast effects
 - c. Fallout
29. In a _____, a major failure has occurred, but an immediate response by the public is not needed.
- a. General Emergency
 - b. Site Area Emergency
 - c. Alert
 - d. Unusual Event
30. If evacuation is required following a nuclear power plant accident, it is recommended that individuals living anywhere closer than ____ miles be evacuated.
- a. 2 to 3
 - b. 3 to 5
 - c. 5 to 10
 - d. 15
31. A detonation of a nuclear explosive above 100,000 feet of altitude is called _____.
- a. An air burst
 - b. A high-altitude burst
 - c. A sub-cosmic burst
 - d. A surface burst

32. Nuclear explosions can be _____ of times more powerful than the largest conventional weapon.
- a. Hundreds
 - b. Thousands
 - c. Millions
 - d. Billions
33. The total energy released in a nuclear explosion, is the explosion's:
- a. Thermal energy
 - b. Blast
 - c. Energy yield
 - d. Nuclear energy
34. The immediate destructive action of a nuclear explosion is caused by this.
- a. Heat
 - b. Radiation
 - c. Shock
 - d. Dust
35. A nuclear explosion which releases energy equivalent to 7,000,000 tons of TNT:
- a. Is called a 7 kiloton burst
 - b. Has an energy yield of 7 kilotons
 - c. Is called a 7 megaton burst
 - d. Has a thermal energy release of 7 million kilograms

36. Just as in an emergency resulting from a nuclear power accident, the three most important ways of reducing the radiation exposure from fallout from a nuclear weapon are:
- Time, shelter, and gender
 - Dose rate, distance, and time
 - Dose rate, distance, and shielding
 - Time, distance, and shielding
37. Radioactive fallout makes the surface it comes into contact with radioactive. (True or False?)
- True
 - False
38. Radiological survey instruments:
- Will not be very reliable after a nuclear detonation because of weak batteries and no sure way of checking the strength of those batteries
 - Will give just an approximate answer which will need to be corrected using the "7: 10 Rule of Thumb"
 - Are the most accurate and reliable means of determining exposure levels
 - Will be very reliable following a nuclear detonation since they usually use AC line current
39. According to the "7:10 Rule of Thumb," if the exposure rate one hour after detonation of a nuclear weapon is 500 R/hr, the exposure rate approximately 14 days later (343 hours) will be approximately:
- 50 R/hr
 - 5 R/hr
 - 0.5 R/hr
 - 0.05 R/hr
40. The 7:10 Rule of Thumb:
- Is 100 percent accurate
 - Helps estimate future exposure levels
 - Is more reliable than radiological survey instrument readings
 - Is accurate to within ± 10 percent

Radiological Emergency Management Independent Study Course

41. Everyone is exposed to radiation on a continuing basis from either _____ or sources.
- a. Uranium, thorium
 - b. Radon, uranium
 - c. Natural, man-made
 - d. Terrestrial, extra-terrestrial
42. Radiation that individuals are exposed to on a continuing basis which is considered non life-threatening is also known as this kind of radiation?
- a. Cosmic
 - b. Intrinsic
 - c. Background
 - d. Uneventful
43. Just under half of man's exposure to external natural radiation comes from?
- a. Radon
 - b. Cosmic radiation
 - c. Rocks
 - d. Food
44. Radon dose comes primarily from its daughter products which are _____?
- a. Ingested
 - b. Counted
 - c. Inhaled
 - d. Touched

45. The two radionuclides which concentrate in seafood are:
- a. Lead and mercury
 - b. Thorium and mercury
 - c. Lead and polonium
 - d. Polonium and mercury
46. By far, the radionuclide used in most nuclear medicine procedures is:
- a. Carbon-14
 - b. Strontium-90
 - c. Technicium-99m
 - d. Cobalt-60
47. Nuclear medicine techniques work through the detection of this kind of radiation, injected into the body by adding a radioisotope to a certain drug:
- a. Alpha particles
 - b. X-rays
 - c. Gamma-rays
 - d. Neutrons
48. Cancerous tumor cells can be treated by high energy _____ or _____.
- a. Neutrons, alpha particles
 - b. Neutrons, electrons
 - c. Gamma rays, X-rays
 - d. Gamma rays, neutrons

49. Most debris from a nuclear weapons test:

- a. Fell immediately
- b. Was pushed into the troposphere
- c. Was pushed into the stratosphere
- d. Disintegrated

50. Many smoke detectors contain:

- a. Americium-241
- b. Carbon-14
- c. Strontium-90
- d. Iodine