



**US Army Corps
of Engineers**
New Orleans District

**LAKE PONTCHARTRAIN, LA.
AND VICINITY
LAKE PONTCHARTRAIN
HIGH LEVEL PLAN**

**DESIGN MEMORANDUM NO. 18
GENERAL DESIGN**

**ST. CHARLES PARISH
NORTH OF AIRLINE HIGHWAY**

**IN TWO VOLUMES
VOLUME I**

TC
7
.P6
dm 18
1989
v.1
c.1

FEBRUARY 1989

SERIAL NO. 23

CELMN-ED-SP (1110-2-115-a)

24 Feb 89

MEMORANDUM FOR See Distribution

SUBJECT: Lake Pontchartrain, LA & Vic GDM No. 18, St. Charles Parish.

1. A copy of the subject GDM is enclosed for your use and information.
2. If you desire additional copies, please contact Vann Stutts ext. 2614.

Encl
as

Seall
FREDERIC M. CHATRY
Chief, Engineering Division

DISTRIBUTION:

~~C/Ops & Red. Div~~
C/Real Estate Div
C/Plng Div
✓ C/Const Div *JK*
C/New Orleans Res Ofc
~~C/IM - SL~~
~~C/PMO~~
~~C/Value Engr~~
C/Life Cycle Proj Mtg. (*copy hand carried.*)



DEPARTMENT OF THE ARMY

NEW ORLEANS DISTRICT, CORPS OF ENGINEERS

P.O. BOX 60267

NEW ORLEANS, LOUISIANA 70160-0267

REPLY TO
ATTENTION OF:

CELMN-ED-SP

February 8, 1989

MEMORANDUM FOR COMMANDER, LOWER MISSISSIPPI VALLEY DIVISION,
ATTN: CELMV-ED-PG

SUBJECT: Lake Pontchartrain, Louisiana and Vicinity, High Level
Plan, Design Memorandum No. 18 - General Design, St. Charles
Parish, North of Airline Highway

1. The subject design memorandum is submitted for review and approval, and has been prepared generally in accordance with the provisions of ER 1110-2-1150, dated November 1984.

2. A summary of the current status of the Clean Water Act, endangered species, Environmental Impact Statement (EIS) and cultural resources investigations is as follows:

a. There is deposition of dredged and hauled fill material into waters of the U.S. associated with the tentatively selected plan. A Section 404(b)(1) Evaluation was filed with the Environmental Protection Agency (EPA) in 1982 for the original levee work. Subsequently, another Section 404(b)(1) Evaluation was filed with EPA in December 1988 for modifications to the levee design. An application was made for Water Quality Certification in December 1988.

b. Endangered Species Assessments, completed in 1982 and June 1984, concluded that the tentatively selected plan would not adversely impact any endangered species or their critical habitat. The U. S. Fish and Wildlife Service (USFWS) concurred with these assessments.

c. A final Environmental Impact Statement (EIS) was completed in 1975. A final supplement to this EIS was filed with EPA in December 1984. An Environmental Assessment (EA) addressing realignments, additional structures, crossings of landfills, and oil and gas waste pits was mailed to the public in December 1988.

D. A comprehensive cultural resources survey of the levee alignment was completed in March 1988. No significant archeological sites were found.

CELMN-ED-SP

SUBJECT: Lake Pontchartrain, Louisiana and Vicinity, High Level Plan, Design Memorandum No. 18 - General Design, St. Charles Parish, North of Airline Highway

3. Designs presented in this document are, in general, based on the following. The reinforcing fabric for the levee was designed for a safety factor of 1.0 with respect to "pull out", and the stresses in the fabric were limited to those corresponding to 5% strain. The "pull out" capacity was calculated by multiplying the estimated cohesion of the fill by the embedded length of the fabric (including both top and bottom surfaces). The 5% strain criterion was utilized to minimize long term creep of the geotextile.

4. Results to date for the ongoing Bonnet Carre' Test Section, while only partially complete, demonstrate that the foregoing design is overly conservative. We plan to provide a revised analysis of design with the plans and specifications when submitted. In general, we currently anticipate the following changes to design criteria used herein.

a. The initial lift would be designed with allowable stresses in the reinforcing fabric in excess of those corresponding to 5% strain, probably in the 7% to 8% range. A gain in foundation strengths is expected for future lifts (the GDM design is based on this assumption). This gain in strength will, we believe, operate to limit reinforcing fabric strains to less than 5% for future lifts when creep could be a potential problem.

b. The pull out capacity of the reinforcing fabric is expected to be substantially increased over that used in the GDM based on Bonnet Carre' data now available.

c. In the Test Sections, material placed as uncompacted fill was determined by testing after placement to have higher shear strengths than those normally associated with this method of placement (400 psf vs. 200 psf). This is attributed to the higher quality fill that is available in the Bonnet Carre' Spillway. The same source of material will be utilized for the St. Charles project, with the added positive impact of semicompacted placement.

5. This report was scheduled to be submitted to LMVD by 31 Jan 1989. This delay will not cause a delay in the start of construction.

CELMN-ED-SP

SUBJECT: Lake Pontchartrain, Louisiana and Vicinity, High Level
Plan, Design Memorandum No. 18 - General Design, St. Charles
Parish, North of Airline Highway

6. Approval of this report and project plan as a basis for
preparation of plans and specifications is recommended.

FOR THE COMMANDER:

A handwritten signature in black ink, appearing to read 'Frederic M. Chatry', with a long horizontal line extending to the right.

Encl (16 cys, fwd sep)

FREDERIC M. CHATRY
Chief, Engineering Division

CELMV-ED-PG (CELMN-ED-SP/8 Feb 89) (1105-2-10c) 1st End Mr. Bardwell/ts/5925
SUBJECT: Lake Pontchartrain, Louisiana and Vicinity, High Level Plan, Design
Memorandum No. 18 - General Design, St. Charles Parish, North of Airline Highway

DA, Lower Mississippi Valley Division, CE, Vicksburg, MS 39181-0080

09 MAY '89

FOR Commander New Orleans District, ATTN: CELMN-ED-SP

1. The subject GDM 18 is approved subject to comments in enclosure 2. Additionally, you should confirm that a Class B permit to cross State-designated natural and scenic streams will be provided by the State of Louisiana.
2. We suggest that a meeting be held to discuss your proposed responses to the enclosed comments. Our point of contact for making the meeting arrangements is Mr. Jack Bardwell, CELMV-ED-P, telephone 601/634-5925. The schedule should include time prior to the meeting for this office to study your proposed responses.

FOR THE PRESIDENT OF THE COMMISSION:



FRED H. BAYLEY III
Chief, Engineering Division

2 Encls
wd 15 cys of encl 1
added one encl
2. as

CF:
CEEC-EB (w/10 cys encls 1 & 2)

US Army Corps of Engineers
Lower Mississippi Valley Division
Vicksburg, MS 39180

LMVD technical staff comments on Lake Pontchartrain, LA, and Vicinity High Level Plan, St. Charles Parish North of Airline Highway Design Memorandum No. 18, General Design

1. The following comments refer to CELMN-ED-SP, 8 Feb 89, carrying memorandum:

a. Para 2a. This paragraph incorrectly states the process. The Corps of Engineers does not "file" Section 404(b)(1) evaluations with EPA, instead it provides a copy to EPA for review and comment. Application for Water Quality Certification was made to the State under Section 401 of the Clean Water Act.

b. Paras 3 and 4b. Refer to para a(4) of the CELMV-ED-PG 5th End to GDM No. 17. This office still considers that the pullout resistance of a geotextile in contact with clay is related to the overburden pressure (normal load) on the geotextile. This concept has been clearly indicated by both laboratory and field pullout tests. During evaluation of the Bonnet Carre' geotextile field pullout test data for application to this levee design, it should be taken into consideration that the test loading was relatively quick compared to the long-term loading that will be experienced in the actual levee. An appropriate factor of safety should be applied to the field pullout derived resistances to account for long-term loading, submergence, fill moisture content, and other possible differences between as constructed and test conditions.

c. Paras 4 and 4a. The revised design analysis discussed in the following paragraphs could alter the proposed levee system as presented in the DM. You should consider this possibility in scheduling the development of plans and specifications. Delaying the June 89 completion of the plans and specifications should not effect the start of construction since the first contract is not scheduled for award until September 1990. The reanalysis should be based on the following:

(1) We do not concur with the proposal to utilize design geotextile strains of 7 to 8% in the first lift. In order to limit foundation and embankment distortions, design geotextile strains should be limited to 5%. Finite element model results indicate that strains in the foundation soils are as much as 3 times those in the geotextile reinforcement. At the reinforced Bonnet Carre' test sections, considerable embankment and foundation straining was evident before significant strain was measured in the geotextile.

(2) A levee design should be developed that takes into account a foundation shear strength gain during construction similar to that experienced at the Bonnet Carre' test sections. This levee design should be optimized by developing a design which balances the costs of geotextile reinforcement versus stability berm requirements to achieve the overall economic design consonant with environmental considerations. It may be possible to reduce reinforcement strength requirements by increasing stability berm size and thereby allowing competition from other lower strength geosynthetics such as geogrids. Phased construction, employed during the first lift contract to take full advantage of this expected foundation strength gain, should greatly reduce geotextile strength requirements

and eliminate the need for 2 layers. Phased construction would involve constructing the levee to a lower grade through the entire length of the contract during Phase I, then, beginning at the original starting point of the Phase I construction, construct the entire levee to final grade during Phase II. Since haul fill will be used, this procedure should not significantly increase fill cost. Instrumentation (piezometers, inclinometers, and settlement plates) should be installed during Phase I to monitor foundation consolidation and embankment performance, and borings should be made prior to Phase II fill placement. The Phase II stability berms could be adjusted depending on the performance of Phase I.

(3) A design and cost estimate for an unreinforced earth levee with clay capped hydraulically pumped sand stability berms should be developed and presented. Data from the unreinforced Bonnet Carre' test section (settlement, backfigured strengths, foundation strength gain, etc.) should be considered in this design. We believe an unreinforced levee with sand berms may be cost competitive with the reinforced levee and doesn't require specialized construction techniques. The added environmental impacts should be evaluated with the new design.

d. Paras 4 and 4b. These paragraphs seem to conclude that the test data obtained from the Bonnet Carre' reinforced levee test sections indicate that the values of geotextile/soil pullout resistance used in this GDM are overly conservative. We know of no data obtained from the reinforced test sections which might indicate the pullout capacity of the geotextile. As we understand, most of the strain gages mounted on the geotextile became inoperative after only 1 or 2 percent strain.

2. The following comments refer to Vol I, GDM 18.

a. General. There are some discrepancies in the text and plate concerning how many swing gates will be needed. Para 28, page 20 shows 2 swing gates. Pages 24 and 31 mention 3 swing gates and paragraph 37b shows 4 swing gates. These discrepancies should be resolved.

b. Page 5, par 6. According to this paragraph, pumping plants may be constructed by the local sponsor which may permit a local credit for the cost of the gravity drains. If so, the pumps would become part of the Federal project. As was the case with the Larose to Golden Meadow Hurricane Protection Project, this would result in a need for additional environmental studies by the Corps, because the installation and operation of pumps would result in significant wetland loss of approximately 3000 Ac. inside the protected area. Information on additional public review requirements, the need for a supplement to the final EIS, and potential additional mitigation needs and local requirements to cover new mitigation costs should be discussed. It should not be assumed or inferred that pumping plants will be permitted after full disclosure and public review. In addition, the gravity structures are designed to permit flow in both directions. The elimination of one or more of the structures with the addition of a pump station may reduce the desired interchange of fresh water into the protected area. This change should be evaluated.

c. Page 6, para 7d. The table on page 6 reflects costs to Orleans Levee District. This should be corrected to read "Pontchartrain Levee District".

d. Page 7, paragraph after para m. The local requirement for project mitigation should be added to the items of local cooperation.

e. Page 23, para 35a. The general location and alignment of the floodwall is not shown on Plate 1 as indicated in this paragraph.

f. Page 25, para 37a. The design of the levee, floodwalls and other related structures should be based on the condition that the water surface elevation on the protected side may be lowered if the pumping stations are installed.

g. Page 29, para 40c and Plate 29. The bridges at the drainage structures are discussed in this paragraph and details are presented on Plate 29. It is noted that the crest elevation of the road's subbase is at 4.0 ft NGVD. From the hydraulic data presented on page A-41, events in excess of 10 years will inundate the subbase. Therefore, the crest elevation of the subbase should be increased to 5.0 ft NGVD, to ensure that the roadway elevation will be above the 100 year flood stage.

h. Page 32, para 45.A. This paragraph and the additional environmental data in the report states "silt screens would be installed to define and contain construction turbidity to minimize any excavated materials loss." The cost tables do not show these screens and further discussion with CELMN-ED-DL indicates this cost is not included in other items. Therefore, the silt screen locations and types should be shown and their cost should be included in the cost tables.

i. Page 35, para 52. This section should include a discussion of the currently recommended mitigation plan, its status, and how it is to be implemented.

j. Page 36, para 56. The project economics should be revised to reflect the current price level and discount rate.

k. Page 37, para 57. The remaining costs for mitigation should be discussed in this paragraph.

l. Table 7, Cost Estimates.

(1) Page 38. The subtotal for the relocations based on the itemized costs shown should be \$713,250 in lieu of \$813,250.

(2) Page 55. The subtotal of cost account 11 is \$50,000 too high based on the itemized costs shown. Item 7 does not have a cost shown, which may explain the discrepancy.

(3) Page 59-60. The cost of Bayou Trepagnier Drainage Structure does not include a cost for dewatering. This item should be reviewed and corrected if necessary.

(4) Page 63, Cross Bayou Drainage Structure. The concrete quantities appear to be in error. This structure is twice the size of Bayou Trepagnier with concrete quantities shown to be considerable less. The concrete quantities should be checked and corrected as necessary.

m. Page A-37, Table 18. The flow lengths for some of the areas are essentially the same, however, the time of concentration varies considerably. This variation should be explained.

n. Page A-38, para A-10d. The stage-storage curves for each of the five subareas should be presented for use in verifying the study results.

o. Page A-38, para A-11.

(1) The head loss through the Airline Highway embankment of 0.5 ft should not be assumed but should be based on hydraulic computations using existing prototype conveyances for culverts, bridges, etc.

(2) The report does not discuss the landside or floodside channels which will convey flow to and from the drainage structure. These channels should be sized to ensure that designed flow conveyance is available and supporting documentation included in the report.

(3) It is noted that several of the drainage structures are located in or adjacent to pipeline channels. You should document in the report that these channels can be used as conveyance waterways for Federal projects.

(4) The drainage structures should have adequate capacity to handle inflow due to storms, and also any additional inflow due to levee under and through seepage at high river stages.

p. Appendix B, Volume I.

(1) Pertinent correspondence should also contain the Corps letters of response to the resource agencies.

(2) EA and FONSI. The EA and FONSI transmittal letter to interested parties indicates that these documents deal with the modifications of a segment of the St. Charles Parish hurricane protection levee. However, the EA and FONSI do not clearly deal with evaluation of proposed project changes since the 1984 Supplement I to the Final EIS. The EA and FONSI should clearly state that the purpose of preparing the EA was to determine if changes in project design which had occurred since completion of the reevaluation report would cause significant environmental impacts or whether any new information or new legal requirements needed to be addressed. The purpose of the EA was not to reevaluate the entire St. Charles Parish levee project again and to conclude it would cause no significant impacts. The 1984 Supplement I to the Final EIS established the significant impacts of that work. A letter should be prepared and sent to all recipients of the EA/FONSI that makes it clear that these NEPA documents only apply to minor changes in project design and not to the entire St. Charles Parish levee segment. Copies of the Corps letter of response mentioned in the previous comment should also be made available to agencies and interested parties.

q. Plate 43. The I-Wall to T-Wall connection shown on this plate is considered inadequate for the calculated differential deflections. The connection presented in the plans and specifications for the West Esplanade to Lakefront Floodwall, Jefferson Parish, Louisiana, should be used.

3. The following comments refer to Vol 2, GDM 18.

a. Computation Sheets D-23 thru D-34. The elevations of the geotextile reinforcement used for these embedment calculations do not agree with the geotextile elevations shown on the typical sections on Plates 11-15, Vol I. For example, for Design Reach 2, the geotextile elevations are 2-ft lower on the stability plates and embedment calculations, evidently allowing for settlement during construction. However, unless it is certain that both layers of cloth will settle 2 ft during construction, particularly near and beyond the levee toe, the geotextile elevations used in the embedment calculations should be increased.

b. Plates 79-81. During the reanalysis discussed above in para 1c(2), the design shear strengths for clays should be reevaluated using estimated shear strength gains during construction similar to that experienced at the Bonnet Carre' test sections. In addition, it is noted that at depth, the Q-test results and selected design strength lines fall below a C/P = 0.22 line. These low test results are likely the result of a high degree of sample disturbance and/or the inability of the soil to maintain its insitu effective stress after sampling. It is considered that the design strength line below about el-32 should be increased approximately to the C/P=0.22 line.

c. Plates 143-147. Refer to Pile Note 2. All piles, both tension and compression, should be driven into Pleistocene.

d. Plates 143 and 145. No negative skin friction is shown on these plates. A value should be added or an explanation furnished for not considering negative skin friction.

4. The following are minor comments noted on Vol 1.

a. Table of Contents, para 31. "Assess Roads" should be "Access Roads".

b. Page 18, Table 2. The Q-case, Kt should be 0.7 in lieu of 1.7.

c. Page 37, para 57. In the penultimate sentence, "cost showing" should be "cost sharing."

d. Page A-38, para A-10d. "Planimetered" is misspelled.

CELMN-ED-SP (CELMN-ED-SP/8 Feb 89) (1110-2-1150a) 2d End
Mr. Stutts/mn/2614

SUBJECT: Lake Pontchartrain, Louisiana and Vicinity, High Level
Plan, Design Memorandum No. 18 - General Design, St. Charles
Parish, North of Airline Highway.

DA, New Orleans District, Corps of Engineers, P. O. Box 60267,
New Orleans, LA 70160-0267 15 Sept 89

FOR Commander, Lower Mississippi Valley Division, ATTN:
CELMV-ED-PG

The following provides our responses to comments contained in the
1st endorsement and to Technical Staff comments contained in
Enclosure 2.

1st Endorsement Comments.

Comment 1. We have applied for a Class B permit. Processing by
the State will not be completed until Shell Oil Company and the
State agree on a course of action regarding potential
contamination and possible cleanup of the bottom sediments in
Bayou Trepagnier.

Technical Staff Comments (Enclosure 2).

1. Comment 1.a. Comment noted.
2. Comment 1.b. Comment noted (see our response to comment
1.c.(2) below).
3. Comment 1.c.(1). Concur. Strain will be limited to 5%.
4. Comment 1.c.(2). Alternative, 1st lift, levee sections have
been designed for Reaches 1 (strongest) and 2A (weakest), taking
into consideration gains in foundation shear strengths during
construction by utilizing a factor of safety of 1.2 for
stability. Refer to paragraph 32. below for further discussion
of gains in strength. LMVD's strength envelope of $\phi = 20^\circ$ and
 $c = 150$ psf was used for computation of pullout. Various
strengths of reinforcement were used, and the corresponding
stability berms required were determined. The designs include an
8 foot levee crown and controlled compaction for the clay fill in
the main levee section. The gains in strength of the foundation
will be utilized to obtain a factor of safety of 1.3 during the
additional required lifts (see Enclosures 3 through 6 for the
stability analyses of the recommended alternative). Phased
construction under a single contract is not considered practical

CELMN-ED-SP

SUBJECT: Lake Pontchartrain, Louisiana and Vicinity, High Level Plan, Design Memorandum No. 18 - General Design, St. Charles Parish, North of Airline Highway.

for contractual reasons. Phased construction as outlined in this comment will have a very high potential of requiring that contract modifications are made during the Phase II portion of the contract. Awarding a contract knowing in advance that there is a high potential for modification is in our opinion unacceptable.

5. Comment 1.c.(3). An alternative, unreinforced earth levee, was considered during the preparation of the GDM but dismissed because it was much more expensive than the reinforced section. This section was redesigned utilizing an 8 foot crown and control compaction for the clay fill in the main levee section. Hydraulically-pumped sand was utilized to the maximum extent possible to yield the most economical section constructable. However, this was not the most economical alternative.

The estimated cost per linear foot of levee was prepared for the several alternatives discussed in paragraph 4 above, and for the unreinforced levee. A plot of an alternative plan's cost per linear foot for the two soil reaches discussed in paragraph 4 is shown in Enclosure 7. As can be seen from this plot, for the design constraints discussed above and in paragraph 32. below, the most cost effective design employs a medium strength, 700 pound per inch single layer fabric. For comparison, the original GDM plan cost per linear foot for Reach 2A has been recomputed using a geotextile cost more reflective of current bid prices. Note, no adjustments were made for the geotextile anchorage length for this exercise. Based on the foregoing, upon satisfactory approval of the design procedures outlined in this endorsement, we propose to redesign the entire St. Charles Parish Levee using the single layer 700 pound per inch geotextile. An approximate total cost for this plan was prepared. An approximate total cost for the first lift for this plan is estimated to be about \$17.0 million. This compares to the \$25.2 million for the GDM design.

6. Comment 1.d. Comment noted.

7. Comment 2.a. The correct number of swing gates is three. Delete the reference to the swing gate at Bayou Trepagnier (paragraph 37.b., ii) of Enclosure 1.

8. Comment 2.b. Do not concur. The pumping stations would be constructed and operated in accordance with permits obtained by local interests; any impacts of such construction and operation

CELMN-ED-SP

SUBJECT: Lake Pontchartrain, Louisiana and Vicinity, High Level Plan, Design Memorandum No. 18 - General Design, St. Charles Parish, North of Airline Highway.

have to be dealt with as part of that process. The Federal interest in the pumping stations, insofar as the hurricane project is concerned, would be limited to ensuring that they are so configured as to afford the same level of protection against tidal overflow as would the features of the hurricane project they would replace. Project credit to the local sponsor would accrue in the form of savings to the hurricane protection project resulting from substitution of the pumping stations for the gravity drainage structures.

9. Comment 2.c. Concur.

10. Comment 2.d. Concur (see status of mitigation paragraph 15. below).

11. Comment 2.e. Concur. Delete the second to last sentence in paragraph 35.a.(1) of Enclosure 1.

12. Comment 2.f. Concur. If pumping stations are installed, the protected side low water case will be modified to reflect the appropriate design water level. For the most part, the centerline of the proposed GDM levee alignment is a sufficient distance from the Airline Highway borrow canal to be affected by drawdown in the canal. In those cases where interior drainage ditches convey flow to the proposed pumping station/drainage structures, the influence of the low water case on the stability of the structure and appurtenant floodwalls will be checked.

13. Comment 2.g. The crest elevation of the road's subbase (4.0 ft. NGVD) exceeds the 100-year headwater elevation with the culverts open (see page A-40). The 100-year event presented on page A-41 applies to a 100-year rainfall coincident with a high lake level (i.e., culverts closed). The rarity of these coincident events does not, in our opinion, warrant increasing the crest elevation of the subbase to 5.0 ft. NGVD. Also, the stability requirements for the adjacent tie-in T-walls (Plate 139) dictate that the roadway be no higher unless the culverts are extended.

14. Comment 2.h. Concur. The cost tables do not show a line item itemization for silt screens. Silt screens are to be used only at the 6 or 7 locations where major streams, canals and drainage ditches are closed by the proposed levee crossings. The cost of the screens is considered minimal and is more than

CELMN-ED-SP

SUBJECT: Lake Pontchartrain, Louisiana and Vicinity, High Level Plan, Design Memorandum No. 18 - General Design, St. Charles Parish, North of Airline Highway.

sufficiently covered by the 25 percent contingencies used in the estimate. Details of the silt screen deployment will be presented in the plans and specifications for the levee and structures.

15. Comment 2.i. Concur. A draft mitigation study was prepared in March 1988. A tentatively selected plan was identified which would protect approximately 5 miles of Manchac Wildlife Management Area from shoreline erosion, thus preserving 1,100 average annual acres of wetlands. Since that time, the intended assurer for the mitigation project was unable to obtain cost-share funds due to State budget cuts. Following several months of legal consultation, the Mitigation Cost Sharing Agreements (MCA) are scheduled for preparation and should be negotiated in the near future. We are presently waiting for a firm date indicating when these MCAs will be completed and signed.

16. Comment 2.j. Concur. The project economics were updated in accordance with guidelines outlined in EC11-2-156 dated 31 March 1989. As specified in the referenced EC, using the latest approved economic reanalysis of the Lake Pontchartrain project, the remaining benefits to remaining costs ratio is 5.0 to 1 at the project discount rate. At the current Federal discount rate, the remaining benefits to remaining costs ratio is 1.9 to 1.

17. Comment 2.k. Concur. The total remaining cost of mitigation is \$6,900,000. This is comprised of a Federal share of approximately \$4,830,000 and a non-Federal share of approximately \$2,070,000. The mechanism for distribution and timing of cost share payments from local assurers will be outlined in the individual MCAs.

18. Comment 2.1.(1). Concur.

19. Comment 2.1.(2). Concur. Item 7 was accidentally left out of the table. The line item cost of \$50,000 for clearing 100 acres of borrow area is inserted.

20. Comment 2.1.(3). We have reviewed the dewatering requirement for the Bayou Trepagnier drainage structure and find that sump pumps are all that is needed for the structure excavation. However, we plan to take additional soil borings during the preparation of plans and specifications and will review this position when more detailed soils data are available.

CELMN-ED-SP

SUBJECT: Lake Pontchartrain, Louisiana and Vicinity, High Level Plan, Design Memorandum No. 18 - General Design, St. Charles Parish, North of Airline Highway.

21. Comment 2.1.(4). Concur. The concrete quantities have been reviewed and corrected as necessary. Revised cost estimates are enclosed as Enclosure 8.

22. Comment 2.m. The method used to compute the times of concentrations is outlined in the Soil Conservation Service's Technical Release No. 55 titled "Urban Hydrology For Small Watersheds". Time of concentration is computed by summing all the travel times for consecutive components of the drainage conveyance system. Components are treated as sheet flow, shallow concentrated flow, open channel flow, or some combination of these items. In addition to flow length, urban systems are significantly affected by surface roughness, channel shape and flow patterns, and slope. Although the flow lengths for some of the areas are essentially the same, the flow path from the most hydraulically distant point is not. This led to variations in time of concentration.

23. Comment 2.n. The stage-storage curves for each of the five subareas is enclosed as Enclosure 91 through 95.

24. Comment 2.o.(1). Do not concur. As part of this project, surveys were completed in October of 1986 for culverts through Airline Highway adjacent to the then-proposed location of interior drainage culverts. This was done to define flow patterns near the proposed interior drainage culverts. At that time, a decision was made to defer taking surveys of all openings through Airline Highway. Because of the large sump and interflow that occurs between areas, any analysis of the flow and corresponding head loss would be prone to considerable error and, in our opinion, amount to just an exercise in number crunching. Past experience indicates that an estimate of 0.5 feet head loss through the Airline Highway embankment is conservative. The additional expenditure of funds and labor in an attempt to refine this value is, in our view, unwarranted.

25. Comment 2.o.(2). The channels have been designed and sized to convey the design flow with existing channel slopes using Manning's Equation. Design channel "n" values were set at 0.023. Schematics of land side and flood side channels and their tie-ins to existing drainage systems are shown on Plate 2 for the

CELMN-ED-SP

SUBJECT: Lake Pontchartrain, Louisiana and Vicinity, High Level Plan, Design Memorandum No. 18 - General Design, St. Charles Parish, North of Airline Highway.

Bayou Trepagnier Structure, Plate 6 for the Cross Bayou Structure, Plate 7 for the St. Rose Structure, Plate 9 for the Walker Canal Structure, and Plate 10 for the Parish Line Canal Structure. A schedule of elevations and dimensions is given on Plates 22 and 23.

26. Comment 2.o.(3). Concur.

27. Comment 2.o.(4). It has been our experience during recent floods, including the 1973 flood, that sand boils have not developed in this reach of the Mississippi River Levee. There has also been no documented history of significant underseepage in this reach that would overburden the interior drainage system. Accordingly, flow amounts due to seepage from the Mississippi River would not impact recommended drainage structure sizes.

28. Comment 2.p.(1). Concur. The resource agency letter not having a response included in the GDM is the U.S. Department of Interior, Fish and Wildlife Service, coordination letter dated November 9, 1988. The District is reviewing the feasibility of the service's request to shift the levee alignment towards Airline Highway, U.S. 61. A copy of the District's response to the coordination letter will be furnished by separate endorsement when it is available.

29. Comment 2.p.(2). Do not concur. The purpose and extent of coverage of the EA/FONSI is clearly spelled out in the first paragraph of each of the two documents. The EA clearly states that it was prepared to supplement the FSEIS, which did not address the several topics that are covered in the EA. Subsequent to mailing the EA/FONSI, no adverse comments were received during the comment period. We take this to mean that there is no confusion on the part of the recipients. Therefore, an additional letter to EA/FONSI recipients is not deemed necessary. The confusion, if any, seems to be on the part of the United States Environmental Protection Agency (EPA) which sent three separate and totally different responses concerning the EA/FONSI (see enclosures 10, 11, and 12). Because of the concordant issues raised by EPA and the USFWS, we are confident that resolution of the USFWS issues will satisfy EPA (see

CELMN-ED-SP

SUBJECT: Lake Pontchartrain, Louisiana and Vicinity, High Level Plan, Design Memorandum No. 18 - General Design, St. Charles Parish, North of Airline Highway.

paragraph 28. above). The additional spurious issue raised by EPA concerning Section 404(b)(1) (Enclosure 12, Comment 3, May 10, 1989 letter) is totally without basis. The proposed levee centerline has, from the outset of environmental and engineering studies, been located about 800 feet north of the north shoulder of Airline Highway. The project mitigation plan and FSEIS were based on the assumption that the levee centerline would be so placed. Accordingly, the 800 foot distance does not represent a change in design occurring since the July 1984 Report and FSEIS.

30. Comment 2.g. Concur.

31. Comment 3.a. The typical sections shown on Plates 11-15 do not show estimated construction settlements. The embedment calculations and stability analyses presented utilize an estimated construction settlement of at least two feet across the total width of the geotextile. We believe that this settlement will occur because of the highly organic nature of the foundation material.

32. Comment 3.b. Concur. The design strength lines were increased below elevation 32.0 NGVD to match a C/P ratio of 0.22. However, this increase had no effect on the new designs. The gain in strength during construction was taken into consideration by utilizing a 1.2 factor of safety for design of the first lift. This design procedure is the equivalent of utilizing a 1.3 factor of safety and the corresponding higher assumed values of cohesion. The difference between these higher assumed values and the values obtained from in-situ testing represents the expected gain in strength during construction. The recommended procedure generally insures a minimum 1.2 factor of safety at all times, even if the assumed gain in strength does not occur as expected.

33. Comment 3.c. Concur. Additional borings will be taken at structure sites to locate the Pleistocene during preparation of plans and specifications.

34. Comment 3.d. Paragraph 27.e(3)(a) of Enclosure 1 states that negative skin friction was considered only for the case where berms were added for stability, thus causing settlements to occur. No fill will be added at the locations represented by plates 143 and 145; therefore, negative skin friction was considered to be not applicable.

CELMN-ED-SP

SUBJECT: Lake Pontchartrain, Louisiana and Vicinity, High Level Plan, Design Memorandum No. 18 - General Design, St. Charles Parish, North of Airline Highway.

35. Comment 4.a. Through d. Comment noted.

The following additional errors have been detected and are corrected as follows:

a. Plate 145's title is changed to "Railroad Gate - Pile Capacity Curves".

b. Plate 146's title is changed to "T-Wall Pile Capacity Curves, Station 490+00 to Airport Ext.".

c. In Plate 147's title, change "Station 490+00 to Airport Ext." to "Station 72+50 to 490+00".

FOR THE COMMANDER:



FREDERIC M. CHATRY
Chief, Engineering Division

12 Encls
(3-12) added



LEGEND

- EXISTING IMPROVEMENTS**
- LEVEE
 - SEAWALL
- AUTHORIZED IMPROVEMENTS**
- NEW LEVEE
 - ENLARGEMENT OF EXISTING LEVEE
 - FLOODWALL IN EXISTING LEVEE
 - SEAWALL STRENGTHENING
 - DRAINAGE STRUCTURE
 - STRUCTURE-NAVIGABLE
 - PUMPING STATION
 - PROJECT GRADES
 - LEVEE STATION
 - PARISH LINE
 - STATE LINE
 - LOCATION OF WORK COVERED IN THIS DOCUMENT

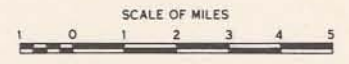

LAKE PONTCHARTRAIN, LA. AND VICINITY
HURRICANE PROTECTION

**AUTHORIZED
PLAN OF PROTECTION**

U.S. ARMY ENGINEER DISTRICT, NEW ORLEANS
CORPS OF ENGINEERS

FILE NO. H-4-29540

LAKE PONTCHARTRAIN, LOUISIANA AND VICINITY
HIGH LEVEL PLAN
DESIGN MEMORANDUM NO. 18 - GENERAL DESIGN
ST. CHARLES, PARISH NORTH OF AIRLINE HIGHWAY

TABLE OF CONTENTS VOLUME I

<u>Paragraph</u>	<u>Title</u>	<u>Page</u>
PROJECT AUTHORIZATION		
1	Authority	
	a. Public Law	1
	b. House Document	1
	c. BERH Recommendation	1
2	Purpose and Scope	1
3	Local Cooperation	2
	a. Flood Control Act of 1965 (Public Law 89-298)	2
	b. Water Resources Development Act of 1974 (Public Law 93-251)	3
4	Project Document Investigation	4
5	Investigations Made Subsequent to Project Authorization	4
6	Planned Future Investigations	5
7	Local Cooperation Requirements	5
8	Status of Local Cooperation	7
9	Views of Local Interests	7
LOCATION OF PROJECT AND TRIBUTARY AREA		
10	Project Location	8
PROJECT PLAN		
11	General	8
12	Departures from Project Document Plan	9

TABLE OF CONTENTS (CONT'D)

<u>Paragraph</u>	<u>Title</u>	<u>Page</u>
HYDROLOGY AND HYDRAULICS		
13	Hydrology and Hydraulics	9
	a. General	9
	b. Surface Drainage	10
GEOLOGY		
14	Physiography	11
15	General Geology	11
16	Investigation	11
17	Subsidence and Seismic Activity	11
18	Groundwater Resources	12
19	Mineral Resources	12
20	Foundation Conditions	12
SOILS AND FOUNDATION INVESTIGATION AND DESIGN		
21	General	12
22	Field Investigation	13
23	Laboratory Tests	14
24	Foundation and Soil Conditions	14
25	Design Problems	14
26	Types of Protective Works	15
27	Design Analyses	15
	a. Bearing Capacity of the Geotextile Reinforced Levee	15
	b. Stability	15
	c. Seepage Blanket	17
	d. Cantilever I-Wall	17
	e. T-Wall	17
	f. Settlement	19
	g. Drainage Structure Dewatering During Construction	20
	h. Bridge	20
	i. Erosion Protection	20

TABLE OF CONTENTS (CONT'D)

<u>Paragraph</u>	<u>Title</u>	<u>Page</u>
	DESCRIPTION OF PROPOSED STRUCTURES AND IMPROVEMENTS	
28	Levees	20
	METHOD OF CONSTRUCTION	
29	Recommended Levee Construction	20
	OTHER LEVEE PLANS CONSIDERED	
30	Alternative Levee Plans Considered	20
	ACCESS ROADS	
31	Assess Roads	21
	RELOCATIONS	
32	General	21
	RAMPS	
33	Ramps	22
	SOURCE OF CONSTURCTION MATERIALS	
34	Source of Construction Materials	22
	a. Source of Construction Materials for Floodwall and Structures	22
	b. Source of Fill for Levee	22
	c. Source of Sand for Sand Base	22
	DESCRIPTION OF PROPOSED FLOODWALLS, GATES AND DRAINAGE STRUCTURES	
35	Floodwalls, Gates, and Drainage Structures	22
	a. Floodwalls	22
	b. Gates	23
	c. Bridge Crossing	24
	d. Utility Relocations	24
	e. Alternate Plan for Structures	24

TABLE OF CONTENTS (CONT'D)

<u>Paragraph</u>	<u>Title</u>	<u>Page</u>
STRUCTURAL DESIGN		
36	Criteria for Structural Design	25
37	Basic Data	25
	a. Water Elevations	25
	b. Floodwall Gross Grade	25
	c. Unit Weights	27
	d. Uniform Live Loads	27
	e. Design Loads	27
38	Design Methods	27
39	Location and Alignment	
40	Drainage Structures	28
	a. General	28
	b. Loading Cases	28
	c. Bridge at Drainage Structure	28
	d. Bridge at Vicinity of Cross Bayou Drainage Structure	29
41	I-Type Floodwall	29
	a. General	29
	b. Loading Cases	29
	c. Joints	29
42	T-Type Floodwall	29
	a. General	29
	b. Loading Cases	29
	c. Joints	30
43	Swing Gates and Gate Monoliths	30
	a. General	30
	b. Loading Cases	30
44	Cathodic Protection and Corrosion Control	31
	a. Cathodic Protection for Steel Sheet Piling	31
	b. Corrosion Control	31
ENVIRONMENTAL EFFECTS		
45	Biological Impacts	31
	a. Scenic Streams	31
	b. Levee Realignment	32
	c. Landfill Crossings	32
	d. Drilling Waste Pits	33

TABLE OF CONTENTS (CONT'D)

<u>Paragraph</u>	<u>Title</u>	<u>Page</u>
46	Endangered Species	33
47	Recreation	33
48	Esthetics	34
49	Cultural	34
50	Noise	34
51	Community Cohesion	34
COMPLIANCE WITH ENVIRONMENTAL LAWS		
52	Compliance with Environmental Laws	34
COORDINATION WITH OTHER AGENCIES		
53	Coordination with Other Agencies	35
	a. General	35
	b. Environmental Coordination	35
REAL ESTATE REQUIREMENTS		
54	General	36
OPERATION AND MAINTENANCE		
55	General	
ECONOMICS		
56	Economic Justification	36
ESTIMATE OF REMAINING COST		
57	General	37
58	Comparison of Estimates	64
	a. Levees and Floodwalls	64
	b. Engineering and Design	64
	c. Supervision and Administration	65
	d. Lands and Damages	65
	e. Relocations	65

TABLE OF CONTENTS (CONT'D)

<u>Paragraph</u>	<u>Title</u>	<u>Page</u>
59	Schedule for Design and Construction	65
60	Funds Required by Fiscal Year	67

FEDERAL AND NON-FEDERAL COST BREAKDOWN

61	Federal and Non-Federal Cost Breakdown	68
----	--	----

RECOMMENDATIONS

62	Recommendation	68
----	----------------	----

TABLES

<u>No.</u>	<u>Title</u>	<u>Page</u>
1	Design Reaches	13
2	Concrete Piles	18
3	Steel H-Piles	18
4	Utility Relocation Schedule	21
5	Relevant Structural Design Data	25
6	Pertinent Stresses for Reinforced Concrete Design	27
7	Estimate of First Cast	38
8	Comparison of Estimates	64
9	Schedule for Design and Construction	66
10	Federal and Non-Federal Funding by Fiscal Year	67
11	Federal and Non-Federal Cost Breakdown	68

TABLE OF CONTENTS (CONT'D)

PLATES

<u>No.</u>	<u>Title</u>
1	Index and Vicinity Map
2	Plan and Profile Sta. 0+00 to Sta. 44+00
3	Plan and Profile Sta. 44+00 to Sta. 89+00
4	Plan and Profile Sta. 89+00 to Sta. 157+00
5	Plan and Profile Sta. 157+00 to Sta 224+00
6	Plan and Profile Sta. 224+00 to Sta. 295+00
7	Plan and Profile Sta. 295+00 to Sta 359+00
8	Plan and Profile Sta. 359+00 to Sta. 404+00
9	Plan and Profile Sta. 404+00 to Sta. 465+00
10	Plan and Profile Sta. 465+00 B/L to Sta. 523+99.1 C/L
11	Typical Design Sections
12	Typical Design Sections
13	Typical Design Sections
14	Ramp Crossing and Canal
15	Ramp Crossing/Pipeline and Pipeline Sections
16	Landfill Sections
17	Floodwall at I-310 Interchange
18	Floodwall at I-310 Interchange - Profile Sta. 500+00 W/L to Sta. 511+50 W/L
19	Floodwall at I-310 Interchange - Profile Sta. 511+50 W/L to Sta. 517+12.5 W/L
20	Floodwall at I-310 Interchange Typical Sections
21	Floodwall at I-310 Interchange - Swing Gate Details
22	Sluice Gate Structures - Typical Plan
23	Sluice Gate Structures - Typical Profile

TABLE OF CONTENTS (CONT'D)

PLATES

<u>No.</u>	<u>Title</u>
24	Sluice Gate Structures - Sections
25	Bayou Trepagnier Drainage Structure - Plan and Pile Layout
26	Cross Bayou Drainage Structure - Plan and Pile Layout
27	St. Rose Drainage Structure - Plan and Pile Layout
28	Parish Line Canal and Walker Canal Drainage Structure - Plan and Pile Layout
29	Typical Section Thru Structure
30	Cross Bayou and Bayou Trepagnier Drainage Structures - Sectional Elevations
31	St. Rose, Walker Canal, and Parish Line Canal Drainage Structures - Sectional Elevations
32	Floodwall Vicinity Good Hope Field Facility Profile
33	Floodwall at Shell Oil Company Good Hope Field Facility Typical Sections
34	Good Hope Field Facility Swing Gate Details
35	Swing Gate Seal Details
36	Vicinity Railroad Gate - Profile
37	Vicinity Railroad Gate - Sections
38	Railroad Swing Gate - Details
39	Railroad Gate Seal Details
40	Bridge Vicinity of Cross Bayou Sections and Details
41	Typical Wall Sections
42	Typical Wall Sections
43	Typical Wall Joints

TABLE OF CONTENTS (CONT'D)

PLATES

<u>No.</u>	<u>Title</u>
44	Utility Crossings
45	Alternative Plan C.M.P Drainage Structures Plan
46	Alternative Plan C.M.P. Drainage Structures Typical Section
47	Alternative Plan C.M.P. Drainage Structures Preload Sections
48	Bonnet Carre Spillway Barrow Site
49	Borrow Locations for Sand Pits
50	Borrow Locations for Sand Pits
50A	Alternate Alignment

TABLE OF CONTENTS VOLUME II

51	Soil and Plates Geologic Profile
52	Soil and Plates Geologic Profile
53	Soil and Plates Geologic Profile - Alternate Alignmnet
54	Soil and Plates Geologic Profile
55	Soil and Geologic Profile
56	Soil and Geologic Profile
57	Soil and Geologic Profile
58	Soil and Geologic Profile
59	Soil and Geologic Profile
60	Soil Borings Along Levee B/L
61	Soil Borings Along Levee B/L
62	Soil Borings Along Levee B/L
63	Soil Borings Along Levee B/L

TABLE OF CONTENTS (CONT'D)

PLATES

<u>No.</u>	<u>Title</u>
64	Soil Borings Along Levee B/L
65	Soil Borings Along Levee B/L
66	Bonnet Carre Borrow Borings
67	Bonnet Carre Borrow Borings
68	Undisturbed Boring 1-SCU
69	Undisturbed Boring 2-SCU
70	Undisturbed Boring 3-SCU
71	Undisturbed Boring 4-SCU
72	Undisturbed Boring 5-SCU
73	Undisturbed Boring 6-SCU
74	Undisturbed Boring 7-SCU
75	Undisturbed Boring 8-SCU
76	Undisturbed Boring 9-SCU
77	Undisturbed Boring 10-SCU
78	Undisturbed Boring 11-SCU
79	Design Soil Parameters
80	Design Soil Parameters
81	Design Soil Parameters
82	Geotextile Reinforced Levee Section Reach 1-Protected Side
83	Geotextile Reinforced Levee Section Reach 2-Flood Side
84	Geotextile Reinforced Levee Section Reach 2A-Protected Side
85	Geotextile Reinforced Levee Section Reach 2A-Flood Side
86	Geotextile Reinforced Levee Section Reach 2B-Protected Side
87	Geotextile Reinforced Levee Section Reach 2B-Flood Side

TABLE OF CONTENTS (CONT'D)

PLATES

<u>No.</u>	<u>Title</u>
88	Geotextile Reinforced Levee Section Reach 3A-Protected Side
89	Geotextile Reinforced Levee Section Reach 3A-Flood Side
90	Geotextile Reinforced Levee Section Reach 3B-Protected Side
91	Geotextile Reinforced Levee Section Reach 3B-Flood Side
92	Unreinforced Levee Section Reach 4-Protected Side (Landfill)
93	Unreinforced Levee Section Reach 4-Protected Side (Landfill)
94	Geotextile Reinforced Levee Section Reach 5-Protected Side
95	Geotextile Reinforced Levee Section Reach 5-Flood Side
96	Geotextile Reinforced Levee Section Reach 6A-Protected Side
97	Geotextile Reinforced Levee Section Reach 6A-Flood Side
98	Geotextile Reinforced Levee Section Reach 6B-Protected Side
99	Geotextile Reinforced Levee Section Reach 6B-Flood Side
100	Geotextile Reinforced Levee Section Reach 7-Protected Side
101	Geotextile Reinforced Levee Section Reach 7-Flood Side
102	Geotextile Reinforced Levee Section Reach 8-Protected Side
103	Geotextile Reinforced Levee Section Reach 8-Flood Side
104	Typical Geotextile Reinforced Canal Closure - Protected Side
105	Typical Geotextile Reinforced Canal Closure - Flood Side
106	Typical Geotextile Reinforced Pipeline Crossing - Protected Side
107	Typical Geotextile Reinforced Pipeline Crossing - Flood Side
108	Typical Geotextile Reinforced Ramp/Pipeline Crossing - Protected Side

TABLE OF CONTENTS (CONT'D)

PLATES

<u>No.</u>	<u>Title</u>
109	Typical Geotextile Reinforced Ramp/Pipeline Crossing - Flood Side
110	Typical Geotextile Reinforced Ramp Crossing - Protected Side
111	Typical Geotextile Reinforced Ramp Crossing - Flood Side
112	Shell Oil Field T-Wall Approximate Sta. 149+70 - Protected Side - Deep Seated Stability Analysis
113	Shell Oil Field T-Wall Approximate Sta. 149+70 - Flood Side - Deep Seated Stability Analysis
114	Shell Oil Field I-Wall Approximate Sta. 149+70 (1st Lift)- Protected Side - Stability Analysis
115	Shell Oil Field I-Wall Approximate Sta. 149+70 (1st Lift)- Flood Side - Stability Analysis
116	Shell Oil Field Cantilever Sheet Pile Analysis Approximate Sta. 149+70
117	I-Wall (West of I-310 T-Wall) Stability Analysis Protected Side
118	I-Wall (West of I-310 T-Wall) Cantilever Sheet Pile Analysis
119	T-Wall Beneath I-310 Sta. 357+00 to Sta. 370+00 Flood Side Deep Seated Stability Analysis
120	T-Wall Beneath I-310 Sta. 357+00 to Sta. 370+00 Flood Side Deep Seated Stability Analysis
121	I-Wall (East of I-310) Stability Analysis - Sta. 370+00 to Sta. 370+90 (1st Lift) - Protected Side
122	I-Wall (east of I-310) Stability Analysis - Sta. 370+00 to Sta. 370+90 (1st Lift) - Flood Side
123	I-Wall (East of I-310) Cantilever Sheet Pile Analysis - Sta. 370+00 to Sta. 370+90
124	Parish Line R/R Gate I-Wall - Approximate Sta. 518+40 Stability Analysis - Protected Side
125	Parish Line R/R Gate I-Wall - Approximate Sta. 518+40 - Stability Analysis - Flood Side

TABLE OF CONTENTS (CONT'D)

PLATES

<u>No.</u>	<u>Title</u>
126	Parish Line Railroad Gate I-Wall Cantilever Sheet Pile Analysis
127	Parish Line Railroad Gate T-Wall Approximate Sta. 518+40 - Protected Side - Deep Seated Stability Analysis
128	Parish Line Railroad Gate T-Wall Approximate Sta. 518+40 - Flood Side - Deep Seated Stability Analysis
129	I-Wall from R/R Gate to Airport Ext. (1st Lift) Stability Analysis
130	Stability Analysis - I-Wall from R/R Gate to Airport Ext.
131	Drainage Structure Typical I-Wall Stability - Protected Side (1st Lift)
132	Drainage Structure Typical I-Wall Stability - Flood Side (1st Lift)
133	Drainage Structure Typical Cantilever Analysis
134	Drainage Structure - Deep Seated Stability Analysis
135	Deep Seated Stability Analysis W/Earth Pressures and Typical Section Through Flood Side Wingwall
136	Deep Seated Stability Analysis W/Earth Pressures and Typical Section Through Protected Side Wingwall
137	Deep Seated Stability Analysis W/Earth Pressures next to Structure Typical T-Wall
138	Deep Seated Stability Analysis Typical T-Wall with Stability Berm Approximate 90' from Drainage Str.
139	Stability Analysis - Skewed Section from T-Wall to Channel
140	Stability Analysis - I-Wall into Channel
141	Drainage Structure Typical Excavation Cut Stability Analysis
142	Drainage Structure Typical Stockpile and Channel Cut
143	Drainage Structure Typical Pile Capacity Curves Sta. 72+50 to Sta. 490+00
144	T-Wall - Typical Pile Capacity Curves Sta. 72+50 to Sta. 490+00

TABLE OF CONTENTS (CONT'D)

PLATES

<u>No.</u>	<u>Title</u>
145	T-Wall and Wingwall HP 12"x53" Typical Pile Capacity Curves Sta. 72+50 to Sta. 490+00
146	Railroad Gate Pile Capacity Curves
147	Typical Pile Capacity Curves Sta. 490+00 to Airport Ext.
148	Settlement vs Time
149	Bridge Crossing Stability Analysis - North Side
150	Bridge Crossing Stability Analysis - South Side
A	Soil Boring Legend

APPENDIX

VOLUME I

A	Hydrology and Hydraulics
B	Pertinent Correspondence
C	Detailed Cost Estimates

APPENDIX

VOLUME II

D	F&M Design Calculations
E	Soil Test Data Sheets

LAKE PONTCHARTRAIN, LOUISIANA AND VICINITY
HIGH LEVEL PLAN
DESIGN MEMORANDUM NO. 18 - GENERAL DESIGN
ST. CHARLES, PARISH NORTH OF AIRLINE HIGHWAY

PROJECT AUTHORIZATION

1. Authority.

a. Public Law. Public Law 298, 89th Congress, 1st Session, approved 27 October 1965, authorized the "Lake Pontchartrain, Louisiana, and Vicinity," hurricane protection project, substantially in accordance with the recommendations of the Chief of Engineers in House Document No. 231, 89th Congress, 1st Session, except that the recommendations of the Secretary of the Army in that document shall apply with respect to the Seabrook Lock feature of the project.

b. House Document. The report of the Chief of Engineers dated 4 March 1964, printed in House Document No. 231, 89th Congress, 1st Session, submitted for transmission to Congress the report of the Board of Engineers for Rivers and Harbors, accompanied by the reports of the District and Division Engineers and the concurring report of the Mississippi River Commission for those areas under its jurisdiction. The report of the Board of Engineers for Rivers and Harbors stated: "For protection from hurricane flood levels, the reporting officers find that the most suitable plan would consist of a barrier extending generally along US Highway 90 from the easternmost levee to high ground east of the Rigolets, together with floodgates and a navigation lock in the Rigolets, and flood and navigation gates in Chef Menteur Pass; construction of a new lakeside levee in St. Charles Parish extending from the Bonnet Carre Spillway guide levee to and along the Jefferson Parish line; extension upward of the existing riprap slope protection along the Jefferson Parish levee; enlargement of the levee landward of the seawall along the 4.1 mile lakefront, and construction of a concrete-capped sheetpile wall along the levee west of the Inner Harbor Canal in New Orleans."

c. BERH Recommendation. The report of the Chief of Engineers stated: "The Board (of Engineers of Rivers and Harbors) recommends authorization for construction essentially as planned by the reporting officers...I concur in the recommendation of the Board of Engineers for Rivers and Harbors."

2. Purpose and Scope. This memorandum presents the essential data, assumptions, criteria, and computations for developing the plan, design, and cost estimates for constructing the St. Charles Parish north of Airline Highway levee and associated drainage structures to high level standards (i.e., no barriers in the Chef Menteur and Rigolets Passes).

The recommended designs contained in this DM reflect the least costly method of providing the authorized standard project hurricane protection. The bases for the recommended levee alignment are detailed in the "Lake Pontchartrain, Louisiana and Vicinity Hurricane Protection Project - Reevaluation Study" dated July 1984. The plan detailed in this GDM covers approximately 9.5 miles of earthen levee; five gravity drainage structures; two roadway swing gates; two road ramps; and approximately 5,160 feet of floodwall. The recommended levee alignment is shown on Plate 1. On the eastern end of the project, the levee will tie into the recently constructed airport extension levee which lies just north of the T. L. James Industrial Park near the Jefferson/St. Charles Parish boundary line. The line of protection will continue from this point angling south, southwest towards U. S. Highway 61 (Airline Highway) to a point approximately 800 feet north of Highway 61 in the vicinity of the junctions of Almedia Road and Highway 61. From this point, the levee continues westward parallel to Highway 61 for a distance of about 6 miles where, near the western limits of the work, the levee will turn north to go around the existing Shell Oil Company tank farm area near Norco, Louisiana. At that point, the western limits of work, the levee will tie into the east guide levee of the Bonnet Carre Spillway.

The levee design employs two layers of the new super high strength geotextiles as reinforcement. Construction will be accomplished by pumping sand from Mississippi River borrow pits to form a base upon which to place the first layer of fabric. Levee construction will be of semicompacted clay obtained from borrow pits in the Bonnet Carre Spillway.

3. Local Cooperation.

a. Flood Control Act of 1965 (Public Law 89-298). The conditions of local cooperation pertinent to this GDM and as specified in the report of the Board of Engineers for Rivers and Harbors and concurred by the report of the Chief of Engineers are as follows:

"...That the barrier plan for protection from hurricane floods of the shores of Lake Pontchartrain...be authorized for construction, ... Provided that prior to construction of each separable independent feature local interest furnish assurances satisfactory to the Secretary of the Army that they will, without cost to the United States:

"(1) Provide all lands, easements, and rights-of-way, including borrow and spoil disposal areas, necessary for construction of the project;

"(2) Accomplish all necessary alterations and relocations to roads, railroads, pipelines, cables, wharves, drainage structures, and other facilities made necessary by the construction works;

"(3) Hold and save the United States free from damages due to the construction works;

"(4) Bear 30 percent of the first cost, to consist of the fair market value of the items listed in subparagraphs (1) and (2) above and a cash contribution presently estimated at \$14,384,000 for the barrier plan...to be paid either in a lump sum prior to initiation of construction or in installments at least annually in proportion to the Federal appropriation prior to start of pertinent work items, in accordance with construction schedules as required by the Chief of Engineers, or, as a substitute for any part of the cash contribution, accomplish in accordance with approved construction schedules items of work of equivalent value as determined by the Chief of Engineers, the final apportionment of costs to be made after actual costs and values, have been determined;

"(5) For the barrier plan, provide an additional cash contribution equivalent to the estimated capitalized value of operation and maintenance of the Rigolets navigation lock and channel to be undertaken by the United States, presently estimated at \$4,092,000, said amount to be paid either in a lump sum prior to initiation of construction of the barrier or in installments at least annually in proportion to the Federal appropriation for construction of the barrier;

"(6) Provide all interior drainage and pumping plants required for reclamation and development of the protected areas;

"(7) Maintain and operate all features of the works in accordance with regulations prescribed by the Secretary of the Army, including levees, floodgates, approach channels, drainage structures, drainage ditches or canals, floodwalls, seawalls, and stoplog structures, but excluding the Rigolets navigation lock and channel and the modified dual purpose Seabrook lock; and

"(8) Acquire adequate easements or other interest in land to prevent encroachment on existing ponding areas unless substitute storage capacity or equivalent pumping capacity is provided promptly, provided that construction of any of the separable independent features of the plan may be undertaken independently of the others, whenever funds for that purpose are available and the prescribed local cooperation has been provided..."

b. Water Resources Development Act of 1974 (Public Law 93-251).

The local interest payment procedures outlined in the original conditions of local cooperation were modified in 1974 as follows: "The hurricane-flood protection project on Lake Pontchartrain, Louisiana, authorized by Section 204 of the Flood Control Act of 1965 (Public Law 89-298) is hereby modified to provide that non-Federal public bodies may agree to pay the unpaid balance of the cash payment due, with interest,

in yearly installments. The yearly installments will be initiated when the Secretary determines that the project is complete, but in no case shall the initial installment be delayed more than ten years after the initiation of project construction. Each installment shall not be less than one twenty-fifth of the remaining unpaid balance plus interest on such balance, and the total of such installments shall be sufficient to achieve full payment, including interest, within twenty five years of the initiation of project construction."

4. Project Document Investigations. Studies and investigations made in connection with the report on which authorization is based (House Document No. 231, 89th Congress, 1st Session) consisted of: research of information which was available from previous reports and existing projects in the area; extensive research in the history and records of hurricanes; damage and characteristics of hurricanes; extensive tidal hydraulics investigations involving both office and model studies relating to the ecological impact of the project on Lakes Pontchartrain and Borgne; an economic survey; and survey scope design and cost studies. A public hearing was held in New Orleans on 13 March 1956 to determine the views of local interests.

5. Investigations Made Subsequent to Project Authorization. In December 1977, a Federal court injunction was issued stopping construction of portions of the authorized project. The injunction was issued on the basis that the 1975 Final Environmental Impact Statement (FEIS) for the Lake Pontchartrain project was inadequate. The court directed, among other things, that the FEIS be rectified to include adequate development and analysis of alternatives to the then ongoing proposed action. The results of these studies are contained in a three volume report entitled "Lake Pontchartrain, Louisiana and Vicinity Hurricane Protection Project, Reevaluation Study", dated July 1984. The reevaluation report recommended a "tentatively selected" high level plan of protection. This recommendation necessitated the preparation of this report as part of the Lake Pontchartrain Hurricane Protection Project, and the engineering and environmental studies discussed herein. Surveys and studies accomplished in preparing this GDM include the following:

- a. Alternative plan studies to develop alternative methods of construction required to optimize the proposed plan of protection;
- b. Aerial and hydrographic surveys;
- c. Soils investigations including general and undisturbed type borings and associated laboratory investigations;
- d. Detailed design studies for alternative plans (including stability analysis);

e. Tidal hydraulic studies required for establishing design grades for protective works based on the latest revised hurricane parameters furnished subsequent to project authorization by the National Weather Service and hydrologic design studies necessary to design the interior drainage structures presented in this report.

f. Real Estate requirements;

g. Detailed cost estimates for the proposed plan of protection as well as alternative plans and necessary utility relocations;

h. Environmental effects and evaluations; and

i. A comprehensive public meeting for the "tentatively selected" high level plan held on 12 April 1984.

6. Planned Future Investigations. Upon satisfactory approval of this GDM, additional detailed Engineering Designs and Specifications will be prepared to support construction of this project feature. Some additional field surveys are anticipated at this time to support these designs. Additionally, the St. Charles Parish Council has expressed a desire to, if economically feasible, construct pumping stations at several locations where we now propose to place gravity drainage structures. The Council has retained the services of a consulting engineering firm to look into the feasibility of pumping stations. Should this scenario of pumping stations in place of gravity drainage structures materialize, then it will be necessary to conduct additional engineering cost studies. It has been explained to the Parish Council that construction of pumping stations at Federal cost is not authorized under the Lake Pontchartrain, Louisiana and Vicinity Project. However, credits as work in kind may be given to the local sponsor if the pumping stations eliminate the need to build one or more of the gravity drainage structures.

7. Local Cooperation Requirements. The conditions of local cooperation as specified in the authorizing laws are quoted in Paragraph 3. These conditions are applicable to the "Barrier Plan." A post authorization report for a "High Level Plan" recommended that assurances be amended. A complete list of local assurance items (as amended) are set forth as follows:

a. Provide all lands, easements, and rights-of-way, including borrow and spoil disposal areas necessary for construction, operation, and maintenance of the project; and

b. Accomplish all necessary alterations and relocations to roads, railroads, pipelines, cables, wharves, drainage structures, and other facilities required by the construction of the project;

c. Hold and save the United States free from damages due to the construction works; and

d. Bear 30 percent of the first cost, to consist of the fair market value of the items listed in subparagraphs (a) and (b) above and a cash contribution as presently estimated below, to be paid either in a lump sum prior to initiation of construction or in installments at least annually in proportion to the Federal appropriation prior to start of pertinent work items, in accordance with construction schedules as required by the Chief of Engineers, or, as a substitute for any part of the cash contribution, accomplish in accordance with approved construction schedules items of work of equivalent value as determined by the Chief of Engineers, the final apportionment of costs to be made after actual costs and values have been determined:

COST TO ORLEANS LEVEE DISTRICT
(\$1,000,000's)

	FIRST COST ^{1/}	LOCAL SHARE
St. Charles	55.7	16.7

^{1/} Cost to complete after October 1979; October 1981 price levels.

e. Delete the following item in full because it pertains only to the barrier plan:

Provide an additional cash contribution equivalent to 30.4% of the estimated capitalized value of maintenance and operation of the Rigolets navigation lock and channel to be undertaken by the United States, the cash consideration is estimated at \$2,805,900, the final determination to be made after construction is complete, said amount to be paid either in a lump sum prior to initiation of construction of the barrier or in installments at least annually in proportion to the Federal appropriation for construction of the barrier;

f. Provide all interior drainage and pumping plants required for reclamation and development of the protected areas;

g. Maintain and operate all features of the project in accordance with regulations prescribed by the Secretary of the Army, including levees, floodgates and approach channels, drainage structures, drainage ditches or canals, floodwalls, and stoplog structures [the remainder of this item is deleted];

h. Acquire adequate easements or other interest in land to prevent encroachment on existing ponding areas unless substitute storage capacity or equivalent pumping capacity is provided promptly;

i. Comply with the applicable provisions of the "Uniform Relocation Assistance and Real Property Acquisition Policies Act of 1970", Public Law 91-646;

j. Assume the responsibility to pay its share of the non-Federal project costs [the remainder of this item is deleted];

k. As a minimum, adhere to the payment schedule of the deferred payment plan, the apportionment of costs to be made as actual costs, values, and schedules are determined. The first payment under the deferred payment plan was due on 1 October 1976, with subsequent payments being due on 1 October of each succeeding year, up to and including 1 October 1990. Interest is charged on the unpaid balance during this period at the rate of 3.125 percent per annum. Cash contributions required subsequent to 30 September 1991 shall be computed in accordance with the basic 30 percent requirement stipulated in Section 204 of the Flood Control Act of 1965, Public Law 89-298 and House Document 231, 89th Congress;

l. Recognizes that subsections (b), (c), and (e) of Section 221 of the "Flood Control Act of 1970", Public Law 91-611 shall apply to paragraph (k) above.

m. Comply with Section 601 of Title VI of the Civil Rights Act of 1964, Public Law 88-352, that no person shall be excluded from participation in, denied the benefits of, or subjected to discrimination in connection with the Project on the grounds of race, creed, or national origin.

While the above requirements reflect the present agreements of local assurance as signed in April 1987, they do not address the need for mitigation as required by the Fish and Wildlife Coordination Act of 1958, 16 U.S.C. 661 et seq. (PL 85-624, Aug 58).

8. Status of Local Cooperation. New agreements of assurances covering all local cooperation requirements and a deferred payment plan for the Barrier Plan as authorized by Public Law 93-251 were executed by the Pontchartrain Levee District on 20 September 1976. These assurances were accepted on behalf of the United States on 7 December 1977. Amended assurances for the High Level Plan were executed by the local sponsor on 20 April 1987, and accepted by the United States on 7 August 1987.

9. Views of Local Interests. The Pontchartrain Levee District is the agency responsible for providing local interest assurances for this

feature of the project. The plan of protection presented herein has been coordinated with the Levee Board and their engineering staff and bears the approval of that agency.

LOCATION OF PROJECT AND TRIBUTARY AREA

10. Project Location. The St Charles Parish north of Airline Highway levee, a feature of the Lake Pontchartrain, Louisiana and Vicinity Hurricane Protection Project as shown on Plate 1, is located in southeastern Louisiana in St. Charles Parish on the east bank of the Mississippi River. The levee will be oriented in an east-west direction and will separate the developed areas in St. Charles Parish from the approximately 26,000 acres of wetlands on the north side of the levee. On its east end, the levee will tie into the Jefferson/St. Charles Return Levee just south of the new east-west runway extension. In general, the levee will parallel Airline Highway to where, at its western limits, it will turn north to go around the Shell Oil Company tank farm and tie into the east guide levee of the Bonnet Carre Spillway.

PROJECT PLAN

11. General. The project, as shown on the flyleaf map, consists of two separate and distinct major features - the Chalmette Area Plan and the Lake Pontchartrain High Level Plan. The Lake Pontchartrain High Level Plan is further subdivided into the New Orleans East and the New Orleans West Area Units. The St. Charles Parish levee is a feature of the New Orleans West Area Unit. Plan layout and plan profile are shown on Plates 2 through 10.

The proposed levee will be constructed of semicompacted haul clay fill founded on a sand bed and reinforced by 2 layers of high strength geotextile. Sand will be hydraulically pumped from borrow areas in the Mississippi River and clay borrow will be hauled from the Bonnet Carre Spillway. The net levee grade varies from elevation 13.0 N.G.V.D.^{1/} on the western limits of the work to elevation 12.0 N.G.V.D. on the eastern limits near the Jefferson/St. Charles Parish line. It is expected that the levee construction will require four lifts which, for the purpose of this DM, are scheduled over a 20 year period. However, prelift soil borings will be made between lifts to insure that the anticipated consolidation and settlement produce the gains in soil strengths necessary to accomplish the upcoming proposed lift. If possible, the

^{1/} Elevations throughout this GDM are in feet referenced to National Geodetic Vertical Datum (NGVD) unless otherwise noted.

third and fourth lifts will be accelerated in order to complete the construction sooner. It should be pointed out that the use of the high strength geotextile allows the first lift to be economically overbuilt so that the levee crown will always be above the 100-year frequency stillwater level. Therefore, once the first lift is in place and the five proposed concrete box culvert drainage structures are completed, the lands on the protected side of the levee will enjoy a relatively high degree of flood protection. As scheduled, the time required for the first lift plus the construction of the drainage control structures is expected to take about 5 years. A schedule of design and construction is presented in a later paragraph in this report. In general, the levee base plus stability berm will vary in width from as little as 190 feet to as much as 430 feet (see typical sections Plates 11 through 13). The gravity drainage structures have been designed so that positive closure can be achieved by closing vertical lift gates to prevent storm surges from entering the protected area. The structures have been designed to pass the 24-hour 25-year frequency rainfall event. Details of the hydrology and hydraulic design are discussed in Appendix A, Volume I.

12. Departures From Project Document Plan. The project document plan (Barrier Plan) called for constructing a levee along the shoreline of Lake Pontchartrain at a location approximately five miles north of the alignment recommended in this GDM. The Barrier Plan lakefront alignment was to have tied into the existing Jefferson Parish Lakefront Levee in the vicinity of the Parish line canal at its eastern limit and follow the shoreline of the lake to where it would join the northern end of the east guide levee of the Bonnet Carre Spillway at the western limit. The 1984 reevaluation report did in fact reexamine the authorized Barrier Plan alignment as well as others. The only plan found to be economically feasible was the alignment recommended herein. Details of the plan evaluation and selection process are given in the "Lake Pontchartrain, Louisiana and Vicinity Hurricane Protection Project - Reevaluation Study", July 1984.

HYDROLOGY AND HYDRAULICS

13. Hydrology and Hydraulics.

a. General. The Hydrology and Hydraulics Analysis Design Memorandum for the Lake Pontchartrain Barrier Plan was presented in a series of three separate reports entitled "Design Memorandum No. 1" and subtitled "Part I - Chalmette, Part II - Barrier, and Part III - Lakeshore; it was approved on 6 March 1969. These documents present detailed descriptions and analyses of the tidal hydraulic methods and procedures used in the tidal hydraulic assumptions, and criteria used and results of studies which provide the bases for determining surges,

routing, wind tides, runup, overtopping, and frequencies. The criteria applicable to this levee feature and the hydraulic designs are presented in Appendix A, Volume I, of this memorandum.

b. Surface Drainage. The proposed levee and floodwall construction will intercept the natural surface drainage in the project area. Therefore, five drainage structures have been incorporated in the levee to accommodate the surface runoff. The structures have been strategically located and sized to allow for maintenance of runoff patterns to the fullest extent possible. Details of the interior drainage design are contained in Appendix A, Volume I.

GEOLOGY

14. Physiography. The project site is located on the Deltaic Plain portion of the Mississippi River Alluvial Plain. Specifically, the project is located on the southern edge of the Lake Pontchartrain Basin and east of the Mississippi River. Dominant physiographic features include natural levee ridges, crevasse-splay deposits, marsh, swamps and lakes. Elevations vary from approximately +10 to +15 ft. NGVD along the natural levee of the Mississippi River to 0 ft. NGVD in the backswamp and marsh areas.

15. General Geology. Only the geologic history since the end of the Pleistocene Epoch is pertinent to the project. At the close of the Pleistocene, sea level was approximately 360 to 400 feet below present sea level and the Mississippi River was entrenched into the older Pleistocene sediments west of the project area. As sea level rose to its present stand, the entrenched valley was filled with sediment by the Mississippi River, resulting in an increase in meandering and channel migration. This meandering and channel migration has resulted in a series of deltas extending into the Gulf of Mexico. Seven Holocene deltas are recognized in the lower Mississippi River Valley; however, only four are relevant to the project area. The oldest of the four deltas in the vicinity of the project was the Cocadrie Delta whose distal ends extended across the New Orleans area from west to east. Following the Cocadrie Delta in the vicinity of the project was the St. Bernard Delta which followed the same general course as the Cocadrie Delta but extended further to the east. It was during this period that maximum sedimentation into the project area occurred via the Metairie/Bayou Sauvage Distributary. A shifting of the river course upstream in response to a shorter route to the Gulf resulted in the formation of the Lafourche Delta southwest of the project. A final shift of the river brought the flow into its present course, forming the Plaquemine Delta just south of New Orleans and the present Balize Delta below the Plaquemine Delta. Development of the deltas below New Orleans, coupled with the restriction of floodwaters, resulted in the gradual degradation of the study area through subsidence and shoreline retreat.

16. Investigation. Preliminary investigations of the project area consisted of the utilization of aerial photographs, topographic maps, geologic maps, engineering and geologic reports and other literature. An actual on-site subsurface investigation was conducted along the proposed centerline of the project. Fifty seven total borings were drilled at various stations along the proposed centerline. Eleven 5-inch undisturbed borings and forty six 1-7/8 inch I.D. general type borings were drilled.

17. Subsidence and Seismic Activity. The project area is located in a region of active subsidence. Although actual subsidence rates for the area vary considerably, estimated subsidence rates for the area in the vicinity of the project average 0.40 ft/100 yrs., and increase towards the south of the project area. Seismically, the site is located in an area of low seismicity.

18. Groundwater Resources. Shallow freshwater aquifers are found in the vicinity of the project and extend to depths of up to 700 to 800 feet below sea level. Below these freshwater aquifers, brackish and saline water aquifers occur. The project will have no effect on these shallow aquifers and will not adversely affect their water quality or yields.

19. Mineral Resources. Several hydrocarbon reservoirs are located in the region. One, the Good Hope Oil and Gas Field is traversed by the project; however, the project will not impact production. Shell dredging within Lake Pontchartrain and sand dredging in the Mississippi River will not be affected by the project.

20. Foundation Conditions. Engineering properties of the sediment beneath the project vary greatly. Generally, the subsurface consists of Holocene deposits varying in depth from 55 feet to 80 feet and underlain by Pleistocene deposits. Specifically, from Station 0+00 to Station 27+00, the Holocene is between 55 and 80 feet thick and from Station 27+00 to Station 505+00, the Holocene sequence is comprised of marsh-swamp deposits throughout the project except between Station 0+00 and Station 205+00 and between Station 360+00 and Station 480+00, where natural levee deposits overlie the marsh-swamp deposits. The marsh-swamp deposits are characterized by high wood and organic material contents and high water contents. Underlying the marsh-swamp deposits is a sequence of deposits which include crevasse-splay deposits, interdistributary deposits and lacustrine deposits which vary in thickness. From Station 0+00 to Station 240+00, this sequence is between 12 and 27 feet thick and from Station 240+00 to Station 505+00, the sequence is between 30 and 40 feet thick. These materials consist of clays, silts and sands which exhibit lower wood and organic material contents and lower water contents than the deposits above or below. Beneath the sequence of crevasse-splay, interdistributary and lacustrine deposits, prodelta clays are found from Station 0+00 to Station 310+00 and vary in thickness between 5 and 20 feet. The bottom of the Holocene

sequence is formed by Bay-sound deposits which vary in thickness from 5 to 20 feet and extend throughout the project. Underlying the Holocene in the project are the Pleistocene lean clays, fat clays and silty sands. These Pleistocene deposits are oxidized and exhibit a marked decrease in water content when compared to the overlying Holocene deposits. Moreover, the Pleistocene deposits, which vary in consistency from stiff to very stiff, normally yield unconfined compressive strengths that exceed those in the Holocene deposits.

SOILS AND FOUNDATIONS INVESTIGATION AND DESIGN

21. General. This section includes the soils and foundations investigation and design of the hurricane protection works for St. Charles Parish.

a. The project extends from the Bonnet Carre Lower Guide Levee to the Jefferson - St. Charles Parish Return Levee (a distance of approximately 10 miles). The proposed levee alignment is approximately 800 feet north of Airline Highway in St. Charles Parish.

The St. Charles Parish Hurricane Protection System was divided into seven (7) soil reaches. However, fourteen (14) design reaches were used based on soil conditions, levee elevations, stillwater elevation, and existing field conditions such as landfill areas, oil fields, and the proposed I-310 Interchange. Design reaches are listed in Table 1 below.

TABLE 1
DESIGN REACHES

<u>Soil/Design Reach</u>	<u>B/L Sta. to B/L Sta.</u>	<u>SHP Levee Elevation (Net)</u>
1	0+00 to 72+50	13.0
2A	72+50 to 170+00	13.0
2B	170+00 to 265+00	12.5
3A	265+00 to 283+00	12.5
3B	283+00 to 331+00	12.0
4	331+40 to 370+90 (Landfill & I-310)	12.0
5	370+90 to 425+00	12.0
6A	425+50 to 470+00 (Non Continuous)	12.0
6B	440+80 to 449+20 (Landfill)	12.0
7	470+00 to 495+00	12.0
8	495+00 to R/R Gate	12.0

b. The recommended design presented is a full earthen levee section with geotextile reinforcement over a sand working base except for the following design reaches:

(1) Reach 4 - Unreinforced earthen levee over a landfill area and I-wall and T-wall beneath the proposed I-310 interchange.

(2) Reach 6 - Unreinforced earthen levee over a landfill area.

c. Additionally, proposed are five drainage structures, two floodgates, one bridge, numerous canal closures and pipeline and road crossings along the St. Charles Parish Hurricane Protection Alignment. Two alternatives for a typical drainage structure located at Cross Bayou were investigated: a soil-founded structure and a pile-founded structure. The pile-founded structure is the recommended alternative. Typical pipeline, ramp/pipeline, and ramp crossings are also presented.

22. Field Investigation.

a. A total of eleven (11) 5-inch diameter undisturbed and forty six (46) general type soil borings were taken and tested by the Corps of Engineers for the design of the St. Charles project. The approximate locations of these soil borings are shown on Plates 2 through 10 and 50A. The general type borings, 1-GSC through 48-GSC (note borings 4-GSC & 42 GSC were not taken), extend to an elevation between -60 and -70 ft. NGVD; and 11 undisturbed soil borings, 1-SCU thru 11-SCU, extend to an approximate elevation of -80 ft. NGVD. Plates 60 through 65 show logs of all soil borings taken along the alignment. Plates 68 through 78 show the undisturbed soil borings with the applicable soil data.

b. Twenty eight (28) general type borrow borings were taken in the Bonnet Carre Spillway to classify proposed borrow material, see Plates 48, 67 and 68 for location of logs. Prior to preparation of plans and specifications, general type borrow borings will be taken in the Mississippi River to locate the required sand source.

23. Laboratory Tests. All samples obtained from the borings were visually classified and water content determinations were made on all cohesive samples. Consolidation (C) tests and Unconfined Compression (UCT), Unconsolidated - Undrained Triaxial (Q), Consolidated-Undrained Triaxial (R), and Consolidated- Drained Direct (S) Shear tests were performed on selected samples from the undisturbed borings. Liquid and plastic limit determinations were made on all samples tested for shear and/or consolidation. Results of laboratory tests are shown on soil boring Plates 68 through 78, and on the detailed laboratory test data sheets, Appendix E, Volume II.

24. Foundation and Soil Conditions. A generalized soil profile delineating the subsurface conditions along the project alignment is shown on the soil and geologic profile Plates 51 through 59. A detailed description of the foundation conditions can be found in the Geology section. Design shear strengths and stratifications are shown on Plates 79 through 81.

25. Design Problems. The principal problems to be resolved in the foundation design were as follows:

- a. Type of protection
- b. Very low soil shear strength along levee alignment
- c. Stability of the recommended Geotextile reinforced earthen levee
- d. Overall bearing capacity of reinforced levee
- e. Geotextile embedment length
- f. Construction Sequence of reinforced levee
- g. Settlements
- h. Type of protection for landfill areas
- i. Seepage through the landfills
- j. Deep seated analyses of the T-walls including unbalanced loads on the T-walls
- k. Type of foundation for the drainage structures: pile founded or soil-founded
- l. Structural excavation and dewatering required to construct the structures in the dry
- m. Bearing pile lengths and subgrade reaction data on the piles for the T-walls, floodgates and structures
- n. Negative skin friction on the piles beneath the T-walls

26. Types of Protective Works.

a. Design alternatives were investigated for cost comparison (see section 30 for description). The recommended alternative is a full earthen geotextile reinforced levee and is presented in this design memorandum. The levee would be constructed with hauled clay over a hydraulically-pumped sand base.

b. I-walls and T-walls will be constructed for the tie-ins to the drainage structures, floodgates, and beneath the proposed I-310 Interchange. I-wall will also be constructed between the proposed railroad gate and the existing airport levee.

c. For the landfill areas, unreinforced full earth levee section will be constructed.

27. Design Analyses.

a. Bearing Capacity of the Geotextile Reinforced Levee. Since the reinforced embankment acts as a unit, overall bearing capacity has to be checked to insure that the embankment will not punch into the foundation soil. All Geotextile reinforced sections have been analyzed, based on a report by R. K. Rowe and K. L. Soderman for reinforced levees, and were found to be adequate (see Appendix D, Volume II). The Rowe and Soderman report presents design bearing capacity factors for rigid footings. The design bearing capacity factors consider the effect of increasing undrained strength with depth as well as the effect of the relative thickness of the soil deposit. A synopsis of the figures and equations as presented in the Rowe and Soderman report is included in the appendix; these figures and equations were used to analyze overall bearing capacity.

b. Stability.

(1) Shear Stabilities of the Earthen Levee with Geotextile Reinforcement. The stability of the levee was determined by the LMVD Method of Planes using the design "Q" shear strengths with hydraulic loading. To overcome the weak foundation soil strengths, geotextile reinforcement was introduced to stabilize the levee section. The required geotextile tensile strength for a factor of safety of 1.3 was based on the larger value of the following two analyses:

(a) From the LMVD Method of Planes analyses, the following equation was used to determine the critical wedges which required the maximum tensile strength for the geotextile:

$$T = \frac{(D_a - D_p) \text{ F.S.} - (R_a - R_b - R_p)}{12}$$

Where

T = tensile strength in lbs/in. at 5% strain and less than 40% of ultimate

F.S. = factor of safety.

(b) Once the critical wedges were determined by the LMVD Method of Planes, these failure surfaces were checked by the Spencer method with the PC-SLOPE microcomputer program. The Spencer method considered the location of the Geotextile in determining the required Geotextile tensile strength. For Geotextile tensile strength requirements larger than 1600 lb/in, a two-layer system was used with two-thirds (2/3) of the required tensile strength in the bottom layer and one-third (1/3) in the upper layer with a minimum of 3 feet of fill between and over the fabric layers.

The embedment length (L) of the fabric for pull-out was calculated by the following equation:

$$L = \frac{T}{(\gamma_1 h_1 \tan \phi_1 + C_1) + (\gamma_2 h_2 \tan \phi_2 + C_2)}$$

1 denotes soil parameter above geotextile

2 denotes soil parameter below geotextile

"L" was measured from the critical active wedge into the anchorage zone and an equal length was placed in the active wedge zone. Also, the bottom layer of fabric was extended past the anchorage embedment requirement to attain a factor of safety of 1.3 of the levee berm in certain cases. Plates 82 through 91 and 94 through 111 show the stability analyses and the placement of the geotextile. The embedment calculations are shown in Appendix D, Volume II.

For the pipeline crossings, the levee was designed by the LMVD Method of Planes for a minimum factor of safety of 1.3 without the geotextile reinforcement, and the reinforcement was used to attain a factor of safety of 1.5 for the pipeline crossings.

(2) Shear Stability of Unreinforced Earthen Levee and I-wall Levee. The stability of the levee and levee with I-wall was determined by the LMVD Method of Planes using the design "Q" strengths with appropriate hydraulic loading and was designed for a minimum factor of safety of 1.3. Results are shown on Plates 92, 93, 114, 115, 117, 121, 122, 124, 125, 129 through 132, and 140.

c. Seepage Blanket. A seepage blanket over the landfills is required. A minimum three (3)-foot thick clay cover was used for the seepage blanket. The required seepage blanket length was analyzed by Lane's Weighted Creep Ratio Method utilizing a LWCR value of 8.5. Lane's Weighted Creep Ratio is the ratio of the weighted creep distance to maximum differential head. The weighted creep distance was calculated as one-third (1/3) of the horizontal creep path distance.

d. Cantilever I-wall.

(1) I-wall Stability. The required penetration for the stability of the sheet pile wall was determined by the method of planes analysis for both the short term (Q) and long term (S) cases. The wall was analyzed for the short term case using the soil design "Q" strengths and for the long term (S) case using the "S" shear strengths of $C=0$ and $O=23^0$ for the clay strata. Factors of safety of

- (a) Short term (Q) Case
 - 1.5 for static water
 - 1.0 for static water plus 2 feet of freeboard
- (b) Long term (S) Case
 - 1.2 for static water

were applied to the design shear strength as follows: ϕ developed = $\arctan(\tan \phi_{\text{available}}/\text{factor of safety})$ and cohesion/factor of safety. Using the resulting shear strength, net lateral soil and water pressure diagrams were developed for movement toward each side of the sheet pile. With these pressure distributions, the summation of horizontal forces was equated to zero for various tip penetrations, and the overturning moments about the tip of the sheets were determined. The required depth of penetration to satisfy the stability criteria was determined where the summation of the moments were equal to zero. Both "Q" and "S" Cases were analyzed and the governing case presented on Plates 116, 118, 123, 126, and 133. Additionally, the governing tip penetrations were checked to satisfy the minimum tip to headwater ratio of 3 to 1 in the "S" Case. The sheet pile was extended if required.

(2) Seepage Cutoff. The required penetration for seepage cutoff was analyzed by utilizing Lane's Weighted Creep Ratio Method. The weighted creep distance was calculated as the sum of the vertical creep path distance plus one-third of the horizontal path distance. Lane's Weighted Creep Ratio is the ratio of the weighted creep distance to the maximum differential head. The deeper penetration of the two analyses (stability and creep ratio) was selected as the recommended tip elevation of the sheet pile. The cantilever stability analyses governed the penetration. An example of seepage calculation is shown on I-wall stability Plate 116.

e. T-wall.

(1) Deep Seated Stability Analysis. A conventional stability analysis utilizing a 1.30 factor of safety incorporated into the soil parameters was performed for various potential failure surfaces beneath the T-wall sections. Summation of horizontal driving and resisting forces results are shown on the shear stability Plates 112, 113, 119, 120, 127, 128 and 134 through 138. Negative resultant forces for all failure surfaces indicate that no additional load needs to be carried by the structure. Positive resultant forces greater than the positive resultant at the base of the structure indicate that this additional load must be carried by the structure and by the pile below the slip plane.

(2) Seepage Cutoff. Steel sheet pile cutoff will be used beneath the T-wall to provide protection against excessive seepage during a hurricane. The analyses performed are the same as described in paragraph d. and a sample calculation is shown on T-wall analysis Plate 112.

(3) Bearing Pile Foundations.

(a) Typical ultimate compression and tension pile capacities versus tip elevations were developed for 12 and 14 inch square prestressed concrete piles and for HP 12x53 steel H-Pile. Overburden stress in the soft clay material was limited to D/B=15 in the "S" case. Negative skin friction ("Q" case) was calculated for the piles when stability berms are constructed above the T-wall base. The design parameters used are shown in Tables 2 and 3.

TABLE 2
CONCRETE PILES

	Q-Case						S-Case					
	ϕ	K_c	K_t	N_c	N_q	ζ	ϕ	K_c	K_t	N_c	N_q	ζ
Clay	0°	1	1.7	9	1.0	0	23°	1	0.7	0	10.0	23°

TABLE 3
STEEL H-PILES

	Q-Case						S-Case					
	ϕ	K_c	K_t	N_c	N_q	ζ	ϕ	K_c	K_t	N_c	N_q	ζ
Clay	0°	1	1	9	1	0	23°	1	0.7	0	10.0	15°

The results of design pile loads versus tip elevations are shown on Plates 143 through 147. The recommended pile tip elevations for cost estimating purposes are based on applying a factor of safety of 2.0 in both compression and tension since pile loads tests will be performed. For piles with negative skin friction, the following equation should be used:

Q(All) Qult
= F.S. - NEG Skin Friction

(b) For T-walls with positive resultant forces determined from the deep seated stability analysis, the design loads plus these additional loads must be carried by the piles below the critical slip plane. Positive resultant earth forces are applied to the sheet pile cutoff wall beneath the structure. The cutoff wall is, in turn, designed to transfer the earth loads to the base of the structure and thus to the pile foundation. From the positive resultant forces, a net pressure diagram is applied to the sheet pile from the base of the structure to the critical slip plane elevation. The pressure diagram was calculated by taking the difference between the resultant force at the base of the structure and the resultant force at each stratum.

(c) During construction, test piles will be driven and load tested in the project area. The results of the pile load tests will be used to determine the length of the service piles.

(d) Subgrade moduli curves for estimating lateral resistance of the soil beneath the drainage structures and T-walls are shown on the pile capacity curve plates.

f. Settlement.

(1) Estimates of settlements beneath the all earthen levee with geotextile and the levee with I-wall were based on consolidation test data from the undisturbed borings. Settlement analyses consisted of developing curves of load (P) versus void ratio (e); load (P) versus depth; load (P) versus C_v and percent consolidation ($U_z\%$) versus time (t) for the strata in which consolidation will occur. One-way drainage was assumed in the settlement versus time calculation due to the nature of the clay soils. The computed settlement was increased by 25 percent to include the effect of possible lateral displacement of the foundation. Additionally, 10 percent shrinkage of the fill materials was added. Estimates of ultimate settlement versus time, including settlement between lift construction of the earthen levee for Soil Reach 2A (B/L Sta 72+50 to B/L Sta 170+00) are shown on Plate 148. It is estimated that approximately 1.5 to 2.0 feet of settlement will occur during initial levee construction. This settlement is not included in the settlement curves. Basing settlement calculations on Soil Reach 2A, it is estimated that three (3) additional levee lifts will be required to maintain the levee to net grade during the life of the project. For the I-wall embankment, two (2) additional levee lifts will be required. The levee would be rebuilt to the following elevations when it has settled to approximately the indicated elevations.

<u>Lift</u>	<u>Est. Time (yrs)</u>	<u>Approx. Settled Levee Elev. (NGVD)</u>	<u>Rebuilt Levee-Reach 2A Levee Elev. (NGVD)</u>
Initial	0	---	13.0 (HLP)
2nd	4	10.0	14.0
3rd	11 (7 yrs after 2nd lift)	11.0	14.0
4th	20 (9 yrs after 3rd lift)	12.0	15.0

(2) Settlement of the T-wall is considered to be negligible, since the piles will be embedded into the Pleistocene material and the major loads are caused by hurricane-induced stage of insufficient duration for consolidation to occur.

g. Drainage Structure Dewatering During Construction. In order to build these structures in the dry and insure stability for the structure excavations during construction, dewatering systems may be required. The method by which the groundwater is to be lowered is to be left to the contractor with performance specifications being prepared on an "end-result" basis. The specifications will allow the use of walls, sumps, pumps, etc., as well as wellpoints. The dewatering system design

with wellpoints is presented in Appendix D, Volume for cost estimating purposes only.

h. Bridge. A mass stability analysis and a deep seated stability analysis were performed on the bridge crossing as shown on Plates 149 and 150.

i. Erosion Protection. Due to the short duration of the hurricane flood stage and the resistant nature of the clayey soils, no erosion protection other than sodding is considered necessary on the levee slopes.

DESCRIPTION OF PROPOSED STRUCTURES AND IMPROVEMENTS

28. Levees. The project levee consists of the construction of new embankment extending from the Bonnet Carre Lower Guide Levee to the Jefferson-St. Charles West Return Levee as modified by the New Orleans International Airport East - West Runway Extension Hurricane Protection Levee. The project levee is approximately 9.5 miles in length and is generally located 850 feet north of U.S. Highway 61 (locally referred to as Airline Highway). Five drainage structures, two floodgates, a floodwall at I-310, and various ramp crossings are also within the levee alignment. The detailed alignment and profile of the project levee are shown on Plates 2 through 10. Typical levee design sections are shown on Plates 11 through 16.

METHOD OF CONSTRUCTION

29. Recommended Levee Construction. The recommended plan of construction consists of hydraulically pumping sand from selected sites in the Mississippi River for use as a haul road and a base for the high strength geotextile to reinforce the hauled clay fill. Since there are ten soil reaches along the length of the alignment, each reach varies slightly in length of fabric, strength of fabric and number of layers of fabric. The clay will be hauled from selected borrow areas in the Bonnet Carre Spillway (see Plates 48, 49 and 50 for location of proposed borrow areas and sand pits, respectively). After time has elapsed for required settlement and consolidation, subsequent semicompacted lifts will be constructed by hauling material from the borrow areas in Bonnet Carre Spillway.

OTHER LEVEE PLANS CONSIDERED

30. Alternative Levee Plans Considered. Other levee design alternatives considered were all clay levee, I-wall, and sand core levee. Based on preliminary cost/foot estimates, the recommended plan of a sand base, high strength geotextile to reinforce the clay fill was the most economically feasible method of construction. Consequently, this is the design recommended and detailed in this document.

In addition to the different methods of construction, an alternative levee alignment in the vicinity of NORCO, Louisiana, was also investigated. This alignment was investigated at the request of Shell Oil Company. The Shell Oil Company alignment is shown on Plate 50A. Since the area in question is wetland, environmental clearance for the alternative alignment will be required. Shell Oil representatives have met with NOD personnel to discuss requirements to obtain the necessary permits. Depending upon whether or not this permit is denied or issued, the levee alignment in the reach shown on Plate 50A may take either the Shell alternative alignment or the GDM alignment. However, the length of levee required is the same for both alignments.

ACCESS ROADS

31. Access Roads. Vehicular access to the project site is available via U.S. Highway 61 (Airline Hwy), the private shell and earth roads intersecting Airline Hwy and the levee alignment, private road within T.L. James Industrial Park and Bonnet Carre Spillway Lower Guide Levee. The Contractor will be required to comply with all local ordinances regarding hauling over public roads. Additionally, the Contractor will be responsible for maintenance to the roads utilized in the hauling operations.

RELOCATIONS

32. General. Under the authorizing law, local interests are responsible for the accomplishment of "...all necessary alterations and relocations to roads, railroads, pipelines, cables, wharves, drainage structures and other facilities made necessary by the construction work,...". For the levee reach covered in this memorandum, there are no residences required. A summary of the existing utilities requiring relocation is shown in Table 4.

TABLE 4
UTILITY RELOCATION SCHEDULE

Station	Item Description	Disposition
1+50 C/L	6" gas line	pass through floodwall
94+90 B/L	8" products line	raise/relocate over levee
131+80 B/L	3" oil line	raise/relocate over levee
132+05 B/L	2-1/2" gas line	raise/relocate over levee
132+11 B/L	3 wire overhead powerline	raise/relocate over levee
145+16 B/L	2-6" pipelines	raise/relocate over levee
146+55 B/L	3" gas lift flowline	raise/relocate over levee
149+90 C/L	6" saltwater line	pass through floodwall
149+90 C/L	2" high pressure gas line	pass through floodwall
149+90 C/L	2-3" flowlines	pass through floodwall
149+90 C/L	6" bulk oil and waterline	pass through floodwall

TABLE 4(con't)
UTILITY RELOCATION SCHEDULE

Station	Item Description	Disposition
149+90 C/L	2" salt water line	pass through floodwall
149+90 C/L	4" high pressure gas line	pass through floodwall
150+50 C/L	4"oil line	pass through floodwall
159+41 B/L	2-3" blow line	raise/relocate over levee
	2" injection line	
	2" salt water line	
282+90 B/L	16" gas line	raise/relocate over levee
283+22 B/L	2-wire overhead powerline	raise/relocate over levee
284+06 B/L	20" gas line	raise/relocate over levee
518+08 C/L	fiber optic telephone cable	pass through floodwall
518+65 C/L	Fiber optic telephone cable	pass through floodwall
520+70 C/L	6" gas line	pass through floodwall

The above list of pipelines , powerlines and telephone cables will be relocated by local interests in accordance with criteria set forth for hurricane protection levee and floodwall crossings. These criteria will be furnished to local interests.

RAMPS

33. Ramps. In lieu of gates, ramps will be constructed with crown elevations at net grade. The ramps are required to provide access for the private roads located at B/L stations 131+94, 159+31 and 196+40. Ramp crossing design sections are shown on Plates 14 and 15. Note that the ramp sections for the roads at Stations 131+94 and 159+31 are combination ramp/pipeline crossing design sections since pipelines are located adjacent to the roads. The pipelines will be raised and relocated over the ramp crossings as per our standard pipeline crossing criteria.

SOURCE OF CONSTRUCTION MATERIALS

34. Source of Construction Materials.

a. Source of Construction Materials for Floodwall and Structures.

"Lake Pontchartrain Hurricane Protection, Source of Construction Materials," DM #12, revised, contains a listing of the sources of materials that are commercially available in the region to construct the structures and floodwalls described in this DM.

b. Source of Fill for Levee. The levee fill material will be truck hauled clay which will be obtained from selected borrow areas in the Bonnet Carre Spillway as shown on Plate 48. Soil boring logs for the borrow areas are shown on Plates 66 and 67.

c. Source of Sand for Sand Base. The sand base will be hydraulically pumped from selected sites in the Mississippi River as shown on Plates 49 and 50. The borings in the sand borrow areas are being obtained at this time. The sand borings will be available for the first lift levee construction.

DESCRIPTION OF PROPOSED FLOODWALLS, GATES AND DRAINAGE STRUCTURES

35. Floodwalls, Gates, and Drainage Structures.

a. Floodwalls. I-type and T-type floodwalls will be provided in lieu of levees at the following locations:

(1) Station 1+10.50 C/L to Station 5+79.50 C/L (approximately Station -01+80.00 B/L to Station 3+70.00 B/L), Station 253+48.20 C/L to Station 259+01.20 C/L (approximately Station 253+00.00 B/L to Station 259+00.00 B/L), Station 325+90.00 B/L to Station 331+10.00 B/L, Station 451+77.09 C/L to Station 456+36.09 C/L (approximately Station 451+00.00 B/L to Station 455+10.00 B/L), and Station 513+72.60 C/L to Station 517+71.60 C/L (approximately Station 503+00.00 B/L to Station 506+50.00 B/L). These floodwalls are in the vicinity of Bayou Trepagnier, Cross Bayou, St. Rose, Walker Canal, Parish Line Canal, respectively, and cross these channels with drainage structures. The elevation of the floodwalls varies as shown on Plate 23. The general location and alignment of the proposed floodwalls are shown on Plate 1. The detailed alignment and profile of the floodwalls and features contiguous thereto are shown on Plates 2, 6, 7, 8, 10, 22 and 23. The typical design sections are shown on Plate 24.

(2) Station 500+00.00 W/L to Station 517+12.00 W/L (approximately between Station 356+32.10 B/L and Station 372+83.20 B/L). This floodwall is in the vicinity of the proposed ramps for the I-310 highway. At each end, the floodwall will tie into the new levee. The elevation of the floodwall varies as shown on Plate 18. The general location and alignment of the proposed floodwall are shown on Plate 1. The detailed alignment and profile of the floodwall and features contiguous thereto are shown on Plates 7, 8, 17, 18 and 19. The typical design sections are shown on Plate 20.

(3) Station 148+60.70 C/L to Station 154+16.70 (approximately between Station 148+30.00 B/L and 153+50.00 B/L). This floodwall is located in the vicinity of the Good Hope Oil Field facility. The elevation of the floodwall varies as shown on Plate 32. The general location and alignment of the proposed floodwall are shown on Plate 1. The detailed alignment and profile of the floodwall and features contiguous thereto are shown on Plates 4 and 32. The typical design sections are shown on Plate 33.

(4) Station 517+71.60 C/L to Station 523+99.10 C/L (approximately between Station 506+50.00 B/L and 516+32.00 B/L). This floodwall is located in the vicinity of the Illinois Central Railroad tracks on the south side of the New Orleans International Airport runway extension. The floodwall crosses the railroad tracks with a steel swing gate. At the east end, the floodwall will tie into the existing levee around the airport runway extension. The elevation of the floodwall varies as shown on Plate 36. The general location and alignment of the proposed floodwall are shown on Plate 1. The detailed alignment and profile of the floodwall and features contiguous thereto are shown on Plates 10 and 36. The typical design sections are shown on Plate 37.

b. Gates.

(1) Swing Gates. Three steel swing gates will be included in the floodwall reaches. The locations are across the access shell road to the Good Hope Oil Field Facility (24 feet wide opening, centerline at Station 509+50.00 W/L); and across the Illinois Central Railroad tracks (32 feet wide opening, centerline at Station 518+34.10 W/L). Details of these gates are shown on Plates 21, 34, 35, 38 and 39.

(2) Drainage Structures. Five drainage structures will be included in the floodwall reaches in the vicinity of the drainage canals. The drainage structures will consist of reinforced concrete structures supported by precast, prestressed concrete piles with a steel sheet pile cutoff. The structure will contain vertical lift gates of various sizes and numbers as follows:

<u>Structure</u>	<u>Station</u>	<u>Number and Size of Sluice Gates</u>
Bayou Trepagnier	4+05 C/L	3, each 5' X 5'
Cross Bayou	256+24.7 C/L	6, each 6' X 6'
St. Rose Canal	328+50 B/L	2, each 6' X 6'
Walker Canal	454+06.6 C/L	1, each 4' X 4'
Parish Line Canal	516+02.1 C/L	1, each 4' X 4'

A reinforced concrete one-lane bridge will be included at each of the structures to provide access across the structures. Details of these drainage structures are shown on Plates 24 through 31.

c. Bridge Crossing. A bridge crossing the borrow pit canal of U.S. Highway 61 (Airline Highway) will be provided in the vicinity of the Cross Bayou drainage structure. This bridge will serve as the access to the construction site for the Cross Bayou drainage structure and for the levee and floodwall in that area. The details of the bridge crossing are shown on Plates 6 and 40.

d. Utility Relocations. The existing pipeline crossing the flood protection alignment will be relocated over the earthen levees or through the floodwalls. Pipelines relocated over the levee will be relocated in accordance with criteria set forth for hurricane protection crossings. Pipelines relocated through the floodwall section will be passed through a sleeve welded to the sheet pile cutoff wall as shown on Plate 44. The pipelines in the vicinity of Station 149.90.00 C/L will be relocated over the T-wall section at Shell Oil Co. using a pile supported pipe rack as shown on Plate 33. Locations of utilities crossing the flood protection are shown on Plates 2 through 10.

e. Alternate Plan for Structures. Full earthen levee in lieu of floodwalls, and soil founded structures with corrugated metal pipe (CMP) culverts in lieu of pile-founded reinforced concrete box culvert structures, were investigated for crossing the existing canals. The alternate plan was not recommended because large, long term soil settlement would cause damage to the soil-founded structures, as shown on Plates 45 through 47. Detailed cost estimates for the alternative structural plan are contained in Appendix C, Volume I.

STRUCTURAL DESIGN

36. Criteria for Structural Design. The structural design presented herein complies with standard engineering practice and criteria set forth in Engineering Manuals and Engineering Technical Letters for Civil Works Construction published by the Office of the Chief of Engineers, subject to modifications indicated by engineering judgement and experience to meet local conditions. The floodwall design is similar to the design presented in the Lake Pontchartrain, La. and Vicinity, High Level Plan, Orleans Parish Lakefront Levee West of IHNC Design Memorandum No 13, General Design approved February 1985.

37. Basic Data. Basic data relevant to the design of the protective works are shown in the following table:

TABLE 5

RELEVANT STRUCTURAL DESIGN DATA

<u>a. Water elevations:</u>	<u>Elevations (feet N.G.V.D.)</u>
Wind tide level (Lake Pontchartrain)	11.50
Wind tide level (Bayou Trepagnier)	11.00
Wind tide level (Cross Bayou)	10.50
Wind tide level (St. Rose)	10.00
Wind tide level (Parish Line Canal)	10.00
Land side of floodwall	0.00 to -0.50

b. Floodwall Gross Grade:

Elevations
(feet N.G.V.D.)

i) Floodwall at proposed I-310

Interchange:

(Stationing refers to W/L)

I-Wall (500+00.00 to 501+30.00)	12.50
I-Wall (501+30.00 to 507+31.00)	12.00
I-Wall (507+31.00 to 509+33.00)	12.50
I-Wall & Swing Gate (509+33.00 to 509+67.00)	12.00
I-Wall (509+67.00 to 510+30.00)	12.50
I-Wall (510+30.00 to 512+32.00)	12.00
I-Wall (512+32.00 to 514+52.00)	12.50
I-Wall (514+52.00 to 516+14.00)	12.00
I-Wall (516+14.00 to 517+12.50)	12.50

ii) Floodwall in Vicinity of

Bayou Trepagnier:

(Stationing refers to C/L)

I-Wall (1+10.50 to 2+90.50)	13.50
I-Wall & Swing Gate (2+90.50 to 5+19.50)	13.00
I-Wall (5+19.50 to 5+79.50)	13.50

iii) Floodwall in Vicinity of

Cross Bayou:

(Stationing refers to C/L)

Elevations
(Feet N.G.V.D.)

I-Wall (253+48.20 to 254+08.20)	12.00
T-Wall & Drainage Structure (254+08.20 to 258+41.20)	12.50
I-Wall (258+41.20 to 259+01.20)	13.00

iv) Floodwall in Vicinity of St. Rose:

(Stationing refers to B/L)

I-Wall (325+90.00 to 326+50.00)	12.50
T-Wall & Drainage Structure (326+50.00 to 330+50.00)	12.00
I-Wall (330+50.00 to 331+10.00)	12.50

v) Floodwall in Vicinity of Walker Canal:

(Stationing refers to C/L)

I-Wall (451+77.09 to 452+37.09)	12.50
T-Wall & Drainage Structure (452+37.09 to 455+76.09)	12.00
I-Wall (455+76.09 to 456+36.09)	12.50

- vi) Floodwall in Vicinity of Parish Line Canal:
(Stationing refers to C/L)
- | | |
|---|-------|
| I-Wall (513+72.60 to 514+32.60) | 12.50 |
| T-Wall & Drainage Structure
(514+32.60 to 517+52.60) | 12.00 |
| I-Wall (517+52.60 to 517+71.60) | 12.50 |
- vii) Floodwall Vicinity of Good Hope Field Facility:
(Stationing refers to C/L)
- | | |
|--|-------|
| I-Wall (148+60.70 to 149+71.70) | 13.50 |
| T-Wall & Swing Gate (149+71.70 to 150+85.70) | 13.00 |
| I-Wall (150+85.70 to 154+16.70) | 13.50 |
- viii) Floodwall Vicinity of R/R Gate:
(Stationing refers to C/L)
- | | |
|--|-------|
| T-Wall & Swing Gate (517+71.60 to 518+96.60) | 12.00 |
| I-Wall (518+96.60 to 523+99.10) | 12.50 |

c. Unit Weights. The following unit weights were used in design calculations:

<u>Item/Description</u>	<u>lbs. per cu.ft.</u>
Water	64.00
Concrete	150.00
Steel	490.00
Riprap	132.00
Saturated Sand	122.00
Saturated Clay	110.00
Saturated Shell	117.00

d. Uniform Live Loads. The following values for uniform live loads were used for design:

<u>Item/Description</u>	<u>lbs. per square foot</u>
Floors for Vertical Lift Gate Machinery	100

e. Design Loads:

Earth Pressure (lateral)	See Plates 135 through 137
Winds Loads	50 lbs./s.f.
Water Loads	See Plates 135 through 137

38. Design Methods:

Reinforced Concrete: The design of reinforced concrete structures is in accordance with the requirements of the strength design method of the current ACI Building Code, as modified by the guidelines of "Strength Design Criteria for Reinforced Concrete Hydraulic Structures", ETL 1110-2-312 dated 10 March 1988. The basic minimum 28-days compressive strength concrete will be 3,000 psi except for prestressed concrete piling, where the minimum will be 5,000 psi. For convenient reference, pertinent stresses are tabulated below:

TABLE 6

PERTINENT STRESSES FOR REINFORCED CONCRETE DESIGN

Reinforced Concrete

f'c	3,000 psi
fy (Grade 60)	48,000 psi
Maximum flexural reinforcement ratio	0.25 x balance ratio
Minimum flexural reinforcement ratio	200/fy
f'c (for prestressed concrete piles)	5,000 psi
fy (prestressing strand grade 250)	250,000
fy (prestressing strand grade 270)	270,000

39. Location and Alignment: The flood protection will consist of earthen levee, I-wall, T-wall, gate monoliths for Roadway and Railroad crossings, and drainage structures at existing drainage canals and bayous as described in paragraph 11. above. At the east end of the flood protection, the new floodwall will tie into the existing New Orleans International Airport Extension Earthen Levee. At the west end of the flood protection, the new levee will tie into the existing earthen east guide levee of the Bonnet Carre Spillway. The general location and alignment of the proposed floodwalls are shown on Plate 1. The detailed alignment and profiles of the floodwall and features contiguous thereto are shown on Plates 2 through 10, 17 through 24, 32, 33, 36, 37, 41, and 42.

40. Drainage Structures.

a. General. The drainage structures will consist of reinforced concrete box culverts supported on precast, prestressed concrete piles with a steel sheet pile cutoff. The structures will contain vertical lift gates as indicated on Plates 24 through 31. A reinforced concrete one-lane bridge will be included at each of the structures to provide access across the structures.

b. Loading Cases. The pile designs for the drainage structures, based on the use of a pile test, are designed with a factor of safety = 2.0. The following load cases were used for the preliminary design of the drainage structures:

Case I: Dead loads only, no backfill or water loads, no wind, impervious sheet pile cutoff, no dynamic wave force (100% forces used).

Case II: Static water pressure to SWL, no wind, pervious sheet pile cutoff, no dynamic wave force (100% forces used).

Case III: Static water pressure to SWL, no wind, impervious sheet pile cutoff, no dynamic wave force (100%, forces used).

Case IV: Static water pressure with water level 2 feet above SWL, no wind, impervious sheet pile cutoff, no dynamic wave force. (75% forces used).

Case V: Static water pressure with water level 2 feet above SWL, no wind, pervious sheet pile cutoff, no dynamic wave force (75% forces used).

Case VI: No water, wind from flood side (75% forces used).

c. Bridge at Drainage Structures. The drainage structures include a one-lane bridge designed in accordance with AASHTO requirements for an H-10 loading for a single truck to connect the levee on each end of the drainage structure. A detail of the bridges is shown on Plate 29.

d. Bridge at Vicinity of Cross Bayou Drainage Structure. The one-lane bridge was designed in accordance with AASHTO requirements for an H-20 loading for a single truck to serve as an access to the construction site for the Cross Bayou Drainage Structure with U.S. Hwy 61.

41. I-Type Floodwall.

a. General. The I-wall will consist of steel sheet piling driven into the new levee embankment. The upper portion of the sheet piling will be capped with concrete. The sheet piling will be driven to the required depth with 9 inches of the sheet piling extending above the finished net grade elevation. The concrete portion of the floodwall will extend from 2 feet below the finished levee crown to the elevations described in paragraph 37. above.

b. Loading cases. In the design of the I-wall, the following loading cases were considered:

Case I: Water to SWL, Q-case FS=1.5.

Case II: Water to SWL + 2 feet freeboard, Q-case, FS=1.0.

Case III: Water to SWL, S-case, FS=1.2.

c. Joints. Expansion joints in the I-wall will be spaced approximately 30 feet apart, adjusted to fall at sheet pile interlocks. To compensate for expansion, contraction, or displacement, three-bulb water stops and premolded expansion joint fillers will be provided. Where the I-wall joins the T-wall, the deflection of the I-wall will produce a lateral displacement. To compensate for this displacement, a special detail in the sheet piling connection and in the I-wall have been designed to prevent water from flowing through this joint (see Plate 43).

42. T-Type Floodwall:

a. General. T-wall will be constructed between the wall line stations indicated in Table 5. The T-wall will consist of a reinforced concrete stem on a monolithic concrete base supported on piles (prestressed concrete or HP steel piles). The base of the T-wall will be constructed on a four-inch thick concrete stabilization slab. A continuous steel sheet pile seepage cutoff wall will be provided beneath the base slab for seepage cutoff purposes (see Plates 20, 24, 33 and 37).

b. Loading Cases. The pile designs for the T-walls, based on the use of a pile test, are designed with a factor of safety = 2.0. The following load cases were used for the preliminary design of the T-walls:

Case I: Dead loads only, no backfill or waterloads, no wind, impervious sheet pile cutoff, no dynamic wave force (100% forces used).

Case II: Static water pressure to SWL, no wind, pervious sheet pile cutoff, unbalanced load soil load applied to sheet pile cutoff wall, no dynamic wave force (100% forces used).

Case III: Static water pressure to SWL, no wind, impervious sheet pile cutoff, no dynamic wave force (100% forces used).

Case IV: Static water pressure with water level 2 feet above SWL, no wind, impervious sheet pile cutoff, no dynamic wave force (75% forces used).

Case V: Static water pressure with water pressure, with water level 2 feet above SWL, no wind, pervious sheet pile cutoff, no dynamic wave force (75% forces used).

Case VI: No water, wind from land side (75% forces used).

Case VII: No-water, wind from canal side (75% forces used).

c. Joints. Expansion joints in the T-wall will be spaced not more than sixty feet apart. The joints will be adjusted to fall at sheet pile interlocks. To compensate for expansion, contraction, or displacement, three-bulb waterstops and premolded expansion joint fillers will be provided.

43. Swing Gates and Gate Monoliths.

a. General. Swing Gates will be constructed at Stations 150+28.7 C/L, 509+50 W/L and 518+34.1 W/L. The gate monoliths for the steel swing gates will consist of a reinforced concrete stem on a monolithic concrete base supported on prestressed concrete piles. The base of the gate monoliths will be constructed on a four-inch thick concrete stabilization slab. A continuous steel sheet pile seepage cutoff wall will be provided beneath the base slab for seepage cutoff purposes (see Plates 21, 34, 35, 38 and 39).

b. Loading Cases. The pile designs for the swing gate monoliths, based on the use of a pile test, are designed with a factor of safety = 2.0. The following load cases were used for the preliminary design of the swing gate monoliths:

- Case I: Gate closed, static water pressure to SWL, no wind, impervious sheet pile cutoff, no dynamic wave force (100% forces used).
- Case II: Gate closed, static water pressure to SWL, no wind, pervious sheet pile cutoff, no dynamic wave force (100% forces used).
- Case III: Gate closed, static water pressure with water level 2 feet above SWL, no wind, impervious sheet pile cutoff, no dynamic wave force (75% forces used).
- Case IV: Gate closed, static water pressure with water level 2 feet above SWL, no wind, pervious sheet pile cutoff, no dynamic wave force (75% forces used).
- Case V: Gate open, no wind, truck or train on protected side edge of base slab (100% forces used).
- Case VI: Gate open, no wind, truck or train on flood side edge of base slab (100% forces used).
- Case VII: Gate open, no wind, truck or train on protected side edge of base slab (100% forces used).
- Case VIII: Gate open, no wind, truck or train on flood side edge of base slab (100% forces used).

Case IX: Gate open, wind from protected side, truck or train on flood side edge of base slab (75% forces used).

Case X: Gate open, wind from flood side, truck or train on protected side edge of base slab (75% forces used).

44. Cathodic Protection and Corrosion Control.

a. Cathodic Protection for Steel Sheet Piling. All steel sheet piling will be bonded together to obtain electrical continuity, and no corrosion protection measures will be provided. Cathodic protection can be installed in the future if the need arises. The sheet piles will be bonded together with No. 6 reinforcing bar welded to the top of each sheet pile. Flexible jumpers insulated with cross-linked polyethylene will be welded or brazed to adjacent sheet piles at the monolith joints 3 inches below the bottom of the concrete.

b. Corrosion Control. All exposed ferrous metal components will be either galvanized or stainless steel to provide for corrosion control.

ENVIRONMENTAL EFFECTS

45. Biological Impacts.

a. Scenic Streams.

Approximately 0.72 acres of bayou bottom and associated banks would be replaced by water control structures. These habitats would no longer function as productive wetlands. The benthic community at the proposed locations would be eliminated or permanently displaced. Wildlife that utilizes the banks would use the levees and adjacent banks for forage and resting. Levee construction across the bayous would not affect the bald eagle, and conversion of the bayous and their banks to water control structures would have minimum effect on the general ecological balance in the vicinity.

Little foreign material would be allowed to enter the bayous or borrow canal during construction of the box culverts. Silt screens would be installed to define and contain construction turbidity to minimize any excavated material loss. The only effect on water quality caused by the levee construction would be a temporary increase in local turbidity, which would result in lowered dissolved oxygen and increased biological oxygen demand adjacent to the levee toes until the material settled out of the water column.

Of major concern in Bayou Trepagnier are pollutants trapped in the bottom sediments. Shell Oil Company has historically used the bayou (since the 1920's) as a receiving stream for its plant operation waters, including cooling water and settling pond water. The water column in

the bayou is relatively clean. Typical of the pollutants trapped in the bottom sediments are oil and grease, zinc, chromium, and lead.

The Shell refinery is currently under remedial demand order pursuant to L.R.S. 30:1149 to clean up the bayou in two phases. Phase I is to clean up the sediments in the area of the hurricane levee crossing to ensure that the Corps levee construction stays on schedule. Phase II is to clean up the remainder of Bayou Trepagnier.

b. Levee Realignment.

Approximately 2.89 acres of fresh marsh and 1.93 acres of canal bottom would be replaced by elevated grassy habitat. These habitats would no longer function as productive wetlands, since they would be filled and replaced by a levee. This would result in a long term loss of productive wetlands from the area ecosystem. Short term losses to wildlife would occur in this specific area during construction. When levee vegetation is established, some wildlife benefits would be realized, and the area would be utilized by small game animals and birds for foraging.

There would also be increased potential for soil erosion during the interim between shaping work and revegetation. During this period, runoff from the fill material would cause short term increases in turbidity in the immediate surface area.

c. Landfill Crossings.

Approximately 10 acres of disturbed scrub/shrub would be replaced with an elevated grassy clay cap. The cap would be utilized by small game and birds for foraging, as was the scrub/shrub. Short term losses to wildlife would occur during specific site construction. There is an increased potential for higher runoff velocities from the landfill as a result of the additional elevation provided by the levee cap. Some scouring of the landfill could result, which would cause short term increases in immediate water turbidity and accelerated long term loading of pollutants into the area ecosystem. The clay cap was designed with the load-bearing capacities of the landfill taken into account.

The clay cap toe elevations would be as gradual as possible to keep runoff velocities minimal. Additionally, the cap and landfill around the cap would be grassed to further reduce and absorb runoff. There would be no excavation of the landfill. The Louisiana Office of Solid Waste has no objections to this clay cap (personal communication).

d. Drilling Waste Pits.

Approximately 3 acres of mixed wet bottomland hardwoods and water habitat would be replaced by elevated grassy habitat. These habitats would no longer function as productive wetlands, since they would be

filled and replaced by a levee. When levee vegetation is established, some wildlife benefits would be realized, including a resting and forage area for small game animals and birds.

Of particular concern with these pits is the possibility of contaminants in the sediments. The pits historically have contained wastes from drilling activities, including oils and greases, drilling muds, and cuttings and packing materials. Sediments in the pits usually have a high heavy metal content, particularly lead.

Possible environmental impacts resulting from disturbing pit sediments would not be of concern during construction. All abandoned pits are to be cleaned up by their owners, according to state regulations, by February 1989, (personal communication, Louisiana Department of Environmental Quality), which is well before the construction start date.

46. Endangered Species. A bald eagle's nest is located approximately 1.9 miles west of the levee realignment location at the airport runway extension. There will be no impact on the bald eagle nesting site. No other endangered species are known to be located in the project area.

47. Recreation. The scenic stream crossings would have some effect on recreation in Cross Bayou Canal. The levee would not allow most boaters to use the waterway to gain access to the Airline Highway borrow canal or to launch boats at Airline Highway for access to Bayou La Branche. Canoes and small flatboats could be carried over the levee, but larger powerboats would not be able to pass. However, a shelled boat launch area and bridge would be constructed to reestablish public access. The area does possess the natural resources for excellent fishing, boating, crabbing, photography, birdwatching, and other outdoor sports. There would be little effect on the recreational value of Bayou Trepagnier. The center of the levee crossing is approximately 400 feet north from the bayou source, which is pumped outfall from oilfield settling ponds. The levee realignment would have little or no effect on recreation at the airport extension site. Waste pit and landfill areas crossed by the levee would have little or no effect on area recreation.

Total annual recreational dollars lost (hunting and fishing) by the activities addressed in this Environmental Assessment (EA), including realignment at the airport, structure placement in the bayous, crossing landfills and waste pits, would be negligible.

48. Esthetics. Initial construction would result in cleared swamp/forest habitat, which is generally considered not esthetically pleasing. During construction of the levee, increased local turbidity in water and possible dusty and muddy conditions of access roads would be considered unesthetic. After construction is complete, the grassed levee could be considered esthetic. The overall esthetic impacts of this project are not considered significant.

49. Cultural. A comprehensive cultural resource survey of the St. Charles Parish levee alignment has been completed by Coastal Environments, Inc., under contract to this office. The survey was completed in March 1988. The survey of the area covered the stream reaches, levee realignment, waste pits and landfill. No significant archeological sites were found. The State Historic Preservation Officer would be notified if any evidence is found of a previous inhabitation, or if archeological features are observed during construction.

50. Noise. Pile driving at the water control structure locations and earth moving equipment would create the largest source of noise during construction. There are no residences within the primary noise impact zone, which is considered to be up to 400 feet from the construction site. There are several businesses and camps along the levee route that are approximately 400 to 500 feet from construction areas. The levels of noise increase caused by the levee construction are not expected to interfere with any camp or commercial activity. Animals in the immediate project area would be temporarily displaced by construction noise.

51. Community Cohesion. Construction of the levee would provide necessary hurricane flood protection for this portion of St. Charles Parish. Local community growth would be promoted. Disruption in localized traffic patterns would be sporadic and of short duration. Initial movement of equipment onto and off the site would account for the major portion of traffic increase.

COMPLIANCE WITH ENVIRONMENTAL LAWS

52. Compliance with Environmental Laws. An Environmental Assessment (EA) and unsigned Finding of No Significant Impact (FONSI) have been prepared and circulated for public comment. Compliance with the Endangered Species Act has been achieved. Cultural compliance has been achieved. A Section 404(b)(1) evaluation and a Coastal Zone Management (CZM) Consistency Determination have been prepared, circulated, and found to be in compliance by the Environmental Protection Agency and CZM.

COORDINATION WITH OTHER AGENCIES

53. Coordination with Other Agencies.

a. General. As previously mentioned, the State of Louisiana, Department of Public Works, was appointed project coordinator for the State by the Governor of Louisiana. This agency has functioned to coordinate the needs, desires, and interests of state agencies and the Corps of Engineers. The Pontchartrain Levee District will provide the local cooperation for this feature of the hurricane protection project.

The project plan presented herein is acceptable to both of the above agencies. The entire Lake Pontchartrain hurricane protection project, including this project feature, has been discussed at numerous public and private meetings since its authorization. Such meetings have been held before regional, state, local, community, social, and educational organizations and have served generally to inform the public of the proposed works, to explain project functions, and to solicit the public input.

b. Environmental Coordination. Details of water control structure placement and construction in the scenic streams, crossing of the landfills, levee realignment, and cleanup of oil and gas waste pits and bayou/canal sediments, have all been closely coordinated with the following agencies and groups:

U.S. Fish and Wildlife Service
Louisiana Department of Natural Resources, Coastal Division
Louisiana Department of Environmental Quality, Inactive and Abandoned Hazardous Waste Sites Division
Louisiana Department of Environmental Quality, Water Pollution Control Division
Louisiana Department of Wildlife and Fisheries
Louisiana Department of Environmental Quality, Solid Waste Division
Shell Oil Company, Norco

The Environmental Assessment was provided to the public in December 1988. A copy of the EA and FONSI is contained in Appendix B, Volume I of this report. Copies of pertinent compliance documents and coordination letters are also provided in Appendix B, Volume I.

REAL ESTATE REQUIREMENTS

54. General. All rights-of-way and construction easements required for construction of this levee and appurtenant structures including drainage canals will be acquired by the Pontchartrain Levee District and furnished without cost to the United States. Rights-of-way limits are shown on plates 2 through 10. Local interests are required to assume the cost of relocation assistance to persons and business displaced by such acquisition pursuant to the requirement of Public Law 91-646. However, no relocation of this type are contemplated for the recommended plan.

OPERATION AND MAINTENANCE

55. General. The St. Charles Parish Hurricane Protection Levee will be maintained and operated at the expense of local interests (Pontchartrain Levee District) as a feature of local cooperation for the project. The

estimate of the annual operation and maintenance costs for the levee and floodwall protection features which are detailed in this GDM are as follows:

a. Levee Maintenance (360 acres)	39,000 per year
b. Three (3) Steel Gages	900 per year
c. Floodwall Maintenance (5160 feet)	5,500 per year
d. Five (5) Drainage Structures	<u>6,000</u> per year
Total	51,400 per year

ECONOMICS

56. Economic Justification.

The current economic analysis for the entire Lake Pontchartrain, Louisiana and Vicinity Hurricane Protection Project is contained in the Reevaluation Study entitled "Lake Pontchartrain, Louisiana and Vicinity Hurricane Protection Project," dated December 1983. Based on October 1981 price levels, and the project interest rate of 3 1/8 percent, the benefit-cost ratio for the project as a whole was 4.2 to 1. The project is currently under construction and a remaining benefit-remaining cost ratio at the project interest rate is 9.9 to 1 and at the current Federal discount rate is 5.0 to 1. The Reevaluation Study also broke out separable project areas (SPA) for incremental justification. The St. Charles Parish, North of Airline Highway reach is a part of the New Orleans-Jefferson SPA. The computed benefit-cost ratio for the New Orleans-Jefferson area was 5.0 to 1 in the 1984 Reevaluation Study. Updating this SPA for price levels and interest rates produces a remaining benefit to remaining cost ratio of 6.0 to 1 at the project interest rate and 1.6 to 1 at the current Federal interest rate.

ESTIMATE OF REMAINING COST

57. General. Based on October 1988 price levels, the estimated first cost for construction of the St. Charles Parish North of Airline Highway Levee Alignment and appurtenant drainage structures (high level plan) is \$68,714,000. Of this cost, \$53,979,000 is for the levees and floodwalls feature, \$6,485,000 for Engineering and Design, \$5,400,000 for Supervision and Administration, \$1,240,000 for Relocations and \$1,601,000 for Land, Easement and Rights-of-ways. Not included in the \$68.7 million figure is the sunk cost of \$1,140,000 for Real Estate which was previously expended by the Pontchartrain Levee District for lakefront rights-of-way. These rights-of-way cost along with all other Engineering and Design, and Supervision and Administration Cost previously sunk in support of designing and constructing the Barrier Plan are consider part of the overall total project cost and will be included in the cost showing calculations in accordance with the prescribed formula (see Table 11). The detailed estimate of first cost is shown in Table-7.

TABLE 7
LAKE PONTCHARTRAIN, LOUISIANA AND VICINITY
HIGH LEVEL PLAN LEVEE
GDM NO. 18 - ST. CHARLES PARISH NORTH OF AIRLINE HIGHWAY

ESTIMATE OF FIRST COST
October 1988 Price Levels

Cost Acct. No.	Item/Description	Estimated Quantity	Unit	Unit Price	Estimated Amount
01	Lands Easements Right-of-Way see ID #90113		LS	\$ L.S.	\$ 1,601,000
02	RELOCATIONS				
	1 - 6" PONTCHARTRAIN HP GAS LINE		LS	L.S.	21,000
	1 - 8" SHELL NORCO PRODUCT LINE	600	FT.	L.S.	60,000
	1 - 3" SHELL NORCO CRUDE OIL LINE	600	FT.	L.S.	45,000
	1 - 2 1/2" EXXON GAS LINE	600	FT.	L.S.	54,000
	3 WIRE OVERHEAD POWERLINE	600	FT.	L.S.	36,000
	2 - 6" SHELL WESTERN PIPELINES	650	FT.	L.S.	71,500
	1 - 3" SHELL WESTERN GAS LIFT FLOWLINE	550	FT.	L.S.	57,750
	2 - 3" SHELL WESTERN BLOWLINES	550	FT.	L.S.	23,000
	1 - 2" SHELL WESTERN INJECTION LINE	550	FT.	L.S.	23,000
	1 - 2" SHELL WESTERN SALTWATER LINE	550	FT.	L.S.	23,000
	1 - 16" UNITED GAS PIPELINE	600	FT.	L.S.	105,000
	2 WIRE OVERHEAD POWERLINE	600	FT.	L.S.	39,000
	1 - 20" UNITED GAS PIPELINE	600	FT.	L.S.	38,000
	1 - SHELL WESTERN ELEVATED PIPE RACK:8 P/L's 2"-4" DIAM.		LS	L.S.	50,000
	1 - 4" SHELL WESTERN LINE		LS	L.S.	6,000
	2 - FIBER OPTIC CABLES		LS	L.S.	16,000
	1 - 6" UNITED GAS PIPELINE		LS	L.S.	45,000
	SUBTOTAL				\$ 813,250

TABLE 7 (CONT'D)
 LAKE PONTCHARTRAIN, LOUISIANA AND VICINITY
 HIGH LEVEL PLAN LEVEE
 GDM NO. 18 - ST. CHARLES PARISH NORTH OF AIRLINE HIGHWAY

ESTIMATE OF FIRST COST
 October 1988 Price Levels

Cost Acct. No.	Item/Description	Estimated Quantity	Unit	Unit Price	Estimated Amount
	CONTINGENCIES (25%)				\$ 202,750
	TOTAL RELOCATIONS				1,016,000
	ENGINEERING & DESIGN (12%)				122,000
	SUPERVISION & ADMINISTRATION (+10%)				122,000
02	RELOCATIONS TOTAL COSTS				1,240,000

TABLE 7 (CONT'D)
 LAKE PONTCHARTRAIN, LOUISIANA AND VICINITY
 HIGH LEVEL PLAN LEVEE
 GDM NO. 18 - ST. CHARLES PARISH NORTH OF AIRLINE HIGHWAY

ESTIMATE OF FIRST COST
 October 1988 Price Levels

Cost Acct. No.	Item/Description	Estimated Quantity	Unit	Unit Price	Estimated Amount
	LEVEES REACH - I 295+00 To 513+77 (Not Continuous)				
	<u>1st Lift Construction</u>				
11	1. MOB & DEMOB	Lump Sum	LS	\$ LS	\$ 350,000
	2. SEMI COMPACTED FILL (Haul-Bonnet Carre Spillway)	400,000	CY	5.00	2,000,000
	3. UNCOMPACTED FILL (Haul-Bonnet Carre Spillway)	230,000	CY	4.50	1,035,000
	4. SAND (Pump-Miss. River)	315,000	CY	1.80	567,000
	5. CLEARING (Levee)	50	AC	1000	50,000
	6. CLEARING & GRUBBING (Below Fabric)	40	AC	2000	80,000
	7. CLEARING (Borrow Area)	55	AC	500	27,500
	8. GEOFABRIC				
	a. 600 #/in	8000	SY	6.50	52,000
	b. 700 #/in	22,500	SY	7.00	157,500
	c. 750 #/in	24,000	SY	7.50	180,000
	d. 800 #/in	4,500	SY	7.50	33,750
	e. 900 #/in	39,000	SY	12.00	468,000
	f. 1150 #/in	19,000	SY	15.00	285,000
	g. 1350 #/in	33,000	SY	17.00	561,000
	h. 1400 #/in	35,500	SY	17.00	603,500
	i. 1600 #/in	60,500	SY	18.00	1,089,000
	9. FERTILIZE & SEEDING	80	AC	500	40,000
	SUBTOTAL				\$ 7,579,250

TABLE 7 (CONT'D)
 LAKE PONCHARTRAIN, LOUISIANA AND VICINITY
 HIGH LEVEL PLAN LEVEE
 GDM NO. 18 - ST. CHARLES PARISH NORTH OF AIRLINE HIGHWAY

ESTIMATE OF FIRST COST
 October 1988 Price Levels

Cost Acct. No.	Item/Description	Estimated Quantity	Unit	Unit Price	Estimated Amount
	CONTINGENCIES (25%)				\$ 1,895,750
11	TOTAL CONSTRUCTION				9,475,000
30	ENGINEERING & DESIGN (12%)				1,137,000
31	SUPERVISION & ADMINISTRATION (10%)				948,000
TOTAL COSTS					\$ 11,560,000

TABLE 7 (CONT'D)
 LAKE PONTCHARTRAIN, LOUISIANA AND VICINITY
 HIGH LEVEL PLAN LEVEE
 GDM NO. 18 - ST. CHARLES PARISH NORTH OF AIRLINE HIGHWAY

ESTIMATE OF FIRST COST
 October 1988 Price Levels

Cost Acct. No.	Item/Description	Estimated Quantity	Unit	Unit Price	Estimated Amount
	LEVEES REACH - I (295+00 To 513+77)				
	<u>2nd Lift Construction</u>				
11	1. MOB & DEMOB	Lump Sum	LS	\$ LS	\$ 30,000
	2. SEMI COMPACTED FILL (Haul-Bonnet Carre Spillway)	375,000	CY	5.00	1,875,000
	3. CLEARING (Levee)	90	AC	250	22,500
	4. CLEARING (Borrow Area)	30	AC	500	15,000
	5. FERTILIZE & SEEDING	90	AC	500	45,000
	6. RAISING SHEET PILING (P.Z - 22)	3040	SF	2.50	7,600
	SUBTOTAL				1,995,100
	CONTINGENCIES (25%)				498,900
11	TOTAL CONSTRUCTION				2,494,000
30	ENGINEERING & DESIGN (12%)				303,000
31	SUPERVISION & ADMINISTRATION (10%)				253,000
	TOTAL COST				\$ 3,050,000

TABLE 7 (CONT'D)
 LAKE PONTCHARTRAIN, LOUISIANA AND VICINITY
 HIGH LEVEL PLAN LEVEE
 GDM NO. 18 - ST. CHARLES PARISH NORTH OF AIRLINE HIGHWAY

ESTIMATE OF FIRST COST
 October 1988 Price Levels

Cost Acct. No.	Item/Description	Estimated Quantity	Unit	Unit Price	Estimated Amount
	LEVEES REACH - I (295+00 To 513+77)				
	<u>3rd Lift Construction</u>				
11	1. MOB & DEMOB	Lump Sum	LS	\$ LS	\$ 30,000
	2. SEMI COMPACTED FILL (Haul-Bonnet Carre Spillway)	315,000	CY	5.00	1,575,000
	3. CLEARING (Levee)	90	AC	250	22,500
	4. CLEARING (Borrow Area)	25	AC	500	12,000
	5. FERTILIZE & SEEDING	90	AC	500	45,000
	6. RAISING SHEET PILING (P Z - 22)	3,040	SF	2.50	7,600
	SUBTOTAL				1,692,600
	CONTINGENCIES (25%)				423,400
11	TOTAL CONSTRUCTION				2,116,000
30	ENGINEERING & DESIGN (12%)				254,000
31	SUPERVISION & ADMINISTRATION (10%)				210,000
	TOTAL COST				\$ 2,580,000

TABLE 7 (CONT'D)
 LAKE PONTCHARTRAIN, LOUISIANA AND VICINITY
 HIGH LEVEL PLAN LEVEE
 GDM NO. 18 - ST. CHARLES PARISH NORTH OF AIRLINE HIGHWAY

ESTIMATE OF FIRST COST
 October 1988 Price Levels

Cost Acct. No.	Item/Description	Estimated Quantity	Unit	Unit Price	Estimated Amount
	LEVEES REACH - I (295+00 To 513+77)				
	<u>4th Lift Construction</u>				
11	1. MOB & DEMOB	Lump Sum	LS	\$ LS	\$ 30,000
	2. SEMI COMPACTED FILL (Haul-Bonnet Carre Spillway)	375,000	CY	5.00	1,875,000
	3. CLEARING (Levee)	80	AC	250	20,000
	4. CLEARING (Borrow Area)	30	AC	500	15,000
	5. FERTILIZE & SEEDING	80	AC	500	40,000
	6. CONCRETE IN I-WALLS	653	CY	330	215,490
	7. STRUCTURAL EXCAVATION	502	CY	8.00	4,016
	8. STRUCTURAL BACKFILL	252	CY	10.00	2,520
	9. REMOVE & DISPOSE EXISTING DAMAGED SHEET PILING	14,895	SF	4.00	59,580
	10. STEEL SHEET PILING (P Z - 22)	9,790	SF	12.00	117,480
	SUBTOTAL				2,979,086
	CONTINGENCIES (25%)				594,914
11	TOTAL CONSTRUCTION				2,974,000
30	ENGINEERING & DESIGN (12%)				357,000
31	SUPERVISION & ADMINISTRATION (10%)				299,000
	TOTAL COST				\$ 3,630,000

TABLE 7 (CONT'D)
 LAKE PONTCHARTRAIN, LOUISIANA AND VICINITY
 HIGH LEVEL PLAN LEVEE
 GDM NO. 18 - ST. CHARLES PARISH NORTH OF AIRLINE HIGHWAY

ESTIMATE OF FIRST COST
 October 1988 Price Levels

Cost Acct. No.	LEVEES REACH I - DRAINAGE STRUCTURES & FLOODWALLS - STAS. 295+00 to 513+77				
	Item/Description	Quantity	Unit	Unit Price	Amount
	ST. ROSE CANAL DRAINAGE STRUCTURE - STA. 328+50 B/L -----				
11	1 MOB & DEMOB	LS	LS	\$ 100,000.00	\$ 100,000
	2 CLEARING & GRUBBING	18	AC	1,500.00	27,000
	3 EXCAVATION AT STRUCTURE	10,430	CY	2.00	20,860
	4 CHANNEL EXCAVATION	18,515	CY	1.50	27,773
	5 STRUCTURE DEWATERING	LS	LS	250,000.00	250,000
	6 SHELL BACKFILL	2,350	CY	18.00	42,300
	7 EMBANKMENT SEMICOMPACTED FILL	4,590	CY	6.50	29,835
	8 EMBANKMENT UNCOMPACTED FILL	3,080	CY	6.25	19,250
	9 LEVEE SAND BASE	875	CY	5.00	4,375
	10 RIPRAP	119	TONS	20.00	2,382
	11 FERTILIZING & SEEDING	15	AC	500.00	7,500
	12 STEEL SHEET PILE, PZ-22	10,380	SF	12.00	124,560
	13 12" UNTREATED TIMBER PILES	1,600	LF	6.00	9,600
	14 14" x 14" PRESTRSD CONC PILES	6,064	LF	20.00	121,280
	15 COMPRESSION PILE TEST	3	EA	18,000.00	54,000
	16 ADDITIONAL COMP PILE TEST	3	EA	14,000.00	42,000
	17 TENSION PILE TEST	3	EA	19,000.00	57,000
	18 TENSION PILE TEST	3	EA	14,000.00	42,000

TABLE 7 (CONT'D)
 LAKE PONTCHARTRAIN, LOUISIANA AND VICINITY
 HIGH LEVEL PLAN LEVEE
 GDM NO. 18 - ST. CHARLES PARISH NORTH OF AIRLINE HIGHWAY

ESTIMATE OF FIRST COST
 October 1988 Price Levels

Cost Acct. No.	LEVEES REACH I - DRAINAGE STRUCTURES & FLOODWALLS - STAS. 295+00 to 513+77					
	Item/Description	Quantity	Unit	Unit Price	Amount	
	ST. ROSE CANAL DRAINAGE STRUCTURE - STA. 328+50 B/L =====					
11	19	12 x 53 STEEL H-PILES	4,700	LF	\$ 24.00	\$ 112,800
	20	CONCRETE IN STAB. SLAB	64	CY	70.00	4,480
	21	CONCRETE IN SLUICE GATE STRUC	379	CY	330.00	125,070
	22	CONC. IN T-WALL BASE	282	CY	200.00	56,400
	23	CONC. IN T-WALL STEM	186	CY	330.00	61,380
	24	(6'x 6') SLUICE GATES & MACHINERY INCL ELECTRICAL	2	EA	\$ 43,000.00	\$ 86,000
	25	MISCELLANEOUS METALS (TRASH RACKS, HAND RAILS, & GRATING)	LS	LS	12,000.00	12,000
	26	SHELL ROAD	240	CY	22.00	5,280
	SUBTOTAL ST. ROSE DRAINAGE STRUCTURE					\$ 1,445,123

TABLE 7 (CONT'D)
 LAKE PONTCHARTRAIN, LOUISIANA AND VICINITY
 HIGH LEVEL PLAN LEVEE
 GDM NO. 18 - ST. CHARLES PARISH NORTH OF AIRLINE HIGHWAY

ESTIMATE OF FIRST COST
 October 1988 Price Levels

Cost Acct. No.	LEVEES REACH I - DRAINAGE STRUCTURES & FLOODWALLS - STAS. 295+00 to 513+77					
	Item/Description	Quantity	Unit	Unit Price	Amount	
	FLOODWALL VIC. I-310 - STAS. 356+32.1 B/L TO 372+83.2 B/L -----					
11	1	MOB & DEMOB	LS	LS	\$100,000.00	\$ 100,000
	2	CLEARING & GRUBBING	9	ACRE	1,500.00	13,500
	3	FERTILIZING & SEEDING	9	ACRE	500.00	4,500
	4	EMBANKMENT UMCOMPACTED FILL	13,740	CY	6.75	92,745
	5	EMBANKMENT SEMICOMPACTED FILL	3,580	CY	7.00	25,060
	6	LEVEE SAND BASE	8,440	CY	6.50	54,860
	7	STRUCTURAL EXCAVATION	3,780	CY	8.00	30,240
	8	STRUCTURAL BACKFILL	810	CY	10.00	8,100
	9	PZ-22, STEEL SHEET PILING	24,110	SF	12.00	289,320
	10	12"x12" PRESTRSD CONC PILING	25,221	LF	18.00	453,978
11	11	COMPRESSION PILE TEST	1	EA	18,000.00	18,000
	12	ADDITIONAL COMP PILE TEST	1	EA	14,000.00	14,000
	13	TENSION TEST	1	EA	19,000.00	19,000
	14	ADDITIONAL TENSION TEST	1	EA	14,000.00	14,000
	15	CONC IN STAB SLAB	96	CY	70.00	6,720
	16	CONC IN T-WALL BASE	715	CY	200.00	143,000
	17	CONC IN T-WALL STEM	408	CY	330.00	134,640
	18	STRUCTURAL STEEL SWING GATE	LS	LS	12,000.00	12,000
	FLOODWALL AT I-310					\$ 1,433,663

TABLE 7 (CONT'D)
 LAKE PONTCHARTRAIN, LOUISIANA AND VICINITY
 HIGH LEVEL PLAN LEVEE
 GDM NO. 18 - ST. CHARLES PARISH NORTH OF AIRLINE HIGHWAY

ESTIMATE OF FIRST COST
 October 1988 Price Levels

Cost
Acct.
No.

LEVEES REACH I - DRAINAGE STRUCTURES & FLOODWALLS - STAS. 295+00 to 513+77					
	Item/Description	Quantity	Unit	Unit Price	Amount
	WALKER CANAL DRAINAGE STRUCTURE - STA 454+06.6 C/L -----				
11	1 MCB & DEMOB	LS	LS	\$100,000.00	\$ 100,000
	2 CLEARING & GRUBBING	14	ACRE	1,500.00	21,000
	3 EXCAVATION AT STRUCTURE	7,282	CY	2.00	14,564
	4 CHANNEL EXCAVATION	7,172	CY	1.50	10,758
	5 STRUCTURE DEWATERING	LS	LS	200,000.00	200,000
	6 SHELL BACKFILL	2,715	CY	18.00	48,870
	7 EMBANKMENT SEMICOMPACTED FILL	4,390	CY	7.00	30,730
	8 EMBANKMENT UNCOMPACTED FILL	3,675	CY	6.75	24,806
	9 FERETILIZING & SEEDING	14	ACRE	500.00	7,000
	10 LEVEE SAND BASE	875	CY	6.75	5,906
	11 RIPRAP	94	TONS	20.00	1,880
	12 STEEL SHEET PILE PZ-22	9,561	SF	12.00	114,732
	13 12" x 12" PRESTRSD CONC PILES	1,590	LF	18.00	28,620
	14 14" x 14" PRESTRSD CONC PILES	3,536	LF	20.00	70,720
	15 COMPRESSION PILE TEST	3	EA	18,000.00	54,000
	16 ADDITIONAL COMP PILE TEST	3	EA	14,000.00	42,000
	17 TENSION PILE TEST	3	EA	19,000.00	57,000

TABLE 7 (CONT'D)
 LAKE PONCHARTRAIN, LOUISIANA AND VICINITY
 HIGH LEVEL PLAN LEVEE
 GDM NO. 18 - ST. CHARLES PARISH NORTH OF AIRLINE HIGHWAY

ESTIMATE OF FIRST COST
 October 1988 Price Levels

Cost Acct. No.	LEVEES REACH I - DRAINAGE STRUCTURES & FLOODWALLS - STAS. 295+00 to 513+77					
	Item/Description	Quantity	Unit	Unit Price	Amount	
	<u>WALKER CANAL DRAINAGE STRUCTURE - STA 454+06.6 C/L</u>					
11	18	ADDITIONAL TENSION PILE TEST	3	EA	\$ 14,000.00	\$ 42,000
	19	12 x 53 STEEL H-PILE	4,880	LF	24.00	117,120
	20	CONCRETE IN STAB. SLAB	45	CY	70.00	3,150
	21	CONCRETE IN SLUICE GATE STRUC	235	CY	330.00	77,550
	22	CONC. IN T-WALL BASE	273	CY	200.00	54,600
	23	CONC. IN T-WALL STEM	161	CY	330.00	53,130
	24	(4 x 4) SLUICE GATES & MACHINERY INCL ELECTRICAL	1	EA	30,000.00	30,000
	25	MISCELLANEOUS METALS (TRASH RACKS, HAND RAILS & GRATING)	LS	LS	4,000.00	4,000
	26	SHELL ROAD	210	CY	22.00	4,620
	SUBTOTAL WALKER CANAL DRAINAGE STRUCTURE					\$ 1,218,757
	<u>PARISH LINE CANAL DRAINAGE STRUCTURE - STA 516+02.1 C/L</u>					
11	1	MOB & DEMOB	LS	LS	\$100,000.00	\$ 100,000
	2	CLEARING & GRUBBING	13	ACRE	1,500.00	19,500
	3	EXCAVATION AT STRUCTURE	6,874	CY	2.00	13,748

TABLE 7 (CONT'D)
 LAKE PONTCHARTRAIN, LOUISIANA AND VICINITY
 HIGH LEVEL PLAN LEVEE
 GDM NO. 18 - ST. CHARLES PARISH NORTH OF AIRLINE HIGHWAY

ESTIMATE OF FIRST COST
 October 1988 Price Levels

Cost Acct. No.	LEVEES REACH I - DRAINAGE STRUCTURES & FLOODWALLS - STAS. 295+00 to 513+77					
	Item/Description	Quantity	Unit	Unit Price	Amount	
	WALKER CANAL DRAINAGE STRUCTURE - STA 454+06.6 C/L =====					
11	18	ADDITIONAL TENSION PILE TEST	3	EA	\$ 14,000.00	\$ 42,000
	19	12 x 53 STEEL H-PILE	4,880	LF	24.00	117,120
	20	CONCRETE IN STAB. SLAB	45	CY	70.00	3,150
	21	CONCRETE IN SLUICE GATE STRUC	235	CY	330.00	77,550
	22	CONC. IN T-WALL BASE	273	CY	200.00	54,600
	23	CONC. IN T-WALL STEM	161	CY	330.00	53,130
	24	(4 x 4) SLUICE GATES & MACHINERY INCL ELECTRICAL	1	EA	30,000.00	30,000
	25	MISCELLANEOUS METALS (TRASH RACKS, HAND RAILS & GRATING)	LS	LS	4,000.00	4,000
	26	SHELL ROAD	210	CY	22.00	4,620
	SUBTOTAL WALKER CANAL DRAINAGE STRUCTURE					\$ 1,218,757
	PARISH LINE CANAL DRAINAGE STRUCTURE - STA 516+02.1 C/L =====					
11	1	MOB & DEMOB	LS	LS	\$100,000.00	\$ 100,000
	2	CLEARING & GRUBBING	13	ACRE	1,500.00	19,500
	3	EXCAVATION AT STRUCTURE	6,874	CY	2.00	13,748

TABLE 7 (CONT'D)
 LAKE PONTCHARTRAIN, LOUISIANA AND VICINITY
 HIGH LEVEL PLAN LEVEE
 GDM NO. 18 - ST. CHARLES PARISH NORTH OF AIRLINE HIGHWAY

ESTIMATE OF FIRST COST
 October 1988 Price Levels

Cost Acct. No.	LEVEES REACH I - DRAINAGE STRUCTURES & FLOODWALLS - STAS. 295+00 to 513+77				
	Item/Description	Quantity	Unit	Unit Price	Amount
	PARISH LINE CANAL DRAINAGE STRUCTURE - STA 516+02.1 C/L =====				
11	4 CHANNEL EXCAVATION	4,500	CY	\$ 1.50	\$ 6,750
	5 STRUCTURE DEWATERING	LS	LS	200,000.00	200,000
	6 SHELL BACKFILL	2,595	CY	18.00	46,710
	7 EMBANKMENT SEMICOMPACTED FILL	3,780	CY	7.50	28,350
	8 EMBANKMENT UNCOMPACTED FILL	1,840	CY	7.25	13,340
	9 LEVEE SAND BASE	440	CY	\$ 7.00	\$ 3,080
	10 FERTILIZING & SEEDING	11	ACRE	500.00	5,500
	11 RIPRAP	94	TONS	20.00	1,880
	12 STEEL SHEET PILE, PZ-22	8,457	SF	12.00	101,484
	13 12" x 12" PRESTRSD CONC PILES	2,106	LF	18.00	37,908
	14 14" x 14" PRESTRSD CONC PILES	3,900	LF	20.00	78,000
	15 COMPRESSION PILE TEST	3	EA	18,000.00	54,000
	16 ADDITIONAL COMP PILE TEST	3	EA	14,000.00	42,000
	17 TENSION PILE TEST	3	EA	19,000.00	57,000
	18 ADDITIONAL TENSION PILE TEST	3	EA	14,000.00	42,000

TABLE 7 (CONT'D)
 LAKE PONTCHARTRAIN, LOUISIANA AND VICINITY
 HIGH LEVEL PLAN LEVEE
 GDM NO. 18 - ST. CHARLES PARISH NORTH OF AIRLINE HIGHWAY

ESTIMATE OF FIRST COST
 October 1988 Price Levels

Cost Acct. No.	LEVEES REACH I - DRAINAGE STRUCTURES & FLOODWALLS - STAS. 295+00 to 513+77					
	Item/Description	Quantity	Unit	Unit Price	Amount	
	PARISH LINE CANAL DRAINAGE STRUCTURE - STA 516+02.1 C/L =====					
11	19	12 x 53 STEEL H-PILES	4,792	LF	\$ 24.00	\$ 115,008
	20	CONCRETE IN STAB. SLAB	45	CY	70.00	3,150
	21	CONCRETE IN SLUICE GATE STRUC	231	CY	330.00	76,230
	22	CONC. IN T-WALL BASE	273	CY	200.00	54,600
	23	CONC. IN T-WALL STEM	161	CY	330.00	53,130
	24	(4 x 4) SLUICE GATE & MACHINERY INCL ELECTRICAL	1	EA	30,000.00	30,000
	25	MISCELLANEOUS METALS (TRASH RACKS, HAND RAILS, & GRATING)	LS	LS	4,000.00	4,000
	26	SHELL ROAD	180	CY	22.00	3,960
	SUBTOTAL PARISH LINE CANAL DRAINAGE STRUCTURE					\$ 1,191,328

TABLE 7 (CONT'D)
 LAKE PONTCHARTRAIN, LOUISIANA AND VICINITY
 HIGH LEVEL PLAN LEVEE
 GDM NO. 18 - ST. CHARLES PARISH NORTH OF AIRLINE HIGHWAY

ESTIMATE OF FIRST COST
 October 1988 Price Levels

Cost Acct. No.	LEVEES REACH I - DRAINAGE STRUCTURES & FLOODWALLS - STAS. 295+00 to 513+77				
	Item/Description	Quantity	Unit	Unit Price	Amount
	FLOODWALL/SWING GATE VIC. ILLINOIS CENTRAL RAILROAD STA 518+34.1 C/L =====				
11	1 MOB & DEMOB	LS	LS	\$100,000.00	\$ 100,000
	2 CLEARING & GRUBBING	4	ACRE	1,500.00	6,000
	3 FERTILIZING & SEEDINGTE STRUC	4	ACRE	500.00	2,000
	4 EMBANKMENT UNCOMPACTED FILL	24,720	CY	7.25	179,220
	5 EMBANKMENT SEMICOMPACTED FILL	2,190	CY	7.50	16,425
	6 LEVEE SAND BASE	3,265	CY	7.00	22,855
	7 STRUCTURAL EXCAVATION	120	CY	8.00	960
	8 STRUCTURAL BACKFILL	114	CY	10.00	1,140
	9 PZ-22, STEEL SHEET PILING	10,482	SF	12.00	125,784
	10 14" x 14" PRESTRSD CONC PILING	3,320	LF	20.00	66,400
	11 CONC IN STAB SLAB	8	CY	70.00	560
	12 CONC IN T-WALL BASE	60	CY	200.00	12,000
	13 CONC IN T-WALL STEM	32	CY	330.00	10,560
	14 FALSEWORK FOR RR SWING GATE	LS	LS	20,000.00	20,000
	15 STRUCTURAL STEEL SWING GATES	LS	LS	20,000.00	20,000
11	SUBTOTAL FLOODWALL VIC. ILLINOIS CENTRAL RAILROAD				\$ 584,904

TABLE 7 (CONT'D)
 LAKE PONTCHARTRAIN, LOUISIANA AND VICINITY
 HIGH LEVEL PLAN LEVEE
 GDM NO. 18 - ST. CHARLES PARISH NORTH OF AIRLINE HIGHWAY

ESTIMATE OF FIRST COST
 October 1988 Price Levels

Cost Acct. No.	LEVEES REACH I - DRAINAGE STRUCTURES & FLOODWALLS - STAS. 295+00 to 513+77				
	Item/Description	Quantity	Unit	Unit Price	Amount
		SUBTOTAL			\$ 5,872,774
		20% CONTINGENCIES			1,174,555
11		TOTAL CONSTRUCTION (R)			7,047,000
30		ENGINEERING & DESIGN 12%			846,000
31		SUPERVISION & ADMINISTRATION 10%			705,000
		TOTAL CONST. OF FLOODWALLS & DRAINAGE STRUCS. AT REACH I			\$ 8,598,000

TABLE 7 (CONT'D)
LAKE PONTCHARTRAIN, LOUISIANA AND VICINITY
HIGH LEVEL PLAN LEVEE
GDM NO. 18 - ST. CHARLES PARISH NORTH OF AIRLINE HIGHWAY

ESTIMATE OF FIRST COST
October 1988 Price Levels

Cost Acct. No.	Item/Description	Estimated Quantity	Unit	Unit Price	Estimated Amount
	LEVEES REACH - II (0+00 To 295+00) (Not Continuous)				
	<u>1st Lift Construction</u>				
11	1. MOB & DEMOB	Lump Sum	LS	\$ LS	\$ 450,000
	2. SEMI COMPACTED FILL (Haul-Bonnet Carre Spillway)	740,000	CY	4.00	2,960,000
	3. UNCOMPACTED FILL (Haul-Bonnet Carre Spillway)	540,000	CY	3.50	1,890,000
	4. SAND (Pump-Miss. River)	560,000	CY	2.50	1,400,000
	5. CLEARING (Levee)	80	AC	1000	80,000
	6. CLEARING & GRUBBING(Below Fab.)	65	AC	2000	130,000
	7. CLEARING (Borrow Area-BCS)				
	8. GEOFABRIC				
	a. 650 #/in	16,000	SY	6.50	104,000
	b. 700 #/in	5,500	SY	7.00	38,500
	c. 900 #/in	75,000	SY	12.00	900,000
	d. 950 #/in	33,000	SY	12.00	396,000
	e. 1250 #/in	80,000	SY	15.50	1,240,000
	f. 1350 #/in	8,000	SY	17.00	136,000
	g. 1500 #/in	12,000	SY	17.50	210,000
	h. 1600 #/in	145,000	SY	18.00	2,610,000
	FERTILIZE & SEEDING	135	AC	500	67,500
11	SUBTOTAL				12,667,000
	CONTINGENCIES (25%)				3,167,000
	TOTAL CONSTRUCTION				15,834,000
30	ENGINEERING & DESIGN (12%)				1,900,000
31	SUPERVISION & ADMINISTRATION (10%)				1,586,000
	TOTAL COSTS				\$ 19,320,000

TABLE 7 (CONT'D)
 LAKE PONTCHARTRAIN, LOUISIANA AND VICINITY
 HIGH LEVEL PLAN LEVEE
 GDM NO. 18 - ST. CHARLES PARISH NORTH OF AIRLINE HIGHWAY

ESTIMATE OF FIRST COST
 October 1988 Price Levels

Cost Acct. No.	Item/Description	Estimated Quantity	Unit	Unit Price	Estimated Amount
	<u>LEVEES REACH II (0+00 to 295+00)</u> <u>2ND LIFT CONSTRUCTION</u>				
11	1. MOB & DEMOB	LUMP SUM	LS	LS	\$ 30,000.00
	2. SEMICOMPACTED FILL (HAUL-BONNET CARRE SPILLWAY)	755,000	CY	4.00	3,020,000.00
	3. CLEARING (LEVEE)	155	AC	250.00	38,750.00
	4. CLEARING (BORROW AREA)	65	AC	500.00	32,500.00
	5. FERTILIZE & SEEDING	155	AC	500.00	77,500.00
	6. RAISING SHEET PILING (PZ-22)	1,620	SF	2.50	4,050.00
	SUBTOTAL				\$3,202,800.00
	CONTINGENCIES (25%)				801,200.00
11	TOTAL, CONSTRUCTION				4,004,000.00
30	ENGR & DESIGN (12%)				483,000.00
31	SUPVR & ADMIN (10%)				403,000.00
	TOTAL COSTS				\$4,890,000.00

TABLE 7 (CONT'D)
 LAKE PONTCHARTRAIN, LOUISIANA AND VICINITY
 HIGH LEVEL PLAN LEVEE
 GDM NO. 18 - ST. CHARLES PARISH NORTH OF AIRLINE HIGHWAY

ESTIMATE OF FIRST COST
 October 1988 Price Levels

Cost Acct. No.	Item/Description	Estimated Quantity	Unit	Unit Price	Estimated Amount
	<u>LEVEES REACH II (0+00 to 295+00)</u> <u>3RD LIFT CONSTRUCTION</u>				
11	1. MOB & DEMOB	LUMP SUM	LS	LS	\$ 30,000.00
	2. SEMICOMPACTED FILL (HAUL-BONNET CARRE SPILLWAY)	480,000	CY	4.00	1,920,000.00
	3. CLEARING (LEVEE)	155	AC	250.00	38,750.00
	4. CLEARING (BORROW AREA)	40	AC	500.00	20,000.00
	5. FERTILIZE & SEEDING	155	AC	500.00	77,500.00
	6. RAISING SHEET PILING (PZ-22)	1,620	SF	2.50	4,050.00
	SUBTOTAL				\$2,090,300.00
	CONTINGENCIES (25%)				522,700.00
11	TOTAL, CONSTRUCTION				2,613,000.00
30	ENGR & DESIGN (12%)				314,000.00
31	SUPVR & ADMIN (10%)				263,000.00
	TOTAL COSTS				\$3,190,000.00

TABLE 7 (CONT'D)
 LAKE PONTCHARTRAIN, LOUISIANA AND VICINITY
 HIGH LEVEL PLAN LEVEE
 GDM NO. 18 - ST. CHARLES PARISH NORTH OF AIRLINE HIGHWAY

ESTIMATE OF FIRST COST
 October 1988 Price Levels

Cost Acct. No.	Item/Description	Estimated Quantity	Unit	Unit Price	Estimated Amount
	<u>LEVEES REACH II (0+00 to 295+00)</u> <u>4TH LIFT CONSTRUCTION</u>				
11	1. MOB & DEMOB	LUMP SUM	LS	LS	\$ 30,000.00
	2. SEMICOMPACTED FILL (HAUL-BONNET CARRE SPILLWAY)	550,000	CY	4.00	2,200,000.00
	3. CLEARING (LEVEE)	150	AC	250.00	37,500.00
	4. CLEARING (BORROW AREA)	45	AC	500.00	22,500.00
	5. FERTILIZE & SEEDING	150	AC	500.00	75,000.00
	6. CONCRETE IN I-WALLS	359	CY	330.00	118,470.00
	7. STRUCTURAL EXCAVATION	266	CY	8.00	2,128.00
	8. STRUCTURAL BACKFILL	134	CY	10.00	1,340.00
	9. REMOVE & DISPOSE EXISTING DAMAGED SHEET PILING	9,530	SF	4.00	38,120.00
	10. STEEL SHEET PILING (PZ-22)	9,730	SF	12.00	116,760.00
11	SUBTOTAL				\$2,641,818.00
	CONTINGENCIES (25%)				661,182.00
	TOTAL, CONSTRUCTION				3,303,000.00
30	ENGR & DESIGN (12%)				397,000.00
31	SUPVR & ADMIN (10%)				330,000.00
	TOTAL COSTS				\$4,030,000.00

TABLE 7 (CONT'D)
 LAKE PONTCHARTRAIN, LOUISIANA AND VICINITY
 HIGH LEVEL PLAN LEVEE
 GDM NO. 18 - ST. CHARLES PARISH NORTH OF AIRLINE HIGHWAY

ESTIMATE OF FIRST COST
 October 1988 Price Levels

Cost Acct. No.	LEVEES REACH II - DRAINAGE STRUCTURES & FLOODWALLS - STAS. 0+00 B/L to 295+00 B/L				
	Item/Description	Quantity	Unit	Unit Price	Amount
	BAYOU TREPAGNIER DRAINAGE STRUCTURE - STA.. 4+05 C/L -----				
11	1 MOB & DEMOB	LS	LS	\$100,000.00	\$ 100,000.00
	2 CLEARING & GRUBBING	25	ACRE	1,500.00	21,000.00
	3 EXCAVATION AT STRUCTURE	13,000	CY	2.00	26,000.00
	4 CHANNEL EXCAVATION	20,100	CY	1.50	30,150.00
	5 SHELL BACKFILL	2,470	CY	18.00	44,460.00
	6 EMBANKMENT SEMICOMPACTED FILL	2,970	CY	5.00	14,850.00
	7 EMBANKMENT UNCOMPACTED FILL	2,605	CY	4.75	12,374.00
	8 LEVEE SAND BASE	875	CY	4.00	3,500.00
	9 FERTILIZING & SEEDING	10	ACRE	500.00	5,000.00
	10 RIPRAP	225	TONS	20.00	4,500.00
	11 STEEL SHEET PILE, PZ-22	11,170	SF	12.00	134,040.00
	12 12" X 12" PRESTRSD CONC PILES	1,080	LF	18.00	19,440.00
	13 14" X 14" PRESTRSD CONC PILES	4,345	LF	20.00	86,900.00
	14 COMPRESSION PILE TEST	3	EA	18,000.00	54,000.00
	15 ADDITIONAL COMP PILE TEST	3	EA	14,000.00	42,000.00
	16 TENSION PILE TEST	3	EA	19,000.00	57,000.00
	17 ADDITIONAL TENSION PILE TEST	3	EA	14,000.00	42,000.00
	18 12 X 53 STEEL H-PILES	4,260	LF	24.00	102,240.00

TABLE 7 (CONT'D)
 LAKE PONTCHARTRAIN, LOUISIANA AND VICINITY
 HIGH LEVEL PLAN LEVEE
 GDM NO. 18 - ST. CHARLES PARISH NORTH OF AIRLINE HIGHWAY

ESTIMATE OF FIRST COST
 October 1988 Price Levels

Cost Acct. No.	LEVEES REACH II - DRAINAGE STRUCTURES & FLOODWALLS - STAS. 0+00 B/L to 295+00 B/L				
	Item/Description	Quantity	Unit	Unit Price	Amount
	BAYOU TREPAGNIER DRAINAGE STRUCTURE - STA.. 4+05 C/L -----				
19	CONCRETE IN STAB. SLABS	27	CY	\$ 70.00	\$ 1,890.00
20	CONCRETE IN SLUICE GATE STRUC	319	CY	330.00	105,270.00
21	CONC. IN T-WALL BASE	151	CY	200.00	30,200.00
22	CONC. IN T-WALL STEM	120	CY	330.00	39,600.00
23	5' X 5' SLUICE GATES, & MACHINERY INCL ELECTRICAL	3	EA	35,000.00	105,000.00
24	MISCELLANEOUS METALS (TRASH RACK, HANDRAILS, GRATING, ETC.)	LS	LS	15,000.00	15,000.00
25	SHELL ROAD	209	CY	22.00	4,598.00
11	SUBTOTAL BAYOU TREPAGNIER DRAINAGE STRUCTURE				\$1,101,012.00
	FLOODWALL AT SHELL OIL CO. GOOD HOPE OILFIELD FACILITY -----				
1	MOB & DEMOB	LS	LS	\$35,000.00	35,000.00
2	CLEARING & GRUBBING	4	ACRE	1,000.00	4,000.00
3	FERTILIZING & SEEDING	4	ACRE	500.00	2,000.00
4	EMBANKMENT UNCOMPACTED FILL	18,335	CY	5.00	91,675.00

TABLE 7 (CONT'D)
 LAKE PONTCHARTRAIN, LOUISIANA AND VICINITY
 HIGH LEVEL PLAN LEVEE
 GDM NO. 18 - ST. CHARLES PARISH NORTH OF AIRLINE HIGHWAY

ESTIMATE OF FIRST COST
 October 1988 Price Levels

Cost Acct. No.	LEVEES REACH II - DRAINAGE STRUCTURES & FLOODWALLS - STAS. 0+00 B/L to 295+00 B/L				
	Item/Description	Quantity	Unit	Unit Price	Amount
	FLOODWALL AT SHELL OIL CO. GOOD HOPE OILFIELD FACILITY =====				
	5 EMBANKMENT SEMICOMPACTED FILL	1,985	CY	5.25	10,421.00
	6 LEVEE SAND BASE	2,470	CY	4.75	11,733.00
	7 STRUCTURAL EXCAVATION	30	CY	8.00	240.00
	8 STRUCTURAL BACKFILL	90	CY	10.00	900.00
	9 PZ-22, STEEL SHEET PILING	11,190	SF	12.00	134,280.00
	10 12" X 12" PRESTRSD CONC PILING	2,584	LF	18.00	46,512.00
	11 CONC IN STAB SLAB	4	CY	70.00	280.00
	12 CONC IN T-WALL BASE	30	CY	200.00	6,000.00
	13 CONC IN T-WALL STEM	30	CY	330.00	9,900.00
	14 STRUCTURAL STEEL SWING GATES	LS	LS	15,000.00	15,000.00
11	SUBTOTAL FLOODWALL AT GOOD HOPES OILFIELD FACILITY				\$367,941.00

TABLE 7 (CONT'D)
 LAKE PONTCHARTRAIN, LOUISIANA AND VICINITY
 HIGH LEVEL PLAN LEVEE
 GDM NO. 18 - ST. CHARLES PARISH NORTH OF AIRLINE HIGHWAY

ESTIMATE OF FIRST COST
 October 1988 Price Levels

LEVEES REACH II - DRAINAGE STRUCTURES & FLOODWALLS - STAS. 0+00 B/L to 295+00 B/L					
Cost Acct. No.	Item/Description	Quantity	Unit	Unit Price	Amount
	CROSS BAYOU DRAINAGE STRUCTURE - STA. 256+24.7 C/L =====				
11	1 MOB & DEMOB	LS	LS	\$100,000.00	\$ 100,000.00
	2 CLEARING & GRUBBING	25	ACRE	1,500.00	37,500.00
	3 EXCAVATION AT STRUCTURE	14,330	CY	2.00	28,660.00
	4 STRUCTURE DEWATERING	LS	LS	350,000.00	350,000.00
	5 CHANNEL EXCAVATION	20,900	CY	1.50	31,350.00
	6 SHELL BACKFILL	2,490	CY	18.00	44,820.00
	7 EMBANKMENT SEMICOMPACTED FILL	3,780	CY	6.00	22,680.00
	8 EMBANKMENT UNCOMPACTED FILL	1,840	CY	5.75	10,580.00
	9 LEVEE SAND BASE	875	CY	5.00	4,375.00
	10 FERTILIZING & SEEDING	20	CY	500.00	10,000.00
	11 RIPRAP	110	TONS	20.00	2,200.00
	12 STEEL SHEET PILE, PZ-22	11,340	SF	12.00	136,080.00
	13 12" X 12" PRESTRSD CONC PILES	2,880	LF	18.00	51,840.00
	14 14" X 14" PRESTRSD CONC PILES	11,320	LF	20.00	226,400.00
	15 COMPRESSION PILE TEST	3	EA	18,000.00	54,000.00
	16 ADDITIONAL COMP PILE TEST	3	EA	14,000.00	42,000.00
	17 TENSION PILE TEST	3	EA	19,000.00	57,000.00
	18 ADDITIONAL TENSION PILE TEST	3	EA	14,000.00	42,000.00
	19 12 X 53 STEEL H-PILES	4,700	LF	24.00	112,800.00

TABLE 7 (CONT'D)
 LAKE PONTCHARTRAIN, LOUISIANA AND VICINITY
 HIGH LEVEL PLAN LEVEE
 GDM NO. 18 - ST. CHARLES PARISH NORTH OF AIRLINE HIGHWAY

ESTIMATE OF FIRST COST
 October 1988 Price Levels

Cost Acct. No.	LEVEES REACH II - DRAINAGE STRUCTURES & FLOODWALLS - STAS. 0+00 B/L to 295+00 B/L					
	Item/Description	Quantity	Unit	Unit Price	Amount	
	CROSS BAYOU DRAINAGE STRUCTURE - STA. 256+24.7 C/L -----					
11	20	CONCRETE IN STAB. SLAB	399	CY	\$ 70.00	\$ 27,930.00
	21	CONCRETE IN SLUICE GATE STRUC	136	CY	330.00	44,880.00
	22	CONC. IN T-WALL BASE	151	CY	200.00	30,200.00
	23	CONC. IN T-WALL STEM	120	CY	330.00	39,600.00
	24	6' X 6' SLUICE GATES & MACHINERY INCL ELECTRICAL	6	EA	\$43,000.00	258,000.00
	25	MISCELLANEOUS METALS (TRASH RACK, HANDRAILS, GRATING, ETC.)	LS	LS	38,000.00	38,000.00
11		SUBTOTAL STRUCTURE COST				\$1,802,895.00
	BRIDGE AT CROSS BAYOU -----					
11	26	SHELL ACCESS ROAD	534	CY	\$ 22.00	11,748.00
	27	ROAD EMBANKMENT SUBGRADE	3,600	CY	5.00	18,000.00
	28	STEEL SHEET PILE, PZ-22	460	SF	12.00	5,520.00
	29	14" X 14" PRSTRD CONC PILES	2,380	LF	20.00	47,600.00
	30	CONCRETE IN PILE BENTS	37	CY	400.00	14,800.00
	31	CONCRETE PRECAST SLABS (12" X 3' X 20')	2,400	SF	20.00	48,000.00
	32	BRIDGE RAILS	320	LF	35.00	11,200.00

TABLE 7 (CONT'D)
 LAKE PONTCHARTRAIN, LOUISIANA AND VICINITY
 HIGH LEVEL PLAN LEVEE
 GDM NO. 18 - ST. CHARLES PARISH NORTH OF AIRLINE HIGHWAY

ESTIMATE OF FIRST COST
 October 1988 Price Levels

Cost Acct. No.	Item/Description	Quantity	Unit	Unit Price	Amount
	LEVEES REACH II - DRAINAGE STRUCTURES & FLOODWALLS - STAS. 0+00 B/L to 295+00 B/L				
	BRIDGE AT CROSS BAYOU -----				
33	MUCK BACKFILL	1,570	CY	2.50	\$ 3,925.00
11	SUBTOTAL BRIDGE COST				\$160,793.00
11	SUBTOTAL DRAINAGE STRUCTURE & BRIDGE AT CROSS BAYOU				\$1,963,688.00
11	SUBTOTAL				\$3,432,641.00
	20% CONTINGENCIES				686,528.00
	TOTAL CONSTRUCTION (R)				4,119,000.00
30	ENGINEERING & DESIGN (12%)				494,000.00
31	SUPERVISION & ADMIN. (10%)				412,000.00
	TOTAL, CONST. OF FLOODWALLS AND DRAINAGE STRUCS. AT REACH II				\$5,025,000.00

58. Comparison of Estimates. The current estimate of \$68,714,000 for the High Level Plan North of Airline Highway Levee Alignment represents a decrease of \$6,400,000 when compared to the cost estimate contained in the current PB-3 effective 1 October 1988. The PB-3 estimate is based on a survey scope estimate contained in the "Lake Pontchartrain, Louisiana and Vicinity Hurricane Protection Project, Reevaluation Study", dated July 1984. Cost estimates contained in the reevaluation report have been indexed up to October 1988 levels for the PB-3 estimate. Additionally, the PB-3 estimate includes all prior sunk costs on this project feature. Table 8 shows a comparison by accounts of the PB-3 estimates and those contained in this GDM. The decrease in cost is explained in the following subparagraphs:

TABLE 8

COMPARISON OF ESTIMATES
PB-3 and GDM Remaining Cost
Oct 88 Price Levels
Incremental Cost Estimate

Feature	PB-3 (eff Oct 88) \$	GDM (Oct 88 Prices) \$	Differences GDM & PB-3 \$
11 LEVEES & FLOODWALLS	54,189,000	53,979,000	-210,000
30 ENGINEERING & DESIGN	9,912,000	6,485,000	-3,427,000
31 SUPERVISION & ADMINISTRATION	8,288,000	5,409,000	-2,879,000
01 LAND & DAMAGES	2,093,000	1,601,000	-492,000
02 RELOCATIONS	<u>632,000</u>	<u>1,240,000</u>	<u>+608,000</u>
TOTAL	75,114,000	68,714,000	-6,400,000

a. Levees and Floodwalls. The net decrease in the Levees and Floodwalls account of \$210,000 is well within the allowable error of estimate and requires no explanation.

b. Engineering and Design. The \$3,427,000 decrease in the Engineering and Design cost estimate is in large part due to the GDM estimate representing remaining cost and is not reflective of prior sunk cost. Engineering and Design costs sunk through FY 88 are \$2,743,000. Therefore, the actual differences between the GDM and PB-3 estimates is a reduction of only \$684,000.

c. Supervision and Administration. The net decrease in the Supervision and Administration (S&A) of \$2,878,000 also does not include sunk S&A cost prior to FY 89. However, the sunk S&A cost is only \$344,000. Therefore, the actual difference in the PB-3 and GDM S&A cost is a decrease of \$2,534,000. The GDM & S&A cost is based on taking a percentage of the remaining construction cost on the project. The percentage used is reflective of the percentage actually spent on similar projects constructed in the New Orleans District.

d. Lands and Damages. Table 8 shows a net decrease in the Lands and Damages account of \$492,000. The GDM estimate for Lands and Damages does not include the sunk cost of \$1,140,000 expended by the Pontchartrain Levee District to construct the barrier plan lakefront alignment. When the sunk cost is taken into account, there is actually a net increase in cost for this feature of \$648,000. The increase in cost for this feature is primarily due to a more detailed estimate of land values rather than a requirement for additional lands to construct the project.

e. Relocations. The net increase in estimated Relocation cost of \$608,000 is due to a more detailed knowledge of actual, required relocations which are detailed in this report. The survey scope estimate contained in the PB-3 estimate was obtained from a review of available maps showing pipelines rather than detailed field surveys and discussions with facility owners.

59. Schedule for Design and Construction. The sequence of contracts and Schedule for Design and Construction for the recommended plan are shown in Table 9 below.

TABLE 9

SCHEDULE FOR DESIGN AND CONSTRUCTION
ST. CHARLES PARISH NORTH OF AIRLINE HIGHWAY
HURRICANE PROTECTION

CONTRACTS	PLANS & SPEC		CONSTRUCTION			CONSTRUCTION COST ^{1/} \$
	Start	Complete	Adv.	Award	Complete	
<u>REACH I</u>						
<u>LEVEE</u>						
1st Lift	Jan 89	Jun 89	Jul 90	Sep 90	Oct 91	10,330,000
2nd Lift	Sep 93	Dec 94	Sep 95	Nov 95	Aug 96	2,720,000
3rd Lift	Jan 01	Mar 02	Jan 03	Mar 03	Sep 03	2,300,000
4th Lift	Jan 10	Feb 11	Jan 12	Mar 12	Sep 12	3,240,000
<u>STRUCTURES</u>						
St. Rose, I-310 Waker Canal, Parish Line Canal D.S. Illinois Cent RR	Jan 89	Sep 90	Jul 91	Sep 91	Apr 93	7,680,000
<u>REACH II</u>						
<u>LEVEE</u>						
1st Lift	Feb 89	Nov 89	Apr 91	Jun 91	Feb 93	17,260,000
2nd Lift	Jan 95	Sep 96	Jan 97	Mar 97	Jan 98	4,370,000
3rd Lift	Feb 02	Jul 03	Jan 04	Mar 04	Oct 04	2,850,000
4th Lift	Feb 11	Jun 12	Jan 13	Mar 13	Nov 13	3,600,000
<u>STRUCTURES</u>						
Bayou Trepagnier D.S. Good Hope Oilfield F.W. Cross Bayou D.S. & Bridge	Feb 90	Mar 91	Aug 92	Oct 92	Nov 93	4,490,000

^{1/} This cost includes contingencies, Federal and Non-Federal Construction Cost and Federal and Non-Federal Supervision and Inspection (S&I) Costs (S&I Cost is computed as 90% of Supervision and Administration Cost).

60. Funds Required by Fiscal Year. To maintain the schedule for design and construction for the St. Charles Parish High Level Plan Levee as shown in Table 9 above, Federal and Non-Federal funds will be required by Fiscal Year as follows:

TABLE 10

FEDERAL AND NON-FEDERAL FUNDING BY FISCAL YEAR

		\$
Funds required	FY 89	2,931,000
Funds required	FY 90	4,065,000
Funds required	FY 91	13,097,000
Funds required	FY 92	15,682,000
Funds required	FY 93	11,043,000
Funds required	FY 94	694,000
Funds required	FY 95	315,000
Funds required	FY 96	2,972,000
Funds required	FY 97	2,988,000
Funds required	FY 98	1,497,000
Funds required	FY 99	-
Funds required	FY 00	-
Funds required	FY 01	97,000
Funds required	FY 02	236,000
Funds required	FY 03	2,497,000
Funds required	FY 04	2,603,000
Funds required	FY 05	337,000
Funds required	FY 06	-
Funds required	FY 07	-
Funds required	FY 08	-
Funds required	FY 09	-
Funds required	FY 10	136,000
Funds required	FY 11	299,000
Funds required	FY 12	3,511,000
Funds required	FY 13	2,939,000
Funds required	FY 14	<u>775,000</u>
 TOTAL COST		 68,714,000

FEDERAL AND NON-FEDERAL COST BREAKDOWN

61. Federal and Non-Federal Cost Breakdown. The Federal and Non-Federal costs for the high level plan design and construction work described in this GDM are shown in Table 11 below:

TABLE 11

FEDERAL AND NON-FEDERAL COST BREAKDOWN
(Oct 88 Price Levels)

<u>Item</u>	<u>Federal</u> \$	<u>Non-Federal</u> \$	<u>Total</u> ^{1/} \$
Levees & Floodwalls	51,100,000	17,860,000	68,960,000
Lands & Damages	-	2,741,000	2,741,000
Relocations	-	1,240,000	1,240,000
TOTAL	51,100,000	21,841,000	72,941,000

^{1/} This table contains all sunk costs prior to FY 89 used for designs and purchase of Rights-of-Way for the Barrier Plan as well as Engineering and Design and Supervision and Administration Costs associated with the preparation of this GDM.

RECOMMENDATIONS

62. Recommendations. The plan of improvement for the high level plan presented herein is the least costly plan that provides the authorized level of protection, uses the minimum acquisition of wetlands and achieves early-on a high degree of flood protection for the developed area on the east bank of St. Charles Parish. It is recommended that this plan be approved as the basis of preparing plans and specifications for this project.

LAKE PONTCHARTRAIN, LOUISIANA AND VICINITY
HIGH LEVEL PLAN
DESIGN MEMORANDUM No. 18 - GENERAL DESIGN
ST. CHARLES PARISH NORTH OF AIRLINE HIGHWAY

APPENDIX A, VOLUME I

HYDROLOGY & HYDRAULICS

LAKE PONTCHARTRAIN, LOUISIANA AND VICINITY
HIGH LEVEL PLAN
DESIGN MEMORANDUM NO. 18 GENERAL DESIGN
ST. CHARLES PARISH NORTH OF AIRLINE HIGHWAY LEVEE ALIGNMENT
APPENDIX A
HYDROLOGY & HYDRAULIC

TABLE OF CONTENTS

<u>Paragraph No.</u>	<u>Title</u>	<u>Page No.</u>
<u>SECTION I - ANALYSIS</u>		
A-1	General	A-1
A-2	Description	A-1
A-3	Climatology	A-2
	a. Climate	
	b. Temperature	
	c. Rainfall	
	d. Wind	
A-4	Hydrologic Regimen	A-4
	a. General	
	b. Runoff and Streamflow	
	c. Stages, Waves and Tides	
	d. Salinity	
A-5	Water Quality	A-16
	a. Criteria and Standards	
	b. Data	
	c. Effects	
A-6	Description and Verification of Procedures	A-23
	a. Hurricane Memorandums	
	b. Historical Storms used for Verification	
	c. Synthetic Storms	
	d. Surges	
	e. Routing	
	f. Wind Tides	
A-7	Frequency Estimates	A-28
	a. Procedure	
	b. Relationship	

TABLE OF CONTENTS (cont'd)

PLATES

<u>Plate No.</u>	<u>Title</u>
A-1	VICINITY MAP
A-2	CLIMATOLOGICAL STATIONS
A-3	WIND ROSE
A-4	ISOVEL PATTERN, HURRICANE OF SEP 1915
A-5	ISOVEL PATTERN, HURRICANE OF SEP 1947
A-6	ISOVEL PATTERNS, STANDARD PROJECT HURRICANE TRACK A
A-7	ISOVEL PATTERNS, STANDARD PROJECT HURRICANE TRACK F
A-8	FREQUENCY OF HURRICANE CENTRAL PRESSURE, ZONE B
A-9	HURRICANE TRACKS
A-10	LAKE PONTCHARTRAIN ROUTING
A-11	STAGE HYDROGRAPH, HURRICANE OF 19 SEPTEMBER 1947
A-12	STAGE HYDROGRAPH, HURRICANE OF 17-18 SEPTEMBER 1957
A-13	STANDARD PROJECT HURRICANE - STAGE HYDROGRAPHS
A-14	WIND TIDE LEVEL FORECAST CURVES
A-15	LAKE PONTCHARTRAIN - TYPICAL WIND TIDE CONTOURS
A-16	MAXIMUM SURGE CONTOURS - STANDARD PROJECT HURRICANE
A-17	STAGE - FREQUENCY SOUTH SHORE OF LAKE PONTCHARTRAIN
A-18	STAGE - FREQUENCY CURVE - ST CHARLES PARISH
A-19	VICINITY MAP, SUB - AREAS AND CULVERT LOCATIONS
A-20	STAGE - VOLUME CURVE
A-21	DRAINAGE STRUCTURE DESIGN DATA - SUBDRAINAGE AREA: "NORCO"
A-22	DRAINAGE STRUCTURE DESIGN DATA - SUBDRAINAGE AREA: "NSARPY & ORMDES"
A-23	DRAINAGE STRUCTURE DESIGN DATA - SUBDRAINAGE AREA: "SWAMP"
A-24	DRAINAGE STRUCTURE DESIGN DATA - SUBDRAINAGE AREA: "STROSE"
A-25	DRAINAGE STRUCTURE DESIGN DATA - SUBDRAINAGE AREA: "WALKER"
A-26	DRAINAGE STRUCTURE DESIGN DATA - SUBDRAINAGE AREA: "JAMES"

TABLE OF CONTENTS (cont'd)

TABLES

<u>Table No.</u>	<u>Title</u>	<u>Page No.</u>
A-1	METEOROLOGIC STATIONS	A-2
A-2	MONTHLY TEMPERATURE-NEW ORLEANS AT MOISANT AIRPORT, 30-YEAR NORMALS (1951-1980)	A-3
A-3	MONTHLY RAINFALL-NEW ORLEANS AT MOISANT AIRPORT, 30-YEAR NORMALS (1951-1980)	A-4
A-4	WIND SUMMARIES-NEW ORLEANS AT MOISANT AIRPORT (1966-1986)	A-5
A-5	WINDSPEED-NEW ORLEANS AT MOISANT AIRPORT-PERCENTAGE FREQUENCY (1949-1978)	A-7
A-6	HYDROLOGIC STATIONS	A-8
A-7	PERTINENT STREAMFLOW DATA (1938-1985)	A-12
A-8	MAXIMUM STAGES-LAKE PONTCHARTRAIN	A-14
A-9	WAVE DATA	A-15
A-10	SUMMARY OF APPLICABLE CRITERIA AND STANDARDS	A-20
A-11	STATISTICAL SUMMARY OF WATER QUALITY FOR SELECTED PARAMETERS	A-22
A-12	HURRICANE CHARACTERISTICS	A-25
A-13	CENTRAL PRESSURE INDEX VS WIND TIDE LEVEL-LAKE PONTCHARTRAIN REACH-NEW ORLEANS	A-30
A-14	STAGE FREQUENCY, SOUTH SHORE- LAKE PONTCHARTRAIN	A-31
A-15	DESIGN HURRICANE CHARACTERISTICS	A-32
A-16	DESIGN HURRICANE WINDTIDE LEVELS AND DESIGN ELEVATIONS OF PROTECTIVE STRUCTURES	A-34
A-17	SELECTED CULVERTS	A-36
A-18	PERTINENT DATA 25-YEAR DESIGN EVENT	A-37
A-19	HEADWATER ELEVATION	A-40
A-20	PONDING ELEVATION	A-41

LAKE PONTCHARTRAIN, LOUISIANA AND VICINITY
HIGH LEVEL PLAN
ST. CHARLES PARISH, NORTH OF AIRLINE HIGHWAY
LEVEE ALIGNMENT
APPENDIX A
HYDROLOGY AND HYDRAULICS

SECTION I - ANALYSIS

A-1. General. This appendix presents all hydrologic and hydraulic design criteria and analyses associated with the St. Charles hurricane protection levee north of Airline Highway. The overall plan of improvement is described in detail in the main body of this memorandum and references to the main text are cited where appropriate.

A-2. Description.

a. St. Charles Parish is located in southeast Louisiana approximately 10 miles west of New Orleans, Louisiana. The total land area contained within the parish limits is 421 square miles, of which 288 square miles is land area and 133 square miles is water. According to U.S. Census Bureau figures, the population has increased from 24,219 in 1960 to 29,950 in 1970. St. Charles Parish is divided by the Mississippi River. The parish is bounded by Lake Pontchartrain on the north and on the south by Lake Salvador. These lakes, together with the small bayous and canals flowing into these lakes, provide drainage for the parish. The major waterways in the south are Ellington, Cousin and Blouin Canals, and Bayous Gauche and Des Allemands. The major northern bayous are Trepagnier and La Branche. Several manmade canals provide additional drainage.

b. Approximately seven percent of the parish has been developed, with the remainder of land being water, marsh, wooded, or vacant. Within the flood plains studied, most of the developed land consists of industrial plants with some pipeline rights-of-way and public and semi-public buildings. A smaller percentage of the developed land has single family residences and an even smaller percentage has private businesses. The majority of development is adjacent to U.S. Highway 61 on the east bank and U.S. Highway 90 on the west bank. Several state and parish roads and three private railroads also serve the residents of St. Charles parish.

c. The plan of improvement for St. Charles Parish consists of a levee to be constructed north and generally parallel to Airline Highway from Bonnet Carre Spillway on the west to the St. Charles Parish boundary on the east plus associated interior drainage which consists of culverts at 5 locations. The study area is depicted on Plate A-1 and is limited to the portion of St. Charles Parish north of the Mississippi River which is often designated as the East Bank of the Mississippi River. The study area is also limited to the area downstream of the Bonnet Carre Spillway.

A-3. Climatology.

a. Climate. The project area is located in a subtropical latitude having mild winters and hot, humid summers. During the summer, prevailing southerly winds produce conditions favorable for convective thundershowers. In the colder seasons, the area experiences frontal passages which produce squalls and sudden temperature drops. River fogs are prevalent in the winter and spring when the temperature of the Mississippi River is somewhat colder than the air temperature. Climatological data for the area are contained in monthly and annual publications by the U.S. Department of Commerce, Weather Bureau, titled "Climatological Data for Louisiana, and "Local Climatological Data, New Orleans, La." Table A-1 lists active meteorological stations in and adjacent to the study area. These stations are also shown on the map in Plate A-2.

TABLE A-1
METEOROLOGIC STATIONS

MAP INDEX NO. (PLATE 2)	PRECIPITATION & TEMPERATURE STATIONS	LENGTH OF RECORDS (YRS.) TO 1986	Precipitation	Temperature
1	NEW ORLEANS - AUDUBON PARK	98	98	
2	NEW ORLEANS - MOISANT AIRPORT	34	34	
3	RESERVE (NR)	86	86	
4	SLIDELL	31	31	
5	DONALDSONVILLE (NR)	98	99	
6	LOUISIANA NATURE CENTER	8	8	
7	PARADIS (NR)	73	33	
OMS	HAMMOND (NR)	91	92	
OMS	ST BERNARD (NR)	22	22	
OMS	COVINGTON	94	94	
OMS	CARVILLE (NR)	49	48	
OMS	BATON ROUGE AIRPORT	119	99	

RECORDING PRECIPITATION STATIONS

8	NEW ORLEANS ALGIERS	88	-
9	NEW ORLEANS DPS 14 - CITRUS	33	-
10	NEW ORLEANS WATER PLANT - DUBLIN	94	-
11	NEW ORLEANS DPS 5 - JOURDAN	54	-
12	NEW ORLEANS DPS 3 - LONDON	94	-
13	NEW ORLEANS DPS 6 - METAIRIE	38	-
14	GONZALES	10	-

TABLE A-1 (CONT.)
NON-RECORDING PRECIPITATION STATIONS

15	NEW ORLEANS CITY HALL	10	-
OMS	BATON ROUGE CENTRAL	9	-
OMS	ABITA SPRINGS FIRE TOWER	15	-

LEGEND: NR NON-RECORDING
 OMS OFF MAP STATION

b. Temperature. The average annual normal temperature is 68.0° F. This is based on temperature records at New Orleans Moisant Airport and Reserve, Louisiana for the period of 1951-1980. Maximum temperatures over the period of record were 102° F at Moisant on 22 August 1980 and 107° F at Reserve occurring on three days, 13 July 1901, 31 July 1917, and 14 June 1918. Minimum temperatures were 14° F at Moisant occurring twice on 24 January 1963 and 25 December 1983 and 11° F at Reserve on 11 January 1982. The monthly and annual normals for these two stations are shown in Table A-2. Station locations are provided on the map in Plate A-2.

TABLE A-2
 MEAN MONTHLY TEMPERATURE (°F)
 30 YEAR NORMALS (1951-1980)

	JAN	FEB	MAR	APR	MAY	JUN	JUL	AUG	SEP	OCT	NOV	DEC	ANN
MOISANT	52.4	54.7	61.4	68.7	74.9	80.3	82.1	81.7	78.5	69.2	60.0	54.5	68.2
RESERVE	51.1	53.7	60.3	68.3	74.9	80.4	82.2	81.8	78.4	68.9	59.7	53.5	67.8
AVERAGE	51.8	54.2	60.9	68.5	74.9	80.4	82.2	81.8	78.5	69.9	59.9	54.1	68.0

c. Rainfall. Precipitation is generally heavy in two fairly definite rainy periods. Summer showers occur from about mid-June to mid-September, and heavy winter rains generally occur from mid-December to mid-March. The drainage area tributary to Lake Pontchartrain is served by 34 precipitation stations of the U.S. Weather Bureau, with periods of record ranging from 7 to 118 years. Based on the 30-year normals for the period 1951-1980 and from the U.S. Weather Bureau stations New Orleans at Moisant Airport and Reserve, the average annual normal precipitation is 60.28 inches, with variations of plus or minus 50 percent. Extreme monthly rainfalls exceeding 12 inches are not uncommon. Average monthly normal rainfalls range from a normal 6.62 inches in July to a normal of 2.84 inches in October. Several stations have experienced calendar months in which no rainfall was recorded. Snow occurs infrequently in the area. An 8.2-inch snowfall occurred in New Orleans on 14-15 February 1895. The last measurable snowfall in New Orleans occurred on 31 December 1963 when 4.5 inches fell. Table A-3 gives the 30 year normals for the New Orleans at Moisant Airport and Reserve along with maximum and minimum extremes during the period of record. Location of the precipitation stations are shown on Plate A-2.

TABLE A-3
MEAN MONTHLY TEMPERATURE (°F)
30 YEAR NORMALS (1951-1980)

	JAN	FEB	MAR	APR	MAY	JUN	JUL	AUG	SEP	OCT	NOV	DEC	ANN
MOISANT	4.97	5.23	4.73	4.50	5.07	4.63	6.73	6.02	5.87	2.66	4.06	5.27	59.74
RESERVE	5.13	5.58	5.15	4.51	5.29	4.31	6.50	5.70	5.95	3.01	4.07	5.62	60.82
AVERAGE	5.05	5.41	4.94	4.51	5.18	4.47	6.62	5.86	5.91	2.84	4.07	5.45	60.28

MAXIMUM MONTHLY: Moisant 19.09in. Mar 1948
 Reserve 17.08in. Jan 1966
 MINIMUM MONTHLY: Moisant 0.0in. Oct 1952, Oct 1963
 Reserve 0.0in. Oct 1952, Oct 1978

d. Wind. The U.S. Weather Bureau anemometer coverage at Moisant Airport in Kenner, Louisiana, was installed in 1949. This anemometer provides the longest record available adjacent to the lake. Table A-4 shows the average monthly wind speeds and its resultant direction for the years 1965-1986. The average wind velocity over this period is 7.8 mph, but winds over 100 mph are experienced occasionally in hurricanes. The predominant wind directions are north-northeast from September through February and southeast from March through June. Plate A-3 is a wind rose for New Orleans at Moisant based on the period of record of 1949-1978. The frequency of wind speeds and direction from this wind rose is summarized in Table A-5.

A-4. Hydrologic Regimen.

a. General. The water level in Lake Pontchartrain is subject to variations from direct rainfall, tributary inflow, wind-driven water movements, and flow through the Rigolets and Chef Menteur Passes and the Inner harbor Navigation Canal caused by tidal variations originating in the Gulf of Mexico. Infrequently, lake level is influenced by diversion of Mississippi River floodflow through Bonnet Carre Spillway. Combinations of these factors determine the salinity regimen in the lake. Locations and periods of record of hydrologic stations in Lake Pontchartrain Basin are shown in Table A-6.

b. Runoff and Streamflow. Runoff from the 4,700 square miles north and west of Lakes Pontchartrain and Maurepas, estimated to average five million acre-feet annually, drains into the lakes via the Amite, Tickfaw, Natalbany, Tangipahoa, and Tchefuncta Rivers, and Bayous Lacombe, Bonfouca, and Liberty. Streamflow records are available at six locations on these streams and four locations on the Pearl River for the periods of record listed in Table A-7. New Orleans and adjacent parishes are drained by outfall canals that discharge directly into Lake Pontchartrain. Yearly fresh water inflow records show considerable variations, as shown in Table A-7.

TABLE A-4
 Wind Summaries, New Orleans at Moisant Airport (1966-1986)

Average Wind Speed													
YEAR	JAN	FEB	MAR	APR	MAY	JUN	JUL	AUG	SEP	OCT	NOV	DEC	ANN
1966	9.6	10.5	9.5	10.7	8.7	7.3	6.2	6.4	5.7	7.6	7.4	8.6	8.2
1967	8.3	9.5	9.0	9.3	9.1	6.8	6.2	5.9	7.0	7.4	8.0	9.8	8.0
1968	9.2	10.0	9.3	9.1	8.4	5.6	5.7	5.2	6.4	6.8	8.9	9.3	7.8
1969	9.7	9.8	10.0	8.6	7.3	7.2	6.5	6.8	6.7	9.7	8.0	9.1	8.3
1970	9.5	9.2	9.8	9.9	8.5	6.8	5.4	6.0	6.7	7.7	8.0	7.4	7.9
1971	8.4	9.8	9.8	8.5	7.9	5.3	5.7	5.0	6.5	4.8	8.0	8.7	7.4
1972	8.9	8.6	9.1	10.2	7.3	9.3	7.5	6.4	7.0	8.3	9.9	9.4	8.5
1973	9.6	10.2	12.0	11.5	10.0	6.7	6.7	6.3	7.9	7.0	9.6	11.4	9.1
1974	9.2	11.0	10.8	10.7	8.2	7.4	5.0	5.2	8.6	7.4	8.5	8.5	8.4
1975	9.4	8.6	11.0	10.0	7.4	6.5	6.5	4.9	6.3	6.4	8.0	7.8	7.7
1976	9.6	8.8	10.5	7.6	8.4	6.9	5.4	5.7	6.0	8.5	7.9	8.2	7.8
1977	9.8	8.5	8.5	7.3	5.7	5.3	4.4	5.5	5.4	6.6	8.1	8.8	7.0
1978	9.1	8.9	8.5	8.6	7.9	5.9	5.5	5.3	6.3	6.1	6.7	10.0	7.4
1979	10.5	9.0	9.3	8.0	7.2	6.5	6.7	4.4	8.0	6.7	8.1	6.3	7.6
1980	7.6	8.0	9.8	8.8	7.5	7.4	5.6	5.7	5.3	5.9	6.4	5.9	7.0
1981	7.6	8.3	7.7	7.3	7.8	6.9	5.7	4.8	5.7	7.0	7.3	8.6	7.1
1982	9.8	8.3	8.9	9.4	6.5	6.2	4.6	4.4	7.1	7.5	7.6	10.0	7.5
1983	8.0	10.0	8.8	10.4	7.8	6.3	5.8	5.3	6.0	6.8	8.3	10.0	7.8
1984	8.0	8.7	7.8	9.4	8.2	4.7	4.1	5.8	9.2	7.6	9.6	8.8	7.7
1985	9.4	10.1	9.7	9.2	8.3	7.8	6.1	7.3	8.6	9.6	8.1	8.2	8.5
1986	9.1	10.8	9.2	9.0	9.1	6.7	6.7	6.6	6.8	7.5	9.8	8.6	8.3
AVERAGE	9.1	9.3	9.5	9.2	8.0	6.7	5.7	5.6	6.8	7.3	8.2	8.8	7.8

TABLE A-4 (cont'd)
 Wind Summaries, New Orleans at Moisant Airport (1966-1986)
 Resultant Direction*

YEAR	JAN	FEB	MAR	APR	MAY	JUN	JUL	AUG	SEP	OCT	NOV	DEC	ANN
1966	02	04	07	16	07	07	23	15	02	03	03	05	05
1967	03	02	13	15	16	11	21	02	05	06	05	08	09
1968	03	35	12	16	15	19	12	05	06	04	04	06	07
1969	07	02	02	13	09	18	24	09	04	05	36	01	05
1970	03	03	08	17	19	21	29	12	08	03	32	06	09
1971	02	12	13	15	13	23	20	01	07	04	04	12	09
1972	07	07	12	15	04	20	14	34	12	06	02	06	08
1973	02	36	16	16	20	18	24	04	10	07	13	20	12
1974	12	24	16	13	16	16	25	13	05	06	06	16	12
1975	09	21	14	11	15	18	25	17	03	05	08	04	10
1976	04	19	15	15	15	13	25	01	04	02	02	02	07
1977	01	09	13	14	13	21	20	12	15	03	10	13	11
1978	01	01	28	15	16	12	19	11	08	03	08	07	07
1979	01	04	15	14	14	15	17	13	04	11	03	03	08
1980	06	06	09	20	15	22	27	13	09	04	02	02	08
1981	02	02	21	15	13	16	22	11	05	06	10	04	09
1982	11	01	12	10	13	22	21	21	06	06	06	10	09
1983	04	05	29	18	15	12	10	11	07	05	10	03	08
1984	03	08	16	18	14	17	13	18	06	13	04	12	12
1985	34	04	14	13	20	19	23	11	08	08	09	02	09
1986	01	23	10	15	15	18	24	33	13	08	05	03	10

*Wind direction - Numerals indicate tens of degrees clockwise from true north. 00 indicates calm, 09 east, 18 south, 27 west, 36 north. Resultant wind is the vector sum of wind directions and speed divided by number of observations.

TABLE A-5
WINDSPEED
NEW ORLEANS AT MOISANT AIRPORT
PERCENTAGE FREQUENCY (1949-1978)

SPEED GROUPS (MPH)

DIRECTION	0-3	4-13	14-19	20-25	26-32	32+	TOTAL
N	0.0	4.9	2.1	0.3	0.1	0.0	7.4
NNE	0.0	4.0	1.5	0.2	0.0	0.0	5.7
NE	0.0	5.0	1.6	0.2	0.0	0.0	6.8
ENE	0.0	4.9	1.4	0.1	0.0	0.0	6.4
E	0.0	4.3	1.0	0.1	0.0	0.0	5.4
ESE	0.0	3.6	0.7	0.1	0.0	0.0	4.4
SE	0.0	4.0	0.9	0.1	0.0	0.0	5.0
SSE	0.0	4.5	1.6	0.2	0.0	0.0	6.3
S	0.0	6.2	2.1	0.3	0.1	0.0	8.7
SSW	0.0	4.0	0.8	0.2	0.0	0.0	5.0
SW	0.0	3.0	0.4	0.0	0.0	0.0	3.4
WSW	0.0	2.1	0.4	0.0	0.0	0.0	2.5
W	0.0	2.4	0.5	0.1	0.0	0.0	3.0
WNW	0.0	2.0	0.5	0.1	0.0	0.0	2.6
NW	0.0	2.0	0.8	0.2	0.1	0.0	3.1
NNW	0.0	2.7	1.4	0.3	0.1	0.0	4.5
CALM	20.0	-	-	-	-	-	20.00
TOTAL	20.0	59.6	17.7	2.5	0.4	0.0	100.00

TABLE A-6
HYDROLOGIC STATIONS

MAP INDEX NO. (PLATE A-2)	STATION	PERIODS OF RECORD		STAGE EXTREMES (NGVD)			
		TYPES OF WATER LEVEL GAGE	RECORDS AVAILABLE THRU 1986	MAXIMUM	MINIMUM	DATE	DATE
16	Amite River at Port Vincent	Auto Recorder and Staff	Gage Heights, Dec 1954 to Jun 1974 and Jun 1975 to date. Discharge, last observation - Apr 1980	14.59	-1.16	Apr 83	Aug 83
17	Amite River at French Settlement	Auto Recorder and Staff	Gage Heights, Intermittent 1947-1951 and daily. Dec 1954 to date. Discharge, last observation - 8 in 1977	7.4	-1.5	Apr 78	Dec 54
18	Petite Amite River NR St. Paul	Auto Recorder and Staff	Gage Heights, Intermittent Mar 1950 to May 1951 and daily Oct 1951 to date	4.72	-1.6	Apr 73	Dec 56
19	Reserve Canal near Lake Maurepas	Auto Recorder and Staff	Gage Heights, Jan 1979 to date	5.5*	-1.14	Oct 85**	Mar 81
20	Tlickfaw River near Springfield	Auto Recorder and Staff	Gage Heights, May 1947 to date. Discharge, last observation-7 in 1977	6.51*	-1.43	Oct 85	Dec 54
21	Pass Manchac near Pontchatoula	Staff	Gage Heights, July 1955 to date	5.4	-2.0	Oct 85	Jan 61
22	Bayou Bonfouca at Slidell	Staff	Gage Heights, Aug 1962 to date	6.8 (affected by Hurricane)	-0.6	Aug 69	Feb 63
23	Lake Pontchartrain at Frenier	Auto Recorder and Staff	Gage Heights, Sep 1931 to Sep 1965 and Jan 1969 (watermark) to date	2.09*	-2.1	Sep 65	Jan 38

* Caused by hurricane

** From Incomplete Record

TABLE A-6
HYDROLOGIC STATIONS
(CONT'D)

MAP INDEX NO. (PLATE A-2)	STATION	PERIODS OF RECORD		STAGE EXTREMES (NGVD)			
		TYPES OF WATER LEVEL GAGE	RECORDS AVAILABLE THRU 1986	MAXIMUM	MINIMUM	DATE	DATE
24	Lake Pontchartrain at Mandeville	Auto Recorder and Wire Weights	Gage Heights, Sep 1931 to date	6.95*	-2.25	Sep 47	Jan 38
25	Lake Pontchartrain at Midlake near New Orleans	Auto Recorder and Wire Weights	Gage Heights, Aug 1957 to date	6.14*	-1.28	Oct 85	Mar 65
26	Lake Pontchartrain at West End	Auto Recorder and Staff	Gage Heights, Sep 1931 to Nov 1946 and Mar 1949 to date	6.11*	-2.2	Oct 85	Jan 38
27	Lake Pontchartrain (Irish Bayou) near South Shore	Auto Recorder and Staff	Gage Heights, May 1949 to date	7.16*	-1.30	Aug 69	Jul 54
28	Rigolets near Lake Pontchartrain	Auto Recorder and Staff	Gage Heights, Sep 1931 to date	9.0*	-1.90	Aug 69	Jan 38
29	Lake Borgne at Rigolets	Auto Recorder and Staff	Gage Heights, Dec 1957 to Sep 1965 and Jul 1967 to date	12.25* (watermark)	-2.4	Aug 69	Feb 78
30	Chef Menteur Pass near Lake Borgne	Auto Recorder and Staff	Gage Heights, Apr-Jun 1945, Feb & Mar 1950, Jul 57-Sep 65 and Oct 67 to date. Discharge 1937 and 1945	9.07*	-1.69	Sep 65	Feb 78

* Caused by hurricane

TABLE A-6
HYDROLOGIC STATIONS
(CONT'D)

MAP INDEX NO. (PLATE A-2)	STATION	PERIODS OF RECORD		STAGE EXTREMES (NGVD)		
		TYPES OF WATER LEVEL GAGE	RECORDS AVAILABLE THRU 1986	MAXIMUM	MINIMUM	DATE
31	Mississippi River- Gulf Outlet at	Auto Recorder and Staff	Gage Heights, June 1961 to date	11.06*	-2.7	Aug 69 Mar 65
32	Bayou Dupre at Floodgate (west)	Auto Recorder and Staff	Gage Heights, Aug 1975 to date	3.53*	-1.94	Oct 85 Jan 79
33	Bayou Dupre Floodgate (east)	Auto Recorder and Staff	Gage Heights, Aug 1975 to date	7.61*	-1.78	Oct 85 Feb 78
34	Bayou Bienvenue at Paris Road	Auto Recorder and wire height	Gage Heights, t Dec 1974 to date	4.82	-1.78	May 78 Jan 77
35	Bayou Bienvenue at Floodgate (west)	Auto Recorder and Staff	Gage Heights, May 1975 to date	3.91	-2.03**	Apr 80 May 78
36	Bayou Bienvenue at Floodgate (east)	Auto Recorder and Staff	Gage Heights, Dec 1974 to date	7.98*	-1.89	Oct 85 Jan 79
37	Intracoastal Pass Waterway near Paris Road Bridge	Auto Recorder and Staff	Gage Heights, Apr 1948 to date	10.04*	-2.19	Sep 65 Mar 65
38	Inner Harbor Navigation Canal near Seabrook Bridge	Auto Recorder and Staff	Gage Heights, Daily, Aug 1962 to date	6.47*	-1.53	Aug 69 Mar 65

* Caused by hurricane

** From incomplete record

TABLE A-6
HYDROLOGIC STATIONS
(CONT'D)

MAP INDEX NO. (PLATE A-2)	STATION	PERIODS OF RECORD		RECORDS AVAILABLE		STAGE EXTREMES (NGVD)			
		TYPES OF WATER LEVEL GAGE	TYPES OF WATER LEVEL GAGE	THRU 1986	THRU 1986	MAXIMUM	DATE	MINIMUM	DATE
39	Inner Harbor Navigation Canal (IWW) at Florida Ave. Bridge	Auto Recorder and Wire Weight	Gage Heights, July 1944 to date			9.82*	Aug 69	-1.45	Jan 81
40	Inner Harbor Navigation Canal	Staff	Gage Heights, May 1922 to date			10.61*	Sep 65	-1.90	Feb 85
41	Intracoastal Waterway at Harvey Lock	Wire Weight	Gage Heights, Jan 1925 to date			4.74*	Oct 85	-1.28	Jan 40
42	Intracoastal Waterway at Algier's Lock	Auto Recorder and Wire Weight	Gage Heights, May 1956 to date			4.45*	Oct 85	-1.64*	Sep 65
OMS	Bayou Terre Aux Bouefs at Delacroix	Auto Recorder and Staff	Gage Heights, May 1975 to date			6.86*	Oct 85	-1.29	Feb 78
OMS	Bayou Barataria at Barataria	Auto Recorder and Staff	Gage Heights, Jan-Sep 1950, and Nov 1951 to date			4.25*	Oct 85	-0.58	Sep 65
OMS	Bayou Barataria at Lafitte	Auto Recorder and Staff	Gage Heights, Oct 1955 to Dec 1960 and May 1963 to date			5.05*	Oct 85	-0.60	Jan 56

* Caused by hurricane

OMS - off map station

TABLE A-7
PERTINENT STREAMFLOW DATA (1938-1985)

INFLOW POINT	TOTAL DRAINAGE AREA MI2	CAGE LOCATION*	CAGE DRAINAGE AREA MI2	PERIOD OF RECORD	AVERAGE DISCHARGE	MAXIMUM DISCHARGE		MINIMUM DISCHARGE	
						RATE	DATE	RATE	DATE
Amite River	2,373	NR Deneham Springs	1,280	9/38 to date	2,016	112,000	4/8/83 10/18/56	271	10/17/56
Tickfaw River	735	At Holden	247	10/40 to date	370	22,470	4/7/83	65	10/1-4/69
		Natalbany River at Baptist	79.5	8/43 to date	115	9,810	4/7/83	1.8	11/2-5/63
Tangipahoa River	895	At Robert	646	10/38 to date	1,149	85,000	4/7/83	245	10/30/68 thru 11/3/68
Tchefuncta River	459	NR Folsom	955	1/43 to date	161	29,800	4/5/83	26	9/4/68 and 9/15/68
		Bogue Falaya at Covington	88.2	1964 to date	-	12,700**	4/8/83	-	-
Pearl River	8,689	At Bogalusa	6,573	10/38 to date	9,881	129,000	4/24/79	1,020	10/29/63 thru 11/1/63
		Bogue Chitto NR Bush	1,213	10/37 to date	1,912	131,700	4/8/83	366	10/22,23,26 and 29/68
		At Pearl River	3,494	10/63-9/70 to date	9,470 (1964-70)	230,000	4/9/83	1,580	10/24/63 and 11/10/63
		Bogue Lusa Creek at Bogalusa	72.7	10/63 to date	117	9,350	4/7/83	5	10/27-28/67

*U.S. Geological Survey Cage Stations
**Previous Flood Discharge - 8,610 CFS 4/27/64

c. Stages, Salinities, Waves and Tides.

(1) Lake stages.

(a) The purpose of Bonnet Carre Spillway is to divert floodwater from the Mississippi River to the Gulf of Mexico via Lake Pontchartrain. Bonnet Carre Spillway has been designed to pass 250,000 cfs to Mississippi River floodwater at design stage to the Gulf of Mexico via Lake Pontchartrain. The Old River Control Structure, the Morganza Floodway, and Bonnet Carre Spillway will be operated to divert sufficient floodwater from the Mississippi River to minimize the flood damages in the lower river reaches and prevent the discharge in the Mississippi River from exceeding 1,250,000 cfs at New Orleans. Studies indicate that the operations of the spillway produced maximum increases in lake level of about 0.8 foot in 1937, 1.5 feet in 1945, 1.0 foot in 1950, and 0.7 foot in 1973 and again in 1979. The effects of Bonnet Carre operation on stages in Lake Pontchartrain were evaluated as part of a physical model study made by the U.S. Army Engineer Waterways Experiment Station in Vicksburg, Mississippi, in 1963 (1). The report indicates that for the passage of flows at or near the design discharge of 250,000 cfs, the operation of the spillway would increase stages in Lake Pontchartrain by about 0.7 foot for average high water stages in Lake Borgne. An analysis of the effects of Bonnet Carre on lake stages during the 1973 and 1979 operations indicates that these model results are generally valid.

(b) For the 1983 Flood, analysis of observed tidal data of a comparable period before and during the Bonnet Carre Spillway operation indicated the actual rise in lake level was approximately 0.5 foot.

(c) The maximum observed recorded stage in Lake Pontchartrain of 13.0 feet occurred at Frenier on 29 September 1915. The minimum of minus 2.25 feet occurred at Mandeville on 26 January 1938. The mean lake stage for the period from 1961 through 1985 was 1.5 feet.

(d) Maximum stages occur in Lake Pontchartrain during hurricane activity in the vicinity. A list of high stages recorded during hurricanes is presented in Table A-8.

TABLE A-8
 MAXIMUM STAGES - LAKE PONTCHARTRAIN

<u>LOCATION</u>	<u>DATE</u>	<u>STAGE- FT. NGVD</u>	
Mandeville	20 Sep 1909	8.0	
West End	20 Sep 1909	6.2	
Frenier	29 Sep 1915	13.0	
West End	29 Sep 1915	6.0	
West End	19 Sep 1947	5.4	
Mandeville	19 Sep 1947	6.8	
New Orleans	4 Sep 1948	4.9	
Frenier	24 Sep 1956	6.8	"Flossy"
Little Woods	24 Sep 1956	7.0	
West End	24 Sep 1956	5.3	
Mandeville	27 Jun 1957	4.1*	"Audrey"
Frenier	9 Aug 1957	3.3	"Bertha"
Frenier	18 Sep 1957	4.5	"Esther"
Mandeville	10 Sep 1961	5.5	"Carla"
Frenier	17 Sep 1963	4.0	"Cindy"
Mandeville	4 Oct 1964	6.4	"Hilda"
Frenier	10 Sep 1965	12.1	"Betsy"
Frenier	Aug 1969 (Watermark)	4.6	"Camille"
Mandeville	18 Aug 1969	4.6	
West End	17 Aug 1969	5.2	
Irish Bayou	18 Aug 1969	7.2**	
Rigolets	18 Aug 1969	9.0**	
Shell Beach	17 Aug 1969	11.1**	
Mandeville	8 Sep 1974	5.0	"Carmen"
Frenier	8 Sep 1974	4.5	
West End	8 Sep 1974	5.2	
Frenier	5 Sep 1977	4.2	"Babe"
Little Woods	4 Sep 1977	4.5	
Frenier	28 Oct 1985	7.58	"Juan"
Mandeville	28 Oct 1985	6.5	
Midlake	29 Oct 1985	6.14**	
West End	28 Oct 1985	6.1**	
Irish Bayou	28 Oct 1985	6.0 (FIR)	

* Possibly higher, gauge failed during storm.

** New record established.

FIR - From Incomplete Record

(2) Waves. In August 1957, two wave gages were installed on the east side of the Greater New Orleans Expressway Bridge, Station Ten at the north end, and Station Four on the south end. Both are approximately one-quarter mile from shore. In 1958, Station Nine was established at Frenier, with the gage on the tower approximately 1,200 feet from shore. Locations are shown on Plate A-2. Pertinent observed data are listed on Table A-9.

TABLE A-9
WAVE DATA

<u>Station</u>	<u>Significant Waves</u>		<u>Maximum Waves</u>	
	<u>Range</u> ft.	<u>Wind</u> m.p.h.	<u>Height</u> ft.	<u>Date</u>
4	0.1 to 4.9	30	8.3	9 October 1958
9	0.1 to 4.9	29	7.8	9 October 1958
10	0.1 to 5.3	40	9.0	10 May 1959

(3) Tides. The normal tide has a general range of one-half foot in Lake Pontchartrain and is diurnal in nature. However, wind effects usually mask the daily ebb and flood variations. Because of the annual volume of freshwater inflow (estimated to average 5 million acre-feet), tides and storm surges, enormous volumes of water pass in both directions through the Rigolets, Chef Menteur Pass, Lake Borgne, Mississippi Sound, Inner Harbor Navigation Canal, and Mississippi River-Gulf Outlet. With so many variables operating on the several elements of the system, the current patterns are continually changing.

(4) Salinities.

(a) Salinities in Lakes Pontchartrain and Maurepas are influenced by the river systems to the north and west of the lakes and by the saline waters of Lake Borgne, Chandeleur Sound, Mississippi Sound, and Brenton Sound to the southeast. Saline water enters the systems via the Rigolets and Chef Menteur Pass. The IHNC provides an avenue for saline water from the MR-GO to enter Lake Pontchartrain. Fresh water from the Pearl River system can also enter via these natural tidal passes. The Bonnet Carre Spillway is occasionally utilized to divert Mississippi River water into Lake Pontchartrain during large floods.

(b) Several salinity monitoring stations were analyzed over their periods of record. The stations are Pass Manchac near Ponchatoula, Lake Pontchartrain at Little Woods, Chef Menteur Pass near Lake Borgne, and Lake Pontchartrain at North Shore. The data indicate that the lowest salinities are generally in the late spring and the highest in the summer and late fall. This reflects seasonal variations in freshwater inflows from the major rivers

and streams. The salinities of Lake Pontchartrain and Maurepas normally range from fresh to brackish. Salinities average less than 0.2 ppt in Lake Maurepas while averaging about 4.1 ppt in Lake Pontchartrain. The lowest mean monthly salinity in Lake Pontchartrain (2.6 ppt) occurs in May while the maximum (5.9 ppt) occurs in October. The salinity regime is subject to drastic change during floods on the river and streams discharging into Lake Maurepas and Pontchartrain, Bonnet Carre Spillway openings, and hurricanes.

(c) Analyses of salinity data indicate that the most notable increase in average annual salinity occurred after 1963. The salinity data were further aggregated to the period prior to 1963 and to the period subsequent to 1963. Mean monthly salinities increased for all months for the period subsequent to 1963. This increase can be attributed primarily to the completion of the MR-GO in 1963 which provided a major access for saline water to enter Lakes Maurepas, Pontchartrain, and Borgne.

(d) Analysis of monthly summaries of salinity for pre and post MR-GO conditions indicates that mean annual salinities have increased by:

- o 1.1 ppt at Lake Pontchartrain, North Shore
- o 1.8 ppt at Lake Pontchartrain, Little Woods
- o 0.2 ppt at Pass Manchac near Pontchatoula
- o 2.0 ppt at Chef Menteur Pass near Lake Borgne

(e) Salinity data available indicate that the salinity regime in the Lake Pontchartrain Basin has become somewhat stabilized in the period since 1963. Although there remains no significant increase in mean annual salinity, salinity variations may be considerable. During periods of low inflow, salinities may increase to as high as 5.0 ppt in Lake Maurepas and as high as 20 ppt in the vicinity of the IHNC (Schurtz, 1982).

A-5. Water Quality

a. Water Quality Criteria and Standards. (1) The Louisiana Department of Environmental Quality (LDEQ) has promulgated water quality standards for water bodies and stream segments in the State of Louisiana. These standards are intended to preserve the quality of Louisiana waters for their designated uses and for protection of aquatic life. The United States Environmental Protection Agency (USEPA) has established water quality criteria for many other constituents for which no State of Louisiana standards exist.

(2) Descriptive, non-numerical standards have been established by LDEQ for the following general water quality parameters: aesthetics; color; floating, suspended and settleable solids; taste and odors; toxic substances; oil and grease; foaming or frothing materials; nutrients; and turbidity. Numerical standards have been established for the following general parameters: pH; chlorides; sulfates and dissolved solids; dissolved oxygen; temperature; and bacteria.

(3) The USEPA has established water quality criteria for the protection of aquatic life and human health. These criteria are periodically updated to accurately reflect the latest scientific knowledge concerning the identifiable effects of waterborne pollutants on human health, aquatic life and various water uses. The EPA criteria are not regulatory, but present a scientific basis for developing water quality standards that are appropriate to the conditions and potential impacts that exist in particular states, river basins and other areas. The latest major update "Quality Criteria for Water 1986" has been amended twice to include more recent information on certain contaminants.

(4) In 1980 criteria documents for 65 toxic pollutants were published. Additional criteria documents were published in 1985. The 1986 document summarizes all of the contaminants for which criteria had been developed to that time. Derivation of a national criterion for a particular substance requires, as a first step, the collection and review of all available information concerning toxicity to and bioaccumulation by aquatic organisms. If enough acceptable aquatic toxicity data are available, they are used to estimate the highest 1-hour average concentration that should not result in unacceptable effects on aquatic organisms and their uses. In some cases, the aquatic toxicity criterion is made a function of a water quality characteristic such as pH, salinity or hardness. Chronic toxicity effects are likewise evaluated to determine the highest 4-day average concentration that would be acceptable, again possibly as a function of a water quality characteristic. The acute and chronic criteria should not be exceeded at a particular site more than once every three years, on the average.

(5) A state may appropriately modify EPA criteria to reflect local conditions, and submit its proposed standards for EPA approval as consistent with the goals of the Clean Water Act. Water quality criteria and standards applicable to the project area are on Table A-10.

b. Water Quality Data. (1) The United States Geological Survey, (USGS) regularly monitored water quality at several stations in and near Lake Pontchartrain from 1974 to 1981. The Pass Manchac near Manchac sampling station is nearest the project site. Since 1978, the Louisiana Department of Environmental Quality (LDEQ) has also collected water quality data in Pass Manchac, at the Interstate Highway 55 bridge. These data include monthly observations of general physical and chemical parameters, nutrients, metals and toxic organic compounds, including pesticides. Table A-11 presents a statistical summary of water quality data at the LDEQ station for 17 parameters. Variability of the data is reflected by the standard deviation values, and non-uniformity or skewness of the distributions is indicated by the differences between the mean and median, or 50 percent exceedence, values.

(2) The observed data were compared to their respective EPA freshwater aquatic life or State of Louisiana criteria values to identify which parameters are indicative of water quality problems. There were a few periods during the summer months of certain years when the standard of 32°C was equalled or exceeded. Dissolved oxygen was rarely observed below the standard of 5.0 mg/L. Dissolved oxygen saturation percentages were consistently high, averaging nearly 90 percent.

(3) Total alkalinity is a measure of the buffering capacity of water bodies. Although its average value of 34 mg/L is well above the EPA minimum of level of 20 mg/L, about 5 percent of the measurements were below that criterion. The lowest pH measurements equalled the minimum state standard of 6.5, but most observations were between 6.9 and 7.3. The sulfate and chloride data revealed about 10 and 15 percent violations of the respective standards of 200 and 1600 mg/L.

(4) Suspended solids, or total non-filterable residue, averaged only 25 mg/L. Turbidity, which is a measure of resistance to light penetration in the water column by suspended matter and other impurities, was likewise characteristically low, averaging 25 FTU with occasional elevated values usually corresponding to high discharges from the Amite River.

(5) Nutrient levels were generally within desirable ranges, i.e. high enough for aquatic productivity requirements but well below what would constitute a tendency for eutrophication. Nitrite + nitrate and total phosphorus averaged 0.13 and 0.10 mg/L, respectively, and maintained a fairly consistent ratio of nitrogen to phosphorus, which is desirable from a water quality management standpoint. No specific criteria or standards have been promulgated for these parameters.

(6) Fecal coliform levels are monitored to determine whether pathogens in discharged human or animal waste materials are a serious threat to the designated water uses, which include primary contact recreation on the vicinity of Lake Pontchartrain. Only about 10 percent of the measurements were in excess of the 200 MPN/100mL standard, indicating the absence of any significant bacterial pollution sources.

(7) Heavy metals occur naturally in the earth's crust, and some of these are essential in trace quantities for the life processes of many species. Higher metal concentrations are usually found in and near industrial and urbanized areas where polluted wastewater enters surface water bodies.

(8) Arsenic levels were observed to be well below the EPA chronic toxicity criterion of 190 ug/L for freshwater aquatic life throughout the period of record. Cadmium levels exceeded the chronic toxicity criterion of 2.0 ug/L about 30 percent of the time, and exceeded the acute criterion of 8.6 ug/L in less than 5 percent of the observations. These criteria are based on a typical hardness level of 200 ug/L. Only the total recoverable phase of a metal is likely to be bioavailable. Metal concentrations reported as "total" are considered approximately equivalent to the "total recoverable" concentrations, which are the basis for the EPA criteria.

(9) Total chromium was observed above the chronic toxicity criterion for hexavalent chromium of 11 ug/L less than 10 percent of the time, and never approached the corresponding hardness-dependent criterion for trivalent chromium of 370 ug/L. Trivalent chromium is much more prevalent than the hexavalent form, so it is highly unlikely that the chronic criterion would have been violated by any of the observations.

(10) Total lead concentrations exceeded the hardness-dependent chronic toxicity criterion of 7.7 ug/L with a frequency of about 60 percent, and the acute toxicity criterion of 200 ug/L was exceeded in less than 5 percent of the cases.

c. Water Quality Effects.

(1) Since no water quality data is directly available from either the proposed borrow site for levee material in the Bonnet Carre Spillway or the construction site along Airline Highway, the referenced data base for the Pass Manchac station has been evaluated as a reasonably reliable substitute for site-specific data. The anticipated nature of the levee construction method, utilizing draglines and bulldozers to place and shape the stockpiled material to be hauled from the borrow area would present minimal opportunities for contaminant transport over significant distances.

(2) Since two surface sediment samples taken at the Bonnet Carre borrow site revealed no sizable concentrations of potentially toxic substances, there is no reason to believe that levee construction would significantly impair the chemical integrity of adjacent waters except perhaps under very temporary and localized circumstances during and immediately following the erosion and leaching of surface sediments from stockpiles or the partially constructed levee by rainfall runoff. Standard and modified elutriate tests were conducted to simulate such effects. Although these tests indicate that certain metals and nutrients might be temporarily released from suspended sediment particles during such conditions, there would generally be insufficient hydraulic energy available to transport the sediments and their chemical constituents very far from their points of origin. There would also be a strong tendency for most of these dissolved constituents to again become chemically or physically bound to sediment particles within a short time, rendering them virtually harmless to aquatic life.

(3) There would be significant turbidity increases in adjacent waters and wetlands during such events probably accompanied by localized dissolved oxygen deficits. These effects would be temporary and would not be expected to produce any measurable changes on the life processes of the aquatic community beyond the immediate area. As the new levees become stabilized and vegetated, even such localized disturbances should cease to occur.

(4) The provision of adequate culvert capacity through the new levee for drainage of the protected area and the effected interchange of tidal waters should prevent any significant changes in general water quality in the long-term that would be directly attributable to levee construction activities.

TABLE A-10
SUMMARY OF APPLICABLE CRITERIA AND STANDARDS

Units	Water Quality Parameter	Louisiana Standards	USEPA Freshwater Aquatic Life Criteria	
			Chronic Toxicity****	Acute Toxicity****
mg/L	Alkalinity, as CaCO ₃		20(min.)	
mg/L	Ammonia, Un-ionized		.0013-.050***	.018-.37***
mg/L	Chloride	1600		
mg/L	Chlorine, Total Residual		11	19
mg/L	Chloroform		1.2	29
MPN/100mL	Coliform, Fecal	200/400		
PCU	Color	75*		
ug/L	Cyanide, Total		5.2	22
mg/L	Oil and Grease		.01x96-HrLC ₅₀	
mg/L	Oxygen, Dissolved	5.0		
SU	pH	6.5-9.5		
mg/L	Solids, Dissolved	3000		
mg/L	Sulfate	200		
°C	Temperature	32		
NTU	Turbidity	50**		
<u>Metals*****</u>				
mg/L	Arsenic, Trivalent		190	360
ug/L	Cadmium		.66-2.0	1.8-8.6
ug/L	Chromium, Hexavalent		11	16
ug/L	Chromium, Trivalent		120-370	980-3100
ug/L	Copper		6.5-21	9.2-34
ug/L	Iron		1000(min.)	
ug/L	Lead		1.3-7.7	34-200
ug/L	Mercury, Divalent		.012	2.4
ug/L	Nickel		88-280	790-2500
ug/L	Zinc		59-190	65-210
<u>Synthetic Hydrocarbons</u>				
		Chronic Toxicity****	Acute Toxicity****	
ug/L	Aldrin		3.0	
ug/L	BHC			100
ug/L	Chlordane	.0043	2.4	
ug/L	DDD		.60	
ug/L	DDE		1050	
ug/L	DDT	.0010	1.1	
ug/L	Dieldrin	.0019	2.5	
ug/L	Endrin	.0023	.18	
ug/L	Heptachlor		.0038	.52
ug/L	Lindane		.080	2.0
ug/L	Methoxychlor		.03	
ug/L	Mirex		.001	
ug/L	Phenol	50		
ug/L	PCB	.014	2.0	
ug/L	Toxaphene		.0002	.73

- * General criterion for public water supply.
- ** General guideline for estuarine water bodies.
- *** Toxicity varies with pH and temperature. Ranges shown correspond to: pH=6.5, temperature=10°C; pH=9.5, temperature=30°C.
- **** Chronic and acute toxicity values shown are average concentrations not to be exceeded for 4-day and 1-hour periods more than once in 3 years, on the average.
- ***** Values shown are for total recoverable concentrations. Ranges shown correspond to CaCO₃ hardness values of 50 and 200 mg/L.

TABLE A-11
 STATISTICAL SUMMARY OF WATER QUALITY DATA FOR SELECTED PARAMETERS
 PASS MANCHAC AT MANCHAC (Mar 1978-Feb 1987)

Units	Parameter	Number of Observations	Mean	Standard Deviation	Median
Deg C	Temperature	107	21.7	7.2	23.6
TU	Turbidity	103	25	32	14
Mmno	Specific Conductivity @25 °C	100	2000	1600	1700
Mg/L	Dissolved Oxygen	107	8.1	1.8	7.8
Percent	Oxygen Saturation	107	88	15	91
SU	pH	107	7.1	0.2	7.1
Mg/L	Alkalinity, Total as CaCO ₃	100	34	9	34
Mg/L	Nonfilterable Residue, Total (Suspended Solids)	102	25	30	18
Mg/L	Nitrite & Nitrate, Total as N	106	.13	.13	.10
Mg/L	Phosphorus, Total as P	105	.10	.06	.09
Mg/L	Chloride, Total	102	810	900	570
Mg/L	Sulfate, Total	95	97	83	77
Ug/L	Arsenic, Total	94	4.0	6.0	2.2
Ug/L	Cadmium, Total	99	1.8	2.6	1.0
Ug/L	Chromium, Total	93	5.0	7.5	2.8
Ug/L	Lead, Total	96	28	54	15
MPN/100ML	Fecal Coliform	96	120	300	20

A-6. Description and Verification of Procedures.

a. Hurricane Memorandums. The Hydrometeorological Section (HMS), U.S. Weather Bureau, cooperated in the development of hurricane criteria for experienced and potential hurricanes in the study area. The HMS memorandums provided frequency data, isovel and rainfall patterns, pressure profiles, hurricane paths, and other parameters required for the hydraulic computations. Those relative to experienced hurricanes are based on reevaluation of historic meteorologic and hydrologic data. Those relative to potential hurricanes contain generalized estimates of hurricane parameters that are based on the latest research and concept of hurricanes theory. Memorandums pertinent to the study are listed in Section III, Bibliography.

b. Historical Storms used for Verifications. Three observed storms, with known parameters and effects, were used to establish and verify procedures and relationships for determining surge heights, wind tide levels (WTL's), inflow into Lake Pontchartrain, overtopping flows, and ultimately, flood elevations that would result from synthetic hurricanes. These two storms occurred in September of 1915 (4) and September 1947 (5) as shown on Plates A-4 and A-5. A third storm occurred on 16 September 1957.

(1) The hurricane of 29 September 1915 had a central pressure index (CPI) of 27.87 inches, an average forward speed of 6 knots, and a maximum wind speed of 99 mph at a radius of 29 nautical miles. This hurricane approached the mainland from the south. At the Lake Borgne entrance to the Rigolets, a high water elevation of about 10 feet was experienced and the average elevation in Lake Pontchartrain rose to 6 feet. This storm was not used for verification of levee overtopping because the present lakefront levee system was not in existence in 1915.

(2) The 19 September 1947 hurricane had a CPI of 28.57 inches, an average forward speed of 16 knots, and a maximum windspeed of 72 mph at a radius of 33 nautical miles. The direction of approach of this hurricane was approximately from the east. In Lake Borgne, at the entrance to the Rigolets, the maximum water surface elevation was 10 feet NGVD, and in Lake Pontchartrain, the maximum elevation was 5 feet NGVD. However, because of the rapid forward speed of this storm, the average water elevation in lake Pontchartrain did not reach its maximum at the time that the winds were critical to the south shore. The step-type seawall was in place along the New Orleans lakefront during this storm, and a fairly reliable flood line of overtopping flows was available for verification.

(3) Tropical storm Esther occurred on 16 September 1957, and the resultant elevations were accurately registered by stage recording gages at many locations within the study area. These records were available for verification of routing procedures. This storm was not severe enough to cause flooding.

c. Synthetic Storms. Computed flood elevations, resulting from synthetic storms, are necessary for frequency and design computations. Parameters for certain synthetic storms and methods for derivation of others were furnished by the National Weather Service. The standard project hurricane (SPH) for the entire Louisiana coast was used for all locations in the study area with changes only in path and forward speed.

(1) SPH for the Louisiana coast was derived by the National Weather Service from a study of 42 hurricanes that occurred in the region over a period of 57 years (6). SPH paths critical to different locations in the study area and isovel patterns at critical hours are shown on Plates A-6 and A-7. Based on subsequent studies of more recent hurricanes, the National Weather Service has revised the SPH wind field patterns and other characteristics over the years. Wind field patterns were revised after Hurricane Betsy in 1965 to reflect the intensified wind speeds (7), (8), (9). After Hurricane Camille in 1969, the Weather Service completely revised hurricane characteristics for the SPH, including the wind speeds, central pressure and radii. (10) In their publication (11) NOAA has expanded and generalized the latest SPH characteristics. For design of the Lake Pontchartrain and Vicinity Hurricane Protection Project High Level Plan, the SPH, as defined after Hurricane Betsy, was used. To assure that all the segments of the project would be compatible, SPH parameters have not been changed since construction began. Modifications and adjustments of these parameters subsequent to Hurricane Betsy have not significantly changed the characteristics of the SPH.

(a) The SPH for the Louisiana coastal region has a frequency of once in 100 years. The CPI that corresponds to this frequency is 27.6 inches. CPI probabilities are based on the following relationship. (12):

$$P = \frac{100 (M-0.5)}{Y}$$

Where P = percent change of occurrence per year
M = number of the event (rank)
Y = number of years of record

(b) Radius of maximum winds is an index of hurricane size. The average radius of 12 hurricanes occurring in the New Orleans area is 36 nautical miles. From relationships of CPI and radius of maximum winds of gulf coast hurricanes (12), a radius of 30 nautical miles is considered representative for an SPH having a CPI of 27.6 inches.

(c) Different forward speeds are necessary to produce SPH effects at various locations within the study area. In Lake Pontchartrain, the forward speed is a particularly critical factor and may be as important as the track itself. Sufficient time must elapse between the time of maximum elevation at the entrances to Chef Menteur Pass and the Rigolets and the time of maximum critical winds at the Lake Pontchartrain shore in question to allow for maximum inflow into the lake. The SPH for the south shore, patterned after the September 1915 hurricane, has an average forward speed of 6 knots.

An average forward speed of 11 knots was used for the SPH along the west shore of Lake Borgne at the entrance to the passes into Lake Pontchartrain.

(d) Maximum theoretical gradient wind (12) is expressed as:

$$V = 73 (P_n - P_o) - R(0.575 f)$$

where V_{gx} = maximum gradient wind speed in miles per hour

P_n = asymptotic pressure in inches

P_o = central pressure in inches

R = radius of maximum winds in nautical miles

f = coriolis parameter in units of hour^{-1}

The estimated wind speed (30 feet above ground level)

(V_x) (13) in the region of highest speeds is obtained as follows:

$$V_x = 0.8885 V_{gx} + 0.5T$$

where T = forward speed in miles per hour.

From these relationships, a wind speed of approximately 100 mph was obtained.

(2) Other synthetic storms of different frequency and CPI are derived from the SPH. Other CPI's for desired frequencies are obtained from the graph shown on Plate A-8. V_{gx} 's corresponding to any other CPI are determined similarly by use of the method described for the SPH. Variations in CPI's of historic storms were accomplished by the same procedure (12). Characteristics of synthetic storms and some historic storms are listed in Table A-12.

TABLE A-12
HURRICANE CHARACTERISTICS

<u>Hurricane*</u>	<u>CPI</u> inches	<u>Radius of</u> <u>max. winds</u> nautical miles	<u>Forward</u> <u>speed</u> knots	<u>Vx</u> m.p.h.
Sep 1915	27.87	29	10	99
Sep 1947	28.57	33	16	72
Sep 1956	28.76	30	10	80
Sep 1965	27.79	32	20	122
Track A PMH	26.90	30	6	114
Track A SPH	27.60	30	6	100
Track A Mod H	28.30	30	6	83
Track F PMH	26.90	30	11	114
Track F SPH	27.60	30	11	100
Track F Mod H	28.30	30	11	80

*Tracks are shown on Plate A-9.

d. Surges.

Maximum hurricane surge heights along the western shores of Lake Borgne at the entrances to Lake Pontchartrain were computed by use of a one dimensional steady-state wind tide formula. A detailed description of the formula and its verification is contained in Design Memorandum No. 1, Hydrology and Hydraulic Analysis, Part I - Chalmette (14).

e. Routing.

Since the major hurricane damage in the study area results from storm induced effects on Lake Pontchartrain, it was necessary to establish a method to determine the hydraulic regimen in the lake at any time during the hurricane occurrence. This procedure involves the construction of a stage hydrograph for Lake Borgne, and the simultaneous hourly calculations of flows through Lake Pontchartrain's natural inlet and outlet passes, tilt and stage-volume relationships in Lake Pontchartrain and Lake Maurepas, accumulated rainfall, and overflow from the lake to the land areas.

(1) Prerequisite to any routing is the choice of an actual or hypothetical hurricane of known or designated characteristics. It is then possible to develop surge heights for any point in Lake Borgne for selected storm. For routing purposes, Long Point, which is east of the mouth of the Rigolets, was selected as the critical point for a hydrograph. The hydrograph for Long Point reflects stages at the mouths of both the Rigolets and Chef Menteur Pass. Construction of such a hydrograph of hourly stages at the mouth of the two passes was based on a method developed by R.O. Reid (15) that was modified by using the maximum surge elevation computed by the incremental setup method as the peak of the hydrograph for the critical period. A comparison of the rising portion of the hydrograph thus derived, with one obtained by computing surge elevations at hourly intervals, indicated agreement between the two methods. Final stages for the recession portion of the hydrograph could not be computed by the incremental setup method because of the offshore wind directions prevailing after the peak stage. The recession produced by Reid's method (15), obtained by rotating the hydrograph about the peak ordinate, indicated stages considerably lower than corresponding stages for the 1947 hurricane surge. The observed stages of the 1957 storm surge also indicated that the recession was somewhat slower at intermediate stages in Lake Borgne. It was therefore necessary to estimate the recession portion of the hydrograph to verify routing procedures. Storm surge hydrographs for Long Point for each storm investigated were determined by identical procedures.

(2) Storms tides flow in and out of Lake Pontchartrain through two major natural passes and an artificial canal. Rating tables, derived by reverse routing of observed storms, were developed for use in routing through the passes and canal. The elevation of Lake Borgne at Long Point was determined from the average of records obtained from automatic tide gage recorders located at the mouths of the passes and at Shell Beach. Elevations of Lake Pontchartrain were determined from records of the automatic tide gages located in Lake Pontchartrain at U.S. Highway 11 and at West End. Although there was a fairly consistent relationship between head and flow, there was no consistency when a parameter of stage was introduced.

The combined rating of the Rigolets, Chef Menteur Pass, flow over U.S. Highway 90 in vicinity of the passes, and Inner Harbor Navigation Canal was based on the period 25 July to 11 August 1957, during which time a minor storm accompanied by moderate stages was experienced. The empirical relationship, $Q = 560H^{0.935}$ was derived from plots of the data, and used to compute a rating table.

(3) Storage tables for the range of stages were made for Lake Pontchartrain. The storage amounts include the volumes contained in the adjacent marsh areas when the stages exceed the surface elevation of these marshes.

(4) Cumulative amount of rainfall that is coincident with the storm significantly affects the lake elevations and hence the routing procedure. The amount of this rainfall was calculated by the methods described in U.S. Weather Bureau memorandums (16), (17), using a moderate rainfall that would be coincident with a tropical storm. For routing purposes, rainfall was considered as additional inflow into Lake Pontchartrain. The effect of cumulative rainfall is to raise the lake level.

(5) Stages, wind tide elevations, and waves induce flow over the shore protective structures. Adjustments were made in the routing procedure to account for the quantities that overtopped these structures.

(6) With the above-mentioned items resolved, the routing procedure was reduced to the successive approximation type problem in which the variable factors were manipulated until a condition of balance between flows and storages was obtained for the incremental time intervals. A typical routing computation is illustrated on Plate A-10. The 1947 and 1915 hurricanes were routed by this procedure. Routed average stages for Lake Pontchartrain were found to be in reasonable agreement with the observed average stages for the two hurricanes. The degree of agreement between the observed and computed stages that were obtained by use of the routing procedure verifies the methods and rating tables used. Observed and computed average stages for the 1947 and 1957 hurricanes are shown on Plates A-11 and A-12. All other hurricanes studied were routed using similar procedures. The resultant stage hydrograph for the SPH critical to the south shore of Lake Pontchartrain is shown on Plate A-13.

f. Wind Tides. The storms under consideration are accompanied by strong winds. The effect of strong winds blowing over a shallow inclosed body of water, such as Lake Pontchartrain, is to drive large quantities of water ahead of the winds. It was necessary for purposes of routing and overflow computations to determine the windtide levels (WTL) for Lake Pontchartrain. This was accomplished by dividing the lake into four or five segments that are roughly parallel to the wind directions, and by calculating setup and setdown for each of the segments. The average windspeed and average depth in each segment were determined from isovel and hydrographic charts for each wind tide computation. The storm isovel patterns were furnished by the U.S. Weather Bureau (18), (19). The computation of wind along each zone was based on the segmental integration method (20) and was calculated by use of the step-method formulas (21) that were modified as follows:

$$\text{Setup} = d_t \times \sqrt{\frac{0.00266 u^2 FN + 1}{d_t^2} - 1}$$

$$\text{Setdown} = d_t \times \left[\left(1 - \sqrt{\frac{1 - 0.0026 u^2 FN}{d_t^2}} \right) \right]$$

Where: Setup or setdown in feet is measured above or below mean water level (m.w.l.) of the surge in the lake.

d_t = av. depth of fetch in feet below m.w.l.
 u = windspeed in m.p.h. over fetch
 F = fetch length in miles, node to shoreline
 N = planform factor, equal generally to unity

(1) Graphs were constructed from the above formulas to determine setup and setdown quickly about any nodal elevation, Plate A-15. Volumes of water along the zones, represented by the setup and setdown with respect to a nodal elevation, were determined and the water surface profiles adjusted until the setup and setdown volumes balanced within 5 percent. Water surface contours were then drawn for several even-foot nodal elevations, and the tilt and WTL's were determined from the contour sketch. In the routing of surges, pertinent wind tides and tilts for other nodal elevations were interpolated from the contour sketches for the even-foot nodes. Typical wind tide computations are illustrated on Plate A-15.

(2) Maximum computed and observed setup elevations for the 1947 hurricane, were 4.9 feet and 5.4 feet at West End. Computed stages for the 1915 hurricane compared favorably with observed high water marks. Wind tide levels for all hurricanes studied were computed by applying the same methods and procedures described above. Maximum surge height contours in the Lake Borgne area and maximum WTL contours in the Lake Pontchartrain area were developed for the SPH. These contours are shown on Plate A-16. The contours represent the maximum elevations that would be experienced for the occurrence of a hurricane in the SPH category for the most critical storm path.

A-7. Frequency estimates.

a. Procedure.

(1) The area along the south shore of Lake Pontchartrain was used in developing a procedure for making frequency estimates since more historical hurricane data were available for this area than for any other location. The maximum WTL or stage for a specific area is a measure of the character of storm that produces it. In order to use data from early hurricanes which caused high wind tides along the south shore of Lake Pontchartrain, it was necessary to analyze meteorologic factors and to adjust the observed data to represent stages that would have occurred had presently existing protective

works then been in place. It was found that adjustments were required for the 1893 and 1901 hurricanes. Along the south shore of Lake Pontchartrain, determinations of maximum WTL's were from the adjusted historical data from the locus of points through which a representative WTL-frequency curve would pass in the low-stage, high-frequency region. Probabilities for historical data on the curve shown on Plate A-17 were calculated by means of the formula:

$$P = \frac{100 (M-0.5)}{Y}$$

The WTL for the PMH, which has an infinite return period, establishes another limit for the frequency curve in the high-stage, low frequency region. However, because of the lack of historical data for the region of the curve between these two extremes, the synthetic WTL-frequency relationships were developed to show the shape of the curve in this region. In the process of formulating such relationships, it was necessary to correlate the following hurricane parameters: central pressure index, paths of approach, wind velocities, radii to maximum winds, and forward speeds of translation.

(2) Prior to 1900, information of record dealt primarily with loss of life and damage in the more densely populated areas, with practically no reference to water surface elevations caused by hurricanes. Only since 1900 has detailed information been available on flooding in coastal Louisiana and in adjacent areas. Subsequent to the widely destructive September 1915 hurricane, Charles W. Oakey, Senior Drainage Engineer, Office of Public Roads and Rural Engineering, U.S. Department of Agriculture, made a thorough survey of the coastal areas between Biloxi, Mississippi, and Palacios, Texas. The 1915 investigation is the only known area-wide study containing reliable stages until the investigation of hurricane "Flossy", September 1956, was completed. The data indicate that there is no locality along the Louisiana coast which is more prone to hurricane attack than other localities.

(3) The first requirement in the development of synthetic frequency relationships for localities within the study area was to select representative critical hurricane paths of approach for the particular locale in question. For the passes into Lake Pontchartrain, track F is the critical path for the design hurricane. For the south shore of Lake Pontchartrain, track A was selected to represent the hurricane situation that would produce critical conditions. These tracks are shown on Plate A-9.

(4) After hurricane paths were selected, surge heights and wind tides were developed, as described previously, for at least three storms of different CPI values for each track. Each hurricane selected for the representative paths were assumed to have the same radius of maximum winds, the same forward speed of translation, and the same adjustment for any land effects. Only CPI's and wind velocities were adjusted to develop these three storms. Results of these computations for the New Orleans reach of Lake Pontchartrain are shown in Table A-13. Wind tide elevations for storms with other CPI values were obtained graphically by plotting the above data and reading from the resulting curves.

TABLE A-13

CENTRAL PRESSURE INDEX VS. WIND TIDE LEVEL
LAKE PONTCHARTRAIN REACH - NEW ORLEANS

PATH A		PATH F	
<u>Central pressure index (CPI)</u>	<u>Max. wind tide level</u>	<u>Central pressure index (CPI)</u>	<u>Max. wind tide level</u>
inches	NGVD	inches	NGVD
26.9	12.7	27.6	7.7
27.6	11.2	27.87	6.6
28.5	8.2	28.57	4.8

(5) Hurricane characteristics of area-representative storms were developed in cooperation with U.S. Weather Bureau. This agency has made a generalized study of hurricane frequencies for a 400-mile zone along the central gulf coast, Zone B, from Cameron, La., to Pensacola, Fla., and has presented the results in a memorandum. (12) Frequencies for hurricane central pressure indexes that were presented in the report, as shown on Plate A-8, reflect the probability of hurricane recurrence from any direction in the midgulf coastal area. In order to establish frequencies for the localities under study, it was assumed that a hurricane whose track is perpendicular to the coast will ordinarily cause high tides and inundation for a distance of about 50 miles along the coast. Thus, the number of occurrences in the 50-mile subzone would be 12.5 percent of the number of occurrences in the 400-mile zone, provided that all hurricanes traveled in a direction normal to the coast. However, the usual hurricane track is oblique to the shoreline as shown in table 2 of the HMS memorandum. (12) The average projection along the coast of this 50-mile swath for the azimuths of 42 Zone B hurricanes is 80 miles. Since this is 1.6 times the width of the normal 50-mile strip affected by a hurricane, the probability of occurrence of any hurricane in the 50-mile subzone would be 1.6 times the 12.5 percent, or 20 percent of the probability for the entire midgulf Zone B. Thus, 20 percent of the Zone B frequencies shown on Plate A-8 was used to represent the CPA-frequencies in the 50-mile subzone that is critical for each study locality.

(6) The azimuths of tracks observed in the vicinity of landfall were divided into quadrants corresponding to the four cardinal points. In Zone B, 24 tracks were from the south, 14 from the east, 3 from the west, and 1 from the north. Hurricanes with tracks having major components from the south or east are more critical relative to WTL's within the study area than hurricanes from other directions. Approximately two-thirds of all experienced hurricanes have come from a southerly direction, whereas about one-third have come from the east. The average azimuth of tracks from the south is 180°. Tracks from the east had an average azimuth of 115°. Approximately these azimuths were used in computing WTL's. Further adjustment of the probability of occurrence was made by using two-thirds of the probability for WTL's computed for hurricanes approaching from the south and one-third of the probability for WTL's computed for hurricanes approaching from the east.

The probabilities of equal stages for both groups of tracks were then added arithmetically to develop a curve representing a synthetic probability of recurrence of maximum wind tide levels for hurricanes from all directions. Table A-14 presents these computations and those of the previous paragraph for the New Orleans reach.

TABLE A-14

STAGE-FREQUENCY
SOUTH-SHORE - LAKE PONTCHARTRAIN

New Orleans			PATH A		PATH F	
CPI	Reach		WTL	Freq.*	WTL	Freq.*
<u>1</u>	<u>ZONE B</u>	<u>80-mi. subzone</u>	<u>4</u>	<u>(67% Col. 3)</u>	<u>6</u>	<u>(33% Col. 3)</u>
<u>in.</u>	<u>2</u>	<u>3</u>	<u>NGVD</u>	<u>5</u>	<u>ft. NGVD</u>	<u>7</u>
	<u>occ/100 years</u>			<u>occ/100 yrs.</u>		<u>occ/100 yrs.</u>
27.6	1	0.2	11.5	0.13	8.0	0.07
27.8	2	0.4	10.9	0.27	7.0	0.13
28.1	5	1.0	9.8	0.67	6.1	0.33
28.3	10	2.0	9.1	1.34	5.6	0.66
28.6	20	4.0	8.0	2.68	4.9	1.32
29.0	40	8.0	6.5	5.36	4.1	2.64

$$*Freq. = \frac{100}{\text{Return period years}}$$

(7) Using the shape of the synthetic stage-frequency curve as a guide, it was then possible to complete a final curve for the New Orleans reach between the predetermined limits mentioned previously.

(8) Lack of historical data prevented the similar development of WTL-frequency relationships for other localities within the study area. For the remaining reaches, wind tide levels were calculated for Zone B hurricanes of different frequencies by using different combinations of critical paths and distribution of azimuths of incidence. It followed that a Zone B hurricane of a particular frequency would have the same recurrence period for any locale in the study area since all are within the same subzone. Therefore, the final stage - frequency curves for the remaining areas were developed by plotting the computed stages for several different Zone B hurricanes at the corresponding frequencies indicated for the south shore of Lake Pontchartrain. Only two-thirds of the hurricanes from the south or east are most critical relative to WTL's along the south shore of Lake Pontchartrain, while all of the hurricanes from the south or east are equally critical to the area affected by Lake Borgne. Therefore, the most critical WTL along the south shore of Lake Pontchartrain for a Zone B hurricane of given frequency occurs only two-thirds as often as the most critical WTL along the shores of Lake Borgne for the same hurricane.

b. Relationships. Based on the above described procedures, stage-frequency relationships were established for the south shore of Lake Pontchartrain. Stage-frequency curves are shown on Plate A-17.

A-8. Design Hurricane.

a. Selection of the design hurricane. The standard project hurricane was selected as the design hurricane (Des H) due to the urban nature of the study area. A design hurricane of lesser intensity which would indicate a lower levee grade and an increased frequency would expose the protected areas to hazards to life and property that would be disastrous in event of the occurrence of a hurricane of the intensity and destructive capability of the standard project hurricane.

b. Characteristics. The characteristics of the Des H for the proposed plan of protection are identical to the standard project hurricane described in detail in Table A-15. However, due to transposition of the regional SPH to the smaller study area the design hurricane would have a probability of recurrence of only once in about 300 years in the study area. The path of the Des H's was located to produce maximum hurricane tides along the entire length of the proposed structure. The Des H is a theoretical hurricane but some of similar intensity have been experienced in the area. Table A-15 is a summary of the Des H characteristics.

TABLE A-15
DESIGN HURRICANE CHARACTERISTICS

<u>Location</u>	<u>CPI</u> (inches)	<u>Max. winds</u> (m.p.h)	<u>Radius of max. winds</u> (miles)	<u>Forward speed</u> (knots)	<u>Direction of approach</u>	<u>Track</u> (plate A-6)
Lake Pontchartrain South Shore	27.6	100	30	6	South	A

c. Normal Predicted Tides. The average tidal range in Lake Pontchartrain is 0.5 foot. Lake Pontchartrain has an average elevation of about 1.5 foot. In determining the elevation of design surges and wind tide levels, the mean normal predicted tide was assumed to occur at the critical period.

d. Design Tide. The hurricane tide is the maximum stillwater surface elevation experienced at a given location during the passage of a hurricane. It reflects the combined effects of the hurricane surge and wind tide. Design hurricane tides were computed for conditions reflecting the proposed protective works. The resulting stillwater elevations, are based on the Standard Project Hurricane (SPH).

e. Waves and Freeboard. For current conditions, waves are not a factor in determining freeboard for this levee. The levee is fronted by a wooded swamp which will interfere with the translation of waves toward the levee. A freeboard of 2 feet is recommended as a margin of safety for this levee. For future conditions, sea level rise and subsidence will cause continued depredations of the swamp fronting the levee. By the year 2040, the changed conditions fronting this levee may require a wave berm to be added to the flood side of the levee and raising of the levee elevation one foot.

f. Levee Heights. The methods used to determine levee heights are summarized as follows.. As described in paragraph I-6. and I-7. an open coast storm surge model was used to determine stages in Lake Borgne. The surge from Lake Borgne was then routed into Lake Pontchartrain. The surface of the lake behaves like a shallow bowl of water with the water surface tilted toward the down wind shore, that is in the direction towards which the wind is blowing. Stage frequency curves were developed by the methods described in paragraph I-7. for Frenier and West End gages. The location of the peak surge height changes as the hurricane moves along the critical track. The appropriate stage frequency curves were determined at the lakefront for the Jefferson - St. Charles Parish Line and for the Lower Guide Levee of Bonnet Carre Spillway. The combined curve showing stage frequencies at the lakeshore for these two locations is shown on Plate A-18. The shoreline is the locus of peak stages. Inland from the shoreline, the water surface slopes downward as the surge travels inland over the marsh and through the swamp. Higher friction causes higher dissipation of energy and thus the drop-off rate varies with the thickness and type of vegetation. Over marshes, the average drop-off rate is 1 foot per 2.75 miles and through swamps, the average drop-off rate is 1 foot per 2 miles. Calculated design stages at the lake shore are listed in Table A-16 along with design levee heights, computed by adding 2 feet of freeboard to the stage at the levee alignment.

TABLE A-16

DESIGN HURRICANE
WINDTIDE LEVELS AND
DESIGN ELEVATION OF PROTECTIVE STRUCTURES

Location	<u>Windtide Level</u> (ft)		<u>Freeboard</u> (ft)	<u>Elev. of Protective levees</u> (ft)
	(Lake Pontchartrain)	(Airline Highway Alignment)		
NORCO to New Sarpy	13.0	11.0	2.0	13.0
New Sarpy to Pipeline Canal	12.7	10.5	2.0	12.5
Pipeline Canal to Almedia	12.1	10.0	2.0	12.0
Almedia to T. L. James	11.8	10.0	2.0	12.0
T. L. James to Kenner	11.5	10.0	2.0	12.0

SECTION II - INTERIOR DRAINAGE

A-1 Description. The drainage plan consists of culverts at 5 locations. Culvert sizes, locations and subdrainage areas are shown on Plate A-19 and listed in Table 17. The drainage area that will be enclosed on completion of the St. Charles Parish levee is approximately 20 square miles. This area shown in Plate A-19 is bounded on the west by the Bonnet Carre Spillway, on the south by the Mississippi River, on the east by the St. Charles Parish boundary and on the north by the proposed levee alignment just north of Airline Highway. The drainage basin was divided into subdrainage areas using information gathered from field inspections, U.S.G.S. quadrangle maps and the St. Charles Parish Drainage Study (1986) prepared by Dawson Engineers. The following labels were used in the computer models to describe each subdrainage area:

- NORCO - Norco area
- NSARPY - New Sarpy area
- ORMDES - Ormond and Destrahan area
- SWAMP - Swampy area between Destrahan
and St. Rose
- STROSE - St. Rose area
- WALKER - Area between Almedia and the
T.L. James development
- JAMES - T.L. James area

Subdrainage area boundaries are defined in Plate A-19 and pertinent data is listed in Table 18.

TABLE 17

ST. CHARLES PARISH

HURRICANE PROTECTION PROJECT

SELECTED CULVERTS

Subdrainage area	Concrete Box Culverts		Outlet Location*
	Number	Size (ft.)	
NORCO	3	5 x 5	Bayou Trapagnier
NSARPY, ORMDES & SWAMP	6	6 x 6	Cross Bayou Canal
STROSE	2	6 x 6	Canal connecting to Pipeline Canal from the east
WALKER	1	4 x 4	Ditch along levee
JAMES	1	4 x 4	(Parish Line) Duncan Canal

*Culvert Locations are shown on Plate A-19.

TABLE 18
PERTINENT DATA
25-YEAR DESIGN EVENT

Rainfall = 10.4 in.
Average Lake Elevation = 1.6 ft. N.G.V.D.
(50% duration elevation + 0.4 ft. tidal)
Interior Damage Elevation = 3.4 ft. N.G.V.D.
- 0.5 (loss thru Airline Hwy. Embankment)
Max. Design Sump Pool Elevation = 2.9 ft. N.G.V.D.
Design Head on Structure = 1.3 ft.

SUBDRAINAGE AREA CHARACTERISTICS										CULVERT DESIGN DATA				
Subdrainage Area Designation	Area (sq. mi.)	SCS CN	%Area * Impervious	Flow Length (ft.)	Tc (hr.)	Rainfall Excess (in.)	Structure Invert (ft. NGVD)	# of Structures	Structure Size (ft.)	Max. Design Inflow (cfs)	Max. Design Outflow (cfs)	Headwater Stage (ft. NGVD)		
NORCO	3.7	91	73	19000	4.9	9.2	-3.5	3	5x5	1369	532	2.8		
NSARPY	2.7	89	70	15800	4.3	9.2								
ORMDES	6.3	88	69	21300	8.1	9.3	-5.3	6	6x6	4001	1441	2.7		
SWAMP	2.9	86	81	18000	3.3	9.6								
STROSE	3.5	88	69	16600	5.0	9.4	-5.0	2	6x6	1263	510	2.8		
WALKER	0.5	88	61	4900	4.5	9.1	-3.5	1	4x4	300	111	2.8		
JAMES	0.5	92	66	4300	4.4	9.3	-3.0	1	4x4	304	111	2.8		

* % Area Impervious includes area that is shallow, swampy and wet during most of the year. (This was not included in the Curve Numbers.)

A-10 Data Developed. a. The inverted-V unit hydrograph was developed for each subdrainage area. The time of concentration (Tc) of each subdrainage area was calculated using methodology outlined in the Soil Conservation Service's Technical Release No. 55 titled Urban Hydrology for Small Watersheds.

b. Runoff data for the area was developed using the HEC - 1, Flood Hydrograph Package (Revised 1985) Computer Program. Infiltration rates were calculated within the computer model using the Soil Conservation Service (SCS) curve number and the percent of the area that is impervious. The SCS curve number for each subdrainage area is based on soil type and land use. Table 18 lists subdrainage area curve numbers (CN) along with other subdrainage area characteristics.

c. Inflow hydrographs for the design storms for the drainage structures were synthesized with the use of values contained in the U.S. Weather Bureau Technical Paper No. 40, "Rainfall Frequency Atlas of the United States," published in 1961. The following Table lists the rainfalls used in the HEC-1 computer model:

TP-40 RAINFALL

Frequency	24 Hour Rainfall
1 yr	4.6
2 yr	5.7
5 yr	7.6
10 yr	9.0
25 yr	10.4
50 yr	11.5
100 yr	13.0

d. The storage curve for the Airline Highway levee alignment was taken from plainmetered data for alternative studies conducted prior to preparation of this GDM. (See Plate A-20.

A-11. Drainage Structures. a. The drainage structures were designed to have sufficient capacity to dispose of inflows from high intensity storms without excessive overflow of lands and to provide for prompt evacuation of impounded runoff following periods of gate closure. A storm with a frequency of 25 years and a duration of 24 hours was assumed to occur coincident with a Lake Pontchartrain stage of 1.6 ft. N.G.V.D. This lake stage is based on a 50 percent duration elevation of 1.2 ft. N.G.V.D. with a 0.4 ft tidal influence. An interior sump damage elevation of 3.4 ft. N.G.V.D. and an assumed loss of 0.5 ft. through the Airline Highway embankment yields 2.9 ft. N.G.V.D. as the maximum headwater (sump pool) elevation on the structure. Flows through the structures with submerged outlets and operating under various heads were

computed by use of the formula $Q = CA(2gh)^{0.50}$ where

Q = discharge in c.f.s.

C = coefficient of discharge

A = clear structure area in square feet

g = acceleration due to gravity

h = difference in upstream and downstream water levels

The value of "C" for concrete box culverts is 0.80 for the various culvert sizes selected.

b. After the culverts were sized, a computer run was made for the entire basin combined to verify that the 2.9 ft. N.G.V.D. headwater elevation was not exceeded. Pertinent data for the culvert design is listed in Table 18.

c. Table 19 shows the stage-frequency data for the area with the culverts open, and Plate A-21 thru A-26 show inflow/outflow - stage hydrography for the design storm (25 yr). Table 20 indicates stage frequency data for a high lake level with drainage culverts closed. Table 19 and 20 show the close correlation between the subdrainage area model and the entire basin model.

TABLE 19

ST. CHARLES PARISH HURRICANE PROTECTION PROJECT

HEADWATER ELEVATION

COMPARISON OF ENTIRE BASIN MAX. STAGE TO SUBDRAINAGE AREA MAX. STAGES

CULVERTS OPEN - MAX STAGE (FT. NGVD)

Subdrainage area	Entire Basin	NORCO	NSARPY ORMDES SWAMP	WALKER	ALMED	JAMES
Event						
1 - YR	2.0	2.0	2.0	2.0	2.0	2.0
2 - YR	2.1	2.2	2.1	2.1	2.1	2.1
5 - YR	2.3	2.5	2.3	2.4	2.4	2.4
10 - YR	2.5	2.7	2.5	2.6	2.6	2.6
25 - YR	2.8	2.8	2.7	2.8	2.8	2.8
50 - YR	2.9	3.1	2.9	3.0	3.0	3.0
100 - YR	3.2	3.4	3.1	3.3	3.2	3.2

TABLE 20

ST. CHARLES PARISH HURRICANE PROTECTION PROJECT

PONDING ELEVATION

COMPARISON OF ENTIRE BASIN MAX. STAGE TO SUBDRAINAGE AREA MAX. STAGES

CULVERTS CLOSED (everything stored) - MAX STAGE (FT. NGVD)

Subdrainage area	Entire Basin	NORCO	NSARPY ORMDDES SWAMP	STROSE	WALKER	JAMES
Event						
1 - YR	2.9	2.9	2.9	2.9	2.9	2.9
2 - YR	3.2	3.1	3.2	3.2	3.1	3.1
5 - YR	3.6	3.6	3.6	3.6	3.6	3.6
10 - YR	4.0	3.9	4.0	4.0	3.9	3.9
25 - YR	4.2	4.2	4.2	4.2	4.2	4.2
50 - YR	4.4	4.4	4.4	4.4	4.3	4.3
100 - YR	4.6	4.6	4.6	4.6	4.6	4.6

SECTION III - BIBLIOGRAPHY

- (1) U.S. Army Corps of Engineers Waterways Experiment Station, "Effects on Lake Pontchartrain, La., of Hurricane Surge Control Structures and Mississippi River-Gulf Outlet Channel," Technical Report No. 2-636, November 1963.
- (2) U.S. Army Corps of Engineers Waterways Experiment Station, "Lake Pontchartrain and Vicinity Hurricane Protection Plan - Prototype Data Acquisition and Analysis," Technical Report No. HL-82-2, January 1982.
- (3) U.S. Weather Bureau, "Characteristics of United States Hurricanes Pertinent to Levee Design for Lake Okeechobee, Florida," Hydrometeorological Report No. 32, March 1954.
- (4) U.S. Weather Bureau, "Revised Wind Fields Vicinity of Lake Pontchartrain, Hurricane of September 29, 1915," Memorandum HUR 7-39, August 16, 1957.
- (5) U.S. Weather Bureau, "Wind Speed and Direction Charts for the Lake Pontchartrain, Chandeleur and Breton Sounds and Mississippi Delta Regions, Hurricane of September 19, 1947," Memorandum HUR 7-37, June 12, 1957.
- (6) U.S. Weather Bureau, "Meteorological Considerations Pertinent to Standard Project Hurricane, Atlantic and Gulf Coasts of the United States," Hydrometeorological Report No. 33, November 1959.
- (7) U.S. Weather Bureau, "Standard Project Hurricane Wind Field Patterns (revised) to replace Existing Patterns in NHRP Report No. 33, for Zones B and C," Memorandum HUR 7-84, August 17, 1965.
- (8) U.S. Weather Bureau, "Adjustments to SPH isovel patterns in Memoranda HUR 7-62, 7-62A, 7-63, 7-64, and 7-65," Memorandum HUR 7-85, November 3, 1965.
- (9) U.S. Weather Bureau, "Ratio Chart to adjust Isovel Patterns in HUR 7-40 to Level of Updated SPH Patterns," Memorandum HUR 7-85A, February 17, 1966.
- (10) National Weather Service, "Revised Standard Project Hurricane Criteria for the Atlantic and Gulf Coasts of the United States," Memorandum HUR 7-120, July 31, 1972.

- (11) National Weather Service, "Meteorological Criteria for Standard Project Hurricane and Probable Maximum Hurricane Windfields, Gulf and East Coasts of the United States," NOAA Technical Report NWS23, September 1979.
- (12) U.S. Weather Bureau, "Hurricane Frequency and Correlations of Hurricane Characteristics for the Gulf of Mexico Area, P.L. 71," Memorandum HUR 2-4, August 30, 1957.
- (13) U.S. Weather Bureau, "SPH Parameters and Isovels, Mid-Gulf Coast U.S. Zone B, and SPH Lake Pontchartrain, La.," Memorandum HUR 7-42, October 11, 1957.
- (14) U.S. Army Corps of Engineers, New Orleans District, "Lake Pontchartrain, Louisiana and Vicinity, Design Memorandum No. 1 Hydrology and Hydraulic Analysis, Part 1 - Chalmette," August 1966.
- (15) Reid, Robert O. "Approximate Response of Water Level on a Sloping Shelf to a Wind Fetch Which Moves Towards Shore," Beach Erosion Board, Technical Memorandum No. 83, June 1956.
- (16) U.S. Weather Bureau, "Hurricane Rainfall Estimates Applicable to Middle Gulf Standard Project Hurricanes, Tracks A, C, F, D, and B, New Orleans Study, Zone B," Memorandum HUR 3-5, November 30, 1959.
- (17) U.S. Weather Bureau, "Estimates of Moderate Hurricane Rainfall Applicable to Middle Gulf Standard Project Hurricanes," "Memoandum HUR 3-5a, December 11, 1959.
- (18) U.S. Weather Bureau, "Louisiana Hurricane of September 29, 1915, Transposed to a Critical Track," Memorandum HUR 7-40, September 6, 1957.
- (19) U.S. Weather Bureau, "SPH Wind Fields for Track F with Forward Speed 5 Knots Critical for Area I," Memorandum HUR 7-63, September 21, 1959.
- (20) U.S. Army Engineer District, Jacksonville, "Design Memorandum, Wind Tides Produced by Hurricanes," Partial Definite Project Report, Central and Southern Florida Project, for Flood Control and Other Purposes, Part IV, Supplement 2, Section 3, July 26, 1956.
- (21) Bretschneider, C.L. "Prediction of Wind Waves and Set-up in Shallow Water, with Special Application to Lake Okeechobee, Florida," Unpublished Paper, Texas A&M College, August 1954.

- (22) Dawson Engineers Incorporated, Baton Rouge, Louisiana, "St. Charles Parish Drainage Study", December 1986.
- (23) Soil Conservation Service, Technical Release No. 50, "Urban Hydrology for Small Watersheds."
- (24) U.S. Weather Bureau Technical Paper No. 40, "Rainfall Frequency Atlas of the United States", 1961.

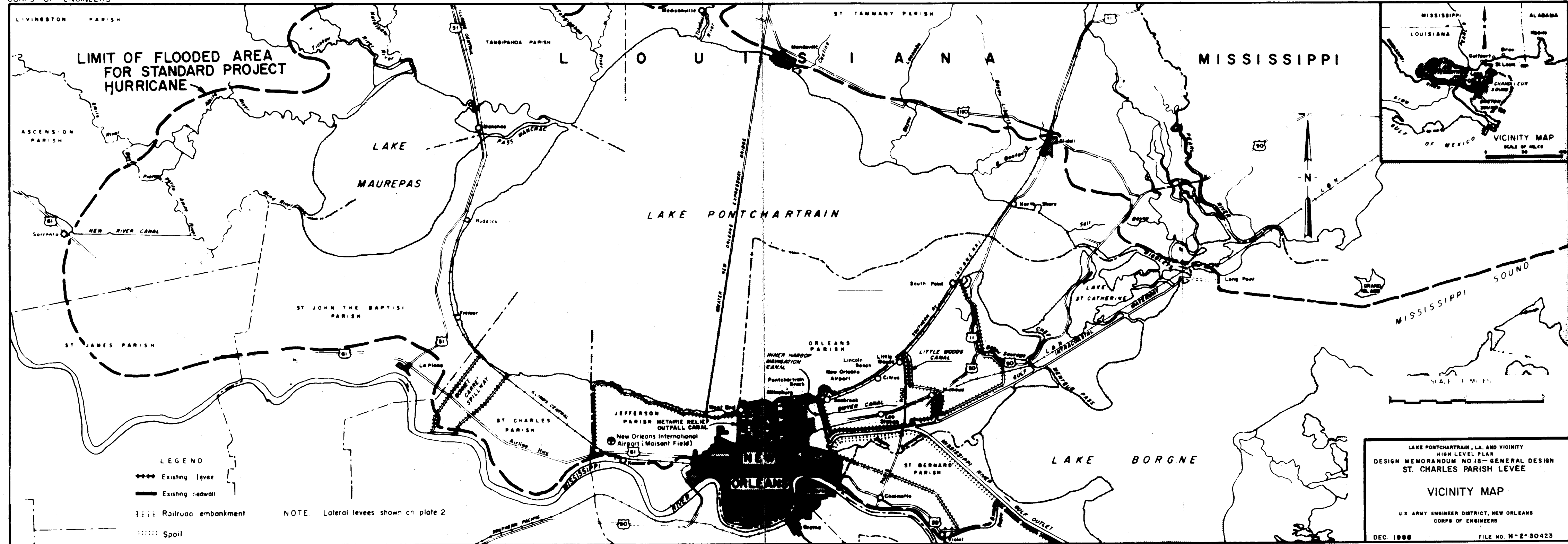

LEGEND

- ◆◆◆ Existing levee
- Existing seawall
- |||| Railroad embankment
- Spoil

NOTE: Lateral levees shown on plate 2

LAKE PONTCHARTRAIN, LA. AND VICINITY
 HIGH LEVEL PLAN
 DESIGN MEMORANDUM NO. 18 - GENERAL DESIGN
 ST. CHARLES PARISH LEVEE

VICINITY MAP

U.S. ARMY ENGINEER DISTRICT, NEW ORLEANS
 CORPS OF ENGINEERS

DEC 1968 FILE NO. M-2-30423

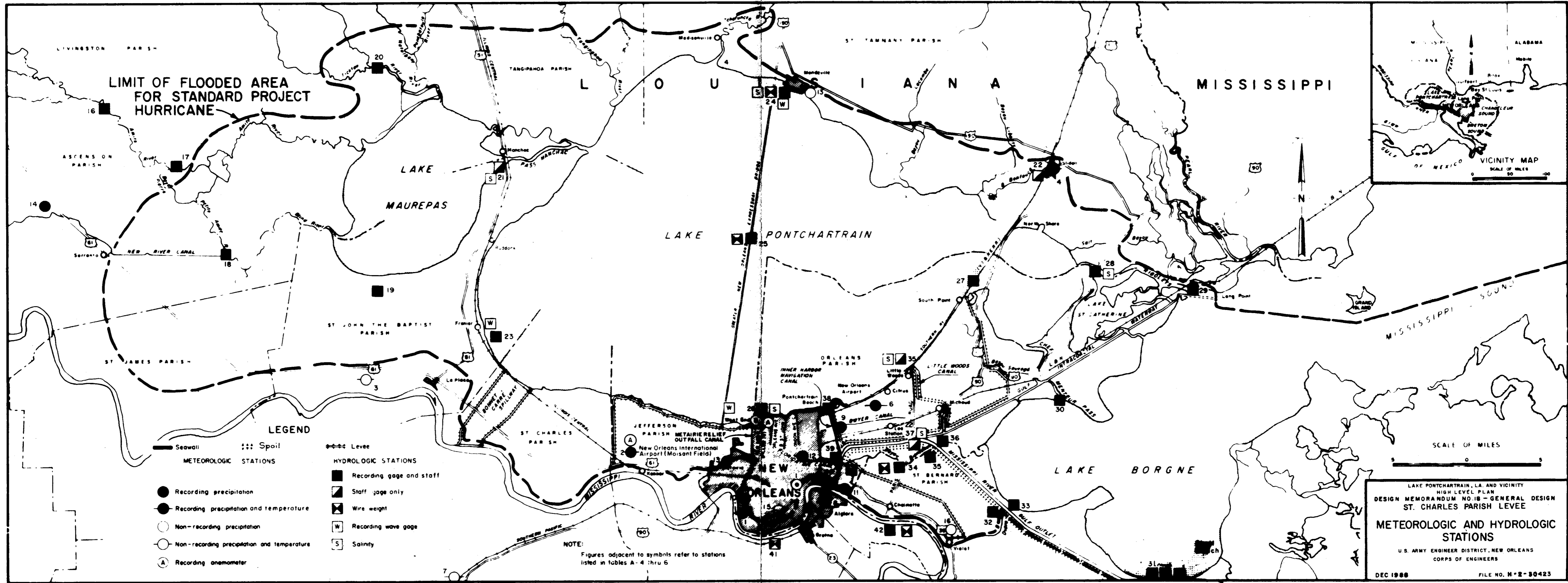

LIMIT OF FLOODED AREA FOR STANDARD PROJECT HURRICANE

LEGEND

- | | | |
|---|----------------------------|-----------------------|
| — Seawall | ⋯ Spoil | — Levee |
| ● Recording precipitation | ■ Recording gage and staff | ■ Staff gage only |
| ● Recording precipitation and temperature | ⊠ Wire weight | W Recording wave gage |
| ○ Non-recording precipitation | S Salinity | |
| ○ Non-recording precipitation and temperature | | |
| A Recording anemometer | | |

NOTE: Figures adjacent to symbols refer to stations listed in tables A-4 thru 6

LAKE PONTCHARTRAIN, LA. AND VICINITY
 HIGH LEVEL PLAN
 DESIGN MEMORANDUM NO. 18 - GENERAL DESIGN
 ST. CHARLES PARISH LEVEE
 METEOROLOGIC AND HYDROLOGIC STATIONS
 U.S. ARMY ENGINEER DISTRICT, NEW ORLEANS
 CORPS OF ENGINEERS
 DEC 1966 FILE NO. H-2-30423

WIND ROSE

Percentage Frequency
Annual

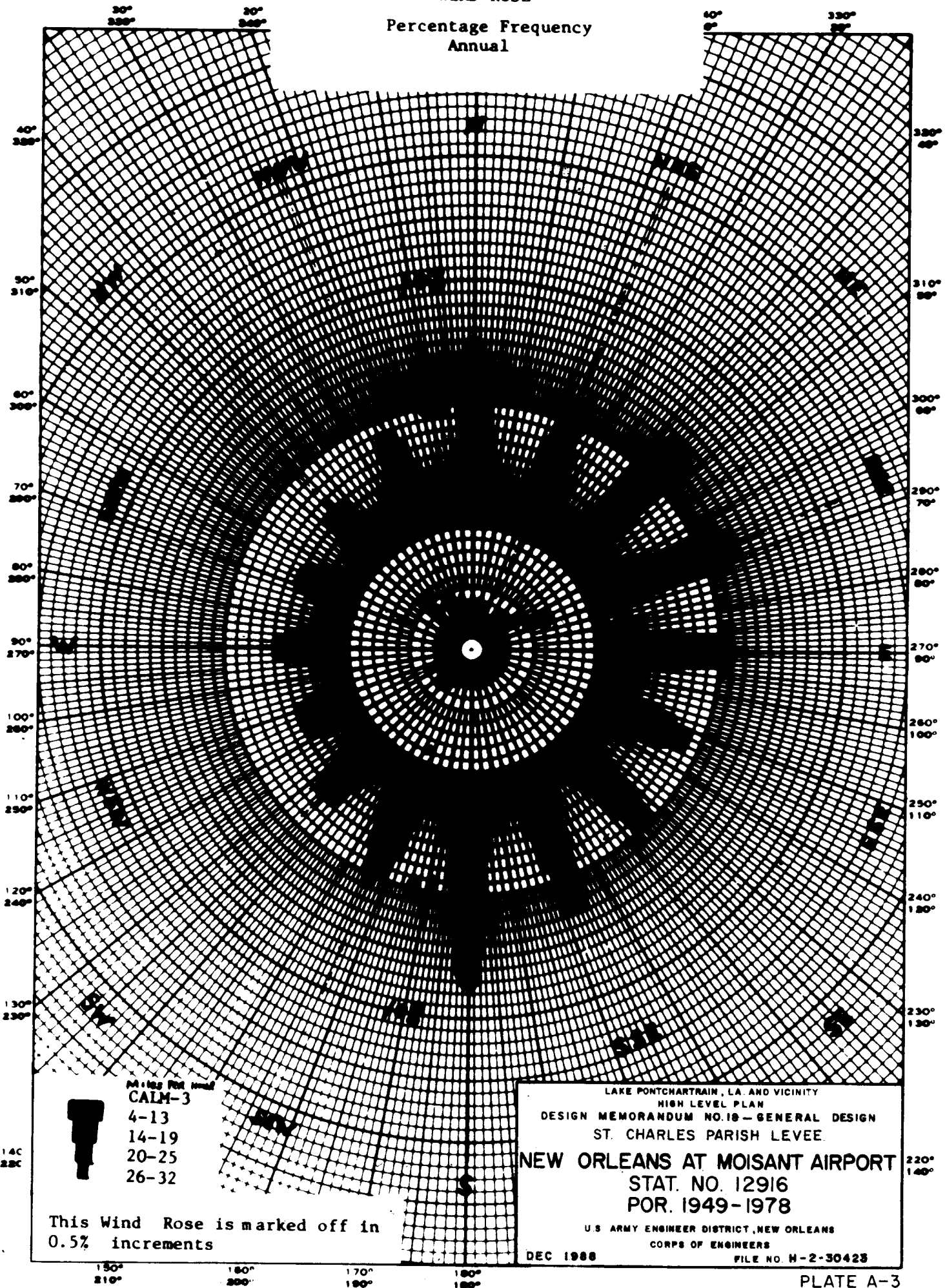

Miles Per Hour
 CALM-3
 4-13
 14-19
 20-25
 26-32

14C
22C

This Wind Rose is marked off in 0.5% increments

LAKE PONTCHARTRAIN, LA. AND VICINITY
 HIGH LEVEL PLAN
 DESIGN MEMORANDUM NO. 18 - GENERAL DESIGN
 ST. CHARLES PARISH LEVEE
NEW ORLEANS AT MOISANT AIRPORT
 STAT. NO. 12916
 POR. 1949-1978

U.S. ARMY ENGINEER DISTRICT, NEW ORLEANS
 CORPS OF ENGINEERS
 DEC 1988
 FILE NO. H-2-30425

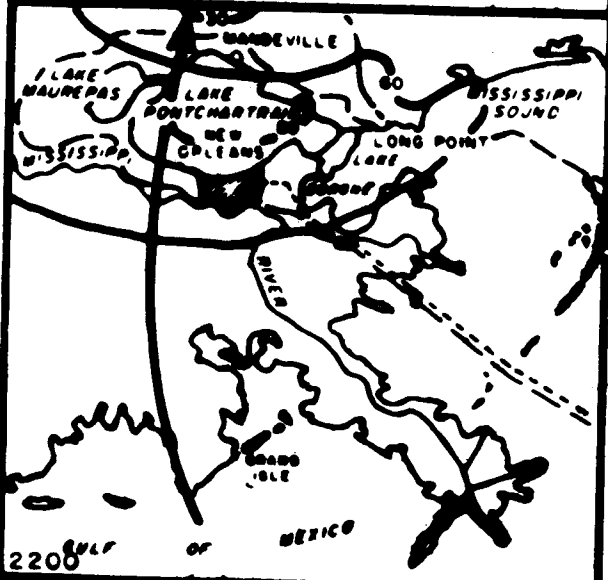
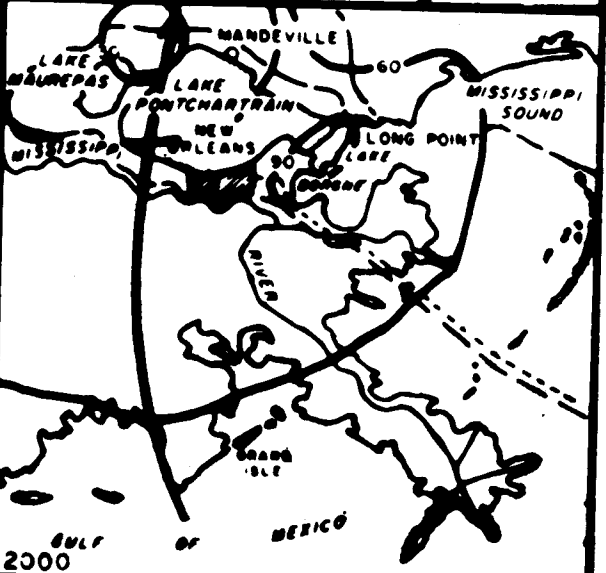
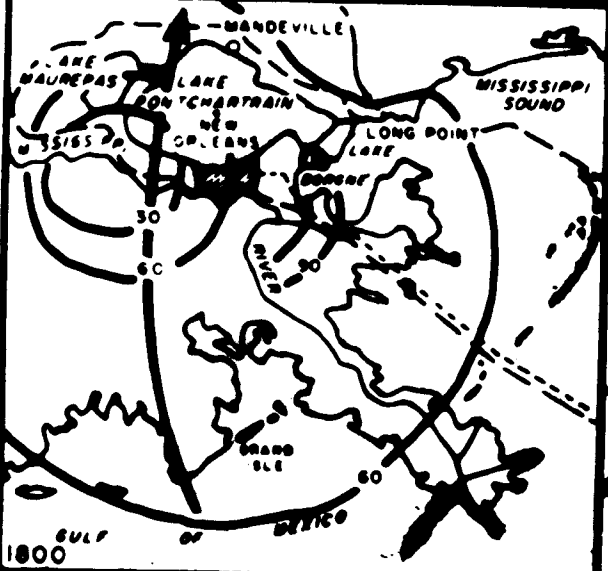
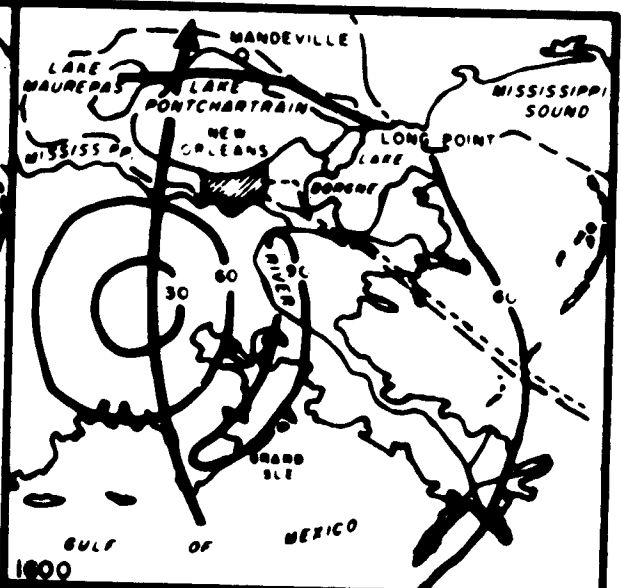
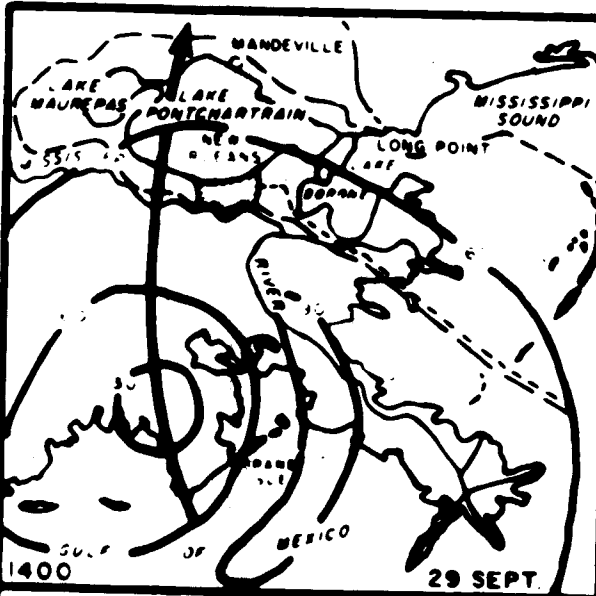

- LEGEND**
- Study area
 - 30 Average wind velocity
 - ← Hurricane path

LAKE PONTCHARTRAIN, LA. AND VICINITY
 HIGH LEVEL PLAN
 DESIGN MEMORANDUM NO. 18 - GENERAL DESIGN
 ST. CHARLES PARISH LEVEE
 HURRICANE OF
 28 SEPT. TO 1 OCT. 1915
 ISOVEL PATTERNS

25 0 SCALE OF MILES 25 50

U.S. ARMY ENGINEER DISTRICT, NEW ORLEANS
 CORPS OF ENGINEERS

DEC 1988

FILE NO. H-2-30423

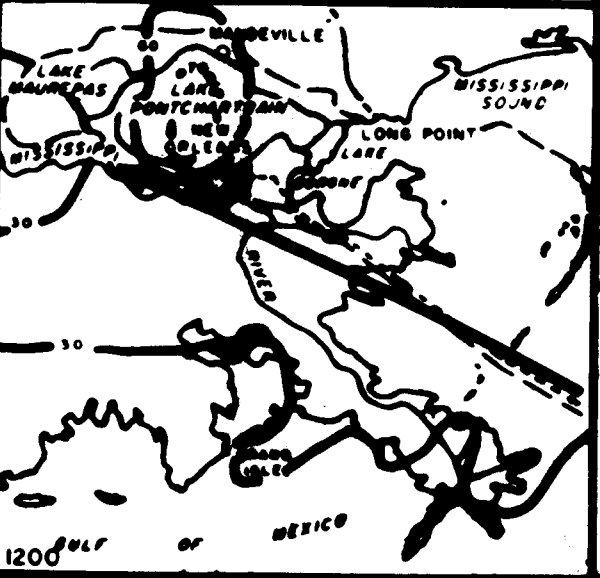
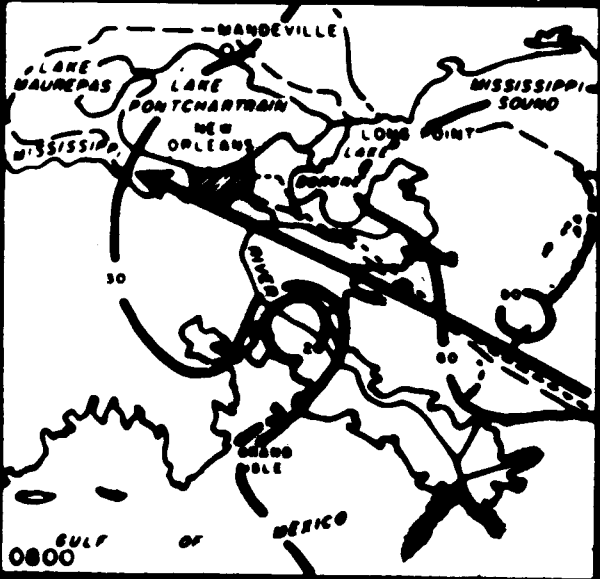
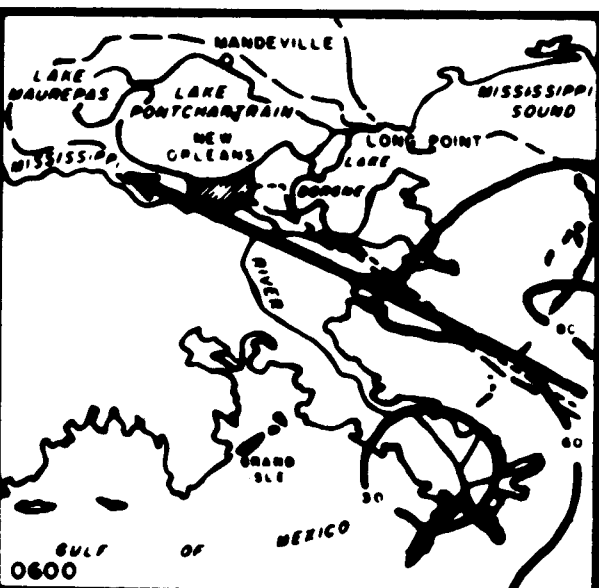
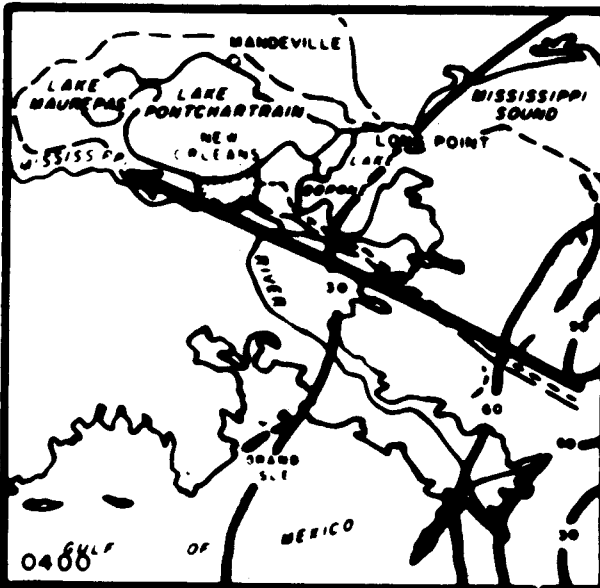

LEGEND

- Study area
- ↻ Average wind velocity
- ➔ Hurricane path

LAKE PONTCHARTRAIN, LA. AND VICINITY
 HIGH LEVEL PLAN
 DESIGN MEMORANDUM NO. 18—GENERAL DESIGN
 ST. CHARLES PARISH LEVEE
 HURRICANE OF 19 SEPT 1947
 ISOVEL PATTERNS
 SCALE OF MILES
 0 25 50
 U.S. ARMY ENGINEER DISTRICT, NEW ORLEANS
 CORPS OF ENGINEERS

DEC 1968

FILE NO. H-2-30423

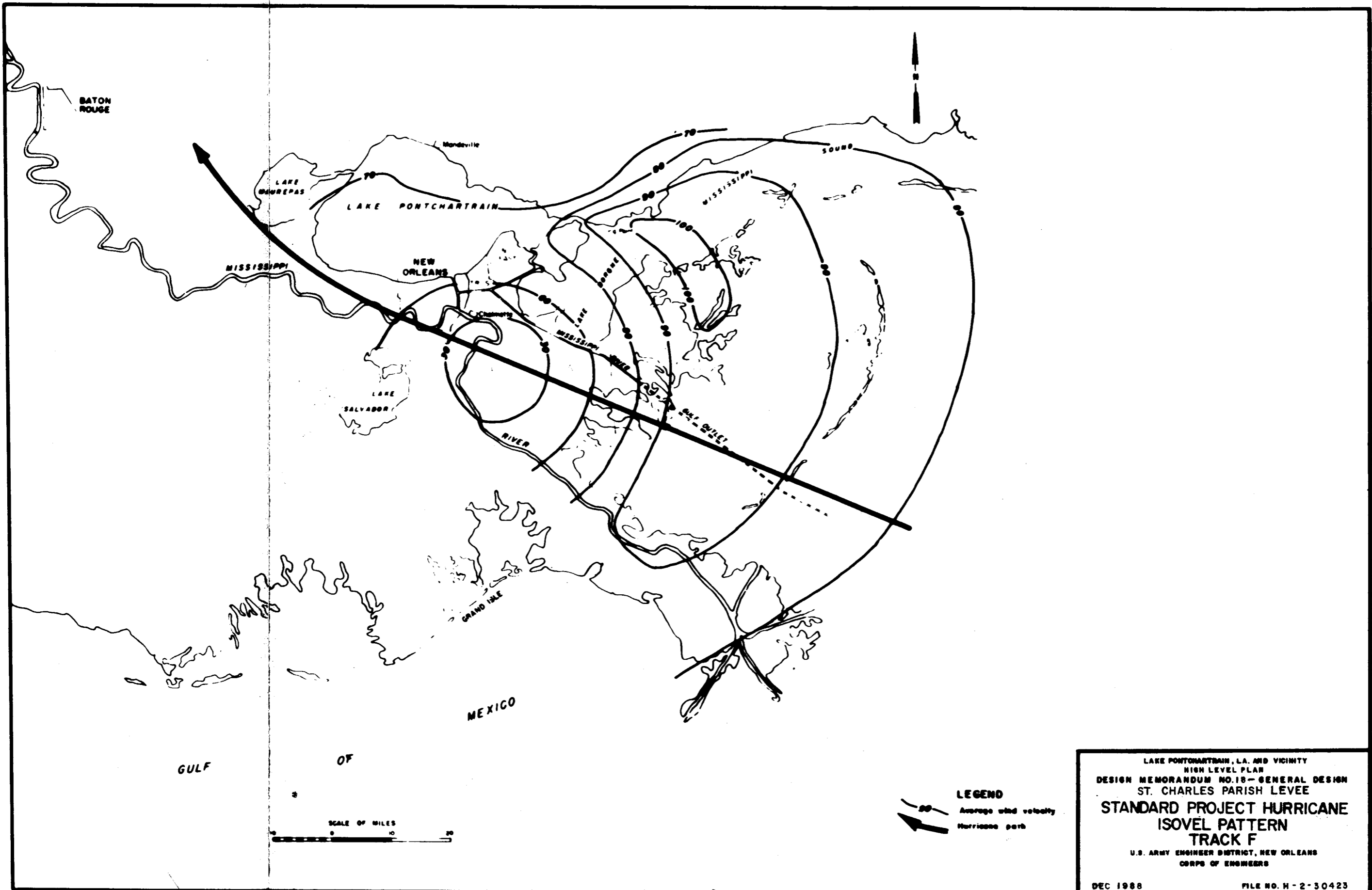
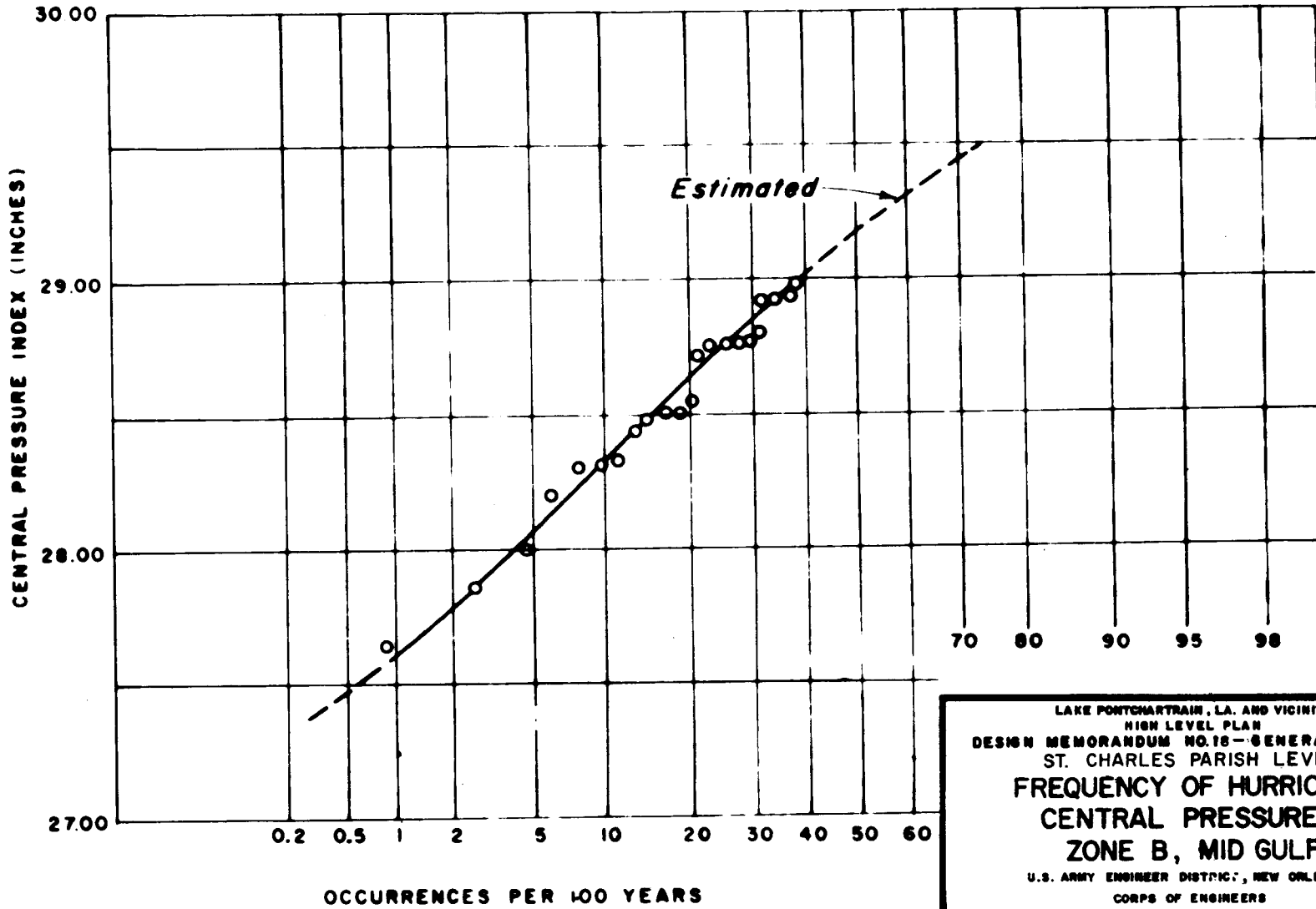
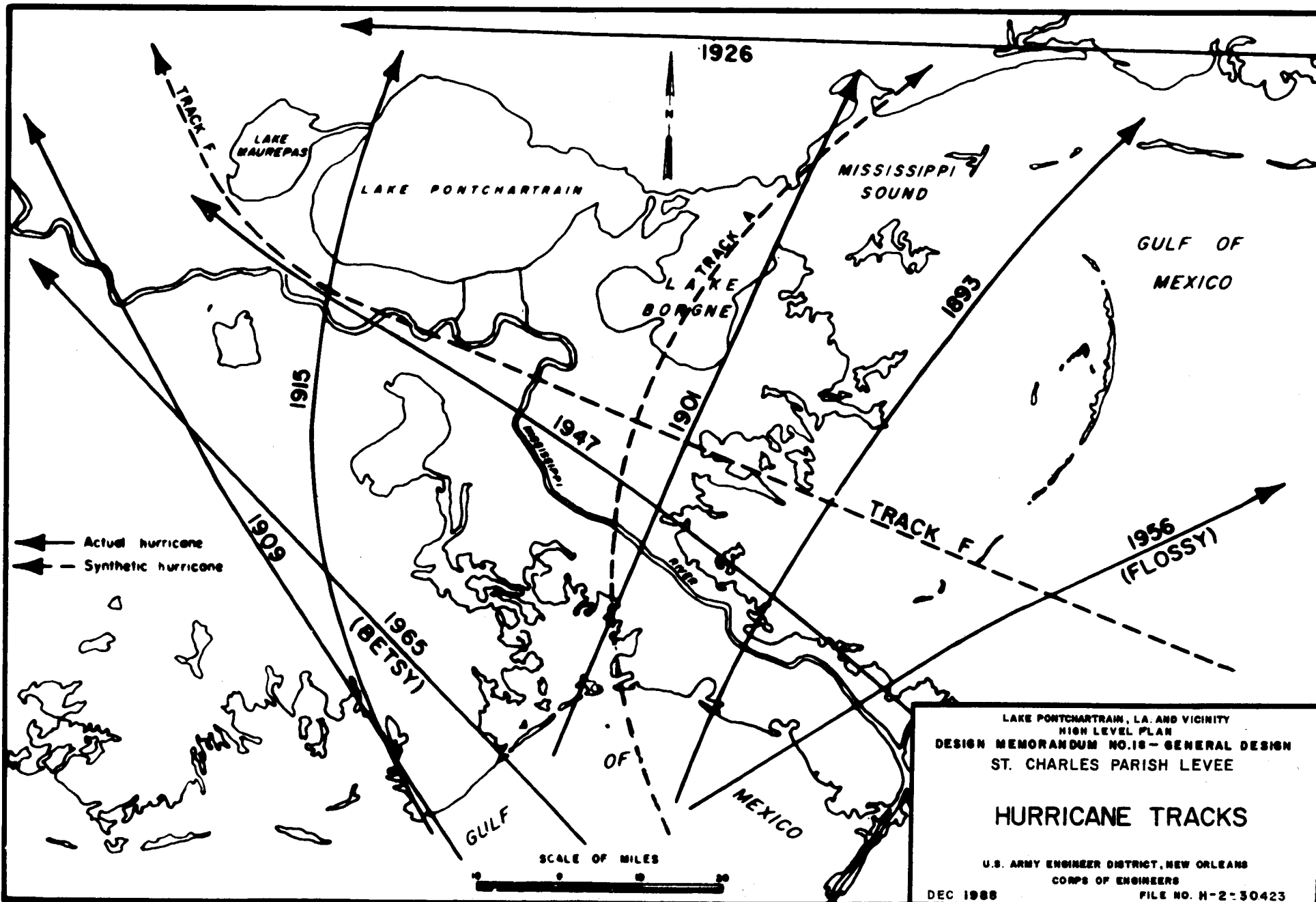

PLATE A-8



LAKE PONTCHARTRAIN, LA. AND VICINITY
HIGH LEVEL PLAN
DESIGN MEMORANDUM NO. 18 - GENERAL DESIGN
ST. CHARLES PARISH LEVEE
**FREQUENCY OF HURRICANE
CENTRAL PRESSURES
ZONE B, MID GULF**
U.S. ARMY ENGINEER DISTRICT, NEW ORLEANS
CORPS OF ENGINEERS
DEC 1966 FILE NO. H-2-30423

PLATE A-8



HOURS DEFERRED TO LANDFALL	EL. IN LAKE BORGNE		EL. IN LAKE PONTCHARTRAIN		FLOW INTO LAKE PONTCHARTRAIN					L. PONT. STORAGE		OVERFLOW	FLOW INTO L. MAUREPAS	STAGES IN PASS MANCHAC					FLOW INTO LAKE MAUREPAS		STAGE IN LAKE MAUREPAS							
	EL. IN L. BORGNE	AV. OF (2)	AV. EL. IN L. PONT.	EL. AT MWT. 11	AV. OF (8)	HEAD BE- TWEEN L. BORGNE & L. PONT.	FLOW IN- TO L. PONT.	VOLUME OF FLOW FOR 2 HOURS	RAIN IN L. PONT.	VOLUME OF RAIN FOR 2 HOURS	TOTAL IN- FLOW INTO L. PONT.	STORAGE IN L. PONT. FOR 2 HOURS	STORAGE L. PONT.	FLOW OVER L. PONT. LEVELS FOR 2 HOURS	FLOW INTO L. MAUREPAS	EL. IN LAKE MAUREPAS L. PONT. SIDE	EL. IN LAKE MAUREPAS LAKE MAUREPAS SIDE	AV. OF (17)	TILT IN L. PONT.	TILT IN L. MAUREPAS	EL. IN PASS MANCHAC	AV. OF (20)	HEAD BE- TWEEN L. PONT. & L. MAUREPAS	FLOW INTO L. MAUREPAS	VOLUME OF FLOW FOR 2 HOURS	STORAGE IN EL. IN L. MAUREPAS	STAGE IN LAKE MAUREPAS	
	FEET N.S.V.B.	FEET N.S.V.B.	FEET N.S.V.B.	FEET N.S.V.B.	FEET N.S.V.B.	FEET	1000 C.F.S.	1000 B.S.F.	FEET	1000 B.S.F.	1000 B.S.F.	1000 B.S.F.	1000 B.S.F.	1000 B.S.F.	1000 B.S.F.	FEET N.S.V.B.	FEET N.S.V.B.	FEET N.S.V.B.	FEET	FEET	FEET N.S.V.B.	FEET N.S.V.B.	FEET	1000 C.F.S.	1000 B.S.F.	1000 B.S.F.	FEET N.S.V.B.	
2	9.94		3.91	2.33		0.67	4814.0	351.2	0.112	13.7	364.9	1970.4	346.5	2.3	16.1	225.1	1.12	3.34	4.52	1.21	0.24	1.00	0.84	3.64	165.0	13.0	226.2	1.13
4	10.25	9.86	2.26	0.09	1.21	0.27	4043.2	336.9	0.052	48.0	370.9	2317.1	351.7	11.6	15.6	241.2	1.27	5.20	6.52	2.91	1.08	0.73	0.90	5.18	101.6	15.1	240.0	1.24
6	9.54	9.11	0.27	3.10	1.22	1.54	2810.6	192.6	0.125	19.6	242.2	2648.0	202.5	25.0	13.9	254.0	1.91	6.55	6.00	3.91	0.68	1.07	1.32	9.70	100.5	15.0	255.1	1.40
8	8.64	7.43	7.00	2.94	7.43	0.00	0.0	0.0	0.100	21.0	21.0	2871.8	-47.7	20.9	13.0	270.7	1.53	5.61	5.11	-0.25	-0.07	1.27	1.22	3.29	100.2	13.1	270.4	1.33
10	6.19		7.11	0.90					0.075			2883.6				284.5	1.65	6.51		-4.29	-0.24	2.00				283.8	1.29	

EXPLANATION:

- ① FROM LAKE BORGNE HYDROGRAPH DERIVED BY THE METHOD DESCRIBED IN PARAGRAPH 1-5 (1) AND SHOWN ON PLATE A-13
- ② ASSUMED
- ③ OBTAINED FROM WATER SURFACE CONTOURS DERIVED FROM WIND SETUP COMPUTATIONS FOR LAKE PONT., SAMPLE SHOWN ON PLATE A-13
- ④ ① - ③
- ⑤ FROM CHEF MENTEUR PASS AND RIGOLETS RATING CURVE SHOWN BELOW
- ⑥ FROM RAINFALL ESTIMATES DESCRIBED IN PARAGRAPH 1-5E(A)
- ⑦ ① + ⑥
- ⑧ FROM LAKE PONT. STORAGE CURVE SHOWN BELOW FOR THE ELEVATION IN ④
- ⑨ ① - ⑧
- ⑩ BY THE PROCEDURES DESCRIBED IN PARAGRAPH 1-7E
- ⑪ CORRESPONDING ELEVATION FOR VOLUME IN ① FROM LAKE MAUREPAS STORAGE CURVE SHOWN BELOW
- ⑫ SAME AS EXPLANATION FOR ①
- ⑬ ① - ⑫
- ⑭ 1/3 OF ⑫, ESTIMATED AS 1/3 OF THE TILT OF LAKE PONTCHARTRAIN SINCE LAKE MAUREPAS IS 1/3 AS WIDE.
- ⑮ ① - ⑭
- ⑯ FROM PASS MANCHAC RATING CURVE SHOWN BELOW
- ⑰ CORRESPONDING ELEVATION FOR VOLUME IN ⑫ FROM LAKE MAUREPAS STORAGE CURVE SHOWN BELOW

SAMPLE ROUTING

WATER SURFACE PROFILES

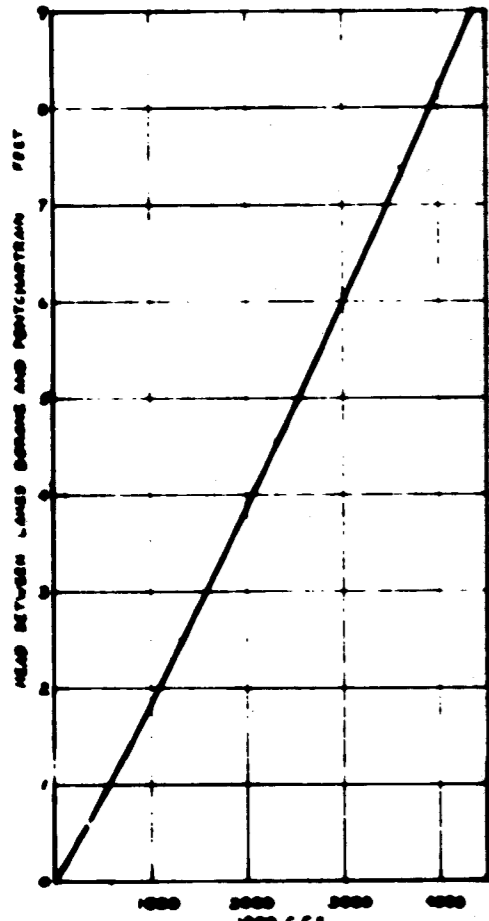
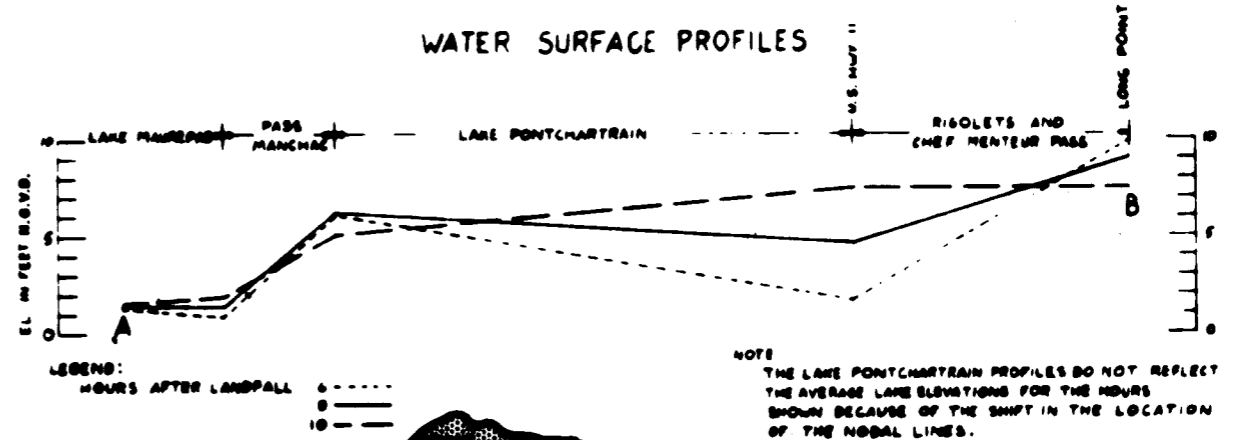

CHEF MENTEUR PASS & RIGOLETS FLOW

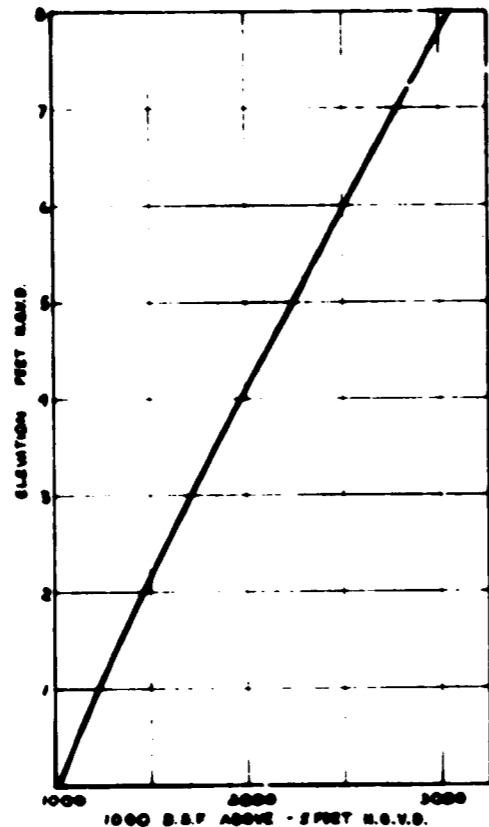

LAKE PONTCHARTRAIN STORAGE

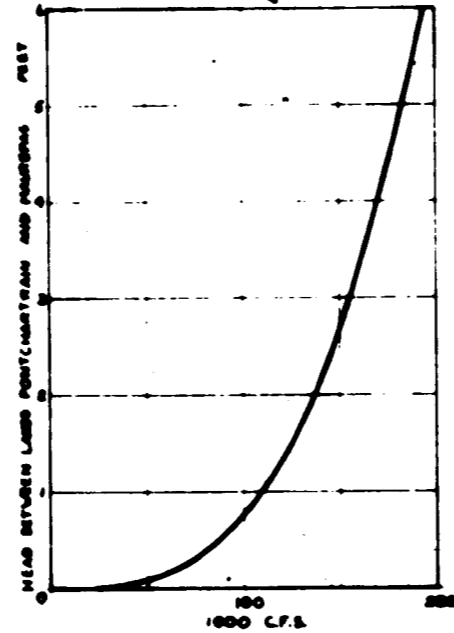

PASS MANCHAC FLOW

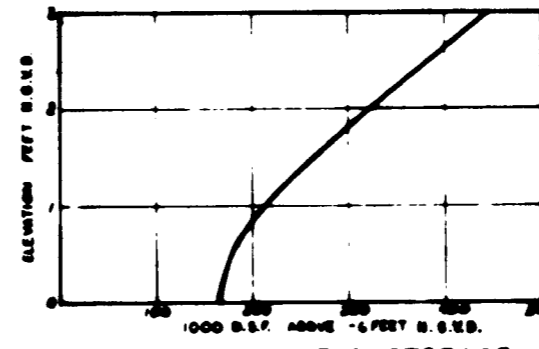

LAKE MAUREPAS STORAGE

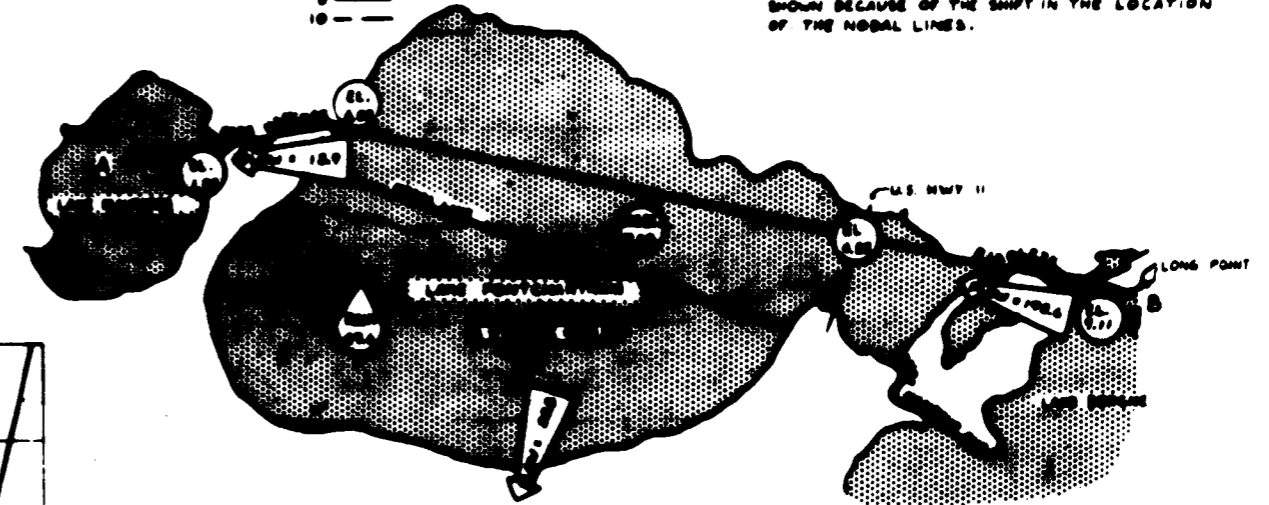

ROUTING DIAGRAM

6 TO 8 HOURS AFTER LANDFALL

NOTE:
FLOW AND RAIN IN 1000 B.S.F.
ELEVATIONS IN FEET N.S.V.B.

LAKE PONTCHARTRAIN, LA. AND VICINITY
HIGH LEVEL PLAN
DESIGN MEMORANDUM NO. 18 - GENERAL DESIGN
ST. CHARLES PARISH LEVEE

LAKE PONTCHARTRAIN ROUTING

U.S. ARMY ENGINEER DISTRICT, NEW ORLEANS
CORPS OF ENGINEERS

DEC 1968

FILE NO. H-2-30423

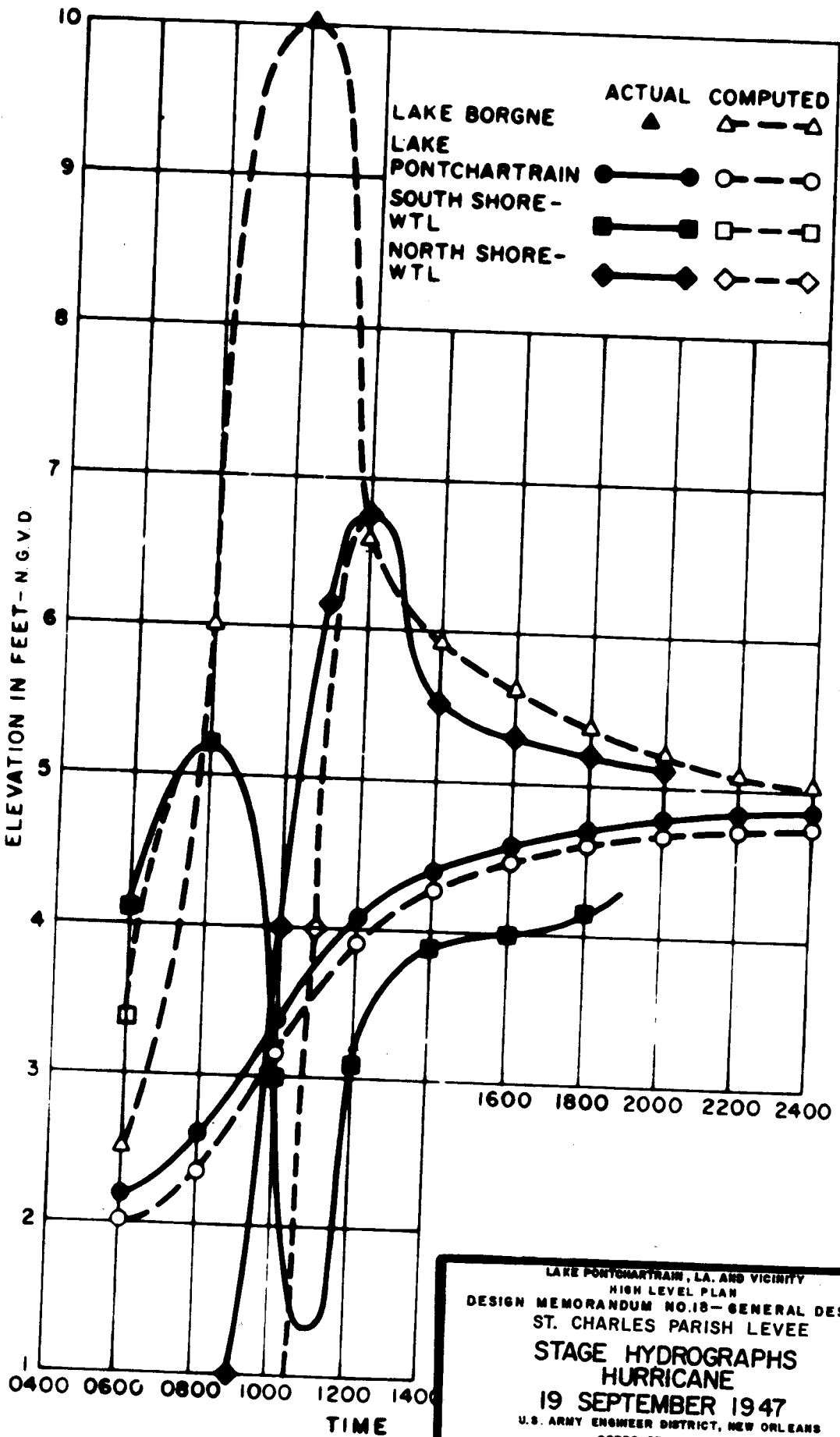

LAKE PONTCHARTRAIN, LA. AND VICINITY
 HIGH LEVEL PLAN
 DESIGN MEMORANDUM NO. 18 - GENERAL DESIGN
 ST. CHARLES PARISH LEVEE
 STAGE HYDROGRAPHS
 HURRICANE
 19 SEPTEMBER 1947
 U.S. ARMY ENGINEER DISTRICT, NEW ORLEANS
 CORPS OF ENGINEERS

DEC 1988

FILE NO. M-2-30423

PLATE A-11

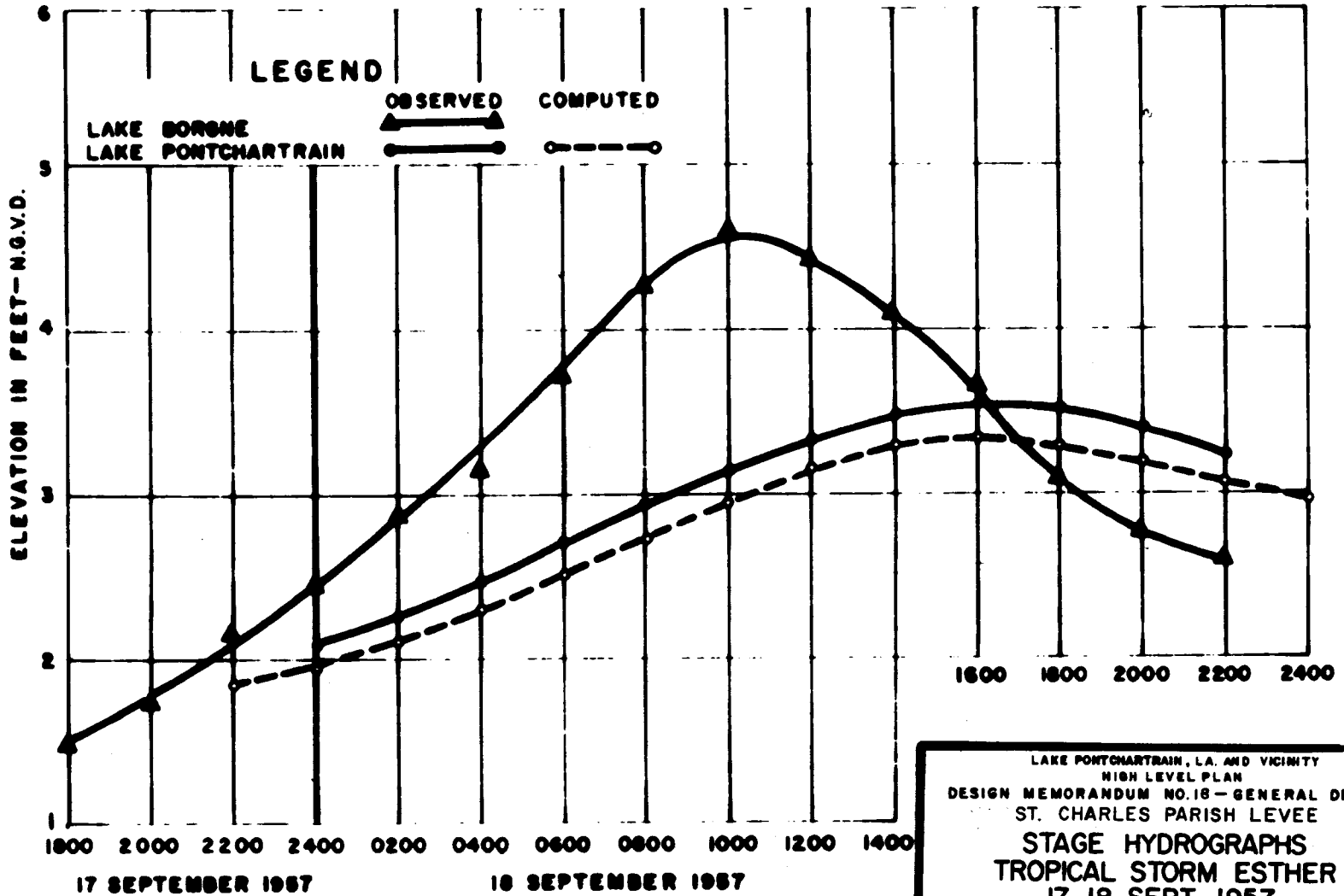

LAKE PONTCHARTRAIN, LA. AND VICINITY
HIGH LEVEL PLAN
DESIGN MEMORANDUM NO. 18 - GENERAL DESIGN
ST. CHARLES PARISH LEVEE
STAGE HYDROGRAPHS
TROPICAL STORM ESTHER
17-18 SEPT., 1957
U.S. ARMY ENGINEER DISTRICT, NEW ORLEANS
CORPS OF ENGINEERS
DEC 1988 FILE NO. H-2-50423

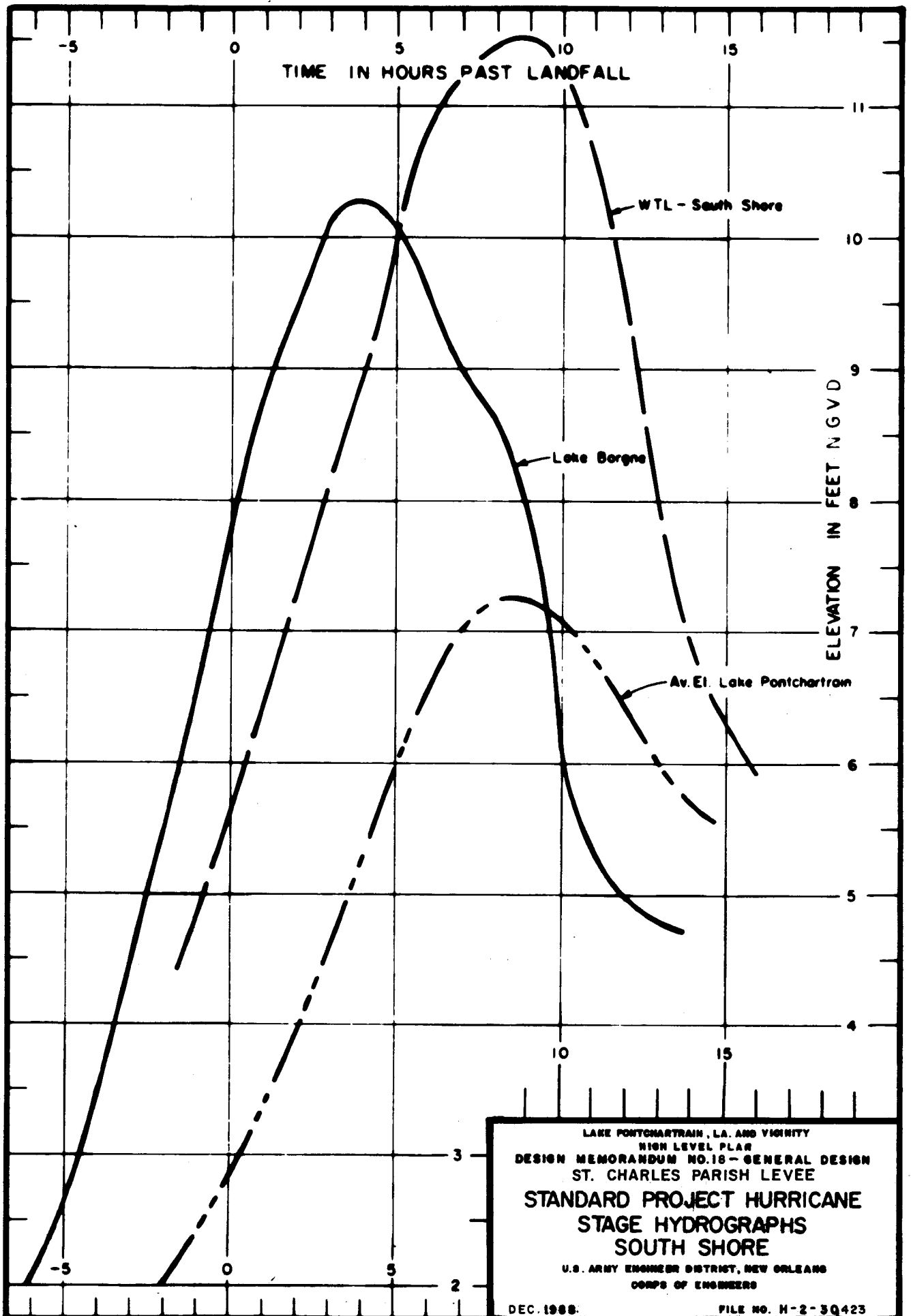

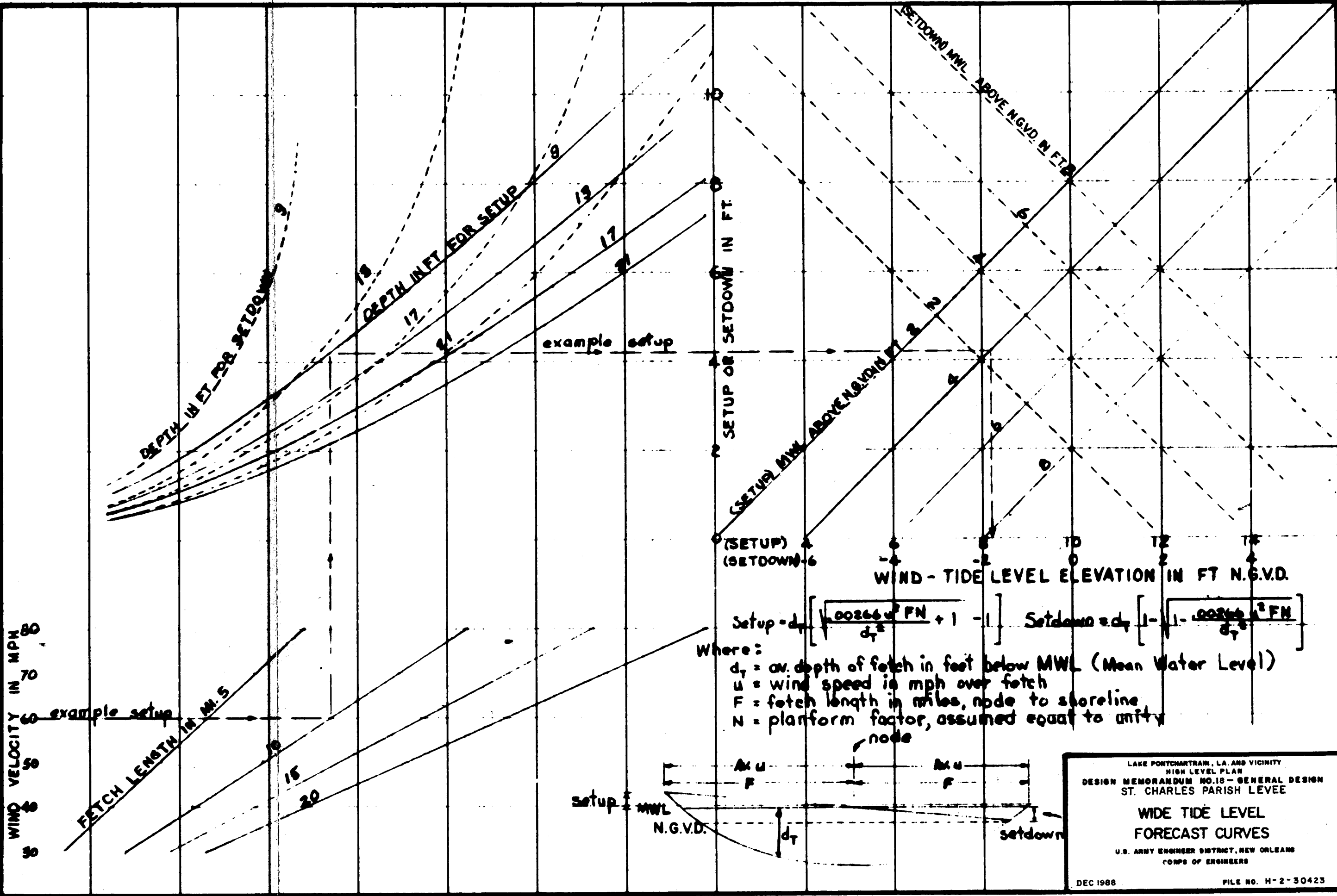

WIND VELOCITY IN MPH
80
70
60
50
40
30

example setup

FETCH LENGTH IN M.S.
10
15
20

DEPTH IN FT FOR SETUP
9
12
13
17

example setup

SETUP OR SETDOWN IN FT
10
8
6
4
2
0

(SETUP) MWL ABOVE N.G.V.D. IN FT
12
10
8
6
4
2
0

WIND-TIDE LEVEL ELEVATION IN FT N.G.V.D.
12
10
8
6
4
2
0

$$\text{Setup} = d_T \left[\sqrt{\frac{0.0266 u^2 F N}{d_T^2} + 1} - 1 \right] \quad \text{Setdown} = d_T \left[1 - \sqrt{1 - \frac{0.0266 u^2 F N}{d_T^2}} \right]$$

Where:
 d_T = av. depth of fetch in feet below MWL (Mean Water Level)
 u = wind speed in mph over fetch
 F = fetch length in miles, node to shoreline
 N = planform factor, assumed equal to unity

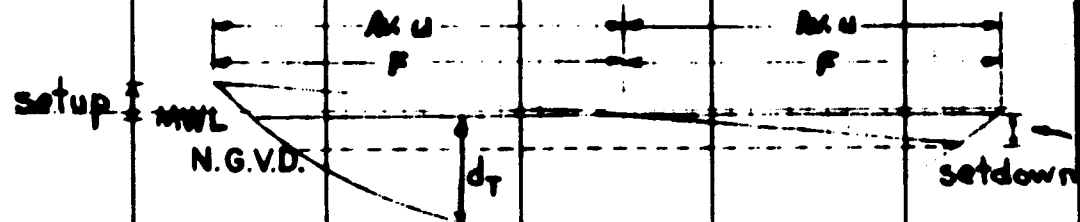

LAKE PONTCHARTRAIN, LA. AND VICINITY
 HIGH LEVEL PLAN
 DESIGN MEMORANDUM NO. 18 - GENERAL DESIGN
 ST. CHARLES PARISH LEVEE
 WIDE TIDE LEVEL
 FORECAST CURVES
 U.S. ARMY ENGINEER DISTRICT, NEW ORLEANS
 CORPS OF ENGINEERS

DEC 1988 FILE NO. H-2-30423

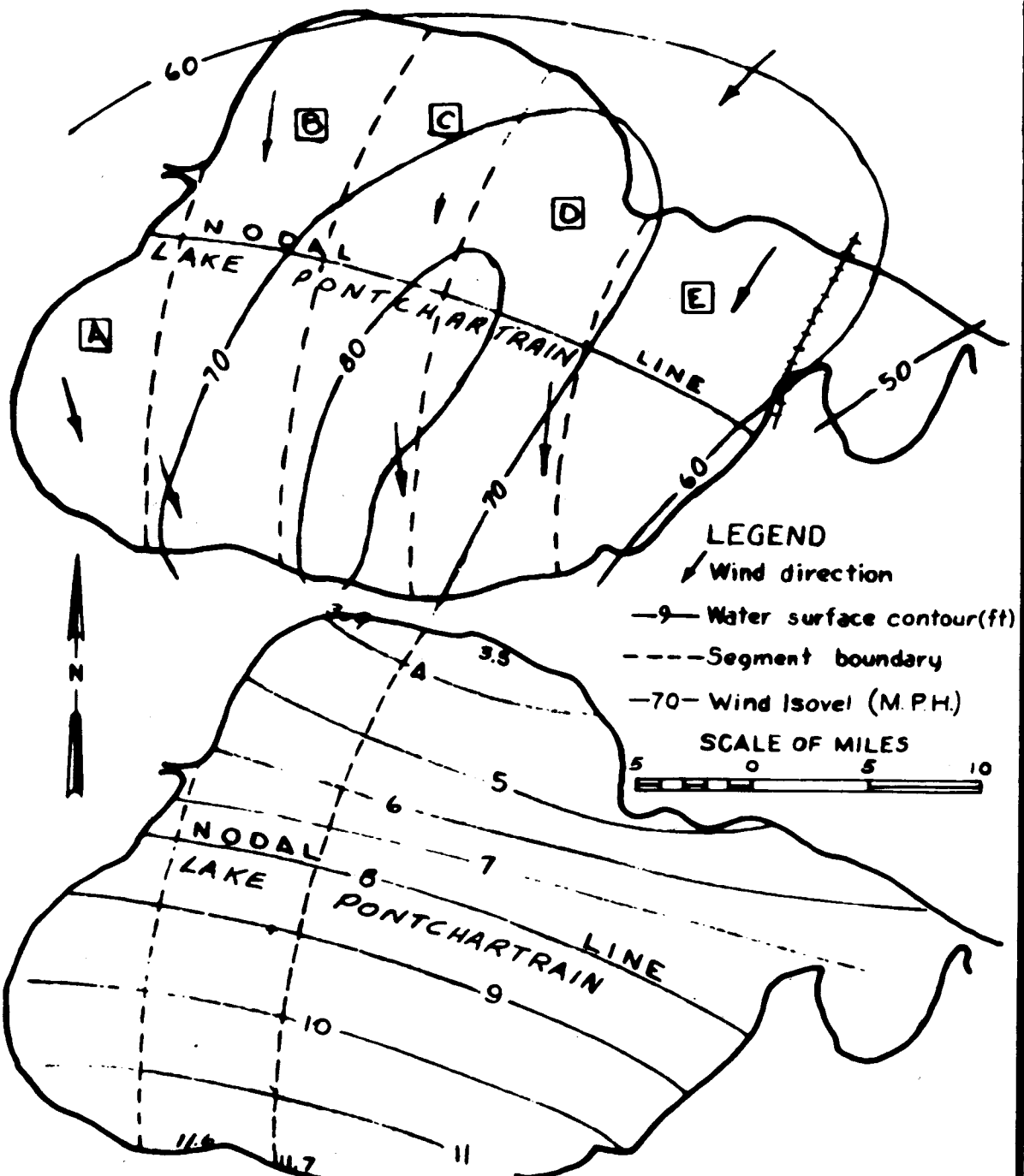

Sample: 8 hours after landfall - Track A-SPH

Setdown:

$$S = \frac{0.00266 \left(\frac{60^2}{14.2} \right) (1.0)}{1} + 0.0 - 4.1 = -4.1$$
 + 0.0 - WTL
 + 3.4 - WTL

Setup:

$$S = 20.5 \left[\frac{0.00266 \left(\frac{70^2}{20.5} \right) (1.1)}{1} \right] - 1$$
 + 3.6 - WTL
 + 2.0 - WTL
 + 1.6 - WTL

Interpolate with data for MWL = 6.0' to obtain WTL's for routed MWL = 7.28'

LAKE PONTCHARTRAIN, LA. AND VICINITY
 HIGH LEVEL PLAN
 DESIGN MEMORANDUM NO. 15 - GENERAL DESIGN
 ST CHARLES PARISH LEVEE
 LAKE PONTCHARTRAIN
 TYPICAL
 WIND TIDE CONTOURS
 U.S. ARMY ENGINEER DISTRICT, NEW ORLEANS
 CORPS OF ENGINEERS

DECEMBER 1988 FILE NO. M-2-30423

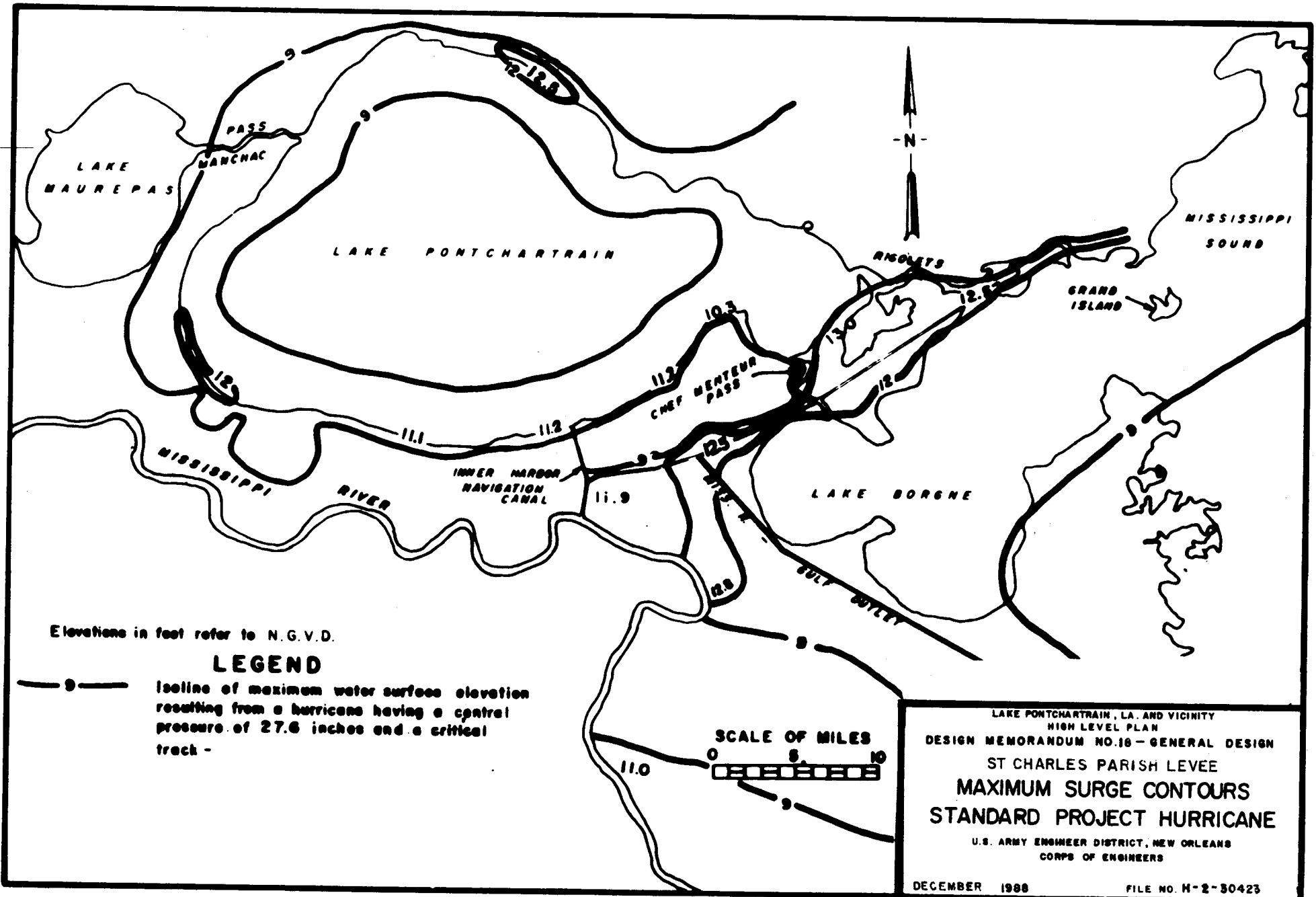

LEGEND

- (A) Hurricane tracks from the south
- (B) Hurricane tracks from the east
- (C) Combined hurricane tracks
- (D) Shifted to experienced frequency plot
- Experienced stage frequency

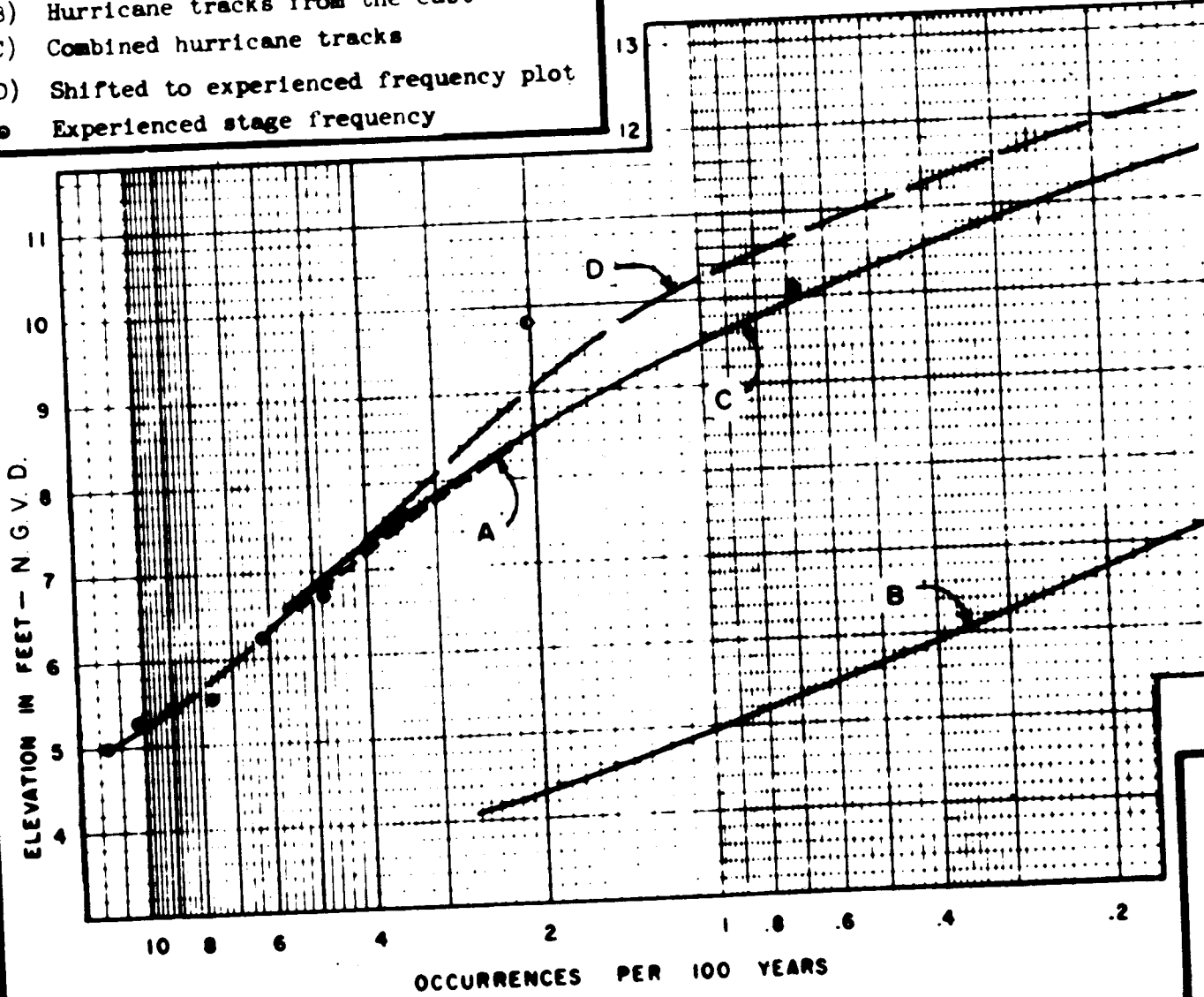

FREQUENCY ANALYSIS

M	Years	Wind tide level (ft.)	(1) Probability
1	1901	10.1	.685
2	1893	9.8	2.05
3	1965	7.6	3.42
4	1915	6.7	4.79
5	1909	6.2	6.16
6	1947	5.5	7.53
7	1956	5.4	8.90
8	1964	5.3	10.27
9	1926	5.0	11.64

(1) Probability
 $P = \frac{100}{M - 0.5}$ where
 M = Number of the event (rank)
 Y = Number of years of record (73)

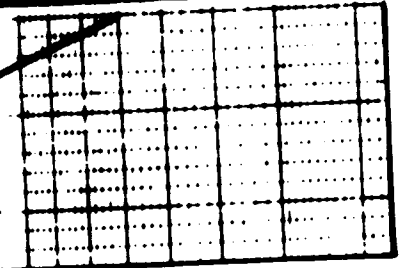

1 .08 .06 .04

LAKE PONTCHARTRAIN, LA. AND VICINITY
 HIGH LEVEL PLAN
 DESIGN MEMORANDUM NO. 15 - GENERAL DESIGN
 ST. CHARLES PARISH LEVEE
 STAGE - FREQUENCY
 SOUTH SHORE OF
 LAKE PONTCHARTRAIN
 U.S. ARMY ENGINEER DISTRICT, NEW ORLEANS
 CORPS OF ENGINEERS
 DEC 1968 FILE NO. H-2-30423

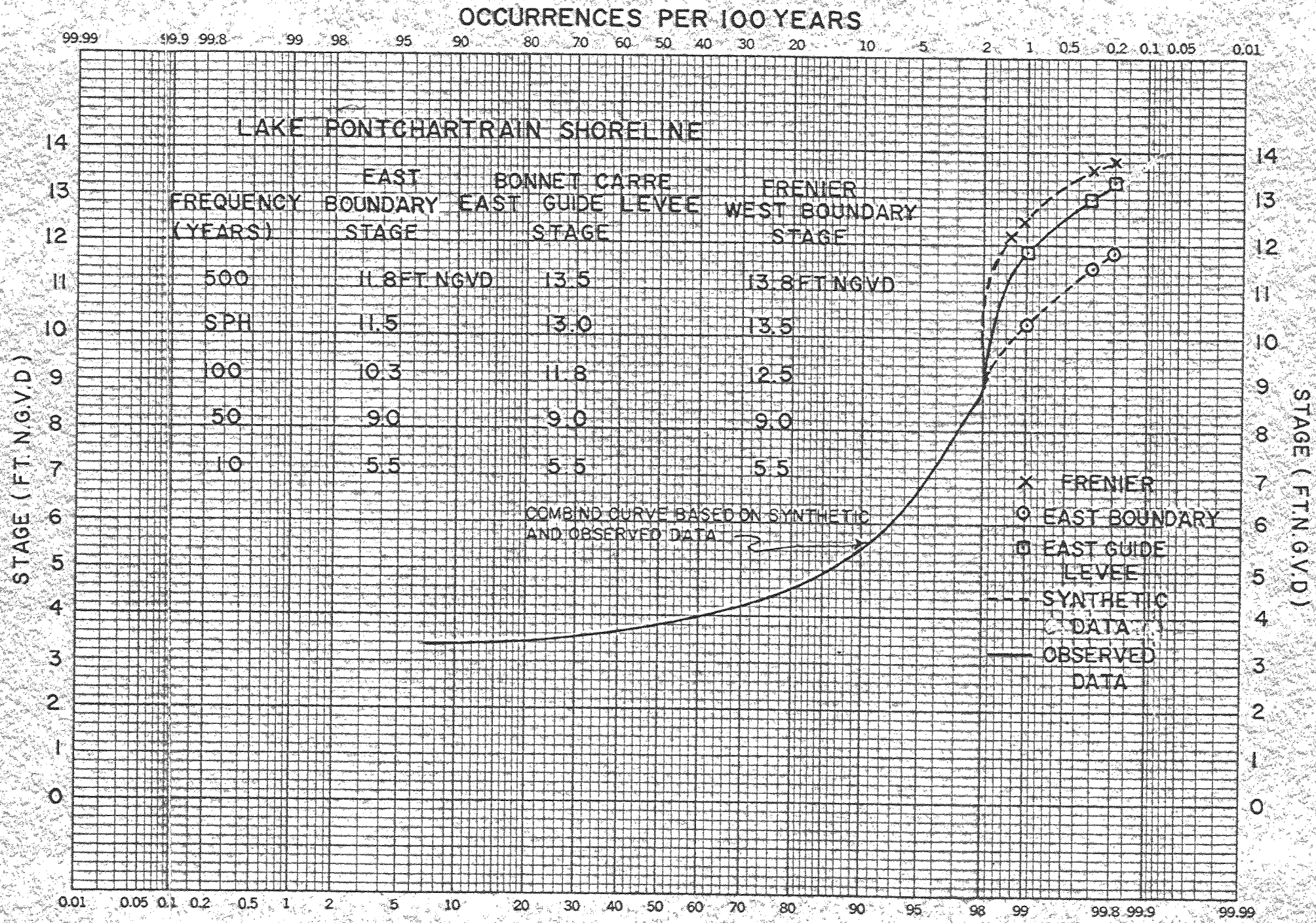

LAKE PONTCHARTRAIN, LA. AND VICINITY
HIGH-LEVEL PLAN
DESIGN MEMORANDUM NO. 18 - GENERAL DESIGN
ST. CHARLES PARISH LEVEE

STAGE
FREQUENCY EASTBANK

U.S. ARMY ENGINEER DISTRICT, NEW ORLEANS
CORPS OF ENGINEERS

DEC. 1988 FILE NO. H-2-30423

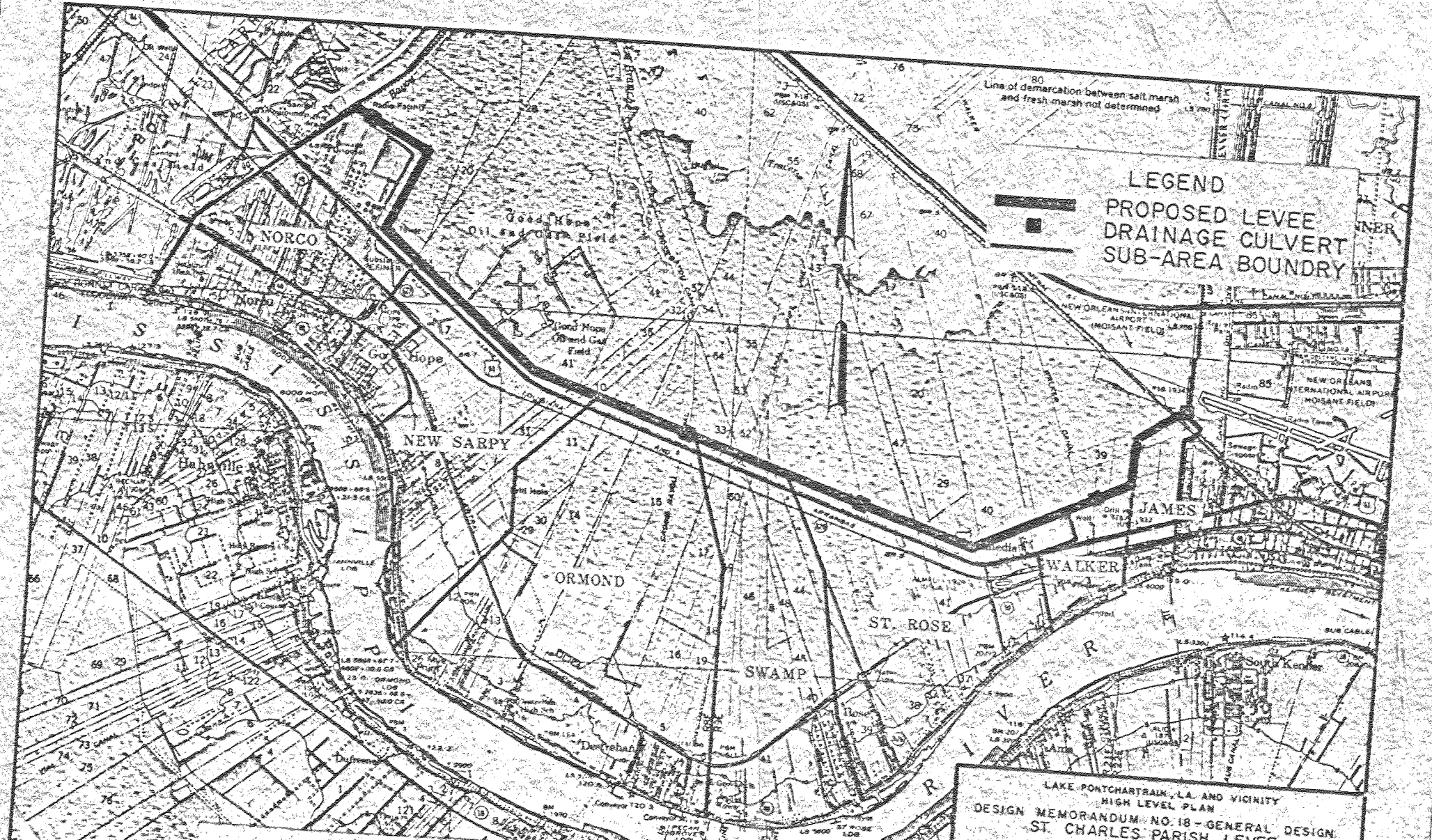

LAKE PONTCHARTRAIN, LA. AND VICINITY
 HIGH LEVEL PLAN
 DESIGN MEMORANDUM NO. 18 - GENERAL DESIGN
 ST. CHARLES PARISH LEVEE

**VICINITY MAP
 SUB-AREAS & CULVERT LOCATIONS**

U.S. ARMY ENGINEER DISTRICT, NEW ORLEANS
 CORPS OF ENGINEERS

DEC 1988

FILE NO. H-2-30423

ELEVATION (FT. N.G.V.D.)

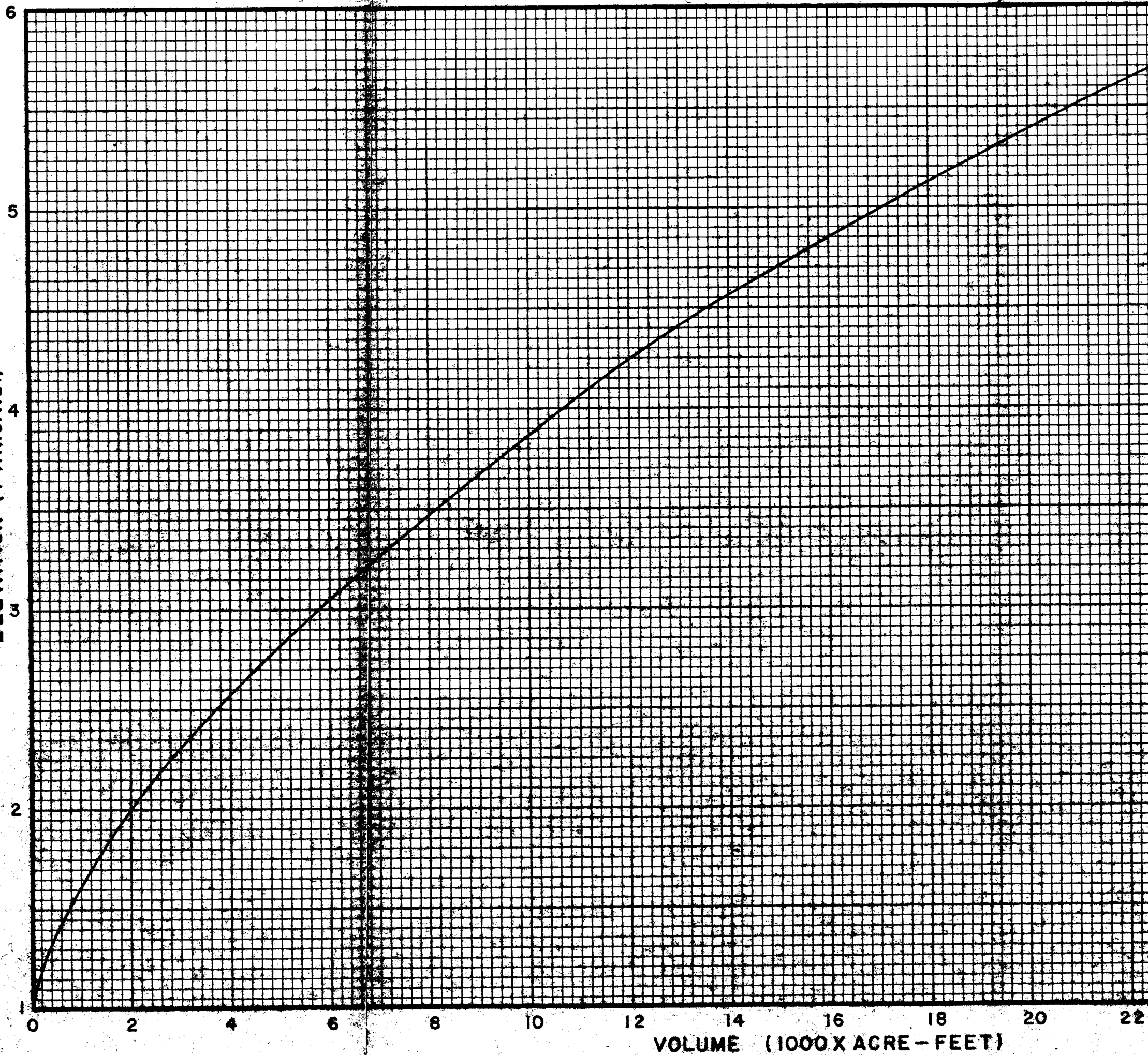

24 26 28

LAKE PONTCHARTRAIN, LA. AND VICINITY
HIGH LEVEL PLAN
DESIGN MEMORANDUM NO. 18 - GENERAL DESIGN

ST. CHARLES PARISH
HURRICANE PROTECTION PROJECT
AIRLINE HIGHWAY LEVEE ALIGNMENT
STAGE — VOLUME CURVE

U.S. ARMY ENGINEER DISTRICT NEW ORLEANS
CORPS OF ENGINEERS

SEC. 1900 FILE NO. N-2-36423

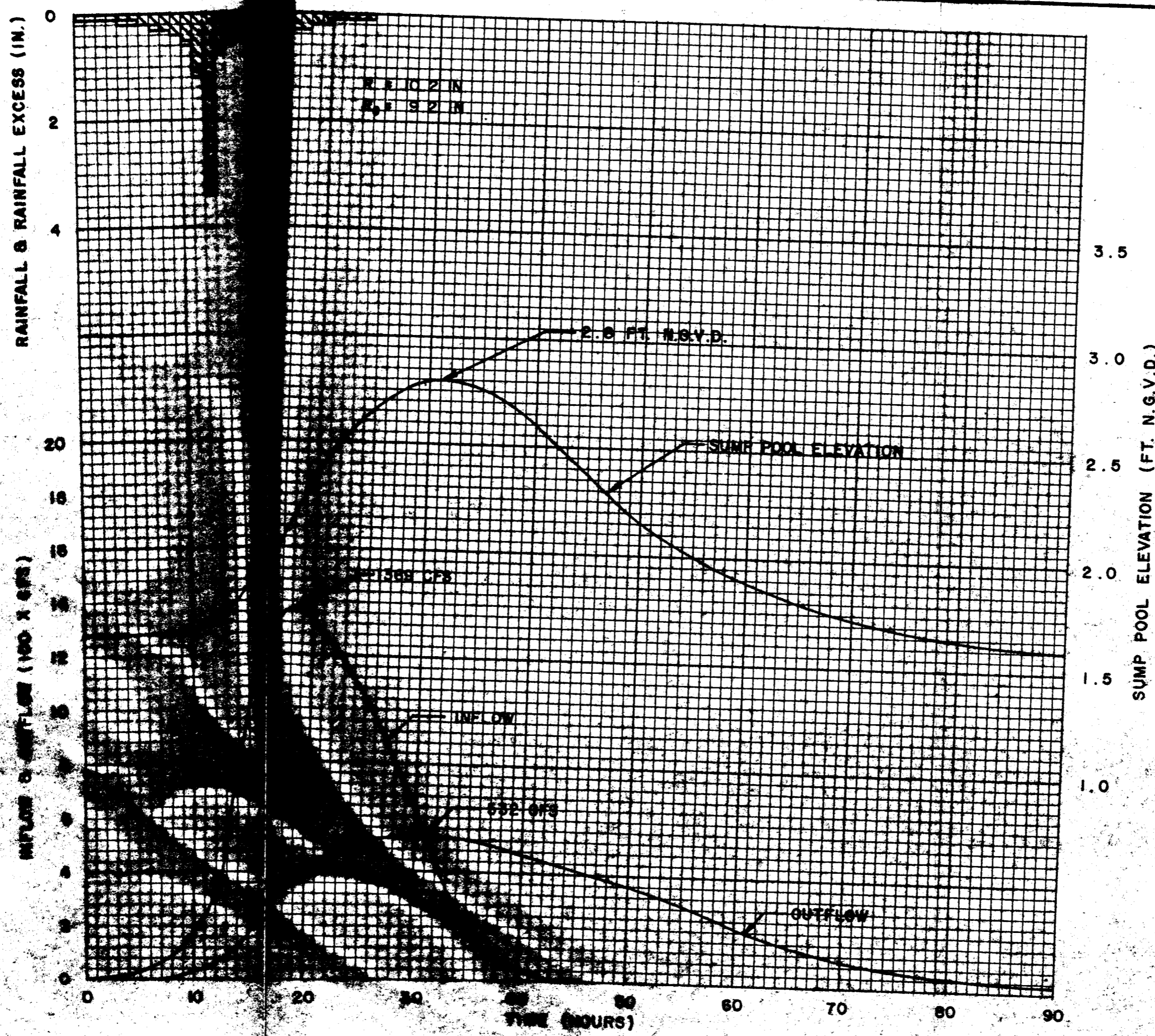

LAKE PORTCHERRYMAN, L.A. AND VICINITY
 WASH. LEVEL PLAN
 DESIGN MEMORANDUM NO. 18 - GENERAL DESIGN
 ST. CHARLES PARISH LEVEE
 AIRLINE HIGHWAY LEVEE ALIGNMENT
 DRAINAGE STRUCTURE DESIGN DATA
 SUBDRAINAGE AREA: NORCO
 U.S. ARMY ENGINEER DISTRICT, NEW ORLEANS
 CORPS OF ENGINEERS
 DEC 1968

FILE NO. W-2-30423

PLATE A-21

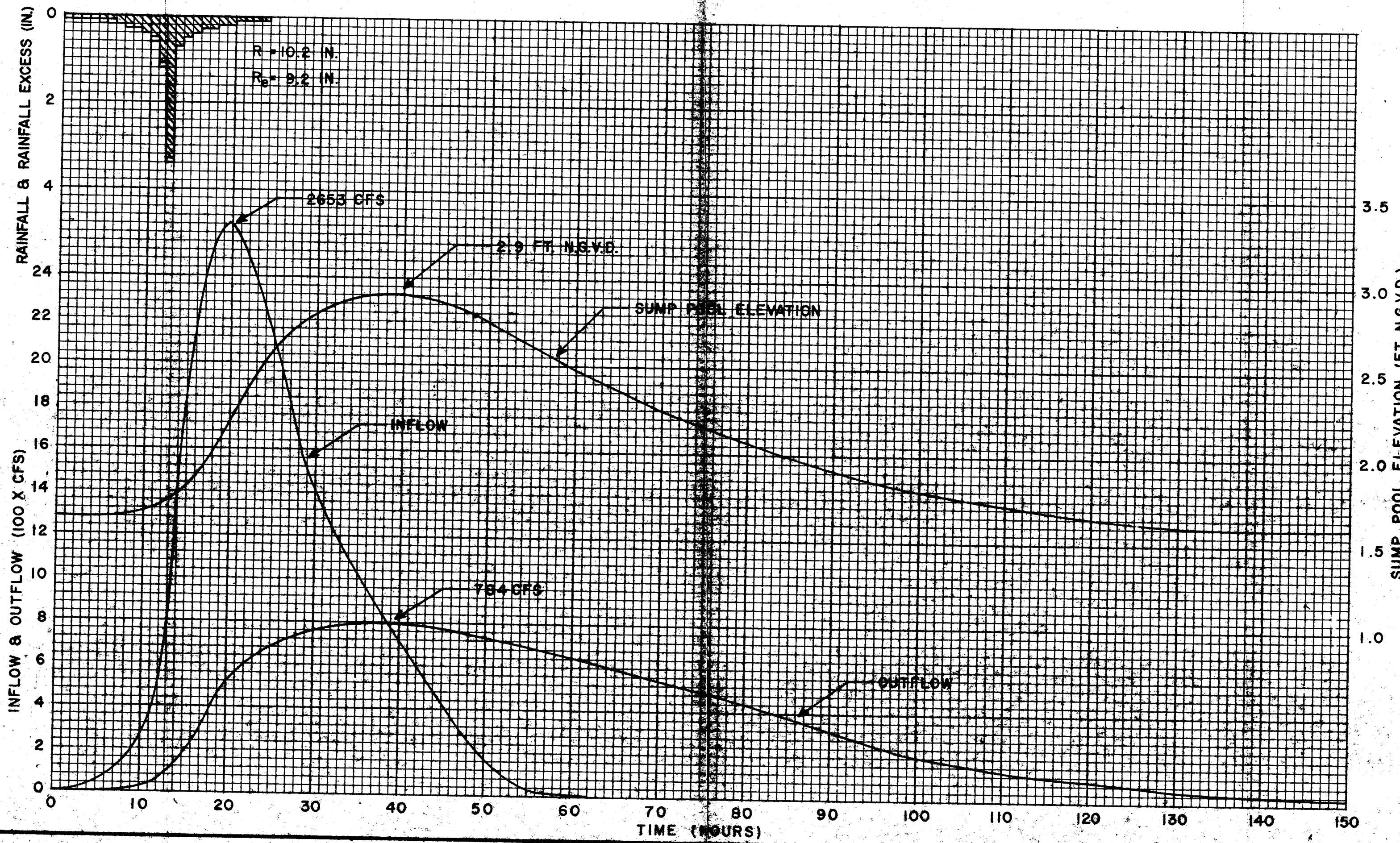

LAKE PONTCHARTRAIN, LA., AND VICINITY
 HIGH-LEVEL PLAN
 DESIGN MEMORANDUM NO. 18, GENERAL DESIGN
 ST. CHARLES PARISH LEVEE
 AIRLINE HIGHWAY LEVEE ALIGNMENT
 DRAINAGE STRUCTURE DESIGN DATA
 SUBDRAINAGE AREA: NSARPY & ORMDES
 U.S. ARMY ENGINEER DISTRICT, NEW ORLEANS
 CORPS OF ENGINEERS
 DEC. 1966 FILE NO. H-2-30483

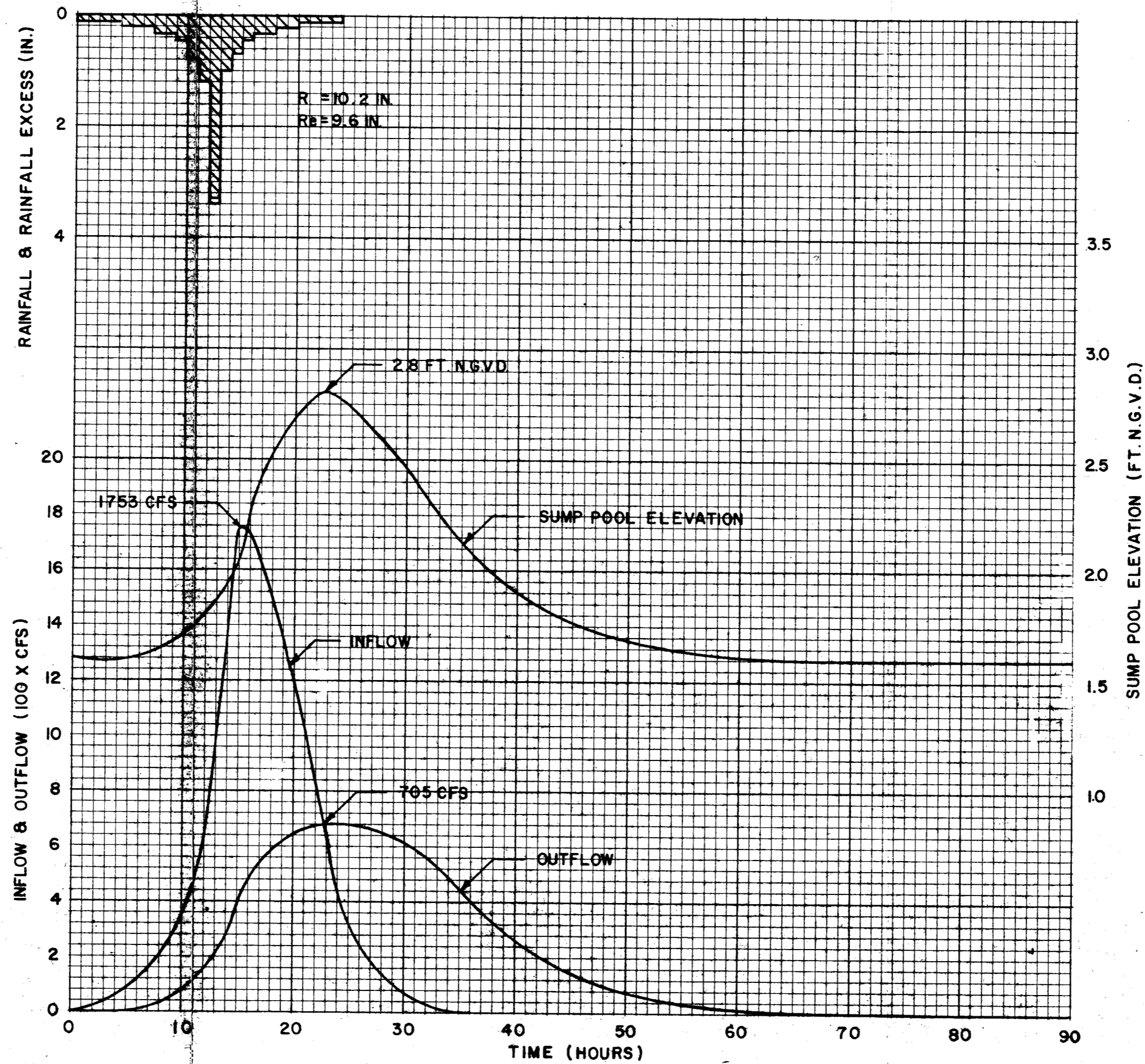

LAKE PONTCHARTRAIN, LA. AND VICINITY
HIGH LEVEL PLAN
DESIGN MEMORANDUM NO. 18 - GENERAL DESIGN
ST. CHARLES PARISH LEVEE
AIRLINE HIGHWAY LEVEE ALIGNMENT
DRAINAGE STRUCTURE DESIGN DATA
SUBDRAINAGE AREA: "SWAMP"
U.S. ARMY ENGINEER DISTRICT, NEW ORLEANS
CORPS OF ENGINEERS

DEC 1966

FILE NO. H-2-30423

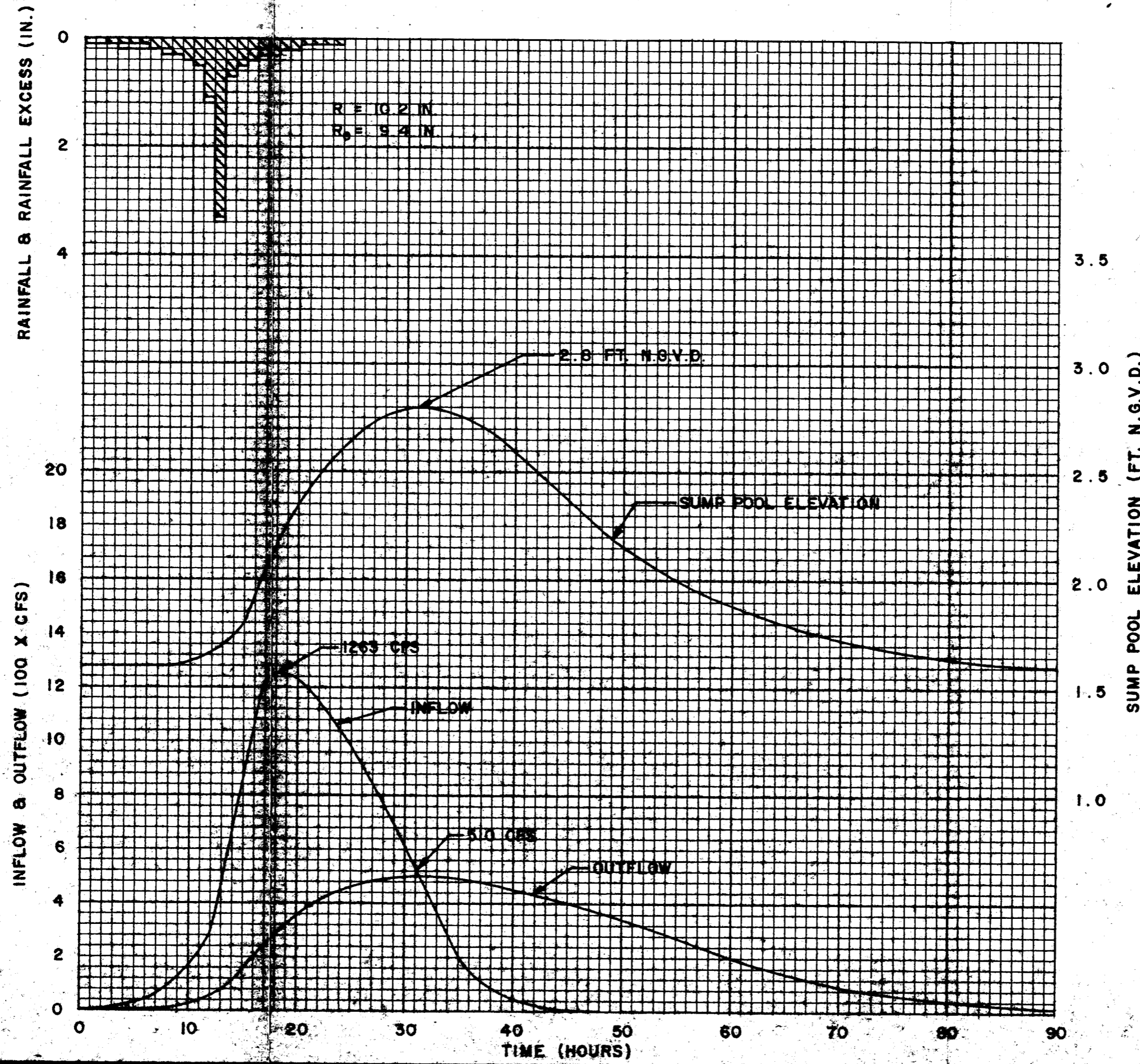

LAKE PONTCHARTRAIN, LA. AND VICINITY
HIGH LEVEL PLAN
DESIGN MEMORANDUM NO. 18 - GENERAL DESIGN
ST. CHARLES PARISH LEVEE
AIRLINE HIGHWAY LEVEE ALIGNMENT
DRAINAGE STRUCTURE DESIGN DATA
SUBDRAINAGE AREA: ST. ROSE
U.S. ARMY ENGINEER DISTRICT, NEW ORLEANS
CORPS OF ENGINEERS

DEC 1966 FILE NO. H-2-30423

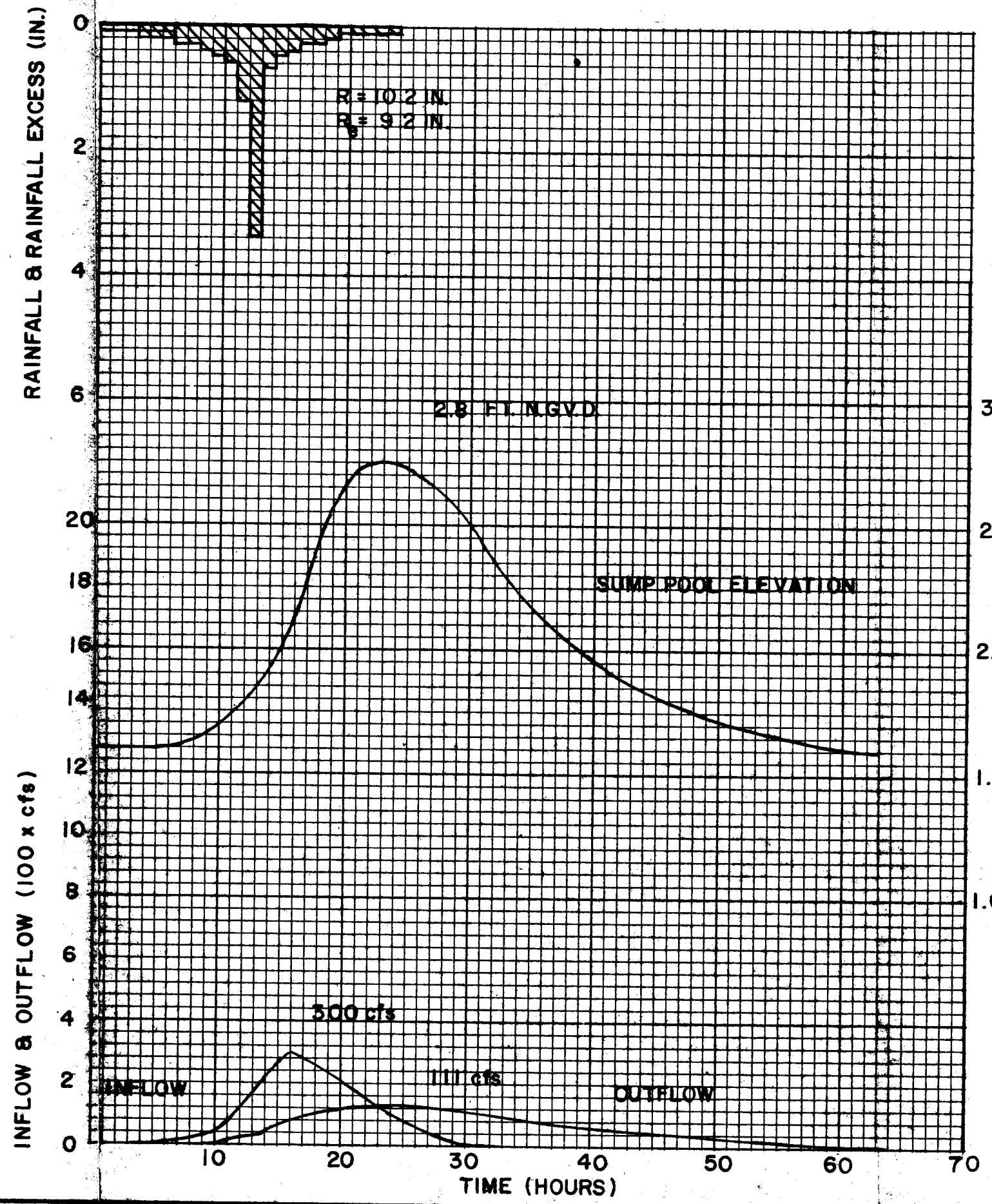

LAKE PONTCHARTRAIN, LA. AND VICINITY
 HIGH LEVEL PLAN
 DESIGN MEMORANDUM NO. 18 - GENERAL DESIGN
ST. CHARLES PARISH LEVEE
 AIRLINE HIGHWAY LEVEE ALIGNMENT
 DRAINAGE STRUCTURE DESIGN DATA
 SUBDRAINAGE AREA: WALKER
 U.S. ARMY ENGINEER DISTRICT, NEW ORLEANS
 CORPS OF ENGINEERS
 DEC. 1968 FILE NO. H-2-30423

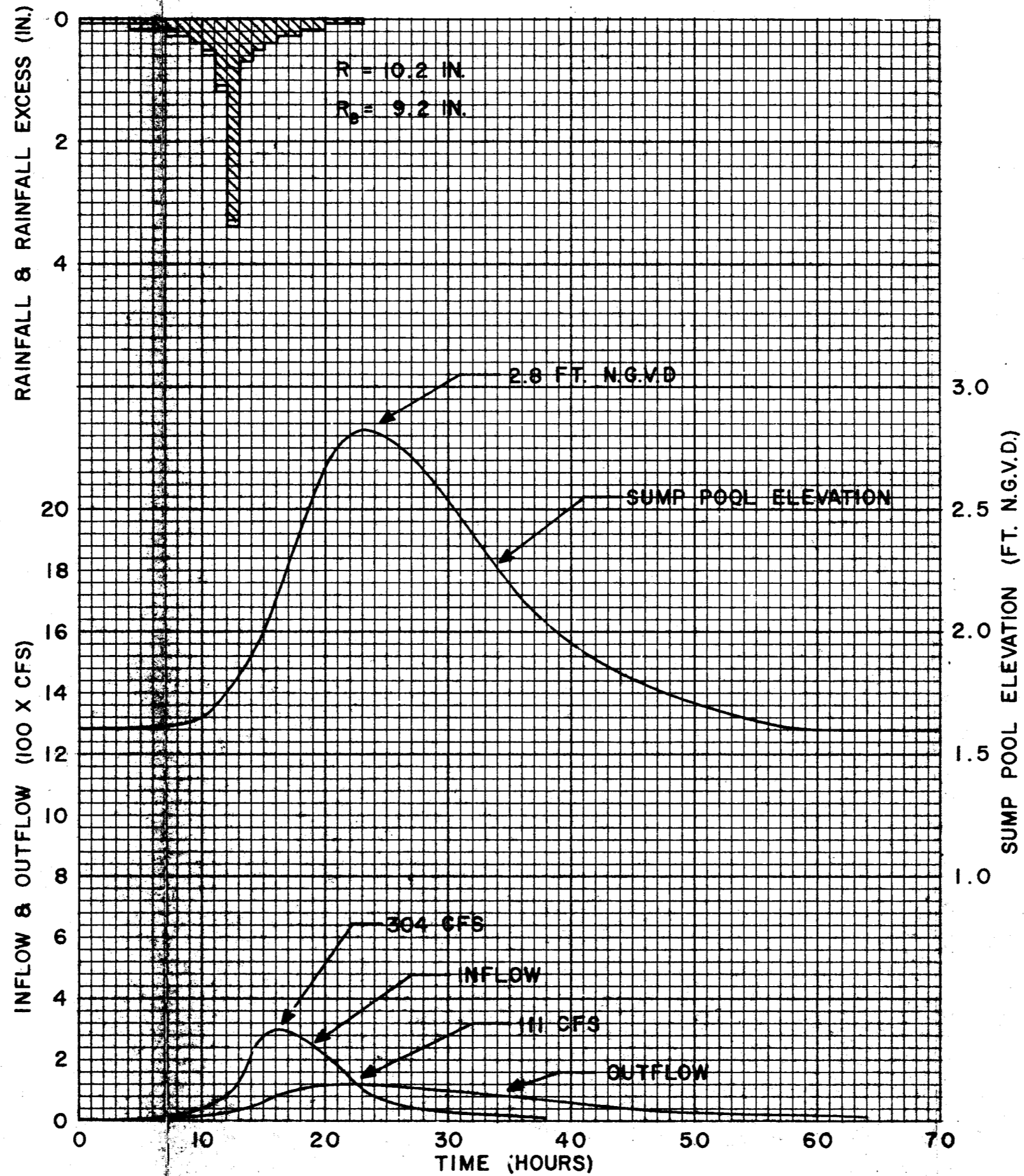

LAKE PONTCHARTRAIN, LA. AND VICINITY
 HIGH LEVEL PLAN
 DESIGN MEMORANDUM NO. 18 - GENERAL DESIGN
 ST. CHARLES PARISH LEVEE
 AIRLINE HIGHWAY LEVEE ALIGNMENT
 DRAINAGE STRUCTURE DESIGN DATA
 SUBDRAINAGE AREA: JAMES
 U.S. ARMY ENGINEER DISTRICT, NEW ORLEANS
 CORPS OF ENGINEERS
 DEC. 1966 FILE NO. H-2-30423

LAKE PONTCHARTRAIN, LOUISIANA AND VICINITY
HIGH LEVEL PLAN
DESIGN MEMORANDUM No. 18 - GENERAL DESIGN
ST. CHARLES PARISH NORTH OF AIRLINE HIGHWAY

APPENDIX B, VOLUME I

PERTINENT CORRESPONDENCE



United States Department of the Interior

825 Kaliste Saloom Rd.
Brandywine Bldg. II, Suite 102
Lafayette, Louisiana 70508

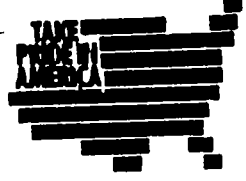

November 9, 1988

Colonel Lloyd K. Brown
District Engineer
U.S. Army Corps of Engineers
Post Office Box 60267
New Orleans, Louisiana 70160

Dear Colonel Brown:

Reference is made to the General Design Memorandum being developed for the St. Charles Parish, North of U.S. Highway 61 feature of the Lake Pontchartrain, Louisiana, and Vicinity Hurricane Protection Project. By letter dated July 16, 1988, the Fish and Wildlife Service (Service) provided a supplement to the July 1984 Fish and Wildlife Coordination Act Report on the above-referenced project. In that supplemental report, the Service recommended that four design elements be incorporated in the subject General Design Memorandum. Those design elements were discussed during a June 17, 1988, interagency meeting held at the Louisiana Department of Environmental Quality headquarters in Baton Rouge and during subsequent conversations between our respective staffs.

The following statements reiterate the Service's recommendations, summarize our interpretation of the Corps of Engineers' (Corps) response, and provide a formal request for more information:

1. Service recommendation: The levee right-of-way should be reduced to the minimum width necessary for construction.

Interpretation of Corps' response: The base width of the proposed levee is currently estimated to range from 300 to 350 feet.

Request for Additional Information: What is the total right-of-way width for the levee as presently proposed? Is that width the minimum needed for construction?

2. Service recommendation: The levee should be aligned immediately north of U.S. Highway 61 as indicated by the Service on the plans provided to your staff on May 24, 1988.

Interpretation of Corps' response: The centerline of the levee is currently planned to be approximately 800 feet north of U.S. Highway 61. This response was provided despite two important points: a) the July 1984 Main Report and Final Supplement I to the Environmental Impact Statement for the subject project stated that the levee would be located "...just north of U.S. Highway 61..." and (in another

portion of that document) "...immediately north of U.S. Highway 61...", and b) a member of your engineering staff indicated that it may be technically feasible for the centerline to be as close as 300 feet north of U.S. Highway 61.

Request for Additional Information: What is the currently proposed alignment? Is it technically (i.e., from an engineering/safety standpoint) feasible to move the levee closer to U.S. Highway 61?

3. Service recommendation: The water control structures should be large enough to maintain existing flows from each respective "sub-area" and equipped with sluice gates to remain completely open except during the threat of a hurricane.

Interpretation of Corps Response: It is currently planned that the Norco "sub-area" would have a "small" water control structure on Bayou Trepanier and a "large" structure on Engineers' Canal. Details regarding the remaining structures (i.e., number, location, size) have not been finalized. Structures would remain completely open except during the threat of a hurricane.

Request for additional information: What are the currently proposed design specifics (location, size, invert elevation) for all water control structures to be incorporated in the levee? The Service remains interested in providing input regarding the design of all water control structures.

4. Service recommendation: The abandoned petroleum drilling sites and solid waste landfills should be tested for priority pollutants (as listed by the Environmental Protection Agency) prior to excavation or deposition of material. Any treatment or disposal of that material should be accomplished in consultation with the Louisiana Department of Environmental Quality, the Environmental Protection Agency, and the Service.

Interpretation of Corps' response: The Louisiana Office of Conservation has indicated that all of the petroleum drilling sites are scheduled to be cleaned-up by January 1989. That agency is presently investigating the status of the scheduled clean-up. The Corps remains undecided as to design of the levee in the area of the two solid waste landfills. The Louisiana Department of Environmental Quality has issued, to Shell Oil, a plan for remedial action concerning contaminated sediments in Bayou Trepanier.

Request for additional information: What is the current status of the abandoned petroleum drilling sites and what is the Corps' current plan regarding levee alignment in the area of those sites and in the area of the two solid waste landfills?

Please provide us with the above-requested information before the General Design Memorandum for the referenced project feature is finalized. Depending on your response to the above questions, it may be necessary to

modify our previous findings and recommendations. Your cooperation in this matter will be greatly appreciated. Please have your staff contact Quin Kinler of this office if they have any questions regarding this matter.

Sincerely yours,



David W. Frugé
Field Supervisor

QJK/pl

Attachments: as stated

cc: EPA, Dallas, TX
LA Dept. of Wildlife and Fisheries, Baton Rouge, LA
LA Dept. of Natural Resources (CMD), Baton Rouge, LA
NMFS, Baton Rouge, LA
FWS, Atlanta, GA (AWE)
St. Charles Parish, Dept. of Planning and Zoning, Hahnville, LA

January 30, 1989
Norco, Louisiana

Dr. David A. Vigh
Corps of Engineers
P. O. Box 60267
New Orleans, LA 70160-0267

Re: CELMN-PD-RE

Dear Mr. Vigh:

We find the environmental assessment for the St. Charles area hurricane levee to be acceptable, but would ask that you consider the following modifications.

- #1 Consider the installation of only one structure in the Bayou Trepagnier/Engineers Canal area. Some flow should be discharged or diverted into Bayou Trepagnier, but Engineers Canal should get most of the drainage.
- #2 Closely co-ordinate the storm drainage needs for the Parish with construction of the levee.
- #3 Recreation. Eliminate the proposed boat launch on Bayou La Branche. An alternate would be to improve the boat launch on the Engineers Canal at the rear of the East Guide Levee of the Bonne Carre Floodway. This launch provides access to Bayou La Branche.
- #4 Recreation. Consider maintaining the top of the levee along it's length as a hiking/nature trail.
- #5 Mitigation. We still feel that some funds for mitigation should be directed to the Lake Ponchartrain shoreline in St. Charles Parish. The Ponchartrain Levee Board own a strip along the lakeshore.

We appreciate being able to make recommendations for this project and look forward to working with you to insure that this project is completed on schedule.

Yours truly,

M. L. Cambre
M. L. Cambre



UNITED STATES DEPARTMENT OF COMMERCE
National Oceanic and Atmospheric Administration
NATIONAL MARINE FISHERIES SERVICE

Southeast Regional Office
9450 Koger Boulevard
St. Petersburg, FL 33702

February 6, 1989

F/SER114/PK:jk
504/389-0508

Dr. David A. Vigh
New Orleans District, CELMN-PD-RE
Department of the Army, Corps of Engineers
P. O. Box 60267
New Orleans, LA 70160-0267

Dear Dr. Vigh:

The National Marine Fisheries Service (NMFS) has reviewed the Environmental Assessment (EA) and the unsigned Finding of No Significant Impact (FONSI) on modifications of a segment of the St. Charles Parish area hurricane protection levee, Lake Pontchartrain, Louisiana, and Vicinity Hurricane Protection Project. Since we did not receive a copy of these documents until January 26, 1989, you granted us a time extension until February 8, 1989, to provide comments.

It appears that your preferred alternative for proposed realignment of the levee around the New Orleans Airport is the least damaging. The proposed levee crossing the scenic stream and a tributary to a scenic stream also appear to have been minimized. However, the NMFS is concerned that the levee crossing of the two landfill sites and the oil field waste pits would disturb and redistribute pollutants into the aquatic ecosystem of Lake Pontchartrain. To evaluate and minimize this risk, rigorous pollutant testing and strict adherence to Louisiana Department of Environmental Quality and U.S. Environmental Protection Agency guidelines for treatment or disposal of contaminated material is necessary.

The paragraph "Factors Considered in Determinations" in the FONSI should be corrected to indicate that the proposed changes would have only minimal adverse impacts...in addition to those impacts already described. As stated in our previous letter dated April 11, 1984, "...the wetlands loss still anticipated in St. Charles Parish could be further reduced by realigning the levee, now proposed to be parallel and slightly north of Airline Highway, to be contiguous to that highway." The "slightly north" alignment now would place the centerline of the levee approximately 800 ft. north of Airline Highway with a base width of 300 ft.



Neither this EA nor the FONSI addresses the capacity or operational plan for the box culverts. The NMFS recommends that the box culverts to be placed to maintain flows in the scenic stream, a tributary to a scenic stream and the drainage ditch be sufficiently large so as not to interrupt existing hydrology. Gates on the structures should be closed only when hurricanes threaten the project area.

Thank you for the opportunity to comment on this EA and FONSI.

Sincerely yours,

for 
for Andreas Mager, Jr.
Acting Assistant Regional Director
Habitat Conservation Division

Shell Oil Company • Shell Chemical Company

A Division of Shell Oil Company



Norco Manufacturing Complex
P. O. Box 10
Norco, Louisiana 70079

January 30, 1989

CERTIFIED MAIL - RETURN RECEIPT REQUESTED

Dr. David A. Vigh
U. S. Army Corps of Engineers
CELMN-PD-RE
P. O. Box 60267
New Orleans, LA 70160-0267

Re: Environmental Assessment-Lake Pontchartrain, Louisiana,
and Vicinity Hurricane Protection Project

Dear Dr. Vigh:

This will acknowledge receipt of the Environmental Assessment ("EA") on the captioned matter which calls for comments from interested parties by January 30, 1989. Shell has identified three areas of concern in the EA and offers the following comments.

1. In the section of the EA entitled "Biological Impact" the report states on p7 that the Shell Refinery is under a Remedial Demand Order to clean up the sediments in Bayou Trepagnier in two phases. This is incorrect. Several weeks after the Army Corps circulated the EA, the Secretary of the Louisiana Department of Environmental Quality ("DEQ") issued a Remedial Demand Order dated January 11, 1989, which would require Shell to perform a Remedial Investigation Feasibility Study for Bayou Trepagnier in two phases. A copy of the Order is enclosed. The Order calls for an investigation to characterize whether there are in fact any environmental problems posed by contaminants which DEQ claims have accumulated in the Bayou sediments and if so to evaluate appropriate remedial measures. The Order does not provide for clean-up which can only be required if it is ultimately shown that the sediments in question pose an imminent and substantial endangerment to health or the environment. For your information Shell is currently considering a response to the Order.
2. There is a statement on p7 indicating that there are pollutants trapped in the bottom sediments of Bayou Trepagnier that are of "major concern." Since this statement purports to apply to the entire 3 1/2 mile course of the Bayou, we question its relevance in the EA to the Army Corps project which will only affect approximately 400 feet of the Bayou.

To support the statement that the bottom sediments are a "major concern," the EA attaches 1985 sediment data charts prepared by the Louisiana DEQ. Shell has reviewed these charts, which may be part of an overall DEQ environmental report on Bayou Trepagnier which is not yet final, and questions not only the accuracy of the data upon which the charts are based but also the conclusion on p7 of the EA that the pollutants trapped in the bottom sediments constitute a major concern. In this regard Shell commissioned three studies by independent consultants to determine whether any heavy metals, which may exist in the sediments of Bayou Trepagnier, are toxic to the surrounding environment. The reports of the Shell consultants, which were provided to the DEQ in July, 1988, conclude that any metals or other substances which may exist in the sediments of the Bayou have not had any toxic effect on the quality of the water in the Bayou or on plant or animal life in the water or on the land surrounding the Bayou. Copies of these reports are enclosed. For your information Shell has commissioned several additional studies from its consultants to further corroborate their findings which will be furnished to DEQ and which we will be pleased to share with you when the studies are complete.

3. In the section of the EA entitled "Scenic Streams," a statement is made on p2 that the currently permitted industrial effluent from Shell's Refinery will be redirected to the nearby Engineers Canal. We would note that this is an issue which has been raised by the Louisiana DEQ Water Permit Section. In this regard in the fall of 1988 the DEQ developed several options concerning the possibility of rerouting Shell's Refinery effluent and circulated these options to several other affected state agencies. Shell received a copy of the outline and some of the responses from the other state agencies in late December, and a meeting was held with DEQ in mid-January. However there has been no resolution of this issue.

Copies of the above correspondence are enclosed. Please note that the Coastal Zone authorities (Department of Natural Resources) commented that rerouting some or all of the current Shell effluent from Bayou Trepagnier to the Engineers Canal might have a significant adverse impact on the wetlands area immediately surrounding the Bayou.

Finally, while the issue of the rerouting of the Shell effluent will have to be ultimately resolved between Shell and the state agencies, we would strongly suggest that any culvert structures installed in Bayou Trepagnier by the Army Corps as part of the Hurricane Levee Project be designed in a manner which will not impede the current effluent flow to the Bayou.

Thank you very much for providing Shell the opportunity to comment on the Army Corps' Environmental Assessment of its Hurricane Levee Project.

Very truly yours,

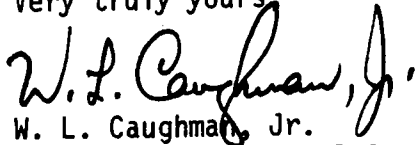
A handwritten signature in black ink that reads "W. L. Caughman, Jr." The signature is written in a cursive style with a large, prominent initial "W".

W. L. Caughman, Jr.
Manager Environmental Conservation

BFA:tnt

Enclosures



JAN 26 1989

United States Department of the Interior

825 Kaliste Saloom Rd.
Brandywine Bldg. II, Suite 102
Lafayette, Louisiana 70508

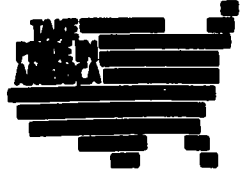

January 25, 1989

Colonel Richard V. Gorski
District Engineer
U.S. Army Corps of Engineers
Post Office Box 60267
New Orleans, Louisiana 70160

Dear Colonel Gorski:

The Fish and Wildlife Service (Service) has reviewed the Environmental Assessment and an unsigned Finding of No Significant Impact on modifications of the St. Charles Parish, North of U.S. Highway 61 feature of the Lake Pontchartrain, Louisiana, and Vicinity Hurricane Protection Project.

Based on the Environmental Assessment, it appears that the environmental effects of crossing a scenic stream and its tributary, crossing two landfill sites, and realigning the levee at the Moisant International Airport runway extension have been minimized to the greatest extent practicable. The Service remains concerned, however, that there may be environmental contaminant-related problems associated with the disturbance of several abandoned oil field waste pits. The Environmental Assessment identifies potential pit contaminants (i.e., oil and grease, drilling muds, cuttings, and packing materials) and states that all abandoned pits are to be cleaned-up by their owners, according to state regulations, by February 1989. State regulations, however, do not normally require inspection or review of data regarding the adequacy of clean-up efforts. Consequently, environmental contaminants may remain on site. The Service, therefore, recommends that the oil field waste pit sites be tested for priority pollutants (as listed by the Environmental Protection Agency) following pit closure, with the results furnished to the Service for review and comment prior to excavation or deposition of material for levee construction. If priority pollutants are identified, the Service further recommends that treatment or disposal of contaminated material be accomplished in consultation with the Louisiana Department of Environmental Quality, the Environmental Protection Agency, and the Service prior to levee construction in the vicinity of the closed waste pits.

Provided that the recommended testing (and treatment or disposal, if necessary) of the abandoned oil field waste pit sites is accomplished, the Service would concur with a Finding of No Significant Impact for the specific issues of the crossing of a scenic stream and its tributary, the crossing of the landfills, the disturbance of petroleum waste pits, and realignment of the levee at Moisant International Airport. However, the Service does not concur with the statement in the unsigned Finding of No

Significant Impact that implementation of this project (St. Charles Parish, North of U.S. Highway 61 feature) "...would result in only minimal adverse impacts to fish and wildlife resources..." or with the conclusion that "...the action would have no significant adverse impact on the human environment." Construction of the proposed levee would eliminate approximately 360 acres of forested wetlands. Improper design or operation of water control structures could alter the hydrology of approximately 3,000 acres of forested wetlands located south of U.S. Highway 61. Furthermore, locating the levee (center line) approximately 800 feet north of U.S. Highway 61, versus "...just north of U.S. Highway 61..." as stated in the July 1984 Main Report and Final Supplement I to the Environmental Impact Statement, would significantly increase the likelihood of commercial/industrial development of about 500 acres of forested wetlands located between the proposed levee and U.S. Highway 61. The Service does not consider these impacts and potential impacts to fish and wildlife resources to be minimal or insignificant.

To minimize impacts, the Service continues to recommend, as indicated in letters dated June 16, 1988, and November 9, 1988, that the following design elements be incorporated in the General Design Memorandum being prepared for the subject project feature:

1. The levee right-of-way should be reduced to the minimum width necessary for construction.
2. The levee should be aligned immediately north of U.S. Highway 61 as indicated by the Service on the plats provided to your staff on May 24, 1988.
3. The water control structures should be large enough to maintain existing flows from each respective "sub-area" and equipped with sluice gates to remain completely open except during the threat of a hurricane.
4. The abandoned petroleum drilling sites should be tested for priority pollutants (as listed by the Environmental Protection Agency) following pit closure, with the results furnished to the Service for review and comment prior to excavation or deposition of material for levee construction. If priority pollutants are identified, the treatment or disposal of contaminated material should be accomplished in consultation with the Louisiana Department of Environmental Quality, the Environmental Protection Agency, and the Service prior to levee construction in the vicinity of the closed pits. (This recommendation represents a modified version of the one presented in our previous letters; it has been changed to address pit closures which should be nearly complete and to acknowledge that the landfill crossings have been adequately addressed.)

Our November 9, 1988, letter (copy attached) formally requested additional information regarding each of the Service's recommendations on this project feature. We have not received the requested information. Therefore, we reiterate our request for that information, and ask that we be provided the opportunity to review and provide comments on the draft General Design Memorandum.

Your cooperation in this matter will be greatly appreciated. Please contact
Quin Kinler of this office if you have any questions regarding our comments
and recommendations.

Sincerely yours,



David W. Frugé
Field Supervisor

QJK/pl

Attachment: as noted

cc: EPA, Dallas, TX
LA Dept. of Wildlife and Fisheries, Baton Rouge, LA
LA Dept. of Natural Resources (CMD), Baton Rouge, LA
NMFS, Baton Rouge, LA
FWS, Atlanta, GA (AWE)
St. Charles Parish, Dept. of Planning and Zoning, Hahnville, LA

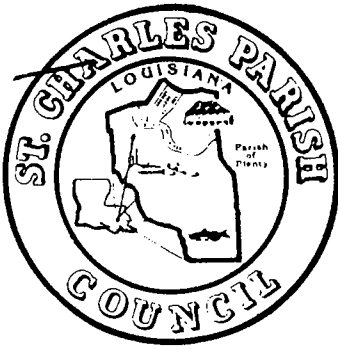

ST. CHARLES PARISH COUNCIL

P. O. BOX 302 • HAHNVILLE, LOUISIANA 70057
(504)783-6246 (504)466-1990

January 25, 1989

COUNCIL

VICTOR E. BRADLEY, JR.
COUNCILMAN AT LARGE, DIVISION A

STEVE SIRMON
COUNCILMAN AT LARGE, DIVISION B

CHRIS A. TREGRE
DISTRICT I

JAY ROBERTS
DISTRICT II

STEVEN R. TALBOT
DISTRICT III

DANNY SOMME
DISTRICT IV

CURTIS T. JOHNSON, SR.
DISTRICT V

RICHARD DUHE
DISTRICT VI

DON GRIMES
DISTRICT VII

U. S. Corps of Engineers
Attn: Planning Division
P. O. Box 60267
New Orleans, LA 70160

Gentlemen:

We are forwarding herewith for your records a copy of Resolution No. 3261 providing written comments from the St. Charles Parish Council concerning the Environmental Assessment and Finding of No Significant Impact for the Evaluation of Impacts to Scenic Streams, Landfills, Oil and Gas Waste Pits and Levee Realignment for the Lake Pontchartrain, Louisiana, and Vicinity Hurricane Protection Project which has been reviewed by the St. Charles Parish Wetlands Review Committee.

Please accept these comments as a part of your record for this project.

Sincerely,

JOAN BECNEL
COUNCIL SECRETARY

JB/sbl

Enclosure

cc: Mr. Steve Sirmon
Ms. Gretchen Binet w/ Enclosure

A motion was made by Mr. TREGRE seconded by
Mr. JOHNSON to adopt the following:

RESOLUTION NO. 3261

A resolution providing written comments from the St. Charles Parish Council concerning the Environmental Assessment and Finding of No Significant Impact for the Evaluation of Impacts to Scenic Streams, Landfills, Oil and Gas Waste Pits and Levee Realignment for the Lake Pontchartrain, Louisiana and Vicinity Hurricane Protection Project which has been reviewed by the St. Charles Parish Wetlands Review Committee.

BE IT RESOLVED by the St. Charles Parish Council acting as the Governing Authority of the Parish:

SECTION I. That the St. Charles Parish Council Wetlands Review Committee has reviewed the Environmental Assessment as stated above and unanimously recommended that the following comments be formally submitted to the United States Army Corps of Engineers for consideration:

- The waste pits and landfill sites scheduled for closure in the levee right-of-way be properly filled and graded to insure levee construction schedule adherence.
- The Remediation Program for Bayou Trepagnier contamination be actively pursued to again insure levee construction schedule adherence.
- The Corps of Engineers is advised that St. Charles Parish will be applying for a Section 404 permit to install pumps along the proposed levee, and that a possible pump site will be along Cross Bayou Canal where a shell boat launch is proposed for construction by the Corps of Engineers.

SECTION II. That a copy of this resolution shall be forwarded to all interested parties.

The foregoing Resolution having been submitted to a vote, the vote thereon was as follows:

YEAS: BRADLEY, SIRMON, TREGRE, ROBERTS, TALBOT, SOMME', JOHNSON,
DUHE, MORGAN

NAYS: NONE

ABSENT: NONE

And the Resolution was declared adopted this 23rd day of
January, 1989, to become effective five (5) days after
publication in the Official Journal.

krebs / murray

August 4, 1988

8892 river road
p. o. box 426
destrehan, la 70047
(504) 764-7275

Mr. A. Van Stutts
Department of the Army
New Orleans District, Corps of Engineers
Post Office Box 60267
New Orleans, Louisiana 70160-0267

RE: St. Charles Parish Consultant
Our Project Number 488-0055

Dear Mr. Stutts:

On May 4, 1988 the St. Charles Parish Council appointed the firm of Krebs/Murray to provide professional technical and environmental services to address the need for pumps and associated drainage systems in conjunction with the East Bank Hurricane Protection Levee.

In accordance with our meeting of May 24, 1988 and our recent conversations concerning the East Bank Hurricane Protection Levee and based on action taken by the St. Charles Parish Wetlands Committee on August 4, 1988, we wish to inform you that the St. Charles Parish Council desires to pursue the design and construction of two (2) or three (3) pump stations in place of the proposed culverts (with flap gates) within the levee. The locations of the stations have not yet been determined, however, runoff will be pumped north of Airline Highway and/or to the Bonnet Carre Spillway.

The pump stations are to be designed by Krebs/Murray. It is our understanding that the design will be coordinated with and approved by the Corps. It is also our understanding that funds for the design will be provided by St. Charles Parish. We would appreciate any information you may have concerning the credit that the Parish would receive for the design fee and construction cost.

If you should have any questions concerning the information contained herein, feel free to contact us.

Sincerely,

KREBS/MURRAY

E. Forrest Forbes, P. E.

Paul Murray, A.I.A.



UNITED STATES ENVIRONMENTAL PROTECTION AGENCY

REGION VI

1445 ROSS AVENUE, SUITE 1200
DALLAS, TEXAS 75202

JAN 12 1989

Mr. R.H. Schroeder, Jr.
Chief, Planning Division
COE, New Orleans District
P.O. Box 60267
New Orleans, Louisiana 70160-0267

Dear Mr. Schroeder:

In complying with Section 309 of the Clean Air Act, we have completed our review of your agency's Environmental Assessment and Finding of No Significant Impact on modifications to the St. Charles area hurricane protection levee, Lake Pontchartrain, Louisiana.

Based on the environmental assessment and coordination with various State agencies listed on page 12, it would appear that potential impacts of the project are adequately addressed. We have no further comment to offer.

Thank you for the opportunity to provide comments at this time.

Sincerely yours,

A handwritten signature in cursive script that reads "Norm Thomas".

Norm Thomas
Chief
Federal Activities Branch (6E-F)



State of Louisiana

DEPARTMENT OF NATURAL RESOURCES

BUDDY ROEMER
GOVERNOR

RAYMOND W. STEPHENS, JR.
SECRETARY

December 22, 1988

Mr. R. H. Schroeder, Jr.
Chief, Planning Division
Department of the Army
New Orleans District, Corps of Engineers
P. O. Box 60267
New Orleans, LA 70160-0267

RE: C880609, Coastal Zone Consistency
Finding of No Significant Impact;
Modification on a segment of the
St. Charles area hurricane protection levee,
Lake Pontchartrain, LA and Vicinity Hurricane
Protection Project

Dear Mr. Schoeder:

The above referenced project has been reviewed by this office and has been found to be consistent, to the maximum extent practicable, with the Louisiana Coastal Resources Program as required in Section 307(c)(1)(2) of the Coastal Zone Management Act of 1972, as amended.

Sincerely,

R. W. STEPHENS, JR

By:

T. W. Howey
Assistant Director

RWS:TWH/LN/se

cc: Mr. Ronald Ventola
U.S. Army, Corps of Engineers



BUDDY ROEMER
GOVERNOR

State of Louisiana
DEPARTMENT OF ENVIRONMENTAL QUALITY

PAUL H. TEMPLET, Ph.D.
SECRETARY

December 9, 1988

Dr. David A. Vigh
U.S. Army Corp of Engineers
New Orleans District
Planning Division
CELMN-PD-RE
P.O. Box 60267
New Orleans, La 70160-0267

RE: Hurricane Protection Levee Project
American Waste and Pollution Control, Inc.
Pelican Landfill
D-089-0187

Jefferson Disposal Co.
City of Kenner Landfill
TD-089-00/0

Browning-Ferris Industries, Inc.
West St. Charles Landfill
D-089-2093

Dear Dr. Vigh:

We have reviewed the above referenced proposal and have no objection to the conceptual design of this project. However, be advised that due to the nature and characteristics of the refuse and the underlying soil, an extensive engineering study concerning the bearing capacity and settlement of the site should be conducted in order to prevent any future failure of the structure.

If you have any questions, please contact this office.

Sincerely,

John Koury
Administrator

JK/BS/jcl



State of Louisiana

DEPARTMENT OF NATURAL RESOURCES

BUDDY ROEMER
GOVERNOR

RAYMOND W. STEPHENS, JR.
SECRETARY

November 20, 1988

U. S. Army Corps of Engineers
New Orleans District
Planning Division
CELMN - PD - RE
P. O. Box 60267
New Orleans, LA 70160-0267

Attention Mr. David Vigh

Re: Hurricane Protection Levee Alignment Survey
Good Hope Field
Pit Inventory

Gentlemen:

As a result of a request by the Corps of Engineers, a site survey was performed in order to determine the location and status of oilfield pits in the Good Hope Field. Only two pits were identified. Both were on property operated by Shell Oil Co. and were in the process of being closed in accordance with the guidelines of Statewide Order No. 29-B. No other pits were discovered.

The Office of Conservation (OC) will request that Shell provide documentation that closure was performed in accordance with the rule. If requested, OC will provide the Corps with such documentation.

You may contact Mr. Carroll Wascom at 504/342-5515 if you have any questions.

Yours very truly,

J. PATRICK BATCHELOR, Commissioner
Office of Conservation

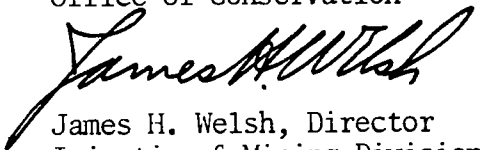
James H. Welsh, Director
Injection & Mining Division

CDW:lg



DEPARTMENT OF THE ARMY

NEW ORLEANS DISTRICT, CORPS OF ENGINEERS

P.O. BOX 60267

NEW ORLEANS, LOUISIANA 70160-0267

REPLY TO
ATTENTION OF:

Planning Division
Environmental Analysis Branch

TO INTERESTED PARTIES

Enclosed for your information is an Environmental Assessment (EA) and an unsigned Finding of No Significant Impact (FONSI) on modifications of a segment of the St. Charles area hurricane protection levee, Lake Pontchartrain, Louisiana, and Vicinity Hurricane Protection Project.

This EA addresses the environmental effects of crossing a scenic stream, the tributary of a scenic stream, crossing of several landfill sites, disturbance of several abandoned oil and gas waste pits, and construction of a levee realignment at the New Orleans airport runway extension.

Your views, comments, and recommendations concerning these documents are requested by January 30, 1989. Inquiries relating to this action should be addressed to Dr. David A. Vigh, U.S. Army Corps of Engineers, CELMN-PD-RE, P.O. Box 60267, New Orleans, Louisiana 70160-0267, telephone (504) 862-2540.

A handwritten signature in cursive script, reading "R. H. Schroeder, Jr.", is positioned above the typed name.

R. H. Schroeder, Jr.
Chief, Planning Division

Enclosure



DEPARTMENT OF THE ARMY

NEW ORLEANS DISTRICT, CORPS OF ENGINEERS

P.O. BOX 60267

NEW ORLEANS, LOUISIANA 70160-0267

REPLY TO
ATTENTION OF:

Planning Division
Environmental Analysis Branch

LAKE PONTCHARTRAIN, LOUISIANA, AND VICINITY HURRICANE PROTECTION PROJECT EVALUATION OF IMPACTS TO SCENIC STREAMS, LANDFILLS OIL AND GAS WASTE PITS AND LEVEE REALIGNMENT

FINDING OF NO SIGNIFICANT IMPACT (FONSI)

Description of Action. The U. S. Army Corps of Engineers, New Orleans District, proposes to provide hurricane protection to St. Charles Parish by constructing a new levee system as part of the Lake Pontchartrain Hurricane Protection system. To accomplish this objective, it would be necessary to construct water control structures in a scenic stream and in a tributary to a scenic stream. It would also be necessary to cross several landfills and oil and gas waste pits resulting from drilling operations. The levee would have to be realigned at Moisant International Airport due to construction of the airport runway extension.

Factors Considered in Determination. Implementation of this project would result in only minimal adverse impacts to fish and wildlife resources, endangered species, cultural resources, recreation, esthetics, and noise. Project implementation would provide much needed hurricane protection for a portion of St. Charles Parish and precipitate the clean-up of several problem pollution sites in this portion of the parish.

Public Involvement. There has been a long history of public involvement in this project. A formal public meeting was held in New Orleans on March 15, 1956, during formulation of the original plan. From 1956 thru 1981, several documents were completed and subjected to public review including a final Environmental Impact Statement (EIS) in 1975, in which the court enjoined specific elements of the EIS until impacts were better described. The tentatively selected plan was chosen in 1981.

Public meetings were then held in New Orleans on November 21, 1981 and April 12, 1984, to discuss the tentatively selected plan. An additional public meeting was held in June of 1984 to discuss mitigation.

Since 1984, additional concern has been expressed by various state and Federal agencies regarding impacts of the levee in St. Charles Parish because its' alignment would cross a scenic stream, a tributary to a scenic stream, several landfills, several oil and gas waste pits and had to be realigned at the airport. Close coordination with the U.S. Fish and Wildlife Service and Louisiana Departments of Natural Resources, Environmental Quality, and Wildlife and Fisheries, have resulted in the project as described in this FONSI and the accompanying Environmental Assessment (EA).

A copy of the FONSI and EA will be sent to all concerned governmental agencies and organizations. These documents are on file at the U.S. Army Corps of Engineers, New Orleans District, and are available to the public upon request. Any inquiries should be directed to Dr. David A. Vigh at (504) 862-2540.

Conclusion. This office has assessed the environmental impacts of the proposed action and has determined that the action would have no significant adverse impact on the human environment. Therefore, no supplement to the Lake Pontchartrain, Louisiana, and Vicinity Hurricane Protection Project, Final Supplement 1 to the Environmental Impact Statement will be prepared.

Date

Harold E. Manuel, Jr.
Major, Corps of Engineers
Temporary District Engineer

INTRODUCTION

This Environmental Assessment (EA) has been prepared to supplement the Lake Pontchartrain and Vicinity, Hurricane Protection Project Final Environmental Impact Statement (FEIS). The FEIS did not adequately address the impacts to two scenic streams, oil and gas waste pits, and several landfills in St. Charles Parish. This EA corrects that inadequacy. In addition, now that a Moisant Airport runway is being extended, realignment of the hurricane protection levee is necessary. This EA discusses the need for and impacts of the realignment.

NEED

The proposed levee would cross a scenic stream, the tributary of a scenic stream, several oil and gas waste pits, and several landfills. A different route would not avoid these features or be less environmentally damaging and still provide adequate hurricane protection. The realignment of the levee near the airport is necessary due to the airport runway extension project, which crosses the formerly proposed hurricane levee alignment.

PROJECT DESCRIPTION

The U.S. Army Corps of Engineers proposes to provide hurricane protection for the metropolitan New Orleans area by improving the existing hurricane protection levee systems and constructing new levee systems.

The area of concern is west of New Orleans, specifically St. Charles Parish, where the proposed levee would cross a scenic stream tributary of Bayou La Branche, Cross Bayou Canal, and the scenic stream, Bayou Trepagnier, several landfills near the airport and several abandoned oil and gas waste pits. A levee

LAKE PONTCHARTRAIN, LOUISIANA AND VICINITY
HIGH LEVEL PLAN
DESIGN MEMORANDUM No. 18 - GENERAL DESIGN
ST. CHARLES PARISH NORTH OF AIRLINE HIGHWAY

APPENDIX B, VOLUME I

PERTINENT CORRESPONDENCE

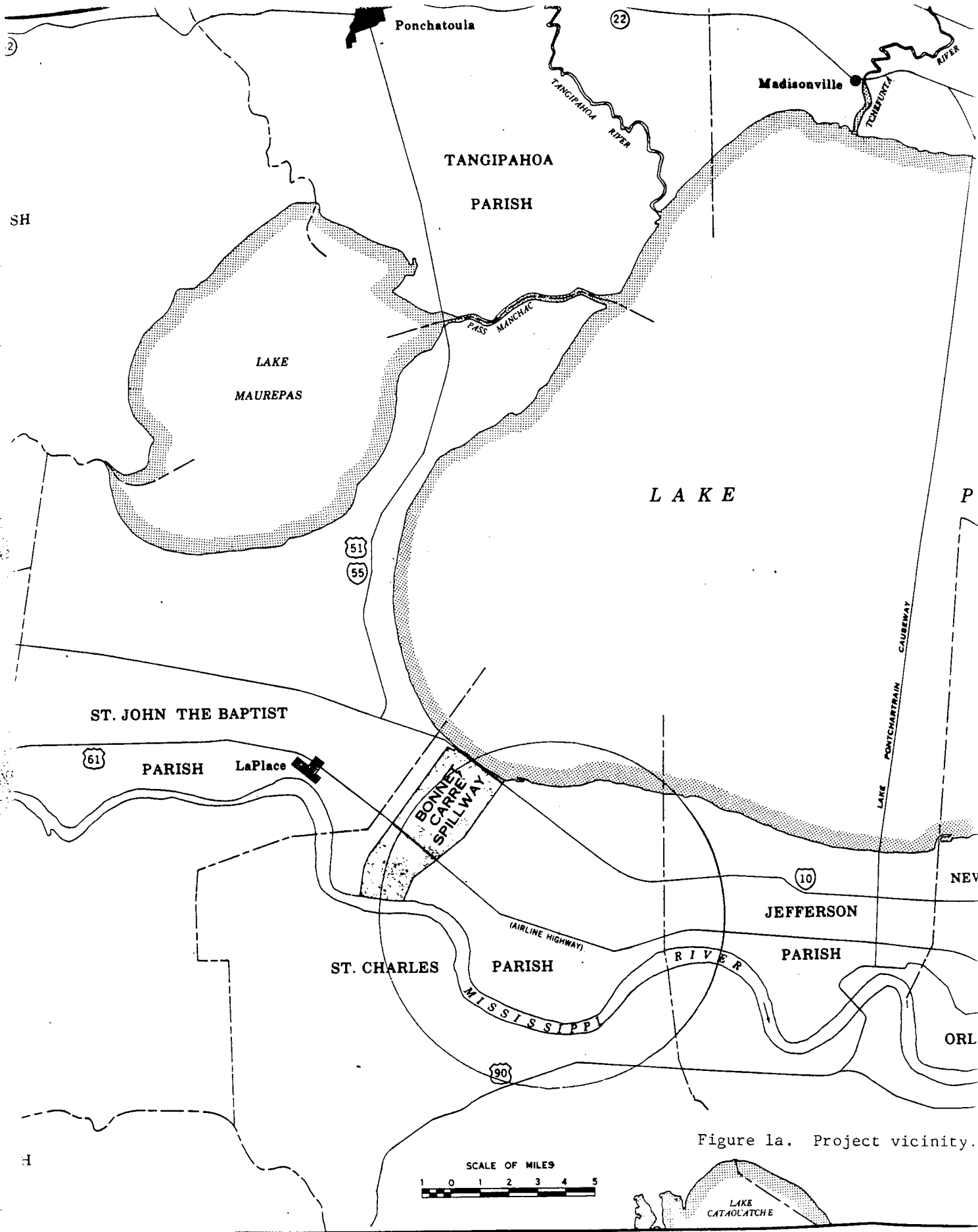

Figure 1a. Project vicinity.

LULING QUADRANGLE
 LOUISIANA
 7.5 MINUTE SERIES (TOPOGRAPHIC)
 NE/4 HAHNVILLE 15' QUADRANGLE

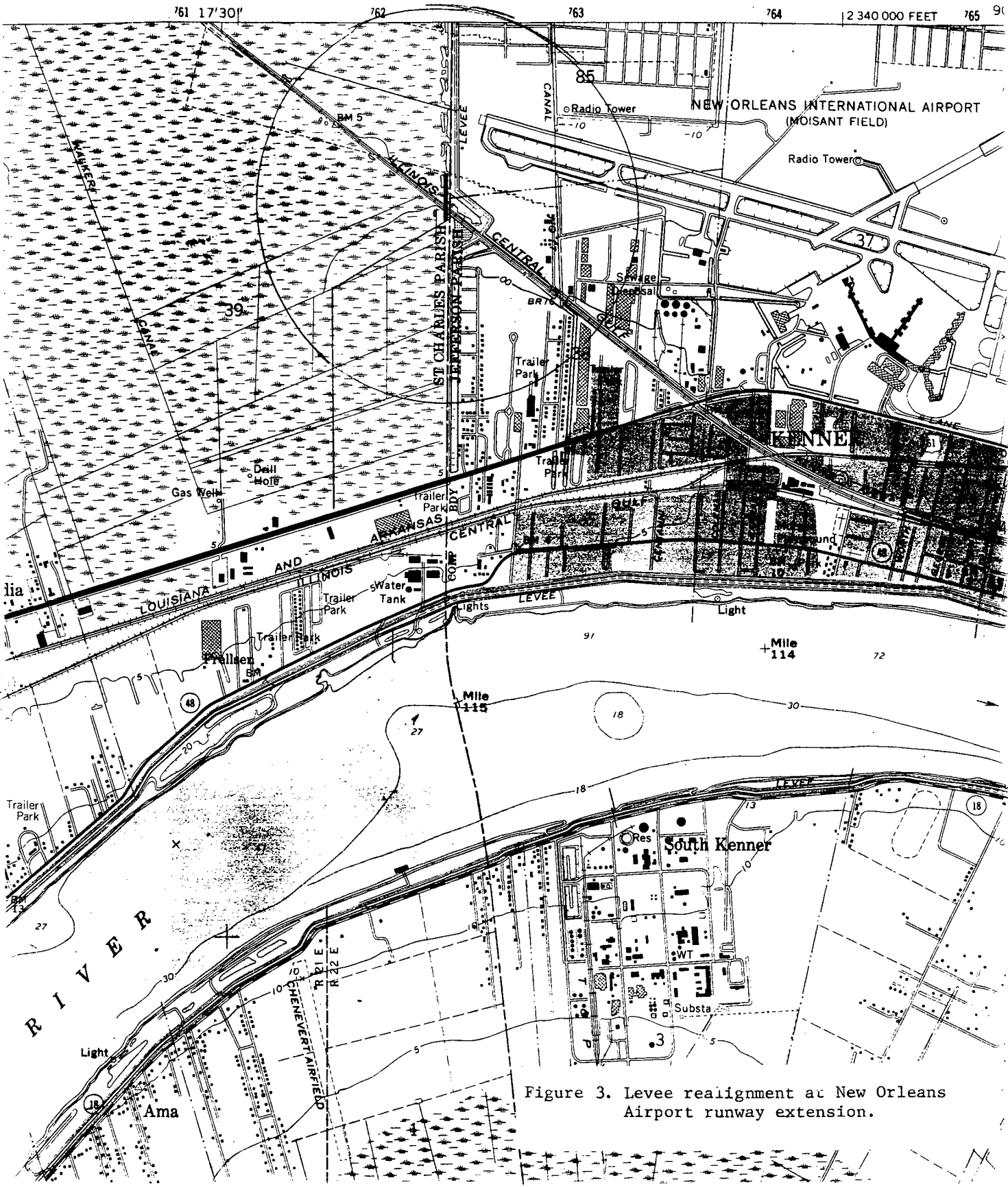

Figure 3. Levee realignment at New Orleans Airport runway extension.

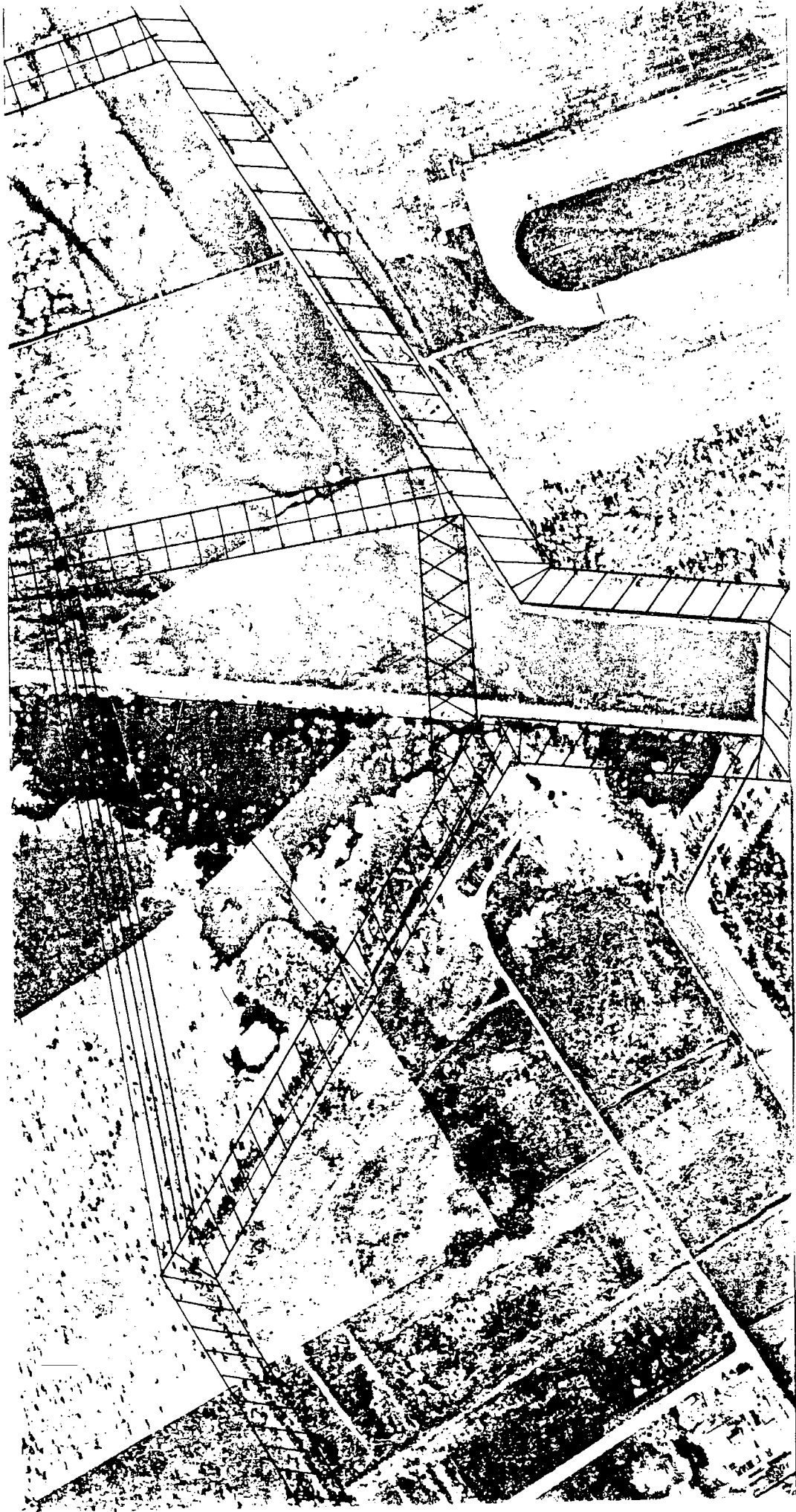

Figure 4. Proposed realignment at New Orleans Airport showing the original route (///), the runway extension levee (+++), the alternate route dropped from consideration (===) and the preferred alternative (XXX).

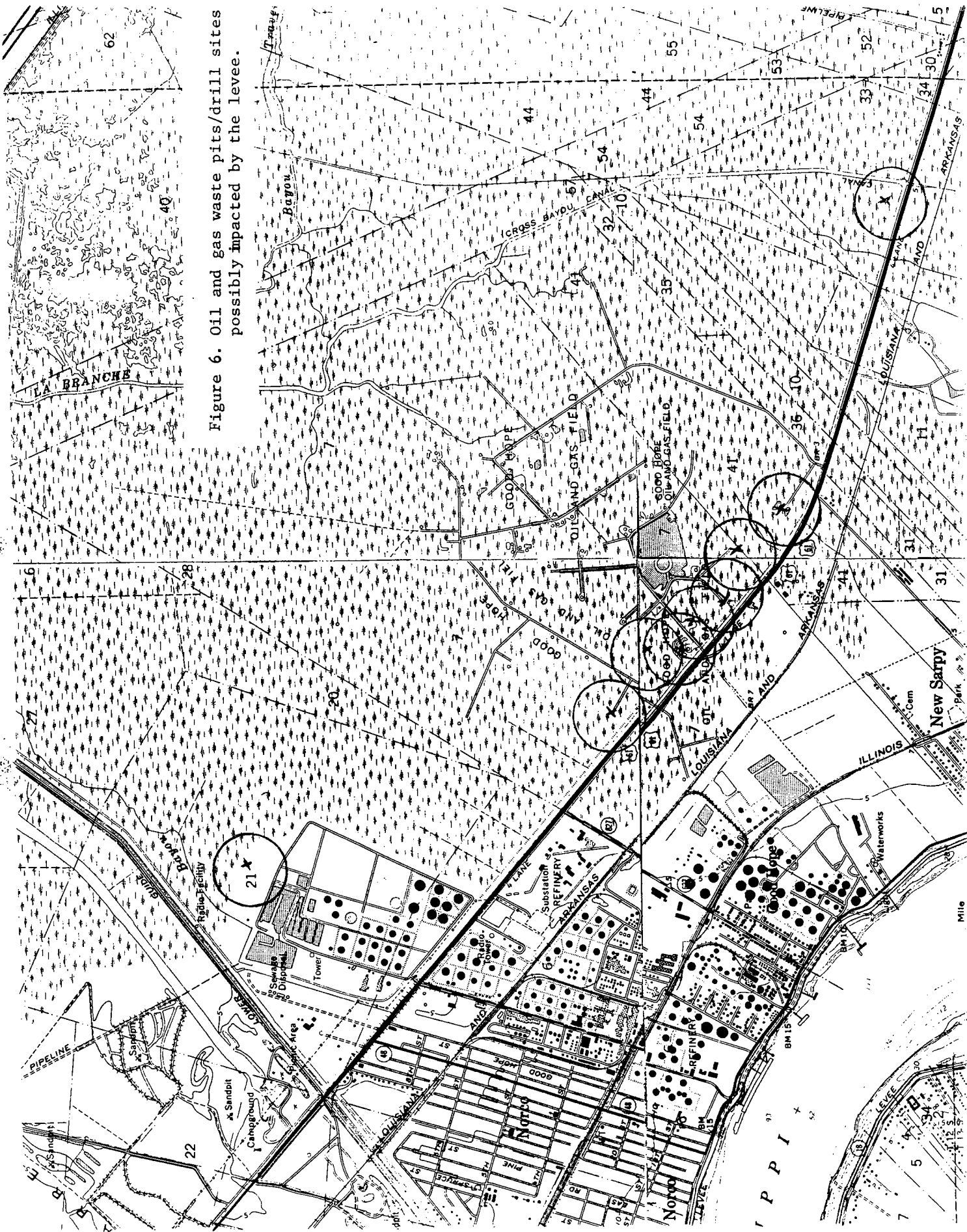

Figure 6. Oil and gas waste pits/drill sites possibly impacted by the levee.

realignment is necessary at the junction with the airport runway extension levee (Figure 1a).

Scenic Streams

The levee would cross the Cross Bayou Canal in Section 33, Township 12 South, Range 8 East; it would cross Bayou Trepagnier in Section 21, Township 12 South, Range 8 East, as shown on the vicinity maps (see Figures 1 and 2). The crossing sites are located approximately three miles north of New Sarpy, Louisiana.

The proposed levees would bisect the two streams, would have an average height of about 13.0 feet, and would be approximately 300 feet in base width. The base width is a function of engineering constraints for the levee height and site material. At Cross Bayou Canal, the centerline of the levee is approximately 800 feet north of Airline Highway. Box culvert structures would be installed in the bayou to maintain the normal water regime. At Bayou Trepagnier, the centerline of the levee would be approximately 400 feet from the back levee of Shell Norco Oil Refinery. Culvert structures with flap gates would be installed in Bayou Trepagnier at this location. Large concrete box culvert structures would be installed on Engineers Canal to control the major amounts of flow from Shell outfall and area storm drainage.

Levee Realignment

The levee realignment is located in Section 39, Township 12 South, Range 22 East, located at Kenner, Louisiana, as shown by Figure 3. The levee would be contiguous with the back of the T.L. James property and would proceed to the Illinois Central Gulf railroad, as originally proposed. At the railroad, instead of heading southward and going around a drainage ditch, the levee would cut across the drainage ditch to the runway extension. The

levee would have an average height of about 13.0 feet and would be approximately 350 feet in base width. The levee would have a box culvert structure to allow water in the drainage ditch to escape. A shorter alignment was for the levee to go from the northwest corner of the T.L. James' property and go straight across the marsh to tie in with the runway extension levee. This alignment, though several hundred feet shorter than the preferred alignment, would impact a greater amount of wetlands; therefore, this plan was dropped from further consideration (Figure 4).

Landfill Crossings

The landfills are located in Sections 43, 47 and 40, Township 12 South, Range 9 East, located near Almedia, Louisiana, as shown in Figure 5. The centerline of the levee would intersect the landfills approximately 800 feet north from Airline Highway. Across the landfills, a clay cap would be constructed, built approximately 3 feet above the landfill height. No excavation or sheet piling would be done in the landfills. The total cap size over the landfills is approximately 3,000 feet long by 150 feet wide.

Drilling Waste Pits

The waste pits are located in Sections 7, 21, 33 and 41, Township 12 South, Range 8 East, near Good Hope Oil and Gas Field at Norco, Louisiana, as shown by Figure 6. The levee would partially or completely disturb these pits. They would be graded and filled with the contents buried or displaced as required by the levee alignment. The levee would go around any active well sites.

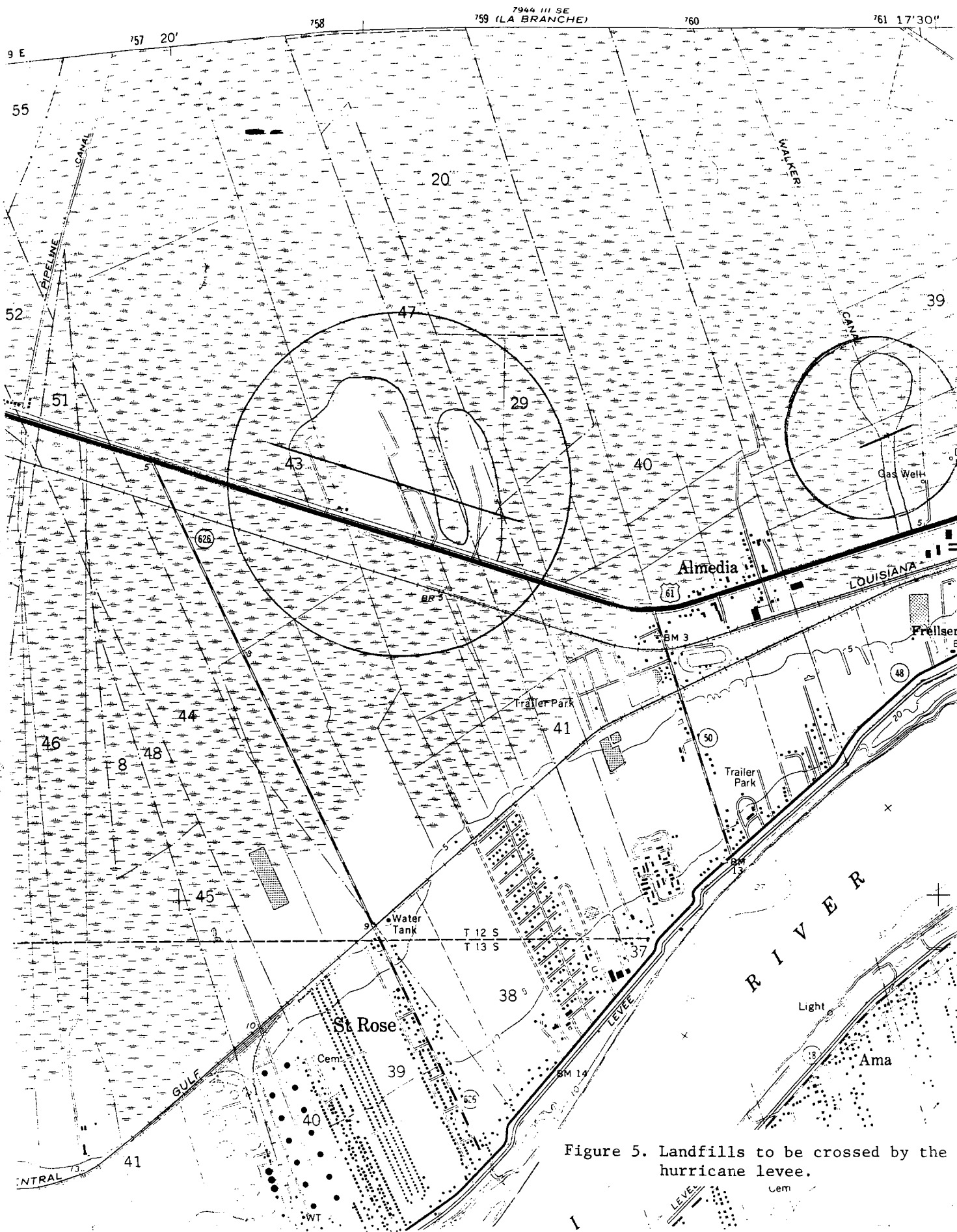

Figure 5. Landfills to be crossed by the hurricane levee.

ENVIRONMENTAL SETTING

The areas affected by these actions are in the lower Mississippi Deltaic Plain. The study area specifically involves four sites: wetlands in the levee realignment of the Lake Pontchartrain to U.S. Highway 61 levee at the site of the airport runway extension, those waterways and wetlands at the scenic streams crossings of the airport to Bonnet Carre' Spillway levee, wetlands at the waste pits, and the scrub/shrub community at the landfill crossings.

Scenic Streams

Vegetation in the area of the bayou crossings is characterized by black willow, bitter pecan, hackberry, American elm, Drummond red maple, sycamore, baldcypress, tupelogum, pumpkin ash, swamp privet, water hyacinth, water pennywort, duckweed, cottonwood, water oak, and Nuttall oak. The area has wet bottomland hardwoods, with occasional cypress/tupelogum.

Wildlife in the vicinity of the proposed crossings includes populations of opossums, nutria, bats, racoons, skunk, deer, squirrel, mice, rabbits, and armadillo. A variety of amphibians and reptiles are also present in or near the bayous, including the American alligator. Numerous avian species are common to the vicinity of the proposed crossings, including owls, egrets and ibis. An active bald eagle nest is located approximately two miles northeast of the Cross Bayou levee crossing and approximately 1.9 miles west of the airport. The benthic community at the proposed project locations includes crawfish, crabs, and various small invertebrate animals. The bayous contain several species of fish, including bullhead and blue catfish, gar, crappie, and numerous species of sunfish. The geology in the vicinity of the levee crossings is similar to much of the

surrounding area and includes lowland and water areas between the natural levee deposits of the Mississippi River and the Pleistocene escarpment to the north and west. Soils of the area are the Barbary-Fausse association, which are level, poorly drained soils having a mucky or clayey surface and clayey underlying material. The dominant feature of the area is Lake Pontchartrain. Surveys done in these areas indicate no unique geological formations or other apparent natural and physical features or similar resources that would be detrimentally affected by the proposed levees.

Levee Realignment

The site of the realignment is fresh marsh. Plants in the proposed right-of-way include bull tongue, deer pea, maidencane, duckweed, wiregrass, water pennywort, spike rush, and water hyacinth. Wildlife, the benthic community, and geology of the levee realignment site are similar to that discussed in the scenic streams portion of this report. The eagle's nest is located approximately 1.9 miles west of the realignment location at the airport runway extension.

Landfill Crossings

Adjacent to the landfills, where the levee would intersect, is typical tupelogum - baldcypress swamp as is found along other portions of the levee alignment. The landfills themselves are best characterized as disturbed, upland scrub/shrub, which includes grasses, blackberry, hackberry, trumpetcreeper, poison ivy, rattlebox and various sedges. Wildlife and underlying geology of these sites are similar to that discussed in the scenic streams portion of this report. The eagle's nest is located approximately 1.5 miles north of the landfill locations.

Drilling Waste Pits

The waste pits themselves are characterized as having typical stream or marsh vegetation in them, depending on the degree of isolation and pit depth at each site. The remnants of the containment levees and drill pads have willow and red maple growing on them, with other scattered species typical of wet bottomland hardwood forests. Wildlife and geology of these sites are similar to that discussed in the scenic stream portion of this report.

BIOLOGICAL IMPACTS

Scenic Streams

Approximately 0.72 acre of bayou bottom and associated banks would be replaced by water control structures. These habitats would no longer function as productive wetlands. The benthic community at the proposed locations would be eliminated or permanently displaced. Wildlife that utilizes the banks would use the levees and adjacent banks for forage and resting. Levee construction across the bayous would not affect the bald eagle, and conversion of the bayous and their banks to water control structures would have minimum effect on the general ecological balance in the vicinity.

Little foreign material would be allowed to enter the bayous or borrow canal during construction of the box culverts. Silt screens would be installed to define and contain construction turbidity to minimize any excavated material loss. The only effect on water quality caused by the levee construction would be a temporary increase in local turbidity, which would result in lowered dissolved oxygen and increased biological oxygen demand adjacent to the levee toes until the material settled out of the water column.

Of major concern in Bayou Trepagnier are pollutants trapped in the bottom sediments. Shell Oil Company has historically used the bayou (since 1920's) as a receiving stream for its plant operation waters, including cooling water and settling pond water. The water column in the bayou is relatively clean. Typical of the pollutants trapped in the bottom sediments are oil and grease, zinc, chromium, and lead. Appendix I shows sample sites and pollutant levels from a state survey done during the summer of 1985.

The Shell refinery is currently under remedial demand order pursuant to L.R.S. 30:1149 to clean up the bayou in two phases. Phase I is to clean up the sediments in the area of the hurricane levee crossing to ensure that the Corps levee construction stays on schedule. Phase II is to clean up the remainder of Bayou Trapagnier.

The Corps will be required to take sediment samples at Cross Bayou Canal and Engineer Canal to establish pollutant levels and determine remedial action if necessary.

Levee Realignment

Approximately 2.89 acres of fresh marsh and 1.93 acres of canal bottom would be replaced by elevated grassy habitat. These habitats would no longer function as productive wetlands, since they would be filled and replaced by a levee. This would result in a long term loss of productive wetlands from the area ecosystem. Short-term losses to wildlife would occur in this specific area during construction. When levee vegetation is established, some wildlife benefits would be realized, and the area would be utilized by small game animals and birds for foraging. The levee realignment would not affect the bald eagle nesting site.

There would also be increased potential for soil erosion during the interim between shaping work and revegetation. During this period, runoff from the fill material would cause short-term increases in turbidity in the immediate surface area.

Landfill Crossings

Approximately 10 acres of disturbed scrub/shrub would be replaced with an elevated grassy clay cap. The cap would be utilized by small game and bird for foraging, as was the scrub/shrub. Short-term losses to wildlife would occur during specific site construction. This work would not affect the bald eagle nesting site. There is an increased potential for higher runoff velocities from the landfill as a result of the additional elevation provided by the levee cap. Some scouring of the landfill could result, causing short-term increases in immediate water turbidity and accelerated long-term loading of pollutants into the area ecosystem. The clay cap was designed with the load bearing capacities of the landfill taken into account.

The clay cap toe elevations would be as gradual as possible to keep runoff velocities minimal. Also, the cap and landfill around the cap would be grassed to further reduce and absorb runoff. There will be no excavation of the landfill. The Louisiana Office of Solid Waste has no objections to this clay cap (personal communication).

Drilling Waste Pits

Approximately 3 acres of mixed wet bottomland hardwoods, and water habitat would be replaced by elevated grassy habitat. These habitats would no longer function as productive wetlands, since they would be filled and replaced by a levee. When levee

vegetation is established, some wildlife benefits would be realized, including a resting and forage area for small game animals and birds.

Of particular concern with these pits is the possibility of contaminants in the sediments. The pits historically have contained wastes from drilling activities including oils and greases, drilling muds, and cuttings and packing materials. Sediments in the pits usually have a high heavy metal content, particularly lead.

Possible environmental impacts resulting from disturbing pit sediments would not be of concern during construction. All abandoned pits are to be cleaned-up by their owners, according to state regulations, by February 1989, (personal communication, Louisiana Department of Environmental Quality), which is well before construction start date.

RECREATION

The scenic stream crossings would have some effect on recreation in Cross Bayou Canal. The levee would not allow most boaters to use the waterway to gain access to the Airline Highway borrow canal or to launch boats at Airline Highway for access to Bayou La Branche. Canoes and small flatboats could be carried over the levee, but larger powerboats would not be able to pass. However, a shelled boat-launch area and bridge would be constructed to reestablish public access. The area does possess the natural resources necessary to provide excellent fishing, boating, crabbing, photography, birdwatching, and other outdoor sports. There would be little effect on the recreation value of Bayou Trepagnier. The center of the levee crossing is approximately 400 feet north from the bayou source, which is pumped outfall from oilfield settling ponds. The levee

realignment would have little to no effect on recreation at the airport extension site. Waste pit and landfill areas crossed by the levee would have little to no effect on area recreation.

Total annual recreational dollars lost (hunting and fishing) by the activities addressed in this EA, including realignment at the airport, structure placement in the bayous, crossing landfills and waste pits, would be negligible to no additional dollars lost.

CULTURAL RESOURCES

A comprehensive cultural resource survey of the St. Charles Parish levee alignment has been completed by Coastal Environments, Inc., under contract to this office. The survey was completed in March 1988. The survey of the area covered the stream reaches, levee realignment, waste pits and landfill. No significant archeological sites were found. The State Historic Preservation Officer would be notified if any evidence is found of a previous inhabitation, or if archeological features are observed during construction.

BIBLIOGRAPHY

U.S. Army Corps of Engineers. 1984. Lake Pontchartrain, Louisiana, and Vicinity Hurricane Protection Project EIS. New Orleans District. Vol. 1, 2, 3.

Soil Conservation Service. 1987. Soil Survey of St. Charles Parish, Louisiana.

N-Y Associates, Inc. 1978. Environmental Assessment of East Bank, St. Charles Parish, Louisiana--201 Facilities Plan.

Center for Wetland Resources, Louisiana State University. 1985. A Comprehensive Wetland Management Plan for the La Branche Wetlands, St. Charles Parish, Louisiana.

Coastal Environments, Inc. 1988. A Cultural Resources Survey of the Proposed Right-of-Way of the St. Charles Parish Hurricane Protection Levee, St. Charles Parish, Louisiana. Draft Report.

COORDINATION

Details of water-control structure placement and construction in the scenic streams, crossing of the landfills, levee realignment, and clean-up of oil and gas waste pits and bayou/canal sediments, have all been closely coordinated with the following agencies and groups:

U.S. Fish and Wildlife Service

Louisiana Department of Natural Resources, Coastal Division

Louisiana Department of Environmental Quality, Inactive and Abandoned Hazardous Waste Sites Division

Louisiana Department of Environmental Quality, Water Pollution Control Division

Louisiana Department of Wildlife and Fisheries

Louisiana Department of Environmental Quality, Solid Waste Division

Shell Oil Company, Norco

Copies of this EA will be distributed to the agencies and people listed below:

Federal

Honorable J. Bennet Johnston

Honorable John B. Breaux

Honorable Billy Tauzin

Department of the Interior
Assistant Secretary for Program, Development and Budget
Office of Environmental Project Review

U.S. Fish and Wildlife Service,
Field Supervisor, Lafayette

Regional EIS Coordinator
Region VI
U.S. Environmental Protection Agency

Federal (Cont'd)

The Administrator
U.S. Environmental Protection Agency

U.S. Department of Commerce
National Oceanic & Atmospheric Administration
National Marine Fisheries Service

National Marine Fisheries Service
Habitat Conservation Division

Regional Administrator, Region VI
U.S. Department of Housing and Urban Development

Advisory Council on Historic Preservation

Bayou Sauvage National Wildlife Refuge
Attn: Tom Barnes

U.S. Department of Transportation
Federal Highway Administration

Gulf of Mexico Fishery Management Council

State

Assistant Secretary
Department of Transportation and Development
Office of Public Works

Maurice B. Watson
Louisiana Department of Wildlife and Fisheries
Ecological Studies Section

Secretary
Louisiana Department of Wildlife and Fisheries

Department of Natural Resources
Coastal Resource Analyst
Division of State Lands

Department of Natural Resources
Office of Environmental Affairs

Department of Natural Resources
Coastal Resources Program
Consistency Coordinator

State (Cont'd)

State Historic Preservation Officer
Department of Culture, Recreation and Tourism

Local

Board of Levee Commissioners of the Orleans Levee District

St. Charles Parish Council

Regional Planning Commission
Jefferson-Orleans, St. Bernard-St. Tammany Parishes

City of New Orleans
City Planning Commission

Board of Commissioners for the Pontchartrain Levee District

Board of Commissioners of the Lake Borgne Levee District

St. Bernard Parish Police Jury

Board of Levee Commissioners of the East Jefferson Levee District

Environmental

Mr. Barry Kohl
Orleans Audubon Society

Environmental Defense Fund

Mr. Oliver Houck

M.L. Cambre
St. Charles Environmental Council

Delta Chapter, Sierra Club

Randy P. Lanctot
Executive Director
Louisiana Wildlife Federation

League of Women Voters of Louisiana

Shell Oil Company

Compliance with Regulations

Distribution of this EA will bring these features into full compliance with applicable regulations of the Department of the Army and other Federal and state agencies.

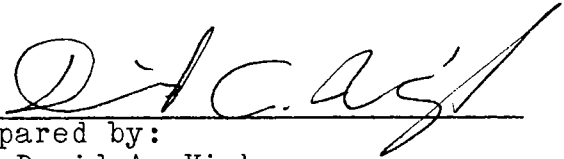
Prepared by:
Dr. David A. Vigh
Fishery Biologist

11/23/88
Date

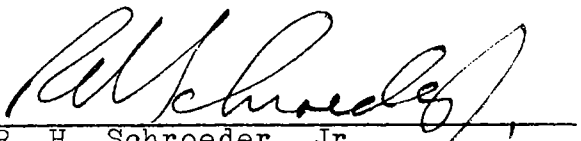

R. H. Schroeder, Jr.
Chief, Planning Division

APPENDIX 1

BAYOU TREPAGNIER SURVEY

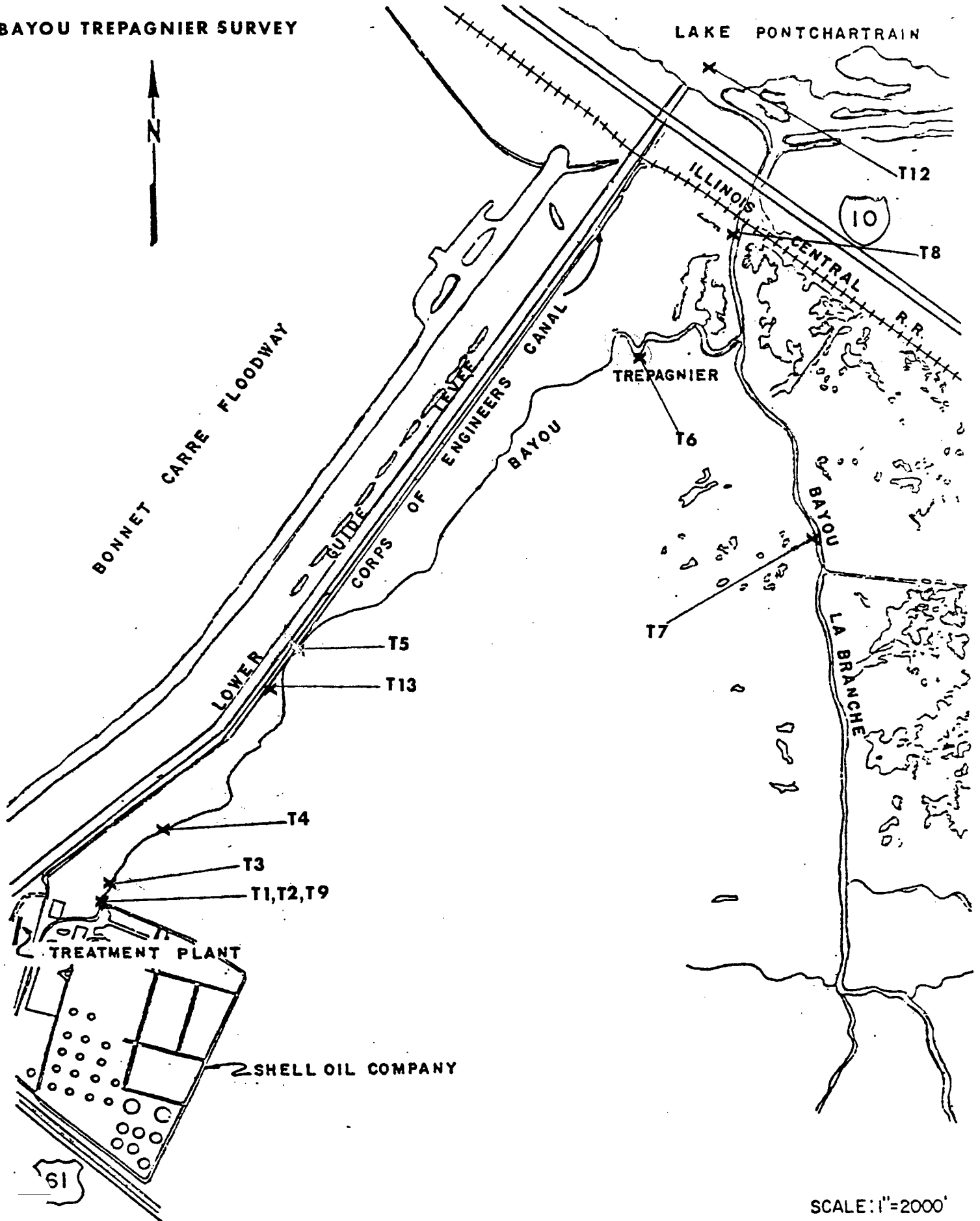

LAKE PONTCHARTRAIN



TREPAGNIER

10

61

LA BRANCHE

TREATMENT PLANT

SHELL OIL COMPANY

SCALE: 1"=2000'

BAYOU TREPAGNIER SEDIMENT DATA
OIL & GREASE
July 11, 1985

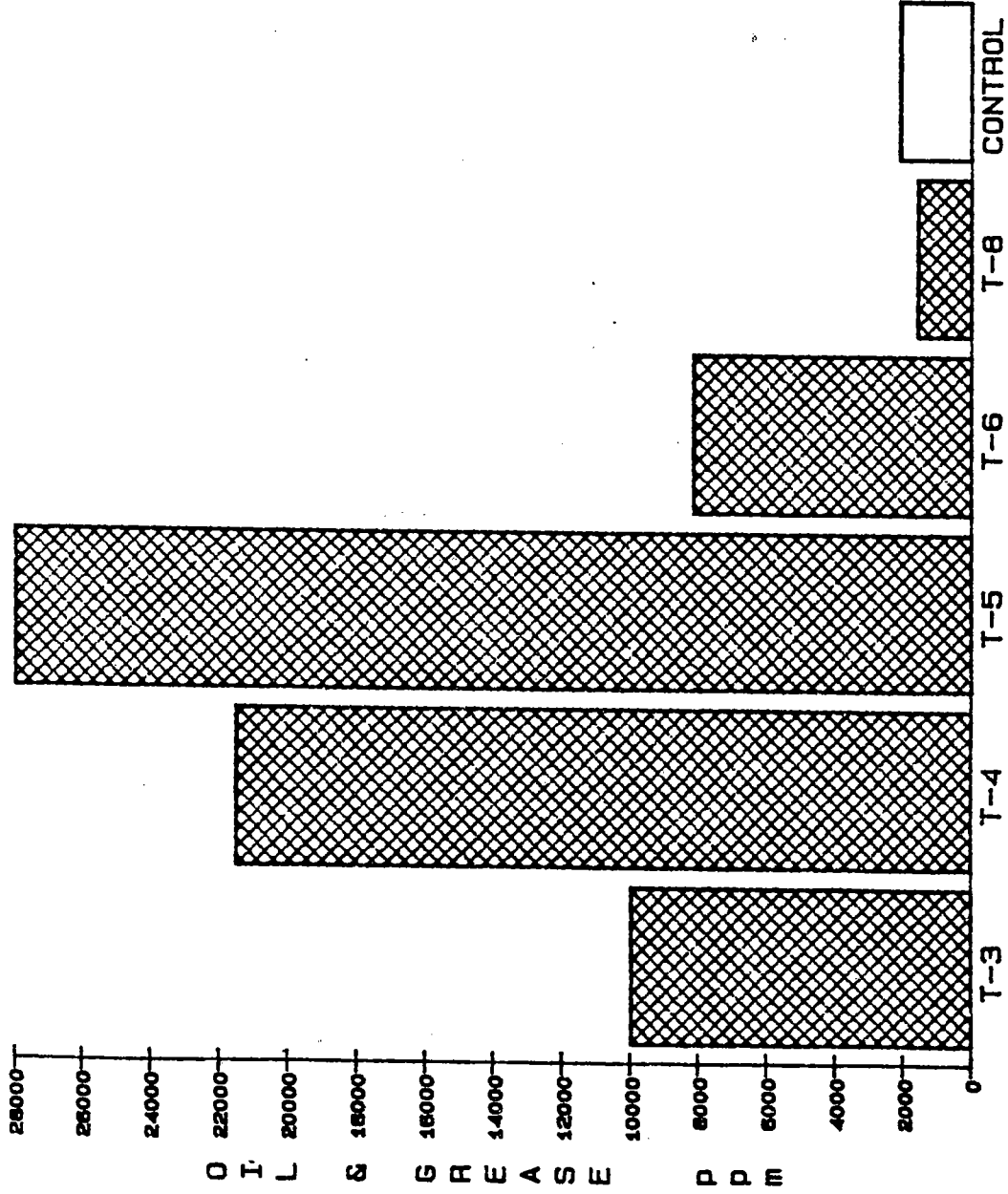

DOWNSTREAM ORDER FROM OUTFALL
(EXCLUDING CONTROL)

BAYOU TREPAGNIER SEDIMENT DATA

ZINC

July 11, 1985

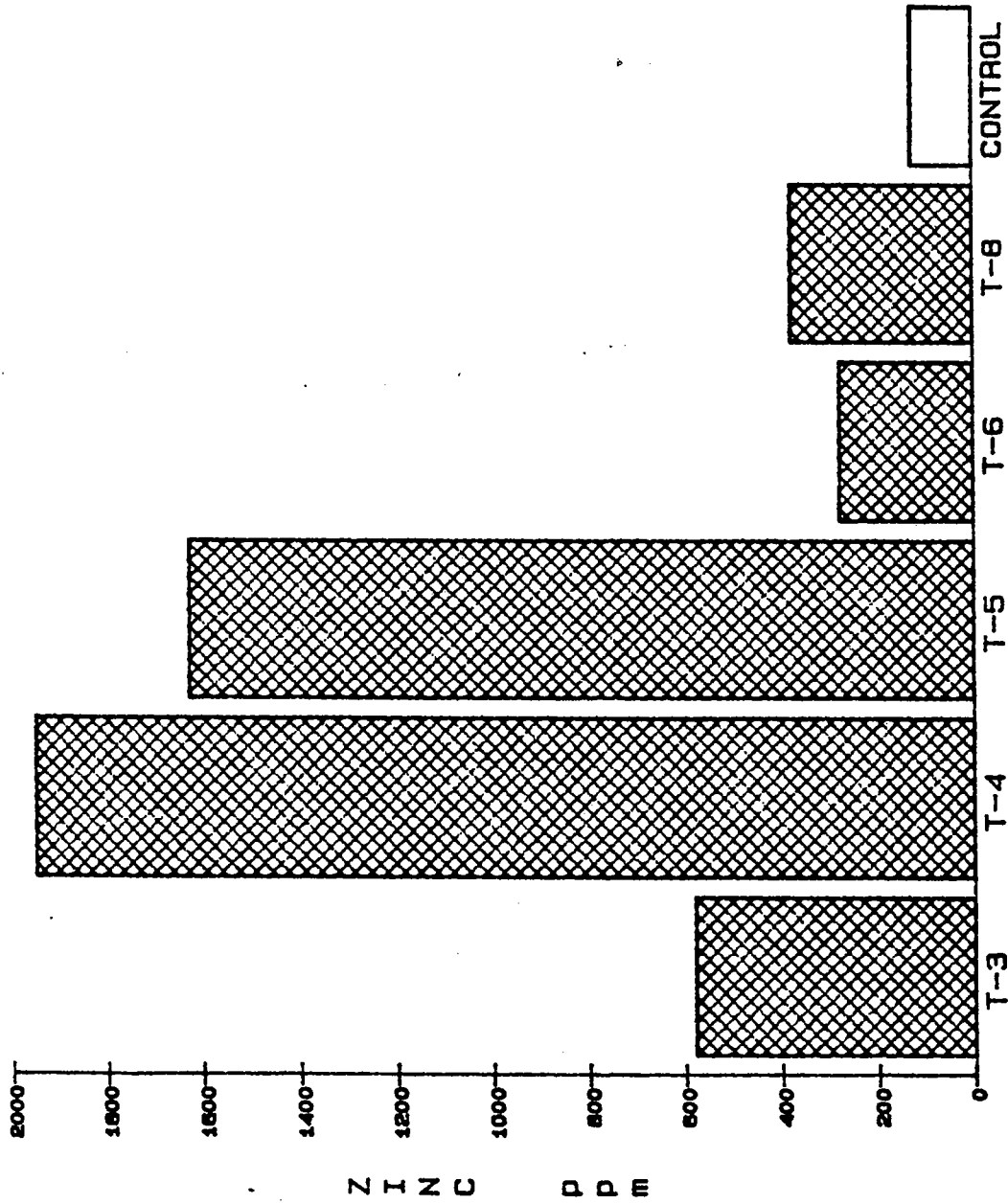

DOWNSTREAM ORDER FROM OUTFALL
(EXCLUDING CONTROL)

BAYOU TREPAGNIER SEDIMENT DATA
CHROMIUM
July 11, 1985

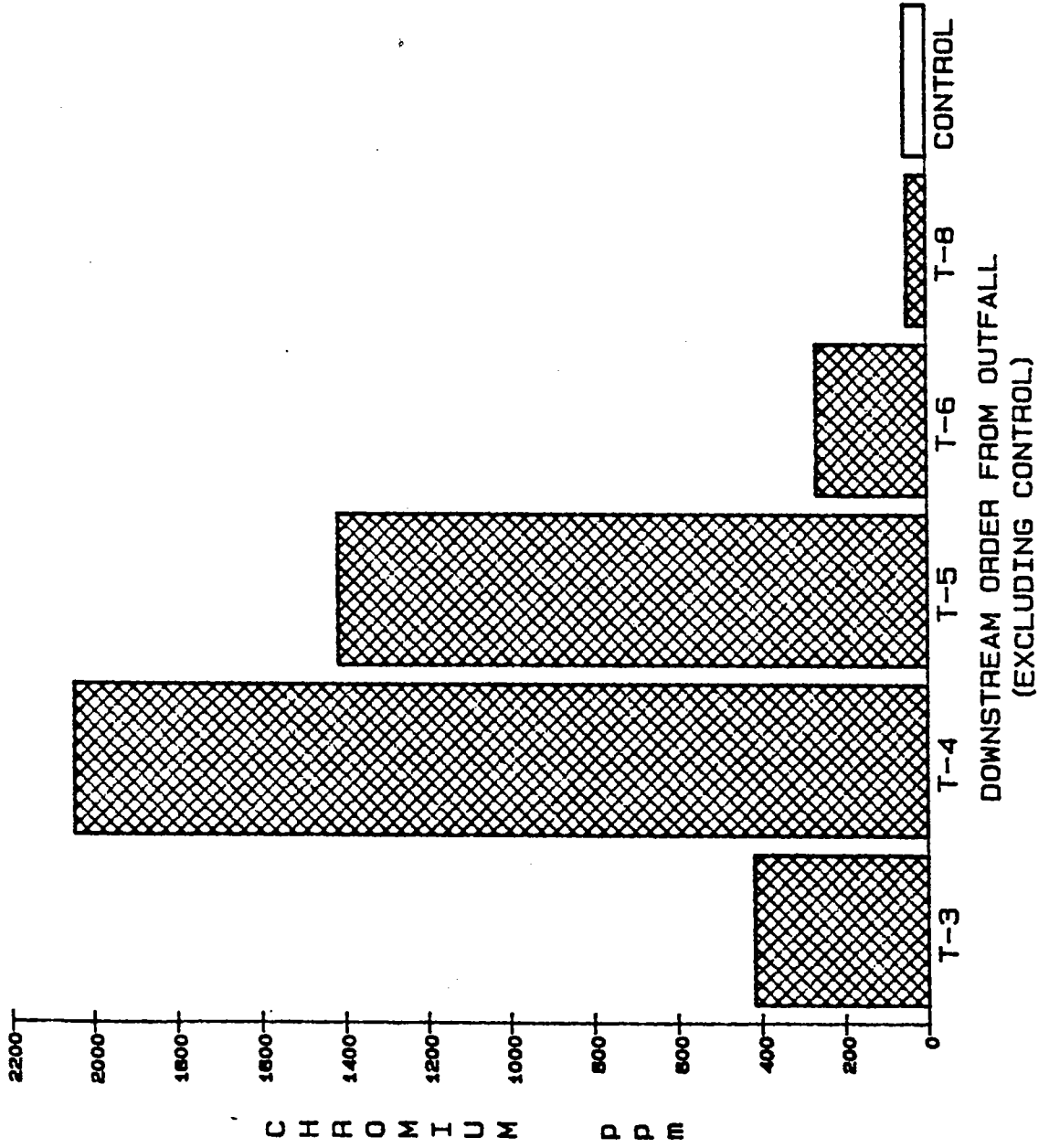

BAYOU TREPAGNIER SEDIMENT DATA
LEAD
July 11, 1985

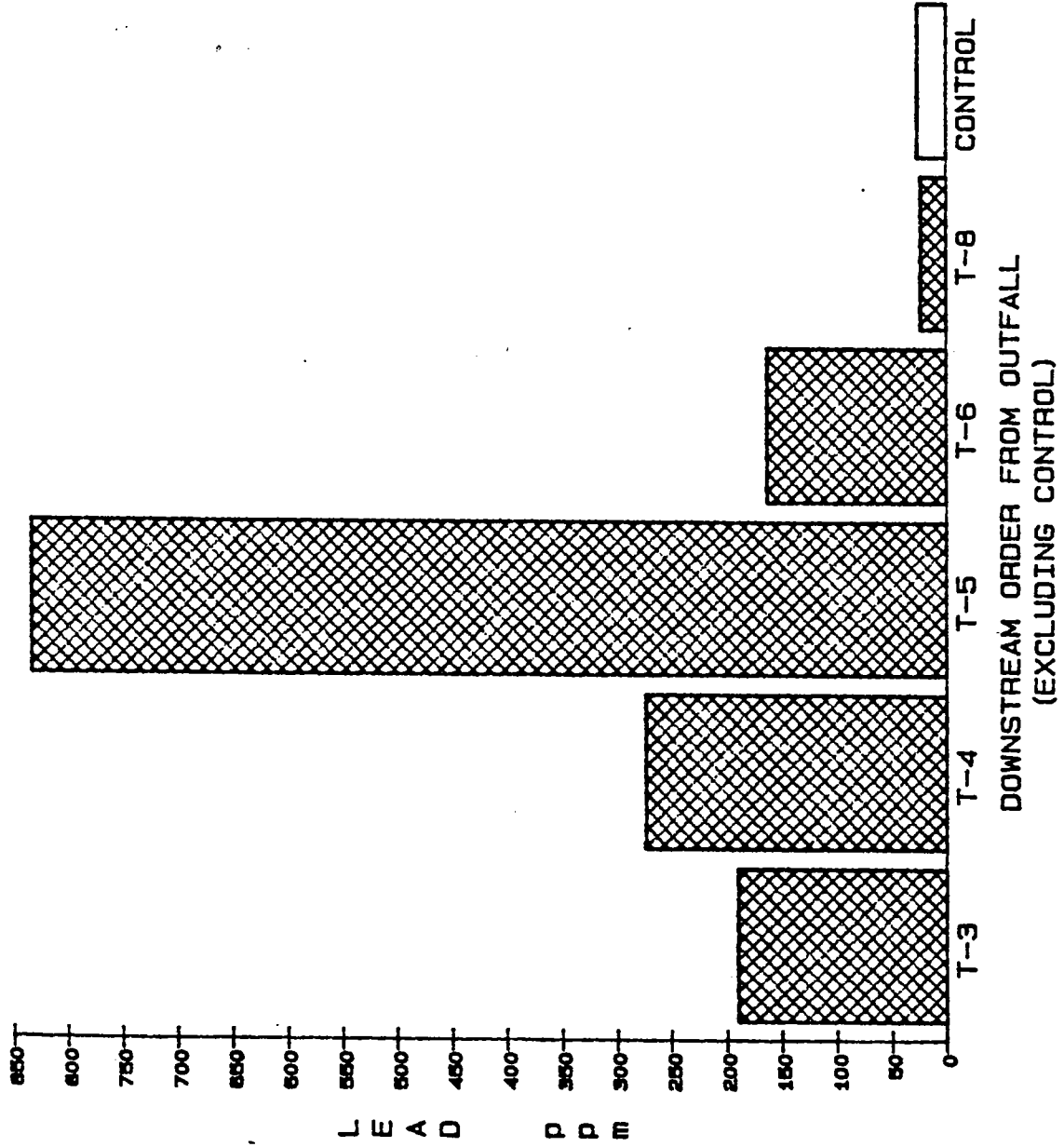



DEPARTMENT OF THE ARMY

NEW ORLEANS DISTRICT, CORPS OF ENGINEERS

P.O. BOX 60267

NEW ORLEANS, LOUISIANA 70160-0267

REPLY TO
ATTENTION OF:

Planning Division
Environmental Analysis Branch

Mr. Charles J. Killebrew
Scenic Rivers Coordinator
Louisiana Department of Wildlife
and Fisheries
P.O. Box 15570
Baton Rouge, Louisiana 70895

Dear Mr. Killebrew:

Enclosed is a petition for a Class B Permit for the use of natural and scenic rivers in St. Charles Parish, Louisiana. The work would affect Bayou Trepagnier and a tributary of Bayou La Branche, Cross Bayou Canal. The proposed work is part of the approved Lake Pontchartrain, Louisiana, and Vicinity Hurricane Protection project.

Sincerely,

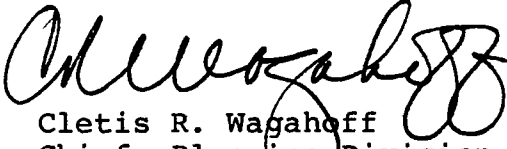

Cletis R. Wagahoff
Chief, Planning Division

Enclosure

REPORT ON
PROPOSED LEVEE CROSSINGS OF CROSS BAYOU CANAL
AND BAYOU TREPAGNIER IN ST. CHARLES PARISH
LOUISIANA

BY
U.S. ARMY CORPS OF ENGINEERS
NEW ORLEANS DISTRICT
NOVEMBER 1987

DESCRIPTION OF THE PROJECT

The U.S. Army Corps of Engineers, New Orleans District, proposes to construct a hurricane protection levee system for the metropolitan New Orleans area. This system would provide for improving existing hurricane protection in portions of the parishes of Orleans, Jefferson, St. Bernard, and St. Charles. The area of specific concern is in St. Charles Parish where a proposed levee crosses a scenic stream tributary of Bayou La Branche, Cross Bayou Canal, and the scenic stream Bayou Trepagnier. The levee would cross the Cross Bayou Canal in Section 33, Township 12 South, Range 8 East, and the levee would cross Bayou Trepagnier in Section 21, Township 12 South, Range 8 East, as shown on the vicinity maps (Figures 1 and 2). The crossing sites are located approximately three miles north of New Sarpy, Louisiana.

The proposed levee would bisect the two streams, would have an average height of about 13.0 feet, and would be approximately 300 feet in base width. The based width is a function of engineering constraints for the levee height and site material. At Cross Bayou Canal, the centerline of the levee is about 800 feet north of Airline Highway. Box culvert structures would be installed in the levee to maintain the existing flow regime. At Bayou Trepagnier, the levee would be contiguous with the existing tank farm levee owned by Norco Oil Refinery. Box culvert structures would also be installed in this bayou crossing. Appendix 1 contains photographs of the two bayou crossings.

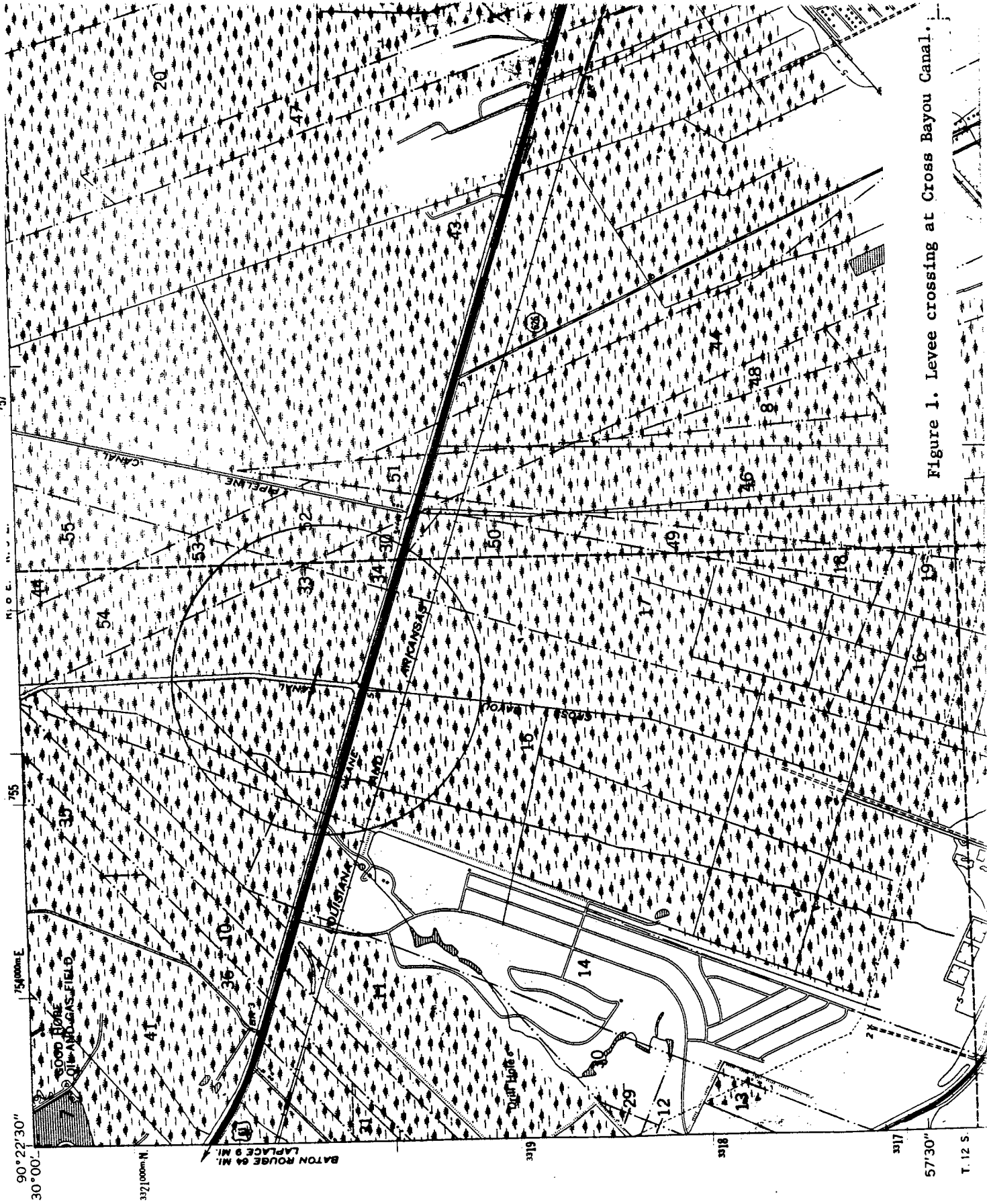

Figure 1. Levee crossing at Cross Bayou Canal.

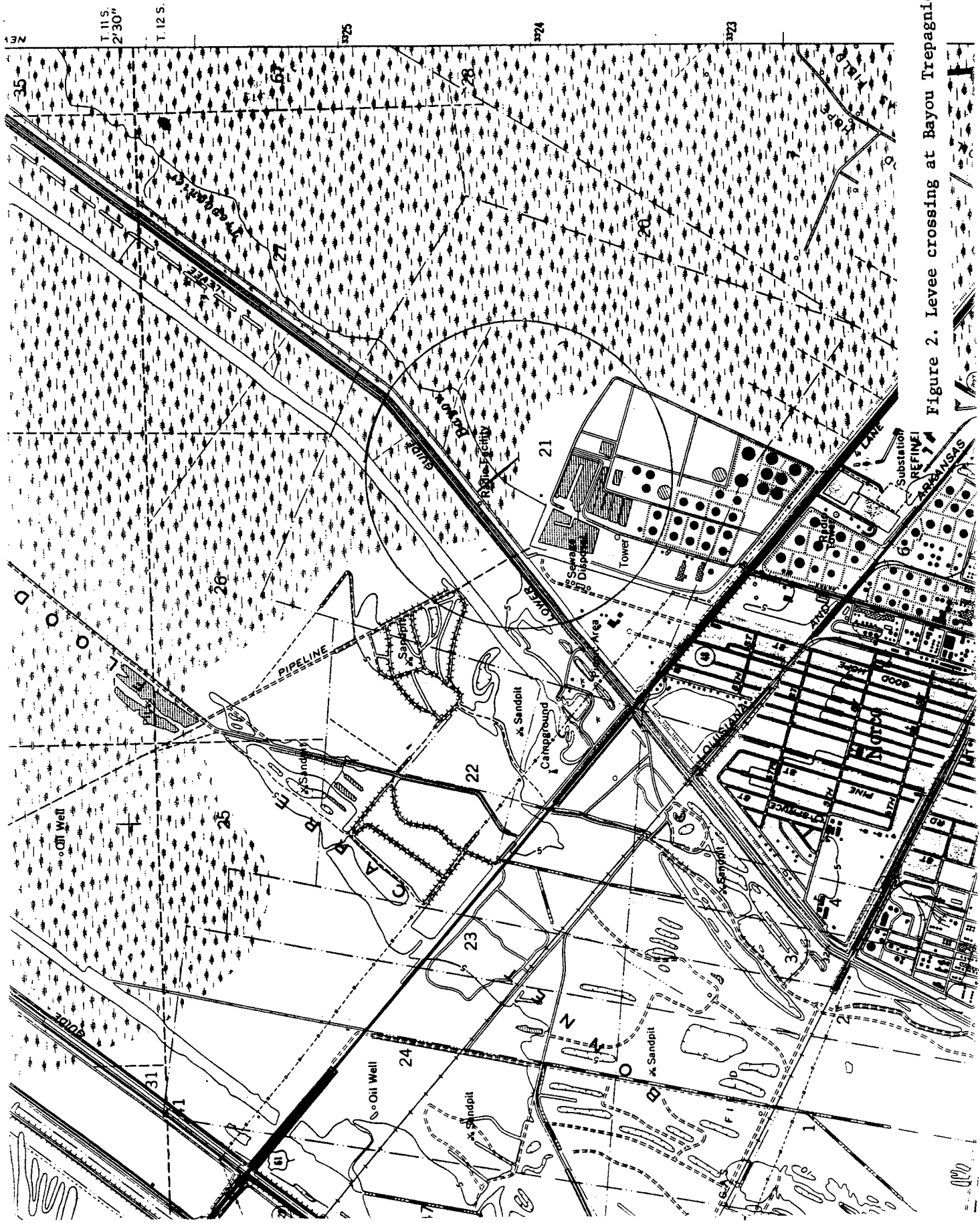

Figure 2. Levee crossing at Bayou Trepagnier.

EFFECTS OF CONSTRUCTION OF THE PROPOSED LEVEES

It is anticipated that the effects of this project on wilderness quality (a), scenic value (b), and recreation (d) would be minimal.^{1/} The levees adjacent to the box culverts would be vegetated with grasses and the surrounding disturbed cypress swamp/wet bottomland hardwood forest would revegetate naturally.

Vegetation (i) in the area of the crossings is characterized by black willow, bitter pecan, hackberry, American elm, Drummond red maple, sycamore, baldcypress, tupelogum, pumpkin ash, swamp privet, water hyacinth, water pennywort, duckweed, cottonwood, water oak and Nuttall oak.

Wildlife (f) in the vicinity of the proposed crossing sites is known to include populations of opossums, moles, nutria, bats, racoons, skunk, deer, squirrel, mice, rabbits, and armadillo. A variety of amphibians and reptiles is also known to be present in or near the bayous, including the American alligator. In the vicinity of the proposed crossings, numerous avian species are common including owls, kites, and ibis. An active bald eagle nest is located approximately two miles northeast of the Cross Bayou levee crossing. Levee construction will not affect the eagles. Approximately 0.72 acres of bayou bottom and associated banks would be replaced by water control structures. The benthic community at the proposed project locations will be eliminated or permanently displaced. The

^{1/} Letters in parenthesis refer to parameters listed in "Guidelines and Procedures for Administration of the Natural and Scenic Rivers System Act."

bayous contain several species of fish, including bullhead and blue catfish, gar, crappie, and numerous species of sunfish. Wildlife that utilizes the banks would also use the levees for forage and resting. Conversion of the bayous and their banks to water control structures would have a minimal effect on the general ecological balance (c) in the vicinity.

The project would have little effect on recreation (d) in Cross Bayou Canal. The levee itself would prevent most boaters from using the waterway to gain access to the Airline Highway borrow canal or launching boats at Airline for access to Bayou La Branch. Canoes and small flatboats could be carried over the levee, but larger powerboats would not be able to pass. However, a public ramp will be constructed to maintain access for boaters. The area does possess natural resources to provide excellent fishing, boating, crabbing, photography, birdwatching, and other outdoor sports. The levee would have little or no effect on recreation in Bayou Trepagnier as the crossing will be as close as practicable to the source, a pump station at holding ponds of Norco Oil Refinery.

Little foreign matter would be allowed to enter the bayous or borrow canal during construction of the box culverts. Silt screens would be installed to define and contain construction turbidity to minimize any excavated material loss. The only effect on water quality (j) caused by the levee and culvert construction would be a temporary increase in local turbidity, which would result in lowered dissolved oxygen and increased biological oxygen demand adjacent to the levee toes and culverts until material settles out of the water column.

The geology (h) in the vicinity of the levee crossings is similar to much of that of the surrounding area and includes lowland and water areas between the natural levee deposits of

the Mississippi River and the Pleistocene escarpment to the north and west. Soils of the area are the Barbary-Fausse association: level, poorly drained soils that have a mucky or clayey surface and clayey underlying material. The dominant topographic feature of the area is Lake Pontchartrain. Surveys done in the areas indicated no unique geological formations or other apparent natural and physical features (k) or similar resources that would be detrimentally affected by the proposed levees.

There are no known archeological sites (g) within the construction area of the proposed levee crossings. The administrator of the Natural and Scenic Rivers System would be notified if any evidence is found of previous inhabitation or if archeological features are observed during construction.

ALTERNATIVES TO THE PROPOSED PROJECTS

There are no practicable alternatives to the location of the levees crossing the scenic stream and the tributary to a scenic stream. The hurricane protection levee alignment crosses the bayous at the indicated locations (Figures 1 and 2). The stream crossings tie into the adjacent levee alignment. If the proposed bayou crossings were not constructed (no action alternative), the integrity of the hurricane protection levee system would be severely compromised. Also, a solid levee could be constructed across the streams, but the environmental impacts would be too great.

A different design of the levee structure at Cross Bayou Canal is possible, such as a gate structure, for maintaining boat access into La Branche wetlands from Airline Highway. However, this would greatly increase costs in excess of \$1.5 million. At Bayou Trepagnier, no gate structures are deemed necessary to maintain boat access as the levee will be as close as practicable to the source, a pump station at Norco oilfield settling ponds. Other sites near the levee alignment are available for public access to Bayou Trepagnier.

ACTIONS TO MINIMIZE DETRIMENTAL EFFECTS

Efforts to minimize adverse environmental effects of the proposed bayou crossings include: retention dikes utilized for any hydraulic dredge material placement; placement of silt screens on either side of the levee crossings; planting the adjacent levee with grasses; and installation of box culvert structures to maintain existing hydrologic patterns of both bayous.

To minimize the public impacts of reduced access to Cross Bayou Canal and La Branche Wetlands, a ramp with culverts will be constructed across the Airline Highway borrow ditch and across the levee to permit recreational boaters safe access to Cross Bayou Canal. The cost of providing this access is minimal, approximately \$120,000.00.

BIBLIOGRAPHY

- U.S. Army Corps of Engineers. 1984. Lake Pontchartrain, Louisiana, and Vicinity Hurricane Protection Project EIS. New Orleans District. Vol. 1, 2, 3.
- Soil Conservation Service. 1987. Soil Survey of St. Charles Parish, Louisiana.
- N-Y Associates, Inc. 1978. Environmental Assessment of East Bank, St. Charles Parish, Louisiana--201 Facilities Plan.
- Center for Wetland Resources, Louisiana State University. 1985. A Comprehensive Wetland Management Plan for the La Branche Wetlands, St. Charles Parish, Louisiana.

APPENDIX 1



(a)



(b)

Photographs showing Cross Bayou Canal from (a) Airline Highway and
(b) from the canal looking towards the highway.



(a)



(b)

Photographs showing Cross Bayou Canal from (a) Airline Highway and
(b) from the canal looking towards the highway.

C O N S I S T E N C Y D E T E R M I N A T I O N
Louisiana Coastal Zone Management Program

C.10.1. Introduction

Section 307 of the Coastal Zone Management Act of 1972, 16 U.S.C. 1451 et. seq., required that "each Federal agency conducting or supporting activities directly affecting the coastal zone shall conduct or support those activities in a manner which is, to the maximum extent practicable, consistent with approved state management programs." In accordance with Section 307, a consistency determination has been made for the Lake Pontchartrain, Louisiana and Vicinity Hurricane Protection project; specifically, the scenic stream crossings and levee realignment at New Orleans airport, both in St. Charles Parish. Coastal Use Guidelines were written to implement the policies and goals of the Louisiana Coastal Resources Program, and to serve as a set of performance standards for evaluating projects. Compliance with Section 307 of the Louisiana Coastal Resources Program requires compliance with applicable Coastal Use Guidelines. An evaluation of the projects relative to each guideline is presented in paragraph C.10.3. A determination of the consistency of the project with the guidelines is presented in paragraph C.10.4. It should be noted that the hurricane protection levee alignment for St. Charles Parish proposed in the 1983 Final EIS was determined to be consistent with the Louisiana Coastal Resources Program (LCRP).

10.2. Project Description

The U.S. Army Corps of Engineers proposes to construct a hurricane protection levee for the metropolitan New Orleans area. The levee would provide for improving existing hurricane protection levee systems and constructing new levee systems.

The levee would transect portions of the parishes of Orleans, Jefferson, St. Bernard, and St. Charles. The specific actions of concern are in

St. Charles Parish, where the proposed levee crosses a scenic stream tributary of Bayou LaBranche, Cross Bayou Canal; the scenic stream Bayou Trepagnier; a levee realignment at the junction with the airport runway extension levee; several landfills and several oil and gas waste pits.

Scenic Streams

The levee would cross the Cross Bayou Canal in Section 33, Township 12 South, Range 8 East, and the levee would cross Bayou Trepagnier in Section 21, Township 12 South, Range 8 East. The crossing sites are located approximately 3 miles north of New Sarpy, Louisiana.

The proposed levee would bisect the two streams, would have an average height of about 13.5 feet, and be approximately 300 feet in base width. The base width is a function of engineering constraints for the levee height and site material. At Cross Bayou Canal, the centerline of the levee is 800 feet from Airline Highway. A concrete box culvert structure would be installed with screw-type gate structures. At Bayou Trepagnier, the centerline of the levee would be approximately 400 feet from the back levee of Norco Oil Refinery. This is based on a levee alignment that parallels the existing Norco Refinery levees to the Spillway guide levee. A small culvert structure would be placed in Bayou Trepagnier and a large concrete box culvert structure with screw-type gates would be placed in Engineer canal.

Levee Realignment

The levee realignment is located in Section 39, Township 12 South, Range 22 East, located at Kenner, Louisiana. The levee would toe-in with the back of the T.L. James property to the Illinois Central Gulf railroad as originally proposed. At the railroad, instead of heading southward and going around a drainage ditch, the levee would cut across to the runway extension, with the toe being partially in the drainage ditch and parallel to the ditch. The levee would have an average height of about 14 feet and

be approximately 350 feet in base width. The levee would have culvert/flapgate structures to allow water in the drainage ditch to escape northerly into the wetlands.

Landfill Crossings

The landfills are located in Sections 43, 47 and 40, Township 12 South, Range 9 East, located near Almedia, Louisiana. The centerline of the levee would intersect the landfills approximately 800 feet north from Airline Highway. Across the landfills, a clay cap would be constructed, built approximately 3 feet above the landfill height. No excavation or sheet piling would be done in the landfills. The total cap size over the landfills is approximately 3,000 feet long by 150 feet wide.

Drilling Waste Pits

The waste pits are located in Sections 7, 21, 33 and 41, Township 12 South, Range 8 East, near Good Hope Oil and Gas Field at Norco, Louisiana. The levee would partially or completely disturb these pits. They would be graded and filled with the contents buried or displaced as required by the levee alignment. The levee would go around any active well sites.

C.10.3. Guidelines

1. Guidelines Applicable to All Uses

Guideline 1.1: The guidelines must be read in their entirety. Any proposed use may be subject to the requirements of more than one guideline or section of guidelines and all applicable guidelines must be complied with.

Response 1.1: Acknowledged.

Guideline 1.2: Conformance with applicable water and air quality laws, standards and regulations and with other laws, standards and regulations that have been incorporated into the coastal resources program shall be deemed in conformance with the program except to the extent that these guidelines would impose additional requirements.

Response 1.2: Acknowledged.

Guideline 1.3: The guidelines include both general provisions applicable to all uses and specific provisions applicable only to certain types of uses. The general guidelines apply in all situations. The specific guidelines apply only to the situations they address. Specific and general guidelines should be interpreted to be consistent with each other. In the event there is an inconsistency, the specific should prevail.

Response 1.3: Acknowledged.

Guideline 1.4: These guidelines are not intended to nor shall they be interpreted so as to result in an involuntary acquisition or taking of property.

Response 1.4: Acknowledged.

Guideline 1.5: No use or activity shall be carried out or conducted in such a manner as to constitute a violation of the terms of a grant or donation of any lands or waterbottoms to the State or any subdivision thereof. Revocations of such grants and donations shall be avoided.

Response 1.5: Acknowledged.

Guideline 1.6: Information regarding the following general factors shall be utilized by the permitting authority in evaluating whether the proposed use is in compliance with the guidelines.

Response 1.6: Acknowledged.

Guideline 1.7: It is the policy of the coastal resources program to avoid the following adverse impacts. To this end, all uses and activities shall be planned, sited, designed, constructed, operated, and maintained to avoid to the maximum extent practicable significant:

Guideline 1.7 (a): Reduction in the natural supply of sediment and nutrients to the coastal system by alterations of freshwater flow.

Response 1.7 (a): In St. Charles Parish, water-flow structures would be installed to equal or exceed that currently provided for by the bayous and sheet flow in the airport runway area.

Guideline 1.7 (b): Adverse economic impacts on the locality of the use and affected governmental bodies.

Response 1.7 (b): There would be no significant economic impacts, except for shared construction and maintenance costs.

Guideline 1.7 (c): Detrimental discharges of inorganic nutrient compounds into coastal waters.

Response 1.7 (c): During dredging and fill deposition of levee materials, a minor and temporary discharge of inorganic materials would occur in the stream/bayou crossings. Pollutants currently trapped in the bayou sediments and oil waste pits will be cleaned up prior to construction.

Guideline 1.7 (d): Alterations in the natural concentration of oxygen in coastal waters.

Response 1.7 (d): During hydraulic dredging and levee construction, suspended sediments would be released into the surrounding wetlands and water bodies. This release could decrease oxygen levels in the waters immediately surrounding the construction site by inhibiting photosynthesis or heating of the water. Some particles could contain chemically reduced

substances, such as sulfides, which have a high chemical oxygen demand (COD) while other particles may have micro-organisms attached that could decompose organic matter and create a biological oxygen demand (BOD). A localized and temporary reduction in dissolved oxygen would occur in the immediate areas of discharge.

Guideline 1.7 (e): Destruction or adverse alterations of streams, wetlands, tidal passes, inshore waters and water bottoms, beaches, dunes, barrier, islands, and other natural biologically valuable areas or protective coastal features.

Response 1.7 (e): In St. Charles Parish, the scenic stream levees and structures would impact approximately 0.72 acres of bayou bottom and parallel Airline Highway (US 61), and a number of structures would be installed to equal or exceed the present flow through Airline Highway. The acreage impacted has been reduced to the maximum extent practicable. The levee realignment at the airport would impact approximately 4.49 acres of wetlands and 1.93 acres of canal bottom, but installed structures would maintain waterflow. The waste pits and landfills would not be considered natural biologically valuable areas.

Guideline 1.7 (f): Adverse disruption of existing social patterns.

Response 1.7 (f): Construction of the hurricane protection levees is not expected to significantly disrupt existing social patterns. However, there is expected to be a temporary disruption of recreational use of the levees, parks, boat-launching areas, and nearshore fishing waters during construction. After construction, large powerboats will have access to LaBranch wetlands through Cross Bayou Canal by way of a bridge and shelled launch area.

Guideline 1.7 (g): Alterations of the natural temperature regime of coastal waters.

Response 1.7 (g): No permanent changes in temperature regimes are expected. Increased suspended solids produced during construction could absorb incident radiation and slightly increase the temperatures of local water bodies, especially near the surface. Any increase would be temporary and not significant.

Guideline 1.7 (h): Detrimental changes in existing salinity regimes.

Response 1.7 (h): There would be no detrimental change in existing salinity regimes.

Guideline 1.7 (i): Detrimental changes in littoral and sediment transport processes.

Response 1.7 (i): There would be no detrimental change in existing sediment transport processes.

Guideline 1.7 (j): Adverse effects of cumulative impacts.

Response 1.7 (j): The project could add to the adverse environmental impacts occurring in the wetlands surrounding New Orleans. The physical presence of the hurricane levees would eliminate more wetland habitat. However, wetland destruction has been reduced to the maximum extent practicable.

Guideline 1.7 (k): Detrimental discharges of suspended solids into coastal waters, including turbidity resulting from dredging.

Response 1.7 (k): The projects would have minimal, short-term impacts on turbidity.

Guideline 1.7 (l): Reduction or blockage of water flow or natural circulation patterns within or into an estuarine system or a wetland forest.

Response 1.7 (l): In the St. Charles Parish alignment, structures would be installed to maintain present circulation patterns.

Guideline 1.7 (m): Discharges of pathogens or toxic substances into coastal waters.

Response 1.7 (m): Based on elutriate analysis, various pollutants already present in the environment would be temporarily relocated, but levels would not be increased significantly, particularly after Bayou Trepagnier and the oil waste pits are cleaned up.

Guideline 1.7 (n): Adverse alteration or destruction of archeological, historical, or other cultural resources.

Response 1.7 (n): At present, no cultural resources are recorded in the area of the alignment right-of-way for the entire levee length in St. Charles Parish.

Guideline 1.7 (o): Fostering of detrimental secondary impacts in undisturbed or biologically highly productive wetland areas.

Response 1.7 (o): The levee realignment at the airport, scenic stream crossings, landfill crossings and waste pit crossings are all expected to have little to no detrimental secondary impacts on wetlands.

Guideline 1.7 (p): Adverse alteration or destruction of unique or valuable habitats, critical habitat for endangered species, important wildlife, or fishery breeding or nursery areas designated wildlife management or sanctuary areas, or forestlands.

Response 1.7 (p): The project would not impact any such unique or valuable habitats.

Guideline 1.7 (q): Adverse alteration or destruction of public parks, shoreline access points, public works, designated works, designated recreation areas, scenic rivers, or other areas of public use and concern.

Response 1.7 (q): The water control structure and levee would have some effect on recreation in Cross Bayou Canal. The levee will not allow most boaters to use the waterway to gain access to the Airline Highway borrow canal or to launch boats at Airline for access to Bayou LaBranche wetlands. Canoes and small flat boats could be carried over the levee, but larger powerboats will not be able to pass. The Corps will construct a shelled launch and bridge to maintain and enhance access to the LaBranche wetlands. The area does possess the natural resources to provide excellent fishing, boating, crabbing, photography, birdwatching and other outdoor sports. There would be little effect on the recreation value of Bayou Trepagnier. This levee crossing is approximately 400 feet from the bayou source, which is pumped outfall from oilfield settling ponds. The levee realignment would have little to no effect on recreation at the airport extension site.

Guideline 1.7 (r): Adverse disruptions of coastal wildlife and fishery migratory patterns.

Response 1.7 (r): The project is not expected to disrupt any wildlife or fishery migration patterns.

Guideline 1.7 (s): Land loss, erosion, and subsidence.

Response 1.7 (s): The project will not increase land loss, erosion, and subsidence.

Guideline 1.7 (t): Increases in the potential for flood, hurricane or other storm damage, or increases in the likelihood that damage would occur from such hazards.

Response 1.7 (t): The primary objective of the project is to reduce flood damage due to hurricanes.

Guideline 1.7 (u): Reduction in the long-term biological productivity of the coastal ecosystem.

Response 1.7 (u): The stream crossings and realignment would have minor long-term impacts on productivity. The wetland acres impacted would be filled and converted from productive swamp, marsh, and shallow water habitats, to much less productive upland, grass-type levees. The oil and gas waste pits and landfills currently have little biological productivity.

Guideline 1.8: In those guidelines in which the modifier "maximum extent practicable" is used, the proposed use is in compliance with the guideline if the standard modified by the term is complied with. If the modified standard is not complied with, the use would be in compliance with the guideline if the permitting authority finds, after a systematic consideration of all pertinent information regarding the use, the site and the impacts of the use as set forth in Guideline 1.6, and a balancing of their relative significance, that the benefits resulting from the proposed use would clearly outweigh the adverse impacts resulting from noncompliance with the modified standard and there are no feasible and practical;

alternative locations, methods, and practices for the use that are in compliance with the modified standard and:

(a) Significant public benefits would result from the use, or;

(b) The use would serve important regional, state or national interest, including the national interest in resources and the siting of facilities in the coastal zone identified in the coastal resources program, or;

(c) The use is coastal water dependent.

Response 1.8: Acknowledged.

Guideline 1.9: Uses shall to the maximum extent practicable be designed and carried out to permit multiple concurrent uses that are appropriate for the location and to avoid unnecessary conflicts with other uses of the vicinity.

Response 1.9: Acknowledged.

Guideline 1.10: These guidelines are not intended to be, nor shall they be, interpreted to allow expansion of governmental authority beyond that established by LA R.S. 49:213.21, as amended; nor shall these guidelines be interpreted so as to require permits for specific uses legally commenced or established prior to the effective date of the coastal use permit program nor to normal maintenance or repair of such uses.

Response 1.10: Acknowledged.

2. Guidelines for Levees.

Guideline 2.1: The leveeing of unmodified or biologically productive wetlands shall be avoided to the maximum extent practicable.

Response 2.1: The realignments in St. Charles Parish have been designed to avoid wetlands to the maximum extent possible and tie in with the airport levees. The scenic stream crossings bridge adjacent hurricane levees and no other practicable siting is possible. The waste pits and landfills are not considered very biologically productive.

Guideline 2.2: Levees shall be planned and sited to avoid segmentation of wetland areas and systems to the maximum extent practicable.

Response 2.2: The proposed levee alignments either follow existing alignments or have been designed to avoid segmentation of wetlands to the maximum extent practicable.

Guideline 2.3: Levees constructed for the purpose of developing or otherwise changing the use of wetland area shall be avoided to the maximum extent practicable.

Response 2.3: Levees, as proposed by this project, are constructed for the purpose of preventing floods associated with hurricanes.

Guidelines 2.4: Hurricane and flood protection levees shall be located at the non-wetland/wetland interface or landward to the maximum extent practicable.

Response 2.4: The proposed levees would be located as near to the non-wetland/wetland interface or landward to the maximum extent practicable and still maintain the project objectives of preventing hurricane-induced flooding.

Guideline 2.5: Impoundment levees shall be constructed only in wetland areas as part of approved water or marsh-management projects or to prevent the release of pollutants.

Response 2.5: Proposed levees are not impoundment levees, they are to prevent hurricane induced flooding.

Guideline 2.6: Hurricane or flood protection levee systems shall be designed, built, and thereafter operated and maintained, utilizing best practical techniques to minimize disruptions of existing hydrologic patterns, and the interchange of water, beneficial nutrients and aquatic organisms between inclosed wetlands and those outside the levee system.

Response 2.6: The proposed levee system would utilize existing levee alignments to the maximum extent possible to minimize disruption of flow patterns, water and nutrient exchange, and transport of aquatic organisms. Where necessary to traverse wetlands, water control structures are included in levee design to preserve normal flow through the area involved.

3. Guidelines For Linear Facilities

Not Applicable

4. Guidelines For Dredged Spoil Deposition

Guideline 4.1: Spoil shall be deposited utilizing the best practical techniques to avoid disruption of water movement, flow, circulation, and quality.

Response 4.1: Dredged material from the Mississippi River and hauled sands from the Bonnet Carre' Spillway would be placed along the Airline Highway alignment. Minor changes in water movement, flow, circulation, could occur; however, the impacts would be negligible due to packing, containment dikes, and the use of silt screens.

Guideline 4.2: Spoil shall be used beneficially to the maximum extent practicable to improve productivity or create new habitat, reduce or compensate for environmental damage done by dredging activities, or to prevent environmental damage. Otherwise, existing spoil disposal areas or upland disposal shall be utilized to the maximum extent practicable rather than creating new disposal areas.

Response 4.2: Because spoil material would be used to construct levees, it would not be available for wetland habitat creation. A grassy-upland habitat area would be constructed.

Guideline 4.3: Spoil shall not be disposed of in a manner that could result in the impounding or drainage of wetlands or the creation of development sites unless the spoil deposition is part of an approved levee or land surface alteration project.

Response 4.3: Deposition would not impound or drain wetlands.

Guidelines 4.4: Spoil shall not be disposed of on marsh, known oyster or clam reefs, or in areas of submersed vegetation to the maximum extent practicable.

Response 4.4: Dredged material would not impact any oyster or clam reefs. Approximately 4.49 acres of fresh marsh and 2.65 acres of stream habitat would be eliminated.

Guideline 4.5: Spoil shall not be disposed of in such a manner as to create a hindrance to navigation or fishing, or hinder timber growth.

Response 4.5: The project would cross Cross Bayou Canal, a tributary to the scenic stream Bayou LaBranche, and would cross Bayou Trepagnier. The levee crossing would not hinder navigation on Bayou Trepagnier as it would be near the source. However, navigation would be hindered on the Cross Bayou Canal. The levee crossing would restrict access for fishing and recreation into the LaBranche wetlands area. Small boats or canoes could be carried over the levee, but larger powerboats would not be able to cross. A shelled public access launch and bridge will be constructed to maintain and enhance public access to LaBranche wetlands.

Guideline 4.6: Spoil disposal areas shall be designed and constructed and maintained using the best practical techniques to retain the spoil at the site, reduce turbidity, and reduce shoreline erosion when appropriate.

Response 4.6: Turbidity, and associate impacts, would be reduced with silt curtains and containment dikes at the stream crossings and levee realignment.

Guideline 4.7: The alienation of state-owned property shall not result from spoil deposition activities without the consent of the Department of Natural Resources.

Response 4.7: The filling of state-owned property, the stream bottoms is acknowledged.

6. Guidelines For Surface Alterations

Guidelines 6.1: Industrial, commercial, urban, residential, and recreation uses are necessary to provide adequate economic growth and development. To this end, such uses would be encouraged in areas of the coastal zone that are suitable for development. Those uses shall be consistent with other guidelines and shall, to the maximum extent practicable, take place only:

(a) On lands five feet or more above sea level or within fast lands;
or

(b) On lands that have foundation conditions sufficiently stable to support the use, and where flood and storm hazards are minimal or where protection from these hazards could be reasonably well achieved, and where the public safety would not be unreasonably endangered; and

- 1) The land is already in high intensity of development use, or
- 2) There is adequate supporting infrastructure, or
- 3) The vicinity has a tradition of use for similar habitation or development.

Response 6.1: The St. Charles levee (including stream crossings, waste pit crossings, landfill crossing and realignment at the airport) would parallel Airline Highway, and is the most practicable alignment to protect the developed areas of St. Charles Parish.

Guideline 6.2: Public and private works projects, such as levees, drainage improvements, roads, airports, ports, and public utilities, are necessary to protect and support needed development and shall be encouraged. Such projects shall, to the maximum extent practicable, take place only when:

(a) They protect or serve those areas suitable for development pursuant to Guideline 6.1; and

(b) They are consistent with other guidelines; and

(c) They are consistent with all relevant adopted state, local and regional plans.

Response 6.2: The scenic stream crossings, waste pit crossings, landfill crossing and levee realignment are consistent with all relevant adopted state, local and regional plans, namely the Hurricane Protection Project.

Guideline 6.3: BLANK (Deleted)

Guideline 6.4: To the maximum extent practicable, wetland areas shall not be drained or filled. Any approved drain or fill project shall be designed and constructed using best practical techniques to minimize present and future property damage and adverse environmental impacts.

Response 6.4: Acknowledged.

Guideline 6.5: Coastal water dependent uses shall be given special consideration in permitting because of their reduced choice of alternatives.

Response 6.5: Not applicable.

Guidelines 6.6: Areas modified by surface alteration activities shall, to the maximum extent practicable, be revegetated, refilled, cleaned and restored to their predevelopment condition upon termination of the use.

Response 6.6: The levees would be vegetated, and most adjacent areas affected during construction would revert to predevelopment conditions.

Guideline 6.7: Site clearing shall to the maximum extent practicable be limited to areas immediately required for physical development.

Response 6.7: Site clearing would be reduced to the maximum extent practicable.

Guideline 6.8: Surface alterations shall, to the maximum extent practicable, be located away from critical wildlife areas and vegetation areas. Alterations in wildlife preserves and management areas shall be conducted in strict accordance with the requirements of the wildlife management body.

Response 6.8: No critical vegetation or wildlife areas would be impacted.

Guideline 6.9: Surface alterations that have high adverse impacts on natural functions shall not occur, to the maximum extent practicable, on barrier islands and beaches, isolated cheniers, isolated natural ridges or levees, or in wildlife and aquatic species breeding or spawning areas, or in migratory routes.

Response 6.9: None of these unique areas would be impacted.

Guideline 6.10: The creation of low dissolved oxygen conditions in the water or traps for heavy metals shall be avoided to the maximum extent practicable.

Response 6.10: Reference Guidelines 1.7 (d) and 1.7 (m).

Guideline 6.11: Surface mining and shell dredging shall be carried out utilizing the best practical techniques to minimize adverse environmental impacts.

Response 6.11: Not Applicable.

Guideline 6.12: The creation of underwater obstructions that adversely affect fishing or navigation shall be avoided to the maximum extent practicable.

Response 6.12: No underwater obstructions would be constructed that would adversely affect fishing or navigation.

Guideline 6.13: Surface alteration sites and facilities shall be designed, constructed, and operated using the best practical techniques to prevent the release of pollutants or toxic substances into the environment and minimize other adverse impacts.

Response 6.13: Reference Guideline 1.7.

Guideline 6.14: To the maximum extent practicable, only material that is free of contaminants and compatible with the environmental setting shall be used as fill.

Response 6.14: Contaminant-free fill material compatible with the environmental setting shall be used to the maximum extent practicable.

7. Guidelines For Hydrologic And Sediment Transport Modifications

Guideline 7.1: The controlled diversion of sediment-laden waters to initiate new cycles of marsh building and sediment nourishment shall be encouraged and utilized whenever such diversion would enhance the viability

and productivity of the outfall area. Such diversions shall incorporate a plan for monitoring and reduction and/or amelioration of the effects of pollutants present in the freshwater source.

Response 7.1: Not Applicable.

Guideline 7.2: Sediment deposition systems may be used to offset land loss, to create or restore wetland areas, or to enhance building characteristics of a development site. Such systems shall be utilized only as part of an approved plan. Sediment from these systems shall be discharged only in the area that the proposed use is to be accomplished.

Response 7.2: Not Applicable.

Guideline 7.3: Undesirable deposition of sediments in sensitive habitat or navigation areas shall be avoided through the use of the best preventive techniques.

Response 7.3: Not Applicable.

Guideline 7.4: The diversion of freshwater through siphons and controlled conduits and channels, and overland flow to offset saltwater intrusion and to introduce nutrients into wetlands, shall be encouraged and utilized whenever such diversion would enhance the viability and productivity of the outfall area. Such diversions shall incorporate a plan for monitoring and reduction and/or amelioration of the effects of pollutants present in the freshwater source.

Response 7.4: Not Applicable.

Guideline 7.5: Water or marsh management plans shall result in an overall benefit to the productivity of the area.

Response 7.5: Not Applicable.

Guideline 7.6: Water control structures shall be assessed separately, based on their individual merits and impacts and in relation to the overall water or marsh management plan of which they are a part.

Response 7.6: New water control structures installed in the St. Charles Parish levee would allow free movement of water except during a hurricane. The existing structures, however, would be left "as is".

Guideline 7.7: Weirs and similar water control structures shall be designed and built using the best practical techniques to prevent "cut arounds", permit tidal exchange in tidal areas, and minimize obstruction of the migration of aquatic organisms.

Response 7.7: Refer to 7.6 above.

Guideline 7.8: Impoundments that prevent normal tidal exchange and/or the migration of aquatic organisms shall not be constructed in brackish and saline areas to the maximum extent practicable.

Response 7.8: Not Applicable.

Guideline 7.9: Withdrawal of surface and ground water shall not result in saltwater intrusion or land subsidence to the maximum extent practicable.

Response 7.9: Not Applicable.

8. Guidelines for Disposal of Wastes

Not Applicable

9. Guidelines for Uses that Result in the Alteration of Waters Draining into Coastal Waters

Not Applicable

10. Guidelines for Oil, Gas, and Other Mineral Activities

Not Applicable

C.10.4. Consistency Determination

In the December 1983 Appendix to the Reevaluation Report, the New Orleans District, U.S. Army Corps of Engineers,, determined that implementation of the Lake Pontchartrain, Louisiana, and Vicinity project was consistent, to the maximum extent practicable, with the State of Louisiana's approved Coastal Zone Management Program. Subsequent correspondence from the Coastal Management Division of the Department of Natural Resources (CMD/DNR) indicated that the St. Charles Parish levee alignment is consistent with the Louisiana Coastal Resources Program to the maximum extent practicable. The Corps maintains that the proposed scenic stream crossings, levee realignment at the New Orleans airport, landfill crossings and waste pit conflicts are consistent to the maximum extent practicable with the Coastal Zone Management Program.

The following short form 404(b)(1) evaluation follows the format designed by the Office of the Chief of Engineers, (OCE). As a measure to avoid unnecessary paperwork and to streamline regulation procedures while fulfilling the spirit and intent of environmental statutes, New Orleans District is using this format for all proposed project elements requiring 404 evaluation, but involving no significant impact.

PROJECT DESCRIPTION.

See attached PROJECT DESCRIPTION.

1. Review of Compliance (§230.10 (a)-(d)).

Preliminary

Final

A review of this project indicates that:

a. The discharge represents the least environmentally damaging practicable alternative and if in a special aquatic site, the activity associated with the discharge must have direct access or proximity to, or be located in the aquatic ecosystem to fulfill its basic purpose (if no, see section 2 and information gathered for environmental assessment alternative);

YES NO

YES NO

b. The activity does not appear to: (1) violate applicable state water quality standards or effluent standards prohibited under Section 307 of the Clean Water Act; (2) jeopardize the existence of Federally listed endangered or threatened species or their habitat; and (3) violate requirements of any Federally designated marine sanctuary (if no, see section 2b and check responses from resource and water quality certifying agencies);

YES NO

YES NO

c. The activity will not cause or contribute to significant degradation of waters of the United States including adverse effects on human health, life stages of organisms dependent on the aquatic ecosystem, ecosystem diversity, productivity and stability, and recreational, esthetic, and economic values (if no, see section 2);

YES NO

YES NO

d. Appropriate and practicable steps have been taken to minimize potential adverse impacts of the discharge on the aquatic ecosystem (if no, see section 5).

YES NO

YES NO

2. Technical Evaluation Factors (Subparts C-F).

N/A Not Significant

Significant

a. Physical and Chemical Characteristics of the Aquatic Ecosystem (Subpart C).

- (1) Substrate impacts.
- (2) Suspended particulates/turbidity impacts.
- (3) Water column impacts.
- (4) Alteration of current patterns and water circulation.
- (5) Alteration of normal water fluctuations/hydroperiod.
- (6) Alteration of salinity gradients.

	X	
	X	
	X	
	X	
	X	
X		

- (1) Depth of water at disposal site X
- (2) Current velocity, direction, and variability at disposal site X
- (3) Degree of turbulence X
- (4) Water column stratification _____
- (5) Discharge vessel speed and direction _____
- (6) Rate of discharge X
- (7) Dredged material characteristics (constituents, amount, and type of material, settling velocities X
- (8) Number of discharges per unit of time _____
- (9) Other factors affecting rates and patterns of mixing (specify) _____

Appropriate references:

See item number three and Environmental Assessment

b. An evaluation of the appropriate factors in 4a above indicates that the disposal site and/or size of mixing zone are acceptable.

YES NO

5. Actions to Minimize Adverse Effects (Subpart H).

All appropriate and practicable steps have been taken, through application of the recommendations of §230.70-230.77 to ensure minimal adverse effects of the proposed discharge.

YES NO

Actions taken:

- 1). Silt screens where appropriate
- 2). Retain~~ment~~ment dikes at stream crossings
- 3). Grass planting on levee
- 4). Culvert structures for water flow
- 5). Interagency coordination for clean-up procedures

6. Factual Determination (§230.11).

A review of appropriate information as identified in items 2-5 above indicates that there is minimal potential for short- or long-term environmental effects of the proposed discharge as related to:

- a. Physical substrate at the disposal site (review sections 2a, 3, 4, and 5 above) YES NO
- b. Water circulation, fluctuation and salinity (review sections 2a, 3, 4, and 5) YES NO
- c. Suspended particulates/turbidity (review sections 2a, 3, 4, and 5) YES NO
- d. Contaminant availability (review sections 2a, 3, and 4). YES NO
- e. Aquatic ecosystem structure and function (review sections 2b and c, 3, and 5). YES NO

- f. Disposal site (review sections 2, 4, and 5).
- g. Cumulative impact on the aquatic ecosystem.
- h. Secondary impacts on the aquatic ecosystem.

(YES) NO
 (YES) NO
 (YES) NO

7. Evaluation Responsibility.

- a. This evaluation was prepared by: Ken Froehlich
 Position: Environmental Resources Specialist
 Date: 12/6/88
- b. This evaluation was reviewed by: Sue Hawes
 Position: Chief, Environmental Section
 Date: 12/6/88

8. Findings.

- a. The proposed disposal site for discharge of dredged or fill material complies with the Section 404(b)(1) guidelines _____
- b. The proposed disposal site for discharge of dredged or fill material complies with the Section 404(b)(1) guidelines with the inclusion of the following conditions X

Contaminated sediment removal prior to levee construction (petroleum waste pits, Bayou Trepagnier).

- c. The proposed disposal site for discharge of dredged or fill material does not comply with the Section 404(b)(1) guidelines for the following reason(s):
 - (1) There is a less damaging practicable alternative _____
 - (2) The proposed discharge will result in significant degradation of the aquatic ecosystem _____
 - (3) The proposed discharge does not include all practicable and appropriate measures to minimize potential harm to the aquatic ecosystem _____

Date: 13 DEC 88

Harold E. Manuel, Jr.
 Harold E. Manuel, Jr.
 Major, Corps of Engineers
 Temporary District Engineer

PROJECT DESCRIPTION. A Section 404(b)(1) Evaluation, signed 3 Nov 83, covered levee work in St. Charles Parish (Figure 1a). This Supplement analyzes impacts not described in that 404 and a change in levee alignment. The unanalyzed impacts involved the crossing of two scenic streams, Cross Bayou Canal and Bayou Trepagnier (Figures 1 and 2). The levee design at Cross Bayou Canal would have an average height of approximately 13 feet with a base width of approximately 300 feet and would incorporate a box culvert to maintain the normal water flow regime. The Bayou Trepagnier site would be a similar design with the addition of flap gates to the box culvert structure. The centerline of the new levee at Bayou Trepagnier would be approximately 400 feet from the back levee of the Shell Norco Refinery. An additional concrete box culvert would be placed in Engineer Canal to control surface runoff in the vicinity of the Shell outfall. The levee crossings and associated culverts would impact approximately 0.72 acres of bayou bottom with 36,000 cubic yards (cy) of trucked-in fill material and concrete structures. The crossing at Bayou Trepagnier would not be built until the contaminated sediments in the bayou are removed by Shell Oil.

The second unanalyzed impact involves the traversal of several oil and gas drilling waste pits near Good Hope Oil and Gas Field at Norco in St. Charles Parish (Figure 3). The levee height and base width would be consistent with previously discussed design criteria. The pits would be excavated to remove contaminants prior to levee construction. Approximately 3 acres of mixed bottomland hardwoods would be impacted by levee construction.

The existing levee on the western boundary of New Orleans International Airport would be relocated to accommodate a runway extension (Figures 4 and 5). The height of the levee would be 13 feet with a base width of approximately 350 feet. A box culvert would be incorporated into the levee design to facilitate drainage from an existing ditch. The new levee would impact approximately 4.82 acres of fresh marsh with the placement of 140,000 cy of hydraulically dredged Mississippi River sand and trucked-in fill material.

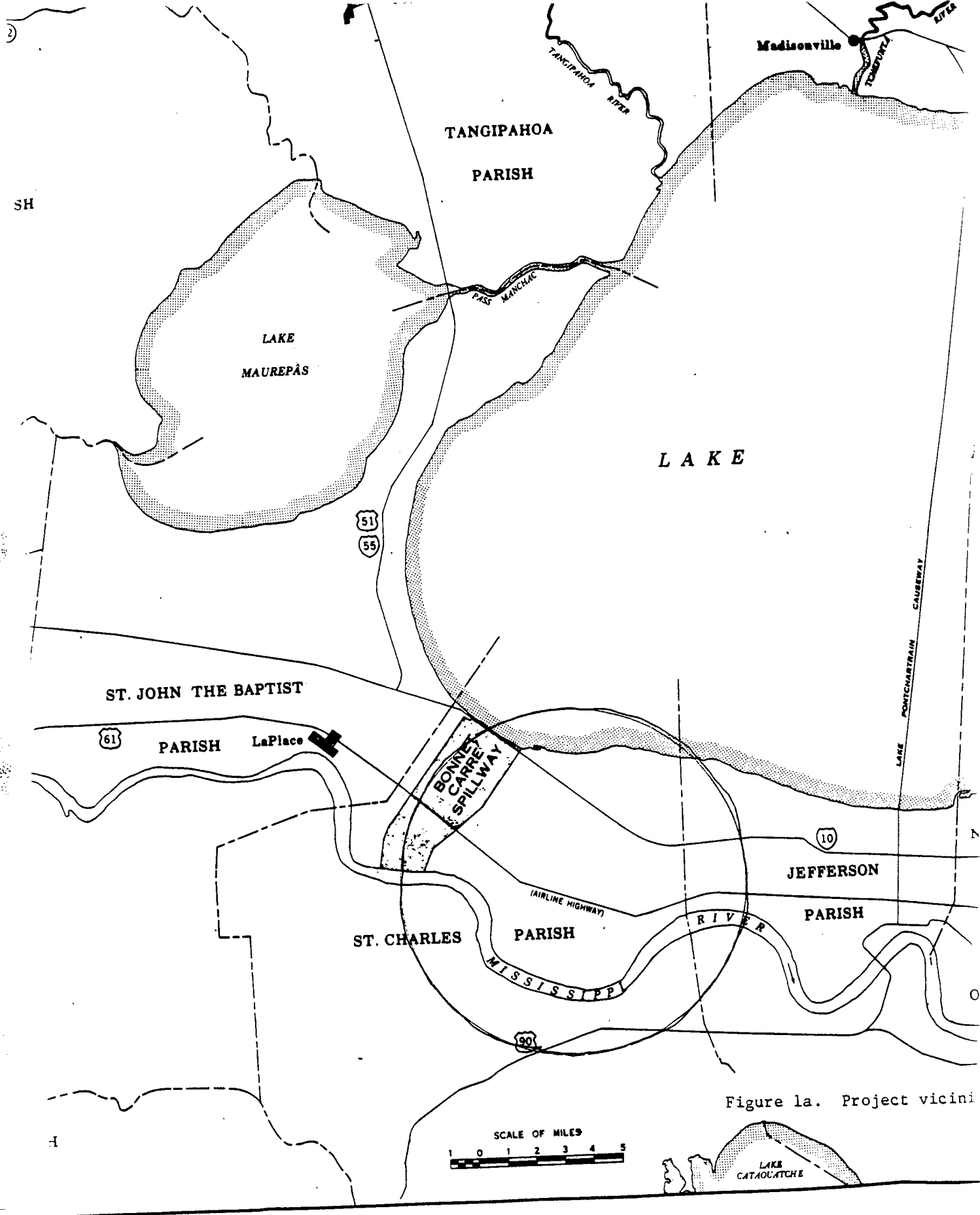

Figure 1a. Project vicinity



Figure 1. Levee crossing at Cross Bayou Ca

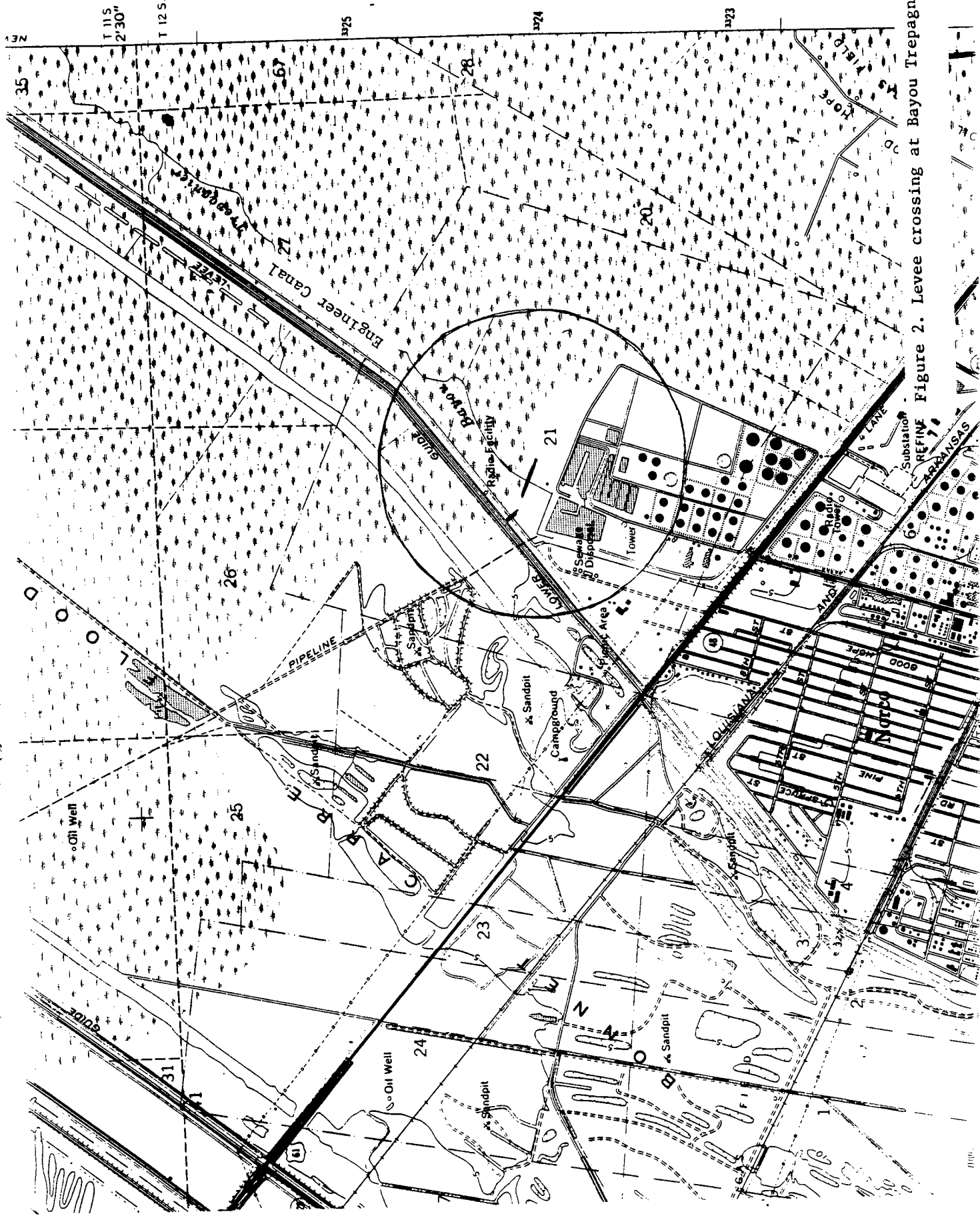

Figure 2. Levee crossing at Bayou Trepagnier.

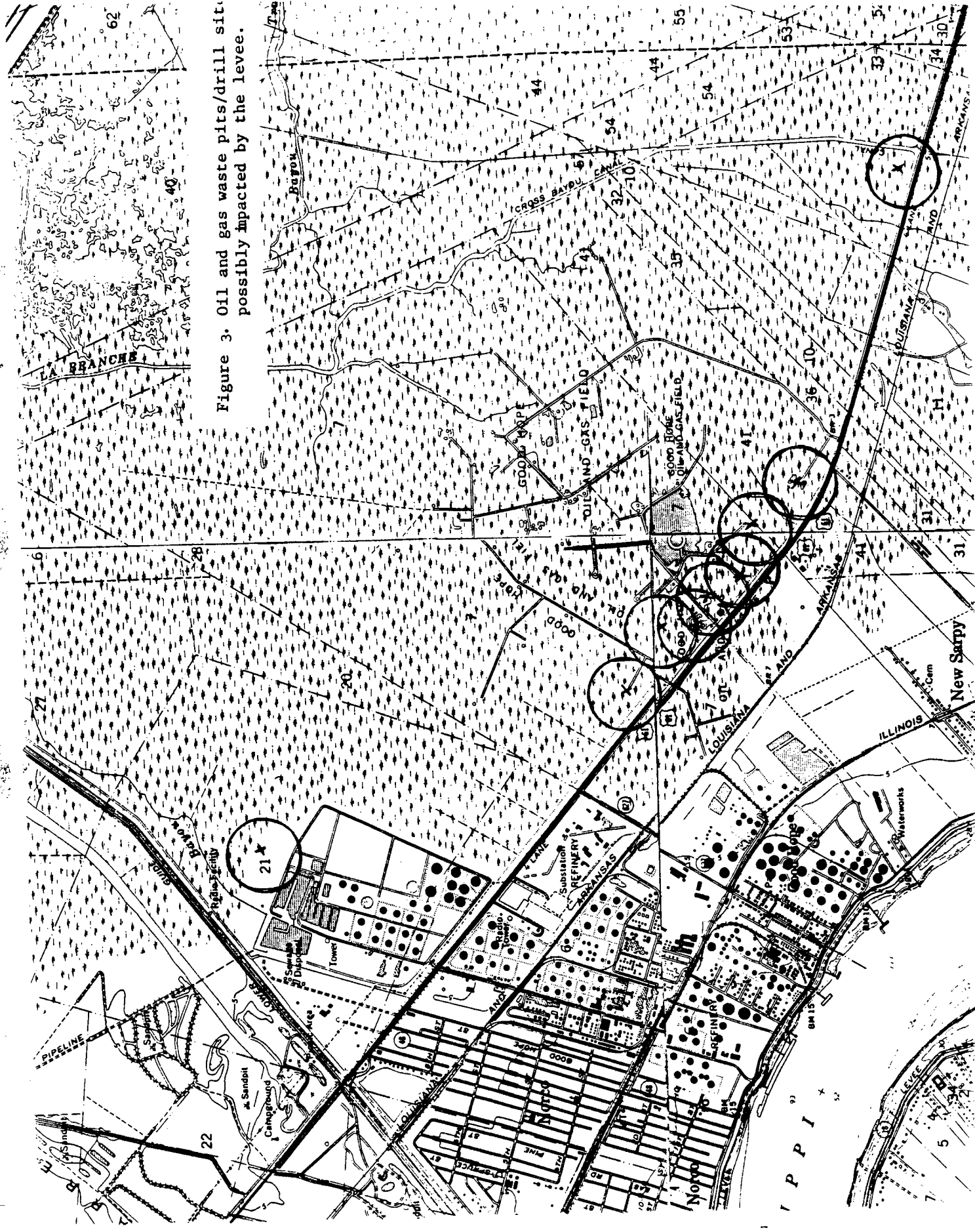

Figure 3. Oil and gas waste pits/drill silt possibly impacted by the levee.

LULING QUADRANGLE
LOUISIANA
7.5 MINUTE SERIES (TOPOGRAPH)
NE/4 HAHNVILLE 15' QUADRANGLE

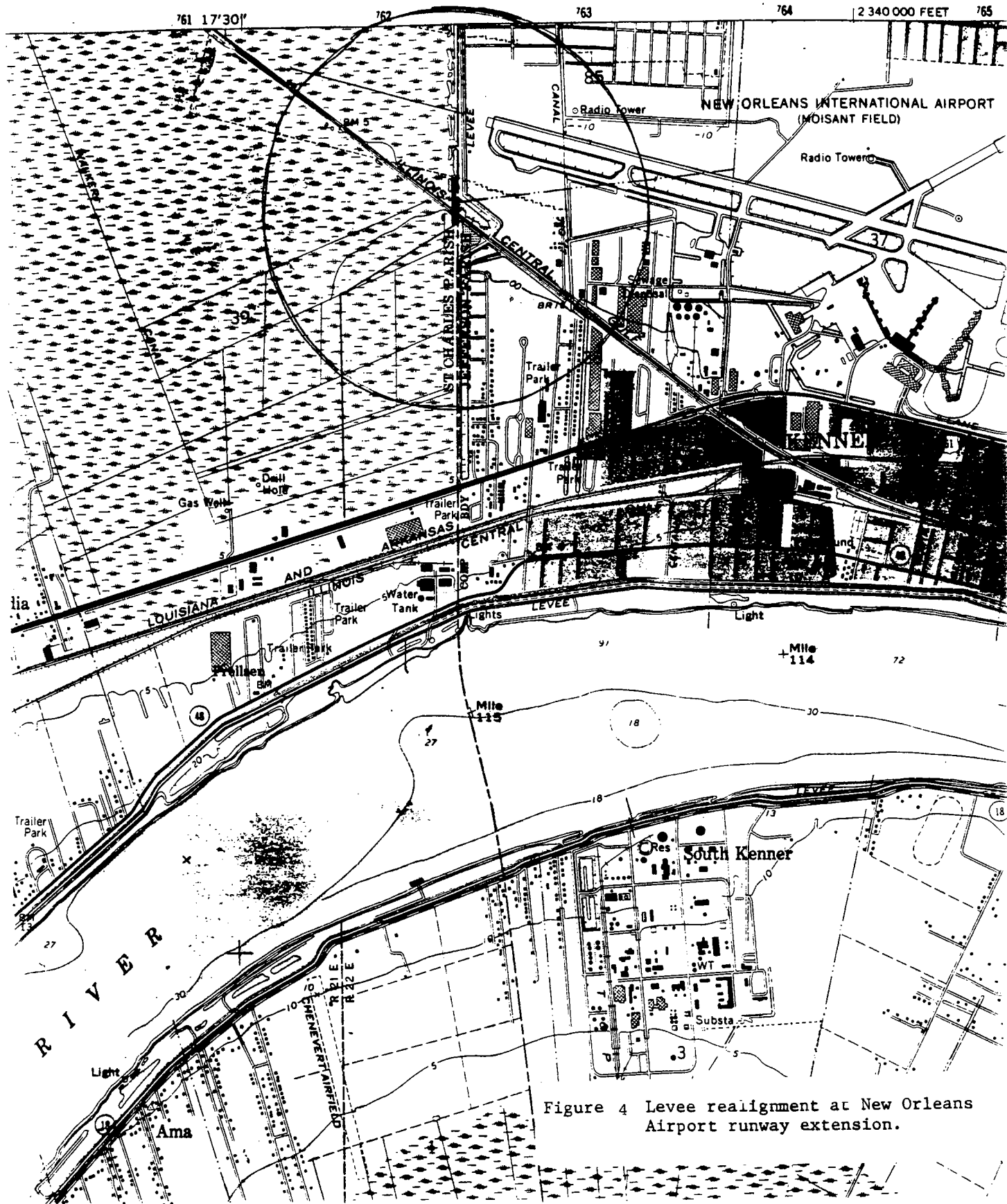

Figure 4 Levee realignment at New Orleans Airport runway extension.

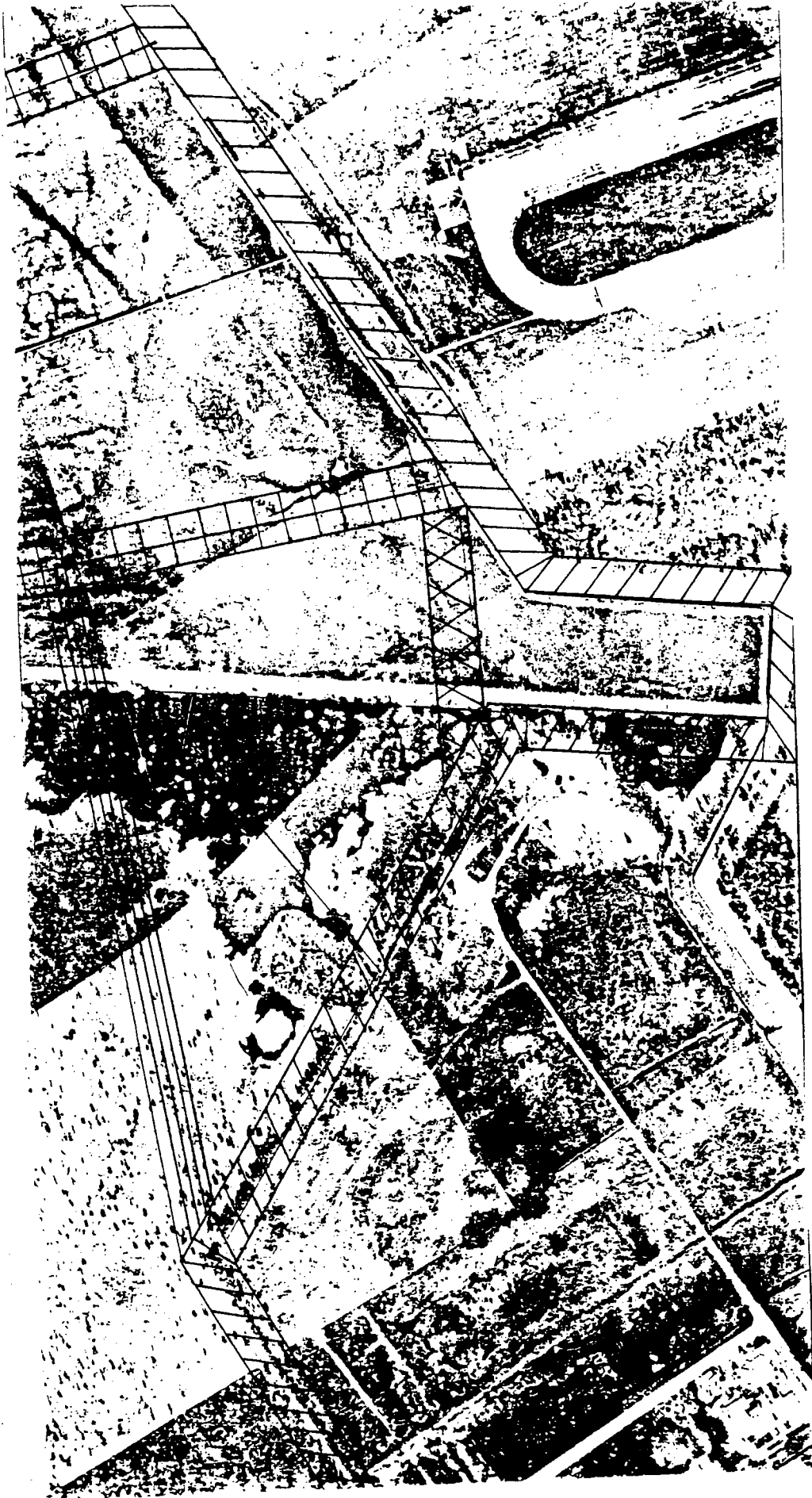

Figure 5. Proposed realignment at New Orleans Airport showing the original route (///), the runway extension levee (+++), the alternate route dropped from consideration (XXX) and the preferred alternative (XXX).

LAKE PONTCHARTRAIN, LOUISIANA AND VICINITY
HIGH LEVEL PLAN
DESIGN MEMORANDUM No. 18 - GENERAL DESIGN
ST. CHARLES PARISH NORTH OF AIRLINE HIGHWAY

APPENDIX C, VOLUME I

DETAILED COST ESTIMATES

REVISED
REAL ESTATE COST ESTIMATE
LAKE PONTCHARTRAIN LOUISIANA AND VICINITY
HURRICANE PROTECTION LEVEE
NORTH OF AIRLINE HIGHWAY
ST. CHARLES PARISH, LOUISIANA

NOD Recommended Plan

ESTIMATE OF COSTS (Date of Value - October 1988)

(a) <u>Lands & Damages</u>	<u>Acres</u>	<u>Unit Value</u>	<u>Total Value</u>
Fee Acquisition (Structure)			
Potential Commercial/Industrial	20	\$20,000	\$ 400,000
Wet Woodland	83	750	62,250
Perpetual Levee Right-of-Way			
Wet Woodland	240	750	180,000
Potential Industrial	27	20,000	540,000
Improvements			10,000
Severance Damage			<u>0</u>
Total (R)			\$1,192,000
(b) Contingencies 25% (R)			298,000
(c) <u>Acquisition Costs</u> (Estimated 65 tracts)			
Non-Federal	65 @ \$1,400 per tract		91,000
Federal			20,000
(d) <u>PL 91-646</u>			<u>0</u>
(e) Total Estimated Real Estate Cost			\$1,601,000

This estimate is a revision to Real Estate Cost Estimates Identification Numbers 71029 and 71014.

Several private roads and fences were observed in the proposed new right-of-way.

In addition to these privately owned items, several pipelines, oil production equipment and utility lines also appear as being in the new right-of-way. Because the Real Estate Division legal counsel has not provide an Attorney's opinion of compensable interests for this project, the Appraisal Branch is deferring its estimate of relocation costs until such time as eligibility is determined.

This estimate is based on maps and acreage computations as provided by CELMN-ED-DL.

BARNIE L. McDONALD
Appraiser
13 January 1989

APPROVED BY:



JOSEPH G. KOPEC
Review Appraiser
13 January 1989

TABLE 1A
 COST ESTIMATE - ST CHARLES PARISH GDM
 BAYOU TREPAGNIER DRAINAGE STRUCTURE - STA 4+05 C/L

Item	Description	Quantity	Unit	Unit Price	Amount
1	MOB & DEMOB	LS	LS	\$100,000.00	\$100,000
2	CLEARING & GRUBBING	14	ACRE	\$1,500.00	\$21,000
3	EXCAVATION AT STRUCTURE	13,000	CY	\$2.00	\$26,000
4	CHANNEL EXCAVATION	20,100	CY	\$1.50	\$30,150
5	SHELL BACKFILL	2,470	CY	\$18.00	\$44,460
6	EMBANKMENT SEMICOMPACTED FILL	2,970	CY	\$5.00	\$14,850
7	EMBANKMENT UNCOMPACTED FILL	2,605	CY	\$4.75	\$12,374
8	LEVEE SAND BASE	875	CY	\$4.00	\$3,500
9	FERTILIZING & SEEDING	10	ACRE	\$500.00	\$5,000
10	RIPRAP	225	TONS	\$20.00	\$4,500
11	STEEL SHEET PILE,PZ-22	11,170	SF	\$12.00	\$134,040
12	12" X 12" PRESTRSD CONC PILES	1,080	LF	\$18.00	\$19,440
13	14" X 14" PRESTRSD CONC PILES	4,345	LF	\$20.00	\$86,900
14	COMPRESSION PILE TEST	3	EA	\$18,000.00	\$54,000
15	ADDITIONAL COMP PILE TEST	3	EA	\$14,000.00	\$42,000
16	TENSION PILE TEST	3	EA	\$19,000.00	\$57,000
17	ADDITIONAL TENSION PILE TEST	3	EA	\$14,000.00	\$42,000
18	12 X 53 STEEL H-PILES	4,260	LF	\$24.00	\$102,240
19	CONCRETE IN STAB. SLABS	27	CY	\$70.00	\$1,890
20	CONCRETE IN SLUICE GATE STRUC	319	CY	\$330.00	\$105,270
21	CONC. IN T-WALL BASE	151	CY	\$200.00	\$30,200
22	CONC. IN T-WALL STEM	120	CY	\$330.00	\$39,600
23	5'X5' SLUICE GATES, & MACHINERY INCL ELECTRICAL	3	EA	\$35,000.00	\$105,000
24	MISCELLANEOUS METALS- (TRASH RACK, HANDRAILS, GRATING, ETC.)	LS	LS	\$15,000.00	\$15,000
SUBTOTAL					\$1,096,414

UPDATE OF JAN 11 1989

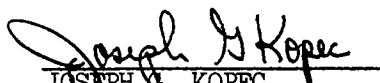
TABLE 1A - CON'T
 COST ESTIMATE - ST CHARLES PARISH GDM
 BAYOU TRÉPAGNIER DRAINAGE STRUCTURE - STA 4+05 C/L

Item	Description	Quantity	Unit	Unit Price	Amount
25	SHELL ROAD	209	CY	\$22.00	\$4,598
		SUBTOTAL			\$1,101,012
		20% CONTINGENCIES			\$220,202
		TOTAL CONSTRUCTION (R)			\$1,321,000
		ENGINEERING & DESIGN 12%			\$159,000
		SUPERVISION & ADMIN. 10%			\$132,000
		TOTAL STRUCTURE COST			\$1,612,000
	RELOCATIONS				
1	6 INCH DIA HP GAS LINE THRU STEEL SHEET PILE WALL	LS	LS	\$21,000.00	\$21,000
		SUBTOTAL			\$21,000
		20% CONTINGENCIES			\$4,200
		TOTAL CONSTRUCTION (R)			\$25,000
		ENGINEERING & DESIGN 12%			\$3,000
		SUPERVISION & ADMIN. 10%			\$3,000
		TOTAL RELOCATIONS COST			\$31,000
		TOTAL COSTS			\$1,643,000

UPDATE OF JAN 11 1989

TABLE 1B
 COST ESTIMATE - ST CHARLES PARISH GDM
 BAYOU TREPAGNIER DRAINAGE STRUCTURE (2ND & 3RD LIFTS) - STA 4+05 C/L

Item	Description	Quantity	Unit	Unit Price	Amount
1	MOB & DEMOB*	LS	LS	\$20,000.00	\$20,000
2	CLEARING	1	ACRE	\$1,000.00	\$1,000
3	EMBANKMENT UNCOMPACTED FILL	2,175	CY	\$4.75	\$10,331
4	EMBANKMENT SEMICOMPACTED FILL	565	CY	\$5.00	\$2,825
5	FERTILIZING & SEEDING	1	ACRE	\$500.00	\$500
6	RAISING SHEET PILING,PZ-22	480	SF	\$2.50	\$1,200
*PRICE FOR MOB & DEMOB IS REDUCED SINCE THIS JOB WILL BE COMBINED WITH A LEVEE CONTRACT					
SUBTOTAL					\$35,856
20% CONTINGENCIES					\$7,171
TOTAL CONSTRUCTION (R)					\$43,000
ENGINEERING & DESIGN 12%					\$5,000
SUPERVISION & ADMIN. 10%					\$4,000
TOTAL COSTS					\$52,000

UPDATE OF JAN 11 1989

TABLE 1C
 COST ESTIMATE - ST CHARLES PARISH GDM
 BAYOU TREPAGNIER DRAINAGE STRUCTURE (I-WALL CAPPING) - STA 4+05 C/L

Item	Description	Quantity	Unit	Unit Price	Amount
1	MOB & DEMOB		LS		
			LS	\$20,000.00	\$20,000
2	CONCRETE IN I-WALLS	108	CY	\$330.00	\$35,640
3	STRUCTURAL EXCAVATION	90	CY	\$8.00	\$720
4	STRUCTURAL BACKFILL	45	CY	\$10.00	\$450
5	REMOVE & DISPOSE EXISTING DAMAGED STEEL SHEET PILING	2,730	SF	\$4.00	\$10,920
6	STEEL SHEET PILING,PZ-22	1,830	SF	\$12.00	\$21,960
SUBTOTAL					\$89,690
20% CONTINGENCIES					\$17,938
TOTAL CONSTRUCTION (R)					\$108,000
ENGINEERING & DESIGN 12%					\$13,000
SUPERVISION & ADMIN. 10%					\$11,000
TOTAL COSTS					\$132,000

UPDATE OF JAN 11 1989

PAGE 4 OF 4

TOTAL STRUC. COST

\$1,848,000

TOTAL RELOC. COST

\$31,000

TABLE 11A
 COST ESTIMATE - ST CHARLES PARISH GDM
 BAYOU TREPAGNIER DRAINAGE STRUCTURE (ALTERNATIVE) - PRELOADING STA 4+05 C/L

Item	Description	Quantity	Unit	Unit Price	Amount
1	MOB & DEMOB		LS LS	\$25,000.00	\$25,000
2	CLEARING & GRUBBING	7	ACRE	\$1,500.00	\$10,500
3	EXCAVATION	13,890	CY	\$2.00	\$27,780
4	SHELL FILL	19,685	CY	\$18.00	\$354,330
5	WICK DRAINS	207,900	LF	\$.55	\$114,345
6	FILTER FABRIC (1250#/INCH)	5,935	SY	\$14.00	\$83,090
7	SAND FILL (HAUL FROM BONNE CARRE)	50,905	CY	\$4.00	\$203,620
8	FERTILIZING & SEEDING	7	ACRE	\$500.00	\$3,500
SUBTOTAL					\$822,165
20% CONTINGENCIES					\$164,433
TOTAL CONSTRUCTION (R)					\$987,000
ENGINEERING & DESIGN 12%					\$118,000
SUPERVISION & ADMIN. 10%					\$99,000
TOTAL COSTS					\$1,204,000

UPDATE OF JAN 11 1989

TABLE 11B
 COST ESTIMATE - ST CHARLES PARISH GDM
 BAYOU TREPAGNIER DRAINAGE STRUCTURE (ALTERNATIVE) - STA 4+05 C/L

Item	Description	Quantity	Unit	Unit Price	Amount
1	MOB & DEMOB	LS	LS	\$100,000.00	\$100,000
2	CLEARING	7	ACRE	\$1,000.00	\$7,000
3	CLEARING & GRUBBING	7	ACRE	\$1,500.00	\$10,500
4	EXCAVATION AT STRUCTURE	2,560	CY	\$2.00	\$5,120
5	SAND REMOVAL	33,535	CY	\$1.00	\$33,535
6	CHANNEL EXCAVATION	17,835	CY	\$1.50	\$26,753
7	EMBANKMENT UNCOMPACTED FILL	3,320	CY	\$4.75	\$15,770
8	EMBANKMENT SEMICOMPACTED FILL	14,725	CY	\$5.00	\$73,625
9	GEOTEXTILE SEPERATOR FABRIC	830	SY	\$2.00	\$1,660
10	CONCRETE SAND	651	CY	\$20.00	\$13,020
11	RIPRAP	456	TONS	\$20.00	\$9,120
12	CONCRETE IN STAB. SLAB	35	CY	\$70.00	\$2,450
13	CONCRETE IN BASE SLAB	116	CY	\$200.00	\$23,200
14	CONCRETE IN HEADWALLS & WINGWALLS	71	CY	\$330.00	\$23,430
15	CONCRETE IN SLUICE GATE STRUC	56	CY	\$330.00	\$18,480
16	STEEL SHEET PILE,PZ-22	2,664	SF	\$12.00	\$31,968
17	FERTILIZING & SEEDING	10	ACRE	\$500.00	\$5,000
18	(5'X5') SLUICE GATES & MACHINERY INCL ELECTRICAL	5	EA	\$35,000.00	\$175,000
19	MISL. METALS	LS	LS	\$22,100.00	\$22,100
20	60-INCH CMP CULVERTS	1,400	LF	\$200.00	\$280,000
SUBTOTAL					\$877,731

UPDATE OF JAN 12 1989

TABLE 11B - (CON'T)
 COST ESTIMATE - ST CHARLES PARISH GDM
 BAYOU TREPAGNIER DRAINAGE STRUCTURE (ALTERNATIVE) - STA 4+05 C/L

Item	Description	Quantity	Unit	Unit Price	Amount
21	SHELL ROAD	209	CY	\$22.00	\$4,598
		SUBTOTAL			\$882,329
		20% CONTINGENCIES			\$176,466
		TOTAL CONSTRUCTION (R)			\$1,059,000
		ENGINEERING & DESIGN 12%			\$127,000
		SUPERVISION & ADMIN. 10%			\$106,000
		TOTAL STRUCTURE COST			\$1,292,000
	RELOCATIONS				
1	6 INCH DIA HP GAS LINE OVER LEVEE SECTION	LS	LS	\$40,000.00	\$40,000
		SUBTOTAL			\$40,000
		20% CONTINGENCIES			\$8,000
		TOTAL CONSTRUCTION (R)			\$48,000
		ENGINEERING & DESIGN 12%			\$6,000
		SUPERVISION & ADMIN. 10%			\$5,000
		TOTAL RELOCATIONS COST			\$59,000
		TOTAL COSTS			\$1,351,000

UPDATE OF JAN 11 1989

TABLE 2A
 COST ESTIMATE - ST CHARLES PARISH GDM
 CROSS BAYOU DRAINAGE STRUCTURE - STA 256+24.7 C/L

Item	Description	Quantity	Unit	Unit Price	Amount
1	MOB & DEMOB	LS	LS	\$100,000.00	\$100,000
2	CLEARING & GRUBBING	25	ACRE	\$1,500.00	\$37,500
3	EXCAVATION AT STRUCTURE	14,330	CY	\$2.00	\$28,660
4	STRUCTURE DEWATERING	LS	LS	\$350,000.00	\$350,000
5	CHANNEL EXCAVATION	20,900	CY	\$1.50	\$31,350
6	SHELL BACKFILL	2,490	CY	\$18.00	\$44,820
7	EMBANKMENT SEMICOMPACTED FILL	3,780	CY	\$6.00	\$22,680
8	EMBANKMENT UNCOMPACTED FILL	1,840	CY	\$5.75	\$10,580
9	LEVEE SAND BASE	875	CY	\$5.00	\$4,375
10	FERTILIZING & SEEDING	20	CY	\$500.00	\$10,000
11	RIPRAP	110	TONS	\$20.00	\$2,200
12	STEEL SHEET PILE,PZ-22	11,340	SF	\$12.00	\$136,080
13	12" X 12" PRESTRSD CONC PILES	2,880	LF	\$18.00	\$51,840
14	14" X 14" PRESTRSE CONC PILES	11,320	LF	\$20.00	\$226,400
15	COMPRESSION PILE TEST	3	EA	\$18,000.00	\$54,000
16	ADDITIONAL COMP PILE TEST	3	EA	\$14,000.00	\$42,000
17	TENSION PILE TEST	3	EA	\$19,000.00	\$57,000
18	ADDITIONAL TENSION PILE TEST	3	EA	\$14,000.00	\$42,000
19	12 X 53 STEEL H-PILES	4,700	LF	\$24.00	\$112,800
20	CONCRETE IN STAB. SLAB	399	CY	\$70.00	\$27,930
21	CONCRETE IN SLUICE GATE STRUC	136	CY	\$330.00	\$44,880
22	CONC. IN T-WALL BASE	151	CY	\$200.00	\$30,200
23	CONC. IN T-WALL STEM	120	CY	\$330.00	\$39,600
24	(6'X6') SLUICE GATES & MACHINERY INCL ELECTRICAL	6	EA	\$43,000.00	\$258,000
25	MISCELLANEOUS METALS (TRASH RACK, HANDRAILS, GRATING, ETC.)	LS	LS	\$38,000.00	\$38,000
SUBTOTAL STRUCTURE COST					\$1,802,895

UPDATE OF JAN 11 1989

TABLE 2B
 COST ESTIMATE - ST CHARLES PARISH GDM
 CROSS BAYOU DRAINAGE STRUCTURE (2ND & 3RD LIFTS) - STA 256+24.7 C/L

Item	Description	Quantity	Unit	Unit Price	Amount
1	MOB & DEMOB*	LS	LS	\$20,000.00	\$20,000
2	CLEARING	1	ACRE	\$1,000.00	\$1,000
3	EMBANKMENT UNCOMPACTED FILL	1,090	CY	\$5.75	\$6,268
4	EMBANKMENT SEMICOMPACTED FILL	305	CY	\$6.00	\$1,830
5	FERTILIZING & SEEDING	1	ACRE	\$500.00	\$500
6	RAISING SHEET PILING, PZ-22	240	SF	\$2.50	\$600
*PRICE FOR MOB & DEMOB IS REDUCED SINCE THIS JOB WILL BE COMBINED WITH A LEVEE LIFT CONTRACT					
SUBTOTAL					\$30,198
20% CONTINGENCIES					\$6,040
TOTAL CONSTRUCTION (R)					\$36,000
ENGINEERING & DESIGN 12%					\$4,000
SUPERVISION & ADMIN. 10%					\$4,000
TOTAL COSTS					\$44,000

UPDATE OF JAN 11 1989

TABLE 2C
 COST ESTIMATE - ST CHARLES PARISH GDM
 CROSS BAYOU DRAINAGE STRUCTURE (I-WALL CAPPING) - STA 256+24.7 C/L

Item	Description	Quantity	Unit	Unit Price	Amount
1	MOB & DEMOB	LS	LS	\$20,000.00	\$20,000
2	CONCRETE IN I-WALLS	49	CY	\$330.00	\$16,170
3	STRUCTURAL EXCAVATION	45	CY	\$8.00	\$360
4	STRUCTURAL BACKFILL	23	CY	\$10.00	\$230
5	REMOVE & DISPOSE EXISTING DAMAGED STEEL SHEET PILING	1,200	SF	\$4.00	\$4,800
6	STEEL SHEET PILING, PZ-22	800	SF	\$12.00	\$9,600
SUBTOTAL					\$51,160
20% CONTINGENCIES					\$10,232
TOTAL CONSTRUCTION (R)					\$61,000
ENGINEERING & DESIGN 12%					\$7,000
SUPERVISION & ADMIN. 10%					\$6,000
TOTAL COSTS					\$74,000

UPDATE OF JAN 11 1989

PAGE 4 OF 4

TOTAL STRUC. COST=====

\$3,037,000

TABLE 21A
 COST ESTIMATE - ST CHARLES PARISH GDM
 CROSS BAYOU DRAINAGE STRUCTURE (ALTERNATIVE) - PRELOADING STA 256+24.7 C/L

Item	Description	Quantity	Unit	Unit Price	Amount
1	MOB & DEMOB	LS	LS	\$50,000.00	\$50,000
2	CLEARING & GRUBBING	8	ACRE	\$1,500.00	\$12,000
3	EXCAVATION	30,140	CY	\$2.00	\$60,280
4	SHELL FILL	42,725	CY	\$18.00	\$769,050
5	WICK DRAINS	331,800	LF	\$.55	\$182,490
6	FILTER FABRIC (1250#/IN)	7,523	SY	\$14.00	\$105,322
7	SAND FILL (HAUL FROM BONNE CARRE)	69,300	CY	\$5.00	\$346,500
8	FERTILIZING & SEEDING	8	ACRE	\$500.00	\$4,000
SUBTOTAL STRUCTURE COST					\$1,529,642
8	BRIDGE ESTIMATE SHELL ACCESS ROAD	534	CY	\$22.00	\$11,748
9	ROAD EMBANKMENT SUBGRADE	3,600	CY	\$5.00	\$18,000
10	STEEL SHEET PILE, PZ-22	460	SF	\$12.00	\$5,520
11	14"X14" PRSTRD CONC PILES	2,380	LF	\$20.00	\$47,600
12	CONCRETE IN PILE BENTS	37	CY	\$400.00	\$14,800
13	CONCRETE PRECAST SLABS	2,400	SF	\$20.00	\$48,000
14	BRIDGE RAILS	320	LF	\$35.00	\$11,200
15	MUCK BACKFILL	1,570	CY	\$2.50	\$3,925
SUBTOTAL BRIDGE COST					\$160,793
SUBTOTAL					\$1,690,435
20% CONTINGENCIES					\$338,087
TOTAL CONSTRUCTION (R)					\$2,029,000
ENGINEERING & DESIGN 12%					\$243,000
SUPERVISION & ADMIN. 10%					\$203,000
TOTAL COST					\$2,475,000

UPDATE OF JAN 11 1989

TABLE 21B
 COST ESTIMATE - ST CHARLES PARISH GDM
 CROSS BAYOU DRAINAGE STRUCTURE (ALTERNATIVE) - STA 256+24.7 C/L

Item	Description	Quantity	Unit	Unit Price	Amount
1	MOB & DEMOB	LS	LS	\$100,000.00	\$100,000
2	CLEARING	8	ACRE	\$1,000.00	\$8,000
3	CLEARING & GRUBBING	17	ACRE	\$1,500.00	\$25,500
4	EXCAVATION AT STRUCTURE	9,178	CY	\$2.00	\$18,356
5	SAND REMOVAL	47,000	CY	\$1.00	\$47,000
6	CHANNEL EXCAVATION	18,910	CY	\$1.50	\$28,365
7	EMBANKMENT UNCOMPACTED FILL	3,445	CY	\$5.75	\$19,809
8	EMBANKMENT SEMICOMPACTED FILL	20,080	CY	\$6.00	\$120,480
9	GEOTEXTILE SEPERATOR FABRIC	1,917	SY	\$2.00	\$3,834
10	CONCRETE SAND	1,927	CY	\$20.00	\$38,540
11	RIPRAP	729	TONS	\$20.00	\$14,580
12	CONCRETE IN STAB. SLAB	43	CY	\$70.00	\$3,010
13	CONCRETE IN BASE SLAB	162	CY	\$200.00	\$32,400
14	CONCRETE IN HEADWALLS & WINGWALLS	154	CY	\$330.00	\$50,820
15	CONCRETE IN SLUICE GATE CHAMBER	153	CY	\$330.00	\$50,490
16	STEEL SHEET PILE, PZ-22	4300	SF	\$12.00	\$51,600
17	FERTILIZING & SEEDING	20	ACRE	\$500.00	\$10,000
18	(6'X6') SLUICE GATES, MACHINERY INCL ELECTRICAL	12	EA	\$43,000.00	\$516,000
19	MISL. METALS	LS	LS	\$62,500.00	\$62,500
20	72-INCH CMP CULVERTS	3,840	LF	\$220.00	\$844,800
21	SHELL ROAD	250	CY	\$22.00	\$5,500
		SUBTOTAL			\$2,051,584
		20% CONTINGENCIES			\$410,317
		TOTAL CONSTRUCTION (R)			\$2,462,000
		ENGINEERING & DESIGN 12%			\$295,000
		SUPERVISION & ADMIN. 10%			\$246,000
		TOTAL COSTS			\$3,003,000

UPDATE OF JAN 11 1989

TABLE 21C
 COST ESTIMATE - ST CHARLES PARISH GDM
 CROSS BAYOU DRAINAGE STRUCTURE (ALT.) - CMP CULVERT REPLACEMENT - 2 EACH

Item	Description	Quantity	Unit	Unit Price	Amount
1	MOB & DEMOB	LS	LS	\$50,000.00	\$50,000
2	CLEARING	1	ACRE	\$1,000.00	\$1,000
3	STRUCTURAL EXCAVATION & BACKFILL	9,180	CY	\$18.00	\$165,240
4	EMBANKMENT SEMICOMPACTED FILL	6,930	CY	\$6.00	\$41,580
5	CONCRETE SAND	1,927	CY	\$20.00	\$38,540
6	72-INCH CMP CULVERTS	3,840	LF	\$220.00	\$844,800
7	RIPRAP REMOVAL & REPLACEMENT	166	TONS	\$4.00	\$664
8	FERTILIZING & SEEDING	1	ACRE	\$500.00	\$500
SUBTOTAL					\$1,142,324
20% CONTINGENCIES					\$228,465
TOTAL CONSTRUCTION (R)					\$1,371,000
ENGINEERING & DESIGN 12%					\$164,000
SUPERVISION & ADMIN. 10%					\$137,000
TOTAL COSTS					\$1,672,000

UPDATE OF JAN 11 1989

TABLE 3A
 COST ESTIMATE - ST CHARLES PARISH GDM
 ST ROSE CANAL DRAINAGE STRUCTURE - STA 328+50.0 B/L

Item	Description	Quantity	Unit	Unit Price	Amount
1	MOB & DEMOB	LS	LS	\$100,000.00	\$100,000
2	CLEARING & GRUBBING	18	ACRE	\$1,500.00	\$27,000
3	EXCAVATION AT STRUCTURE	10,430	CY	\$2.00	\$20,860
4	CHANNEL EXCAVATION	18,515	CY	\$1.50	\$27,773
5	STRUCTURE DEWATERING	LS	LS	\$250,000.00	\$250,000
6	SHELL BACKFILL	2,350	CY	\$18.00	\$42,300
7	EMBANKMENT SEMICOMPACTED FILL	4,590	CY	\$6.50	\$29,835
8	EMBANKMENT UNCOMPACTED FILL	3,080	CY	\$6.25	\$19,250
9	LEVEE SAND BASE	875	CY	\$5.00	\$4,375
10	RIPRAP	119	TONS	\$20.00	\$2,380
11	FERTILIZING & SEEDING	15	ACRE	\$500.00	\$7,500
12	STEEL SHEET PILE, PZ-22	10,380	SF	\$12.00	\$124,560
13	12" UNTREATED TIMBER PILES	1,600	LF	\$6.00	\$9,600
14	14" X 14" PRESTRSD CONC PILES	6,064	LF	\$20.00	\$121,280
15	COMPRESSION PILE TEST	3	EA	\$18,000.00	\$54,000
16	ADDITIONAL COMP PILE TEST	3	EA	\$14,000.00	\$42,000
17	TENSION PILE TEST	3	EA	\$19,000.00	\$57,000
18	ADDITIONAL TENSION PILE TEST	3	EA	\$14,000.00	\$42,000
19	12 X 53 STEEL H-PILES	4,700	LF	\$24.00	\$112,800
20	CONCRETE IN STAB. SLAB	64	CY	\$70.00	\$4,480
21	CONCRETE IN SLUICE GATE STRUC	379	CY	\$330.00	\$125,070
22	CONC. IN T-WALL BASE	282	CY	\$200.00	\$56,400
23	CONC. IN T-WALL STEM	186	CY	\$330.00	\$61,380
24	(6'X6') SLUICE GATES- & MACHINERY INCL ELECTRICAL	2	EA	\$43,000.00	\$86,000
SUBTOTAL					\$1,427,843

UPDATE OF JAN 11 1989

TABLE 3A - CONT
 COST ESTIMATE - ST CHARLES PARISH GDM
 ST ROSE CANAL DRAINAGE STRUCTURE - STA 328+50.0 B/L

Item	Description	Quantity	Unit	Unit Price	Amount
25	MISCELLANEOUS METALS (TRASH RACKS, HAND RAILS, & GRATING)	LS	LS	\$12,000.00	\$12,000
26	SHELL ROAD	240	CY	\$22.00	\$5,280
SUBTOTAL					\$1,445,123
20% CONTINGENCIES					\$289,025
TOTAL CONSTRUCTION (R)					\$1,734,000
ENGINEERING & DESIGN 12%					\$208,000
SUPERVISION & ADMIN. 10%					\$173,000
TOTAL COST					\$2,115,000

UPDATE OF JAN 11 1989

TABLE 3B
 COST ESTIMATE - ST CHARLES PARISH GDM
 ST ROSE CANAL DRAINAGE STRUCTURE (2ND & 3RD LIFTS) - STA 328+50.0 B/L

Item	Description	Quantity	Unit	Unit Price	Amount
1	MOB & DEMOB*	LS	LS	\$20,000.00	\$20,000
2	CLEARING	1	ACRE	\$1,000.00	\$1,000
3	EMBANKMENT UNCOMPACTED FILL	1,090	CY	\$6.25	\$6,813
4	EMBANKMENT SEMICOMPACTED FILL	285	CY	\$6.50	\$1,853
5	FERTILIZING & SEEDING	1	ACRE	\$500.00	\$500
6	RAISING SHEET PILING, PZ-22	240	SF	\$2.50	\$600
*PRICE FOR MOB & DEMOB IS REDUCED SINCE THIS JOB WILL BE COMBINED WITH A LEVEE LIFT CONTRACT					
SUBTOTAL					\$30,765
20% CONTINGENCIES					\$6,153
TOTAL CONSTRUCTION (R)					\$37,000
ENGINEERING & DESIGN 12%					\$4,000
SUPERVISION & ADMIN. 10%					\$4,000
TOTAL COSTS					\$45,000

UPDATE OF JAN 11 1989

TABLE 3C
 COST ESTIMATE - ST CHARLES PARISH GDM
 ST ROSE CANAL DRAINAGE STRUCTURE (I-WALL CAPPING) - STA 328+50.0 B/L

Item	Description	Quantity	Unit	Unit Price	Amount
1	MOB & DEMOB	LS	LS	\$20,000.00	\$20,000
2	CONCRETE IN I-WALLS	48	CY	\$330.00	\$15,840
3	STRUCTURAL EXCAVATION	45	CY	\$8.00	\$360
4	STRUCTURAL BACKFILL	23	CY	\$10.00	\$230
5	REMOVE & DISPOSE EXISTING DAMAGED, STEEL SHEET PILING	1,170	SF	\$4.00	\$4,680
6	STEEL SHEET PILING, PZ-22	780	SF	\$12.00	\$9,360
SUBTOTAL					\$50,470
20% CONTINGENCIES					\$10,094
TOTAL CONSTRUCTION (R)					\$61,000
ENGINEERING & DESIGN 12%					\$7,000
SUPERVISION & ADMIN. 10%					\$6,000
TOTAL COST					\$74,000

UPDATE OF JAN 11 1989

PAGE 4 OF 4

TOTAL STRUC. COST=====

\$2,308,000

TABLE 31A
 COST ESTIMATE - ST CHARLES PARISH GDM
 ST ROSE CANAL DRAINAGE STRUCTURE (ALTERNATIVE) PRELOADING - STA 328+50.0 B/L

Item	Description	Quantity	Unit	Unit Price	Amount
1	MOB & DEMOB	LS	LS	\$25,000.00	\$25,000
2	CLEARING & GRUBBING	7	ACRE	\$1,500.00	\$10,500
3	EXCAVATION	12,590	CY	\$2.00	\$25,180
4	SHELL FILL	17,850	CY	\$18.00	\$321,300
5	WICK DRAINS	169,650	LF	\$.55	\$93,308
6	FILTER FABRIC (1250#/IN)	6,245	SY	\$14.00	\$87,430
7	SAND FILL (HAUL FROM BONNE CARRE)	35,640	CY	\$5.00	\$178,200
8	FERTILIZING & SEEDING	7	ACRE	\$500.00	\$3,500
SUBTOTAL					\$744,418
20% CONTINGENCIES					\$148,884
TOTAL CONSTRUCTION (R)					\$893,000
ENGINEERING & DESIGN 12%					\$107,000
SUPERVISION & ADMIN. 10%					\$89,000
TOTAL COST					\$1,089,000

UPDATE OF JAN 11 1989

TABLE 31B
 COST ESTIMATE - ST CHARLES PARISH GDM
 ST ROSE CANAL DRAINAGE STRUCTURE (ALTERNATIVE) - STA 328+50.0 B/L

Item	Description	Quantity	Unit	Unit Price	Amount
1	MOB & DEMOB	LS	LS	\$100,000.00	\$100,000
2	CLEARING	7	ACRE	\$1,000.00	\$7,000
3	CLEARING & GRUBBING	11	ACRE	\$1,500.00	\$16,500
4	EXCAVATION AT STRUCTURAL	2,410	CY	\$2.00	\$4,820
5	SAND REMOVAL	35,640	CY	\$1.50	\$53,460
6	CHANNEL EXCAVATION	16,684	CY	\$1.50	\$25,026
7	EMBANKMENT UNCOMPACTED FILL	3,815	CY	\$6.25	\$23,844
8	EMBANKMENT SEMICOMPACTED FILL	16,290	CY	\$6.50	\$105,885
9	GEOTEXTILE SEPERATOR FABRIC	626	SY	\$2.00	\$1,252
10	CONCRETE SAND	482	CY	\$20.00	\$9,640
11	RIPRAP	463	TONS	\$20.00	\$9,260
12	CONCRETE IN STAB. SLAB	27	CY	\$70.00	\$1,890
13	CONCRETE IN BASE SLAB	89	CY	\$200.00	\$17,800
14	CONCRETE IN HEADWALLS & WINGWALLS	64	CY	\$330.00	\$21,120
15	CONCRETE IN SLUICE GATE CHAMBER	41	CY	\$330.00	\$13,530
16	STEEL SHEET PILE,PZ-22	2,241	SF	\$12.00	\$26,892
17	FERTILIZING & SEEDING	15	ACRE	\$500.00	\$7,500
18	(6'X6') SLUICE GATES, & MACHINERY INCL ELECTRICAL	3	EA	\$43,000.00	\$129,000
19	MISL. METALS	LS	LS	\$19,000.00	\$19,000
20	72-INCH CMP CULVERTS	960	LF	\$220.00	\$211,200
21	SHELL ROAD	240	CY	\$22.00	\$5,280
		SUBTOTAL			\$809,899
		20% CONTINGENCIES			\$161,980
		TOTAL CONSTRUCTION (R)			\$972,000
		ENGINEERING & DESIGN 12%			\$117,000
		SUPERVISION & ADMIN. 10%			\$97,000
		TOTAL COST			\$1,186,000

UPDATE OF JAN 11 1989

TABLE 31C
 COST ESTIMATE - ST CHARLES PARISH GDM
 ST ROSE CANAL DRAINAGE STRUCTURE (ALT.) - CMP CULVERT REPLACEMENT - 2 EACH

Item	Description	Quantity	Unit	Unit Price	Amount
1	MOB & DEMOB	LS	LS	\$50,000.00	\$50,000
2	CLEARING	1	ACRE	\$1,000.00	\$1,000
3	FERTILIZING & SEEDING	1	ACRE	\$500.00	\$500
4	STRUCTURAL EXCAVATION & BACKFILL	2,410	CY	\$18.00	\$43,380
5	EMBANKMENT SEMICOMPACTED FILL	1,715	CY	\$6.50	\$11,148
6	CONCRETE SAND	482	CY	\$20.00	\$9,640
7	72-INCH CMP CULVERTS	960	LF	\$220.00	\$211,200
8	RIPRAP REMOVAL & REPLACEMENT	76	TONS	\$4.00	\$304
SUBTOTAL					\$327,172
20% CONTINGENCIES					\$65,434
TOTAL CONSTRUCTION (R)					\$393,000
ENGINEERING & DESIGN 12%					\$47,000
SUPERVISION & ADMIN. 10%					\$39,000
TOTAL COST					\$479,000

UPDATE OF JAN 11 1989

TABLE 4A
 COST ESTIMATE - ST CHARLES PARISH GDM
 WALKER CANAL DRAINAGE STRUCTURE - STA 454+06.6 C/L

Item	Description	Quantity	Unit	Unit Price	Amount
1	MOB & DEMOB	LS	LS	\$100,000.00	\$100,000
2	CLEARING & GRUBBING	14	ACRE	\$1,500.00	\$21,000
3	EXCAVATION AT STRUCTURE	7,282	CY	\$2.00	\$14,564
4	CHANNEL EXCAVATION	7,172	CY	\$1.50	\$10,758
5	STRUCTURE DEWATERING	LS	LS	\$200,000.00	\$200,000
6	SHELL BACKFILL	2,715	CY	\$18.00	\$48,870
7	EMBANKMENT SEMICOMPACTED FILL	4,390	CY	\$7.00	\$30,730
8	EMBANKMENT UNCOMPACTED FILL	3,675	CY	\$6.75	\$24,806
9	FERTILIZING & SEEDING	14	ACRE	\$500.00	\$7,000
10	LEVEE SAND BASE	875	CY	\$6.75	\$5,906
11	RIPRAP	94	TONS	\$20.00	\$1,880
12	STEEL SHEET PILE,PZ-22	9,561	SF	\$12.00	\$114,732
13	12" X 12" PRESTRSD CONC PILES	1,590	LF	\$18.00	\$28,620
14	14" X 14" PRESTRSD CONC PILES	3,536	LF	\$20.00	\$70,720
15	COMPRESSION PILE TEST	3	EA	\$18,000.00	\$54,000
16	ADDITIONAL COMP PILE TEST	3	EA	\$14,000.00	\$42,000
17	TENSION PILE TEST	3	EA	\$19,000.00	\$57,000
18	ADDITIONAL TENSION PILE TEST	3	EA	\$14,000.00	\$42,000
19	12 X 53 STEEL H-PILES	4,880	LF	\$24.00	\$117,120
20	CONCRETE IN STAB. SLAB	45	CY	\$70.00	\$3,150
21	CONCRETE IN SLUICE GATE STRUC	235	CY	\$330.00	\$77,550
22	CONC. IN T-WALL BASE	273	CY	\$200.00	\$54,600
23	CONC. IN T-WALL STEM	161	CY	\$330.00	\$53,130
24	(4'X4') SLUICE GATES- & MACHINERY INCL ELECTRICAL	1	EA	\$30,000.00	\$30,000
SUBTOTAL					\$1,210,137

UPDATE OF JAN 11 1989

TABLE 4A - CON'T
 COST ESTIMATE - ST CHARLES PARISH GDM
 WALKER CANAL DRAINAGE STRUCTURE - STA 454+06.6 C/L

Item	Description	Quantity	Unit	Unit Price	Amount
25	MISCELLANEOUS METALS (TRASH RACKS, HAND RAILS, & GRATING)	LS	LS	\$4,000.00	\$4,000
26	SHELL ROAD	210	CY	\$22.00	\$4,620
SUBTOTAL					\$1,218,757
20% CONTINGENCIES					\$243,751
TOTAL CONSTRUCTION (R)					\$1,463,000
ENGINEERING & DESIGN 12%					\$176,000
SUPERVISION & ADMIN. 10%					\$146,000
TOTAL COST					\$1,785,000

UPDATE OF JAN 11 1989

TABLE 4B
 COST ESTIMATE - ST CHARLES PARISH GDM
 WALKER CANAL DRAINAGE STRUCTURE (2ND & 3RD LIFTS) - STA 454+06.6 C/L

Item	Description	Quantity	Unit	Unit Price	Amount
1	MOB & DEMOB*	LS	LS	\$20,000.00	\$20,000
2	CLEARING	1	ACRE	\$1,000.00	\$1,000
3	EMBANKMENT UNCOMPACTED FILL	1,090	CY	\$6.75	\$7,358
4	EMBANKMENT SEMICOMPACTED FILL	280	CY	\$7.00	\$1,960
5	FERTILIZING & SEEDING	1	ACRE	\$500.00	\$500
6	RAISING SHEET PILING, PZ-22	240	SF	\$2.50	\$600
<p>*PRICE FOR MOB & DEMOB IS REDUCED SINCE THIS JOB WILL BE COMBINED WITH A LEVEE LIFT CONTRACT</p>					
SUBTOTAL					\$31,418
20% CONTINGENCIES					\$6,284
TOTAL CONSTRUCTION (R)					\$38,000
ENGINEERING & DESIGN 12%					\$5,000
SUPERVISION & ADMIN. 10%					\$4,000
TOTAL COST					\$47,000

UPDATE OF JAN 11 1989

TABLE 4C
 COST ESTIMATE - ST CHARLES PARISH GDM
 WALKER CANAL DRAINAGE STRUCTURE (I-WALL CAPPING) - STA 454+06.6 C/L

Item	Description	Quantity	Unit	Unit Price	Amount
1	MOB & DEMOB	LS	LS	\$20,000.00	\$20,000
2	CONCRETE IN I-WALLS	48	ACRE	\$330.00	\$15,840
3	STRUCTURAL EXCAVATION	45	CY	\$8.00	\$360
4	STRUCTURAL BACKFILL	23	CY	\$10.00	\$230
5	REMOVE & DISPOSE EXISTING DAMAGED STEEL SHEET PILING	1,170	SF	\$4.00	\$4,680
6	STEEL SHEET PILING, PZ-22	780	SF	\$12.00	\$9,360
SUBTOTAL					\$50,470
20% CONTINGENCIES					\$10,094
TOTAL CONSTRUCTION (R)					\$61,000
ENGINEERING & DESIGN 12%					\$7,000
SUPERVISION & ADMIN. 10%					\$6,000
TOTAL COST					\$74,000

UPDATE OF JAN 11 1989

PAGE 4 OF 4

TOTAL STRUC COST-----

\$1 053 000

TABLE 41A
 COST ESTIMATE - ST CHARLES PARISH GDM
 WALKER CANAL DRAINAGE STRUCTURE (ALTERNATIVE) PRELOADING - STA 454+06.6 C/L

Item	Description	Quantity	Unit	Unit Price	Amount
1	MOB & DEMOB	LS	LS	\$25,000.00	\$25,000
2	CLEARING & GRUBBING	7	ACRE	\$15,000.00	\$105,000
3	EXCAVATION	9,202	CY	\$2.00	\$18,404
4	SHELL FILL	13,045	CY	\$18.00	\$234,810
5	WICK DRAINS	148,200	LF	\$.55	\$81,510
6	FILTER FABRIC (1250#/IN)	5,545	SY	\$14.00	\$77,630
7	SAND FILL (HAUL FROM BONNE CARRE)	41,020	CY	\$6.75	\$276,885
8	FERTILIZING & SEEDING	7	ACRE	\$500.00	\$3,500
SUBTOTAL					\$822,739
20% CONTINGENCIES					\$164,548
TOTAL CONSTRUCTION (R)					\$987,000
ENGINEERING & DESIGN 12%					\$118,000
SUPERVISION & ADMIN. 10%					\$99,000
TOTAL COST					\$1,204,000

UPDATE OF JAN 11 1989

TABLE 41B
 COST ESTIMATE - ST CHARLES PARISH GDM
 WALKER CANAL DRAINAGE STRUCTURE (ALTERNATIVE) - STA 454+06.6 C/L

Item	Description	Quantity	Unit	Unit Price	Amount
1	MOB & DEMOB	LS	LS	\$100,000.00	\$100,000
2	CLEARING	7	ACRE	\$1,000.00	\$7,000
3	CLEARING & GRUBBING	7	ACRE	\$1,500.00	\$10,500
4	EXCAVATION AT STRUCTURE	939	CY	\$2.00	\$1,878
5	SAND REMOVAL	30,385	CY	\$1.00	\$30,385
6	CHANNEL EXCAVATION	6,480	CY	\$1.50	\$9,720
7	EMBANKMENT UNCOMPACTED FILL	3,420	CY	\$6.75	\$23,085
8	EMBANKMENT SEMICOMPACTED FILL	13,065	CY	\$7.00	\$91,455
9	GEOTEXTILE SEPERATOR FABRIC	443	SY	\$2.00	\$886
10	CONCRETE SAND	260	CY	\$20.00	\$5,200
11	RIPRAP	360	TONS	\$20.00	\$7,200
12	CONCRETE IN STAB. SLAB	20	CY	\$70.00	\$1,400
13	CONCRETE IN BASE SLAB	66	CY	\$200.00	\$13,200
14	CONCRETE IN HEADWALLS & WINGWALLS	48	CY	\$330.00	\$15,840
15	CONCRETE IN SLUICE GATE CHAMBER	25	CY	\$330.00	\$8,250
16	STEEL SHEET PILE, PZ-22	1,968	SF	\$12.00	\$23,616
17	FERTILIZING & SEEDING	14	ACRE	\$500.00	\$7,000
18	(4'X4') SLUICE GATES & MACHINERY INCL ELECTRICAL	2	EA	\$30,000.00	\$60,000
19	MISL. METALS	LS	LS	\$11,300.00	\$11,300
20	60-INCH CMP CULVERTS	560	LF	\$200.00	\$112,000
21	SHELL ROAD	210	CY	\$22.00	\$4,620
SUBTOTAL					\$544,535
20% CONTINGENCIES					\$108,907
TOTAL CONSTRUCTION (R)					\$653,000
ENGINEERING & DESIGN 12%					\$78,000
SUPERVISION & ADMIN. 10%					\$65,000
TOTAL COST					\$796,000

UPDATE OF JAN 11 1989

TABLE 41C
 COST ESTIMATE - ST CHARLES PARISH GDM
 WALKER CANAL DRAINAGE STRUCTURE (ALT.) - CMP CULVERT REPLACEMENT - 2 EACH

Item	Description	Quantity	Unit	Unit Price	Amount
1	MOB & DEMOB	LS	LS	\$50,000.00	\$50,000
2	CLEARING	1	ACRE	\$1,000.00	\$1,000
3	STRUCTURAL EXCAVATION & BACKFILL	940	CY	\$18.00	\$16,920
4	EMBANKMENT SEMICOMPACTED FILL	920	CY	\$7.00	\$6,440
5	CONCRETE SAND	260	CY	\$20.00	\$5,200
6	60-INCH CMP CULVERTS	560	LF	\$200.00	\$112,000
7	RIPRAP REMOVAL & REPLACEMENT	64	TONS	\$4.00	\$256
SUBTOTAL					\$191,816
20% CONTINGENCIES					\$38,363
TOTAL CONSTRUCTION (R)					\$230,000
ENGINEERING & DESIGN 12%					\$28,000
SUPERVISION & ADMIN. 10%					\$23,000
TOTAL COST					\$281,000

UPDATE OF JAN 11 1989

PAGE 3 OF 3

TOTAL STRUC. COST=====

\$2,562,000

TABLE 5A
 COST ESTIMATE - ST CHARLES PARISH GDM
 PARISH LINE CANAL DRAINAGE STRUCTURE - STA 516+02.1 C/L

Item	Description	Quantity	Unit	Unit Price	Amount
1	MOB & DEMOB	LS	LS	\$100,000.00	\$100,000
2	CLEARING & GRUBBING	13	ACRE	\$1,500.00	\$19,500
3	EXCAVATION AT STRUCTURE	6,874	CY	\$2.00	\$13,748
4	CHANNEL EXCAVATION	4,500	CY	\$1.50	\$6,750
5	STRUCTURE DEWATERING	LS	LS	\$200,000.00	\$200,000
6	SHELL BACKFILL	2,595	CY	\$18.00	\$46,710
7	EMBANKMENT SEMICOMPACTED FILL	3,780	CY	\$7.50	\$28,350
8	EMBANKMENT UNCOMPACTED FILL	1,840	CY	\$7.25	\$13,340
9	LEVEE SAND BASE	440	CY	\$7.00	\$3,080
10	FERTILIZING & SEEDING	11	ACRE	\$500.00	\$5,500
11	RIPRAP	94	TONS	\$20.00	\$1,880
12	STEEL SHEET PILE,PZ-22	8,457	SF	\$12.00	\$101,484
13	12" X 12" PRESTRSD CONC PILES	2,106	LF	\$18.00	\$37,908
14	14" X 14" PRESTRSD CONC PILES	3,900	LF	\$20.00	\$78,000
15	COMPRESSION PILE TEST	3	EA	\$18,000.00	\$54,000
16	ADDITIONAL COMP PILE TEST	3	EA	\$14,000.00	\$42,000
17	TENSION PILE TEST	3	EA	\$19,000.00	\$57,000
18	ADDITIONAL TENSION PILE TEST	3	EA	\$14,000.00	\$42,000
19	12 X 53 STEEL H-PILES	4,792	LF	\$24.00	\$115,008
20	CONCRETE IN STAB. SLAB	45	CY	\$70.00	\$3,150
21	CONCRETE IN SLUICE GATE STRUC	231	CY	\$330.00	\$76,230
22	CONC. IN T-WALL BASE	273	CY	\$200.00	\$54,600
23	CONC. IN T-WALL STEM	161	CY	\$330.00	\$53,130
24	(4'X4') SLUICE GATE - & MACHINERY INCL ELECTRICAL	1	EA	\$30,000.00	\$30,000
SUBTOTAL					\$1,183,368

UPDATE OF JAN 11 1989

TABLE 5B
 COST ESTIMATE - ST CHARLES PARISH GDM
 PARISH LINE CANAL DRAINAGE STRUCTURE (2ND & 3RD LIFTS) - STA 516+02.1

Item	Description	Quantity	Unit	Unit Price	Amount
1	MOB & DEMOB*	LS	LS	\$20,000.00	\$20,000
2	CLEARING	1	ACRE	\$1,000.00	\$1,000
3	EMBANKMENT UNCOMPACTED FILL	440	CY	\$7.25	\$3,190
4	EMBANKMENT SEMICOMPACTED FILL	145	CY	\$7.50	\$1,088
5	FERTILIZING & SEEDING	1	ACRE	\$500.00	\$500
6	RAISING SHEET PILING, PZ-22	120	SF	\$2.50	\$300
*PRICE FOR MOB & DEMOB IS REDUCED SINCE THIS JOB WILL BE COMBINED WITH A LEVEE LIFT CONTRACT					
SUBTOTAL					\$26,078
20% CONTINGENCIES					\$5,216
TOTAL CONSTRUCTION (R)					\$31,000
ENGINEERING & DESIGN 12%					\$4,000
SUPERVISION & ADMIN. 10%					\$3,000
TOTAL COST					\$38,000

UPDATE OF JAN 11 1989

TABLE 5C
 COST ESTIMATE - ST CHARLES PARISH GDM
 PARISH LINE CANAL DRAINAGE STRUCTURE (I-WALL CAPPING) - STA 516+02.1 C/L

Item	Description	Quantity	Unit	Unit Price	Amount
1	MOB & DEMOB	LS	LS	\$20,000.00	\$20,000
2	CONCRETE IN I-WALLS	24	CY	\$330.00	\$7,920
3	STRUCTURAL EXCAVATION	23	CY	\$8.00	\$184
4	STRUCTURAL BACKFILL	11	CY	\$10.00	\$110
5	REMOVE & DISPOSE EXISTING DAMAGED STEEL SHEET PILING	590	SF	\$4.00	\$2,360
6	STEEL SHEET PILING, PZ-22	390	SF	\$12.00	\$4,680
SUBTOTAL					\$35,254
20% CONTINGENCIES					\$7,051
TOTAL CONSTRUCTION (R)					\$42,000
ENGINEERING & DESIGN 12%					\$5,000
SUPERVISION & ADMIN. 10%					\$4,000
TOTAL COST					\$51,000

UPDATE OF JAN 11 1989

PAGE 4 OF 4

TOTAL STRUC COST-----

\$1 872 000

TABLE 51A
 COST ESTIMATE - ST CHARLES PARISH GDM
 PARISH LINE CANAL DRAINAGE STRUCTURE (ALTERNATIVE) PRELOADING-STA 516+02.1 C/L

Item	Description	Quantity	Unit	Unit Price	Amount
1	MOB & DEMOB	LS	LS	\$25,000.00	\$25,000
2	CLEARING & GRUBBING	7	ACRE	\$1,500.00	\$10,500
3	EXCAVATION	7,534	CY	\$2.00	\$15,068
4	SHELL FILL	10,680	CY	\$18.00	\$192,240
5	WICK DRAINS	120,060	LF	\$.55	\$66,033
6	FILTER FABRIC (1250#/IN)	4,890	SY	\$14.00	\$68,460
7	SAND FILL (HAUL FROM BONNE CARRE)	44,650	CY	\$7.50	\$334,875
8	FERTILIZING & SEEDING	7	CY	\$500.00	\$3,500
SUBTOTAL					\$715,676
20% CONTINGENCIES					\$143,135
TOTAL CONSTRUCTION (R)					\$859,000
ENGINEERING & DESIGN 12%					\$103,000
SUPERVISION & ADMIN. 10%					\$86,000
TOTAL COST					\$1,048,000

UPDATE OF JAN 11 1989

TABLE 51B
 COST ESTIMATE - ST CHARLES PARISH GDM
 PARISH LINE CANAL DRAINAGE STRUCTURE (ALTERNATIVE) - STA 516+02.1 C/L

Item	Description	Quantity	Unit	Unit Price	Amount
1	MOB & DEMOB	LS	LS	\$100,000.00	\$100,000
2	CLEARING	7	ACRE	\$1,000.00	\$7,000
3	CLEARING & GRUBBING	5	ACRE	\$1,500.00	\$7,500
4	EXCAVATION	484	CY	\$2.00	\$968
5	SAND REMOVAL	29,268	CY	\$1.00	\$29,268
6	CHANNEL EXCAVATION	3,717	CY	\$1.50	\$5,576
7	EMBANKMENT UNCOMPACTED FILL	3,030	CY	\$7.25	\$21,968
8	EMBANKMENT SEMICOMPACTED FILL	11,570	CY	\$7.50	\$86,775
9	GEOTEXTILE SEPERATOR FABRIC	291	SY	\$2.00	\$582
10	CONCRETE SAND	137	CY	\$20.00	\$2,740
11	RIPRAP	118	TONS	\$20.00	\$2,360
12	CONCRETE IN STAB. SLAB	15	CY	\$70.00	\$1,050
13	CONCRETE IN BASE SLAB	49	CY	\$200.00	\$9,800
14	CONCRETE IN HEADWALLS & WINGWALLS	37	CY	\$330.00	\$12,210
15	CONCRETE IN SLUICE GATE CHAMBER	13	CY	\$330.00	\$4,290
16	STEEL SHEET PILE,PZ-22	1,740	SF	\$12.00	\$20,880
17	FERTILIZING & SEEDING	11	ACRE	\$500.00	\$5,500
18	(4'-6" X 4'-6") SLUICE GATES & MACHINERY INCL ELECTRICAL	1	EA	\$32,000.00	\$32,000
19	MISL. METALS	LS	LS	\$7,000.00	\$7,000
20	54-INCH CMP CULVERTS	280	LF	\$150.00	\$42,000
21	SHELL ROAD	180	CY	\$22.00	\$3,960
SUBTOTAL COST					\$403,426

UPDATE OF JAN 11 1989

TABLE 51B - CON'T
 COST ESTIMATE - ST CHARLES PARISH GDM
 PARISH LINE CANAL DRAINAGE STRUCTURE (ALTERNATIVE) - STA 516+02.1 C/L

Item	Description	Quantity	Unit	Unit Price	Amount
	FLDWALL @ RAILROAD SWING GATE (ALTERNATIVE)				
20	STEEL SHEET PILING, PZ-22	1,160	SF	\$12.00	\$13,920
21	COMPRESSION PILE TEST*	1	EA	\$18,000.00	\$18,000
22	ADDITIONAL COMP PILE TEST*	1	EA	\$14,000.00	\$14,000
23	TENSION PILE TEST*	1	EA	\$19,000.00	\$19,000
24	ADDITIONAL TENSION PILE TEST*	1	EA	\$14,000.00	\$14,000
	*PILE TESTS REQUIRED FOR PILE SUPPORTED RR SWING GATE MONOLITHS. FOR THE PRIMARY OPTION ,THE PILE TEST RESULTS FROM THE DRAINAGE STURCTURE WILL BE USED FOR THE RAILROAD SWING GATE MONOLITHS				
	SUBTOTAL				\$482,346
	20% CONTINGENCIES				\$96,469
	TOTAL CONSTRUCTION (R)				\$579,000
	ENGINEERING & DESIGN 12%				\$69,000
	SUPERVISION & ADMIN. 10%				\$58,000
	TOTAL COST				\$706,000

UPDATE OF JAN 11 1989

TABLE 51C
 COST ESTIMATE - ST CHARLES PARISH GDM
 PARISH LINE CANAL DRAINAGE STRUC. (ALT. - 2ND & 3RD LIFTS OF I-WALL)

Item	Description	Quantity	Unit	Unit Price	Amount
1	MOB & DEMOB*	LS	LS	\$20,000.00	\$20,000
2	CLEARING	1	ACRE	\$1,000.00	\$1,000
3	EMBANKMENT UNCOMPACTED FILL	780	CY	\$7.25	\$5,655
4	EMBANKMENT SEMICOMPACTED FILL	206	CY	\$7.50	\$1,545
5	FERTILIZING & SEEDING	1	ACRE	\$500.00	\$500
6	RAISING SHEET PILING, PZ-22	220	SF	\$2.50	\$550
*PRICE FOR MOB & DEMOB IS REDUCED SINCE THIS JOB WILL BE COMBINED WITH A LEVEE LIFT CONTRACT					
SUBTOTAL					\$29,250
20% CONTINGENCIES					\$5,850
TOTAL CONSTRUCTION (R)					\$35,000
ENGINEERING & DESIGN 12%					\$4,000
SUPERVISION & ADMIN. 10%					\$4,000
TOTAL COST					\$43,000

UPDATE OF JAN 11 1989

TABLE 51E
 COST ESTIMATE - ST CHARLES PARISH GDM
 PARISH LINE DRAINAGE STRUCTURE (ALT.) - CMP CULVERT REPLACEMENT - 2 EACH

Item	Description	Quantity	Unit	Unit Price	Amount
1	MOB & DEMOB	LS	LS	\$50,000.00	\$50,000
2	CLEARING	1	ACRE	\$1,000.00	\$1,000
3	FERTILIZING & SEEDING	1	ACRE	\$500.00	\$500
4	STRUCTURAL EXCAVATION & BACKFILL	485	CY	\$18.00	\$8,730
5	SEMICOMPACTED FILL EMBANKMENT	460	CY	\$7.50	\$3,450
6	CONCRETE SAND	137	CY	\$20.00	\$2,740
7	54-INCH CMP CULVERTS	280	LF	\$150.00	\$42,000
8	RIPRAP REMOVAL & REPLACEMENT	32	TONS	\$4.00	\$128
SUBTOTAL					\$108,548
20% CONTINGENCIES					\$21,710
TOTAL CONSTRUCTION (R)					\$130,000
ENGINEERING & DESIGN 12%					\$16,000
SUPERVISION & ADMIN. 10%					\$13,000
TOTAL COST					\$159,000

UPDATE OF JAN 11 1989
 PAGE 6 OF 6
 TOTAL STURC. COST ===== \$2,208,000

TABLE 6A
 COST ESTIMATE - ST CHARLES PARISH GDM
 SHELL GOODHOPE OILFIELD FLOODWALL - STA 150+28.7 C/L

Item	Description	Quantity	Unit	Unit Price	Amount
1	MOB & DEMOB	LS	LS	\$35,000.00	\$35,000
2	CLEARING & GRUBBING	4	ACRE	\$1,000.00	\$4,000
3	FERTILIZING & SEEDING	4	ACRE	\$500.00	\$2,000
4	EMBANKMENT UNCOMPACTED FILL	18,335	CY	\$5.00	\$91,675
5	EMBANKMENT SEMICOMPACTED FILL	1,985	CY	\$5.25	\$10,421
6	LEVEE SAND BASE	2,470	CY	\$4.75	\$11,733
7	STRUCTURAL EXCAVATION	30	CY	\$8.00	\$240
8	STRUCTURAL BACKFILL	90	CY	\$10.00	\$900
9	PZ-22, STEEL SHEET PILING	11,190	SF	\$12.00	\$134,280
10	12"X12" PRESTRSD CONC PILING	2,584	LF	\$18.00	\$46,512
11	CONC IN STAB SLAB	4	CY	\$70.00	\$280
12	CONC IN T-WALL BASE	30	CY	\$200.00	\$6,000
13	CONC IN T-WALL STEM	30	CY	\$330.00	\$9,900
14	STRUCTURAL STEEL SWING GATES	LS	LS	\$15,000.00	\$15,000
SUBTOTAL					\$367,941
20% CONTINGENCIES					\$73,588
TOTAL CONSTRUCTION (R)					\$442,000
ENGINEERING & DESIGN 12%					\$53,000
SUPERVISION & ADMIN. 10%					\$44,000
TOTAL FLOODWALL COST					\$539,000

UPDATE OF JAN 11 1989

TABLE 6B
 COST ESTIMATE - ST CHARLES PARISH GDM
 SHELL GOODHOPE OILFIELD FLOODWALL(2ND & 3RD LIFTS) - STA 150+28.7 C/L

Item	Description	Quantity	Unit	Unit Price	Amount
1	MOB & DEMOB*	LS	LS	\$20,000.00	\$20,000
2	CLEARING	4	ACRE	\$1,000.00	\$4,000
3	FERTILIZING & SEEDING	4	ACRE	\$500.00	\$2,000
4	EMBANKMENT UNCOMPACTED FILL	3,825	CY	\$5.00	\$19,125
5	EMBANKMENT SEMICOMPACTED FILL	1,250	CY	\$5.25	\$6,563
6	RAISING SHEET PILING, PZ-22	900	SF	\$2.50	\$2,250
*PRICE FOR MOB & DEMOB IS REDUCED SINCE THIS JOB WILL BE COMBINED WITH A LEVEE LEVEE CONTRACT					
SUBTOTAL					\$53,938
20% CONTINGENCIES					\$10,788
TOTAL CONSTRUCTION (R)					\$65,000
ENGINEERING & DESIGN 12%					\$8,000
SUPERVISION & ADMIN. 10%					\$6,000
TOTAL COST					\$79,000

UPDATE OF JAN 11 1989

TABLE 6C
 COST ESTIMATE - ST CHARLES PARISH GDM
 SHELL GOODHOPE OILFIELD FLOODWALL (I-WALL CAPPING) - STA 150+28.7 C/L

Item	Description	Quantity	Unit	Unit Price	Amount
1	MOB & DEMOB	LS	LS	\$20,000.00	\$20,000
2	STRUCTURAL EXCAVATION	131	CY	\$8.00	\$1,048
3	STRUCTURAL BACKFILL	66	CY	\$10.00	\$660
4	REMOVE & DISPOSE EXISTING DAMAGED STEEL SHEET PILING	5,600	SF	\$4.00	\$22,400
5	STEEL SHEET PILING, PZ-22	7,100	SF	\$12.00	\$85,200
6	CONCRETE IN I-WALLS	202	CY	\$330.00	\$66,660
SUBTOTAL					\$195,968
20% CONTINGENCIES					\$39,194
TOTAL CONSTRUCTION (R)					\$235,000
ENGINEERING & DESIGN 12%					\$28,000
SUPERVISION & ADMIN. 10%					\$24,000
TOTAL COST					\$287,000

UPDATE OF JAN 11 1989

PAGE 4 OF 4
 TOTAL FLDWL. COST ===== \$984,000
 TOTAL RELOC. COST ----- \$82,000

TABLE 7A
 COST ESTIMATE - ST CHARLES PARISH GDM
 FLOODWALL VICINITY OF I-310/US HWY 61 INTERCHANGE - STA 363+01.39 B/L

Item	Description	Quantity	Unit	Unit Price	Amount
1	MOB & DEMOB	LS	LS	\$100,000.00	\$100,000
2	CLEARING & GRUBBING	9	ACRE	\$1,500.00	\$13,500
3	FERTILIZING & SEEDING	9	ACRE	\$500.00	\$4,500
4	EMBANKMENT UNCOMPACTED FILL	13,740	CY	\$6.75	\$92,745
5	EMBANKMENT SEMICOMPACTED FILL	3,580	CY	\$7.00	\$25,060
6	LEVEE SAND BASE	8,440	CY	\$6.50	\$54,860
7	STRUCTURAL EXCAVATION	3,780	CY	\$8.00	\$30,240
8	STRUCTURAL BACKFILL	810	CY	\$10.00	\$8,100
9	PZ-22, STEEL SHEET PILING	24,110	SF	\$12.00	\$289,320
10	12"X12" PRESTRSD CONC PILING	25,221	LF	\$18.00	\$453,978
11	COMPRESSION PILE TEST	1	EA	\$18,000.00	\$18,000
12	ADDITIONAL COMP PILE TEST	1	EA	\$14,000.00	\$14,000
13	TENSION TEST	1	EA	\$19,000.00	\$19,000
14	ADDITIONAL TENSION TEST	1	EA	\$14,000.00	\$14,000
15	CONC IN STAB SLAB	96	CY	\$70.00	\$6,720
16	CONC IN T-WALL BASE	715	CY	\$200.00	\$143,000
17	CONC IN T-WALL STEM	408	CY	\$330.00	\$134,640
18	STRUCTURAL STEEL SWING GATE	LS	LS	\$12,000.00	\$12,000
SUBTOTAL					\$1,433,663
20% CONTINGENCIES					\$286,733
TOTAL CONSTRUCTION (R)					\$1,720,000
ENGINEERING & DESIGN 12%					\$206,000
SUPERVISION & ADMIN. 10%					\$172,000
TOTAL COST					\$2,098,000

UPDATE OF JAN 11 1989

TABLE 7B
 COST ESTIMATE - ST CHARLES PARISH GDM
 FLDWL VIC OF I-310/US HWY 61 INTERCHANGE (2ND & 3RD LIFTS) - STA 363+01.39B/L

Item	Description	Quantity	Unit	Unit Price	Amount
1	MOB & DEMOB*	LS	LS	\$20,000.00	\$20,000
2	CLEARING	5	ACRE	\$1,000.00	\$5,000
3	FERTILIZING & SEEDING	5	ACRE	\$500.00	\$2,500
4	EMBANKMENT UNCOMPACTED FILL	7,875	CY	\$6.75	\$53,156
5	EMBANKMENT SEMICOMPACTED FILL	1,350	CY	\$7.00	\$9,450
6	RAISING SHEET PILING, PZ-22	1,440	SF	\$2.50	\$3,600
*PRICE FOR MOB & DEMOB IS REDUCED SINCE THIS JOB WILL BE COMBINED WITH A LEVEE LEVEE CONTRACT					
SUBTOTAL					\$93,706
20% CONTINGENCIES					\$18,741
TOTAL CONSTRUCTION (R)					\$112,000
ENGINEERING & DESIGN 12%					\$13,000
SUPERVISION & ADMIN. 10%					\$11,000
TOTAL COST					\$136,000

UPDATE OF JAN 11 1989

TABLE 7C
 COST ESTIMATE - ST CHARLES PARISH GDM
 FLOODWALL VIC. OF I-310/US HWY 61 INTERCHANGE(I-WALL CAPPING)-STA 363+01.39B/L

Item	Description	Quantity	Unit	Unit Price	Amount
1	MOB & DEMOB	LS	LS	\$20,000.00	\$20,000
2	STRUCTURAL EXCAVATION	222	CY	\$8.00	\$1,776
3	STRUCTURAL BACKFILL	111	CY	\$10.00	\$1,110
4	REMOVE & DISPOSE EXISTING DAMAGED STEEL SHEET PILING	6,935	SF	\$4.00	\$27,740
5	STEEL SHEET PILING, PZ-22	4,570	SF	\$12.00	\$54,840
6	CONCRETE IN I-WALLS	310	CY	\$330.00	\$102,300
SUBTOTAL					\$207,766
20% CONTINGENCIES					\$41,553
TOTAL CONSTRUCTION (R)					\$249,000
ENGINEERING & DESIGN 12%					\$30,000
SUPERVISION & ADMIN. 10%					\$25,000
TOTAL COST					\$304,000

UPDATE OF JAN 11 1989

PAGE 3 OF 3
 TOTAL FLDWL COST ===== \$2,538,000

TABLE 8A
 COST ESTIMATE - ST CHARLES PARISH GDM
 FLOODWALL/SWING GATE VIC. ILLINOIS CENTRAL RAILROAD - STA 518+34.1 C/L

Item	Description	Quantity	Unit	Unit Price	Amount
1	MOB & DEMOB	LS	LS	\$100,000.00	\$100,000
2	CLEARING & GRUBBING	4	ACRE	\$1,500.00	\$6,000
3	FERTILIZING & SEEDING	4	ACRE	\$500.00	\$2,000
4	EMBANKMENT UNCOMPACTED FILL	24,720	CY	\$7.25	\$179,220
5	EMBANKMENT SEMICOMPACTED FILL	2,190	CY	\$7.50	\$16,425
6	LEVEE SAND BASE	3,265	CY	\$7.00	\$22,855
7	STRUCTURAL EXCAVATION	120	CY	\$8.00	\$960
8	STRUCTURAL BACKFILL	114	CY	\$10.00	\$1,140
9	PZ-22, STEEL SHEET PILING	10,482	SF	\$12.00	\$125,784
10	14"X14" PRESTRSD CONC PILING	3,320	LF	\$20.00	\$66,400
11	CONC IN STAB SLAB	8	CY	\$70.00	\$560
12	CONC IN T-WALL BASE	60	CY	\$200.00	\$12,000
13	CONC IN T-WALL STEM	32	CY	\$330.00	\$10,560
14	FALSEWORK FOR RR SWING GATE	LS	LS	\$20,000.00	\$20,000
15	STRUCTURAL STEEL SWING GATES	LS	LS	\$20,000.00	\$20,000
SUBTOTAL					\$583,904
20% CONTINGENCIES					\$116,781
TOTAL CONSTRUCTION (R)					\$701,000
ENGINEERING & DESIGN 12%					\$84,000
SUPERVISION & ADMIN. 10%					\$70,000
TOTAL FLOODWALL COST					\$855,000

UPDATE OF JAN 11 1989

TABLE 8A - (CON'T)
 COST ESTIMATE - ST CHARLES PARISH GDM
 FLOODWALL/SWING GATE VIC. ILLINOIS CENTRAL RAILROAD - STA 518+34.1 C/L

Item	Description	Quantity	Unit	Unit Price	Amount
	RELOCATIONS				
1	US SPRINT FIBER OPTICS CABLE THRU STEEL SHEET PILE WALL	LS	LS	\$8,000.00	\$8,000
2	MCI FIBER OPTICS CABLE THRU STEEL SHEET PILE WALL	LS	LS	\$8,000.00	\$8,000
3	6" DIA UNITED GAS PIPELINE THRU STEEL SHEET PILE WALL	LS	LS	\$45,000.00	\$45,000
SUBTOTAL					\$61,000
20% CONTINGENCIES					\$12,200
TOTAL CONSTRUCTION (R)					\$73,000
ENGINEERING & DESIGN 12%					\$9,000
SUPERVISION & ADMIN. 10%					\$7,000
TOTAL RELOCATION COSTS					\$89,000
TOTAL COSTS					\$944,000

UPDATE OF JAN 11 1989

TABLE 8B
 COST ESTIMATE - ST CHARLES PARISH GDM
 FLDWL/SWING GATE VIC. ILLINOIS CENTRAL RR (2ND & 3RD LIFTS) - STA 518+34.1 C/L

Item	Description	Quantity	Unit	Unit Price	Amount
1	MOB & DEMOB*	LS	LS	\$20,000.00	\$20,000
2	CLEARING	3	ACRE	\$1,000.00	\$3,000
3	FERTILIZING & SEEDING	3	ACRE	\$500.00	\$1,500
4	EMBANKMENT UNCOMPACTED FILL	4,000	CY	\$7.25	\$29,000
5	EMBANKMENT SEMICOMPACTED FILL	1,500	CY	\$7.50	\$11,250
6	RAISING SHEET PILING, PZ-22	1,000	SF	\$2.50	\$2,500
*PRICE FOR MOB & DEMOB IS REDUCED SINCE THIS JOB WILL BE COMBINED WITH A LEVEE LEVEE CONTRACT					
SUBTOTAL					\$67,250
20% CONTINGENCIES					\$13,450
TOTAL CONSTRUCTION (R)					\$81,000
ENGINEERING & DESIGN 12%					\$10,000
SUPERVISION & ADMIN. 10%					\$8,000
TOTAL COST					\$99,000

UPDATE OF JAN 11 1989

TABLE 8C
 COST ESTIMATE - ST CHARLES PARISH GDM
 FLDWL/SWING GATE VIC. ILLINOIS CENTRAL RR (I-WALL CAPPING)) - STA 518+34.1 C/L

Item	Description	Quantity	Unit	Unit Price	Amount
1	MOB & DEMOB*	LS	LS	\$20,000.00	\$20,000
2	STRUCTURAL EXCAVATION	167	CY	\$8.00	\$1,336
3	STRUCTURAL BACKFILL	84	CY	\$10.00	\$840
4	REMOVE & DISPOSE EXISTING DAMAGED STEEL SHEET PILING	5,030	SF	\$4.00	\$20,120
5	STEEL SHEET PILING, PZ-22	3,270	SF	\$12.00	\$39,240
6	CONCRETE IN I-WALLS	223	CY	\$330.00	\$73,590
SUBTOTAL					\$155,126
20% CONTINGENCIES					\$31,025
TOTAL CONSTRUCTION (R)					\$186,000
ENGINEERING & DESIGN 12%					\$22,000
SUPERVISION & ADMIN. 10%					\$19,000
TOTAL COST					\$227,000

UPDATE OF JAN 11 1989

PAGE 4 OF 4
 TOTAL FLDWL COST ===== \$1,280,000
 TOTAL RELOC COST ===== \$89,000

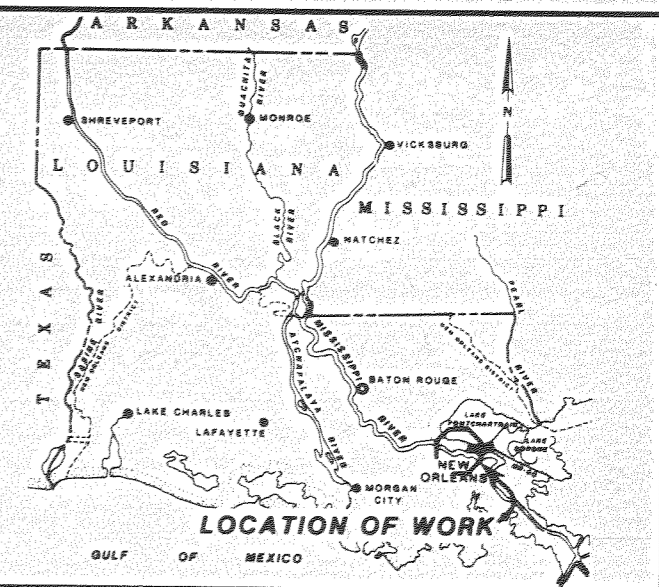
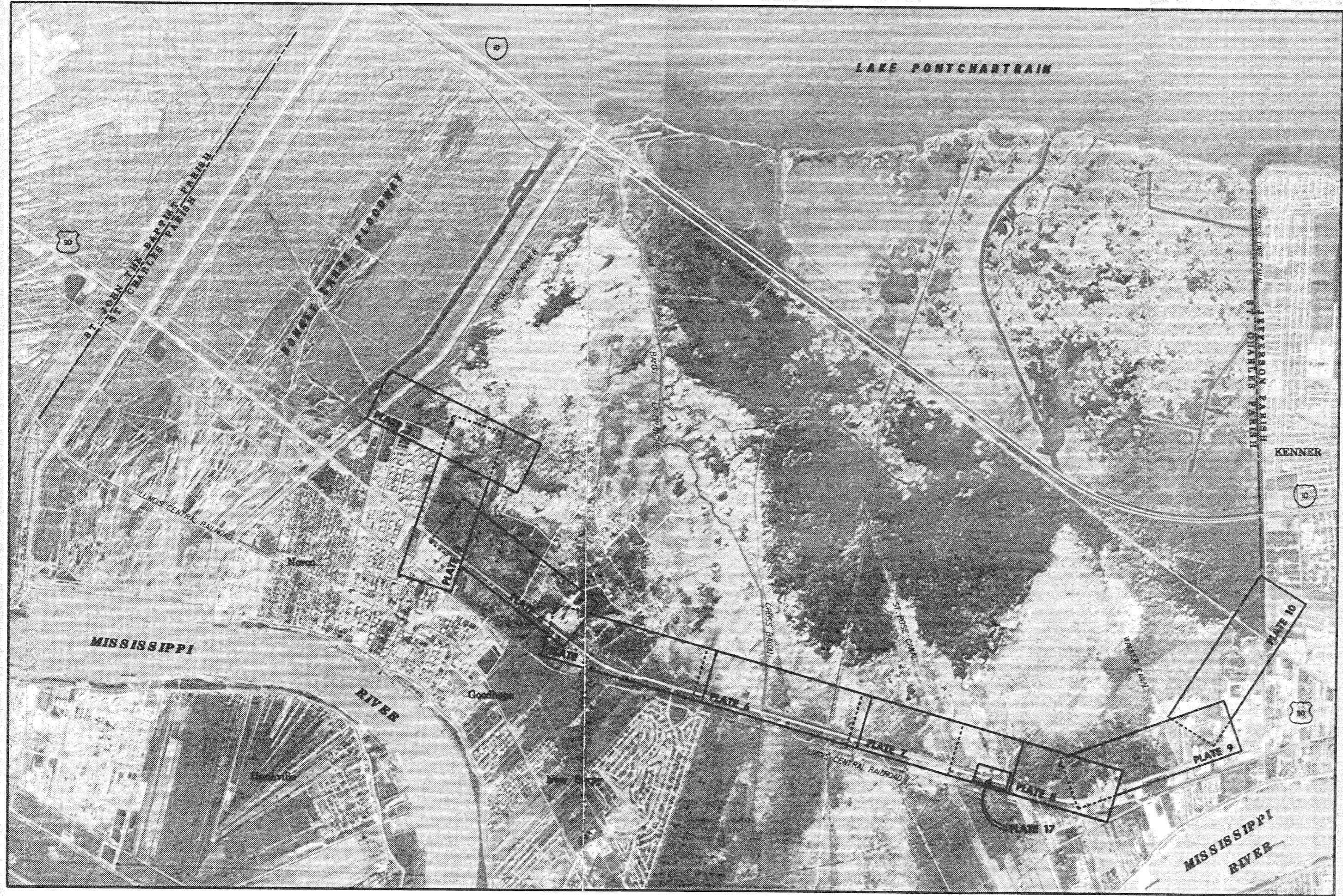

VICINITY MAP
SCALE OF MILES

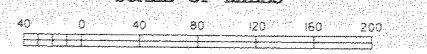

SCALE IN FEET

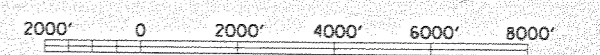

**COMPUTER
AIDED
DESIGN
DRAWING**

LAKE PONTCHARTRAIN, LA. AND VICINITY
HIGH LEVEL PLAN
DESIGN MEMORANDUM NO. 18, GENERAL DESIGN
ST. CHARLES PARISH
NORTH OF AIRLINE HIGHWAY
INDEX AND VICINITY MAP

U. S. ARMY ENGINEER DISTRICT, NEW ORLEANS
CORPS OF ENGINEERS
DATE: JANUARY 1989 FILE NO. H-2-30423

30423SA32.DGN

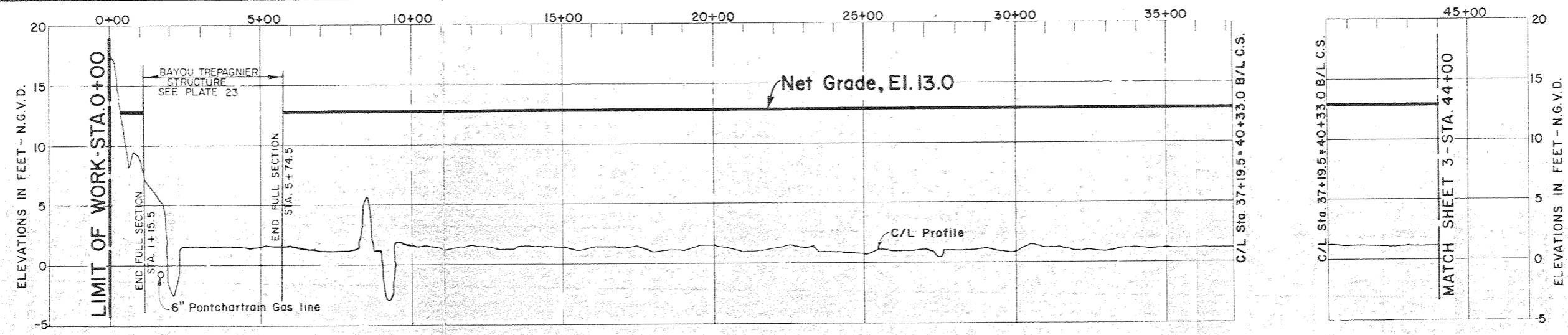
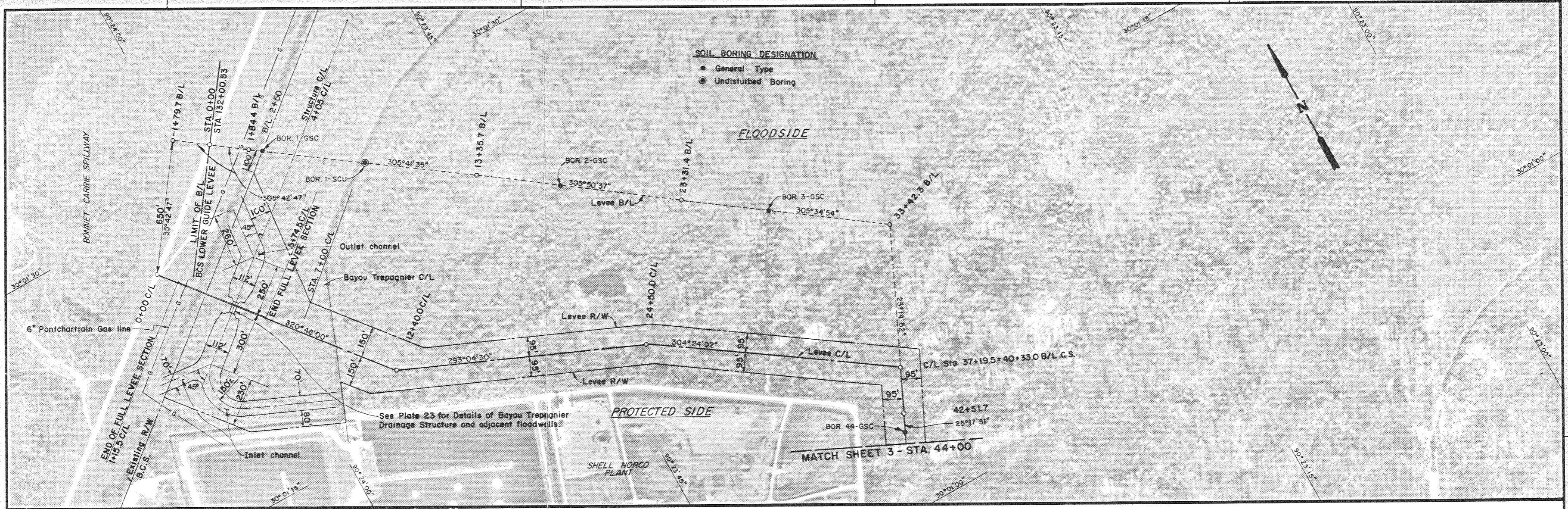

SCALE IN FEET
 200 0 200 400 600

NOTES:
 Uncontrolled mosaic prepared from aerial photos flown Nov. 1985

LAKE PONTCHARTRAIN, LA. AND VICINITY
 HIGH LEVEL PLAN
 DESIGN MEMORANDUM NO. 18 - GENERAL DESIGN
ST. CHARLES PARISH
NORTH OF AIRLINE HIGHWAY
PLAN AND PROFILE
STA. 0+00 TO STA. 44+00
 U. S. ARMY ENGINEER DISTRICT, NEW ORLEANS
 CORPS OF ENGINEERS
 DATE _____ FILE NO. H-2-30423

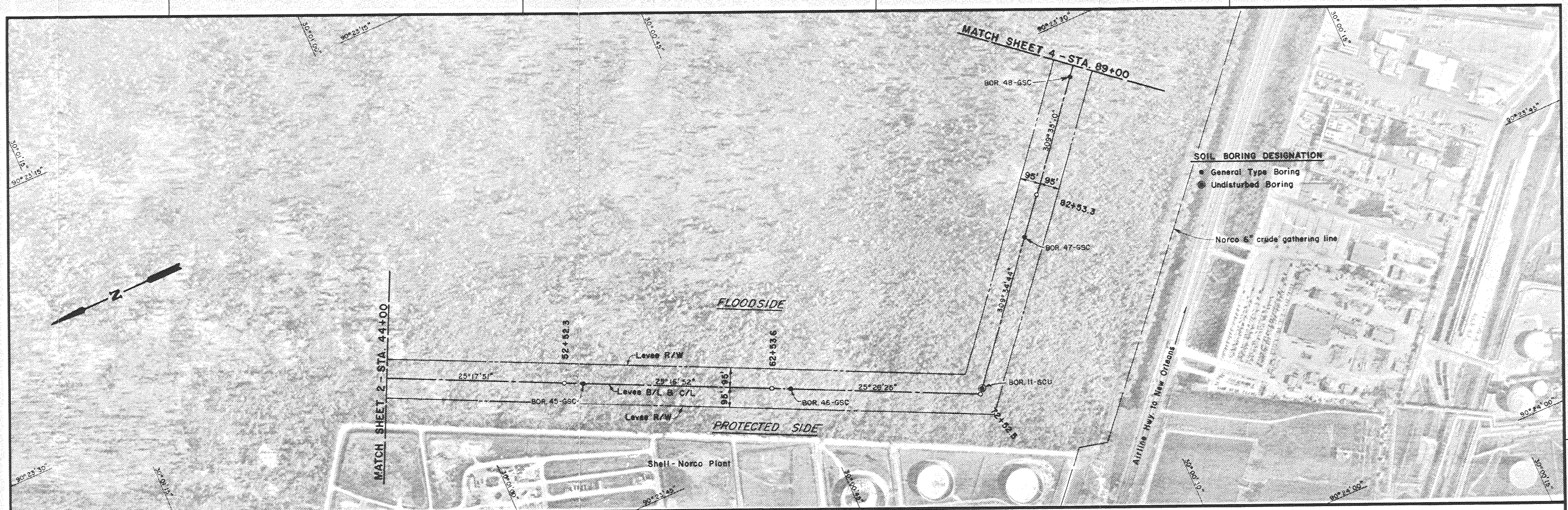

SOIL BORING DESIGNATION
 ● General Type Boring
 ● Undisturbed Boring

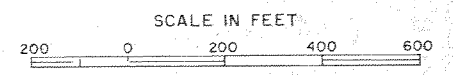
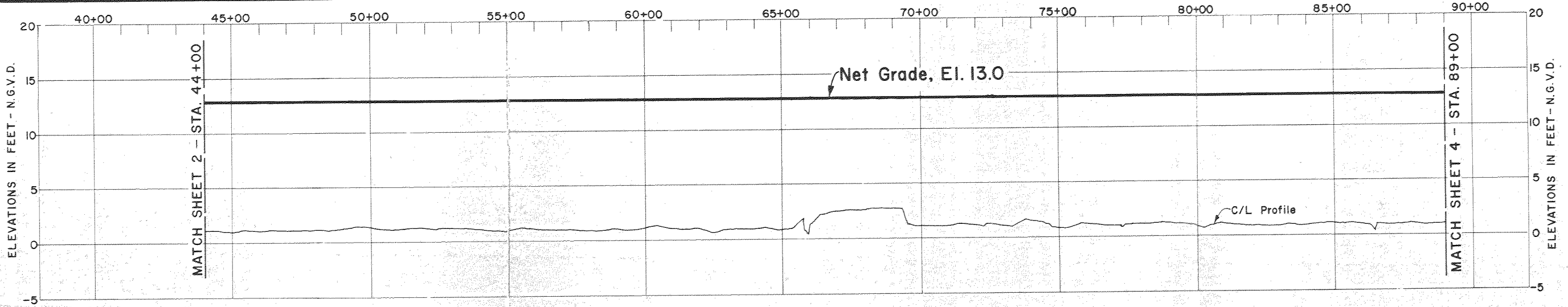

NOTES:
 Uncontrolled mosaic prepared from aerial photos flown Nov. 1985

LAKE PONTCHARTRAIN, LA. AND VICINITY
 HIGH LEVEL PLAN
 DESIGN MEMORANDUM NO. 18 - GENERAL DESIGN
ST. CHARLES PARISH
 NORTH OF AIRLINE HIGHWAY
PLAN AND PROFILE
STA. 44+00 TO STA. 89+00
 U. S. ARMY ENGINEER DISTRICT, NEW ORLEANS
 CORPS OF ENGINEERS
 DATE _____ FILE NO. H-2-30423

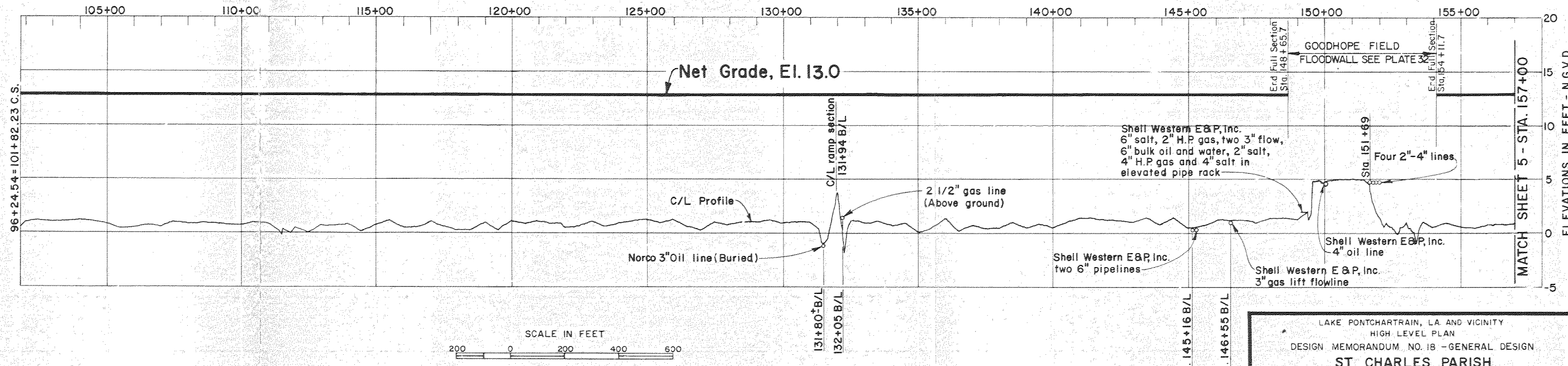
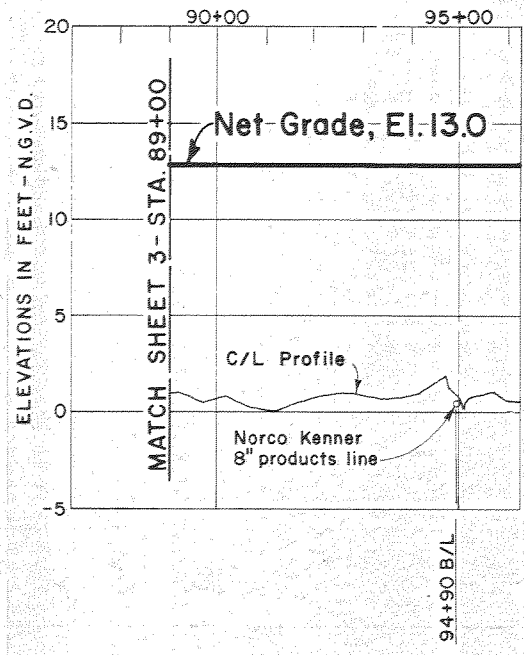
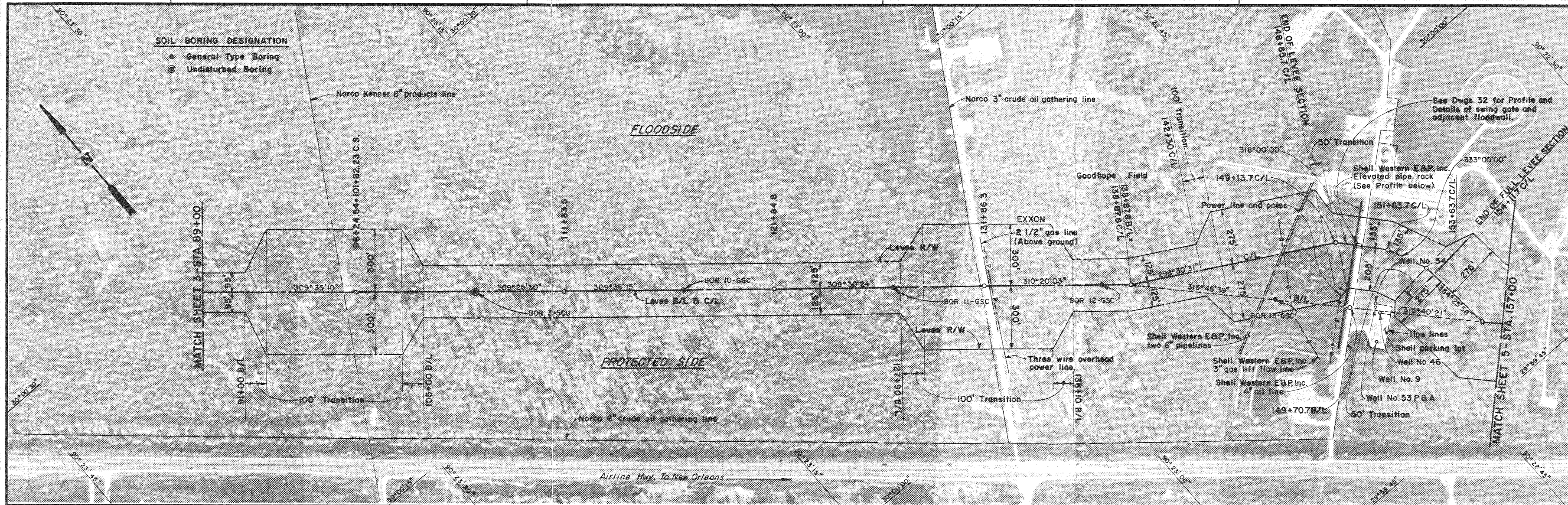

NOTES:
 Uncontrolled mosaic prepared from aerial photos flown
 November 1985.

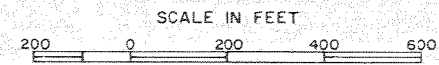

LAKE PONTCHARTRAIN, LA AND VICINITY
 HIGH LEVEL PLAN
 DESIGN MEMORANDUM NO. 18 - GENERAL DESIGN
ST CHARLES PARISH
NORTH OF AIRLINE HIGHWAY
PLAN AND PROFILE
STA. 89+00 TO STA. 157+00
 U. S. ARMY ENGINEER DISTRICT, NEW ORLEANS
 CORPS OF ENGINEERS
 FILE NO. H-2-30423

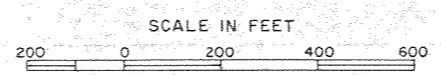
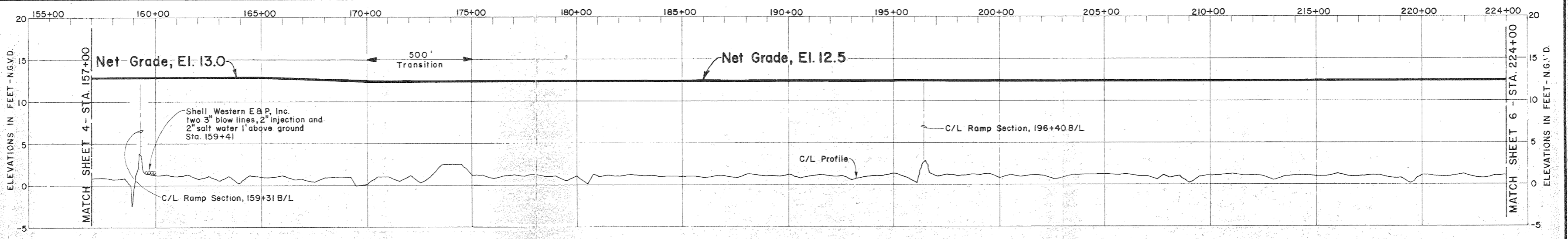
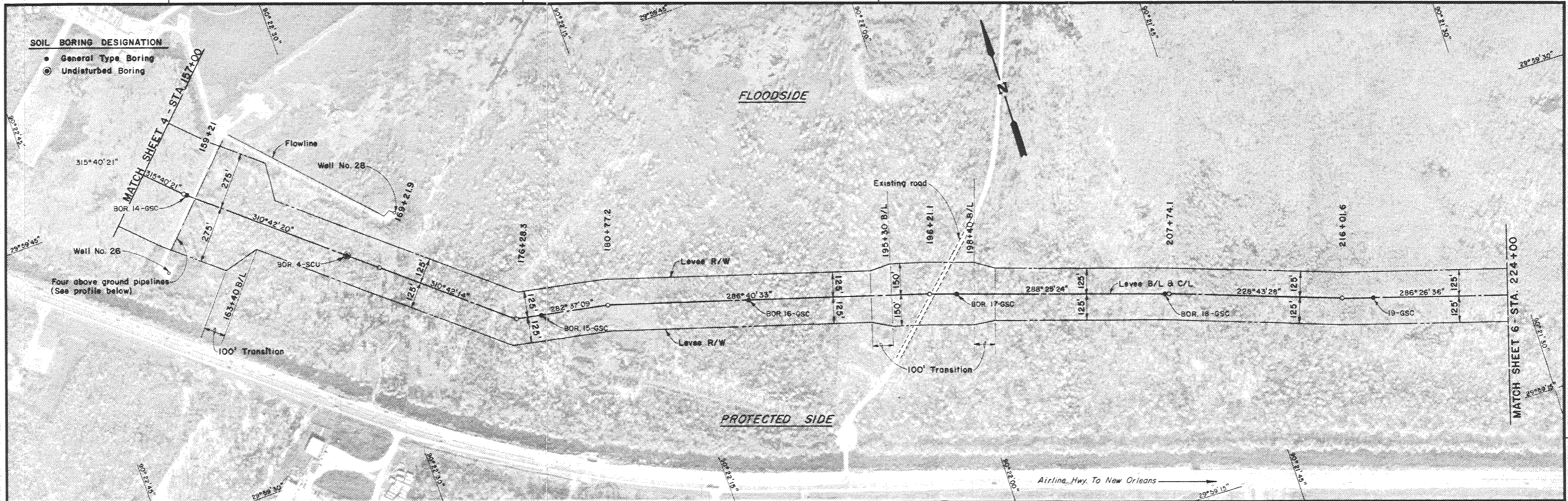

NOTES:
 Uncontrolled mosaic prepared from aerial photos flown November 1985.

LAKE PONTCHARTRAIN, LA. AND VICINITY
 HIGH LEVEL PLAN
 DESIGN MEMORANDUM NO. 18 - GENERAL DESIGN
 ST. CHARLES PARISH
 NORTH OF AIRLINE HIGHWAY
PLAN AND PROFILE
 STA. 157+00 TO STA. 224+00
 U. S. ARMY ENGINEER DISTRICT, NEW ORLEANS
 CORPS OF ENGINEERS
 DATE _____ FILE NO. H-2-30423

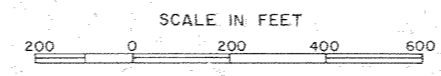
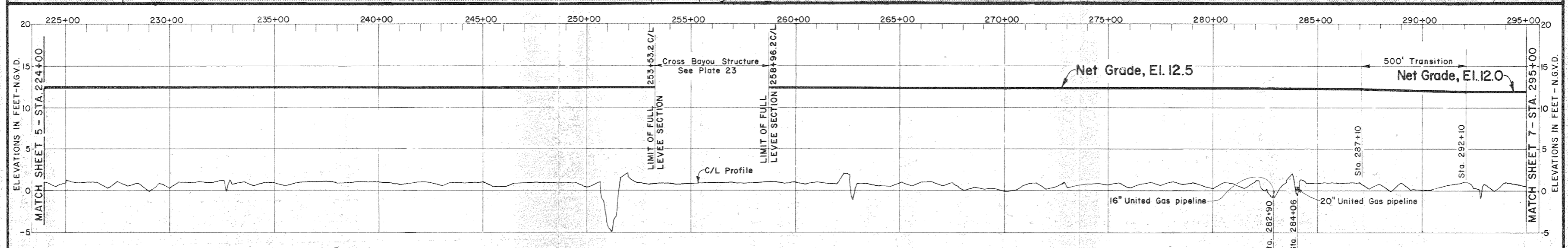
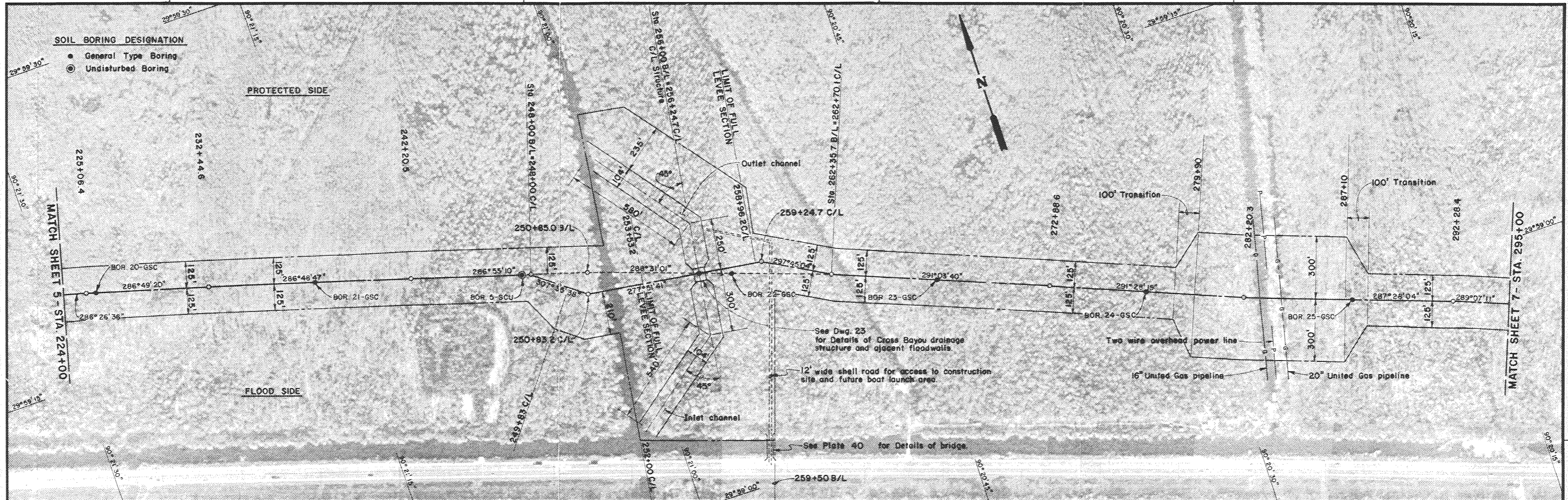

NOTES:
Uncontrolled mosaic prepared from aerial photos flown Nov. 1985.

LAKE PONTCHARTRAIN, LA AND VICINITY
HIGH LEVEL PLAN
DESIGN MEMORANDUM NO. 18 - GENERAL DESIGN
ST. CHARLES PARISH
STATION OF AIRLINE HIGHWAY
PLAN AND PROFILE
STA. 224+00 TO STA. 295+00
U. S. ARMY ENGINEER DISTRICT, NEW ORLEANS
CORPS OF ENGINEERS
DATE _____ FILE NO. H-2-30423

SOIL BORING DESIGNATION

- General Type Boring
- Undisturbed Boring

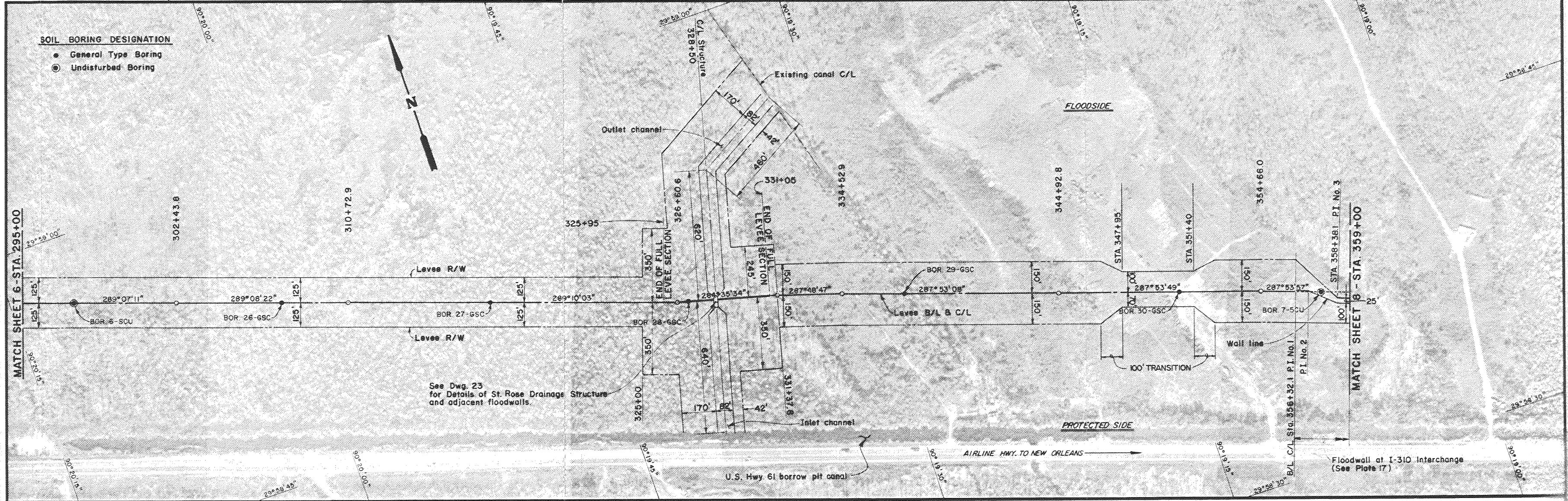
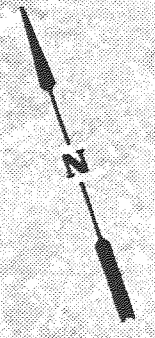

See Dwg. 23
for Details of St. Rose Drainage Structure
and adjacent floodwalls.

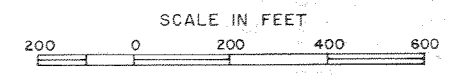
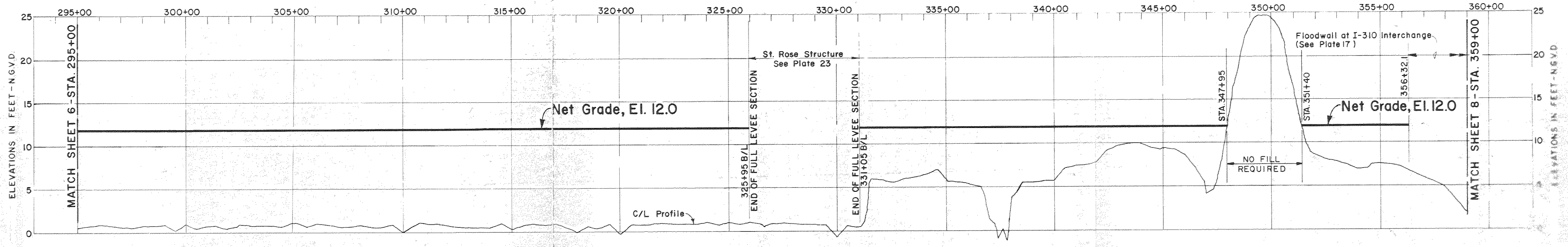

NOTES:
Uncontrolled mosaic prepared from aerial photos flown Nov. 1985.

LAKE PONTCHARTRAIN, LA. AND VICINITY
HIGH LEVEL PLAN
DESIGN MEMORANDUM NO 18 - GENERAL DESIGN
ST. CHARLES PARISH
NORTH OF AIRLINE HIGHWAY
PLAN AND PROFILE
STA. 295+00 TO STA. 359+00
U. S. ARMY ENGINEER DISTRICT, NEW ORLEANS
CORPS OF ENGINEERS
DATE _____ FILE NO. H-2-30423

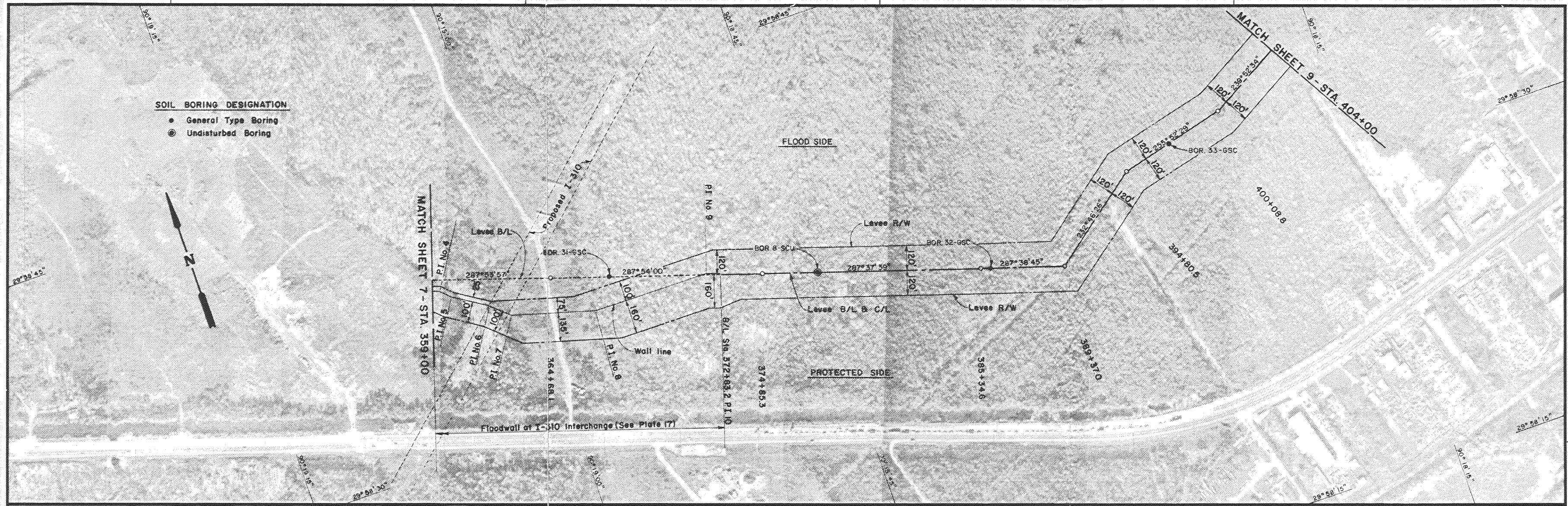

SOIL BORING DESIGNATION
 ● General Type Boring
 ⊙ Undisturbed Boring

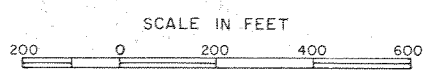
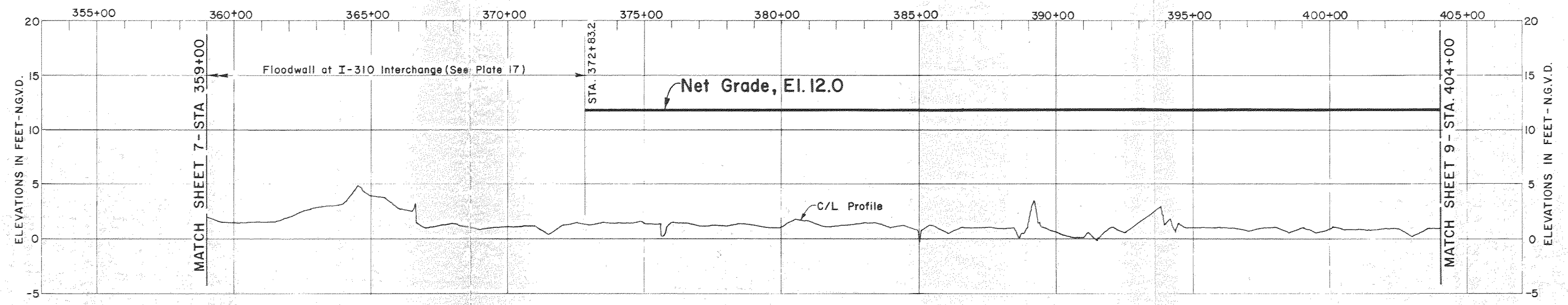

NOTES:
 Uncontrolled mosaic prepared from aerial photos flown Nov. 1985

LAKE PONTCHARTRAIN, LA. AND VICINITY
 HIGH LEVEL PLAN
 DESIGN MEMORANDUM NO. 18 - GENERAL DESIGN
ST. CHARLES PARISH
NORTH OF AIRLINE HIGHWAY
PLAN AND PROFILE
STA. 359+00 TO STA. 404+00
 U. S. ARMY ENGINEER DISTRICT, NEW ORLEANS
 CORPS OF ENGINEERS
 DATE _____ FILE NO. H-2-30423

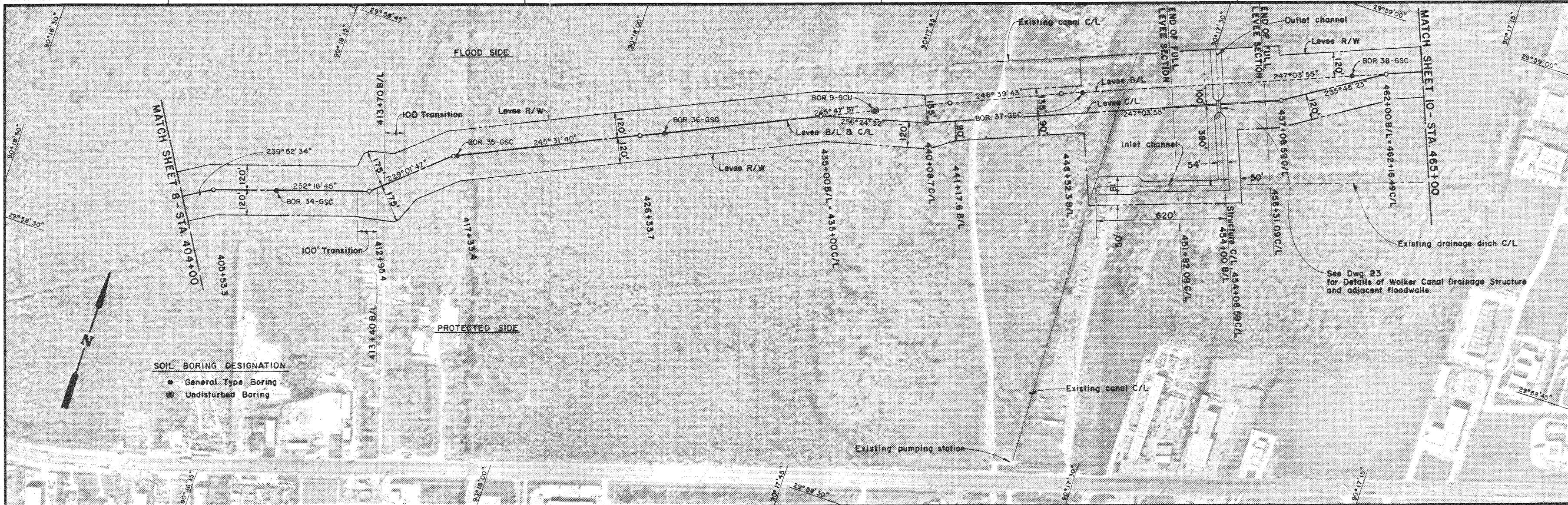

SOIL BORING DESIGNATION

- General Type Boring
- ⊙ Undisturbed Boring

See Dwg. 23
for Details of Walker Canal Drainage Structure
and adjacent floodwalls.

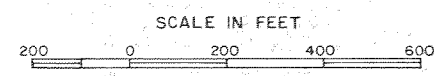
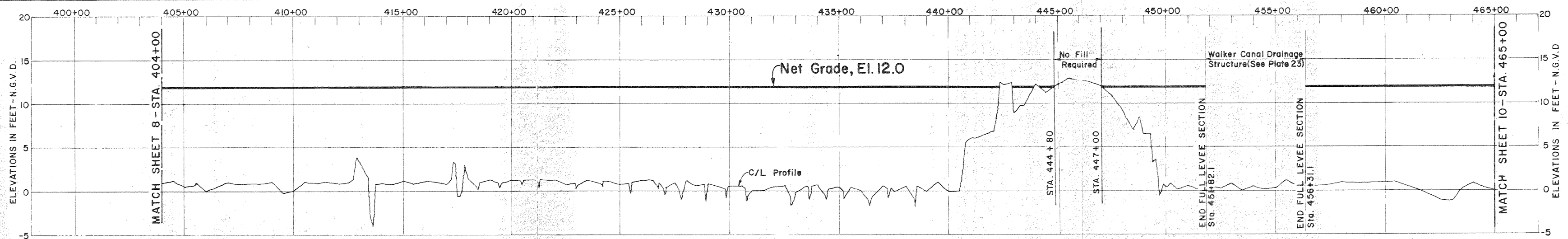

NOTES:
Uncontrolled mosaic prepared from aerial photos flown Nov. 1985.

LAKE PONTCHARTRAIN, LA. AND VICINITY
HIGH LEVEL PLAN
DESIGN MEMORANDUM NO. 18 - GENERAL DESIGN
ST. CHARLES PARISH
NORTH OF AIRLINE HIGHWAY
PLAN AND PROFILE
STA. 404+00 TO STA. 465+00
U. S. ARMY ENGINEER DISTRICT, NEW ORLEANS
CORPS OF ENGINEERS

DATE FILE NO. H-2-30423

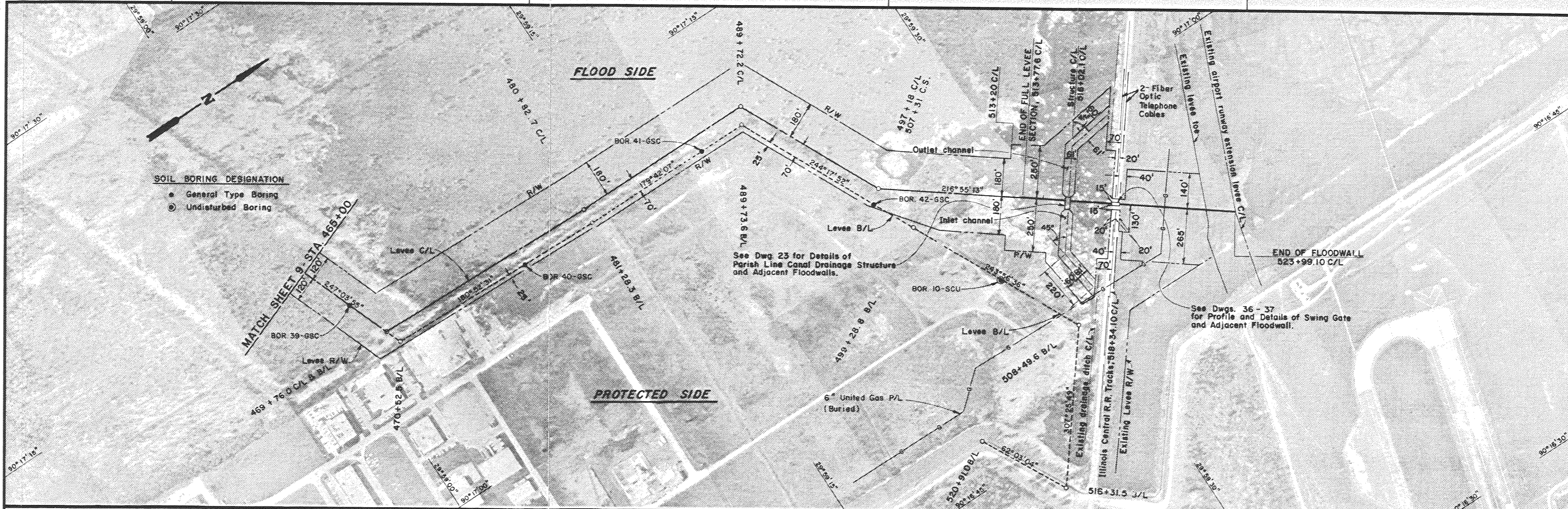

SOIL BORING DESIGNATION

- General Type Boring
- ⊙ Undisturbed Boring

See Dwg. 23 for Details of Parish Line Canal Drainage Structure and Adjacent Floodwalls.

See Dwg. 36 - 37 for Profile and Details of Swing Gate and Adjacent Floodwall.

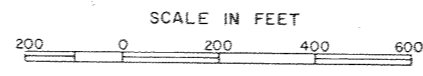
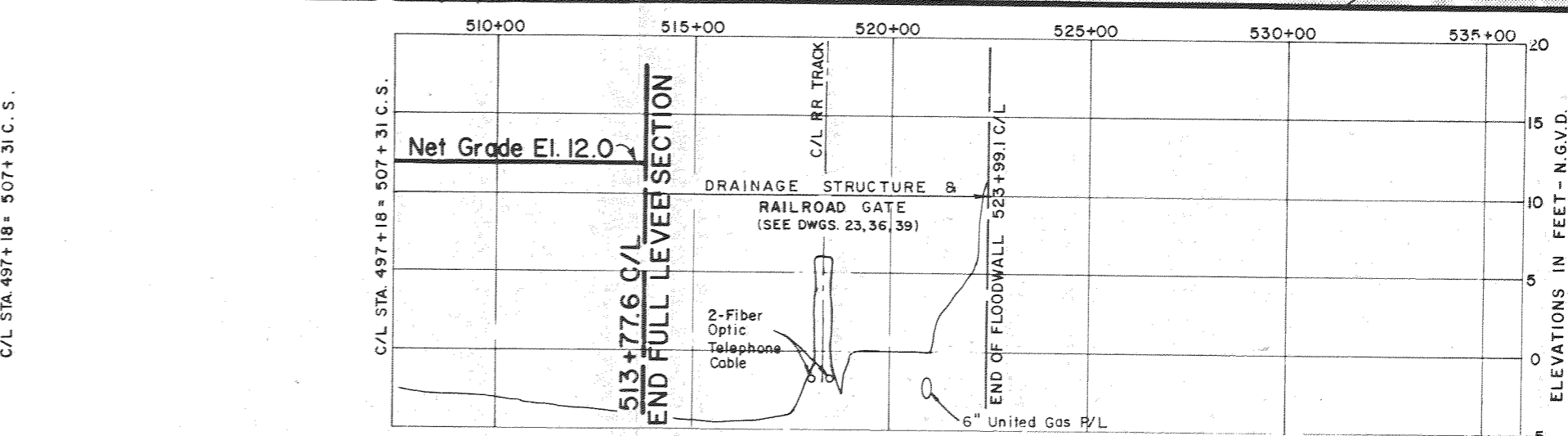
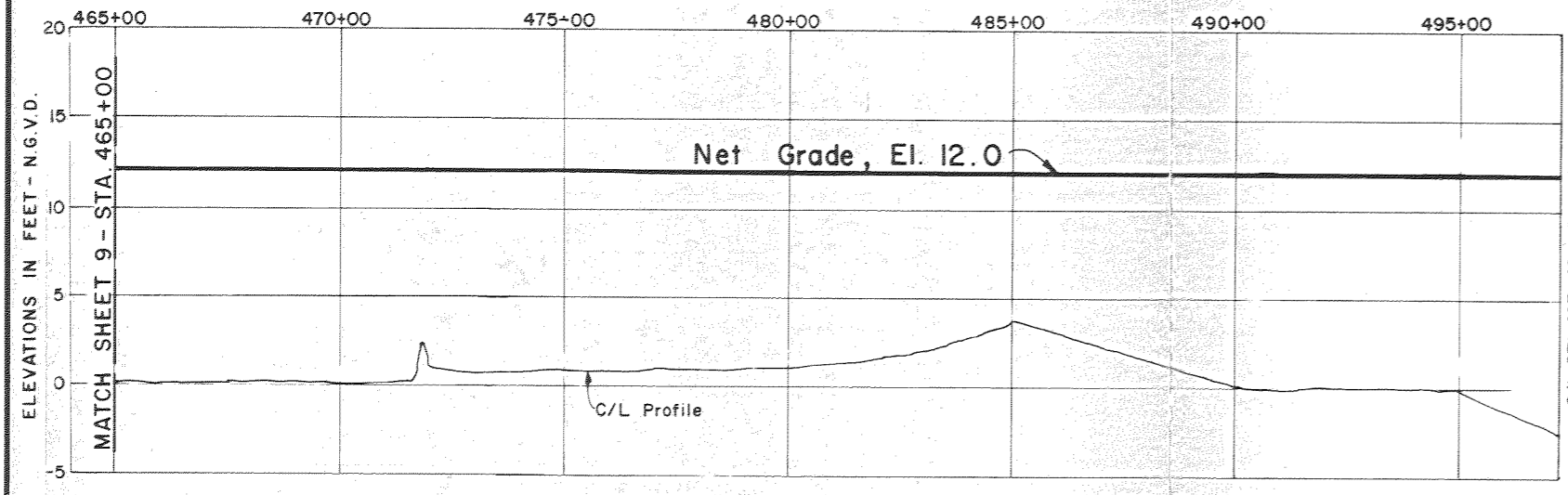

NOTE: Uncontrolled mosaic prepared from aerial photos flown Nov. 1985.

LAKE PONTCHARTRAIN, LA. AND VICINITY
HIGH LEVEL PLAN
DESIGN MEMORANDUM NO. 18- GENERAL DESIGN
ST. CHARLES PARISH
NORTH OF AIRLINE HIGHWAY
PLAN AND PROFILE
STA. 465 + 00 B/L TO STA. 523 + 99.1 C/L
U. S. ARMY ENGINEER DISTRICT, NEW ORLEANS
CORPS OF ENGINEERS
DATE: FILE NO. H-2-30423

FLOOD SIDE

PROTECTED SIDE

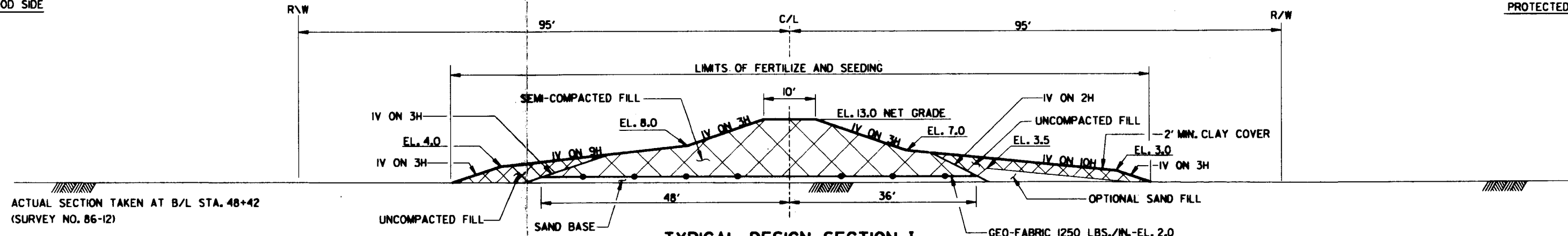

TYPICAL DESIGN SECTION I

NOT TO SCALE

C/L STA. 5+74.5 TO STA. 8+10
C/L STA. 10+50 TO STA. 91+00

FLOOD SIDE

PROTECTED SIDE

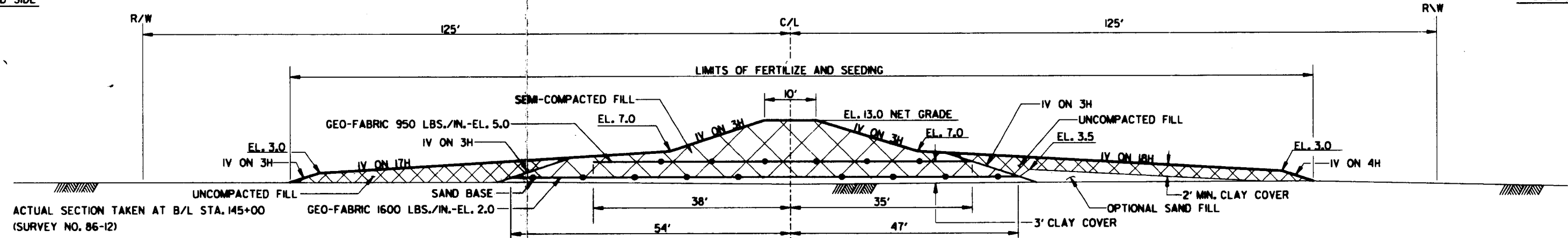

TYPICAL DESIGN SECTION II

NOT TO SCALE

C/L STA. 105+00 TO STA. 127+90
C/L STA. 136+10 TO STA. 142+30
C/L STA. 163+40 TO STA. 170+00
(500' TRANSITION FROM STA. 170+00 TO 175+00)

FLOOD SIDE

PROTECTED SIDE

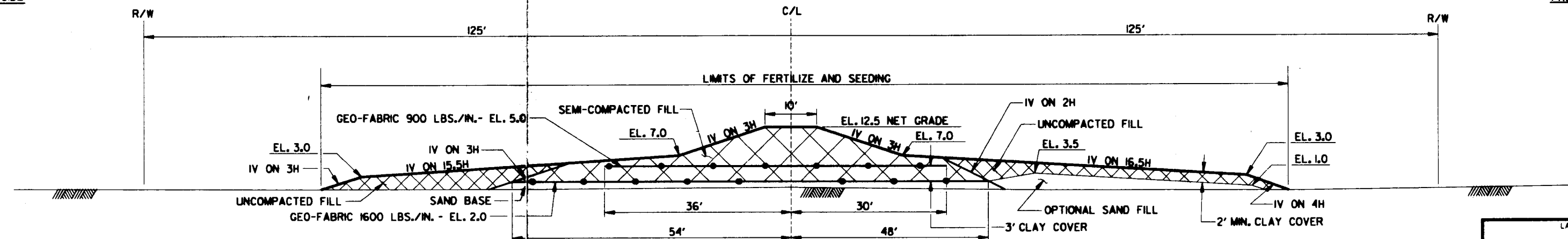

TYPICAL DESIGN SECTION III

NOT TO SCALE

C/L STA. 175+00 TO STA. 195+30
C/L STA. 197+50 TO STA. 249+65
C/L STA. 258+96 TO STA. 265+00
(500' TRANSITION FROM STA. 265+00 TO STA. 270+00)

NOTE:

ALL ABOVE SECTIONS DESIGNED FOR 0.5 FOOT OVERBUILD TOLERANCE (CROWN, SLOPE AND BERMS) AND 1.0 FOOT TEMPORARY STOCKPILE OVERBUILD ON THE LEVEE BERMS AND SIDE SLOPES.

COMPUTER AIDED DESIGN DRAFTING

LAKE PONTCHARTRAIN, LA. AND VICINITY
HIGH LEVEL PLAN
DESIGN MEMORANDUM NO. 18 - GENERAL DESIGN
ST. CHARLES PARISH
NORTH OF AIRLINE HIGHWAY
TYPICAL DESIGN SECTIONS
U. S. ARMY ENGINEER DISTRICT, NEW ORLEANS
CORPS OF ENGINEERS
DATE: FILE NO. H-2-30423

FLOOD SIDE

PROTECTED SIDE

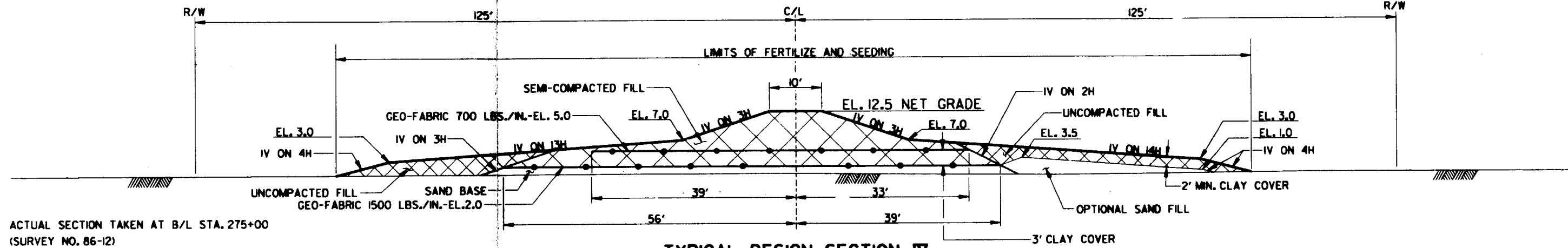

TYPICAL DESIGN SECTION IV

NOT TO SCALE
C/L STA. 270+00 TO 278+90

FLOOD SIDE

PROTECTED SIDE

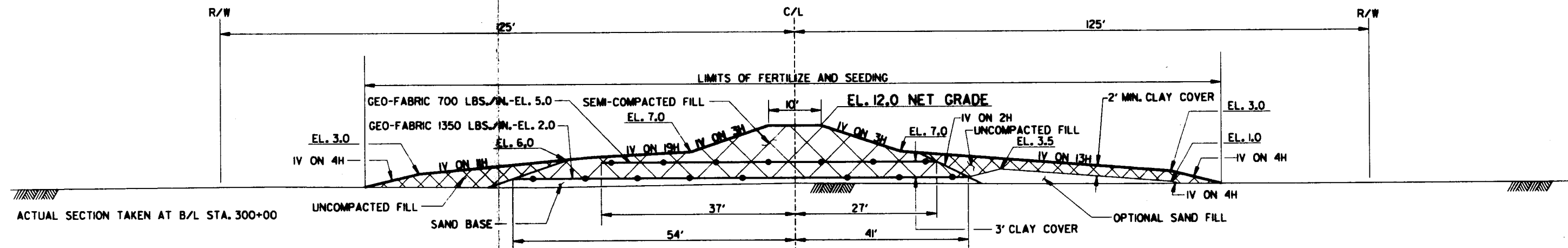

TYPICAL DESIGN SECTION V

NOT TO SCALE
C/L STA. 288+10 TO 325+95

FLOOD SIDE

PROTECTED SIDE

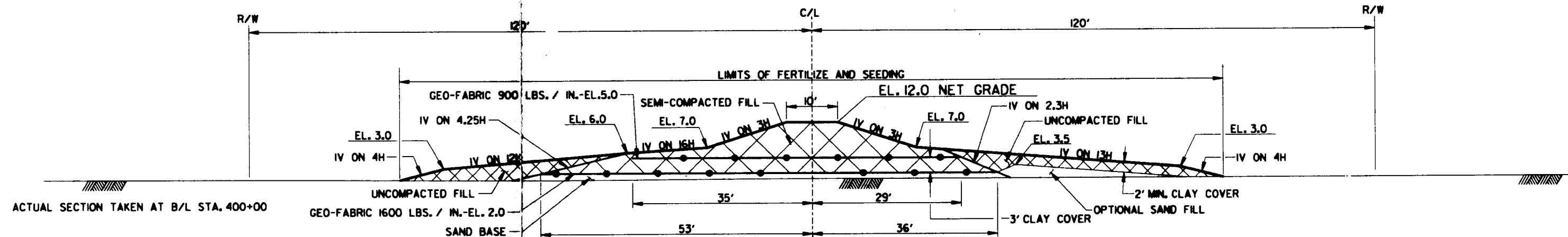

TYPICAL DESIGN SECTION VI

NOT TO SCALE
C/L STA. 372+83 TO 412+40
C/L STA. 414+70 TO 425+00
(500' TRANSITION FROM STA. 425+00 TO 430+00)

SEE NOTE, PLATE II.

COMPUTER
AIDED
DESIGN
DRAFTING

LAKE PONTCHARTRAIN, LA. AND VICINITY
HIGH LEVEL PLAN
DESIGN MEMORANDUM NO. 18 - GENERAL DESIGN
ST. CHARLES PARISH
NORTH OF AIRLINE HIGHWAY
TYPICAL DESIGN SECTIONS
U. S. ARMY ENGINEER DISTRICT, NEW ORLEANS
CORPS OF ENGINEERS
DATE: FILE NO. H-2-30423

30423L12
SAM2

FLOOD SIDE

PROTECTED SIDE

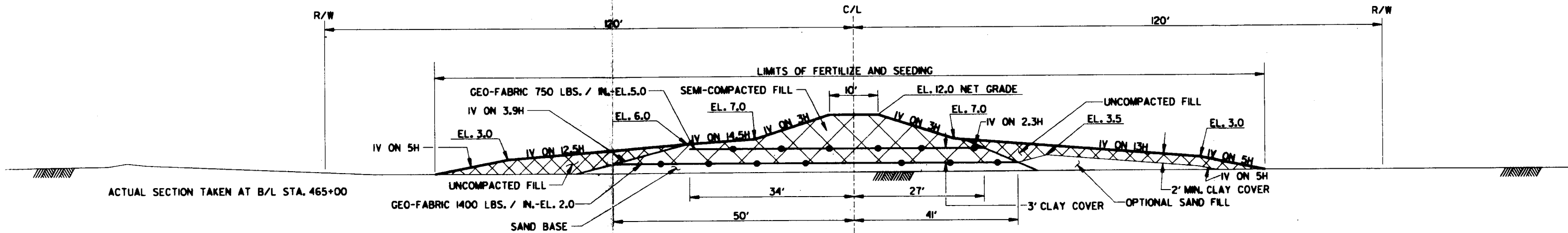

TYPICAL DESIGN SECTION VII
 NOT TO SCALE
 C/L STA. 430+00 TO STA. 439+75
 C/L STA. 450+50 TO STA. 470+00
 (500' TRANSITION FROM STA. 470+00 TO 475+00)

FLOOD SIDE

PROTECTED SIDE

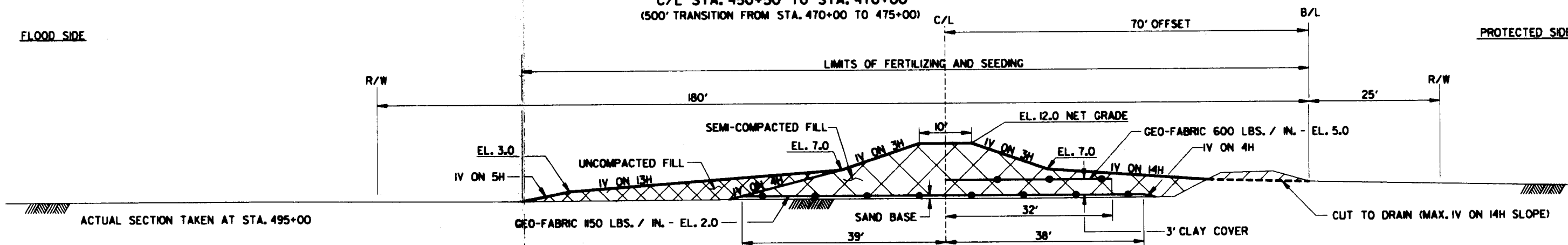

TYPICAL DESIGN SECTION VIII
 NOT TO SCALE
 C/L STA. 475+00 TO 497+18 = 507+31CS
 (300' TRANSITION FROM STA. 507+31 TO 510+31)

FLOOD SIDE

PROTECTED SIDE

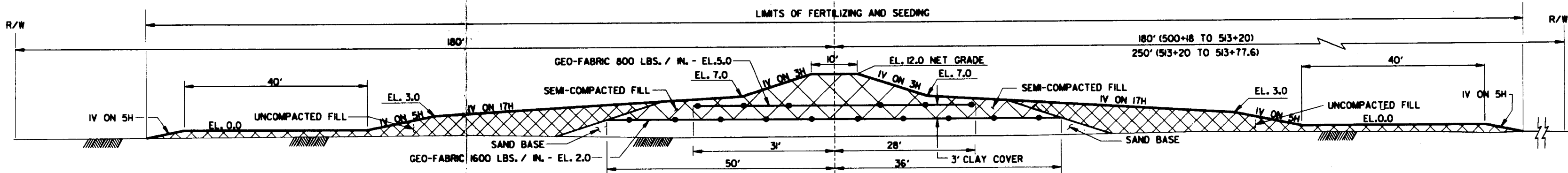

TYPICAL DESIGN SECTION IX
 NOT TO SCALE
 C/L STA. 510+31 TO STA. 513+77

NOTE: SEE NOTE, PLATE II.

COMPUTER
AIDED
DESIGN
DRAFTING

LAKE PONTCHARTRAIN, LA. AND VICINITY
 HIGH LEVEL PLAN
 DESIGN MEMORANDUM NO. 18 - GENERAL DESIGN
ST. CHARLES PARISH
 NORTH OF AIRLINE HIGHWAY
TYPICAL DESIGN SECTIONS
 U. S. ARMY ENGINEER DISTRICT, NEW ORLEANS
 CORPS OF ENGINEERS
 DATE: FILE NO. H-2-30423

30423LK13
SAM3

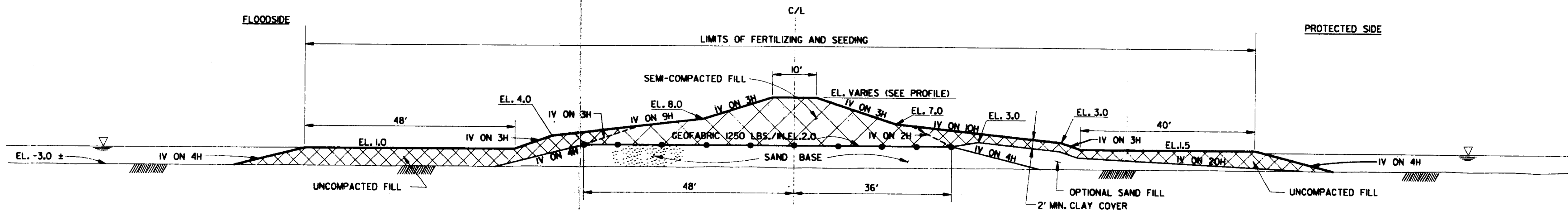

TYPICAL CANAL CLOSURE SECTION I

NOT TO SCALE
 C/L STA. 9+10 TO 9+50
 C/L STA. 250+65 TO 253+53
 C/L STA. 413+40 TO 413+70

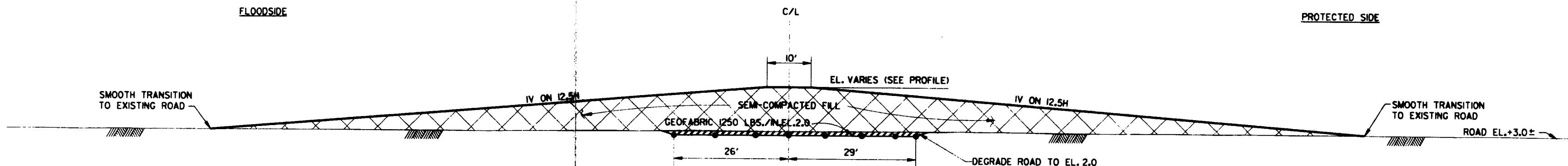

TYPICAL RAMP CROSSING SECTION II

NOT TO SCALE
 C/L STA. 195+80 TO 197+00
 (50' TRANSITIONS FROM 195+00 TO 195+80 AND 197+00 TO 197+50)

- NOTES:
1. THESE SECTIONS ARE DESIGNED FOR 0.5 FT. OVERBUILD TOLERANCE (CROWN, SLOPES, AND BERMS) AND 1.0 FT. TEMPORARY STOCKPILE OVERBUILD ON THE LEVEE BERMS AND SIDE SLOPES.
 2. ABOVE CANAL CLOSURE SECTION BASED ON SOIL REACH I.
 3. SMOOTH 100 FOOT TRANSITIONS BETWEEN SECTIONS UNLESS OTHERWISE NOTED.

LAKE PONTCHARTRAIN, LA. AND VICINITY
 HIGH LEVEL PLAN
 DESIGN MEMORANDUM NO. 18 - GENERAL DESIGN
ST. CHARLES PARISH
NORTH OF AIRLINE HIGHWAY
RAMP CROSSING AND CANAL
CLOSURE SECTIONS
 U. S. ARMY ENGINEER DISTRICT, NEW ORLEANS
 CORPS OF ENGINEERS
 DATE: FILE NO. H-2-30423

FLOOD SIDE

PROTECTED SIDE

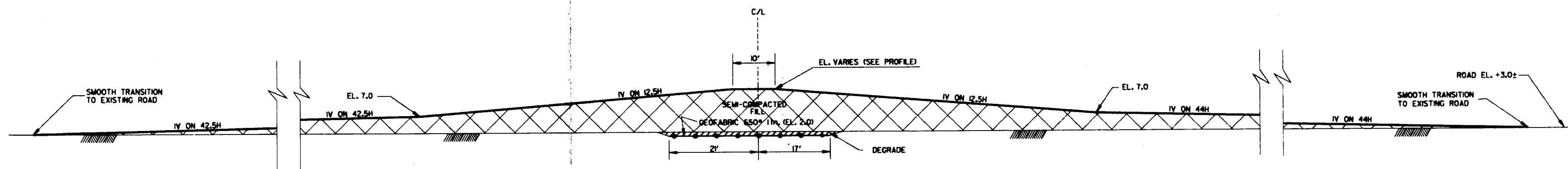

TYPICAL RAMP CROSSING/PIPELINE CROSSING SECTION XII

NOT TO SCALE
C/L STA. 128+90 TO 135+10
C/L STA. 154+12 TO 162+40

FLOOD SIDE

PROTECTED SIDE

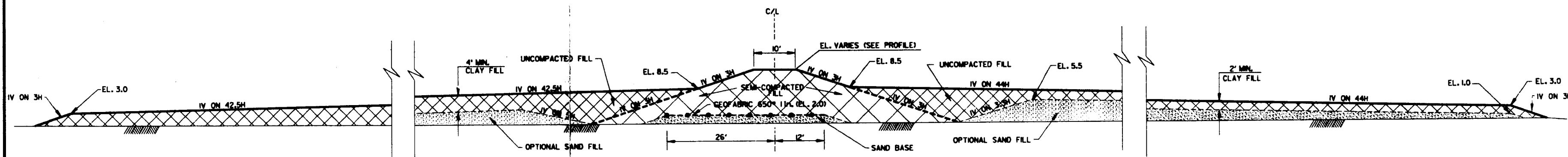

TYPICAL PIPELINE CROSSING SECTION XIII

NOT TO SCALE
C/L STA. 0+00 TO C/L STA. 1+15.5
C/L STA. 92+00 TO 96+24 = 101+82 C.S. TO 104+00
C/L STA. 143+30 TO 148+65
C/L STA. 279+90 TO 287+10

- NOTES:
1. THESE SECTIONS ARE DESIGNED FOR 0.5 FT. OVERBUILD TOLERANCE (CROWN, SLOPES, AND BERMS) AND 1.0 FT. TEMPORARY STOCKPILE OVERBUILD ON THE LEVEE BERMS AND SIDE SLOPES.
 2. SMOOTH 100 FOOT TRANSITIONS BETWEEN SECTIONS UNLESS OTHERWISE NOTED.

LAKE PORTCHARTRAIN, LA. AND VICINITY
HIGH LEVEL PLAN
DESIGN MEMORANDUM NO. 18 - GENERAL DESIGN
ST. CHARLES PARISH
NORTH OF AIRLINE HIGHWAY
RAMP CROSSING / PIPELINE
AND PIPELINE SECTIONS
U. S. ARMY ENGINEER DISTRICT, NEW ORLEANS
CORPS OF ENGINEERS
DATE: FILE NO. H-2-30423

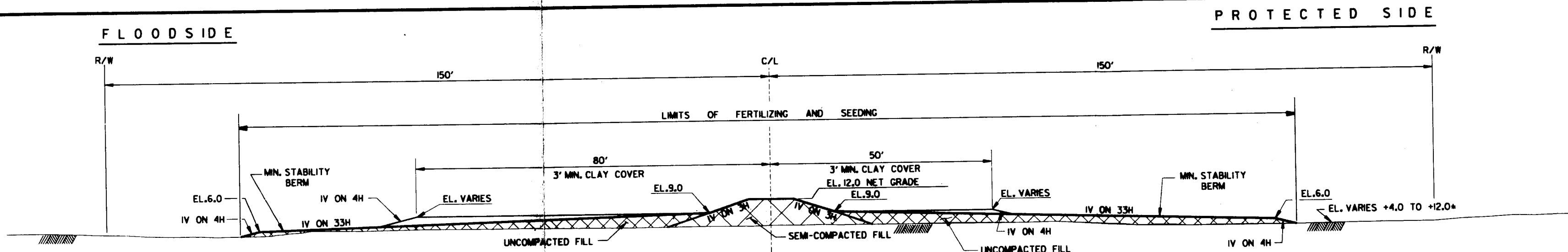

TYPICAL LANDFILL SECTION XIV
 C/L STA. 331+05 TO STA. 356+32 (NOT-CONTINUOUS)
 NOT TO SCALE

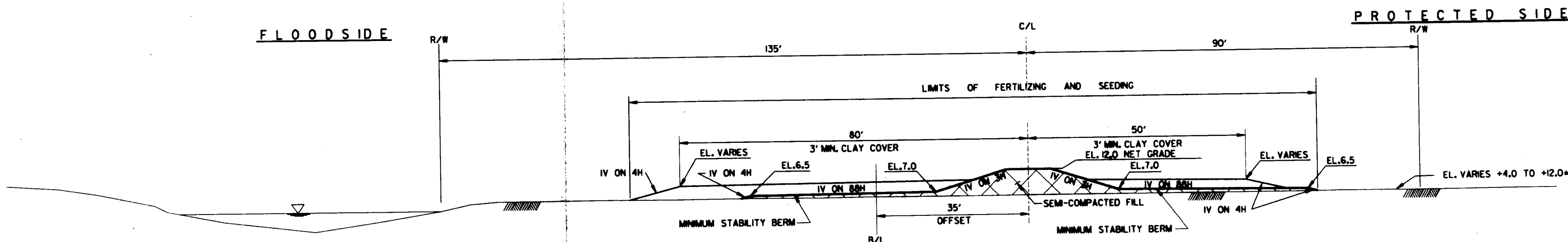

TYPICAL LANDFILL SECTION XV
 C/L STA. 440+75 TO STA. 449+50 (NOT-CONTINUOUS)
 NOT TO SCALE

- NOTES:
1. MINIMUM 3' CLAY COVER ABOVE LANDFILL SECTIONS ONLY WHEN NATURAL GROUND IS AT +8.0' OR BELOW. CLAY COVER VARIES IN THICKNESS FROM 3' TO 0' WHEN EL. VARIES FROM +8' TO +11', RESPECTIVELY. NO MINIMUM CLAY COVER IS REQUIRED FOR SEEPAGE WHEN NATURAL GROUND IS ABOVE 11'.
 2. THESE SECTIONS ARE DESIGNED FOR 0.5' OVERBUILD TOLERANCE (CROWN, SLOPES, AND BERMS) AND 1' TEMPORARY STOCKPILE OVERBUILD ON THE LEVEE BERMS AND SIDE SLOPES.
 3. SMOOTH 100 FOOT TRANSITIONS BETWEEN SECTIONS UNLESS OTHERWISE NOTED.

COMPUTER
 AIDED
 DESIGN
 DRAFTING

LAKE PONTCHARTRAIN, LA. AND VICINITY
 HIGH LEVEL PLAN
 DESIGN MEMORANDUM NO. 1B - GENERAL DESIGN
 ST. CHARLES PARISH
 NORTH OF AIRLINE HIGHWAY
LANDFILL SECTIONS

U. S. ARMY ENGINEER DISTRICT, NEW ORLEANS
 CORPS OF ENGINEERS
 DATE: FILE NO. H-2-30423

PELICAN
LANDFILL

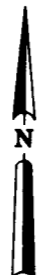

FLOODWALL ALIGNMENT		
P.I. NO.	W/L STATION	AZIMUTH
1	500+00.0 = STA. 356+32.18/L STA. 356+32.10/L	
		287° 53' 57"
2	500+71.1	311° 33' 35"
3	502+06.0	289° 36' 00"
4	503+13.05	311° 02' 43"
5	503+76.05	302° 15' 07"
6	505+61.39	311° 41' 04"
7	506+73.63	286° 30' 17"
8	510+86.49	270° 28' 15"
9	516+37.35	287° 54' 00"
10	517+12.5 = STA. 372+83.2 B/L STA. 373+44.58 C/L	

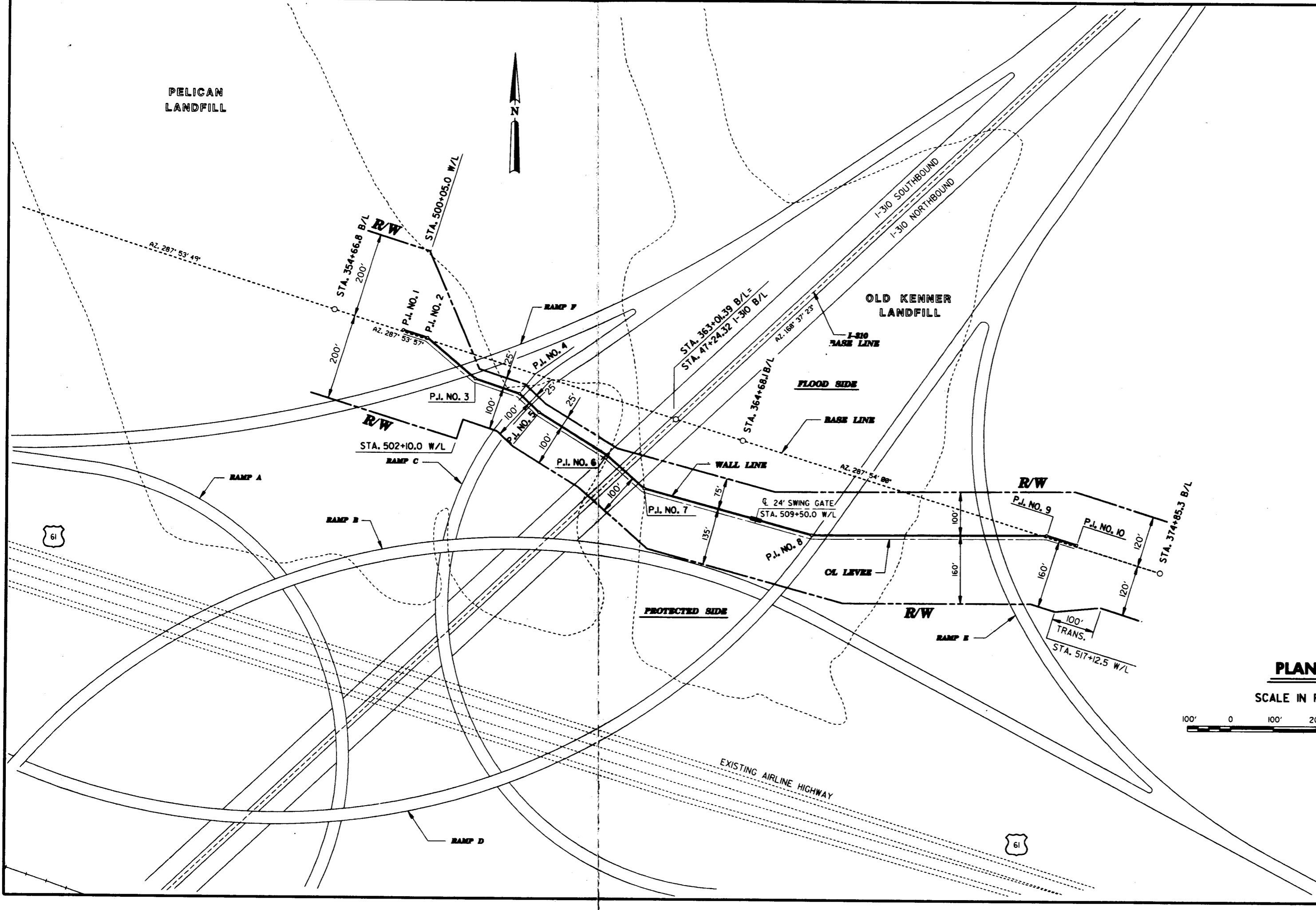

PLAN
SCALE IN FEET

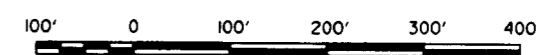

COMPUTER
AIDED
DESIGN
DRAFTING

LAKE FORTCHARTRAIN, LA. AND VICINITY
HIGH LEVEL PLAN
DESIGN MEMORANDUM NO. 18, GENERAL DESIGN
ST. CHARLES PARISH
NORTH OF AIRLINE HIGHWAY
**FLOODWALL AT I-310 INTERCHANGE
PLAN**
U. S. ARMY ENGINEER DISTRICT, NEW ORLEANS
CORPS OF ENGINEERS
DATE: JANUARY 1989 FILE NO. H-2-30423

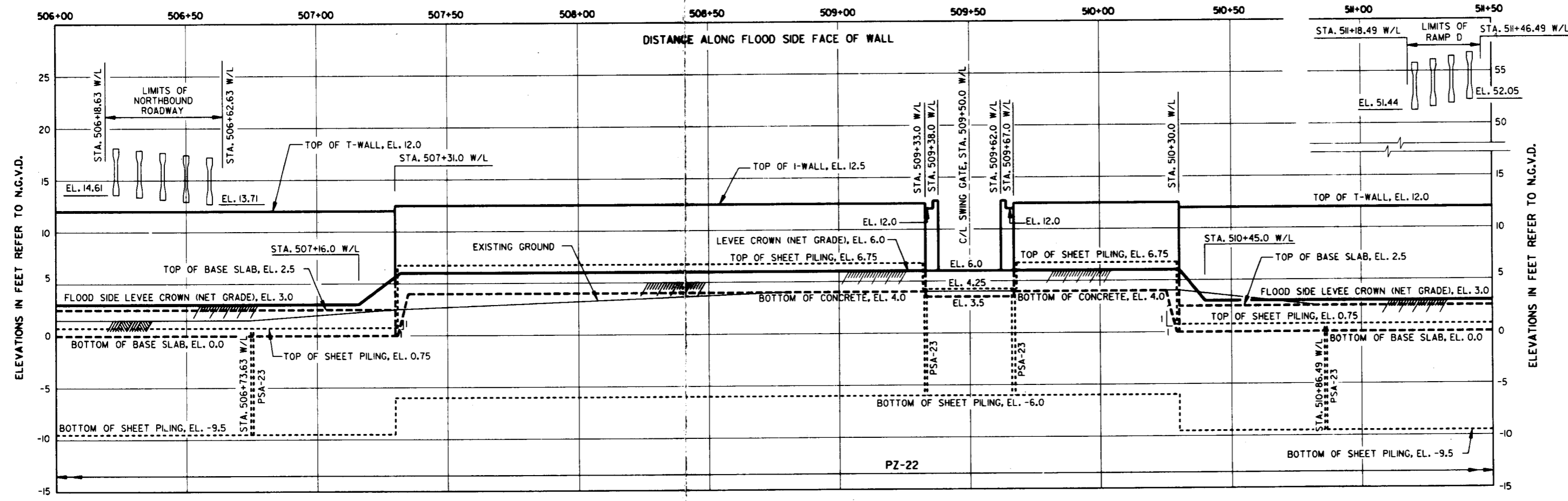
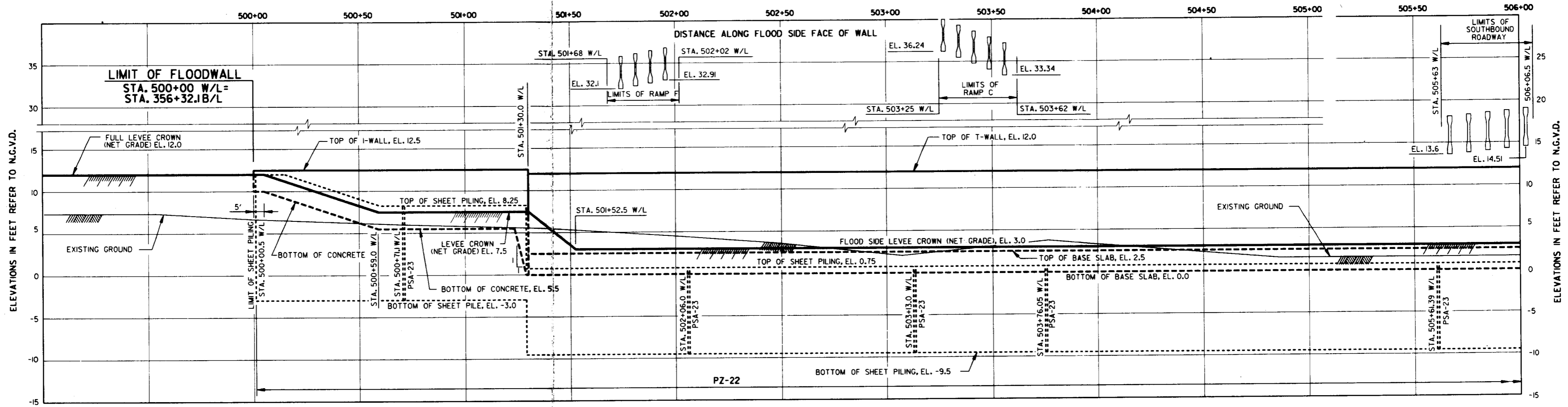

PROFILE
 SCALE: HOR. 1" = 20'
 VERT. 1" = 5'

**COMPUTER
 AIDED
 DESIGN
 DRAFTING**

LAKE PONTCHARTRAIN, LA AND VICINITY
 HIGH LEVEL PLAN
 DESIGN MEMORANDUM NO. 18, GENERAL DESIGN
 ST. CHARLES PARISH
 NORTH OF AIRLINE HIGHWAY
**FLOODWALL AT I-310 INTERCHANGE
 PROFILE**
 STA. 500+00 WL TO STA. 511+50 WL
 U. S. ARMY ENGINEER DISTRICT, NEW ORLEANS
 COEFS OF ENGINEERS
 DATE: JANUARY 1989 FILE NO. H-2-30423

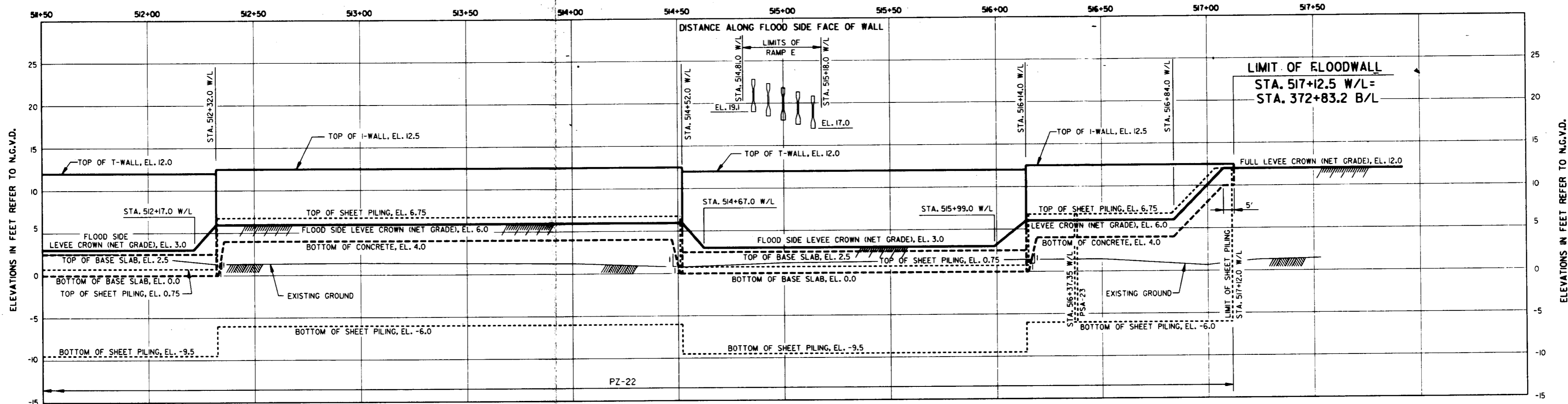

PROFILE
 SCALE: HOR. 1" = 20'
 VERT. 1" = 5'

**COMPUTER
 AIDED
 DESIGN
 DRAFTING**

LAKE FORTCHARTRAIN, LA AND VICINITY
 HIGH LEVEL PLAN
 DESIGN MEMORANDUM NO. 18, GENERAL DESIGN
 ST. CHARLES PARISH
 NORTH OF AIRLINE HIGHWAY
**FLOODWALL AT I-310 INTERCHANGE
 PROFILE**
 STA. 511+50 WL TO STA. 517+12.5 WL
 U. S. ARMY ENGINEER DISTRICT, NEW ORLEANS
 CORPS OF ENGINEERS
 DATE: JANUARY 1989 FILE NO. H-2-30423

304235A03.DGN

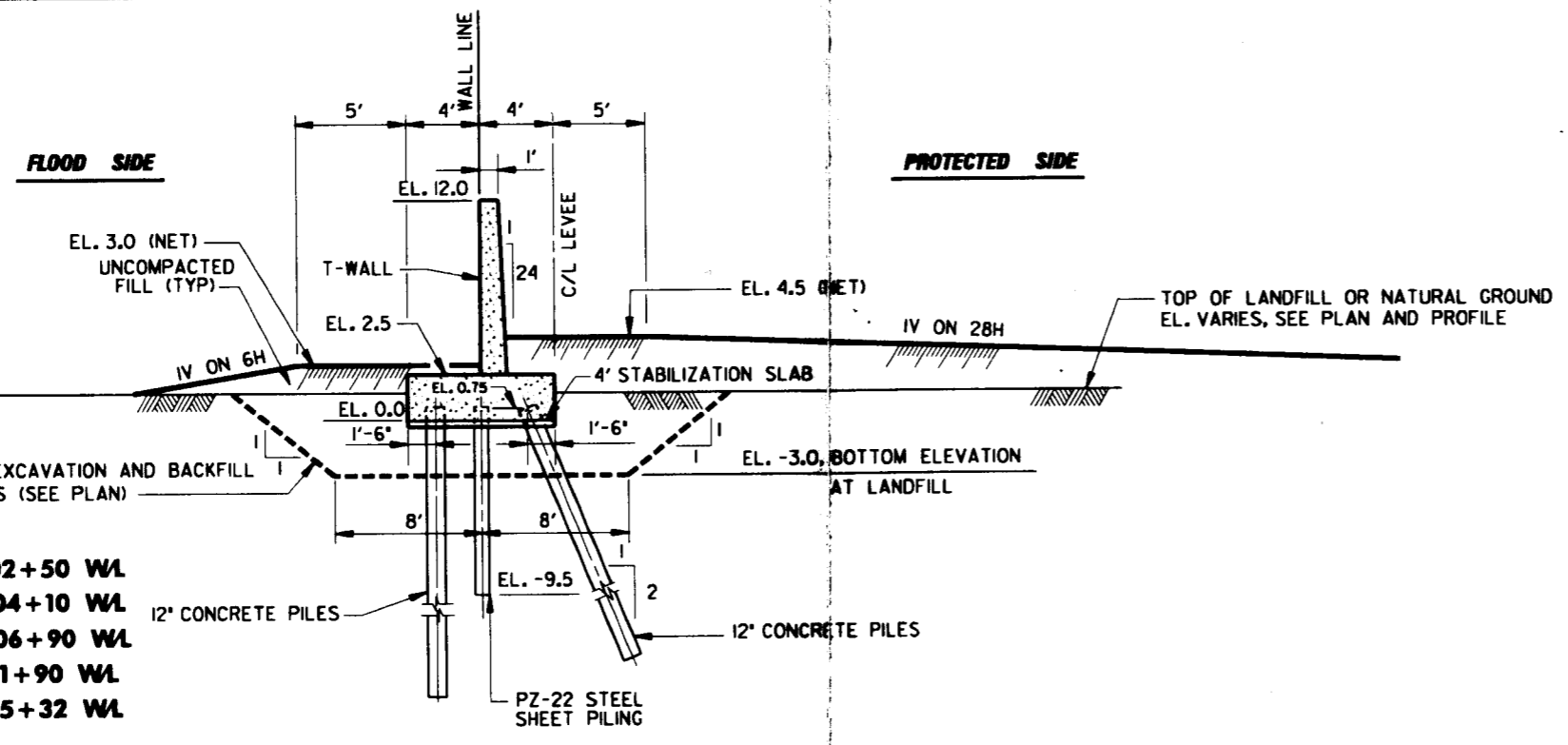

STA. 501+30 WL TO STA. 502+50 WL
 STA. 502+90 WL TO STA. 504+10 WL
 STA. 505+30 WL TO STA. 506+90 WL
 STA. 510+70 WL TO STA. 511+90 WL
 STA. 514+52 WL TO STA. 515+32 WL

TYPICAL SECTIONS

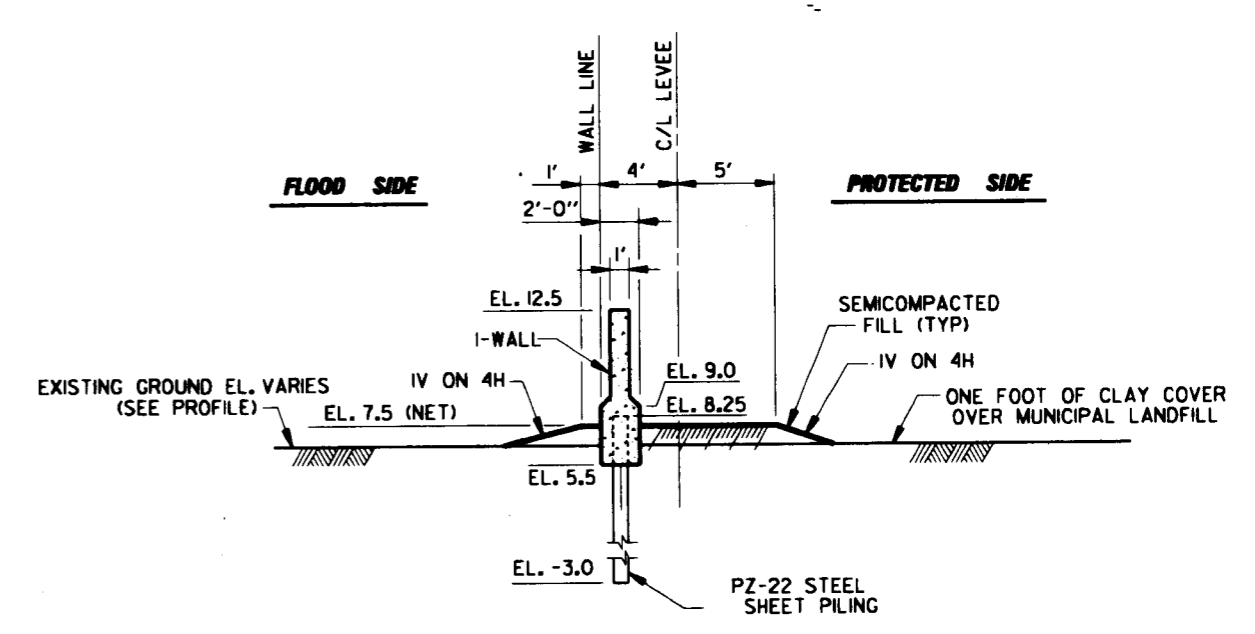

TYPICAL SECTION
STA. 500+59 WL TO STA. 501+30 WL

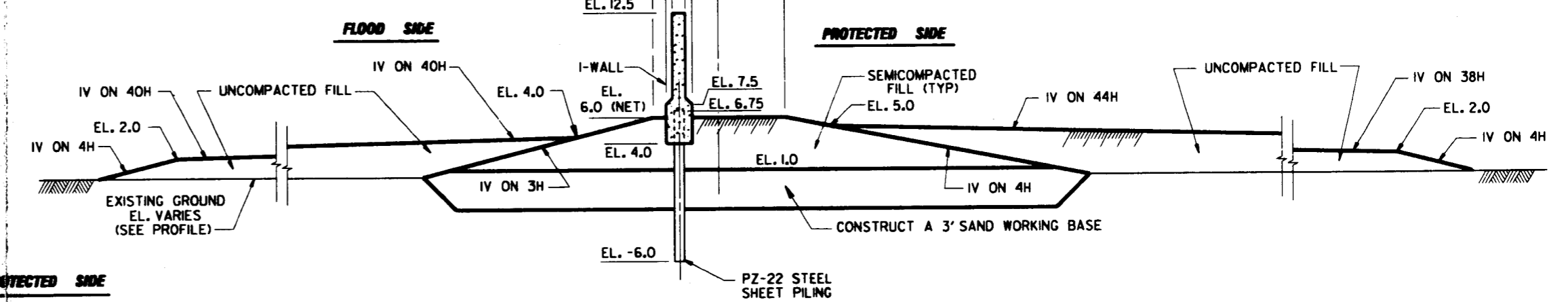

TYPICAL SECTIONS
 STA. 507+31 WL TO STA. 509+33 WL
 STA. 509+67 WL TO STA. 510+30 WL
 STA. 512+32 WL TO STA. 514+52 WL
 STA. 516+14 WL TO STA. 516+84 WL

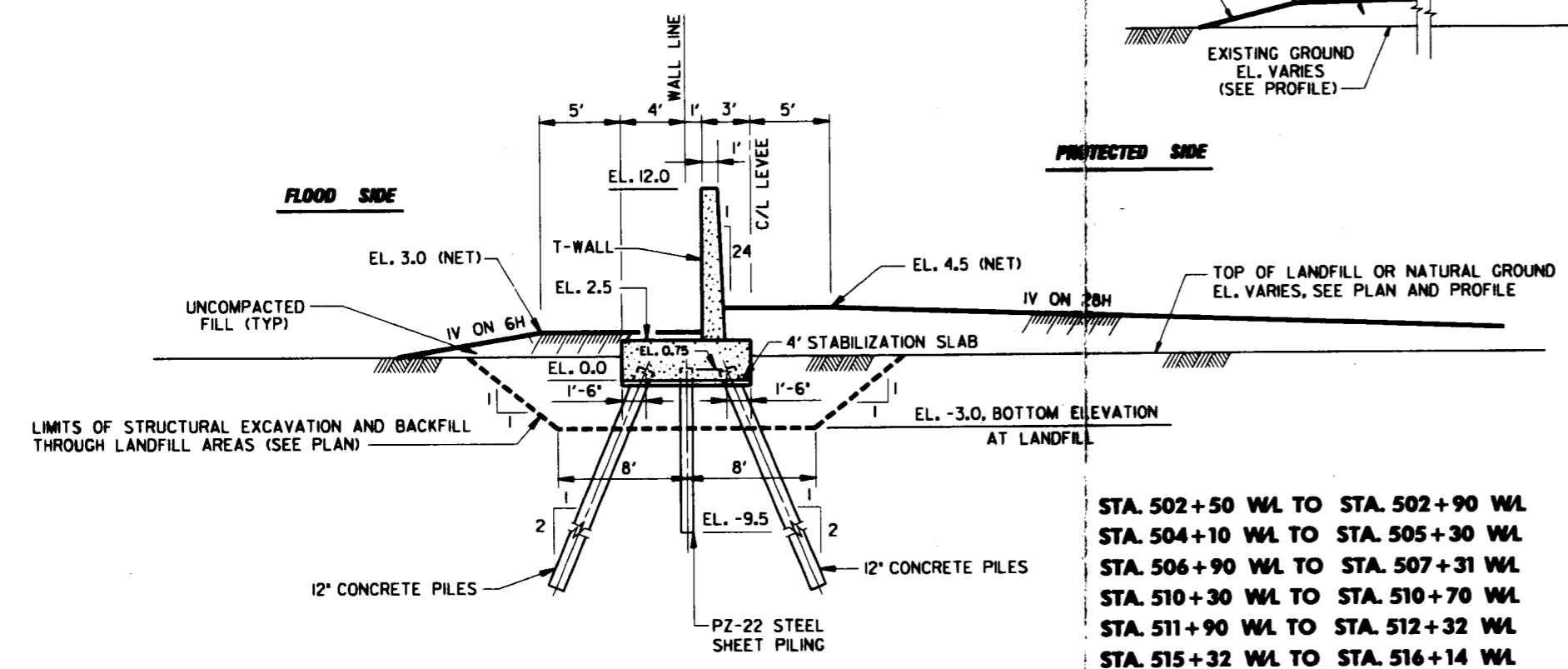

STA. 502+50 WL TO STA. 502+90 WL
 STA. 504+10 WL TO STA. 505+30 WL
 STA. 506+90 WL TO STA. 507+31 WL
 STA. 510+30 WL TO STA. 510+70 WL
 STA. 511+90 WL TO STA. 512+32 WL
 STA. 515+32 WL TO STA. 516+14 WL

TYPICAL SECTIONS

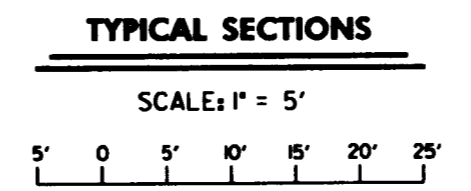

COMPUTER
AIDED
DESIGN
DRAFTING

LAKE PORTCHARTRAIN, LA. AND VICINITY
 HIGH LEVEL PLAN
 DESIGN MEMORANDUM NO. 18, GENERAL DESIGN
 ST. CHARLES PARISH
 NORTH OF AIRLINE HIGHWAY
FLOODWALL AT I-310 INTERCHANGE
TYPICAL SECTIONS
 U. S. ARMY ENGINEER DISTRICT, NEW ORLEANS
 CORPS OF ENGINEERS
 DATE: JANUARY 1989 FILE NO. H-2-30423

30423SA04.DGN

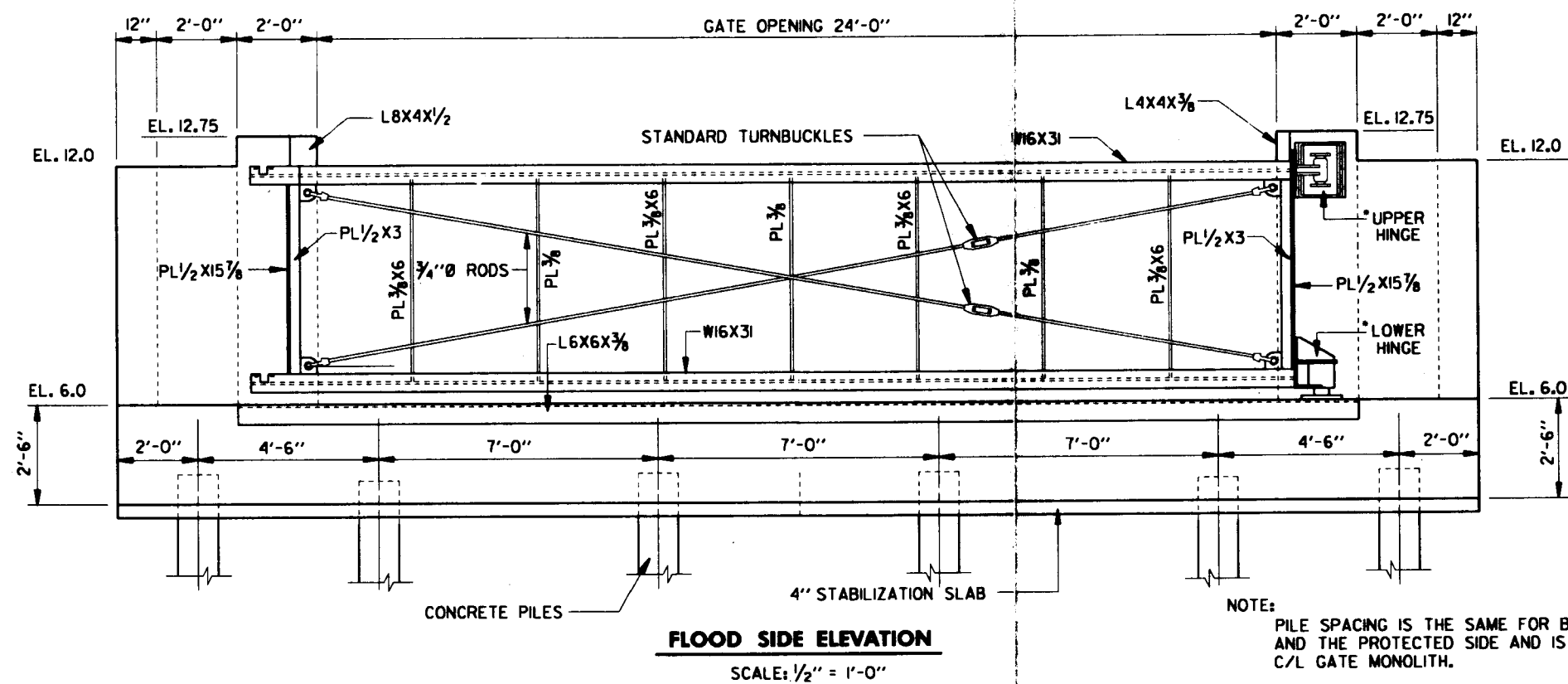
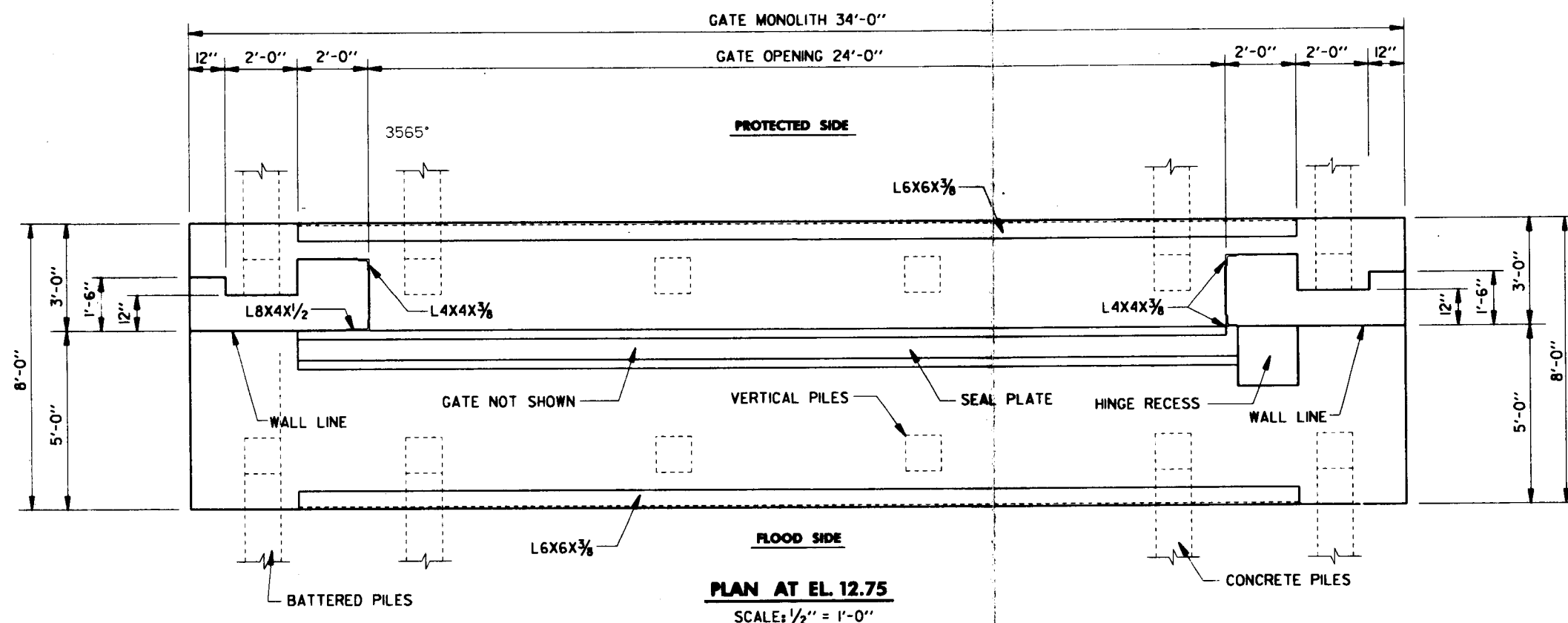

NOTE: PILE SPACING IS THE SAME FOR BOTH THE FLOOD SIDE AND THE PROTECTED SIDE AND IS SYMMETRICAL ABOUT C/L GATE MONOLITH.

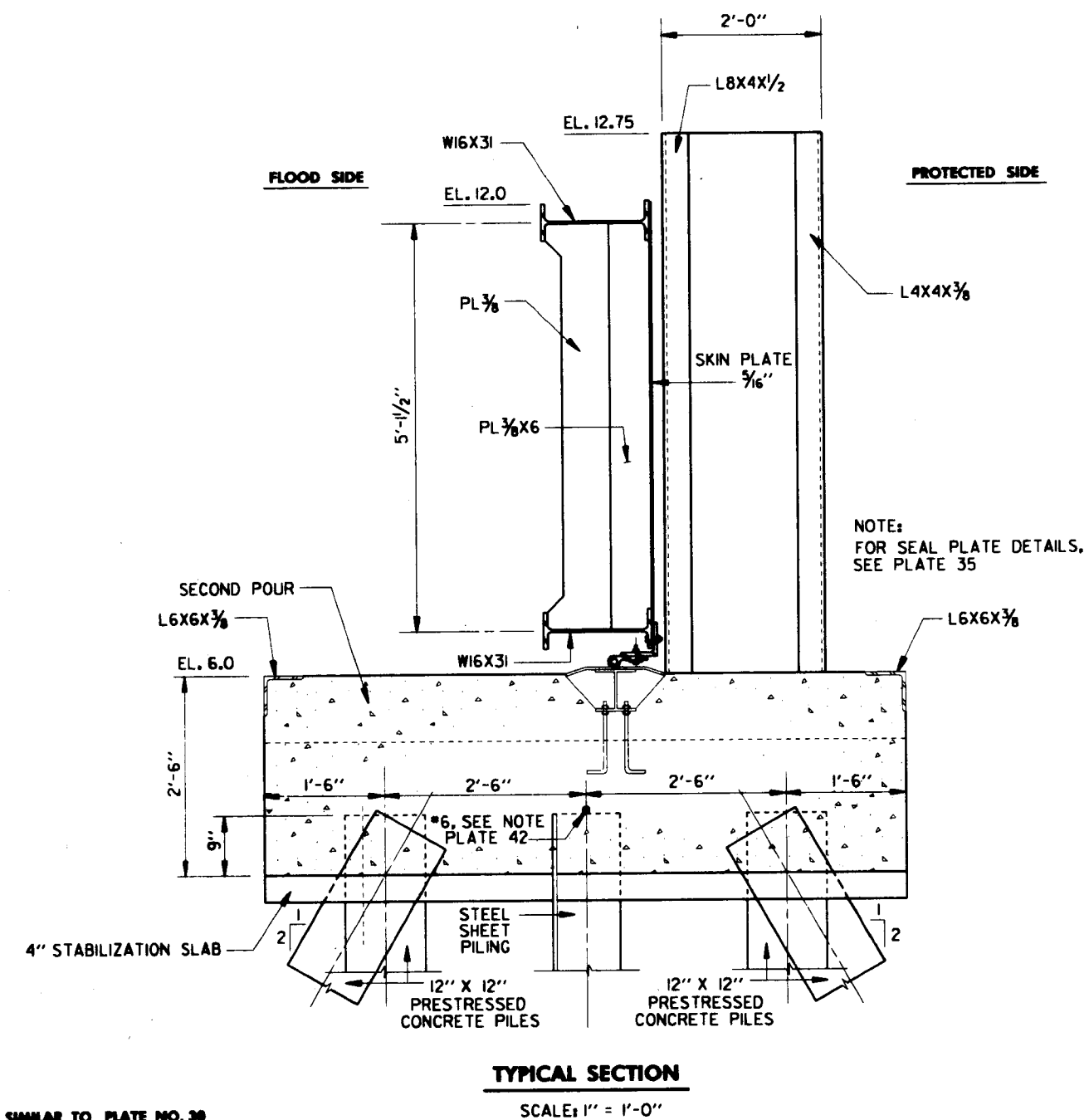

NOTE: HINGE DETAILS ARE SIMILAR TO PLATE NO. 30 OF DESIGN MEMORANDUM NO. 17, JEFFERSON PARISH LAKEFRONT LEVEE.

COMPUTER
AIDED
DESIGN
DRAFTING

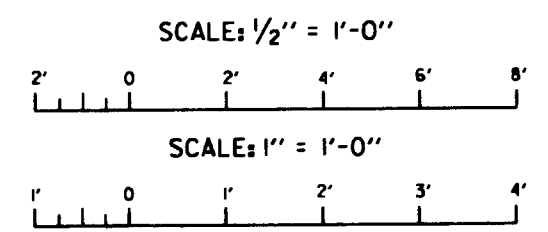

LAKE PORTCHARTRAIN, LA AND VICINITY
HIGH LEVEL PLAN
DESIGN MEMORANDUM NO. 18, GENERAL DESIGN
ST. CHARLES PARISH
NORTH OF AIRLINE HIGHWAY
FLOODWALL AT I-310 INTERCHANGE
SWING GATE DETAILS
U. S. ARMY ENGINEER DISTRICT, NEW ORLEANS
CORPS OF ENGINEERS
DATE: JANUARY 1969 FILE NO. H-2-30423

30423SA31.DGN

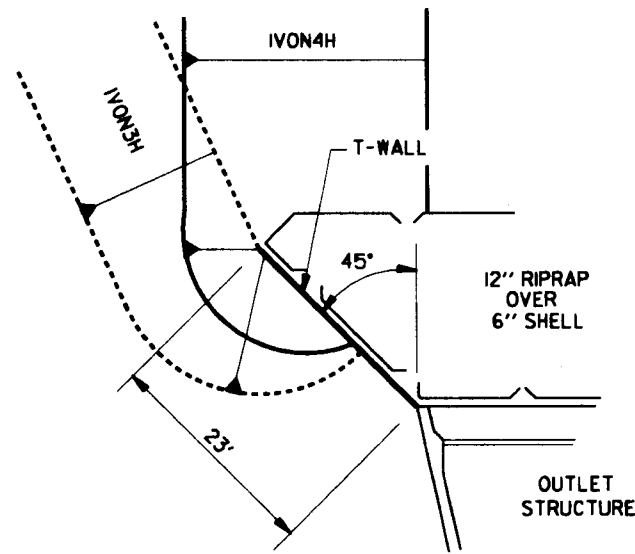

DETAIL 1
SCALE: 1" = 10'

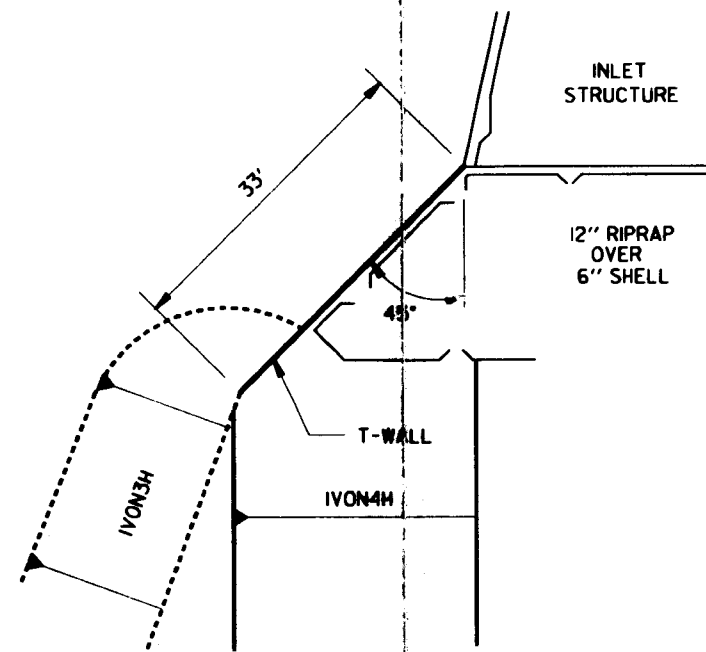

DETAIL 2
SCALE: 1" = 10'

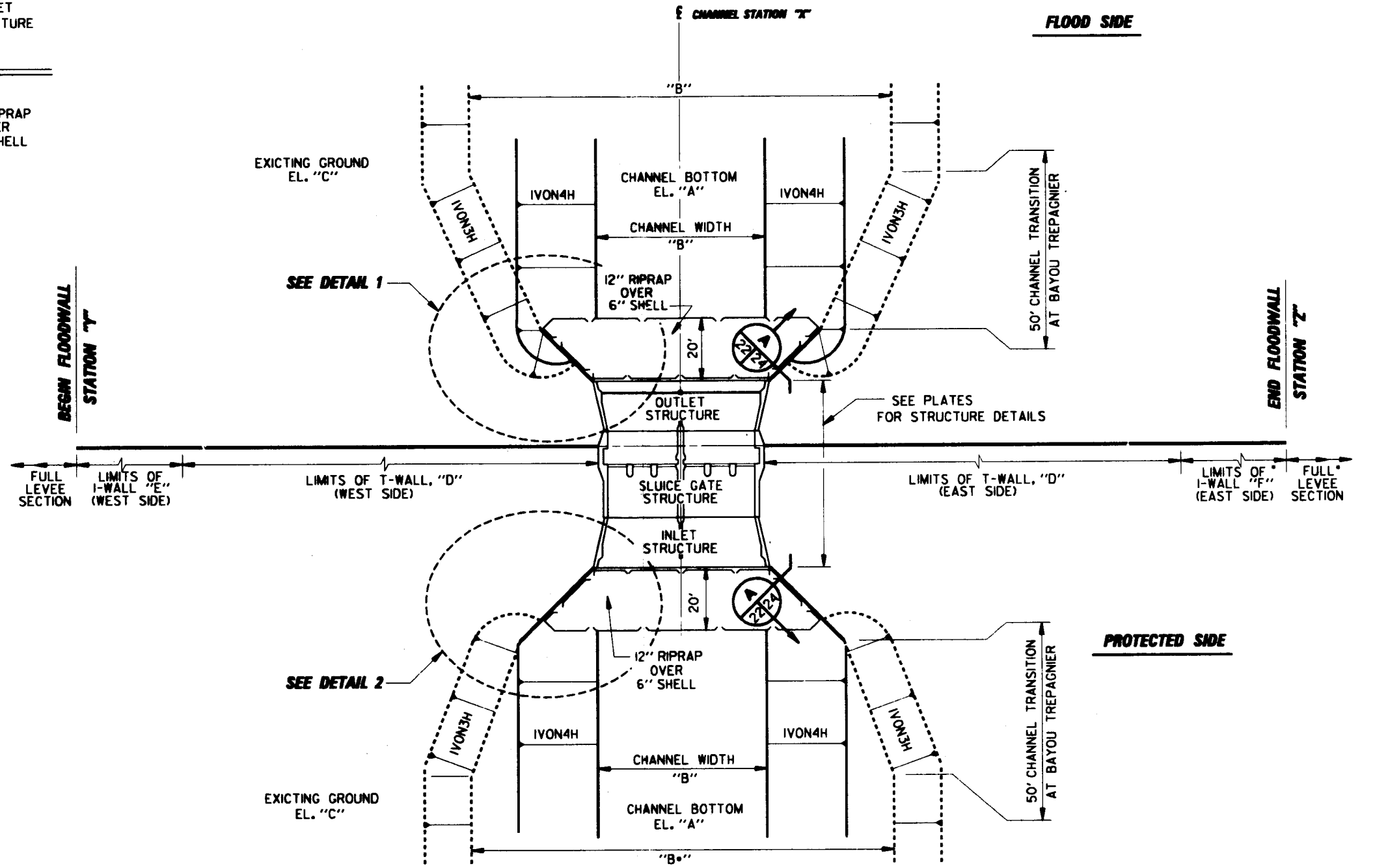

PLAN
SCALE: 1" = 20'

SCHEDULE OF ELEVATIONS AND DIMENSIONS													STATIONING		
LOCATION	A	B	C	D	E	F	G	H	J	K	L	M	X	Y	Z
BAYOU TREPAGNIER	-3.5	81'	1.5±	102'	180'	60'	13.0	14.0	-8.5	-5.5	34'	68'	4+05.0 C/L	1+10.5 C/L	5+79.5 C/L
CROSS BAYOU	-5.3	54'	1.0±	190'	60'	60'	12.5	13.5	-5.5	-5.5	110'	80'	256+24.7 C/L	253+48.2 C/L	259+01.2 C/L
ST. ROSE	-5.0	33'-6"	1.0±	190'	60'	60'	12.0	13.0	-5.5	-5.5	110'	80'	328+50.0 B/L	325+90.0 B/L	331+10.0 B/L
WALKER CANAL	-3.5	22'	0.5±	160'	60'	60'	12.0	13.0	-5.5	-5.5	80'	80'	454+06.59 C/L	451+77.09 C/L	456+36.09 C/L
PARISH LINE CANAL	-3.0	33'	0.5±	160'	60'	0*	12.0	13.0	-5.5	-5.5	80'	80'	516+02.1 C/L	513+72.60 C/L	517+71.60 C/L

*NOTE:
T-WALL EAST OF PARISH LINE CANAL TO TIE INTO FLOODWALL AT SWING GATE AT STA 517+71.60 C/L. SEE PLATE 36.

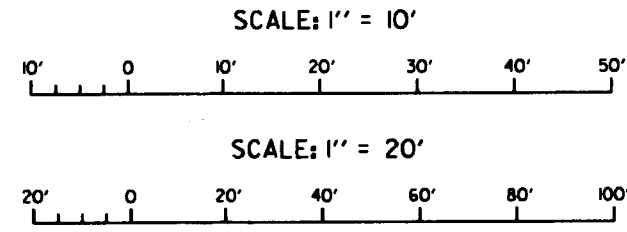

COMPUTER
AIDED
DESIGN
DRAFTING

LAKE FORTCHARTRAIN, LA AND VICINITY
HIGH LEVEL PLAN
DESIGN MEMORANDUM NO. 18, GENERAL DESIGN
ST. CHARLES PARISH
NORTH OF AIRLINE HIGHWAY
SLUICE GATE STRUCTURES
TYPICAL PLAN
U. S. ARMY ENGINEER DISTRICT, NEW ORLEANS
CORPS OF ENGINEERS
DATE: JANUARY 1969 FILE NO. H-2-30423

STATIONING ALONG C/L LEVEE

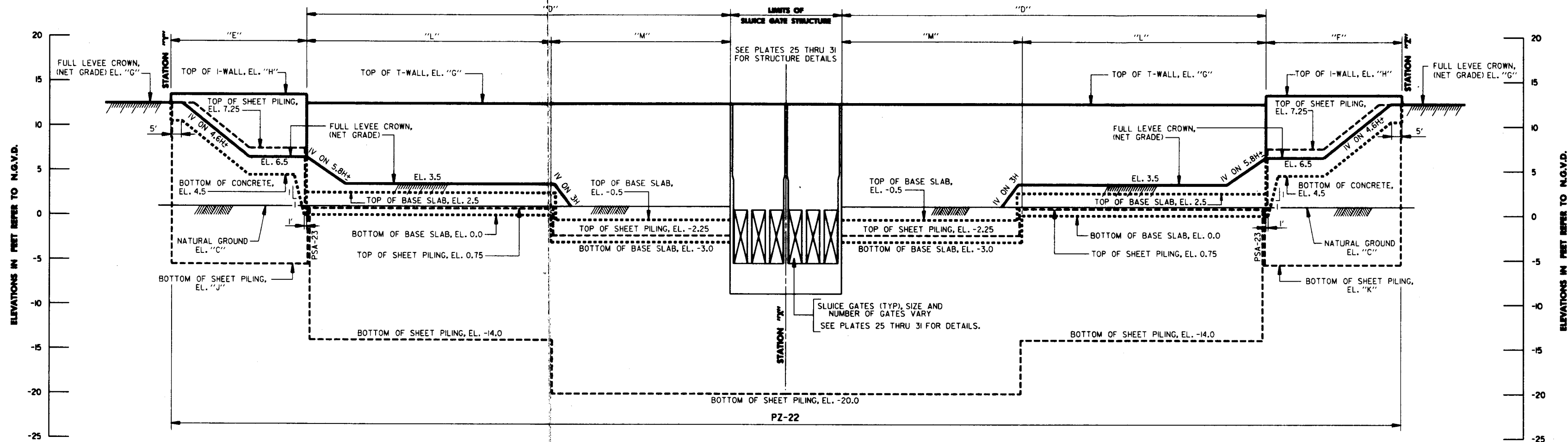

**SLUICE GATE STRUCTURES
TYPICAL PROFILE**

SCALE: HOR. 1"=20'
VERT. 1"=5'

SCHEDULE OF ELEVATIONS AND DIMENSIONS													STATIONING		
LOCATION	A	B	C	D	E	F	G	H	J	K	L	M	X	Y	Z
BAYOU TREPAGNIER	-3.5	8'	1.5±	102'	180'	60'	13.0	13.5	-8.5	-5.5	34'	68'	4+05.00 C/L	1+10.50 C/L	5+79.50 C/L
CROSS BAYOU	-5.3	54'	1.0±	190'	60'	60'	12.5	13.0	-5.5	-5.5	110'	80'	256+24.70 C/L	253+48.20 C/L	259+04.20 C/L
ST. ROSE	-5.0	33'-6"	1.0±	190'	60'	60'	12.0	12.5	-5.5	-5.5	110'	80'	328+50.00 B/L	325+90.00 B/L	331+10.00 B/L
WALKER CANAL	-3.5	22'	0.5±	160'	60'	60'	12.0	12.5	-5.5	-5.5	80'	80'	454+06.59 C/L	451+77.09 C/L	456+36.09 C/L
PARISH LINE CANAL	-3.0	33'	0.5±	160'	60'	0'	12.0	12.5	-5.5	-5.5	80'	80'	516+02.10 C/L	513+72.60 C/L	517+71.60 C/L

* NOTE:

T-WALL EAST OF PARISH LINE CANAL TO TIE INTO FLOODWALL AT SWING GATE AT STA 517+71.60 C/L. SEE PLATE 36.

COMPUTER
AIDED
DESIGN
DRAFTING

LAKE FORTCHARTRAM, LA AND VICINITY
HIGH LEVEL PLAN
DESIGN MEMORANDUM NO. 18, GENERAL DESIGN
ST. CHARLES PARISH
NORTH OF AIRLINE HIGHWAY
**SLUICE GATE STRUCTURES
TYPICAL PROFILE**
U. S. ARMY ENGINEER DISTRICT, NEW ORLEANS
CORPS OF ENGINEERS
DATE: JANUARY 1989 FILE NO. H-2-30423

30423SA21.DGN

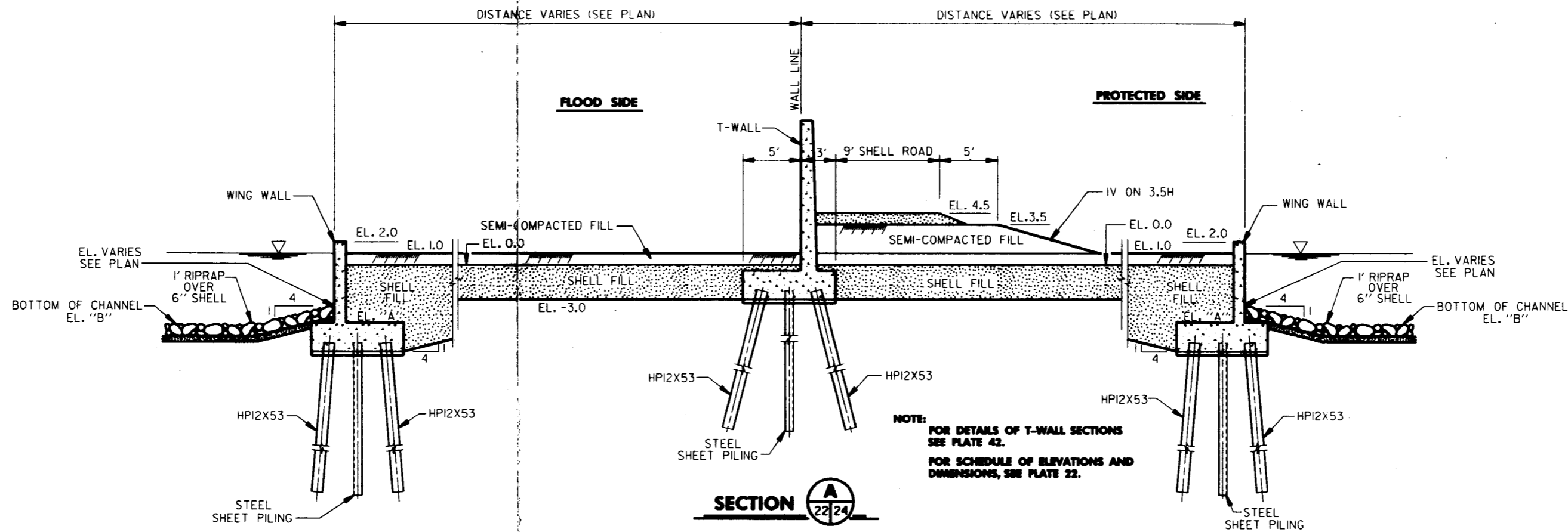

NOTE:
FOR DETAILS OF T-WALL SECTIONS
SEE PLATE 42.
FOR SCHEDULE OF ELEVATIONS AND
DIMENSIONS, SEE PLATE 22.

SECTION A
22/24

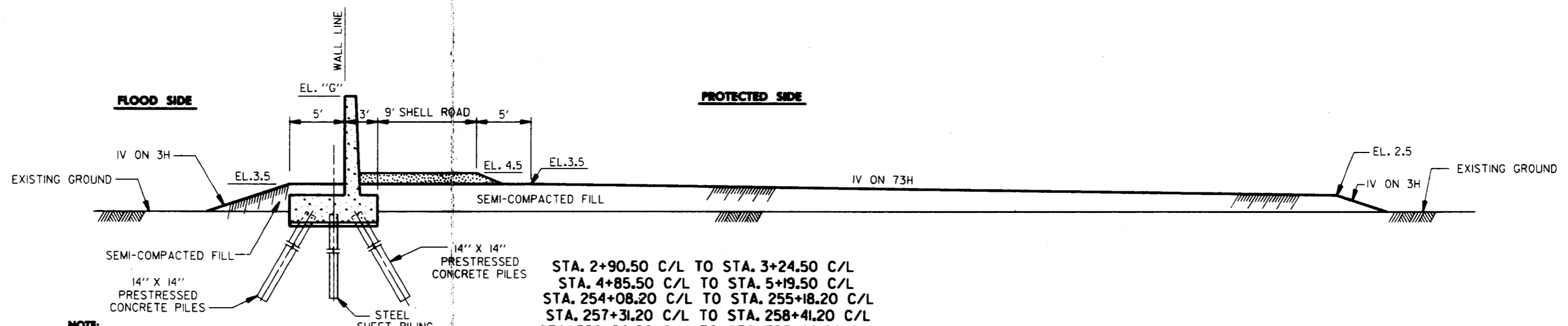

NOTE:
FOR DETAILS OF T-WALL SECTIONS
SEE PLATE 42.
FOR SCHEDULE OF ELEVATIONS AND
DIMENSIONS, SEE PLATE 22.

- STA. 2+90.50 C/L TO STA. 3+24.50 C/L
- STA. 4+85.50 C/L TO STA. 5+19.50 C/L
- STA. 254+08.20 C/L TO STA. 255+18.20 C/L
- STA. 257+31.20 C/L TO STA. 258+41.20 C/L
- STA. 326+50.00 B/L TO STA. 327+60.00 B/L
- STA. 329+40.00 B/L TO STA. 330+50.00 B/L
- STA. 452+37.09 C/L TO STA. 453+17.09 C/L
- STA. 454+96.09 C/L TO STA. 455+76.09 C/L
- STA. 514+32.60 C/L TO STA. 515+12.60 C/L
- STA. 516+91.60 C/L TO STA. 517+71.60 C/L

TYPICAL T-WALL SECTION

SCALE: 1" = 5'-0"

SCALE: 1" = 5'

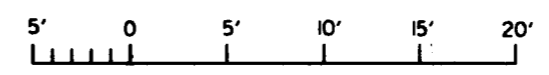

COMPUTER
AIDED
DESIGN
DRAFTING

LAKE FORTCHARTRAIN, LA. AND VICINITY
HIGH LEVEL PLAN
DESIGN MEMORANDUM NO. 18, GENERAL DESIGN
ST. CHARLES PARISH
NORTH OF AIRLINE HIGHWAY
SLUICE GATE STRUCTURES
SECTIONS
U. S. ARMY ENGINEER DISTRICT, NEW ORLEANS
CORPS OF ENGINEERS
DATE: JANUARY 1969 FILE NO. H-2-30423

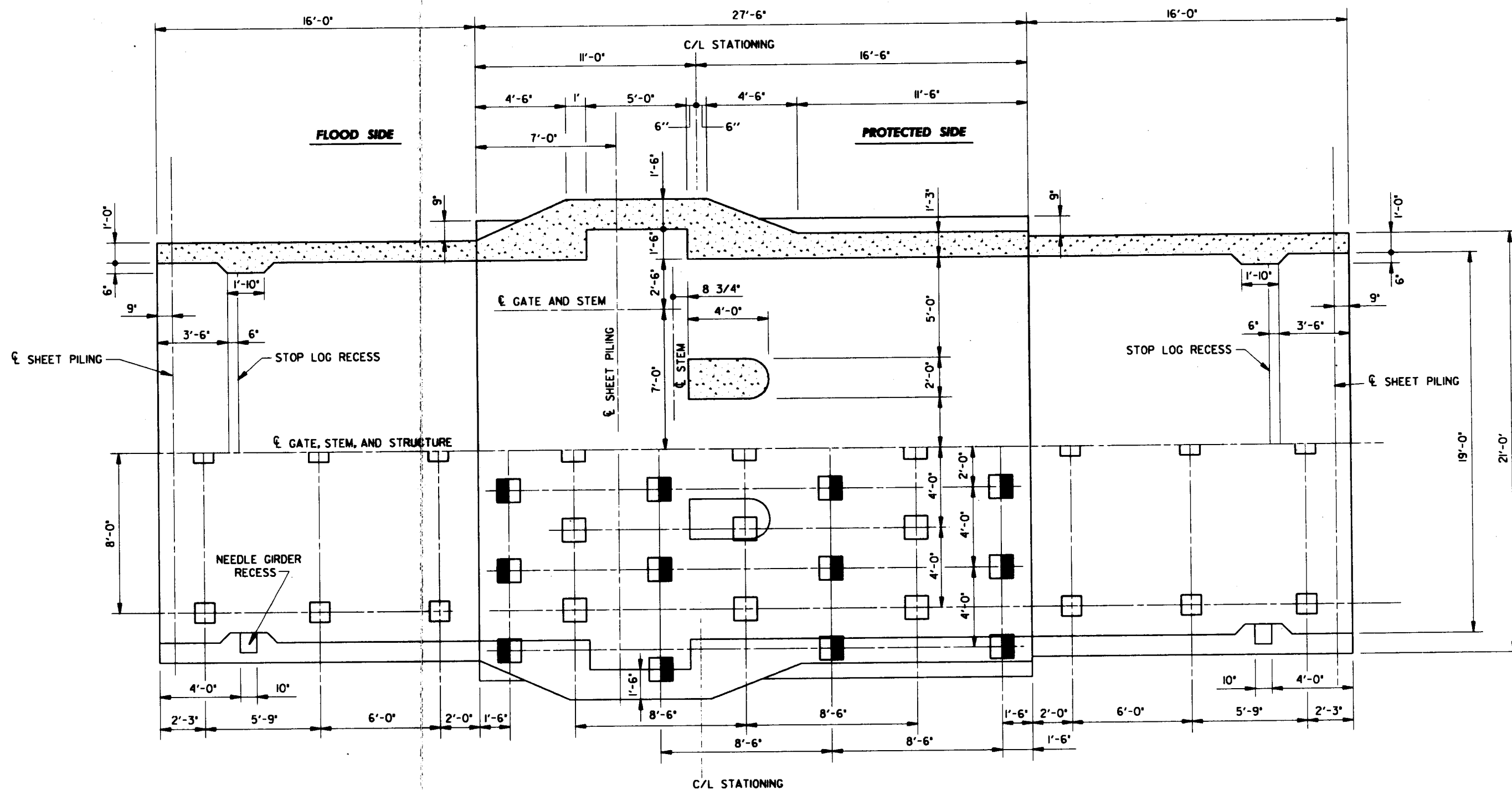

30423SA27.DGN



BAYOU TREPAGNIER DRAINAGE STRUCTURE

SCALE: 3/8" = 1'-0"

LEGEND

-  14" X 14" PRESTRESSED CONCRETE BATTERED PILES. SHADED SIDE INDICATES DIRECTION OF BATTER. ALL PILES BATTERED 2V ON 1H.
-  14" X 14" PRESTRESSED CONCRETE VERTICAL PILES.
-  12" X 12" PRESTRESSED CONCRETE VERTICAL PILES.

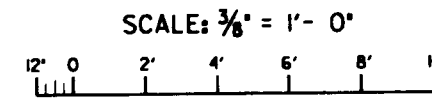

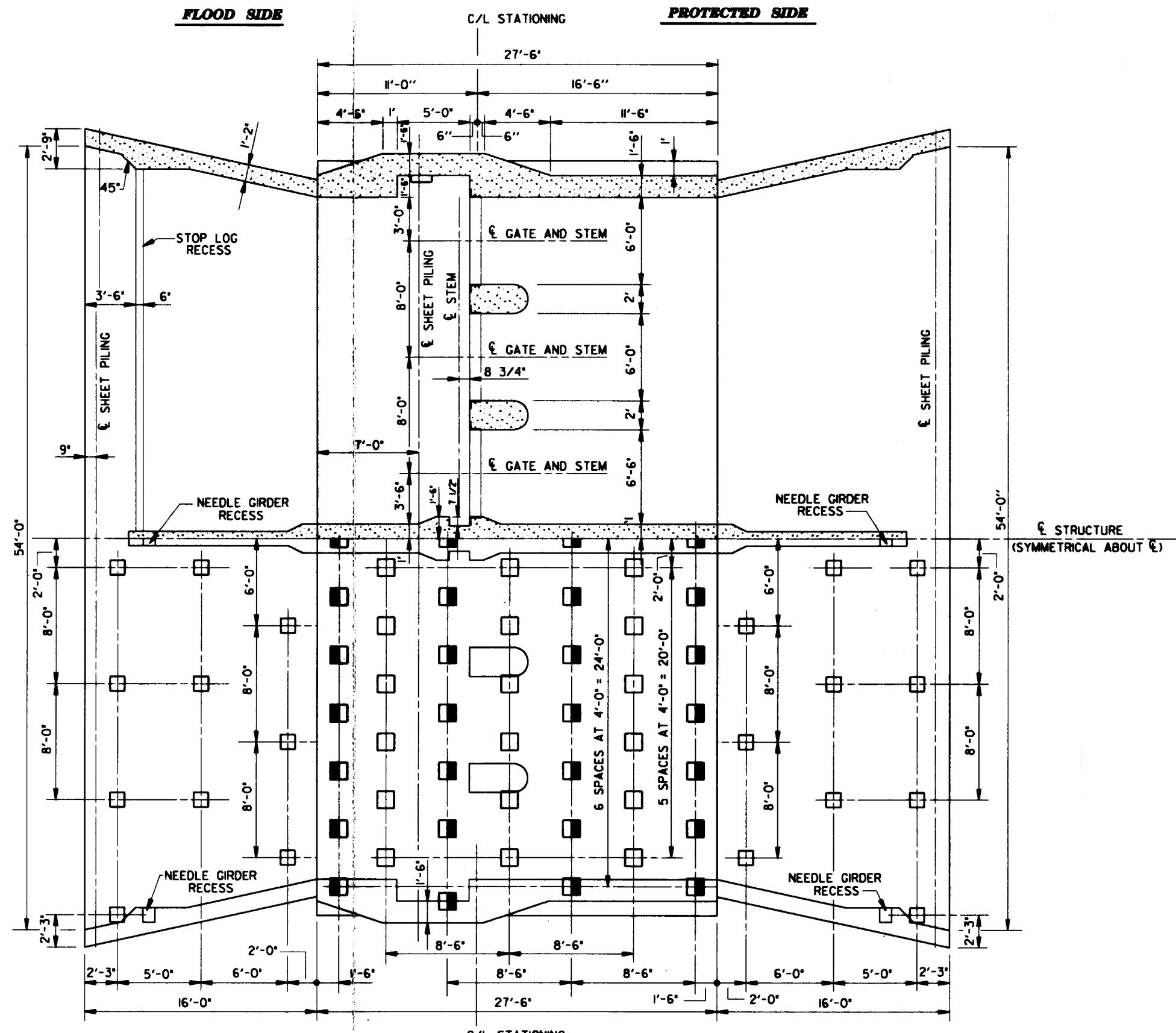

**COMPUTER
AIDED
DESIGN
DRAFTING**

LAKE FORTCHARTRAIN, LA. AND VICINITY
HIGH LEVEL PLAN
DESIGN MEMORANDUM NO. 18, GENERAL DESIGN
ST. CHARLES PARISH
NORTH OF AIRLINE HIGHWAY
**BAYOU TREPAGNIER DRAINAGE STRUCTURE
PLAN AND PILE LAYOUT**
U. S. ARMY ENGINEER DISTRICT, NEW ORLEANS
CORPS OF ENGINEERS
DATE: JANUARY 1989 FILE NO. H-2-30423



LEGEND

-  14' X 14' PRESTRESSED CONCRETE BATTERED PILES. SHADED SIDE INDICATES DIRECTION OF BATTER. ALL PILES BATTERED 2V ON H.
-  14' X 14' PRESTRESSED CONCRETE VERTICAL PILES.
-  12' X 12' PRESTRESSED CONCRETE VERTICAL PILES.

**CROSS BAYOU DRAINAGE STRUCTURE
PLAN AND PILE LAYOUT**

SCALE: 1/4" = 1'-0"

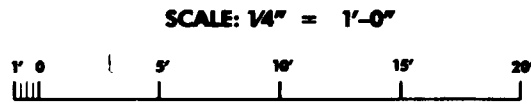

**COMPUTER
AIDED
DESIGN
DRAFTING**

LAKE PORTCHARTRAIN, LA AND VICINITY
HIGH LEVEL PLAN
DESIGN MEMORANDUM NO. 18, GENERAL DESIGN
ST. CHARLES PARISH
NORTH OF AIRLINE HIGHWAY
**CROSS BAYOU DRAINAGE STRUCTURE
PLAN AND PILE LAYOUT**
U. S. ARMY ENGINEER DISTRICT, NEW ORLEANS
CORPS OF ENGINEERS
DATE: JANUARY 1989 FILE NO. H-2-30423

30423SA06.DGN

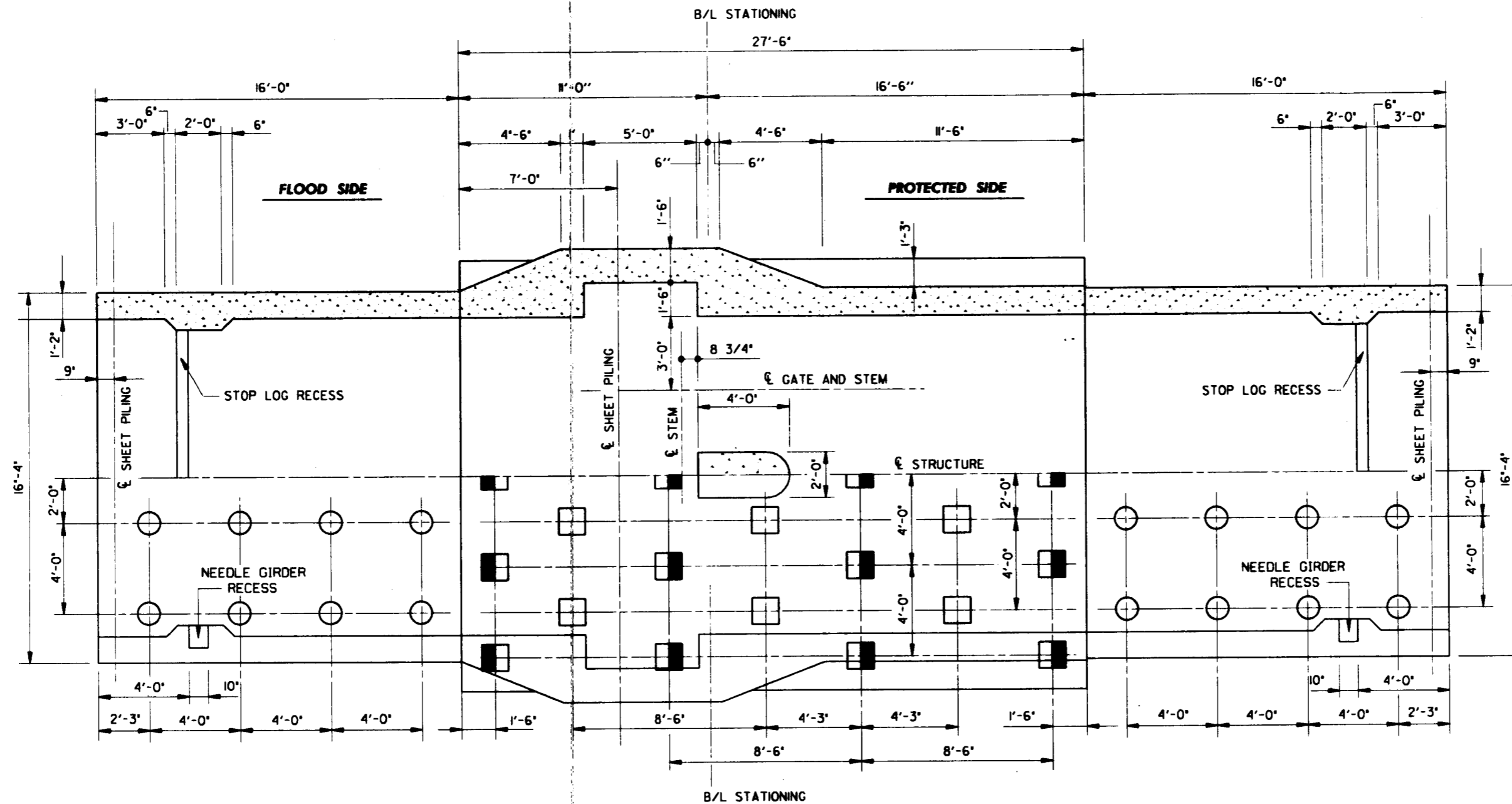

LEGEND

- 14' X 14' PRESTRESSED CONCRETE BATTERED PILES.
 SHADED SIDE INDICATES DIRECTION OF BATTER.
 ALL PILES BATTERED 2V ON IH.
- 14' X 14' PRESTRESSED CONCRETE VERTICAL PILES.
- 12' TIMBER VERTICAL PILES.

ST. ROSE DRAINAGE STRUCTURE

SCALE: 3/8" = 1'-0"

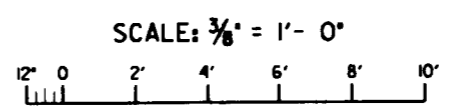

**COMPUTER
AIDED
DESIGN
DRAFTING**



LAKE FORTCHARTRAIN, LA. AND VICINITY
HIGH LEVEL PLAN
DESIGN MEMORANDUM NO. 18, GENERAL DESIGN
ST. CHARLES PARISH
NORTH OF AIRLINE HIGHWAY
ST. ROSE DRAINAGE STRUCTURE
PLAN AND PILE LAYOUT
U. S. ARMY ENGINEER DISTRICT, NEW ORLEANS
CORPS OF ENGINEERS
DATE: JANUARY 1989 FILE NO. **H-2-30423**

30423SA09.DGN

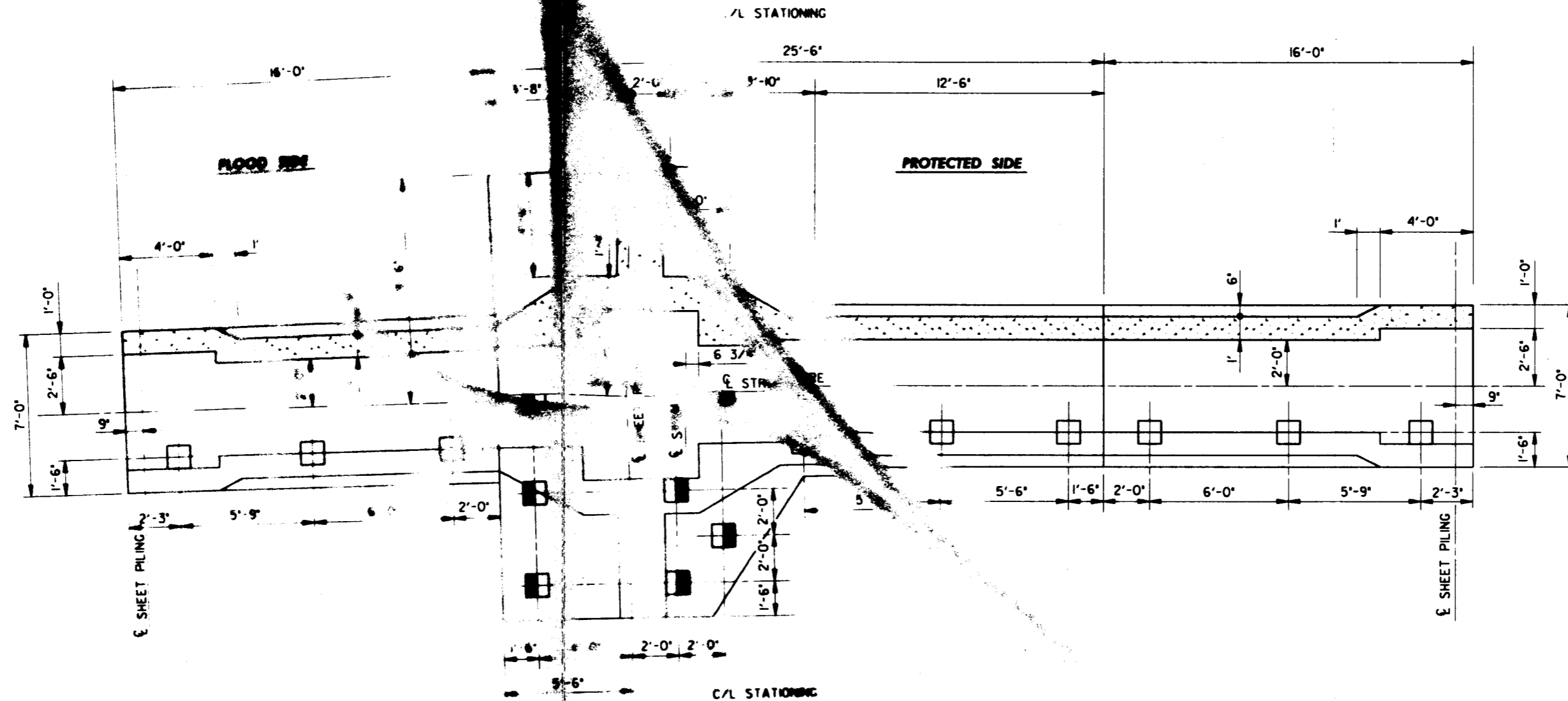
30423SAT1.DGN



LEGEND

-   12" X 12" PRESTRESSED CONCRETE BATTERED PILES. SHADED SIDE INDICATES DIRECTION OF BATTER. ALL PILES BATTERED 2V ON 1H.
-  12" X 12" PRESTRESSED CONCRETE VERTICAL PILES.

**PARISH LINE CANAL DRAINAGE STRUCTURE
AND
WALKER CANAL DRAINAGE STRUCTURE**

SCALE: 3/8" = 1'- 0"

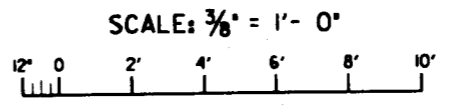

**COMPUTER
AIDED
DESIGN
DRAFTING**

LAKE FORTCHARTRAD, LA AND VICINITY
HIGH LEVEL PLAN
DESIGN MEMORANDUM NO. 18, GENERAL DESIGN
ST. CHARLES PARISH
NORTH OF AIRLINE HIGHWAY
**PARISH LINE CANAL AND
WALKER CANAL DRAINAGE STRUCTURE
PLAN AND PILE LAYOUT**
U. S. ARMY ENGINEER DISTRICT, NEW ORLEANS
CORPS OF ENGINEERS
DATE: JANUARY 1989 FILE NO. H-2-30423

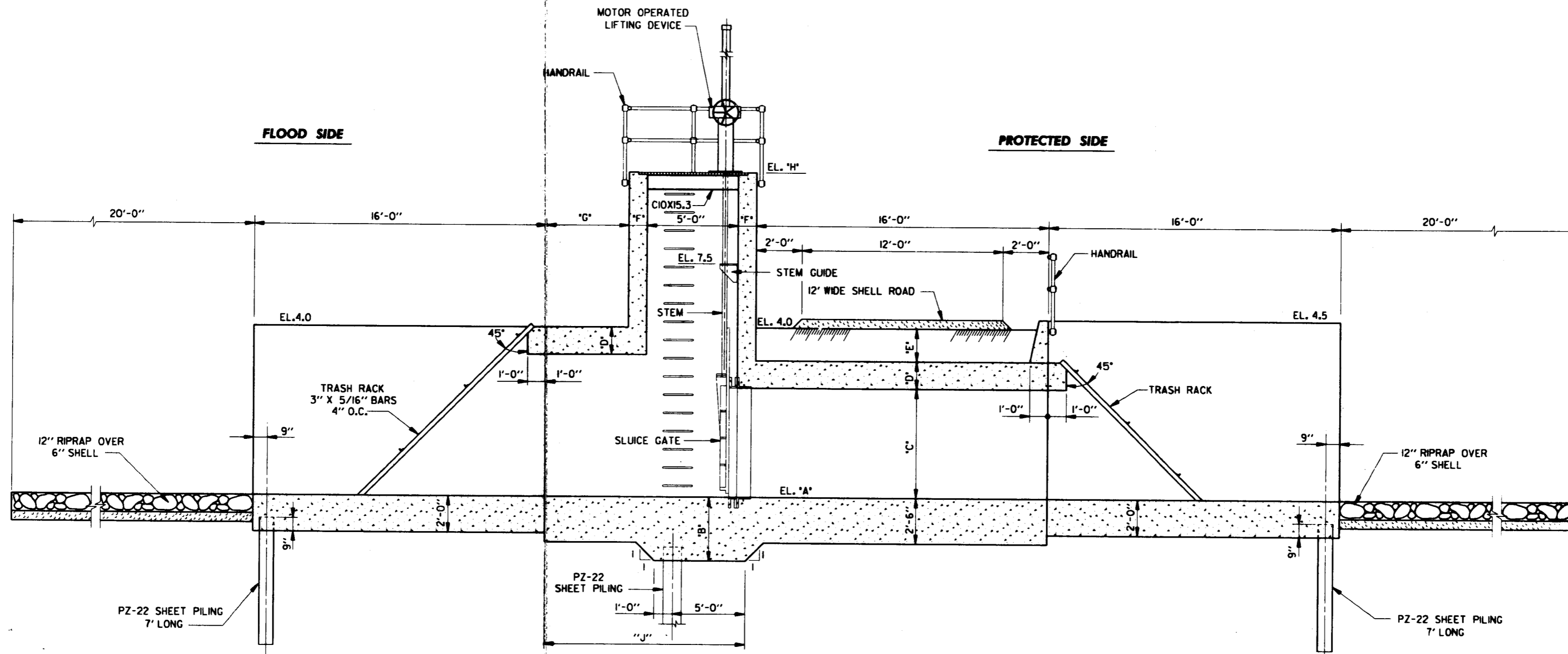

NOTE:
FILES NOT SHOWN FOR CLARITY.

TYPICAL SECTION THRU STRUCTURES

SCALE: 3/8" = 1'-0"

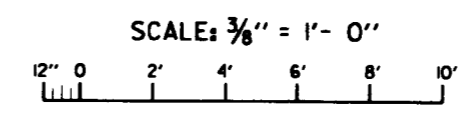

COMPUTER
AIDED
DESIGN
DRAFTING

ELEVATION AND DIMENSION SCHEDULE					
ELEVATION / DIMENSION	BAYOU TREPAGNIER	CROSS BAYOU	ST. ROSE CANAL	WALKER CANAL	PARISH LINE CANAL
A	-3.5	-5.3	-5.0	-3.5	-3.0
B	3'-6"	3'-6"	3'-6"	3'-0"	3'-0"
C	5'-0"	6'-0"	6'-0"	4'-0"	4'-0"
D	1'-3"	1'-6"	1'-3"	1'-0"	1'-0"
E	1'-3"	1'-10"	1'-9"	2'-6"	2'-0"
F	1'-0"	1'-0"	1'-0"	10"	10"
G	4'-6"	4'-6"	4'-6"	2'-10"	2'-10"
H	13.0	12.5	12.0	12.0	12.0
J	12'-0"	12'-0"	12'-0"	10'-6"	10'-6"

LAKE FORTCHARTRAIN, LA AND VICINITY
HIGH LEVEL PLAN
DESIGN MEMORANDUM NO. 18, GENERAL DESIGN
ST. CHARLES PARISH
NORTH OF AIRLINE HIGHWAY
**TYPICAL SECTION
THRU STRUCTURE**
U. S. ARMY ENGINEER DISTRICT, NEW ORLEANS
CORPS OF ENGINEERS
DATE: JANUARY 1969 FILE NO. H-2-30423

30423SA05.DGN

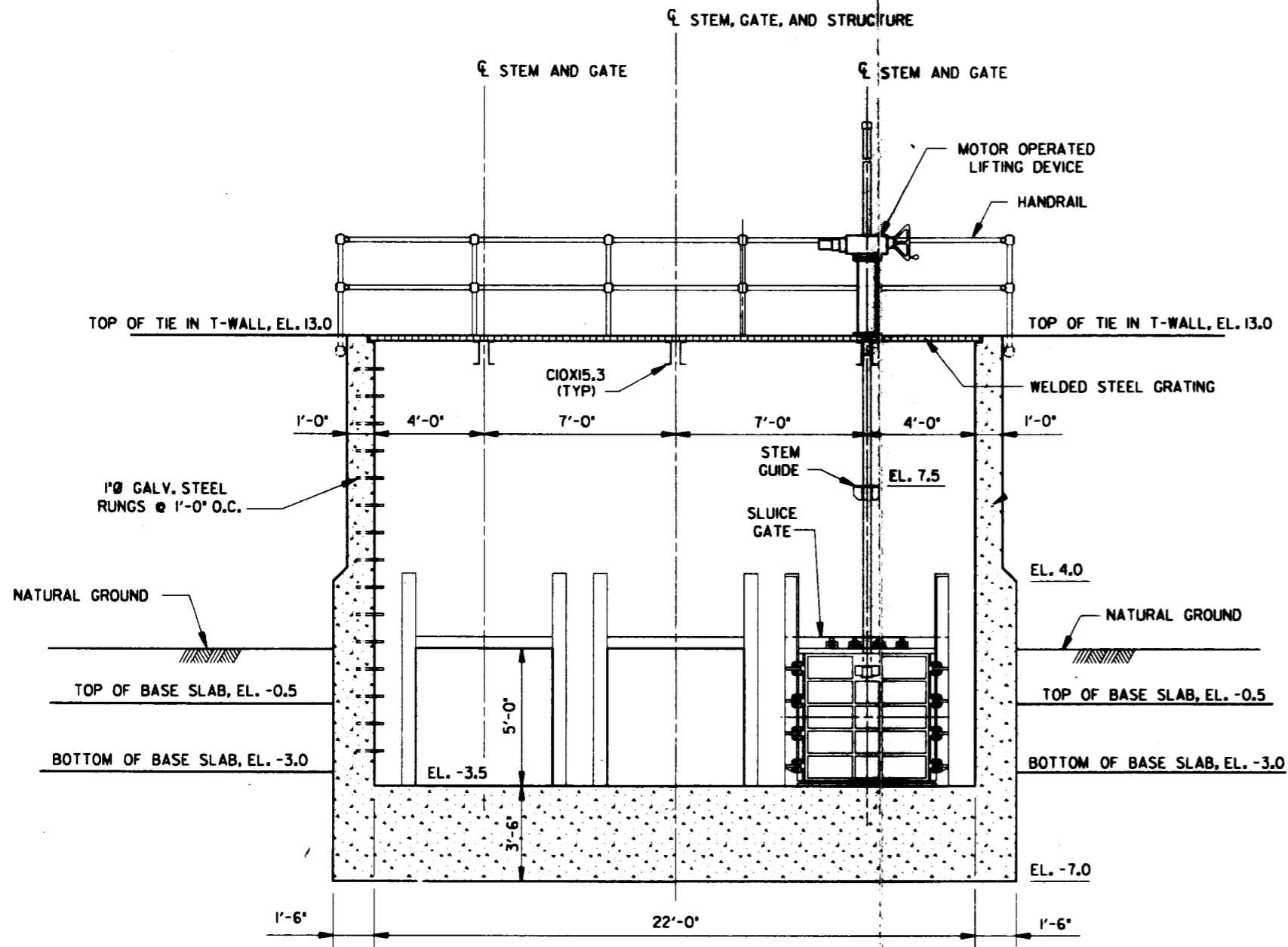

SECTIONAL ELEVATION
BAYOU TREPAGNIER DRAINAGE STRUCTURE

SCALE: $\frac{3}{8}'' = 1' - 0''$

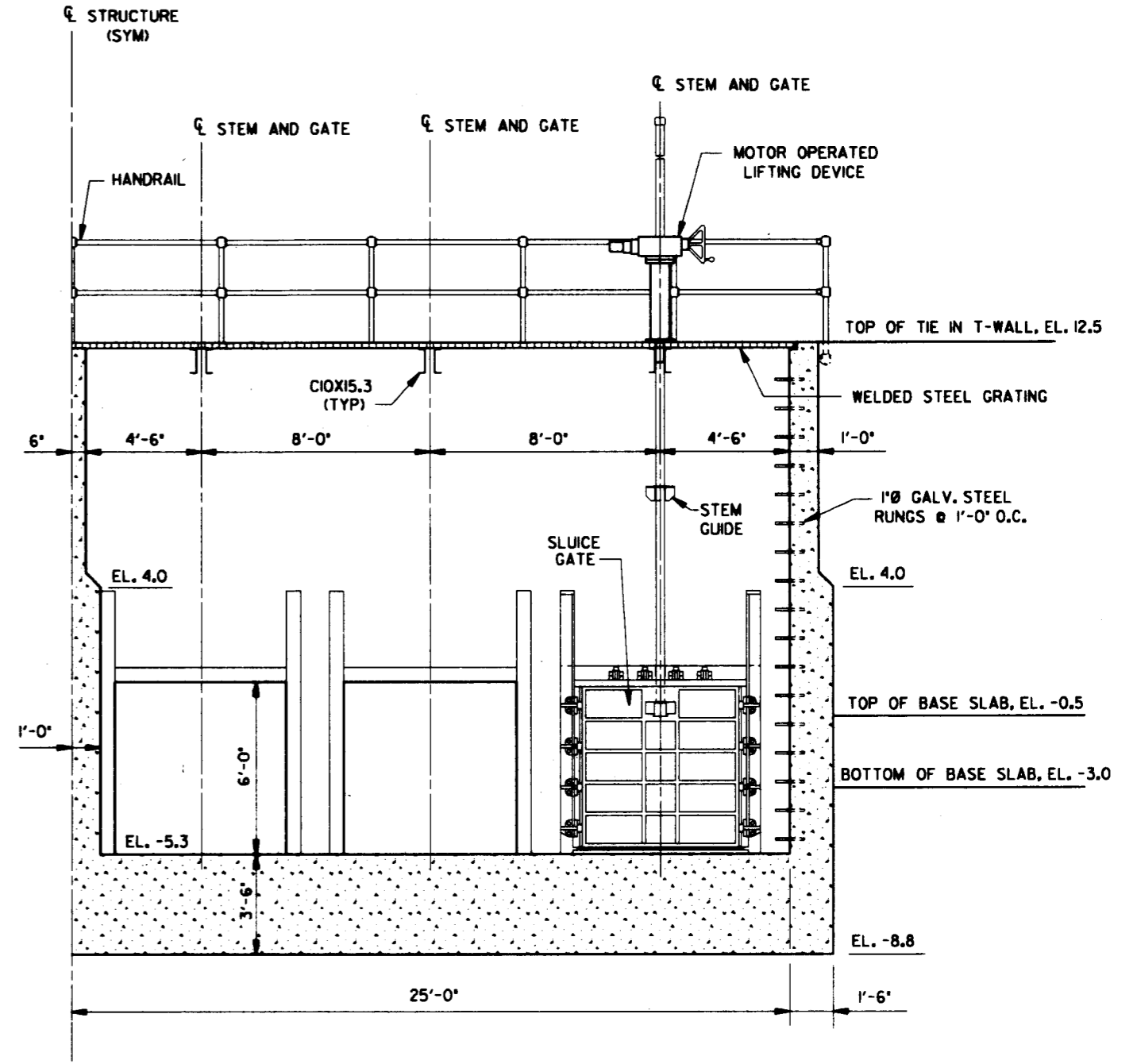

SECTIONAL ELEVATION
CROSS BAYOU DRAINAGE STRUCTURE

SCALE: $\frac{3}{8}'' = 1' - 0''$

**COMPUTER
 AIDED
 DESIGN
 DRAFTING**

LAKE PORTCHARTRAIN, LA. AND VICINITY
 HIGH LEVEL PLAN
 DESIGN MEMORANDUM NO. 18, GENERAL DESIGN
 ST. CHARLES PARISH
 NORTH OF AIRLINE HIGHWAY
 CROSS BAYOU AND
 BAYOU TREPAGNIER DRAINAGE STRUCTURES
SECTIONAL ELEVATIONS
 U. S. ARMY ENGINEER DISTRICT, NEW ORLEANS
 CORPS OF ENGINEERS
 DATE: JANUARY 1969 FILE NO. H-2-30423

30423SA08.DGN

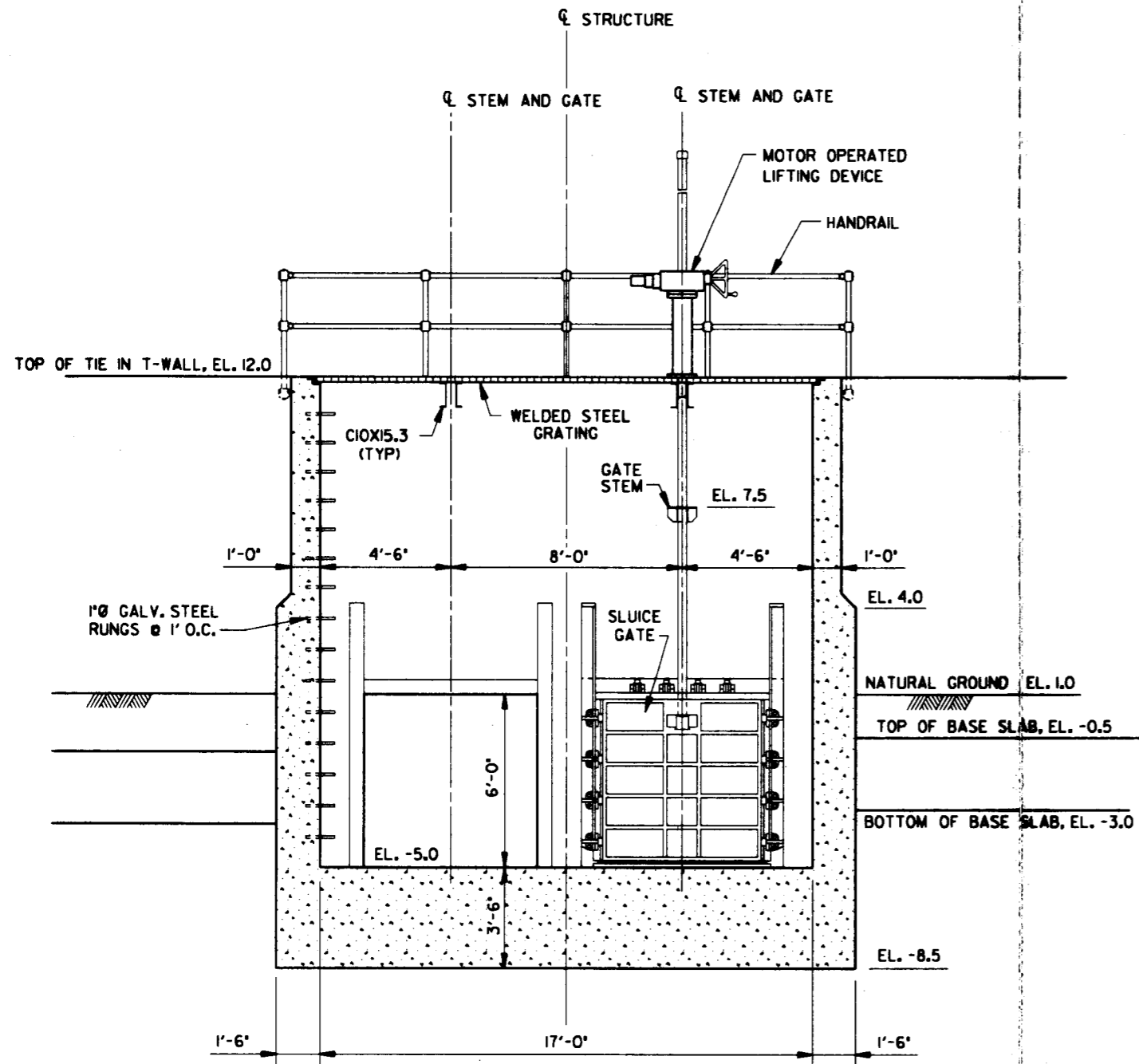

**SECTIONAL ELEVATION
ST. ROSE DRAINAGE STRUCTURE**

SCALE: $\frac{3}{8}'' = 1' - 0''$

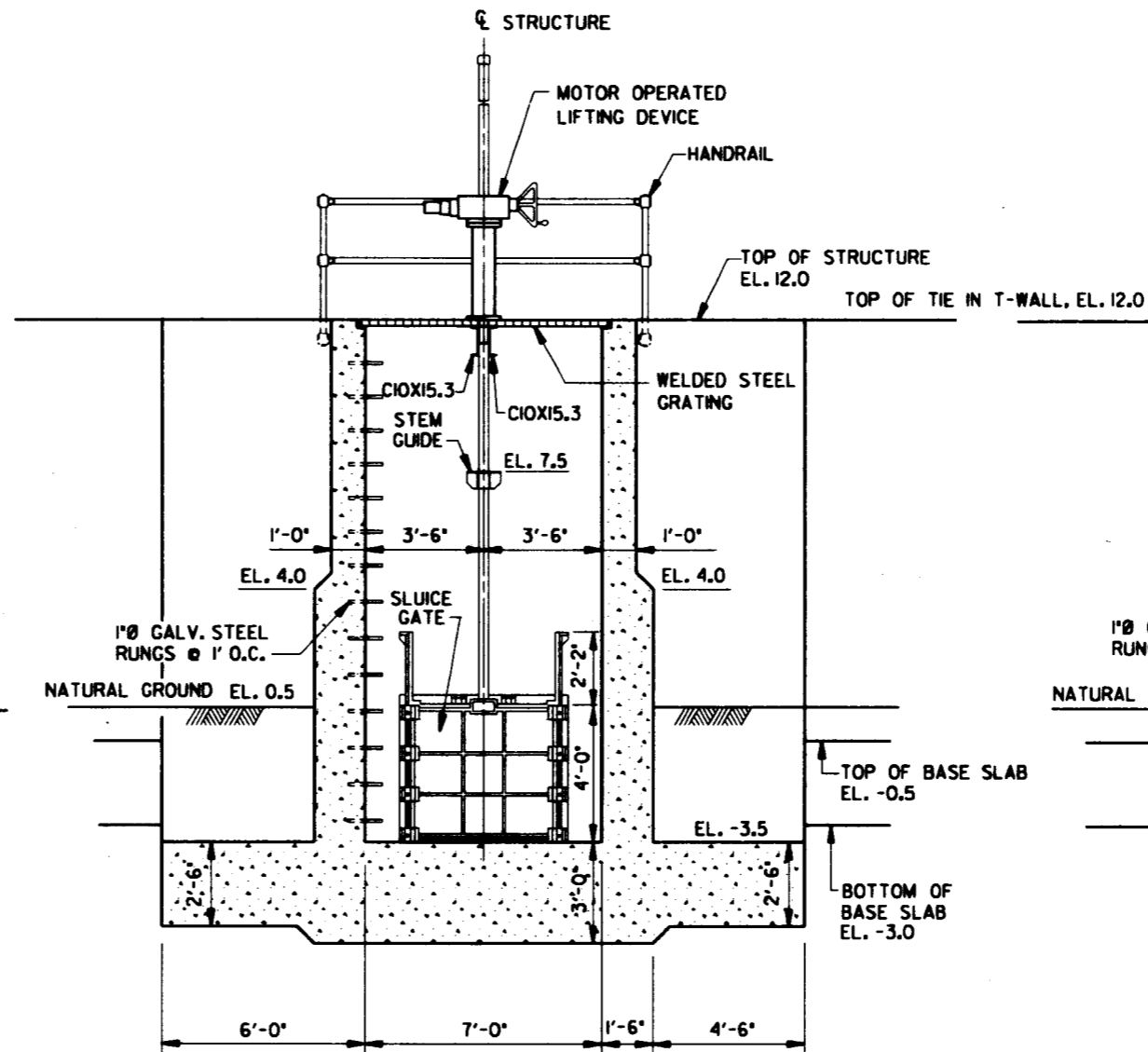

**SECTIONAL ELEVATION
WALKER CANAL DRAINAGE STRUCTURE**

SCALE: $\frac{3}{8}'' = 1' - 0''$

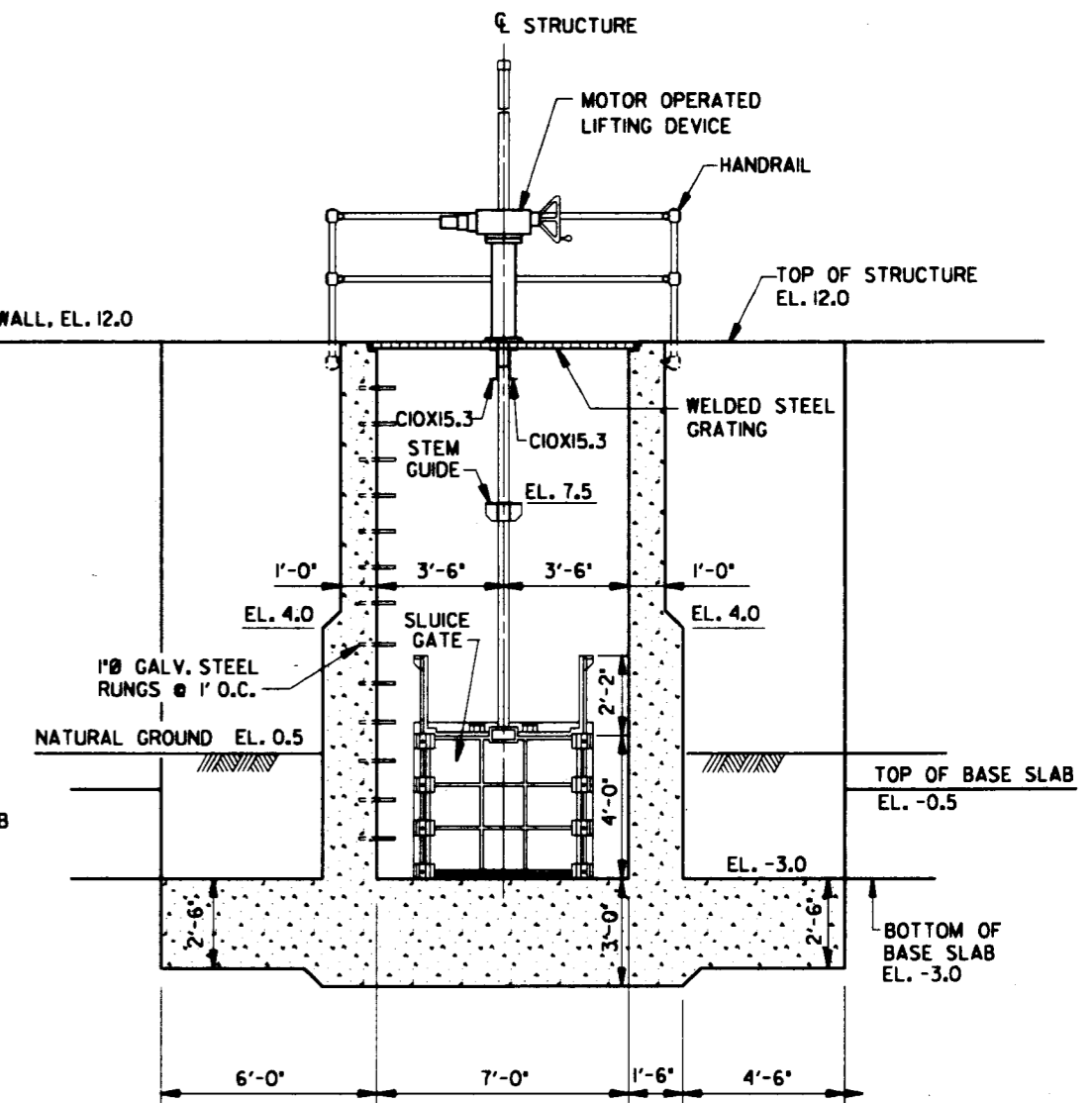

**SECTIONAL ELEVATION
PARISH LINE CANAL DRAINAGE STRUCTURE**

SCALE: $\frac{3}{8}'' = 1' - 0''$

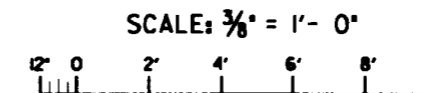

**COMPUTER
AIDED
DESIGN
DRAFTING**

LAKE FORTCHARTRAIN, LA. AND VICINITY
HIGH LEVEL PLAN
DESIGN MEMORANDUM NO. 18, GENERAL DESIGN
ST. CHARLES PARISH
NORTH OF AIRLINE HIGHWAY
ST. ROSE, WALKER CANAL, AND
PARISH LINE CANAL DRAINAGE STRUCTURES
SECTIONAL ELEVATIONS
U. S. ARMY ENGINEER DISTRICT, NEW ORLEANS
CORPS OF ENGINEERS
DATE: JANUARY 1989 FILE NO. H-2-30423

30423SA07.DGN

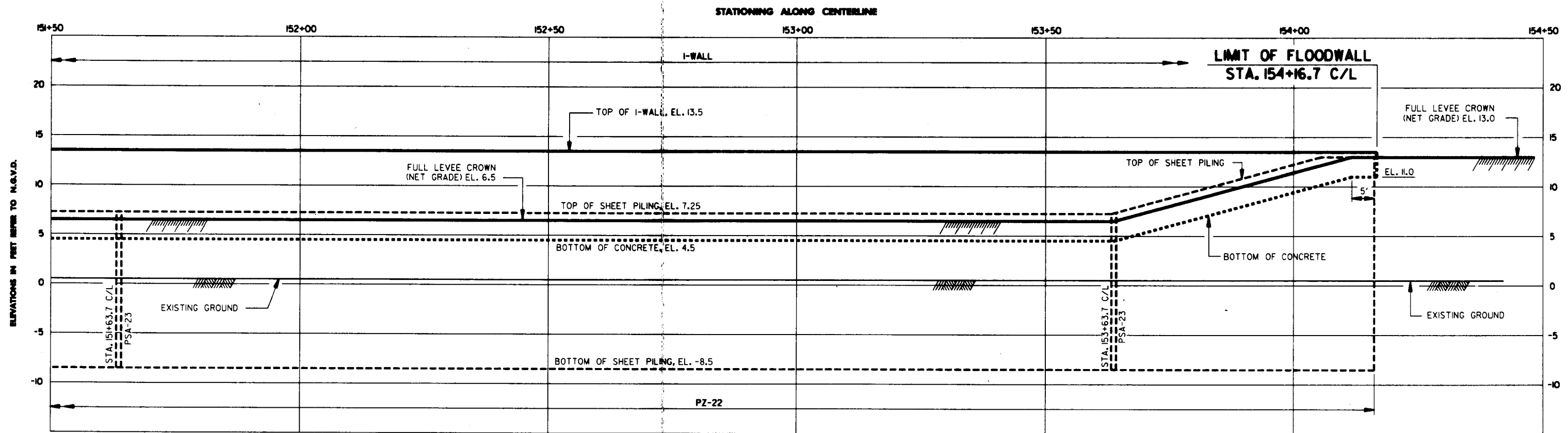
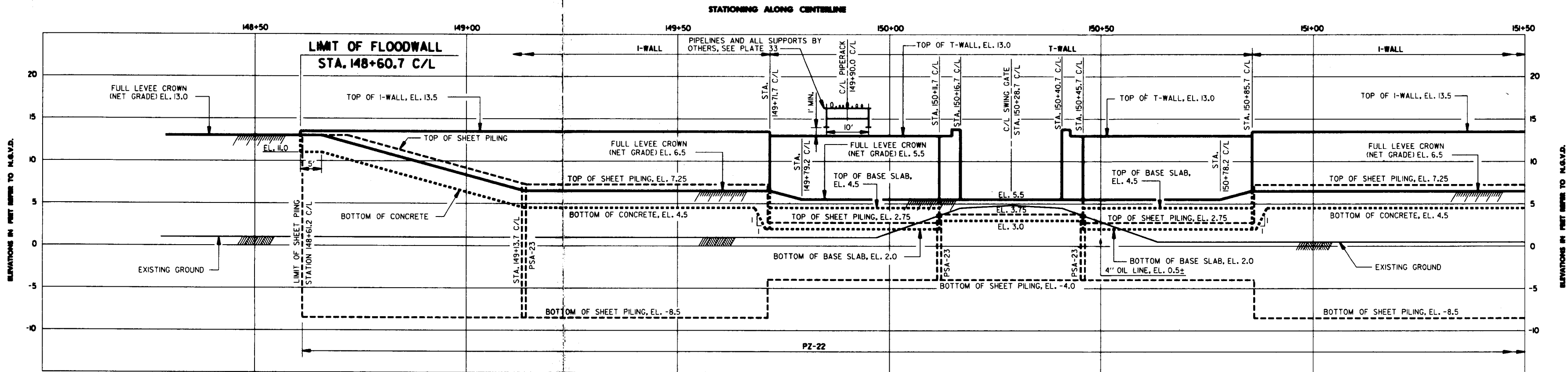

PROFILE
 SCALE: HOR. 1" = 10'
 VERT. 1" = 5'

**COMPUTER
 AIDED
 DESIGN
 DRAFTING**

LAKE PORTCHARTRAIN, LA AND VICINITY
 HIGH LEVEL PLAN
 DESIGN MEMORANDUM NO. 18, GENERAL DESIGN
ST. CHARLES PARISH
 NORTH OF AIRLINE HIGHWAY
FLOODWALL VICINITY
GOODHOPE FIELD FACILITY
PROFILE
 U. S. ARMY ENGINEER DISTRICT, NEW ORLEANS
 CORPS OF ENGINEERS
 DATE: JANUARY 1969 FILE NO. H-2-30423

304235A18.DGN

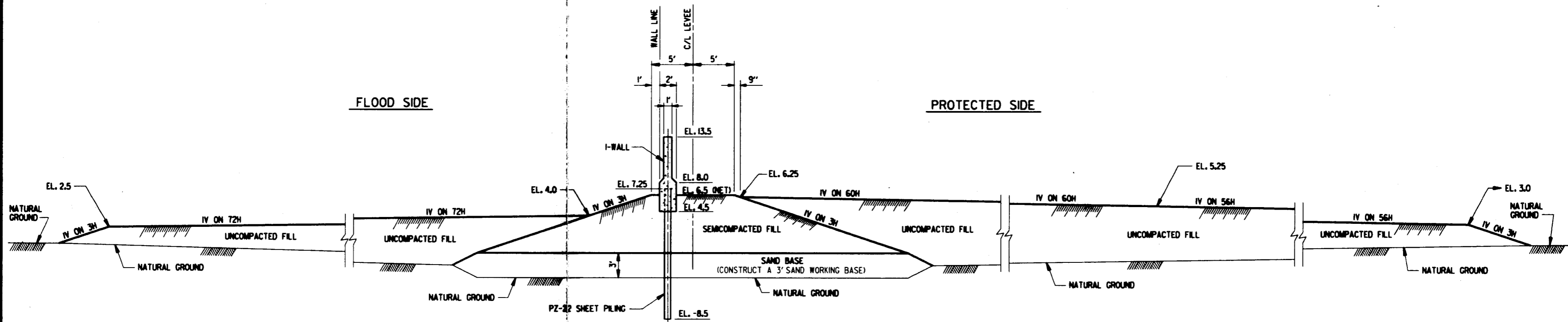

TYPICAL SECTION

STA. 148+60.70 C/L TO STA. 149+71.70 C/L
 STA. 150+85.70 C/L TO STA. 154+16.70 C/L

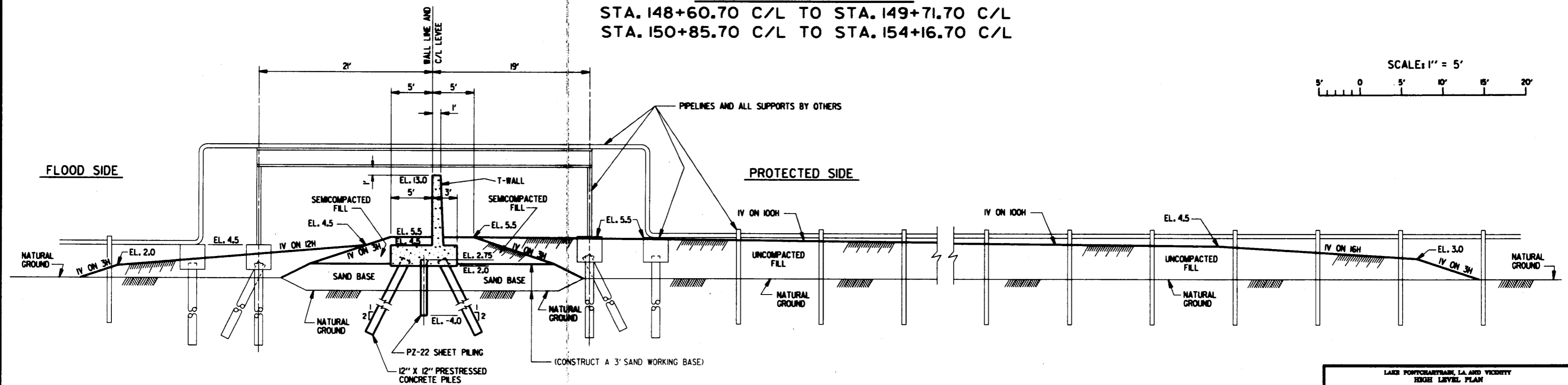
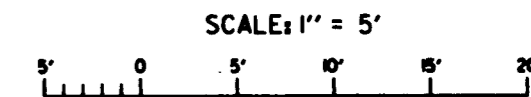

TYPICAL SECTION

STA. 149+71.70 C/L TO STA. 150+11.70 C/L
 STA. 150+45.70 C/L TO STA. 150+85.70 C/L

COMPUTER
 AIDED
 DESIGN
 DRAFTING

LAKE FORTCHARTRAIN, LA. AND VICINITY
 HIGH LEVEL PLAN
 DESIGN MEMORANDUM NO. 18, GENERAL DESIGN
 ST. CHARLES PARISH
 NORTH OF AIRLINE HIGHWAY
 FLOODWALL AT SHELL OIL CO.
 GOODHOPE FIELD FACILITY
TYPICAL SECTIONS
 U. S. ARMY ENGINEER DISTRICT, NEW ORLEANS
 CORPS OF ENGINEERS
 DATE: JANUARY 1969 FILE NO. H-2-30423

304235828.DGN

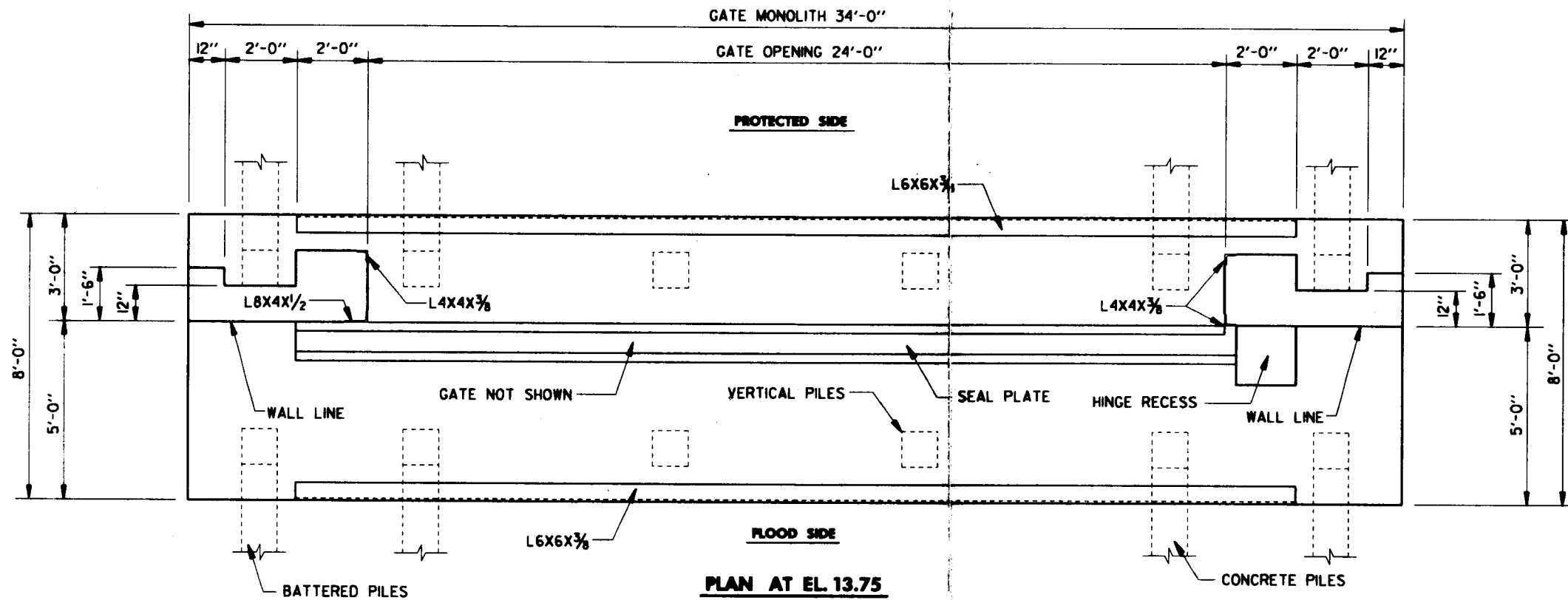

PLAN AT EL. 13.75
SCALE: 1/2" = 1'-0"

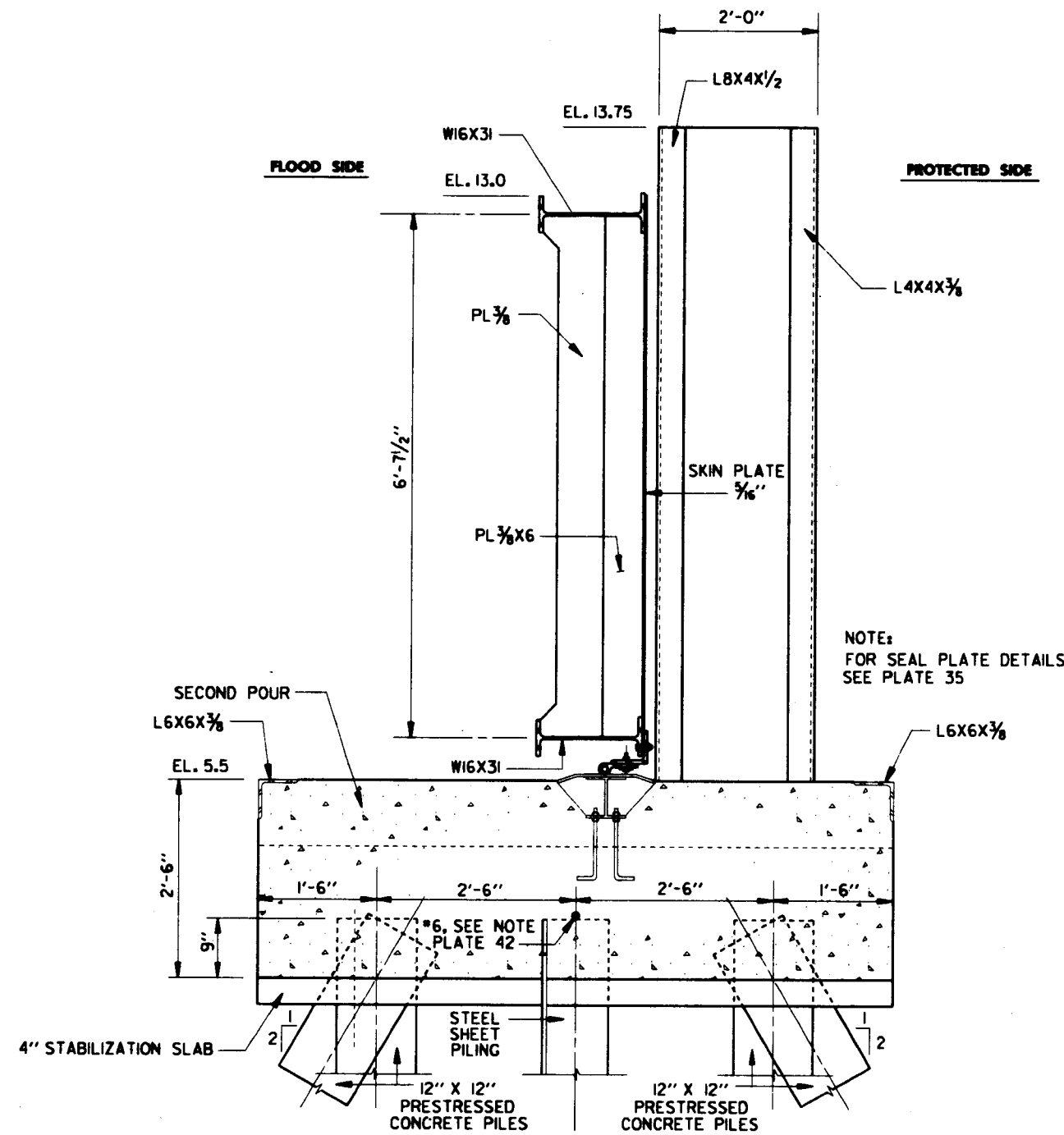

TYPICAL SECTION
SCALE: 1" = 1'-0"

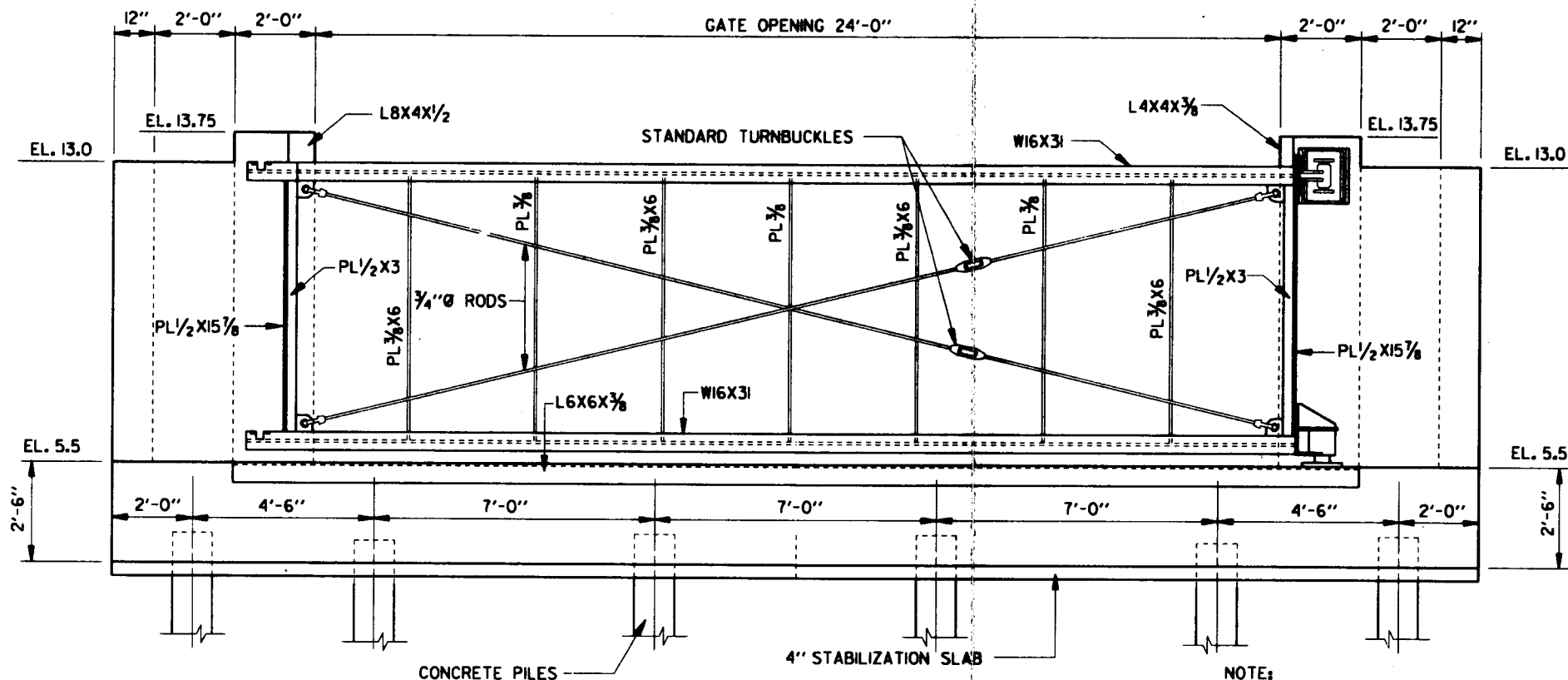

FLOOD SIDE ELEVATION
SCALE: 1/2" = 1'-0"

NOTE: PILE SPACING IS THE SAME FOR BOTH THE FLOOD SIDE AND THE PROTECTED SIDE AND IS SYMMETRICAL ABOUT C/L GATE MONOLITH.

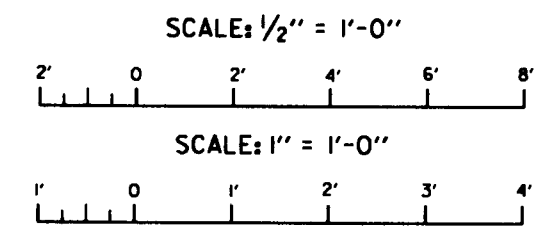

COMPUTER AIDED DESIGN DRAFTING

LAKE PONCHARTRAIN, LA. AND VICINITY
HIGH LEVEL PLAN
DESIGN MEMORANDUM NO. 18, GENERAL DESIGN
ST. CHARLES PARISH
NORTH OF AIRLINE HIGHWAY
GOODHOPE FIELD FACILITY
SWING GATE DETAILS
U. S. ARMY ENGINEER DISTRICT, NEW ORLEANS
CORPS OF ENGINEERS
DATE: JANUARY 1989 FILE NO. H-2-30423

30423SA17.DGN

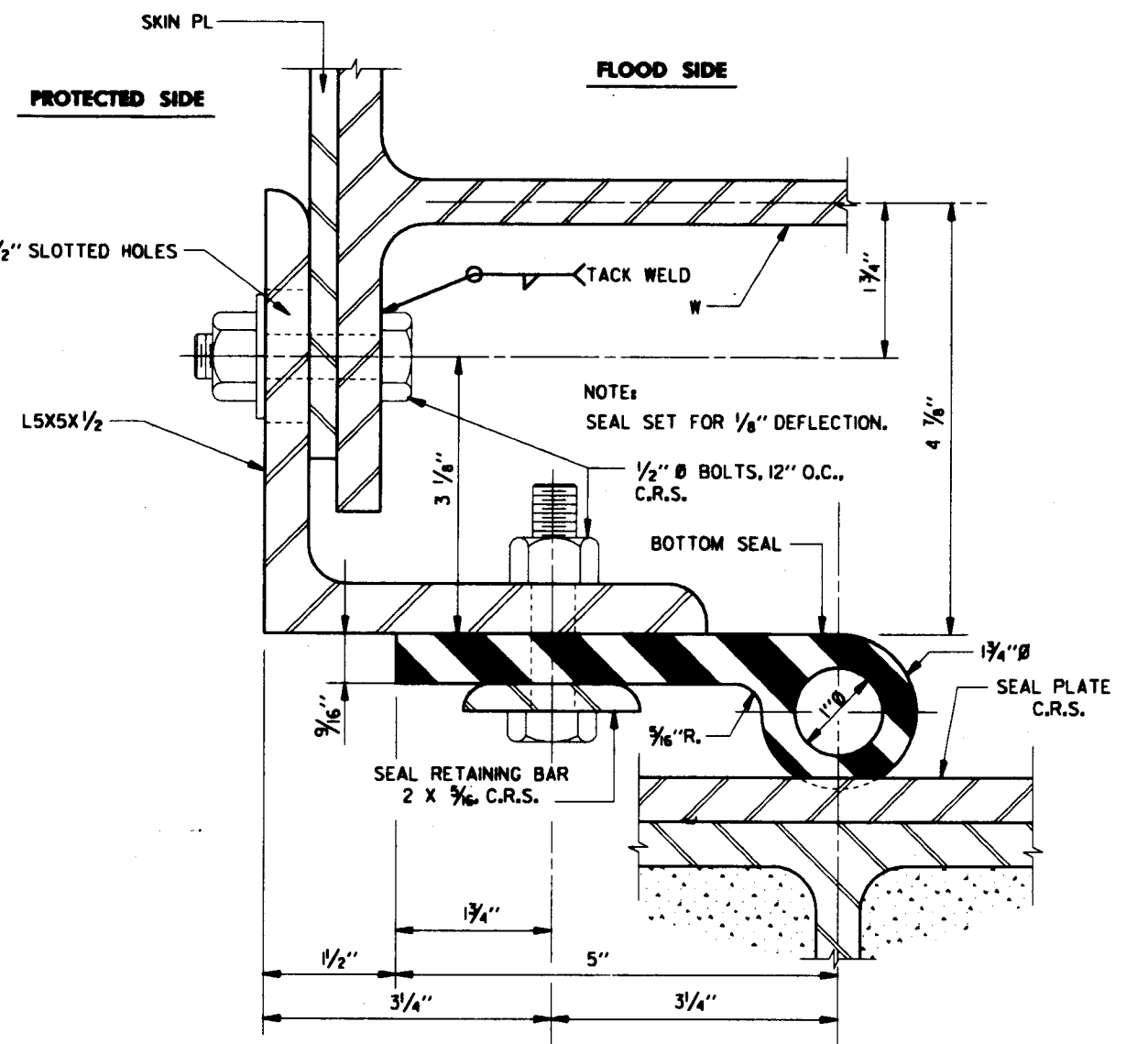
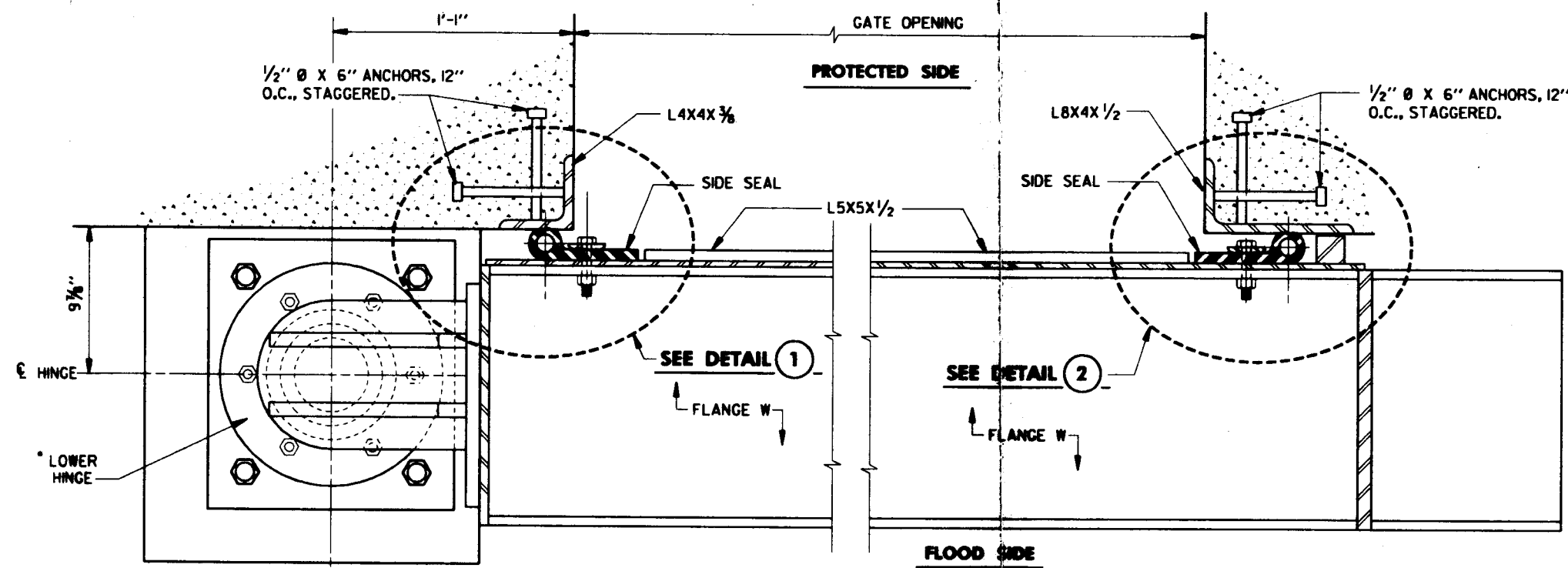

NOTE: HINGE DETAILS ARE SIMILAR TO PLATE NO. 30 OF DESIGN MEMORANDUM NO. 17, JEFFERSON PARISH LAKEFRONT LEVEE.

SECTION THRU SWING GATE
SCALE: 3" = 1'-0"

SECTION THRU BOTTOM SEAL
SCALE: FULL SIZE

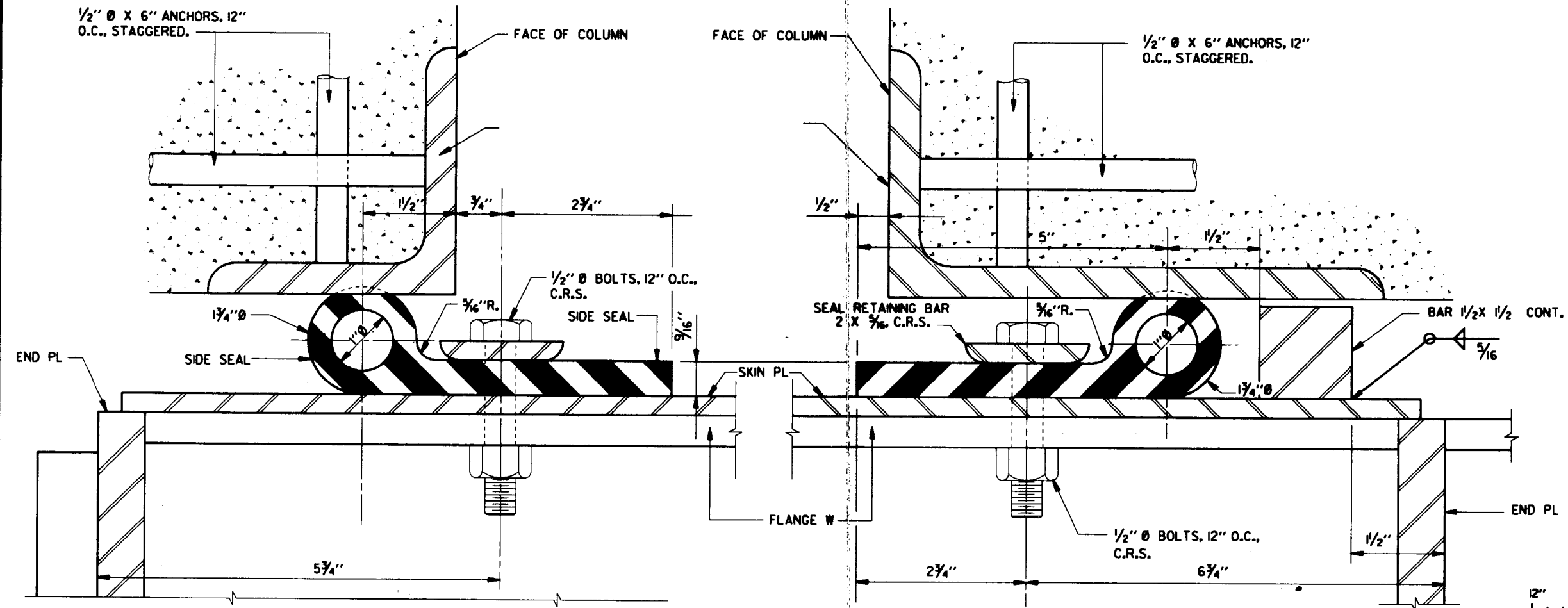

DETAIL 1
SCALE: FULL SIZE

DETAIL 2
SCALE: FULL SIZE

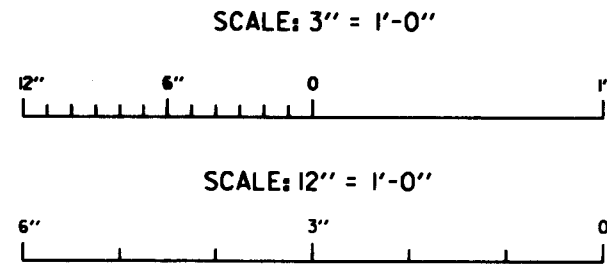

COMPUTER AIDED DESIGN DRAFTING

LAKE FORTCHARTRAIN, LA AND VICINITY
HIGH LEVEL PLAN
DESIGN MEMORANDUM NO. 18, GENERAL DESIGN
ST. CHARLES PARISH
NORTH OF AIRLINE HIGHWAY
SWING GATE SEAL DETAILS
U. S. ARMY ENGINEER DISTRICT, NEW ORLEANS
CORPS OF ENGINEERS
DATE: JANUARY 1989 FILE NO. H-2-30423

30423SA16.DGN

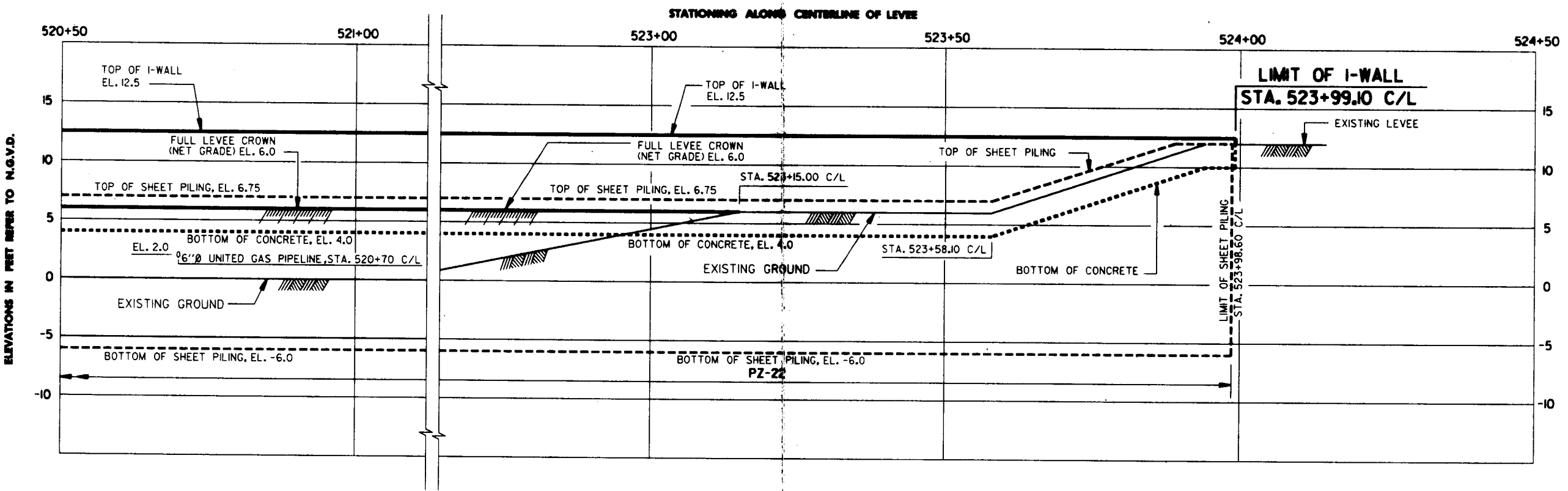
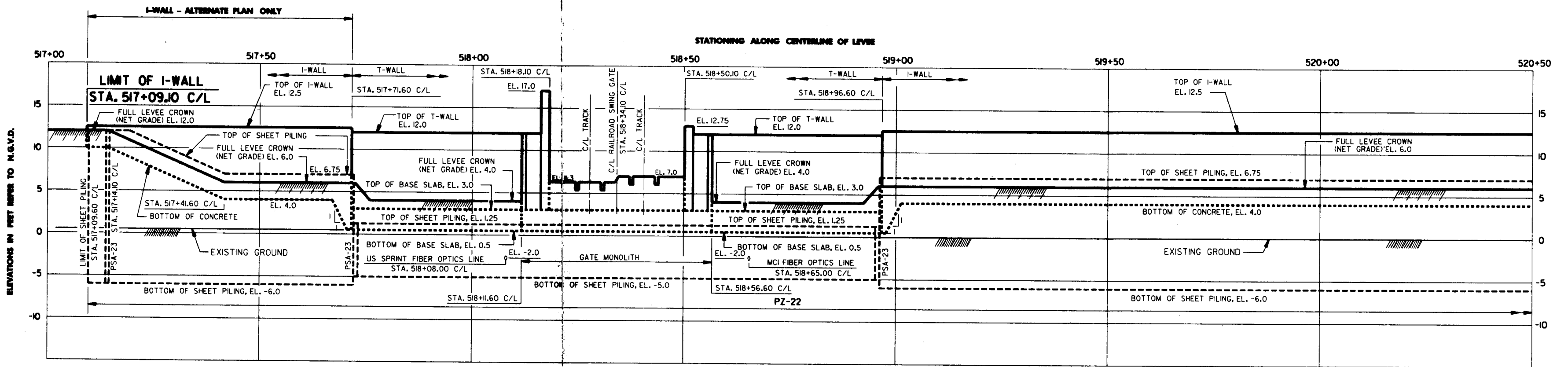

PROFILE
 SCALE: HOR. 1"=10'
 VERT. 1"=5'

**COMPUTER
 AIDED
 DESIGN
 DRAFTING**

LAKE PORTCHARTRAIN, LA. AND VICINITY
 HIGH LEVEL PLAN
 DESIGN MEMORANDUM NO. 18, GENERAL DESIGN
 ST. CHARLES PARISH
 NORTH OF AIRLINE HIGHWAY
 VICINITY RAILROAD GATE
PROFILE
 U. S. ARMY ENGINEER DISTRICT, NEW ORLEANS
 CORPS OF ENGINEERS
 DATE: JANUARY 1989 FILE NO. H-2-30423

30423SA22.DGN

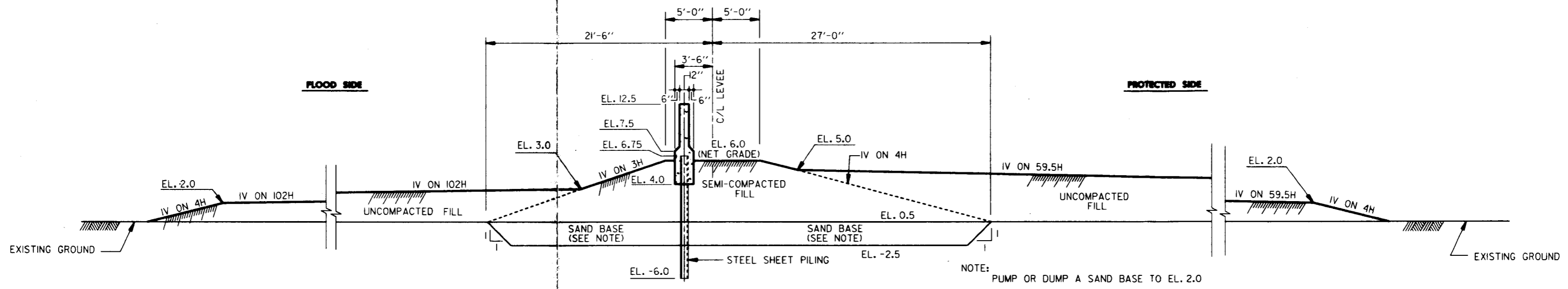

TYPICAL I-WALL SECTION (ALTERNATE PLAN)

STA. 517+09.10 CL TO STA. 517+71.60 CL

SCALE: 1" = 5'

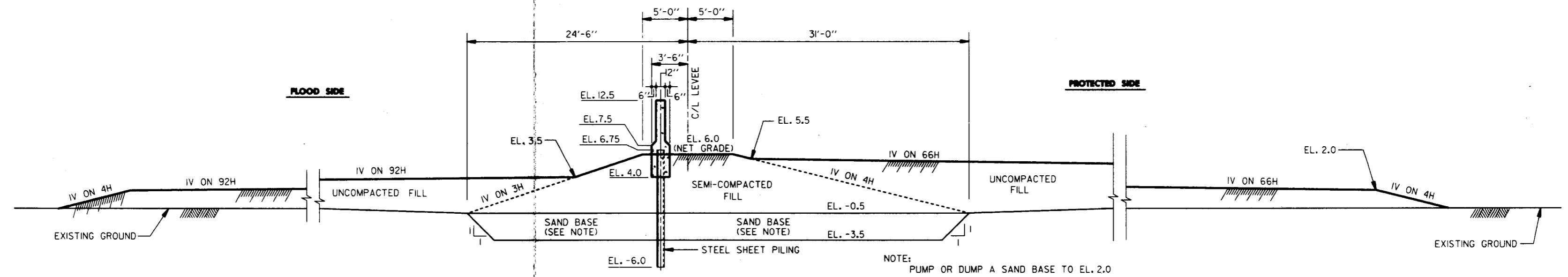

TYPICAL I-WALL SECTION (ALTERNATE PLAN)

STA. 518+96.60 CL TO STA. 523+99.10 CL

SCALE: 1" = 5'

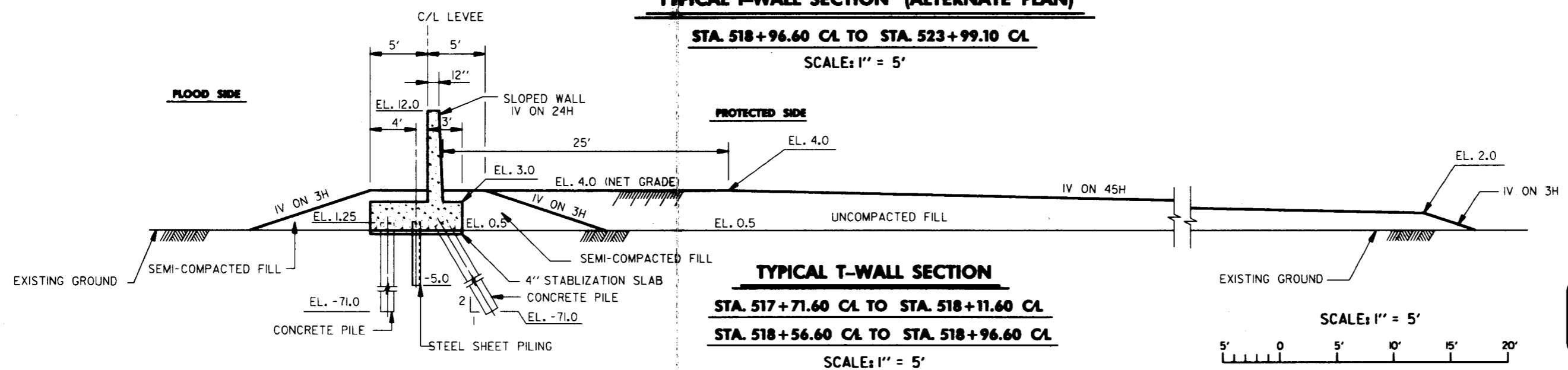

TYPICAL T-WALL SECTION

STA. 517+71.60 CL TO STA. 518+11.60 CL

STA. 518+56.60 CL TO STA. 518+96.60 CL

SCALE: 1" = 5'

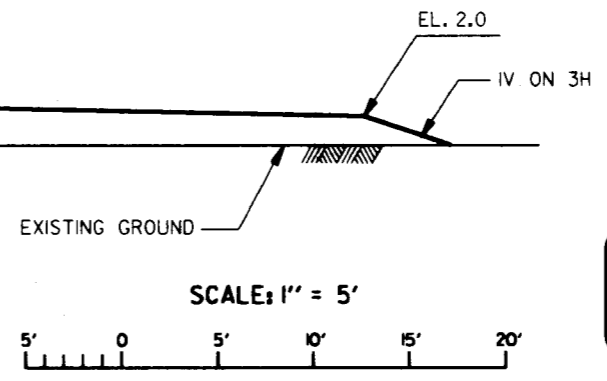

**COMPUTER
AIDED
DESIGN
DRAFTING**

LAKE FORTCHARTRAIN, LA. AND VICINITY
HIGH LEVEL PLAN
DESIGN MEMORANDUM NO. 18, GENERAL DESIGN
ST. CHARLES PARISH
NORTH OF AIRLINE HIGHWAY
VICINITY RAILROAD GATE
SECTIONS
U. S. ARMY ENGINEER DISTRICT, NEW ORLEANS
CORPS OF ENGINEERS
DATE: JANUARY 1989 FILE NO. H-2-30423

SA2330423.DGN

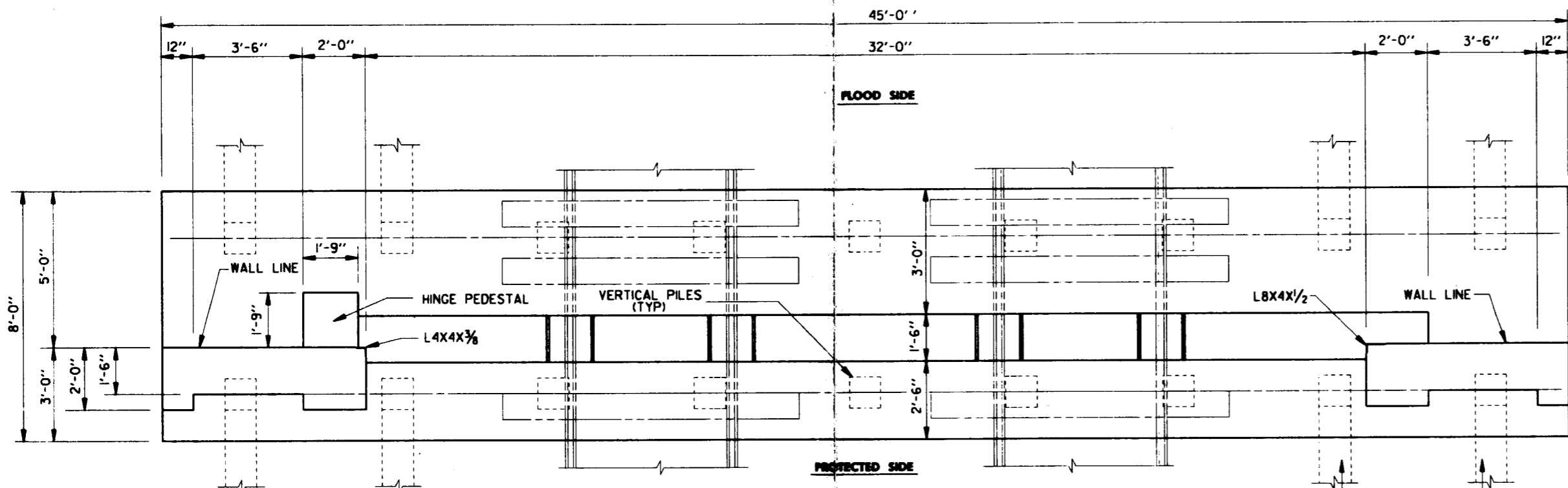

NOTE:
HINGE DETAILS ARE SIMILAR TO PLATE NO. 30
OF DESIGN MEMORANDUM NO. 17,
JEFFERSON PARISH LAKEFRONT LEVEE.

PLAN AT EL. 18.0
SCALE: 1/2" = 1'-0"

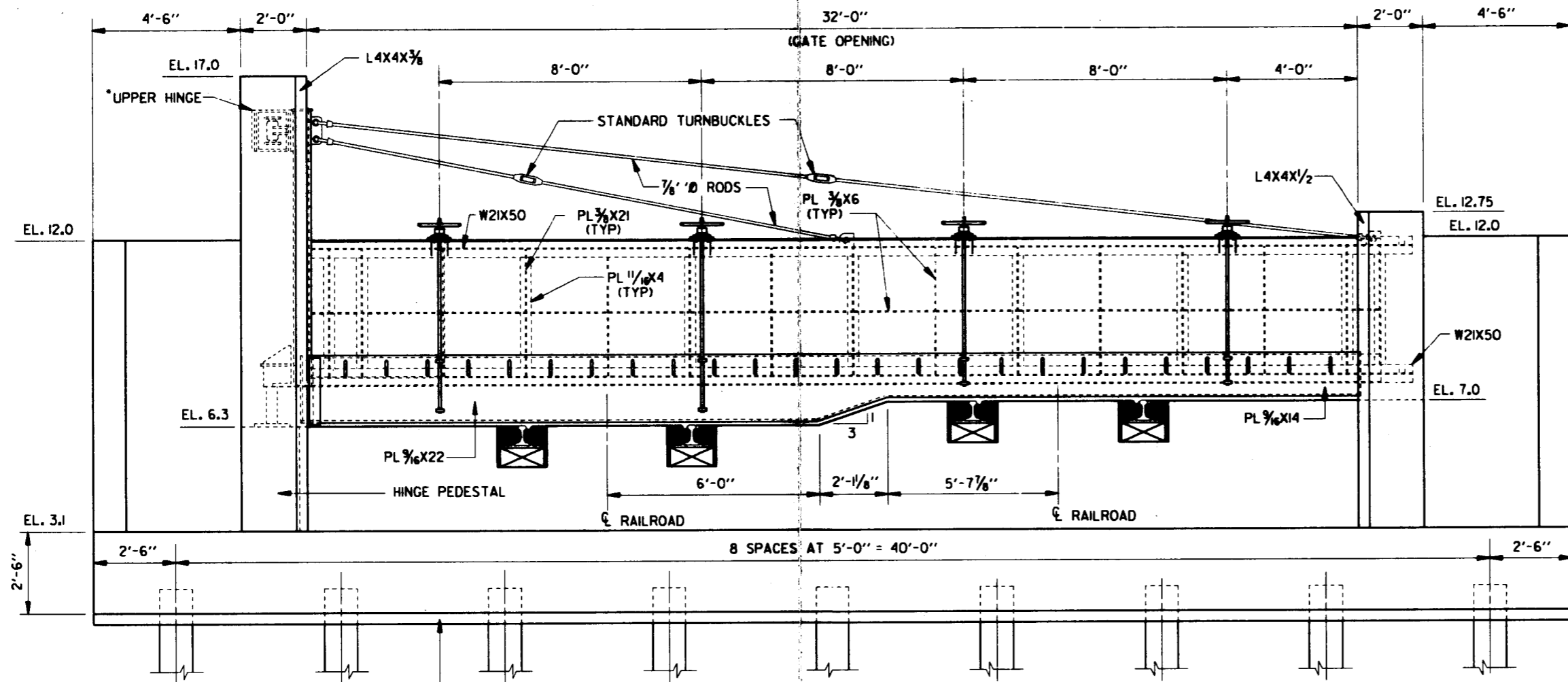

PROTECTED SIDE ELEVATION
SCALE: 1/2" = 1'-0"

NOTE:
PILE SPACING IS THE SAME FOR BOTH THE FLOOD SIDE
AND THE PROTECTED SIDE AND IS SYMMETRICAL ABOUT
C/L GATE MONOLITH.

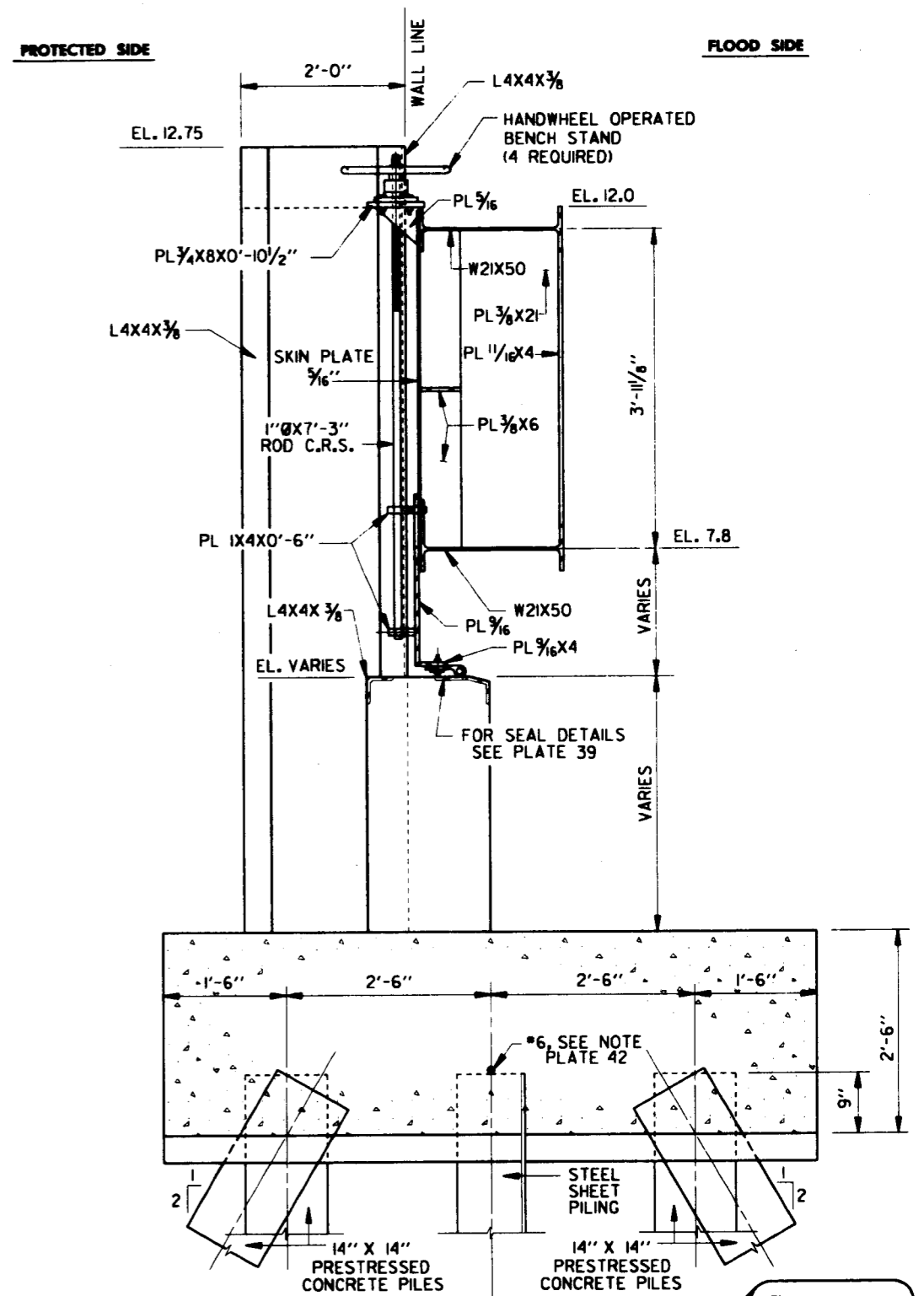

TYPICAL SECTION
SCALE: 1" = 1'-0"

**COMPUTER
AIDED
DESIGN
DRAWING**

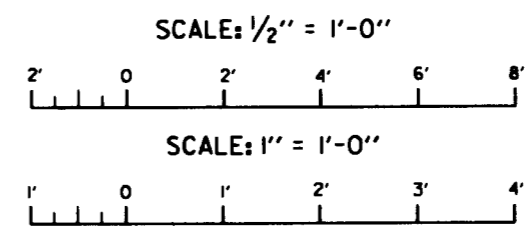

LAKE FORTCHARTRAIN, LA. AND VICINITY
HIGH LEVEL PLAN
DESIGN MEMORANDUM NO. 18, GENERAL DESIGN
ST. CHARLES PARISH
NORTH OF AIRLINE HIGHWAY
**RAILROAD SWING GATE
DETAILS**
U. S. ARMY ENGINEER DISTRICT, NEW ORLEANS
CORPS OF ENGINEERS
DATE: JANUARY 1969 FILE NO. H-2-30423

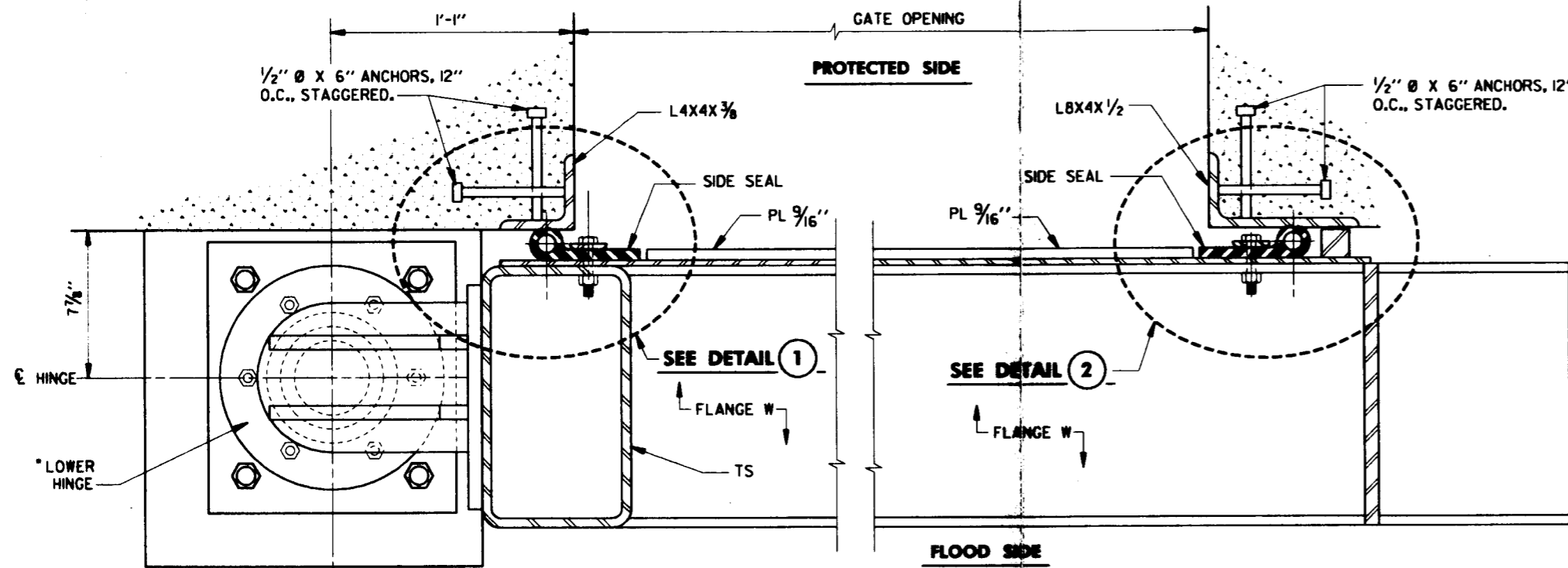

SECTION THRU SWING GATE

SCALE: 3" = 1'-0"

NOTE: HINGE DETAILS ARE SIMILAR TO PLATE NO. 30 OF DESIGN MEMORANDUM NO. 17, JEFFERSON PARISH LAKEFRONT LEVEE.

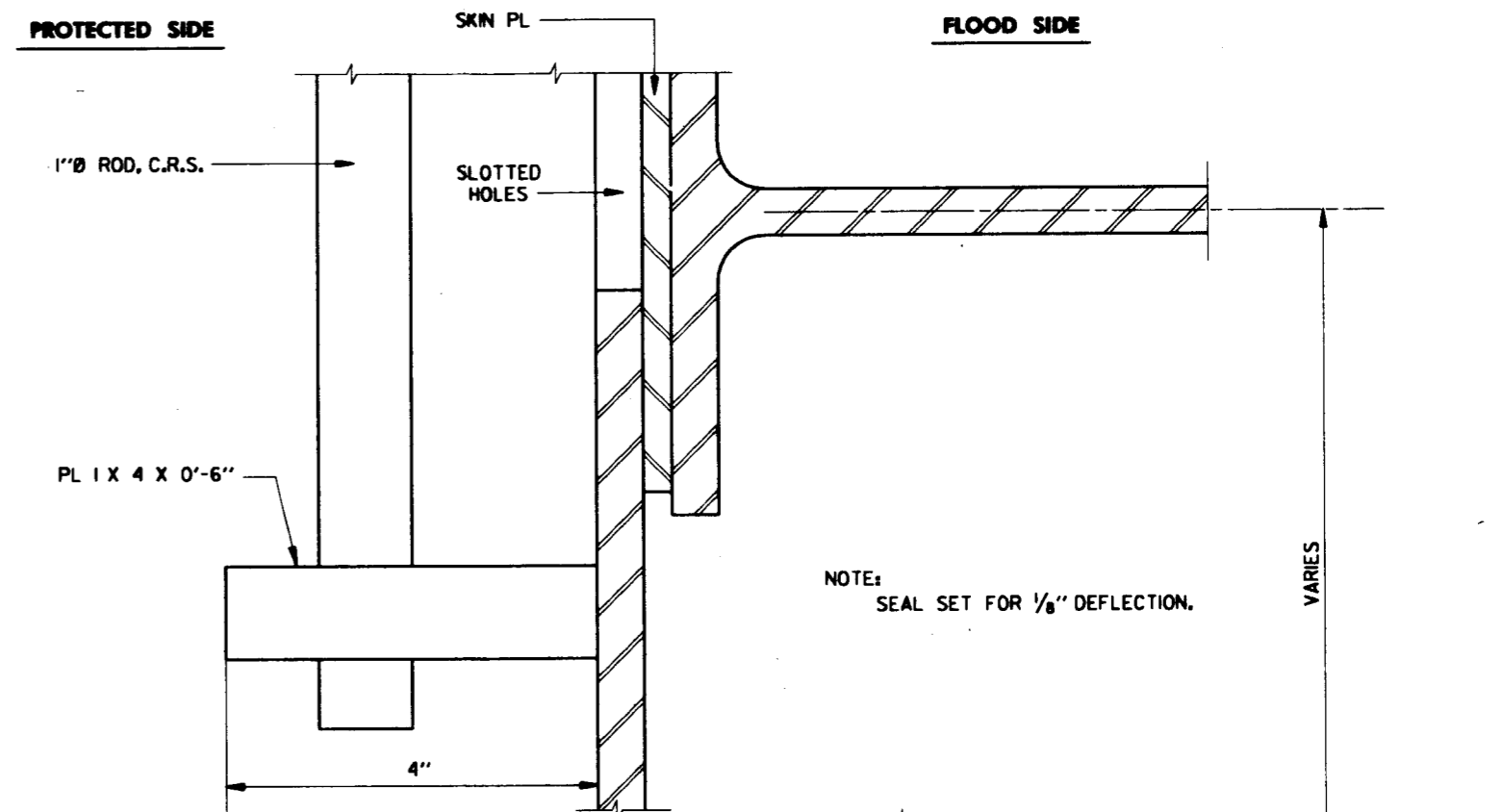

SECTION THRU BOTTOM SEAL

SCALE: FULL SIZE

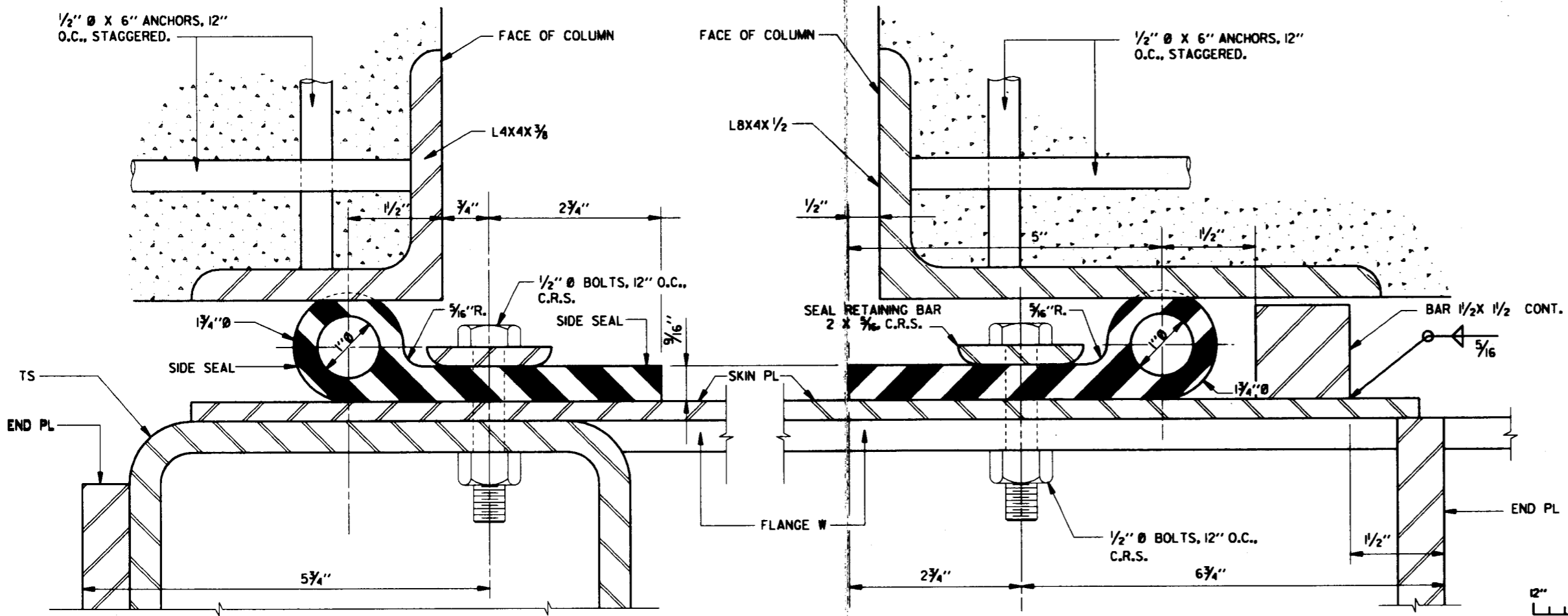

DETAIL 1

SCALE: FULL SIZE

DETAIL 2

SCALE: FULL SIZE

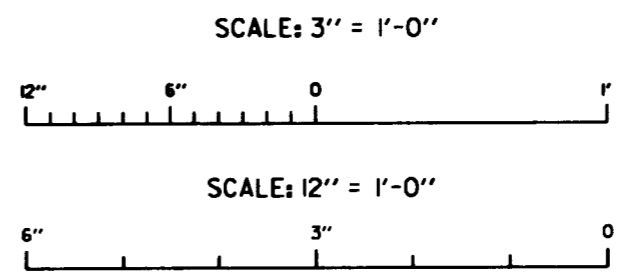

COMPUTER AIDED DESIGN DRAFTING

LAKE PONTCHARTRAIN, LA. AND VICINITY
HIGH LEVEL PLAN
DESIGN MEMORANDUM NO. 18, GENERAL DESIGN
ST. CHARLES PARISH
NORTH OF AIRLINE HIGHWAY
RAILROAD GATE SEAL DETAILS
U. S. ARMY ENGINEER DISTRICT, NEW ORLEANS
CORPS OF ENGINEERS
DATE: JANUARY 1969 FILE NO. H-2-30423

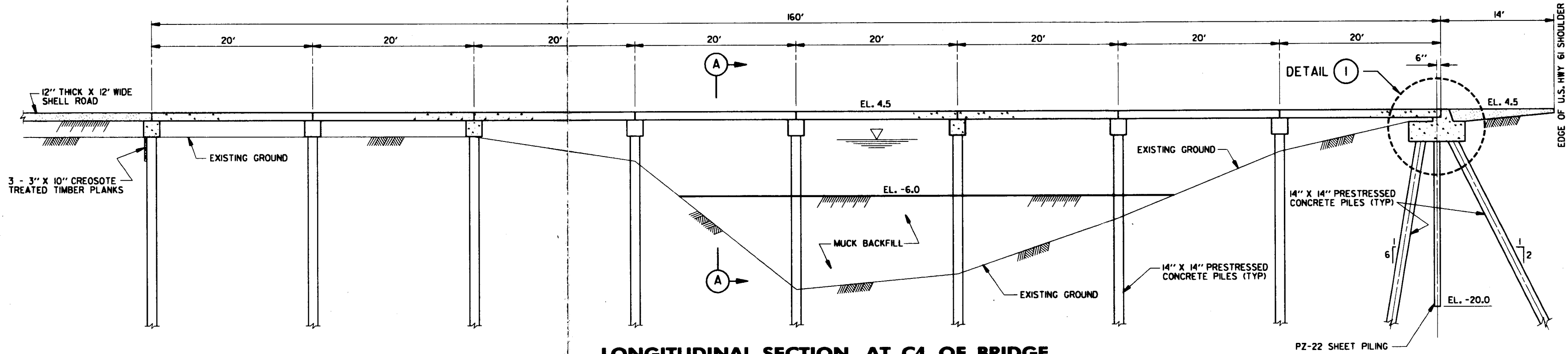

LONGITUDINAL SECTION AT CL OF BRIDGE

SCALE: $\frac{3}{16}'' = 1' - 0''$

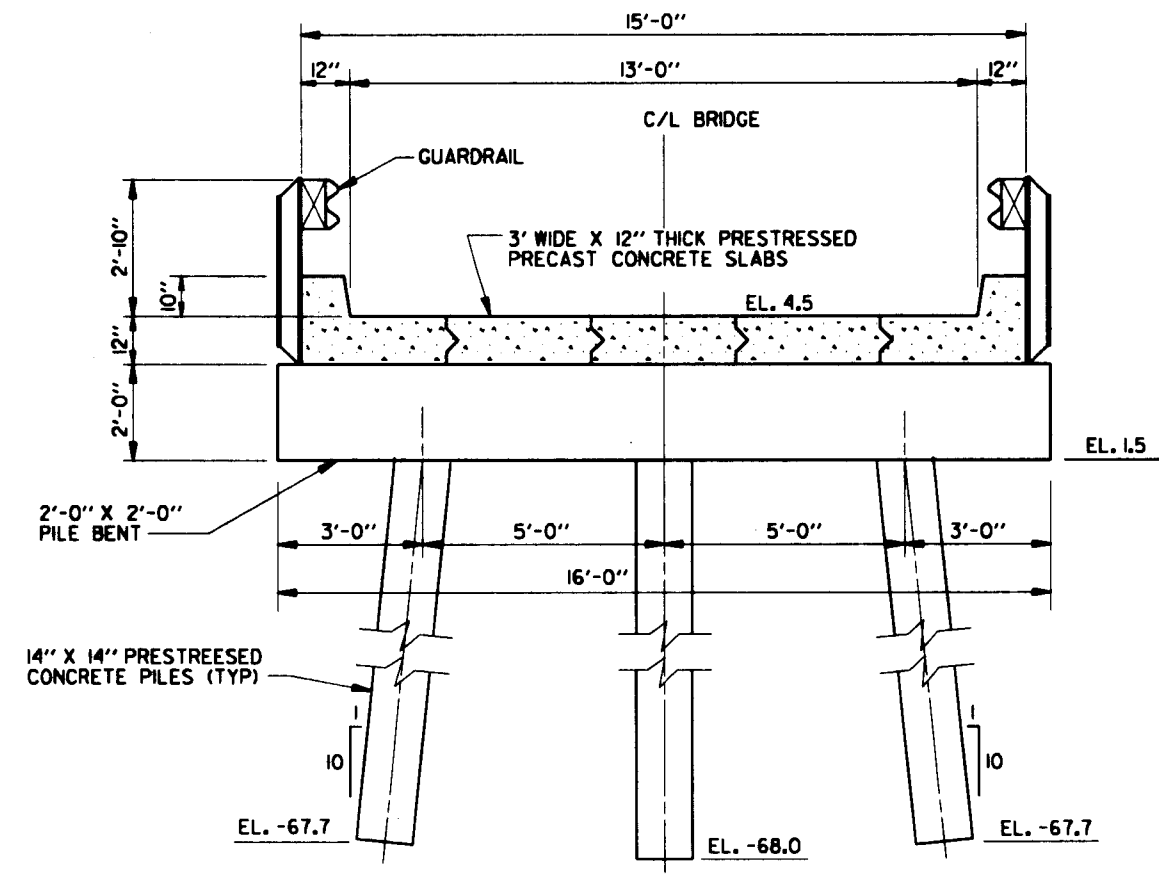

SECTION A
SCALE: $\frac{1}{2}'' = 1' - 0''$

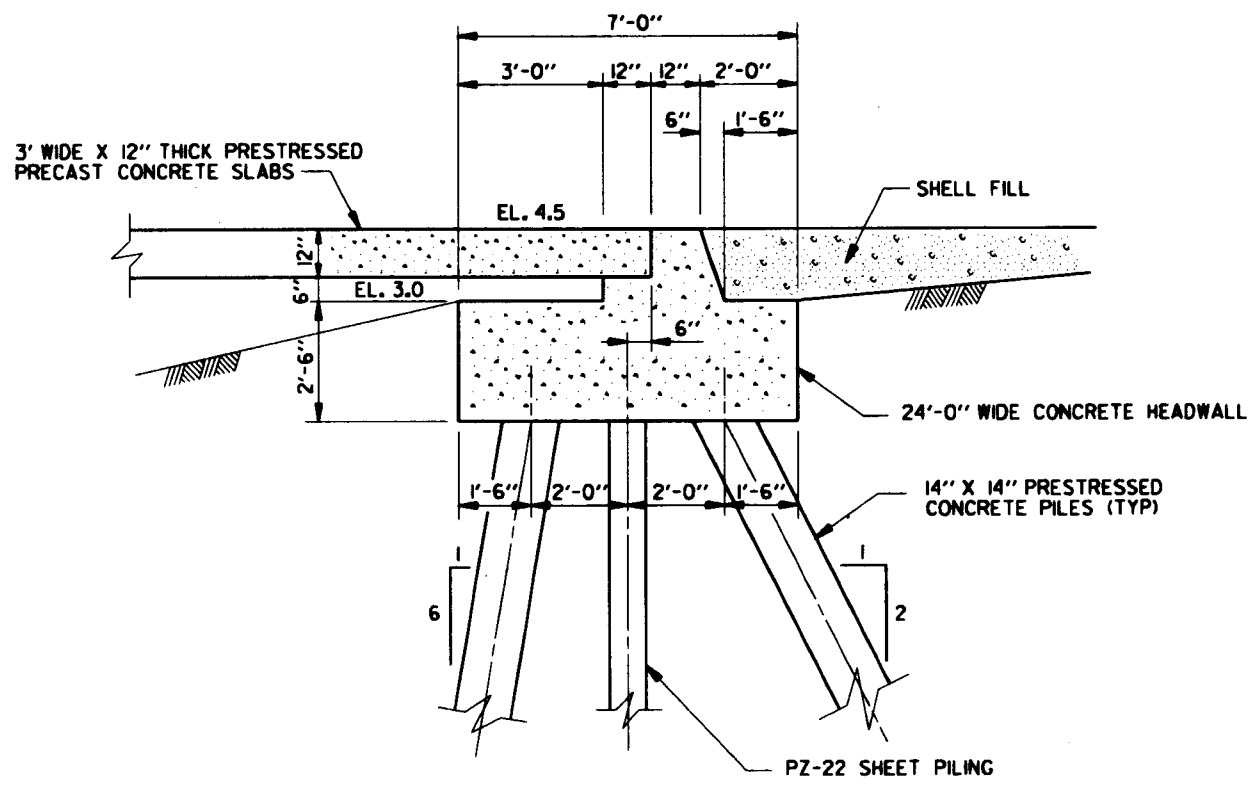

DETAIL 1
SCALE: $\frac{1}{2}'' = 1' - 0''$

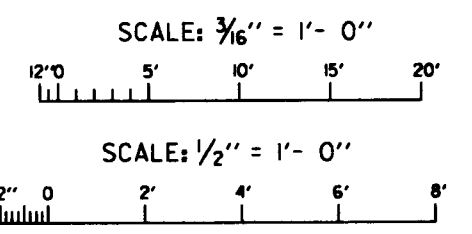

**COMPUTER
AIDED
DESIGN
DRAFTING**

LAKE FORTCHARTRAIN, LA AND VICINITY
HIGH LEVEL PLAN
DESIGN MEMORANDUM NO. 18, GENERAL DESIGN
ST. CHARLES PARISH
NORTH OF AIRLINE HIGHWAY
**BRIDGE VICINITY OF CROSS BAYOU
SECTIONS AND DETAIL**
U. S. ARMY ENGINEER DISTRICT, NEW ORLEANS
CORPS OF ENGINEERS
DATE: JANUARY 1969 FILE NO. H-2-30423

304235B29.DGN

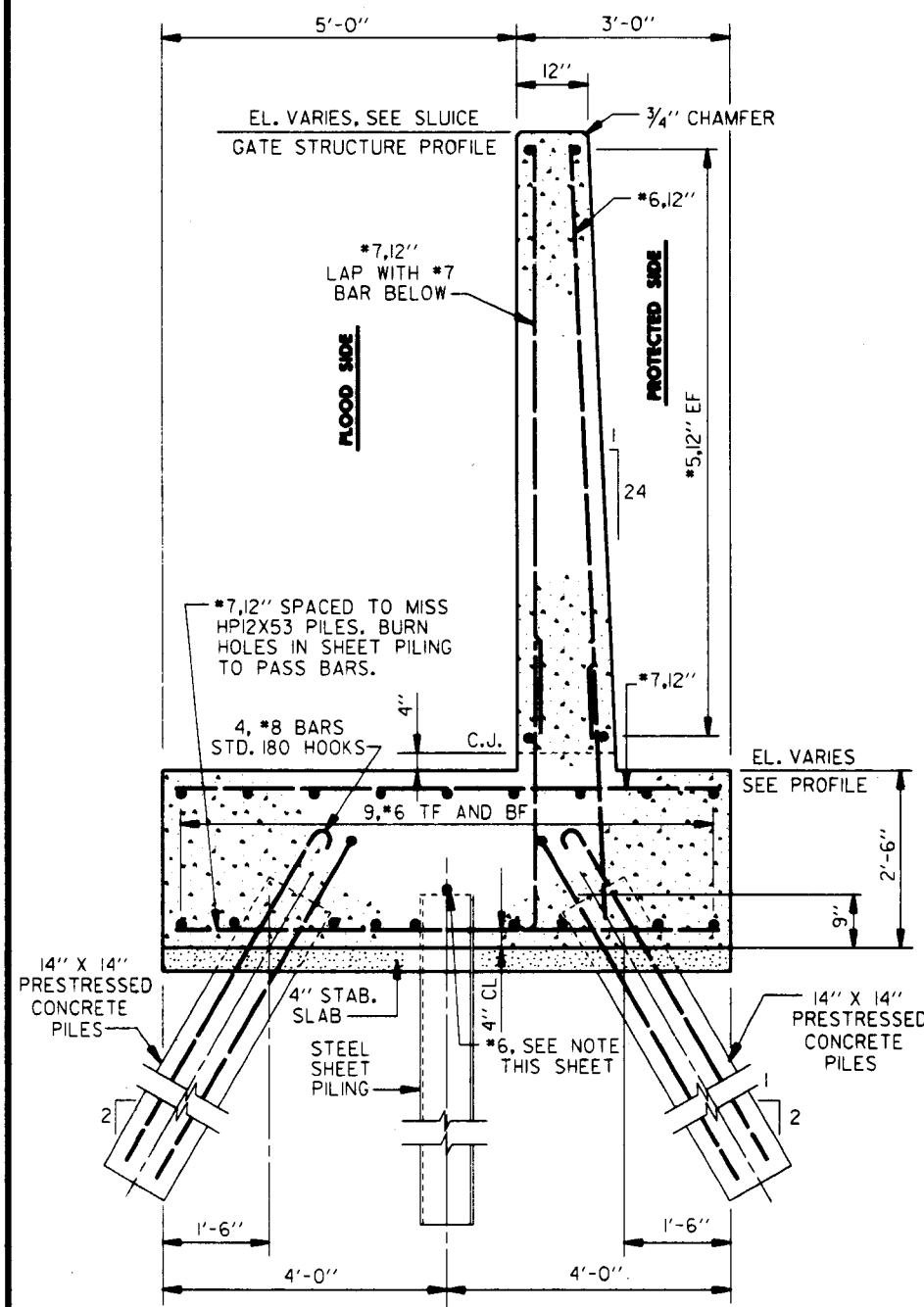

STA. 2+90.50 C/L TO STA. 3+24.50 C/L
 STA. 4+85.50 C/L TO STA. 5+19.50 C/L
 STA. 254+08.20 C/L TO STA. 255+18.20 C/L
 STA. 257+31.20 C/L TO STA. 258+41.20 C/L
 STA. 326+50.00 B/L TO STA. 327+60.00 B/L
 STA. 329+40.00 B/L TO STA. 330+50.00 B/L
 STA. 452+37.09 C/L TO STA. 453+17.09 C/L
 STA. 454+96.09 C/L TO STA. 455+76.09 C/L
 STA. 514+32.60 C/L TO STA. 515+12.60 C/L
 STA. 516+91.60 C/L TO STA. 517+71.60 C/L

TYPICAL T-WALL SECTION
SCALE: 3/4" = 1'-0"

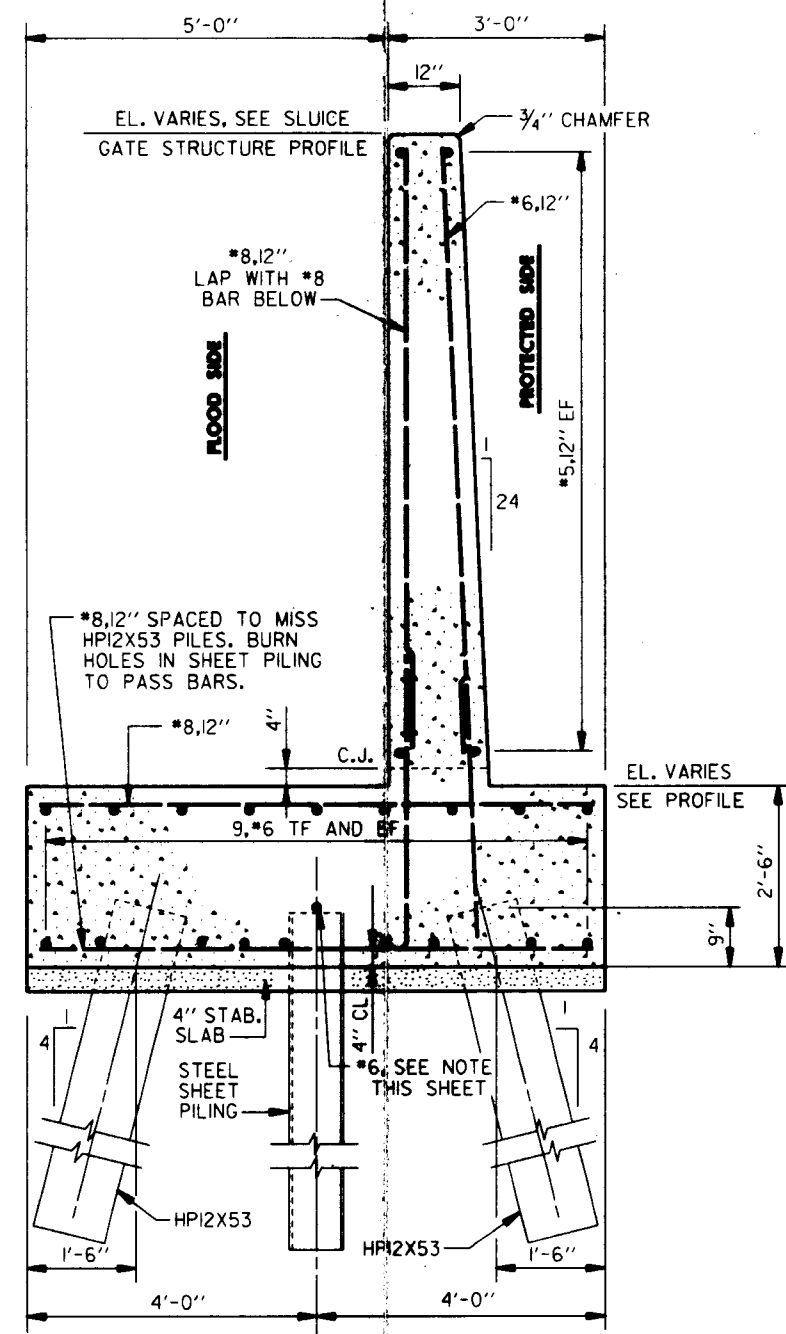

STA. 3+24.50 C/L TO STA. 3+92.50 C/L
 STA. 4+17.50 C/L TO STA. 4+85.50 C/L
 STA. 255+18.20 C/L TO STA. 255+98.20 C/L
 STA. 256+51.20 C/L TO STA. 257+31.20 C/L
 STA. 327+60.00 B/L TO STA. 328+40.00 B/L
 STA. 328+60.00 B/L TO STA. 329+40.00 B/L
 STA. 515+12.60 C/L TO STA. 515+92.60 C/L
 STA. 516+11.60 C/L TO STA. 516+91.60 C/L

TYPICAL T-WALL SECTION
SCALE: 3/4" = 1'-0"

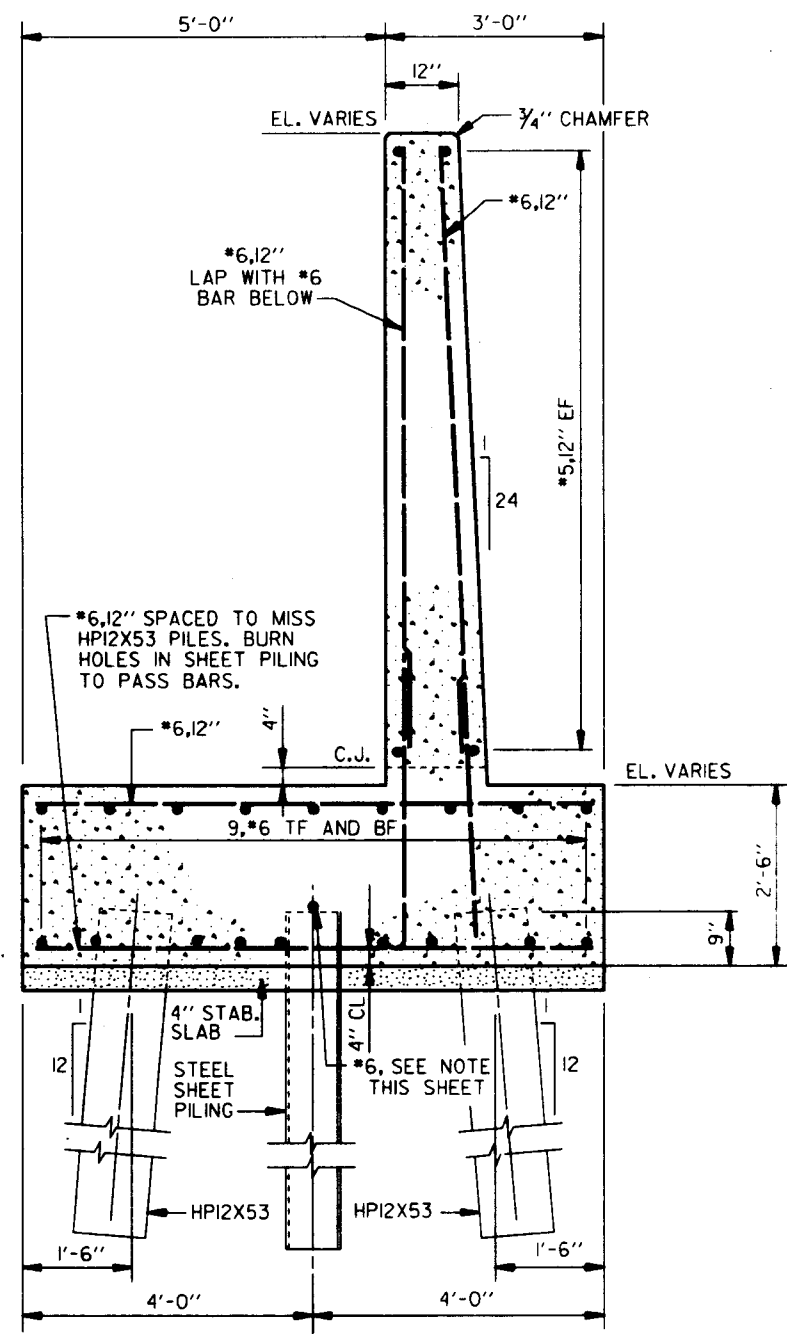

TYPICAL WING WALL SECTION AT SLUICE GATE STRUCTURES
SCALE: 3/4" = 1'-0"

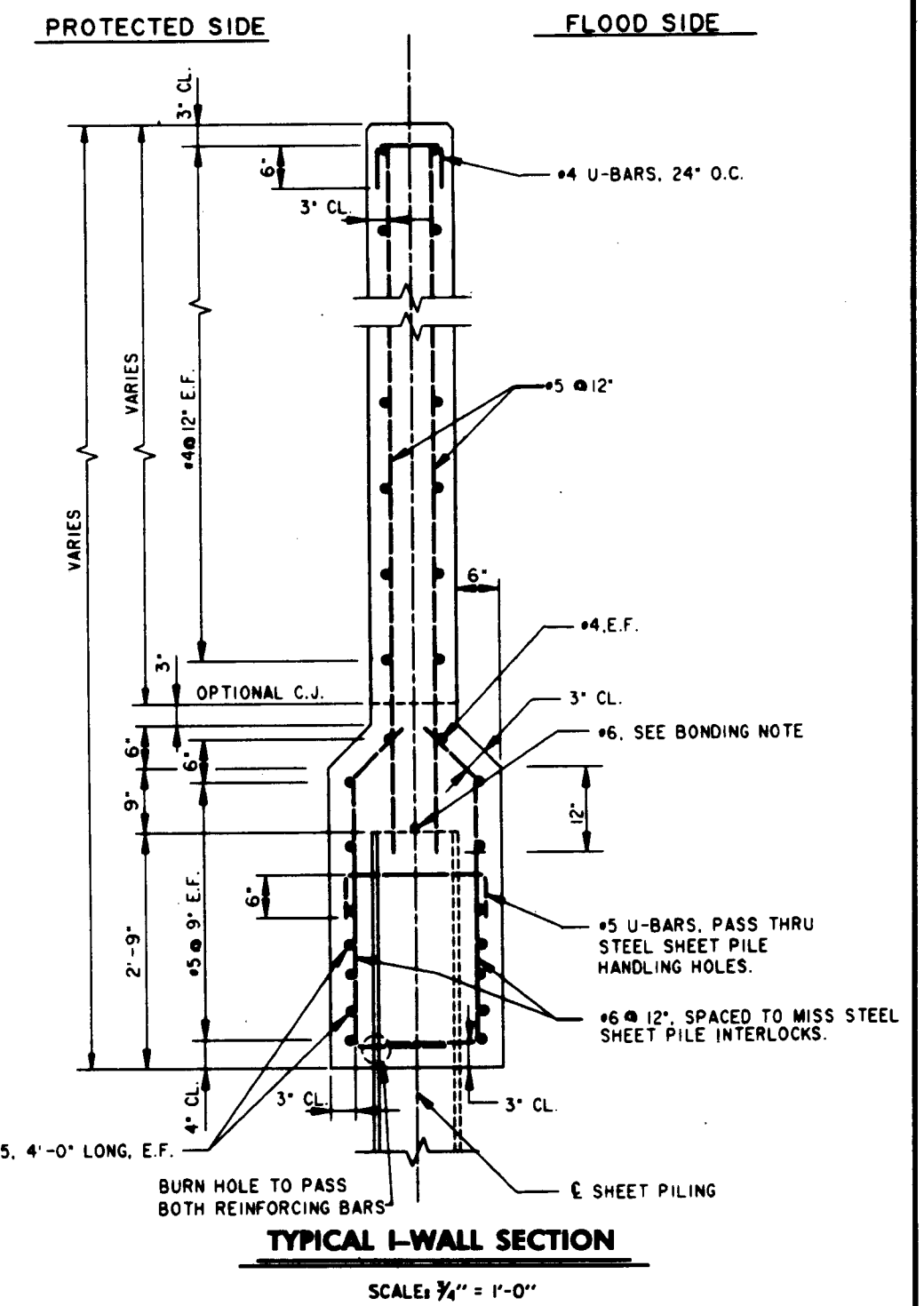
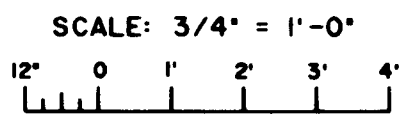

TYPICAL I-WALL SECTION
SCALE: 3/4" = 1'-0"

BONDING NOTE:
 #6 REINFORCING BAR SHALL BE WELDED ACROSS THE TOP OF EACH SHEET PILE. #6 REINFORCING BAR SHALL NOT EXTEND ACROSS THE MONOLITH JOINT. INSTALL FLEXIBLE JUMPER AT ALL MONOLITH JOINTS. JUMPERS SHALL BE INSULATED NO. 1/0 AWG COPPER TYPE USE INSULATED WITH A MINIMUM OF 95 MILS OF CROSS LINKED POLYETHYLENE IN A 8" DIA. LOOP. JUMPERS SHALL BE WELDED AS SPECIFIED TO ADJACENT STEEL SHEET PILES 3' BELOW THE BOTTOM OF THE CONCRETE CAP. WELDED CONNECTIONS SHALL BE COATED WITH SPLICING EPOXY TO OBTAIN MOISTURE PROOF JOINTS.
 #6 REINFORCING BARS SHALL BE WELDED TO THE LAST THREE SHEET PILING AT EACH END OF THE MONOLITH AS SHOWN FOR CONTINUITY.
 SPLICING OF #6 REINFORCING BAR, EXCEPT THAT SHOWN, WILL NOT BE ALLOWED.

COMPUTER AIDED DESIGN DRAFTING

LAKE FORTCHARTRAIN, LA AND VICINITY
 HIGH LEVEL PLAN
 DESIGN MEMORANDUM NO. 18, GENERAL DESIGN
 ST. CHARLES PARISH
 NORTH OF AIRLINE HIGHWAY
TYPICAL WALL SECTIONS
 U. S. ARMY ENGINEER DISTRICT, NEW ORLEANS
 CORPS OF ENGINEERS
 DATE: JANUARY 1969 FILE NO. H-2-30423

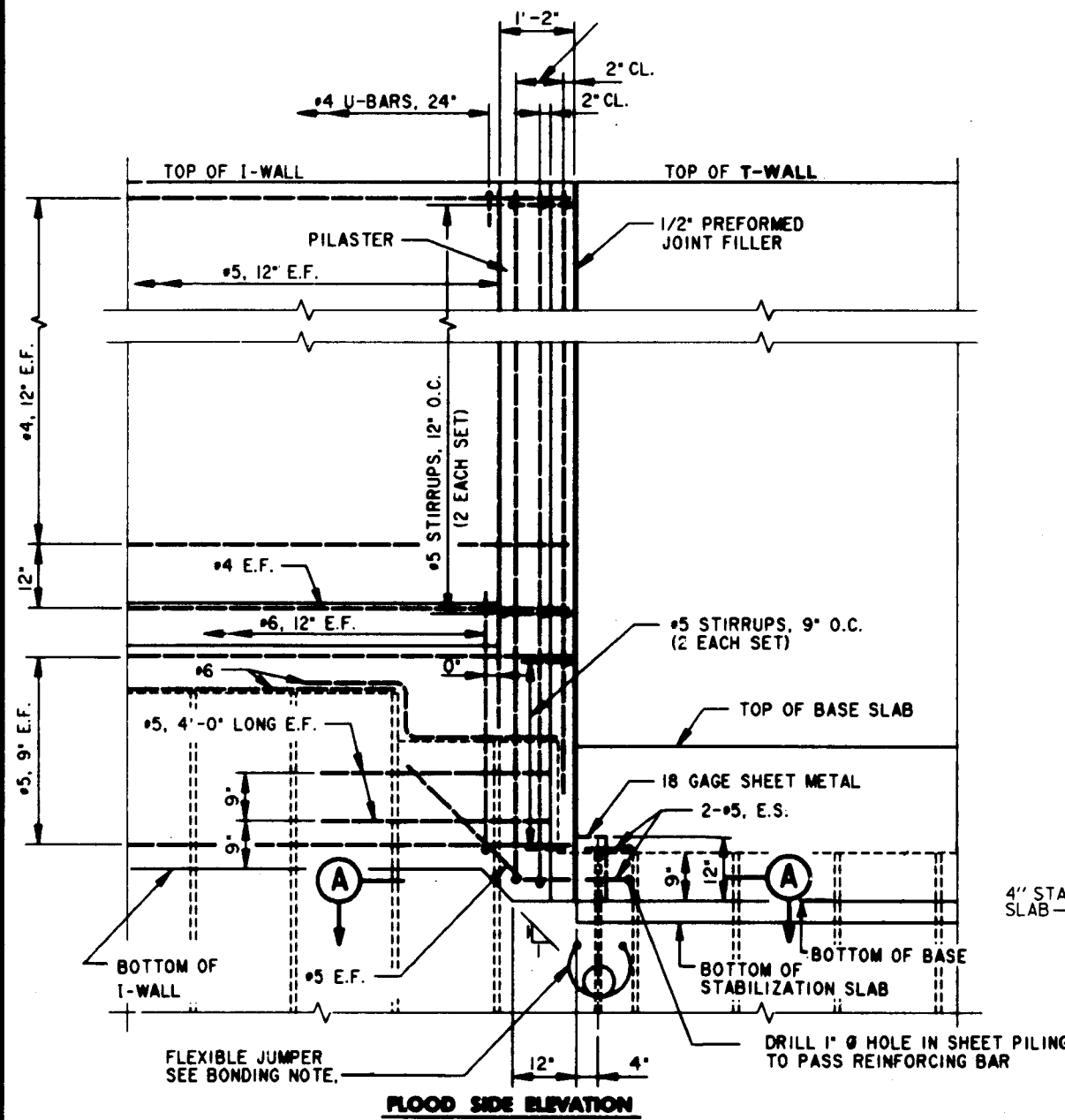

REINFORCEMENT - I-WALL TO T-WALL
SCALE: 3/4" = 1'-0"

BONDING NOTE:
#6 REINFORCING BAR SHALL BE WELDED ACROSS THE TOP OF EACH SHEET PILE. #6 REINFORCING BAR SHALL NOT EXTEND ACROSS THE MONOLITH JOINT. INSTALL FLEXIBLE JUMPER AT ALL MONOLITH JOINTS. JUMPERS SHALL BE INSULATED NO. 1/0 AWG COPPER TYPE USE INSULATED WITH A MINIMUM OF 95 MILS OF CROSS LINKED POLYETHYLENE IN A 8" DIA. LOOP. JUMPERS SHALL BE WELDED AS SPECIFIED TO ADJACENT STEEL SHEET PILES 3" BELOW THE BOTTOM OF THE CONCRETE CAP. WELDED CONNECTIONS SHALL BE COATED WITH SPLICING EPOXY TO OBTAIN MOISTURE PROOF JOINTS.
#6 REINFORCING BARS SHALL BE WELDED TO THE LAST THREE SHEET PILING AT EACH END OF THE MONOLITH AS SHOWN FOR CONTINUITY.
SPLICING OF #6 REINFORCING BAR, EXCEPT THAT SHOWN, WILL NOT BE ALLOWED.

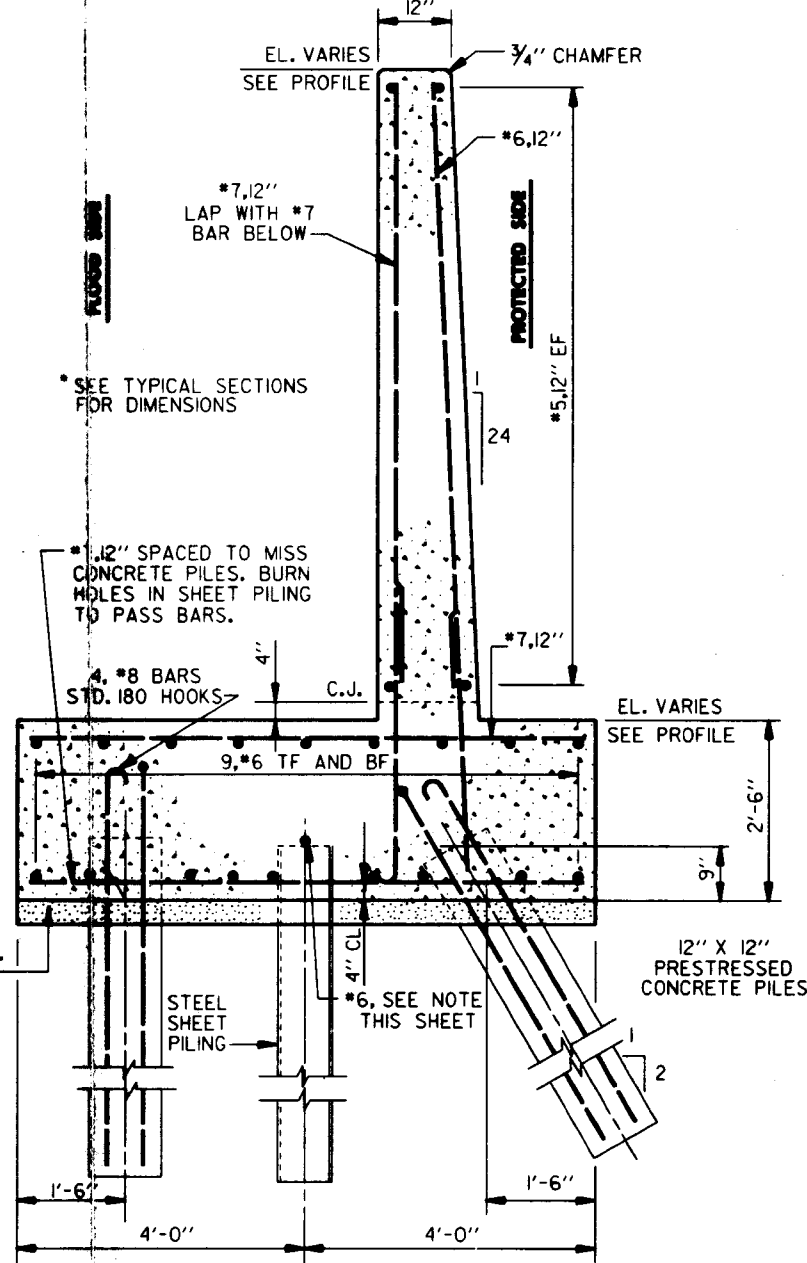

12" X 12" PRESTRESSED CONCRETE PILES
14" X 14" PRESTRESSED CONCRETE PILES

STA. 501+30 W/L TO STA. 502+50 W/L
STA. 502+90 W/L TO STA. 504+10 W/L
STA. 505+30 W/L TO STA. 506+90 W/L
STA. 510+70 W/L TO STA. 511+90 W/L
STA. 514+52 W/L TO STA. 515+32 W/L
STA. 517+71.60 C/L TO STA. 518+11.58 C/L
STA. 518+56.68 C/L TO STA. 518+96.68 C/L

TYPICAL T-WALL SECTION
SCALE: 3/4" = 1'-0"

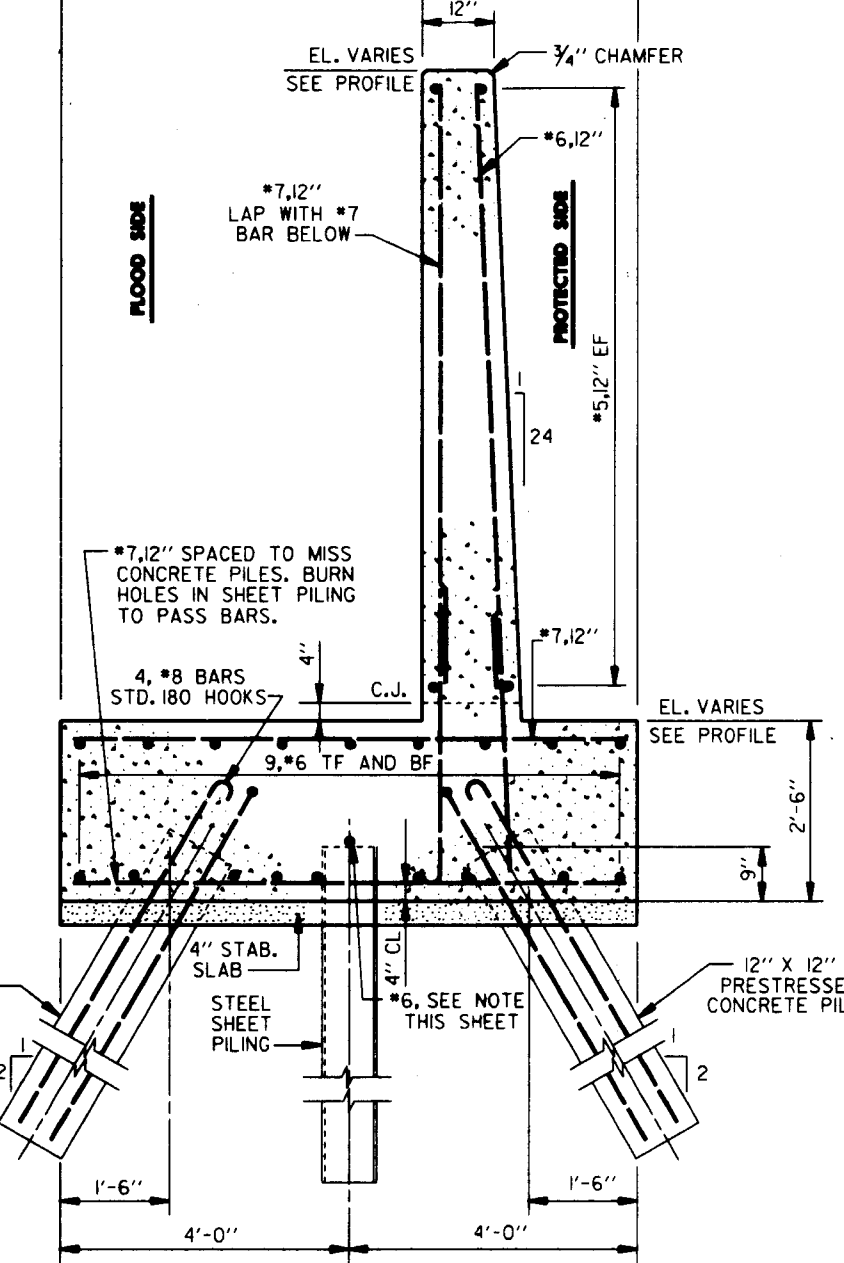

12" X 12" PRESTRESSED CONCRETE PILES
14" X 14" PRESTRESSED CONCRETE PILES

STA. 149+71.70 C/L TO STA. 150+11.70 C/L
STA. 150+45.70 C/L TO STA. 150+85.70 C/L
STA. 502+50 W/L TO STA. 502+90 W/L
STA. 504+10 W/L TO STA. 505+30 W/L
STA. 506+90 W/L TO STA. 507+31 W/L
STA. 510+30 W/L TO STA. 510+70 W/L
STA. 511+90 W/L TO STA. 512+32 W/L
STA. 515+32 W/L TO STA. 516+14 W/L

TYPICAL T-WALL SECTION
SCALE: 3/4" = 1'-0"

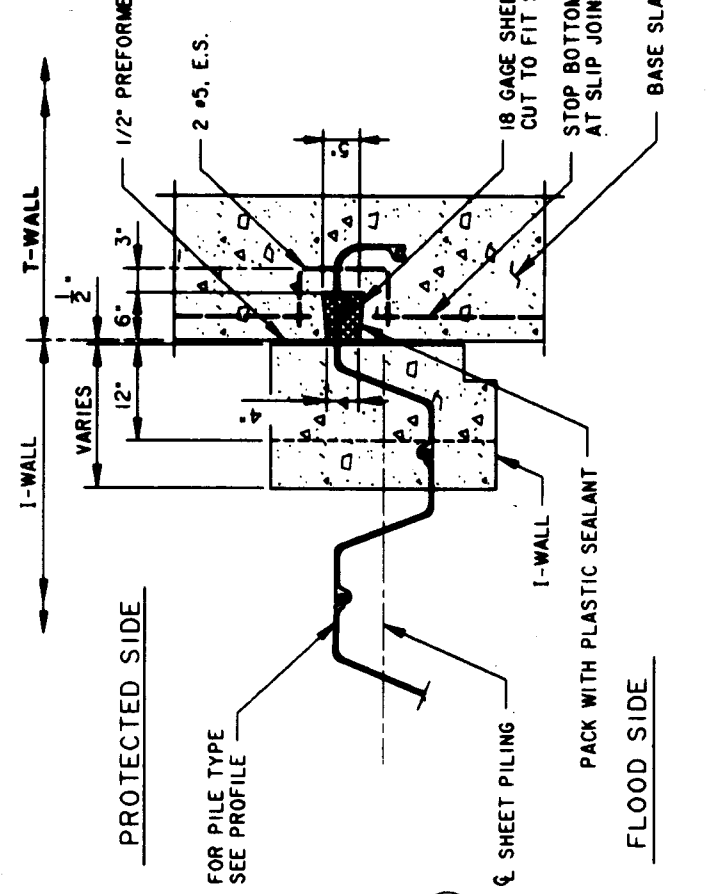

SECTION A
SCALE: 1" = 1'-0"

SCALE: 3/4" = 1'-0"
12" 0 1' 2' 3' 4'
SCALE: 1" = 1'-0"
12" 0 1' 2' 3'

COMPUTER AIDED DESIGN DRAFTING

LAKE FORTCHAPRAH, LA AND VICINITY
EDGE LEVEL PLAN
DESIGN MEMORANDUM NO. 18, GENERAL DESIGN
ST. CHARLES PARISH
NORTH OF AIRLINE HIGHWAY
TYPICAL WALL SECTIONS
U. S. ARMY ENGINEER DISTRICT, NEW ORLEANS
CORPS OF ENGINEERS
DATE: JANUARY 1989 FILE NO. H-2-30423

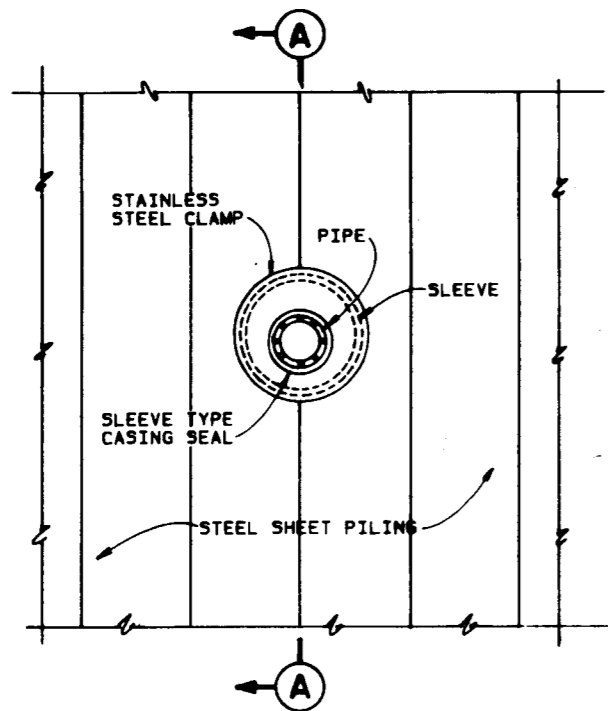

ELEVATION

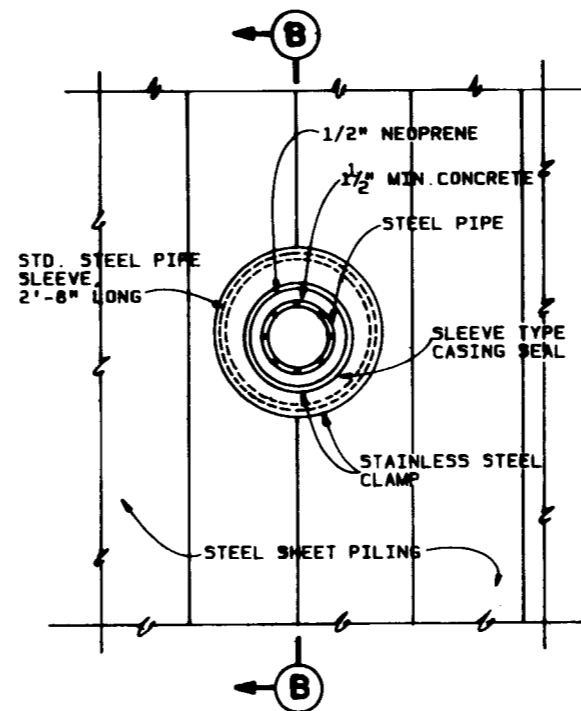

ELEVATION

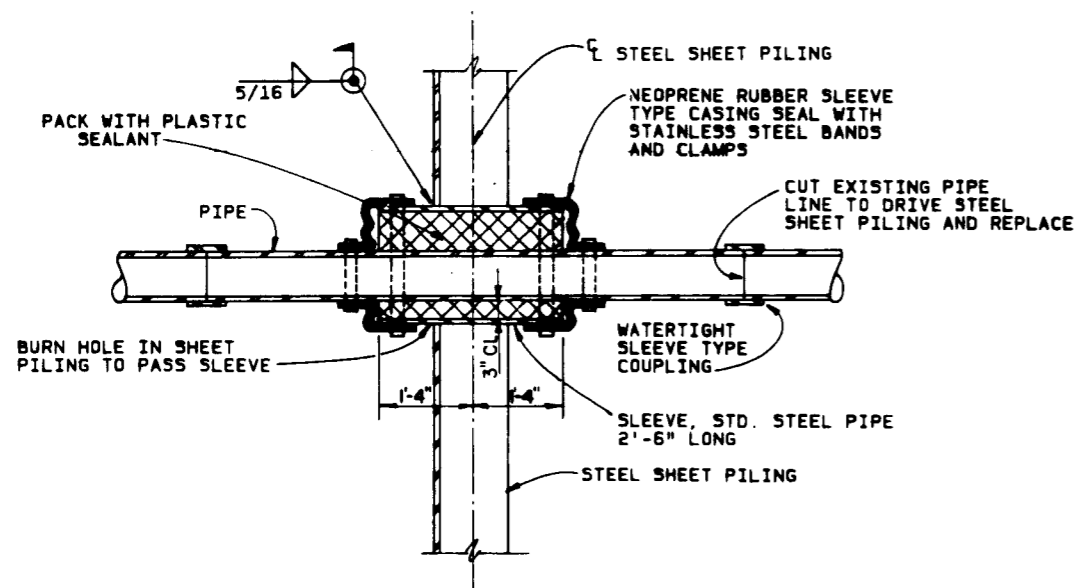

SECTION A
TYPICAL PIPE
THRU STEEL SHEET PILING
SCALE: 3/4" = 1'-0"

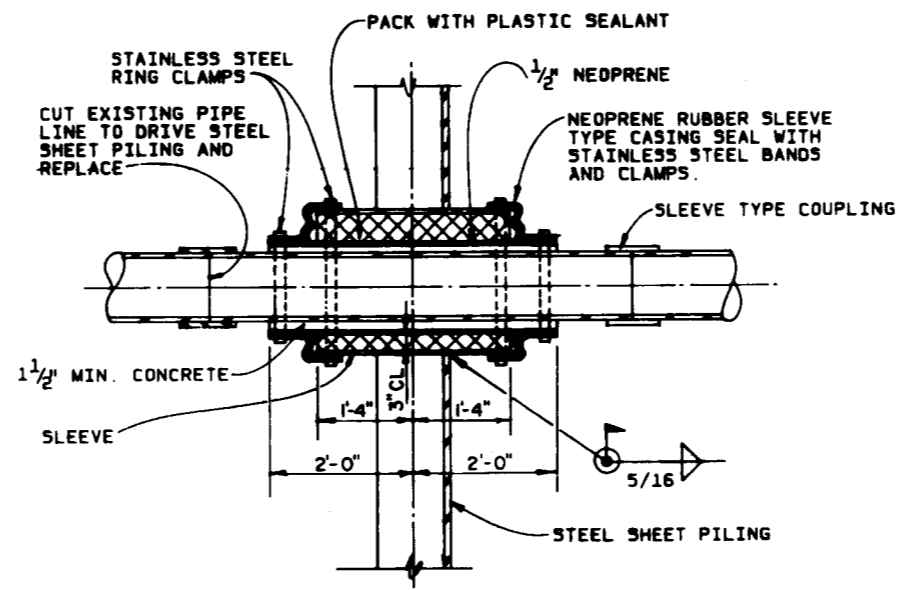

SECTION B
TYPICAL GAS PIPE
THRU STEEL SHEET PILING
SCALE: 3/4" = 1'-0"

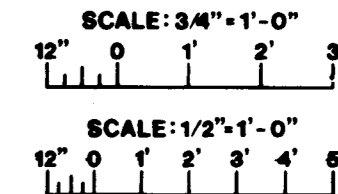

**COMPUTER
AIDED
DESIGN
DRAFTING**

LAKE FORTCHARTRAIN, LA AND VICINITY
HIGH LEVEL PLAN
DESIGN MEMORANDUM NO. 18, GENERAL DESIGN
ST. CHARLES PARISH
NORTH OF AIRLINE HIGHWAY
UTILITY CROSSINGS DETAILS
U. S. ARMY ENGINEER DISTRICT, NEW ORLEANS
CORPS OF ENGINEERS
DATE: JANUARY 1989 FILE NO. H-2-30423

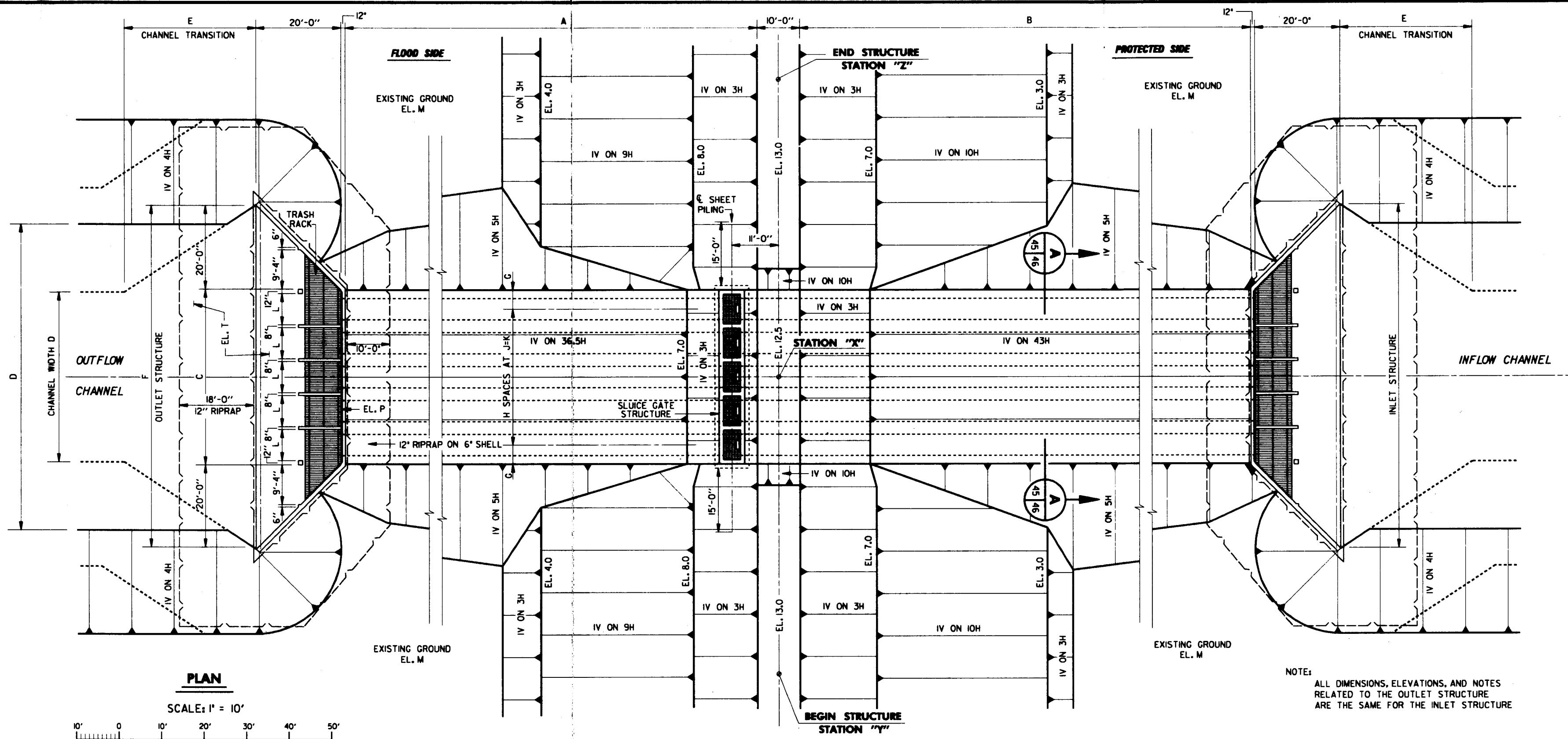

PLAN
SCALE: 1" = 10'

NOTE:
ALL DIMENSIONS, ELEVATIONS, AND NOTES
RELATED TO THE OUTLET STRUCTURE
ARE THE SAME FOR THE INLET STRUCTURE

		SCHEDULE OF ELEVATIONS AND DIMENSIONS																		STATIONING					
LOCATION	CULVERT SIZE	A	B	C	D	E	F	G	H	J	K	L	M	N	P	Q	R	S	T	U	V	W	X	Y	Z
BAYOU TREPAIGNER	5-5' CMP	126'	145'-6"	41'	81'	0'	81'	4'-6"	4	8'	32'	7'-4"	1.5±	4.5	4.0	-4.5	-13.5	-1.5	-3.5	-2.5	-3.5	-5.3	4+05.00 C/L	1+10.50 C/L	5+79.50 C/L
CROSS BAYOU	12-6' CMP	144'-3"	167'	109'	54'	172'	140'	5'	11	9'	99'	8'-4"	1.0±	4.0	3.5	-6.3	-14.0	-3.3	-5.3	-4.3	-5.3	-7.3	256+24.70 C/L	253+48.20 C/L	259+01.20 C/L
ST. ROSE	3-6' CMP	144'-3"	167'	28'	33'-6"	63'	65'	5'	2	9'	18'	8'-4"	1.0±	4.0	3.5	-6.0	-14.0	-3.0	-5.0	-4.0	-5.0	-7.0	328+50.00 B/L	325+90.00 B/L	331+10.00 B/L
WALKER CANAL	2-5' CMP	126'	145'-6"	17'	22'	70'	57'	4'-6"	1	8'	8'	7'-4"	0.5±	4.5	4.0	-4.5	-14.5	-1.5	-3.5	-2.5	-3.5	-5.5	454+06.59 C/L	451+77.09 C/L	456+36.09 C/L
PARISH LINE CANAL	1-4' CMP	126'	145'-6"	8'-6"	33'	31'	48'-6"	4'-3"	-	-	-	6'-10"	0.5±	4.5	4.0	-4.0	-14.5	-1.0	-3.0	-2.0	-3.0	-5.0	516+02.10 C/L	513+72.60 C/L	517+71.60 C/L

COMPUTER
AIDED
DESIGN
DRAFTING

LAKE PORTCHARTRAIN, LA. AND VICINITY
HIGH LEVEL PLAN
DESIGN MEMORANDUM NO. 18, GENERAL DESIGN
ST. CHARLES PARISH
NORTH OF AIRLINE HIGHWAY
ALTERNATIVE PLAN
C.M.P. DRAINAGE STRUCTURES
PLAN
U. S. ARMY ENGINEER DISTRICT, NEW ORLEANS
CORPS OF ENGINEERS
DATE: JANUARY 1989 FILE NO. H-2-30423

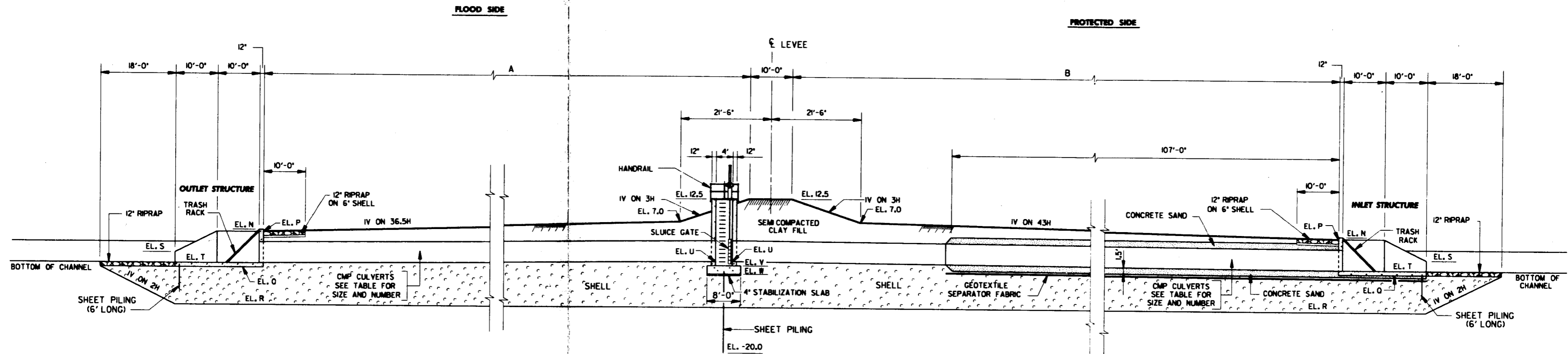

**ALTERNATIVE PLAN
C.M.P. DRAINAGE STRUCTURES
TYPICAL SECTION**

SCALE: 1" = 10'

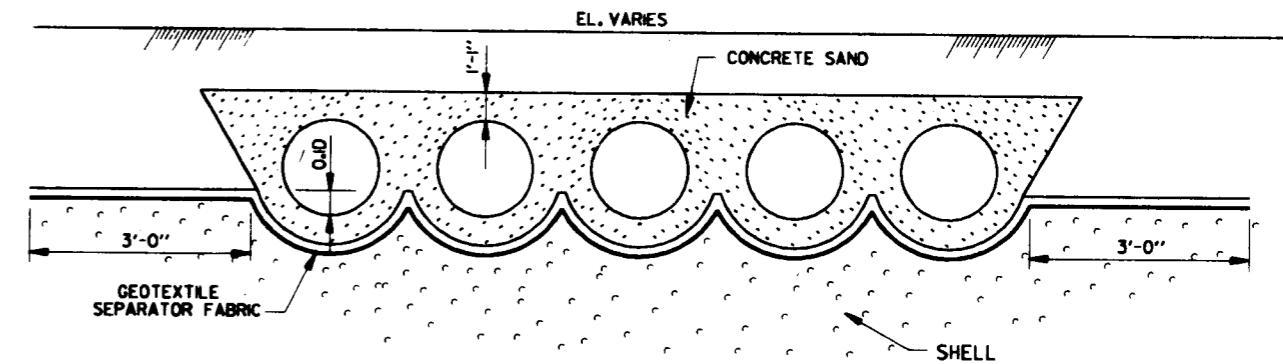

SECTION A

SCALE: 1" = 5'

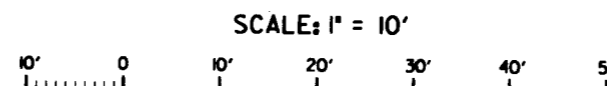
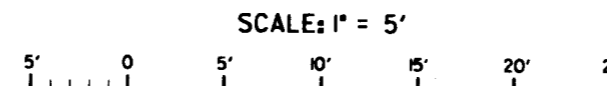

**COMPUTER
AIDED
DESIGN
DRAFTING**

SCHEDULE OF ELEVATIONS AND DIMENSIONS																						
LOCATION	CULVERT SIZE	A	B	C	D	E	F	G	H	J	K	L	M	N	P	Q	R	S	T	U	V	W
BAYOU TIBAGNIER	5'-5" CMP	126'	145'-6"	41'	81'	0'-0"	81'-0"	4'-6"	4	8'-0"	32'	7'-4"	1.5±	4.5	4.0	-4.5	-13.5	-1.5	-3.5	-2.5	-3.5	-5.3
CROSS BAYOU	12'-6" CMP	144'-3"	167'	109'	54'	172'	140'	5'-0"	11	9'-0"	99'	8'-4"	1.0±	4.0	3.5	-6.3	-14.0	-3.3	-5.3	-4.3	-5.3	-7.3
ST. ROSE	3'-6" CMP	144'-3"	167'	28'	33'-6"	63'	65'	5'-0"	2	9'-0"	18'	8'-4"	1.0±	4.0	3.5	-6.0	-14.0	-3.0	-5.0	-4.0	-5.0	-7.0
WALKER CANAL	2'-5" CMP	126'	145'-6"	17'	22'	70'	57'	4'-6"	1	8'-0"	8'-0"	7'-4"	0.5±	4.5	4.0	-4.5	-14.5	-1.5	-3.5	-2.5	-3.5	-5.5
PARISH LINE CANAL	1'-4" CMP	126'	145'-6"	8'-6"	33'	31'	48'-6"	4'-3"	—	—	—	6'-10"	0.5±	4.5	4.0	-4.0	-14.5	-1.0	-3.0	-2.0	-3.0	-5.0

LAKE FORTCHARTRAIN, LA AND VICINITY
HIGH LEVEL PLAN
DESIGN MEMORANDUM NO. 18, GENERAL DESIGN
ST. CHARLES PARISH
NORTH OF AIRLINE HIGHWAY
**ALTERNATIVE PLAN
C.M.P. DRAINAGE STRUCTURES
TYPICAL SECTION**
U. S. ARMY ENGINEER DISTRICT, NEW ORLEANS
CORPS OF ENGINEERS
DATE: JANUARY 1989 FILE NO. H-2-30423

30423SAI3

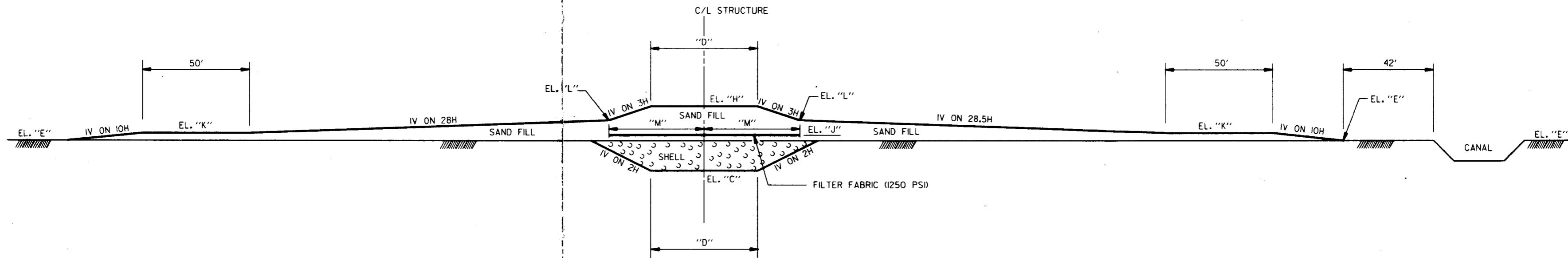

TYPICAL PRELOAD SECTION ALONG CL LEVEL

SCALE: 1" = 20'

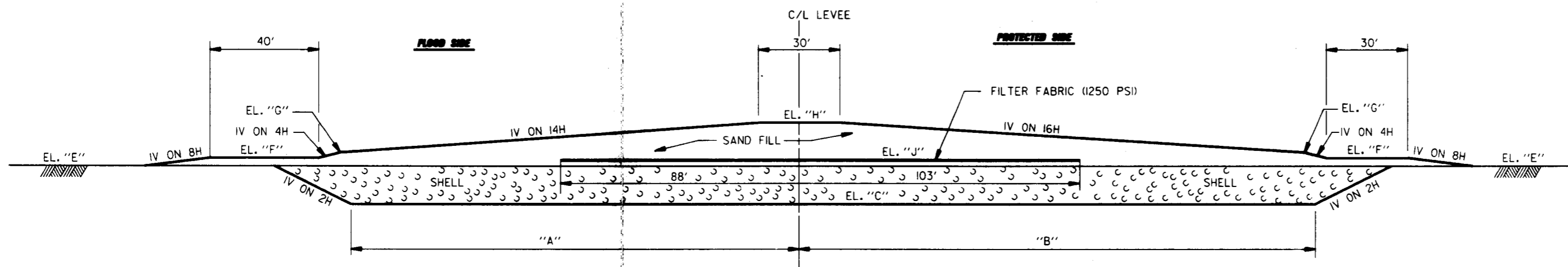

TYPICAL PRELOAD SECTION THRU CL STRUCTURE

SCALE: 1" = 20'

SCHEDULE OF ELEVATIONS AND DIMENSIONS												
LOCATION	A	B	C	D	E	F	G	H	J	K	L	M
BAYOU TRASPASNER	151'	170'-6"	-13.5	41'	1.5±	4.5	6.5	17.5	3.5	5.0	11.0	45'-6"
CROSBY BAYOU	169'-3"	192'	-14.0	109'	1.0±	4.0	6.0	17.0	3.0	4.5	10.5	79'-6"
ST. BOBE	169'-3"	192'	-14.0	28'	1.0±	4.0	6.0	17.0	3.0	4.5	10.5	39'
WALKER CANAL	151'	170'-6"	-14.5	17'	0.5±	3.5	5.5	16.5	2.5	4.0	10.0	33'-6"
PARISH LINE CANAL	151'	170'-6"	-14.5	8'-6"	0.5±	3.5	5.5	16.5	2.5	4.0	10.0	29'-3"

CONSTRUCTION SEQUENCE:

1. DREDGE DOWN TO ELEVATION "C".
2. PLACE SHELL TO ELEVATION "E".
3. PLACE SAND TO ELEVATION "J".
4. INSTALL WICK DRAINS, 3.5' ON CENTER, TO ELEVATION -55 (TRIANGLE LAYOUT) IN AREA= (D+40) X (A+B).
5. PLACE FILTER FABRIC, (1250 PSI CAPACITY).
6. COMPLETE SAND FILL.
7. PRELOAD FOR MINIMUM OF 9 MONTHS.

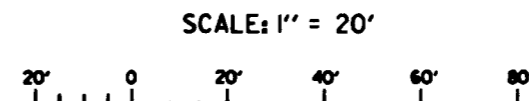

COMPUTER
AIDED
DESIGN
DRAFTING

LAKE FORTCHARTRAIN, LA. AND VICINITY
HIGH LEVEL PLAN
DESIGN MEMORANDUM NO. 18, GENERAL DESIGN
ST. CHARLES PARISH
NORTH OF AIRLINE HIGHWAY
ALTERNATIVE PLAN
C.M.P. DRAINAGE STRUCTURES
PRELOAD SECTIONS
U. S. ARMY ENGINEER DISTRICT, NEW ORLEANS
CORPS OF ENGINEERS
DATE: JANUARY 1969 FILE NO. H-2-30423

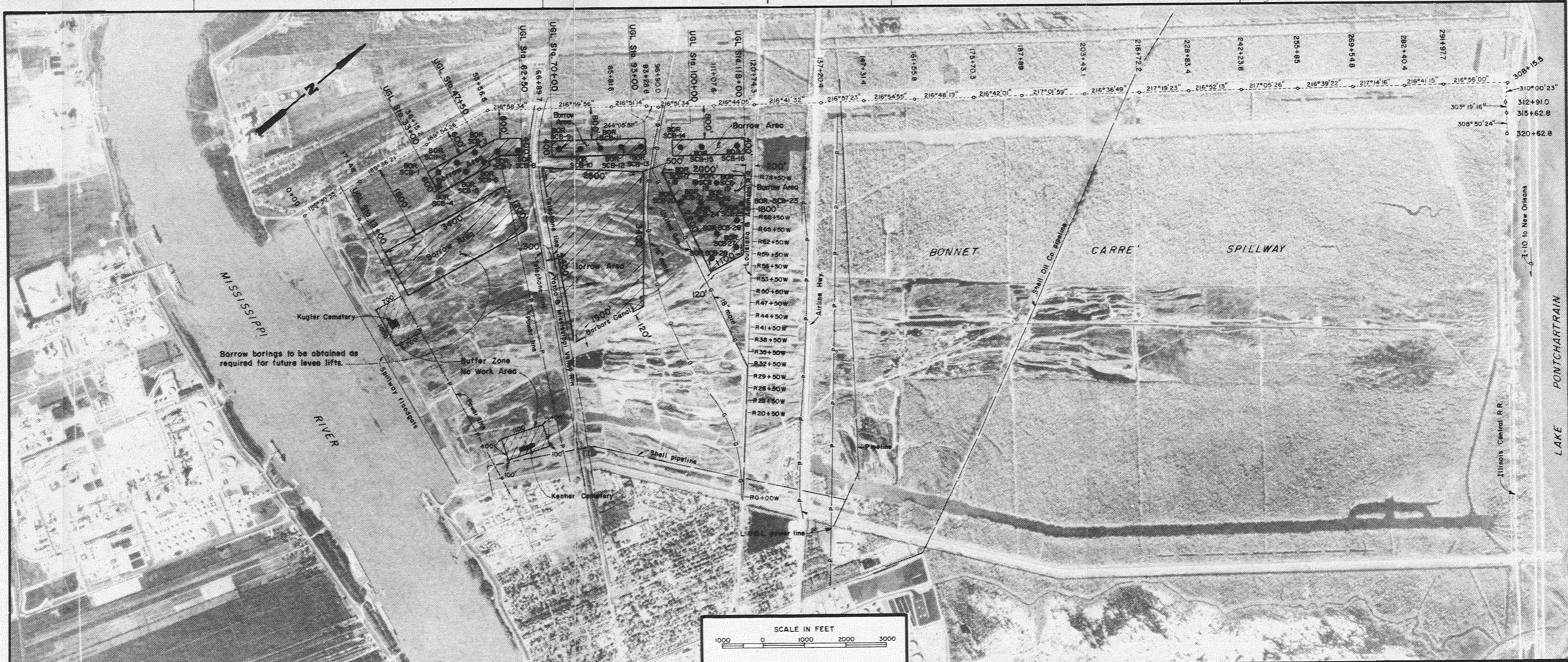

NOTE: See Plates 66 & 67 for borrow boring logs.

REVISION	DATE	DESCRIPTION
LAKE PONTCHARTRAIN, LA. AND VICINITY HIGH LEVEL PLAN DESIGN MEMORANDUM NO. 18 - GENERAL DESIGN ST. CHARLES PARISH NORTH OF AIRLINE HIGHWAY BONNET CARRE' SPILLWAY BORROW SITE U. S. ARMY ENGINEER DISTRICT, NEW ORLEANS CORPS OF ENGINEERS DATE: _____ FILE NO. H-2-30423		

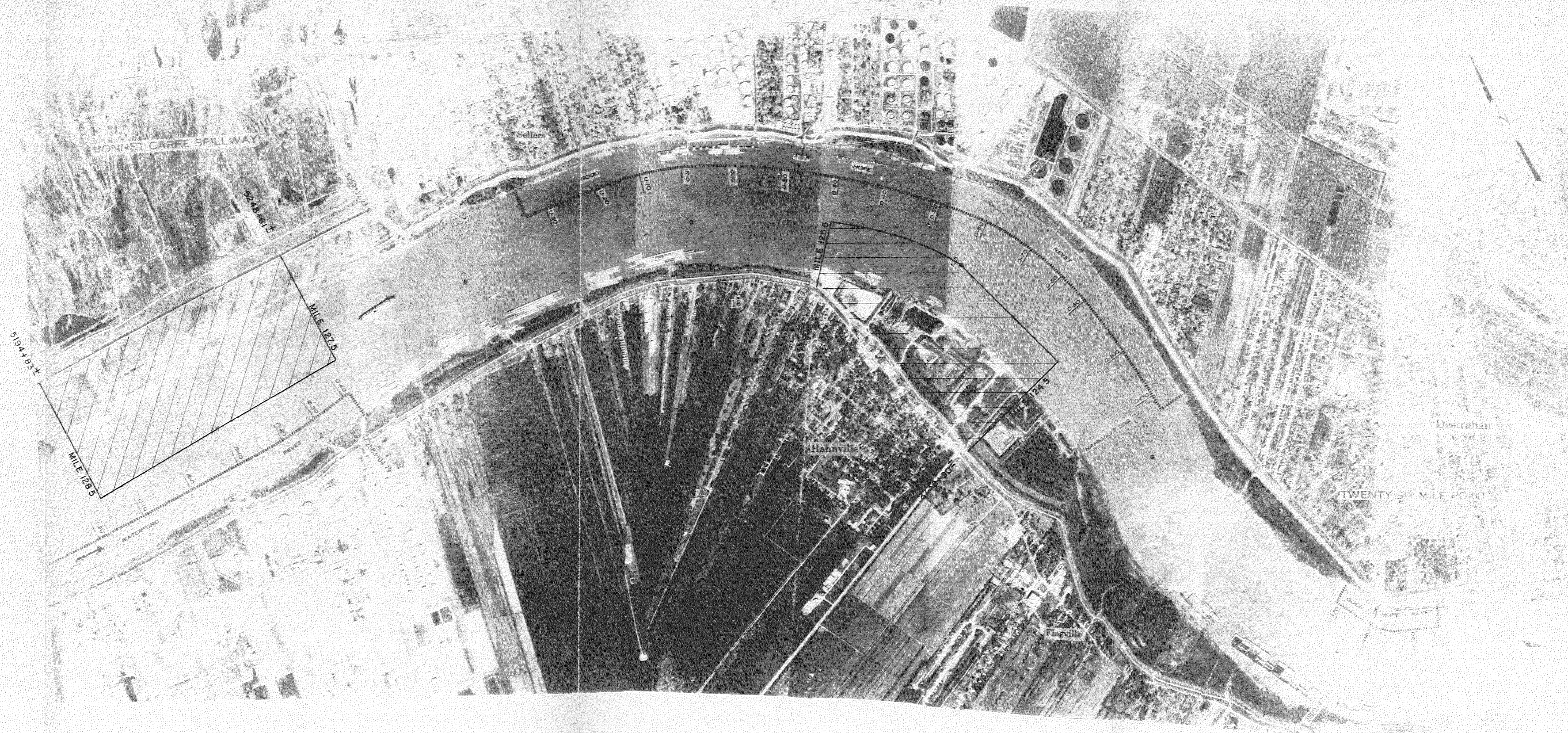

NOTE: BORROW BORING LOCATIONS AND LOGS TO BE FURNISHED AT A LATER DATE.

LAKE PONTCHARTRAIN, LA. AND VICINITY
 HIGH LEVEL PLAN
 DESIGN MEMORANDUM NO. 18 - GENERAL DESIGN
 ST. CHARLES PARISH
 NORTH OF AIRLINE HIGHWAY
**BORROW LOCATIONS
 FOR SAND PITS**
 U. S. ARMY ENGINEER DISTRICT, NEW ORLEANS
 CORPS OF ENGINEERS
 DATE _____ FILE NO. H-2-30423

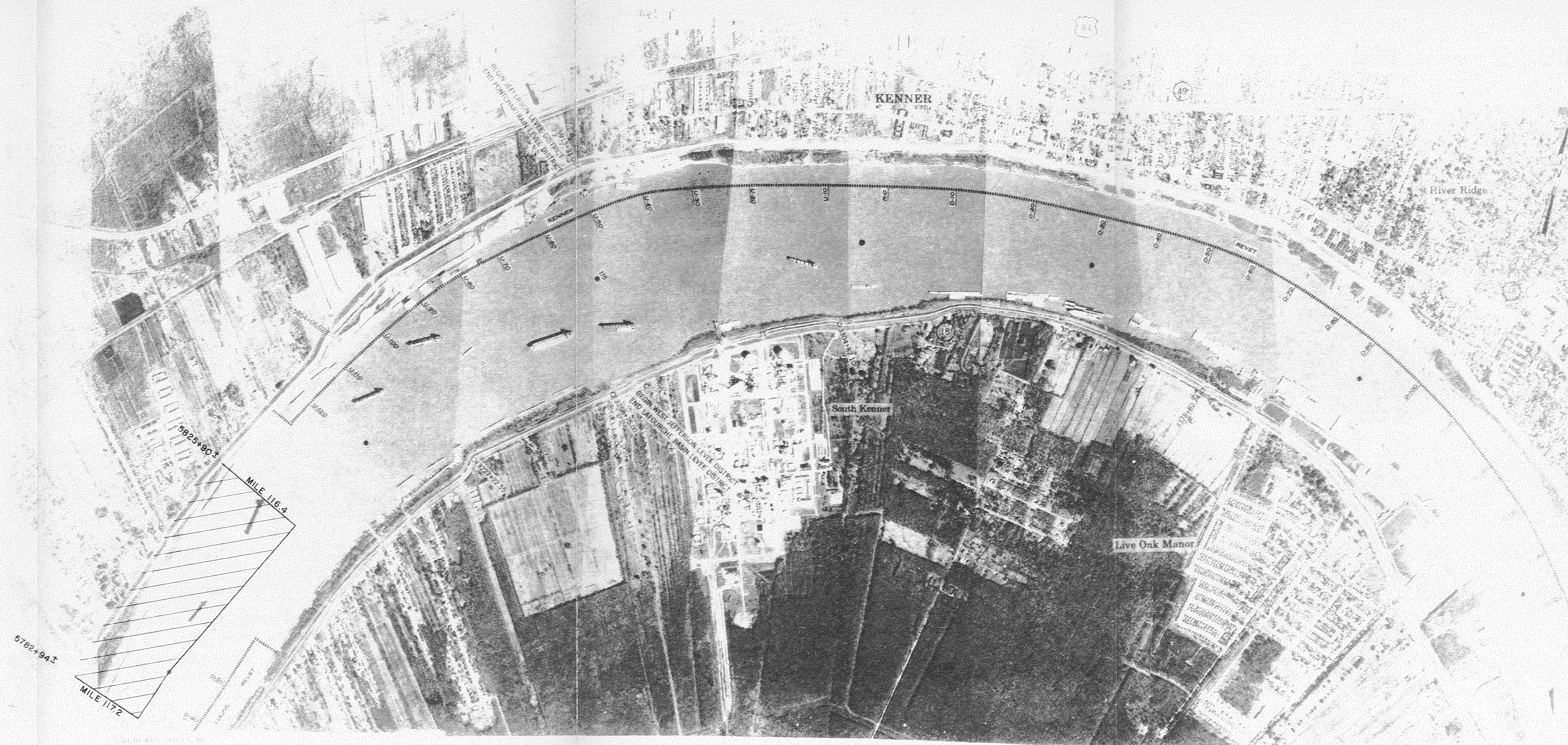

NOTE: BORROW BORING LOCATIONS AND LOGS TO BE FURNISHED AT A LATER DATE.

LAKE PONTCHARTRAIN, LA. AND VICINITY
 HIGH LEVEL PLAN
 DESIGN MEMORANDUM NO. 1B - GENERAL DESIGN
 ST. CHARLES PARISH
 NORTH OF AIRLINE HIGHWAY
**BORROW LOCATIONS
 FOR SAND PITS**
 U. S. ARMY ENGINEER DISTRICT, NEW ORLEANS
 CORPS OF ENGINEERS
 DATE _____ FILE NO. H-2-30423

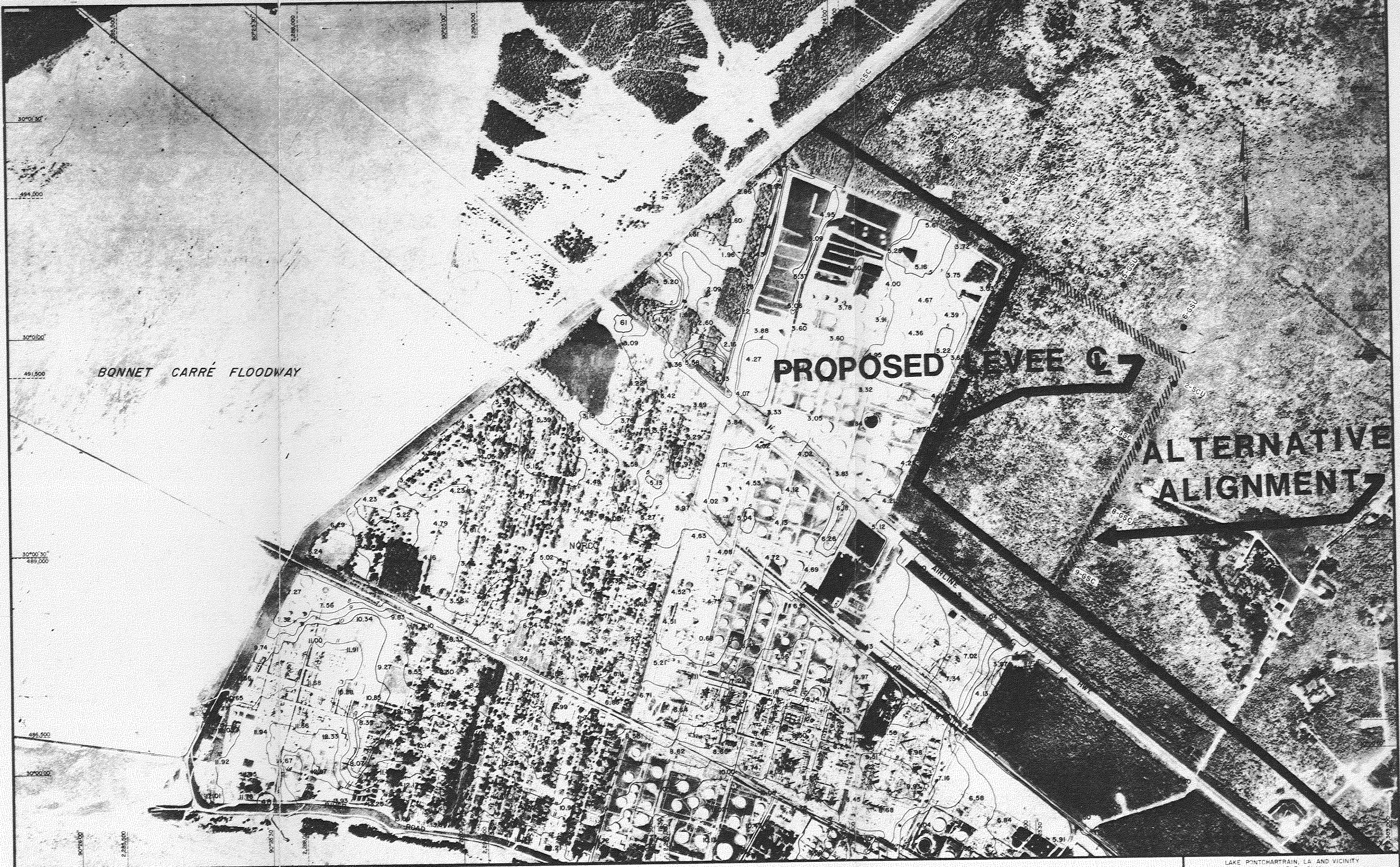

30°01'30"
494,000
30°01'00"
491,500
30°00'30"
489,000
486,500
30°00'00"
484,000
30°58'30"
2,284,000
30°58'00"
2,281,500
30°57'30"
2,279,000

BONNET CARRÉ FLOODWAY

PROPOSED EVEE

ALTERNATIVE ALIGNMENT

NORCO

AIRLINE

SCALE IN FEET
500 0 500 1000 1500

NOTES
INSIDE THE PLAN AREA POLYCONIC PROJECTION-1927
NORTH AMERICAN DATUM IS SHOWN BY SOLID TICKS AND
LAMBERT CONFORMAL CONIC PROJECTION IS SHOWN BY
DASHED TICKS
PREPARED FROM AERIAL PHOTOS FLOWN MAY 1979
DECIMAL POINT OF ELEVATION DENOTES HORIZONTAL POSITION
SPOT ELEVATIONS REFERENCED TO NATIONAL GEODETIC VERTICAL
DATUM OF 1929, 1976-1977 EPOCH

REVISION	DATE	DESCRIPTION	BY

LAKE PONTCHARTRAIN, LA AND VICINITY
HIGH LEVEL PLAN
DESIGN MEMORANDUM NO. 18, GENERAL DESIGN
ST. CHARLES PARISH
NORTH OF AIRLINE HIGHWAY

ALTERNATIVE LEVEE ALIGNMENT

U.S. ARMY ENGINEER DISTRICT, NEW ORLEANS
CORPS OF ENGINEERS
DATE JANUARY 1989 FILE NO. H-2-30423