



U.S. Department of Transportation  
**Federal Highway Administration**

Publication No. FHWA-RD-01-095

---

# **Hydraulics of Dale Boulevard Culverts**

---

**Performance Curve for a Prototype of  
Two Large Culverts in Series**

---

**Dale Boulevard, Dale City, Virginia**

---

Prepared for

**Federal Emergency Management Agency**

**July 2001**

## FOREWORD

This report documents a Turner Fairbank Highway Research Center hydraulic laboratory study that was done for the Federal Emergency Management Agency (FEMA) to develop a performance curve for a prototype of two large culverts in series. This report will be of interest to drainage engineers in several states where culverts in series are used. This report is being distributed as a web document only.

T. Paul Teng, P.E.  
Director, Office of Infrastructure  
Research and Development

## NOTICE

This document is disseminated under the sponsorship of the DOT in the interest of information exchange. The United States Government assumes no liability for its contents or use thereof. this report does not constitute a standard, specification, or regulation.

The United States Government does not endorse products or manufacturers. Trade and manufacturers' names appear in this report only because they are considered essential to the object of the document.

**Technical Report Documentation Page**

1. Report No. FHWA-RD-01-095		2. Government Accession No.		3. Recipient's Catalog No.	
4. Title and Subtitle  Hydraulics of Dale Boulevard Culverts Performance Curve for a Prototype of Two Large Culverts in Series Dale Boulevard, Dale City, Virginia				5. Report Date July , 2001	
				6. Performing Organization Code	
				8. Performing Organization Report No.	
7. Author(s) Edward Umbrell, Ken Young, Christine Estes, Stuart M. Stein, David R. Pearson					
9. Performing Organization Name and Address  GKY and Associates, Inc. 5411-E Backlick Road Springfield, VA 22151				10. Work Unit No. (TRAIS)	
				11. Contract or Grant No.	
				13. Type of Report and Period Covered	
12. Sponsoring Agency Name and Address  Office of Infrastructure Research and Development Federal Highway Administration 6300 Georgetown Pike McLean, VA 22101-2296					
				14. Sponsoring Agency Code	
15. Supplementary Notes  Contracting Officer's Technical Representative (COTR): J. Sterling Jones, HRDI Contributors: Moe Khine, Jeff Smith, and Jeff Gangai, Dewberry, Davis, and Associates, Inc.; John F. Magnotti, Federal Emergency Management Agency					
16. Abstract  Dewberry, Davis, and Associates, Inc. were performing the Neabsco Creek Flood Insurance Study at the Dale Boulevard culvert for FEMA, but had no guidelines for modeling the two culverts in series. A laboratory study was developed to support the FEMA study and evaluate the hydraulics of culverts in series.  This report summarizes model testing performed on a prototype culvert for the purpose of addressing the objective of the FEMA study, which is to determine the base flood elevation upstream of the culvert. A performance curve was developed for the culvert to increase the accuracy of the FEMA study.					
17. Key Words  Culverts, culvert design coefficients, culverts in series, inlet control, outlet control, hydraulic design.			18. Distribution Statement  No restrictions. This document is available to the public through the National Technical Information Service (NTIS), Springfield, VA 22161		
19. Security Classif. (of this report) Unclassified		20. Security Classif. (of this page) Unclassified		21. No. of Pages 53	22. Price

## SI\* (MODERN METRIC) CONVERSION FACTORS

APPROXIMATE CONVERSIONS TO SI UNITS					APPROXIMATE CONVERSIONS FROM SI UNITS				
Symbol	When You Know	Multiply By	To Find	Symbol	Symbol	When You Know	Multiply By	To Find	Symbol
<b>LENGTH</b>					<b>LENGTH</b>				
in	inches	25.4	millimeters	mm	mm	millimeters	0.039	inches	in
ft	feet	0.305	meters	m	m	meters	3.28	feet	ft
yd	yards	0.914	meters	m	m	meters	1.09	yards	yd
mi	miles	1.61	kilometers	km	km	kilometers	0.621	miles	mi
<b>AREA</b>					<b>AREA</b>				
in <sup>2</sup>	square inches	645.2	square millimeters	mm <sup>2</sup>	mm <sup>2</sup>	square millimeters	0.0016	square inches	in <sup>2</sup>
ft <sup>2</sup>	square feet	0.093	square meters	m <sup>2</sup>	m <sup>2</sup>	square meters	10.764	square feet	ft <sup>2</sup>
yd <sup>2</sup>	square yards	0.836	square meters	m <sup>2</sup>	m <sup>2</sup>	square meters	1.195	square yards	yd <sup>2</sup>
ac	acres	0.405	hectares	ha	ha	hectares	2.47	acres	ac
mi <sup>2</sup>	square miles	2.59	square kilometers	km <sup>2</sup>	km <sup>2</sup>	square kilometers	0.386	square miles	mi <sup>2</sup>
<b>VOLUME</b>					<b>VOLUME</b>				
fl oz	fluid ounces	29.57	milliliters	mL	mL	milliliters	0.034	fluid ounces	fl oz
gal	gallons	3.785	liters	L	L	liters	0.264	gallons	gal
ft <sup>3</sup>	cubic feet	0.028	cubic meters	m <sup>3</sup>	m <sup>3</sup>	cubic meters	35.71	cubic feet	ft <sup>3</sup>
yd <sup>3</sup>	cubic yards	0.765	cubic meters	m <sup>3</sup>	m <sup>3</sup>	cubic meters	1.307	cubic yards	yd <sup>3</sup>
NOTE: Volumes greater than 1000 l shall be shown in m <sup>3</sup> .									
<b>MASS</b>					<b>MASS</b>				
oz	ounces	28.35	grams	g	g	grams	0.035	ounces	oz
lb	pounds	0.454	kilograms	kg	kg	kilograms	2.202	pounds	lb
T	short tons (2000 lb)	0.907	megagrams (or "metric ton")	Mg (or "t")	Mg (or "t")	megagrams (or "metric ton")	1.103	short tons (2000 lb)	T
<b>TEMPERATURE (exact)</b>					<b>TEMPERATURE (exact)</b>				
°F	Fahrenheit temperature	5(F-32)/9 or (F-32)/1.8	Celsius temperature	°C	°C	Celsius temperature	1.8C + 32	Fahrenheit temperature	°F
<b>ILLUMINATION</b>					<b>ILLUMINATION</b>				
fc	foot-candles	10.76	lux	lx	lx	lux	0.0929	foot-candles	fc
fi	foot-Lamberts	3.426	candela/m <sup>2</sup>	cd/m <sup>2</sup>	cd/m <sup>2</sup>	candela/m <sup>2</sup>	0.2919	foot-Lamberts	fi
<b>FORCE and PRESSURE or STRESS</b>					<b>FORCE and PRESSURE or STRESS</b>				
lbf	poundforce	4.45	newtons	N	N	newtons	0.225	poundforce	lbf
lbf/in <sup>2</sup>	poundforce per square inch	6.89	kilopascals	kPa	kPa	kilopascals	0.145	poundforce per square inch	lbf/in <sup>2</sup>

\* SI is the symbol for the International System of Units. Appropriate rounding should be made to comply with Section 4 of ASTM E380.

(Revised September 1993)

## Table of Contents

---

<b>INTRODUCTION.....</b>	<b>1</b>
<b>FLOW CONDITIONS AT THE SITE .....</b>	<b>2</b>
<b>MODEL STUDY.....</b>	<b>3</b>
<b>MODEL SCALE .....</b>	<b>6</b>
<b>MODEL RUNS.....</b>	<b>8</b>
<b>LABORATORY AND HEC-2 ANALYSIS .....</b>	<b>9</b>
<b>EVALUATION OF CULVERTS IN SERIES AS A DESIGN ALTERNITIVE .....</b>	<b>14</b>
<b>ANALYZING CULVERTS IN SERIES.....</b>	<b>18</b>
<b>DERIVATION OF DESIGN COEFFICIENTS.....</b>	<b>19</b>
<b>Inlet Control Results.....</b>	<b>19</b>
Unsubmerged Flow .....	20
Submerged Flow .....	20
<b>Outlet Control Results.....</b>	<b>23</b>
<b>Outlet Control Entrance Loss Coefficient .....</b>	<b>24</b>
<b>Friction Loss Coefficient .....</b>	<b>26</b>
<b>Contraction Loss Coefficient .....</b>	<b>27</b>
<b>Exit Loss.....</b>	<b>29</b>
<b>CONCLUSIONS AND RECOMMENDATIONS.....</b>	<b>31</b>
<b>APPENDIX A – REFERENCES .....</b>	<b>33</b>
<b>APPENDIX B – SUMMARY DATA.....</b>	<b>34</b>

## List of Figures

---

Figure 1. View of culvert looking downstream. ....	1
Figure 2. Location of Neabsco Creek, Prince William County, Virginia. ....	2
Figure 3. Test facility set up for Dale Boulevard culvert. ....	4
Figure 4. Inlet of test facility set up for Dale Boulevard culvert. ....	5
Figure 5. Diagram of scaled model set up for the Dale Boulevard culvert. ....	7
Figure 6. Diagram of scaled model set up for the contraction benchmark tests. ....	7
Figure 7. Modeled inlet dimensions for the Dale Boulevard culvert. ....	8
Figure 8. EGL and HGL for experiments with imposed tailwater conditions. ....	10
Figure 9. Culvert performance curve. ....	12
Figure 10. Cross section view of BFE results (100-yr). ....	13
Figure 11. Profile view of BFE results (100-yr). ....	14
Figure 12. Superimposed HGLs for $Q = 1 \text{ ft}^3/\text{s}$ (prototype for $500 \text{ ft}^3/\text{s}$ ). ....	16
Figure 13. Superimposed HGLs for $Q = 2 \text{ ft}^3/\text{s}$ (prototype for $1000 \text{ ft}^3/\text{s}$ ). ....	16
Figure 14. Superimposed HGLs for $Q = 3 \text{ ft}^3/\text{s}$ (prototype for $1500 \text{ ft}^3/\text{s}$ ). ....	17
Figure 15. Superimposed HGLs for $Q = 3.5 \text{ ft}^3/\text{s}$ (prototype for $1750 \text{ ft}^3/\text{s}$ ). ....	17
Figure 16. Superimposed HGLs for $Q = 4 \text{ ft}^3/\text{s}$ (prototype for $2000 \text{ ft}^3/\text{s}$ ). ....	18
Figure 17. EGL analysis through a culvert system. ....	24
Figure 18. Typical EGL analysis used to determine head losses. ....	25
Figure 19. Typical results of benchmark contraction experiments. ....	28
Figure 20. Typical contraction loss with EGL axis amplified. ....	29
Figure 21. Mitered 30-degree wingwall configuration. ....	32

## List of Tables

---

Table 1. Modeled conditions. ....	3
Table 2. Dale City culvert invert elevation. ....	3
Table 3. Experimental test matrix. ....	6
Table 4. Model and prototype discharges and tailwaters. ....	8
Table 5. Water surface elevations upstream of the culvert entrance. ....	11
Table 6. Results of laboratory calibration for HEC-2. ....	12
Table 7. Culvert design coefficients. ....	21
Table 8. Summary of culvert design constants. ....	22
Table 9. Entrance loss coefficients for outlet control. ....	27
Table 10. Contraction loss coefficients for the culverts in series. ....	29
Table 11. Inlet control data. ....	34
Table 12. Outlet control data for entrance loss coefficient. ....	39
Table 13. Summary Data for Full Pipe Contraction Losses. ....	45

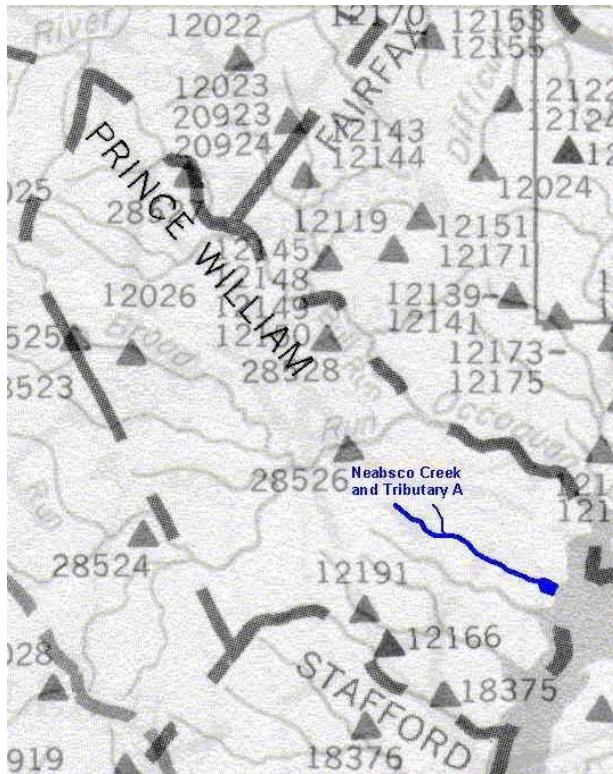
## INTRODUCTION

A special culvert installation in Dale City, Virginia, was the subject of a Federal Emergency Management Agency (FEMA) study that impacted several homeowners upstream of the culvert. The culvert required special consideration because it has two size barrels connected in series with the inverts aligned. The upstream 25-ft (7.6-m) length of 10.5-ft (3200-mm) diameter concrete pipe is connected in series to a 163-ft (49.7-m) length of 9.5-ft (2896-mm) diameter concrete pipe. Figure 1 shows a view looking downstream through this culvert.



**Figure 1. View of culvert looking downstream.**

The culvert was designed by the Virginia Department of Transportation (VDOT) for the Dale Boulevard crossing of Neabsco Creek tributary A. Figure 2 depicts the location of this tributary in Prince William County.



**Figure 2. Location of Neabsco Creek, Prince William County, Virginia.**

The culvert could be considered a low-cost improved inlet design, but there are no guidelines for evaluating the hydraulics of culverts connected in series either in the FHWA’s Hydraulic Design Series No. 5 (HDS-5), “Hydraulic Design of Culverts,” or in the Corps of Engineers HEC-RAS computer program. An issue in the FEMA study was whether the 9.5-ft (2896-mm) barrel or the 10.5-ft (3200-mm) barrel controlled the headwater depth upstream of the culvert. Moreover, the inlet to the 10.5-ft (3200-mm) barrel is a commonly used 45-degree flared-end section that is not specifically covered by HDS-5 or HEC-RAS.

Consultants to FEMA recommended a model study of the culvert at the Federal Highway Administration (FHWA) Hydraulic Laboratory located at the Turner Fairbank Highway Research Center (TFHRC). The immediate objective of the model study was to resolve the floodplain boundary issue for the Dale City site. The long-range research objectives were to evaluate the effectiveness of culverts in series as an improved inlet concept, to develop a design strategy for culvert barrels connected in series and to determine design coefficients for a commonly used pre-cast flared-end section for circular pipe.

## **FLOW CONDITIONS AT THE SITE**

FEMA’s consultants provided data from the FEMA study for the Neabsco Creek Flood Insurance Study (FIS) at the Dale Boulevard culvert. These data are listed in table 1.



**Table 1. Modeled conditions.**

Discharge (ft <sup>3</sup> /s)	Return Period (yrs)	HEC-2 Modeled	Scale Modeled	Tailwater Depth above downstream invert of culvert (ft)	Tailwater Elevation (ft)
500			X	6.86	222.96
939	5	X			
1000			X	7.88	223.98
1279	50	X			
1418	100	X			
1500			X	8.72	224.92
1750			X	9.24	225.34
1861	500	X			
2000			X	9.56	225.66

1 ft = 0.305 m, 1 ft<sup>3</sup>/s = 0.028 m<sup>3</sup>/s

Culvert invert elevations provided by FEMA’s consultants are listed in table 2.

**Table 2. Dale City culvert invert elevation.**

Location	Culvert Invert Elev. (ft)	Length (ft)
Downstream end of 9.5-ft barrel	216.1	163
Junction of two barrels	218.55	
Upstream end of 10.5-ft barrel	218.93	25

1 ft = 0.305 m

The average slope of the culvert invert is 1.5 percent which is steep enough to expect that the culvert could be in inlet control where changes to the entrance might significantly influence the headwater elevations.

Preliminary HEC-2 runs for the base 100-yr flood indicated that the water surface elevations upstream of the culvert might vary between 235.96 ft (71.921 m) and 239.94 ft (73.134 m) depending on what assumptions were made for the culvert headwater control conditions. That 4-ft difference in water-surface elevations upstream of the culvert was enough to determine whether or not several homes were in or out of the floodplain. The water-surface elevation for the base flood, the base flood elevation (BFE), that would result in a determination that those homes are out of the floodplain was around 237.6 ft (72.328 m).

## MODEL STUDY

The model study was initiated as an agreement among the FHWA hydraulics laboratory, FEMA’s project manager, and their consultants.

The culvert test facility was already in place included an 8-ft by 8-ft (2.43-m by 2.43-m) head box, a 4-ft- (1.219-m)-wide by 10-ft- (3.480-m)-long tail box with a manually adjustable tailgate to control tailwater depths and a 5.0-ft<sup>3</sup>/s (0.14-m<sup>3</sup>/s) pump to provide various flows through the test facility. Different entrance sections can be installed in the head box and various culvert models can be installed between the head box and the tail box. Figure 3 shows the culvert test facility set up to model the Dale Boulevard culvert.



**Figure 3. Test facility set up for Dale Boulevard culvert.**

Figure 4 is a detailed view showing the culvert inlet, which is comparable to the view of the actual culvert inlet in figure 1.



**Figure 4. Inlet of test facility set up for Dale Boulevard culvert.**

Pressure ports were installed in the head box along the inverts of the culvert models and in the tail box. Pressure lines were connected to a single differential pressure transducer through a valving manifold. Each pressure port was monitored by the same transducer to avoid electronic sensor drift problems. The differential pressure readings were related to a static standpipe so that the relative hydraulic grade line (HGL) elevations could be plotted directly from the pressure port readings; atmospheric pressure or other variations led to slightly different datums from day to day. Velocities used to determine the corresponding energy grade line (EGL) elevations were calculated by dividing the pump discharge by the flow area based on the pressure port readings. No direct velocity measurements were made inside the culvert models. Entrance losses and contraction losses for the system were calculated from the EGL information.

One series of tests modeled the culvert configuration as it existed and simulated the discharges and the corresponding tailwater depths for this site to resolve the floodplain boundary issue for FEMA. This test series was labeled “dbvarTW” to indicate that the tailwater (TW) varied with the discharge according to the information that was supplied by Dewberry Davis and Assoc. Benchmark tests, which modeled full-length single diameter 9.5-ft (2895-mm) and 10.5-ft (3200-mm) culvert barrels, were conducted to demonstrate where and by how much the enlarged end segment affected the headwater elevations. Comparing the Dale Boulevard configuration to these benchmark configurations run with the same discharges and tailwater conditions was an

effective way to illustrate whether the Dale Boulevard culvert was controlled by the short entrance pipe segment or the long, smaller-diameter segment. Other tests were run for different tailwater conditions for the research objective of deriving design coefficients and loss coefficients for general applications.

Table 3 summarizes the experimental conditions and the objectives of laboratory testing for this study.

**Table 3. Experimental test matrix.**

Test Series	TW conditions	Objective
Dale Boulevard, 10.5S/9.5L	As specified for each discharge	Resolve headwater elevations for the FEMA study
10.5-ft benchmark	As specified for each discharge	Compare with Dale Boulevard series
9.5-ft benchmark	As specified for each discharge	Compare with Dale Boulevard series
10.5-ft benchmark	Low	Derive inlet control regression coefficients, K <sub>2</sub> , M <sub>2</sub> , c, and Y for the 45-degree flared entrance section for the concrete pipe
9.5-ft benchmark	Low	Derive inlet control coefficients for the 45-degree flared entrance section for the concrete pipe
10.5-ft benchmark	High to submerge entrance	Derive outlet control entrance loss coefficient, K <sub>e</sub>
9.5-ft benchmark	High to submerge entrance	Derive outlet control entrance loss coefficient, K <sub>e</sub>
Contraction benchmark, 10.5L/9.5L	Varied	Isolate the contraction loss for the junction of two pipes in series

1 ft = 0.305 m

The laboratory readings for the results presented in this report are in data files located in the Turner Fairbank Hydraulic Laboratory.

## MODEL SCALE

A 1:12 Froude model scale was selected to optimize the pumping capacity for the test facility. The 1:12 scale happens to be convenient because the hydraulic roughness of concrete pipe scales approximately to the hydraulic roughness of acrylic tubing at this scale. The 1:12 scale is convenient because the length dimensions, including the HGL and EGL elevations, map directly from inches in the model to feet in the prototype.

The following Froude Number scaling ratios were used:

$$L_R = \frac{L_m}{L_p} = \frac{1}{12} \text{ (selected)}$$

$$Dia_R = \frac{Dia_m}{Dia_p} = L_R = \frac{1}{12}$$

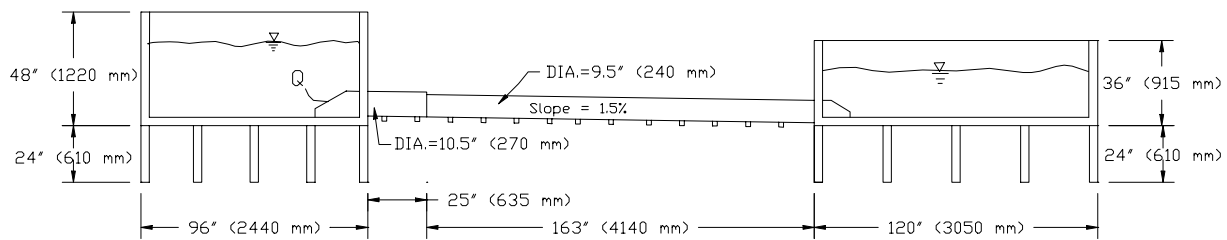
$$V_R = \frac{V_m}{V_P} = L_R^{1/2} = \left(\frac{1}{12}\right)^{1/2} = \frac{1}{3.5}$$

$$Q_R = \frac{Q_m}{Q_P} = V_R L_R^2 = L_R^{5/2} = \frac{1}{500}$$

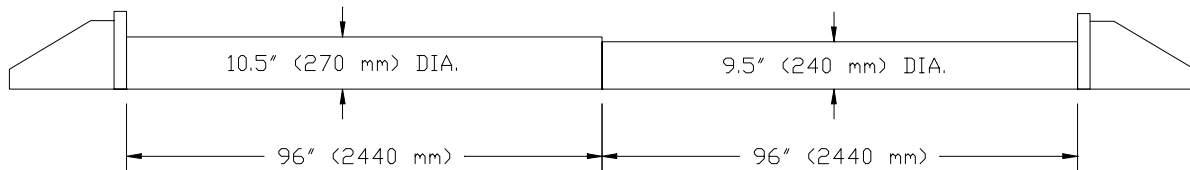
where:

$L_R$ = Length Ratio	$L_m$ = Model Length	$L_P$ = Prototype Length
$Dia_R$ = Diameter Ratio	$Dia_m$ = Model Diameter	$Dia_P$ = Prototype Diameter
$V_R$ = Velocity Ratio	$V_m$ = Model Velocity	$V_P$ = Prototype Velocity
$Q_R$ = Flow Ratio	$Q_m$ = Model Flow	$Q_P$ = Prototype Flow

Figures 5 and 6 depict diagrams of the scaled model set up for the Dale Boulevard and the contraction benchmark set-ups respectively.

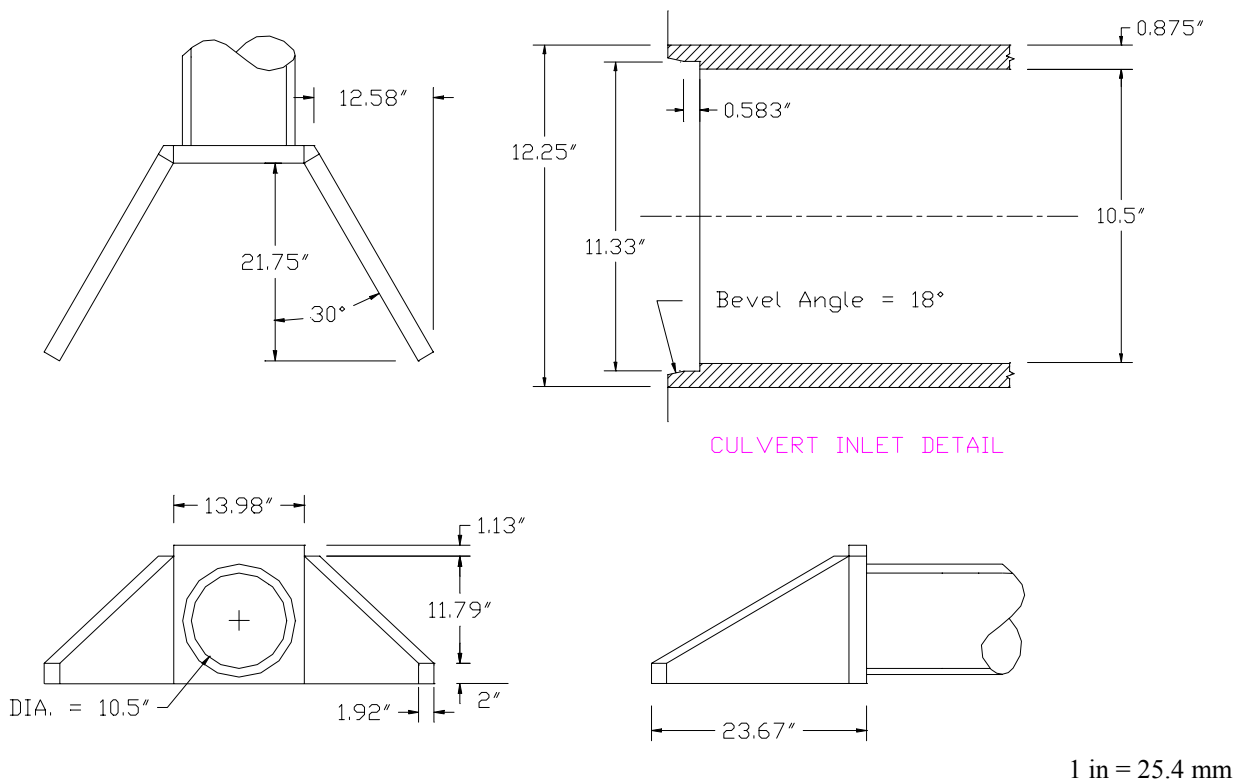


**Figure 5. Diagram of scaled model set up for the Dale Boulevard culvert.**



**Figure 6. Diagram of scaled model set up for the contraction benchmark tests.**

Figure 7 details the modeled inlet dimensions.



**Figure 7. Modeled inlet dimensions for the Dale Boulevard culvert.**

## MODEL RUNS

Five distinct discharges and corresponding tailwaters were used to run the Dale Boulevard culvert model to determine what water-surface profiles would result upstream. The discharge was varied to encompass the flows up to the 500-yr return period for the culvert system. Table 4 lists the discharges and corresponding tailwaters for the variable-discharge runs.

**Table 4. Model and prototype discharges and tailwaters.**

Prototype Discharge (ft <sup>3</sup> /s)	Model Discharge (ft <sup>3</sup> /s)	Prototype Tailwater (ft)	Model Tailwater (in)
500	1.00	6.86	6.86
1000	2.00	7.88	7.88
1500	3.01	8.72	8.72
1750	3.51	9.24	9.24
2000	4.01	9.56	9.56

1 ft = 0.305 m, 1 ft<sup>3</sup>/s = 0.028 m<sup>3</sup>/s

In order to better examine the energy losses through the transition between the two culverts in series, a contraction benchmark culvert was also analyzed. This set-up allowed a more detailed analysis to be performed on the flow through the culvert contraction. The set-up effectively

shifted the contraction downstream so that the flow had a longer distance over which to stabilize. Both inlet control and outlet control conditions were tested for this set-up.

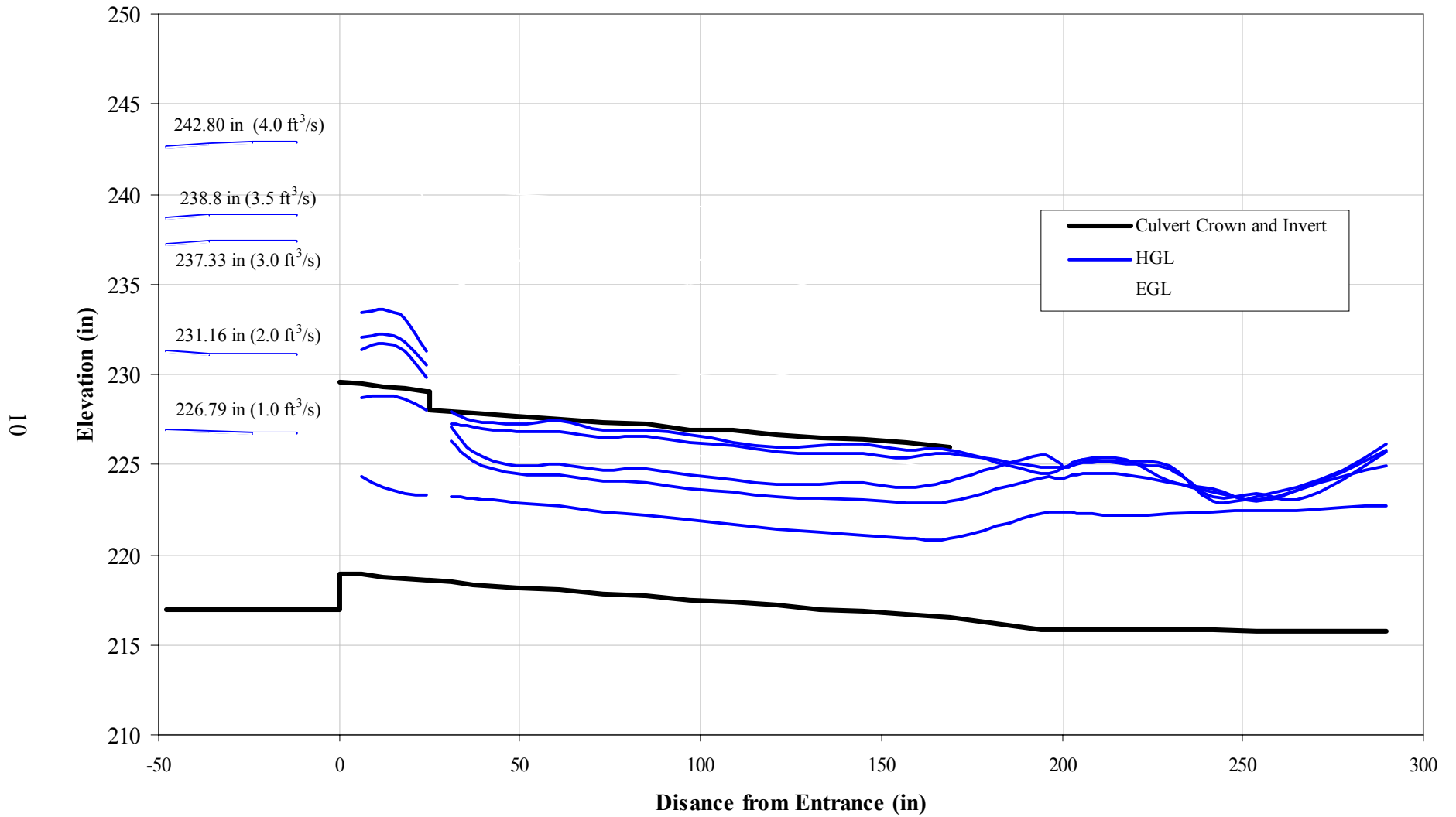
## **LABORATORY AND HEC-2 ANALYSIS**

The Dale Boulevard culvert model was analyzed using pressure ports to measure hydraulic grade line (HGL). The measurements resulted in a slightly variable datum from day-to-day. The variable datum was adjusted to scale the datum to the invert at the culvert entrance. This was done by regressing datum to length and determining the intercept value at the model culvert entrance. This intercept value was used to adjust the readings. This placed all the laboratory results on the same absolute datum.

The energy grade line (EGL) elevations were computed for each port by adding the velocity head,  $V^2/2g$ , to the HGL. The same pressure ports that measured the HGL also measured the invert elevations. For partially full flow, the difference between the HGL elevation and the invert elevation was the flow depth at that locations. The flow area was computed from the flow depth and the velocity was then computed as  $Q/A$ . If the difference between the HGL and the invert was greater than the diameter, then the barrel was full and the flow area was simply the full area of the barrel.

The tailwater conditions were set using step backwater HEC-2 results of Neabsco Creek below the prototype which were provided by FEMA's consultants. These conditions were imposed upon the laboratory experiments.

Figure 8 shows the EGL and HGL for the experiments with the imposed tailwater conditions. The results of these runs led to the performance curve for the compound culvert.



1 in = 25.4 mm, 1 ft<sup>3</sup>/s = 0.028 m<sup>3</sup>/s

**Figure 8. EGL and HGL for experiments with imposed tailwater conditions.**



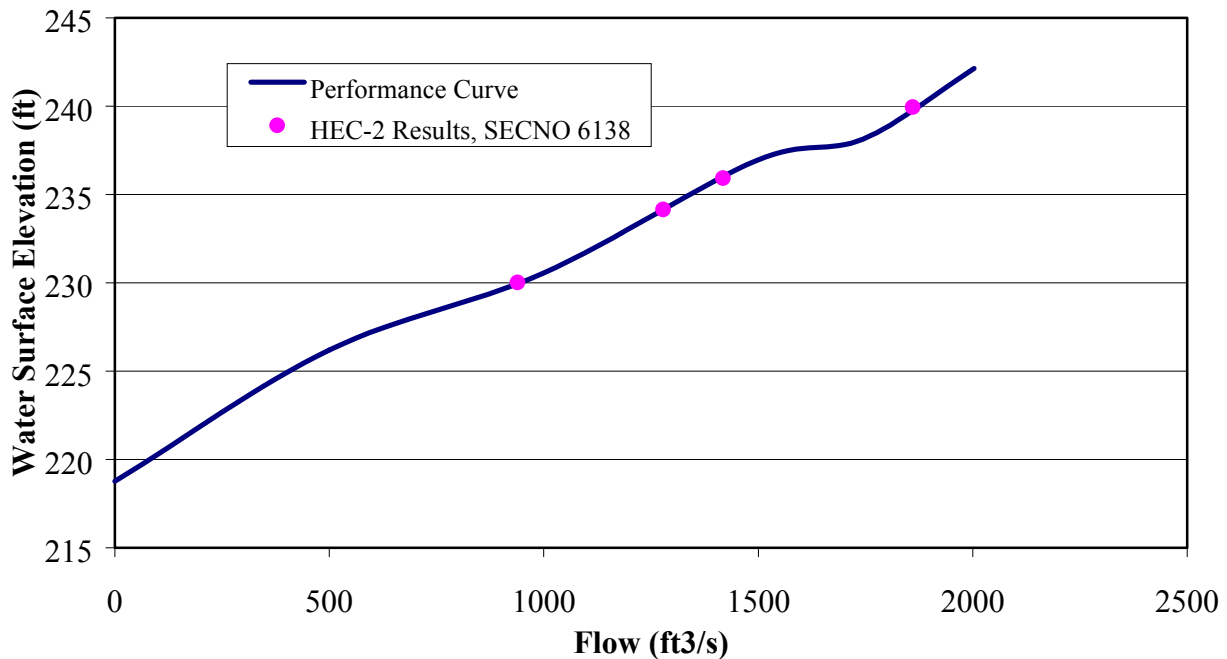
Headwater elevations from the laboratory experiments, listed in the second column of table 5 are based on the tailwater conditions given in table 4. It is important to note that the head box used for these experiments was approximately 10 times the culvert diameter and the approach flow velocity was negligible. Had the laboratory experiments actually modeled, the approach velocity would have provided part of the energy to move water through the culvert and the water surface elevations measured upstream of the culvert would have been slightly lower. Most culvert experiments are done this way, and the regressions for losses are based on energy losses not changes in water surface elevations. That means the headwater elevation in experimental culvert hydraulics really refers to the energy grade line (EGL) and not the hydraulic grade line (HGL) as is typically assumed. HEC-2 results were used to estimate the velocity head that would have been measured if the approach channel had been modeled to determine water surface elevations (HGL elevations) upstream of the culvert entrance. Results are shown in table 5 and plotted in figure 9.

**Table 5. Water surface elevations upstream of the culvert entrance.**

Flow (ft <sup>3</sup> /s)	Headwater Elevation from Laboratory Experiments (ft)*	Velocity Head From HEC-2 Data (ft)	Estimated Velocity Head for Laboratory Experiments (ft)	Source	Est W.S. Elevation for approach Channel (ft)**
500	226.79		0.072	Extrapolated	226.72
939		0.130			
1000	231.16		0.134	Interpolated	231.03
1279		0.130			
1418		0.140			
1500	237.33		0.141	Interpolated	237.19
1750	238.80		0.166	Interpolated	238.63
1861		0.180			
2000	242.80		0.196	Extrapolated	242.60

\* EGL; \*\* HGL

1 ft = 0.305 m, 1 ft<sup>3</sup>/s = 0.028 m<sup>3</sup>/s



1 ft = 0.305 m, 1 ft³/s = 0.028 m³/s

**Figure 9. Culvert performance curve.**

The last step of the specific analysis is to use the figure 9-corrected performance curve in place of the original rating curve used in the HEC-2 FIS model, and run the HEC-2 computer model again. This leads to the headwaters listed in table 6.

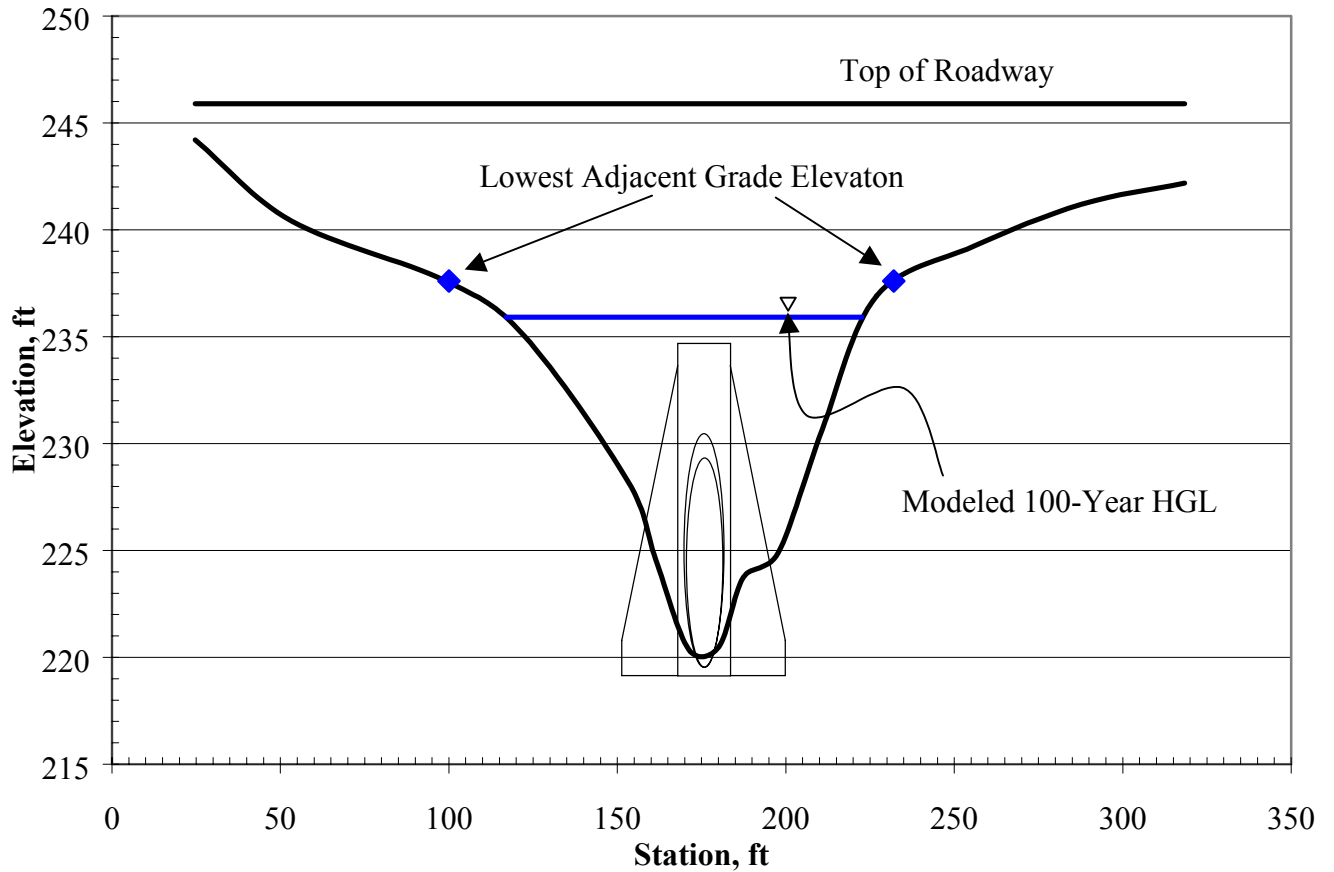
**Table 6. Results of laboratory calibration for HEC-2.**

Return Period (yr)	Flow (ft³/s)	Water Surface Elevation (ft)
10	939	230.02
50	1279	234.14
100	1418	235.92
500	1861	239.94

1 ft = 0.305 m, 1 ft³/s = 0.028 m³/s

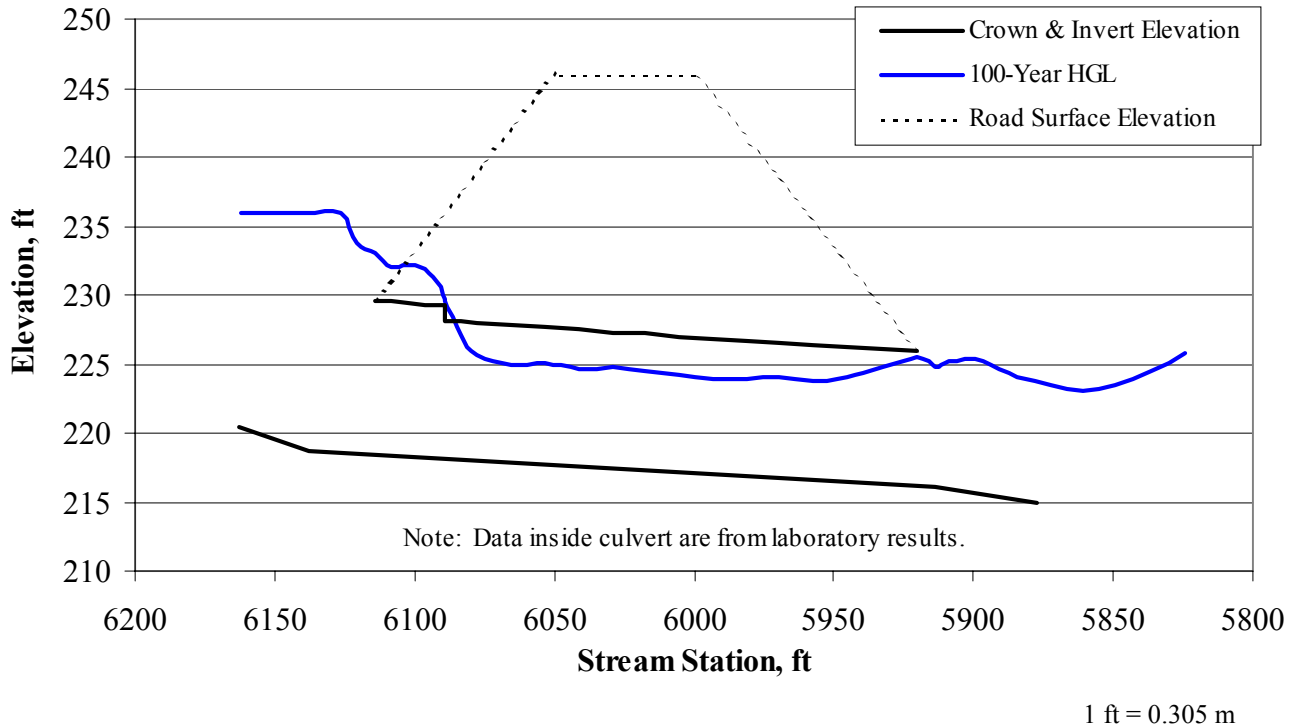
The cross section 6138 just upstream of the culvert and profile of the 1 percent annual chance (100-yr) results are shown in figures 10 and 11. The 100-yr return period has a water surface elevation of 235.92 ft (71.908m) at cross section 6138 based on the laboratory results and adjusting the water surface elevations to account for the velocity head being implicitly included in the headwater computation. The houses in question for this study were located between SECNOs 6138 and 7113 and the lowest adjacent grade (LAG) elevation was determined to be 237.5 ft (72.420 m). The FEMA letter of map revision (LOMR) indicated 100-yr return period water surface elevations of 236.01 ft (72.936 m) and 236.46 ft (72.073 m) at cross sections 6138 and 7113, respectively. The FEMA LOMR water surface elevations are based on the laboratory results but do not include the adjustment to account for the velocity head being implicitly included in the headwater computation. The velocity head adjustment lowers the expected water

surface elevations, is fairly minor in this case and is not normally used in studies of this type even though it is theoretically appropriate (in the opinion of the authors). Either way, the LAG elevation is above the 1 percent chance water surface elevations between cross sections 6138 and 7113 and the house of interest should not be inundated by the 1 percent chance flood.



1 ft = 0.305 m

**Figure 10. Cross section 6138 view of 1 percent annual chance results (100-yr).**



**Figure 11. Profile view of BFE results (100-yr).**

## EVALUATION OF CULVERTS IN SERIES AS A DESIGN ALTERNATIVE

There were three alternatives for sizing the culvert at this site. The first was a straight 9.5-ft (2896-mm) culvert, which was modeled as the 9.5 benchmark test series. The second was a 10.5-ft (3200-mm) culvert, which was modeled as the 10.5 benchmark test series. The third was the 10.5/9.5-ft (3200/2896-mm) barrels in series, which was the one actually constructed and was modeled as “10.5/9.5 db.”

The questions are “How much is gained by using the enlarged upstream section in series with a smaller culvert?” and “How would one analyze expected performance?” Figures 12 through 16 superimpose the hydraulic grade lines for each model at each discharge and illustrate the respective advantages. Actually, the advantage of the 10.5/9.5 culvert series over the straight 9.5-ft (2896-mm) culvert is quite limited but the greatest advantage happens to occur right at the base flood condition.

The relative hydraulic grade lines that would occur at 500 ft<sup>3</sup>/s (14 m<sup>3</sup>/s) for all three models are shown in figure 12. All three operated at unsubmerged inlet control at this discharge and there is very little difference in the headwater equation for a 10.5-ft (3200-mm) culvert and a 9.5-ft (2896-mm) culvert for this condition.

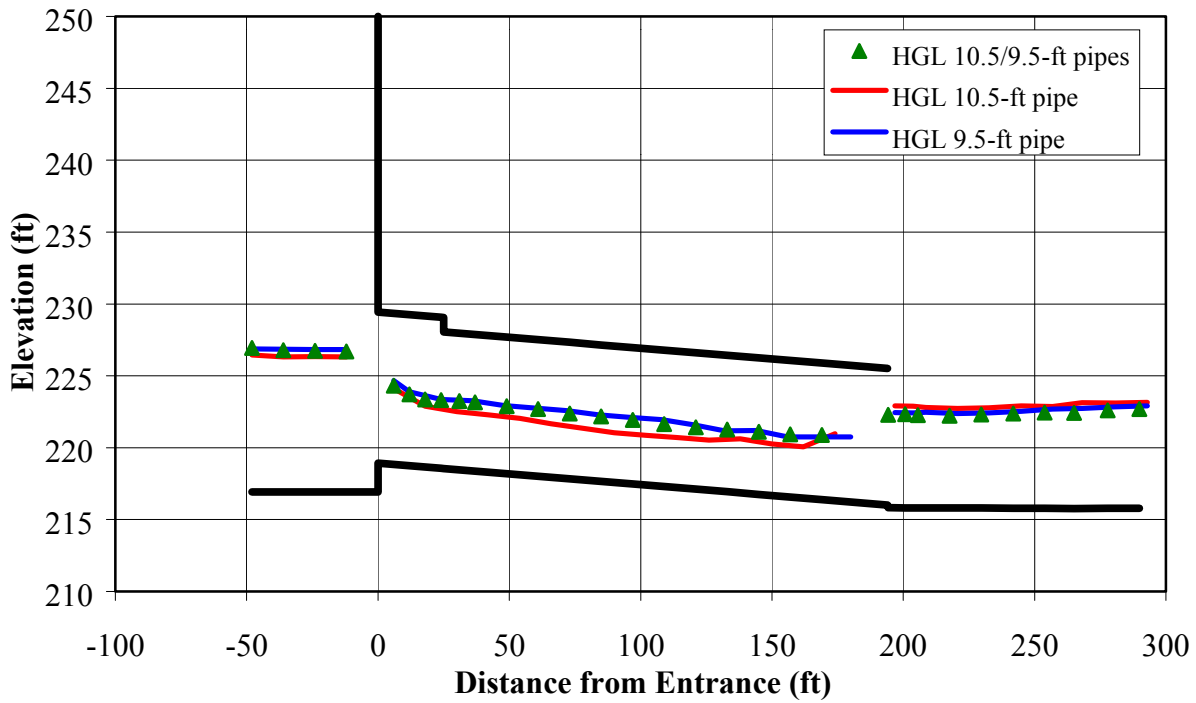
At 1000 ft<sup>3</sup>/s (28 m<sup>3</sup>/s), shown in figure 13, the 9.5-ft (2896-mm) and the 10.5-ft (3200-mm) culverts operated at submerged inlet control but the losses at the contraction were sufficient to cause the enlarged end section of the series model to flow almost full and it started to show a

slight headwater decrease from the 9.5-ft (2896-mm) culvert. However, at 1500 ft<sup>3</sup>/s (42 m<sup>3</sup>/s), which happens to be close to the base flood with a 100-year return interval, figure 14 shows that there is significant headwater decrease. This occurs because the 9.5-ft (2896-mm) culvert model is still at submerged inlet control, but the 10.5-ft (3200-mm) model flowed full and was in outlet control. The headwater reduction at this discharge was approximately 1.7 ft, (0.518-m) which could be significant for this site.

At 1750 ft<sup>3</sup>/s (49 m<sup>3</sup>/s), the 9.5-ft culvert also is in outlet control and the series culverts showed no headwater decrease as illustrated in figure 15. In fact, all three models had almost the same headwater at this discharge because the 10.5-ft (3200-mm) culvert was still in submerged inlet control. At 2000 ft<sup>3</sup>/s (56 m<sup>3</sup>/s) all assumptions generate outlet control and there is essentially no advantage between the series model and the model of the 9.5-ft (2896-mm) culvert as illustrated in figure 16. Apparently the contraction loss at the intersection of the two barrels nearly matches the difference between the friction loss in the enlarged section and the friction loss in an equal length of the smaller diameter culvert.

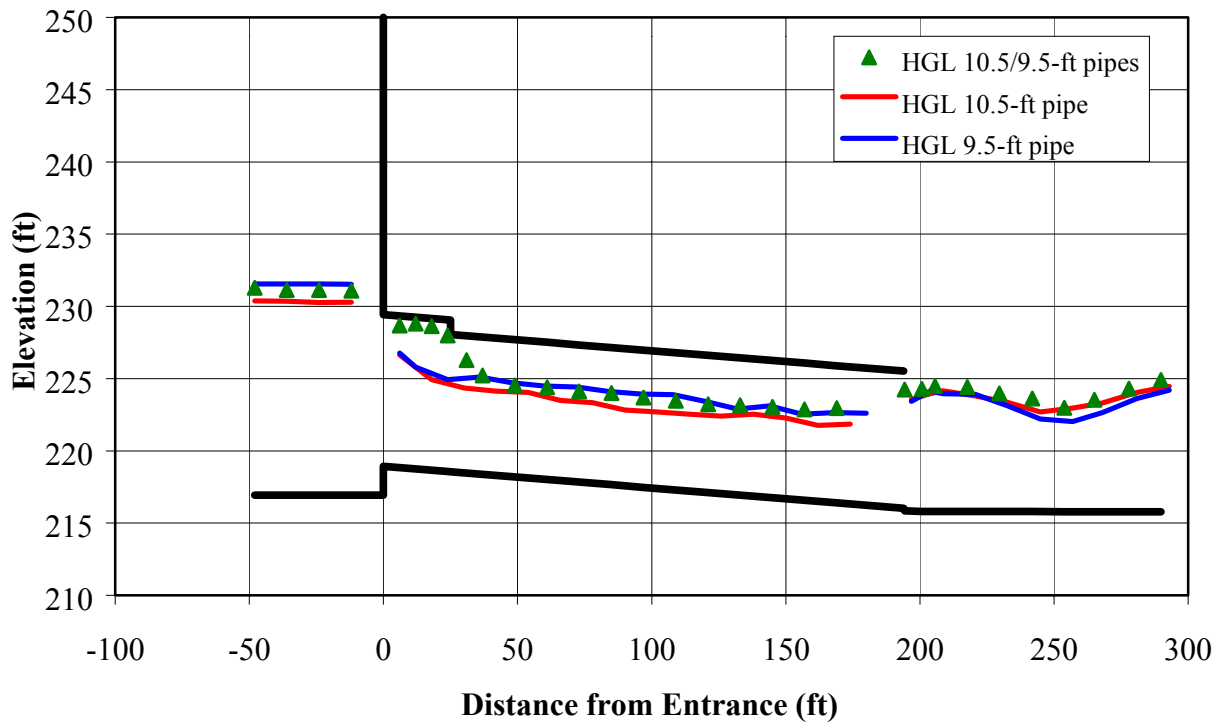
Figures 15 and 16 for the model of the 10.5-ft (3200-mm) culvert illustrate the difference between inlet control and outlet control. This particular configuration carries 15 percent more flow at almost no increase in headwater as it went from inlet control to outlet control.

Thus it would appear that whether by accident or by design, the 10.5/9.5 (3200/2896) design happens to reduce headwater elevations at the base flood condition. Since FEMA studies do focus on the base flood condition, the 10.5/9.5 (3200/2896) culverts in series design is a success for reducing headwaters at the base flood condition.



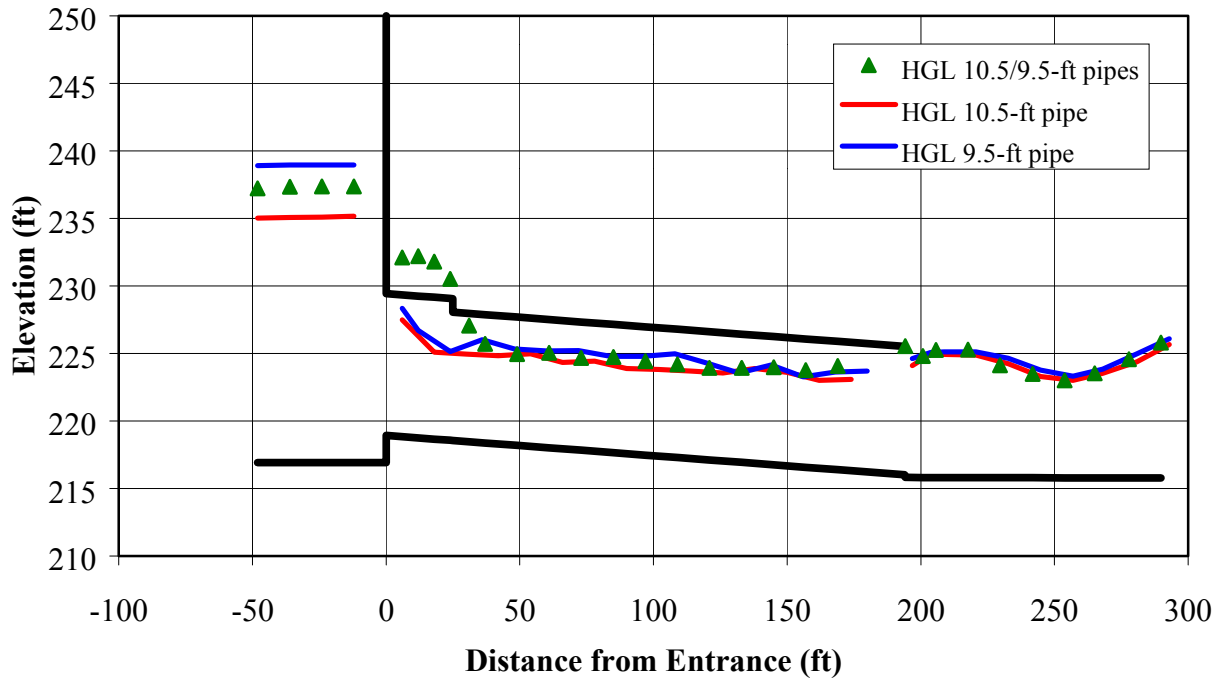
1 ft = 0.305 m, 1 ft<sup>3</sup>/s = 0.028 m<sup>3</sup>/s

**Figure 12. Superimposed HGLs for  $Q = 1 \text{ ft}^3/\text{s}$  (prototype for  $500 \text{ ft}^3/\text{s}$ ).**



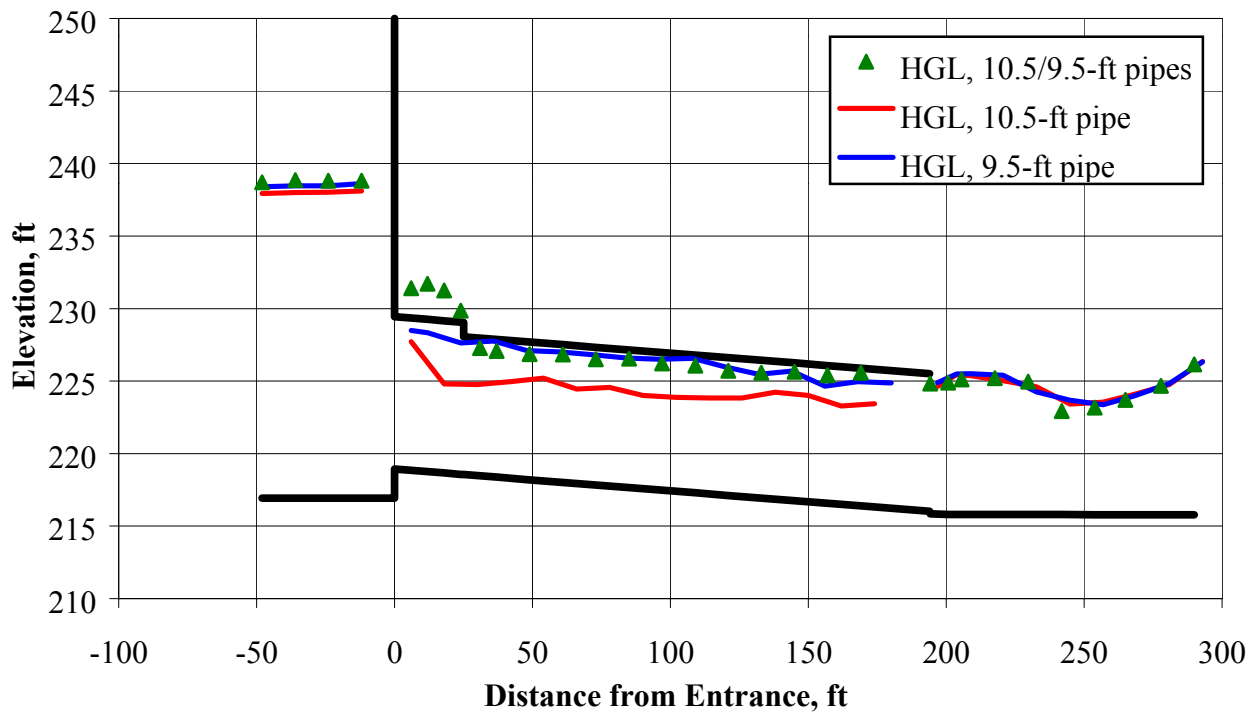
1 ft = 0.305 m, 1 ft<sup>3</sup>/s = 0.028 m<sup>3</sup>/s

**Figure 13. Superimposed HGLs for  $Q = 2 \text{ ft}^3/\text{s}$  (prototype for  $1000 \text{ ft}^3/\text{s}$ ).**



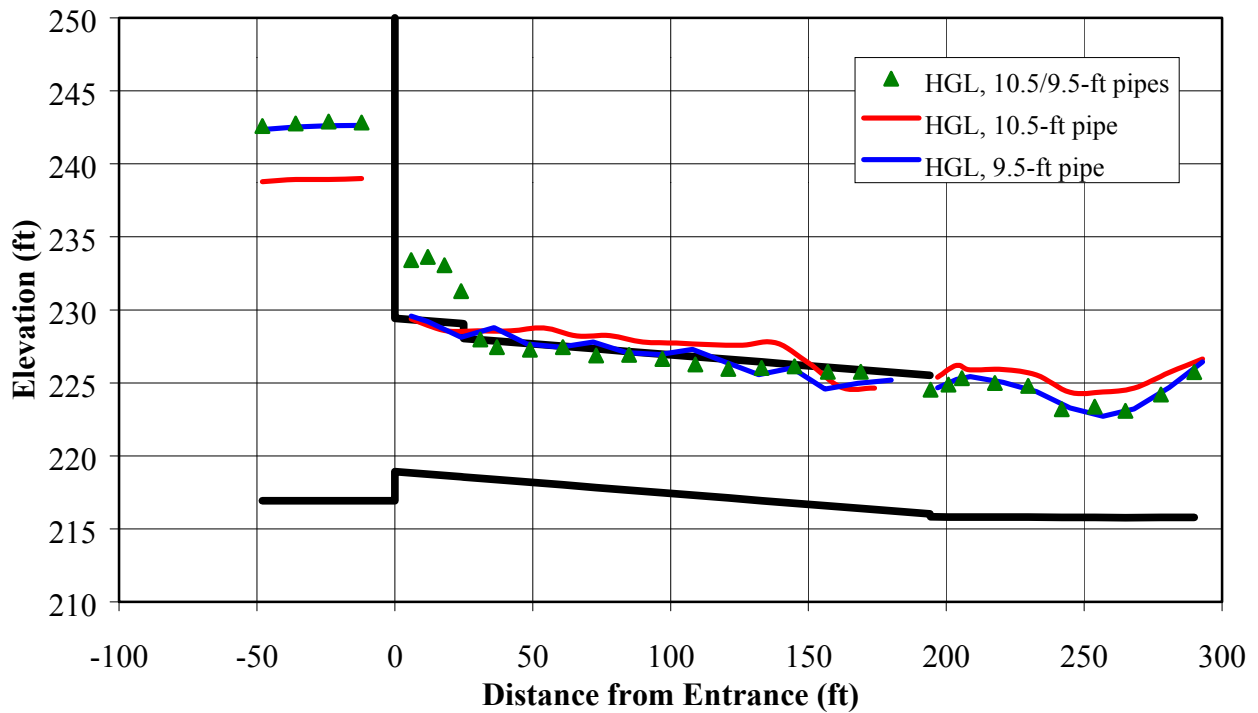
1 ft = 0.305 m, 1 ft<sup>3</sup>/s = 0.028 m<sup>3</sup>/s

Figure 14. Superimposed HGLs for  $Q = 3 \text{ ft}^3/\text{s}$  (prototype for  $1500 \text{ ft}^3/\text{s}$ ).



1 ft = 0.305 m, 1 ft<sup>3</sup>/s = 0.028 m<sup>3</sup>/s

Figure 15. Superimposed HGLs for  $Q = 3.5 \text{ ft}^3/\text{s}$  (prototype for  $1750 \text{ ft}^3/\text{s}$ ).



1 ft = 0.305 m, 1 ft<sup>3</sup>/s = 0.028 m<sup>3</sup>/s

Figure 16. Superimposed HGLs for  $Q = 4 \text{ ft}^3/\text{s}$  (prototype for  $2000 \text{ ft}^3/\text{s}$ ).

## ANALYZING CULVERTS IN SERIES

How can one analyze this type of an installation without a model study? There is no easy answer because each installation could be very unique, but if the situation is similar to the one modeled where the ratio of diameters  $D_2/D_1$  was approximately 0.9, some of the observation from this study could certainly be a guide. For most discharges assume the smaller diameter controls and compute headwater for a full length smaller diameter culvert. The one place that it will differ is where the critical flow depth of the smaller barrel is near the crown (say 80 to 90 percent of the culvert diameter). Then the enlarged section is likely to go into outlet control and the headwater can be computed as

$$H_W = k_e \left( \frac{V_1^2}{2g} \right) + \left( \frac{K_U n^2 L_1}{R_{h1}^{4/3}} \right) \cdot \frac{V_1^2}{2g} + k_{cont} \left( \frac{V_1^2}{2g} \right) + (H_C)_2 \quad (1)$$

Where:

- $H_W$  = Headwater depth, ft.
- $L_1$  = Length of larger-diameter barrel, ft.
- $D_1$  = Diameter of larger-diameter barrel, ft.
- $k_e$  = Entrance loss coefficient.
- $k_{cont}$  = Contraction loss coefficient.



- $V_1$  = Velocity in the upstream barrel, ft/s.  
 $g$  = Acceleration of gravity, 32.2 ft/s<sup>2</sup> (9.81 m/s<sup>2</sup>).  
 $n$  = Manning's roughness coefficient.  
 $H_{c2}$  = Specific head at critical flow for the downstream barrel ( $y_{c2} + \frac{V_{c2}^2}{2g}$ ), ft.  
 $y_{c2}$  = Critical flow depth for the downstream barrel, ft.  
 $V_{c2}$  = Critical flow velocity for the downstream barrel, ft/s.  
 $K_U$  = Units factor for system of units; 29 for English units, 19.6 for SI units.

The contraction loss coefficient  $k_{cont}$  is needed to use the above expression. This coefficient can be derived from experimental results and it can be specific for a limited range of depths at the entrance of the smaller culvert. Tests with the contraction moved to the center of the total length were designed to isolate the contraction loss to derive this coefficient.

## DERIVATION OF DESIGN COEFFICIENTS

Flow through culverts is categorized as either inlet control or outlet control. Inlet control occurs when the culvert is on a steep slope and flow through the barrel is free surface and at supercritical velocities. Under these conditions downstream disturbances to the water surface cannot be propagated upstream and the control section must be upstream or at the inlet of the culvert. Then the only thing that affects the headwater is the energy required to get the flow through the entrance to the culvert. Outlet control occurs anytime the culvert is flowing full or the culvert is on a mild slope with subcritical velocities. Then the headwater is governed by the tailwater plus the entrance loss, the exit loss and hydraulic losses through the barrel. Culverts tend to operate more efficiently in outlet control and the headwater can actually drop a little when inlet control switches to outlet control by adding enough tail water to make the barrel flow full. This observation was evidenced in figures 15 and 16 where the headwater depth hardly changed at all for the 10.5-in culvert when the discharge was increased by approximately 15 percent. That culvert was operating under inlet control at the lower discharge but the barrel filled and it switched to outlet control at the higher discharge. Designers usually check for both conditions and use the one that requires the higher headwater.

### Inlet Control Results

The flow can either be termed unsubmerged inlet control or submerged inlet control. The inlet is usually unsubmerged when the discharge divided by the product of the culvert area and the square root of the depth is less than 3.5 ( $Q/AD^{0.5} < 3.5$ ). The basic equation fit for an unsubmerged inlet is a weir equation where the headwater is related to discharge raised to an exponent with an expected value around 0.67. The inlet is usually submerged when the discharge divided by the product of the culvert area and the square root of the depth is greater than 4.0 ( $Q/AD^{0.5} > 4.0$ ). The basic equation fit for a submerged inlet is an orifice equation where the headwater is related to discharge raised to an exponent with an expected value of 2. The area between the ratios 3.5 and 4.0 is a transition zone where the inlet may be unsubmerged or submerged depending on the efficiency of the entrance but neither of the basic equation fits are quite applicable. Formulas (1) and (2) show the two equations that can be used to evaluate

unsubmerged flow through a culvert. Formula (3) shows the submerged flow equation. All formulas were taken from the FHWA's Hydraulic Design Series No. 5 (HDS-5).

### Unsubmerged Flow

$$\text{Form (1)} \quad \frac{H_W}{D} = \frac{H_c}{D} + K_1 \left[ \frac{Q}{AD^{0.5}} \right]^{M_1} - 0.5S \quad (2)$$

$$\text{Form (2)} \quad \frac{H_W}{D} = K_2 \left[ \frac{Q}{AD^{0.5}} \right]^{M_2} - 0.5S \quad (3)$$

### Submerged Flow

$$\frac{H_W}{D} = c \left[ \frac{Q}{AD^{0.5}} \right]^2 + Y - 0.5S \quad (4)$$

where:

$H_W$	=	Headwater measured from the inlet invert to the EGL, ft.
$D$	=	Interior height of culvert barrel, ft.
$H_c$	=	Specific head at critical depth $(y_c + \frac{V_c^2}{2g})$ , ft.
$Q$	=	Discharge, ft <sup>3</sup> /s.
$A$	=	Full cross sectional area of culvert barrel, ft <sup>2</sup> .
$S$	=	Culvert barrel slope, ft/ft.
$K_L, M_1, K_2, M_2, c, Y$	=	Culvert design constants.
$K_{Sl}$	=	Slope correction coefficient.
-0.5		HDS-5-suggested value for inlets other than mitered.
+0.7		HDS-5-suggested value for mitered inlets.

HDS-5 lists design coefficients for a wide range of inlets, but none of them exactly match the inlet for the Dale Blvd site. Computer implementations of HDS-5, like the culvert algorithm in HECRAS, do not allow the user to input design coefficients even if the specific experimental values are available. The only way to use those algorithms is to find an inlet that has almost the same coefficients even if the inlet descriptions do not fit.

Several HDS-5 inlets were compared to the experimental results to find the closest fit. HDS-5 Chart 1, Scale 1 is for a square-edge circular inlet with a headwall. HDS-5 Chart 3, Scale A is for a circular pipe with 45-degree bevel with no wingwalls. The fairly common 30-degree wingwall end section with a 2:1 miter slope such as the one used at the Dale Boulevard site is not listed in HDS-5 for a circular pipe. HDS-5 does list a 30-degree wingwall end section for a rectangular culvert as Chart 8, Scale 1, but it does not indicate whether the walls are mitered to the embankment slope. Nevertheless, that is the closest match that was available. It is also thought that the enlarged end section for the Dale Boulevard installation might perform

somewhat like a tapered inlet listed as Chart 55 in HSD-5. Design coefficients for those charts are listed in table 7 and will be compared with the experimental results for the Dale Boulevard installation.

**Table 7. Culvert design coefficients.**

Chart	Culvert Shape	Scale	Description	Inlet Control						
				Unsubmerged				Submerged		Outlet Control
				$K1$	$M1$	$K2$	$M2$	$c$	$Y$	
1	Circular	1	Square-edge w/headwall	0.0098	2.0			0.0398	0.67	0.5
3	Circular	A	45-degree beveled ring	0.0018	2.5			0.300	0.74	0.2
8	Rectangular	1	30-degree wingwall	0.015	0.705			0.0385	0.81	n/a
55	Circular	1	Smooth tapered inlet throat			0.534	0.555	0.0196	0.89	

All of the culverts were analyzed under inlet control flow conditions. A wide range of discharges were routed through each culvert and the corresponding headwaters were recorded for each flow. Each culvert was analyzed using both the unsubmerged and submerged inlet control equations. Design constants were calculated using simple linear regression analysis techniques. The calculated design constants  $K_2$ ,  $M_2$ ,  $c$ , and  $Y$  are listed in table 8. For unsubmerged flow, both Form 1 and Form 2 equations were examined. Calculating critical flow specific head,  $H_c$ , is tedious and for that reason, Form 1 of the unsubmerged flow equation was not used for the analysis of the Dale Boulevard data. For submerged flow, the regression was done assuming that the slope correction would be  $-0.5S$ , but the suggested slope correction in HDS-5 is  $+0.7S$  for a mitered inlet. The Dale Boulevard inlet section is mitered to the embankment slope and the  $+0.7S$  slope correction is appropriate. Since a linear regression was done to determine the coefficients for the submerged flow data, the intercept,  $Y$ , can be adjusted for the appropriate slope correction by subtracting the  $0.5S$  constant that was added to the headwater data before the regression and subtracting another  $0.7S$  for the slope correction that will be applied for a mitered inlet. The net effect is to reduce the regressed values of  $Y$  by  $1.2S$  or  $1.2 \times 0.015 = 0.018$ . The last two columns of table 8 contain the regressed values and the adjusted values of the  $Y$  intercept. The adjusted values should be used for a mitered inlet and the corresponding slope correction term in equation (4) should be  $+0.7S$ .

Figure 17 compares the average Dale Boulevard result from table 8 with the HDS-5 inlets listed in table 7. Figure 17 is based on applying the design coefficients listed in the tables to a circular 9.5-ft diameter barrel. Form 1 of the unsubmerged flow equation was used to generate data for the HDS-5 Charts 3 and 8 inlets. All of the inlets have almost the same curve for unsubmerged flow, but they deviate considerably for submerged flow. The Dale Boulevard enlarged-diameter entrance section is less efficient than a Chart 55 inlet and is between the Chart 3 and 8 inlets.

**Table 8. Summary of culvert design constants.**

Test Series	Culvert Description	Unsubmerged			Submerged	
		Form 2			$Y$	$Y$
		$K_2$	$M_2$	$c$	Regressed for $-0.5S$ slope correction	Adjusted for $+0.7S$ slope correction
Inlet1bm	10.5"	0.491	0.584	0.030	0.70	0.68
Inlet4bm	10.5"	0.500	0.583	0.030	0.72	0.70
Inlet5bm	10.5"	0.518	0.569	0.030	0.72	0.70
Inlet13bm	9.5"	0.502	0.571	0.030	0.69	0.67
Average	9.5" & 10.5"	0.503	0.577	0.030	0.71	0.69

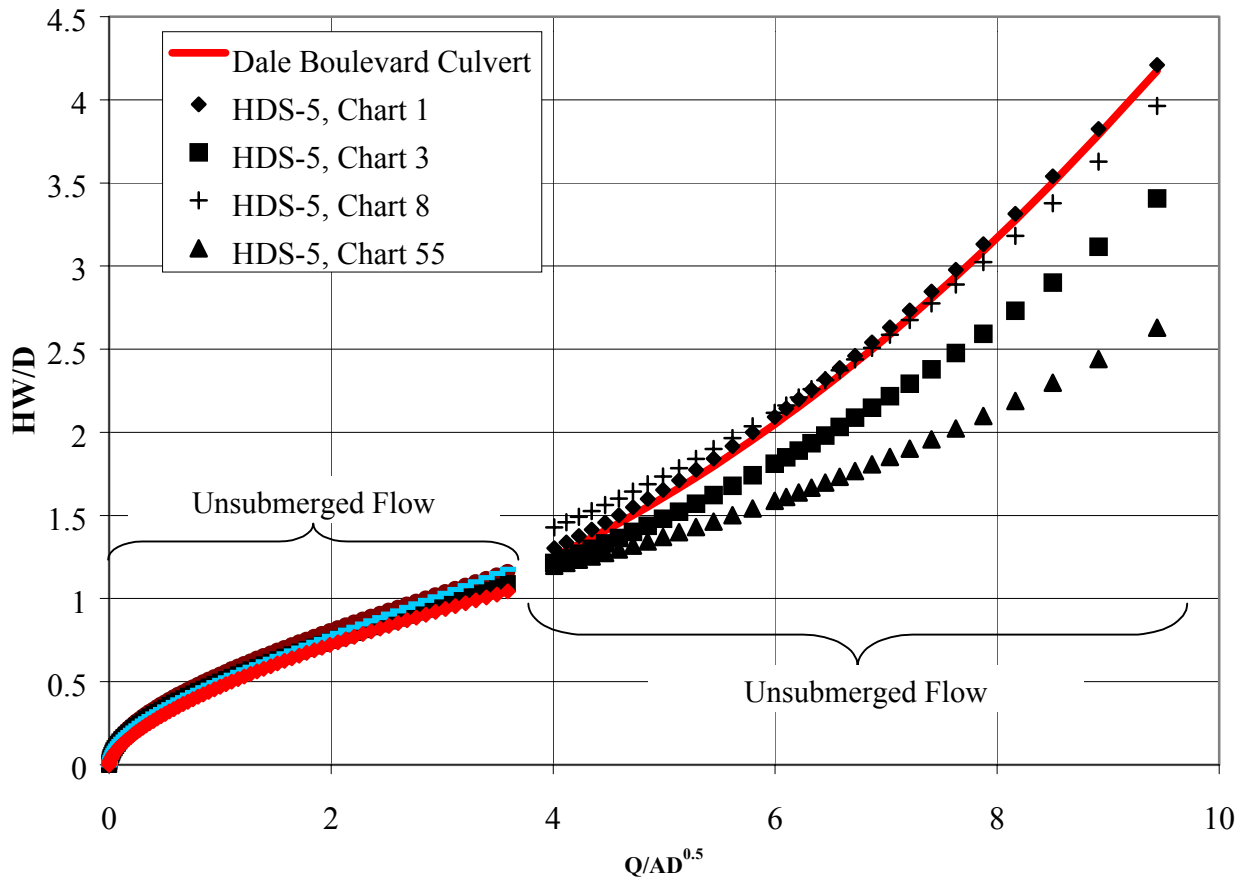
The above coefficients apply to the mitered 30-degree wingwall entrance section illustrated in figure 7.

Inlet7db	Dale Blvd	0.474	0.570	0.039	0.61	0.59
Inlet11db	Dale Blvd	0.518	0.569	0.030	0.72*	0.70*
Inlet30db	Dale Blvd	0.453	0.675			
Inlet31db	Dale Blvd	0.484	0.643	0.040	0.63	0.61
Average	Dale Blvd	0.470	0.623	0.040	0.62	0.60

The above Dale Blvd coefficients consider the mitered 30-degree wingwall entrance and the enlarged section as the inlet to the smaller diameter downstream barrel. The diameter of the downstream barrel was used in equations (3) and (4) to derive these coefficients. These coefficients implicitly account for control being at either the entrance or the contraction.

\* Suspected outlier; not included in average

1 in = 25.4 mm



**Figure 17. Performance curves for Dale Boulevard inlet control versus HDS-5.**

### Outlet Control Results

As noted previously, all of the hydraulic losses, including the entrance loss, the friction loss in the barrel, the exit loss and other minor losses including a contraction loss if applicable affect the headwater for a culvert operating in outlet control. Outlet control experiments were used to compute the entrance loss coefficients, the contraction loss coefficients, and the Manning's  $n$  value for the pipes. We did not analyze exit losses in this study but it was considered for further research had we proceeded with a second phase study.

The slope of the culvert was steep in these experiments but we established outlet control for lower discharges by increasing the tailwater to force full flow. When the culvert barrel was flowing full, it was in outlet control. Equation (5) below is the basic energy balance equation for culverts operating in outlet control. Figure 18 illustrates the losses involved in the energy balance for a straight culvert without different barrel diameters in series.

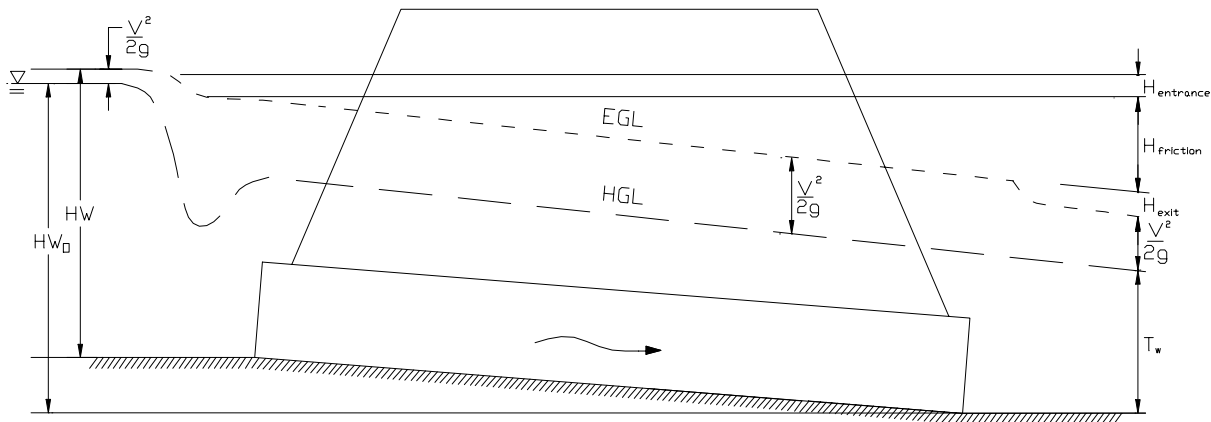
$$HW = TW + \frac{V_d^2}{2g} + \sum H_L - S \cdot L \quad (5)$$

where:

- $HW$  = Headwater measured from the inlet invert to the EGL, ft.
- $TW$  = Tailwater flow depth measured above the outlet invert.
- $V_d$  = Downstream velocity
- $\sum H_L$  =  $H_{L_e} + H_{L_f} + H_{L_{exit}} + H_{L_{contr}}$
- $L$  = Length of culvert.
- $S$  = Culvert barrel slope, ft/ft.
- $H_{L_e}$  = Entrance loss
- $H_{L_f}$  = Friction loss
- $H_{L_{exit}}$  = Exit loss
- $H_{L_{contr}}$  = Contraction loss (for the compound culverts in series)

It is important to note that HW in the above expression and in the basic definition sketch from HDS-5 (figure III-8, HDS-5, p. 36) is measured from the culvert invert to the EGL, not the HGL, in the headwater pool. For this study, the velocity in the head box was assumed to be negligible.

During the experiments, the hydraulic head was measured at each port, and the velocity head ( $V^2/2g$ ) was then added to determine total energy head for points along the EGL. The loss coefficients and Manning's "n" were determined by analyzing various segments of the EGL. It was not necessary to solve the entire energy balance equation at once.



**Figure 18. EGL analysis through a culvert system.**

### Outlet Control Entrance Loss Coefficient

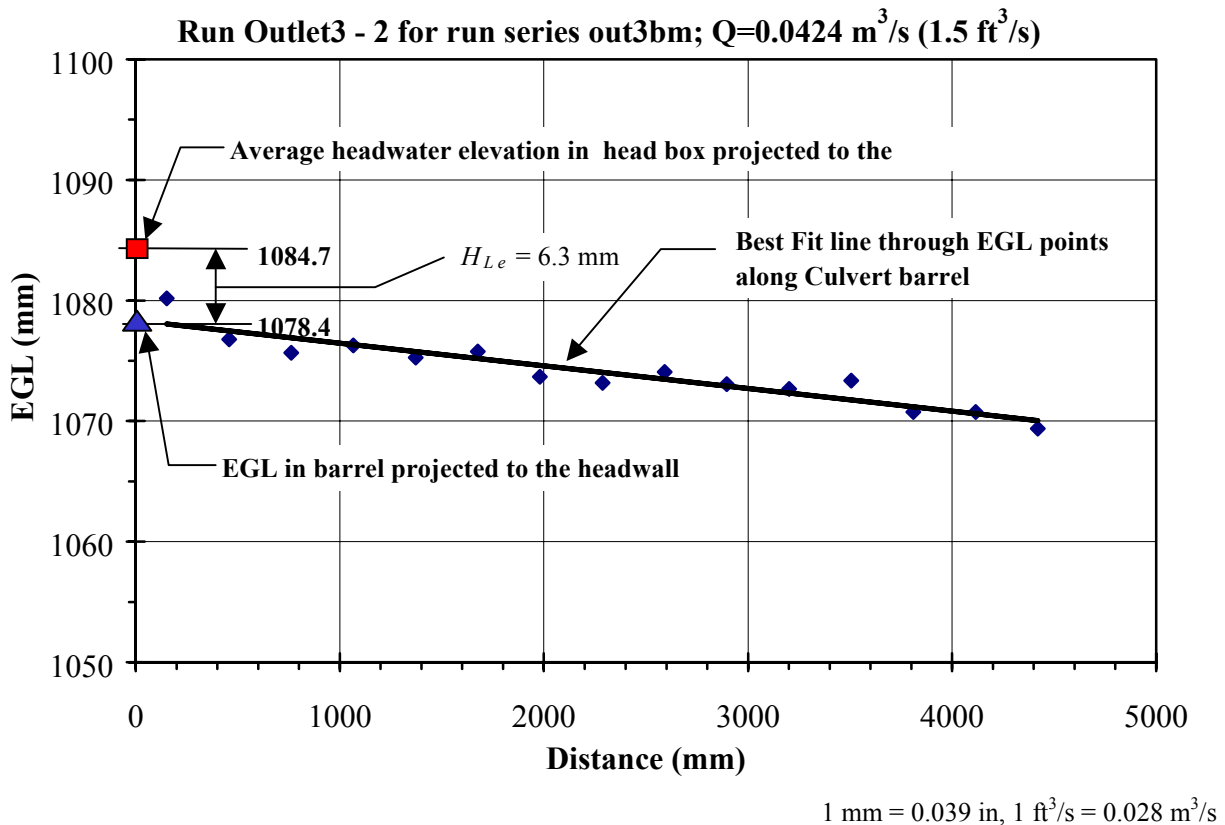
The entrance loss,  $H_{L_e}$ , was determined by projecting a best fit line through the energy points for the pressure ports in the culvert barrel to the headwall and subtracting the projected value from the EGL in the head box (the headwater) as illustrated in figure 19 for one run in the series

out3bm. The entrance loss was actually computed in a spreadsheet but the technique is illustrated in figure 19. The entrance loss coefficient,  $K_{ent}$ , for outlet control was then determined from equation (6) below. The entrance loss coefficients for several discharges in a run series were then averaged in the spreadsheet to yield one value listed in table 9 below.

$$H_{Le} = K_{ent} \left( \frac{V^2}{2g} \right) \quad (6)$$

where:

- $K_{ent}$  = Entrance loss coefficient.
- $H_{Le}$  = Entrance losses, ft.
- $g$  = Gravitational constant, ft/s<sup>2</sup>.
- $V$  = Velocity in the culvert barrel, ft/s.



**Figure 19. Typical EGL analysis used to determine head losses.**

Table 9 shows outlet control entrance loss coefficients derived from the laboratory benchmark culvert runs. The average value 0.12 is less than the typical value of 0.2 for circular pipes found in HDS-5 and tabulated previously in table 7.

## Friction Loss Coefficient

HDS-5 expressed friction loss in terms of Manning's hydraulic roughness coefficient "n". Manning's equation is not dimensionless and is normally written as:

$$V = \frac{K_U}{n} R_h^{2/3} S_F^{1/2} \quad (7)$$

where:

- $V$  = Velocity, ft/s.
- $R_h$  = Hydraulic Radius = D/4 for a circular section flowing full, ft.
- $S_F$  = Friction slope, ft/ft.
- $n$  = Manning's roughness coefficient.
- $K_U$  = Coefficient for system of units; 1.49 for English units, 1.0 for SI units.

Manning's equation can be rearranged to solve for the friction slope. The head loss due to friction is the friction slope multiplied by the length of barrel at that friction slope to yield the following expression that is in HDS-5.

$$H_{LF} = S_F L = \frac{V^2 n^2}{K_U^2 R_h^{4/3}} = \frac{2gn^2}{K_U^2 R_h^{4/3}} \left( \frac{V^2}{2g} \right) = \frac{K_{U1} n^2}{R_h^{4/3}} \left( \frac{V^2}{2g} \right) \quad (8)$$

where:

$$\begin{aligned} K_{U1} &= 2g/K_U^2 = 2(32.2)/(1.49)^2 = 29 \text{ for English units.} \\ &= 2(9.81)/1.0 = 19.62 \text{ for SI units.} \end{aligned}$$

Manning's "n" was determined for the culvert models by fitting a linear regression EGL through the total energy points along the culvert barrel. The slope of the EGL is the friction slope and Manning's "n" can be determined from either form of Manning's equation.

The experimental values of Manning's "n" for the acrylic tubes used to model the culvert barrels are given in table 9.



**Table 9. Entrance loss coefficients for outlet control.**

Run Series	Description	$K_{ent}$	Manning's "n"
out3bm	10.5"	0.24*	0.0095
out35bm	10.5"	0.10	0.0097
out36bm	10.5"	0.12	0.0100
out14bm	9.5"	0.13	0.0100
out16bm	9.5"	0.12	0.0100
out19bm	9.5"	0.13	0.0100
Average		0.12	0.0099

The 0.0099 value for Manning's "n" can be scaled to prototype by examining Manning's equation as follows:

$$\frac{V_m}{V_P} = \frac{\frac{K_{U1} (R_h^{2/3})_m (S_F)_m}{n_m}}{\frac{K_{U1} (R_h^{2/3})_P (S_F)_P}{n_P}} = \frac{n_P \left( \frac{R_{hm}}{R_{hP}} \right)^{2/3}}{n_m} \dots OR \dots \frac{n_m}{n_P} = \frac{L_R^{2/3}}{V_R} = L_R^{1/6} \quad (9)$$

where:

$$L_R = \text{length scaling ratio, 1:12 for this study.}$$

Then,

$$n_P = 12^{1/6} n_m = 12^{1/6} 0.0099 = 0.0149$$

which is in the mid range of values given for concrete pipe with good joints and rough walls. That means the headwater elevations measured in this model study could be used directly without adjustment for pipe roughness.

### Contraction Loss Coefficient

The contraction loss coefficient was determined using methods similar to the ones described above for the entrance loss coefficient except that EGLs for the upstream pipe and the downstream pipe were projected to the joint of the two pipes. It was difficult to establish a good representative EGL for the short section of upstream pipe for the Dale Boulevard model. Therefore, to calculate the  $K_{cont}$  coefficients, the contraction benchmark culvert set up with equal lengths of pipe on each side of the joint, as illustrated in figure 6, was used.

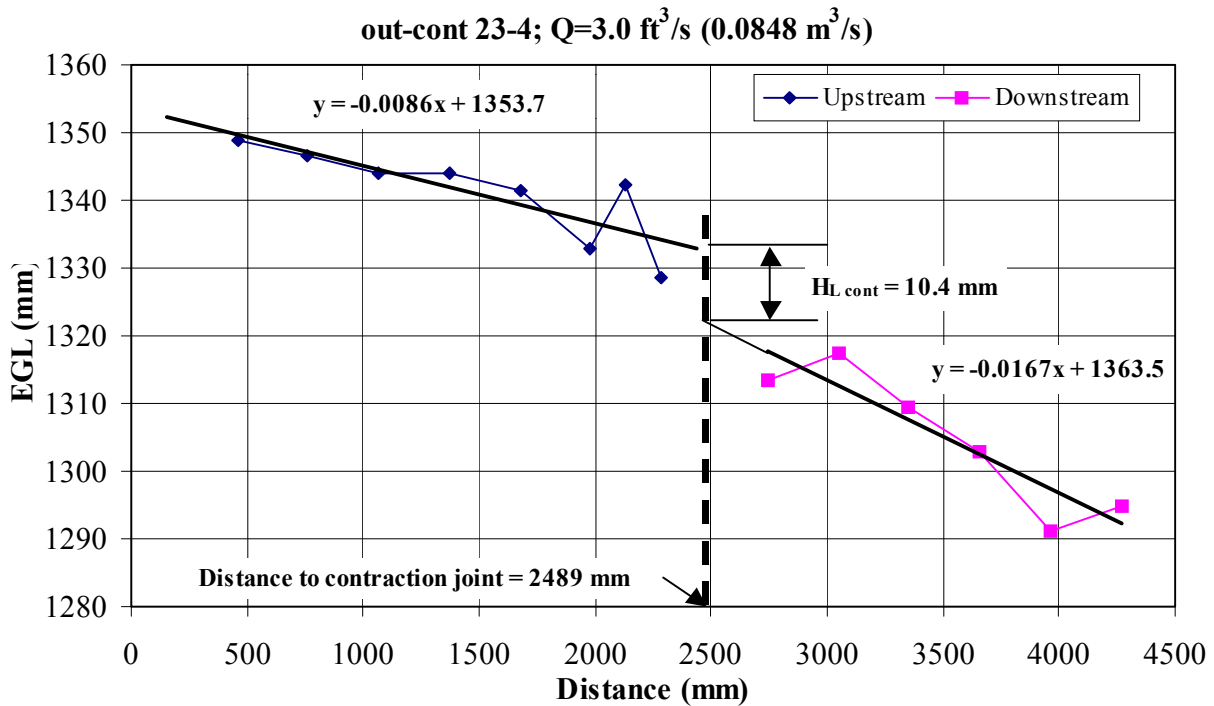
The contraction benchmark culvert consisted of a 98-in- (2489-mm)-long, 10.5-in- (267-mm)-diameter culvert in series with a 98-in (2489-mm)-long, 9.5-in (241-mm)-diameter culvert.

Pressure ports were positioned along the length of both barrels. With this set up, was possible to project EGLs for both pipes onto a common plane at the joint of pipes to determine head loss,  $H_{L,cont}$ , attributed to the contraction as illustrated in figure 19 for one of the discharges for run serious out-cont23. The contraction loss coefficient,  $K_{cont}$ , was then computed from equation (10),

$$H_{L,cont} = K_{cont} \frac{V_1^2}{2g} \quad (10)$$

where:

$V_1$  = velocity in the upstream culvert, ft/s.



1 mm = 0.039 in, 1 ft<sup>3</sup>/s = 0.028 m<sup>3</sup>/s

**Figure 20. Typical results of benchmark contraction experiments.**

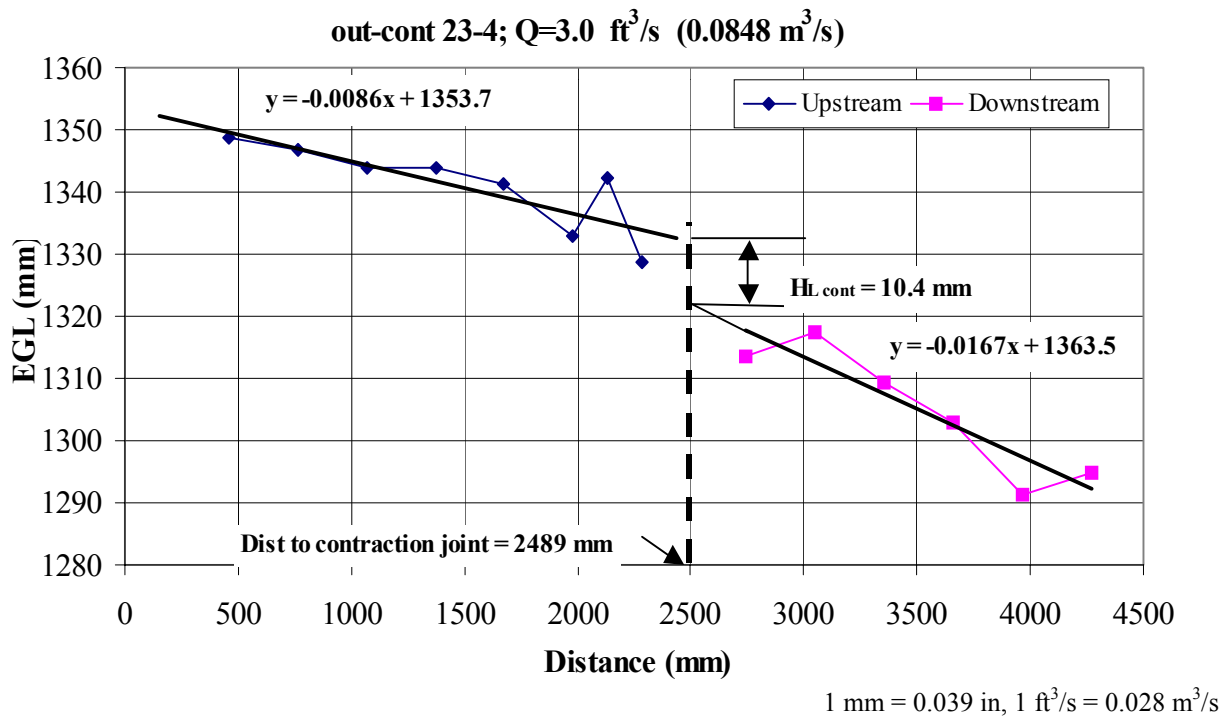


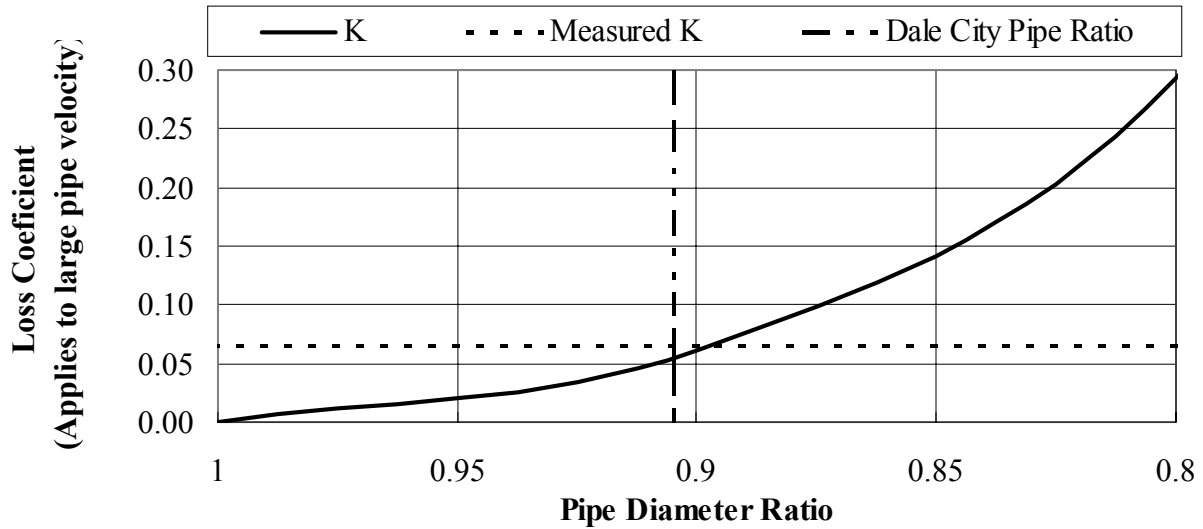
Table 10 lists experimentally derived contraction coefficients. The coefficients are to be applied to the upstream velocity head to calculate the contraction loss and are limited to full flow conditions, at least for the upstream culvert, and to the specific condition of the upstream culvert being approximately 10 percent larger in diameter than the downstream culvert and the inverts being aligned.

**Table 10. Contraction loss coefficients for the culverts in series.**

Run Series	Description	$K_{cont}$	
		Range of Values	Average
out_cont23	10.5"/9.5"	0.04-0.13	0.09
out_cont24	10.5"/9.5"	0.05-0.09	0.07
out_cont34	10.5"/9.5"	0.04-0.08	0.06
		Overall Average	0.073

A check of Handbook values for series culverts aligned along their centerlines (recall that the Dale City culverts have matching inverts at their juncture) shows that the Table 10 values are in agreement with tabulated contraction and expansion loss coefficients. Data obtained from "Loss Coefficients for Enlargements and Contractions Based on Velocity in Small Pipe" from "Flow of Fluids Through Valves, Fittings and Pipe," (Appendix A, Reference 4) were converted to velocity in the large pipe by continuity. Figure 22 depicts these coefficients for expansions and contractions in the range of pipe ratios 0.8 to 1.0 within which expansions and contractions have equivalent losses. Also shown on figure 22 are the measured loss coefficient (.065 is the average

of the Table 10 measurements) and the Dale City pipe ratio (0.905). The handbook prediction for the Dale City case would be on the order of 0.05. The larger measured value may be attributable to the handbook and Dale City situations being slightly different – the handbook case has aligned centerlines and the Dale City case has matching inverts.



**Figure 22. Handbook contraction/expansion coefficients**

It is important to note that the contraction/expansion coefficients are only strictly applicable for full pipe flow. However one might stretch the applicability for the transition where the upstream pipe is full but the downstream is still in inlet control.

Thus it would appear that for full-flow culverts in series (culvert diameter ratios between 0.8 and 1.0) one could calculate friction losses, contraction/expansion losses ( $K_{cont} \approx 0.065$  or as defined by figure 22), and entrance losses ( $K_e \approx 0.12$ ) to estimate upstream headwater using equation (1).

### Exit Loss

The exit loss can be expressed as a function of the change in velocity at the outlet of the culvert barrel written as:

$$H_{L\ exit} = K_{EXIT} \left[ \frac{V_O^2}{2g} - \frac{V_{TW}^2}{2g} \right] \quad (11)$$

where:

- $V_O$  = Velocity at the outlet of the culvert barrel, ft/s.
- $V_{TW}$  = Channel tail water velocity downstream of the culvert barrel, ft/s.
- $K_{EXIT}$  = Exit loss coefficient.

We did not examine exit losses in this study although a second phase was proposed to look at exit losses under different tail water conditions. Designers typically use  $K_{EXIT} = 1.0$  and neglect the downstream velocity head, but those assumptions would have resulted in an overestimate of several feet for the highest discharges at the Dale Boulevard site.

The exit loss coefficient is a function of type of end section and the tail water depth. When the tail water was near the crown of the culvert at the outlet, we observed that the jet of water created its own tapered exit section of active flow. The energy did not actually drop suddenly at the exit because the flow did not suddenly redistribute evenly in the downstream channel. If the energy of the active flow been measured downstream of the culvert, the computed exit loss probably would have been relatively low.

## CONCLUSIONS AND RECOMMENDATIONS

1. The 1-percent annual chance elevation of 235.92 ft (71.908m) at cross section 6138 from this study and the 1-percent annual chance elevations of 236.01 ft (71.936 m) at cross section 6138 and 236.45 ft (72.070 m) at cross section 7113 from the FEMA letter of map revision (LOMR) analysis are all below the lowest adjacent grade (LAG) elevation of 237.6 ft (72.420 m) for the houses located between these two cross sections. These houses should not be inundated by the 1-percent annual flood chance.
2. The slight differences in the water surface elevations determined in this study and those cited in the FEMA LOMR are due to the velocity head deduction that was taken in this study. The losses in culvert hydraulics are energy losses rather than hydraulic grade losses. In the opinion of the authors, the headwater computation for a culvert implicitly includes the velocity head for the approach channel flow; therefore, that velocity head was deducted from the headwater to establish the water surface elevation upstream of the culvert. That adjustment is typically not made in studies of this type and the effect was small (0.08 ft (0.024 m) at cross section 6138).
3. The laboratory work removed the uncertainty of not knowing which culvert diameter or appropriate inlet coefficients to use in the analysis.
4. The precise means of modeling the Dale Boulevard culvert is to utilize the performance curve depicted in figure 9 in the HEC-2 context. In the flow range of the 100-yr flood, it appeared that when the 10.5-ft (3200-mm) section was flowing full and the 9.5-ft (2806-mm) section was unsubmerged, the inlet acted as an improved inlet.
5. The following coefficients are appropriate to use when analyzing the Dale Boulevard culverts with the HDS-5 design equations. The Form 2 equation was used for this analysis for the unsubmerged flow data. The inlet control coefficients account for the effects of the enlarged end section and are based on the velocity head for the smaller-diameter pipe. The slope correction term to be used for the submerged flow equation should be  $+0.07S$  since the inlet is mitered to the embankment slope, where  $S$  is the culvert slope in ft/ft (m/m). The outlet control coefficients are based on the velocity head for the upstream pipe.

Inlet Control				Outlet Control	
$K_2$	$M_2$	$c$	$Y$	$K_{ent}$	$K_{cont}$
0.47	0.623	0.040	0.60	0.14	0.073

6. The following design coefficients are for a mitered 45-degree wingwall inlet to a round concrete pipe as shown in figure 23 without the enlarged section. These coefficients are very close to the coefficients for the Dale Boulevard installation because the enlarged end section did not influence the headwater significantly for most of the discharges included in the experiments. The slope correction term for submerged flow for this inlet should also be  $+0.7S$ .

Inlet Control				Outlet Control	
$K_2$	$M_2$	$c$	$Y$	$K_{ent}$	
0.503	0.577	0.030	0.71	0.14	



**Figure 23. Mitered 30-degree wingwall configuration.**

7. The contraction coefficient for a slightly larger round pipe butting into a slightly smaller round pipe (within 10 percent of each other) is  $K_{cont} = 0.073$  applied to the incoming velocity head.
8. To generalize coefficients, additional testing would be needed. Runs with different pipe diameters, varying barrel lengths, and different barrel slopes could be examined.
9. As the flow passes from the head box into the short 10.5-in (267-mm) section of pipe, the flow is very difficult to analyze. Additional studies could focus on the vena contracta and how it relates to the energy losses through the contraction.
10. It would be useful to enhance both HY-8 and HEC-RAS so that user-defined coefficients can be used for unusual culvert configurations. Such user defined coefficients can be derived in scale model hydraulic experiments.
11. Additional research is recommended to examine exit loss assumptions especially as they apply to culverts that function as relief openings on a flood plain.

## APPENDIX A – REFERENCES

1. Norman, Jerome M., Robert J. Houghtalen, and William J. Johnston, “Hydraulic Design of Highway Culverts,” Hydraulic Design Series No. 5 (HDS-5), Federal Highway Administration report no. FHWA-IP-85-15, Sept 1985 .
2. US Army Corps of Engineers, “HEC-RAS River Analysis System Hydraulic Reference Manual,” Version 2.0, Hydrologic Engineering Center, Davis, CA., April 1997.
3. Young, G. Kenneth and Joseph S. Krolak, , “HY-8-Culverts (Analysis and Design),” HYDRAIN-INTEGRATED DRAINAGE DESIGN COMPUTER SYSTEM; Version 5.0, Volume VI, Federal Highway Administration report no. FHWA-RD-92-061, July 1994.
4. Crane Company, "Loss coefficients for enlargements and contractions based on velocity in small pipe," Flow of Fluids Through Valves, Fittings and Pipe, Tech. Paper No. 410, Crane Co., 300 Park Ave., N.Y., 1969
5. FEMA Letter of Map Revision (LOMR), Case No. 01-03-123P, under review by FEMA as of July 15, 2001 for issuance, based on personal communication with Jeff Smith, Dewberry & Davis LLC, July 23, 2001.

**APPENDIX B – SUMMARY DATA**

**Table 11. Inlet control data.**

Refer to table 8

1 ft = 0.305 m, 1 ft<sup>3</sup>/s = 0.028 m<sup>3</sup>/s

<b>Q (ft<sup>3</sup>/s)</b>	<b>HW (ft)</b>	<b>Q/(AD0.5)</b>	<b>Inlet Condition</b>
<b><i>“inlet1bm”</i></b>			
0.000	0.000	0.000	unsubmerged
0.283	0.297	0.502	unsubmerged
0.494	0.388	0.879	unsubmerged
0.766	0.498	1.362	unsubmerged
1.010	0.606	1.796	unsubmerged
1.300	0.692	2.310	unsubmerged
1.448	0.747	2.574	unsubmerged
1.752	0.838	3.114	unsubmerged
1.960	0.909	3.484	
2.260	1.030	4.018	
2.518	1.122	4.476	submerged
2.751	1.230	4.891	submerged
2.949	1.327	5.242	submerged
3.242	1.474	5.764	submerged
3.464	1.596	6.159	submerged
3.747	1.540	6.661	submerged
3.973	1.713	7.063	submerged
<b><i>“inlet4bm”</i></b>			
0.000	0.000	0.000	unsubmerged
0.247	0.278	0.439	unsubmerged
0.505	0.405	0.898	unsubmerged
0.745	0.511	1.325	unsubmerged
1.014	0.602	1.802	unsubmerged
1.250	0.683	2.223	unsubmerged
1.515	0.778	2.693	unsubmerged
1.752	0.853	3.114	unsubmerged
1.999	0.952	3.554	



Refer to table 8

1 ft = 0.305 m, 1 ft<sup>3</sup>/s = 0.028 m<sup>3</sup>/s

<b>Q (ft<sup>3</sup>/s)</b>	<b>HW (ft)</b>	<b>Q/(AD0.5 )</b>	<b>Inlet Condition</b>
2.250	1.038	3.999	
2.465	1.125	4.382	
2.740	1.244	4.872	submerged
2.966	1.361	5.274	submerged
3.249	1.504	5.776	submerged
3.454	1.602	6.140	submerged
<b><i>“inlet5bm”</i></b>			
0.000	0.000	0.000	unsubmerged
0.251	0.292	0.439	unsubmerged
0.505	0.423	0.898	unsubmerged
0.756	0.529	1.325	unsubmerged
1.017	0.625	1.802	unsubmerged
1.257	0.705	2.223	unsubmerged
1.504	0.790	2.693	unsubmerged
1.748	0.866	3.114	unsubmerged
1.995	0.959	3.554	
2.260	1.045	3.999	
2.472	1.123	4.382	
2.747	1.241	4.872	submerged
2.977	1.355	5.274	submerged
3.242	1.486	5.776	submerged
3.450	1.597	6.140	submerged
<b><i>“inlet13bm”</i></b>			
0.000	0.000	0.000	unsubmerged
0.519	0.443	1.185	unsubmerged
0.759	0.540	1.734	unsubmerged
0.996	0.631	2.274	unsubmerged
1.275	0.727	2.911	unsubmerged
1.490	0.812	3.403	
1.755	0.927	4.007	
1.995	1.039	4.556	
2.253	1.165	5.144	submerged

Refer to table 8

1 ft = 0.305 m, 1 ft<sup>3</sup>/s = 0.028 m<sup>3</sup>/s

<b>Q (ft<sup>3</sup>/s)</b>	<b>HW (ft)</b>	<b>Q/(AD0.5 )</b>	<b>Inlet Condition</b>
2.500	1.315	5.709	submerged
2.744	1.482	6.265	submerged
3.245	1.339	7.410	submerged
3.500	1.415	7.991	submerged
3.754	1.586	8.571	submerged
4.005	1.773	9.144	submerged
4.234	1.937	9.668	submerged
3.998	1.779	9.128	submerged
3.757	1.595	8.579	submerged
3.496	1.434	7.983	submerged
3.242	1.334	7.402	submerged
3.041	1.190	6.942	submerged
2.747	1.053	6.273	submerged
2.493	0.982	5.693	submerged
2.253	0.941	5.144	submerged
2.002	0.904	4.572	submerged
1.741	0.917	3.975	submerged
1.511	0.821	3.451	submerged
1.261	0.730	2.879	unsubmerged
1.003	0.632	2.290	unsubmerged
0.752	0.531	1.717	unsubmerged
0.501	0.420	1.145	unsubmerged
<b><i>“inlet7db”</i></b>			
0.000	0.000	0.000	unsubmerged
0.247	0.265	0.564	unsubmerged
0.491	0.376	1.121	unsubmerged
0.780	0.493	1.782	unsubmerged
1.010	0.572	2.306	unsubmerged
1.236	0.647	2.822	unsubmerged
1.533	0.754	3.499	unsubmerged
1.762	0.852	4.024	
2.006	0.963	4.580	

Refer to table 8

1 ft = 0.305 m, 1 ft<sup>3</sup>/s = 0.028 m<sup>3</sup>/s

<b>Q (ft<sup>3</sup>/s)</b>	<b>HW (ft)</b>	<b>Q/(AD0.5)</b>	<b>Inlet Condition</b>
2.250	1.066	5.136	submerged
2.514	1.209	5.741	submerged
2.726	1.336	6.225	submerged
2.991	1.494	6.830	submerged
3.242	1.656	7.402	submerged
3.471	1.810	7.926	submerged
<b><i>“inlet11db”</i></b>			
0.000	0.000	0.000	unsubmerged
0.498	0.385	0.885	unsubmerged
0.752	0.490	1.337	unsubmerged
1.003	0.579	1.783	unsubmerged
1.254	0.667	2.229	unsubmerged
1.501	0.767	2.668	unsubmerged
1.759	0.867	3.127	unsubmerged
2.009	0.984	3.572	unsubmerged
2.250	0.964	3.999	
2.490	1.005	4.426	
2.751	1.048	4.891	submerged
2.988	1.116	5.311	submerged
3.252	1.329	5.782	submerged
3.503	1.420	6.228	submerged
3.754	1.584	6.674	submerged
4.008	1.752	7.126	submerged
4.248	1.949	7.553	submerged
<b><i>“inlet30db”</i></b>			
0.000	0.000	0.000	unsubmerged
0.343	0.291	0.609	unsubmerged
0.516	0.371	0.917	unsubmerged
0.657	0.432	1.168	unsubmerged
0.844	0.503	1.501	unsubmerged
1.109	0.638	1.971	unsubmerged
1.353	0.721	2.405	unsubmerged

Refer to table 8

1 ft = 0.305 m, 1 ft<sup>3</sup>/s = 0.028 m<sup>3</sup>/s

<b>Q (ft<sup>3</sup>/s)</b>	<b>HW (ft)</b>	<b>Q/(AD0.5 )</b>	<b>Inlet Condition</b>
1.607	0.813	2.857	unsubmerged
1.755	0.877	3.120	
1.854	0.924	3.296	submerged
<b><i>“inlet31db”</i></b>			
0.000	0.000	0.000	unsubmerged
0.317	0.317	0.766	unsubmerged
0.397	0.397	1.153	unsubmerged
0.458	0.458	1.492	unsubmerged
0.530	0.530	1.911	unsubmerged
0.591	0.591	2.314	unsubmerged
0.684	0.684	2.677	unsubmerged
0.728	0.728	3.080	unsubmerged
0.782	0.782	3.411	unsubmerged
0.864	0.864	3.862	
0.933	0.933	4.217	
1.001	1.001	4.572	submerged
1.063	1.063	4.927	submerged
1.134	1.134	5.273	submerged
1.240	1.240	5.749	submerged
1.332	1.332	6.080	submerged
1.425	1.425	6.443	submerged
1.538	1.538	6.854	submerged
1.643	1.643	7.192	submerged
1.757	1.757	7.563	submerged

**Table 12. Outlet control data for entrance loss coefficient.**

Series OUT3bm; Diameter = 10.5 in (266.7 mm); A=0.05586 m <sup>2</sup>							
Run	1	2	3	4	5	6	7
$Q$ (m <sup>3</sup> /s)	.0284	.0424	.0563	.0707	.0846	.0991	.1132
n	0.010	0.0084	0.0103	0.0091	0.0090	0.0097	0.0099
$H_{L_e}$ (mm)	1.53	7.22	12.92	21.50	28.24	33.30	45.70
$K_{ent}$	0.12	0.25	0.25	0.26	0.24	0.21	0.22
Horizontal Distance (mm)	EGL (mm)	EGL (mm)	EGL (mm)	EGL (mm)	EGL (mm)	EGL (mm)	EGL (mm)
0.0	1043.6	1082.7	1122.9	1179.6	1245.0	1308.9	1388.3
0.0	1043.8	1085.4	1124.7	1179.0	1243.7	1316.9	1394.0
0.0	1044.5	1085.1	1123.5	1180.3	1242.1	1317.4	1398.4
0.0	1044.4	1085.4	1123.7	1180.5	1242.8	1314.9	1403.7
152.4	1042.9	1080.2	1110.9	1164.0	1218.7	1281.1	1351.5
457.2	1041.5	1076.8	1106.8	1152.2	1207.9	1270.9	1333.3
762.0	1041.4	1075.7	1108.7	1152.4	1208.4	1272.8	1332.1
1066.8	1041.7	1076.3	1106.8	1153.8	1207.7	1267.6	1331.7
1371.6	1041.1	1075.3	1105.9	1153.2	1209.4	1267.7	1341.1
1676.4	1041.5	1075.8	1104.3	1149.5	1203.8	1264.6	1326.5
1981.2	1040.3	1073.7	1102.3	1152.2	1201.2	1262.8	1323.5
2286.0	1040.5	1073.2	1101.0	1143.3	1194.7	1252.4	1311.6
2590.8	1041.0	1074.1	1098.9	1143.5	1196.0	1249.2	1307.0
2895.6	1039.0	1073.1	1096.0	1142.5	1197.3	1249.9	1305.5
3200.4	1039.4	1072.7	1099.5	1143.4	1195.0	1244.9	1305.1
3505.2	1039.6	1073.4	1098.9	1147.2	1191.4	1249.4	1309.3
3810.0	1039.3	1070.8	1096.8	1139.9	1193.4	1240.4	1289.4
4114.8	1038.0	1070.8	1093.8	1133.7	1181.9	1232.8	1283.2
4419.6	1038.1	1069.4	1091.3	1136.4	1180.9	1231.9	1280.7

Note: Data at horizontal distances 152.4, 457.2, and 4419.6 mm omitted from regression for “n” and  $H_{L_e}$ .  
 1 in = 25.4 mm, 1 m<sup>2</sup> = 10.76 ft<sup>2</sup>, 1 m<sup>3</sup>/s = 35.31 ft<sup>3</sup>/s

**Table 12. Outlet control data for entrance loss coefficient (continued).**

Series OUT35bm; Diameter = 10.5 in (266.7 mm); A=0.05586 m <sup>2</sup>						
Run	1	2	3	4	5	6
$Q$ (m <sup>3</sup> /s)	0.0424	0.0570	0.0710	0.841	0.0990	0.1122
n	0.0095	0.0099	0.0096	0.0104	0.0095	0.0096
$H_{L_e}$	3.15	5.90	10.86	11.11	15.00	16.09
$K_{ent}$	0.11	0.11	0.13	0.10	0.09	0.08
Horizontal Distance (mm)	EGL (mm)	EGL (mm)	EGL (mm)	EGL (mm)	EGL (mm)	EGL (mm)
0.0	1175.1	1226.5	1278.0	1334.2	1407.0	1473.3
0.0	1177.1	1221.7	1277.6	1334.2	1405.6	1478.2
0.0	1175.2	1222.8	1276.5	1334.9	1407.3	1484.0
0.0	1175.8	1223.9	1277.2	1339.5	1408.2	1485.2
152.4	1173.8	1223.7	1278.8	1348.3	1396.5	1507.8
457.2	1172.9	1214.2	1265.2	1321.9	1387.0	1467.2
762.0	1169.7	1215.8	1262.2	1317.7	1381.2	1456.0
1066.8	1171.1	1213.8	1261.6	1315.5	1381.9	1450.6
1371.6	1171.2	1213.6	1259.7	1313.2	1379.4	1446.5
1676.4	1169.7	1211.4	1257.9	1307.5	1374.1	1442.4
1981.2	1168.5	1209.1	1252.0	1304.4	1366.9	1431.6
2286.0	1169.3	1209.0	1253.4	1304.4	1368.2	1427.3
2590.8	1167.2	1207.4	1253.1	1302.4	1368.0	1425.3
2895.6	1166.8	1206.0	1249.2	1298.4	1363.3	1421.8
3200.4	1167.1	1206.3	1249.3	1295.5	1362.4	1421.3
3505.2	1166.1	1205.8	1248.7	1295.6	1361.4	1419.5
3810.0	1163.3	1199.6	1241.7	1285.5	1343.5	1408.6
4114.8	1165.9	1205.7	1246.3	1288.7	1347.3	1409.4
4419.6	1164.7	1203.1	1243.9	1294.5	1347.9	1406.7

Note: Data at Horizontal distances 152.4, 457.2, and 4419.6 mm omitted from regression for “n” and  $H_L$ .  
 1 in = 25.4 mm, 1 m<sup>2</sup> = 10.76 ft<sup>2</sup>, 1 m<sup>3</sup>/s = 35.31 ft<sup>3</sup>/s

**Table 12. Outlet control data for entrance loss coefficient (continued).**

Series OUT36bm; Diameter = 10.5 in (266.7 mm); A=0.05586 m <sup>2</sup>						
Run	1	2	3	4	5	6
$Q$ (m <sup>3</sup> /s)	0.0423	0.0569	0.0711	0.844	0.0982	0.1131
n	0.0113	0.0110	0.0095	0.0099	0.0105	0.0093
$H_{L_e}$	4.78	4.18	11.54	13.89	12.73	27.49
$K_{ent}$	0.16	0.08	0.14	0.12	0.08	0.13
Horizontal Distance (mm)	EGL (mm)	EGL (mm)	EGL (mm)	EGL (mm)	EGL (mm)	EGL (mm)
0.0	1126.7	1165.1	1216.8	1274.9	1338.4	1416.9
0.0	1125.0	1166.6	1217.3	1274.1	1339.1	1423.3
0.0	1123.9	1165.3	1218.4	1273.6	1339.4	1419.9
0.0	1125.4	1165.7	1218.4	1275.0	1342.3	1418.9
152.4	1122.8	1163.5	1213.3	1269.5	1336.6	1412.3
457.2	1120.7	1159.6	1205.1	1256.3	1318.3	1387.5
762.0	1118.6	1157.1	1201.7	1255.5	1314.3	1383.9
1066.8	1117.6	1155.3	1200.9	1250.8	1316.2	1380.3
1371.6	1117.0	1155.1	1199.5	1248.3	1316.1	1379.6
1676.4	1116.0	1154.5	1199.0	1244.9	1310.5	1366.7
1981.2	1114.0	1151.9	1192.7	1239.8	1290.4	1359.6
2286.0	1114.2	1152.6	1194.1	1244.4	1294.5	1356.5
2590.8	1113.2	1149.6	1191.8	1239.4	1298.0	1362.5
2895.6	1112.7	1148.3	1189.5	1240.8	1289.3	1353.5
3200.4	1111.4	1147.6	1191.4	1239.2	1289.4	1348.5
3505.2	1111.6	1146.0	1188.7	1238.3	1286.0	1344.6
3810.0	1108.5	1139.0	1179.2	1217.6	1270.6	1344.6
4114.8	1110.3	1143.3	1188.1	1226.5	1280.4	1340.2
4419.6	1107.8	1141.2	1184.4	1223.5	1273.0	1342.9

Note: Data at horizontal distances 152.4, 457.2, and 4419.6 mm omitted from regression for “n” and  $H_{L_e}$ .  
 1 in = 25.4 mm, 1 m<sup>2</sup> = 10.76 ft<sup>2</sup>, 1 m<sup>3</sup>/s = 35.31 ft<sup>3</sup>/s

**Table 12. Outlet control data for entrance loss coefficient (continued).**

Series OUT14bm; Diameter = 9.5 in (241.3 mm); A=0.0457 m <sup>2</sup>							
Run	1	2	3	4	5	6	7
$Q$ (m <sup>3</sup> /s)	.0284	.0427	.0570	.0707	.0853	.0990	.1123
$n$	.0111	.0104	.0106	.0101	.0100	.0097	.0096
$H_{L_e}$	3.93	6.54	8.62	14.88	21.13	21.58	26.86
$K_{ent}$	0.21	0.15	0.11	0.12	0.12	0.09	0.09
Horizontal Distance (mm)	EGL (mm)	EGL (mm)	EGL (mm)	EGL (mm)	EGL (mm)	EGL (mm)	EGL (mm)
0.0		1143.7	1202.4	1282.4	1373.3	1466.5	1568.6
0.0	1088.5	1145.2	1205.4	1282.9	1375.9	1473.1	1575.8
0.0	1089.1	1144.3	1206.9	1284.2	1371.0	1466.1	1575.3
0.0	1088.7	1144.5	1205.0	1285.5	1374.8	1466.3	1573.7
152.4	1085.5	1139.1	1196.7	1271.8	1355.5	1449.9	1552.4
304.8	1085.2	1136.8	1191.6	1265.9	1353.3	1444.8	1543.6
609.6	1083.6	1134.6	1185.6	1258.6	1337.0	1427.0	1525.9
914.4	1083.8	1135.7	1189.6	1262.5	1346.4	1438.9	1534.1
1219.2	1082.0	1131.4	1187.5	1256.1	1335.7	1418.4	1512.2
1524.0	1081.5	1131.4	1185.6	1249.8	1327.1	1412.8	1506.5
1828.8	1080.7	1130.2	1183.4	1250.3	1315.9	1409.9	1499.4
2133.6	1080.9	1129.5	1184.3	1246.8	1323.3	1408.7	1495.5
2438.4	1080.0	1129.2	1183.7	1246.4	1319.9	1403.3	1496.4
2743.2	1080.0	1128.8	1181.7	1246.6	1322.5	1410.1	1496.2
3048.0	1079.0	1126.2	1173.8	1238.5	1312.8	1392.6	1478.7
3352.8	1078.8	1124.5	1168.3	1231.5	1300.7	1377.3	1462.1
3657.6	1078.2	1124.2	1170.1	1234.4	1306.1	1386.3	1468.5
3962.4	1076.7	1120.2	1161.4	1221.7	1282.4	1357.2	1438.0
4267.2	1076.2	1120.6	1165.4	1224.8	1288.8	1366.2	1447.0
4572.0	1076.3	1119.9	1167.9	1223.6	1288.1	1365.7	1445.7

Note: Data at Hor dist 152.4, &4572.0 mm omitted from regression for “n” and  $H_{L_e}$ .

1 in = 25.4 mm, 1 m<sup>2</sup> = 10.76 ft<sup>2</sup>, 1 m<sup>3</sup>/s = 35.31 ft<sup>3</sup>/s



**Table 12. Outlet control data for entrance loss coefficient (continued).**

Series OUT16bm; Diameter = 9.5 in (241.3 mm); A=0.0457 m <sup>2</sup>				
Run	1	2	3	4
$Q$ (m <sup>3</sup> /s)	.0283	.0571	.0850	.1132
$n$	.0111	.0104	.0106	.0101
$H_{L_e}$	3.93	6.54	8.62	14.88
$K_{ent}$	0.21	0.15	0.11	0.12
Horizontal Distance (mm)	EGL (mm)	EGL (mm)	EGL (mm)	EGL (mm)
0.0		1204.7	1365.5	1584.4
0.0	1084.2	1206.2	1369.8	1588.3
0.0	1085.0	1207.2	1372.0	1587.3
0.0	1084.9	1205.8	1371.4	1586.0
152.4	1083.0	1197.1	1351.8	1560.2
304.8	1081.8	1194.2	1350.8	1553.7
609.6	1081.2	1187.1	1336.2	1531.2
914.4	1080.6	1186.7	1341.3	1544.0
1219.2	1079.5	1185.6	1332.2	1518.5
1524.0	1079.5	1183.4	1326.6	1504.4
1828.8	1078.8	1184.6	1329.2	1508.3
2133.6	1077.7	1182.3	1319.7	1503.5
2438.4	1078.2	1181.4	1319.9	1500.4
2743.2	1077.8	1181.5	1320.0	1505.6
3048.0	1077.1	1177.1	1307.3	1486.9
3352.8	1076.5	1172.4	1299.6	1466.6
3657.6	1076.6	1173.9	1304.0	1474.5
3962.4	1074.5	1166.4	1278.8	1440.8
4267.2	1073.9	1167.2	1280.2	1451.5
4572.0	1074.3	1165.9	1280.1	1450.3

Note: Data at horizontal distances 152.4 and 4572.0 mm omitted from regression for “ $n$ ” and  $H_{L_e}$ .  
 1 in = 25.4 mm, 1 m<sup>2</sup> = 10.76 ft<sup>2</sup>, 1 m<sup>3</sup>/s = 35.31 ft<sup>3</sup>/s

**Table 12. Outlet control data for entrance loss coefficient (continued).**

Series OUT14bm; Diameter = 9.5 in (241.3 mm); A=0.0457 m <sup>2</sup>					
Run	1	2	3	4	5
$Q$ (m <sup>3</sup> /s)	.0420	.0569	.0707	.0848	.0989
n	.0118	.0107	.0102	.0100	.0092
$H_{L_e}$	0.57	6.98	11.52	27.75	44.04
$K_{ent}$	0.01	0.09	0.09	0.16	0.18
Horizontal Distance (mm)	EGL (mm)	EGL (mm)	EGL (mm)	EGL (mm)	EGL (mm)
0.0	1169.7	1222.1	0.0	1363.6	1464.1
0.0	1168.6	1223.1	0.0	1371.5	1469.4
0.0	1169.1	1223.5	0.0	1372.2	1470.5
0.0	1168.3	1220.8	0.0	1364.5	1469.0
152.4	1169.3	1216.6	152.4	1344.8	1445.7
304.8	1167.3	1212.6	304.8	1342.9	1436.2
609.6	1164.6	1208.3	609.6	1325.4	1411.4
914.4	1164.4	1209.6	914.4	1329.8	1417.9
1219.2	1162.1	1204.9	1219.2	1316.8	1393.0
1524.0	1160.3	1202.3	1524.0	1312.5	1389.9
1828.8	1159.4	1202.9	1828.8	1316.4	1399.1
2133.6	1157.0	1199.4	2133.6	1310.8	1386.2
2438.4	1156.9	1199.3	2438.4	1312.2	1388.5
2743.2	1155.5	1199.7	2743.2	1313.1	1390.7
3048.0	1154.1	1196.1	3048.0	1303.1	1379.4
3352.8	1152.0	1186.1	3352.8	1287.8	1361.5
3657.6	1151.4	1190.0	3657.6	1286.4	1371.7
3962.4	1146.4	1182.3	3962.4	1268.3	1343.7
4267.2	1146.9	1182.2	4267.2	1278.6	1353.3
4572.0	1144.9	1182.3	4572.0	1276.0	1349.7

Note: Data at horizontal distances 152.4 and 4572.0 mm omitted from regression for “n” and  $H_{L_e}$ .  
 1 in = 25.4 mm, 1 m<sup>2</sup> = 10.76 ft<sup>2</sup>, 1 m<sup>3</sup>/s = 35.31 ft<sup>3</sup>/s

**Table 13. Summary Data for Full Pipe Contraction Losses**

Series OUT_CONT23; Upstream barrel diameter = 10.5 in (266.7 mm); Downstream barrel diameter = 9.5 in (241.3 mm)												
Run	1		2		3		4		5		6	
$Q$ (m <sup>3</sup> /s)	0.0424		0.0570		0.0704		0.0848		0.0991		0.1132	
u.s. barrel $V^2/2g$ (mm)	29.4		53.1		81.0		117.5		160.4		209.3	
$H_{L\ CONT}$	0.46		2.27		-0.40		10.36		18.71		13.81	
$K_{\ CONT}$	0.02		0.04		--		0.13		0.12		0.07	
Horizontal Distance (mm)	EGL u.s. (mm)	EGL d.s. (mm)	EGL u.s. (mm)	EGL d.s. (mm)	EGL u.s. (mm)	EGL d.s. (mm)	EGL u.s. (mm)	EGL d.s. (mm)	EGL u.s. (mm)	EGL d.s. (mm)	EGL u.s. (mm)	EGL d.s. (mm)
152.4	1171.5		1226.4		1291.4		1364.3		1456.5		1574.5	
457.2	1168.9		1221.5		1282.3		1348.9		1442.5		1546.3	
762.0	1168.2		1220.8		1281.4		1346.7		1444.8		1549.8	
1066.8	1167.1		1218.2		1275.7		1344.0		1434.0		1537.1	
1371.6	1167.1		1217.4		1276.6		1343.9		1436.7		1538.8	
1676.4	1165.5		1214.4		1274.8		1341.3		1440.8		1530.6	
1981.2	1163.4		1212.8		1268.2		1333.0		1426.0		1514.9	
2133.6	1163.6		1216.2		1268.7		1342.2		1429.2		1529.8	
2286.0	1160.9		1212.1		1264.6		1328.7		1413.7		1510.6	
2438.4												
2743.2		1159.5		1206.2		1259.1		1313.6		1392.4		1487.2
3048.0		1159.8		1206.6		1260.5		1317.4		1387.9		1487.2
3352.8		1158.5		1205.5		1256.6		1309.3		1395.6		1493.7
3657.6		1156.5		1201.5		1247.8		1303.0		1378.5		1458.0
3962.4		1153.6		1195.1		1239.6		1291.2		1361.9		1441.6
4267.2		1153.4		1198.5		1244.6		1294.8		1366.8		1464.5

Note: Data at horizontal distance 152.4 mm omitted from regression for  $H_{L\ CONT}$ .

1 in = 25.4 mm, 1 m<sup>2</sup> = 10.76 ft<sup>2</sup>, 1 m<sup>3</sup>/s = 35.31 ft<sup>3</sup>/s

**Table 13. Summary Data for Full Pipe Contraction Losses (continued).**

Series OUT_CONT24; Upstream barrel diameter = 10.5 in (266.7 mm); Downstream barrel diameter = 9.5 in (241.3 mm)										
Run	1		2		3		4		5	
$Q$ (m <sup>3</sup> /s)	0.0564		0.0707		0.0850		0.0990		0.1128	
u.s. barrel $V^2/2g$ (mm)	52.0		81.6		118.0		160.1		207.8	
$H_{L\ CONT}$	2.75		6.76		-2.10		6.32		19.07	
$K_{CONT}$	0.05		0.08		--		0.05		0.09	
Horizontal Distance (mm)	EGL u.s. (mm)	EGL d.s. (mm)	EGL u.s. (mm)	EGL d.s. (mm)	EGL u.s. (mm)	EGL d.s. (mm)	EGL u.s. (mm)	EGL d.s. (mm)	EGL u.s. (mm)	EGL d.s. (mm)
152.4	1200.3		1259.1		1335.4		1422.6		1523.1	
457.2	1183.9		1252.2		1324.8		1405.7		1500.3	
762.0	1181.3		1248.7		1320.8		1409.4		1500.2	
1066.8	1176.1		1245.3		1314.3		1399.4		1486.7	
1371.6	1175.8		1247.0		1317.4		1402.4		1491.9	
1676.4	1175.2		1243.5		1311.1		1398.3		1487.8	
1981.2	1172.8		1239.0		1305.5		1381.1		1476.9	
2133.6	1174.1		1242.3		1307.3		1392.6		1487.7	
2286.0	1167.9		1233.7		1299.0		1372.8		1469.4	
2438.4										
2743.2		1162.8		1223.8		1294.7		1360.6		1444.2
3048.0		1162.9		1224.2		1295.7		1362.9		1451.3
3352.8		1161.4		1223.2		1290.2		1365.2		1442.8
3657.6		1158.5		1215.3		1283.5		1357.2		1426.1
3962.4		1152.0		1209.3		1268.1		1335.1		1415.1
4267.2		1154.9		1209.8		1276.1		1338.9		1425.8

Note: Data at horizontal distance 152.4 mm omitted from regression for  $H_{L\ CONT}$ .

1 in = 25.4 mm, 1 m<sup>2</sup> = 10.76 ft<sup>2</sup>, 1 m<sup>3</sup>/s = 35.31 ft<sup>3</sup>/s

**Table 13. Summary Data for Full Pipe Contraction Losses (continued).**

Series OUT_CONT34; Upstream barrel diameter = 10.5 in (266.7 mm); Downstream barrel diameter = 9.5 in (241.3 mm)												
Run	1		2		3		4		5		6	
$Q$ (m <sup>3</sup> /s)	0.0190		0.0281		0.0373		0.0471		0.0560		0.0658	
u.s. barrel $V^2/2g$ (mm)	5.897		12.89		22.72		36.24		51.22		70.72	
$H_{L\ CONT}$	-0.1		1.0		0.3		1.6		3.3		4.0	
$K_{\ CONT}$	--		0.07		0.01		0.04		0.06		0.06	
Horizontal Distance (mm)	EGL u.s. (mm)	EGL d.s. (mm)	EGL u.s. (mm)	EGL d.s. (mm)	EGL u.s. (mm)	EGL d.s. (mm)	EGL u.s. (mm)	EGL d.s. (mm)	EGL u.s. (mm)	EGL d.s. (mm)	EGL u.s. (mm)	EGL d.s. (mm)
152.4	1061.1		1078.7		1118.8		1154.0		1192.5		1238.4	
457.2	1060.2		1079.0		1118.1		1152.1		1189.6		1232.7	
762.0	1061.3		1079.1		1117.1		1152.7		1187.4		1232.9	
1066.8	1060.8		1078.4		1116.2		1152.0		1186.5		1229.8	
1371.6	1060.7		1079.0		1116.7		1150.2		1186.7		1227.4	
1676.4	1060.6		1077.7		1115.4		1150.1		1184.2		1224.5	
2006.6	1059.3		1077.1		1114.9		1147.3		1180.4		1222.9	
2159.0	1059.8		1077.2		1115.5		1148.0		1183.0		1223.7	
2311.4	1058.6		1075.5		1114.1		1146.7		1179.8		1219.9	
2463.8	1059.6		1076.1		1110.3		1142.9		1178.2		1217.6	
2616.2						1080.2		1092.2		1104.0		1115.4
2768.6						1080.3		1092.7		1102.4		1112.9
3098.8		-1050.7		1057.5		1079.6		1091.7		1103.1		1113.4
3403.6		-1051.0		1057.0		1078.9		1091.2		1100.1		1112.9
3708.4		-1051.0		1057.7		1077.9		1089.9		1100.5		1111.1
4013.2		-1050.3		1057.3		1076.5		1088.4		1098.8		1108.5
4318.0		-1049.5		1057.5		1076.3		1087.6		1097.9		1106.7

Note: Data at horizontal distance 152.4 mm omitted from regression for  $H_{L\ CONT}$ .

1 in = 25.4 mm, 1 m2 = 10.76 ft2, 1 m3/s = 35.31 ft3/s

**Table 13. Summary Data for Full Pipe Contraction Losses (continued).**

Series OUT_CONT34 (cont'd); Upstream barrel diameter = 10.5 in (266.7 mm); Downstream barrel diameter = 9.5 in (241.3 mm)										
Run	7		8		9		10		11	
$Q$ (m <sup>3</sup> /s)	0.0756		0.0837		0.0944		0.1032		0.1132	
u.s. barrel $V^2/2g$ (mm)	93.36		114.43		145.56		173.96		209.31	
$H_{L\ CONT}$	6.2		4.6		9.3		13.6		13.0	
$K_{CONT}$	0.07		0.04		0.06		0.08		0.06	
Horizontal Distance (mm)	EGL u.s. (mm)	EGL d.s. (mm)	EGL u.s. (mm)	EGL d.s. (mm)	EGL u.s. (mm)	EGL d.s. (mm)	EGL u.s. (mm)	EGL d.s. (mm)	EGL u.s. (mm)	EGL d.s. (mm)
152.4	1288.4		1336.9		1407.7		1453.7		1527.1	
457.2	1283.2		1328.5		1395.8		1443.7		1508.1	
762.0	1279.4		1325.8		1387.3		1441.3		1498.8	
1066.8	1285.6		1322.9		1389.0		1439.7		1492.6	
1371.6	1282.2		1317.6		1387.2		1431.8		1493.1	
1676.4	1276.6		1317.5		1378.3		1425.8		1488.2	
2006.6	1267.3		1311.4		1373.2		1416.8		1473.3	
2159.0	1272.3		1315.7		1380.7		1421.5		1485.0	
2311.4	1263.5		1305.5		1362.9		1411.2		1468.5	
2463.8	1262.1		1302.9		1362.8		1408.6		1467.2	
2616.2		1126.8		1139.5		1151.9		1153.2		1157.6
2768.6		1124.0		1138.3		1148.6		1149.9		1155.0
3098.8		1127.6		1137.6		1144.1		1143.3		1156.0
3403.6		1124.4		1134.0		1149.3		1150.7		1166.4
3708.4		1121.5		1135.8		1140.0		1143.3		1145.6
4013.2		1117.9		1129.6		1137.2		1139.5		1137.9
4318.0		1117.4		1126.2		1135.8		1137.7		1145.1

Note: Data at horizontal distance 152.4 mm omitted from regression for  $H_{L\ CONT}$ .

1 in = 25.4 mm, 1 m<sup>2</sup> = 10.76 ft<sup>2</sup>, 1 m<sup>3</sup>/s = 35.31 ft<sup>3</sup>/s