

VEGETATION CONTROL FOR SAFETY

A Guide for
Street and Highway Maintenance Personnel

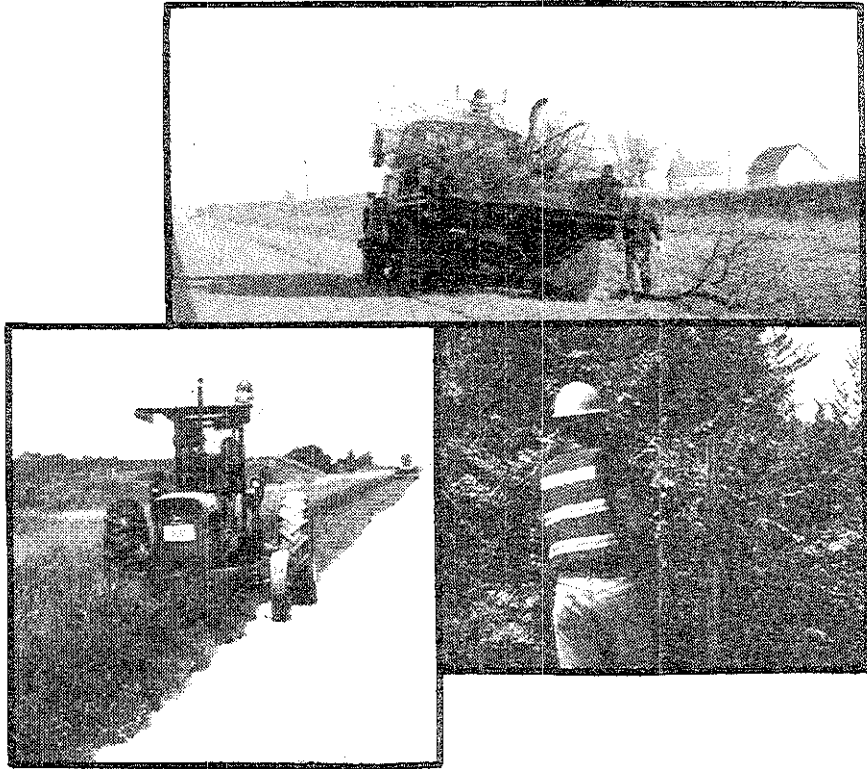

U. S. Department
of Transportation

Federal Highway
Administration
Office of Highway Safety

FHWA-RT-90-003

Prepared under the Rural Transportation
Assistance Program Project 70 by the
Technology Transfer Center,
Iowa State University,
Ames, Iowa 50011

Notice

This document is disseminated under the sponsorship of the Department of Transportation in the interest of information exchange. The United States Government assumes no liability for its content or use thereof.

The contents of this report reflect the views of the authors, who are responsible for the facts and the accuracy of the data presented herein. The contents do not necessarily reflect the official policy of the Department of Transportation.

This report does not constitute a manual, handbook, standard, specification, or regulation.

The United States Government does not endorse products or manufacturers. Trademarks or manufacturer's names appear herein only because they are considered essential to the object of this document.

TABLE OF CONTENTS

	page
I. Introduction	1
Goals for vegetation control	1
Examples of problems	1
II. Line of Sight Clearance	7
Keeping signs and traffic control devices visible	7
Traffic control considerations during maintenance	9
Intersection clear sight distance	16
Private property owner agreement	21
III. Trees in Clear Zone	29
IV. Mowing for Safety	31
Types of mowing	31
Mowing operation notes	31
Traffic control for mowing operations	35
V. Summary of Safety Tips for Vegetation Control	37

I. INTRODUCTION

The purpose of this handbook is to help maintenance workers be aware of safe ways to

- mow
- cut brush
- control other vegetation

to increase traffic safety. During the growing season, grass, weeds, and brush often limit a driver's view of approaching vehicles. Likewise, lush vegetation can act as a screen that hides pedestrians and bikers from drivers and vice versa. Be alert for places where vegetation needs to be cut back. The following pictures show examples of problem vegetation.

Goals for vegetation control

The main goals for vegetation control include

- keeping signs and vehicles visible to drivers as well as pedestrians and bike riders in cross walks, at street lights, at uncontrolled intersections, and on bike paths
- helping pedestrians and bike riders see on-coming traffic more easily
- improving winter road maintenance in snow and ice areas

Examples of problems



Brush hides this sign. In bright daylight, the sign can be seen but not clearly. At night a driver may completely miss seeing the sign. This brush should be cut immediately.



Here is an example of a sign being blocked completely by bushes. Even though this is not a STOP sign, a YIELD sign, or similar critical sign, the bushes should be trimmed as soon as possible.



This is an example of trees in the roadside ditch that were never cut as small saplings and have grown so big they are a hazard. People now think of them as prized trees and would object if you cut them, even for safety.



These trees in the roadside ditch are too close to the road. They have been planted in the road right of way by the resident as part of a wind break. Your agency should have a policy on planting trees within the right-of-way. For example, you might not allow trees within the clear zone.



This intersection has tall grass and weeds in the ditch and a backslope area that creates a hazard. There is a STOP sign, but after stopping, a driver must pull out onto the edge of the main road to see around the weeds. Vegetation in the ditches has to be kept low enough to allow good sight distance at intersections.



Hazard markers on low volume roads can be hidden by tall grass. This picture shows a marker at the end of a culvert that can be seen fairly well in daylight but will be partially hidden at night by the grass.

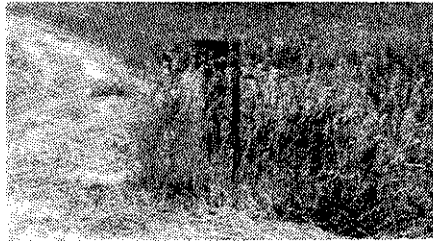

This photograph shows a hazard marker that will be completely hidden at night because the grass will shadow the marker from car headlights. Maintenance crews have mowed around the hazard marker. But they need to stop to trim around the marker or come back later to trim up.



Here tree limbs that have been trimmed back in previous years are beginning to grow back in front of the sign. Maintenance patrols need to look for trees and brush that block the view of signs or other traffic control devices.



In urban areas, trees and shrubs can grow out over the street, blocking a driver's view of cars, trucks, bicycles, and pedestrians. If the street right of way extends back from the curb at least a few feet, this vegetation should be trimmed to permit vehicles entering the street to see traffic approaching in the curb lane.



Sometimes the vegetation restricting a driver's line of sight at a city street intersection requires more than minor trimming. Drivers waiting at this STOP sign had trouble seeing pedestrians on the sidewalk and vehicles approaching from the left.

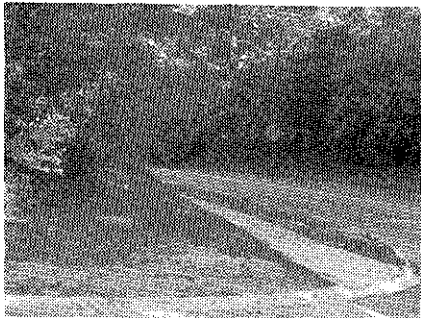

At this same location, street maintenance crews flattened the slope from the sidewalk to the property line and cut the trees and bushes. A landscape architect for the city placed low-growing plants on the yard slope to reduce future maintenance. This method greatly improved drivers' visibility of the conflicting traffic.



This photograph shows a rural roadside that has been well maintained only on the foreslope into the ditch. Brush in the ditch and on the back-slope is beginning to block the STOP AHEAD sign. Soon it will block the driver's view of the STOP sign in the far distance. If these young trees are allowed to continue growing, they will become hazards.

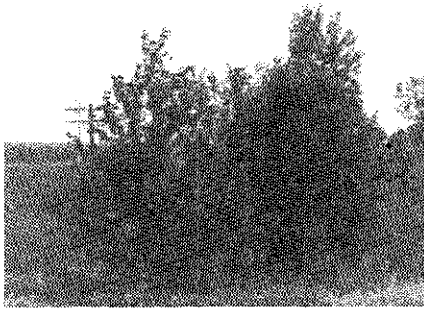

Visibility is a special concern at railroad crossings. At this rural railroad crossing, a driver cannot see a train coming from the right because small trees and brush completely block the view of the tracks. The highway agency and the railroad cooperated in cutting these trees and greatly improved crossing safety.

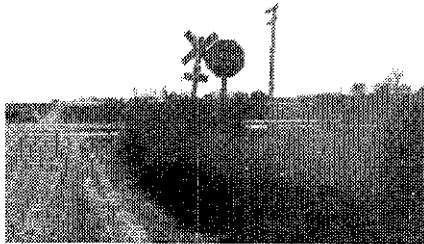

This is another rural railroad crossing. It has STOP signs in addition to the railroad crossbuck warning. But grass and weeds have been permitted to grow up in front of the STOP sign. Since the railroad tracks are on a sharp rise in the road, the grass and weeds prevent vehicle headlights from shining on the STOP sign at night. This vegetation needs to be cut immediately.

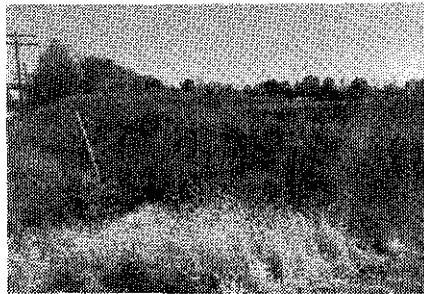

This photograph shows a suburban railroad crossing where vegetation on a knoll blocked a driver's view of trains on the track. Cutting the vegetation helped, but moving some earth was needed too.



A cooperative effort of the railroad and highway maintenance crews resulted in cutting back the knoll and adding lights on the street approach.

NOTES

II. Line of Sight Clearance

Drivers approaching an intersection need a clear line of sight along crossroads early enough to see any conflicting vehicles, pedestrians, and bicyclists to avoid a collision. Drivers also need an unobstructed line of sight to any roadside signs or hazards far enough in the distance to allow them to react safely to each situation.

Keeping signs and traffic control devices visible

- Suggested maintenance steps
 1. Look for signs and other traffic control devices blocked by brush, trees, grass, or weeds when on routine maintenance patrol.

Often a small branch from an overhanging tree or some bush near the sign is all that needs to be cut back. If vegetation along the ditch or shoulder blocks a driver's view of a sign, then cut enough to allow a driver sufficient time to see the sign and respond to its message. If your agency has a policy on how far from a sign vegetation has to be cleared for a safe view, then follow that policy. If you do not have such a policy, the following is a suggested guideline to allow a driver 3 to 5 seconds to read and obey the sign:

CLEAR DISTANCE TO SEE SIGN

Speed Limit (MPH)	Noncritical Signs (feet)	Critical Signs (feet)
30	150	250
40	200	350
50	250	450
60	300	600

Critical signs are STOP, YIELD, DO NOT ENTER, ONE WAY, WRONG WAY, and other regulatory signs. Noncritical signs are destination guide signs, parking regulations, advance warning signs, and similar warning or information signs.

2. Pull maintenance vehicle off the traveled lane and place traffic control warnings.
 3. Cut or trim trees, brush, weeds, or grass to clear a driver's line of sight to the sign or traffic control device. **Always wear protective leather gloves, safety glasses or goggles, orange safety vests, hard hats, and leather boots (not sneakers or soft shoes).**
 4. Paint the stubs of brush or small trees with a weed killer solution to keep it from growing back.
 5. Collect limbs and large brush to haul away for disposal or run them through a chipper if available.
 6. Look for moving traffic when removing the temporary traffic control warnings and leaving the site. Drivers may not realize you are through working and probably will not expect you to pull onto the traffic lane.
 7. Watch especially for overhead power lines and electrified farm fences when cutting brush. Never touch a wire farm fence when an electrical storm is in the vicinity of your work.
- Suggested equipment

Take along the following suggested equipment when cutting brush or other vegetation to clear the line of sight to signs or other traffic control devices.

1. **Leather gloves** to protect your hands from cuts and nicks
2. **Hard hats** to protect your head from a falling limb or flying debris during cutting and clearing
3. **Safety glasses or goggles** to protect your eyes from flying chips or particles during cutting and clearing
4. **Orange safety vests** to reduce accidental injury from vehicles and hunters by making workers more visible
5. **Chain saw, fuel, bar oil** to cut small trees and large brush

6. **Gasoline powered “weed eater”** to cut grass and small weeds away from sign support and similar areas
7. **Brush knife or machete** to cut small brush
8. **Loppers** (long handled side cutters) to cut small low-hanging branches and large woody weeds
9. **Tree trimming saw with small branch lopper** (on a telescoping pole handle) to cut higher branches from overhanging trees that are blocking the view of sign or traffic control device
10. **Tall step ladder** to help cut branches near the tree trunk to limit regrowth
11. **Axe** to chop down small saplings

Traffic control considerations during maintenance

Three suggested traffic control plans are shown in the following sketches to help guide traffic around your work.

- One is for two-lane, two-way roads where a shoulder has to be closed.
- The second applies when you can get all your vehicles and equipment off the shoulder or completely over the street curb. Here you want to warn drivers that you are working off the edge of the road. You do not want them to drift off the road into your area.
- The third applies to a lane that has to be closed when you will have equipment or people in or on a traveled lane. Lanes may have to be closed when the shoulder or foreslope beyond the shoulder is too narrow to permit loading trimmings or maneuvering equipment completely off the traveled lanes.

Typical Traffic Control Layout for Shoulder Closure

NOTES:

1. Daytime operation and short repair duration.
2. Use this layout when repair work is on or within 2 feet of the traveled way (traffic lane).
3. Flaggers, if used, should use STOP/SLOW paddles instead of red flags.
4. Buffer zone may be reduced or extended depending on available sight distance.
5. Keep parked vehicles away from the traffic as much as possible.
6. Keep buffer zone free of obstacles or hazards.

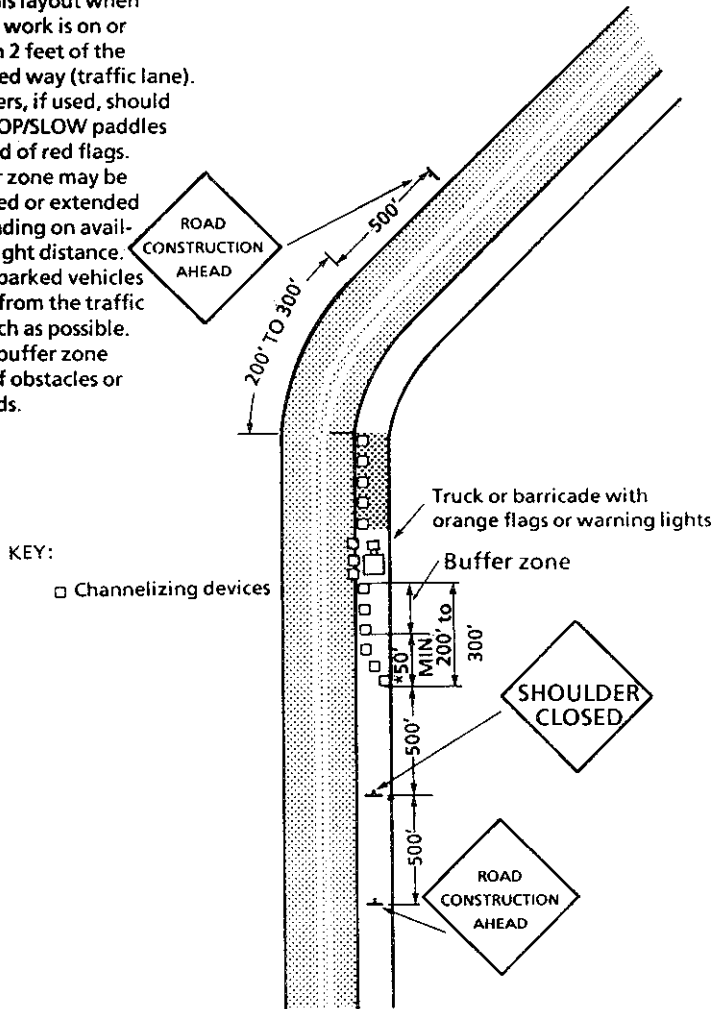

*See taper cone spacing table

Equipment Check List-Shoulder Closure Work Zone Traffic Control Devices

1. Cones:		
Taper, see table below for spacing of five cones		5
Buffer zone (minimum of five spaced at 2 times speed in MPH)	_____	
Work area (minimum of five spaced at 2 times speed in MPH)	_____	
	TOTAL	_____
 2. Signs:		
ROAD CONSTRUCTION AHEAD		2
SHOULDER CLOSED		1

Spacing Guideline for
Suggested 5-cone Shoulder
Taper

Road speed limit (MPH)	Cone spacing (ft)
20	10
25	10
30	15
35	20
40	30
45	45
50	50
55	55

NOTES:

1. You will need at least 15 cones. Depending on where the work is, the kind of road, and other conditions, more devices might be needed. When in doubt, use more cones. **YOUR SAFETY IS AT STAKE.**
2. Any of several delineation devices may be used: cones, type 1 or type 2 barricades, drums, tubular markers, or vertical panels. Check with your supervisor for local policy.
3. Maximum spacing between devices is approximately equal in feet to the speed limit in MPH.

NOTES

Typical Traffic Control Layout for Equipment Placed off the Shoulder or Over the Street Curb

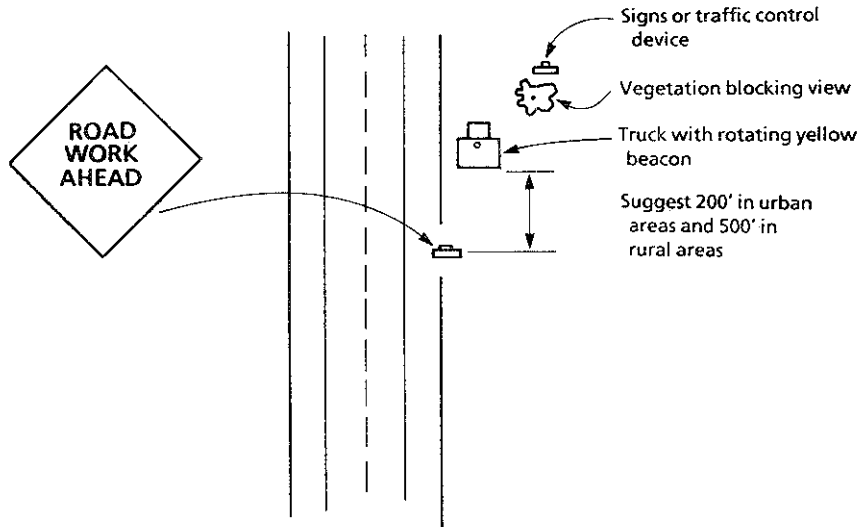

ROAD CONSTRUCTION AHEAD or ROAD WORK AHEAD signs may be replaced with other signs such as the SHOULDER WORK sign. The SHOULDER WORK sign may be used for work adjacent to the shoulder.

If the work area is in the median of a divided highway, an advance warning sign should be used on the left side of the roadway. Depending on the width of the median and the location of the work, warning signs may be needed for the opposing traffic.

Typical Traffic Control Layout for Lane Closure

NOTES:

1. Daytime operation and short repair duration.
2. Use this layout when repair work is on or within 2 feet of the traveled way (traffic lane).
3. Flaggers should use STOP/SLOW paddles instead of red flags.
4. Buffer zone may be reduced or extended depending on available sight distance.
5. Keep parked vehicles away from the traffic as much as possible.
6. Keep buffer zone free of obstacles or hazards.

KEY:

- Flagger
- Channelizing devices

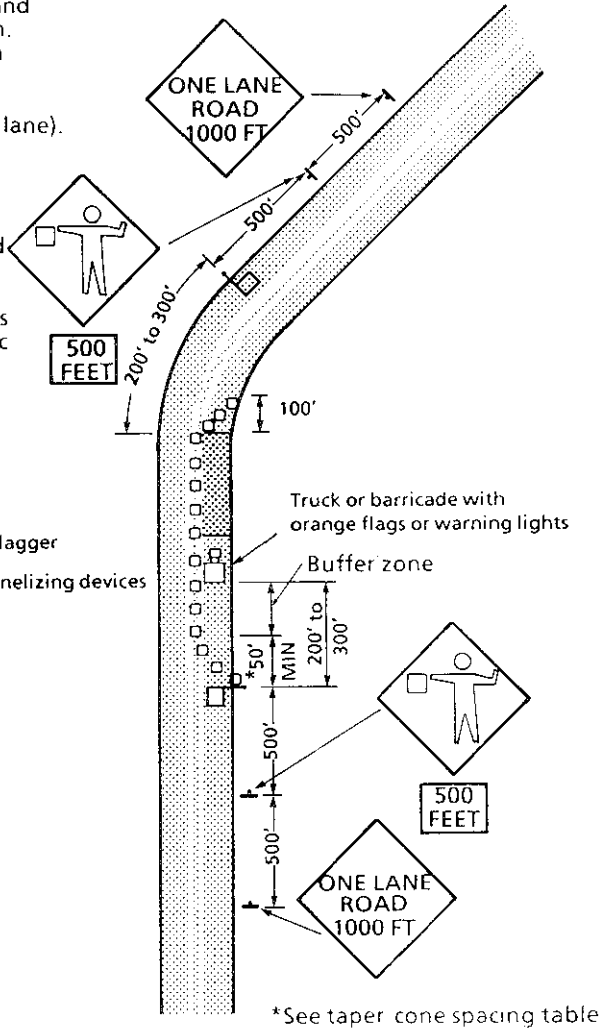

Equipment Check List–Lane Closure Work Zone Traffic Control Devices

1. Cones:

Taper, see table below for spacing of cones (minimum of five)	_____
Buffer zone (minimum of five spaced at 2 times speed in MPH)	_____
Work area (minimum of five spaced at 2 times speed in MPH)	_____
End section	5
TOTAL	_____

2. STOP/SLOW paddles 2

3. Signs:

ONE LANE ROAD AHEAD	2
FLAGGER AHEAD, with distance plate	2

Suggested Spacing for Cones in a Taper

Road speed limit (MPH)	No. of cones	Lane Width		
		10'	11'	12'
20	5	18	19	20
25	6	21	23	25
30	7	25	27	30
35	8	29	32	35
40	9	34	37	40
45	13	38	42	45
50	13	42	46	50
55	13	46	51	55

NOTES:

1. You will need at least 20 cones. Depending on where the work is, the kind of road, and other conditions, more devices might be needed. When in doubt, use more cones. **YOUR SAFETY IS AT STAKE.**
2. Any of several delineation devices may be used: cones, type 1 or type 2 barricades, drums, tubular markers, or vertical panels. Check with your supervisor for local policy.
3. Maximum spacing between devices is approximately equal in feet to the speed limit in MPH.

In cities, you will often be cutting vegetation so drivers can see signs and other traffic control devices at intersections. When one of the streets is a minor street and you can work safely away from the traffic, try to park your vehicle on that street and carry your equipment to the major street. This will interfere with fewer drivers and create fewer hazards to you and other workers.

Intersection clear sight distance

When an intersection has no STOP or YIELD signs to control who enters the intersection first, drivers must be able to see each other, pedestrians, and bicyclists soon enough to avoid a collision.

- Urban

In city residential street areas, the sketch below illustrates the general guideline for a clear sight triangle at intersections. The property line for a city corner lot will probably be a square corner that comes right up to the corner of the streets. Usually you are not permitted to work outside the right-of-way lines. Some cities have a city ordinance giving the city a sight distance easement. Such an ordinance gives you as the maintenance worker the authority to ask the property owner to trim any trees or shrubs back if they are blocking the corner sight triangle or else to cut them as you see fit. However, check with your supervisor before working outside the city's right-of-way. No shrubs or plants in such an area should be allowed to grow more than 3 feet high.

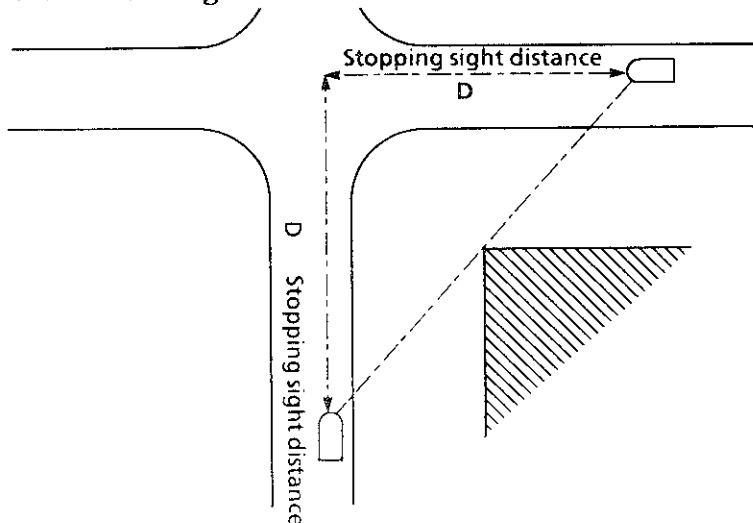

At intersections with no stop signs (or with stop signs only at the cross street), drivers from all (both) directions need to be able to see oncoming traffic soon enough to be able to stop. This stopping sight distance is distance D in the drawing above. The table below lists the stopping sight distance needed for different speed limits on a street.

Speed Limit (mph)	Stopping Sight Distance (ft)
20	125
30	215
40	330
50	470
60	650
70	845

- Rural

Rural intersections also need to have clear intersection sight distances. The following sketch shows a typical rural intersection sight problem. In rural areas we expect higher speed limits and need the longer stopping sight distances listed in the table under the urban heading above.

Stopping Sight Distance Intersections and Access Points

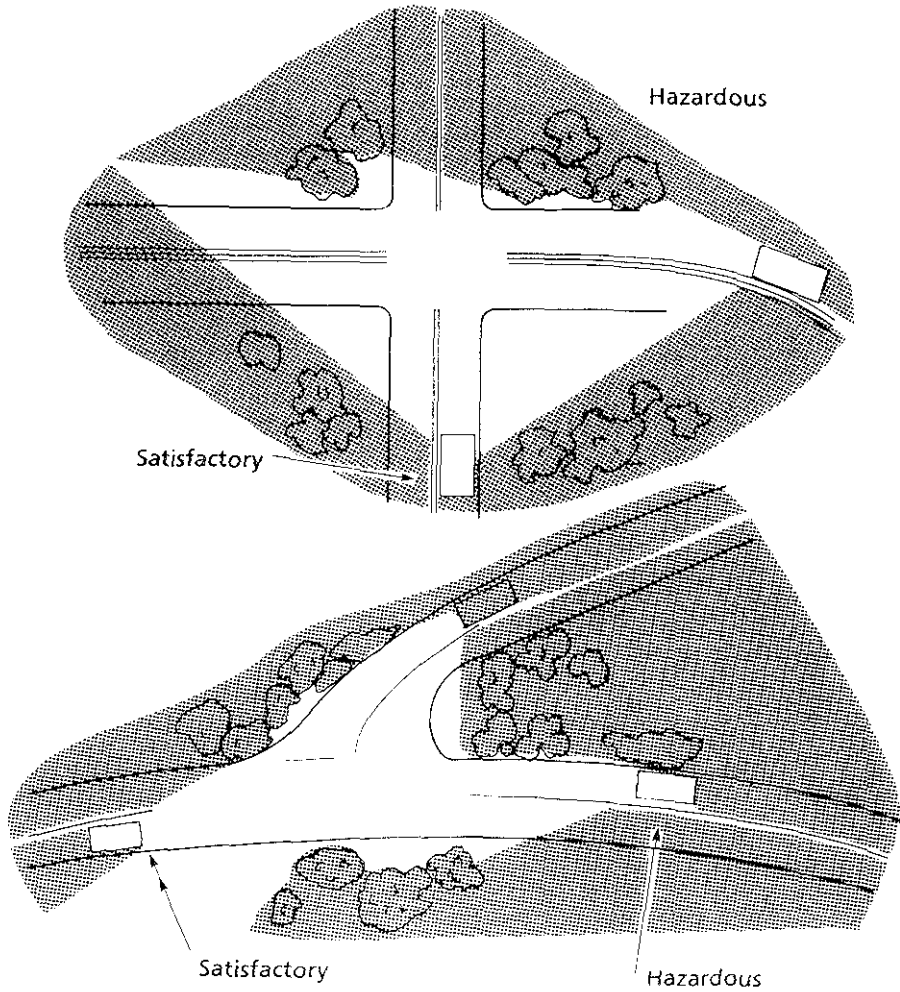

- Curves and median crossovers

When vehicles are traveling along the inside of curves, the driver needs to be able to see ahead around the curve for the same stopping sight distance as at intersections. Cut brush, weeds, or trees growing in the roadside ditch that block the view of drivers on the inside of the curve in order to let them see a full stopping sight distance.

On divided roadways with median crossovers similar to those shown in the sketch below, drivers entering a median crossover must be able to see approaching vehicles for a clear distance at least as long as for the intersection sight distance shown earlier. Vehicles using a median crossover will usually be entering the traffic lanes at slow speed. Providing good sight distance at median crossovers allows the higher-speed drivers on the through lane to avoid collisions with vehicles entering their lane from a median crossover.

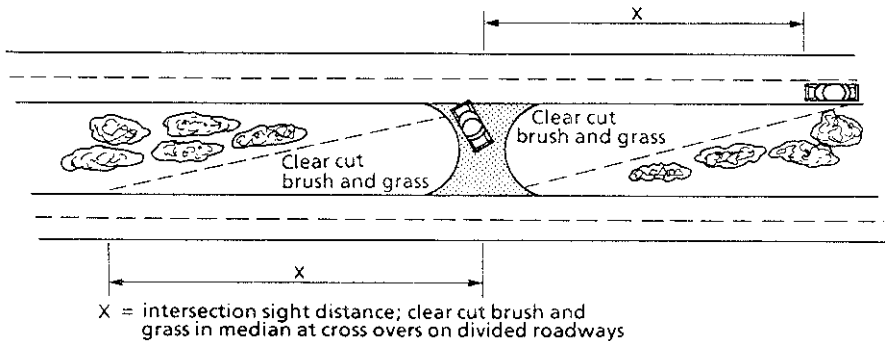

- Railroad crossings of highways and streets

At-grade crossings are a special case of intersections. The most important thing to do in vegetation maintenance at railroad crossings is to make sure the signs and signals for the crossing can be clearly seen by drivers, bike riders, and others approaching the crossing.

- * Clear vegetation to the railroad crossing signs and the advance warning signs to provide good sight distance.

- * Clear vegetation to provide good sight distance of all flashing signals when a crossing has signals.
- * The suggested clear sight distance for signs and signals at railroad crossings are

Speed limit (mph)	Clear distance to see sign (ft)
30	250
40	350
50	450
60	600

The next most important thing to do is cutting vegetation to give the driver a clear view of any train coming from either side. This clear view is labeled the "approach sight triangle" in the figure shown below. Brush and vegetation along the road should be cut back so the clear view distance extends back from the railroad track as far as possible. This is the distance labeled "stopping sight distance" in the figure. Vegetation along the railroad right of way may be a significant part of the problem. **DO NOT ENTER THE RAILROAD RIGHT OF WAY TO CUT VEGETATION UNLESS YOU ARE UNDER THE SUPERVISION OF PROPER RAILROAD EMPLOYEES** and have been authorized to do so by your maintenance supervisor. When you cut the vegetation, trim it enough so that normal growth will not reach to a height of 3 feet for at least one month.

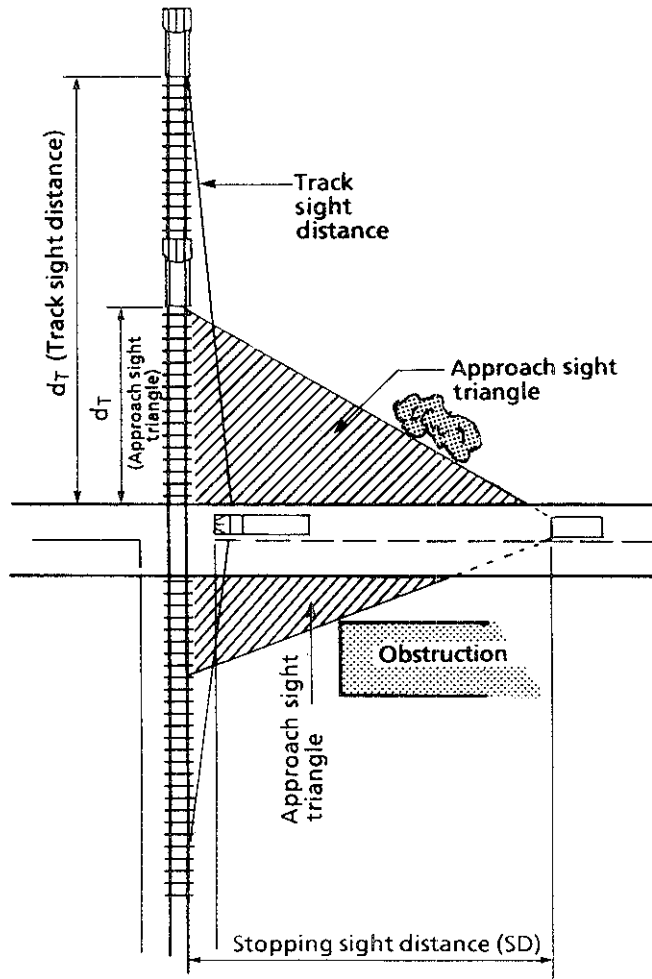

Private property owner agreement

Most private property owners are willing to cooperate in improving traffic safety. They should be required to keep all bushes and shrubs at a height of 3 feet or lower and to trim all trees and hanging branches to a minimum height of 7 feet. The following sample letter and form is suggested as a way of contacting private property owners to ask them to remove vegetation blocking the intersection sight distance. If notice is provided and homeowners do not respond in a reasonable time, most public agencies have regulatory powers to remove the designated vegetation at the home owner's expense. Check with your supervisor.

(Month/day/year)

(Property Owner)
(Address)
(City, State Zip)

In a recent survey of your area, street maintenance workers observed the following problems that exist on your property.

- (Code #) _____ Your shrubs and bushes on the corner are obstructing drivers' views and must be cut down to not more than _____ feet high. (See attached drawing.)
- _____ A tree branch hanging over the street or sidewalk limits view or access and must be cut to _____ feet above the surface of the sidewalk or street. (See attached drawing.)
- _____ A bush is obstructing the sidewalk or street and must be cut back to 12 in. from the edge of the sidewalk or curb. (See attached drawing.)
- _____ Bushes less than 25 ft from the intersection block the driver's view. (See attached drawing.)

If you have questions please call _____. If you need help correcting the problem, the City will do the work and bill you for the cost. To obtain a cost estimate and authorize the City to do the work, call _____ during business hours.

We will inspect your property again in _____ days to check on the work unless you have arranged for the City to do the work before then.

Sincerely,

(_____), Director

SIGHT OBSTRUCTION
CORRECTION REPORTING

REFERENCE #: _____

OBSTRUCTION ADDRESS: _____

OWNER NAME AND ADDRESS: _____

1ST LETTER SENT DATE: _____

PROBLEM: _____

DATE CORRECTED: _____

COMMENTS OR PROBLEMS: _____

NAME: _____

ADDRESS: _____

THANK YOU

Street Corner With Walkway

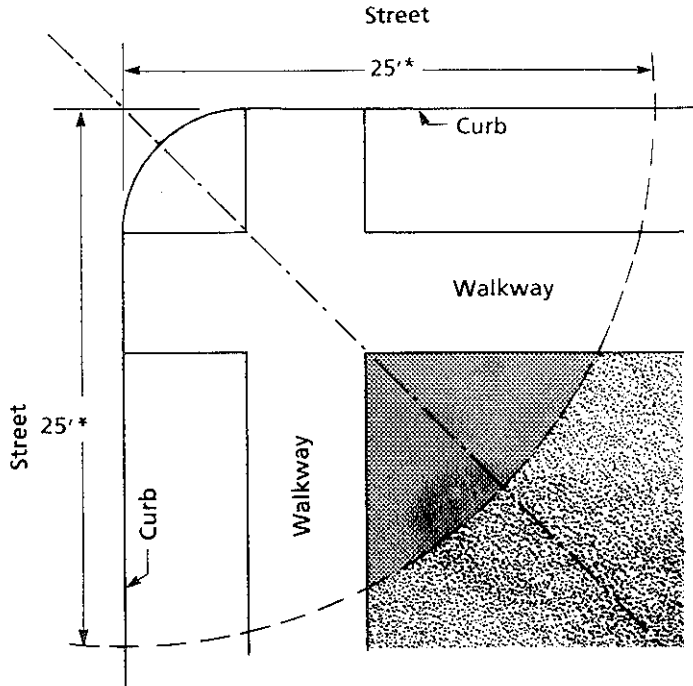

 Bushes and shrubs in this area must be no more than 3'** in height.

* Change to your local requirements. Some agencies use 50'.

** Some agencies use 2.5'. Change to your local requirements.

Street Corner Without Walkway

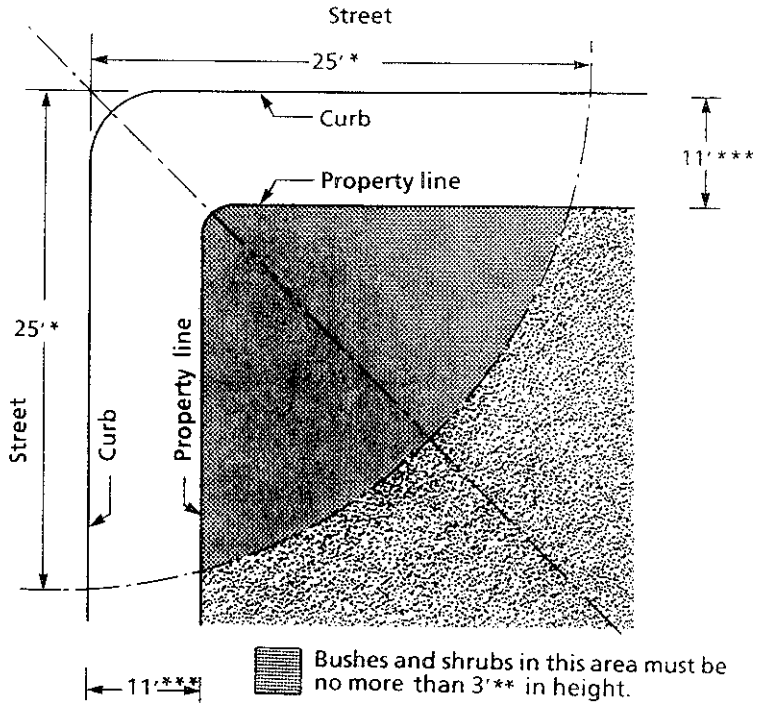

* Change to your local requirements. Some agencies use 50'

** Some agencies use 2.5'. Change to your local requirements.

*** Plat and street plan distance from curb to property line. Change to specific distance for actual site location.

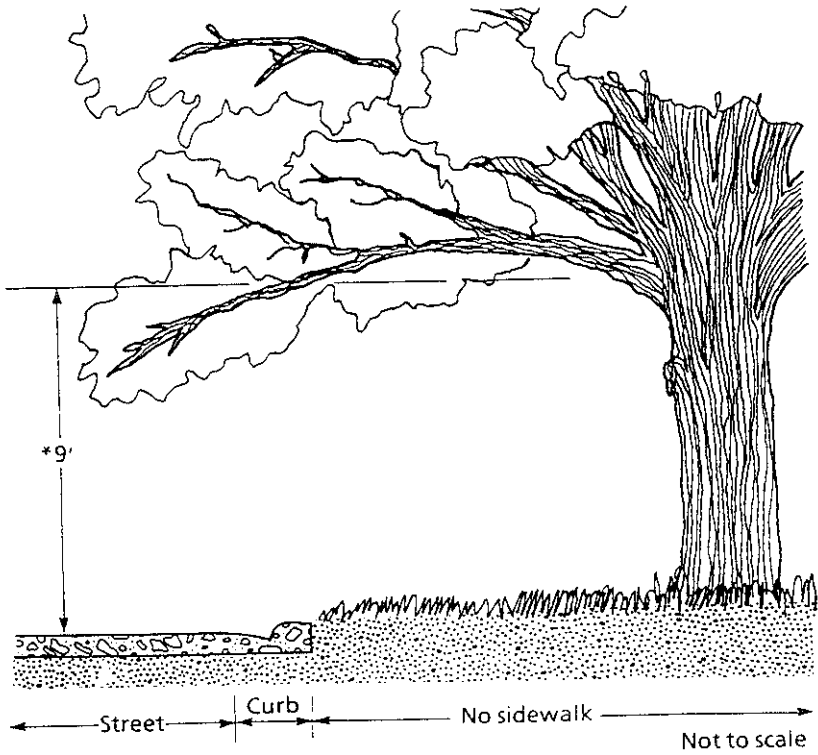

Branches should be trimmed so that there is 9' of clear space above the pavement (street and/or sidewalk).

*Change to your local requirements.

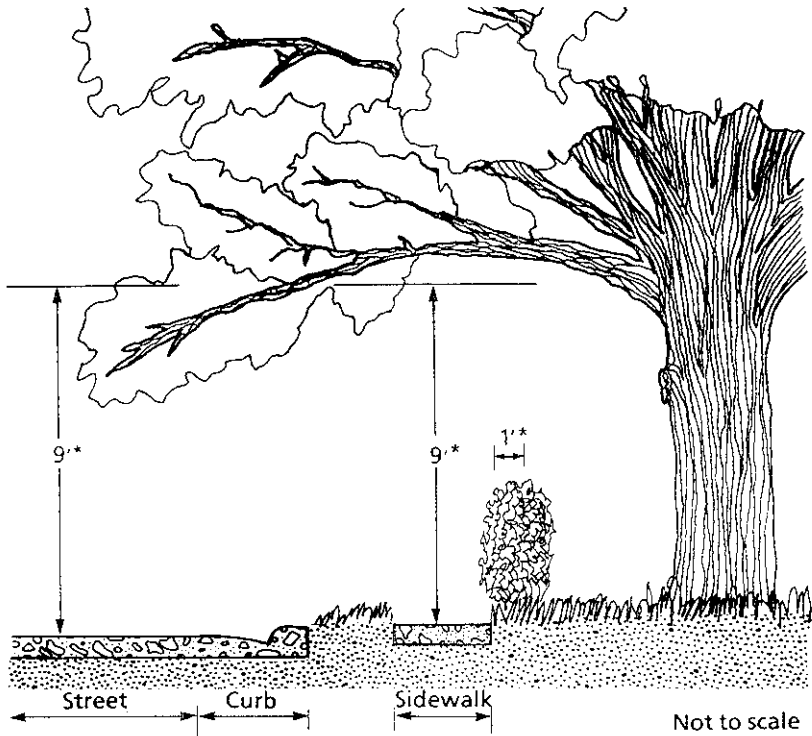

Branches should be trimmed so that there is 9' of clear space above the pavement (street and/or sidewalk). Bushes obstructing sidewalks should be trimmed back so that there is 1' clearance between the bush and the sidewalk.

*Change to your local requirements.

Clear zone illustration

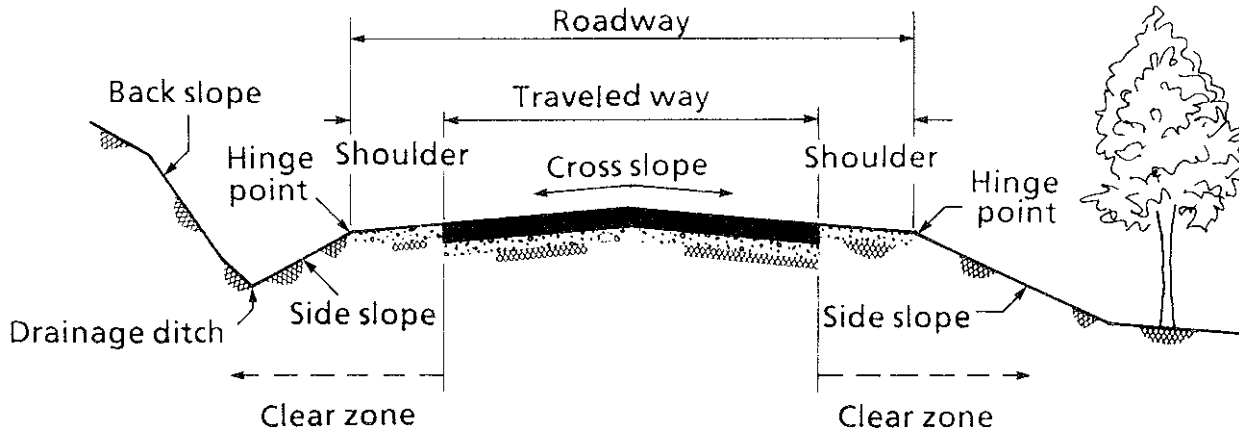

Hinge Point Point where the slope rate changes.

Clear Zone That area along the side of the traveled way including the shoulder that is available for recovery of an errant vehicle.

III. Trees in Clear Zone

Trees growing in a clear zone are a special problem. Evergreen trees or trees in full leaf in the highway right-of-way block the driver's sight distance for signs and intersections. Trees with trunks larger than the posts used to support signs (typically 4 inches in diameter) can be a hazard to any vehicle hitting them.

On highways we want to keep the roadside clear of trees and other obstructions for a distance of up to 30 feet if we have that much room in the right of way. A clear zone gives a driver who runs off the road a good chance to bring the vehicle under control without a crash. In removing trees in the right of way to maintain this clear zone, there are two things to remember.

1. Cut trees close enough to the ground so that no stump remains to be a hazard.

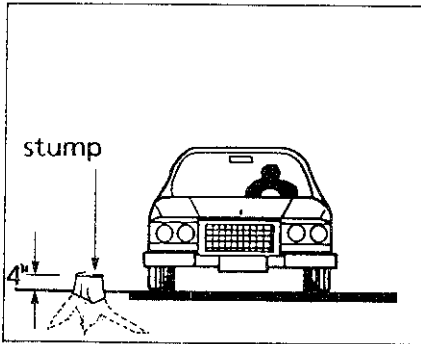

Small diameter trees should be cut off no more than 4 inches from the ground. Large diameter trees should be cut flush with the ground. Trees of any size growing on a slope should be cut flush with the ground.

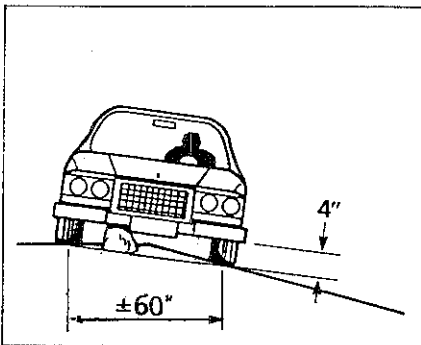

Snagging occurs when a vehicle undercarriage catches on a stump or other object. Generally, any stump higher than 4 inches above the surrounding ground can cause snagging.

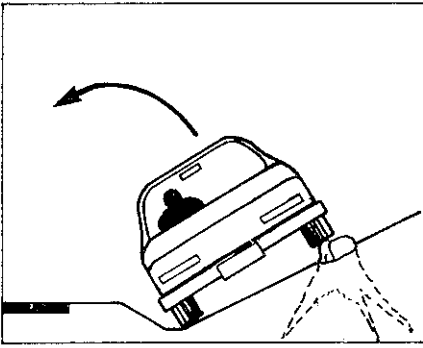

Rolling of the vehicle occurs when the wheel or the under-carriage rides up on a stump on a slope. Cutting a stump off as close to flush with the slope as possible minimizes the roll over danger.

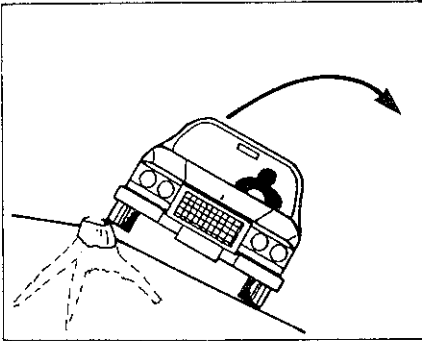

2. All trees within the clear zone should be cut while they are still small saplings rather than even small trees. At that time they are easy to cut off at ground level and cause no stump problems. Also, no one will be tempted to try to save a beautiful but hazardous tree in the highway clear zone.

IV. Mowing for Safety

Types of mowing

Road and street maintenance workers do three general types of mowing. In order of importance, these include: safety mowing, transition mowing, and selective mowing.

- Safety mowing:
 1. Makes sure signs and other traffic control devices, guardrails, and other safety features can be seen.
 2. Provides good sight distance for drivers approaching intersections, driving along curves, and approaching interchanges.

- Transition mowing:

Makes a smooth change from a narrow mowed width to a wide mowed width when different widths of right-of-way are mowed.



- Contour or selective mowing:
 1. Makes a natural blending of the maintained roadside with native or planted growth.
 2. Shows off landscaping or wildflower areas or dresses up an interchange entrance to an urban area.

The following figure illustrates the three classes of mowing for both two-lane and multilane roads.

Mowing operations notes

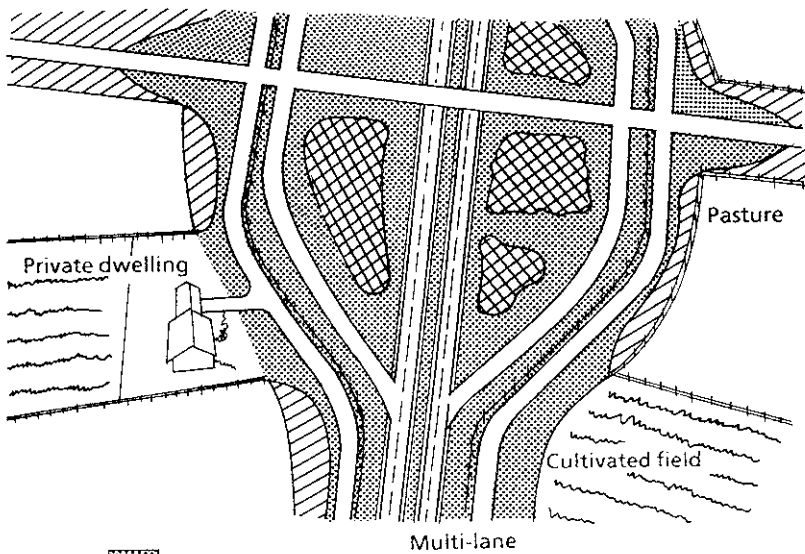
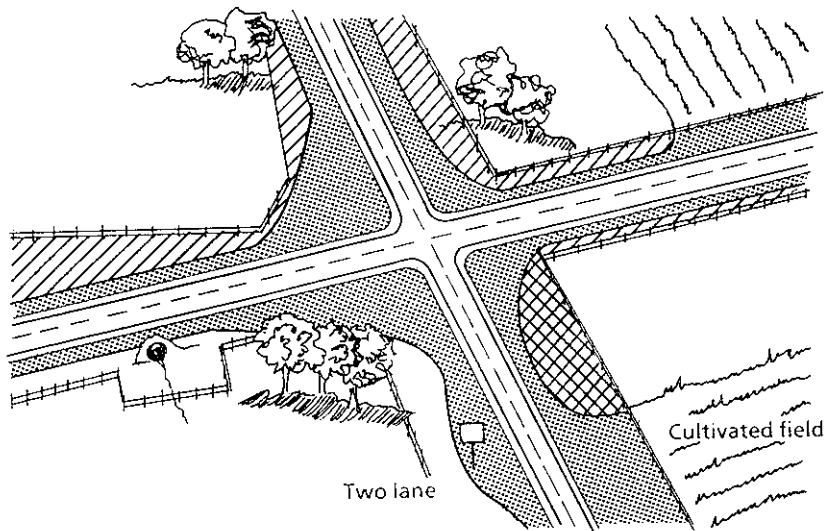
- DON'T:
 1. Mow too often. (This wastes money, exposes mowing crews to traffic hazards more than needed, and can damage the vegetation.)
 2. Mow at the wrong time. (Good timing reduces the frequency of mowing required by cutting the vegetation in the right stage of growth.)
 3. Mow too short. (Leaving the proper height helps maintain the stand of vegetation and keeps small litter objects hidden.)



-  Safety mowing
-  Contour mowing
-  Selective or transition mowing

4. Mow steep slopes if you don't need to. (Steep slope operations increase risk of mower accidents.)
5. Mow patterns inconsistently and mow a regular area incompletely. (Drivers watch the pattern of a mowed area to help understand the safety of an area. Consistent mowing of similar areas helps drivers evaluate the safety of the roadway.)
6. Mow when wet. (This is hard on equipment.)
7. Operate equipment carelessly and scar trees and shrubs. (Mowing is tedious but care must be taken to avoid accidents and preserve valuable plantings.)

● **DO:**

1. Avoid mowing slopes steeper than 2.5:1 with a regular mower unit.
2. Mow slopes steeper than 2.5:1 with a side-mounted mower on a boom if the tractor unit remains on flatter surfaces while mowing.
3. Operate side-mounted or boom mower units on the uphill side of the tractor to limit the possibility of overturning the tractor.
4. Replace broken or lost chain guards to deflect debris immediately. Using flail type mowers reduces the amount of debris thrown.
5. Cover all v-belts, drive chains, and power takeoff shafts.
6. Raise mowers when crossing driveways or roadways.
7. Shut off power before checking any mower unit. Block a mower before changing, sharpening, or replacing a blade. Any blade being re-installed should be checked for cracks or damage that will lead to failure.
8. Use flashing signals and slow-moving-vehicle signs on all mower tractors.
9. Use signs to warn traffic, such as MOWING AHEAD, MOWING AREA, ROAD WORK AHEAD, or similar legends. Signs should not be more than one to two miles ahead of the mowing. Signs saying MOWING NEXT _____ MILES may be used in advance of the operation if your agency wants, but the distance limits should not be shorter than two miles nor longer than five miles.

- Suggested mowing limits:

The following table lists suggested limits on how far to mow in different roadway situations. Your individual agency may have different standards, but if it does not, use these as a starting point.

SUGGESTED MOWING LIMITS (Measured Along Surface of Slopes)

	On slopes 2.5:1 or less	On slopes more than 2.5:1 up to 1:1 within 20' outside of pavement edge	More than 1:1 slopes within 10' outside of pavement edge
Backslopes	Mow 15' outside of pavement edge	With side-mounted units mow one swath width past slope that does not exceed 2.5:1	Mow brush and as required for sight distance
Foreslopes	Mow 15' or entire width up to 25' outside of pavement edge or one pass on the backslope to maintain drainage	With side-mounted units mow one swath width past slope that does not exceed 2.5:1	Mow brush up to 15' or entire width and as required for sight distance
Downslopes	Mow 15' outside of pavement edge	With side-mounted units mow one swath width past slope that does not exceed 2.5:1	Mow brush and as required for sight distance
	On slopes 2.5:1 or less	On slopes more than 2.5:1 up to 1:1 within 20' outside of pavement edge	More than 1:1 slopes within 10' outside of pavement edge
Median Areas	Mow 15' outside of pavement edge or entire width if less than 50'	With side-mounted units mow one swath width past slope that does not exceed 2.5:1	Mow brush and as required for sight distance
Interchange Areas	Mow 15' from pavement edge and any areas that obstruct sight distances or areas used for snow storage or entire area in urban areas	With side-mounted units mow one swath width past slope that does not exceed 2.5:1	Mow brush and as required for sight distance
Guardrail	Mow 3' behind guardrail	Mow brush for 3' behind guardrail and as required for sight distance	Mow brush for 3' behind guardrail and as required for sight distance

Traffic control for mowing operations

Mowing is a moving operation taking place off the roadway. Therefore, it requires different traffic control from other maintenance operations.

The most important thing to remember is to make the mower unit highly visible to drivers. That way drivers will be alert to you and be able to avoid any potential collisions.

1. Operate rotating yellow beacons on mower tractors.
2. Install slow-moving-vehicle signs on all mower tractors.
3. Install yellow flasher lights on roll bars or the top of tractor cabs and operate these at all times.
4. Install an orange flag or pennant on a whip to show the location of the tractor in high grass or over the edge of slopes.
5. Operate the tractor with headlights on at all times.

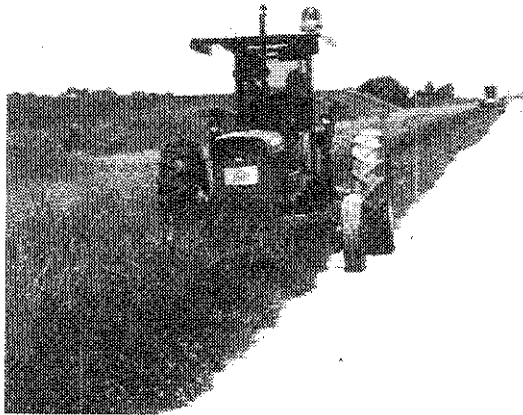

Warning signs such as **MOWING AHEAD**, **ROAD WORK AHEAD**, and similar signs may be placed along the road. The **MOWING AHEAD** sign is preferred. The sign is to be used in advance of mowing operations on the right of way. Place it on the shoulder so the approaching driver can read the message easily.

As work progresses, move the signs so they are one to two miles between the sign and the actual mowing work. Mount the sign on a sturdy portable support that will not be knocked over or blown down easily. Cover or remove the sign during the lunch break or any other times when work is not in progress. But do not cover or remove the signs if you have stopped mowing to repair or adjust equipment because the warning to drivers is important to safety operations.

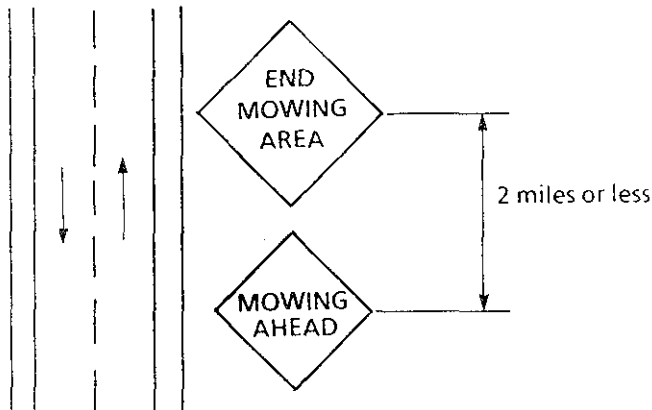

NOTES:

1. **MOWING AHEAD** and **END MOWING AREA** signs should not be placed more than about 2 miles apart.
2. In a "wide" median, place signs next to the lane nearest the mower operation.
3. Depending on the width of the median and the location of the work, warning signs may be needed on both roadways of a divided road or street.

V. Summary of Safety Tips for Vegetation Control

1. **Wear the proper personal safety equipment when conducting vegetation control.**
 - A hard hat and safety goggles to protect your head and eyes from injury by twigs, flying chips, or debris that may be kicked up
 - Leather gloves and shoes or boots with hard toes and hard soles
 - An orange safety vest (You will not be as obvious as you would if you were operating a large piece of equipment.)
2. **Turn on rotating yellow beacons when operating mower units.**
3. **Display a slow moving vehicle symbol** (reflective triangle) on the rear of a mower unit moving down the road. If the tractor has flasher lights, operate them to warn traffic that you are moving slowly with respect to normal traffic flow.
4. **Be alert for signs** marking areas requiring limited mowing and vegetation control because of wildlife habitat. If you think these "no-mow" areas are becoming a safety problem, report it to your supervisor for review.
5. **Face oncoming traffic** as much as possible when cutting vegetation around hazard marker panels and other signs or safety hardware near the edge of the roadway. Be alert at all times for a vehicle out of control or being driven too close to you.
6. **Check the chain guard** or other mower covers intended to keep debris from being thrown out of a mower before starting up any mower unit. Never operate a mower with a defective debris guard. A small rock, a piece of can, a broken bottle thrown out from under a mower can be a lethal projectile.
7. **Wear ear plugs, "muffs," or other protective devices** when operating a chain saw for any extended period of time and when operating a mower tractor.

NOTES