

**Emission Factor Documentation for AP-42  
Section 9.9.2**

**Cereal Breakfast Food**

**Final Report**

**For U. S. Environmental Protection Agency  
Office of Air Quality Planning and Standards  
Emission Factor and Inventory Group**

**EPA Contract 68-D2-0159  
Work Assignment No. II-03**

**MRI Project No. 4602-03**

**August 1995**

Emission Factor Documentation for AP-42  
Section 9.9.2

Cereal Breakfast Food

Final Report

For U. S. Environmental Protection Agency  
Office of Air Quality Planning and Standards  
Emission Factor and Inventory Group  
Research Triangle Park, NC 27711

Attn: Mr. Dallas Safriet (MD-14)

EPA Contract 68-D2-0159  
Work Assignment No. II-03

MRI Project No. 4602-03

August 1995

## NOTICE

The information in this document has been funded wholly or in part by the United States Environmental Protection Agency under Contract No. 68-D2-0159 to Midwest Research Institute. It has been reviewed by the Office of Air Quality Planning and Standards, U. S. Environmental Protection Agency, and has been approved for publication. Mention of trade names or commercial products does not constitute endorsement or recommendation for use.

## PREFACE

This report was prepared by Midwest Research Institute (MRI) for the Office of Air Quality Planning and Standards (OAQPS), U. S. Environmental Protection Agency (EPA), under Contract No. 68-D2-0159, Work Assignment No. II-03. Mr. Dallas Safriet was the requester of the work.

Approved for:

MIDWEST RESEARCH INSTITUTE

Roy Neulicht  
Program Manager  
Environmental Engineering Department

Jeff Shular  
Director, Environmental Engineering  
Department

August 1995



## TABLE OF CONTENTS

	<u>Page</u>
LIST OF FIGURES .....	vi
LIST OF TABLES .....	vi
1. INTRODUCTION .....	1-1
2. INDUSTRY DESCRIPTION .....	2-1
2.1 INDUSTRY CHARACTERIZATION .....	2-1
2.2 PROCESS DESCRIPTION .....	2-1
2.2.1 Traditional Cereals .....	2-2
2.2.2 Ready-To-Eat Cereals .....	2-6
2.3 EMISSIONS .....	2-19
2.4 EMISSION CONTROL TECHNOLOGY .....	2-20
3. GENERAL DATA REVIEW AND ANALYSIS PROCEDURES .....	3-1
3.1 LITERATURE SEARCH AND SCREENING .....	3-1
3.2 DATA QUALITY RATING SYSTEM .....	3-1
3.3 EMISSION FACTOR QUALITY RATING SYSTEM .....	3-2
4. REVIEW OF SPECIFIC DATA SETS .....	4-1
4.1 REVIEW OF SPECIFIC DATA SETS .....	4-1
4.2 DEVELOPMENT OF CANDIDATE EMISSION FACTORS .....	4-1
5. PROPOSED AP-42 SECTION .....	5-1

## LIST OF FIGURES

<u>Figure</u>		<u>Page</u>
2-1	Traditional oat cereal production . . . . .	2-3
2-2	Typical instant cook farina cereal production . . . . .	2-7
2-3	Process diagram for cereal flake production . . . . .	2-9
2-4	Process diagram for extruded flake production . . . . .	2-12
2-5	Gun-puffed whole grain production . . . . .	2-14
2-6	Extruded gun puffed cereal production . . . . .	2-16
2-7	Whole grain shredded cereal production . . . . .	2-17

## LIST OF TABLE

<u>Table</u>		<u>Page</u>
2-1	LEADING BREAKFAST CEREAL PRODUCING STATES . . . . .	2-1

EMISSION FACTOR DOCUMENTATION FOR AP-42 SECTION 9.9.2  
Cereal Breakfast Food

1. INTRODUCTION

The document *Compilation of Air Pollutant Emission Factors* (AP-42) has been published by the U. S. Environmental Protection Agency (EPA) since 1972. Supplements to AP-42 have been routinely published to add new emission source categories and to update existing emission factors. AP-42 is routinely updated by EPA to respond to new emission factor needs of EPA, State and local air pollution control programs, and industry.

An emission factor is a representative value that attempts to relate the quantity of a pollutant released to the atmosphere with an activity associated with the release of that pollutant. Emission factors usually are expressed as the weight of pollutant divided by the unit weight, volume, distance, or duration of the activity that emits the pollutant. The emission factors presented in AP-42 may be appropriate to use in a number of situations, such as making source-specific emission estimates for areawide inventories for dispersion modeling, developing control strategies, screening sources for compliance purposes, establishing operating permit fees, and making permit applicability determinations. The purpose of this report is to provide background information from test reports and other information to support preparation of AP-42 Section 9.9.2, Cereal Breakfast Food.

This background report consists of five sections. Section 1 includes the introduction to the report. Section 2 gives a description of the cereal breakfast food industry. It includes a characterization of the industry, a description of the different process operations, a characterization of emission sources and pollutants emitted, and a description of the technology used to control emissions resulting from these sources. Section 3 is a review of emission data collection (and emission measurement) procedures. It describes the literature search, the screening of emission data reports, and the quality rating system for both emission data and emission factors. Section 4 details emission factor development for cereal breakfast food. It includes the review of specific data sets and a description of how candidate emission factors were developed. Section 5 presents the AP-42 Section 9.9.2, Cereal Breakfast Food.



## 2. INDUSTRY DESCRIPTION

This section provides a brief review of the trends in the breakfast cereal industry and an overview of the production process. No emission data exist for the cereal breakfast food industry.

### 2.1 INDUSTRY CHARACTERIZATION<sup>1-2</sup>

Breakfast cereal products were originally sold as milled grains of wheat and oats that required further cooking in the home prior to consumption. In this century, due to efforts to reduce the amount of in-home preparation time, breakfast cereal technology has evolved from the simple procedure of milling grains for cereal products that require cooking to the manufacturing of highly sophisticated ready-to-eat products that are convenient and quickly prepared.

In 1987, there were approximately 53 companies involved in the production of breakfast cereals (SIC 2043). These companies produced approximately 307 million dollars in inventory and employed approximately 16,000 people. These figures increased from 1982, when 52 companies employed 15,600 people. The leading states in employment were Michigan, California, and Illinois, employing 3,800 people (23.8 percent), 2,100 people (13.1 percent), and 2,000 people (12.5 percent), respectively. Approximately 80 percent of breakfast cereal manufacturers are located in 10 States, which are shown in Table 2-1.

TABLE 2-1. LEADING BREAKFAST CEREAL PRODUCING STATES

State	No. of facilities	
	Total	With under 20 employees
California	13	6
Minnesota	5	2
Illinois	4	0
Massachusetts	4	2
Ohio	4	1
Iowa	3	1
Michigan	3	0
New York	2	0
Pennsylvania	2	0
Tennessee	2	0

### 2.2 PROCESS DESCRIPTION<sup>1,3-4</sup>

Breakfast cereals can be categorized into traditional (hot) cereals that require further cooking or heating before consumption and ready-to-eat (cold) cereals that can be consumed from the box or with the addition of milk. Traditional cereals are those that are sold in the market as processed raw grains or as cooked grains requiring the addition of hot water. Ready-to-eat cereals are cereals manufactured from grain products that have been cooked and modified in some way (e.g., flaked,

puffed, or shredded). Ready-to-eat cereals also include cereal mixes, such as granola. The process descriptions in this section were adapted primarily from reference 3 and represent generic processing steps. Actual processes may vary considerably between plants, even those producing the same type of cereal.

## 2.2.1 Traditional Cereals

Traditional cereals are those requiring cooking or heating prior to consumption and are made from oats, farina (wheat), rice, and corn. Almost all (99 percent) of the traditional cereal market are products produced from oats (over 81 percent) and farina (approximately 18 percent). Cereals made from rice, corn (excluding corn grits), and wheat (other than farina) make up less than 1 percent of traditional cereals.

2.2.1.1 Oat Cereals. For centuries oats were considered weeds in barley and wheat fields of Europe. In the 18th and 19th centuries oats became a cereal crop in Scotland and are currently the primary ingredient in traditional cereal production. The three types of oat cereals are old-fashioned oatmeal, quick oatmeal, and instant oatmeal. Old-fashioned oatmeal is made of rolled oat groats (dehulled oat kernels) and is prepared by adding water and boiling for up to 30 minutes. Quick oat cereal consists of flakes made by rolling cut groats thinner than old-fashioned oats and is prepared by adding water and cooking for 1 to 15 minutes. Instant oatmeal is similar to quick oats but with additional treatments, such as the incorporation of gum to improve hydration, and is prepared by adding hot water directly to the product and stirring; no other cooking is required. The major steps in the production of traditional oat cereal include grain receiving, cleaning, drying, hulling, groat processing, steaming, and flaking. The process diagram for the production of old-fashioned and quick oat cereals is shown in Figure 2-1. Production of instant oatmeal is slightly different and is discussed at the end of this section.

2.2.1.1.1 Receiving. Oats arrive at the mill via bulk railcar or truck and are sampled to ensure suitable quality for milling. Suitable milling oats should weigh at least 36 pounds per bushel (lb/bu); be relatively undamaged by weather, insects, disease, or mold; be of suitable width (not too thin); and free from insect infestation. Grain that is infested with insects must undergo treatment utilizing approved fumigants before it can be milled. Once the grain is deemed acceptable, it is passed over a receiving separator to remove coarse material, such as field trash, and fine material, such as chaff dust. The oats are binned according to milling criteria, such as weight, and are maintained so that blends sent to the mill are uniform. Raw grain handling and processing is discussed in greater detail in AP-42 Section 9.9.1, Grain Elevators and Processes.

2.2.1.1.2 Cleaning and drying. Cleaning removes foreign material, such as dust, stems, and weed seeds, and oats that are unsuitable for milling, such as doubled oats, pin oats, light oats, and hulled oats. Doubled oats contain two groats, neither of which are well developed, and have a high percentage of hull. The groat is the portion of the oat that remains after the hull has been removed and is the part processed for human consumption. Pin oats contain very thin groats. Light oats may be of acceptable milling size, but contain a high percentage of hull. Hulled oats lack the protective hull cover and are subject to shattering during the hulling process. The cleaning process utilizes several devices to take advantage of particular physical properties of the grain. For example, screens utilize the overall size of the grain, aspirators and gravity tables utilize grain density, and discs with indent pockets and/or indent cylinders utilize the grain length or shape. After completing the cleaning process, the grain is called clean milling oats or green oats.

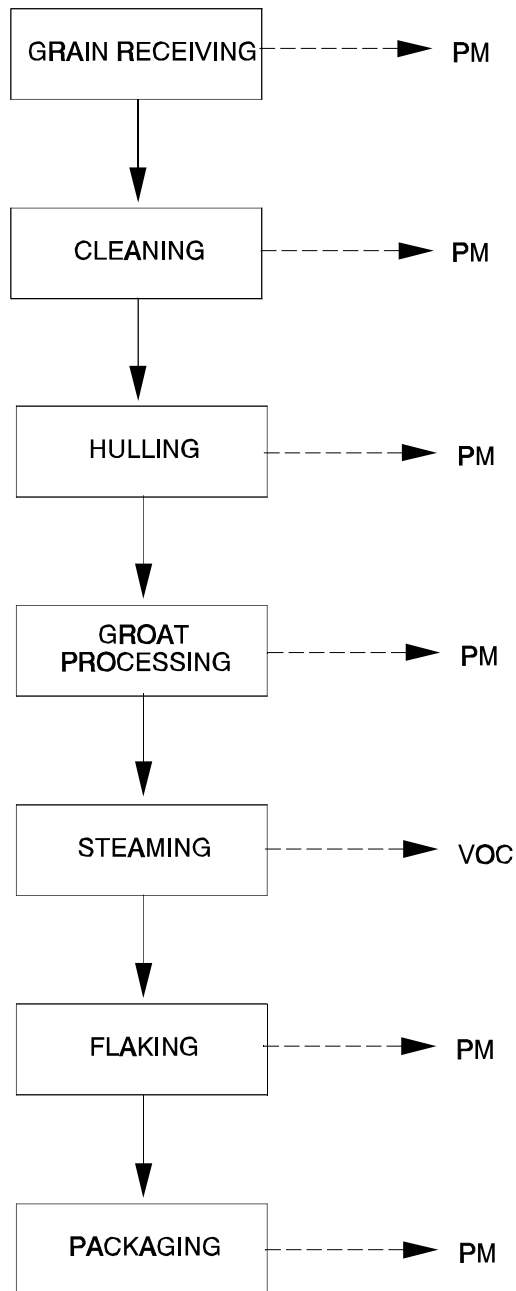

Figure 2-1. Traditional oat cereal production.

In traditional processes, the green oats are dried in a stack of circular pans heated indirectly by steam to a surface temperature of 93° to 100°C (200° to 212°F). The green oats begin in the top pan and are moved across its surface by a large rotary sweep. After one revolution around the pan, the oats drop through a chute to the next pan and are again moved around the surface. This process continues until the oats reach the bottom pan. The dried oats are then binned. In the past, this process was necessary to prepare the oats for stone milling. However, due to the development of new hulling equipment, most facilities have eliminated the need for drying pans. Instead, the pans have been replaced with enclosed vertical or horizontal grain conditioners. Today, most old-fashioned oat and all quick oat cereals are produced by performing the drying stage after the hulling stage.

2.2.1.1.3 Hulling. In the traditional process, the oats were dried to shrink the groat away from the hull and to facilitate hulling with rotating millstones. The set of stones consisted of one stationary bed stone with a millstone rotating above it. The objective of this process was to set the stones just far enough apart to break apart the hull and leave the groat unground. Today, instead of stone hulling, most facilities use the impact huller, which separates the hull from the groat by impact. In impact hulling, the oats are fed through a rotating disc and flung out to strike the wall of the cylindrical housing tangentially, which separates the hull from the groat. The cylinder wall is designed so that the friction between it and the hull approaches or exceeds that between the hull and the groat. The mixed material then falls to the bottom of the huller and is subjected to aspiration to separate the hulls and the groats. Any oats that are not hulled are separated using an indent cylinder, a table separator, or a disc separator and are returned for another pass through the huller.

Unlike traditional stone hulling, impact hulling does not require predrying of the oats, although some facilities still use the traditional dry-pan process to impart a more nutty and less raw or green flavor to the final product. Most facilities, however, utilize enclosed vertical or horizontal grain conditioners or kilns because of the inefficiency of drying hulls (hulls are dried only to be discarded). The grain conditioners have both direct (sparging) steam and indirect steam to heat the oats and impart flavor to the groats comparable to that resulting from the pan drying process. Although grain conditioners can be used on unhulled oats, they are typically used to process groats following separation from the hulls.

2.2.1.1.4 Groat processing. Groat processing involves polishing, sizing, and cutting (for quick oats production). After the groats are hulled, the groats are sized to separate the largest groats from the average-sized groats. The large groats are used to make the so-called old-fashioned oats and the other groats are cut using steel cutters to make quick oats, which cook considerably faster than old-fashioned oats. The cutting process utilizes revolving drums with countersunk holes through which the groats fall to be cut by stationary knives positioned on the outer surface of the drum. The groat can usually be cut into three to five pieces, depending on its size.

2.2.1.1.5 Steaming. After groat processing, the groats (either whole or cut pieces, depending on the end product) typically pass through an atmospheric steamer located above the rollers. The groats must remain in contact with the live steam long enough to achieve a moisture content increase from 8 to 10 percent up to 10 to 12 percent, which is sufficient to provide satisfactory flakes when the whole or steel-cut groats are rolled. Contact with the steam also increases the temperature of the groats, which has a plasticizing effect and ensures that lipolytic enzymes are inactivated for product stability.

2.2.1.1.6 Flaking. The production of old-fashioned oat and quick oat flakes is the same, except for the starting material (old-fashioned oats start with whole groats and quick oats start with

steel-cut groats). Both products are rolled between two cast iron equal-speed rolls in rigid end frames. Feeder rolls uniformly distribute the groats across the roll gap to ensure uniform thickness. The rolls are carefully adjusted to give the flake thickness required by the particular product. Quick-oat products are rolled thinner than old-fashioned oats. Following rolling, the flakes are typically cooled by drawing ambient air through the mass of flakes, although other cooling devices may also be used. After the flakes are cooled, the finished product is directed to packaging bins for holding.

2.2.1.1.7 Instant oatmeal. Instant oatmeal is produced similarly to quick oatmeal through the steaming stage. After the groats are steamed, they are rolled thinner than those of quick oatmeal. The final product, along with specific amounts of hydrocolloid gum, salt, and other additives, is packaged into premeasured individual servings. The most important difference between instant oatmeal and other oatmeal products is the addition of hydrocolloid gum, which replaces the natural oat gums that would be leached from the flakes during traditional cooking, thus accelerating hydration of the flakes.

2.2.1.1.8 Packaging. The standard package for old-fashioned and quick oatmeal is the spirally wound two-ply fiber tube with a paper label. In the past, the tube was opened by pulling a string or tape to tear the label and release the top cap. Today, these packages are being replaced with tubes with easier-opening plastic top caps that have a plastic rim and include a reusable snap-on cap. Folded cartons are also used to package old-fashioned and quick oatmeal. These cartons can be printed or can be covered with printed paper wrappers. If the latter is used, the blank cartons are filled and sealed before the paper wrapper is added to prevent sifting of the contents of the package and chances for infestation.

Most of the instant hot cereals are packed in individual, single-serving pouches. These pouches are of a relatively simple structure of paper that is extrusion-coated with a layer of polyethylene, which forms a seal when heated. The pouch products are produced on horizontal form-fill-seal equipment or single-lane continuous-motion equipment. Products that contain moisture-sensitive ingredients, such as fruit, or that require protection against flavor loss are packaged in pouches that have a layer of polyvinylidene chloride applied before the layer of polyethylene.

2.2.1.2 Farina Cereals. Cereals made from farina are the second largest segment of the traditional hot cereal market, making up 18 percent. Farina is a federally standardized product defined as a food prepared by grinding and bolting cleaned wheat (other than durum and red durum wheat) to such a fineness that when tested by methods prescribed by the U.S. Code of Federal Regulations, 100 percent of the ground wheat passes through a No. 20 sieve but not more than 3 percent passes through a No. 100 sieve. In practical terms, farina is essentially wheat endosperm in granular form that is free from bran and germ. The preferred wheat for producing farina is hard red or winter wheat because the granules of endosperm for these types of wheat stay intact when hot cereals are prepared at home.

Farina cereal production begins with the receiving and milling of hard red or winter wheat. Information on wheat receiving, handling, and milling can be found in AP-42 Section 9.9.1, Grain Elevators and Processes. After milling, traditional farina cereals are packaged. Quick cook farina cereals are prepared primarily by the addition of disodium phosphate, with or without the further addition of a proteolytic enzyme. An instant (cook-in-the-bowl) product may be made by wetting and pressure-cooking the farina, then flaking and redrying prior to portion-packaging. A simplified process diagram for quick cook farina cereal is shown in Figure 2-2.

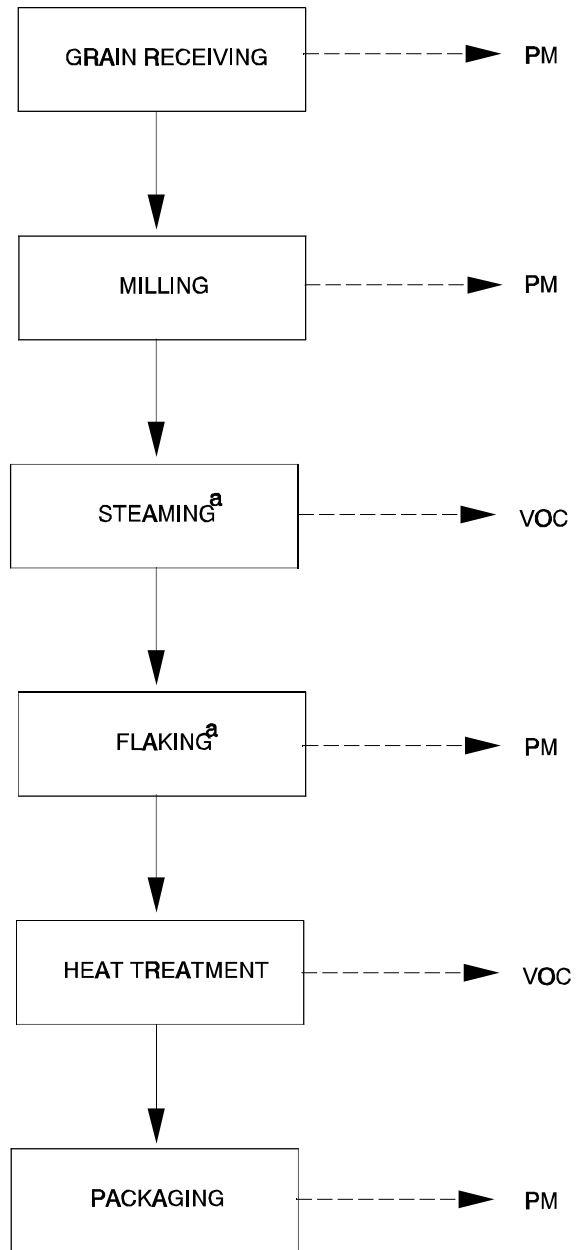

<sup>a</sup>Not required for traditional or quick-cooking farina cereals.

Figure 2-2. Typical instant cook farina cereal production.

Several additives have been developed over the years to reduce the required cooking time for farina cereals and to make them more nutritious. Addition of disodium phosphate, pepsin, gums, special hydration mediums, or solutions of sodium hydroxide and ammonium salt reduce cooking time of farina cereals. Special thickeners, such as carboxymethyl cellulose, have been used to improve the texture and cookability of farina products. Thiamin, riboflavin, niacin, and wheat germ can be added to increase nutrient content. Also, fruit preserves and spices can be added to farina cereals to enhance flavor.

2.2.1.3 Wheat, Rice, and Corn Cereals. Other traditional cereals include whole wheat cereals, rice products, and corn products. These cereals make up less than 1 percent of the traditional cereal market and are not discussed in great detail.

2.2.1.3.1 Whole wheat cereals. Whole wheat traditional cereals include milled, rolled, and cracked wheat products. Milled cereals are made in a hard wheat flour mill by drawing off medium-grind milled streams. Rolled wheat products are produced by a process similar to that used for oat groats, which includes cleaning, sizing, steaming, and rolling. This process results in a flake wheat product that resembles rolled oats in the dry form but makes a distinctive cooked product. Cracked wheat products are produced by steel-cutting or coarsely grinding wheat. These products require longer cooking than quick oat products but have an attractive nutty flavor and a chewy consistency that is less gelatinous than that of cooked steel-cut oats. The distinctive flavor of cracked wheat is obtained by mildly toasting it in a rotary oven or dryer.

2.2.1.3.2 Rice products. Rice products have yet to find acceptance as a hot cereal, although rice can be ground into particles about the size of farina and cooked into a hot cereal resembling farina.

2.2.1.3.3 Corn products. Corn products include corn grits, cornmeal, corn flour, and corn bran. Corn grits are served in some parts of the United States as a breakfast food, but primarily as a vegetable accompaniment to the main breakfast item. Corn grits are therefore not usually classified as a breakfast cereal although they can be consumed as such. Similarly, cornmeal, corn flour, and corn bran are used primarily as ingredients in the preparation of other foods and are not classified as breakfast cereals.

## 2.2.2 Ready-To-Eat Cereals

In the United States, the word "cereal" is typically synonymous with a product that is suitable for human consumption without further cooking at home and is usually eaten at breakfast. These ready-to-eat cereals, which were developed after traditional breakfast cereals (e.g., oatmeal), make up the bulk of the breakfast cereal market due primarily to their convenience and quick preparation time. Ready-to-eat cereals are relatively shelf-stable, lightweight, and convenient to ship and store. They are made from, in order of quantities produced, corn, wheat, oats, and rice. Additional flavor and fortifying ingredients may also be added. Ready-to-eat cereals are typically grouped by cereal form rather than the type of grain used. These groups are flaked cereals, extruded flaked cereals, gun-puffed whole grains, extruded gun-puffed cereals, shredded whole grains, extruded shredded cereals, oven-puffed cereals, and granola cereals.

2.2.2.1 Flaked Cereals. Flaked cereals are made directly from whole grain kernels or parts of kernels of corn, wheat, or rice. The grain must be processed in such a way as to obtain particles, called flaking grits, that form one flake each. One or more intermediate size reductions and sizing or

screening operations may be necessary to provide the proper size flaking grits. The production of flaked cereals involves preprocessing, mixing, cooking, delumping, drying, cooling and tempering, flaking, toasting, and packaging. Grain preparation, including receiving, handling, cleaning, and hulling, for flaked cereal production is similar to that discussed under traditional cereal production (Section 2.2.1) and in AP-42 Section 9.9.1, Grain Elevators and Processes; it is not included in this discussion. Figure 2-3 shows a typical process diagram for flaked cereal production.

2.2.2.1.1 Preprocessing. Before the grains can be cooked and made into flakes, they must undergo certain preprocessing steps. For corn, this entails dry milling regular field corn to remove the germ and the bran from the kernel, leaving chunks of endosperm. Corn milling is discussed in detail in AP-42 Section 9.9.1, Grain Elevators and Processes. These chunks are approximately one half to one third the size of the whole kernel and are raw, unflavored, and unsuitable for flaking until they have been processed. Wheat flakes begin with whole wheat kernels that have all seed parts intact (germ, bran, and endosperm) instead of the broken chunks of endosperm used for corn flakes. The wheat is preprocessed by breaking open the kernels using a process known as bumping, which involves steaming the kernels lightly and running them through a pair of rolls to slightly crush the kernels. Care is taken during the bumping process not to produce flour or fine material. Rice does not require any special preprocessing steps for the production of rice flakes other than those steps involved in milling rough rice to form the polished head rice that is the normal starting material.

2.2.2.1.2 Mixing. The first step in converting raw grits, either corn, wheat, or rice, into flakes is to mix the grits with a flavor solution that includes sugar, malt, salt, and water. Master batches of the flavor solution are typically prepared and then added to the cooker batch of grits in specific quantities. The amount of added flavor solution is measured by weight and not by volume, as temperature and viscosity variations can result in fluctuations in volume of the master batch. Inaccurate and haphazard proportioning of ingredients results in differences in the handling and the quality of the grits during subsequent processing steps and ultimately in the final product.

2.2.2.1.3 Cooking. The weighed amounts of raw grits and the flavor solution are then charged into batch cookers. The cookers are capable of being rotated and are built to withstand direct steam injection under pressure. Some facilities load the grits and flavor solution simultaneously, close the lid, and rotate the contents four to five times to obtain a uniform dispersion throughout the grain mass. Other facilities add the grits first, close the cooker lid, begin rotating the cooker, and then add the flavor solution. Both loading processes are practiced in industry. After the grits are evenly coated with the flavor syrup, steam is released into the rotating cooker to begin the cooking process. The grits are typically cooked at a steam pressure of 15 to 18 pounds per square inch (psi). Corn grits require a cooking time of approximately 2 hours. Rice grits require approximately 60 minutes. Wheat grits require only 30 to 35 minutes.

The cooking is complete when each kernel or kernel part has been changed from a hard, chalky white to a soft, translucent, golden brown. A properly cooked batch contains particles that are rubbery but firm and resilient under finger pressure, and that contain no raw starch. If raw starch is present after cooking, it shows up as white spots in the finished product. Undercooked batches contain large numbers of grain particles with chalky white centers, while overcooked batches are excessively soft, mushy, and sticky.

When the cooking is complete, rotation stops, the steam is turned off, and vents located on the cooker are opened to reduce the pressure inside the cooker to ambient conditions and to cool its contents. The exhaust from these vents may be connected to a vacuum system for more rapid cooling.



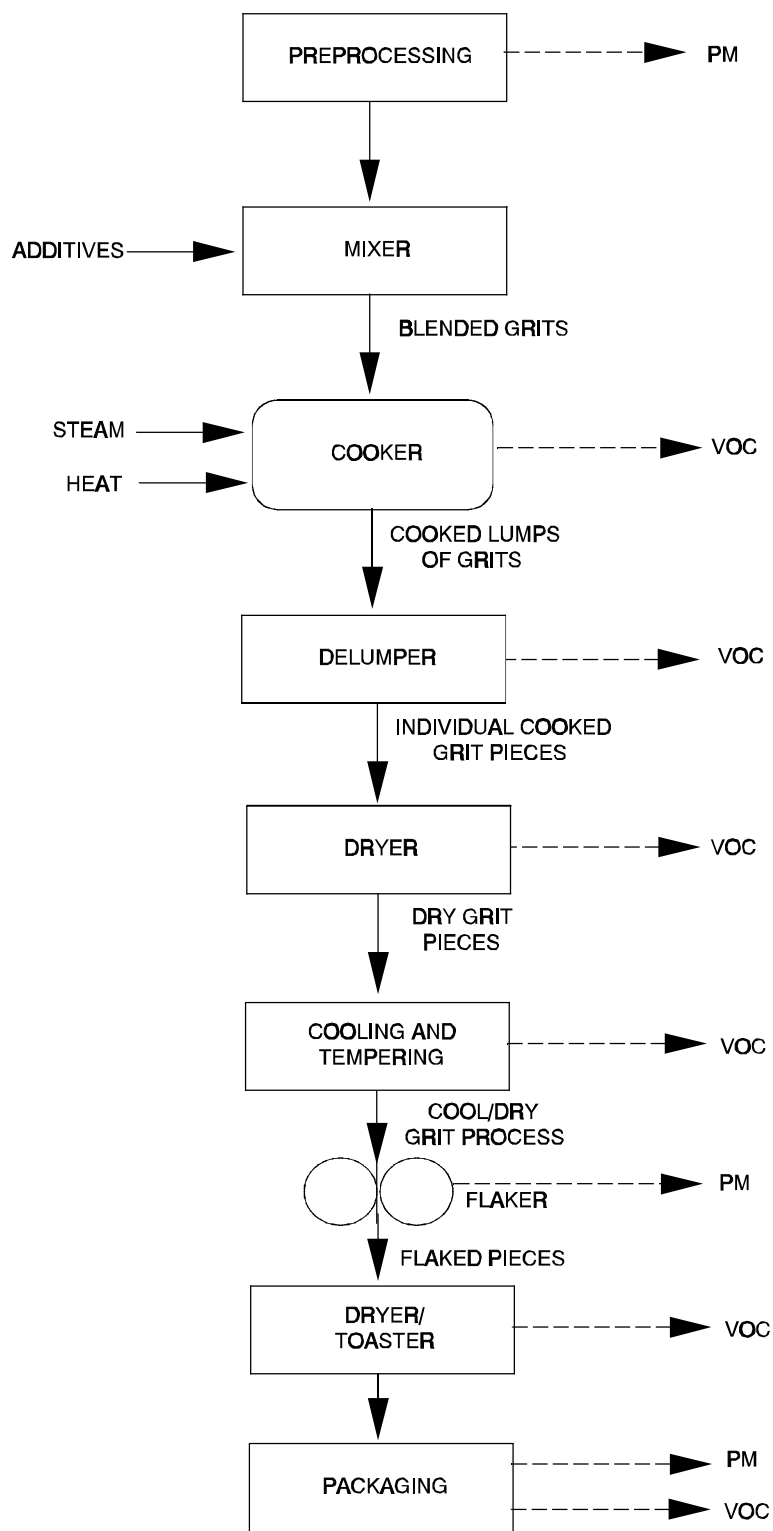

Figure 2-3. Process diagram for cereal flake production.<sup>1</sup>

After pressure is relieved, the cooker is uncapped and the rotation restarted.

2.2.2.1.4 Delumping. The cooked grits are then dumped onto moving conveyor belts located under the cooker discharge. The conveyors then pass through delumping equipment to break and size the loosely held-together grits into mostly single grit particles. Delumping equipment usually consists of the main body, containing fixed combs or fingers; one or more rotating shafts, on which breaking bars or projections are mounted; a grid or screen device (e.g., flatbed gyrating sifters, rotating-wire screeners, or perforated-drum screeners) to hold the product in the breaker until the desired particle size is achieved; and a drive train, consisting of a motor with or without a speed reducer. Large volumes of air are typically drawn through the delumping equipment to help cool the product, to skin over the individual pieces (to remove the stickiness), to remove steam vapor (which is released as the cooling takes place), and to remove fine dust or particles from the product stream. It may be necessary to perform delumping and cooling in different steps to get proper separation of the grits so that they are the optimum size for drying; in this case, cooling is typically performed first to stop the cooking action and to eliminate stickiness from the grit surface.

For wheat and rice flakes, the material leaving the cooker tends to be in tightly-lumped balls ranging in size from that of golf balls to that of soccer balls. Consequently, more than one lump breaker is usually necessary, with those closest to the cooker performing the coarse breaking and those farther downstream performing the finer breaking.

2.2.2.1.5 Drying. After cooking and delumping, the grits are metered in a uniform flow to the dryer. The most common type of dryer used is a wide, perforated conveyor unit passing through a surrounding chamber in which the temperature, humidity, and airflow can be controlled. Drying should result in a minimum of skinning over of the particle surface, which impedes the removal of moisture from the center of the grit. Drying is typically performed at temperatures below 121°C (250°F) and under controlled humidity, which prevents case hardening of the grit and greatly decreases the time needed for drying to the desired moisture level. Desired end moisture levels for corn, wheat, and rice grits are 10 to 14 percent, 16 to 18 percent, and 17 percent, respectively.

2.2.2.1.6 Cooling and tempering. After drying, the grits are cooled to ambient temperature, usually in an unheated section of the dryer. In certain hot climates or plant conditions, however, some refrigerated air may be required. Cooling the grits prevents darkening and quality loss during the flaking process. After they are cooled, the grits are tempered by holding them in large accumulating bins to allow the moisture content to equilibrate between the grit particles as well as from the center of the individual particles to the surface. For corn flakes, tempering also reduces the occurrence of blistering during toasting. Tempering times of approximately 8 hours are preferred for rice flakes, while times for corn and wheat flakes are just a few hours.

2.2.2.1.7 Flaking. After tempering, the grits pass between pairs of very large metal rolls which press the grits into very thin flakes. The rolls are usually made of chilled iron with a hollow center to allow the passage of cooling water through them, which helps maintain a roll surface temperature of 43° to 46°C (110° to 115°F). The flow of the cooling water is accomplished by a continuous spiral groove channeled from one end to the other in the interior of the roll. Most rolls exert a pressure of approximately 40 tons to flatten the grits into flakes, and are equipped with roll knives to scrape the flakes from the rolls. The flow of material into the rolls must be uniform in speed and evenly spaced across the whole width of the rolls. No special preparation is required to flake wheat or rice grits; corn grits require steaming or heating to make their surfaces sticky enough to allow the rolls to "grab" them and draw them in.

Older-style rolls produce approximately 150 lb of flakes per hour, whereas newer style produce between 400 and 800 lb of flakes per hour. Flaking rolls are typically mounted on a floor or mezzanine directly over the feed to the oven. Also, it is common for a facility to have two pairs of rolls feeding one oven.

2.2.2.1.8 Toasting. Flakes are toasted by suspending them in a hot air stream, rather than by laying them onto a flat baking surface like those used for cookies and crackers. Most toasting ovens rotate at a constant rate (determined by the product type and production rate) and slope from the feed end to the discharge end. The rotation and slope of the oven should be such that the flakes are suspended in the air for as long as possible. The ovens are perforated on the inside to allow air flow and these perforations should be as large as possible for good air flow but small enough so that flakes cannot catch in them. Properly toasted flakes have the correct color (checked visually by the oven operator or electronically using color-measuring meters) and moisture content (approximately 1 to 3 percent). Oven temperatures range from 274° to 329°C (525° to 625°F) for corn and wheat flakes (rice flake temperatures are slightly higher), and the flake remains in the oven approximately 90 seconds.

2.2.2.1.9 Packaging. Packaging for flaked breakfast cereals is the same as that for all ready-to-eat breakfast cereals and is discussed in Section 2.2.2.9 of this section.

2.2.2.2 Extruded Flaked Cereals. Extruded flakes differ from traditional flakes in that the grit for flaking is formed by extruding mixed ingredients through a die and cutting pellets of the dough into the desired size. The steps in extruded flake production are preprocessing, mixing, extruding, drying, cooling and tempering, flaking, toasting, and packaging. The primary difference between extruded flake production and traditional flake production is that extruded flakes replace the cooking and delumping steps used in traditional flake production with an extruding step. Figure 2-4 shows a typical process diagram for extruded flake production.

Preprocessing of grains and mixing of ingredients for extruded flakes are basically the same as for traditional flakes, except for the addition of natural or artificial color to the flavor solution. Color addition is required for extruded flakes because when the ingredients are processed in the extrusion systems more mechanical working takes place, and the resulting flakes often appear dull or gray in color.

Extruded flakes do not undergo a cooking and delumping process like traditional flakes, but instead are extruded into the desired shape and size. The extruder is a long, barrel-like apparatus that performs several operations along its length. The first part of the barrel kneads or crushes the grain and mixes the ingredients together. The flavor solution, consisting of water, sugar, salt, malt, and natural or artificial color, may be added directly to the barrel of the extruder by means of a metering pump. Heat input to the barrel of the extruder near the feed point is kept low to allow the ingredients to mix properly before any cooking or gelatinization starts. Heat is applied to the center section of the extruder barrel to cook the ingredients. The die is located at the end of the last section, which is generally cooler than the rest of the barrel. The dough remains in a compact, rather than expanded, form as it extrudes through the die to prevent moisture flash-off. A rotating knife slices the dough

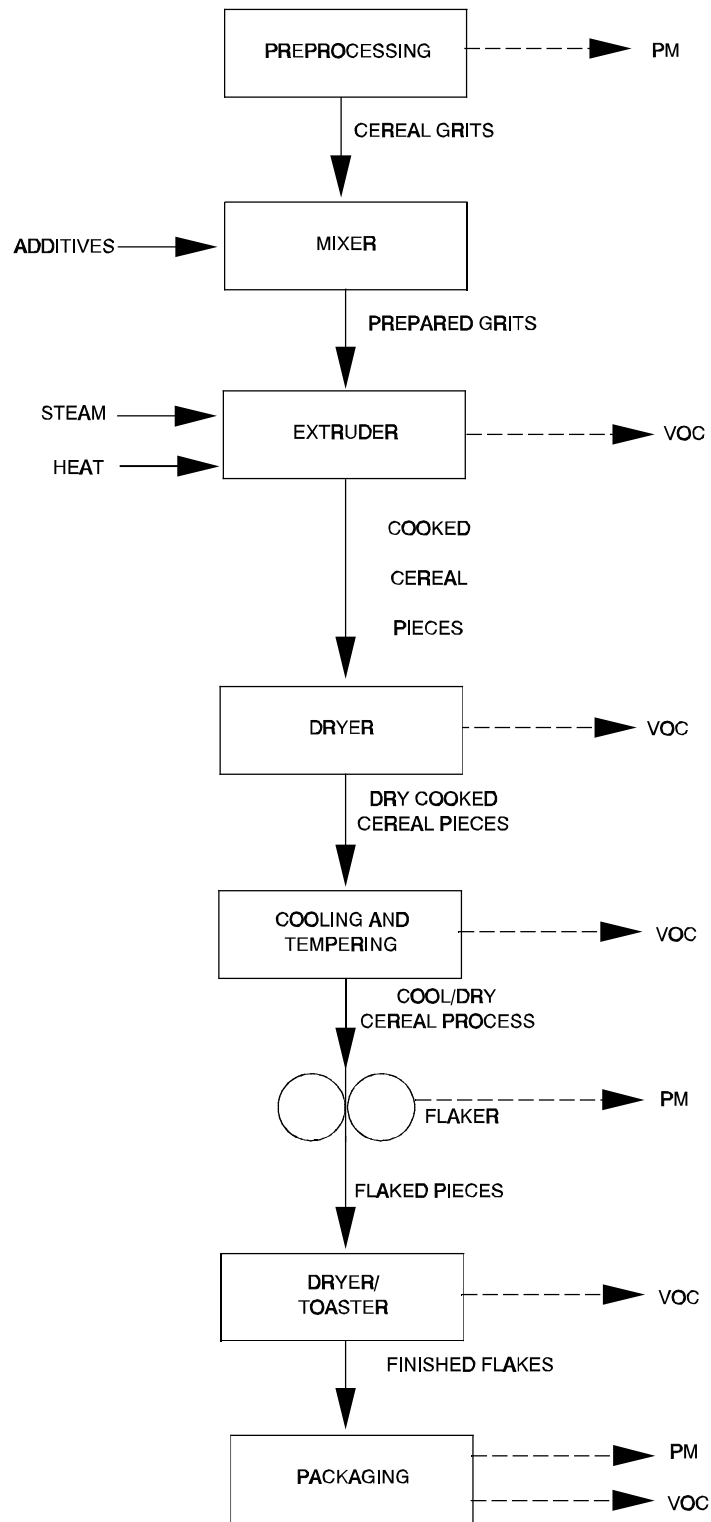

Figure 2-4. Process diagram for extruded flake production.<sup>1</sup>

into properly-sized pellets as it extrudes through the die. The pellets typically have a moisture content of 22 to 24 percent.

The remaining steps for extruded flakes (drying, cooling, flaking, toasting, and packaging) are the same as for traditional flake production discussed earlier. Tempering, although required for traditional flake production, is necessary for extruded flakes only if there is a great difference between the surface moisture and the internal moisture of the extruded pellets.

2.2.2.3 Gun-Puffed Whole Grains. Gun-puffed whole grains are formed by cooking the grains and then subjecting them to a sudden large pressure drop. As steam under pressure in the interior of the grain seeks to equilibrate with the surrounding lower-pressure atmosphere, it forces the grains to expand quickly or "puff". Rice and wheat are the only types of grain used in gun-puffed whole grain production, which involves pretreatment, puffing, screening, drying, and cooling. Figure 2-5 shows a typical gun-puffed whole grain production process.

2.2.2.3.1 Pretreatment. Wheat requires pretreating to prevent the bran from loosening from the grain in a ragged, haphazard manner, in which some of the bran adheres to the kernels and other parts to be blown partially off the kernels. One form of pretreatment is to add 4 percent, by weight, of a saturated brine solution (26 percent salt) to the wheat. The water in the brine solution is used for steam to generate puffing, and the salt toughens the bran during preheating and makes it adhere to itself. Another form of pretreatment, called pearling, removes part of the bran altogether before puffing. The grain is passed through a machine in which revolving, high-speed silicon carbide stones are mounted, which abrade the bran off of the kernels. The bran particles are then removed by air suction and deposited in a dust collector. The only pretreatment required for rice is normal milling to produce head rice. Milling of rice is discussed in AP-42 Section 9.9.1, Grain Elevators and Processes.

2.2.2.3.2 Puffing. Puffing can be performed with manual single-shot guns, automatic single-shot, automatic multiple-shot guns, or continuous guns. In manual single-shot guns, grain is loaded into the opening of the gun and the lid is closed and sealed using a system of levers and cams. As the gun begins to rotate on shafts mounted on each side of the gun body, gas burners heat the sides of the gun body, causing the moisture in the grain to convert to steam. When the internal pressure reaches 200 psi (approximately 9-12 minutes), the lid is opened and the sudden change in pressure causes the grain to puff. The puffed grain is then released into a continuously vented bin.

Automatic single-shot guns operate on the same principle, except that steam at 200 psi is injected directly into the gun body. This reduces the time required to condition the grain for puffing from 9 to 12 minutes to approximately 90 seconds. Multiple-shot guns have several barrels mounted on a slowly rotating wheel so that each barrel passes the load and fire positions at the correct time. The load, steam, and fire process for any one barrel is identical to that of the single-shot gun.

2.2.2.3.3 Final processing. After the grain is puffed, it must be screened and dried before it is packaged. Screening removes any unpuffed kernels, bran and dust particles, and small, broken puffed kernels. Drying reduces the moisture content of the puffed grain from 5 to 7 percent to 1 to 3 percent. The final product is very porous and absorbs moisture rapidly and easily. Therefore, it must be packaged in materials that possess good moisture barrier qualities. Packaging materials are discussed in greater detail in Section 2.2.2.9 of this section.

2.2.2.4 Extruded Gun-Puffed Cereals. Extruded gun-puffed cereals use a meal or flour as the starting ingredient instead of whole grains. The flour is produced by milling corn, rice, and wheat,

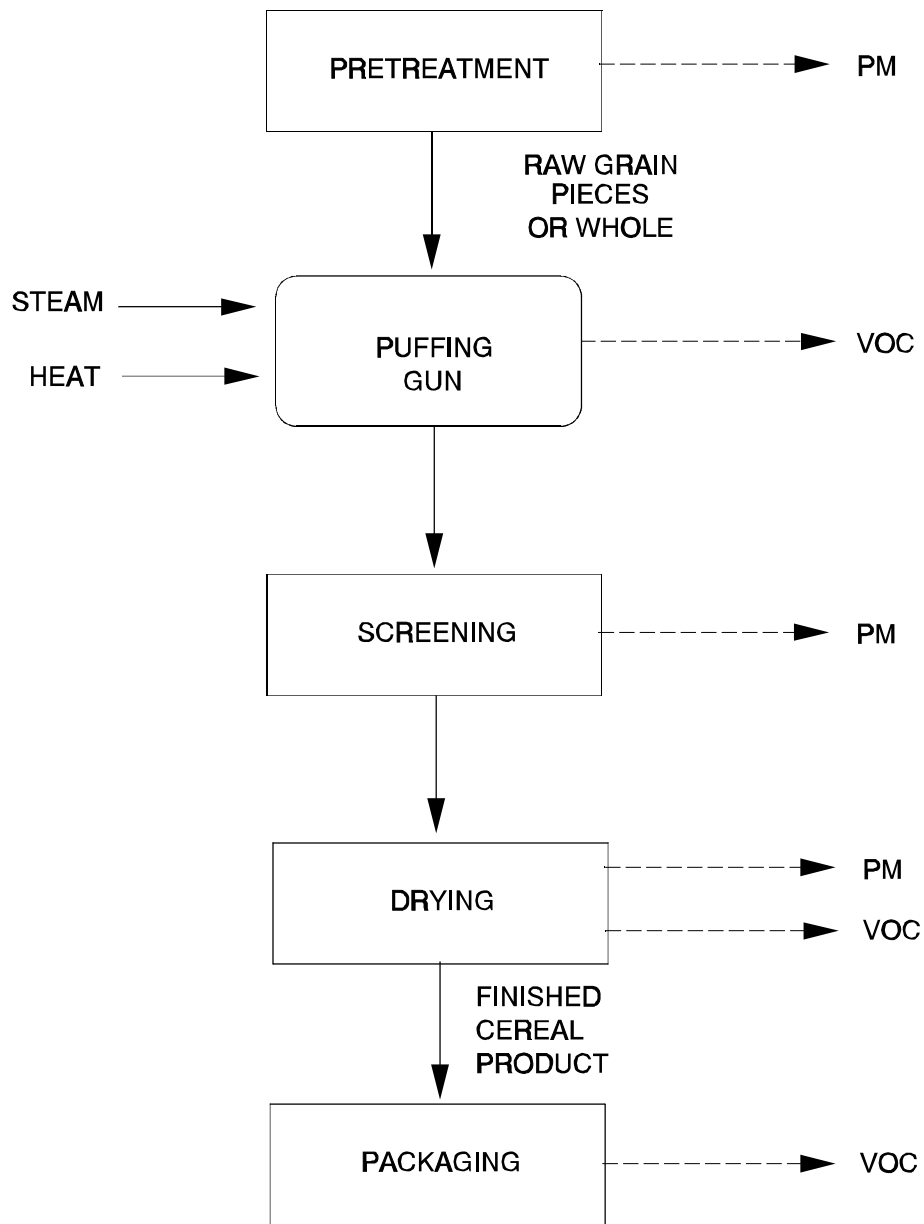

Figure 2-5. Gun-puffed whole grain production.<sup>1</sup>

and is discussed in detail in AP-42 Section 9.9.1, Grain Elevators and Processes. The dough cooks in the extruders and is then formed into the desired shape when extruded through a die. The extrusion process for gun-puffed cereals is similar to that for extruded flake production discussed earlier. After the dough is extruded, it is dried and tempered from a moisture content of 20 to 24 percent to a moisture content of 9 to 12 percent. It then undergoes the same puffing and final processing steps as described for whole grain gun-puffed cereals. Many extruded gun-puffed cereals are coated with sugar and fortified with nutrients before packaging. A general process diagram of extruded gun-puffed cereal production is shown in Figure 2-6.

2.2.2.5 Shredded Whole Grains. Although rice, corn, and other grains can be used, wheat is primarily used for whole grain shredding and, therefore, is the only process discussed. White wheat is the most desirable raw material because it produces shredded wheat biscuits that bake to a golden brown. Red wheat can also be used, but the color of the finished product is darker and less appealing. The steps involved in producing whole-grain shredded cereal are grain cleaning, cooking, cooling and tempering, shredding, biscuit formation, biscuit baking, and packaging. Figure 2-7 shows a typical whole-grain shredded cereal process.

2.2.2.5.1 Grain cleaning. Before the wheat is cooked, any sticks, stones, chaff, dust, and other foreign material must be removed. Cleaning operations for wheat are discussed in AP-42 Section 9.9.1, Grain Elevators and Processes.

2.2.2.5.2 Cooking. Cooking is typically performed in batches with excess water at temperatures slightly below the boiling point at atmospheric pressure. Cooking vessels usually have horizontal baskets that rotate within a stationary housing and are big enough to hold 50 bushels of raw wheat. Steam is injected directly into the water to heat the grain. Cooking is completed in about 30 to 35 minutes when the center of the kernel endosperm turns from starchy white to translucent gray. The grain has a moisture content of 45 to 50 percent after the cooking cycle.

2.2.2.5.3 Cooling and tempering. After the cooking cycle is completed, the water is drained from the vessel and the cooked wheat is dumped and conveyed to cooling units. These units are either vertical, louvered units through which air is drawn or horizontal, vibratory, perforated pans through which refrigerated air is circulated. The purpose of the cooling units is to surface-dry the wheat and to reduce the temperature to ambient levels, thus stopping the cooking process. After the grain is cooled, it is placed in large holding bins and allowed to temper for up to 24 hours. Tempering allows the moisture level in the grain to equilibrate. The kernels also become more firm during the tempering process, which is vital for obtaining shreds strong enough for cutting and for handling as unbaked biscuits.

2.2.2.5.4 Shredding. Shredding squeezes the wheat kernels between one roll with a smooth surface and another roll with a grooved surface. A comb is positioned against the grooved roll with each tooth fitting into one of the grooves. As the roll revolves, its grooves fill with cooked wheat and the comb teeth then pick the wheat shred from the groove. The shreds fall to a conveyor running parallel to the shredding grooves. In the traditional process, each pair of rolls forms one layer of the finished biscuit. Industry variations in the grooved roll include rolls with single layers, rolls with grooves across the rolls that produce cross shreds, rolls with U-shaped grooves, and rolls with V-shaped grooves. Because surface temperatures at optimum shredding are 35° to 46°C (95° to 115°F), it is sometimes necessary to cool the rolls with water.

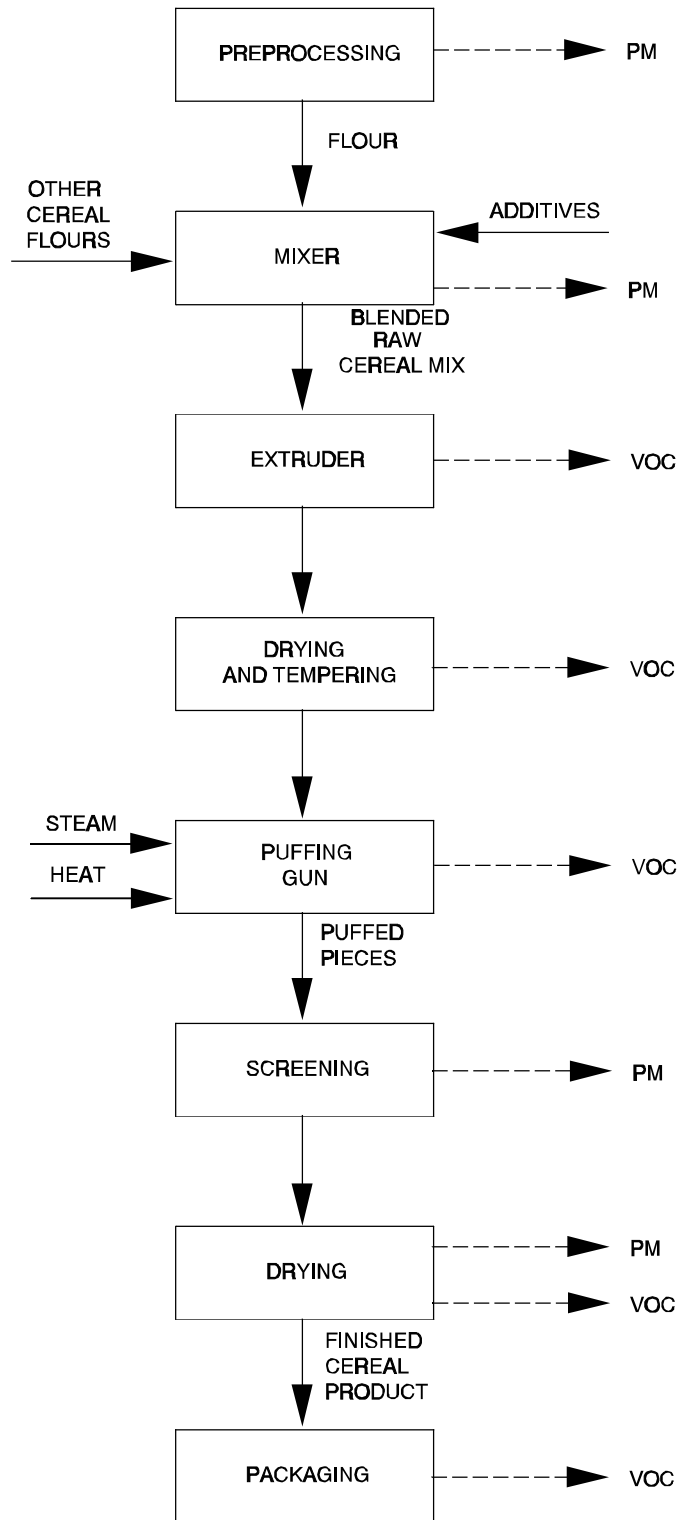

Figure 2-6. Extruded gun puffed cereal production.<sup>1</sup>



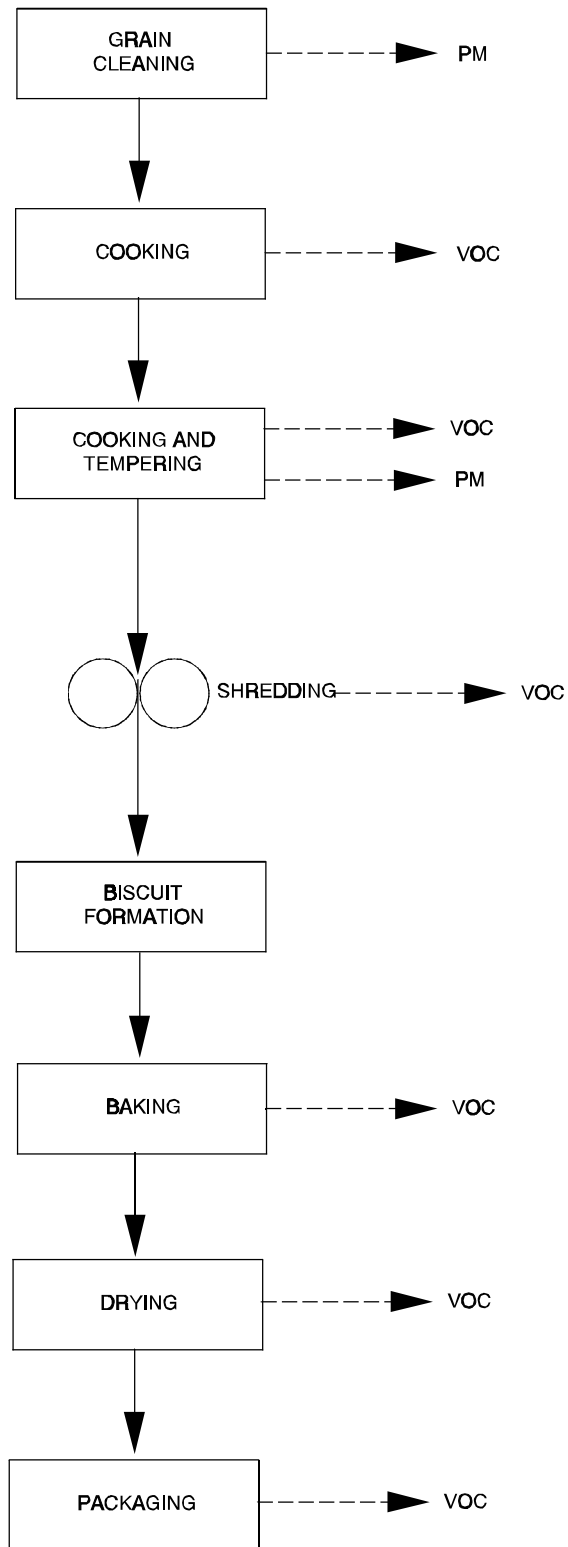

Figure 2-7. Whole grain shredded cereal production.

2.2.2.5.5 Biscuit formation. After the shreds are produced, they fall in layers onto a conveyor moving under the rolls. If each pair of rolls lays down only one layer of shreds, 10 to 20 pairs of rolls are needed to produce a sufficiently deep web of layers to form large shredded wheat biscuits. Larger-capacity rolls may be used that are capable of laying down the equivalent of several layers each, thus reducing the number of pairs of rolls required. After the web of many layers of shreds reaches the end of the shredder, it is fed through a cutting device to form the individual biscuits. The edges of the cutting device are dull, rather than sharp, so that the cutting action is part cutting and part squeezing, which compresses the edges of the biscuit together and makes the shreds stick to each other. This action forms a crimped joint, which holds the shreds together in biscuit form.

2.2.2.5.6 Baking. After the individual biscuits are formed, they are baked in a band or continuous conveyor-belt oven. The oven is broken into different heat zones so that the major heat input to the biscuits is in the first few zones. An increase occurs in the biscuit height and moisture is removed in the middle zones. Color development and final moisture removal occurs in the final zones on the oven. Oven temperatures are 204° to 315°C (400° to 600°F). The moisture level of the biscuits entering the oven is approximately 45 percent and falls to approximately 4 percent as the biscuit leaves the oven. The final product has a moisture content of 1 to 3 percent. Shredded wheat is highly susceptible to oxidative rancidity, so it is often treated with antioxidants to prolong freshness and shelf life.

2.2.2.5.7 Packaging. After the biscuits are baked and dried, they are ready for packaging. Packaging of breakfast cereals is discussed in Section 2.2.2.9 of this section.

2.2.2.6 Extruded Shredded Cereals. Extruded shredded cereals are made in much the same way as whole-grain shredded cereals except that extruded shredded cereals use a meal or flour as a raw material instead of whole grains. Raw grains include wheat, corn, rice, and oats, and because the grains are used in flour form, they can be used alone or in mixtures. The steps involved in extruded shredded cereal production are grain preprocessing (including grain receiving, handling, and milling), mixing, extruding, cooling and tempering, shredding, biscuit formation, baking, drying, and packaging. The preprocessing, mixing, extruding, and cooling and tempering steps are the same as those discussed for other types of cereal. Shredding, biscuit formation, baking, drying, and packaging are the same as for whole-grain shredded cereal. Extruded shredded cereals are typically made into small, bite-size biscuits, instead of the larger biscuits of whole-grain shredded wheat. Consequently, fewer layers of shreds are required per biscuit.

2.2.2.7 Oven-Puffed Cereals. Oven-puffed cereals are made almost exclusively using whole-grain rice or corn or mixtures of these two grains. Rice and corn inherently puff in the presence of high heat and the proper moisture content, whereas wheat and oats do not. The grains are mixed with sugar, salt, water, and malt and then pressure-cooked for approximately an hour to a moisture content of 28 percent. After cooking, the grain is conveyed through a cooling and sizing operation, which returns the grain to ambient temperature and breaks any agglomerates into individual kernels. After cooling and sizing, the kernels are dried to a moisture content of 17 percent and tempered for 4 to 8 hours to ensure moisture equilibration. After tempering, the kernels are bumped, which involves passing the kernels through flaking rolls to flatten them slightly. Although flattened, the kernels are not as thin as flakes. After bumping, the kernels are dried again to reduce the moisture content from 17 percent to 9 to 11 percent. The kernels are then oven-puffed, which requires a proper balance between kernel moisture content and oven temperature. Oven-puffing is characterized by extremely high temperatures (288° to 343°C or 550° to 650°F) in the latter half of the oven cycle and is accomplished in approximately 90 seconds. After puffing, the cereal is cooled, fortified with vitamins

(if necessary), and frequently treated with antioxidants to preserve freshness. The final product is then packaged.

2.2.2.8 Granola Cereals. Granola cereals are ready-to-eat cereals that are prepared by taking regular, old-fashioned whole-rolled oats or quick-cooking oats (see Traditional Oat Cereals, Section 2.2.1.1) and mixing them with other ingredients, such as nut pieces, coconut, brown sugar, honey, malt extract, dried milk, dried fruits, water, cinnamon, nutmeg, and vegetable oil. This mixture is then spread in a uniform layer onto the band of a continuous dryer or oven. The layer is uniformly toasted until it is a light brown and has a moisture content of approximately 3 percent. The toasted layer is then broken into chunks. Granola cereals typically do not contain any antioxidants or artificial flavors or colors.

2.2.2.9 Packaging. The package materials for ready-to-eat breakfast cereals include printed paperboard cartons, protective liners, and the necessary adhesives. The cartons are printed and produced by carton suppliers and are delivered, unfolded and stacked on pallets, to the breakfast cereal manufacturers. The liners, also supplied by outside sources, must be durable and impermeable to moisture or moisture vapor. However, cereals that are not hygroscopic and/or retain satisfactory texture in moisture equilibrium with ambient atmosphere do not require moisture-proof liners. The most common type of liners used today are made of high-density polyethylene (HDPE) film because of its availability and low cost. The adhesives used in cereal packaging are water-based emulsions and hot melts. The cereal industry is the second largest user of adhesives for consumer products.

The unfolded printed cartons arrive at the cereal packaging line in small stacks. The cartons are then folded on the sides and glued on the bottom as they advance to the filling area. At the filling area, liners are filled with cereal using scales to ensure proper product weight. Electronically operated weight checkers are also used to double-check the weight of the product, allowing small overweights but no underweights. Liner sealers then seal the liners, which are then inserted into the awaiting open cartons. The tops of the cartons are then glued and closed. The glue applicator is designed to permit easy opening and reclosing of the carton by the consumer. The finished product is then loaded onto pallets, either manually or automatically, and the pallets are wrapped in plastic to prevent damage and shifting during shipment. Several variations of packaging lines may be used in the ready-to-eat breakfast cereal industry, including lines that fill the liners either before or after they have been inserted into the carton and lines that utilize more manual labor and less automated equipment.

## 2.3 EMISSIONS

Air emissions may arise from a variety of sources in breakfast cereal manufacturing. Particulate matter (PM) emissions result mainly from solids handling and mixing. For breakfast cereal manufacturing, PM emissions occur during the milling and processing of grain, as the raw ingredients are dumped, weighed, and mixed, as the grains are hulled, and possibly during screening, drying, and packaging. Emission sources associated with grain milling and processing include grain receiving, precleaning and handling, cleaning house separators, milling, and bulk loading. Applicable emission factors for these processes are presented in AP-42 Section 9.9.1, Grain Elevators and Processes. There are no data on PM emissions from mixing of ingredients or packaging for breakfast cereal production.

Volatile organic compound (VOC) emissions may potentially occur at almost any stage in the production of breakfast cereal, but most usually are associated with thermal processing steps, such as drying, steaming, heat treatment, cooking, toasting, extruding, and puffing. Adhesives used during

packaging of the final product may also be a source of VOC emissions. No information is available, however, on any VOC emissions resulting from these processes of breakfast cereal manufacturing.

## 2.4 EMISSION CONTROL TECHNOLOGY

Control technology to control PM emissions from breakfast cereal manufacturing is similar to that discussed in AP-42 Section 9.9.1, Grain Elevators and Processes. Because of the operational similarities, emission control methods are similar in most grain milling and processing plants. Cyclones or fabric filters are often used to control emissions from grain handling operations (e.g., unloading, legs, cleaners, etc.) and also from other processing operations. Fabric filters are used extensively in flour mills. However, certain operations within milling operations are not amenable to the use of these devices and alternatives are needed. Wet scrubbers, for example, are applied where the effluent gas stream has a high moisture content. No information exists for VOC emission control technology for breakfast cereal manufacturing.

## REFERENCES FOR SECTION 2

1. R. E. Tribelhorn, "Breakfast Cereals," *Handbook of Cereal Science and Technology*, K. J. Lorenz and K. Kulp, Editors. Marcel Dekker, Inc., 1991.
2. *1987 Census of Manufactures: Grain Mill Products*, Industry Series. U.S. Department of Commerce, Bureau of Census. Issued April 1990.
3. R. B. Fast, "Manufacturing Technology of Ready-to-eat Cereals," *Breakfast Cereals and How They Are Made*, R. B. Fast and E. F. Caldwell, Editors. American Association of Cereal Chemists, Inc., 1990.
4. D. L. Maxwell and J. L. Holohan, "Breakfast Cereals," *Elements of Food Technology*, N. W. Desrosier, Editor. AVI Publishing Company, Inc., 1977.

### 3. GENERAL DATA REVIEW AND ANALYSIS PROCEDURES

#### 3.1 LITERATURE SEARCH AND SCREENING

Data for this investigation were obtained primarily through literature searches. Because this is a new section, the AP-42 background files located in the Emission Factor and Inventory Group (EFIG) did not contain any information on the industry, processes, or emissions. Information on the industry was also obtained from the *Census of Manufactures*. In addition, representative trade associations were contacted for assistance in obtaining information about the industry and emissions.

To screen out unusable test reports, documents, and information from which emission factors could not be developed, the following general criteria were used:

1. Emission data must be from a primary reference:
  - a. Source testing must be from a referenced study that does not reiterate information from previous studies.
  - b. The document must constitute the original source of test data. For example, a technical paper was not included if the original study was contained in the previous document. If the exact source of the data could not be determined, the document was eliminated.
2. The referenced study should contain test results based on more than one test run. If results from only one run are presented, the emission factors must be down rated.
3. The report must contain sufficient data to evaluate the testing procedures and source operating conditions (e.g., one-page reports were generally rejected).

A final set of reference materials was compiled after a thorough review of the pertinent reports, documents, and information according to these criteria.

#### 3.2 DATA QUALITY RATING SYSTEM<sup>1</sup>

As part of the analysis of the emission data, the quantity and quality of the information contained in the final set of reference documents were evaluated. The following data were excluded from consideration:

1. Test series averages reported in units that cannot be converted to the selected reporting units;
2. Test series representing incompatible test methods (i.e., comparison of EPA Method 5 front half with EPA Method 5 front and back half);
3. Test series of controlled emissions for which the control device is not specified;
4. Test series in which the source process is not clearly identified and described; and
5. Test series in which it is not clear whether the emissions were measured before or after the control device.

Test data sets that were not excluded were assigned a quality rating. The rating system used was that specified by EFIG for preparing AP-42 sections. The data were rated as follows:

A—Multiple tests that were performed on the same source using sound methodology and reported in enough detail for adequate validation. These tests do not necessarily conform to the methodology specified in EPA reference test methods, although these methods were used as a guide for the methodology actually used.

B—Tests that were performed by a generally sound methodology but lack enough detail for adequate validation.

C—Tests that were based on an untested or new methodology or that lacked a significant amount of background data.

D—Tests that were based on a generally unacceptable method but may provide an order-of-magnitude value for the source.

The following criteria were used to evaluate source test reports for sound methodology and adequate detail:

1. Source operation. The manner in which the source was operated is well documented in the report. The source was operating within typical parameters during the test.

2. Sampling procedures. The sampling procedures conformed to a generally acceptable methodology. If actual procedures deviated from accepted methods, the deviations are well documented. When this occurred, an evaluation was made of the extent to which such alternative procedures could influence the test results.

3. Sampling and process data. Adequate sampling and process data are documented in the report, and any variations in the sampling and process operation are noted. If a large spread between test results cannot be explained by information contained in the test report, the data are suspect and are given a lower rating.

4. Analysis and calculations. The test reports contain original raw data sheets. The nomenclature and equations used were compared to those (if any) specified by EPA to establish equivalency. The depth of review of the calculations was dictated by the reviewer's confidence in the ability and conscientiousness of the tester, which in turn was based on factors such as consistency of results and completeness of other areas of the test report.

### 3.3 EMISSION FACTOR QUALITY RATING SYSTEM<sup>1</sup>

The quality of the emission factors developed from analysis of the test data was rated using the following general criteria:

A—Excellent: Developed only from A-rated test data taken from many randomly chosen facilities in the industry population. The source category is specific enough so that variability within the source category population may be minimized.

B—Above average: Developed only from A-rated test data from a reasonable number of facilities. Although no specific bias is evident, it is not clear if the facilities tested represent a random sample of the industries. The source category is specific enough so that variability within the source category population may be minimized.

C—Average: Developed only from A- and B-rated test data from a reasonable number of facilities. Although no specific bias is evident, it is not clear if the facilities tested represent a random sample of the industry. In addition, the source category is specific enough so that variability within the source category population may be minimized.

D—Below average: The emission factor was developed only from A- and B-rated test data from a small number of facilities, and there is reason to suspect that these facilities do not represent a random sample of the industry. There also may be evidence of variability within the source category population. Limitations on the use of the emission factor are noted in the emission factor table.

E—Poor: The emission factor was developed from C- and D-rated test data, and there is reason to suspect that the facilities tested do not represent a random sample of the industry. There also may be evidence of variability within the source category population. Limitations on the use of these factors are footnoted.

The use of these criteria is somewhat subjective and depends to an extent upon the individual reviewer. Details of the rating of each candidate emission factor are provided in Section 4.

#### REFERENCE FOR SECTION 3

1. *Technical Procedures for Developing AP-42 Emission Factors and Preparing AP-42 Sections*, EPA-454/B-93-050, Office of Air Quality Planning and Standards, U. S. Environmental Protection Agency, Research Triangle Park, NC, October 1993.

#### 4. REVIEW OF SPECIFIC DATA SETS

This section describes the references and test data that were evaluated to determine if pollutant emission factors could be developed for AP-42 Section 9.9.2, Cereal Breakfast Food.

##### 4.1 REVIEW OF SPECIFIC DATA SETS

No source tests or other documents were located during the literature search that could be used to develop emission factors for this AP-42 section.

##### 4.2 DEVELOPMENT OF CANDIDATE EMISSION FACTORS

No emissions factors were developed because no source tests or emissions data were found. Particulate emission factors for grain processing are presented in AP-42 Section 9.9.1, Grain Elevators and Processes.