

970528CWE5012

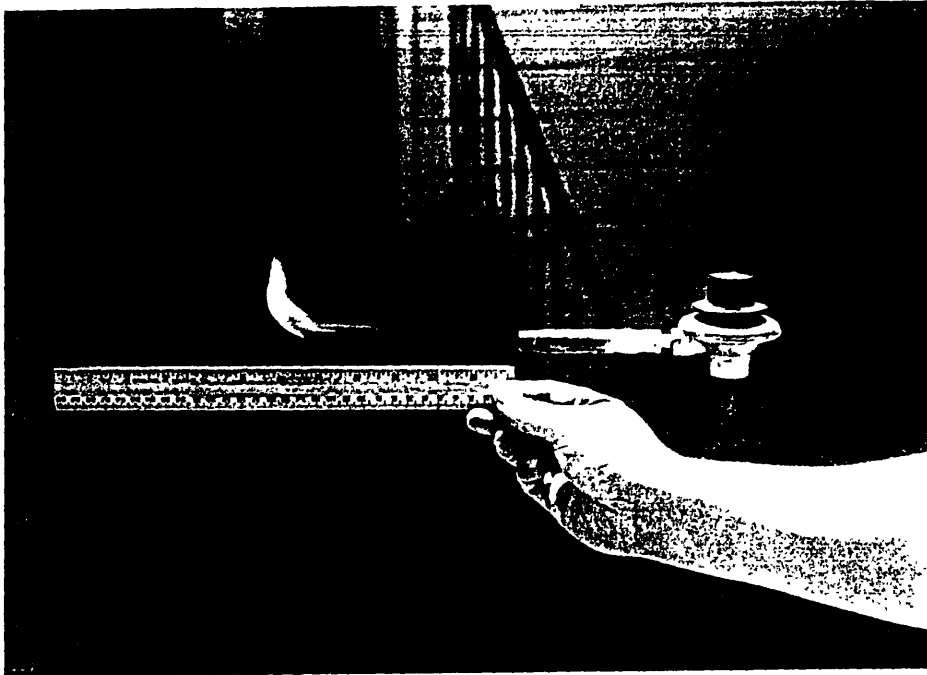

PHOTOGRAPH 5:  
Reenactment of flame intensity, another view. The flame,  
representative of the one at the time of the event, is about 6-  
1/2 inches long.

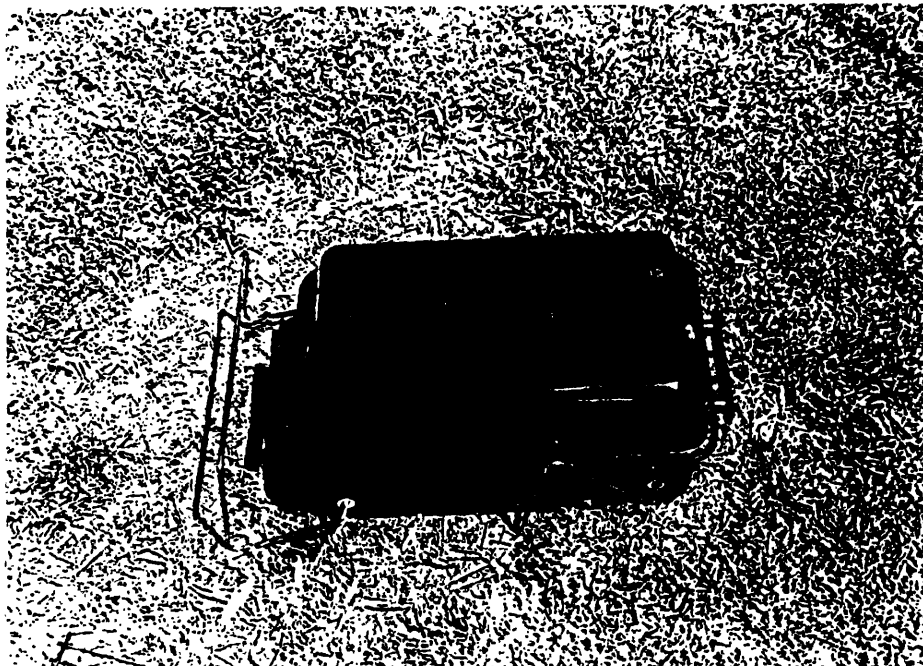

PHOTOGRAPH 6:  
The subject LP gas grill, another view.

56

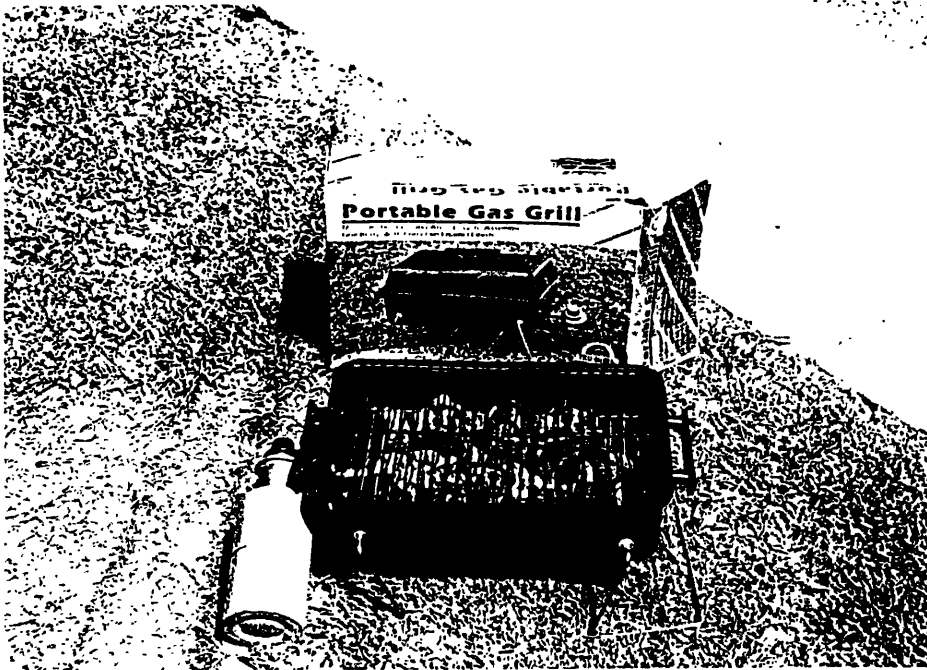

PHOTOGRAPH 7:  
The subject gas grill. Seen here is the entire grill minus its cover.

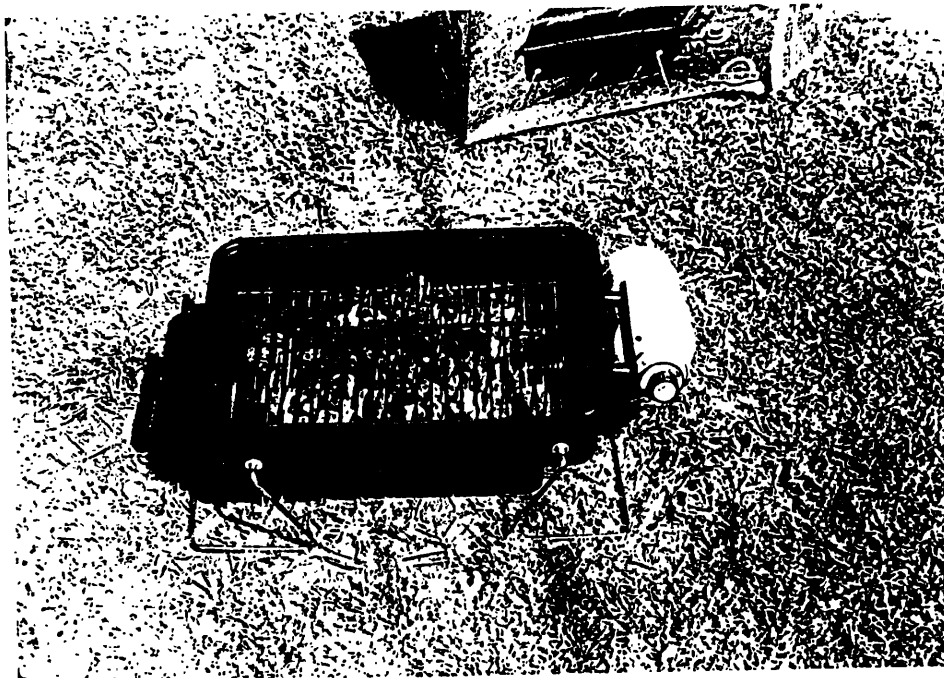

PHOTOGRAPH 8:  
The gas grill, another view.

57

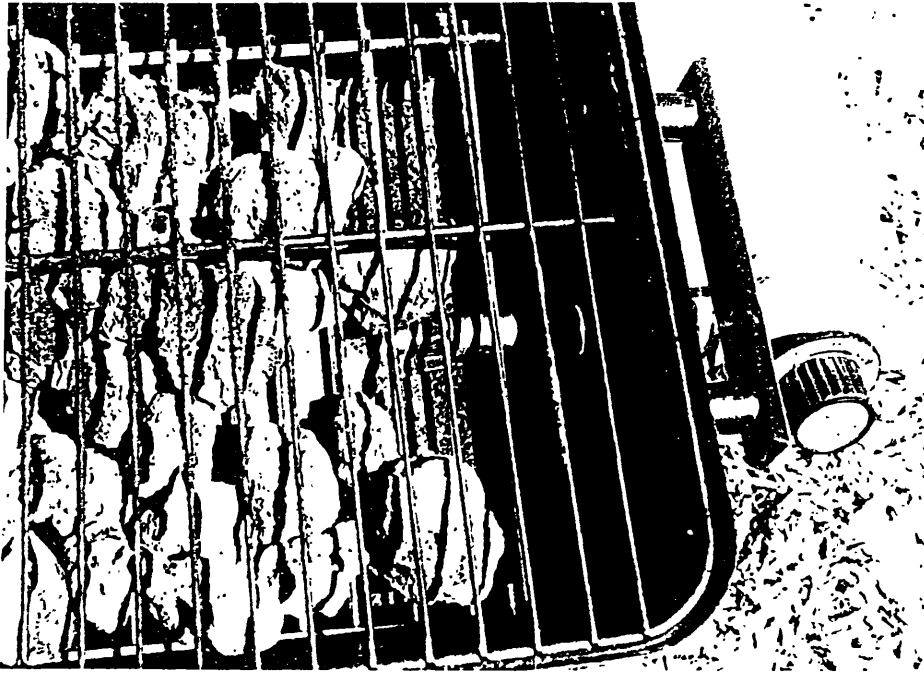

PHOTOGRAPH 9:  
Looking through the top grill and the lava rock grill, one can see the burner tube.

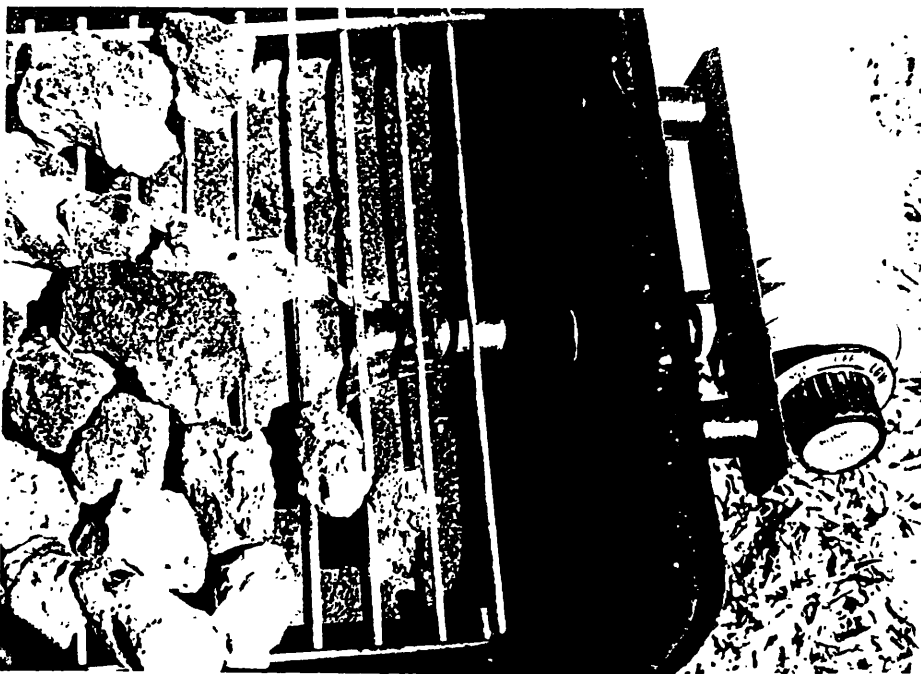

PHOTOGRAPH 10:  
Same view as the previous photograph, but with the top grill removed.

58

970528CWE5012

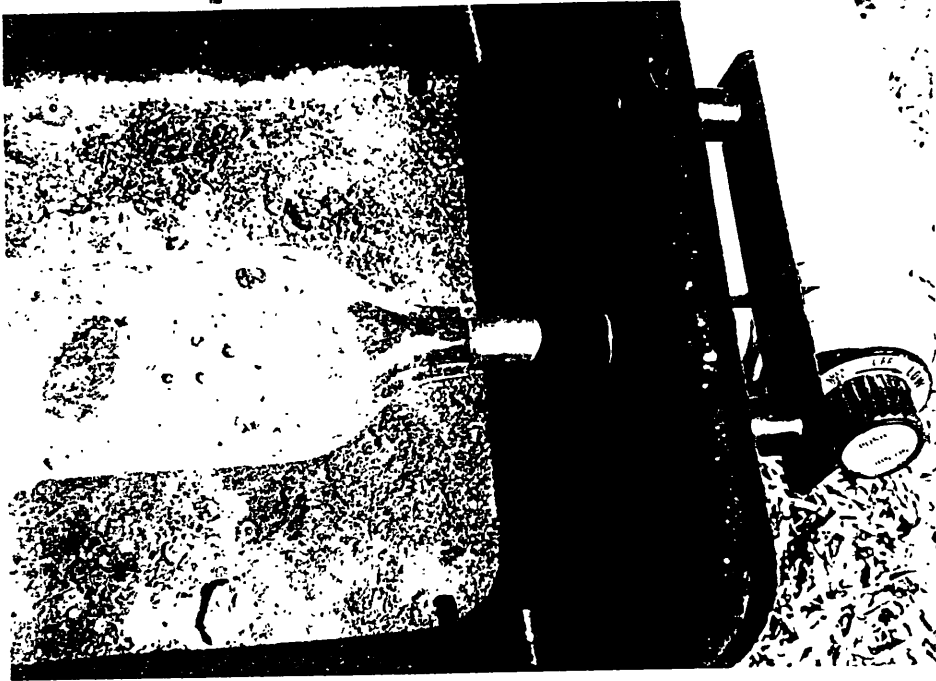

PHOTOGRAPH 11:  
Same view as the previous photograph, but with the lava rock grill removed.

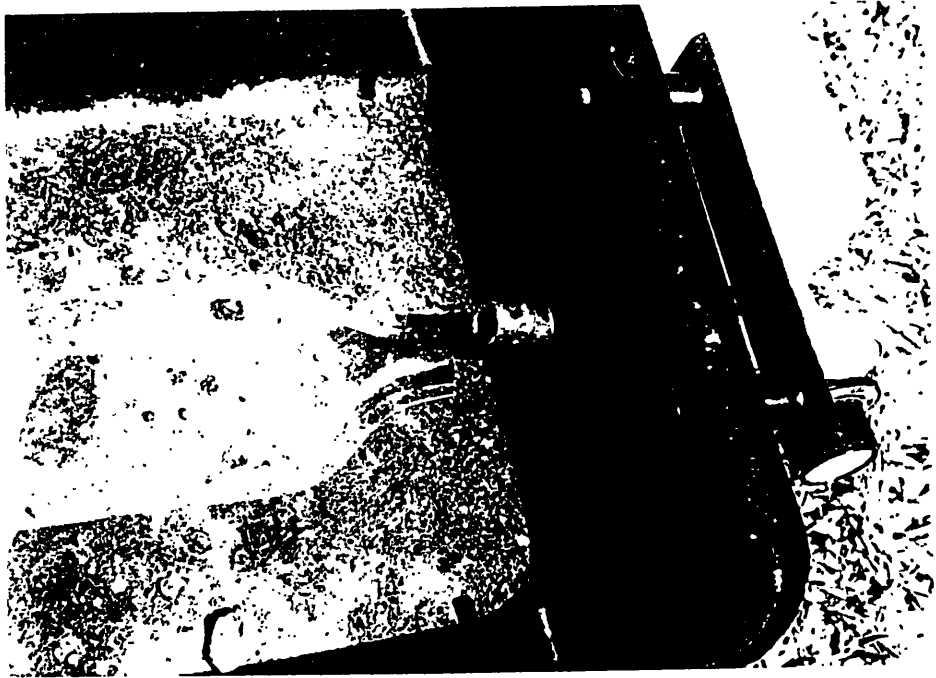

PHOTOGRAPH 12:  
Same view as the previous photograph, but with the burner tube displaced.

59

970528CWE5012

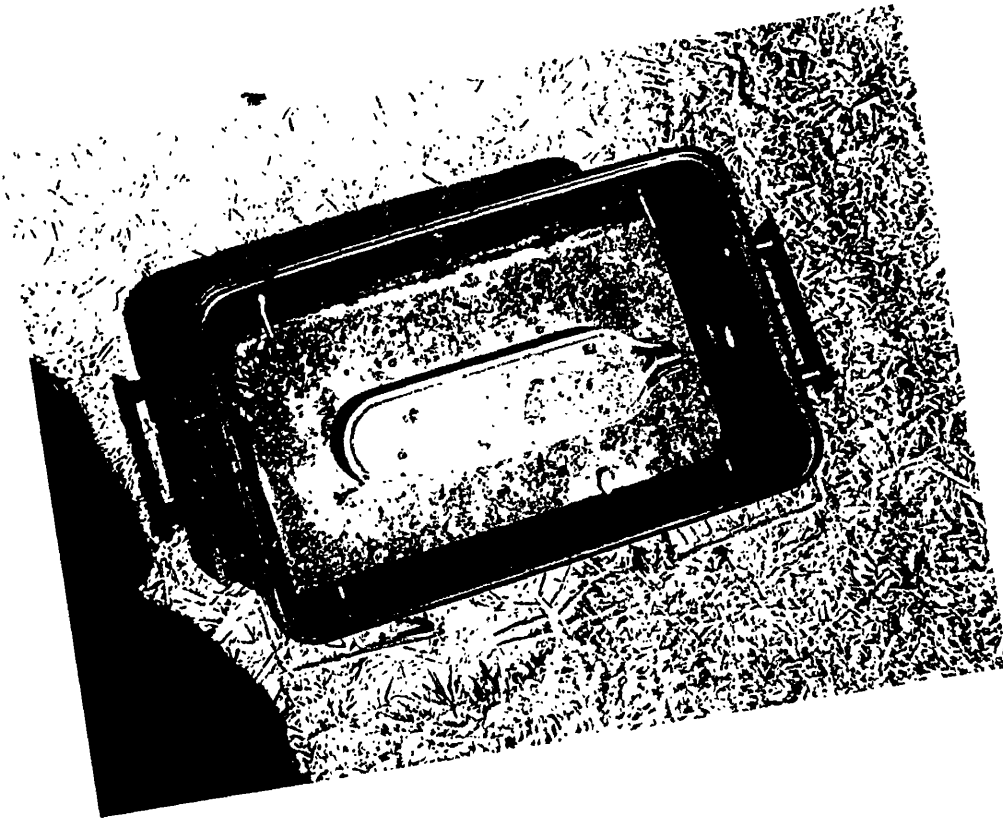

PHOTOGRAPH 13:  
Overall view of the grill burner.

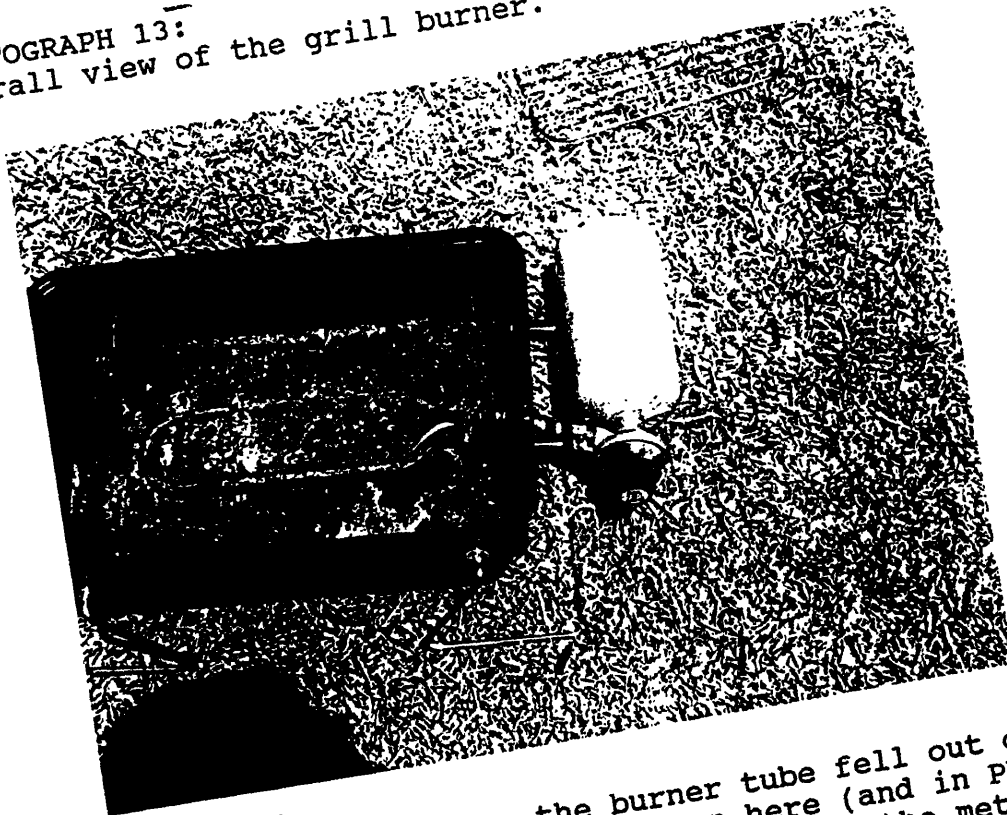

PHOTOGRAPH 14:  
Sequence of events: When the burner tube fell out of the grill burner and slid to the position seen here (and in Photograph 12), the burner tube hit the side of the hole in the metal housing and stayed there for a moment before falling completely out.

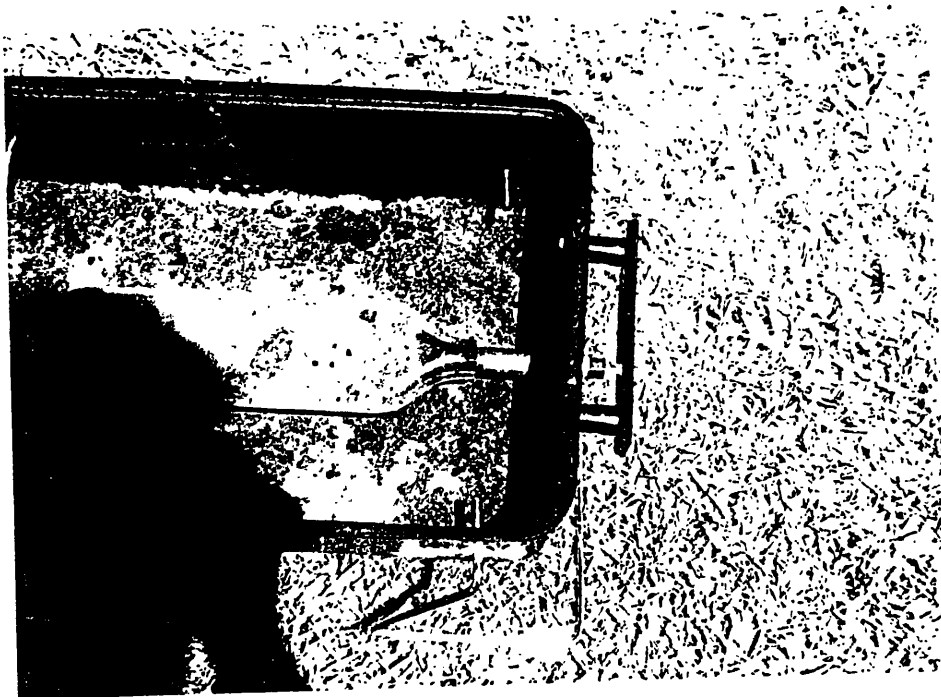

PHOTOGRAPH 14A:  
This is how the respondent found the burner and burner pipe when he opened the cardboard container. The gas control was elsewhere in the box.

61

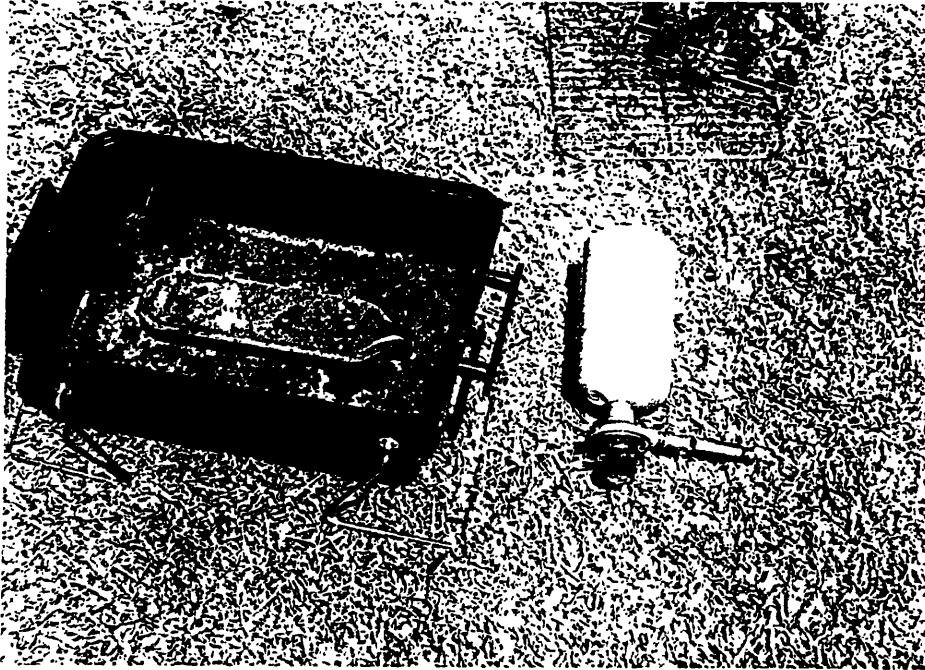

**PHOTOGRAPH 15:**

Sequence of events: After a moment in the position shown in the previous photograph, the bottle and assembly fell completely out of the housing.

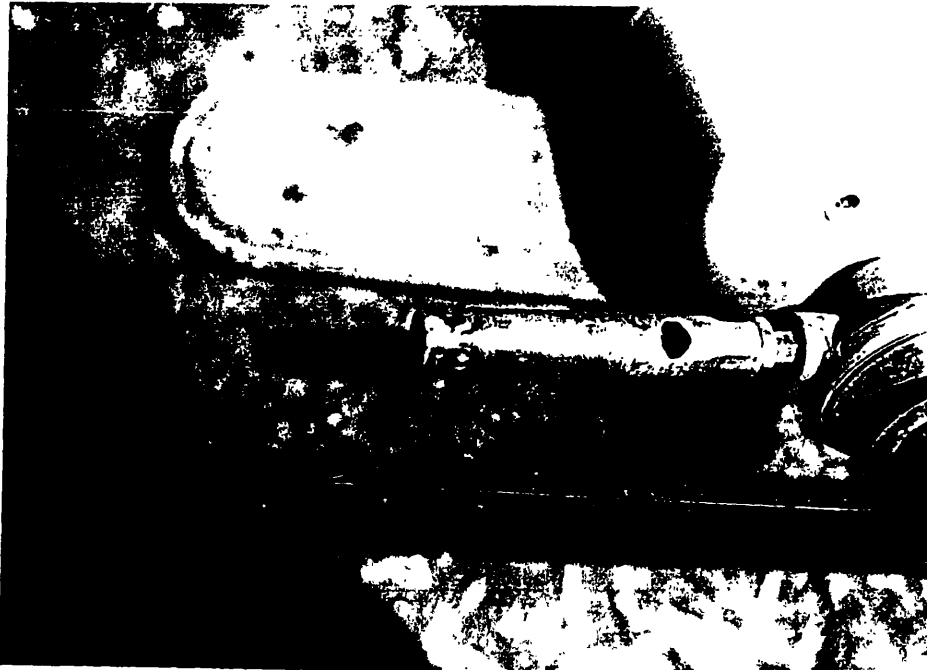

**PHOTOGRAPH 16:**

Close-up of the burner tube end. The end is fluted with six ridges (and six more or less flat sides), and it fits into corresponding flutes in the grill burner; friction holds the tube in place. The small circular spots on the end are not holes; they are reflections of deflections in the metal.

62

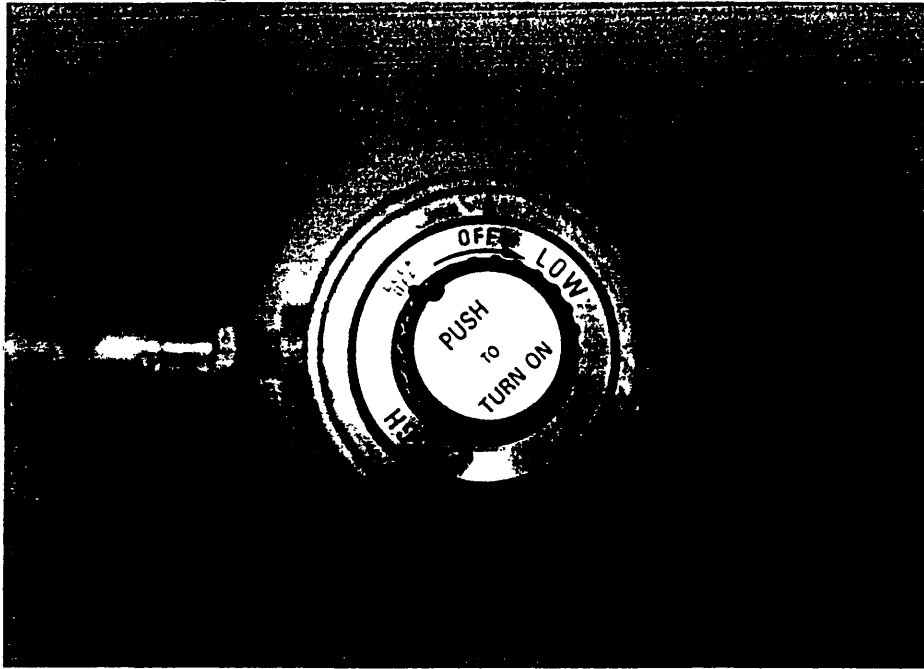

PHOTOGRAPH 17:  
The gas control. The top reads "push to turn on"; the positions are "lock off off low med high".

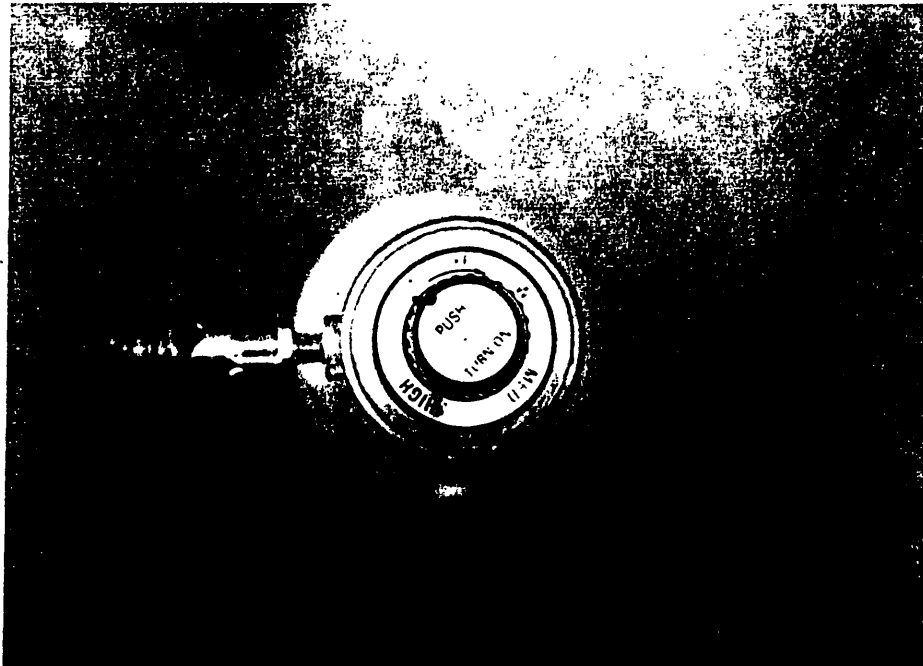

PHOTOGRAPH 18:  
Another view of the gas control.

67



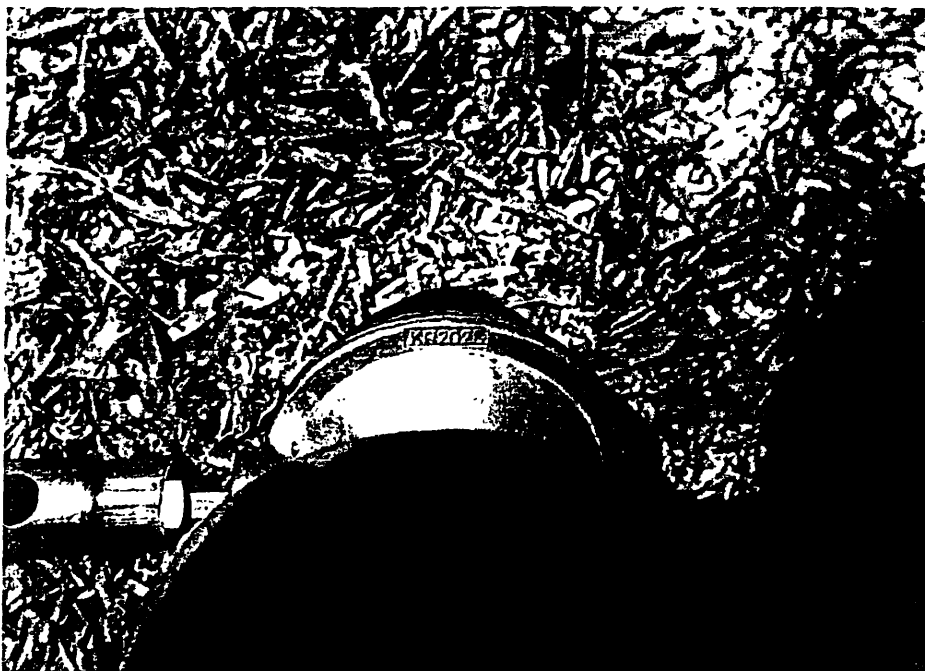

PHOTOGRAPH 19:  
Labeling on the gas control; it reads "KR202L".



PHOTOGRAPH 20:  
Additional labeling on the gas control; it reads "11 96".

64

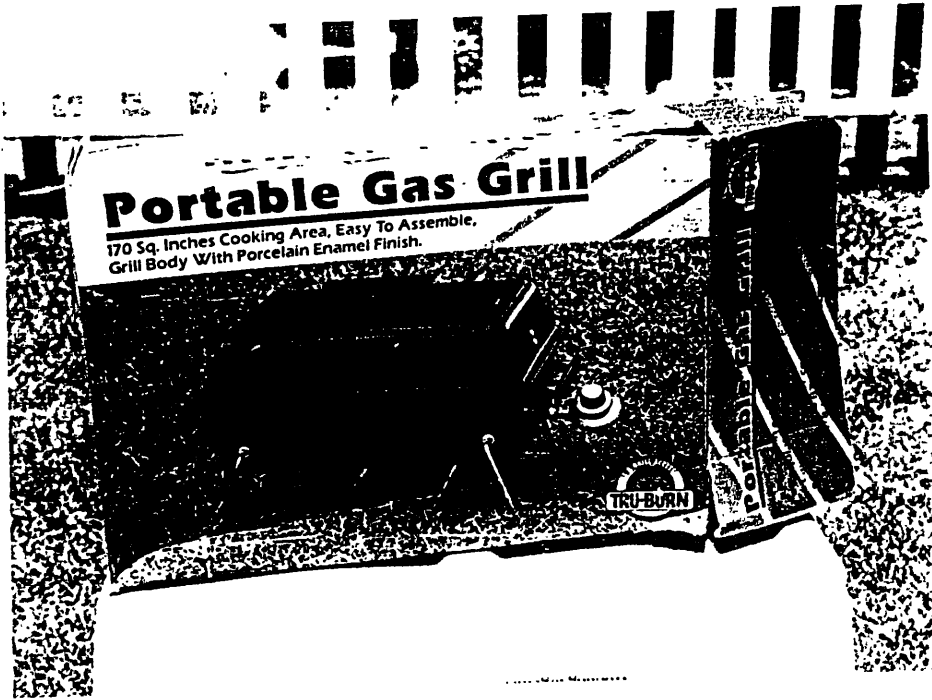

PHOTOGRAPH 21:  
The container, front panel.



PHOTOGRAPH 22:  
Container end panel.

65

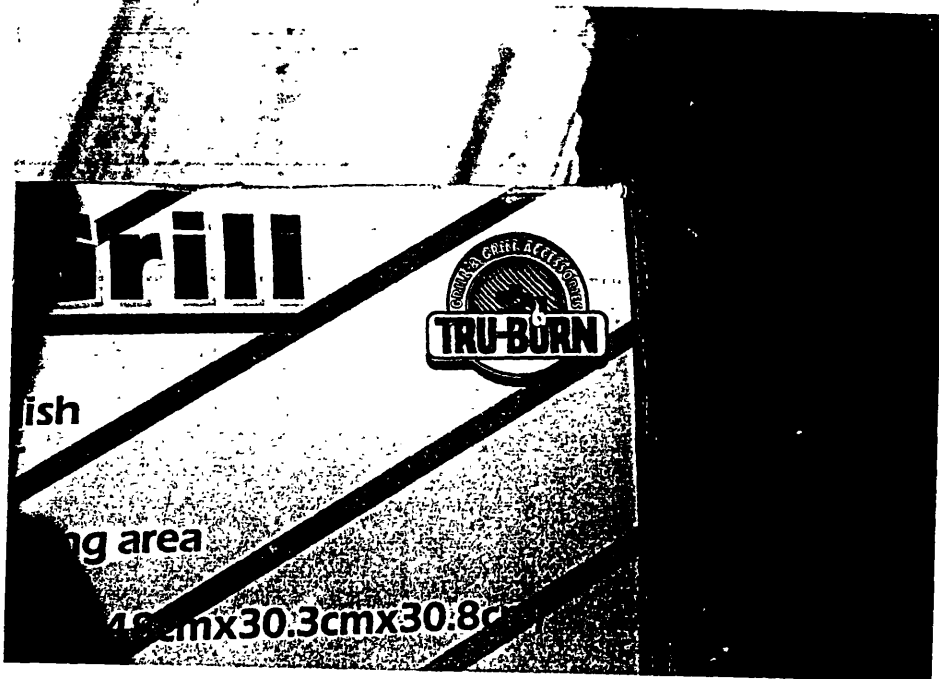

PHOTOGRAPH 23:  
Close-up of the brand name seen in Photograph 22; it reads in part "Grill and Grill accessories TRU-BURN \*\*\*".



PHOTOGRAPH 24:  
The other end panel.

6/6



PHOTOGRAPH 25:

Close-up of the manufacturer's identification; it reads in part "Made in China for Kmart Corporation Troy, Michigan 48084 Code: 0-118731-116 \*\*\*". The product code reads "0 24838 17000 1".

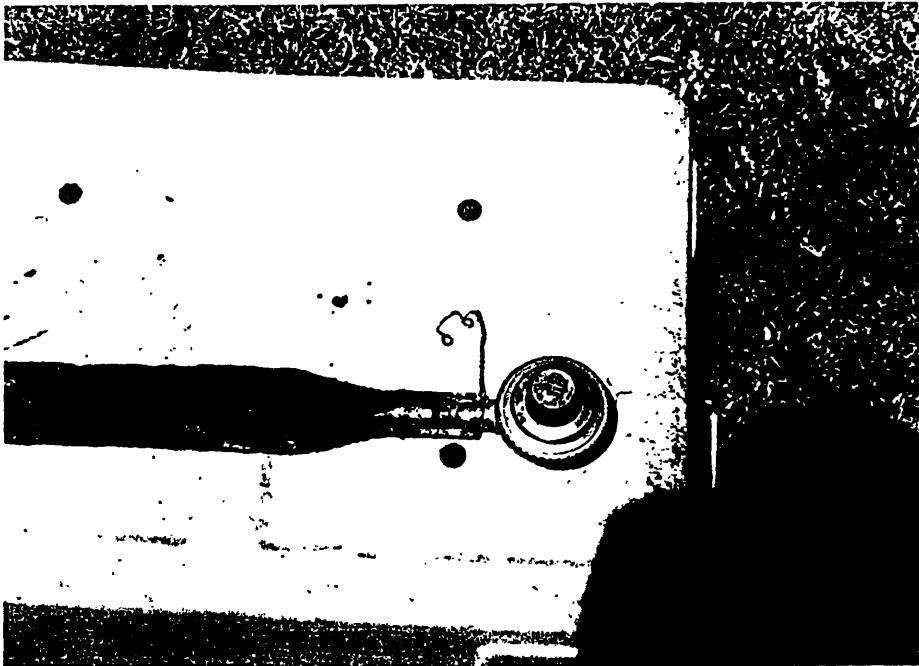

PHOTOGRAPH 26:

One solution to the detachment problem: Seen here is a domestically made competitor's model. There are two differences between this unit and the subject grill: (1): The gas control connects directly to the burner without first going through a tube. (2): The assembly is provided with a locking device.

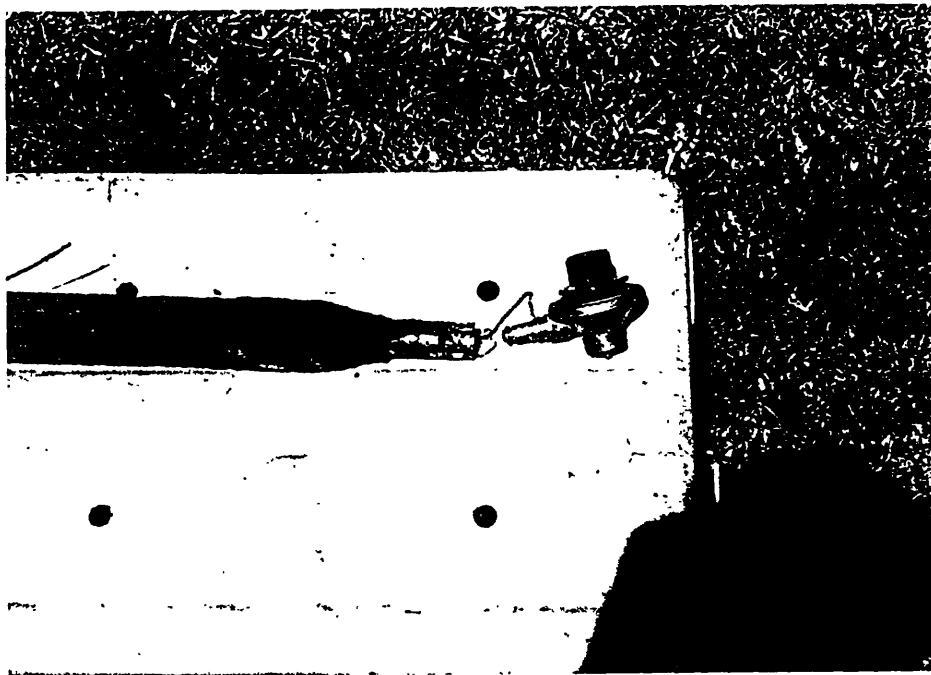

PHOTOGRAPH 27:  
Another view of the competitor's model.



PHOTOGRAPH 28:  
The clip, identified by the arrow, secures the connection.

CS

FOR OFFICIAL USE ONLY

<b>CONSUMER PRODUCT SAFETY COMMISSION ENGINEERING REPORT FOR SECTION 15</b>	PSA 0954.97	FOCR
	FILE#	
	SAMPLE NO: 97-860-6276	
	CPSC SEAL: intact	
	REF	Incident report 970528CWE5012
TO:	L. George Gayman, FOCR	DATE: October 27, 1997
THROUGH:	signed by George F. Sushinsky, Team Leader	
FIRM:	K mart Corporation,	Troy MI
PRODUCT:	Table top LP gas grill - TRU BURN	
POTENTIAL HAZARD:	LP gas leak; Fire/explosion	
EVALUATION REQUESTED:	Examine the grill. Can attachment of the gas cylinder separate while the grill is in use? What circumstances could result in separation of the cylinder from the grill? Is there need for a retention mechanism on the cylinder or burner tube to keep the cylinder assembly properly connected to the burner during use?	
Laboratory Analyst:	signed by John Griffith 301-413-0181	Date: October 27, 1997

Background:

The sample (97-860-6276) is a portable gas grill. This grill was involved in the incident covered in the referenced incident report. The grill measures 480 mm, by 303 mm by 308 mm (18.1 by 12.0 by 12.0 in). As received, the grill consists of a porcelain enamelled base and cover, a cooking grill, an 11,000 BTU burner, a regulator, and a burner tube connecting the regulator to the burner. The grill is supported on legs made of bent metal rods that also serve to secure the cover of the grill to the base for storage. (See photographs 1, 2, 6, 7, and 8 of the incident report.) A propane tank connects to the regulator during use. The product's instructions were not included with the sample.

The burner tube is approximately 100 mm (4 in) long. It has one six-sided faceted end that fits into a mating, six-sided receptacle of the burner manifold. The tube is held in position by friction.

In the incident report, The respondent reported that the "4"

69

long metal gas pipe (gas pipe connects gas valve to grill) detached from grill ... 8" high flames were shooting out of the gas pipe ..."

The incident report includes 28 photographs documenting the incident including a solution to the described problem.

#### Tests:

LSE staff performed tests intended to measure the forces to dislodge the burner tube from the burner manifold. These tests included the application of either vertical or horizontal forces at the gas regulator. The horizontal forces measured either the force to fully insert the tube into the manifold or to separate the tube from the manifold. The vertical forces were applied to note the effect on tube/manifold separation.

#### Results:

The results of tests show:

1. Compressive forces between 22 and 40 N (5 and 9 lbf) is needed to fully seat the burner tube into the burner.
2. Tensile forces between 18 and 31 N (4 and 7 lbf) is needed to fully remove the burner tube from the burner.
3. Purely vertical forces up to approximately 62 N (14 lbf) produce little observable movement of the burner tube when it is attached to the burner.

#### Discussion:

The press fit friction between the burner tube and burner is the only means for keeping the tube attached to the burner on this sample. This friction, with the burner tube fully seated in the burner, can be overcome with forces as low as 18 N (4 lbf). At this force level, the tube could separate from the burner and result in the incident as portrayed in the incident report. The force levels for separation could be even lower if the tube is not fully seated in the burner

How this separation force was produced in the reported incident is unknown. Photographs 1 and 3 of the incident report may provide some clues to the answer. Photograph 1 reportedly shows the grill as it was positioned on a wire rack just before the incident. Photograph 3 reportedly shows the grill after separation of the burner tube occurred. In Photograph 3, the right leg of the grill is shown to be rotated from its initial position and the propane bottle, regulator and burner tube are on the deck separated from the grill. This rotation, if accurately portrayed, appears to be the result of a gross reaction to an unknown event. In order for the leg to move from the position shown in Photograph 1 to that shown in Photograph 3, the whole

70

grill would have shifted to the left by about 80 mm (3.1 in). With this amount shift it would be possible for the propane bottle to pull with enough force to separate the tube from the burner.

Upon examination of the sample, it was noted that the legs to the grill allowed a gentle rocking to the grill. as it sat on a flat base. This rocking may have initiated the movement of the grill on the wire rack and loosened the tube connection to further exacerbate the conditions leading to the incident.

Conclusions:

The PSA request asks questions about the possibility of the tube separating during use, and the need for positive retention of the burner tube to the burner. With a relatively small amount of force (18 N [4 lbf]), the tube can separate from the burner. A retention device would prevent accidental separation.

71







\*\*\*\*FOR OFFICIAL USE ONLY\*\*\*\*

PRODUCT SAFETY ASSESSMENT (PSA) TECHNICAL EVALUATION REQ

Requested by: L. George Gayman

Or

FOCR

Date Submitted: 3/17/98

Prio

*Just ahead!  
OK to proceed!  
R*

PRODUCT INFORMATION

Manufacturer: Kmart Corporation

City: Troy

State: MI

Product: Table-top, portable LP Gas Grill.

NEISS Code: 3248

Brand name, model, etc. "TRU-BURN" brand; UPC Code 0-24838-17000-1; Kmart item #043-11-87-31-116.

Sample number: 97-860-6276 (collected during IDI 970528CWE5012); 98-830-3415 (New Unit) & 98-830-3416 (Char-Broil unit)

Sample Disposition: Return to Requestor

Store at Whse

Other:

IDI Number: IDI 970528CWE5012.

EVALUATION REQUESTED: Please have Engineering Sciences examine the new Kmart grill sampled under 98-830-3415 and the assembly instructions attached to the EIR dated 1/27/98. The concern is with the two-piece burner system and the connection of the burner manifold to the burner tube. Please refer to PSA #0954.97 done on sample 97-860-6276. Please measure the diameter of the connecting components for the manifold and the burner tube, and perform force measurements on the assembly and detachment of these components as was done on 97-860-6276 under PSA #0954.97. Is this connection mechanism for attachment of the burner tube to the manifold adequate to prevent accidental loosening and separation of these two components during use of the grill? Is the concept of a two-piece burner system a safe idea? Sample 98-830-3416 is a Char-Broil portable LP gas grill that has a one piece burner system. Please compare these two systems and offer your comments and observations.

EPI ASSESSMENT: Dates: From: To: Sort by Mfg. Yes No

IDI IPII NEISS Comments NEISS Estimates Deaths NFIRS

Hazard: LP gas could leak from grill due to loose connection. Hazard Code: 32103

Requested Completion Date: 04/24/98

Locations of: Samples: Off. of Comp. Files: Carlos Perez

PSA ACTION (FOR PSA USE ONLY)

Request number: 0463.98

Date Processed: 3/18/98

Date Requested: 4/24/98

Due Date:

Assigned to:

Organization:

Technical Off.

Request Summary:

Comments:

Exhibit "A"  
 Kmart Corporation  
 1/27/78 Inspection

**U.S. CONSUMER PRODUCT SAFETY COMMISSION  
 NOTICE OF INSPECTION**

1. DATE <i>1/27/78</i>	3. FROM (Area Office and Address) <i>U.S. Consumer Product Safety Commission        4330 Reservoir Road        Washington, D.C. 20531</i>
2. TIME <i>9</i> A.M. <i>3</i> P.M.	

4. TO	A. NAME AND TITLE OF INDIVIDUAL <i>Charles J. Haines</i>		Charles J. Haines Sub-Regional Admin.	Kmart Corporation 10000 W. 15th Ave. Denver, Colorado 80202 Telephone: 303-751-1000 Telex: 153128
	B. FIRM NAME <i>Kmart Corporation</i>			
	C. NUMBER AND STREET ADDRESS <i>10000 W. 15th Ave.</i>			
	D. CITY, STATE AND ZIP CODE <i>Denver, Colorado 80202</i>			

Notice of Inspection is hereby given pursuant to:

- Flammable Fabrics Act (15 U.S.C. 1191 *et seq.*);
- Federal Trade Commission Act (15 U.S.C. 41 *et seq.*);
- Sections 16, 19 and 27 of the Consumer Product Safety Act (15 U.S.C. 2065, 2068 and 2076)
- Section 704(a) of the Federal Food, Drug, and Cosmetic Act (21 U.S.C. 374(a)) [Authority for inspections in connection with the Poison Prevention Packaging Act of 1970 (15 U.S.C. 1471 *et seq.*)] and/or
- Section 11(b) of the Federal Hazardous Substances Act as Amended (15 U.S.C. 1270(b)).

**6. FREEDOM OF INFORMATION REQUIREMENTS**

Those from whom information is requested should state whether any of the information submitted is believed to contain or relate to a trade secret or other matter which should be considered by the Commission to be confidential and whether any of the information is believed to be entitled to exemption from disclosure by the Commission under the provisions of the Freedom of Information Act (15 U.S.C. 552). Any statement asserting this claim of confidentiality must be in writing, and any request for exemption of the information from disclosure must be made in accordance with the Commission's Freedom of Information Act regulations, 16 CFR Part 1015.

7. SIGNATURE (Authorized CPSC Official): *Charles J. Haines*  
*Charles J. Haines*

*75*

Exhibit "B"  
Kmart Inspection  
1/27/98 Ins. ction

(02)

# U.S. Consumer Product Safety Commission

W276 N878 Woodridge Lane • Waukesha, WI. 53188 • (414) 650-1216 • (414) 650-1217 fax

January 19, 1998

Charlene J. Haines  
Kmart Corporation  
3100 W. Big Beaver Road  
Troy, MI. 48084

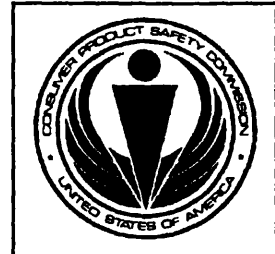

Re: 1/26/98 Inspection Visit

Dear Atty. Haines:

As we discussed by telephone this morning, I will be visiting your firm in person on 1/26/98 to obtain information regarding two different products distributed by Kmart. The first is a "Tru-Burn" table top LP gas grill, the second is a "Loving Wonders" plastic single stroller with accessories.

**Regarding the gas grill**, the CPSC has received a complaint from a consumer who reported that the gas cylinder/regulator assembly separated from its connection with the burner tube while the grill was lighted. I hope to address the following questions during our meeting:

- 1) Please list all table top gas grill models sold by Kmart and the manufacturer of each. Provide dates of first/last distribution and number of units sold for each model grill. If any/all of the grill models are imported, is Kmart the actual importer? If so, please provide a copy of the import documentation for each model grill. If not, from whom does Kmart purchase the grills? Provide a copy of a purchase invoice and bill of lading documenting Kmart's purchase of each model LP gas grill from the supplier.
- 2) Provide any instructional literature, assembly instructions or brochures that come with each model grill. If several models are depicted in a single publication that will suffice.
- 3) Provide copies of any and all complaints regarding these LP gas table top grills. This information to include a copy of the consumer's complaint letter, any Kmart complaint form documenting the complaint, any Kmart adjuster claims, and any correspondence between the consumer and your firm. What was the resolution of each complaint. Provide copies of documentation pertaining to any lawsuits or other civil actions brought against Kmart by consumers. What is the status of each suit? If settlement was reached, provide terms.
- 4) Provide documentation regarding the total number of returns for each model table top LP gas grill, broken down by year and reason for return. Does Kmart do any examination or testing of such returned products, or arrange for such testing to be done? Please provide copies of any such records. What is the disposition of returned products and are they available for CPSC examination?

76

5) Is any initial product testing done on these grills, either by the supplier/manufacturer or at Kmart's direction? Provide copies. Does such testing cover the integrity of the connection of the gas cylinder/regulator assembly tubing and the burner tube? Do the products claim certification with any voluntary standards for such products?

6) Attached is a copy of the consumer complaint received by the CPSC. What is Kmart's assessment of this incident?

Regarding the "**Loving Wonders**" plastic single stroller, CPSC has become aware of several such products that have plastic end caps of the tubing that may detach easily and pose a choking hazard for young children.

1) Provide dates of first and last distribution, and number of units sold. Is this product imported, and if so is Kmart the actual importer? Please provide a copy of the import documentation. If purchased from a domestic vendor, please provide a copy of a purchase invoice and bill of lading documenting Kmart's purchase of the product from that supplier.

2) Provide any instructional literature, assembly instructions or brochures that come with this toy stroller. Are there any age labeling recommendations or warnings of potential small part choking hazards on the packaging or the literature?

3) Provide copies of any and all complaints. This information to include a copy of the consumer's complaint letter, any Kmart complaint form documenting the complaint, any Kmart adjuster claims, and any correspondence between the consumer and your firm. What was the resolution of each complaint. Provide copies of documentation pertaining to any lawsuits or other civil actions brought against Kmart by consumers. What is the status of each suit? If settlement was reached, provide terms.

4) Provide documentation regarding the total number of returns, broken down by year and reason for return. Does Kmart do any examination or testing of such returned products, or arrange for such testing to be done? Please provide copies of any such records.

As we discussed, it will be necessary for me to collect samples of both the grills and the baby stroller. I will require one unit of each LP gas table top grill model, and 12 units of the baby stroller product. I appreciate your cooperation in these matters, and look forward to your continued assistance.

Sincerely yours,



Dennis R. Blasius  
Federal Investigator

77

Exhibit "C"  
Kmart Inspection  
1/27/98

DES



Deborah L. Miela  
Trade Regulation Counsel  
248 643 1053  
dmiela@kmart.com

Charlene J. Haines  
248 643 5705  
chaines@kmart.com

Kmart Corporation  
International Headquarters  
3100 West Big Beaver Road  
Troy MI 48084-3163  
248 643 1054 Facsimile

January 27, 1998

**HAND-DELIVERED**

Mr. Dennis Blasius, Compliance Officer  
U.S. Consumer Product Safety Commission  
W276 N878 Woodridge Lane  
Waukesha, WI 53188

Dear Mr. Blasius:

We have compiled the following information in response to your January 19, 1998 facsimile.

1. Please list all table top grill models sold by Kmart and the manufacturer of each. Provide dates of first/last distribution and number of units sold for each model grill. If any/all of the grill models are imported, is Kmart the actual importer? If so, please provide a copy of the import documentation for each model grill. If not, from whom does Kmart purchase the grills? Provide a copy of a purchase invoice and bill of lading documenting Kmart's purchase of each model LP gas grill from the supplier.

- 1a. Tru Burn table top gas grill - 17"  
UPC Code: 0-24838-17000-1  
Kmart Code: 043-11-87-31-116  
Purchased from Lien Mou Industrial Factory Co. Ltd. - Manufacturer;  
Kmart Corporation - Importer  
Date of first distribution: Approximately December 1996  
Date of last distribution: Current item being sold  
1996 Sales: 265  
1997 Sales: 43,112

Copies of the import orders for the above Tru Burn grill in question have been attached.

- 1b. Char Broil table top grill  
Purchased from Char Broil  
200 Brookstone Centre Parkway, Suite 310  
Columbus, GA 31904  
UPC Code: 0-47362-51230-7  
Kmart Code: 043-11-80-29-1100  
Date of first distribution: Approximately March 1996  
Date of last distribution: Current item being sold  
1996 Sales: 29,634  
1997 Sales: 37,406

78

Mr. Dennis Blasius  
Page 2  
January 27, 1998

- 1c. Char Broil table top grill  
Purchased from Char Broil  
UPC Code: 0-47362-51000-6  
Kmart Code: 043-11-17-50-1100  
Date of first distribution: Approximately September 1991  
Date of last distribution: Last receipt of grills in Shakopee, MN Distribution Center,  
March 20, 1996 (Discontinued Item).  
1996 Sales: 7,826  
1997 Sales: 199

Copies of purchase orders for the Char Broil grills are not available at this time. We believe that the grills are imported by Char Broil.

2. Provide any instructional literature, assembly instructions or brochures that come with each model grill. If several models are depicted in a single publication, that will suffice.

Any instructional literature, assembly instructions or brochures that come with the Tru-Burn grill will be contained in the grill package. We didn't open packages, assuming you may prefer to do so at the time of your visit. We have requested samples of the Char Broil grills. They have not arrived at this time.

3. Provide copies of any and all complaints regarding these LP gas table top grills. This information to include a copy of the consumer's complaint letter, any Kmart complaint form documenting the complaint, any Kmart adjuster claims, and any correspondence between the consumer and your firm. What was the resolution of each complaint? Provide copies of documentation pertaining to any lawsuits or other civil actions brought against Kmart by consumers. What is the status of each suit? If settlement was reached, provide terms.

Kmart is unaware of any additional incidents regarding the any of the LP gas table top grills sold at Kmart stores.

4. Provide documentation regarding the total number of returns for each model table top LP gas grill, broken down by year and reason for return. Does Kmart do any examination or testing of such returned products, or arrange for such testing to be done? Please provide copies of such records. What is the disposition of returned products and are they available for CPSC examination?

Information regarding customer returns are currently kept at the daily level only for the most current 22 days. Information older than 22 days is kept on cartridges. Merchandise return history cartridges would take a minimum of three weeks to load and additional time to run reports. Also, this report would not include information as to why the merchandise was returned.

We are continuing to investigate as to whether information on grills returned to the supplier is available.

5. Is any initial product testing done on these grills, either by the supplier/manufacturer or at Kmart's direction? Provide copies. Does testing cover the integrity of the connection of the gas cylinder/regulator assembly tubing and burner tube? Do the products claim certification with any voluntary standards for such products?

We are checking with our Quality Assurance Lab for this information.

79



Mr. Dennis Blasius  
Page 3  
January 27, 1998

6. What is Kmart's assessment of this incident?

The Tru Burn grill was evaluated (in response to the Wesley Wong's complaint) by Kmart's Quality Assurance Department. No safety defects were found. A copy of the evaluation report is attached.

**"LOVING WONDERS" PLASTIC STROLLER**

1. Provide dates of first and last distribution and number of units sold. If this product is imported, and if so, is Kmart the actual importer? Please provide a copy of the import documentation. If purchased from a domestic vendor, please provide a copy of the purchase invoice and bill of lading documenting Kmart's purchase of the product from that supplier.

The stroller in question has not been sold at Kmart locations at this time. Approximately 14,000 have been ordered and the shipment should be arriving in Kmart Distribution Centers in early February. Kmart Corporation is the actual importer of the product.

2. Provide any instructional literature, assembly instructions or brochures that come with this toy stroller. Are there any age labeling recommendations or warnings of potential small part choking hazards on the package or the literature?

We do not have any instructional literature regarding the stroller at this time. Kmart Co-Buyer Rick Schmid has requested a sample of the stroller.

3. Provide copies of any and all complaints. This information to include a copy of the consumer's complaint letter, any Kmart complaint form documenting the complaint, any Kmart adjuster claims, and any correspondence between the consumer and your firm. What was the resolution of each complaint? Provide copies of documentation pertaining to any lawsuits or other civil actions brought against Kmart by consumers. What is the status of each suit? If settlement was reached, provide terms.

N/A. This item is a new item which has not been sold in any Kmart stores at this time.

4. Provide documentation regarding the total number of returns, broken down by year and reason for return. Does Kmart do any examination or testing of such returned products, or arrange for such testing to be done? Please provide copies of such records.

N/A. This item is a new item which has not been sold in any Kmart stores at this time.

If you require additional information, please let me know.

Sincerely,



Charlene J. Haines



ORDER CONTRACT

Exhibit "D"  
Kmart Inspection  
1/27/98 inspection  
Telephone:  
Facsimile:

QES

KI MART CORPORATION  
3100 W BIG BEAVER RD  
TROY MICHIGAN  
48084 USA

ORDER DATE: 09/03/96 CONTRACT NO: K3129 ITEM CODE: 640-118731-116 BUYER: LVW LARRY VANDERWERFF  
DIV: 1 DEPT NO: 43 UPC CARTON ID: 10024838170008 FACTORY: 3647

ITEM: TABLETOP GAS GRILL

Manufacturer: LIEN MOU INDUSTRIAL FACTORY CO LTD  
556 MIN WOO ROAD,  
HSIN-CHU CITY,  
TAIWAN, R.O.C.

FOREIGN AGENT: KKTP KMART TAIWAN LTD  
FOREIGN OFFICE: RKKTP KMART TAIWAN LTD  
PRODUCTION OFFICE: PKKTP KMART TAIWAN LTD  
SHIP VIA: (X)SEA ( )AIR ( )TRUCK/RAIL  
VIA LINE:  
Payment to be made by (X) CHECK or ( ) Letter of Credit  
LC#: BANK: BANKOA  
LC Transferable: No

Each item to be marked: MADE IN CHINA (MAINLAND)  
Embark/Go-down: CHINA (MAINLAND)

LIFESTYLE: HARDLINES  
TRADEMARK: NO TRADEMARK ON THIS ORDER  
BRAND NAME: NONE

Total Cartons	Total SET	per SET	Total Cost of Order	Terms
12,495	49,980	\$9.500	\$474,810.00	FOB

PER CTN	KGS	LBS	NET WT	CBM	CUF.FT	SET per Inner	Inners per outer carton	Total SET per outer export ctn	Packing Instruction
	22.600	49.824		.079500	2.808	1	4	4	CASEPACK

	per SET	per CARTON	per SET	per CARTON	per SET	per CARTON
F.O.B. PRICE	\$9.500	\$38.000	IMPORT CHRG 1.70%	.197	.787	DC ALLOWANCE
DUTY	.542	2.166	BANK FEE	%		ROYALTY
COUNTER VEILING			PIER CHRG			COST OUT OF DC 11.95
USER FEE	.019	.076	TICKET DUTY			SELLING PRICE 21.99 21.99
HARBOR FEE	.019	.076	ASSIST			GROSS MARGIN .456353
OCEAN FREIGHT 51	1.014	4.055	EXCISE TAX			MARKON 45.6353
TARIFF # KHCH1			ODC TAX			
AGENT FEE 5%	.475	1.900	DEFECT	.190	.760	TOTAL SELLING VALUE FOR ORDER:
BUYER CRDT	%		SERVICE			
AGENT 2	%		DECON FEE			\$1,099,060.20
WAREHOUSE	%		LANDED COST	11.95	47.82	

HTS #	\$/HTS UNIT	HTS DUTY %	NET NET WGT per HTS UNIT	WT RATE %	SPECIAL QTY / HTS UNIT	#HTS UNITS per PIECE	QUOTA #	CVD RATE

BINDING RULE # OR PRECLASS #

BUYER/DATE	MDSE. MGR-SALES/DATE	OFFICE/DATE	INTERNATIONAL DEPT./DATE

Special Instructions:

( ) RETURN SHEET # \_\_\_\_\_  
Conveyable : N

( ) DEFERRED PMT. \_\_\_ Days

81

ORDER CONTRACT

KMART CORPORATION  
 2100 W BIG BEAVER RD  
 TROY MICHIGAN  
 48084 USA

(CONTINUED)

Telephone:  
 Facsimile:

ORDER DATE: 09/03/96      CONTRACT NO: K3129      ITEM CODE: 640-118731-116      BUYER: LVW LARRY VANDERWERFF  
 DIV: 1      DEPT NO: 43      UPC CARTON ID: 10024838170008      FACTORY: 3647

ITEM: TABLETOP GAS GRILL

UPC NUMBER

024838170001

SHIPPING SCHEDULE

Reference (PO)	Discharge Point	Final Dest. (DC)	Ship Date	Cancel Date	Cartons	Quantity (EA)
116	C	CAN	CAN	12/01/96		1,396
125		COR	COR	12/01/96	735	2,940
121		DEN	DEN	12/01/96	735	2,940
123		GEO	GEO	12/01/96	735	2,940
119		GNB	GNB	12/01/96	735	2,940
115		LAW	LAW	12/01/96	735	2,940
120	C	MAN	MAN	12/01/96		1,184
122		OCA	OCA	12/01/96	735	2,940
118		ONT	ONT	12/01/96	735	2,940
124	C	SHA	SHA	12/01/96		868
114	C	SPK	SPK	12/01/96		1,916
128		CAN	CAN	01/01/97	735	2,940
134	C	COR	COR	01/01/97		392
131	C	DEN	DEN	01/01/97		864
133	C	GEO	GEO	01/01/97		484
130	C	GNB	GNB	01/01/97		996
127	C	LAW	LAW	01/01/97		508
110		MAN	MAN	01/01/97	735	2,940
109		MOR	MOR	01/01/97	735	2,940
111		SHA	SHA	01/01/97	735	2,940
108		SPK	SPK	01/01/97	735	2,940
135		WAR	WAR	01/01/97	735	2,940
117		MOR	MOR	02/15/97	735	2,940
126		WAR	WAR	02/15/97	735	2,940
132		OCA	OCA	02/28/97	735	2,940
129		ONT	ONT	02/28/97	735	2,940
137	C	CAN	CAN	03/01/97		1,048
106	C	COR	COR	03/01/97		392
102	C	DEN	DEN	03/01/97		864
104	C	GEO	GEO	03/01/97		484
139	C	GNB	GNB	03/01/97		996
136	C	LAW	LAW	03/01/97		508
101	C	MAN	MAN	03/01/97		888
113	C	MOR	MOR	03/01/97		2,972
103	C	OCA	OCA	03/01/97		952
138	C	ONT	ONT	03/01/97		1,920
105	C	SHA	SHA	03/01/97		648
112	C	SPK	SPK	03/01/97		1,440
107	C	WAR	WAR	03/01/97		1,896

Summary by Final Destination (DC)

Discharge Point	Cartons	Quantity
--------------------	---------	----------

82 ✓

CAN

735

2,940

23

83

## Summary by Final Destination (DC)

Discharge Point	Cartons	Quantity
COR	735	2,940
DEN	735	2,940
GEO	735	2,940
GNB	735	2,940
LAN	735	2,940
MAN	735	2,940
MOR	1,470	5,880
OCA	1,470	5,880
ONT	1,470	5,880
SHA	735	2,940
SPK	735	2,940
WAR	1,470	5,880

## Summary by SHIPPING SCHEDULE DATE

DATE	Cartons	Quantity
12/01/96	5,145	20,580
01/01/97	4,410	17,640
02/15/97	1,470	5,880
02/28/97	1,470	5,880

## Fiber Information

## Additional Information

84

ORDER CONTRACT  
(CONTINUED)

Page: 4

KMART CORPORATION  
3100 W BIG BEAVER RD  
TROY MICHIGAN  
48084 USA

Telephone:  
Facsimile:

ORDER DATE: 09/03/96      CONTRACT NO: K3129      ITEM CODE: 640-118731-116      BUYER: LVW LARRY VANDERWERFF  
DIV: 1      DEPT NO: 43      UPC CARTON ID: 10024838170008      FACTORY: 3647

ITEM: TABLETOP GAS GRILL

HH1

4404R

SPECIAL PROJECT SPRING

K mart Corporation

I M P O R T   O R D E R      Page 3

Order: K3129      Code: 11-87-31      Document: 4404 R

ITEM: TABLE TOP GAS GRILL

BASIC

TABLE TOP PORTABLE BBQ GAS GRILL 17"

COLOR: LID & BODY BLACK

MATERIAL: TOP & BOTTOM: STEEL SHEET. SHEET THICKNESS: 0.6MM

WIRE DIA. OF COOKING GRILL 3.5X2.5 MM AND CHARCOAL GRILL

3.3X4.5MM, WIRE DIA. OF LEGS: 6MM BURNER: 1 PC, GAS

REGULATOR WITH FILTER: 1 PC BAKELITE HANDLES: 3 PCS & LAVA

ROCKS : 1 BAG (2.2 LBS)

FINISH: TOP & BOTTOM: PORCELAIN ENAMEL

COOKING GRILL, STEEL LEGS: CHROME-PLATED CHARCOAL GRILL:

ZINC-PLATED

PACKING: EA PACKED INTO TRU-BURN COLOR BOX. 4 SETS/CTN

OUTER CARTON MARKINGS:

REFER TO KMART CORP. "CARTON MARKING INSTRUCTIONS".

NOTE: CARTONS MUST BE PACKED TO INNER AND OUTER PIECE

COUNTS SPECIFIED ON THE ORDER. PARTIAL OR ODD PACKED

CARTONS ARE NOT PERMITTED FOR SHIPMENT.

VENDOR IS TO DEVELOP AND FORWARD PACKAGE PROOFS TO THE

KMART OVERSEAS LOCAL OFFICE 60 DAYS PRIOR TO SHIP DATE

M E R C H A N D I S E      I N F O R M A T I O N

Spec No: 640118731116K3129

Spec Type: MDSENAPP      MERCHANDISE SPEC FOR HARDLINES

TICKET LABEL INFORMATION

Factory:

Address:

ORDER CONTRACT

KMART CORPORATION  
3100 W BIG BEAVER RD  
TROY MICHIGAN  
48084 USA

Telephone:  
Facsimile:

ORDER DATE: 05/21/97 CONTRACT NO: I0757 ITEM CODE: 640-118731-116 BUYER: LVW LARRY VANDERWERFF  
DIV: 1 DEPT NO: 43 UPC CARTON ID: 10072000716738 FACTORY: 3647

ITEM: TABLE TOP GAS GRILL - 17"

Manufacturer: LIEN MOU INDUSTRIAL FACTORY CO LTD  
556 MIN WOO ROAD,  
HSIN-CHU CITY,  
TAIWAN, R.O.C.

FOREIGN AGENT: KKTP KMART TAIWAN LTD  
FOREIGN OFFICE: RKKTP KMART TAIWAN LTD  
PRODUCTION OFFICE: PKGKH KMART HONG KONG OFFICE  
SHIP VIA: (X)SEA ( )AIR ( )TRUCK/RAIL  
VIA LINE:  
Payment to be made by (X) CHECK or ( ) Letter of Credit  
LC#: BANK: BANKOA  
LC Transferable: No

Each item to be marked: MADE IN CHINA (MAINLAND)  
Embark/Go-down: CHINA (MAINLAND)

LIFESTYLE: HARDLINES  
TRADEMARK: NO TRADEMARK ON THIS ORDER  
BRAND NAME: NONE

Total Cartons	Total Piece	per Piece	Total Cost of Order	Terms
1,470	5,880	\$9.590	\$56,389.20	FOB

PER CTN	KGS:	22.600	CBM:	.079500	Piece per Inner:	4	Packing Instruction:
	LBS:	49.824	CUF.FT:	2.808	Inners per outer carton:	1	CASEPACK
	NET WT:				Total Piece per outer export ctn:	4	

	per Piece	per CARTON	per Piece	per CARTON	per Piece	per CARTON
F.O.B. PRICE	\$9.590	\$38.360	IMPORT CHR	1.70%	.186	.743
DUTY	.163	.652	BANK FEE	%		
COUNTER VEILING			PIER CHR			DC ALLOWANCE
USER FEE	.020	.081	TICKET DUTY			ROYALTY
HARBOR FEE	.012	.048	ASSIST			COST OUT OF DC
OCEAN FREIGHT 33	.656	2.624	EXCISE TAX			SELLING PRICE
TARIFF # KHCH9			ODC TAX			GROSS MARGIN
AGENT FEE 5%	.480	1.918	DEFECT			MARKON
BUYER CRDT %			SERVICE			TOTAL SELLING VALUE FOR ORDER:
AGENT 2 %			DECON FEE	24.000	.477	1.908
WAREHOUSE %			LANDED COST		11.58	46.33

HTS #	\$/HTS UNIT	HTS DUTY %	NET NET WGT per HTS UNIT	WT RATE %	SPECIAL QTY / HTS UNIT	#HTS UNITS per PIECE	QUOTA #	CVD RATE
7321.1300.40	9.59	1.7						

BINDING RULE # OR PRECLASS #

BUYER/DATE | MDSE. MGR-SALES/DATE | OFFICE/DATE | INTERNATIONAL DEPT./DATE

Special Instructions:

( ) RETURN SHEET # \_\_\_\_\_

( ) DEFERRED PMT. \_\_\_ Days

Conveyable : N

ORDER CONTRACT  
(CONTINUED)

KMART CORPORATION  
3100 W BIG BEAVER RD  
TROY MICHIGAN  
48084 USA

Telephone:  
Facsimile:

ORDER DATE: 05/21/97      CONTRACT NO: I0757      ITEM CODE: 640-118731-116      BUYER: LVW LARRY VANDERWERFF  
DIV: 1      DEPT NO: 43      UPC CARTON ID: 10072000716738      FACTORY: 3647

ITEM: TABLE TOP GAS GRILL - 17"

UPC NUMBER

072000716731

SHIPPING SCHEDULE

Reference (PO)	Discharge Point	Final Dest. (DC)	Ship Date	Cancel Date	Cartons	Quantity (EA)
801	WCD	WCD	12/19/97			5,880

Summary by Final Destination (DC)

Discharge Point	Cartons	Quantity
CAN	120	480
DEN	120	480
GEO	240	960
GNB	90	360
LAW	90	360
MAN	90	360
MOR	75	300
OCA	300	1,200
ONT	90	360
SHA	60	240
SPK	75	300
WAR	120	480
WCD		5,880

Summary by SHIPPING SCHEDULE DATE

DATE	Cartons	Quantity
12/19/97		5,880



Fiber Information

Additional Information

COMMERCIAL INVOICE IN DUPLICATE (COPIES OR ORIGINALS ACCEPTABLE.)  
PACKING LIST IN DUPLICATE (COPIES OR ORIGINALS ACCEPTABLE.)  
COMBINED DRAWINGS ACCEPTABLE.  
SEPARATE INVOICES MUST BE ISSUED FOR EACH DESTINATION (COPIES OR ORIGINALS  
ACCEPTABLE.)  
ON BOARD NON NEGOTIABLE SEAWAY BILL OR ONE ON BOARD OCEAN BILL OF LADING  
CONSIGNED TO KMART CORPORATION MARKED FREIGHT COLLECT AND FORWARDERS CARGO  
RECEIPT ISSUED BY ACS LOGISTICS LTD. (COPIES OR ORIGINALS ACCEPTABLE)  
INSURANCE TO BE AFFECTED BY BUYER KMART CORPORATION  
ALL SHIPMENTS TO BE MADE AS SPECIFIED IN BUYER'S ORDER NO. \_\_\_\_\_  
WITH SHIPMENT TO COMMENCE ON \_\_\_\_\_  
BUT IN ANY EVENT NOT LATER THAN \_\_\_\_\_.  
REFERENCE (PO) FROM ORDER CONTRACT SHIPPING SCHEDULE MUST BE SPECIFIED ON THE  
COMMERCIAL INVOICE FOR EACH SHIPMENT COVERED ON THE INVOICE  
KMART INSPECTION CERTIFICATE (COPIES OR ORIGINALS ACCEPTABLE.)

85

ORDER CONTRACT  
(CONTINUED)

KMART CORPORATION  
3100 W BIG BEAVER RD  
TROY MICHIGAN  
48084 USA

Telephone:  
Facsimile:

ORDER DATE: 05/21/97      CONTRACT NO: I0757      ITEM CODE: 640-118731-116      BUYER: LVW LARRY VANDERWERFF  
DIV: 1      DEPT NO: 43      UPC CARTON ID: 10072000716738      FACTORY: 3647

ITEM: TABLE TOP GAS GRILL - 17"

TS1

PRODUCT LIABILITY INSURANCE CERTIFICATE REQUIRED COVERING ALL SHIP DATES  
7431R  
SPECIAL PROJECT SPRING

CARTON UPC #:10072000716738

K mart Corporation  
I M P O R T   O R D E R      Page 3

Order: K3828      Code: 11-87-31      Document: 7431 R  
SPECIAL PROJECT SPRING

TABLE TOP PORTABLE GAS GRILL - 17"

SEASONAL ITEM  
COLOR: BLACK  
MATERIAL: TOP & BOTTOM: STEEL SHEET.  
SHEET THICKNESS: 0.6MM  
WIRE DIA. OF COOKING GRILL 3.5 X 2.5MM AND CHARCOAL GRILL  
3.3 X 4.5MM  
WIRE DIA. OF LEGS: 6MM. 3PCS OF BAKELITE HANDLES &  
LAVA ROCK: 1 BAG (2.2 LBS)  
GAS REGULATOR WITH FILTER. 1PC  
FINISH: TOP & BOTTOM: PORCELAIN ENAMEL.  
COOKING GRILL, STEEL LEGS: CHROME-PLATED  
CHARCOAL GRILL: ZINC PLATED  
LOGO "BBO-PRO" WILL BE BURNT ONTO THE TOP LID HANDLE  
PACKING: EACH PACKED INTO COLOR BOX, 4 PCS/CTN.  
CHINA PORT - HUANG PU, CHINA  
UPC SYMBOL IS REQUIRED ON THIS ITEM

OUTER CARTON MARKINGS:

REFER TO KMART CORP. "CARTON MARKING INSTRUCTIONS".  
NOTE: CARTONS MUST BE PACKED TO INNER AND OUTER PIECE  
COUNTS SPECIFIED ON THE ORDER. PARTIAL OR ODD PACKED  
CARTONS ARE NOT PERMITTED FOR SHIPMENT.  
VENDOR IS TO DEVELOP AND FORWARD PACKAGE PROOFS TO THE  
KMART OVERSEAS LOCAL OFFICE 60 DAYS PRIOR TO SHIP DATE  
WHEN NEW PACKAGE DESIGNS ARE REQUIRED.  
END OF DOCUMENT.....

M E R C H A N D I S E    I N F O R M A T I O N

Spec No: I0757640118731116

Spec Type: MDSENAPP    MERCHANDISE SPEC FOR HARDLINES

TICKET LABEL INFORMATION

Factory:

Address:

89



ORDER CONTRACT  
(CONTINUED)

KMART CORPORATION  
3100 W BIG BEAVER RD  
TROY MICHIGAN  
48084 USA

Telephone:  
Facsimile:

ORDER DATE: 05/21/97      CONTRACT NO: K3821      ITEM CODE: 640-118731-116      BUYER: LVW LARRY VANDERWERFF  
DIV: 1      DEPT NO: 43      UPC CARTON ID: 10072000716738      FACTORY: 3647

ITEM: TABLE TOP GAS GRILL - 17"

UPC NUMBER

07200716731

SHIPPING SCHEDULE

Reference (PO)	Discharge Point	Final Dest. (DC)	Ship Date	Cancel Date	Cartons	Quantity (EA)
119	C	COR	COR	10/10/97		2,000
130	C	DEN	DEN	10/10/97		2,000
123	C	OCA	OCA	10/10/97		4,000
101	C	ONT	ONT	10/10/97		4,000
120	C	COR	COR	11/05/97		2,000
110	C	GEO	GEO	11/05/97		4,000
127	C	GNB	GNB	11/05/97		2,000
106	C	LAW	LAW	11/05/97		2,000
124	C	OCA	OCA	11/21/97		4,000
102	C	ONT	ONT	11/21/97		2,000
104	C	SPK	SPK	11/21/97		2,000
111	C	GEO	GEO	12/06/97		2,000
107	C	MOR	MOR	12/06/97		4,000
114	C	CAN	CAN	12/21/97		2,000
116	C	MAN	MAN	12/21/97		2,000
128	C	GNB	GNB	01/06/98		2,000
121	C	SHA	SHA	01/06/98		2,000
122	C	WAR	WAR	01/06/98		2,000
131	C	DEN	DEN	01/24/98		2,000
112	C	GEO	GEO	01/24/98		2,000
117	C	MAN	MAN	01/24/98		2,000
108	C	MOR	MOR	01/24/98		2,000
105	C	SPK	SPK	01/24/98		2,000
125	C	OCA	OCA	02/20/98		2,000
103	C	ONT	ONT	02/20/98		2,000
115	C	CAN	CAN	03/16/98		2,000
113	C	GEO	GEO	03/16/98		2,000
129	C	GNB	GNB	03/16/98		2,000
109	C	MOR	MOR	03/16/98		2,000
126	C	OCA	OCA	03/31/98		2,000
801		WCD	WCD	03/31/98	1,470	5,880
118	C	MAN	MAN	04/15/98		2,000

Summary by Final Destination (DC)

Discharge Point	Cartons	Quantity
WCD	1,470	5,880

Summary by SHIPPING SCHEDULE DATE

DATE	Cartons	Quantity
------	---------	----------

91

03/31/98

1,470

5,880

az ✓

Summary by SHIPPING SCHEDULE DATE

DATE	Cartons	Quantity

Fiber Information

Additional Information

COMMERCIAL INVOICE IN DUPLICATE (COPIES OR ORIGINALS ACCEPTABLE.)  
 PACKING LIST IN DUPLICATE (COPIES OR ORIGINALS ACCEPTABLE.)  
 COMBINED DRAWINGS ACCEPTABLE.  
 SEPARATE INVOICES MUST BE ISSUED FOR EACH DESTINATION (COPIES OR ORIGINALS ACCEPTABLE.)  
 ON BOARD NON NEGOTIABLE SEAWAY BILL OR ONE ON BOARD OCEAN BILL OF LADING  
 CONSIGNED TO KMART CORPORATION MARKED FREIGHT COLLECT AND FORWARDERS CARGO  
 RECEIPT ISSUED BY ACS LOGISTICS LTD. (COPIES OR ORIGINALS ACCEPTABLE)  
 INSURANCE TO BE AFFECTED BY BUYER KMART CORPORATION  
 ALL SHIPMENTS TO BE MADE AS SPECIFIED IN BUYER'S ORDER NO. \_\_\_\_\_  
 WITH SHIPMENT TO COMMENCE ON \_\_\_\_\_  
 BUT IN ANY EVENT NOT LATER THAN \_\_\_\_\_.  
 REFERENCE (PO) FROM ORDER CONTRACT SHIPPING SCHEDULE MUST BE SPECIFIED ON THE  
 COMMERCIAL INVOICE FOR EACH SHIPMENT COVERED ON THE INVOICE  
 KMART INSPECTION CERTIFICATE (COPIES OR ORIGINALS ACCEPTABLE.)

93

ORDER CONTRACT  
(CONTINUED)

KMART CORPORATION  
3100 W BIG BEAVER RD  
TROY MICHIGAN  
48084 USA

Telephone:  
Facsimile:

ORDER DATE: 05/21/97      CONTRACT NO: K3821      ITEM CODE: 640-118731-116      BUYER: LVW LARRY VANDERWERFF  
DIV: 1      DEPT NO: 43      UPC CARTON ID: 10072000716738      FACTORY: 3647

ITEM: TABLE TOP GAS GRILL - 17"

TS1

PRODUCT LIABILITY INSURANCE CERTIFICATE REQUIRED COVERING ALL SHIP DATES  
7424R  
SPECIAL PROJECT SPRING

CARTON UPC NUMBER:10072000716738

K mart Corporation  
I M P O R T   O R D E R      Page 3

Order: K3821      Code: 11-87-31      Document: 7424 R  
SPECIAL PROJECT SPRING

TABLE TOP PORTABLE GAS GRILL - 17"

SEASONAL ITEM  
COLOR: BLACK  
MATERIAL: TOP & BOTTOM: STEEL SHEET.  
SHEET THICKNESS: 0.6MM  
WIRE DIA. OF COOKING GRILL 3.5 X 2.5MM AND CHARCOAL GRILL  
3.3 X 4.5MM  
WIRE DIA. OF LEGS: 6MM. 3PCS OF BAKELITE HANDLES &  
LAVA ROCK: 1 BAG (2.2 LBS)  
GAS REGULATOR WITH FILTER. 1PC  
FINISH: TOP & BOTTOM: PORCELAIN ENAMEL.  
COOKING GRILL, STEEL LEGS: CHROME-PLATED  
CHARCOAL GRILL: ZINC PLATED  
LOGO "BBO-PRO" WILL BE BURNT ONTO THE TOP LID HANDLE  
PACKING: EACH PACKED INTO COLOR BOX, 4 PCS/CTN.  
CHINA PORT - HUANG PU, CHINA  
UPC SYMBOL IS REQUIRED ON THIS ITEM

OUTER CARTON MARKINGS:

REFER TO KMART CORP. "CARTON MARKING INSTRUCTIONS".  
NOTE: CARTONS MUST BE PACKED TO INNER AND OUTER PIECE  
COUNTS SPECIFIED ON THE ORDER. PARTIAL OR ODD PACKED  
CARTONS ARE NOT PERMITTED FOR SHIPMENT.  
VENDOR IS TO DEVELOP AND FORWARD PACKAGE PROOFS TO THE  
KMART OVERSEAS LOCAL OFFICE 60 DAYS PRIOR TO SHIP DATE  
WHEN NEW PACKAGE DESIGNS ARE REQUIRED.  
END OF DOCUMENT.....

M E R C H A N D I S E   I N F O R M A T I O N

Spec No: 640118731116K3821

Spec Type: MDSENAPP      MERCHANDISE SPEC FOR HARDLINES

TICKET LABEL INFORMATION

Factory: .

Address:

ORDER CONTRACT

KMART CORPORATION  
3100 W BIG BEAVER RD  
TROY MICHIGAN  
48084 USA

Telephone:  
Facsimile:

ORDER DATE: 05/21/97 CONTRACT NO: I0756 ITEM CODE: 640-118731-116 BUYER: LVW LARRY VANDERWERFF  
DIV: 1 DEPT NO: 43 UPC CARTON ID: 10072000716738 FACTORY: 3647

ITEM: TABLE TOP GAS GRILL - 17"

Manufacturer: LIEN MOU INDUSTRIAL FACTORY CO LTD  
556 MIN WOO ROAD,  
HSIN-CHU CITY,  
TAIWAN, R.O.C.

FOREIGN AGENT: KKTP KMART TAIWAN LTD  
FOREIGN OFFICE: RKKTP KMART TAIWAN LTD  
PRODUCTION OFFICE: PKCHK KMART HONG KONG OFFICE  
SHIP VIA: (X)SEA ( )AIR ( )TRUCK/RAIL  
VIA LINE:  
Payment to be made by (X) CHECK or ( ) Letter of Credit  
LC#: BANK: BANKOA  
LC Transferable: No

Each item to be marked: MADE IN CHINA (MAINLAND)  
Embark/Go-down: CHINA (MAINLAND)

LIFESTYLE: HARDLINES  
TRADEMARK: NO TRADEMARK ON THIS ORDER  
BRAND NAME: NONE

Total Cartons	Total Piece	per Piece	Total Cost of Order	Terms
		\$9.590	\$0.00	FOB

PER	KGS:	22.600	CBM:	.079500	Piece per Inner:	4	Packing Instruction:
CTN	LBS:	49.824	CUF.FT:	2.808	Inners per outer carton:	1	CASEPACK
	NET WT:			Total Piece per outer export ctn:	4		

	per Piece	per CARTON	per Piece	per CARTON	per Piece	per CARTON
F.O.B. PRICE	\$9.590	\$38.360	IMPORT CHR	1.70%	.186	.743
DUTY	.163	.652	BANK FEE	%		
COUNTER VEILING			PIER CHR			
USER FEE	.020	.081	TICKET DUTY			
HARBOR FEE	.012	.048	ASSIST			
OCEAN FREIGHT 33	.656	2.624	EXCISE TAX			
TARIFF # KHCH9			ODC TAX			
AGENT FEE 5%	.480	1.918	DEFECT			
BUYER CRDT %			SERVICE			
AGENT 2 %			DECON FEE 24.000	.477	1.908	\$ .00
WAREHOUSE %			LANDED COST	11.58	46.33	
						TOTAL SELLING VALUE FOR ORDER:

HTS #	\$/HTS UNIT	HTS DUTY %	NET NET WGT per HTS UNIT	WT RATE %	SPECIAL QTY / HTS UNIT	#HTS UNITS per PIECE	QUOTA #	CVD RATE
7321.1300.40	9.59	1.7						

BINDING RULE # OR PRECLASS #

BUYER/DATE	MDSE. MGR-SALES/DATE	OFFICE/DATE	INTERNATIONAL DEPT./DATE
------------	----------------------	-------------	--------------------------

Special Instructions:

( ) RETURN SHEET # \_\_\_\_\_  
Conveyable : N

( ) DEFERRED PMT. \_\_\_ Days

95



ORDER CONTRACT

KMART CORPORATION  
 3100 W BIG BEAVER RD  
 TROY MICHIGAN  
 48084 USA

(CONTINUED)

Telephone:  
 Facsimile:

ORDER DATE: 05/21/97      CONTRACT NO: 10756      ITEM CODE: 640-118731-116      BUYER: LVW LARRY VANDERWERFF  
 DIV: 1      DEPT NO: 43      UPC CARTON ID: 10072000716738      FACTORY: 3647

ITEM: TABLE TOP GAS GRILL - 17"

UPC NUMBER

072000716731

SHIPPING SCHEDULE

Reference (PO)	Discharge Point	Final Dest. (DC)	Ship Date	Cancel Date	Cartons	Quantity (EA)
801	C	WCD	12/25/97			5,880

Summary by Final Destination (DC)

Discharge Point	Cartons	Quantity

Summary by SHIPPING SCHEDULE DATE

DATE	Cartons	Quantity

Fiber Information

Additional Information

COMMERCIAL INVOICE IN DUPLICATE (COPIES OR ORIGINALS ACCEPTABLE.)  
 PACKING LIST IN DUPLICATE (COPIES OR ORIGINALS ACCEPTABLE.)  
 COMBINED DRAWINGS ACCEPTABLE.  
 SEPARATE INVOICES MUST BE ISSUED FOR EACH DESTINATION (COPIES OR ORIGINALS ACCEPTABLE.)  
 ON BOARD NON NEGOTIABLE SEAWAY BILL OR ONE ON BOARD OCEAN BILL OF LADING  
 CONSIGNED TO KMART CORPORATION MARKED FREIGHT COLLECT AND FORWARDERS CARGO  
 RECEIPT ISSUED BY ACS LOGISTICS LTD. (COPIES OR ORIGINALS ACCEPTABLE)  
 INSURANCE TO BE AFFECTED BY BUYER KMART CORPORATION  
 ALL SHIPMENTS TO BE MADE AS SPECIFIED IN BUYER'S ORDER NO. \_\_\_\_\_  
 WITH SHIPMENT TO COMMENCE ON \_\_\_\_\_  
 BUT IN ANY EVENT NOT LATER THAN \_\_\_\_\_.  
 REFERENCE (PO) FROM ORDER CONTRACT SHIPPING SCHEDULE MUST BE SPECIFIED ON THE  
 COMMERCIAL INVOICE FOR EACH SHIPMENT COVERED ON THE INVOICE  
 KMART INSPECTION CERTIFICATE (COPIES OR ORIGINALS ACCEPTABLE.)

96

ORDER CONTRACT  
(CONTINUED)

KMART CORPORATION  
3100 W BIG BEAVER RD  
TROY MICHIGAN  
48084 USA

Telephone:  
Facsimile:

ORDER DATE: 05/21/97      CONTRACT NO: I0756      ITEM CODE: 640-118731-116      BUYER: LVW LARRY VANDERWERFF  
DIV: 1      DEPT NO: 43      UPC CARTON ID: 10072000716738      FACTORY: 3647

ITEM: TABLE TOP GAS GRILL - 17"

TS1

PRODUCT LIABILITY INSURANCE CERTIFICATE REQUIRED COVERING ALL SHIP DATES  
7431R  
SPECIAL PROJECT SPRING

CARTON UPC #:10072000716738

K mart Corporation  
I M P O R T   O R D E R      Page 3

Order: I0756      Code: 11-87-31      Document: 7431 R  
SPECIAL PROJECT SPRING

TABLE TOP PORTABLE GAS GRILL - 17"

SEASONAL ITEM  
COLOR: BLACK  
MATERIAL: TOP & BOTTOM: STEEL SHEET.  
SHEET THICKNESS: 0.6MM  
WIRE DIA. OF COOKING GRILL 3.5 X 2.5MM AND CHARCOAL GRILL  
3.3 X 4.5MM  
WIRE DIA. OF LEGS: 6MM. 3PCS OF BAKELITE HANDLES &  
LAVA ROCK: 1 BAG (2.2 LBS)  
GAS REGULATOR WITH FILTER. 1PC  
FINISH: TOP & BOTTOM: PORCELAIN ENAMEL.  
COOKING GRILL, STEEL LEGS: CHROME-PLATED  
CHARCOAL GRILL: ZINC PLATED  
LOGO "BBO-PRO" WILL BE BURNT ONTO THE TOP LID HANDLE  
PACKING: EACH PACKED INTO COLOR BOX, 4 PCS/CTN.  
CHINA PORT - HUANG PU, CHINA  
UPC SYMBOL IS REQUIRED ON THIS ITEM

OUTER CARTON MARKINGS:

REFER TO KMART CORP. "CARTON MARKING INSTRUCTIONS".  
NOTE: CARTONS MUST BE PACKED TO INNER AND OUTER PIECE  
COUNTS SPECIFIED ON THE ORDER. PARTIAL OR ODD PACKED  
CARTONS ARE NOT PERMITTED FOR SHIPMENT.  
VENDOR IS TO DEVELOP AND FORWARD PACKAGE PROOFS TO THE  
KMART OVERSEAS LOCAL OFFICE 60 DAYS PRIOR TO SHIP DATE  
WHEN NEW PACKAGE DESIGNS ARE REQUIRED.  
END OF DOCUMENT.....

M E R C H A N D I S E    I N F O R M A T I O N

Spec No: I0756640118731116

Spec Type: MDSENAPP    MERCHANDISE SPEC FOR HARDLINES

TICKET LABEL INFORMATION

Factory:

Address:

97

ORDER CONTRACT

KMART CORPORATION  
3100 W BIG BEAVER RD  
TROY MICHIGAN  
48084 USA

Telephone:  
Facsimile:

ORDER DATE: 05/21/97 CONTRACT NO: K3828 ITEM CODE: 640-118731-116 BUYER: LVW LARRY VANDERWERFF  
DIV: 1 DEPT NO: 43 UPC CARTON ID: 10072000716738 FACTORY: 3647

ITEM: TABLE TOP GAS GRILL - 17"

Manufacturer: LIEN MOU INDUSTRIAL FACTORY CO LTD  
556 MIN WOO ROAD,  
HSIN-CHU CITY,  
TAIWAN, R.O.C.

FOREIGN AGENT: KKTP KMART TAIWAN LTD  
FOREIGN OFFICE: RKKTP KMART TAIWAN LTD  
PRODUCTION OFFICE: PKKHK KMART HONG KONG OFFICE  
SHIP VIA: (X)SEA ( )AIR ( )TRUCK/RAIL  
VIA LINE:  
Payment to be made by (X) CHECK or ( ) Letter of Credit  
LC#: BANK: BANKOA  
LC Transferable: No

Each item to be marked: MADE IN CHINA (MAINLAND)  
Embark/Go-down: CHINA (MAINLAND)

LIFESTYLE: HARDLINES  
TRADEMARK: NO TRADEMARK ON THIS ORDER  
BRAND NAME: NONE

Total Cartons	Total Piece	per Piece	Total Cost of Order	Terms
17,640	70,560	\$9.590	\$676,670.40	FOB

PER CTN	KGS	CBM	LBS	CUF.FT	Piece per Inner	Inners per outer carton	Total Piece per outer export ctn	Packing Instruction
	22.600	.079500	49.824	2.808	4	1	4	CASEPACK
	NET WT:							

	per Piece	per CARTON	per Piece	per CARTON	per Piece	per CARTON
F.O.B. PRICE	\$9.590	\$38.360	IMPORT CHRG 1.70%	.186	.743	DC ALLOWANCE
DUTY	.163	.652	BANK FEE %			ROYALTY
COUNTER VEILING			PIER CHRG			COST OUT OF DC 11.58
USER FEE	.020	.081	TICKET DUTY			SELLING PRICE 21.99 21.99
HARBOR FEE	.012	.048	ASSIST			GROSS MARGIN .473252
OCEAN FREIGHT 33	.656	2.624	EXCISE TAX			MARKON 47.3252
TARIFF # KHCH9			ODC TAX			
AGENT FEE 5%	.480	1.918	DEFECT			TOTAL SELLING VALUE FOR ORDER:
BUYER CRDT %			SERVICE			
AGENT 2 %			DECON FEE 24.000	.477	1.908	\$1,551,614.40
WAREHOUSE %			LANDED COST	11.58	46.33	

HTS #	\$/HTS UNIT	HTS DUTY %	NET NET WGT per HTS UNIT	WT RATE %	SPECIAL QTY / HTS UNIT	#HTS UNITS per PIECE	QUOTA #	CVD RATE
7321.1300.40	9.59	1.7						

BINDING RULE # OR PRECLASS #

BUYER/DATE	MDSE. MGR-SALES/DATE	OFFICE/DATE	INTERNATIONAL DEPT./DATE

Special Instructions:

( ) RETURN SHEET # \_\_\_\_\_  
Conveyable : N

( ) DEFERRED PMT. \_\_\_\_\_ Days

98

ORDER CONTRACT  
(CONTINUED)

X MART CORPORATION  
3100 W BIG BEAVER RD  
TROY MICHIGAN  
48084 USA

Telephone:  
Facsimile:

ORDER DATE: 05/21/97      CONTRACT NO: K3828      ITEM CODE: 640-118731-116      BUYER: LVW LARRY VANDERWERFF  
DIV: 1      DEPT NO: 43      UPC CARTON ID: 10072000716738      FACTORY: 3647

ITEM: TABLE TOP GAS GRILL - 17"

UPC NUMBER

072000716731

SHIPPING SCHEDULE

Reference (PO)	Discharge Point	Final Dest. (DC)	Ship Date	Cancel Date	Cartons	Quantity (EA)
801	WCD	WCD	12/05/97			11,760
802	WCD	WCD	12/13/97			11,760
807	C	WCD	12/17/97			5,880
803	WCD	WCD	12/27/97		3,675	14,700
804	WCD	WCD	01/20/98		3,675	14,700
805	WCD	WCD	01/25/98		2,205	8,820
806	WCD	WCD	03/16/98		2,205	8,820

Summary by Final Destination (DC)

Discharge Point	Cartons	Quantity
COR	735	2,940
DEN	735	2,940
GEO	735	2,940
GNB	735	2,940
MOR	735	2,940
OCA	735	2,940
ONT	735	2,940
SPK	735	2,940
WCD	11,760	70,560

Summary by SHIPPING SCHEDULE DATE

DATE	Cartons	Quantity
12/05/97		11,760
12/13/97		11,760
12/27/97	3,675	14,700
01/20/98	3,675	14,700
01/25/98	2,205	8,820
03/16/98	2,205	8,820

*Handwritten initials*

Fiber Information

-----  
Additional Information

-----  
COMMERCIAL INVOICE IN DUPLICATE (COPIES OR ORIGINALS ACCEPTABLE.)  
PACKING LIST IN DUPLICATE (COPIES OR ORIGINALS ACCEPTABLE.)  
COMBINED DRAWINGS ACCEPTABLE.  
SEPARATE INVOICES MUST BE ISSUED FOR EACH DESTINATION (COPIES OR ORIGINALS  
ACCEPTABLE.)  
ON BOARD NON NEGOTIABLE SEAWAY BILL OR ONE ON BOARD OCEAN BILL OF LADING  
CONSIGNED TO KMART CORPORATION MARKED FREIGHT COLLECT AND FORWARDERS CARGO  
RECEIPT ISSUED BY ACS LOGISTICS LTD. (COPIES OR ORIGINALS ACCEPTABLE)  
INSURANCE TO BE AFFECTED BY BUYER KMART CORPORATION  
ALL SHIPMENTS TO BE MADE AS SPECIFIED IN BUYER'S ORDER NO. \_\_\_\_\_  
WITH SHIPMENT TO COMMENCE ON \_\_\_\_\_  
BUT IN ANY EVENT NOT LATER THAN \_\_\_\_\_.  
REFERENCE (PO) FROM ORDER CONTRACT SHIPPING SCHEDULE MUST BE SPECIFIED ON THE  
COMMERCIAL INVOICE FOR EACH SHIPMENT COVERED ON THE INVOICE  
KMART INSPECTION CERTIFICATE (COPIES OR ORIGINALS ACCEPTABLE.)

100

ORDER CONTRACT  
(CONTINUED)

KMART CORPORATION  
3100 W BIG BEAVER RD  
TROY MICHIGAN  
48084 USA

Telephone:  
Facsimile:

ORDER DATE: 05/21/97      CONTRACT NO: K3828      ITEM CODE: 640-118731-116      BUYER: LVW LARRY VANDERWERFF  
DIV: 1      DEPT NO: 43      UPC CARTON ID: 10072000716738      FACTORY: 3647

ITEM: TABLE TOP GAS GRILL - 17"

TS1

PRODUCT LIABILITY INSURANCE CERTIFICATE REQUIRED COVERING ALL SHIP DATES  
7431R  
SPECIAL PROJECT SPRING

CARTON UPC #:10072000716738

K mart Corporation  
I M P O R T   O R D E R      Page 3

Order: K3828      Code: 11-87-31      Document: 7431 R  
SPECIAL PROJECT SPRING

TABLE TOP PORTABLE GAS GRILL - 17"

SEASONAL ITEM  
COLOR: BLACK  
MATERIAL: TOP & BOTTOM: STEEL SHEET.  
SHEET THICKNESS: 0.6MM  
WIRE DIA. OF COOKING GRILL 3.5 X 2.5MM AND CHARCOAL GRILL  
3.3 X 4.5MM  
WIRE DIA. OF LEGS: 6MM. 3PCS OF BAKELITE HANDLES &  
LAVA ROCK: 1 BAG (2.2 LBS)  
GAS REGULATOR WITH FILTER. 1PC  
FINISH: TOP & BOTTOM: PORCELAIN ENAMEL.  
COOKING GRILL, STEEL LEGS: CHROME-PLATED  
CHARCOAL GRILL: ZINC PLATED  
LOGO "BBO-PRO" WILL BE BURNT ONTO THE TOP LID HANDLE  
PACKING: EACH PACKED INTO COLOR BOX, 4 PCS/CTN.  
CHINA PORT - HUANG PU, CHINA  
UPC SYMBOL IS REQUIRED ON THIS ITEM

OUTER CARTON MARKINGS:

REFER TO KMART CORP. "CARTON MARKING INSTRUCTIONS".  
NOTE: CARTONS MUST BE PACKED TO INNER AND OUTER PIECE  
COUNTS SPECIFIED ON THE ORDER. PARTIAL OR ODD PACKED  
CARTONS ARE NOT PERMITTED FOR SHIPMENT.  
VENDOR IS TO DEVELOP AND FORWARD PACKAGE PROOFS TO THE  
KMART OVERSEAS LOCAL OFFICE 60 DAYS PRIOR TO SHIP DATE  
WHEN NEW PACKAGE DESIGNS ARE REQUIRED.  
END OF DOCUMENT.....

M E R C H A N D I S E    I N F O R M A T I O N

Spec No: 640118731116K3828

Spec Type: MDSENAPP    MERCHANDISE SPEC FOR HARDLINES

TICKET LABEL INFORMATION

Factory:

Address:

182

Exhibit "E"  
Kmart Corporation  
1/27/98 Inspection  
DRB

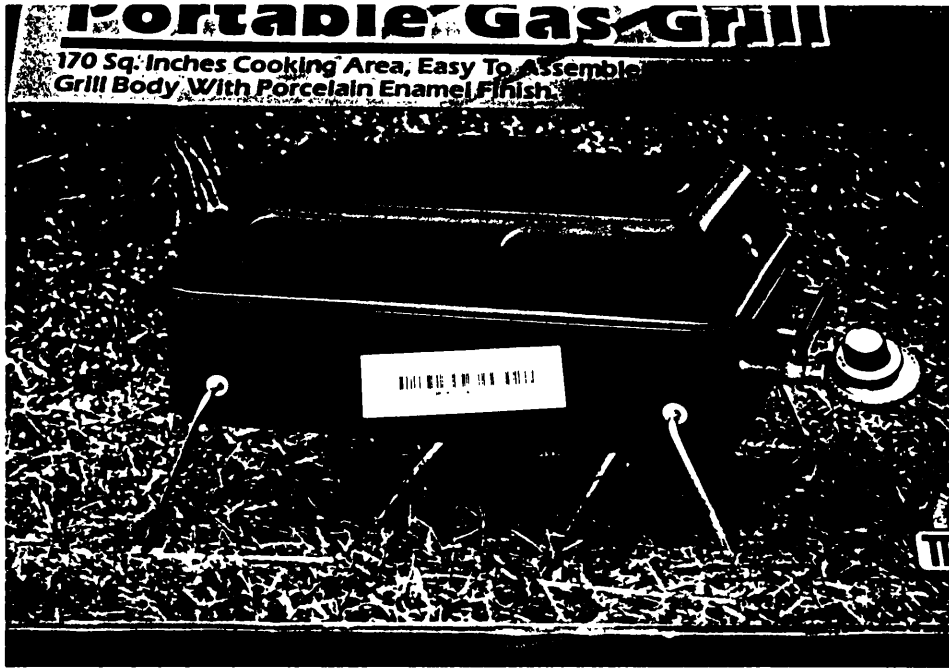

Photos of sample #98-830-3415, the "Tru-Burn" model gas grill.

103

Exhibit "E"  
Kmart Corporation  
1/27/98 Inspection  
DRB

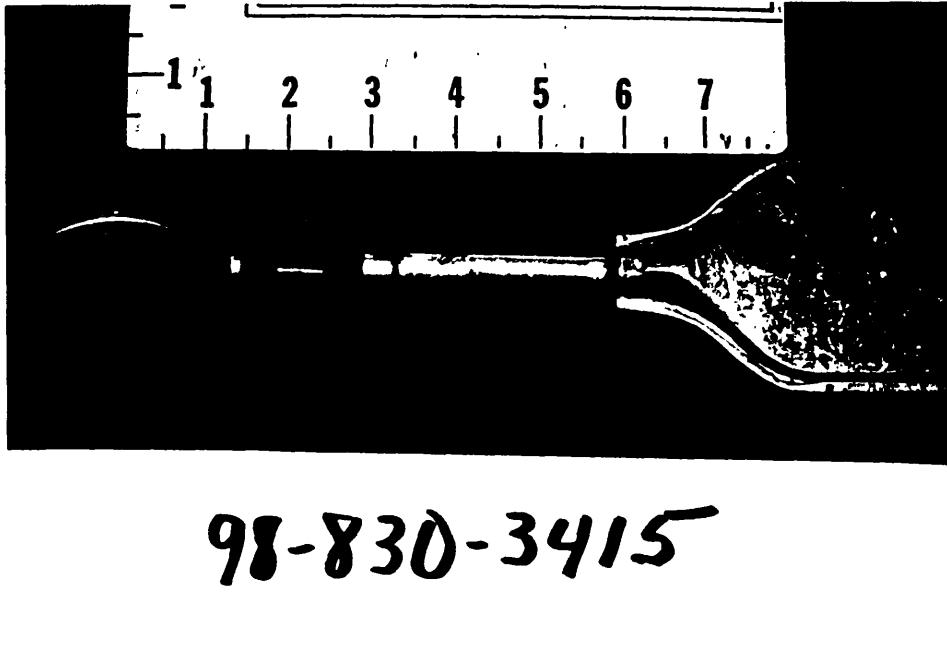

Photos of the gas regulator and burner assembly.

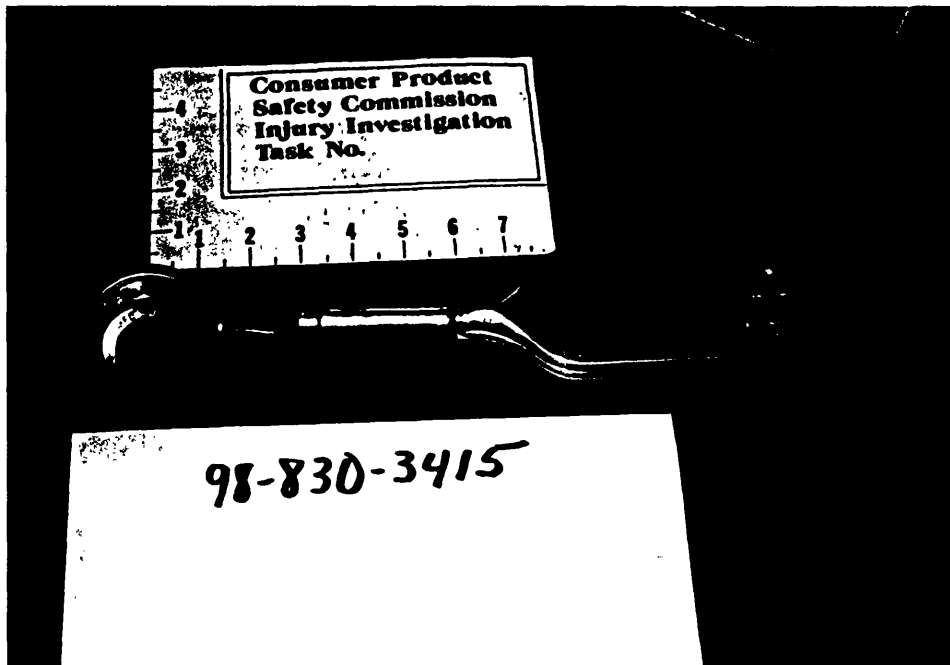

101



Exhibit "E"  
Kmart Corporation  
1/27/98 Inspection  
DRB

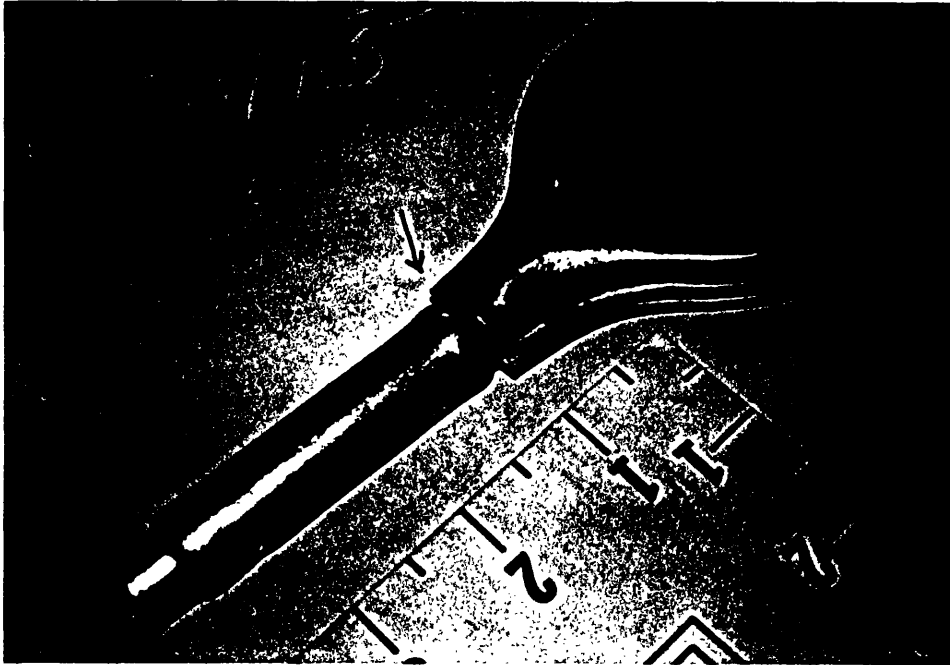

Photos of the gas regulator and burner assembly.

105

Exhibit "F"  
 Kmart Corp from  
 1/27/78 inspection

002



# Portable Gas Grill Assembly Instruction

## The Other Choice.

Assembly Diagram Bolts and Parts List

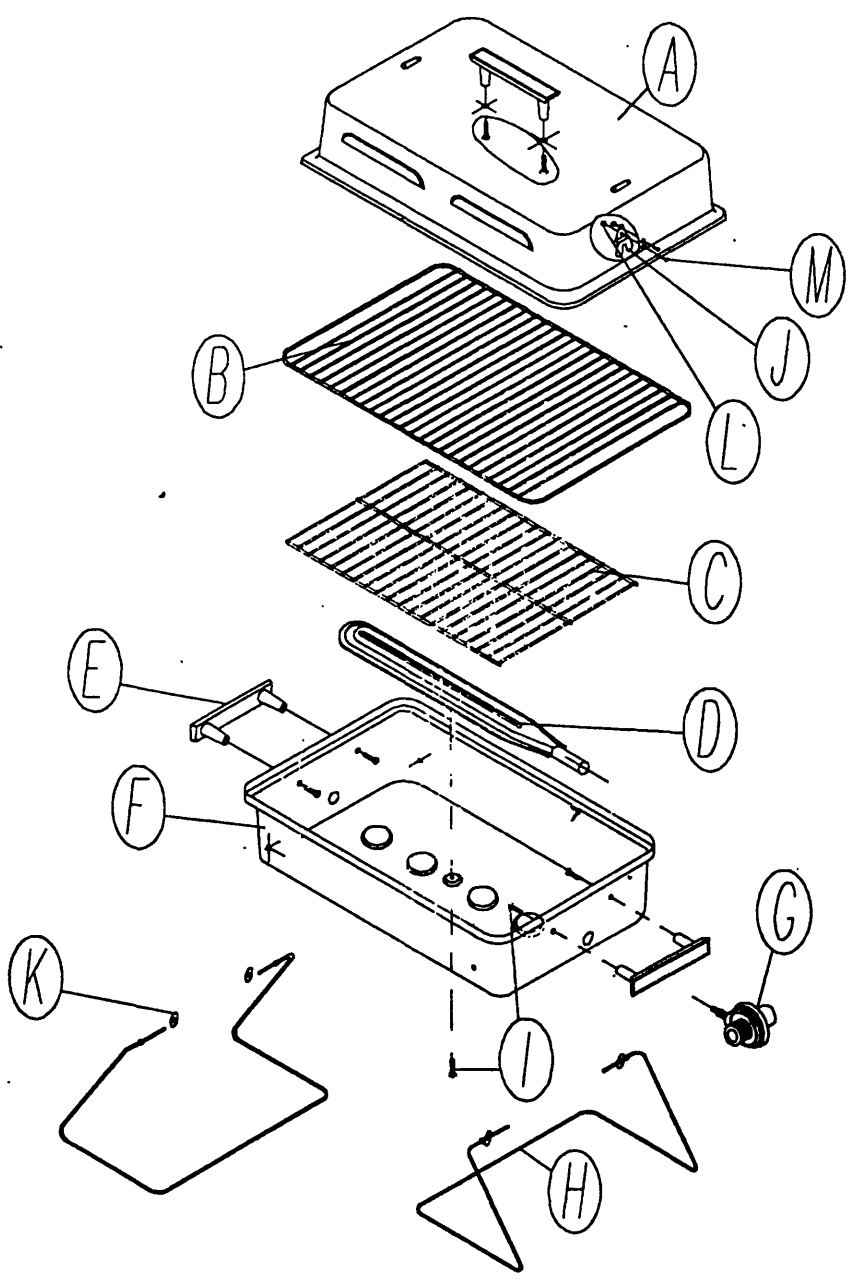

Part	Description	Q'ty
A	Grill Top	1
B	Cooking Grill	1
C	Lava Rock Grate	1
D	Burner	1
E	Bakelite Handle	3
F	Grill Bottom	1
G	Regulator	1
H	Steel Wire Leg	2
I	3/4" Bolts	7
J	Lid Bracket	2
K	Washers	4
L	7/16" Nut	4
M	7/16" Bolts	4

106  
~~106~~

---

# Kmart Corporation

**To:** Charlene Haines  
**Company:** KMART  
**cc:** Sal Incalcaterra  
Chris Gullen - KIH  
Chuck Hajduk - KIH

**From:** *Jim* JIM DONOHUE  
**Department:** KMART  
**Phone:** (248) 637-6501  
**Fax:** (248) 643-4245  
**Date:** 9/22/97

**Pages Including Cover:** 1

**RE: TRU-BURN PORTABLE LP GAS GRILL**

Dear Charlene,

With reference to your letter of September 17, 1997, and in response to your request, I am enclosing the Hardline Quality Assurance evaluation report # 24096-1CC.

Please note that Romel Mascapac, our mechanical engineer, evaluated the product, and did not find any safety defects. I have also checked with Chuck Hajduk, and he does not have any other complaints on this item.

If you have any pertinent questions, please advise.

Best Regards

*107*



**KMAR. PERFORMANCE STANDARI**  
**SUMMARY OF TEST RESULTS FOR**  
**GAS GRILL (ANSI Z21.58)**

PRODUCT DESCRIPTION:	TABLE TOP GAS GRILL
UPC #	
MANUFACTURER	LIEN MOU
QA CONTROL NO:	24096-1CC
KMART CODE	
ITEM #	
COUNTRY OF ORIGIN	CHINA
DATE OF ANALYSIS:	15-Sep-97
ANALYSIS BY:	R. MACASPAC

TESTED PROPERTY	REQUIREMENT	RESULTS	RATING
-----------------	-------------	---------	--------

**LABELED INFORMATION**

PRODUCER MARKINGS		BBQ PRO	SATISFACTORY
LABELED CONTENT	AS CLAIMED	1 GRILL	SATISFACTORY

**PHYSICAL PROPERTIES**

OVERALL DIMENSIONS (LXWXH)	AS LABELED (+- 5%)	16 3/4" X 10 7/8" X 6 1/2" (W/LID 9 1/2")	SATISFACTORY
AREA OF GRILL (LXW)/(SQ. IN.)	AS LABELED (+- 5%)	14 1/4" X 10 1/8"	SATISFACTORY
TOTAL AREA (SQ. IN.)	AS LABELED (+- 5%)	N/A	
SIDE/FRONT SHELF		"	
RIGHT: (LXW)/(SQ. IN.)	AS LABELED (+- 5%)	"	
LEFT (LXW)/(SQ. IN.)	AS LABELED (+- 5%)	"	
FRONT: (LXW)/(SQ. IN.)	AS LABELED (+- 5%)	"	
WARMING RACK		"	
TYPE	AS CLAIMED	"	
LXW (SQ. IN.)	AS LABELED (+- 5%)	"	
AUTOMATIC LIFT	AS CLAIMED	"	
HOUSING (FRAME)			
TYPE	AS CLAIMED	STEEL	SATISFACTORY
THICKNESS(BODY)	AS LABELED (+- 5%)	0.94mm	SATISFACTORY
GRILL			
TYPE	AS CLAIMED	CHROME PLATED	SATISFACTORY
DIAMETER	AS LABELED (+- 5%)	3.5mm/2.4mm	SATISFACTORY
CERAMIC/ LAVA BRIQUETTES	AS CLAIMED	N/A	

**CONSTRUCTION QUALITIES**

MATERIAL QUALITY	NO MAJOR DEFECT	NO MAJOR DEFECT	SATISFACTORY
WORKMANSHIP	NO MAJOR DEFECT	LEGS*	UNSATISFACTORY

**PERFORMANCE FEATURES**

100



**Quality Assurance  
Evaluation (Hardlines)**

Buyer:	<u>L VANDERWERFF</u>	Q.A. Control No:	<u>24096 - 1CC</u>
Department:	<u>43</u>	Log-In Date:	<u>12-Sep-97</u>
Requested By:	<u>L VANDERWERFF</u>	Completion Date:	<u>18-Sep-97</u>
Test Type:	<u>COMPLAINT</u>	Assigned to:	<u>R MACASPAC</u>

**Product Information**

Brand Name: National Brand Private Label

Detailed Description:  
TABLE TOP GAS GRILL

Vendor: LIEN MOU  
 Address: \_\_\_\_\_  
 Address: \_\_\_\_\_  
 Kmart Code: \_\_\_\_\_  
 Duns No: IMPORT  
 This Product is: COMPLAINT

Kmart Corporation  
 International Headquarters  
 Quality Assurance Department  
 3100 W. Big Beaver Road  
 Troy MI 48084-3163  
 Phone (810) 643-1722  
 Fax (810) 643-4245

**Analysis Performed**

- PERFORMANCE
- PHYSICAL PROPERTIES
- CONSTRUCTION

Sample Cost(s)	Test Charge	Priority Surcharge	Total Charge
	<u>\$280.00</u>		to Vendor: <u>\$280.00</u>

<b>Evaluation:</b>	<u>Approved</u>	<u>Approved*</u>	<u>X</u>
	<u>Corrective Action</u>	<u>Rejected</u>	

**Conclusion:**

THE PRODUCT WAS EVALUATED DUE TO COMPLAINT/INCIDENT ISSUE. THE CUSTOMER ALLEGES THAT THE LP GAS CANISTER ASSEMBLY OF A BRAND NEW SMALL PORTABLE GRILL DETACHED ITSELF FROM THE BURNER AND ROLLED ONTO A WOODEN FLOOR. (SEE ATTACHED REPORT)

A NEW SAMPLE WAS PROVIDED BY THE MERCHANDISING DEPARTMENT. NO SAFETY DEFECTS WERE FOUND REGARDING THE USE OF THE PRODUCT. THE BURNER PIPE STAYED INTACT AND COULD NOT BE DISLodge EVEN WHEN A TENSILE AND TORQUE FORCE WAS APPLIED.



**Q.A. Representative:** \_\_\_\_\_

Testing of vendor's merchandise is not a substitute for vendor's own testing and other Quality Assurance related obligations in connection with its sale of merchandise to Kmart. Kmart testing shall not limit Kmart's rights, or diminish or remove any of vendor's responsibilities, under Kmart's purchase order terms and conditions including, without limitations, those relating to warranty and indemnification under paragraphs 2 & 3 thereof.

*Handwritten signature/initials*



**KMART PERFORMANCE STANDARD**  
**SUMMARY OF TEST RESULTS FOR**  
**GAS GRILL (ANSI Z21.58)**

PRODUCT DESCRIPTION:	TABLE TOP GAS GRILL
UPC #	
MANUFACTURER	LIEN MOU
QA CONTROL NO:	24096-1CC
KMART CODE	
ITEM #	
COUNTRY OF ORIGIN	CHINA
DATE OF ANALYSIS:	15-Sep-97
ANALYSIS BY:	R. MACASPAC

TESTED PROPERTY	REQUIREMENT	RESULTS	RATING
HEAT GENERATION (BTU)	AS RATED (+- 10%)	10919 BTU/HR	SATISFACTORY
EASE OF IGNITION	AS CLAIMED	N/A	
STABILITY	MIN. 20 LBS. TO TIP-OVER		
RIGHT		N/A	
LEFT		N/A	
FRONT		43°	SATISFACTORY
BODY LOAD- UNIFORMLY APPLY WEIGHT FOR 5 MIN. WITHOUT DEFECT			
< 25 LBS: APPLY 25 LBS	NO MAJOR DEFECT	SOME DEFLECTION	*SATISFACTORY
25- 75: APPLY 75 LBS	NO MAJOR DEFECT	N/A	
> 75 LBS: APPLY 150 LBS	NO MAJOR DEFECT	N/A	
MOBILITY (WHEELS)	SHALL NOT HAVE ANY BINDING	N/A	
TEMPERATURE @ MAX. HIGH SETTING		N/A	
HOOD HANDLE	MAX. 300 DEG. F.	167°F	SATISFACTORY
BURNER HANDLE		N/A	
- METALLIC	MAX. 40° F RISE OVER ROOM TEMP.		
- NON-METALLIC	MAX. 60° F RISE ABOVE ROOM TEMP.		
GRILL AREA (RT/LEFT)		NO MORE THAN 30° RISE	SATISFACTORY
WARMING RACK		293°F	
TOP HOUSING		N/A	
FRONT VIEWING AREA		360°F	SATISFACTORY
SIDE HOUSING		N/A	
TEMPERATURE INDICATOR		284°F	SATISFACTORY
	SHALL PROVIDE PROPER LEVEL OF TEMPERATURE	N/A	
LOW		.	
MEDIUM		.	
HIGH		.	
COOKING PERFORMANCE CHARACTERISTICS @ HIGH	SUBJECTIVE		
HOT DOG		ACCEPTABLE	SATISFACTORY
HAMBURGER ( 1/4 LBS)		ACCEPTABLE	SATISFACTORY

**KMAR. PERFORMANCE STANDARD**

**SUMMARY OF TEST RESULTS FOR  
GAS GRILL (ANSI Z21.58)**

PRODUCT DESCRIPTION:	TABLE TOP GAS GRILL
UPC #	
MANUFACTURER	LIEN MOU
QA CONTROL NO:	24096-1CC
KMART CODE	
ITEM #	
COUNTRY OF ORIGIN	CHINA
DATE OF ANALYSIS:	15-Sep-97
ANALYSIS BY:	R. MACASPAC

TESTED PROPERTY	REQUIREMENT	RESULTS	RATING
CHICKEN (FILLET)		ACCEPTABLE	SATISFACTORY
CLEANABILITLY		ACCEPTABLE	SATISFACTORY
TIMER	SHALL BE ACCURATE (+- 5%) MIN.	N/A	
EASE OF ASSEMBLY		EASY TO ASSEMBLE	SATISFACTORY

**FUNCTIONAL FEATURES**

FRONT VIEWING GLASS	AS CLAIMED	N/A	
TEMPERATURE INDICATOR	AS CLAIMED	N/A	
TWO BURNERS	AS CLAIMED	N/A	
AUTOMATIC IGNITOR	AS CLAIMED	N/A	
FUEL INDICATOR	AS CLAIMED	N/A	
TIMER	AS CLAIMED	N/A	
HANDLE TYPE	AS CLAIMED	PLASTIC	SATISFACTORY
WHEELS (DIAMETER)	AS CLAIMED	N/A	
BOTTOM SHELF - TYPE	AS CLAIMED	N/A	

**PRODUCT PACKAGING**

FPLA CONFORMANCE	SHALL CONFORM TO FPLA AND ANSI Z21.58.	N/A	
TRADEMARKS OR COPYRIGHTS		N/A	
INSTRUCTIONS/DIRECTIONS	SHALL PROVIDE CLEAR AND EASY TO FOLLOW USER/ASSEMBLY INSTRUCTIONS.	INCLUDED	SATISFACTORY

**COMMENTS:**

\*THE LEGS OF THE GRILL WERE NOT ABLE TO ADEQUATELY SECURE THE COVER.  
THE CONSTRUCTION TOLERANCE MUST BE IMPROVED.

Exhibit "H"

892

U.S. CONSUMER PRODUCT SAFETY COMMISSION		1. AREA Kmart Corporation 1/27/78 1178 1178 1178
---	--	---

2. NAME OF INDIVIDUAL Chasene Harris	3. TITLE OF INDIVIDUAL Attorney	4. DATE 1/27/78
---	------------------------------------	--------------------

5. FIRM NAME Kmart Corporation	6. SAMPLE NUMBER 98-830-3415
-----------------------------------	---------------------------------

7. NUMBER AND STREET 1100 W. LINDA RD	8. CITY AND STATE (Include Zip Code) TAMPA, FL 33604
--	---

9. SAMPLES COLLECTED (Describe fully. List lot, serial, model numbers and other positive identification)

The following samples were collected by the Consumer Product Safety Commission pursuant to Section 27(f) of the Consumer Product Safety Act (15 U.S.C. 2076(f) and/or Section 11(b) of the Federal Hazardous Substances Act (15 U.S.C. 1270(b) and/or Sections 5(c) and (d) of the Flammable Fabrics Act (15 U.S.C. 1194(c) and (d) and/or Section 704(c) of the Federal Food Drug and Cosmetic Act (21 U.S.C. 374(c)) [Authority for sample collections made in connection with the Poison Prevention Packaging Act of 1970 (15 U.S.C. 1471 et seq.)], and receipt for said samples is hereby acknowledged. Sections cited are quoted on the reverse side of this form.

— ONE "Trex-Bond" PORTABLE GAS GRILL, UPC # 0-24838-17000-1, unit is new, unopened.

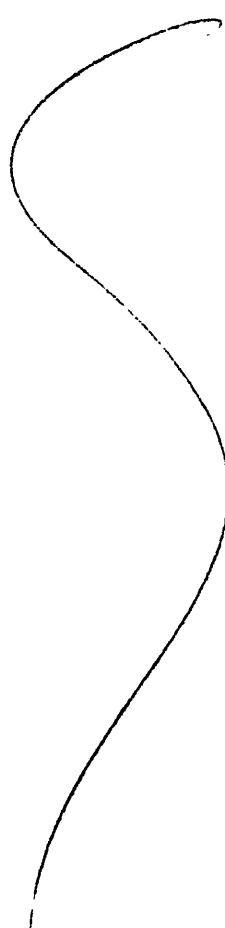

112

10. SAMPLES	11. SAMPLES WERE	12. COLLECTOR
a. AMOUNT RECEIVED FOR SAMPLE	<input checked="" type="checkbox"/> PURCHASED	a. NAME (Print or type) Dennis J. Seamus
b. SIGNATURE (Person from whom sample received) Chasene Harris	<input type="checkbox"/> BORROWED (To be returned)	b. SIGNATURE Dennis J. Seamus



Exhibit "I"  
Kmart Corporation  
1/27/98 Inspection

(98)

AFFIDAVIT SAMPLE NO.  
98-830-3415

STATE OF MICHIGAN COUNTY OF OAKLAND

Before me, DENNIS R. BLASIUS, a duly authorized employee of the Consumer Product Safety Commission, appropriately designated by the Chairman of said Commission pursuant to provisions of the Consumer Product Safety Act (sec. 27 (b)(2), 86 Stat. 1228; 15 U.S.C. 2076 (b)(2)), to administer or take oaths, affirmations, and affidavits, personally appeared \_\_\_\_\_ in the county and State aforesaid, who, being first duly

sworn, deposes and says: that I am an attorney for the Kmart Corporation and as such have sufficient knowledge to make this statement. THAT ON 1/27/97 I PROVIDED CPSC INVESTIGATOR DENNIS BLASIUS WITH ONE NEW "TEN-BURN" LABEL FOR GAS GRILL, UPC# 0-24838-17000-1; THESE GRILLS ARE IMPORTED BY KMAKT FROM THE CHINESE MANUFACTURER, WEN MOU INDUSTRIAL FACTORY CO., LTD. NO PURCHASE ORDER, INVOICING, OR OTHER SIMILAR IMPORT DOCUMENTATION IS AVAILABLE.

AFFIANT'S SIGNATURE & TITLE C. J. Haines, Attorney

FIRM (Name and address, include ZIP Code)  
Kmart Corporation  
3100 W. Big BEAVER RD.  
TROY, MI. 48064

Subscribed and sworn to before me at TROY, MI (City and State)

this 27th day of JANUARY, 1998.

Dennis Blasius  
(Employee's Signature)

EMPLOYEE OF THE CONSUMER PRODUCT SAFETY COMMISSION ACTING IN ACCORDANCE WITH AUTHORITY GRANTED IN THE ABOVE STATED DECLARATION.

117

Exhibit "J"  
Kmart Corporation  
1/27/98 action

(222)

J.S. Consumer Product  
SAMPLE COLLECTION REPORT

1. Sample Flag		2. Date Collected 1/27/98		3. Sample Type and Number: 98-830-3415 <input checked="" type="radio"/> Physical <input type="radio"/> Documentary	
4a. Product Name LP GAS GRILL		4b Model TRU-BURN		4c NEISS 3248	
5. Assignment Number		6. Complete for Import Samples Port of Entry: _____ Country of Origin: _____ Entry No. and Date: _____ Customs Contact: _____		7. MIS 32100	
8. Hours Activity _____ Travel <u>  2  </u> <u>  0.5  </u>		9a Home RO FOCR		9b Collecting RO FOCR	
10. Sample Cost		11. Invoice Value of Lot		12. Size of Lot 1	
Units unt		13. Manufacturer/Importer # LIE001 LIEN MOU INDUSTRIAL FACTOR 556 MIN WOO RD. HSIN-CHU CITY, TAIWAN,		14. Shipper/Foreign Manufacturer SAME	
15. Dealer/Import Broker # KMA002 Kmart Corporation 3100 W. BIG BEAVER TROY, MI 48084		16. Supporting documents attached: Invoice No. and Date: _____ Date Shipped: _____ Shipping Record and Date: _____ Affidavit Signer's name, title and date: <u>SIGNED BY C. HAINES, CORP. ATTY, 1/27/98.</u>			
17. Product Identification: Product is described as a "Tru-Burn" model LP gas table top grill, manufactured by #13 above and imported and distributed in the U.S. by #15 above. Grill is black porcelain enamel, 17" long, with chrome leg					
18. Reason for collection/analysis needed: <input type="radio"/> FHSA <input checked="" type="radio"/> CPSC <input type="radio"/> FFA <input type="radio"/> PPPA <input type="radio"/> RSA F/U to IDI #970528CWE5012- burner failure on grill.					
19. Summary of Field Screening: See photos attached to E.I. report.					
20. Sample size/Method of Collection: Sample was collected during inspection visit to #13 above on 1/27/98. Sample remained in my custody, in the CPSC office, or in the locked GOV from time of collection until later shipment to the Sample					
21. Identification on sample: " 98-830-3415		DRB 1/27/98		22. Identification on seal and date: "98-830-3415 Dennis Blasius 1/27/98"	
23a. Sample delivered to: SAMP CUST VIA RPS		23b Date 2/18/98		24. Report/Record Sent to: FOCR	
25. Laboratory/Office: LSC ___ LSE ___ CRM ___ CCA <u>X</u> Other <u>SALTZMAN</u>					
26. Remarks: Attachments: Sample collection receipt, most recent contract order documentation, brief affidavit, copy of orig. inspection and sample collection request. Please forward to Lori Saltzman, CCA. PSA request					
27. Related Samples: 97-860-6276, 98-830-3416					
28a Collector's name/title: Dennis Blasius Resident Investigator			28b Collector's signature/date: <u>Dennis E. Blasius</u> 2/17/98		
29a Reviewer's name/title:			29b Reviewer's signature/date: <u>[Signature]</u>		

114