



Federal Register

**Tuesday,
June 24, 2003**

Part II

Department of Transportation

**National Highway Traffic Safety
Administration**

**49 CFR Part 571
Federal Motor Vehicle Safety Standards;
Child Restraint Systems; Final Rule**

DEPARTMENT OF TRANSPORTATION**National Highway Traffic Safety Administration****49 CFR Part 571**

[Docket No. NHTSA-03-15351]

RIN 2127-AI34

Federal Motor Vehicle Safety Standards; Child Restraint Systems

AGENCY: National Highway Traffic Safety Administration (NHTSA), Department of Transportation.

ACTION: Final rule.

SUMMARY: This document makes a number of revisions to the Federal safety standard for child restraint systems, including amendments for incorporating improved test dummies and updated procedures used to test child restraints and extension of the standard to apply it to child restraints recommended for use by children up to 65 pounds (30 kilograms). This action strengthens the technical underpinnings of the standard and ensures that a firmer foundation is laid for possible technical improvements in the future. Child restraints will be tested using the most advanced test dummies available today and tested to conditions representing current model vehicles. This final rule fulfills the mandate of the Transportation Recall Enhancement, Accountability and Documentation Act of 2000 that the agency undertake rulemaking on the safety of child restraints.

DATES: The amendments made in this rule are effective December 22, 2003. The incorporation by reference of certain publications listed in the rule is approved by the Director of the Federal Register as of December 22, 2003. If you wish to petition for reconsideration of this rule, your petition must be received by August 8, 2003.

ADDRESSES: If you wish to petition for reconsideration of this rule, you should refer in your petition to the docket number of this document and submit your petition to: Administrator, Room 5220, National Highway Traffic Safety Administration, 400 Seventh Street SW., Washington, DC 20590.

FOR FURTHER INFORMATION CONTACT: For non-legal issues, you may call Mike Huntley of the NHTSA Office of Crashworthiness Standards, at 202-366-0029.

For legal issues, you may call Deirdre Fujita of the NHTSA Office of Chief Counsel, at 202-366-2992.

You may send mail to both of these officials at the National Highway Traffic

Safety Administration, 400 Seventh St., SW., Washington, DC 20590.

SUPPLEMENTARY INFORMATION:**Table of Contents**

- I. Executive Summary
- II. Background
- III. The TREAD Act
- IV. Responsible Regulation
- V. Response to the TREAD Act
 - a. NPRM For This Final Rule
 - b. ANPRM On Side Impact Protection
 - c. TREAD Programs on Labeling and Consumer Information
- VI. Post-NPRM Testing
- VII. Summary of Comments on the NPRM
 - a. General Comments on the Proposals
 - b. Updated Bench Seat
 - c. Crash Pulse
 - d. New Dummies
 - e. Application of the Standard
 - f. Injury Criteria
- VIII. Amendments
 - a. Updated Bench Seat
 - 1. Post-NPRM Test Program
 - i. Seat Back Rotation
 - ii. HIC Measurements
 - iii. Chest Acceleration
 - iv. Head Excursion
 - v. Knee Excursion
 - vi. Summary of PAX Testing
 - 2. Response to Comments
 - i. Seat Back and Cushion Angles
 - ii. Belt Systems On The Standard Seat Assembly
 - iii. Fixed Seat Back
 - iv. Future Work
 - b. Crash Pulse
 - 1. On Widening The Corridor
 - 2. Increase Pulse Severity
 - 3. Decrease Pulse Severity
 - c. New Dummies
 - 1. Post-NPRM Test Program
 - i. Tests With The 3-Year-Old Dummies
 - ii. Tests With The 6-Year-Old Dummies
 - 2. Commenters Generally Supportive
 - i. Hybrid III 6-Year-Old Dummy
 - ii. Weighted 6-Year-Old Dummy
 - 3. Specific Issues Relating To The Use Of The New Dummies In Standard No. 213
 - i. Seat Back Height Requirement
 - ii. Padding Requirement
 - d. Application of the Standard
 - e. Injury Criteria
 - 1. Post-NPRM Testing
 - i. JPMA
 - ii. NHTSA Series I and II
 - iii. Results of JPMA and NHTSA Series I and II
 - iv. NHTSA Series III
 - 2. Comments and Conclusions
 - i. Head Injury Criterion (HIC)
 - ii. Chest Injury Criteria
 - iii. Neck
 - f. Leadtime
- IX. Regulatory Notices and Analyses

I. Executive Summary

This document makes a number of revisions to Federal Motor Vehicle Safety Standard (FMVSS) No. 213, "Child Restraint Systems" (49 CFR 571.213). The revisions incorporate four elements into the standard: (a) An updated bench seat used to dynamically

test add-on child restraint systems; (b) a sled pulse that provides a wider test corridor; (c) improved child test dummies; and (d) expanded applicability to child restraint systems recommended for use by children weighing up to 65 pounds. This action strengthens the technical underpinnings of the standard and ensures that a firmer foundation is laid for possible technical improvements in the future. Child restraints will be tested using the most advanced test dummies available today and tested to conditions representing current model vehicles. This final rule does not adopt the scaled injury criteria developed for the occupant protection standard (FMVSS No. 208), except that the time interval used to calculate the head injury criterion is amended from an unlimited time interval to 36 milliseconds.

This final rule fulfills the mandate in the Transportation Recall Enhancement, Accountability and Documentation Act (the TREAD Act) (November 1, 2000, Pub. L. 106-414, 114 Stat. 1800) to initiate a rulemaking for the purpose of improving the safety of child restraints.¹

Section 14(a) of the TREAD Act mandated that the agency "initiate a rulemaking for the purpose of improving the safety of child restraints, including minimizing head injuries from side impact collisions." Section 14(b) identified specific elements that the agency must consider in its rulemaking. The Act gave the agency substantial discretion over the decision whether to issue a final rule on the specific elements. Section 14(c) specified that if the agency does not incorporate any element described in § 14(b) in a final rule, the agency shall explain in a report to Congress the reasons for not incorporating the element in a final rule.

In response to Section 14, the agency examined possible ways of revising and updating its child restraint standard. Today's final rule is substantially based on a combination of pre- and post-TREAD Act agency activities, including research studies of child restraints and dummies by NHTSA following issuance of the NPRM. This final rule was also developed based on extensive information provided by comments to the NPRM. Several factors relating to child restraint performance and use in this country guided the agency in its decision-making on this rulemaking, in addition to the statutory mandates

¹ It also follows up on the agency's announcement in its November 2000 Draft Child Restraint Systems Safety Plan (Docket NHTSA-7938) that the agency will be undertaking rulemaking on these and other elements of Standard No. 213 (65 FR 70687; November 27, 2000).

governing the agency's rulemaking activities. These factors are outlined in Section IV of this preamble.

The agency also issued an advance notice of proposed rulemaking (ANPRM) published concurrently with the NPRM, in which comments were sought on the agency's work on developing a possible side impact protection standard for child restraint systems. This advanced notice is discussed in Section V of today's preamble. The ANPRM announced that the agency had conducted extensive testing and analysis over the year proceeding the ANPRM to develop a possible side impact protection standard for children in child restraints but acknowledged that there are many unknowns. The agency sought comment on the suitability of the test procedures it was considering, on appropriate injury criteria for children in side impacts, on cost beneficial countermeasures, and on other issues. Additionally, after the ANPRM was published the agency evaluated possible mitigation concepts, such as adding padding material to the child restraint system. After reviewing the comments and the results of its post-ANPRM study, the agency has decided that the level and amount of effort needed to further develop and validate a side impact component for incorporation into FMVSS No. 213 far exceeds what could be accomplished within the time constraints of the TREAD Act. While an NPRM is not feasible at this time, NHTSA's research into improved side impact protection requirements for child restraints will continue as an ongoing agency program.

The updates to the seat assembly are based on studies that NHTSA contracted to have done in response to the TREAD Act. This final rule makes the following changes: the seat bottom cushion angle is increased from 8 degrees off horizontal to 15 degrees; the seat back cushion angle is increased from 15 degrees off the vertical to 20 ± 1 degrees; the spacing between the anchors of the lap belt is increased from 222 millimeters (mm) to 400 mm in the center seating position and from 356 mm to 472 mm in the outboard seating positions; and the seat back of the seat assembly is changed, from a flexible seat back to one that is fixed, to represent a typical rear seat in a passenger car.

The changes to the sled pulse are based on studies conducted in response to the TREAD Act. The test corridor is widened to make it easier for more test facilities to reproduce. The wider corridor extends the pulse from 80 milliseconds (ms) to approximately 90 ms in duration. The expanded corridor

does not reduce the stringency of the test, and makes it easier to conduct compliance tests at speeds closer to 30 mph.

This document enhances the use of test dummies in the evaluation of child restraints under Standard No. 213. NHTSA replaces most of the existing dummies with the new 12-month-old Child Restraint Air Bag Interaction (CRABI) dummy, and the state-of-the-art Hybrid III 3- and 6-year-old dummies. NHTSA also incorporates a weighted 6-year-old dummy (*i.e.*, a Hybrid III 6-year-old dummy to which weights have been added) to test the structural integrity of child restraints recommended for use by children weighing 50 to 65 lb. Incorporation of the weighted, 62 lb, dummy is viewed as an interim measure until such time as the Hybrid III 10-year-old dummy becomes available. Because the weighted dummy will be available for use in dynamic testing of child restraints for older children, this final rule extends the application of FMVSS No. 213 to child restraint systems for children who weigh 65 lb or less.

The agency has decided against adopting the scaled injury criteria developed in the context of the advanced air bag rulemaking of FMVSS No. 208. The agency was unable to confirm the existence of a safety problem that the scaled injury limits of FMVSS No. 208 would remedy. Relatedly, not enough is known about what modifications to child restraints could be made for the restraints to meet the proposed injury limits. In balancing the effects of meeting the scaled injury criteria against the possible impacts on the price of restraints, the agency determined that the scaled injury limits should not be added to FMVSS No. 213 at this time.

NHTSA has examined the benefits and costs of these amendments, wishing to adopt only those amendments that contribute to improved safety, and mindful of the principles for regulatory decisionmaking set forth in Executive Order 12866, Regulatory Planning and Review. Its efforts to do so, however, have been limited by several factors. One is the limited time allowed by the schedule specified in the TREAD Act for initiating and completing this rulemaking. That has limited the amount and variety of information that the agency could obtain and testing that the agency could conduct to examine the efficacy of possible countermeasures under consideration and the effects of the various proposed amendments on child restraint performance. The other is the lack of specific accident data on children in motor vehicle crashes

generally. For example, there is little available data on neck injury in children involved in motor vehicle crashes.

Together, these limitations have made it difficult to assess and compare the benefits and costs of this rulemaking.

The agency does not believe that updating the seat assembly and revising the crash pulse would affect dummy performance to an extent that benefits would accrue from such changes. The amendment of FMVSS No. 213 incorporating use of the new dummies in compliance tests, including testing with a weighted 6-year-old dummy, would result in a one-time cost of \$1.68 million for manufacturers to purchase the new test dummies and \$1.39 to \$3.44 million to certify existing child restraints to the new dummies and test requirements. The annual long-term costs are estimated to be \$31,200 to test new models of booster seats (including built-in restraints) with a weighted 6-year-old dummy. We believe that use of the new dummies, in itself, would not necessitate redesign of child restraints.

II. Background

Of the 31,910 passenger vehicle occupants killed in 2001, 1,003 were children ages 0 through 10 years old. Four hundred ninety-seven (497) of these were less than 5 years old. The failure to use occupant restraints is a significant factor in most fatalities resulting from motor vehicle crashes for both adults and children. Of the 31,910 passenger vehicle occupants killed in 2001, over half (55 percent) were unrestrained. Forty-six (46) percent of the 1,003 child occupant fatalities, ages 0 through 10 years old, were unrestrained. For child occupants less than 5 years old, 45 percent of the 497 fatalities were unrestrained.² In 2001, 202 child occupants under 5 years of age were killed while restrained in child restraints, and another 32,000 were injured.

NHTSA developed three strategies for reducing the number of children killed and injured in motor vehicle crashes in this country. (*See* Planning Document, 65 FR 70687; November 27, 2000; Docket NHTSA 7938.) The first of these was a strategy designed to increase restraint use among all children and to ensure that the appropriate restraint systems are used correctly. The agency

² Of the 2,787,000 passenger vehicle occupants injured in crashes in 2001, only 12 percent (324,000) were reported as unrestrained. The rates are about the same for child occupants. For children ages 0–10 years old, an estimated 147,000 were injured in motor vehicle traffic crashes in 2001, and 12 percent (18,000) of these children were unrestrained. Of the 59,000 child occupants less than 5 years of age who were injured, 11 percent (6,000) were unrestrained.

estimated that if all children ages 0–4 years old were restrained in child restraint systems, 173 lives could have been saved in 1998. Additional studies have shown that as many as 68 additional deaths to children ages 0–6 years old could be prevented each year by eliminating misuse of child restraints. The agency conducts national campaigns to educate the public about the importance of buckling children into child restraint systems.

The second strategy was to improve existing requirements for the performance and testing of child restraint systems. Since NHTSA first began regulating child safety seats in 1971, the agency has made numerous improvements to the original Federal safety standard. On a frequent basis, the agency has issued planning documents or has held public meetings on child passenger safety issues at the attention of the agency and the agency's long view of possible regulatory actions that might be taken in response. The public is invited to comment on the agency's plans. The November 2000 Planning Document announced that the agency planned to undertake rulemaking to update the bench seat and belt geometry used in Standard No. 213's compliance test, revise the crash pulse used in the test, incorporate state-of-the-art infant, 3-year-old and 6-year-old crash test dummies and child-specific injury criteria, and continue efforts working with the Society of Automotive Engineers in developing a 10-year-old child test dummy. The plan also stated that the agency would conduct research into possible side impact test requirements for child restraints and developing a test dummy appropriate for use in side impact tests. In addition, the plan announced that NHTSA would begin testing child restraints in full frontal and side impact vehicle crash tests under the agency's New Car Assessment Program.

The third strategy called for improved mechanisms for getting safety information to consumers, to increase the likelihood that child restraints would be purchased and correctly used. The agency sought to improve the information it provided to consumers, both on the performance and proper use of child restraint systems, as well as on defect investigations and safety recalls.

In November 2000, the TREAD Act was enacted. Section 14 of the TREAD Act directed NHTSA to initiate a rulemaking for the purpose of improving the safety of child restraints and included specific elements, listed below, that the agency had to consider as part of the rulemaking. Most of the elements for consideration had been

included in NHTSA's Planning Document as part of the strategy for improving the safety of child restraints. Thus, Section 14 reaffirmed the importance of the agency's planned programs for amending Standard No. 213. Nonetheless, the TREAD Act had very tight deadlines for initiating and completing the rulemaking which also defined for the agency the actions it could take and complete within those deadlines.

III. The TREAD Act

Section 14 of the TREAD Act directed NHTSA to initiate a rulemaking for the purpose of improving the safety of child restraints by November 1, 2001, and to complete it by issuing a final rule or taking other action by November 1, 2002. The relevant provisions in Section 14 are as follows:

(a) In General. Not later than 12 months after the date of enactment of this Act, the Secretary of Transportation shall initiate a rulemaking for the purpose of improving the safety of child restraints, including minimizing head injuries from side impact collisions.

(b) Elements for Consideration. In the rulemaking required by subsection (a), the Secretary shall consider—

(1) Whether to require more comprehensive tests for child restraints than the current Federal motor vehicle safety standards requires, including the use of dynamic tests that—

(A) Replicate an array of crash conditions, such as side-impact crashes and rear-impact crashes; and

(B) Reflect the designs of passenger motor vehicles as of the date of enactment of this Act;

(2) Whether to require the use of anthropomorphic test devices that—

(A) Represent a greater range of sizes of children including the need to require the use of an anthropomorphic test device that is representative of a ten-year-old child; and

(B) Are Hybrid III anthropomorphic test devices;

(3) Whether to require improved protection from head injuries in side-impact and rear-impact crashes;

(4) How to provide consumer information on the physical compatibility of child restraints and vehicle seats on a model-by-model basis;

(5) Whether to prescribe clearer and simpler labels and instructions required to be placed on child restraints;

(6) Whether to amend Federal Motor Vehicle Safety Standard No. 213 (49 CFR 571.213) to cover restraints for children weighing up to 80 pounds;

(7) Whether to establish booster seat performance and structural integrity

requirements to be dynamically tested in 3-point lap and shoulder belts;

(8) Whether to apply scaled injury criteria performance levels, including neck injury, developed for Federal Motor Vehicle Safety Standard No. 208 to child restraints and booster seats covered by in [sic] Federal Motor Vehicle Safety Standard No. 213; and

(9) Whether to include [a] child restraint in each vehicle crash tested under the New Car Assessment Program.

(c) Report to Congress. If the Secretary does not incorporate any element described in subsection (b) in the final rule, the Secretary shall explain, in a report to the Senate Committee on Commerce, Science, and Transportation and the House of Representatives Committee on Commerce submitted within 30 days after issuing the final rule, specifically why the Secretary did not incorporate any such element in the final rule.

(d) Completion. Notwithstanding any other provision of law, the Secretary shall complete the rulemaking required by subsection (a) not later than 24 months after the date of the enactment of this Act.

IV. Responsible Regulation

The agency developed its proposed and final rules responding to the TREAD Act while bearing in mind and in some cases, balancing, several compelling principles and considerations that generally come to the forefront in rulemaking in this area. These are discussed below.

(a) When used, child restraints are highly effective in reducing the likelihood of death and or serious injury in motor vehicle crashes. NHTSA estimates ("Revised Estimates of Child Restraint Effectiveness," Hertz, 1996) that for children less than one-year-old, a child restraint can reduce the risk of fatality by 71 percent when used in a passenger car and by 58 percent when used in a pickup truck, van, or sport utility vehicle (light truck). Child restraint effectiveness for children between the ages 1 to 4 years old is 54 percent in passenger cars and 59 percent in light trucks. The failure to use occupant restraints is a significant factor in most fatalities resulting from motor vehicle crashes. For child occupants less than 5 years old, 45 percent of the 497 fatalities in 2001 were unrestrained.

Over the past decade, the agency has sought to increase use of vehicle seat belt and child restraint systems. NHTSA conducts national campaigns to educate the public about the importance of buckling children into child restraint systems, supports efforts by state and

local organizations that wish to establish child safety seat fitting stations (locations within a community where parents and caregivers can learn how to install and properly use child restraints), and works with partners to train educators that can teach the public about using child restraints. If more child restraints were used, children's lives would certainly be saved in significant numbers.

If child restraints were made more effective, some lives could also possibly be saved. However, in making regulatory decisions on possible enhancements, the agency must bear in mind the consumer acceptance of cost increases to an already highly-effective item of safety equipment. Any enhancement that would significantly raise the price of the restraints could potentially have an adverse effect on the sales of this voluntarily-purchased equipment. The net effect on safety could be negative if the effect of sales losses exceeds the benefit of the improved performance of the restraints that are purchased. Thus, to maximize the total safety benefits of its efforts to extend and upgrade its restraint requirements, the agency must balance those improvements against impacts on the price of restraints. The agency must also consider the effects of improved performance on the ease of using child restraints. If the use of child restraints becomes overly complex, the twin problems of misuse and nonuse of child restraints could be exacerbated.

(b) Estimating the net effect on safety of this rulemaking, consistent with the principles for regulatory decisionmaking set forth in Executive Order 12866, Regulatory Planning and Review, was limited by several factors. One was the lack of specific accident data on children in motor vehicle crashes generally. Second, the limited time allowed by the schedule specified in the TREAD Act for initiating and completing this rulemaking limited the amount and variety of information that the agency could obtain and testing that the agency could conduct to examine the efficacy of possible countermeasures and the effects of various proposed amendments on child restraint performance. Together, these limitations made it difficult to assess and compare the benefits and costs of this rulemaking.

(c) The rulemaking schedule imposed by the TREAD Act also limited the rulemaking to elements that could be completed within the statutory schedule. The development of an anthropomorphic test device representing a 10-year-old child could not be completed within the timeframe

of the TREAD Act and so was not part of the rulemaking, notwithstanding its inclusion as an element for consideration in NHTSA's Planning Document and in Section 14 of the TREAD Act. Development of a seat cushion with different stiffness characteristics for the test seat assembly could not be completed and analyzed in time to be included in this rulemaking. Development of a side impact test procedure, injury criteria, and cost-effective countermeasures also could not be completed within the TREAD Act rulemaking schedule. Work is continuing in some of these areas. While ideally the agency would have wanted to address all related aspects of the standard, what could be accomplished in the near term was addressed and what could not but should will be pursued in the future.

V. Response to the TREAD Act

Bearing in mind the principles and considerations discussed in the previous section, the agency initiated several actions following enactment of the TREAD Act. These are summarized below.

a. NPRM for This Final Rule

On May 1, 2002 (67 FR 21806, docket 11707), the agency published a notice of proposed rulemaking (NPRM) proposing to incorporate five elements into the standard: (a) An updated bench seat used to dynamically test add-on child restraint systems; (b) a sled pulse that provides a wider test corridor; (c) improved child test dummies; (d) expanded applicability to child restraint systems recommended for use by children weighing up to 65 pounds; and (e) new or revised injury criteria to assess the dynamic performance of child restraints. The 60-day comment period provided by the NPRM on the proposals was extended an additional 30 days in response to petitions from the Juvenile Products Manufacturers Association and ARCCA, Inc. 67 FR 44416; July 2, 2002.

The proposed updates to the seat assembly were based on studies that NHTSA contracted to have done in response to the TREAD Act. The NPRM proposed the following changes: the seat bottom cushion angle would be increased from 8 degrees off horizontal to 15 degrees; the seat back cushion angle would be increased from 15 degrees off the vertical to 22 degrees; the spacing between the anchors of the lap belt would be increased from 222 millimeters (mm) to 392 mm in the center seating position and from 356 mm to 472 mm in the outboard seating positions; and the seat back of the seat assembly would be changed, from a

flexible seat back to one that is fixed, to represent a typical rear seat in a passenger car.

The agency also proposed to widen the corridor of the sled pulse to make it easier for more test facilities to reproduce. The wider corridor extends the pulse from 80 milliseconds (ms) to approximately 90 ms in duration. The agency believed that the expanded corridor would not reduce the stringency of the test, and would also make it easier to conduct compliance tests at speeds closer to 30 mph.

The NPRM proposed two initiatives toward enhancing the use of test dummies in the evaluation of child restraints under Standard No. 213. NHTSA proposed to replace some of the existing dummies with the new 12-month-old Child Restraint Air Bag Interaction (CRABI) dummy, and the state-of-the art Hybrid III 3- and 6-year-old dummies. NHTSA also proposed testing child restraints for older children with a weighted 6-year-old dummy (*i.e.*, a Hybrid III 6-year-old dummy to which weights have been added). The total weight of the dummy would be 62 lb. The agency sought to use the weighted dummy as an interim measure to test child restraints that are recommended for children weighing 50 to 65 lb, until such time as a Hybrid III 10-year-old dummy now in development becomes available.

The NPRM proposed to extend Standard No. 213 to apply to child restraint systems for children who weigh 65 lb or less. Restraints recommended for children weighing 50 to 65 lb would be tested with the weighted 6-year-old dummy.

The proposal to use the new and scaled injury criteria of Standard No. 208 was based on research that the agency had done in support of the agency's May 2000 final rule on advanced air bag technology, which amended Standard No. 208 by, among other things, adjusting the criteria and performance limits to account for motor vehicle injury risks faced by different size occupants (65 FR 30680; May 12, 2000), as well as on NCAP and sled testing done in response to the TREAD Act. The NPRM proposed to adopt the scaled Head Injury Criterion (HIC) limits from the Standard No. 208 rulemaking into Standard No. 213, as well as the chest deflection and acceleration limits. The Nij neck criterion was also proposed to be added to Standard No. 213, but without the limits on axial force.

NHTSA estimated that the proposal to use the new and scaled injury criteria of Standard No. 208 would prevent an estimated 3–5 fatalities and 5 MAIS 2–

5 non-fatal injuries for children ages 0–1 annually. In addition, the proposal would save 1 fatality and mitigate 1 MAIS 2–5 injury in the 4- to 6-year-old age group annually. The agency did not believe that updating the seat assembly and revising the crash pulse would affect dummy performance to an extent that benefits would accrue from such changes.

NHTSA did not identify countermeasures to improve child restraint performance in frontal tests that would allow child restraint manufacturers to meet the proposed neck injury criterion. Consequently, the agency was unable to estimate the costs of such countermeasures. Comments were requested on possible countermeasures and their costs. The agency believed that the proposal to use new dummies in compliance tests, including testing with a weighted 6-year-old dummy, could result in increased testing costs for manufacturers that want to certify their restraints using the tests that NHTSA will use in compliance testing. NHTSA estimated that use of the new dummies and other changes to the test procedure would add testing costs of \$2.72 million. The agency believed that those changes would not result in redesign of child restraints.

b. ANPRM On Side Impact Protection

On May 1, 2002, concurrent with the publication of the NPRM and in further response to section 14(b) of the TREAD Act, NHTSA issued an advance notice of proposed rulemaking (ANPRM) seeking public comments on the agency's work on developing near-term a possible side impact protection standard for child restraint systems. 67 FR 21836, May 1, 2002; Docket No. 02–12151.

The ANPRM primarily addressed side impact protection for children in child restraints in the following areas: (a) Determination of child injury mechanisms in side impacts, and crash characteristics associated with serious and fatal injuries to children in child restraints; (b) development of test procedures, a suitable test dummy and appropriate injury criteria; and (c) identification of cost beneficial countermeasures. Uncertainties in these areas, together with the statutory schedule for this rulemaking, made it difficult for the agency to assess and make judgments on the benefits and costs of a rulemaking on side impact protection. The ANPRM also requested comments on the appropriateness of proposing to incorporate a rear impact test procedure into FMVSS No. 213 for rear-facing child restraint systems.

The agency received approximately 17 comments on the ANPRM. Commenters expressed qualified support for NHTSA's efforts to enhance child passenger protection in side impact crashes, but were concerned about the uncertainties with respect to the three areas highlighted above. A number of commenters believed that a dynamic test should account for some degree of vehicle intrusion into the occupant compartment, which overall the tests that the agency had been considering did not.

Following publication of the ANPRM, the agency began a program of child restraint systems side impact testing that continues today, for completion in fall 2003. Some of the side impact testing in which the agency is engaged is as follows:

- Initial evaluation of mitigation concepts, such as adding padding material to the child restraint system (CRS), modifying the size of the side wings of the CRS, effect of rigid lower anchorages and additional tethering of the CRS for rear-facing CRS in a side impact.
- Initial evaluation of mitigation concepts, such as adding padding material to the child restraint, modifying the size of the side wings of the CRS, rigid lower anchorages and additional tethering of the CRS for forward-facing CRS in a side impact.

If the results from the above two evaluations are successful in reducing injury levels, NHTSA will consider conducting a test series to determine if the stiffer shoulder/upper arm area of the HIII 3-year-old dummy influences head/neck performance, as compared to the TNO Q3 dummy developed by a European test dummy manufacturer.

Upon further consideration of the comments on the ANPRM and the agency's side impact test program, we have decided not to issue an NPRM and final rule on side and rear impact protection at this time and thus are withdrawing the action. A full explanation of the agency's reasons for this decision is set forth in a report to Congress that NHTSA has issued concurrently with today's final rule.³ To summarize, the agency found that for side crashes: (a) Data are not widely available as to how children are being injured and killed in side impacts (*e.g.*, to what degree injuries are caused by intrusion of an impacting vehicle or

other object); (b) potential countermeasures for side impact intrusion have not been developed; and (c) there is not a consensus on an appropriate child test dummy and associated injury criteria for side impact testing. There was widespread support for NHTSA to monitor the progress of the International Standards Organization (ISO) to develop a harmonized side impact test procedure. A preliminary draft of an ISO side impact test procedure includes specifications for an intruding door member. However, no dummies are available at the present time whose construction is designed for side impact validation. Given the lack of an approved test device, and corresponding injury criteria, a final version of an ISO test procedure is not expected in the near future.

The level and amount of effort needed to further develop and validate the ISO side impact test procedure far exceeds what could be accomplished within the time constraints of the TREAD Act. While an NPRM is not feasible at this time, NHTSA's research into improved side impact protection requirements for child restraints will continue as an ongoing agency program.

c. TREAD Programs on Labeling and Consumer Information

Two other regulatory initiatives on child restraint systems were completed in response to Section 14 of the TREAD Act. Pursuant to § 14(b)(5) of the Act, the agency issued a final rule on October 1, 2002 (67 FR 61523, Docket 10916) on Standard No. 213's labeling and owner's manual requirements. The final rule amends the format, location, and content of some of Standard No. 213's labeling requirements to make the labels and instructions clearer and simpler.

In addition, pursuant to § 14(g) of the Act, NHTSA published a final rule establishing an ease-of-use child restraint ratings program on November 2, 2002 (*see* 67 FR 67491; November 5, 2002, Docket 01–10053). The ratings program constituted the first step toward enhancing the safety of children through a consumer information program. The program established no binding obligation on any manufacturer. Rather, it will inform consumers about the features of child restraints that make child restraints easier to use, and will evaluate each child restraint on those features.

NHTSA is also continuing an evaluation of whether to establish two complementary consumer information programs. The first would be based on child restraint dynamic performance.

³ The report is issued in response to subsection 14(c) of the TREAD Act, which directs NHTSA to explain in a report to Congress why the agency did not incorporate any element described in subsection 14(b) in a final rule.

The second would involve expanding the agency's New Car Assessment Program to include consumer information on how vehicles do in protecting child occupants. The agency will be conducting two pilot programs in these areas to assess how the agency should proceed. These programs are described in detail in a Response to Comments, Notice of Final Decision accompanying the November 5, 2002 final rule (67 FR 67448; Docket 01-10053-67).

VI. Post-NPRM Testing

The agency conducted several research projects since publication of the NPRM in an effort to assess whether the proposed changes would reduce the safety currently afforded by child restraints. NHTSA conducted three test projects, which are fully discussed in sections VIII.a.1, VIII.c.1, and VIII.e.1 of this preamble. The first test project related to the effect the revisions to the test seat assembly might have on the dynamic performance of child restraints. Dummies currently specified in FMVSS No. 213 were tested with child restraints on the revised seat assembly, and the performance of the dummies was compared to that observed in compliance tests. The second test project related to assessing any performance differences that may exist between the Hybrid II and the Hybrid III dummies. The third test project involved evaluating whether child restraints tested with the Hybrid III dummies could meet the proposed scaled HIC, chest injury limits, and Nij measures. Reports relating to these projects have been placed in the docket for this rulemaking.

VII. Summary of Comments on the NPRM

NHTSA received approximately 35 comments on the May 1, 2002 NPRM for this final rule. Commenters included child restraint manufacturers, motor vehicle manufacturers, motor vehicle dealers and other industry associations, child passenger safety consumer groups, the National Transportation Safety Board, child safety research and testing organizations, and private individuals. The Juvenile Products Manufacturers Association (JPMA) conducted a series of 80 sled tests of child restraints in response to the NPRM and included the results of the testing in its comment.

a. General Comments on the Proposals

The commenters generally expressed support for the regulatory goals of the NPRM to enhance child passenger

safety.⁴ However, many underscored concerns that the rulemaking undertaken by the agency in response to the TREAD Act could possibly indirectly cause a reduction in child passenger safety, particularly with respect to applying new (neck loading, chest deflection) and revised (scaled HIC and chest acceleration limits) injury criteria used to assess the dynamic performance of child restraints. Commenters expressing these concerns were diverse. The JPMA, representing child restraint manufacturers Britax, Cosco, Evenflo, Graco/Century, and Peg Perego, believed that NHTSA should be concerned about "unintended consequences of multiple, unevaluated changes to 213, as well as the adverse consequences of substantial cost increases." In a separate comment on the NPRM, Evenflo expressed opposition to "revisions that do not have proven likelihood of enhancing child passenger safety on an aggregate basis." Evenflo urged: "Our goal should be to adopt changes that will definitively enhance child passenger safety, not to undertake changes solely for the purpose of making changes." Graco was concerned that some portions of the proposed revisions may have little benefit to child passenger safety and may "negatively affect the past efforts of the agency." The commenter said it assumed that costs of child

⁴ Several commenters believed that the NPRM did not "meet the spirit intended by Congress" in enacting Section 14 of the TREAD Act because the estimated benefits of the proposed changes were at most 6 fatalities and 6 serious injuries annually (quote from ARCCA's comment, page 2.) Stephen Syson (Syson-Hille & Associates), Martha Bidez (Bidez & Associates) and ARCCA suggested that the agency undertake rulemaking beyond the proposals of the NPRM. Among the suggested rulemaking were the following from these commenters: the prohibition of lap belts; require manufacturers to put child-safe restraints in cars; recall all low-shield booster seats; require that Standard No. 208 (49 CFR § 571.208) criteria for children be met in every passenger seating position; require manufacturers to label vehicle seats that do not meet Standard No. 213 requirements without a child restraint in place; require that "survival space" be maintained in the rear seat in rear impact crashes; and require all seats, seat belts and child restraints be designed to prevent submarining and to retain occupants under all collision circumstances; require vehicles to provide a minimum allowable clearance for all seating positions where a child restraint system can be installed; require child restraints to provide both upper and lower body restraint on the hard boney portions of the body; amend Standard No. 213 to limit protrusions and sharp corners contactable in any crash and to improve padding on back and side wings.

The rulemakings suggested by these commenters go beyond those included in the NPRM for consideration by the agency within the tight deadlines of the act. The suggestions will be considered suggestions for future rulemaking. Copies of the comments will be placed in Docket 7938 (NHTSA plan for future work on child passenger safety).

restraints will increase "because of increased testing costs and most likely increased parts or the use of more advanced technology that will enable the restraints to meet new requirements." The commenter was concerned that, as the child restraint costs rise, the rates of child restraint use may fall.

This concern was echoed by other commenters. TraumaLink at the Children's Hospital of Philadelphia stated that data collected through its "Partners for Child Passenger Safety" study indicate that children in child restraints do extremely well in all types of crashes. "The extremely low injury rate in child restraints indicates that despite substantial misuse, these devices perform exceedingly well across the range of crash severities and directions of impact * * * It is important to consider the unintended consequences of these [proposed] changes, both in terms of inadvertent reduction in the current excellent performance of the CRS [child restraint system] or the resultant increase in cost." The National Safe Kids Campaign (Safe Kids) urged the agency "to be mindful of the practicalities and costs associated with changes that might overly burden child restraint and vehicle manufacturers, thereby requiring them to discontinue certain product models or pass on unreasonable costs to consumers. Child safety seats must remain both affordable and safe." The American Academy of Pediatrics stated, "While the Academy strongly supports the proposed measures to make child restraints even more protective than they are today, these improvements cannot come at the expense of fewer children using child restraints or more children using outdated car safety seats." The Association of International Automobile Manufacturers, Inc., expressed concern that "the lack of use or the misuse of child restraint systems presents a far greater opportunity to improve child passenger safety than seeking enhanced performance of child restraint systems, particularly if the consequence of the enhanced performance is decreased use and increased misuse."

Safe Kids also expressed concern that increased prices of child restraints could affect State child restraint use laws. Safe Kids stated that most parents and caregivers will be expected to purchase a minimum of two or three restraints for each child to comply with evolving State child restraint use laws that extend coverage to more and more children. "As those seats become more expensive, legislators may be reluctant to make important legislative

improvements to their states child restraint laws.”

b. Updated Bench Seat

There was unanimous support for amending Standard No. 213's specifications for the test seat assembly used to test child restraints in the agency's compliance tests. Almost all of the commenters believed that the test seat assembly should be more representative of the seats of newer passenger vehicles. Two commenters (Martha Bidez, Public Citizen) had an opposing view. Ms. Bidez believed that the seat assembly should either have features representing seats in the average age vehicle in the U.S. (which the commenter stated is 9 years old) or features that present the most demanding (“worst case”) conditions under which child restraints should be tested. Public Citizen suggested that the agency should adjust its testing, or create another test, that will measure the effectiveness of child restraints in older cars.

Amending the seat cushion angle by increasing it from 8 degrees off horizontal to 15 degrees was generally supported, as was amending the seat back angle by increasing it from 15 degrees off vertical to 22 degrees. Several commenters viewed these changes as aligning the bench seat more with the ECE Regulation 44 seat assembly bench and suggested that the agency completely use the ECE Regulation 44 seat dimensions.

Most commenters agreed with the proposals for amending the seat belts on the test seat assembly. Some commenters expressed concerns about certain aspects of the test seat assembly's seat belts that were not addressed by the NPRM, such as the vertical location of the lap belt anchorages.

On the other hand, commenters did not see eye-to-eye on the proposal to change the seat back to represent a fixed vehicle seat. Supporters of the change believed that a fixed seat back replicates today's seat back in passenger cars and harmonizes with the test bench setups for ECE, Canadian and Australian regulations. Some commenters were concerned that not enough was known about how fixing the seat back would affect child restraint system performance, while others opposed the proposal believing that fixing the seat back would result in a less rigorous test condition.

Several commenters responded to the NPRM's request for comments on the agency's decisions against changing, at this time the length of the bench seat's bottom seat cushion, including a floor to

the seat assembly; and changing the stiffness of the seat assembly's cushion. A number of commenters believed that the stiffness of the seat cushion has a strong effect on child restraint performance. Some commenters were uncertain whether performance would be affected and suggested that testing and research be completed before changing the foam.

c. Crash Pulse

The comments focused generally on the issues of the sled pulse shape (widening of the corridor) and severity. Many commenters agreed with the agency that widening the corridor of the sled pulse from 80 milliseconds (ms) to approximately 90 ms in duration would allow more laboratories to run the compliance test without decreasing the effectiveness of the testing. However, child restraint manufacturers expressed concern that widening the corridor will make the standard more stringent, because child restraint manufacturers will have to design products that can comply at the new extremes of the compliance corridor. These commenters also believed that a wider test corridor will necessarily lead to more lab-to-lab variability during certification and compliance testing, which, the commenters stated, increases the compliance burden on manufacturers.

ARCCA, Inc. believed that the Standard No. 213 pulse is actually less severe than all of the 30 mph barrier test pulses from actual vehicles, and that the standard's pulse severity should be increased. All other commenters did not want to increase the severity of the crash pulse. Many expressed the view that the velocity change should not be raised because the current test is already reflective of the top few percent of crashes. A number of commenters believed that the crash pulse should be reduced in severity because the most frequent crashes involving children in child restraints are those with lower crash pulse severities than the test pulse. Others believed that a relatively severe, “worst case” scenario should be replicated.

d. New Dummies

Commenters generally supported using the CRABI and Hybrid III 3-year-old dummies in Standard No. 213 compliance tests, in place of the 9-month and Hybrid II 3-year-old dummies now used by the agency. However, a number of commenters expressed concerns that the Hybrid III 6-year-old dummy's neck was too flexible for use in testing child restraints. These commenters suggested that the agency continue its use of the Hybrid II 6-year-

old dummy rather than use the Hybrid III dummy in its place. Most commenters objected to using the weighted Hybrid III 6-year-old dummy (weighted to 62 lb) to assess injury reference values in compliance tests of child restraints recommended for use by children weighing over 50 lb. Most believed that the dummy's weighting produced a dummy that was unrepresentative of a 62 lb child. Some were concerned that the weights could interfere with the proper functioning of the dummy's instrumentation. Some of these commenters suggested that the dummy should be used only to assess the structural integrity of child restraints in the standard's dynamic test, and not the capability of the restraint to limit head excursion or forces to the dummy's head, neck or chest areas.

e. Application of the Standard

Of the commenters addressing application of the standard, a majority supported increasing the weight limit contained in the “child restraint system” definition. Most of these commenters supported increasing the weight limit to 65 lb with a future increase to 80 lb upon introduction of the 10-year-old dummy. A few commenters opposed establishing 65 lb as an intermediate step in favor of amending the standard directly to 80 lb. There were also a few divergent comments on whether the agency should extend the regulation to a maximum weight beyond that of the heaviest dummy used in the standard.

f. Injury Criteria

The agency received widely divergent comments on the proposal to limit measurement of HIC to 15 milliseconds and to use the injury criteria of Standard No. 208 that were scaled for children. The Alliance, UMTRI and SafetyBeltSafe supported the use of a 15 ms limit on the head injury criterion (HIC) limit as a more realistic way to assess head and brain injury, with the lower HIC values proposed for each dummy. JPMA stated that it was willing to consider supporting a 15 ms limit (HIC 15), if the agency can undertake research to assure that there will not be unintended consequences from countermeasures needed to meet HIC 15. However, JPMA did not support the other proposed new injury criteria, including the scaled HIC values. The commenter stated that the tests of child restraints it conducted with the proposed CRABI and Hybrid III dummies produced injury reference values that exceeded the proposed limits, which the commenter said is a concern given the high level of

effectiveness of current child restraints. The commenter suggested that it might be more feasible to use the FMVSS No. 208 criteria in FMVSS No. 213 if the agency were to specify a “more realistic crash pulse for FMVSS No. 213, such as the one contained in the FMVSS No. 208 sled test.” Graco was concerned that some seats that have historically performed well in the real world and in compliance testing would fail the new criteria.

A few commenters supported while others opposed the proposals to adopt a new chest deflection criterion and to adopt the chest acceleration limits that were scaled for children and incorporated into FMVSS No. 208. JPMA, TraumaLink, UMTRI, SafetyBeltSafe and others opposed incorporation of the proposed chest deflection and reduced chest acceleration limits, because these types of injuries do not occur in children in child restraint systems. These commenters and others suggested that the agency collect data on chest deflection to establish a database that could be used to evaluate these measures more in the future.

Virtually all parties commenting on this aspect of the proposal opposed the modified Nij neck criterion (modified from the criterion in FMVSS No. 208 in that the limits on axial force were excluded). JPMA, SafetyBeltSafe, UMTRI, TraumaLink and others did not support adopting the proposed Nij criterion at this time because the relationship between the criterion and real-world injuries “under the type of loading simulated by FMVSS 213” is “not well established” (quoting UMTRI). SafetyBeltSafe believed that neither Nij as proposed nor Nij with a limit on tension should be used as a

compliance criterion unless these are proven to be useful predictors of child neck injury. The Insurance Institute for Highway Safety (IIHS) was concerned that studies of real-world crashes indicate that neck injuries due to inertial forces appear to be rare, and, the commenter stated, it is not clear how child restraints could be better designed to lower neck injury measures.

VIII. Amendments

a. Updated Bench Seat

1. Post-NPRM Test Program

As discussed in the NPRM, NHTSA had initiated a test program in response to the TREAD Act to assess seat parameters of production seats, working with the U.S. Naval Air Warfare Center Aircraft Division at Patuxent River, Maryland (PAX). PAX analyzed seat geometry data, including seat cushion angle, seat back angle, seat cushion length, seat back length, tether anchor locations, child restraint anchorage system anchor locations, and seat belt locations.

After publication of the NPRM, PAX conducted a series of dynamic tests using a revised test seat assembly that had been constructed incorporating the changes to the test seat assembly proposed in the NPRM. These tests were conducted with the dummies currently specified in FMVSS No. 213 (the newborn and TNO 9-month, and Hybrid II 3- and 6-year-old dummies), and with various types of child restraints (rear-facing infant only, rear- and forward-facing convertible, forward-facing “hybrid boosters” (a child restraint that can be used as a forward-facing restraint with harness for toddlers up to 40 lb and as a belt-positioning booster with children over 40 lb), and both backless and high-back boosters).

The results from this series of dynamic sled tests were compared to actual compliance tests that the agency had conducted to determine what effect, if any, the revisions to the test seat assembly might have on the dynamic performance of child restraints. NHTSA compared measurements taken for seat back rotation in rear-facing tests, and HIC, chest acceleration, and head and knee excursion in forward-facing tests. All of the proposed changes were simultaneously incorporated into the test seat assembly, and were not individually assessed for its effect on child restraint performance.

i. Seat Back Rotation. The effect of the revised test seat assembly on measured seat back rotation in rear-facing tests did not show a clear pattern.

Rear-facing tests were conducted using the revised test seat assembly with rear-facing infant only seats using the newborn dummy, and rear-facing convertible restraints using the newborn and Hybrid II 9-month-old dummies. In tests of rear-facing restraints, HIC and chest acceleration are not currently measured, since the newborn and 9-month-old dummies are not instrumented. Further, head and knee excursion are not measured. The only measured parameter in testing rear-facing child restraints is provided in S5.1.4 of FMVSS No. 213, which specifies that when a rear-facing child restraint is tested, the angle between the system’s back support surface for the child and the vertical shall not exceed 70°.

The seat back rotation measured in these tests is compared to the seat back rotation measured in NHTSA compliance tests of the identical child restraints in Table 1 below.

TABLE 1.—SEAT BACK ROTATION IN REAR-FACING TESTS

Child restraint	Type	Dummy	Seat back rotation (degrees) relative to vertical— Test seat assembly		Change (%)
			Existing	Revised	
Evenflo On-My-Way	Infant only ...	Newborn	43	51.5	+19.8
Century 560	Infant only ...	Newborn	46	42.5	-7.6
Evenflo On-My-Way	Infant only ...	9-month	57	53.9	-5.4
Century 560	Infant only ...	9-month	52	52.9	+1.7
Century Accel	Convertible ..	Newborn	Not tested	50.7	N/A
Century STE 2000	Convertible ..	Newborn	Not tested	40	N/A
Cosco Triad (LATCH ⁵)	Convertible ..	Newborn	Not tested	43.1	N/A
Century STE 2000	Convertible ..	9-month	42	50.6	+20.5
Cosco Touriva	Convertible ..	9-month	51	63	+23.5

⁵“LATCH” stands for “Lower Anchors and Tethers for Children,” a term that was developed by manufacturers and retailers to refer to the standardized child restraint anchorage system required by FMVSS No. 225. This preamble uses the term to describe either an FMVSS No. 225 anchorage system in a vehicle or a child seat that attaches to an FMVSS No. 225 child restraint anchorage system.

The data indicated no clear effect of the revised test seat assembly on measured seat back rotation in rear-facing tests. In tests using the newborn dummy and two different rear-facing infant-only child restraints, the seat back rotation angle increased by 19.8 percent over that measured in the comparable compliance test in one, and decreased by 7.6 percent in the other. When the same infant-only seats were tested rear facing with the 9-month-old dummy, the restraint that had previously shown increased seat back rotation with the newborn dummy decreased by 5.4 percent over that measured in the comparable compliance test, while the restraint that had shown decreased seat back rotation with the newborn dummy increased by 1.7

percent over that measured in the comparable compliance test. In all cases, the measured seat back rotation was well under the FMVSS No. 213 limit of 70°.

Tests were conducted using the revised test seat assembly on three different rear-facing convertible child restraints with the newborn dummy. In each case, the measured seat back rotation angle was well below the FMVSS No. 213 limit.

PAX also conducted tests of two different rear-facing convertible child restraints with the 9-month-old dummy using the revised test seat assembly. In each of these tests, the seat back rotation increased by at least 20 percent over that measured in the comparable FMVSS No. 213 compliance tests

conducted on the existing test seat assembly. Again, however, the rotation was within the allowable limits.

ii. HIC Measurements. Generally speaking, HIC increased in tests with the Hybrid II 3-year-old dummy, and decreased in tests with the 6-year-old.

Sled tests were conducted using the revised test seat assembly with the Hybrid II 3-year-old dummy in forward-facing convertible restraints, and in forward-facing hybrid boosters using the restraint's internal harness (in the toddler seat mode), and with the Hybrid II 6-year-old dummy in both backless and high back belt-positioning booster restraints. The HIC measured in these tests is compared to the HIC measured in NHTSA compliance tests of the same model child restraints in Table 2 below.

TABLE 2.—HIC IN TESTS OF FORWARD-FACING CHILD RESTRAINTS

Child restraint	Type	Dummy (Hybrid II)	HIC ₁₅ Test seat assembly		Change (%)
			Existing	Revised	
Cosco Touriva	Convertible	3-year	500	703	+40.6
Century Accel	Convertible	3-year	480	627	+30.5
Century Breverra	Hybrid Booster	3-year	659	670	+1.6
Cosco High Back Booster	Hybrid Booster	3-year	535	446	-16.6
Cosco Grand Explorer	Backless BPB	6-year	438	267	-39.0
Cosco Grand Explorer	Backless BPB	6-year	438	328	-25.1
Century Breverra	High-back BPB	6-year	308	209	-32.0
Cosco High Back Booster	High-back BPB	6-year	399	381	-4.6

The effect of the revised seat assembly on HIC measurements appear to be varied, and largely dependent on the dummy used in the testing. In three of four tests conducted with the 3-year-old dummy, the measured HIC was higher using the revised test seat assembly as compared to compliance tests performed on the existing test seat assembly. This includes both tests conducted using forward-facing convertible restraints, and one of two tests using a forward-facing hybrid booster with its internal harness system.

However, in each of four tests conducted with the 6-year-old dummy, two each with backless boosters and high back boosters, the measured HIC was lower than in the identical compliance tests conducted on the existing test seat assembly. Overall, some measurements differed by as much as ± 40 percent between tests conducted on the two different test seat assemblies. All HIC measurements were well within the existing limit of 1000.

iii. Chest Acceleration. Chest acceleration measurements were

recorded using the Hybrid II 3- and 6-year-old dummies in the same series of tests outlined in Table 2 above. Table 3 details the recorded chest acceleration in these tests as well as the comparable compliance tests of the identical child restraints. The measured chest accelerations decreased in each of the tests using the 3-year-old dummy in the revised test seat assembly. The measured chest accelerations generally increased in tests using the 6-year-old dummy in the revised test seat assembly.

TABLE 3.—CHEST ACCELERATION IN TESTS OF FORWARD-FACING CHILD RESTRAINTS

Child restraint	Type	Dummy (Hybrid II)	Chest acceleration (g)—Test seat assembly		Change (%)
			Existing	Revised	
Cosco Touriva	Convertible	3-year-old	42	40.4	-3.8
Century Accel	Convertible	3-year-old	46	26.8	-41.7
Century Breverra	Hybrid Booster	3-year-old	40	29.2	-27.0
Cosco High Back Booster	Hybrid Booster	3-year-old	44	41.6	-5.5
Cosco Grand Explorer	Backless BPB	6-year-old	44	49.2	+11.8
Cosco Grand Explorer	Backless BPB	6-year-old	44	38.6	-12.3
Century Breverra	High-back BPB	6-year-old	33	35.1	+6.4
Cosco High Back Booster	High-back BPB	6-year-old	40	42.4	+5.5

All chest acceleration measurements recorded were well within the current limit of 60 g's maximum. It is noted, however, that while most chest acceleration measurements were comparable in magnitude between the two test seat assemblies, there was one test in which the measured values differed by 42 percent for the same child

restraint. *iv. Head Excursion.* It is not evident whether use of the revised test seat assembly will have a positive or negative effect on measured head excursion.

In the tests outlined in Tables 2 and 3, *supra*, head excursion was measured. In addition, head excursion was measured in sled tests performed with

the TNO 9-month-old dummy on two different forward-facing convertible restraints. Head excursion was compared to the head excursion measured in compliance tests of the identical child restraints using the same dummies. Table 4 provides this comparison.

TABLE 4.—HEAD EXCURSION IN TESTS OF FORWARD-FACING CHILD RESTRAINTS

Child restraint	Type	Dummy (Hybrid II)	Head excursion (mm)— Test seat assembly		Change (%)
			Existing	Revised	
Cosco Touriva	Convertible	9-month-old	432	434	+0.6
Century Accel	Convertible	9-month-old	483	396	-17.9
Cosco Touriva	Convertible	3-year-old ..	660	498	-24.6
Century Accel	Convertible	3-year-old ..	635	495	-22.0
Century Breverra	Hybrid Booster	3-year-old ..	483	572	+18.4
Cosco High Back Booster	Hybrid Booster	3-year-old ..	432	572	+32.4
Cosco Grand Explorer	Backless Booster	6-year-old ..	381	363	-4.7
Cosco Grand Explorer	Backless Booster	6-year-old ..	381	457	+20.0
Century Breverra	High-back Booster	6-year-old ..	457	500	+9.4
Cosco High Back Booster	High-back Booster	6-year-old ..	432	447	+3.5

In three of four tests conducted using forward-facing convertible child restraints, a decrease in head excursion was observed in tests using the revised test seat assembly. However, in tests conducted on the revised seat assembly using forward-facing hybrid boosters, backless and high back belt-positioning booster seats, a marginal increase in head excursion was observed. All measured head excursions, on the existing and revised test seat assemblies,

were well within the established 813 mm limit prescribed in FMVSS No. 213.⁶

v. Knee Excursion. For the tests of forward-facing child restraints outlined in Table 4 above, NHTSA also measured the dummy's knee excursion. These results were compared to the knee excursion measured in compliance tests of the identical child restraints using the same dummies. The knee excursion measurements did not demonstrate a

direct correlation between tests conducted with the revised test seat assembly versus the existing test seat assembly, or with the type of child restraint used or the test dummy used. Table 5 presents the results. As with the other injury criteria discussed above, all knee excursion measurements were well within the established 915 mm limit prescribed in FMVSS No. 213.

TABLE 5.—KNEE EXCURSION IN TESTS OF FORWARD-FACING CHILD RESTRAINTS

Child restraint	Type	Dummy (Hybrid II)	Knee excursion (mm)— Test seat assembly		Change (%)
			Existing	Revised	
Cosco Touriva	Convertible	9-month-old	483	546	+13.2
Century Accel	Convertible	9-month-old	559	485	-13.2
Cosco Touriva	Convertible	3-year-old ..	813	671	-17.5
Century Accel	Convertible	3-year-old ..	762	681	-10.7
Century Breverra	Hybrid Booster	3-year-old ..	584	696	+19.1
Cosco High Back Booster	Hybrid Booster	3-year-old ..	635	660	+4.0
Cosco Grand Explorer	Backless Booster	6-year-old ..	686	610	-11.1
Cosco Grand Explorer	Backless Booster	6-year-old ..	686	653	-4.8
Century Breverra	High-back Booster	6-year-old ..	610	500	-17.9
Cosco High Back Booster	High-back Booster	6-year-old ..	686	701	+2.2

vi. Summary of PAX Testing. Overall, while differences were seen in tests using identical child restraints on the existing versus the revised test seat assembly, NHTSA did not identify any specific trends along specified parameters, *i.e.*, child restraint type, dummy, *etc.* All of the measured injury

criteria in the tests were well within the established limits of FMVSS No. 213. This leads the agency to conclude that the changes to the standard test seat assembly will not have a significant effect on compliance test results of child restraint systems that meet the current requirements of the standard.

Manufacturers will not need to redesign their restraints due to the changes in the seat assembly.

2. Response to Comments

There was unanimous support for amending Standard No. 213's specifications for the test seat assembly

⁶Excursions are measured from Point Z identified in Figure 1B of FMVSS No. 213, which is located

in the same place on both the existing and revised test seat assemblies.

used to test child restraints in the agency's compliance tests. Almost all of the commenters believed that the test seat assembly should be more representative of the seats of newer passenger vehicles.

i. Seat Back and Cushion Angles.

Amending the seat cushion angle by increasing it from 8 degrees off horizontal to 15 degrees was generally supported. Several commenters viewed these changes as aligning the bench seat more with the ECE Regulation 44 seat assembly bench. Ford believed that the proposed change to the seat cushion angle would help make rigid attachment LATCH infant seats commercially viable in the U.S., and would help facilitate the use of infant restraints by reducing the need for consumers to add towels or pool noodles as spacers under the restraints. Ms. Bidez and Public Citizen opposed the proposed change to the seat cushion angle, stating that seat cushion angle should represent the average angle of a 9-year-old vehicle, not a new vehicle. Ms. Bidez stated that older seat cushions are more horizontal and do not contain any anti-submarining structural components.

The agency has decided to revise the seat cushion angle as proposed. Increasing seat cushion angle from 8 degrees off horizontal to 15 degrees will make the seat assembly more representative of currently manufactured vehicle seats and will reduce or eliminate the need for supplementary devices, such as rolled towels or swimming noodles, now being used with infant seats to compensate for the difference in seat cushion angle of the current seat assembly and new vehicle seats. The agency does not agree with Ms. Bidez and Public Citizen that the seat assembly should be representative of seats in 9-year-old vehicles. Such a rearward-looking approach ensures the obsolescence of the standard, since seats in the vehicle fleet are already in the process of being replaced by the seats of more modern design.

UMTRI expressed concern that tests of child restraints on a seat assembly with a seat cushion at the proposed 15 degree angle to horizontal generally resulted in decreased head excursion values of about two inches and increased chest accelerations by an average of 4 g. UMTRI suggested reducing the allowable head excursion limit in Standard No. 213 by two inches to compensate for the change. JPMA disagreed with UMTRI's comment that the head excursion limit should be changed, stating its belief that there is no difference in safety since the reference point from which head

excursion is measured is unchanged.

JPMA further stated that—

the fact that the increased angle allows the child's head to travel a longer distance in the real world will permit the manufacturers to utilize that additional movement to manage some of the crash energy without making other, perhaps less desirable, changes to other restraint parameters. For example, the harness system could include measures and/or devices to add energy absorption similar to vehicle retractor torsional load limiters, which were implemented with air bags as a means to reduce chest compression. Such devices require that a small amount of additional head excursion be permitted in the real world to achieve a longer ride-down and take advantage of the vehicle's 'crumple zone.' * * *

The agency does not agree that testing on the new seat assembly will result in across-the-board reductions in dummy head excursions as compared to head excursions of dummies tested on the current assembly. It is not evident from the agency's test data that use of the revised test seat assembly will have a positive or negative effect on measured head excursion. Table 4, supra, provides test results comparing head excursion measurements in a total of 10 tests using the revised test seat assembly and using the existing test seat assembly (compliance test results). These tests were conducted using (1) the 9-month-old dummy in two different forward-facing convertible restraints, (2) the 3-year-old dummy in two forward-facing convertible restraints and two forward-facing hybrid booster restraints, and (3) the 6-year-old dummy in two backless boosters and in two high back belt-positioning boosters. In three of four tests conducted using forward-facing convertible child restraints, a decrease in head excursion was observed in tests using the revised test seat assembly. However, in tests conducted on the revised seat assembly using forward-facing hybrid boosters, backless and high back belt-positioning booster seats, a marginal increase in head excursion was observed.

While differences of up to +32.4 percent and -24.6 percent were measured in tests using the revised and existing test seat assemblies, there was no distinctive trend across dummy or child restraint types. Thus, the agency cannot conclude that the new seat assembly necessarily results in a less rigorous test of a child restraint's ability to limit head excursion as compared to the existing seat assembly. Further, all measured head excursions on the existing and revised test seat assemblies in NHTSA's program were well within the established 813 mm limit prescribed in FMVSS No. 213. Thus, the agency does not believe that there has been a

showing of a safety need to reduce the head excursion limit to take account of the effect of testing on the new test assembly.

In response to JPMA's comment about increased head excursion benefiting overall child restraint performance due to increased "ride down" of crash forces, the agency agrees that generally speaking, increased ride down can help reduce head, neck and chest accelerations. However, increased ride down obviously must not come at the cost of increased risk of head impacts due to excessive head excursions in a crash. Thus, the agency does not concur with any implication that head excursions beyond what is permitted by Standard No. 213 is acceptable. The agency is concerned that child restraints that might meet the head excursion requirements of the standard when tested on the new test seat assembly might allow excessive head excursion when used in actual vehicles whose seat cushions are more like the current seat assembly. The agency asks the public for help in monitoring this situation and providing information of a real world problem should one occur. If there are unreasonable excessive head excursions due to child restraints being used on vehicle seats that are flatter than the revised seat assembly, reducing the head excursion limit of the standard will be considered by the agency.

Amending the seat back angle by increasing it from 15° off vertical to 22° was widely supported. Several commenters viewed these changes as aligning the bench seat more with the ECE Regulation 44 seat assembly bench, which has a seat back angle of 20 ± 1°. In response to commenters and in further consideration of the agency's efforts to harmonize its standards where possible, the agency amends the seat back angle by increasing it to 20 ± 1° to make it consistent with the test seat assembly of ECE Regulation 44. The agency believes that the difference between 22° and 20 ± 1° is negligible and should have no significant effect on child restraint performance.

ii. Belt Systems On The Standard Seat Assembly. The commenters generally agreed with the proposals for amending the seat belts on the test seat assembly. Almost all of the commenters supported increasing the spacing between the anchors of the lap belt from 222 millimeters (mm) to 392 mm in the center seating position and from 356 mm to 472 mm in the outboard seating positions. JPMA stated that it does not object to the proposal, but noted that the potential effect in side impact testing is unknown. Ms. Bidez suggested that the anchors should be set not at an averaged

spacing but at the maximum anchorage spacing "now allowed" for vehicle manufacturers in any seat position.

This final rule adopts the proposals, except the spacing between the anchors of the lap belt in the center seating position will be 400 mm, rather than 392 mm as proposed. The agency believes that the 8 mm difference between 400 and 392 mm is negligible, yet the 400 mm specification will make the spacing identical to that of the test seat assembly of ECE Regulation 44, so it is adopted. The lap belt anchorage spacing in the outboard seating position is revised to 472 mm, as proposed. (The ECE regulation specifies a spacing of 400 mm for both lap only tests and lap/shoulder tests. The agency cannot conclude that the difference between 472 mm and 400 mm is insignificant, so the agency is not adopting the ECE specification.) In response to Ms. Bidez, the Federal motor vehicle safety standards specify a minimum spacing for the anchorages, not a maximum. As to setting the anchorages at the maximum spacing that the agency has measured in its test program, the agency declines this suggestion. The agency does not have sufficient information to form the basis for a conclusion that a safety need exists to set the anchorages at the widest spacing observed on a vehicle seat. Further, setting the anchorages at the maximum spacing was not proposed in the NPRM or evaluated in the agency's test program at PAX River.

A few commenters expressed some concerns about certain aspects of the test seat assembly's seat belts that were not addressed by the NPRM. GM, the Alliance, and ARCCA, Incorporated (ARCCA), stated that the seat belt lower anchors for both the center and outboard seating configurations do not represent typical anchorage locations found on new vehicles. As stated by the Alliance, "The lap belt anchorages are too far back and too low and the lower anchors for the outboard seat are too high to represent a typical rear seat." GM and the Alliance also believed that the current two-piece lap and shoulder belt should be replaced with a three-point continuous loop shoulder/lap belt with a simulated retractor. Ford suggested that, to improve reproducibility of test results, the standard should specify a "reasonably tight" tolerance of $8\% \pm 1\%$ elongation at 10,000 N for the belt webbing used on the standard test bench.

The agency did not pursue revising the fore-and-aft and vertical placement of the seat belt anchorages in response to the TREAD Act. This was due in part to the short deadlines of the TREAD

Act. In addition, information from a 1994 test program indicated an absence of a need to change those anchorage locations. In 1994, the agency explored locating lap and shoulder belt anchorages on the standard seat assembly in a test program supporting rulemaking amending FMVSS No. 213 to facilitate the production of belt-positioning booster seats. The agency found that the fore-aft and vertical placement of the lap belt had a negligible effect on the performance of the child restraints evaluated in the program. 59 FR 37167, 37171; July 21, 1994. Nonetheless, in that rulemaking the agency placed the inboard anchor to reflect the location of the average condition identified by the research. The agency believes that those fore-aft and vertical locations are still sufficiently representative of current vehicles so as to provide a true and thorough evaluation of a child restraint's performance in a crash.

Given agency resources and rulemaking priorities, NHTSA does not anticipate exploring in the near future whether the fore-aft and vertical placement of the lap belt anchorages should be changed, or whether the current two-piece lap and shoulder belt should be replaced with a three-point continuous loop lap/shoulder belt with a simulated retractor. Our assessment of the safety need for such a rulemaking could change, if new information arises that indicates that these issues should be explored.

In response to the issue raised by Ford, the elongation of the standard belt webbing used in FMVSS No. 213's compliance test was not discussed in the NPRM. It should be noted that specifying elongation of the webbing was addressed by NHTSA in the July 21, 1994 final rule on belt-positioning boosters (59 FR at 37171). Under current FMVSS No. 213 test procedures, NHTSA tests child restraint systems using webbing that is typical of that installed in vehicles. NHTSA obtains webbing material from seat belt suppliers. These suppliers also furnish vehicle manufacturers with the webbing used in motor vehicles. This aspect of the compliance test increases the likelihood that the belts used to attach child restraints to the standard seat assembly are those that will actually be used by consumers to attach the restraints to their vehicle seats.

The belt webbing is required by FMVSS No. 209 (S4.2(c)) to meet elongation requirements. Ford believed that the elongation allowed by that standard is too varied ("from zero to twenty percent for a lap belt, * * * up to 30 percent for the pelvic portion of

a lap/shoulder belt, and * * * up to 40 percent for the upper torso portion of a lap/shoulder belt. Such a large permitted variation in choice of belt webbing elongation could markedly affect FMVSS 213 dynamic test results.") Ford did not provide data substantiating that differences in test results were obtained that were attributed to the use of webbing with different elongation characteristics. The agency also cannot conclude that testing with webbing with a "tight tolerance" of 8 percent, as Ford suggested, is preferable over testing with webbing with a larger tolerance, e.g., closer to the 30 or 40 percent limit. Given agency resources and priorities, the agency can not conclude that a need exists to initiate rulemaking on this aspect of FMVSS No. 213 in the near future.

iii. Fixed Seat Back. Commenters did not see eye-to-eye on the proposal to change the seat back to represent a fixed vehicle seat. Graco, TraumaLink, the Alliance, Safekids, Evenflo, JPMA and Xportation supported the proposal. JPMA stated that a fixed seat back replicates today's motor vehicle seat back and harmonizes with the test bench setups for ECE, Canadian and Australian regulations. Xportation said that it did not believe that motion of seat backs in vans is significant to the performance of child restraints. On the other hand, General Motors agreed with the proposal that a fixed seat back would be more representative of the rear seat of today's passenger cars, but expressed concern that a fixed back would not be representative of free-standing seats in vans and other multipurpose passenger vehicles. GM believed that it was unclear how fixing the seat back would affect child restraint system performance and suggested that NHTSA should study the issue.

Advocates and Ms. Bidez expressed concern that changing to a rigid seat back may result in a less rigorous test condition, even though, the commenter believed, "many children will be seated in seats with flexible seat backs." ARCCA believed that the configuration that results in the more severe test of a child restraint should be selected.

In an effort to assure that the proposed fixed seatback configuration does not pose a less stringent test condition for dynamic tests of child restraints than the existing flexible seatback, NHTSA conducted a series of rigid versus flexible seatback tests at the agency's Vehicle Research and Test Center (VRTC) on September 23-27, 2002. The proposed seatback and seat base angles were used.

Six pairs of tests using rigid and flexible seatbacks were conducted using

the CRABI-12-month, and the Hybrid III 3- and 6-year-old dummies in rear- and forward-facing seat configurations, all with lap or lap and shoulder belt attachments (a top tether was not used). Charts providing plots of the normalized injury criteria measurements from these tests for HIC, chest acceleration and head and knee excursions are provided in the document titled, "Comparison of Flexible and Rigid Seat Backs—FMVSS No. 213 Test Assembly," which has been placed in the docket.

The CRABI 12-month-old dummy was tested in a rear-facing infant-only child restraint with both the rigid and the flexible seat backs. Charts A and B of the aforementioned document provide plots of the normalized injury criteria measurements from these tests for HIC and chest acceleration. There are no established head and knee excursion limits for rear-facing child restraints.

The Hybrid III 3-year-old dummy was tested in three forward-facing child restraints—a 5-point harness, an overhead shield, and a shield-type booster with the shield in place—using both the rigid and flexible seat backs as in the tests with the CRABI dummy. Charts C through K provide plots of the normalized injury criteria measurements from these tests for HIC, chest acceleration, head and knee excursion.

Similar tests were conducted using the Hybrid III 6-year-old dummy in both a backless belt-positioning booster and in a high-back belt-positioning booster seat. The plots of the normalized injury criteria measurements are provided in Charts L through Q of the document.

In each of the tested configurations (e.g., 3-year-old dummy in an overhead shield convertible restraint), only one set of rigid versus flexible comparison tests was run. As such, the data used to evaluate the effects of the seat back are limited at best. The data were inconclusive as to whether a rigid seat back represents a less vigorous test. Review of the data indicates that, in some cases, the move to a rigid seat back resulted in a reduction in measured dummy response (lower HIC and chest g's for the 3-year-old dummy in overhead shield convertible). However, other cases show increases in dummy response when the rigid seat back is used (higher HIC for 3-year-old dummy in 5-point harness convertible, shield booster; also for 6-year-old dummy in backless belt-positioning booster). Importantly, NHTSA notes that where differences in performance were noted for a particular injury criteria in a tested configuration, those differences were typically very small. Furthermore, in nearly each instance, results for both the

rigid and the flexible configurations were within a 20 percent compliance margin indicating a level of performance that is well within the established limits.

Based on the above data, NHTSA concludes that any differences seen between testing conducted with a rigid versus a flexible seat back would be minimal, and therefore, a move to a rigid seat back would not represent a less stringent test for child restraints. Further, the agency notes that there are more passenger cars (with rigid seat backs) than vans and multipurpose vehicles (with more flexible seat backs) in the existing vehicle fleet. As such, the move to a rigid seat back would more closely represent the existing vehicles on the road. The rigid seat back, on balance, will not be a less stringent requirement, and that it will allow child restraint performance optimization more representative of the vehicle fleet. In addition, a rigid seat back further harmonizes the standard's test seat assembly with ECE Regulation 44, which specifies a rigid seat back in testing child restraints to that standard. For the above reasons, NHTSA is adopting the rigid seat back as proposed in the NPRM.

Figure 1A of FMVSS No. 213 is revised to reflect the above changes, as is the drawing package of the seat assembly that is incorporated by reference into the standard. (This final rule makes a technical amendment to 49 CFR 571.5 to provide information on obtaining copies of the drawing package).

iv. Future Work. The agency tentatively decided in the NPRM that certain features of the bench seat need not be changed because they either reflected the design of production seats or are different but the difference was deemed not to have an effect on child restraint performance in dynamic testing.

Seat Cushion Length: NHTSA found that the current FMVSS No. 213 seat assembly has a seat pan length that is about 50 mm longer than the average seat pan length observed in today's vehicle fleet. The agency did not believe that the difference was significant. Commenters Consumers Union, Ms. Bidez, SafetyBeltSafe and ARCCA believed that the agency should consider shortening the length of the seat cushion to reflect a more demanding test condition. Ford commented that the current seat cushion is about the same length as a typical rear seat cushion, but suggested that the support for the seat cushion be extended to more realistically support the front edge of the cushion.

NHTSA continues to believe that the length of the seat cushion of the standard seat assembly need not be changed, as it closely reflects production seats and because there is no information indicating that the difference in seat cushion length may affect child restraint performance on the seat. In addition, in view of the time constraints of the TREAD Act, NHTSA did not assess seat cushion support. However, the agency does not believe that seat support is critical. While some existing passenger cars will likely have a seat cushion that is supported more fully toward the leading edge of the cushion, vans and SUVs with bench-type seats that are removable or foldable, or individual seats such as "Captains Chairs" typically found in the second row of seating positions, will likely have much less support toward the leading edge of the seat cushion than in passenger cars. The agency does not anticipate undertaking efforts to evaluate which of these conditions would provide a more stringent test.

Test Bench Floor: Graco and Ford indicated support for the addition of a floor onto the test bench for testing or rating⁷ child restraints. NHTSA does not believe that the standard seat assembly needs a floor because child restraints must meet the requirements of FMVSS No. 213 when attached to the seat assembly by use of the seat belts and LATCH system, without use of supplemental floor braces or other attachments. The commenters also suggest that an agency consumer information program rating the performance of child restraints should utilize all features with which the restraint is equipped, including those that are optional, *i.e.*, that are not necessary for the restraint to meet Standard No. 213. The agency will consider the suggestion when developing its upcoming consumer information pilot programs relating to child restraint performance.

Seat Cushion Stiffness: The question of the stiffness of the seat cushion attracted most of the comments relating to features of the seat assembly that the NPRM did not propose to change. The NPRM stated that the agency was interested in increasing the stiffness of the cushion, but was uncertain what differences, if any, could be seen in

⁷ Section 14(g) of the TREAD Act directed NHTSA to establish a child restraint safety ratings program. The agency has established an ease of use ratings program and will be conducting pilot programs on possible ratings programs geared toward rating child restraint performance in sled tests and vehicle performance in frontal vehicle crash tests. 67 FR 67491 (November 5, 2002) (Docket 02-10053).

dynamic testing. Comments were requested on what the stiffness should be (67 FR at 21812).

Several commenters believed that the stiffness of the seat cushion has a strong effect on child restraint performance. Consumers Union (CU) commented that it believed that cushion stiffness plays a major role in child restraint installation and suggested that further tests and analysis were needed. UMTRI expressed concern that the foam of the present test seat assembly is softer than many seats in the current fleet: "Instead of representing a worst-case scenario, the response of the soft foam and its tendency to bottom-out on to the unrealistically stiff plywood backing can lead to misleading results that can reduce the level of child passenger safety." Ms. Bidez believed that cushion stiffness has a critical influence on child restraint performance relative to head excursion. These commenters did not provide supporting data.

Some commenters were uncertain whether performance would be affected. JPMA stated that it conducted a small group of tests to evaluate the effect of foam in the tests, but the results "yielded more questions than it answered." Without elaborating on its statement, JPMA provided data from a test program it conducted on foam that was 4 inches thick with a 25 percent compression/deflection resistance of 49.5 lb.⁸ The effect on the performance of test dummies in various types of child restraints was varied. JPMA stated that it did not believe that there is yet enough information to evaluate what the foam firmness and density should be, or how child restraint performance would be affected by changing the foam. In its own comment, Graco also expressed that it was unsure of how performance would be affected and suggested that testing and research be completed before changing the foam.

Commenters had different views as to how the seat cushion foam should be changed. JPMA expressed cautious support for changing the foam to resemble more closely the foam thickness and compression of rear seats in real-world automobiles. UMTRI suggested that the agency characterize the overall seat stiffness of several modern vehicles and select a foam stiffness that matches a mean response.

⁸The foam in the current seat assembly is thicker and softer than the foam tested by JPMA. The foam in the current seat assembly is 6 inches thick. Two pieces of foam (one 2 inches and one 4 inches) may be used to achieve the required dimension. To be suitable for compliance testing, foam inserts must compress 25 percent under the following load limits: (1) 45–55 pounds for the 2-inch thick foam, and (2) 21–27 pounds for the 4-inch thick foam.

Ford stated that current rear seats are typically thinner and firmer than the test bench seat cushion. Ms. Bidez believed that the test cushion must reflect the softer seats of the majority of used vehicles on the road today. ARCCA believed that the seat cushion in Standard No. 213 may be too thick to match the vehicle seats, thereby allowing more deflection before becoming stiffer. The commenter suggested that the standard "should err on the side of a softer cushion which will likely result in increased occupant excursion * * *."

After reviewing the comments and considering the agency's research needs and limited resources, NHTSA has decided not to endeavor at this time to change the stiffness of the standard seat assembly's seat cushion foam. As discussed in the NPRM, NHTSA is aware of data that indicate that the stiffness of the seat assembly cushion might not have a marked effect on child restraint performance. The agency conducted a study in 1988 comparing the stiffness characteristics of the seat assembly cushion with the characteristics of then current seats. 67 FR at 21812. Most vehicle seats were stiffer than the FMVSS No. 213 seat assembly. Sled tests were performed in the study to compare the dummy responses of the standard's seat cushion, a representative seat cushion that was softer, and a stiff cushion. The agency concluded that dummy response differences were not sufficiently large or consistent to warrant specifying a different cushion than that used in the current test seat assembly. Because possibly revising this parameter of the seat assembly would require further research, utilizing scarce agency resources, for disproportionate safety benefits, the agency will not pursue changing seat cushion stiffness for the time being.

Harmonize With Transport Canada: Several commenters concurred with the NPRM that the proposed changes to the test seat assembly would advance harmonization with ECE Regulation 44 in that the seat cushion and seat back angles would be similar, as would the lateral spacing of the seat belt anchors and the rigidity of the seat back. However, the Alliance, General Motors and Evenflo noted that the test bench would differ from that used by Transport Canada in testing child restraints to the Canadian child restraint standard. These commenters urged NHTSA to work with Transport Canada to ensure that the test benches are harmonized.

NHTSA regularly coordinates its vehicle safety plans and programs with

Transport Canada and the agencies work closely on regulatory initiatives concerning child restraint safety. Harmonizing the countries' requirements to the extent consistent with the safety needs of each country is a goal shared by both entities. Specifically with respect to the TREAD Act, NHTSA has discussed each of the revisions with Transport Canada. Transport Canada is aware of the changes, and the agencies will continue efforts to harmonize regulations to the extent possible.

b. Crash Pulse

The comments received on this aspect of the NPRM focused generally on the issues of the sled pulse shape (widening of the corridor) and severity.⁹

1. On Widening the Corridor

As for widening the corridor of the sled pulse from 80 milliseconds (ms) to approximately 90 ms in duration, all but few of the commenters responding to this issue supported the change. Many agreed with the agency that the change would allow more laboratories to run the compliance test "without decreasing the effectiveness of the testing" (quoting UMTRI). SafetyBeltSafe (SBS) also agreed with NHTSA's assessment, explained in the preamble to the NPRM, that the pulse would enable tests to be conducted closer to 30 mph.

The JPMA and Graco did not support revising the corridor. JPMA stated that widening the corridor necessarily makes the standard more stringent, because child restraint manufacturers will have to design products that can comply at the new extremes of the compliance corridor. The commenter stated that difficulties experienced by test labs in fitting their pulses within the existing corridor "should be addressed by insisting that the test labs figure out how to meet the existing test corridor."

⁹Ford was concerned that the proposed pulse only specified sled movement during the first 90 ms, but limited dummy responses for 300 ms. Ford stated: "Braking of a Hyge sled can have a substantial effect on dummy kinematics and readings during rebound. Hyge sled tests are generally considered to be unrealistic during the rebound phase because of sled braking. If the agency believes that it is essential to limit dummy measurements during rebound, and the agency plans to use a Hyge-type sled for audit testing, sled accelerations between 90 and 300 ms should be limited to specify an objective test pulse." The agency does not agree that sled braking has caused objectivity problems in the past. The FMVSS No. 208 sled test (see Figure 6 of that standard) specifies a sled corridor only to 130 ms, but at least 300 ms of data is collected in measuring injury criteria. There have not been any problems with the effect of the braking of Hyge sleds on dummy kinematics and readings during rebound. Accordingly, the agency is not specifying a pulse corridor between 90 and 300 ms.

JPMA and Graco believed that a wider test corridor will necessarily lead to more lab-to-lab variability during certification and compliance testing, which, the commenters stated, increases the compliance burden on manufacturers. JPMA stated that the agency did not provide data on the effect of the different crash pulse with the new bench seat, and believed that the agency must assess the effect of a wider sled pulse corridor on child restraint compliance.

The agency responds by concurring that the revision to the pulse could affect the manufacture of child restraints. Widening the test corridor from 80 ms to approximately 90 ms in duration does enable NHTSA to test child restraints closer to 30 mph than the present. To the extent that the 30 mph tests are more stringent than tests conducted in the past at slightly lower speeds, that result is a desired outcome of the amendment. Widening the corridor improves the effectiveness of the test. Child restraint manufacturers will have to certify that their child restraints meet the requirements of FMVSS No. 213 when tested using the test pulse, possibly at a higher velocity. They may have to conduct some testing to ensure that the restraints can be certified to the requirements when

tested in the more effective manner using this pulse. The agency acknowledged in the NPRM the likely need for manufacturers to retest their restraints because of the new seat assembly and, by implication, due to the changes to the crash pulse (67 FR at 21829). However, the agency believed then and continues to do so now that it is unlikely that child restraints must be redesigned because of the change in the assembly and pulse.¹⁰ Restraints are generally manufactured with enough of a compliance margin that will allow them to meet the requirements of the standard when tested at a slightly higher velocity.

To illustrate, NHTSA examined some of the work that was performed in support of the development of the child restraint ratings program required under Section 14(g) of the TREAD Act. As part of this effort, the agency examined the margin by which existing child restraints meet the injury limits currently specified in FMVSS No. 213. In model year 2000, the agency tested 50 upright, forward-facing child restraints in accordance under the agency's

¹⁰Note that the agency is not specifying a "new" crash pulse. Rather, the final rule puts a corridor specification around the existing pulse which allows the agency to conduct compliance tests at velocities closer to 30 mph.

FMVSS No. 213 compliance test program. Twenty-four (24) seats were tested without a top tether, and 26 seats were tested with a top tether. We secured all seats with only a lap belt (no lower anchorages or shoulder belts). Currently, to pass the FMVSS No. 213 compliance test, a child restraint must achieve dummy injury numbers of a HIC less than 1,000 and a resultant chest acceleration of less than 60 G's. As shown below in Figure 1, regardless of whether we equipped the child restraints with a top tether, all child restraints achieved dummy injury readings below the maximum allowable values. Figures 2 and 3 illustrate the margin of compliance for HIC and chest acceleration, respectively. The margin of compliance is one minus the measured injury reading divided by the injury assessment reference value (IARV) times 100. Higher percentages are better, having less probability of injury. Regarding the HIC, all model year 2000 child restraints tested easily fall within the limits specified by the FMVSS No. 213 compliance tests. Most had a compliance margin of more than 50%. Although the margin is not as large for chest acceleration, all tested child restraints passed this compliance requirement as well.

BILLING CODE 4910-59-P

Figure 1

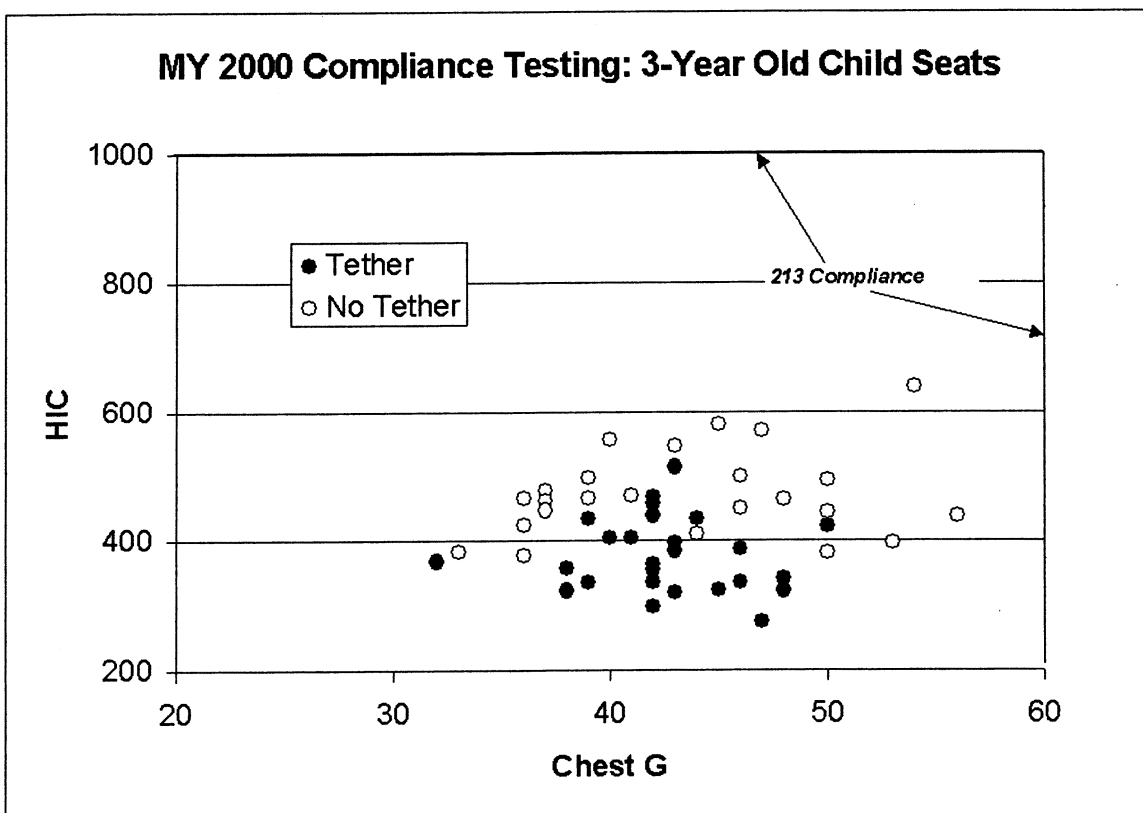

Figure 2: HIC Compliance Margins

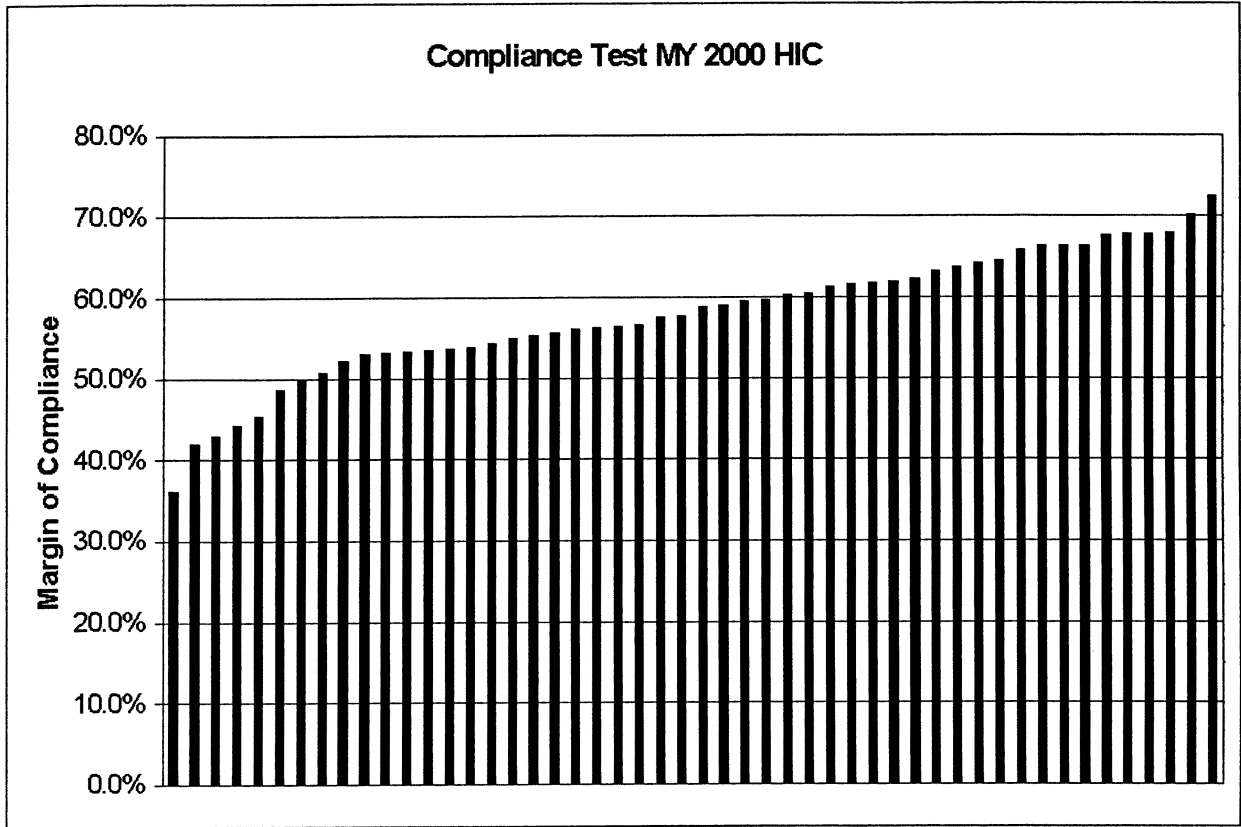
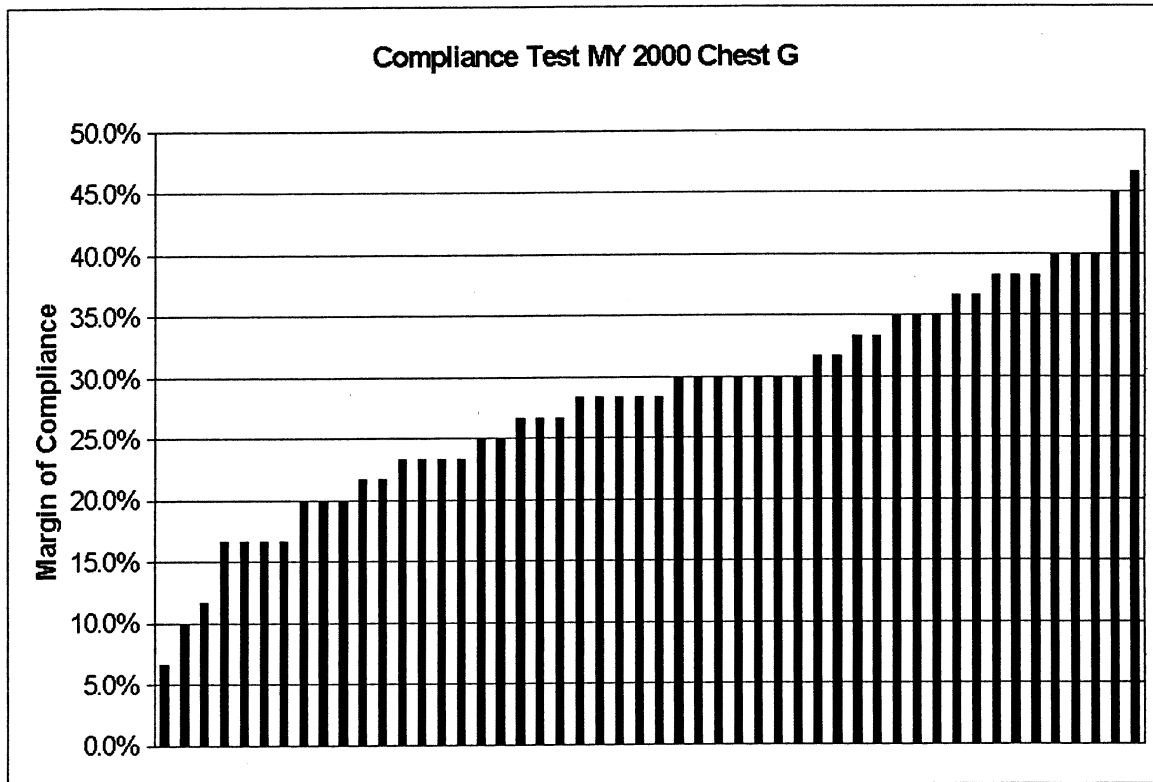

Figure 3: Chest G Compliance Margins**BILLING CODE 4910-59-C**

FMVSS. No. 213 also has a requirement for head and knee excursions. Head excursion is limited to 720 mm (28 in) when a top tether is used, and 813 mm (32 in) without use of a top tether. Knee excursion is limited to 915 mm (36 in). Figures 4 and

5 below illustrate the margin of compliance for head excursion and knee excursion, respectively. Head and knee excursion limits are compliance limits imposed to reduce the chances of a child striking the vehicle interior or submarining (sliding under the belt feet first) in an automotive crash. Head and

knee excursions are much closer to the compliance limits than HIC and chest acceleration. This may reflect attention to occupant protection, since increases in distance traveled by the occupant reduces the forces experienced by the occupant.

BILLING CODE 4910-59-P

Figure 4: Head Excursion

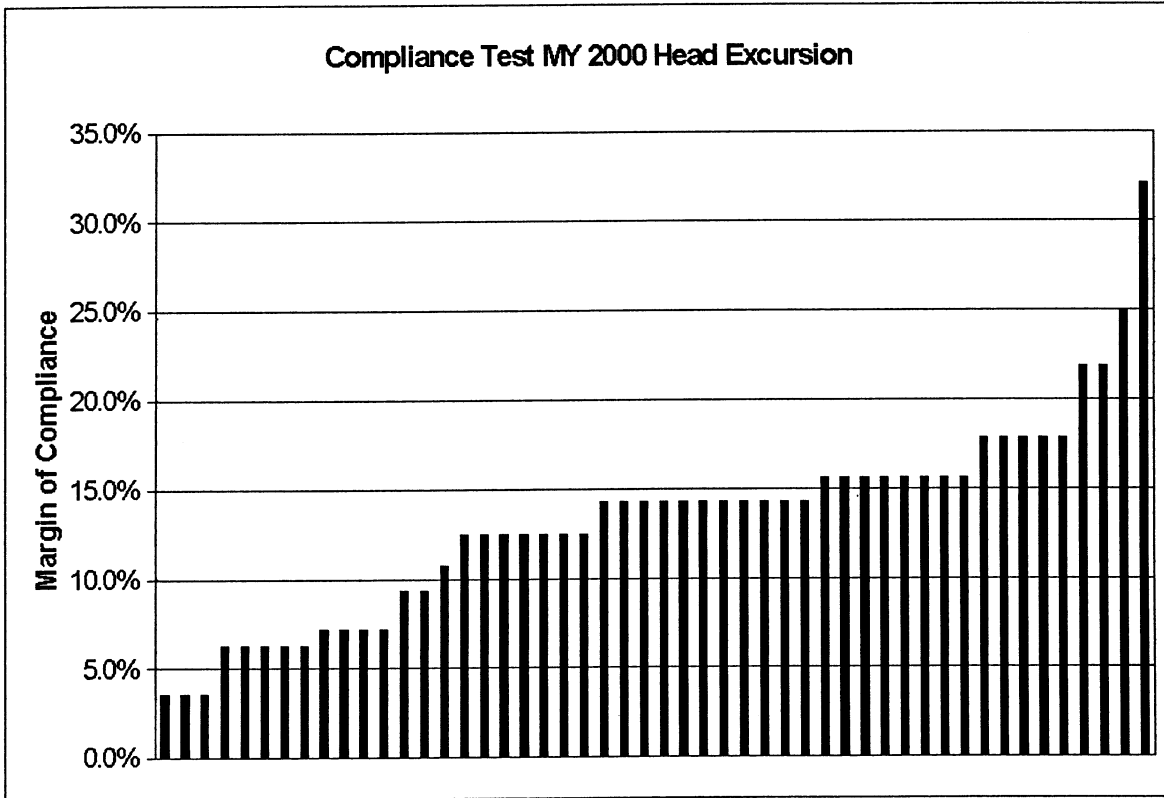
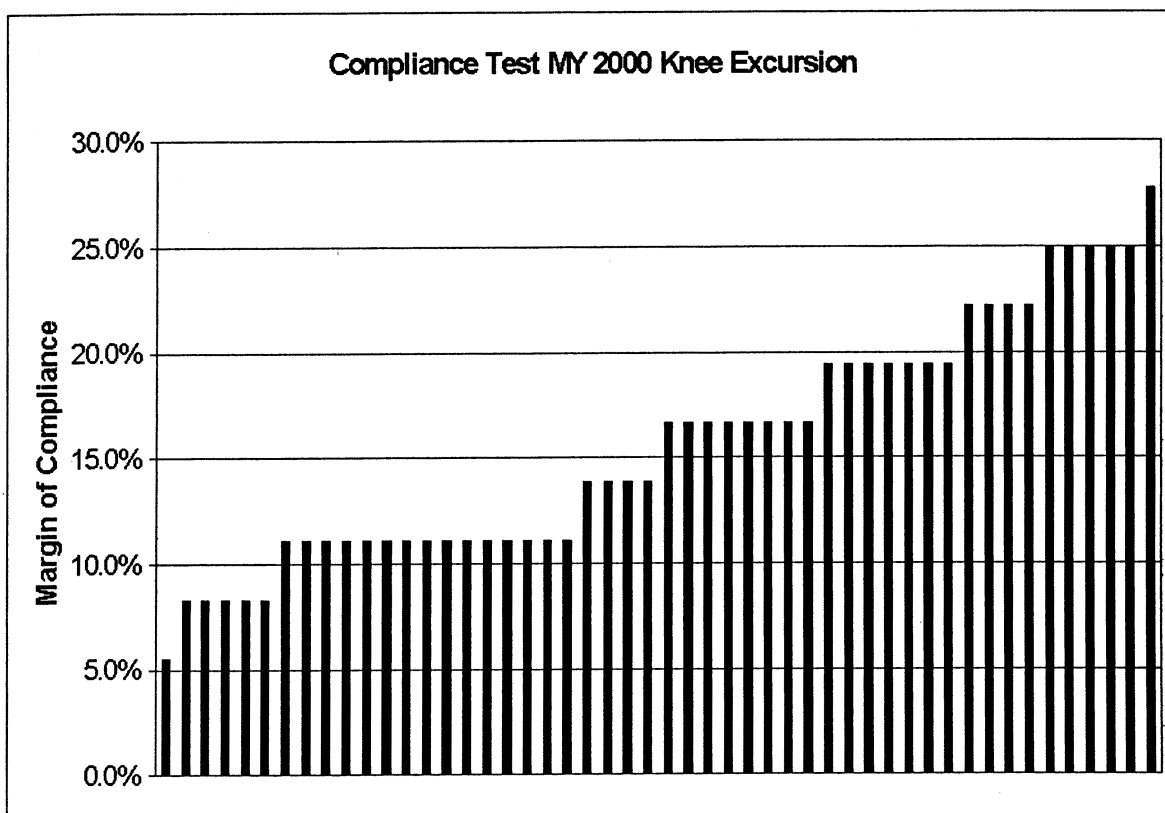

Figure 5: Knee Excursion

proposed corridor in the NPRM.” ARCCA stated:

This minimum acceleration level should be high enough to ensure that a child restraint will offer acceptable performance and be capable of remaining structurally intact. Testing performed by one auto manufacturer in a minivan demonstrated that various child restraints structurally failed in 30 mile per hour sled testing using the vehicle’s barrier crash pulse. By setting a high minimum peak acceleration, confidence can be gained in the ability of a child seat to remain structurally intact and protect a child no matter in what vehicle it is installed.

ARCCA suggested that the agency specify in Standard No. 213 that the test pulse must fall within a specific corridor and must have a velocity of at least 30 mph and a peak acceleration of at least some predetermined value. ARCCA believed that that acceleration value should be based on the values obtained from barrier crash tests and be greater than the majority of all FMVSS No. 208 tests reported. ARCCA was also concerned about how the values presented in Table 4 of the NPRM were calculated, especially the peak g values. The commenter believed that the values in the NPRM were erroneously based on “average pulses” *i.e.* point-by-point averaging of the pulse data to form a single curve for a class of vehicles. ARCCA stated that the problem with this method is that when pulses with peaks at different times are combined, the resulting peak is less than either of the pulses averaged. “This is due to the fact that the crash pulses are out of phase. This is similar to the principle used in noise cancellation devices, when two waves are superimposed the magnitude of the resulting pulse is less.”

The agency does not agree with ARCCA that the standard’s pulse is deficient and should be increased. The pulse is representative of a severe crash and subjects child restraints to “worst case” testing in a sufficient manner. The severity of a crash pulse is determined through a combination of three factors: the acceleration onset rate, the peak acceleration, and the time duration of the pulse. The data presented in the PAX report are based on FMVSS No. 208 rigid barrier testing at 30 mph impact speed (approximately 32 mph total change in velocity, ΔV) and New Car Assessment Program (NCAP) rigid barrier testing at 35 mph (approximately 37 mph ΔV).

The FMVSS No. 213 pulse was very similar to the pulses generated by sport utility vehicles (SUVs), trucks and small school buses in an FMVSS No. 208 (32 mph ΔV) crash test. NHTSA believes that the pulse should be severe enough

to be adequately representative of these vehicles since child restraints are regularly and increasingly used in these types of vehicles. That is, the stringency of the pulse is justified to better ensure that each child restraint will not have structural degradation in a crash and will limit forces to the child’s head, neck and torso to tolerable levels, no matter the vehicle the child is in.

ARCCA was correct that the agency had averaged the pulses for the three classes of vehicles (SUVs, trucks and a small school bus) to develop a composite pulse for each vehicle class, and that the composite pulses had peak acceleration levels that are typically lower than the highest peak accelerations measured in the individual tests. However, the averaged pulses allowed the agency to examine general trends with respect to the crash parameters that determine the performance of vehicles in a crash. As such, they are representative of the pulses of vehicles in which child restraints are likely to be used and provide a reasonable foundation upon which the standard’s pulse can be based. Further, the agency is unaware of the testing to which ARCCA referred that allegedly demonstrated “that various child restraints structurally failed in 30 mile per hour sled testing using the vehicle’s barrier crash pulse.” To the contrary, child restraints have proven very effective in real world crashes and have performed well in the agency’s studies of child restraint performance in vehicles tested in NCAP 35-mph frontal crashes.

ARCCA suggested that the standard specify that the dynamic test will be conducted at velocities of not less than 30 mph. This specification is unnecessary, since the standard currently requires the dynamic tests to be frontal barrier impact simulations “at a velocity change of 48 km/h [30 mph] with the acceleration of the test platform entirely within the curve shown in Figure 2 * * *.” Thus, the agency already conducts the dynamic test at velocities as close as possible to 30 mph without exceeding 30 mph or causing the pulse to fall outside of the curve of Figure 2 of the standard.

ARCCA believed that the velocity of the sled test should be increased from 30 mph to 33 mph to replicate the change in velocity typically seen in a 208 barrier test. “For the 213 pulse to be near the 30 mph barrier test the velocity, acceleration and duration would all have to be increased.” The commenter also believed that, since “well-restrained adult occupants are capable of surviving crashes comparable to a 35 mph barrier crash where the

change in velocity is closer to 40 mph,” tests of child restraints should be performed at the levels specified by the agency in testing vehicles in the New Car Assessment Program.

In contrast, all other commenters except ARCCA commenting on this issue did not want to increase the severity of the crash pulse. SafetyBeltSafe (SBS) believed that the velocity change should not be raised to 33 mph because “the current test is already reflective of the top few percent of crashes.” SBS stated that increasing the velocity “will not significantly improve child restraint performance in the real world but will surely make the products more expensive.” Graco stated that if the pulse were increased to 33 mph, it would expect a large number of child restraints needing to be redesigned with “minimal benefit to child passenger safety.” UMTRI stated that the change in velocity for the test should remain at 30 mph, stating that it conducted a recent analysis of National Automotive Sampling System (NASS) data from 1995–2000 which showed that a 30 mph change in velocity is more severe than approximately 98 percent of the frontal impact crashes nationwide. UMTRI further noted that since the NASS database only includes tow-away crashes, “this is a conservative estimate of the percentage of frontal impacts that are less severe than 30 mph.” UMTRI was concerned that increasing the velocity of the test is not likely to increase safety, but will increase consumer cost of child restraints and may lead to child restraint designs that could make the restraints less effective or more easily misused at lower severity crashes, “which occur much more frequently.” The Insurance Institute for Highway Safety (IIHS) stated that its review of NASS cases showed that child restraints designed to pass the current 30 mph sled test are providing very good protection to children in frontal crashes. IIHS also stated, “There was no indication, based on an analysis of injuries, crash description, and photos in these 10 frontal crashes that designing child restraints to withstand higher crash forces could have prevented or mitigated any of the serious or fatal injuries.”

NHTSA concurs with these comments that the standard’s crash pulse adequately meets a safety need. Increasing the severity could necessitate the redesign of many child restraints and could increase costs of the restraints to manufacturers, without a proportionate safety benefit. Thus, the agency concludes that the pulse should not be made more severe at this time.

3. Decrease Pulse Severity

While there was almost unanimous agreement among commenters that the crash pulse should not be increased, commenters expressed opposing opinions on whether the severity of the test pulse should be decreased. The crash pulse is more severe than most other pulses, but is similar to crash pulses of large sport utility vehicles and light trucks (passenger vehicles that are becoming more and more popular for use as family vehicles) and very similar to the crash pulse of small school buses. The agency determined in the NPRM that the crash pulse should maintain its level of stringency so as to replicate vehicle crashes involving vehicles that had relatively severe crash pulses. Some commenters disagreed, believing that the crash pulse should be reduced in severity because the most frequent crashes involving children in child restraints are those with lower crash pulse severities than the test pulse, while others agreed that a relatively severe, "worst case" scenario should be replicated.

In support of reducing the severity of the crash pulse, the Alliance of Automobile Manufacturers (Alliance) stated that the current sled pulse represents—

an extremely rare "worst case" [(e.g., a stiff vehicle hitting a full-width non-deformable wall at high speed)]. As a result the addition of the new dummies/injury criteria coupled with this unrepresentative test pulse may create significantly unintended consequences such as reduced availability and increased costs of compliant restraints as well as the addition of features that may make them more cumbersome and less user friendly. All of which will reduce their use in the real world.

The Alliance stated that an attachment it submitted with its comment contains an analysis comparing the severity (acceleration pulses) of full frontal barrier crashes with vehicle-to-vehicle crash tests. "In this analysis a 30 mph full frontal barrier test is found equivalent to a 41 mph vehicle-to-vehicle crash. A reduced speed of 22 mph for full frontal rigid barrier test is found to represent vehicle-to-vehicle crashes with 50%–100% overlap, with each vehicle traveling at 30 mph."

Along the same lines, General Motors (GM) believed that the crash pulse should represent the most frequent collision event. The commenter urged

research to define the real world collision speeds and deceleration pulses at which the majority of the harm to children occurs. GM believed that increasing the pulse duration and widening the corridor increases the pulse severity somewhat, and coupling this increase with the use of the new test dummies and injury criteria "could make compliance more difficult." GM suggested that NHTSA consider using the FMVSS No. 208 generic sled pulse if the final rule adopts the Hybrid III test dummies and injury measures proposed in the NPRM.

The Children's Hospital of Philadelphia (TraumaLink) supported altering the pulse to be more representative of the passenger car environment to "make it more relevant to a larger proportion of the real-world crash-involved population." The commenter stated that out of the 59,968 children studied in TraumaLink's Partners for Child Passenger Safety study, only 24.1 percent of children were riding in SUV's and light trucks.

In contrast, in support of the agency's decision not to reduce the severity of the crash pulse, Advocates for Highway and Auto Safety (Advocates) believed that although cars remain more numerous in the vehicle fleet, use of an LTV crash pulse is representative of real-world crash experience given that increasing numbers of LTVs have entered the fleet and are frequently used as passenger and family vehicles. The commenter also discussed why it believed the crash pulse should replicate the "worst case" scenario over the "most frequent" or "average" crash:

Although Advocates has urged the agency to update its test procedures in certain respects to ensure that they are representative of the modern vehicle fleet, this does not mean that critical test procedures should mirror the attributes or test the performance of only the "average" vehicle. While test procedures should be representative of the vehicle fleet in many respects, not all tests or test procedures should be based on the most common or average vehicle in the fleet. To ensure safety protection for all vehicle occupants, critical aspects of test procedures should replicate more stringent conditions than would be experienced in the average vehicle. This is especially true when only one test and a single set of test conditions are used as the basis for compliance. Thus, although there are still more cars than LTVs on U.S. highways, and even though more children are injured while riding in cars than are injured while riding in LTVs, the FMVSS 213 sled test should replicate the faster

acceleration onset rate and higher peak acceleration exerted in an SUV crash pulse. Of the two, the LTV crash pulse presents the more stringent test condition. Using the LTV-like crash pulse ensures that children exposed to such a severe force, as well as children exposed to less severe conditions in cars, will be afforded protection. The reverse, however, is not true. If FMVSS 213 adopted a car-like sled test crash pulse, children in cars may be protected but that same degree of safety would not necessarily be provided to children in LTVs with "stiffer" frames that transfer more of the crash generated energy to the occupants. As a result, Advocates concurs in the agency's judgment that the existing FMVSS 213 crash pulse be retained.

After reviewing all the comments on this issue, NHTSA has decided to retain the current severity of the pulse and not reduce it. The agency concurs with Advocates that to ensure safety protection for as many child occupants as possible, "critical aspects of test procedures should replicate more stringent conditions than would be experienced in the average vehicle," and that, given that child restraints are used with a wide range of vehicle types and are involved in crashes of varying degrees of severity, such a critical aspect is the sled pulse. Accordingly, the agency declines to replicate the crash conditions of the most frequent collision event.

GM suggested that NHTSA consider using the FMVSS No. 208 generic sled pulse if this final rule adopts the Hybrid III test dummies and injury measures proposed in the NPRM. As discussed later in this preamble, this final rule adopts the Hybrid III test dummies but does not adopt the majority of the injury measures proposed in the NPRM. Nonetheless, the agency makes the following observations about the suggestion to use the FMVSS No. 208 generic sled pulse. The generic sled pulse is less severe than the FMVSS No. 213 pulse. As shown in the following overlay of the existing FMVSS No. 213 pulse with the FMVSS No. 208 generic sled pulse, the former has a greater onset rate, higher peak acceleration and shorter time duration. Further, the FMVSS No. 208 sled pulse, with a peak acceleration of about 17 g's, is less stringent than most 30 mph passenger vehicle crashes. Because the FMVSS No. 208 sled pulse is less severe than the FMVSS No. 213 pulse, this final rule declines the suggestion to adopt it.

BILLING CODE 4910-59-P

Federal Motor Vehicle Safety Standard 213 vs FMVSS 208

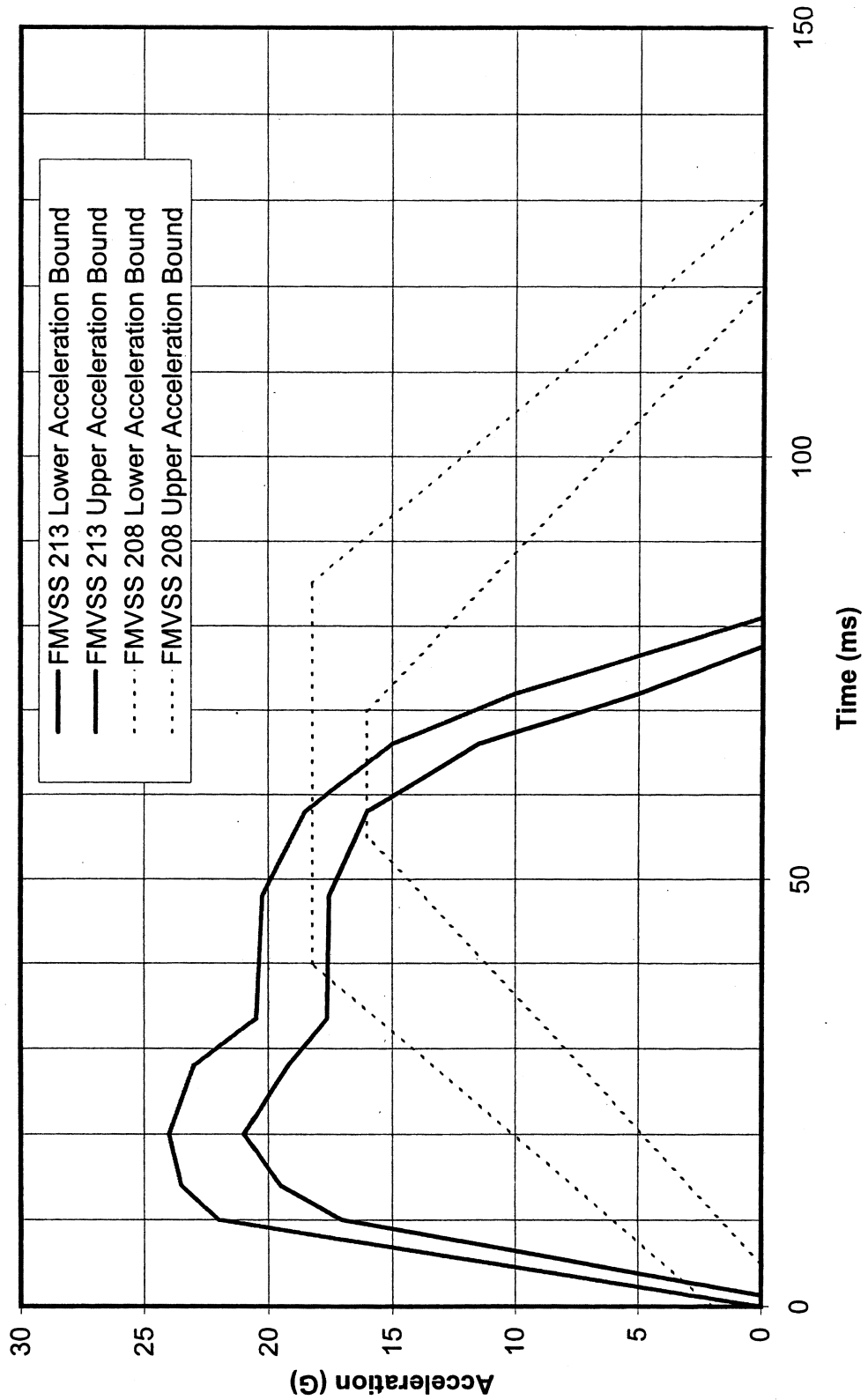

c. New Dummies

1. Post-NPRM Test Program

As part of the test program conducted for NHTSA at the Patuxent River (PAX) test center, PAX conducted a series of dynamic sled tests to evaluate identical child restraints on the revised test seat assembly using both the Hybrid II and the Hybrid III 3- and 6-year-old

dummies. All of these tests were conducted with the restraints attached to the test seat assembly with the lap belt only, as would be done in a compliance test. Similar comparison tests were conducted with the Hybrid II 9-month-old and the CRABI 12-month-old dummy, but as the 9-month-old dummy is uninstrumented, little

comparative information was gleaned from these tests. Accordingly, the data from the latter tests are not provided.

i. Tests With The 3-Year-Old Dummies. The following Table 6 illustrates the injury criteria measurements for the test series using the Hybrid II and Hybrid III 3-year-old dummies:

TABLE 6.—TESTS WITH THE HYBRID II AND HYBRID III 3-YEAR-OLDS

Child restraint	Dummy	HIC _{unlimited}		Chest acceleration		Head excursion		Knee excursion	
		Value	Change	Value	Change	Value	Change	Value	Change
Cosco Touriva	Hybrid II	702.8		40.4		19.6		26.4	
	Hybrid III	446.8	-256	37.6	-2.8	15.5	-4.1	26.4	0
Century Accel	Hybrid II	626.5		26.8		19.5		26.8	
	Hybrid III	355.3	-271.3	36.1	+9.3	19.9	+0.4	25.2	-1.6
Century Breverra	Hybrid II	669.7		29.2		22.5		27.4	
	Hybrid III	536.8	-132.9	50.1	+20.9	21.3	-1.2	29.1	+1.7
Cosco HB Booster	Hybrid II	446.4		41.6		22.5		26	
	Hybrid III	704.9	+258.5	41.6	0	13.4	-9.1	22.4	-3.6

The Cosco Touriva and the Century Accel are both forward-facing convertible child restraints, and the Century Breverra and the Cosco High Back Booster are forward-facing hybrid boosters. All were tested with the dummy in the restraint's internal harness system.

The results from this series of testing appear to be mixed. Three of four tests showed a marked decrease in measured HIC values when testing with the Hybrid III dummy as compared to the

Hybrid II dummy, while the fourth test in the series resulted in a significant increase (446.4 to 704.9) in HIC values. Similar results are seen when looking at chest acceleration and head and knee excursions. The varied results can be attributable in part to the very limited sample size of child restraints tested. No repeatability tests were performed. All injury numbers were well within the current limits prescribed in FMVSS No. 213.

ii. Tests With The 6-Year-Old Dummies. A similar series of tests was conducted with the Hybrid II and Hybrid III 6-year-old dummies in both backless and high back belt-positioning booster seats on the revised test seat assembly. As was the case in tests with the 3-year-old dummies, the test results for the 6-year-old dummies show considerable fluctuation and no clear trends.

The following Table 7 outlines the results of these tests:

TABLE 7.—TESTS WITH THE HYBRID II AND HYBRID III 6-YEAR-OLDS

Child restraint	Dummy	HIC		Chest acceleration		Head excursion		Knee excursion	
		Value	Change	Value	Change	Value	Change	Value	Change
Cosco Gr. Explorer	Hybrid II	267.1		49.2		14.3		24	
Evenflo Right Fit	Hybrid III	357.6	+90.5	37.8	-11.4	11.7	-2.6	19.6	-4.4
Cosco Gr. Explorer	Hybrid II	328.2		38.6		18		25.7	
Evenflo Right Fit	Hybrid III	276.2	-52	36	-2.6	19.1	+1.1	21	-4.7
Century Breverra	Hybrid II	209.4		35.1		19.7		19.7	
	Hybrid III	415.7	+206.3	41.4	+6.3	20	+0.3	11.7	-8.0
Cosco HB Booster	Hybrid II	380.7		42.4		17.6		27.6	
	Hybrid III	756.1	+375.4	38.3	-4.1	18.4	+0.8	24	-3.2

The original test matrix called for testing each restraint with both the Hybrid II and the Hybrid III 6-year-olds to facilitate a direct comparison between the two dummies, as was done for the other dummies. However, during the conduct of the sled tests at PAX, the Cosco Grand Explorer was instead inadvertently tested twice with the Hybrid II 6-year-old, and the Evenflo Right Fit was tested twice with the Hybrid III 6-year-old.

NHTSA acknowledges that this makes a direct comparison between the two

dummies in the same restraint impossible. However, unlike rear-facing infant seats and forward-facing toddler seats, there is very little difference in design characteristics between the two backless booster seats in question that would influence the dynamic response of the dummies in a sled test. As such, NHTSA has included the data for information.

Further, it is noted that VRTC conducted a study comparing the performance between the Hybrid II and the Hybrid III child dummy families in

support of the NPRM for this final rule. (See Docket NHTSA-2002-11707-1; report dated April 12, 2002.) The report concluded in part that sled test results generally show fairly consistent dummy performance with the Hybrid II and Hybrid III child dummies.

2. Commenters Generally Supportive

Commenters generally supported using the CRABI 12-month-old and the Hybrid III 3-year-old dummies in Standard No. 213 compliance tests, in place of the TNO 9-month and the

Hybrid II 3-year-old dummies now used by the agency. There was support for the use of the Hybrid III 6-year-old dummy in compliance tests, with the exception of a few commenters (discussed below). There was general concern about the need for and capabilities of the weighted Hybrid III 6-year-old dummy.

i. Hybrid III 6-Year-Old Dummy.

Several commenters expressed concern about the biofidelity of the unweighted Hybrid III (HIII) 6-year-old dummy's neck and hips and the suitability of the dummy for use in testing child restraints. TraumaLink stated that, based on a sled test program it conducted at a test lab, they had "significant concerns" regarding the performance of the dummy. "The tests revealed extremely large neck elongation unlikely to be seen in real children in real crashes and resulted in high calculated injury values. These results suggest a pattern of injuries that we do not see in our real world experience."

SafetyBeltSafe referred to the tests performed by TraumaLink to conclude that "We do not now believe that the HIII 6-year-old dummy is an appropriate test device to simulate a restrained child" because of "unrealistic stretching and bending of this dummy's neck while tightly restrained by a lap-shoulder belt in a booster. The result was that the dummy's face directly contacted the chest, generating an unrealistic and unacceptably high HIC." SafetyBeltSafe also stated that test data from NHTSA's Vehicle Research and Test Center indicated that tests with the dummy generated "[head] excursion increases of from 2.1 to 4.5 inches in a booster with lap-shoulder belt. The likely reason for this is that the neck is not a true Hybrid III type neck, as it lacks the metal disks needed to limit its bending." The commenter was also concerned about the dummy's "permanently flexed hips, which, unlike the new 10-year-old design, do not allow a slouched position and may inhibit submarining in non-optimal booster designs."

Ford Motor Company likewise stated that the Hybrid III dummies are much more likely to experience head-to-knee contacts than Hybrid II dummies, because of the more flexible ribs and neck of the HIII dummies. Further, Ford said that a 1984 study (Culver *et al.*) showed that adult HIII dummy HIC readings were about twice those recorded in dummy head to cadaver knee impacts. Further, Ford stated that because the HIII 6-year-old dummy does not have the metal plates that segment and limit bending of the necks of the HIII adult dummies, the HIII 6-year-old

dummy may be more likely to experience head-to-leg contacts than "the three-year-old." Ford asked in its comment how the agency would treat head acceleration spikes that could be caused by head-to-knee contacts. The commenter also suggested that load cells be used on the ASIS of the pelvis of the 6-year-old dummy to evaluate the tendency to submarining under the lap belt during testing of booster seats, because, Ford stated without elaborating, the current limit on knee excursion is not an effective way to limit submarining in tests of belt-positioning boosters.

NHTSA disagrees with the commenters that the HIII 6-year-old dummy should not be used in FMVSS No. 213 testing. The neck of the HIII 6-year-old is currently performing within the specifications established by the Hybrid III Dummy Family Task Force of the Society of Automotive Engineers (SAE). The agency is not aware of specific test information and/or data substantiating the claims of the commenters that the dummy is an unsuitable test device for FMVSS No. 213 testing.

When the dummy was incorporated into the regulation on anthropomorphic test devices, 49 CFR part 572, the agency made the following determinations (65 FR 2059) about the dummy:

Based on NHTSA's use of the H-III6C 6-year-old dummy in calibration tests and in frontal impact tests involving restraints such as air bags and belts, we have concluded that this dummy is suitable for both research and compliance safety assessments. The dummy is not only considerably more biofidelic than its predecessor, the part 572 subpart I 6-year-old dummy, but it also has considerably more extensive instrumentation to measure impact responses such as forces, accelerations, moments, and deflections in conducting tests to evaluate vehicle occupant protection systems.

The agency continues to believe that the performance of child restraint systems will be more thoroughly and precisely assessed by use of the HIII dummy because of the dummy's enhanced biofidelity and extensive instrumentation. With regard to concerns about the dummy's neck, it should be noted that the Hybrid II dummy currently in use also does not have the metal disks. Since the Hybrid III is more biomechanically based, we continue to believe that it provides a more humanlike response than the Hybrid II version of the dummy.

Sled tests have shown the HIII 6-year-old to be a suitable replacement for the existing HII 6-year-old in FMVSS No. 213 compliance tests. None of the sled

testing conducted with the HIII 6-year-old dummy at VRTC or PAX in support of the TREAD Act has indicated that head-to-chest or head-to-knee impacts is an issue. Such impacts are not typical.¹¹ NHTSA believes that if head-to-knee contact occurs, there are likely design concerns with respect to the particular child restraint that should be addressed to eliminate such contact. We also believe it would be very difficult, if not impossible, to establish an objective means to determine if, and if so to what extent, head-to-knee contact influenced HIC measurement in FMVSS No. 213 compliance testing. Consequently, head acceleration spikes caused by head-to-knee contacts will be included in the HIC computation. Further, the agency continues to believe that the HIII dummy is needed to better assess the injury mechanisms to children.

The agency is not entirely convinced that neck elongation is not occurring to children in real crashes. We believe it possible that neck injury may sometimes not be diagnosed even though it occurs. Since a child's neck is not fully developed, detection of injuries is more difficult and injuries could manifest in later years. Also, for fatal injuries, there is often a reluctance to conduct autopsies in deference to family sensitivity. Consequently, the cause of death may be listed as massive head injury, while injury to the neck may have also occurred.

The agency is continuing to conduct research to establish better neck injury response and injury criteria for children. Research may show the presence of neck injury and a possible need for a neck injury criterion in FMVSS No. 213. If that occurs, a test dummy incorporated into the standard that offers improved biofidelity and neck instrumentation would prove useful. Because we believe that the current neck on the HIII 6-year-old dummy provides improved biofidelity over the current dummy and is suitable for compliance purposes, this final rule adopts the dummy into FMVSS No. 213 as proposed.

ii. Weighted 6-Year-Old Dummy. A majority of commenters raised concerns with the biofidelity of the weighted 6-year-old-dummy, which is intended to model a 50th percentile 8-year-old child. IIHS and NTSB commented on the importance of height in measuring

¹¹ The agency is aware of only one instance in which there was significant head-to-knee contact in an FMVSS No. 213 test environment using a Hybrid III dummy. In this case, a 6-year-old dummy was tested in a backless belt-positioning booster. In the test, the shoulder portion of the belt system slipped off the dummy's shoulder. It is unclear what caused this to happen.

seat belt fit and injury criteria, particularly head excursion. Both determined that the weighted dummy failed to accurately represent the height of booster occupants. NTSB stated that the addition of weight to the dummy's spine and pelvis was not representative of weight distribution in an actual child. Ford expressed concern that the weighting of the 6-year-old dummy could result in inaccurate output of the injury criteria. Ford expected the weighted dummy to show abnormally high chest deflection and abnormally low chest acceleration, and higher head excursion. Ford was also concerned that the low relative mass of the lower extremities could reduce knee excursion compared to a more biofidelic dummy. Ford stated that adding mass to the spine and lengthening the lumbar spine might result in the weighted dummy not submarining under conditions that would cause a more biofidelic dummy to submarine. Public Citizen, Graco, and the Alliance commented that the weighted dummy would not perform the same as the 10-year-old dummy which NHTSA has been developing and which was referenced in Public Law 107-318 (Dec. 4, 2002; 116 Stat. 2772) ("Anton's Law").¹²

IIHS, ACTS, Public Citizen, the Alliance, and GM stated that the lack of biofidelity should preclude the use of the weighted dummy. Many commenters urged the agency to develop the 10-year-old dummy as an alternative. Public Citizen urged the agency to move ahead with regulations in anticipation of the 10-year-old dummy's future availability. NTSB suggested using the European 10-year-old dummy (P-series) as an interim measure. While acknowledging the existence of problems with the P-series, NTSB stated that European dummy would better represent height and seat belt fit.

While raising concerns with biofidelity, a number of commenters agreed that, if necessary, the weighted 6-year-old dummy could be used in a limited capacity to test the structural

integrity of child restraints until such time as the Hybrid III 10-year-old dummy became available. Evenflo also supported using the weighted dummy to measure head excursion.

The agency agrees that the Hybrid III 10-year-old dummy, envisioned by Anton's Law, represents the long-term solution to the issue of testing booster seats certified for higher weights. Development of the Hybrid III 10-year-old dummy is proceeding as quickly as possible, but this dummy is not currently ready for use in compliance tests. The agency is currently testing the Hybrid III 10-year-old dummy to determine its suitability for FMVSS No. 213 compliance testing. A notice proposing to incorporate this dummy into Part 572 for use in compliance testing is expected to be published in early 2004.

Despite limited results showing a general correlation between the testing performance of the weighted 6-year-old dummy and the Hybrid III 6-year-old dummy, the agency is persuaded by the comments that the weighted dummy should not be used for testing with full instrumentation. The weighted dummy would not perform the same as the 10-year-old dummy in development and it may not accurately represent an 8-year-old child. IIHS stated that the weighted dummy is too short to represent the tallest occupants for whom boosters are recommended, noting that "[s]itting height is an important factor in testing booster seats because a poorly designed booster may permit too much head excursion for taller occupants. Weight is, at most, a secondary issue for the restraints because the vehicle belts, which are not subject to testing under this standard, restrain the inertia of booster seat occupants."

While the 0.7-inch increase in sitting height achieved through the addition of weights to the Hybrid III 6-year-old dummy is comparable to that of a 50th percentile 8-year-old child, the overall weight and height, and consequently the weight distribution, are not. The 50th percentile 8-year-old child is 50.5 inches tall, as compared to the 50th percentile 6-year-old child which is 45.5 inches tall. The weight added to the 6-year-old dummy is not distributed as it would normally be on a 50th percentile 8-year-old, making injury measurements suspect.

The agency agrees that the kinematics of the weighted 6-year-old dummy may not be representative of the older child that it attempts to model and it could potentially interact with the belt system differently than a dummy developed to represent an 8-year-old child. Therefore, the weighted dummy will be used only

as a means of ballast to evaluate the structural integrity of the tested child restraint. While the weighted dummy will not be instrumented to determine compliance, it will be instrumented to collect data for use in research.

Anton's Law¹³ directs the agency to initiate a rulemaking proceeding to establish performance requirements for child restraints, including booster seats, for the restraint of children weighing more than 50 lb. Through use of the weighted 6-year-old dummy, the structural integrity of a CRS recommended for children between 50 and 65 lb can be tested. NHTSA recommends children to be placed in booster seats until they are 8-years old, or 57 inches tall. The weight of a 50th percentile 8-year-old male is approximately 57 lb. The weight of a 50th percentile 8-year, 9 month-old male is approximately 62 lb. Use of the 62 lb weighted dummy as ballast ensures that booster seats certified up to 65 lb will not structurally fail in a crash.

While several commenters suggested using alternative dummies as an interim measure, none of the suggested alternatives are appropriate even for use as ballast. NTSB recommended using the European P-series 10-year-old dummy in a limited capacity to provide a better means of evaluating proper seat belt fit and to enhance efforts to enact booster seat laws in the states. NHTSA is not confident in the ability of the P-series dummy to uniformly load the restraint system in a manner necessary for the evaluation of the booster seat, even structurally. The P-series dummy is designed with too many degrees of freedom, and its interaction with a restraint system would be inconsistent.

AAP suggested using the Hybrid III 5th percentile female to test child restraints to allow regulation up to 80 lb in advance of the availability of the Hybrid III 10-year-old dummy. The weight of the Hybrid III 5th percentile female dummy is 108 lb, 28 lb heavier than the maximum weight of a child that the child restraint would be certified for in compliance testing. The heavier weight of the 5th percentile female dummy would not offer an accurate representation of an 8-year-old or even 10-year-old child.

3. Specific Issues Relating to the Use of the New Dummies in Standard No. 213

i. Seat Back Height Requirement.

S5.2.1.1 specifies that each child

¹³ Section 3 of Public Law 107-318 directs the Secretary of Transportation to consider whether to include injury performance criteria for child restraints, including booster seats and other products for use in passenger motor vehicles for the restraint of children weighing more than 50 pounds.

¹² On December 4, 2002, Congress enacted Public Law 107-318 (Anton's Law) "to provide for the improvement of the safety of child restraints in passenger motor vehicles, and for other purposes." Section 4 of Public Law 107-318 directed that—

(a) Not later than 24 months after the date of the enactment of this Act, the Secretary shall develop and evaluate an anthropomorphic test device that simulates a 10-year old child for use in testing child restraints used in passenger motor vehicles.

(b) Within 1 year following the development and evaluation carried out under subsection (a), the Secretary shall initiate a rulemaking proceeding for the adoption of an anthropomorphic test device as developed under subsection (a).

Other provisions relating to child restraint performance were also included in the statute.

restraint system shall provide head restraint by means of a continuous seat back. Subsection (a) of S5.2.1.1 specifies that for child restraints recommended for use by children weighing less than 20 lb, the height of the seat back must be not less than 18 inches. If a restraint were recommended for children weighing 20 to 40 lb, the seat back height must be not less than 20 inches.

Some rear-facing infant car seat/carriers, which are designed with a handle for toting the infant outside of the vehicle, are recommended for use with infants weighing only up to 20 lb. Under current S5.2.1.1, these restraints (recommended for children up to 20 lb) must have a seat back of a height of not less than 18 inches. This final rule amends S5.2.1.1 to require these restraints to have a seat back height of not less than 20 inches.

The agency proposed to use the CRABI dummy in place of the 9-month-old dummy in all tests in which the latter dummy is used, including tests of rear-facing infant car seat/carriers. Thus, it was proposed that the CRABI (at 22 lb) would be used to test car seat/carriers. Comments were requested on the appropriateness of using the CRABI dummy to test infant car seat/carriers recommended for children up to 20 lb, when the 22-lb dummy is heavier than the children recommended for the restraints. Comments were requested on whether all infant car seat/carriers have back supports that are high enough to support the CRABI.

No commenter opposed the use of the CRABI in place of the 9-month old dummy, but some issues were raised about possible effects of using the dummy to test infant seats. Graco suggested that S5.2.1.1 could be deleted, for lack of a safety need, if Standard No. 213 were amended to specify use of the CRABI dummy to assess the ability of a rear-facing restraint to limit the rearward excursion of the dummy in Standard No. 213's dynamic test (S5.1.3.2).¹⁴ Evenflo stated that several infant-only restraints do not have backs high enough to support the CRABI 12-month-old dummy. The commenter suggested that replacement of the 9-month-old dummy by the CRABI in 4 years would help minimize the financial impact to child restraint manufacturers.

¹⁴ Under S7.1(c) of Standard No. 213, child restraints recommended for use by children weighing 22 to 27 lb are tested with the 3-year-old (33 lb) dummy. Graco suggested that a weighted CRABI 12-month-old or an 18-month-old dummy be used instead of the 3-year-old dummy. Given the agency's resources and the safety issues before the agency, NHTSA will not be undertaking rulemaking at this time on the weighted CRABI or on an 18-month-old dummy.

In response to Graco, NHTSA agrees that S5.2.1.1 and S5.1.3.2 both provide protection to a rear-facing child in a frontal impact by limiting occupant excursion outside of the confines of the restraint system. However, the agency is unable to conclude that the two requirements serve the same safety need for rear-facing restraints. S5.2.1.1 specifies seat back height and width requirements and also limits how far rearward the test dummy's head may rotate during dynamic testing. These requirements may provide protection in dynamic conditions other than that replicated by the Standard No. 213 sled test. A child restraint might be able to meet S5.1.3.2 with a seat back that is lower or narrower than that specified by S5.2.1.1. Deleting S5.2.1.1's requirements for rear-facing restraints could reduce some of the current protections afforded by child restraints. Thus, the agency declines to delete S5.2.1.1.

At the same time, however, the agency has concluded that with the incorporation of the CRABI dummy into the standard, amendments to S5.2.1.1 are in order. Information indicates that infants should be positioned rear-facing until at least 12-months old, until such time their neck and muscular structure are developed to more adequately support their head. If rear-facing infant seats were recommended for use with an infant until the infant weighs 22 lb, there is a greater likelihood that parents will keep their infants in the rear-facing restraint until the infant reaches or is closer to reaching 12 months of age than if the restraint were only recommended for infants up to 20 lb. (The agency believes that many infants are positioned forward-facing in a toddler restraint after being transitioned out of a rear-facing car seat/carrier, and that many of these infants are not developmentally ready to be forward-facing in the vehicle.)

The agency is amending S5.2.1.1(a) to encourage the production of rear-facing infant car seat/carriers that are recommended for use by infants up to 12 months in age. The agency is amending the table in S5.2.1.1(a) such that infant car seat/carriers must have a minimum seat back height of 20 inches.¹⁵ The effect of this is to require all rear-facing infant restraints to be large enough for an average 12-month-old. As a practical matter, this is not a drastic change. Seventy-five percent of the infant-only seats that have been

¹⁵ More specifically, the section is amended to specify that restraints certified for children weighing less than 40 lb must have a minimum seat back height of 20 inches.

evaluated in the agency's ease-of-use ratings program were certified for children weighing up to 22 lb and thus already are manufactured with 20-inch seat backs.

This final rule does not require manufacturers to recommend on the labels accompanying infant restraints that the restraints are recommended for infants up to 22 lb, but provides the incentive for them to do so. Because the 22-lb CRABI will be the test instrument used in compliance tests of the infant seats, and because under S5.2.1.1(a) the infant seats must have a minimum seat back of 20 inches, the agency believes that manufacturers will certify most if not all infant restraints to 22 lb.

The agency is providing for a 2-year leadtime for this change. Evenflo stated that several models of infant-only restraints do not have backs high enough to support the CRABI 12-month-old dummy and will thus have to be redesigned. Evenflo suggested that replacement of the 9-month-old dummy by the CRABI in 4 years would help minimize the financial impact to child restraint manufacturers. JPMA suggested a 3 year leadtime. NHTSA declines to provide such long leadtimes suggested by Evenflo and JPMA because there could be safety benefits associated with keeping more infants rear-facing until they are at least 12-months old, which could result from the change to the CRABI and to S5.2.1.1 of Standard No. 213. The short deadlines of the TREAD Act also indicate Congress's interest in having the standard be upgraded as quickly as possible. The 2-year leadtime NHTSA is providing balances the safety benefits with the need for some child restraint manufacturers to modify some of their seats.

ii. Padding Requirement. The agency asked for comment on deleting S5.2.3, which specifies a padding requirement for child restraints used by children weighing less than 22 lb. The agency had specified the requirement (whose thickness and static compression specifications are compliance-tested statically) because there was no instrumented infant test dummy available at the time (1979) the requirement was adopted. The agency's goal was to establish dynamic test requirements for infant restraints, so that the total energy absorption capability of the padding and underlying structure could be measured. (44 FR 72131, 72135). Graco and Xportation supported deleting S5.2.3. Since today's final rule incorporates use of the instrumented CRABI 12-month-old dummy for use in testing restraints recommended for children under 22 lb, we are deleting S5.2.3, as proposed.

4. Leadtime

The agency proposed in the NPRM that manufacturers be provided two years of leadtime, after publication of a final rule, before specifying the use of the CRABI and Hybrid III dummies in compliance tests. The NPRM proposed using the weighted 6-year-old dummy in compliance tests 180 days after publication of a final rule. JPMA supported the addition of the new dummies to the standard, provided that the agency gives "a phase in of at least three years from the issuance of the final rule * * * to avoid costly recertification requirements for existing seats, and to avoid the possible elimination of some current seats from the marketplace." JPMA stated that because of dimensional differences between the proposed CRABI 12-month-old and the 9-month-old dummy currently used to test infant-only child restraints, the commenter believed that the use of the CRABI dummy will likely result in the elimination of current infant-only child restraints. JPMA stated that "millions of dollars of tooling and development testing will be rendered worthless" by incorporating the new dummies and that "[m]anufacturers should be given a longer lead time before having to endure the several financial consequences of these changes."¹⁶ Evenflo commented that the agency "must recognize that the use of the new dummies will have a significant affect [sic] on manufacturers' test costs, which will ultimately be reflected in the price of child restraints."

The agency is providing for a 2-year leadtime for the changeover to the new dummies. As explained above, the agency believes there are safety benefits associated with keeping more infants rear-facing until they are at least 12-months old, which could result from the change to the CRABI and to S5.2.1.1 of Standard No. 213. At the same time, the two year leadtime is provided to lessen the cost impacts of the rule on manufacturers' testing costs (retesting current child restraints on the new seat assembly using the new dummies, and at test speeds closer to 30 mph) and possible retooling costs.

NHTSA believes there also are safety benefits to testing the structural integrity of child restraints recommended for children weighing from 50 to 65 lb. However, an effective date short of approximately two years is not provided for use of the weighted dummy because the rulemaking

incorporating the dummy into 49 CFR part 572 is not yet completed. The NPRM was published May 7, 2003; 68 FR 24417. The rulemaking should be completed with sufficient time to allow manufacturers to certify their restraints to Standard No. 213 by the two-year compliance date.

d. Application of the Standard

Most commenters supported increasing the weight limit in the definition of "child restraint system" above the current 50 lb. The only commenter opposed to any increase was the Automotive Coalition for Traffic Safety, because of concern with the weighted 6-year-old dummy. Of those supporting an increase, a majority supported increasing the weight to 65 lb based on the use of the weighted 6-year-old dummy, with future amendments increasing the weight to 80 lb upon the introduction of the 10-year-old dummy. Advocates stated that it would support increasing the limit to 65 lb upon showing that the weighted 6-year-old dummy (62 lb) is sufficient to assess child restraint use with children weighing up to 65 lb. Graco suggested that the agency should defer increasing the limit to the time the 10-year-old dummy is available.

Several commenters did not support an intermediate level of 65 lb and preferred amending the standard now to specify the application to restraints recommended for children up to 80 lb. Ms. Bidez supported incorporating the 10-year-old dummy in its current form and amending the weight limit to reflect the 80 lb weight of the 10-year-old dummy. AAP recommended using the 5th percentile female to allow regulation up to 80 lb in advance of the 10-year-old dummy. E-Z-On believed that the limit should be extended to 80 lb, and that costs to vehicle and child restraint manufacturers to provide stronger anchorages and hardware would be minimal.

The agency agrees with commenters in that the weight limit in the definition of "child restraint system" should be increased above 50 lb. While the weighted 6-year-old dummy injury measurement reliability may not be sufficient for compliance testing, the dummy is suitable for testing the structural integrity of child restraints up to 65 lb. Use of the weighted dummy provides an interim weight limit in advance of the Hybrid III 10-year-old dummy. The agency is confident in the ability of the 62-lb-weighted dummy to test restraints certified up to 65 lb. There will be only a 3-lb difference between the weighted dummy and the maximum certification weight. The

Hybrid II 3 year-old, weighing 33 lb, has proven efficient at testing child restraint systems certified with a maximum weight of 40 lb.

However, the weighted 6-year-old dummy is not sufficient to assess the dynamic performance of a child restraint in restraining an 80-lb child, and as stated above, use of an alternative dummy to allow increasing the limit to 80 lb is not appropriate. The agency is not confident in the ability of the European P-series 10-year-old dummy to uniformly load the restraint, and the Hybrid III 5th percentile female is 35 percent heavier than the suggested maximum weight of 80 lb.

For the aforementioned reasons, NHTSA is increasing the reference to the weight limit in the definition of "child restraint system" from 50 lb to 65 lb. This amendment, effective in 180 days, affects primarily manufacturers of child restraints recommended for older children, *i.e.*, booster seat and harness manufacturers. The agency does not anticipate that manufacturers will have to redesign their restraints to certify compliance using the weighted 6-year-old dummy. However, the rulemaking to incorporate the weighted 6-year-old dummy into part 572 is not complete, so the agency is specifying that compliance testing with the weighted dummy will not begin for two years. Manufacturers are permitted the option of voluntarily using the weighted dummy prior to the mandatory compliance date.

Several comments were submitted on whether manufacturers should be prohibited from recommending their seats for children of weights higher than the heaviest dummy used to test the restraint. Consumer Union stated that the agency should limit manufacturers' ability to advertise child restraint weight maximums only to the weight of the heaviest dummy used for its certification testing. Alternatively, Consumer Union stated that the agency should develop dummies that are at the maximum weight advertised for the restraint, or require the addition of ballast weights to existing test dummies.

In contrast, TraumaLink believed that manufacturers should be permitted to recommend child restraints at weights above that of the heaviest dummy used to test the restraint. TraumaLink stated that there was no field data to indicate a problem with convertible restraints (typically recommended for children up to 40 lb) which have been tested with a 33 lb dummy (the Hybrid II 3-year-old). Limiting the regulation based on the heaviest dummy, TraumaLink continued, would place artificial limits on the protections afforded children. Similarly, AAP opposed limiting a

¹⁶ The commenter supported the proposal in the NPRM of allowing manufacturers the option of using the new dummies before the mandatory compliance date of the standard.

manufacturer's ability to recommend a child restraint for a weight above that of the heaviest dummy used to test the restraint. AAP stated that such a restriction could mislead parents into thinking that children should use seat belts once the child is heavier than 62 lb, when in fact, most children do not fit seat belts until a much heavier weight.

In a rulemaking amending FMVSS No. 213 to incorporate several test dummies into the standard (61 FR 30827; June 18, 1996), NHTSA responded to Consumer's Union (CU) belief, expressed during that rulemaking, that restraints (e.g., convertible child seats) should not be permitted to be recommended for children weighing more than the largest test dummy used to test the restraint (e.g., 33 lb). The agency determined that such an approach was unnecessarily restrictive, given that there has been no showing that the wider array of dummies incorporated into Standard No. 213 by that rulemaking were insufficient surrogates for the children for whom the restraints are recommended. The agency also believed that CU's suggestion could have unintended safety consequences, because it would have the effect of forcing young children out of child restraints specifically designed for them (typically 20 to 40 lb) and into restraints that may not be appropriate for their size, i.e., booster seats for a 3-year-old or the vehicle's belt systems. The agency believed that while it might be hypothetically possible that a restraint that passed FMVSS No. 213 when tested with a dummy could fail when restraining a child weighing slightly more than the dummy, on balance, the possibility of such a failure is outweighed by the safety risk of forcing children into restraints that might not adequately restrain them.

NHTSA reaffirms the conclusions reached in that rulemaking and concurs with the views of TraumaLink and AAP that information on tests with current test dummies does not indicate a need to restrict recommending child restraints for children weighing more than the test dummies used to test the restraint. As to CU's suggestion for developing dummies that reach the maximum weight recommended for a restraint or requiring the addition of ballast weights to existing dummies, this suggestion is beyond the scope of the present rulemaking.

e. Injury Criteria

1. Post-NPRM Testing

i. JPMA. In its comment to the NPRM, JPMA stated that it had conducted a series of 80 sled tests at Veridian Engineering in response to the proposal, to try to understand how the proposed dummies performed compared to the dummies currently in use. The tests also evaluated the proposed changes to the standard bench seat, as well as the proposed injury criteria. JPMA described its test plan as including all test modes for all of the proposed dummies with representative samples of all types of child restraint/harness combinations and installation methods, including lap belt only, lap/shoulder belt, and LATCH. JPMA acknowledged that: "While a total of 80 tests were conducted, this series only begins to explore the results of the proposed changes and does not allow analysis of the net effect of each change, nor does it provide enough history to define the potential variability in test results which could occur. Much more testing is required to define the new effect of each change and the potential variation which can have a significant impact on design and ability to define compliance margins."

ii. NHTSA Series I and II. PAX conducted a series of dynamic sled tests for NHTSA to evaluate the performance of various child restraints on the revised test seat assembly. The tests used the CRABI and Hybrid III 3- and 6-year-old dummies to evaluate whether these dummies could meet the proposed scaled HIC, chest injury limits and Nij measures. Time and resource considerations limited the testing to 5-point harness rear-facing infant seats, convertible safety seats, and belt-positioning seats. Restraints were evaluated while installed using a lap belt, a lap/shoulder belt, and the LATCH system. HIC measurements were obtained, but testing problems arose with respect to the neck injury and chest deflection data. Because of these problems, NHTSA conducted a second series of dynamic sled tests at VRTC to replicate the tests performed at PAX with the 3- and 6-year-old dummies. These tests were conducted using the same type of child restraints.

iii. Results of JPMA and NHTSA Series I and II. The charts provided in a docket submission titled "Comparison of PAX/VRTC and JPMA Sled Tests" summarizes the results of the testing performed by both NHTSA and by JPMA. For HIC and chest acceleration, results are presented for both the proposed scaled injury limits and for the same tests using the existing injury

criteria limits stated in FMVSS No. 213. Because chest deflection and Nij limits are not currently specified in FMVSS No. 213, the only charts provided are for the proposed criteria limits.

NHTSA testing performed at PAX and VRTC, described in the NPRM, resulted in dummy responses that were generally within the injury limits proposed in the NPRM, with the exception of Nij. (While acceptable Nij readings were found in tests using the Hybrid III 3-year-old dummy, there were widespread failures in both rear- and forward-facing tests using the CRABI 12-month old dummy and each of four tests with the Hybrid III 6-year-old dummy.) However, the test results presented by JPMA were quite different. JPMA's testing, using the revised test seat assembly and new dummies as NHTSA tested, but across a wider variety of child restraint types, showed very mixed results. In many instances, the measured injury parameters either exceeded or marginally passed the scaled injury limits proposed in the NPRM. Further, there were many JPMA tests that resulted in either failing or marginal results when using the existing injury criteria. This raised questions regarding the combined effect of the changes to the test seat assembly, incorporation of the new dummies, and use of the scaled injury criteria limits together.

iv. NHTSA Series III. In an effort to determine if the use of varying restraint types in the JPMA testing (as opposed to NHTSA's use of 5-point harness restraints only) could be identified as the predominant factor in explaining the disparity between the JPMA and NHTSA test results, NHTSA conducted a third series of sled tests. These tests were performed at VRTC, and attempted to closely parallel the testing performed by JPMA. In addition to a number of additional 5-point harness restraints, NHTSA also tested forward-facing convertible overhead shield child restraints, and shield-type boosters both with and without the shield.

A total of 20 additional tests were conducted in this third series of sled tests. The results of this series of sled tests more closely paralleled those found in the JPMA tests, in that a wider range of failing and marginal test results were seen as compared to the predominately passing results seen in the PAX test series. The testing of 5-point harness restraints at PAX resulted in injury values that were predominately within the established or proposed limits (with the exception of Nij). However, the VRTC Series III tests showed a wider variation in both marginal and failing responses that appear to be a result of the restraint type

that was tested, even though all restraint types meet the current FMVSS No. 213 requirements and appear to be equally effective based upon field studies. Not all VRTC results were similar to those of JPMA, however, as the HIC₁₅ results for the CRABI dummy were typically better in the VRTC tests than in the JPMA tests. Overall, the VRTC follow-on tests did confirm the wider range of test results found in the JPMA testing. The follow-on testing results can be found in the docket.

2. Comments and Conclusions

i. Head Injury Criterion (HIC). The agency received widely divergent comments on the proposal to limit measurement of HIC to 15 milliseconds and to use the injury criteria of Standard No. 208 that were scaled for children. The Alliance, UMTRI and SafetyBeltSafe supported the use of a 15 ms limit on the head injury criterion (HIC) limit as a more realistic way to assess head and brain injury, with the lower HIC values proposed for each dummy. In contrast, Advocates stated that it was "reluctant to change the duration of HIC measurement from 36 ms to 15 ms without more definitive evidence that this change would not inhibit accurate HIC measurements associated with non-contact head injuries." Advocates suggested that NHTSA should scale the injury assessment reference values for children even if the agency decides not to shorten the HIC measurement duration, to "take into account the different anatomy of children." Ford stated that, while the purpose of the 15 ms limit on the HIC calculation interval is to try to differentiate between HICs caused by hard head contacts and non-contact HICs due to head whipping, the 15 ms HIC measurement should not be used to differentiate between non-contact and "chance contact" of the dummy's head with the dummy's knees.

JPMA stated that it was willing to consider supporting a 15 ms limit (HIC₁₅), if the agency can undertake research to assure that there will not be unintended consequences from countermeasures needed to meet HIC₁₅. However, JPMA did not support the other proposed new injury criteria, including the scaled HIC values. The commenter stated that the tests of child restraints it conducted with the proposed CRABI and Hybrid III dummies produced injury reference values that exceeded the proposed limits, which the commenter said is a concern given the high level of effectiveness of current child restraints. The commenter suggested that it might be more feasible to use the FMVSS No.

208 criteria in FMVSS No. 213 if the agency were to specify a "more realistic crash pulse for FMVSS No. 213, such as the one contained in the FMVSS No. 208 sled test." Graco questioned why the scaled HIC values would be applied to in-position child restraint testing if they were derived from out-of-position occupant airbag testing. Graco believed that the values might not be "applicable to child restraint testing with a 213-style pulse." The commenter stated that it saw minimal benefit to child passenger safety from using the proposed injury criteria. It was concerned that some seats that have historically performed well in the real world and in compliance testing would fail the new criteria.

Response: This final rule retains the existing FMVSS No. 213 HIC threshold of 1000 for the CRABI 12-month-old and Hybrid III 3- and 6-year-old dummies.

Since the TREAD Act directed NHTSA to consider adopting the scaled injury criteria adopted by the May 2000 final rule on advanced air bags, NHTSA proposed that the HIC limits of 390₁₅, 570₁₅ and 700₁₅ be incorporated into FMVSS No. 213 for tests with the CRABI 12-month-, and Hybrid III 3- and 6-year-old dummies, respectively. However, NHTSA believed that it should take a cautious approach in modifying the head injury tolerance level set by the HIC requirement. The agency requested comments on issues related to the proposed injury criteria, such as on what risk levels are acceptable, what factors should be considered in selecting performance limits and whether the same limits as in FMVSS No. 208 should be established for the child restraint standard. The agency noted that the two standards address different sources of potential harm to children. The injury criteria for children in FMVSS No. 208 are intended to minimize the risk from a deploying air bag (ensuring that the air bag deploys in a manner much less likely to cause serious or fatal injury to out-of-position occupants). The injury criteria in FMVSS No. 213 are intended to limit the severity of forces imposed on a child during a crash. Child restraints meeting these criteria have worked effectively to maintain high levels of performance in crashes. Because the injury criteria of the standards are intended to minimize risks from different injury sources, the agency stated that it might be reasonable to have non-identical criteria.

In this final rule, NHTSA has decided against incorporating the scaled injury limits used in FMVSS No. 208 because the data obtained from the JPMA and NHTSA (series III) test programs

indicate that current child restraints generally do not meet the proposed limits. There are several reasons why this was a concern for the agency. First and foremost, child restraints are currently highly effective in reducing the likelihood of death and/or serious injury in motor vehicle crashes. The agency was unable to identify a safety problem that the scaled injury limits of FMVSS No. 208 would remedy.

Second, it is unknown what modifications to child restraints would be necessary for the restraints to meet the proposed injury limits. Commenters did not provide information on how child restraints that failed to meet the proposed Nij and other limits could be modified to meet the criteria. Assuming that the restraints could be redesigned to meet the proposed injury limits, there would likely be costs associated with the redesign which would result in increases in the price of the restraints. As noted above in section IV of this preamble, the agency considers the consumer acceptance of cost increases to child restraints (an already highly-effective item of safety equipment) in determining the net safety effects of changes to the child restraint standard. In balancing the effects of meeting the scaled injury criteria against the possible impacts on the price of restraints, the agency determined that the net effect on safety could be negative in this instance because of the minimal benefits of such a change, weighed against the delayed replacement of old restraints by current owners or non-purchase by non-owners. For these reasons, in accordance with the TREAD Act, we have considered whether to apply scaled injury criteria performance levels developed for FMVSS No. 208 to child restraints and have determined it would not be prudent to do so.

NHTSA is adopting HIC₃₆ with a limit of 1000 for all tests with the Hybrid III and CRABI dummies. This final rule does not adopt the 15 ms window that was proposed in the NPRM. This is because the shorter time interval would likely substantially reduce the values calculated for the HIC in compliance tests. Further, as discussed later in this section, NHTSA is not incorporating a neck injury criterion into FMVSS No. 213. A 36 ms time interval to measure HIC allows the HIC measurement in FMVSS No. 213 to capture risk of neck injury indirectly. Given that the agency is declining to adopt a neck injury criterion at this time, the longer measurement window associated with HIC₃₆, as opposed to HIC₁₅, will provide reasonable assurances that a child's neck will not be subjected to excessive forces in a crash. The 36 ms time

interval to measure HIC is consistent with the injury threshold used in FMVSS No. 208 for the Hybrid III 50th percentile dummy prior to the incorporation of scaled injury limits and Nij for advanced air bags.

Limiting the duration over which HIC is calculated to a maximum of 36 ms, while limiting HIC to 1000, assures that the acceleration level of the child's head will not exceed 60 g's for any period greater than 36 ms. The 60 g

acceleration limit was set as a reasonable head injury threshold by the originators of the "Wayne State Tolerance Curve", which was used in the development of the HIC calculation.

The change to a 36 millisecond time measurement for HIC will not necessarily result in lower HIC values in compliance testing because of the changeover in this rulemaking to the new dummy family. NHTSA compared the differences between using the HIC₃₆

criterion in testing with the Hybrid III dummy family and using the existing criterion, HIC_{unlimited}, in testing with the Hybrid II family. The following tables outline the results of comparison tests performed on identical child restraints, using the FMVSS No. 213 proposed (Table 8) and existing seat assemblies (Table 9), with both Hybrid III and Hybrid II 3-year-old dummies.

TABLE 8.—COMPARISON TESTS OF 3-YEAR-OLD HYBRID III AND HYBRID II DUMMIES ON PROPOSED SEAT ASSEMBLY [Hybrid III HIC₃₆ vs Hybrid II HIC_{Unlimited} 3-Year-Old Child Dummy (Tested Using with The NPRM Proposed Seat Assembly)]

	Hybrid III* HIC ₃₆	Hybrid III HIC _{Unlimited}	Trend
Cosco Touriva Convertible, Lap Belt, No Tether	~434	703	Hybrid III HIC ₃₆ <i>Less than</i> Hybrid II HIC _{Unlimited} .
Century Accel Convertible, Lap Belt, No Tether	~344	627	Hybrid III HIC ₃₆ <i>Less than</i> Hybrid II HIC _{Unlimited} .
Century Breverra Hybrid, Lap Belt, No Tether	~521	670	Hybrid III HIC ₃₆ <i>Less than</i> Hybrid II HIC _{Unlimited} .
Cosco HB Booster Hybrid, Lap Belt, No Tether	~684	446	Hybrid III HIC ₃₆ <i>Greater than</i> Hybrid II HIC _{Unlimited} .

* HIC₃₆ were not calculated, the relationship HIC₃₆ = 0.97

* HIC_{Unlimited} was used to approximate HIC₃₆.

TABLE 9.—COMPARISON TESTS OF 3-YEAR-OLD HYBRID III AND HYBRID II DUMMIES ON EXISTING SEAT ASSEMBLY [Hybrid III HIC₃₆ vs Hybrid II HIC_{Unlimited} 3-Year-Old Child Dummy (Tested Using Existing FMVSS No. 213 Seat Assembly)]

	Hybrid III HIC ₃₆	Hybrid II HIC _{Unlimited}	Trend
FF Convertible, Lap Belt	671	385	Hybrid III HIC ₃₆ <i>Greater than</i> Hybrid II HIC _{Unlimited} .
FF Convertible, Lap Belt	479	
FF Convertible, Lap Belt	424	
Average	671	429	
FF Convertible, Lap and Tether	303	387	Hybrid III HIC ₃₆ <i>Less than</i> Hybrid II HIC _{Unlimited} .
FF Convertible, Lap and Tether	362	396	
Average	333	392	
FF Convertible, LATCH	292	281	Hybrid III HIC ₃₆ <i>Greater than</i> Hybrid II HIC _{Unlimited} .
FF Convertible, LATCH	518	336	
Average	408	309	
FF Hybrid, Lap and Tether	452	392	=
FF Hybrid, Lap and Tether	439	501	
Average	446	447	

In some of the tests Hybrid III HIC₃₆ results were higher, and in other tests the HII HIC_{Unlimited} results were higher. On the other hand, in a limited number of tests with the 6-year-old dummies, the Hybrid III HIC₃₆ numbers were higher. All in all, the agency determined that the data are inconclusive as to any differences in how the Hybrid II and Hybrid III dummies measure HIC. In any event, the agency's tests of child restraints has not found any difference between HIC_{Unlimited} and HIC₃₆ in terms of compliance passage rates. Thus, the agency has concluded that the impact on child restraint performance relating to the change to HIC₃₆ will be insignificant.

ii. *Chest Injury Criteria.* Some commenters supported while others opposed the proposals to adopt a new chest deflection criterion and to adopt the chest acceleration limits that were

scaled for children and incorporated into FMVSS No. 208. The Alliance supported the proposals. Ms. Bidez supported the proposed chest deflection criteria, stating that "although no significant reports of chest injury in children have yet occurred, prudence and systems engineering dictates [sic] that excessive chest deflection be monitored to prevent the introduction of "new" injury mechanisms in the quest to prevent other injury mechanisms with improved restraint design."

JPMA opposed the proposed chest injury criteria for the reasons explained in the preceding section. TraumaLink also opposed incorporation of the proposed chest deflection and reduced chest acceleration limits, because according to data it has collected in its study, "These types of injuries do not occur in children in [child restraint systems]." TraumaLink further stated:

"We are concerned about the tradeoff between including these more restrictive thoracic criteria and reducing the overall protection of the head through increased head excursions and accelerations." These concerns were echoed by UMTRI, which stated that the relationship between the chest deceleration and deflection limits and field injuries under the type of loading simulated in FMVSS No. 213 are not well established. "Introducing these injury criteria now [including neck injury] could lead to counterproductive child restraint designs because many restraints that perform well in the field, particularly booster seats, are likely to exceed the new injury tolerance measures."

SafetyBeltSafe also opposed the proposed chest injury criteria. It expressed concern that the new seat bench assembly has an added slope to

the seat cushion that results in a "harder stop as the restraint bottom[s] out against the plywood platform." The commenter was concerned that, if the chest acceleration limit were reduced, child restraints that are already close to the current limit could fail the test with no change in how they actually perform in the field. "To counteract this possibility [of failing the test], a manufacturer could soften the system, allowing more head excursion (due again to the geometry change), to keep the chest acceleration in check. This would obviously be counterproductive to child safety." In addition, SafetyBeltSafe believed that the proposed chest deflection limit "does not relate to any evident injury among restrained child passengers" and thus would not advance child safety. JPMA, UMTRI and SafetyBeltSafe suggested that the agency collect data on chest deflection to establish a database that could be used to evaluate these measures more in the future.

Ford stated that in its sled tests of booster seats using the Hybrid III six-year-old dummy and the FMVSS No. 213 sled pulse, none of the tested boosters could be certified as meeting the proposed limits. "Boosters that showed good shoulder belt fit routinely measured chest acceleration at or near the 60 g limit and chest deflection very near the 40 mm limit. Dummy chest values were sometimes below the compliance limit, but were seldom far enough below the limit to provide a reasonable compliance margin." The commenter believed that boosters do improve child safety when used properly, and that "if dynamic testing of boosters is continued, the test procedure needs a major overhaul to effectively differentiate between acceptable and unacceptable designs."

Response: This final rule does not adopt the proposed chest injury criteria relating to acceleration and deflection. A safety need for adopting the proposal has not been established. NHTSA is persuaded by the commenters that there are not sufficient data that demonstrate that children have been seriously injured due to excessive chest acceleration or deflection in current restraint designs. Historically, the majority of child injuries are to the head as opposed to the chest. The agency is concerned about possible negative effects of adopting the proposed chest injury criteria on increased head excursion, as noted by SafetyBeltSafe. Further, not enough is known about the countermeasures that could be employed to meet the proposed criteria. If child restraint manufacturers were to redesign their restraints to meet such

requirements, the agency is concerned about the possibility of those revised designs compromising other aspects of the occupant's injury protection.

The data presented by JPMA, and to a lesser degree, the follow-on tests conducted at VRTC, show difficulty for current restraints to meet the scaled chest criteria, and also show problems for certain restraint types to meet the existing requirements with the revised test seat assembly and new dummies. Redesigning the restraints to meet the requirements, assuming such redesign is practicable, would involve a cost increase to manufacturers, which would be passed on to consumers. The agency does not believe that the cost increase is justified in this instance, and is concerned about the possible effect the cost increase could have on the purchase and use of child restraints. For the aforementioned reasons, we conclude that it is not in the interest of safety to adopt the chest injury criteria developed for FMVSS No. 208 into FMVSS No. 213.

iii. Neck. Virtually all parties commenting directly on this aspect of the proposal opposed the modified Nij neck criterion (modified from the criterion in FMVSS No. 208 in that the limits on axial force were excluded). The Alliance stated that it believes that serious neck injuries in child restraints are most likely caused by excessive upper neck tension, and not by exceeding the proposed Nij criterion. The commenter thus suggested the agency should specify neck tension and compression limits, as follows, when testing with the CRABI 12-month-, the HIII three-year- and the HIII six-year-old dummies, respectively: 780, 1430 and 1890 N for peak tension; and 960, 1380 and 1820 N for peak compression. The Alliance further stated, however, that applying these limits while maintaining the current sled pulse is likely to make compliance with the requirements impossible or possible only with substantial cost increases. The commenter suggested that NHTSA modify the crash pulse "to make it more representative of the current crash environment" instead of eliminating neck tension. Ms. Bidez stated that "Nij does not appear to predict cervical distraction injuries in children * * *." The commenter suggested that "the duration of the axial distraction load as influenced by the presence or absence of adequate torso restraint appears to be a more valid predictor of (spinal cord injury without radiographic abnormality) SCIWORA injuries among children in the absence of head contact."

JPMA, SafetyBeltSafe, UMTRI, TraumaLink and others did not support adopting the proposed Nij criterion at this time. SafetyBeltSafe believed that neither Nij as proposed nor Nij with a limit on tension should be used as a compliance criterion unless these are proven to be useful predictors of child neck injury. UMTRI believed that Nij should not be incorporated at this time because the relationship between the criterion and real-world injuries "under the type of loading simulated by FMVSS 213 are [sic] not well established." The Insurance Institute for Highway Safety (IIHS) was concerned that studies of real-world crashes indicate that neck injuries due to inertial forces appear to be rare, yet, the commenter stated, it is not clear how child restraints could be better designed to lower neck injury measures. Ford stated that, in its sled tests of booster seats, "Upper neck tensions and extension moments above the FMVSS 208 criteria were also routinely measured. Every test exceeded at least one of the Nij limits."

TraumaLink was concerned about the state of knowledge about pediatric neck injury and suggested that not enough was known to proceed at this time. The commenter stated that data on the biomechanical response of the pediatric neck to trauma are severely limited and as a result, the neck of current child dummies may not be representative of the real child. The commenter also believed that efforts to include pediatric neck tolerance levels in regulatory efforts are scientifically premature. TraumaLink further stated:

More research is needed to understand the movement of the child's neck in traumatic events and the likelihood for injury before enacting regulatory standards, but our results indicate that this work is of paramount importance. We believe that this research may reveal the importance of neck tension and suggest that exclusion of limits on peak tension in the test procedure is not appropriate. Therefore, we feel that the neck injury measures should be calculated but not used in the pass/fail criteria in the FMVSS 213 test to build the fund of knowledge needed to further refine the injury measure.

Similarly, commenters JPMA, SafetyBeltSafe, UMTRI and the IIHS suggested that more research is needed on neck injury among restrained children. Some of these suggested that NHTSA measure neck force and moment parameters during compliance tests to become familiar with the range of results.

Response: The agency has decided not to incorporate Nij into FMVSS No. 213 compliance tests at this time. Both NHTSA and JPMA testing has clearly demonstrated that existing child

restraints that have historically performed very well in the field cannot meet the proposed neck injury limits in the majority of test cases. Neither NHTSA nor child restraint manufacturers have identified any countermeasures that could be incorporated into existing designs that would promote compliance with the proposed requirements. Further, NHTSA agrees that there is a lack of injury data to demonstrate a need to incorporate neck injury criteria at this time. As discussed in the section regarding head injury criterion, the adoption of a 36 ms measurement window for HIC, as opposed to the 15 ms window that was presented in the NPRM, will also serve as surrogate of sorts for a neck injury criterion to ensure that children continue to be well protected.

NHTSA does not believe that enough is known regarding neck injury for children at this time. As the agency is not proposing the incorporation of Nij in this final rule, NHTSA likewise does not feel that it is appropriate at this time to specify neck tension limits or any other neck criterion. These are areas where the agency could perform additional research in the coming years, as warranted by a safety need and the demands on the agency's resources.

In accordance with the TREAD Act, NHTSA has considered adopting the neck injury criteria developed for FMVSS No. 208 into FMVSS No. 213. For the aforementioned reasons, we conclude that incorporating the criteria into Standard No. 213 is not warranted at this time.

f. Leadtime

The TREAD Act required NHTSA to complete this rulemaking by November 1, 2002. With that date in mind, the agency made the following conclusions about the dates on which compliance with the requirements will become mandatory.

a. NHTSA believes that manufacturers could begin certifying their child restraints based on testing done on the new seat assembly and pulse in approximately 2 years (*i.e.*, the effective date for the change will be August 1, 2005). NPRM proposed a 2-year leadtime, which Graco supported. While the agency does not expect the changes to the seat assembly to have a major effect on the results of compliance tests, restraint manufacturers will likely have to conduct testing to confirm compliance of their restraints. This will be a financial impact on the manufacturers that could be spread out over a 2-year time period. The agency

does not anticipate any lives saved or injuries avoided from the amendment.

b. This final rule provides for about a 2-year effective date for the requirement to use the new CRABI and Hybrid III dummies in compliance tests (the effective date for the change will be August 1, 2005). The agency does not expect that the changes to the dummies will have a significant effect on the results of compliance tests, with the exception of some infant-only car seat/carriers. However, restraint manufacturers will likely have to conduct testing to confirm compliance of their restraints. This will be a financial impact on the manufacturers that could be spread out over a 2-year time period. Some infant-only restraints do not have backs high enough to support the CRABI 12-month-old dummy and will thus have to be redesigned.

The agency cannot estimate any lives saved or injuries avoided from the amendment. There could be safety benefits associated with keeping more infants rear-facing until they are at least 12-months old, which could result from the change to the CRABI and to having infant car seat/carriers be designed with higher back support structures.

c. As for using the weighted 6-year-old dummy to test restraints (typically booster seats) recommended for children with masses of over 22.7 kg (weights over 50 lb), this rule specifies a 2-year leadtime for the requirement (the effective date for the change will be August 1, 2005). We do not anticipate that manufacturers will have to redesign their booster seats or safety harnesses to certify compliance using the dummy. However, the rulemaking to incorporate the weighted 6-year-old dummy into part 572 is not complete, so the effective date is provided to account for the completion of that rulemaking. (The part 572 NPRM was published May 7, 2003; 68 FR 24417.)

d. Manufacturers are permitted the option of voluntarily using the new sled assembly and pulse and the new test dummies prior to the date (August 1, 2005) on which they would be required to do so. **Note**, however, that this final rule also specifies that a manufacturer's selection of a compliance option (*e.g.*, to use the new dummies prior to the mandatory compliance date) must be made prior to, or at the time of the compliance test and that the selection is irrevocable for that child restraint. This provision is needed for NHTSA to efficiently carry out its enforcement responsibilities. The agency wants to avoid the situation of a manufacturer confronted with an apparent noncompliance (based on a compliance

test) with the option it has selected responding to that noncompliance by maintaining that its products comply with a different option for which the agency has not conducted a compliance test. To ensure that the agency will not be asked to conduct multiple compliance tests, first for one compliance option, then for another, this rule requires manufacturers to select the option by the time it certifies the child restraint system and prohibits them from thereafter selecting a different option for the restraint.

IX. Rulemaking Analyses and Notices

a. Executive Order 12866 (Regulatory Planning and Review) and DOT Regulatory Policies and Procedures

The agency has considered the impacts of this final rule under Executive Order 12866 and the Department of Transportation's regulatory policies and procedures. While the NPRM was reviewed under the Executive Order, this document was not reviewed because it is considerably narrower than the NPRM and has minimal costs. This document was treated as "not significant" under the Department of Transportation's regulatory policies and procedures.

The estimated costs for this final rule are discussed in NHTSA's final regulatory evaluation (FRE) for this final rule.¹⁷ There is a one-time cost of \$1.68 million for manufacturers to purchase the new test dummies and \$1.39 to \$3.44 million to certify existing child restraints to the new dummies and test requirements. The annual long-term costs are estimated to be \$31,200 to test new models of booster seats (including built-in restraints) with a weighted 6-year-old dummy. We believe that use of the new dummies, in itself, would not necessitate redesign of child restraints. The new dummies perform similarly to the ones presently used in compliance testing.

The agency does not believe that updating the seat assembly and revising the crash pulse will affect dummy performance to an extent that benefits would accrue from such changes, nor will benefits be gained by the change to the dummies. There could be safety benefits associated with keeping more

¹⁷ NHTSA's final regulatory evaluation (FRE) discusses issues relating to the potential costs, benefits and other impacts of this regulatory action. The FRE is available in the docket for this rule and may be obtained by contacting Docket Management at the address or telephone number provided at the beginning of this document. You may also read the document via the Internet, by following the instructions in the section below entitled, "Viewing Docket Submissions." The FRE will be listed in the docket summary.

infants rear-facing until they are at least 12-months old, which could result from the change to the CRABI and to having infant car seat/carriers be designed with higher back support structures. However, the agency cannot quantify any lives saved or injuries avoided from the amendment.

b. Regulatory Flexibility Act

The Regulatory Flexibility Act of 1980, as amended, requires agencies to evaluate the potential effects of their proposed and final rules on small businesses, small organizations and small governmental jurisdictions. I hereby certify that this final rule will not have a significant economic impact on a substantial number of small entities. NHTSA estimates there to be about 13 manufacturers of child restraints, four or five of which could be small businesses.

This rule will not generally increase the testing that NHTSA conducts of child restraints, except that booster seats, harnesses and other types of child restraints that could be recommended for children weighing over 50 lb will be tested with the weighted 6-year-old dummy, in addition to the dummies presently used to assess the performance of the restraint (generally these are the 3-year-old and the unweighted 6-year-old dummies). Thus, the certification responsibilities of manufacturers will not generally be affected. The agency does not believe this final rule will impose a significant economic impact on small entities, because these businesses currently must certify their products to the dynamic test of Standard No. 213. That is, the products of these manufacturers already are subject to dynamic testing using child test dummies. The effect of this final rule on most child restraints is to subject them to testing with new dummies in place of existing ones, and/or an additional dummy. Testing child restraints on a new seat assembly is not expected to significantly affect the performance of the restraints.

c. Executive Order 13132 (Federalism)

Executive Order 13132 requires NHTSA to develop an accountable process to ensure "meaningful and timely input by State and local officials in the development of regulatory policies that have federalism implications." "Policies that have federalism implications" is defined in the Executive Order to include regulations that have "substantial direct effects on the States, on the relationship between the national government and the States, or on the distribution of power and responsibilities among the

various levels of government." Under Executive Order 13132, the agency may not issue a regulation with Federalism implications, that imposes substantial direct compliance costs, and that is not required by statute, unless the Federal government provides the funds necessary to pay the direct compliance costs incurred by State and local governments, the agency consults with State and local governments, or the agency consults with State and local officials early in the process of developing the proposed regulation. NHTSA also may not issue a regulation with Federalism implications and that preempts State law unless the agency consults with State and local officials early in the process of developing the proposed regulation.

We have analyzed this final rule in accordance with the principles and criteria set forth in Executive Order 13132 and have determined that this rule does not have sufficient Federal implications to warrant consultation with State and local officials or the preparation of a Federalism summary impact statement. The rule will not have any substantial impact on the States, or on the current Federal-State relationship, or on the current distribution of power and responsibilities among the various local officials.

d. Unfunded Mandates Reform Act

Section 202 of the Unfunded Mandates Reform Act of 1995 (UMRA) requires Federal agencies to prepare a written assessment of the costs, benefits and other effects of proposed or final rules that include a Federal mandate likely to result in the expenditure by State, local or tribal governments, in the aggregate, or by the private sector, of more than \$100 million in any one year (\$100 million adjusted annually for inflation, with base year of 1995). (Adjusting this amount by the implicit gross domestic product price deflator for the year 2000 results in \$109 million.) This final rule will not result in costs of \$109 million or more to either State, local, or tribal governments, in the aggregate, or to the private sector. Thus, this final rule is not subject to the requirements of sections 202 of the UMRA.

e. National Environmental Policy Act

NHTSA has analyzed this final rule for the purposes of the National Environmental Policy Act. The agency has determined that implementation of this action will not have any significant impact on the quality of the human environment.

f. Executive Order 12778 (Civil Justice Reform)

This final rule will not have any retroactive effect. Under 49 U.S.C. 21403, whenever a Federal motor vehicle safety standard is in effect, a State may not adopt or maintain a safety standard applicable to the same aspect of performance which is not identical to the Federal standard, except to the extent that the state requirement imposes a higher level of performance and applies only to vehicles procured for the State's use. 49 U.S.C. 21461 sets forth a procedure for judicial review of final rules establishing, amending or revoking Federal motor vehicle safety standards. That section does not require submission of a petition for reconsideration or other administrative proceedings before parties may file suit in court.

g. Paperwork Reduction Act

Under the Paperwork Reduction Act of 1995, a person is not required to respond to a collection of information by a Federal agency unless the collection displays a valid OMB control number. This final rule does not contain any collection of information requirements requiring review under the Paperwork Reduction Act.

h. National Technology Transfer and Advancement Act

Section 12(d) of the National Technology Transfer and Advancement Act of 1995 (NTTAA) directs us to use voluntary consensus standards in our regulatory activities unless doing so would be inconsistent with applicable law or otherwise impractical. Voluntary consensus standards are technical standards (e.g., materials specifications, test methods, sampling procedures, and business practices) that are developed or adopted by voluntary consensus standards bodies, such as the International Organization for Standardization (ISO). The NTTAA directs us to provide Congress, through OMB, explanations when we decide not to use available and applicable voluntary consensus standards. The agency searched for, but did not find, voluntary consensus standards for use at this time.

i. Viewing Docket Submissions

You may read the comments received by Docket Management at Room PL-401, 400 Seventh Street, SW., Washington, DC, 20590 (telephone 202-366-9324). You may visit the Docket from 10 a.m. to 5 p.m., Monday through Friday.

You may also see the comments on the Internet. To read the comments on the Internet, take the following steps:

(1) Go to the Docket Management System (DMS) Web page of the Department of Transportation (<http://dms.dot.gov/>).

(2) On that page, click on "search."

(3) On the next page (<http://dms.dot.gov/search/>), type in the four-digit docket number shown at the beginning of this document. Example: If the docket number were "NHTSA-2002-1234," you would type "1234." After typing the docket number, click on "search."

(4) On the next page, which contains docket summary information for the docket you selected, click on the desired comments. You may download the comments. However, since the comments are imaged documents, instead of word processing documents, the downloaded comments are not word searchable.

Anyone is able to search the electronic form of all comments received into any of our dockets by the name of the individual submitting the comment (or signing the comment, if submitted on behalf of an association, business, labor union, etc.). You may review DOT's complete Privacy Act Statement in the **Federal Register** published on April 11, 2000 (Volume 65, Number 70; Pages 19477-78) or you may visit <http://dms.dot.gov>.

List of Subjects in 49 CFR Part 571

Motor vehicle safety, Reporting and recordkeeping requirements, Tires, Incorporation by Reference.

PART 571—[AMENDED]

■ In consideration of the foregoing, NHTSA amends 49 CFR part 571 as set forth below.

■ 1. The authority citation for Part 571 continues to read as follows:

Authority: 49 U.S.C. 322, 30111, 30115, 30117 and 30166; delegation of authority at 49 CFR 1.50.

■ 2. Section 571.5 is amended by renumbering the current paragraph (b)(10) as (b)(11) and adding a new paragraph (b)(10), to read as follows:

§ 571.5 Matter incorporated by reference

* * * * *

(10) *Child Restraint Systems Seat Assembly Drawing Package.* Copies may be obtained by contacting: Leet-Melbrook, 18810 Woodfield Road, Gaithersburg, MD, 20879, telephone (301) 670-0090.

* * * * *

■ 3. Section 571.213 is amended by:

- a. Revising the definition of "child restraint system" in S4;
- b. Adding S5(d);
- c. Revising the introductory text of S5.1.2;
- d. Adding S5.1.2.1 and S5.1.2.2;
- e. Revising the table to S5.2.1.1(a);
- f. Revising the introductory text of S5.2.1.2,
- g. Revising S5.2.3.1 and S5.9(a);
- h. Revising S6.1.1(a)(1), S6.1.1(b)(1) and S6.1.1(d), and the introductory text of S6.2.3;
- i. Revising S7, and S9.1(c);
- j. Adding S9.1(d), S9.1(e) and S9.1(f);
- k. Revising S9.3, S10.2.1(b)(2), S10.2.1(c)(1)(i) introductory text, and S10.2.1(c)(2);
- l. Revising Figure 1A; and,
- m. Adding Figure 2A.

The revised and added text and figures read as follows:

§ 571.213 Standard No. 213, Child restraint systems.

* * * * *

S4. Definitions.

Child restraint system means any device, except Type I or Type II seat belts, designed for use in a motor vehicle or aircraft to restrain, seat, or position children who weigh 30 kilograms (kg) or less.

* * * * *

S5. Requirements.

* * * * *

(d) Each child restraint tested with a part 572 subpart N dummy that is weighted to weigh 28.2 kg need not meet S5.1.2 and S5.1.3.

* * * * *

S5.1.2 *Injury criteria.* When tested in accordance with S6.1 and with the test dummies specified in S7, each child restraint system manufactured before August 1, 2005, that, in accordance with S5.5.2, is recommended for use by children whose mass is more than 10 kg shall—

* * * * *

S5.1.2.1 When tested in accordance with S6.1 and with the test dummies specified in S7, each child restraint system manufactured on or after August 1, 2005 shall'

(a) Limit the resultant acceleration at the location of the accelerometer mounted in the test dummy head such that, for any two points in time, t1 and t2, during the event which are separated by not more than a 36 millisecond time interval and where t1 is less than t2, the maximum calculated head injury criterion (HIC36) shall not exceed 1,000, determined using the resultant head acceleration at the center of gravity of the dummy head, ar, expressed as a multiple of g (the acceleration of

gravity), calculated using the expression:

$$HIC = \left[\frac{1}{(t_2 - t_1)} \int_{t_1}^{t_2} a dt \right]^{2.5} (t_2 - t_1)$$

(b) The resultant acceleration calculated from the output of the thoracic instrumentation shall not exceed 60 g's, except for intervals whose cumulative duration is not more than 3 milliseconds.

S5.1.2.2 At the manufacturer's option (with said option irrevocably selected prior to, or at the time of, certification of the restraint), child restraint systems manufactured before August 1, 2005 may be tested to the requirements of S5 while using the test dummies specified in S7.1.2 of this standard according to the criteria for selecting test dummies specified in that paragraph. That paragraph specifies the dummies used to test child restraint systems manufactured on or after August 1, 2005. If a manufacturer selects the dummies specified in S7.1.2 to test its product, the injury criteria specified by S5.1.2.1 of this standard must be met. Child restraints manufactured on or after August 1, 2005 must be tested using the test dummies specified in S7.1.2.

* * * * *

S5.2 Force distribution.

* * * * *

S5.2.1.1 * * *

(a) * * *

TABLE TO S5.2.1.1(A)

Weight ¹	Height ² (mm)
Not more than 18 kg	500
More than 18 kg	560

¹When a child restraint system is recommended under S5.5 for use by children of the above weights.

²The height of the portion of the system seat back providing head restraint shall not be less than the above.

* * * * *

S5.2.1.2 The applicability of the requirements of S5.2.1.1 to a front-facing child restraint, and the conformance of any child restraint other than a car bed to those requirements, is determined using the largest of the test dummies specified in S7 for use in testing that restraint, provided that the 6-year-old dummy described in subpart I or subpart N of part 572 of this title is not used to determine the applicability of or compliance with S5.2.1.1. A front-facing child restraint system is not required to comply with S5.2.1.1 if the target point on either side

of the dummy's head is below a horizontal plane tangent to the top of—

* * * * *

S5.2.3.1 Each child restraint system other than a child harness, manufactured before August 1, 2005, that is recommended under S5.5.2 for a child whose mass is less than 10 kg and that is not tested with the Part 572 Subpart R dummy, shall comply with S5.2.3.

S5.9 Attachment to child restraint anchorage system.

(a) Each add-on child restraint anchorage system manufactured on or after September 1, 2002, other than a car bed, harness and belt-positioning seat, shall have components permanently attached to the system that enable the restraint to be securely fastened to the lower anchorages of the child restraint anchorage system specified in Standard No. 225 (§ 571.213) and depicted in Drawing Package SAS-100-1000 with Addendum A: Seat Base Weldment (consisting of drawings and a bill of materials), dated October 23, 1998, or in Drawing Package, "NHTSA Standard Seat Assembly; FMVSS No. 213, No. NHTSA-213-2003," (consisting of drawings and a bill of materials) dated June 3, 2003 (incorporated by reference; see § 571.5). The components must be attached by use of a tool, such as a screwdriver. In the case of rear-facing child restraints with detachable bases, only the base is required to have the components.

* * * * *

S6.1.1 Test conditions.

(a) Test devices.

(1) Add-on child restraints.

(i) The test device for add-on restraint systems manufactured before August 1, 2005 is a standard seat assembly consisting of a simulated vehicle bench seat, with three seating positions, which is described in Drawing Package SAS-100-1000 with Addendum A: Seat Base Weldment (consisting of drawings and a bill of materials), dated October 23, 1998 (incorporated by reference in § 571.5). The assembly is mounted on a dynamic test platform so that the center SORL of the seat is parallel to the direction of the test platform travel and so that movement between the base of the assembly and the platform is prevented.

(ii) The test device for add-on restraint systems manufactured on or after August 1, 2005 is a standard seat assembly consisting of a simulated vehicle bench seat, with three seating positions, which is depicted in Drawing Package, "NHTSA Standard Seat Assembly; FMVSS No. 213, No. NHTSA-213-2003," (consisting of

drawings and a bill of materials) dated June 3, 2003 (incorporated by reference; see § 571.5). The assembly is mounted on a dynamic test platform so that the center SORL of the seat is parallel to the direction of the test platform travel and so that movement between the base of the assembly and the platform is prevented.

* * * * *

(b) * * *

(1) Test Configuration I, are at a velocity change of 48 km/h with the acceleration of the test platform entirely within the curve shown in Figure 2 (for child restraints manufactured before August 1, 2005) or in Figure 2A (for child restraints manufactured on or after August 1, 2005), or for the specific vehicle test with the deceleration produced in a 48 km/h frontal barrier crash.

* * * * *

(d)(1) When using the test dummies specified in 49 CFR Part 572, subparts C, I, J, or K, performance tests under S6.1 are conducted at any ambient temperature from 19°C to 26°C and at any relative humidity from 10 percent to 70 percent.

(2) When using the test dummies specified in 49 CFR Part 572, subparts N, P or R, performance tests under S6.1 are conducted at any ambient temperature from 20.6°C to 22.2°C and at any relative humidity from 10 percent to 70 percent.

* * * * *

S6.2.3 Pull the sling tied to the dummy restrained in the child restraint system and apply the following force: 50 N for a system tested with a newborn dummy; 90 N for a system tested with a 9-month-old dummy; 90 N for a system tested with a 12-month-old dummy; 200 N for a system tested with a 3-year-old dummy; or 270 N for a system tested with a 6-year-old dummy; or 350 N for a system tested with a weighted 6-year-old dummy. The force is applied in the manner illustrated in Figure 4 and as follows:

* * * * *

S7 Test dummies. (Subparts referenced in this section are of part 572 of this chapter.) S7.1 Dummy selection. Select any dummy specified in S7.1.1, S7.1.2 or S7.1.3, as appropriate, for testing systems for use by children of the height and mass for which the system is recommended in accordance with S5.5. A child restraint that meets the criteria in two or more of the following paragraphs in S7 may be tested with any of the test dummies specified in those paragraphs.

S7.1.1 Child restraints that are manufactured before August 1, 2005, are subject to the following provisions:

(a) A child restraint that is recommended by its manufacturer in accordance with S5.5 for use either by children in a specified mass range that includes any children having a mass of not greater than 5 kg, or by children in a specified height range that includes any children whose height is not greater than 650 mm, is tested with a newborn test dummy conforming to part 572 subpart K.

(b) A child restraint that is recommended by its manufacturer in accordance with S5.5 for use either by children in a specified mass range that includes any children having a mass greater than 5 but not greater than 10 kg, or by children in a specified height range that includes any children whose height is greater than 650 mm but not greater than 850 mm, is tested with a newborn test dummy conforming to part 572 subpart K, and a 9-month-old test dummy conforming to part 572 subpart J.

(c) A child restraint that is recommended by its manufacturer in accordance with S5.5 for use either by children in a specified mass range that includes any children having a mass greater than 10 kg but not greater than 18 kg, or by children in a specified height range that includes any children whose height is greater than 850 mm but not greater than 1100 mm, is tested with a 9-month-old test dummy conforming to part 572 subpart J, and a 3-year-old test dummy conforming to part 572 subpart C and S7.2, provided, however, that the 9-month-old dummy is not used to test a booster seat.

(d) A child restraint that is recommended by its manufacturer in accordance with S5.5 for use either by children in a specified mass range that includes any children having a mass greater than 18 kg, or by children in a specified height range that includes any children whose height is greater than 1100 mm, is tested with a 6-year-old child dummy conforming to part 572 subpart I.

(e) A child restraint that is manufactured on or after August 1, 2005, and that is recommended by its manufacturer in accordance with S5.5 for use either by children in a specified mass range that includes any children having a mass greater than 22.7 kg, or by children in a specified height range that includes any children whose height is greater than 1100 mm, is tested with a part 572 subpart N dummy that is weighted to weigh 28.2 kg.

S7.1.2 Child restraints that are manufactured on or after August 1,

2005, are subject to the following provisions.

(a) A child restraint that is recommended by its manufacturer in accordance with S5.5 for use either by children in a specified mass range that includes any children having a mass of not greater than 5 kg, or by children in a specified height range that includes any children whose height is not greater than 650 mm, is tested with a newborn test dummy conforming to part 572 subpart K.

(b) A child restraint that is recommended by its manufacturer in accordance with S5.5 for use either by children in a specified mass range that includes any children having a mass greater than 5 but not greater than 10 kg, or by children in a specified height range that includes any children whose height is greater than 650 mm but not greater than 850 mm, is tested with a newborn test dummy conforming to part 572 subpart K, and a 12-month-old test dummy conforming to part 572 subpart R.

(c) A child restraint that is recommended by its manufacturer in accordance with S5.5 for use either by children in a specified mass range that includes any children having a mass greater than 10 kg but not greater than 18 kg, or by children in a specified height range that includes any children whose height is greater than 850 mm but not greater than 1100 mm, is tested with a 12-month-old test dummy conforming to part 572 subpart R, and a 3-year-old test dummy conforming to part 572 subpart P and S7.2, provided, however, that the 12-month-old dummy is not used to test a booster seat.

(d) A child restraint that is recommended by its manufacturer in accordance with S5.5 for use either by children in a specified mass range that includes any children having a mass greater than 18 kg, or by children in a specified height range that includes any children whose height is greater than 1100 mm, is tested with a 6-year-old child dummy conforming to part 572 subpart N.

(e) A child restraint that is manufactured on or August 1, 2005, that is recommended by its manufacturer in accordance with S5.5 for use either by children in a specified mass range that includes any children having a mass greater than 22.7 kg or by children in a specified height range that includes any children whose height is greater than 1100 mm is tested with a part 572 subpart N dummy that is weighted to weigh 28.2 kg.

S7.1.3 *Voluntary use of alternative dummies.* At the manufacturer's option (with said option irrevocably selected

prior to, or at the time of, certification of the restraint), child restraint systems manufactured before August 1, 2005 may be tested to the requirements of S5 while using the test dummies specified in S7.1.2 according to the criteria for selecting test dummies specified in that paragraph. Child restraints manufactured on or after August 1, 2005, must be tested using the test dummies specified in S7.1.2.

* * * * *

S9.1 *Type of clothing.*

* * * * *

(c) *12-month-old dummy (49 CFR Part 572, Subpart R).* When used in testing under this standard, the dummy specified in 49 CFR part 572, subparts R, is clothed in a cotton-polyester based tight fitting sweat shirt with long sleeves and ankle long pants whose combined weight is not more than 0.25 kg.

(d) *Hybrid II three-year-old and Hybrid II six-year-old dummies (49 CFR part 572, subparts C and I).* When used in testing under this standard, the dummies specified in 49 CFR part 572, subparts C and I, are clothed in thermal knit, waffle-weave polyester and cotton underwear or equivalent, a size 4 long-sleeved shirt (3-year-old dummy) or a size 5 long-sleeved shirt (6-year-old dummy) having a mass of 0.090 kg, a size 4 pair of long pants having a mass of 0.090 kg, and cut off just far enough above the knee to allow the knee target to be visible, and size 7M sneakers (3-year-old dummy) or size 12½M sneakers (6-year-old dummy) with rubber toe caps, uppers of dacron and cotton or nylon and a total mass of 0.453 kg.

(e) *Hybrid III 3-year-old dummy (49 CFR Part 572, Subpart P).* When used in testing under this standard, the dummy specified in 49 CFR part 572, subpart P, is clothed in thermal knit, waffle-weave polyester and cotton underwear or equivalent, a size 4 long-sleeved shirt (3-year-old dummy) or a size 5 long-sleeved shirt (6-year-old dummy) having a mass of 0.090 kg, a size 4 pair of long pants having a mass of 0.090 kg, and cut off just far enough above the knee to allow the knee target to be visible, and size 7M sneakers with rubber toe caps, uppers of dacron and cotton or nylon and a total mass of 0.453 kg.

(f) *Hybrid III 6-year-old dummy (49 CFR Part 572, Subpart N) and Hybrid III weighted 6-year-old dummy.* When used in testing under this standard, the dummy specified in 49 CFR part 572, subpart N, weighted and unweighted, is clothed in a light-weight cotton stretch short-sleeve shirt and above-the-knee pants, and size 12½ M sneakers with rubber toe caps, uppers of dacron and

cotton or nylon and a total mass of 0.453 kg.

* * * * *

S9.3 *Preparing dummies.* (Subparts referenced in this section are of Part 572 of this chapter.)

S9.3.1 When using the test dummies conforming to Part 572 Subpart C, I, J, or K, prepare the dummies as specified in this paragraph. Before being used in testing under this standard, dummies must be conditioned at any ambient temperature from 19° C to 25.5° C and at any relative humidity from 10 percent to 70 percent, for at least 4 hours.

S9.3.2 When using the test dummies conforming to Part 572 Subparts N (weighted and unweighted), P, or R, prepare the dummies as specified in this paragraph. Before being used in testing under this standard, dummies must be conditioned at any ambient temperature from 20.6° C to 22.2° C and at any relative humidity from 10 percent to 70 percent, for at least 4 hours.

* * * * *

S10.2.1 * * *

(b) * * *

(2) When testing rear-facing child restraint systems, place the newborn, 9-month-old or 12-month-old dummy in the child restraint system so that the back of the dummy torso contacts the back support surface of the system. For a child restraint system which is equipped with a fixed or movable surface described in S5.2.2.2 which is being tested under the conditions of test configuration II, do not attach any of the child restraint belts unless they are an integral part of the fixed or movable surface. For all other child restraint systems and for a child restraint system with a fixed or movable surface which is being tested under the conditions of test configuration I, attach all appropriate child restraint belts and tighten them as specified in S6.1.2. Attach all appropriate vehicle belts and tighten them as specified in S6.1.2. Position each movable surface in accordance with the instructions that the manufacturer provided under S5.6.1 or S5.6.2. If the dummy's head does not remain in the proper position, tape it against the front of the seat back surface of the system by means of a single thickness of 6 mm-wide paper masking tape placed across the center of the dummy's face.

(c)(1)(i) When testing forward-facing child restraint systems, extend the arms of the 9-month-old or 12-month-old test dummy as far as possible in the upward vertical direction. Extend the legs of the 9-month-old or 12-month-old test dummy as far as possible in the forward horizontal direction, with the dummy

feet perpendicular to the centerline of the lower legs. Using a flat square surface with an area of 2,580 square mm, apply a force of 178 N, perpendicular to:

* * * * *

(2) When testing rear-facing child restraint systems, extend the dummy's

arms vertically upwards and then rotate each arm downward toward the dummy's lower body until the arm contacts a surface of the child restraint system or the standard seat assembly in the case of an add-on child restraint system, or the specific vehicle shell or the specific vehicle, in the case of a built-in child restraint system. Ensure

that no arm is restrained from movement in other than the downward direction, by any part of the system or the belts used to anchor the system to the standard seat assembly, the specific shell, or the specific vehicle.

* * * * *

BILLING CODE 4910-59-P

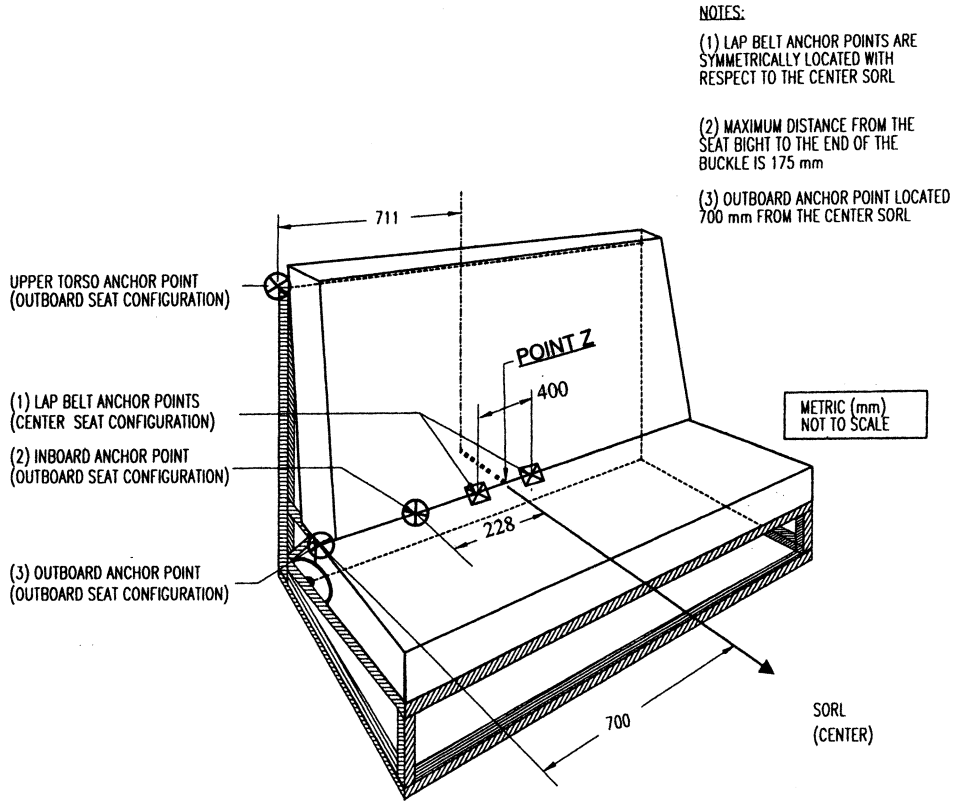

SEAT ORIENTATION REFERENCE LINE AND BELT ANCHORAGE POINT LOCATIONS ON THE STANDARD SEAT ASSEMBLY
Figure 1A

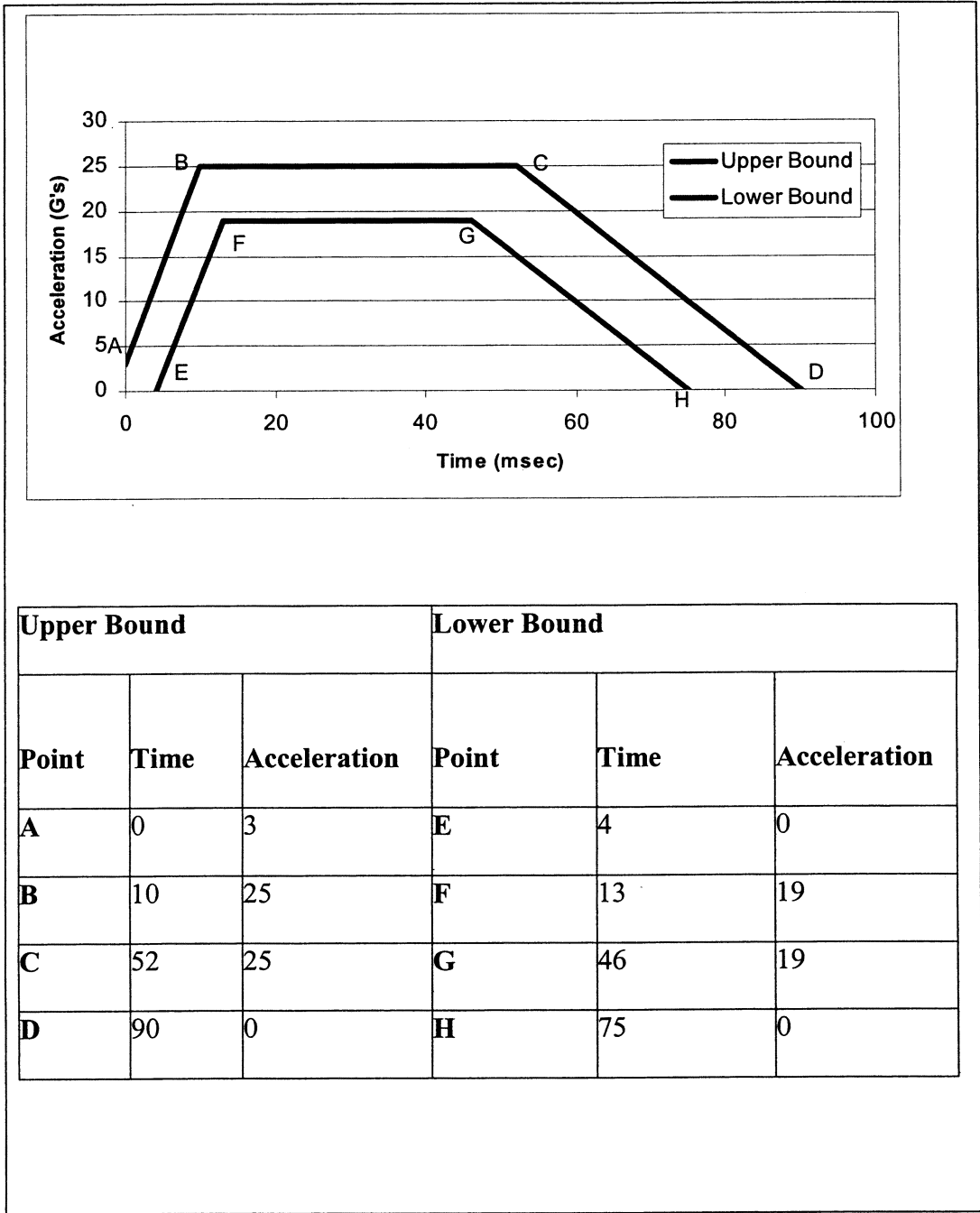

Figure 2A

Issued on: June 4, 2003.

Jeffrey W. Runge,

Administrator.

[FR Doc. 03-14425 Filed 6-23-03; 8:45 am]

BILLING CODE 4910-59-C