

## 1.0 PURPOSE

The purpose of this document is to provide a test procedure to be used by Electrical Safety Division (ESD) personnel to determine the explosion-proof (X/P) characteristics of prototype enclosures per 30 CFR 18.62.

## 2.0 SCOPE

This Standard Test procedure (STP) applies to prototype enclosures submitted for approval and certification where explosion-proof characteristics are required.

## 3.0 REFERENCES

- 3.1. 30 CFR Part 18.62 "Tests to determine explosion-proof characteristics"
- 3.2. International Electrotechnical Commission (IEC) Publication 79-1 - "Electrical Apparatus for Explosive Gas Atmospheres"

## 4.0 DEFINITIONS

- 4.1. Afterburning - The combustion of a flammable mixture that is drawn into an enclosure after an internal explosion has occurred.
- 4.2. Direct Sampling Arrangement - A test setup where the explosion-proof enclosure is placed in the gallery and the gas-out is connected directly to the X/P enclosure and a pump and is separate from the circulating system. The gas-out line also serves as a sampling point.
- 4.3. Dummies - Parts substituted during explosion testing for internal electrical components.
- 4.4. Gallery - A chamber used to safely conduct explosion tests, usually having a top opening, sealed with a paper diaphragm.
- 4.5. General Enclosures - Enclosures with an internal free volume of 2000 cu. inches or greater and 10 feet long maximum.
- 4.6. Pressure Piling - The development of abnormal pressure as a result of accelerated rate of burning of a gas-air mixture, frequently caused by restricted configurations within enclosures. The rate of acceleration necessary is 2 psi per millisecond.
- 4.7. Small Enclosures and Headlights - Enclosures with an internal free volume of 2000 cubic inches or less, and about 1.5 feet maximum length.

4.8. Standard Test Vessel - A vessel designed to test enclosures with volume less than about 30 cubic inches. The enclosure under test is connected to the standard test vessel and the fittings for the transducers and gas-in and gas-out are connected to the standard test vessel rather than the enclosure. A standard test vessel should be of approximately spherical or cubic shape with a volume in excess of 4 liters. The A&CC's current version is 22.4 liters in volume.

4.9. Tube Luminaires - Tubes used to house fluorescent lights. Usually tubes are made of polycarbonate.

## 5.0 TEST EQUIPMENT

5.1. Explosion Test gallery

5.2. Control Panel for Explosion Testing

5.3. Methane Monitoring System

5.4. Spark plug

5.5. Pressure monitoring System, consisting of an oscilloscope or strip chart recorder. An oscilloscope is recommended for high frequency response.

5.6. Coal Dust having a minimum of 22% dry volatile matter and a minimum heat constant of 11,000 moist BTU ground to a fineness of minus 200 mesh U.S. Standard sieve series.

## 6.0 TEST SAMPLES

6.1. One prototype explosion-proof enclosure.

6.2. For enclosures with lenses requiring test, 4 lens samples must be provided. Alternatively 4 enclosures with lenses may be supplied.

## 7.0 PROCEDURES

7.1. GENERAL TEST PROCEDURES

7.1.1. Check for pressure piling.

7.1.2. Check for integrity of flame paths and general mechanical design.

7.1.3. Check for weakened areas and areas of minimal design.

- 7.1.4. With dummies installed, choose spark locations most likely to cause pressure piling.
- 7.1.5. With dummies removed, choose spark location to produce the highest pressure.
- 7.1.6. Centralize ignition location: cross-sectional center when firing from the ends and geometrical center when firing from the center.
- 7.1.7. If explosion pressure exceeds 80 psig, then recheck test fittings for tightness: dope and retighten if necessary to assure that the explosion-proof enclosure is adequately sealed against stray leakage.
- 7.1.8. Keep fittings short - especially for small enclosures.
- 7.1.9. For enclosures having a free volume less than 300 cu. in., the use of 3/8" solenoid valves is recommended.
- 7.1.10. For enclosures between approximately 30 and 300 cu. in. of free volume, the direct sampling setup is recommended.
- 7.1.11. For enclosures having a free volume less than 30 cu. in., the 22.4 liter standard test vessel arrangement is recommended.
- 7.1.12. If an area of an enclosure is suspected of being damaged during explosion testing or the design of a flame path is questionable then additional tests may be conducted using a 9.6% mixture in the enclosure and 7.0% in the gallery. International Electrotechnical Commission (IEC) tests per Publication 79-1 - "Electrical Apparatus for Explosive Gas Atmospheres" may be considered.
- 7.1.13. When connecting valves, ignition system and transducer systems to the enclosure, ensure that signal lines (i.e., transducer cables) are segregated from current carrying lines to minimize noise interference.
- 7.1.14. Connect gas-in and gas-out valve assemblies to the enclosure in locations appropriate to assure good flow, and mixing. Generally, on an empty, rectilinear enclosure this will be as far apart as possible. Not all configurations can be predicted. The use of additional valves and blowers may be considered. The following diagram should serve as a general guide.

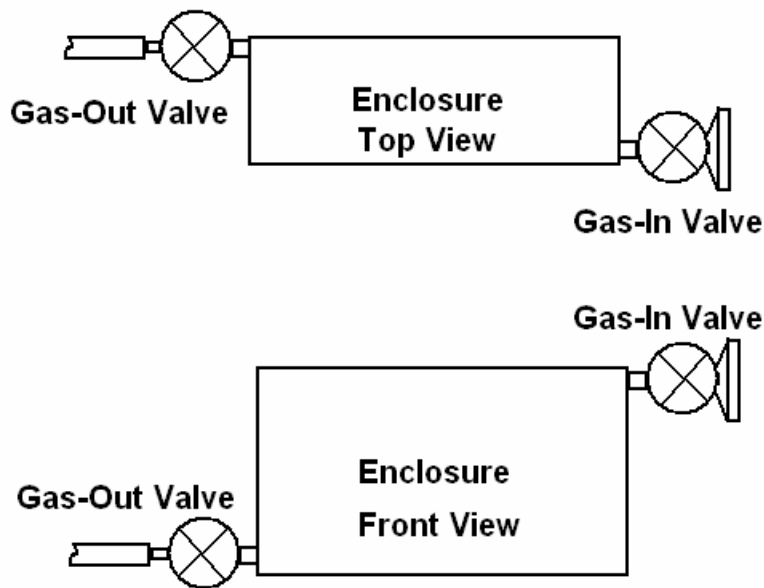

7.1.15. Before and after explosion testing, larger enclosures will need to be measured and marked so as to be able to determine deformation changes as a result of testing.

7.1.16. A minimum of 16 tests must be conducted.

## 7.2. SPECIFIC TEST PROCEDURES

7.2.1. Tests are conducted in a gallery with observation ports at all sides. Video Recording equipment may also be considered for observing tests.

7.2.2. The enclosure is filled with and surrounded by an explosive mixture of natural gas and air or methane and air.

7.2.3. If natural gas is used, the content of methane and ethane shall total at least 98.0 by volume per centum with nitrogen and propane the remainder.

7.2.4. The enclosure and gallery gas concentrations shall be monitored using a methane monitoring system, with an accuracy of  $\pm 0.1$  by volume per centum.

7.2.5. The enclosure and gallery gas concentration shall not differ by more than  $\pm 0.3$  by volume per centum at the time of ignition.

7.2.6. The methane monitoring system should be calibrated before use, using bottled calibration gases of concentration appropriate to the tests.

- 7.2.7. The internal mixture shall be ignited by an electrical spark of 100 millijoules or greater. A single spark plug is used for all testing.
- 7.2.8. Pressure-time records shall be obtained for each test to identify pressure piling.
- 7.2.9. The pressure measuring and recording system shall have a frequency response of 40 hertz (10 ms sample rate for digital systems) or greater and shall provide rate of rise detail equivalent to recorder chart speed of at least 25 mm/s for all tests using dummies. An oscilloscope is recommended; chart recorders may also be used.
- 7.2.10. The accuracy of the pressure record trace shall be within +/-1 psi at 100 psig static.
- 7.2.11. The enclosure and gallery atmosphere shall be completely purged and recharged with a fresh combustible mixture as needed. This may occur after every test for large enclosures. A 40 to 1 or greater gallery to enclosure volume ratio per test may be used to determine frequency of purging necessary.
- 7.2.12. After each test, the pressure-time shall be examined for spike pressure peaks and for a sudden increase in the rate of pressure rise. Pressure piling occurs when the rate of rise is 2 psi/millisecond or faster.
- 7.2.13. If this occurs, and no pressure peaks exceed 125 psig, then at least six additional tests, as follows, shall be conducted using the same ignition location. The following tests can be discontinued if a pressure in excess of 125 psig is recorded.
- 7.2.14. Two tests shall be repeats of the previous tests.
- 7.2.15. Two tests will be conducted with a gas concentration 1 percentage point above and 1 percentage point below the original concentration.
- 7.2.16. Two tests shall be conducted with the spark beyond (one test) and behind (one test) the original location by one-half the distance between the original location and any restriction or physical interference to the spark. No change will be greater than six inches.
- 7.2.17. If any pressure peak exceeds 125 psig, the manufacturer must either make constructional changes that will result in a reduction of pressure to 125 psi or less or conduct static pressure tests of the enclosure, with the enclosure

withstanding a static pressure of twice the highest value recorded in any previous tests.

- 7.2.18. If the rate of pressure rise is extremely steep, identical tests may be conducted employing a high frequency response (4000 hertz or greater) pressure measuring and recording system to more accurately verify the excess pressures.
- 7.2.19. Tests must be conducted under conditions most likely to result in test failure, such as 9.6%CH<sub>4</sub> gas-air mixture, optimum spark location, and testing with and without dummies. Placement of the electrical spark must be determined on a case by case basis for the various size and shape enclosures and the internal component configurations. Attempt to centralize the ignition location cross-sectionally when firing from the ends and geometrically when firing from the center.
- 7.2.20. When previously certified cable glands are to be used on an enclosure, at least one complete gland assembly, including the acceptable cable, of each type shall be tested. The remaining stuffing boxes may be plugged.
- 7.2.21. Explosion testing of windows and lenses shall not be conducted within 24 hours after the drop weight tests are completed. Windows and lenses shall be inspected for explosion damage at least 24 hours after testing.
- 7.3. EXPLOSION TESTING SEQUENCE - GENERAL SIZE ENCLOSURES
- 7.3.1. FIRST SERIES - 2 tests at each ignition. If using a strip chart recorder, use 25 mm/s recorder paper speed to check for pressure piling.
- 7.3.1.1. With dummies installed and a 9.6% CH<sub>4</sub> mixture, conduct two tests each with ignition at each end and at the center of the enclosure for a total of six tests.

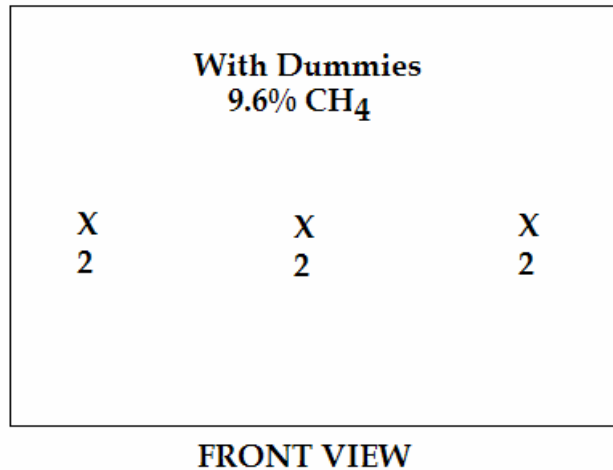

7.3.2. SECOND SERIES - 5 mm/s recorder paper speed normally acceptable for rest of tests. This second series of tests is to check flame paths and general mechanical design.

7.3.2.1. With dummies removed and a 9.6% CH<sub>4</sub> mixture, conduct one test each with ignition at each end of the enclosure and four tests with ignition at the center of the enclosure for a total of six tests.

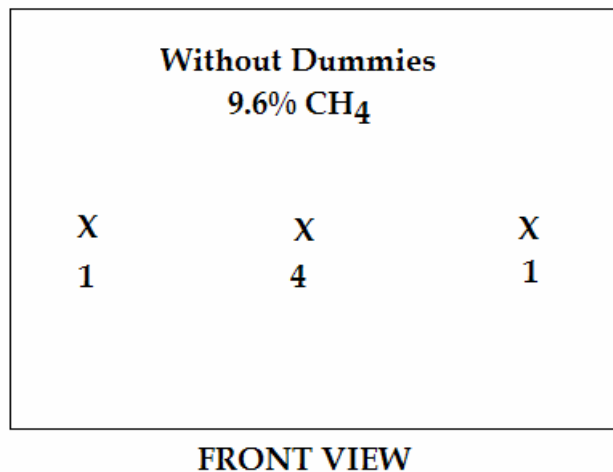

7.3.3. THIRD SERIES - If one of the tests with dummies produced a pressure higher than without by more than 2 psi, then that configuration will be used.

- 7.3.3.1. With dummies removed and a 6.8 to 7.2% CH<sub>4</sub> mixture, conduct two tests with ignition at the center of the enclosure.

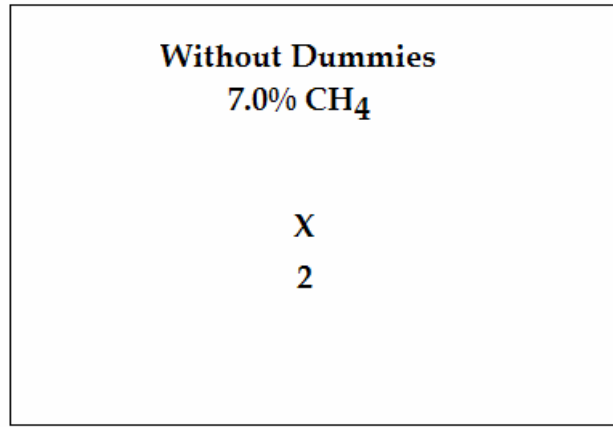

**FRONT VIEW**

- 7.3.3.2. With dummies removed and a 9.6% CH<sub>4</sub> mixture, and coal dust inserted through any opening in the enclosure, conduct two tests with ignition at the center of the enclosure. The quantity of coal dust should be approximately 0.05 ounces per cubic foot of enclosure volume.

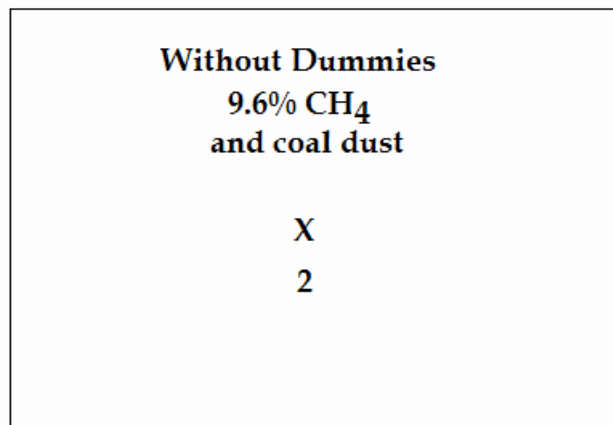

**FRONT VIEW**

- 7.4. In the event that an enclosure consists of more than one chamber isolated by a feed through, insulated stud, or similar item, the following additional tests shall be conducted.



- 7.4.1. Two additional ignition points shall be used, one near geometric center of the chamber and one as far away from the isolating device as practical, for each chamber. Recording of pressure should be on both sides of the barrier.
- 7.4.2. Each chamber should be tested separately as per 7.3.1 through 7.3.2.
- 7.4.3. The isolating device shall be removed and 2 tests at 9.6% CH<sub>4</sub> mixture shall be conducted at each of the additional ignition points.
- 7.4.4. Remaining tests shall be conducted as per 7.3.3.

#### 7.5. SMALL ENCLOSURES AND HEADLIGHTS

- 7.5.1. FIRST SERIES - Conduct two tests with dummies with ignition at the center of the enclosure. If the dummies and or constructional details form a 60% restriction or greater which divides the enclosure into two volumes, conduct 2 tests with ignition in each volume (4 tests total) instead of central ignition. Otherwise conduct 4 additional tests at the center. If using a strip chart recorder, use 25mm/s recorder speed. Six tests total.

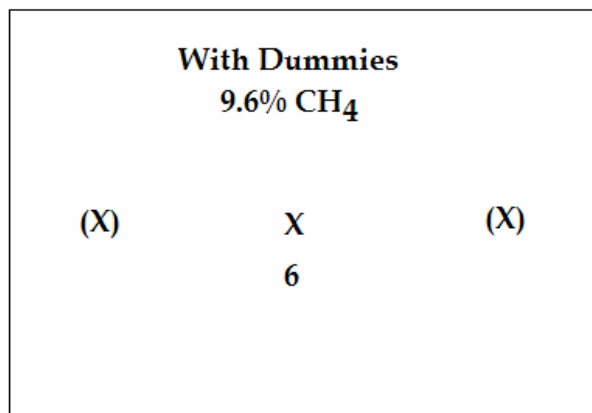

**FRONT VIEW**

- 7.5.2. SECOND SERIES - If using a strip chart recorder, 5mm/s recorder paper speed is normally acceptable for remaining tests.

- 7.5.2.1. With dummies removed and 9.6% CH<sub>4</sub> mixture, conduct six tests with ignition at the center of the enclosure.

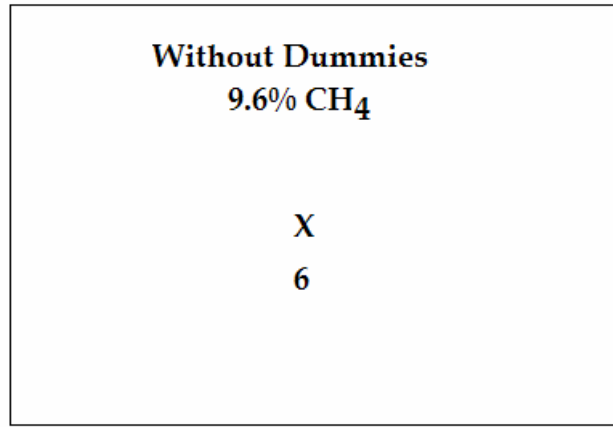

**FRONT VIEW**

- 7.5.3. THIRD SERIES A total of 16 tests minimum must be performed.

- 7.5.3.1. With dummies removed and 7.0% CH<sub>4</sub> mixture, conduct two tests with ignition at the center of the enclosure. (Note: Leave the dummies in if they resulted in the highest test pressure.)

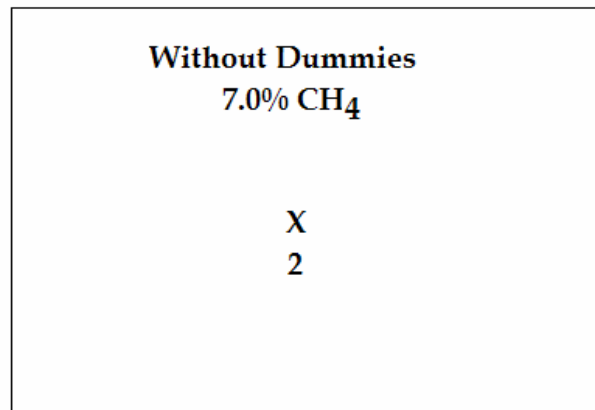

**FRONT VIEW**

- 7.5.3.2. With dummies removed and 9.6% CH<sub>4</sub> mixture and coal dust inserted through any opening in the enclosure, conduct two tests with ignition at the center of the enclosure.

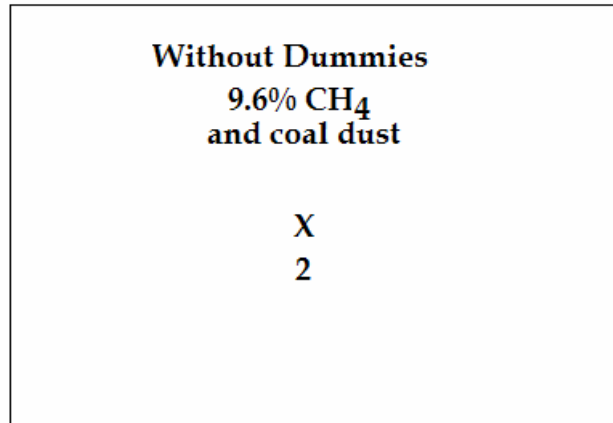

FRONT VIEW

- 7.5.3.3. The other three samples shall have tests each as described in 7.5.2.1. If the lenses in the lights are made of polycarbonate, then the first sample shall have 3 tests as described in 7.5.2.1, wait at least 24 hours, and then conduct the remaining tests as described in 7.5.3.1, and 7.5.3.2

#### 7.5.4. TUBE LUMINAIRES

- 7.5.4.1. FIRST SERIES - The tube luminaires shall be tested in the vertical position with the ignition point located in the bottom housing, using 9.6% CH<sub>4</sub> mixture. Some tests with the tube in a horizontal position shall be conducted. When horizontal tests are conducted, try both 8.6% CH<sub>4</sub> and 9.6% CH<sub>4</sub>, because in some horizontal tubes, 8.6% will produce the highest pressures. If using a strip chart recorder, 5 mm/s recorder paper speed is acceptable. Conduct 4 vertical and 2 horizontal tests.

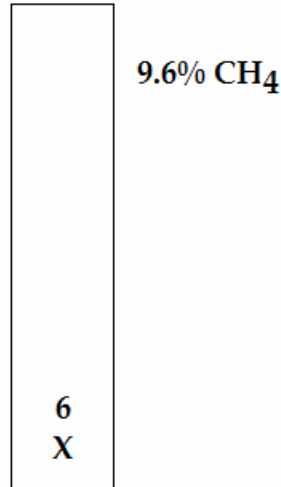

7.5.4.2. SECOND SERIES. A total of 10 tests minimum must be performed.

7.5.4.2.1. Using a 7.0% CH<sub>4</sub> mixture, conduct two tests.

7.5.4.2.2. Using a 9.6% CH<sub>4</sub> mixture and with coal dust inserted through any opening in the assembly, conduct two tests. Use the vertical/horizontal position which generated the greatest pressure.

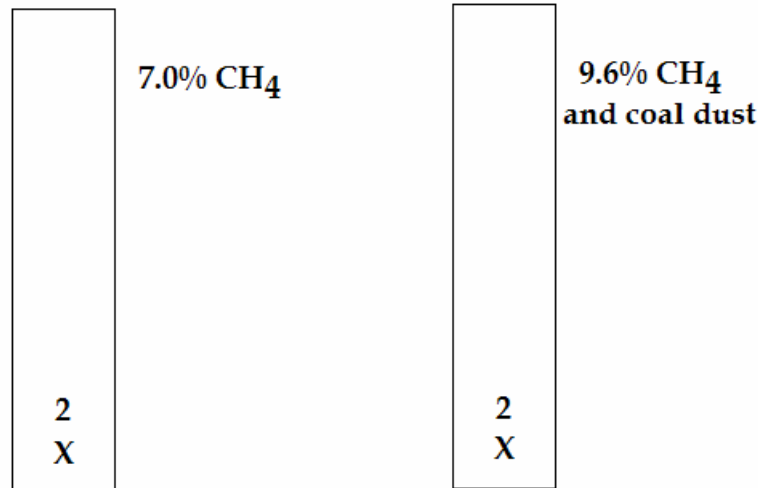

7.5.4.2.3. The other three samples shall have three tests each as described in 7.5.2.1. If the lens tube is made of polycarbonate, then the first sample shall have three tests as described in 7.5.4.2, wait at least 24 hours, and then conduct the remaining tests as described in 7.5.4.2.1, and 7.5.4.2.2.

## 7.6. OPTIONAL TEST SETUPS FOR SMALLER ENCLOSURES

7.6.1. Enclosures 30 to 300 cubic inches in volume are to be tested using the direct sampling method, as shown here.

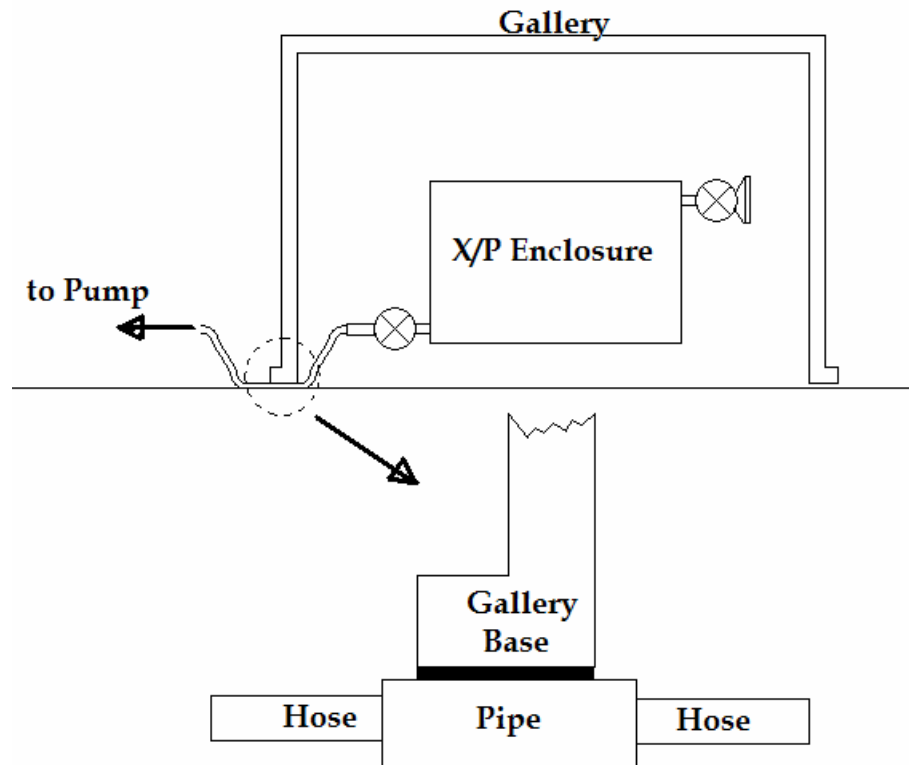

7.6.2. Conduct a minimum of six tests using a 9.6% CH<sub>4</sub> mixture. For permissible connectors two of the six tests are to be conducted with plug withdrawn to the safety stop, or point where the circuit is interrupted.

7.6.3. Conduct a minimum of two tests using a 7.0% CH<sub>4</sub> mixture. For permissible connectors, two additional tests must be performed with plug withdrawn to the safety stop.

7.6.4. Insert coal dust through any opening in the enclosure and conduct a minimum of two tests as described in 7.6.2.

7.6.5. A minimum of sixteen tests must be performed. The additional tests should be conducted with the CH<sub>4</sub> mixture that resulted in the highest pressures.

- 7.7. Enclosures less than 30 cubic inches will be tested in the 22.4 liter standard test vessel and set up as shown here.

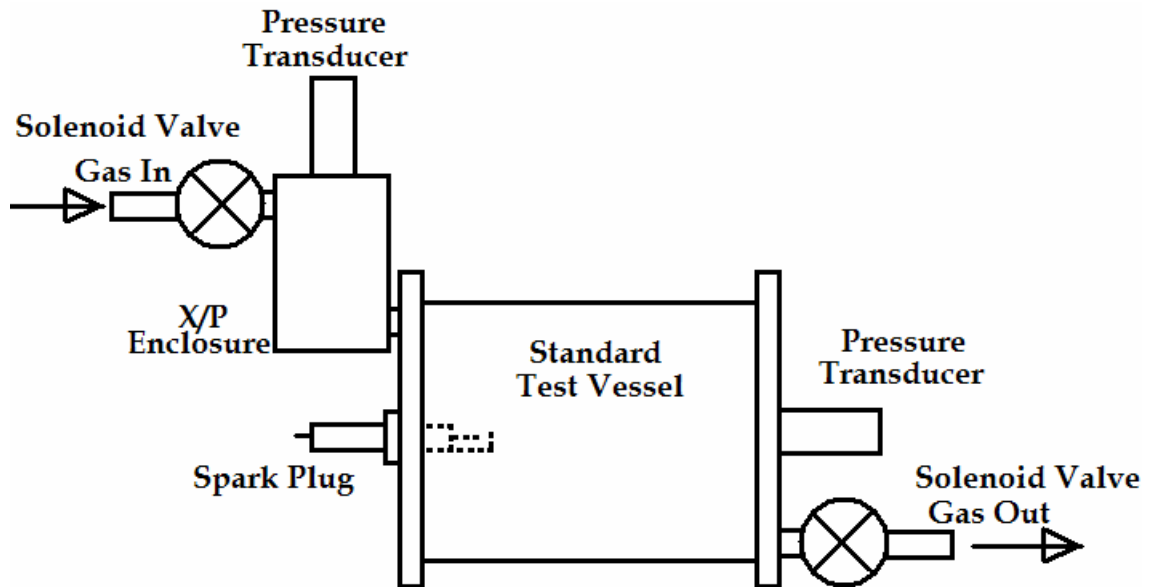

- 7.7.1. Conduct a minimum of six tests in which the standard test vessel explosion is about 60 psig (7.1% CH<sub>4</sub>). Use a 2 inch spark plug centrally located as shown in the illustration. For permissible connectors, two of the six tests will be conducted with the plug withdrawn to the safety stop.
- 7.7.2. Conduct two tests using a 7.0% CH<sub>4</sub> mixture. For permissible connectors, 2 additional tests with the plug withdrawn to the safety stop will be performed.
- 7.7.3. A minimum of sixteen tests will be performed, with the additional tests conducted with the CH<sub>4</sub> mixture which resulted in the highest pressures.
- 7.7.4. Dummies will not be used in the small boxes when using the standard test vessel. Dummies are used to check for pressure piling. If pressure piling appears to be likely, the direct sampling method should be used.
- 7.7.5. A small volume and some leakage will greatly reduce the explosion pressures. Therefore, all plumbing should be wrench tight.

## 8.0 TEST DATA

8.1. All data should be reported on the test sheets, Data Sheet #2 – Sketch of Enclosure and Test Hole Locations (page 1) , and Explosion Tests (Page 2). (See Attached.)

Data should include:

- 8.1.1. Test Number.
- 8.1.2. Gallery CH<sub>4</sub> Concentration.
- 8.1.3. Enclosure CH<sub>4</sub> Concentration
- 8.1.4. Presence of Dummies
- 8.1.5. Presence of Coal Dust
- 8.1.6. Location of Spark plug
- 8.1.7. Location of Transducer(s)
- 8.1.8. Pressure(s) Recorded
- 8.1.9. Visibility of Smoke, Flame or Sparks

## 9.0 PASS/FAIL CRITERIA

- 9.1. Acceptable performance for an enclosure is:
- 9.1.1. No discharge of flame,
  - 9.1.2. No ignition of the explosive mixture in the gallery,
  - 9.1.3. No development of afterburning,
  - 9.1.4. No rupture of any part,
  - 9.1.5. No permanent distortion of any planar surface of the enclosure exceeding 0.040" per linear foot,
  - 9.1.6. No excessive clearances along flame-arresting paths following retightening of fastenings, as required,

9.1.7. No pressure exceeding 125 psi, unless the enclosure has withstood a static pressure of twice the highest value recorded in the tests.

9.1.8. Looseness or physical damage to a window or lens.



U.S. Department of Labor  
Mine Safety and Health Administration  
Approval and Certification Center  
Electrical Safety Division  
Triadelphia, WV 26059

Date: \_\_\_\_\_ MR: \_\_\_\_\_

To: \_\_\_\_\_ PAR: **00XXXXX** \_\_\_\_\_

From: \_\_\_\_\_ MFG: MSHA Machine \_\_\_\_\_

Subject: Explosion Tests Enclosure Type: Controller

Reference: Title 30 CFR, Part 18.62 \_\_\_\_\_

Sketch of Enclosure and Test Hole Locations:

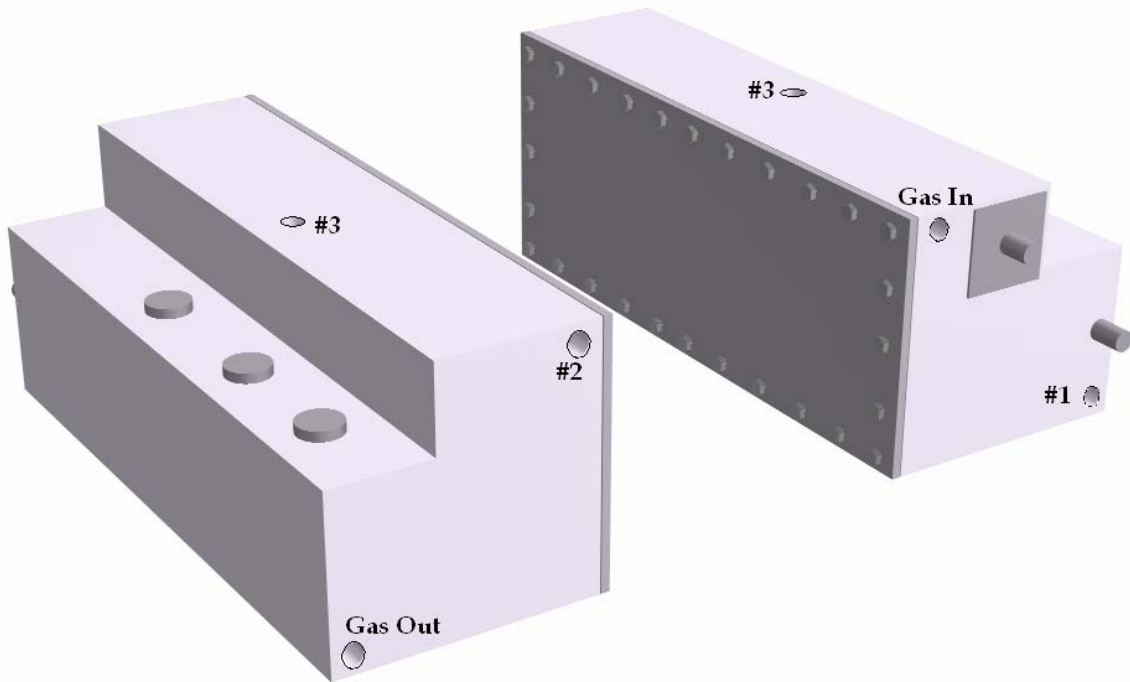

**Subject: Explosion Tests**

MR: \_\_\_\_\_  
 PAR: xxxxxx

Data Sheet 2  
 DATE: \_\_\_\_\_

Test Conditions									Test Results			
Test No.	Gallery % CH4	Body % CH4	Coal Dust	Dummies	Ignition Point	P1 Point	P2 Point	P3 Point	P1 Max. PSIG	P2 Max. PSIG	P3 Max. PSIG	Flame Sparks Smoke
1	9.6	9.6	no	no	1	2			60	60		no
2	9.6	9.6	no	no	1	2			59	60		no
3	9.7	9.7	no	no	1	2			60	61		no
4	9.7	9.7	no	no	1	2			58	59		no
5	9.7	9.7	no	no	1	3			60	61		no
6	9.7	9.7	no	no	1	3			60	60		no
7	9.7	9.7	no	no	1	3			59	59		no
8	9.7	9.7	no	no	1	3			59	59		no
9	9.7	9.7	no	no	3	1			60	60		no
10	9.7	9.7	no	no	3	1			60	61		no
11	9.7	9.7	no	no	3	1			59	60		no
12	9.7	9.7	no	no	3	1			60	60		no
13	7.1	7.1	yes	no	3	1			42	43		no
14	7.1	7.1	yes	no	3	1			41	41		no
15	9.7	9.7	yes	no	3	1			59	60		no
16	9.7	9.7	yes	no	3	1			59	59		no
17												
18												
19												
20												
21												
22												
23												
24												
25												