



**In cooperation with:**

**The University of Missouri-Columbia,  
The Missouri Department of Conservation, and  
NatureServe**

# **Mapping Vegetation Communities in Ozark National Scenic Riverways: Final Technical Report to the National Park Service**

By Robert A. Chastain, Matthew A. Struckhoff, Keith W. Grabner, Esther D. Stroh, Hong He, David R. Larsen, Timothy A. Nigh and Jim Drake

Open-File Report 2006-1354

**U.S. Department of the Interior  
U.S. Geological Survey**

**U.S. Department of the Interior**

Dirk Kempthorne, Secretary

**U.S. Geological Survey**

Mark Myers, Director

U.S. Geological Survey, Reston, Virginia 2006

For product and ordering information:

World Wide Web: <http://www.usgs.gov/pubprod>

Telephone: 1-888-ASK-USGS

For more information on the USGS—the Federal source for science about the Earth, its natural and living resources, natural hazards, and the environment:

World Wide Web: <http://www.usgs.gov>

Telephone: 1-888-ASK-USGS

Suggested citation:

Chastain, R.A., Struckhoff, M.A., Grabner, K.W., Stroh, E.D., He, H., Larsen, D.R., Nigh, T.A., and Drake, J., 2006, Mapping vegetation communities in Ozark National Scenic Riverways—final technical report to the National Park Service: U.S. Geological Survey Open-File Report 2006-1354, 90 p., plus appendices.

Any use of trade, product, or firm names is for descriptive purposes only and does not imply endorsement by the U.S. Government.

Although this report is in the public domain, permission must be secured from the individual copyright owners to reproduce any copyrighted material contained within this report.

# Mapping Vegetation Communities in Ozark National Scenic Riverways: Final Technical Report to the National Park Service

Matthew Struckhoff, Keith Grabner, Esther Stroh  
U.S. Geological Survey-Columbia Environmental Research Center



Robert Chastain, Hong He and David Larson  
University of Missouri-Forestry Department



Timothy Nigh  
Missouri Department of Conservation



Jim Drake  
NatureServe



In conjunction with  
Mike Story and Karl Brown (National Park Service Vegetation Mapping Coordinators)  
National Park Service, Natural Resources Information Division, Inventory and  
Monitoring Program



October 2006



# Executive Summary

## Abstract

Vegetation communities were mapped at two levels in Ozark National Scenic Riverways (ONSR) using a hybrid combination of statistical methods and photointerpretation. The primary map includes 49 cover classes, including 24 classes that relate to vegetation associations currently described by the United States National Vegetation Classification Standard (USNVC; The Nature Conservancy, 1994a). The remaining types include cultural features, ruderal communities on abandoned agricultural lands, and non-vegetated classes. Overall map classification accuracy is 63 percent. The secondary mapping level aggregates communities with similar appearance and ecologically related associations into Community Types. The resultant 33-class Community Type map has an overall classification accuracy of 77 percent and identifies groups of communities based on resource management goals within the park. Important additional products include 1) a general probability map for all vegetation associations, which can be used to assess final classification certainty, and 2) individual probability maps for each association, which can be used to identify areas that have a high likelihood of supporting a given type, beyond where that type was identified in the final map products. Other secondary map products include data layers derived from primary color-infrared imagery, secondary imagery data and digital elevation models. A field key and photo guide to associations and complete community descriptions were produced, along with a photo guide of fuel conditions. Wildland fuels data were used to generate a fuels map based upon Anderson's fuels models (1982).

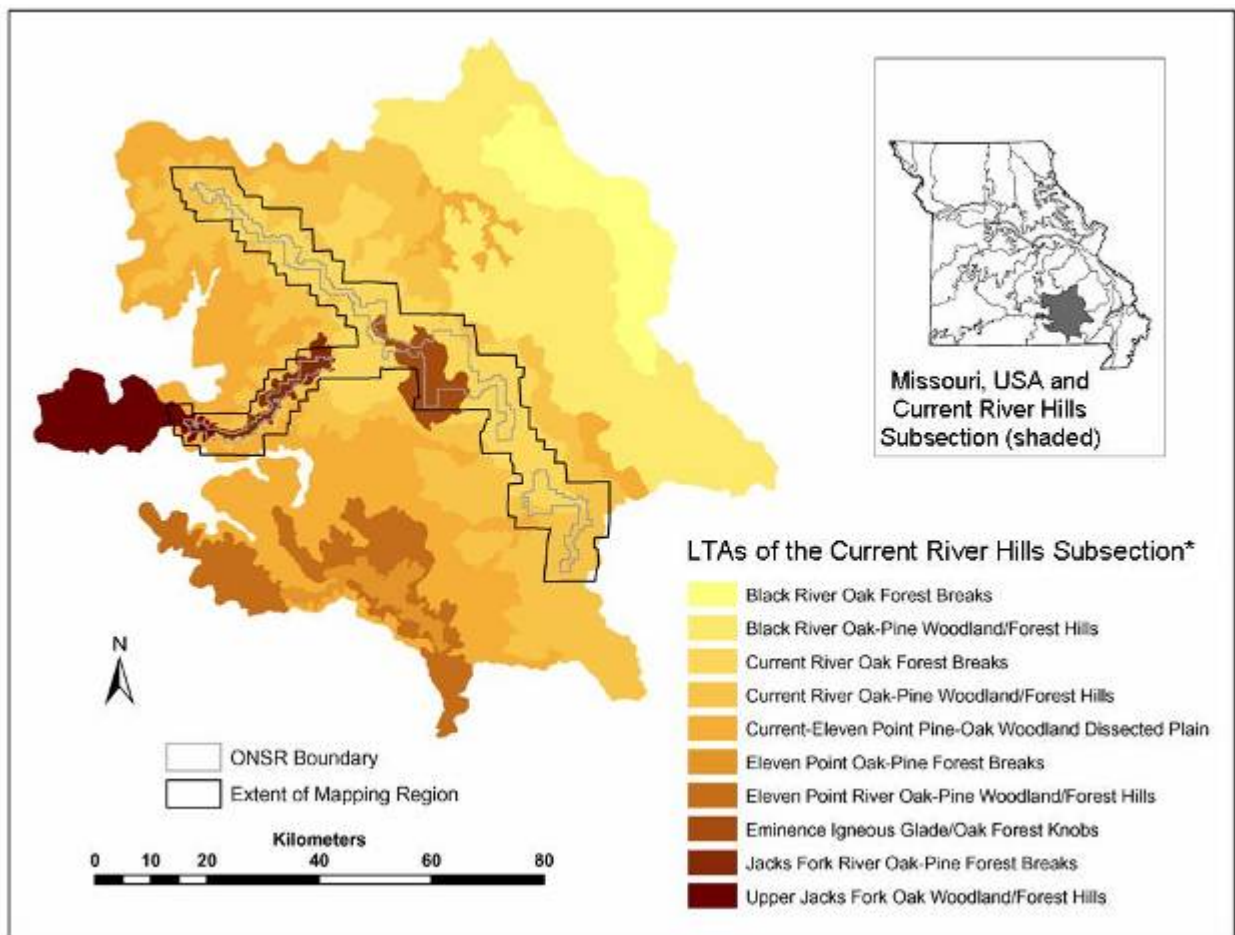
## Setting

Ozark National Scenic Riverways encompasses approximately 33,257 ha (82,180 acres) along the Current and Jacks Fork Rivers in southeastern Missouri. It is located in the Current River Hills Subsection of the Ozark Highlands Section (Avers *et al.* 1994). The park purchase unit includes an additional 23,000 ha, most of which is private land and lands owned by other groups, including the State of Missouri. The mapping region is 141,854 ha (350,529 acres) and encompasses ONSR as well as areas immediately surrounding the park land (Figure ES-1). The landscape is characterized by gently rolling dissected plains underlain by resistant sandstones of the Roubidoux formation and deeply dissected drainages that cut into dolomites of the Ordovician Gasconade Formation. The deepest drainages cut into Cambrian Eminence-Potosi Formation; one area of the subsection is defined by domes of Precambrian igneous substrate, portions of which have been exposed by erosion (Nigh and Schroeder, 2002).

The Ozarks are perhaps the oldest continuously exposed land mass in North America; the region has likely supported plant life for 100 million years, and was not glaciated during any of the last four major continental glaciation events. The continuous exposure and lack of glaciation has resulted in high biological diversity of plant communities and high levels of endemism (The Nature Conservancy, 2003). Presettlement vegetation was characterized by oak and pine woodlands and forests heavily influenced by aboriginal and natural fires (Guyette and Cutter, 1991; Ladd, 1991) and interspersed with small and large patches of other natural communities including fens, wetlands, and glades (The Nature Conservancy, 2003). The landscape is now dominated by second-growth forest; most of the Ozarks were logged between 1880 and 1920 (Cunningham and Hauser, 1992). The second growth forests contain less pine, while uniform,

younger forests have replaced the woodland/forest mosaic, and many glades have overgrown with eastern red cedar (*Juniperus virginiana*, Nigh and Schroeder, 2002).

When the Ozark National Scenic Riverways was established in 1964, it was created from public and private lands with a variety of uses, including relatively intact areas with minimal evidence of human disturbance, parcels of land that were being used for grazing, logging, and row cropping (and various combinations of these activities), and areas that had been previously used in these manners but where activity had ceased prior to the establishment of the park. Many of these activities continue to a limited extent on privately- and publicly-owned parcels within the ONSR purchase unit. The result is a landscape of immense native biological diversity overlaid with a diversity of past and continuing human uses in various stages of regrowth, with some plant communities fairly intact and others significantly altered from what they had been prior to Euro-American settlement.



**Figure ES-1.** Study area map.

\*Nigh and others, 2000.

## Approach

To develop a USNVC association-level vegetation community map to the required accuracy standards, it was necessary to predict landscape scale vegetation community patterns based on the combined influence of environmental resource gradients, landform, and the

influence of past and present land use patterns and disturbance regimes. This challenge was met by acquiring numerous remote sensing, topographic and field-collected vegetation datasets from which we derived a large set of variables to train a statistical classification. Remote sensing data supplied variables that discriminated vegetation communities based on differences in their color, spectra, greenness, brightness, and texture. Topographic data facilitated differentiation of vegetation communities based on indirect gradients (e.g. landform position, slope, aspect), which can be related to variations in resource gradients (light, water, nutrients) and disturbance gradients (suitability for agriculture, fire susceptibility). The hybrid approach used in this study supplemented statistical classification based upon the above data with photointerpretation and digitization from current and historical aerial photographic sources.

Data used to characterize community structure and composition and for use in multivariate data analysis were collected at 318 plots. These points, and an additional 751 observation points were field-classified as a given vegetation association for use as training data for remote sensing. Data sufficient to characterize wildland fuel-loading for many USNVC associations were also collected at a subset of 777 observation points and plots. Accuracy assessment was based upon 2057 validation observations obtained from points withheld from the statistical classification, additional field observations, and from photointerpretation observations located within human-dominated land-cover categories. Details of the methods used for data processing, field data collection, statistical classification of vegetation communities, multivariate characterization of vegetation associations and accuracy assessment procedures are described in detail in the body of the report.

## Ecological Systems Mapping

The National Vegetation Classification is a hierarchical system. The highest level of the USNVC, the “Class,” splits communities into broad physiognomic categories (forest, woodland, shrubland, herbaceous, etc.). Unfortunately, vegetation communities often are spatially related to one another, though they may have little in common structurally or compositionally. For example, within the mapping area, glades are herbaceous communities that are usually associated with physiognomically distinct woodlands. The spatial relationship of such communities confounds aggregation into broader groups within the USNVC hierarchy when mapping. Therefore, in addition to mapping such groups of communities to the association level, we adopted NatureServe’s (2005) ecological systems approach to generate a fewer-class, higher-accuracy Community Type map. Community Types, and the more broadly defined “Ecological Systems,” that we identified were based upon discussions with resource management staff both within the park and at other land management agencies in the area. They are more relevant to management goals and methods and improve mapping accuracy to a greater degree than would aggregation to the USNVC alliance level. A crosswalk of the Community Types and Ecological Systems identified for this project and their relationship to ecological systems developed by NatureServe is included in Appendix 5. A crosswalk comparing Ecological Systems identified in our study with management groups identified by two other widely used Missouri-based classification systems is included in Appendix 4.

## Significantly Altered Communities

The National Vegetation Classification Standard provides guidelines for classification of communities that can be considered neither natural nor semi-natural. However, early discussions with resource managers at ONSR indicated that adoption of this classification system would fail to account for many cultural features, timber management areas, and ruderal communities within the mapping area. In order to map the full spectrum of communities extant in the park, our mapping approach included classification of those communities not treated by existing systems and their subtypes. We identified a suite of altered vegetation associations that could potentially be found within the study area based on our knowledge of the current conditions within the park and discussions with resource management staff regarding types that were critical to management activities. Descriptions of altered communities are attached as Appendix 16. Appendix 6 provides a crosswalk of our identified altered vegetation associations to Ecological Systems used in this study.

## Results

### Vegetation associations

Twenty-four classes relating to USNVC vegetation associations were mapped using statistical classification techniques. Another 7 classes that represent cultural, significantly altered, and non-vegetated communities were also mapped statistically. Statistical classification was augmented by heads-up digitization for an additional 18 cultural and altered types, predominantly ruderal communities and timber management areas. All communities encountered during this project, as well as additional communities potentially extant within the study area are included in the list of vegetation associations (Appendix 2) and the field key to communities (Appendix 17). All of the USNVC associations either encountered during this study or possibly extant in the study area are described in Appendix 15. Significantly altered vegetation associations that require descriptions receive them in Appendix 16.

### Vegetation Maps

The primary map product is a 49-class vegetation association map, which includes 24 classes that relate directly to USNVC associations and which were classified using statistical methods. The map also includes two hand-digitized glade complex types, and 23 significantly altered communities or cultural classes (Figure ES-2 [detail], Appendix 12 [full map]). Overall map classification accuracy is 63 percent. The secondary mapping level aggregates communities with similar appearance and ecologically related associations into Community Types, which also are based upon resource management issues within the park. These Community Types aided mapping to a much greater extent than USNVC alliances and are more relevant to resource management goals and methods within the park. The resultant 33-class Community Type map (Figure ES-3 [detail], Appendix 13 [full map]) has an overall classification accuracy of 77 percent.

Total area and percent coverage of USNVC communities and significantly altered land cover types are given in (Table ES-1). The two most common land cover types within both ONSR and the greater mapping area belong to the Black Oak - White Oak - (Scarlet Oak) Forest Alliance. The Black Oak-White Oak-Hickory/Dogwood Forest covers 19,843 ha (34 percent) of



the ONSR purchase unit and 43,388 ha (31 percent) of the mapping area. The Ozark Black Oak-Scarlet Oak Forest accounts for 9,492 ha (16 percent) of the park and 27,555 ha (20 percent) of the mapping area. Together, these two vegetation associations provide more than 50 percent of cover at either scale. They have been mapped together in the 33-class Community Type map as the Mixed Oak-Hickory Forest. The third and fourth most abundant classes within ONSR are the White Oak/Dogwood Forest (5094 ha; 9 percent) and the White Oak - Mixed Oak Dry-Mesic Alkaline Forest (4869 ha; 8 percent). These communities have been aggregated in the 33-class map as the White Oak Forest Community Type, and collectively cover more than 16 percent of the park. The two next most abundant classes within the park include actively managed and abandoned agricultural fields in various successional stages. Together, these account for 9 percent of the park area. Agricultural fields and pastures are the third most abundant class within the full mapping area.

### Wildland Fuels and Fuels maps

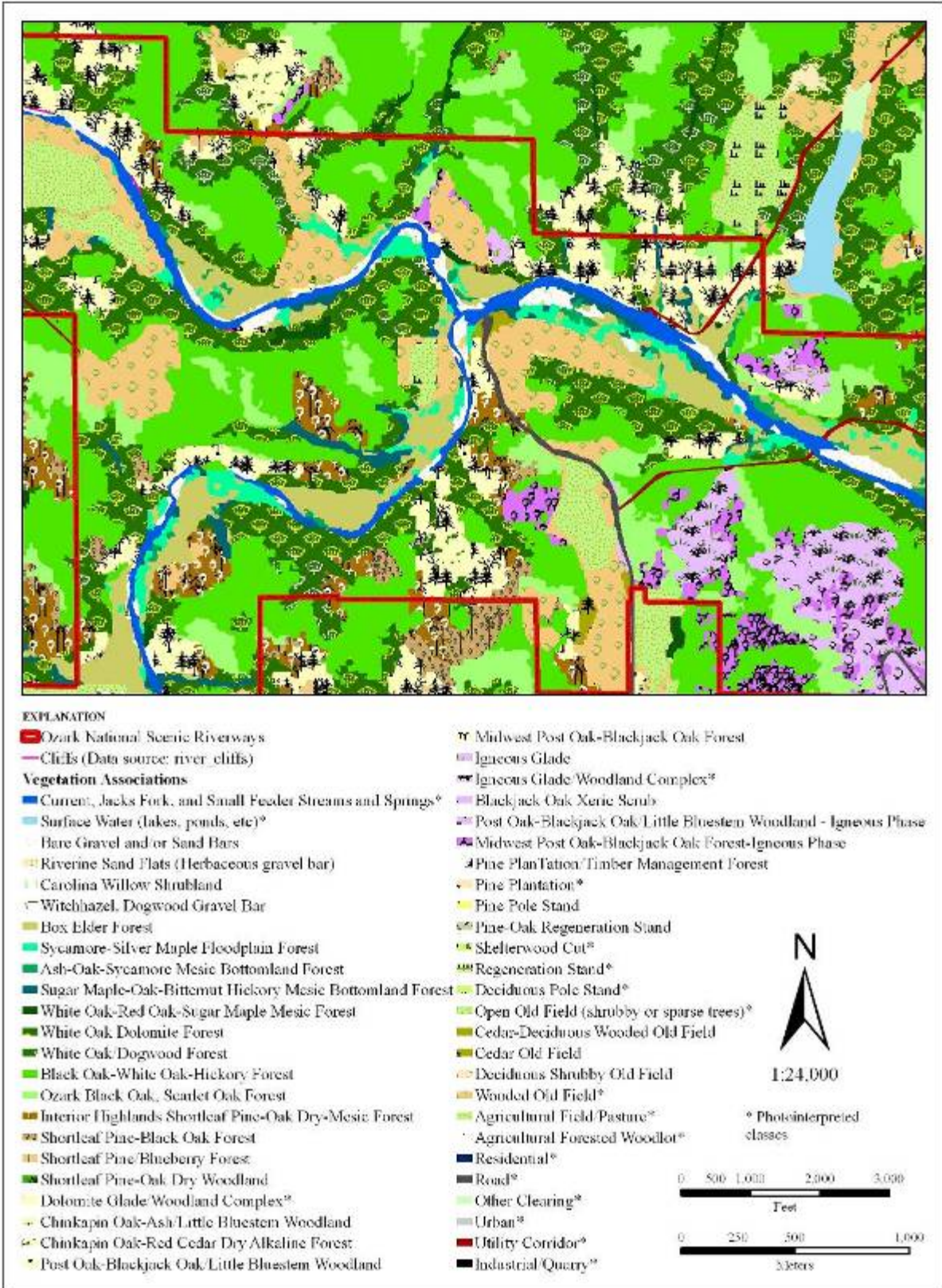
Fuels data tables for each association (Appendix 18) summarize fuel loading and identify the most appropriate Anderson (1982) fuels model, National Fire Danger Rating System (NFDRS) model, and Comprehensive Fuels model (Scott and Burgan, 2005). Spreadsheet versions of these data allow one to join fuel models with vegetation associations and Community Types within a GIS platform, the first step toward integrating the vegetation map with a spatially explicit fire behavior simulation model. We generated digital and hard-copy maps of fuels classes for the 49-class USNVC vegetation association classification (Figure ES-4) based upon Anderson (1982), the most commonly applied fuels model. However, Anderson's system was developed in western systems that are dominated by coniferous forests, and it may not provide the most appropriate model for fuels conditions in eastern deciduous forests. Therefore, classifications from the recently produced Comprehensive Fuels model (Scott and Burgan, 2005) have been provided in attribute tables for the USNVC vegetation association shapefiles. This fuels model identifies a greater number of classes, many of which were developed for deciduous forests and which may be more appropriate for the study area. However, the Comprehensive Fuels model has not yet been widely adopted in the United States. Classifications from the NFDRS, which can be used to assess fire danger across multiple scales, have also been provided in attribute tables for the USNVC vegetation association shapefiles. Fuels maps based upon either the Comprehensive Fuels model or the NFDRS can be generated in a GIS environment.

**Table ES-1.** Area and percent coverage of USNVC associations and land cover types in the ONSR purchase unit (57,678 ha) and the larger mapping area (139,953 ha).

Park Area (ha)	Park %	Full Map Area (ha)	Full Map %	USNVC Association/Landcover type (Code*)	49-Class Grid Code
19843.2	34.40	43388.34	31.00	Black Oak - White Oak - Hickory Forest (2076†)	5
9491.6	16.46	27555.48	19.70	Ozark Black Oak, Scarlet Oak Forest (2399†)	10
5094.2	8.83	9637.54	6.89	White Oak/Dogwood Forest (2066†)	2
4868.8	8.44	9912.55	7.08	White Oak Dolomite Forest (2070†)	3
2711.1	4.70	10175.82	7.27	Agricultural field/pasture (SA21, SA22, SA23)	37
2509.2	4.35	3751.22	2.68	Wooded old field (SA10, SA11, SA13, SA14, SA15)	33
2012.9	3.49	5119.91	3.66	Interior Highlands Shortleaf Pine-Oak Dry-mesic Forest (7489†)	13
1544.6	2.68	3177.67	2.27	Chinkapin Oak-Red Cedar Dry Alkaline Forest (2108†)	6
956.5	1.66	4461.55	3.19	Shortleaf Pine-Black Oak Forest (2401†)	12
878.7	1.52	986.11	0.70	River (non-vegetated, includes springs and tributaries)	28
753.9	1.31	853.85	0.51	Ash-Oak-Sycamore Mesic Bottomland Forest (2410†)	22
700.3	1.21	1984.19	1.42	White Oak-Red Oak-Sugar Maple Mesic Forest (2058†)	1
674.4	1.17	1591.07	1.14	Chinkapin Oak-Ash/Little Bluestem Woodland (2143†)	7
666.6	1.16	779.74	0.56	Box Elder Forest (5033†)	25
659.2	1.14	743.33	0.53	Sycamore-Silver Maple Floodplain Forest (7334†)	26
655.5	1.14	1030.88	0.74	Road (SA32)	34
572.4	0.99	668.16	0.48	Sugar Maple-Oak-Hickory Mesic Bottomland Forest (2060†)	21
570.3	0.99	995.86	0.71	Open old field (SA09, SA12, SA20, SA23, SA36)	43
304.5	0.53	577.18	0.41	Igneous glade/woodland complex (includes 2075i†)	32, 45
258.3	0.45	481.24	0.34	Utility corridor (SA33, SA34)	35
252.3	0.44	350.3	0.25	Riverine Sand Flats (2049†, includes vegetated stream margins), Bare gravel bars†	20, 27
225.0	0.39	1797.74	1.28	Post-Black-(Blackjack) Oak/Little Bluestem Woodland (2149†)	8, 29
178.6	0.31	840.71	0.60	Regeneration Stand (SA02, SA05)	38
173.2	0.30	951.63	0.68	Deciduous Shrubby Old Field (SA09†)	17
140.6	0.24	271.26	0.19	Dolomite glade/woodland complex	44
120.9	0.21	361.37	0.26	Midwest Post Oak-Blackjack Oak Forest (2075†)	4
92.1	0.16	547.9	0.39	Cedar-Deciduous Wooded Old Field (SA13†)	18
91.6	0.16	677.17	0.48	Shortleaf Pine-Oak Dry Woodland (2393†)	9
88.5	0.15	737.35	0.53	Residential (SA16, SA17, SA18, SA19, SA35)	48
88.5	0.15	105.4	0.08	Carolina Willow Shrubland (3899†)	24
88.4	0.15	1466.15	1.05	Shelterwood cut (SA01, SA04)	39
77.1	0.13	323.4	0.23	Cedar Old Field (SA15†)	19
69.9	0.12	345.36	0.25	Deciduous Pole Stand (SA03, SA06, SA08)	40
61.9	0.11	1180.01	0.84	Pine-Oak Regeneration Stand (SA05†)	14
49.7	0.09	338.67	0.24	Other Clearing (SA31)	36
47.5	0.08	583	0.42	Shortleaf Pine/Blueberry Forest (2400†)	11
35.8	0.06	69.21	0.05	Igneous Glade (2243†)	30
30.3	0.05	45.4	0.03	Witchhazel-Dogwood Gravel Wash (3898†)	23
20.7	0.04	159.01	0.11	Pine Pole Stand (SA08†)	16
9.3	0.02	61.27	0.04	Pine plantation/Timber management area (SA07†, SA07)	15, 41
5.6	0.01	63.86	0.05	Surface water (non-vegetated pond and lakes)	42
3.7	0.01	5.71	0.00	Blackjack Oak Scrub Woodland (2425†)	31
0.6	0.00	233.06	0.17	Agricultural forested woodlot (SA37)	46
0.0	N/A	63.34	0.05	Industrial/quarry (SA26, SA27)	49
0.0	N/A	502.74	0.36	Urban (SA28, SA29, SA30)	47

\*For USNVC associations, the last four digits of the USNVC codes (CEGL00####) are displayed. Codes that begin with "SA" represent significantly altered vegetation communities not described by the USNVC.

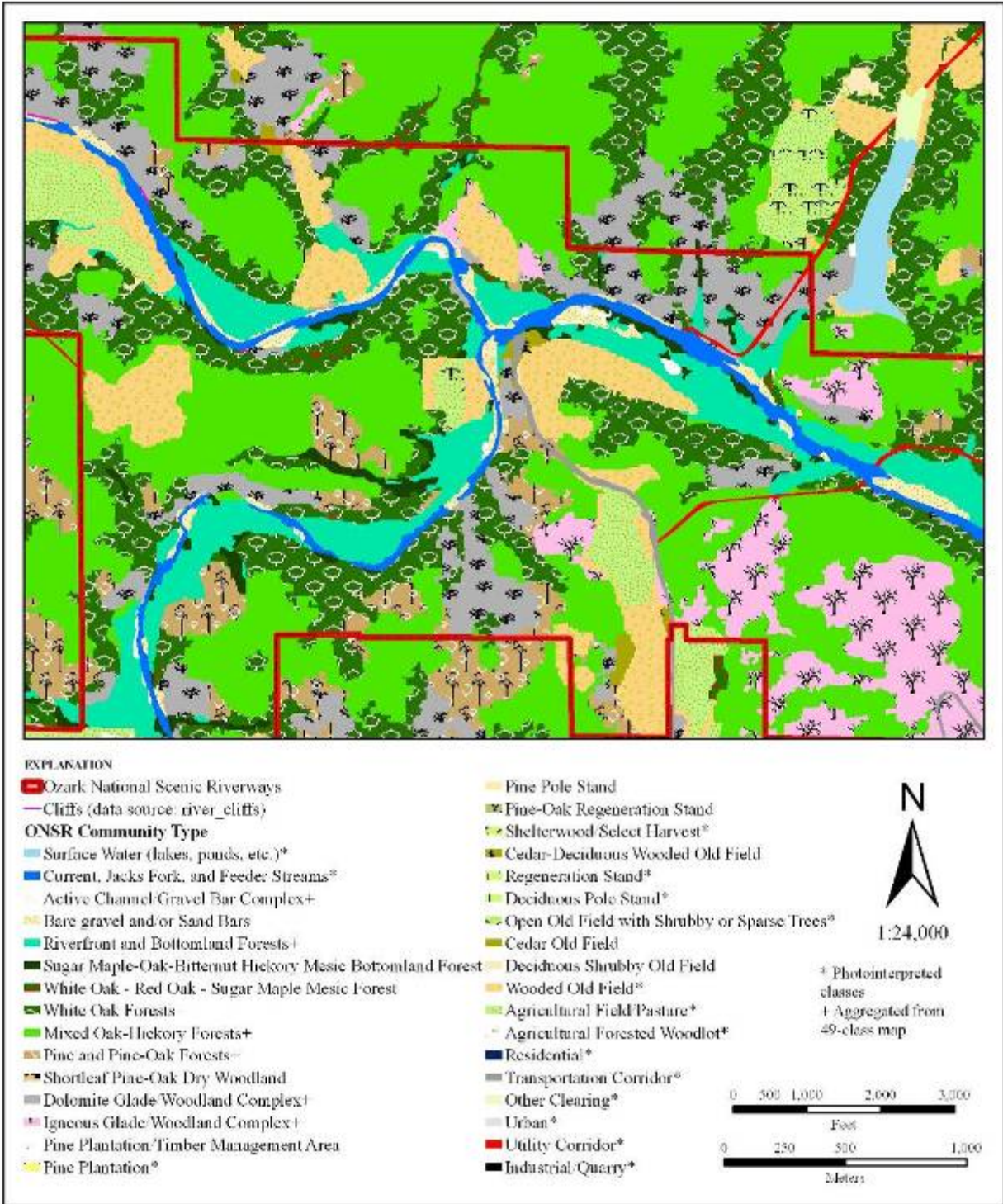
†Statistically classified types (all others were hand-delineated from aerial photographs).



**Figure ES-2.** Detail of 49-class USNVC vegetation association map\*.

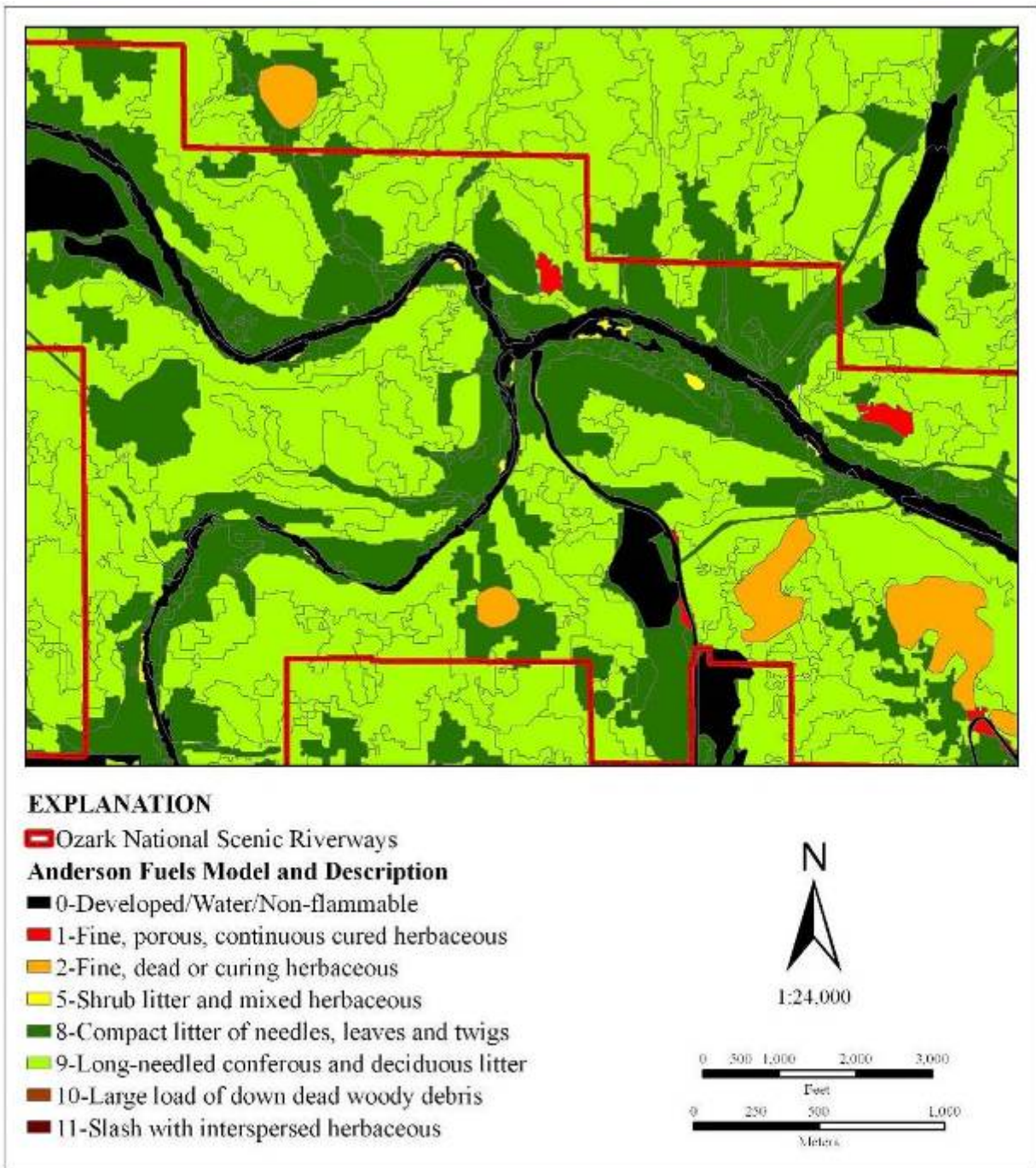
\* Full 49-class USNVC vegetation association map is available in Appendix 12





**Figure ES-3.** Detail of 33-class Community Type map with types aggregated to improve accuracy and aid in resource management planning\*.

\*Full 33-class Community Type map is available in Appendix 13.



**Figure ES-4.** Detail of Anderson Fuels Model map.



## Implications for Resource Management

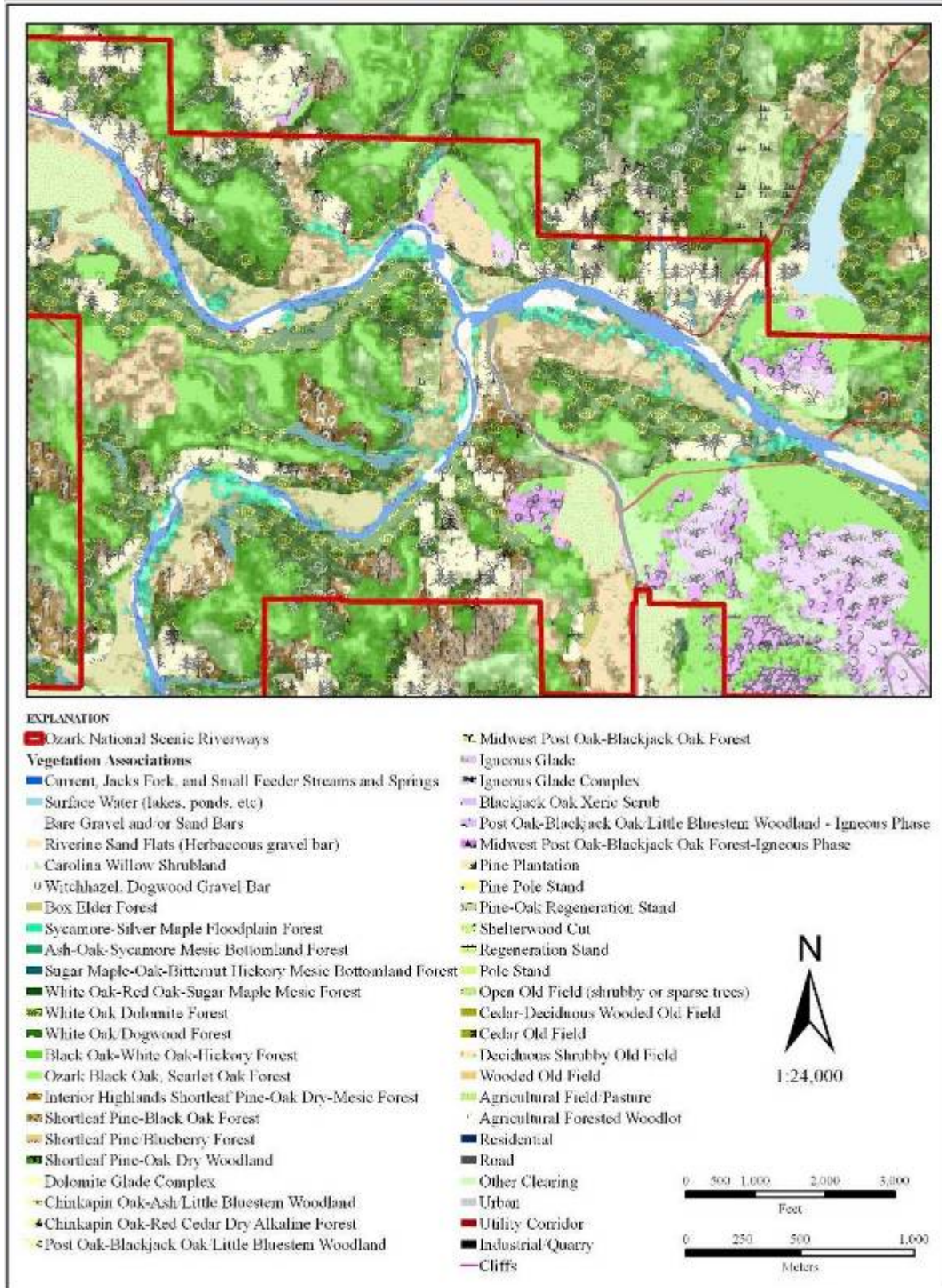
### Ecological Systems Groupings

The Ecological Systems used in this project were designed to facilitate resource management planning within the mapping area. Given the lower overall accuracy of the 49-class USNVC association-level map and the complexity involved in interpreting it, we believe that the 33-class Community Type map provides a more reliable and useful product. For many of the aggregated types, the 49-class map yields polygons that are too small to reasonably guide management. By contrast, within the 33-class map, the groupings of Community Types that are either similar to one another or spatially related provide a scale more appropriate to making management decisions.

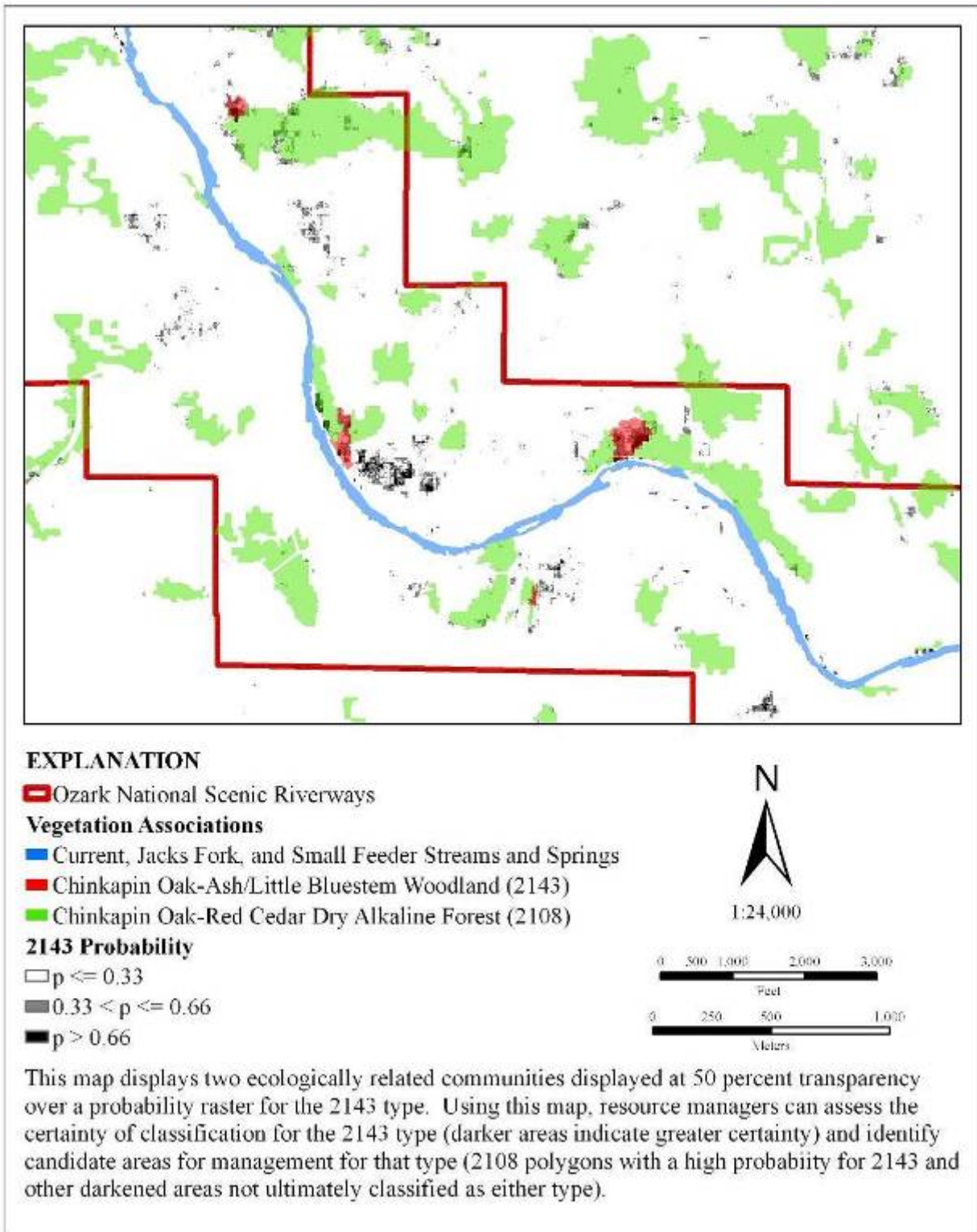
### Utilizing Probability Maps

We produced two types of probability maps in this project. This first type, or overall probability map, is a raster data file that is a by-product of the statistical mapping approach. The value of each grid cell indicates the probability that a given cell was individually classified as the same vegetation association as the polygon of which it is part in the final classification map. The 49-class vegetation association map or the 33-class Community Type map can be displayed in a GIS platform over a probability map for all of the classification types. This allows resource managers to assess the certainty of map classifications. Figure ES-5 displays the 49-class map at 50 percent transparency over the probability map displayed as a continuous variable for all classes, with brighter areas indicate higher classification certainty. Figure ES-5 illustrates the case which is often evident in the field: certainty of classification decreases near community boundaries as one type transitions into another.

The second type of probability map is the individual probability map, which shows the probability that a cell was classified as a particular type regardless of the final classification of the polygon it occupies in the final classification map. High probabilities suggest that a given site possesses either the vegetative components (detectable in the photo data) or the ecological conditions (as evidenced in the photo data or the topographic variables used in the statistical classification) to support a given type. Individual probability maps may be used to identify appropriate sites when managing for target communities, beyond where they are identified in the final classification map. Figure ES-6 shows an example of how candidate sites for restoration management might be identified using individual probability maps. Polygons classified as the Chinkapin Oak-Ash/Little Bluestem Woodland (2143) are shown in red and the ecologically related Chinkapin Oak-Red Cedar Dry Alkaline Forest (2108) polygons are shown in green. The 2143 type is important to resource managers for its high biological diversity. This type was once more common, but it is now infrequent due to invasion by red cedar, probably as a result of fire suppression. This change has likely caused many examples of the 2143 type to convert to the 2108 type, while retaining certain component species. Areas identified as the 2108 type might be suitable for restoration to the 2143 type with mechanical removal of cedar and/or prescribed fire to control woody invasion. This map shows some areas within 2108 polygons that had high probability for 2143 types. In addition, there are some areas outside of either 2108 or 2142 polygons with high probability of the 2143 type that can be further investigated in the field. Such maps can significantly aid resource management planning by suggesting candidate sites for management activity and can be created for those associations that were mapped statistically.



**Figure ES-5.** 49-class map displayed over probability raster for all classes, with brighter areas indicating higher classification certainty.



**Figure ES-6.** Vegetation associations 2143 and 2108 displayed over probability raster for the 2143 type.



## Options for Management Decisions

The ecological systems approach used in this study increased both the accuracy and the utility of the final map products. This suggests that revisions could be made to the USNVC hierarchy to improve accuracy and management utility of vegetation maps. Other vegetation mapping efforts have experienced difficulties similar to those we encountered with respect to the broad conceptual jump between the USNVC formation and alliance levels, and the national program is being updated to address this issue (Federal Geographic Data Committee, 2006). However, the proposed changes may be unable to address the mapping problem encountered when physiognomically and floristically distinct communities occur together in ways that confound mapping but which are relevant to management. In our study, igneous glades and associated woodlands are an example of such communities, frequently occurring as complexes of physiognomically distinct units which are, individually, below the minimum mapping unit. In order to address the local spatial relationships that may exist between these types of communities, it may be necessary to maintain a separate parallel hierarchical system designed to address mapping goals and management interests.

The USNVC currently does a poor job of addressing the numerous ruderal and timber management vegetation associations that occur in the ONSR mapping area. We identified 19 significantly altered vegetation associations that are not treated under the current USNVC, but which have critical habitat implications for wildlife. It is our suspicion that many of the significantly altered vegetation associations we identified in our study are common in the Ozark Plateau as well as locations east of the Mississippi River. Revisions to the USNVC to account for significantly altered types would be a tremendous improvement to the classification system.

Comparison of the results of pilot classifications of vegetation communities in the ONSR and the final classification of the entire ONSR mapping region indicate that a hybrid combination of statistical methods and photointerpretation is needed to obtain adequate overall and class-wise accuracy levels. We recommend that future vegetation mapping projects within this program incorporate a hybrid approach such as that used here, if it is within capabilities.

## References

- Anderson, H.E. 1982. Aids to determining fuel models for estimating fire behavior. USDA Forest Service General Technical Report INT-122. 22p. Intermountain Forest and Range Experiment Station. Ogden, Ut.
- Avers, P.E., Cleland, D.T., McNab, W.H., Jensen, M.E., Bailey, R.G., King, T., Goudey, C.B. and Russell, W.E. 1994. The national hierarchical framework of ecological units. ECOMAP, USDA Forest Service, Washington, D.C.
- Cunningham, B. and Hauser, C. 1992. The decline of the Missouri Ozark forest between 1880 and 1920. In Journet, A.R. and Spratt, H.G., eds. Proc: Towards a Vision for Missouri's Public Forests. March 27-28, 1992. Southeast Missouri State University, Cape Girardeau, MO. 14-19.
- Federal Geographic Data Committee. 1996. National Vegetation Classification Standard, Version 2-Working Draft. FGDC-STD-005 (Version 2). FGDC Secretariat, U.S. Geological Survey. Reston, VA. 62 p.

- Guyette, R.P. and Cutter, B.E. 1991. Tree ring analysis of fire history in a post oak savanna in the Missouri Ozarks. *Natural Areas Journal*, 11: 93-99.
- Joy, S.M., Reich, R.M. and Reynolds, R.T. 2003. A non-parametric, supervised classification of vegetation types on the Kaibob National Forest using decision trees. *International Journal of Remote Sensing*, 24(9), 1835-1852.
- Ladd, D. 1991. Reexamination of the role of fire in Missouri oak woodlands. Charleston, IL: *Proceedings of the Oak Woods Management Workshop*: 67-80.
- NatureServe. 2005. International ecological classification standard: Terrestrial ecological classifications. NatureServe Central Databases. Arlington, VA. U.S.A. Data current as of 30 September, 2005. ([www.natureserve.org](http://www.natureserve.org))
- Nigh, T.A. and Schroeder, W.A. 2002. Atlas of Missouri Ecoregions. Missouri Department of Conservation, Jefferson City, Missouri.
- Scott, J.H. and Burgan, R.E. 2005. Standard fire behavior fuel models: A comprehensive set for use with Rothermel's surface fire spread model. USDA Forest Service. General Technical Report RMRS-GTR-153. Rocky Mountain Research Station. 72p.
- The Nature Conservancy. 1994a. Standardized national vegetation classification system. Report to U.S. Dept. of Interior. The Nature Conservancy, Arlington, VA and Environmental Systems Research Institute, Redlands, CA  
<http://biology.usgs.gov/npsveg/classification/index.html>.
- The Nature Conservancy Ozarks Ecoregional Assessment Team. 2003. Ozarks ecoregional and conservation assessment. Minneapolis, MN: The Nature Conservancy Midwestern Resource Office. 48 pp. + 5 appendices.

## Contacts



U.S. Department of Interior  
United States Geological Survey - Biological Resources Division  
Website: <http://www.usgs.gov>

Mike Mulligan  
USGS Program Coordinator - USGS-NPS Vegetation Mapping Program  
U.S. Geological Survey  
Center for Biological Informatics  
P.O. Box 25046  
Building 810, Room 8000, MS-302 Denver Federal Center  
Denver, Colorado 80225-0046  
Phone: (303) 202-4240  
E-Mail: [mike\\_mulligan@usgs.gov](mailto:mike_mulligan@usgs.gov)  
Website: <http://biology.usgs.gov/cbi>

Matthew Struckhoff, Keith Grabner, Esther Stroh  
Ecologists  
U.S. Geological Survey  
Columbia Environmental Research Center  
4200 New Haven Rd  
Columbia, MO 65201  
Phone: (573) 875-5399  
E-Mail: [mstruckhoff@usgs.gov](mailto:mstruckhoff@usgs.gov); [kgrabner@usgs.gov](mailto:kgrabner@usgs.gov); [esther\\_stroh@usgs.gov](mailto:esther_stroh@usgs.gov)  
Website: <http://www.cerc.usgs.gov/>



University of Missouri-School of Natural Resources  
Department of Forestry  
Website: <http://www.snr.missouri.edu/forestry>

Robert Chastain  
Remote Sensing Specialist  
IMNW-LEW-PWE MS17  
Box 339500, Bldg. 2012  
Fort Lewis, WA 98433-9500.  
Phone: (253) 966-1664  
E-mail: [robert.chastain2@us.army.mil](mailto:robert.chastain2@us.army.mil)

Hong He, David Larson  
Associate Professors  
203 ABNR  
University of Missouri  
Columbia, MO 65211  
Phone: (573) 882-7242  
E-mail: [heh@missouri.edu](mailto:heh@missouri.edu); [larsond@missouri.edu](mailto:larsond@missouri.edu)



Missouri Department of Conservation  
Website: <http://www.mdc.mo.gov/>

Timothy Nigh  
Resource Scientist  
Missouri Department of Conservation  
Resource Science Center  
1110 S. College Ave 65201  
Phone: (573) 882-9880  
E-mail: [Timothy.Nigh@mdc.mo.gov](mailto:Timothy.Nigh@mdc.mo.gov)



NatureServe

Website: <http://www.natureserve.org>

Jim Drake

Program Coordinator

1101 West River Parkway, Suite 200

Minneapolis, Minnesota 55415

Phone: (612) 331-0729

E-mail: [jim\\_drake@natureserve.org](mailto:jim_drake@natureserve.org)



U.S. Department of the Interior  
National Park Service  
Website: <http://www.nps.gov>

Karl Brown  
NPS Program Coordinator - USGS-NPS Vegetation Mapping Program  
National Park Service, WASO  
1201 Oakridge Drive, Suite 200  
Fort Collins, CO 80525  
Phone: (970) 225-3591  
E-mail: [Karl\\_Brown@nps.gov](mailto:Karl_Brown@nps.gov)

Victoria Grant  
Natural Resource Manager  
Ozark National Scenic Riverways  
151 Highway 76  
Van Buren, MO  
Phone: (573) 323-4236  
E-Mail: [Victoria\\_grant@nps.gov](mailto:Victoria_grant@nps.gov)  
Website: <http://www.nps.gov/ozar>

## **Acknowledgements**

We would like to thank Victoria Grant of the National Park Service Ozark National Scenic Riverways for frequent feedback and helpful input throughout the entire project. Field assistance was provided by: Dan Tenaglia, Dan Twyman, Jessie Bebb, Todd Weakley, Raun Oberman, Benjamin King and Jean Perry. Wenchun Wu and Kevin Hosman scanned, orthorectified and mosaiced the original aerial photos, assisted by University of Missouri students Jessie Beck, Sarah Bellchamber, Joseph Berg, Yunjeong Jang, Annie Meyer and Geovanne Stighen. Philip A. Townsend and Jane R. Foster at the Appalachian Laboratory of the University of Maryland Center for Environmental Science assisted in applying the discriminant analysis method.



# Contents

Executive Summary .....	iii
Contacts .....	xvii
Acknowledgements .....	xxii
Contents .....	xxiii
List of Tables .....	xxv
List of Figures .....	xxvi
List of Appendices .....	xxvii
Introduction .....	1
Background .....	1
Setting .....	1
Objective .....	5
Classification Structure .....	5
USNVC .....	5
Additional Classification Elements .....	6
Ecological Systems .....	6
Cultural and Altered Communities .....	7
Missouri Classification Systems .....	8
Methods .....	9
Approach .....	9
Field Methods .....	9
Development of the Field Key .....	9
Existing Community Characterization and Remote Sensing Training Data .....	10
New Community Characterization and Remote Sensing Training Data .....	10
Vegetation Plot Data .....	11
Classification and Location Data .....	12
Environmental Data .....	13
Vegetation Description Data .....	13
Wildland Fuels Data .....	13
Data Quality Control in Field Sampling .....	14
Multivariate Analysis of Plot Data .....	14
Map Production .....	16
Data .....	16
Aerial Photos .....	16
2003 National Agriculture Imagery Program Photo Data .....	17
Landsat TM/ETM+ .....	18
Topographic Information .....	19
Field Training Data .....	19
Statistical Classification Approach .....	21
Pilot Area Test of Statistical Methods .....	21
Discriminant Analysis Statistical Model .....	22
Decision Rule Classification for River Channel and Gravel Bars .....	22
Photointerpretation and Digitizing .....	23
Validation .....	23
Sample Location .....	23

Classification and Location Data .....	25
Environmental Data.....	26
Vegetation Description Data.....	26
Results .....	27
Field Sampling .....	27
Sampled Communities .....	27
Natural Communities.....	27
Altered Vegetation Associations.....	28
Multivariate Analysis of Plot Data .....	28
Local Expressions of USNVC Associations within the Mapping Area .....	31
Wildland Fuels.....	31
Community Mapping .....	33
Community Classification .....	34
Map Accuracy .....	34
Probability Mapping.....	41
Species Importance Values.....	41
Discussion.....	43
An Altered Landscape .....	43
Undersampled Vegetation associations .....	44
Field-based Sources of Map Discrepancies .....	44
Map Accuracies.....	45
Probability Maps.....	47
Management Implications .....	52
Ecological Systems Groupings.....	52
Woodland/Forest Conundrum .....	52
Wildland Fuels Map.....	53
Options for Future Mapping Projects.....	56
Field Sampling .....	56
Remote Sensing.....	56
References.....	58

## List of Tables

Table 1. USNVC classification structure.....	6
Table 2. Vegetative cover classes assigned to individual species within plots.....	12
Table 3. Mean fuel loading and standard errors (in parentheses) by USNVC association.....	32
Table 4. Mean fuel loading and standard errors (in parentheses) for sampled altered vegetation associations.....	33
Table 5. Area and percent coverage of vegetation associations and land cover types in the ONSR purchase unit (57,678 ha) and the larger mapping area (139,953 ha). ....	35
Table 6. Error matrix of USNVC associations and other land cover categories. ....	38
Table 7. Accuracy report for USNVC vegetation associations and other land cover categories. ....	42
Table 8. Accuracy report for aggregated OSNR Community Types.....	42

## List of Figures

Figure 1. Study area map.....	3
Figure 2. Generalized depiction of the sedimentary geologic strata and associated potential vegetation in the Current River Hills subsection (from Nigh and others, 2000).....	4
Figure 3. Generalized depiction of Precambrian geology and associated potential vegetation communities in the Current River Hills subsection (from Nigh and others, 2000).....	4
Figure 4. Vegetation sampling plot design. ....	12
Figure 5. Correlogram of illumination/albedo surface indicating a high amount of spatial dependence at about 2 meters in both the x and y directions.....	18
Figure 6. Distribution of sampling points and location of statistical classification pilot area.....	20
Figure 7. Schematic representation of polygon centroid (the median X and Y coordinates, defined by the dark circles) calculation and the effects on sample point location. ....	24
Figure 8. NMS ordination of USNVC association-level mean Importance Values for tree and shrub species for tree-dominated communities in ONSR. ....	30
Figure 9. Detail of 49-class USNVC vegetation association map.....	36
Figure 10. Detail of 33-class Community Type map with types aggregated to improve accuracy and aid in resource management planning.....	37
Figure 11. Detail of 49-class map displayed over probability raster for all classes, with brighter areas indicating higher classification certainty.....	49
Figure 12. Vegetation associations 2143 and 2108 displayed over probability raster for the 2143 type.....	51
Figure 13. Detail of Anderson Fuels Model map. ....	55

## List of Appendices

- Appendix 1. Schematic maps of quarter- and two-meter photomosaics.
- Appendix 2. Community list and hierarchical classification scheme for vegetation communities in the ONSR mapping region.
- Appendix 3. Crosswalk comparing USNVC vegetation associations in Ozark National Scenic Riverways and surrounding area to communities of the Current River Hills Subsection included in the Atlas of Missouri Ecoregions (Nigh and Schroeder 2002) and to communities described in the Terrestrial Natural Communities of Missouri (Nelson 2005).
- Appendix 4. Crosswalk of ecological systems used in the mapping area and management groups identified by the Missouri Ecological Classification System (MOECS; Nigh and others 2000) for the Current River Hills subsection.
- Appendix 5. Crosswalk of ecological systems used in the mapping area with ecological systems developed by NatureServe.
- Appendix 6. Crosswalk of ecological systems used to map altered communities within the mapping area and Anderson's classification system for built-up and aquatic features (Anderson 1976) and the Federal Geographic Data Committee (FGDC) classification of cultivated lands.
- Appendix 7. Automated classification data derivatives and transformation techniques.
- Appendix 8. Results of importance value (IV) calculations for the major USNVC vegetation associations in the ONSR mapping area, with average cover and relative frequency presented by species and the number of field observations listed.
- Appendix 9. List of Deliverables to ONSR personnel.
- Appendix 10. Data Dictionary.
- Appendix 11. Map codes and descriptions.
- Appendix 12. 49-Class USNVC Vegetation Association Map (reduced copy).
- Appendix 13. 33-Class Community Type Map (reduced copy).
- Appendix 14. ROC Graphs of select groups of communities and the Mixed Oak-Hickory/Dogwood Forest.
- Appendix 15. ONSR USNVC Natural Community Descriptions.
- Appendix 16. ONSR Altered Community Descriptions.
- Appendix 17. Field Key to ONSR Vegetation Communities.
- Appendix 18. ONSR USNVC Community Fuel Loading Photo Key.
- Appendix 19. Pilot Area Test of Two Statistical Classification Methods.
- Appendix 20. Details of the Discriminant Analysis Statistical Model.



# Introduction

## Background

This study was conducted in cooperation with the U.S. Geological Survey (USGS) - National Park Service (NPS) Vegetation Mapping Program (USGS – NPS, 2005), a cooperative effort to classify, describe, and map vegetation communities in 280 national park units across the United States. The program uses the U.S. National Vegetation Classification Standard (USNVC) as the national standard to describe mapped vegetation communities. The USNVC is a hierarchical classification system with seven levels. The physiognomic levels (System, Class, Subclass, Group, and Formation) are a modification of the UNESCO world physiognomic classification of vegetation (The Nature Conservancy, 1999). The floristic levels (Alliance and Association) are described using procedures outlined in Grossman and others (1998) and are frequently refined and aggregated as work progresses in previously unmapped areas. The USNVC has been adopted to the formation level by the Federal Geographic Data Committee for use by all U.S. Federal agencies. While formal adoption by Federal agencies of the alliance- and association-level standard is still pending, it is the standard generally used in vegetation mapping projects of this sort. NatureServe maintains and updates all vegetation descriptions in cooperation with numerous conservation agencies and organizations in the United States (NatureServe, 2005).

The project was developed through the collaboration of the U.S. Geological Survey, the University of Missouri-Columbia Department of Forestry (UMC) and the Missouri Department of Conservation (MDC). USGS personnel involved in this project had extensive experience in other projects related to Ozark flora. UMC faculty had similarly extensive experience in remote sensing and modeling of forests. Personnel at MDC had worked many years developing and refining an ecological classification system for Missouri. The location of all the collaborators in close proximity within one city (Columbia, Missouri) meant that field and remote sensing portions of the project would be intensely collaborative, with field personnel assisting in photo interpretation, and remote sensing personnel assisting with field work frequently throughout the project. All of the work was conducted in close collaboration with the National Park Service by providing once or twice yearly updates of progress, and requests for feedback on draft products. We also worked closely with NatureServe to refine USNVC associations and develop ecological systems groupings of similar vegetation communities. Our approach to constructing a vegetation map for the Ozark National Scenic Riverways was to link aerial photo interpretation, field data, other ancillary data and an ecological classification system model to develop a statistical vegetation classification approach of the natural and altered vegetation associations in the mapping area.

## Setting

Ozark National Scenic Riverways encompasses approximately 33,257 ha (82,180 acres) along the Current and Jacks Fork Rivers in southeastern Missouri. It is located in the Current River Hills Subsection of the Ozark Highlands Section of the national hierarchical framework of ecological units (Avers and others, 1994). The park purchase unit includes an additional 23,000 ha, most of which is private land and lands owned by other groups, including the State of Missouri. The mapping region (UTM Zone 15 North, NAD83; 611300, 4074000 by 691400,

4149400 or 36.79N, 91.753W by 37.484N, 90.841W) is 141,854 ha (350,529 acres) and encompasses ONSR as well as areas immediately surrounding the park land (Figure 1).

The Missouri Ecological Classification System (MOECS, Nigh and others, 2000; Nigh and Schroeder, 2002) used environmental and floristic data from relatively intact and undisturbed communities in order to construct an ecological classification system for the Current River Hills Subsection. The MOECS classification subdivides the Current River Hills subsection into Landtype Associations (LTAs), landscape-scale divisions based upon topography, geologic parent materials, soil associations and potential vegetation alliances (Figure 1). Within LTAs, Ecological Landtypes (ELTs) are site-scale units based upon topography, geologic parent materials, soil series and potential vegetation associations. Seventeen ELTs were described (based on field data) within nine LTAs in the Current River Hills Subsection (Nigh and others, 2002). Another fourteen ELTs relevant to our study area were identified but not sampled by the MOECS, and descriptions for these are based upon qualitative information for these types.

The Current-Eleven Point Pine-Oak Woodland Dissected Plains LTA and the Current River Oak-Pine Woodland/Forest Hills LTAs are dominated by gently rolling dissected plains underlain by resistant sandstones of the Roubidoux formation and deeply dissected drainages that cut into dolomites in the upper portion of the Ordovician Gasconade Formation (Figure 2). The former LTA intersects minimally with the park, though it covers a larger portion of the mapping area outside park boundaries along the Jacks Fork River. The Current River Oak-Pine Woodland/Forest Hills LTA is represented primarily by a large patch near the downstream terminus of the park, though scattered portions can be found elsewhere in the park. Within the broader mapping area, this LTA is abundant along the Jacks Fork River, upper reaches of the Current River, and toward the southern terminus of the park.

Portions of the park along the Jacks Fork River are dominated by the Jacks Fork River Oak-Pine Forest Breaks, while most of the remaining area in the park and greater mapping area lies in the Current River Oak Forest Breaks. These LTAs include the deepest drainages, which cut into the lower portions of the Gasconade formation and into the Cambrian Eminence-Potosi formation (Figure 2; Nigh and Schroeder, 2002). The Roubidoux and Upper Gasconade formations are less prominent, occasionally forming narrow, erosion resistant caps and secondary summits. The Eminence Igneous Glade/Oak Forest Knobs LTA forms the remaining portion of the park and mapping area, and is defined by domes of Precambrian igneous substrate, portions of which have been exposed by erosion (Figure 3; Nigh and Schroeder, 2002).

Soils formed in Roubidoux residuum are low in soluble bases, and once supported vast tracts of forest dominated by shortleaf pine (*Pinus echinata*), particularly in the western, less dissected portions of the subsection. Root-restricting fragipans in the subsoil on ridges and benches tended to support open forests and woodlands dominated by Post oak (*Quercus stellata*) and pine, with other upland oaks and hickories. Anthropogenic and natural fires were a critical component in the evolution of both types of communities. Areas that are dominated by this stratum tend to be relatively flat, and have therefore been and continue to be subject to the most intensive agricultural activity, particularly grazing.

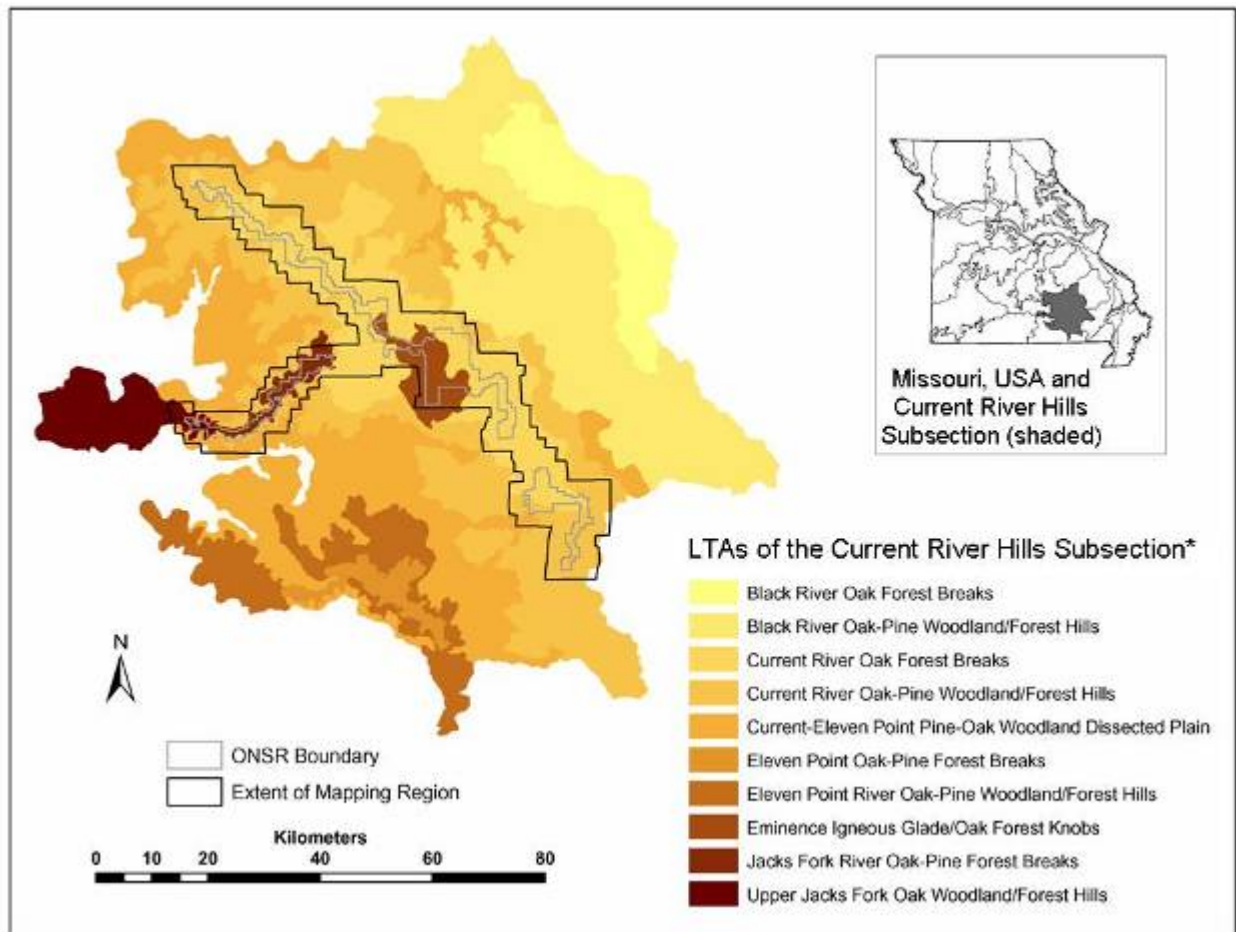
Soils formed in the residuum of the upper portion of the Gasconade have moderate base saturation, though embedded chert nodules can weather to form more neutral soils. Furthermore, hillslope sediment from the Roubidoux formation can create an acidic mantle on top of soils derived from the upper Gasconade. For the most part, this geologic stratum supports forests dominated by generalist species of oak and hickory, though pockets of acidic soils can favor



open forest and woodlands dominated by plants that thrive in acidic soils, including pine. In some areas, bedrock is exposed or near the surface. Historically, these areas supported forest openings called glades, which are dominated by herbaceous plants and woody shrubs. Fire suppression has allowed invasion of glades by woody species, particularly eastern red cedar (*Juniperus virginiana*).

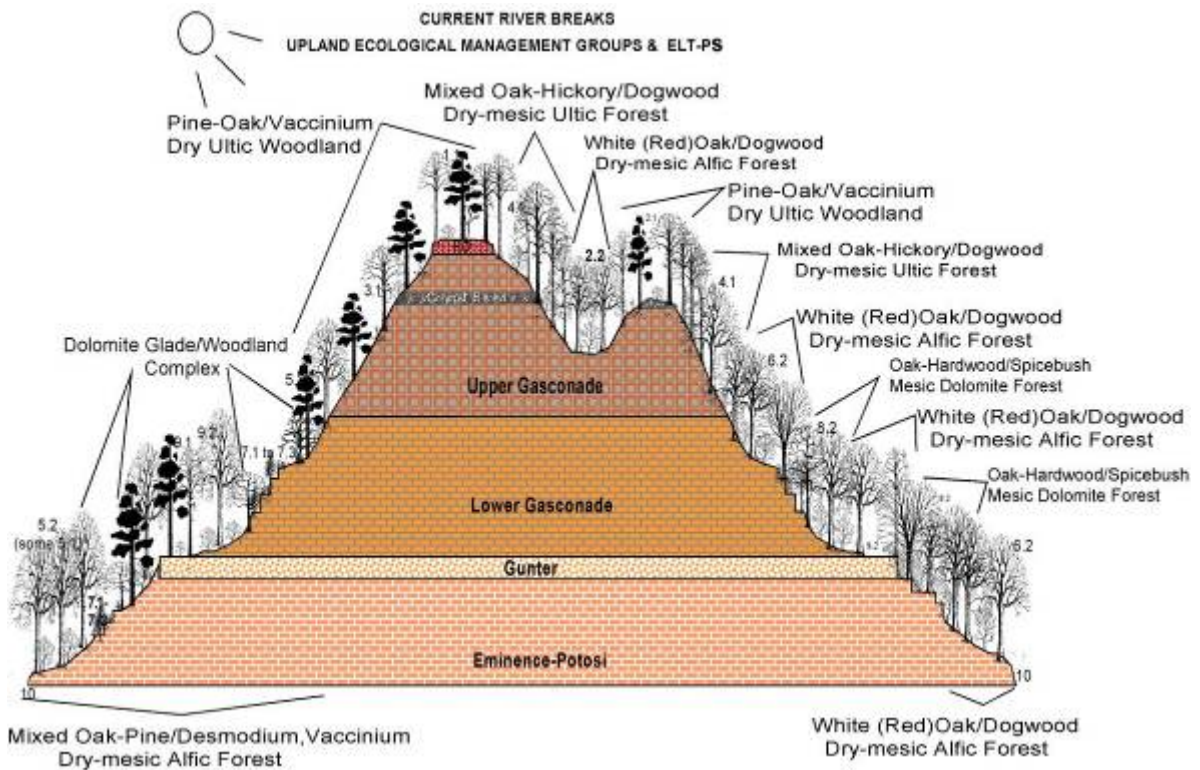
The lower portion of the Gasconade and the Eminence-Potosi formations are higher in soluble bases and lack a significant chert component. As a general rule, these strata yield soils that support forests dominated by white oak (*Quercus stellata*). Where base saturation is highest (where bedrock is at or near the surface), vegetation is dominated by plants that thrive in basic soils. On protected slopes with northern or northeastern aspects, dominants other than white oak include ash (*Fraxinus americana*) and Chinkapin oak (*Q. meuhlenbergii*). On exposed slopes with more southerly aspects, these areas may support glades and open woodlands dominated by chinkapin oak and ash.

Igneous bedrock weathers to acidic soils. Exposed igneous bedrock typically yields glades dominated by plants that can survive in acidic, seasonally xeric conditions. Usually these glades are interspersed with woodlands dominated by post oak, black oak (*Quercus velutina*) and blackjack oak (*Q. marilandica*), which give way to mixed oak and hickory forests as soil depth increases (Figure 3; Nigh and Schroeder, 2002; Nigh and others, 2000).

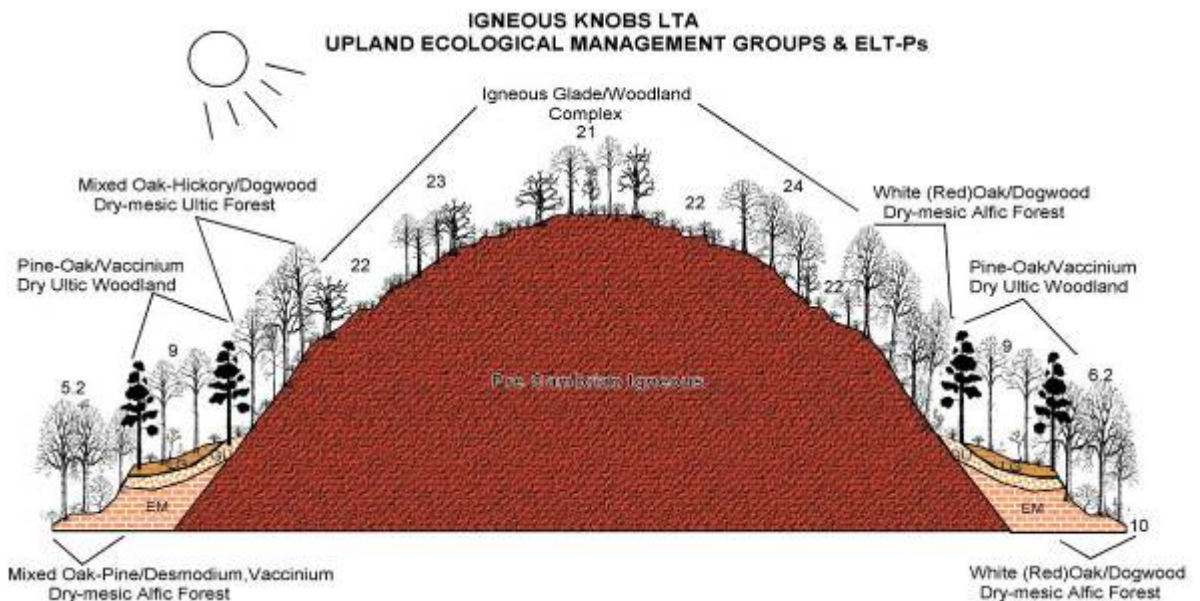


**Figure 1.** Study area map.

\*Nigh and others, 2000.



**Figure 2.** Generalized depiction of the sedimentary geologic strata and associated potential vegetation in the Current River Hills subsection (from Nigh and others, 2000).



**Figure 3.** Generalized depiction of Precambrian geology and associated potential vegetation communities in the Current River Hills subsection (from Nigh and others, 2000).

The Ozarks are perhaps the oldest continuously exposed land mass in North America; the region has likely supported plant life for 100 million years, and was not glaciated during any of the last four major continental glaciation events. The continuous exposure and lack of glaciation has resulted in extreme biological diversity of plant communities and high levels of endemism (The Nature Conservancy, 2003). Presettlement vegetation was characterized by oak and pine woodlands and forests heavily influenced by aboriginal and natural fires (Guyette and Cutter, 1991; Ladd, 1991) and interspersed with small and large patches of other natural communities including fens, wetlands, and glades (The Nature Conservancy, 2003). The landscape is now dominated by second-growth forest; most of the Ozarks were logged between 1880 and 1920 (Cunningham and Hauser, 1992). The second growth forests contain less pine; uniform, younger forests have replaced the woodland/forest mosaic, and many glades have overgrown with eastern red cedar (*Juniperus virginiana*, Nigh and Schroeder, 2002).

When the Ozark National Scenic Riverways was established in 1964, it was created from public and private lands with a variety of uses, including relatively intact areas with minimal evidence of human disturbance, parcels of land that were being used for grazing, logging, and row cropping (and various combinations of these activities), and areas that had been previously used in these manners but where activity had ceased prior to the establishment of the park. Many of these activities continue to a limited extent on privately- and publicly-owned parcels within the ONSR purchase unit. The result is a landscape of immense native biological diversity overlaid with a diversity of past and continuing human uses in various stages of regrowth, with some plant communities fairly intact and others significantly altered from what they had been prior to Euro-American settlement. Many plant communities are altered to such an extent that they are considered “cultural” or “early successional” types. Since the USNVC has traditionally focused on accounting for “natural” or “semi-natural” types, no appropriate description of many of the most altered communities at the park currently exists in the National Vegetation Classification System. Nor are these types well represented by provisional types being considered for inclusion in the USNVC.

## **Objective**

The main objective of this project was to create a vegetation community map at USNVC association-level using an extensive array of data from numerous sources, such as field-based and remotely sensed data. Classification approaches that are typically employed in remote sensing studies proved inadequate in pilot investigations, so a novel approach was developed to use the available data to its highest potential. Our approach involved mining the available data with the intent of capturing 1) species-level niche differentiation, 2) past land use history, 3) patterns of current land use, and 4) differential responses to disturbance, as all of these factors influence patterns of current vegetation communities seen on the landscape in the ONSR mapping region.

## **Classification Structure**

### **USNVC**

The National Vegetation Classification is a hierarchical system based upon physiognomic characteristics in the top five levels and by floristic components in the lowest two levels (Table 1). At the very upper end, the Class splits the USNVC into broad physiognomic categories (forest, woodland, shrubland, herbaceous, etc.). Subsequent divisions are based on refinements

to this division, down to the Formation level. The floristic levels of the USNVC are the Alliance and Association. Species composition, particularly abundant and diagnostic species in the uppermost strata, is the primary criterion used to define these two levels. Roughly defined, dominant plant species are those that are most abundant. Diagnostic species are strongly tied to a particular vegetation association, primarily due to environmental constraints. Each association is defined by its diagnostic or dominant species, which are frequently incorporated into the association name, as in the *Pinus echinata* / *Vaccinium (arboreum, pallidum, stamineum)* Forest). Alliances are groups of associations that share dominant and/or diagnostic species.

**Table 1.** USNVC classification structure.

<b>Level</b>	<b>Primary Basis For Classification</b>	<b>Example</b>
Class	Growth form and structure of vegetation	Forest
Subclass	Growth form characteristics (e.g., leaf phenology)	Deciduous forest
Group	Leaf types, corresponding to climate	Cold-deciduous forest
Subgroup	Relative human impact (natural/semi-natural or cultural)	Natural/semi-natural
Formation	Additional physiognomic and environmental factors, including hydrology	Temporarily flooded cold-deciduous woodland
Alliance	Dominant/diagnostic species of uppermost or dominant stratum	<i>Pinus echinata</i> Forest Alliance
Association	Additional dominant/diagnostic species from any strata	<i>Pinus echinata</i> / <i>Vaccinium (arboreum, pallidum, stamineum)</i> Forest

## Additional Classification Elements

### Ecological Systems

During the scoping meetings and preliminary reconnaissance, we realized that in some instances, the USNVC would provide an inappropriate framework for mapping. Unfortunately, certain vegetation communities are frequently spatially related to one another, though they may have little in common structurally or compositionally. For example, within the mapping area, glades are herbaceous communities that are usually associated with physiognomically distinct woodlands. In the USNVC hierarchy, these two vegetation associations would be split out at Class, even though they have similar ecological processes and intergrade with one another frequently. Also, the two physiognomic classes often occur in complexes that hinder mapping each element individually because the units are often smaller than the minimum mapping unit of 0.5 ha. Since these two communities are related in terms of ecological processes, vegetation, and other important attributes, and since the two associations cannot be reliably distinguished from one another using remote sensing, it is often appropriate to think of them as one map class.

In order to address the above mapping issues, and to identify broader classes relevant to resource management within the park, we adopted NatureServe's (2005) ecological systems approach to generate a fewer-class, higher-accuracy map. Ecological systems mapping approaches were developed to allow users to classify vegetation based on ecological processes and group associations with similar ecological processes but not necessarily similar physiognomy into units. These units, called systems, are well suited for combining related associations into higher level systems groupings. Ecological systems mapping allows us to accurately identify ecologically related, though physiognomically distinct communities in a manner that is useful to resource managers. We aggregated vegetation associations at two levels: The "Ecological System" is a broad scale division based upon physiognomy, hydrologic

attributes, dominant plant groups and, if an altered system, human activity. The “Community Type” level subdivides the Ecological System based primarily upon substrate and dominant plant species. Altered types are further subdivided by the nature of the human disturbance. Mapping in this project was performed as the USNVC association level and the Community Type level.

Although ecological systems are technically not part of the USNVC, ecological systems are defined by their component USNVC association level units. Therefore, systems can be easily related back to the USNVC when needed. Using ecological systems improves both the utility and the accuracy of the end products. The Ecological Systems used in this study are based upon those developed by NatureServe, but they have been modified to address mapping issues and the concerns of resource managers at ONSR. Nevertheless, the Ecological Systems developed for ONSR relate to NatureServe’s ecological systems in much the same way that local community descriptions relate to their global USNVC counterparts. Local Ecological Systems may include only a subset of the communities identified in NatureServe’s systems, and information on the composition, abundance, distribution, and environmental parameters of local Ecological Systems are used to inform the description of the broader ecological systems.

The specific ecological systems mapping approach incorporated in this project was preferable to grouping communities upward into the USNVC alliance level for three reasons. First, it addressed the problem of how to map physiognomically distinct communities that co-occur in the landscape. Second, it reduced the number of classes to a greater degree than alliance-level mapping would have done. Within the study area, mapping at the alliance level would have reduced the number of classes by only a few, while mapping at the Community Type level reduced the number of classes by 16, from 49 to 33. Finally, through discussions with resource management staff both within the park and at other land management agencies in the area, we were able to identify classification units that were relevant to management goals and methods. A crosswalk of the Community Types and Ecological Systems identified for this project and their relationship to ecological systems developed by NatureServe is included in Appendix 5. Conceptually, ecological systems are akin to an intermediate level between the alliance and formation levels of the USNVC system and function much like management groups identified in the MOECS and used by Missouri resource managers. A crosswalk comparing Ecological Systems identified in our study with management groups identified by MOECS is included in Appendix 4.

### Cultural and Altered Communities

The National Vegetation Classification Standard (The Nature Conservancy, 1994a) established guidelines for classification of communities that can be considered neither natural nor semi-natural. This system combines elements of the land use and land cover classification system typically used to map urban and water features (Anderson and others, 1976), and a coarse system for classifying actively cultivated lands. However, early discussions with resource managers at ONSR indicated that adoption of these classification systems would fail to account for many vegetation associations that were known to occur within the mapping area. The park includes land that had once been privately owned and used for grazing, row crops, timber, and/or homesteads. Much of the land was abandoned in the 1930’s and most of the remaining uses of this type ceased when the park was created in 1964; these lands are now in various stages of succession and regrowth. Furthermore, there is a high concentration of public lands managed for timber outside of the park, but within the mapping area. As a result, there is currently an array of ruderal and timber management communities that are addressed neither by the USNVC, nor by

the broad categories of the land use/land cover and cultivated lands systems described above. Grossman and others (1998) provide a framework for identifying ruderal communities, but they stop short of suggesting ways to classify the various altered vegetation associations. In order to map the full spectrum of communities extant in the park and provide a better description of ruderal and timber management areas that might have critical habitat implications for wildlife, our mapping approach included classification of those communities not treated by existing systems and their subtypes. We developed a suite of altered vegetation associations that could potentially be found within the study area based on our knowledge of the current conditions within the park and discussions with resource management staff regarding types that were critical to management activities. This classification was updated as new information was gathered during field data collection. Descriptions of altered communities are attached as Appendix 16, which is retained as a separate electronic document (Appendix 16-ONSR Altered Community Descriptions). Appendix 6 relates altered vegetation associations to Ecological Systems used in this study.

## Missouri Classification Systems

Two classification systems are widely accepted and used by natural resource managers in Missouri to describe local vegetation communities; the previously mentioned Missouri Ecological Classification System and *The Terrestrial Natural Communities of Missouri* (Nelson, 1985; Nelson, 2005). The MOECS was not intended to give a map of current vegetation conditions, but resulted in a map and classification system akin to one of potential natural vegetation. The MOECS is used regularly by state and Federal agencies in Missouri for management planning purposes. Nelson's (1985, 2005) work also focused on relatively intact native vegetation communities, and his original work (Nelson, 1985) formed the foundation for the USNVC global descriptions of many of the communities identified in our study. Near the completion of this project, a revised version of *The Terrestrial Natural Communities of Missouri* was published (Nelson, 2005). We have included a crosswalk relating USNVC communities identified in this study to communities identified by MOECS and to Terrestrial Natural Communities identified by Nelson (2005) in Appendix 3.



# Methods

## Approach

To develop a USNVC association-level vegetation community map to the required accuracy standards, it was necessary to predict landscape scale vegetation community patterns based on the combined influence of landform-mediated resource gradients as well as the influence of past and present land use patterns and anthropogenic disturbance regimes. This challenge was met by acquiring numerous remote sensing, topographic and field-collected vegetation datasets from which we derived a large set of variables to train a statistical classification. We supplemented this method with photointerpretation and digitization from current and historical aerial photographic sources. We used a hybrid approach to produce the final vegetation community map; we combined a unique data mining statistical approach with a photointerpretative mapping approach using a spatial overlay. The logic behind the overlay order was based on the manner in which anthropogenic land cover modification is superimposed over relatively natural vegetation communities.

## Field Methods

### Development of the Field Key

We developed a field key of vegetation associations prior to field sampling based on the extensive knowledge and experience of project personnel with vegetation communities in and around the park. USGS ecologists had led field data collection for the Missouri Ecological Classification System (MOECS) project; Missouri Department of Conservation personnel had developed the MOECS model and had been involved in development of Missouri community descriptions used in the USNVC. This collective experience and the reconnaissance activities performed prior to initial sampling provided sufficient information to determine the suite of communities that we would likely encounter in the mapping area. After field data collection began, modifications were made as needed to the field key in order to accommodate our expanding knowledge of the vegetation associations. If an unknown vegetation association was encountered (for example, a type that clearly failed to match the description for any of the communities likely to be in the mapping area), it was first compared to other existing USNVC vegetation associations that had not been included previously in our classification to determine if it matched any of those communities. If so, that association was incorporated into the field key. If not, the community was given a provisional name and plot data were collected as described in the following section. Furthermore, field notes were used to describe the new vegetation association and to determine its relationship, if any, to other known vegetation associations.

Because evidence of human disturbance frequently is among the most obvious characteristics of a community, the key is first divided into two sections. The first section covers natural and semi-natural communities that are consistent with the USNVC. The second section covers culturally and significantly altered vegetation associations, which are not included in the USNVC. Some vegetation associations are represented in both sections of the key, because they exhibit characteristics that suggest that they could be classified as either natural or originating from human disturbance.

Subsequent to the natural/altere division, the key follows the structure of the USNVC hierarchy through the initial levels:

- I. Physiognomic type (forests, woodlands, shrublands, herbaceous and sparse herbaceous), then
  - A. Woody leaf phenology, if community is a forest, woodland or shrubland, or
  - B. Habitat or substrate type, if community is herbaceous (or management activity, for cultural types).

Beyond these divisions, communities are generally grouped together in a manner that parallels the USNVC hierarchy. Therefore, associations that are closely related in the USNVC hierarchy (for example, within the same alliance) tend to be closely grouped in the key. The field key is attached as Appendix 17, which is retained as a separate electronic document (Appendix 17-Field Key to ONSR Vegetation Communities).

## Existing Community Characterization and Remote Sensing Training Data

Vegetation data had been collected from more than 500 sampling points in the study area for the MOECS project between 1996 and 2000. In the MOECS project, vegetation data were analyzed in relation to environmental conditions using multivariate analyses to classify relatively undisturbed ecological communities (Becker, 1999; Grabner, 2001). We used The Nature Conservancy's guidelines for the USGS-NPS program for incorporating existing data into vegetation mapping efforts (The Nature Conservancy, 1996) to determine the utility of the MOECS data for our mapping effort. We determined that the data were sufficient for classification and mapping, except that they lacked a field-classification to a USNVC vegetation association and certain environmental measurements. Therefore, we collected classification and environmental data for each previously sampled point that we re-visited during this project and used the datasets for classification and mapping of USNVC communities. These data were augmented by new plot data collected during this project using methods described below.

## New Community Characterization and Remote Sensing Training Data

Following USNVC guidelines for sampling large parks, we used a modification of the gradsect sampling technique (Austin and Heyligers, 1989), which deliberately samples across steep environmental gradients in order to capture the greatest diversity of sampling units. The mapping area had previously been classified according to Landtype Associations (LTAs) by the Missouri Ecological Classification System (Figure 1; Nigh and others, 2000; Nigh and Schroeder, 2002). We structured our sampling plan to capture important LTAs within the mapping area: the Current River Breaks, the Current River Hills, the Jacks Fork Breaks, and the Eminence (Igneous) Knobs. A fifth LTA, the Pine-Oak Plains, is minimally represented in the mapping area. Within each of these LTAs, we identified principal sampling areas based upon the following factors: 1) high ecological variability as suggested by the Ecological Landtype model developed for the region (Nigh and others, 2000); and 2) significant public land ownership. Where possible, sampling was directed to areas for which there were significant existing data in order to facilitate field classification of plots sampled during previous studies but for which no field classifications had been made. Also, these areas typically provided a high amount of public land ownership which allowed for more complete sampling across environmental gradients. Principal sampling area boundaries were drawn to incorporate the maximum ecological diversity.

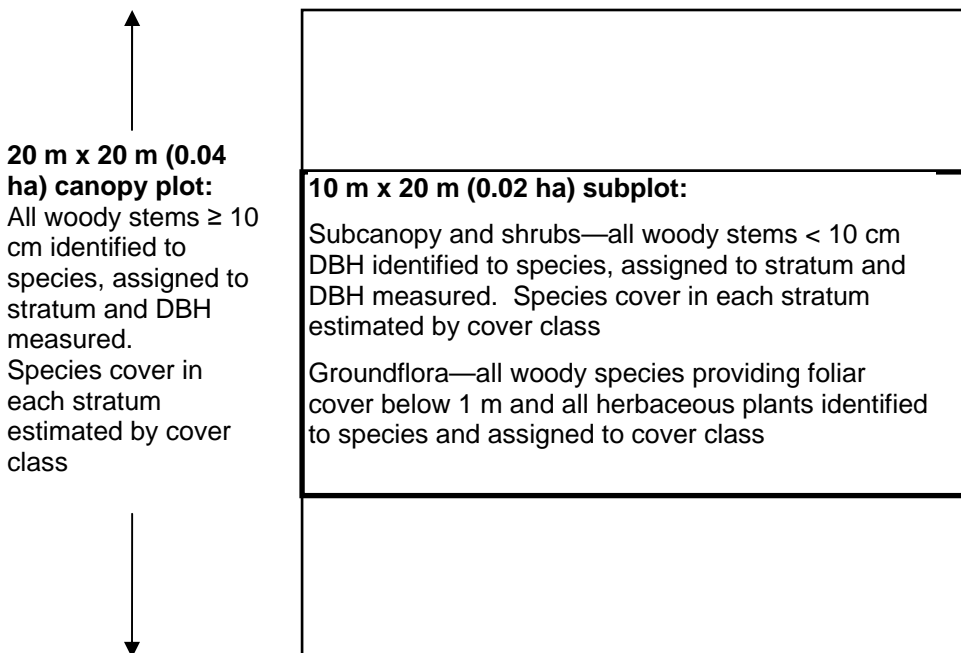


Initially, sampling within each principal sampling area was stratified by Ecological Landtype (ELT, Nigh and others, 2000; Nigh and Schroeder, 2002). We generated a random sampling point within each of ten randomly selected polygons of each ELT type. (If a polygon included a point that had been previously sampled during the MOECS project and for which there were sufficient data to characterize the vegetation association, that point was used rather than the randomly generated point.) During the second season, sampling was based upon a preliminary classification map generated using training data from the first year. We used this map to identify sites with provisionally high vegetation community diversity and to stratify second-season sampling.

During both sampling years, we collected three types of data: 1) classification data used as training data for remote sensing, 2) plot data for characterizing community structure and composition and for use in multivariate data analysis, and 3) wildland fuels data for characterizing fuel loads within each vegetation association. We collected classification, environmental, vegetation description and wildland fuels data at every point visited. Plot data were collected at points only if additional data were needed in order to reach the ten sample minimum needed to characterize each vegetation association. Once we had plot data from ten examples of a given vegetation association, plot-level sampling was discontinued for that type, but wildland fuels and classification data were collected.

#### Vegetation Plot Data

Where plot data were collected, we followed guidelines established by the USGS-NPS Vegetation Mapping program (The Nature Conservancy, 1994b). Within forests and woodlands, we laid out a 20 x 20 m plot along the cardinal directions (Figure 4). Within this plot, we identified to species and measured the diameter at breast height (DBH) of every tree stem with a DBH greater than or equal to 10 cm. Within a 10 x 20 m subplot oriented along the cross-slope axis of the plot, we identified to species and measured to the nearest centimeter every woody stem taller than one meter and having a DBH less than 10 cm. For trees and shrubs, we assigned each stem to the appropriate vegetative stratum and assigned each species to a vegetative cover class within each stratum where it was recorded (Table 2). For herbaceous vegetation and for all woody stems providing foliar cover below one meter, we identified each plant within the 10 x 20 m subplot to species and assigned each species to a cover class. Shrubby and herbaceous communities were sampled using a 10 x 20 m plot within which the same data were collected as in the 10 x 20 m subplot above. Data from previous projects that were used in this study had been collected using this plot design.



**Figure 4.** Vegetation sampling plot design.

**Table 2.** Vegetative cover classes assigned to individual species within plots.

Code	Range of Class*	Class midpoint
01	$>0-<1\%$	0.3%
03	$1-<5\%$	3%
10	$5-<15\%$	10%
20	$15-<25\%$	20%
30	$25-<35\%$	30%
40	$35-<45\%$	40%
50	$45-<55\%$	50%
60	$55-<65\%$	60%
70	$65-<75\%$	70%
80	$75-<85\%$	80%
90	$85-<95\%$	90%
98	$95-<100\%$	97.5%

\*Adopted from The Nature Conservancy, 1994b

#### Classification and Location Data

We classified each point into a USNVC vegetation type using the field key, ranked its quality from 1 to 5 (the degree to which that community matched the description in the current USNVC), and estimated (by pacing to the closer of the community terminus or 100 m) its extent in meters in each cardinal direction from the sampling point. If the community designation at a given sampling point was assigned a low quality rank, a secondary designation of the vegetation association was assigned. Additionally, we collected the following spatial information as required by the Vegetation Mapping Program (The Nature Conservancy, 1994b.): Park Name (OZAR), Site, USGS quad name, USGS quad code, Easting, Northing and elevation (UTM NAD83, Zone 15N) derived using a hand-held Global Positioning System (GPS), GPS estimated

positional error, and waypoint. We recorded any comments we had relating to the classification of the community and took at least one digital voucher photograph at each point.

Location data were collected using a Thales MobileMapper GPS. This unit offers 3- to 5-m real-time Wide Area Augmentation System (WAAS)-corrected accuracy, with sub-meter post-processed accuracy. Final coordinates were calculated by averaging values recorded once every second for a minimum of 180 seconds per sample. Data were post-processed using Thales MobileMapper Office software and correction data downloaded from continually operating reference stations operated by the National Geodetic Survey (2005). Approximately 86 percent of the GPS data were corrected in this manner. An additional 12 percent of the GPS data were real-time WAAS-corrected. Two percent of data were uncorrected.

While in the field, we also manually recorded coordinates into databases developed using Handbase software for Palm handheld PDA's. Unlike post-processed data from the GPS receiver, recorded values at each point represent the average value of a minimum of 180 *uncorrected* field readings. Therefore, there were often slight discrepancies between field-recorded UTM coordinates and those derived from downloaded, post-processed data. Values derived using GIS software and post-processing correction data were assumed to be superior to field estimates.

#### Environmental Data

We also collected environmental data at each location. Data included slope, aspect, geological stratum, topographic position, field identification of the MOECS ELT, surficial geology and surface soil texture. The hydrologic regime of each point was assessed based on Cowardin and others (1979).

#### Vegetation Description Data

Vegetation description data follows Vegetation Mapping Program standards (The Nature Conservancy, 1994b.). We assigned each point to a physiognomic class, identified the dominant leaf type within the community, and identified the leaf phenology of both woody (evergreen or deciduous) and herbaceous (annual or perennial) vegetation. We identified between one and three dominant species within each vegetative stratum and assigned each to a cover class. Finally, we noted evidence of human disturbance, use of the area by animals, and diagnostic species outside of the plot (if a plot was used) or not listed among dominant plants.

#### Wildland Fuels Data

We estimated fuel loading and structure at the association level using standard fuel inventory techniques developed by Brown (1974) and Brown and others (1981). Along a 15.24 m (50 ft) transect associated with each sampling point, we tallied woody debris in three diameter size categories: 1 hr (0-0.6 cm or 0-0.25 in), 10 hr (0.61-2.54 cm or 0.26-1 in), 100 hr (2.55 – 7.62 cm or 1.01-3 inch), and measured the diameter for 1,000 hr fuels (greater than 7.62 cm or 3 in). 1 hr and 10 hr fuels were tallied in the first 1.82 m (6 ft) of the transect, 100 hr fuels were tallied in the first 3.65 m (12 ft) of the transect, and 1,000 hr fuels were sampled along the entire transect. Finally, we measured duff and litter depth and fuel height at 1.52 m (5 ft) intervals along the transect. Litter fuel loading estimates based on duff and litter depth followed Brown (1974).

Wildland fuel loadings were tested to determine if there were differences among USNVC associations using Multi-Response Permutation Procedure (MRPP) in the multivariate statistical

program PC-Ord4 (McCune and Grace 2002). MRPP was selected because it avoids the assumption of a normal distribution within the data for analysis. The results of MRPP are a measure of effect size and a p-value. Effect size described within MRPP is the chance-corrected within-group agreement ( $A$ ) statistic. If  $A = 0$ , then the heterogeneity within groups equals expectation by chance (McCune and Grace, 2002). An  $A$  value near 0.1 is common when analyzing ecological data. Additionally, when results indicate a significant difference when the effect size is small ( $A=0.01$ ) and the sample size is large ( $N=200$ ), conclusions need to consider if results are ecologically significant or statistically significant. Significance of analysis was determined by evaluating the p-value (if  $p=0.05$  then significant) and the  $A$  statistic ( $A=0.05$  random distribution), and if sample size is greater than 200, then results were evaluated both ecologically and statistically. Fine fuel loading analysis was conducted using litter, 1 hour, 10 hour, and 100 hour fuel loadings. Total fuel loading was analyzed using MRPP using litter, 1 hour, 10 hour, 100 hour, 1,000 hour solid, and 1,000 hour rotten fuels.

### Data Quality Control in Field Sampling

One of the most detrimental potential problems encountered during field sampling was inconsistent use of the field key by different crews leading to inconsistent classification of communities. To mitigate the potential for sampling error of this type, each sampling season included two weeks of intensive botanical training and training in the use of the field key to vegetation associations. Other quality control measures included periodic, independent re-sampling of field-classified communities to ensure consistent classification. When discrepancies between the classifications applied by independent crews were discovered, the community was classified to the correct type by the USGS ecologist in charge of field sampling, and crews were re-instructed in use of the key and the critical criteria to consider in order to distinguish between the two confused types.

### Multivariate Analysis of Plot Data

The classification process used a combination of qualitative and quantitative analyses to derive the final community list and plot assignments. Pre-existing datasets used in this project had been revisited and qualitatively classified by field crews. New plots had been qualitatively assigned to a USNVC association and plot data had been collected. Qualitative plot assignments from all datasets were then compared to the results of quantitative analyses to generate the final classification for each plot.

The data for each plot were stored in three separate tables, one with groundcover data (forbs, graminoids, tree seedlings, and small shrubs), one with shrub and sapling data, and one with tree canopy and subcanopy data. The groundcover dataset used cover as the abundance measure. Shrub and tree data collected specifically for this project also included cover estimates, but pre-existing data from the MOECS project included only density and basal area. Because the groundcover and woody (tree and shrub) data were measured differently, we could not combine all three datasets unless we reduced the data to presence/absence. Many USNVC associations are differentiated based on relative abundances of certain species and we felt we would lose too much information if we used presence/absence data. Given that the MOECS data represented a large and valuable portion of the dataset and that much information would be lost if data were reduce to presence/absence resolution, we chose to combine the tree and shrub data and used importance value (IV) as the abundance measure for the quantitative analyses. We felt using the tree and shrub data would give a better classification for the mapping area because it is primarily

forested. Additionally, it would better match what the mappers would see while working on map production.

From the 318 points at which plot data were collected, we eliminated plots that were clearly disturbed or dominated by herbaceous vegetation. The former type was eliminated because the USNVC has traditionally focused on accounting for “natural” or “semi-natural” types. No appropriate description of many of the most impacted communities at the park exists in the National Vegetation Classification System. The latter type (herbaceous communities) was eliminated because there were too few plots to conduct a rigorous quantitative analysis. These were relatively easy to assign to USNVC associations simply by examining the individual plot data.

The tree and shrub data from the remaining 314 plots were exported to PC-Ord (McCune and Mefford, 1999) for multivariate analyses. We maintained the difference between shrub and tree strata so a species could appear in a plot as both and the importance values would be treated separately during analysis. Analytical methods have different assumptions, strengths, and weaknesses so we employed more than one and compared results. For this project we used two ordination methods, Detrended Canonical Analysis (DCA) and Non-metric Multidimensional Scaling (NMS).

Although the analytical techniques used are a common method to analyze ecological data, it is important to keep in mind that this was all done in the context of the USNVC (Grossman and others, 1998). In both the initial qualitative plot assignments and the quantitative analyses, we were continually comparing the results to existing USNVC associations to determine when groups of plots fit those USNVC associations. That is, during analysis we were trying to maintain a regional and national view instead of describing communities purely based on local variations. Maintaining a regional view while analyzing a local dataset sometimes affected how the plots were grouped. For example, there were *Salix caroliniana*-dominated plots and *Platanus occidentalis*-dominated plots that were similar throughout the analyses but they were separated into two associations based partly on the fact that we know there are *Salix caroliniana* stands and *Platanus occidentalis* stands in other parts of the central US that are not as closely related in species composition.

We began with all plots provisionally tagged with a USNVC association name based on the opinion of the field crew and knowledgeable local ecologists. The process of giving final classification names to the plots was an iterative one in which the quantitative analyses were run, the results examined and interpreted, certain plots assigned to an USNVC association and removed, and then the process begun again. After each analysis iteration, summary statistics were calculated for each provisional USNVC association and the plots were compared for internal consistency and similarity to the range-wide USNVC description and for how they clustered on the ordinations. In general, when the plots provisionally tagged to a USNVC association were relatively similar to each other and to the general USNVC concept (as indicated by proximity on the ordination plots), they were classified as that USNVC association and removed from further analyses. Plots labeled as part of a given association that were separated from others on the ordination graph were examined for removal from that association and, if they were removed, were left in the dataset for further analyses. There were nine iterations of analyses before all plots were assigned to USNVC associations.

## Map Production

### Data

The independent variables used as input for statistical classification include panchromatic and multispectral remote sensing image data that depict the magnitude of electromagnetic reflectance of the vegetation communities in different wavelengths as well as the textural patterns of their brightness, and topographic data that represent indirect gradients spatially segregating vegetation communities (Parker, 1982; Austin and Smith, 1989; Franklin, 1995). Specifically, the electromagnetic reflectance classification inputs include Landsat Thematic Mapper (TM) multispectral satellite image data obtained during both leaf-on (07/05/00) and leaf-off (03/13/02) conditions; derivatives and indices of Landsat data that depict relative levels of greenness; reflectance and textural information derived from high resolution color-infrared (CIR) aerial photographs obtained in October, 2002 and summer 2003; and greenness indices derived from the aerial photographs. Topographic variables and indices were derived from digital elevation model (DEM) data, and serve as measurable surrogates to the direct gradients of exposure, moisture availability, temperature, and growing season length associated with landform position and morphology (Parker, 1982; Austin and Smith, 1989; McNab, 1989, 1993). These spatial classification inputs represent the spectral reflectivity of actual vegetation communities present on the landscape and characterize differences resulting from environmental niche specialization of component species in these communities, such as moisture and light environment differences. In this sense, these classification inputs represent both actual and potential vegetation community patterns on the landscape in the ONSR.

### Aerial Photos

Color-infrared (CIR) 1:12,000-scale aerial photographs were acquired over the ONSR mapping region in October, 2002. The 612 photographs were scanned into digital form at a resolution of 0.25 m cells and orthorectified using the OrthoBASE functions contained in the Leica Photogrammetry Suite extension of the ERDAS Imagine® software, version 8.7. At least 5 ground control points (GCPs) were obtained for each photo frame by locating ground features, such as road intersections and building corners that were discernable on both the October, 2002 aerial photo images and corresponding National Agricultural Imagery Program (NAIP) 2m orthophotos that served as reference images. These GCPs were used to perform aerial triangulation between the camera and features on the images, and the results of the triangulation were then orthorectified using a 10 m resolution DEM and a nearest neighbor resampling method to create an output raster image with 0.25 meter square pixels. The positional accuracy of the orthorectified images was examined using the ‘swipe’ function in ERDAS Imagine to compare the locations of landmarks on these images with the NAIP orthophotos. A maximum tolerance of a 15 m spatial discrepancy between the two image sources was established. If a greater spatial discrepancy was found on any location on an image, it was re-rectified using additional GCPs.

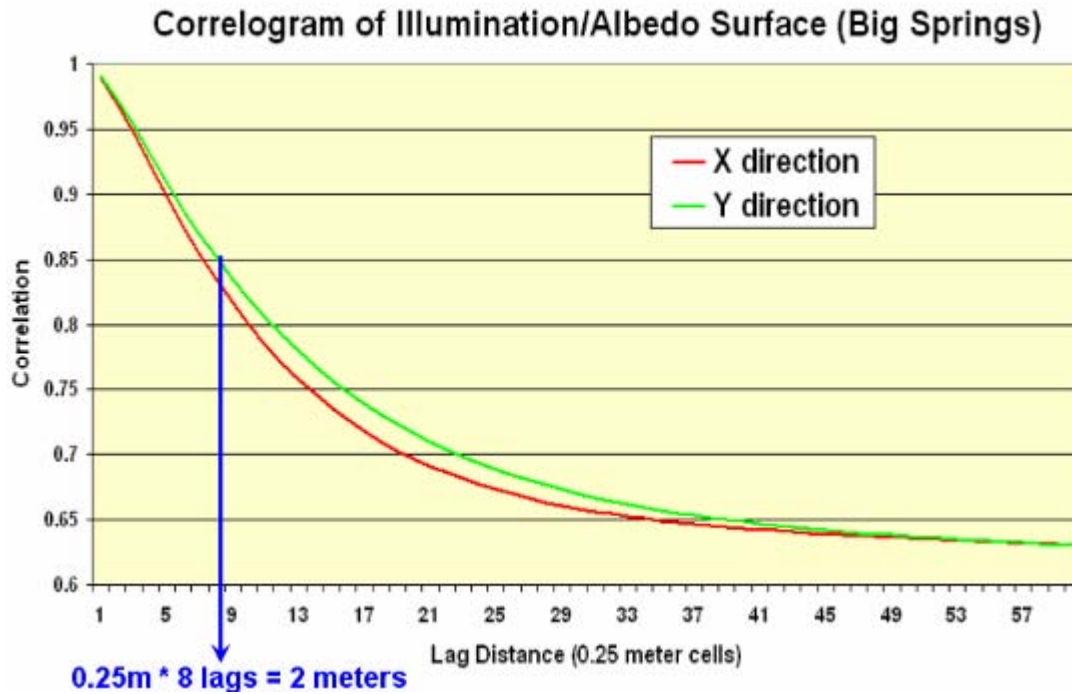
Photomosaics were produced from the individual orthorectified October, 2002 photo image frames using the mosaic tool in the ERDAS Imagine software. Hard cutlines were created to enforce transitions in overlapping areas between adjacent photo image frames, so that no photo image frame transitions abruptly into its neighboring photo image frame at the location of the cutline between them. Nine photomosaics were generated, with file sizes ranging from 5 to 20 gb (Figure A1-1).

Numerous data derivatives were obtained from the October, 2002 aerial photo image data to support the statistical classification of vegetation associations. These derivatives facilitate the discrimination of vegetation associations based on differences in their color, level of greenness and brightness, and texture. The large file sizes for the 0.25 m resolution photomosaic images precluded the extraction of derivative information, so a correlation analysis was performed on these image data to determine a level of spatial resolution that would reduce the size of these image files to a manageable level while maintaining a sufficient resolution to support the extraction of textural information. To accomplish this, illumination/albedo surfaces (the square root of the sum of the squares of the infrared, red, and green image bands from the October, 2002 CIR image data) were generated for three test areas. Illumination/albedo was chosen as the image data derivation from which to assess image texture in forested areas, because this measure combines both illumination and overall reflectance variations in the three CIR bands, and accentuates the boundaries of individual tree canopies and the shadows on their peripheries (Warner and others, 1998). Correlograms were produced from the illumination/albedo surfaces to examine scales of spatial dependence in the three test areas, and a spatial resolution of 2 meters was chosen as the best compromise between data size reduction and textural information retention (Figure 5). Four 2-meter resolution photomosaics were created for the ONSR mapping region, with files ranging in size from 534 to 850 mb (Figure A1-2). The October, 2002 photo image data was further degraded to 15- and 30-meter resolutions to assess the utility of derivatives obtained from these coarser resolutions. Table A7-1 in Appendix 7 lists the data derivatives obtained from the three spatial scales of the October, 2002 photo image data.

In datasets that indicate masking of shadows, dark regions associated with vegetative crown shadowing were masked for the red, green, and near infrared spectral bands of the high resolution CIR aerial photo imagery to enhance the performance of the greenness indices calculated using these data. Identifying dark (shadowed) regions was undertaken by setting a brightness threshold that separated dark from bright areas apparent on an illumination/albedo surface, which was calculated as a combination of reflectance intensities in the three spectral bands of the CIR photo image data. The bright regions identified in the illumination/albedo surface served as a mask template that was then applied to the 2-meter resolution CIR aerial photo data, and the vegetation greenness indices (SQVI and NDVI) were subsequently calculated using these data. The 14-meter resolution masked CIR photo image data resulted from degrading the resolution of the 2-meter CIR aerial photo image data.

### 2003 National Agriculture Imagery Program Photo Data

Because the October, 2002 aerial photos were obtained during a period of phenological browning-down in the mapping area, additional aerial photographs were obtained for peak growing season conditions. A set of 2003 1-meter color-infrared National Agriculture Imagery Program (NAIP) photographs were acquired for this purpose. These data were degraded 2 meter similarly to the 2002 aerial photo data for data volume considerations. Greenness indices were derived and reflectance values in the infrared, red, and green wavelengths were obtained, as well as medians of these derivatives calculated within a 15x15 pixel moving window (Table A7-2).



**Figure 5.** Correlogram of illumination/albedo surface indicating a high amount of spatial dependence at about 2 meters in both the x and y directions.

#### Landsat TM/ETM+

The vegetation community mapping approach employed in our study employed both leaf-off Enhanced Thematic Mapper (ETM+) and growing season multispectral Landsat Thematic Mapper (TM) image data from path 24 row 34. The winter (leaf-off) image was acquired on March 13, 2002, and was geographically referenced to UTM zone 15 NAD 83 coordinates using 45 GCPs that were identifiable both on the Landsat and reference NAIP orthophoto images. The resulting average root mean square error (RMSE) was 0.2454 for the portion of the image that covered the mapping area, indicating that the spatial error between the map source and image data is expected to be less than one quarter of a 30x30 meter ETM+ pixel. The growing season TM image was obtained on July 5, 2000, and was geographically referenced to UTM zone 15 NAD 83 coordinates using 40 GCPs that were identifiable on both the Landsat and reference NAIP orthophoto images with an average RMSE of 0.3135, indicating an expected spatial error of less than a third of a TM pixel. The TM and ETM+ image data were corrected to at-sensor reflectance following Markham and Barker (1986) and parameters published in the Landsat 7 Science Data Users Handbook (Irish, 2000).

An empirical topographic normalization technique was applied to the TM data to reduce the influence of differential solar illumination related to topography (Allen, 2000). An empirical model relating solar illumination angle to differential reflectance of forested pixels was developed band by band. The regression equation and parameter values for each band are given in Table A7-3

The 6 Landsat visible and infrared bands typically contain substantial redundancy, which was reduced via principal components to three bands (PC1, PC2, and PC3), explaining more than 95 percent of the variance in both of the original images. A tasseled cap transformation was



applied using coefficients from Huang and others (2002) to derive the widely used Brightness (soils), Greenness (vegetation), and Wetness (plant canopy and soils) indices (Crist and Kauth, 1986). In addition, the Normalized Difference Vegetation Index (NDVI), computed from the Landsat data as  $(\text{NIR} - \text{Red}) / (\text{NIR} + \text{Red})$ , and the Normalized Difference Moisture Index (NDMI,  $[\text{MIR} - \text{red}] / [\text{MIR} + \text{red}]$ ) were derived from the original image data. These indices correlate to leaf area, biomass, percent green cover, productivity, and photosynthetic activity (Tucker and Compton, 1979; Sellers, 1985). The six original Landsat non-thermal spectral bands, the NDVI and NDMI vegetation indices described above, and other data transformations were combined into image data ‘stacks’ to be sampled for input into classification models (Table A7-4 in Appendix 7).

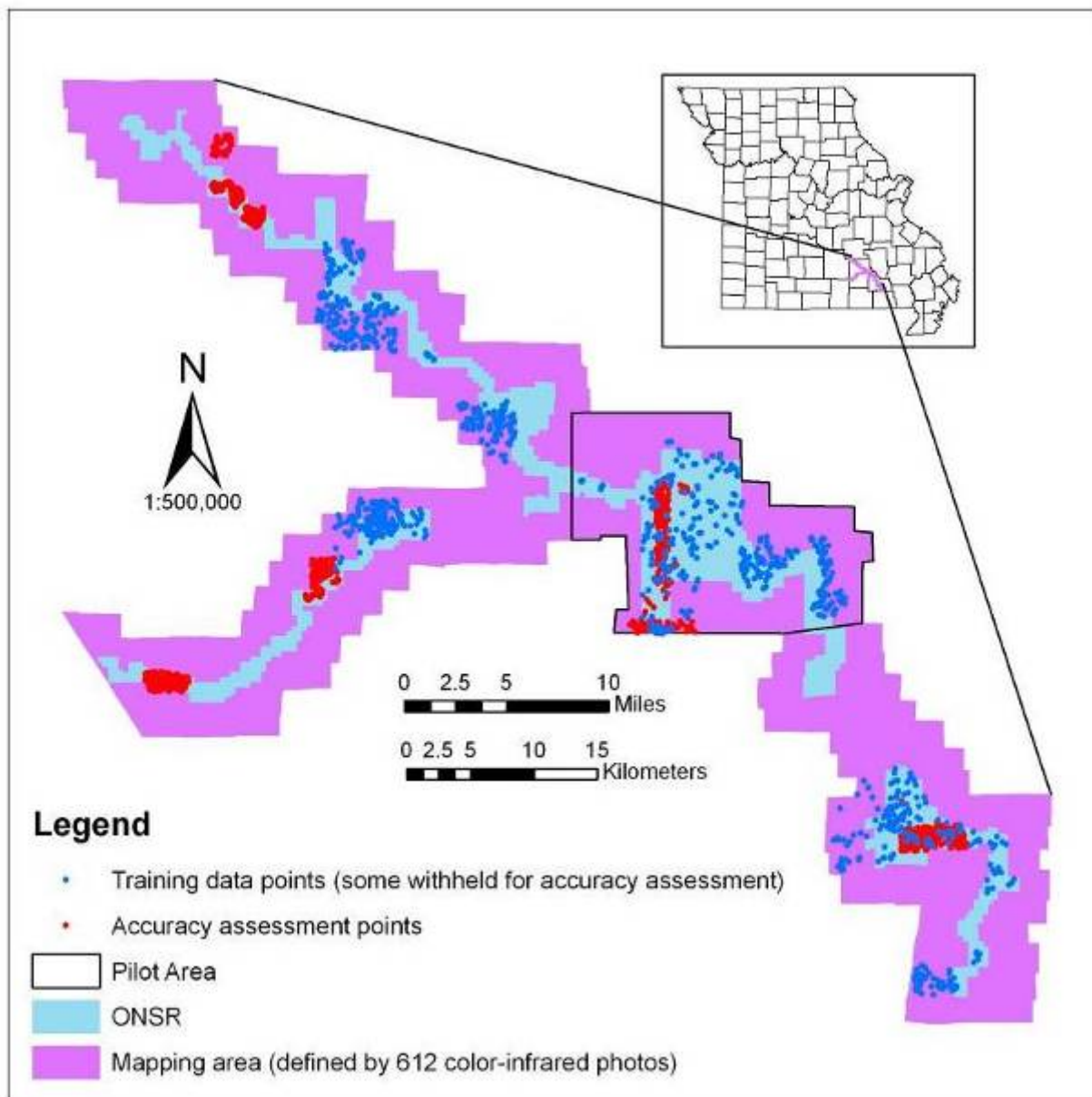
### Topographic Information

Differences in color and other spectral reflectance characteristics are often not sufficient to distinguish similar plant communities from each other, so ancillary data are frequently used as input in remote sensing classifications to reduce this confusion. Specifically, topographic data can be used to distinguish among different suites of plant species based on niche specialization related to topographic gradients (Frank, 1988; Ohmann and Gregory, 2002). Topographic indices and other derivatives that have been developed as landscape-scale representations of gradients associated with landform shape and position were obtained from a 10 m DEM of the study area (Table A7-5 in Appendix 7). These indices represent measurements of indirect gradients hypothesized to control species distribution (Austin and Smith, 1989; Franklin, 1995). Topographic indices have been used to characterize the spatial distribution of species in predictive mapping (Parker, 1982; McNab, 1989, 1993; Iverson and others, 1997), but have infrequently been used with remote sensing data. From the DEM data, the indirect gradients of slope, Beers-transformed aspect (Beers and others, 1966), elevation, slope position, and slope curvature were derived to act as measurable surrogates to the direct gradients of exposure, moisture availability, temperature, and growing season length. The Arc/Info command SLOPE was used to calculate degrees of slope angle from DEM data. The Arc/Info command ASPECT was used to derive slope aspect in positive degrees from 0 to 360 based on the direction of maximum change in elevation from each cell. Beers-transformed aspect uses the equation  $\cos(\text{aspect} - 45) + 1$  to transform the circular distribution of slope aspect into a continuous linear distribution ranging from 0 to 2; 0 being a grid cell that faces southwest, a value of 1 indicating either northwest or southeast, and 2 being northeast. Relative slope position was calculated using an Arc macro language (AML) program in which the slope position is calculated relative to localized ridge tops and valley bottoms. The resulting grid cell values range from 0 to 100, where 0 is a valley bottom and 100 is a ridgetop. Slope curvature was calculated using the CURVATURE command available in the Arc/Info GRID module. The terrain relative moisture index (TRMI; included in deliverables) represents an additive combination of slope angle, slope position, slope aspect (Beers-transformed), and curvature (Parker 1982). These topographic gradients were used as independent variables similar to the remote sensing data to help differentiate USNVC vegetation associations based on the gradient affinities of their component species.

### Field Training Data

A total of 3,237 field observations extracted data from the 92 discriminating variables listed in the tables of Appendix 7 (Figure 6). The 3,237 observation points were gleaned from

1,069 field points, with the additional 2,168 observations located at a distance of 40 meters using field notations on the extent of the vegetation association in each cardinal direction from the primary sampling point. These derived “sample” points were weighted equally with the primary sampling location. Spatially continuous image files containing the discriminating variables obtained from the aerial photo images, Landsat images, and topographic data were sampled at the 3,237 sample points using the ‘Convert Pixels to ASCII’ ERDAS Imagine utility, so that 3,237 values for each discriminating variable could be combined in an Excel tabular format. This table was then used as the input dataset for subsequent analysis in Statistical Analysis Software (SAS; SAS Institute Inc., 2004).



**Figure 6.** Distribution of sampling points and location of statistical classification pilot area.

## Statistical Classification Approach

### Pilot Area Test of Statistical Methods

Statistical classification techniques entail a systematic search for pattern in data, and as such can produce predictions for unknown cases as well as yield information on the structure of the support data (Breiman and others, 1984). Whereas supervised classification methods using nonparametric, maximum likelihood or minimum distance decision rules to extrapolate continuous raster maps from training data have been widely used for vegetation mapping with remote sensing data, tree regression represents a novel approach, and one that is becoming more prominent in light of its ability to identify the inputs that produce the best separability in classification problems. Regression trees have been demonstrated to produce robust results for land cover classification in a number of environments and over a spectrum of scales (Friedl and Brodley, 1997; Hansen and others, 2000; Joy and others, 2003; de Colstoun and others, 2003). Regression tree-based models differ from linear and additive logistic models for classification problems in that they recursively split the data into homogeneous subsets. This layered approach represents a simpler method, with classes forming at each step by splitting the data at each node based on a function that maximizes the reduction of class impurity (Therneau and Atkinson, 1997). Regression trees are also valuable data mining tools, in that the most relevant independent variables are chosen for the separate nodes (Venables and Ripley, 1994), and the structure of the resulting tree is heuristically valuable, providing insight into the predictive structure of the support data even in cases where it is not homogenous over the measurement space (Breiman and others, 1984).

Before a methodology was developed to map vegetation communities for the entire ONSR mapping area, a pilot area was delineated to test candidate statistical methods to classify the numerous USNVC association types present. The goals of the pilot project were to explore within a spatial subset of the ONSR mapping area; 1) the potential for statistically classifying and subsequently mapping the USNVC vegetation association types to an accuracy level consistent with National Vegetation Mapping Program standards using remote sensing and topographic data inputs, and 2) the inherent differentiability of the various vegetation communities found in the ONSR region. The accuracy of maps produced through the use of a supervised maximum likelihood decision rule classification and a regression tree classification were compared so that both the relative utility of these approaches, as well as the inherent discernability of the different USNVC vegetation associations could be assessed. Details of the pilot area test of statistical methods are described in Appendix 19.

Rather low accuracy results were obtained from the two classification approaches tested in this pilot study. The regression tree model for the association level vegetation communities was marginally more accurate overall (39.2% with a kappa value of 0.367). While the maximum likelihood decision rule classification result was only 5 percent less accurate overall at 34.5% (kappa = 0.314), certain vegetation associations were mapped more accurately using the former approach compared to the latter. The low accuracy results obtained in this pilot investigation point out some limitations associated with using statistical classifiers alone in complex land cover mapping problems. For example, numerous USNVC vegetation association types were not discernable by the regression tree model, and were consequently left out of the results. Some of the categories in a predetermined classification scheme will not be classified by regression tree model due to inseparability or rarity, especially when the tree model result is optimized through

pruning. In addition, the maximum likelihood decision rule classification lacks an efficient and trustworthy method for variable selection, and thus often generates a non-parsimonious classification model.

In this pilot investigation, regression trees indicated the importance of particular independent variables and where they are valuable for distinguishing both natural and human altered vegetation community classes. It was determined that the ultimate utility of regression tree classification for mapping USNVC vegetation associations may be realized by applying its information content towards a preliminary stratification of the study area so that separate classification models can be applied within each relatively more homogeneous region. The primary splits identified by the association level regression tree (Figure A19-2) separate the pilot study area into vegetation communities that occur on igneous knobs, in bottomland areas (including old fields), and those that occur on the remainder of the upland hills and breaks. The ONSR mapping area was split using Ecological Land Type (ELT) data to produce masks for the bottomland, igneous glade, and hills and breaks regions. Further, it was decided that due to the numerous categories in the USNVC association-level classification scheme and copious independent variables available for classification model input, discriminant analysis represented a more appropriate method to pursue, as this statistical approach has shown promise with large hyperspectral remote sensing input datasets (Clark and others, 2005; Karimi and others, 2005).

#### Discriminant Analysis Statistical Model

A discriminant analysis statistical model was developed to discern differences between the various USNVC vegetation association types. Discriminant analysis is a statistical approach in which the difference between two or more groups is discerned using several variables simultaneously (Klecka, 1980). This method can be used as a means to assign all of the cases in a dataset to the group to which they most closely resemble. In this application, discriminant analysis was used to classify all of the pixels in a study area as the land cover type to which they have the highest probability of membership using a linear combination of a set of discriminating variables derived from remote sensing and/or ancillary data. A collection of 92 discriminating variables obtained from remote sensing and topographic data sources served as potential training data for this statistical classification approach. Separate statistical classifications were performed for bottomland areas, hills and breaks, and igneous knobs as delineated using an ELT classification. The progression of this statistical classification approach entailed: 1) variable selection using stepwise discriminant analysis, 2) reduction of dimensionality using canonical discriminant analysis, 3) classification based on the probabilities generated using discriminant analysis with the canonical functions created in step (2), and 4) application of the canonical functions and discriminant analysis classification results to image datasets using ERDAS Imagine. This approach is described in more detail in Appendix 20.

#### Decision Rule Classification for River Channel and Gravel Bars

A decision rule classification separate from the discriminant analysis method described above and in Appendix 20 was applied to discriminate the river channel and non-vegetated (bright) gravel bar features in the ONSR mapping region. These features were classified separately so that a detailed characterization of the locations of the river channel and bare gravel bars could be obtained. Because the spatial expression of these ephemeral features changes with each high discharge event, this portion of the map should be regarded as somewhat of a 'snapshot' of the location of the river channel and gravel bar complex in October, 2002

(Jacobson and Gran, 1999). Furthermore, vegetative cover on gravel bars mapped in this manner is also ephemeral, such that these gravel bars are likely synonymous with Riverine Sand Flats as recognized by the USNVC. This classification was performed within an area limited to a spatial mask that contained river channel and bright gravel bar land cover features. Infrared, red, and green reflectance combined with the first and third principal components and vegetation index (IR/R) from the 2-meter October, 2002 photo images served as input data for this classification. The classification used the non-parametric parallelepiped decision rule with maximum likelihood used to solve for overlaps and unclassified pixels.

## Photointerpretation and Digitizing

Portions of the ONSR mapping area that have been significantly altered, such as roads, fields, cutover areas, utility corridors, urban and residential areas, and quarries were photointerpreted and digitized from the 0.25-meter resolution October, 2002 aerial photo images using ArcMap. Other land cover features such as surface water and glade-woodland complex areas were also digitized from these images. The decision to digitize these features rather than attempting to discriminate them using the automated statistical classification approach was based on the low accuracy results obtained in the pilot area classifications. Some land cover features, such as the agricultural forested woodlots (SA37), were digitized and identified as woodlots rather than classified along with other forested areas because these areas are expected to function differently than more contiguous forested areas with respect to species composition and habitat characteristics (Boutin and Jobin, 1998; Andren, 1994; Nupp and Swihart, 2000; Reunanen and Grubb, 2005). Furthermore, these woodlots occur on private lands where sampling was not an option. Therefore, there is no way of characterizing the composition and structure of these types, nor any means of identifying subtypes or assessing the habitat function of them.

In addition, historic agricultural fields and pastures were photointerpreted and digitized from an aerial photo mosaic obtained in the mid-1960s over the ONSR mapping region. This was done in an attempt to identify historic land-use patterns during this period, as more than two thirds of the fields apparent in this imagery that are located in what is now the ONSR park have been abandoned and are now in various successional stages of reforestation. The digitized human-dominated features, glade complexes, historic fields, and the classified river channel and bare gravel bars were superimposed over the discriminant analysis results for the hills and breaks, bottomland, and igneous glade regions. The logic of overlay order follows a manner in which anthropogenic land cover modification is superimposed over natural vegetation communities.

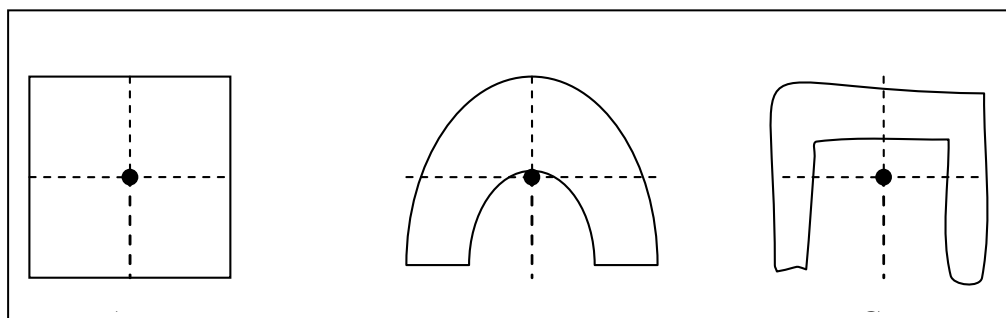
## Validation

### Sample Location

A stratified sample of randomly located points intended to serve as locations for map validation observations was generated using an ArcGIS extension developed by Hawthorne tools (Beyer, 2004). This extension is designed to create a user-defined number of randomly located points in each polygon of a shapefile (grid files had been converted to shapefiles for this process). The sampling universe was limited to public lands to ensure that access would be possible for field personnel. Next, a GIS function (ArcGIS NEAR command) was used to exclude any randomly located field sampling points located within 30 meters from vegetation type polygon boundaries. This step was performed in an attempt to minimize both GPS spatial

registration errors and to reduce sampling in transitional and/or ecotonal areas during field validation. In addition, polygon centroids were generated to supplement these random points so that smaller and irregularly-shaped polygons would also be included in the sampling universe. Sampling points within 30 m of a polygon edge were eliminated and replaced with a point located at the calculated polygon centroid. All such points were sampled to test map accuracy.

Prior to accuracy assessment field sampling, we identified a number of anomalies in how the classification map interacted with field sampling, with potential consequences for accuracy assessment measures. First, some communities, while distinct and recognizable in the field, were frequently below the minimum mapping unit size of 0.5 ha. Mapping algorithms used to eliminate noise from the classification map frequently elided the small polygons representing these communities and classified them as the surrounding matrix community. This occurred in two common scenarios: 1) polygons with a small area, regardless of shape, and 2) linear features less than 30 m wide, even when the total area exceeded the minimum mapping unit. Second, some communities frequently occur as a complex of vegetation associations, all of which are below the minimum mapping unit. Algorithms used to simplify the classification map often forced these communities into a single type, rather than mapping each polygon within the complex. Finally, despite our criterion that eliminated sampling points within 30 m of the edge of mapped polygons, the points where classifications were made in the field frequently occurred on the transition between two or more types. This was likely due either to 1) spatial errors associated with the photo-rectification process, 2) the calculated location of the polygon centroid (Figure 7), or 3) field inaccuracies in GPS equipment leading to navigation error.



**Figure 7.** Schematic representation of polygon centroid (the median X and Y coordinates, defined by the dark circles) calculation and the effects on sample point location.

We modified accuracy assessment sampling in order to address the above anomalies by collecting four different types of point features: Communities, Inclusions, Transitions and Complexes. Community features were defined as field sampling points in relatively large, homogenous areas. Inclusions were defined as communities below the minimum mapping unit that were distinct from the surrounding matrix community. Transitions were defined as the interface between two or more distinct communities. Narrow linear communities between two vegetation associations were mapped as transitions rather than as inclusions. Complexes were defined as aggregations of communities in which the individual polygons were below the minimum mapping unit. Inclusion of these multiple sample point types provided additional information to assess accuracy that simply moving sample points to homogenous areas would not have provided. For example, when sampling points fall on ecotones between two

communities, identification of both communities present provides an accuracy assessment for more than one polygon.

We established a goal of at least 30 validation points for every classified type. Given the linear nature of the mapping area and the implications that this had for sampling efficiency, it was necessary to identify appropriate sampling areas based upon community diversity, public land ownership, and accessibility. Therefore, we necessarily risked excluding mapped polygons of some of the rarer vegetation associations. However, within the pre-determined sampling areas, as the minimum goal was reached for the most abundant classes, we focused our attention on rarer types following guidelines established by the USGS-NPS Vegetation Mapping Program. Final sampling focused exclusively on the rarest communities. Field-visited points were augmented by previously visited points withheld from training data and photointerpretation observations located in human dominated land-cover categories. (Sampling distribution of vegetation associations for accuracy assessment is summarized in Table 6 and Table 7 of the “Map Accuracy” section that follows.)

## Classification and Location Data

Field data collection procedures for accuracy assessment were similar to those used for community characterization and the development of training data, except that no plot data were collected. We classified each point into the most appropriate vegetation type and ranked its quality (the degree to which that community matched the description in the current USNVC). Because we wished to maintain the highest degree of field sampling independence, field crews were given only sample point locations, rather than polygon maps. We did not want mapped polygons to influence how field crews interpreted conditions on the ground. As a result, classification was based exclusively upon the vegetation visible from the sample point (typically between 0.5 and 1.0 hectares, or up to 100 m in every direction for forest and woodland types), rather than on a sample area that may have been suggested by mapped polygons. Transition areas were not included in the classification and ranking when sampling points fell in otherwise homogenous areas. If the community at a given sampling point was assigned a low quality rank, a secondary classification of the vegetation association was assigned. Additionally, we collected the following spatial information based upon USGS-NPS vegetation mapping guidelines (The Nature Conservancy, 1994b): Park Name, Site, USGS quad name, USGS quad code, Easting and Northing (UTM NAD83, Zone 15N), elevation (as derived with GPS), GPS estimated positional error, and waypoint. We recorded any comments we had relating to the classification of the community and took at least one digital voucher photograph at each point. Because we no longer needed training data for the development of photo signatures, the extent of the community in each cardinal direction was not estimated.

For inclusions, transitions and complexes, we collected additional data in order to describe the spatial interaction of communities. For inclusions, we estimated the length, width and area, described the basic shape, and classified the matrix community. For transitions, we classified and recorded the azimuth to the community on either side of the sampling point. (Distance to each vegetation association was not estimated, because it was assumed to be zero where two or more communities meet.) For complexes, we identified the complex type and recorded all of the vegetation associations included in the complex around the sample point.

## Environmental Data

Environmental data collected at each point were similar to that collected in previous years and included slope, aspect, geological stratum, topographic position, and surficial geology. Field classification of the ELT and description of the surface soil texture were not included.

## Vegetation Description Data

To describe the vegetation at each point, we assigned it to a physiognomic class, identified the dominant leaf type within the community, and identified the leaf phenology of both woody and herbaceous vegetation. We made one modification that greatly reduced sampling time at each point and increased the number of sampling points visited during the season. Rather than describe the dominant species within each stratum, we described the dominant species only within the critical stratum used to identify the physiognomic class of the community: Canopy trees for forests and woodlands, shrub layers for shrub lands, and groundflora for herbaceous and sparse herbaceous types. Up to six dominant species were identified and assigned a cover class. We recorded evidence of human disturbance or use by animals, and identified any diagnostic species not included in the critical stratum (for example, in the shrub layers below a forest or woodland canopy). Finally, we recorded a justification for the classification applied to the community.



# Results

## Field Sampling

### Sampled Communities

#### Natural Communities

The final map includes 22 vegetation associations currently recognized by the USNVC and one provisional phase of a USNVC type. One USNVC vegetation association, the Post Oak-Blackjack Oak/Little Bluestem Woodland (2149\*), is represented by two classes in the final map, because it was mapped separately on both dolomite and igneous substrates. This geological division resulted from the mapping process, rather than from any particular compositional or structural differences between the community depending on substrate. As a result, the final map includes 24 statistically-mapped classes that relate directly to USNVC associations.

During the community characterization phase of this project, we encountered 26 vegetation associations currently recognized by the USNVC. Two of these types were later subsumed into similar communities based upon preliminary multivariate analysis, qualitative field observations about the spatial patterns of and similarities between the communities, and discussions with park resource managers relating to the value of retaining these types as separate entities. A White Oak-Red Oak/Dogwood Forest (2067) was absorbed by the compositionally and structurally similar White-Oak/Dogwood Forest (2066). Combining these two types also is consistent with recommendations in the descriptions for these types in the current USNVC (NatureServe, 2005). A River Birch-Sycamore Forest (2086) was absorbed by the Sycamore-Silver Maple Floodplain Forest (7334), both because it shares many compositional and structural features with the latter type, and because, in the few instances where it does occur, it tends to be well below the minimum mapping size of 0.5 ha. Two other types, the Water Lily Aquatic Wetland (2386) and the Ozark Fen (2404), had only one sample, leaving 22 USNVC communities with sufficient data to develop training sets for statistical classification. We also identified one new community, provisionally called Midwest Post Oak - Blackjack Oak Forest – Igneous Phase (2075i). Where encountered, this community consistently exhibited evidence of human disturbance. It has provisionally been included as a subtype of the existing Midwest Post Oak - Blackjack Oak Forest (2075).

An additional 18 USNVC vegetation associations (for a total of 41 natural and semi-natural types) have been included in the community descriptions for the project area. Five of these types were encountered in the study area only during the accuracy assessment phase of the project. These include Dry Dolomite Cliff (2291), Moist Dolomite Cliff (2292), Ozark Dolomite Glade (2398), Shortleaf Pine / Little Bluestem Woodland (2404) and Vegetated Spring Branch (not currently described by USNVC). Descriptions of these types are based on qualitative information collected at the sight and on Nelson (2005). Six of the additional communities had been previously encountered by researchers involved in this project in the vicinity of the mapping area: Prairie Fen (2416), Red Maple Forested Seep (2407), Dry Igneous Cliff (2286), Moist Igneous Cliff (2289), Dolomite Talus (2308) and Igneous Talus (5203). Four other

---

\* Throughout this report, natural and semi-natural vegetation associations are referred to by the last four digits of the USNVC code in the format “CEGL00####”. Significantly altered communities are designated by a code in the format of “SA##”. Refer to Appendix 2 for a complete list of communities and corresponding codes.

types—Post Oak Flatwoods (2405), Overcup Oak Pond Forest (4642), Buttonbush Sinkhole Pond Marsh (4742) and Sinkhole Pond Marsh (2413)—were included because the Missouri Natural Heritage Database contains records of these communities near the mapping area. Finally, a Floodplain Canebrake type (3836) was included because it had been reported in the mapping area. However, this type appears intended to describe natural stands of cane growing without canopy cover. We encountered open-grown cane stands only along the margins of old fields, suggesting that within the mapping area this is not a natural vegetation association.

All the USNVC communities encountered in this project, as well as communities not encountered in this project but reported from the study area, are included in the final list of communities (Appendix 2). Descriptions for these communities are attached as Appendix 15, which is retained as a separate electronic document (Appendix 15-ONSR USNVC Natural Community Descriptions). These communities are also included in the final key to vegetation associations (Appendix 17).

### Altered Vegetation Associations

We encountered 25 cultural communities, altered vegetation associations and non-vegetated classes during this study. We had sufficient data from seven of the 25 encountered types to develop training sets for statistical classification. The remaining 18 encountered types were classified using heads-up photointerpretation techniques. An additional thirteen altered vegetation associations are known or believed to occur within the study area. These communities tend to occur within the study area on private lands, where no sampling was conducted. All altered vegetation associations are included in the list of vegetation associations (Appendix 2), the set of altered community descriptions (Appendix 16) and the field key to communities (Appendix 17).

### Multivariate Analysis of Plot Data

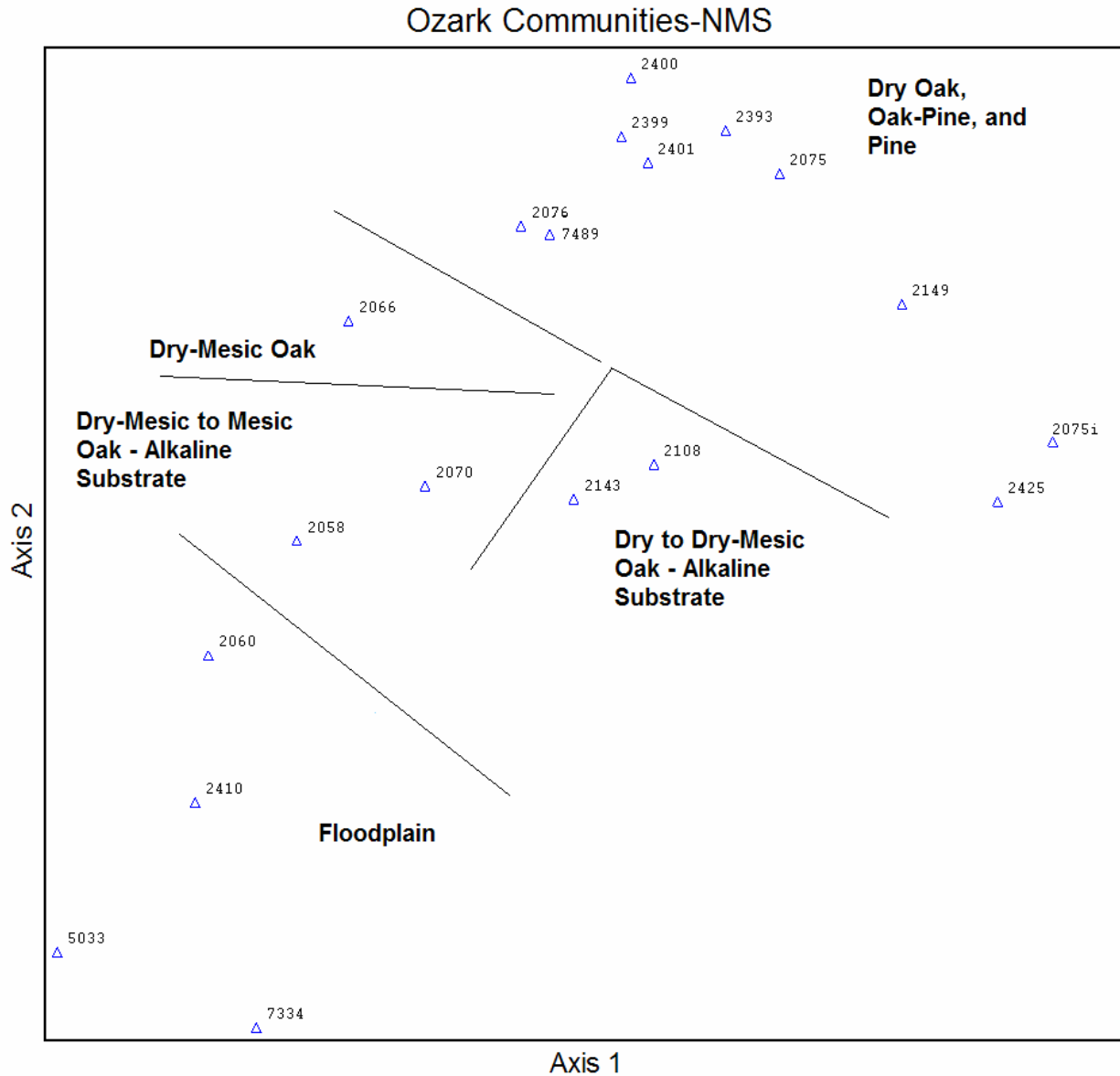
Multivariate analysis examined the relationships between the natural vegetation associations for which plot data had been collected. These associations were divided into 16 upland forests or woodlands, four floodplain forests, two floodplain shrublands, one herbaceous glade, and three herbaceous wetlands. One of the upland forest types (2075i) is thought to be a “phase” or variant of the Midwest Post Oak-Blackjack Oak Forest (2075). There are significant differences between the plots in these two groups, however, and it is likely that they would be split into two associations if more data were available. Descriptions of each USNVC vegetation association as it appears in the project area and its range-wide characteristics are in Appendix 15.

The strongest gradient in the plot data appeared to be moisture. The initial analyses showed the floodplain shrublands and floodplain forests with the exception of the Box Elder Forest (5033) plots separated from the bulk of the upland forest and woodlands. The plots in these floodplain associations were dominated by species such as *Platanus occidentalis*, *Acer negundo*, *Salix caroliniana*, and *Hamamelis vernalis* with lesser amounts of *Fraxinus pennsylvanica*, *Ulmus americana*, and *Lindera benzoin*. *Acer negundo* is an aggressive species that can occur in a variety of settings after disturbance so the plots dominated by *Acer negundo* and little else had a wider variety of associated species and environmental settings than is the case for most associations. The *Acer negundo*-dominated plots were kept in the dataset for further iterations of the analyses to see if some individual plots would fit better with other associations. Similarly, the Sugar Maple-Oak-Bitternut Hickory Mesic Bottomland Forest (2060) had been retained for further iterations, because its species composition included more

hardwoods that caused it to group with upland types. Final interpretation of the results suggested keeping this with the floodplain types.

Further iterations essentially broke off groups of plots at one or both ends of the perceived moisture gradient. For example, after plots in the floodplain associations were removed, the Blackjack Oak Scrub Woodland (2425) was identified and removed. One break in this pattern was when forests and woodlands with thin soils over alkaline bedrock formed one end of the ordination plot. These forests and woodlands were dominated by *Quercus muehlenbergii* and/or *Juniperus virginiana*. Plots continued to be separated on the apparent moisture gradient after that until what remained was one large group of plots representing the widespread oak, oak-pine, and pine forests and woodlands of the Ozarks area. Patterns were apparent in the ordination graphs with plots in certain associations clustered in certain areas but there was a lot of overlap in species composition between these associations. When examining a subset of the data with a limited ecological gradient and floristic makeup, other factors such as past land use or differences between sampling protocols when collecting the data can have noticeable effects and may have explained some of the mixing. It is possible that having a dataset with the groundcover data combined with the shrub and tree data would help distinguish between some of these communities.

The relationship between the associations as defined by the final plot assignments is shown in Figure 8. This figure was produced by combining all the individual plots in each association and generating an average importance value for each species across all plots in the association. These summary importance values were used in an NMS ordination where each “sample” was the association. Only associations dominated by trees were included to make the figure clearer. Broad groupings of associations can be seen clearly ranging from the floodplain forests on the lower left through the mesic upland forests, dry-mesic oak forests and alkaline forests and woodlands, up to the dry oak, oak-pine, and pine forests and woodlands at the top of the figure. The abundance of *Pinus echinata* did not appear to strongly separate associations any more than abundance of other species did. That is, even though *Pinus echinata* is readily distinguishable from the predominantly deciduous trees within ONSR in the field and in mapping exercises, it does not appear to signal a dramatic difference in ecological conditions as judged by ordinations of these plot data. The associations (2075i and 2425) on the upper part of the far right side of the ordination graph were characterized by an abundance of *Quercus marilandica*, *Quercus stellata*, *Carya texana*, and *Ulmus alata*. The 2425 community is restricted to dry sites, while the 2075i type had a broader ecological niche. Its species composition may be the result of fire suppression, possibly in conjunction with past grazing.



**Figure 8.** NMS ordination of USNVC association-level mean Importance Values for tree and shrub species for tree-dominated communities in ONSR.

When discrepancies were encountered between field classification and classification using multivariate techniques, data were revisited and compared with field knowledge of the plot in questions. Eighteen plots were reanalyzed in this manner, of which 10 were left unchanged. Four of the questionable plots included cover from evergreen species (*Juniperus virginiana* or *Pinus echinata*) at approximately 25 percent, the cusp between a mixed type and a deciduous community. These species can have relatively small crowns, even with large diameter trunks. Thus, field investigation of such types where evergreen cover is just below 25 percent may classify as a mixed type in ordination analysis, particularly when importance values are used. In short, ordination based on importance values weights evergreen species more than field investigations based on foliar cover. A similar phenomenon can occur where evergreen cover approaches 75 percent, the cusp between a mixed type (less than 75 percent relative cover by

evergreen species) and a true evergreen dominated community. Other common causes of discrepancies between field and ordination classifications arose from classifying the wrong community (3 plots). Typically, this was limited to floodplain areas where communities are often small and linear and displacement of a few meters due to navigational errors can place field crews into a different vegetation association.

## Local Expressions of USNVC Associations within the Mapping Area

There were few occasions where sampled communities failed to match well the descriptions from the existing USNVC. Fewer than 180 of the more than 2000 sampled points were ranked as fair or poorer representatives of the vegetation association to which they were assigned in the field. Of these, only 26 (about 1%) were rated as being poorly representative of the type. Typically, such instances resulted from one of two scenarios: 1) Sampling points fell into areas that represented inclusions or transition zones between two or more vegetation types. In this scenario, sample points tended to exhibit characteristics of the composition and structure typical for both types, which made classification difficult. 2) Sampled areas exhibited significant evidence of human disturbance, though it was still recognizable as a particular USNVC vegetation association. Often in such instances, one vegetative stratum (usually the groundflora) would reflect the effects of human activity much more than other layers.

## Wildland Fuels

Mean fuel loads for each fuel classes in every USNVC vegetation association are listed in Table 3 and for altered vegetation communities in Table 4. Some community types, such as lawn, roads, and other cultural features were not sampled for fuels or were not encountered during the study. Therefore, these tables collectively have fewer categories than the final 49-class map. The results of our fine fuel loading MRPP analysis indicated that there was no statistical difference in fuel loading among USNVC associations, and the distribution of fine fuel loads were similar to a random distribution among associations ( $A=0.032$ ,  $p=0.000$ ). MRPP analysis indicated that there was no difference in total fuel loading among USNVC associations. Heterogeneity within total fuel loading data was similar to a chance distribution ( $A=0.011$ ,  $p=0.003$ ). Our results were determined as not significant because the  $A$  values were close to 0, meaning heterogeneity was similar to a chance distribution and the sample size for analysis was large (762 samples). A large sample size can result in a significant difference even when the effect size is small (McCune and Grace 2002). Thus determining significance of analysis consisted of evaluating both the  $A$  value and  $p$ -value, and we used a  $p$ -value  $>0.05$  as a guide for significance. Nevertheless, the data collected and summarized for this project provide a broad picture of the range of fuel-loading conditions extant in the park. A wildland fuel loading photo guide for USNVC associations is attached as Appendix 18, which is retained as a separate electronic document (Appendix 18-ONSR USNVC Community Fuel Loading Photo Key). The wildland fuel photo guide contains mean, minimum, and maximum fuel loading for each USNVC association sampled, as well as photographs of representative examples of each vegetation association.

**Table 3.** Mean fuel loading and standard errors (in parentheses) by USNVC association.

USNVC Association			Mean Fuel Loading Tons/Acre							
Code	Name	N	Duff	Litter	1 Hour	10 Hour	100 Hour	1,000 Solid	1,000 Rotten	Total (Excl.duff)
2049	Riverine Sand Flats (Herbaceous Gravel Bar)	1	0.00 (0.00)	0.00 (0.00)	0.00 (0.00)	0.00 (0.00)	0.00 (0.00)	0.00 (0.00)	0.00 (0.00)	0.00 (0.00)
2058	White Oak-Red Oak-Sugar Maple Mesic Forest	24	2.94 (0.78)	2.72 (0.37)	0.25 (0.003)	1.48 (0.22)	3.47 (0.67)	2.10 (0.76)	1.75 (0.76)	11.77 (9.80)
2060	Sugar Maple-Oak-Bitternut Hickory Mesic Bottomland Forest	12	0.35 (0.32)	1.68 (0.34)	0.22 (0.004)	1.54 (0.48)	3.86 (1.50)	2.08 (1.49)	5.17 (3.21)	15.45 (3.66)
2066	White Oak/Dogwood Dry- Mesic Forest	57	4.65 (0.58)	3.02 (0.18)	0.29 (2.40)	1.59 (0.14)	2.87 (0.40)	6.38 (2.02)	2.14 (0.72)	16.44 (2.18)
2070	White Oak-Mixed Oak Dry-Mesic Alkaline Forest	61	4.11 (0.50)	3.12 (0.17)	0.32 (0.002)	1.54 (0.14)	2.57 (0.34)	3.96 (1.00)	1.46 (0.42)	12.98 (1.28)
2075	Midwest Post Oak- Blackjack Oak Forest	4	8.39 (2.26)	4.78 (0.47)	0.18 (0.004)	1.13 (0.73)	1.56 (1.56)	2.80 (2.80)	0.00 (0.00)	10.46 (3.20)
2075i	Midwest Post Oak- Blackjack Oak Forest (Igneous Phase)	4	6.91 (1.81)	3.00 (0.41)	0.21 (0.10)	1.99 (1.12)	2.63 (2.00)	0.00 (0.00)	0.00 (0.00)	7.84 (3.35)
2076	Black Oak-White Oak- Hickory Forest	268	8.89 (0.33)	3.60 (0.008)	0.26 (0.0006)	1.93 (0.007)	3.24 (0.19)	4.68 (0.89)	2.38 (0.42)	16.09 (1.01)
2108	Chinquapin Oak-Red Cedar Dry Alkaline Forest	29	5.39 (0.88)	2.76 (0.33)	0.27 (0.003)	1.10 (0.18)	2.72 (0.43)	0.49 (0.22)	1.12 (0.54)	8.47 (0.88)
2143	Chinquapin Oak-Ash/Little Bluestem Woodland	20	4.61 (0.97)	2.85 (0.47)	0.32 (0.004)	1.27 (0.16)	1.79 (0.53)	1.67 (0.96)	1.06 (0.61)	8.97 (1.42)
2149	Post Oak-Blackjack Oak/Little Bluestem Wdln	22	4.91 (0.80)	2.61 (0.29)	0.21 (0.003)	1.43 (0.43)	2.64 (0.71)	3.13 (2.18)	0.18 (0.14)	10.20 (2.64)
2243	Ozark Igneous Glade	2	3.61 (3.61)	1.05 (1.05)	0.01 (0.01)	0.00 (0.00)	0.00 (0.00)	3.94 (3.94)	0.00 (0.00)	4.99 (4.97)
2393	Shortleaf Pine-Oak Dry Woodland	7	8.74 (2.87)	3.09 (0.64)	0.27 (0.006)	1.88 (0.62)	2.66 (1.05)	1.03 (1.03)	3.28 (3.28)	12.21 (3.89)
2399	Ozark Black Oak-Scarlet Oak Forest	73	10.64 (0.76)	3.79 (0.19)	0.24 (0.001)	1.96 (0.16)	3.30 (0.35)	5.71 (2.33)	1.56 (0.35)	16.56 (2.49)
2400	Shortleaf Pine/Blueberry Forest	5	15.56 (1.48)	2.82 (0.15)	0.23 (0.004)	2.05 (0.44)	1.71 (0.81)	0.29 (0.29)	4.42 (3.13)	11.52 (3.74)
2401	Shortleaf Pine-Black Oak Forest	36	11.69 (1.03)	4.04 (0.26)	0.30 (0.002)	1.64 (0.18)	3.39 (0.76)	7.69 (4.54)	2.15 (0.64)	19.20 (4.63)
2404	Ozark Fen	1	0.43 (0.00)	0.62 (0.00)	0.04 (0.00)	0.87 (0.00)	2.08 (0.00)	15.50 (0.00)	0.00 (0.00)	19.11 (0.00)
2410	Ash-Oak-Sycamore Mesic Bottomland Forest	14	0.27 (0.27)	0.82 (0.17)	0.25 (0.004)	1.43 (0.28)	2.08 (0.69)	5.71 (2.17)	4.08 (2.54)	14.37 (3.21)
2425	Blackjack Oak Xeric Scrub Woodland	3	11.76 (3.97)	5.14 (2.23)	0.13 (0.005)	0.90 (0.67)	4.29 (1.12)	0.00 (0.00)	0.00 (0.00)	10.46 (1.12)
2899	Carolina Willow Shrubland	1	0.00 (0.00)	0.00 (0.00)	0.00 (0.00)	0.00 (0.00)	0.00 (0.00)	0.00 (0.00)	0.00 (0.00)	0.00 (0.00)
5033	Box Elder Forest	15	0.03 (0.03)	0.61 (0.22)	0.12 (0.003)	0.87 (0.16)	1.94 (0.59)	1.83 (0.79)	0.57 (0.33)	4.07 (1.31)
7334	Sycamore-Silver Maple Floodplain Forest	19	0.38 (0.19)	1.32 (0.34)	0.22 (0.003)	1.05 (0.22)	1.53 (0.41)	9.50 (2.84)	0.76 (0.38)	14.38 (3.48)
7489	Interior Highlands Shortleaf Pine-Oak Dry- Mesic Forest	51	10.40 (0.84)	3.66 (0.20)	0.27 (0.002)	1.85 (0.17)	2.92 (0.35)	2.38 (0.72)	1.50 (0.56)	12.57 (1.04)

**Table 4.** Mean fuel loading and standard errors (in parentheses) for sampled altered vegetation associations.

USNVC Association			Mean Fuel Loading Tons/Acre							
Code	Name	N	Duff	Litter	1 Hour	10 Hour	100 Hour	1,000 Solid	1,000 Rotten	Total (Excl. duff)
SA01	Oak-Hickory Shelterwood/Select Harvest	8	6.69 (2.07)	3.24 (0.31)	0.26 (0.005)	1.00 (0.48)	4.24 (1.65)	8.15 (3.91)	0.98 (0.62)	17.88 (3.77)
SA02	Regeneration Stand	7	10.50 (2.80)	4.23 (0.43)	0.34 (0.004)	2.67 (0.67)	2.73 (0.76)	6.75 (6.75)	4.57 (3.62)	21.30 (9.96)
SA03	Oak-Hickory Pole Stand	2	9.14 (0.21)	2.83 (0.27)	0.46 (0.001)	1.59 (0.72)	0.00 (0.00)	5.18 (5.18)	0.00 (0.00)	10.06 (6.17)
SA04	Pine-Oak Shelterwood/Select Harvest	1	0.85 (0.00)	1.08 (0.00)	0.31 (0.00)	1.36 (0.00)	2.17 (0.00)	0.00 (0.00)	1.87 (0.00)	6.80 (0.00)
SA05	Pine-Oak Regeneration Stand	1	5.53 (0.00)	4.42 (0.00)	0.45 (0.00)	8.71 (0.00)	6.24 (0.00)	0.00 (0.00)	0.00 (0.00)	19.82 (0.00)
SA07	Pine Plantation/Timber Management Forest	2	3.61 (0.64)	2.40 (0.62)	0.26 (0.06)	0.22 (0.22)	1.05 (1.05)	0.00 (0.00)	0.00 (0.00)	3.93 (1.51)
SA08	Pine Pole Stand	1	7.65 (0.00)	2.71 (0.00)	0.57 (0.00)	3.48 (0.00)	0.00 (0.00)	0.00 (0.00)	0.00 (0.00)	6.76 (0.00)
SA09	Deciduous Shrubby Old Field	3	3.26 (3.26)	1.83 (1.03)	0.08 (0.08)	0.14 (0.14)	2.07 (2.07)	0.00 (0.00)	0.00 (0.00)	4.14 (2.57)
SA10	Deciduous Forested Old Field	20	3.42 (1.26)	2.39 (0.28)	0.25 (0.003)	1.53 (0.24)	3.54 (0.88)	1.93 (0.90)	1.93 (0.94)	11.58 (1.73)
SA11	Pine-Deciduous Wooded Old Field	1	0.85 (0.00)	2.02 (0.00)	0.23 (0.00)	1.30 (0.00)	4.15 (0.00)	3.99 (0.00)	0.00 (0.00)	11.69 (0.00)
SA15	Cedar Old Field	2	2.76 (2.33)	1.24 (0.46)	0.08 (0.06)	0.69 (0.69)	0.00 (0.00)	0.00 (0.00)	0.00 (0.00)	2.01 (0.29)

To integrate fuel loading data with the vegetation map, we developed spreadsheet versions of fuels data tables for both the USNVC associations map and the Community Type map. The fuel data tables identify the Anderson (1982) fuel model, the National Fire Danger Rating System (NFDRS) model, and a new expanded set of fuel models known as the Comprehensive Fuels model (Scott and Burgan, 2005). Fuel models were selected that best described the fuel and fire behavior conditions associated with each association. Associating fuel models with vegetation associations and Community Types is the first step toward integrating the vegetation map with a spatially explicit fire behavior simulation model, such as Fire Area Simulator (FARSITE; Finney, 1998; Keane and others, 1999).

## Community Mapping

Vegetation communities in Ozark National Scenic Riverways (ONSR) were mapped at two levels using a hybrid combination of statistical methods and photointerpretation. The primary mapping level is to the highly detailed association level of the USNVC. This map includes 49 cover classes. Twenty-four of these classes relate to USNVC vegetation associations. The remaining types include cultural features, non-vegetated features, and ruderal communities on abandoned agricultural lands. Overall map classification accuracy is 63 percent. The secondary mapping level combines communities with similar appearance and ecologically



related communities into Community Types, which are subunits of even more broadly defined Ecological Systems. Ecological Systems and Community Types identified for this project aided mapping to a much greater extent than alliance-level mapping and are more relevant to resource management within the park. This map includes 33 classes and overall classification accuracy is 77 percent. The scale of both maps is 1:24000, and the grain of the raster-formatted vegetation map is 10 by 10 meter grid cells. Spatial accuracy is less than or equal to fifteen meters.

## Community Classification

The USNVC association-level map for the ONSR mapping region produced through a combination of statistical classifications of vegetation communities and photointerpretation and digitization of land cover features contains 49 categories (Table 5; Figure 9 [map detail], Appendix 12 [full map]). As such, it has been produced to meet USGS-NPS vegetation mapping goals, at a much higher level of detail than the more typical six (Joy and others, 2003) or eleven categories (de Colstoun and others, 2003) of land cover maps produced using remote sensing inputs. The thematic classes of the map may be aggregated into more general scheme as needed to increase its overall or class-wise accuracy. For this project, we have aggregated thematic classes into 33 Community Types as part the ecological systems (Appendix 2) approach adopted to address management concerns and to increase map accuracy (Figure 10 [detail], Appendix 13 [full map]).

Total area and percent coverage of USNVC communities and significantly altered land cover types are given in (Table 5). The two most common land cover types within both ONSR and the greater mapping area belong to the Black Oak - White Oak - (Scarlet Oak) Forest Alliance. The Black Oak-White Oak-Hickory/Dogwood Forest (2076) covers 19,843 ha (34 percent) of the ONSR purchase unit and 43,388 ha (31 percent) of the mapping area. The Ozark Black Oak-Scarlet Oak Forest (2399) accounts for 9,492 ha (16 percent) of the park and 27,555 ha (20 percent) of the mapping area. Together, these two vegetation associations provide more than 50 percent of cover at either scale. They have been mapped together in the 33-class Community Type map as the Mixed Oak-Hickory Forest. The third and fourth most abundant classes within ONSR are the White Oak/Dogwood Forest (2066; 5094 ha; 9 percent) and the White Oak - Mixed Oak Dry-Mesic Alkaline Forest (2070; 4869 ha; 8 percent). These communities have been aggregated in the 33-class map as the White Oak Forest Community Type, and collectively cover more than 16 percent of the park. The two next most abundant classes within the park include actively managed and abandoned agricultural fields in various successional stages. Together, these account for 9 percent of the park area. Agricultural fields and pastures (SA21, SA22, SA23) are the third most abundant class within the full mapping area.

## Map Accuracy

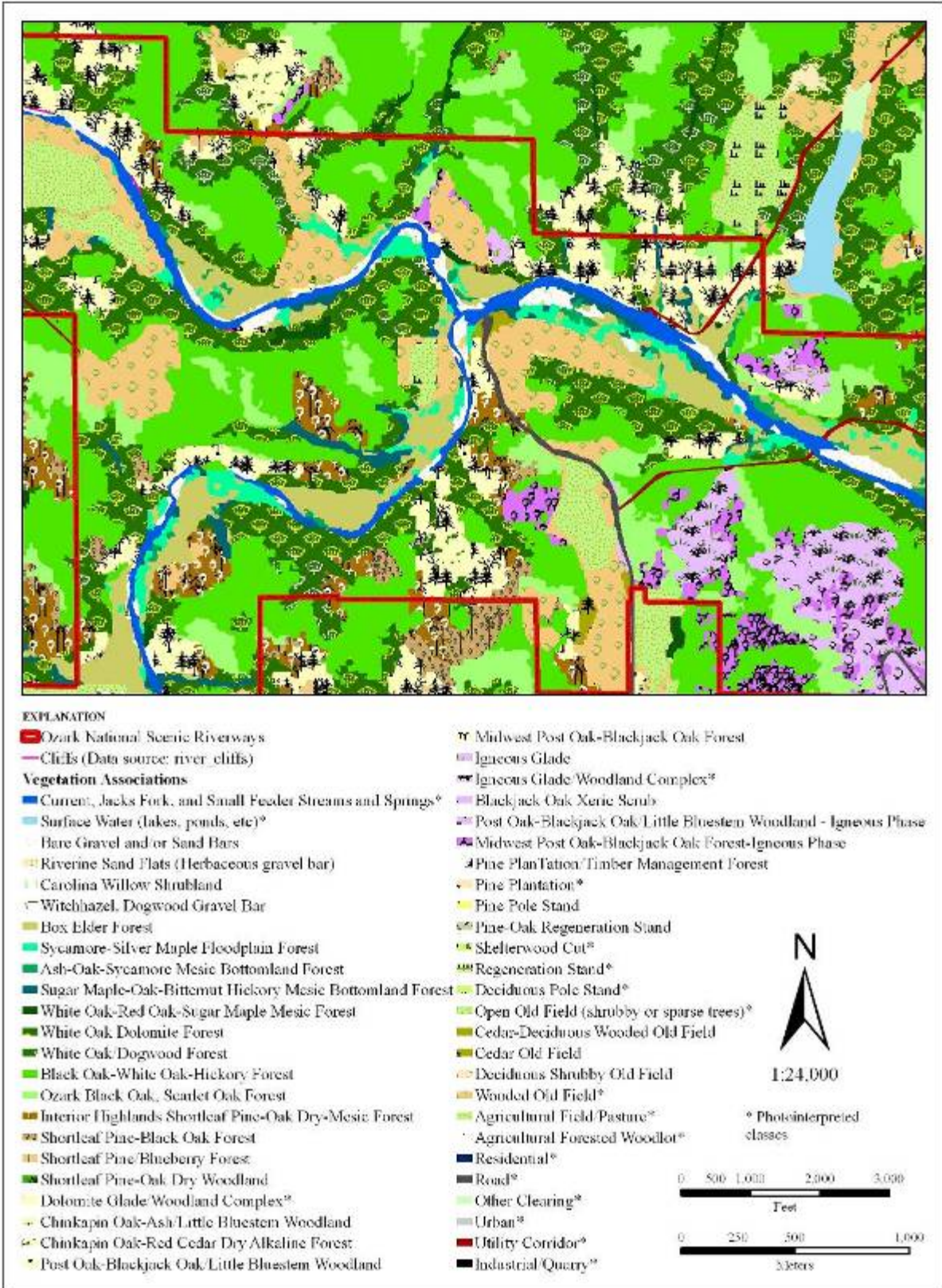
The overall accuracy of the USNVC association level map (Figure 9 [detail], Appendix 12 [full map], Table A11-1 in Appendix 11) for the ONSR mapping region is 62 percent, with a kappa statistic of 0.596. This estimate of overall accuracy is based on 2057 validation observations obtained from points withheld from the statistical classification, field observations obtained in the summer of 2005, and from photointerpretation observations located within human-dominated land-cover categories. The error matrix (Table 6) indicates areas where confusion occurred between mapping categories, and was used to calculate the user's and producer's accuracies for the various categories (Table 7). These tables include only 35 categories, as some cultural map classes were aggregated for accuracy assessment purposes.

**Table 5.** Area and percent coverage of vegetation associations and land cover types in the ONSR purchase unit (57,678 ha) and the larger mapping area (139,953 ha).

Park Area (ha)	Park %	Full Map Area (ha)	Full Map %	USNVC Association/Landcover type (Code*)	49-Class Grid Code
19843.2	34.40	43388.34	31.00	Black Oak - White Oak - Hickory Forest (2076†)	5
9491.6	16.46	27555.48	19.70	Ozark Black Oak, Scarlet Oak Forest (2399†)	10
5094.2	8.83	9637.54	6.89	White Oak/Dogwood Forest (2066†)	2
4868.8	8.44	9912.55	7.08	White Oak Dolomite Forest (2070†)	3
2711.1	4.70	10175.82	7.27	Agricultural field/pasture (SA21, SA22, SA23)	37
2509.2	4.35	3751.22	2.68	Wooded old field (SA10, SA11, SA13, SA14, SA15)	33
2012.9	3.49	5119.91	3.66	Interior Highlands Shortleaf Pine-Oak Dry-mesic Forest (7489†)	13
1544.6	2.68	3177.67	2.27	Chinkapin Oak-Red Cedar Dry Alkaline Forest (2108†)	6
956.5	1.66	4461.55	3.19	Shortleaf Pine-Black Oak Forest (2401†)	12
878.7	1.52	986.11	0.70	River (non-vegetated, includes springs and tributaries)	28
753.9	1.31	853.85	0.51	Ash-Oak-Sycamore Mesic Bottomland Forest (2410†)	22
700.3	1.21	1984.19	1.42	White Oak-Red Oak-Sugar Maple Mesic Forest (2058†)	1
674.4	1.17	1591.07	1.14	Chinkapin Oak-Ash/Little Bluestem Woodland (2143†)	7
666.6	1.16	779.74	0.56	Box Elder Forest (5033†)	25
659.2	1.14	743.33	0.53	Sycamore-Silver Maple Floodplain Forest (7334†)	26
655.5	1.14	1030.88	0.74	Road (SA32)	34
572.4	0.99	668.16	0.48	Sugar Maple-Oak-Hickory Mesic Bottomland Forest (2060†)	21
570.3	0.99	995.86	0.71	Open old field (SA09, SA12, SA20, SA23, SA36)	43
304.5	0.53	577.18	0.41	Igneous glade/woodland complex (includes 2075i†)	32, 45
258.3	0.45	481.24	0.34	Utility corridor (SA33, SA34)	35
252.3	0.44	350.3	0.25	Riverine Sand Flats (2049†, includes vegetated stream margins), Bare gravel bars†	20, 27
225.0	0.39	1797.74	1.28	Post-Black-(Blackjack) Oak/Little Bluestem Woodland (2149†)	8, 29
178.6	0.31	840.71	0.60	Regeneration Stand (SA02, SA05)	38
173.2	0.30	951.63	0.68	Deciduous Shrubby Old Field (SA09†)	17
140.6	0.24	271.26	0.19	Dolomite glade/woodland complex	44
120.9	0.21	361.37	0.26	Midwest Post Oak-Blackjack Oak Forest (2075†)	4
92.1	0.16	547.9	0.39	Cedar-Deciduous Wooded Old Field (SA13†)	18
91.6	0.16	677.17	0.48	Shortleaf Pine-Oak Dry Woodland (2393†)	9
88.5	0.15	737.35	0.53	Residential (SA16, SA17, SA18, SA19, SA35)	48
88.5	0.15	105.4	0.08	Carolina Willow Shrubland (3899†)	24
88.4	0.15	1466.15	1.05	Shelterwood cut (SA01, SA04)	39
77.1	0.13	323.4	0.23	Cedar Old Field (SA15†)	19
69.9	0.12	345.36	0.25	Deciduous Pole Stand (SA03, SA06, SA08)	40
61.9	0.11	1180.01	0.84	Pine-Oak Regeneration Stand (SA05†)	14
49.7	0.09	338.67	0.24	Other Clearing (SA31)	36
47.5	0.08	583	0.42	Shortleaf Pine/Blueberry Forest (2400†)	11
35.8	0.06	69.21	0.05	Igneous Glade (2243†)	30
30.3	0.05	45.4	0.03	Witchhazel-Dogwood Gravel Wash (3898†)	23
20.7	0.04	159.01	0.11	Pine Pole Stand (SA08†)	16
9.3	0.02	61.27	0.04	Pine plantation/Timber management area (SA07†, SA07)	15, 41
5.6	0.01	63.86	0.05	Surface water (non-vegetated pond and lakes)	42
3.7	0.01	5.71	0.00	Blackjack Oak Scrub Woodland (2425†)	31
0.6	0.00	233.06	0.17	Agricultural forested woodlot (SA37)	46
0.0	N/A	63.34	0.05	Industrial/quarry (SA26, SA27)	49
0.0	N/A	502.74	0.36	Urban (SA28, SA29, SA30)	47

\*Codes that begin with "SA" represent significantly altered vegetation communities not described by the USNVC.

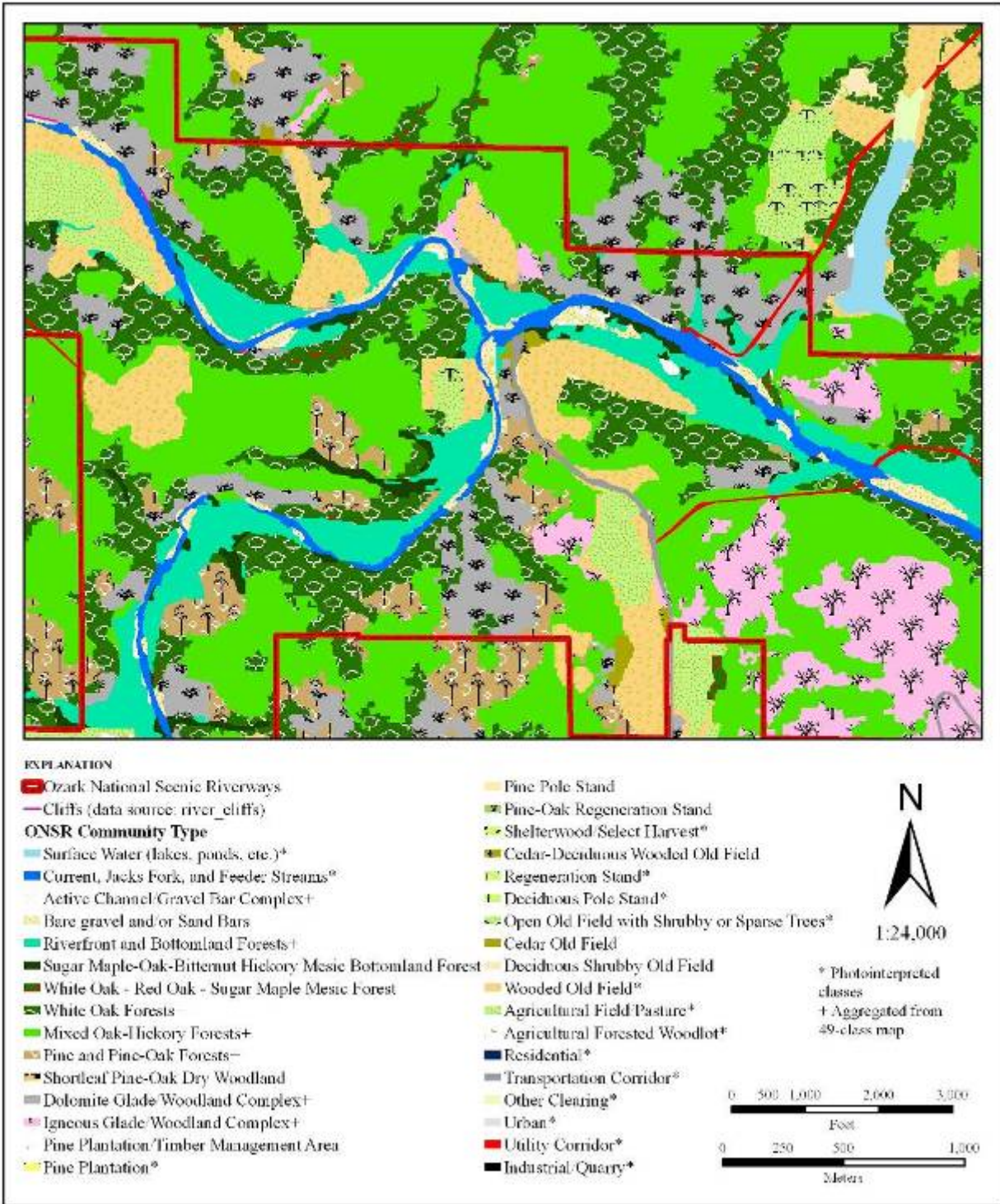
†Statistically classified types (all others were hand-delineated from aerial photographs).



**Figure 9.** Detail of 49-class USNVC vegetation association map\*.

\* Full 49-class USNVC vegetation association map is available in Appendix 12





**Figure 10.** Detail of 33-class Community Type map with types aggregated to improve accuracy and aid in resource management planning\*.

\*Full 33-class Community Type map is available in Appendix 13.

**Table 6.** Error matrix of USNVC associations and other land cover categories.

Map Classification (Bold boxes = Community Types; Agricultural Forested Woodlots and Surface Water not assessed.)	49-Class Grid codes	Reference Data (ground truth)																
		2058	2066	2070	2076	2399	Dolomite Glade Complex	2108	2143	2149	Igneous Glade Complex	2243	2425	2075	2393	2400	2401	7489
White Oak-Red Oak-Sugar Maple Mesic Forest (2058)	1	18	14	8	3			1										1
White Oak/Dogwood Forest (2066)	2	3	57	37	27			2										5
White Oak Dolomite Forest (2070)	3	4	17	32	28	2		4	4					2	2			1
Black Oak-White Oak-Hickory Forest (2076)	5		15	3	242	18			1					5			3	2
Ozark Black Oak, Scarlet Oak Forest (2399)	10		2		47	47		1						5	3		16	5
Dolomite Glade Complex	44						10	5	1	5						2		
Chinquapin Oak-Red Cedar Dry Alkaline Forest (2108)	6			5	1			69	9	1					8		6	5
Chinquapin Oak-Ash/Little Bluestem Woodland (2143)	7			1	4		2		18					1	1		1	
Post Oak-Blackjack Oak/Little Bluestem Woodland (2149)	8,29		1			1				4	1			6				1
Ozark Igneous Glade Complex (includes 2075i)	32,45									4	42	1	4					
Ozark Igneous Glade (2243)	30				1					3		3	3	3	1		1	
Blackjack Oak Xeric Scrub (2425)	31									2	1		2	1				
Midwest Post Oak-Blackjack Oak Forest (2075)	4									2				7			1	
Shortleaf Pine-Oak Dry Woodland (2393)	9				3	1			1	1	1				7		1	
Pine/Blueberry Forest (2400)	11					1									1	1	1	
Shortleaf Pine-Black Oak (2401)	12				5	1								2	3	1	42	20
Interior Highlands Shortleaf Pine-Oak Dry-mesic Forest (7489)	13		1		8	1		5	1								4	35
Bare Gravel Bar	27																	
Riverine Sand Flats (2049)	20																	
Witchhazel, Dogwood Gravel Wash (3898)	23																	
Carolina Willow Shrubland (3899)	24																	
Ash-Oak-Sycamore Mesic Bottomland Forest (2410)	22	1		2														
Box Elder Forest (5033)	25																	
Sycamore-Silver Maple Floodplain Forest (7334)	26		1	1														
Sugar Maple-Oak-Bitternut Hickory Mesic Bottomland Forest (2060)	21	2		4	1													
Wooded Old Field	18,19,33		2		1			2	1									
Open Old Field	17,43			2					1									
Shelterwood Harvest	39																	1
Regeneration/Pole Stand	14,16,38,40					1												
Pine Plantation	15,41				1													
River	28																	
Roads	34																	
Utility Corridor	35																	
Agricultural Field/Pasture/Other Clearing	36,37																	
Residential/Urban/Industrial	47,48,49																	
Totals		28	110	95	372	73	12	89	37	22	45	4	9	32	28	2	76	76

**Table 6.** Error matrix of USNVC associations and other land cover categories (cont'd).

Map Classification (Bold boxes = Community Types; Agricultural Forested Woodlots and Surface Water not assessed.)	49-Class Grid Codes	Reference Data (ground truth)																Total		
		Gravel Bar	2049	3898	3899	2410	5033	7334	2060	Wooded Old Field	Open Old Field	Shelterwood	Regen. Stand	Pine Plant.	River	Road	Utility Corr.		Field/Pasture	Urban
White Oak-Red Oak-Sugar Maple Mesic Forest (2058)	1							6	2	7		2	1		1					64
White Oak/Dogwood Forest (2066)	2								4	1			1							137
White Oak Dolomite Forest (2070)	3								1	8	1									106
Black Oak-White Oak-Hickory Forest (2076)	5										1									290
Ozark Black Oak, Scarlet Oak Forest (2399)	10									2		1								129
Dolomite Glade Complex	44																			23
Chinquapin Oak-Red Cedar Dry Alkaline Forest (2108)	6					1				3					2					110
Chinquapin Oak-Ash/Little Bluestem Woodland (2143)	7							2		1		2	1							34
Post Oak-Blackjack Oak/Little Bluestem Woodland (2149)	8,29									1		7								22
Ozark Igneous Glade Complex (includes 2075i)	32,45																			51
Ozark Igneous Glade (2243)	30																			15
Blackjack Oak Xeric Scrub (2425)	31																			6
Midwest Post Oak-Blackjack Oak Forest (2075)	4																			10
Shortleaf Pine-Oak Dry Woodland (2393)	9																			15
Pine/Blueberry Forest (2400)	11									1		1								6
Shortleaf Pine-Black Oak (2401)	12										1									75
Interior Highlands Shortleaf Pine-Oak Dry-mesic Forest (7489)	13									7	1	1			2			1		67
Bare Gravel Bar	27	53																		53
Riverine Sand Flats (2049)	20		8	2	2															12
Witchhazel, Dogwood Gravel Wash (3898)	23		2	5	4															11
Carolina Willow Shrubland (3899)	24			2	28	2		1												33
Ash-Oak-Sycamore Mesic Bottomland Forest (2410)	22			1	2	23	10	25	6	16	2				2	2				92
Box Elder Forest (5033)	25					4	25	8	4	2										43
Sycamore-Silver Maple Floodplain Forest (7334)	26				3	3	4	55		3									1	71
Sugar Maple-Oak-Bitternut Hickory Mesic Bottomland Forest (2060)	21					1	2	8	17	6										41
Wooded Old Field	18,19,33					1	1			144	6	3							2	163
Open Old Field	17,43				1					19	12					1		3		39
Shelterwood Harvest	39										3									4
Regeneration/Pole Stand	14,16,38,40										1	18			2					22
Pine Plantation	15,41								1											2
River	28				1									51						52
Roads	34														72	2				74
Utility Corridor	35															38				38
Agricultural Field/Pasture/Other Clearing	36,37										2						68	4		74
Residential/Urban/Industrial	47,48,49																	73		73
Totals		53	10	10	41	35	42	105	35	221	24	18	25	1	52	80	43	68	84	2057

The producer's accuracy (total correctly classified observations divided by the total observations of one ground reference type classified into any category) indicates the probability that a reference location is correctly classified, and is a measure of omission error or how well a land cover type can be classified given the available training data (Jensen, 1996). User's accuracy (total correctly classified observations divided by the total ground reference observations classified into a category that are correctly or incorrectly classified) is the probability that a location on a classification map actually represents that category on the ground, and is referred to as commission error (Lillesand and Kiefer, 1994). The USGS-NPS Vegetation Mapping program has a goal of 80 percent for both within class and overall accuracy. Where this goal can not be attained, the program allows for a number of approaches to increase accuracy levels, including aggregation of classes into broader categories, the approach used with the identification of local Ecological Systems and Community Types.

Additional products of the statistical mapping approach used in this study are per-class receiver operating characteristic (ROC) curves and Kappa statistics. ROC curves have been used to assess the results of remote sensing classifications on a class-wise basis (Pontius and Schneider, 2001; Gardner and Urban, 2003). Kappa statistic is an indicator of the extent to which the percentage of correct values in an error matrix is due to true agreement with actual ground conditions as opposed to chance agreement (Lillesand and Kiefer, 1994). In other words, the kappa statistic is a measure of how well an overall classification represents a result that is better than a random result, and can be used to compare two or more similar classification error matrices (Jensen, 1996).

Using the ecological systems approach developed early in the project, we also produced a 33-class community-type map. Riverine shrublands and gravel bars were aggregated upward into an "Active Channel/Gravel Bar Complex" and bottomland forests were combined into a "Riverfront and Bottomland Forests" type. Dry-mesic, white oak dominated forests were aggregated into a "White Oak Forests" type, oak and hickory forests with greater than 25 percent pine cover were aggregated into a "Pine and Pine-Oak Forests" type, and oak and hickory dominated forests lacking significant pine were combined into a "Mixed Oak-Hickory Forests" type. Glades and associated woodlands on both igneous and dolomite substrates were combined into "Igneous Glade/Woodland Complex" and "Dolomite Glade/Woodland Complex" types, respectively. A crosswalk of USNVC types, OSNR Ecological Systems and NatureServe Ecological Systems is contained in Appendix 5.

The above aggregations improved overall accuracy to 77.5 percent ( $\kappa = 0.716$ ) and provided a simpler, easier to understand map of communities within the mapping area (Figure 10 [detail], Appendix 13 [full map]). For example, when examined individually, the user's accuracies for the Ozark Black Oak-Scarlet Oak Forest (2399) and the Black Oak-White Oak-Hickory Forest were 36 and 83 percent. When combined into the Mixed Oak-Hickory Forest Community Type, user's accuracy improved to 84 percent. Grouping the White Oak/Dogwood Forest (2066, user's accuracy = 42 percent) and the White Oak-Mixed Oak Dry-Mesic Alkaline Forest (2070; user's accuracy = 30 percent) into the White Oak Forest Community Type improved user's accuracy to 59 percent (Table 8). Aggregation of the Shortleaf Pine/Blueberry Forest (2400), the Interior Highlands Shortleaf Pine-Oak Dry-mesic Forest (7489) and the Shortleaf Pine-Black Oak Forest (2401) into the Pine and Pine-Oak Forest Community Type improved user's accuracy from a mean value of 42 percent to a collective value of 70 percent. Aggregation of communities into the Dolomite and Igneous Glade/Woodland Complexes improved user's accuracy from mean values of 49 and 51 percent to 66 and 82 percent,



respectively. The “Active Channel/Gravel Bar Complex” had an aggregated user’s accuracy of 95 percent, compared with a mean accuracy value of 65 percent for the three classes include in that Community Type. Inclusion of the separately-mapped, non-vegetated Bare Gravel Bars class increases accuracy to 97 percent. Finally, aggregation of riverfront and floodplain forests into the Riverfront and Bottomland Forests Community Type improved accuracy from a mean value of 53 percent for individual communities to 76 percent overall.

## Probability Mapping

A method developed in the signal detection literature termed a receiver operating characteristic (ROC) curve has been increasingly used to assess the results of remote sensing classifications and other models which predict a homogeneous category in each grid cell (Pontius and Schneider, 2001; Gardner and Urban, 2003). ROC curves are generated by plotting the probability of detection against the probability of false positives (the probability of false alarm). Classification model validation data can be used to plot ROC curves for all of the categories of a land cover map, and the area under these curves (AUC) function as a comparative per-class measure of their discrimination strength or accuracy. AUC values were calculated from a family of ROC curves to obtain per-class measures of classification accuracy for all of the classified associations in the vegetation map (Figures A14-1 through A14-4 in Appendix 14). Communities 2075 and 2149 had high probabilities of detection only at high false positive values. Both of these vegetation associations are rare, with sample sizes of 5 and 4 respectively. Probability of detection may also be plotted against thresholds of the discriminant analysis probabilities mapped on a per-pixel basis to identify target class probability values (Figure A14-5 in Appendix 14). For example, if you wished to identify only the pixels on the probability map with a probability of detection of 80 percent or greater, you can cross reference 0.8 on the y-axis with the threshold value of the mapped probability on the x-axis for every mapped class, and filter the individual association probability maps using the probability values obtained from the ROC curve plot for each association.

## Species Importance Values

Although the identification of the spatial arrangement and prevalence of USNVC vegetation associations on the landscape are the most useful features of this vegetation map for management purposes, species importance values were also calculated for the primary USNVC vegetation associations found in the ONSR mapping area (Appendix 8). These importance values scores were calculated using observations obtained during validation data collected in the summer of 2005. The average cover of the individual species recorded was multiplied with the relative frequency of occurrence of these species at the validation locations where the vegetation map was ‘correct.’ Information on what species are present and their relative importance in each USNVC association type should serve as a useful guide to the vegetation composition found within the USNVC association map polygons. It can also serve as a baseline against which to compared future conditions and assess the impact of management activities.

**Table 7.** Accuracy report for USNVC vegetation associations and other land cover categories.

USNVC Association/Land Cover Type (Forested Woodlots & Surface Water not assessed)	49-Class Grid Code	Producer's Accuracy	Producer's Acc. N	User's Accuracy	User's Acc. N
White Oak-Red Oak-Sugar Maple Mesic Forest (2058)	1	0.64	28	0.28	64
White Oak/Dogwood Forest (2066)	2	0.52	110	0.42	137
White Oak Dolomite Forest (2070)	3	0.34	95	0.30	106
Black Oak-White Oak-Hickory Forest (2076)	5	0.65	372	0.83	290
Ozark Black Oak, Scarlet Oak Forest (2399)	10	0.64	73	0.36	129
Dolomite Glade/Woodland Complex	44	0.83	12	0.43	23
Chinquapin Oak-Red Cedar Dry Alkaline Forest (2108)	6	0.78	89	0.63	110
Chinquapin Oak-Ash/Little Bluestem Woodland (2143)	7	0.49	37	0.53	34
Post Oak-Blackjack Oak/Little Bluestem Woodland (2149)	8,29	0.18	22	0.18	22
Igneous Glade/Woodland Complex	32,45	0.93	45	0.82	51
Ozark Igneous Glade (2243)	30	0.75	4	0.20	15
Blackjack Oak Xeric Scrub (2425)	31	0.22	9	0.33	6
Midwest Post Oak-Blackjack Oak Forest (2075)	4	0.22	32	0.70	10
Shortleaf Pine-Oak Dry Woodland (2393)	9	0.25	28	0.47	15
Pine/Blueberry Forest (2400)	11	0.50	2	0.17	6
Shortleaf Pine-Black Oak (2401)	12	0.55	76	0.56	75
Interior Highlands Shortleaf Pine-Oak Dry-mesic Forest (7489)	13	0.46	76	0.52	67
Bare Gravel Bar	27	1.00	53	1.00	53
Riverine Sand Flats (2049; herbaceous gravel bars vegetated stream margins)	20	0.80	10	0.67	12
Witchhazel, Dogwood Gravel Wash (3898)	23	0.50	10	0.45	11
Carolina Willow Shrubland (3899)	24	0.68	41	0.84	33
Ash-Oak-Sycamore Mesic Bottomland Forest (2410)	22	0.66	35	0.25	92
Box Elder Forest (5033)	25	0.60	42	0.58	43
Sycamore-Silver Maple Floodplain Forest (7334)	26	0.52	105	0.77	71
Sugar Maple-Oak-Bitternut Hickory Mesic Bottomland Forest (2060)	21	0.49	35	0.41	41
Wooded old field	18,19,33	0.65	221	0.88	163
Open Old Field with Shrubby or Sparse Tree	17,43	0.50	24	0.31	39
Shelterwood cut	39	0.17	18	0.75	4
Regeneration/Pole stand	14,16,38,40	0.72	22	0.82	22
Pine Plantation	15,41	0.00	1	0.00	2
River (non-vegetated)	28	0.98	52	0.98	52
Road	34	0.90	80	0.97	74
Utility corridor	35	0.88	43	1.00	38
Agricultural Field/Pasture/Other Clearing	36,37	1.00	68	0.92	74
Residential/Urban/Industrial	47,48,49	0.87	84	1.00	73

**Table 8.** Accuracy report for aggregated OSNR Community Types.

Community Type	Producer's Accuracy %	Producer's Validation N	User's Accuracy %	User's Validation N
Dolomite Glade/Woodland Complex	78	160	66	189
Igneous Glade/Woodland Complex	74	90	82	82
Active Channel/Gravel Bar Complex	87	61	95	56
Bottomland Forest	86	182	76	206
White Oak Forest	70	205	59	243
Mixed Oak-Hickory Forest	80	445	84	419
Upland Pine and Pine-Oak Forest	68	154	70	148

# Discussion

## An Altered Landscape

The impacts of human activity are visible throughout the mapping area, even among those communities that represent “natural” types. Collectively, human-altered classes account for approximately 10 percent (7,000 ha; 17,000 ac) of the park purchase unit area. The most abundant altered types are actively managed fields and pastures (2,711 ha; 6,699 ac), and abandoned agricultural fields in various successional stages (2,509 ha; 6,200 ac). Roads occupy at least 600 ha (1,500 ac) within the park.

During the early part of the 20<sup>th</sup> century, the forests were extensively harvested, with only the most difficult to reach communities left standing. Field evidence of this activity remains today in remnant stumps that are scattered across the landscape. For example, copious remnant pine stumps often are found in what is now a deciduous forest, suggesting that harvest practices, perhaps in combination with alterations of the fire regime, have altered the composition of many of the forests and woodlands to types that are dominated less by pine and more by oaks. Less obvious may be shifts in species composition due to selective harvesting. Such impacts are often only expressed as a subtle shift in species composition (often only in one vegetative strata) away from what one might expect on a given landform.

At the same time, the effects of settlement activities are visible. In addition to those types that are obviously human-altered, such as old fields or non-vegetated areas, we frequently encountered types that exhibit only scant evidence of human alteration. These types may reasonably be classified as “natural,” though their expression tends to deviate from idealized concepts of the communities as understood from the USNVC descriptions. The deviation is such that these communities are distinguishable from truly “natural” types that simply represent the extremes of the natural range of expression for the USNVC type. Unlike timber management areas, which are distributed throughout the landscape, these communities tend to be limited to areas where topography favored subsistence farming, such as broad summits and floodplains along the main rivers, tributary creeks and intermittent upland waterways.

Human disturbance did seem to have significant influence on the structure and composition of two vegetation associations that we encountered repeatedly in this study. Within floodplains, the Box Elder Forest (5033) was the second most abundant type, covering more than 700 ha of the park and representing more than one quarter of the area mapped as bottomland forest. Nearly all examples exhibited vegetative and non-vegetative evidence of human disturbance (such as uniform stand age, an abundance of disturbance-favored species in one or more strata, fence lines, remnant roads and/or trash heaps). Therefore, as encountered in the study area, this vegetation association may not well represent that type described by the existing USNVC, even though its species composition and structure match the current USNVC description fairly well.

Human activity is also the most likely origin of the type that appears to be derived from the Midwest Post Oak - Blackjack Oak Forest (2075). This type had provisionally been assigned the name Midwest Post Oak - Blackjack Oak Forest-Igneous Phase (2075i) in recognition of the fact that it was limited to igneous substrates. However, the type consistently included species that respond favorably to disturbance in the shrub and groundflora layers. This may have been the result of grazing. Furthermore, the canopy was typically comprised of scattered large oaks consistent with the community name, accompanied by a high abundance of black hickory of

uniform height and trunk diameter. This pattern suggests that black hickory has invaded areas that might otherwise better match the description for the Midwest Post Oak - Blackjack Oak Forest (2075). We suspect that grazing combined with fire suppression has allowed black hickory to become abundant in these forests. The two communities are retained as separate entities in this study. However, the altered type will probably be treated as a phase of the type that is currently described in the USNVC.

## **Undersampled Vegetation Associations**

A few of the communities that were encountered in mapping area are exceptionally rare. This rarity makes these vegetation associations of particular interest to resource managers, but it also makes them difficult to map over a large area. The likelihood of encountering these types while collecting training data is low, a fact that hinders the development of dependable photosignatures for either automated, statistical classification or for manual photointerpretation. Two such types, the Water Lily Aquatic Wetland (2386) and the Ozark Fen (2404) were encountered only once during the early phases of sampling. The two examples of a Vegetated Spring Branch (no USNVC code) were not encountered until late in accuracy assessment sampling. These three types share the additional attribute that they tend to be small, and are often obscured by surrounding communities. Two other types, the Dry Dolomite Cliff (2291) and the Moist Dolomite Cliff (2292) are not particularly rare, but they occupy little horizontal space. This fact both reduces the likelihood that they would be encountered using the stratified approach initially employed in this study and means that there are little or no photographic data from which to develop a photosignature. Final mapping of these features was done in the field for a portion of the park (data file = river\_cliffs), a step that may be required to accurately inventory all such rare and small vegetation associations.

## **Field-based Sources of Map Discrepancies**

We sometimes encountered conflicts in how a community should be classified inherent to the community itself. For example, occasionally the canopy composition and structure of a forest would suggest classification as one association type, while the understory and/or groundflora would suggest a different type. In such cases, we favored the classification as indicated by what we termed the “critical” stratum, the uppermost stratum with at least 15 to 25 percent cover, as this stratum is visible to remote sensors. However, if the evidence in inferior strata was strong enough to support it, we would provide a secondary classification and provide a justification for why the sample point was classified as one type and not the other.

Secondly, we had to address a problem that faces all studies of this sort that must draw conceptual lines where they may not exist in nature. Frequently, we encountered communities that matched well the idealized type of two or more vegetation associations. For example, many sampled points could have reasonably been classified as either the Ozark Black Oak-Scarlet Oak Forest (2399) or the Black Oak-White Oak-Hickory Forest (2076). We approached this problem by ranking how well each sampled point represented an idealized version of the vegetation association and by providing secondary classifications where there was uncertainty about the proper classification to apply. (Usually, uncertainty was directly reflected in the amount of time a crew would spend trying to classify a given sample point.) During the data mining portion of the map classification, the ranking data provided the remote sensor with information that could be used to aid in the selection of training data.

Few classification errors were attributable to interpretation of the field key or to a poor understanding of the set of communities that could potentially be encountered in the study area. Quality control measures implemented during field sampling quickly indicated classification problems and ambiguities in the field key. For example, a random subset of communities was independently resampled to check for classification errors. Field crew classifications were compared to classifications applied by the USGS personnel in charge of field sampling (whose classifications were assumed to be correct). There was concurrence between independent samples in approximately 90 percent of communities sampled in this manner. Agreement between independent samples of points increased as sampling progressed and as updates were incorporated into the field key.

Updates to the field key and classification included alterations to the key structure, clarification of ambiguous phrasing within the key, and the addition or elimination of vegetation associations as deemed necessary. We adopted a conservative approach when eliminating vegetation associations, doing so only after consultation with resource management staff regarding the implications of removal on both management of resources and map accuracy. For example, a White Oak-Red Oak/Dogwood Forest (2067) and the River Birch-Sycamore Forest (2086) initially included in the classification scheme were eliminated due to similarities in structure and species composition to other, more abundant types and because the management implications of eliminating them was minimal. Conversely, we liberally incorporated new types (on a provisional basis) to ensure that if repeatedly encountered they would be properly identified. One such example is the Midwest Post Oak-Blackjack Oak Forest-Igneous Phase (2075i), a type that was included in the classification on the day it was first encountered and was thereafter identified on numerous occasions.

## **Map Accuracies**

The level of accuracy obtained for the 49 category USNVC association-level map was surprisingly high considering the limitations associated with representing vegetated landscapes using hard classification maps, as required by the USGS-NPS vegetation mapping program. Generating a classification scheme involves simplifying the complexity of the natural world so that every case can be placed in a single category. In vegetated landscapes, certain cases will inevitably not fit into a category as well as others, but instead suggest membership in more than one category or perhaps not fit distinctly into any of the categories of the classification scheme. This is a direct result of the fact that the ecological conditions that drive species distributions form complex mosaics of communities and continuous, gradual change from one vegetation association to another. Specifically, some vegetation communities encountered in observations in the ONSR mapping region are compositionally transitional, ecotonal, or are not well described by this categorization scheme. Historic and current land-use patterns as well as numerous natural disturbance regimes in the ONSR give rise to complexity that can be difficult to capture in a categorization scheme that is straightforward enough for use in a classification problem. The Importance Value calculations are a useful tool with which to identify potential sources of map error and to aid land managers in the interpretation of map products.

For some of the aggregated types, mapping accuracy, though improved, is still below the 80 percent goal desired by the USGS-NPS Vegetation Mapping Program. For example, the White Oak Forest Community Type has an accuracy of only 59 percent, probably due to confusion between its component associations (2066 and 2070) and the most abundant vegetation class, the Black Oak – White Oak – Hickory Forest (2076), which shares many

diagnostic species, particularly white oak. Confusion between these abundant types suppressed not only within class accuracy, but also overall accuracy. However, the Ecological Systems and Community Types used in this study were designed to address management issues as well as to address mapping difficulties arising from community similarities and spatial arrangement issues. Therefore, we believe that further aggregation to improve accuracy would diminish the utility of the final products for resource management planning.

Many of the classification errors that were found during field accuracy assessment included cases that were misclassified into categories that are similar to that observed during field validation visits. For example, the validation data contains a total of 22 cases of confusion between White Oak-Red Oak-Sugar Maple Mesic Forest (2058) and white oak forest associations (2066 and 2070). This confusion is reasonable given the fact that the five species identified as being most important in the 22 cases that were misclassified as 2058, but observed to be 2066 or 2070 during field validation, are also identified as the most important species in the correctly classified 2058 validation observations. These misclassified cases can be said to be compositionally transitional communities that share similarities with both the mixed hardwood mesic forest and white oak forest associations. Confusion also existed between the Ozark Black Oak-Scarlet Oak Forest (2399) and Shortleaf Pine-Black Oak Forest (2401) associations. A total of 16 cases of confusion exist where a location was misclassified as 2399, but found to be 2401 during field validation. In these confused cases, black oak was observed to be the most important species overall, and half of these cases contain less than 20 percent cover of shortleaf pine. Again, these errors are reasonable because the validation observations were obtained in what may be termed compositionally transitional communities.

Confusion between upland woodland association types (2108, 2143, 2149 and 2393) and areas that have been shelterwood cut occurred due to similarities in their reflective signatures. The shelterwood management method opens up forest canopies in a manner that mimics the appearance of upland woodlands in some cases. For example, a user's accuracy of only 15.8 percent was obtained for the Post Oak-Blackjack Oak/Little Bluestem Woodland association (2149). Confusion with shelterwood cuts occurring outside the ONSR management area accounts for most of these misclassification errors. Also typical are the circumstances for Chinkapin Oak-Red Cedar Dry Alkaline Forest (2108), Chinkapin Oak-Ash/Little Bluestem Woodland (2143), and Shortleaf Pine-Oak Dry Woodland (2393), where user's accuracies were lower outside the ONSR boundary compared to inside. This is related to the fact that timber management activities are more prevalent outside the ONSR boundaries. Unfortunately, secondary features of harvest activity such as roads do not dependably indicate harvest areas, as nearly all ridges (near harvested areas or not) within the mapping area have roads on them. Furthermore, these roads are inconsistently visible beneath the canopy.

The results from the pilot study test of statistical classification techniques indicate that certain vegetation communities may be more accurately mapped through photointerpretation rather than through an automated classification approach. The search for repeated patterns that drives a statistical classifier tends to be undermined by the anomalous land use patterns that produce the altered ('SA##') vegetation and land cover types. For example, harvested and regenerating timber stands and the old field association types can occur in numerous landscape positions and have varying reflectance signatures, but we found that they can be readily photointerpreted and superimposed over a statistically classified map to improve mapping accuracy. A spatial overlay of this type would be logically consistent with the manner in which anthropogenic modifications are superimposed on a landscape matrix of relatively natural plant

communities. Furthermore, dolomite and igneous glades – which are sparsely treed savanna-like communities that contain bright rocky areas, green vegetation, and dark shadows – represent reflectively mixed targets that defy accurate statistical classification using remote sensing image data (Smith, 2001). It may likewise be more appropriate to photointerpret and superimpose these communities over the mapped results of an automated statistical classifier.

## Probability Maps

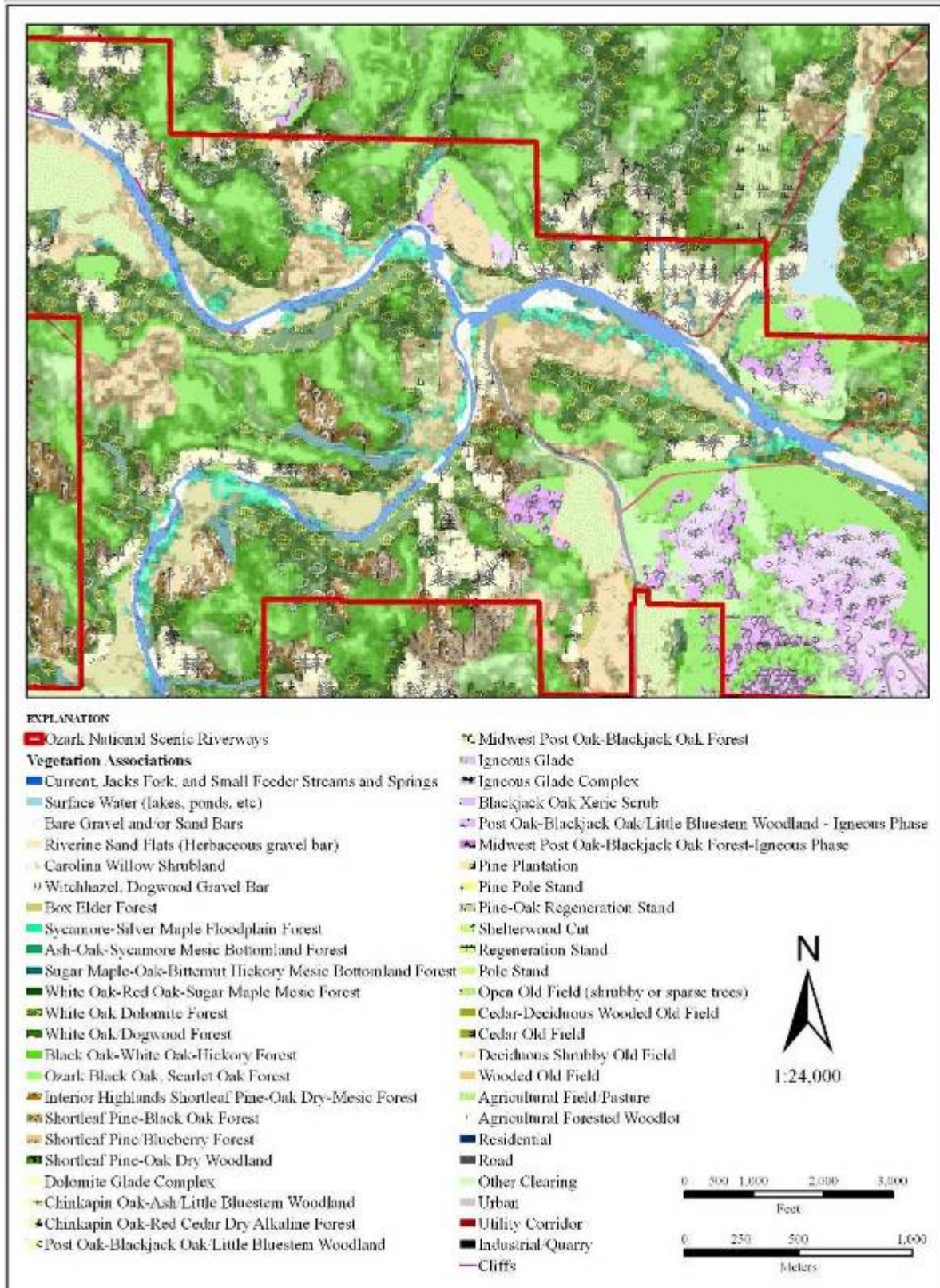
Among the advantages of mapping USNVC vegetation associations using probabilities from discriminant analysis is that a probabilistic approach combines the ability to derive hard classifications (polygon maps) while retaining spatially continuous information on the probability of class membership for all of the categories in a classification scheme. This mapping approach permits analysis of the spatial structure of uncertainty and the potential for detecting transitional and ecotonal regions, thus characterizing a landscape mosaic of vegetation communities in a manner more consistent with actual ground conditions. In addition, a hard classification map typically contains no information about classification uncertainty, whereas it should be anticipated that uncertainty will rise as proximity to patch edges increases, due to decreasing homogeneity in the floristic and/or structural characteristics of vegetation communities near patch boundaries. In a pilot investigation of the spatial structure of uncertainty in the ONSR region vegetation map, statistically significant spatial structure was evident in the probabilities of class membership as a function of proximity to patch edge in the two most common vegetation association classes in the study area – the mixed oak-hickory/dogwood (2076) and black oak, scarlet oak forest (2399) classes. ANOVA results indicate that significant increases occur in average probability of class membership as distance increases from patch edges. The rise in classification uncertainty as patch boundaries are approached may be due to the prevalence of ecotonal communities in these regions.

Probability maps for the various USNVC association categories can be utilized to assess the spatial structure of error and uncertainty in the ONSR vegetation map. While the overall accuracy of the final ONSR vegetation association map provides a map user with a general sense of map accuracy and reliability, it should be emphasized that per-class accuracy measures such as the user's accuracy and ROC curves contain important measures pertaining to the reliability of individual classes. Specifically, ROC curves offer per-class comparative measures of discrimination strength, but they can also be used to determine which areas on the map contain more certainty compared to others. By plotting probability of detection against mapped discriminant analysis probability thresholds, ROC curve information can be used to reveal target levels of discernability, and actual patch boundaries may be located more accurately based on certainty benchmarks obtained from accuracy validation data and related back to class membership probabilities.

As an example of how probability maps can be used by resource managers to assess the certainty of map classifications, either the 49-class vegetation association map or the 33-class Community Type map can be displayed in a GIS platform over a probability map for all of the classification types. This probability map is a raster data file that is a by-product of the statistical mapping approach. The value of each grid cell indicates the probability that a given cell was individually classified as the same vegetation association as the polygon of which it is part in the final classification map. For example, if a polygon is classified as a Chinkapin Oak-Ash Woodland (2143), the probability value for an individual grid cell within the polygon will be the probability that that cell was individually classified as the 2143 type (even if, individually, that

cell had a higher probability of being another type). Probability may be displayed as a continuous variable or it may be broken up into discrete classes. Figure 11 displays the 49-class map at 50 percent transparency over the probability map displayed as a continuous variable for all classes. Brighter areas indicate higher classification certainty. Figure 11 illustrates the case which was often evident in the field: certainty of classification (or representativeness of vegetation association) decreases near community boundaries as one type transitions into another.

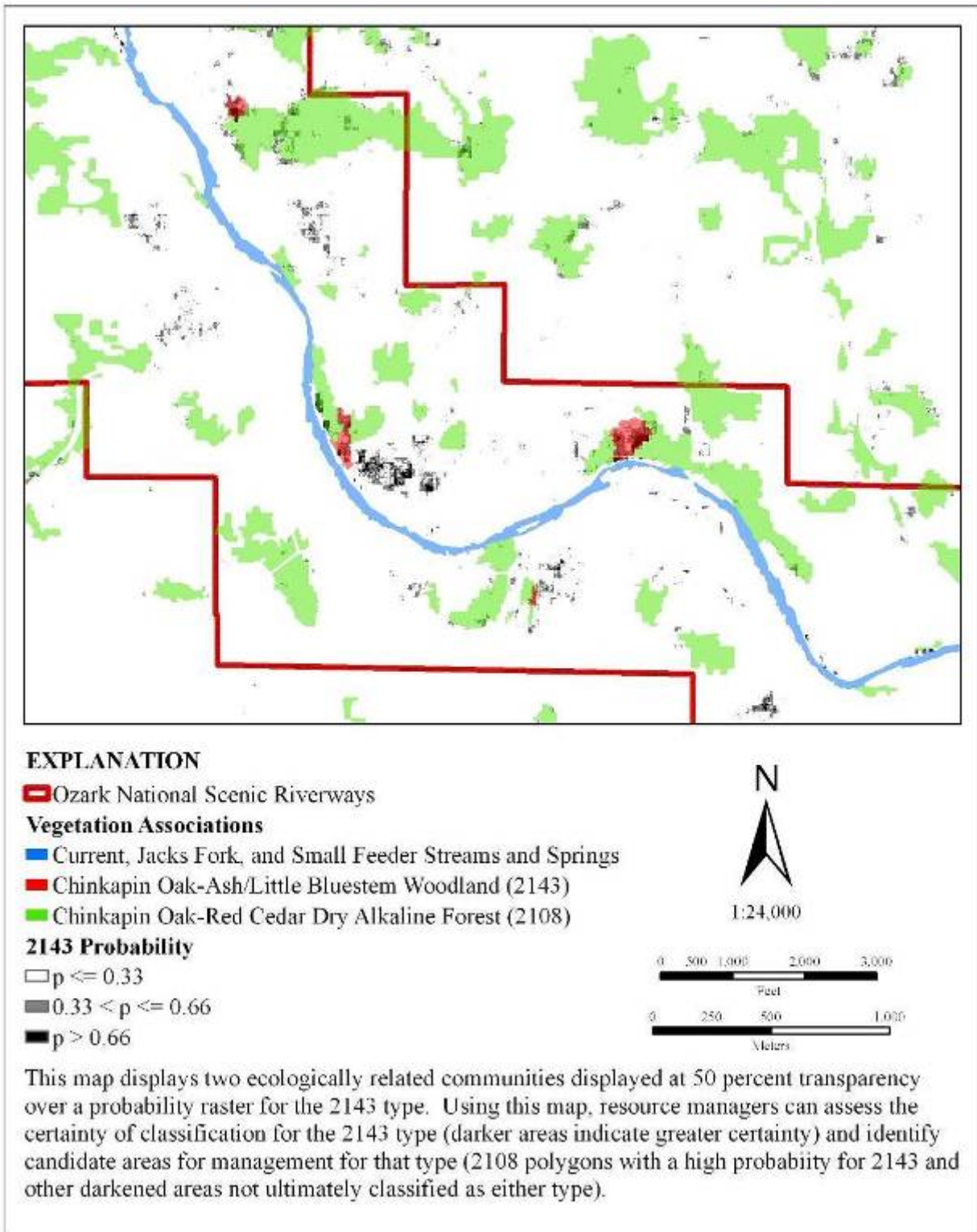




**Figure 11.** Detail of 49-class map displayed over probability raster for all classes, with brighter areas indicating higher classification certainty.

Probability maps for the individual classes may be used by resource managers to assess the classification certainty for specific communities of interest, and to identify locations within the mapping where a given type is likely to occur, beyond where it was identified in the final classification map. These can also be used to identify areas that may respond favorably to management when managing for a particular community. Unlike the probability map for all classes shown in Figure 11, individual probability maps show the probability that a cell was classified as a particular type, regardless of the final classification of the polygon of which it was a member in the final classification map. Therefore, even if a polygon was classified as one vegetation association, resource managers can assess the probability that the individual cells within that polygon were classified as another type.

Figure 12 examines just such a relationship. Polygons classified as the Chinkapin Oak-Ash/Little Bluestem Woodland (2143) are shown in red and the ecologically related Chinkapin Oak-Red Cedar Dry Alkaline Forest (2108) polygons are shown in green. The 2143 type is important to resource managers for its high biological diversity. Once more common, it is now infrequent due to invasion by red cedar as a result of past fire suppression. This change has caused many examples of the 2143 type to convert to the 2108 type, though many of the component species are likely present. Areas identified as the 2108 type might be suitable for restoration to the 2143 type with mechanical removal of cedar and prescribed fire management to control future woody invasion. The probability raster allows one to assess the certainty of the polygons classified as 2143 (darker red indicates higher probability) and to find areas where the 2143 type is more likely to be found, beyond where it was identified by final classification. Such maps can significantly aid resource management planning by suggesting candidate sites for management activity and can be created for those associations that were mapped statistically.



**Figure 12.** Vegetation associations 2143 and 2108 displayed over probability raster for the 2143 type.



## Management Implications

### Ecological Systems Groupings

The Ecological Systems used in this project were designed to facilitate resource management planning within the mapping area. Given the lower overall accuracy of the 49-class USNVC association-level map and the complexity involved in interpreting it, we believe that the 33-class Community Type map provides a more reliable and useful product. For many of the aggregated types, the 49-class map yields polygons that are too small to reasonably guide management. By contrast, within the 33-class map, the groupings of vegetation associations that are either similar to one another or spatially related provide a scale more appropriate to making management decisions. Furthermore, though important for understanding ecological processes and assessing resource conditions, community boundaries may not relate to where management action can be applied practically. While aggregation of types does not necessarily address this disconnect between ecological realities and management practicality, it can help to identify broader areas over which to conduct management activities in order to maximize benefits. For example, when determining the location of fire lines for prescribed burns in igneous woodlands, polygons based on aggregated types will suggest a minimum area over which to apply treatment that would include nearby Midwest Post Oak-Blackjack Oak Forests (2075) that should respond favorably to fire. Indeed, applications such as this are the impetus behind the development of ecological systems nationwide (Comer and others, 2003).

The fact the ecological systems approach used in this study increased both the accuracy and the utility of the final map products suggests that perhaps revisions should be made to the USNVC hierarchy. Other vegetation mapping efforts have experienced difficulties similar to those we encountered with respect to the broad conceptual jump between the USNVC formation and alliance levels, and the national program is being updated to address this issue (Federal Geographic Data Committee, 2006). However, the proposed changes may be unable to address the mapping problem encountered when physiognomically and floristically distinct communities often occur together in ways that confound mapping but which are relevant to management. In our study, igneous glades and associated woodlands are an example of such communities, frequently occurring as complexes of physiognomically distinct units which are, individually, below the minimum mapping unit. In order to address the local spatial relationships that may exist between these types of communities, it may be necessary to maintain a separate parallel hierarchical system designed to address mapping goals and management interests.

### Woodland/Forest Conundrum

There are frequent discrepancies between conventions used by resource managers within the study area regarding usage of the terms “woodland” and “forest,” and these discrepancies are not necessarily resolved by USNVC classification. For example, many of the vegetation associations that are classified as “forests” based on canopy and subcanopy structure according to USNVC standards are considered “degraded” woodlands based upon standards commonly used in the Missouri Ozarks. Usually, fire suppression is cited as the reason for allowing invasion by less fire-tolerant species and canopy closure within the mapping area (Nigh and others, 2000, Ladd, 2005, Nelson, 2005). These interpretations are based upon an understanding of the historic disturbance regimes within which native flora evolved and the effect fire had on the distribution of plant communities. In this context, application of the “woodland” classification to types that are currently forested by USNVC standards represents an

identification of the “potential” vegetation community given a management regime that mimics the historic ecological processes, and is not a reflection of current conditions. As such, these interpretations offer a broader interpretation of woodland than does the USNVC. Conversely, many resource managers involved in timber management operations would classify as forests vegetation associations that would qualify as woodlands based upon USNVC standards. Their primary criterion may be the amount of merchantable timber available in a given area, a measure that frequently acts as a surrogate for tree density and height, but which may ignore components in lower vegetative strata.

This study adheres to the USNVC standards for determining whether a type is forest or woodland. Forests were generally defined as having more than 80 percent cover in the canopy, with a complex understory of multiple layers. The forest designation can safely be applied to the more mesic vegetation associations, such as the White Oak Dolomite Forest (2070), the White Oak/Dogwood Forest (2066), mesic hardwood forests in both uplands and bottomlands (2058 and 2060), and all of the floodplain forests (2410, 5033 and 7334). Woodlands were generally defined as having less than 80 percent cover in the canopy, or, if more than 80 percent cover, then having open understory and shrub layers and a well developed groundflora. Also included in woodlands were communities with stunted canopies which may or may not exceed 80 percent closure. The woodland designation can safely be applied to those types that are recognized as such by Nelson (2005) and Nigh and Schroeder (2002). In between these two ends of the spectrum, there are the Ozark Black Oak-Scarlet Oak Forest (2399), the Shortleaf Pine/Blueberry Forest (2400), the Midwest Post Oak-Blackjack Oak Forest (2075) and its human-modified, igneous expression (2075i). Based on current condition, it is appropriate to think of these as forests that, with management (particularly prescribed burning) can be transformed into woodlands more typical of the area prior to European settlement and the widespread suppression of wildfires. This appears to be the basis for much of the current resource management at Ozark National Scenic Riverways, particularly the application of prescribed burning.

## Wildland Fuels Map

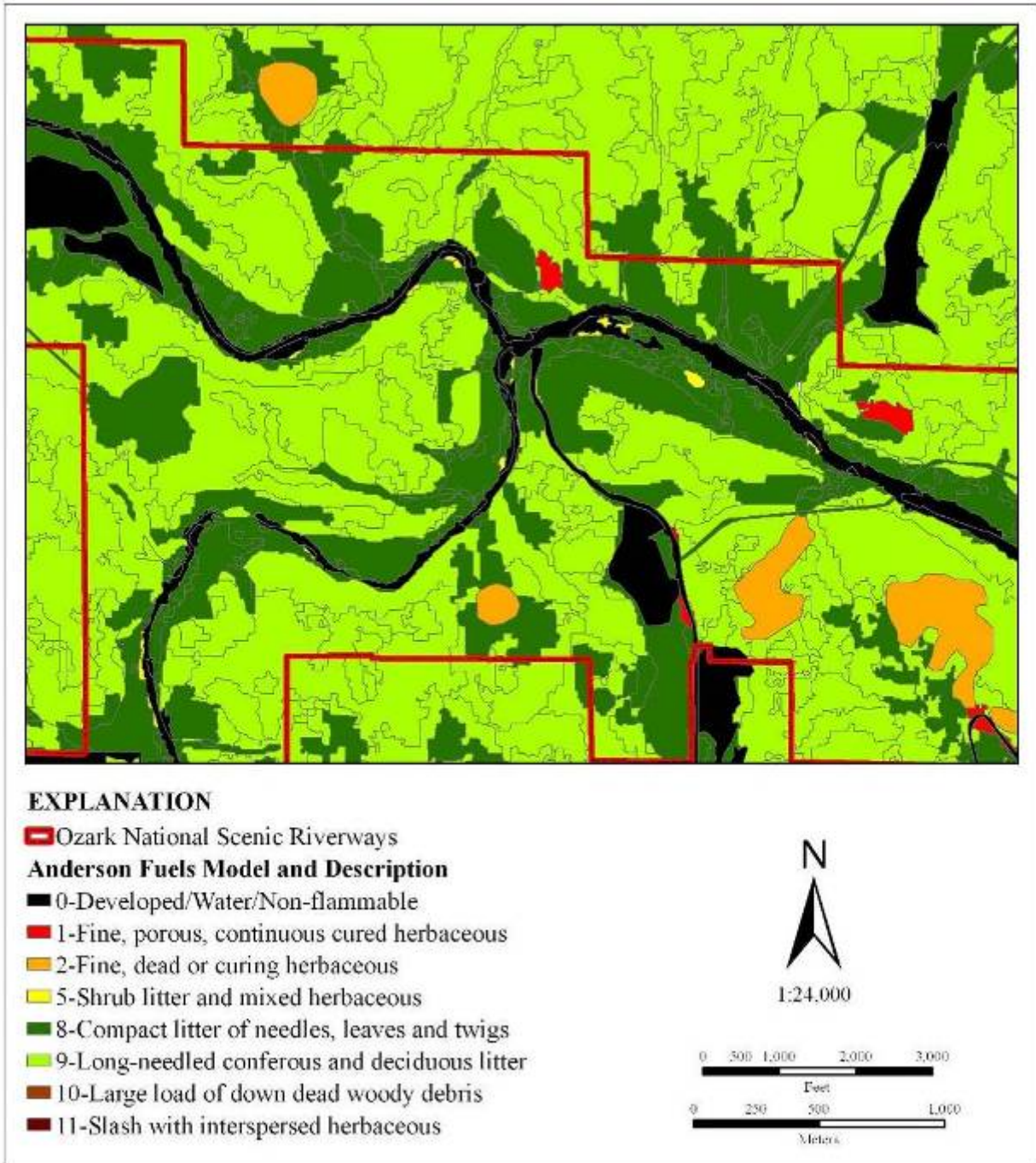
Fuels data were collected with the primary intent of describing the condition of wildland fire fuels within each vegetation association and generating a fuel-loading map based on broad, commonly applied fuels classes. We generated digital and hard-copy maps (Figure 13) of fuels classes based upon the United States Forest Service classification developed by Anderson and others (1976). At present, this is the most commonly applied fuels model. However, because Anderson’s system was developed in western systems dominated by coniferous forests, it may not provide the conceptual resolution appropriate for fuels conditions in eastern, deciduous forests. Therefore, polygons within the shapefile of USNVC types have been attributed with classifications from the recently produced Comprehensive Fuels model (Scott and Burgan, 2005). This latter model identifies a greater number of classes, many of which were developed for deciduous forests and may be more appropriate for the study area. However, the Comprehensive Fuels model has not yet been widely adopted in the United States. Polygons within the shapefile of USNVC types have also been attributed with classifications from National Fire Danger Rating System (NFDRS) model, which can be used to assess fire danger across multiple scales. Fuels maps based upon either the Comprehensive Fuels model or the NFDRS can be generated in a GIS environment.

The finding of no statistically significant differences in fuel loading between USNVC associations is not unexpected, given that fuels data collection was designed less to test for

differences between fuels loads than to provide a coarse description of fuels for each USNVC association. The primary factors restricting more intensive sampling were a limited budget and insufficient time. As a result, sampling intensity and distribution were not sufficient to overcome the inherent variability of fuel loading within each vegetation association. This was particularly true for rarer communities.

Nevertheless, some general patterns emerge from the fuels data (Table 3 and Table 4). For example, USNVC associations that occur in the riparian zone generally have lower total fuel loading than other associations. There may be subtle differences in upland fuel loading, but our data was unable to capture those differences. Fuel loading in USNVC associations that are frequently managed with prescribed fire did not appear to be different from the other upland associations that were sampled. Sampling was not intense enough to properly assess these differences. Additionally we did not target communities that are currently managed with prescribed fire to compare against those communities that have not been treated with prescribed fire.

Fuels data were used to develop data tables that are linked to the vegetation association map in a GIS platform, enabling the creation of a coarse fuel map for ONSR in which Anderson (1982) fuel models can be displayed for each USNVC association. This coarse fuel map can be used to evaluate the spatial continuity of fuel conditions throughout the mapping area. Additionally, the fuels map enables resource and fire managers to use spatial fire spread models, such as FARSITE (Finney, 1998; Keane and others, 1999), which will permit the evaluation of prescribed fire and wildfire scenarios within ONSR. This tool will enable managers to estimate the impacts of prescribed fire or wildfire decisions and to refine prescribed fire planning.



**Figure 13.** Detail of Anderson Fuels Model map.

## Options for Future Mapping Projects

### Field Sampling

The sampling approach used in this study met programmatic requirements and facilitated development of the final classification map. Using a combination of gradsects sampling with stratification based upon the MOECS Ecological Landtype model ensured that we sampled across the broadest range of environmental conditions that we could expect to find in the park. Of necessity, sampling was clustered in study sites that had a high percentage of public land ownership and high ecological diversity, as well as being accessible. Nevertheless, study site selection was also guided by the objective of sampling from a broad range of Landtype Associations with good spatial distribution within the park. This was particularly true during the accuracy assessment phase, during which time particular emphasis was placed on sampling in areas for which data were lacking (Figure 6).

The plot design utilized in this study provided adequate data for ordination analysis. A larger plot (such as the 20 x 50 m plot used in the NPS fire effects monitoring program) may have provided a more complete set of data for characterizing overstory trees, but would have added significantly to the time needed for sampling. Similarly, more intensive sampling at each point potentially could have improved fire fuels characterization. However, the greatest shortcoming of the fire fuels data from this project was the low sample size in many of the vegetation association types. Increasing sample intensity at each point would not have addressed this problem.

Within the study area, collection of some environmental data provided little help in the field classification of vegetation associations, nor were such data valuable in the multivariate analysis of plot data. For example, surficial geology and soil texture and drainage were not incorporated into any of the analysis of data. Within the study area, these data are secondary to more readily assessable environmental conditions such as geologic parent material, landscape position and slope aspect as indicators to potential vegetation associations. Furthermore, classification of soil texture and drainage requires an additional suite of knowledge and training of field staff in order to provide precise and accurate data. Given the additional demands associated with collecting environmental data, future vegetation mapping projects may want to modify the program data collection standards to focus on those environmental parameters that are the best indicators of potential vegetation type in the mapping area and that can be accurately and precisely measured in a short amount of time with a minimal amount of training of field staff.

### Remote Sensing

Comparison of the results of pilot classifications of vegetation communities in the ONSR and the final classification of the entire ONSR mapping region indicate that a hybrid combination of statistical methods and photointerpretation is needed to obtain adequate overall and class-wise accuracy levels. We recommend that future vegetation mapping projects within this program incorporate a hybrid approach such as that used here, if it is within capabilities. Splitting the study into three more homogenous regions to simplify the classification problem and applying a discriminant analysis approach based upon probabilities of USNVC association type membership proved to be a good alternative to the decision rule classification approach more typically applied with remote sensing data. While the decision rule classification approach



is robust, it lacks an objective input variable selection method. The mapping approach applied here also provided superior results compared to the regression tree approach applied during pilot investigations, as difficulties associated with missing categories in the classification output were avoided. Regression trees are able to objectively choose input variables, but they use only one variable at a time, and therefore do not take full advantage of the multidimensionality of the input data. Further, regression trees are often more effective in describing the input data, but can be notoriously unsuccessful in predicting novel cases. Finally, this mapping effort demonstrates the utility of the regression tree approach in providing a heuristic tool for landscape scale stratification when mapping complex systems.

It may be practical to consider alternate data sources that are more cost-effective compared to obtaining new aerial photography data to map vegetation communities. The results of the correlogram analysis indicated that the highest spatial resolution needed for textural analysis of vegetation communities in the ONSR mapping region was two meters. For similar mapping applications, it may be more feasible to acquire commercial high resolution satellite CIR imagery such as Quickbird (launched 10/18/2001) rather than flying an aerial photography mission. At the time of publication of this document (2006), the cost for orthorectified, 2.4 m resolution, multispectral (blue, green, red, and infrared spectral bands) Quickbird imagery was \$18 per square kilometer after an academic discount is applied. At this pricing rate, the cost for coverage for the ONSR mapping region (1418.5 square km) would total \$25,533. This variety of high resolution commercial satellite imagery is produced in digital form, thereby further cutting the total cost of data acquisition by drastically reducing the extensive amount of time it takes to scan and orthorectify individual aerial photo frames.

Imagery from the National Agricultural Imagery program may also be a useful, readily available data source. These data can be freely obtained from the United States Department of Agriculture Geospatial Data Gateway (<http://datagateway.nrcs.usda.gov/>). However, these data are collected during the height of the growth season, which means that they may not be as effective for remote sensing needs as data collected during periods of higher phenological separation between vegetation associations (for example, near fall senescence). NAIP data were not yet available at the initiation of this project and were therefore used only as a secondary data source.

## References

- Allen, T.R. 2000. Topographic normalization of Landsat Thematic Mapper data in three mountain environments. *Geocarto International*, 15(2): 13-19.
- Anderson, H.E. 1982. Aids to determining fuel models for estimating fire behavior. USDA Forest Service General Technical Report INT-122. 22p. Intermountain Forest and Range Experiment Station. Ogden, Ut.
- Anderson, J.R., Hardy, E.E. and Roach, J.T. 1976. Land use and land cover classification System for use with remote sensing data. Geological Survey Professional Paper 964. A revision of the land use classification system as presented in US. Geological Circular 671. U. S. Government Printing Office, Washington, D.C.
- Andren, H. 1994. Effects of habitat fragmentation on birds and mammals in landscapes with different proportions of suitable habitat; a review. *Oikos*, 71(3): 355-366.
- Austin, M.P. and Smith, T.M. 1989. A new model for the continuum concept. *Vegetatio*, 83(1-2): 35-47.
- Austin, M.P. and Heyligers, P.C. 1989. Vegetation survey design for conservation: Gradsect sampling of forests in north-eastern New South Wales. *Biological Conservation*, 50, 13-32.
- Avers, P.E., Cleland, D.T., McNab, W.H., Jensen, M.E., Bailey, R.G., King, T., Goudey, C.B. and Russell, W.E. 1994. The national hierarchical framework of ecological units. ECOMAP, USDA Forest Service, Washington, D.C.
- Becker, C. 1999. Multifactor classification of intermittent creeks in Southeast Missouri Ozarks. Master's thesis, University of Missouri-Columbia.
- Beers, T.W., Dress, P.E. and Wensel, L.C. 1966. Aspect transformation in site productivity research. *Journal of Forestry*, 64: 691-692.
- Beyer, H.L. 2004. Hawth's analysis tools for ArcGIS. Available at <http://www.spataleecology.com/htools>.
- Boutin, C. and Jobin, B. 1998. Intensity of agricultural practices and effects on adjacent Habitats. *Ecological Applications*, 8(2): 544-557.
- Breiman, L., Friedman, J.H., Olshen, R.A. and Stone, C.J. 1984. *Classification and Regression Trees*. Chapman and Hall, New York.
- Brown, J.K. 1974. Handbook for inventorying downed dead woody material. USDA Forest Service. General Technical Report. INT-16. 24p. Intermountain Forest and Range Experiment Station. Ogden, UT.
- Brown, J.K., Oberheu, R.D. and Johnston, C.M. 1981. Handbook for inventorying surface fuels and biomass in the Interior West. USDA Forest Service. General Technical Report. INT-129. 48p. Intermountain Forest and Range Experiment Station. Ogden, UT.
- Cowardin, L. W., Carter, V., Golet, F.C. and LaRoe, E. T. 1979. Classification of wetlands and deepwater habitats of the United States. Biological Service Program, U.S. Fish and

- Wildlife Service, FWS/OBS 79/31. Office of Biological Services, Fish and Wildlife Service, U.S. Department of Interior, Washington, D.C., USA.
- Clark, M.L., Roberts, D.A. and Clark, D.B. 2005. Hyperspectral discrimination of tropical tree species at leaf to crown scales. *Remote Sensing of Environment*, 96(3-4): 375-398.
- Comer, P., Faber-Langendoen, D., Evans, R., Gawler, S., Josse, C., Kittel, G., Menard, S., Pyne, M. Reid, M., Schulz, K., Snow, K. and Teague, J. 2003. Ecological systems of the United States: A working classification of U.S. terrestrial systems. NatureServe, Arlington, Virginia.
- Crist, E.P. and Kauth, R.J. 1986. The tasseled cap de-mystified. *Photogrammetric Engineering and Remote Sensing*, 8(2): 81-86.
- Cunningham, B. and Hauser, C. 1992. The decline of the Missouri Ozark forest between 1880 and 1920. In Journet, A.R. and Spratt, H.G., eds. *Proc: Towards a Vision for Missouri's Public Forests*. March 27-28, 1992. Southeast Missouri State University, Cape Girardeau, MO. 14-19.
- De Colstoun, E.C.B., Story, M.H., Thompson, C., Commiso, K., Smith, T.G. and Irons, J.R. 2003. National park vegetation mapping using multitemporal Landsat 7 data and a decision tree classifier. *Remote Sensing of Environment*, 85(3), 316-327.
- Federal Geographic Data Committee. 1996. National Vegetation Classification Standard, Version 2-Working Draft. FGDC-STD-005 (Version 2). FGDC Secretariat, U.S. Geological Survey. Reston, VA. 62 p.
- Finney, M.A. 2004. FARSITE: Fire Area Simulator-Model development and evaluation. USDA Forest Service. Research Paper RMRS-RP-4. Rocky Mountain Research Station. 47p.
- Frank, T.D. 1988. Mapping dominant vegetation communities in the Colorado Rocky Mountain front range with Landsat Thematic Mapper and digital terrain data. *Photogrammetric Engineering and Remote Sensing*, 54(12): 1727-1734.
- Franklin, J. 1995. Predictive vegetation mapping: Geographic modelling of biospatial patterns in relation to environmental gradients. *Progress in Physical Geography*, 19(4): 474-499.
- Friedl, M.A. and Brodley, C.E. 1997. Decision tree classification of land cover from remotely sensed data. *Remote Sensing of Environment*, 61(3), 399-409.
- Gardner, R.H. and Urban, D.L. 2003. Model validation and testing: Past lessons, present concerns, future prospects. In Canham, C.D., Cole, J.C. and Lauenroth, W.K., eds. *The Role of Models in Ecosystem Science*. Princeton University Press, Princeton, NJ.
- Grabner, J. 2001. Patterns in upland forest vegetation in relation to geology, topography and soils: An approach to ecological land classification in the Southeast Missouri Ozarks. Master's thesis, University of Missouri-Columbia.
- Grossman, D.H., Faber-Langendoen, D., Weakley, A.S., Anderson, M., Bourgeron, P., Crawford, R., Goodin, K., Landaal, S., Metzler, K., Patterson, K.D., Pyne, M., Reid, M. and Sneddon, L. 1998. International classification of ecological communities: terrestrial vegetation of the United States, Volume I. The National Vegetation Classification System: development, status, and applications. The Nature Conservancy, Arlington, Virginia, USA.

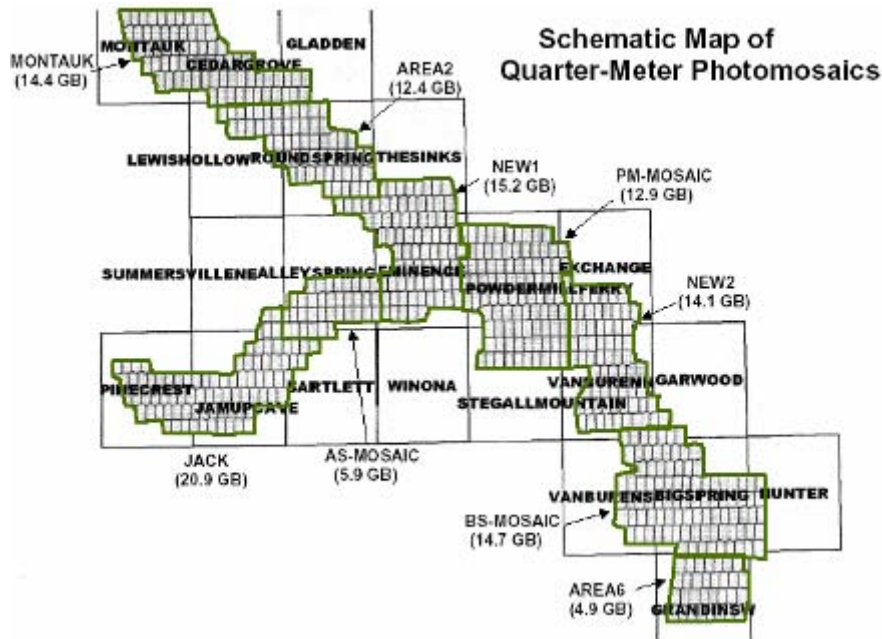
- Guyette, R.P. and Cutter, B.E. 1991. Tree ring analysis of fire history in a post oak savanna in the Missouri Ozarks. *Natural Areas Journal*, 11: 93-99.
- Hansen, M.C., DeFries, R., Townshend, J.R.G. and Sohlberg, R. 2000. Global land cover classification at 1 km spatial resolution using a classification tree approach. *International Journal of Remote Sensing*, 21(6-7), 1331-1364.
- Huang, C., Wylie, B., Homer, C., Yang, L. and Zylstra, G. 2002. Derivation of a tasseled cap transformation based on Landsat 7 at-satellite reflectance. *International Journal of Remote Sensing*, 23(8): 1741-1748.
- Irish, R.R. 2000. Landsat 7 science data user's handbook, Chapter 11: Data Products. Report 430-15-01-003-0, National Aeronautics and Space Administration, [http://ltpwww.gsfc.nasa.gov/IAS/handbook/handbook\\_htmls/chapter11/chapter11.htm](http://ltpwww.gsfc.nasa.gov/IAS/handbook/handbook_htmls/chapter11/chapter11.htm)
- Iverson, L.R., Dale, M.E., Scott, C.T. and Prasad, A. 1997. A GIS-derived integrated moisture index to predict forest composition and productivity of Ohio forests (U.S.A.). *Landscape Ecology*, 12: 331-348.
- Jacobson, R.B. and Gran, K.B. 1999. Gravel sediment routing from widespread, low-intensity landscape disturbance, Current River basin, Missouri. *Earth Surface and Processes and Landforms*, 24: 897-917.
- Jensen, J.R. 1995. *Introductory Digital Image Processing: A Remote Sensing Perspective*. 316 pp. Prentice Hall, Upper Saddle River, New Jersey.
- Joy, S.M., Reich, R.M. and Reynolds, R.T. 2003. A non-parametric, supervised classification of vegetation types on the Kaibob National Forest using decision trees. *International Journal of Remote Sensing*, 24(9), 1835-1852.
- Karimi, Y., Prasher, S.O., McNairn, H., Bonnell, R.B., Dutilleul, P. and Goel, R.K.. 2005. Classification accuracy of discriminant analysis, artificial neural networks, and decision trees for weed and nitrogen stress detection. *Transactions of the ASAE*, 48(3): 1261-1268.
- Keane, R.E., Mincemoyer, S.A., Schmidt, K.M. and Garner, J.L. 1999. Mapping fuels for fire management on the Gila National Forest, New Mexico. In Gollberg, G.E., Neueschwander, L.F. and Ryan, K.C., eds. *Proc: The Joint Fire Science Conference and Workshop "Crossing the Millennium Integrating Spatial Technologies and Ecological Principles"*. June 15-17, 1999. Boise, ID.
- Klecka, W.R. 1980. *Discriminant Analysis*. Sage University Paper Series on Quantitative Applications in the Social Sciences, 07-019. Beverly Hills, CA: Sage Publications.
- Ladd, D. 1991. Reexamination of the role of fire in Missouri oak woodlands. *Charleston, IL: Proceedings of the Oak Woods Management Workshop: 67-80.*
- Ladd, D. 2005. Director of Science for the Missouri Chapter of The Nature Conservancy. Personal communication.
- Lillesand, T.M. and Keifer, R.W. 1994. *Remote Sensing and Image Analysis*. 3rd edition. Wiley, New York.

- Markham, B.L. and Barker, J.L. 1986. Landsat MSS and TM post-calibration dynamic ranges, exo-atmospheric reflectance, and at-satellite temperatures. *Landsat Technical Notes (EOSAT)*, 1: 3-8. [http://ltpwww.gsfc.nasa.gov/IAS/handbook/pdfs/L5\\_cal\\_document.pdf](http://ltpwww.gsfc.nasa.gov/IAS/handbook/pdfs/L5_cal_document.pdf) (accessed April 2004).
- McNab, W.H. 1989. Terrain shape index: Quantifying effect of minor landforms on tree height. *Forest Science*, 35(1): 91-104
- McNab W.H. 1993. A topographic index to quantify the effect of mesoscale landform on site productivity. *Canadian Journal of Forest Research*, 23: 1100-1107.
- McCune, B. and Grace, J.B. 2002. *Analysis of Ecological Communities*. MjM Software Design. Glenden Beach, OR. 300pp.
- National Geodetic Survey. 2005. Data from Bloomfield, MO continually operating reference station. <http://www.ngs.noaa.gov/CORS/Data.html>.
- NatureServe. 2005. International ecological classification standard: Terrestrial ecological classifications. NatureServe Central Databases. Arlington, VA. U.S.A. Data current as of 30 September, 2005. ([www.natureserve.org](http://www.natureserve.org))
- Nelson, P.W. 1985. *The Terrestrial Natural Communities of Missouri*. Missouri Natural Areas Committee, Jefferson City. 197 pp. Revised edition, 1987.
- Nelson, P. 2005. *The Terrestrial Natural Communities of Missouri*. Natural Areas Committee, Missouri Dept. of Conservation. Jefferson City, MO. 500 pp.
- Nigh, T., Buck, C., Grabner, J., Kabrick, J. and Meinert, D. 2000. An ecological classification system for the Current River Hills. Working Draft. Missouri Department of Conservation, Jefferson City, MO.
- Nigh, T.A. and Schroeder, W.A. 2002. *Atlas of Missouri Ecoregions*. Missouri Department of Conservation, Jefferson City, Missouri.
- Nupp, T.E. and Swihart, R.K. 2000. Landscape-level correlates of small-mammal assemblages in forest fragments of farmland. *Journal of Mammology*, 81(2): 512-526.
- Ohmann, J.L. and Gregory, M.J. 2002. Predictive mapping of forest composition and structure with direct gradient analysis and nearest neighbor imputation in coastal Oregon, USA. *Canadian Journal of Forest Research*, 32(4): 725-741.
- Parker, A. J. 1982. The topographic relative moisture index: An approach to soil-moisture assessment in mountain terrain. *Physical Geography*, 3(2): 160-168.
- Pontius, R.G. and Schneider, L.C. 2001. Land-cover change model validation by an ROC method for the Ipswich watershed, Massachusetts, USA. *Agriculture, Ecosystems, and Environment*, 85: 239-248.
- Reunanen, I. and Grubb, T.C. 2005. Densities of eastern chipmunks (*Tamias Striatus*) in farmland woodlots with increasing area and isolation. *American Midland Naturalist*, 154(2): 433-441.
- SAS Institute Inc. 2004. *Statistical Analysis Software*. Version 8. The SAS Institute Inc. Cary, NC.

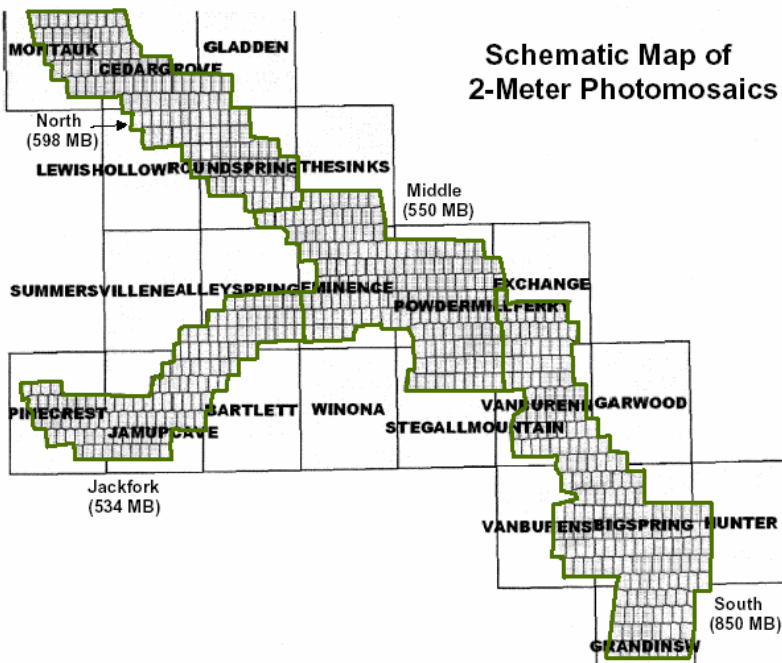
- Scott, J.H. and Burgan, R.E. 2005. Standard fire behavior fuel models: A comprehensive set for use with Rothermel's surface fire spread model. USDA Forest Service. General Technical Report RMRS-GTR-153. Rocky Mountain Research Station. 72p.
- Sellers, P.J. 1985. Canopy reflectance, photosynthesis and transpiration. *International Journal of Remote Sensing*, 6:1335-1372.
- Smith, A. 2001. Delineation of glade complexes in the southeast Missouri Ozarks using multi-temporal multi-spectral satellite imagery. MS thesis, Southern Illinois University.
- Therneau, T.M. and Atkinson, E.J. 1997. Technical Report Series No. 61: An Introduction to Recursive Partitioning Using the RPART Routines. Department of Health Science Research, Mayo Clinic, Rochester, Minnesota.
- The Nature Conservancy. 1994a. Standardized national vegetation classification system. Report to U.S. Dept. of Interior. The Nature Conservancy, Arlington, VA and Environmental Systems Research Institute, Redlands, CA  
<http://biology.usgs.gov/npsveg/classification/index.html>.
- The Nature Conservancy. 1994b. Field methods for vegetation mapping. Report to U.S. Dept. of Interior. The Nature Conservancy, Arlington, VA and Environmental Systems Research Institute, Redlands, CA <http://biology.usgs.gov/npsveg/fieldmethods/index.html>.
- The Nature Conservancy. 1996. Methodology for assessing the utility of existing data for vegetation mapping. Report to U.S. Dept. of Interior. The Nature Conservancy, Arlington, VA and Environmental Systems Research Institute, Redlands, CA  
<http://biology.usgs.gov/npsveg/existdata/index.html>.
- The Nature Conservancy. 1999. Seeing the Forest and the Trees: Ecological Classification for Conservation. Maybury, K.P., editor. The Nature Conservancy, Arlington, Virginia.
- The Nature Conservancy Ozarks Ecoregional Assessment Team. 2003. Ozarks ecoregional and conservation assessment. Minneapolis, MN: The Nature Conservancy Midwestern Resource Office. 48 pp. + 5 appendices.
- Tucker, C.J. and Compton, J. 1979. Red and photographic infrared linear combinations for monitoring vegetation. *Remote Sensing of Environment*, 8: 127-150.
- USGS-NPS. 2006. USGS – NPD Vegetation Mapping Program.  
<http://biology.usgs.gov/npsveg/>
- Venables, W.N. and Ripley, B.D. 1994. *Modern Applied Statistics with S-Plus*. Springer Verlag, New York.
- Warner, T.A., Lee, J.Y. and McGraw, J.B. 1998. Delineation and identification of individual trees in the eastern deciduous forest. Automated Interpretation of High Spatial Resolution Digital Imagery for Forestry. Victoria, British Columbia, Canada, February 10-12, 1998. D.A. Hill and D.G. Leckie, editors. Natural Resources Canada, Canadian Forest Service, Pacific Forestry Centre, Victoria, British Columbia. pp. 81-91

Appendix 1. Schematic maps of quarter- and two-meter photomosaics.

### Appendix 1. Schematic maps of quarter- and two-meter photomosaics.



**Figure A1-1.** Mapping region schematic of the extents of the quarter-meter photomosaics shown with the footprints of the individual photo frames and the boundaries of the 1:24,000-scale USGS quadrangles.



**Figure A1-2.** Mapping region schematic of the extents of the two-meter photomosaics shown with the footprints of the individual photo frames and the boundaries of the 1:24,000-scale USGS quadrangles.

Appendix 1. Schematic maps of quarter- and two-meter photomosaics.



Appendix 2. Community list and hierarchical classification scheme for vegetation communities in the ONSR mapping region.

**Appendix 2. Community list and hierarchical classification scheme for vegetation communities in the ONSR mapping region.**

USNVC Vegetation Association	USNVC Code	ONSR Community Type	ONSR Ecological System
<b>Forests</b>			
Post Oak Flatwoods	2405	Post Oak Flatwoods	Upland Oak Forests
Ozark Black Oak, Scarlet Oak Forest	2399	Mixed Oak-Hickory Forests	
Black Oak-White Oak-Hickory Forest	2076		
White Oak Dolomite Forest	2070	White Oak Forests	
White Oak/Dogwood Forest	2066		
White Oak-Red Oak-Sugar Maple Mesic Forest	2058	Oak-Mixed Hardwood Mesic Upland Forests	Mesic Upland Forests
Pine/Blueberry Forest	2400	Pine and Pine-Oak Forests	Upland Pine and Pine-Oak Forests
Shortleaf Pine-Black Oak	2401		
Interior Highlands Shortleaf Pine-Oak Dry-mesic Forest	7489		
Overcup Oak Pond Forest	4642	Sinkhole Pond Forest	Wet Forests
Red Maple Forested Seep	2407	Forested Seep	
Sugar Maple-Oak-Bitternut Hickory Mesic Bottomland Forest	2060	Mixed Hardwood Mesic Bottomland Forests	Bottomland Forests
Sycamore-Silver Maple Floodplain Forest	7334	Riverfront and Bottomland Forests	
Box Elder Forest	5033		
Ash-Oak-Sycamore Mesic Bottomland Forest	2410		

Appendix 2. Community list and hierarchical classification scheme for vegetation communities in the ONSR mapping region.

<b>Woodlands</b>			
Post Oak-Blackjack Oak/Little Bluestem Woodland	2149	Dolomite Woodland Complexes	Upland Oak Woodlands
Chinquapin Oak-Ash/Little Bluestem Woodland	2143		
Chinquapin Oak-Red Cedar Dry Alkaline Forest	2108		
Ozark Dolomite Glade	2398		
Midwest Post Oak-Blackjack Oak Forest	2075	Igneous Woodland Complexes	
Midwest Post Oak-Blackjack Oak Forest (igneous phase)	2075i		
Post Oak-Blackjack Oak/Little Bluestem Woodland	2149		
Blackjack Oak Xeric Scrub	2425		
Ozark Igneous Glade	2243		
Shortleaf Pine/Little Bluestem Woodland	2402	Pine and Pine-Oak Woodlands	Pine and Pine-Oak Woodlands
Shortleaf Pine-Oak Dry Woodland	2393		

Appendix 2. Community list and hierarchical classification scheme for vegetation communities in the ONSR mapping region.

<b>Shrublands/Herbaceous</b>			
Riverine Sand Flats (Herbaceous Gravel Bar)	2049	Active Channel/Gravel Bar Complex	Riverine Shrublands/Herbaceous Communities
Witchhazel, Dogwood Gravel Wash	3898		
Carolina Willow Shrubland	3899		
Floodplain Canebrake	3836	Floodplain Communities	
Water Lily Aquatic Wetland	2386	Sloughs	Riverine Emergent Aquatic Communities
Vegetated Spring Branch	N/A	Springs	
Ozark Fen	2404	Fens	Fens
Ozark Prairie Fen	2416		
Buttonbush Sinkhole Pond Swamp	4742	Marshes	Marshes
Sinkhole Pond Marsh	2413		
Dry Igneous Cliff	2286	Cliffs	Cliffs and Talus
Moist Igneous Cliff	2289		
Dry Dolomite Cliff	2291		
Moist Dolomite Cliff	2292		
Dolomite Talus	2308	Talus	
Igneous Talus	5203		

Appendix 2. Community list and hierarchical classification scheme for vegetation communities in the ONSR mapping region.

<b>Altered Communities</b>				
Oak-Hickory Regeneration Stand	SA02	Regeneration Stand	Timber Management Area	
Pine-Oak Regeneration Stand	SA05			
Oak-Hickory Shelterwood/Select Harvest	SA01	Shelterwood/Select Harvest		
Pine-Oak Shelterwood/Select Harvest	SA04			
Oak-Hickory Pole Stand	SA03	Pole Stand		
Pine-Oak Pole Stand	SA06			
Pine Pole Stand	SA08			
Pine Plantation	SA07	Pine Plantation		
Pine-Deciduous Shrubby Old Field	SA12	Open Old Field with Shrubby or Sparse Trees	Old Fields	
Deciduous Shrubby Old Field	SA09			
Herbaceous Old Field	SA23			
Cedar-Deciduous Shrubby Old Field	SA36	Wooded Old Field		
Deciduous Forested Old Field	SA10			
Pine-Deciduous Wooded Old Field	SA11			
Cedar-Deciduous Wooded Old Field	SA13			
Pine Old Field	SA14			
Cedar Old Field	SA15			
Agricultural Forested Woodlot	SA37	Agricultural Woodlot		Agricultural Field/Pasture
Hayfield/Grazing Land	SA20	Agricultural Field/Pasture		
Close Grown Monoculture	SA21			
Row Crops	SA22			
Deciduous Wooded Residence	SA16	Residential		Residential
Evergreen-Deciduous Wooded Residence	SA17			
Evergreen Wooded Residence	SA18			
Lawn	SA19			
Residential (structures)	SA35			
Industrial	SA26	Industrial/Quarry	Industrial/Quarry	
Industrial/Commercial	SA27			
Commercial	SA28	Urban	Urban	
Commercial/Services	SA29			
Mixed	SA30			
Other Clearing	SA31	Other Clearing	Other Clearing	
Transportation Corridor (Road)	SA32	Trans. Corridor	Trans. Corridor	
Shrubby Utility Corridor	SA33	Utility Corridor	Utility Corridor	
Herbaceous Utility Corridor	SA34			
Hatchery	SA24	Surface Water	Surface Water	
Lake/Pond	SA25			
River (Non-vegetated portion)		River	River	

**Appendix 3. Crosswalk comparing USNVC vegetation associations in Ozark National Scenic Riverways and surrounding area to communities of the Current River Hills Subsection included in the Atlas of Missouri Ecoregions (Nigh and Schroeder 2002) and to communities described in the Terrestrial Natural Communities of Missouri (Nelson 2005).**

USNVC Vegetation Association	Code	Atlas of Missouri Ecoregions	Terrestrial Natural Communities of Missouri Community Type and Subtype ( <i>italics</i> )
<b>Forests</b>			
<i>Evergreen Forest</i>			
Shortleaf Pine/Blueberry Forest	2400	Shortleaf Pine/Bluestem Dry Chert or Sandstone Woodland	Dry Chert or Sandstone Woodland <i>Shortleaf pine, little bluestem</i>
<i>Deciduous Forests</i>			
Upland Deciduous Forest			
Midwest Post Oak-Blackjack Oak Forest	2075	Post Oak-Blackjack Oak/Bluestem Dry Chert, Sandstone or Igneous Woodland	Dry Igneous or Chert Woodland <i>Post oak, blackjack oak, little bluestem</i> Dry Sandstone Woodland <i>Post oak, black oak, scarlet oak, little bluestem</i>
Midwest Post Oak-Blackjack Oak Forest (igneous phase)	2075i	Post Oak-Blackjack Oak/Bluestem Dry Igneous Woodland	Dry Igneous Woodland <i>Post oak, blackjack oak, little bluestem</i> Dry-Mesic Igneous Forest <i>Black oak, white oak, hickory/dogwood</i>
Post Oak Flatwoods	2405	Post Oak Flatwoods	Upland Flatwoods
Ozark Black Oak-Scarlet Oak Forest	2399	Post Oak, Black Oak, Scarlet Oak Dry Chert or Sandstone Woodland	Dry Chert or Sandstone Woodland <i>Post oak, black oak, scarlet oak, little bluestem</i>
Black Oak-White Oak-Hickory Forest	2076	Mixed Oak-Hickory/Dogwood Dry-Mesic Chert (Sandstone, Igneous) Forest (or Upland Waterway Forest)	Dry-Mesic Chert, Sandstone or Igneous Forest <i>Black oak, white oak, hickory/dogwood</i> Dry-mesic Bottomland Forest
White Oak/Dogwood Dry-Mesic Forest	2066	White Oak/Dogwood Dry-mesic Chert (Igneous) Forest White Oak/Dogwood Dry-Mesic Chert (Igneous) Upland Waterway Forest	Dry-Mesic Chert or Igneous Forest <i>White oak, northern red oak/dogwood</i> Dry-mesic Bottomland Forest
White Oak-Mixed	2070	White Oak-Mixed	Dry-Mesic Limestone/Dolomite

Appendix 3. USNVC—*Atlas of Missouri Ecoregions—Terrestrial Natural Communities of Missouri Community Crosswalk*

Oak Dry-Mesic Alkaline Forest		Oak/Redbud Dry-mesic Limestone/Dolomite Forest	Forest or Woodland Dry-mesic Bottomland Forest
White Oak-Red Oak-Sugar Maple Mesic Forest	2058	Red Oak, White Oak, Sugar Maple Mesic Limestone/Dolomite Forest	Mesic Limestone/Dolomite Forest <i>White oak, northern red oak, sugar maple/spicebush</i> <i>Sugar maple, basswood/pawpaw</i> (less common) Mesic Bottomland Forest
<b>Bottomland Deciduous Forest</b>			
Sycamore-Silver Maple Floodplain Forest	7334	Sycamore, Cottonwood, Willow Riverfront Forest	Riverfront Forest <i>Sycamore, cottonwood, black willow</i>
Box Elder Forest	5033	Green Ash, American Elm, Sugarberry Riverfront Forest	Riverfront Forest <i>Slippery elm, green ash, hackberry, oak</i>
Ash-Oak-Sycamore Mesic Bottomland Forest	2410	Green Ash, American Elm, Sugarberry Riverfront Forest	Riverfront Forest <i>Slippery elm, green ash, hackberry, oak</i>
Sugar Maple-Bitternut Hickory Mesic Bottomland Forest	2060	Red Oak, Sugar Maple, Bitternut Hickory Mesic Bottomland Forest	Mesic Bottomland Forest
<b>Saturated Deciduous Forest</b>			
Red Maple Forested Seep	2407	Ozark Forested Fen	Forested Fen
Overcup Oak Pond Forest	4642	N/A	N/A
<b>Mixed Forest</b>			
Interior Highlands Shortleaf Pine-Oak Dry-mesic Forest	7498	Shortleaf Pine, White Oak Dry-mesic Chert (Igneous, Sandstone) Forest	Dry-Mesic Chert or Sandstone Forest <i>Shortleaf pine, white oak/dogwood</i>
Shortleaf Pine-Black Oak Forest	2401	Shortleaf Pine-Oak/Vaccinium Dry Chert (Sandstone, Igneous) Woodland	Dry Chert, Sandstone or Igneous Woodland <i>Shortleaf pine, oak, lowbush blueberry</i>

Appendix 3. USNVC—*Atlas of Missouri Ecoregions—Terrestrial Natural Communities of Missouri Community Crosswalk*

<b>Woodlands</b>			
<i>Evergreen Woodlands</i>			
Shortleaf Pine/Little Bluestem Woodland	2402	Shortleaf Pine/Bluestem Dry Igneous Woodland	Dry Igneous Woodland <i>Shortleaf pine, little bluestem</i>
<i>Deciduous Woodlands</i>			
Post Oak-Blackjack Oak/Little Bluestem Woodland	2149	Post Oak-Blackjack Oak/Bluestem Dry Chert, (Sandstone, Igneous) Woodland	Dry Chert, Sandstone or Igneous Woodland <i>Post oak, blackjack oak, little bluestem</i>
Blackjack Oak Xeric Scrub	2425	Igneous Glade	Igneous Glade
Chinquapin Oak-Ash/Little Bluestem Woodland	2143	Chinquapin Oak-Ash (Red Cedar)/Little Bluestem Dry Limestone/Dolomite Woodland	Dry Limestone/Dolomite Woodland Dry-Mesic Limestone/Dolomite Woodland
<i>Mixed Woodlands</i>			
Shortleaf Pine-Oak Dry Woodland	2393	Shortleaf Pine-Oak/Vaccinium Dry Chert (Sandstone, Igneous) Woodland	Dry Chert Woodland <i>Shortleaf pine, post oak/lowbush blueberry</i>
Chinquapin Oak-Red Cedar Dry Alkaline Forest	2108	Chinquapin Oak-Ash (Red Cedar)/Little Bluestem Dry Limestone/Dolomite Woodland	Dry Limestone/Dolomite Woodland
<b>Shrublands</b>			
<i>Evergreen Shrublands</i>			
Floodplain Canebrake	3836	N/A	N/A
<i>Deciduous Shrublands</i>			
Buttonbush Sinkhole Pond Swamp	4742	Sinkhole Pond Shrub Swamp	Pond Shrub Swamp
Witch Hazel-Dogwood Gravel Wash	3898	Gravel Wash	Gravel Wash <i>Witch hazel, swamp dogwood, ninebark</i>
Carolina Willow Shrubland	3899	Gravel Bar	Gravel Wash <i>Willow/water willow</i>

Appendix 3. USNVC—*Atlas of Missouri Ecoregions—Terrestrial Natural Communities of Missouri Community Crosswalk*

<b>Herbaceous</b>			
<i>Herbaceous Fens and Marshes</i>			
Sinkhole Pond Marsh	2413	Sinkhole Pond Marsh	Pond Marsh
Ozark Fen	2404	Ozark Marl Fen Ozark Deep Muck Fen	Ozark Fen <i>Marly</i> <i>Mucky</i>
Ozark Prairie Fen	2416	Ozark Prairie Fen	Prairie Fen
<i>Herbaceous Glades</i>			
Ozark Dolomite Glade	2398	Dolomite Glade	Dolomite Glade
Ozark Igneous Glade	2243	Igneous Glade	Igneous Glade
<i>Herbaceous Sloughs and Gravel Bars</i>			
Riverine Sand Flats (Herbaceous gravel bar)	2049	Riverine Sand Flats	Gravel wash <i>Willow/water willow</i>
Water Lily Aquatic Wetland	2386	Midwest Water Lilly, American Lotus Deep Marsh	Freshwater Marsh <i>Water lily, American lotus deep marsh</i>
<i>Vegetated Springs</i>			
Vegetated Spring Branch	N/A	Groundwater Springs	Limestone/Dolomite Spring

### Appendix 3 References

- Nelson, P.W. 1985. The Terrestrial Natural Communities of Missouri. Missouri Natural Areas Committee, Jefferson City. 197 pp. Revised edition, 1987.
- Nigh, T.A. and Schroeder, W.A. 2002. Atlas of Missouri Ecoregions. Missouri Department of Conservation, Jefferson City, Missouri.



**Appendix 4. Crosswalk of ecological systems used in the mapping area and management groups identified by the Missouri Ecological Classification System (MOECs; Nigh and others 2000) for the Current River Hills subsection.**

USNVC Vegetation Association	Code	ONSR Community Type	ONSR Ecol. System	MOECs Management Groups
<b>Forests</b>				
Post Oak Flatwoods	2405	Post Oak Flatwoods	Upland Oak Forests	Mixed Oak (Scarlet, Black)-Hickory/Dogwood/Desmodium Dry-mesic Ultic (Chert, Igneous, Bottomland) Forest
Ozark Black Oak, Scarlet Oak Forest	2399	Mixed Oak-Hickory Forests		
Black Oak-White Oak-Hickory Forest	2076			
White Oak-Mixed Oak Dry-mesic Dolomite Forest	2070	White Oak Forests		
White Oak/Dogwood Dry-Mesic Forest	2066			
White Oak-Red Oak-Sugar Maple Mesic Forest	2058	Oak-Mixed Hardwood Mesic Upland Forests	Mesic Upland Forests	Mixed Hardwood Mesic Bottomland Forest
Pine/Blueberry Forest	2400	Pine and Pine-Oak Forests	Upland Pine and Pine-Oak Forests	Pine-Oak/Vaccinium (Bluestem) Dry Ultic (Chert) Woodlands
Shortleaf Pine-Black Oak Forest	2401			
Interior Highlands Shortleaf Pine-Oak Dry-mesic Forest	7489			
Overcup Oak Pond Forest	4642	Sinkhole Pond Forest	Wet Forests	Sinkholes
Red Maple Forested Seep	2407	Forested Seep		Fens and Seeps
Sugar Maple-Oak-Bitternut Hickory Mesic Bottomland Forest	2060	Mixed Hardwood Mesic Bottomland Forests	Bottomland Forests	Mixed Hardwood Mesic Bottomland Forest
Sycamore-Silver Maple Floodplain Forest	7334	Riverfront and Bottomland Forests		
Box Elder Forest	5033			
Ash-Oak-Sycamore Mesic Bottomland Forest	2410			

Appendix 4. ONSR Ecological Systems-MOECS Management Units Crosswalk

<b>Woodlands</b>				
Post Oak-Blackjack Oak/Little Bluestem Woodland	2149	Dolomite Woodland Complexes	Upland Oak Woodlands	Dolomite Glade and Woodland Complexes
Chinquapin Oak-Ash/Little Bluestem Woodland	2143			
Chinquapin Oak-Red Cedar Dry Alkaline Forest	2108			
Ozark Dolomite Glade	2398			
Midwest Post Oak-Blackjack Oak Forest	2075	Igneous Woodland Complexes		Igneous Glade and Woodland Complexes
Midwest Post Oak-Blackjack Oak Forest (igneous phase)	2075i			
Post Oak-Blackjack Oak/Little Bluestem Woodland	2149			
Blackjack Oak Xeric Scrub	2425			
Ozark Igneous Glade	2243			
Shortleaf Pine/Little Bluestem Woodland	2402	Pine and Pine-Oak Woodlands	Pine and Pine-Oak Woodlands	Pine-Oak/Vaccinium (Bluestem) Dry Ultic (Chert) Woodlands
Shortleaf Pine-Oak Dry Woodland	2393			

Appendix 4. ONSR Ecological Systems-MOECS Management Units Crosswalk

<b>Shrublands/Herbaceous</b>				
Riverine Sand Flats (Herbaceous gravel bar)	2049	Active Channel/Gravel Bar Communities	Riverine Shrublands/Herbaceous Communities	Gravel Bar and Gravel Washes
Witchhazel, Dogwood Gravel Bar	3898			
Carolina Willow Shrubland	3899			
Floodplain Canebrake	3836	Floodplain Communities		N/A
Water Lily Aquatic Wetland	2386	Sloughs	Riverine Emergent Aquatic Communities	Gravel Bar and Gravel Washes
Vegetated Spring Branch	N/A	Springs		N/A
Ozark Fen	2404	Fens	Fens	Fens and Seeps
Ozark Prairie Fen	2416			
Buttonbush Sinkhole Pond Swamp	4742	Marshes	Marshes	Sinkholes
Sinkhole Pond Marsh	2413			
Dry Igneous Cliff	2286	Cliffs	Cliffs and Talus	Cliffs
Moist Igneous Cliff	2289			
Dry Dolomite Cliff	2291			
Moist Dolomite Cliff	2292			
Dolomite Talus	2308	Talus		N/A
Igneous Talus	5203			N/A

**Appendix 4 References**

Nigh, T., Buck, C., Grabner, J., Kabrick, J. and Meinert, D. 2000. An ecological classification system for the Current River Hills. Working Draft. Missouri Department of Conservation, Jefferson City, MO.

## Appendix 4. ONSR Ecological Systems-MOECS Management Units Crosswalk

**Appendix 5. Crosswalk of ecological systems used in the mapping area with ecological systems developed by NatureServe.**

USNVC Vegetation Association	Code	ONSR Community Type	ONSR Ecological System	NatureServe Ecological System (2005)
<b>Forests</b>				
Post Oak Flatwoods	2405	Post Oak Flatwoods	Upland Oak Forests	Ozark-Ouachita Dry Oak Woodland CES202.707
Ozark Black Oak, Scarlet Oak Forest	2399	Mixed Oak-Hickory Forests		
Black Oak-White Oak-Hickory Forest	2076			
White Oak Dolomite Forest	2070	White Oak Forests		Ozark-Ouachita Dry-Mesic Oak Forest CES202.708
White Oak/Dogwood Forest	2066			
White Oak-Red Oak-Sugar Maple Mesic Forest	2058	Oak-Mixed Hardwood Mesic Upland Forests	Mesic Upland Forests	
Pine/Blueberry Forest	2400	Pine and Pine-Oak Forests	Upland Pine and Pine-Oak Forests	Ozark-Ouachita Shortleaf Pine-Oak Forest and Woodland CES202.313
Interior Highlands Shortleaf Pine-Oak Dry-mesic Forest	7489			
Shortleaf Pine-Black Oak Forest	2401			
Overcup Oak Pond Forest	4642	Sinkhole Pond Forest	Wet Forests	Central Interior Highlands and Appalachian Sinkhole and Depression Pond CES202.018
Red Maple Forested Seep	2407	Forested Seep		Interior Highlands Forested Acid Seep CES202.321
Sugar Maple-Oak-Bitternut Hickory Mesic Bottomland Forest	2060	Mixed Hardwood Mesic Bottomland Forests	Bottomland Forests	Ozark-Ouachita Riparian CES202.703
Sycamore-Silver Maple Floodplain Forest	7334			South-Central Interior Large Floodplain CES202.705
Box Elder Forest	5033			
Ash-Oak-Sycamore Mesic Bottomland Forest	2410			North-Central Interior Floodplain CES202.694

Appendix 5. ONSR Ecological Systems-NatureServe Ecological Systems Crosswalk

<b>Woodlands</b>				
Post Oak-Blackjack Oak/Little Bluestem Woodland	2149	Dolomite Woodland Complexes	Upland Oak Woodlands	Central Interior Highlands Dry Acidic Glade and Barrens CES202.692
Chinquapin Oak-Ash/Little Bluestem Woodland	2143			Central Interior Highlands Calcareous Glade and Barrens CES202.691
Chinquapin Oak-Red Cedar Dry Alkaline Forest	2108			
Ozark Dolomite Glade	2398			
Midwest Post Oak-Blackjack Oak Forest	2075	Igneous Woodland Complexes		Ozark-Ouachita Dry Oak Woodland CES202.707
Midwest Post Oak-Blackjack Oak Forest (igneous phase)	2075i			N/A
Post Oak-Blackjack Oak/Little Bluestem Woodland	2149			Central Interior Highlands Dry Acidic Glade and Barrens CES202.692
Blackjack Oak Xeric Scrub	2425			
Ozark Igneous Glade	2243			
Shortleaf Pine/Little Bluestem Woodland	2402	Pine and Pine-Oak Woodlands	Pine and Pine-Oak Woodlands	Ozark-Ouachita Shortleaf Pine-Oak Forest and Woodland CES202.313
Shortleaf Pine-Oak Dry Woodland	2393			

Appendix 5. ONSR Ecological Systems-NatureServe Ecological Systems Crosswalk

<b>Shrublands/Herbaceous</b>				
Riverine Sand Flats (Herbaceous gravel bar)	2049	Active Channel/Gravel Bar Communities	Riverine Shrublands/Herbaceous Communities	Ozark-Ouachita Riparian CES202.703
Witchhazel, Dogwood Gravel Wash	3898			South-Central Interior Large Floodplain CES202.705
Carolina Willow Shrubland	3899			
Floodplain Canebrake	3836	Floodplain Communities	Riverine Emergent Aquatic Communities	N/A
Water Lily Aquatic Wetland	2386	Sloughs		
Vegetated Spring Branch	N/A	Springs	Fens	Ozark-Ouchita Fen CES202.052
Ozark Fen	2404	Fens		
Ozark Prairie Fen	2416			
Buttonbush Sinkhole Pond Swamp	4742	Marshes	Marshes	Central Interior Highlands and Appalachian Sinkhole and Depression Pond CES202.018
Sinkhole Pond Marsh	2413			
Dry Igneous Cliff	2286	Cliffs	Cliffs and Talus	Central Interior Acidic Cliff and Talus CES202.689
Moist Igneous Cliff	2289			
Dry Dolomite Cliff	2291			Central Interior Calcareous Cliff and Talus CES202.690
Moist Dolomite Cliff	2292			
Dolomite Talus	2308	Talus	Central Interior Acidic Cliff and Talus CES202.689	
Igneous Talus	5203			

**Appendix 5 References**

NatureServe. 2005. International ecological classification standard: Terrestrial ecological classifications. NatureServe Central Databases. Arlington, VA. U.S.A. Data current as of 30 September, 2005. ([www.natureserve.org](http://www.natureserve.org))

Appendix 5. ONSR Ecological Systems-NatureServe Ecological Systems Crosswalk



Appendix 6. Crosswalk of ecological systems used to map altered communities.

**Appendix 6. Crosswalk of ecological systems used to map altered communities within the mapping area and Anderson’s classification system for built-up and aquatic features (Anderson, 1976) and the Federal Geographic Data Committee (FGDC) classification of cultivated lands.**

USNVC Vegetation Association	Code	ONSR Community Type	ONSR Ecological System	Level 2 Anderson or FGDC ( <i>italics</i> )	Level 1 Anderson or FGDC ( <i>italics</i> )
<b>Vegetated Features</b>					
Oak-Hickory Regeneration Stand	SA02	Regeneration Stand	Timber Management Area	N/A	N/A
Pine-Oak Regeneration Stand	SA05				
Oak-Hickory Shelterwood/Select Harvest	SA01	Shelterwood/Select Harvest			
Pine-Oak Shelterwood/Select Harvest	SA04				
Oak-Hickory Pole Stand	SA03	Pole Stand			
Pine-Oak Pole Stand	SA06				
Pine Pole Stand	SA08				
Pine Plantation	SA07	Pine Plantation			
Pine-Deciduous Shrubby Old Field	SA12	Open Old Field with	Old Fields		
Deciduous Shrubby Old Field	SA09	Shrubby or Sparse Trees			
Herbaceous Old Field	SA23				
Cedar-Deciduous Shrubby Old Field	SA36				
Deciduous Forested Old Field	SA10	Wooded Old Field			
Pine-Deciduous Wooded Old Field	SA11				
Cedar-Deciduous Wooded Old Field	SA13				
Pine Old Field	SA14				
Cedar Old Field	SA15				
Agricultural Forested Woodlot	SA37	Agricultural Woodlot	Agricultural Field/Pasture		
Hayfield/Grazing Land	SA20	Agricultural Field/Pasture		<i>Close grown</i>	<i>Herbaceous</i>
lose Grown Monoculture	SA21				
Row Crops	SA22			<i>Row Crop</i>	

Appendix 6. Crosswalk of ecological systems used to map altered communities.

<b>Cultural and Built-up Features</b>					
Deciduous Wooded Residence	SA16	Residential	Residential	Residential	Urban or Built-up Land
Evergreen-Deciduous Wooded Residence	SA17				
Evergreen Wooded Residence	SA18				
Lawn	SA19				
Residential (structures)	SA35				
Industrial	SA26	Industrial/ Quarry	Industrial/ Quarry	Industrial	
Industrial/Commercial	SA27			Industrial and Commercial Complexes	
Commercial	SA28	Urban	Urban	Commercial and Services	
Commercial/Services	SA29			Mixed Urban or Built-up Land	
Mixed	SA30				
Other Clearing	SA31	Other Clearing	Other Clearing	Other Urban or Built-up Land	
Transportation Corridor (Road)	SA32	Trans. Corridor	Trans. Corridor	Transportation, Communication and Utilities	
Shrubby Utility Corridor	SA33	Utility Corridor	Utility Corridor		
Herbaceous Utility Corridor	SA34				
Hatchery	SA24	Surface Water	Surface Water	Lakes	Water (non-vegetated portion)
Lake/Pond	SA25				

**Appendix 6 References**

Anderson, J.R., Hardy, E.E. and Roach, J.T. 1976. Land use and land cover classification System for use with remote sensing data. Geological Survey Professional Paper 964. A revision of the land use classification system as presented in US. Geological Circular 671. U. S. Government Printing Office, Washington, D.C.

## Appendix 7. Automated classification data derivatives and transformation techniques.

**Table A7-1.** Data derivatives obtained from the October 2002 aerial photo images.

ir2m	Reflectance in the infrared wavelength from 2 meter resolution image data
red2m	Reflectance in the red wavelength (2 meter resolution)
green2m	Reflectance in the green wavelength (2 meter resolution)
illalb2m	Illumination/albedo surface; 2 meter resolution ( $\text{Sqrt}(\text{IR}^2 + \text{Red}^2 + \text{Green}^2)$ )
div112m	Diversity of brightness values in the illumination/albedo surface (11x11 window)
sd112m	Standard deviation of brightness values in the illumination/albedo surface (11x11)
variance2m	Variance of brightness values in the illumination/albedo surface (11x11)
propbright15	Proportion of bright pixels in a 15x15 neighborhood (2 meter resolution)
propbright25	Proportion of bright pixels in a 25x25 neighborhood (2 meter resolution)
sqvi2m	Square root vegetation index; 2 meter resolution ( $\text{Sqrt}(\text{IR}/\text{Red})$ )
ndvi2m	Normalized difference vegetation index; 2 meter resolution ( $\text{Red} - \text{IR}/\text{Red} + \text{IR}$ )
pc12m	Principal component 1 (2 meter resolution)
pc22m	Principal component 2 (2 meter resolution)
pc32m	Principal component 3 (2 meter resolution)
shadir2m	Infrared reflectance with shadows masked out (2 meter)
shadred2m	Red reflectance with shadows masked out (2 meter)
shadgreen2m	Green reflectance with shadows masked out (2 meter)
msqvi2m	Square root vegetation index with shadows masked (2 meter resolution)
mndvi2m	Normalized difference vegetation index with shadows masked (2 meter)
ir14m	Reflectance in the infrared wavelength (14 meter resolution)
red14m	Reflectance in the red wavelength (14 meter resolution)
green14m	Reflectance in the green wavelength (14 meter resolution)
illalb14m	Illumination/albedo surface; 14 meter resolution ( $\text{Sqrt}(\text{IR}^2 + \text{Red}^2 + \text{Green}^2)$ )
sqvi14m	Square root vegetation index; 14 meter resolution ( $\text{Sqrt}(\text{IR}/\text{Red})$ )
ndvi14m	Normalized difference vegetation index; 14 meter resolution ( $\text{Red} - \text{IR}/\text{Red} + \text{IR}$ )
pc114m	Principal component 1 (14 meter resolution)
pc214m	Principal component 2 (14 meter resolution)
pc314m	Principal component 3 (14 meter resolution)
shadir14m	Infrared reflectance with shadows masked out (14 meter)
shadred14m	Red reflectance with shadows masked out (14 meter)
shadgreen14m	Green reflectance with shadows masked out (14 meter)
msqvi14m	Square root vegetation index with shadows masked (14 meter)
mndvi14m	Normalized difference vegetation index with shadows masked (14 meter)
ir30m	Reflectance in the infrared wavelength (30 meter resolution)
red30m	Reflectance in the red wavelength (30 meter resolution)
green30m	Reflectance in the green wavelength (30 meter resolution)
illalb30m	Illumination/albedo surface; 30 meter resolution ( $\text{Sqrt}(\text{IR}^2 + \text{Red}^2 + \text{Green}^2)$ )
sqvi30m	Square root vegetation index; 30 meter resolution ( $\text{Sqrt}(\text{IR}/\text{Red})$ )
ndvi30m	Normalized difference vegetation index; 30 meter resolution ( $\text{Red} - \text{IR}/\text{Red} + \text{IR}$ )
pc130m	Principal component 1 (30 meter resolution)
pc230m	Principal component 2 (30 meter resolution)
pc330m	Principal component 3 (30 meter resolution)
shadir30m	Infrared reflectance with shadows masked out (30 meter)
shadred30m	Red reflectance with shadows masked out (30 meter)
shadgreen30m	Green reflectance with shadows masked out (30 meter)
msqvi30m	Square root vegetation index with shadows masked (30 meter)
mndvi30m	Normalized difference vegetation index with shadows masked (30 meter)

**Table A7-2.** Data derivatives obtained from the summer 2003 NAIP image data (2-meter resolution).

naipir	NAIP infrared reflectance
naipred	NAIP red reflectance
naipgreen	NAIP green reflectance
naipirmedian15	Median of infrared reflectance in a 15x15 neighborhood
naipredmedian15	Median of red reflectance in a 15x15 neighborhood
naipgreenmedian15	Median of green reflectance in a 15x15 neighborhood
naipndvi	Normalized difference vegetation index
naipndvimedian15	Median of NDVI in a 15x15 neighborhood
naipsqvi	Square root vegetation index
naipsqvimedian15	Median of square root vegetation index in a 15x15 neighborhood

**Normalization of TM data**

An empirical model relating solar illumination angle to differential reflectance of forested pixels was developed band by band for TM data. The regression equation and parameter values for each band are given in Table A7-3. An empirical model relating solar illumination angle to differential reflectance of forested pixels was developed band by band ( $\cos(i)$ ), computed pixel by pixel from a 30 m digital elevation model and solar azimuth and elevation values for the Landsat overflight) such that illumination corrected reflectance ( $R_i$ ) is calculated as:

$$R_i = R_o - \cos(i) \cdot M - B + \hat{R}$$

where M and B are regression parameters,  $R_o$  is the original reflectance, and  $\hat{R}$  is the mean reflectance (Meyer and others, 1993). Regression parameters for each study area are reported in Table A7-3.

**Table A7-3.** Model parameters applied to cos-i correction of Landsat data for the winter ETM+ (n=1,123) and summer TM (n=1,125) images.

Parameter	Enhanced Thematic Mapper (ETM) Bands					
	ETM+1	ETM+2	ETM+3	ETM+4	ETM+5	ETM+6
Winter ETM Image (03/13/02)						
Mean	66.47	49.79	56.65	67.82	94.79	60.59
R2	0.7517	0.8543	0.8648	0.9262	0.8696	0.8362
Intercept	-147.72	-9.733	62.612	70.64	97.486	97.222
Slope	4.72	3.54	1.836	1.415	0.729	1.145
p	>.0001	>.0001	>.0001	>.0001	>.0001	>.0001
Summer TM Image (07/05/00)						
Mean	38.25	27.59	16.71	157.86	79.98	37.43
R2	0.3467	0.4645	0.5691	0.8486	0.7339	0.654
Intercept	146.89	148.83	139.72	112.23	110.21	130.54
Slope	1.003	1.321	2.726	0.463	0.938	1.462
p	>.0001	>.0001	>.0001	>.0001	>.0001	>.0001

Normalization equation takes the form of  $Y = \text{old TM radiance} - \cos i \cdot \text{slope} - \text{intercept} + \text{mean}$  where Y is the new TM/ETM radiance.

Appendix 7. Automated classification data derivatives and transformation techniques.

**Table A7-4.** Data derivatives obtained from summer and winter Landsat TM/ETM image data (30-meter resolution).

<b>tmsum_b1</b>	Band 1 (blue: 0.45-0.52 $\mu\text{m}$ ) from July 5, 2000 TM image
<b>tmsum_b2</b>	Band 2 (green: 0.52-0.60 $\mu\text{m}$ ) from July 5, 2000 TM image
<b>tmsum_b3</b>	Band 3 (red: 0.63-0.69 $\mu\text{m}$ ) from July 5, 2000 TM image
<b>tmsum_b4</b>	Band 4 (infrared: 0.76-0.9 $\mu\text{m}$ ) from July 5, 2000 TM image
<b>tmsum_b5</b>	Band 5 (mid-IR: 1.55-1.75 $\mu\text{m}$ ) from July 5, 2000 TM image
<b>tmsum_b6</b>	Band 7 (mid-IR: 2.08-2.35 $\mu\text{m}$ ) from July 5, 2000 TM image
<b>tmsum_pc1</b>	Principal component 1 from July 5, 2000 TM image
<b>tmsum_pc2</b>	Principal component 2 from July 5, 2000 TM image
<b>tmsum_pc3</b>	Principal component 3 from July 5, 2000 TM image
<b>tmsum_tc1</b>	Tasseled cap brightness from July 5, 2000 TM image
<b>tmsum_tc2</b>	Tasseled cap greenness from July 5, 2000 TM image
<b>tmsum_tc3</b>	Tasseled cap wetness from July 5, 2000 TM image
<b>tmsum_ndvi</b>	NDVI (IR - Red / IR + Red) obtained from July 5, 2000 TM image
<b>tmsum_ndmi</b>	NDMI (IR - MIR / IR + MIR) obtained from July 5, 2000 TM image
<b>tmwin_b1</b>	Band 1 (blue: 0.45-0.52 $\mu\text{m}$ ) from March 13, 2002 ETM image
<b>tmwin_b2</b>	Band 2 (green: 0.52-0.60 $\mu\text{m}$ ) from March 13, 2002 ETM image
<b>tmwin_b3</b>	Band 3 (red: 0.63-0.69 $\mu\text{m}$ ) from March 13, 2002 ETM image
<b>tmwin_b4</b>	Band 4 (infrared: 0.76-0.9 $\mu\text{m}$ ) from March 13, 2002 ETM image
<b>tmwin_b5</b>	Band 5 (mid-IR: 1.55-1.75 $\mu\text{m}$ ) from March 13, 2002 ETM image
<b>tmwin_b6</b>	Band 7 (mid-IR: 2.08-2.35 $\mu\text{m}$ ) from March 13, 2002 ETM image
<b>tmwin_pc1</b>	Principal component 1 from March 13, 2002 ETM image
<b>tmwin_pc2</b>	Principal component 2 from March 13, 2002 ETM image
<b>tmwin_pc3</b>	Principal component 3 from March 13, 2002 ETM image
<b>tmwin_tc1</b>	Tasseled cap brightness from March 13, 2002 ETM image
<b>tmwin_tc2</b>	Tasseled cap greenness from March 13, 2002 ETM image
<b>tmwin_tc3</b>	Tasseled cap wetness from March 13, 2002 ETM image
<b>tmwin_ndvi</b>	NDVI (IR - Red / IR + Red) obtained from March 13, 2002 ETM image
<b>tmwin_ndmi</b>	NDMI (IR - MIR / IR + MIR) obtained from March 13, 2002 ETM image

Appendix 7. Automated classification data derivatives and transformation techniques.

**Table A7-5.** Topographic data derivatives obtained from 10 meter resolution digital elevation data.

<b>slope</b>	Slope angle in degrees – values range from 0-90
<b>beer100</b>	Beers-transformed slope aspect; index ranges from 0 to 200, with 0 being a grid cell that faces southwest, 100 indicating either northwest or southeast and 200 being northeast; the formula is $(\cos(\text{aspect} - 45) + 1) * 100$
<b>trnbeer</b>	Slope multiplied by Beers transformed aspect
<b>rsp</b>	Relative slope position; ranges from 0 to 100, where 0 is a valley bottom and 100 is a ridgetop.
<b>tci</b>	Topographic convergence index (TCI) is a measure of potential wetness; the formula is $\ln\alpha/\tan\beta$ where $\ln\alpha$ is the log of the upslope contributing area of a grid cell and $\tan\beta$ is the tangent of the slope of a grid cell
<b>trmi</b>	Parker's terrain relative moisture index; computed as slope + aspect + curvature + slope position; ranges in value from 0 to 60
<b>rise</b>	Elevation rise in meters from Current or Jacks Fork Rivers; river channels have an elevation value of 0

### Appendix 7 References

Meyer, P., Itten, K.I., Kellenberger, T., Sandmeier, S. and Sandmeier, R. 1993. Radiometric corrections of topographically induced effects on Landsat data in an alpine environment. ISPRS Journal of Photogrammetry and Remote Sensing, 48(4): 17-28.

Appendix 8. Results of importance value (IV) calculations for the major USNVC vegetation associations in the ONSR mapping area

**Appendix 8. Results of importance value (IV) calculations for the major USNVC vegetation associations in the ONSR mapping area, with average cover and relative frequency presented by species and the number of field observations listed.**

N.B. values are based upon vegetative cover estimates for dominant species collected when describing vegetation, rather than upon plot data

Species Abbreviation Key:

acerneg = *Acer negundo*  
acerrub = *Acer rubra*  
acersac = *Acer saccharum*  
acersacn = *Acer saccharinum*  
betunig = *Betula nigra*  
caryalb = *Carya alba*  
carycor = *Carya cordiformis*  
carygla = *Carya glabra*  
caryova = *Carya ovata*  
carytex = *Carya texana*  
celtocc = *Celtis occidentalis*  
fraxame = *Fraxinus americana*  
fraxpen = *Fraxinus pennsylvanicus*  
gledtri = *Gleditsia triacanthos*  
juglnig = *Juglans nigra*  
junivir = *Juniperus virginiana*  
nysssyl = *Nyssa sylvatica*  
pinuech = *Pinus Echinata*  
platocc = *platanus occidentalis*  
popudel = *populus deltoides*  
queralb = *Quercus alba*  
quercoc = *Quercus coccinea*  
quermac = *Quercus macrocarpa*  
quermar = *Quercus marilandica*  
quermue = *Quercus muehlenbergii*  
querrub = *Quercus rubra*  
quersh = *Quercus shumardii*  
querstel = *Quercus stellata*  
quervel = *Quercus velutina*  
salicar = *Salix caroliniana*  
sassalb = *Sassafras albidum*  
tiliame = *Tilia americana*  
ulmuala = *Ulmus alata*  
ulmuame = *Ulmus americana*  
umlurub = *Ulmus rubra*

Appendix 8. Results of importance value (IV) calculations for the major USNVC vegetation associations in the ONSR mapping area

<b>USNVC = 2058, N = 14</b>			
<b>spp</b>	<b>cover</b>	<b>relfreq</b>	<b>IV</b>
queralb	28.40	0.43	0.1217
acersac	24.23	0.50	0.1211
carycor	21.97	0.50	0.1099
querrub	16.73	0.57	0.0956
quermue	12.17	0.43	0.0521
juglnig	14.25	0.29	0.0407
fraxame	14.33	0.21	0.0307
carygla	20.00	0.14	0.0286
platocc	8.52	0.21	0.0183
ulmurub	20.00	0.07	0.0143
caryalb	19.60	0.07	0.0140
tiliame	6.50	0.14	0.0093
ulmuame	10.00	0.07	0.0071
celtocc	8.50	0.07	0.0061
pinuech	0.85	0.07	0.0006
<b>USNVC = 2066, N = 32</b>			
<b>spp</b>	<b>cover</b>	<b>relfreq</b>	<b>IV</b>
queralb	52.47	1.00	0.5247
querrub	19.16	0.81	0.1557
carygla	10.66	0.41	0.0433
quercoc	11.44	0.28	0.0322
quervel	8.80	0.31	0.0275
caryalb	12.60	0.16	0.0197
juglnig	7.12	0.25	0.0178
acersac	5.76	0.25	0.0144
carycor	7.88	0.13	0.0098
ulmurub	10.00	0.06	0.0063
pinuech	9.25	0.06	0.0058
nyssyl	5.33	0.09	0.0050
fraxame	3.00	0.16	0.0047
quermue	3.00	0.03	0.0009
fraxpen	1.89	0.03	0.0006
<b>USNVC = 2070, N = 18</b>			
<b>spp</b>	<b>cover</b>	<b>relfreq</b>	<b>IV</b>
queralb	34.43	0.89	0.3061
quermue	17.12	0.78	0.1332
querrub	17.92	0.72	0.1294
carycor	10.54	0.44	0.0468
fraxame	8.44	0.50	0.0422
platocc	13.86	0.28	0.0385



Appendix 8. Results of importance value (IV) calculations for the major USNVC vegetation associations in the ONSR mapping area

acersac	11.26	0.28	0.0313
carygla	20.00	0.11	0.0222
juglnig	5.09	0.33	0.0170
pinuech	6.95	0.22	0.0154
caryalb	20.00	0.06	0.0111
junivir	10.00	0.11	0.0111
nysssyl	6.50	0.11	0.0072
gledtri	4.10	0.17	0.0068
ulmurub	10.00	0.06	0.0056
quercoc	8.50	0.06	0.0047
fraxpen	1.89	0.06	0.0011
<b>USNVC = 2075, N = 5</b>			
<b>spp</b>	<b>cover</b>	<b>relfreq</b>	<b>IV</b>
quervel	26.70	0.80	0.2136
querste	21.20	0.80	0.1696
carytex	26.25	0.40	0.1050
querrub	22.70	0.40	0.0908
queralb	8.80	0.60	0.0528
carygla	6.30	0.20	0.0126
celtten	3.80	0.20	0.0076
quercoc	3.80	0.20	0.0076
pinuech	3.00	0.20	0.0060
juglnig	1.89	0.20	0.0038
<b>USNVC = 2076, N = 70</b>			
<b>spp</b>	<b>cover</b>	<b>relfreq</b>	<b>IV</b>
queralb	25.98	0.94	0.2450
quercoc	25.27	0.80	0.2021
quervel	19.89	0.83	0.1648
carygla	16.79	0.37	0.0624
caryalb	16.68	0.23	0.0381
pinuech	7.22	0.34	0.0247
querste	10.03	0.10	0.0100
querrub	7.28	0.11	0.0083
carytex	10.75	0.06	0.0061
juglnig	4.72	0.07	0.0034
caryova	20.00	0.01	0.0029
nysssyl	6.50	0.03	0.0019
caryalb	10.00	0.01	0.0014
ulmuala	10.00	0.01	0.0014
celtten	3.00	0.01	0.0004
<b>USNVC = 2399, N = 38</b>			
<b>spp</b>	<b>cover</b>	<b>relfreq</b>	<b>IV</b>

Appendix 8. Results of importance value (IV) calculations for the major USNVC vegetation associations in the ONSR mapping area

quervel	30.58	0.97	0.2977
quercoc	29.49	0.89	0.2639
queralb	10.54	0.84	0.0888
pinuech	9.26	0.53	0.0488
querste	12.13	0.29	0.0351
caryalb	11.58	0.11	0.0122
carygla	5.20	0.05	0.0027
carytex	2.21	0.08	0.0017
quermac	3.00	0.03	0.0008
celtten	2.55	0.03	0.0007
<b>USNVC = 2108, N = 30</b>			
<b>spp</b>	<b>cover</b>	<b>relfreq</b>	<b>IV</b>
junivir	31.63	1.00	0.3163
quermue	19.31	0.93	0.1803
querrub	14.78	0.73	0.1084
queralb	14.18	0.33	0.0473
acersac	7.09	0.30	0.0213
faguame	10.55	0.20	0.0211
querste	9.02	0.17	0.0150
pinuech	6.22	0.13	0.0083
juglnig	4.49	0.17	0.0075
platocc	3.17	0.10	0.0032
carygla	8.50	0.03	0.0028
quervel	8.50	0.03	0.0028
carytex	6.30	0.03	0.0021
caryova	3.00	0.03	0.0010
sassalb	3.00	0.03	0.0010
<b>USNVC = 2143, N = 12</b>			
<b>spp</b>	<b>cover</b>	<b>relfreq</b>	<b>IV</b>
quermue	21.63	0.92	0.1983
querrub	14.90	0.75	0.1118
querste	13.26	0.42	0.0553
queralb	16.67	0.25	0.0417
junivir	7.12	0.42	0.0297
fraxame	6.75	0.33	0.0225
juglnig	11.40	0.08	0.0095
caryalb	5.05	0.17	0.0084
acersac	4.65	0.17	0.0078
carycor	6.30	0.08	0.0053
caryova	6.30	0.08	0.0053
ulmurub	2.07	0.17	0.0035
<b>USNVC=2149, N = 4</b>			

Appendix 8. Results of importance value (IV) calculations for the major USNVC vegetation associations in the ONSR mapping area

<b>spp</b>	<b>cover</b>	<b>relfreq</b>	<b>IV</b>
querste	14.08	1.00	0.1408
quervel	20.00	0.67	0.1333
carytex	23.55	0.50	0.1178
queralb	10.00	0.75	0.0750
carygla	20.00	0.25	0.0500
pinuech	10.00	0.50	0.0500
querrub	6.30	0.25	0.0158
quercoc	3.00	0.25	0.0075
quermar	1.89	0.25	0.0047
<b>USNVC = 2398, N = 8</b>			
<b>spp</b>	<b>cover</b>	<b>relfreq</b>	<b>IV</b>
junivir	25.00	0.50	0.1250
andrscop	40.00	0.25	0.1000
querste	15.75	0.50	0.0788
quermue	4.75	0.50	0.0238
querrub	6.50	0.25	0.0163
boutcurt	10.00	0.13	0.0125
commrich	10.00	0.13	0.0125
liatpych	10.00	0.13	0.0125
quershu	10.00	0.13	0.0125
rudbmiss	10.00	0.13	0.0125
<b>USNVC = 2393, N = 7</b>			
<b>spp</b>	<b>cover</b>	<b>relfreq</b>	<b>IV</b>
pinuech	20.00	1.00	0.2000
querste	17.14	1.00	0.1714
quervel	18.00	0.71	0.1286
quercoc	16.67	0.43	0.0714
queralb	8.17	0.86	0.0700
quermar	8.67	0.43	0.0371
quermue	3.00	0.29	0.0086
<b>USNVC = 2401, N = 38</b>			
<b>spp</b>	<b>cover</b>	<b>relfreq</b>	<b>IV</b>
pinuech	28.19	1.00	0.2819
quercoc	22.41	0.92	0.2064
quervel	18.94	0.89	0.1695
queralb	10.47	0.79	0.0826
querste	15.59	0.39	0.0615
carygla	5.20	0.05	0.0027
caryalb	10.00	0.03	0.0026
carytex	3.00	0.03	0.0008
quermar	3.00	0.03	0.0008

Appendix 8. Results of importance value (IV) calculations for the major USNVC vegetation associations in the ONSR mapping area

<b>USNVC = 7489, N = 24</b>			
<b>spp</b>	<b>cover</b>	<b>relfreq</b>	<b>IV</b>
pinuech	27.53	1.00	0.2753
queralb	22.81	1.00	0.2281
quercoc	17.16	0.83	0.1430
quervel	11.60	0.63	0.0725
carygla	11.40	0.33	0.0380
querrub	13.15	0.17	0.0219
caryalb	15.17	0.13	0.0190
querste	5.53	0.08	0.0046
juglnig	8.50	0.04	0.0035
nysssyl	2.94	0.04	0.0012
<b>USNVC = 3899, N = 12</b>			
<b>spp</b>	<b>cover</b>	<b>relfreq</b>	<b>IV</b>
platocc	21.93	1.00	0.2193
salicar	17.51	1.00	0.1751
betunig	2.07	0.17	0.0035
diosvir	3.00	0.08	0.0025
ulmurub	1.80	0.08	0.0015
acersacn	1.14	0.08	0.0010
juglnig	1.14	0.08	0.0010
amorfru	1.00	0.08	0.0008
<b>USNVC = 2410, N = 11</b>			
<b>spp</b>	<b>cover</b>	<b>relfreq</b>	<b>IV</b>
platocc	26.67	1.00	0.2667
juglnig	17.85	0.82	0.1460
fraxpen	23.17	0.27	0.0632
carycor	12.88	0.45	0.0585
acersacn	29.75	0.18	0.0541
acerneg	11.38	0.36	0.0414
quermac	19.00	0.18	0.0345
fraxame	12.00	0.27	0.0327
querrub	10.63	0.27	0.0290
ulmurub	6.80	0.27	0.0185
queralb	18.90	0.09	0.0172
ulmuame	10.00	0.09	0.0091
quershu	8.50	0.09	0.0077
acersac	3.00	0.09	0.0027
<b>USNVC = 5033, N = 8</b>			
<b>spp</b>	<b>cover</b>	<b>relfreq</b>	<b>IV</b>
acerneg	43.53	1.00	0.4353

Appendix 8. Results of importance value (IV) calculations for the major USNVC vegetation associations in the ONSR mapping area

platocc	20.64	0.50	0.1032
acersacn	26.67	0.38	0.1000
fraxame	30.00	0.13	0.0375
fraxpen	11.50	0.25	0.0288
ulmurub	11.28	0.25	0.0282
celtocc	20.00	0.13	0.0250
juglnig	10.00	0.25	0.0250
quermue	17.00	0.13	0.0213
gledtri	6.28	0.25	0.0157
betunig	10.00	0.13	0.0125
quermac	10.00	0.13	0.0125
<b>USNVC = 7334, N = 31</b>			
<b>spp</b>	<b>cover</b>	<b>relfreq</b>	<b>IV</b>
platocc	43.15	1.00	0.4315
acersacn	22.18	0.42	0.0930
acerneg	16.56	0.35	0.0588
ulmurub	14.68	0.32	0.0474
juglnig	13.25	0.19	0.0256
popudel	13.31	0.16	0.0215
betunig	11.86	0.16	0.0191
ulmuame	16.67	0.10	0.0161
liritul	34.00	0.03	0.0110
gledtri	10.00	0.06	0.0065
salicar	20.00	0.03	0.0065
celtocc	9.25	0.06	0.0060
fraxame	10.00	0.03	0.0032
fraxpen	10.00	0.03	0.0032
acersac	8.50	0.03	0.0027
queralb	8.50	0.03	0.0027
carycor	3.00	0.03	0.0010
quermac	3.00	0.03	0.0010
<b>USNVC = 2060, N = 10</b>			
<b>spp</b>	<b>cover</b>	<b>relfreq</b>	<b>IV</b>
queralb	26.84	0.80	0.2147
acersac	22.95	0.80	0.1836
querrub	21.68	0.80	0.1734
carycor	21.18	0.50	0.1059
juglnig	16.00	0.50	0.0800
quermue	13.33	0.30	0.0400
platocc	18.30	0.20	0.0366
nysssyl	9.25	0.20	0.0185
tiliame	5.95	0.20	0.0119
faguame	10.00	0.10	0.0100

Appendix 8. Results of importance value (IV) calculations for the major USNVC vegetation associations in the ONSR mapping area

quershu	10.00	0.10	0.0100
ulmurub	10.00	0.10	0.0100
caryova	3.00	0.10	0.0030

## **Appendix 9. List of Deliverables to ONSR personnel.**

Ozar\_map (polygon coverage)

Ozar\_classmap (shapefile)

Ozar49class (10m GRID)

Ozar33class (10m GRID)

Ozar\_probmap (10m GRID)

All of the individual probability maps from the various vegetation associations

River-cliff (shapefile containing 108 cliff features digitized on the Current River between Pulltite and Van Buren)

Vegetation field plot locations used for training statistical classification (point file)

Vegetation map validation observation locations (point file)

Missouri Natural Heritage Database points clipped to ONSR mapping region

Digitized old fields from 1960s aerial photo mosaic

Aerial photo mosaic of northern section (Current River) of mapping area (2m resolution)

Photo mosaic of middle section (Current River) of mapping area (2m resolution)

Photo mosaic of southern section (Current River) of mapping area (2m resolution)

Photo mosaic of western section (Jack's Fork) of mapping area (2m resolution)

9 sections of 0.25 meter resolution photo mosaics

NAIP aerial photo mosaic of mapping area (2m resolution)

DEM elevation

DEM-derived elevation rise from river channel

DEM derived slope in degrees

DEM-derived slope aspect in degrees

DEM-derived Beers transformed slope aspect (ranges from 0-2)

DEM-derived slope and aspect multiplied

DEM-derived relative slope position (ranges from 0-100)

DEM-derived Iverson's index (60% TCI + 40% Beers)

DEM-derived TRMI (slope + aspect + curvature + slope position)

DEM-derived TCI ( $\ln a/\tan B$ )

Landsat 6 band image stack

Landsat first 3 principal components

Landsat tasseled cap brightness, greenness, and wetness

Landsat normalized difference vegetation index

Landsat normalized difference moisture index

Digitized features for entire ONSR mapping area

LTA

ELT

Underlying geology

Surface Geology

Appendix 9: List of Deliverables to ONSR personnel.



**Appendix 10. Data Dictionary.****Table A10-1.** Delineation Codes for Photointerpreted Digitized Areas (INFO field in coverages north\_delin, mid\_delin, south\_delin, jack\_delin = type).

<b>type</b>	<b>Potential Communities</b>	<b>Description</b>
1	SA32	Road/Transportation Corridor
2	SA33, SA34	Utility Corridor
3	SA31	Other Clearings
4	SA20, SA21, SA22	Agricultural Field/Pasture
5	SA02, SA05	Regeneration Stand
6	SA01, SA04	Shelterwood/Select Harvest
7	SA03, SA06, SA08	Pole Stand
8	SA07	Pine Plantation
9	River	Current, Jack's Fork, and Small Feeder Streams and Springs
10	SA24, SA25	Surface Water
11	SA09, SA12, SA23, SA36	Open Old Field (shrubby or sparse trees)
12	2398, 2149, 2143, 2108	Dolomite Glade/Woodland Complex
13	2243, 2149, 2425, 2075, 2075i	Igneous Glade/Woodland Complex
14	SA10, SA11, SA13, SA14, SA15	Wooded Old Field
15	SA37	Agricultural Forested Woodlot
16	SA28, SA29, SA30	Urban
17	SA16, SA17, SA18, SA19, SA35	Residential
18	SA26, SA27	Industrial/Quarry

**Table A10-2.** Codes for Digitized old fields ('INFO field in oldfield coverage = type).

<b>type</b>	<b>Potential Communities</b>	<b>Description</b>
1	SA23	row crop or fallow field (bright)
2	SA20	pasture
3	SA09, SA12, SA36	pasture with trees
4	Selectively Cut (SA01, SA03, SA04, SA06), Regeneration Stand (SA02, SA05), or Old Field Successional Sere (SA10, SA11, SA13, SA14, SA15)	clearing with many trees



Appendix 11. Map codes and descriptions.

**Appendix 11. Map codes and descriptions.**

**Table A11-1.** Grid codes for 49 class “Vegetation Association” level map of Ozark National Scenic Riverways (OZAR49class; Overall accuracy = 62% (kappa = .596); INFO field in Ozar\_map coverage = grid-code).

Statistically Classified Types		
grid-code	Included types	Description
1	2058	White Oak-Red Oak-Sugar Maple Mesic Forest
2	2066	White Oak/Dogwood Forest (includes types initially identified as White Oak-Red Oak Dry Mesic Acid Forest (2067)).
3	2070	White Oak Dolomite Forest
4	2075	Midwest Post Oak-Blackjack Oak Forest
5	2076	Black Oak-White Oak-Hickory Forest
6	2108	Chinkapin Oak-Red Cedar Dry Alkaline Forest
7	2143	Chinkapin Oak-Ash/Little Bluestem Woodland
8	2149	Post Oak-Blackjack Oak/Little Bluestem Woodland
9	2393	Shortleaf Pine-Oak Dry Woodland
10	2399	Ozark Black Oak, Scarlet Oak Forest
11	2400	Shortleaf Pine/Blueberry Forest
12	2401	Shortleaf Pine-Black Oak Forest
13	7489	Interior Highlands Shortleaf Pine-Oak Dry-Mesic Forest
14	SA05	Pine-Oak Regeneration Stand
15	SA07	Pine Plantation/Timber Management Forest
16	SA08	Pine Pole Stand
17	SA09	Deciduous Shrubby Old Field
18	SA13	Cedar-Deciduous Wooded Old Field
19	SA15	Cedar Old Field
20	2049	Riverine Sand Flats (Herbaceous gravel bar)
21	2060	Sugar Maple-Oak-Bitternut Hickory Mesic Bottomland Forest
22	2410	Ash-Oak-Sycamore Mesic Bottomland Forest
23	3898	Witchhazel, Dogwood Gravel Bar
24	3899	Carolina Willow Shrubland
25	5033	Box Elder Forest
26	7334	Sycamore-Silver Maple Floodplain Forest (includes types originally identified as River Birch-Sycamore Forest (2086)).
27	Bare gravel bar	Bare Gravel and/or Sand Bars
29	2149	Post Oak-Blackjack Oak/Little Bluestem Woodland - Igneous Phase
30	2243	Igneous Glade
31	2425	Blackjack Oak Xeric Scrub
32	2075i	Midwest Post Oak-Blackjack Oak Forest-Igneous Phase

Appendix 11. Map codes and descriptions.

**Table A11-1.** Grid codes for 49 class “Vegetation Association” level map of Ozark National Scenic Riverways (OZAR49class; Overall accuracy = 62% (kappa = .596); INFO field in Ozar\_map coverage = grid-code).

Photointerpreted Types		
grid-code	Included types	Description
28	River	Current, Jack’s Fork, and Small Feeder Streams and Springs
33*	SA10, SA11, SA13, SA14, SA15	Wooded Old Field
34	SA32	Road
35*	SA33, SA34	Utility Corridor
36	SA31	Other Clearing
37*	SA20, SA21, SA22	Agricultural Field/Pasture
38*	SA02, SA05	Regeneration Stand
39*	SA01, SA04	Shelterwood Cut
40*	SA03, SA06, SA08	Pole Stand
41	SA07	Pine Plantation
42*	SA24, SA25	Surface Water (lakes, ponds, etc)
43*	SA09, SA12, SA23, SA36	Open Old Field (shrubby or sparse trees)
44	2398, 2149, 2143, 2108	Dolomite Glade/Woodland Complex
45	2243, 2149, 2425, 2075, 2075i	Igneous Glade/Woodland Complex
46	SA37	Agricultural Forested Woodlot
47*	SA28, SA29, SA30	Urban
48*	SA16, SA17, SA18, SA19, SA35	Residential
49*	SA26, SA27	Industrial/Quarry

\*Aggregated to Community Type hierarchical level.

Appendix 11. Map codes and descriptions.

**Table A11-2.** Grid codes for 33 class, Community Type level map of Ozark National Scenic Riverways (OZAR33class; Overall Accuracy = 77.5% (kappa = .761), INFO field in Ozar\_map coverage = gridc77).

<b>Gridc77</b>	<b>Community Type</b>	<b>Included Vegetation Associations</b>
1	White Oak - Red Oak - Sugar Maple Mesic Forest †	2058
3*	White Oak Forests	2066, 2070
9	Shortleaf Pine-Oak Dry Woodland †	2393
10*	Mixed Oak-Hickory Forests	2076, 2399
13*	Pine and Pine-Oak Forests	2400, 2401, 7489
14	Pine-Oak Regeneration Stand †	SA05
15	Pine Plantation †	SA07
16	Pine Pole Stand †	SA08
17	Deciduous Shrubby Old Field †	SA09
18	Cedar-Deciduous Wooded Old Field †	SA13
19	Cedar Old Field †	SA15
21	Sugar Maple - Oak - Bitternut Hickory Mesic Bottomland Forest †	2060
24*	Active Channel/Gravel Bar Complex	2049, 3898, 3899
26*	Riverfront and Bottomland Forests	2410, 5033, 7334
27	Bare gravel and/or Sand Bars	Bare Gravel bar
28	Current, Jack's Fork, and Small Feeder Streams and Springs	River
44*	Dolomite Glade/Woodland Complex	2108, 2143, 2149, 2398
45*	Igneous Glade/Woodland Complex (includes statistically classified 2243)	2075, 2075i, 2149, 2243, 2425
33	Wooded Old Field	SA10, SA11, SA13, SA14, SA15
34	Transportation Corridor †	SA32
35	Utility Corridor	SA33, SA34
36	Other Clearing †	SA31
37	Agricultural Field/Pasture	SA20, SA21, SA22
38	Regeneration Stand	SA02, SA05
39	Shelterwood/Select Harvest	SA01, SA04
40	Pole Stand	SA03, SA06, SA08
41	Pine Plantation/Timber Management Area †	SA07
42	Surface Water	SA24, SA25
43	Open Old Field with Shrubby or Sparse Trees	SA09, SA12, SA23, SA36
46	Agricultural Forested Woodlot †	SA37
47	Urban	SA28, SA29, SA30
48	Residential	SA16, SA17, SA18, SA19, SA35
49	Industrial/Quarry	SA26, SA27

\*Aggregated to Community Type hierarchical level from 49 class map

†Vegetation Association name for non-aggregated types

## Appendix 11. Map codes and descriptions.

### **Codes for river\_cliffs shapefile:**

*Description – This file contains 108 cliff features immediately adjacent or very proximate to the Current River channel between Pulltite landing and the highway 60 bridge in Van Buren.*

*Locations of these cliffs were obtained via GPS by boat.*

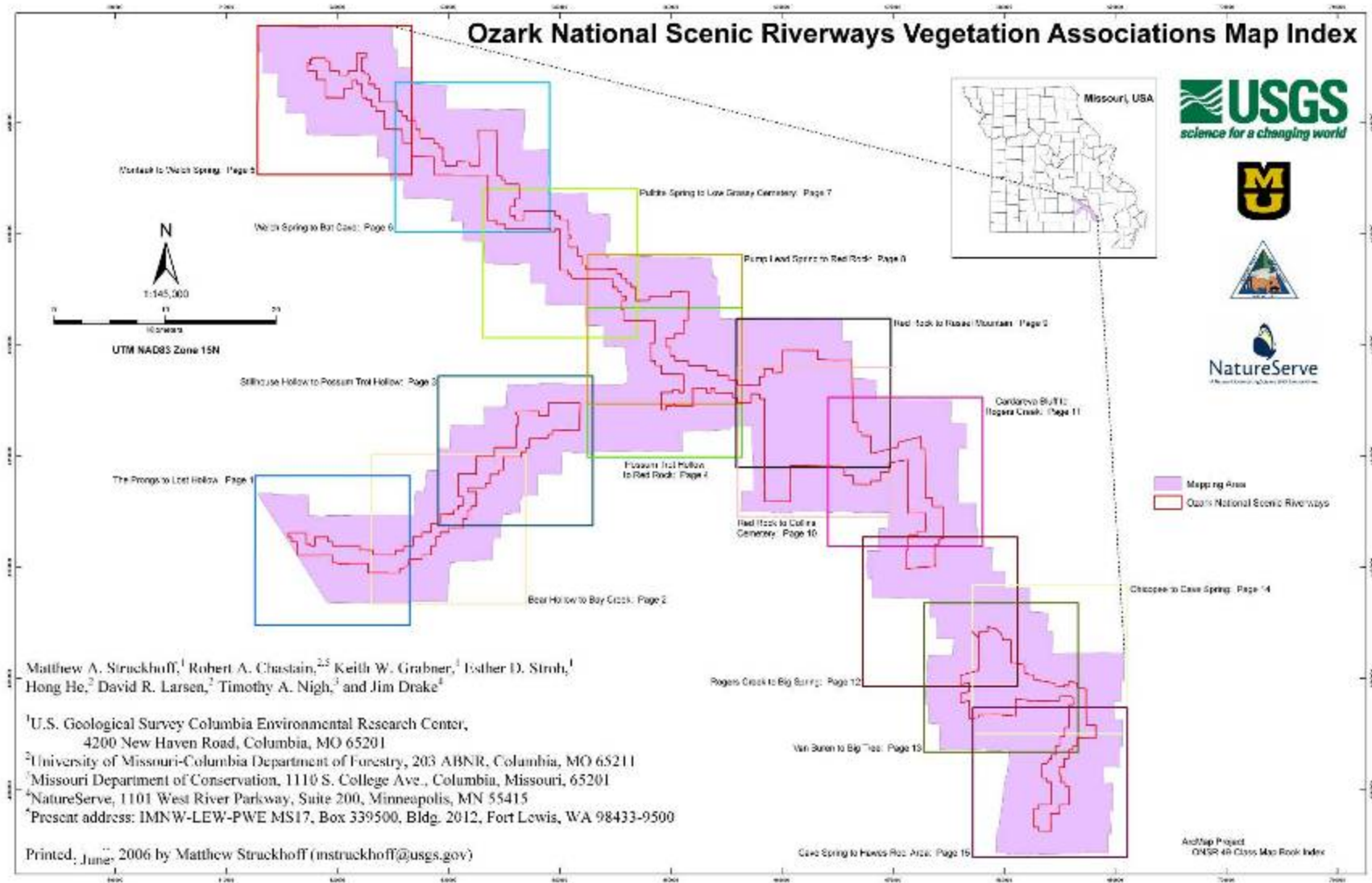
Ht\_short: Text field indicating the shortest estimated height of cliff feature

Ht\_tall: Text field indicating the tallest estimated height of cliff feature

Notes: Text field containing comments on the morphology of cliff feature

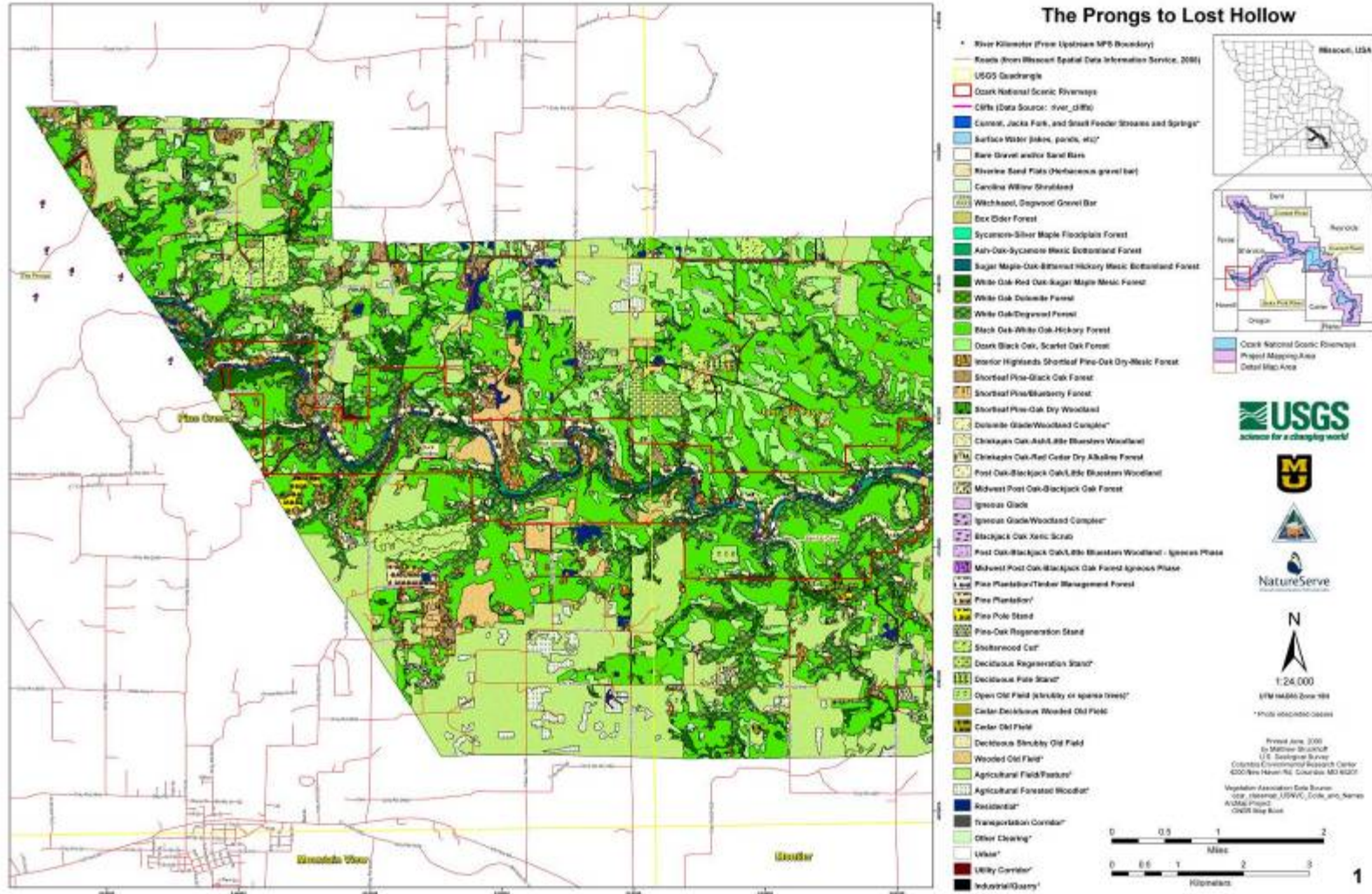
Appendix 12. 49-Class USNVC Vegetation Association Map

Appendix 12. 49-Class USNVC Vegetation Association Map (reduced copy\*).



\* Other than Map Index, map scale as displayed is 1:100,000. Original maps are 1:24,000.

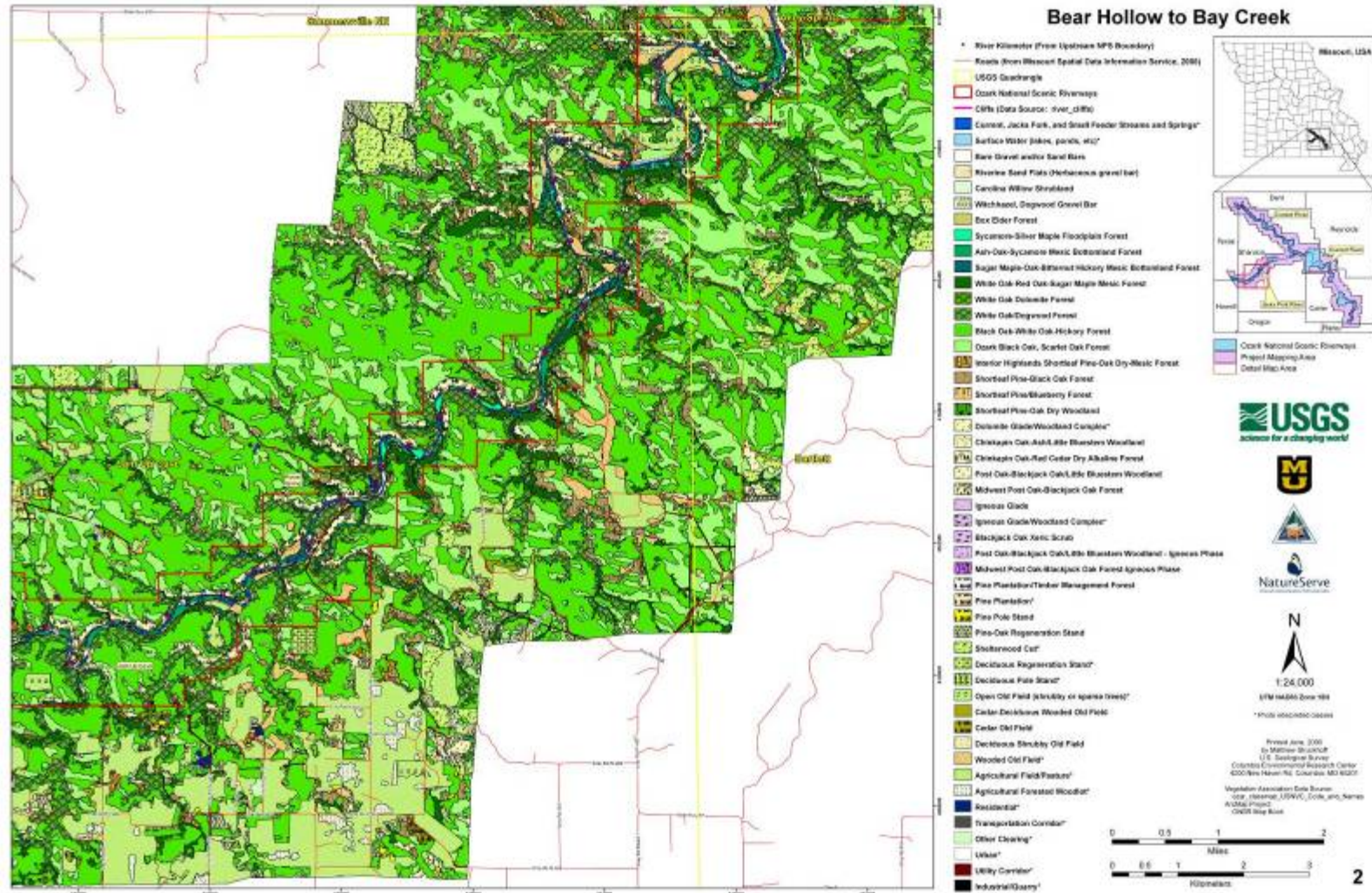
Appendix 12. 49-Class USNVC Vegetation Association Map



\* Other than Map Index, map scale as displayed is 1:100,000. Original maps are 1:24,000.



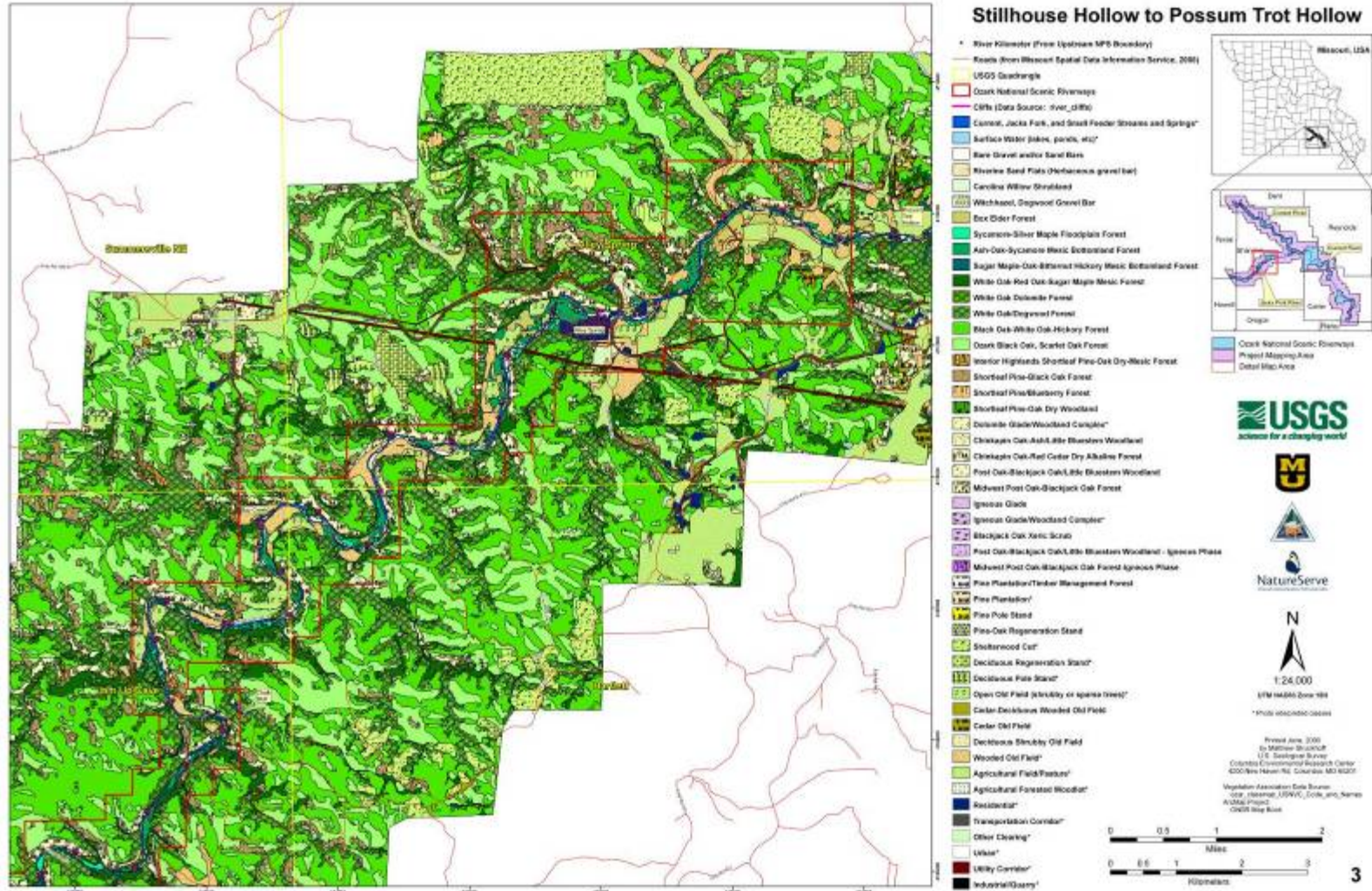
Appendix 12. 49-Class USNVC Vegetation Association Map



\* Other than Map Index, map scale as displayed is 1:100,000. Original maps are 1:24,000.



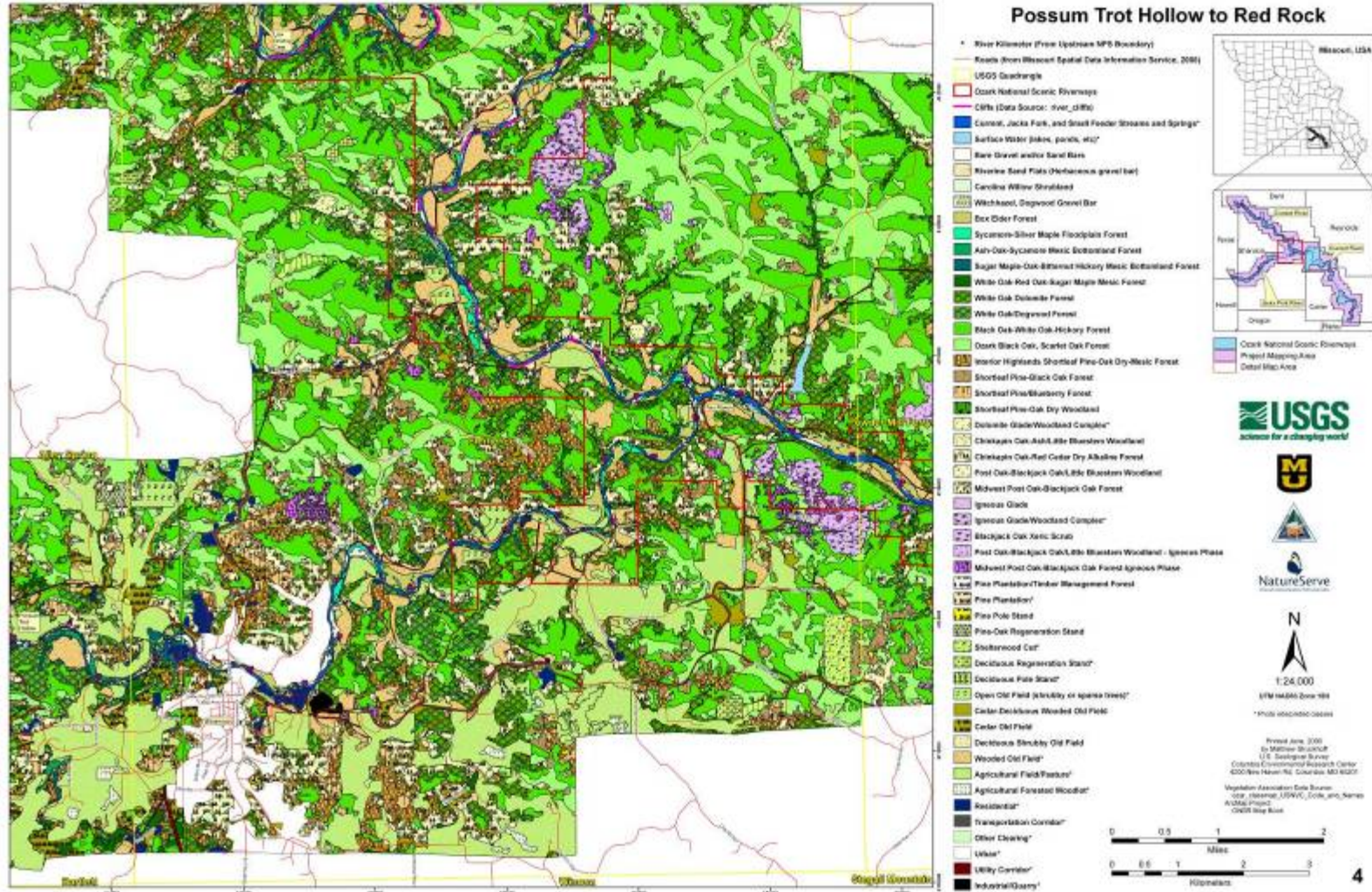
Appendix 12. 49-Class USNVC Vegetation Association Map



\* Other than Map Index, map scale as displayed is 1:100,000. Original maps are 1:24,000.



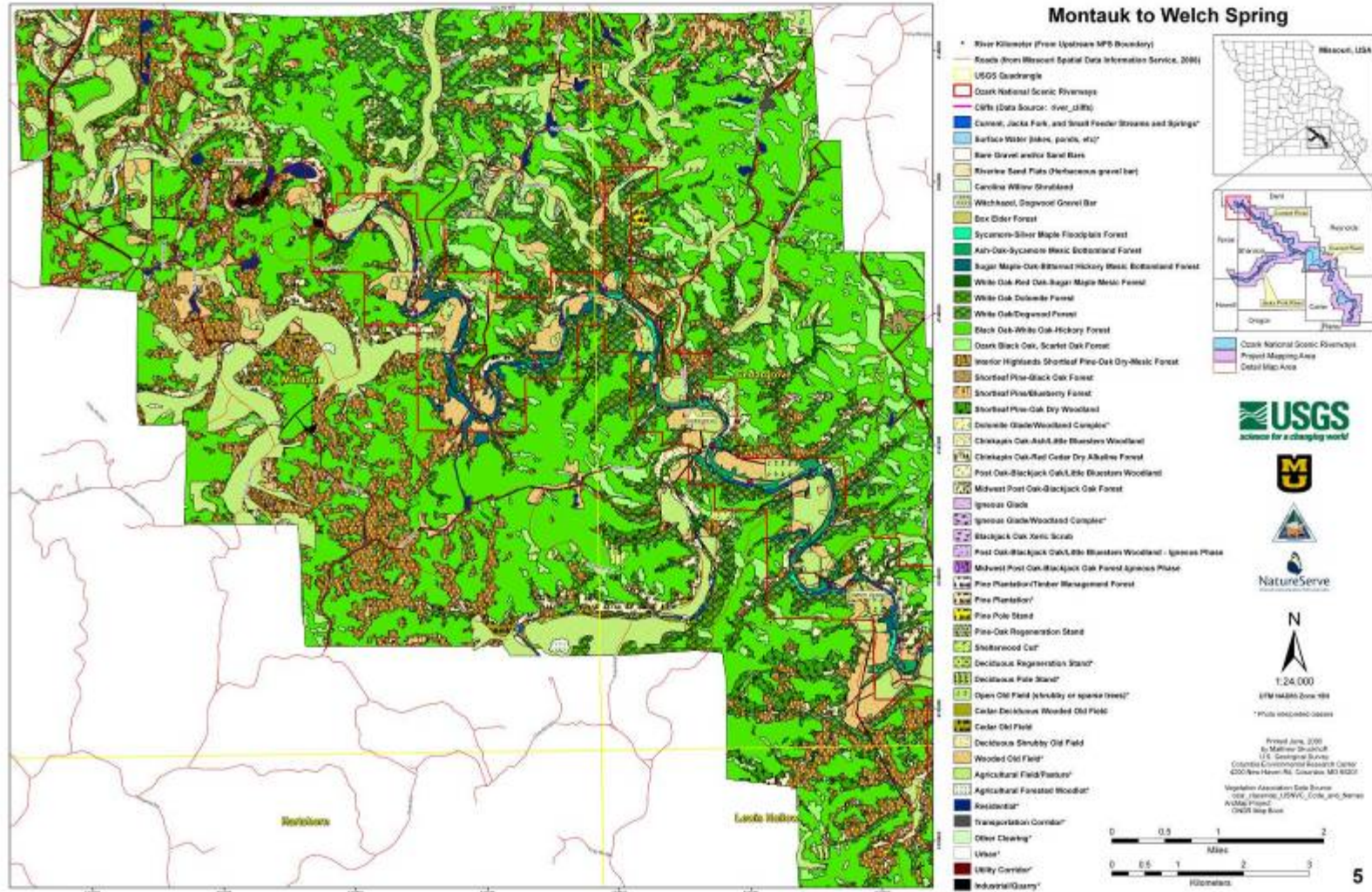
Appendix 12. 49-Class USNVC Vegetation Association Map



\* Other than Map Index, map scale as displayed is 1:100,000. Original maps are 1:24,000.



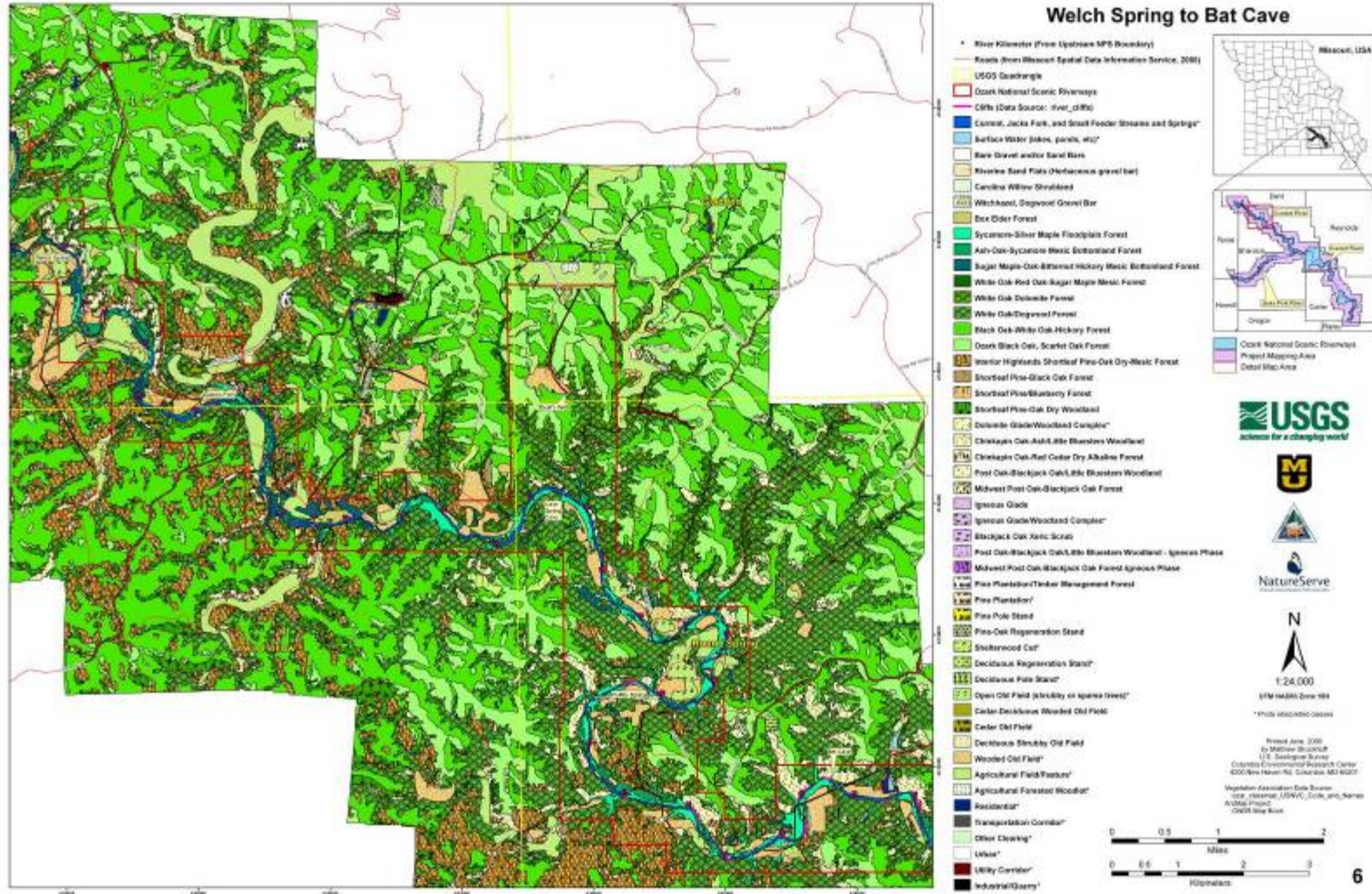
Appendix 12. 49-Class USNVC Vegetation Association Map



\* Other than Map Index, map scale as displayed is 1:100,000. Original maps are 1:24,000.



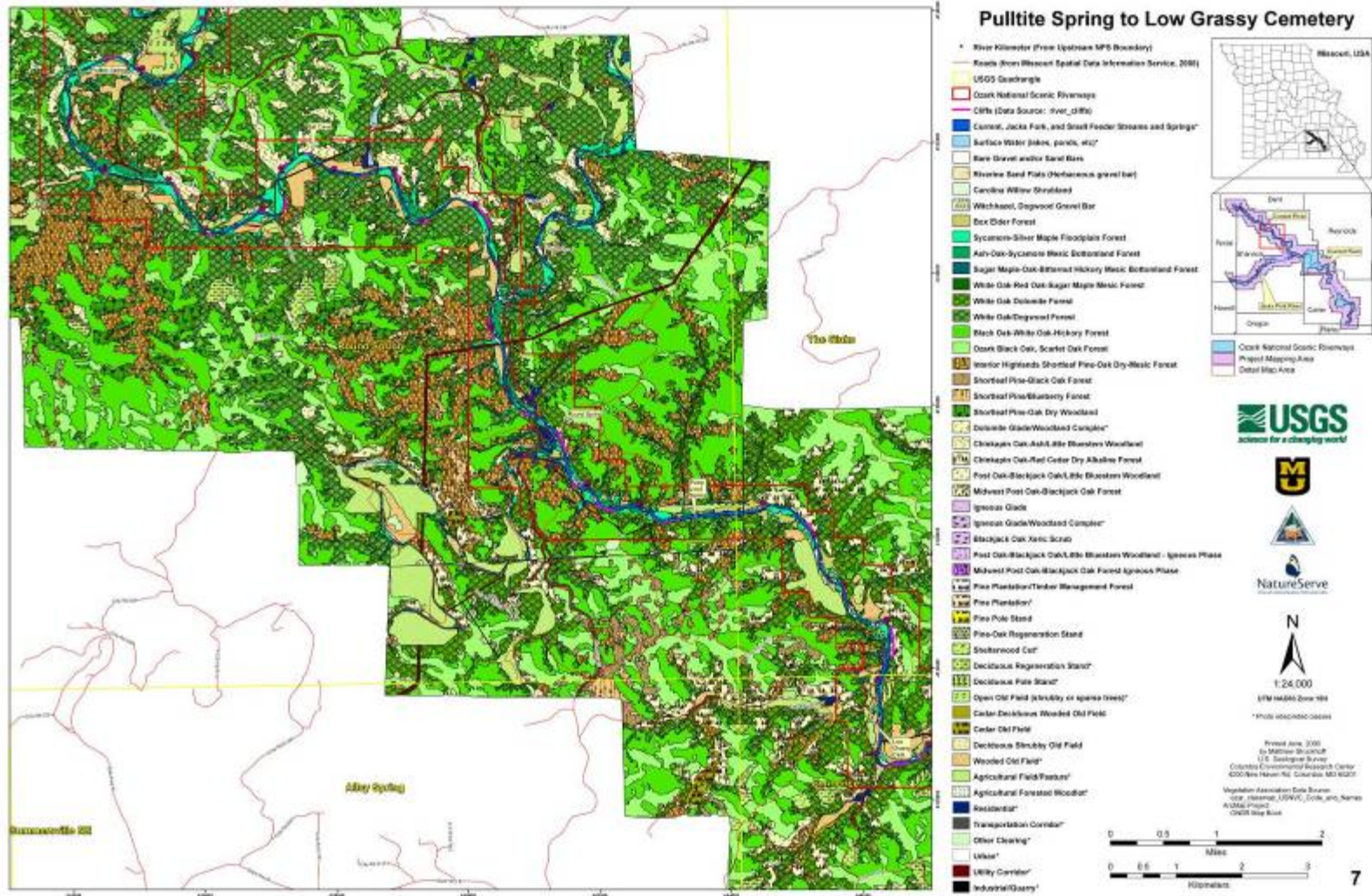
Appendix 12. 49-Class USNVC Vegetation Association Map



\* Other than Map Index, map scale as displayed is 1:100,000. Original maps are 1:24,000.



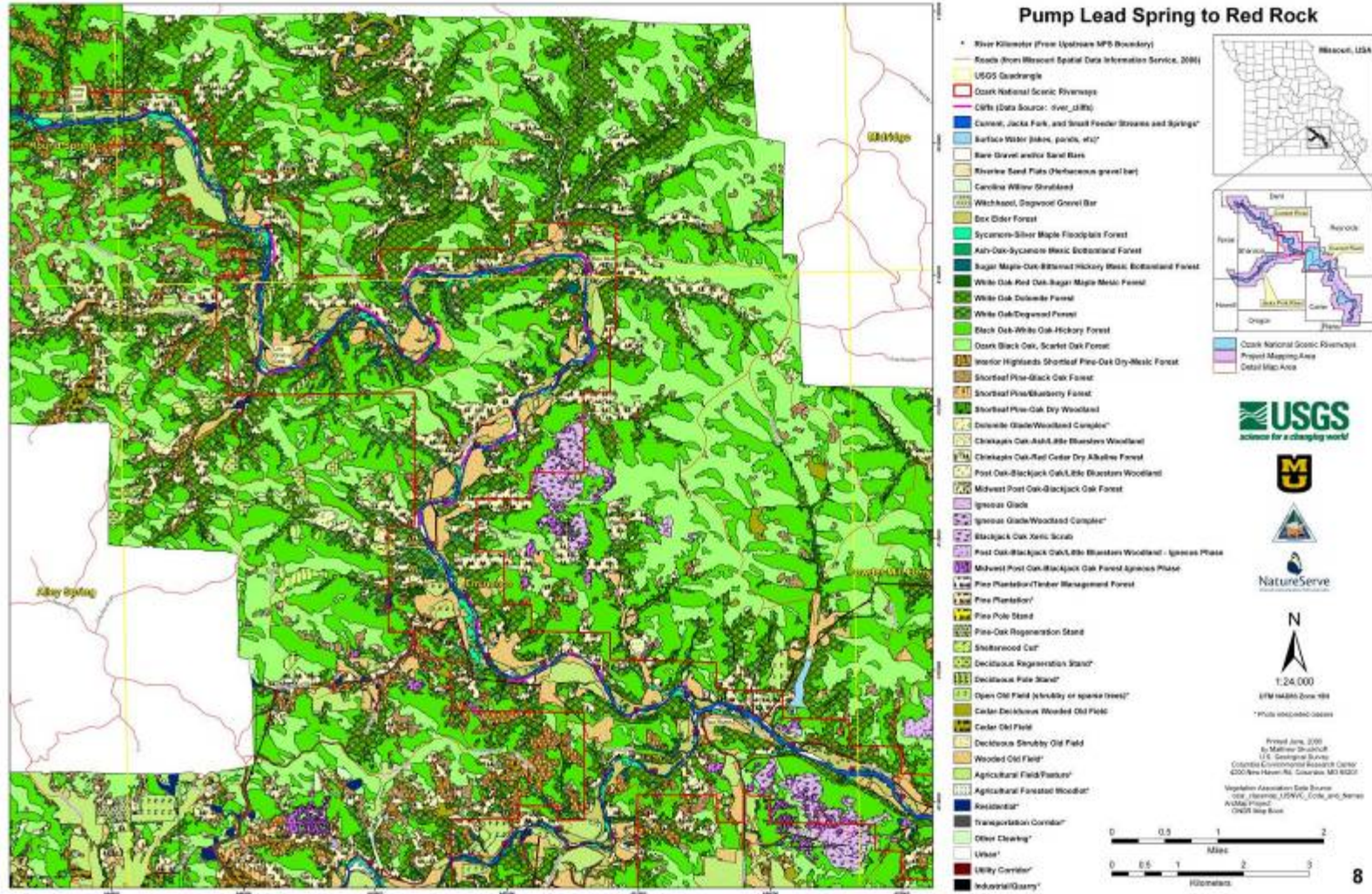
Appendix 12. 49-Class USNVC Vegetation Association Map



\* Other than Map Index, map scale as displayed is 1:100,000. Original maps are 1:24,000.



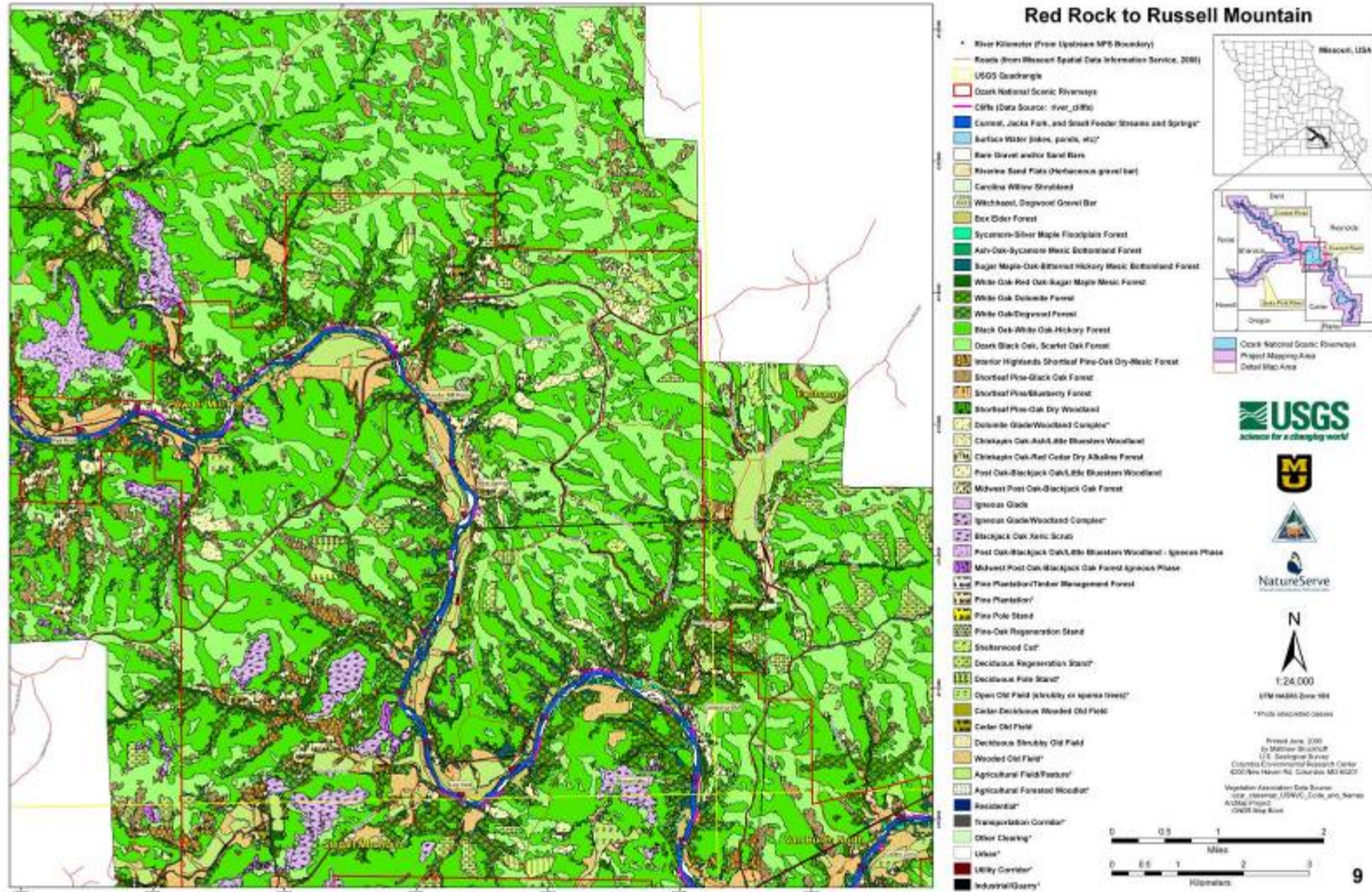
Appendix 12. 49-Class USNVC Vegetation Association Map



\* Other than Map Index, map scale as displayed is 1:100,000. Original maps are 1:24,000.



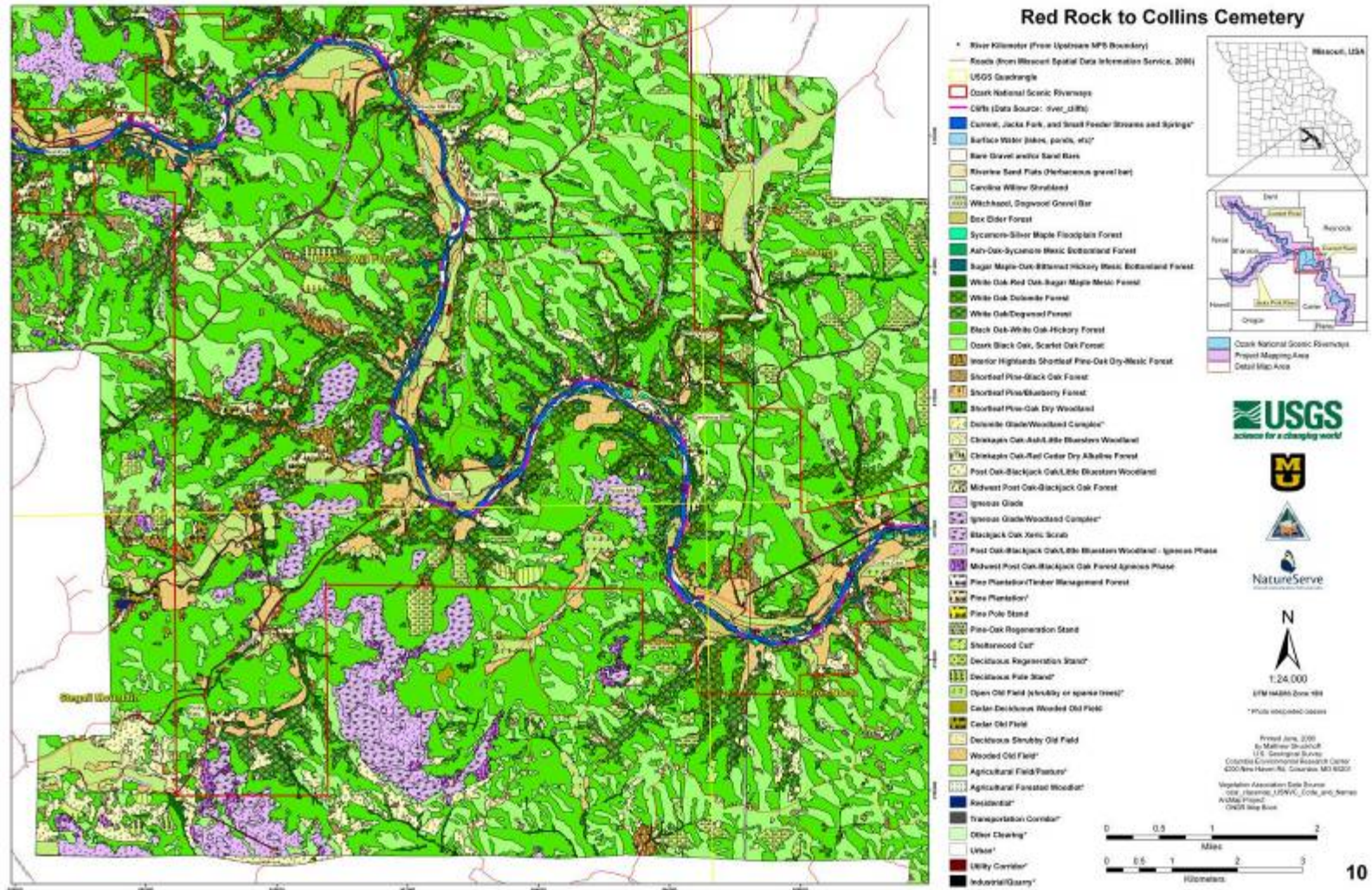
Appendix 12. 49-Class USNVC Vegetation Association Map



\* Other than Map Index, map scale as displayed is 1:100,000. Original maps are 1:24,000.



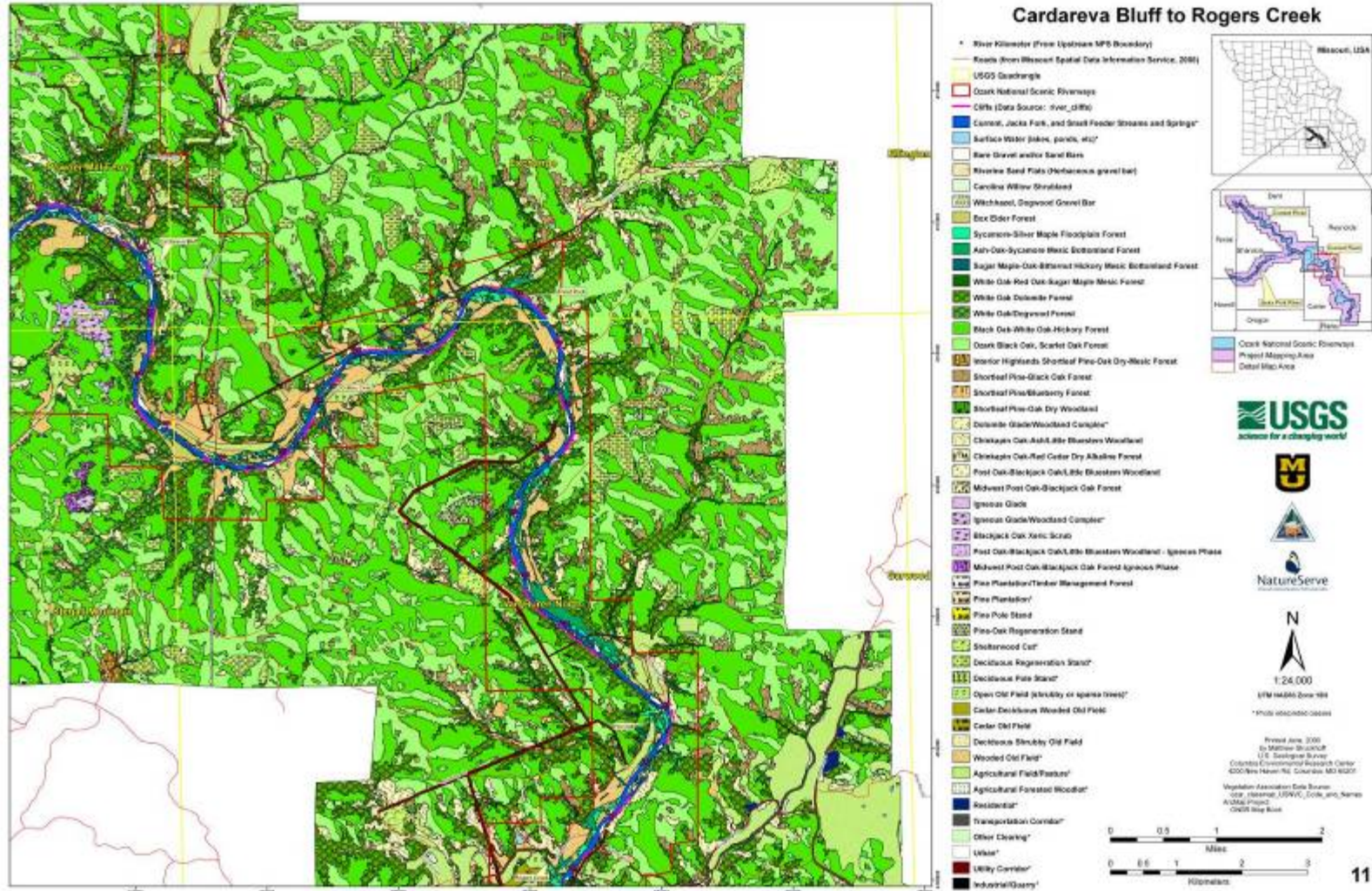
Appendix 12. 49-Class USNVC Vegetation Association Map



\* Other than Map Index, map scale as displayed is 1:100,000. Original maps are 1:24,000.



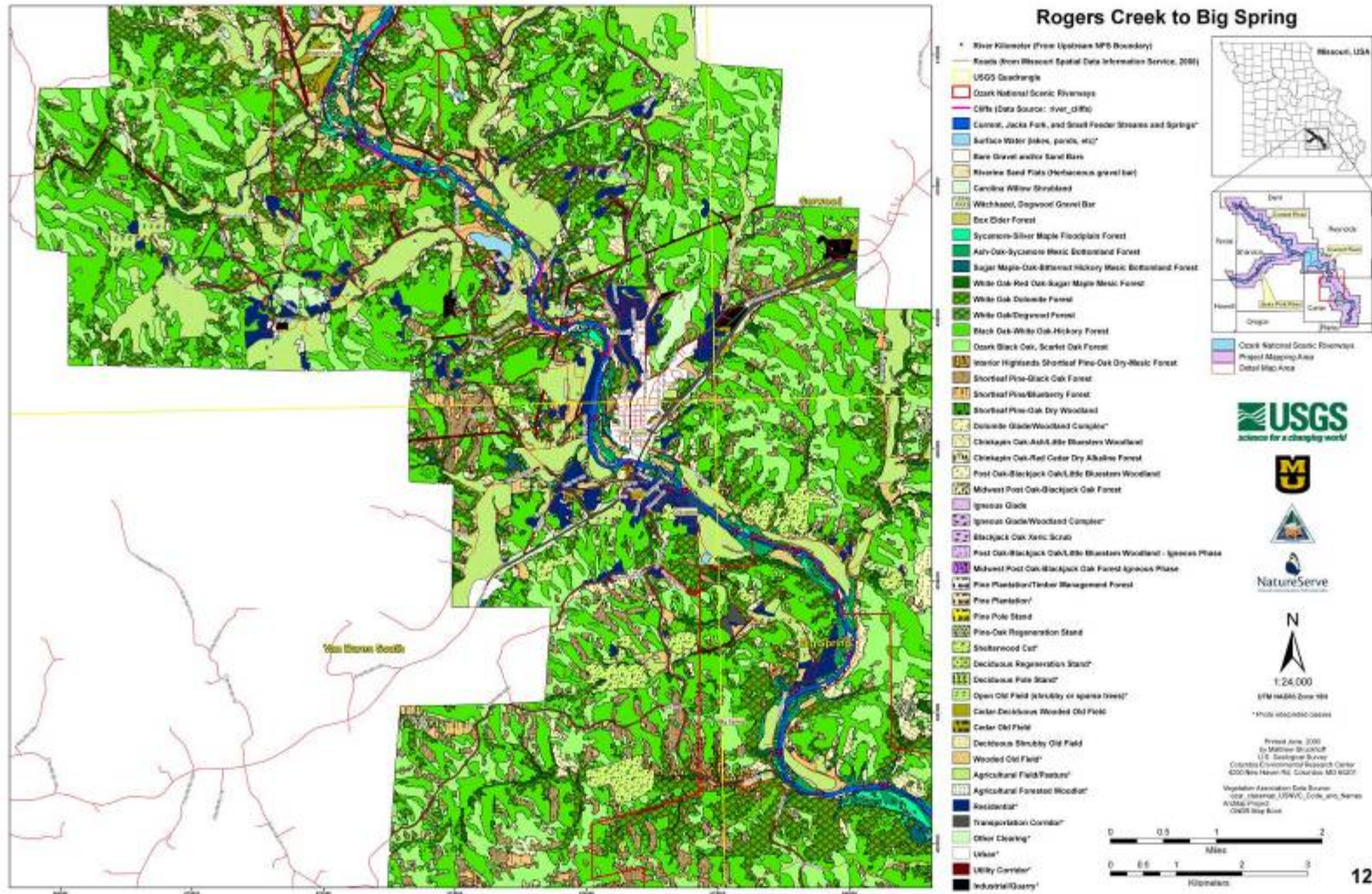
Appendix 12. 49-Class USNVC Vegetation Association Map



\* Other than Map Index, map scale as displayed is 1:100,000. Original maps are 1:24,000.



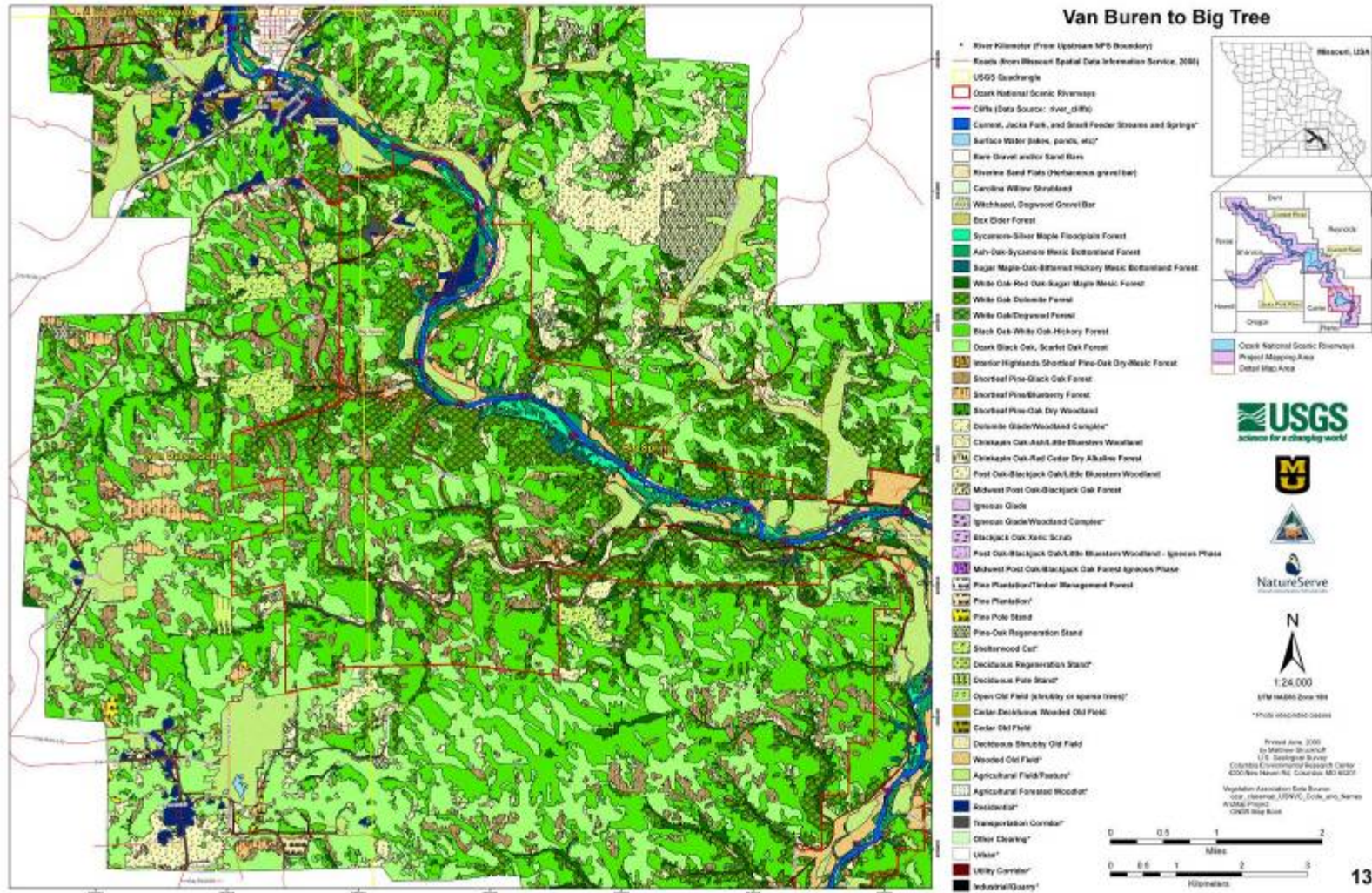
Appendix 12. 49-Class USNVC Vegetation Association Map



\* Other than Map Index, map scale as displayed is 1:100,000. Original maps are 1:24,000.



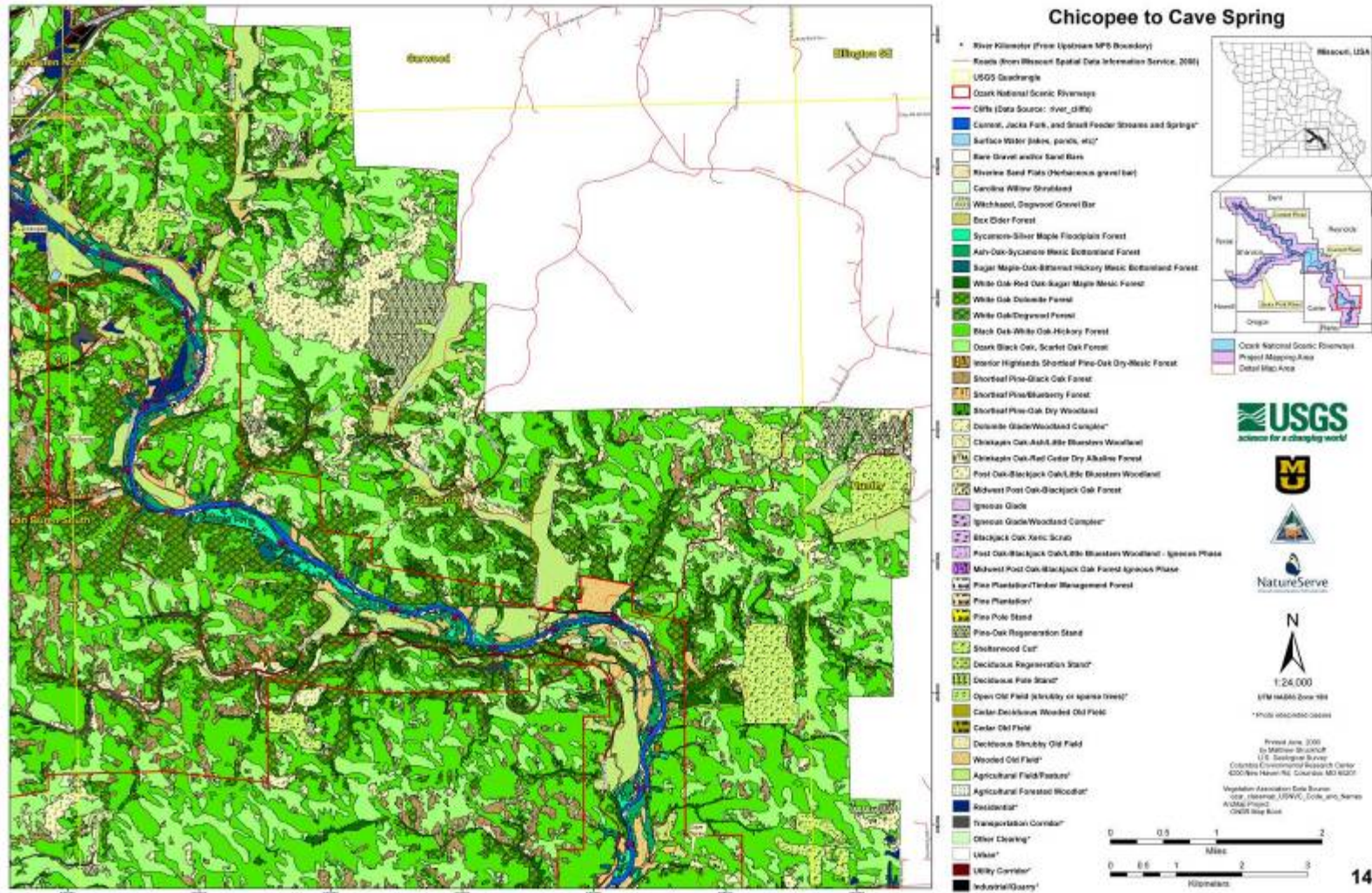
Appendix 12. 49-Class USNVC Vegetation Association Map



\* Other than Map Index, map scale as displayed is 1:100,000. Original maps are 1:24,000.



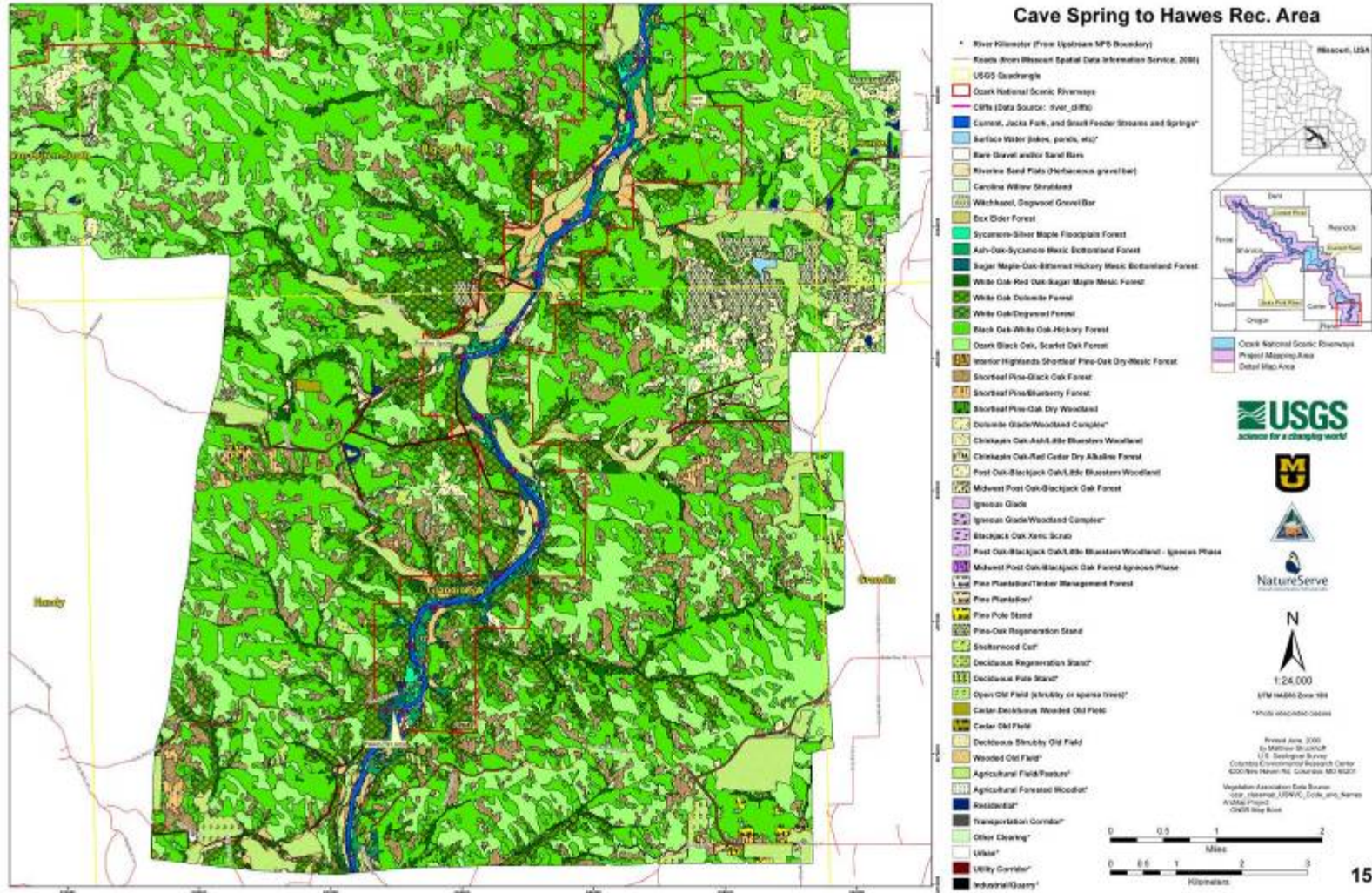
Appendix 12. 49-Class USNVC Vegetation Association Map



\* Other than Map Index, map scale as displayed is 1:100,000. Original maps are 1:24,000.



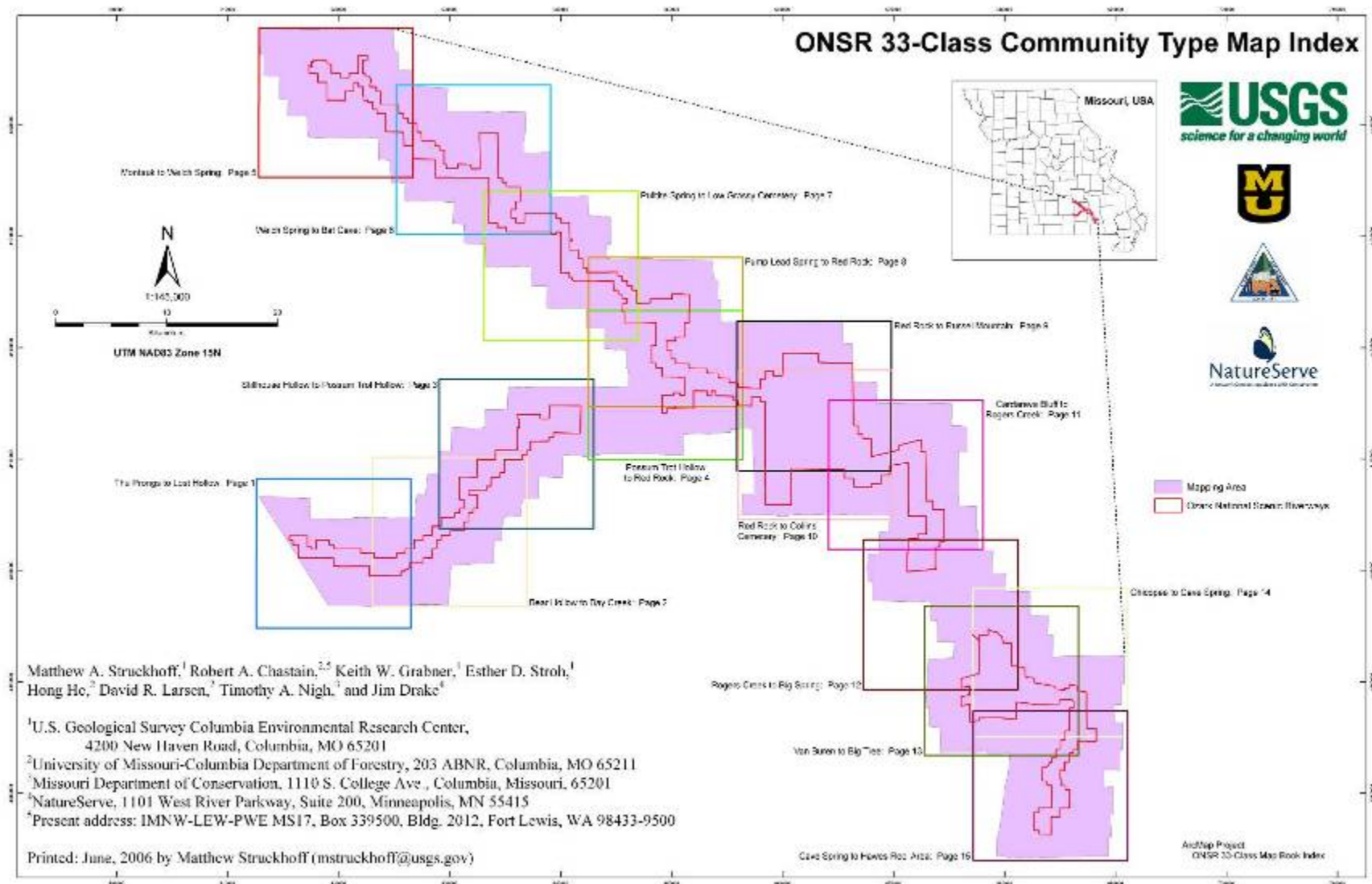
Appendix 12. 49-Class USNVC Vegetation Association Map



\* Other than Map Index, map scale as displayed is 1:100,000. Original maps are 1:24,000.

Appendix 13. 33-Class Community Type Map

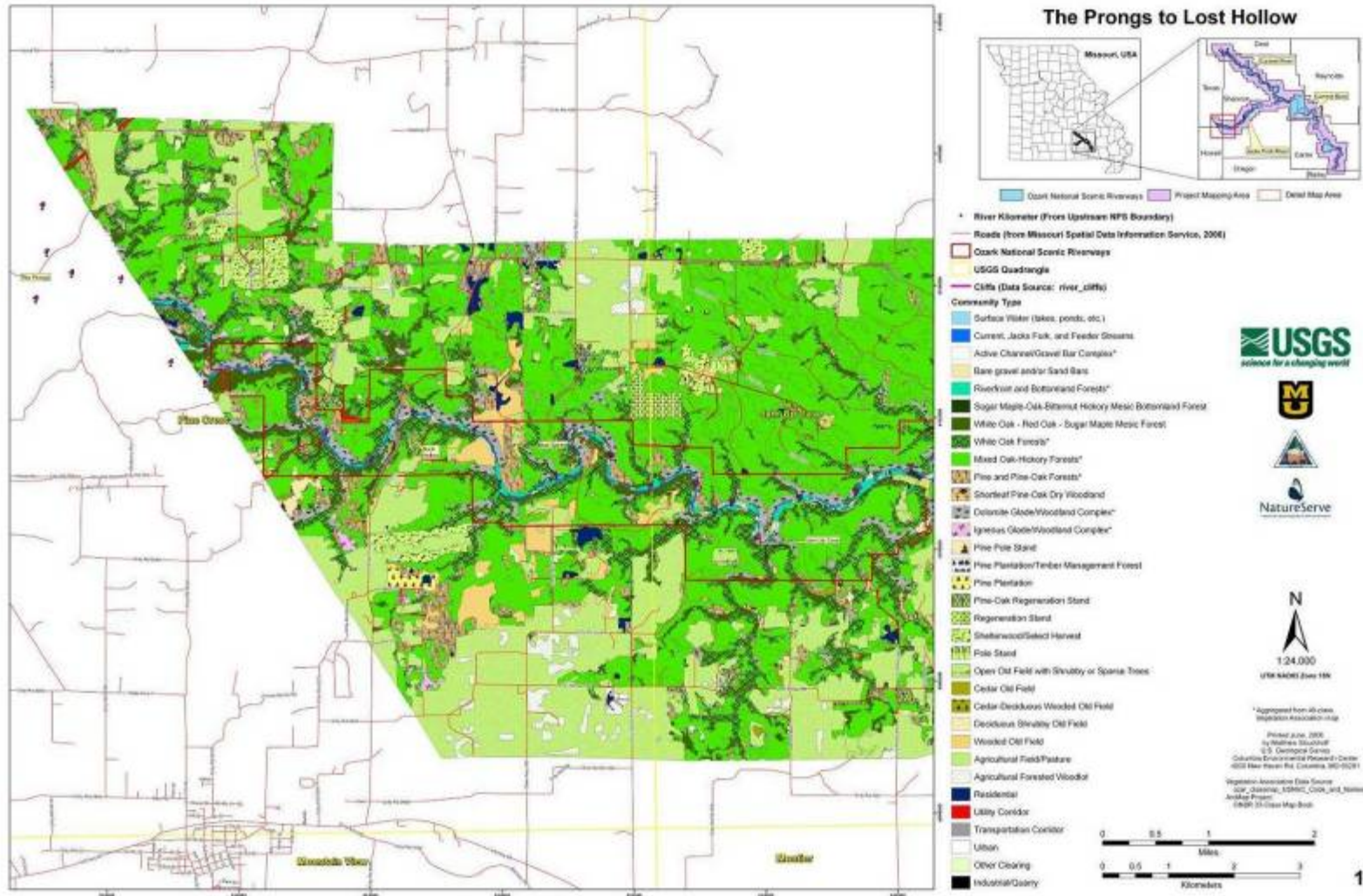
Appendix 13. 33-Class Community Type Map (reduced copy\*).



\* Other than Map Index, map scale as displayed is 1:100,000. Original maps are 1:24,000.

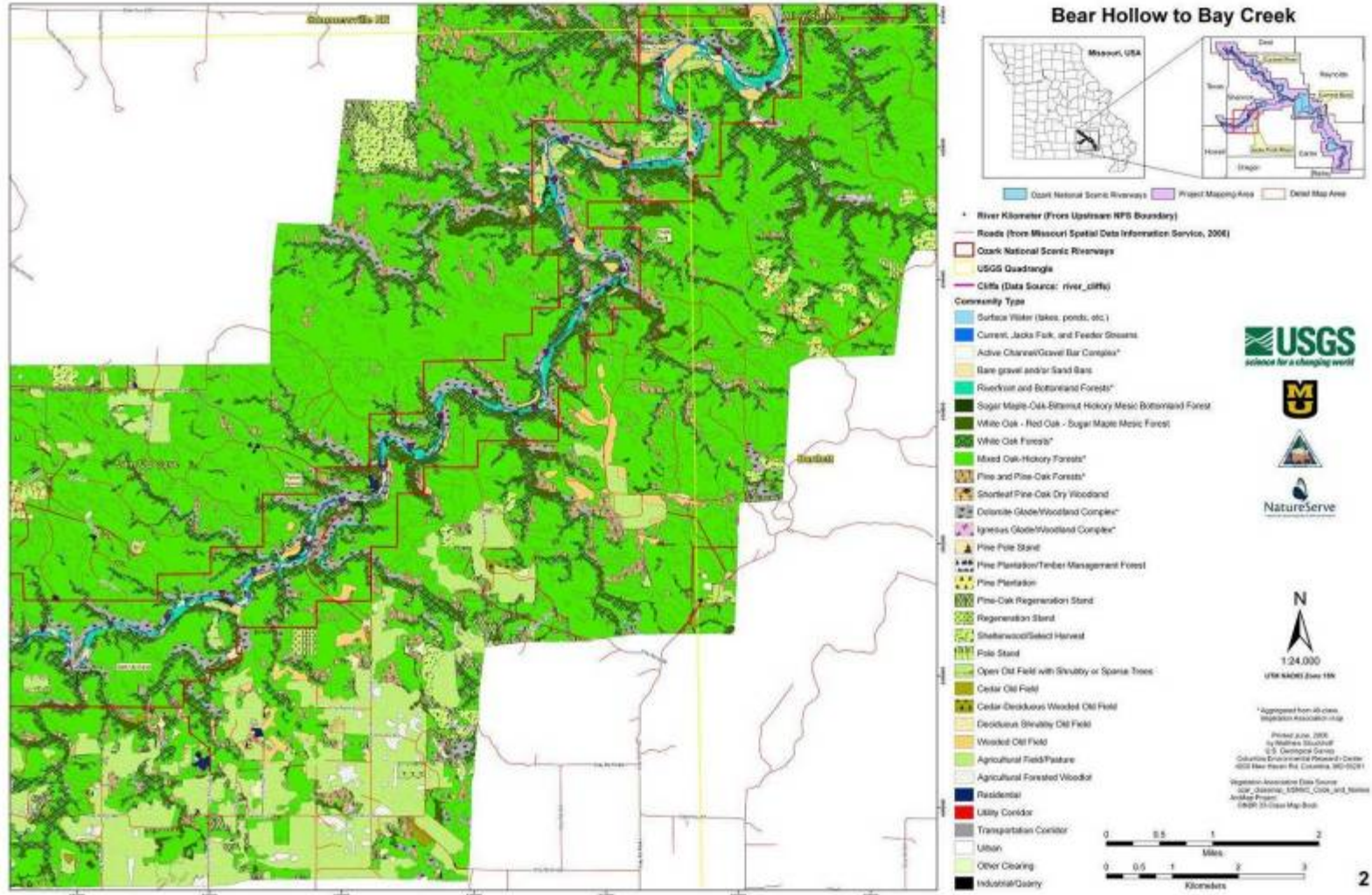


Appendix 13. 33-Class Community Type Map



\* Other than Map Index, map scale as displayed is 1:100,000. Original maps are 1:24,000.

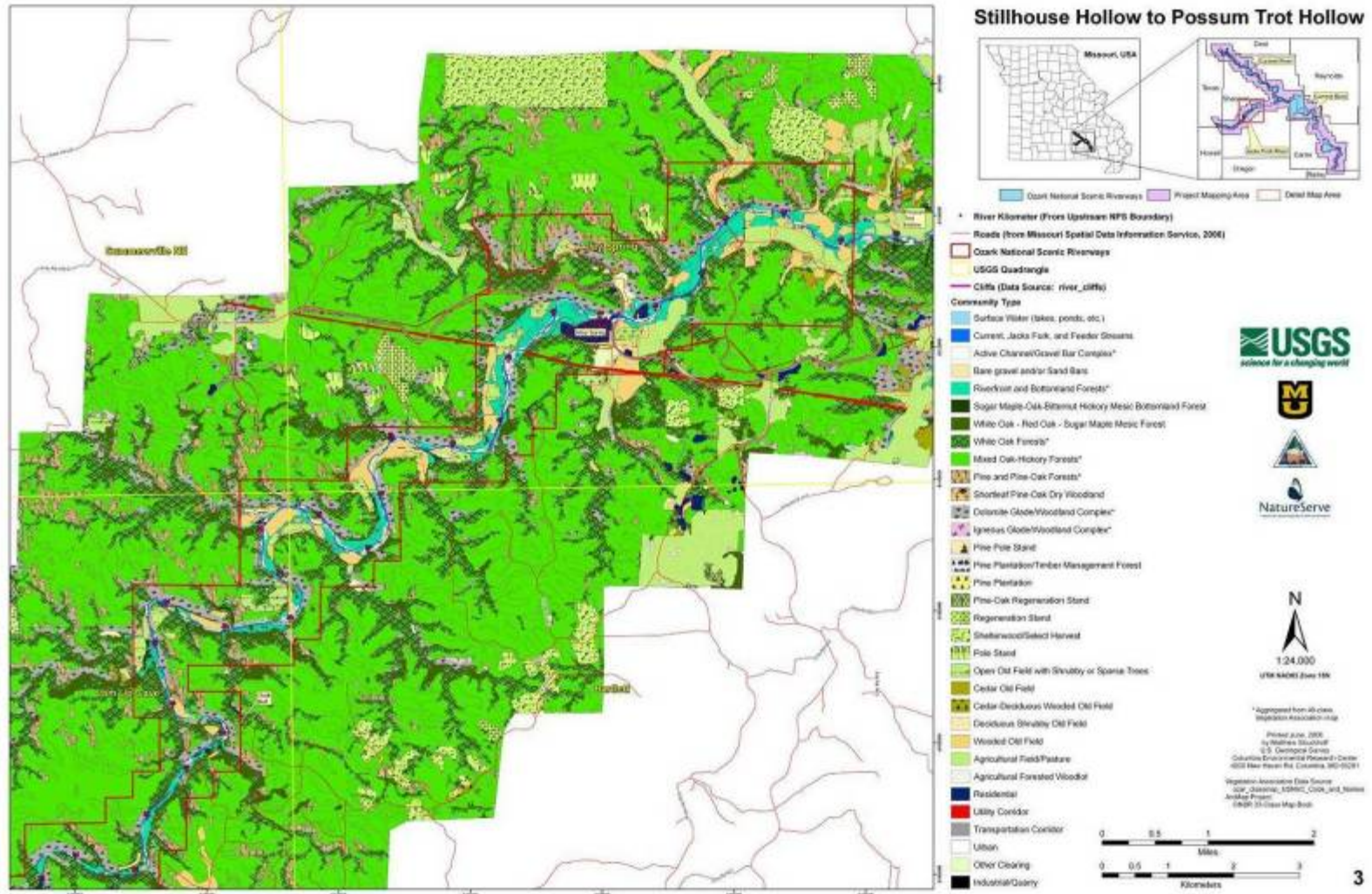
Appendix 13. 33-Class Community Type Map



\* Other than Map Index, map scale as displayed is 1:100,000. Original maps are 1:24,000.

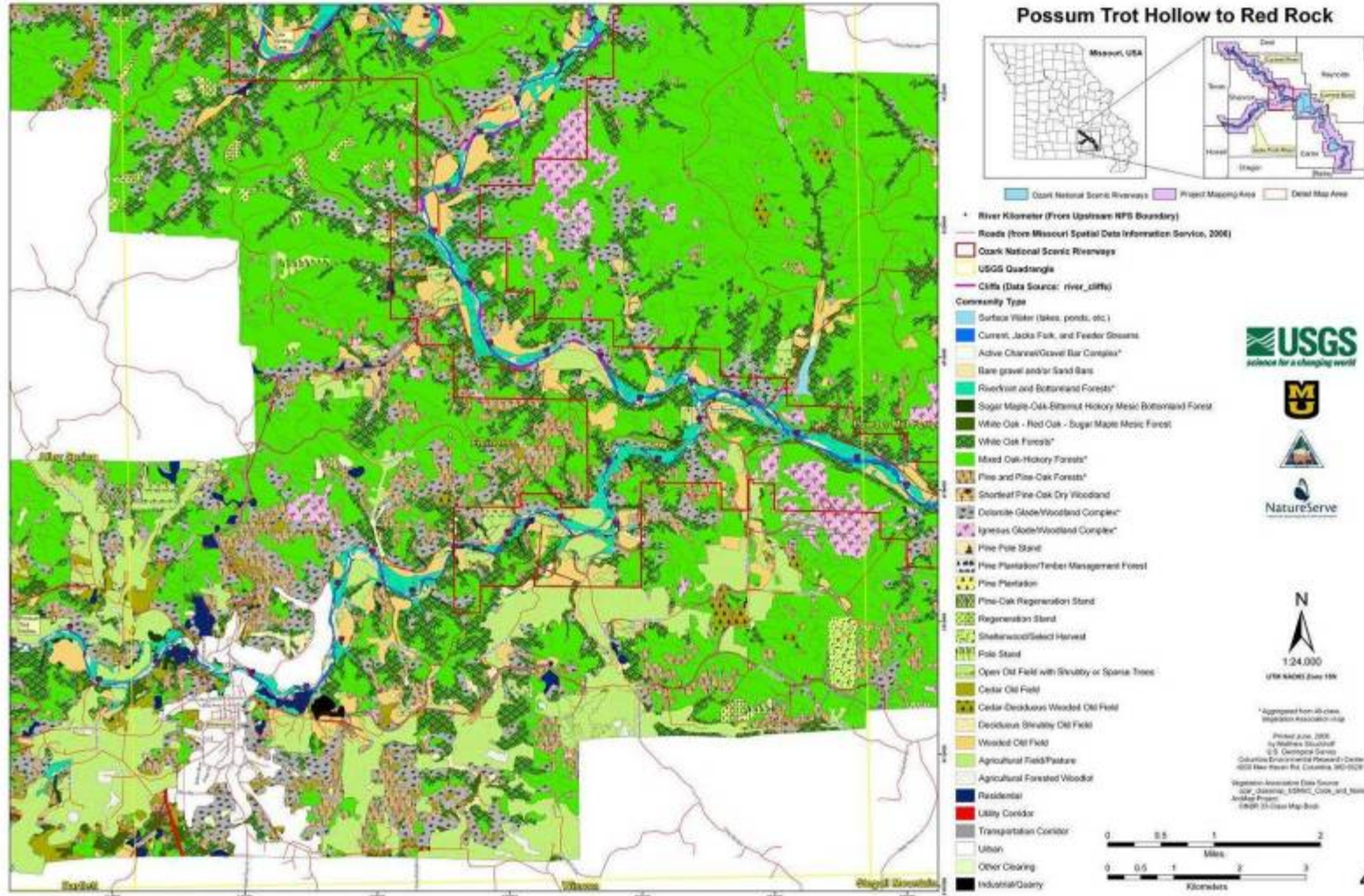


Appendix 13. 33-Class Community Type Map



\* Other than Map Index, map scale as displayed is 1:100,000. Original maps are 1:24,000.

Appendix 13. 33-Class Community Type Map



\* Other than Map Index, map scale as displayed is 1:100,000. Original maps are 1:24,000.

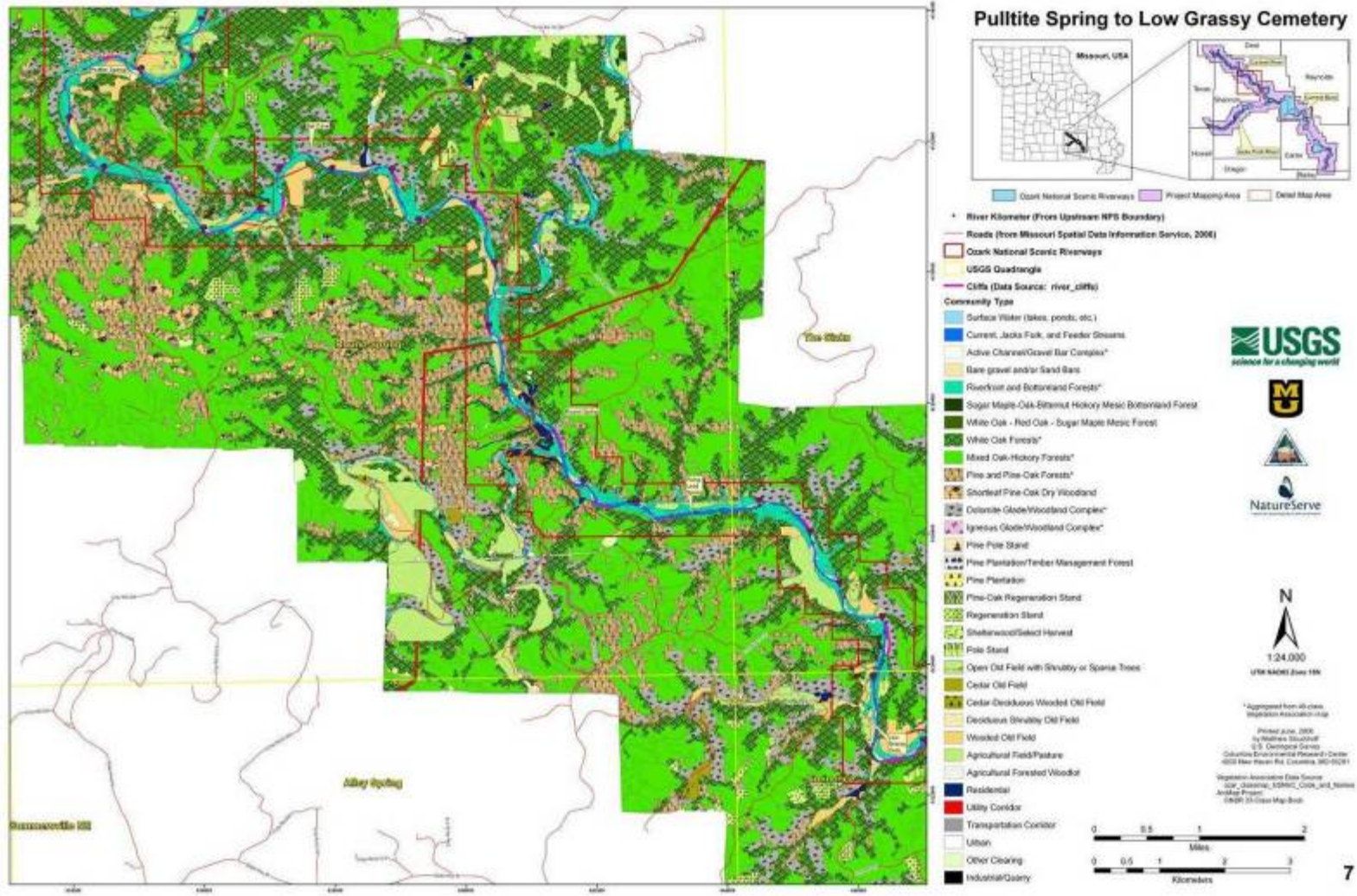






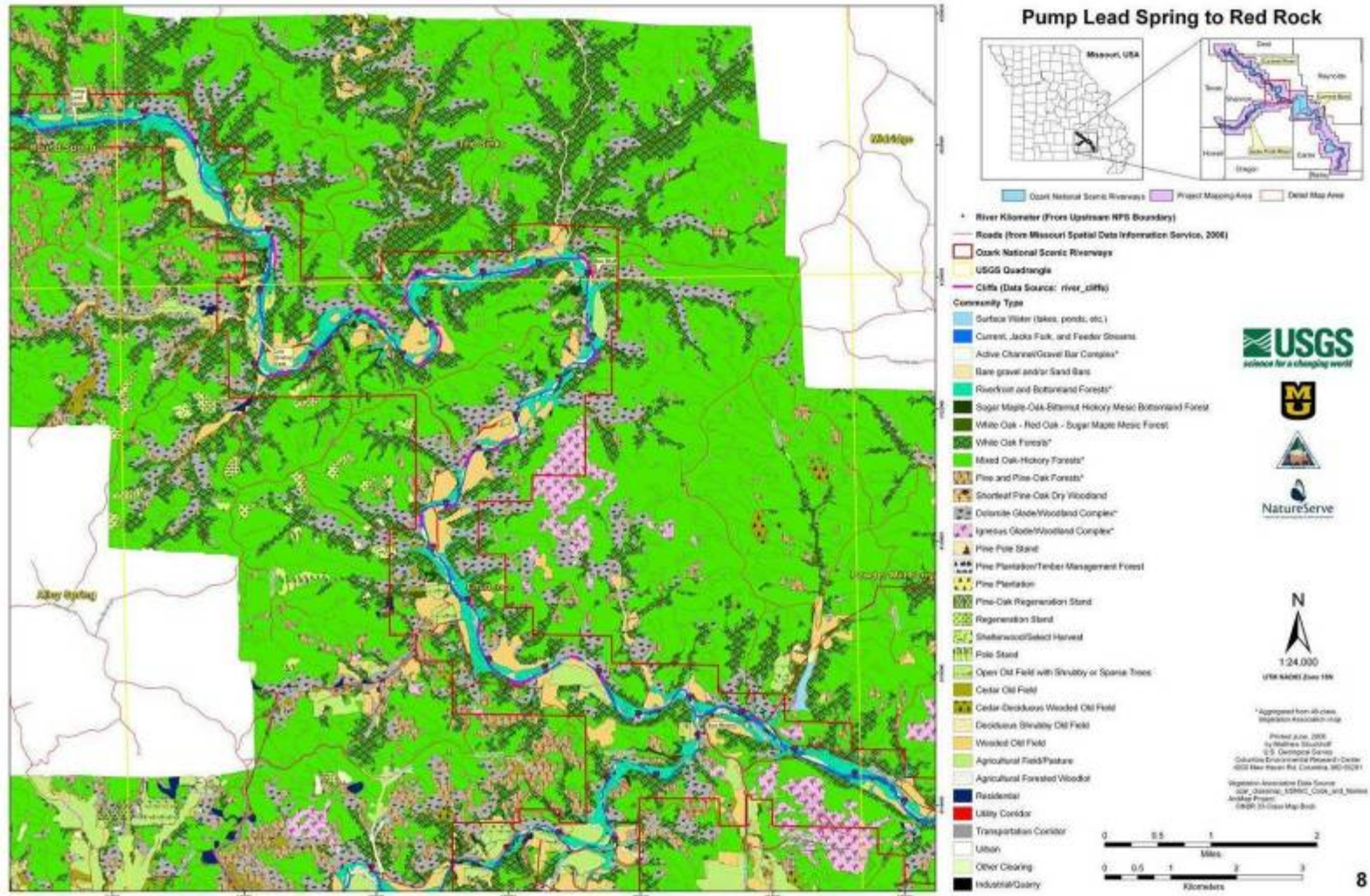


Appendix 13. 33-Class Community Type Map



\* Other than Map Index, map scale as displayed is 1:100,000. Original maps are 1:24,000.

Appendix 13. 33-Class Community Type Map



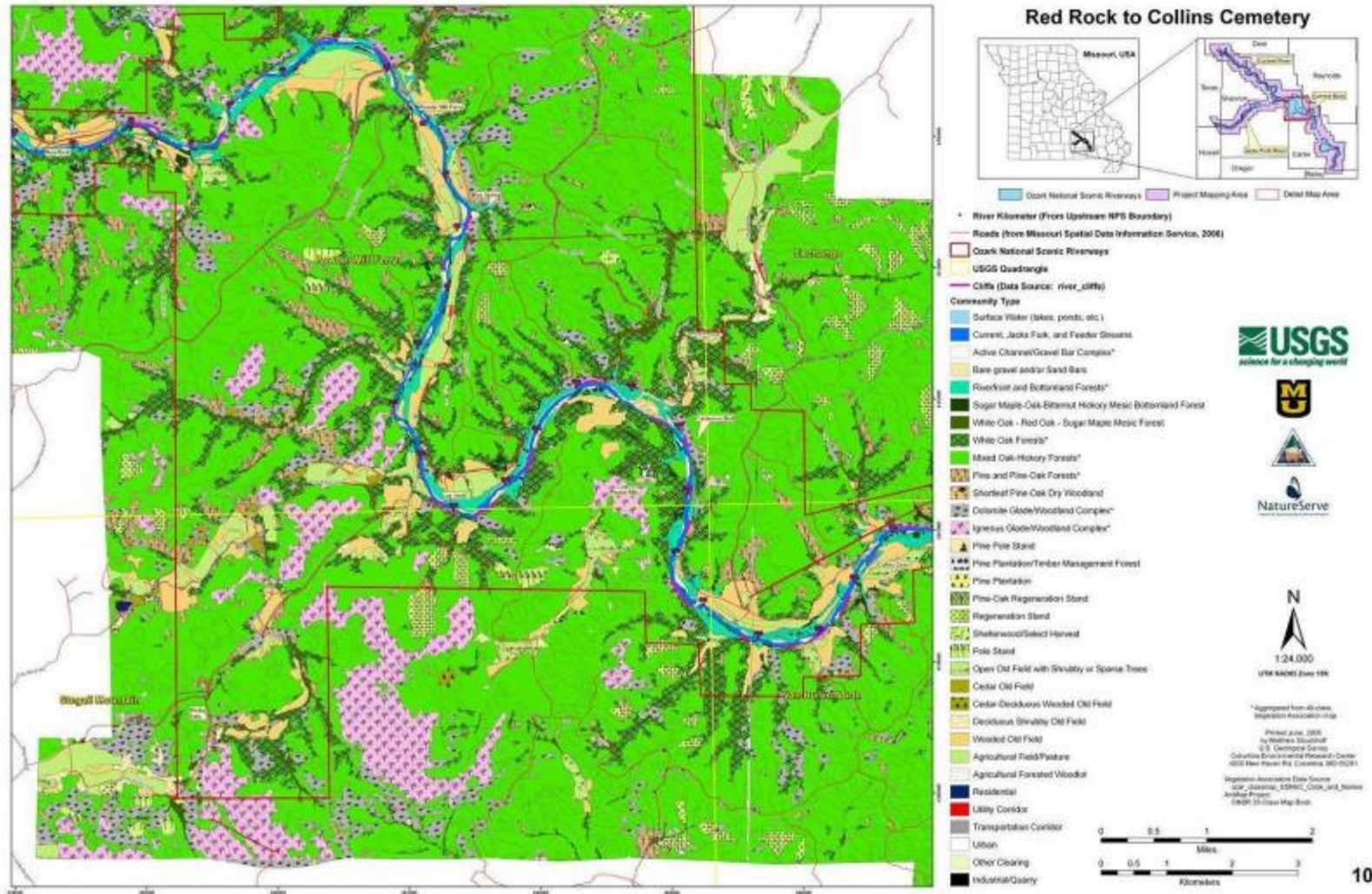
\* Other than Map Index, map scale as displayed is 1:100,000. Original maps are 1:24,000.





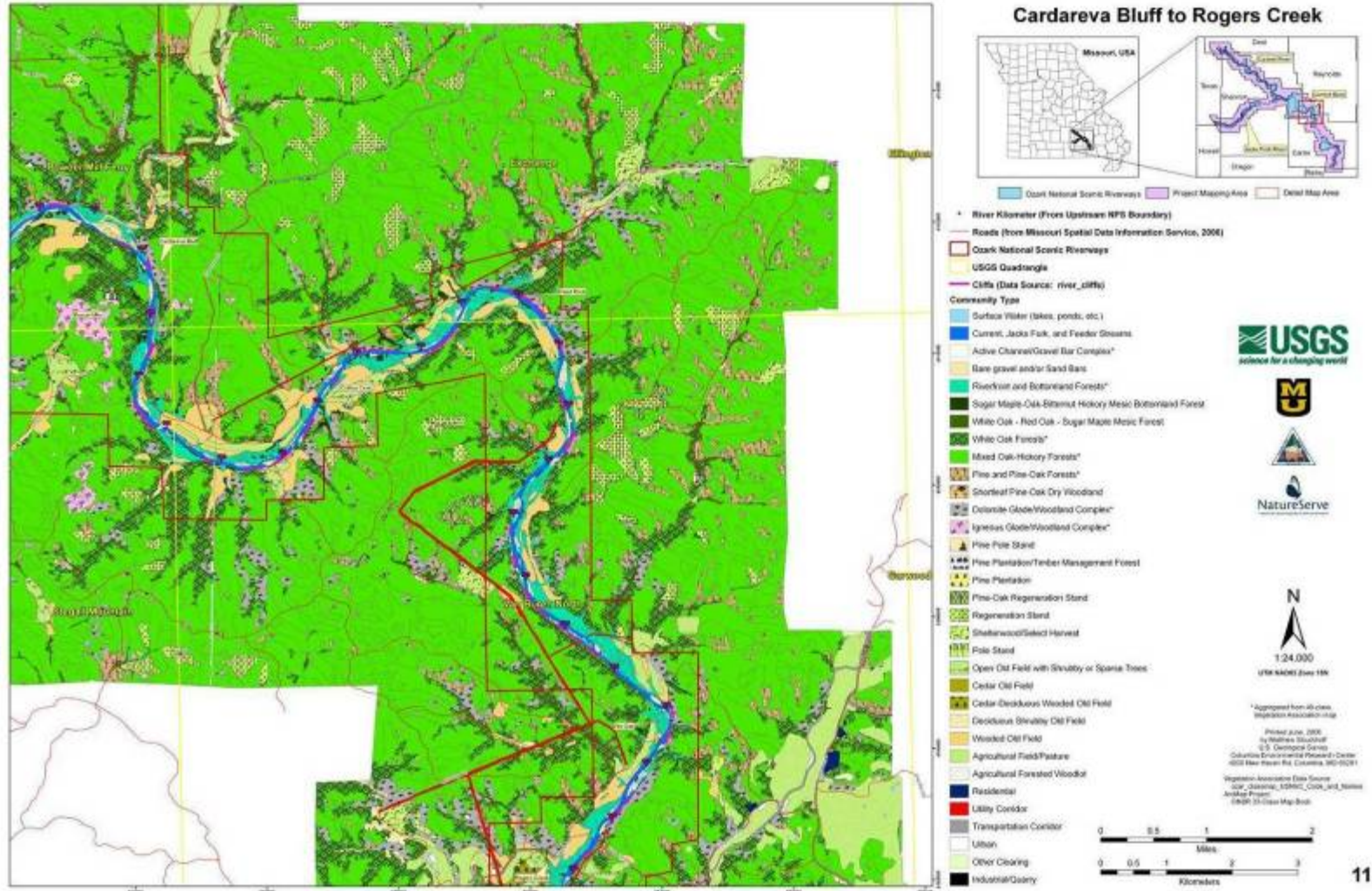


Appendix 13. 33-Class Community Type Map



\* Other than Map Index, map scale as displayed is 1:100,000. Original maps are 1:24,000.

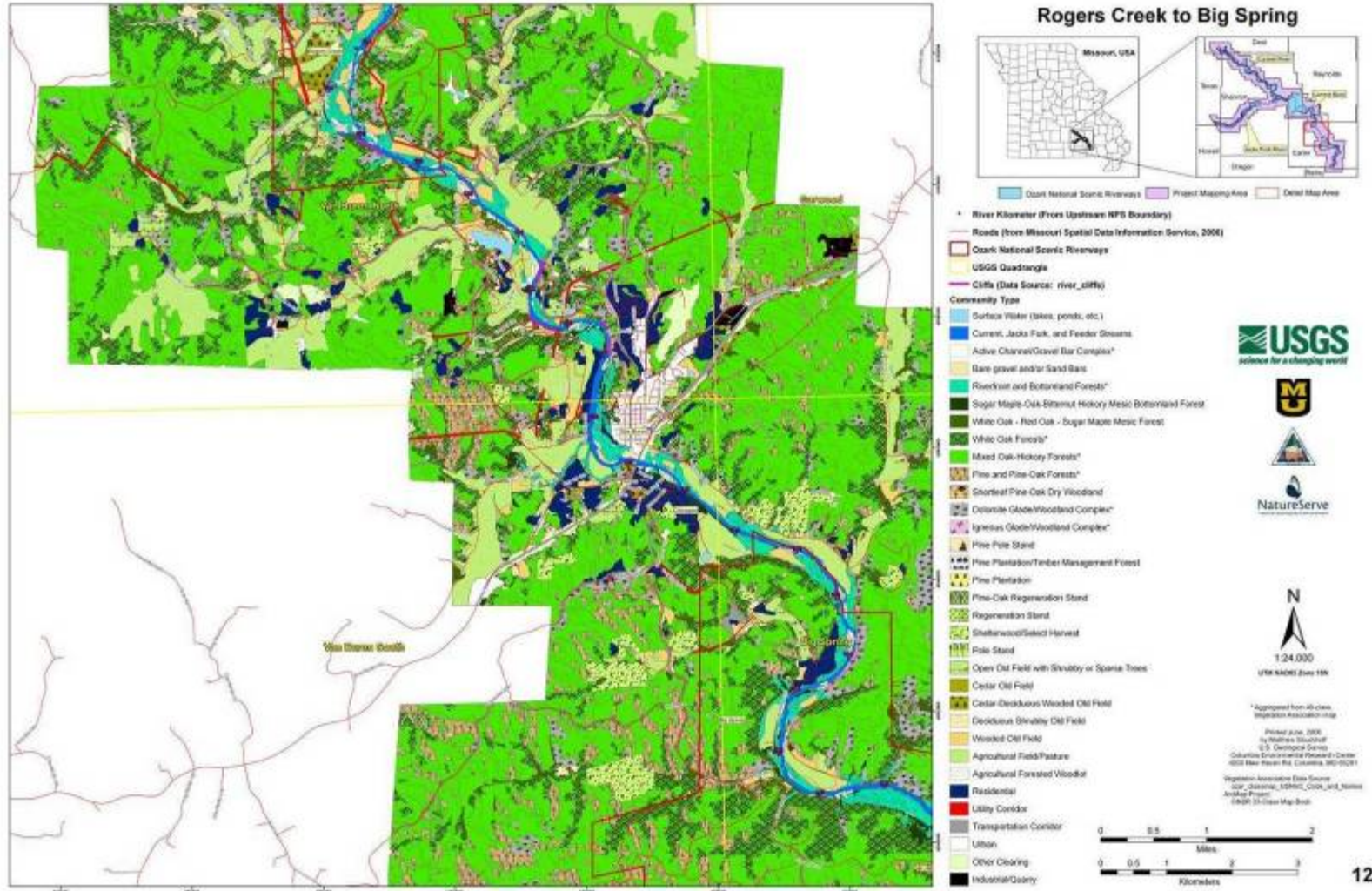
Appendix 13. 33-Class Community Type Map



\* Other than Map Index, map scale as displayed is 1:100,000. Original maps are 1:24,000.



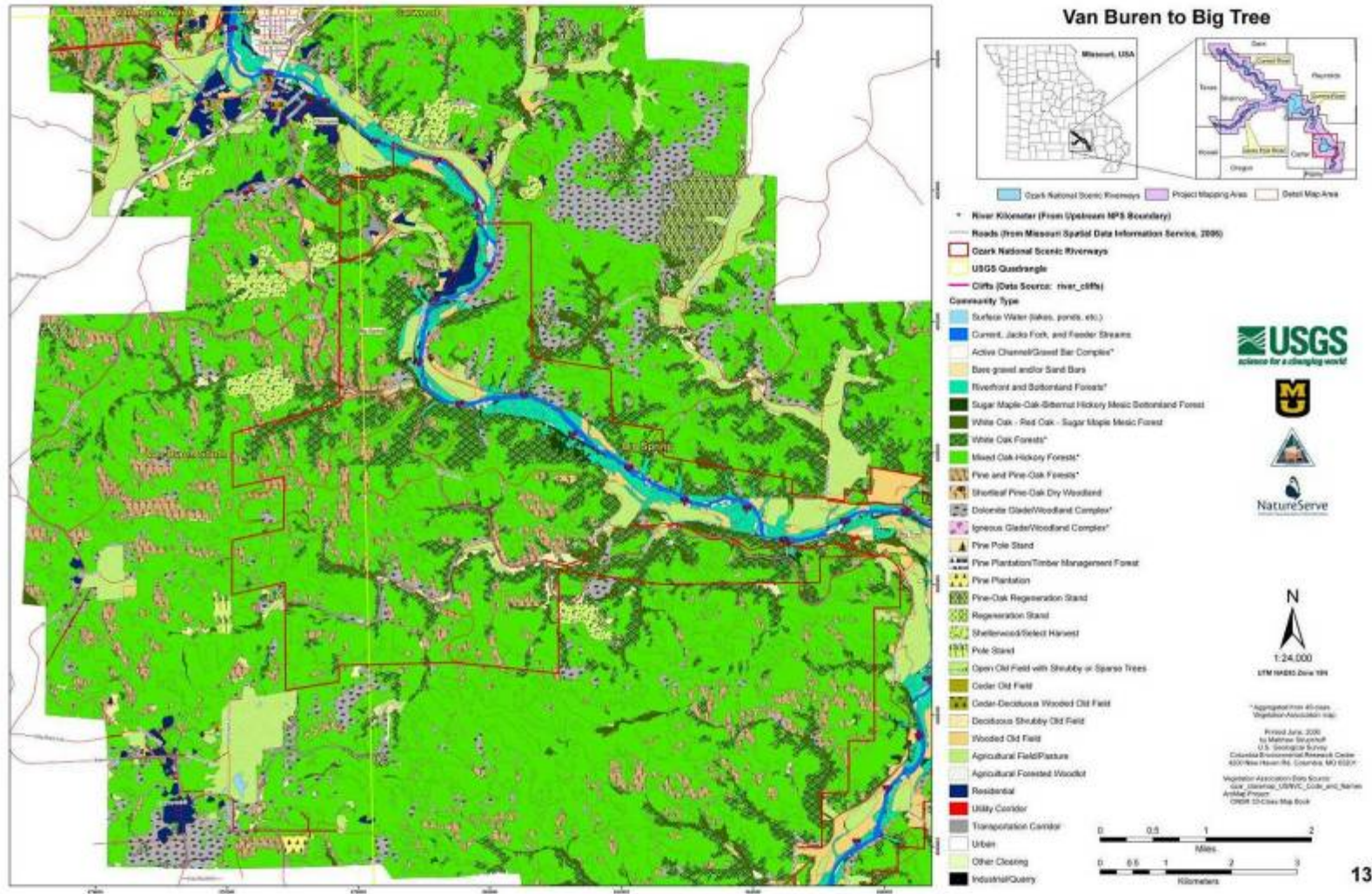
Appendix 13. 33-Class Community Type Map



\* Other than Map Index, map scale as displayed is 1:100,000. Original maps are 1:24,000.

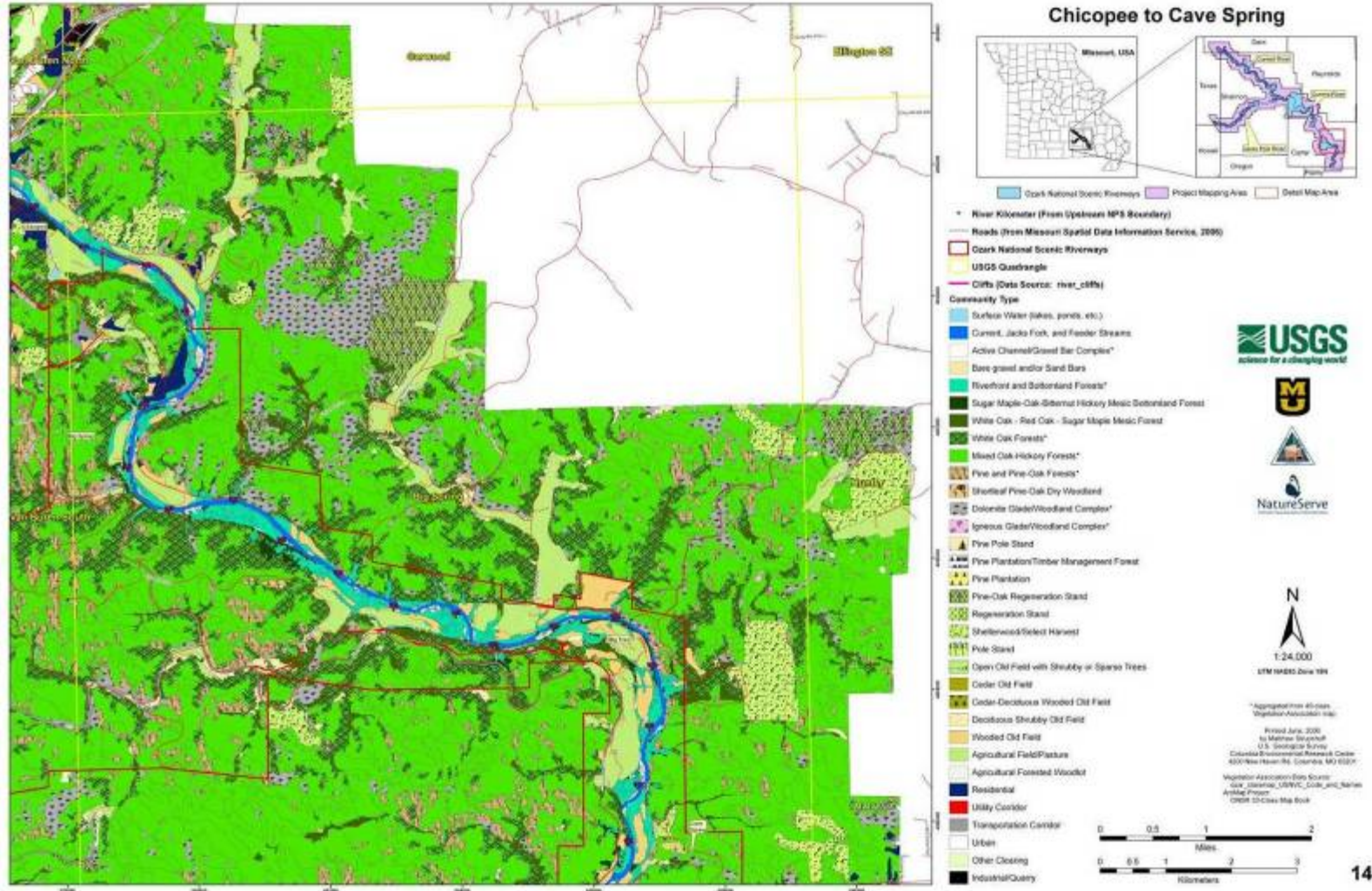


Appendix 13. 33-Class Community Type Map



\* Other than Map Index, map scale as displayed is 1:100,000. Original maps are 1:24,000.

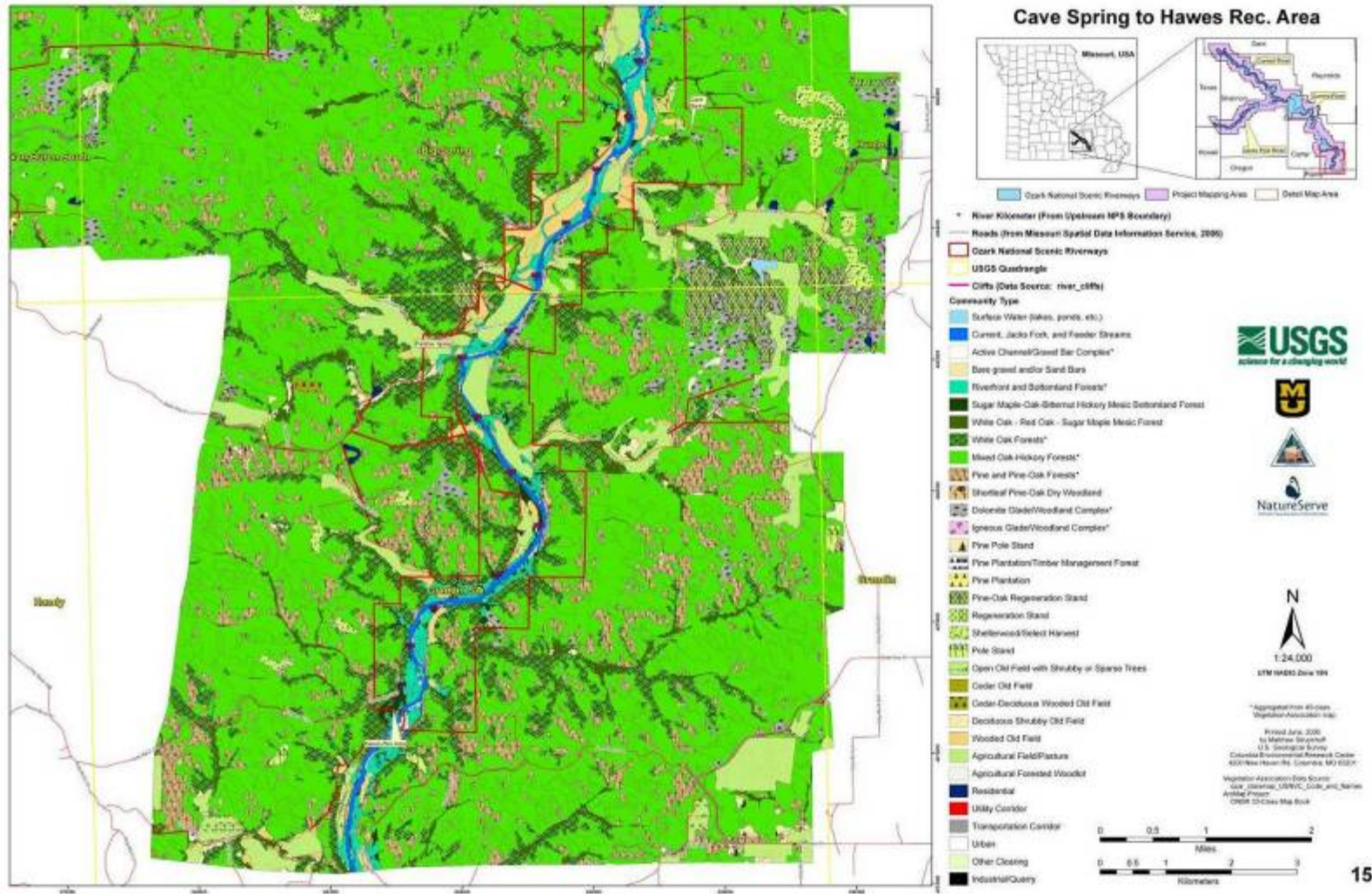
Appendix 13. 33-Class Community Type Map



\* Other than Map Index, map scale as displayed is 1:100,000. Original maps are 1:24,000.

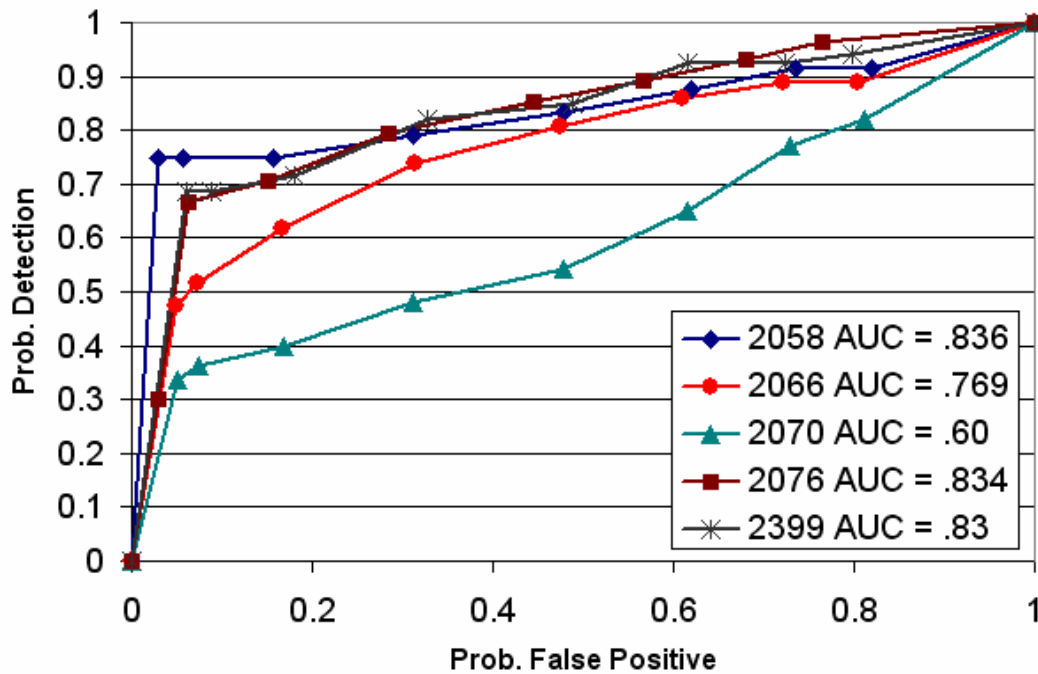


Appendix 13. 33-Class Community Type Map

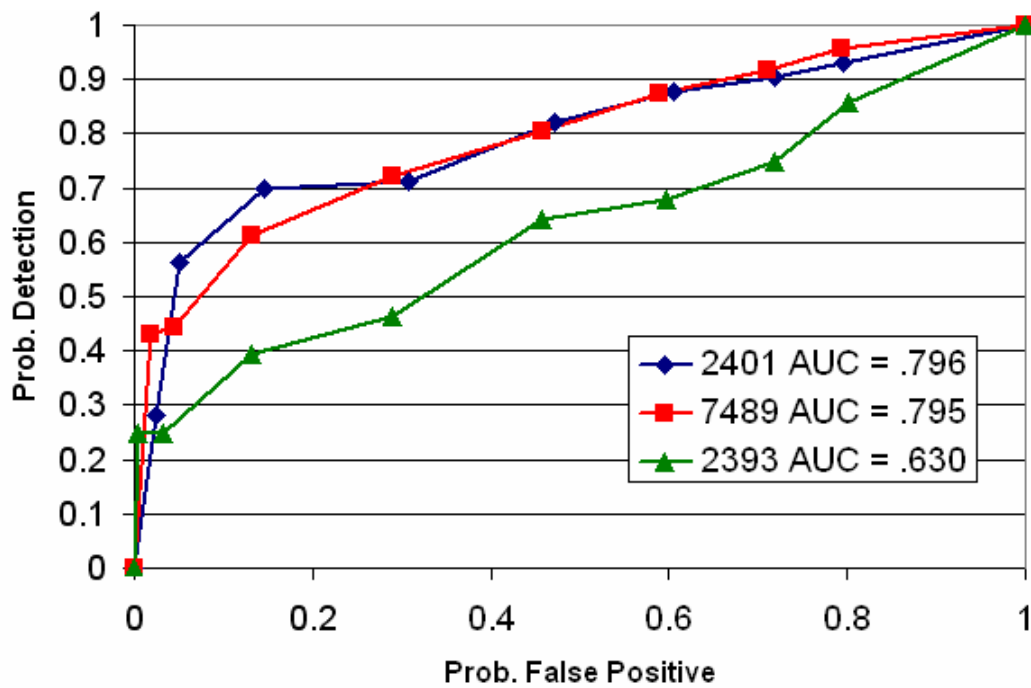


\* Other than Map Index, map scale as displayed is 1:100,000. Original maps are 1:24,000.

**Appendix 14. ROC Graphs of select groups of communities and the Mixed Oak-Hickory/Dogwood Forest.**



**Figure A14-1.** ROC graph of mesic and upland oak and hickory forests



**Figure A14-2.** ROC graph of pine and pine-oak forests and woodlands

Appendix 14. ROC Graphs of select groups of communities and of the Mixed Oak-Hickory/Dogwood Forest (2076)

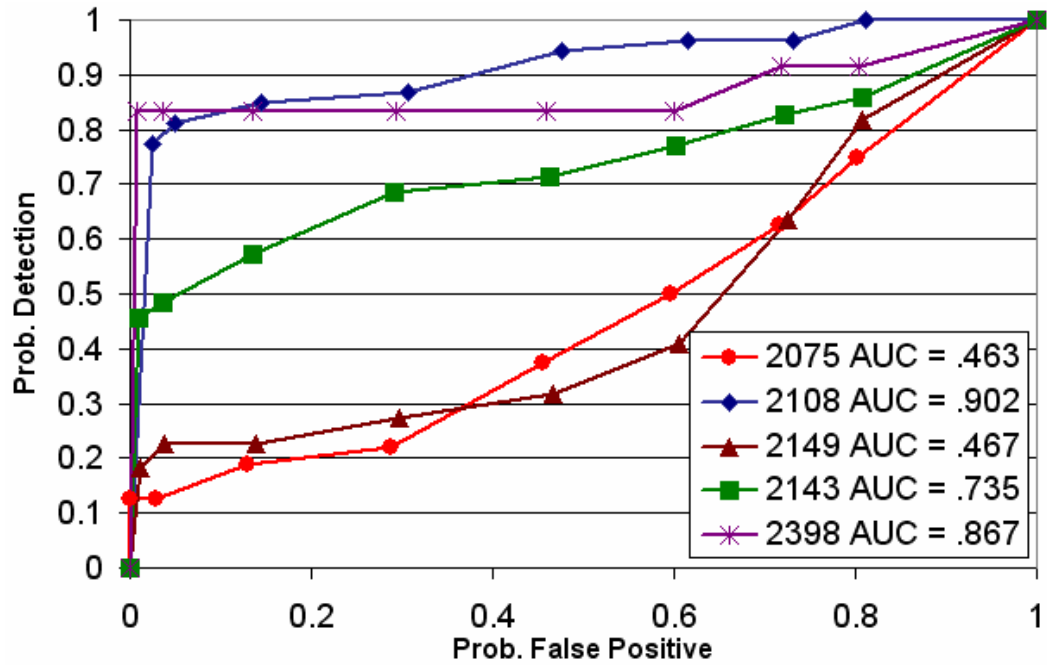


Figure A14-3. ROC graph of dolomite woodlands and glades

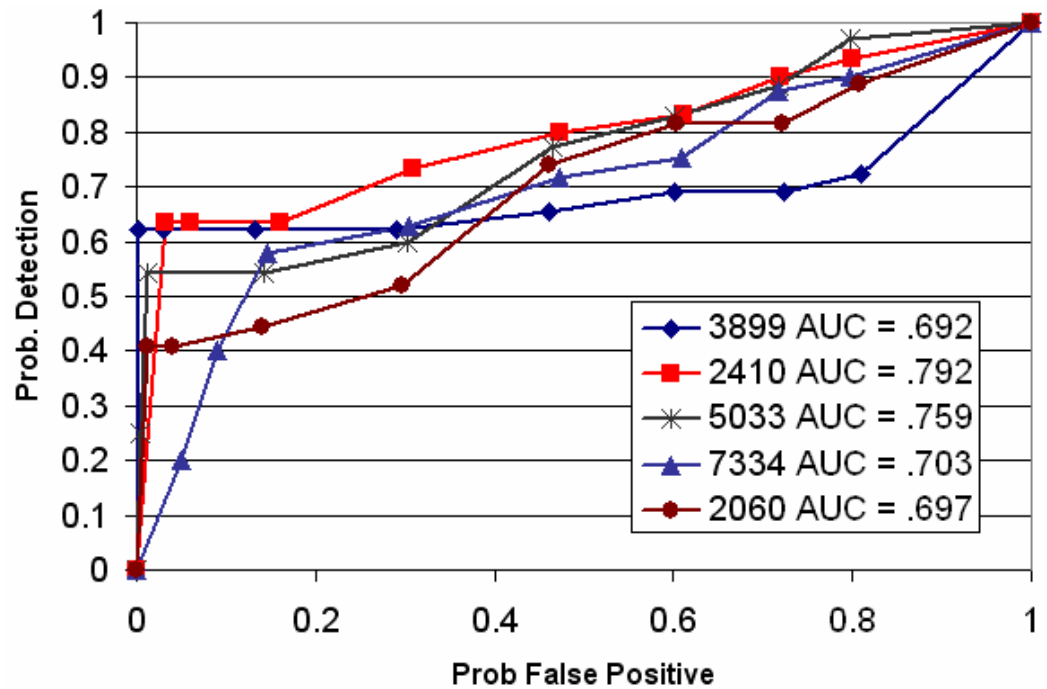
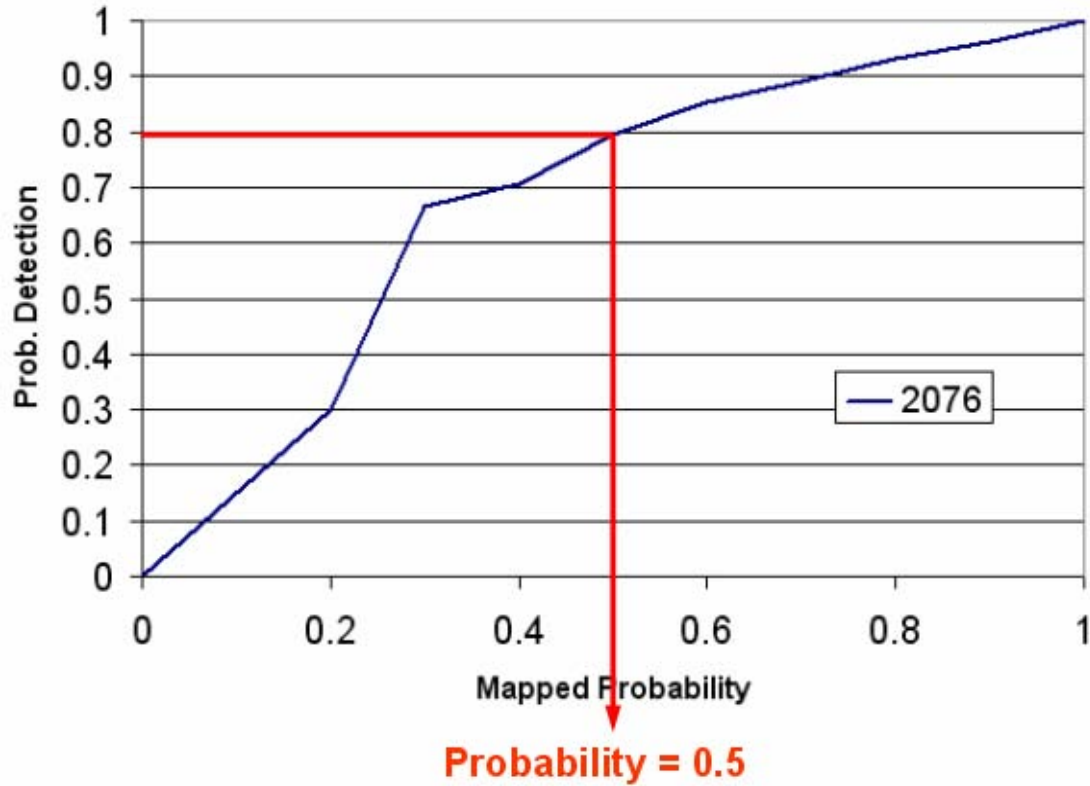


Figure A14-4. ROC curve graphs of bottomland forests.



Appendix 14. ROC Graphs of select groups of communities and of the Mixed Oak-Hickory/Dogwood Forest (2076)



**Figure A14-5.** ROC curve graph for the Mixed Oak-Hickory/Dogwood Forest (2076) with the probability of detection plotted against the thresholds of the mapped probabilities obtained from discriminant analysis.

Appendix 14. ROC Graphs of select groups of communities and of the Mixed Oak-Hickory/Dogwood Forest (2076)

Appendices 15-18

**Appendices 15-18.**

The following appendices are contained in separate documents:

**Appendix 15. ONSR USNVC Natural Community Descriptions.**

**Appendix 16. ONSR Altered Community Descriptions.**

**Appendix 17. Field Key to ONSR Vegetation Communities.**

**Appendix 18. ONSR USNVC Community Fuel Loading Photo Key.**



## Appendix 19. Pilot Area Test of Two Statistical Classification Methods.

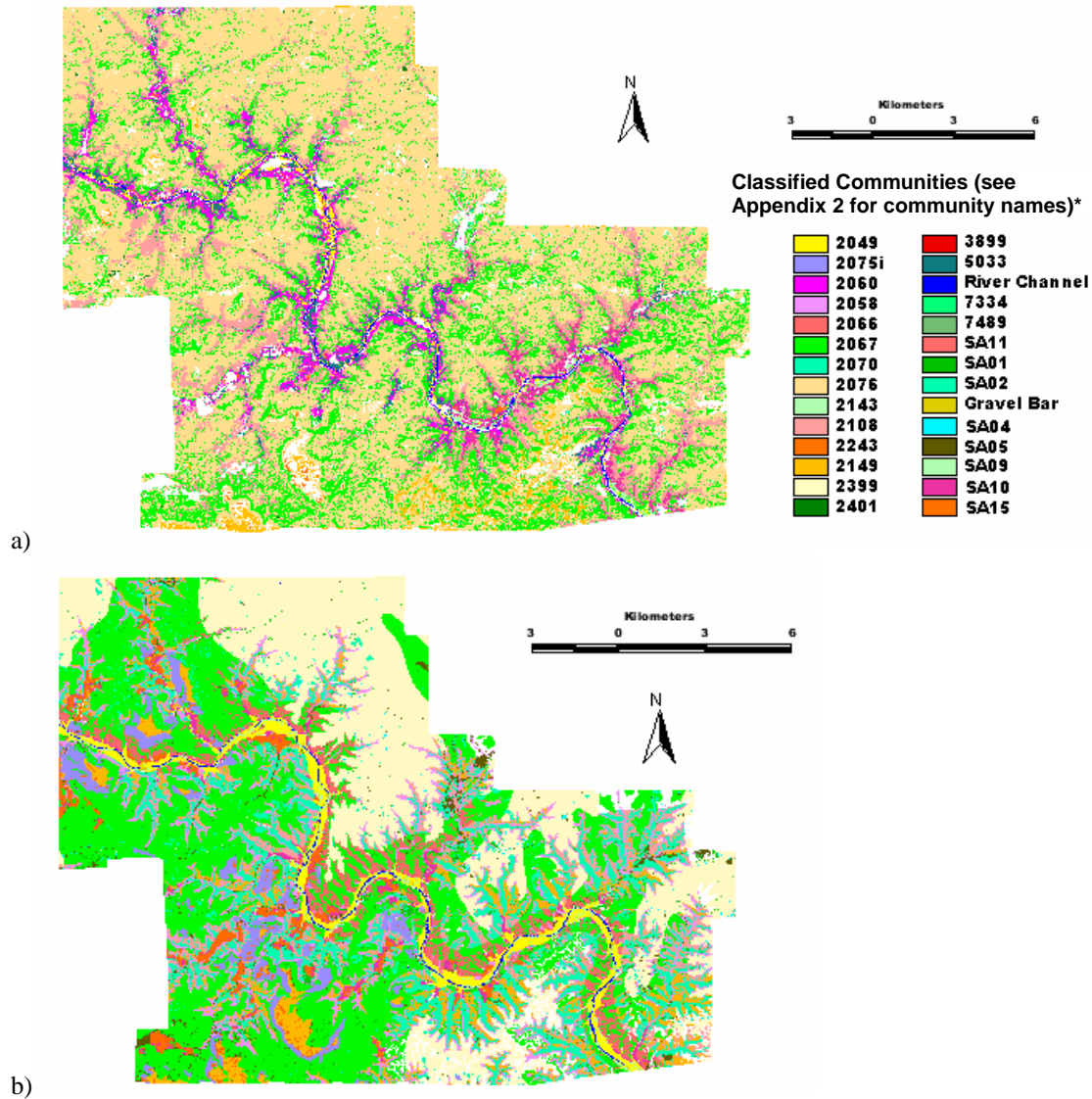
Training data used to support a classification using both nonparametric and maximum likelihood decision rules were obtained using ERDAS Imagine version 8.7 to create feature space objects that function as nonparametric signatures. These signatures were produced by drawing polygonal training areas around field survey plot locations, so that the spatial data in the immediate vicinity could be associated with those locations. A subset of less than half of the available survey points was used to train the classification, and the remaining data were set aside to validate the resulting map. The signatures were evaluated to determine which of the inputs should be included to optimize the classification by examining the transformed divergence, a measure of statistical distance between signatures. A nonparametric parallelepiped decision rule was used to assign individual training data cases to vegetation association types based on patterns in the independent variables. Cases that either fell into more than one class (overlap), or were not within any of the parallelepiped class boundaries (unclassified) were placed in one of the classes based on the result of a maximum likelihood decision rule. The choice to classify all of the training cases was motivated by the desire to emulate as closely as possible the greedy algorithm employed by the regression tree classification also performed for this pilot study, thus enhancing the comparability of the results of the two classification approaches. The map of the pilot area that resulted from this classification is shown in map A of Figure A19-1.

The Recursive Partitioning and Regression Trees (RPART) package in the R statistical software version 1.8.1 was used to develop a regression tree based on the training data described above. The `class` method was used to create a regression tree model to classify plant community associations, using the Gini index of impurity as a splitting rule to maximize impurity reduction during data splitting at tree nodes with prior probabilities  $p$  proportional to observed class frequencies. A generalized Gini index of impurity is defined as the expected cost of misclassification. No pruning was applied to the greedy outcome of the regression tree to maximize the number of vegetation associations classified by the tree model. A set of if-then statements based on the parameters in the regression tree was coded and run in the ArcGIS GRID module to produce the pilot area association level map shown in map B of Figure A19-1.

Rather low accuracy results were obtained from the two classification approaches tested in this pilot study. The regression tree model for the association level vegetation communities was marginally more accurate overall (39.2% with a kappa value of 0.367). While the maximum likelihood decision rule classification result was only 5 percent less accurate overall at 34.5% (kappa = 0.314), certain vegetation associations were mapped more accurately using former approach compared to the latter (e.g. 2058, 2070, 2149, SA02 and SA04). The low accuracy results obtained in this pilot investigation point out some limitations associated with using statistical classifiers alone in complex land cover mapping problems. For example, numerous USNVC vegetation association types were not discernable by the regression tree model, and were consequently left out of the results. Some of the categories in a predetermined classification scheme will not be classified by regression tree model due to inseparability or rarity, especially when the tree model result is optimized through pruning. In addition, the maximum likelihood decision rule classification lacks an efficient and trustworthy method for variable selection, and thus often generates a non-parsimonious classification model.



Appendix 19. Pilot Area Test of Two Statistical Classification Methods



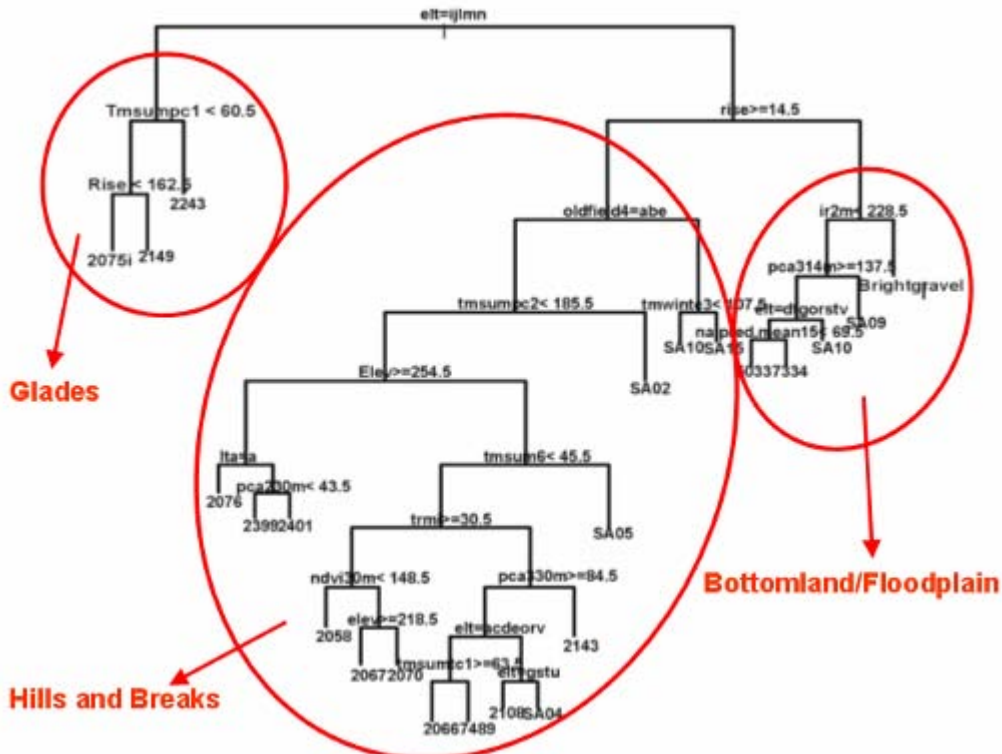
**Figure A19-1.** Comparison of maps produced using decision rule classification (a, 28 classes), and regression tree classification (b, 22 classes).

\*Legend applies to both maps

In this pilot investigation, regression trees indicated the importance of particular independent variables and where they are valuable for distinguishing both natural and human altered vegetation community classes. It was determined that the ultimate utility of regression tree classification for mapping USNVC vegetation associations may be realized by applying its information content towards a preliminary stratification of the study area so that separate classification models can be applied within each relatively more homogeneous region. The primary splits identified by the association level regression tree (Figure A19-2) separate the pilot study area into vegetation communities that occur on igneous knobs, in bottomland areas (including old fields), and those that occur on the remainder of the upland hills and breaks. The ONSR mapping area was split using Ecological Land Type (ELT) data to produce masks for the bottomland, igneous glade, and hills and breaks regions. Further, it was decided that due to the

## Appendix 19. Pilot Area Test of Two Statistical Classification Methods

numerous categories in the USNVC association-level classification scheme and copious independent variables available for classification model input, discriminant analysis represented a more appropriate method to pursue, as this statistical approach has shown promise with large hyperspectral remote sensing input datasets (Clark and others, 2005; Karimi and others, 2005).



**Figure A19-2.** Regression tree used to produce maps in Figure A19-1, with structural features that suggested performing three separate classifications on each of the groups identified.

### Appendix 19 References

- Clark, M.L., Roberts, D.A. and Clark, D.B. 2005. Hyperspectral discrimination of tropical tree species at leaf to crown scales. *Remote Sensing of Environment*, 96(3-4): 375-398.
- Karimi, Y., Prasher, S.O., McNairn, H., Bonnell, R.B., Dutilleul, P. and Goel, R.K.. 2005. Classification accuracy of discriminant analysis, artificial neural networks, and decision trees for weed and nitrogen stress detection. *Transactions of the ASAE*, 48(3): 1261-1268.

## Appendix 19. Pilot Area Test of Two Statistical Classification Methods

## Appendix 20. Details of the Discriminant Analysis Statistical Model.

Stepwise discriminant analysis was first applied to determine which of the 92 discriminating variables from the remote sensing and topographic data layers were most valuable in predicting land cover type membership for all of the pixels in the study area. The STEPDISC procedure in SAS software was applied using the stepwise selection method on the complete set of 92 variables in the training dataset. A total of 58 out of 92 variables (63 percent) were chosen for the breaks and hills section of the study area, 24 out of 92 variables (26.1 percent) were chosen for the igneous areas, and 38 out of 92 variables (41.3 percent) were chosen for the bottomlands portion of the overall study area.

The SAS software canonical discriminant analysis (CANDISC) procedure was then applied using variables chosen by the stepwise analysis. A canonical discriminant function is a linear combination of the discriminating variables, and takes the mathematical form:

$$f_{km} = u_0 + u_1X_{1km} + u_2X_{2km} + \dots + u_pX_{pkm}$$

where  $f_{km}$  = value (score) on the canonical discriminant function for case  $m$  in group  $k$ ,  $X_{ikm}$  = value on discriminating variable  $X_i$  for case  $m$  in group  $k$ , and  $u_i$  = coefficients which produce the desired characteristics in the function. The maximum number of unique canonical functions that can be derived is equal to the number of categories in the classification minus one, or the number of discriminating variables, whichever is fewer. Thus, canonical functions are useful as a method to reduce the dimensionality of classification problems. For example, the 38 discriminating variables that went into the bottomlands classification were reduced to 6 uncorrelated canonical variables through this method, because there is a total of 7 USNVC association types that serve as target categories for classification in the bottomland areas.

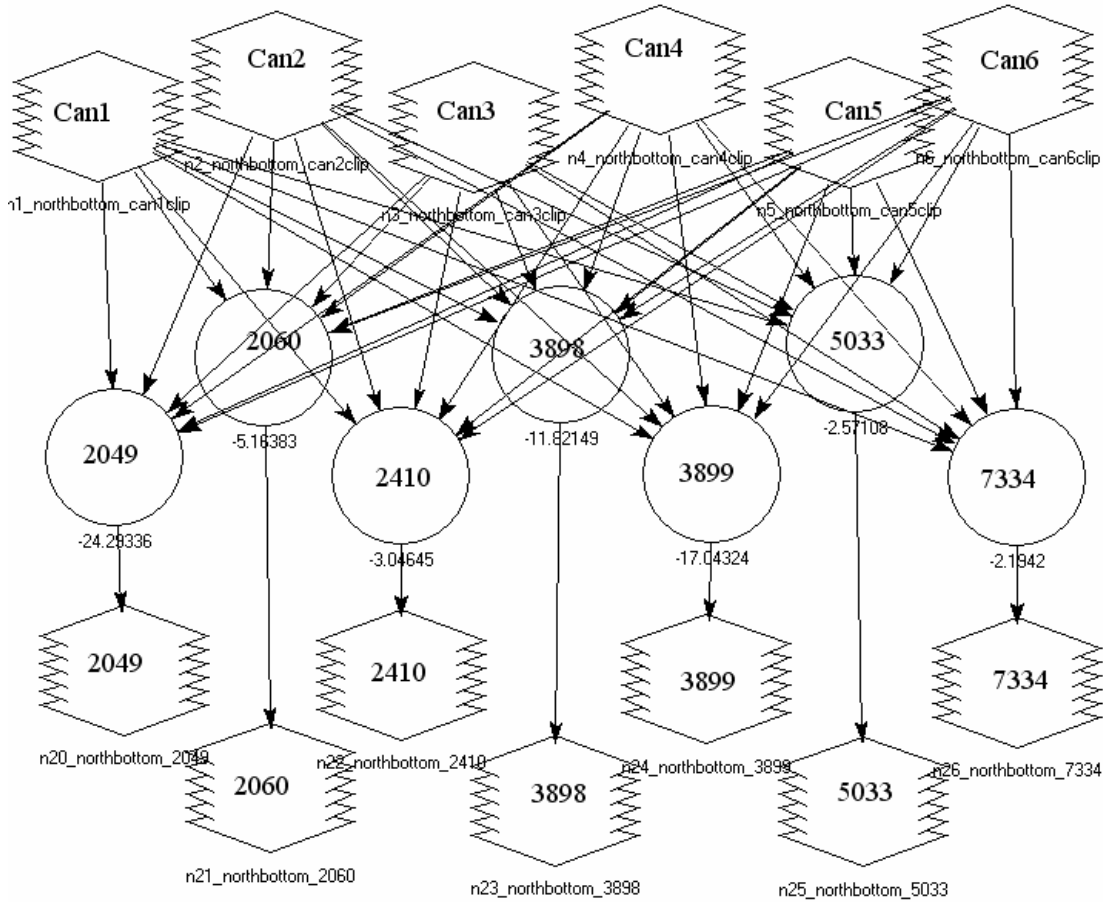
3) The discriminant analysis (DISCRIM) procedure in SAS software was applied to classify the bottomlands, igneous areas, and hills and breaks separately using the canonical discriminant functions that were created in the CANDISC procedure as calibration data. This classification method utilizes a linear combination of the canonical functions to predict the category (USNVC association) to which each training data case most likely belongs. Posterior probabilities of category membership were then computed from the results of this classification approach (Klecka, 1980).

4) The ERDAS Imagine Model Maker was used to apply the results from the discriminant analysis to image datasets. The first step involved mathematically combining the various images representing the input discriminating variables to produce images containing continuous representations of the canonical discriminant functions used in the classification model. This was accomplished by copying the raw canonical coefficients from SAS software output into a 'function definition' in ERDAS Imagine Model Maker (Figure A20-1). Next, the discriminant function coefficients from SAS software output were similarly incorporated into a second ERDAS model wherein all of the canonical discriminant functions were combined to produce images containing classification scores for all of the USNVC association categories in the bottomland portion of the ONSR mapping region (Figure A20-2). Using these classification scores, posterior probabilities of group membership for all of the USNVC association types (ERDAS model not shown) were computed. A final ERDAS model was used to combine all of the USNVC association categories into a single thematic image using a conditional statement in the function definition dialog to assign to each cell the map category with the highest probability for that cell location (Figure A20-3). A second image was also created in this model to store the value of the highest probability for each cell.



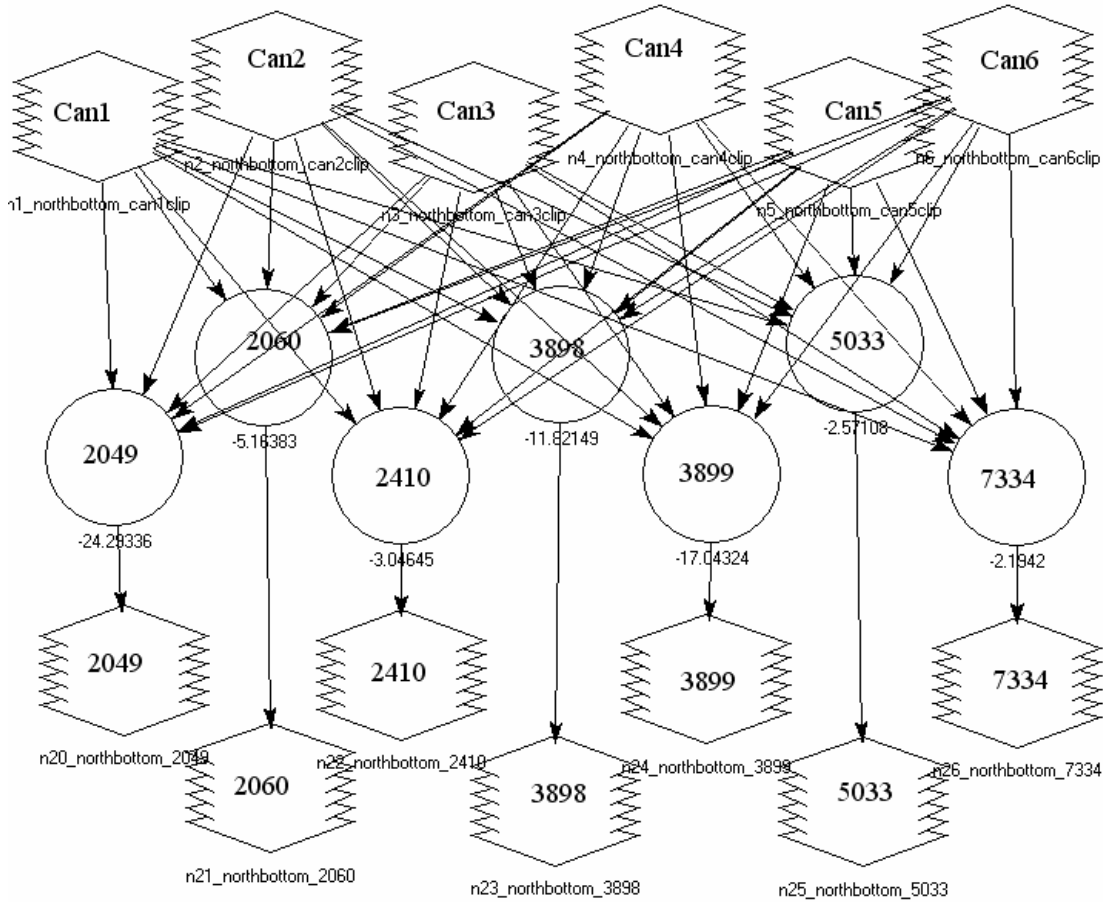


Appendix 20. Details of the Discriminant Analysis Statistical Model



**Figure A20-2.** Graphic environment of the ERDAS Imagine Model Maker showing the combination of all of the canonical discriminant functions to produce images containing classification scores for all of the USNVC association categories in the bottomland portion of the ONSR mapping region.

Appendix 20. Details of the Discriminant Analysis Statistical Model



**Figure A20-3.** Graphic environment of the ERDAS Imagine Model Maker showing 1) the generation of the USNVC association thematic image using a conditional statement in the function definition dialog to assign the category with the highest probability to each cell (right), and 2) a second image that stores the value of the highest probability for each cell (left).