

EPA-AA-TEB-511-83-10

EPA Evaluation of the Mesco Moisture Extraction System Under
Section 511 of the Motor Vehicle Information
and Cost Savings Act

by

Edward Anthony Barth

July 1983

Test and Evaluation Branch
Emission Control Technology Division
Office of Mobile Sources
U.S. Environmental Protection Agency

TECHNICAL REPORT DATA <i>(Please read Instructions on the reverse before complete)</i>		
1. REPORT NO. EPA-AA-TEB-511-83-10	2.	3. PB84-146014
4. TITLE AND SUBTITLE EPA Evaluation of the Mesco Moisture Extraction System Under Section 511 of the Motor Vehicle Information and Cost Savings Act.		5. REPORT DATE July 1983
7. AUTHOR(S) Edward Anthony Barth		6. PERFORMING ORGANIZATION CODE
9. PERFORMING ORGANIZATION NAME AND ADDRESS U.S. Environmental Protection Agency Office of Mobile Sources Test and Evaluation Branch Ann Arbor, MI 48105		8. PERFORMING ORGANIZATION REPORT NO.
12. SPONSORING AGENCY NAME AND ADDRESS		10. PROGRAM ELEMENT NO.
		11. CONTRACT/GRANT NO.
		13. TYPE OF REPORT AND PERIOD COVERED Technical
		14. SPONSORING AGENCY CODE
15. SUPPLEMENTARY NOTES		
16. ABSTRACT <p>This document announces the conclusions of the EPA evaluation of the Mesco Moisture Extraction System device under the provisions of Section 511 of the Motor Vehicle Information and Cost Savings Act.</p> <p>The evaluation of the Mesco Moisture Extraction System was conducted upon the application of the manufacturer. The device is an exhaust gas recirculation (EGR) system. The device supplements the EGR system of a vehicle by adding cooled and filtered exhaust gas to the carburetor. The ignition timing is also advanced. This combination of advanced timing and supplemental EGR is claimed to result in longer cleaner burn that improves engine performance and reduces emissions.</p> <p>EPA fully considered all of the information submitted by the applicant. The evaluation of the Mesco Moisture Extraction System was based on that information and our engineering judgment. The applicant failed to submit adequate data which would substantiate his claims. Although the additional EGR and the prescribed ignition timing adjustments of the engine have the potential to affect both fuel economy and emissions, there are no technical reasons to assume that these effects would be beneficial. Thus, in the absence of appropriate test data, EPA has no technical reason to support the claims made for the device or to continue the evaluation on its own.</p>		
17. KEY WORDS AND DOCUMENT ANALYSIS		
a. DESCRIPTORS	b. IDENTIFIERS/OPEN ENDED TERMS	c. COSATI Field/Group
Automobiles Exhaust Emissions Fuel Consumption Tests	Fuel Economy Gas Saving Devices	
18. DISTRIBUTION STATEMENT Release Unlimited	19. SECURITY CLASS (This Report) unclassified	21. NO. OF PAGES 70
	20. SECURITY CLASS (This page) unclassified	22. PRICE

EPA Form 2220-1 (9-73)

NOTICE

**THIS DOCUMENT HAS BEEN REPRODUCED
FROM THE BEST COPY FURNISHED US BY
THE SPONSORING AGENCY. ALTHOUGH IT
IS RECOGNIZED THAT CERTAIN PORTIONS
ARE ILLEGIBLE, IT IS BEING RELEASED
IN THE INTEREST OF MAKING AVAILABLE
AS MUCH INFORMATION AS POSSIBLE.**

EPA Evaluation of the Mesco Moisture Extraction System Under Section 511 of the Motor Vehicle Information and Cost Savings Act

The Motor Vehicle Information and Cost Savings Act requires that EPA evaluate fuel economy retrofit devices and publish a summary of each evaluation in the Federal Register.

EPA evaluations are originated upon the application of any manufacturer of a retrofit device, upon the request of the Federal Trade Commission, or upon the motion of the EPA Administrator. These studies are designed to determine whether the retrofit device increases fuel economy and to determine whether the representations made with respect to the device are accurate. The results of such studies are set forth in a series of reports, of which this is one.

The evaluation of the "Mesco Moisture Extraction System" was conducted upon the application of the manufacturer. The device is an exhaust gas recirculation (EGR) system. The device supplements the EGR system of a vehicle by adding cooled and filtered exhaust gas to the carburetor. The ignition timing is also advanced. This combination of advanced timing and supplemental EGR is claimed to result in a longer, cleaner burn that improves engine performance and reduces emissions.

1. Title:

Application for Evaluation of Mesco Moisture Extraction System Under Section 511 of the Motor Vehicle Information and Cost Savings Act

The information contained in sections two through five which follow, was supplied by the applicant.

2. Identification Information:

a. Marketing Identification of the Product:

Trade Name: Mesco Inc.
Marketing Name: Mesco Moisture Extraction System
Trademark: Logo as appears in cover letter. (Attachment B)
Other Methods: U.S. Patent No. 4,356,806

b. Inventor and Patent Protection:

(1) Inventor

Charles W. Fresh
2618 E. Elm St.
Phoenix, Arizona 85016

(2) Patent

No. 4,356,806 (Attachment A)

c. Applicant:

(1) Mesco Inc. (An Arizona Corporation)
2618 E. Elm Street
Phoenix, Arizona 85016

(2) Principals

Charles W. Freesh - President
Mildred C. Freesh - Sec/Treasurer
Lance V. Freesh - V.P. Operations

Note: Mesco Inc., is a wholly owned subsidiary of Martin Research Corporation (An Arizona Corporation), the officers of which are the same as Mesco Inc.

(3) Charles W. Freesh (primary) and Lance V. Freesh are authorized to represent Mesco, Inc. in communication with EPA.

d. Manufacturer of the Product:

(1) Mesco Inc.
2618 E. Elm Street
Phoenix, Arizona 85016
(602)-955-6580

(2) Principals

Charles W. Freesh - President
Mildred C. Freesh - Sec/Treasurer
Lance V. Freesh - V.P. Operations

3. Description of Product:

a. Purpose:

"The objective of Mesco Moisture Extraction System is to improve the operation of internal combustion engines [by] reducing fuel consumption, improving performance and reducing pollutant emissions.

"The means of achieving this objective is to recycle cooled and condensed exhaust gases back into the combustion cycle. A portion of the exhaust gases are extracted, cooled, filtered, and metered into the intake manifold continuously during engine operation. No moving parts or electrical controls are employed in operation."

b. Applicability:

(1) Vehicles

"The device submitted for evaluation in this application is generally applicable to passenger vehicles and trucks using gasoline or propane fuel and powered by conventional internal combustion engines.

"Different make, model and model years of vehicles require correspondingly different approaches to physical installation due to different configurations of tailpipe, bellypan etc. However, experimental installations performed by Mesco Inc. prior to the submission of this application have indicated that engine size, carburetor type and type of transmission are not significant factors in relation to the operability of the submitted device.

"The operation of the submitted device is not significantly affected by the use of leaded or unleaded fuels.

"A significant factor in the operability of the submitted device is the ability to advance the ignition timing beyond the manufacturer's recommended setting. Late model vehicles having electronically controlled ignition timing which is not adjustable would not likely show substantial improvements in operation when equipped with the submitted device as an after-market installation.

"The submission of this application does not include the evaluation of the submitted device for application on diesel fueled engines."

(2) Environmental

"The submitted device has been evaluated on a test vehicle for operation in city, highway and mountain driving with environmental conditions ranging from sea level to 8500 feet elevation, 7 to 97 percent humidity and temperatures ranging from 0 to 107 degrees Fahrenheit. An improvement in fuel economy and performance was noted in all of the aforementioned conditions. Similar results have been noted on other vehicles upon which experimental installations of the submitted device have been made."

c. Theory of Operation:

"A portion of the exhaust gases are extracted from the end of the vehicle tailpipe by a tailpipe adapter. These gases are then cooled by a finned tube heat exchanger and introduced into a filter which filters particulates from the gases and performs a secondary cooling of the gases by means of expansion. The cooled gases and condensate are then passed through a second finned tube heat exchanger for additional cooling and metered into the intake manifold of the engine by a venturi tube. The venturi tube performs the dual function of metering the flow and atomizing the condensate. A convenient way of introducing the recycled moisture into the intake manifold is by means of a tee in the line between the PCV valve and the intake manifold.

"The combination of advanced ignition timing with the introduction of atomized moisture into the combustion chamber results in a longer, cleaner burn which in turn results in improved engine performance and reduced emissions."

d. Construction and Operation:

"A copy of the specifications for the Moisture Extraction System is enclosed." (Attachment B)

e. Specific Claims for the Product:

"A copy of the initial Mesco brochure is enclosed and will be revised after completion of officially sanctioned EPA tests. The results of the testing will govern future advertising." (Attachment C)

f. Cost And Marketing Information:

"Mesco Moisture Extraction System units are currently in the stage of limited production manufacturing.

"Mesco unit installation will be performed by Mesco Inc. or duly authorized dealers. The current marketing approach is not geared to a shelf product.

"The wholesale price to dealers is currently one hundred forty dollars (\$140.00) for a complete installation kit for vehicles equipped with a single tailpipe exhaust system. The suggested retail installed price is two hundred ten dollars (\$210.00) plus applicable taxes.

"The wholesale price to dealers is currently one hundred eighty-five dollars (\$185.00) for a complete installation kit for vehicles equipped with a dual tailpipe exhaust system. The suggested retail installed price is two hundred sixty dollars (\$260.00) plus applicable taxes."

4. Product Installation, Operation, Safety and Maintenance:

a. Installation - Instructions, Equipment, and Skills Required:

"A draft of the Moisture Extraction System Installation Instructions is enclosed. (Attachment D)

b. Operation:

"Operation instructions are contained within the enclosed Installation Instructions."

c. Effects on Vehicle Safety:

"Safety recommendations are contained within the enclosed Installation Instructions."

d. Maintenance:

"Maintenance recommendations are contained within the enclosed Installation Instructions."

5. Effects on Emissions and Fuel Economy:

a. Unregulated Emissions:

"Other than the cooling of exhaust gases, the submitted device performs no chemical process upon existing exhaust gases nor introduces additional chemical components. Evaporative emissions originating from the device are not substantially significant during vehicle use or when not used."

"No known failure of the submitted device has been observed or reported in three years of testing and evaluation by Mesco Inc."

b. Regulated Emissions and Fuel Economy:

"This data to be provided as test results from an independent laboratory recognized by the EPA."

"A recommended test plan for obtaining this data is enclosed." (Attachment E)

The following Sections are EPA's analysis and conclusions for the device.

6. Analysis

EPA evaluated the application and found no problems with the information supplied regarding device identification, purpose, construction, operation, claims, marketing, and vehicle safety.

7.

Installation and checkout of the single tailpipe system can probably be done in four hours as stated (Attachment C). But installation of the dual system will take about one hour longer.

Therefore, the total cost of the single tailpipe system would probably be at least \$330. (and \$410 for the dual system) for those users who have the device installed by a mechanic. This is based on the above assumed retail price of \$210 (\$260 dual tailpipe) and installation requiring approximately four hours (five hours for a dual tailpipe) at \$30 per hour.

b. Installation, Operation, Safety and Maintenance:

(1) Installation - Instructions, Equipment and Skills Required:

The specifications show that the "moisture flow control jet insert" (or flow control orifice) is to be sized to the cubic inch displacement of the engine (Attachment B). However, the detailed parts list provided in the installation instructions shows only one part number, MES 8, for the assembly that contains the flow control jet.

Also, another key component of the system, the "moisture extractor tube assembly" is only available for two inch (outside diameter) and larger tailpipes (Attachment D). Since most small and compact vehicles have smaller tailpipes, the extractor assembly will not fit these vehicles unless a tailpipe adapter bushing is used. These adapters are not provided with the installation kit but they are available at many automotive parts stores.

(2) Maintenance:

Since the primary cooling tube of the device is installed along the rear fender wall and frame, it is exposed to the dirt and mud that is thrown up by the rear wheel. The cooling fins will therefore tend to cake-up with dirt since they are spaced only one-eighth of an inch apart. This build-up will actually insulate the supplemental EGR extracted by the device exhaust rather than cool it.

Thus, it will also be necessary to periodically clean the fins. To adequately clean these tube fins will probably require removal of the rear wheel and tire plus unclamping the finned tube to permit the side of it that is mounted against the frame to be cleaned. The applicant makes no mention of this problem and the need to clean the cooling tubes.

c. Effects on Emissions and Fuel Economy:

(1) Unregulated Emissions:

The applicant submitted no data on unregulated emissions. The applicants' statement that the "...device performs no chemical process upon existing exhaust gases..." is incorrect. The advance in ignition timing and the supplemental EGR added by the device will affect the combustion process and emissions. However, it is judged that these changes are unlikely to appreciably affect unregulated emissions.

The statement of the applicant about the effect of the device on evaporative emissions is misleading (See Section 5a). Evaporative emissions are a regulated emission. However, EPA does agree with the statement of the applicant that the effect of the device on evaporative emissions would be minimal (See Section 6f).

(2) Regulated Emissions and Fuel Economy:

The applicant did not submit test data in accordance with the Federal Test Procedure and the Highway Fuel Economy Test. These two test procedures are the primary ones recognized by EPA for evaluation of fuel economy and emissions for light duty vehicles.*

The supplemental EGR provided by the Mesco device and the prescribed timing adjustment will change the engine calibration of the vehicle. The references given in the bibliography provide an indication of the potential effect of the device for a known initial engine calibration. However to determine the actual effect of the device on a particular vehicle, the appropriate testing (LA-4 and HFET) must be performed.

*The requirement for test data following these procedures is stated in the policy documents that EPA sends to each potential applicant. EPA requires duplicate test sequences before and after installation of the device on a minimum of two vehicles. A test sequence consists of a cold start FTP plus a HFET or, as a simplified alternative, a hot start LA-4 plus a HFET. Other data which have been collected in accordance with other standardized procedures are acceptable as supplemental data in EPA's preliminary evaluation of a device.

The applicant was aware of this requirement and submitted a test plan for the device with the application (See Attachment E). EPA reviewed this plan and commented on it (See Attachment F). However, after initially indicating that he would test the device, the applicant failed to undertake the appropriate testing. Therefore, EPA was obligated to complete the evaluation using the information available (Attachment I). The applicant was advised that any test data or additional information would be accepted as part of a new application.

7. Conclusions

EPA fully considered all of the information submitted by the applicant. The evaluation of the Mesco Moisture Extraction System was based on that information and our engineering judgment.

The applicant failed to submit adequate data which would substantiate his claims. Although the additional EGR and the prescribed ignition timing adjustments of the engine have the potential to affect both fuel economy and emissions, there are no technical reasons to assume that these effects would be beneficial. Thus, in the absence of appropriate test data, EPA has no technical reason to support the claims made for the device or to continue the evaluation on its own.

FOR FURTHER INFORMATION CONTACT: Merrill W. Korth, Emission Control Technology Division, Office of Mobile Sources, Environmental Protection Agency, 2565 Plymouth Road, Ann Arbor, MI 48105, (313) 668-4299.

BIBLIOGRAPHY

1. Gumbleton, James J., Robert A. Bolton, and H. Walter Lang, "Optimizing Engine Parameters With Exhaust Gas Recirculation", SAE Paper 74104.
2. Schweikart, John F. and James J. Gumbleton, "Emission Control With Lean Mixtures", SAE Paper 760026.
3. Miles, Donald L. and George W. Niepoth, "Optimizing Engine and Car Design for Fuel Economy and Emissions", SAE Paper 760855.
4. Whitmyer, Alan, "The Effect of Ignition Timing Modifications on Emissions and Fuel Economy", Environmental Protection Agency; Technology Assessment and Evaluation Branch, Report 76-4.
5. Novak, J.M. and P.N. Blumberg, "Parametric Simulation of Significant Design and Operating Alternatives Affecting the Fuel Economy and Emissions of Spark-Ignited Engines", SAE Paper 780943.
6. Currie, James H., David S. Grossman, and James J. Gumbleton, "Energy Conservation with Increased Compression Ratio and Electronic Knock Control", SAE Paper 790173.
7. Trella, Thomas, "Spark Ignition Engine Fuel Economy Control Optimization - Techniques and Procedures", SAE Paper 790179.
8. Honig, G., H. Decker, and S. Rohde, "Electronic Spark Control Systems, Part I: Microcomputer-Controlled Ignition System, Part II: Bosch Knock Control", SAE Paper 810059.
9. Trella, Thomas J., "Fuel Economy Potential of Diesel and Spark Ignition-Powered Vehicles in the 1980's", SAE Paper 810514.

List of Attachments

- Attachment A** Patent 4,356,806 (provided with 511 Application).
- Attachment B** Specifications for Mesco Moisture Extraction System (provided with 511 Application).
- Attachment C** Sales brochure (provided with 511 Application).
- Attachemnt D** Installation Instructions (provided with 511 Application).
- Attachment E** Mesco, Inc. suggested test plan (provided with 511 Application).
- Attachment F** Letter of February 17, 1983 from EPA to Charles W. Freesh of Mesco, Inc. acknowledging receipt of 511 Application and describing test plan for device.
- Attachment G** Undated letter received March 28, 1983 from Charles W. Freesh of Mesco, Inc. providing copy of the test plan for the device.
- Attachment H** Letter of April 5, 1983 from EPA to Charles W. Freesh of Mesco, Inc. requesting information on proposed testing of the device.
- Attachment I** Letter of May 27, 1983 from EPA to Charles W. Freesh of Mesco, Inc. announcing EPA intention to close out evaluation, since Mesco, Inc. was not taking positive action to test device.
- Attachment J** Letter of June 13, 1983 from Charles W. Freesh of Mesco, Inc. notifying EPA of proposed testing.
- Attachment K** Letter of June 22, 1983 from EPA to Charles W. Freesh of Mesco, Inc. commenting on proposed testing.

Title: EPA Evaluation of the Mesco Moisture Extraction System Under
Section 511 of the Motor Vehicle Information and Cost Savings Act

ATTACHMENT A

Page(s) 12 - 15
Background of the Invention (Patent)

Not clearly reproducible from submitted document. Copy will be furnished upon request from the U. S. Environmental Protection Agency, Emission Control Technology Division, Test & Evaluation Branch, 2565 Plymouth Rd., Ann Arbor, MI 48105.

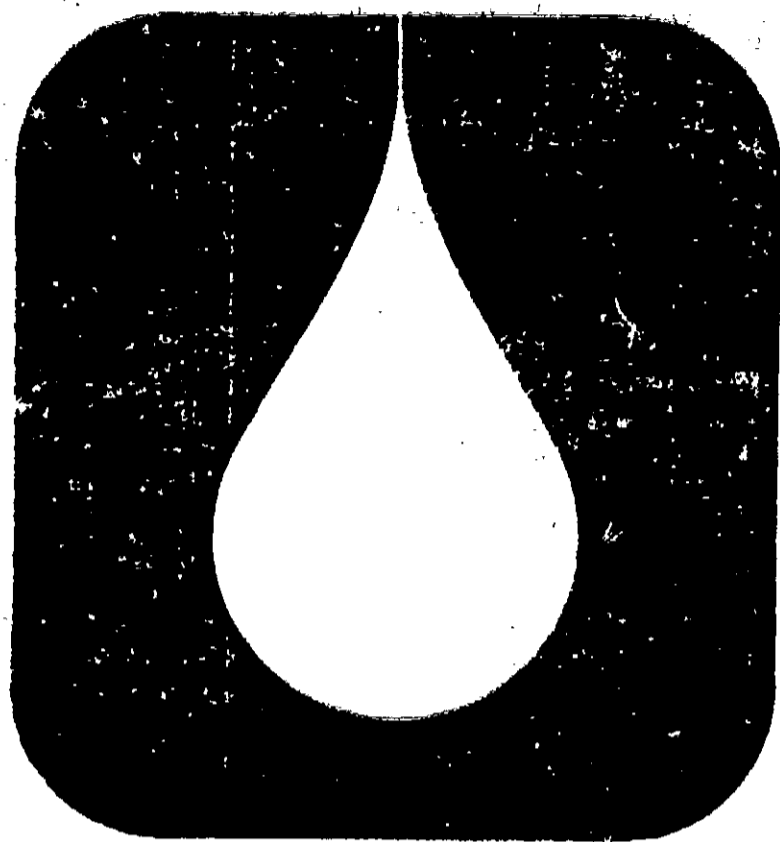

**Moisture
Extraction
System**

SPECIFICATIONS

INDEX

- PLATE A TYPICAL "MESCO" INSTALLATION FOR CARS, PICKUPS AND TRUCKS.
- PLATE-B MOISTURE EXTRACTION TUBE.
- PLATE C PRIMARY FINNED TUBE ASSEMBLY.
- PLATE D HORIZONTAL FILTER ASSEMBLY.
- PLATE E SECONDARY FINNED TUBE ASSEMBLY.
- PLATE F SHUT-OFF VALVE ASSEMBLY.
- PLATE G MOISTURE FLOW JET INSTALLATION.
INSTALLATION OF TEE IN PCV LINE.
- PLATE H OPTIONAL FILTER MOUNT LOCATIONS.
MOISTURE EXTRACTION TUBE PERMISSABLE ARC OF ROTATION.
- PLATE I MISC. MESCO HARDWARE.

TYPICAL "MESCO" INSTALLATION FOR CARS PICKUPS AND TRUCKS

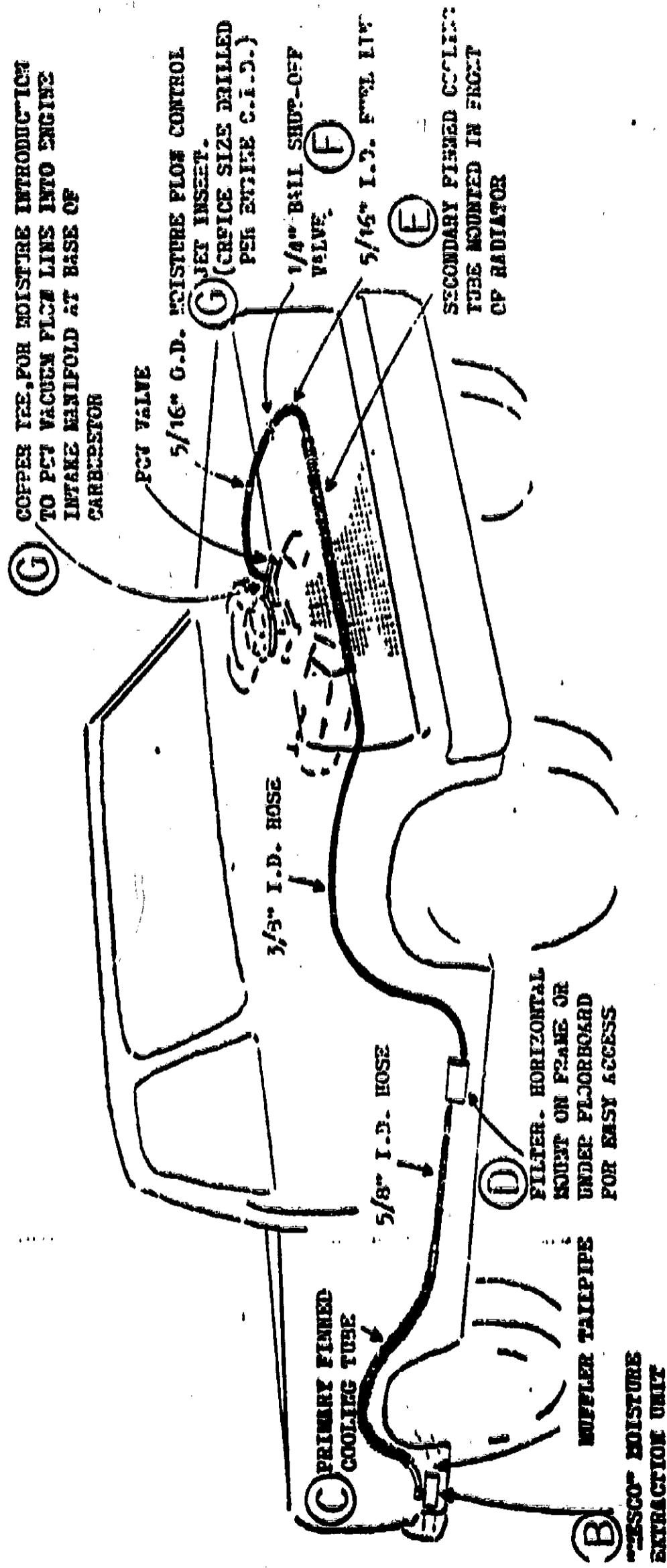
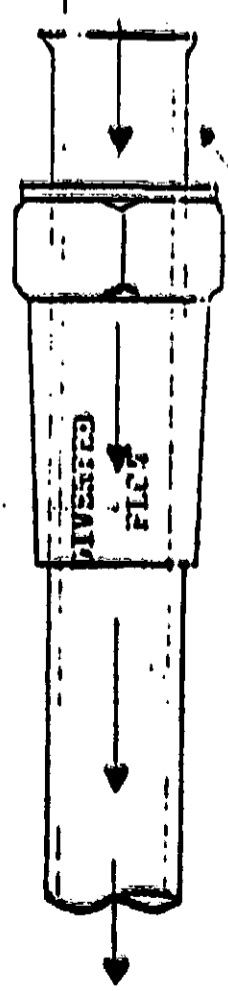
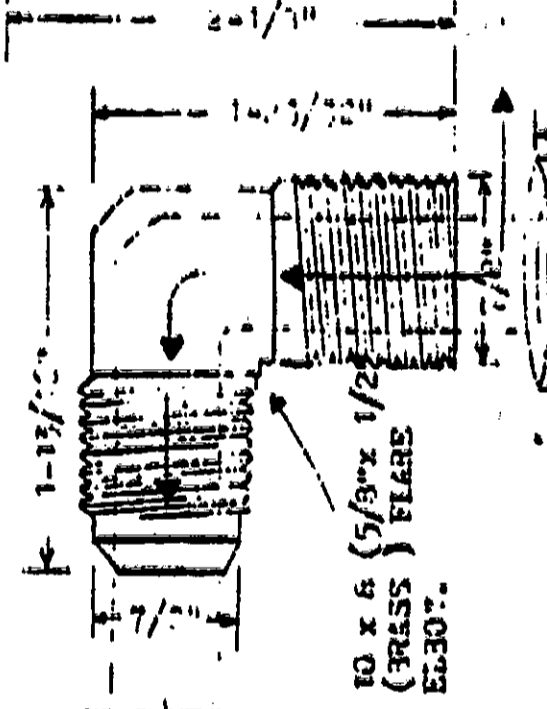
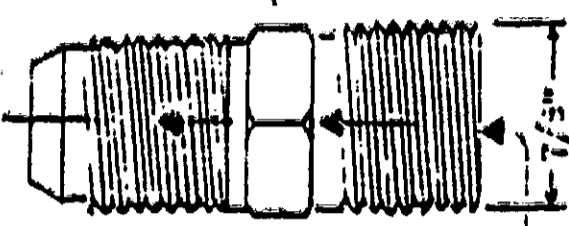

PLATE **(A)**

10 x 9 (5/8" x 1/2" (BRASS) FLARE HALF INCH.
 ALTERNATE FOR TUBE BLOCK IN DIRECT-IGNEL ROUTING OF DIVERTED GAS FLOW.



INLET END OF "MESCO" PRIMARY FLAMED COCATALYTIC TUBE ASSEMBLY.

MESCO TAKE OFF TUBE

NO. MES-100-2.25 TUBE SHOWN (FULL SERIES) FOR INSTALLATION OF WHEEL MULTIPLE (2-1/4" S.D.)

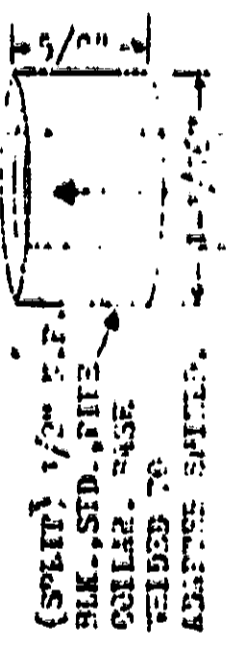

(SPLIT) 1/2" S.P. BLK.-SLD. PIPE COLLAR. BASE WELDED TO ADAPTER SHIELD.

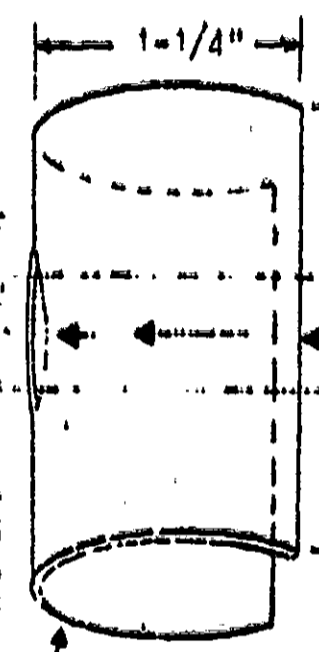

ADAPTER SHIELD. 12 GAUGE STEEL. FITTED WITH 3/4" HOLE. WERE WELDED TO TAKE OFF TUBE.

INNER END OF TAKE OFF TUBE. END S.W.T. TO RECEIVE 2-1/4" O.D. TAILPIPE.

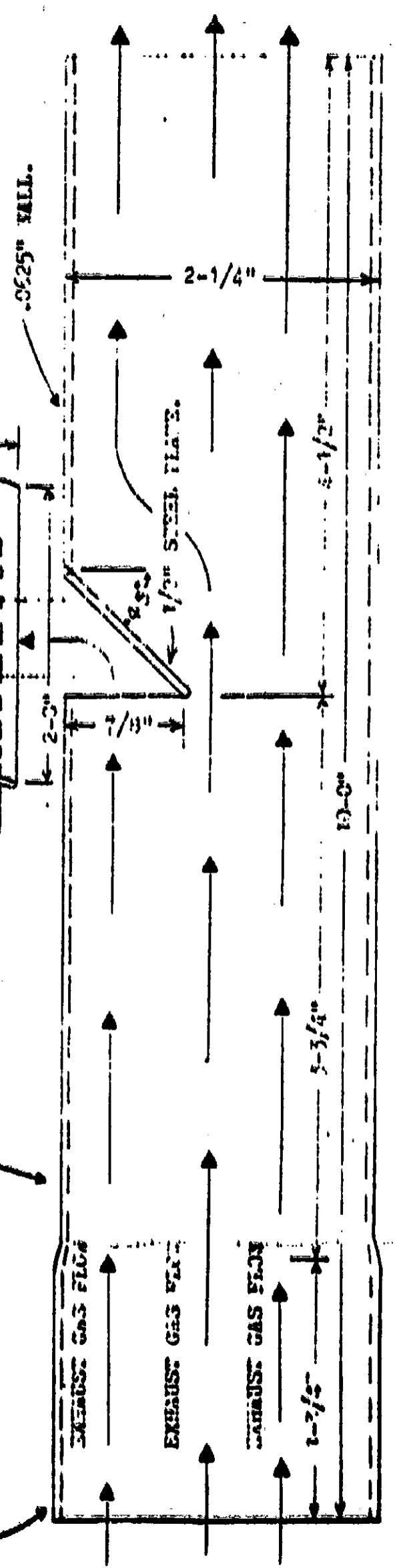
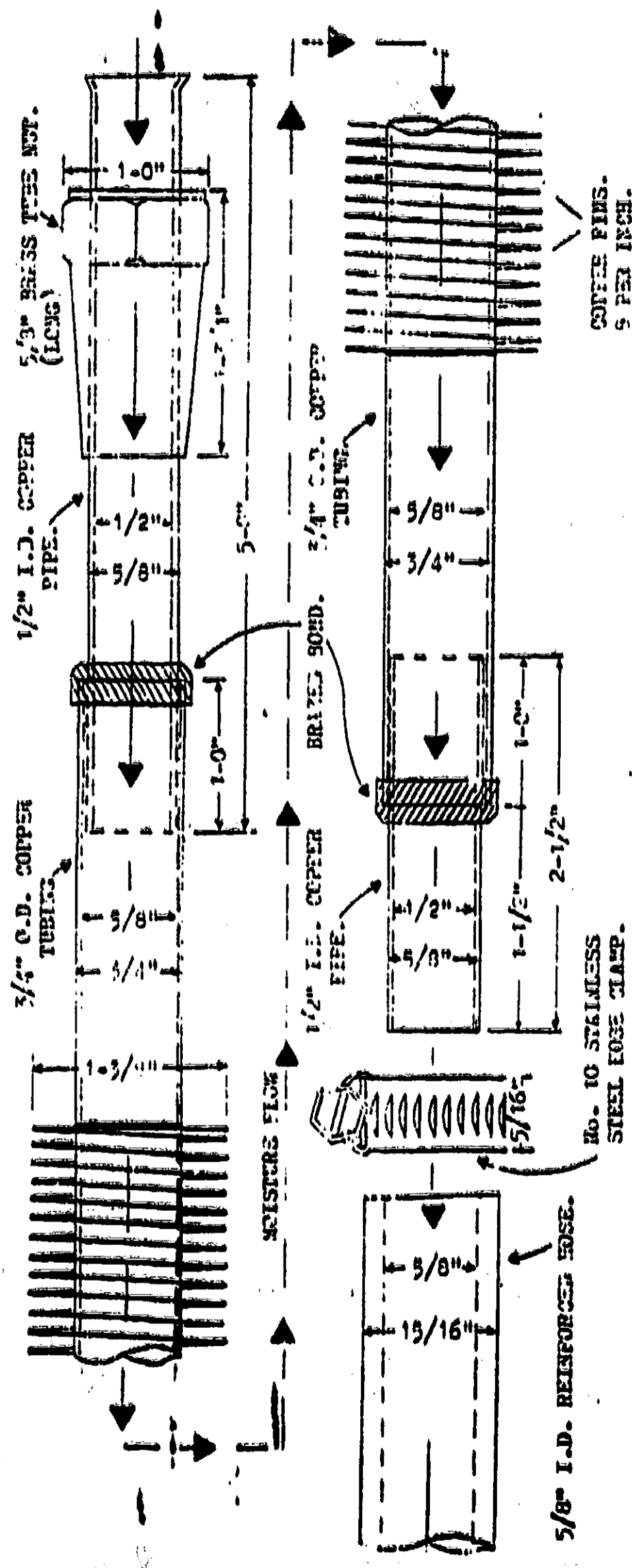

PLATE B



"MESCO" PRIMARY FINNED TUBE ASSEMBLY

FULL SCALE

FINNED AREA OF 48-0" OR MAIN TUBE.
 TOTAL LENGTH OF FINNED TUBE ASSEMBLY EQUALS 59-1/2".

PLATE C

"MESCO" HORIZONTAL FILTER ASSEMBLY

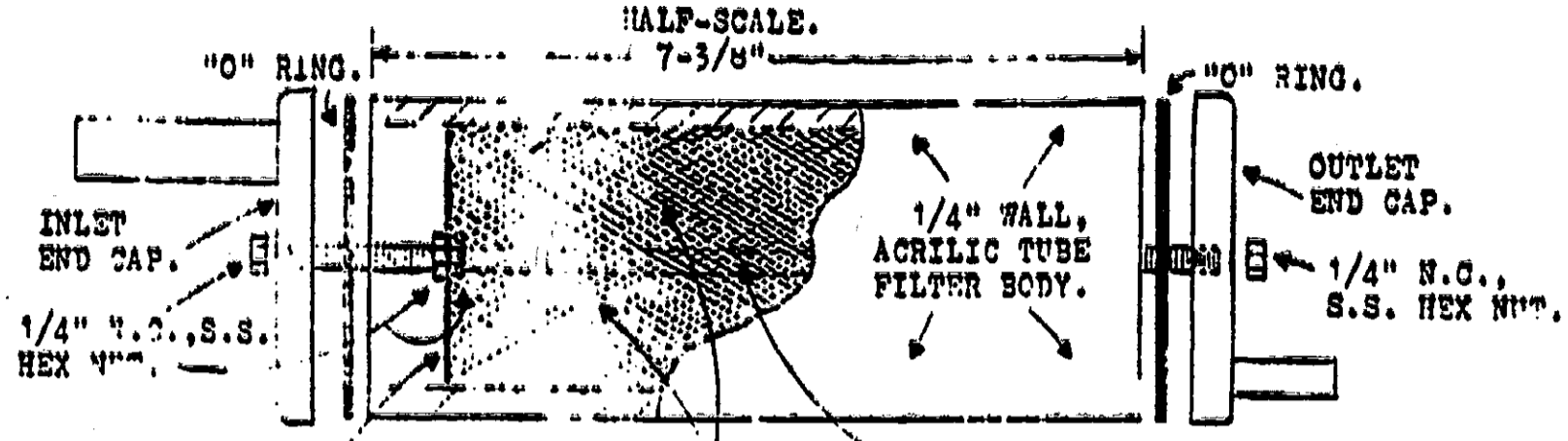

PERFORATED BRASS BAFFLE PLATE. SEE DETAIL BELOW.

FILTER ELEMENT. 6-0" WIDE x 56-0" LONG. STAINLESS STEEL. DOUBLE MESH. SPEC. T-304 S.S.

1/4" x 8-1/2" N.C., ALL THREAD, STAINLESS STEEL ROD.

PLATE (D)

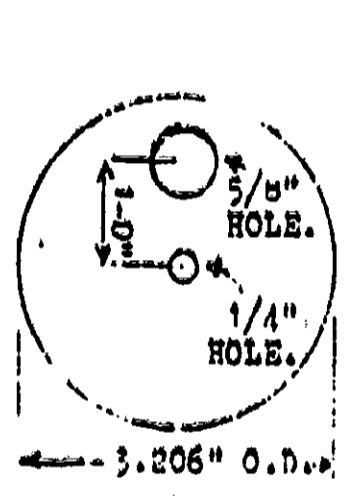

END VIEW. SINGLE INLET CAP.

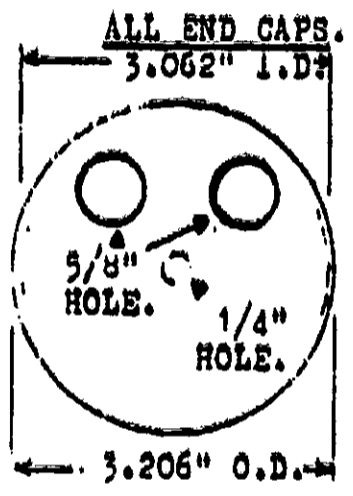

END VIEW. DOUBLE INLET CAP.

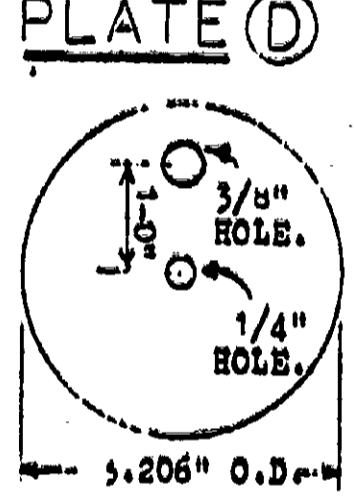

END VIEW. ALL OUTLET CAPS.

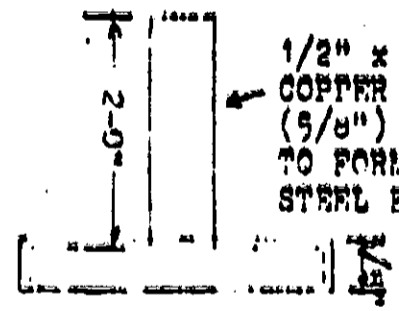

SIDE VIEW. SINGLE INLET CAP.

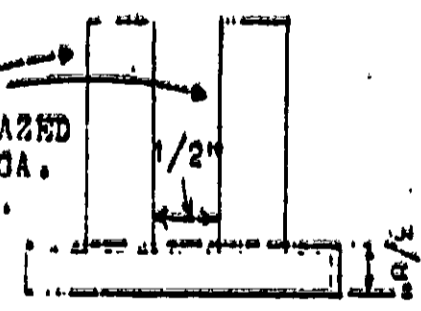

SIDE VIEW. DOUBLE INLET CAP.

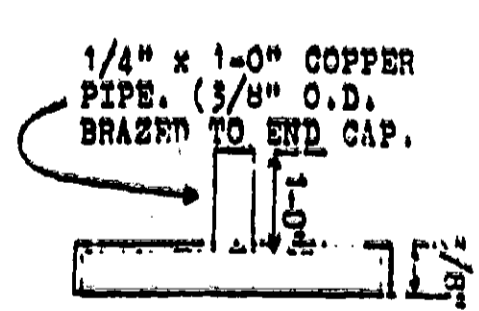

SIDE VIEW. ALL OUTLET CAPS.

NOTE: ALL CAPS HAVE BAKED ENAMEL INTERNAL AND EXTERNAL SURFACE.

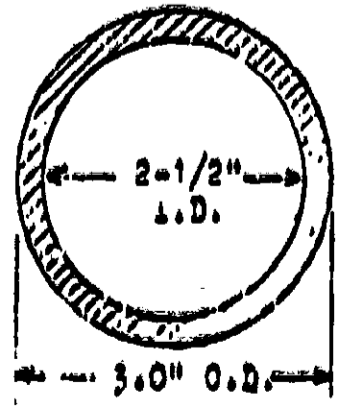

CROSS SECTION OF FILTER BODY.

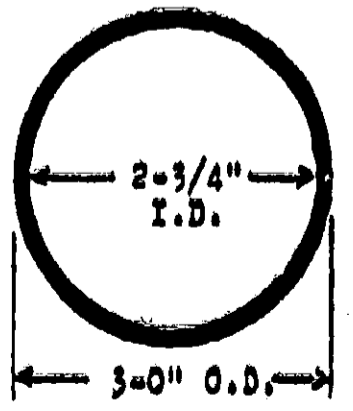

1/8" DIAMETER RING. SPEC. 2-212.

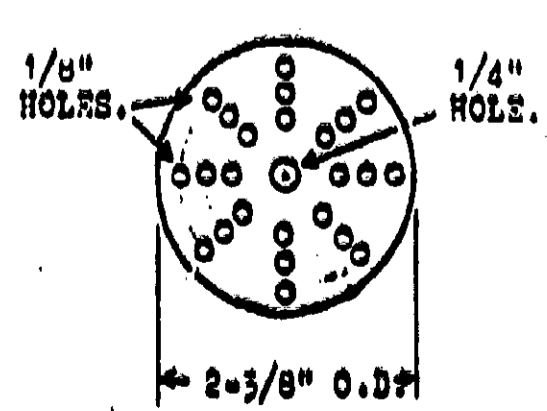

1/4" THICK, BRASS BAFFLE PLATE.

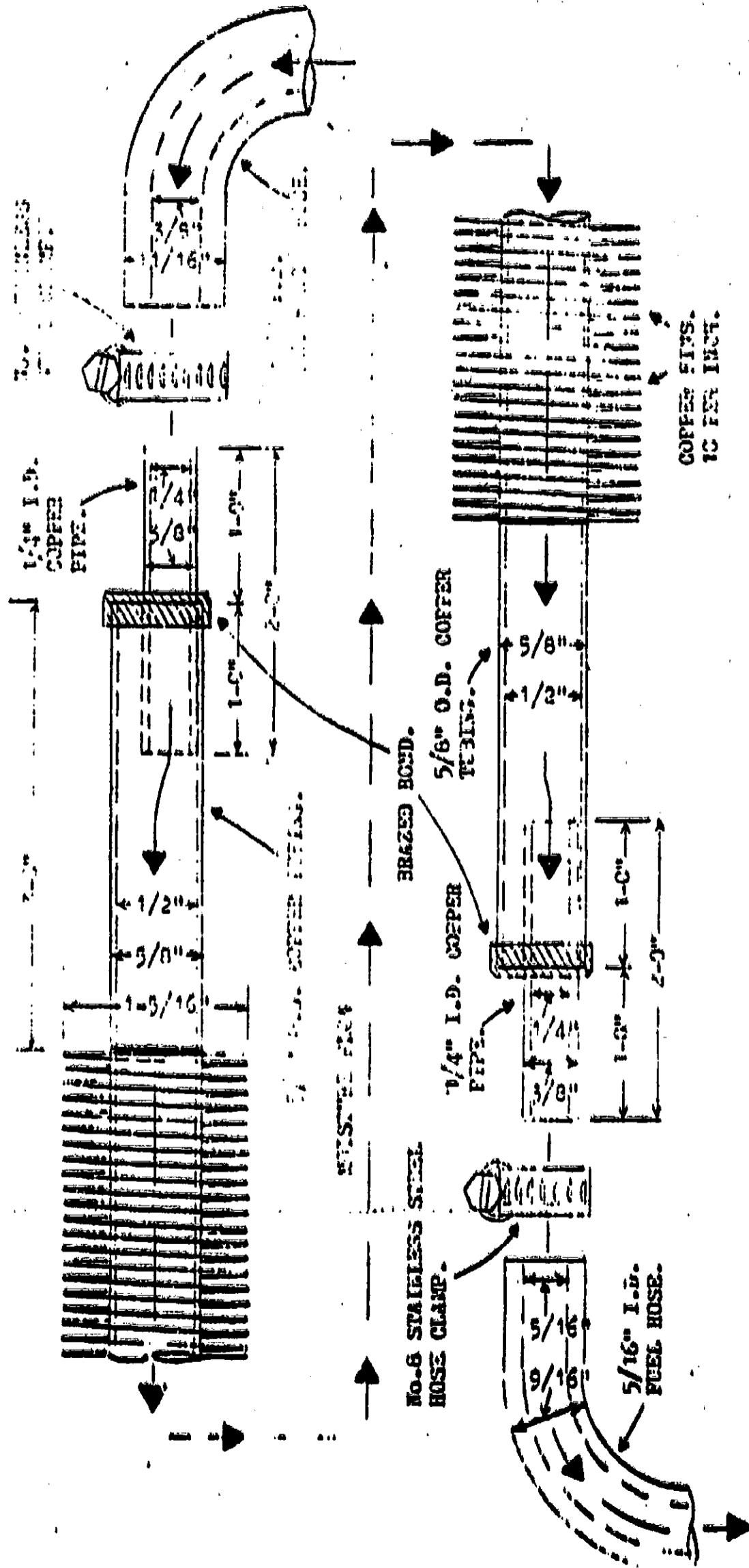

"MESCO" SECONDARY FINNED TUBE ASSEMBLY

FULL SCALE

FINNED AREA OF 24.0^{sq} ON MAIN TUBE.

TOTAL LENGTH OF FINNED TUBE ASSEMBLY TUBES 30.0ⁱⁿ

PLATE (E)

"MESCO" SHUT OFF VALVE ASSEMBLY

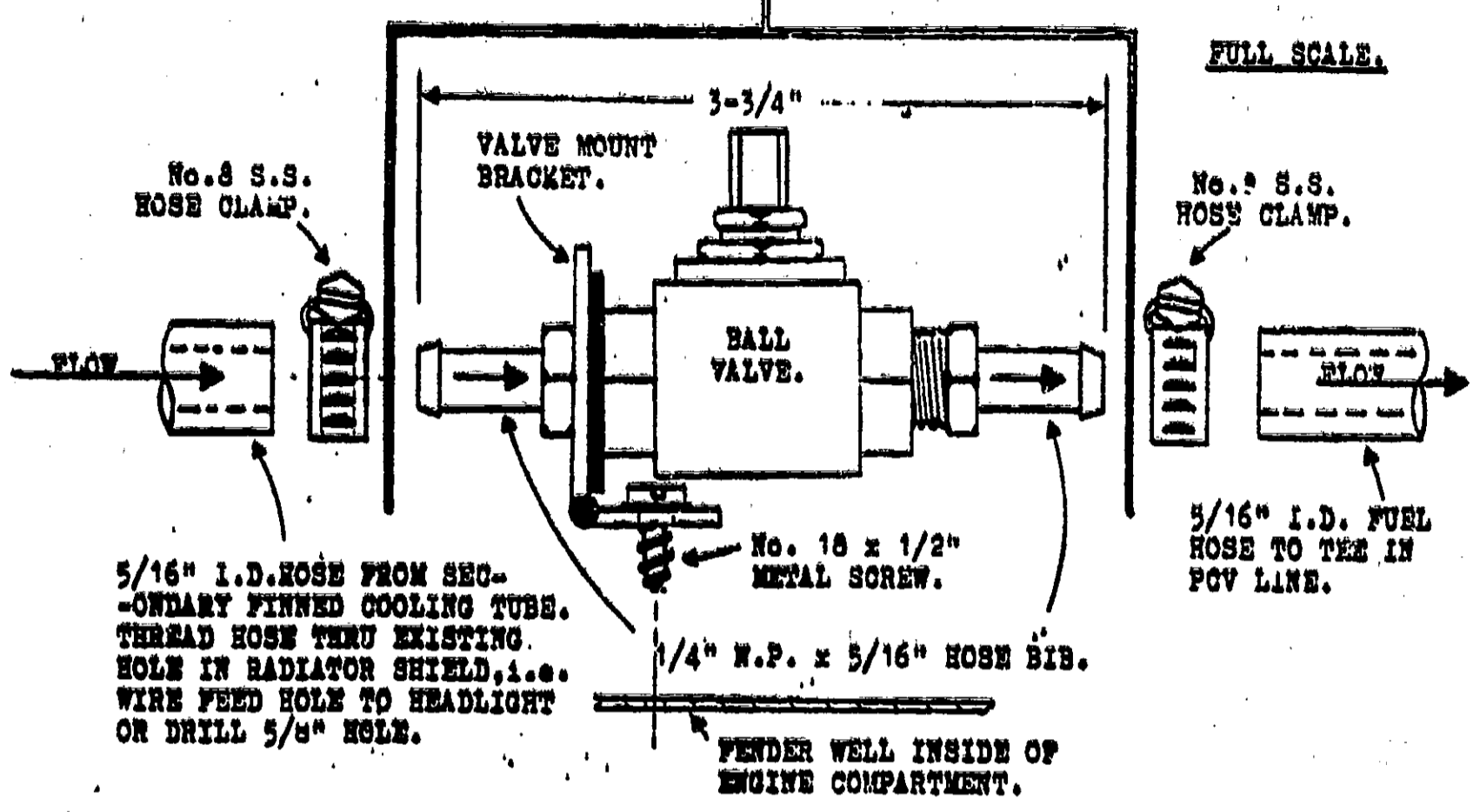

NOTE: 1/4" N.P.T. BRASS, NEOPRENE SEATED BALL VALVE IS FULL OPEN WHEN FLAT SIDES ON TOP OF VALVE STEM ARE ALIGNED WITH FLOW LINE. VALVE MAY BE CLOSED BY TURNING STEM 1/4 TURN. CLOSE ONLY TO ISOLATE MOTOR PROBLEMS SUCH AS IGNITION ETC.

ALTERNATE MOUNTING.

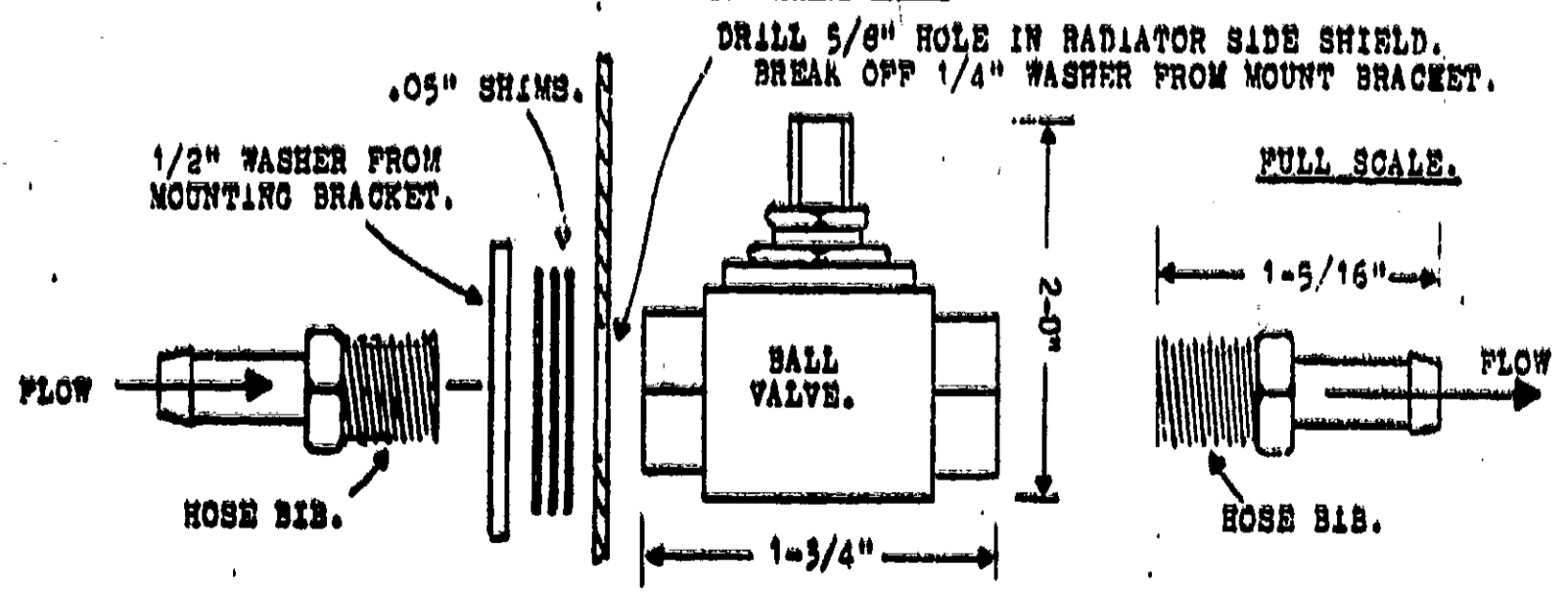

"MESCO" MOISTURE FLOW JET INSTALLATION

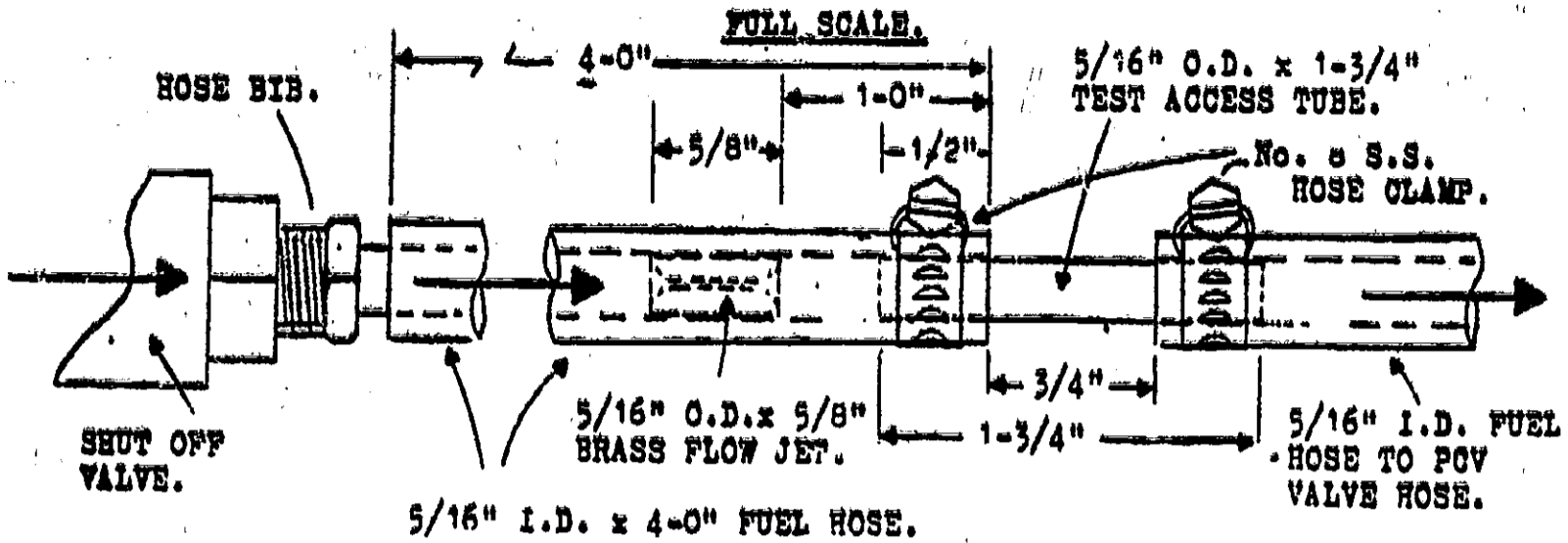

INSTALLATION OF "TEE" IN PCV LINE

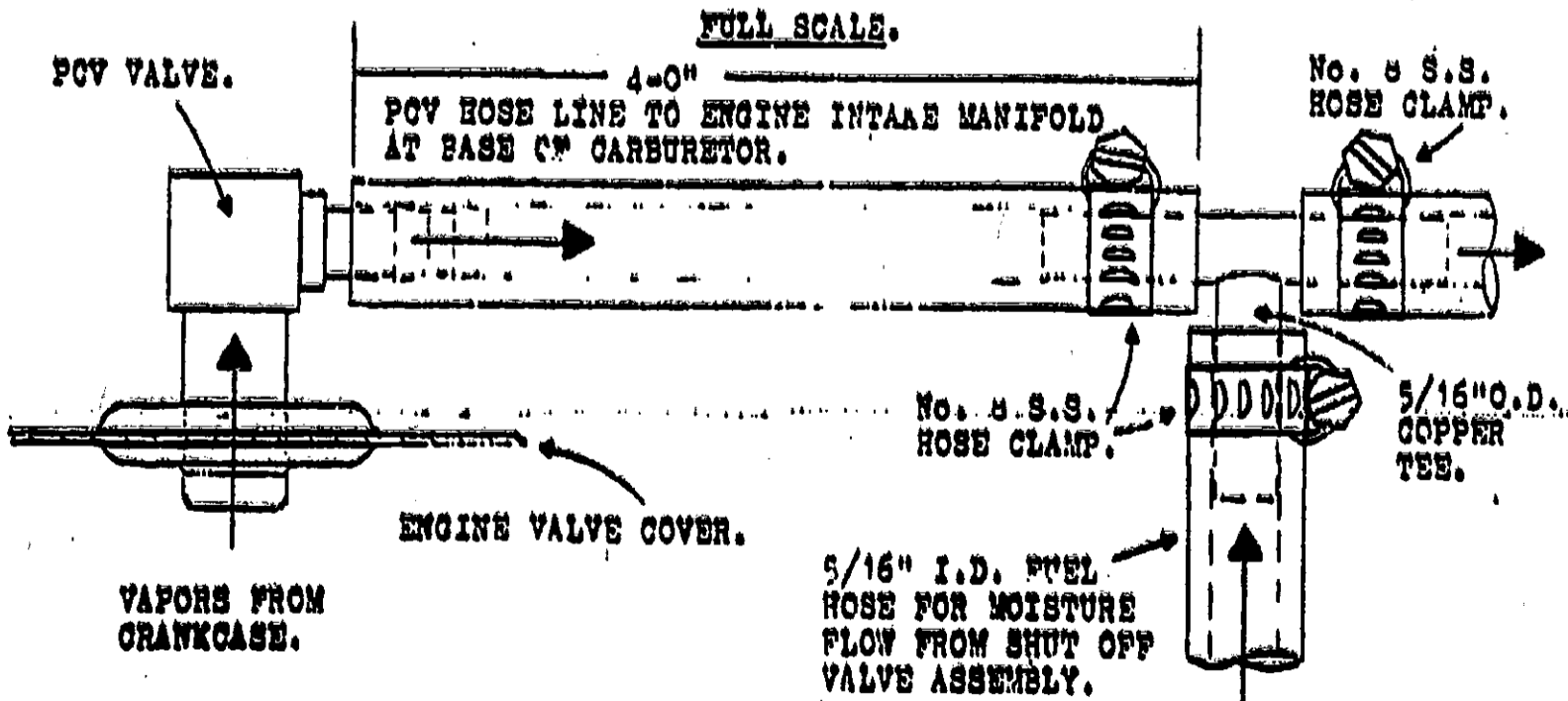

NOTE: SELECT HORIZONTAL FILTER MOUNT LOCATION TO ACCOMODATE FLOW HOSES AND FOR EASY ACCESS TO CLEAN FILTER ELEMENT AT 5,000 TO 8,000 MILE INTERVAL.

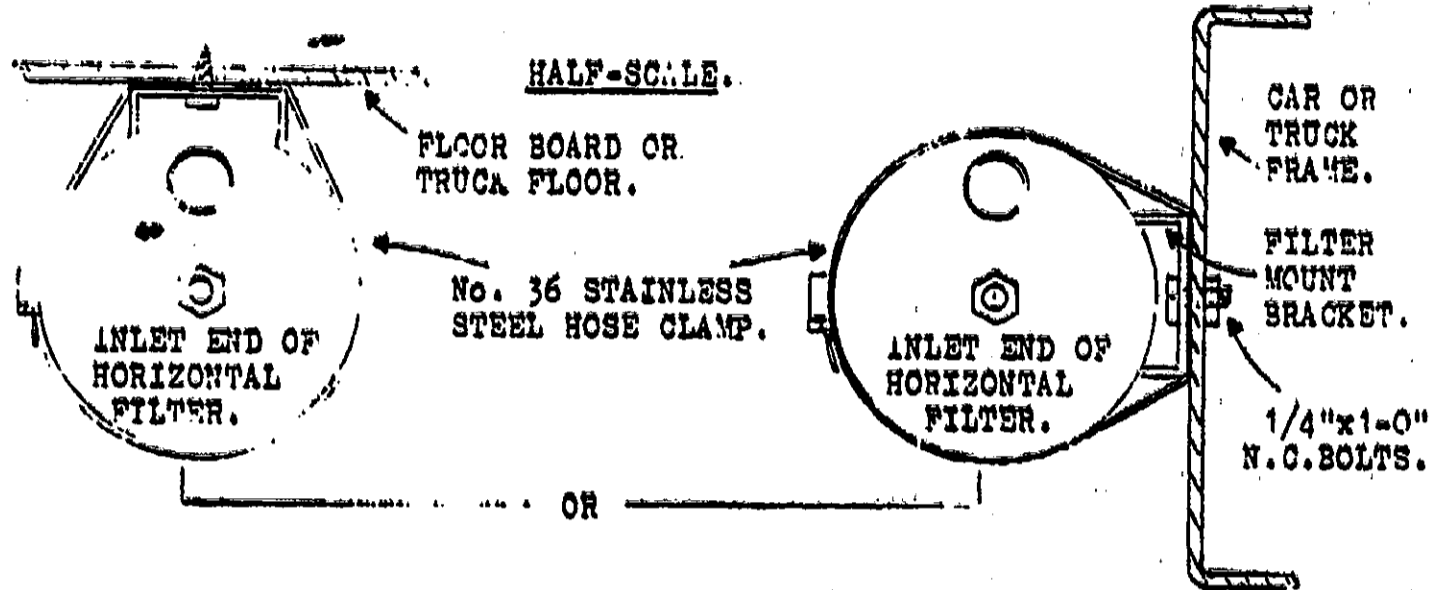

- TOP -

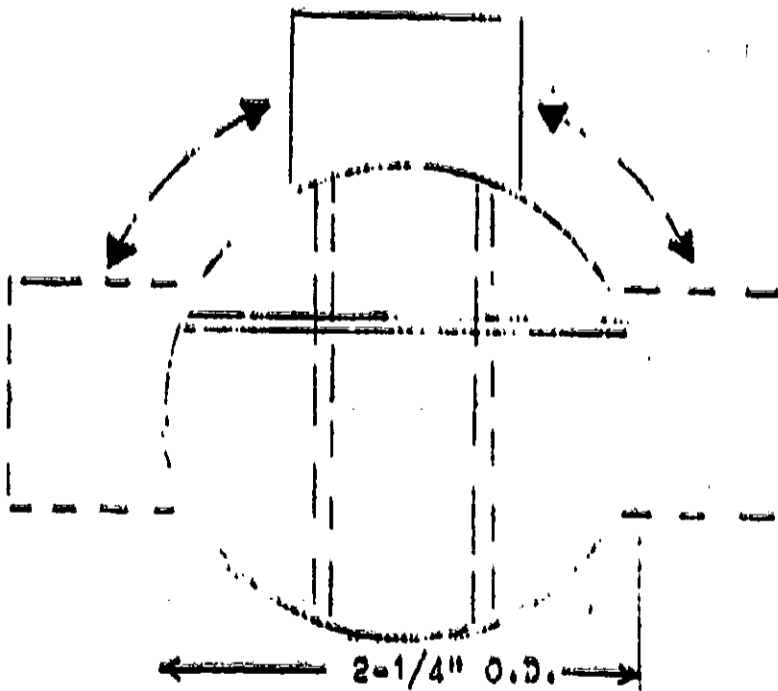

INLET END VIEW OF "MESCO" TAKE OFF TUBE. 1/2" N.P.T. FLOW OUTLET COLLAR CAN BE ROTATED THRU A ARC OF 180 DEGREES TO ACCOMODATE INSTALLATION OF PRIMARY FINNED COOLING TUBE.

NOTE: DO NOT LOCATE FLOW OUTLET COLLAR ON BOTTOM SIDE OF TAKE OFF TUBE.

"MESCO" 100-2.25 MOISTURE TAKE OFF TUBE, END VIEW.

FULL SCALE.

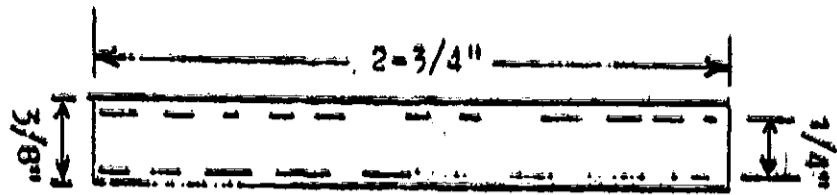

VISUAL FLOW TUBE (PLASTIC).

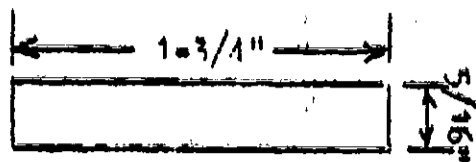

TEST ACCESS TUBE (COPPER).

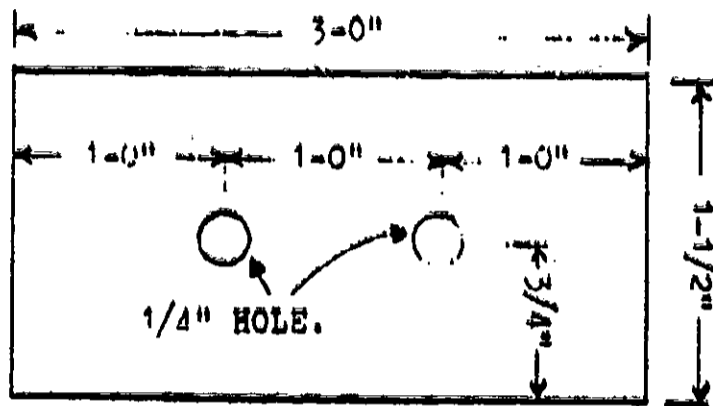

TOP VIEW

(BRACKET) FILTER MOUNT

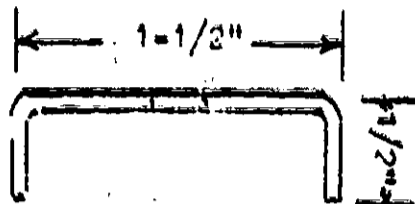

END VIEW.

(BRACKET) FILTER MOUNT.

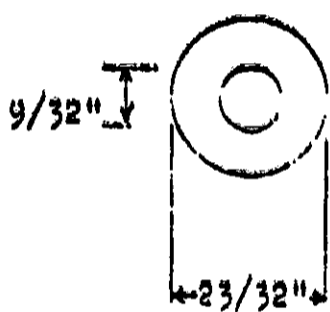

1/4" CUT WASHER.

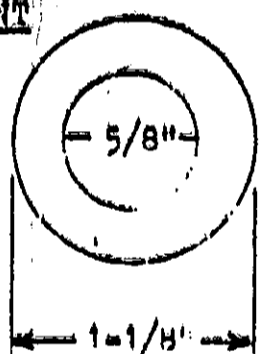

.05" SHIM.

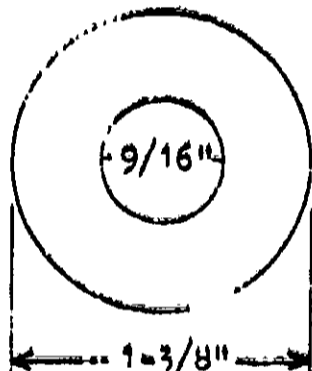

1/2" CUT WASHER.

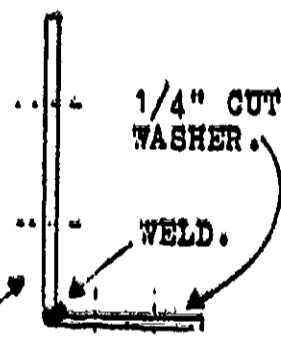

SIDE VIEW.

SHOT OFF VALVE MOUNT BRACKET.

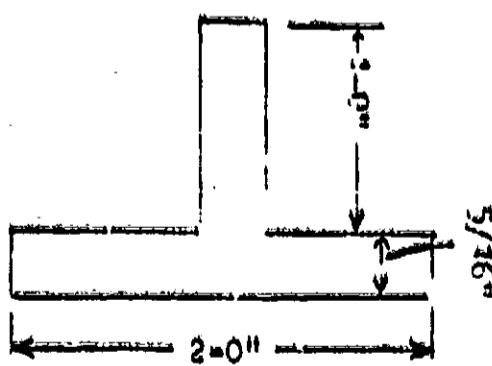

SIDE VIEW:

5/16" O.D. COPPER TEE.

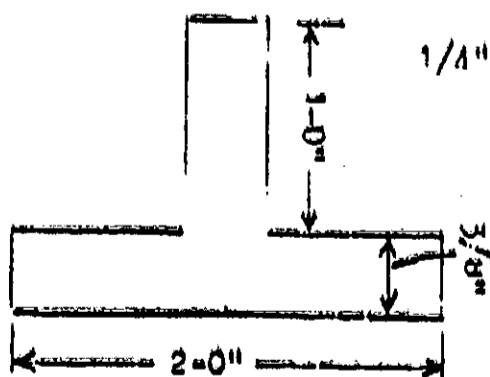

SIDE VIEW:

3/8" O.D. COPPER TEE.

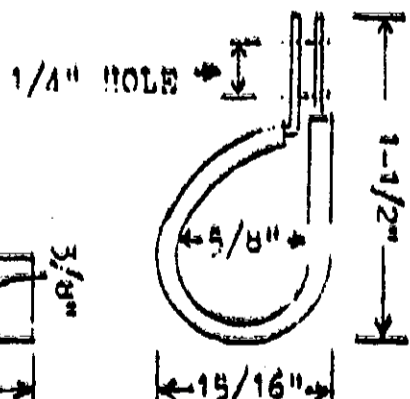

SIDE VIEW.

5/8" I.D. CLAMP. INSULATED.

----- ALL ITEMS. FULL SCALE. -----

MISC. MESCO HARDWARE

Moisture Extraction System

How does it work?

Hot of the exhaust gases are extracted from the top of the cooled and filtered (Mabene) is condensed in the secondary cooler and secondary filter. Then it is metered into the intake manifold as the engine runs.

Where do you add the water?

You don't. The moisture is condensed from the cooled exhaust gases.

How much does it improve mileage?

Tests and records from previous installations have shown that better than 10% improvement can consistently be expected. Some of the units have shown as much as 20% improvement.

Improve mileage & reduce maintenance on American made standard use cars, pickups, trucks & vans.

West Side
MILEAGE UNLIMITED
 247-5344
 972-6819

Does it really give more power?

You can actually feel the difference. Water injection was used on fighter planes in World War II for the sole reason of increasing power. The same principle applies to today's cars and trucks.

What effect does it have on emissions?

Every vehicle that we have tested in an Arizona certified test station has shown a reduction in carbon monoxide (CO) to negligible amounts and a substantial reduction in hydrocarbons (HC). Ask to see our results.

What effect does the system have on the engine?

The engine runs cooler. Compression is often improved because the engine becomes decarbonized and spark plugs tend to last longer. Tune-ups are required less frequently. We have found no adverse effects.

Where can you get one?

Call or come and see us at the address below. Installation and checkout time takes about 4 hours.

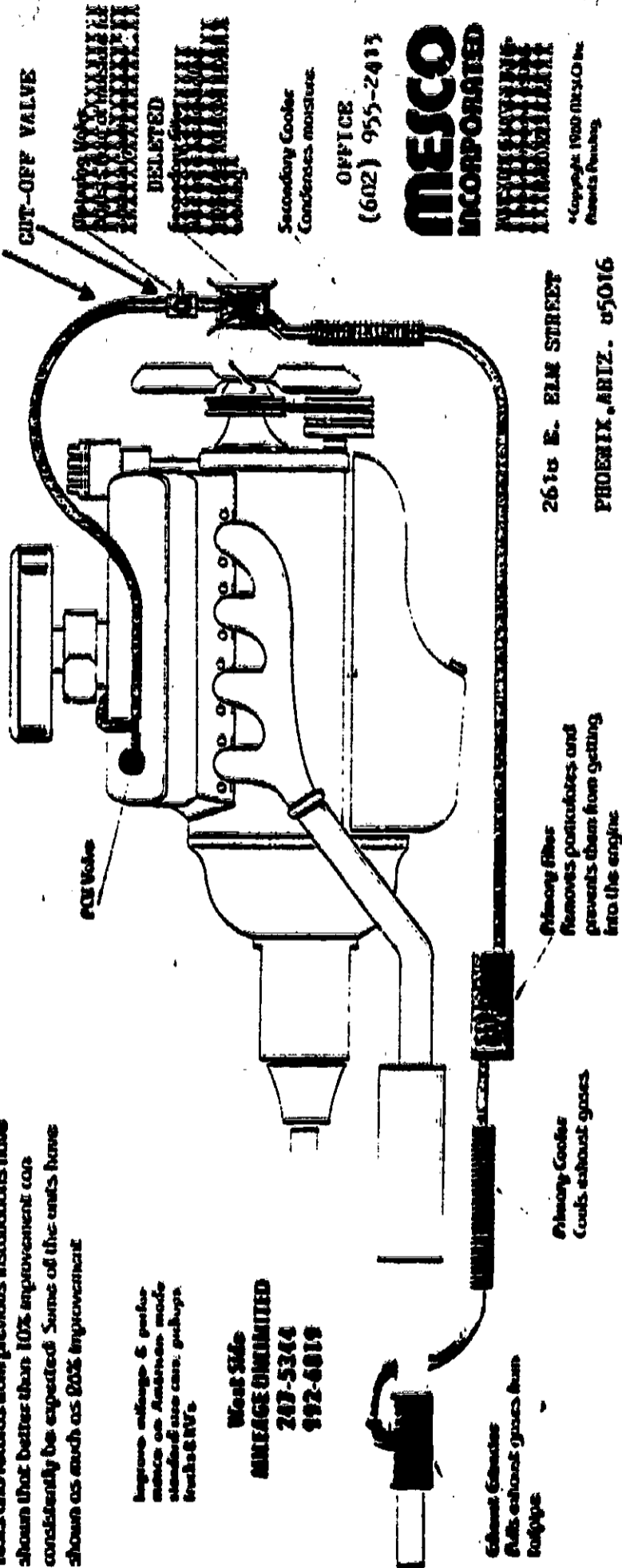

2616 E. ELM STREET
 PHOENIX, ARIZ. 85016

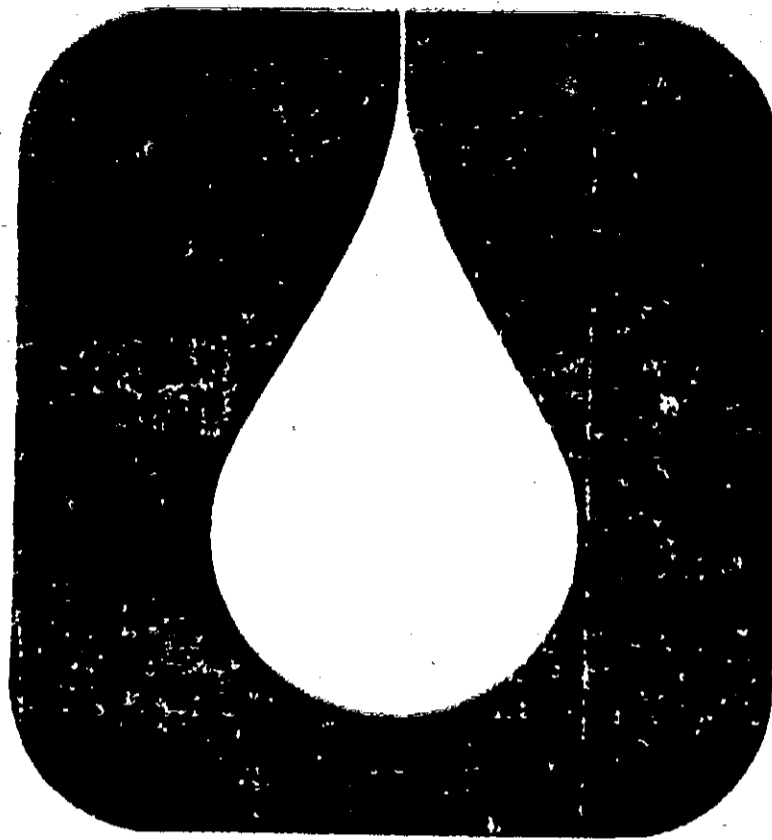

Moisture Extraction System

INSTALLATION
INSTRUCTIONS

I N D E X

INSTALLATION INSTRUCTIONS

	PAGE
STEP 1	
Single Muffler and Tailpipe. Tailpipe O.D. Measurement of 2-0", 2-1/4" and 2-1/2" on Cars Vans, Pickups and Trucks	1-2
Tools Needed	1
Package Parts	1-2
Moisture Extraction System. Illustration	2-A
Filter Components. Illustration	2-B
Filter Mounting Options and Exhaust Extractor Optional locations. Illustration	2-C
Installation Photos	2-D, 2-E
STEP 2	
Mounting the Exhaust Extractor	3-4
STEP 3	
Mounting of Primary Heat Exchanger Tube	4
STEP 4	
Mounting the Filter Assembly	5-6
STEP 5	
Installing the Secondary Heat Exchanger Tube ... Secondary Heat Exchanger Mounting. Illustration	6-7 6-A
STEP 6	
Mounting the Cut-Off Valve Assembly	8-9
Cut-Off Valve Assembly. Illustration	8-A
STEP 7	
Connecting the 5/16" I.D. Hose Assembly (8) 5/16" I.D. Hose Assembly Illustration	9-10 9-A
STEP 8	
Watching it Work	10
STEP 9	
Tuning	10-11
Maintenance	12-13
Pickups, Vans and Trucks Equipped with Dual Muffler and Tailpipes. Tailpipe O.D. Measurement of 2-0", 2-1/4" and 2-1/2"	13
Trucks Equipped with Single or Dual Tailpipes. Tailpipes O.D. Measurement of 3-0" and Over	14
Parts List	15-16

INSTALLATION INSTRUCTIONS

For Model 100-XX* Moisture Extraction System for vehicles equipped with single muffler and tailpipe. Tailpipe O.D. Measurement of 2-0", 2-1/4" or 2-1/2". XX* denotes O.D. of tailpipe.

NOTE: This installation will take between two and four hours depending upon the characteristics of your vehicle.

TOOLS YOU WILL NEED

- Adjustable Wrench
- Flat Tip Screwdriver
- Knife or Pruning Shears
- Hacksaw
- 1/8" and 1/4" Drill Bits
- Timing Light

STEP 1. Remove the parts from the package. The package should contain the parts as listed below and illustrated on Page 2-A.

<u>ITEM</u>	<u>QTY</u>	<u>DESCRIPTION</u>
1	1	Exhaust Extractor
2	1	1/2" 8 x 10 Brass (90 Deg.) Flare Elbow
3	1	1/2" 8 x 10 Straight Brass Half Union
4	1	Primary Heat Exchanger Tube (54" Long)
5	1	Filter Assembly

STEP 1. (Cont'd.)

<u>ITEM</u>	<u>QTY</u>	<u>DESCRIPTION</u>
6	1	Cut-Off Valve Assembly
7	1	Secondary Heat Exchanger Tube (26" Long)
8	1	5/16" I.D. Hose Assembly (With Tee, S, Visual Tube and Brass Flow Jet)
9	10	5/8" I.D. Hose
10	8	3/8" I.D. Hose
11	1	#48 Stainless Steel Hose Clamp
12	2	Filter Assembly Mounting Bracket
13	2	#10 Stainless Steel Hose Clamps
14	8	#6 Stainless Steel Hose Clamps
15	1	XX" Muffler Clamp
16	8	1/8" x 1/2" Sheet Metal Screws
17	3	1/2" Tubing Clamps
18	2	3/4" Conduit Clamps
19	4	10" Nylon Ties
20	3	1/4" x 3/4" Bolt and Nut Assemblies
21	1	1-1/2" x 2-0" Rubber Insulation Tube
22	1	#36 Stainless Steel Hose Clamp
23	1	3/8" O.D. x 2-1/2" Clear Plastic Visual Tube
24	1	1/8" x 36" Steel Template Rod

IMPORTANT: Prior to installing the Moisture Extraction System, inspect your exhaust system to insure that there are no holes in the exhaust tubing or muffler, and that tailpipe and muffler are well secured. Check to see that PCV Valve is in good condition.

FIGURE 1. MOISTURE EXTRACTION SYSTEM ASSEMBLY.

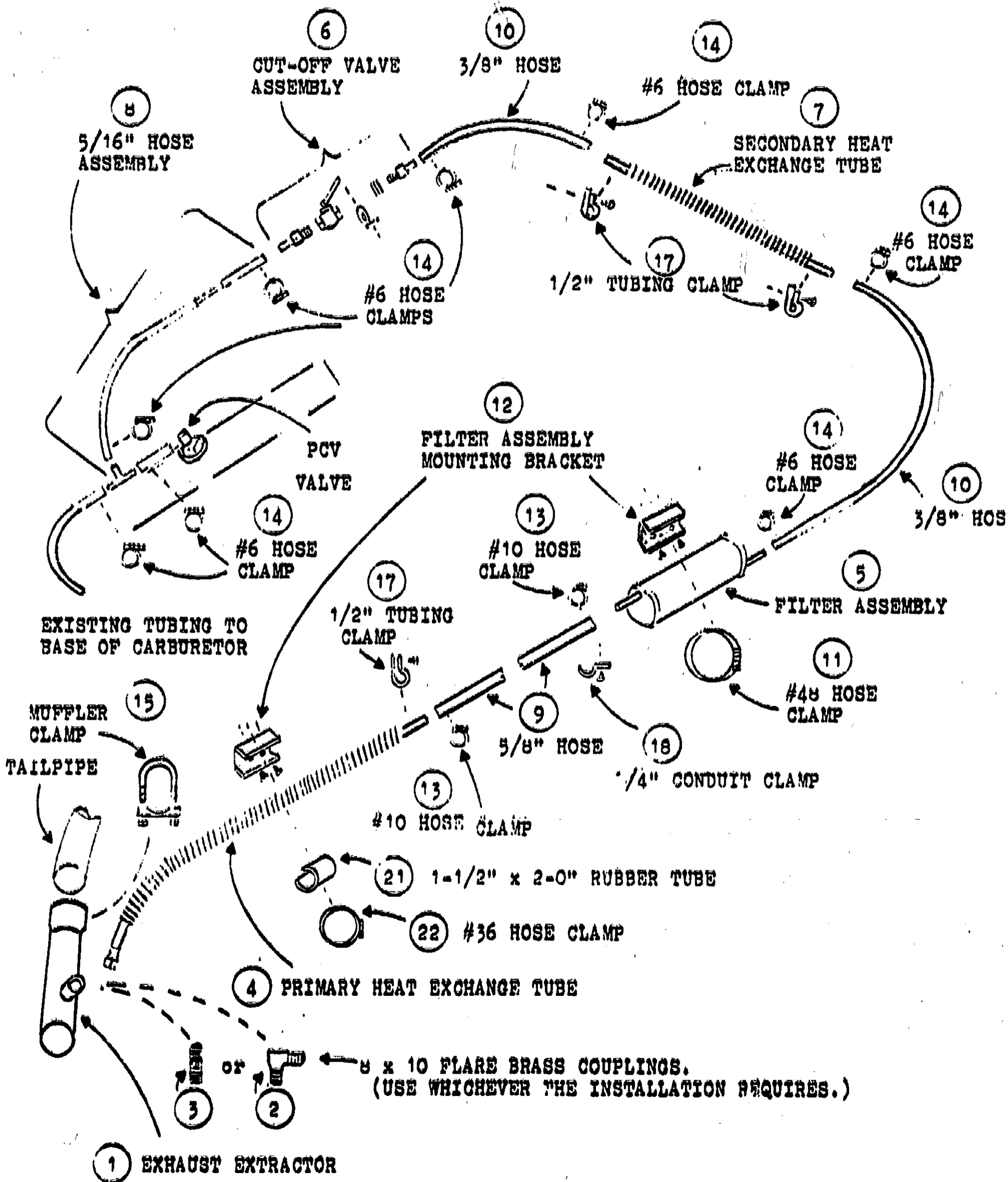

"MESCO" HORIZONTAL FILTER ASSEMBLY 33

HALF-SCALE.

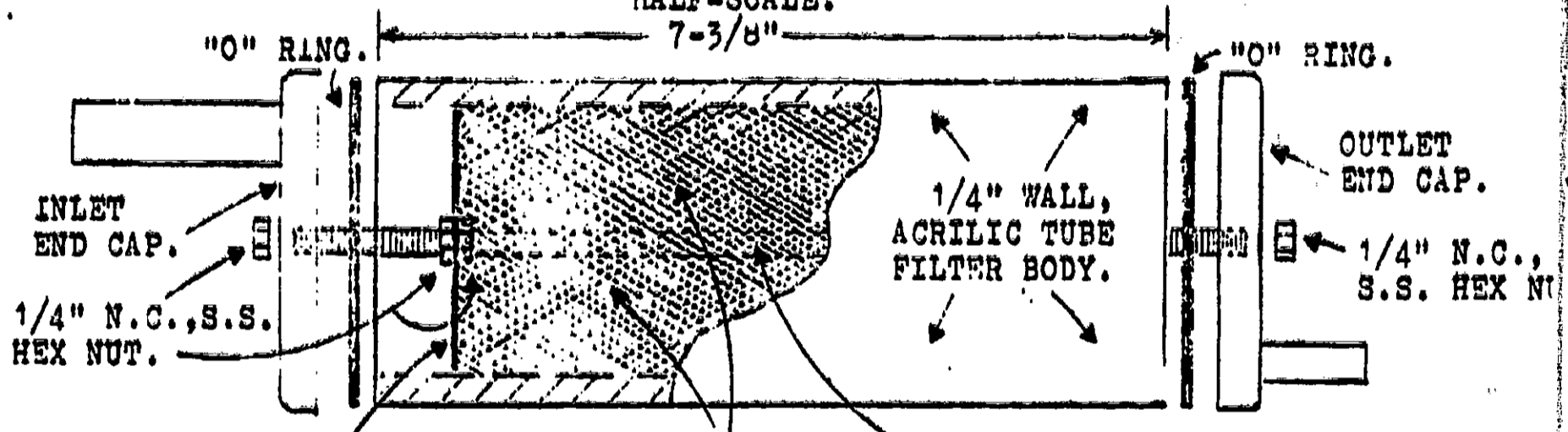

PERFORATED BRASS
BAFFLE PLATE.
SEE DETAIL BELOW.

FILTER ELEMENT.
6-0" WIDE x 56-0" LONG.
STAINLESS STEEL.
DOUBLE MESH:
SPEC. T-304 S.S.

1/4" x 8-1/2" N.C.,
ALL THREAD, STAINLESS
STEEL ROD.

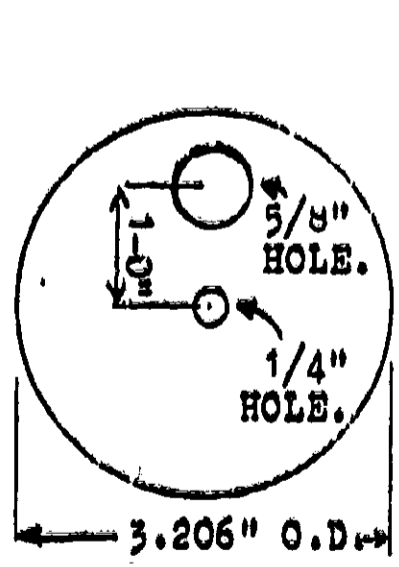

END VIEW. SINGLE
INLET CAP.

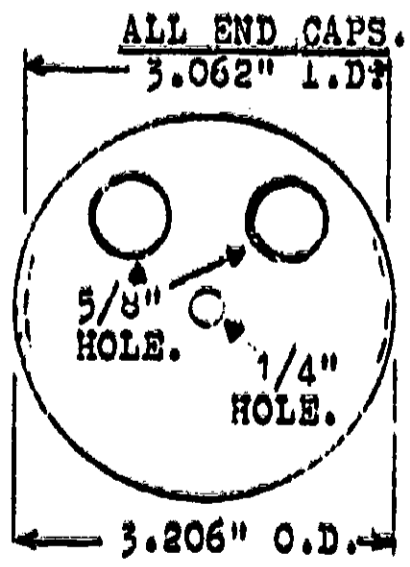

END VIEW. DOUBLE
INLET CAP.

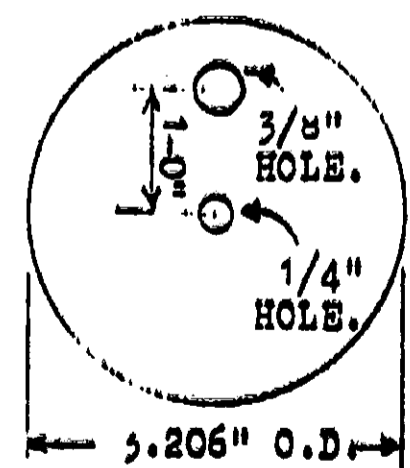

END VIEW. ALL
OUTLET CAPS.

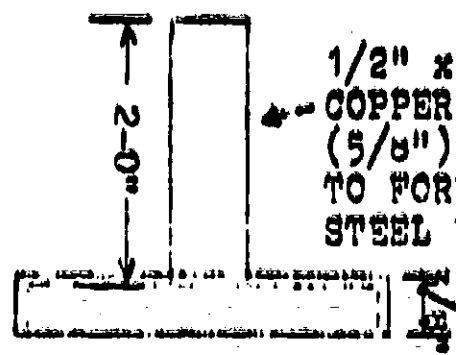

SIDE VIEW.

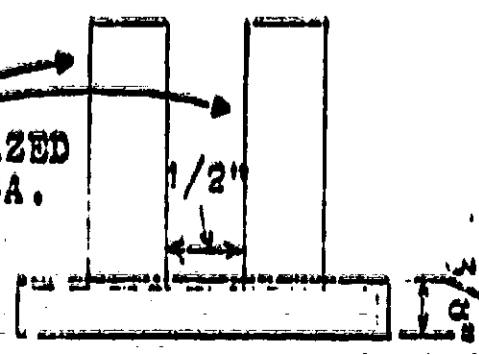

SIDE VIEW.

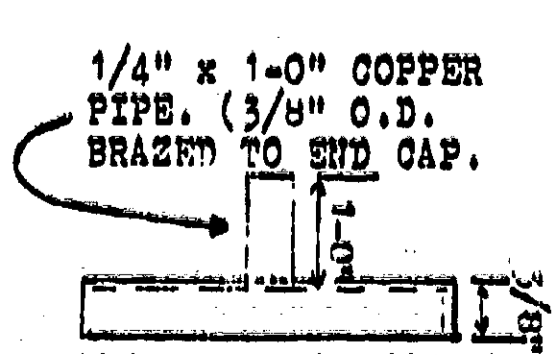

SIDE VIEW.



PERFORATED BRASS BAFFLE PLATE. SEE DETAIL BELOW.

FILTER ELEMENT. 6-0" WIDE x 56-0" LONG. STAINLESS STEEL. DOUBLE MESH. SPEC. T-304 S.S.

1/4" x 8-1/2" N.C., ALL THREAD, STAINLESS STEEL ROD.

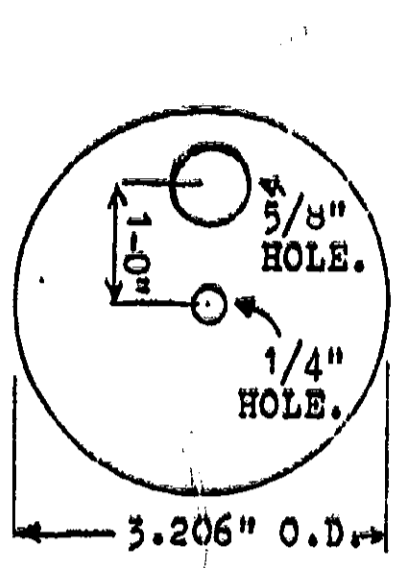

END VIEW. SINGLE INLET CAP.

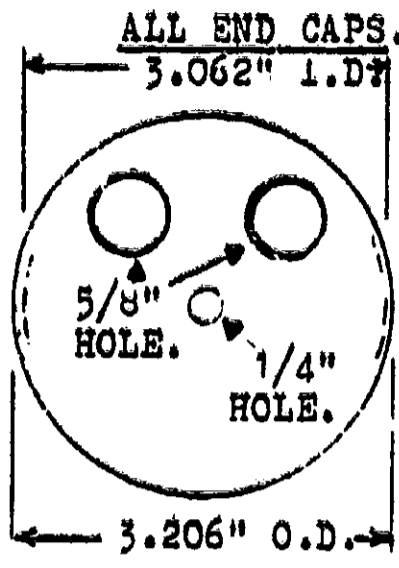

END VIEW. DOUBLE INLET CAP.

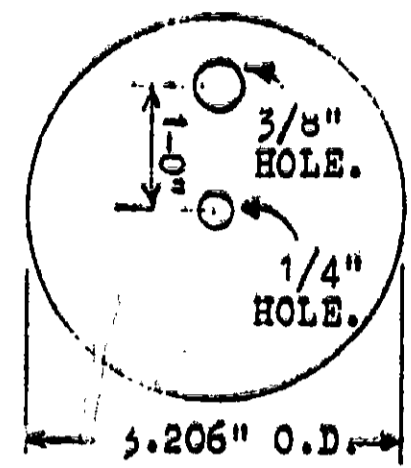

END VIEW. ALL OUTLET CAPS.

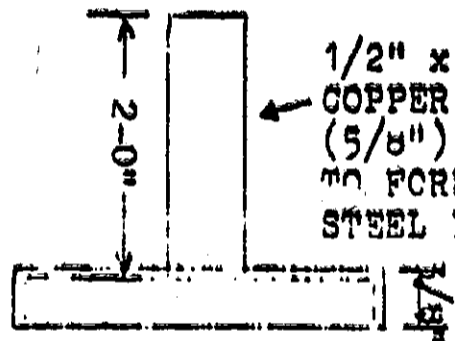

SIDE VIEW. SINGLE INLET CAP.

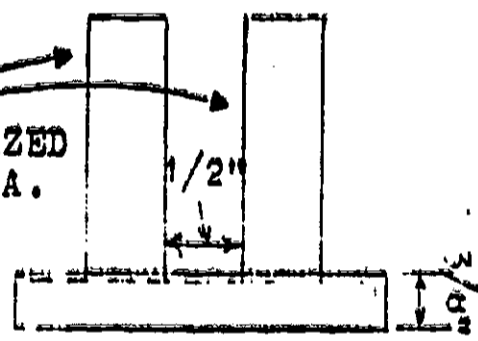

SIDE VIEW. DOUBLE INLET CAP.

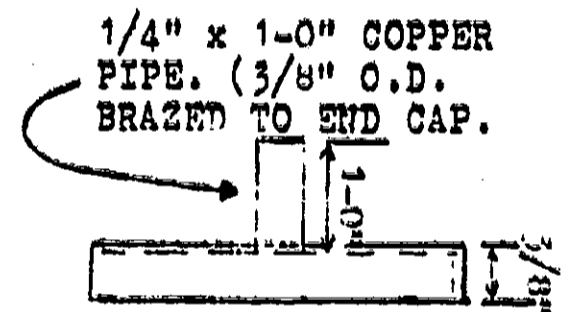

SIDE VIEW. ALL OUTLET CAPS.

NOTE: ALL CAPS HAVE BAKED ENAMEL INTERNAL AND EXTERNAL SURFACE.

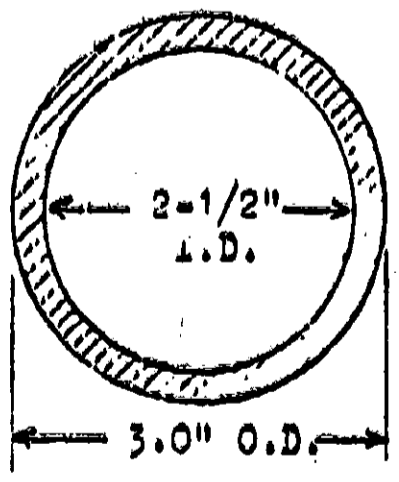

CROSS SECTION OF FILTER BODY.

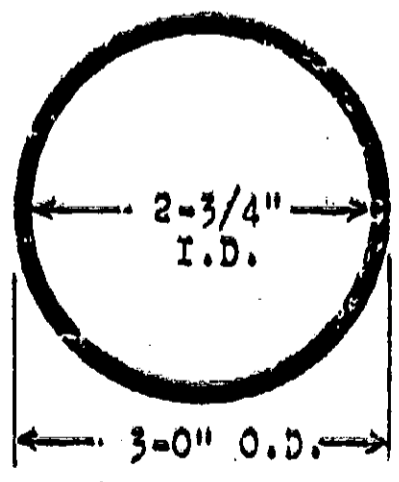

1/8" DIAM. (O.D.) RING. SPEC. 2-232.

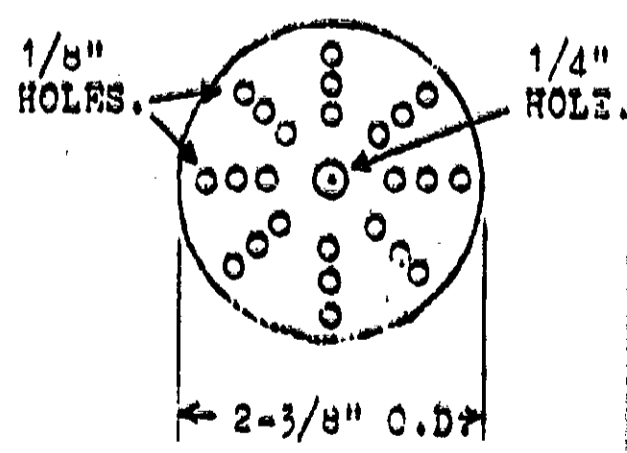

1/8" THICK, BRASS BAFFLE PLATE.

NOTE: SELECT HORIZONTAL FILTER MOUNT LOCATION TO ACCOMMODATE FLOW HOSES AND FOR EASY ACCESS TO CLEAN FILTER ELEMENT AT 5,000 TO 8,000 MILE INTERVAL.

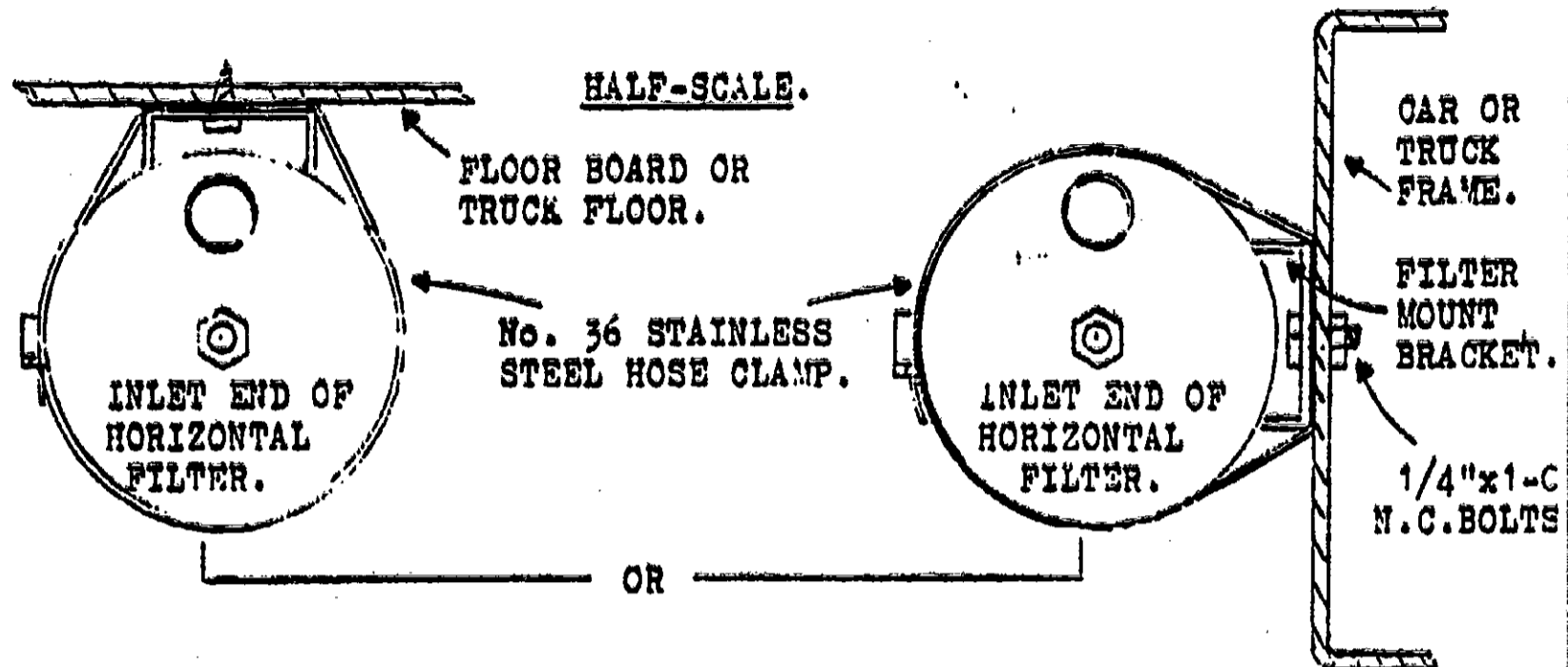

- TOP -

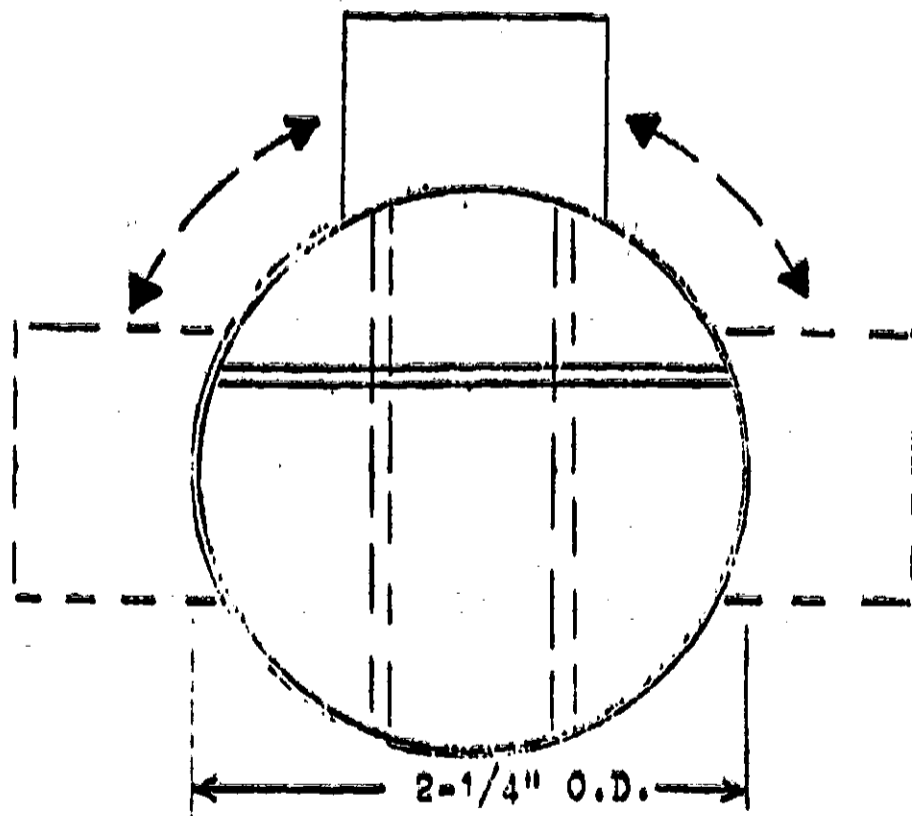

INLET END VIEW OF "MESCO" TAKE OFF TUBE. 1/2" N.P.T. FLOW OUTLET COLLAR CAN BE ROTATED THRU A ARC OF 180 DEGREES TO ACCOMMODATE INSTALLATION OF PRIMARY FINNED COOLING TUBE.

NOTE: DO NOT LOCATE FLOW OUTLET COLLAR ON BOTTOM SIDE OF TAKE OFF TUBE.

"MESCO" 100-2.25 MOISTURE TAKE OFF TUBE, END VIEW.

FULL SCALE.

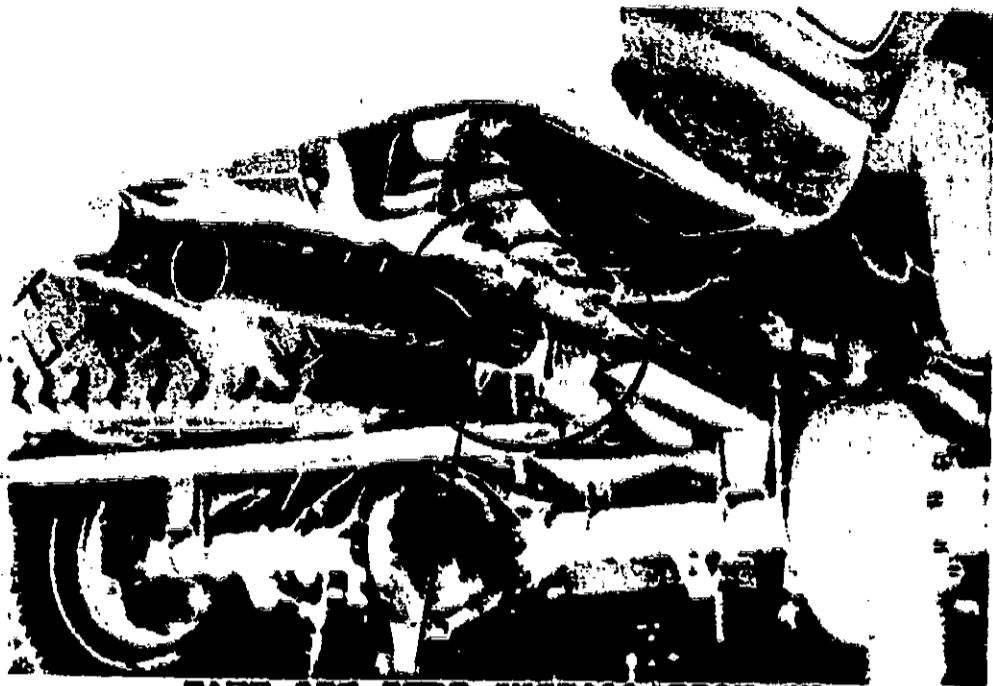

TAKE OFF TUBE INSTALLATION ON
SINGLE REAR EXHAUST TAILPIPE.

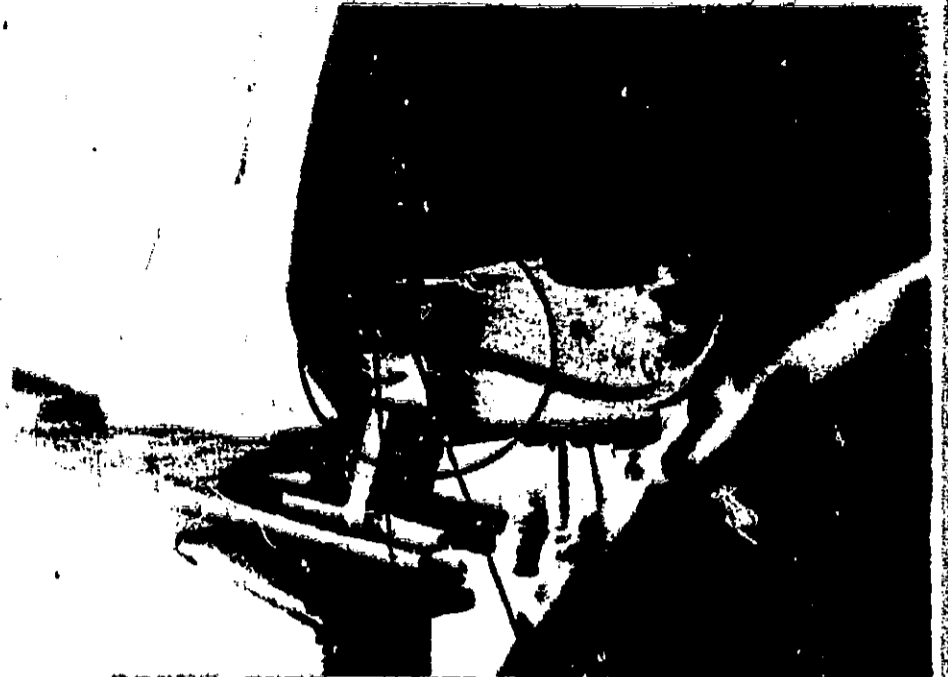

RIGHT SIDE FILTER MOUNT UNDER
FLOORBOARD. FILTER OUTLET END VIEW.

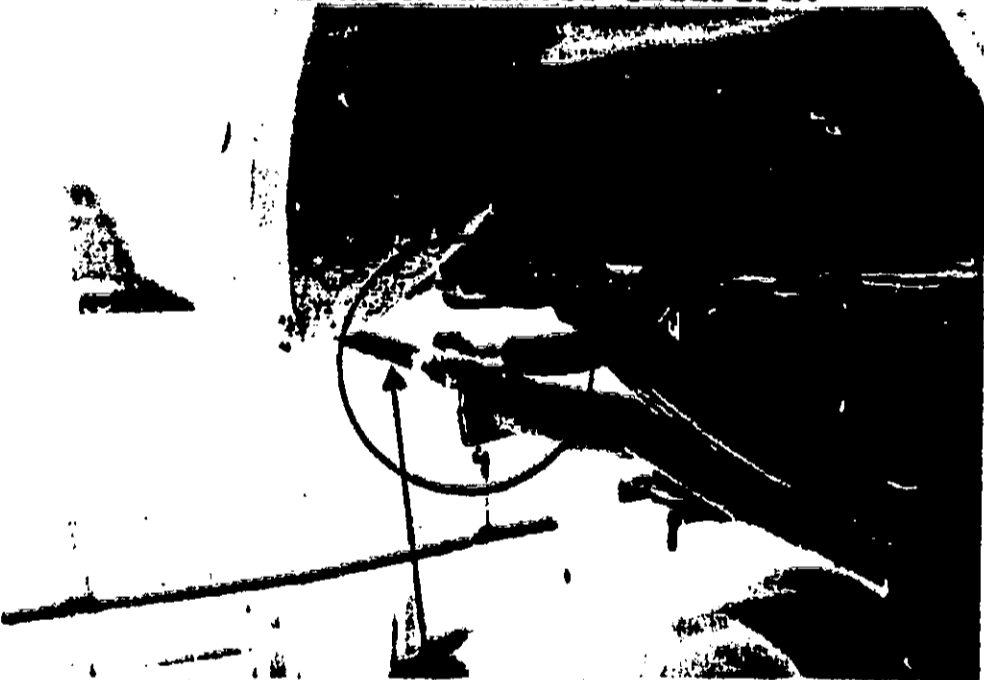

TAKE OFF TUBE INSTALLATION ON
SINGLE REAR EXHAUST TAILPIPE.

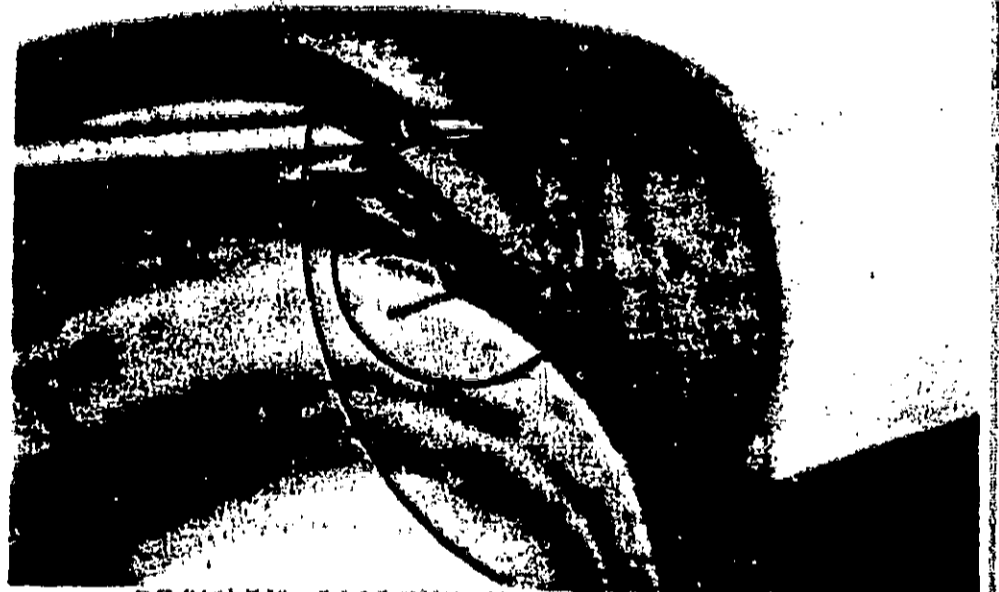

PRIMARY COOLING TUBE STABILIZED BY
INSULATED CLAMP ON FENDER BRACE.



TAKE OFF TUBE INSTALLATION ON
SIDE EXHAUST TAILPIPE.

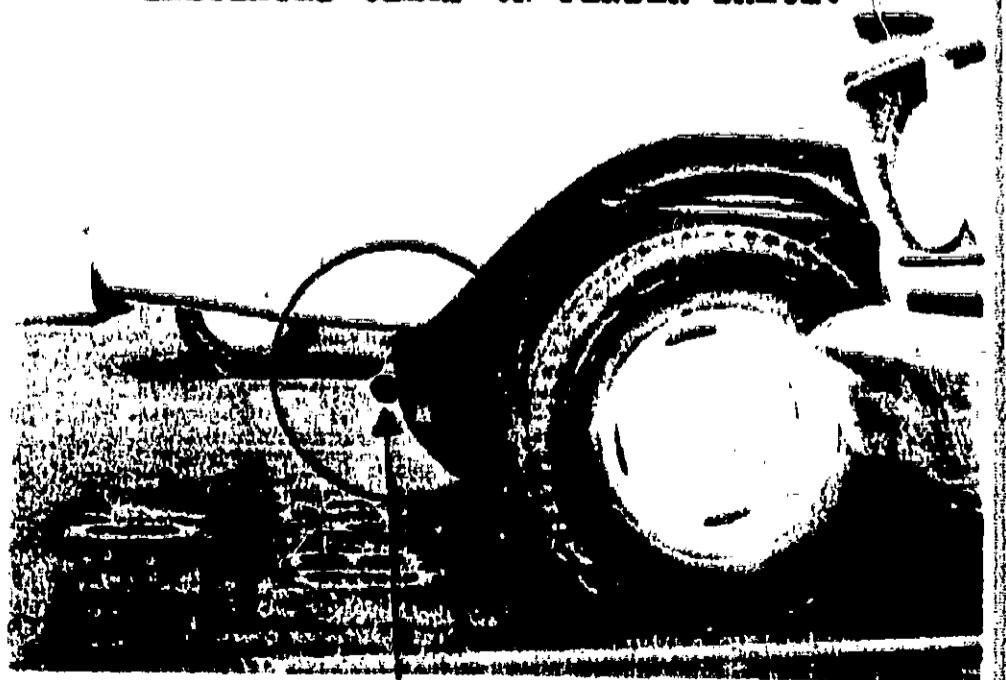

TAKE OFF TUBE INSTALLATION ON
SIDE EXHAUST TAILPIPE.

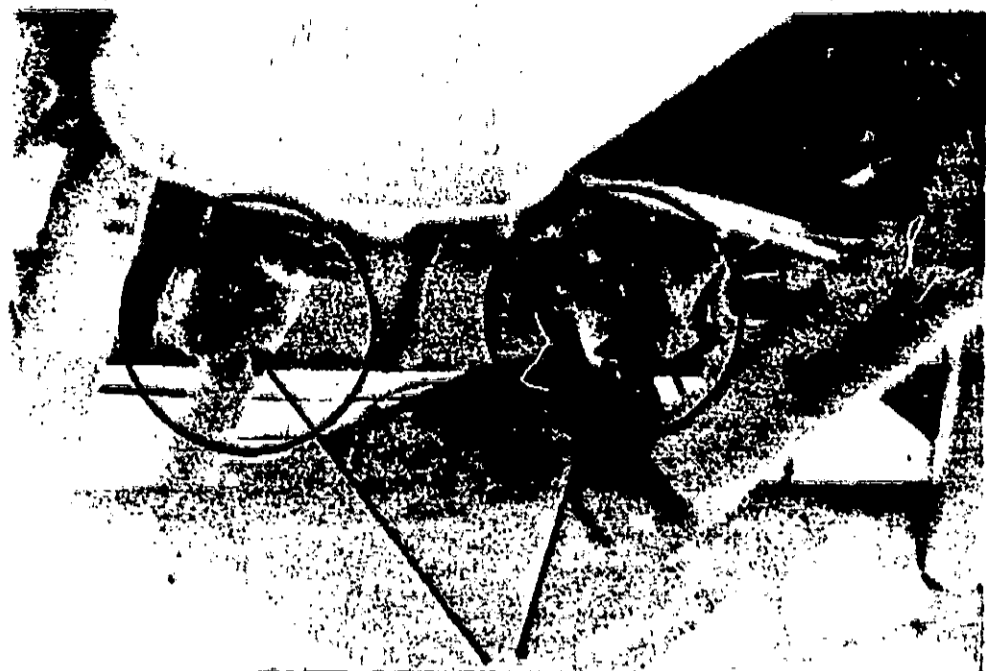

TAKE OFF TUBES MOUNTED ON DUAL EXHAUST TAILPIPES.

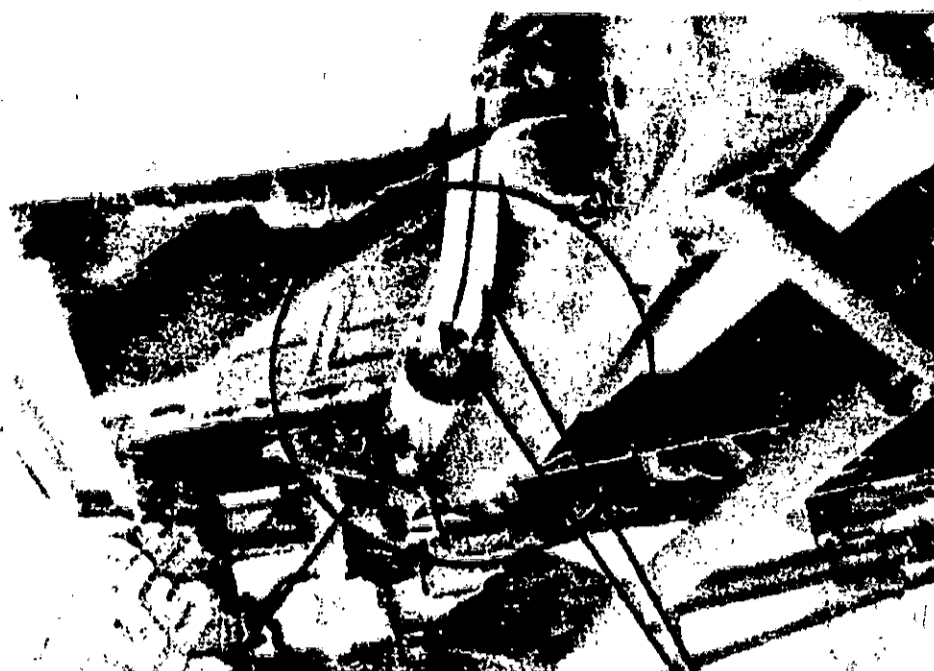

FILTER WITH DUAL INLET HOSES. DUAL INSTALLATION ON 4 x 4 VEHICLE.

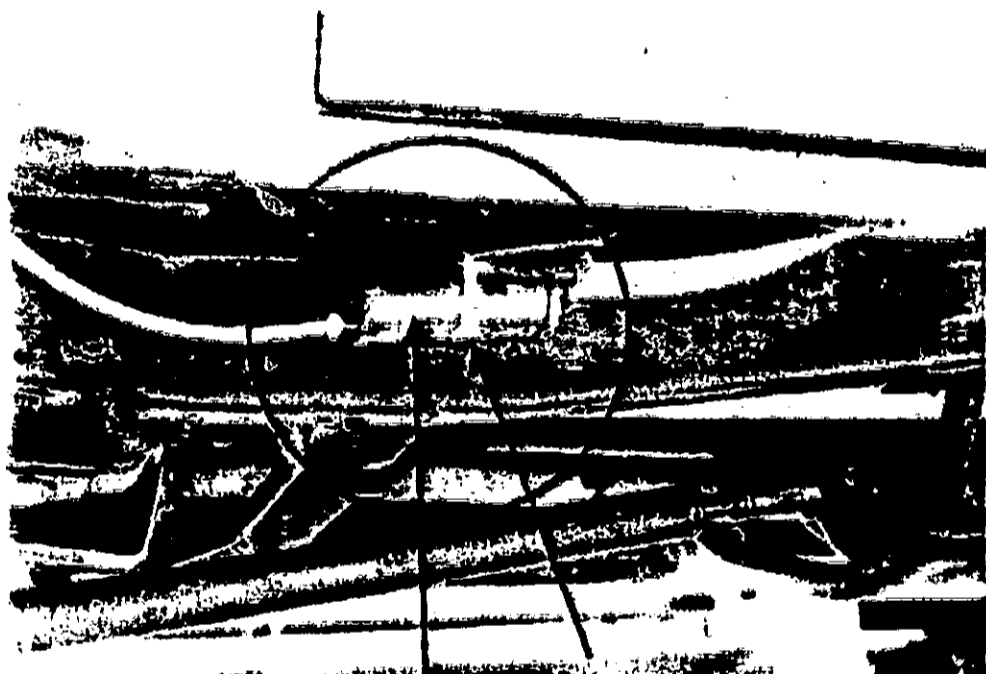

LEFT SIDE FILTER MOUNTING ON 4 x 4 VEHICLE WITH DUAL EXHAUST SYSTEM.

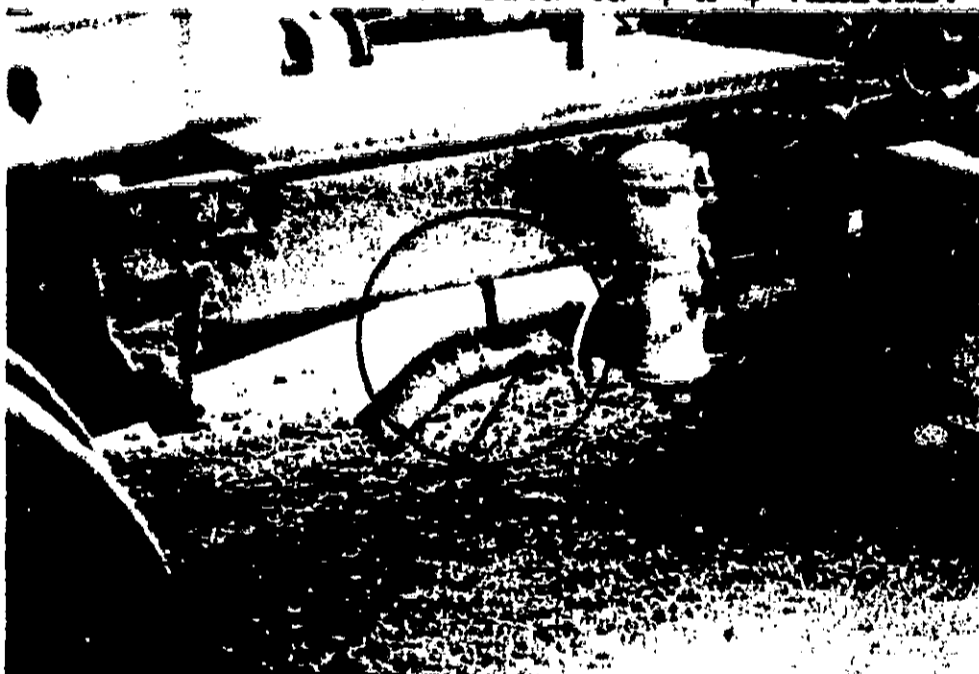

TAKE OFF TUBE MOUNTED ON 4-0" O.D. TAILPIPE, FORD 900 SERIES

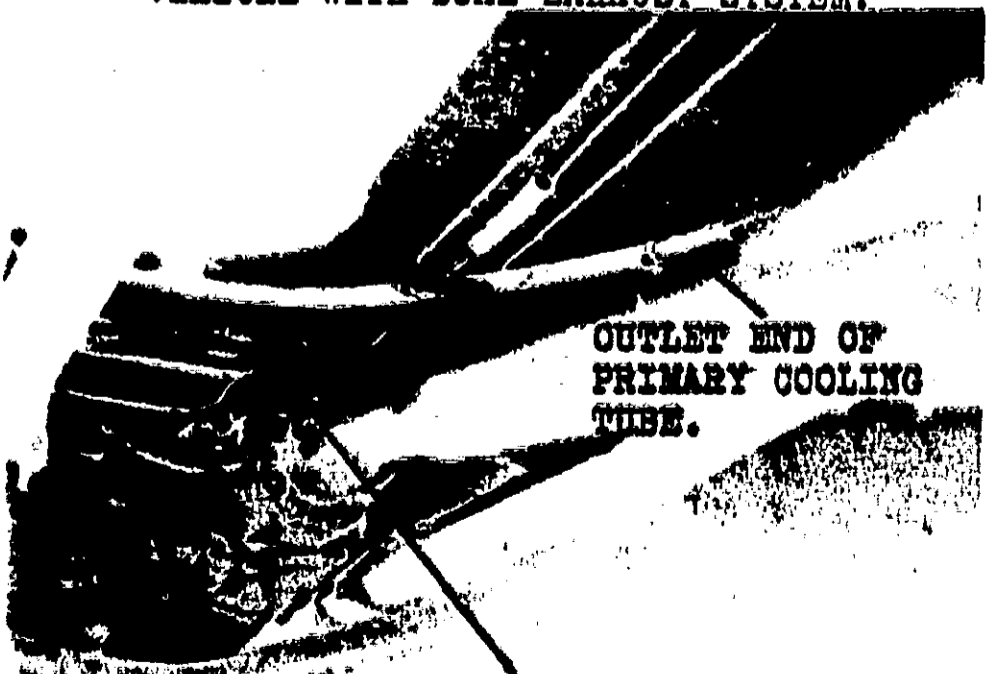

OUTLET END OF PRIMARY COOLING TUBE.

CROSS OVER FLOW HOSE SHOWN ATTACHED TO VEHICLE FRAME MEMBER.



SECONDARY COOLING TUBE MOUNTING. FORD 900 SERIES.



STEP 2. Mounting the Exhaust Extractor.

Select a suitable straight section of tailpipe eight or ten inches from the end of the tailpipe, and lay the exhaust extractor with selected brass fitting (2) or (3) screwed in hand tight, alongside of tailpipe. Side outlet port of exhaust extractor can be pointed up or sideways (See Page 2-C) in a convenient direction for connection with intake end of primary heat exchanger tube. Mark location of swaged end and brass outlet fitting of exhaust extractor (1) on tailpipe. Use furnished 1/8" x 36" steel template rod and bend rod in gradual bends, starting at fitting mark on tailpipe to simulate route of primary heat exchanger tube forward.

NOTE: Routing should be made to insure that there will be no interference between the heat exchanger tube and the tire or the suspension system of the vehicle when the suspension system is fully compressed or extended. Avoid direct contact with fuel lines.

Using gloves or suitable hand protection, bend the primary heat exchanger tube to the template form with the brass sleeve nut of the tube towards the exhaust extractor location of the tailpipe. Route remaining part of tube forward to allow connection of 5/8" flow

STEP 2. Mounting the Exhaust Extractor (Cont'd.)

hose to filter. A verticle rise of 12 inches is allowable in forming of tube. At this time, temporarily place formed tube in position to check final location of exhaust extractor.

Again place exhaust extractor alongside of selected position on tailpipe and check line-up of flare nut fitting on primary heat exchanger tube. (See illustrations on Pages 2-D and 2-E). Make straight cut across tailpipe allowing 1-1/2" in length for slip over of swaged end of exhaust extractor. Mark tailpipe 1-1/2" forward of the cut and install exhaust extractor on tailpipe. If swaged end of exhaust extractor does not readily slide onto tailpipe, clean end of tailpipe or cut lateral 1-1/2" expansion slits in swaged end of exhaust extractor to allow installation. Connect flare nut of primary heat exchanger tube to brass outlet fitting of exhaust extractor.

STEP 3. Mounting of Primary Heat Exchanger Tube (4).

Recheck route clearance of primary heat exchanger tube before permanently attaching heat exchanger tube to inside vertical wall of wheel well, fender stay bar, truckbed or vehicle frame. (See illustrations on pages 2-D and 2-E). Install muffler clamp to securely fasten extractor tube to tailpipe.

STEP 4. Mounting the Filter Assembly (5).

Select a location approximately midway (front and rear) under the body on the same side of the frame as the primary heat exchanger had been mounted in order to mount the filter assembly in a horizontal position with sufficient road clearance. There are often holes in the frame which may be used for this purpose. Insure that the selected mounting location for the filter assembly will accommodate connecting hoses to the front and rear of the filter and that the filter may be readily accessed for periodic cleaning. (See Maintenance).

If holes are not available in the frame, drill 1/8" holes in the underbody panel using the two holes in the filter mounting bracket (12) as a guide. (Page 2-C illustrates two mounting options). Place the large 48 stainless steel clamp (11) between the two mounting holes and use the metal screws (16) to secure the bracket and clamp to the underbody or frame.

Place the filter assembly (5) against the bracket with the 5/8" tube at the top and pointing toward the primary heat exchanger just installed in Step 3. Tighten down the #48 hose clamp until the filter assembly is snug within the bracket. Do not overtighten this

STEP 4. Mounting the Filter Assembly (5) (Cont'd.)

this clamp as distortion of the filter body may result.

Connect one end of the 5/8" I.D. Hose (9) to the 5/8" O.D. tube at the top rear of the filter assembly (5) using the #10 hose clamp (13). Route the hose back to the front end of the primary heat exchanger (4). Using the knife or pruning shears, cut the hose off at this point, leaving enough slack so that the hose may be slipped approximately 1 inch over the end of the heat exchanger. Secure the hose on the end of the heat exchanger using the #10 hose clamp (13). If there is any objectionable slack in the hose between the heat exchanger and the filter assembly, this may be secured against the frame or underbody using the 3/4" conduit clamps (18).

STEP 5. Installing the Secondary Heat Exchanger (7).

As illustrated on Page 6-A, place the secondary heat exchanger (7) across the upper front of the radiator, selecting the locations for two holes in the metal side shield surrounding the radiator which may be used to secure the secondary heat exchanger (7) using the 1/2" tubing clamps (17) and metal screws (16). DO NOT use the radiator water jacket for securing

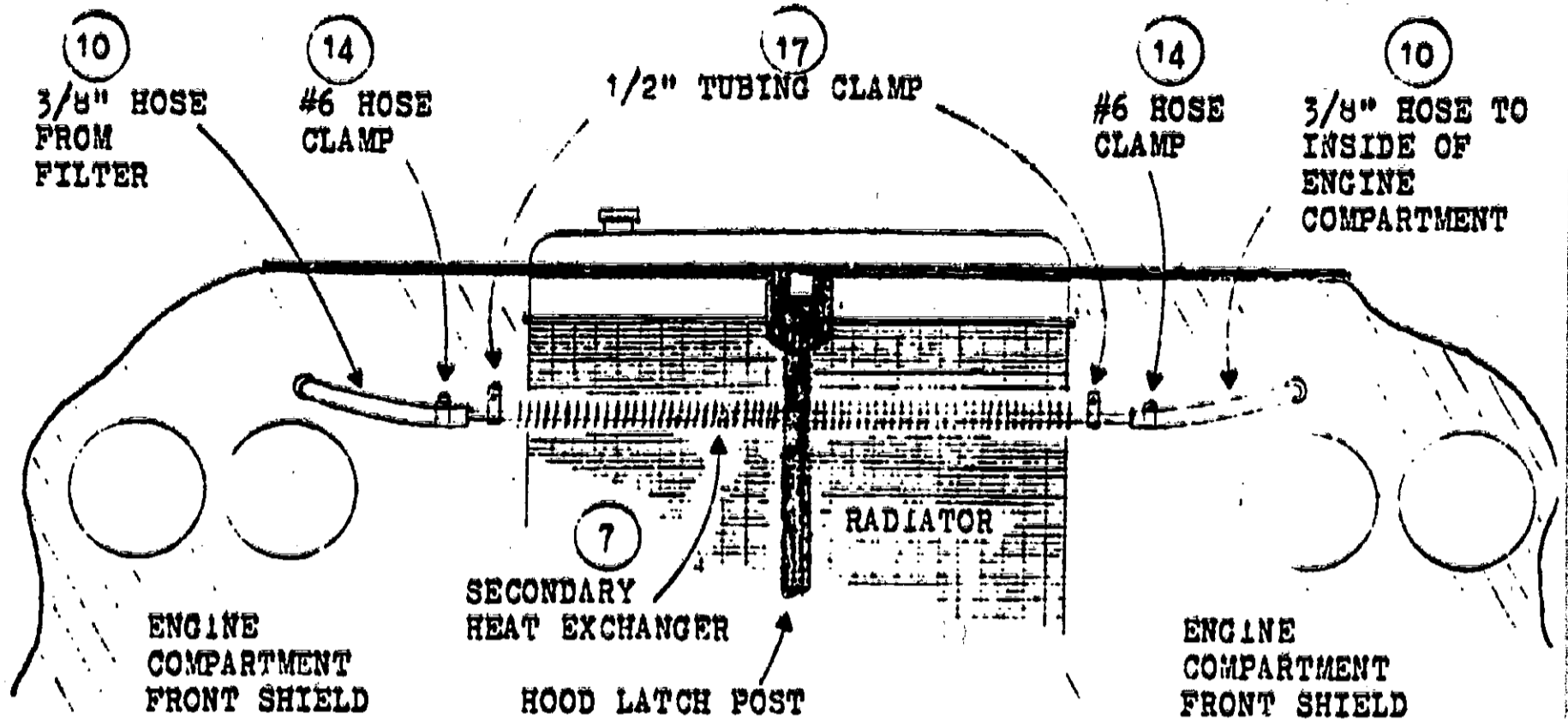

FIGURE 4. EXAMPLE OF SECONDARY HEAT EXCHANGER MOUNTING AS SEEN FROM FRONT OF VEHICLE.

(NO SCALE)

	MESCO INC	
	2618 E. ELM STREET PHOENIX, AZ 85016 (602) 273-6764 • (602) 955-2413	
MOISTURE EXTRACTION SYSTEM		
MODEL NO.	<input type="text"/>	
CARRIER NO.	<input type="text"/>	
TIMING AS RECEIVED	<input type="text"/>	BTOC
MESCO INSTALLATION TIMING	<input type="text"/>	BTOC
INSTALLATION DATE	<input type="text"/>	

HI-HEAT RESISTANT ADHESIVE UNIT IDENTIFICATION LABEL.

BLUE BACKGROUND WITH ALUMINIZED PANELS.

STEP 5. Installing the Secondary Heat Exchanger (7). (Cont'd.)
the secondary heat exchanger. Drill two 1/8" holes in the metal sideshield in the locations selected, and secure the secondary heat exchanger using the tubing clamps and metal screws, leaving at least 1 inch of exposed tubing on either end so that hoses may be connected.

NOTE: If your vehicle is equipped with airconditioning or an oil cooler mounted in front of the radiator, it may be easier to secure the secondary heat exchanger to the inside of the grille using the nylon ties (19).

Connect one end of the 3/8" I.D. Hose (10) to the end of the secondary heat exchanger which is on the same side of the vehicle as the filter assembly had been mounted. Secure the hose with a #6 hose clamp (14). Route the remaining hose down to the filter assembly, avoiding as much as possible hot areas of the engine compartment or proximity to the exhaust system. Using a knife or pruning shears, cut off the hose at a suitable length so that it may be secured approximately 3/4" onto the front tube of the filter assembly (5). Secure the hose to the front tube of the filter assembly using a #6 hose clamp (14). As before, any objectionable slack in the hose may be secured using the nylon ties (19).

STEP 6. Mounting the Cut-Off Valve Assembly (6).

The cut-off valve is provided as a means for shutting off the moisture flow extraction system in order to perform some engine diagnostics and not as a metering device. Install cut-off valve between secondary heat exchangers (7) and the tee connection in the PCV line.

Two alternate methods of mounting cut-off valve are shown on Page 8-A.

Method 1 - Mounting on Radiator Sideshield.

Drill 5/8" hole in radiator side shield at approximate level of outlet end tube of secondary heat exchanger (7). Avoid interference with existing engine components. Remove the hose bib, bracket and spacer shims from the cut-off valve assembly and break off the 1/4" washer from the mounting bracket. Place the mounting bracket washer and shims on the threaded end of the hose bib and insert bib end through the 5/8" hole in the sideshield, screw bib into the cut-off valve on inner side of the sideshield as shown on Page 8-A. Tighten bib until the cut-off valve is securely held against sideshield.

- 8 2 -

"MESCO" SHUT OFF VALVE ASSEMBLY

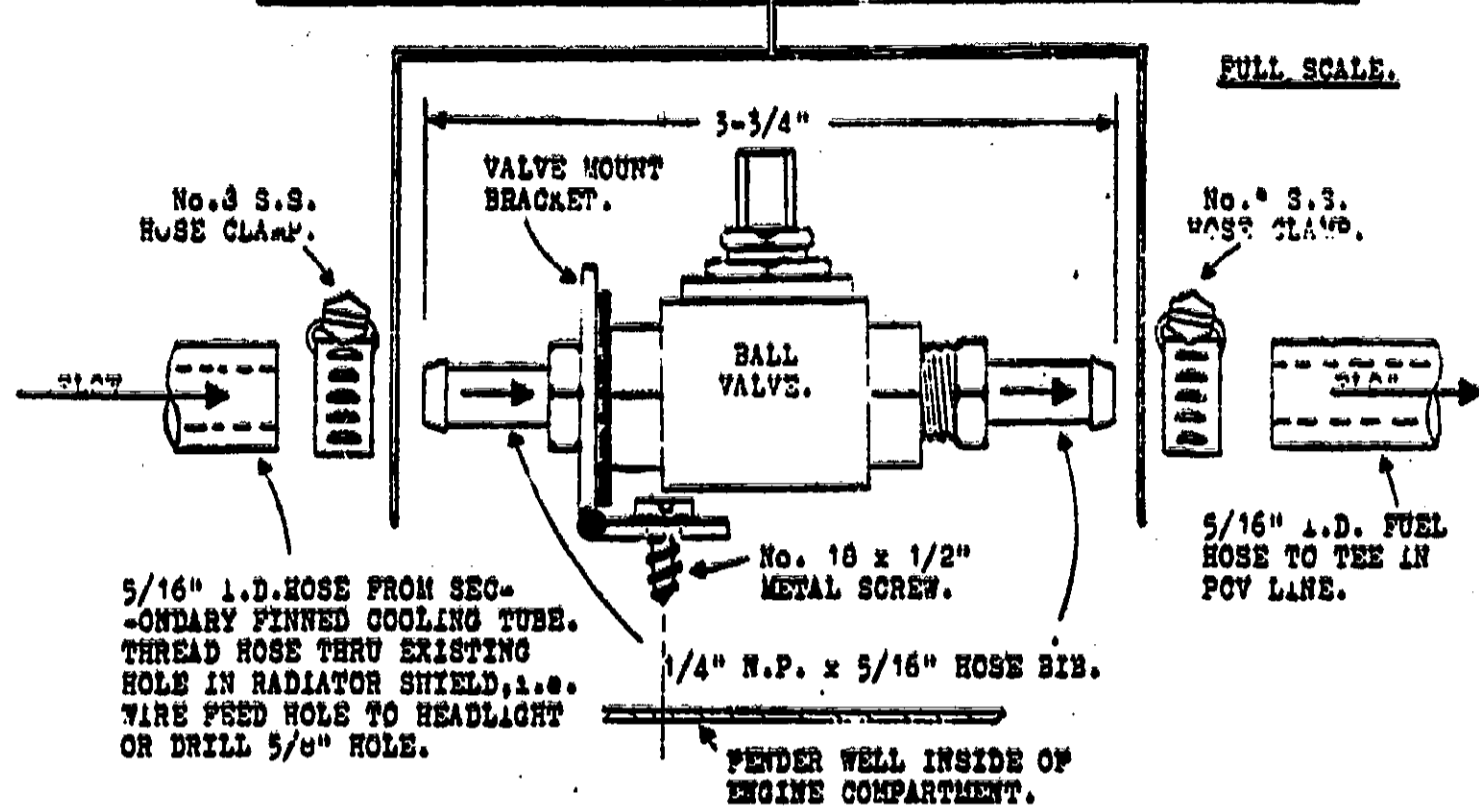

NOTE: 1/4" N.P.T. BRASS, NEOPRENE SEATED BALL VALVE IS FULL OPEN WHEN FLAT SIDES ON TOP OF VALVE STEM ARE ALIGNED WITH FLOW LINE. VALVE MAY BE CLOSED BY TURNING STEM 1/4 TURN. CLOSE ONLY TO ISOLATE MOTOR PROBLEMS SUCH AS IGNITION ETC.

ALTERNATE MOUNTING.

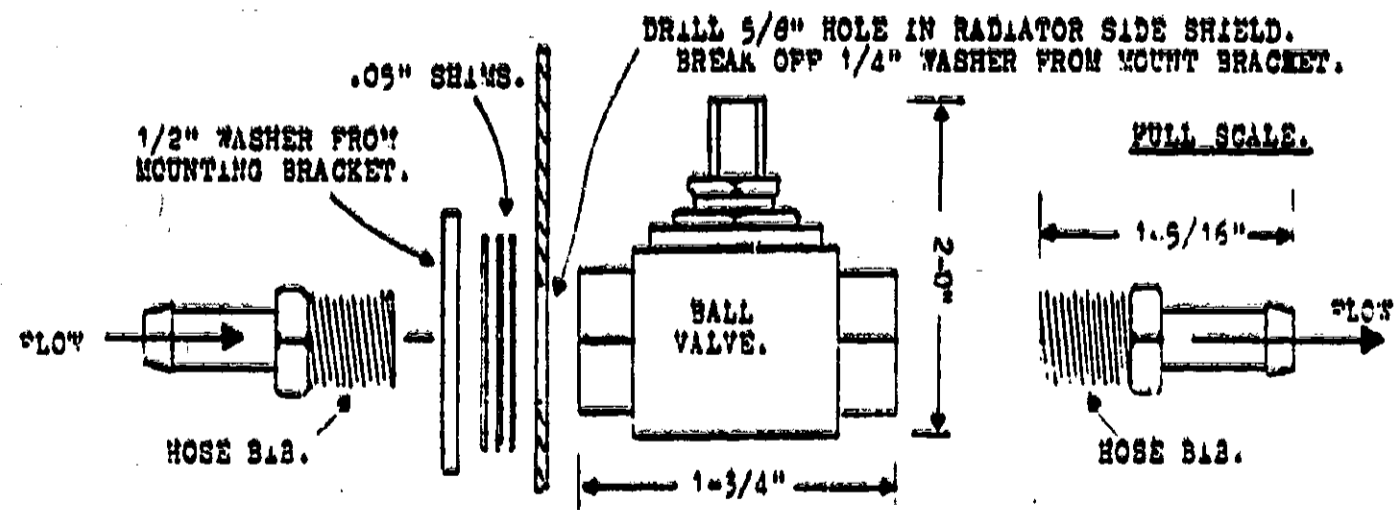

STEP 6. Mounting the Cut-Off Valve Assembly (6). (Cont'd.)

Method 2 - Mounting on Fender Well

Drill a 1/4" hole in inside fender well at approximately the same level of outlet tube of secondary heat exchanger (7). Remove hose bib, bracket and shims from out-off valve assembly. Secure bracket to fender well with 1/4" x 3/4" bolt. Reassemble cut-off valve assembly as shown on Page 8-A. Align valve to permit hose connections. Using 3/8" I.D. hose, connect outlet end of secondary heat exchanger (7) to hose bib of out-off valve. Secure hose with #6 hose clamps (14). Valve is fully open when flat sides on top of valve stem are aligned with flow line.

STEP 7. Connecting the 5/16" I.D. Hose Assembly (8).

Locate the hose connecting the PCV valve to the intake manifold and cut this hose at approximately 3" from the PCV valve using a knife or pruning shears. Insert the tee at this point as illustrated on bottom half of Page 9-A. Connect the short piece of 5/16" I.D. hose containing the brass flow jet as shown at top of Page 9-A, to outlet bib of cut-off valve. Hose assembly will come unitized with brass flow jet in place and 3/8" x 2-1/2" clear plastic visual tube instead of 3/4" x 1-3/4" brass test access tube as shown at top of Page 9-A. Route remaining 5/16" I.D.

- 9 1 -

"MESCO" MOISTURE FLOW JET INSTALLATION

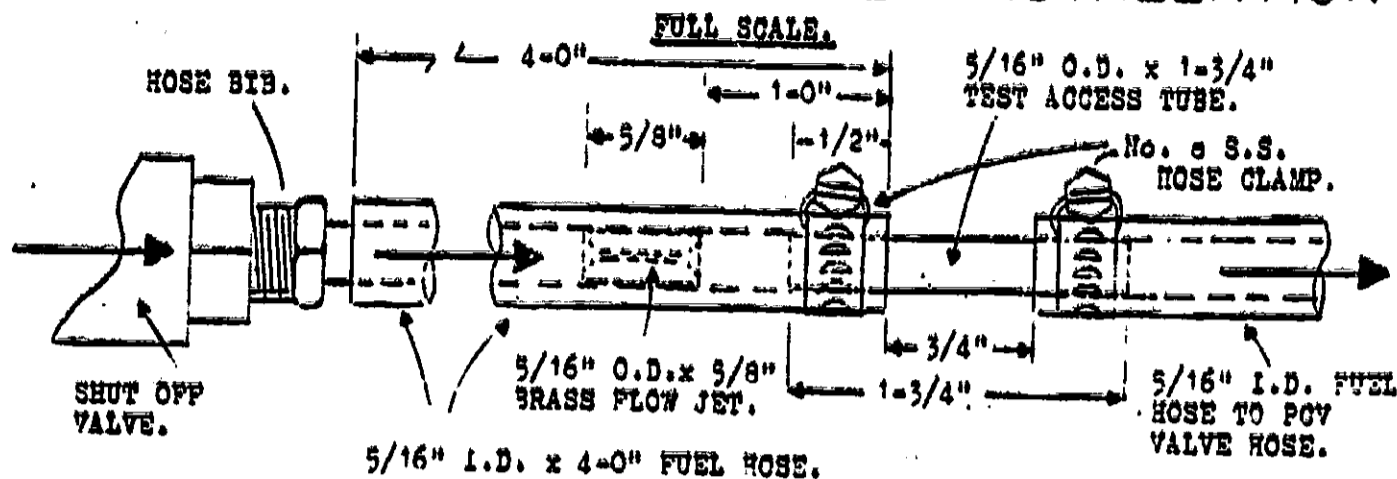

INSTALLATION OF "TEE" IN PCV LINE

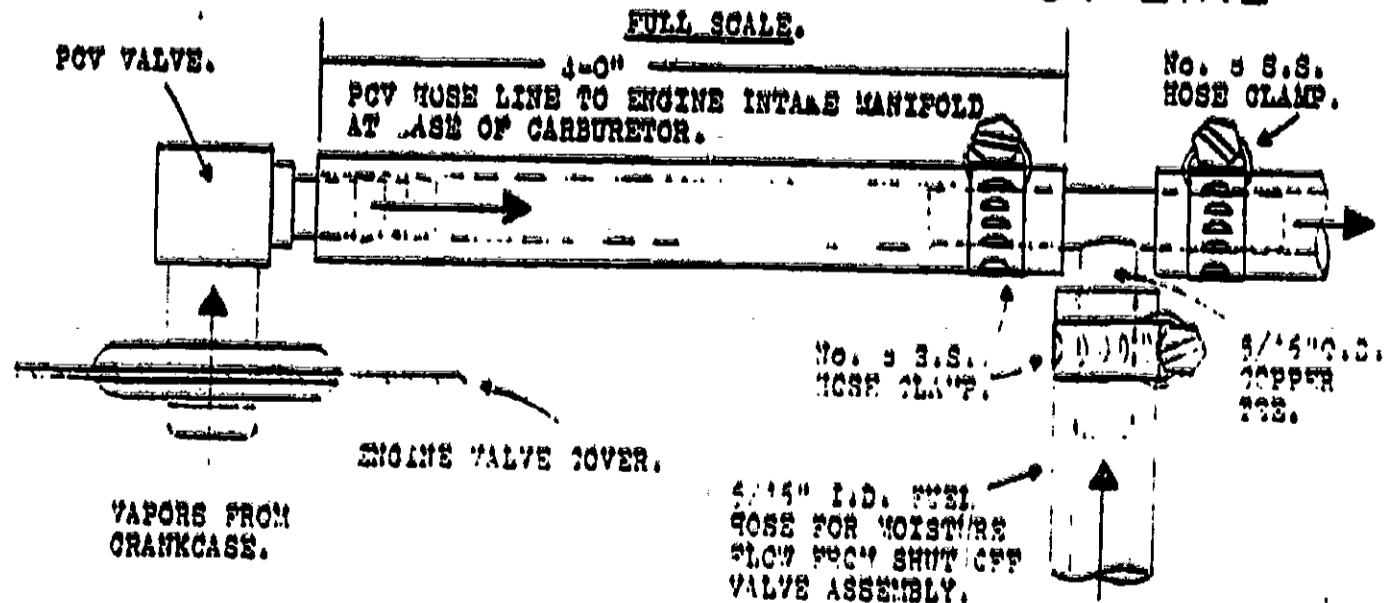

STEP 7. Connecting the 5/16" I.D. Hose Assembly (8). (Cont'd.)

hose to installed tee in PCV line and secure with #6 hose clamps as shown on lower section of Page 9-A.

STEP 8. Watching It Work.

With the transmission in "Park" or "Neutral" and with the Emergency Brake on, start the engine and let it idle. Insure that the cut-off valve is open. In several minutes the plastic visual tube between the cut-off valve and the tee in the PCV line should become cloudy with tiny moisture droplets, followed shortly thereafter by a thin trickle of moisture running through the tube. This indicates that the unit is operating correctly. While waiting for the moisture to build up in the system, you may want to proceed with the engine tuning in Step 9.

STEP 9. Tuning.

Using a timing light, loosen the distributor and advance the timing 6° beyond the manufacturer's specified ignition setting. For example, if the manufacturer recommends the ignition timing to be set to 8° BTDC, advance the timing to 14° BTDC and tighten the distributor.

STEP 9. Tuning. (Cont'd.)

NOTE: On late model vehicles equipped with a thermal timing delay, the engine must be warmed up before making this adjustment and/or the vacuum hose disconnected from the distributor during the time the adjustment is made.

If your vehicle pings at this advanced ignition setting, retard the timing by 1-2° or until the pinging stops. (A well-used mechanic's technique is to advance the timing until the engine just begins to ping under load, and then to retard the timing 1°.)

For best results, take your vehicle to a local service station or garage that performs smog emissions testing and have them balance your carburetor for minimum emissions while the system is working. They can also set the ignition timing for you if you do not care to do it yourself.

If your vehicle uses premium fuel, you may now find that your vehicle will now run just as well on regular fuel.

The clear plastic tube can remain in place or be replaced by furnished 5/16" O.D. x 1-3/4" test access tube. The inside of the clear plastic tube will become stained after many miles of use. Tube can be removed, washed clean and put back in place.

Maintenance

There are only two items on the Moisture Extraction System that require periodic maintenance: The Filter Assembly and the Brass Flow Jet.

It is recommended that every 5000-8000 miles (or as often as you change oil) that you clean the filter mesh and inspect the flow jet.

The filter assembly is constructed as shown on Page 2-B. In order to clean the filter mesh, remove the 1/4" hex nuts from the front and back filter caps. Loosen the #48 hose clamp and remove filter body, stainless steel mesh element and baffle bar rod. Unroll the mesh element and wash clean, along with the filter body and baffle rod. Cleaning may be done with soapy water or shop solvents. Reroll filter mesh element on baffle rod bar and reinsert in filter body. Wipe carbon from inside of filter caps. Assemble filter units as removed with special attention that brass baffle plate is located at inlet end of filter and that "O" rings are properly located in filter caps. Place a small amount of silicon sealer on rod threads extending out of filter caps. Replace hex nuts on rod and tighten hex nuts snug.

WARNING: The moisture contained in the filter assembly is not pure water and is likely to be slightly acidic. If this moisture gets into your eyes, rinse immediately with clear water.

Maintenance (Cont'd.)

Brass flow jet is located in short 5/16" I.D. outlet hose of cut-off valve. This hose section can be removed and visual inspection made of jet opening. Replace as removed.

NOTE: The operation of the moisture extraction system removes and prevents carbon build-up in an engine. Therefore, if your vehicle has more than 10,000 miles accumulated when this installation is made, it is recommended that you clean the filter after the first 2000 miles of operation and normal maintenance periods thereafter.

Pickups, vans and truck equipped with dual mufflers and tailpipes. Tailpipe O.D. measurement of 2-0", 2-1/4", and 2-1/2".

Install exhaust extractor on each tailpipe as instructed on Pages 2 and 3. Install filter assembly equipped with dual inlet cap at selected location. See Pages 3 and 4. Crossover of primary heat exchanger tube from opposite vehicle side of filter location must be routed over driveshaft to insure clearance for driveshaft movement. (See photos). Connect outlet end of each primary heat exchanger tube to inlet tubes of filter with 5/8" I.D. hose and #10 hose clamps. To complete installation of system from filter to intake manifold, follow same procedure used in installing moisture extraction system on vehicles equipped with single muffler and tailpipe.

Trucks equipped with single or dual tailpipes. Tailpipe O.D. measurement of 3-0" and over.

Moisture extraction systems are available for trucks with tailpipes O.D. of 3-0" and over that are equipped with single or dual tailpipes. Most of these installations involve in-line welding of moisture extractor on tailpipe. See your local dealer or contact:

MESCO, INC.
2618 E. Elm Street
Phoenix, Arizona 85016
(602) 955-2413

MESCO, Inc.
4525½ E. Van Buren St.
Phoenix, Arizona 85008
(602) 273-6764

"MESCO" MOISTURE EXTRACTION SYSTEMS

PARTS LIST

<u>PART NO.</u>	<u>DESCRIPTION</u>
MES 100-2.00	Moisture Extractor Tube Assembly for 2-0" O.D. Exhaust Tailpipe
MES 100-2.25	" " " " " 2-1/4" O.D. " "
MES 100-2.50	" " " " " 2-1/2" O.D. " "
MES 100-2.75	" " " " " 2-3/4" O.D. " "
MES 100-3.00	" " " " " 3-0" O.D. " "
MES 100-3.50	" " " " " 3-1/2 O.D. " "
MES 100-4.00	" " " " " 4-0" O.D. " "
MES 100-X2.00	Muffler Clamp
MES 100-X2.25	" "
MES 100-X2.50	" "
MES 100-X2.75	" "
MES 100-X3.00	" "
MES 100-X3.50	" "
MES 100-X4.00	" "
MES 2	1/2" 8 x 10 Brass 90 Deg. Flare Elbow
MES 3	1/2" 8 x 10 Brass Half Union
MES 4	Primary Heat Exchanger Tube (54" Long)
MES 5	Filter Assembly With Single Inlet Tube
MES 5A	Filter Assembly With Dual Inlet Tubes
MES 6	Cut-Off Valve Assembly
MES 7	Secondary Heat Exchanger Tube (26" Long)

"MESCO" Moisture Extraction Systems

Parts List (Cont'd.)

- MES 8 5/16" I.D. Hose Assembly With Tee's Visual Tube and Brass Flow Jet
- MES 9 5/8" I.D. Hose
- MES 10 3/8" I.D. Hose
- MES 11 #48 Stainless Steel Hose Clamp
- MES 12 Filter Assembly Mounting Bracket
- MES 13 #10 Stainless Steel Hose Clamp
- MES 14 #6 Stainless Steel Hose Clamp
- MES 15 Muffler Clamp (Order Per Size)
- MES 16 1/8" x 1/2" Sheet Metal Screw
- MES 17 1/2" Tubing Clamp
- MES 18 3/4" Conduit Clamp
- MES 19 10" Nylon Tie
- MES 20 1/4" x 3/4" N.C. Bolt and Nut Assembly
- MES 21 1-1/2" x 2-0" Rubber Insulation Tube
- MES 22 #36 Stainless Steel Hose Clamp
- MES 23 3/8" O.D. x 2-1/2" Clear Plastic Visual Tube
- MES 24 1/8" x 36" Steel Template Rod

TEST PLAN FOR MESCO EVALUATION

1. TEST FACILITY

The facility used for the testing will be the University of Santa Clara Mechanical Engineering Test Laboratory, Santa Clara, California.

The test coordinator will be Ms. Kelly Erin O'Brian of the above facility.

2. TEST APPROACH

The vehicle to be tested will be provided by Mesco Corporation. The test vehicle will be subjected to four identical series of tests, each comprising a cold-soak period, a cold-start, city test series and a highway test series. Testing will be performed using the chassis dynamometer and emissions analysis facilities at the above facility.

The testing will take place on four consecutive days in the above identified facility with no modifications other than those subsequently identified to the test vehicle between tests.

3. TEST PROCEDURE

The testing will be completed in four steps as follows :

A. Baseline Test

1. The test vehicle will be run through the full test series with no operational modifications.
2. CO, CO₂, HCx and NOx emissions will be collected and analyzed.
3. Fuel consumption will be monitored.

B. Timing Adjustment Test

1. The test vehicle will be run through the full test series with the ignition timing advanced a specified number of degrees beyond the noted baseline setting.
2. CO, CO₂, HCx and NOx emissions will be collected and analyzed.
3. Fuel consumption will be monitored.

C. MESCO Device Operational Test

1. The test vehicle will be run through the full test series with the MESCO device installed and operational.
2. No other modifications to the ignition timing, carburetion or other vehicle operational adjustments will be performed.
3. CO, CO₂, HCx and NOx emissions will be collected and analyzed.
4. Fuel consumption will be monitored.

D. Emissions Control Equipment Test

1. The catalytic converter will be removed and replaced with straight exhaust tubing.
2. The EGR valve will be disabled.
3. The veractor pump will be disabled.
4. No other modifications to the ignition timing, carburetion or other vehicle operational adjustments will be performed.
5. The test vehicle will be run through the full test series with the MESCO device installed and operational.
6. CO, CO₂, HCx and NOx emissions will be collected and analyzed.
7. Fuel consumption will be monitored.



UNITED STATES ENVIRONMENTAL PROTECTION AGENCY

ANN ARBOR, MICHIGAN 48105

February 17, 1983

OFFICE OF
AIR, NOISE AND VIBRATION

Mr. Charles W. Fraesh
President, Mesco Inc.
2618 East Elm Street
Phoenix, Arizona 85016

Dear Mr. Fraesh:

We received your letter of January 29 in which you applied for an EPA evaluation of your Mesco device and requested our comments on your proposed test plan.

Our Engineering Evaluation Group has conducted a review of your application. The information supplied appears to satisfactorily describe your device. It appears that you are now ready to undertake testing at an independent laboratory. I have enclosed a copy of the basic test plan for 511 evaluations, a description of the test cycles, and a list of representative vehicles.

Since it is clear the device will affect emissions and fuel economy, the testing should include the complete Federal Test Procedure. However, either cold start or hot start testing would be acceptable to us for this stage of the evaluation. Test Plan B (parameter adjustments required and no mileage accumulation required) is appropriate for your device. You may use the Test Sequence Code that you feel is most appropriate. Two vehicles will need to be tested. This will require a minimum of 12 FTPs and 12 HFETs. If you wish, you may supplement these tests with additional tests such as the Emission Control Equipment Test given in your application.

We have considered the test plan you proposed but find that it does not have a sufficient number of tests and vehicles. With normal test-to-test and vehicle variability, the test sequence outlined in the preceding paragraph is the minimum needed to indicate that any changes noted in testing are statistically significant.

By March 11, please let us know the test sequence you select, the laboratory you have selected, and the scheduled dates for your testing. Also, please let me know how you intend to monitor fuel consumption. If you have any questions or require further information, please contact me at (313) 668-4299.

Sincerely,

Merrill W. Korth
Device Evaluation Coordinator
Test and Evaluation Branch

Enclosure

Received 3-28-83 mark

59

ATTACHMENT G

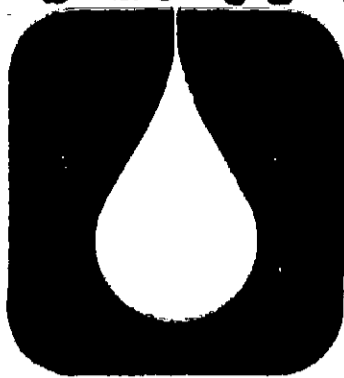

MESCO
INCORPORATED

2618 East Elm Street
Phoenix, Arizona 85016
(602) 955-6580

2618 East Elm Street
Phoenix, Arizona 85016
(602) 955-6580

ENVIRONMENTAL PROTECTION AGENCY
MOTOR VEHICLE EMISSION LABORATORY
2565 PLYMOUTH ROAD
ANN HARBOR, MICHIGAN 48105

ATTN: MR. MERRILL W. NORTH

Dear Sir:

Per our conversation by phone on March 22, 1983 I am forwarding a copy of the TEST PLAN FOR MESCO EVALUATION, Revision 1 of March 9, 1983. The original was mailed to your office on March 11, 1983.

I appreciate your courtesy call explaining the change in policy that requires additional testing by the EPA Laboratory but I believe this change in policy will inhibit submissions by inventors of Add-on devices that could possibly benefit the EPA program.

Yours respectfully,

Charles W. Freesh Pres.
Charles W. Freesh

TEST PLAN FOR MESCO EVALUATION
Revision 1
March 9, 1983

1. GENERAL

This test plan is the first revision of the test plan for Mesco Inc. Moisture Extraction System, submitted to the EPA as part of the application for evaluation of the Mesco Moisture Extraction System.

This test plan has been revised to incorporate comments and recommendations from EPA personnel and test personnel at the University of Santa Clara Mechanical Engineering Laboratory.

2. TEST FACILITY

The facility used for the testing will be the University of Santa Clara Mechanical Engineering Test Laboratory, Santa Clara, California.

The test coordinator will be Ms. Kelly Erin O'Brian of the above facility.

3. TEST APPROACH

The vehicles to be tested will be provided by Mesco Corporation. Testing will be performed using the chassis dynamometer and emissions analysis facilities at the above facility.

The testing will take place in the above identified facility with no modifications other than those subsequently identified to the test vehicle between tests.

Two vehicles will be used for test evaluation. Each vehicle will be evaluated with a series of 511 type LA-4 and HWFET

test procedures. No cold soak period will be employed between tests and all test series will be performed using commercially available unleaded fuel obtained from the same source on the same day. The tests to be performed are outlined in the following:

3.1 Vehicle #1

The first vehicle will be submitted to the following test sequences:

1. Baseline Tests

- No modifications to vehicle.
 - a. LA4 + HWFET series with gravimetric fuel consumption monitoring.
 - b. Repeat of LA4 + HWFET series with no gravimetric fuel consumption monitoring.

2. Device Tests

- Moisture Extraction System installed and ignition timing adjusted.
 - a. LA4 + HWFET series with gravimetric fuel consumption monitoring.
 - b. Repeat of LA4 + HWFET series with no gravimetric fuel consumption monitoring.

3. Parameter Tests

- Moisture Extraction System removed and ignition timing setting retained.
 - a. LA4 + HWFET series with gravimetric fuel consumption monitoring.
 - b. Repeat of LA4 + HWFET series with no gravimetric fuel consumption monitoring.

4. Emissions Control Equipment Tests

- Moisture Extraction System re-installed, ignition timing setting retained, catalytic converter removed, EGR valve disabled and air pump disabled.
 - a. LA4 + HWFET series with gravimetric fuel consumption monitoring.
 - b. Repeat of LA4 + HWFET series with no gravimetric fuel consumption monitoring.

5. Vehicle restored to Baseline condition.

3.2 Vehicle #2

The second vehicle will be submitted to the following test sequences:

1. Baseline Tests

- No modifications to vehicle.

a. LA4 + HWFET series

b. Repeat of LA4 + HWFET series

2. Device Tests

- Moisture Extraction System installed and ignition timing adjusted.

a. LA4 + HWFET series

b. Repeat of LA4 + HWFET series

3. Parameter Tests

- Moisture Extraction System removed and ignition timing setting retained.

a. LA4 + HWFET series

b. Repeat of LA4 + HWFET series

4. Vehicle restored to Baseline condition.

4. TEST TYPES

The types of tests are differentiated by the condition of the vehicle while the test procedures are being performed. The four types of tests which will be performed are as follows:

A. Baseline Test

1. The test vehicle will be submitted to the test series with no operational modifications.
2. CO, CO₂, HCx and NOx emissions will be collected and analyzed.
3. Fuel consumption will be monitored by calculation of CO₂ emissions and, where designated, by consumed weight (gravimetric) method.

B. Device Test

1. The test vehicle will be submitted to the test series with the MESCO device installed and operational. Ignition timing will be advanced a specified number of degrees beyond the noted baseline setting.
2. No other modifications to the carburetion or other vehicle operational adjustments will be performed.
3. CO, CO₂, HCx and NOx emissions will be collected and analyzed.
4. Fuel consumption will be monitored by calculation of CO₂ emissions and, where designated, by consumed weight (gravimetric) method.

C. Parameter Test

1. The test vehicle will be submitted to the test series with the device removed. The ignition timing will be retained at the previous advanced setting. No other modifications to the vehicle will be performed.
2. CO, CO₂, HCx and NOx emissions will be collected and analyzed.
3. Fuel consumption will be monitored by calculation of CO₂ emissions and, where designated, by consumed weight (gravimetric) method.

D. Emissions Control Equipment Test

1. The test vehicle will be submitted to the test series with the MESCO device re-installed and operational.
2. The catalytic converter will be removed and replaced with straight exhaust tubing.
3. The EGR valve will be disabled.
4. The veractor pump will be disabled.
5. No other modifications to the ignition timing, carburetion or other vehicle operational adjustments will be performed.
6. CO, CO₂, HCx and NOx emissions will be collected and analyzed.
7. Fuel consumption will be monitored by calculation of CO₂ emissions and, where designated, by consumed weight (gravimetric) method.



UNITED STATES ENVIRONMENTAL PROTECTION AGENCY
ANN ARBOR, MICHIGAN 48105

67
ATTACHMENT H

OFFICE OF
AIR, NOISE AND RADIATION

April 5, 1983

Mr. Charles W. Freesh
President, Masco Inc.
2618 East Elm Street
Phoenix, AZ 85016

Dear Mr. Freesh:

We received your undated letter on March 28 in which you provided a revised test plan for the Masco device.

The test plan you submitted is acceptable. However, you did not identify the two test vehicles you selected or give the test dates. Also, the test plan did not state that the test lab would prepare the vehicles and install the device. I presume the vehicles will be selected from our recommended list and that the lab will prepare them as outlined in the basic test plan I sent you.

Our evaluations of the effectiveness of devices is based largely on the independent lab results and, if required, our own confirmatory testing. The change in policy requiring applicants to bear the costs of confirmatory testing by EPA is as a result of a recent ruling. We are now beginning to implement this directive but have not finalized the procedures. We anticipate that those devices well along in the process will be exempt but that more recent applicants like yourself, will be charged. In either case, it is in your interest to complete testing as soon as possible.

By April 20, please let me know the scheduled dates of your testing at the University of Santa Clara. Please contact me if you have any questions or require further information.

Sincerely,

Merrill W. Korth
Merrill W. Korth
Device Evaluation Coordinator
Test and Evaluation Branch



UNITED STATES ENVIRONMENTAL PROTECTION AGENCY

ANN ARBOR, MICHIGAN 48105

May 27, 1983 .

OFFICE OF
AIR, NOISE AND RADIATION

Mr. Charles W. Freesh, President
Mesco, Inc.
2618 East Elm Street
Phoenix, AZ 85016

Dear Mr. Freesh:

This letter is to inform you of our intended action with respect to our evaluation of the "Mesco" device.

As you know, we need additional test data which support the claims for the device. Based on our conversations, your letter that we received on March 28, and our letter of April 5, it was our understanding that you planned to test the device in the immediate future (within two weeks) at the University of Santa Clara. However, we find that you have taken no positive action to meet this schedule and question whether you are serious about having your device evaluated.

Because of the need to complete our evaluation in a timely manner, we have established a deadline of June 17 for you to submit the appropriate test data. If you do not meet this deadline, we plan to terminate the program since we have no technical reasons for continuing the evaluation on our own.

A final evaluation report will be prepared and a notice published in the Federal Register announcing the conclusions of our evaluation and the availability of the final report. You will be sent a draft copy of the final report and the notice prior to their release. Additionally, Mesco will be added to our list as a device for which an evaluation was performed. This list is distributed to interested parties upon request.

If you do not complete the test program now and should decide to have the device evaluated in the future, a new application will be required. I will be glad to work with you at that time. If you have any questions regarding this matter, please contact me at (313) 668-4299.

Sincerely,

A handwritten signature in cursive script that reads "Merrill W. Korth".

Merrill W. Korth
Device Evaluation Coordinator
Test and Evaluation Branch

file "MESCO" 69

ATTACHMENT J



MESCO
INCORPORATED

2618 East Elm Street
Phoenix, Arizona 85016

~~2618 East Elm Street
Phoenix, Arizona 85016
4801-27-2744~~

June 13, 1983

Environmental Protection Agency
Motor Vehicle Emission Laboratory
2565 Plymouth Road
Ann Arbor, Mich. 48105

Attn: Mr. Merrill W. Korth

Dear Sir:

An amended (appendix 1) State of California Air Resources Board Vehicle Code Section 27156 Exemption Application Form has been forwarded on June 7, 1983 to Mr. John Chao of the California Air Resources Board.

C. A. R. B. required tests will be conducted at the University of Santa Clara Mechanical Engineering Laboratory, Santa Clara, California.

The test coordinator will be Ms. Kelly Erin O'Brien of the above facility.

A copy of test results will be forwarded to your office.

Yours respectfully

Charles W. Freesh

Charles W. Freesh
Pres. Mesco Inc.



UNITED STATES ENVIRONMENTAL PROTECTION AGENCY
ANN ARBOR, MICHIGAN 48105

70

ATTACHMENT K

OFFICE OF
AIR, NOISE AND RADIATION

June 22, 1983

Mr. Charles W. Freesh, President
Mesco, Inc.
2618 East Elm Street
Phoenix, Arizona 85016

Dear Mr. Freesh:

We received your letter of June 13, 1983 in which you advised us of your current test plan for the "Mesco Moisture Extraction System."

- You stated that the purpose of the testing was to conduct the sequence required by the CARB. If you are still planning to meet our requirements, you should be aware that there are several differences in the CARB and EPA evaluation programs. We suggest that you review the test package and test plan we sent you previously to ensure that your testing will meet our requirements as well as those for the CARB.

While we will be glad to review the test results, we are obligated to complete the 511 process in a timely manner and are continuing with our evaluation. Any new data will be incorporated in the evaluation if they arrive before it is completed.

If we can be of any further assistance, please contact me at (313) 668-4299.

Sincerely,

Merrill W. Korth
Merrill W. Korth
Device Evaluation Coordinator
Test and Evaluation Branch