

**ET Toolbox**  
**Evapotranspiration Toolbox for the Middle**  
**Rio Grande**  
**A Water Resources Decision Support Tool**

**Al Brower**

October 8, 2008

Version 2.1



Water and Environmental Resources Division  
Technical Service Center  
Denver, Colorado  
Bureau of Reclamation  
US Department of the Interior

## Contents

<b>1</b>	<b>Acknowledgements</b>	<b>1</b>
<b>2</b>	<b>Introduction - About This Document</b>	<b>2</b>
<b>3</b>	<b>Purpose of the AWARDS/ET Toolbox</b>	<b>3</b>
<b>4</b>	<b>Overview of the AWARDS and ET Toolbox</b>	<b>4</b>
4.1	Data Flow Diagram . . . . .	5
4.2	AWARDS Overview . . . . .	6
4.3	ET Toolbox Overview . . . . .	7
4.4	Chronology of Events . . . . .	9
<b>5</b>	<b>Accessing the AWARDS and ET Toolbox</b>	<b>13</b>
5.1	MAP with Quantitative Precipitation Estimation (QPE) and River Reaches	13
5.2	Windows and Options Access . . . . .	14
<b>6</b>	<b>AWARDS Products</b>	<b>15</b>
6.1	River Reach and Chama/Velarde Windows . . . . .	15
6.2	Daily Weather Station Data . . . . .	15
6.3	ET Charts . . . . .	16
6.4	Other Areas . . . . .	16
<b>7</b>	<b>ET Toolbox Products</b>	<b>17</b>
7.1	River Reach and Chama/Velarde Windows . . . . .	17
7.2	Daily Weather Station Data . . . . .	18
7.3	Grid Cell Detail Tables . . . . .	18
7.4	Reach Summary Products Menus . . . . .	18
7.4.1	Reach Summary Tables . . . . .	19
7.4.2	Reach Summary Plots . . . . .	20
7.4.3	Daily ET Rate Table . . . . .	20
7.5	URGWOM ET Maps . . . . .	21
7.6	Basin Overview Plots . . . . .	21
7.6.1	With Present Division Rain . . . . .	22
7.6.2	With Present Hourly Rain . . . . .	22
7.6.3	Daily Archived Images . . . . .	22
<b>8</b>	<b>Automated Weather Station Data</b>	<b>23</b>
8.1	Middle Rio Grande Conservancy District . . . . .	23
8.2	New Mexico Climate Center . . . . .	25
8.3	METAR System . . . . .	26

<i>CONTENTS</i>	III
<b>9 Weather Forecasting</b>	<b>28</b>
9.1 National Digital Forecast Database (NDFD) . . . . .	28
9.2 National Centers for Environmental Prediction (NCEP) . . . . .	29
<b>10 NEXRAD Precipitation Estimates</b>	<b>30</b>
<b>11 Effective Rainfall Estimates</b>	<b>31</b>
<b>12 Penman Reference ET Calculation</b>	<b>32</b>
<b>13 AWARDS/ET Toolbox Calculations</b>	<b>33</b>
13.1 Daily ET . . . . .	33
13.2 Coefficient (KC) . . . . .	33
13.2.1 Coefficient (KC) based on Month . . . . .	33
13.2.2 Coefficient (KC) based on Growing Degree Days . . . . .	33
13.3 Daily ET Limits - Special Case . . . . .	34
13.4 Vegetative and Open Water Daily Consumptive Use (DCU) - ET Toolbox Only . . . . .	35
13.5 Total Grid Cell DCU - ET Toolbox Only . . . . .	35
13.6 River Reach and Diversion DCU) - ET Toolbox Only . . . . .	35
13.7 DCU Values in Cubic Feet Per Second - ET Toolbox Only . . . . .	35
<b>14 Veg. and Open Water Coefficients and Related Data</b>	<b>37</b>
<b>15 GIS Land Classification</b>	<b>41</b>
15.1 Reaches 1-8 . . . . .	41
15.2 Rio Chama/Velarde . . . . .	42
<b>16 Open Water Evaporation Estimates</b>	<b>43</b>
16.1 Rio Grande Evaporation . . . . .	43
16.2 Elephant Butte Reservoir Evaporation . . . . .	43
16.3 Wet Sands Evaporation) . . . . .	44
<b>17 Stream Flow Data</b>	<b>45</b>
17.1 MRGCD Stream Flow Data . . . . .	46
17.2 USBR Pumping Stations . . . . .	48
17.3 USGS Stream Flow Data . . . . .	48
17.4 Schematics . . . . .	50
17.4.1 Valley Cross Sections . . . . .	50
17.4.2 Irrigation Diversions . . . . .	52
17.5 Direct Links to USGS Gage Information . . . . .	52

<i>CONTENTS</i>	IV
<b>18 Tamarisk Research</b>	<b>53</b>
<b>19 Field Scheduling</b>	<b>54</b>
<b>20 Interface with RiverWare</b>	<b>55</b>
<b>21 Historic ET Toolbox Processing - 1975 to 2005</b>	<b>56</b>
<b>22 Data Flow - Computer Processing</b>	<b>59</b>
<b>23 ET Toolbox Research</b>	<b>61</b>
<b>24 References</b>	<b>63</b>
<b>25 FIGURES</b>	<b>64</b>

## List of Figures

1	ET Toolbox Home Page . . . . .	65
2	New Mexico ET Products Menu - Part 1 . . . . .	66
3	New Mexico ET Products Menu - Part 2 . . . . .	67
4	Rio Grande Map - Awards . . . . .	68
5	Colored Topography . . . . .	69
6	River Reach 3 - Awards . . . . .	70
7	MRGCD Daily Weather Data . . . . .	71
8	ET Chart . . . . .	72
9	Rio Grande Map - ET Toolbox . . . . .	73
10	River Reach 3 - ET Toolbox . . . . .	74
11	Grid Cell Detail . . . . .	75
12	ET Summary Products Menu - Reach 3 . . . . .	76
13	Reach 3 Summary . . . . .	77
14	Reach 3 Daily Consumptive Use And Rainfall . . . . .	78
15	Reach 3 Daily Consumptive Use With Stream Flow And Running Averages . . . . .	79
16	Daily ET Rates . . . . .	80
17	URGWOM ET - Reach 3 . . . . .	81
18	With Present Division Rain Matrix . . . . .	82
19	With Present Hourly Rain Matrix . . . . .	83
20	MRGCD Weather Station Network . . . . .	84
21	MRGCD Hourly Weather Data . . . . .	85
22	MRGCD Temperature-Humidity Plot . . . . .	86
23	MRGCD Volumetric Soil Water Content Plot . . . . .	87
24	MRGCD Fuel Moisture Plot . . . . .	88
25	5-km NDFD Grid For Reach 2 . . . . .	89
26	New Mexico, Texas, and Oklahoma Radar Coverage . . . . .	90
27	River Reach 7 - ET Toolbox . . . . .	91
28	Penman Reference ET Equation . . . . .	92
29	Limited ET As Calculated At The Luis Lopez Station . . . . .	93
30	Alfalfa Curve # 10 . . . . .	94
31	Corn Curve # 15 . . . . .	95
32	Wheat Curve # 31 . . . . .	96
33	Wheat>1300 GDD Curve # 31a . . . . .	97
34	Spring Barley Curve # 32 . . . . .	98
35	Sorghum Curve # 20 . . . . .	99
36	Orchard # 83 . . . . .	100
37	Grape Curve # 50 . . . . .	101
38	Cottonwood Curve # 61 . . . . .	102

39	Salt Cedar Curve # 60 . . . . .	103
40	Marsh Curve # 81 . . . . .	104
41	Open Water Curve # 80 . . . . .	105
42	Turf-Park Curve # 6 . . . . .	106
43	Rio Chama - ET Toolbox . . . . .	107
44	River Reach 8 - ET Toolbox . . . . .	108
45	Elephant Butte Reservoir Evaporation Menu . . . . .	109
46	Elephant Butte Detail . . . . .	110
47	Elephant Butte Daily Evaporation Rates . . . . .	111
48	Elephant Butte Plot . . . . .	112
49	Total Pumping Stations . . . . .	113
50	Stream Flow Products . . . . .	114
51	MRGCD North Schematic . . . . .	115
52	MRGCD Belen Schematic . . . . .	116
53	MRGCD South Schematic . . . . .	117
54	Socorro Main Canal Gage Heading . . . . .	118
55	Socorro Main Canal Gage Information . . . . .	119
56	Valley Cross Section . . . . .	120
57	Gage Information - Valley Cross Section at San Felipe . . . . .	121
58	Total Cochiti Diversion . . . . .	122
59	Cochiti Diversion Gage Information . . . . .	123
60	Tamarisk ET Model and Comparisons - Plot . . . . .	124
61	Tamarisk ET Model and Comparisons - Text . . . . .	125
62	Irrigation Scheduling Products - Candelaria Farms . . . . .	126
63	Candelaria Farms Soil Data . . . . .	127
64	Candelaria Farms Hourly Weather and Soil Data . . . . .	128
65	Candelaria Farms Daily Field Data and Irrigation Schedule . . . . .	129
66	Candelaria Farms Daily Field Data and Irrigation Schedule Plot . . . . .	130
67	URGWOM Consumptive Use - Reach 1 . . . . .	131
68	URGWOM Consumptive Use - All Reaches . . . . .	132
69	Flow Diagram of Weather Data, Page 1 - Real-Time Hourly from the Middle Rio Grande Conservancy District (MRGCD) . . . . .	133
70	Flow Diagram of Weather Data, Page 2 - Real-Time Daily from the Middle Rio Grande Conservancy District (MRGCD) . . . . .	134
71	Flow Diagram of Weather Data, Page 3 - Real-Time from the New Mexico State University Climate Center (NMSUCC) . . . . .	135
72	Flow Diagram of Weather Data, Page 4 - Real-Time METAR from NOAA	136
73	Flow Diagram of Weather Data, Page 5 - Forecast 5-km NDFD data from the National Digital Forecast Database (NDFD) . . . . .	137

74	Flow Diagram of Weather Data, Page 6 - Forecast NCEP QPF days 4-7 precipitation data from the National Centers for Environmental Prediction (NCEP) . . . . .	138
75	Flow Diagram of Weather Data, Page 7 - Forecast Data Processing . . .	139
76	Flow Diagram of Gage Data, Page 1 - Gage Data from the Middle Rio Grande Conservancy District (MRGCD) . . . . .	140
77	Flow Diagram of Gage Data, Page 2 - Gage Data from the Middle Rio Grande Conservancy District (Cont.) . . . . .	141
78	Flow Diagram of Gage Data, Page 3 - Gage Data from the United States Geological Survey (USGS) . . . . .	142
79	Flow Diagram of Gage Data, Page 4 - Gage Data from the United States Geological Survey (USGS) Direct . . . . .	143
80	Flow Diagram of NEXRAD Data, Page 1 - QPESUMS Data from the National Severe Storms Laboratory (NSSL) . . . . .	144
81	Flow Diagram of NEXRAD Data, Page 2 - QPESUMS Data from the National Severe Storms Laboratory (NSSL) . . . . .	145
82	Flow Diagram of NEXRAD Data, Page 3 - QPESUMS Data from the National Severe Storms Laboratory (NSSL) . . . . .	146
83	Flow Diagram of Awards and ET Toolbox Processing, Page 1 - RESTART	147
84	Flow Diagram of Awards and ET Toolbox Processing, Page 2 - REFERENCE ET . . . . .	148
85	Flow Diagram of Awards and ET Toolbox Processing, Page 3 - CROP ET	149
86	Flow Diagram of Awards and ET Toolbox Processing, Page 4 - ET CHART	150
87	Flow Diagram of Awards and ET Toolbox Processing, Page 5 - OPEN WATER . . . . .	151
88	Flow Diagram of Awards and ET Toolbox Processing, Page 6 - OPEN WATER (Cont.) . . . . .	152
89	Flow Diagram of Awards and ET Toolbox Processing, Page 7 - ET TOOLBOX . . . . .	153
90	Flow Diagram of Awards and ET Toolbox Processing, Page 8 - REPORTS	154
91	Flow Diagram of Awards and ET Toolbox Processing, Page 9 - REPORTS (Cont.) . . . . .	155
92	Flow Diagram of Awards and ET Toolbox Processing, Page 10 - REPORTS (Cont.) . . . . .	156
93	Flow Diagram of Awards and ET Toolbox Processing, Page 11 - NDFD COMPARISONS . . . . .	157
94	Flow Diagram of Awards and ET Toolbox Processing, Page 12 - FIELD SCHEDULING . . . . .	158
95	Flow Diagram of Awards and ET Toolbox Processing, Page 13 - TAMARISK RESEARCH . . . . .	159

**List of Tables**

1	Effective Rain As A Percent Of Total Rain (r) . . . . .	31
2	Agricultural Classifications . . . . .	38
3	Riparian Classifications . . . . .	39
4	Open Water Classifications . . . . .	40
5	Urban Classifications . . . . .	40



## 1 Acknowledgements

There are numerous people who contributed to the research and development of the ET Toolbox. The significant contributors, listed alphabetically are:

Ra Aman - Bureau of Reclamation Contract Computer Specialist, for his knowledge in programming and scripting, and masterful work with graphics products.

Salim Bawazir - New Mexico State University Assistant Professor, for his research of crop and riparian water use.

Steve Bowser - Bureau of Reclamation Hydraulic Engineer, for his technical, planning, and budgeting support.

David Gensler - Middle Rio Grande Conservancy District, for his development assistance and dedication to providing weather and stream flow data.

Steve Hansen - Bureau of Reclamation Deputy Area Manager, for his water management insights that led to the developmental ideas of the ET Toolbox, and funding support.

Curt Hartzell - Bureau of Reclamation Meteorologist (retired), for his team leadership, radar and meteorological knowledge, program management, and visions for the ET Toolbox.

Dave Matthews - Bureau of Reclamation Supervisory Meteorologist (retired), for his dedication and support, and for marketing into other Reclamation project areas.

Tom Pruitt - Bureau of Reclamation Civil Engineer, for his superior computer abilities, technical support, and understanding of the intricate operation of the ET Toolbox.

Nabil Shafike - State of New Mexico Interstate Stream Commission, for his dedication to the ET Toolbox and provider of funding support.

Richard Stodt - Bureau of Reclamation Meteorologist, for his meteorological knowledge and team leadership.

There were many others who also contributed in the areas of computer support, GIS efforts, and budgeting, and provided personal support and encouragement.

Al Brower - Bureau of Reclamation Civil Engineer (retired)

## 2 Introduction - About This Document

This documentation is intended to provide information on the data sources, calculations, and formulations of the many output products of the Agricultural Water Resources Decision Support (AWARDS) system and the Evapotranspiration Toolbox (ET Toolbox). It also provides user guidance for navigating through these products located on the Internet.

This document was requested primarily by users of the products in New Mexico; therefore it is focused on the operations in the Middle Rio Grande. However, it does contain components that are valid in other AWARDS/ET Toolbox project areas.

This document was written using the LaTeX, pronounced lay-tek, typesetting program operating on a Unix based computer, and saved as a pdf document. Some of the figures were produced by PC Windows software called SmartDraw.

This pdf document is written to more easily accommodate reading and printing using the Acrobat reader available on personal computers. Using an Internet accessible computer allows access to the numerous website products.

The embedded figures (outlined in red on the computer monitor) are static, dated when aspects of this document were written. Dynamic real-time figures and tables are available by clicking on the W (outlined in blue on the computer monitor) following the figure number. This will activate an Internet link via the users web browser to the AWARDS/ET Toolbox website. The address is: <http://www.usbr.gov/pmts/rivers/awards/>

However, accessing the website during the winter months may produce limited ET and stream flow results.

The website links to other organizations are outlined in blue on the computer monitor.

Since the AWARDS/ET Toolbox development is an on-going process, this document will be modified as related program changes and additions take place.

### **3 Purpose of the AWARDS/ET Toolbox**

The primary purpose of the AWARDS/ET Toolbox system is to estimate high-resolution daily rainfall and water depletions (crop and riparian vegetation ET, and open water evaporation) within specified river reaches, and to provide these daily values for input into RiverWare, which is the river modeling and water accounting system used by the Upper Rio Grande Water Operations Model (URGWOM). The URGWOM is a multi-agency effort to develop a numerical computer surface water model that will cover the Rio Grande from its headwaters in Colorado to Fort Quitman, Texas. The purpose of the URGWOM is to provide a daily water operations accounting tool that can be used for basin-wide water management and planning.

Other purposes include presentation of near real-time rainfall, ET, and stream flow conditions as frequently as possible within a readily accessible Internet site. These data can be used by water managers, river operations and irrigation district personnel, the scientific and farming communities, and the general public who may be interested in the various levels of water management issues.

The definition of a toolbox is "a case for carrying or storing hand tools". The intent of the AWARDS/ET Toolbox system is to provide tools to the user community that help define the supplies and demands upon the river system. This toolbox is the carrier for the "tools", and a storage medium for historic ET and related products.

## 4 Overview of the AWARDS and ET Toolbox

Toolbox (ET Toolbox) system is used for estimating daily water use requirements at a resolution useful for implementation in the Upper Rio Grande Water Operations Model (URGWOM). The URGWOM is a multi-agency effort to develop a numerical computer surface water model that will cover the Rio Grande from Colorado to Fort Quitman, Texas.

The purpose of the URGWOM is to provide a daily water operations accounting tool that can be used for basin-wide water management and planning. The goal of the ET Toolbox project is to develop a methodology for automatically inputting daily riparian and crop water use estimates, open water evaporation estimates, and rainfall estimates to the URGWOM. The initial development work is focused on the Middle Rio Grande area from Cochiti Dam to Elephant Butte reservoir in New Mexico. ET of riparian vegetation and irrigated crops, and open water evaporation, accounts for about 60 percent of the water depletions over this section of the Rio Grande.

Future expansion may include the area north of Cochiti Dam to the Colorado border, and south of Elephant Butte reservoir to Fort Quitman, TX. The current version of the ET Toolbox does include the Chama/Velarde area north of Cochiti Dam.

Note that all time related information throughout the AWARDS/ET Toolbox system is on Mountain Standard Time (MST) throughout the year. Therefore, during Mountain Daylight Time temporal scaling will be one hour behind clock time.

The Middle Grande Conservancy District (MRGCD) divisions (diversions) as used within the AWARDS/ET Toolbox system are listed in the following table:

Cochiti  
 Ansostura (presented in the ET Toolbox as Albuquerque)  
 Isleta (presented in the ET Toolbox as Belen North and Belen South)  
 San Acacia (presented in the ET Toolbox as Socorro)

The newer river reaches boundaries as used within the ET Toolbox system are listed in the following table. These reaches were implemented within the ET Toolbox on May 8, 2007. At that time the entire year 2007 was re-processed using these new reach delineations. Note that the Bernardo gage is non-operative. The Highway 346 gage is now used as a substitute.

River Reach 1	Cochiti Dam gage to San Felipe gage
River Reach 2	San Felipe gage to Alameda gage
River Reach 3	Alameda gage to Central Avenue gage
River Reach 4	Central Avenue gage to Isleta gage
River Reach 5	Isleta gage to Bernardo gage (Hwy. 346)
River Reach 6	Bernardo gage to San Acacia gage
River Reach 7	San Acacia gage to San Marcial gage (includes the Bosque Del Apache)
River Reach 8	San Marcial gage to north end of Elephant Butte Reservoir

### 4.1 Data Flow Diagram

The following diagram shows the overall data flow into and out of the AWARDS and ET Toolbox processes.

This diagram shows the principal data inputs and resulting outputs of the AWARDS and ET Toolbox processes. Note that many of the inputs are shared between them, and outputs from AWARDS are used in the ET Toolbox.

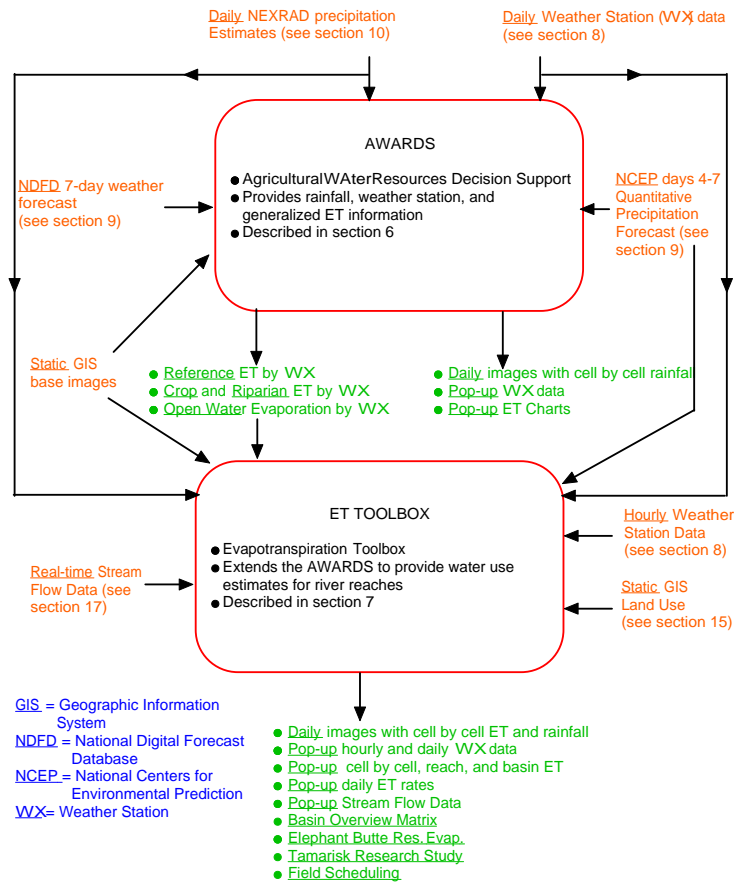

AWARDS and ET Toolbox Data Flow Diagram.

## 4.2 AWARDS Overview

In late FY1997, Reclamation's Albuquerque Area Office became aware of a newly developed AWARDS system for the Lugert-Altus Irrigation district in southwest Oklahoma. The AWARDS system is an automated information system on the Internet designed to assist water managers and users by providing easy access to rainfall and crop water use estimates. AWARDS uses rainfall estimates based on data from the NEXRAD (NEXT generation weather surveillance RADar) radar systems and remote automated weather stations. The Albuquerque Area Office requested that the AWARDS system be implemented in the Rio Grande, primarily as the foundation for the development of the desired ET Toolbox.

The primary purpose of the AWARDS system is to improve the efficiency of water management and irrigation scheduling by providing guidance on when and where to deliver water, and how much to apply. The resulting ET charts from AWARDS provide this guidance. AWARDS systems that have been implemented east of the Continental Divide use the NEXRAD Hydroview Multisensor Precipitation Estimation System (MPE) program (radar and gage) hourly product produced by the National Weather Service's (NWS) River Forecast Centers (RFCs) on a 4 km grid scale.

However, for the Middle Rio Grande, the Pecos Basin, and Upper Rio Grande in Colorado, a different precipitation system was implemented on June 15, 2007. This is the Quantitative Precipitation Estimation and Segregation Using Multiple Sensors (QPESUMS) on an approximate 1-km grid. These QPESUMS (abbreviated to QPE) data are automatically collected into the AWARDS/ET Toolbox computer via The Local Data Manager (LDM) from the National Severe Storms Laboratory (NSSL). The entire year back to January 1, 2007 was re-processed based on the QPE.

(Those west of the Divide use the NEXRAD Level II produced by the National Climate Data Center. Reclamation's Precipitation Accumulation Algorithm is applied to the Level II data to derive the precipitation estimates on a 2 km grid scale.)

The National Digital Forecast Database (NDFD) weather forecasting data are used for calculating the seven-day forecast ET. This forecast is on a 5-km grid. Days 4-7 forecast rain are obtained from the National Centers for Environmental Prediction (NCEP) on a 1 degree by 1 degree resolution.

Automated weather stations in AWARDS system areas transmit surface weather data via radio signal, phone, or satellite to local computer systems. The daily data are then automatically collected from the local computer systems, via File Transfer Protocol (FTP), into the AWARDS/ET Toolbox computer.

Lastly, the Modified-Penman method is used to calculate reference ET for each weather station. Weather data used for calculating reference ET are the maximum and minimum temperatures, average relative humidity, average wind speed, and solar radiation for the previous 24-hour Mountain Standard Time (MST) day.

Coefficients are applied to the reference ET to provide water use estimates for crops, riparian, and open water. These estimates, ET and rainfall forecasts, and effective rainfall are integrated into the images via pop-up charts.

Reservoir operators, water managers, and on-farm water users access the AWARDS system products via the Internet to make their operational decisions.

An AWARDS system brochure is available at: (Agricultural Water Resources Decision Support (AWARDS)).

The address is: <http://www.usbr.gov/pmts/rivers/awards/awards.html>

In summary, these are the inputs and outputs of the AWARDS system:

#### Inputs

- 1) Daily NEXRAD (QPE) precipitation estimates
- 2) Daily and hourly weather station data
- 3) Static GIS base images
- 4) NDFD 7-Day forecast weather data (rainfall for days 1-4 only)
- 5) NCEP days 4-7 forecast rainfall

#### Outputs

- 1) Daily NEXRAD (QPE) rainfall images
- 2) Daily and hourly weather station data (hourly for information only)
- 3) Reference ET by weather station
- 4) Crop and riparian ET by weather station
- 5) Open water evaporation by weather station
- 6) ET charts containing past ET, forecast ET, NDFD, NCEP, and effective rainfall

Refer to AWARDS Products (section 6) for more information on the operation of the AWARDS system.

### 4.3 ET Toolbox Overview

The AWARDS/ET Toolbox computer first operates on the AWARDS system requirements, generating rainfall images and ET charts. It then expands these requirements into the finer resolution ET products to provide detailed water use estimates for the QPE cells and river reaches.

The ET Toolbox is an extension of the AWARDS system. The reference ET, crop and riparian ET, and open water evaporation, are input from the AWARDS system. It also uses the following components that are not applied in the AWARDS system:

- 1) GIS land use
- 2) Hourly weather data from the South Bosque NMSU station
- 3) Real-time stream flow data

Note that the effective rainfall component that is tabulated in the AWARDS ET charts is not used in the ET Toolbox. Future use depends upon accessing additional data sources and research.

GIS land use is added to specify crop, riparian, and open water acreage within each QPE grid cell (resolution about 1 km x 1 km) along the Middle Rio Grande. The newer GIS information for land classification is used. This is a combination of the 2000 IKONOS satellite imagery at 4 meter multi-spectral resolution and the 2001 Utah State University (USU) aerial photography at .5 meter resolution. The IKONOS is used from Cochiti Dam to Elephant Butte Reservoir headwaters (Reaches 1-8). The USU exists in a small part of Reach 3, Reaches 4-7, and part of Reach 8. Wherever the USU exists, the IKONOS was erased and the USU was inserted. This replaces the 1992/93 Land Use Trend Analysis (LUTA), plus others. This change was made on June 8, 2004 when the entire year back to January 1 was re-processed using the newer IKONOS and USU classifications.

All of the vegetation data sets are transposed to the QPE grid cell resolution. GIS methodologies are then used to compare these data sets to determine changes in the vegetation and water depletion over time. The most recent and accurate data sets that cover the areas of interest are chosen for the ET Toolbox. A single land use data set is then assigned to each reach, thereby providing a means to summarize ET into specific groupings.

Grid cells are assigned to near-by weather stations, and then either a single weather station, or multiple weather stations, are assigned to to each reach. Grid cells can easily be reassigned whenever new weather stations are installed, land use data sets become available, or groupings are added or modified.

The primary purpose of this effort is to estimate daily rainfall and water depletions for each QPE grid cell and the specified river reaches. These daily ET estimates and summary year-to-date cumulative ET estimates are available to users and water managers via the Internet. The daily cumulative river reach ET estimates are provided to the URGWOM for use by RiverWare, using a Data Storage System developed by the U.S. Army Corps of Engineers Hydrologic Engineering Center.

The products include real-time access to weather station and stream gage data provided by the Middle Rio Grande Conservancy District (MRGCD), radar rainfall estimates, and links to United States Geological Survey (USGS) stream gage data. The AWARDS/ET Toolbox system also receives daily weather data from the New Mexico Climate Center at New Mexico State University (NMSU) for calculating ET and Internet posting. Graphical plots of 5-day and 10-day running averages of daily ET are available to help detect water requirement trends. Other plots include total daily agricultural, riparian, and urban ET, and open water evaporation.

Weather forecasting for the purposes of predicting ET for today and the next six days, and for substituting data for non-reporting weather stations, is accomplished by using the National Digital Forecast Database (NDFD) weather forecast parameters.

In summary, these are the inputs and outputs of the ET Toolbox system:



**Inputs**

- 1) Daily NEXRAD (QPE) precipitation estimates
- 2) Daily and hourly weather station data
- 3) Static GIS base images
- 4) Static GIS land use
- 5) NDFD 7-Day forecast weather data (rainfall for days 1-4 only)
- 6) NCEP days 4-7 forecast rainfall
- 7) Real-time stream flow data

**Outputs**

- 1) Daily NEXRAD (QPE) rainfall images
- 2) Daily and hourly weather station data (hourly for information only)
- 3) Cell by cell, reach, and basin ET
- 4) Daily ET rates
- 5) URGWOM ET maps
- 6) Stream flow data
- 7) Basin Overview

Refer to ET Toolbox Products (section 7) for more information on the operation of the ET Toolbox.

#### **4.4 Chronology of Events**

The table on the following page shows some of the significant events that have occurred during the development of the AWARDS/ET Toolbox system, back to May, 2004:

DATE	EVENT
Oct. 8, 2008	Various edits, additional USBR Pumping Station information, and new Flow Diagram figures results in version 2.1.
Aug. 28, 2008	The Basin Overview Plots were modified. The green plots of Daily Consumptive Use are now Daily Net Water Use which is the Daily Consumptive Use minus Rain.
May 1, 2008	New Stream Flow Products figure in the documentation results in version 2.0.1.
Apr. 24, 2008	Version 2.0 of the documentation is completed.
Dec. 10, 2007	Removed Los Chavez Bosque weather station and installed Toni Barrow Farm weather station in Reach 5.
Oct. 23, 2007	Revised the web-site New Mexico home page to allow more direct access to the Awards and ET Toolbox products.
Oct. 4, 2007	Added forecast rain for forecast days 4-7. These data are Quantitative Precipitation Forecasts from the National Centers for Environmental Prediction Global Forecasting System model. The resolution of this forecasted days 4-7 rain is 1 degree by 1 degree (110km north-south by 90km east-west).
June 21, 2007	Modified the New Mexico home page to allow a more direct link to the MRGCD Stream Flow Schematics. These also remain available from the New Mexico map.
June 15, 2007	The old AWARDS/ET Toolbox based on the HRAP 4x4 km grid, 3-day Eta forecast, and old URGWOM river reach delineations was shut down. User's were automatically redirected to the new QPESUMS (abbreviated to QPE) site that is briefly explained in the May 8, 2007 notes, below.
June 13, 2007	Modified the AWARDS ET charts by replacing the QPF (Quantitative Precipitation Forecast) values with 3-day NDFD (National Digital Forecast Data).  Removed the Candelaria Farms Future 3-days Air Temperature and Relative Humidity plot since we no longer acquire hourly forecast data.
May 8, 2007	Numerous changes were made: <ol style="list-style-type: none"> <li>1. Quantitative Precipitation Estimation and Segregation Using Multiple Sensors (QPESUMS) on an approximate 1-km grid.</li> <li>2. Eight new URGWOM river reaches.</li> <li>3. Seven-day National Digital Forecast Database</li> </ol>

6. Implemented open water evaporation estimates for the Rio Grande using the FLO2D model.
7. Estimating wet sands evaporation within the banks of the Rio Grande.
8. Estimating evaporation from Elephant Butte Reservoir
9. Estimating Tamarisk ET in the Bosque Del Apache using the Utah State Univ. model.
10. Removed cell rainfall postings.
11. Revised design of the Middle Rio Grande web site.

The old HRAP 4-km, old reaches, and 3-day Eta 12-km forecast site was still available until June 15, 2007.

- |               |   |
|---------------|---|
| June, 2006    | Rio Chama/Velarde area window was created, using an estimated crop land distribution of 30% orchard, 30% alfalfa, and 40% pasture grass.  |
| April 6, 2006 | Generated historic ET summation information for each of the eight new URGWOM river reaches, based on the HRAP 4-km grid cells, for years 2000-2005.   |
| April, 2006   | Implemented a new stream flow schematic for the MRGCD Belen Division  |
| May, 2005     | Implemented Candelaria Farms Fird Scheduling and soil moisture measurements at many MRGCD weather stations  |
| Aug. 4, 2004  | The NMSUCC South Bosque (SBOS) hourly data is now included in the MRGCD Weather Station Network hourly pop-up image (fig. 20 in the documentation).<br>This supports the ET Model for Tamarisk - see July 14, 2004.   |
| July 27, 2004 | MRGCD weather stations are added:<br><br>CQFN Cisto Quintana Farm - NM - MRGCD - May 4,2004<br>CSBN Corrales Bosque - NM - MRGCD - May 4,2004<br>PDFN Prices Dairy Farm - NM - MRGCD - July 13,2004<br>BWWN Bosque Farms - NM - MRGCD - May 6, 2004<br>LCZN Los Chavez Bosque - NM - MRGCD - July 13,2004<br>GWFN Gus Wagner Farm - Nm - MRGCD - July 13,2004<br><br>The AWARDS/ET Toolbox is rerun each day from January 1. Therefore, data from the the NCEP Eta 12 km model is used until the station is active. |
| July 14, 2004 | Added the Model for Daily Evapotranspiration of Tamarisk at the Bosque Del Apache, as detailed in a paper by Hipps and Hattori, USU.  |

- June 29, 2004 Modified nexrad rainfall usage; now based on vegetative start and terminate dates rather than the entire year.
- June 8, 2004 Now Using the newer GIS information for land classification, a combination of the 2000 IKONOS satellite imagery at 4 meter resolution and the 2001 Utah State University (USU) aerial photography at .5 meter resolution. The IKONOS is used from Cochiti Dam to Elephant Butte Reservoir headwaters (Reaches 1-7). The USU exists in a small part of Reach 3, Reaches 4, 5, and 6, and part of Reach 7. Wherever the USU exists, the IKONOS was erased and the USU was inserted.
- This replaces the 1992/93 Land Use Trend Analysis (LUTA), plus others. The Toolbox was/is rerun every day from January 1, 2004 to present with these newer GIS data for all vegetation groups.
- The historic runs, from 1975 through 2003, continue to be based on the LUTA, plus others.
- June 7, 2004 Implemented the Nambe window.
- June 3, 2004 The Daily ET Rate Tables now contain the GIS classification number.
- May 26, 2004 MRGCD weather stations are added:
- BBAN Bosque Bar - NM - MRGCD - Mar. 2, 2004  
 ASFN Adolf Sanchez Farm - NM - MRGCD - May 4, 2004
- The AWARDS/ET Toolbox is rerun each day from January 1. Therefore, data from the the NCEP Eta 12 km model is used until the station is active.

## 5 Accessing the AWARDS and ET Toolbox

Access to the AWARDS/ET Toolbox home page is via the Internet at:

<http://www.usbr.gov/pmts/rivers/awards/> (figure 1 W).

This page is titled "AWARDS - NEXRAD - ET Toolbox", which shows a map of the AWARDS and ET Toolbox project areas.

Clicking on Middle Rio Grande provides the "NEXRAD Rainfall, Weather Station, and ET Products for the Rio Grande Basin in New Mexico" menu of available products:

- 1) Rio Grande Basin AWARDS System and ET Toolbox Project Areas
- 2) Historic Data
- 3) Archived Radar Precipitation Products (QPE)
- 4) Links to Real-Time and Forecasted Weather Data
- 5) Related Links

(figure 2 and it's continuation figure 3 W).

The above will henceforth be called the New Mexico menu.

The website has evolved over the years based on the needs and special interests of various users, and therefore contains products that may not be of interest to everyone.

This documentation is focused on the Rio Grande Basin AWARDS System and ET Toolbox Project Areas component (No. 1 in the above table). The other products in the above table contain historic, archived, and interesting links, which are not specifically addressed in this documentation.

Most of the products are available by clicking on "MAP with Quantitative Precipitation Estimation (QPE) and River Reaches"

**NOTE:** For directly accessing many of the products, the user can click on the options from the New Mexico menu.

### 5.1 MAP with Quantitative Precipitation Estimation (QPE) and River Reaches

Clicking on "MAP with Quantitative Precipitation Estimation (QPE) and River Reaches" pops-up an inter-active AWARDS/ET Toolbox window labeled "Image of QPE Sums latest day rain over middle Rio Grande". This image will henceforth be called the inter-active AWARDS/ET Toolbox image (figure 4 W) showing the specific windows outlined in white over the Middle Rio Grande. A colored elevation scale is provided by clicking on "see elev. terrain" (figure 5 W).

Windows generally contain lands that receive water from a diversion dam usually located at the northern most edge of the window. Exceptions are when multiple windows are needed for clarity, or when diversions are not defined. Other windows define the URGWOM river reaches one through eight. The color scale at the bottom of these inter-active AWARDS/ET Toolbox windows, and subsequent windows, represents the

24-hour rainfall intensities, in inches, that are mapped into each of the approximate 1 km x 1 km QPE grid cells.

The AWARDS system and ET Toolbox products are turned on and off by clicking on the box labeled "+ or - ETTool".

The ET Toolbox products are available by clicking the box labeled "+ ETTool". found throughout the various pop-up windows. Refer to ET Toolbox Products (section 7).

For the AWARDS system ET charts, click the box labeled "- ETTool". For these areas, refer to AWARDS Products (section 6).

## 5.2 Windows and Options Access

Within each window there are small rectangular boxes containing red lettering. These allow the user to move between windows, go to the AWARDS/ET Toolbox home page, go to the New Mexico menu, go to the parent window, turn on/off the ET Toolbox vs AWARDS, look at the past seven days, perform a 1 week animation, look at weather station or stream flow data, look at River Reach summaries, look at URGWOM ET maps, etc. These options allow quick movement around the website.

## 6 AWARDS Products

The purpose of the AWARDS system is to provide generalized ET information for improving water use efficiency. The resulting rainfall estimate images and ET charts were developed to achieve this goal. Refer to the AWARDS/ET Toolbox Calculations (section 13) for information on the calculation of ET as used in the AWARDS system.

Access to the AWARDS products is from the New Mexico menu (figure 2 W) where the user should choose "MAP with Quantitative Precipitation Estimation (QPE) and River Reaches".

The resulting image (figure 4 W) shows the NEXRAD rainfall estimates throughout the Rio Grande. Each rainfall pixel is on an approximate 1 km scale. The 1 km rainfall is represented by the color intensity scale at the bottom of the image. These are daily (midnight-midnight) summations of hourly rain in inches. Refer to NEXRAD Precipitation Estimates (section 10) for more information.

This image will henceforth be called the inter-active AWARDS image.

The user will first notice the diversion and river reach windows on the image that are outlined in white.

By default, this is an image of the AWARDS products.

(To go to the ET Toolbox products when in AWARDS, click in the box labeled "+ ETTool")

### 6.1 River Reach and Chama/Velarde Windows

Clicking within a window in this inter-active AWARDS image allows access to the AWARDS products. This is an example image for river reach 3 labeled "Image of QPESums latest day rain over reach3 in Albuquerque area" (figure 6 W).

**NOTE:** A more direct way to access the above image is via the New Mexico menu (figure 2 W) [choosing reach 3:](#)

Awards ET Charts for Chama/Velarde (C/V) and Reaches 1-8  
 Click within dots for cell-by-cell charts  
 Click on "day" for specific daily rain - Click on "1 wk anim" for rain animation  
 C/V 1 2 3 4 5 6 7 8

### 6.2 Daily Weather Station Data

Daily weather station data are available by clicking on the yellow or green plus signs (+) shown in many of the windows. This example shows the daily data at the Candelaria Farms weather station (figure 7 W).

**NOTE:** A more direct way to access the weather data is via the New Mexico menu (figure 2 W) [choosing "Weather Station Data and Plots"](#). Refer to Automated Weather Station Data (section 8) for more information.

### 6.3 ET Charts

ET charts are available by clicking into the QPE cells, defined by white dots at their corners, to pop-up a generalized ET chart showing the ET for all crops, riparian vegetation, and open water (Flow2DWater) that may be in the area. This example is for the QPE cell 2336 x 1517 in the River Reach 3 area served by the Candelaria Farms weather station (figure 8 W).

No acreages or rainfall values are used in these calculations. The heading at the top of each chart shows the name of the weather station data that were used to calculate the daily crop water use for the past four days, using the Modified-Penman Reference ET Equation. Refer to Penman Reference ET Calculation (section 12) for more information.

ET for seven forecast days, starting with today, are provided as calculated from the NDFD data. Refer to Weather Forecasting (section 9) for more information.

The sum of ET to-date and the sum for the last seven and 14 days is shown. Each weather station is assigned to an array of QPE cells, therefore the ET portion of the charts may be identical for nearby cells. The start (plant) and terminate (harvest) dates are also given. An example date value of 101 represents January 1. The value 1020 represents October 20.

Ner the bottom of each chart is a posting of the NEXRAD rainfall estimates for the QPE cell. The "NEXRAD hrs avail" will always be 24, since the NEXRAD data are collected via the Local Data Manager (LDM) from the National Severe Storms Lab of NOAA on a daily bases. The total rain and calculated effective rain are provided. Refer to Effective Rainfall Estimates (section 11) for more information.

The columns headed NDFD are the forecast rainfalls for the next 3 days. The columns headed NCEP are the forecast rainfalls for days 4 through 7. Refer to Weather Forecasting (section 9) for more information.

The NEXRAD monthly total rain (since the beginning of the current year) and the QPE cell number are also provided.

### 6.4 Other Areas

Areas represented in the AWARDS system that do not have calculated ET but are available for rainfall viewing are Alcalde, Nambe, Truth or Consequences, Derry, El Paso NW, and El Paso SE. These can be accessed from the inter-active AWARDS image (figure 4 W).

**NOTE:** A more direct way to access the above areas is via the New Mexico menu (figure 2 W) choosing "Rain only in Other Areas".



## 7 ET Toolbox Products

For operational and management purposes, the ET Toolbox provides products for river reaches and, as a special case, the Chama - Velarde area. This allows operation and management entities access to various consumptive use breakouts depending upon their requests and needs. Refer to the AWARDS/ET Toolbox Calculations (section 13) for information on the calculation of ET as used in the ET Toolbox system.

Access to the ET Toolbox products is from the New Mexico menu (figure 2 W) where the user should choose "MAP with Quantitative Precipitation Estimation (QPE) and River Reaches".

The resulting image (figure 4 W) shows the NEXRAD rainfall estimates throughout the Rio Grande. Each rainfall pixel is on an approximate 1 km scale. The 1 km rainfall is represented by the color intensity scale at the bottom of the image. These are daily (midnight-midnight) summations of hourly rain in inches. Refer to NEXRAD Precipitation Estimates (section 10) for more information.

This image will henceforth be called the inter-active AWARDS/ET Toolbox image.

The user will first notice the diversion and river reach windows on the image that are outlined in white.

By default, this is an image of the AWARDS products. To get to the ET Toolbox products, click in the box labeled "+ ETTool".

(To go to the AWARDS products when in the ET Toolbox, click in the box labeled "- ETTool")

The resulting image (figure 9 W) is similar to the AWARDS image, except it contains more options. First, it shows the NEXRAD rainfall estimates throughout the Rio Grande. Each rainfall pixel is on the 1 km scale. The 1 km rainfall is represented by the color intensity scale at the bottom of the image. These are daily (midnight-midnight) summations of hourly rain. Refer to NEXRAD Precipitation Estimates (section 10) for more information.

This image will henceforth be called the inter-active ET Toolbox image.

The user will first notice the diversion and river reach windows on the image that are outlined in white.

Other options are available by clicking in the boxes.

(To go back to the AWARDS products when in the ET Toolbox, click in the box labeled "- ETTool")

### 7.1 River Reach and Chama/Velarde Windows

Clicking within a window in this inter-active ET Toolbox image allows access to the ET Toolbox products. This is an example image for river reach 3 labeled "Image of QPESums latest day rain over reach3 in Albuquerque area" (figure 10 W).

**NOTE:** A more direct way to access the above image is via the New Mexico menu (figure 2 W) choosing reach 3:

ET Toolbox Consumptive Use Details for Chama/Velarde (C/V) and Reaches 1-8  
 Click within dots for cell-by-cell details  
 Click on "day" for specific daily rain - Click on "1 wk anim" for rain animation  
 C/V 1 2 3 4 5 6 7 8

## 7.2 Daily Weather Station Data

Daily weather station data are available by clicking on the yellow or green plus signs (+) shown in many of the windows. This example shows the daily data at the Candelaria Farms weather station (figure 7 W).

**NOTE:** A more direct way to access the weather data is via the New Mexico menu (figure 2 W) choosing "Weather Station Data and Plots". Refer to Automated Weather Station Data (section 8) for more information.

## 7.3 Grid Cell Detail Tables

Grid cell detail tables are available by clicking into the QPE cells, defined by white dots at their corners, to pop-up a cell detail table showing the acres of each crop, riparian, open water, and urban species in the cell as defined by the GIS data set. Clicking within a grid cell (figure 10 W) will pop up a cell detail table showing the acres of each crop, riparian, open water, and urban species in the cell as defined by the GIS data set. This example is for QPE cell 2336 x 1517 in the River Reach 3 area served by the Candelaria Farms weather station (figure 11 W).

The table includes the consumptive use for the last seven days and the next seven forecast days, and the totals by type, such as agricultural crops. Today is considered the first of the forecast days. Near the bottom of the table are the daily NEXRAD rainfall estimates for the cell. The URGWOM water use is the total consumptive use minus the NEXRAD rain. All quantities are in acre-feet. Those in parentheses are in cfs.

## 7.4 Reach Summary Products Menus

The ET Toolbox Summary for all reaches is accessible from the square box at the upper left corner of the inter-active AWARDS/ET Toolbox image (figure 9 W). The menu that pops-up is titled "ET Summary Products (To-Date) from Cochiti Gage to Elephant Butte Reservoir". This menu provides information similar to that described below for reaches, except there no daily ET rate tables.

Reach summary products, including tables and plots, are available by clicking in the appropriate boxes from this example, which is reach 3 (figure 10 W). As an example,

clicking in the "River Reach 3 Summary" box from the Reach 3 image will pop-up this ET Summary Products (To-Date) menu (figure 12 W). The options available are a table, two types of plots, and daily ET rates by vegetative type. These are explained in the following five sub-sections.

**NOTE:** A more direct way to access the summary products is via the New Mexico menu (figure 2 W) choosing reach 3:

ET Toolbox Summary Products for Chama/Velarde (C/V) and Reaches 1-8  
C/V 1 2 3 4 5 6 7 8

### 7.4.1 Reach Summary Tables

Clicking on "Table" from the ET Summary Products (To-Date) menu (figure 12 W) provides the following table data for river reach 3 (figure 13 W). The classification source used for determining the consumptive is noted. A number of weather stations and NDFD model cells have been used for the calculations. The table shows, for each day, the total consumptive use in cubic feet per second (cfs) with a breakdown for each type (agricultural, riparian, open water, and urban). The daily rain is the NEXRAD rainfall estimate. The daily URGWOM water use is the consumptive use minus the NEXRAD rain. Five and 10 day running averages of the water use are also provided. The total URGWOM water use to-date in acre-feet since January 1 is included.

The forecast method (FM) column next to the date signifies the method used to calculate the consumptive use for seven forecast days, starting with today. An F indicates the 5-km grid NDFD model weather forecast parameters were used, including NDFD model forecast rainfall for the first three forecast days. In rare cases when the NDFD model data were not available, an A indicates that an average of the last three days were used. In this case, the forecast rainfall will be zero. At the bottom of the cell summary is a tabulation of the acres of each type. The fallow and idle types are not included in the consumptive use calculations, but are noted here for information only.

Included in these summary tables are the daily flow differences, with five and 10 day running averages, as reported from real-time gage station data. Refer to Stream Flow Data for gage information (section 17).

Following is a listing of the stream flow gages used to calculate the daily flow differences in the ET Toolbox Summary and reaches 1 through 8 summaries. The daily flows are an average of all the readings (usually at 30-minute intervals) acquired throughout the day. Note that the Bernardo gage is non-operative. The Highway 346 gage is now used as a substitute.

ET Toolbox	Cross section at Cochiti Dam minus cross section at San Marcial
River Reach 1	Cross section at Cochiti Dam minus cross section at San Felipe
River Reach 2	Cross section at San Felipe minus cross section at Alameda
River Reach 3	Cross section at Alameda minus cross section at Central Avenue
River Reach 4	Cross section at Central Avenue minus cross section at Isleta
River Reach 5	Cross section at Isleta minus cross section at Bernardo (Hwy. 346)
River Reach 6	Cross section at Bernardo (Hwy. 346) minus cross section at San Acacia
River Reach 7	Cross section at San Acacia minus cross section at San Marcial (includes the Bosque Del Apache)
River Reach 8	Cross section at San Marcial minus cross section at Elephant Butte (future?)

### 7.4.2 Reach Summary Plots

There are two plots available from the ET Summary Products (To-Date) menu (figure 12 W).

**NOTE:** A more direct way to access these two plots is via the New Mexico menu (figure 2 W) [choosing reach 3:](#)

Consumptive Use Plots with:  
 Stream Depletion for Reaches: All 1 2 3 4 5 6 7 8  
 Rain for Reaches: All 1 2 3 4 5 6 7 8

**7.4.2.1 Plot of last 14 and 7 forecast days - Total Consumptive Use, Agricultural, Riparian, Open Water, and Urban - also Rain** The first plot (figure 14 W) contains a chart (in cfs) of the total daily consumptive use, affected by rain, and traces for each type, unaffected by rain. This is an example of river reach 3. The other river reaches and Cochiti gage to Elephant Butte Reservoir are similar. A bar chart of the NEXRAD rainfall estimate (in cfs) is also included. These data are plotted for the past 14 days, plus the seven forecast days (dashed traces), starting with today. A break in a trace indicates there were no data available for that period of time.

**7.4.2.2 Plot of last 14 and 7 forecast days - Total Consumptive Use with Five and Ten-Day Running Averages - also Stream Gage** The second plot for river reaches and Cochiti gage to Elephant Butte Reservoir contains a chart (in cfs) of the total daily consumptive use, affected by rain, and traces of the five and 10 day running averages of the total (figure 15 W). Also included are similar running average traces of the actual stream flow data from real-time gage stations, an attribute requested by Reclamation personnel. These data are plotted for the past 14 days, plus the seven forecast days (dashed traces), starting with today. A break in a trace indicates there were no data available for that period of time.

### 7.4.3 Daily ET Rate Table

Another system of tables is available from the ET Summary Products menu for each of the reaches (figure 12 W). These are the daily ET rates. They contain the daily ET rates

for each species within each type for the reach, with a notation of the acres. The source of the classification is the 2000 IKONOS unless noted by (USU) for the 2001 Utah State University. Clicking on a species, such as Alfalfa, pops-up the table containing detailed information about the parameters used to calculate ET (figure 16 W). These include the acres, planting and termination dates (start and stop dates), reference ET, coefficient, ET, total water use, NEXRAD rain, and URGWOM water use, for each day from the planting date through yesterday. These are the data that are accumulated for the ET Toolbox and reach tables.

## 7.5 URGWOM ET Maps

These maps (figure 17 W example of reach 3) show the URGWOM ET that is mapped into each of the approximate 1km x 1km QPE grid cells. The ET has been reduced by the NEXRAD rain; therefore negative representation is possible. The color scale at the bottom of these maps provides the inches of daily URGWOM ET.

**NOTE:** [A more direct way to access these maps is via the New Mexico menu](#) (figure 2 W) [choosing reach 3:](#)

ET Toolbox URGWOM ET Maps for Chama/Velarde (C/V) and Reaches 1-8  
Click on "1 wk anim" for ET animation  
C/V 1 2 3 4 5 6 7 8

## 7.6 Basin Overview Plots

The Basin Overview Plots (previously named the Situation Analysis Matrix) are available from the New Mexico menu (figure 2 W). There are two matrixes that show the past, current (today), and predicted (future) status of the stream flow, rainfall, and consumptive use. These matrixes are With Present Division Rain (figure 18 W) and With Present Hourly Rain (figure 19 W). The area of consideration is from the Otowi gage to the San Marcial gage. The period for the past is seven days, and the predicted is seven days as determined by the NDFD forecast period. The past rainfall is the summation of NEXRAD over all the QPE grid cells for the area.

The daily consumptive use is the total of agricultural, riparian, open water, and urban for the area. This daily consumptive use was changed to daily net water use (daily consumptive use minus rain) on August 28, 2008 as shown on the dynamic real-time images.

All units are in cfs, except the current (today) rainfall is in inches.

Currently there are no data available for predicting stream flow at the Otowi and San Marcial gages. The matrixes will be completed when these become available.

### 7.6.1 With Present Division Rain

The current (today) rainfall, as reported on the With Present Division Rain Matrix, (figure 18 W) is a average of the weather stations located in each division:

Division	ID	Averaged Weather Stations
Cochiti	COC	Pena Blanca, Cisto Quintana Farm, Angostura
Albuquerque	ABQ	Angostura, Corrales Bosque, Candelaria Farms, Bosque Bar, Prices Dairy Farm
Belen	BEL	Bosque Farms, Toni Barrow Farm, Jarales, Adolf Sanchez Farm, and San Acacia
Socorro	SOC	San Acacia, Lemitar Nature Center, Gus Wagner Farm, Luis Lopez, North Bosque

The Present Division Rain matrix displays a color coded stacked bar when there is rain for each hour in each division.

### 7.6.2 With Present Hourly Rain

The current (today) rainfall, as reported on the With Present Hourly Rain Matrix, is a average of all the reporting MRGCD hourly weather station rainfall quantities since midnight (figure 19 W). Refer to section 8.1 for a listing of the MRGCD weather stations. The x-axis labeled "Sep 13, 2002" should be ignored.

### 7.6.3 Daily Archived Images

Archived matrixes are also available from the New Mexico menu (figure 2 W). Click on Daily Archived Images under the Basin Overview Plots heading. Then go to the desired year. The files in the directory are named SAdivrain for present division rain, and SAavgrain for present hourly rain. Each is followed by yymmda01.png.

## 8 Automated Weather Station Data

Weather data from three sources are used, or presented, within the AWARDS and ET Toolbox products. They are:

Middle Rio Grande Conservancy District (MRGCD)  
New Mexico Climate Center (NMCC)  
METAR System



Example of automated weather station used in the MRGCD network.

### 8.1 Middle Rio Grande Conservancy District

MRGCD weather station network presently consists of 16 sites.

Hourly data are automatically received from this network via File Transfer Protocol (FTP) at 12 minutes past each hour. Clicking on "WX. Stn. Data" from the The inter-active AWARDS/ET Toolbox images (figure 4 W or figure 9 W) pops-up an image showing the location of the MRGCD weather station network shown with the yellow + signs and site ID's. The diagram on the right side of this image indicates what is available by clicking in each of the quadrants of a the + sign (figure 20 W).

**NOTE:** A more direct way to access the weather data is via the New Mexico menu (figure 2 W) choosing "Weather Station Data and Plots".

Clicking in the top left of the plus (+) signs pops-up the hourly weather data for the last 24-hours (figure 21 W). This is an example of the MRGCD Candelaria Farms station.

Clicking in the top right of the plus (+) signs pops-up the temperature-humidity plot for the last seven days. These are developed only for the MRGCD weather stations (figure 22 W).

Clicking in the bottom right of the plus (+) signs pops-up the volumetric soil water content and rain for the last seven days. There is also a plot of the volumetric soil water content for all of the days of the year, to-date. These are developed only for the MRGCD agricultural weather stations, and some of these stations have in-operative soil moisture equipment (figure 23 W).

For the MRGCD weather stations located in bosque areas, clicking in the bottom right of the plus (+) signs pops-up the fuel moisture and rain for the last 14 days. These stations are: CSBN, BBAN, and LNCN (figure 24 W). Refer to the table below get the site names.

Clicking in the bottom left of the plus (+) signs pops-up the 24-hr (daily) gage precipitation accumulations that are used in estimating ET. These data are received around 1:12 AM MST from the MRGCD (figure 7 W). This is also an example of the MRGCD Candelaria Farms station.

The table contains the the station name, source, elevation, and latitude/longitude location.

Data for the past seven days is shown in the upper part of the table consisting of maximum and minimum temperatures, average wind speed, relative humidity, rain, and solar radiation as measured by the station's sensors. The rain gage monthly totals since the beginning of the year are also tabulated. The bottom part of the table contains all of the data for each day since January 1st with the latest day first. Included in this listing is the calculated Modified-Penman Reference ET. Refer to Penman Reference ET Calculation (section 12) for more information.

If station data are unavailable for a day, alternate weather data from the NDFD weather forecast model from the previous day are used. Refer to Weather Forecasting (section 9) for more information. An alternate data key provides information on data that may have been substituted. Example: In the Alternate Weather Data column `ndfd1TS` means the NDFD model 1st forecast day temperatures and solar radiation were used. In cases when the NDFD model data are also unavailable, data from a nearby weather station are used, with the 1st 4 character station ID posted under Alternate Weather Data. If that weather station is also unavailable, a second alternate station is used.

These 24-hour (daily) gage precipitation accumulations are also shown in **yellow** on the inter-active AWARDS/ET Toolbox image, and sub-images, preceded by a + sign. The site ID's are shown if accumulations are not available. The plus (+) signs locate the stations by latitude and longitude. This is an example of the reach 3 sub-window (figure 10 W) and the pop-up Candelaria Farms 24-hour data (figure 7 W).

The Operational MRGCD weather stations are (from north to south), with the al-



ternate station names:

Site Name	ID	1st Alternate	2nd Alternate	3rd Alternate
Pena Blanca	PBLN	for5.172.099	CQFN	ANGN
Cisto Quintana Farm	CQFN	for5.171.097	PBLN	ANGN
Angostura	ANGN	for5.168.094	CQFN	CSBN
Corrales Bosque	CSBN	for5.167.092	ANGN	CFMN
Candelaria Farms	CFMN	for5.165.089	CSBN	BBAN
Bosque Bar	BBAN	for5.165.087	CFMN	PDFN
Prices Dairy Farm	PDFN	for5.165.086	BBAN	BWWN
Bosque Farms	BWWN	for5.164.082	losl	PDFN
Toni Barrow Farm	TBFN	for5.162.080	losl	JRLN
Jarales	JRLN	for5.162.078	ASFN	TBFN
Adolf Sanchez Farm	ASFN	for5.162.076	JRLN	IHFN
San Acacia	IHFN	for5.159.070	LNCN	GWFN
Lemitar Nature Center	LNCN	for5.159.068	IHFN	GWFN
Gus Wagner Farm	GWFN	for5.159.066	LNCN	LLZN
Luis Lopez	LLZN	for5.159.063	BANN	GWFN
North Bosque	BANN	for5.159.061	LLZN	sbos

Note in the above table that the NDFD model 5 km cell is always the 1st alternate. The x-y cell identification, like 172.099, is a locator in the 5 km grid. More information about the MRGCD can be found at: <http://www.mrgcd.com/> (Middle Rio Grande Conservancy District)

## 8.2 New Mexico Climate Center

In addition to the MRGCD network, previous day's meteorological data are also obtained via FTP from: <http://weather.nmsu.edu/> New Mexico Climate Center (NMCC) at New Mexico State University. The 24-hr data are received at 5:30 AM and again at 10:30 AM MST to get missing data. Only three sites, Alcalde, South Bosque, and North Elephant Butte Lake are used for ET estimation. The Los Lunas station may be used since it is an alternate site for some MRGCD stations (see above MRGCD listing). The same criteria as detailed above for the MRGCD apply to the NMCC weather data, except these are shown in **green** on all of the images. Also, only the South Bosque station has hourly data (these hourly data will potentially be used for Elephant Butte Reservoir evaporation estimates). The same table details, and rules for alternate weather data, apply as described above in section 8.1 for MRGCD data.

The NMCC network weather stations are (from north to south), with the alternate station names:

Site Name	ID	Ownership	1st Alternate	2nd Alternate	3rd Alternate
Alcalde Agricultural Science Center	alca	NMCC	for5.178.109	PBLN	CQFN
Los Lunas Agricultural Science Center	losl	NMCC	for5.163.081	TBFN	BWWN
South Bosque	sbos	NMCC	for5.158.059	BANN	LLZN
North Elephant Butte Lake	elfb	NMCC	for5.152.046	lake	
South Elephant Butte Lake	lake	NMCU	for5.150.046	elfb	
Derry Station	derr	NMCC	for5.149.038	elfb	
NMSU Golf Course	nmsu	NMCC	for5.158.026	nws	hort
Las Cruces National Weather Service	nws	NWS	for5.158.026	hort	nmsu
Horticultural Experimental Station	hort	NMCC	for5.158.026	nmsu	nws
Leyendecker Plant Science Research Center	lasc	NMCC	for5.158.024	hort	nws

Other NMCC stations outside of the Rio Grande basin may show on some of the images.

### 8.3 METAR System

The word METAR is from the French, "message d'observation meteorologique reguliere pour l'aviation," and is thought to have originated as a contraction from METeorologique ("Weather") Aviation Reguliere ("Routine"). The Federal Aviation Administration (FAA) and National Oceanic and Atmospheric Administration (NOAA) specifically define a METAR as an "aviation routine weather report," an approximate translation of the French.

The AWARDS/ET Toolbox system also collects 24-hr precipitation accumulations from these stations (or site IDs if data are missing) that are shown in pink, preceded by a square, on the inter-active AWARDS/ET Toolbox image and sub-images on the Internet (figure 9 W). An example station name identifier is KGNT. Data from the METAR sites are not used for the calculation of ET, because these weather stations do not have solar radiation sensors. There are no pop-up data associated with these stations since only precipitation is reported. These data are obtained from: <http://weather.noaa.gov/weather/metar.shtml> (METAR Data Access).

METAR sites (from north to south) are:

ID	-W Lon.	+N Lat.	Elev.	Site Name
KLAM	-106.2692	35.8797	2179	Los Alamos Airport NM
K4SL	-107.1833	35.8000	2106	Torreon NM
KLVS	-105.1425	35.6514	2091	Las Vegas Municipal Airport NM
KSAF	-106.0950	35.6106	1930	Santa Fe County Municipal Airport NM
KGNT	-107.9022	35.1661	1987	Grants-Milan Municipal Airport NM
KAEG	-106.7950	35.1450	1779	Albuquerque, Double Eagle II Airport NM
KABQ	-106.6147	35.0417	1618	Albuquerque International Airport NM
KCQC	-105.6667	35.0000	2160	Clines Corners NM
K4MY	-106.0500	34.9833	1890	Moriarty NM
K4CR	-105.6833	34.1000	1981	Corona / Lincoln NM
KSRR	-105.5333	33.4667	2076	Ruidoso Regional NM
KROW	-104.5078	33.3081	1112	Roswell Industrial Air Center Airport NM
KTCS	-107.2681	33.2367	1469	Truth Or Consequences Municipal Airport NM
KHMN	-106.1000	32.8500	1248	Holloman Air Force Base NM
KATS	-104.4675	32.8525	1081	Artesia Municipal Airport NM
KALM	-105.9833	32.8333	1279	Alamogordo-White NM
KSVC	-108.1500	32.6333	1659	Silver City / Grant NM
K2C2	-106.4833	32.3833	1244	White Sands NM
KCNM	-104.2633	32.3425	985	Carlsbad, Cavern City Air Terminal Airport NM
KLRU	-106.9219	32.2894	1358	Las Cruces International Airport NM
KDMN	-107.7206	32.2622	1311	Deming Municipal Airport NM
K5T6	-106.7047	31.8808	1253	Santa Teresa, Dona Ana County Airport NM
KGDP	-104.8089	31.8311	1692	Pine Springs, Guadalupe Mountains National Park TX
KELP	-106.3758	31.8111	1206	El Paso International Airport TX

## 9 Weather Forecasting

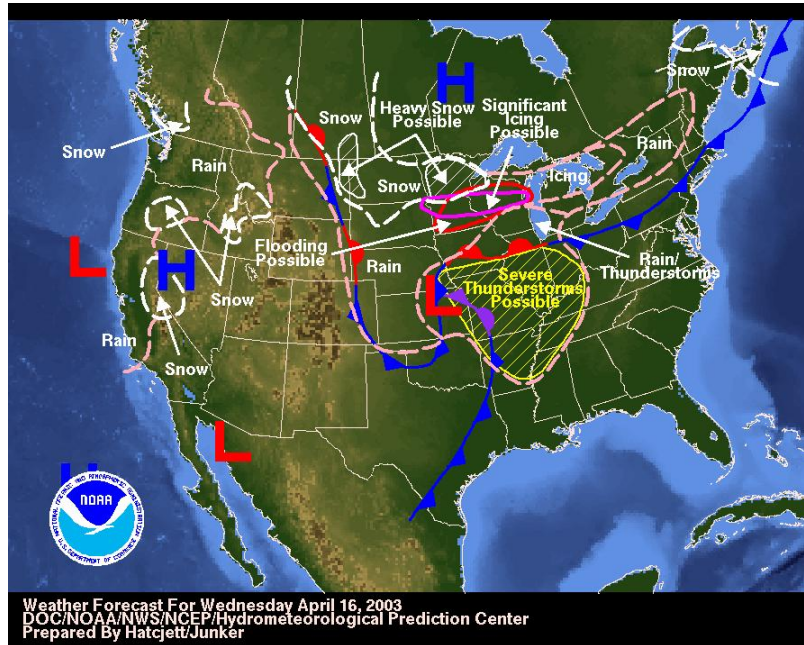

Example Weather Forecast Map.

### 9.1 National Digital Forecast Database (NDFD)

The NDFD weather forecast parameters at an approximate 5-km grid resolution are used for the AWARDS and ET Toolbox ET forecasts for today and the next six days. See this WEB site for detailed information about the NDFD: <http://www.weather.gov/ndfd/> (National Digital Forecast Database).

The NDFD data of the Southern Rocky Mountain subset are collected at 5:30 PM each day via FTP. These data include maximum and minimum temperatures, temperature, relative humidity, wind speed, and precipitation. The forecast period is seven days. For example, the data acquired at 5:30 PM MST on March 7 (0030 UTC March 8) contains forecasts for March 8 through 14. An exception is the precipitation which is for three days (March 8 through 10). The projection frequency of each data element is described in the table (Description of NDFD Database Contents) within the above WEB site after clicking on "Access to the data and a description of the NDFD elements can be found here". These forecasted data are assigned to nearby weather stations.

Here is an example of the 5-km NDFD grid (NDFD cell) for reach 2 (figure 25). The x,y numbering system (in red) is used to identify the approximate 5-km grid cells. Each weather station is cross referenced to a NDFD cell. The Angostura (ANGN) weather station is assigned to NDFD cell 168,94 and the Corrales Bosque (CSBN) station is

assigned to cell 167,92. All weather and ET forecasting for the stations, and forecast from the previous day if the station data are unavailable for today, are provided by the data from the assigned NDFD cells.

Note that there are no solar radiation data. Therefore solar radiation is calculated through an algorithm developed from procedures described in FAO-56 (FAO) and The Astronomical Almanac (1998), using extraterrestrial radiation, clear sky radiation, maximum and minimum temperatures, and applicable coefficients.

## **9.2 National Centers for Environmental Prediction (NCEP)**

The forecast rain for days 4-7 (March 11 through March 14) are Quantitative Precipitation Forecasts from the Environmental Prediction Global Forecasting System model. The resolution of this is 1 degree by 1 degree (110km north-south by 90km east-west). This data are also assigned to nearby weather stations. See this WEB site for detailed information about the NCEP: <http://www.ncep.noaa.gov/> (National Centers for Environmental Prediction).

## 10 NEXRAD Precipitation Estimates

Radar-based precipitation estimates are used in the AWARDS/ET Toolbox to offset ET demands. Accurate quantitative precipitation estimates (QPE) are obtained from The National Severe Storms Laboratory (NSSL), an agency within NOAA. The next generation QPE is called National Mosaic and Next Generation QPE (Q2), which is the most current product used in the AWARDS/ET Toolbox. It continues NSSL's departure from radar-centric precipitation estimation and moves toward a multi-sensor approach focused on high-resolution integration of radar, satellite, model, and surface observations to produce very high-resolution precipitation estimates. For more information about QPE and Q2, visit the WEB site for the NSSL at: [http://www.nssl.noaa.gov/research/hydromet/\(W\)](http://www.nssl.noaa.gov/research/hydromet/(W)).

Data files in the netcdf (network Common Data Form) format are obtained from the NSSL via the LDM (Local Data Manager) process at approximately 0600, 0700, and 0800 UTC. These multiple data pulls assure that the latest product is acquired for the prior day. For New Mexico, only tile 6 is used. At 4:22 and 8:22 AM local time the computer converts the data from netcdf to text readable files, extracts only the 24-hour data for the prior day, extracts the segment of tile 6 appropriate for the Rio Grande basin, and plots the 1/100 degree (approximately 1 km resolution) precipitation estimates onto the images.

This (figure 26) shows the overlapping radar coverage for NM, TX, OK, and parts of CO and KS. The specific radars used in the QPESUMS product for the Middle Rio Grande are:

KABX	Albuquerque
KFDX	Cannon AFB
KHDX	Holloman AFB
KEPX	El Paso, TX

Rainfall (average depth) for each QPE grid cell located over the agricultural, riparian, open water, and urban acreage along the Rio Grande is used in the water use calculations. These precipitation estimates are represented by a color spectrum placed at the bottom of each inter-active ET Toolbox window. This is an example of river reach 7 (figure 27 W).

## 11 Effective Rainfall Estimates

The effective precipitation process explained here is not currently used within the ET Toolbox. It is tabulated and appended to the AWARDS ET charts (figure 8 W) for reference only. It is not applied to the ET in the charts. Refer to AWARDS Products (section 6) for more information.

By definition, effective rainfall is that portion of rainfall that contributes to meeting the ET requirement of a crop (ASAE, 1983). Rainfall that neither leaves as surface runoff nor contributes to excess surface drainage may be effective precipitation in the context of irrigation management. Soil types, terrain slope, and soil moisture are not current components of the AWARDS system; therefore this simplified method apparently developed by the Bureau of Reclamation is implemented. The published method bases effective precipitation on increments of monthly rainfall. The AWARDS system uses this monthly process to reduce daily total rainfall into daily effective precipitation (not a scientifically proven assumption). The relationships used are:

Table 1: Effective Rain As A Percent Of Total Rain ( $r$ )

Total Rain (in)	Effective Rain (%)
$r < .5$	100
$0.5 \leq r \leq 1.0$	95
$1.0 < r \leq 2.0$	90
$2.0 < r \leq 2.0$	85
$3.0 < r \leq 2.0$	75
$4.0 < r \leq 2.0$	55
$5.0 < r \leq 2.0$	35
$6.0 < r$	5

When future research provides a better method, possibly by using soil types, terrain slope, and remotely sensed soil moisture, then the above will be replaced and used within the ET Toolbox product to more accurately estimate daily water use requirements.

## 12 Penman Reference ET Calculation

The Modified-Penman Reference ET Equation written in Fortran (figure 28) and most of the crop and riparian coefficients that are used in the ET Toolbox were provided by Dr. Salim Bawazir at the New Mexico State University (NMSU) on March 16, 2000. This is the Penman calculation with evapotranspiration referenced to grass (Eto in inches), as modified by Dr. Ted Sammis at New Mexico State University (1985). This equation requires daily weather data consisting of maximum and minimum temperatures, relative humidity, solar radiation, and wind.

Calculations of Reference ET by other methods, for comparison purposes only, are also done within the AWARDS/ET Toolbox computer, with the results stored in internal files. These methods are:

1. Penman-Monteith Combination
2. 1982 Kimberly-Penman as used in Reclamation's Agrimet Program
3. Modified-Penman referenced to grass, an earlier version (Sammis et al. (1985))
4. American Society of Civil Engineer's (ASCE) Standardized Method based on the ASCE Penman-Monteith Equation will be a future addition



ET



## 13 AWARDS/ET Toolbox Calculations

### 13.1 Daily ET

Calculation of daily ET, as applied in the AWARDS system, and Daily Consumptive Use (DCU), as applied in the ET Toolbox, is initially based upon derivation of the Reference ET (Eto) and vegetative or open water coefficient (KC). The coefficient is dependent on either the Growing Degree Days or the Month of the year.

As a general rule, no ET is calculated (it is set to zero) before the start date or after the stop date.

A vegetation or open water coefficient (KC) is applied to the Eto to determine the daily ET in inches using the formula:

$$\text{Daily ET} = (\text{KC}) (\text{Daily Eto})$$

where Daily Eto is the Reference ET as calculated by the Penman equation. Refer to Penman Reference ET Calculation (section 12). Graphs of coefficients are presented as Growing Degree Days (GDD) or Months. Refer to Veg. and Open Water Coefficients and Related Data (section 14).

### 13.2 Coefficient (KC)

#### 13.2.1 Coefficient (KC) based on Month

Dr. Jensen (1998) performed a study on open water evaporation for the Lower Colorado River. The monthly coefficients for open water in the Parker Dam to Imperial Dam reach along the Lower Colorado are being used for the Middle Rio Grande. Improved coefficients for open water and wet sands are forthcoming from on-going research studies at Elephant Butte Reservoir. Refer to Open Water Evaporation Estimates (section 16).

Other monthly coefficients from Dr. Jensen's report are used for Marsh, Orchard, and Nursery Stock.

If coefficients are based on Months, then the KC is interpolated from the curve represented in the graph. For example, a coefficient for open water would be .87 on July 15 (figure 41).

#### 13.2.2 Coefficient (KC) based on Growing Degree Days

If the vegetation or open water coefficient is based on GDD's, then the following is used to find the Growing Degree Days.

The GDD's are accumulated heat that will contribute to plant growth and development from planting to harvest, or bud break to defoliation. The advantage of the GDD method is that the coefficient is dependent on temperature, producing a lower coefficient

in cooler weather and a higher coefficient in warmer weather. The calculated ET is then effected as determined by the above formula (section 13.1).

The average method was chosen in New Mexico (King, et al., 2000) for determination of GDD using:

$$\text{Daily GDD} = ((\text{daily max temperature} + \text{daily min temperature}) / 2) - \text{base temperature}$$

In the above equation, The daily maximum (max) and minimum (min) temperatures are replaced with cutoff temperatures when the cutoff temperatures are exceeded. An example is Corn with a maximum cutoff temperature of 30 degrees C, and a minimum cutoff temperature of 10 degrees C. If the daily maximum temperature is 32 degrees C, it is reset to the maximum cutoff temperature of 30 degrees C. If the daily minimum temperature is 5 degrees C, it is reset to the minimum cutoff temperature of 10 degrees C.

Refer to the figures in the Veg. and Open Water Coefficients and Related Data (section 14) for the cutoff and base temperatures. If they are not noted in the figures, then they are not applied to the above equation.

A special case exists for riparian vegetation. If the daily maximum temperature is less than the minimum cutoff temperature, then the daily maximum is set to the minimum cutoff. An example is Salt Cedar, with a minimum cutoff of 15.5 degrees C. If the daily maximum is 14 degrees C, it then is reset to 15.5 degrees.

Once the daily GDD is found, this value of GDD is added to the GDD summation to-date. The summation is then applied to the polynomial function, as defined on the graphs, to get the KC.

The daily GDD as calculated above is not allowed to be negative, in which case it is set to zero, thereby rendering the summation of GDD to be static and the KC to be static. The ET will continue to be calculated until the stop date is reached, at which time the ET will be set to zero.

If the stop date is reached before the daily GDD is negative, the ET is set to zero at the stop date.

A further improvement might be to set the ET to zero when the end of the GDD curve is reached, such as 1700 for Corn.

Crop coefficients were taken from King et al. (2000) and Jensen (1998). The coefficients for Salt Cedar and Cottonwood (predominate riparian types) were received from Dr. Salim Bawazir, NMSU (personal correspondence) as a result of extensive field studies in 1999 at the Bosque Del Apache National Wildlife Refuge.

### 13.3 Daily ET Limits - Special Case

Limits are applied to daily ET calculated at the Luis Lopez weather station. These limits are intended as a short term solution for adjusting high consumptive use in the Socorro,

NM area due to clay soil types, requested by Jim Farmer of the Natural Resources Conservation Center in Socorro. The values (figure 29) are the maximum daily ET in inches allowed at the Luis Lopez weather station, based on month of the year. No limits are applied here for omitted vegetation or when there are no values in the table represented in the figure.

### **13.4 Vegetative and Open Water Daily Consumptive Use (DCU) - ET Toolbox Only**

Computer processes were developed to collect all of the required data sets and calculate the Daily Consumptive Use (DCU) in acre feet for each vegetative type (or open water) within each HRAP grid cell using:

$$\text{Vegetative type DCU} = (\text{Daily ET})(\text{Acres})/12$$

where Acres is the vegetative or open water acreage of the grid cell. Refer to GIS Land Classification (section 15).

### **13.5 Total Grid Cell DCU - ET Toolbox Only**

All of the acre feet values are summed to arrive at an estimated consumptive use for each grid cell. The NEXRAD estimated daily accumulated rainfall (in acre feet) is then subtracted.

$$\text{Total Grid Cell DCU} = \text{Sum of Vegetative type DCU's} - \text{Rainfall}$$

### **13.6 River Reach and Diversion DCU) - ET Toolbox Only**

All of the grid cell totals are summed for each river reach and diversion.

$$\text{River Reach DCU} = \text{Sum of Total Grid Cell DCU values within the river reach.}$$

$$\text{Diversion DCU} = \text{Sum of Total Grid Cell DCU values within the diversion.}$$

### **13.7 DCU Values in Cubic Feet Per Second - ET Toolbox Only**

The DCU values in acre feet per day are also converted to flow in cubic feet per second (cfs) for use by water managers and in the URGWOM, where:

$$\text{cfs} = \text{acre feet}/1.98347$$



Toolbox.

## 14 Veg. and Open Water Coefficients and Related Data

The following four tables separate the classifications into Agriculture, Riparian, Open Water, and Urban. The Plant (Start) and Harvest (Stop) Date are used as beginning and ending points in the ET calculations. No ET is calculated before the start date or after the stop date. Current classification sources are the year 2000 IKONOS (IKONOS) and year 2001 Utah State University (USU). See section 15.

The CLASS number is the classification number provided by IKONOS or USU. The CURVE number is an internal reference to the associated crop curve. the TYPE code is either a "G" indicating that the curve is based on Growing Degree Days, or a "M" indicating that the curve is based on Months.

Clicking on a FIG (figure), within the four tables, provides an x-y plot of the coefficients (KC) vs the Growing Degree Days (GDD) or Month, including a tabulation of the data. If a GDD plot, the polynomial function, cutoff temperatures, and base temperature are also provided. The cutoff temperatures are not applied if they are not provided. Refer to ET Toolbox Calculations (section 13) for more information on how these data are used.

Refer to Open Water (section 16) for more information on how these data are used. The open water evaporation is calculated from modeled areas (FLO-2D) or area-capacity tables.

Numerous classifications do not have developed coefficients. In these cases, substitute coefficients are used until research is completed. Example: The Corn coefficients are used for Chili. It is extremely difficult to pick the appropriate substitution especially with the riparian classifications that have mixtures of vegetations. Improvements to these coefficients will greatly enhance the accuracy of water use estimates.

Table 2: Agricultural Classifications

AGRICULTURAL	F I G	C L A S S	C U R V E	T Y P E	SUBSTITUTE	PLANT (START) DATE	HARVEST (STOP) DATE	CLASS SOURCE
Alfalfa	30	101	10	G	-	Jan. 1	Oct. 20	IKONOS
Corn	31	102	15	G	-	Apr. 29	Nov. 20	IKONOS
Pasture	42	103	6	G	Turf-Park	Mar. 15	Oct. 20	IKONOS
Wheat <sup>†</sup>	32	104	31	G	-	Apr. 10	Aug. 10	IKONOS
Wheat>1300 GDD <sup>†</sup>	33	104	31a	G	-	Apr. 10	Aug. 10	IKONOS
Oats	34	105	32	G	Sp. Barley	Apr. 10	Aug. 10	IKONOS
Sorghum	35	106	20	G	-	May 17	Dec. 20	IKONOS
Sudan Grass	42	107	6	G	Turf-Park	Mar. 15	Oct. 20	IKONOS
Chile	31	108	15	G	Corn	Apr. 29	Nov. 20	IKONOS
Vegetables	31	109	15	G	Corn	Apr. 29	Nov. 20	IKONOS
Orchard	36	110	83	M	-	Jan. 1	Dec. 31	IKONOS
Nursery Stock	36	111	83	M	Orchard	Jan. 1	Dec. 31	IKONOS
Vineyard	37	112	50	G	Grapes	Apr. 1	Oct. 20	IKONOS
Crops	31	327	15	G	Corn	Apr. 29	Nov. 20	USU

---

<sup>†</sup>(when the Growing Degree Days sum exceeds 1300, the Wheat>1300 GDD is used)

Table 3: Riparian Classifications

RIPARIAN	F I G	C L A S S	C U R V E	T Y P E	SUBSTITUTE	PLANT (START) DATE	HARVEST (STOP) DATE	CLASS SOURCE
Cottonwood Bosque/W	38	150	61	G	Cottonwood	Apr. 5	Nov. 21	IKONOS
Cottonwood/SC/WM*	38	152	61	G	Cottonwood	Apr. 5	Nov. 21	IKONOS
Cottonwood/RO/WM†	38	153	61	G	Cottonwood	Apr. 5	Nov. 21	IKONOS
Cottonwood/SC/RO/WM‡	38	155	61	G	Cottonwood	Apr. 5	Nov. 21	IKONOS
Salt Cedar WL/W§	39	156	60	G	Salt Cedar	Apr. 5	Nov. 21	IKONOS
Salt Cedar/RO/WM†	39	157	60	G	Salt Cedar	Apr. 5	Nov. 21	IKONOS
Russian Olive WL/W§	38	159	61	G	Cottonwood	Apr. 5	Nov. 21	IKONOS
Willow	38	161	61	G	Cottonwood	Apr. 5	Nov. 21	IKONOS
Shrubland	38	163	61	G	Cottonwood	Apr. 5	Nov. 21	IKONOS
Grassland	38	164	61	G	Cottonwood	Mar. 15	Oct. 20	IKONOS
Wetland	40	165	81	M	Marsh	Jan. 1	Dec. 31	IKONOS
Sparce Vegetation Cottonwood	38	167	61	G	Cottonwood	Mar. 15	Oct. 20	IKONOS
Dense Tamarisk	38	305	61	G	-	Apr. 5	Nov. 21	USU
Sparce Tamarisk	39	306	60	G	Salt Cedar	Apr. 5	Nov. 21	USU
Gooding Willow	39	307	60	G	Salt Cedar	Apr. 5	Nov. 21	USU
Gooding Willow	38	309	61	G	Cottonwood	Apr. 5	Nov. 21	USU
Acacia Bushes	38	310	61	G	Cottonwood	Apr. 5	Nov. 21	USU
Wet Soil/wet land	40	311	81	M	Marsh	Jan. 1	Dec. 31	USU
Grasses	38	312	61	G	Cottonwood	Mar. 15	Oct. 20	USU
Coyote Willow	38	321	61	G	Cottonwood	Apr. 5	Nov. 21	USU
Russian Olive	38	322	61	G	Cottonwood	Apr. 5	Nov. 21	USU
Elm Tree	38	323	61	G	Cottonwood	Apr. 5	Nov. 21	USU

\*(SC = Salt Cedar/WM = Willow Mix)

†(RO = Russian Olive/WM = Willow Mix)

‡(SC = Salt Cedar/RO = Russian Olive/WM = Willow Mix)

§(WL = Woodland/W = with inclusions of Willow)

Table 4: Open Water Classifications

OPEN WATER	F I G	C L A S S	C U R V E	T Y P E	SUBSTITUTE	PLANT (START) DATE	HARVEST (STOP) DATE	CLASS SOURCE
FLO2D Water	41	90	80	M	-	Jan. 1	Dec. 31	FLO-2D
Elep. Butte Reservoir Water	41	91	80	M	Open Water	Jan. 1	Dec. 31	Area-Cap
Wet Sands	41	99	80	M	Open Water	Jan. 1	Dec. 31	FLO-2D

Table 5: Urban Classifications

URBAN	F I G	C L A S S	C U R V E	T Y P E	SUBSTITUTE	PLANT (START) DATE	HARVEST (STOP) DATE	CLASS SOURCE
Turf Park	42	113	6	G		Mar. 15	Oct. 20	IKONOS



## 15 GIS Land Classification



River front near the Bosque riparian research site.

### 15.1 Reaches 1-8

Prior to June 8, 2004 the Middle Rio Grande Land Use Trend Analysis (LUTA) Geographic Information System (GIS) data base for 1992/93 was used in the AWARDS/ET Toolbox system. After that date, a combination of the July 2000 IKONOS satellite imagery at 4 meter spectral resolution land use data set and the year 2001 Utah State University (USU) aerial photography at .5 meter resolution was used.

The IKONOS was acquired from the MRGCD and the New Mexico Interstate Stream Commission. The IKONOS is used from Cochiti Dam to Elephant Butte Reservoir headwaters (Reaches 1-8). The USU exists in a small part of Reach 3, Reaches 4, 5, 6, 7, and part of Reach 8. Wherever the USU exists, the IKONOS was erased and the USU was inserted. The USU has a less east-west extent than the IKONOS, basically following just the river corridor. Also, the USU coverage is mostly riparian, whereas the IKONOS is both agricultural and riparian.

The GIS data were transposed to the nominal 1 km QPE grid cell resolution for use in the ET Toolbox with the NEXRAD-based 24-hr rainfall estimates. An important component of the ET Toolbox is determination of the vegetative growth acreage of agricultural crops, riparian vegetation, and open water in each of the 1 km QPE grid cells. These data are then applied to the empirically derived ET to produce a daily volumetric water requirement for each QPE cell. Refer to ET Toolbox Calculations (section 13).

Additional year 2002 riparian GIS efforts by the Endangered Species (ES) Collaborative Program are now available. Comparisons of the LUTA, IKONOS, USU, and ES have been made and are available from the AWARDS/ET Toolbox staff.

There is a need to develop a methodology for updating the GIS vegetation and open water indexing data to detect changes and update the ET Toolbox at least once during each annual growing season. The constraints are that the technology used must be cost permissive, timely, and sufficiently accurate (e.g. 90%) for use in water resources management.

## 15.2 Rio Chama/Velarde

The Rio Chama/Velarde area is north of the IKONOS and USU coverage. The MRGCD provided GIS acreage information of the agricultural lands which are shown as white polygons in this image, which were resolved to the 1 km QPE cells (figure 43 W). The MRGCD also provided a quick estimate of the agricultural acreage that is applied to the total acreage of each cell:

Crop	Percent
Alfalfa	30
Orchard	30
Pasture Grass	40

There are approximately 1460 1 km cells within the entire Reach 1-8 area, including the Rio Chama/Velarde.

## 16 Open Water Evaporation Estimates

The evaporation from open water and wet sands contributes significantly to the water depletion in the Middle Rio Grande valley. Research is underway to determine and measure the evaporative demand by using LIght Detection And Ranging (LIDAR) and other technologies. A consortium of groups and programs are at work on this research, consisting of the Bureau of Reclamation, <http://www.lanl.gov> (Los Alamos National Labs), <http://www.nmsu.edu> (New Mexico State University), <http://www.usu.edu> (Utah State University), <http://www.uiowa.edu> (University of Iowa), and others. A year long effort was initiated in 2001 on Elephant Butte reservoir to determine the actual evaporation from the lake surface. A tower was constructed and instrumented, and the Los Alamos Raman LIDAR was on the lake in September 2001 to determine the extent of the measurements by the tower instrumentation (IIHR 2003).

The results of this research program should provide a means of determining an evaporative demand. Real-time reservoir area based on height versus surface area tables can then be used in the calculation of daily evaporative use.

Meanwhile, coefficients developed by Dr. Jensen (1998) on open water evaporation for the Lower Colorado River in the Parker Dam to Imperial Dam reach are used for the Middle Rio Grande.

### 16.1 Rio Grande Evaporation

A 2-dimensional dynamic flood routing model named FLO-2D is used to estimate the daily surface area of the Rio Grande. Inputs are the real-time flow conditions provided from the USGS stream flow gaging system. Refer to Stream Flow Data (section 17) for information about the gaging system. More information about the FLO-2D model is available at: <http://www.flo-2d.com/> (FLO-2D).

### 16.2 Elephant Butte Reservoir Evaporation

To find the daily reservoir evaporation value, real-time reservoir elevation data are acquired from the El Paso Field Division Office. This elevation is then applied against an area-capacity table to get the water surface acreage of the reservoir.

Reference ET, from the Penman equation, (section 12) is calculated from nearby weather stations. Open water coefficients (from Dr. Jensen) are applied against the reference ET to get the evaporation in inches. This value is then applied against the water surface acreage to get the open water evaporation in acre-feet.

Access to the Elephant Butte Reservoir evaporation is from the Reach 8 ET Toolbox image (figure 44 W).

NOTE: A more direct way to access the above image is via the New Mexico menu (figure 2 W) choosing "Elephant Butte Reservoir Evaporation".

Clicking on Elephant Butte Reservoir evaporation provides an option menu (figure 45 W). The options available are Last 7 and 7 Forecast Day's Evaporation (figure 46 W), Daily Evaporation Rates (figure 47 W), and Plot of Elephant Butte Open Water Evaporation & Acres (year-to-date) (figure 48 W). These data are for Sept. 18 rather than Sept. 12, 2007. There also are historic data available from the menu. An improvement to the above process for determining reservoir evaporation is underway. The plan is to use the results of a field research study done in September, 2001. The associated evaporation model is described in "Lake Evaporation Estimation in Arid Environments (Final Report)", dated July 2003. This model requires specific hourly weather data at and above the reservoir surface.

### 16.3 Wet Sands Evaporation)

Currently, the determination of area of wet sands within the Rio Grande corridor is the difference between the bank-to-bank area minus the FLO-2D area. Evaporation is assumed to occur from the surface and shallow sub-surface area difference.

## 17 Stream Flow Data

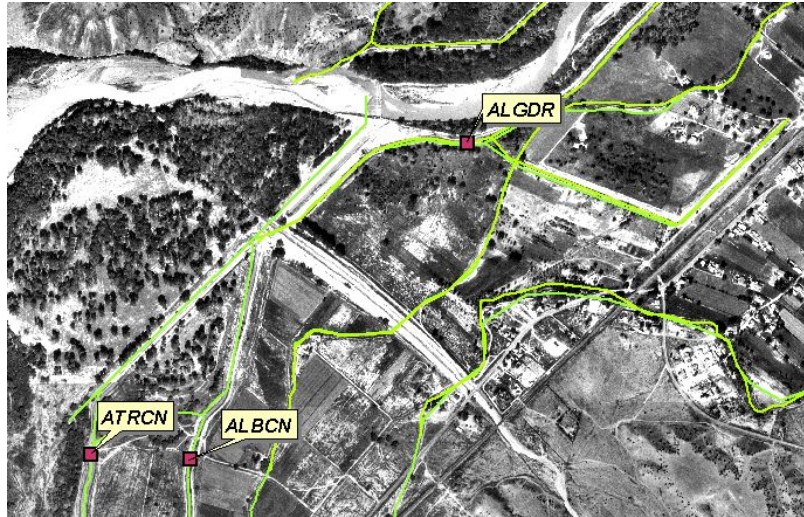

Gage Station Products in the Angostura Dam Area.

As an enhancement to the ET Toolbox, users at the Middle Rio Grande Conservancy District and USBR requested near real-time graphs and text of stream flow conditions throughout the valley. This allows direct comparison of consumptive use estimates and stream flow, considering an approximate five day lag for water released at Cochiti Dam to arrive at the San Marcial gage. District personnel developed schematics of the diversions and return flows.

The stream flow information is acquired from the MRGCD stream gage network. Two data sets are received:

The first set is MRGCD managed gage station and USBR pumping station data transmitted directly to the district office via radio telemetry. These data are for the top of the hour and at 30 minutes after the hour. This set is then automatically received into the ET Toolbox from the MRGCD office via FTP at 15 and 45 minutes past each hour.

The second set is USGS managed gage station data received at the district office via the US Corps of Engineers (USCOE) who get it from the USGS. These USGS data are provided in 15-minute intervals, but to be consistent with the MRGCD data which are in 30-minute intervals, the minute 15 and 45 are ignored. The USGS data are automatically received into the ET Toolbox from the MRGCD office via FTP at 20 minutes after each of the following hours: midnight, 4:00 AM, 8:00 AM, noon, 4:00 PM, and 8:00 PM.

Also, some USGS data, that are not available via the USCOE/MRGCD route, are received directly from the USGS via FTP at 10 and 40 minutes past each hour.

The gage naming criteria differ between the MRGCD, USBR, and USGS managed stations. The following sub sections define these criteria.

## 17.1 MRGCD Stream Flow Data

The MRGCD uses a three character gage name followed by DV (diversion), CN (canal), DR (drain), WW (waste way), UP (Rio Grande above Isleta Dam), DN (Rio Grande below Isleta Dam), and XC (cross section). An example MRGCD gage is CORCN.

Following is a table of the MRGCD gage stations. Some data are missing because they were not provided by the district or the gages are not yet installed. The type code d+h means that both discharge (d), in cfs, and height or stage (h) in feet, are reported.

Name	Type	Latitude	Longitude	Long Name	Description
ALGDR	d+h	35.379	106.496	Algodones Riverside Drain	Return flow from Cochiti Division along east side, empties into Atrisco Feeder, not in to river
ALBCN	d+h	35.370	106.505	Albuquerque Main Canal	Diversion from river to east side at Angostura Dam
ATFCN	d+h	35.370	106.509	Atrisco Feeder Canal	Diversion from river to east side at Angostura Dam
ANGDV	d+h			Total Angostura Diversion	ALGDR+ALBCN+ATFCN
CORCN	d+h	35.276	106.602	Corrales Main Canal	Flow carried in siphon from Atrisco Feeder on east side to west side, no diversion or return
SANWW	d+h	35.227	106.591	Sandia Lakes Wasteway	Return flow to river, excess bled off east side canals
UCRDR	d+h	35.205	106.641	Upper Corrales Drain Outfal	Return flow to river from Corrales area canals
CORWW	d+h	35.161	106.674	Corrales Main Wasteway	Return flow to river from Corrales area canals
LCRDR	d+h	35.161	106.674	Lower Corrales Drain Outfall	Return flow to river, very minor
ATSCN	d+h				
CENWW	d+h	35.096	106.688	Central Avenue Wasteway	Return flow to river, excess bled off Atrisco Feeder at intake to Atrisco Siphon
ARMCN	d+h	35.088	106.683	Armijo Acequia	Medium sized ditch feeding old Atrisco area
BERCN	d+h				
ATDCN	d+h	35.087	106.683	Atrisco Ditch	Small ditch feeding old Atrisco area
ARECN	d+h	35.088	106.695	Arenal Main Canal	Large canal feeding southwest Albuquerque/Isleta Pueblo
ALBDR	d+h	35.089	106.676	Albuquerque Drain At Tingley	Flow in eastside drain past Central Avenue, no diversion or return
ARSDR	d+h	34.935	106.679	Albuquerque Drain Outfall	Return flow to river from east side of Albuquerque Division
ATRDR	d+h	34.935	106.685	Atrisco Drain Outfall	Return flow to river from west side of Albuquerque Division
BELCN	d+h	34.899	106.701	Belen Highline Canal At HDG	Diversion from river to west side at Isleta Dam
PERCN	d+h	34.895	106.689	Peralta Main Canal At HDG	Diversion from river to east side at Isleta Dam
CHICN	d+h	34.905	106.683	Chical Lateral At HDG	Diversion from river to east side at Isleta Dam
CHACN	d+h	34.904	106.683	Chical Acequia At Heading	Diversion from river to east side at Isleta Dam
CACCN	d+h	34.902	106.683	Cacique Acequia At Heading	Diversion from river to east side at Isleta Dam
ISLUP	d+h				
ISLDV	d+h			Total Isleta Diversion	BELCN+PERCN+CHICN+CHACN+CACCN=ISLDV for total diversion from river at Isleta Dam
ISLDN	d+h	34.904	106.684	Rio Grande Below Isleta Dam	Flow in river just below Isleta Dam, difficult gaging location, so frequent shifts
240WW	d+h				
PERWW	d+h	34.692	106.741	Peralta Main Wasteway	Return flow to river from east side north of Belen
LP1DR	d+h				
BELDR	d+h				
NBLWW	d+h				
LP2DR	d+h				
FD3WW	d+h	34.571	106.771	Feeder 3 Wasteway	Return flow to river from west side south of Belen
STYWW	d+h				
SABDR	d+h				
SFRDR	d+h				
LSJDR	d+h	34.414	106.794	Lower San Juan Drain Outfall	Return flow to river from east side near mouth of Rio Puerco
UN7DR	d+h	34.265	106.877	Unit 7 Drain At San Acacia	Return flow from west side of Belen Division, empties directly into Socorro Main Canal
SNADV	d+h			Total San Acacia Diversion	SOCCN-UN7DR
SOCCN	d+h	34.254	106.897	Socorro Main Canal Heading	Flow in Socorro Main Canal below San Acacia Dam
SADCN	d+h			San Antonio Ditch At BdA Boundary	
SMSCN	d+h			Socorro Main South At BdA Boundary	
ELMDR	d+h			Elmendorf Drain At BdA Boundary	
SOCDR	d+h			Socorro Drain At BdA Boundary	

## 17.2 USBR Pumping Stations

Pumping stations managed by the USBR use a three character gage name followed by PS (pumping station). An example pumping station is NCPPS.

Following is a table of the pumping stations. The type code d+h means that both discharge (d), in cfs, and height or stage (h) in feet, are reported.

Name	Type	Description
NCPPS	d+h	Neil Cupp Pumping Station - USBR
NBYPs	d+h	North Boundary Pumping Station - USBR
SBYPs	d+h	South Boundary Pumping Station - USBR
FCRPS	d+h	Fort Craig Pumping Station - USBR

An additional pumping station file named TOTPS (total pumping station) provides the combined daily values of the above four stations, a combined daily average, a total-to-date for each station in ac-ft, and a total-to-date of all four stations in ac-ft. Data in this file are only available from May through September which spans the normal period of operation. It is available from the New Mexico menu figure 3 W), choosing Pumping Station Data under Historic Data. Click on the current year and then TOTPS.gage figure 49 W). This will be available later from the South Schematic.

## 17.3 USGS Stream Flow Data

The USGS uses the Standard Hydrometeorological Exchange Format (SHEF) convention. This is a three character gage name followed by the 1st character of the state name, followed by a number representing the state's alphabetical order. New Mexico (N) is the 5th state (5). Therefore all USGS gages in New Mexico are identified by N5 in the 4th and 5th character positions. Colorado is C2. An example USGS gage is OTWN5.

Following is a table of the USGS gage stations. The type code d+h means that both discharge (d) in cfs and height or stage (h) in feet, are reported. The type code s+e is used for reservoir status gages. It means that both the storage (s) in acre feet and reservoir elevation (e) in feet above sea level, are reported. The source column indicates whether the data are received via the USCOE/MRGCD route or directly from the USGS.



Name	Type	Description	Source
RLPN5	d+h	Rio Chama Near La Puente	USCOE/MRGCD
ELVN5	s+e	El Vado Dam	USGS
RCEN5	d+h	Rio Chama Below El Vado	USGS
RCAN5	d+h	Rio Chama Above Abiquiu Dam	USGS
ABIN5	s+e	Abiquiu Reservoir	USCOE/MRGCD
AICN5	d+h	Rio Chama Below Abiquiu Dam	USGS
LOBC2	d+h	Rio Grande Near Lobatas, CO	USCOE/MRGCD
EMBN5	d+h	Rio Grande At Embudo	USGS
OTWN5	d+h	Rio Grande At Otowi Bridge, Near San Ildefonso, NM	USGS
COCN5	s+e	Cochiti Lake	USCOE/MRGCD
SILN5	d+h	Rio Grande Below Cochiti, Sile, Cochiti Canal	USGS
CCCN5	d+h	Rio Grande Below Cochiti, Sile, Cochiti Canal	USCOE/MRGCD
CTDN5	d+h	Rio Grande Below Cochiti, Sile, Cochiti Canal	USGS
SFPN5	d+h	Rio Grande At San Felipe	USGS
JECN5	d+h	Jemez River Below Jemez Dam	USGS
ABQN5	d+h	Rio Grande At Albuquerque	USGS
ISLN5	d+h	Rio Grande At Isleta Lakes Near Isleta, NM	USGS
ZZZN5*	d+h	Rio Grande Near Bosque Farms, NM	USGS
BELN5	d+h	Rio Grande At State Hwy 346 Near Bosque, NM	USGS
RFBN5	d+h	Rio Grande Floodway At Bernardo (Not Available)	USCOE/MRGCD
BNDN5	d+h	Rio Puerco At Bernardo	USGS
SNAN5	d+h	Rio Grande Floodway At San Acacia	USGS
SMCN5	d+h	San Marcial Conveyance Channel On Rio Grande	USGS
SMFN5	d+h	San Marcial Floodway On Rio Grande	USGS

---

\*(The ZZZ is a temporary name until the actual SHEF ID is determined)

## 17.4 Schematics

All of the data are assembled into text files and plots; in some instances combining data for valley cross sections and operations. These data are best viewed from the MRGCD North, Belen Division, and South Schematics, available by clicking on Stream Flow Data from the inter-active ET Toolbox window (figure 4 W). This pops-up a Stream Flow Products window (figure 50 W).

From there, click on either of the boxes labeled MRGCD North Schematic (figure 51 W) or Belen Division (figure 52 W) or MRGCD South Schematic (figure 53 W).

**NOTE:** A more direct way to access the schematics is via the New Mexico menu (figure 2 W) choosing the North, Belen, or South Schematic:

MRGCD North Schematic, MRGCD Belen Division Schematic, MRGCD South Schematic

The following text is included after each schematic for guidance:

Middle Rio Grande Conservancy District (MRGCD) Gage Schematic (Under Development)

Values in boxes are latest discharges in cfs.

Click on green boxes for MRGCD gage plots.

Click on yellow boxes for USGS gage plots.

Click on green boxes on the left for Valley Cross Sections of MRGCD and USGS gage combinations and daily consumptive use.

Values in boxes are latest total discharges in cfs.

Click on orange boxes for RGSM pumping station plots.

The schematics are updated every 30-minutes, as noted by the posted date and time at the bottom. All times are Mountain Standard Time (MST) throughout the year. The schematics show the inflows and outflows throughout the MRGCD.

Green boxes are MRGCD gages, yellow boxes are USGS gages, and orange boxes are USBR pumping stations.

Values posted in the boxes are the latest discharges in cfs. No value in a box means the stream flow gage network has not been established. Clicking on a box with a value, or N/A (Not Available), pops-up a graph containing two charts. This is an example of the Socorro Main Canal Heading (figure 54 W). The bottom chart shows the height (stage) of the gage in feet and the top shows the discharge (stream flow) in cfs. A table to the right of the graph provides the year-to-date gage information (figure 55).

### 17.4.1 Valley Cross Sections

Valley Cross Sections on the left of the north schematic (figure 51 W) represent river reaches 1 through 8 from Cochiti to San Marcial. An example valley cross section is SFPXC.

Following is a table of the Valley Cross Sections. Note the gages that are totaled for each of the cross sections.

Name	Description	Gages Totaled
CTDXC	Cross Section at Cochiti	SILN5 CCCN5 CTDN5
SFPXC	Cross Section at San Felipe	SFPN5 CMCCN
XXXXC*	Cross Section at Alameda (undefined)	
ABQXC	Cross Section at Albuquerque	ABQN5 ALBDR ATSCN
XXXXC*	Cross Section at Isleta (undefined)	
RFBXC	Cross Section at Bernardo	RFBN5 SFRDR LSJDR
SNAXC	Cross Section at San Acacia	SNAN5 SOCCN
SMCXC	Cross Section at San Marcial	SMFN5 SMCN5

---

\*(The XXX is a temporary name until the actual SHEF ID is determined)

This is an example cross section at San Felipe (figure 56 W).

These cross sections contain summations of individual gages (in some cases both MRGCD and USGS) with a trace for each. The gage information table on the upper right (figure 57) shows the data for each gage, the total, and the daily average. An M means the data for the chart are missing.

The daily consumptive use chart at the bottom allows comparison of stream flow and consumptive use with the forecast consumptive use shown with dashed lines. This is done for all cross sections except San Marcial. The comparable reach summary report is also shown on the right (figure 13).

#### **17.4.2 Irrigation Diversions**

Irrigation diversions on the right of the north schematic (figure 51 W) represent the four district diversion points. This is an example of the Cochiti diversion, named COCDV, (figure 58 W) with a summation of USGS gages at the two canals, SILN5 and CCCN5, below Cochiti Dam.

The gage information table on the right (figure 59) shows the data for each gage, the total, and the daily average.

Some images of gage locations are also shown.

### **17.5 Direct Links to USGS Gage Information**

Clicking on the white triangles found on many of the pop-up windows throughout the AWARDS/ET Toolbox system provides real-time Internet links to USGS gage graphs and text data. This is an example available by clicking on the white triangle for Otowi Bridge in the Alcalde window of (figure 4 W) or (figure 50 W). The address for this USGS gage is: [http://waterdata.usgs.gov/nm/nwis/uv/gen\\_stn\\_pg?station=08313000](http://waterdata.usgs.gov/nm/nwis/uv/gen_stn_pg?station=08313000) (Rio Grande at Otowi Bridge).

## 18 Tamarisk Research

A Tamarisk Research Study was accomplished to provide water use planners with long-term evapotranspiration estimates, methods, and models to predict the consumptive use of water by tamarisk (saltcedar). (Hippis 2004).

A daily evapotranspiration model was developed as a result of the research. This ET model is within the ET Toolbox, located within river reach 7. Clicking on reach 7 from the inter-active AWARDS/ET Toolbox window (figure 4 W) and then clicking on "+ ETTool" and "Tamarisk ET model and comparisons" will pop-up this plot and text information (figure 60 W).

**NOTE:** A more direct way to access the above is via the New Mexico menu (figure 2 W) choosing "Tamarisk ET Model Research and Comparisons".

The plot shows the comparison of tamarisk ET as calculated via the Penman equation and appropriate crop coefficients, with the ET model described in the above referenced paper. The South Bosque weather station hourly data are used in the ET model, whereas the Penman equation method uses daily South Bosque data.

The model is designed and valid for the period when the plants have their full green leaves. The approach uses a form of the Penman-Monteith equation that considers coupling of the surface with the regional atmosphere, and a separate model for stomatal conductance. Therefore, the model functions only within the 500 to 1450 sum of growing degree days. Also, the depth to ground water (WTdepth) is set at 200 cm until real-time data are available.

The text table to the right of the plot (figure 61 W) lists the ET Toolbox ET(in) and the ET model daytime ET (in), along with appropriate background data. The address for the Tamarisk study is: <http://tamarisk.nmsu.edu/> (Tamarisk Research Study).

## 19 Field Scheduling

There is a field scheduling component to the ET Toolbox that was implemented in May, 2005. This prototype scheduling routine is based on real-time ET estimates on an Alfalfa field at the Candelaria Farms site in Albuquerque, river reach 3. Clicking on reach 3 from the inter-active AWARDS/ET Toolbox window (figure 4 W) and then clicking on "+ ETTool" and Candelaria Farms Field Scheduling" will pop-up an option menu (figure 62 W) that contains Irrigation Scheduling Products (To-Date).

**NOTE:** A more direct way to access the above is via the New Mexico menu (figure 2 W) choosing "Candelaria Farms Field Scheduling on Alfalfa Field"

A table of daily soil temperature and moisture (figure 63 W) and a plot of soil moisture and rain (figure 23 W) at the Candelaria Farms weather station are reported here.

Next is a table of hourly weather and soil temperature/moisture data (figure 64 W).

There is also a plot of hourly air temperature and relative humidity (figure 22 W).

The field scheduling results are presented in both tabular (figure 65 W) and plot form (figure 66 W). The sum depletion is based on the the daily Crop ET. When this quantity reaches the allowable depletion a suggested irrigation amount is posted. The real-time soil moisture quantity (Volumetric Water Content) is currently not used in the calculation, although it's use could be used if/when soil conditions and irrigation events are more closely monitored. Note that the forecasted 7-days are included in the table and plot.

Photos of the Candelaria Farm alfalfa field area are available.

Historic soil temperature and moisture, and field scheduling at the Alfalfa field at Candelaria Farms, is also available from the menu.

## 20 Interface with RiverWare

ET Toolbox files for each of the eight river reaches are available for the URGWOM team to access at around 7:15 AM MST each day. The river reach boundaries are listed in the following table.

River Reach 1	Cochiti Dam gage to San Felipe gage
River Reach 2	San Felipe gage to Alameda gage
River Reach 3	Alameda gage to Central Avenue gage
River Reach 4	Central Avenue gage to Isleta gage
River Reach 5	Isleta gage to Bernardo gage
River Reach 6	Bernardo gage to San Acacia gage
River Reach 7	San Acacia gage to San Marcial gage (includes the Bosque Del Apache)
River Reach 8	San Marcial gage to north end of Elephant Butte Reservoir

These ET Toolbox files contain daily consumptive use rate (inches/day) for all agricultural, riparian, and urban vegetation classifications. Refer to AWARDS/ET Toolbox Calculations (section 13) for more information.

A sample ET Toolbox file (for Reach 1) for a short period of time in August and September (figure 67) is shown here. It contains data for each classification that is in the reach (the version available to the URGWOM team shows all data for the current year). The data for the last seven lines are forecast values based on the National Digital Forecast Database (NDFD) 5-km grid.

A sample ET Toolbox file for all reaches for a short period of time in August and September (figure 68) is shown here. It contains data for all classifications in each reach (the version available to the URGWOM team shows all data for the current year). The data for the last seven lines are forecast values based on the National Digital Forecast Database (NDFD) 5-km grid. Some quantities are negative because they are adjusted for rainfall.

These ET Toolbox files are not available from the website, therefore no web address is provided here. They are internal files processed in the computer system, and made available daily for use by the URGWOM team. The above two figures exist in this document only for information purposes - they are not intended to be accessed by the casual user of the ET Toolbox.

A file containing the classification keys and a file containing the acreage of each classification split between the east and west sides of the Rio Grande are also provided.

The tasks of developing the Data Management Interfaces (DMIs) between the ET Toolbox files, the Hydrologic Engineer Center - Data Storage System (HEC-DSS), and RiverWare were accomplished by the URGWOM team. Please contact the URGWOM team for information on how these provided data are used in the RiverWare Model. There address is: <http://www.spa.usace.army.mil/urgwom/default.asp> (URGWOM).

## 21 Historic ET Toolbox Processing - 1975 to 2005

At the request of the URGWOM team, historic consumptive use values were processed to satisfy a requirement of determining agricultural and riparian water depletions in each of the river reaches. The results of this study were used to calibrate the URGWOM.

Years 1984 through 1998 were processed using a combination of the Alcalde and Los Lunas weather stations. Temperature and relative humidity from the Los Lunas station and solar radiation and wind from the Alcalde station were used to calculate the Penman Reference ET.

Years 1975 through 1983 were processed differently. For these years there were no data from Alcalde, and only temperature and precipitation data were available at Los Lunas. Therefore, a monthly comparison of temperature and precipitation was made with years 1984 through 2000. Daily relative humidity, solar radiation, and wind data from the closest matched month in the period 1984 through 2000 were then used to calculate the Penman Reference ET. An Excel spread sheet has been developed that shows the Los Lunas precipitation and temperature data, and a comparison of monthly precipitation and average temperatures for each year 1975 through 1983, with 1984 through 2000.

Access to the spread sheet is available through the Internet at:

[http://www.usbr.gov/pmts/rivers/awards/Nm2/rg/NM\\_LosLunasCOOPdata.xls](http://www.usbr.gov/pmts/rivers/awards/Nm2/rg/NM_LosLunasCOOPdata.xls) (W).

Page seven of the spread sheet contains documentation of the procedures used.

Years 1999 through the last most current year used temperature, relative humidity, solar radiation, and wind data from various weather stations for calculating the Penman Reference ET. The stations were assigned to specific 4 km x 4 km HRAP grid cells within each reach. Note that these are the original reaches in place before 2006:



1999	Reaches 1 and 2	Alcalde
	Reach 3	Rio Grande Nursery (NMCC)
	Reach 4	Los Lunas
	Reach 5	Boy's Ranch
	Reach 6	North Bosque
2000	Reach 1	Pena Blanca and Angostura
	Reach 2	Angostura
	Reach 3	Angostura, Rio Grande Nursery, and Albuquerque Golf Course (NMCC)
	Reach 4	Bosque Bar (MRGCD), Rio Grande Nursery, Los Lunas, Jarales, and Boy's Ranch
	Reach 5	Boy's Ranch
	Reach 6	Luis Lopez, North Bosque, and South Bosque
2001	Reach 1	Pena Blanca and Angostura
	Reach 2	Angostura
	Reach 3	Angostura, Rio Grande Nursery, and Albuquerque Golf Course (NMCC)
	Reach 4	Bosque Bar (MRGCD - through Dec 6), Rio Grande Nursery, Los Lunas, Jarales, and Boy's Ranch
	Reach 5	Boy's Ranch and San Acacia
	Reach 6	San Acacia, Luis Lopez, North Bosque, and South Bosque
2002	Reach 1	Pena Blanca and Angostura
	Reach 2	Angostura
	Reach 3	Angostura, Rio Grande Nursery, and Albuquerque Golf Course (NMCC)
	Reach 4	Rio Grande Nursery, Los Lunas, Jarales, and Boy's Ranch
	Reach 5	Boy's Ranch and San Acacia
	Reach 6	San Acacia, Luis Lopez, North Bosque, and South Bosque
	Reach 7	South Bosque
2003	Reach 1	Pena Blanca and Angostura
	Reach 2	Angostura
	Reach 3	Angostura and Candelaria Farms
	Reach 4	Candelaria Farms, Los Lunas, Jarales, and Boy's Ranch
	Reach 5	Boy's Ranch and San Acacia
	Reach 6	San Acacia, Luis Lopez, North Bosque, and South Bosque
	Reach 7	South Bosque

Additional MRGCD weather stations were added in 2004 and assigned to appropriate river reaches as data from them became available.

Occasionally data from weather stations were not available. In these cases interim substitutions were made while repairs were underway, or permanent replacements were made if new or nearby stations were available.

In all historic processing through 1998, only weather station precipitation data were used since NEXRAD data were not collected for the ET Toolbox until 1999. The historic data posted on the website for 1999 through the last most complete year uses NEXRAD precipitation. This is an important item to note when comparing 1975 through 1998 precipitation data with 1999 through current year precipitation data.

Numerous reruns of the historic ET Toolbox processing for 1975 through 1998 have occurred. The more recent was in February 2003 to correct problems with the agricultural acreage and precipitation in reach 6.

For these historic calculations, the vegetative acreage from the 1992/93 LUTA for reaches 1 through 5 were used, as well as the combinations of data sources for reach 6. Refer to GIS Land Classification (section 15).

The same crop coefficients and Penman Reference ET Equation were used. The only variance from year-to-year was the weather data.

The year 2001 ends on December 6 due to the Department of the Interior shutdown of Internet communications.

Additional historic processing was requested by the URGWOM team in 2006. This request was for processing years 2000 through 2005 using the new eight river reach delineations based on the 4km x 4km HRAP grid cells, not the 1-km QPE grid cells that started in 2007. It was also based on the newer IKONOS and Utah State University land classification. Refer to the New Mexico menu, (figure 3 W) Historic Data, ET Summary Information by New River Reaches (1-8), for the summaries and a listing of weather station assignments to the new reaches.

## 22 Data Flow - Computer Processing

There are many data sets used in the ET Toolbox that are acquired either hourly or daily through the use of scripts. These scripts are run on a Sun Sunblade 2000 Computer Workstation using the Solaris 9 UNIX operating system. The computer is located in the Bureau of Reclamation's Technical Service Center, Water Resources Services Division, at the Denver Federal Center, Lakewood, Colorado. The scripts call various computer programs written mostly in FORTRAN, although some C and Python programming is also used.

Abbreviations used in the flow diagrams are:

CU	Consumptive Use
CSU	Colorado State University
DOS	Disk Operating System
ET	Evapotranspiration
FLO-2D	Two-Dimensional Flood Routing model
FTP	File Transfer Protocol
IDS	Integrated Decision Support
ISP	Internet Service Provider
NCAR	National Center for Atmospheric Research
NDFD	National Digital Forecast Database
NEXRAD	NEXt generation RADar
QPE	Quantitative Precipitation Estimates
QPESUMS	Quantitative Precipitation Estimation and Segregation Using Multiple Sensors
USACOE	United States Army Corps of Engineers
USBR	United States Bureau of Reclamation
USGS	United States Geological Survey
WEB	World-Wide Web (Internet)
Web	World-Wide Web (Internet)
WX	Weather Station

Click on the following subjects to access flow diagrams of the function of each major script, called program, and related data flow. These figures are not available on the website.

Weather (Real-Time and Forecast)  
(figure 69 figure 70 figure 71 figure 72 figure 73 figure 74 figure 75)

Gage Data - (Real-Time Stream Flow and Reservoir Status)  
(figure 76 figure 77) figure 78) figure 79)

NEXRAD Data  
(figure 80 figure 81) figure 82)

AWARDS and ET Toolbox Processing  
(figure 83 figure 84 figure 85 figure 86 figure 87 figure 88 figure 89  
figure 90 figure 91 figure 92 figure 93 figure 94 figure 95)

A more detailed document is being developed for the ET Toolbox program developers and managers to help guide them through the complex operation of the computer system.

## 23 ET Toolbox Research

Future ET Toolbox research could include studies to:

1. Revise evaporation demands based on results of open water and wet sands field studies.
2. Improve the Elephant Butte Reservoir evaporation estimation using the Reservoir Evaporation research model developed in July, 2003. Requirements are real-time reservoir surface weather data.
3. Study and implement a rainfall/runoff model to better predict ungaged inflows to streams/river(s).
4. Improve the riparian vegetation ET coefficients and make other equation changes based on the results of the ET field studies.
5. Implement real-time water table monitoring at or near the South Bosque weather station for use in the tamarisk ET model.
6. Modify ET for less than potential conditions.
7. Implement, for comparison purposes and possible use, the ASCE Standardized Reference ET Equation.
8. Determine if adding soil moisture fields from Land Surface Models and observations, and soil types and slope, can be used in the ET Toolbox to improve the efficiency of water management.
9. Improve estimates of effective precipitation using soil types and slope, and soil moisture.
10. Improve the situation analysis matrix with predicted stream flow data.
11. Install additional weather stations in critical ET demand areas.
12. Provide weather station calibration and data quality resources to improve ET reliability.
13. Implement a field scheduling component (beyond current Candelaria Farms study) based on real-time soil moisture monitoring, soil types, and plant growth, to improve irrigation delivery demands.
14. Access and use real-time ground water level information for integration into a system-wide water balance feature.
15. Improve the Stream Flow Schematics to include greater detail and missing data.
16. Improve the Web site, and include an interactive component for users to run "what-if" scenarios.
17. Convert from the Sun Solaris computer system to a PC Linux computer.



AWARDS/ET Toolbox Computer

## 24 References

1. American Society of Agricultural Engineers (ASAE), 1983:  
Design And Operation Of Farm Irrigation Systems.
2. Jensen, M.E., 1998:  
Coefficients for Vegetative Evapotranspiration and Open Water Evaporation for the Lower Colorado River Accounting System. Report prepared for the U.S. Bureau of Reclamation, Boulder City, Nevada.
3. King, J.P., A.S. Bawazir, and T.W. Sammis, 2000:  
Evapotranspiration Crop Coefficients as a Function of Heat Units for Some Agricultural Crops in New Mexico. Technical Completion Report for Project No. 01-4-23955, New Mexico State University
4. Sammis, T.W., C.L. Mapel, D.G. Lugg, R.R. Lansford, J.T. McGuckin, 1985:  
Evapotranspiration Crop Coefficients
5. Predicted Using Growing Degree Days. Transactions of the ASAE (American Society of Agricultural Engineers) 28(3), pp. 773-780.
6. FAO Irrigation and Drainage Paper No. 56
7. Astronomical Almanac (1998)
8. IIHR Report No. 430, July 2003:  
Lake Evaporation Estimation In Arid Environmentsa
9. Hipps and Hattori, Utah State University, April 2004:  
Model for Daily Evapotranspiration of Tamarisk at the Bosque del Apache

**25 FIGURES**



U.S. Department of the Interior | Bureau of Reclamation Contact Us | Site Map



# RECLAMATION

*Managing Water in the West*

Search Reclamation  
 >>

[Reclamation Home](#)

[Regional Offices](#)

[Newsroom](#)

[Library](#)

[Dataweb](#)

[Programs](#)

[Water Operations](#)

[Technical Service Center](#)

[Watershed and Rivers Software](#)



U.S. Department of the Interior

Technical Service Center, Watershed and Rivers Software

## AWARDS – NEXRAD – ET Toolbox

Near Real-Time Information for Operational Water Management Decision Support

**NEXRAD Precipitation and ET Products**  
(Click in colored project areas below)

---

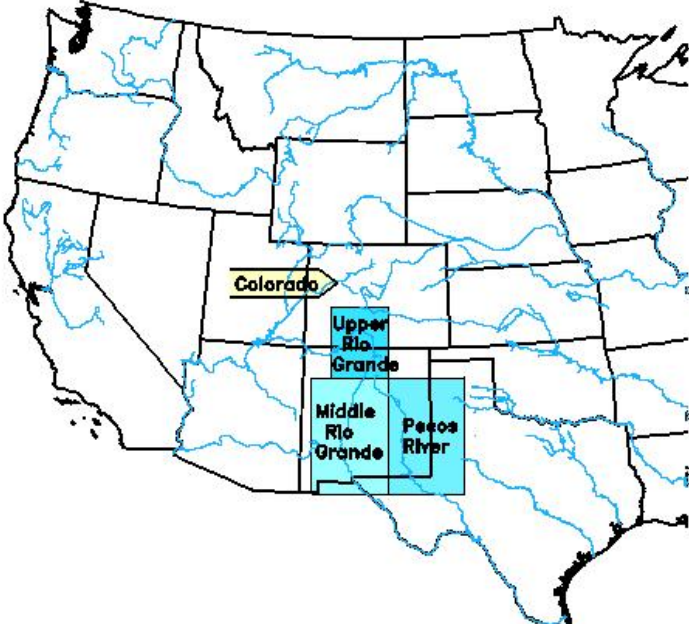

Figure 1: ET Toolbox Home Page

The image is a screenshot of a web page from the Bureau of Reclamation. At the top, there is a navigation bar with the text "U.S. Department of the Interior | Bureau of Reclamation" on the left and "Contact Us | Site Map" on the right. Below this is a banner image of a dam with the word "RECLAMATION" in large white letters and the tagline "Managing Water in the West" in a smaller font. On the left side of the page is a blue sidebar containing a search box, a list of navigation links (Reclamation Home, Regional Offices, News room, Library, Dataweb, Technical Service Center, Watershed and Rivers Software), and the Bureau of Reclamation logo. The main content area is white and features the title "NEXRAD Rainfall, Weather Station, and ET Products for the Rio Grande Basin" in blue. Below the title is a red heading "Rio Grande Basin AWARDS System and ET Toolbox Project Areas". The page lists various data products and tools, each with a brief description and a list of links for different reaches (1-8) or consumption volumes (C/V). The links are color-coded: blue for general reach links and red for C/V links. The products listed include: MAP with Quantitative Precipitation Estimation (QPE) and River Reaches; Basin Overview Plots (Present Division Rain, Present Hourly Rain, Daily Archived Images); Consumptive Use Plots (Stream Depletion for Reaches, Rain for Reaches); Stream Flow Data (MRGCD North Schematic, MRGCD Belen Division Schematic, MRGCD South Schematic); Weather Station Data and Plots (Awards ET Charts for Chama/Velarde and Reaches 1-8, ET Toolbox Consumptive Use Details for Chama/Velarde and Reaches 1-8, ET Toolbox URGWOM ET Maps for Chama/Velarde and Reaches 1-8, ET Toolbox Summary Products for Chama/Velarde and Reaches 1-8); Candelaria Farms Field Scheduling on Alfalfa Field; Soil and Fuel Temperature and Moisture at Weather Stations; Tamarisk ET Model Research and Comparisons; Elephant Butte Reservoir Evaporation; Rain only in Other Areas (Alcalde Nambé Truth or Consequences, Derry Las Cruces, El Paso NW, El Paso SE); Information on the AWARDS System; Documentation of the ET Toolbox (pdf version); and Recent changes to the AWARDS/ET Toolbox.

U.S. Department of the Interior | Bureau of Reclamation

Contact Us | Site Map

**RECLAMATION**  
Managing Water in the West

Search Reclamation  
 >>

Reclamation Home  
 Regional Offices  
 News room  
 Library  
 Dataweb  
 Technical Service Center  
 Watershed and Rivers Software

  
 U.S. Department of the Interior

**NEXRAD Rainfall, Weather Station, and ET Products for the Rio Grande Basin**

**Rio Grande Basin AWARDS System and ET Toolbox Project Areas**

[MAP with Quantitative Precipitation Estimation \(QPE\) and River Reaches](#)

**Basin Overview Plots:**  
[Present Division Rain](#), [Present Hourly Rain](#), [Daily Archived Images](#)

**Consumptive Use Plots with:**  
 Stream Depletion for Reaches: [All](#) [1](#) [2](#) [3](#) [4](#) [5](#) [6](#) [7](#) [8](#)  
 Rain for Reaches: [All](#) [1](#) [2](#) [3](#) [4](#) [5](#) [6](#) [7](#) [8](#)

**Stream Flow Data:**  
[MRGCD North Schematic](#), [MRGCD Belen Division Schematic](#), [MRGCD South Schematic](#)

**Weather Station Data and Plots**

**Awards ET Charts for Chama/Velarde (C/V) and Reaches 1-8**  
 Click within dots for cell-by-cell charts  
 Click on "day" for specific daily rain - Click on "1 wk anim" for rain animation  
[C/V](#) [1](#) [2](#) [3](#) [4](#) [5](#) [6](#) [7](#) [8](#)

**ET Toolbox Consumptive Use Details for Chama/Velarde (C/V) and Reaches 1-8**  
 Click within dots for cell-by-cell details  
 Click on "day" for specific daily rain - Click on "1 wk anim" for rain animation  
[C/V](#) [1](#) [2](#) [3](#) [4](#) [5](#) [6](#) [7](#) [8](#)

**ET Toolbox URGWOM ET Maps for Chama/Velarde (C/V) and Reaches 1-8**  
 Click on "1 wk anim" for ET animation  
[C/V](#) [1](#) [2](#) [3](#) [4](#) [5](#) [6](#) [7](#) [8](#)

**ET Toolbox Summary Products for Chama/Velarde (C/V) and Reaches 1-8**  
[C/V](#) [1](#) [2](#) [3](#) [4](#) [5](#) [6](#) [7](#) [8](#)

[Candelaria Farms Field Scheduling on Alfalfa Field](#)

[Soil and Fuel Temperature and Moisture at Weather Stations](#)

[Tamarisk ET Model Research and Comparisons](#)

[Elephant Butte Reservoir Evaporation](#)

**Rain only in Other Areas**  
[Alcalde Nambé Truth or Consequences](#) [Derry Las Cruces](#) [El Paso NW](#) [El Paso SE](#)

[Information on the AWARDS System](#)

[Documentation of the ET Toolbox \(pdf version\)](#)  
 (Soon to be revised to reflect recent changes)

[Recent changes to the AWARDS/ET Toolbox](#)

Figure 2: New Mexico ET Products Menu - Part 1



U.S. Department  
of the Interior

---

Historic Data

[1-hour](#) Weather Data from MRGCD Operated Automated Weather Stations.

[24-hour](#) Weather Data from MRGCD Operated Automated Weather Stations and New Mexico State University Automated Weather Stations.

[ET Summary Information](#) by New River Reaches 1-8.

[Gage Data](#) from Middle Rio Grande Conservancy District (MRGCD) and USGS

[Pumping Station Data](#) from USBR

[Tamarisk ET Model and Comparisons](#)

---

Archived Radar Precipitation Products (QPE)

1-Year of [Archived Daily](#) Upper Rio Grande QPE Sums Estimated Rainfall Images

---

Links to Real-Time and Forecasted Weather Data

[NCAR RAP Real-Time Weather Data](#) (Satellite Loops etc.)

6-hour [Animation loop of recent satellite west U.S. images](#) -- GOES WEST IR from NOAA

6-hour [Animation loop of recent satellite east U.S. images](#) -- GOES EAST IR from NOAA

[HPC National Quantitative Precipitation Forecast \(QPF\) Graphics](#)  
[Day 1](#) [Day 2](#) [Day 3](#) [Day 4-5](#)

Medium Range Forecasts from the HPC:  
Red = Max. Temperature, Blue = Min. Temperature, Green = Prob. of Precip.  
[Day 3](#) Max / Min Temp and PoP Forecasts  
[Day 4](#) Max / Min Temp and PoP Forecasts  
[Day 5](#) Max / Min Temp and PoP Forecasts  
[Day 6](#) Max / Min Temp and PoP Forecasts  
[Day 7](#) Max / Min Temp and PoP Forecasts

Current Monthly and Seasonal [Climate Outlook](#) from the CPC

Current U.S. [Drought Monitor](#) from the CPC

---

Related Links

- ◆ [Current Atmospheric Soundings \(Skew-T\) for Albuquerque, NM \(ABQ\) and El Paso, TX \(EPZ\)](#)
- ◆ [GoTo NWS West Gulf River Forecast Center, Fort Worth, TX Home Page](#)
- ◆ [GoTo NWS Albuquerque, NM Home Page](#)
- ◆ [GoTo NWS El Paso, TX Home Page](#)
- ◆ [GoTo Sevilleta LTER Program, University of New Mexico](#)
- ◆ [GoTo New Mexico Climate Center](#)
- ◆ [BackTo the AWARDS NEXRAD ET Toolbox Home Page](#)

---

Disclaimer Statement

Send comments or questions to:  
[Tom Pruiitt \(tpruitt@do.us.br.gov\)](mailto:tpruitt@do.us.br.gov) 303-445-2512  
Civil Engineer, Ground Water & Drainage Group  
[Richard Stodit \(rsfodit@do.us.br.gov\)](mailto:rsfodit@do.us.br.gov) 303-445-2474  
Meteorologist, River Systems & Meteorology Group

Bureau of Reclamation  
Technical Service Center  
Denver, Colorado

Figure 3: New Mexico ET Products Menu - Part 2

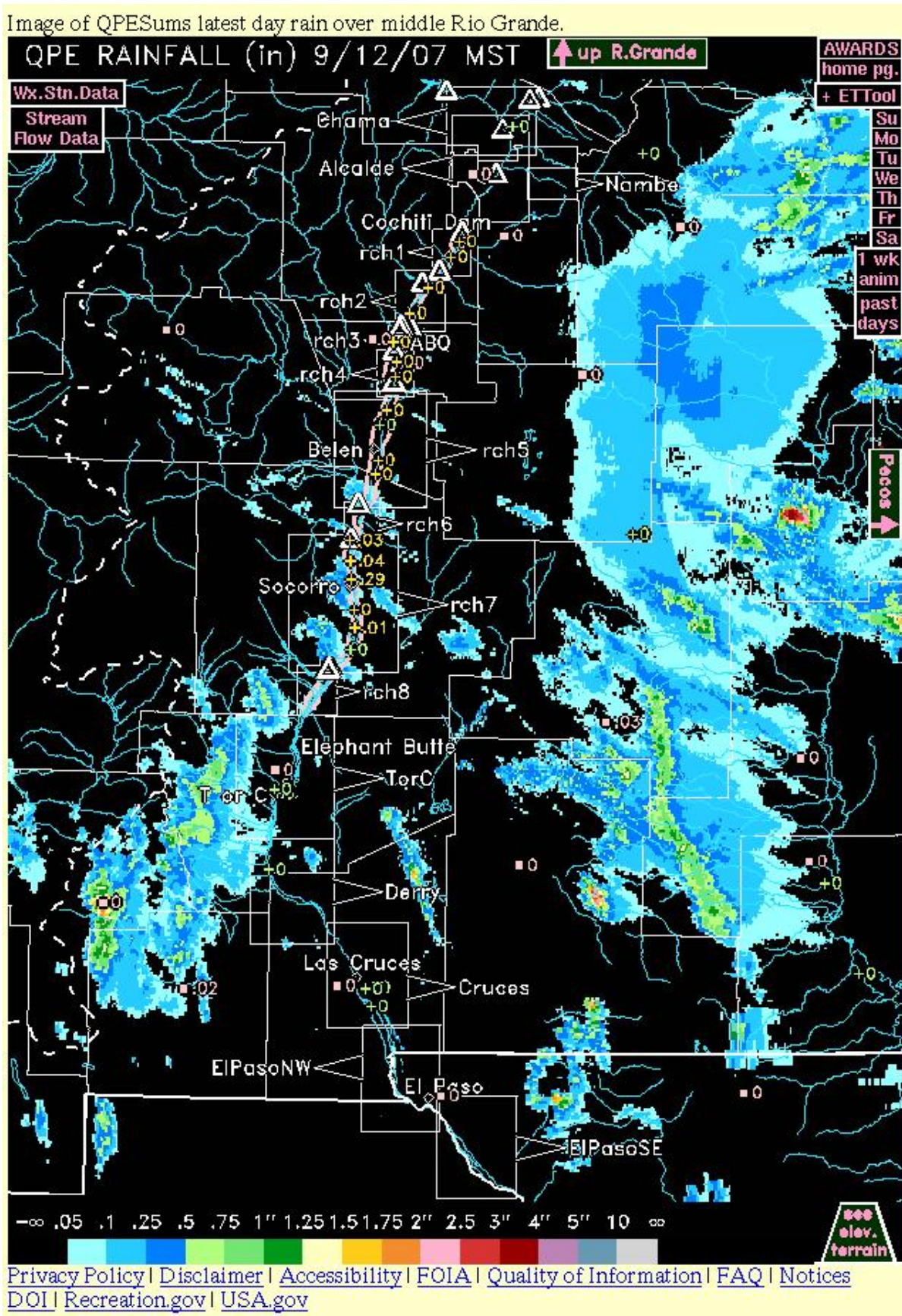

Figure 4: Rio Grande Map - Awards

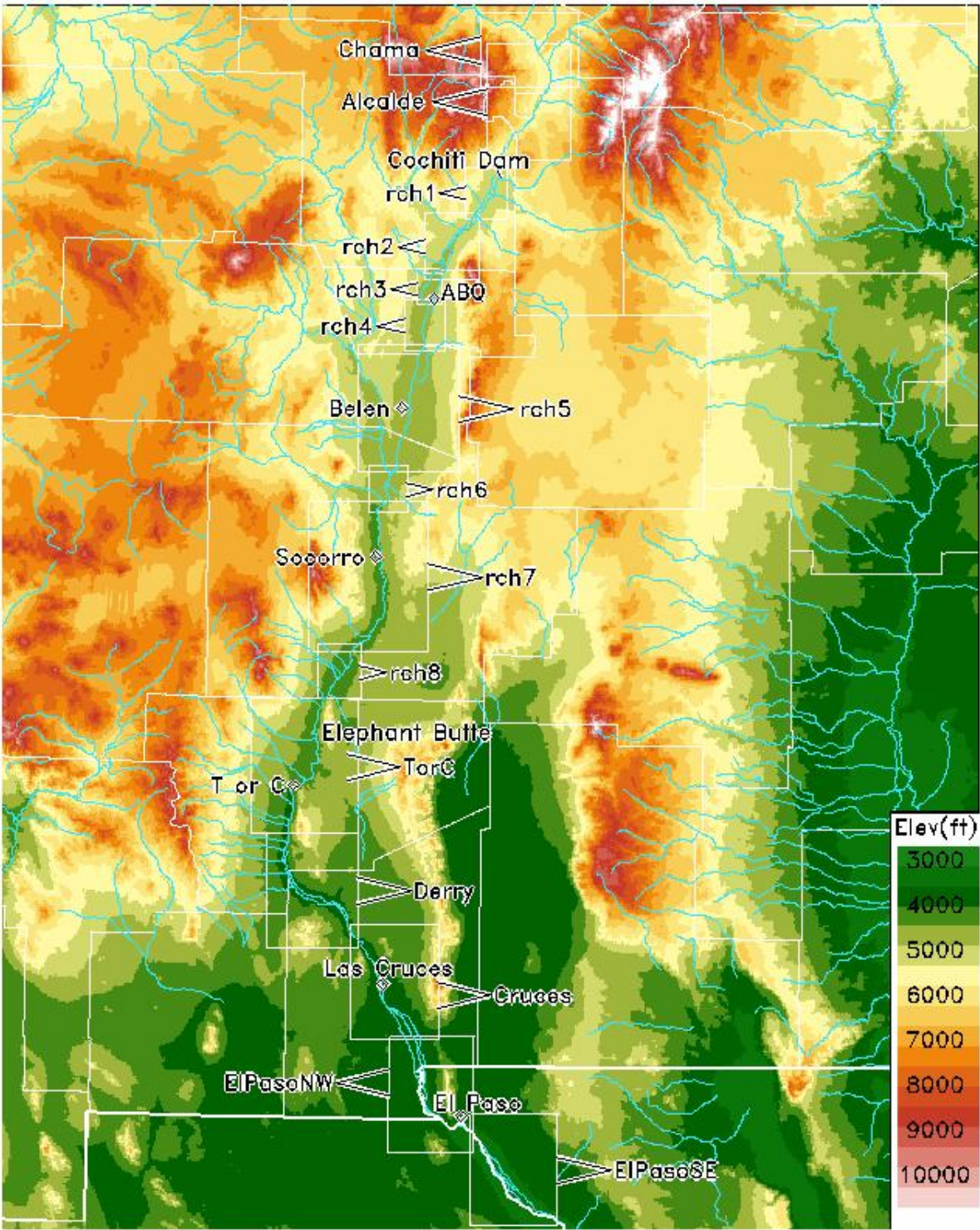

Figure 5: Colored Topography

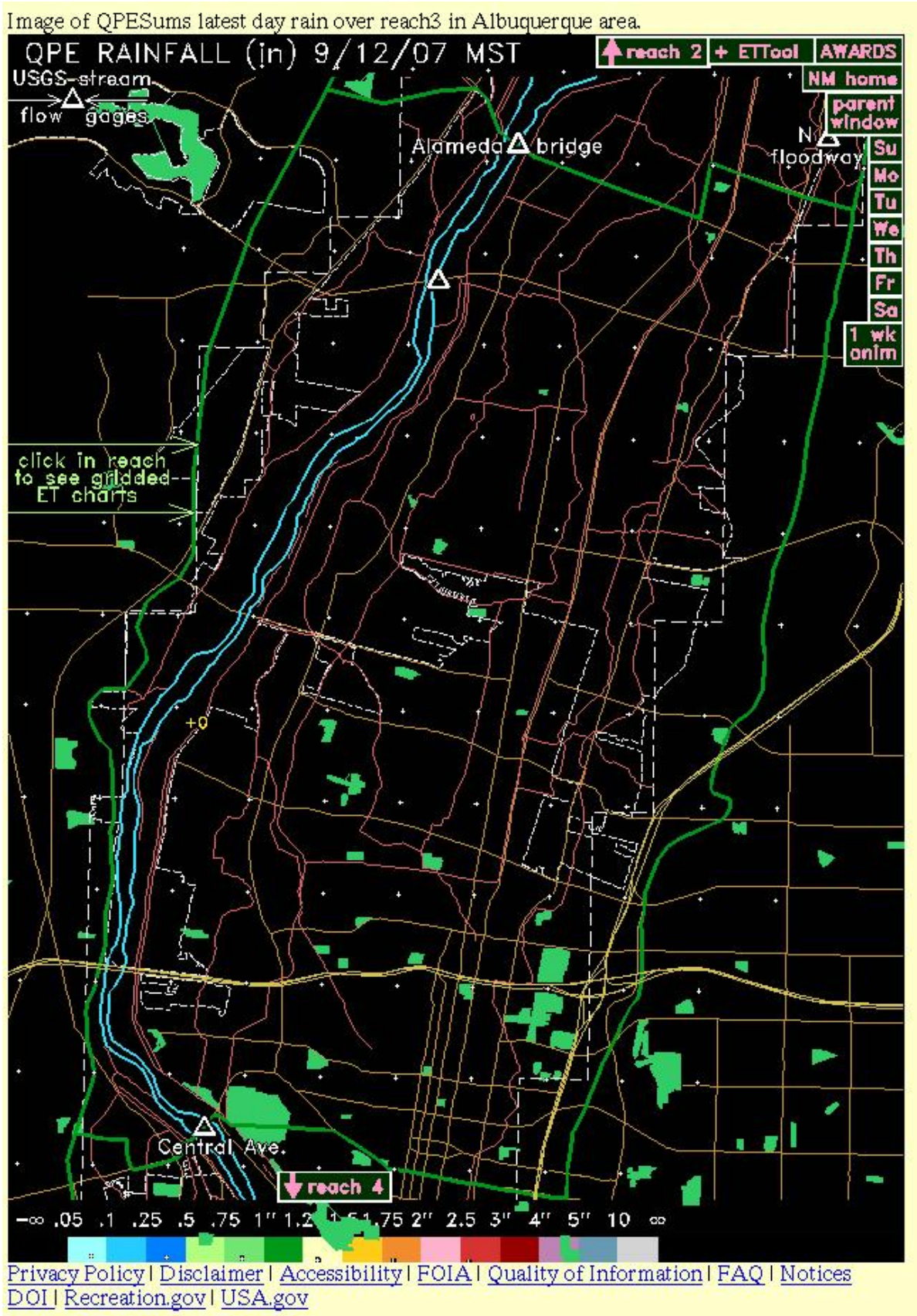

Figure 6: River Reach 3 - Awards

Printed by Al Brower

Sep 13, 07 10:51		CFMN.txt							Page 1/5
Candelaria Farms Station - Weather Data - 2007									
Name: CFMN Source: mrgcd		Sep	Sep	Sep	Sep	Sep	Sep	Sep	
Elev. 4967 ft		6	7	8	9	10	11	12	
Lat. 35.133		----	----	----	----	----	----	----	
Lon. 106.683									
Max. Temp. (F)		80.0	86.0	88.0	86.0	87.0	82.0	86.0	
Min. Temp. (F)		56.0	57.0	61.0	59.0	57.0	62.0	57.0	
Avg. Wind (Mi/Hr)		3.4	6.4	5.4	10.2	7.8	4.6	5.0	
Rel. Hum. (%)		72.5	47.5	40.0	59.5	53.5	55.0	43.0	
Rain (In)		0.00	0.02	0.00	0.02	0.11	0.02	0.00	
Solar Rad. (Mj/Sq m)		10.60	30.10	30.00	29.90	29.80	27.30	29.60	
=====		Alternate Data Key							
Gage Monthly Total Rain:		-----							
January	0.20	ndfd == 5 km ndfd model							
February	0.57	eta == 12 km eta model							
March	0.53	[1-7] == forecast day							
April	3.72	T == Temperature							
May	0.82	W == Wind							
June	0.22	H == Humidity							
July	0.37	R == Rain							
August	0.09	r == nexrad radar Rain							
September	0.32	S == Solar Radiation							
=====		???? == weather station							
Daily Weather Data and Reference ET									
Month	Day	Max. Temp (F)	Min. Temp (F)	Avg. Wind (Mi/Hr)	Rel. Hum. (%)	Rain (In)	Solar Radiation (Mj/Sq m)	Penman Ref. ET (In)	Alternate Weather Data
		--[T]---	---	[W]	[H]	[Rr]	[S]	(In)	
Sep	12	86.0	57.0	5.0	43.0	0.00	29.60	0.34	ndfd1TWHrS
Sep	11	82.0	62.0	4.6	55.0	0.02	27.30	0.29	ndfd1TWHrS
Sep	10	87.0	57.0	7.8	53.5	0.11	29.80	0.36	ndfd1TWHrS
Sep	9	86.0	59.0	10.2	59.5	0.02	29.90	0.37	ndfd1TWHrS
Sep	8	88.0	61.0	5.4	40.0	0.00	30.00	0.36	ndfd1TWHrS
Sep	7	86.0	57.0	6.4	47.5	0.02	30.10	0.36	ndfd1TWHrS
Sep	6	80.0	56.0	3.4	72.5	0.00	10.60	0.11	
Sep	5	94.0	54.0	2.1	61.0	0.00	18.20	0.22	
Sep	4	94.0	51.0	1.9	58.5	0.00	19.00	0.23	
Sep	3	95.0	54.0	1.0	58.5	0.00	18.20	0.21	
Sep	2	90.0	56.0	0.9	53.0	0.00	16.50	0.18	ndfd1H
Sep	1	91.0	54.0	1.4	63.0	0.15	16.80	0.18	
Aug	31	90.0	60.0	1.4	65.5	0.01	15.40	0.16	
Aug	30	88.0	57.0	1.8	66.5	0.00	19.50	0.20	
Aug	29	94.0	60.0	3.5	62.5	0.01	18.30	0.22	
Aug	28	92.0	56.0	2.2	62.5	0.00	19.60	0.22	
Aug	27	92.0	54.0	2.6	64.0	0.00	16.70	0.19	
Aug	26	94.0	58.0	2.9	59.5	0.00	17.80	0.22	
Aug	25	96.0	56.0	1.3	59.5	0.00	17.80	0.20	
Aug	24	96.0	58.0	1.3	61.5	0.00	16.80	0.19	
Aug	23	96.0	65.0	4.6	56.0	0.01	16.90	0.23	
Aug	22	101.0	52.0	3.3	53.0	0.00	19.00	0.26	
Aug	21	101.0	50.0	0.7	52.0	0.00	20.70	0.24	
Aug	20	97.0	64.0	5.4	29.5	0.00	31.40	0.41	ndfd1TWHrS
Aug	19	98.0	59.0	1.6	58.0	0.00	19.20	0.22	
Aug	18	95.0	59.0	1.5	58.0	0.00	18.90	0.21	
Aug	17	96.0	56.0	1.2	58.0	0.00	18.80	0.21	
Aug	16	98.0	56.0	1.7	56.5	0.00	19.40	0.23	
Aug	15	101.0	57.0	1.0	57.5	0.00	20.10	0.23	
Aug	14	95.0	61.0	1.9	58.0	0.00	20.90	0.23	
Aug	13	99.0	57.0	1.3	55.0	0.00	21.00	0.24	
Aug	12	102.0	63.0	2.0	54.0	0.00	20.70	0.25	

Thursday September 13, 2007

1/5

Figure 7: MRGCD Daily Weather Data

Printed by Al Brower

Oct 16, 07 11:46		REA3.CFMN.2336.1517.txt											Page 1/1					
Candelaria Farms Station													mrgcd					
ESTIMATED CROP WATER USE - SEP 13, 2007																		
CROP	START DATE	DAILY CROP WATER USE - (IN)				FORECAST PENMAN ET									TERM DATE	SUM ET	7 DAY USE	14 DAY USE
		PENMAN ET				SEP	SEP	SEP	SEP	SEP	SEP	SEP	SEP	SEP				
		9	10	11	12	13	14	15	16	17	18	19						
FLO2DWater	101	0.33	0.32	0.25	0.30	0.32	0.32	0.31	0.31	0.31	0.30	0.30	1231	40.3	1.9	3.2		
WetSands	101	0.33	0.32	0.25	0.30	0.32	0.32	0.31	0.31	0.31	0.30	0.30	1231	40.3	1.9	3.2		
Alfalfa	101	0.37	0.36	0.28	0.33	0.35	0.35	0.34	0.34	0.33	0.32	0.33	1020	45.0	2.2	3.6		
Corn	429	0.25	0.23	0.18	0.20	0.21	0.20	0.19	0.18	0.17	0.16	0.16	1120	25.2	1.5	2.6		
Pasture	315	0.24	0.23	0.19	0.22	0.23	0.24	0.23	0.23	0.23	0.22	0.23	1020	26.9	1.4	2.3		
Wheat	410	0.00	0.00	0.00	0.00	0.00	0.00	0.00	0.00	0.00	0.00	0.00	810	8.7	0.0	0.0		
Oats	410	0.00	0.00	0.00	0.00	0.00	0.00	0.00	0.00	0.00	0.00	0.00	810	15.0	0.0	0.0		
Sorghum	517	0.17	0.16	0.12	0.13	0.14	0.13	0.12	0.12	0.11	0.10	0.10	1220	18.8	1.0	1.8		
Turf Grass	315	0.24	0.23	0.19	0.22	0.23	0.24	0.23	0.23	0.23	0.22	0.23	1020	26.9	1.4	2.3		
CotwBosque	405	0.26	0.25	0.20	0.24	0.25	0.25	0.25	0.25	0.24	0.23	0.24	1121	18.7	1.5	2.5		
Cotw/SCW	405	0.26	0.25	0.20	0.24	0.25	0.25	0.25	0.25	0.24	0.23	0.24	1121	18.7	1.5	2.5		
Cotw/ROW	405	0.26	0.25	0.20	0.24	0.25	0.25	0.25	0.25	0.24	0.23	0.24	1121	18.7	1.5	2.5		
Cotw/SCROW	405	0.26	0.25	0.20	0.24	0.25	0.25	0.25	0.25	0.24	0.23	0.24	1121	18.7	1.5	2.5		
SaltCW	405	0.36	0.35	0.28	0.33	0.35	0.36	0.35	0.34	0.33	0.32	0.33	1121	26.4	2.1	3.5		
SaltC/ROW	405	0.36	0.35	0.28	0.33	0.35	0.36	0.35	0.34	0.33	0.32	0.33	1121	26.4	2.1	3.5		
RusOliveW	405	0.26	0.25	0.20	0.24	0.25	0.25	0.25	0.25	0.24	0.23	0.24	1121	18.7	1.5	2.5		
Willow	405	0.26	0.25	0.20	0.24	0.25	0.25	0.25	0.25	0.24	0.23	0.24	1121	18.7	1.5	2.5		
Shrubland	405	0.26	0.25	0.20	0.24	0.25	0.25	0.25	0.25	0.24	0.23	0.24	1121	18.7	1.5	2.5		
Grassland	315	0.25	0.24	0.19	0.22	0.23	0.24	0.23	0.23	0.22	0.21	0.22	1020	20.8	1.5	2.4		
Wetland	101	0.41	0.40	0.32	0.37	0.39	0.40	0.39	0.39	0.37	0.36	0.37	1231	49.4	2.4	4.0		
SparceVeg	315	0.25	0.24	0.19	0.22	0.23	0.24	0.23	0.23	0.22	0.21	0.22	1020	20.8	1.5	2.4		
Cottonwood	405	0.26	0.25	0.20	0.24	0.25	0.25	0.25	0.25	0.24	0.23	0.24	1121	18.7	1.5	2.5		
DTamarisk	405	0.36	0.35	0.28	0.33	0.35	0.36	0.35	0.34	0.33	0.32	0.33	1121	26.4	2.1	3.5		
STamarisk	405	0.36	0.35	0.28	0.33	0.35	0.36	0.35	0.34	0.33	0.32	0.33	1121	26.4	2.1	3.5		
GWillow	405	0.26	0.25	0.20	0.24	0.25	0.25	0.25	0.25	0.24	0.23	0.24	1121	18.7	1.5	2.5		
Acacia/Bus	405	0.26	0.25	0.20	0.24	0.25	0.25	0.25	0.25	0.24	0.23	0.24	1121	18.7	1.5	2.5		
Wetland2	101	0.41	0.40	0.32	0.37	0.39	0.40	0.39	0.39	0.37	0.36	0.37	1231	49.4	2.4	4.0		
Grasses	315	0.25	0.24	0.19	0.22	0.23	0.24	0.23	0.23	0.22	0.21	0.22	1020	20.8	1.5	2.4		
CWillow	405	0.26	0.25	0.20	0.24	0.25	0.25	0.25	0.25	0.24	0.23	0.24	1121	18.7	1.5	2.5		
RussOlive	405	0.26	0.25	0.20	0.24	0.25	0.25	0.25	0.25	0.24	0.23	0.24	1121	18.7	1.5	2.5		
ElmTree	405	0.26	0.25	0.20	0.24	0.25	0.25	0.25	0.25	0.24	0.23	0.24	1121	18.7	1.5	2.5		
Crops	429	0.25	0.23	0.18	0.20	0.21	0.20	0.19	0.18	0.17	0.16	0.16	1120	25.2	1.5	2.6		
NEXRAD HRS AVAIL		24	24	24	24	NDFD	NDFD	NDFD	NCEP	NCEP	NCEP	NCEP						
TOTAL RAIN		0.00	0.15	0.04	0.00	0.00	0.00	0.00	0.00	0.00	0.00	0.00						
EFFECTIVE RAIN		0.00	0.15	0.04	0.00	0.00	0.00	0.00	0.00	0.00	0.00	0.00						
NEXRAD MONTHLY TOTAL RAIN:																		
JANUARY		0.44																
FEBRUARY		0.34																
MARCH		1.67																
APRIL		4.05																
MAY		2.91																
JUNE		1.57																
JULY		3.93																
AUGUST		3.73																
SEPTEMBER		1.94																

(2336x1517)

Tuesday October 16, 2007

1/1

Figure 8: ET Chart



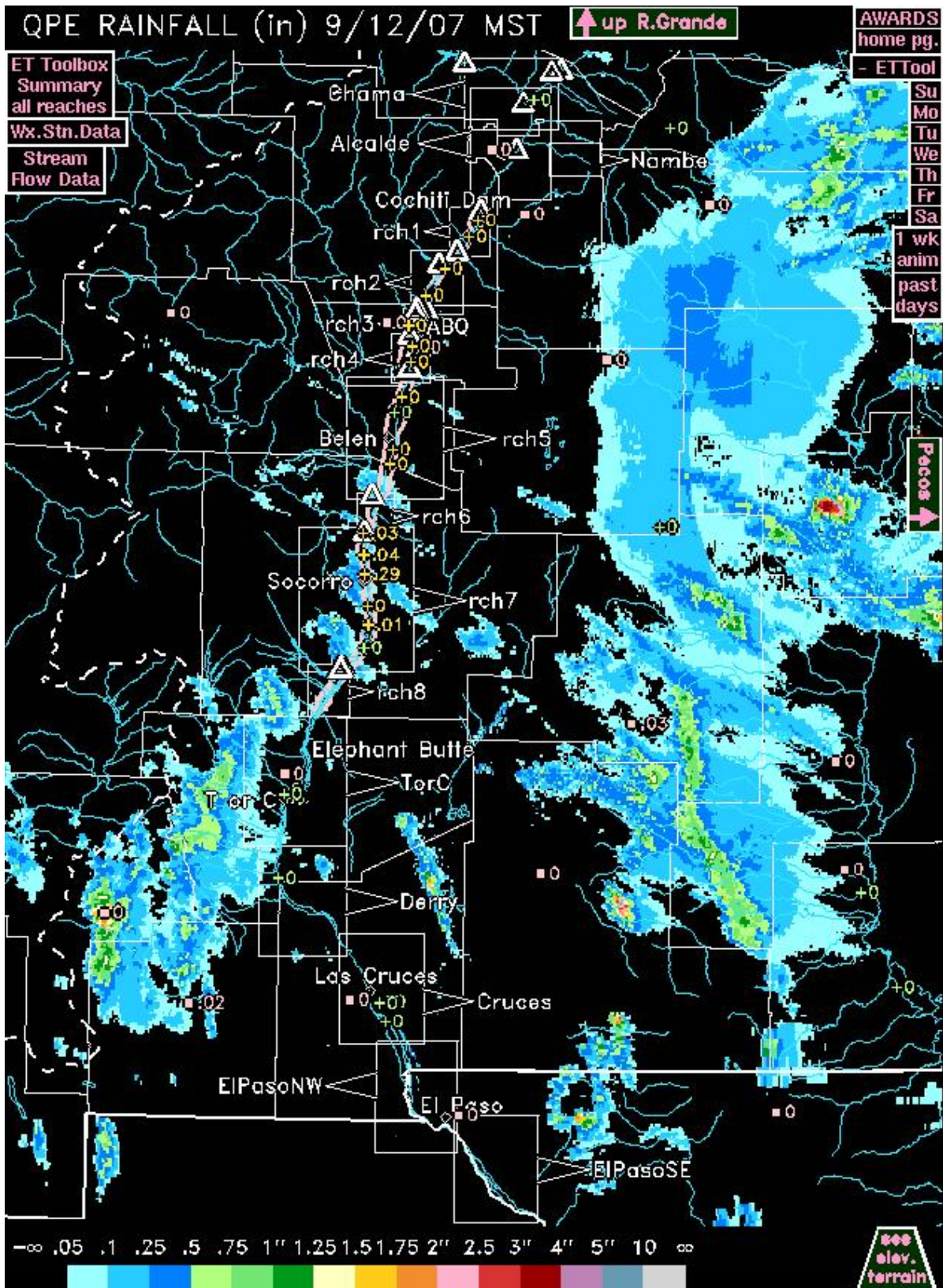

Figure 9: Rio Grande Map - ET Toolbox

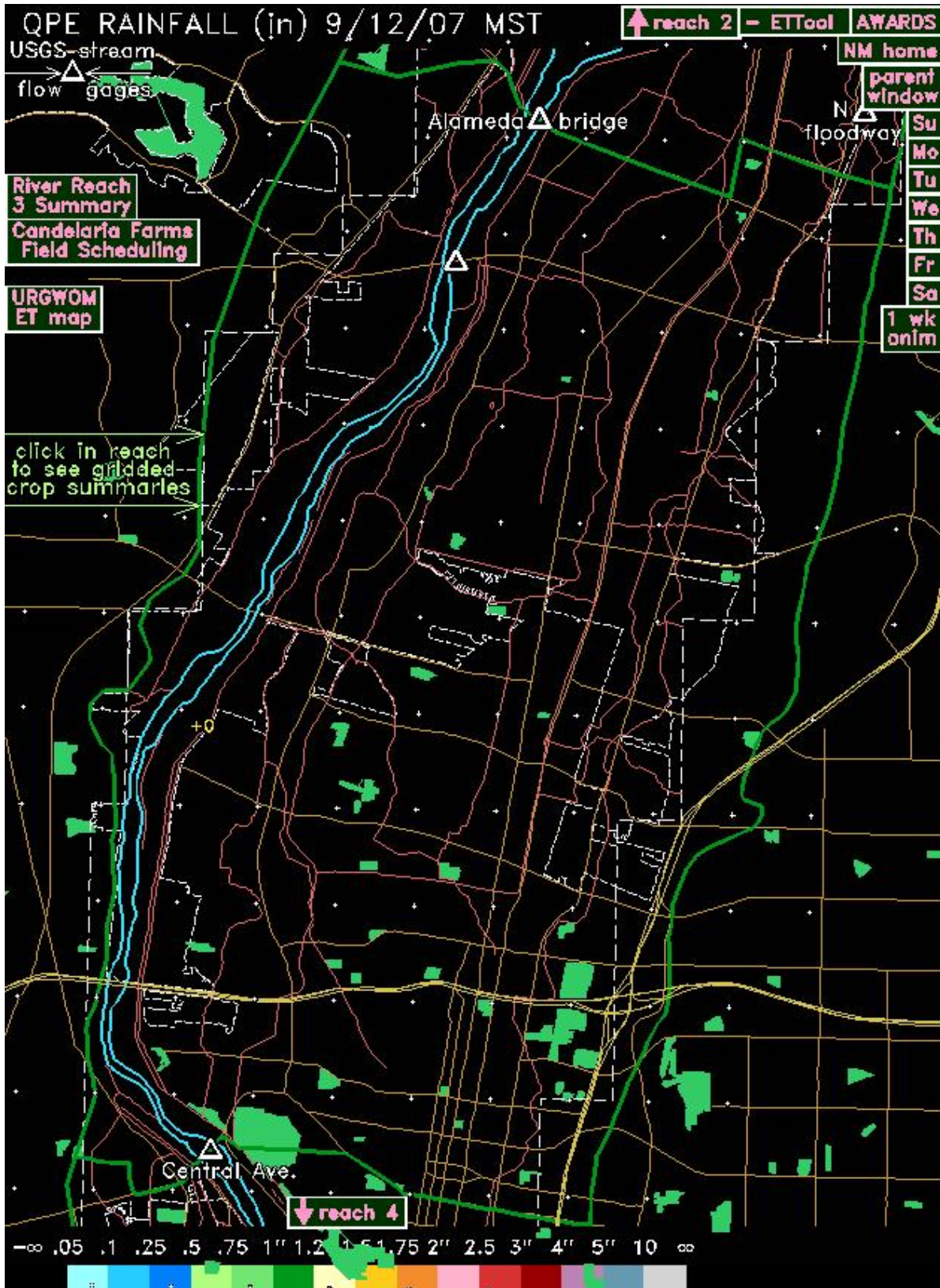

Figure 10: River Reach 3 - ET Toolbox

Printed by Al Brower

Dec 27, 07 12:02		REA3.etcrop.2336.1517.txt										Page 1/1			
ET TOOLBOX CELL DETAILS															
URGWOM Reach 3 (Alameda to Central Ave. gage)															
Vegetation classification: IKONOS 2000 + USU 2001 (Except open water)															
Cell number: 2336x1517															
Weather station: Candelaria Farms Station															
Note: Final values are subject to change with updated weather data, which could occur multiple times during periods of local weather station data feed instability.															
Last 7 and 7 Forecast Day's URGWOM Water Use in Acre-Feet (CFS)															
Consumptive Use		2007							Forecast						
Crop	Acres	Sep. 6	Sep. 7	Sep. 8	Sep. 9	Sep. 10	Sep. 11	Sep. 12	Sep. 13	Sep. 14	Sep. 15	Sep. 16	Sep. 17	Sep. 18	Sep. 19
Alfalfa	17.3	0.2	0.5	0.5	0.5	0.5	0.4	0.5	0.5	0.5	0.5	0.5	0.5	0.5	0.5
Corn	13.0	0.1	0.3	0.3	0.3	0.2	0.2	0.2	0.2	0.2	0.2	0.2	0.2	0.2	0.2
Pasture	57.7	0.3	1.1	1.1	1.1	1.1	0.9	1.1	1.1	1.1	1.1	1.1	1.1	1.1	1.1
Chili	6.2	0.0	0.1	0.1	0.1	0.1	0.1	0.1	0.1	0.1	0.1	0.1	0.1	0.1	0.1
Vegetables	8.7	0.1	0.2	0.2	0.2	0.2	0.1	0.2	0.2	0.2	0.1	0.1	0.1	0.1	0.1
Orchard	5.7	0.0	0.2	0.2	0.2	0.2	0.1	0.1	0.2	0.2	0.2	0.2	0.1	0.1	0.1
Nursery St	0.3	0.0	0.0	0.0	0.0	0.0	0.0	0.0	0.0	0.0	0.0	0.0	0.0	0.0	0.0
Vineyard	1.3	0.0	0.0	0.0	0.0	0.0	0.0	0.0	0.0	0.0	0.0	0.0	0.0	0.0	0.0
Turf Grass	9.5	0.1	0.2	0.2	0.2	0.2	0.2	0.2	0.2	0.2	0.2	0.2	0.2	0.2	0.2
CotwBosque	14.1	0.1	0.3	0.3	0.3	0.3	0.2	0.3	0.3	0.3	0.3	0.3	0.3	0.3	0.3
Cotw/ROW	4.0	0.0	0.1	0.1	0.1	0.1	0.1	0.1	0.1	0.1	0.1	0.1	0.1	0.1	0.1
SaltCW	0.8	0.0	0.0	0.0	0.0	0.0	0.0	0.0	0.0	0.0	0.0	0.0	0.0	0.0	0.0
RusOliveW	2.0	0.0	0.0	0.0	0.0	0.0	0.0	0.0	0.0	0.0	0.0	0.0	0.0	0.0	0.0
Shrubland	14.9	0.1	0.3	0.3	0.3	0.3	0.2	0.3	0.3	0.3	0.3	0.3	0.3	0.3	0.3
Grassland	13.9	0.1	0.3	0.3	0.3	0.3	0.2	0.3	0.3	0.3	0.3	0.3	0.3	0.3	0.2
SparceVeg	0.0	0.0	0.0	0.0	0.0	0.0	0.0	0.0	0.0	0.0	0.0	0.0	0.0	0.0	0.0
Totals	169.5	1.1	3.6	3.6	3.7	3.6	2.9	3.3	3.5	3.5	3.4	3.4	3.3	3.2	3.3
		( 0.6)	( 1.8)	( 1.8)	( 1.9)	( 1.8)	( 1.4)	( 1.7)	( 1.8)	( 1.8)	( 1.7)	( 1.7)	( 1.7)	( 1.6)	( 1.7)
Agricul.	110.2	0.7	2.4	2.4	2.5	2.4	1.9	2.2	2.3	2.3	2.2	2.2	2.2	2.1	2.1
		( 0.4)	( 1.2)	( 1.2)	( 1.2)	( 1.2)	( 0.9)	( 1.1)	( 1.2)	( 1.2)	( 1.1)	( 1.1)	( 1.1)	( 1.0)	( 1.1)
Riparian	49.8	0.3	1.0	1.0	1.1	1.0	0.8	1.0	1.0	1.0	1.0	1.0	1.0	0.9	1.0
		( 0.2)	( 0.5)	( 0.5)	( 0.5)	( 0.4)	( 0.5)	( 0.5)	( 0.5)	( 0.5)	( 0.5)	( 0.5)	( 0.5)	( 0.5)	( 0.5)
Open Water	0.0	0.0	0.0	0.0	0.0	0.0	0.0	0.0	0.0	0.0	0.0	0.0	0.0	0.0	0.0
		( 0.0)	( 0.0)	( 0.0)	( 0.0)	( 0.0)	( 0.0)	( 0.0)	( 0.0)	( 0.0)	( 0.0)	( 0.0)	( 0.0)	( 0.0)	( 0.0)
Urban	9.5	0.1	0.2	0.2	0.2	0.2	0.2	0.2	0.2	0.2	0.2	0.2	0.2	0.2	0.2
		( 0.0)	( 0.1)	( 0.1)	( 0.1)	( 0.1)	( 0.1)	( 0.1)	( 0.1)	( 0.1)	( 0.1)	( 0.1)	( 0.1)	( 0.1)	( 0.1)
NEXRAD															
Rainfall Est.		0.0	0.0	0.1	0.0	2.1	0.6	0.0	0.0	0.0	0.0	0.0	0.0	0.0	0.0
		( 0.0)	( 0.0)	( 0.1)	( 0.0)	( 1.1)	( 0.3)	( 0.0)	( 0.0)	( 0.0)	( 0.0)	( 0.0)	( 0.0)	( 0.0)	( 0.0)
URGWOM															
Water Use		1.1	3.6	3.5	3.7	1.4	2.3	3.3	3.5	3.5	3.4	3.4	3.3	3.2	3.3
		( 0.6)	( 1.8)	( 1.7)	( 1.9)	( 0.7)	( 1.2)	( 1.7)	( 1.8)	( 1.8)	( 1.7)	( 1.7)	( 1.7)	( 1.6)	( 1.7)

Tuesday March 25, 2008

1/1

Figure 11: Grid Cell Detail



ET Summary Products (To-Date)  
Reach 3

OPTIONS:

Table

Plot of last 14 and 7 forecast days – Total, Agriculture, Riparian, Open Water, and Urban – also Rain

Plot of last 14 and 7 forecast days – Total and Running Averages – also Stream gage

Click on red for Daily Agricultural ET Rates – Total 9222 Acres – 3221 from the 2000 IKONOS Satellite Imagery and 1 from the 2002 Utah State University (USU) Aerial Study:

Crop	Acres	Crop	Acres	Crop	Acres	Crop	Acres
Alfalfa	472	Chili	213	Corn	357	Crops (USU)	1
Nursery St	11	Orchard	134	Pasture	1720	Vegetables	287
Vineyard	26	Wheat	1	-----	-----	-----	-----

Click on red for Daily Riparian ET Rates – Total 3759 Acres – 3380 from the 2000 IKONOS Satellite Imagery and 379 from the 2002 Utah State University (USU) Aerial Study:

Crop	Acres	Crop	Acres	Crop	Acres	Crop	Acres
Cottonwood (USU)	305	Cottonwood Bosque (w/ inclusions of Willow)	725	Cottonwood/Russian Olive/Willow mix	264	Coyote Willow (USU)	7
Dense Tamarisk (USU)	45	Gooding Willow (USU)	1	Grasses (USU)	7	Grassland	713
Russian Olive woodland (w/ inclusions of Willow)	81	Russian Olives (USU)	10	Sparse Tamarisk (USU)	2	Salt Cedar Woodland (w/ inclusions of Willow)	228
Shrubland	1,339	Sparse Vegetation	28	Wetland	2	Wet Soil/wet land (USU)	2
Willow	0	-----	-----	-----	-----	-----	-----

Click on red for Daily Open Water Evaporation Rates – Variable Acres:

Crop	Acres	Crop	Acres	Crop	Acres	Crop	Acres
Open Water (FLO-2D)	Variable	Wet Sands	Variable	-----	-----	-----	-----

Click on red for Daily Urban ET Rates – Total 236 Acres from the 2000 IKONOS Satellite Imagery:

Crop	Acres	Crop	Acres	Crop	Acres	Crop	Acres
Turf Grass	236	-----	-----	-----	-----	-----	-----

Figure 12: ET Summary Products Menu - Reach 3

ET TOOLBOX REACH SUMMARY

Summary for: URGWOM Reach 3 (Alameda to Central Ave. gage)  
 Vegetation classification: IKONOS 2000 + USU 2001 (Except open water)  
 ET TOOLBOX classes (ag. + rip. + open water + urb.): 7918.4 acres

(Daily URGWOM Water Use = Daily Consumptive Use Total - Rain)

Note: Final values are subject to change with updated weather data, which could occur multiple times during periods of local weather station data feed instability.

Month	Day	2007			Daily Consumptive Use			Daily URGWOM Water Use			Daily URGWOM Water Use			Daily Flow Difference			
		F	M	F	Total	Agriculture	Riparian	Open Water	Total	5-Day Avg.	10-Day Avg.	Jan. 1, 2007	AC-FT	Total	5-Day Avg.	10-Day Avg.	CFS
Sep.	19	F			31.1			8.8	2.3	0.0	0.0	81.4	76.2	None	None	None	None
Sep.	18	F			77.9			8.8	2.3	0.0	0.0	82.5	76.2	None	None	None	None
Sep.	17	F			81.2			36.8	2.3	0.0	0.0	77.9	76.9	None	None	None	None
Sep.	16	F			83.5			38.3	2.3	0.0	0.0	84.0	76.9	None	None	None	None
Sep.	15	F			84.0			39.9	2.3	0.0	0.0	83.5	77.3	None	None	None	None
Sep.	14	F			86.1			40.1	2.3	0.0	0.0	86.1	71.7	None	None	None	None
Sep.	13	F			85.2			40.5	2.4	0.0	0.0	86.1	67.3	None	None	None	None
Sep.	12	F			69.0			33.4	2.3	0.0	0.0	69.7	53.8	None	None	None	None
Sep.	11	F			65.0			27.6	2.3	0.0	0.0	65.0	55.4	None	None	None	None
Sep.	10	F			86.4			32.2	1.9	11.3	43.3	70.6	45.8	2	None	None	None
Sep.	9	F			90.0			40.4	2.3	11.3	43.3	64.5	45.8	74	None	None	None
Sep.	8	F			87.2			41.9	2.4	7.4	49.7	64.1	42.3	33	None	None	None
Sep.	7	F			87.6			40.5	2.3	3.1	43.6	57.7	38.1	3	None	None	None
Sep.	6	F			87.3			40.5	2.3	2.0	42.5	49.4	25.3	None	None	None	None
Sep.	5	F			87.3			5.6	1.7	13.0	20.3	21.2	None	None	None	None	None
Sep.	4	F			56.9			26.1	1.5	6.4	32.5	20.6	None	None	None	None	None
Sep.	3	F			53.1			24.3	1.4	10.2	34.5	20.6	None	None	None	None	None
Sep.	2	F			45.9			21.1	1.2	6.7	27.8	18.6	20.6	None	None	None	None
Sep.	1	F			18.9			21.1	1.2	8.7	29.8	1.2	21.0	6	None	None	None
Aug.	31	F			39.3			17.9	1.0	3.2	21.1	2.2	17.8	37	None	None	None
Aug.	30	F			39.3			16.2	1.0	3.2	19.4	15.2	7.3	48	None	None	None
Aug.	29	F			39.3			17.9	1.0	3.2	21.1	15.2	7.3	31	None	None	None
Aug.	28	F			39.3			17.9	1.0	3.2	21.1	15.2	7.3	48	None	None	None
Aug.	27	F			39.3			17.9	1.0	3.2	21.1	15.2	7.3	48	None	None	None
Aug.	26	F			48.9			25.9	1.4	12.5	38.4	22.7	7.4	62	None	None	None
Aug.	25	F			51.2			25.9	1.4	12.5	38.4	22.7	7.4	62	None	None	None
Aug.	24	F			49.3			22.6	1.2	21.5	44.1	14.7	9	25	None	None	None
Aug.	23	F			68.0			28.6	1.7	0.9	29.5	40.7	18.6	64	None	None	None
Aug.	22	F			62.6			27.8	1.6	0.3	28.1	43.8	20.6	64	None	None	None
Aug.	21	F			106.6			47.3	0.0	0.0	47.3	67.2	55.8	92	None	None	None
Aug.	20	F			57.4			26.1	2.7	0.0	26.1	64.2	59.5	106	None	None	None
Aug.	19	F			57.4			26.1	2.7	0.0	26.1	64.2	59.5	106	None	None	None
Aug.	18	F			54.8			24.4	1.4	0.0	24.4	55.3	55.3	88	None	None	None
Aug.	17	F			52.2			24.4	1.4	0.4	25.8	55.3	57.2	83	None	None	None
Aug.	16	F			59.8			26.2	1.5	0.0	26.2	54.5	55.7	75	None	None	None
Aug.	15	F			59.8			26.2	1.5	0.0	26.2	54.9	55.4	75	None	None	None
Aug.	14	F			59.8			26.2	1.5	0.0	26.2	55.9	56.1	59	None	None	None
Jan.	6	F			1.4			0.0	0.0	3.1	-1.7	0.8	None	None	None	None	None
Jan.	5	F			1.9			0.0	0.0	2.0	1.9	0.8	None	None	None	None	None
Jan.	4	F			1.9			0.0	0.0	0.0	1.9	None	None	None	None	None	None
Jan.	3	F			1.9			0.0	0.0	0.0	1.9	None	None	None	None	None	None
Jan.	2	F			1.4			0.0	0.0	0.0	1.4	None	None	None	None	None	None
Jan.	1	F			1.9			0.0	0.0	0.0	1.9	None	None	None	None	None	None

Irrigated Ag acreage = 3223.9  
 Riparian acreage = 3750.4  
 Open Water acreage = 698.6 (daily variable)  
 Urban acreage = 235.5  
 Total (ag. + rip. + open water + urb.) = 7918.4 acres

Fallow acreage = 4239.3  
 Idle acreage = 0.0

Figure 13: Reach 3 Summary

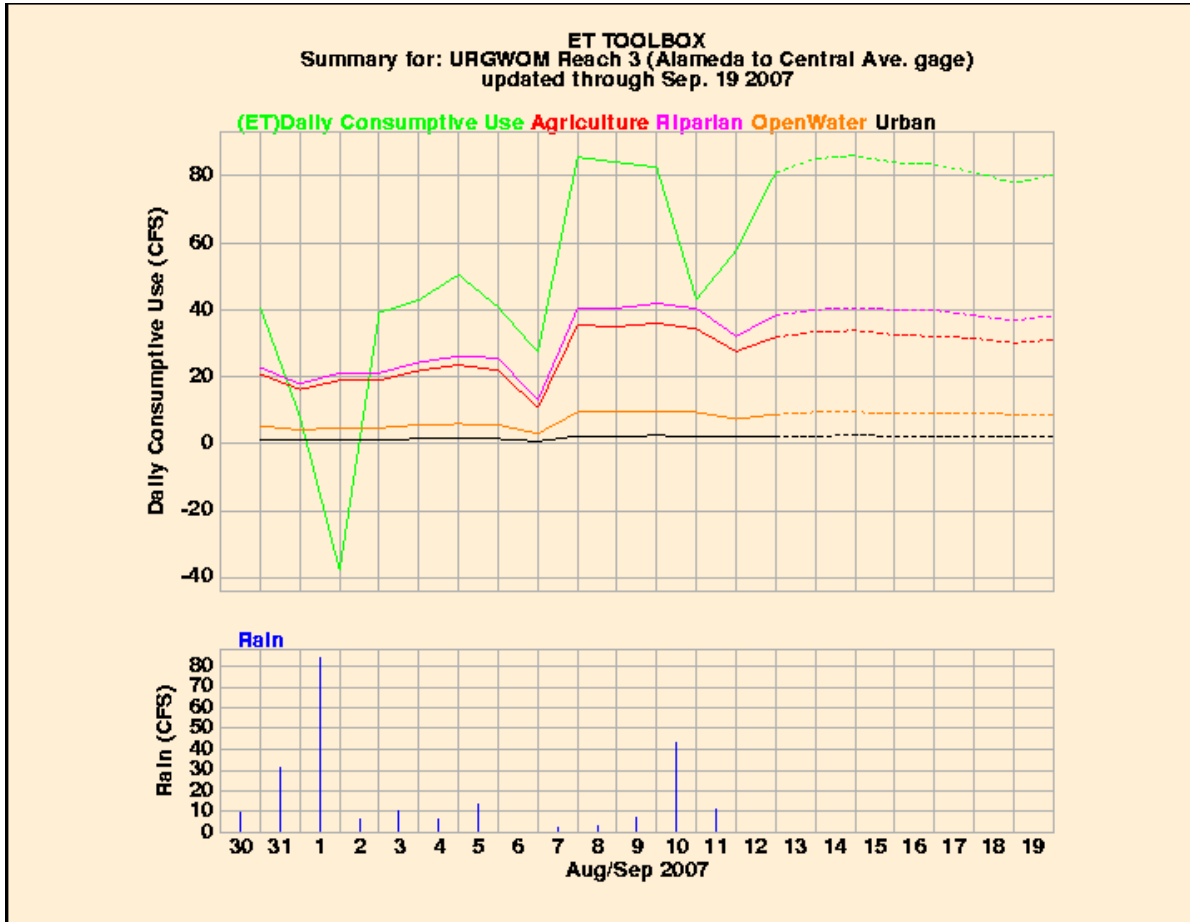

Figure 14: Reach 3 Daily Consumptive Use And Rainfall

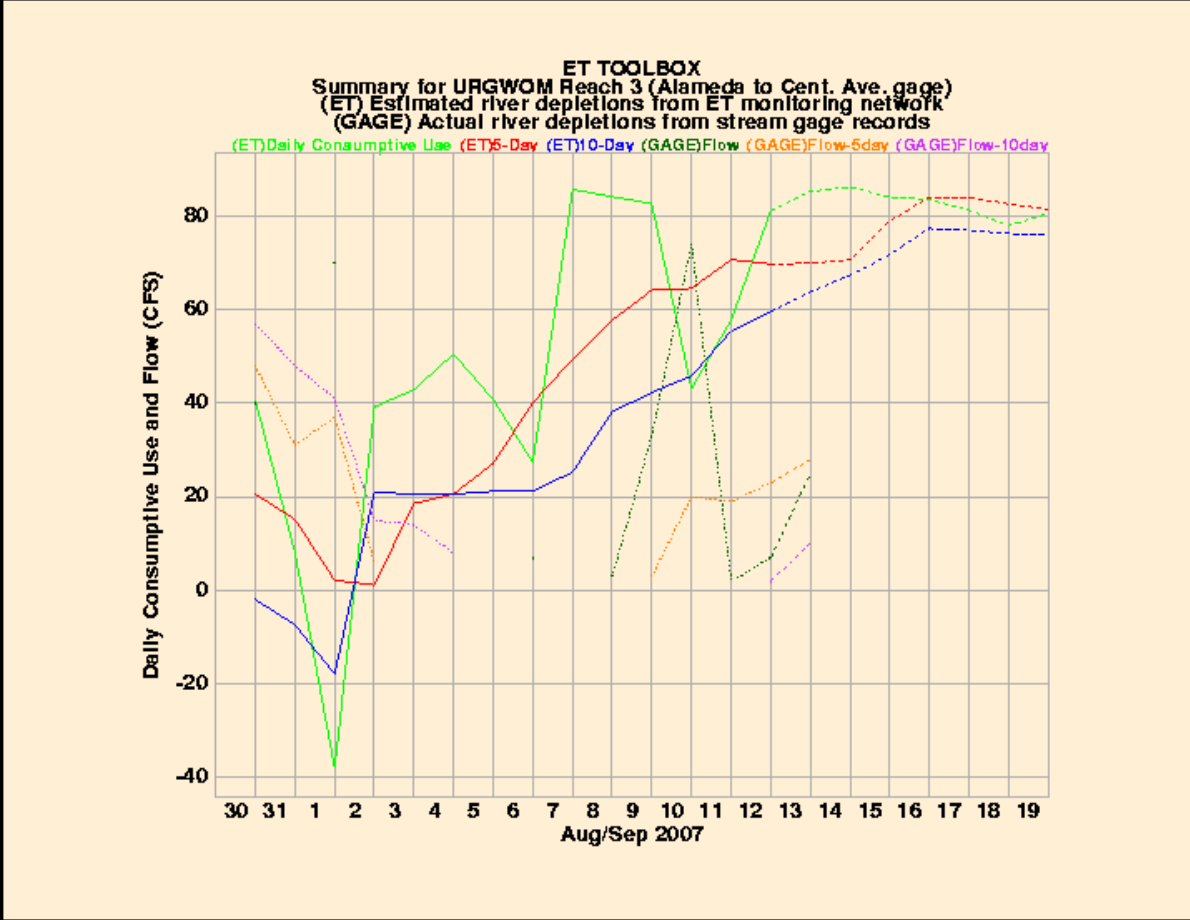

Figure 15: Reach 3 Daily Consumptive Use With Stream Flow And Running Averages

Printed by Al Brower

Mar 25, 08 12:16		REA3.Alfalfa.txt					Page 1/1	
URGWOM Reach 3 (Alameda to Central Ave. gage)								
Daily ET Rates for Alfalfa				Today is: Sep. 13, 2007				
Vegetation Classification: IKONOS 2000 + USU 2001								
Class Number: 101								
Number of 1x1 km cells = 86 Number with Alfalfa = 84								
Weather station(s) used:								
1) CFMN Candelaria Farms Station								
Reference (Ref.) ET is averaged from above weather station(s)								
Crop Coef. is averaged from above weather station(s)								
Crop ET = Ref. ET x Crop Coef.								
Total Water Use = Sum of cell water use								
NEXRAD Rain = Sum of (cell rain x cell crop acres/12)								
URGWOM Water Use = Total Water Use - NEXRAD Rain								
-----								
Acres: 472		Plant Date: Jan. 1		Termination Date: Oct. 20				
Month	Day	Ref. ET (IN)	Crop Coef.	Crop ET (IN)	Total Water Use (AC-FT)	NEXRAD Rain (AC-FT)	URGWOM Water Use (AC-FT)	
Jan.	1	0.08	0.41	0.03	1.17	0.00	1.17	
Jan.	2	0.06	0.41	0.02	0.78	0.00	0.78	
Jan.	3	0.07	0.41	0.03	1.17	0.00	1.17	
Jan.	4	0.07	0.41	0.03	1.17	0.00	1.17	
Jan.	5	0.09	0.41	0.04	1.55	1.43	0.12	
Jan.	6	0.05	0.41	0.02	0.78	2.05	-1.27	
Aug.	14	0.23	1.16	0.27	10.61	0.00	10.61	
Aug.	15	0.23	1.16	0.27	10.61	0.00	10.61	
Aug.	16	0.23	1.15	0.26	10.26	1.51	8.75	
Aug.	17	0.21	1.15	0.24	9.45	0.00	9.45	
Aug.	18	0.21	1.14	0.24	9.45	0.05	9.40	
Aug.	19	0.22	1.13	0.25	9.85	0.00	9.85	
Aug.	20	0.41	1.13	0.46	18.06	0.00	18.06	
Aug.	21	0.24	1.12	0.27	10.61	0.04	10.57	
Aug.	22	0.26	1.12	0.29	11.39	0.11	11.28	
Aug.	23	0.23	1.11	0.26	9.85	49.10	-39.25	
Aug.	24	0.19	1.10	0.21	8.23	0.34	7.89	
Aug.	25	0.20	1.10	0.22	8.65	0.01	8.64	
Aug.	26	0.22	1.09	0.24	9.45	2.59	6.86	
Aug.	27	0.19	1.08	0.21	8.23	2.67	5.56	
Aug.	28	0.22	1.08	0.24	9.45	1.52	7.93	
Aug.	29	0.22	1.07	0.24	9.45	11.35	-1.90	
Aug.	30	0.20	1.06	0.21	8.23	1.21	7.02	
Aug.	31	0.16	1.06	0.17	6.68	3.73	2.95	
Aug.	Totals	7.21		8.28	325.63	93.46	232.17	
Sep.	1	0.18	1.05	0.19	7.48	10.08	-2.60	
Sep.	2	0.18	1.04	0.19	7.48	0.83	6.65	
Sep.	3	0.21	1.04	0.22	8.65	1.30	7.35	
Sep.	4	0.23	1.03	0.24	9.45	0.79	8.66	
Sep.	5	0.22	1.02	0.22	8.65	1.64	7.01	
Sep.	6	0.11	1.02	0.11	4.36	0.00	4.36	
Sep.	7	0.36	1.01	0.36	14.18	0.24	13.94	
Sep.	8	0.36	1.00	0.36	14.18	0.40	13.78	
Sep.	9	0.37	0.99	0.37	14.54	0.83	13.71	
Sep.	10	0.36	0.99	0.36	14.18	5.22	8.96	
Sep.	11	0.29	0.98	0.28	11.00	1.37	9.63	
Sep.	12	0.34	0.97	0.33	13.03	0.00	13.03	
Sep.	Totals	3.21		3.23	127.18	22.69	104.49	
Total To-Date		49.01		45.01	1766.19	522.71	1243.48	

Tuesday March 25, 2008

1/1

Figure 16: Daily ET Rates



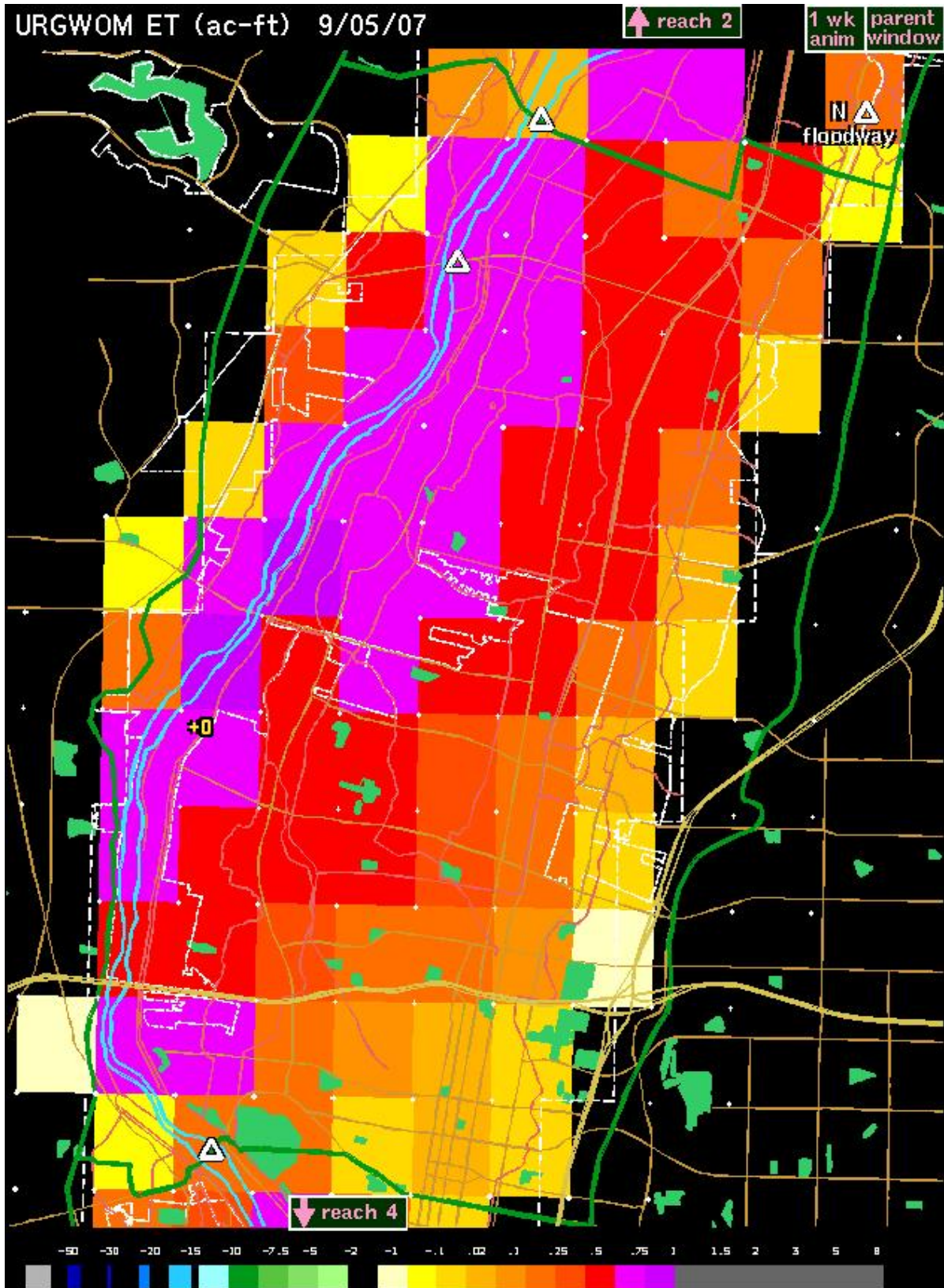

Figure 17: URGWOM ET - Reach 3

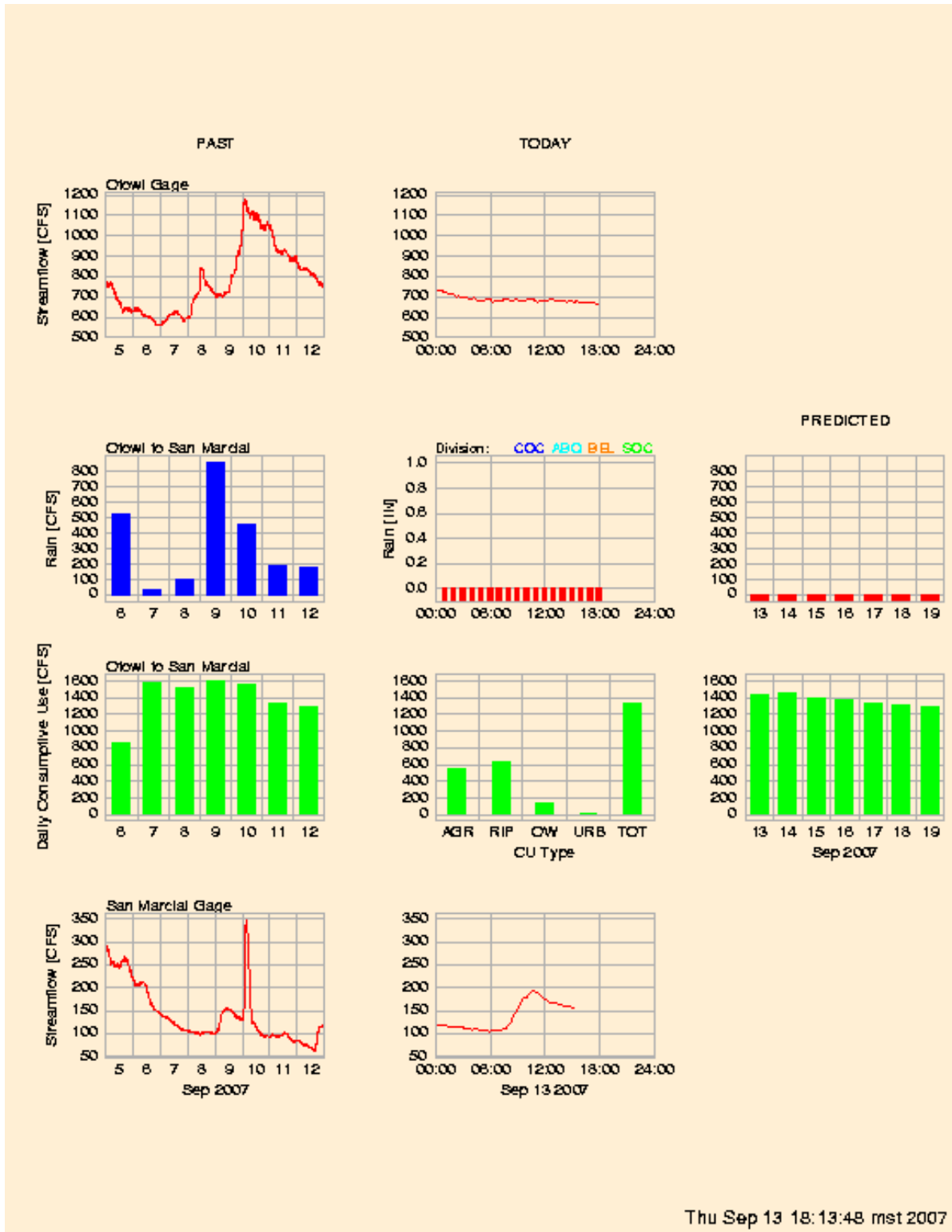

Figure 18: With Present Division Rain Matrix

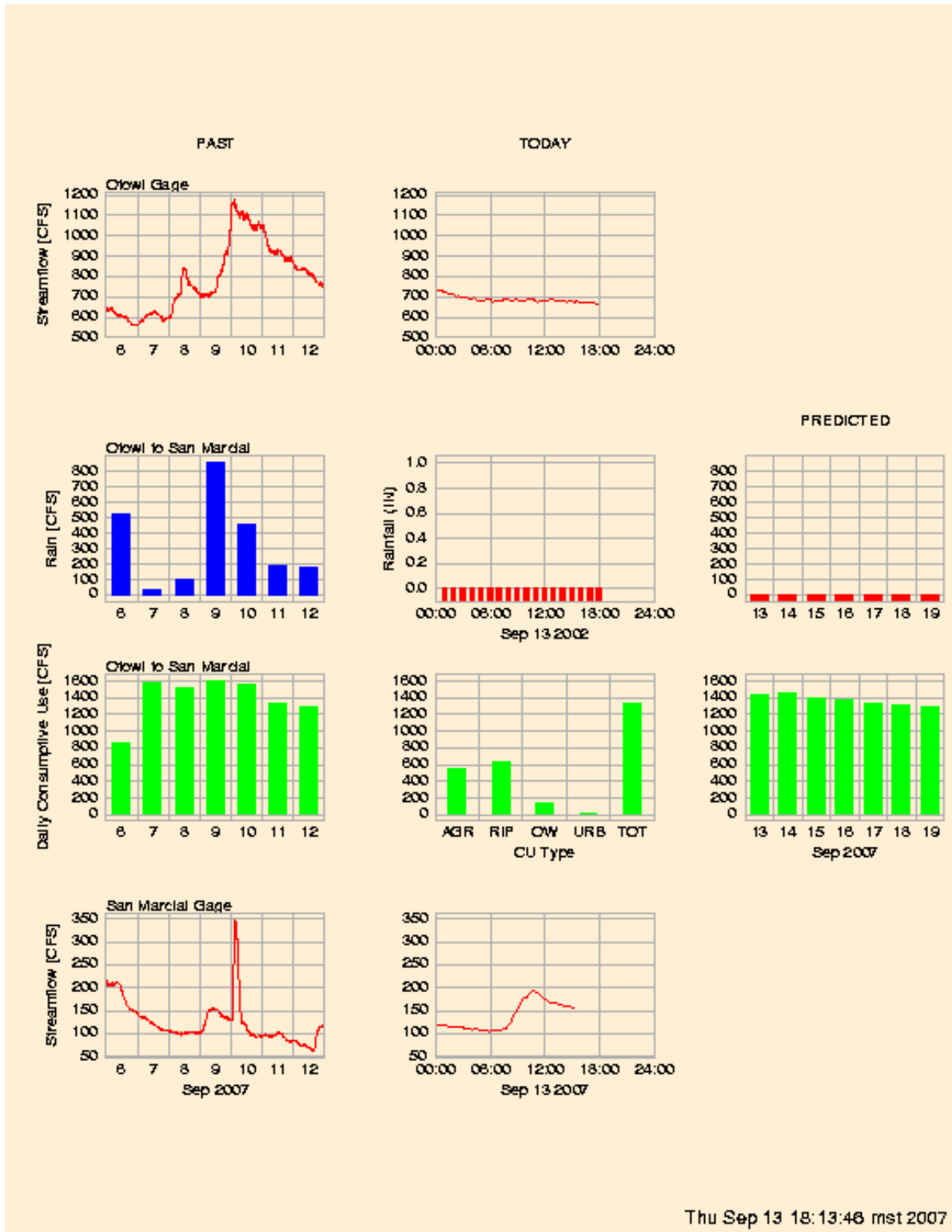

Figure 19: With Present Hourly Rain Matrix



Weather stations data and graphs.

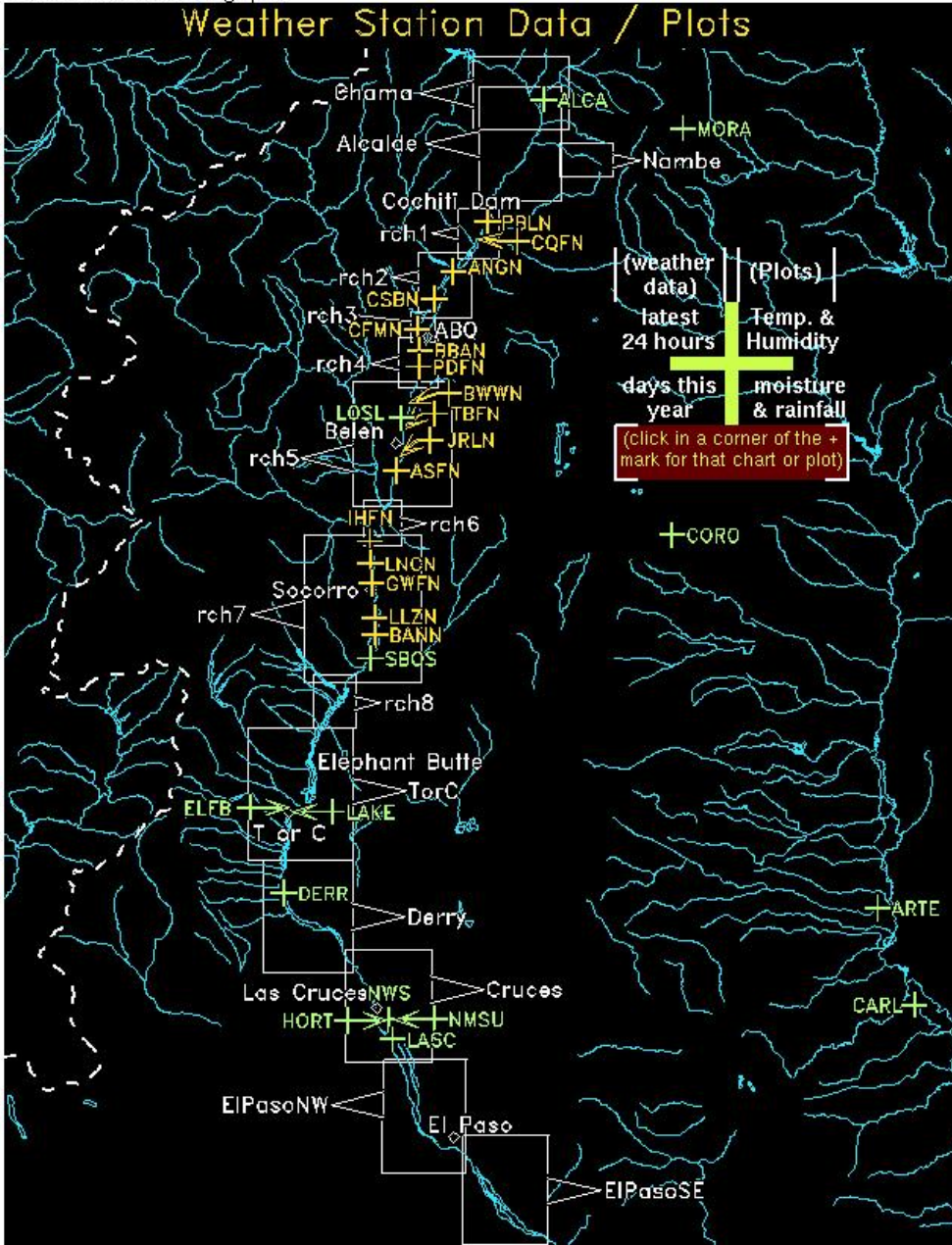

Figure 20: MRGCD Weather Station Network

Printed by Al Brower

Apr 15, 08 9:19		CFMN.hrs.txt							Page 1/1	
Candelaria Farms Station - MRGCD							CFMN			
Hourly Weather Data for Last 24-Hours - 2007										
Month	Day	Time	Temp.	Wind	Wind Dir.	Rel. Hum.	Rain	Solar Radiation	Soil Temp.	Vol. Soil Water Content
		(MST)	(F)	(Mi/Hr)	(Deg)	(%)	(in)	(Mj/Sq m)	(F)	
Sep	07	2AM	54.7	0.0	0	98	0.00	0.00	70.6	30.2
Sep	07	1AM	55.9	0.0	0	97	0.00	0.00	70.7	30.2
Sep	06	12PM	57.5	0.0	0	95	0.00	0.00	70.8	30.3
Sep	06	11PM	60.3	0.0	0	90	0.00	0.00	70.9	30.3
Sep	06	10PM	60.6	0.2	161	90	0.00	0.00	70.9	30.3
Sep	06	9PM	63.7	0.0	161	83	0.00	0.00	70.9	30.3
Sep	06	8PM	67.6	3.0	162	73	0.00	0.00	71.0	30.3
Sep	06	7PM	70.2	4.3	162	66	0.00	0.01	70.9	30.4
Sep	06	6PM	73.6	6.7	159	60	0.00	0.40	70.9	30.4
Sep	06	5PM	75.1	7.0	159	55	0.00	0.52	70.9	30.4
Sep	06	4PM	75.6	7.7	161	54	0.00	0.71	70.8	30.4
Sep	06	3PM	76.0	8.5	159	52	0.00	1.08	70.8	30.4
Sep	06	2PM	74.2	8.1	162	55	0.00	0.74	70.8	30.4
Sep	06	1PM	76.5	8.5	165	51	0.00	1.52	70.7	30.4
Sep	06	12AM	76.3	8.4	164	51	0.00	1.18	70.7	30.5
Sep	06	11AM	77.7	6.6	164	51	0.00	1.70	70.7	30.5
Sep	06	10AM	75.1	7.1	166	53	0.00	1.41	70.7	30.5
Sep	06	9AM	71.6	3.0	164	59	0.00	0.78	70.8	30.5
Sep	06	8AM	64.8	1.6	161	82	0.00	0.34	70.9	30.5
Sep	06	7AM	59.5	0.2	162	99	0.00	0.16	71.1	30.6
Sep	06	6AM	56.6	0.1	162	98	0.00	0.02	71.2	30.6
Sep	06	5AM	56.8	0.0	0	98	0.00	0.00	71.3	30.6
Sep	06	4AM	57.5	0.0	0	97	0.00	0.00	71.5	30.6
Sep	06	3AM	58.2	0.0	162	96	0.00	0.00	71.6	30.7

Tuesday April 15, 2008

1/1

Figure 21: MRGCD Hourly Weather Data

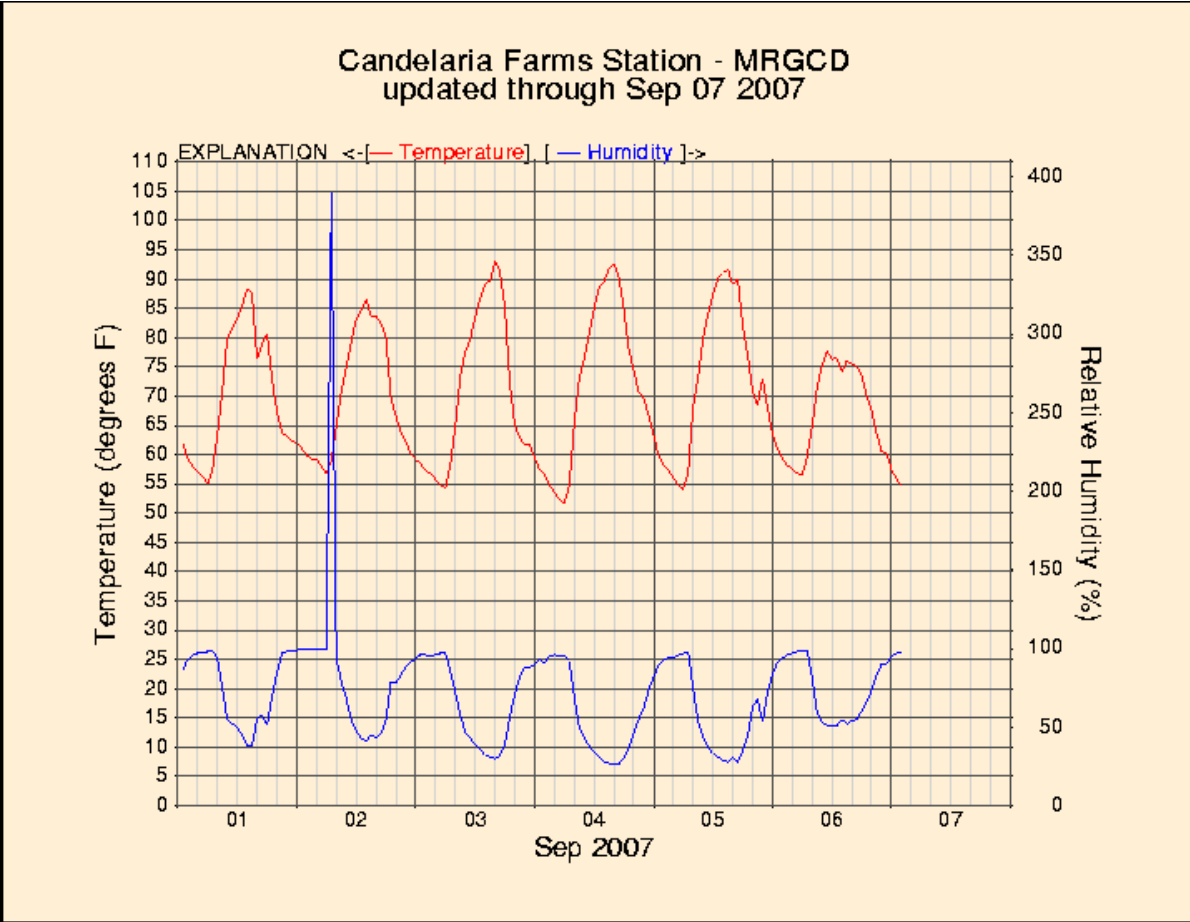

Figure 22: MRGCD Temperature-Humidity Plot

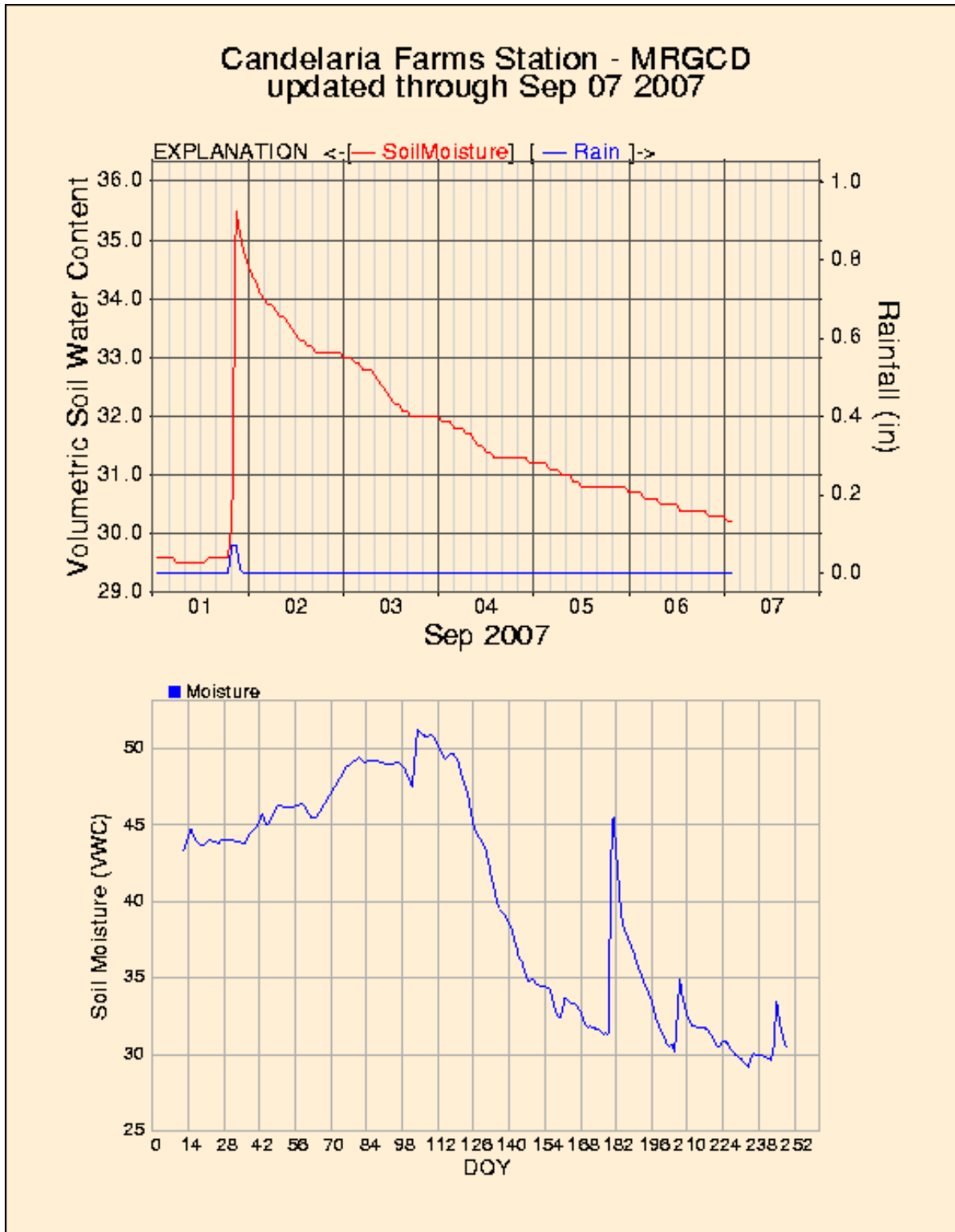

Figure 23: MRGCD Volumetric Soil Water Content Plot

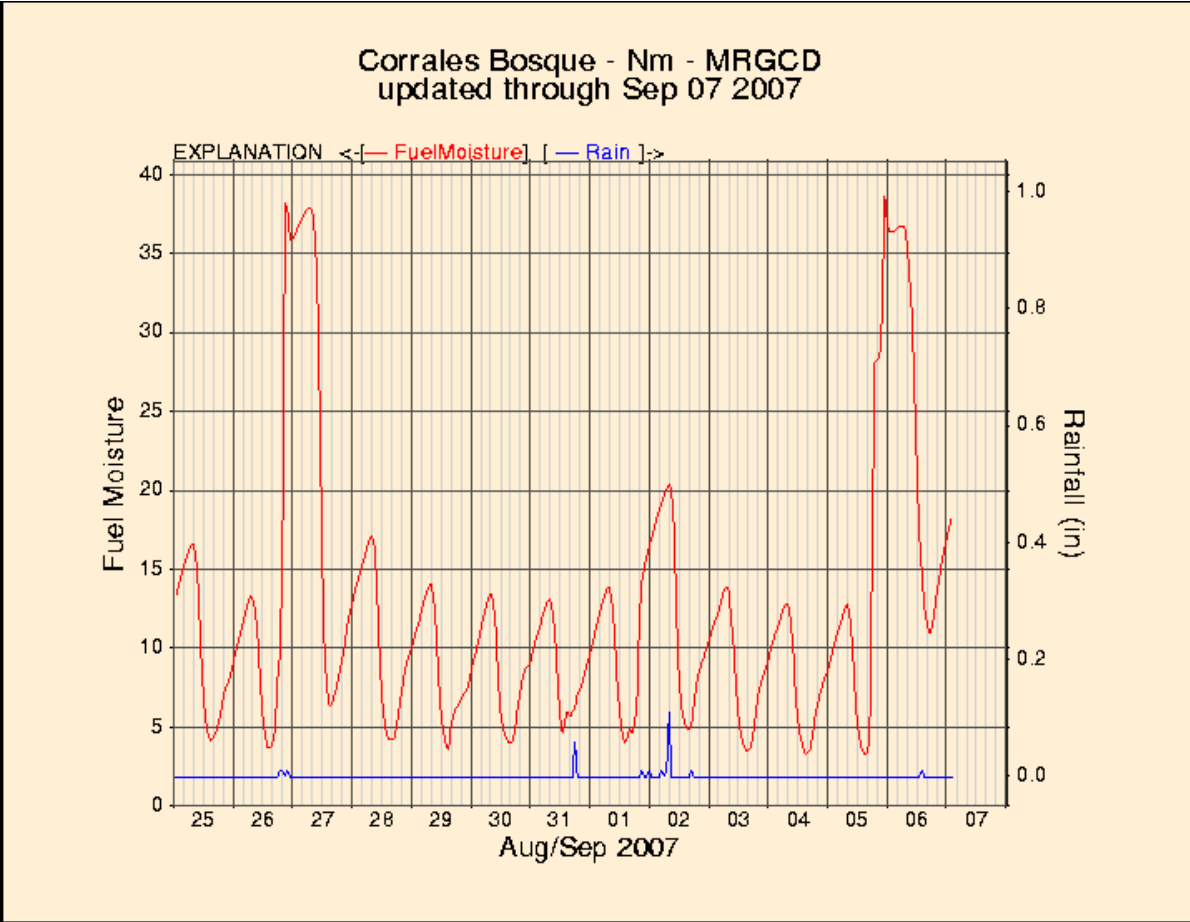

Figure 24: MRGCD Fuel Moisture Plot



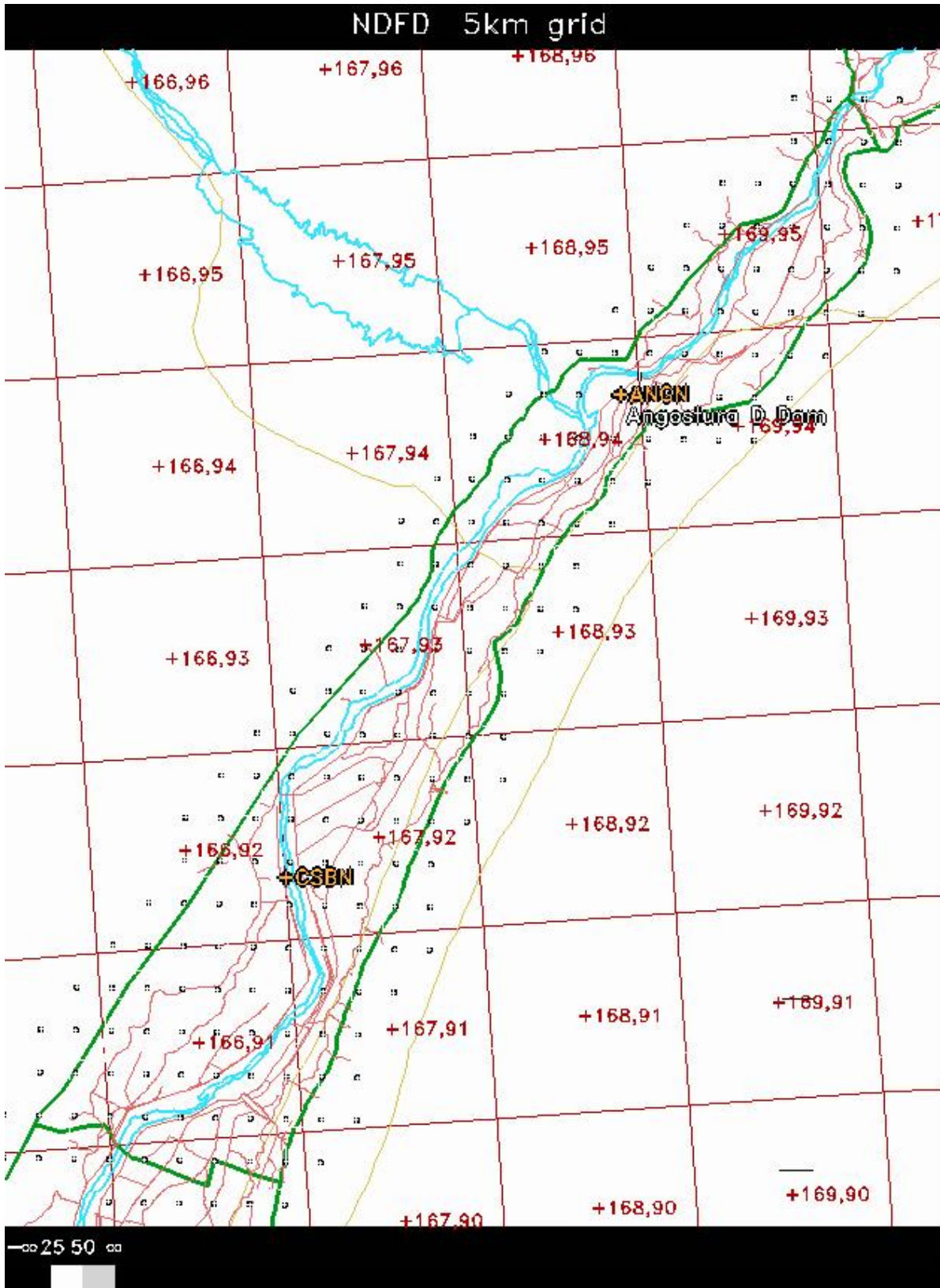

Figure 25: 5-km NDFD Grid For Reach 2

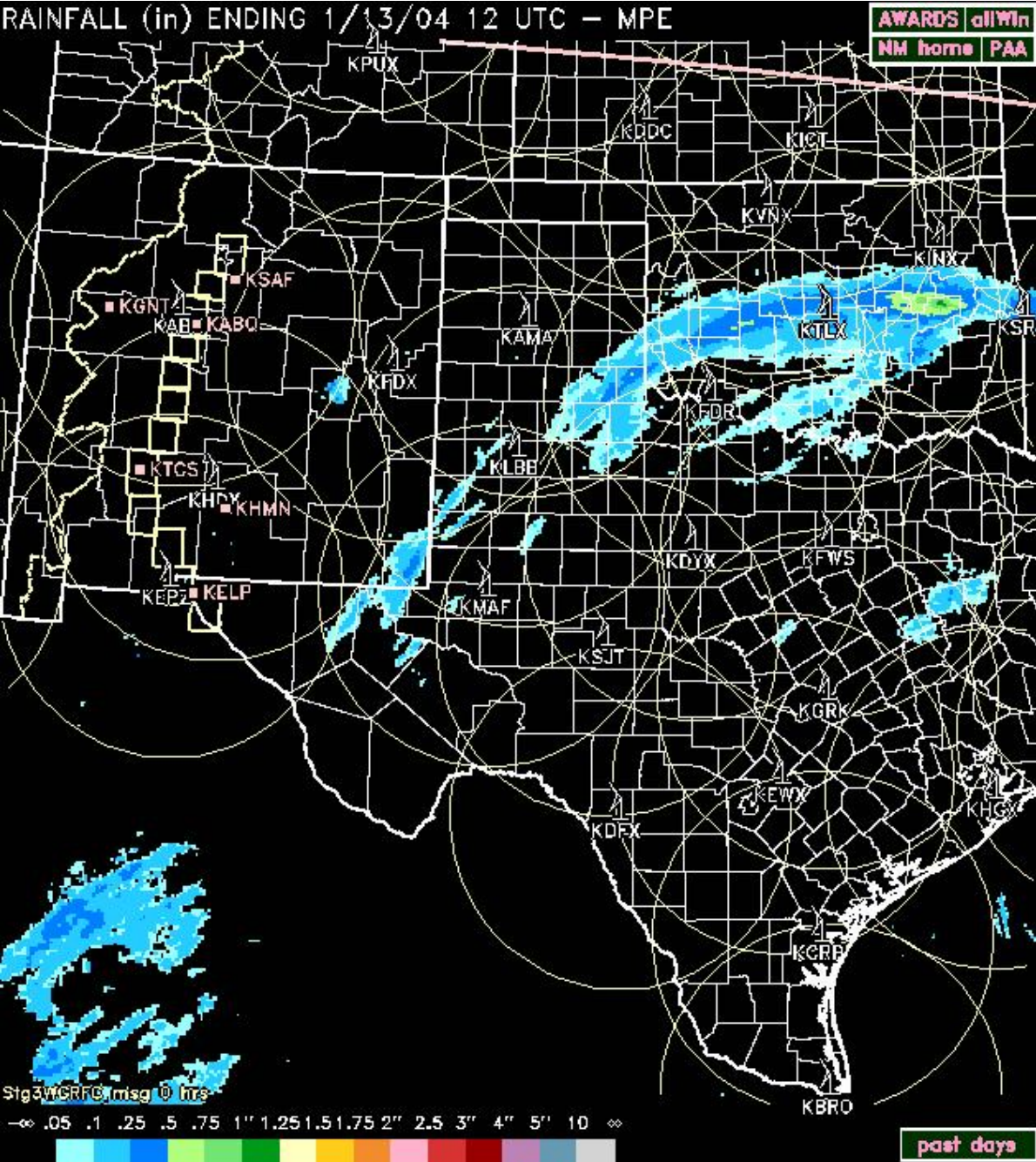

Figure 26: New Mexico, Texas, and Oklahoma Radar Coverage

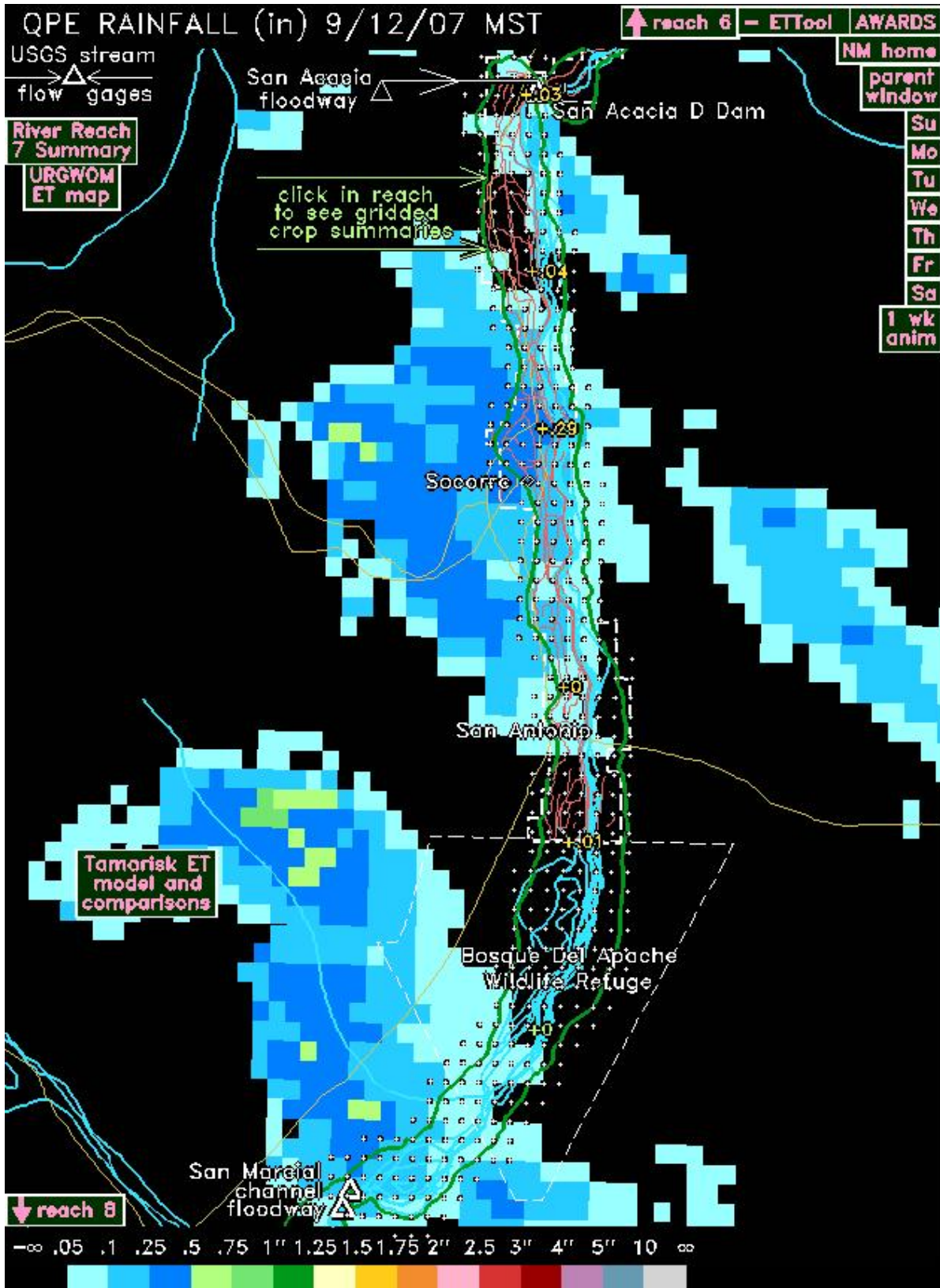

Figure 27: River Reach 7 - ET Toolbox

Jan 31, 02 8:13	Penmanequation.txt	Page 2/2
	<pre> eto = ((delta/(delta+gamma))*rn) + 2 ((gamma/(delta+gamma))*windf*vpdiff) c Find reference et (mm/day) eto = (eto/hl)*10. c Find reference et (in/day) Eto = eto*.03937 return end </pre>	
Jan 31, 02 8:13	Penmanequation.txt	Page 1/2
	<pre> subroutine etpbytes c Penman's equation for reference et (ETr), referenced to grass c This is the modified Penman equation as modified by Dr. Ted Sammis c at the New Mexico State University, as provided by Salim Bawazir c on March 16, 2000. c List of Input Values c Name Value Units Description c elev Input m elevation c tmax Input deg.C maximum temperature c tmin Input deg.C minimum temperature c rhmax Input % maximum relative humidity c rhmin Input % minimum relative humidity c wf_value Input m/sec wind speed c sr_value Input megajoules/m^2.day solar radiation c integer errors2 include 'refet.common' c Initialize c Reflection coefficient, 0.07+0.053*LAI albedo=.21 c Specific heat of air (cal/deg.C/cm^3) cp=.242 c Long wave radiation (cal/cm^2/day) rl=-64. c Perform calculations c Find maximum saturated vapor pressure (mb) svpma = 6.108*exp((17.27*tmax)/(tmax+237.3)) c Find minimum saturated vapor pressure (mb) svpmi = 6.108*exp((17.27*tmin)/(tmin+237.3)) c Find saturated vapor pressure at mean temperature (mb) vps1 = (svpma+svpma)/2.0 c Find actual vapor pressure at mean temperature (mb) vpal = ((svpma*tmin/100.) + (svpmi*tmax/100.))/2. c Find difference between saturated vapor pressure at mean temperature and actual vapor pressure at mean temperature (mb) vpdiff = vps1-vpal c Find average temperature tav9=(tmax+tmin)/2. c Find slope of the saturated vapor pressure curve (mb/deg C) delta = 33.8639*(0.05904*(0.00739*tav9+0.8072)**7 - 0.0000342) c Find latent heat of vaporization (cal/g) hl = 595.0-(0.51*tav9) c Find pressure when elevation is in meters (mb) pr = 1013.0-(0.1035*elev) c Find psychrometric constant gamma = (cp*pr)/(0.622*hl) c Convert average wind speed from meters/second to km/hr w = w*0.2237 c Find wind speed at 2 meters - assumes instrument is at 3.75 meters (km/day) wind2m = (windkm*24.)*((2/3.75)**.2) c Find wind function (km/day) windf = 15.36*(1.0+(0.0062*wind2m)) c Find net solar radiation where sr_value is in mj/m^2/day (cal/cm^2/day) rn=(.95*(1.0-albedo)*sr_value/0.041868)+rl c Find reference et (cal/cm^2/day) </pre>	

Figure 28: Penman Reference ET Equation

Printed by AIBrower

Jun 22, 00 13:20			limits												Page 1/1	
Station	Crop num.	Crop name	Jan.	Feb.	Mar.	April	May	June	July	Aug.	Sep.	Oct.	Nov.	Dec.		
LLZN	1	Alfalfa				.11	.19	.27	.30	.24	.15	.09				
LLZN	2	PastGrass				.10	.16	.22	.25	.21	.14	.08				
LLZN	3	Sorghum					.06	.14	.26	.20	.10					
LLZN	4	Wheat			.04	.12	.26	.11								
LLZN	5	Corn					.09	.13	.25	.24	.16					
LLZN	6	Chili Pep						.01	.09	.23	.18	.01				
LLZN	7	Grapes				.06	.13	.20	.21	.17	.10	.05				
LLZN	33	Misc Vegs				.05	.08	.14	.27	.26	.15	.08				

Wednesday June 11, 2003

1/1

Figure 29: Limited ET As Calculated At The Luis Lopez Station

Figure 30: Alfalfa Curve # 10

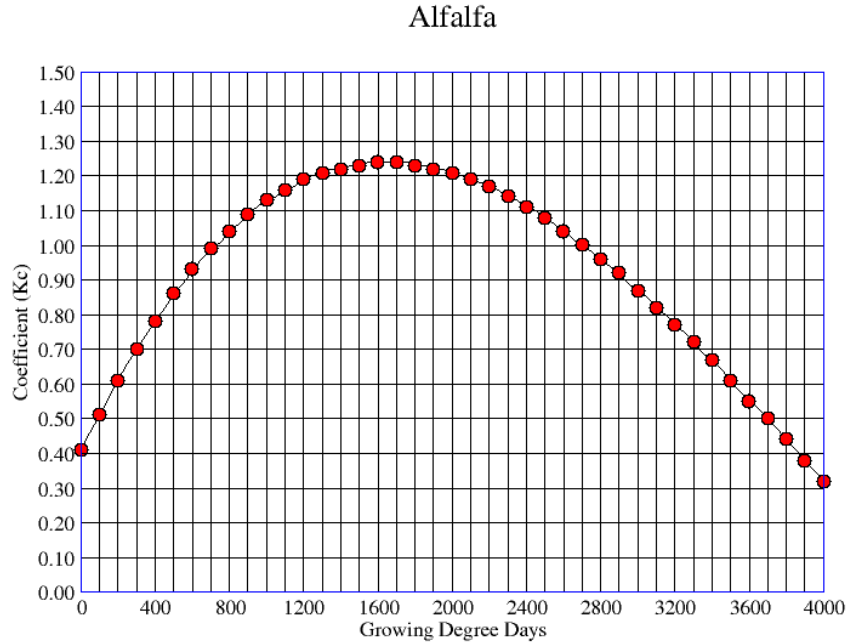

Polynomial Function for Alfalfa

$$Kc = 0.41E+00 + 0.111E-02(GDD) + -0.425E-06(GDD)**2 + 0.356E-10(GDD)**3 + 0.000E+00(GDD)**4 + 0.000E+00(GDD)**5$$

Base Temperature (deg. C) = 5.0

GDD	Kc	GDD	Kc	GDD	Kc	GDD	Kc	GDD	Kc	GDD	Kc	GDD	Kc
0	0.41	600	0.93	1200	1.19	1800	1.23	2400	1.11	3000	0.87	3600	0.55
50	0.46	650	0.96	1250	1.20	1850	1.23	2450	1.10	3050	0.85	3650	0.53
100	0.51	700	0.99	1300	1.21	1900	1.22	2500	1.08	3100	0.82	3700	0.50
150	0.56	750	1.01	1350	1.22	1950	1.22	2550	1.06	3150	0.80	3750	0.47
200	0.61	800	1.04	1400	1.22	2000	1.21	2600	1.04	3200	0.77	3800	0.44
250	0.66	850	1.06	1450	1.23	2050	1.20	2650	1.02	3250	0.75	3850	0.41
300	0.70	900	1.09	1500	1.23	2100	1.19	2700	1.00	3300	0.72	3900	0.38
350	0.74	950	1.11	1550	1.24	2150	1.18	2750	0.98	3350	0.69	3950	0.35
400	0.78	1000	1.13	1600	1.24	2200	1.17	2800	0.96	3400	0.67	4000	0.32
450	0.82	1050	1.14	1650	1.24	2250	1.16	2850	0.94	3450	0.64		
500	0.86	1100	1.16	1700	1.24	2300	1.14	2900	0.92	3500	0.61		
550	0.89	1150	1.17	1750	1.24	2350	1.13	2950	0.89	3550	0.58		

Curve developed by New Mexico State University

Figure 31: Corn Curve # 15

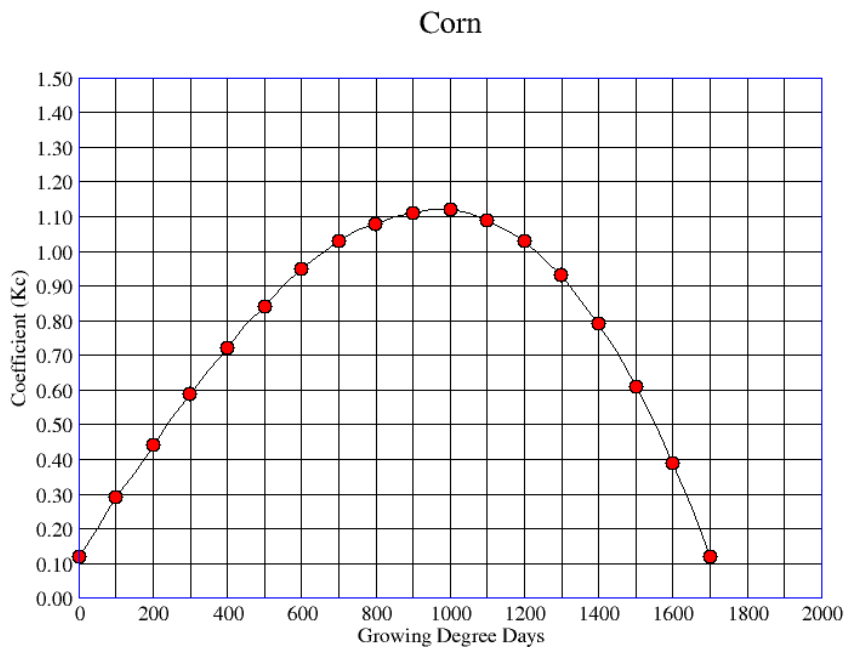

Polynomial Function for Corn

$$Kc = 0.12E+00 + 0.168E-02(GDD) + -0.246E-06(GDD)**2 + -0.437E-09(GDD)**3 + 0.000E+00(GDD)**4 + 0.000E+00(GDD)**5$$

Max. Cutoff Temperature (deg. C) = 30.0

Min. Cutoff Temperature (deg. C) = 10.0

Base Temperature (deg. C) = 10.0

GDD	Kc	GDD	Kc	GDD	Kc
0	0.12	600	0.95	1200	1.03
50	0.20	650	0.99	1250	0.98
100	0.29	700	1.03	1300	0.93
150	0.36	750	1.06	1350	0.86
200	0.44	800	1.08	1400	0.79
250	0.52	850	1.10	1450	0.71
300	0.59	900	1.11	1500	0.61
350	0.66	950	1.12	1550	0.51
400	0.72	1000	1.12	1600	0.39
450	0.79	1050	1.11	1650	0.26
500	0.84	1100	1.09	1700	0.12
550	0.90	1150	1.06		

Curve developed by New Mexico State University

Figure 32: Wheat Curve # 31

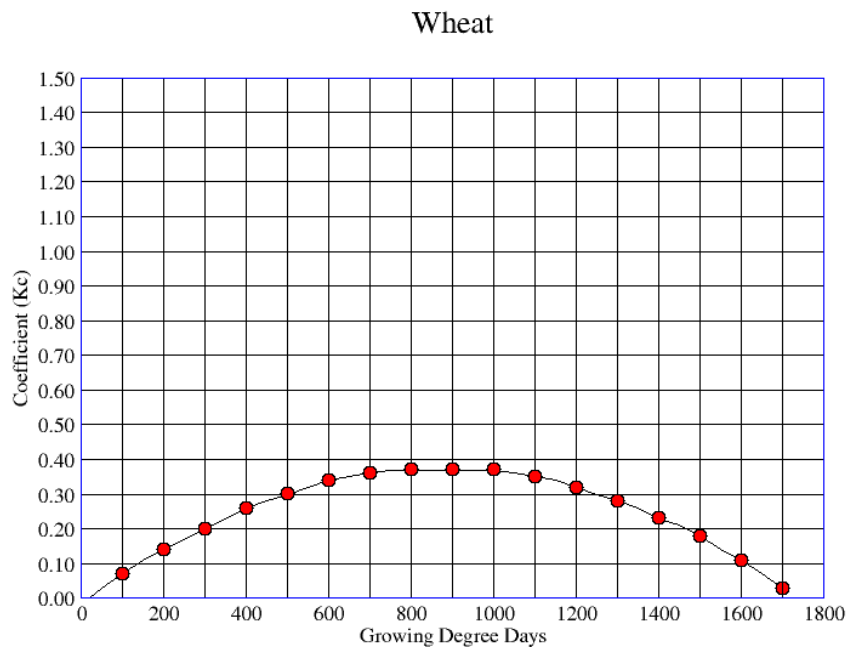

## Polynomial Function for Wheat

$$Kc = -0.17E-01 + 0.894E-03(GDD) + -0.510E-06(GDD)**2 + 0.000E+00(GDD)**3 + 0.000E+00(GDD)**4 + 0.000E+00(GDD)**5$$

Max. Cutoff Temperature (deg. C) = 27.0

Min. Cutoff Temperature (deg. C) = 4.0

Base Temperature (deg. C) = 4.0

GDD	Kc	GDD	Kc	GDD	Kc
50	0.03	650	0.35	1250	0.30
100	0.07	700	0.36	1300	0.28
150	0.11	750	0.37	1350	0.26
200	0.14	800	0.37	1400	0.23
250	0.17	850	0.37	1450	0.21
300	0.20	900	0.37	1500	0.18
350	0.23	950	0.37	1550	0.14
400	0.26	1000	0.37	1600	0.11
450	0.28	1050	0.36	1650	0.07
500	0.30	1100	0.35	1700	0.03
550	0.32	1150	0.34		
600	0.34	1200	0.32		

Curve developed by New Mexico State University



Figure 33: Wheat>1300 GDD Curve # 31a

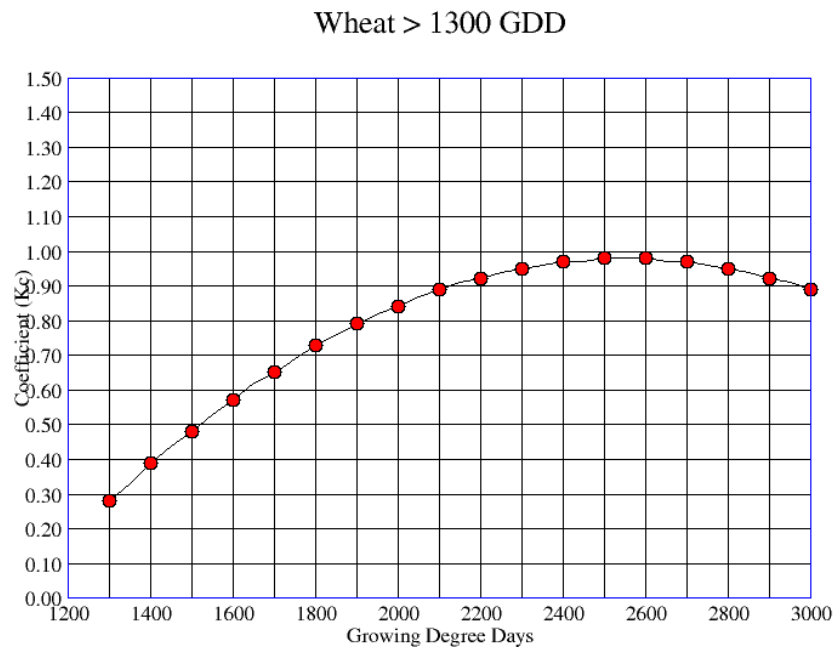

Polynomial Function for Wheat > 1300 GDD

$$Kc = -0.19E+01 + 0.228E-02(GDD) + -0.447E-06(GDD)**2 + 0.000E+00(GDD)**3 + 0.000E+00(GDD)**4 + 0.000E+00(GDD)**5$$

Max. Cutoff Temperature (deg. C) = 27.0

Min. Cutoff Temperature (deg. C) = 4.0

Base Temperature (deg. C) = 4.0

GDD	Kc	GDD	Kc	GDD	Kc
1300	0.28	1900	0.79	2500	0.98
1350	0.33	1950	0.82	2550	0.98
1400	0.39	2000	0.84	2600	0.98
1450	0.44	2050	0.87	2650	0.97
1500	0.48	2100	0.89	2700	0.97
1550	0.53	2150	0.91	2750	0.96
1600	0.57	2200	0.92	2800	0.95
1650	0.62	2250	0.94	2850	0.94
1700	0.65	2300	0.95	2900	0.92
1750	0.69	2350	0.96	2950	0.91
1800	0.73	2400	0.97	3000	0.89
1850	0.76	2450	0.97		

Curve developed by New Mexico State University

Figure 34: Spring Barley Curve # 32

Spring Barley

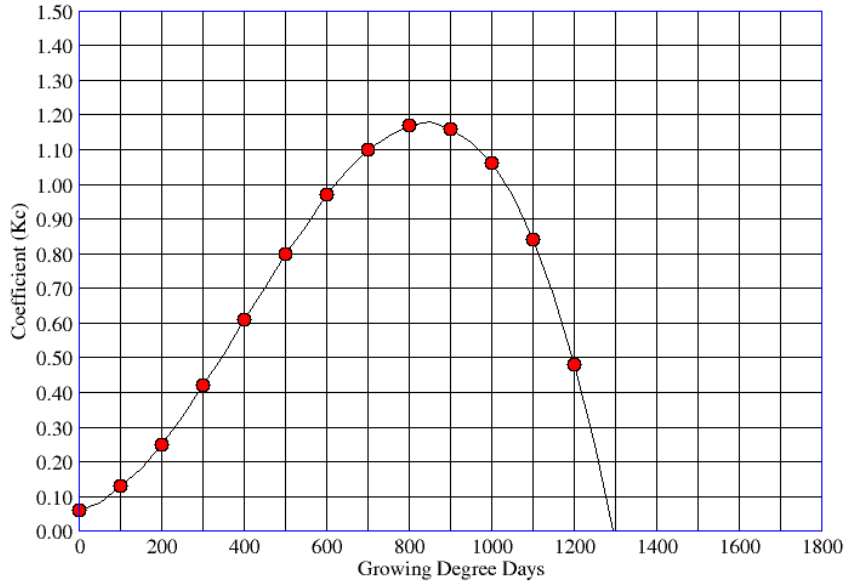

Polynomial Function for Spring Barley

$$Kc = 0.57E-01 + 0.323E-03(GDD) + 0.394E-05(GDD)**2 + \\ -0.326E-08(GDD)**3 + 0.000E+00(GDD)**4 + \\ 0.000E+00(GDD)**5$$

Max. Cutoff Temperature (deg. C) = 30.0

Min. Cutoff Temperature (deg. C) = 5.0

Base Temperature (deg. C) = 5.0

GDD	Kc	GDD	Kc	GDD	Kc
0	0.06	600	0.97	1200	0.48
50	0.08	650	1.04	1250	0.25
100	0.13	700	1.10		
150	0.18	750	1.14		
200	0.25	800	1.17		
250	0.33	850	1.18		
300	0.42	900	1.16		
350	0.51	950	1.12		
400	0.61	1000	1.06		
450	0.70	1050	0.97		
500	0.80	1100	0.84		
550	0.88	1150	0.68		

Curve developed by New Mexico State University

Figure 35: Sorghum Curve # 20

Sorghum

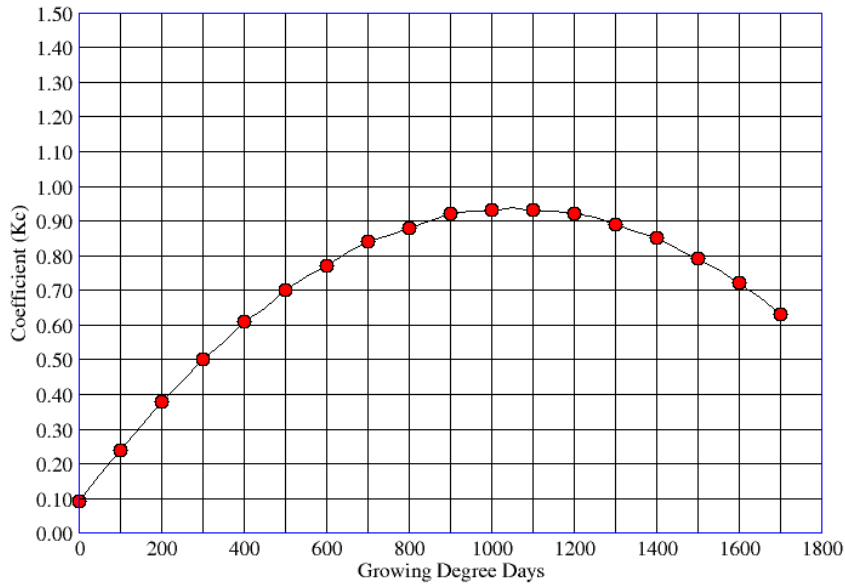

Polynomial Function for Sorghum

$$Kc = 0.89E-01 + 0.159E-02(GDD) + -0.746E-06(GDD)**2 + -0.836E-12(GDD)**3 + 0.000E+00(GDD)**4 + 0.000E+00(GDD)**5$$

Base Temperature (deg. C) = 7.0

GDD	Kc	GDD	Kc	GDD	Kc
0	0.09	600	0.77	1200	0.92
50	0.17	650	0.81	1250	0.91
100	0.24	700	0.84	1300	0.89
150	0.31	750	0.86	1350	0.87
200	0.38	800	0.88	1400	0.85
250	0.44	850	0.90	1450	0.82
300	0.50	900	0.92	1500	0.79
350	0.55	950	0.93	1550	0.76
400	0.61	1000	0.93	1600	0.72
450	0.65	1050	0.94	1650	0.68
500	0.70	1100	0.93	1700	0.63
550	0.74	1150	0.93		

Curve developed by New Mexico State University

Figure 36: Orchard # 83

## Tree Fruit

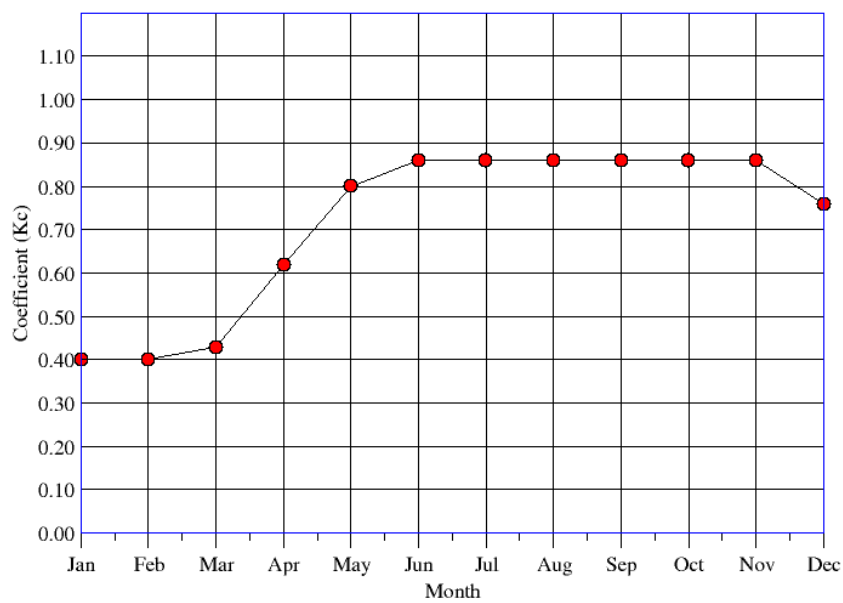

## Monthly Coefficients for Tree Fruit

Month	Crop Coefficient (Kc)
January	0.40
February	0.40
March	0.43
April	0.62
May	0.80
June	0.86
July	0.86
August	0.86
September	0.86
October	0.86
November	0.86
December	0.76

Data from Jensen, M.E., (1998), page D.36

Figure 37: Grape Curve # 50

## Grapes

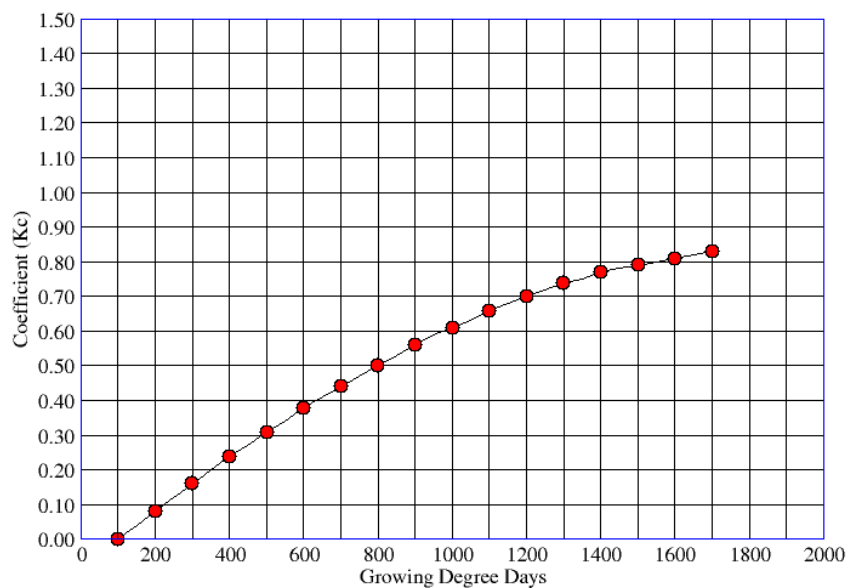

## Polynomial Function for Grapes

$$Kc = -0.91E-01 + 0.881E-03(GDD) + -0.150E-06(GDD)**2 + \\ -0.300E-10(GDD)**3 + 0.000E+00(GDD)**4 + \\ 0.000E+00(GDD)**5$$

Max. Cutoff Temperature (deg. C) = 30.0

Min. Cutoff Temperature (deg. C) = 10.0

Base Temperature (deg. C) = 10.0

GDD	Kc	GDD	Kc	GDD	Kc
150	0.04	750	0.47	1350	0.75
200	0.08	800	0.50	1400	0.77
250	0.12	850	0.53	1450	0.78
300	0.16	900	0.56	1500	0.79
350	0.20	950	0.59	1550	0.80
400	0.24	1000	0.61	1600	0.81
450	0.27	1050	0.63	1650	0.82
500	0.31	1100	0.66	1700	0.83
550	0.34	1150	0.68		
600	0.38	1200	0.70		
650	0.41	1250	0.72		
700	0.44	1300	0.74		

Curve developed by New Mexico State University

Figure 38: Cottonwood Curve # 61

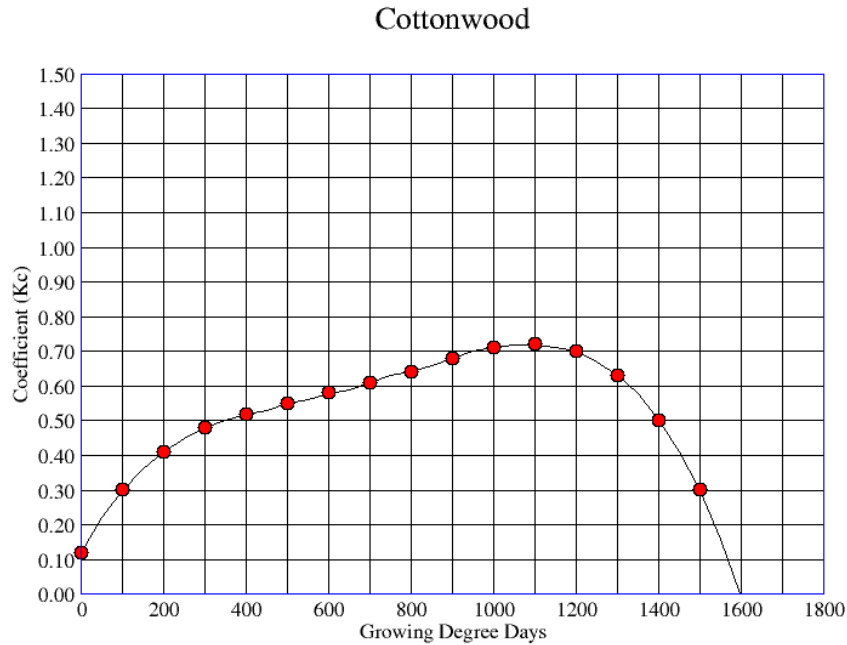

Polynomial Function for Cottonwood

$$Kc = 0.12E+00 + 0.225E-02(GDD) + -0.506E-05(GDD)**2 + 0.585E-08(GDD)**3 + -0.279E-11(GDD)**4 + 0.338E-15(GDD)**5$$

Min. Cutoff Temperature (deg. C) = 15.5

Base Temperature (deg. C) = 15.5

GDD	Kc	GDD	Kc	GDD	Kc
0	0.12	600	0.58	1200	0.70
50	0.22	650	0.59	1250	0.67
100	0.30	700	0.61	1300	0.63
150	0.36	750	0.63	1350	0.58
200	0.41	800	0.64	1400	0.50
250	0.45	850	0.66	1450	0.41
300	0.48	900	0.68	1500	0.30
350	0.50	950	0.70	1550	0.16
400	0.52	1000	0.71		
450	0.53	1050	0.72		
500	0.55	1100	0.72		
550	0.56	1150	0.71		

Curve developed by New Mexico State University

Figure 39: Salt Cedar Curve # 60

Salt Cedar

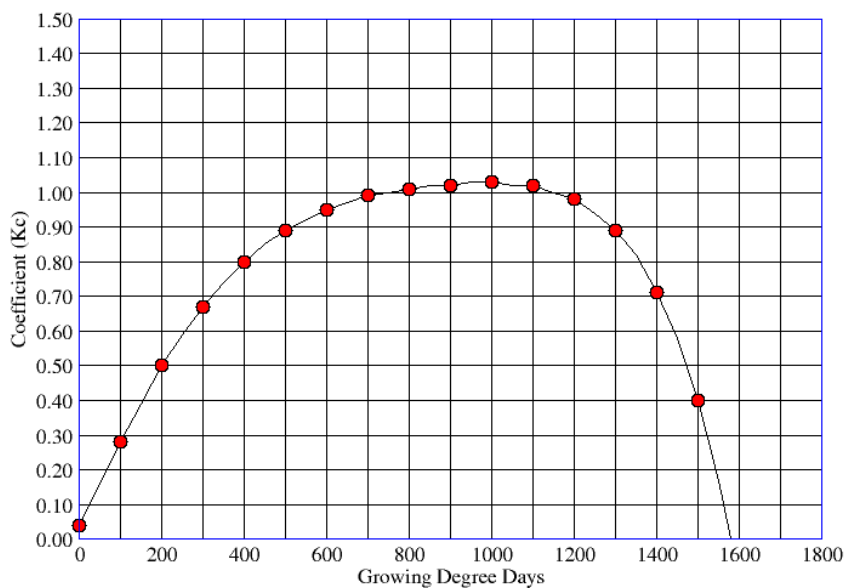

Polynomial Function for Salt Cedar

$$Kc = 0.40E-01 + 0.253E-02(GDD) + -0.653E-06(GDD)**2 + -0.395E-08(GDD)**3 + 0.469E-11(GDD)**4 + -0.163E-14(GDD)**5$$

Min. Cutoff Temperature (deg. C) = 15.5

Base Temperature (deg. C) = 15.5

GDD	Kc	GDD	Kc	GDD	Kc
0	0.04	600	0.95	1200	0.98
50	0.16	650	0.97	1250	0.94
100	0.28	700	0.99	1300	0.89
150	0.39	750	1.00	1350	0.82
200	0.50	800	1.01	1400	0.71
250	0.59	850	1.02	1450	0.58
300	0.67	900	1.02	1500	0.40
350	0.74	950	1.03	1550	0.17
400	0.80	1000	1.03		
450	0.85	1050	1.02		
500	0.89	1100	1.02		
550	0.92	1150	1.00		

Curve developed by New Mexico State University

Figure 40: Marsh Curve # 81

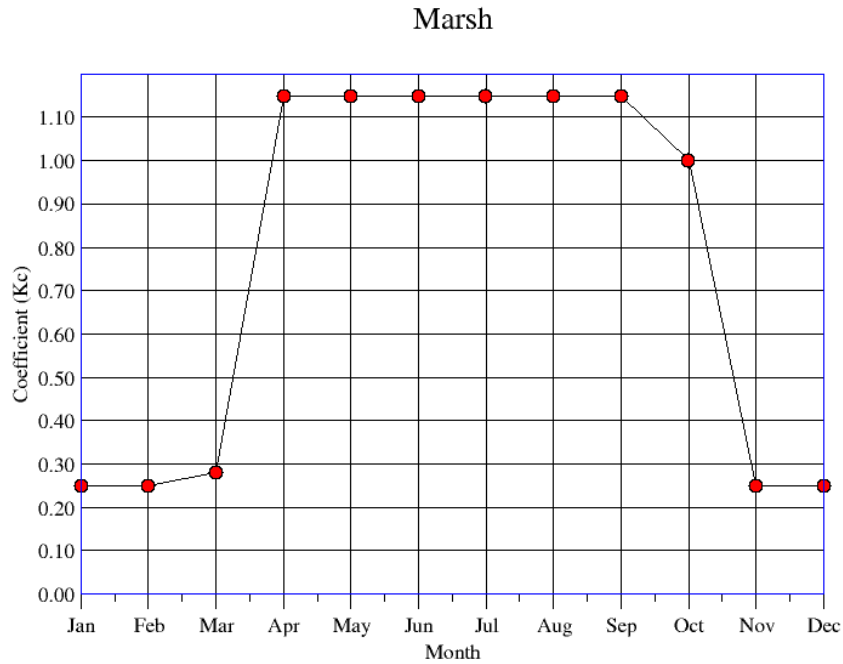

Monthly Coefficients for Marsh

Month	Crop Coefficient (Kc)
January	0.25
February	0.25
March	0.28
April	1.15
May	1.15
June	1.15
July	1.15
August	1.15
September	1.15
October	1.00
November	0.25
December	0.25

Data from Jensen, M.E., (1998), page D.36



Figure 41: Open Water Curve # 80

Open Water

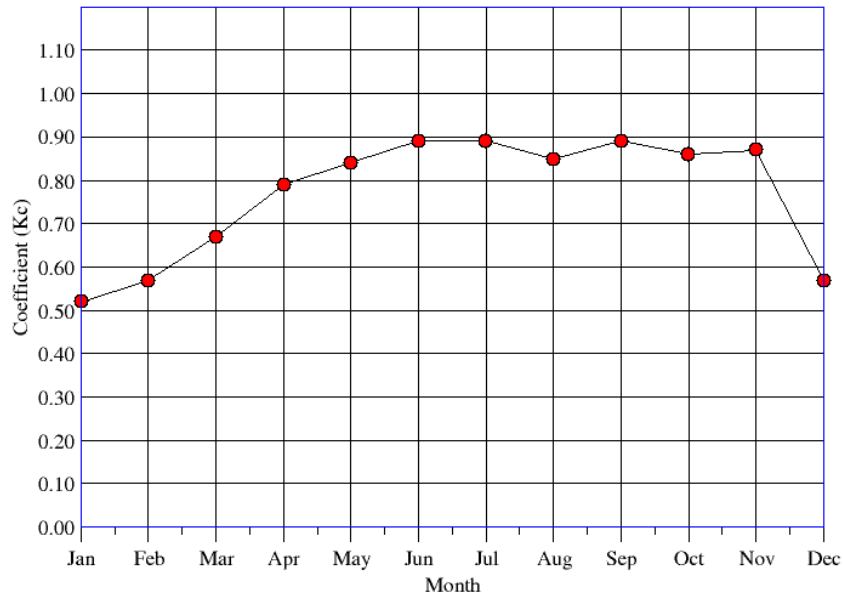

Monthly Coefficients for Open Water

Month	Crop Coefficient (Kc)
January	0.52
February	0.57
March	0.67
April	0.79
May	0.84
June	0.89
July	0.89
August	0.85
September	0.89
October	0.86
November	0.87
December	0.57

Data from Jensen, M.E., (1998), page 33

Figure 42: Turf-Park Curve # 6

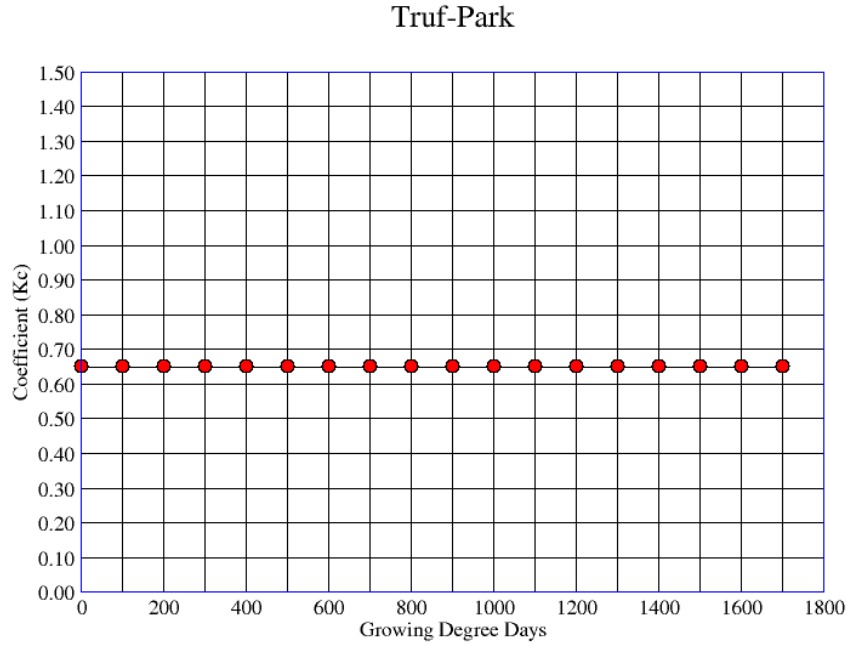

Polynomial Function for Turf-Park

$$Kc = 0.65E+00 + 0.000E+00(GDD) + 0.000E+00(GDD)**2 + 0.000E+00(GDD)**3 + 0.000E+00(GDD)**4 + 0.000E+00(GDD)**5$$

Base Temperature (deg. C) = 5.0

GDD	Kc	GDD	Kc	GDD	Kc
0	0.65	600	0.65	1200	0.65
50	0.65	650	0.65	1250	0.65
100	0.65	700	0.65	1300	0.65
150	0.65	750	0.65	1350	0.65
200	0.65	800	0.65	1400	0.65
250	0.65	850	0.65	1450	0.65
300	0.65	900	0.65	1500	0.65
350	0.65	950	0.65	1550	0.65
400	0.65	1000	0.65	1600	0.65
450	0.65	1050	0.65	1650	0.65
500	0.65	1100	0.65	1700	0.65
550	0.65	1150	0.65		

Curve developed by New Mexico State University

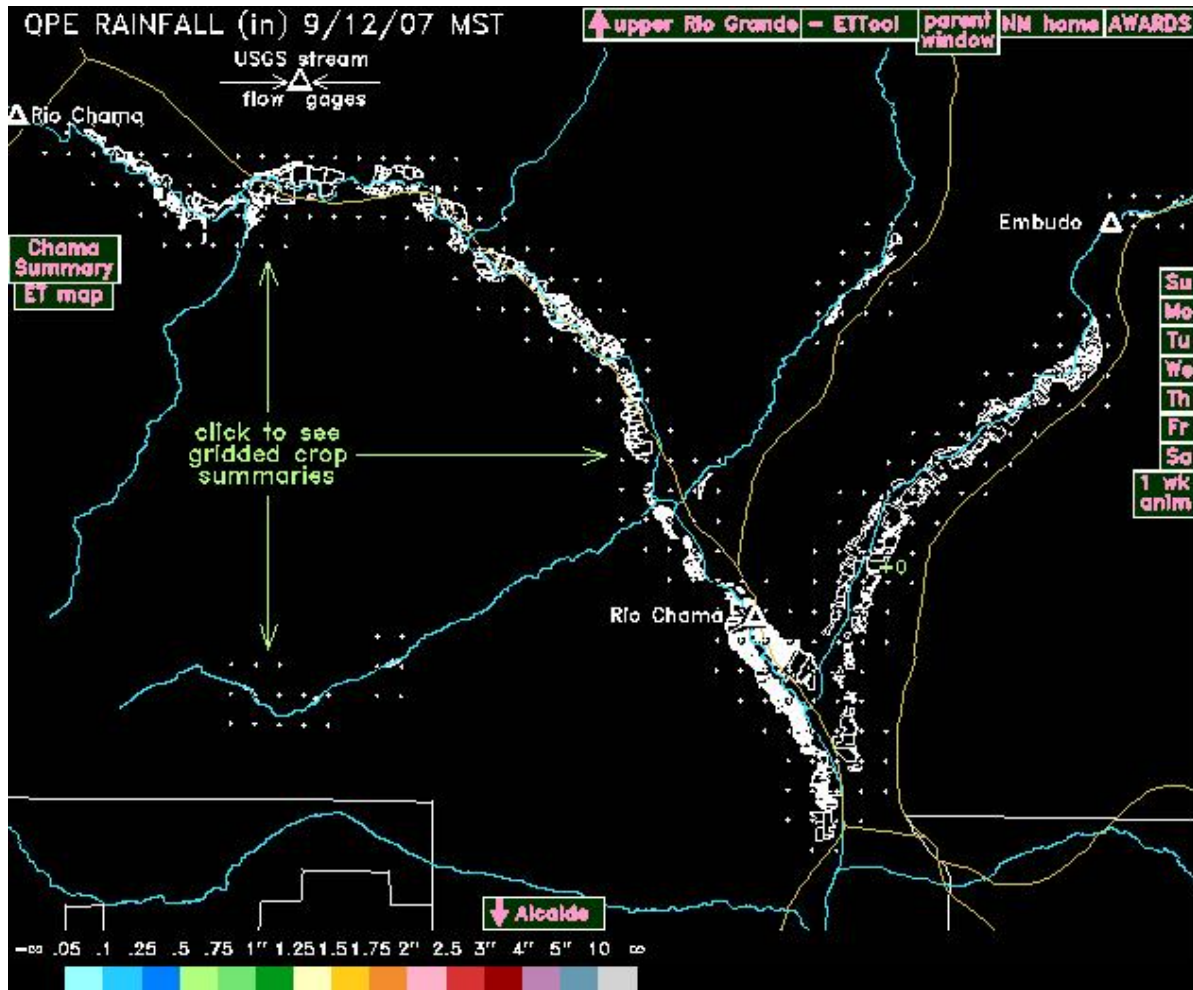

Figure 43: Rio Chama - ET Toolbox

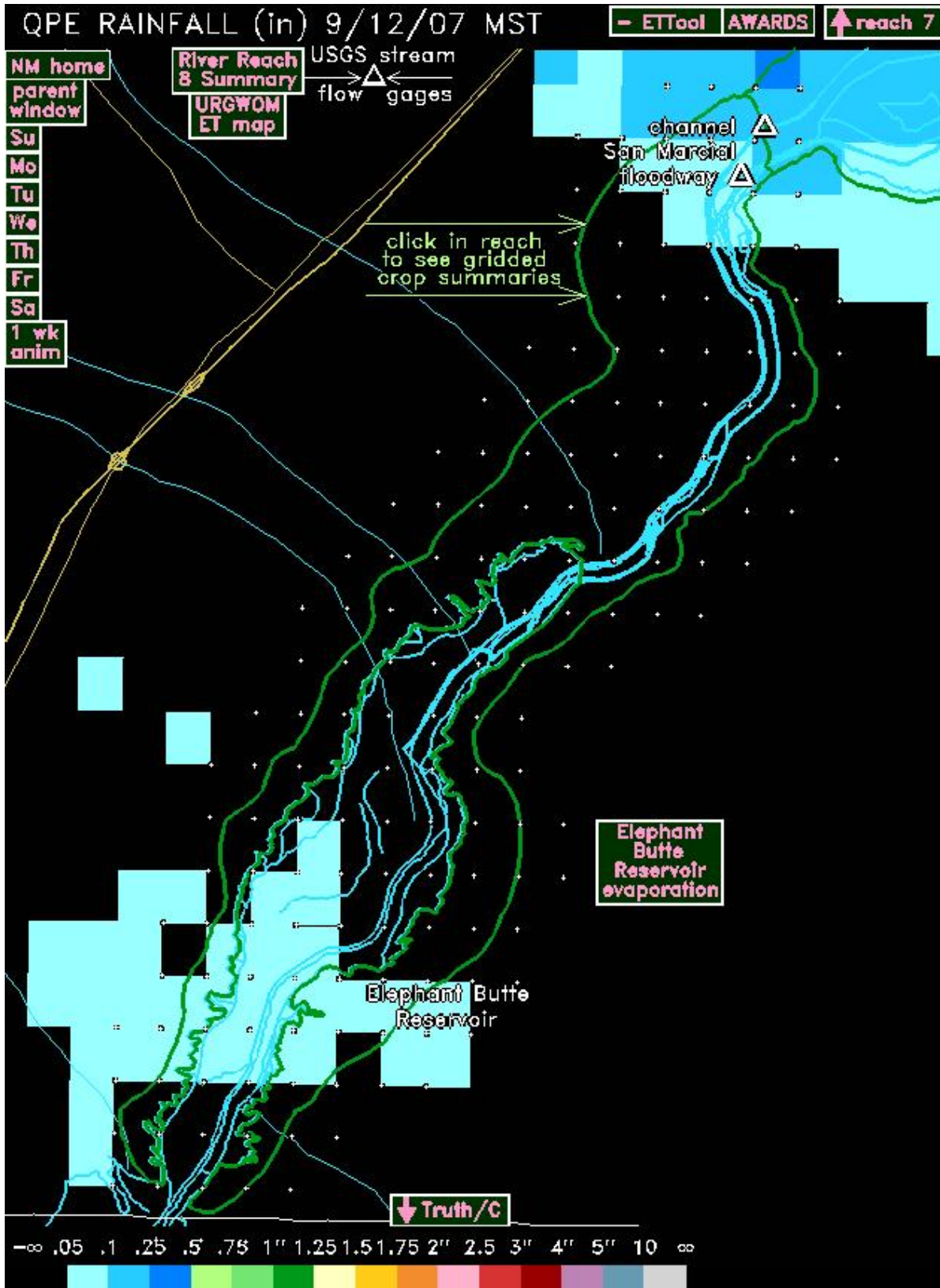

Figure 44: River Reach 8 - ET Toolbox



Figure 45: Elephant Butte Reservoir Evaporation Menu

Printed by Al Brower

Apr 17, 08 9:15		REa8.etcrop.2292.1355.txt														Page 1/1	
ET TOOLBOX CELL DETAILS																	
URGWOM Reach 8 (San Marcial to Elephant Butte)																	
Vegetation classification: IKONOS 2000 + USU 2001 (Except open water)																	
Cell number: 2292x1355																	
Weather station: North Elephant Butte Lake																	
Note: Final values are subject to change with updated weather data, which could occur multiple times during periods of local weather station data feed instability.																	
Last 7 and 7 Forecast Day's URGWOM Water Use in Acre-Feet (CFS)																	
Consumptive Use		2007														Forecast	
Crop	Acres	Sep. 12	Sep. 13	Sep. 14	Sep. 15	Sep. 16	Sep. 17	Sep. 18	Sep. 19	Sep. 20	Sep. 21	Sep. 22	Sep. 23	Sep. 24	Sep. 25		
ElephWater11047.0		0.1	288.5	316.5	316.5	323.7	313.7	285.4	322.2	294.6	313.0	322.2	313.0	313.0	303.8		
Totals	11047.0	0.1	288.5	316.5	316.5	323.7	313.7	285.4	322.2	294.6	313.0	322.2	313.0	313.0	303.8		
		(0.1)	(145.7)	(159.8)	(159.8)	(163.5)	(158.4)	(144.1)	(162.7)	(148.8)	(158.1)	(162.7)	(158.1)	(158.1)	(153.4)		
Agricul.	0.0	0.0	0.0	0.0	0.0	0.0	0.0	0.0	0.0	0.0	0.0	0.0	0.0	0.0	0.0		
		(0.0)	(0.0)	(0.0)	(0.0)	(0.0)	(0.0)	(0.0)	(0.0)	(0.0)	(0.0)	(0.0)	(0.0)	(0.0)	(0.0)		
Riparian	0.0	0.0	0.0	0.0	0.0	0.0	0.0	0.0	0.0	0.0	0.0	0.0	0.0	0.0	0.0		
		(0.0)	(0.0)	(0.0)	(0.0)	(0.0)	(0.0)	(0.0)	(0.0)	(0.0)	(0.0)	(0.0)	(0.0)	(0.0)	(0.0)		
Open Water11047.0		0.1	288.5	316.5	316.5	323.7	313.7	285.4	322.2	294.6	313.0	322.2	313.0	313.0	303.8		
		(0.1)	(145.7)	(159.8)	(159.8)	(163.5)	(158.4)	(144.1)	(162.7)	(148.8)	(158.1)	(162.7)	(158.1)	(158.1)	(153.4)		
Urban	0.0	0.0	0.0	0.0	0.0	0.0	0.0	0.0	0.0	0.0	0.0	0.0	0.0	0.0	0.0		
		(0.0)	(0.0)	(0.0)	(0.0)	(0.0)	(0.0)	(0.0)	(0.0)	(0.0)	(0.0)	(0.0)	(0.0)	(0.0)	(0.0)		
NEXRAD																	
Rainfall Est.		55.2	18.4	0.0	0.0	0.0	0.0	0.0	0.0	82.9	82.9	0.0	0.0	0.0	0.0		
		(27.9)	(9.3)	(0.0)	(0.0)	(0.0)	(0.0)	(0.0)	(0.0)	(41.8)	(41.8)	(0.0)	(0.0)	(0.0)	(0.0)		
URGWOM																	
Water Use		-55.1	270.1	316.5	316.5	323.7	313.7	285.4	322.2	211.7	230.1	322.2	313.0	313.0	303.8		
		(-27.8)	(136.4)	(159.8)	(159.8)	(163.5)	(158.4)	(144.1)	(162.7)	(106.9)	(116.2)	(162.7)	(158.1)	(158.1)	(153.4)		

Figure 46: Elephant Butte Detail

Printed by Al Brower

Apr 17, 08 9:28		REAS.ElephWater.txt					Page 1/1	
URGWOM Reach 8 (San Marcial to Elephant Butte)								
Daily Evap. Rates for ElephWater				Today is: Sep. 21, 2007				
Vegetation Classification: Open Water								
Class Number: 91								
Number of 1x1 km cells = 101 Number with ElephWater = 1								
Weather station(s) used:								
1) sbos South Bosque								
2) elfb North Elephant Butte Lake								
Reference (Ref.) ET is averaged from above weather station(s)								
Open Water (OW) Coef. is averaged from above weather station(s)								
Open Water (OW) Evap. = Ref. ET x Open Water Coef.								
Total Water Use = Sum of cell water use								
NEXRAD Rain = Sum of (cell rain x cell open water acres/12)								
URGWOM Water Use = Total Water Use - NEXRAD Rain								
-----								
Acres: 11005 Plant Date: Jan. 1 Termination Date: Dec. 31								
Month	Day	Ref. ET (IN)	OW Coef.	OW Evap. (IN)	Total Water Use (AC-FT)	NEXRAD Rain (AC-FT)	URGWOM Water Use (AC-FT)	Acres
Jan.	1	0.07	0.52	0.04	54.95	0.00	54.95	13189.00
Jan.	2	0.12	0.52	0.06	88.07	0.00	88.07	13210.00
Jan.	3	0.13	0.52	0.07	99.23	0.00	99.23	13231.00
Jan.	4	0.13	0.53	0.07	88.34	0.00	88.34	13251.00
Jan.	5	0.19	0.53	0.10	132.76	9.17	123.59	13276.00
Jan.	6	0.09	0.53	0.05	66.46	36.68	29.78	13293.00
Aug.	23	0.35	0.88	0.31	329.32	36.68	292.64	11623.00
Aug.	24	0.38	0.88	0.34	395.96	0.00	395.96	11589.00
Aug.	25	0.32	0.88	0.29	365.81	18.34	347.47	11552.00
Aug.	26	0.37	0.88	0.33	335.82	55.02	280.80	11514.00
Aug.	27	0.36	0.88	0.32	315.62	0.00	315.62	11477.00
Aug.	28	0.35	0.89	0.32	334.19	0.00	334.19	11458.00
Aug.	29	0.38	0.89	0.34	371.90	403.52	-31.62	11443.00
Aug.	30	0.34	0.89	0.30	342.27	64.20	278.07	11409.00
Aug.	31	0.31	0.89	0.27	294.16	36.68	257.48	11387.00
Aug.	Totals	11.12		9.69	10838.40	1072.99	9765.41	
Sep.	1	0.30	0.89	0.27	293.36	146.73	146.63	11356.00
Sep.	2	0.31	0.89	0.28	283.45	0.00	283.45	11338.00
Sep.	3	0.32	0.89	0.29	302.03	0.00	302.03	11326.00
Sep.	4	0.33	0.89	0.29	301.73	0.00	301.73	11315.00
Sep.	5	0.37	0.88	0.32	338.88	0.00	338.88	11296.00
Sep.	6	0.09	0.88	0.07	65.85	293.47	-227.62	11289.00
Sep.	7	0.29	0.88	0.26	244.18	0.00	244.18	11270.00
Sep.	8	0.30	0.88	0.26	309.40	146.73	162.67	11251.00
Sep.	9	0.28	0.88	0.25	299.33	36.68	262.65	11225.00
Sep.	10	0.30	0.88	0.26	271.17	155.90	115.27	11221.00
Sep.	11	0.29	0.88	0.26	233.23	18.34	214.89	11195.00
Sep.	12	0.28	0.88	0.25	0.13	55.02	-54.89	0.00
Sep.	13	0.31	0.88	0.28	288.53	18.34	270.19	11169.00
Sep.	14	0.35	0.88	0.31	316.45	0.00	316.45	11169.00
Sep.	15	0.34	0.88	0.30	316.45	0.00	316.45	11169.00
Sep.	16	0.33	0.87	0.29	323.69	0.00	323.69	11098.00
Sep.	17	0.30	0.87	0.26	313.71	0.00	313.71	11072.00
Sep.	18	0.31	0.87	0.27	285.38	0.00	285.38	11047.00
Sep.	19	0.37	0.87	0.32	339.81	0.00	339.81	11021.00
Sep.	20	0.17	0.87	0.15	192.59	357.66	-165.07	11005.00
Sep.	Totals	5.96		5.24	5319.35	1228.89	4090.46	
Total To-Date		75.77		62.32	78509.95	12976.73	65533.20	

Thursday April 17, 2008

1/1

Figure 47: Elephant Butte Daily Evaporation Rates

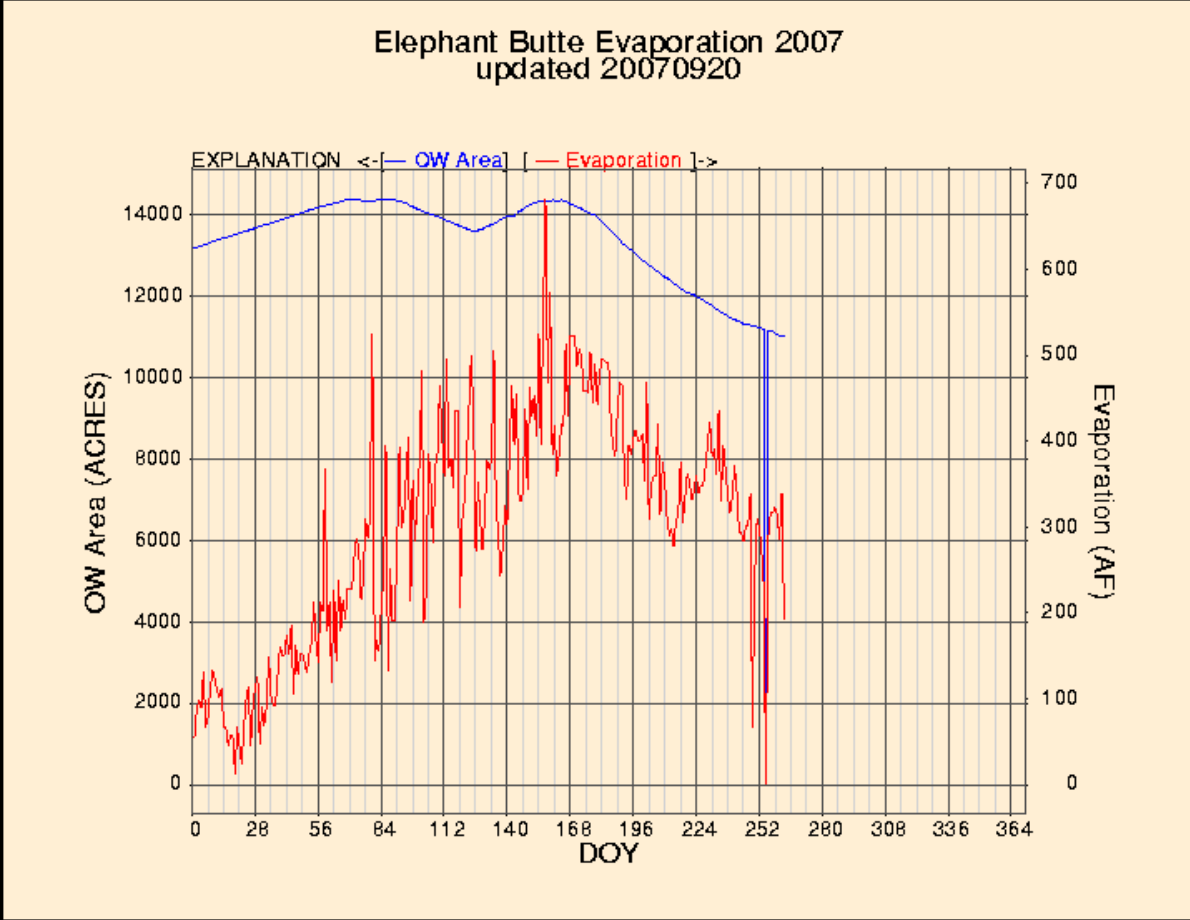

Figure 48: Elephant Butte Plot



Printed by AI Brower

<b>TOTPS.gage</b>													
Gage Information - TOTPS - Total NCPFS NBYFS SBYFS FCRFS Pumping Stations													
Year 2008													
Month	Day	Time	NCPFS	NEYFS	SBYFS	FCRFS	TOTAL	DaAvg	NCPYr	NEYr	SBYr	FCYr	Year
----	---	---	(cfs)	(cfs)	(cfs)	(cfs)	(cfs)	(cfs)	(acft)	(acft)	(acft)	(cfs)	(acft)
Sep	26	08:09:51											
Page 1/1													

Friday September 26, 2008      TOTPS.gage      1/1

Figure 49: Total Pumping Stations



Map of Stream Flow Products.

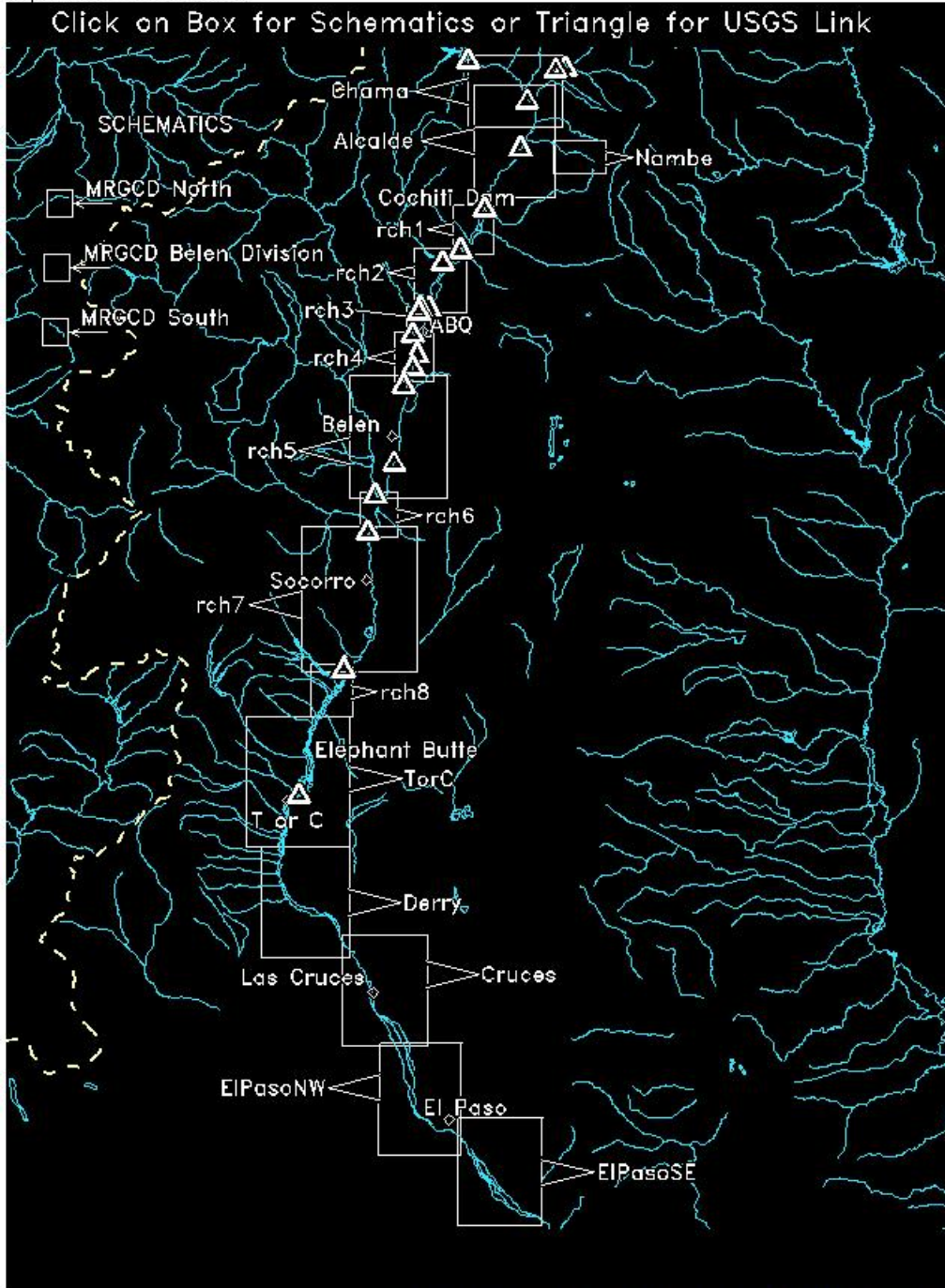

Figure 50: Stream Flow Products

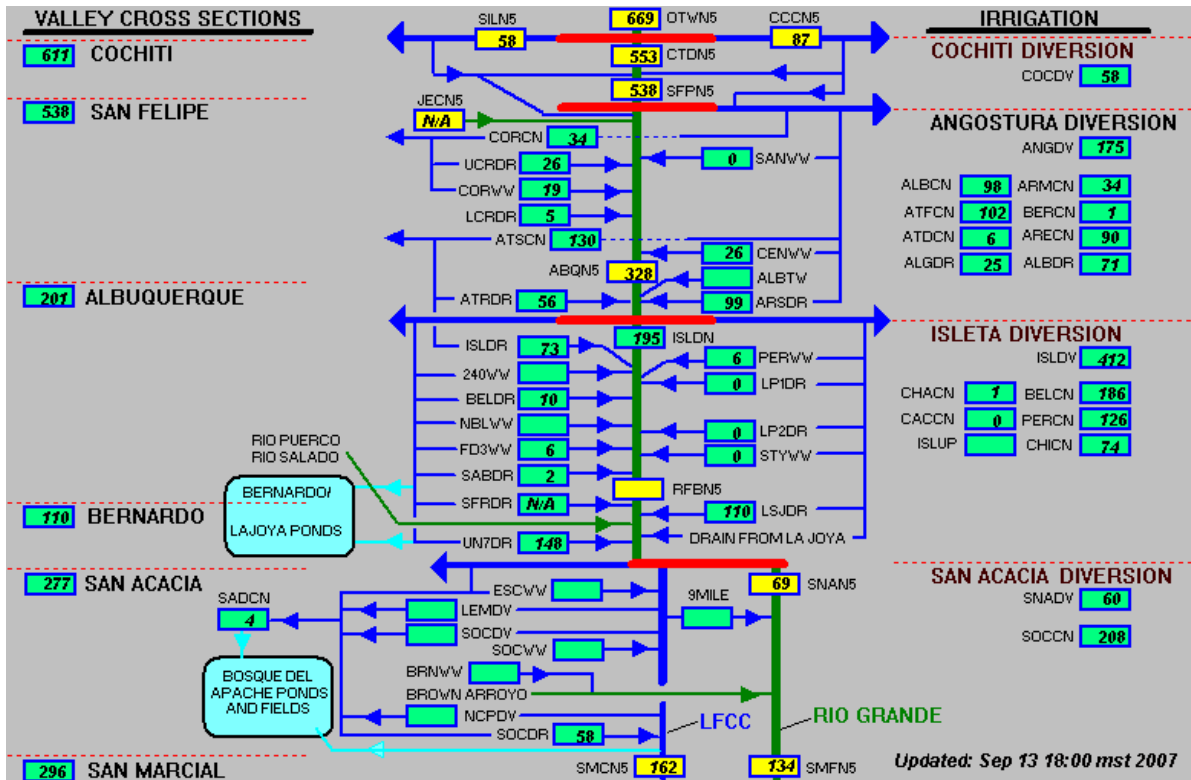

Figure 51: MRGCD North Schematic

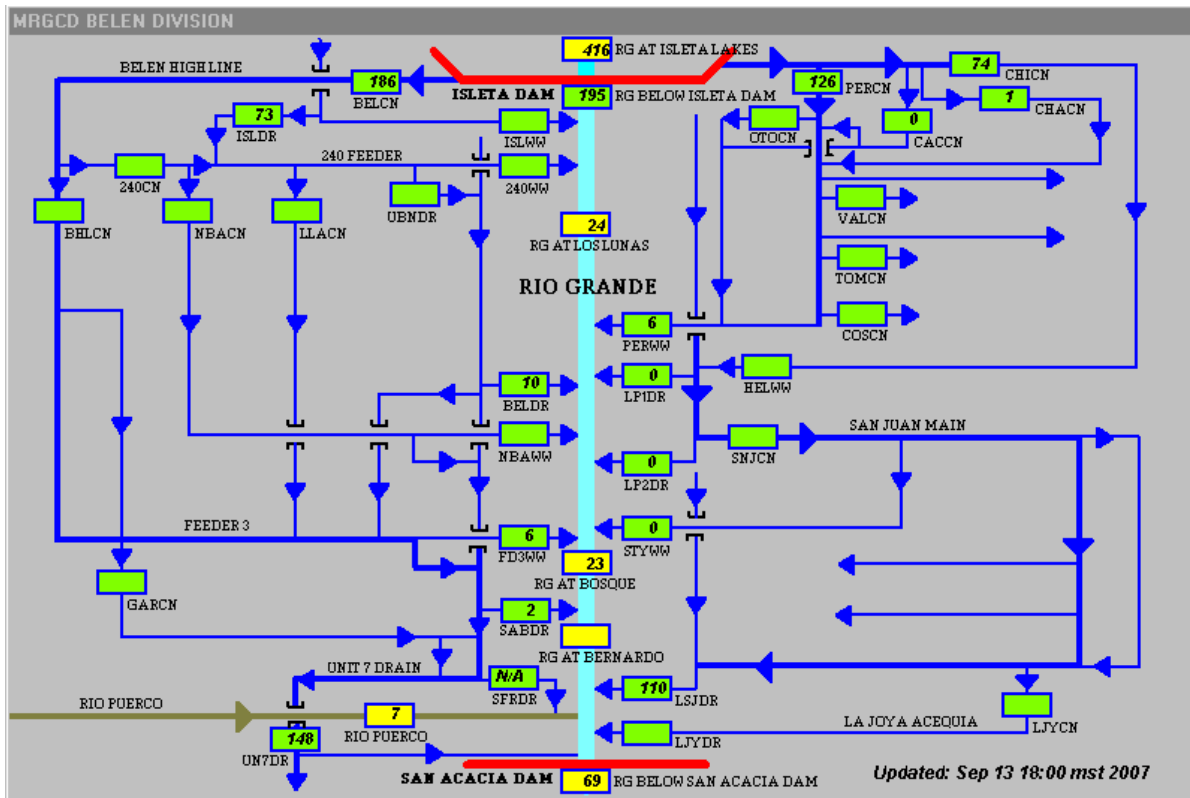

Figure 52: MRGCD Belen Schematic

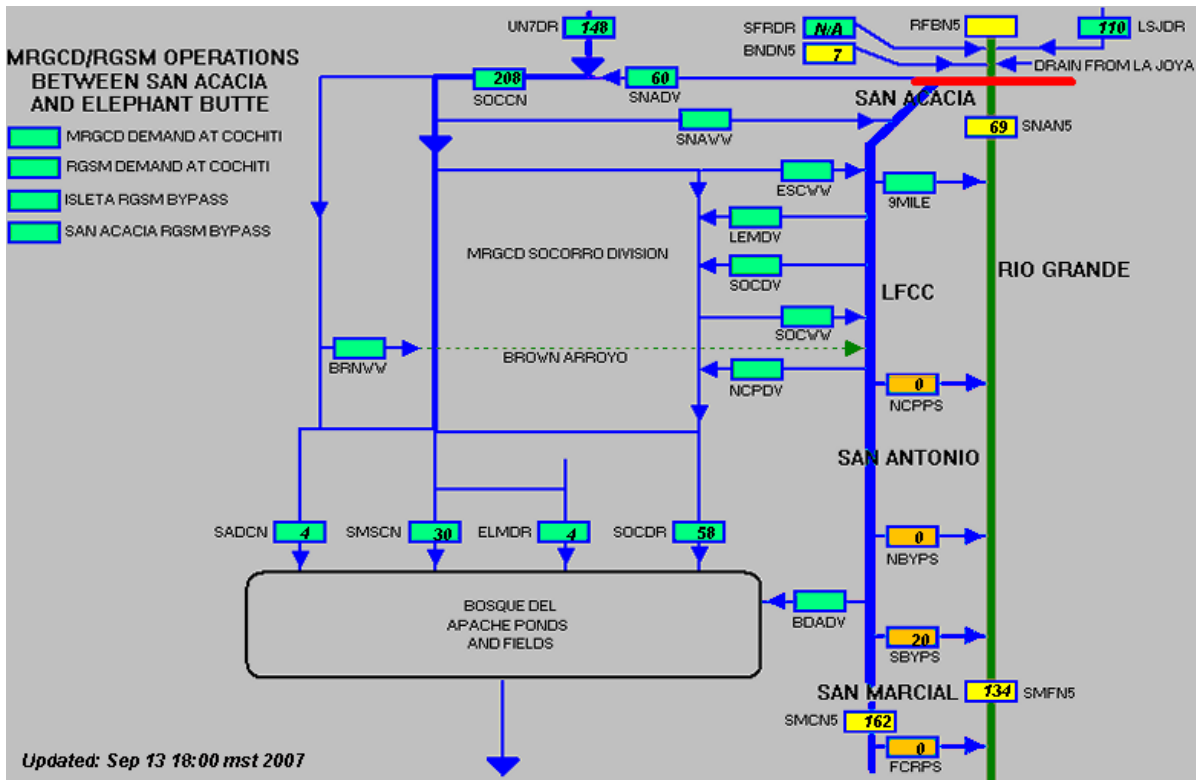

Figure 53: MRGCD South Schematic

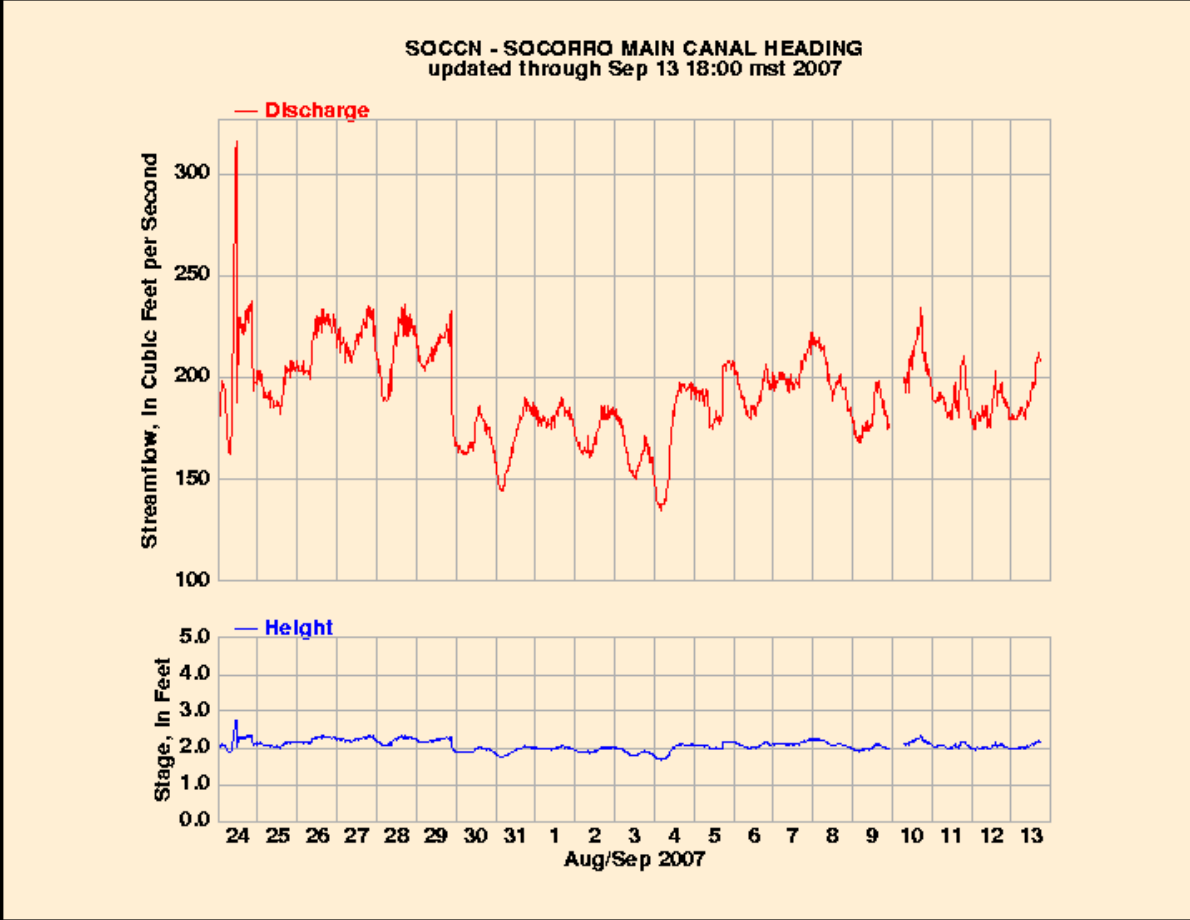

Figure 54: Socorro Main Canal Gage Heading

Printed by Al Brower

Apr 01, 08 12:24		SOCCN.gage		Page 1/1
Gage Information - SOCCN - SOCORRO MAIN CANAL HEADING				
Year 2007				
Month	Day	Time (mst)	Height (ft)	Discharge (cfs)
----	---	----	----	----
Sep	13	1800	2.17	208
Sep	13	1730	2.17	208
Sep	13	1700	2.18	210
Sep	13	1630	2.19	212
Sep	13	1600	2.16	207
Sep	13	1530	2.17	208
Sep	13	1500	2.16	207
Sep	13	1430	2.10	196
Sep	13	1400	2.10	197
Sep	13	1330	2.09	195
Sep	13	1300	2.10	197
Sep	13	1230	2.10	196
Sep	13	1200	2.07	192
Sep	13	1130	2.05	189
Sep	13	1100	2.04	187
Sep	13	1030	2.03	186
Sep	13	1000	2.05	188
Sep	13	930	2.03	186
Sep	13	900	2.01	183
Sep	13	830	1.98	179
Sep	13	800	2.01	182
Sep	13	730	2.00	181
Sep	13	700	2.02	184
Sep	13	630	2.03	185
Sep	13	600	2.03	185
Sep	13	530	2.00	182
Sep	13	500	2.01	183
Sep	13	430	2.00	181
Sep	13	400	2.00	181
Sep	13	330	1.99	179
Sep	13	300	1.99	179
Sep	13	230	1.99	179
Sep	13	200	1.98	179
Sep	13	130	2.00	181
Sep	13	100	1.99	179
Sep	13	30	2.00	182
Sep	13	0	1.99	179
Sep	12	2330	2.00	180
Sep	12	2300	2.00	181
Sep	12	2230	1.98	179
Sep	12	2200	2.04	187
Sep	12	2130	2.03	185
Sep	12	2100	2.03	186
Sep	12	2030	2.03	186
Sep	12	2000	2.06	190
Sep	12	1930	2.04	187
Sep	12	1900	2.06	190
Sep	12	1830	2.10	197
Sep	12	1800	2.10	196
Sep	12	1730	2.07	192
Sep	12	1700	2.07	192
Sep	12	1630	2.08	193
Sep	12	1600	2.08	193
Sep	12	1530	2.03	186
Sep	12	1500	2.08	194
Sep	12	1430	2.14	203
Sep	12	1400	2.10	196
Sep	12	1330	2.08	193
Sep	12	1300	2.05	189
Sep	12	1230	2.05	189
Sep	12	1200	2.00	181
Sep	12	1130	1.96	175
Sep	12	1100	1.99	179

Tuesday April 01, 2008

1/1

Figure 55: Socorro Main Canal Gage Information

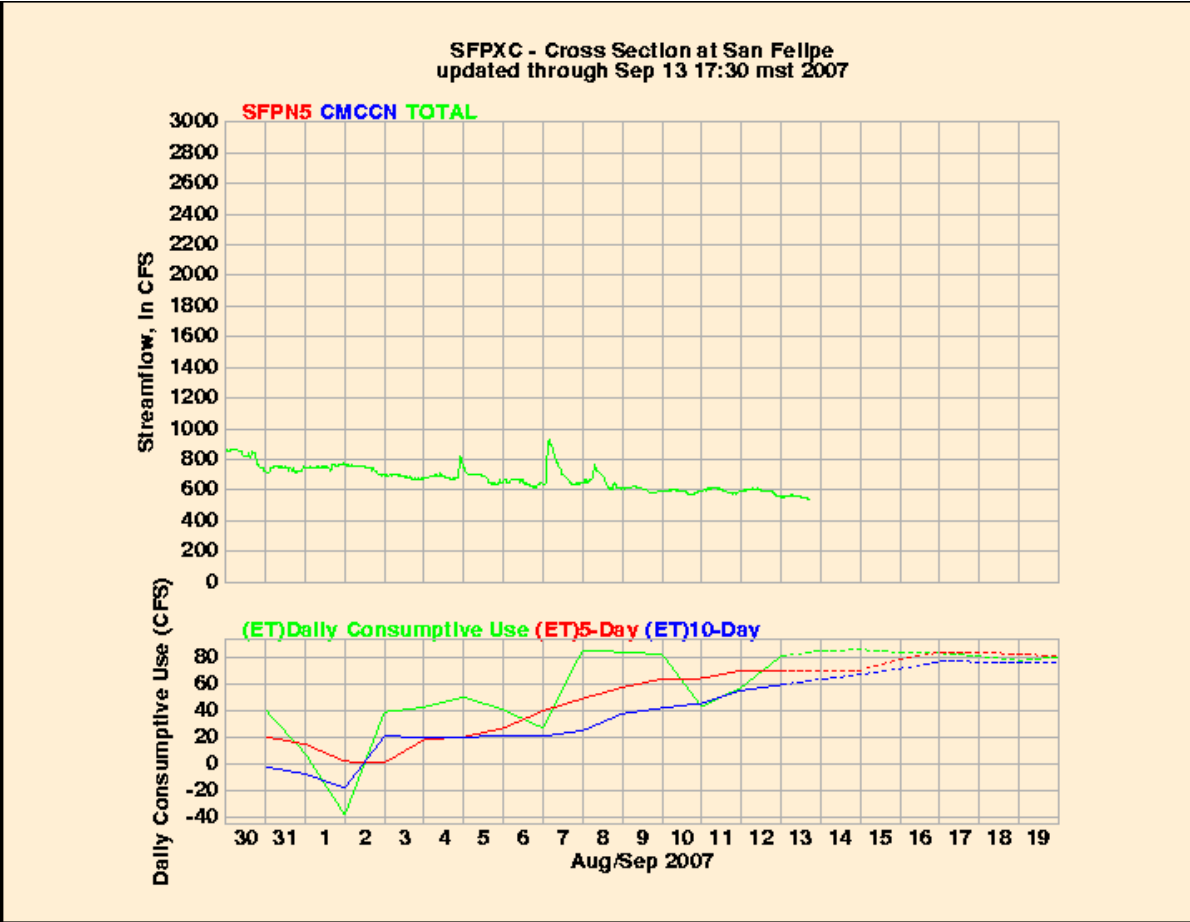

Figure 56: Valley Cross Section



Printed by Al Brower

Apr 01, 08 13:25		SFPXC.gage			Page 1/1	
Gage Information - SFPXC - Cross Section at San Felipe Year 2007						
Month	Day	Time (mst)	SFPN5 (cfs)	CMCCN (cfs)	TOTAL (cfs)	DaAvg (cfs)
----	---	----	----	----	----	-----
Sep	13	1730	538	M	538	555
Sep	13	1700	538	M	538	
Sep	13	1630	538	M	538	
Sep	13	1600	538	M	538	
Sep	13	1530	538	M	538	
Sep	13	1500	538	M	538	
Sep	13	1430	547	M	547	
Sep	13	1400	547	M	547	
Sep	13	1330	547	M	547	
Sep	13	1300	557	M	557	
Sep	13	1230	557	M	557	
Sep	13	1200	567	M	567	
Sep	13	1130	557	M	557	
Sep	13	1100	567	M	567	
Sep	13	1030	567	M	567	
Sep	13	1000	567	M	567	
Sep	13	930	567	M	567	
Sep	13	900	567	M	567	
Sep	13	830	567	M	567	
Sep	13	800	567	M	567	
Sep	13	730	567	M	567	
Sep	13	700	567	M	567	
Sep	13	630	567	M	567	
Sep	13	600	557	M	557	
Sep	13	530	557	M	557	
Sep	13	500	557	M	557	
Sep	13	430	567	M	567	
Sep	13	400	557	M	557	
Sep	13	330	557	M	557	
Sep	13	300	557	M	557	
Sep	13	230	547	M	547	
Sep	13	200	557	M	557	
Sep	13	130	557	M	557	
Sep	13	100	557	M	557	
Sep	13	30	557	M	557	
Sep	13	0	547	M	547	
Sep	12	2330	547	M	547	550
Sep	12	2300	547	M	547	
Sep	12	2230	547	M	547	
Sep	12	2200	547	M	547	
Sep	12	2130	547	M	547	
Sep	12	2100	538	M	538	
Sep	12	2030	538	M	538	
Sep	12	2000	547	M	547	
Sep	12	1930	538	M	538	
Sep	12	1900	538	M	538	
Sep	12	1830	538	M	538	
Sep	12	1800	538	M	538	
Sep	12	1730	547	M	547	
Sep	12	1700	538	M	538	
Sep	12	1630	538	M	538	
Sep	12	1600	538	M	538	
Sep	12	1530	538	M	538	
Sep	12	1500	547	M	547	
Sep	12	1430	547	M	547	
Sep	12	1400	547	M	547	
Sep	12	1330	547	M	547	
Sep	12	1300	557	M	557	
Sep	12	1230	547	M	547	
Sep	12	1200	557	M	557	

Tuesday April 01, 2008

1/1

Figure 57: Gage Information - Valley Cross Section at San Felipe

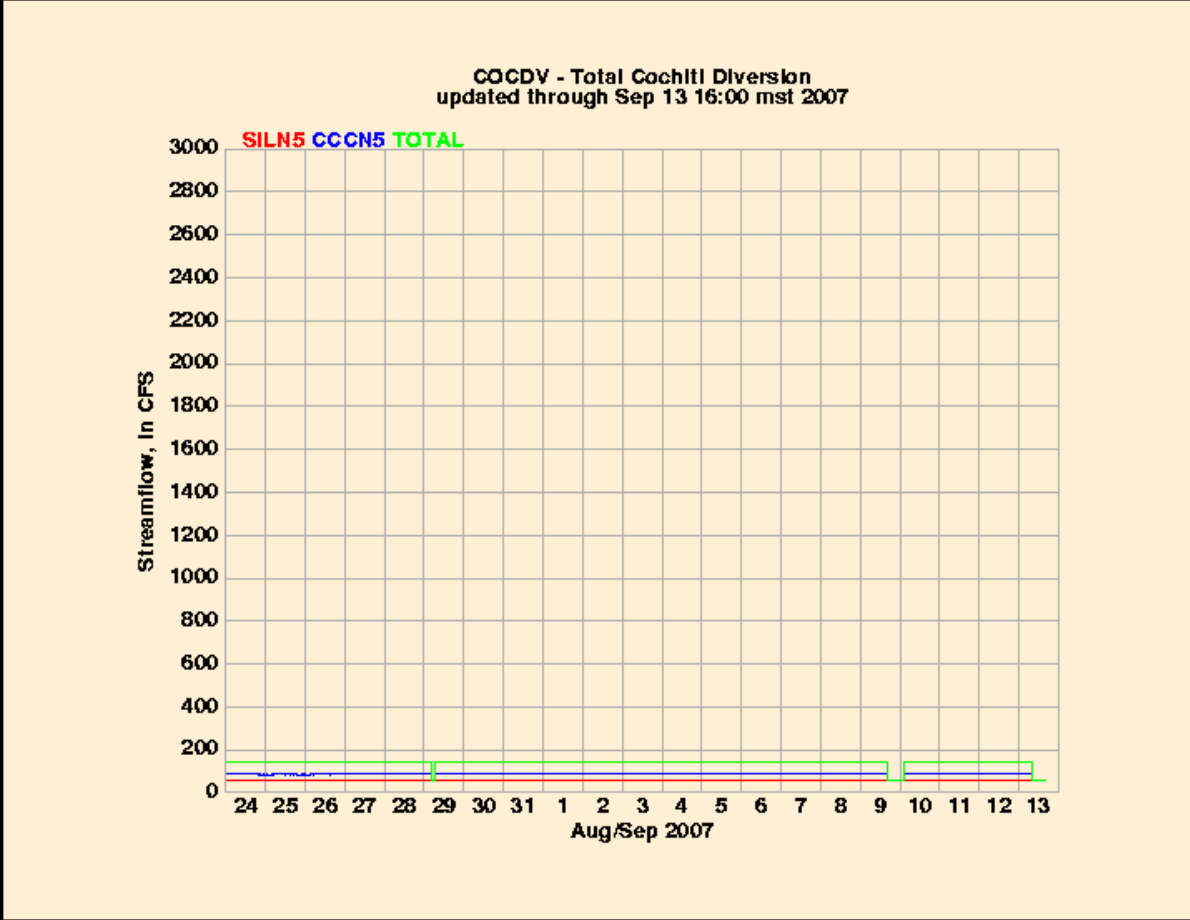

Figure 58: Total Cochiti Diversion

Printed by Al Brower

Apr 01, 08 13:38		COCDV.gage			Page 1/1	
Gage Information - COCDV - Total Cochiti Diversion						
Year 2007						
Month	Day	Time (mst)	SILN5 (cfs)	CCCN5 (cfs)	TOTAL (cfs)	DaAvg (cfs)
----	---	----	----	----	----	-----
Sep	13	1600	58	M	58	102
Sep	13	1530	58	M	58	
Sep	13	1500	58	M	58	
Sep	13	1430	58	M	58	
Sep	13	1400	58	M	58	
Sep	13	1330	58	M	58	
Sep	13	1300	58	M	58	
Sep	13	1230	58	M	58	
Sep	13	1200	58	M	58	
Sep	13	1130	58	M	58	
Sep	13	1100	58	M	58	
Sep	13	1030	58	M	58	
Sep	13	1000	58	M	58	
Sep	13	930	58	M	58	
Sep	13	900	58	M	58	
Sep	13	830	58	M	58	
Sep	13	800	58	87	145	
Sep	13	730	58	87	145	
Sep	13	700	58	87	145	
Sep	13	630	58	87	145	
Sep	13	600	58	86	144	
Sep	13	530	58	86	144	
Sep	13	500	58	87	145	
Sep	13	430	58	86	144	
Sep	13	400	58	86	144	
Sep	13	330	58	86	144	
Sep	13	300	58	86	144	
Sep	13	230	58	86	144	
Sep	13	200	58	86	144	
Sep	13	130	58	86	144	
Sep	13	100	58	86	144	
Sep	13	30	58	86	144	
Sep	13	0	58	86	144	
Sep	12	2330	58	86	144	144
Sep	12	2300	58	86	144	
Sep	12	2230	58	86	144	
Sep	12	2200	58	86	144	
Sep	12	2130	58	86	144	
Sep	12	2100	58	86	144	
Sep	12	2030	58	86	144	
Sep	12	2000	58	87	145	
Sep	12	1930	58	87	145	
Sep	12	1900	58	86	144	
Sep	12	1830	58	87	145	
Sep	12	1800	58	86	144	
Sep	12	1730	58	86	144	
Sep	12	1700	58	87	145	
Sep	12	1630	58	86	144	
Sep	12	1600	58	87	145	
Sep	12	1530	58	86	144	
Sep	12	1500	58	86	144	
Sep	12	1430	58	87	145	
Sep	12	1400	58	87	145	
Sep	12	1330	58	86	144	
Sep	12	1300	58	87	145	
Sep	12	1230	58	87	145	
Sep	12	1200	58	87	145	
Sep	12	1130	58	87	145	
Sep	12	1100	58	87	145	
Sep	12	1030	58	87	145	
Sep	12	1000	58	87	145	
Sep	12	930	58	87	145	

Tuesday April 01, 2008

1/1

Figure 59: Cochiti Diversion Gage Information

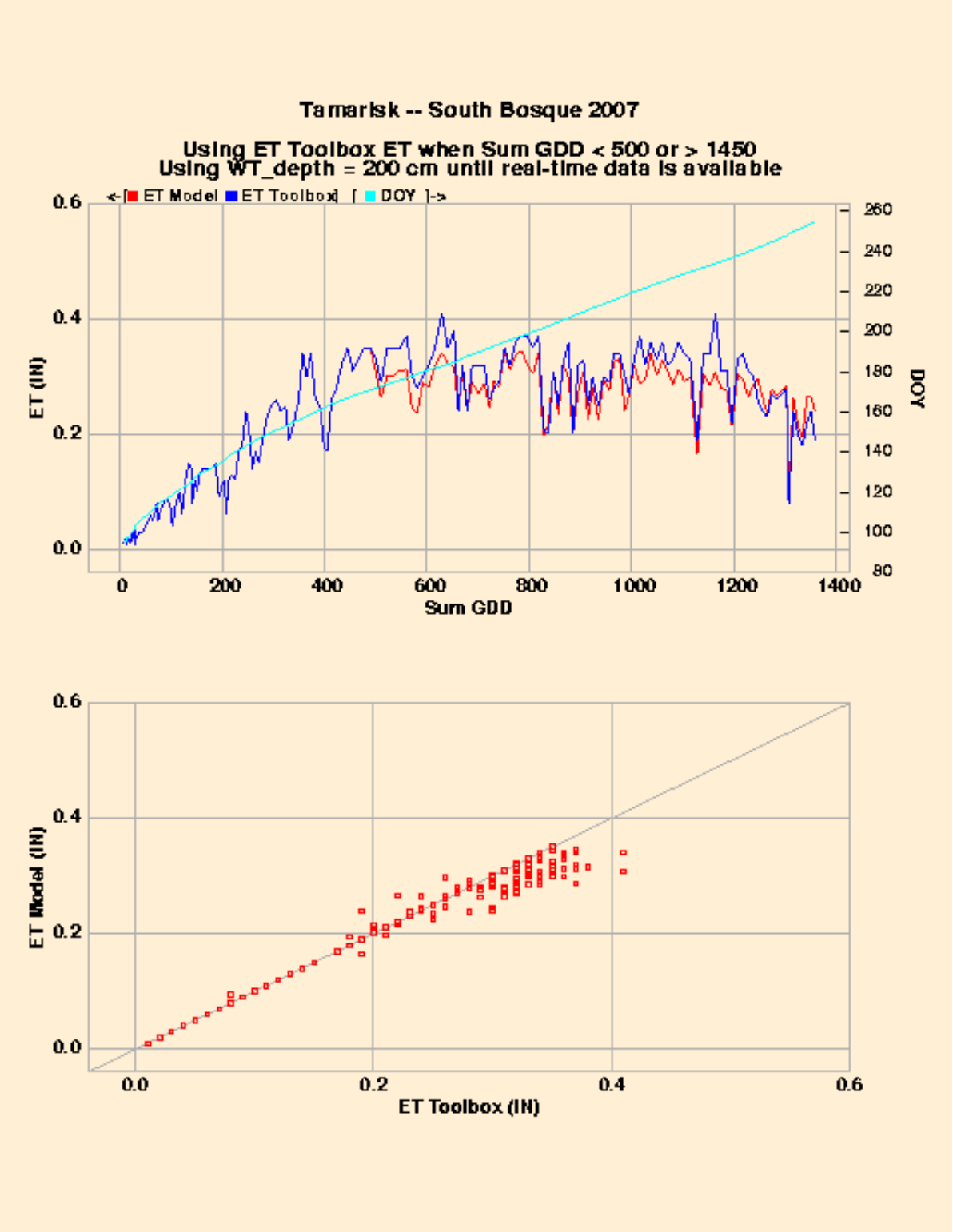

Figure 60: Tamarisk ET Model and Comparisons - Plot

Printed by Al Brower

2007		ET Toolbox - NMSU Mod. Penman Equation					USU - Daily ET Model	
DOY	Date	Ref. ET (in)	GDD	SumGDD	Kc	ET(in)	Daytime ET (mm)	Daytime ET (in)
197	July 16	0.36	11.42	773.4	1.01	0.36	8.576	0.338
198	July 17	0.37	11.69	785.1	1.01	0.37	8.767	0.345
199	July 18	0.37	11.42	796.5	1.01	0.37	8.135	0.320
200	July 19	0.35	11.17	807.7	1.01	0.35	7.746	0.305
201	July 20	0.37	10.62	818.3	1.01	0.37	8.630	0.340
202	July 21	0.21	9.78	828.1	1.01	0.21	5.015	0.197
203	July 22	0.20	8.94	837.0	1.02	0.20	5.498	0.216
204	July 23	0.30	10.34	847.3	1.02	0.31	7.877	0.310
205	July 24	0.25	9.23	856.6	1.02	0.25	5.970	0.235
206	July 25	0.31	9.47	866.0	1.02	0.32	8.155	0.321
207	July 26	0.35	11.17	877.2	1.02	0.36	7.582	0.299
208	July 27	0.20	8.39	885.6	1.02	0.20	5.115	0.201
209	July 28	0.31	10.03	895.6	1.02	0.32	6.958	0.274
210	July 29	0.32	9.75	905.4	1.02	0.33	7.864	0.310
211	July 30	0.24	9.77	915.1	1.02	0.25	5.724	0.225
212	July 31	0.29	8.92	924.1	1.02	0.30	7.129	0.281
213	Aug 1	0.24	11.17	935.2	1.03	0.25	5.738	0.226
214	Aug 2	0.29	9.78	945.0	1.03	0.30	7.540	0.297
215	Aug 3	0.28	10.89	955.9	1.03	0.29	7.017	0.276
216	Aug 4	0.33	10.06	966.0	1.03	0.34	8.279	0.326
217	Aug 5	0.33	10.33	976.3	1.03	0.34	8.372	0.330
218	Aug 6	0.29	10.33	986.6	1.03	0.30	6.088	0.240
219	Aug 7	0.26	8.36	995.0	1.03	0.27	6.834	0.269
220	Aug 8	0.32	10.03	1005.0	1.03	0.33	8.126	0.320
221	Aug 9	0.36	11.14	1016.2	1.03	0.37	7.300	0.287
222	Aug 10	0.31	10.34	1026.5	1.03	0.32	7.490	0.295
223	Aug 11	0.35	11.14	1037.6	1.03	0.36	8.659	0.341
224	Aug 12	0.32	11.42	1049.1	1.02	0.33	7.665	0.302
225	Aug 13	0.35	10.86	1059.9	1.02	0.36	8.352	0.329
226	Aug 14	0.31	10.03	1069.9	1.02	0.32	7.941	0.313
227	Aug 15	0.32	11.14	1081.1	1.02	0.33	7.271	0.286
228	Aug 16	0.35	11.14	1092.2	1.02	0.36	7.938	0.313
229	Aug 17	0.33	10.86	1103.1	1.02	0.34	7.422	0.292
230	Aug 18	0.33	11.72	1114.8	1.01	0.33	7.566	0.298
231	Aug 19	0.19	13.39	1128.2	1.01	0.19	4.181	0.165
232	Aug 20	0.34	12.27	1140.5	1.01	0.34	7.789	0.307
233	Aug 21	0.34	11.97	1152.4	1.00	0.34	7.209	0.284
234	Aug 22	0.41	11.73	1164.2	1.00	0.41	7.814	0.308
235	Aug 23	0.31	10.34	1174.5	0.99	0.31	7.106	0.280
236	Aug 24	0.31	11.14	1185.6	0.99	0.31	7.006	0.276
237	Aug 25	0.22	10.61	1196.2	0.98	0.22	5.450	0.215
238	Aug 26	0.34	10.86	1207.1	0.98	0.33	7.713	0.304
239	Aug 27	0.35	10.03	1217.1	0.97	0.34	7.552	0.297
240	Aug 28	0.32	10.62	1227.8	0.96	0.31	6.719	0.265
241	Aug 29	0.32	10.58	1238.3	0.95	0.30	7.235	0.285
242	Aug 30	0.28	8.39	1246.7	0.95	0.26	7.543	0.297
243	Aug 31	0.26	9.19	1255.9	0.94	0.24	6.718	0.264
244	Sep 1	0.25	9.23	1265.1	0.93	0.23	6.048	0.238
245	Sep 2	0.29	8.92	1274.1	0.92	0.27	7.088	0.279
246	Sep 3	0.29	9.19	1283.3	0.91	0.26	6.767	0.266
247	Sep 4	0.30	9.47	1292.7	0.90	0.27	6.991	0.275
248	Sep 5	0.32	10.03	1302.8	0.89	0.28	7.257	0.286
249	Sep 6	0.09	4.19	1307.0	0.88	0.08	2.405	0.095
250	Sep 7	0.28	9.19	1316.1	0.87	0.24	6.719	0.265
251	Sep 8	0.23	9.47	1325.6	0.86	0.20	5.430	0.214
252	Sep 9	0.21	8.92	1334.5	0.84	0.18	4.928	0.194
253	Sep 10	0.27	8.36	1342.9	0.83	0.22	6.768	0.266
254	Sep 11	0.29	7.53	1350.4	0.82	0.24	6.728	0.265
255	Sep 12	0.24	8.08	1358.5	0.80	0.19	6.071	0.239

Tuesday April 15, 2008

1/1

Figure 61: Tamarisk ET Model and Comparisons - Text

The screenshot shows the Bureau of Reclamation website interface. At the top, there is a navigation bar with "U.S. Department of the Interior | Bureau of Reclamation" on the left and "Contact Us | Site Map" on the right. Below this is a banner image of a dam with the word "RECLAMATION" in large white letters and the tagline "Managing Water in the West" in a smaller font. On the left side, there is a blue sidebar with a search bar and a list of navigation links: "Reclamation Home", "Regional Offices", "Newsroom", "Library", "Dataweb", "Programs", "Water Operations", "Technical Service Center", and "Watershed and Rivers Software". Below the links is the U.S. Department of the Interior logo and the text "U.S. Department of the Interior". The main content area is titled "Irrigation Scheduling Products (To-Date) Candelaria Farms". Underneath the title, there is a section for "OPTIONS:" which includes links for "Table of Daily Soil Temperature/Moisture", "Plot of Daily Soil Moisture/Rain", "Table of Hourly Weather and Soil Temperature/Moisture Data", "Plot of Hourly Air Temperature and Relative Humidity", "Table of Daily Field Data and Irrigation Schedule", and "Plot of Daily Field Data and Irrigation Schedule". Below this is a section for "PHOTOS OF CANDELARIA FARM:" with links for "Looking NW", "Looking West", "Alfalfa Cutting", "Weather Station", "Flume #1", and "Ground Water Well #1". At the bottom, there is a section for "HISTORIC IRRIGATION SCHEDULING PRODUCTS:" with a link for "Irrigation Scheduling". At the very bottom of the page, there is a footer with links for "Privacy Policy | Disclaimer | Accessibility | FOIA | Quality of Information | FAQ | Notices DOI | Recreation.gov | USA.gov".

Figure 62: Irrigation Scheduling Products - Candelaria Farms

Printed by Al Brower

Apr 02, 08 9:51		CFMN.soil		Page 1/1
Soil Temperature and Moisture Reported at CFMN Weather Station Candelaria Farms Station				
Date (2007)	DOY	Soil Temp. (F)	Vol. Soil Water Content	
July 16	197	73.30	32.78	
July 17	198	73.70	32.24	
July 18	199	73.80	31.80	
July 19	200	73.80	31.44	
July 20	201	73.80	31.14	
July 21	202	73.70	30.59	
July 22	203	73.30	30.50	
July 23	204	73.00	30.67	
July 24	205	73.40	30.12	
July 25	206	71.60	32.26	
July 26	207	71.80	34.96	
July 27	208	71.70	33.90	
July 28	209	71.60	33.09	
July 29	210	71.70	32.53	
July 30	211	71.90	32.08	
July 31	212	71.80	31.81	
Aug 1	213	72.20	31.82	
Aug 2	214	72.30	31.71	
Aug 3	215	72.80	31.73	
Aug 4	216	73.20	31.73	
Aug 5	217	73.40	31.69	
Aug 6	218	73.40	31.62	
Aug 7	219	72.60	31.36	
Aug 8	220	72.00	31.12	
Aug 9	221	72.00	30.72	
Aug 10	222	72.60	30.43	
Aug 12	224	73.60	30.82	
Aug 13	225	73.50	30.80	
Aug 14	226	73.60	30.73	
Aug 15	227	73.40	30.36	
Aug 16	228	73.20	30.13	
Aug 17	229	73.00	29.93	
Aug 18	230	73.10	29.85	
Aug 19	231	73.50	29.72	
Aug 21	233	72.90	29.31	
Aug 22	234	73.30	29.11	
Aug 23	235	72.10	29.80	
Aug 24	236	72.10	30.04	
Aug 25	237	72.20	29.99	
Aug 26	238	72.40	29.98	
Aug 27	239	72.30	29.92	
Aug 28	240	72.40	29.86	
Aug 29	241	72.60	29.79	
Aug 30	242	72.50	29.70	
Aug 31	243	72.70	29.64	
Sep 1	244	72.30	30.50	
Sep 2	245	71.80	33.50	
Sep 3	246	71.40	32.39	
Sep 4	247	71.10	31.50	
Sep 5	248	71.20	30.91	
Sep 6	249	71.00	30.47	

Wednesday April 02, 2008

1/1

Figure 63: Candelaria Farms Soil Data

Printed by Al Brower

Apr 02, 08 10:04		CFMN.hrs2.arc.txt							Page 1/1		
Candelaria Farms Station - MRGCD										CFMN	
Hourly Weather Data for Year 2007 To-Date											
Month	Day	Time	Temp.	Wind	Wind Dir.	Rel. Hum.	Rain	Solar Radiation	Soil Temp.	Soil Water Content	
		(MST)	(F)	(Mi/Hr)	(Deg)	(%)	(in)	(Mj/Sq m)	(F)	sm1	sm2
Sep	04	5PM	90.4	3.4	162	27	0.00	0.96	71.1	31.3	31.4
Sep	04	6PM	85.1	4.1	162	30	0.00	0.43	71.3	31.3	31.4
Sep	04	7PM	78.0	3.1	162	37	0.00	0.01	71.5	31.3	31.4
Sep	04	8PM	74.6	2.0	161	46	0.00	0.00	71.6	31.3	31.4
Sep	04	9PM	70.7	0.7	161	55	0.00	0.00	71.7	31.3	31.4
Sep	04	10PM	69.7	1.0	162	62	0.00	0.00	71.7	31.3	31.4
Sep	04	11PM	66.8	0.3	162	73	0.00	0.00	71.7	31.2	31.5
Sep	04	12PM	63.4	0.0	162	82	0.00	0.00	71.6	31.2	31.5
Sep	05	1AM	59.9	0.0	0	89	0.00	0.00	71.6	31.2	31.5
Sep	05	2AM	58.2	0.0	0	93	0.00	0.00	71.5	31.2	31.5
Sep	05	3AM	57.3	0.0	0	94	0.00	0.00	71.4	31.2	31.5
Sep	05	4AM	56.1	0.0	0	94	0.00	0.00	71.3	31.1	31.5
Sep	05	5AM	54.8	0.0	0	96	0.00	0.00	71.2	31.1	31.5
Sep	05	6AM	54.1	0.0	0	97	0.00	0.01	71.0	31.1	31.5
Sep	05	7AM	57.0	0.0	0	98	0.00	0.39	70.9	31.0	31.5
Sep	05	8AM	68.4	0.0	0	74	0.00	0.92	70.7	31.0	31.5
Sep	05	9AM	73.2	1.3	162	54	0.00	1.26	70.6	31.0	31.5
Sep	05	10AM	80.0	3.2	164	44	0.00	1.91	70.5	30.9	31.5
Sep	05	11AM	84.0	3.2	162	37	0.00	2.26	70.4	30.9	31.4
Sep	05	12AM	87.4	3.0	163	33	0.00	2.43	70.5	30.8	31.4
Sep	05	1PM	90.1	4.3	163	31	0.00	2.47	70.5	30.8	31.4
Sep	05	2PM	91.0	6.4	163	29	0.00	2.36	70.7	30.8	31.4
Sep	05	3PM	91.7	5.4	161	28	0.00	1.83	70.9	30.8	31.4
Sep	05	4PM	89.1	3.6	159	31	0.00	1.17	71.1	30.8	31.4
Sep	05	5PM	90.1	6.0	159	28	0.00	1.02	71.3	30.8	31.4
Sep	05	6PM	82.0	6.0	160	35	0.00	0.18	71.5	30.8	31.4
Sep	05	7PM	77.1	2.8	162	44	0.00	0.01	71.7	30.8	31.4
Sep	05	8PM	70.8	0.4	162	63	0.00	0.00	71.8	30.8	31.4
Sep	05	9PM	68.3	0.2	162	68	0.00	0.00	71.8	30.8	31.4
Sep	05	10PM	73.1	2.0	162	53	0.00	0.00	71.8	30.8	31.4
Sep	05	11PM	68.0	1.2	162	72	0.00	0.00	71.8	30.8	31.4
Sep	05	12PM	63.5	0.2	163	84	0.00	0.00	71.8	30.7	31.4
Sep	06	1AM	61.0	0.1	163	91	0.00	0.00	71.7	30.7	31.4
Sep	06	2AM	59.4	0.1	162	94	0.00	0.00	71.7	30.7	31.5
Sep	06	3AM	58.2	0.0	162	96	0.00	0.00	71.6	30.7	31.5
Sep	06	4AM	57.5	0.0	0	97	0.00	0.00	71.5	30.6	31.5
Sep	06	5AM	56.8	0.0	0	98	0.00	0.00	71.3	30.6	31.5
Sep	06	6AM	56.6	0.1	162	98	0.00	0.02	71.2	30.6	31.5
Sep	06	7AM	59.5	0.2	162	99	0.00	0.16	71.1	30.6	31.5
Sep	06	8AM	64.8	1.6	161	82	0.00	0.34	70.9	30.5	31.4
Sep	06	9AM	71.6	3.0	164	59	0.00	0.78	70.8	30.5	31.4
Sep	06	10AM	75.1	7.1	166	53	0.00	1.41	70.7	30.5	31.4
Sep	06	11AM	77.7	6.6	164	51	0.00	1.70	70.7	30.5	31.4
Sep	06	12AM	76.3	8.4	164	51	0.00	1.18	70.7	30.5	31.4
Sep	06	1PM	76.5	8.5	165	51	0.00	1.52	70.7	30.4	31.4
Sep	06	2PM	74.2	8.1	162	55	0.00	0.74	70.8	30.4	31.4
Sep	06	3PM	76.0	8.5	159	52	0.00	1.08	70.8	30.4	31.4
Sep	06	4PM	75.6	7.7	161	54	0.00	0.71	70.8	30.4	31.4
Sep	06	5PM	75.1	7.0	159	55	0.00	0.52	70.9	30.4	31.3
Sep	06	6PM	73.6	6.7	159	60	0.00	0.40	70.9	30.4	31.3
Sep	06	7PM	70.2	4.3	162	66	0.00	0.01	70.9	30.4	31.3
Sep	06	8PM	67.6	3.0	162	73	0.00	0.00	71.0	30.3	31.3
Sep	06	9PM	63.7	0.0	161	83	0.00	0.00	70.9	30.3	31.4
Sep	06	10PM	60.6	0.2	161	90	0.00	0.00	70.9	30.3	31.4
Sep	06	11PM	60.3	0.0	0	90	0.00	0.00	70.9	30.3	31.4
Sep	06	12PM	57.5	0.0	0	95	0.00	0.00	70.8	30.3	31.4
Sep	07	1AM	55.9	0.0	0	97	0.00	0.00	70.7	30.2	31.4
Sep	07	2AM	54.7	0.0	0	98	0.00	0.00	70.6	30.2	31.4

Wednesday April 02, 2008 1/1

Figure 64: Candelaria Farms Hourly Weather and Soil Data



Printed by Al Brower

Apr 02, 08 10:28		fieldsch.CFMN.1.txt						Page 1/1			
Daily Field Data and Irrigation Schedule											
Weather Station: Candelaria Farms Station Last Weather Date: Sep 12, 2007 Duranes Lateral North Ditch Farm Number: 1 Field Number: 1 Crop: Alfalfa Acres: 27.7 Planting Date: Jan 1 Terminate Date: Oct 20 Management Allowable Depletion(%): 65 Irrigation Efficiency(%): 50 Root Zone(in): 60 Soil Water Holding Capacity(in/ft): 2.5 Allowable Depletion = RZ/12*SWHC*MAD/100 = 8.12											
Month	Day	F	Gage	Soil	Soil	Ref.	Crop	Crop	Sum	Suggested Irrigation	
(2007)		r	Rain	Temp.	Moist.	ET	Coef.	ET	Depletion	(IN)	Amount
		(IN)	(IN)	(F)	(VWC)	(IN)		(IN)	(IN)	(IN)	(AC-FT)
Aug	4		0.02	73.20	31.73	0.23	1.21	0.28	3.11		
Aug	5		0.00	73.40	31.69	0.26	1.20	0.31	3.42		
Aug	6		0.00	73.40	31.62	0.19	1.20	0.23	3.65		
Aug	7		0.00	72.60	31.36	0.17	1.19	0.20	3.85		
Aug	8		0.00	72.00	31.12	0.23	1.19	0.27	4.12		
Aug	9		0.00	72.00	30.72	0.29	1.19	0.34	4.46		
Aug	10		0.00	72.60	30.43	0.25	1.18	0.30	4.76		
Aug	11		0.00	72.00	30.00	0.38	1.18	0.45	5.21		
Aug	12		0.00	73.60	30.82	0.25	1.17	0.29	5.50		
Aug	13		0.00	73.50	30.80	0.24	1.17	0.28	5.78		
Aug	14		0.00	73.60	30.73	0.23	1.16	0.27	6.05		
Aug	15		0.00	73.40	30.36	0.23	1.16	0.27	6.32		
Aug	16		0.00	73.20	30.13	0.23	1.15	0.26	6.58		
Aug	17		0.00	73.00	29.93	0.21	1.15	0.24	6.82		
Aug	18		0.00	73.10	29.85	0.21	1.14	0.24	7.06		
Aug	19		0.00	73.50	29.72	0.22	1.13	0.25	7.31		
Aug	20		0.00	72.00	29.00	0.41	1.13	0.46	7.77		
Aug	21		0.00	72.90	29.31	0.24	1.12	0.27	8.04		
Aug	22		0.00	73.30	29.11	0.26	1.12	0.29	8.33	12.50	28.85
Aug	23		0.01	72.10	29.80	0.23	1.11	0.25	0.24		
Aug	24		0.00	72.10	30.04	0.19	1.10	0.21	0.45		
Aug	25		0.00	72.20	29.99	0.20	1.10	0.22	0.67		
Aug	26		0.00	72.40	29.98	0.22	1.09	0.24	0.91		
Aug	27		0.00	72.30	29.92	0.19	1.08	0.21	1.12		
Aug	28		0.00	72.40	29.86	0.22	1.08	0.24	1.36		
Aug	29		0.01	72.60	29.79	0.22	1.07	0.24	1.59		
Aug	30		0.00	72.50	29.70	0.20	1.06	0.21	1.80		
Aug	31		0.01	72.70	29.64	0.16	1.06	0.17	1.96		
Sep	1		0.15	72.30	30.50	0.18	1.05	0.19	2.00		
Sep	2		0.00	71.80	33.50	0.18	1.04	0.19	2.19		
Sep	3		0.00	71.40	32.39	0.21	1.04	0.22	2.41		
Sep	4		0.00	71.10	31.50	0.23	1.03	0.24	2.65		
Sep	5		0.00	71.20	30.91	0.22	1.02	0.22	2.87		
Sep	6		0.00	71.00	30.47	0.11	1.02	0.11	2.98		
Sep	7		0.02	70.00	30.00	0.36	1.01	0.36	3.32		
Sep	8		0.00	70.00	30.00	0.36	1.00	0.36	3.68		
Sep	9		0.02	70.00	30.00	0.37	0.99	0.37	4.03		
Sep	10		0.11	70.00	30.00	0.36	0.99	0.36	4.28		
Sep	11		0.02	70.00	30.00	0.29	0.98	0.28	4.54		
Sep	12		0.00	70.00	30.00	0.34	0.97	0.33	4.87		
Sep	13	F	0.00	70.00	30.00	0.36	0.97	0.35	5.22		
Sep	14	F	0.00	70.00	30.00	0.37	0.96	0.35	5.57		
Sep	15	F	0.00	70.00	30.00	0.36	0.95	0.34	5.91		
Sep	16	F	0.00	70.00	30.00	0.36	0.95	0.34	6.25		
Sep	17	F	0.00	70.00	30.00	0.35	0.94	0.33	6.58		
Sep	18	F	0.00	70.00	30.00	0.34	0.93	0.32	6.90		
Sep	19	F	0.00	70.00	30.00	0.35	0.93	0.33	7.23		
Totals:			6.84			51.50		47.28		49.80	114.96
VWC = Volumetric Water Content											

Wednesday April 02, 2008

1/1

Figure 65: Candelaria Farms Daily Field Data and Irrigation Schedule

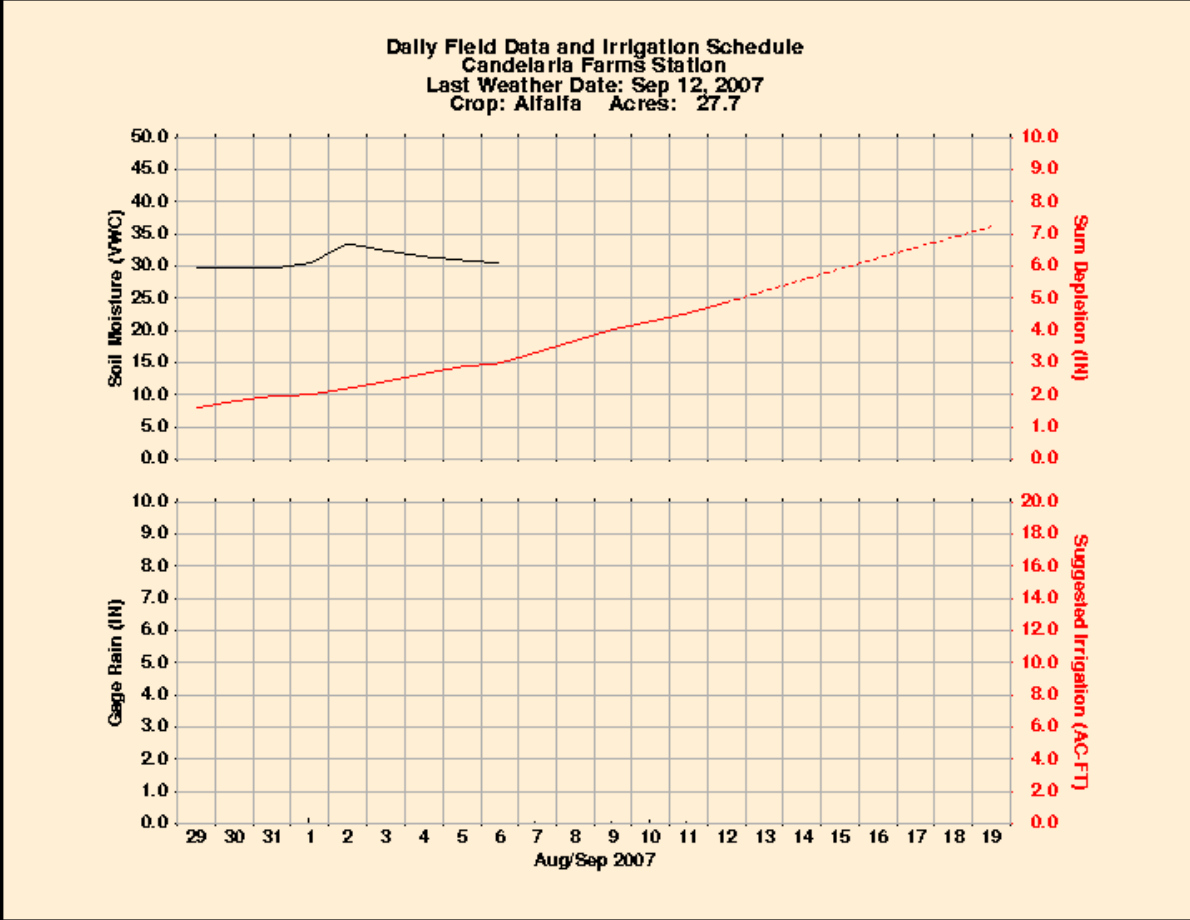

Figure 66: Candelaria Farms Daily Field Data and Irrigation Schedule Plot

Printed by Al Brower

Mar 27, 08 14:37		cu_rate1.txt										Page 1/1	
R	101	102	103	108	109	150	153	156	161	163	164	167	
0815	1	0.398	0.260	0.224	0.341	0.000	0.243	0.241	0.387	0.246	0.249	0.258	0.257
0816	1	0.439	0.390	0.249	0.407	0.000	0.266	0.261	0.471	0.266	0.280	0.302	0.302
0817	1	0.401	0.303	0.224	0.378	0.000	0.246	0.242	0.429	0.246	0.258	0.276	0.277
0818	1	0.365	0.217	0.214	0.303	0.000	0.228	0.224	0.387	0.228	0.236	0.251	0.251
0819	1	0.372	0.217	0.214	0.322	0.000	0.230	0.226	0.410	0.232	0.244	0.266	0.266
0820	1	0.391	0.260	0.224	0.341	0.000	0.246	0.242	0.429	0.246	0.258	0.276	0.277
0821	1	0.426	0.303	0.244	0.378	0.000	0.266	0.262	0.460	0.268	0.278	0.296	0.297
0822	1	0.416	0.303	0.244	0.350	0.000	0.261	0.257	0.460	0.263	0.274	0.296	0.297
0823	1	0.371	0.217	0.219	0.284	0.000	0.237	0.232	0.410	0.236	0.248	0.266	0.266
0824	1	0.389	0.217	0.234	0.284	0.000	0.247	0.244	0.418	0.249	0.256	0.274	0.273
0825	1	0.382	0.217	0.224	0.284	0.000	0.246	0.242	0.429	0.246	0.258	0.276	0.277
0826	1	0.347	0.130	0.204	0.246	0.000	0.225	0.222	0.398	0.226	0.238	0.256	0.258
0827	1	0.363	0.173	0.219	0.255	0.000	0.237	0.232	0.418	0.236	0.248	0.266	0.266
0828	1	0.405	0.087	0.250	0.246	0.000	0.280	0.280	0.387	0.272	0.280	0.272	0.271
0829	1	0.346	0.130	0.209	0.246	0.000	0.229	0.223	0.429	0.232	0.247	0.267	0.267
0830	1	0.319	0.087	0.194	0.218	0.000	0.217	0.214	0.360	0.220	0.226	0.233	0.235
0831	1	0.289	0.087	0.174	0.208	0.000	0.191	0.185	0.360	0.200	0.205	0.222	0.222
0901	1	0.291	0.087	0.179	0.170	0.000	0.196	0.191	0.360	0.202	0.210	0.224	0.224
0902	1	0.312	0.087	0.194	0.170	0.000	0.217	0.214	0.360	0.220	0.226	0.233	0.235
0903	1	0.317	0.087	0.199	0.161	0.000	0.218	0.215	0.360	0.211	0.225	0.233	0.235
0904	1	0.312	0.087	0.199	0.161	0.000	0.218	0.215	0.348	0.211	0.225	0.226	0.227
0905	1	0.298	0.087	0.194	0.161	0.000	0.207	0.204	0.348	0.203	0.216	0.223	0.224
0906	1	0.236	0.043	0.148	0.132	0.000	0.155	0.147	0.336	0.156	0.173	0.194	0.196
0907	1	0.339	0.087	0.224	0.161	0.000	0.235	0.229	0.429	0.239	0.251	0.259	0.259
0908	1	0.290	0.043	0.189	0.132	0.000	0.206	0.202	0.360	0.210	0.218	0.219	0.219
0909	1	0.361	0.043	0.240	0.132	0.000	0.258	0.259	0.376	0.260	0.262	0.248	0.247
0910	1	0.333	0.043	0.224	0.132	0.000	0.230	0.225	0.418	0.231	0.245	0.252	0.251
0911	1	0.246	0.000	0.170	0.066	0.000	0.178	0.177	0.278	0.173	0.183	0.180	0.180
0912	1	0.269	0.000	0.179	0.085	0.000	0.188	0.184	0.318	0.187	0.197	0.196	0.195
0913	1	0.370	0.000	0.255	0.085	0.000	0.271	0.271	0.367	0.266	0.268	0.245	0.244
0914	1	0.364	0.000	0.255	0.028	0.000	0.271	0.271	0.367	0.266	0.268	0.245	0.244
0915	1	0.350	0.000	0.245	0.028	0.000	0.261	0.261	0.348	0.251	0.258	0.235	0.233
0916	1	0.351	0.000	0.250	0.009	0.000	0.261	0.261	0.348	0.251	0.258	0.235	0.233
0917	1	0.345	0.000	0.245	0.009	0.000	0.256	0.257	0.336	0.246	0.253	0.227	0.226
0918	1	0.341	0.000	0.245	0.000	0.000	0.250	0.251	0.336	0.240	0.248	0.225	0.224
0919	1	0.331	0.000	0.235	0.000	0.000	0.240	0.242	0.329	0.237	0.239	0.215	0.214

Thursday March 27, 2008

1/1

Figure 67: URGWOM Consumptive Use - Reach 1

Printed by Al Brower

Mar 27, 08 14:42		cu_use.txt						Page 1/1
	1	2	3	4	5	6	7	8
0815	117.9	155.5	59.8	163.8	595.4	65.4	468.1	220.5
0816	132.6	137.3	47.5	146.7	616.0	68.1	507.7	233.9
0817	121.7	145.2	55.2	147.1	605.3	63.3	474.2	245.7
0818	100.3	44.7	54.4	141.3	469.0	55.5	331.5	260.1
0819	114.3	147.9	57.4	161.1	555.2	58.3	349.8	214.2
0820	121.9	162.7	106.6	154.8	590.4	77.5	535.7	244.5
0821	131.3	156.8	62.3	154.8	604.2	70.1	497.4	229.1
0822	130.3	152.4	67.0	177.7	640.7	68.0	367.8	267.4
0823	-385.6	-362.7	-348.9	30.2	41.3	17.1	-539.1	208.9
0824	-83.0	113.7	46.5	128.7	561.9	-84.8	351.0	242.8
0825	99.5	135.2	51.1	135.2	541.6	32.5	311.8	210.6
0826	-119.4	-22.3	34.9	138.9	452.4	56.5	440.2	211.1
0827	109.7	82.3	27.4	112.1	503.0	52.8	428.7	206.4
0828	72.7	99.3	43.8	136.9	516.5	52.1	427.2	211.8
0829	64.1	57.0	-43.9	-25.4	-1320.2	-151.6	-1049.8	98.0
0830	104.5	116.0	40.7	117.8	469.6	40.8	209.5	204.2
0831	44.1	35.5	8.1	70.6	373.7	-144.5	127.4	178.8
0901	-31.1	73.0	-37.9	67.1	417.0	-60.4	208.9	115.0
0902	92.8	117.5	39.2	117.1	445.8	34.0	361.8	180.6
0903	103.6	115.0	42.9	124.2	458.5	33.9	362.6	189.6
0904	89.2	104.7	50.5	115.1	463.5	38.0	373.4	190.0
0905	61.1	-125.2	40.8	-67.4	474.1	44.6	381.8	210.6
0906	70.5	53.4	27.3	63.0	296.4	-35.5	-135.4	-6.0
0907	116.3	160.8	85.6	154.3	447.5	73.7	343.1	157.1
0908	99.9	132.0	84.1	155.1	424.7	75.0	267.9	166.1
0909	89.0	145.8	82.6	40.8	428.3	53.4	-273.8	170.6
0910	69.6	31.9	43.1	150.4	431.4	78.4	147.7	156.2
0911	-41.1	101.8	57.7	122.4	359.1	65.1	321.0	150.1
0912	91.5	135.0	81.1	139.4	359.3	62.2	210.0	23.8
0913	124.6	153.7	85.2	146.3	417.0	76.6	389.3	38.9
0914	124.5	158.2	86.1	147.8	420.5	80.1	396.6	40.3
0915	119.5	149.8	84.0	142.7	408.0	75.5	381.0	40.3
0916	120.1	147.6	83.5	141.7	400.1	73.5	366.7	38.6
0917	117.5	142.2	81.2	136.3	389.7	72.5	360.9	38.1
0918	115.9	139.9	77.9	131.4	382.9	72.2	346.4	36.5
0919	111.4	139.5	80.5	131.4	368.8	69.8	345.6	36.4

Thursday March 27, 2008

1/1

Figure 68: URGWOM Consumptive Use - All Reaches

WEATHER DATA

A. REAL-TIME MRGCD

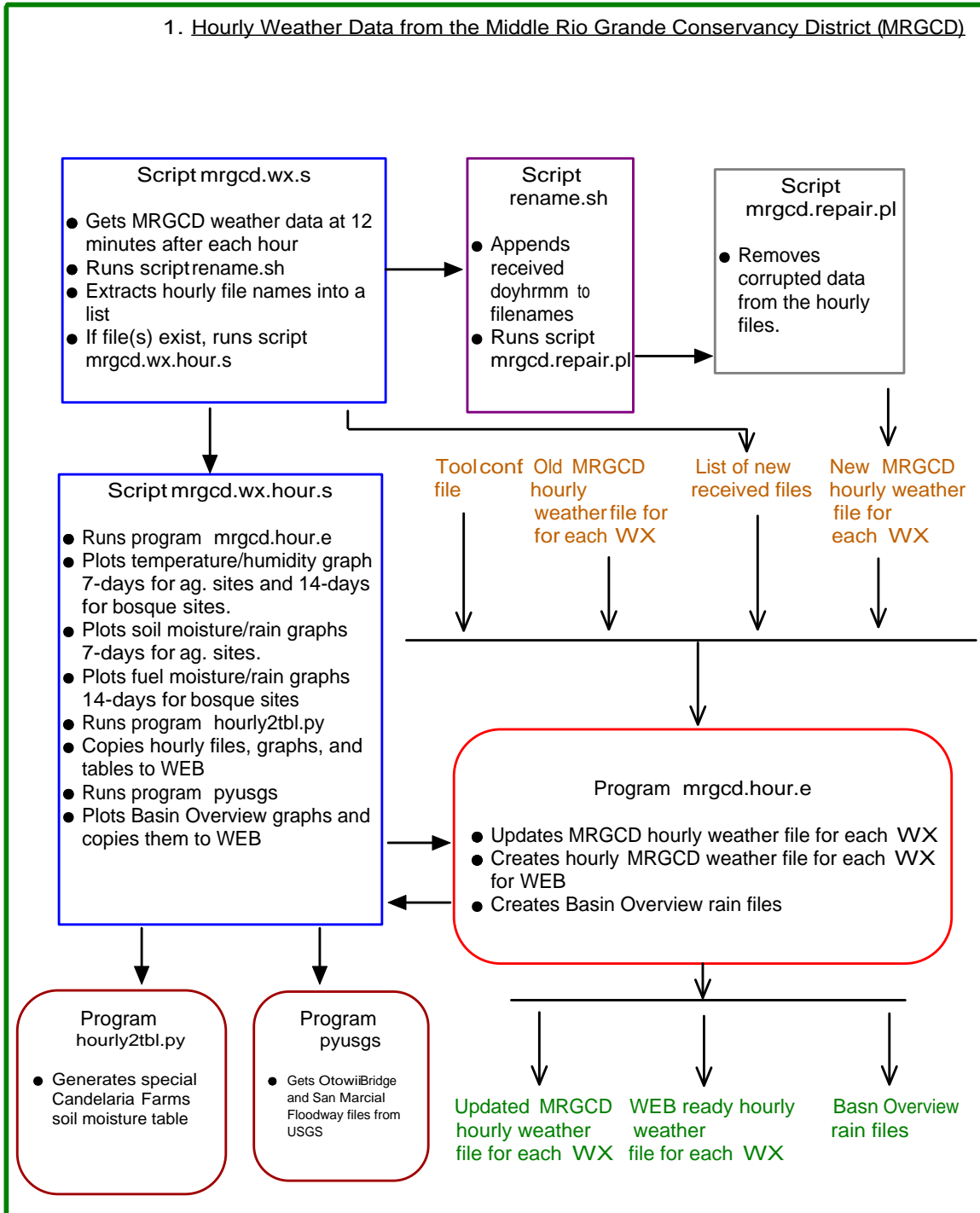

Figure 69: Flow Diagram of Weather Data, Page 1 - Real-Time Hourly from the Middle Rio Grande Conservancy District (MRGCD)

WEATHER DATA

A. REAL-TIME MRGCD

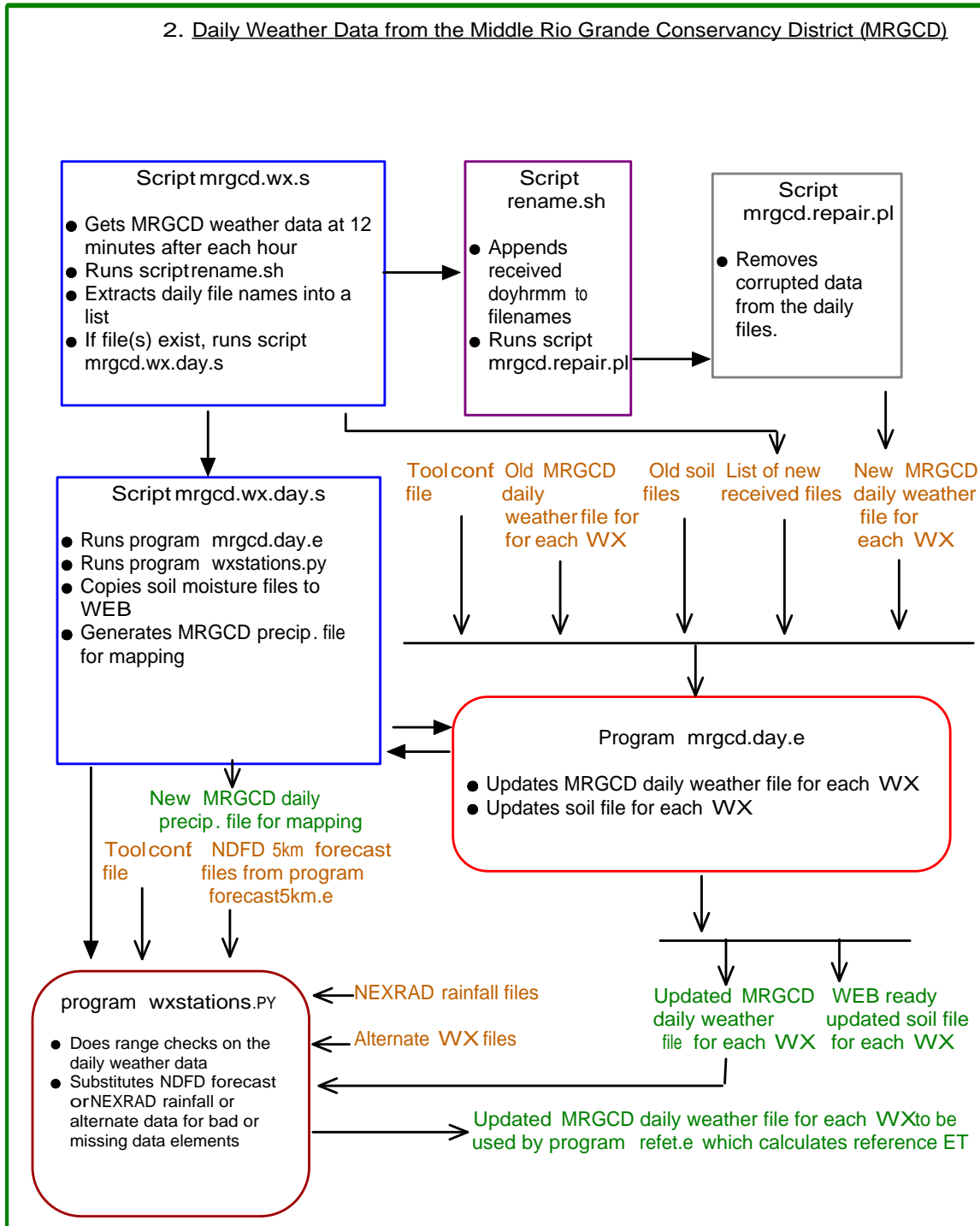

Figure 70: Flow Diagram of Weather Data, Page 2 - Real-Time Daily from the Middle Rio Grande Conservancy District (MRGCD)

WEATHER DATA

A. REAL-TIME NMSUCC

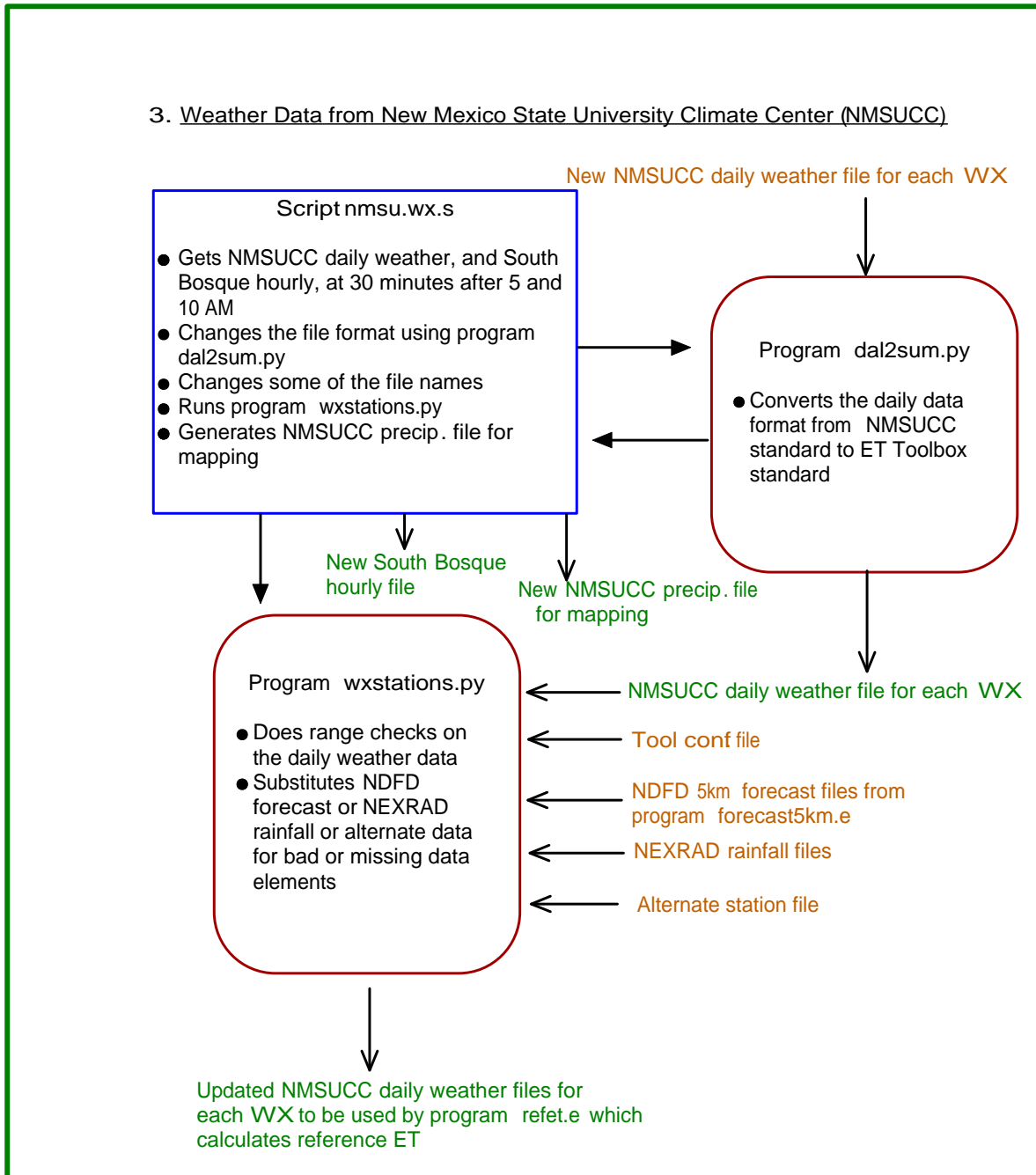

Figure 71: Flow Diagram of Weather Data, Page 3 - Real-Time from the New Mexico State University Climate Center (NMSUCC)

WEATHER DATA

A. REAL-TIME METAR

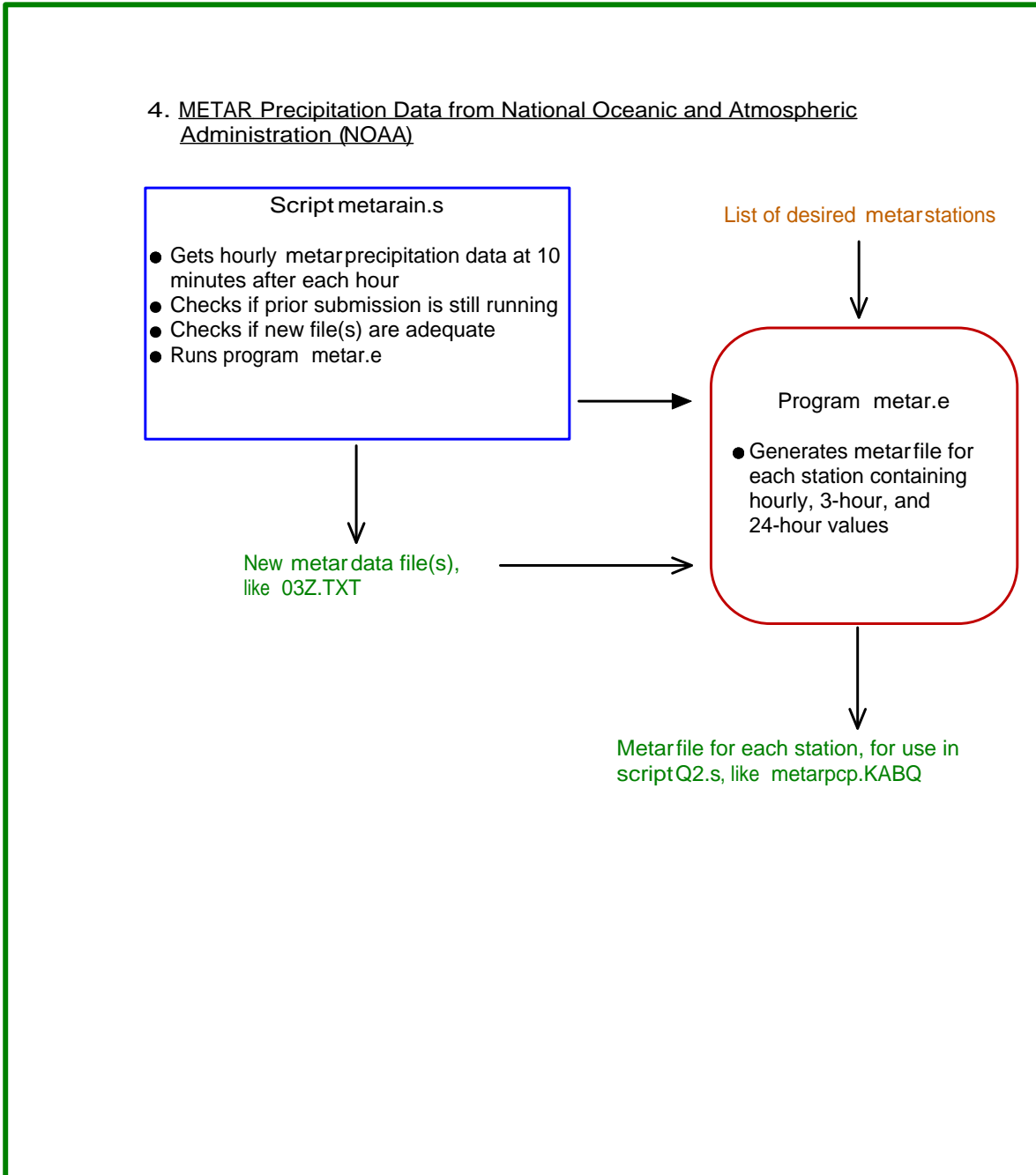

Figure 72: Flow Diagram of Weather Data, Page 4 - Real-Time METAR from NOAA



WEATHER DATA

B. FORECAST

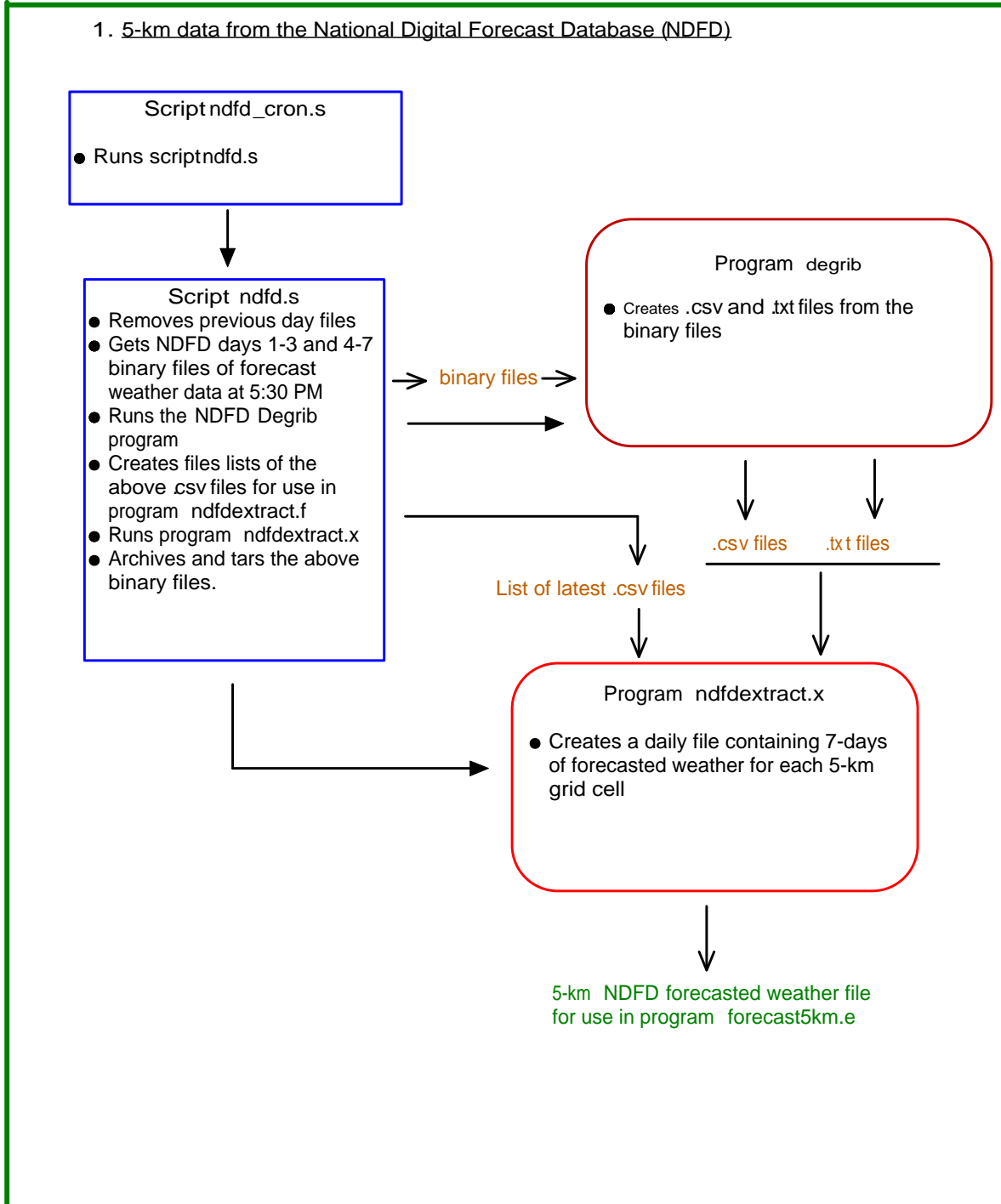

Figure 73: Flow Diagram of Weather Data, Page 5 - Forecast 5-km NDFD data from the National Digital Forecast Database (NDFD)

WEATHER DATA

B. FORECAST

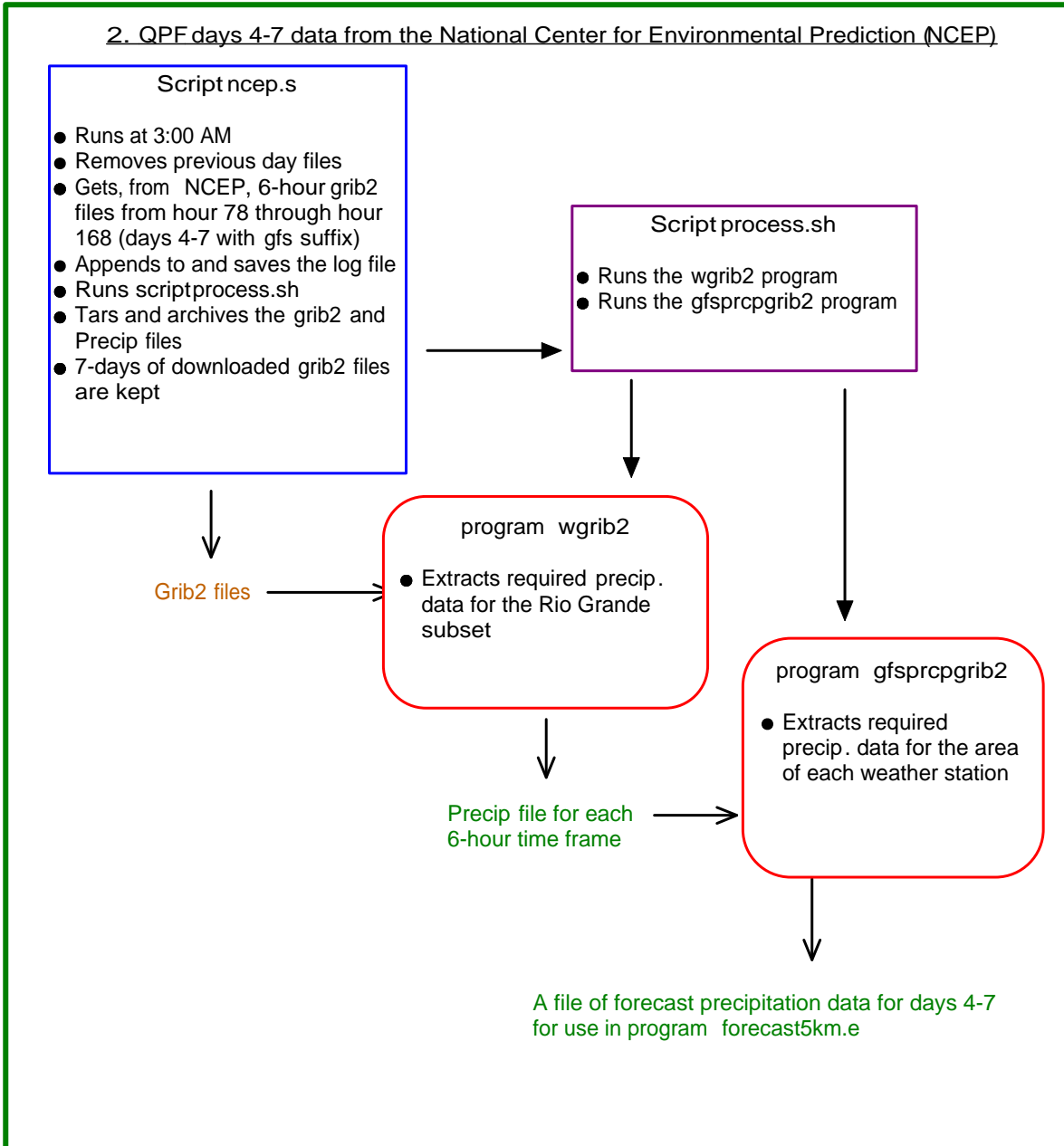

Figure 74: Flow Diagram of Weather Data, Page 6 - Forecast NCEP QPF days 4-7 precipitation data from the National Centers for Environmental Prediction (NCEP)

WEATHER DATA

B. FORECAST

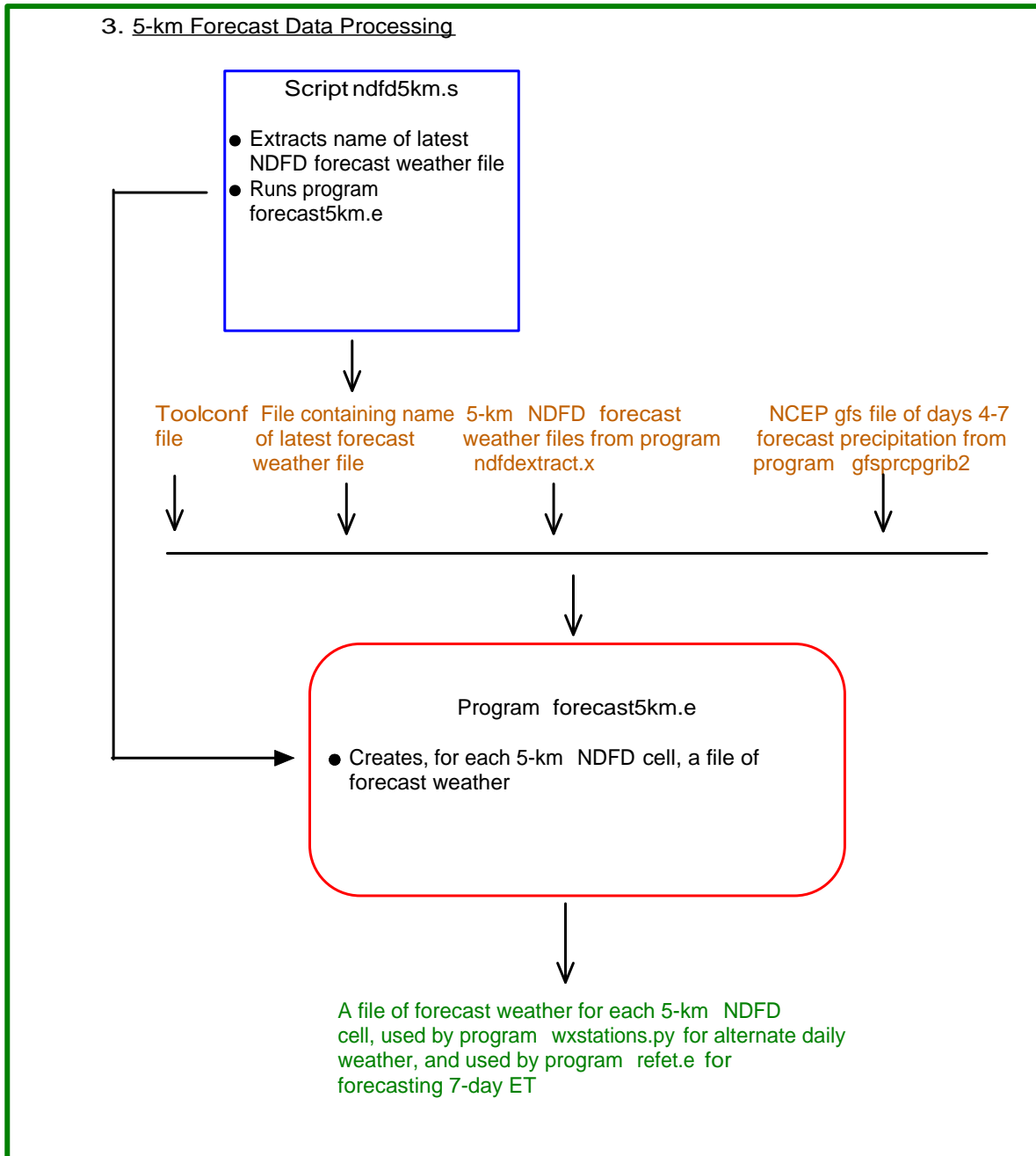

Figure 75: Flow Diagram of Weather Data, Page 7 - Forecast Data Processing

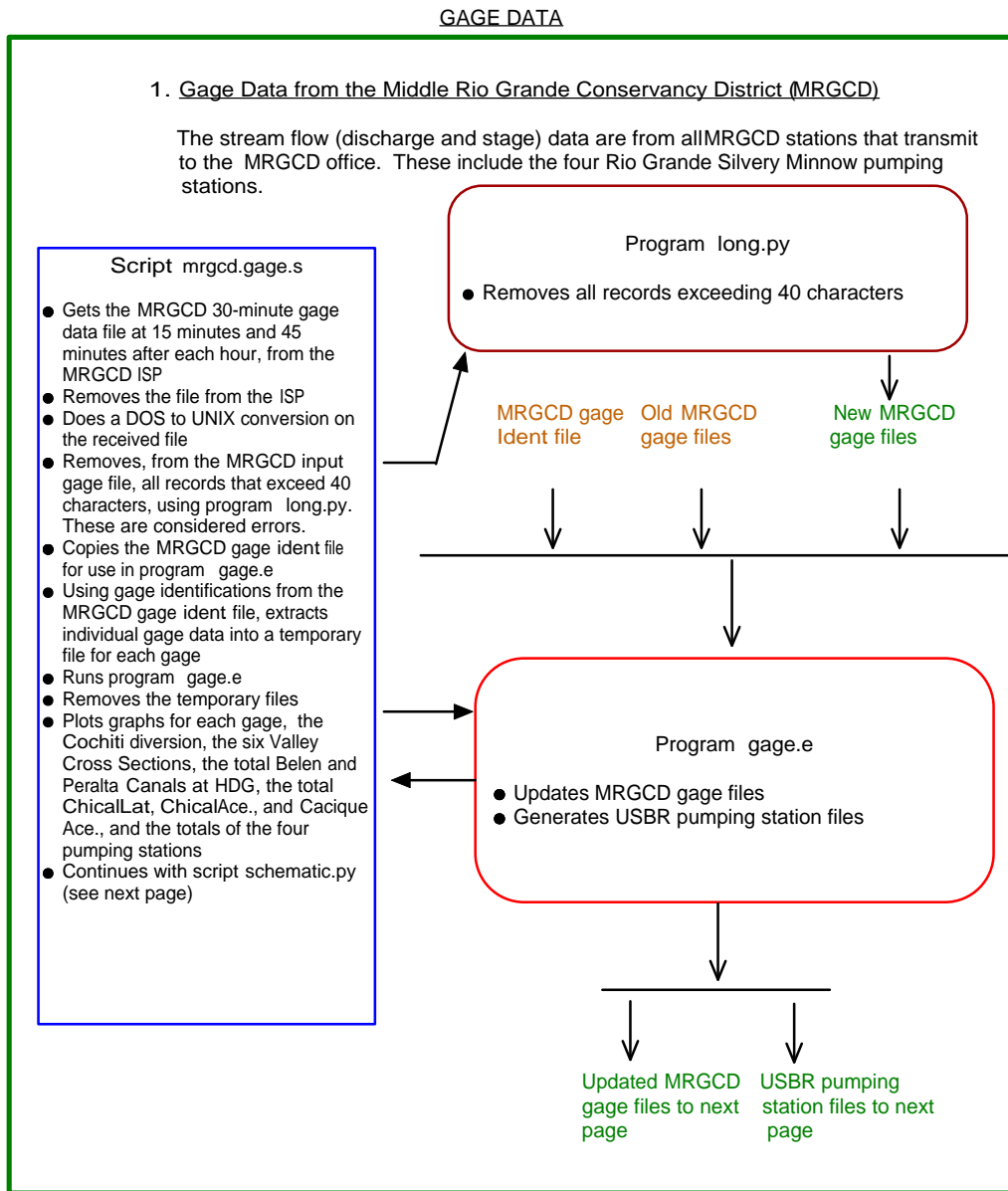

Figure 76: Flow Diagram of Gage Data, Page 1 - Gage Data from the Middle Rio Grande Conservancy District (MRGCD)

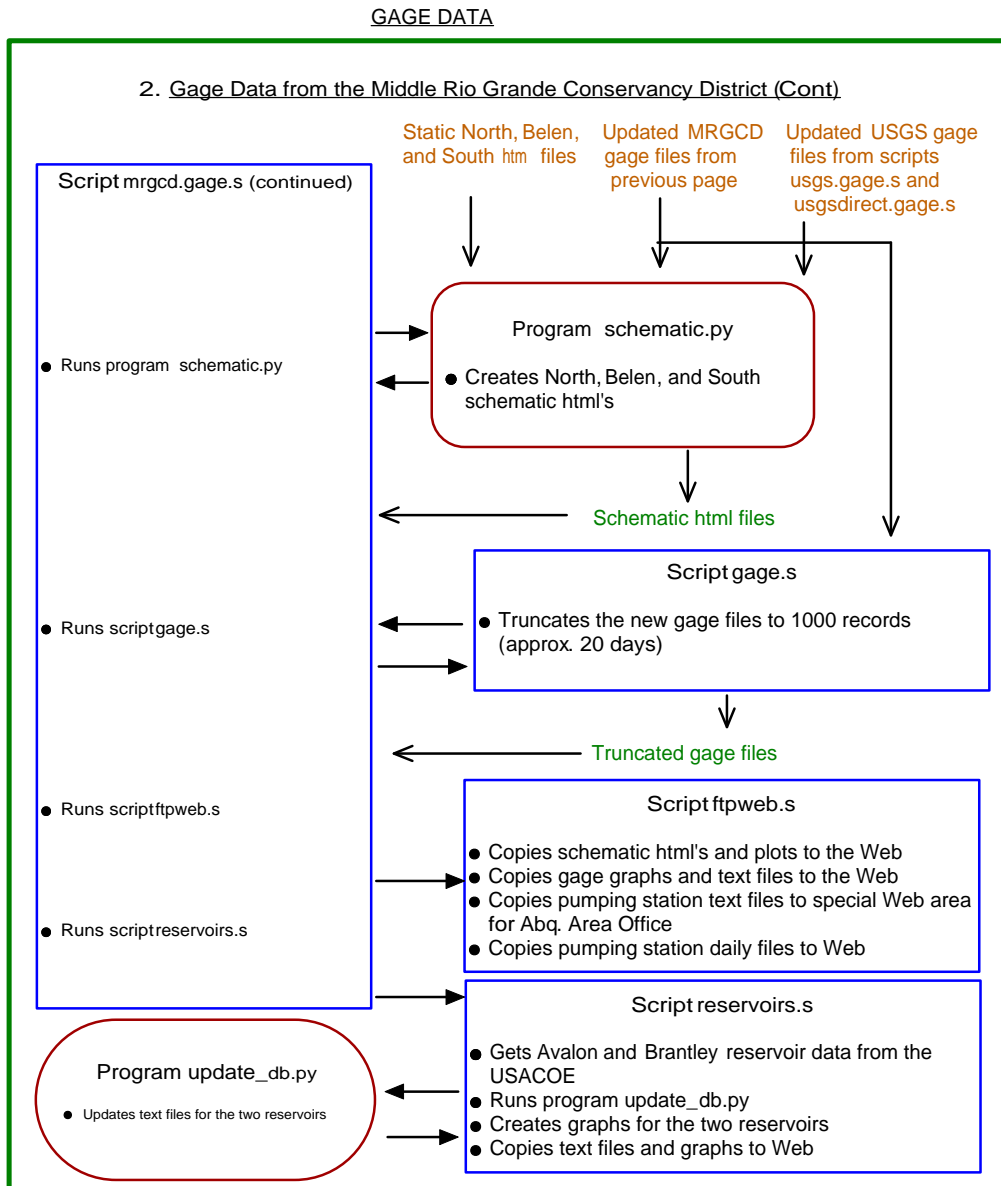

Figure 77: Flow Diagram of Gage Data, Page 2 - Gage Data from the Middle Rio Grande Conservancy District (Cont.)

GAGE DATA

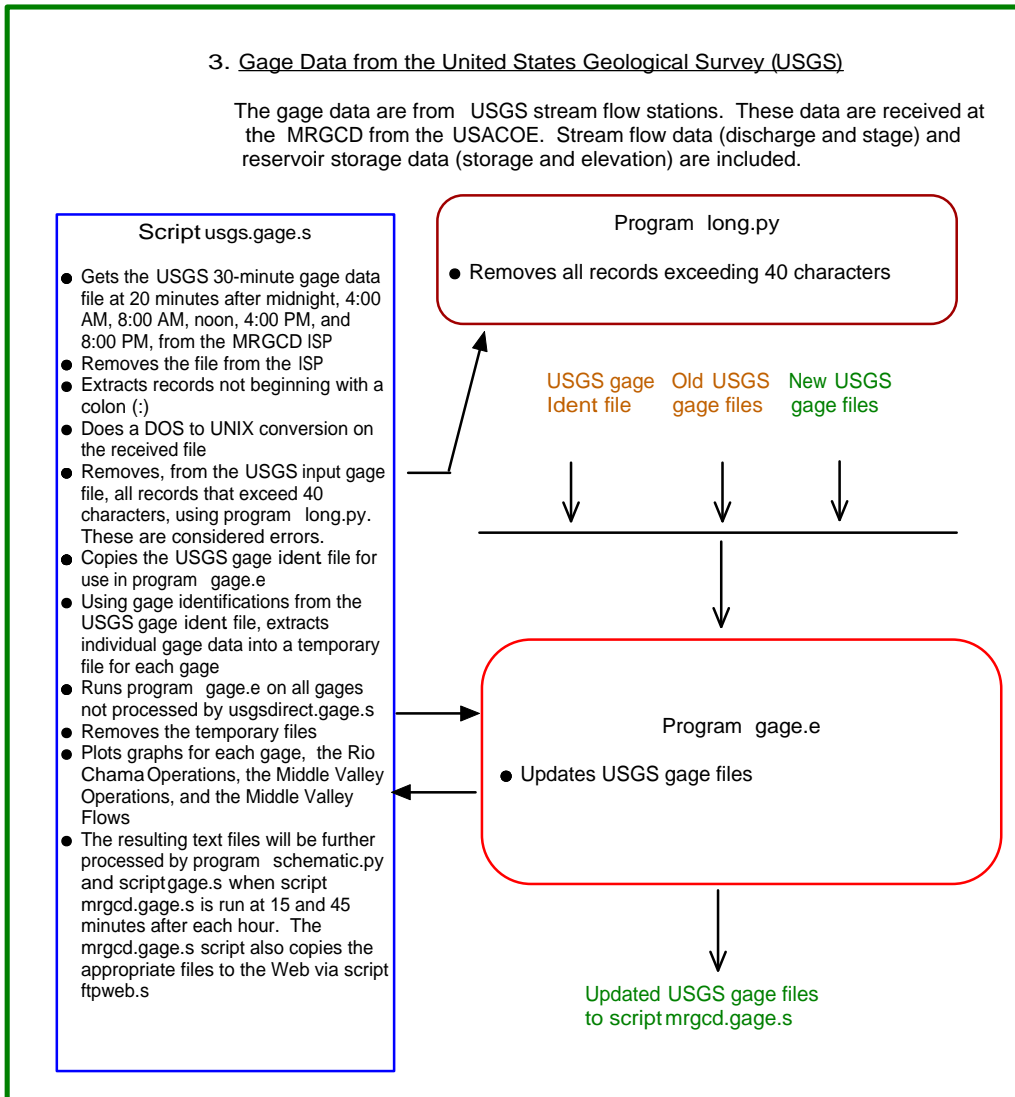

Figure 78: Flow Diagram of Gage Data, Page 3 - Gage Data from the United States Geological Survey (USGS)

GAGE DATA

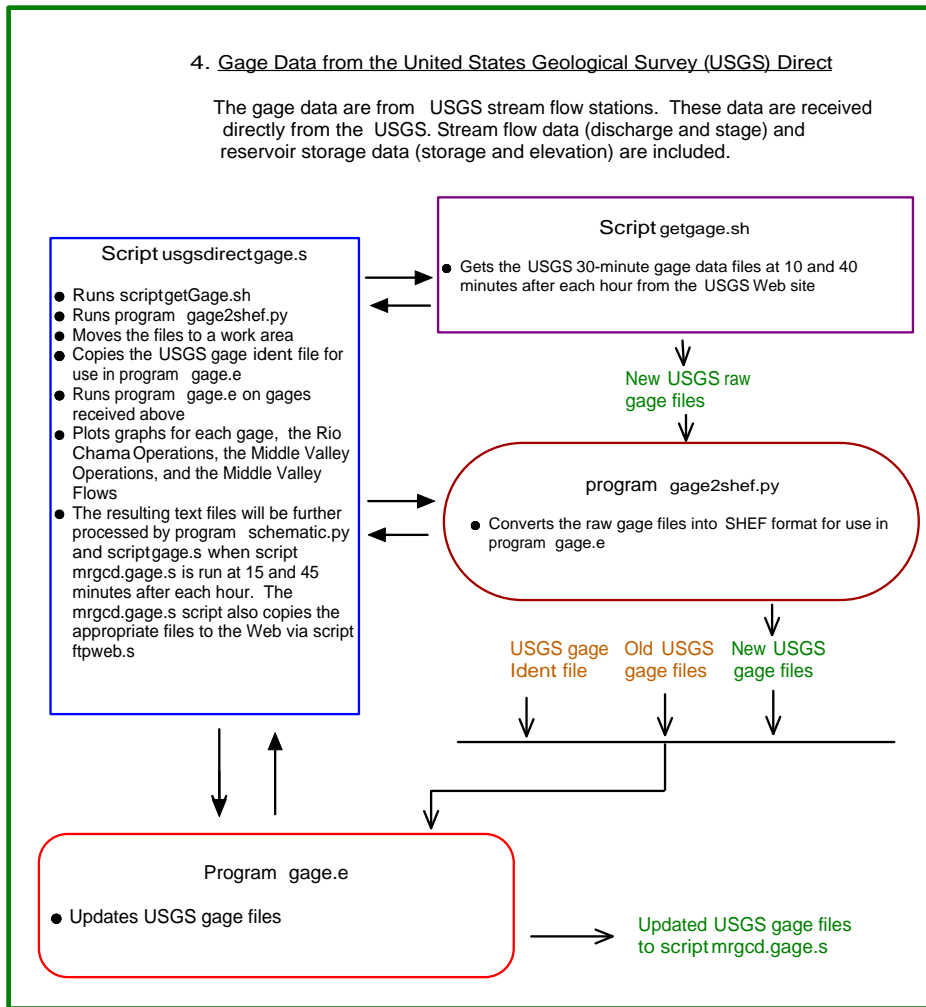

Figure 79: Flow Diagram of Gage Data, Page 4 - Gage Data from the United States Geological Survey (USGS) Direct

NEXRAD DATA

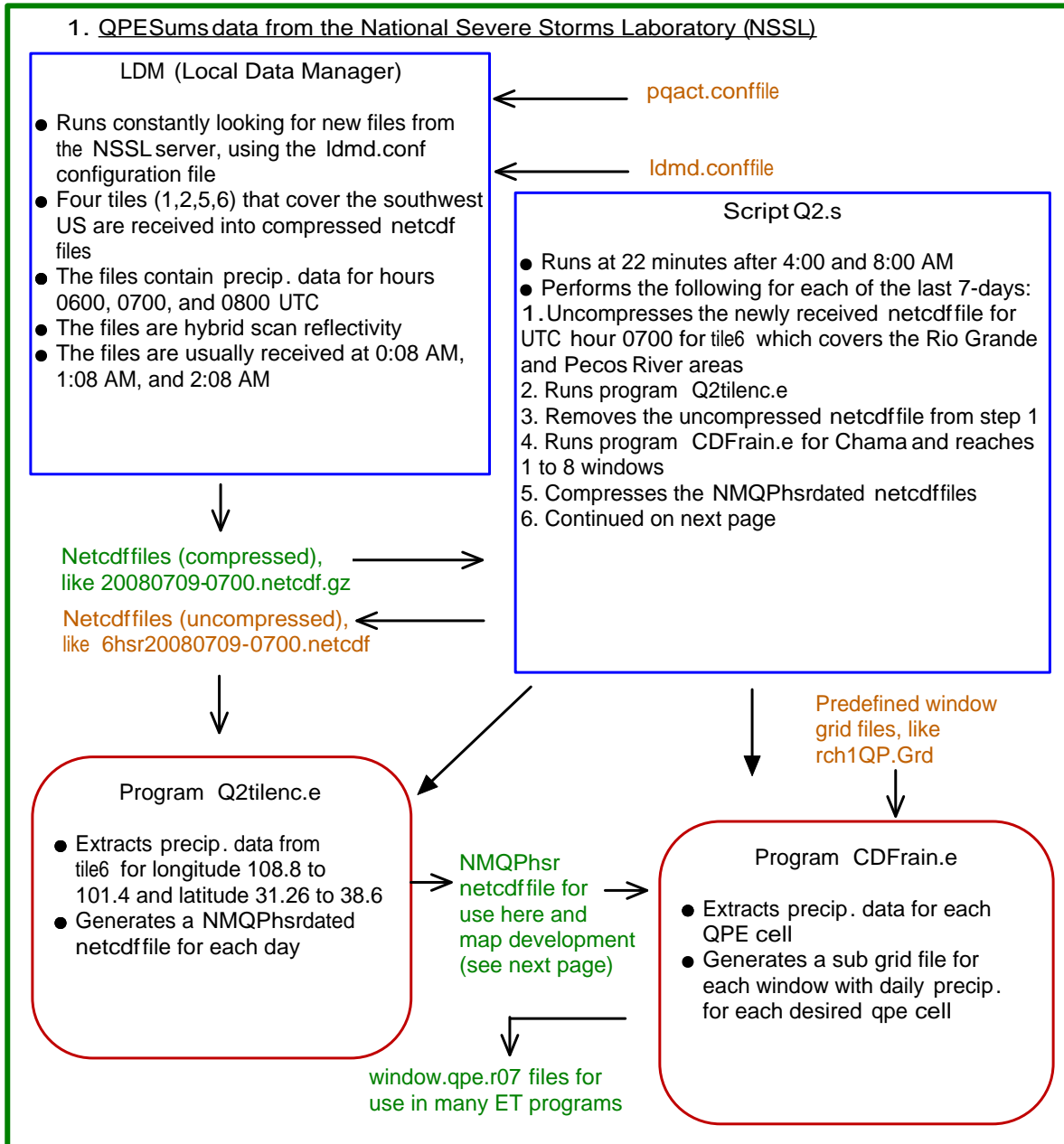

Figure 80: Flow Diagram of NEXRAD Data, Page 1 - QPESUMS Data from the National Severe Storms Laboratory (NSSL)



NEXRAD DATA

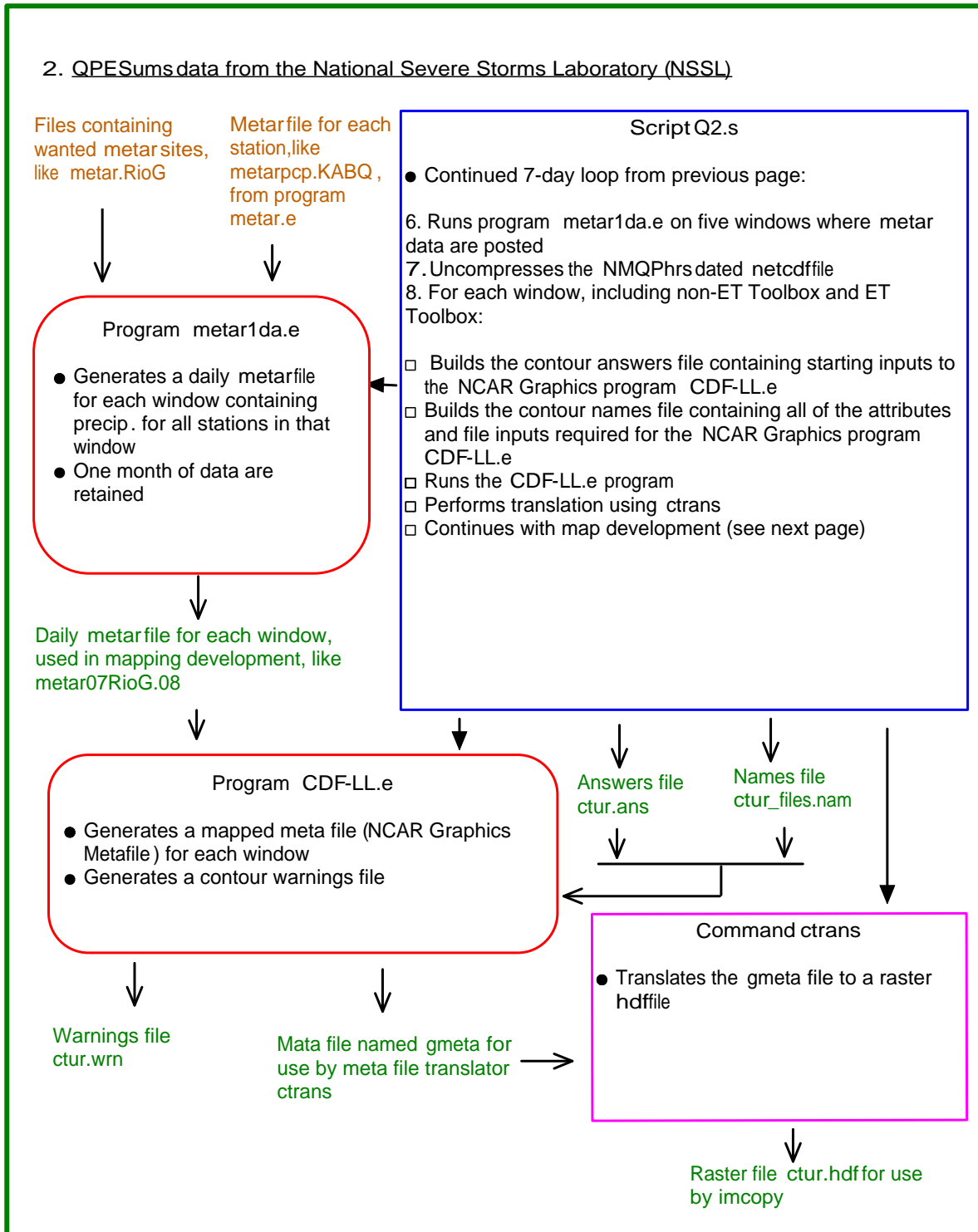

Figure 81: Flow Diagram of NEXRAD Data, Page 2 - QPESUMS Data from the National Severe Storms Laboratory (NSSL)

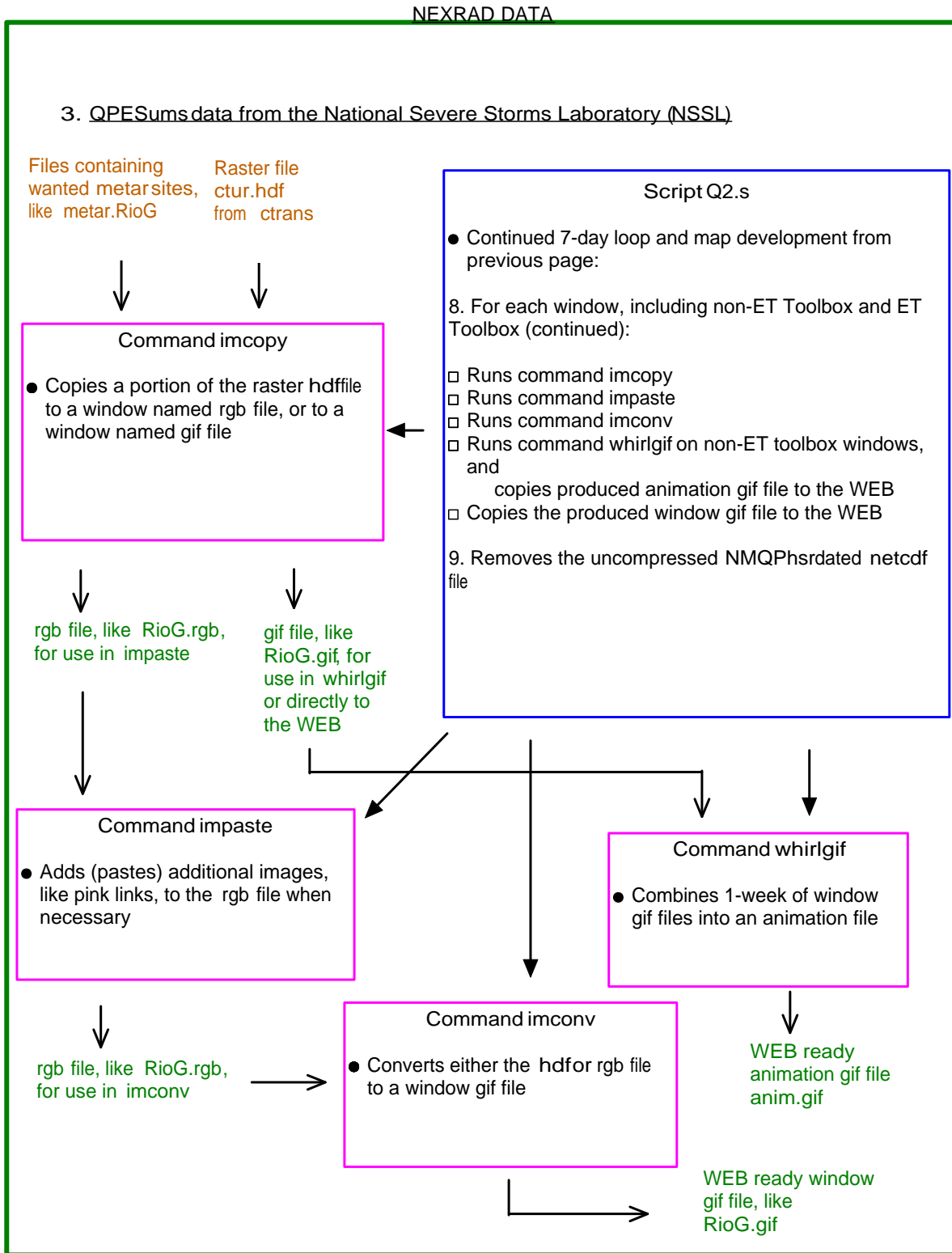

Figure 82: Flow Diagram of NEXRAD Data, Page 3 - QPESUMS Data from the National Severe Storms Laboratory (NSSL)

AWARDS and ET TOOLBOX PROCESSING

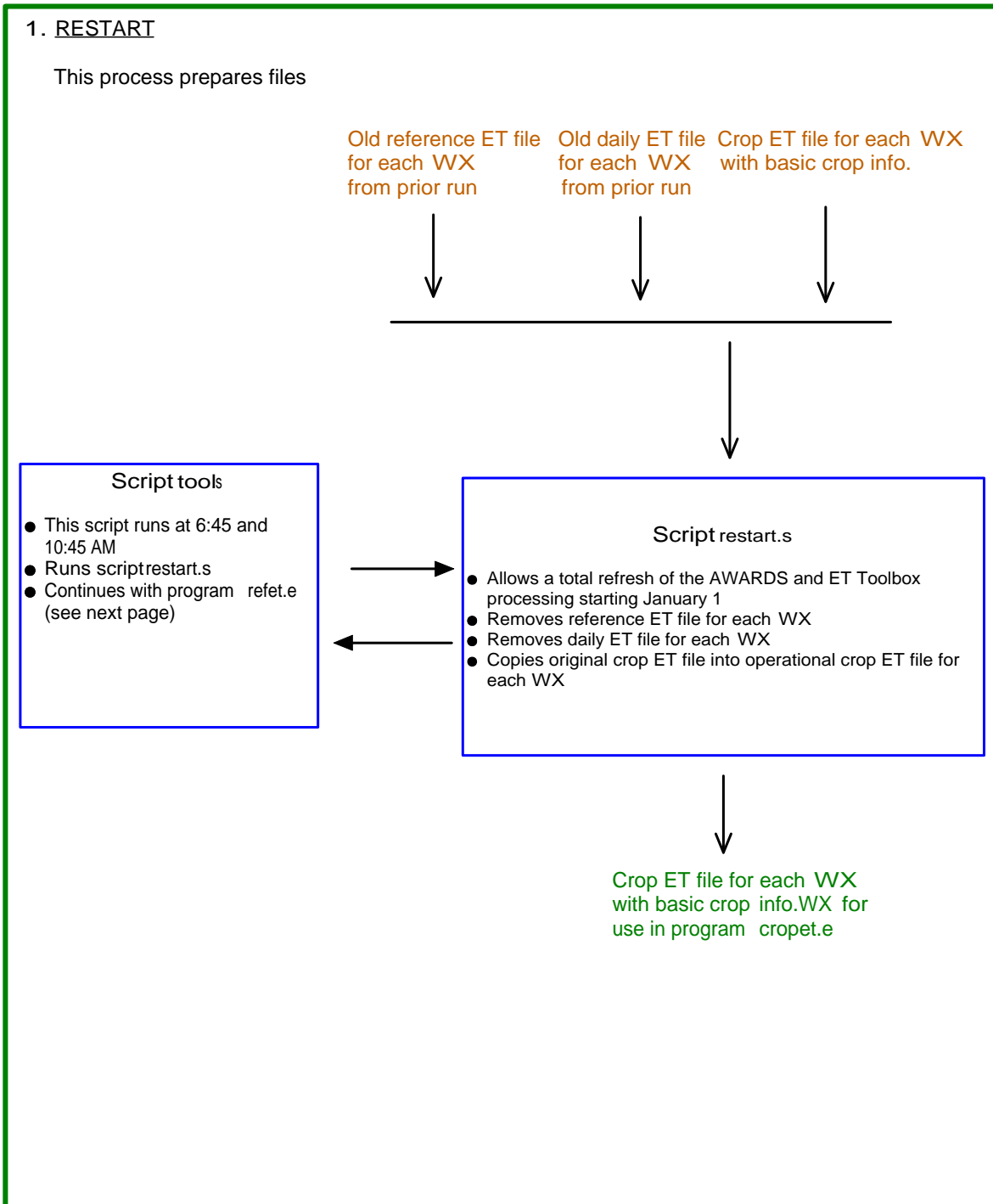

Figure 83: Flow Diagram of Awards and ET Toolbox Processing, Page 1 - RESTART

AWARDS and ET TOOLBOX PROCESSING

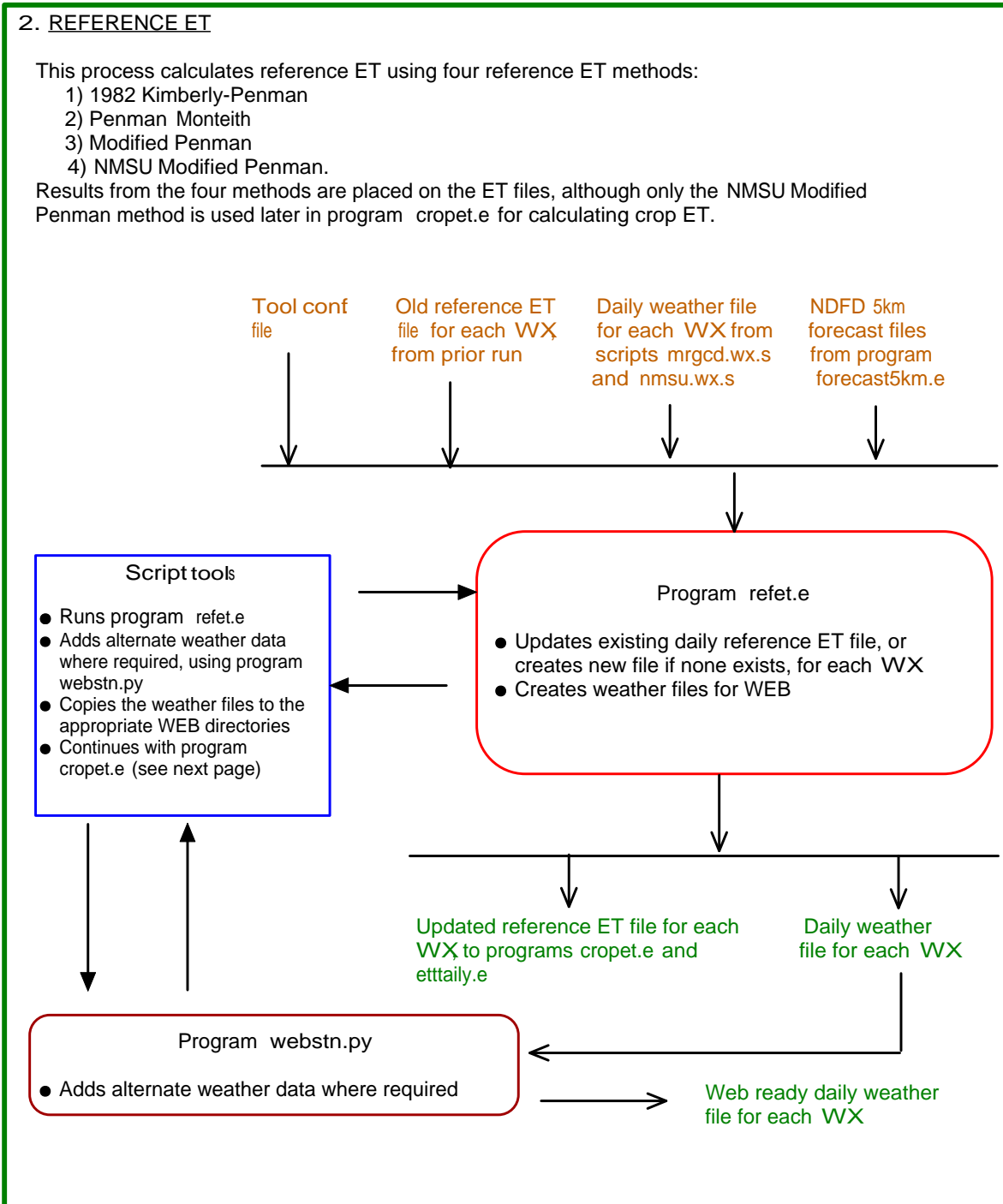

Figure 84: Flow Diagram of Awards and ET Toolbox Processing, Page 2 - REFERENCE ET

AWARDS and ET TOOLBOX PROCESSING

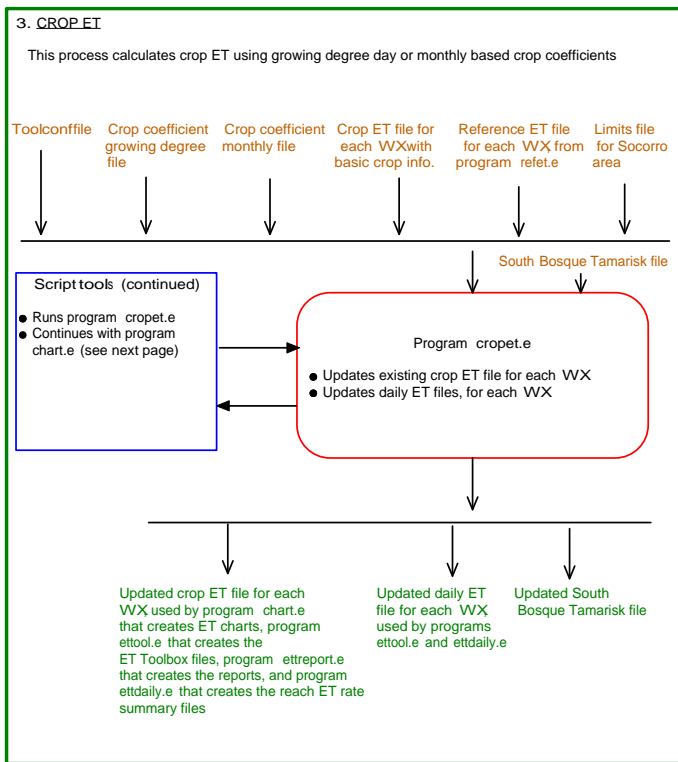

Figure 85: Flow Diagram of Awards and ET Toolbox Processing, Page 3 - CROP ET

AWARDS and ET TOOLBOX PROCESSING

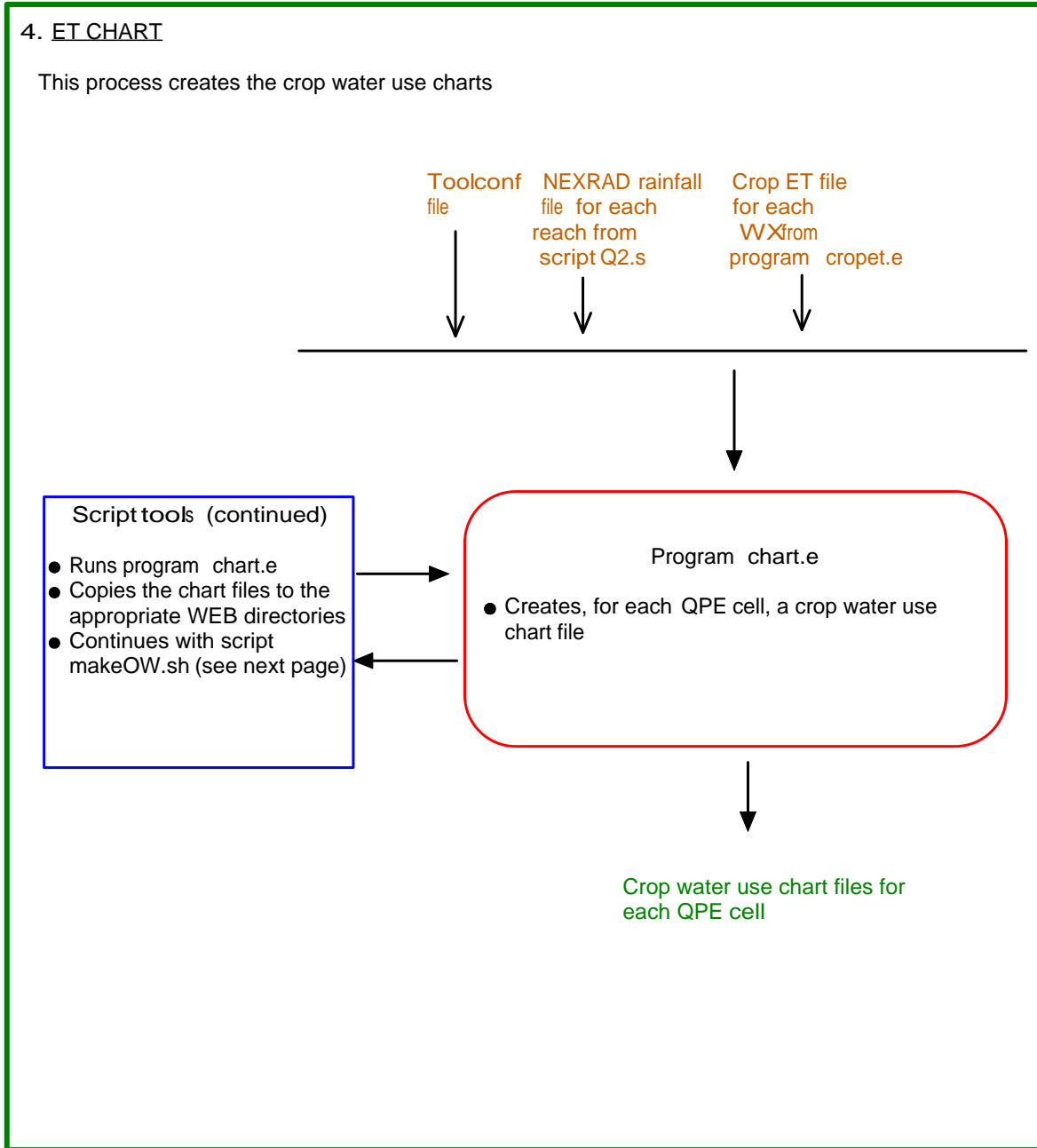

Figure 86: Flow Diagram of Awards and ET Toolbox Processing, Page 4 - ET CHART

AWARDS and ET TOOLBOX PROCESSING

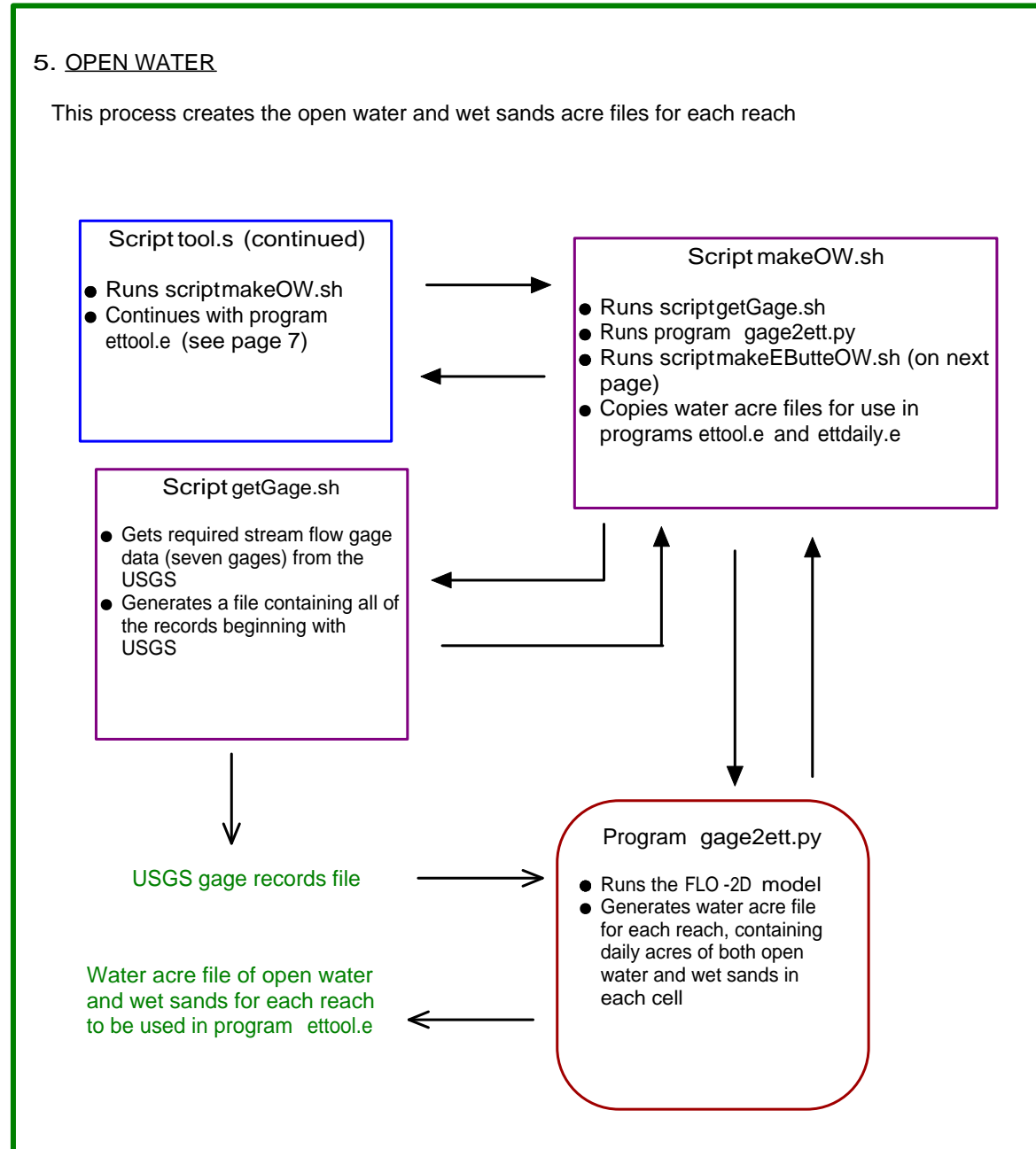

Figure 87: Flow Diagram of Awards and ET Toolbox Processing, Page 5 - OPEN WATER

AWARDS and ET TOOLBOX PROCESSING

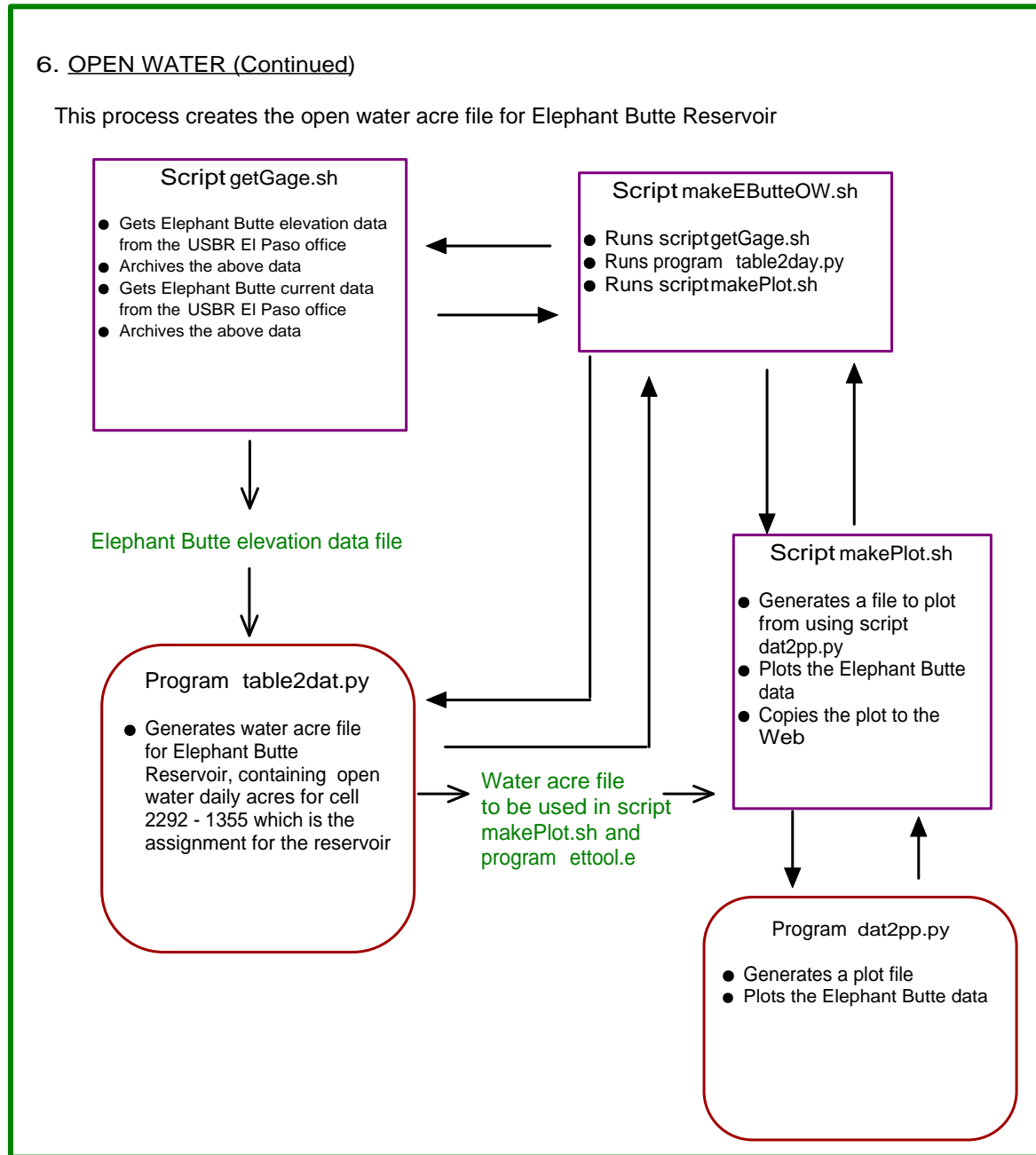

Figure 88: Flow Diagram of Awards and ET Toolbox Processing, Page 6 - OPEN WATER (Cont.)



AWARDS and ET TOOLBOX PROCESSING

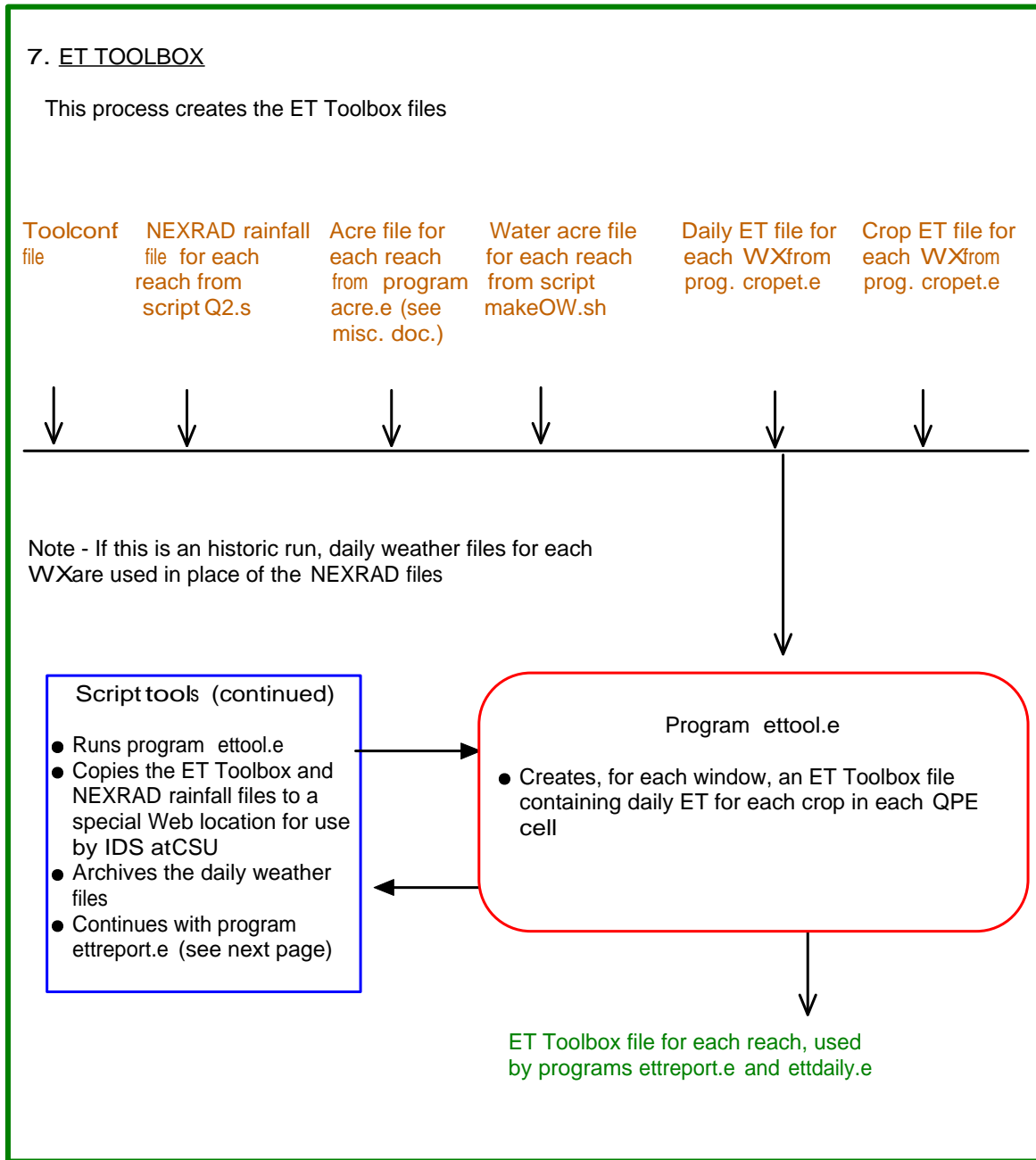

Figure 89: Flow Diagram of Awards and ET Toolbox Processing, Page 7 - ET TOOLBOX

AWARDS and ET TOOLBOX PROCESSING

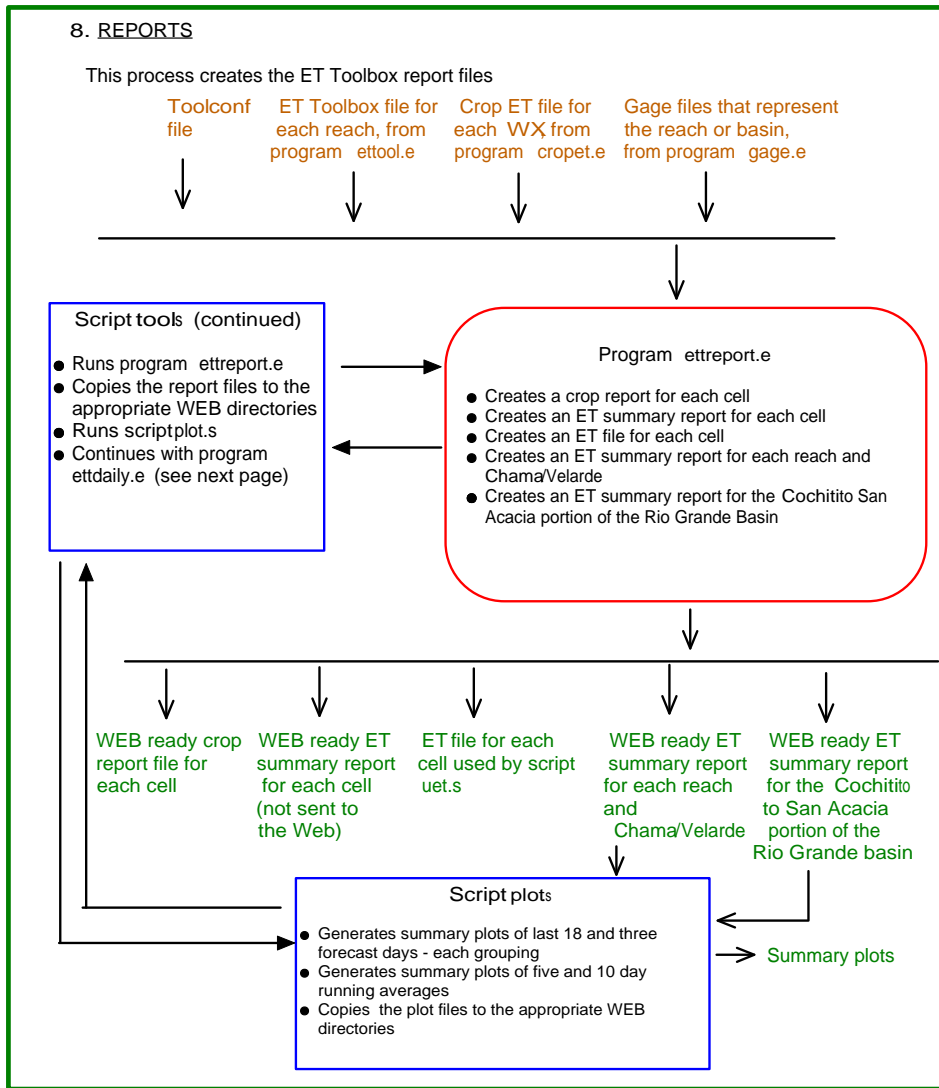

Figure 90: Flow Diagram of Awards and ET Toolbox Processing, Page 8 - REPORTS

AWARDS and ET TOOLBOX PROCESSING

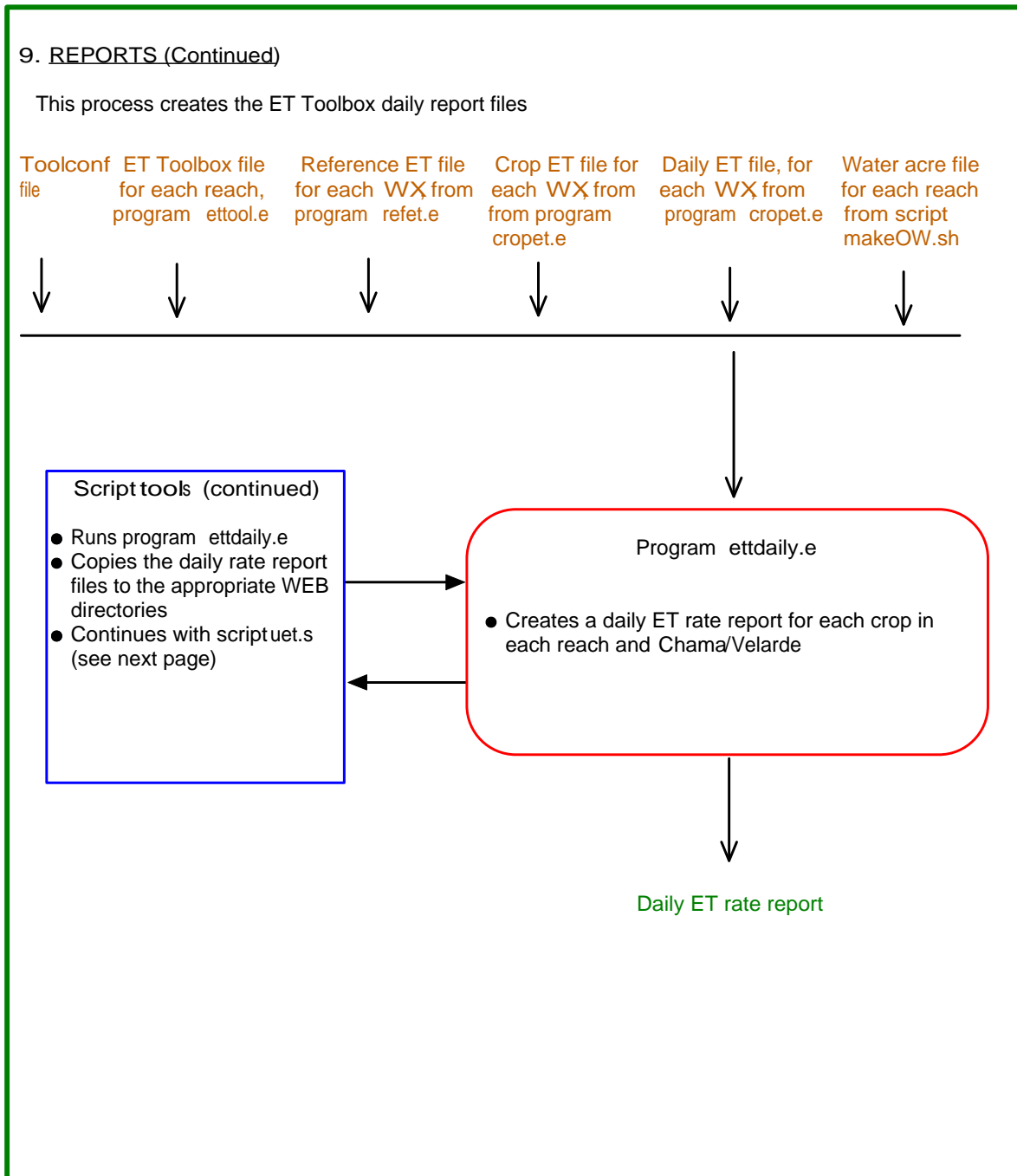

Figure 91: Flow Diagram of Awards and ET Toolbox Processing, Page 9 - REPORTS (Cont.)

AWARDS and ET TOOLBOX PROCESSING

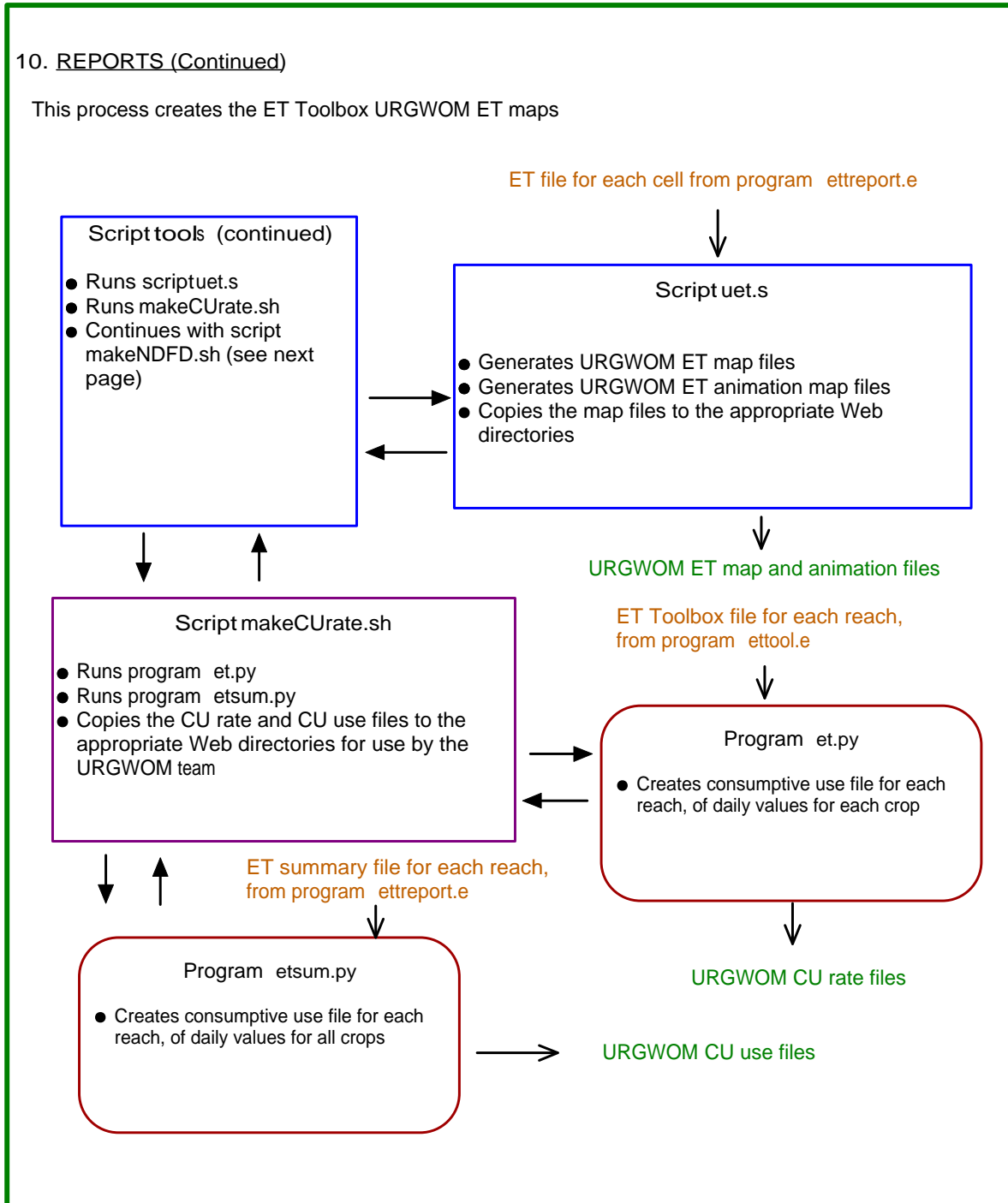

Figure 92: Flow Diagram of Awards and ET Toolbox Processing, Page 10 - REPORTS (Cont.)

AWARDS and ET TOOLBOX PROCESSING

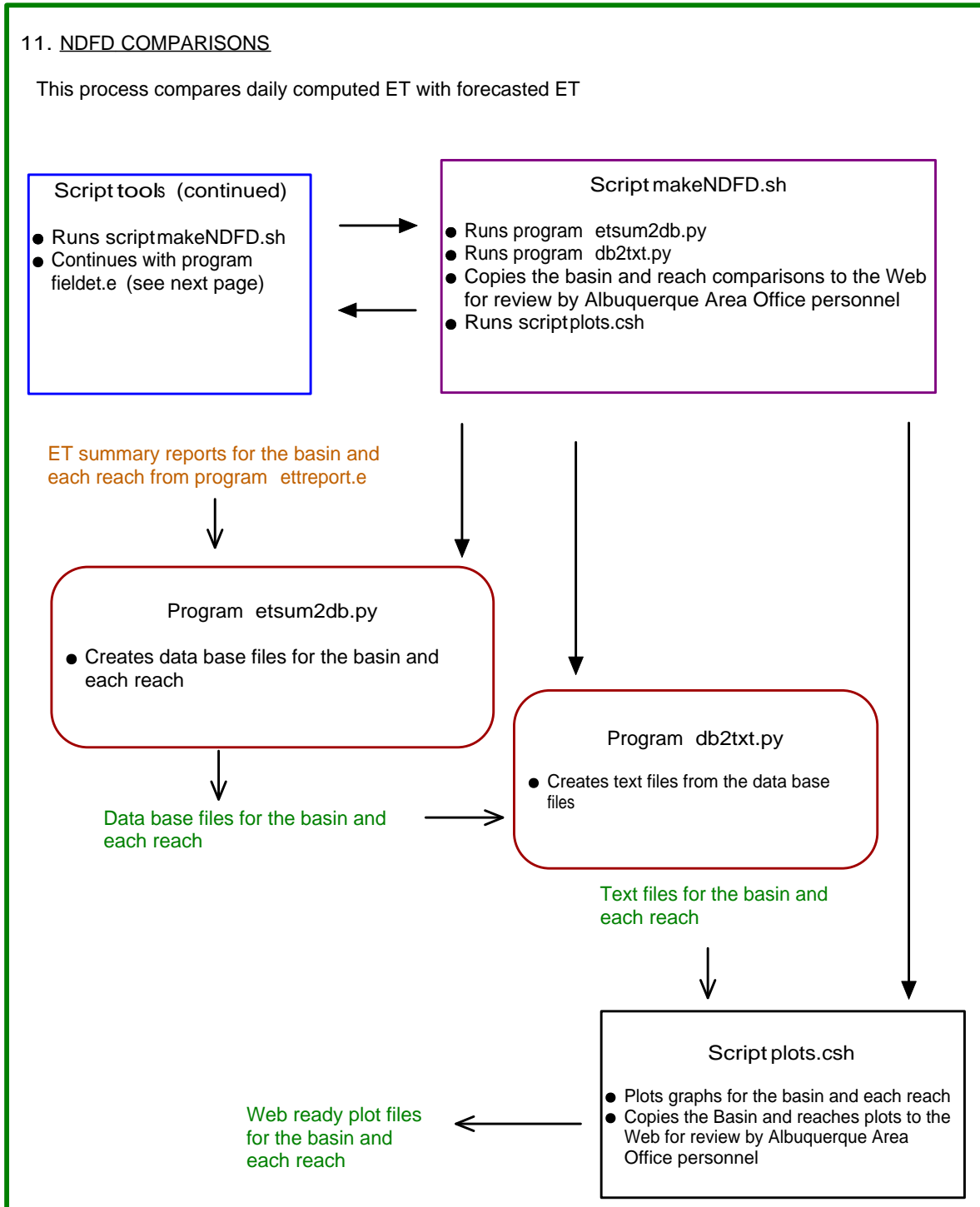

Figure 93: Flow Diagram of Awards and ET Toolbox Processing, Page 11 - NDFD COMPARISONS

AWARDS and ET TOOLBOX PROCESSING

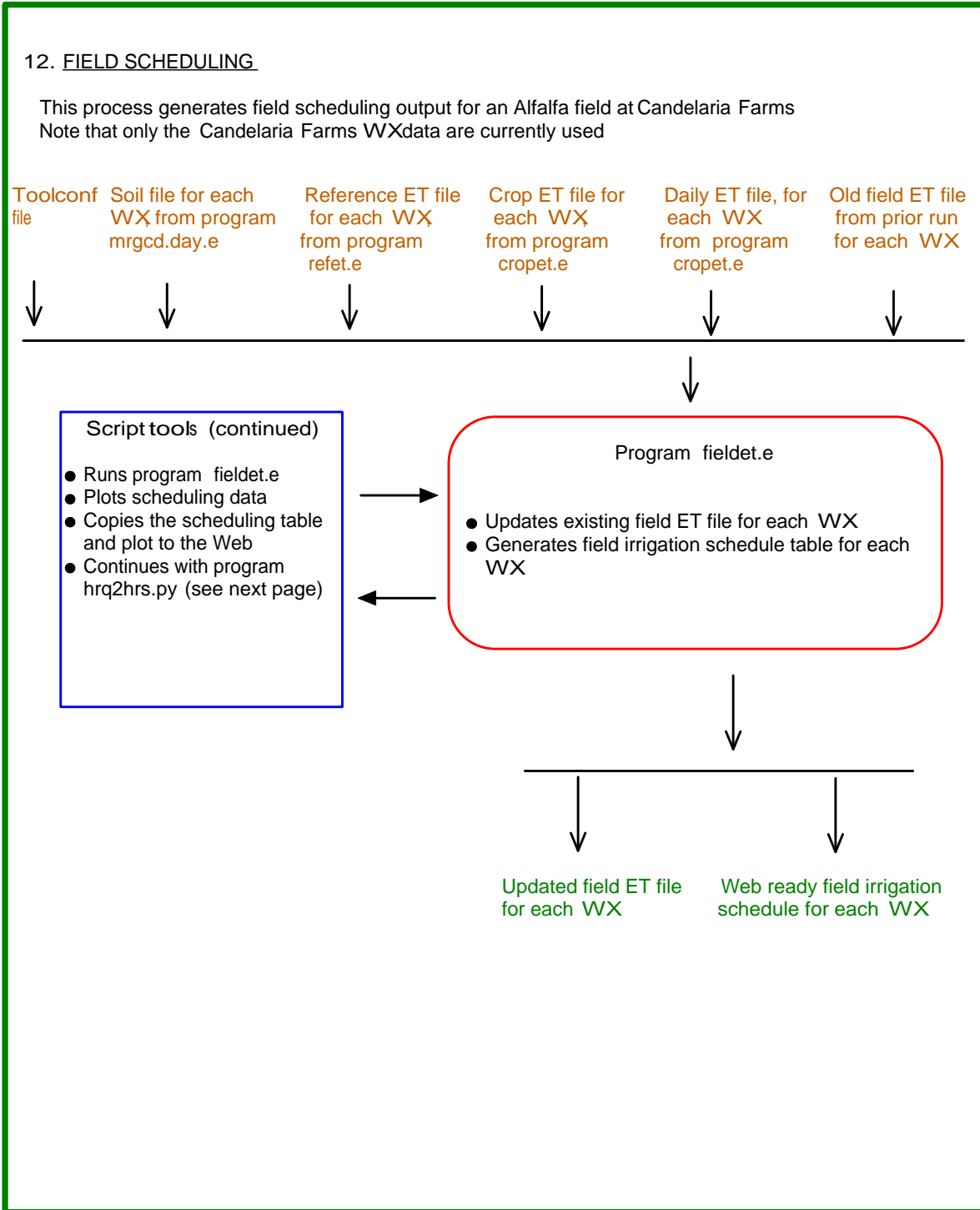

Figure 94: Flow Diagram of Awards and ET Toolbox Processing, Page 12 - FIELD SCHEDULING

AWARDS and ET TOOLBOX PROCESSING

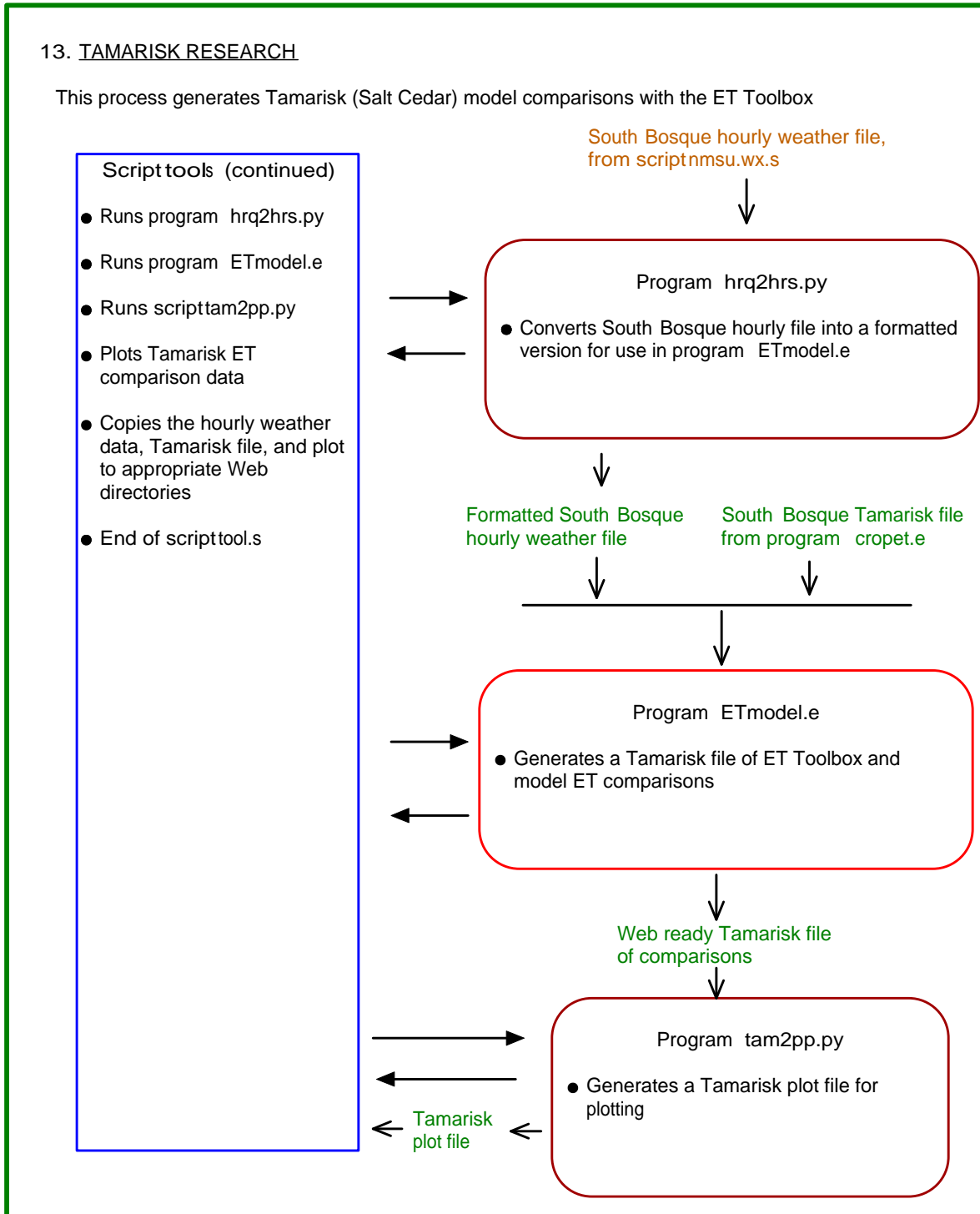

Figure 95: Flow Diagram of Awards and ET Toolbox Processing, Page 13 - TAMARISK RESEARCH