



Entergy Operations, Inc.
1448 S.R. 333
Russellville, AR 72802
Tel 501 858 5000

OCAN060201

June 17, 2002

Nuclear Regulatory Commission
Document Control Desk
Mail Station OP1-17
Washington, DC 20555

Subject: Arkansas Nuclear One - Units 1 and 2
Docket Nos. 50-313 and 50-368
License Nos. DPR-51 and NPF-6
Submittal of Demonstration Report for Volumetric Examination of Vessel Head
Penetration Nozzles

References:

- 1 Entergy letter dated September 4, 2001, *30 Day Response to NRC Bulletin 2001-01 for ANO-1; Circumferential Cracking of VHP Nozzles* (1CAN090102)
- 2 Entergy letter dated September 4, 2001, *30 Day Response to NRC Bulletin 2001-01 for ANO-2; Circumferential Cracking of VHP Nozzles* (2CAN090102)
- 3 Entergy letter dated November 15, 2001, *Supplemental Response To NRC Bulletin 2001-01 Regarding ANO-2 Vessel Head Penetration Inspection Scope* (2CAN110102)
- 4 Entergy letter dated June 3, 2002, *30 Day Post Outage Response to NRC Bulletins 2001-01 and 2002-01 for ANO-2 and Follow-up Response to Bulletin 2002-01 for ANO-1 and ANO-2* (OCAN060203)

Dear Sir or Madam:

On August 3, 2001, the Nuclear Regulatory Commission (NRC) issued NRC Bulletin 2001-01, *Circumferential Cracking of Reactor Pressure Vessel Head Penetration Nozzles*. The bulletin requested information regarding the structural integrity of the reactor pressure vessel head penetration (VHP) nozzles. A 30 day response was provided for Arkansas Nuclear One (ANO), Units 1 and 2 in References 1 and 2, respectively. On November 15, 2001, Entergy supplemented our response to the bulletin for ANO-2 (Ref. 3). In Reference 3, Entergy committed to perform a 100% inspection which would consist of an examination of all of the VHP nozzles essentially 360 degrees around the nozzle. The method for performing the examination would include volumetric examinations of the heat affected zones, wetted surface examinations, effective visual examinations, or some combination thereof.

A088

During discussions with the NRC Staff on April 25, 2002, the NRC staff requested that Entergy provide a report demonstrating the capability of the non-destructive examination (NDE) process for determining the acceptability of the VHP nozzles. Entergy committed to provide this report to the NRC within 30 days after startup from the 2R15 refueling outage. However, in subsequent discussion with the ANO-2 NRC Project Manager, Entergy requested a two week extension until June 17, 2002 to finalize and submit the report. This extension was acceptable to the NRC.

As discussed in the 30 day post outage response to NRC Bulletins 2001-01 and 2002-01 (Ref. 4), Entergy only credited the ultrasonic testing (UT) portion of the nozzle NDE equipment for confirming the integrity of the nozzle and nozzle to J-weld interface. The eddy current (ECT) portion of the flaw detection NDE process would have been used to more accurately determine the length of any flaws identified on the ID surface of the nozzle. However, no Primary Water Stress Corrosion Cracking flaws were detected in the VHP nozzles or J-welds that required further ID flaw evaluation. The attached non-proprietary version of the Wesdyne Report WDI-TJ-007-02-NP, *Demonstration of Volumetric Ultrasonic Inspection of CRDM Nozzles Using the Open Housing Scanner*, provides the inspection capabilities of the NDE process used during 2R15 for the VHP examinations and documents that the inspections were sufficient to detect flaws in the CEDM nozzles or J-welds.

The attached report has been redacted to remove the information that is considered proprietary to Westinghouse. A proprietary version of the document is being submitted under separate cover letter.

If you have any questions or require additional information, please contact Steve Bennett at 479-858-4626.

Sincerely,



Sherrie R. Cotton
Director, Nuclear Safety Assurance

SRC/sab

Attachments

1. Wesdyne Report WDI-TJ-007-02-NP Demonstration of Volumetric Ultrasonic Inspection of CRDM Nozzles Using the Open Housing Scanner (Non-Proprietary)

cc: Mr. Ellis W. Merschoff
Regional Administrator
U. S. Nuclear Regulatory Commission
Region IV
611 Ryan Plaza Drive, Suite 400
Arlington, TX 76011-8064

NRC Senior Resident Inspector
Arkansas Nuclear One
P.O. Box 310
London, AR 72847

Mr. William Reckley
NRR Project Manager Region IV/ANO-1
U. S. Nuclear Regulatory Commission
NRR Mail Stop O-7 D1
One White Flint North
11555 Rockville Pike
Rockville, MD 20852

Mr. Thomas W. Alexion
NRR Project Manager Region IV/ANO-2
U. S. Nuclear Regulatory Commission
NRR Mail Stop 04-D-03
One White Flint North
11555 Rockville Pike
Rockville, MD 20852

Attachment 1

OCAN060201

**Wesdyne Report WDI-TJ-007-02-NP Demonstration of Volumetric Ultrasonic
Inspection of CRDM Nozzles Using the Open Housing Scanner**

Non-Proprietary

43 Pages



Title:

Demonstration of Volumetric Ultrasonic Inspection of CRDM Nozzles Using the Open Housing Scanner for ANO-2

Key Words: Technical Justification	Date: 5/30/02	Document Number: WDI-TJ-007-02-NP	Revision: 0	Plant: ANO-2
--	-------------------------	---	-----------------------	------------------------

WesDyne International LLC Non Proprietary Class 3



Title:

Demonstration of Volumetric Ultrasonic Inspection of CRDM Nozzles Using the Open Housing Scanner for ANO-2

Key Words: Technical Justification	Date: 5/30/02	Document Number: WDI-TJ-007-02-NP	Revision: 0	Plant: ANO-2
--	-------------------------	---	-----------------------	------------------------

WesDyne International LLC Non Proprietary Class 3

© WesDyne International, 2002

Author(s): John P. Lareau	Cognizant Manager: D. Adamonis							
Customer	Required	<input type="checkbox"/>	Yes	<input type="checkbox"/>	No	<input type="checkbox"/>	Date	<input type="checkbox"/>



Title: Demonstration of Volumetric Ultrasonic Inspection of CRDM Nozzles Using the Open Housing Scanner for ANO-2				
Key Words: Technical Justification	Date: 5/30/02	Document Number: WDI-TJ-007-02-NP	Revision: 0	Plant: ANO-2

WesDyne International LLC Non Proprietary Class 3

Author(s): John P. Lareau <i>J P Lareau 6/5/02</i>	Cognizant Manager: D. Adamonis <i>D Adamonis 6/5/02</i>					
Customer	<table border="1"> <tr> <td>Required</td> <td></td> <td>Yes</td> <td>No</td> <td>Date</td> </tr> </table>	Required		Yes	No	Date
Required		Yes	No	Date		

REFERENCES:

- 1) WDI-UT-010, Title: IntraSpect Ultrasonic Procedure for Inspection of Reactor Vessel Head Penetrations, Time of Flight Ultrasonic & Longitudinal Wave
- 2) CRDM/ICI UT Analysis Guidelines

BACKGROUND

Westinghouse has participated in several demonstration efforts to determine the effectiveness of their NDE technology to detect and size PWSCC cracking. These demonstration efforts include the EPRI sponsored demonstrations associated with NRC Generic Letter 97-01 and NRC Bulletin 2001-01, Westinghouse internal demonstrations, and Entergy sponsored demonstrations.

The examination technique and essential variables of the test procedure in Reference 1 and the data analysis guidelines outlined in Reference 2 were developed as a result of the demonstrations performed and actual experience gained performing examinations. A summary of each of these demonstrations is provided below:

- **Demonstration 1: EPRI Demonstration Pursuant to NRC Generic Letter 97-01**

Westinghouse successfully performed procedure demonstrations using the eddy current and ultrasonic examination methods pursuant to NRC Generic Letter 97-01. See Attachment 1 for a detailed summary of Westinghouse Generic Letter 97-01 demonstrations. Note that when the Attachment 1 summary table was originally prepared by the MRP, Westinghouse had not demonstrated capabilities to detect flaws D, E, and F using the RP TOFD 24PCS (5.0 MHz) probe. A supplemental demonstration was performed to add these detection capabilities.

The Generic Letter 97-01 demonstrations were designed to quantify a vendor's capability to detect axial and circumferential flaws initiating on the inside diameter (ID) of the RPV penetration nozzle. Mock-up flaws were implanted in the tube using the electric discharge machining (EDM) process, and squeezed to dimensions that simulate PWSCC using the Cold Isostatic Processing (CIP). The Generic Letter 97-01 demonstrations were conducted and documented by EPRI. These demonstrations were blind; that is, candidates were not given any information about the number, size, or location of flaws.

Details of NDE examination demonstrations pursuant to NRC Generic Letter 97-01 is documented in EPRI Report TR-106260 entitled, "Demonstrations of Inspection Technology for Alloy 600 CRDM Head Penetrations". The abstract of EPRI Report TR-106260 states: " A program has been developed to enable utilities to demonstrate procedures for inspection of Alloy 600 control rod drive mechanism (CRDM) penetrations. The program was developed in coordination with utilities and original equipment manufacturers (OEMS) through a Nuclear Utility Management and Resources Committee (NUMARC) Ad Hoc Advisory Committee (AHAC) and addresses ultrasonic and eddy current procedures used for detection of primary water stress corrosion cracking initiating on the inside surface of penetrations. Realistic, full-scale mockups were designed and fabricated to incorporate the essential features of installed penetrations such as geometry, clearances, distortion caused by welding, and magnetic deposits and scratches that affect

inspection. Intentional flaws were introduced with methods that allowed accurate knowledge of the true flaw size and location. Mockup and flaw fabrication methods were qualified by comparing the ultrasonic and eddy current responses of the mockup flaws with real primary water stress corrosion cracking (PWSCC) in penetration samples from Electricite de France's (EdF's) Bugey plant. The comparisons show that the mockup flaws simulated real PWSCC closely in all essential features important to inspection demonstration. A protocol was developed for conducting demonstrations to measure flaw detection efficiency, flaw location and sizing accuracy, resolution of closely spaced flaws, and false call performance."

The Generic Letter 97-01 demonstrations efforts documented by EPRI Report TR-106260 have been reported and observed previously by the NRC. The EPRI report concludes the following: "The results of the qualification activities demonstrated clearly that the procedures applied were highly effective at detecting flaws. Flaw location and sizing accuracy was also measured and shown to be compatible with flaw evaluation criteria developed by the Ad Hoc Advisory Committee." However, while these demonstrations confirmed Westinghouse's capabilities to detect, locate, and size ID initiated axial and circumferential flaws, the Generic Letter 97-01 mock-up demonstration did not test for detection of outside diameter (OD) initiated flaws.

- **Demonstration 2: MRP Demonstration Pursuant to NRC Bulletin 2001-01**

The MRP developed a demonstration program to detect OD initiated flaws as a result of the Oconee PWSCC flaw findings. See Attachment 1 for a detailed summary of Westinghouse demonstrations for the MRP. The initial MRP demonstrations were attended and reviewed by NRC personnel.

The focus of the demonstration program was the examination for safety-significant cracking on the outside surface of the penetration base material above or near the J-groove weld. Examination of the J-groove weld was not included in the demonstrations.

The demonstration program consisted of two parts:

- i. The first part demonstrated the capability to detect real PWSCC using samples removed from Oconee 3 penetrations. The Oconee samples were small segments of RPV penetration nozzles that contained PWSCC. The samples were removed during the repair process at Oconee 3. These samples contain normal and off-axis PWSCC. The off-axis flaws were used to determine the capability to detect circumferential flaws that were oriented at the maximum weld angle (outermost penetration).
- ii. The second part of the demonstration was on a full-scale mockup consisting of a penetration welded into a simulated section of a RPV head. The mockup contained several simplistic simulations of OD flaws. The flaws in this mockup were not designed to exhibit all expected ultrasonic characteristics of actual PWSCC. However, other pertinent inspection variables were determined as follows:
 - ability to maintain contact in the presence of surface distortion caused by welding
 - access limitations
 - consistency of scan patterns
 - false call sources

Document Number: WDI-TJ-007-02	Revision: 0	Page 4 of 43
--------------------------------	-------------	--------------

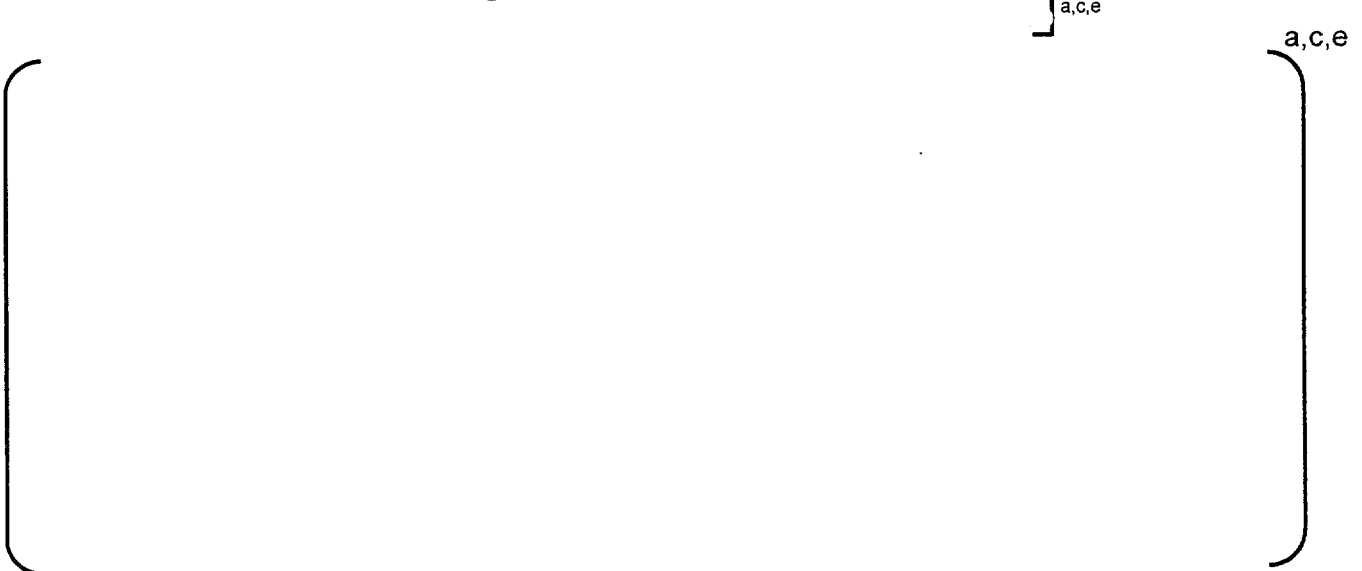
- accurately locating the position of the weld
- accurately positioning flaws with respect to the weld

The demonstration on the full-scale mock-up was performed only with a sword probe and not with the open housing scanner. However, a subsequent demonstration using the open housing scanner was used to inspect an Oconee field removed sample (#56C). The axial shooting PCS24 probe was capable of detecting the axially oriented, and off angle OD PWSCC in this sample. This demonstration was observed by personnel from the Authorized Nuclear Inspection Agency, Entergy and EPRI.

Additionally, Westinghouse performed an internal demonstration using the open housing probe on a spare head from a cancelled plant to demonstrate the capabilities of the procedure, as reported below.

- **Demonstration 3: Westinghouse Demonstrations on the Jamesport RPV Head**

Westinghouse performed internal demonstrations on an actual RPV head (never placed in service) at the Westinghouse Waltz Mill facility. These demonstrations were to develop examination procedures, techniques and tooling for actual examinations. Information acquired from these demonstrations provided excellent data on pre-service indications from weld joint configurations and welding flaws. This data was used to augment analysis guidelines and to demonstrate the capability of the scanner to perform an adequate examination of CRDM nozzles.



Sketches of the nominal coverage areas for each inspection technique are provided in Figures 3 through 6.

Results of the spare RPV head inspection demonstration aided in the development of analysis guidelines for both the detection and sizing of flaws as well as the disposition of false positive signals. Since the J-groove weld is a manual stick welding process, which has never had a volumetric examination, the likelihood of false positives is fairly high. The welding process calls for the root pass to be partially ground off and then penetrant tested. Any PT positive indications would then be further ground out. The grinding process is likely

to penetrate into the nozzle tube wall, especially for repair grinding. At 1/3 thickness, the weld is again ground for an additional PT and finally, the finished weld is ground to contour the filet at the nozzle intersection as well as for a final PT. Each of these steps is likely to affect the tube wall and weld interface indications are prevalent.

a,c,e

(

- **Demonstration 4: Entergy Demonstration of Westinghouse Procedure for Detection Capabilities of Rotating Probe and Data Analysis on Entergy/MRP Mockup**

This demonstration was originated by Entergy and performed in addition to the original 97-01 and MRP demonstrations to complete the detection efforts for flaws in the RPV penetration nozzles. Entergy worked with the MRP and the EPRI NDE Center to develop a full-scale mockup that would contain realistic PWSCC type flaws on the OD of the nozzle and in the J-groove weld. The mockup was fabricated by EPRI. The Entergy/MRP mockup was built to demonstrate that ultrasonic examination procedures were capable of detecting and sizing outside diameter PWSCC type flaws in RPV head nozzles.

The Entergy/MRP mock-up consisted of twelve simulated flaws. Six of the flaws were implanted in the tube using the EDM process, and six were welded using the weld impurity process. The mock-up flaws were subjected to the CIP to squeeze the flaws to dimensions that simulate PWSCC. The tube contained three axial flaws and three circumferential flaws distributed at various depths from 25% to 90% through-wall. Similarly, the J-weld included three axial and three circumferential flaws placed at various depths across the weld from 25% to 100% through-wall. Five flat bottom holes were included in the weld to gauge 0° longitudinal wave detection capabilities. A sketch of the Entergy/MRP mockup is given in Figure 7.

Westinghouse performed a blind demonstration using their inspection procedure on the Entergy/MRP mockup. This demonstration was witnessed by the agency that provides ANII services to Entergy and representatives from Entergy and EPRI. Based on this examination demonstration and subsequent refinements to the analysis process, the demonstration results are provided in the table below:

a,c,e

a,c,e

Based on this demonstration and subsequent analysis guideline improvements, Westinghouse reported sizing errors as specified below for the applicable flaw population in the Entergy/MRP mockup, as follows:

Flaw #	UT Depth (from OD)	Actual Depth	UT Length	Actual Length
2 (circ)	>0.5"	0.54"	1.12"	1.5"
3 (ax)	>0.5"	0.52"	1.64"	2.0"
7 (ax)	0.26"	0.33"	0.92"	1.5"
9 (circ)	0.19"	0.18"	0.48"	0.70"
10 (circ)	0.288"	0.31"	0.74"	1.0"
11 (ax)	0.154"	0.16"	0.88"	1.0"

a,c,e

This demonstration confirmed that Westinghouse's ultrasonic inspection procedure was satisfactory in detection and sizing of OD initiated axial and circumferential flaws, based upon potential developments in the acquisition and analysis for the Westinghouse

] a,c,e

a,c,e

]



- **Demonstration 5 – Entergy Demonstration on a Nozzle ID Welded Repair Mockup**

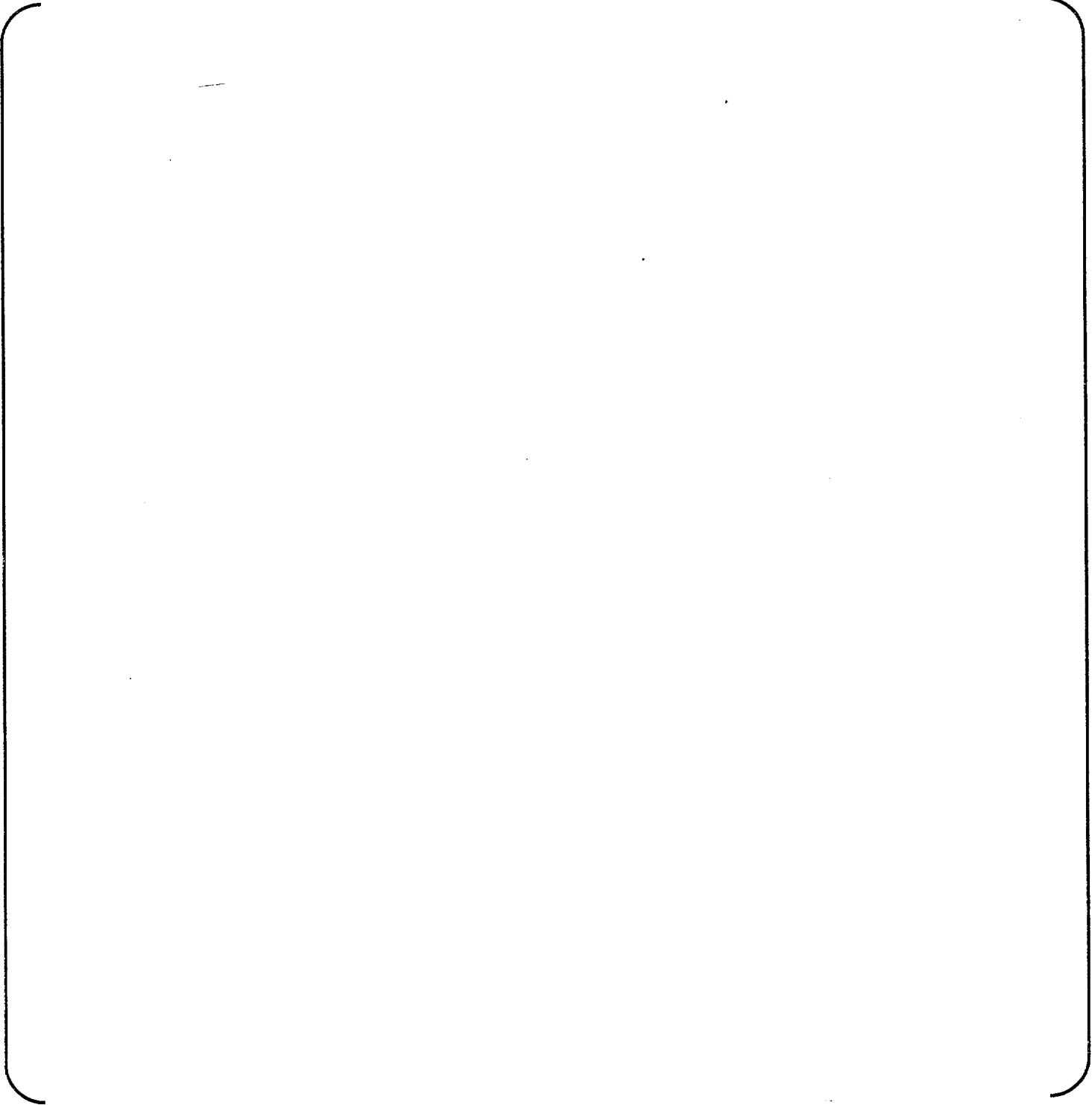
A mockup was made using the weld repair process in a sample of a penetration tube. This mock up is illustrated in Figure 8. A 3/8" (nominal) deep cavity was excavated along the ID of the mockup tube using the EDM process. The sides of the cavity were machined with a 4:1 taper. After welding the cavity, the weld face was machined using an EDM process to be flush with the surrounding base material to the contour of the ID of the tube. To simulate weld flaws, three flat bottom holes were drilled from the OD of the tube in the area of the repair weld. The depth of the holes nominally represented flaws at the weld fusion line with the base material and at one-third and two-thirds the thickness of the repair weld. In addition, a circumferential notch was cut on the OD simulating a flaw extending beyond the edge of the welded repair. Each of these flaws was successfully detected using the same ultrasonic examination procedure with the PCS24 probe used for the initial RPV penetration nozzle examination.

CONCLUSION:

In conclusion, the demonstrations described above provide assurance of Westinghouse inspection capabilities. Demonstrations 1 – 4 confirm that Westinghouse's ultrasonic and eddy current examination procedures are capable of detection and sizing of both ID and OD initiated axial and circumferential flaws in RPV penetration nozzles to satisfy the requirements of NRC Generic Letter 97-01 and NRC Bulletin 2001-01. Demonstration 5 confirmed that a repair weld could be inspected for fabrication flaws.

Document Number: WDI-TJ-007-02	Revision: 0	Page 8 of 43
--------------------------------	-------------	--------------

a,c,e

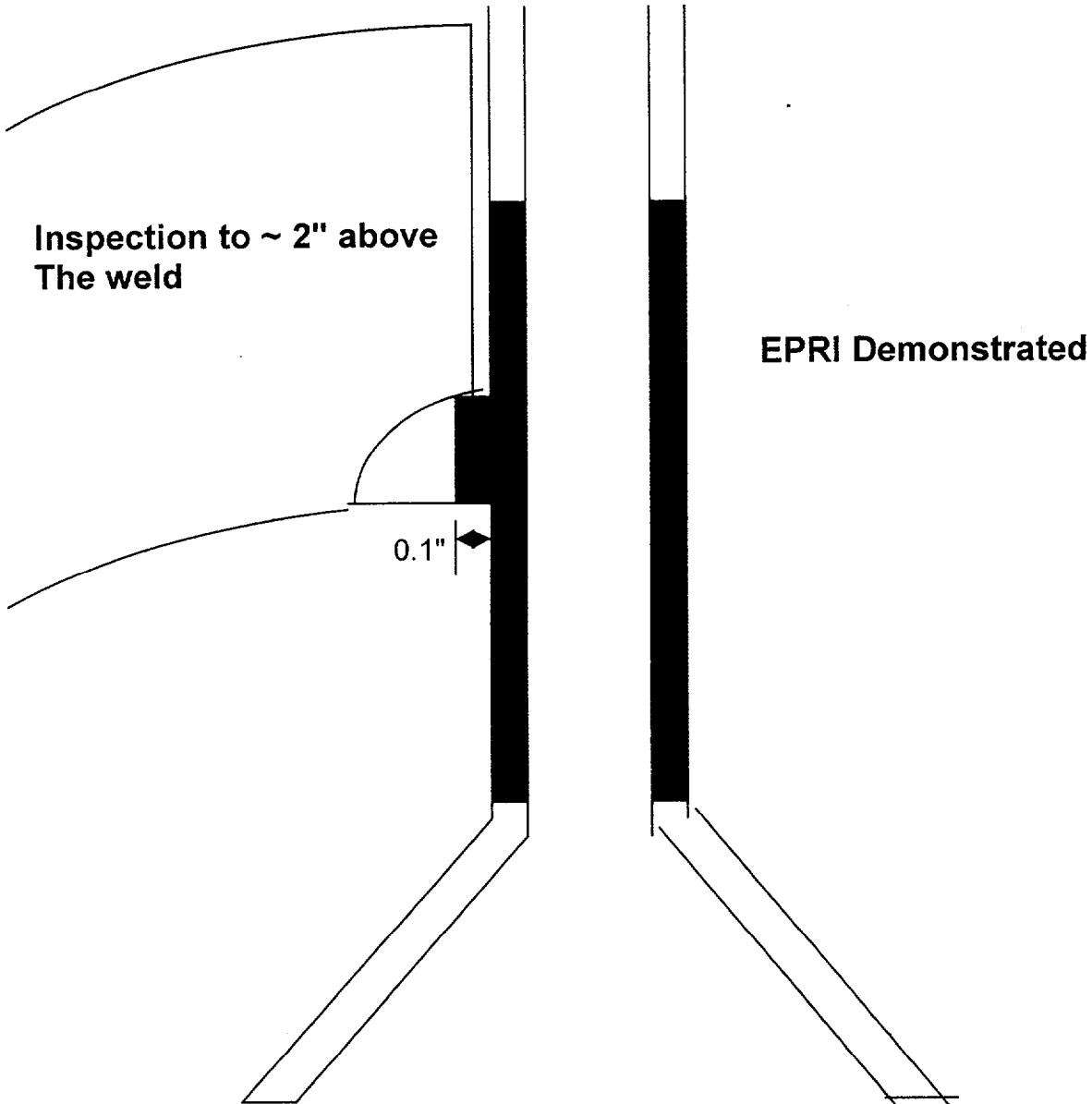


Document Number: WDI-TJ-007-02	Revision: 0	Page 9 of 43
--------------------------------	-------------	--------------

a,c,e

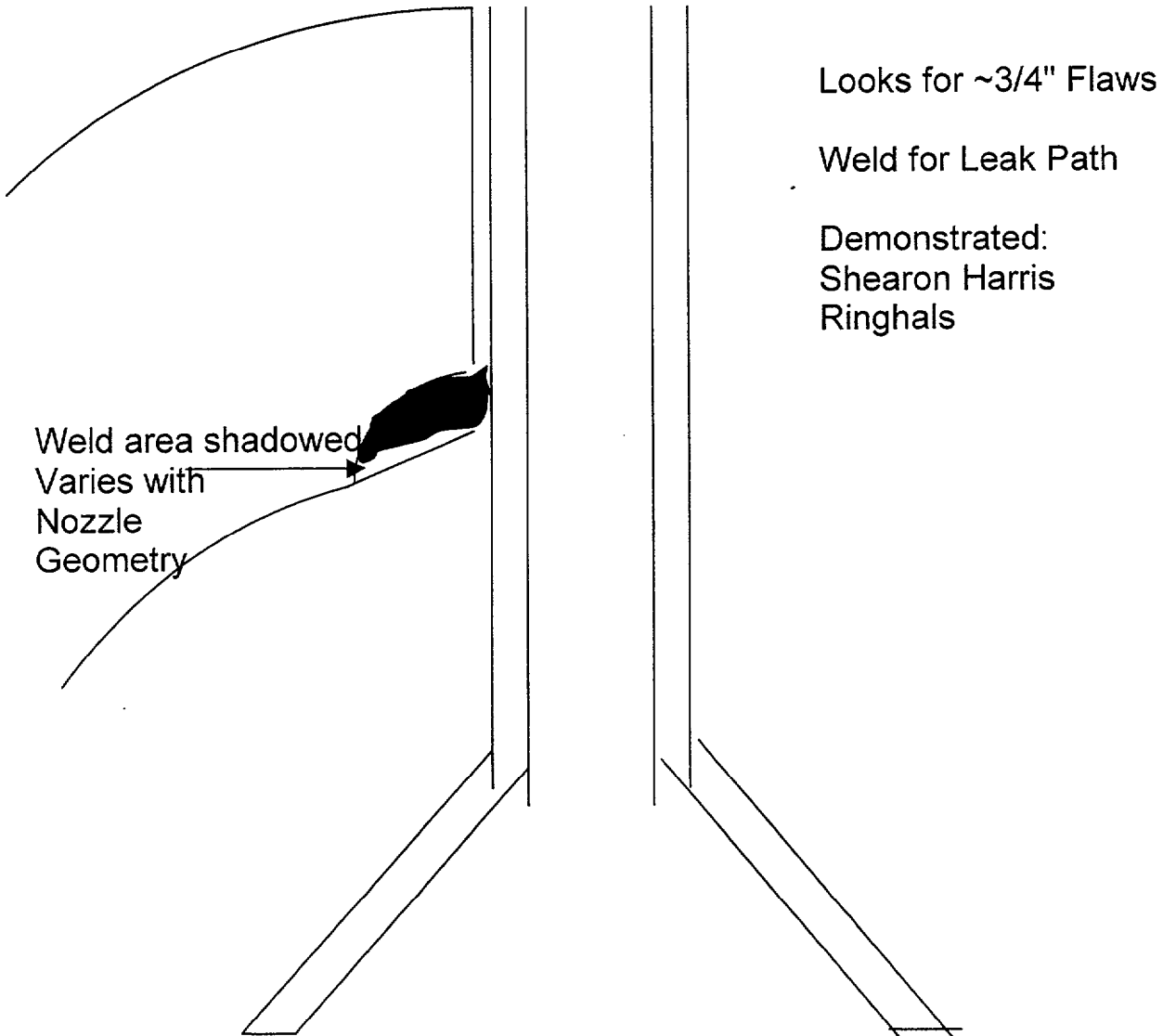


**Figure 3: Open Housing Probe
TOFD UT Area of Coverage**



Note:
Sketch Not To Scale
Nozzle Interference Fit Not Shown
Open Housing Probe Was Performed to ~ 2" above the weld

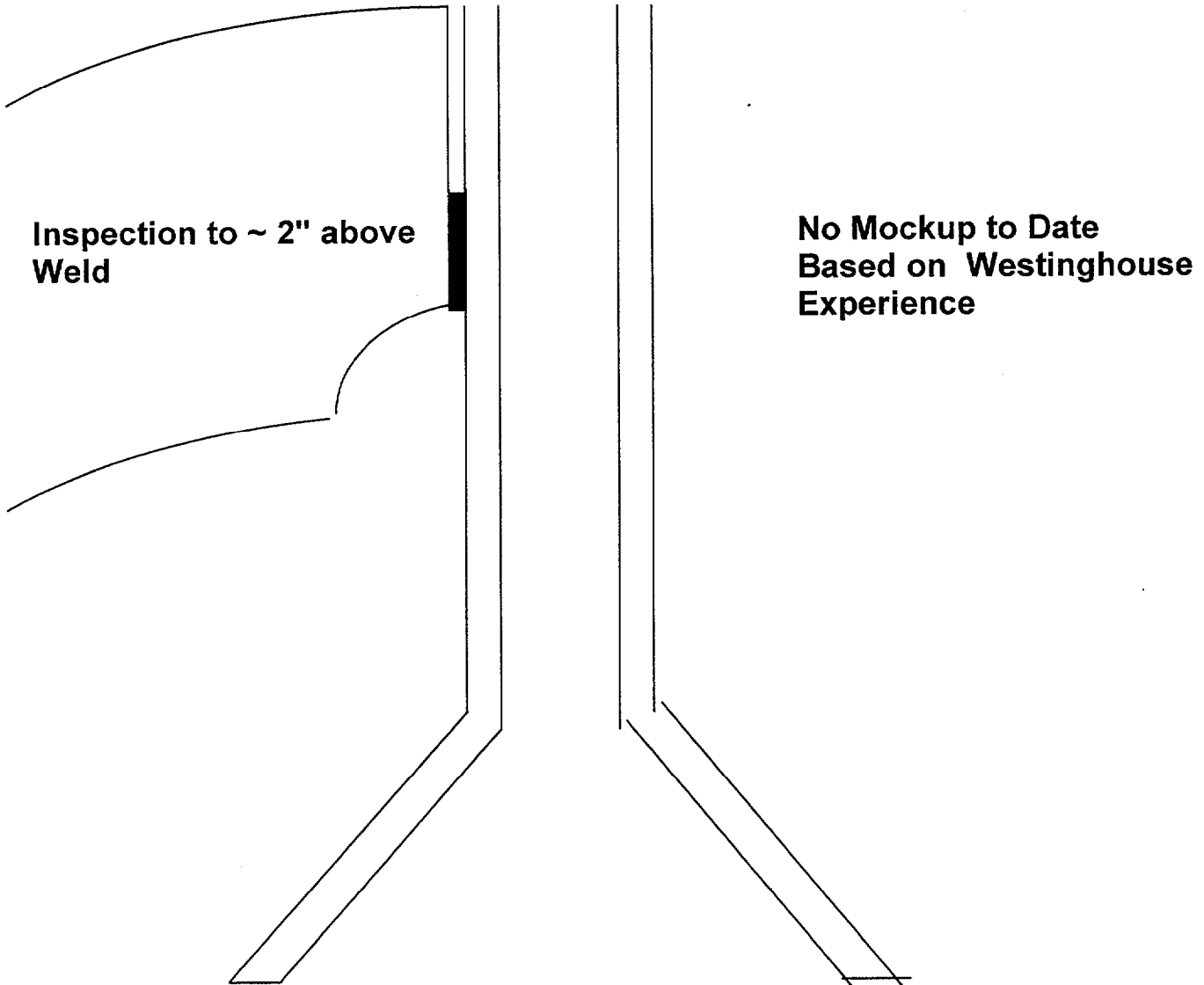
**Figure 4: Open Housing Probe
0 degree UT Area of Coverage**



Note:
Sketch Not To Scale
Nozzle Interference Fit Not Shown
Open Housing Probe Was Performed to ~ 2" above the
weld

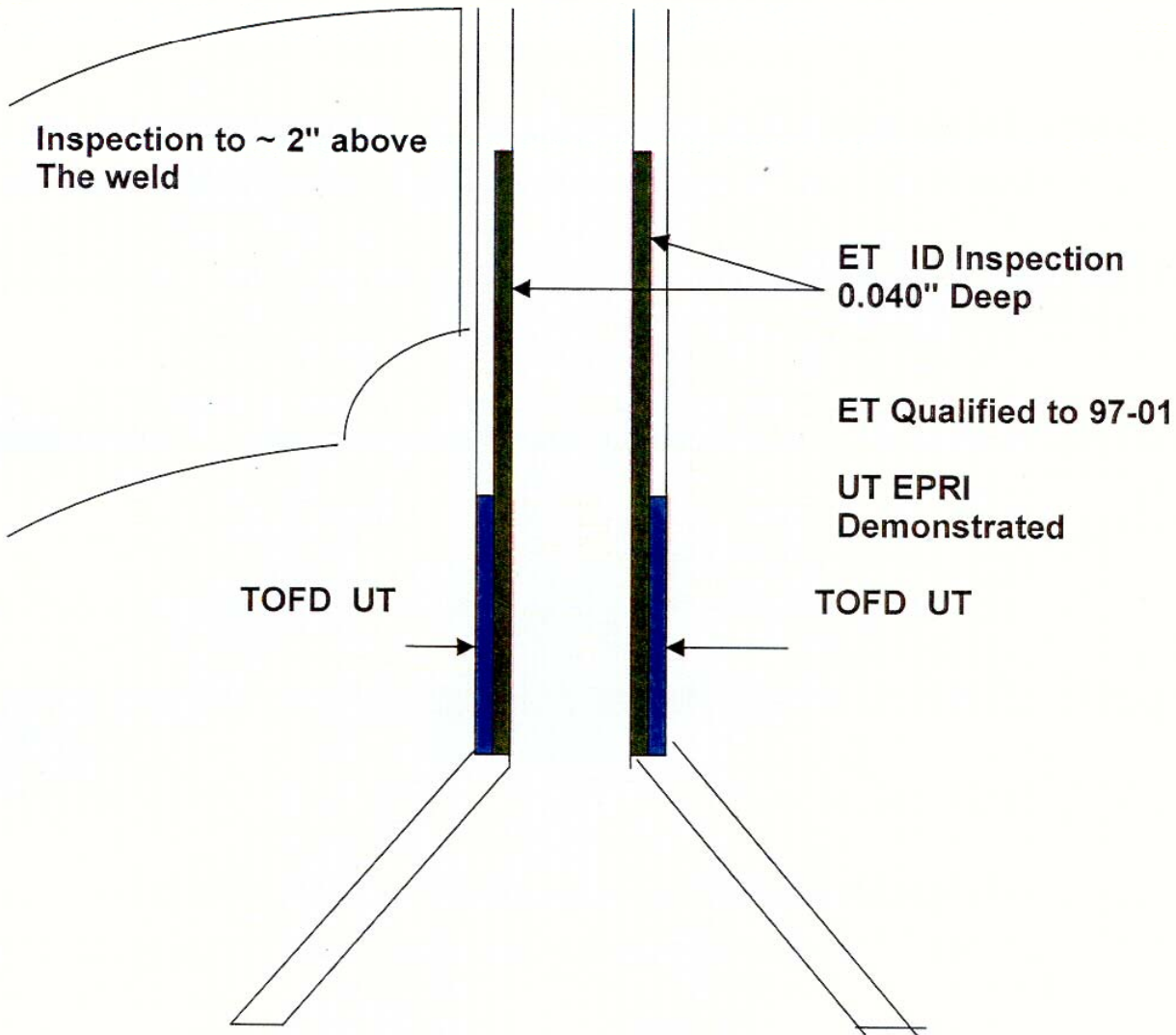
**Figure 5: Open Housing Probe
Loss Of Interference Fit
Area of Coverage**

5 MHz UT



Note:
Sketch Not To Scale
Nozzle Interference Fit Not Shown
Open Housing Probe Was Performed to ~ 2" above the
weld

**Figure 6: Open Housing Probe
Wetted Surfaces
ET & UT TOFD CH 2 (Axial Shooting)
Area of Coverage**

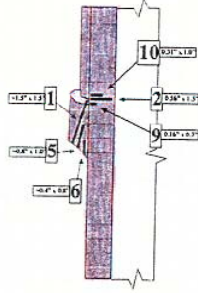


Note:
Sketch Not To Scale
Nozzle Interference Fit Not Shown
Open Housing Probe Was Performed to ~ 2" above the
weld

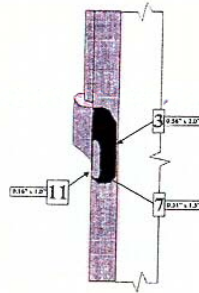
C01

Generic Side-Views of Flaws

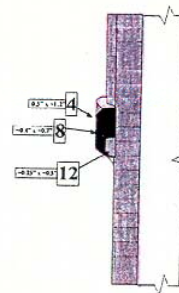
Circumferential PWSCC



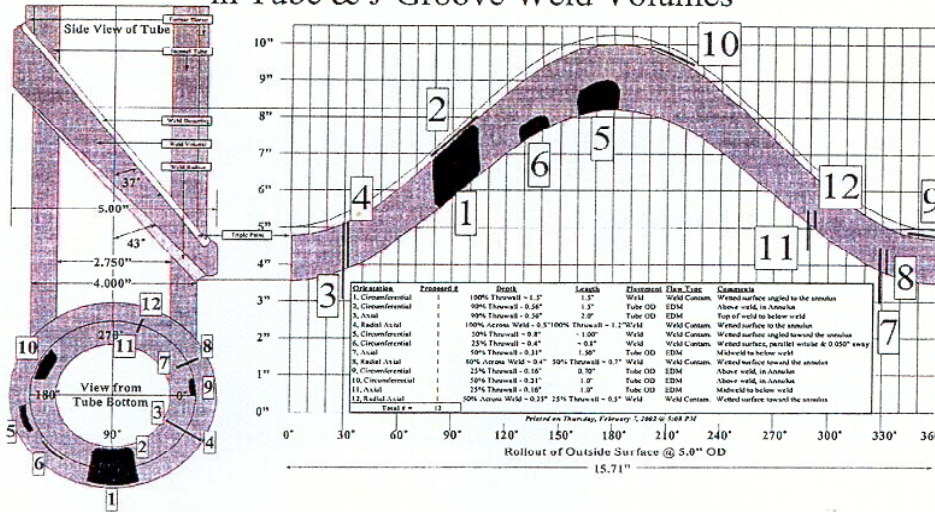
Tube Axial PWSCC



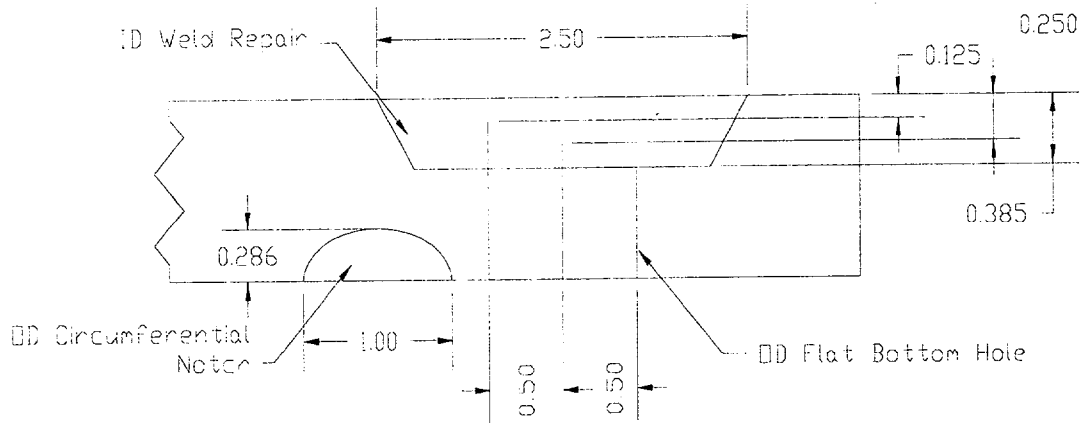
Weld Axial PWSCC



Mockup Proposal for Entergy/MRP CRDM & Flaw Placement in Tube & J-Groove Weld Volumes



002



**Figure 8: Weld Repair Mock Up
(All dimensions in inches)**

Attachment 1: EPRI/MRP Demonstration Results Table

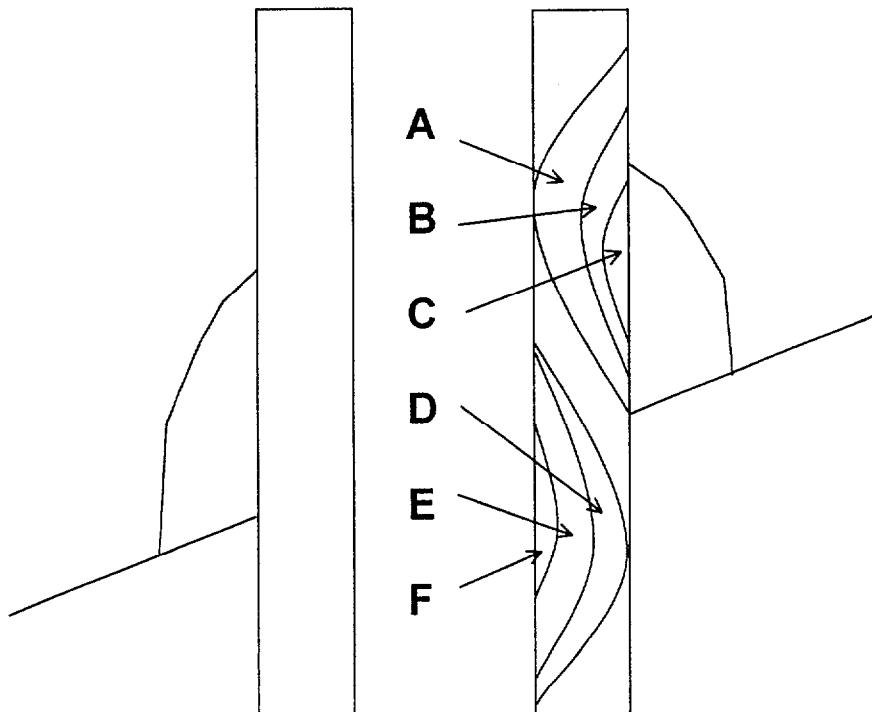
Summary of WesDyne Detection Techniques	A OD to ID	B OD to mid-wall	C Shallow OD-initiated	D ID to OD	E ID to mid-wall	F Shallow ID-initiated	Weld Mapping	Procedure # & Date	Demonstration Date
<i>WesDyne CRDM Demonstrations conducted for 97-01 (ID flaws).</i>									
BP TOFD for Axial flaws (7 mhz)					D, S	D, S	M	EN 2.4.1 GEN 3 (1)	02/1994
BP TOFD for Circ Flaws (7 mhz)					D, S	D, S	N/A	EN 2.4.1 GEN 3 (1)	02/1994
BP ID ET					D, S	D, S	N/A	(1)	02/1994
RP TOFD for Axial Flaws (7 mhz)					D, S	D, S	M	EN 2.4.1 GEN 3 (1)	02/1994
RP ID ET					D, S	D, S	N/A	(1)	02/1994
RP TOFD for Axial (7 mhz)					D, S	D, S	M	STD-AMD-062 (2)	12/1996
RP ID ET					D, S	D, S	N/A	STD-AMD-061 (2)	12/1996
BP TOFD for Axial flaws 10 mhz PCS 10 w/RD-Tech System					D, S	D, S	N/A	PB 447, Rev. 3 05/08/2000 (3)	05/2000
BP TOFD for Axial flaws 6 mhz PCS 18 w/RD-Tech System					D, S	D, S	M	PB 447, Rev. 3 05/08/2000 (3)	05/2000
BP TOFD for Circ flaws 10 mhz PCS 10 w/RD-Tech System					D, S	D, S	N/A	PB 447, Rev. 3 05/08/2000 (3)	05/2000
BP TOFD for Circ flaws 6 mhz PCS 18 w/RD-Tech System					D, S	D, S	M	PB 447, Rev. 3 05/08/2000 (3)	05/2000
BP ID ET					D, S	D, S	N/A	(3)	05/2000
<i>WesDyne CRDM Demonstrations conducted for MRP (OD flaws).</i>									
BP TOFD for Axial flaws 6 mhz PCS 18 & PCS 24 w/RD-Tech System	(4)	(4)	(4)	(4, 5)	(4, 5)	(4, 5)	M	ISHJT-002, Rev. 0, 09/2001 (6)	09/2001
BP TOFD for Circ flaws 6 mhz PCS 18 & PCS 24 w/RD-Tech System	(4)	(4)	(4)	(4, 5)	(4, 5)	(4, 5)	M	ISHJT-002, Rev. 0, 09/2001 (6)	09/2001
BP PE for Circ flaws w/RD-Tech System	(4, 7)	(4, 7)	D	N/A	N/A	N/A	N/A	ISHJT-002, Rev. 0, 09/2001 (6)	09/2001

Attachment 1: EPRI/MRP Demonstration Results Table (Continued)

BP TOFD for Axial flaws 6 mhz PCS 18 w/Intraspect System	(4, 5)	(4, 5)	OR	(4, 5)	(4, 5)	(4, 5)	M	ISHUT-002, Rev.0, 09/2001 (6)	01/2002
BP TOFD for Circ Flaws 6 mhz PCS 24 w/Intraspect System	OR	D	D	(4, 5)	(4, 5)	(4, 5)	M	ISHUT-002, Rev.0, 09/2001 (6)	01/2002
BP TOFD for Axial flaws 6 mhz PCS 18 w/Intraspect System	(4, 5)	(4, 5)	OR	(4, 5)	(4, 5)	(4, 5)	M	ISHUT-002, Rev.0, 09/2001 (6)	01/2002
BP TOFD for Circ Flaws 6 mhz PCS 24 w/Intraspect System	OR	D	D	(4, 5)	(4, 5)	(4, 5)	M	ISHUT-002, Rev.0, 09/2001 (6)	01/2002
RP TOFD (only 5 mhz PCS 24 demonstrated) w/Intraspect System	OR	D	D	(4, 5)	(4, 5)	(4, 5)	M	WDI-UT-008, Rev.0 01/2002 (6)	01/2002

Notes for Table:

- BP: Blade Probe UT/ET.
TOFD: Time-of-Flight-Diffraction UT
PE: Pulse-Echo UT
D: Detected flaw successfully in Oconee specimens or EPRI 97-01 mock-ups. The 97-01 flaws were demonstrated to have similar ET and UT characteristics to PWSCC.
S: Sized flaw successfully in EPRI 97-01 mock-ups. The 97-01 flaws were demonstrated to have similar ET and UT characteristics to PWSCC. Sizing of OD initiated flaws not currently addressed by the MRP demonstration.
M: Weld mapping demonstrated with 97-01 mockups.
RP: Rotating Probe UT/ET.
OR: Outside depth range of probe design.
- (1) Westinghouse Procedure (USA).
(2) ABB/CE Procedure (USA).
(3) Westinghouse TRC Procedure (Sweden).
(4) In the current MRP scope, but it was not demonstrated.
(5) Technically justified, based on the 97-01 demonstration results.
(6) WesDyne Procedure (Includes former Westinghouse-USA, ABB/CE-USA, and Westinghouse TRC-Sweden).
(7) Technically justified, based on detection of the C-type (smaller) flaw.



Attachment 2: Entergy/MRP Mockup Results

Entergy MRP CRDM Mockup Sample Outputs

Mockup:

ID Diameter 2.75", OD Diameter 4.0" , Wall thickness 0.625", Length 15"

Test Setup:

IntraSpect 4 channel UT system

7010 Open housing scanner

Ga1002 Scanner Amp Box

50 foot umbical cable

8 foot probe cables

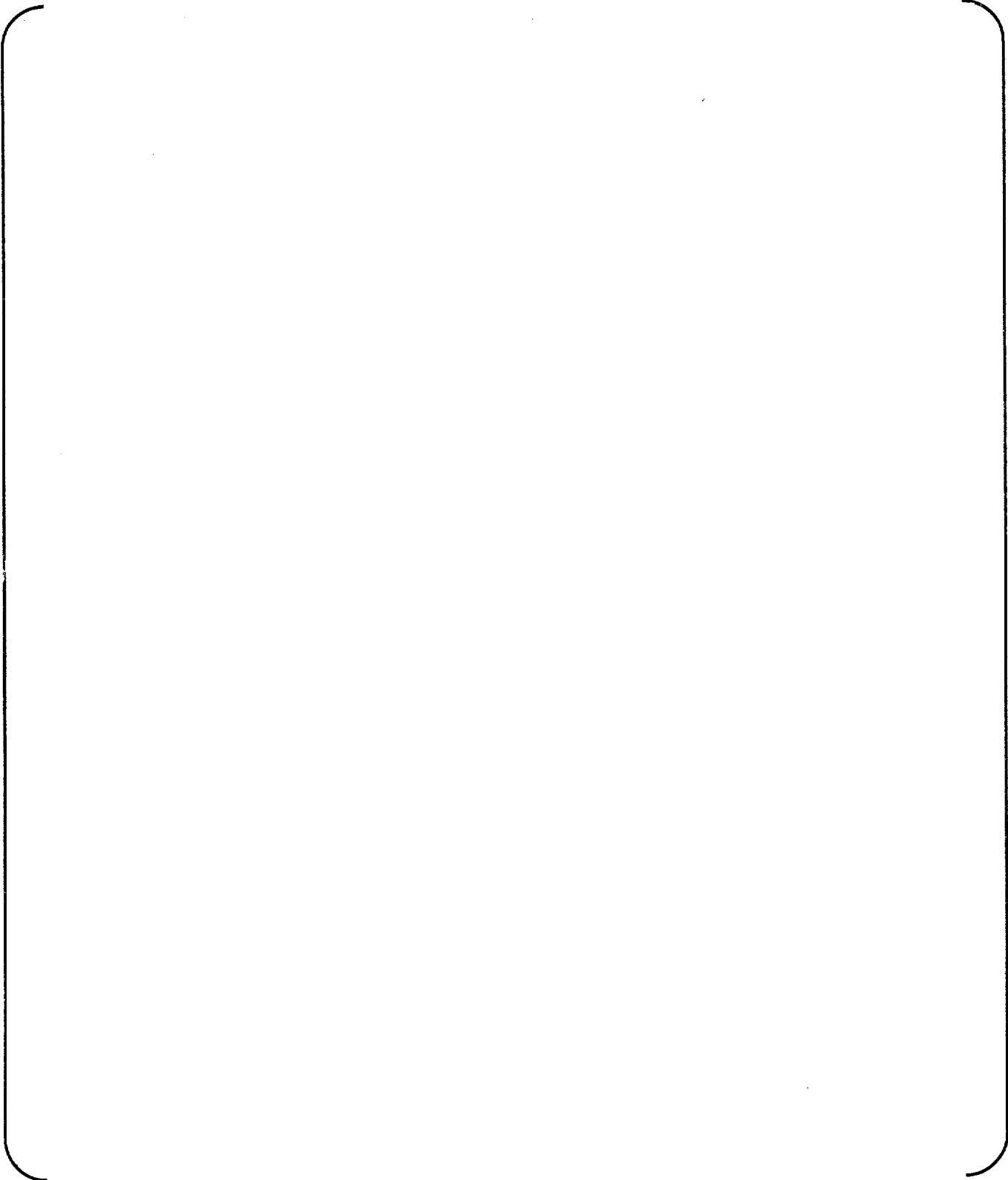
40 db preamp on receiver side

Scanning was perform in the vertical axis (Y) with a sample interval of .04" at 4.0" per second . The probe module was indexed at 1.5 degrees 0 degrees to 366 degrees

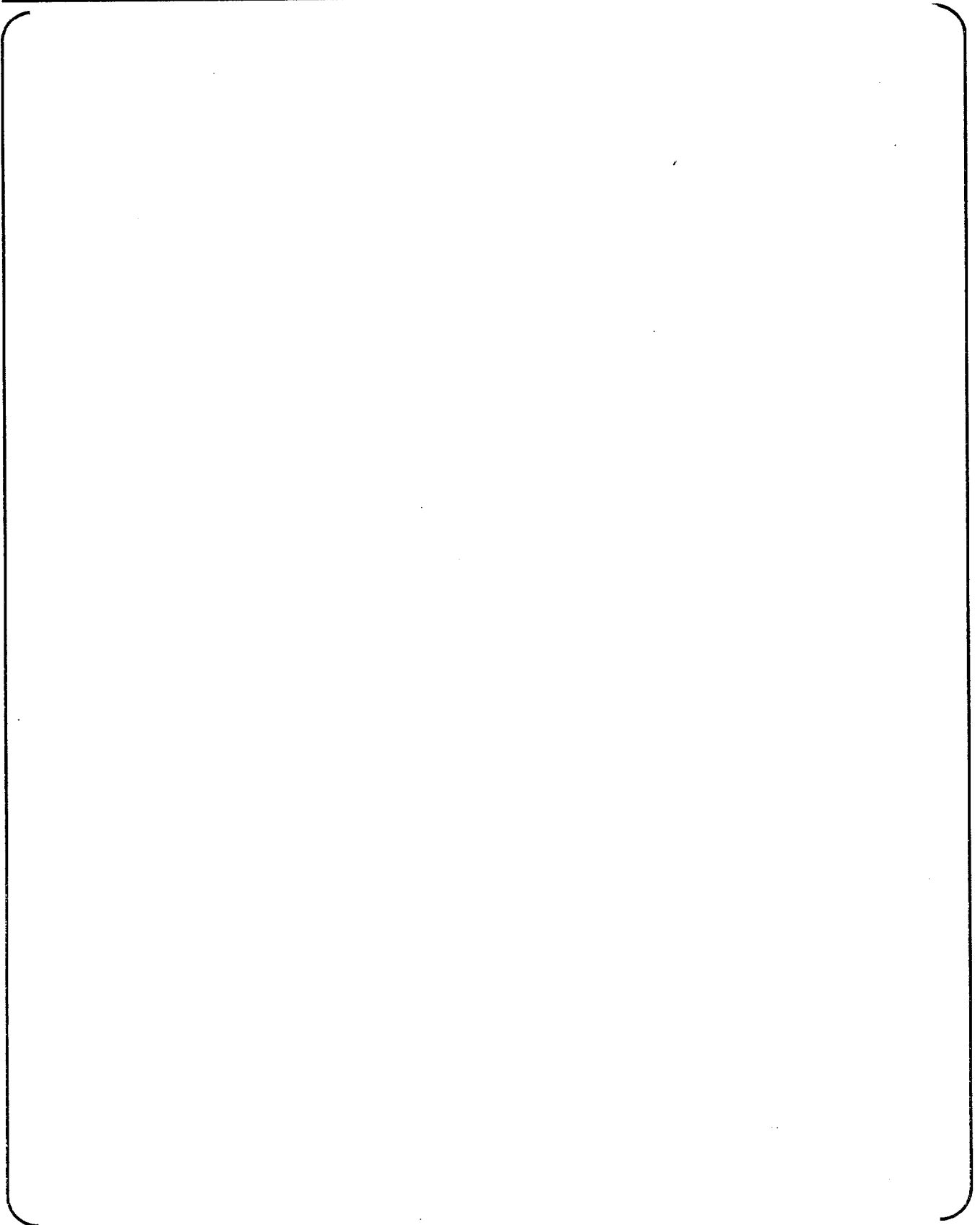
The TOFD probe module consisted of one set of 5 MHz .25" diameter probes with a center spacing of 24 mm orientated in the circumferential plane. A second set of 5 MHz .25" diameter probes with a center spacing of 24 mm was orientated in the axial plane.

The zero degree probe ia a 2.25 Mhz, .25" diameter flat (no focus)

a,c,e

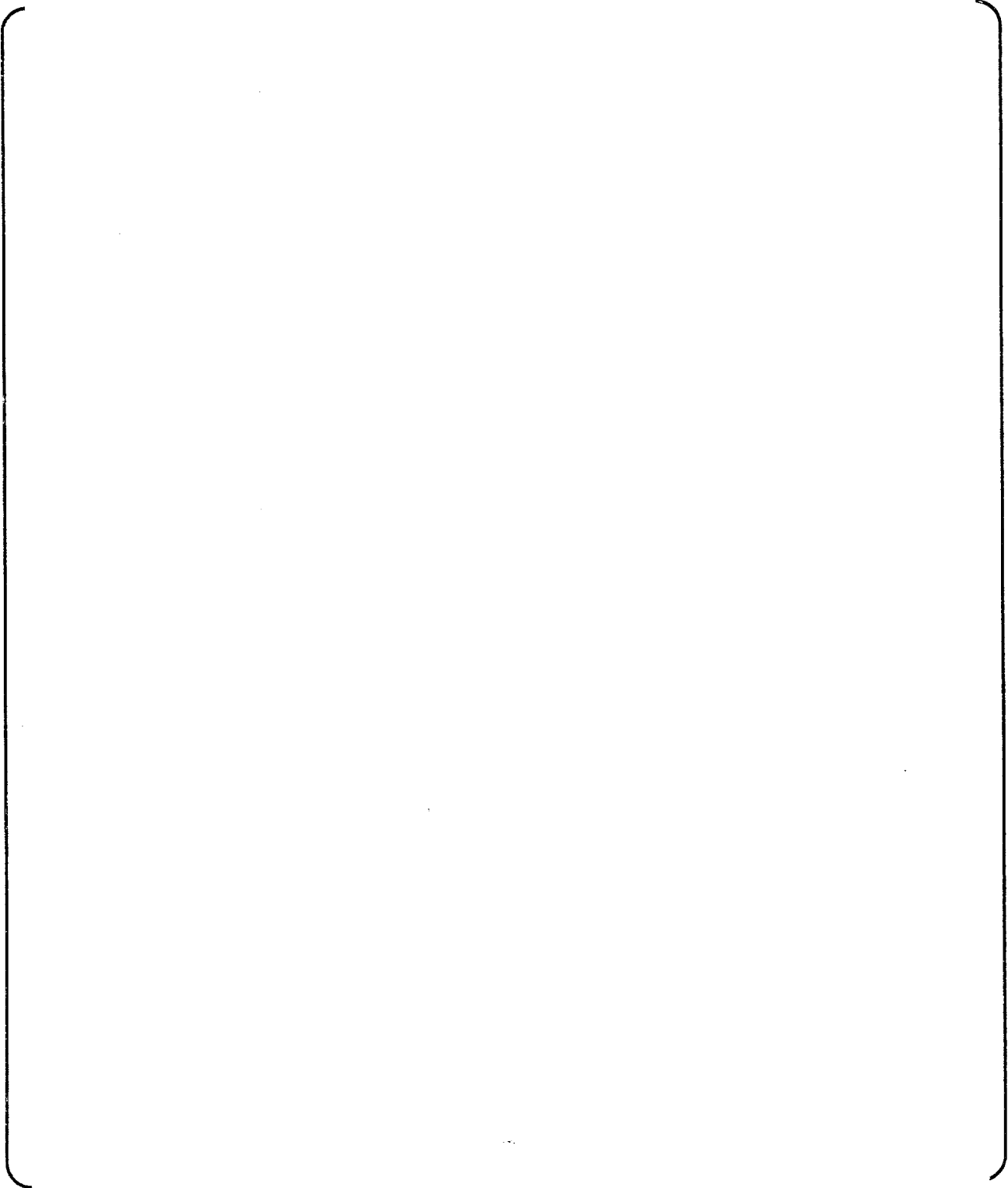


Document Number: WDI-TJ-007-02	Revision: 0	Page 21 of 43
--------------------------------	-------------	---------------

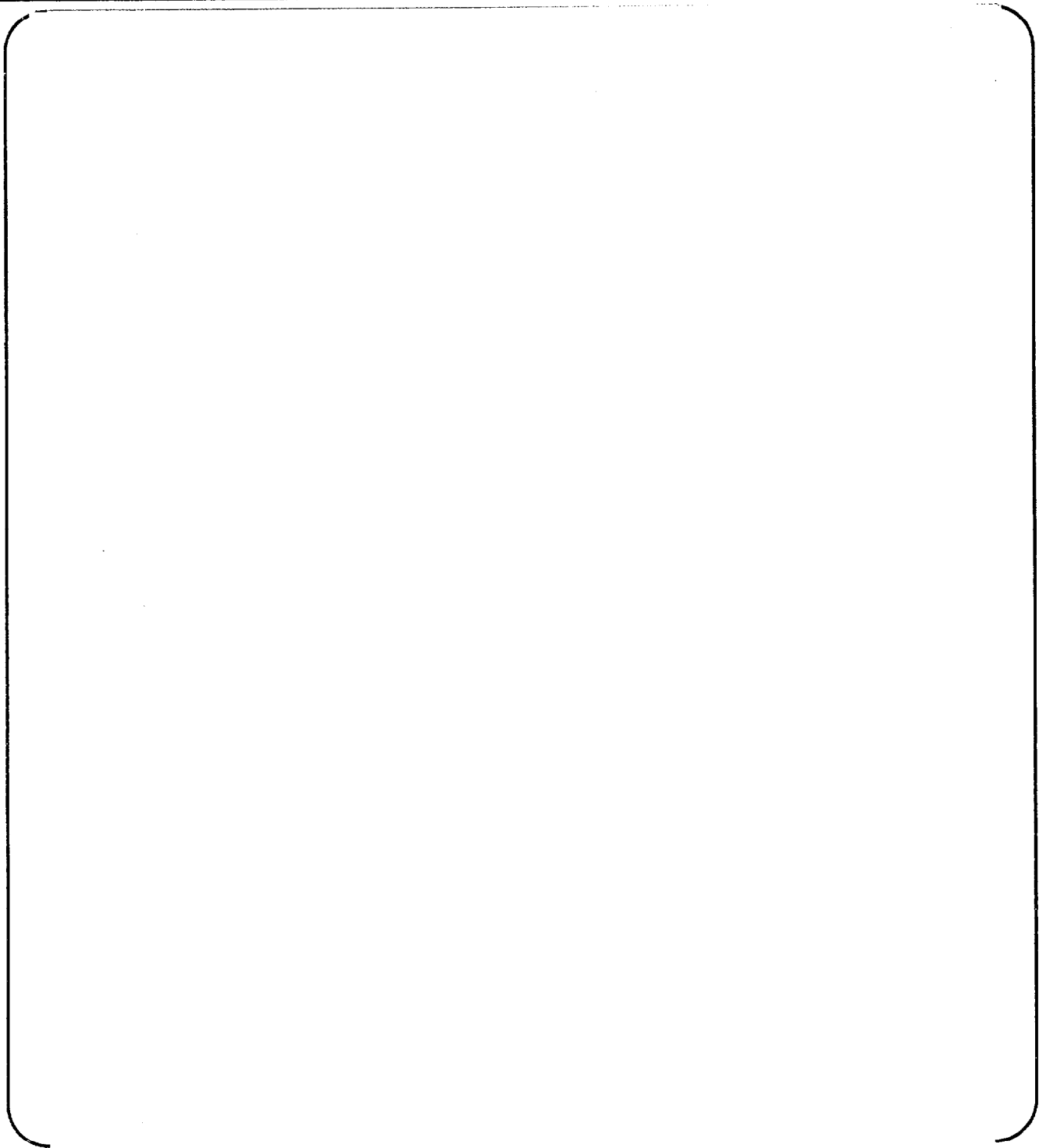


a,c,e

a,c,e



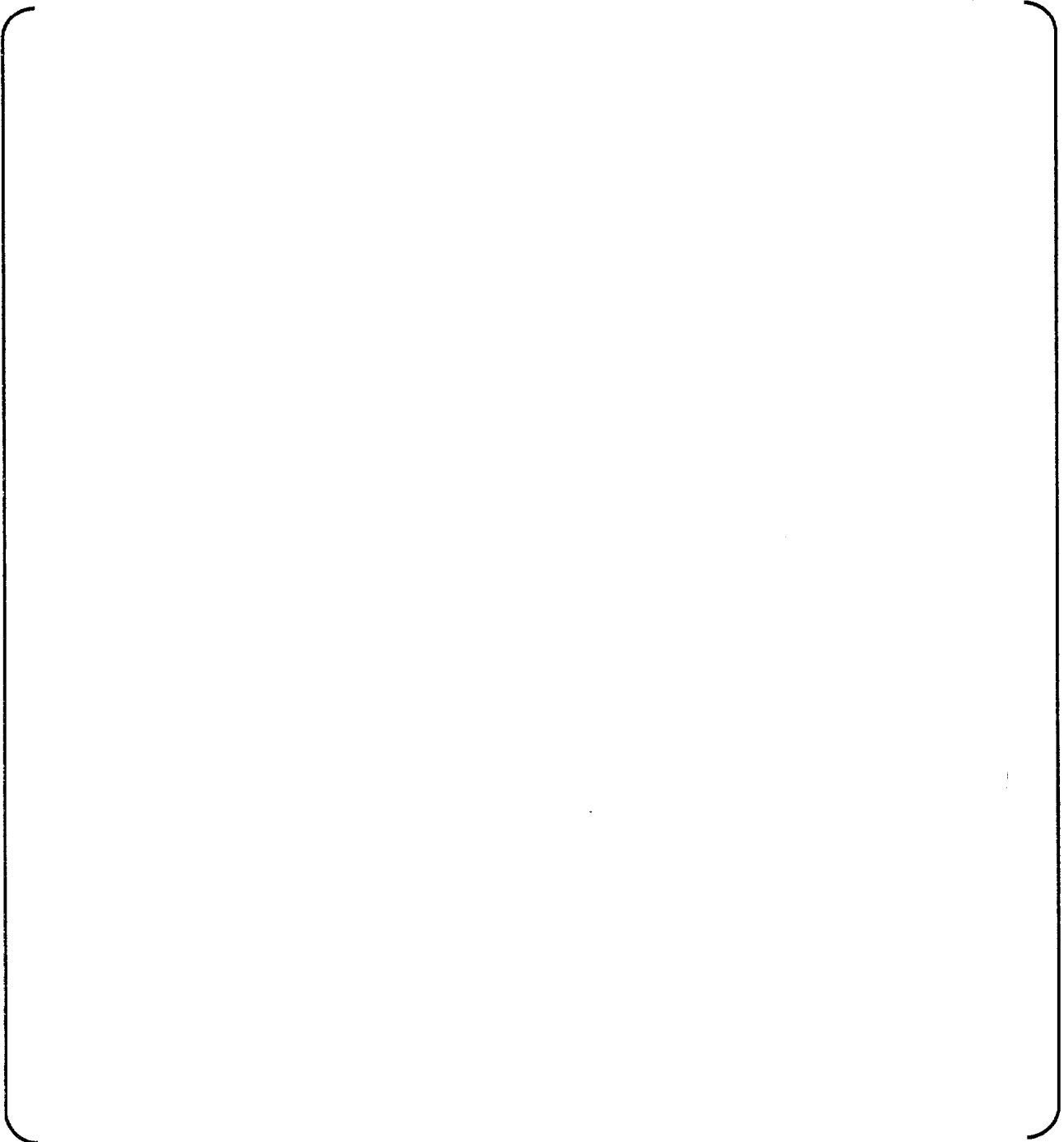
Document Number: WDI-TJ-007-02	Revision: 0	Page 23 of 43
--------------------------------	-------------	---------------

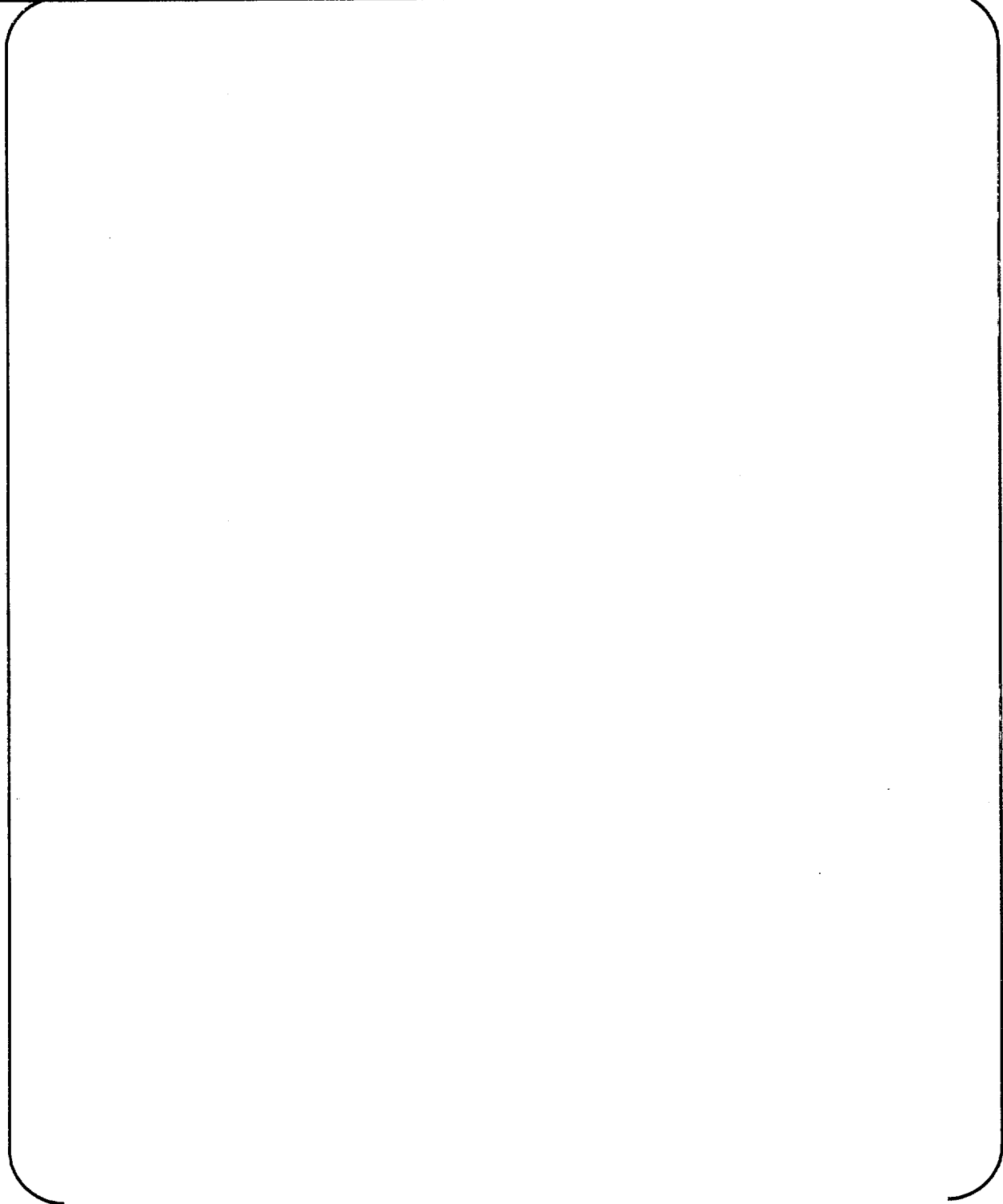


a,c,e

Document Number: WDI-TJ-007-02	Revision: 0	Page 24 of 43
--------------------------------	-------------	---------------

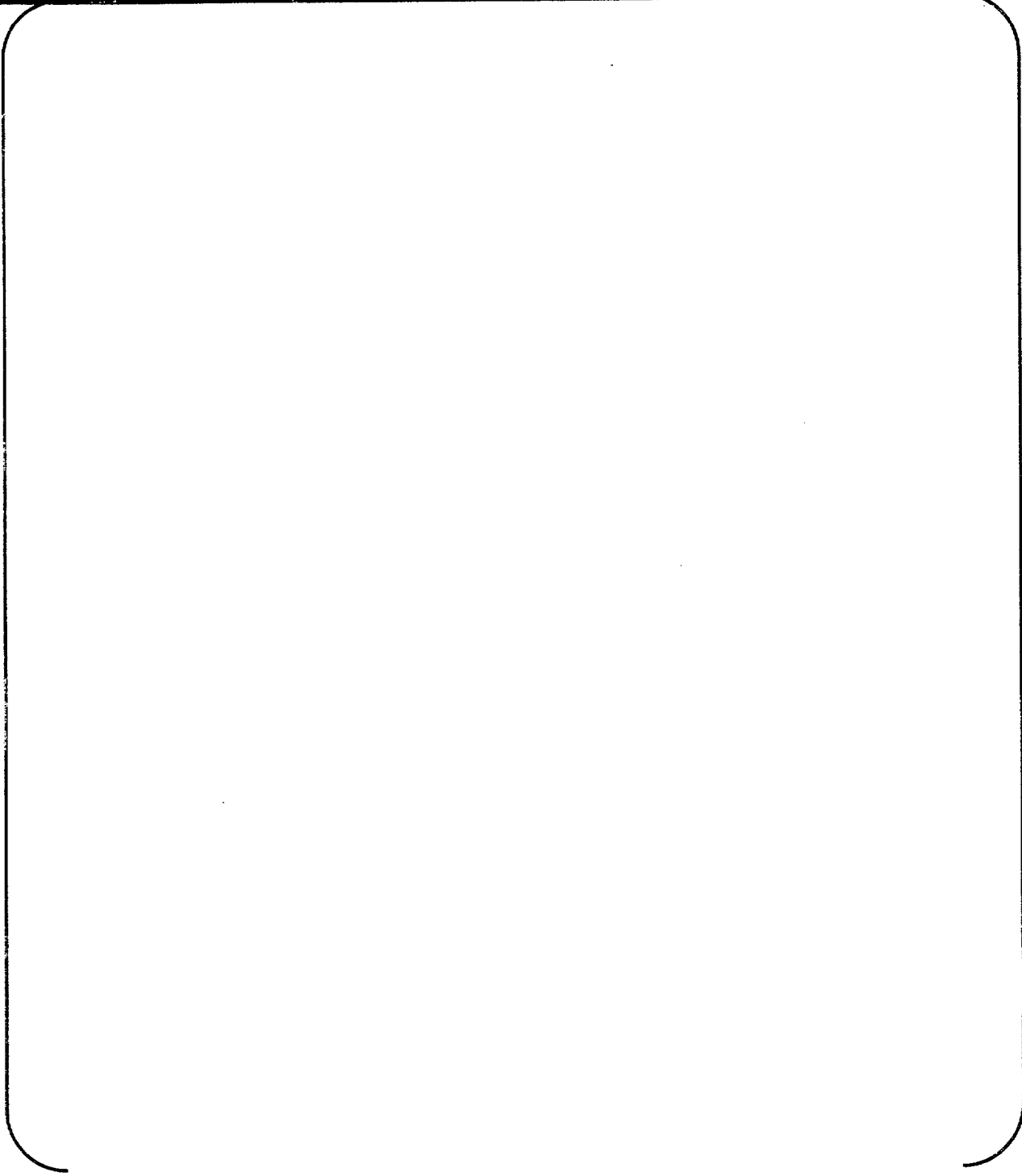
a,c,e

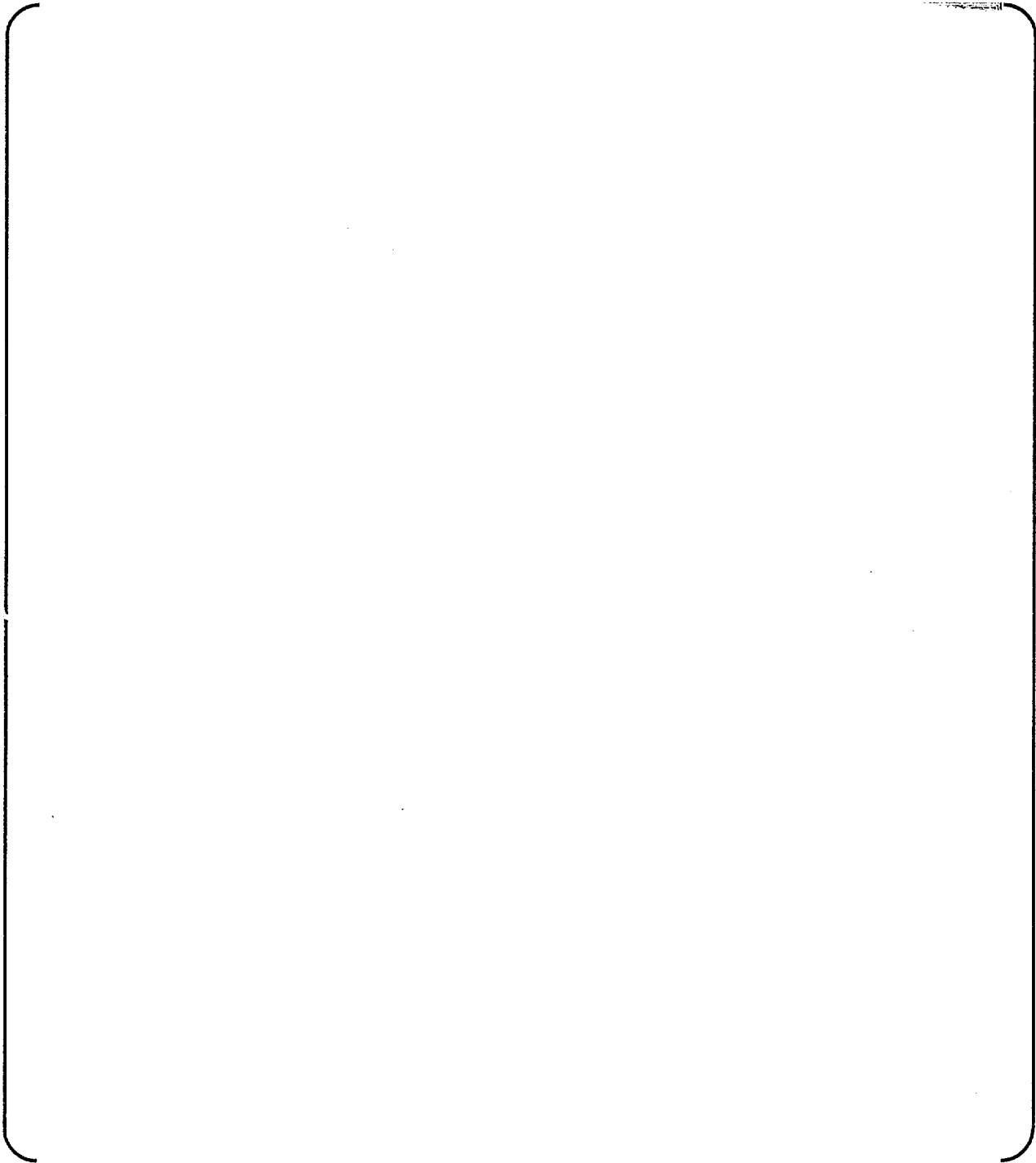




a,c,e

a,c,e

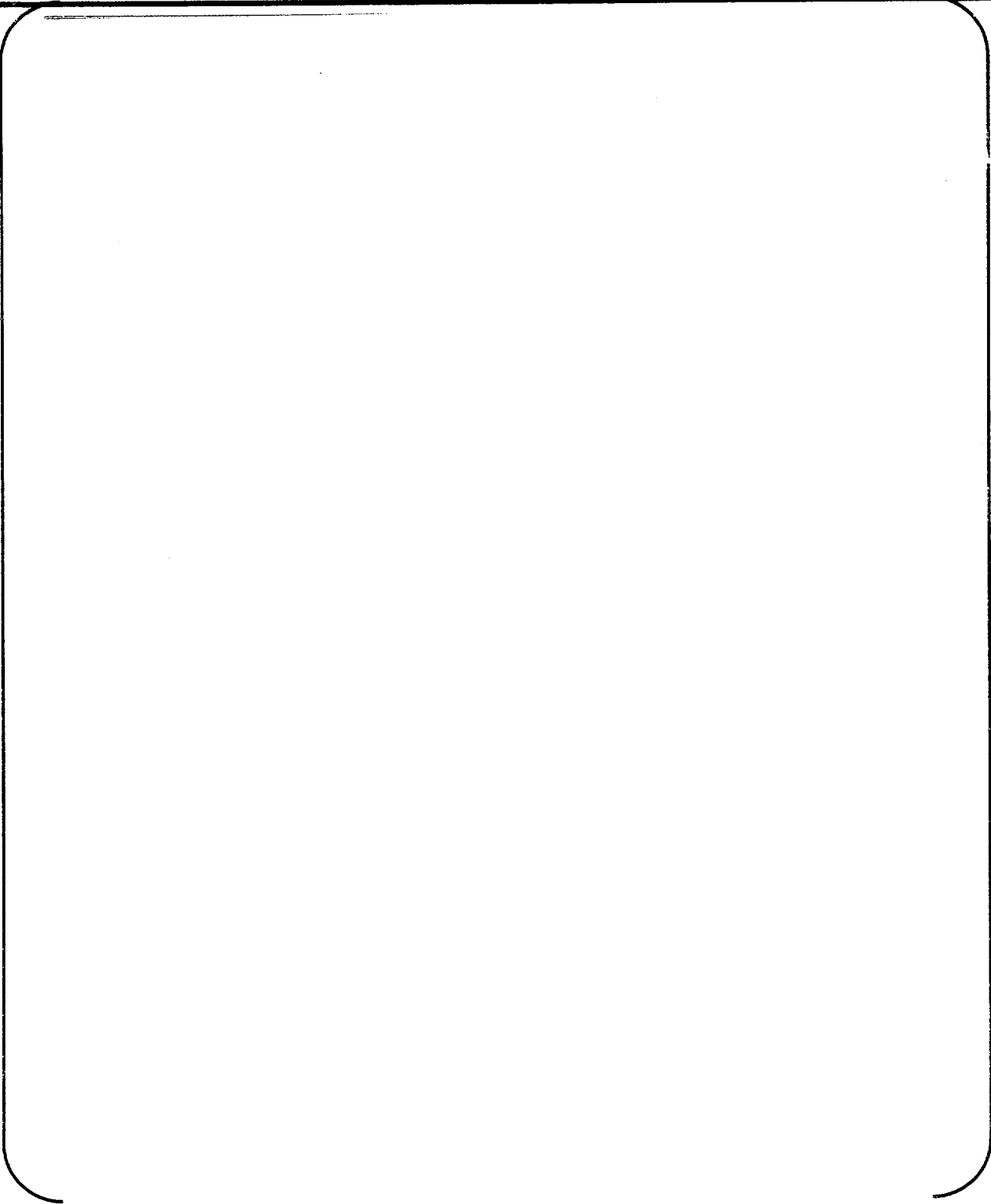




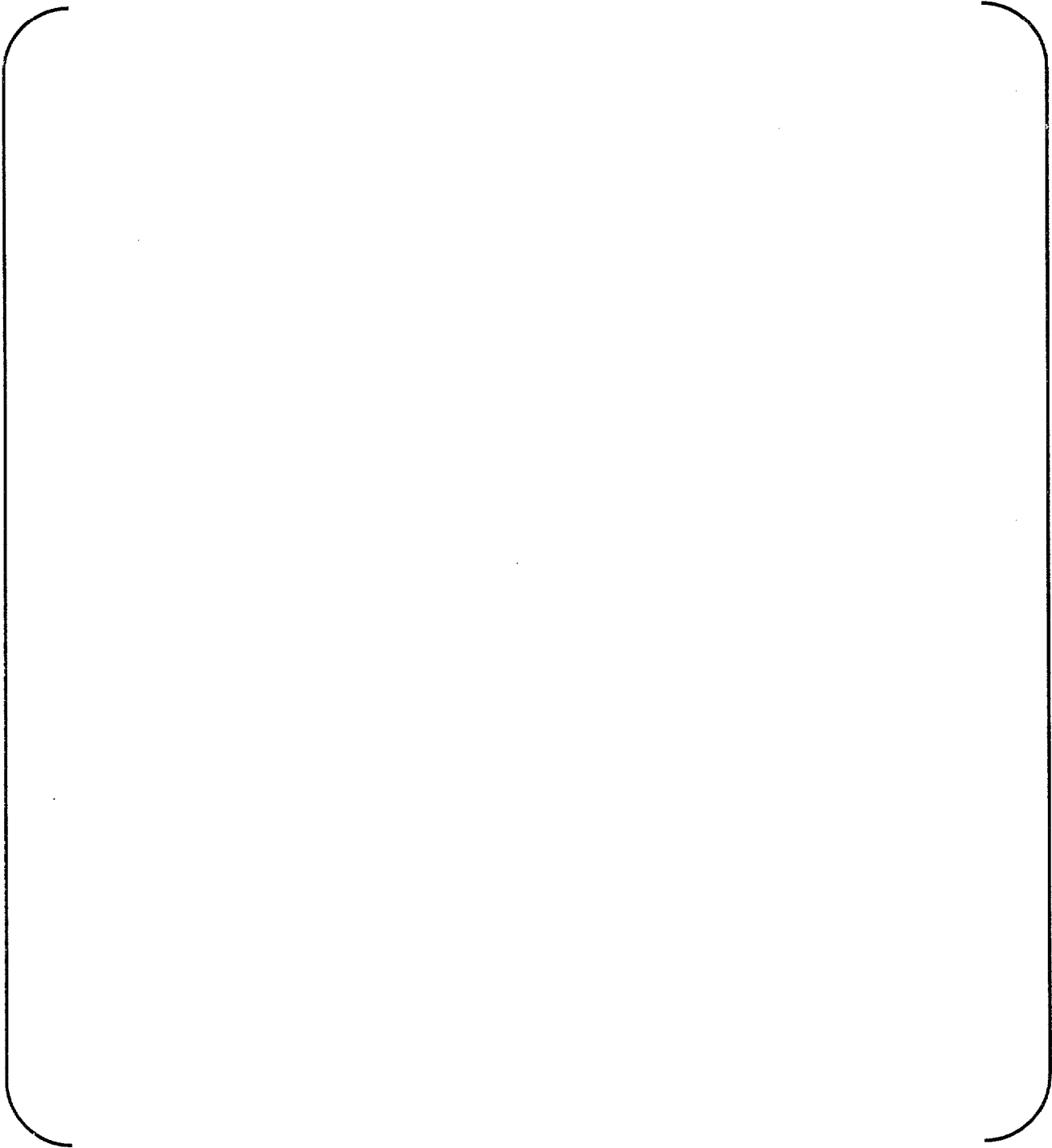
a,c,e

Document Number: WDI-TJ-007-02	Revision: 0	Page 28 of 43
--------------------------------	-------------	---------------

a,c,e

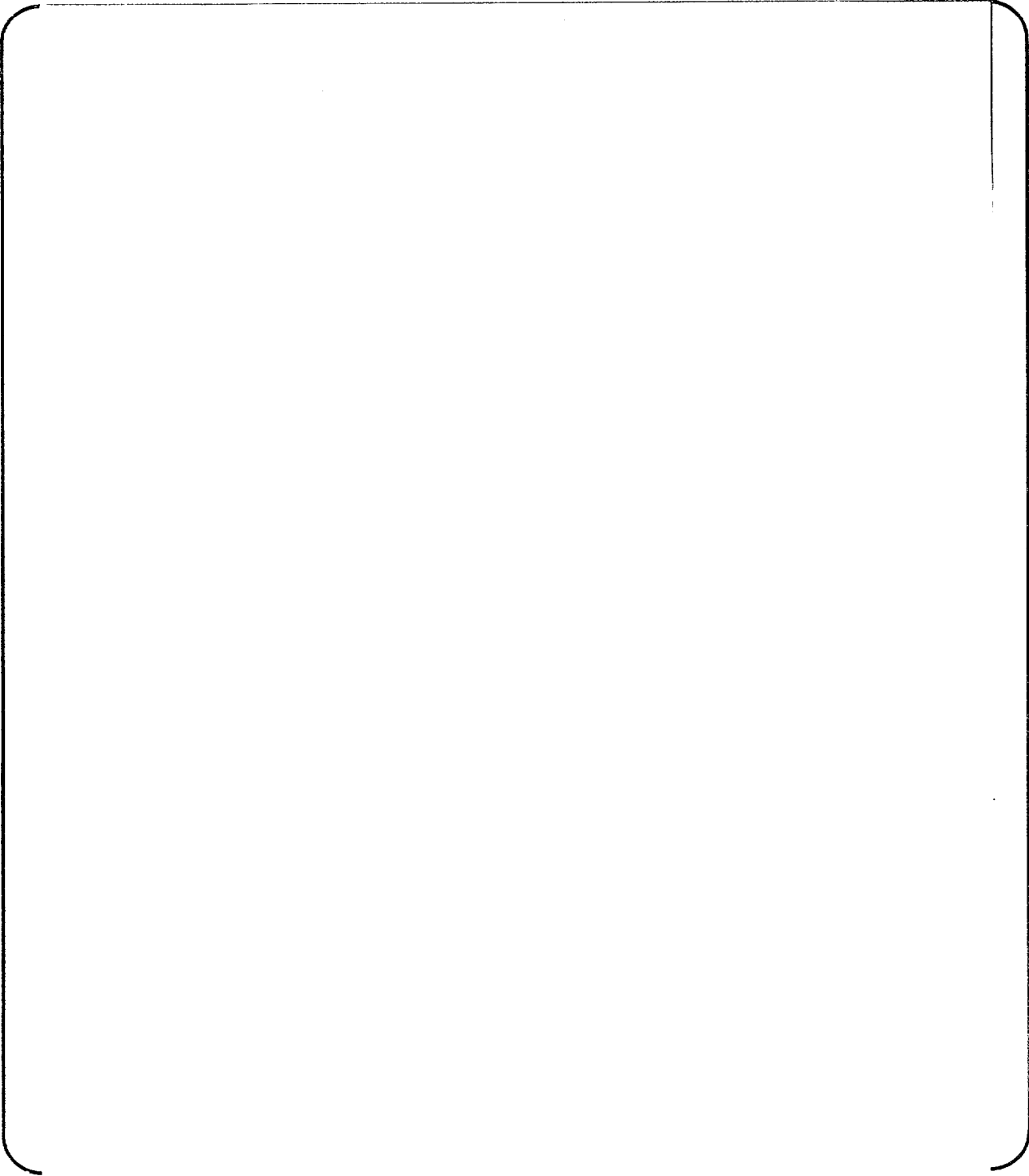


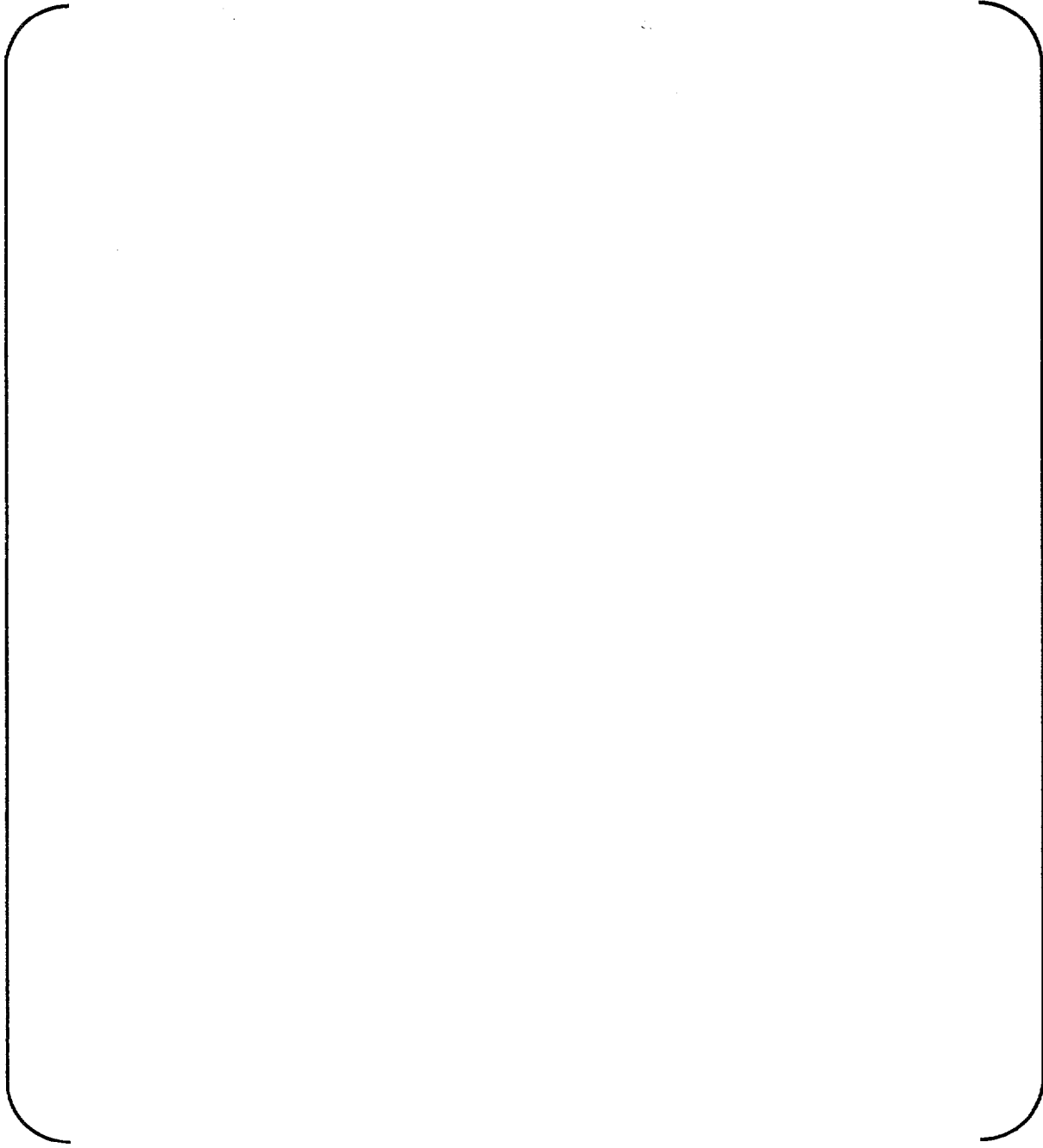
Document Number: WDI-TJ-007-02	Revision: 0	Page 29 of 43
--------------------------------	-------------	---------------



a,c,e

a,c,e

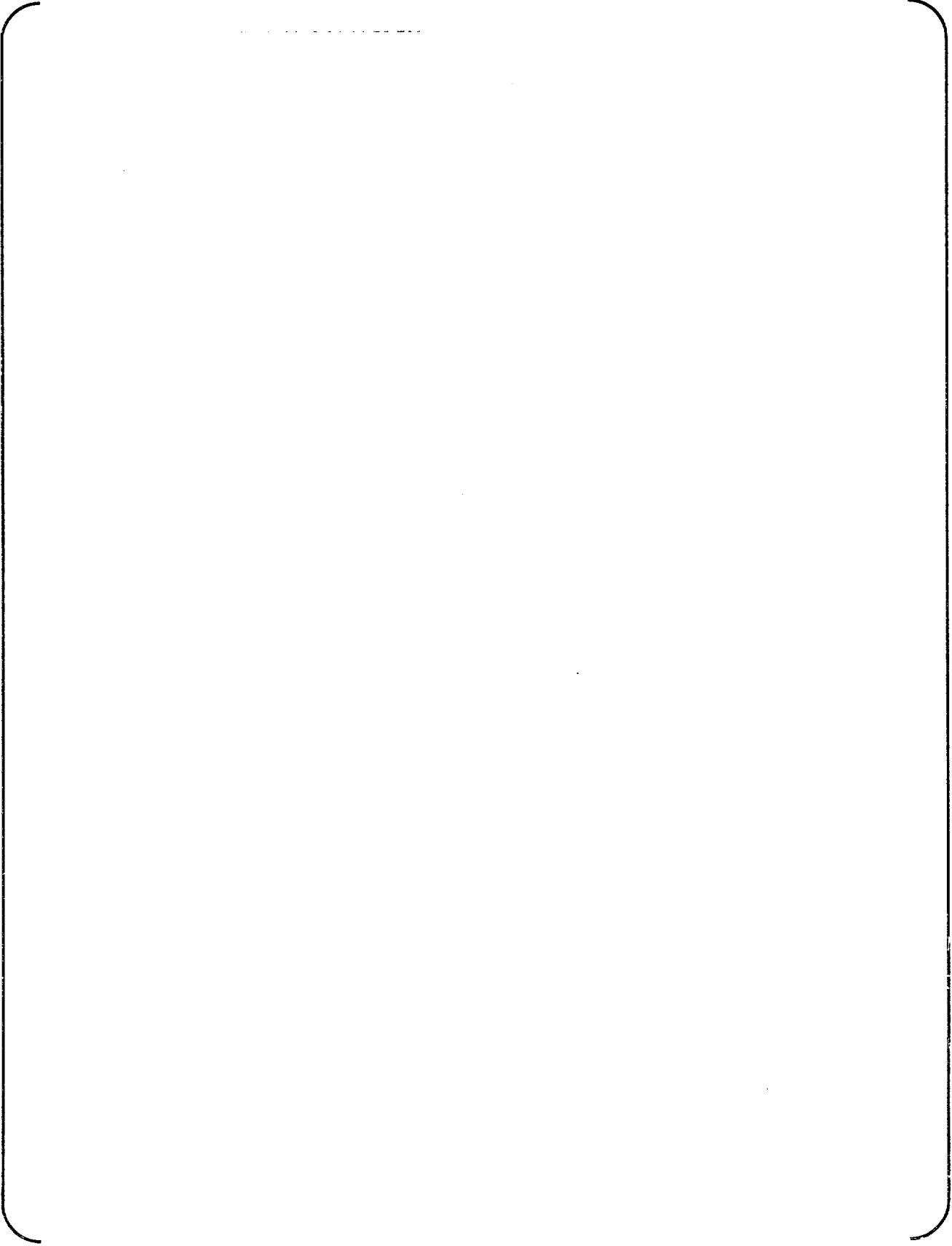




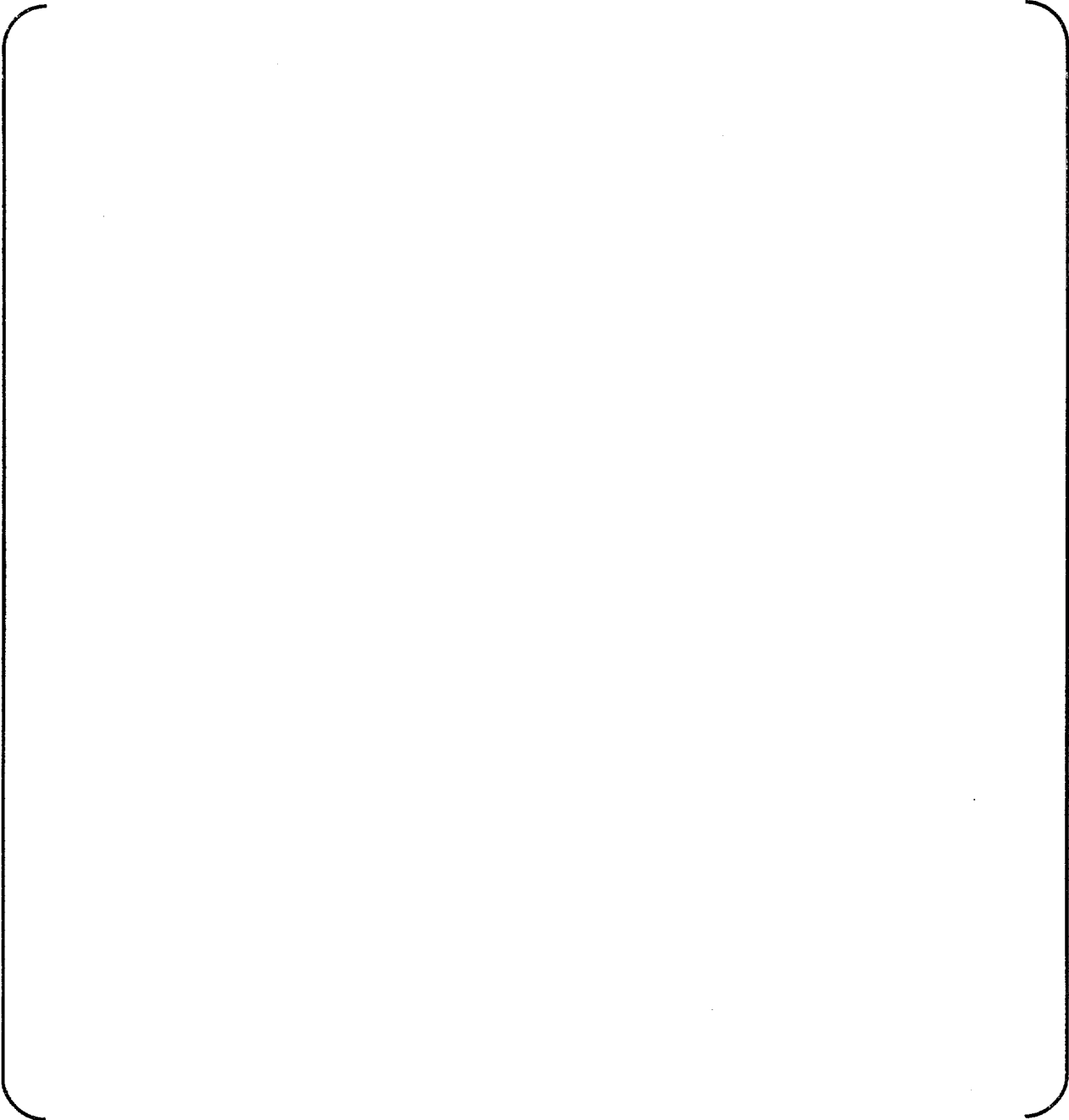
a,c,e

Document Number: WDI-TJ-007-02	Revision: 0	Page 32 of 43
--------------------------------	-------------	---------------

a,c,e

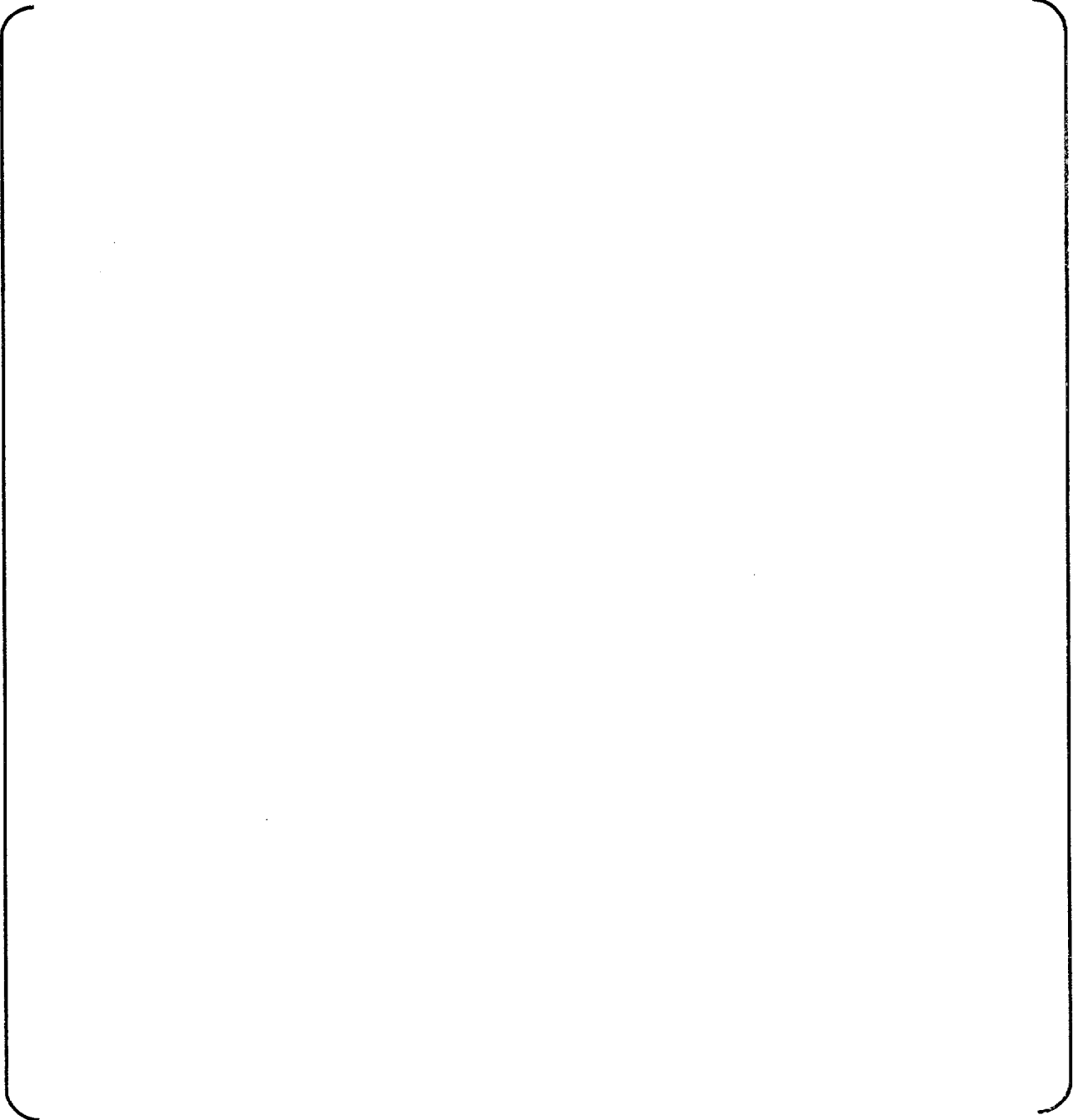


Document Number: WDI-TJ-007-02	Revision: 0	Page 33 of 43
--------------------------------	-------------	---------------



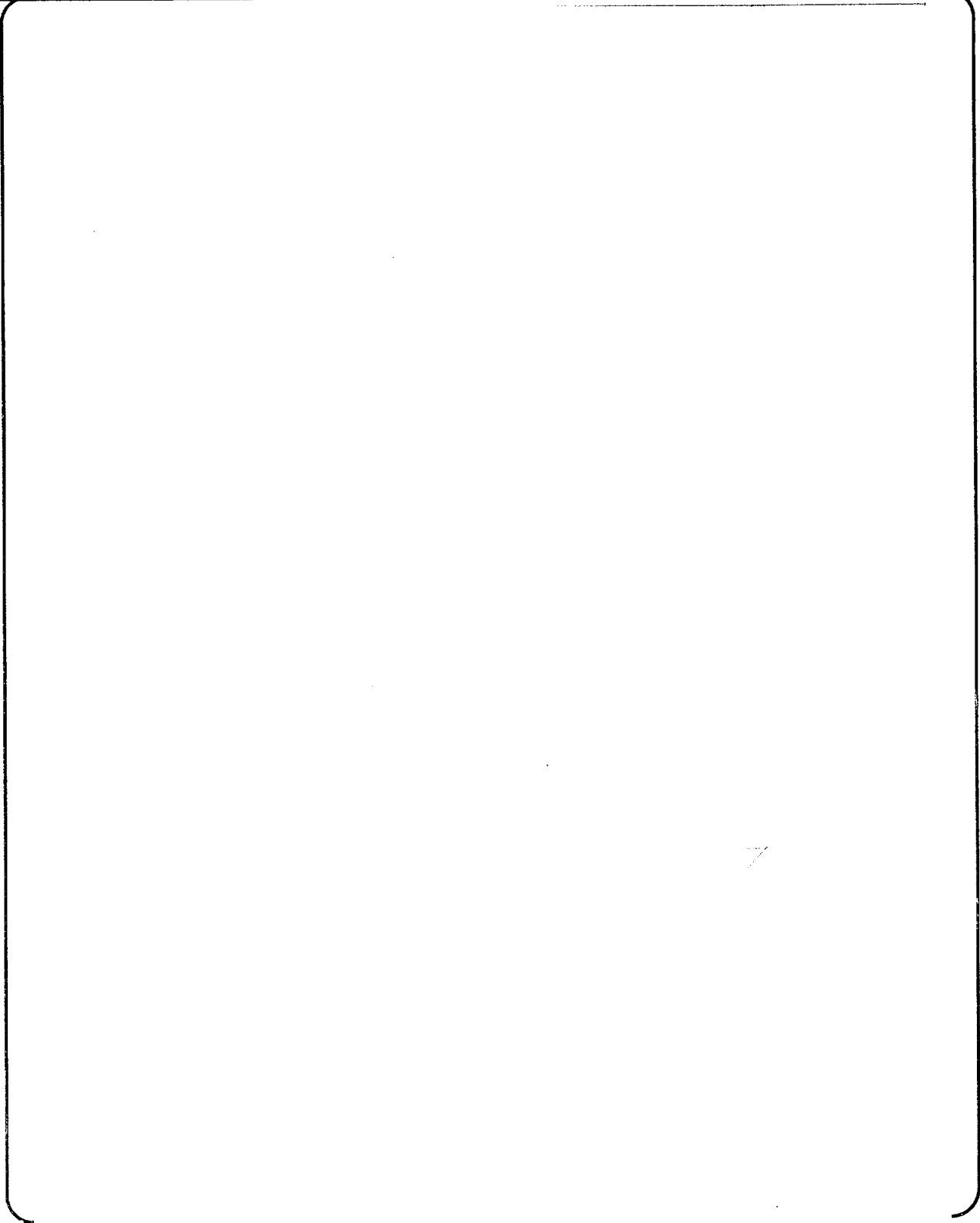
a,c,e

Document Number: WDI-TJ-007-02	Revision: 0	Page 34 of 43
--------------------------------	-------------	---------------



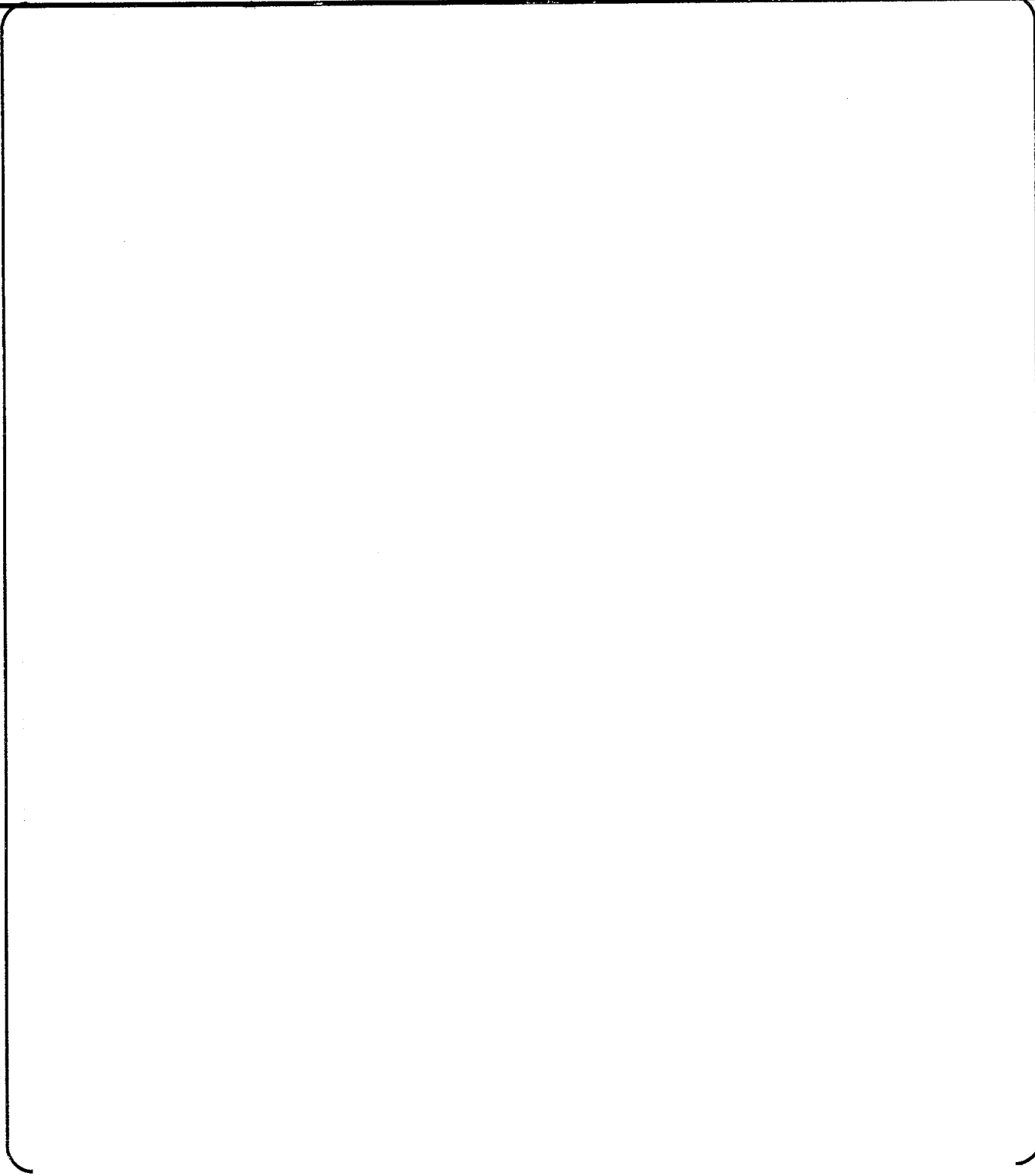
a,c,e

Document Number: WDI-TJ-007-02	Revision: 0	Page 35 of 43
--------------------------------	-------------	---------------

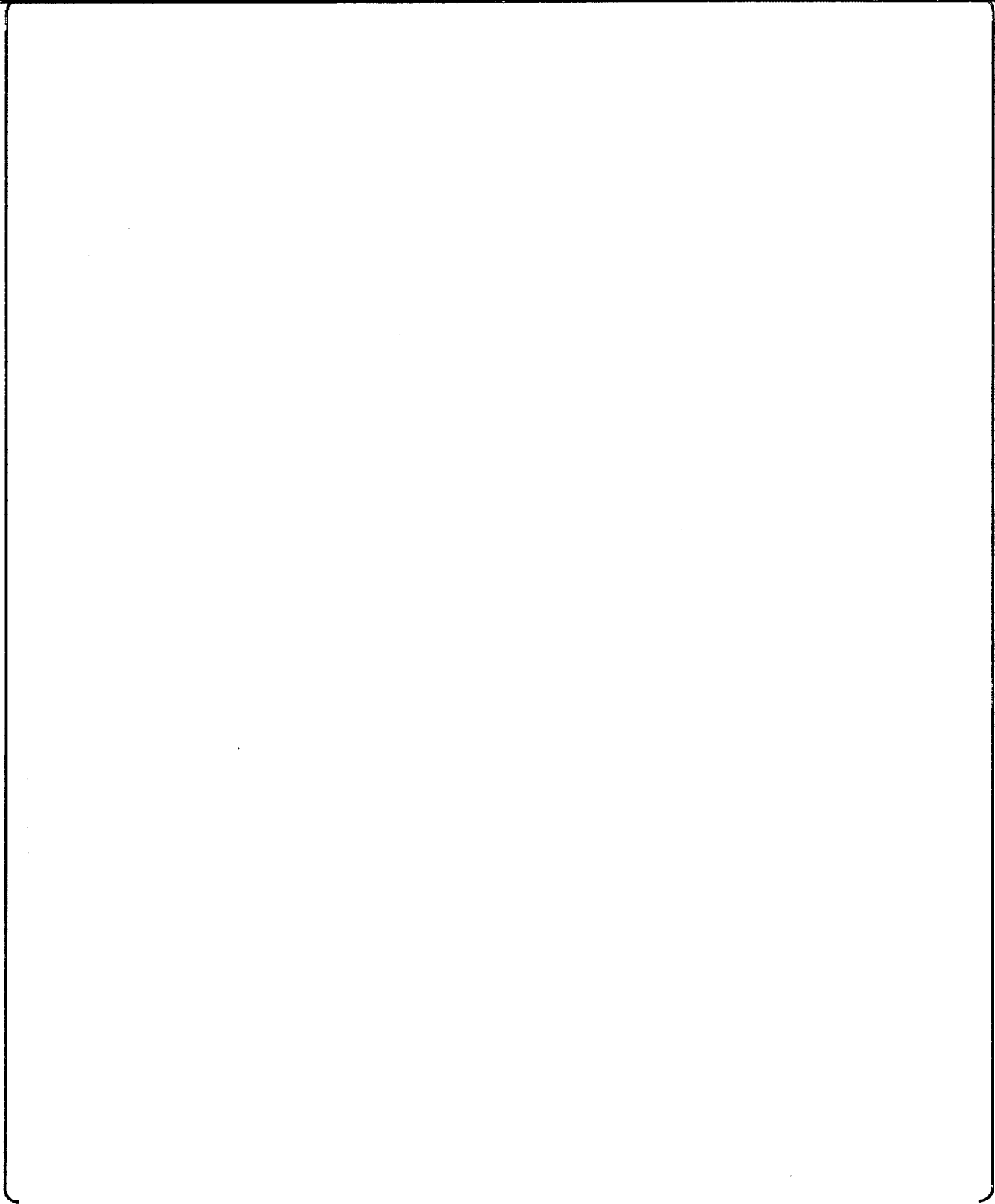


a,c,e

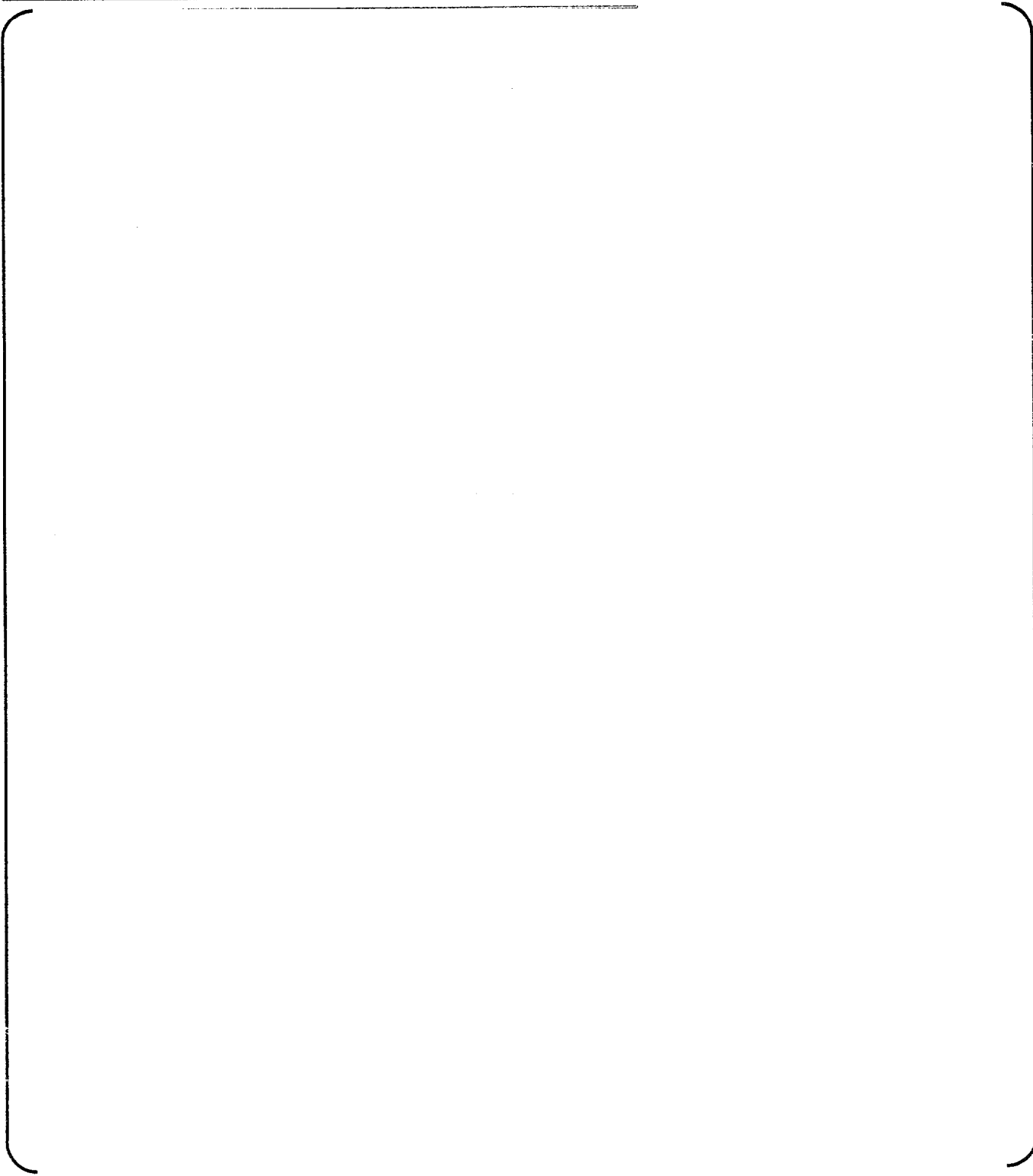
Document Number: WDI-TJ-007-02	Revision: 0	Page 36 of 43
--------------------------------	-------------	---------------



a,c,e

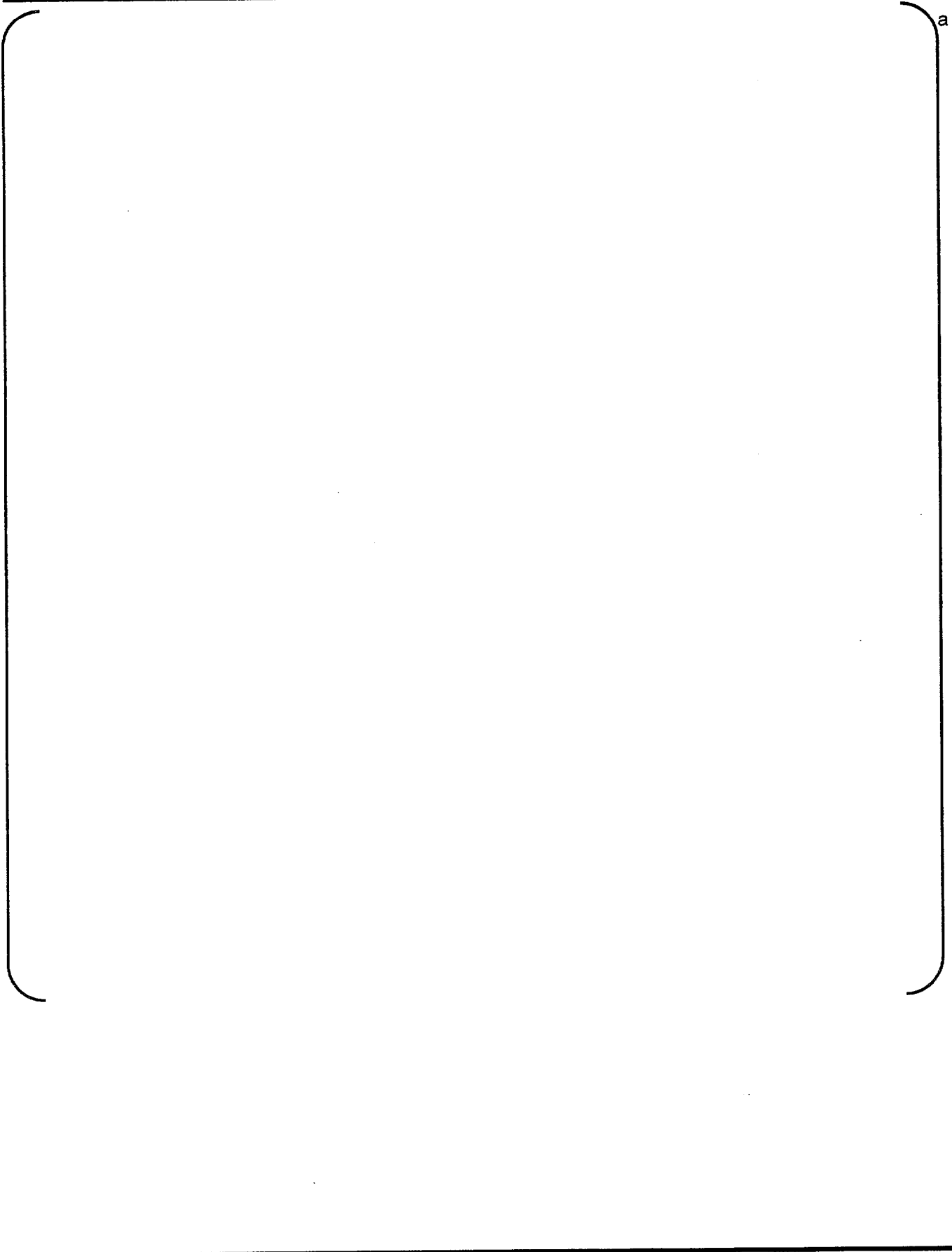


Document Number: WDI-TJ-007-02	Revision: 0	Page 38 of 43
--------------------------------	-------------	---------------



a,c,

Document Number: WDI-TJ-007-02	Revision: 0	Page 39 of 43
--------------------------------	-------------	---------------



a c, e

Attachment 3: Data Analysis Flow Chart and Codes

CRDM Inspection Result Codes

Open Housing Probe Inspections

NDD: No Detectable Defect

WII: Weld Interface Indication

PTI: Penetration Tube Indication Note that an axial flaw may show up on only 2-3 scans on Channel 2

IPA: Indication Profile Analysis Resolution of indication

LOB: Loss of Backwall, linear indication. Main area of interest is just above the weld. This may indicate a deep flaw that is in the "blind" zone of the PCS24.

LCS: Loss of Coupling-Scanner, note the circ extent

LCG: Loss of Coupling-Geometry, note the circ extent

LIF: Loss of Interference Fit (Channel 4, second backwall)

VOL: Volumetric indication (Ch1 and 2 response comparison)

WVI: Weld Volume Indication (within 0.1" beyond fusion interface)

LOF: Lack of Fusion at the tube to weld interface (Channel 3) >50% of weld width

WBI: Weld butter indication (Channel 3, large area indication)

Criteria:

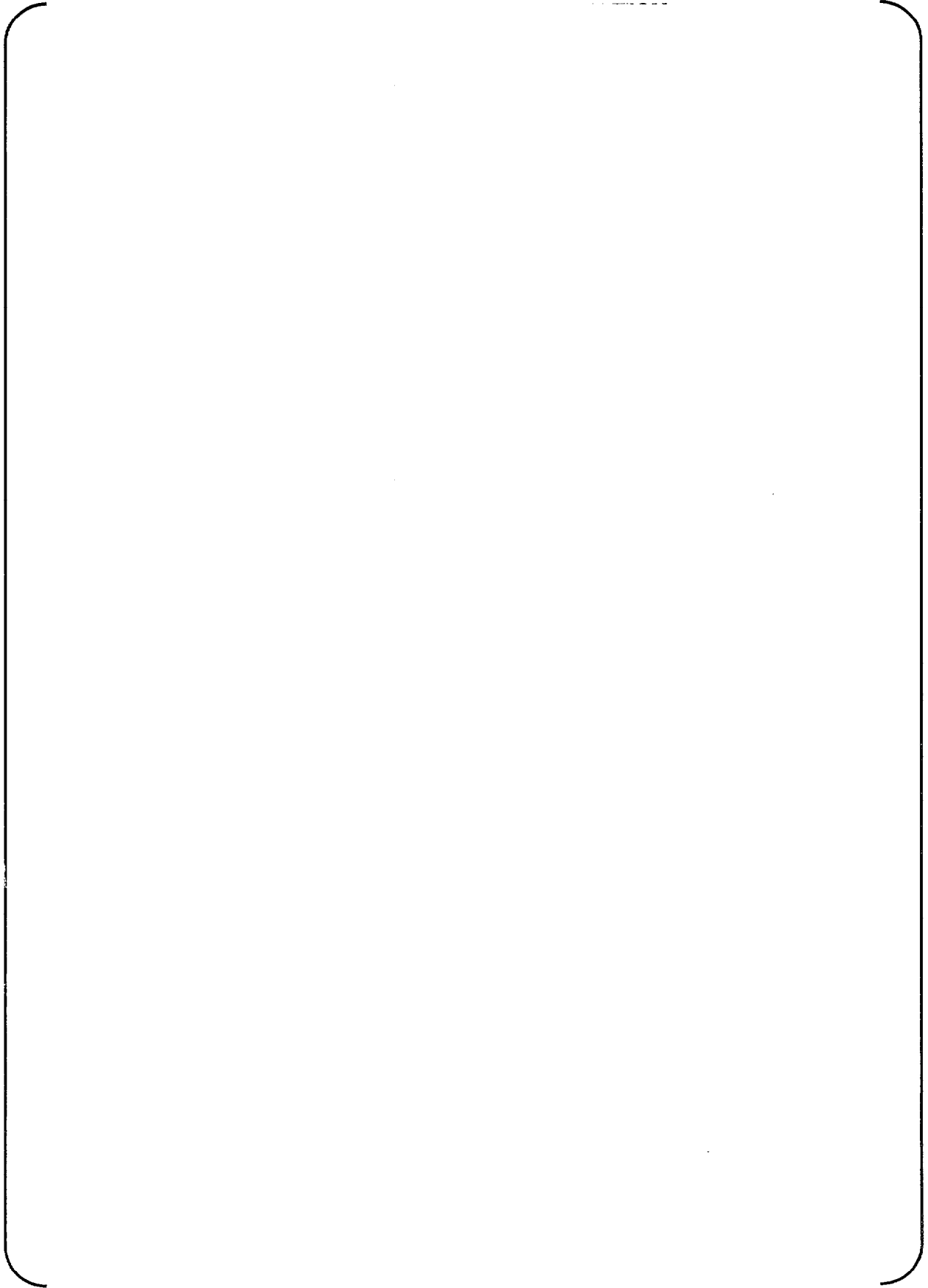
>90% coverage of weld (<10% LCS+LCG) on Channel 2

Weld region at 0 and 180 degree covered (no LCS in this region on Ch2)

PTI and WVI are special interest results

PRINT C SCAN(S) OF CHANNEL 2 TO SHOW ADEQUATE COVERAGE OVER 360 DEGREES

Channel 2 is the primary inspection channel for PTI and WVI indications. Channel 1 is used for additional and confirmatory data. Review every B scan on Channel 2 for axial and circumferential indications.



PWSCC TYPE SIGNALS

Linear in one direction, TOF like in the other hyperbolic echodynamic intermediate amplitude, does not follow weld interface

OR

Linear region with loss of blackwall for PWSCC >0.5" deep from OD

False positives can be caused by

- Weld repairs
- Reflective weld interface grain structure
- Lack of fusion

Suspect signals are categorized as:

Special interest for additional surface inspection on the J groove weld surface

PWSCC, by definition must start on a wetted surface. The tube ID & OD surface flaws are detected with the open housing probe. The J groove weld surface exam is performed with the grooveman ET scanner or liquid penetrant examination.

a,c,e

