

GEOLOGY *and*
GROUND-WATER RESOURCES
of the
ISLAND *of* OAHU,
HAWAII

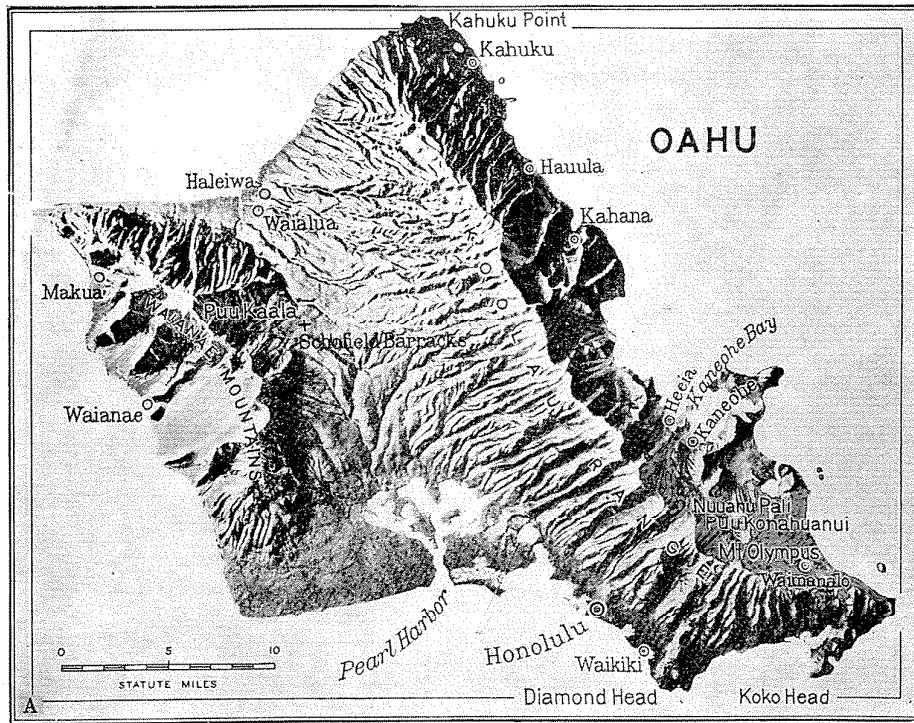

H.T. STEARNS

K.N. VAKSVIK

Reprinted MARCH 2001



A, RELIEF MAP OF OAHU.

Reproduced from the National Geographic Magazine by special permission.

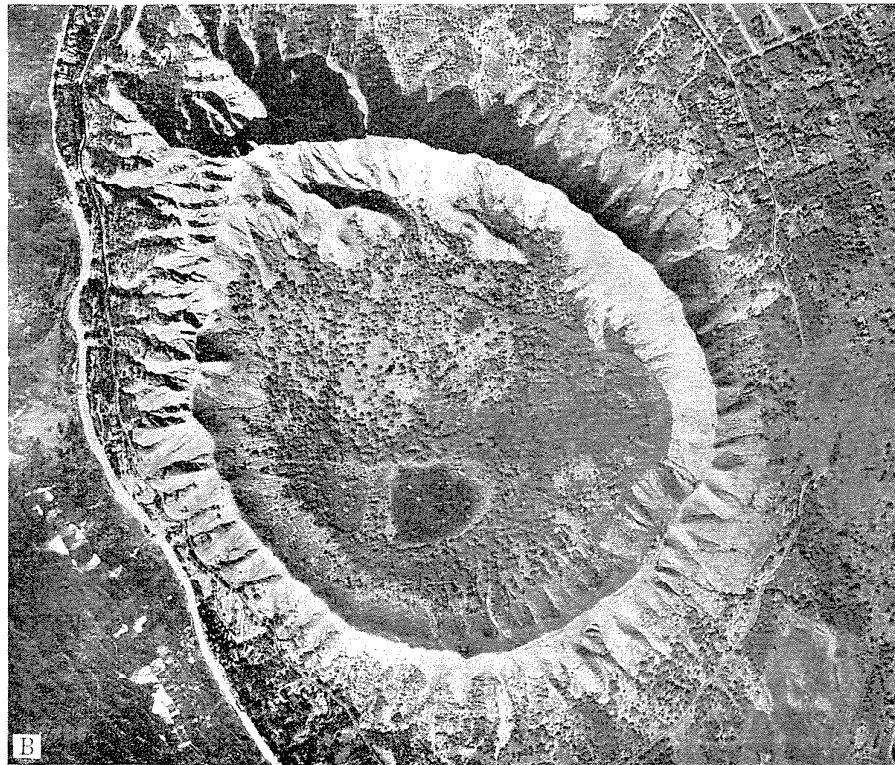

B, AIRPLANE VIEW OF DIAMOND HEAD.

A typical tuff cone showing the wide shallow crater characteristic of such cones. Photograph by 11th Photo Section, Air Corps, Luke Field, T. H.

TERRITORY OF HAWAII
Joseph B. Poindexter, Governor

DEPARTMENT OF PUBLIC LANDS
Charles T. Bailey, Commissioner

DIVISION OF HYDROGRAPHY
MAX H. CARSON, *Chief Hydrographer*

Bulletin 1

GEOLOGY AND GROUND-WATER RESOURCES
OF THE
ISLAND OF OAHU, HAWAII

By
HAROLD T. STEARNS
Geologist, U. S. Geological Survey

and

KNUTE N. VAKSVIK
Artesian Well Engineer, U. S. Geological Survey

Prepared in cooperation with
the U. S. Geological Survey

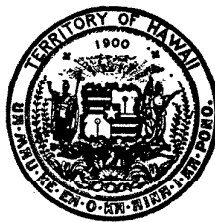

Printed in the
Territory of Hawaii, United States of America
MAY 1935

Printed by
Maui Publishing Company, Limited
Wailuku, Maui
1935

CONTENTS

	Page
Abstract	1
Part 1. Geography and geology, by Harold T. Stearns.....	3
Introduction	3
Location and area.....	3
Historical sketch	3
Population	4
Industries	4
Fauna	5
Flora	6
History and purpose of the investigation.....	7
Acknowledgments	10
Previous investigations and literature.....	11
Volcanic products and processes.....	12
Basalt	12
Volcanic domes	13
Secondary cones	13
Cinder cones	13
Size	13
Composition	14
Color	14
Lava cones	14
Tuff cones	15
Form	15
Composition	15
Phreatomagmatic origin	15
Use of term "ash"	17
Extrusive rocks	17
Pahoehoe	17
Aa	18
Ejecta	19
Criteria for distinguishing mud-flow deposits.....	19
Intrusive rocks	20
Dikes	20
Sills	20
Bosses and plugs	21
Geomorphology	22
Koolau Range	22
Original form	22
Position of eruptive center	23
Stage of dissection	23
Cause of amphitheater-headed valleys	24
Wentworth's theory	24
Author's theory	24
Present stage of the valleys.....	25
Origin of the Koolau Pali	26
Earlier theories of origin	27
Objections to marine theory	27

Part 1. Geography and geology by Harold T. Stearns—Continued.	Page
Geomorphology—Continued.	
Objections to caldera theory.....	27
Objections to faulting theory.....	27
Theory of stream erosion.....	28
Effect of ground water.....	28
Effect of submergence.....	28
Effect of marine abrasion.....	28
Effect of caldera.....	29
Relation of erosion to recovery of ground water.....	29
Waianae Range	29
Present form	29
Origin of Mount Kaala.....	30
Origin of Waianae Pali.....	30
Present form	30
Form prior to submergence	30
The fault theory	31
Objections to fault theory	31
Author's theory	31
Cause of convex shape of Waianae Range.....	32
Waianae cinder cones	32
The north coast precipice.....	33
Schofield Plateau	33
Form	33
Weathered condition of surface.....	34
Origin	34
Development of stream pattern	34
Coastal Plain	35
Marine features	36
The living reef	36
Age of the reef	36
Protection afforded by reef.....	37
Submarine shelves	37
Submarine shelf at 60 to 90 feet.....	37
Submarine shelf at 300 to 360 feet	39
Submarine shelf at 1,800 feet.....	39
Types of beaches	39
Calcareous sand beaches.....	39
Lava-cobble beaches	40
Noncalcareous silt beaches	40
Olivine beaches	41
Tuff-cobble beaches	41
Lithified beaches	41
Benches	43
Terraces	43
Marine cliffs	46
Minor shore features	46
Comparison of rates of abrasion.....	47
Emerged and submerged shore lines.....	47
Origin of Pearl Harbor	48
Minor geomorphic forms	55
Forms due to wind	55

CONTENTS

V

Part 1. Geography and geology by Harold T. Stearns—Continued.	Page
Geomorphology—Continued.	
Dunes	56
Lithified dunes	57
Effects of wind erosion.....	57
Forms due to subaerial weathering.....	58
Predominance of chemical weathering.....	58
Spheroidal weathering	59
Rounding of gravel not primarily due to chemical weathering	59
Lapies	59
Soils	60
Character	60
Types and colors	60
Nephelite-basalt soils	61
Weathering effects on limestone	61
Landslides and boulder trains	62
Forms due to streams	62
Origin of pali grooves	62
Effects of dikes	63
Forms due to post-Koolau eruptions.....	63
Geology	64
Geology and its effect on the recharge and movement of ground water	64
The rocks and their water-bearing properties.....	66
General character and age of rocks.....	66
Stratigraphic section of Oahu.....	67
Tertiary and early Pleistocene (?) volcanic rocks.....	67
Waianae volcanic series	67
Lower basalt	67
Geographic distribution	67
Character and structure	68
Appearance of outcrops	68
Unusual flows in Kuwale Ridge.....	68
Local unconformity in Makaha Valley.....	69
Tuff deposits	69
Water-bearing properties	69
Unconformity between lower and middle basalts....	70
Keaau-Makaha unconformity	70
Keaau-Makua unconformity	71
Cause of erosional interval	72
Middle basalt	72
Geographic distribution	72
Character and structure	72
Water-bearing properties	73
Upper basalt	75
Geographic distribution	75
Character and structure.....	75
Water-bearing properties	76
Dike complex	77
Character and structure	77
Age of the dikes	78

Part 1. Geography and geology by Harold T. Stearns—Continued.	Page
Geology—Continued.	
Waianae volcanic series—Continued.	
Dike systems	78
Water-bearing properties	78
Firefountain deposits	79
Character	79
Distribution	79
Water-bearing properties	80
Talus breccia	80
Character, distribution, and origin	80
Breccia in Nanakuli Valley	80
Effect on ground-water movement	82
Breccia in Lualualci and Waianae Valleys	82
Effect on ground-water movement	83
Breccia in Keaau and Makaha Valleys.....	84
Effect on ground-water movement	86
Intercalated soil	86
Character and distribution	86
Significance	86
Water-bearing properties	87
Kailua volcanic series	88
Amygdaloidal basalt	88
Distribution, character, and structure.....	88
Relation to basalt of Koolau volcanic series.....	89
Effect of hydrothermal alteration on ground water	90
Dike complex	90
Waianae-Koolau erosional unconformity	91
North of Schofield Barracks	91
South of Schofield Barracks	92
Time significance	92
Effect on ground-water movement	92
Koolau volcanic series	92
Basalt	93
Character and structure	93
Water-bearing properties	93
Tuff	93
Occurrence	93
Vitric tuff	93
Lithic tuff	94
Water-bearing properties	95
Dike complex	95
Character and structure	95
Secondary dike system	97
Water-bearing properties	97
Breccia	97
Erosional unconformity	98
Honolulu volcanic series	98
Middle (?) and late Pleistocene lavas and pyroclastic rocks	99

Part 1. Geography and geology by Harold T. Stearns—Continued. Geology—Continued.	Page
Honolulu volcanic series—Continued.	
Lavas and pyroclastic rocks of the Kaena (+95-foot) and Laie (+70-foot) stands of the sea	99
Hawaiioloa volcanics	99
Distribution and character	99
Age relations	99
Water-bearing properties	100
Mokapu basalt	101
Mokulca basalt	101
Rocky Hill volcanics	101
Previous work	101
Distribution and character	102
Age relations	102
Water-bearing properties	103
Kalihi volcanics	103
Character and location of the vent.....	103
Character and location of the lava flow....	104
Manaiki branch of Kalihi volcanics	104
Age relations	104
Water-bearing properties	106
Haiku volcanics	106
Source and character of the basalt	106
Character and structure of the tuff.....	106
Cause of explosion	107
North Haiku flow	107
Age relations	107
Water-bearing properties	108
Aliamanu tuff	108
Location of vent	108
Previous work	108
Source of the upper and lower tuff.....	109
Character	109
Age relations	109
Water-bearing properties	111
Kaneohe volcanics	111
Distribution and character	111
Age relations	111
Water-bearing properties	111
Nuuanu volcanics	112
Location of vent	112
Upper flow	112
Lower flow	113
Age relations	113
Water-bearing properties	114
Pali volcanics	116
Distribution and character	116
Breccia at vent	117
Age relations	117
Water-bearing properties	118
Makawao breccia	118

Part 1. Geography and geology by Harold T. Stearns—Continued.	Page
Geology—Continued.	
Honolulu volcanic series—Continued.	
Distribution and character	118
Age relations	119
Water-bearing properties	119
Moku Manu volcanics	120
Distribution and character	120
Age relations	120
Ulupau tuff	121
Distribution and character	121
Age relations	121
Water-bearing properties	123
Kaaui volcanics	123
Location of vent	123
Tuff deposits	124
Lava flows	124
Sequence of eruptions.....	125
Age relations	126
Water-bearing properties	126
Lavas and pyroclastic rocks of the Waipio (—60±-foot) and Waimanalo (+25-foot) stands of the sea	127
Salt Lake and Makalapa tuffs	127
Distribution	127
Age relations	127
Origin of the Salt Lake	128
Water-bearing properties	129
Ainoni volcanics	129
Distribution and character	129
Age relations	130
Water-bearing properties	130
Maunawili volcanics	131
Distribution and character	131
Age relations	131
Water-bearing properties	132
Training School volcanics	132
Distribution and character	132
Age relations	132
Water-bearing properties	132
Diamond Head tuff	133
Distribution of character	133
Structure of crater	133
Cause and sequence of explosions	135
Age relations	137
Water-bearing properties	138
Kaimuki volcanics	138
Distribution and character	138
Age relations	139
Water-bearing properties	140
Mauumae volcanics	140
Black Point basalt	140

CONTENTS

IX

Part 1. Geography and geology by Harold T. Stearns—Continued.	Page
Geology—Continued.	
Honolulu volcanic series—Continued.	
Distribution and character	140
Previous work	140
Age relations	141
Water-bearing properties	143
Kamanaiki basalt	143
Distribution and character	143
Age relations	144
Water-bearing properties	145
Castle volcanics	145
Punchbowl volcanics	145
Distribution and character	145
Origin of black ash	146
Sequence of eruptions	148
Age relations	148
Water-bearing properties	148
Latest Pleistocene or recent lavas and pyroclastic rocks	149
Lavas and pyroclastic rocks erupted after the Waimanalo (+ 25-foot) stand of the sea.....	149
Basalts and pyroclastic rocks of Koko fissure	149
Manana tuff	149
Distribution and character	149
Age relations	149
Water-bearing properties	150
Koko volcanics	150
Location	150
Previous work	150
Distribution	150
Character	151
Sequence of eruptions	151
Lava flows	152
Age relations	152
Water-bearing properties	152
Kalama volcanics	153
Distribution and character.....	153
Age relations	153
Water-bearing properties	153
Kaohikaipu volcanics	153
Kaupo basalt	154
Distribution and character.....	154
Age relations	154
Water-bearing properties	154
Basalt and firefountain deposits of Tantalus and Sugar Loaf.....	154
Firefountain deposits	154
Distribution and character	154
Previous work	156
Age relations	156
Water-bearing properties	156
Sugar Loaf basalt	158
Distribution and character	158

Part 1. Geography and geology by Harold T. Stearns—Continued.	Page
Geology—Continued.	
Honolulu volcanic series—Continued.	
Origin of ball lava	159
Age relations	160
Displacement of Manoa Stream	160
Water-bearing properties	161
Tantalus basalt	161
Distribution and character	161
Water-bearing properties	162
Summary	163
Quaternary sedimentary rocks	165
Pleistocene sedimentary rocks	165
Consolidated calcareous marine sediments	165
Distribution	165
Fossils and climatic changes	166
Beach sediments	168
Reef limestone	169
Water-bearing properties	169
Consolidated calcareous dunes	169
Consolidated and partly consolidated noncalcareous sediments	170
Distribution and character	170
Water-bearing properties	170
Recent sedimentary rocks	171
Unconsolidated calcareous marine sediments.....	171
Unconsolidated calcareous dunes	171
Unconsolidated noncalcareous sediments.....	171
Distribution and character.....	171
Water-bearing properties	172
Historic artificial fills of marine sediments.....	172
Structure	172
Faults	173
Waianae Range	173
Koolau Range	173
Synclines	173
Kailio syncline	174
Lanikai syncline	174
Cause of synclines	174
Geologic history	174
Petrology and petrography	179
Waianae volcanic series	180
Lower basalt	180
Breccia	182
Middle basalt	182
Upper basalt	182
Kailua volcanic series	183
Amygdaloidal basalt	183
Koolau volcanic series	184
Basalts and pyroclastic rocks	184
Breccia	187
Honolulu volcanic series	187
Basalts and pyroclastic rocks	187
Summary	188

CONTENTS

XI

Part 2. Ground-water resources, by Harold T. Stearns and Knute N.

Vaksvik	199
Climate, by H. T. Stearns	199
Temperature	199
Wind	199
Rainfall	199
Areal distribution	199
Distribution in time	200
Quantity	202
Transpiration and evaporation	202
Lower Luakaha Station in Nuuanu Valley	203
Kaukonahua Station	209
Evaporation at Upper Hoaeae and Maunawili Ranch.....	213
Surface water, by H. T. Stearns	213
Run-off records	213
Rate of run-off	213
Character of stream beds	214
Debris transported by streams	214
Importance of ground water, by H. T. Stearns	214
Basal ground water, by H. T. Stearns	215
Definition	215
Water in the rocks of the coastal plain.....	215
Occurrence	215
Permeability	215
Quality and head	216
Tidal fluctuations	217
Effect of draft on quality	217
Methods for recovery	219
Wells and tunnels that yield water from the rocks of the coastal plain bordering the Waianae Range	219
Wells and tunnels that yield water from the rocks of the coastal plain bordering the Koolau Range	222
Undeveloped supplies	223
Makaha Valley	223
Waianae Valley	224
Lualualei Valley	225
Nanakuli Valley	226
Ewa coral plain	227
Remaining areas	227
Records of quantity and quality of water pumped.....	227
Springs	235
Water in the basalt member of the Koolau volcanic series.....	235
Occurrence	235
Permeability	235
Form of the water table	236
Relation to underlying salt water.....	237
Ghyben-Herzberg principle	237
Areas along the coast without artesian water.....	238

Part 2. Ground-water resources—Continued.	Page
Water in the basalt member of Koolau volcanics series—Cont.	
Artesian water	239
History of artesian development, by K. N. Vaksvik	239
Early sources of water supply.....	239
First attempts to procure artesian water.....	240
Successful wells	243
Unsuccessful wells	243
Effect upon agriculture.....	244
Ewa Plantation	245
Kahuku Plantation	246
Oahu Sugar Co.	246
Waialua Agricultural Co.	246
Honolulu Plantation	247
Laie Plantation	247
Waianae Plantation	247
Rice	248
Bananas and taro	248
Miscellaneous	248
Progress of well drilling in Honolulu.....	248
Occurrence, by H. T. Stearns	250
Relation of artesian to basal ground water	250
Character of caprock	251
Importance of ancient soils	252
Absence of lower confining bed	253
Effect of Ghyben-Herzberg principle	253
Independent application of Ghyben-Herzberg principle on Oahu	256
Change in head and discharge with depth.....	256
Artesian areas, by H. T. Stearns.....	257
Location	257
Cause of separate areas.....	258
Valley fills extending below the water table.....	259
Dikes	259
Soil and sediments	259
Method used to establish artesian areas.....	259
Areas 1 to 4	260
Area 5	260
Area 6	261
Area 7	267
Area 8	267
Area 9	268
Area 10	268
Artesian water in the dike complex, by H. T. Stearns.....	268
Fluctuations in water level, by H. T. Stearns and K. N. Vaksvik	269
Annual and secular fluctuations	269
Fluctuations due to pumping	269
Fluctuations due to barometric changes in pressure....	271

	Page
Part 2. Ground-water resources—Continued.	
Water in the basalt member of Koolau volcanic series—Cont.	
Artesian water—Continued.	
Fluctuations due to tides	272
Fluctuations due to earthquakes	272
Draft, by H. T. Stearns	272
Areas 1 to 4	272
Area 5	275
Area 6	275
Honolulu Plantation Co.	275
Oahu Sugar Co.	280
Ewa Plantation Co.	296
Private and public wells	314
Total draft, area 6	314
Area 7	315
Waialua Agricultural Co.	315
Area 8	318
Kahuku Plantation Co.	318
Areas 9 and 10	323
Nonartesian areas	323
Total draft	323
Safe yield of the artesian areas, by H. T. Stearns.....	324
Effect of salt and type of well on the safe yield.....	324
Areas 1 to 4	325
Area 5	327
Area 6	327
Area 7	328
Area 8	328
Areas 9 and 10	328
Curtailment of waste and losses of artesian water, by	
K. N. Vaksvik	328
Underground leakage in artesian wells	328
Detection of leaks	329
Recasing wells	330
Sealing wells	331
Magnetic method for locating lost wells.....	341
Surface waste	341
Quality, by K. N. Vaksvik	344
Effect of ocean spray	345
Contamination of ground water by direct contact with	
sea water	346
Contamination of artesian wells.....	347
Improvement of quality by reducing depths of	
wells	355
Effect of draft on quality	357
Chemical analyses of Oahu water	361
Tunnels recovering basal ground water in the basalt member	
of the Koolau volcanic series, by H. T. Stearns.....	365
Basal springs supplies by the basalt member of the Koolau	
volcanic series	365

Part 2. Ground-water resources—Continued.	Page
Water in the basalt member of Koolau volcanic series—Cont.	
Basal springs—Continued.	
Honolulu and vicinity	365
Pearl Harbor Springs	365
Location	365
Salinity	366
Quantity	367
Relation to artesian water	368
Discharge affected by pumping from wells.....	369
Possibility of springs in Pearl Harbor Lochs.....	370
Methods for recovery	370
Windward springs	371
Quantity of basal ground water derived from the basalt member of the Koolau volcanic series, by H. T. Stearns....	371
Water in the basalt of Waianae volcanic series, by H. T. Stearns	372
Occurrence	372
Artesian areas	372
Area 11	372
Area 12'	374
Areas along the coast without artesian water.....	375
Between area 11 and Kaena Point	375
Between Gilbert and Waianae	375
Kamaileunu spur	376
Keaau-Makaha spur	376
Keaau-Makua spur	377
Between Makua and Kaena Point	377
Quantity of basal ground water derived from the basalt members of the Waianae volcanic series	377
Perched ground water, by H. T. Stearns	378
Occurrence	378
Water confined by intrusive rocks	379
Water perched on ash beds	381
Water perched on soil	384
Water perched on alluvium	385
Tunnels	386
Tunnels in the Koolau Range	386
Palolo tunnel	386
Kaea tunnels	387
Manoa tunnels	387
Tunnel 1	388
Tunnel 2	389
Tunnel 3	389
Tunnel 4	390
Tunnel 5	390
Woodlawn tunnel	390
Tantalus tunnel 1	390
Tantalus tunnel 2	391
Nuuanu tunnels	391
Dowsett tunnel	391

Part 2. Ground-water resources—Continued.
 Perched ground water, by H. T. Stearns
 Tunnels—Continued.

Page

City and County tunnel 3	392
City and County tunnel 3A	392
City and County tunnel 3B	393
City and County tunnel 4	393
City and County tunnel 4B	393
City and County tunnel 4C	394
Pauoa tunnel	394
Kalihi tunnels	394
Gay tunnel	394
Gay mauka tunnel	395
Kalihi Orphanage tunnels	396
City and County tunnel 1.....	396
City and County tunnel 2.....	397
City and County tunnel 3.....	397
City and County tunnel 4.....	397
City and County tunnel 5.....	398
City and County tunnel 6.....	398
South Halawa tunnel	398
North Halawa tunnel	398
Aiea tunnel	399
Waiahole tunnel system	399
Main Waiahole tunnel	400
Drainage tunnel R	404
Tunnel A	405
Tunnel B	405
Uwau tunnel	405
Waikane tunnel 1	406
Waikane tunnel 2	406
Kahana tunnel 1	407
Waikakalaua tunnels	409
Kaukonahua tunnels	409
Henry tunnel	410
Luluku tunnels	410
Girls Industrial School tunnel	411
Maunawili tunnels	411
O'Shaughnessy tunnel	411
Cooke tunnel	412
Clark tunnel	412
Ainoni tunnel	414
Fault tunnel	414
Korean tunnel	415
Waimanalo tunnels	415
Waimanalo Sugar Co.'s tunnel 1.....	415
Waimanalo Sugar Co.'s tunnel 2.....	415
Waimanalo Sugar Co.'s tunnel 3.....	416
City and County tunnel	416
Tunnels in the Waianae Range	416
Andrews tunnel	416

	Page
Part 2. Ground-water resources—Continued.	
Perched ground water, by H. T. Stearns	
Tunnels—Continued.	
Schofield tunnels	416
North Schofield tunnel	416
Middle Schofield tunnel	417
South Schofield tunnel	417
Kaala tunnel	418
Kaloi tunnels	418
Upper Kaloi tunnel	418
Lower Kaloi tunnel	418
Makakilo tunnel	419
Mutual Radio tunnel	419
Lualualei tunnel	420
Waianae Valley tunnels	421
Tunnel 1	422
Tunnel 2	422
Tunnel 3	422
Tunnel 4	423
Tunnel 6	423
Tunnel 6A	424
Tunnel 7	424
Tunnel 8	424
Tunnel 9	425
Tunnel 11	425
Tunnel 14	425
Tunnel 15	425
Tunnel 16	426
Tunnel 17	426
Tunnel 18	426
Tunnel 19	426
Makaha tunnels	426
Tunnel 1	427
Tunnel 2	427
Tunnel 3	427
Tunnel 3A	427
Tunnel 4	427
Tunnel 5	428
Tunnel 6	428
Tunnel 7	428
Tunnel 8	428
Tunnel 9	428
Tunnel 10	428
Makua tunnels	429
Quantity of perched ground water recovered by tunnels.....	429
Koolau Range	429
Waianae Range	430
Method for conserving water developed by tunnels in the dike complex	435
High-level springs	436
Koolau Range	436

CONTENTS

XVII

Part 2. Ground-water resources—Continued.	Page
Perched ground water by H. T. Stearns—Continued.	
High-level springs—Continued.	
Leeward springs	436
Windward springs	437
Waianae Range	438
Leeward springs	438
Lualualei Valley	438
Waianae Valley	438
Makaha Valley	439
Makua Valley	439
Windward springs	439
Quantity of high-level spring water.....	440
Quality of high-level spring water	440
Koolau Range	440
Waianae Range	441
Quality of perched ground water	441
Quantity of ground water on Oahu, by H. T. Stearns.....	442
Undeveloped ground-water supplies, by H. T. Stearns.....	443
Koolau Range	443
Supplies available for Honolulu	443
Proposed Kalihi-Waiahole ground-water tunnel system	444
Original Kalihi-Waiahole tunnel project	444
Ground-water tunnel project based on present in-	
vestigation	445
Conditions controlling the water supply	446
Conditions controlling the tunnel work.....	449
Further investigation and prospecting	451
Minor high-level projects	451
Kalihi Valley tunnel	452
Nuuanu tunnels	452
Pauoa tunnel	452
Makiki tunnel	453
Pukele tunnel	453
Kaau tunnel	453
Artesian water supplies	455
Areas 1, 2, and 3	455
Area 4	456
Area 5	456
Methods for recharging the artesian areas	458
Summary	459
Area east of Honolulu	459
Pearl Harbor area	460
Windward coast	460
Waianae Range	462
Numbering system for drilled wells by H. T. Stearns.....	463
Index	469

ILLUSTRATIONS

Plate		Page
1.	A , Relief map of Oahu; B , Airplane view of Diamond Head	Frontispiece
2.	Topographic and geologic map of Oahu, showing location of wells and tunnels. To be published in Bulletin 2.....	
3.	A , Typical lithic tuff on the south side of Koko Crater, mantling emerged reef limestone; B , Dike intruded into breccia at Puu Kailio, Lualualei Valley, Waianae Range....	16
4.	A , Platy jointing in fine-grained contact phase of the boss at Palolo Quarry, Palolo Valley; B , Mount Kaala, highest point on Oahu, as seen from the south.....	16
5.	A , View looking up Nuuanu Valley; B , Waimea River, occupying a drowned valley on the northwest end of Koolau Range.....	16
6.	A , Airplane view of the Kalihi wind gap; B , View looking up Honokohau Valley, Maui.....	16
7.	A , Halawa Falls, Molokai; B , Airplane view of a tributary of Lualualei Valley, Waianae Range.....	24
8.	Block diagrams illustrating development of the Pali by erosion	24
9.	A , The Pali west of Kaneohe; B , The southeast end of the Pali	24
10.	A , Ancient marine cliff 1,000 feet high on the north coast of the Waianae Range; B , View looking southwest across the Schofield Plateau.....	48
11.	A , Typical laminated lithified calcareous dune rock near Waimanalo; B , Fretwork weathering in Kailua basalt on North Mokulua Island; C , Basalt talus breccia on North Mokulua Island with calcareous cement.....	48
12.	A , Road cut three quarters of a mile west of Fort Shafter; B , Close-up view of Salt Lake tuff shown in A ; C , Close-up view of fossiliferous beach conglomerate shown in A ..	56
13.	A , Spheroidal weathered boulder in the older alluvium near Kolekole Pass, Waianae Range; B , Makapuu Head, the east point of Oahu, and the Pali.....	56
14.	A , Solution grooves or lapies in basalt near Waimea; B , View looking north to seaward end of Makaha Ridge, Waianae Range; C , Breccia in Puu Kailio showing fine tuffaceous beds	72
15.	A , Tunnel about 20 feet above sea level in upper Waianae aa clinker; B , North Mokulua Island near Lanikai.....	72
16.	A , Air view of the closely spaced dikes in Puu Pueo; B , Unconformity on the Pali road.....	88
17.	A , Unconformity on the Mokapu Peninsula; B , Streak of indurated tuff in road cut on south side of Koko Crater....	88
18.	A , View looking southwest over the Koko Fissure group of craters and Hanauma Bay; B , Even bedded "black sand" or firefountain deposits	152

	Page
Plate 19. A , Firefountain deposits resting unconformably upon soil-covered Koolau basalt, on southwest side of Tantalus; B , Lava balls in Sugar Loaf lava flow; C , Lava balls among the clinkers of the Sugar Loaf lava.....	152
20. Well logs of Oahu plotted graphically.....	168
21. A , Puu Kailio syncline at the euptive center of Waianae Range; B , East limb of the Lanikai syncline and North Mokulua Island.....	176
22. A , First stage in the development of Oahu; B , Second stage in the development of Oahu.....	176
23. A , Third stage in the development of Oahu; B , Fourth stage in the development of Oahu.....	176
24. A , Fifth stage in the development of Oahu; B , Sixth stage in the development of Oahu.....	176
25. A , Seventh stage in the development of Oahu; B , Geologic structure of a typical artesian basin on Oahu.....	176
26. Distribution of rainfall on Oahu and location of rainfall stations	200
27. A , Kaukonahua transpiration station; B , Air view looking southeast toward Diamond Head showing the delta of Kalihi Stream.....	224
28. A , Well 23, dug in reef limestone at Ewa; B , Palolo tunnel in Koolau aa	224
29. Fluctuation of the water level in wells 153, 201, 244, 326, and 377	272
30. Fluctuations of the water level in wells 190, 193, 266, 308, 356, and 396	272
31. Tidal, barometric, and pumping fluctuations in well 319H....	272
32. A , Spring issuing from aa; B , Piezometer tube; C , Moku Manu or Bird Island.....	400
33. Discharge of Kahana and Waikane tunnels in relation to rainfall and tunnel progress.....	408
Figure 1. Comparison of the profiles of cinder, lava, and tuff cones.....	13
2. Profile of surface adjacent to Anahula Stream and Kaukonahua Stream.....	35
3. Profile of the ocean floor seaward from the <i>Lithothamnium</i> ridge near Barbers Point (1 to 5) and near Honolulu (6 and 7) and of the reefless ocean floor southeast of Kaena Point (8 to 11).....	37
4. Profiles showing the 300 and 1800-foot submarine shelves off Oahu.....	38
5. Profiles drawn down the slopes of various alluvial fans showing several distinct marine terraces.....	45
5A. Diagrammatic cross section of the Koolau Range at Honolulu showing basal and perched water tables.....	65
6. Cross section from Puu Keaau, Waianae Range, west-northwest down the ridge.....	71
7. Graphic sections of basalts in Keaau-Makaha Ridge and Kamaileunu Ridge, Waianae Range.....	74
8. Geologic section along Heleakala Ridge at saddle in the Waianae Range.....	81

	Page
Figure 9. Geologic cross section of Kaneohe Valley half a mile above its mouth.....	112
10. Diagrammatic cross section along coast of Uluapan Crater.....	122
11. Structure of Diamond Head.....	134
12. Geologic conditions at Makiki Springs.....	157
13. Outline map of southeastern Oahu showing post-Koolau volcanic vents.....	164
14. Comparative monthly distribution of rainfall on Oahu.....	201
15. Graph showing tidal effect on the water level of a well dug in coral (?) and its absence in a well dug in silt and gravel	218
16. Ground water areas on Oahu.....	236
17. Section of the island of Norderney, Germany.....	238
18. Progress of well drilling in Honolulu.....	250
19. Section of the Waikiki artesian area, Honolulu.....	254
20. Relation of the water level in the Oahu Sugar Co. wells at pump 5 in Waianae basalt and at the adjacent pumps 1 and 6 in Koolau basalt.....	265
21. Relation of static level in well 11 to pumpage from the city wells at Kaimuki Station.....	270
22. Fluctuations of water level in artesian well 144 in relation to changes in barometric pressures and the tide.....	271
23. Log and character of plug in well 76.....	335
24. Plugs in wells 22 and 79.....	337
25. Log and character of plug in well 152.....	339
26. Increase in chloride content of the water in artesian wells with increase in depth.....	352
27. Increase of chloride with depth in well 271 and the freshening of the water by back filling the well.....	356
28. Cone of salt water induced by pumping overlying fresh water	358
29. Map showing location of Pearl Harbor gaging stations.....	366
30. Relation of discharge of Pearl Harbor Springs to static level in adjacent artesian wells.....	369
31. Plan of Alexander Dowsett tunnel, in Nuuanu Valley.....	391
32. Cross section of Koolau Range above main Waiahole bore....	400
33. Ground-water discharge from Waiahole tunnel during construction	402
34. Plan of Clark tunnel, on middle fork of Maunawili Stream, showing position of dikes.....	413

GEOLOGY AND GROUND-WATER RESOURCES
OF THE ISLAND OF OAHU,
HAWAII

BY HAROLD T. STEARNS AND KNUTE N. VAKSVIK

ABSTRACT

Oahu, one of the islands of the Hawaiian group, lies in the Mid-Pacific 2,100 miles southwest of San Francisco. The principal city is Honolulu. The Koolau Range makes up the eastern part of the island, and the Waianae Range the western part. Both are extinct basaltic volcanoes deeply dissected by erosion. The Koolau Volcano was the later to become extinct.

The Waianae Range is made up of three groups of lavas erupted in Tertiary and possibly in early Pleistocene time. The exposed part of the older lava is nearly 2,000 feet thick and consists largely of thin-bedded pahoehoe. It is separated in most places from the middle lavas by an angular unconformity and talus breccia and in a few places by an erosional unconformity. The middle basalts are about 2,000 feet thick and closely resemble the lower ones except that they contain more aa. The upper lavas reach a thickness of about 2,300 feet and are mostly massive aa flows. The last eruptions produced large cinder cones and some nephelite basalts. The Waianae Volcano, like other Hawaiian volcanoes, produced only small amounts of ash, and the lavas were largely extruded from fissures a few feet wide, now occupied by dikes. The center of activity was near Kolekole Pass, at the head of Lualualei Valley.

The Koolau Volcano is made up of two groups of lavas extruded in Tertiary and early Pleistocene (?) time. The older group, the Kailua volcanic series, is greatly altered by hydrothermal action and was extruded from fissures near Lanikai. The flows of the younger group, the Koolau volcanic series, were extruded from fissures about a mile south of the Kailua rift and have an exposed thickness of about 3,000 feet. The Koolau Volcano produced even less ash than the Waianae Volcano, and its flows are thin-bedded pahoehoe and aa. The eruptive center of the Koolau Volcano lies between Kaneohe and Waimanalo.

Great amounts of both the Waianae and Koolau Ranges were removed by fluvial and marine erosion during the Pleistocene. The master streams are characterized by deep amphitheater-headed valleys. After this erosion cycle the island was submerged more than 1,200 feet, and these great valleys were drowned and alluviated. Besides this submergence, several strand lines, preserved up to 100 feet above present sea level occur, which may be due to world-wide changes in sea level in response to the withdrawal and restoration of water concurrent with the advances and recessions of the polar ice caps and to accompanying changes in the ocean floor. During this time of shifting ocean levels spasmodic eruptions occurred on the southeast end of the Koolau Range, producing numerous lava flows and tuff cones, most of which are nephelite basalt. The last of these eruptions occurred in Recent time.

A description of the climate, rates of run-off, and results of experiments to determine evaporation and transpiration in the areas of high rainfall are given. It was found that the consumptive use decreases materially and becomes a very small percentage of the rainfall in the areas of high precipitation.

The lava rocks of the island are very permeable and, because of a rainfall reaching a maximum of 300 inches a year, carry large amounts of ground water, confined and unconfined, basal and perched. The basal ground water floats on salt water because of its lower specific gravity. Consequently for each foot the water table stands above sea level, salt water lies about 42 feet below sea level, in accordance with the Ghyben-Herzberg principle.¹ Rain water entering the lava and not encountering restraining formations normally sinks approximately to sea level and escapes into

¹ Brown, J. S., A study of coastal ground water, with specific reference to Connecticut: U. S. Geol. Survey Water-Supply Paper 537, p. 16, 1925.

the sea along the coast as basal ground water. In most places the lava rocks along the shore are overlain by an impermeable or nearly impermeable caprock consisting of submerged lateritic soils and marine noncalcareous sediments. These deposits retard the escape of basal ground water into the sea and give rise to artesian water, but unlike most other artesian systems, this one has no lower restraining formation.

The artesian water is the principal source of domestic, municipal, and irrigation supplies. The average annual quantity pumped for the period 1928 to 1933 amounted to about 105,000,000,000 gallons, nearly 90 percent of which came from Koolau basalt and the remainder from Waianae basalt.

There are ten artesian areas in the Koolau Range and two in the Waianae Range. Hydraulic gradients in these basins were found to range from 1.2 to 3 feet to the mile. Because of these extremely flat gradients and the high permeability of the aquifers it is possible to reverse the hydraulic gradients by draft and make the water flow from one artesian area to another.

The artesian water levels fluctuate in response to seasonal variations in draft and recharge and in a lesser way to tidal, barometric, and seismic pressures.

The water, as shown by chemical analysis, is of excellent quality except where it is contaminated with sea water. Methods have been devised for freshening wells that have gone salty, for detecting leaks, for sealing leaky and defective wells, and for recharging the artesian basins.

Owing to the danger of the wells becoming brackish with increased draft, it is believed that further large developments will be more successful if shafts are sunk to sea level in the basalt as far inland as practicable, and tunnels are driven from the bottom of the shafts near the top of the saturated zone. Favorable places for such development exist in Honolulu.

In addition to the basal water in the volcanic rocks, water is found in the recent gravel, beach, and dune deposits, and the emerged reef limestone. This water has been recovered by wells and tunnels, and there are favorable localities for developing additional water of this type.

The island contains two types of basal springs,—those like the Pearl Harbor Springs, which issue from basalt and are supplied by overflow and leakage from the artesian basin, and those which issue from the coastal-plain sediments and are mainly return irrigation water. The total quantity of basal ground water issuing as springs is estimated to be 100,000,000 gallons a day.

Ground water occurs at high levels, confined by dikes and perched on tuff, alluvium, and soil beds. These structures give rise to innumerable high-level springs. In the Koolau Range 60 tunnels yield about 33,000,000 gallons daily, of which about 95 percent is obtained from tunnels penetrating the dike complex of the Koolau volcanic series, about 2 percent from tunnels entering post-Koolau ash or tuff deposits, and the remainder from tunnels whose geologic relations are not certainly known. The average daily yield of the tunnels that recover dike water is 2,330 gallons a foot, but the average daily yield of the tunnels in post-Koolau tuff is 450 gallons a foot, and that of the tunnels in alluvium or soil is only 23 gallons a foot.

Owing largely to the much lower rainfall on the Waianae Range, its 35 tunnels (not including two new tunnels under construction) yield only about 2,400,000 gallons daily, about 94 percent of which is believed to be obtained from dike systems. The average daily yield of the tunnels in this range that are supplied by dike systems is 581 gallons a foot, as compared to 5 gallons a foot from tunnels in ash or tuff.

An extensive tunnel system is proposed to develop a large supply of high-level water for Honolulu from the dike complex of the Koolau series, and high-level water can be recovered by tunnels at many other places.

The average daily discharge of all high-level springs in the Koolau Range is about 58,000,000 gallons, of which about 94 percent comes from the Koolau dike complex and about 6 percent from post-Koolau volcanic rocks. The average daily discharge of all high-level springs in the Waianae Range is about 500,000 gallons, of which about 81 percent issues from the dike complex.

PART I—GEOGRAPHY AND GEOLOGY

BY HAROLD T. STEARNS

INTRODUCTION

LOCATION AND AREA

Oahu, one of the islands of the Hawaiian group, lies in the mid-Pacific, about 2,100 miles southwest of San Francisco and 4,665 miles west of Panama. The group as a whole extends for about 2,000 miles in a southeast-northwest direction and is made up of 21 islands and many small islets, reefs, and shoals. Honolulu, the capital and principal port, is on Oahu, and the position of the Territorial observatory in the capitol grounds in Honolulu is $157^{\circ} 18'$ West longitude and $21^{\circ} 18' 2''$ North latitude, or almost the same latitude as Mexico City. Oahu is roughly trapezoidal in shape, with a maximum length of 40 miles from Makapuu Head to Kaena Point, a maximum width of 26 miles from Kahuku Point to Barbers Point, and an area of 598 square miles. (See pl. 1, A). Its coast line is 177 miles long and is more irregular than that of the other islands of the group. As a result, Oahu has better harbor facilities than the other islands. The entire island of Oahu makes up the major part of the County of Honolulu.

HISTORICAL SKETCH

The Hawaiian Islands were discovered by Captain Cook in 1778. He called them the "Sandwich Islands" in honor of the Earl of Sandwich, who was at that time first lord of the British Admiralty, but this name has since been abandoned. The native Hawaiian is Polynesian and is closely related to the Samoan, Tahitian, and Maori. Fornander¹ says the Hawaiian Islands were "undoubtedly occupied by the Hawaiian branch of the Polynesian race as early as 580 A. D." In April, 1795, Kamehameha I invaded Oahu and drove the defenders over Nuuanu Pali. Kamehameha's conquest of the islands brought a new era for the Hawaiian people. He showed great sagacity in government and utilized foreign advisers. Soon after his death, in 1819, the tabu system was abandoned and idolatry abolished. In this same year the first company of pioneer Christian missionaries arrived from Boston and found the Hawaiians in a receptive mood for a new religion. The next great historic event was the bloodless insurrection of January 17, 1893, ending in a provisional government that lasted until July 4, 1894, when the Republic of Hawaii was proclaimed. On August 12, 1898, the Hawaiian Islands were annexed to the United States, and in April, 1900, the United States Congress established a Territorial government.²

¹ Fornander, Abraham, *Fornander collection of Hawaiian antiquities and folk lore*: B. P. Bishop Mus. Mem., vol. 6, pt. 2, p. 222, 1919.

² Alexander, W. D., *A brief history of the Hawaiian people*, New York, American Book Co.

POPULATION

The island of Oahu has a population of 202,887, according to the Federal census of 1930. The population of the principal towns is as follows:

Honolulu	137,582	Wahiawa	3,370
Waipahu	5,874	Aiea	3,021
Ewa	4,739	Waianae	1,202
Waialua	3,370	Pearl City	1,071

The remaining population is scattered throughout the island, largely on the various sugar cane and pineapple plantations. The population of Oahu increased 64.3 percent between 1920 and 1930.

The following table gives a comparison of the racial classification in 1920 and 1930 for Honolulu:

Race	1930	1920
Hawaiian.....	9,675	8,549
Caucasian Hawaiian.....	8,283	5,970
Asiatic Hawaiian.....	5,959	3,102
Caucasian:		
Portuguese.....	12,297	9,978
Puerto Rican.....	2,211	841
Spanish.....	574	636
Other Caucasian.....	23,961	12,670
Chinese.....	19,334	13,383
Japanese.....	47,468	24,522
Korean.....	2,604	1,319
Filipino.....	4,776	2,113
Negro.....	322	198
Other Races.....	118	136
	137,582	83,327

The Hawaiian Islands have frequently been called the "melting pot of races." Certainly the amalgamation of races has been successful so far, but a great problem of education still exists, as shown by the fact that the census of 1930 lists 100,834 people in the Honolulu district, or 72 percent, as illiterate. However, the figures are not as significant as in the United States, because here a large part of the "illiterates" may be educated but are classed as illiterates because they do not speak English.

INDUSTRIES

The sugar and pineapple industries are the most extensive on Oahu, although catering to tourists, fishing, and raising of cattle, taro, lily root, papayas, bananas, avocados, macadamia nuts, and poultry are substantial producers of wealth. The Honolulu Chamber of Commerce states that in 1931 Oahu produced 248,510 short tons of sugar, valued at \$16,545,796; 9,210,745 cases of pineapples, valued at \$25,329,548; and 35,435 cases of tuna, valued at \$163,000. In 1930 there were 529 cattle, 783 horses, 630 mules, 38 burros, 4,073 swine, 12 sheep, 124

goats, and 893 colonies of bees on Oahu. In 1929, 3,481 milk cows gave 2,537,827 gallons of milk, of which 2,349,661 gallons was sold, and 4,593 pounds of butter was made.

Shipping is one of the chief industries of Oahu, through its port of Honolulu. In 1930 the total value of merchandise shipped to the mainland from the Hawaiian group was \$100,856,475, of which the total value of Hawaiian products shipped to the United States was \$98,509,566.

The tourist business of the islands was estimated to be valued at \$6,000,000 in 1925,³ and between \$4,000,000 and \$5,000,000 in 1932.⁴ In 1932, 10,370 tourists visited the Territory, a decline of 34.2 percent from the number in 1931. Honolulu is the point of arrival and departure, and this business yields a substantial part of the value of the industries of Oahu.

FAUNA

Apparently, before the white man's arrival, dogs, pigs, rats, and bats were the only mammals on Oahu. According to legends, dogs and pigs were brought by the Hawaiians. Rats may have arrived by way of wrecked ships. The bat seems to have been the only natural mammalian inhabitant.⁵

Native birds, though less numerous and varied than in the past, still exist in the forest. The introduced mynah bird (*Acridotheres tristis*), English sparrow, rice birds (*Carpodacus mexicanus obscurus* and *Passer domesticus*), and doves are the only ones commonly seen along the roads and in the gardens. The small Japanese dove is numerous in certain localities and the Mongolian pheasant is abundant. Wild turkeys and peacocks are found on the north slope of the Waianae Range. The mongoose, introduced to exterminate the rat, is generally believed to prevent the increase in game birds, as it feeds on both eggs and young birds. Asiatic deer (*Cervus axis*) live in Moanalua Valley, and a few wild goats are found in the dry parts of the Waianae Range and near the east end of the Koolau Range. A band of small kangaroos is reported to be wild in the vicinity of Kalihi Valley. Wild pigs, many of them a cross between the wild Hawaiian pig and introduced breeds, are numerous in most wet areas, especially along the summit of the Waianae Range and in the northern part of the Koolau Range. Although hunted continually, they seem to be in no danger of extermination. No snakes are found on Oahu, but several varieties of harmless lizards are common. Centipedes, scorpions, and the shoe-button spider are found around settlements but are seldom observed in the mountains.

³ Armitage, G. T., Tourist increase; Thrum's Annual, 1927, pp. 94-100.

⁴ Hawaii Tourist Bureau, Annual report to governor for 1932.

⁵ Bryan, W. A., Natural history of Hawaii, p. 295, Honolulu Gazette Co., 1915.

Insect life is abundant, and a large staff of scientists are at work on the problems of the control of insects injurious and beneficial to cane and pineapple. The Mediterranean fruit fly is the most serious pest, because it attacks so many fruits and vegetables. Economically, it prevents the exportation of most Hawaiian fruits.

Land snails of the family Achatinellidae are numerous on certain trees and shrubs in the forest, and usually each valley supports a species of its own.⁶ Some early progenitor probably spread over the mountains of Oahu before their dissection by erosion. The formation of steep-sided canyons appears to have isolated the snails in various valleys, and sufficient time has since elapsed for the specialization of snail shells of varied color and form.

FLORA

The flora of Oahu is tremendously diverse. Besides the great number of plants indigenous to the island, there are hundreds of plants introduced from all parts of the world. Small tree ferns, ohia, kukui, and koa trees are the most prominent native trees in the forest. The kukui is conspicuous because it grows along stream channels, and its large, light-colored leaves stand out in striking contrast to the darker green of the forest.

Among the introduced plants, klu, lantana, guava, and cactus make field work very difficult. In the forest the uluhe or staghorn fern (*Dicranopteris*) seriously impedes travel, and in the areas of lower altitude the spines of the klu (*Vachellia farnesiana*), cactus (*Opuntia megacantha*), kiawe (*Prosopis*), lantana (*Lantana camara*), and wait-a-bit (*Guilandina*) discourage one from leaving the trails. The kiawe or algaroba is the common tree in the semi-arid belts and the beans of this tree and the leaves and branches of the haole koa (*Leucaena glauca*) provide much of the feed for cattle in otherwise barren areas. Cattle depend upon cactus for water in the dry areas, and ranchers state that the cattle learn to prefer it to water. Tripe from cattle living in these areas is said to be inedible, because of the cactus spines that become lodged in the lining of the stomachs.

Several of the native plants such as kokoolau (*Bidens*) and the loulou palm (*Pritchardia*), are sufficiently distinct from valley to valley to be designated as different species by botanists. The seed of *Bidens* is a black rod about a third of an inch long which shows considerable variation in shape. On the introduced kind this rod has two to three barbed prongs, which make it cling to the passer-by. Most of the native species have either lost these barbs, or the barbs are shrunken so that they no longer cling to clothes. Presumably this change in the

⁶ Hyatt, Alpheus, and Pilsbry, H. A., *Manual of conchology*, vol. 21, pp. xi-xix, Philadelphia, 1911.

seed was based on the fact that mammals did not exist on the island, and therefore the plant producing clinging seeds did not have any natural advantage over those lacking them. In fact, in a few species, the seeds are progressing toward a form better adapted for being transported by the wind. Like that of the land snail, the high differentiation of this plant on so small an island is readily accounted for by its isolation on ridges between deep valleys. Thus, the original species of *Bidens* reaching this island evidently spread over the lava domes before their dissection by erosion.⁷ It is interesting to note that both the plants and the snails bear out the geologic observations that the valleys of Oahu are very ancient.

The brilliant flowering trees, such as the poinciana, poinsettia, golden shower, pink shower, wiliwili, and lavender jacaranda, that make this island so beautiful, are too well known to need description. A great variety of hibiscus forms have been developed, and in certain recesses of the forest native hibiscus trees are still to be found. The ever-blooming magenta, flame-colored, and salmon-colored bougainvillea plays a major part in the riot of colors present in the villages of Oahu.

A number of different palms introduced by the white man grow in the lowlands, and a few native palms are seen here and there in the forest. The coconut and date palms and the Australian ironwood (*Casuarina equisetifolia*) thrive with their roots in brackish water.

HISTORY AND PURPOSE OF THE INVESTIGATION

In 1909 W. C. Mendenhall, then in charge of ground-water investigations, now Director of the United States Geological Survey, visited Hawaii. As a result of conferences with Governor Frear and others, he arranged with Marston Campbell, then superintendent of public works, to have T. F. Sedgwick, an employee of the public works department, carry out certain water investigations on Oahu as outlined by Mr. Mendenhall. Mr. Sedgwick located most of the wells then in existence, made systematic monthly readings of static head on wells distributed about the island, and determined the salt content of a large number of samples of well water. This work was continued until 1916, and the data so collected have been essential in all subsequent investigations.

The Territorial Legislature of 1915 authorized the appointment of a commission to investigate and report on the water resources of Hawaii. On this commission were G. K. Larrison, then district engineer of the United States Geological Survey for Hawaii, chairman,

⁷I am indebted to Mr. Otto Degener, formerly botanist at the University of Hawaii, for the data on *Bidens*. I collected *Bidens* from many localities for him and was impressed by their great diversity. The specific names of plants here given are taken from his book entitled "Flora hawaiiensis" (Honolulu Star-Bulletin, 1932).

Arthur G. Smith, and Mr. Sedgwick. These men conducted detailed investigations in the Honolulu district between Diamond Head and Red Hill, and as a result of their recommendations⁸ the Legislature of 1917 passed an act which defines waste of artesian water and gives the chief hydrographer of the Territory authority to investigate and prevent it.

Since 1917 the artesian investigations have been conducted by the Division of Hydrography of the office of the Commissioner of Public Lands, Territory of Hawaii. The successive chief hydrographers of the division have been also district engineers of the United States Geological Survey. Because of lack of funds the collection of well data was much reduced between 1919 and 1921, and from 1921 until 1923 the work was entirely dropped. In 1923 funds were again made available by the legislature and John McCombs was assigned to the work. During his term of service he prepared a report on repairing leaky artesian wells.⁹ In 1926 Penn P. Livingston succeeded Mr. McCombs and in 1927 Knute N. Vaksvik succeeded Mr. Livingston.

A geologic survey of the Territory with special reference to its ground-water resources was requested by Charles J. McCarthy, Governor, in a letter addressed to the Secretary of the Interior August 7, 1919. The first unit systematically surveyed in this manner by the United States Geological Survey in cooperation with the Territory was the Kau District.¹⁰ In 1924, when Max H. Carson became chief hydrographer of the Territory, he suggested to the chief hydraulic engineer of the Geological Survey that the artesian-well data be interpreted and published. In 1927 C. H. Merriam, of C. Brewer & Co., wrote to Governor Wallace R. Farrington suggesting the desirability of such a publication. In 1928 Governor Farrington requested that Oahu be surveyed in the same manner as the Kau District and that the great mass of data on artesian wells be assembled and interpreted. The Territorial Legislature appropriated funds for this investigation. On July 1, 1929, Knute N. Vaksvik, artesian-well engineer, began collecting well data for this report, and on July 16, 1930, I arrived to begin geologic investigations. The Territory paid three-quarters of the cost of the investigation during the fiscal years 1929 and 1930 and one-half after that date. The work was carried on under the direction of O. E. Meinzer, geologist in charge of ground-water investigations in the United States Geological Survey.

⁸ Report of the Water Commission of the Territory of Hawaii to the Governor of Hawaii 1917.

⁹ McCombs, John, Methods of exploring and repairing leaky artesian wells on the island of Oahu, Hawaii: U. S. Geol. Survey Water-Supply Paper 596, pp. 4-24, 1928. Much of the history outlined above has been copied from this report.

¹⁰ Stearns, H. T., and Clark, W. O., Geology and water resources of the Kau District, Hawaii (including parts of Kilauea and Mauna Loa volcanoes), with a chapter on ground water in the Hawaiian Islands by O. E. Meinzer: U. S. Geol. Survey Water-Supply Paper 616, 194 pages, 33 plates and maps, 9 figs., 1930.

On February 13, 1920, Harold S. Palmer began an investigation of the high-level ground water in the Honolulu area under an arrangement by which he received half of his pay from the University of Hawaii and half from the City and County of Honolulu. The work, however, was carried on under the technical direction of Mr. Meinzer and James E. Stewart, then district engineer of the United States Geological Survey and chief hydrographer of the Territory, and the report was transmitted by the Director of the United States Geological Survey on May 31, 1921.

The original program laid out for the present investigation did not call for much new field work. I soon found, however, many new geologic conditions that greatly affect the occurrence of ground water. For this reason it was necessary to spend a whole year instead of about 3 months in field work. From July 1930 to March 1931 I spent most of my time on another report that had not been completed before my arrival. The cost of this unrelated work was, of course, paid from funds other than those set aside for the Oahu investigation. During this period I spent about a month on a special investigation paid for by the United States Navy in connection with condemnation proceedings to acquire land for an ammunition depot in Lualaulei Valley; about 6 weeks on a special investigation for the Board of Water Supply of the City and County of Honolulu, to determine the source of the Pearl Harbor Springs; about 2 weeks as consulting geologist for this board in connection with test borings at Nuuanu Dam 4; and several days determining the proportion of high-level water in Waianae Valley belonging to the Territory. Reports covering these special investigations, except the results of boring, were prepared, and the first two were released to the public in manuscript. The essential data of these reports are included in the present report.

The purpose of this report is to make available and interpret the great mass of data collected in the past relating to the artesian wells of Oahu, to point out methods of developing basal ground water, to determine methods for recharging the artesian basins and for conserving artesian water, and to describe the geologic conditions that determine the occurrence of high-level ground water.

The topographic and geologic map to accompany this report as plate 2 is to be published later in Bulletin 2. It is in process of engraving by the United States Geological Survey.

Honolulu has long been dependent largely upon artesian water, which in dry years is in serious danger of suddenly becoming brackish and unfit for use. The reservoirs in Nuuanu Valley have been repaired, and it is proposed to filter the surface water they collect. However, more water is needed to meet the demands of this growing city. In

addition, the plantations want to use more water every year to take care of the expansion of irrigated areas, and military and naval establishments are seeking new supplies of water. More water is needed at high levels for the camps of the pineapple plantations and for cattle. On Oahu, where rocks are very permeable, where stream flow is flashy, and where storage sites are scarce and usually leaky, ground water is the principal source of water supply and will continue to be so in the future.

The average daily withdrawal of ground water from wells and tunnels is now about 341,000,000 gallons, yet this investigation shows that additional ground water can still be safely developed.

ACKNOWLEDGMENTS

I am particularly indebted to Mr. Max H. Carson, district engineer of the United States Geological Survey, for generous cooperation, intense interest in the investigation, and excellent criticism of this report. Since 1924 he has been in charge of the collection of artesian well data in his dual capacity as chief hydrographer of the Territory and district engineer of the United States Geological Survey, and he has constantly used his efforts to have the valuable well records in the files of his office interpreted and made available. Mr. Charles H. Merriam, of C. Brewer & Co., who took an active interest in the beginning of ground-water studies in the Hawaiian Islands, has been exceedingly helpful in this investigation. It is largely because of his efforts that the Oahu investigation was made in its present detail.

The valuable and faithful assistance rendered by Mr. T. F. Harriss cannot be overemphasized. He accompanied me on all the hazardous trips in the mountains and I am greatly indebted to him for many valuable suggestions during the investigation. He was employed from June 5, 1931, to June 15, 1932.

Mr. W. O. Clark, geologist, Hawaiian Sugar Planters' Association, and Dr. T. A. Jaggar, Jr., director of the Hawaiian Volcano Observatory, visited many of the critical exposures with me, and their valuable criticisms and suggestions during the progress of investigation are greatly appreciated. Mr. Hoyt S. Gale and Dr. Howard A. Powers, who spent several weeks in the field with me at the end of the investigation discussing the various geologic problems, contributed appreciably to the interpretation of field data. Prof. Harold S. Palmer, of the University of Hawaii, placed his extensive geologic library on Oahu at my disposal and was helpful in many other ways. Since 1921 he has made gratis for the Geological Survey numerous chloride determinations.

Mr. E. W. Greene, manager, and Mr. F. C. Cowell, pump superintendent of the Oahu Sugar Co.; Mr. Alvah A. Scott, manager of the Honolulu Plantation Co.; Mr. T. G. S. Walker, manager, and Mr. James N. Orrick, electrical superintendent of the Kahuku Plantation; Mr. Robert Fricke, manager, and Mr. Ernest Brecht, former manager of the Waianae Plantation; Mr. George F. Renton, manager of the Ewa Plantation; Mr. John H. Midkiff, manager, and Mr. C. H. Bischoff, engineer, of the Waialua Agricultural Co.; Mr. William K. Rathburn, manager of the Kahuku ranch; Mr. John McCombs, chief engineer of the Bishop estate; Mr. H. Olstad, manager of the Waiahole Water Co.; Mr. Albert A. Wilson, manager of the Wahiawa Water Co.; Mr. John Herd, manager of the Maunawili ranch; Mr. George A. McEldowney, forester of the Hawaiian Sugar Planters' Association; Mr. Arthur H. Hobart, of the Hobart Engineering Co.; Mr. L. L. McCandless, Delegate to Congress; Mr. Frederick Ohrt, manager, and Mr. Joseph F. Kunesh, hydraulic engineer, of the Honolulu Board of Water Supply; and Mr. Edwin H. Bryan, curator in charge of collections at the Bishop Museum, cooperated in various ways to make the investigation a success. The friendly cooperation of Maj. James I. Muir and the late Maj. Elkin L. Franklin, of the United States Army, in obtaining photographs and arranging airplane flights, is greatly appreciated. Lt. K. P. McNaughton, Lt. Don Z. Zimmerman, and Sgt. Arthur Stolte, of the Air Corps, United States Army, made most of the aerial photographs used herein. Lieutenant Zimmerman's training as a geologist proved exceedingly useful in obtaining photographs of geologic interest.

The transferring of the geology from the field sheets to the final maps submitted for publication was done by Dr. Norah D. Stearns. For this careful work and for much helpful criticism of the manuscript I am very grateful. Most of the well records were compiled by Mrs. Effe Jones, and her careful assembling of these is greatly appreciated.

I am indebted to Messrs. O. E. Meinzer, T. A. Jaggar, Jr., Max H. Carson, John McCombs, H. A. Powers, W. G. Foye, and H. S. Gale for criticizing the manuscript, to Mr. B. H. Lane, editor of the United States Geological Survey, for editing the manuscript, and to Miss Grace Wilmarth for so carefully editing the geologic names and arranging the stratigraphic tables.

PREVIOUS INVESTIGATIONS AND LITERATURE

A great deal has been written about the geology and water resources of Oahu. As an annotated bibliography of the literature is published elsewhere¹¹ it is unnecessary to discuss here the contributions made by

¹¹ Stearns, N. D., Annotated bibliography of Oahu relating to geology and water supply: Div. of Hydrography, Terr. of Hawaii, Bull 3, 1935.

each writer. The first author to recognize a particular geologic or hydrologic feature is credited in the text of this report, and no attempt has been made to review the geologic literature dealing with any one subject.

VOLCANIC PRODUCTS AND PROCESSES

A description of a volcanic island involves the use of many terms not found in textbooks of geology. Further, there is a lack of uniformity in the use of the terms that exist. Consequently this section is given as an introduction to the subject that follows. The volcanic processes that built Oahu and the resulting products are similar to those of the two active volcanoes, Kilauea and Mauna Loa, on the island of Hawaii, hence only the following brief description of them is given in this report. For greater detail the reader is referred to various published reports.¹²

BASALT

The volcanic rocks of Oahu, with few exceptions, are what have long been described as typical Hawaiian basalts. Holmes¹³ defines basalt as "a microlithic or porphyritic igneous rock of a lava flow or minor intrusion, often vesicular or amygdaloidal, having an aphanitic texture as a whole or in the groundmass, and composed essentially of plagioclase (at least as calcic as labradorite), and pyroxene, with or without interstitial glass. When olivine is present, the rock is termed olivine-basalt." One school of petrography defines basalt in terms of the percentage of ferro-magnesian minerals present. Most of the rocks on Oahu contain olivine phenocrysts, but augite phenocrysts are rare. Regardless of which of the definitions given above is used, some of the lava flows would be classified as andesites when examined microscopically. However, the andesites of the Hawaiian Islands almost invariably fulfill the general conception of basaltic flows and are in many places indistinguishable megascopically from them. Thus, it might be said that the andesites of Oahu have a basaltic habit. In field mapping there is no substitute for the term "basalt." Consequently throughout this report that word will be used in a field sense only and not as the petrographic term.

¹² Brigham, W. T., The volcanoes of Kilauea and Mauna Loa: Bishop Museum Mem., vol. 2, no. 4, 1909.

Dana, J. D., Characteristics of volcanoes: New York, Dodd, Mead & Co., 1890.

Hitchcock, C. H., Hawaii and its volcanoes, 1909; 2d ed., with supplement, Honolulu, Hawaiian Gazette Co., 1911.

Jaggard, T. A. Jr., Volcanic investigations at Kilauea: Am. Jour. Sci., 4th ser., vol. 44, pp. 161-220, 1917, and other papers by this author.

Stearns, H. T., and Clark, W. O., Geology and water resources of the Kau District, Hawaii: U. S. Geol. Survey-Supply Paper 616, 1930.

Publications of the Hawaiian Volcano Observatory.

¹³ Holmes, Arthur, The nomenclature of petrology, p. 42, London, 1920.

VOLCANIC DOMES

The Koolau Range consists chiefly of bedded lava flows having dips of about 3° (about 270 feet to the mile) near the summit, which increase to 10° (about 940 feet to the mile) near the shore. The slopes of Mauna Loa range from 250 to 350 feet to the mile near the summit and reach about 1,000 feet to the mile about midway down the southeast slope. The similarity of the angles of slopes indicates that the Koolau Range before erosion was a dome similar in shape to Mauna Loa.

The lava beds in part of the Waianae Range have a slightly steeper dip than those in the Koolau Range, in places as much as 20° . A few of these steep dips, especially between Makaha and Keaau Valleys, are caused by the lavas of the Waianae volcanic series cascading over a rugged preexisting surface. It is evident, however, that the Waianae dome before erosion was steeper than the Koolau Range and was more nearly comparable to the Hualalai dome, on Hawaii, which has slopes exceeding 1,000 feet to the mile.

SECONDARY CONES

Three types of secondary cones are superimposed on the Koolau and Waianae domes—cinder cones, lava cones, and tuff (consolidated ash) cones. The profile of each type is usually sufficiently characteristic to permit its identification even from a considerable distance (fig. 1).

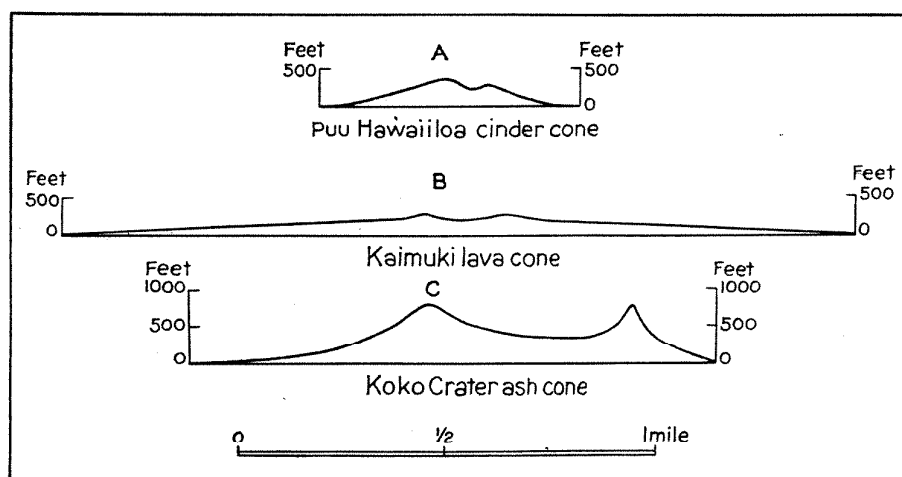

FIGURE 1.—Comparison of the profiles of cinder, lava, and tuff cones. Natural scale.

CINDER CONES

Size.—The cinder cones of Oahu range from 100 to 500 feet in height, though most of them exceed 250 feet, and reach half a mile in diameter. Their unusually large size is perhaps due to their composition, the material being a nephelite basalt instead of normal basalt.

Composition.—The normal cinder cone is produced by a fire fountain or pyro-explosion and consists of bedded magmatic ejecta only. The extremely cellular and light material, which in basaltic eruptions usually occurs in pieces a fraction of an inch across, is known as “pumice.” The larger, slightly heavier, scoriaceous masses are usually termed “cinders,” and those with ellipsoidal, discoidal, or spheroidal forms produced by mechanical forces acting upon them during their flight through the air are called “bombs.”¹⁴ Commonly intermixed with the cinders are clots of vesicular basalt with smooth skins adhering to one another, which are known as “spatter.” Some of the ejecta contain crystals of olivine, augite, or feldspar, but others are made up of amorphous lava or glass containing considerable magnetite or other iron compounds.

If a strong wind is blowing during an eruption an asymmetrical cone is formed, and the pumice may be deposited over an area of several square miles. The pumiceous material of most fire fountains does not exceed one foot in thickness a few hundred feet beyond the edge of the cone and thins rapidly farther away. A few eruptions in the Waianae Range produced unusually large cinder cones; hence the pumice deposits there are more widespread and thicker than ordinary. Pumice deposits are less numerous and thinner in the Koolau Range. Because pumice deposits consist mostly of glassy material, they consolidate to a vitric tuff.¹⁵

Color.—The cinders range in color from red to black but on weathering change to brilliant reds and yellows. The yellow color of the associated tuff beds is commonly a valuable aid in field mapping. The yellow color is usually caused by the alteration of the glass to palagonite, a soft, waxy silica-gel mineraloid. These vitric or glassy tuffs are extremely permeable when originally deposited, but the buried, altered tuff beds are less permeable. For this reason the mapping of deposits of vitric tuff is economically important because they generally hold up perched water wherever they occur fairly continuously interbedded with basalt flows.

LAVA CONES

The Kaimuki lava cone, just north of Diamond Head, is the only secondary lava cone known on Oahu. Doubtless other lava cones existed during the building of the Koolau and Waianae domes, but they have been subsequently buried or removed by erosion. The Kaimuki lava cone is 302 feet high, 1½ miles long, and a little less than half a mile wide. On its summit is a crater 1,400 feet long and 800

¹⁴ Reck, Hans, *Physiographische Studie über vulcanische Bomben: Ergänzungsband Zietschr. Vulcanologie, Tafeln 1-15.* 1915.

¹⁵ Pirsson, L. V., *The microscopical characteristics of volcanic tuff: Am. Jour. Sci., 4th. ser., vol. 40, p. 191, 1915.*

feet wide. The crater rim consists of cinders and extremely thin bedded and highly scoriaceous flow lava. The cone lacks symmetry, because the flows to the south banked against Diamond Head, and the flows to the north were stopped by a spur of the Koolau Range. The lava cone differs from a cinder cone by its gentle slopes (fig. 1) and by consisting mostly of lava flows. A lava cone is caused by very fluid lava welling out quietly with very few or no fire fountains.¹⁶

TUFF CONES

Form.—Profile C in figure 1 is that of a typical tuff cone. The airplane view of Diamond Head, which is a tuff cone (plate 1, B), illustrates how large the crater is in proportion to the width of the cone. Part of this relation is the result of erosion of the flanks of the crater.

Composition.—As shown in plate 3, A, a tuff cone is made up of bedded, commonly laminated consolidated explosion deposits containing a great variety of ejecta. In contrast, the cinder cone consists of magmatic ejecta only, and the lava cone principally of flow lava. A tuff cone consists of an intimate mixture of vitric material belonging to the erupting magma and fragments of the basement rock. All the tuff cones of Oahu contain limestone blocks derived from underlying coral reefs as well as blocks of ancient basalt flows belonging to the Koolau Range. According to the classification of Johnston-Lavis¹⁷ the magmatic ejecta are called “essential”; the related previously cooled basalts, “accessory”; and the limestone and other nonrelated rocks “accidental” ejecta.

The accidental and accessory ejecta are usually stony or lithic material and the essential ejecta generally glassy or vitric material. If the disrupting magma contains crystals such as olivine, augite, or feldspar, these crystals may be so conspicuous as to make crystal tuffs. According to Pirsson's classification, which names the tuff from the dominating type of rock fragments, the cones of Oahu consist of “lithic tuff.”¹⁸

Phreatomagmatic origin.—Tuff cones similar to those on Oahu are not known on Mauna Loa, Hawaii. It is evident, therefore, that some process occurred on Oahu that has not occurred on this active volcano. A special type of tuff cone caused by lava flows entering the sea occurs on Mauna Loa¹⁹ but differs from the Oahu tuff cone in consisting principally of magmatic ejecta with small amounts of sea sand and shells derived from the beach and ocean floor. Fragments of basement rocks such as reef limestone or older basalt are notably absent. Also the

¹⁶ Stearns, H. T., and Clark, W. O. Geology and water resources of the Kau District, Hawaii: U. S. Geol. Survey Water-Supply Paper 616, p. 121, 1930.

¹⁷ Johnston-Lavis, H. T. On the fragmentary ejecta of volcanoes: Geologists Assoc. London Proc., vol. 9, pp. 421-432, 1887.

¹⁸ Pirsson, L. V., op. cit. p. 191.

¹⁹ Stearns, H. T., and Clark, W. O., op. cit. (Water-Supply Paper 616), pp. 125-127.

Hawaii cones usually lack the thin bedding of Oahu tuff cones. The absence in the Mauna Loa cones of lithic fragments from the basement is of course due to the surficial character of the explosions. Field mapping shows definitely that the Oahu cones are not on the seaward end of lava flows. In fact, flows are rarely associated with the cones, and where they occur they form only a very minor part of the mass.

As shown on plate 2, all the tuff cones on Oahu occur close to the sea. The numerous blocks of Koolau basalt and reef rock in all of them indicate that the explosions occurred beneath a reef. Some of the cones, such as Manana Island, probably began by submarine eruptions, and it is evident that the lava column feeding the others encountered, near the surface, reef rock containing water-filled caverns connected with the sea. It is believed that in these cones the usual fire fountains did not occur. Instead, the hot magma came suddenly into contact with water, exploded catastrophically, and blew out great quantities of the basement rock simultaneously with the magmatic material. Material collapsing from the walls of the newly formed crater supplemented by rocks falling back into it would tend to make a temporary plug so that the water rushing into the crater would then cause another steam blast. The consequent sudden relief of pressure on the gases in the magma column probably caused the magma to fly apart violently. Thus the explosions continued until the supplying energy was exhausted. In the Punchbowl and Koko fissure eruptions the explosions died out before the supply of magma was exhausted, with the result that toward the end of the eruption spatter and short flows were extruded.

The history of the eruption along the Koko fissure seems to bear out the relation of water to tuff cones. A crack opened diagonally across the east end of the Koolau Range from one shore to the other. The lava from this crack that erupted through coral produced the Koko Crater tuff cone, but on the windward side, where it broke out in the talus, about 250 feet above sea level, it produced a normal flow. Unfortunately it cannot be definitely established that these eruptions took place at exactly the same time, but there is no field evidence to the contrary. As long ago as 1856 the sequence of eruptions along the Diamond Head-Kaimuki fissure convinced Green²⁰ that water was the causal agent of tuff cones. Proof that basaltic tuff cones are formed by phreatomagmatic explosions is not limited to the field evidence on Oahu. I found a similar relation between tuff cones and ground water in Idaho.²¹ It is certainly a striking fact that all the tuff cones of Oahu lie along the coast and all the cinder cones lie inland.

²⁰ Green, W. L., *Extinct coast craters of Oahu: Sandwich Islands' Monthly Mag.*, vol. 1, no. 6, p. 165, June 1856.

²¹ Stearns, H. T., *Volcanism in the Mud Lake area, Idaho: Am. Jour. Sci.*, 5th ser., vol. 11, p. 358, 1926.

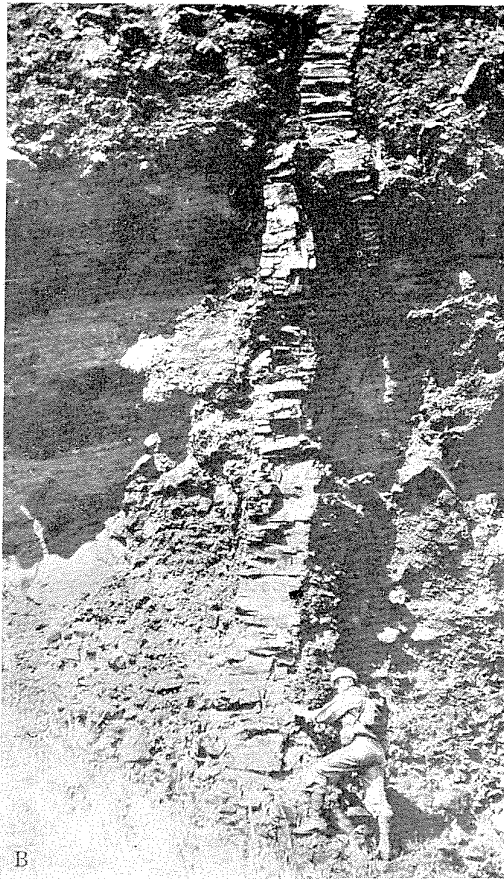

B, DIKE INTRUDED INTO BRECCIA AT PUU KAILIO, LUALUALEI VALLEY, WAIANAË RANGE.

Photograph by Harold T. Stearns

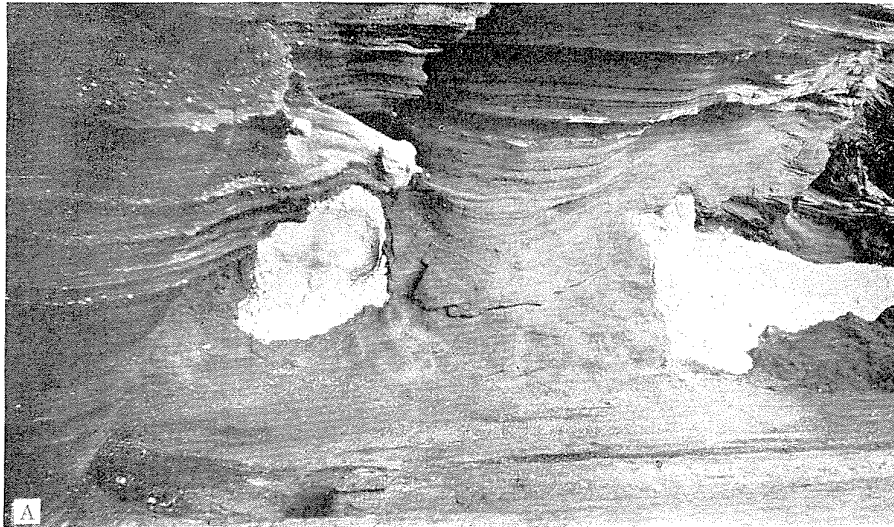

A, TYPICAL LITHIC TUFF ON THE SOUTH SIDE OF KOKO CRATER, MANTLING EMERGED REEF LIMESTONE.

The tiny white spots are limestone ejecta.

Photograph by Willis T. Pope



A, PLATY JOINTING IN FINE-GRAINED CONTACT PHASE OF THE BOSS AT PALOLO QUARRY, PALOLO VALLEY.

Photograph by Harold T. Stearns

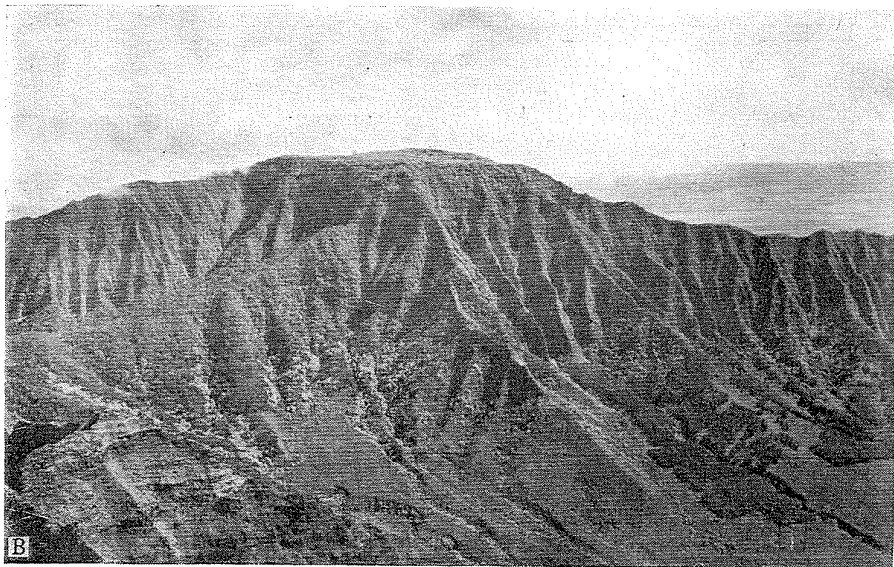

B, MOUNT KAALA, HIGHEST POINT ON OAHU, AS SEEN FROM THE SOUTH.

Waianae Valley lies in the foreground and the head of Makaha Valley is shown on the left. The cliffs are corrugated by stream erosion and terminate in smooth steep alluvial slopes. Photograph by 11th Photo Section, Air Corps, Luke Field, T. H.



A. VIEW LOOKING UP NIUANU VALLEY.

A mature valley having a U-shaped profile in contrast to the V-shaped profile of Waolani Stream, a small tributary on the left. The valley on the right is Pauoa and it is floored by Tantalus basalt and partly filled with contemporaneous firefountain deposits which give it its flat-floor. The peak on the right of the gap at the head of Nuuanu Valley is Konahuanui, the highest mountain in the Koolau Range.



B, WAIMEA RIVER, OCCUPYING A DROWNED VALLEY ON THE NORTHWEST END OF THE KOOLAU RANGE.

The pineapple fields are on slightly modified flow slopes, as shown by the nearly parallel bedding of the flows exposed in the canyon walls. The mouth of the river is blocked by calcareous beach sand after each storm. The buildings rest on a terrace graded to the 25-foot stand of the sea.

Photographs by 11th Photo Section, Air Corps, Luke Field, T. H.



A, AIRPLANE VIEW OF THE KALIHI WIND GAP.

Caused by the beheading of Kalihi Valley by streams on the windward side. The small valley on the right is Kamanaiki, and the cliff in the middle of the valley is caused by the stream of Kamanaiki basalt.

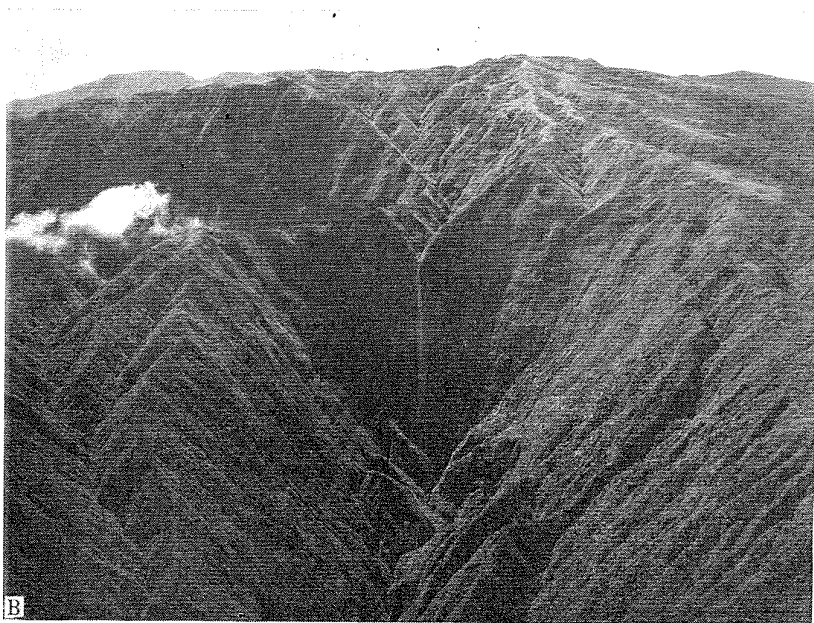

B, VIEW LOOKING UP HONOKOHAU VALLEY, MAUI.

Showing the amphitheater head of Waihee about to behead Honokohau Stream. The flat-topped ridges are slightly modified remnants of the former dome surface. The two tributaries that enter Honokohau Stream below the waterfall are the heads of two adjacent streams that have been captured.

Photographs by 11th Photo Section, Air Corps, Luke Field, T. H.

Use of term "ash."—In much of the geologic literature the terms "ash" and "tuff" are used indiscriminately and with considerable indefiniteness of meaning. Holmes²² defines volcanic ash as "fine-grained pyroclastic material composed of comminuted glass, crystals, and/or cryptocrystalline or microcrystalline rock substance." The word "ash" is used in this report according to that definition. When compacted, such a deposit is referred to as "tuff." On Oahu catastrophic explosions produced most of the ash deposits. Fire fountains such as form basaltic cinder cones do not normally produce appreciable fine-grained deposits of silt and sand size. They produce cinders, spatter, and pumice, all of which are too coarse to form typical ash beds. The fine material, such as "Pele's hair" and "Pele's tears," produced during fire fountains, forms insignificant ash deposits. In some places pumice deposits have weathered into dust, which forms beds not readily distinguishable from ash. Commonly, however, the individual pumice fragments are determinable either megascopically or microscopically. In weathering to palagonite the outlines of the fragments are often intensified, but where the outlines are not evident the fragments may be indicated by clusters of vesicles.

As it is impracticable to study all weathered and compacted deposits of pumice under the microscope, some of them are referred to as "tuffs" in this report because their fine texture, produced secondarily, makes them appear to be consolidated ash. Because the fragments larger than pumice that are produced by fire fountains are always readily distinguishable in the field, even if palagonitized and consolidated, none of them are described herein as tuff. Therefore the term "tuff" in this report may mean either consolidated ash of a catastrophic eruption or weathered compacted pumice. The term "tuff cone" as used here refers to a consolidated ash cone, and although it is well recognized that some of the beds in these cones contain sufficient coarse material to make them agglomerates, the main bulk of the cone is of the size of ash. Thus, if cones like Diamond Head and Punchbowl were not consolidated they would be true ash cones as distinguished from Tantalus or Sugar Loaf, which are cinder cones.

EXTRUSIVE ROCKS

Pahoehoe.—Lava that is laid down with a relatively smooth, billowy surface, in places ropy, is called "pahoehoe." Pahoehoe is supplied to the advancing margin of the flow through a great number of tubes, which range in diameter from a few inches to several feet and connect to form one or more main supply tubes that extend back to the sources of the flow. If the lava in these conduits drains out at the end of an

²² Holmes, Arthur, *The nomenclature of petrology*, p. 36, New York, 1920.

eruption, a lava cavern or tube is formed, like the one at Judd and Mahalo Streets, in Honolulu. Pahoehoe flows range from 10 to 100 feet in thickness, and several beds may accumulate successively during a single eruption. In cross section a typical pahoehoe flow exhibits vertical joint cracks dividing the basalt into polygonal blocks. Horizontal joint cracks dividing the flow into layers a few inches to a foot or two thick generally occur near the top. A glassy skin, which may be altered to palagonite or related mineraloids or to laterite, marks the top of the flow, and a few slaggy masses of red basalt are generally found at the bottom. If the lava is poured out over soil or other sedimentary rocks it may bake them red. The vesicles left by escaping gases are usually almost spherical and increase in number toward the top, giving rise to a cellular crust known locally as "pukapuka" rock. Vertical holes several inches long known as "pipestem vesicles" may characterize the dense basalt just above the base.

The round pellets of secondary minerals filling the vesicles, such as are frequently found near Kailua, are called "amygdules." They are deposited by hot vapors and solutions or by hydrothermal action. Pahoehoe is very permeable, especially near the top and bottom, and although it is generally believed locally that most of the ground water moves through the vesicles, because fragments of the crust are generally recovered from wells when strong flows of water are encountered, the strong flows in pahoehoe are struck at the slaggy contact of one bed with another or in tubes.

Aa.—Besides pahoehoe, there are flows that consist of beds of dense basalt containing irregular stretched and deflated vesicles, lying between and in places including beds of clinkers. These are known as "aa." If these flows are massive, they may have well-developed columnar or platy jointing. Tubes are practically absent, and in places, especially near the margins, the flow may consist entirely of clinker. The clinkers differ from the cinders in being stony instead of glassy, less vesicular, and generally spiny. The lava supplying the margin flows through an open channel 5 to 30 feet wide and the splashing of the lava river sometimes results in spatter that is not distinguishable except for its field relations from that in spatter and cinder cones.

As pahoehoe may change into aa, there are transitory zones where the basalt is neither typical pahoehoe nor typical aa. The cause of the two types of lava is still a problem. A review of the literature covering this subject has been given elsewhere.²³ The clinker portions of aa flows are extremely permeable, and as flows of this type are common on Oahu they form the principal aquifers.

²³ Stearns, H. T., and Clark, W. O., Geology and water resources of the Kau District, Hawaii: U. S. Geol. Survey Water-Supply Paper 616, pp. 108-112, 1930.

Ejecta.—Most kinds of ejecta on Oahu are described above under types of cones. However, during the growth of the Koolau and Waianae domes a few explosions occurred that blasted their way up through the lavas of the domes without magma reaching the surface. These were essentially steam explosions, like the phreatic explosions of 1924 at Kilauea, and the resulting deposits consist entirely of accidental and accessory ejecta. Unlike the explosions forming tuff cones, these explosions did not build cones, but the eruptions were relatively short-lived and the ejecta were hurled to great distances. They were truly catastrophic. In a few places on Oahu the steam explosions have been succeeded by magmatic explosions and such eruptions produced deposits that are essentially lithic but contain minor amounts of pumice.

Catastrophic eruptions cause deep craters, which increase in diameter afterward by collapse. Kaau Crater, near the head of Palolo Valley, was probably formed in this manner. The talus falling into the vent and the blocks that fall back into the crater after the explosion result in very coarse angular breccia, generally structureless, containing blocks that may reach 6 feet in diameter (pl. 3, B). On Oahu these breccias contain a large percentage of intrusive rock fragments.

The explosions from Kaau Crater resulted in a deposit that differs in many respects from the deposits in tuff cones and around the other paroxysmal vents. Most of the other explosions of this type on Oahu occurred before the domes had been dissected by erosion. Consequently their ejecta remained as a more or less complete mantle over the surrounding areas. The Kaau explosion occurred when the Koolau Range was essentially the same as at present, with steep canyons and a well-developed drainage. Thus, the ash fell on steep valley walls, and storms accompanying the explosion or occurring soon afterward swept the unconsolidated ash and ejecta into the stream beds. The streams became so loaded with debris that they reached the consistency of thick mud and were able to carry along large angular blocks. This mud flow is exposed along Palolo Valley and resembles the mud-flow deposit that rushed down Hat Creek from Lassen Peak in California, during the eruption of 1914.

Criteria for distinguishing mud-flow deposits.—The mud-flow deposit of Palolo has better bedding than the sub-aerial lithic-tuff deposits of the ancient Koolau volcanic series but poorer bedding than the tuff cones. Large blocks do not cause bomb sags in the bedding such as are so characteristic of sub-aerial tuff deposits. The bedding has dips parallel to the valley floor, hence it lacks the high dips found in tuff cones. Considerable round and sub-angular stream gravel and boulders are found mixed with the ejecta, and in places the deposit shows stream sorting. Also, it lacks the conspicuous vitric material that fills

the interstices between the lithic fragments of tuff cone deposits. Finally and probably most conclusively, on mapping it proves to be an alluvial deposit filling a valley to a certain depth, instead of a cone or mantle. Fossil tree trunks and branches, such as characterize the mud flow under Fort Shafter, jumbled up with the mud flow instead of standing vertical as in the tuff, form a valuable criterion for distinguishing the two deposits.

Some of the criteria mentioned above may not be applicable to mud flows elsewhere, because a different type of ejecta supplied to the mud flow and a differently shaped valley floor might appreciably change the appearance of the deposit.

Alluvium deposited by streams eroding consolidated tuff cones can be distinguished from mud-flow deposits by its better sorting and by the presence of pebbles and cobbles of tuff derived from the cone. Deposits made by streams eroding unconsolidated tuff cones might not be distinguishable from mud-flows, especially if the ash contained rounded boulders and other accessory and accidental ejecta.

INTRUSIVE ROCKS

Dikes.—The flows of Oahu were fed by magma that rose through fairly vertical straight, narrow cracks. After the eruptions ceased, the magma in these cracks solidified to form dikes. A typical dike is shown in plate 3, B. As the magma forming a dike cools under the weight of the overlying rocks, it forms a rock that is usually denser than the extrusives. The dikes of Oahu range from a few inches to 15 feet in width and may persist for a mile or more. They are characterized by horizontal jointing and have thin glassy borders caused by the more rapid chilling of the magma at the contact with the cold country rock.

Some dikes, especially those formed at shallow depths, have vesicles arranged in bands parallel to the walls; others, instead of having horizontal joints, have closely spaced vertical joints which give them a platy structure. Near Kailua the vesicles and joint cracks are commonly filled with secondary minerals.

Sills.—Sills differ from dikes in that they parallel the bedding of the flows instead of cutting across it. Here and there a dike offsets a few feet by following the bedding planes between two flows, thus forming a short sill. Offshoots from dikes may be injected between bedding for short distances in the form of sills a few feet thick. Except for these small local occurrences, there are few sills on Oahu. One or two extensive sills have commonly been postulated as holding up the perched high-level ground water in the mountains of Oahu. A careful search was made for them, but they were not found.

Most of the sills noted were in places where dikes are not close together, as in the secondary rift zones or at the outer edge of the dike complex. This fact suggests that the scarcity of sills is due to the vertical "grain" of the dike complex caused by hundreds of closely spaced vertical dikes. The magma rising through a fissure in the dike complex is not bordered by horizontal bedding planes through which it can spread laterally, except close to the surface. When close to the surface it can evidently continue upward through the open crack more easily than spread laterally between irregular bedding planes in the flow lavas.

Bosses and plugs.—A relatively small upright intrusive body having a roughly cylindrical form is called a "boss." If it can be established that this body fills a volcanic throat it would then be a "neck" or "plug." For many years a plug rather than dikes was the common conception of the subsurface form of a basaltic volcanic feeder. A few plugs and bosses were noted in the Waianae Range, but they are insignificant features on Oahu.

One example of a boss in the Koolau Range can be seen at the Palolo quarry, in Palolo Valley east of Honolulu. This intrusive is about 250 feet wide, east and west, and 440 feet long, north and south. It solidified within about 800 feet of the surface, but subsequent erosion prevents determining whether or not it served as a feeder to a flow. The rock is a light-gray even-grained holocrystalline basalt with a dark aphanitic or fine-grained contact phase, which exhibits unusually regular platyness, as shown in plate 4, A. A few cavities several inches wide along veins in the middle of the mass are lined with euhedral crystals of augite and feldspar 1 centimeter long.

The several plugs in the Waianae Range taper downward. Some are fills in the craters of cinder cones; others—for example the one at the head of Nanakuli Valley—are cup-shaped but not enclosed by cinders. In the caldera complex at the head of Lualualei Valley there are massive cup-shaped bodies, identified as crater fills, like the present filling in Halemaumau Crater of Kilauea Volcano, because they rest on talus breccia.

GEOMORPHOLOGY

Oahu consists of four major geomorphic provinces—two mountain ranges, a plateau, and a coastal plain. The chief topographic features are the Koolau and Waianae Ranges, two elongated basaltic volcanic domes roughly parallel to each other and trending northwest. The east side of Oahu is made up of the Koolau Range, which is about 37 miles long and 13 miles wide. Its highest point is Puu Konahuanui, 3,105 feet high, 5 miles northeast of Honolulu (pl. 5, A). The Waianae Range, which forms the west side of the island, is about 22 miles long and 9 miles wide. Its culminating peak, Mount Kaala, shown in plate 4, B, is 4,025 feet high. The form of the ranges is shown by the relief map in pl. 1 and by the topographic map, plate 2. Where the two ranges merge there is a fairly smooth area about 14 miles long and 4 miles wide, the Schofield Plateau. It slopes both northwest and southeast toward the sea from a summit about 1,000 feet above sea level. Along the shore of most of the island is a coastal plain, a nearly level belt of land that reaches a maximum width of $5\frac{1}{2}$ miles on the south side of the Schofield Plateau.

KOOLAU RANGE

ORIGINAL FORM

The Koolau Range is made up of beds of basalt, which in general dip away from its crest. The beds have dips of about 3° near the summit but reach a maximum of about 10° near the margin of the range. Prior to dissection by erosion the Koolau Volcano had essentially the same slopes as the bulky Mauna Loa dome, on Hawaii. The Koolau dome, even at the time of its completion, was strikingly asymmetrical, because its lavas on the west were ponded by the preexisting Waianae Range, whereas those on the east, flowing into the sea unobstructed, built steeper slopes. Thus the dips of the Koolau lava beds beneath the Schofield Plateau are mostly less than 5° , whereas on the opposite side of the range marginal dips of about 8° predominate. A similar though less pronounced lack of symmetry occurs on the long axis of the range. Thus, the highest part of the range is in the vicinity of Puu Konahuanui, about 28 miles from the northwest end but only about 9 miles from the southeast end. Erosion subsequent to the cessation of volcanism, although reducing the height of the dome by probably as much as 1,000 feet, did not materially alter the position of the summit.

The eruptive center of a volcanic dome, as shown by Mauna Loa, Kilauea, Haleakala, and other domes in the Pacific, need not be at the geographic center of the mountain. Often more lava is extruded along one rift zone than another. On the basis of the dips of the flows the

Koolau Volcano may be reconstructed relative to present sea level as a land mass extending only a little over a mile beyond its present shore except from Makapuu to the northwest side of Kaneohe Bay. In this embayed area the dome extended several miles seaward of the present coast. As the Koolau Range has been submerged more than 1,000 feet, it originally extended still farther seaward.

POSITION OF ERUPTIVE CENTER

There are five reasons why it is believed that the volcanic center of the Koolau Range lies a little north of Puu Konahuanui, (1) It is close to the highest part of the Koolau Range; (2) a large mass of breccia marking the site of a caldera occurs in this area; (3) the dikes in this area are irregular, are of small size, and have diverse trends; (4) it lies at the intersection of two rift zones; (5) tuff beds intercalated with the Koolau lavas are more numerous in this area.

STAGE OF DISSECTION

The Koolau dome has undergone so much erosion that it is doubtful if any part of the original surface remains. However, a few fairly flat areas along the main divide west of Punaluu Valley appear to have suffered less stripping than any other part of the range. These highland flats are characterized by swamps, and they lie on the main rift zone, as shown by the dikes exposed in the lower part of the cliffs bordering them. Farther northwest there are similar fairly flat divides, as shown in plate 5, B, but sufficient material has been removed to expose dikes in them. The Schofield Plateau is likewise an area where the original flow slopes have been only slightly modified, but that they have been affected by erosion is definitely shown by the isolated erosional remnants of the same flow scattered here and there on the surface of the plateau. Stripping of some of these slopes has proceeded layer by layer, so that the present surface is practically parallel with the original surface of the dome.

Wentworth²⁴ has interpreted the triangular facets on the lower inter-stream spurs of the flanks of both ranges on Oahu as remnants of the original flow slopes. He cites the end of the spur on the east side of Manoa Valley as a type case. On examination of this facet I found however, that several flows are truncated by it. In the next spur to the east the lava flows show dips of 5° in the middle parts, whereas the facet surface has a slope of 8° . A projection of the deep submarine slope off this area to connect with the highest points of the ridges indicates that a considerable thickness of rock has been removed from these slopes by erosion.

²⁴ Wentworth, C. K., *Pyroclastic geology of Oahu*: B. P. Bishop Mus. Bull. 30, p. 9, fig. 3, 1926.

Between the spurs are valleys that readily fall into two groups--those with youthful, **V**-shaped cross sections, and those with mature, **U**-shaped cross sections, more or less amphitheater-headed. Inspection of plate 2 shows that the Schofield Plateau is in a youthful stage of erosion and that the upper slopes of the Koolau Range, except for most of the northeast (windward) side, are maturely dissected. Most of the northeast side of the range, except the north end, is in late maturity or early old age, for the divides have been greatly reduced. Alluviation has done much, however, to widen the valley floors.

The **V**-shaped valleys on Oahu, as elsewhere in the world, are found in areas of both youthful and mature topography. They also characterize tributaries of the **U**-shaped valleys in the late mature areas. A youthful **V**-shaped valley tributary to a mature **U**-shaped valley is well shown in plate 5, A. The flatness of the floors of Kalihi, Nuuanu, Pauoa, and Palolo Valleys and several valleys on the northeast coast of southeastern Oahu has been accentuated by late basalt flows in addition to alluviation.

The present area of maximum rainfall (pl. 26) lies in the northwestern part of the Koolau Range, and yet the streams draining the west slope in this area are in a much younger stage of erosion than those farther southeast, where less rain falls. This anomalous condition is probably due to the fact that before erosion had lowered the summit and removed a large northeastern segment of the dome, the northwestern part was sheltered more from the trade winds than now and therefore received less rain. Furthermore, there is positive evidence of a submergence of Oahu of more than 1,200 feet and some evidence that the trade winds formerly blew from a more easterly direction, and both of these factors would change the conditions of rainfall.

CAUSE OF AMPHITHEATER-HEADED VALLEYS

Wentworth's theory.—Wentworth²⁵ believes that rapid chemical decomposition at the level of the basal water table, influenced by constant warm temperatures and high permeability of the rock, allows a stream to undercut its bed so rapidly at the level of the water table that the mature-valley profile passes abruptly at a waterfall into a youthful profile. This theory implies that mature-valley stream gradients and water-table gradients are the same, but the basal water-table gradient does not exceed 3 feet to the mile whereas these stream gradients are 40 feet or more to the mile.

Author's theory.—My theory is based upon (1) the original slope of the surface, (2) the presence of alternating resistant and nonresistant beds dipping downstream, (3) high rainfall at high altitudes and low

²⁵ Wentworth, C. K., Principles of stream erosion in Hawaii: Jour. Geology, vol. 36, pp. 385-410, 1928.



A, HALAWA FALLS, MOLOKAI.

Showing that composite plungepools made by waterfalls form an amphitheater-headed valley.

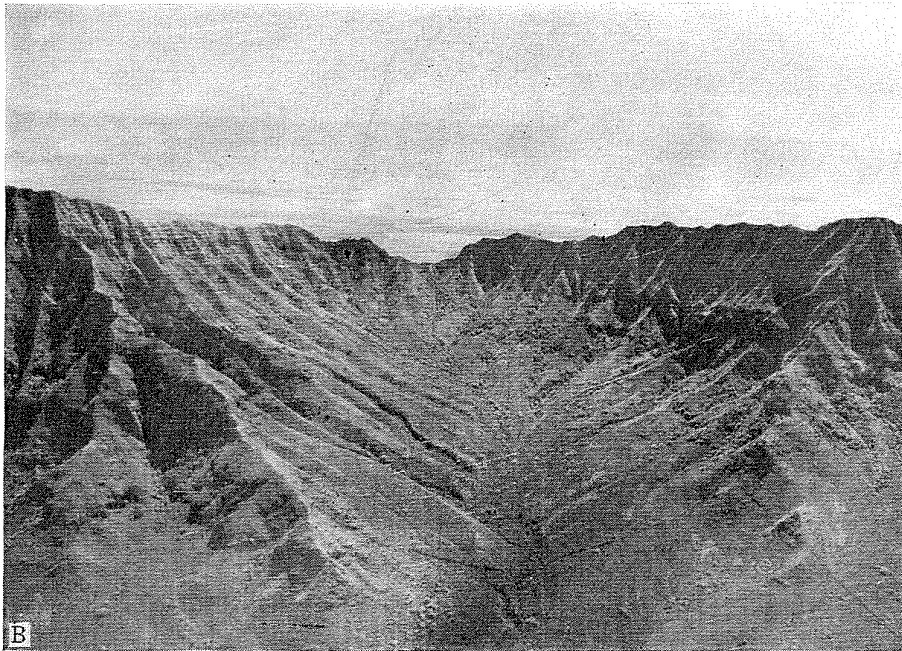

B, AIRPLANE VIEW OF A TRIBUTARY OF LUALUALEI VALLEY,
WAIANAE RANGE.

Showing an old-age amphitheater floored with alluvium. The wind gap is Pohakea Pass.

Photographs by 11th Photo Section, Air Corps, Luke Field, T. H.

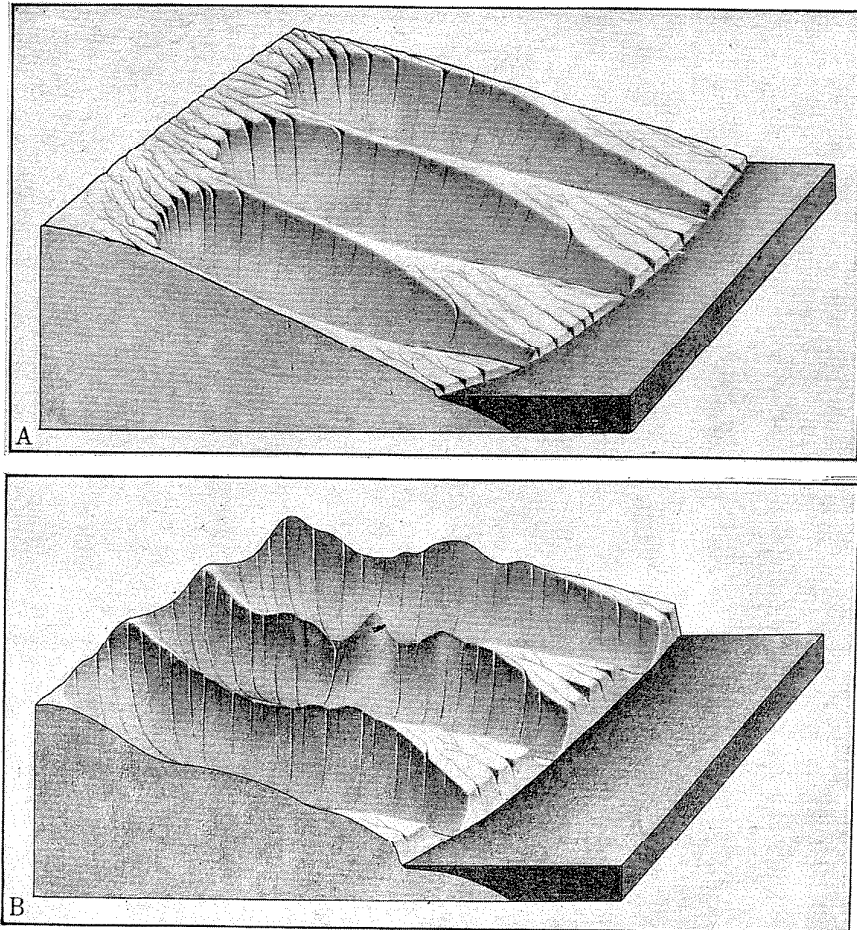

BLOCK DIAGRAMS ILLUSTRATING DEVELOPMENT OF THE
PALI BY EROSION

A, Amphitheater valleys cut in segment of basaltic dome; B, More advanced stage showing removal of interstream divides in the high wet area and the development of high sea cliffs along the coast; C, Beginning of the submergence; D, Final submergence by more than 1200 feet; E, Emergence leaving broad flat valley floors sloping gently seaward and valleys deeply filled with sediments.

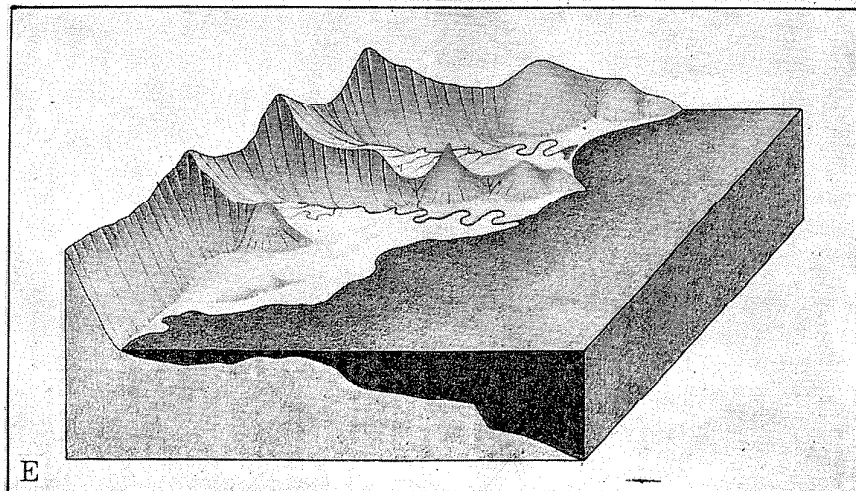
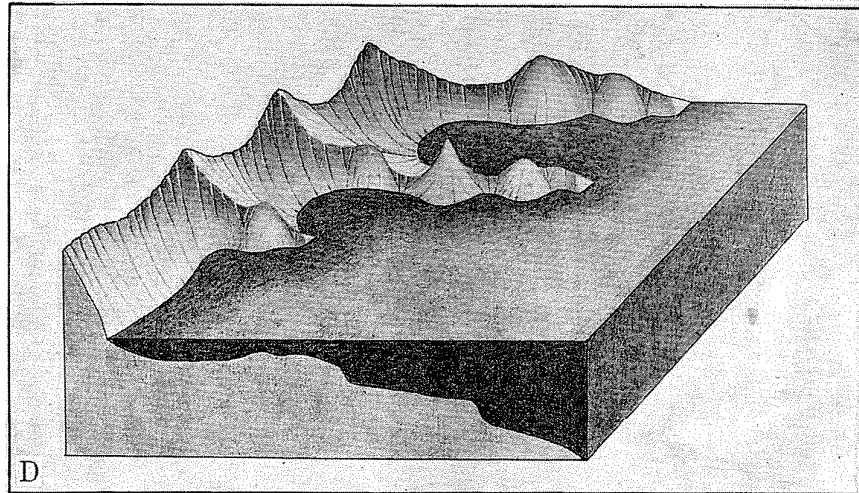
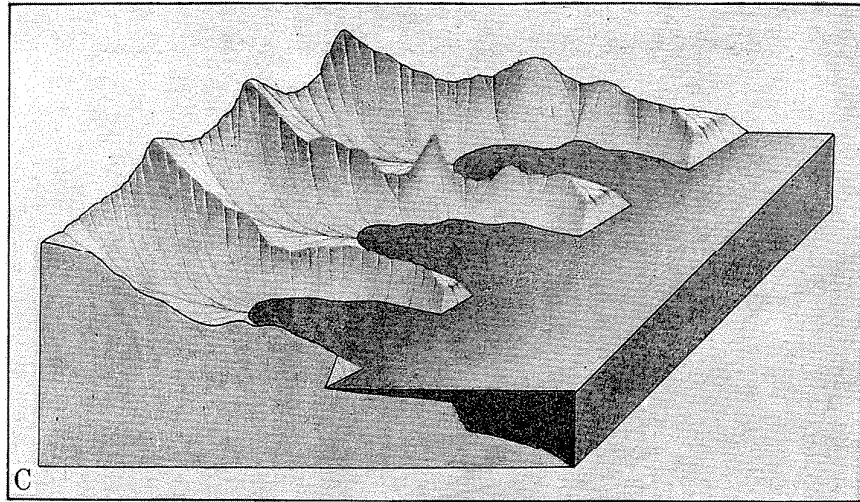

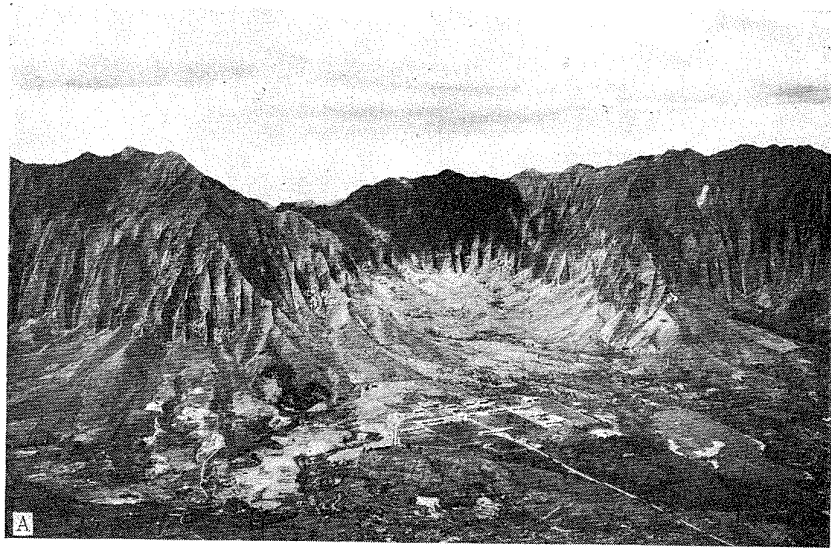

A, THE PALI WEST OF KANEOHE.

Showing the great reentrant at the head of Haiku Valley. The faintly discernible ridge below the insane-asylum buildings is the remnant of an interstream divide. The fairly smooth slopes stretching back to the foot of the Pali are dissected coalesced fans graded to the Kaena stand of the sea. The corrugations in the Pali mark the sites of innumerable waterfalls during rains. Note the white scars of recent landslides.

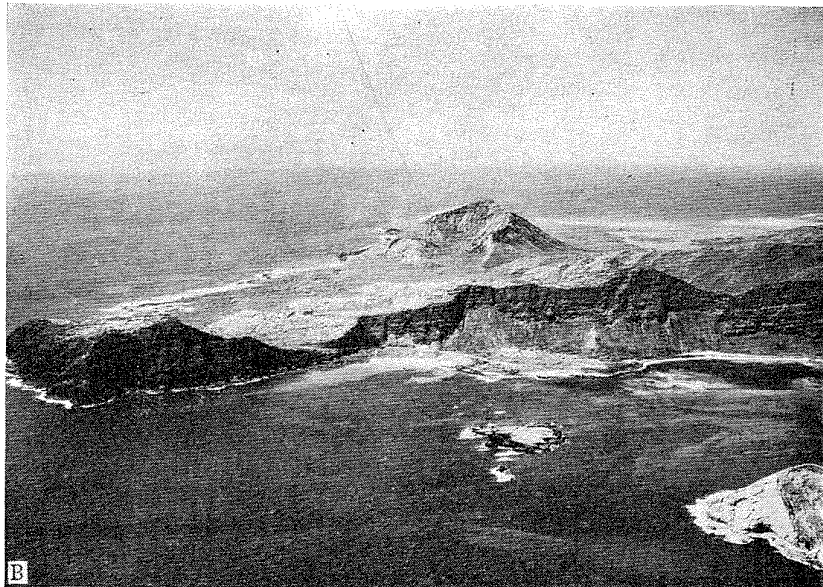

B, THE SOUTHEAST END OF THE PALI.

Originally a product of subaerial denudation, partly submerged and subsequently straightened by marine abrasion. The serrated summit of the Pali is caused by the recession of the Pali and the beheading of leeward valleys. The island in the right foreground is the Manana cone, the island to its left is the Kaohikaipu cinder cone, and in the background is Koko Crater cone. The small platform at the foot of the Pali has been built out of the Kaupo Basalt, which was poured out from a vent in the talus apron. All these volcanic features are relatively recent eruptions along the Koko fissure.

Photographs by 11th Photo Section, Air Corps, Luke Field, T. H.

rainfall at low altitudes on a conical surface, thereby inducing active piracy in the upper parts of the drainage basin and (4) plunge-pool action and landslides removing the divides between tributaries. It is based on the following data:

1. Original slope of the surface. Streams that originally flowed on slopes of about 3° or less have not developed amphitheater-headed canyons. Streams that originally flowed on steeper slopes have developed amphitheaters—for example, Manoa Stream.

2. Alternation of resistant and nonresistant beds, usually dipping down-stream. The nonresistant beds of clinker are undercut beneath the resistant layers of dense basalt and form waterfalls as they are cut backward. These falls increase in height as they follow the dip upstream and tend to coalesce into one high fall. In most of the streams there is a fall point, above which the stream is actively incising its canyon in bedrock and below which the stream is actively cutting laterally. For example, Haiku Stream has a 3.8 percent gradient below the fall line and an 88 percent gradient above the line (dropping 1,500 feet in a horizontal distance of 1,700 feet).

3. Rainfall and stream capture. The streams flowing more or less radially from the center of the dome are spaced relatively far apart in the region of low rainfall at low altitudes. With increasing altitude and rainfall, the streams increase in number, and stream capture becomes dominant (pl. 6, B). Thus the catchment basin of the stream becomes amphitheatrally enlarged near its source. The radial pattern of the drainage on the dome makes this process vastly more effective than it would be on an ordinary linear mountain range. The dominant streams are the first to tap the confined water in the dike complex, and this additional perennial water supply accelerates stream capture by them.

4. Plunge-pool action. Captured tributaries entering a master stream form a rim of coalescing plunge pools about the amphitheater wall at the break in the stream gradient (pl. 7, A). The narrow ridges between the plunge pools are undercut and fail by their own weight, often breaking off during heavy storms along some layer of ash or cinder made weak by saturation and weathering. Landsliding is an active process in Hawaii, but the scars are overlooked because they become covered quickly by vegetation. After the Kona (southerly) storm in November 1930 I counted 14 new landslides in the upper Nuuanu Valley. Streams with low gradients fail to develop high waterfalls, hence are unable to form plunge pools large enough to undermine the intervening divides at the fall line.

Present stage of the valleys.—On Oahu most of the amphitheater-headed valleys are now occupied by streams much smaller than those existing

at the time when the valleys were made. These streams are not competent to remove the landslides, which are reducing the declivity of the walls and aggrading the main valley floors. The heads of youthful amphitheatres on other islands are characterized by exposures of fairly fresh rock all the way to the floor of the valley, and on the floor clean fresh gravel is found. On Oahu, where amphitheater recession is practically ended, the floors of most of the valleys are covered with talus and landslide debris, which form great aprons that extend a considerable way up the slopes of the valley walls, as shown by the mapping of noncalcareous sediments on plate 2. In these valleys, where stream erosion is lessened, chemical and thermal weathering becomes very effective, as shown by the thoroughly rotten condition of most of the older alluvium in the rain belt.

Most of the amphitheater-headed valleys on Oahu have passed from maturity to old age, as shown by the topography on plate 2, because of two factors:

1. Removal of drainage area. The valleys on the northeast (windward) coast became so wide that they eroded the summit of the range to a knife like crest, leaving no appreciable drainage area (pl. 6, A).

2. Decrease in rainfall. At the same time the height of the Koolau dome was reduced by about 1,000 feet by erosion, which greatly decreased the precipitation. The maximum rainfall occurs on windward slopes of Hawaiian volcanoes generally between altitudes of 2,500 and 5,000 feet. Prior to submergence and the reduction of its summit by erosion, the Koolau dome was about 5,000 feet in height, or similar to Kauai, on which an average of 500 inches of rain falls annually. The Koolau summit may therefore have received about double its present rainfall at the time of the erosion of the great valleys. These effects resulted in alluviation, which appreciably modified the former amphitheatres and made them less pronounced, as shown in plate 7, B.

ORIGIN OF THE KOOLAU PALI

The magnificent cliff extending along the crest of the Koolau Range from the east point of Oahu to Kahana Valley is known as "the Pali". The Hawaiian word "pali" means precipice, but when unqualified by a particular place name on Oahu it always refers to the great pali of the Koolau Range. The Pali is a sheer precipice ranging in height from about 500 to 2,500 feet and facing northeast. Except near the east end of Oahu it is not a straight cliff but is decidedly scalloped by a series of great amphitheatres as shown in plate 9, A. Extending northeastward from the buttresses between the main streams are narrow ridges, some of which are separated from the Pali by gaps full of alluvium.

EARLIER THEORIES OF ORIGIN

Dana advanced the view that the Pali was caused by a great fracture or series of fractures with a displacement of not less than 3,100 feet, which dropped the entire eastern part of the mountain. Dutton²⁶ recognized the amphitheatres in the Pali and the ridges to the northeast, reconstructed from these features great valleys in an advanced stage of erosion, and from these observations concluded that the Pali was solely the product of erosion. He did not point out, however, the profound change wrought by alluviation. Hitchcock, Bishop, and Branner followed Dutton, but Davis²⁷ would have the Koolau Range less than half of a former huge symmetrical cone about 40 miles in diameter, the eastern part of which was lost by subsidence, leaving the Pali as a huge fault scarp that has been subsequently modified by erosion. Palmer²⁸ recognized the eccentricity of the dome, and believed that only the northeastern part of the broad east end of the range foundered beneath the sea. Hinds²⁹ prefers to have it the product of faulting and marine abrasion. Thus, faulting, volcanism, and marine and fluvial erosion have been invoked to account for the Pali, but on the basis of the present field study it seems that Dutton was the first to interpret its origin correctly.

Objections to marine theory.—The narrow bedrock ridges of irregular heights shown on plate 2 extending northeastward from the Pali could not have persisted in a sea that formed a marine cliff 2,500 feet high. By assuming that faulting aided marine erosion, the amount of rock to be planed off by the waves is reduced, but the lack of planation of the ridges is still unexplained.

Objections to caldera theory.—The theory that the Pali is only a remnant of a former huge caldera wall, the center of which lies at Mokapu Peninsula, does not stand the weight of the contrary evidence. For instance, such a caldera requires all the dips in the Koolau Range to be southerly. Instead, the dips of the beds in the ridges northwest of Kaneohe Bay are northeast, or toward the caldera. Further, the Koolau rift zone does not radiate from Mokapu Peninsula.

Objections to faulting theory.—If the Pali had been formed by a fault that dropped the northeast side of the Koolau Range at least 3,100 feet, as postulated by Dana, then the rocks at the base of the Pali should be similar to those at the top and consist of layers of flow lava. Instead of bedded lava flows in the ridges at the base of the Pali, dikes are so numerous that in some exposures they replace the flow lavas. A

²⁶ Dutton, C. E., Hawaiian volcanoes: U. S. Geol. Survey 4th Ann. Rept., pp. 214-217, 1884.

²⁷ Davis, W. M., The island of Oahu: Jour. Geography, vol. 22, no. 9, p. 356, 1923.

²⁸ Palmer, H. S., The geology of the Honolulu artesian basin: Honolulu Sewer and Water Commission Suppl., p. 26, 1927.

²⁹ Hinds, N. E. A., The relative ages of the Hawaiian landscapes: California Univ. Dept. Geol. Sci. Bull., vol. 20, p. 186, 1931.

dike complex such as this is exposed only after a rift zone has been denuded several thousand feet.

THEORY OF STREAM EROSION

Stream erosion will satisfactorily explain all the features of the Pali. Five stages in its development are illustrated in plate 8. The form and character of the main rift zone and the dips of the lava beds indicate that the completed Koolau dome in relation to present sea level was roughly canoe shaped and about 40 miles long from northwest to southeast and about 15 miles wide along the axis through Nuuanu Valley and Mokapu Peninsula. During a long cycle of erosion the streams on the northeast (windward) side slowly carved out great amphitheatres, which gradually coalesced at their heads while the sea battered back the ends of the divides. The cliffs at the ends of these divides between Kaaawa and Kahana Valleys are about 750 feet high and, although somewhat modified by subaerial weathering and reduced in height by submergence, are a measure of the amount of marine abrasion during this period. Numerous cliffs over 700 feet high, undoubtedly the product of marine abrasion, occur on the north coast of Maui and on other islands of the group and indicate that sea cliffs of this height are not unusual in the Hawaiian Islands.

Effect of ground water.—The present position of the Pali is somewhat southwest of the former crest of the dome. High level water discharges all along the Pali wall in the form of large springs. These springs, as shown by the Waiahole tunnel, derive a considerable part of their flow from the southwest (leeward) side of the crest. As the valleys on the northeast side were deeper they captured the ground water that normally would have been tributary to the valleys on the southwest. Thus the springs tumbling down the Pali were able to undercut the Pali wall and remove the landslide debris long after little surface drainage remained. This process, accompanied by landsliding of the steep Pali wall, has diverted some of the westward-flowing streams to the east side, such as the head of Nuuanu Stream.

Effect of submergence.—The alluviation that accompanied the drowning of the valleys by more than 1,200 feet after the amphitheatres had coalesced obliterated numerous smaller ridges and many of the main interstream divides near their heads and produced a continuity in the Pali that otherwise would not have been so apparent. This submergence was so gradual that concurrent erosion decreased the declivity of the Pali and further subdued the interstream divides (pl. 8, C, D).

Effect of marine abrasion.—On the southeast end of the Pali, where the interstream ridges were lower and hence completely submerged, the ocean waves battered back the buttresses between the amphitheatres

and produced a straight scarp, which has lost all marks of its former subaerial erosional history, as shown by plate 8, D, and the airplane view in plate 9, B. Without the record of erosional history left by the partly submerged valleys farther northwest, this cliff might be interpreted as a great fault scarp or marine cliff. The great scarps on the coasts of some of the other Hawaiian islands, which have been explained by faulting, might well be reexamined with this history of the Pali in mind.

Effect of caldera.—An elongated caldera a mile or two in diameter was apparently present on the summit of dome, as indicated by the throat breccia near Kaneohe shown on plate 2. Such a depression would have reduced the amount of rock required to be removed by fluvial processes, but the stream pattern now outlined by bedrock ridges does not show its influence. In fact, the throat filling of rubble is now more resistant than the extrusive and intrusive rocks, as shown by the fact that it forms ridges. The caldera appears to have resulted finally in high rather than low topography.

RELATION OF EROSION TO RECOVERY OF GROUND WATER

The long cycle of erosion that produced the Pali has exposed water-confining dikes and cut through enough of them to give rise to numerous large perennial springs. Had this erosion not taken place, the water confined by the dikes of the rift zone, even though in an area of heavy precipitation, might have been too far beneath the mountain to be economically tapped by tunnels, and ash beds and other perching structures if present could not have been located except by expensive borings.

WAIANAE RANGE

PRESENT FORM

The Waianae Range is about 20 miles long and 9 miles wide and forms the western part of Oahu. The western tip of the range and of the island is Kaena Point. As shown by the relief map in plate 1, the crest of the range is distinctly convex to the northeast. Mount Kaala, the highest point, is 4,025 feet above sea level and is the highest point on Oahu. (pl. 4, B).

The earlier flows have dips comparable to those in the Koolau Range, but the later ones, being more massive, came to rest with dips of 10° to 20° , making the final Waianae dome steeper than its Koolau neighbor. Near the seaward end of the Makaha-Keaau Ridge the lava beds have dips as high as 65° where they have cascaded over an unconformity.

The striking features of the Waianae Range are the great flat-floored valleys that indent its western slope and the high, corrugated

and serrated precipice that joins the heads of these valleys. The eastern slope is more gradual and is fluted with relatively small, narrow valleys not at all comparable with those on the opposite side except for the reentrant, now nearly filled with Koolau lavas and alluvium, in which Schofield Barracks is located.

The narrow crest of the range is traversable, except for a few transverse cliffs, which can be skirted, and there are several trails over the range. The road from Schofield Barracks to Waianae through Kolekole Pass is the only one that crosses the crest, and it is too steep for automobiles to ascend the west side.

ORIGIN OF MOUNT KAALA

Mount Kaala lies about $9\frac{1}{2}$ miles from the northwest end of the range and about 12 miles from the southeast end. It is not a peak but a subcircular plateau about a mile across, notched by several small streams. (pl. 4, B.) Except where four narrow ridges radiate from it, the plateau is bounded by precipices 1,000 to 2,000 feet high. The largest of the streams tumbles into the head of Makaha Valley, forming a waterfall 1,000 feet high. A swampy forest covers the plateau, but in the stream beds and in the cliffs surrounding it nearly horizontal and unusually massive lava beds are exposed. It appears that the plateau is caused by the resistance of these massive beds to erosion.

ORIGIN OF WAIANAE PALI

Present form.—As shown on plate 2, the west side of the Waianae Range consists of a pali somewhat higher than the Koolau Pali but less continuous because the interstream divides are higher. These large valleys, named in order from southeast to northwest, are Nanakuli, Lualualei, Waianae, Makaha, Keaau, and Makua. A view of one of these valleys is shown in plate 7, B.

Form prior to submergence.—A well near the village of Waianae passed through about 1,000 feet of sediments, and another well near the geographic center of Lualualei Valley penetrated 1,200 feet of valley fill, indicating that these valleys have been submerged more than 1,200 feet, like those in the Koolau Range. If the thick sediments were removed a series of great amphitheater-headed valleys would be revealed similar to those which formed the Koolau Pali. The isolated ridges, such as Puu o Hulu and Puu Mailiilii, would then become parts of ridges bounding smaller amphitheater-headed tributaries to the main valleys. The stage of erosion that had been reached prior to the submergence was so far advanced that the interstream divides near the heads of the valleys were cut lower than the seaward parts, and the result was the partial coalescence of the amphitheaters. This con-

dition was brought about by the higher rainfall and consequently the greater erosion at the heads of the valleys as compared with their seaward ends. If, before subsidence, erosion had progressed still further, then the interstream divides would have been cut even lower, and the final result would have been a precipice more like the Pali on the Koolau Range. The interstream buttresses on the northwest end of the Waianae precipice have been eroded away by the ocean, leaving a straight cliff 2 miles long. The small reentrant northwest of Makua Valley is the head of a former amphitheater-headed valley which, through submergence and marine erosion, has been nearly obliterated.

The fault theory.—Several geologists³⁰ have put forth the theory that the Waianae Range is only about half of a former nearly circular dome, the southwestern half having subsided beneath the ocean along a fault near the site of the present coast, and that the large valleys were caused by the erosion of this fault scarp.

Objections to fault theory.—The lava beds on the southwest side of the crest have westerly dips, indicating that they came from a source near the highest part of the range and not from a point out at sea. Further, the rift zone from which the lavas issued lies along the crest of the present range (pl. 2) and not out at sea.

The fault theory also requires the summit caldera to be out at sea. In Puu Kailio, at the head of Lualualei Valley, there is a throat breccia that accumulated within a caldera depression. It is shot through with dikes, and all the lavas of the Waianae Range dip away from this place—facts which show that it lay at the center of Waianae activity. It seems likely, therefore, that the unusually large size of Lualualei Valley as compared with others in the Waianae Range is due in part to its tapping the caldera. The presence of a caldera at the head of Lualualei Valley does not, however, explain the rest of the large valleys on the leeward slope of the Waianae dome.

Author's theory.—In the section "Waianae volcanic series" a distinct angular unconformity and an erosional unconformity in the Waianae Range are described. Collapse of the northeastern part of the dome in the early history of the range apparently allowed streams to erode the western slope, while lavas were being extruded on the eastern slope. Thus the valleys on the west side are a great deal older than those on the east side. In addition to this difference in age, the western streams were favored by traversing weaker rocks than the eastern

³⁰ Dana, J. D., *Geology*, in U. S. exploring expedition, 1838-42, vol. 10, p. 259, 1849.
 Davis, W. M., *The island of Oahu: Jour. Geography*, vol. 22, no. 9, p. 356, 1923.
 Palmer, H. S., *The geology of the Honolulu artesian system: Honolulu Sewer and Water Commission Rept., Suppl.*, p. 26, 1927.
 Hinds, N. E. A., *The relative ages of the Hawaiian landscapes: California Univ. Dept. Geol. Sci. Bull.*, vol. 20, no. 6, p. 183, 1931.

streams, and because of the greater depth of their valleys they had tapped perched ground water when the eastern streams had scarcely started to flow.

It is exceedingly unlikely that these great valleys on the west side could have been carved out under present conditions of rainfall. The west side is now virtually a cactus-kiawe desert, and the rainfall on Kaala is only about 110 inches annually. Hitchcock³¹ presented the most plausible explanation of the present relative low rainfall. He pointed out that the Waianae Range doubtless received heavy precipitation until the Koolau Range reached sufficient height to intercept the moisture-laden trade winds that formerly impinged against the older range.

CAUSE OF CONVEX SHAPE OF WAIANAE RANGE

Because much of the early Waianae land mass was bounded by eastward and northward-facing cliffs, the later Waianae flows were in general ponded on the west by these cliffs and were forced to flow northward and eastward. This condition, together with the fact that the main rift zone was curved, explains the building of an asymmetric land mass.

WAIANAE CINDER CONES

Five cinder cones occur on the southeast slope of the Waianae Range, three well preserved and two more or less dissected. They are shown on plate 2 as Puu o Kapolei, Puu Palailai, Puu Makakilo, Puu Kapuai, and Puu Kuuu. The state of preservation of these cones led Hitchcock to correlate them with the post-Koolau cones. They are older than the adjacent Koolau flows because their flows pass beneath the Koolau rocks, and cones of similar age antedate the cliff at the head of Nanakuli Valley. The cones represent the last eruptions of the Waianae Range, and their persistence in so fine a state of preservation can be accounted for only by continual aridity in this area since their formation. Close examination of the area shows that they have suffered erosion, however, comparable to that of the adjacent Waianae slopes, especially when their porosity is considered. Puu o Kapolei is now hardly more than a lava plug, because the cinders that formerly capped it have been practically all removed by erosion. Part of its denudation may be due to its proximity to the coast, where it could have been attacked by former high stands of the sea.

Although these cones antedate the adjacent Koolau flows, they are probably not older than the bulk of the Koolau dome, hence they may have been sheltered from trade winds by the Koolau dome ever since

³¹ Hitchcock, C. H., *Geology of Oahu*: Geol. Soc. America Bull., vol. 11, p. 24, 1900.

they were formed. Their fine preservation in spite of their great age is a striking illustration of the effects of climate upon erosion, for they have persisted during the long epoch while the great valleys on the Koolau dome were carved, and they have even outlived some of the post-Koolau cones.

THE NORTH COAST PRECIPICE

The north coast of the Waianae Range consists of a great escarpment 750 to 1,000 feet, high as shown in plate 10, A. Above it lies a sloping upland that closely parallels the original flow slopes but seems to be considerably modified by erosion. Great talus aprons mantle the lower two-thirds of the cliff, and deep notches have been cut into it by ephemeral streams. Both of these features indicate that it is not of recent origin. It lacks the scallops so typical of the great precipices made by coalescing amphitheater-headed valleys; hence it is the result of either faulting or marine erosion. As no evidence to support the faulting hypothesis was found, this cliff is probably the work of the sea during some former period. It is no higher than many other obvious marine cliffs in the Hawaiian Islands, and its height is comparable to that of the cliffs cut on the ends of the spurs on the northeast coast of Oahu. As it was exposed to wave attack even before the Koolau spurs, there has been ample time for the ocean to remove this segment of the dome. The arid parts of the Waianae Range, which have been affected by so small an amount of fluvial erosion, stand in strong contrast to this great feature, which is apparently solely the product of marine abrasion. Probably nowhere else are there more profound differences in the rates of fluvial and marine erosion than are found in these volcanic islands of the marginal coral seas, where an annual rainfall of 300 inches may occur within 3 or 4 miles of places receiving 20 inches or less. The tendency of the newcomer is to postulate catastrophic processes to account for the great differences in topography, but the effectiveness of the normal everyday work of streams and waves as the great agents of destruction is apparent on longer observation.

SCHOFIELD PLATEAU

FORM

The Schofield Plateau lies between the Koolau and Waianae Ranges. It is about 14 miles long and 5 miles wide and rises from the vicinity of sea level on the south and north sides to an altitude of about 1,000 feet at Schofield Barracks. Kipapa, Waikakaloa, and Waikele Streams have incised narrow canyons over 300 feet deep in the south side, and Kaukonahua, Poamoho, and Opaepa Streams have cut similar

canyons in the north side. (See pl. 10, B.) The dips of the lava beds in the plateau are almost invariably less than 5° and rarely more than 3° , and the surface of the plateau has essentially the same slope as the former lava-flow surfaces. Erosion of the interstream areas has been small and has proceeded downward by practically stripping layer by layer. Here and there on the surface of the plateau are clusters of large dense boulders, which are erosional remnants of the massive part of lava flows.

WEATHERED CONDITION OF SURFACE

The weathering of the basalt on the plateau has reached depths of 50 to 100 feet, and in most places there is 5 to 10 feet of soil cover. The surface of the plateau consists of dark-brown alluvial soils and red lateritic residual soils. Field study has shown that on the plateau area the red color characterizes residual soils on the Koolau flows and that the brown and red-brown colors are limited to the ancient alluvial fans and to transported soils. Where the alluvial soil is shallow or has been cut deeply by streams, the brown color gives way to ashy gray, whereas on the Koolau flows the red soils change to tan with depth. These color differences proved very valuable in differentiating the Koolau lavas from the older alluvium.

ORIGIN

Dana early pointed out from geomorphic evidence that the plateau had resulted from the ponding of the lava streams from the Koolau Range against the eroded slope of the Waianae Range. Plate 2 shows very clearly how the normally westward flowing streams from the Koolau Range were diverted southward on the south side of the Schofield divide and northward on the north side by the pattern of the lava flows, which had been similarly diverted by the Waianae Range.

DEVELOPMENT OF STREAM PATTERN

That the Waianae Range had a well-developed stream pattern when the Koolau lavas were poured out to form the plateau is shown by the fact that these lavas occupy a former amphitheater-headed valley behind Schofield Barracks. Further as shown by plate 2, the plateau has received enormous deposits of detritus from the Waianae Range. At first the streams flowing down the Waianae slope, on reaching the porous Koolau lava flows, diminished rapidly by leakage and lost their load of debris. Even after the streams were able to cross the Koolau lavas, so sharp a change in grade remained that most of the stream load was deposited in this area. During this time a great series of coalescing fans were constructed as the streams

worked their way across the plateau to join the Koolau rivers. The Koolau streams had large rainy drainage basins and soon became deeply entrenched in the plateau. With the excavation of these Koolau canyons, the baselevel of the Waianae tributaries was continually lowered, and this led to the destruction of the Waianae fans. As shown by plate 2, most of the Waianae streams have now cut through the alluvium into the Koolau lavas in their lower stretches, but none of them have cut deep enough in their upper courses to expose the contact of the Waianae and Koolau lavas. North of the Schofield Barracks reentrant alluviation was slight, and Kaukonahua Stream coming from the Koolau Range, has exposed the contact of the two lavas for several miles.

A pronounced steepening of the slope of the plateau occurs at the north and south ends adjacent to the Waianae Range, as shown by the contours on plate 2. The profile of the Koolau surface adjacent to the Waianae Range and Kaukonahua Stream shown in figure 2

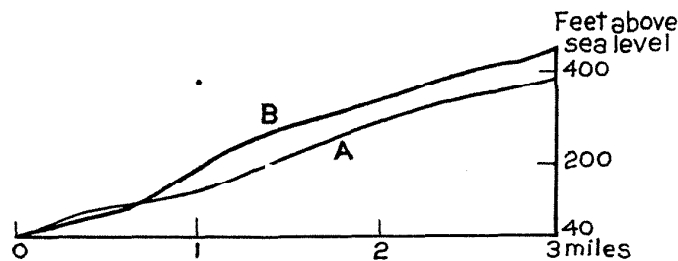

FIGURE 2.—Profile of surface adjacent to Anahula Stream (A) and Kaukonahua Stream (B).

has a steeper slope between altitudes of 60 and 240 feet than is found farther away, as illustrated by the profile near Anahula Stream. These local steepenings appear to be the result of the veneering of ancient marine cliffs along the Waianae shores by the Koolau flows.

COASTAL PLAIN

Along most of the shore of the island of Oahu is a coastal plain (pl. 10, A), which reaches its maximum width of nearly 6 miles at Pearl Harbor, in the reentrant between the Koolau and Waianae Ranges. The plain is interrupted or very narrow at the ends of some of the mountain spurs and near the east and west tips of the island. It is this coastal plain that has made Oahu the commercial center of the Hawaiian Islands, because it has provided excellent harbors and extensive areas of splendid agricultural land, has made highways far less costly, has given to Oahu its great artesian basins.

The plain ranges in altitude from sea level to about 80 feet, but its upper boundary at the mouths of valleys is indefinite where it merges

into the alluvium of the valley floors. It consists essentially of reef limestone and noncalcareous marine sediments, in places augmented by stream deposits and hill wash.

On both the north and south coasts of southeastern Oahu several secondary volcanic cones rise above the level of the plain, and these pyroclastic deposits have added locally to its width. The areal distribution of the various rock types on the surface of the coastal plain and its topography are shown on plate 2. Well logs indicate that these coastal-plain sediments reach a thickness of at least 1,200 feet and that they are thinner at the ends of spurs than at the mouths of valleys.

The coastal plain when examined carefully shows several terrace levels and sufficient unconformities to indicate that it is the product of several shifts of the sea and not a single emergence.

MARINE FEATURES

THE LIVING REEF

Oahu lies at the margin of the coral seas, where only slight cooling of the water is necessary to inhibit the growth of coral. Consequently, although coral and other reef-building organisms live here, they do not flourish as they would in warmer waters. Investigators have demonstrated that the growth of a reef depends upon temperature, water circulation, food supply, intensity of light, character of ocean floor, silt, salinity, and depth of water. It is beyond the scope of this paper to go into this subject³²

Pollock shows that the reefs, both living and fossil, have a much smaller percentage of coral than of the lime-secreting algae known under the general name "Lithothamnium."

The fringing reef of Oahu ranges from a half mile to 3½ miles in width but it is absent on steep shores like those near the east and west points of Oahu and near youthful volcanic features such as the Koko Craters. Kaneohe Bay has the best development of coral. In this bay the coral colonies reach within a few inches of mean sea level, but the water between the colonies, as shown by detailed soundings by the United States Coast and Geodetic Survey, varies only a few feet from a depth of 45 feet, indicating that they are growing on a remarkably level platform.

Age of the reef.—Plate 2 shows extensive areas of emerged reef forming the shore of Oahu. The sea is constantly at work beveling this reef down to the level of the fringing reef platform. The fringing reef of Oahu, although supporting living lime-secreting organisms,

³² For details the reader is referred to Edmondson, C. H., The ecology of an Hawaiian coral reef: B. P. Bishop Mus. Bull. 45, 1928. Pollock, J. B., Fringing and fossil coral reef of Oahu: B. P. Bishop Mus. Bull. 55, 1928. See also the bibliography in each of these books.

is not entirely the product of the present stand of the sea. The last established shift of the sea (see p. 48) was downward and amounted to about 25 feet. Any reef that was growing in the sea at that time and was 30 feet below sea level is now within 5 feet of present sea level. Because of the planing down of old reefs and the lowering in sea level it is impossible to determine just what percentage of the existing reef grew in the present sea.

Protection afforded by reef.—The reef protects much of the shore from the attacks of heavy waves, because the combers break on the *Lithothamnium* ridge at the outer edge of the reef. In general, the depth of the water between this ridge and the shore is 5 to 10 feet. Wherever the reef is present marine erosion is somewhat complicated, because during storms the water may pile up to a level where the great waves will pass completely over the *Lithothamnium* ridge and break on the shore. Further, the intensity of wave attack on the shore varies with the width of the fringing reef, and a set of shore features produced in one place may be absent in another.

SUBMARINE SHELVES

Submarine shelf at 60 to 90 feet.—Several profiles of the ocean floor outside the *Lithothamnium* ridge between Barbers Point and Koko Head and several profiles of the reefless coast southeast of Kaena Point are given for comparison in figure 3. They show a pronounced shelf

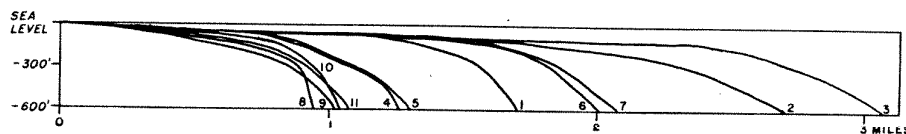
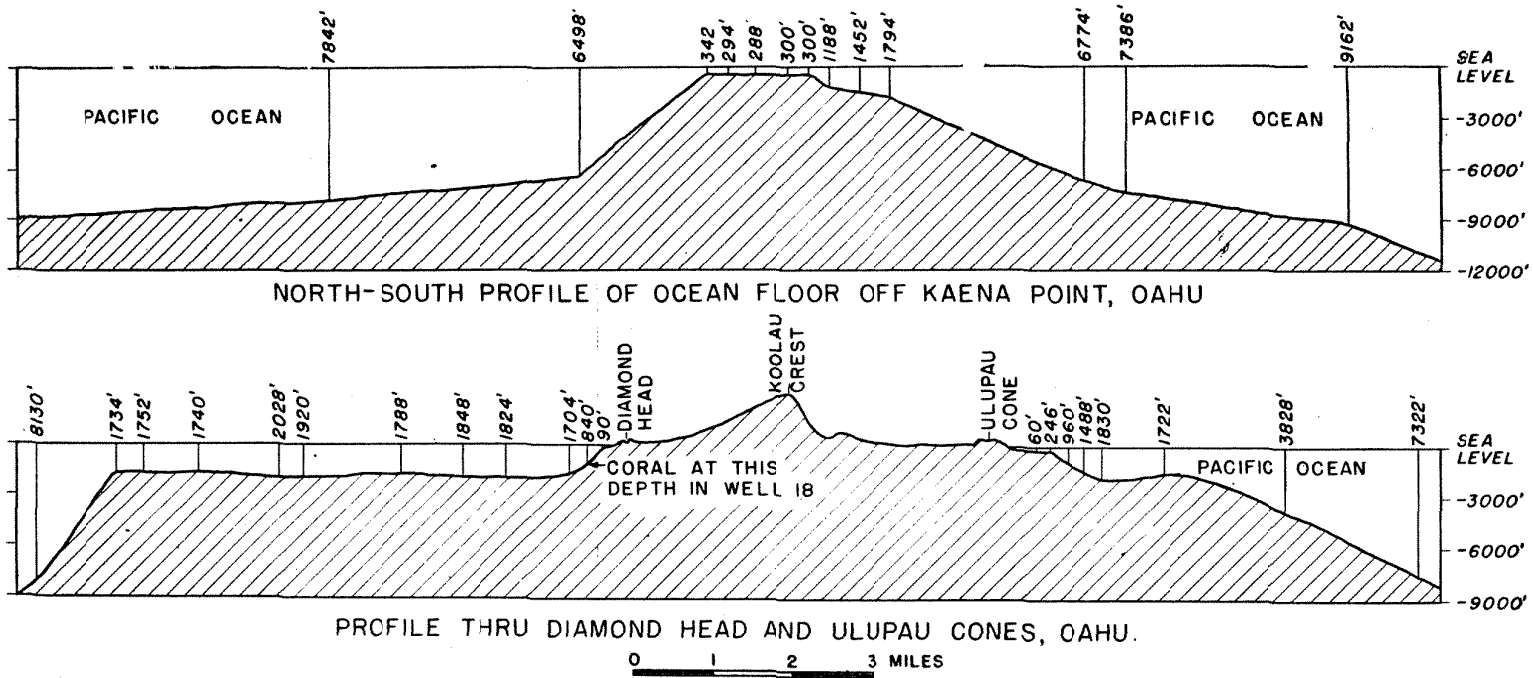

FIGURE 3.—Profiles of the ocean floor seaward from the *Lithothamnium* ridge near Barbers Point (1 to 5) and near Honolulu (6 and 7) and of the reefless ocean floor southeast of Kaena Point (8 to 11).

half a mile to 2 miles wide, extending seaward to a depth of about 90 feet and profiles of the sea bottom adjacent to the rest of the major islands indicate that this shelf is a characteristic of the Hawaiian group. Beyond this depth the sea floor drops off steeply to a lower bench. The question arises whether the prevalence of this shelf on both reef and reefless coasts indicates that it is the normal ocean profile of equilibrium or whether it indicates a submerged and slightly modified coastal plain or reef produced at some lower stand of the sea. Submerged tree molds, submerged lithified dunes, and submerged buried soils show that the sea has stood lower during relatively late geologic time. Partly drowned lithified dunes extend nearly to the edge of the shelf in Laie Bay and strongly suggest that the

FIGURE 4.—Profiles showing the 300- and 1,800-foot submarine shelves off Oahu.



platform is a submerged coastal plain. The present ocean floor near land, with its attendant reef features, presents a complicated history, and rates of growth of living coral cannot be safely extrapolated to determine the age of the fringing reef of Oahu on the basis of its present thickness.

Submarine shelf at 300 to 360 feet.—At a depth of 300 to 360 feet another submarine platform occurs. It is more than a mile wide in places, as shown by the profile of the ocean floor off Kaena Point (fig. 4) and is prevalent on the shores of most of the other islands. Perhaps it is this bench veneered with marine deposits that forms the broad 180-foot shoal known as "Penguin Bank," northwest of Molokai. Evidence given elsewhere⁴² suggests that it is a submerged platform of abrasion. The logs of the wells in the Honolulu area, especially wells 46, 57, 59, and 73, show a wide bench at a depth of 300 feet cut in Koolau basalt.

Submarine shelf at 1800 feet.—A bench varying only a relatively small amount from 1,800 feet below sea level occurs seaward from the 300-foot bench described above. It likewise surrounds most of the other islands and is about 6 miles across off Diamond Head, as shown in figure 4. Evidence given elsewhere⁴² suggests that it is a drowned reef that formerly surrounded all the older islands.

TYPES OF BEACHES

The beaches of Oahu are classified on the basis of the preponderance of the different kinds of material of which they are composed. Named in order of their area the most extensive first, they are calcareous sand beaches, lava-cobble beaches, noncalcareous-silt beaches, olivine-sand beaches, and tuff-cobble beaches. In view of the nearly continuous fringing reef it is obvious that some calcareous sand is found intermixed with the material of the beaches of all types. The calcareous-sand beaches greatly predominate and are the only ones of sufficient extent to be shown on plate 2. The identification of the various emerged beaches of Oahu is based in a large measure upon comparison with these modern beaches.

Calcareous-sand beaches.—Calcareous-sand beaches, of which Waikiki is typical, have made Oahu famous for bathing. They are composed principally of comminuted shells, coral, coralline algae, foraminifers, and echinoderm spines. The scarcity of unbroken and unwaterworn large shells on the beaches indicates the efficacy of marine corrasion. Most of the sand grains are from 0.5 to 2 millimeters in size.³³ The beaches extend generally to 10 feet above sea level but almost nowhere over 20 feet. The upper few feet of many of the beaches shown on

³³ Wentworth, C. K., *Pyroclastic geology of Oahu*: B. P. Bishop Mus. Bull. 30, p. 114, 1926.

plate 2 consists of wind-blown sand too small in area to be differentiated on the map.

Sand islands occur at the mouth of Kaneohe Bay, where the reef approaches a barrier reef in character. Barrier beaches block the mouths of many of the rivers, as shown in plate 5, B. The largest beach deposit on Oahu is about $2\frac{1}{2}$ miles long and 1 mile wide. It forms the shore of Kailua Bay and blocks the mouth of two large valleys, thereby causing the Kawainui and Kaelepulu lagoonal swamps. The barrier beach that causes Kuapa Pond, near Koko Head, is laid against an ancient Hawaiian fish-pond stone wall, hence is a deposit made largely since Hawaiian occupation. Nearby is a typical sand spit. Offshore and bayhead bars occur here and there, and sand deposits project from the southwest side of Manana and Mokulua Islands.

Lava-cobble beaches.—Lava-cobble beaches are found chiefly at the mouths of certain large streams on the northeast coast, along the reefless parts of the coast, especially near Makapuu and Kaena Points, and where rocky spurs and late Koolau flows project into the sea. They are too narrow to be shown on plate 2 and usually do not cover the subjacent lava rock. In fact, many of them occur at storm-wave level, 5 to 10 feet above sea level, and bedrock is exposed between them and the sea. Waterworn boulders reaching 3 feet in diameter are not uncommon.

Noncalcareous-silt beaches.—Noncalcareous-silt beaches are typical of the inner shores of Kaneohe Bay and Pearl Harbor and occur also on the ends of some spurs of weathered rock on the northeast coast. Considerable silt is washed into Pearl Harbor and Kaneohe Bay during each storm, and this material, instead of being carried out to sea as along the parts of the coast where the waves are more turbulent, drops to the floor of the quiet bays and is later worked shoreward. Probably of even greater importance in the formation of silt beaches in this area is the fact that the waves at the heads of these bays are working on noncalcareous sediments and deeply weathered rocks. The notable thing about the Kaneohe shore is the presence of numerous angular and subangular rock fragments among the silt. They are mostly small joint blocks derived from the dikes exposed here and there along the shore and evidently drifted laterally by longshore currents. Well-preserved shells, although rarely abundant, occur in beaches of this type, and a few subrounded fragments of coral, evidently tossed upon the beach by unusual storms, were noted. In several places on Mokapu Peninsula remnants of emerged partly eroded beaches of this type occur. The silt has been washed away, leaving concentrates of angular fragments of rock, a few loose shells, and fragments of coral rock.

Olivine beaches.—Olivine beaches are green to greenish tan, the color depending upon the amount of admixed calcareous sand. They occur along the shores of all the tuff cones and usually contain streaks of black magnetite sand.

Tuff-cobble beaches.—The tuff-cobble beaches are few and occur chiefly around Ulupau and Diamond Head tuff cones. They result from waves working on the talus from these cones. The tuff blocks are weak and are readily rounded.

LITHIFIED BEACHES

Lithified calcareous beaches and cemented lava-cobble beaches form a considerable part of the coast of Oahu at present sea level. Ostergaard³⁴ reports that they contain no shells that are not present in the modern beach. As a rule they are much more poorly consolidated than the older emerged beaches, although in some places they have provided satisfactory building stone. In general they show good bedding parallel to the adjacent unconsolidated beach sediments. No attempt was made to differentiate them on plate 2 from the older consolidated calcareous marine sediments, nor to map them where they form outcrops exposed at low tide or as narrow strips a foot or two wide. They rarely extend over about 3 feet above mean sea level, and it is fairly certain that they were made during the present stand of the sea. In places, however, they cling to emerged reef deposits where they are not easily differentiated. In many places they are now being destroyed or planed off by the waves. I have observed similar beaches on Maui, and they are reported from many other coasts; hence they are not peculiar to Oahu.

Branner³⁵ explains the hardening of Brazilian beach rock (1) by carbonated rain water dissolving out the lime carbonate in the upper portions of calcareous sands and depositing it in the lower portions; (2) by the escape of carbon dioxide from the sea water when the surf breaks upon the beaches; (3) by the escape of carbon dioxide from sea water where it is warmed by the tropical sun; (4) by the submarine escape of carbon dioxide about volcanic vents. He also states that these four processes do not seem competent to account for the lithification of beaches behind older reefs, for which he gives a fifth explanation:

In a region of concentrated rainfall and long droughts, the river mouths become temporarily closed, and the abundant aquatic and other life in the lagoons thus formed contribute to the organic acids of the waters, which, upon penetrating the wall or dam of beach sand, first dissolves the lime and then redeposits it when it

³⁴ Ostergaard, J. M., personal communication.

³⁵ Branner, J. C., The stone reefs of Brazil: Harvard Coll. Mus. Comp. Zoology Bull., vol. 44, p. 196, 1904.

comes in contact with the dense sea water on the ocean side. In this manner some portions of the beaches have been hardened while others have remained incoherent.

Field's explanation of the Florida beach rock³⁶ is essentially a combination of certain parts of the first and fifth theories of Branner, except that he specifies severe storms and the absence of putrefying organic matter.

Daly³⁷ noted that two beaches built during hurricanes in Samoa became lithified within a year. By analysis he found that sands of the ordinary beach are washed free of organic matter, but sands collected from the reef shelf contain roughly 5 percent by weight of organic matter. Such sands with their organic matter are tossed upon the beach only by severe storms. Subsequent bacterial decomposition of the organic material would tend to cause a precipitation of calcium carbonate from the sea water and possibly cement the grains sufficiently to prevent differential movement and permit the sand to serve as a nucleating agent. Heating of the saturated sand at low tide would cause the escape of carbon dioxide and the precipitation of calcium carbonate. This process of cementation might be further supplemented by supersaturation induced by aeration of the interstitial water caused by breakers forcing air through the sand.

Hurricanes do not occur on Oahu, but unusually severe storms might toss up sand containing sufficient organic matter to start the process. Certainly most of the lithified beaches are on exposed parts of the Oahu coast. However, lithified beaches might have various modes of origin. The large barrier beach at Kailua is not lithified, even though fresh water doubtless containing organic acids is percolating through it from the adjacent Kawainui Swamp. (See pl. 2.) A mile farther north, on the same Kailua Bay, a beach separating the ocean from a lagoon is lithified. Perhaps this beach receives more sand during storms. However, it seems more than a coincidence that most of the lithified beaches on Oahu are between lagoons and the sea or at places where large volumes of ground water are flowing into the sea. Sand containing organic matter may be necessary to initiate the process, as Daly points out, but percolating ground water, with perhaps a different temperature from that of sea water, may greatly aid the hardening. Lithification does not occur higher in the beach than the height of the capillary fringe of the water table. Perhaps this is a coincidence, but an observation bearing directly on this subject was made in the drainage ditch cut through the beach ridge seaward from Waimanalo. In this ditch partial lithification has extended to the top of the capillary fringe above the water table but no higher. The beach

³⁶ Field, R. M., Carnegie Inst. Washington Yearbook 18, p. 198, 1919.

³⁷ Daly, R. A., The geology of American Samoa: Carnegie Inst. Washington Pub. 340, pp. 139-140, 1924.

ridge has not received storm sands for a long time, as large trees are growing on it. Perhaps this vegetation is supplying the necessary organic acids.

Observations on Maui show that on arid coasts cobbles can become cemented together by spray alone. Some historic artificial rock platforms have become naturally cemented along La Perouse Bay. Similar cementation was noted on Kupikipikio Point, near Diamond Head, Oahu. It is probable that the lithified cobble beaches along the shore near Kcana Point were formed in this manner, although they may be remnants of an ancient emerged beach.

BENCHES

Two distinct benches occur along most of the shore line of Oahu. The lower bench extends from a little below mean sea level to several feet above and is awash except during low tides in calm weather. The upper bench averages about 5 feet above mean sea level at its seaward edge but in places reaches a height of about 10 feet. The upper bench has been described by Wentworth and Palmer³⁸ as of eustatic origin, caused by the general lowering of ocean level 12 to 15 feet, but all occurrences of this bench can be remnants of a submerged bench cut during the Waimanalo stand, when the sea was 25 feet higher than now (see p. 48), except on the Koko fissure and Manana Island tuffs, which are shown in the following pages to have been erupted after the 25-foot sea had receded. The origin of these benches is very complex and has been discussed elsewhere.³⁹

TERRACES

The streams of Oahu where they flow through alluvium are flanked by conspicuous terraces. Along the northeast coast from Kaneohe to Waikane and on the south coast around Pearl Harbor these terraces are especially well developed and are of sufficient areal extent to show by contours on plate 2. These terraces are carved out of fan-delta deposits graded to various high stands of the sea. The shore ends of the fans merge into marine delta deposits that are not distinguishable from the stream deposits because of the lack of fossils. The terraces slope seaward along the axes of the valleys but are horizontal parallel to the coast. The most prominent terrace is 50 to 100 feet above its stream, the height depending on its distance from the coast and the gradient of the stream. This terrace slopes steeply toward the sea and is remarkably smooth between streams, as shown in plate 9, A. Less conspicuous because of its low height is one about 20 feet above the streams, as shown in plate 5, B. This terrace does not extend as

³⁸ Wentworth, C. K., and Palmer, H. S., Eustatic bench of islands of the North Pacific: Geol. Soc. America Bull., vol. 36, pp. 521-544, 1925.

³⁹ Stearns, H. T., Shore benches on the island of Oahu Hawaii: Geol. Soc. America, abstracts of 1934 meeting p. 40 and complete paper in 1935 bulletin.

far inland as the upper one, apparently because the baselevel of the streams was changed before the cycle was far advanced.

In figure 5 is a series of 23 profiles drawn down the slope of various alluvial fans around the island, showing the slope of the sediments from the 200-foot contour to the sea. Of the 23 profiles, 19 show a distinct break in slope between 90 and 110 feet. This break in slope marks the edge of the highest established marine terrace, and the fact that it coincides with the Kaena (95-foot) stand of the sea indicates that this terrace is graded to that sea. It will hereafter be called the "Kaena terrace" and its wide extent is conclusive evidence that this stand of the sea was of greater length than any which followed. The finest development of this terrace is shown by profile 8, which is drawn across the flat where the road to Waipahu forks from the main highway around the island.

Keaahala Stream a quarter of a mile north of Kaneohe flows through a narrow preexisting gap in a ridge of bedrock. Adjacent to the stream in this gap are noncalcareous sediments, probably marine, with their top forming a terrace 96 feet above sea level. The normal course for this stream is on the north side of the ridge, where it would discharge into the sea at Oahope Pond. It is the only observed example on Oahu of a stream near the sea superimposed on a bedrock divide and entering another drainage basin. It appears that this stream entered the 95-foot sea on the north side of the divide. Then as the sea receded it escaped southward through the gap into Kaneohe Valley, because there was less sediment on the Kaneohe side and consequently lower ground than on the north side.

Profile 14 is drawn down the alluvial slope of Lualualei Valley and across an extensive bench of emerged reef with its top 65 feet above sea level. In this valley the older alluvium is graded to this reef. The Laie (70-foot) stand of the sea is only faintly recorded in the other profiles, a fact which seems to indicate that it was only a temporary halt during the recession of the sea from the Kaena stand. Likewise in many of the profiles there is a terrace at about 40 feet, which seems to indicate a stand of the sea at this level. No littoral marine deposits were found at this level, but the stand may have been too short-lived to have left any. Distinct terraces graded to the Waimanalo (25-foot) stand of the sea and nips at this level are common in the profiles. Profile 10 is the only one in which the alluvium shows any sign of being graded to a sea level higher than the Kaena. It appears to be graded to a 150-foot sea. The valley fill in Keaau and Makua Valleys, not shown in figure 5, is graded to a stand of the sea possibly 250 feet above the present level.

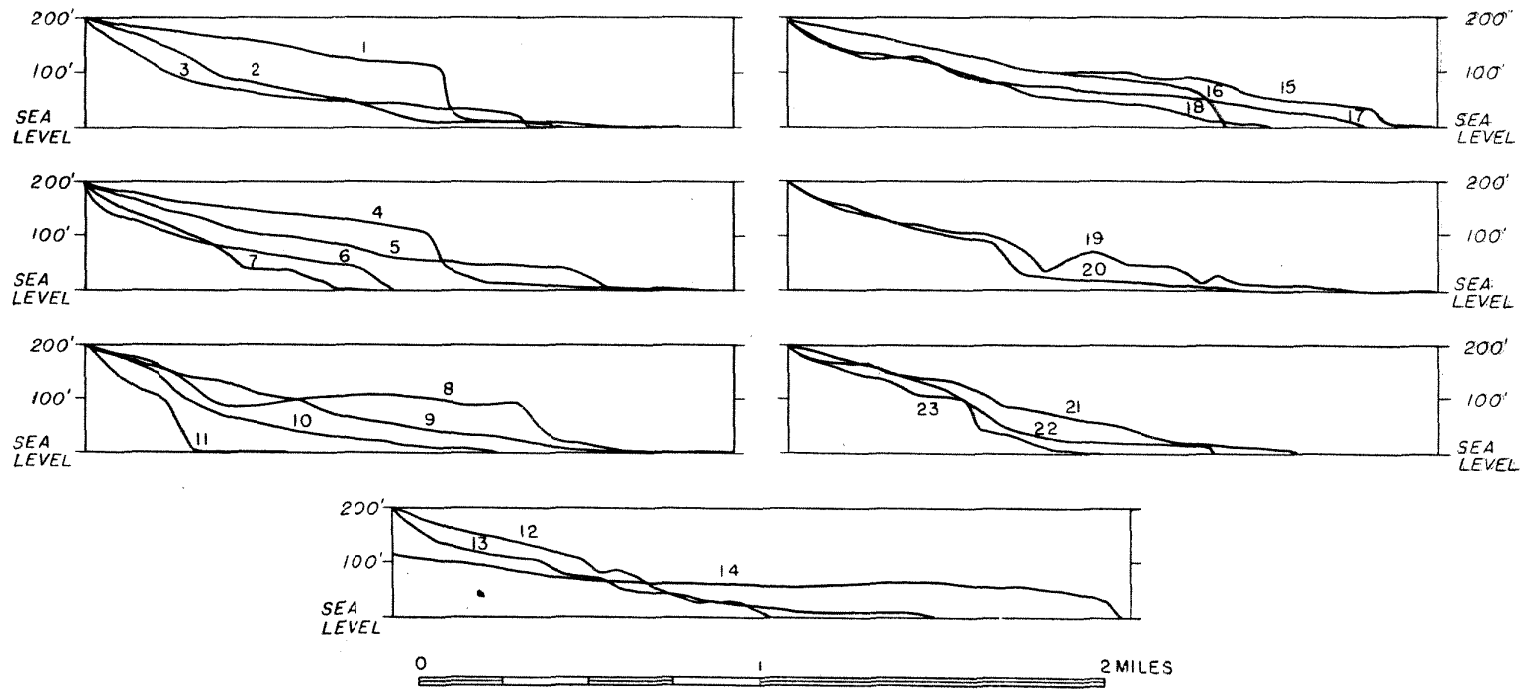

FIGURE 5.—1, 4, 17, near Honouliuli; 2, Nuuanu Valley; 3, 7, 13, 18, near Aiea; 5, 8, near Waipahu; 6, Fort Shafter; 9, Waianae Valley; 10, Makaha Valley; 11, 15, 16, near Heeia; 12, 23, near Libbyville; 14, Lualualei Valley; 19, 20, near Maunawili Stream near Kailua; 21, near Waiahole; 22, Nanakuli Valley, Oahu.

MARINE CLIFFS

Because Oahu has recently emerged from the ocean, most of the great sea cliffs are separated from the water by emerged marine deposits. The cliffs, 400 to 1,000 feet high, that occur near the east and west ends of the island, are only partly the product of marine abrasion and appear to have been very little affected by the present sea. The contours on plate 2 show that cliffs have not been produced by the present sea except in the Koko volcanics and much of this work was probably accomplished immediately after the explosions and before the ash had consolidated. The ancient marine cliffs are found wherever the lava ridges meet the coastal plain. The highest cliffs occur on the northeastern (windward) coasts. As Davis⁴⁰ points out, these cliffed headlands indicate that Oahu's shores have not always had the protection of a fringing reef.

MINOR SHORE FEATURES

Spouting horns are not uncommon along the coast. One occurs on the south coast near Makapuu, and another on the side of Koko Crater is well known. The latter shoots water 40 feet in the air during storms and is known as the "Blowhole." Several natural bridges occur; the largest is probably the one on the south coast between Makua and Kaena Point. It is caused by the waves eroding away the loose parts of an aa flow, leaving the more massive lava to form the bridge.

Mokolii Island, in Kaneohe Bay, is a typical stack. Other stacks occur on the northeast coast and represent residual masses of rock not yet planed down to sea level. Well developed wave-cut notches occur along much of the limestone coast. They are exceedingly well developed in the limestone shore of Pearl Harbor. It is almost impossible to land on Kekepa Island, in Kaneohe Bay, because of the deep notch surrounding it.

Continual exposure of lava rock to ocean spray, wind, and rain produces remarkable fretwork weathering, such as is shown in plate 11, B, a view taken on North Mokulua Island, off Lanikai. At this place the joints are filled with silica, which locally intensifies the etching work. However, similar fretwork was observed along many of the shores where silica apparently does not fill the joints and where the rock is so massive as to be free from visible cracks of any sort. It is often found on the surface of waterworn boulders now out of reach of the waves. The type of salt deposited from the spray and the chemical products of the reaction of these salts on the minerals in the lava rock were not investigated, but some hardening process seems to occur in connection with this reaction. A dark-gray, enamel-like coating found on many lava boulders along the coast evidently resists weathering.

⁴⁰ Davis, W. M., The coral-reef problem: Am. Geog. Soc. Special Pub. 9, 176, 1928.

for some boulders are in so advanced a stage of weathering that only the coated shell remains. The rocks are hard when struck with a hammer, hence the type of weathering is very different from that which takes place in the lateritic belts. In one place angular blocks in a friable siltlike matrix of a landslide had weathered away more rapidly than the surrounding dirt. In the outcrop shown in plate 11, C, lava fragments in a talus breccia along the shore of North Mokulua Island have etched out and left the limestone matrix in relief. This leads to a question as to how much of the weathering is chemical and how much is mechanical.

COMPARISON OF RATES OF ABRASION

The relatively thin flows of Oahu, with their clinker beds, scoriaceous crusts, tubes, and numerous joints, are readily quarried by waves. Tuff is doubtless removed even faster than lava, because it is not only fractured but its individual grains are very weakly cemented. The noncalcareous alluvial deposits are also readily removed, but limestone nearly free of joints seems to withstand wave attack as well as the other rocks of Oahu, if not better. Wentworth⁴¹ has made some computations of the relative rates of marine and fluvial erosion for the Hawaiian group and concludes that the total marine erosion is about one-seventh of the fluvial total. He was handicapped in his study by the fact that the origin of many of the great cliffs in the group is unknown. My observations indicate that the marine work is at least as rapid as fluvial work per unit of area exposed to these processes. Furthermore, Wentworth pointed out that erosional unconformities not then known might vitiate his results. The unconformity found in the Waianae Range during the present investigation and a great erosional unconformity in Haleakala Volcano, on Maui, were not known to him.

On islands like Kahoolawe, where practically no rain falls and there is no fringing reef, marine erosion is certainly many times more rapid than on rainy islands surrounded by a reef, such as Oahu. With shifts of the sea like those in the past, ocean waves are continually given opportunity to make fresh attacks on the land. Thus the problem of relative rates of erosion by these two agents is very complex. Observations on Oahu, however, support Wentworth's general contention that fluvial erosion on that island has been more effective than marine erosion.

EMERGED AND SUBMERGED SHORE LINES

After being deeply dissected by streams, Oahu was submerged more than 1,200 feet, perhaps as a result of isostatic adjustment. There-

⁴¹ Wentworth, C. K. Estimates of marine and fluvial erosion in Hawaii: *Jour. Geology*, vol. 35, pp. 117-123, 1927.

after there developed a series of shore lines whose names and positions in relation to present sea level, tabulated with the oldest at the top, are given below:

Shore Lines on Oahu

Name	Feet above or below present sea level
Olowalu.....	+ 250 ± (Trace only)
Kahuku.....	+ 55
Kahipa.....	- 300 ±
Kaena.....	+ 95
Lale.....	+ 70
Waialae (?).....	+ 40 (?)
Waipio.....	- 60 ±
Waimanalo.....	+ 25

The shore lines above sea level were determined from fossiliferous beach conglomerates or nips cut in lithified dunes, except the 40-foot stand, the existence of which is still questionable, although terraces occur at this level. The depths of the submerged shore lines were determined from various submerged features such as tree molds, lithified dunes, lava-filled valleys, and platforms. Their position in the sequence was determined by erosional unconformities in the marine deposits.

A detailed description of these shore deposits is given elsewhere.⁴²

ORIGIN OF PEARL HARBOR

The origin of Pearl Harbor has been treated at length by Pollock.⁴³ The branching lochs and the geology of the area are shown on plate 2. Branner⁴⁴ in 1903 wrote, "Briefly, this harbor has been formed by the depression beneath the sea of a small group of dendritic valleys previously carved by sub-aerial erosion in horizontal beds of rocks." Davis⁴⁵ evidently agrees with Branner because he states, "The elevated reef (on Oahu) is broadest along the western part of the southern coast, and here it is entered by the branching 'lochs' of Pearl Harbor, which are neither more nor less than drowned valleys of the most normal kind."

Pollock⁴⁶ ends his paper with this statement:

The conclusion of the whole study is that the simple interpretation of Pearl Harbor as a series of drowned dendritic valleys, formed by subaerial erosion, is entirely inadmissible. Except for the deposits of volcanic tuff and some probable subsidences in those deposits on the eastern shore, the land forms in the harbor are marine deposits, have been shaped almost wholly by marine agencies, and subaerial

⁴² Stearns, H. T. Pleistocene shore lines on the islands of Oahu and Maui. Hawaii: Geol. Soc. America, abstract of 1934 meeting pp. 39-40 and in 1935 bulletin.

⁴³ Pollock, J. B., The origin of Pearl Harbor, island of Oahu: Michigan Acad. Sci. papers, vol. 10, pp. 217-250, 1929.

⁴⁴ Branner, J. C. Notes on the geology of the Hawaiian Islands: Am. Jour. Sci., 4th ser., vol. 16, pp. 303-305, 1903.

⁴⁵ Davis, W. M., A. Shaler Memorial study of coral reefs: Am. Jour. Sci., 4th ser., vol. 40, p. 249, 1915.

⁴⁶ Pollock, J. B., Op. cit., p. 250.

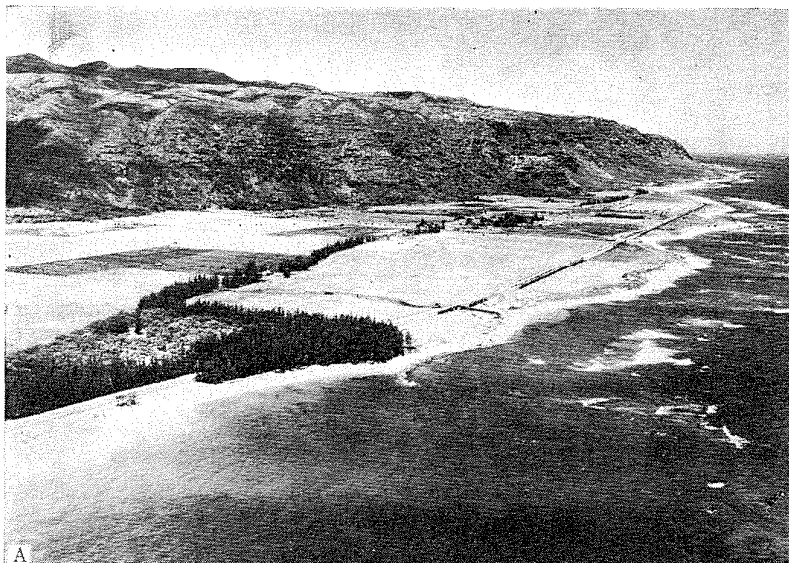

A, ANCIENT MARINE CLIFF 1,000 FEET HIGH ON THE NORTH COAST OF THE WAIANAË RANGE.

Showing the moderately flat upland surface behind it and the wide coastal plain, which is largely a product of marine aggradation, at its foot. The breakers offshore indicate the outer edge of the living reef. The bench projecting from the cliff near the farthest end of the line of trees in the background is caused by the resistance to wave attack of some locally massive lava beds.



B, VIEW LOOKING SOUTHWEST ACROSS THE SCHOFIELD PLATEAU.

Showing the partly dissected slopes of the Koolau Range in the foreground and the east side of the Waianae Range. One of the late cinder cones can be seen on the left end of the Waianae Range.

Photographs by 11th Photo Section, Air Corps, Luke Field, T. H.

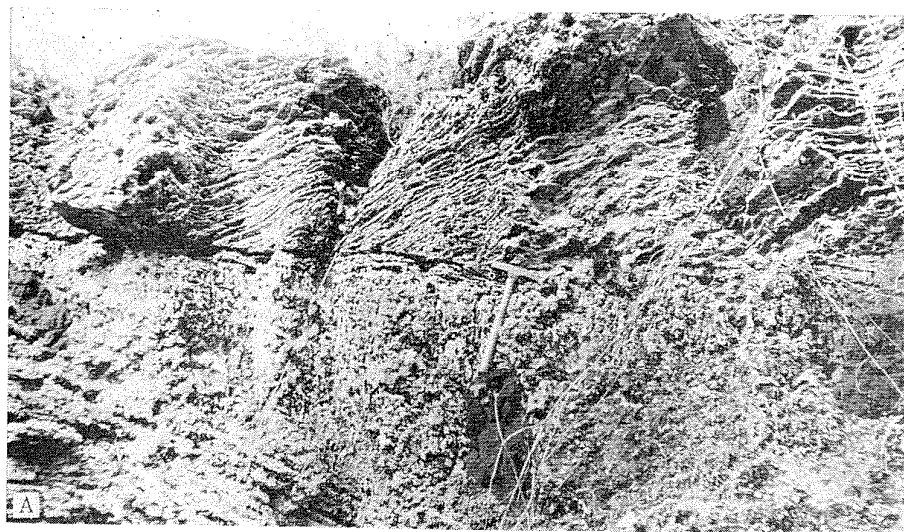

A, TYPICAL LAMINATED LITHIFIED CALCAREOUS DUNE ROCK NEAR WAIMANALO.

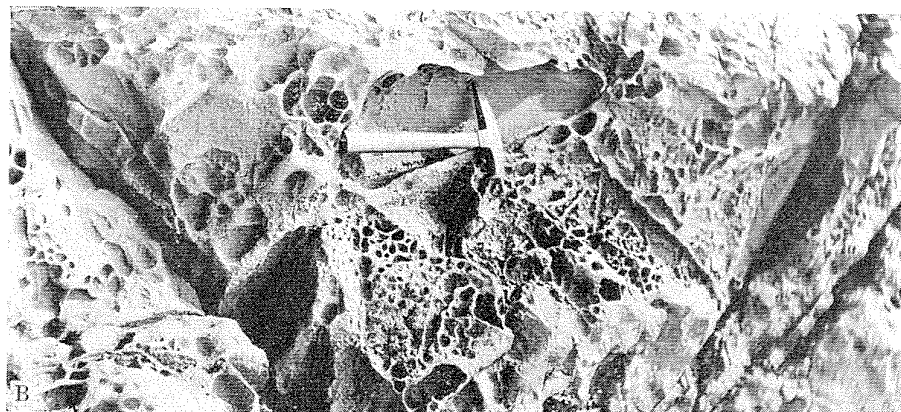

B, FRETWORK WEATHERING IN KAILUA BASALT ON NORTH MOKULUA ISLAND.

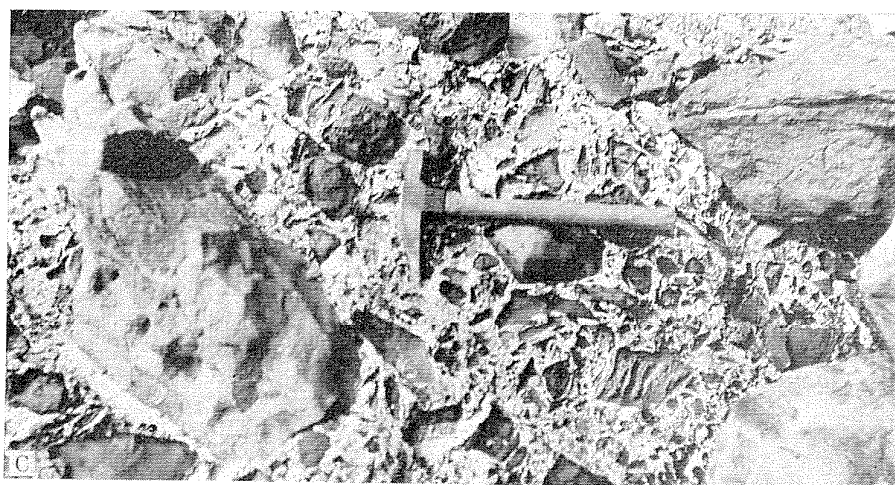

C, BASALT TALUS BRECCIA ON NORTH MOKULUA ISLAND WITH CALCAREOUS CEMENT.

The basalt has been etched out of the matrix.

Photographs by Harold T. Stearns

erosion has modified their topography to a very slight degree. The channels have been formed by tidal currents and wave erosion, and the three main lochs have never been filled to much greater extent than now.

Pollock has brought out valuable evidence which proves that the views of Davis and Branner are not entirely sound. My work, however, does not agree with Pollock's conclusion that these lochs are entirely the result of tidal currents and wave erosion.

Plate 2 shows that Fords Island, Waipio Peninsula, and Puuloa are essentially consolidated calcareous marine sediments with some Salt Lake tuff. The country farther inland consists of terraces of consolidated noncalcareous sediments skirted by lowlands of relatively recent unconsolidated noncalcareous sediments. These younger deposits serve to connect the Pearl City and Waipio Peninsulas to the mainland. It is at once apparent that the erosion cycle that led to dissection of the older rocks in these peninsulas gave way to a cycle of deposition that again connected them.

On the southeast side of the harbor Salt Lake tuff is the principal rock exposed. It lies in nearly horizontal beds which in general dip away from the Salt Lake group of craters. Kuahua Island is composed entirely of horizontal even-bedded tuff and is isolated from the mainland by a channel almost 600 feet wide, which according to Pollock⁴⁷ is 16 feet deep. Near Aiea Bay outcrops of Aliamanu tuff occur, but the explosions that made this tuff played no essential part in the development of the lochs.

At the tuff locality shown on plate 2 near the south end of Waipio Peninsula 4 feet of laminated Salt Lake tuff full of molds of stems and branches of small trees rests on 4 to 12 inches of red soil overlying reef limestone. The soil doubtless required a considerable time to develop after the reef emerged above sea level. It contains numerous weathered fragments of limestone. On this soil trees and shrubs were growing at the time of the Salt Lake eruption, as shown by the molds in the tuff. About 100 feet to the south along the coast the tuff passes beneath sea level, still resting on the soil and containing tree molds; hence there can be no doubt that during the fall of this Salt Lake ash the sea stood lower than at present. The tuff at this point is overlain by 6 feet of emerged reef, and as the tuff was deposited subaerially, the upper reef must be ascribed to an advance of the sea. The subjacent reef has been swept free of the tuff in places nearby and is now overlain by a reef belonging to this later, higher sea.

This one locality thus demands a sea higher than at present to account for the emerged reef beneath the tuff, a sea lower than at present to allow the soil and tuff to accumulate subaerially, and lastly

⁴⁷ *Idem*, p. 234.

an advance of the sea higher than at present to account for the upper reef.

Pollock found this condition in several places but failed to recognize the soil as such, and he also overlooked the significance of the unconformities present. Thus he believed that both limestones, the soil, and the tuff were all marine deposits. It was the thin seams of soft white lime, a fraction of an inch to an inch thick, in the tuff that led him to believe the tuff was submarine. Even at this place, where tree molds occur in the tuff, and at many others, especially around the rim of Salt Lake Crater, these seams of secondary caliche occur. The caliche contains no concurrent fossils, although here and there, near the crater, angular fragments of reef rock and coral have been found in surface deposits of the caliche as a result of the incorporation in it of accidental ejecta weathered from the tuff. Pollock also failed to find fossils in this caliche but mistook the material for calcareous sand deposited under water. On this basis he assumed that all the tuff on Fords Island and Waipio Peninsula was deposited beneath the sea, following Wentworth⁴⁸ in this belief. I found that all of the Salt Lake tuff now exposed was deposited subaerially.

Pollock⁴⁹ reported tree molds below sea level in the tuff near the Southeast Loch but disposed of this significant fact by assuming local subsidence of this particular part of Pearl Harbor. He failed to recognize the significance of the unconformity, for he assumed that the lower reef, the tuff, and the upper reef are deposits of the same stand of the sea. It would follow from this assumption that the limestone overlying the tuff is much younger than the lower limestone, even if subsidence of the land is admitted. The locality illustrated in plate 12, and the section described above, show definitely that the upper limestone, now known to belong to the Waimanalo stand of the sea, is unconformable on the tuff.

Pollock noted places where the tuff did not lie horizontal but showed sags and arches like those illustrated in plate 12, B. This led him to believe that the land in the vicinity of Southeast Loch had been warped since the tuff was ejected. These features, however, were caused by the subaerial deposition of the tuff on an irregular surface. If warping had caused these dips in the tuff, then the underlying sediments should be warped also. This condition was not observed anywhere and in a few places vertical tree molds were found in the tuff, whereas if warping had occurred the tree molds should be tilted.

The geologic history of Pearl Harbor as interpreted from well logs and surface exposures began when the Koolau dome joined the Waia-

⁴⁸ Wentworth, C. K., *Pyroclastic Geology of Oahu*: B. P. Bishop Museum Bull. 30, p. 71, 1926.

⁴⁹ Pollock, J. B., *Op. cit.*, p. 235.

nae dome. At first the shore was probably more indented than at present, but as the Koolau flows continued the present site of Pearl Harbor became dry land. At the cessation of Koolau activity, there was only a slight reentrant in the coast line, and it was somewhat south of the present Pearl Harbor. However, the land at the present site of Pearl Harbor was always much flatter than the adjacent slopes of the Waianae and Koolau domes, as shown by the nearly horizontal beds of Koolau basalt around the harbor. Gradual submergence of the entire island caused the ocean to encroach more on this flat land than on the adjacent areas, with the result that a bay was formed.

Four large streams converge at this bay. Their drainage area receives heavy precipitation and is larger than any other drainage basin on Oahu that reaches the sea at one point. Thus the bay became the dumping ground for vast quantities of sediment. Likewise, the shallow platform at this place favored more extensive reef development than elsewhere around the island; hence both fluvial and marine deposition worked together to obliterate this bay. Well 162 shows that at least 800 feet of sediment has accumulated in this general area since erosion of the Koolau Range began. Thus all signs of a bay at this place would have been obliterated long ago, if submergence had not exceeded deposition.

Pollock⁵⁰ made several mathematical calculations without consulting existing well logs, to establish the depth to bedrock and concluded that it could not have been less than 1,500 feet at Waipio Point and may have been considerably more. Wells 272 and 166 are on an east-west line passing through Waipio Point (pl. 2). Well 272, which is 972 feet deep, passed through all the sediments and went for some distance into bedrock. Well 166 passed through the sediments at about 750 feet below sea level. Well 171 passed through the sediments at 570 feet below sea level. It seems clear from these drilling records that the depth to bedrock at Waipio Point is probably about 600 to 700 feet, and not 1,500 feet. Pollock projected the slopes of the ridges around Pearl Harbor to arrive at his figure. It is about double the real depth to bedrock, because he did not allow for the erosional steepening of the so-called "flow-slope facets."

The history of Pearl Harbor, covering a long period of sedimentation and submergence, evidently includes many events that cannot now be interpreted. Apparently, however, the present configuration of the lochs is a result of relatively recent geologic events. The lower limestone when traced toward the mountains is found to change into a marl and then into noncalcareous muds and conglomerates.

⁵⁰ *op. cit.*, p. 221-222.

The consolidated noncalcareous sediments correlative with the lower limestone are graded to the Kaena (95-foot) stand of the sea. As these limestones occur chiefly near the mouth of the harbor and are replaced by noncalcareous sediments farther inland, the site of the present lochs evidently was at that time floored largely with delta deposits.

During the succeeding Waipio stand the sea fell about 60 feet lower than at present, causing the four major streams to wander across the former harbor floor and join near the present entrance to Pearl Harbor. This shift in the strand line rejuvenated the streams, and during this period they rapidly carved a system of dendritic valleys in the soft noncalcareous sediments.

The hard reef rock of pre-Waipio age near the mouth of the present harbor kept the main stream confined during this erosion cycle, but farther inland, where tributaries were meandering over weak sediments, practically all the divides were removed except for small remnants such as are now exposed in the northeast end of Fords Island, in the highland of Pearl City Peninsula, and in small areas on Waipio Peninsula.

The next event was the Salt Lake eruption, which mantled the area near the mouths of the valleys with tuff. That this area was dry land supporting vegetation at the time of the explosion is shown by the soil underlying the tuff and the tree molds at present sea level. Farther southwest some of the tuff probably fell into the ocean. After the deposition of the tuff, erosion still continued, and much of the tuff, except that on the divides between the streams, was swept away. The theory of local subsidence advanced by Pollock to account for these molds below sea level is not adequate, in view of the fact that the same low stand of the sea is recorded around the entire island.

After this erosion cycle the sea rose about 25 feet, drowning the valleys. Thus the streams were changed from degrading to aggrading, and the drowned valleys began to receive sediments.

The outcrops of marine limestone shown on plate 2 indicate that during the 25-foot stand conditions were unfavorable for coral growth for a mile offshore, but farther south reef grew without difficulty. As the ridges and knolls left between the valleys were now shoals and islands, reef grew most rapidly on and about them and thence spread out toward the drowned channels. This is shown by the geologic section in the bluff on the west side of Waikele Peninsula given below.

Geologic section half a mile south of Waipahu railroad station

	Thickness (feet)	Altitude of base of layer (feet above mean sea level)
Friable brown clayey silt containing gravel and fossil shells at the bottom.....	4.0 +	26.07
Friable limestone consisting of sand grains and a few fossil shells and containing numerous roots casts.....	2.5	23.57
Hard brownish black carbonaceous layer containing a few calcareous sand grains.....	.4	23.17
Compact limestone in a single massive bed containing fossil shells, pebbles and numerous well-rounded calcareous sand grains arranged in crude laminae.....	5.7	17.47
Brown clayey silt without apparent bedding.....	.3	17.17
Bed of fossil oyster shells.....	1.2	15.97
Unconformity		
Brown soil filled with root casts of limonite.....	.5	15.47
Brown clayey marine silt of uniform texture and without apparent bedding. (One clam cast found in it.).....	5.74	9.73
Poorly exposed but apparently same material as above.....	9.73	Sea Level
	30.07+	

It appears from this section that the sea advanced over a soil-covered knoll of marine silts, and a bed of oysters grew there. After the oysters had flourished for a while, currents caused a calcareous beach to advance over them. The overlying carbonaceous material suggests that a shallow lagoon in which vegetation grew was left as the beach was built seaward. This condition did not last long, for currents again began to deposit sand. The presence of gravel at the top of the sand and the complete cessation of calcareous deposition suggests that a gravelly beach was formed. As the top of the marine deposit is 26.07 feet above sea level, the whole calcareous series represents deposition during the Waimanalo stand of the sea. The basal silts are part of the knoll, and the overlying silts are hill wash from the knoll after the recession of this sea.

A little over a mile west of this locality, at the spot of consolidated noncalcareous sediments on the west side of Waipio Peninsula, shown on plate 2, marine limestone rests unconformably on friable siltstone. The limestone contains a few fossil shells and streaks of clay and in places grades into horizontally bedded marine silts with streaks of lime along the laminae. Fossil oyster shells are common in these marine silts and are usually the only recognizable shells in the limestone. A similar unconformity can be seen on the northeast end of Fords Island.

The height to which the Waimanalo reef grew above sea bottom was largely dependent upon the depth of the sea, although mud and floods of fresh water also hindered its development. Thus its major growth occurred adjacent to and on the drowned stream divides, about a mile from the head of the harbor, where the water was clear and shallow.

With the drop of the sea to the present level at the end of the Waimanalo stand, irregular platforms of reef were left above the water wherever their height was within about 25 feet of the surface of the Waimanalo sea. As these reefs were higher along the ancient divides of the drowned valleys, the present lochs roughly occupy the position of the valleys cut during the Waipio stand of the sea. Loki Hanaloha Pond, on Waipio Peninsula, which puzzled Pollock,⁵¹ is probably an area where lime-secreting organisms did not flourish in the Waimanalo sea. It might have been the submarine channel of Waikele Stream at that time.

Pollock correctly recognized the Waimanalo stand and also the fact that the lochs had rounded heads, not at all like drowned dendritic valleys. These rounded heads are largely due to the more rapid removal of the soft noncalcareous sediments by wave action as compared with that of the calcareous sediments. A trip around the north end of Fords Island, where the reef rock rests on soft silt, well illustrates this point. Apparently there was a ridge extending northeastward from the island that has now been largely destroyed by wave action. Here the waves beating on the silt are rapidly removing it and undermining the overlying reef. A few hundred feet farther south, where they beat against limestone, erosion is notably much less effective.

Thus Pollock's contention that these lochs are not simple drowned valleys as described by Branner and Davis is correct, but his view that the lochs were formed only by tidal currents and wave erosion is not tenable in view of the known geologic conditions. Instead, the lochs are partly unwatered drowned valleys, with the original divides now greatly modified by marine sediments. The size of the lochs, especially near their heads, has been appreciably increased by recent wave action.

The late geologic history of Pearl Harbor may be summarized as follows:

1. Deposition of calcareous and noncalcareous sediments in the high seas preceding the Waipio stand.
2. Recession of the sea to the Waipio stand, about 60 feet below present sea level.
3. Cutting of wide valleys by main streams in the approximate position of the present lochs and formation of soil on interstream areas.
4. Deposition of tuff by explosions at Salt Lake craters.
5. Erosion of tuff and continued removal of interstream divides.
6. Submergence by the 25-foot Waimanalo sea and drowning of valleys to form the ancestral Pearl Harbor Lochs.

⁵¹ Pollock, J. B. *op. cit.* p. 231.

7. Growth of irregular reef patches on former stream divides and deposition of noncalcareous sediments near shore.

8. Recession of sea to present level, causing the removal of 25 feet of water from the drowned valleys and the exposure of irregular patches of reef where former divides existed.

9. Widening of lochs by wave action, especially near their heads, where soft silts occurred instead of hard limestone, and formation of deltas at the mouth of each valley.

The history of Pearl Harbor as outlined above has an important bearing on the occurrence of ground water in that vicinity. The long period of sedimentation formed the cap rock of the aquifer. Then the Waipio cycle of erosion cut deep gashes in the sediments and swept away much of the sedimentary cover of the aquifer, which had been deposited by the previous 70-foot and 95-foot seas. The later Wai-manalo sea restored the cap rock over much of the area to about the 25-foot level but left only a thin veneer on most of the interstream divides. This was due to the fact that longshore currents in a series of shallow bays are not effective in drifting the sediments of the streams far from their mouths.

The lowering of the sea to its present level increased the stream grades, with the result that they are now removing such cap rock as was left above sea level. The artesian springs discharge from bed-rock where this cap rock has been either completely or almost completely removed. As the artesian head in the first wells was about 35 feet above sea level in this area, it is evident that sufficient deposits were left by the high stands of the sea to seal most of the holes in the cap rock up to that level. Fortunately, the water supply of this artesian basin is more than adequate to balance the leaks below that level, otherwise the artesian head would be lower. Further discussion of the Pearl Harbor Springs will be found under "Basal springs."

MINOR GEORMORPHIC FORMS

FORMS DUE TO WIND

The prevailing winds are the northeast trades, which sometimes reach velocities adequate to blow down trees and poorly constructed small buildings but are not known to have done serious damage to life and property. They blow steadily, however, except during kona storms, when southerly winds predominate. The southerly winds frequently reach velocities sufficient to blow down branches and small trees and upon descending the steep Pali of the Koolau Range sometimes gather sufficient velocity to do considerable damage to banana and sugar plantations. However, the destructive monsoons of the Tropics do not occur on Oahu. The kona winds blow for only a few

days at a time, hence wind effects are much less pronounced on the leeward (south and west) coast than on the windward (northeast) coast.

DUNES

On all the sandy shores of Oahu the wind is constantly drifting grains of sand and small fragments of shells upward and out of the reach of normal waves. In most places this work does not progress long before waves during storms or spring tides rework the deposit. Thus, a constant struggle goes on between the wind and the water, and joint work of these two agents has produced the beach ridges of Oahu. In cross section these beach ridges commonly show several feet of typical cross-bedded wind-laid sand at the top. In general these wind deposits consist of calcareous grains averaging about 1 millimeter in size and composed of shell fragments, foraminifers, coral fragments, and other marine organisms. Large fragments of corals and shells left by unusually high waves are sometimes found in them. These patches of dunes along the crests of beaches average about 15 feet above sea level and seldom exceed 20 feet. They are not differentiated from beach deposits on plate 2, because of their small area and their intermixture with marine deposits.

Only in one place on the leeward coast of Oahu is there a dune sufficiently large to map on plate 2. It occurs at the seaward end of the Keaau-Makua divide about $5\frac{1}{2}$ miles north of Waianae. It is about 1,400 feet long, 300 feet wide, and 50 feet high and is known as the "Barking Sands," because of the sound it gives forth when it is walked over on a hot, dry day.

On wind-swept Kaena Point dunes 20 to 30 feet high occur, but there are no other dunes large enough to map on the northwest coast. Near Kahuku several patches of dunes reaching a maximum height of 50 feet have drifted half a mile inland. Southeastward from this area the windward coast is free of dunes as far as Mokapu Point. At this place dunes 93 feet high, the highest on the island, are found. From this point nearly to Makapuu extensive areas of dunes occur. Plate 2 shows that these dunes lie shoreward from large bays where ocean currents are depositing great quantities of calcareous sand. The size of the grains in the dunes mapped, except at their margins, where they merge with beach deposits, generally averages about half a millimeter, and large fragments of shells and corals are absent. The dunes show good cross-bedding, are unconsolidated, and rarely show even the slightest trace of cementation. Artificial changes, windbreaks, and the introduction of sand-loving plants have done much to retard the spread and growth of dunes.



A

A, ROAD CUT THREE-QUARTERS OF A MILE WEST OF FORT SHAFTER.

Showing relation of reef of the Waimanalo stand of the sea to the Salt Lake tuff.



B

B, CLOSE-UP VIEW OF SALT LAKE TUFF SHOWN IN A.

Subaerially deposited on eroded surface of tuffaceous marine silts. Molds of vegetation occur at contact.

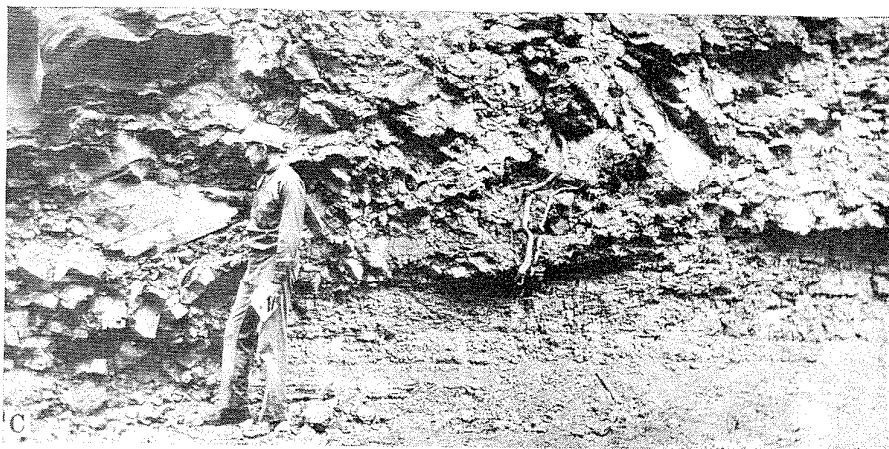

C

C, CLOSE-UP VIEW OF FOSSILIFEROUS BEACH CONGLOMERATE SHOWN IN A.

Containing water-worn and angular fragments of Salt Lake tuff derived from beds shown in B.

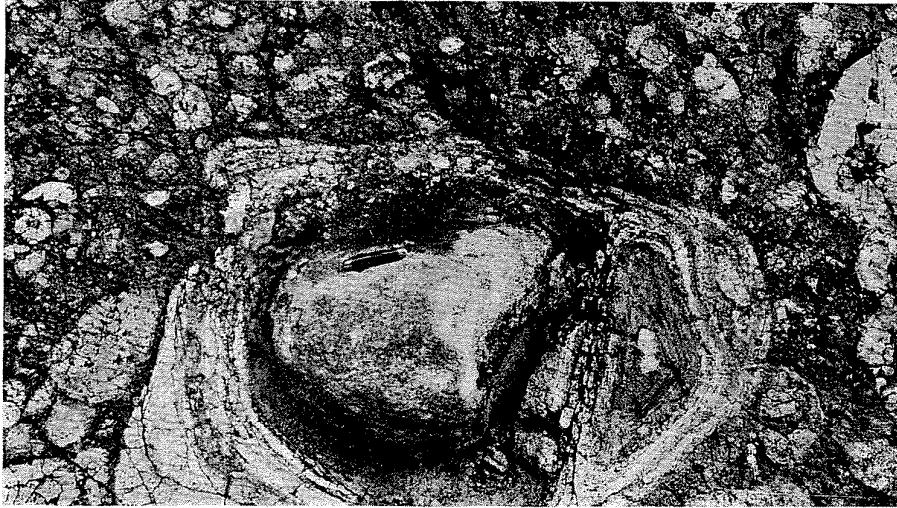

A, SPHEROIDAL WEATHERED BOULDER IN THE OLDER ALLUVIUM NEAR KOLEKOLE PASS, WAIANAE RANGE

Photograph by Harold S. Palmer.



B, MAKAPUU HEAD, THE EAST POINT OF OAHU, AND THE PALI.

Showing how the weaker layers of the lava flows weathering more rapidly than the stronger ones have been etched out mostly as a result of wind action. The wind gap in the foreground is a beheaded valley. Photograph by 11th Photo Section, Air Corps, Luke Field, T. H.

LITHIFIED DUNES

The older lithified dunes, as shown on plate 2, generally occur in the same areas as the present dunes but lie farther inland. They consist entirely of limestone and were apparently lithified by percolating rain water carrying weak acids after they were anchored by vegetation. In most places the deposits can be readily differentiated from beach deposits by the small grain size and the steep laminated cross-bedding (pl. 11, A). The rock is extensively quarried for railroad ballast, road foundations, and walls.

Stratigraphic evidence and the fact that many of the dunes are partly submerged indicates that most of the lithified dunes were formed when the sea stood lower. The lithified dunes are larger than the recent dunes and occur at higher altitudes. Near Waimanalo they are 162 feet high, and near Kahuku they extend 280 feet above sea level. Although most of them still retain much of their original form, the pinnacles and pits on their surfaces indicate that they have been somewhat reduced in size by solution. Near Kahuku several of these dunes blocked valleys $1\frac{1}{2}$ to 2 miles inland, and before consolidation streams doubtless percolated through them. With changes in sea level, which cut off their supply of sand, these dunes became lithified, and the percolation through them developed large limestone caverns, some of which are now collapsed or marked by a line of sink holes. Several depressions near the lithified dunes southeast of Waimanalo are sink holes partly filled with alluvium. On one occasion a stream was observed sinking into one of them.

Some of the outcrops of lithified dunes contain numerous small spiral fossil land snails. These shells, mistaken for marine fossils, have led some geologists to believe that the dunes were marine deposits.

The three tiny patches of lithified dunes on the coast near Makapuu, shown on plate 2, are erosional remnants of more extensive dunes. An area of lithified dune $1\frac{1}{2}$ miles long, a quarter of a mile wide, and 100 feet high occurs on the east side of Diamond Head. On its south side is a cliff with many large sea caves made by a former high stand of the sea. Several erosional remnants of other lithified dunes are exposed in the road cut on the south side of Diamond Head.

In addition to the lithified calcareous dunes, several poorly cemented dunes of black sand, too small to show on plate 2, occur on the southeast side of Diamond Head and on the adjacent Kupikipikio Point. They are described further on page 142.

EFFECTS OF WIND EROSION

Wind scars are common on both ranges, even in such places as the head of Nuuanu Pali, where it rains more than 150 inches annually.

Most of the scars, however, are found on the ridges in the dry areas. History shows that most of the scars started with deforestation. After great storms numerous landslides occur and those in areas exposed to constant winds develop into wind scars, because vegetation cannot get started readily where the humus layer is destroyed. The scar, once started, is enlarged by wind action and there are many areas on Oahu that have been swept clean to bedrock. Various organizations have been spending large sums of money to reclaim these areas, but they have been only partly successful. On the crest of the Koolau Range near Makapuu even crumbly bedrock is being rapidly eroded by the wind. Many of the dikes that cross the crest have been etched away more rapidly than the adjacent flows, leaving shallow trenches.

In favorable places, such as the east point of Oahu and in the Waianae Range, where bare lava flows are exposed to strong winds, the soft layers have been etched out of the lava flows, leaving the hard ones standing in relief, as shown in plate 13, B. The clinker beds in the aa flows yield more rapidly than the flow lava associated with them, and in the pahoehoe flows the vesicular crustal and basal zones etch out. The success of the wind in removing the particles of rock, however, is due to the more rapid weathering of the weaker layers than of the stronger ones, and the scouring effect of the wind is subordinate to its transporting power in the development of this topography. The various layers shown in plate 13, B, do not all indicate individual lava flows; some of them represent simply relative differences of texture of several layers within each flow. Rain wash has assisted the wind in removing the products of weathering on these steep slopes.

FORMS DUE TO SUBAERIAL WEATHERING

Weathering takes place more rapidly in the vesicular parts of flows and in the clinker beds than in the more massive parts. In general, weathering penetrates deeper along dikes than in the adjacent flow rocks, with the result that trenches are left in many places where flow rocks are crossed by dikes. In places where erosion is more active than weathering, dikes usually stand in relief as walls.

PREDOMINANCE OF CHEMICAL WEATHERING

Chemical weathering in these warm climates is the chief agent in forming soil, because frost and ice do not occur. Mechanical disintegration resulting from thermal changes is slight, because diurnal changes in temperature are small. The rocks of the Schofield Plateau are completely rotted to soil 5 to 10 feet deep and partly decomposed an additional 20 to 40 feet. Below the soil are residual boulders with concentric shells in various stages of decomposition typical of spheroidal weathering. Water-worn boulders of alluvial deposits undergo

spheroidal weathering, as shown in plate 13, A, and round boulders produced by spheroidal weathering of massive lava rock are easily confused with boulders rounded by abrasion.

Spheroidal weathering.—The chemical changes occurring during spheroidal weathering of basalt have been described by Palmer⁵² as follows:

1. Water is added in large amounts and is an actual addition.
2. Oxygen is actually added and explains the apparent addition of ferric oxide.
3. Alumina is the most stable element.
4. Sulphur trioxide and titania decrease to amounts between three-eighths and five-eighths of the original amount.
5. Phosphorus pentoxide, silica, ferrous oxide, and potash decrease to amounts between one-eighth and three-eighths of the original amounts.
6. Manganous oxide and soda decrease to amounts between one-sixteenth and one-eighth of the original amounts.
7. Lime and magnesia decrease to about one-hundredth of the amount originally present.

Rounding of gravel not primarily due to chemical weathering.—Wentworth⁵³ attributes most of the rounding of the gravel in the stream beds to chemical weathering rather than to corrasion, and he concludes from this that the streams of high gradient carry relatively little fresh rock debris. He failed to note that the particular streams he referred to were reworking deeply weathered ancient alluvium. Consequently the pebbles and cobbles with weathered skins that he observed in the stream beds were derived from this older deposit and had been transported only short distances. In traversing these stream beds above the ancient alluvial deposits great quantities of hard lava cobbles without weathered skins were found in all stages of being rounded; hence his conclusion does not appear justified. Chemical weathering is much more rapid in Oahu than on the mainland, but its work is slow in valley bottoms compared with the abrasion and plucking by Oahu's swift torrential streams. That Hawaiian streams can effectively gouge out deep canyons without appreciable aid of chemical weathering is shown by the deep gorges cut in recent fresh lava flows on Haleakala Volcano, on Maui.

Lapies.—Grooves like those shown in plate 14, A, occur in many places. Palmer has called them "lapies,"⁵⁴ the term applied by Cvijic^{54a} to similar fluting in limestone, and has correctly attributed them to solution. They are so common on boulders that evidently rain water trickling down the boulder surfaces is adequate to produce them. In

⁵² Palmer, H. S., Soil-forming processes in the Hawaiian Islands from the chemical and mineralogical points of view: *Soil Science*, vol. 31, no. 4, p. 257, 1931.

⁵³ Wentworth, C. K., Pyroclastic geology of Oahu: *B. P. Bishop Mus. Bull.* 30, pp. 65-66, 1926.

⁵⁴ Palmer, H. S., Lapies in Hawaiian basalts: *Geog. Rev.*, vol. 17, pp. 627-631, 1927.

^{54a} Cvijic, Jovan, The evolution of Lapies, a study in karst physiography; *Geog. Rev.*, vol. 14, pp. 26-49, 1924.

some places boulders show several stages of lapies at angles to one another. These cross lapies are caused by the boulder toppling over on its side, so that rain water dripping off the boulder takes a new course and dissolves a new set of grooves across the former ones. The surfaces of many of the post-Koolau nephelite basalt flows are characterized by such fluted boulders and these boulders are especially numerous at the head of Kalihi Valley. Although the composition of the nephelite basalts makes them particularly soluble, lapies have been observed on other types of lava rocks also. Numerous blocks on the north side of the Training School flow (see p. 132) along the highway show what were formerly minute joints enlarged to deep grooves by solution.

SOILS

Character.—The soils of Oahu are largely colloidal and zeolitic. Kaolin clays are practically absent. Considerable work has been done on Oahu soils, and details are given in other publications⁵⁵. The predominating soil is red and is called “laterite.” Deposits of laterite are mined in many parts of the world for their iron content. Clarke⁵⁶ says that laterite, whether it is transported or residual, is essentially a mixture of ferric hydroxide, aluminum hydroxide, and free silica in varying proportions. Because iron compounds are common products of weathering, seams, layers, and joint cracks filled with limonite are frequently observed.

Types and colors.—The soils of Oahu are the product of weathering. They fall into two groups—residual and transported. The residual soils are those formed in place; the transported soils are those which have been moved, thereby losing certain original constituents. The residual soils fall into two major classes—those formed by the decomposition of nontransported reef limestone, tuff, and lava and those formed by the decomposition of transported debris such as alluvium and dunes. There is a marked relation between the color of residual soils on nontransported rocks and the kind of rock, a fact which has been exceedingly useful in mapping the various rock types. Marked differences in color result from differences in temperature and rainfall, but their correlation with present climatic conditions is of little use, because the climates under which many of the soils were formed were probably different from that of today. The color of the soil

⁵⁵ Maxwell, Walter, Lavas and soils of the Hawaiian Islands: Hawaiian Sugar Planters Assoc., Div. Agr. and Chemistry, Spec. Bull. A, Honolulu, 1905.

Kelley, W. P., The function and distribution of manganese in plants and soils: Hawaiian Agr. Experiment Sta. Bull. 26, 56 pp., 1912.

Kelley, W. P. and McGeorge, William, The effect of heat on Hawaiian soils: Hawaiian Agr. Exper. Sta. Bull. 30, 38 pp., 1913.

Kelley, W. P., McGeorge, William, and Thompson, A. R., The soils of the Hawaiian Islands: Hawaiian Agr. Experiment Sta. Bull. 40, 35 pp., 1915.

Lyons, A. B., Chemical composition of Hawaiian soils and of the rocks from which they have been derived: Am. Jour. Sci., 4th ser., vol. 2, pp. 421-429, 1896.

⁵⁶ Clark, F. W., The data of geochemistry, 5th ed.: U. S. Geol. Survey Bull. 770, p. 497, 1924.

varies with depth, and this factor must be considered when using the color of the soil for differentiating rock types, because in places wind and water may have only recently exposed the lower part.

Bright-red to orange-red colors characterize the surface of the residual soil on the tuffs of the coastal plain. A slightly darker red soil covers the Kaimuki volcanics. Dark reddish-brown soil characterizes decomposed limestone surfaces, and dark-red soil covers much of the Koolau flows in the Schofield Plateau. Dark orange-red soil generally indicates weathered pumice deposits in the more arid parts of the Waianae Range, and dark-red soil forms the surface of cinder cones. In the rain belts and in some areas like Wilhelmina Rise, where forests have been removed, the soils on the lavas are black with humus. Brilliant red soil characterizes the weathered dike complex in the drier areas. Dark-brown soil covers the surface of the alluvial fans in the Schofield Plateau area, but lighter browns usually prevail on alluvial deposits elsewhere. The red soils, when transported, become light brown.

Nephelite-basalt soils.—Some of the post-Koolau nephelite basalts, which have rotted to a depth of about 50 feet, must weather much more rapidly than the Koolau lavas, because they are comparatively young. They break down into a light-brown soil, usually shot through with little black stains that are presumably manganese dioxide. Spheroidal weathering is not so common in them as in the other lavas, and a sharp line of demarkation usually occurs between very fresh and thoroughly decomposed rock. The soils of the nephelite basalts do not change color with depth except where the upper surface is stained black by humus, whereas the red soils on other lavas grade downward into tan soil containing chips of nearly decomposed rock and then into gray partly altered rock. Small residual chips of nephelite basalt are seldom seen in its soil.

WEATHERING EFFECTS ON LIMESTONE

The usual solution features of limestone are found in the emerged reef rock. Sink holes, caverns, pinnacles, pits, stalacites, and stalagmites occur here and there in it. Spiny pitted surfaces develop in the limestone along the coast. In the broad flats of emerged reef rock, such as those near Barbers Point and Kahuku, numerous pits 1 to 8 feet in diameter and 2 to 8 feet deep occur. Because similar depressions occur in the living reef, these particular pits were probably original features of the reef before its emergence. Residual soils are thin on the emerged reefs, probably because they occur in a dry climate and are relatively young. In many of the dry areas a thinly laminated caliche-like material has formed on the surface of the limestone.

LANDSLIDES AND BOULDER TRAINS

Landslides are extremely numerous and generally occur during heavy rains. They rarely cause loss of life on Oahu, because most of them are relatively small. Many seem to originate from the failure of the narrow unsupported spurs and from masses of lava rock sliding on a thin streak of rotted saturated clinker or tuff.

A great boulder train stretches for a mile from the foot of the cliff on the northeast side of Nanakuli Valley. It consists of rounded boulders of extremely massive lava, some reaching 30 feet in diameter, lying on the surface of the valley fill. Near the top of the cliff is a great mass of this same rock. Apparently a great landslide from this wall carried blocks of the rock into the valley a long time ago. Subsequent erosion removed the smaller material of the slide but was unable to remove the large blocks, and weathering has since rounded and pitted the surface of the large blocks so that they are no longer angular and no longer look like part of a landslide.

A boulder train of similar appearance occurs in the west side of the head of Kalihi Valley. This train of boulders has a different origin from the one in Nanakuli Valley. The boulders are all Kalihi (post-Koolau) basalt and are residual on the surface of a lava cascade, the intervening material having been removed by weathering and erosion. These boulders show a fine development of lapies.

FORMS DUE TO STREAMS

ORIGIN OF PALI GROOVES

The Koolau and Waianae palis are corrugated by stream channels 100 to 200 feet apart, as shown in plates 4, B, and 9, A. Palmer⁵⁷ has attributed their formation chiefly to solution. As an example, he states that those in the Pali behind Waimanalo have a drainage area of the order of 7 acres, a mean discharge of about one-twelfth of a cubic foot per second if there were no loss by evaporation and transpiration, and a relatively uniform run-off. I examined a large number of these waterfalls while doing field work, including some of those behind Waimanalo described by Palmer and found that they are not single smooth, nearly vertical channels like the miniature fluves unquestionably due to solution, but consist of a series of cascades, each with a deep plunge pool at the bottom 6 to 20 feet wide and 2 to 10 feet deep. These cascades in the channels can be made out by close inspection of plate 9, A, but they are difficult to photograph. It cannot be denied that wherever rocks are kept more or less moist, as they are in these channels, chemical weathering is at work, but these plunge pools indicate that abrasion is by far the most active process in the formation of these

⁵⁷ Op. cit., Geog. Rev., p. 630.

grooves. Furthermore, fresh rock is exposed in the floors of these nearly vertical valleys, and they all terminate in large plunge pools containing huge blocks and boulders of rocks that have come from above. This would not be the case if they were due to solution. Furthermore, field observations over a 3-year period show that the run-off is not relatively uniform. Many days these falls are dry, but several times a year they contain thundering cascades, and at these times it is dangerous to approach them because of falling rocks.

In two places where large logs were wedged at the head of cascades distinct striae were observed in the bedrock of the cascade at angles of 10° to 15° from the vertical, caused unquestionably by boulders being deflected sidewise from the normal downward course. Near Sacred Falls, in Kaluanui Valley, there is a huge symmetrical groove cut in fresh rock in the east wall of the canyon. It is about 30 feet in diameter at the bottom and extends up the canyon wall for about 300 feet, tapering like a great chimney. Dana early called attention to it but did not explain it. Hitchcock⁵⁸ recognized it as the work of a stream. It was dry when visited but the striae on its bare rock walls show conclusively that it is a ground-out gigantic pothole 300 feet deep. It is conspicuous because its walls are bare and it occurs near a scenic spot. This particular groove, because of its bare striated rock walls, is an excellent example of the efficacy of abrasion versus solution in this area. The grooves along the Pali wall are believed to have a similar origin but in general are less symmetrical.

EFFECTS OF DIKES

Along the Pali several massive dikes cause high waterfalls. A few streams running parallel to dikes have cut canyons with one side a vertical wall several hundred feet high consisting of a single dike.

FORMS DUE TO POST-KOOLAU ERUPTIONS

Many of the post Koolau lava flows coursed down valleys. These flows not only built up the valley floors but smoothed out irregularities and displaced drainage. Nuuanu and Manoa Streams were forced to the east side of their valleys by lava flows. Deep pools, such as Kapena and Alapena Pools, in Nuuanu Valley, along streams displaced by lava flows are caused by the stream gouging out weak material at the contact of the lava flow with the older weathered rocks. In Kama-naiki Valley, a tributary of Kalihi Valley, post-Koolau lava forms a resistant lip for a waterfall. (See pl. 6, A.)

Where these lava flows spread over valley fills near the sea, subsequent erosion of the adjacent softer rocks has left the more resistant lava flow in relief in the form of plateaus or mesas. An observer look-

⁵⁸ Hitchcock, C. H., *Geology of Oahu*: Geol. Soc. America, Bull. vol. 2, p. 20, 1900.

ing down from the top of the Pali road can see the plateaus formed by the Kaneohe Training School and Castle lavas. (See pp. 111, 132, and 145 for descriptions of these basalts.) The lower stretches of most streams on Oahu are in alluvium, but where post-Koolau flows occur the stream bed is characterized by nearly continuous exposures of fresh lava.

The post-Koolau eruption on the Pali at the head of Nuuanu Valley filled the former narrow valleys carved in the Pali with lava and cinders. Subsequent erosion cut valleys into the older rocks, but left the lava-filled valleys as ridges.

The post-Koolau tuff eruptions have caused the coastal plain to be locally extended. The Koko eruptions profoundly changed the appearance of the south coast on the east end of Oahu. Kamiloiki Stream was diverted westward into Kuapa Pond, whereas prior to the eruptions it discharged directly into the sea at the mouth of its valley. Maunalua Bay and Kuapa Pond resulted from the Koko eruptions.

The eruption at Salt Lake crater, as Hitchcock⁵⁹ pointed out, diverted Moanalua Stream eastward, thereby forcing it to cut a canyon about 100 feet deep across the nose of a Koolau spur. Likewise, the Punchbowl eruption displaced Pauoa Stream toward the west, so that it is now a tributary of Nuuanu Stream, whereas prior to the eruption it probably discharged directly into the sea.

GEOLOGY

GEOLOGY AND ITS EFFECT ON THE RECHARGE AND MOVEMENT OF GROUND WATER

Most of the potable ground water occurs in volcanic rocks—basaltic lava flows, intrusive rocks, and pyroclastic rocks. The lava flows are extremely permeable, and because they crop out in the belts of heavy rainfall and also extend shoreward under the coastal plain, they form ideal aquifers. Part of the rain falling on these beds runs into the sea in stream channels, part transpires from plants or evaporates, and part sinks into the ground. The part that sinks into the ground below the roots of plants and the capillary zone percolates to the water table. About a quarter of all the rain that falls on the island is accounted for by measurements of springs, tunnels, and wells. There are many places where ground water that cannot be measured is escaping into the sea at tide level or lower; hence, the total ground-water recharge is greater than 25 percent of the rainfall.

The occurrence of artesian water on Oahu is unusual in that a lower confining rock stratum is lacking. The upper confining strata consist of marine silts and clays of former higher stands of the sea and the lateritic soil formed by the decomposition of the lava rock prior to its

⁵⁹ Idem, p. 39.

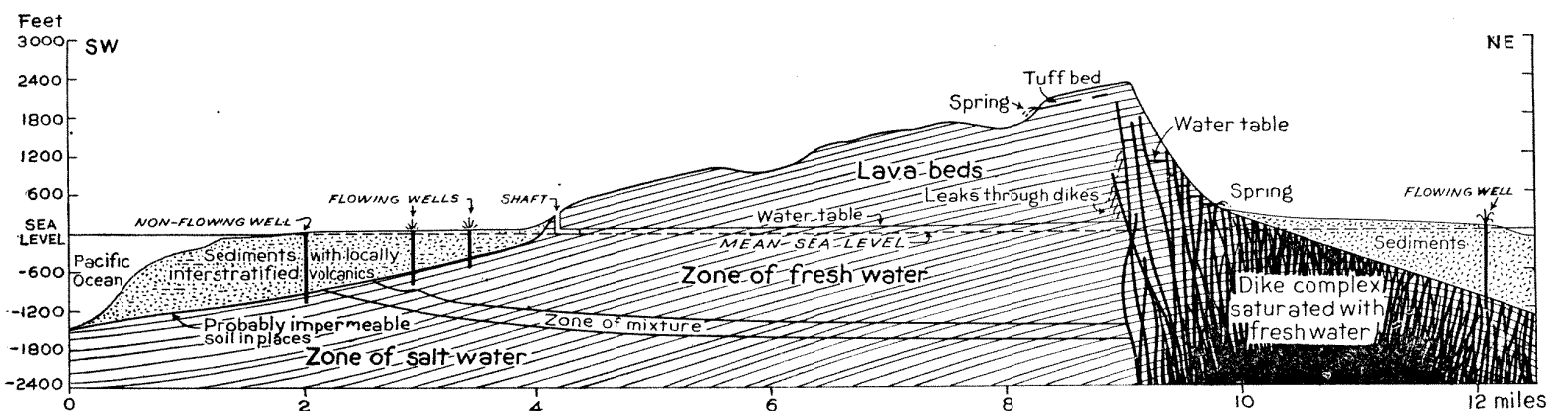

FIGURE 5A.—Diagrammatic section of the Koolau Range at Honolulu showing basal and perched water tables and relation of the fresh water in the dike complex and in the flow lavas to the zone of salt water.

submergence. The fresh artesian water floats on sea water, and partly displaces it, because of a difference in specific gravity. According to the principle of Ghyben-Herzberg, for each foot the water stands in a well above sea level the sea water lies about 42 feet below sea level. Thus if the water in an artesian well stands 10 feet above sea level, the depth to ocean water beneath sea level would be about 420 feet. Because there is a zone in which the fresh water and sea water are mixed the maximum depth at which potable water can be obtained is somewhat less than its calculated amount (fig. 5, A).

The intrusive rocks are largely dikes a few inches to 15 feet wide, which fill the cracks through which the lava supplying the flows is erupted. In general, they occur in definite rift zones, or fundamental major lines of weakness in the volcanic piles. Most of them are nearly impermeable and confine water in the wedges of included flow lavas. In the major rift zones of the two volcanoes, where dikes are numerous, water occurs at high levels and supplies most of the high-level springs and tunnels. Because the dikes increase in number and decrease in permeability with depth, sea water would not extend under the entire island but would occur only

in the permeable flow lavas surrounding these dike complexes or rift zones (fig. 5, A).

Ash and soil beds laid down between the lava flows serve also, locally, to perch ground water above the main basal underground reservoir (fig. 5A). Numerous springs and tunnels depend upon these beds for their supply. Some of the secondary eruptions have produced lava flows and permeable coarse ash deposits, which overlie nearly impermeable deposits of alluvium and soil. These volcanic materials were carefully mapped, because it was found that some of them carry valuable quantities of perched ground water awaiting development.

In addition to the volcanic rocks, the recent gravel, beach, and dune deposits and the emerged reef limestones carry water. The water in the limestone is in general of poor quality, because of contamination by sea water and pollution. Some of it consists of return irrigation water. It has not been extensively developed, nor are the quantities of potable water available nearly as great as in the volcanic rocks. It forms a reserve supply that will not be extensively utilized until the other sources are more fully developed.

THE ROCKS AND THEIR WATER-BEARING PROPERTIES

GENERAL CHARACTER AND AGE OF ROCKS

The igneous rocks of Oahu comprise chiefly basic lava flows and dikes, with subordinate amounts of fragmental material. The sedimentary rocks are in part noncalcareous deposits derived from the weathering and corrasion of the igneous rocks, and in part calcareous sediments that consist of emerged reef limestone and comminuted fragments of marine organisms derived from coral reefs by corrasion and deposited by the wind or the sea.

The lava beds range in thickness from 1 foot to 400 feet, but lava flows thicker than about 75 feet are exceptional and are usually either not normal basalts or are flows confined between valley walls. The flow 400 feet thick is a hornblende-biotite trachyte. Type sections are omitted from most of the following descriptions of formations, because they have little value in indicating the conditions in a basaltic dome.

Fossils are abundant in the emerged reef and beach limestones and indicate that they were deposited in late Pleistocene time. The exposed limestones, however, were deposited very late in the geologic history of Oahu and lie on valley fills 600 to 1,000 feet thick. Limestone is also encountered at more than 1,000 feet below sea level, but fossils have not been recovered from borings penetrating it. The absence of fossils associated with the lavas that make up the Koolau and Waianae domes leaves the age of these rocks uncertain. A study of the rate of growth of the active domes of Kilauea and Mauna Loa

sheds a little light on their age, but even so the rate of lava extrusion at different volcanoes is extremely variable. The absence of any extensive soil bed more than a few inches thick intercalated in the Koolau lavas and of any erosional unconformities indicates that the lavas of the Koolau dome accumulated rather rapidly. Unconformities in the Waianae dome indicate that its growth was interrupted by periods of erosion. These domes are insignificant piles, however, on the great volcanic ridge that rises about 35,000 feet above the adjacent floor to form the Hawaiian archipelago.

By correlating the emerged reefs of Oahu with late shifts of sea level induced by glaciation, it seems probable that the deep valleys on the island were carved during early Pleistocene time. If so, then the building of the Koolau dome ceased in late Tertiary or early Pleistocene time. The Waianae dome is older than the Koolau dome, and its building extends even farther back into the Tertiary. Conchologists and botanists would extend the age of Oahu back even before the Tertiary, to account for the evolution observable in the flora and land snails on Oahu.

A summary of the general stratigraphy of Oahu is given in the subjoined tables. A more detailed description of the rock units is given in the succeeding pages.

TERTIARY AND EARLY PLEISTOCENE (?) VOLCANIC ROCKS

WAIANAË VOLCANIC SERIES

The Waianae volcanic series comprises all the lava flows, intrusive rocks, pyroclastic rocks, breccias, and intercalated soils in the Waianae Range. In most places the basalts can be subdivided into three members. The lower member is as a rule separated from the middle member by a profound angular unconformity and talus breccia. Elsewhere it is separated by ashy soil several inches to 2 feet thick. In most places the middle basalt can be distinguished from the upper one petrologically, but there is no unconformity between them. The dikes that fed the different series can be distinguished from one another in only a few places. In much of the range the three lava members could have been mapped separately, but locally they apparently merge into one another.

LOWER BASALT

Geographic distribution.—The lower basalt of the Waianae volcanic series is exposed southwest of the soil and breccia shown on plate 2 between Makaiwa Gulch, near the southeast end of the Waianae Range, and Waianae Valley. It forms the cliffs bordering the lower parts of Nanakuli and Lualualei Valleys, the entire mountain of Puu Heleakala, 1,890 feet high, on the northwest side of Nanakuli Valley,

and a small area on the north side of Makaha Valley near the coast. From the latter place to the south side of Keaau Valley it is covered by the middle and upper basalts, but from Keaau to Kaena Point it is exposed in the ridges from points near the crest of the Waianae Range to the west coast.

Character and structure.—The lower basalt is predominately pahoehoe and ranges from dense to vesicular and from aphanitic to porphyritic. The dominant phenocryst is olivine, and the feldspar crystals so characteristic of the upper series are not abundant in the lower basalt. Flows with about 50 percent olivine were noted in Puu o Hulu Ridge and in a few other places. Except in Kuwale Ridge the flows range from 20 to 75 feet in thickness and are similar to the thin-bedded basalts of Kilauea Volcano.

The scarcity of tuff beds indicates that the flows were poured out quietly, like Kilauea lavas,⁶¹ and numerous dikes in this series show that most of the lava was erupted from fissures. Soil layers were not observed, hence the lavas must have accumulated fairly rapidly. The beds dip 4° to 14° in directions away from Kolekole Pass, indicating that the center of activity was in the vicinity of the pass. The dips are all southwest, west, or northwest.

Appearance of outcrops.—In dry areas where the basalt is exposed in cliffs it does not form sheer precipices but peculiar scraggly ledges. This characteristic is brought out by contrast in the southeast wall of Nanakuli Valley, where the upper part of the cliff is a nearly vertical gray wall consisting of the upper basalt, whereas the lower basalt below forms a dark-colored gentler bluff with irregular ledges cut by gullies. This difference is caused by the predominance of weaker pahoehoe beds in the lower basalt as compared with the stronger massive aa flows in the upper basalt.

Unusual flows in Kuwale Ridge.—In Kuwale Ridge, between Waianae and Lualualei Valleys, the usual thin-bedded flows give way to massive ones. The lower flow is about 200 feet thick and is capped with a breccia about 50 feet thick which is more like the block lavas that cover the top of trachyte flows than the spiny clinkers on top of a basaltic aa flow. On this breccia is a layer of vitric tuff 6 inches to 3 feet thick, containing small fragments of amygdaloidal pumice, above which is 6 feet of angular breccia glassier than the overlying lava and typical of the bottom of a trachyte aa flow. Above this breccia is a laminated massive bed of bluish-gray rock which has been determined microscopically to be a hornblende-biotite trachyte and which weathers into conspicuous white outcrops. The top of the flow is breccia

⁶¹ Stearns, H. T., and Clark, W. O., Geology and water resources of the Kau District, Hawaii: U. S. Geol. Survey Water-Supply Paper 616, pp. 129-135, 1930.

Stratigraphic Section of Oahu

[Mapped units indicated by *]

Recent sedimentary rocks (Partly water bearing).
Pleistocene sedimentary rocks (contemporaneous with Honolulu volcanic series and partly water bearing).

Honolulu volcanic series:

Recent or latest Pleistocene lavas and pyroclastics:
Basalts and firefountain deposits of Tantalus and Sugar Loaf, (good water bearers):

Tantalus basalt. *	Sugar loaf basalt. *	Contemporaneous fire fountain deposits, locally called "black sand." *	} Occur at Honolulu.
Basalts and pyroclastics of Koko fissure:			
Kaupo basalt. * (salt water)	Kaohikaipu volcanics * (no water)	Koko volcanics. (Overlie Kalama volcanics): Tuff. * (Little water) Basalt. * (Brackish water)	

Kalama volcanics. (Little water)	Manana tuff. * (no water)	} Do not occur near Honolulu.	} Essentially Contemporaneous
Recession of sea to present level.			

Late and middle (?) Pleistocene lavas and pyroclastic rocks (probably all post-middle Pleistocene.):

Lavas and pyroclastic rocks of Waipio (-60±-foot) stand of the sea and Waimanalo (+25-foot) stand of the sea:

Punchbowl volcanics: Basalt. * (In part water bearing) Tuff. * (No water) Castle volcanics. * (Probably little water) Kamanaiki basalt. * (Water in downstream part) Black Point basalt. * Overlies Diamond Head tuff. (No water) Mauumae volcanics. * (No water) Kaimuki volcanics. * Rests on Diamond tuff. (Good water bearer at sea level) Diamond Head tuff. * (Poor water bearer) Training School volcanics. * (Water bearer) Maunawili volcanics. * (Poor water bearer) Ainoni volcanics. * (Good water bearer) Salt Lake tuff. M a k a l a p a } M a p p e d w i t h t u f f . M a p p e d } M a k a l a p a t u f f . w i t h S a l t } L a k e t u f f . } (Poor water bearer)	} Relatively contemporaneous, but erupted from different vents. Occur at and near Honolulu.
Halt of sea at 40-foot (?) level, Waialae stand.	

Lavas and pyroclastic rocks of Kaena (+95-foot) and Laie (+70-foot) stands of the sea:

Kaau volcanics: Tuff. * (No water) Basalt. * (water bearer in places) Ulupau tuff. * (No water) Moku Manu volcanics: Tuff. * (No water) Basalt. * (No water) Makawao breccia. * (Poor water bearer) Pali volcanics: Basalt. * (Little water) Breccia. * (No water) Nuuanu volcanics (3 basalts). * (Water bearers) Kaneohe volcanics. * (Some water) Aliamanu tuff. (Little or no water) (Mapped with Salt Lake tuff) Haiku volcanics: Basalt. * (Water bearer) Tuff. * (No water) Kalihi volcanics. * (Water bearer) Rocky Hill volcanics. * (Probably water-bearer in places) Mokulea basalt. * (No water) Mokapu basalt. * (No water) Hawaiihoa volcanics. * (No water)	} Relatively contemporaneous. Occur at and near Honolulu.
Recession of the sea to a level below the 55-foot stand, Kahipa stand.	

Erosion of deposits of previous stand of the sea.
Halt of sea at 55 feet above present sea level, Kahuku stand.

Great erosional unconformity (early (?) Pleistocene).

Tertiary and early Pleistocene (?): (Part of Koolau volcanic series is younger than Waianae volcanic series.) Erosional unconformity Waianae volcanic series: Intercalated soil. * Talus breccia. * Firefountain deposits. * Dike complex. *	} Essentially Contemporaneous	Koolau volcanic series: Breccia. * Dike complex. * Tuff. * Basalt. * Essentially contemporaneous.	} Main bulk of Koolau basalts was probably erupted at same time as upper basalt member of Waianae volcanic series, but continued after extinction of Waianae volcanic series. Part of Koolau rests on Waianae volcanic series with erosional unconformity. No apparent unconformity between Koolau volcanic series and Kailua series.
Upper basalt member.		Important water bearer, except the breccia which is impermeable.	
Middle basalt member.		Part of Koolau rests on Waianae volcanic series with erosional unconformity.	
Lower basalt member.		No apparent unconformity between Koolau volcanic series and Kailua series.	
Important water bearer, except the breccia.		Kailua volcanic series: Dike complex. * Amygdaloidal basalt. *	Essentially contemporaneous
		Little or no water. Nowhere in contact with Waianae volcanic series. Contemporaneous with lower basalt member of Waianae volcanic series.	

similar to the bottom but less glassy, and the entire flow is about 400 feet thick. Above it is a flow about 200 feet thick, containing opal-filled crevices and numerous crystals of transparent feldspar half an inch across, which are so densely concentrated near the base of the flow as to form a nearly pure feldspar rock. The high feldspar content causes the rock to be crumbly and to weather mechanically to arkosic sand. Massive basalts are exposed in this ridge farther northeast and in the adjacent Puu Kailio.

Local unconformity in Makaha Valley.—A local unconformity occurs within the lower part of the Waianae volcanic series at an altitude of 1,800 feet in the northwest wall of Makaha Valley 2,000 feet northwest of tunnel 8. The unconformity at one point strikes N. 35° W. and dips 75° NE., but in general it is less steep. An 18-inch dike is cut off by it, but a 30-inch dike crosses it. An aa bed overlain by pahoehoe lies below the unconformity, and on it rests a talus breccia a few inches to 1 foot thick, with considerable fine reddish soil-like material in its interstices, overlain by angular flow breccias and irregular bodies of dense basalt. An 8-foot dike apparently injected along this contact crops out on the west side of the exposure and a 6-foot dike on the east side. The discordant beds make up the lower 100 feet of a high cliff, above which the beds appear to be continuous. As these upper beds continue southwestward and are terminated by the major cliff unconformity described on page 84, the unconformity at this place probably represents a small crateral depression along the rift zone early in the history of the Waianae Volcano.

Tuff deposits.—In Puu o Hulu there is a concordant laminated lithic tuff bed 1 inch to 1 foot thick, containing cinders and angular fragments of older basalts as much as 3 inches across. In the south side of Puu Heleakala a 400-foot cinder cone shot full of dikes is exposed interbedded with the lower basalt. The cinder cone was a kipuka (area not covered by a later flow) long enough for several inches of soil to form on its surface before burial. Noteworthy tuff layers were not found elsewhere in the lower basalt.

Water-bearing properties.—The lower basalt is in general very permeable, but because it crops out in a dry area, large yields of water cannot be expected from it. The Waianae Plantation sea level tunnel, in Puu Paheehee, southeast of Waianae, which yields water ranging from 7 to 28 grains of salt a gallon (72 to 290 parts per million of chloride) when pumped at the rate of 120,000 gallons daily, is the only water development in these lavas. Between Nanakuli Valley and Makaiwa Gulch they crop out along the coast at tide level, where any fresh water in them has ample opportunity to escape. This condition means a low water table and indicates that probably only brackish water exists in the lavas in this area. Puu Heleakala has enough of

a cover on its seaward end to probably prevent the rapid escape of fresh water through it into the sea, but on the north side of this peak an outcrop of breccia occurs which may stop ground water from moving seaward through the ridge. Puu o Hulu, the adjacent ridge, is separated from the main mountain intake area by permeable coral. A well dug in coral at Mikilua Camp, on the northeast end of this ridge, yields 10,000 gallons of water daily with 120 grains of salt a gallon (chloride content of 1,246 parts per million). If this ridge contained fresh water it would probably percolate to this well and make it less salty. Another well dug to sea level about a quarter of a mile east of Mikilua Camp also encountered water in coral with over 1,000 parts per million of chloride. Puu Maililii is a detached ridge like Puu o Hulu, and fresh water should not be expected in it.

It is exceedingly doubtful if the lower lavas will yield water on the south side of the seaward end of the Makaha-Keaau Ridge, owing to the breccia separating them at this place from the rest of the ridge. No economical sites for ground-water development in the lower basalt exist in Keaau Valley, owing to the number of dikes and the great depth to sea level east of the dikes. From Makaha to Kaena Point this basalt is exposed at sea level in enough places to allow ground water to escape readily. There are probably sufficient dikes, however, near the mouth of Makua Valley to retard the seaward movement of ground water through the ridges bordering this valley, hence a shaft to the water table connecting with a tunnel at about sea level should yield small supplies of potable water if excavated sufficiently far inland. The site chosen by Clark⁶² at an altitude of 200 feet at the tip of the spur between Makua Stream and its first north tributary appears to be the most satisfactory in the valley.

UNCONFORMITY BETWEEN LOWER AND MIDDLE BASALTS

Keaau-Makaha unconformity.—The lower basalt is separated in the west end of the Keaau-Makaha Ridge from the later lavas by an unconformity. As shown in figure 6, the middle basalt was ponded against an eastward-facing cliff in the lower part of the section, but higher up it cascaded over a preexisting westward-facing steep slope, which is believed to be an erosional surface. The dip of the beds changes from 5° or less to 25° or more at this point, as shown in plate 14, B. The talus breccia and the eastward-facing cliff are described in detail on page 84 and are evidently older than this slope, because they are truncated by it. In most places the middle basalt is likewise truncated by the unconformity for several feet above the breccia.

⁶² Clark, W. O., manuscript report to the Governor's advisory committee on leprosy, on ground water in Makua Valley, April 1930.

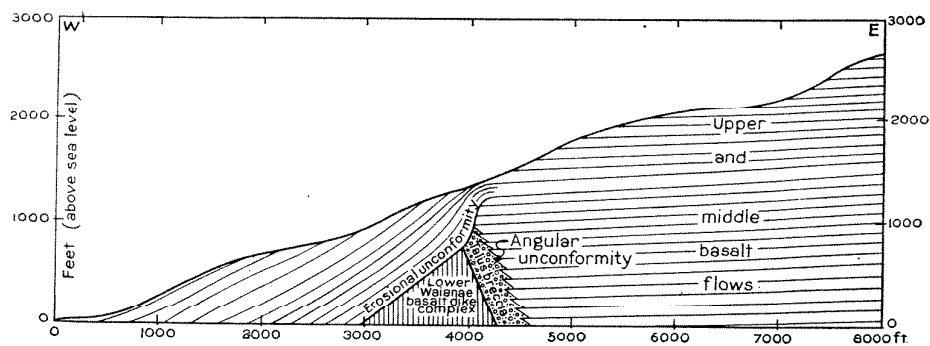

FIGURE 6.—Cross section from Puu Keaau, Waianae Range, west-northwest, down the ridge, showing unconformities between the lower basalt dike complex and the middle and upper basalt flows.

Although the evidence of an erosional interval is meager, it cannot be dismissed. From 2 to 4 inches of hill wash occurs between the dike complex of the lower basalt and the overlying lavas on the north side, and several feet of fine hill wash breccia resting on truncated dikes and slightly rotted rock occurs between the lower and middle basalts on the south side of the ridge. At the latter place an olivine-rich 4-foot dike has been intruded along the unconformity.

The dike complex on the north side of the ridge could have been exposed only by the removal of several hundred to a thousand feet of flow lavas. The absence of a thick soil bed in any place where the older lavas are overlain by younger flows seems to indicate that the erosion interval in which this unconformity was made was probably relatively short. It seems probable that stream or marine erosion, perhaps acting on a fault cliff, caused this precipice during the accumulation of the middle basalts. The erosion appears to have continued even after the middle basalts had begun to cascade over the cliff, because some of them are truncated also.

Keaau-Makua unconformity.—Two small patches of breccia occur on the adjacent Keaau-Makua divide. They rest on an irregular steep surface of the lower basalt member of the Waianae volcanic series and are not in contact with younger lavas. They are cut by dikes, hence they cannot be talus breccia of the present erosion cycle. The bedding in the breccia is vague but in one place appears to strike N. 60° W. and dip 30° SW. Near the upper edge of the southern patch of breccia a vertical 6-foot dike striking N. 78° E., rich in large olivine crystals, is rotted badly and forms a trench, which is cut by a fresh dike striking at right angles to it. Most of this weathering appears to have occurred before the emplacement of the breccia. Between the two patches of breccia, and apparently of similar age, is ancient red soil from 6 inches to 2 feet in thickness, intruded by and preserved behind a dike. These particular breccia and soil outcrops constitute

good evidence of an erosional surface cut in the older basalt, and they are apparently coeval with the unconformity in the Keaau-Makua Ridge.

A view of the fresh barren rocky cliffs in the present Waianac Range readily suggests that if they were flooded by lavas and then partly exhumed, many contacts of lava against lava might be found as free from soil as those just described. On West Maui bedded, thoroughly cemented talus breccias rest on clean, practically unrotted, nearly vertical lava rock walls of many of the canyons; hence deposits of this type are not uncommonly associated with erosional unconformities of great magnitude in the Hawaiian Islands. It is therefore not necessary to resort to faulting to account for the meager soil along the erosional unconformity in the Keaau-Makaha Ridge.

Cause of erosional interval.—The talus breccia (fig. 6) truncated by the unconformity lies against a former high precipice. This barrier must have effectively kept the land to the west and south from being flooded by lava during the time represented by the accumulation of the lava ponded by it. Here, then, is a time interval probably long enough for westward-draining valleys to have been carved in the weak lower basalts. Perhaps further field work in this area will reveal additional data on the history of this land mass. The lower basalt can be traced northward to the head of Keaau Valley, into Makaha-Makua Ridge, and toward Kaala, where it forms inaccessible precipices clothed with tropical vegetation. Perhaps somewhere in the head of Makaha Valley an unconformity separates the lower from the middle basalts. If it is ever found the lower basalt will become a mappable unit, because elsewhere it is separated from the younger rocks by either breccia or a thin soil bed.

MIDDLE BASALT

Geographic distribution.—The middle of the Waianae volcanic series is exposed continuously from the breccia at the head of Nanakuli Valley (pl. 2) around the head of Lualualei and Waianae Valleys. It forms all but the uppermost part of Kamaileunu and most of the Keaau-Makua Ridge southwest of the breccia outcrop crossing the ridge (pl. 2). Lava flows apparently belonging to this member are exposed in the reentrant behind Schofield Barracks, but in the north side of the range between this place and Kaena Point they were not distinguishable with certainty from the lower basalt.

Character and structure.—The flows are evenly bedded, as shown in plate 14, B, and in most places, except for a little more aa and flatter dips, the middle basalt physically resembles the lower basalt. Except in Kamaileunu Ridge they dip southeast, east, and northeast—in short, in directions opposite to the lower basalt. In general they dip away

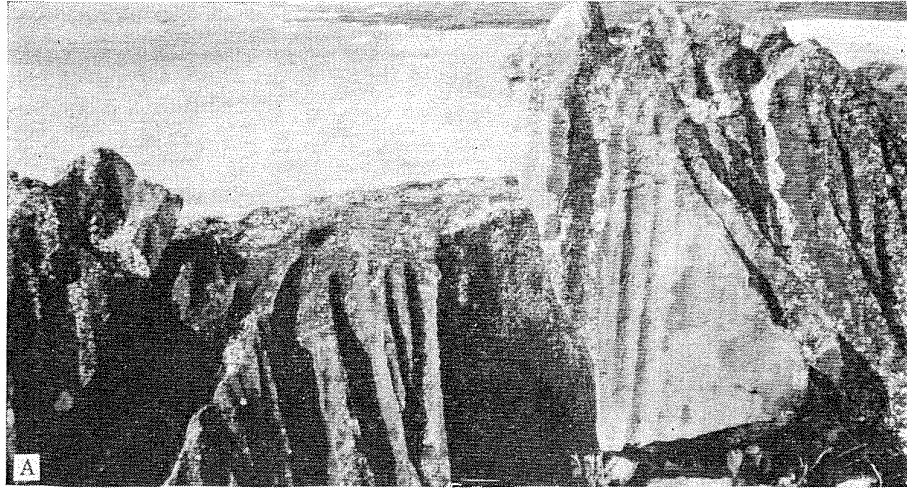

A, SOLUTION GROOVES OR LAPIES IN BASALT NEAR WAIMEA.

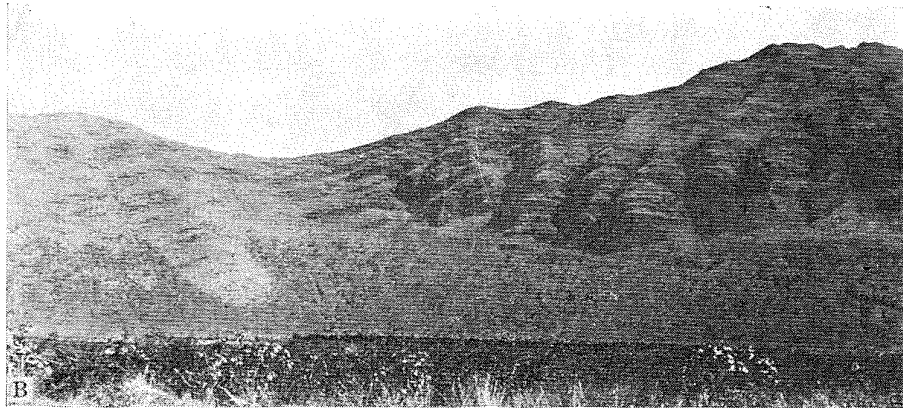

B, VIEW LOOKING NORTH TO SEAWARD END OF MAKAHA RIDGE, WAIANAË RANGE.

Showing change in dips of middle and upper lavas from 3°-5° to 25°-35°, owing to an unconformity.

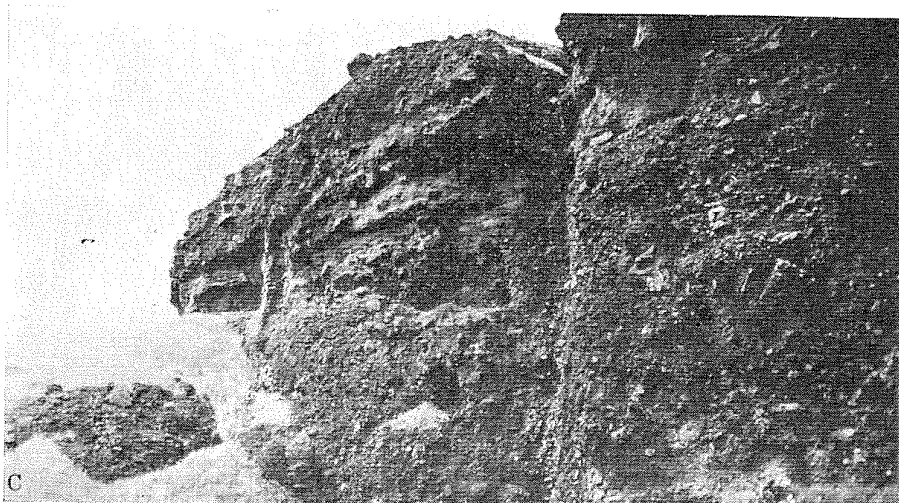

C, BRECCIA IN PUU KAILIO SHOWING FINE TUFFACEOUS BEDS.

Photographs by Harold T. Stearns.

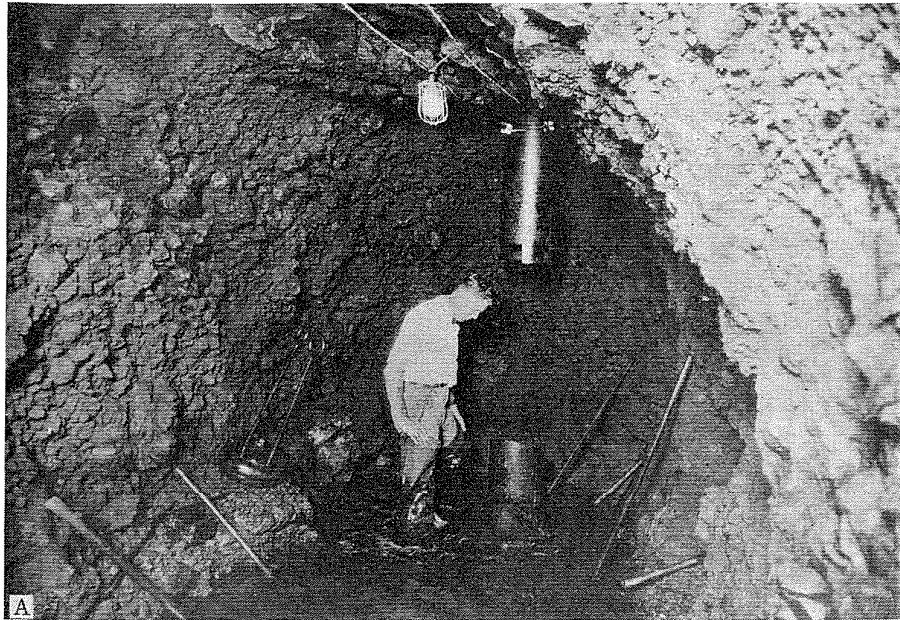

A, TUNNEL ABOUT 20 FEET ABOVE SEA LEVEL IN UPPER
WAIANAË AA CLINKER.

At pump 5. Oahu Sugar Co. Mr. Cowell, pump engineer, stands beside a well casing which has just been cut off, allowing the well to discharge into the tunnel. The circular valve on the left was used to plug the well and consists of compressible rubber. Photograph by Edgeworth, Honolulu. Published by permission of Oahu Sugar Co.

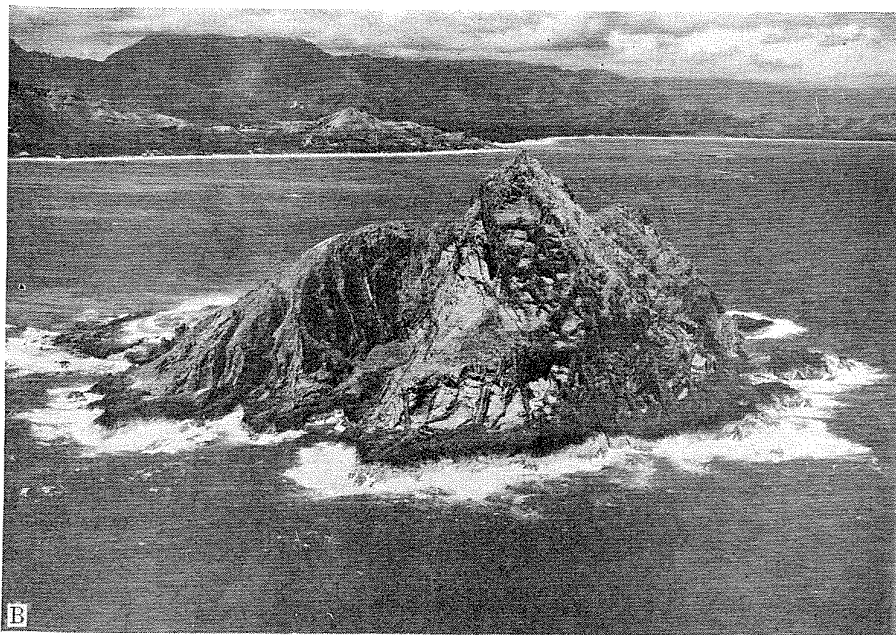

B, NORTH MOKULUA ISLAND, NEAR LANIKAI.

Showing the dike complex of the Kailua volcanic series. Photograph by 11th Photo Section, Air Corps, Luke Field, T. H.

from the vicinity of Kolekole Pass, like the lower basalt, indicating a common center for the two members. Numerous dikes exist in them, showing that they were poured from fissures like the lower member and thin tuff beds occur sparingly, indicating few firefountains.

The middle basalt has an exposed thickness of about 1,800 feet in Heleakala Ridge northeast of the breccia shown on plate 2. At an altitude of about 1,850 feet it is overlain by the upper basalt member, from which it is separated by a thin streak of rotted rock. In the Keaau-Makaha Ridge there occurs a pahoehoe flow at an altitude of 520 feet with about 30 percent of olivine crystals, at 940 feet a pahoehoe flow with 1-inch feldspar crystals, and at 1,300 feet a 3- to 10-inch bed of altered ribbon-type firefountain tuff. Only about 200 feet of the lower 1,500 feet of lava exposed in this cliff consists of aa flows; the rest is pahoehoe. Although a few of the flows are not porphyritic, most of them carry feldspar phenocrysts, and only about one-sixth of them have olivine phenocrysts. A graphic section of this cliff showing the types of lava present is shown in figure 7. The adjacent Kamai-leunu Ridge contains a pahoehoe flow at 510 feet, with about 40 percent olivine; another at 970 feet, with feldspar phenocrysts 1 inch across; and a dense aa flow at 2,120 feet, with about 50 percent olivine. A graphic section of this ridge is also given in figure 7. As the flows are narrow and each one sheaths only a small part of the dome, detailed stratigraphic sections have little significance.

The middle basalt member has not been mapped separately from the upper basalt, because their differentiation would have entailed much additional field work having no bearing on the occurrence of ground water. Where they were distinguished from the lower basalt they are separated by talus breccia (see pl. 2).

On the south side of the Keaau-Makaha Ridge some of the middle basalt flows have cascaded down a 65° slope and changed from massive beds 30 to 60 feet thick to thin clinkery beds 5 to 20 feet thick. In places the lava streams were dashed into little droplets, forming heaps of spatter similar to that in spatter cones, and have dragged along blocks from the cliff face. The contrast of the ponded massive beds with the adjacent spattery, thin-bedded clinker flows is a striking example of the influence of grade on the congealing of lava streams.

Water-bearing properties.—The middle basalt is very permeable and forms the reservoir for most of the water confined in the Waianae Range by dikes. In many places it crops out too high for basal ground water in it to be tapped economically. However, three-quarters of a mile north of Heleakala Peak, at the point of rock on the south side of Lualualei Valley that is being quarried for road material, there is a possibility of developing basal ground water from the middle basalt. Rough computations of recharge on tributary areas indicate that about

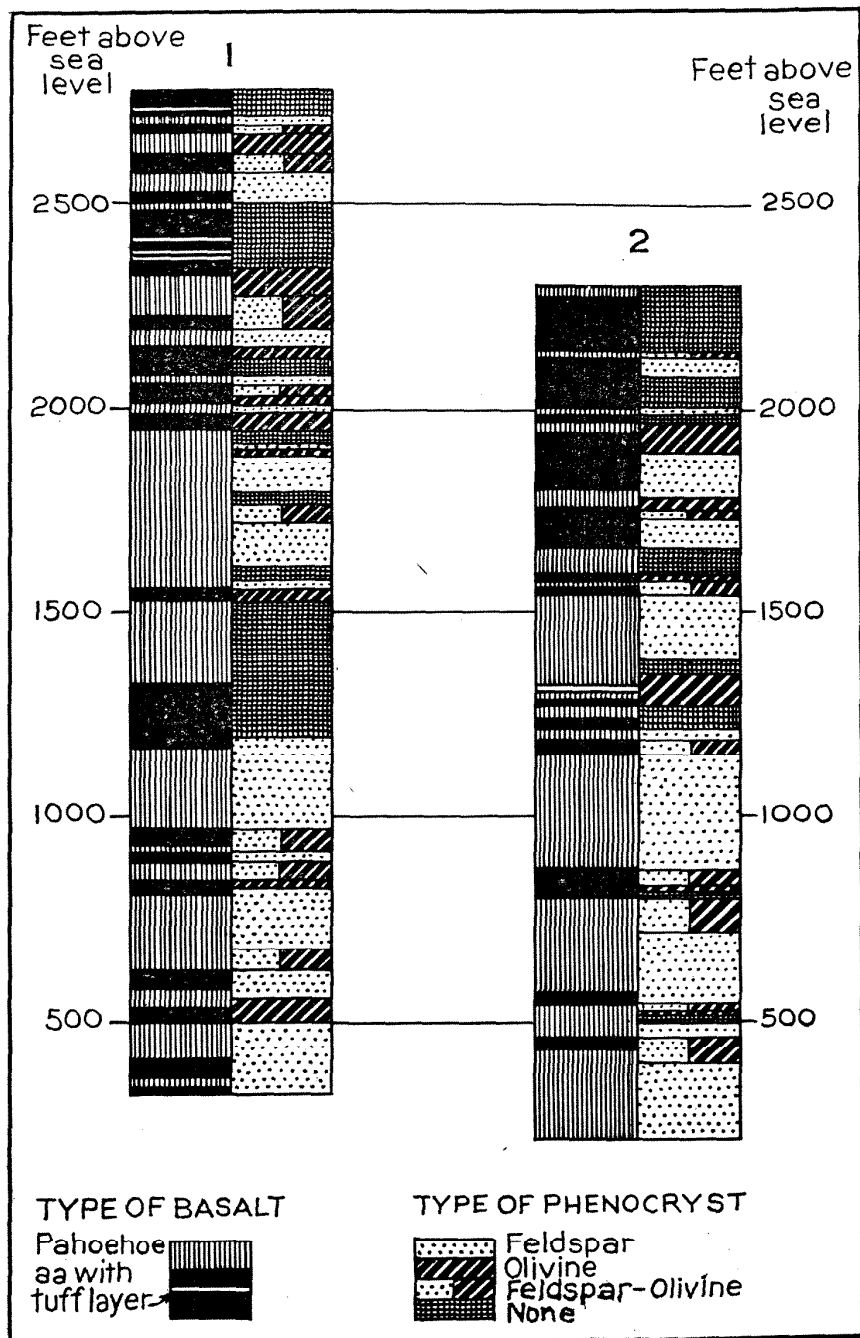

FIGURE 7.—Graphic sections of basalts in Keaau-Makaha Ridge (1) and Kamaileunu Ridge (2), Waianae Range. By T. F. Harriss.

2,000,000 gallons daily might be recovered from a shaft and sea-level tunnel extending partly through the ridge at this place. As the rock is exposed as low as 100 feet above sea level, the lift would not be pro-

hibitive for an irrigation supply. An inclined shaft would probably be more advantageous than a vertical shaft at this place.⁶⁰

A spring formerly discharged from the end of the Kamaileunu Ridge, but now a battery of wells at this point delivers for irrigation about 2,000,000 gallons daily, with a salt content of about 62.5 grains a gallon (650 parts per million of chloride). The middle basalt in the adjacent Keaau-Makaha Ridge is cut off from the rainy summit at basal ground-water level by cemented breccia; hence fresh water probably occurs sparingly in it.

Although no samples were saved from the artesian-well borings on the Waialua Plantation and other lands on the north side of Waianae Range, it seems likely that some of these wells obtain their copious supplies of fresh water from the middle basalt. Large quantities of fresh ground water will doubtless be encountered in it near sea level on the northeast side of the range.

UPPER BASALT

Geographic Distribution.—The upper basalt member of the Waianae volcanic series practically veneers the eastern slopes of the Waianae Range and caps the middle basalt in the spurs on the west side. It is not differentiated from the middle basalt on plate 2, because its separation is a petrographic problem beyond the scope of this work. From the head of the Nanakuli Valley to Gilbert it is separated from the lower basalt by a thin soil as indicated on plate 2.

Character and structure.—The upper basalt member is of variable thickness. It is 2,300 feet thick in the northeastern part of Nanakuli Valley and attains practically the same thickness on the summit of the range, where it forms Kaala Peak. This basalt is characterized by massive aa flows, which, because of their resistance to erosion, form sheer precipices like those around Nanakuli Valley and Kaala Peak.

Single massive layers 50 to 100 feet thick in this member are common, and although they usually have normal clinker phases, the massive lava is commonly platy, gray, and rich in feldspar, either in the groundmass or as conspicuous phenocrysts. Fine-grained and olivine porphyritic basalts are fairly common. In Pohakea Pass, at the head

⁶⁰ In 1932 the Hawaiian Homes Commission asked me to choose a site for a shaft to test the quantity, quality and altitude of the ground water in this ridge. Because this site is on private land, another was selected in the U. S. Navy reservation a short distance away yet sufficiently close to the ridge to make certain the shaft would reach bed rock at sea level. The Commission applied to the Navy for the land but the shaft was not dug at the time owing to delay in obtaining ownership of the site. In 1935 while I was in Washington, D. C., the City and County of Honolulu dug an inclined shaft at 100 feet altitude 485 feet northwest of the site I had marked and too far out in the valley to tap the water in the basalt of the ridge by the time it reached sea level. It was abandoned in March 1935 with the bottom 3.5 feet above sea level and dry. The shaft encountered a few thin streaks of partly decomposed coral and gravel but was mainly in a tight sticky brown clay chiefly, if not entirely, marine. This shaft determined nothing regarding the ground-water conditions in the basalt ridge except that a good cap exists to prevent the escape of the water from the basalt laterally into the valley-fill. It would probably be more economical to drive a new shaft at a point nearer the ridge than to drive a tunnel toward the ridge from the bottom of the shaft. Now that a diamond drill rig exists on Oahu it should be cheaper to drill a test hole than to sink a new shaft.

of Nanakuli Valley, a bed occurs with feldspar crystals reaching 6 inches across in a vesicular fine-grained groundmass. The feldspars make up about 80 percent of the rock and their rapid mechanical weathering gives rise to arkosic sands, which can be traced to the coast. Some fragments of feldspar without the typical cleavage are sufficiently large to yield gems of pale-yellow color weighing several carats.

The flows are mostly not typical basalt but appear to be less basic or on the border line between andesite and basalt. It is this difference in composition that appears to have caused the marked differences in physical characteristics between them and the middle and lower basalts. Several of the late flows on the southeast slope of the range carry nepheline. The lavas did not generally issue quietly in a fluid condition from long cracks, like the Kilauean lavas, but broke out, usually at single points, in great firefountains, which built large cinder cones several hundred feet high. These vents lie either in or close to the main rift zone of the Waianae dome, and such feeding dikes as are exposed are not larger than the rest of the Waianae dikes; hence the mechanism of the extrusion of these lavas is essentially the same as that of typical basalt. Mauna Kea, on Hawaii, and Haleakala, on Maui, are dotted with similar cones and their flows; hence it appears that basaltic domes commonly produce these massive flows in their dying phase of activity. This phase has considerable economic significance, because the time interval between the flows is frequently long enough to develop thin ash soils that will perch ground water. In the Waianae Range most of the springs outside of the dike complex owe their origin to this final phase of volcanism.

The upper lavas are conformable on the underlying basalts, but because of their viscosity they have developed here and there slightly steeper dips. On the southeast slope of the range they attain dips of 22°.

Water-bearing properties.—In most places the upper basalt lies above the basal water table, but on the southeast and east side of the range it reaches sea level and yields water abundantly. An average of about 7,000,000 gallons daily is recovered from these lavas at pump 5 of the Oahu Sugar Co. (well 274), and well 275, nearer the coast, also encountered water of good quality in them. It is believed that the Gilbert wells (276) obtain artesian water from these lavas. The clinker phases are exceedingly porous, as shown by plate 15, A. The occurrence of perched ground water on the soils and vitric tuff beds associated with these lavas is described on page 80.

DIKE COMPLEX

Character and structure.—The area of the dike complex of the Waianae volcanic series is shown on plate 2. It consists of closely spaced gray to black, usually almost vertical single and multiple dikes a few inches to 15 feet thick, intruded into all members of the Waianae series. The dikes are usually microcrystalline and crossjointed, although a few contain conspicuous olivine and feldspar phenocrysts and are platy and vesicular. They are the fissure feeders of the Waianae flows. The amount of extrusive basalt present in the deeply eroded central part of the dike complex is negligible.

It is impracticable to map each of the hundreds of dikes exposed in the Waianae Range. In most of the area of dike complex shown on plate 2 they are so close together that if every one were plotted on the map they would obscure all of the extrusive rock. The boundaries of the dike complex as mapped are in most places rather arbitrary and outside of these boundaries numerous dikes occur that have not been mapped. However, the decrease in the number of dikes beyond the boundary is striking, and generally within an eighth to a quarter of a mile from its edge dikes are absent. This definition holds for all the dike complexes shown on plate 2. They are denuded rift zones, and the confinement of the dikes to narrow belts bears out my observations on Kilauea and Mauna Loa, that the magma is confined to definite permanent fissure zones from the magma reservoir to the surface.⁶³

It was found necessary to stop the mapping of the dike complex at the base of some cliffs, in general because erosion has not sufficiently denuded the rift zone to expose the dikes. Many of the dikes near the head of Lualualai and Waianae Valleys are irregular, thin and not vertical, and locally they form thin, small sills along bedding planes. This condition is apparently due to local intrusions rather than to flank eruptions, because of proximity to the center of activity. Weathering out of some of the dikes at the head of these valleys has produced great cracks parallel to the cliff faces. Farther northwest, however, between Keaau Valley and Kaena Point, some of the massive dikes stand in relief as narrow walls 80 to 100 feet high.

The dikes outside of the dike complex shown on plate 2 are in every way similar to those in the dike complex but are strays from the rift zone or so near the former surface of the rift zone that only a few have yet been exposed by erosion. The cones near Ewa lie in the southeast rift zone and indicate the appearance of the dike complex elsewhere prior to denudation. Dikes tend to diverge slightly at the distal end of the rift zones; hence they are not as close together nor do they confine water as well as those nearer the volcanic center.

⁶³ Stearns, H. T., *op. cit.* (Water-Supply Paper 616), p. 138.

Age of the dikes.—There are three sets of dikes correlative with the three basalt members, and it is impossible to separate them in most areas. However, as mapped on plate 2, the dike complex stops abruptly against breccia in the south wall of Keaau Valley. Most of the dikes northwest of the breccia fed the lower basalt member, and the few dikes shown crossing the breccia belong to either the middle or the upper basalt. Dike feeders of the lower basalt are numerous in Puu o Hulu, at the mouth of Lualualei Valley, and decrease in number northeastward. In Keaau Valley a similar relation was noted in the dikes of the lower Waianae. This condition in both the northwest and southeast dike complexes seems to indicate a slight northward shifting of the fissure eruptions in these two rift zones, beginning with the extrusion of the middle basalt.

Dike systems.—The dikes of the Waianae Range are divisible into three groups or swarms, which define rift zones in the former dome. One extends northwest and enters the sea near Kaena Point, another runs southeast toward Ewa, and a third runs northeast toward Waialua. The northwest and southeast systems of dikes meet at a slight angle which partly caused the curved crest of the Waianae dome, and from these systems most of the lavas were extruded. The northeast dikes indicate a secondary rift radiating from the center of the dome, and extrusion of lava from it must have been negligible, because the dome is built out only slightly in that direction, and the dikes are few.

Water-bearing properties.—Five springs issue between 1,300 and 1,700 feet above sea level from the dike complex at the head of Lualualei Valley. Additional water could be developed in this area by driving tunnels at the site of these springs.⁶⁴ The rainfall is low and the drainage area small, hence probably only a few hundred thousand gallons can be recovered economically. At the present time about 2,000,000 gallons⁶⁵ daily are being discharged from tunnels driven into the dike complex at the head of Waianae Valley. Clark⁶⁶ has estimated from computations of rainfall and runoff that 500,000 to 1,000,000 gallons daily can still be recovered by tunnels in the dike complex at the level of the existing tunnels. Three tunnels at somewhat lower levels driven to the east side of the crest should recover additional water.

Dikes are not abundant in Kamaileunu Ridge (pl. 2), hence conditions do not favor high-level water there. No high-level springs issue from the dike complex in the north wall of Makaha Valley, owing to the small recharge area and low rainfall above it. However, considerable high-level ground water issues from the adjacent floor of Ma-

⁶⁴ Stearns, H. T., High-level water supply for the proposed United States Navy ammunition depot in Lualualei Valley, Waianae District, Oahu, T. H. (manuscript rep't. Dec. 11, 1930).

⁶⁵ Does not include discharge from tunnel no. 19 now being driven.

⁶⁶ Clark, W. O., Ground water of a portion of Waianae (unpublished report to the Attorney General of the Territory of Hawaii, September 1930).

kaha Valley, both from flow lava and from alluvium. It seems likely that this water represents the overflow of ground water dammed by the subjacent dike complex. If this can be demonstrated by test holes, then additional water can probably be developed in this valley. Northwest of Makaha Valley the dike complex lies in a dry belt with small recharge, and such ground water as occurs probably leaks downward to sea level. Several small seeps issue from the dike complex in Makua Valley, but the dissection is too great and the rainfall too low to make these prospects favorable.

The northeast dikes are too few and scattered to offer a prospect for high-level water on that side of the mountain except possibly on the south side of Kaala. A few more dikes are exposed in Kaukonahua Gulch than are shown on plate 2, but no perched ground water was observed there.

FIREFOUNTAIN DEPOSITS

Character.—The firefountain deposits of the Waianae volcanic series consist of the usual cinders, spatter, bombs, pumice, and droplet material. They occur as cinder cones and as thin beds of vitric and crystal-vitric tuff resting on or interlaced with the basalt members of the series.

Distribution.—The areal distribution is shown on plate 2. The only cinder cone found in the lower basalt is exposed in the south side of Puu Heleakala. A thin streak of vitric tuff occurs at about 1,800 feet above sea level in the same basalt in the spur projecting westward from the east wall of Nanakuli Valley, and another occurs in Kuwale Ridge.

Eight eroded cinder cones and their associated vitric tuff beds occur on the south end of the Waianae Range. A large one is exposed in the cliff at the head of Nanakuli Valley at the peak known as "Palikea" (pl. 2). Another occurs a quarter of a mile east of Puu Manawahua. Six occur in line in the same area—namely: Puu Kuua, Puu Kapuai, Puu Makakilo, an unnamed partly buried one between Kapuai and Makakilo, Puu Palailai, and Puu Kapolei. Puu Kapolei has few cinders left on it owing to erosion. A thick bed of vitric tuff laid down close to some cinder cone, now eroded away, is exposed at an altitude of about 2,700 feet in the Makaha-Keaau Ridge. At Puu Kawiwi, in the Waianae-Makaha Ridge, there are bedded cinders indicating that a cone existed close by prior to erosion. Part of a cinder cone is also exposed on the trail to Kaala from Schofield Barracks a little below the summit of Kaala. It gives rise to a small spring and is underlain by lithic tuff indicating a violent explosion at the beginning of the eruption. An eroded cinder cone occurs near Kealia triangulation station, on the crest north of Makua Valley. Another one is exposed in the abandoned

road up *Manini Pali*, on the north coast near *Kaena Point*. Bedded cinders are exposed in the same cliff at the mouth of *Haili Gulch*, near *Kawaihapai*. Between this point and the one near *Kaena Point* there are exposed almost continuously in the cliff several layers of vitric-tuff soil. Several layers of vitric tuff not correlative with any cone are shown on plate 2 elsewhere in the *Waianae Range*. Most of them are in the upper basalt.

Water-bearing properties.—The cinder cones are extremely permeable, but the thin layers of pumice drifted away by the wind from the cones during the firefountains are weathered sufficiently in many places to perch water. The rainfall on the areas of tuff is so low and the beds so discontinuous that only small quantities of water can be recovered from them in any one place. The tunnels in them are described in the section “*Waianae tunnels*” and the perched water on the north-side soil and tuff layer in the section “*Windward Springs, Waianae Range.*”

TALUS BRECCIA

Character, Distribution, and Origin

The talus breccia of the *Waianae volcanic series* consists of poorly bedded and unsorted red, brown, gray, and black angular fragments of basalt as much as 6 feet in diameter firmly held together by an iron-stained cement, apparently silica. It forms narrow outcrops across the head of *Nanakuli Valley*, in *Puu Kailio* and *Kauopuu* in *Lualualei Valley*, in the head of *Waianae Valley*, and in the head of *Keaau Valley*, as shown on plate 2. Because these four areas are isolated it is not possible to prove that the breccia was continuous before erosion. Except in a few places it indicates a profound angular unconformity between the lower and middle basalts. The breccia accumulated as talus at the foot of high cliffs of unknown origin in the older basalt. The lack of weathering of the breccia fragments, however, indicates that it accumulated rapidly or else in a very dry climate. The first explanation is supported by other lines of evidence given in the more detailed discussion that follows, hence the talus probably accumulated at the foot of fault cliffs, although there is little evidence of faulting except in one place.

Breccia in Nanakuli Valley

A fine section of the talus breccia is exposed in *Heleakala Ridge*. As shown somewhat diagrammatically in figure 8, a cliff more than 500 feet high facing north truncated the lower basalt member. These lower lavas dip 8° to 14° in a southerly direction. They include a bed of vitric tuff near the cliff and are even-bedded pahoehoe flows. The same series of lavas reaches a thickness of 1,890 feet less than half a mile southwest of the breccia. The cliff face was practically fresh bare rock when the breccia accumulated, and there is no sign of faulting.

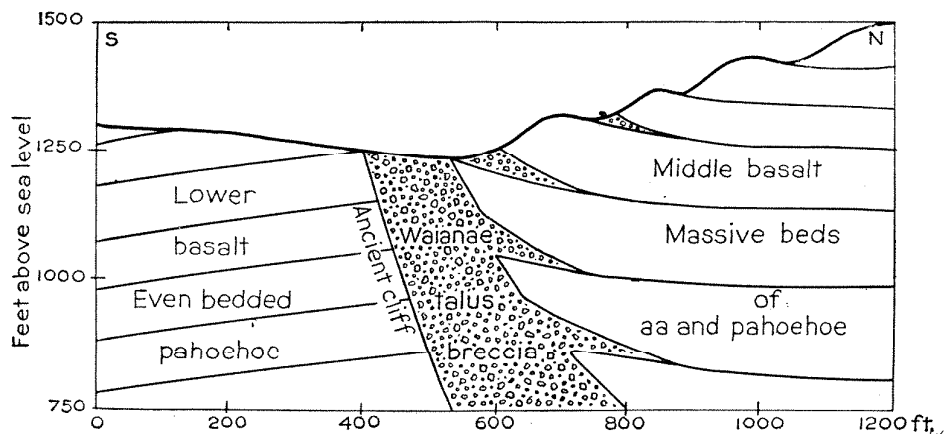

FIGURE 8.—Geologic section along Heleakala Ridge at saddle in the Waianae Range, showing relation of talus breccia of the Waianae volcanic series to lower and middle Waianae lavas.

The middle basalt member, which lies on the north side of the breccia, consists of massive flows of lava, mostly aa at this place, with a thin streak of vitric tuff between the two flows just above the saddle. As shown in figure 8, wedges of talus breccia extend 50 to 100 feet between the flows before they pinch out. The thickness of the flows has been exaggerated in the figure to show these wedges. The presence of breccia between two flows above the saddle indicates that some of the breccia has been removed by erosion. The lava beds strike a little north of west and at the contact with the breccia dip as much as 16° NE., but they flatten to about 5° farther north. The wedges of breccia between the flows indicate that the talus accumulated concurrently with the flows.

If this breccia had accumulated as explosion debris at the foot of a cliff, then it would seem that layers of similar breccia should be intercalated with the middle basalt flows. As this is not so, the breccia at this place is a true talus breccia. All the fragments in the breccia appear to be derived from flows of the lower basalt member.

The massiveness of the middle basalt flows is caused by their ponding against this cliff and breccia before draining northward. At the base of some of the flows the fragments of the breccia are surrounded with tachylyte, or glassy basalt, indicating that the interstices were open at the time the lava was fluid. One dike crosses the breccia as well as the lower and middle basalts in the saddle, but a few of the dikes in the lower basalt member terminate at the cliff. By viewing the exposure from a distance it is evident that all the flows to the north of the breccia down to the lowest exposure 100 feet above sea level are ponded and discordant with the flows to the south. Evidently the cliff unconformity and doubtless the breccia also extend at least to sea level at this place. The lavas are likewise discordant and and litho-

logically different to a height equivalent to the top of Puu Heleakala, or 1,890 feet. How much higher this discordance extended upward in the mountain before erosion carved out this ridge is unknown, but from the visible outcrops this cliff was probably at least 2,000 feet high during the accumulation of the middle basalt. If this cliff was caused by faulting, it may never have had all this height at any one time. However, most of the fault cliffs of this magnitude in Hawaii have secondary parallel displacements adjacent to them. Although the rocks are admirably exposed in Heleakala, not even a small displacement was detected.

The talus breccia, as shown in plate 2, extends about 2 miles eastward and disappears under upper basalt of the Waianae volcanic series at Mauna Kapu, on the east side of Nanakuli Valley. The top of this ancient cliff at this place is about 2,050 feet above sea level and was overflowed by the upper lavas.

The geologic significance of this cliff is difficult to interpret. It is almost too straight for a caldera wall, and moreover it is nearly transverse to the axis of the Waianae Range and the Waianae dike system. Fault cliffs of nearly this magnitude occur on Kilauea⁶⁷ and are caused by the slipping seaward of great slices of the dome. The ancient cliff in Nanakuli Valley isolated the area of lower basalt long enough for changes to take place in the magma reservoir, because when it was finally overtopped on the south side of Nanakuli Valley the lava had a slightly different character.

Effect on ground-water movement.—The breccia at the head of Nanakuli is so tightly cemented on the surface that it appears practically impermeable. If it retains this texture downward to sea level it would effectively dam any ground water percolating seaward and likewise prevent sea water from migrating inland. The dikes in this ridge also act in the same way. The absence of fresh-water springs at tide level in outcrops of the lower basalt near Nanakuli Valley further supports the idea of a ground-water barrier. Prospecting for water should be done in the middle basalt north of the breccia.

Breccia in Lualualei and Waianae Valleys

Breccia forms the north and east sides of Puu Kailio, at the head of Lualualei Valley. It also covers a good part of the adjacent Kauopuu Ridge and forms two small outcrops in Waianae Valley, one near tunnel 2 and one in the stream bed 600 feet downstream from tunnel 15. The breccia in Puu Kailio rests against an eastward- and northward-facing, nearly vertical cliff with its top 1,966 feet above sea level. A few dikes are truncated by the cliff, but many are later and pass

⁶⁷ Stearns, H. T., and Clark W. O., Geology and water resources of the Kau District, Hawaii: U. S. Geol. Survey Water-Supply Paper 616, p. 51, 1930.

through the breccia, as shown in plate 3, B. Prism-shaped masses of breccia are enclosed within a few of the dikes. One offshoot of a dike cuts through an angular block 3 feet in diameter which shows that the mass must have been tightly cemented when this particular dike was injected. This breccia is much better bedded than that in Nanakuli Valley. Some of the beds have a fine texture, as shown in plate 14, C, and resemble closely a coarse lithic tuff, which they may be. It is not easy to account for the segregation of so fine-textured a deposit as part of normal cliff talus, but such beds would be expected if explosions occurred close by.

In the adjacent Kauopuu Ridge the breccia is banked against a northward-facing cliff and in addition mantles the ridge in a manner too complicated to be shown in detail on plate 2. In the upper end of the ridge it is semicircular in plan and is overlain by a massive body of dense rock. It appears at this place to have accumulated in a small crater, which was later filled with lava. There is a marked discordance in the lavas in this ridge. Those on the north end dip 12° NE., and those on the south end dip southwest at similar angles.

When the beds in the Waianae Range are viewed from an airplane it is at once apparent that all of them dip away from the Puu Kailio-Kauopuu area. Before erosion it was probably the highest part of the range, and the breccia at this place appears to have accumulated within a former caldera on the summit of the Waianae volcano. The small crater mentioned above probably lay within the caldera like Halemaumau Crater lies in the Kilauea caldera.

The breccia near tunnel 2 in Waianae Valley is crisscrossed with dikes and forms a single massive outcrop without bedding. Its contact with the adjacent basalts is not exposed. The outcrop near tunnel 15 is brown to gray unsorted cindery breccia, with angular fragments reaching 4 feet in diameter, derived chiefly from dikes. The contact with the basalt strikes N. 75° E. and dips 15° SE. The bedding of the breccia is nearly parallel to the contact, and in one place tachylyte binds the fragments. The basalt is nearly horizontal and has a smooth bottom contact. The presence of so many cinders in the breccia suggests that it is either an explosion breccia or a talus breccia on the wall of a crater that received showers of cinders. Its relation to the breccia near tunnel 2 could not be ascertained. The rocks in Kolealilii Spur seaward from these two outcrops of breccia are thin-bedded pahoehoe typical of the lower basalt member of the Waianae volcanic series. North of the breccia the rocks appear to be the middle lavas of that series, cut by numerous dikes and capped with the upper basalt member.

Effect on ground-water movement.—It is probably a coincidence that most of the high-level water recovered by tunnels in the Waianae Valley

comes from the north side of these two breccia outcrops. The ridge between them is covered with vegetation. If they are connected and extend downward for some distance they might form a barrier to ground-water movement. The breccia may even pass beneath the alluvium to the southeast and connect with that in Kauopuu Ridge. The effect of the breccia in Kauopuu Ridge and Puu Kailio on ground-water conditions is difficult to ascertain. In these areas, as in Waianae Valley, practically all the high-level springs issue from the dike complex north of the breccia.

Breccia in Keaau and Makaha Valleys

Three-quarters of a mile northeast of the mouth of Makaha Stream, at an altitude of 500 feet in the Keaau-Makaha Ridge, is a small patch of firmly cemented breccia, as shown on plate 2. On the east side of this breccia outcrop the middle basalt member of the Waianae series is nearly horizontal and massive, as is characteristic of lavas ponded against a cliff. A few hundred feet to the southwest the lower basalt member crops out. Three quarters of a mile to the north, on the other side of the ridge, another outcrop of breccia occurs. At this place the breccia is banked against a nearly vertical southward-facing cliff and shows bedding typical of a talus apron. It consists of poorly assorted varicolored angular fragments reaching 6 feet in diameter, projecting from a rock-powder matrix. It is 50 to 100 feet thick and dips 38° S. Fragments of dike rock are abundant, and magmatic ejecta are notably absent. The fact that there was no appreciable weathering of the fragments during their accumulation signifies rapid deposition at the foot of a fresh rock cliff.

The rock forming the cliff is the lower basalt member, which has been injected with so many dikes that scarcely any of the flow rock remains. All but two or three of the dikes are truncated by the cliff, and those which pass through the breccia into the overlying flows are distinctly younger and fill fissures that supplied the later lavas. The overlying lavas belong to the middle basalt member of the Waianae volcanic series, consisting at this place of massive ponded aa flows. The relation of the two rocks to the breccia is similar to that in Heleakala Ridge, shown in figure 8. The breccia passes beneath middle and upper basalts to the southwest and is covered with alluvium to the east.

Three-quarters of a mile to the northeast across the alluvium-filled head of Keaau Valley the breccia reappears in the same relation to the lower and middle basalts. The cliff, however, turns from northeast to southeast as it passes through the Keaau-Makaha Ridge for the second time. The breccia is exposed between altitudes of 1,500 and 2,700 feet in this ridge, indicating a cliff at least 1,200 feet high. It

extends downward even farther, and prior to erosion it must have extended upward at least several hundred feet more. It was certainly an impressive cliff at the time the middle and upper basalts were accumulating against it. In Makaha Valley the strike of the breccia abruptly changes from southeast to northeast, which may indicate either that it abuts against a nose of rock projecting from the cliff face, or that the cliff turns. The breccia disappears beneath alluvium and was not found again. Parallel to the breccia of this ridge 100 to 200 feet north of it, is a distinct streak of fine-grained fault breccia 6 inches to 1 foot thick. The amount of displacement along it could not be determined. The fault plane strikes N. 55° W. and dips 52° SW. at an altitude of 2,100 feet. As shown on plate 2, the breccia outcrops, if connected, delineate a cliff semicircular in plan, with the ends 2 miles apart. Its top ranged from about 700 to 3,000 feet above sea level, with its low side on the west. The fault parallel to it in one place suggests faulting as the cause of the cliff. Its semicircular outline may denote that it is the exposed half of a caldera wall, the other part obscured by alluvium or later lavas because of its low height. Or possibly the cliff is in some way connected with the breccia in the adjacent Waianae Valley, and the connection is obscured by vegetation or younger rocks.

If the entire lava fill in Kilauea caldera were exposed in cross section it would reveal intrusive masses, beds of agglomerate, cinders, and numerous dikes, as shown by the 1,000-foot section now exposed in Halemaumau. A section of Mokuaweoweo caldera, on Mauna Loa, would expose numerous cinder cones, beds of pumice, and other products of a great volcanic vent. A section of the ridge jutting south into Makaha Valley south of Puu Keaau (see pl. 14, B) from an altitude of 200 feet to 2,225 feet is given graphically in figure 7. It shows only four thin tuff beds. Three-quarters of a mile northwest of Keaau, in a saddle in the ridge, is a small elliptical intrusive body that is probably a stump of a cinder cone. The 4- to 10-foot bed of firefountain debris at 2,700 feet extending northward between two lava beds was probably ejected from this vent. Dikes are nearly absent in the ridge, and explosion debris and irregular intrusives, such as are ordinarily associated with a large caldera, are not present.

If this cliff is connected with similar features exposed in Waianae and Lualualei Valleys and then assumed to pass under the alluvium of Lualualei Valley to Nanakuli Valley, it would indicate a large land mass composed of older basalts bounded in most places on its north and east sides by a great cliff. Such great cliffs are common in the Hawaiian Islands. The fact that the middle and upper basalts nearly everywhere dip away from such a projected continuous cliff supports

the theory of such a land mass. Further study in the area may find data supporting such a postulate.

Effect on ground-water movement.—A dike complex lies between the breccia and the rain belt, hence there is probably very little basal water moving seaward through the main ridge toward the breccia. Rain water percolating to the basal water table in the ridge between the upper and lower breccia barriers can escape into the alluvium in Makaha Valley. The lower breccia may, however, retard the influx of sea water if water is pumped from the middle basalt in this ridge.

INTERCALATED SOIL

Character and distribution.—A thin bed of red-brown soil 6 inches to 3 feet thick is intercalated in the basalts of the Waianae volcanic series in several places. It is shown on plate 2 because locally it yields water. In many places it contains rotted and partly rotted fine-grained fire-fountain debris, but the bedrock beneath it is sufficiently rotted to show that it includes residual soil from the weathering of flow lavas. As this soil accumulated on a kipuka⁶⁸ of sufficient relief to escape being flooded by basalts, the thickness and extensiveness of the soil vary from place to place, according to the variation in relief of the ancient land mass.

The soil is exposed in a road cut on the main Waianae highway 800 feet east of Makaiwa Gulch, northeast of Gilbert. At this place it separates the lower pahoehoe basalt of the Waianae series from the upper aa lavas of that series. No attempt was made to trace it through the dense thorny brush north of the road. Its approximate position between this point and Nanakuli Valley is shown on plate 2 on the basis of recognition of the lower and upper basalts, because it is known to occur between them. It is again exposed in the southeast wall of Nanakuli Valley, where it can be traced for over 2 miles. It stops at the breccia marking the site of the cliff which abruptly terminates the older basalt at this place. This soil accumulated during the time the older basalt remained as a kipuka.

Significance.—The time required to form soil beds on permeable basaltic domes in low latitudes is largely conjectural, because the rate of formation depends upon temperature, rainfall, chemical composition and physical character of the lava, type of vegetation, configuration of the surface, and amount of ash. The few inches or few feet of soil between the lower and upper basalt members is not impressive as compared with the 5 to 10 feet of soil formed on the basalts of the Schofield Plateau since the extinction of the Koolau Volcano. Furthermore, if most of it consists of decomposed pumice, as is suspected, then the time interval for its accumulation may have been relatively short.

⁶⁸ An islandlike area of older rocks not covered by later flows.

However, because of the high permeability of the surface of a basaltic dome rain may percolate downward so rapidly through crevices that the time required to form the first foot of soil and concurrently to partly decompose the underlying 10 or 20 feet of rock may be many times longer than that necessary to form several additional feet of soil. The first foot of soil greatly retards the downward percolation of rain water and increases the density of plant growth, and hence hastens the subsequent soil formation. Furthermore, the underlying rock, being partly decomposed, is more rapidly disintegrated in this stage.

An impressive example of a soil layer, in most places thinner than that between the lower and upper members of the Waianae series, probably representing a considerable time period, occurs on West Maui. The West Maui volcano, after reaching nearly its final height, ceased erupting normal basalts and became dormant. A soil layer a few inches to 3 feet thick formed. The next lavas erupted were thick trachyte flows. This soil represents a time interval sufficiently long for the underlying magma reservoir to undergo considerable differentiation. Although the time required for such a process is unknown, there is generally agreement that it must be long.

Water-bearing properties.—Numerous small seeps discharge from the soil layer in Nanakuli Valley, but the recharge area above it is small and arid. Nevertheless it apparently plays an important part in the migration of ground water at sea level. Water stands 14 feet above sea level in the artesian wells near Gilbert, and they yield 20,000,000 gallons a day with a small draw-down. These wells apparently obtain their water from the upper basalt, to judge from their shallow depth and the thick exposures of this lava nearby. A little less than 2 miles away, at Kahe Point, the lower basalt crops out at tide level. The normal hydraulic gradient of the basal water table is 3 feet or less to the mile in permeable basalt, yet fresh water springs do not occur at Kahe. Some barrier must prevent the movement of ground water from Gilbert to Kahe. This soil bed that separates the lower from the upper basalt is the only geologic feature known in this area capable of forming the required ground-water dam. It would not need to be very thick nor entirely water-tight to hold back the large volumes of water at Gilbert under a 14-foot head. Perhaps the small spring at tide level at Brown Camp, between Gilbert and Kahe, represents a leak through this soil barrier.

Another soil bed reaching a maximum thickness of about 3 feet divides the upper and lower basalts on the north side of Makua Valley at an altitude of about 1,600 feet. The soil has in most places been formed by the rotting of clinker, but some of it is very compact and breaks with a conchoidal fracture, indicating that ash is mixed with it. Small seeps issue from it in several places, showing that it serves

as a perching formation. The rainfall is so low in this area that it is doubtful if tunneling on this bed for water would be worth while. Small supplies for cattle might be developed by contouring this bed with a tunnel provided the seeps are perennial.

At an altitude of 1,600 feet on the ridge $1\frac{1}{4}$ miles north of Makua station three dikes appear to be truncated by this soil-covered surface, but the exposure is poor. This soil horizon was not mapped in the precipice at the head of Makua Valley, but from an airplane the base of the upper basalt member is distinct, and it is probably underlain by this same soil bed.

KAILUA VOLCANIC SERIES

The Kailua volcanic series is composed of amygdaloidal basalt and its feeding dikes or dike complex. It is distinctly altered by hydrothermal action which has filled its vesicles with secondary minerals. Its source was a little northeast of the rift that supplied the Koolau volcanic series. The Kailua rocks have decidedly different water-bearing properties from the Koolau rocks, which overlie them with apparent conformity. The Kailua series was named for its occurrence in the hills around the village of Kailua.

AMYGDALOIDAL BASALT

Distribution, character, and structure.—The amygdaloidal (name applied to vesicle fillings) basalt of the Kailua volcanic series, as shown on plate 2, forms the low hills surrounding Kailua between Kaneohe and Waimanalo. It consists of flows of pahoehoe and aa as much as 60 feet in thickness, which were poured out of a distinct rift zone a mile northeast of the Koolau rift zone and parallel to it. The clinker beds in the aa flows have been cemented into a hard breccia. The joints, vesicles, and interstices are filled with quartz, zeolites, and other minerals. Quartz geodes are not uncommon, and numerous semiprecious gems have been cut from these various minerals and sold in Honolulu. The late Professor Eakle determined heulandite, epistilbite, calcite, quartz, laumontite, opal, aragonite, and ptilolite from these rocks. The red-brown, buff, light-gray, and green colors of these rocks in most places readily distinguish them from the blue and black lavas of the Koolau volcanic series. This difference in color is largely the result of hydrothermal alteration.

Dunham⁶⁹ from a laboratory study of specimens sent him, believes that because the feldspars are partly replaced by calcite only and because the secondary mineral sequence in the cavities is similar to that in the basalt of the Sugar Loaf volcanics, these minerals in the Kailua basalts were deposited by solutions concurrent with the cooling

⁶⁹Dunham, K. C., Crystal cavities in lavas from the Hawaiian Islands: *Am. Mineralogist*, vol. 18, No. 9, pp. 369-385, 1933.

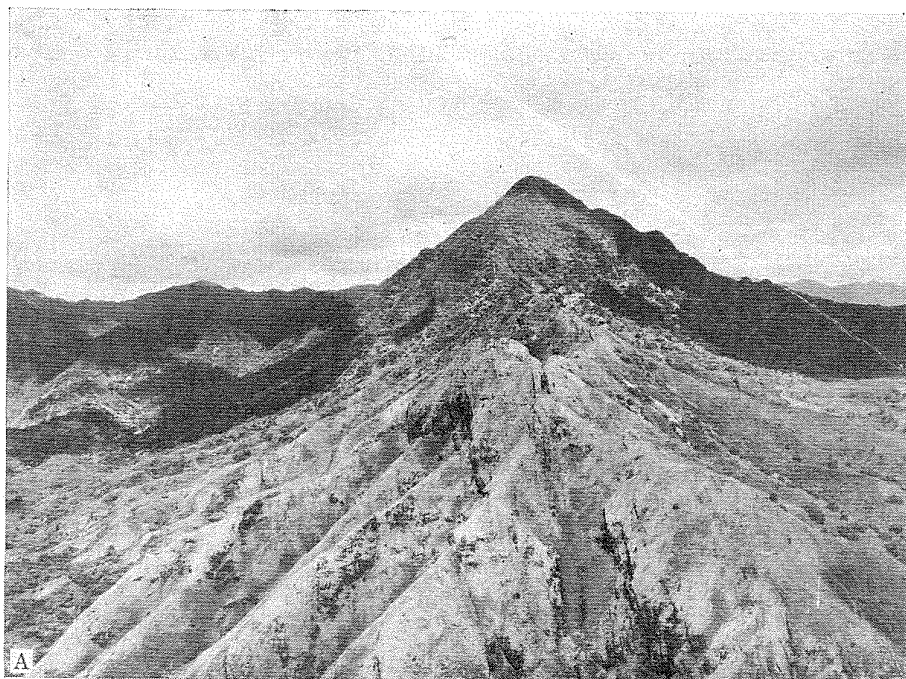

A, AIR VIEW OF THE CLOSELY SPACED DIKES IN PUU PUEO.
In the heart of the dike complex of the Koolau volcanic series near Kaneohe Bay. Photograph by 11th Photo Section, Air Corps, Luke Field, T. H.

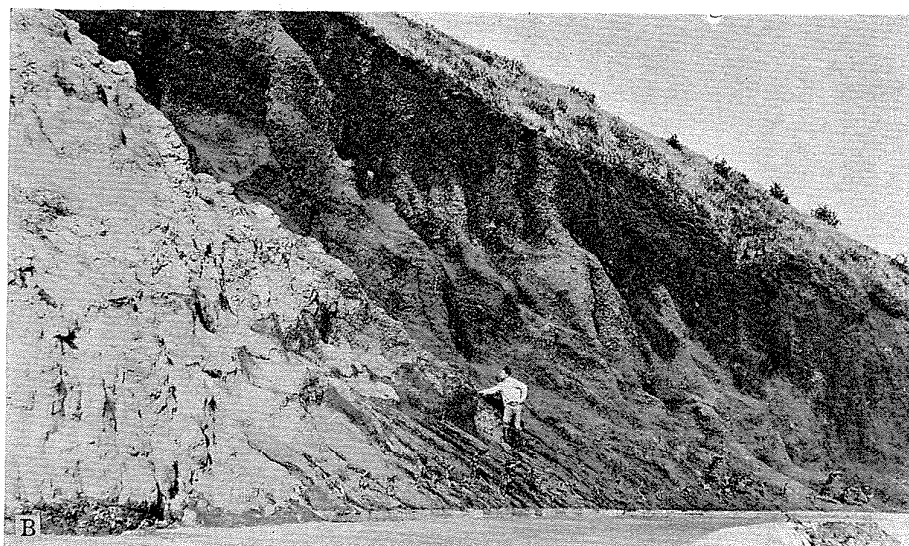

B, UNCONFORMITY ON THE PALI ROAD.
Dark-colored cinders from the Pali eruption (on the right) resting unconformably on the eroded light-colored Koolau basalt (on the left). Photograph by Harold T. Stearns.

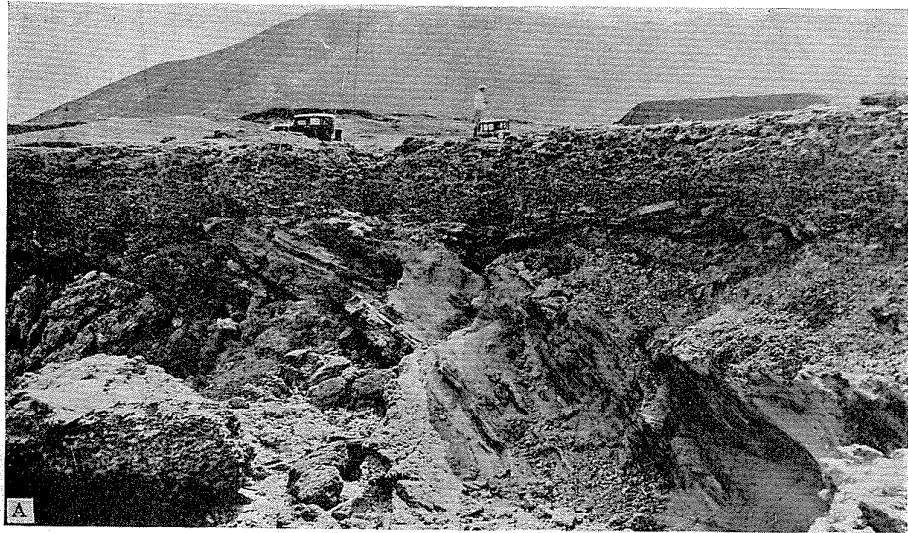

A, UNCONFORMITY ON THE MOKAPU PENINSULA.
Calcareous tuff conglomerate forming horizontal bed resting unconformably upon older steeply-dipping fossiliferous marine sediments in the crater of Ulupau cone. The base of the conglomerate is about 22 feet above mean sea level.

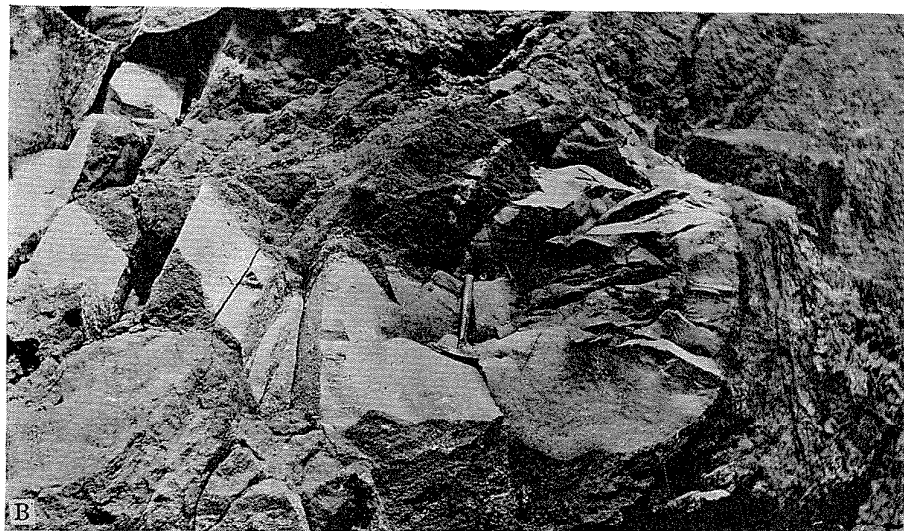

B, STREAK OF INDURATED TUFF IN ROAD CUT ON SOUTH SIDE OF KOKO CRATER.

Photographs by Harold T. Stearns.

of the Kailua flows. The field evidence, however, is contrary to this interpretation. With only one known exception—namely, at Waimea Quarry, the great number of lava flows making up the Koolau dome outside of the vent area do not show zeolitization whereas all the Kailua flows seem to. It is known that the Kailua flows were either directly under or close by the summit caldera of the Koolau Volcano, hence the secondary minerals may have been deposited by ascending vapors during the history of this caldera. If cavities in the breccia can be found containing the same minerals as in the cavities in the lava, then subsequent rather than concurrent hydrothermal action will be established. If it can be proved that the minerals were deposited as each flow cooled then some special condition must have existed during their cooling not common to the other basalts of this type. Possibly the Kailua lavas were poured under the sea, yet the lack of pillow lava and interbedded marine deposits dictates against such a hypothesis.

In general the Kailua flows dip southwest at angles of 10° to 15° from the dike complex of the series, which passes through the Moku-lua Islands. They have an exposed thickness of 600 feet and are slightly folded near Lanikai. Two thin beds of altered vitric tuff were noted interbedded with them.

Relation to basalt of Koolau volcanic series.—The basalt of the Kailua volcanic series is deeply weathered and except along the coast is almost completely covered with lantana and soil, both of which make its relation to the Koolau series obscure. The Waimanalo water-transportation tunnel was examined with the following results: It was entered at the north portal at an altitude of 182 feet, and distances were only roughly determined. The first 200 feet is lined; the next 600 feet is typical amygdaloidal basalt of Kailua series; the next 2,000 feet is nonamygdaloidal dense lava with large joints, mostly vertical; the next 100 feet is amygdaloidal lava; and the remaining 700 feet to Wainiki portal is jointed dense lava. The tunnel is just large enough to crawl through and, being partly lined, is difficult to examine. The dense basalt may be a flat-lying intrusive of later age injected into the amygdaloidal basalt. This could not be established, but there is no doubt that the dense lava is fresher than the amygdaloidal rock and has not been subjected to hydrothermal solutions. No dikes were noted in this 3,600 feet of tunnel. In the next 3,000 feet to the south 51 dikes were counted cutting both amygdaloidal and jointed massive lava, but 2,000 feet of this part of the tunnel is lined, hence it is probable that several times this number of dikes were penetrated. The trends of a few of the thicker dikes are given below.

Thickness and trends of a few dikes in the Waimanalo water-transportation tunnel

Thickness (feet)	Trend
5	N. 70° E.
5	N. 55° W.
5	N. 64° W.
4	N. 75° W.
3	E-W.
3	N. 60° W.
8	N. 85° E.
2½	N. 87° E.

All but two of these dikes are practically vertical. Only 200 feet of the remainder of the tunnel was examined. It was entered at the south portal, and 24 dikes were noted in this distance, even though some of it was lined. About 50 gallons a minute of ground water was discharging from the end of the tunnel on February 11, 1932, during a rainy period.

The Kailua lava in this tunnel appears to pass beneath the basalt of the Koolau volcanic series, but an unconformity or a fault may separate them. Determination of their relation is complicated by poor exposures and the injection of innumerable Koolau dikes. Southwest of Olomana Peak there are a few outcrops of amygdaloidal basalt dipping southwest and overlain conformably by typical Koolau lavas. It appears that there was a slight southwestward shift of the rifting during the growth of the Koolau dome.

Effect of hydrothermal alteration on ground-water.—The basalt of the Kailua series was mapped as a separate unit during this investigation chiefly because its water-bearing characteristics are very different from that of all other lavas on Oahu. The hydrothermal alteration has left it nearly impermeable because secondary minerals have virtually filled all the interstices through which ground water usually moves. Its character below sea level is unknown.

The basalt of the Kailua series crops out only in dry areas, and ground water is dammed off from the rainy Pali region by the dike complex of the Koolau series so that wells drilled into this basalt will generally be unsuccessful or have small yields.

DIKE COMPLEX

The dike complex of the Kailua volcanic series is best exposed in the Mokulua Islands, off Lanikai. An excellent view of the dikes in North Mokulua Island, taken from the air especially for this report by Lt. Don Z. Zimmerman, is shown in plate 15, B. The general trend of the Kailua dikes is N. 50°-70° W. The dikes are so numerous that only a few slices of flow lavas a few inches to a few feet wide exist among them. These remnants are usually shattered, brecciated, and altered. The dikes range in width from a few inches to 8 feet and in color from gray to black. Multiple dikes are numerous, and a few

black, dense, unaltered dikes cut across the older altered ones. Hydrothermal action has filled the vesicles and interstices with secondary minerals, including zeolites. A similar exposure of dike complex makes up the tip of Wailea Point, on the mainland near the islands. The edge of the dike complex is a few hundred feet to the west, but scattered dikes occur beyond. It is believed that the dike complex was the source of the basalt of the Kailua series, because the flows distinctly dip away from this zone of dikes. If it were not for this fact the dikes might be considered intrusions correlative with some of the later Koolau flows. Between the dike complexes of the Kailua and Koolau volcanic series flow lavas of the Kailua series are exposed for about a mile and are relatively free of dikes, indicating that between Kailua and Koolau time there was an appreciable shift rather than a slow progressive westward migration or widening of rift-zone activity. In fact, the existence of a small dome of Kailua basalt, which was later overlapped on the west side by the Koolau dome, will most readily explain the asymmetry of the eastern part of the Koolau Range.

The dike complex of the Kailua series lies in an area too dry to contain confined high-level water. Moreover, it has been rendered almost impermeable by hydrothermal alteration.

WAIANAË-KOOLAU EROSIONAL UNCONFORMITY

North of Schofield Barracks.—The erosional unconformity between the Koolau and Waianae volcanic series is exposed for 2½ miles down Kaukonahua Stream below the mouth of Haleanau Gulch near Schofield Barracks, as shown on plate 2. The Waianae flows dip 10°-15° NE. and the Koolau flows dip 5° NW. at the point of overlap. A few dikes in the Waianae flows are truncated at the contact, indicating an erosional unconformity. Further evidence of erosion is the occurrence of a bed of rotten stream-laid conglomerate filling a small valley carved in Waianae basalt and overlain by Koolau lava 1,000 feet downstream from the mouth of Haleanau Gulch, in the west bank of Kaukonahua Canyon. Talus and hillwash as much as 6 feet thick occurs between the two rocks in several places. The best easily accessible exposure of soil at the contact is in a wasteway on the north wall of Kaukonahua Canyon at the intake of the Wahiawa Reservoir ditch, near the main highway, a little over a mile downstream from Haleanau Gulch. At an altitude of about 650 feet in this wasteway there is about 100 feet of pahoehoe and aa dipping 5° NW. At its base is 6 inches of baked black humus soil, which overlies 6 inches to 2 feet of brown soil, which in turn rests on weathered basalt of the Waianae volcanic series filled with a secondary white mineral. This basalt dips 12° NE. and is partly decomposed for about 50 feet beneath the soil.

The massive black even-bedded flat-lying Koolau flows in the northeast wall of Kaukonahua Canyon stand in considerable contrast to the underlying thin-bedded irregular flows of the Waianae Range.

South of Schofield Barracks.—Basalt of the Koolau volcanic series has been mapped for 1½ miles up Haleanau and Moheakea Gulches. At this place the flows have flooded the lower part of a large amphitheater-shaped depression on the east slope of the Waianae Range. From the mouth of Haleanau Gulch southward to a point half a mile north of well 274, near Puu Kapuai, the Koolau and Waianae contact is obscured by alluvium from the Waianae Range. In a road cut 3,000 feet north of this well a Koolau pahoehoe flow with about 50 percent of olivine phenocrysts rests upon 6 feet of blocky dark-brown ashy soil baked to a depth of 4 inches by the olivine basalt. The rock below is a weathered platy dense blue aa containing about 30 percent of satiny brown olivine phenocrysts in an extremely fine-grained groundmass. It is a typical flow of the upper basalt member of the Waianae series. Angular fragments of the platy aa occur in the soil. This basalt can be traced up the ridge into the Waianae Range, and the overlying Koolau flow can be traced toward Schofield.

Time significance.—The presence of an erosional unconformity between the Koolau and Waianae volcanic series does not necessarily indicate that the two volcanoes were not at one time simultaneously active. It simply means that the Waianae Volcano had ceased activity long enough for streams to have become established and a soil to form before the last of Koolau flows lapped against its slope. The Waianae lavas beneath the soil at the contact near well 274 are distinctly younger than the Waianae lavas beneath the soil at the contact in Kaukonahua Gulch. The fine state of preservation of the cinder cones on the slope of the Waianae Range near well 274 and the smaller amount of decomposition of their lavas seem to indicate that these cones ceased eruption only a relatively short time before the last Koolau lavas came to rest in this area.

Effect on ground-water movement.—The soil and alluvium at the contact appears to serve as a barrier to the movement of ground water from the Koolau to the Waianae basalts, as shown by differences in well heads (see sections "Artesian areas 6 and 12").

KOOLAU VOLCANIC SERIES

The Koolau volcanic series comprises the bulk of lava flows, intrusive rocks, pyroclastic rocks, breccias, and intercalated soils making up the Koolau Range. The series stratigraphically overlies the Kailua volcanic series without any apparent unconformity. It differs from the Kailua volcanic series in that it is not generally amygdaloidal and has a much fresher appearance than the Kailua rocks.

BASALT

Character and structure.—The basalt of the Koolau volcanic series makes up the main mass of the Koolau Range, as shown on plate 2. The individual flows range in thickness from 10 to 80 feet and are gray, blue, red, and black. The clinker phases of the aa flows are generally red, but part of this color is due to weathering. Pahoehoe predominates near the crest, but aa near the periphery of the dome. Even the thick flows are made up of several layers, as shown by the thin beds in plate 13, B. The flows are of the Kilauean type and were extruded in very fluid condition. In many respects they resemble the lower basalt of the Waianae volcanic series. Aphanitic, porphyritic, dense, very vesicular, and columnar jointed flows occur. A few of the aa flows are platy. The prominent phenocrysts are either olivine or feldspar or both, and augite phenocrysts are rarely conspicuous. The absence of erosional unconformities and extensive soil beds indicates that the flows occurred in fairly rapid succession. Except where they form cliffs the surface of these rocks is deeply weathered and in the lower flanks of the range is covered with a thick lateritic soil. The basalt exceeds 3,100 feet in thickness, and in general the flows have dips of 3° near the crest and 5° to 10° near the margin of the range.

Water-bearing properties.—The basalt is almost uniformly permeable and serves both as the intake formation and the water bearer of the major part of the ground-water supply of Oahu. It supplies all the artesian wells of the island except a few near Waialua, Waianae, and Gilbert that penetrate the Waianae basalts. It is the aquifer of all the high-level springs and tunnels and of most of the sea-level springs in the Koolau Range.

TUFF

Occurrence.—Beds of vitric and lithic tuff from a few inches to 10 feet thick intercalated with the flows of the Koolau volcanic series occur sparingly. These deposits are very irregular and within a few feet may change from several feet to a few inches in thickness or disappear entirely. They occur mostly in the upper part of the Koolau section and are, with only a few exceptions, close to the crest of the range. A dozen or more thin beds a few inches to a few feet thick were noted in the cliffs near the head of Nuuanu Valley (pl. 2).

Vitric Tuff.—The vitric tuff consists of red or yellow pumice or drop-let material drifted from cones during firefountains. These deposits form an infinitesimal fraction of the bulk of the Koolau dome. Because of the relative scarcity of vitric-tuff layers in the high cliffs adjacent to the crest of the Koolau Volcano, it is concluded that cinder cones were seldom formed on this volcano. In this respect it resembles Kilauea rather than Mauna Loa or Mauna Kea. Evidently large cinder

cones are not commonly built on low basaltic domes with the Kilauean type of fluid lavas. They are abundant on Mauna Loa, where similar fluid lavas occur, hence the height or age of the dome probably has a direct bearing on the production of cinder cones. Evidently lavas must be very frothy to rise to great heights above sea level. The Waianae dome has large cinder cones on it, but these cones are associated with lavas of different chemical composition from the fluid basalts of the Koolau Range. Other factors besides height of the volcano are evidently important in the formation of cinder cones.

The outcrop of vitric tuff $1\frac{1}{4}$ miles south of Waimanalo in the Pali, at an altitude of 1,500 feet, shown on plate 2, is a cinder cone buried by Koolau lava and subsequently exposed by erosion. It is shot full of dikes. The outcrops of tuff on the west side of Waialaenui Stream near Kaimuki also indicate a cinder cone. These were the only cinder cones found in the Koolau volcanic series.

Lithic tuff.—Beds of lithic tuff, like those of vitric tuff, form an insignificant part of the Koolau dome. The most extensive bed is exposed in the Pali near the east end of the Koolau Range. It contains numerous angular fragments of intrusive and extrusive basalts, indicating that the explosions blasted their way through the dike complex of the Koolau series. It thickens toward Waimanalo and appears to subdivide into several layers, with basalt intervening. This indicates that the single bed farther east accumulated in a kipuka and is the product of more than one explosive eruption. Small seeps of water issue from its surface but not in sufficient amounts to justify exploration. As it contains some magmatic ejecta it appears to have resulted from phreatomagmatic explosions. A similar bed of lithic tuff 15 feet thick containing angular blocks reaching 1 foot in diameter occurs 700 feet southeast of the Nuuanu Valley gap at an altitude of 1,650 feet. Some of this tuff has sifted down in a preexisting crack for 12 feet, so that it now makes a pseudodike. Another bed occurs at an altitude of about 1,800 feet a little farther southeast. What is probably this same bed is exposed again at the falls shown on plate 2 three-quarters of a mile to the southwest, on the south side of Nuuanu Valley. Two tuff beds also occur on the north side of the valley near the Bottomless Falls⁷¹ northeast of Makuku Hill.

Breccia 5 feet thick crops out on the Schofield-Waikane trail at an altitude of 1,300 feet on the divide between Kahana and Waikane Valleys. A mile northwest of this outcrop Kahana development tunnel 1 of the Waiahole Water Co. penetrates 500 feet of coarse angular breccia between 1,300 and 1,800 feet from the portal. Most of the

⁷¹ The streams tumbling over these falls are situated in an eddy in the path of strong trade winds blowing through Nuuanu Gap. Most of the time the water after falling part way down is blown upward by uprushing air, so that it seldom falls to the bottom.

blocks are dike fragments. Many are over 6 inches and some over 2 feet in diameter. The tunnel is 1,975 feet long and penetrates about 120 dikes, but the 500 feet of breccia is cut by 6 or 7 dikes only. It thus appears that this breccia fills an explosion vent. The small number of dikes cutting it suggests that the explosion occurred toward the end of Koolau activity. Perhaps the breccia along the Schofield-Waikane trail, mentioned above, is an agglomerate deposited on the surface of the Koolau dome at the time of this explosion.

Water-bearing properties.—The tuff deposits in the Koolau Range would in many places yield small quantities of perched water to tunnels. However, the demand for small flows of water, such as are recovered from tuff beds in the Waianae Range, does not exist in the Koolau Range because that range is much better watered. The chief value of the tuff beds probably lies in providing soft material for tunneling, in connection with the development of high-level water confined by dikes, but the tuff beds occur so sparingly that they are available for this purpose only in one or two places.

DIKE COMPLEX

Character and structure.—The area of the dike complex of the Koolau volcanic series is shown on plate 2. It consists of basaltic dikes a few inches to 12 feet thick, generally microcrystalline, a few with olivine and feldspar phenocrysts, some platy and vesicular injected into Koolau basalt and filling the cracks through which this basalt was extruded. They fed the Koolau flows, and their great number indicates that fissure eruptions characterized the building of the Koolau dome. The dikes do not widen downward in the 3,000 feet of exposure. The average width near the east end is probably about 2 feet and near the west end about 4 or 5 feet. Near Olomana Peak they are irregular, but farther west they are almost all nearly vertical and parallel.

The dike complex is the denuded main rift zone of the Koolau dome. The dikes increase in number toward the heart of the rift zone and also with depth. Thus, near Kaneohe, where erosion has removed 3,000 to 4,000 feet of rocks from the rift zone, the dikes are so close together that none of the flow rock is visible. Excellent exposures of dikes can be seen along the road from the foot of the Pali to Kailua and along the main highway at Puu Pueo, on the northwest side of Kaneohe Bay. A view of the dikes in this hill, where only small prisms of flow rock exist between them, is shown in plate 16, A.

At an altitude of 2,350 feet on the Schofield-Waikane trail, 500 feet east of the crest and 150 feet below it, the first intrusive rock is exposed. The following table gives the trend of the dikes between this point and the trail forks 4,100 feet to the east at an altitude of 1,250 feet. The dikes are numbered from west to east down the trail.

Trend and thickness of dikes in Schofield-Waikane trail

No.	Thickness (feet)	Trend	No.	Thickness (feet)	Trend
3	8	N. 10° W.	57	4	N. 50° W.
8	5	N. 40° W.	60	8	N. 30° W.
12	12	N. 35° W.	64	6	N. 30° W.
18	11	N. 35° W.	65	9	N. 25° W.
22	3	N. 50° W.	68	6	N. 35° W.
25	9	N. 20° W.	79	6	N. 35° W.
30	4	N. 50° W.	95	6	N. 40° W.
34	9	N. 40° W.	106	5	N. 40° W.
36	4	N. 30° W.	123	3	N. 60° W.
42	9	N. 32° W.	141	3	N. 35° W.
49	8	N. 45° W.	153	10	N. 40° W.

The thickness of the dikes listed is somewhat above the average because the thicker dikes were best exposed. Only one dike dipping 63° SW. was sufficiently divergent from vertical to be noted. Many are multiple dikes. Dike 8 cuts a flow containing feldspar phenocrysts 1 inch across. The adjacent development tunnel 1 of the Waiahole system in Waikane Valley penetrated about 260 dikes in a distance of 2,635 feet. Tunnel 2, also in Waikane Valley, penetrated 126 dikes in the first 1,200 feet. A similar number of dikes were encountered in the adjacent Kahana development tunnel 1. The average trend of the dikes in the dike complex near the east end is about N. 55° W., and at Waikane between N. 30° W. and N. 45° W., but near the west end they become slightly divergent.

The dike complex is practically bounded on the west side by the Pali. As shown by the main Waiahole tunnel, only a few stray dikes occur west of the Pali. The relation is not a coincidence. Here, as on Mauna Loa, activity along the main rift of the Koolau Range built a ridge. Erosion on the east side of this ridge continued until great coalescing amphitheater-headed valleys had cut back a little west of the crest. Beyond this point the valleys could not recede because of lack of drainage area. Thus the Pali, which was formed by these valleys, lies a little southwest of the crest, at nearly the southwest edge of the rift zone. It is in this way that the position of the Pali is due to the original topographic expression of the rift zone. Northwest of Kahana Valley erosion has not proceeded so far, hence the dike complex appears only where the Koolau lavas have been deeply eroded by streams.

Mauna Loa is at present piling up lava more rapidly on the lower ends of the rift zones than on the top of the mountain. If this condition had always prevailed, a dome would never have been built. Thus, in the early phases of a basaltic volcano, superfluent discharge from the summit vent must exceed the discharge from the rifts. The Koolau volcano evidently ceased its activity with a phase similar to the present phase of Mauna Loa, because much flow lava accumulated on the northwest end of the dome.

Secondary dike system.—The numerous dikes shown on plate 2 outside of the dike complex are strays. A sufficient number of dikes striking about S. 30° W. occur at the head of Palolo Valley to indicate a secondary rift trending in this direction. These dikes head toward Olomana Peak, and the lava extruded from them apparently built up a ridge high enough to cause the slight divergence of the drainage east and west of the Palolo-Kaimuki Ridge.

Water-bearing properties.—Numerous large perennial springs issue from the dike complex. The water is held in permeable masses of flow rock between the dikes. Many tunnels have been successful in recovering water confined by the intrusive rock in the dike complex and considerable water still awaits development (see section "Proposed Kalihi-Waiahole ground-water tunnel system").

BRECCIA

Nearly a square mile of the ridge that separates Kaneohe Bay from Kawainui Swamp near Kailua is covered by an oval patch of coarse breccia belonging to the Koolau volcanic series. Another nearly circular patch of the breccia, covering less than half a square mile, occurs on Ulumawao Ridge, nearby. Owing to the thick soil cover, contacts of the breccia with older rocks are exposed in only a few places. The breccia consists of subangular and angular fragments 3 feet or less in diameter, of green, lavender, white, red, and brown amygdaloidal basalt in a sparse fine-grained green matrix. Chlorite, calcite, and silica form the cement. The breccia forms massive dark-colored outcrops from which the fragments project only slightly. Its elastic character is obscure except in fresh pieces and in a few outcrops. The fragments are diverse, however, so that it cannot be a flow breccia. It is cut by numerous dikes, a few of them amygdaloidal, that fit the trend of the dike complex of the Koolau series. The breccia is unconformable on both the basalt of the Kailua volcanic series and the dike complex of the Koolau series. Near Kokokahi it attains a thickness of 520 feet.

The breccia is too thick and too local in distribution to be an agglomerate thrown out during an explosive eruption. It is apparently a throat breccia such as exists in the bottom of Halemaumau, on Kilauea, built up chiefly as talus within a crater or caldera. It appears to mark the site of the main vent of the Koolau Volcano. Except for its extensive hydrothermal alteration it resembles the breccia in Puu Kailio, the volcanic center of the Waianae Range. Cementation has rendered the breccia practically impermeable, with the result that it has weathered less rapidly than the adjacent rocks. Its lack of structure also helped to preserve it from erosion. Thus these rocks, which were probably deep below the Koolau summit at the cessation of volcanic activity are now standing in relief. The breccia at Puu Kailio does

likewise, and this reversal of topography has been observed at other eroded volcanoes.

The fragments of rock in the breccia are indistinguishable from basalt of the Kailua volcanic series because they show zeolitization but they have not been studied sufficiently to determine whether this alteration took place before the fragments were incorporated in the breccia or afterwards (p. 88). The presence of this breccia at the place where for other reasons it is believed that the Koolau caldera should have been located is too great a coincidence to dismiss in favor of any other origin. The hydrothermal cementation of the breccia probably resulted from the continued rise of hot gases in the ancient caldera.

At an altitude of 720 feet on the east side of the ridge a mile north of Ulumawao Peak a bed of wavy, folded, and slightly faulted fine-grained vitric tuff 7 feet thick crops out. It is cut by later dikes. This type of material is what would be expected in a crater breccia where ash-covered segments of a crater floor or walls had collapsed.

The breccia of the Koolau series is so free from joints and so well cemented that it is too impermeable to carry water.

EROSIONAL UNCONFORMITY

After the cessation of lava extrusion the Koolau dome was undercut into cliffs by the ocean and greatly dissected by streams. These streams carved out many deep amphitheater-headed valleys on the northeast (windward) side and smaller ones on the south and west (leeward) side. This cycle of erosion progressed until only narrow divides remained between the valleys on both sides of the range. On the east side the divides were reduced until the heads of the valleys coalesced to form the Pali. Erosion practically ceased when the heads of the valleys were cut back to the southwest side of the divide, because of reduced precipitation and drainage area. This cycle of erosion continued unbroken until the valleys were carved nearly as wide as they are today. Then submergence of the island by more than 1,200 feet led to aggradation of the valley floors and further reduction of the rainfall. The length of this erosion cycle is unknown, but it may have occupied much of early and middle Pleistocene time. After this long period of repose, eruptions again occurred in the southeastern part of the Koolau Range, in the general vicinity of the former Koolau center of activity. These eruptions were small and produced altogether only a small percentage of the bulk of the Koolau dome.

HONOLULU VOLCANIC SERIES

Most of the Honolulu volcanic series (shown on pl. 2) lies at or near the city of Honolulu, hence its name. It includes all the volcanic

deposits correlative with the calcareous and noncalcareous sediments. These deposits are so important as water bearers, and in general the groups of topographic features they form are so conspicuous that the products of each eruptive center are described separately. In the following pages an attempt has been made to date these volcanic rocks geologically. Whether or not the various marine deposits and terraces used to date these eruptions ever become accepted as having a world-wide chronologic significance, they effectively establish time intervals on Oahu.

MIDDLE (?) AND LATE PLEISTOCENE LAVAS AND PYROCLASTIC ROCKS

LAVAS AND PYROCLASTIC ROCKS OF THE KAENA (+95-FOOT) AND LAIE (+70-FOOT) STANDS OF THE SEA

Hawaiiloa Volcanics

Distribution and character.—Puu Hawaiiloa is a fairly symmetrical cinder cone 337 feet high on the northwest corner of Mokapu Peninsula (pl. 2). Basalt more than 100 feet thick has flowed north from it. The surface of the flow is poorly exposed because of the thick brush cover, but at the coast it forms massive cliffs 60 feet high. The top of the flow is 100 feet above sea level. According to Wentworth⁷² it is nepheline-olivine basalt. In places, especially in the pinnacle of dense rock on the cone, olivine segregations are common.

Forming the west shore of the adjacent peninsula for three-quarters of a mile and separated from the Hawaiiloa volcanics by marine sediments and dunes is a ridge of basalt. It is marked by three pinnacles, 100, 71, and 90 feet in height. The northernmost is known as "Pyramid Rock" and the southernmost as "Pali Kilo." These summits have practically the same altitude as the adjacent Hawaiiloa flow. In a road cut on the west side of Pali Kilo balls similar to those in the Sugar Loaf volcanics are common among the clinker.

Age relations.—Dana⁷³ names three vents on this peninsula—Mokapu (now Ulupau Crater), Hawaiiloa, and Pyramid Rock. Pyramid Rock consists of massive, columnar-jointed flow lava not different from the adjacent Hawaiiloa flow. Specimen F86 from this rock was found under the microscope to be similar to Hawaiiloa basalt. There is nothing to indicate a vent at Pyramid Rock.

Wentworth⁷⁴ describes and gives a geologic map of this area. He joins Pali Kilo with the Hawaiiloa flow and considers Pyramid Rock also part of it. Actually the Hawaiiloa flow is isolated from Pali Kilo and Pyramid Rock by sediments, as shown in plate 2. Wentworth⁷⁵ states that eruption of Ulupau Head and Puu Hawaiiloa "may confidently be referred to the time of the 40-foot stand (of the sea)." On the

⁷² Wentworth, C. K., Pyroclastic geology of Oahu: B. P. Bishop Mus. Bull. 30, p. 94, 1926.

⁷³ Dana, J. D., Geology in U. S. exploring expeditions, 1838-42, vol. 10, pp. 248-250, 1849.

⁷⁴ Wentworth, C. K., op. cit., pp. 85-90, fig. 24.

⁷⁵ Idem, p. 90.

same page he also states that "probably the flow lavas from Puu Hawaiiiloa are contemporaneous with the later Punchbowl flows." According to his correlation this would make them of the same age as the firefountain deposits of Tantalus and Sugar Loaf. Fortunately several critical outcrops help to establish the Kaena age of Puu Hawaiiiloa and its flows.

The several acres of reef between Puu Hawaiiiloa and Pali Kilo is believed to belong to the 25-foot stand of the sea. Reef belonging unquestionably to this sea covers all the area between Ulupau Head and Puu Hawaiiiloa. There can be no doubt that Puu Hawaiiiloa and its flows preceded the 25-foot sea.

On the east side of the main flow near its source about 10 feet of thin even-bedded Ulupau tuff rests unconformably upon the basalt. As this flow rests on the cinders of Puu Hawaiiiloa, it is evident that this cone and its flow are older than Ulupau Cone. Ulupau Cone appears to have been carved into cliffs by waves during the Laie stand of the sea, and fossiliferous marine sediments apparently laid down by this same sea occur in its crater; hence Hawaiiiloa is indicated to be as old as the Laie (70-foot) stand of the sea, if not older.

On the west and southwest slopes of Hawaiiiloa a distinct terrace occurs at about the 100-foot level, with a suggestion of another terrace at about the 65-foot level. The presence of the upper terrace, coinciding in altitude with the top of the main flow and the tops of Pali Kilo and Pyramid Rock, strongly suggests that the flows have been beveled by a sea at about the 100-foot level. It seems most plausible to consider the various hills of basalt as part of a branch of the Hawaiiiloa flow subsequently isolated by marine erosion.

Evidence of much marine work is apparent in this area and indicates a considerable age for the basalt. Because of the presence of marine limestone about 70 feet above sea level on Pali Kilo and the wave-cut terrace about 100 feet above sea level on Puu Hawaiiiloa, the eruption that formed this cinder cone and the adjacent flows is considered to have occurred during or before the Kaena stand of the sea. Because Puu Hawaiiiloa and its flow are subaerial in appearance, it is unlikely that they were erupted during the 95-foot stand of the sea. Probably they originated during the later part of the Kahipa stand, when the sea stood lower than at present. If so, this cone would probably be the oldest exposed basalt of the Honolulu volcanic series.

Water-bearing properties.—The cinders and basalt are very permeable but have no hydrologic value because they occur in a very dry area and are isolated from any aquifers that carry fresh water.

Mokapu Basalt

About midway between Ulupau Crater and Puu Hawaiiiloa a knob of basalt sticks up through the emerged reef (pl. 2). Specimen F 85 from this place was determined to be nephelite basalt containing phenocrysts of pyroxenè and olivine. About a mile south of this knob, in the narrowest part of the peninsula, a few blocks of similar rock project through the reef. These two outcrops of basalt appear to be part of an extensive lava flow partly cut away by marine erosion and now nearly obscured by limestone. It is likely that this lava was poured out from a cone subsequently destroyed by the sea, or it may have come from Puu Hawaiiiloa. It is tentatively assigned to the Kaena stand of the sea because it has suffered so much erosion and appears to be at least as old as Puu Hawaiiiloa. The outcrops are too small and in too dry an area to be of value as water bearers.

Mokulea Basalt

Mokulea Rock, in Kailua Bay, consists of massive columnar-jointed basalt. Under the microscope it was found to be nephelite-melilite basalt with olivine and pyroxene phenocrysts. The abundant melilite microphenocrysts indicate that it is not part of the Mokapu basalt and must have come from a cone in Kailua Bay now destroyed by erosion. Fossiliferous deposits were found in crevices in it about 25 feet above sea level, indicating that it is older than the Waimanalo stand of the sea. It is tentatively assigned to the Kaena stand because of the amount of erosion it has suffered. It is too small an island to contain fresh ground water.

Rocky Hill Volcanics

Previous work.—Bordering the north side of Punahou School campus, near the mouth of Manoa Valley, and rising about 130 feet above the adjacent land is Rocky Hill (pl. 2). As early as 1840 Dana⁷⁶ recognized this hill as a cinder cone and described another vent about 400 yards to the east of Rocky Hill. Wentworth⁷⁷ mapped Rocky Hill and two elongated hills to the northeast as extrusions from Manoa dike. He believed that the cinders and lava of this group were extruded at the end of the Tantalus and Sugar Loaf eruptions, but I have found evidence that the Rocky Hill volcanics are much older. Excavations in the northern mound shown by Wentworth as an extrusion from Manoa dike expose basalt that can be traced into the Sugar Loaf flow. The topography and geology of this area suggest that the Sugar Loaf flow covered some mounds of spatter and cinders belonging to the Rocky Hill group of craters.

⁷⁶ Dana, J. D. Geology, in U. S. exploring expedition, 1838-42, vol. 10, p. 243, 1849.

⁷⁷ Wentworth, C. K., Pyroclastic geology of Oahu: B. P. Bishop Mus. Bull. 30, pp. 75-76. fig. 21, 1926.

Distribution and character.—As shown on plate 2, the Rocky Hill group of cones and craters consists of the main cone of Rocky Hill, an undrained crater 1,000 feet to the southeast which is 1,000 feet long and 300 feet wide, a still smaller undrained crater 2,000 feet to the east, a cone of cinder and spatter 1,800 feet to the northeast, and another cone 4,200 feet to the northeast. The last-named cone is only 30 feet high and is a kipuka in the Sugar Loaf flow.

The channel of a lava flow that poured out of Rocky Hill after most of the cinders and spatter were ejected can still be seen on the south side of the hill. Irregular masses of basalt occur in association with the spatter at the other Rocky Hill vents, but because of the extensive lawns in this area the contact of the Sugar Loaf and Rocky Hill volcanics cannot be mapped except on the basis of topography. Wentworth⁷⁸ has identified nephelite basalt from the west face of Rocky Hill and from a ledge near Mills School.

Age relations.—Well 37, on the south slope of Rocky Hill, at an altitude of 30 feet, penetrated 5 feet of soil, 20 feet of cinders and spatter, and finally 35 feet of soft black lava rock. An excavation near this well exposes coarse red spatter and cinders typical of Rocky Hill. Several excavations on the east side of Rocky Hill near the summit expose similar material.

Well 38, which is 200 feet southeast of well 37, at an altitude of 37 feet, passed through 10 feet of alluvium, 20 feet of sand and coral, and 40 feet of black lava and gravel. The "gravel" may have been loose clinker associated with the flow, as it would be difficult for a driller to distinguish the two types of material. The top of the sand and coral in well 38 is 27 feet above sea level, which shows that Rocky Hill is as old as the Waimanalo (25-foot) stand of the sea.

The driller of well 59 reports a layer of rock 10 feet thick intercalated in a massive reef between 82 and 92 feet below sea level. If this rock is lava rock it probably came from Rocky Hill, and because this reef is in all likelihood Kaena reef, Rocky Hill may be contemporaneous with the Kaena stand of the sea. Well 76 has a layer of basalt in the same stratigraphic position as well 59, and as the driller definitely reports it as lava rock there is undoubtedly a lava flow of Kaena age under the coastal plain in this area. Its most likely source is Rocky Hill. The deep weathering of the cinders in Rocky Hill certainly shows that it is considerably older than the Sugar Loaf volcanics. Because it is definitely older than the Waimanalo stand of the sea it is tentatively assigned to the Kaena stand on the basis of the logs of wells 59 and 76.

⁷⁸ Wentworth, C. K., *op. cit.*, p. 93.

All the cones in the Rocky Hill group of craters may not be of the same age as Rocky Hill. The log of well 51 shows lava rock containing water between 223 and 278 feet below sea level and separated from the basalt of the Koolau volcanic series by 40 feet of coral. Well 38 penetrated a bed of hard lava 150 feet thick containing water between 63 and 213 feet below sea level. Because thick massive flows like this are not known in the Koolau series, this layer of lava is probably a post-Koolau valley fill. The basalt penetrated by these two wells may have come from some of the cones in the Rocky Hill group of craters. However, a few large boulders that look like residual remnants of a dissected post-Koolau flow occur in the Woodlawn area, in upper Manoa Valley; hence the lava in these wells may have come from that district.

Water-bearing properties.—On the south side of Rocky Hill Punahou Spring issues at an altitude of about 100 feet. This spring is too high to be overflow of the artesian basin. On March 19, 1921, it was yielding 350,000 gallons daily,⁷⁹ and it is reported to never go dry. The area surrounding the spring is covered with lawns, which make it difficult to determine the origin of the spring. The water appears to be perched by soil or alluvium in the permeable Rocky Hill deposits. Another spring, discharging about 100,000 gallons a day, issues from post-Koolau basalt about half a mile north of the University of Hawaii, on the grounds of the Mid-Pacific Institute, at an altitude of about 110 feet. It is reported to never go dry. The perching formation is not evident but it may be the ash from the crater nearby.

Kalihi Volcanics

Character and location of the vent.—About 1,000 feet southwest of Puu Kahuauhi, near the crest of the Koolau Range, 1,650 feet above the floor near the head of Kalihi Valley, is a mass of cinders covering a little less than a quarter of a square mile (pl. 2). They make a small flat area on an otherwise narrow ridge. Like most flat spots in the rain belt, this place is very swampy, and small springs occur on it. At an altitude of 2,150 feet in Manaiki Valley a small spring discharging several gallons a minute issues from the cinders of this cone. The mass of cinders lies unconformably upon a narrow ridge of Koolau basalt and is all that remains of the cone that gave vent to the Kalihi basalt flows. The cinders exceed 100 feet in thickness, and at their base on the Kalihi side is a 50-foot exposure of lava. At the southeast base several feet of tuff containing accessory ejecta indicates that the first eruptive blast carried out Koolau basalt. The explosion was short-lived, however, because normal firefountains producing cinders, bombs, and considerable pumice followed. At several places on this ridge the tuff is separated from the basalt of the Koolau series by a steep angular unconformity.

⁷⁹ Kunesh, J. F., Surface water supply of the island of Oahu, p. 246, 1929.

Character and location of the lava flow.—As shown on plate 2, directly south of the cinders is an apron of basalt. The lava making up the apex of the apron has been cut in two by a stream. Along the banks of this stream dense columnar-jointed basalt 50 feet thick is exposed, resting unconformably at a high angle on Koolau basalt, which forms the wall of Kalihi Valley. The surface of the apron of lava is deeply weathered and strewn with pitted and grooved residual boulders. For convenience this post-Koolau lava and the associated pyroclastics are called the “Kalihi volcanics.” Tunnels farther downstream that penetrate it indicate that the flow started as pahoehoe. A specimen from the Gay mauka tunnel 1 in this flow was found, under the microscope, to be an analcite-nephelite basalt with phenocrysts of pyroxene and iron oxide pseudomorphous after olivine. The rock commonly contains olivine inclusions 1 to 3 inches across. In a cave on the north bank of Kalihi Stream near the portal of City and County tunnel 3, at an altitude of about 775 feet, Kalihi basalt rests on older alluvium. A similar contact of basalt resting on alluvium is exposed at the Kalihi Orphanage tunnels.

The upper end of the Kalihi basalt occurs at an altitude of 830 feet and the lower end at 220 feet, about a quarter of a mile above the mouth of Kamanaiki Stream. The flow has an exposed length of about 3 miles, and the lower end is concealed by alluvium. Tunnels in upper Kalihi Valley indicate that the Kalihi flow is much wider than shown on plate 2 and that parts of it have been buried by alluvial fans from the adjacent canyon walls. As a branch of the Kamanaiki basalt also enters upper Kalihi Valley, it is not known how much of the lava flooring the valley was derived from the Kalihi cone.

Manaiki branch of Kalihi volcanics.—The Kalihi cone occurs on the divide between Kalihi Valley and the head of Manaiki Stream. The existence of numerous large boulders identified megascopically as nephelite basalt in Manaiki Valley suggest that a flow of Kalihi basalt poured down Manaiki Valley but has been since practically eroded away.

Age relations.—A firefountain deposit that may have come from the Kalihi cone is well exposed in the cut on the private road to the Damon estate leading up the bluff on the southeast side of Manaiki Stream about 1,500 feet northwest of the main entrance to Fort Shafter. The following section is exposed in a horizontal distance of 1,200 feet in this road. The altitudes of the beds are estimated from the topographic map.

The stratigraphy in the Fort Shafter area is complicated, and good horizon markers are lacking, except for the Salt Lake tuff, which can be recognized readily. It is possible that the complications are due to erosional unconformities which are hidden by vegetation; hence the

Geologic section exposed in Damon road cut

	Thickness (feet)	Altitude of top of bed (feet)
Reddish-brown soil.....	1	90
Thin-bedded lithic Salt Lake tuff.....	4	89
Fine brown soil.....	5	85
Brown lenticular pebbly conglomerate.....	2	80
Well-rounded boulders, most of which are mellilite-nephelite basalt containing olivine segregations cemented in a matrix of reworked black vitric-lithic tuff, possibly deposited as a mud flow.....	4	78
Coarse boulder conglomerate. No nephelite basalt boulders noted.....	15	74
Brown sandy silt, possibly a soil.....	.5	59
Stratified water-laid fine pumiceous fire-fountain deposit containing a few waterworm pebbles of Koolau basalt.....	10	58.5
Red residual soil.....	2.5	48.5
Weathered Koolau aa basalt.....	5+	46
	49+	

interpretation of the stratigraphy of the above section may be modified by more detailed work. The well-rounded boulders in the bed with its top 78 feet above sea level appear to be derived from the Manaiki branch of Kalihi basalt, especially because they carry the olivine segregations characteristic of that basalt. If so, sufficient time must have elapsed since the eruption of this lava to round these boulders by stream corrasion. Unfortunately the Manaiki basalt is not represented in the collection of thin sections for comparison. It follows that the stratified water-laid pumice with its top 58.5 feet above sea level is probably pumice from the Kalihi cone, because this cone lies at the head of Manaiki Stream, and such a deposit would be expected at this place. If the nephelite boulder conglomerate is a mud flow, then there must have been an eruption of lithic tuff in this area after the Kalihi eruption. The only eruption that is known to have occurred close by at approximately this time is the Aliamanu outbreak, hence the vitric-lithic tuff intermixed with the boulders is tentatively correlated with that from Aliamanu. However, there is a chance that this tuff came from the Haiku eruption, but this would likewise place the Kalihi eruption in the Kaena stand of the sea.

Because the Aliamanu vent is known to have produced tuffs that lie in the Kaena terrace, the Kalihi eruption, on the basis of the foregoing interpretations, appears to have preceded that of Aliamanu. The assignment of the Kalihi eruption to the Kaena stand of the sea is further supported by the deep weathering of its lava and its nearly complete mantle of older alluvium. However, if the thin silt bed overlying the water-laid pumice in the Damon road cut is soil, then the Kalihi eruption may have taken place during a low stand of the sea before the Kaena (95-foot) stand.

^a The Koolau surface dips downward to the east so that a few feet away 2 feet of brown silt resting on 8 feet of very rotten brown cobble conglomerate underlies the fire-fountain deposit.

Water-bearing properties.—Ground water is now recovered from several tunnels in Kalihi basalt which, except for the Kalihi Orphanage tunnels, penetrate the middle and upper parts of the flow. Some of these tunnels recover water from the contact of the vesicular top of the flow with the dense, massive lower part. In the other tunnels the water is recovered from joint cracks in the massive part. Most if not all of this water is apparently intercepted while in transit to the bottom of the flow. As the basalt occupies a former channel of Kalihi Stream it probably rests on nearly impermeable older alluvium in most places. Usually, the most effective and economical way to recover water from such lavas is to drive a tunnel through the soft alluvium on a contour at the base of the basalt. The present tunnels (see “Kalihi tunnels”) recover ground water moving toward the axis of the valley from side tributaries. If the base of the flow is not too massive, a tunnel driven at its lower contact would collect seepage from Kalihi Stream as well as from the tributaries. It is not thought that the recovery will be large, because the basalt has been deeply incised by Kalihi Stream, which has left most of the more permeable rock above stream level. However, if the bottom contact happens to be slaggy and if the buried gravel of Kalihi Stream is not tightly consolidated, considerable water might be encountered.

Haiku Volcanics

Source and character of the basalt.—The basalt member of the Haiku volcanics crops out along Haiku Stream and the coast near its mouth. The volcanics are named for this stream, which is the first one northwest of Kaneohe that heads at the Pali (pl. 2). The chief source of the basalt must have been near the crest of the Pali at Puu Keahiakahoe, on the south side of Haiku Valley, because it veneers an adjacent waterfall 600 feet high. It evidently cascaded down the Pali wall and flowed to the sea along an ancient valley of Haiku Stream. In most exposures where not deeply weathered it consists of dense columnar-jointed basalt. Specimen F128 from this flow was identified under the microscope as nephelite basalt containing phenocrysts of olivine and two or three microphenocrysts of melilite.

Character and structure of the tuff.—Most of the tributaries in upper Haiku Valley that have cut into the older alluvium expose here and there well-bedded blocky tan lithic tuff belonging to the Haiku volcanics. Blocks of Koolau basalt 3 feet or less in diameter occur in the tuff, and some of them have depressed the bedding and produced typical bomb sags, indicating that they are ejecta. Some of the tuff forms massive beds, but in places it is laminated and very fine-textured. Under the microscope it proves to consist of fragments of basalt, glass, and olivine cemented by a zeolite. The fragments of basalt con-

sist of glass with olivine phenocrysts, olivine basalt, and olivine feldspathoid basalt. The fragments of olivine basalt are part of the basement rocks, whereas the remainder are magmatic in origin and similar to the basalt member. This lithic tuff is in places capped by beds of cinders. The whole deposit exceeds 30 feet in thickness and is overlain by older alluvium.

It can be distinguished from the older alluvium by the presence in it of very fresh dense black basalt. The fragments project from the matrix in most exposures, whereas in the alluvium the boulders are usually just as rotten as the matrix. If some hard material persists in the alluvium, it is a core of a large boulder surrounded by soft shells typical of spheroidal weathering. The tuff is gritty as compared with the soapy texture of the alluvium, is resistant when struck with a pick, and is better bedded than the alluvium. Although the tuff is older than the alluvium, it is fresher, because the alluvium is made up of previously weathered material, whereas the major part of the tuff was fresh when it was laid down. In addition, part of the resistance of the tuff to disintegration may be caused by the zeolite cement.

Cause of explosion.—The magma of this explosion rose through the Koolau dike complex, which contained ground water practically to the surface as shown by numerous perennial springs in this valley. Consequently, sufficient ground water was available to cause a phreatomagmatic explosion, which, however, soon spent itself, and the firefountains and lava flow followed. The ash fell on steep cliffs, and much of it was probably swept away.

North Haiku flow.—On the north side of the upper part of Haiku Valley, at an altitude of about 700 feet, there is a bouldery outcrop of hard black basalt similar microscopically to the nephelite basalt from Puu Keahiakahoe but too high above the valley floor to have been poured from this vent. The boulders weather into the usual fluted forms characteristic of the nephelite basalts. Most likely this flow was never much larger and represents a drooling of lava from a crack in the Pali at the time of the eruption on the south side of the valley. From lack of other evidence it is correlated with the south Haiku eruption.

Age relations.—In several places along Haiku Stream the basalt rests on the tuff. The basalt is aa and in many places exceeds 20 feet in thickness. Consolidated noncalcareous sediments about 25 feet thick cap the basalt near the sea. The lower part of these sediments near Heeia Pond consists of fossiliferous marine siltstone. The character of the small outcrops just east of Oohope Pond suggests that the basalt entered water. The sediments overlying the basalt form distinct terraces along Haiku Stream, and profile 15, figure 5, shows a distinct terrace at the 100-foot level in the sediments overlying this basalt,

which indicates that it was erupted before or during the Kaena stand of the sea.

Water-bearing properties.—Because the basalt occupies a former valley, there may be a possibility of developing water by tunneling across this valley at the base of the basalt. At an altitude of about 150 feet in Haiku Stream several small springs issue from the basalt. Other springs rise in the channel upstream, but exposures are so poor that there is no certainty that the present stream has not somewhere cut across the lava-filled valley and drained it. The topography suggests, however, that the ancient valley lies slightly to the south of the present one. No need exists at present for this water, but should the springs at the head of the valley be diverted to the west side of the island, sufficient need might arise to justify exploring for water in this basalt.

Baskerville Springs issue at an altitude of about 190 feet at the head of a small valley 1,000 feet south of Haiku Stream. The main spring, pumped for domestic use and irrigation, is enclosed in a concrete box, but several other unenclosed springs issue a short distance downstream. The flow an eighth of a mile below the concrete box was estimated on August 8, 1933, at half a million gallons daily. Some of the spring water is heavily charged with limonite. The flow of the springs on January 14, 1914, was 3.2 million gallons daily.⁸⁰ This measurement may have been made farther downstream than the estimate mentioned or in wetter weather. Most exposures near the springs are older alluvium, but there are two outcrops of a thoroughly decomposed olivine basalt, which is probably in place. This basalt may be Haiku basalt, and if so these springs may be the outlet of the underflow of Haiku Valley, although topographically such a source does not seem likely.

Aliamanu Tuff

Location of vent.—Three conspicuous craters lie between Honolulu and Pearl Harbor on the coastal plain. They are Salt Lake, Aliamanu, and Makalapa Craters. Aliamanu Crater is planted with sugar cane and is drained by a tunnel that discharges into Salt Lake. The other two craters are occupied by fish ponds. The form of these craters and their extensive tuff deposits are shown on plate 2.

Previous work.—Dana⁸¹ was apparently the first geologist to describe these cones and craters, but he did not differentiate the two tuffs of different ages in this area. Hitchcock,⁸² however, recognized the presence of an upper and lower tuff near Moanalua station, separated by reef rock, and a soil directly beneath the upper tuff, which was forested

⁸⁰ Kunesh, J. F., Surface water supply of the island of Oahu, 1909-1928: Honolulu Sewer and Water Comm., Rept., Suppl., p. 260, 1929.

⁸¹ Dana, J. D., Geology in U. S. exploring expedition, 1838-42, vol. 10, pp. 245-248, 1849.

⁸² Hitchcock, C. H., Geology of Oahu: Geol. Soc. America Bull., vol. 11, p. 40, 1900.

at the time of the last eruption. He also noted that Moanalua and Halawa Streams had been diverted from their normal courses by these eruptions. Wentworth⁸³ mapped the geology of the area and described the cones in greater detail than any previous writer.

Source of the upper and lower tuff.—Wentworth suspected that the lower tuff came from Aliamanu Crater, and recent excavations in this crater have practically proved it. In the main road cut on the east side of Halawa Gulch the upper tuff rests on a thick red soil, which in turn rests on water-laid tuff. The upper tuff can be traced to Salt Lake Crater; hence no doubt exists as to its source. In 1931 the United States Army excavated several tunnels in the north rim of Aliamanu Crater, which passed through 50 to 100 feet of the typical gray upper tuff into 2 to 4 feet of red soil underlain by large vesicular bombs and spatter. The large size of these ejecta indicates that they were blown out of the vents nearby. Stratigraphically they are correlated with the tuff in the Halawa road cut, which would mean that Aliamanu was the source of the lower tuff and was later mantled and partly filled with Salt Lake ash. The topography southwest of Aliamanu is suggestive of vents similarly mantled by Salt Lake ash.

Character.—The lower or Aliamanu tuff in most exposures is readily distinguishable from the upper tuff by the presence in it of stream rounded gravel or sand, indicating that it was water-laid. It ranges from gray to black.

Age relations.—The stratigraphic relations of the Aliamanu tuff to other rocks are shown by several fine exposures near the crater. On page 105 reasons are given for correlating a bed of tuffaceous conglomerate in the Damon road cut with the Aliamanu eruption. The fact that the nephelite boulders in this bed are all water-worn practically excludes them from being bombs ejected during the Aliamanu eruption. Because no nephelite boulders were noted in the conglomerate underlying the tuffaceous conglomerate, it appears that Manaiki Stream was suddenly diverted to this place by the Aliamanu eruption. Although no fossils were found in the terrace at the Damon road cut, it appears to be graded to the Keana stand of the sea; hence the Aliamanu tuff was probably erupted during that stand.

In the bluff 1,200 feet east of the mouth of Moanalua Stream and half a mile south of the Damon road cut mentioned above, a thin mud flow resting unconformably on pumiceous alluvium is exposed. The lower 4 feet of the mud flow consists of boulders as much as 4 feet in diameter in a black tuffaceous matrix. Above the boulders is about 6 feet of indurated laminated lithic tuff which, at a point nearby along the road, is full of small fragments of fossil wood. The jumbled and broken character of the wood fragments indicates that the mud flow swept

⁸³ Wentworth, C. K., Pyroclastic geology of Oahu: B. P. Bishop Mus. Bull. 30, pp. 60-72, 1926.

considerable vegetation along with it. When it came to rest it was evidently sufficiently plastic to allow the heavy boulders to settle to the bottom. This same mud flow without the laminated facies is also well exposed as a cap rock both above and below the point where the Kamehameha highway crosses the same terrace, west of Kahauiki Stream. Above the concrete septic tanks at Fort Shafter, just south of the lower road crossing over this same stream, the tuffaceous matrix of the boulders is very rich in beautifully preserved fossil leaves and wood. This mud flow is probably correlative with the one in the same terrace at the Damon road cut.

In the bluff along the road about 900 feet north of Aiea railroad station the following section is exposed. The base of the section is about 15 feet above sea level.

Geologic section near Aiea railroad station

	Feet
Dark-gray subaerial thin, horizontally bedded fine lithic Salt Lake-Makalapa tuff containing molds and casts of upright trees....	6
Brown clayey soil.....	3
Dirty gravel.....	1
Horizontally laminated fine-grained lithic Aliamanu (?) tuff, reworked by water and containing leaf casts and carbonaceous material near base, and a few log molds and streaks of gravel above.....	10
Horizontally bedded gravel and silt.....	4
	24

The absence of upright tree molds in the lower tuff and the presence of intercalated gravel indicates that this tuff is water-laid. In the new highway cut nearby the lower tuff contains a mud-flow layer full of fossil plants. Because the bedding of these deposits is horizontal it is likely that they are delta deposits, although no marine fossils were found. The upper tuff at this place fell on a flat surface about 33 feet above sea level and supporting vegetation. Not far away the upper tuff fills a gully cut in this surface, which shows that it is separated from the lower tuff by an erosional unconformity. Since the lower tuff is distinctly older than the Salt Lake-Makalapa tuff, it is probably Aliamanu tuff, although there is a possibility that it came from the Haiku eruption.

In the highway cut on the southeast side of South Halawa Gulch about 10 feet of horizontal laminated lithic tuff containing water-worn pebbles is overlain by a lens of gravel and 5 to 8 feet of bright-red soil. Above the soil is 4 to 10 feet of laminated Salt Lake tuff containing bomb sags and numerous upright tree molds. The base of the soil is about 100 feet above sea level. As the tuff is horizontal it must have fallen on a flat surface—a fact which suggests that the flat surface is a terrace, 100 feet above sea level. The thick red soil is not residual but was washed off the adjacent Koolau spur prior to the deposition

of the Salt Lake tuff. The lower tuff is probably from Aliamanu. It crops out in several places in the adjacent valley in the sides of terraces that are 90 to 100 feet above sea level. As these terraces are correlated with Kaena stand of the sea the Aliamanu eruption apparently occurred when the sea stood 95 feet higher than now.

Water-bearing properties.—The Aliamanu tuff is so fine-grained except at the vent that it is virtually impermeable, and its outcrops are so thin and small that it is probably not even important as a restraining layer in the cap rock of the artesian basins in this area.

Kaneohe Volcanics

Distribution and character.—At 2 miles south of Kaneohe the main highway passes through a cluster of cinder cones, from which a lava flow extends about 2 miles north to the sea (pl. 2). The highest cone rises to 417 feet above sea level and about 200 feet above the subjacent rocks. The bedded cinders composing these cones are well exposed in several cuts along the main highway and, like the flow, are deeply weathered. Fresh exposures of the flow are scarce. At the best one, in the abandoned quarry between the highway and the highest cinder cone along Kamoalii Fork of Kaneohe Stream, 50 feet of basalt is exposed. Specimen F72, from this locality, was determined under the microscope to be an olivine-nephelite basalt. Kaneohe Stream has evidently been diverted westward from its normal course to the sea by this lava.

Age relations.—In most places near the sea the basalt of the Kaneohe volcanics is covered by consolidated noncalcareous sediments, chiefly conglomerates. Likewise the cinders and pumice near the cones are intercalated with conglomerates of a terrace that appears to be graded to the Kaena stand of the sea. Near the coast on the southeast side of the mouth of Kaneohe Stream the basalt has been carved into cliffs by the sea at about 25 feet above present sea level (pl. 2). The basalt and conglomerate are cut through by Kaneohe Stream, and in Kaneohe Valley there are terraces graded to the 25-foot stand of the sea. It appears, therefore, that the basalt was poured out during the Kaena stand of the sea, and that the sediments and the basalt were dissected during the Waipio stand. Then during the Waimanalo stand the valley was partly filled with deposits graded to the 25-foot sea. When the sea fell to the present level these deposits were dissected to form the terraces within the valley. The relations of the various deposits are shown in figure 9.

Water-bearing properties.—The basalt offers little opportunity for obtaining ground water, because it lies in a relatively dry area and has been drained by Kaneohe Stream in so many places. A small spring issues from the cinders resting on basalt on the east side of the little round cinder cone on the north side of the highway, but it is a local

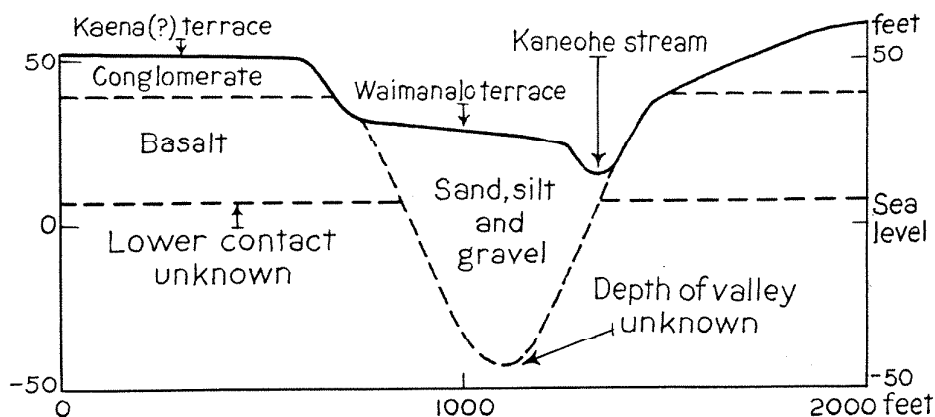

FIGURE 9.—Geologic cross section of Kaneohe Valley half a mile above its mouth, showing relation of the basalt to terraces.

affair. As the basalt probably fills a former valley of Kaneohe Stream, water probably flows near the bottom of the buried valley, but its position could not be determined. The thick lava outcrop from which specimen F72 was obtained looks like the head of a lava fill in a valley, but nothing was found to indicate the position of the seaward end.

Nuuanu Volcanics

Location of vent.—Rising 160 feet above the floor of Nuuanu Valley 1 mile from the Pali Gap is Makuku (formerly Luakaha) cinder cone. It is roughly circular and about 1,800 feet in diameter. Two breached craters indent its summit. The Kamehameha highway has been cut through one side of the cone, leaving a bank about 50 feet high. Brigham⁸⁴ was apparently the first geologist to describe this cone, but no references were found in the literature to the flows that issued from it.

A trench about 4 feet deep dug by the Honolulu Board of Water Supply in 1931 near the west abutment of Nuuanu Dam 4 exposed a lava flow a few feet thick overlying coarse cinders on the slope of Makuku. This flow was found, by drilling, to be confined to a few square rods in area, hence is probably only a trickle on the side of the cone.

Upper flow.—Extending down the valley from near the cone are two lava flows that have a profound influence upon the hydrology of Nuuanu Valley. The upper flow is well exposed along the Kamehameha highway from the spillway at reservoir 2 to the road forks at an altitude of 350 feet. It consists of columnar-jointed basalt about 12 feet thick, overlain by 5 to 10 feet of aa clinkers and underlain by 1 to 4 feet of weathered brown pumiceous ash, which becomes coarser and

⁸⁴ Bingham, W. T., Notes on the volcanoes of the Hawaiian Islands: Boston Soc. Nat. History Mem., vol. 1, pt. 3, p. 354, 1868.

slightly thicker inland. The terminal margin of the flow was not found, because much of the area is covered with lawns and houses, hence on plate 2 it is not differentiated from the lower basalt. Specimen F84, collected from this flow, was determined microscopically as a nephelite-melilite basalt containing phenocrysts of olivine and pyroxene. Well 122, in Honolulu, penetrated only one post-Koolau lava flow; hence it appears that the upper flow of the Nuuanu volcanics terminated before it reached the sea.

Lower flow.—The lower basalt extends from near Lower Luakaha to the sea. It is a nephelite aa basalt containing phenocrysts of olivine. In most exposures it exceeds 50 feet in thickness and where not heavily eroded has 5 to 10 feet of clinker on its surface. The flow has a known length of $4\frac{1}{2}$ miles and near the mouth of Nuuanu Valley is over half a mile wide. Numerous wells at the mouth of the valley near the coast have penetrated as much as 40 to 50 feet of this basalt. It may have flowed some distance into the sea. Because it is overlain by the upper flow from Makuku cone and because it does not carry melilite like the upper flow, there is a possibility that this flow came from some other cone near the head of the valley, which was either not found or has been completely removed by erosion^{84A}.

The best exposures of this lava are found between Alapena and Kapena Pools along Nuuanu Stream, near the end of the Koolau spur on the east side of Nuuanu Valley not far above Judd Street, in Honolulu. These plunge pools are caused by the stream encountering soft materials at the contact of the Nuuanu and Koolau basalts. At Kapena Pool the talus from the wall of Nuuanu Valley can be seen passing beneath the side margin of Nuuanu basalt.

Age relations.—The lower basalt of the Nuuanu volcanics rests on partly consolidated noncalcareous sediments in the lower part of the valley, as indicated by wells 109 and 122. At well 109 the basalt is 40 feet thick and is overlain by 6 feet of coarse conglomerate, 4 feet of black-sand alluvium of the Tantalus and Sugar Loaf volcanics, and 4 feet of brown soil. (For location of wells see pl. 2, and for logs see pl. 20.) At well 122 the basalt is 29 feet thick and overlain by 10 feet of emerged reef belonging to the Waimanalo (25-foot) stand of the sea and 3 feet of taro-patch clay. Over most of the valley the basalt carries a fairly complete soil mantle, but massive ledges of the rock

^{84A} Diamond drilling carried on by the Honolulu Board of Water Supply in 1934 under the direction of C. K. Wentworth as a result of the discovery of these water-bearing lavas has revealed much new data. It has located on the east bank of Nuuanu Stream near Lower Luakaha a cinder and tuff cone nearly covered by 300 feet of later volcanics. The drilling has also revealed a great complexity of lava flows and scoriaceous deposits 350 feet thick lying on 100 to 200 feet of older alluvium and containing two distinct water tables. Whether the volcanic complex represents flows from more than this vent and Makuku cone has not yet been established. See cross section of Nuuanu Valley p. 136, Rep't. of the Honolulu Board of Water Supply 1933-34.

project through lawns and are exposed in road cuts in several places. The rock is well exposed in Waolani Stream.

In the pineapple-canning district at Honolulu wells 114 to 118 penetrated about 45 feet of Nuuanu basalt beneath two layers of reef rock separated by 20 to 40 feet of clay. The upper reef rock belongs to the 25-foot sea; hence its base is probably the Waipio unconformity, and in that case the lower reef would belong to the Kaena stand of the sea, and the lower basalt would have been poured out in the early part of the Kaena stand. If, however, the clay layer only indicates a change in the point at which Nuuanu Stream entered the sea during the Waimanalo stand, then these reefs are of little value in dating this lava.

As shown in figure 5, profile 2, there is a distinct bench in the Nuuanu volcanics at the 90-foot level. This coincides so closely with the Kaena shore line that it seems likely that this bench is wave-cut and the black taro-patch clays below this level are marine. However it may be only the terminal margin of a basalt layer. Rotten older alluvium and a streak of pumice believed to be from the Pali cone, which is correlated with the Kaena stand of the sea, overlies lava in Nuuanu Reservoir 4. Consequently the basalt is probably as old as that stand.

Water-bearing properties.—The basalts displaced Nuuanu Stream from the axis of its valley and forced it eastward against a ridge of Koolau lava. As Nuuanu Stream has nowhere exposed the base of the lower flow, it is evident that the prebasalt channel of this stream is below the present one. This group of volcanics makes a fine conduit to the sea for ground water moving down Nuuanu Valley. The presence of a strong underflow out of Nuuanu Valley is shown by the good yields of fresh water encountered in excavations for buildings in the center of Honolulu.

Beneath the Nuuanu volcanics is a deposit of noncalcareous sediments several hundred feet thick, as shown by the logs of wells 109 and 122. This material is nearly impermeable because of its weathered condition, and the water in the basalt is perched on these sediments. The configuration of upper Nuuanu Valley suggests that similar sediments, although thinner, probably underlie the basalt all the way to its source. Drill holes 75 feet deep in Nuuanu Dam 4 failed to penetrate the base of the basalt in the center of the dam, but the two holes near the east abutment, which passed through the basalt into Koolau rocks, indicated a fairly steep contact.

The basalt flows, the interbedded ash, and the pumice from the Pali eruption account for the heavy leakage (75 percent of the inflow) from Nuuanu Reservoir 4 and for the seepage from the three lower reservoirs in this valley also. It is evident that a thorough geologic study prior to the construction of the reservoirs would have raised serious

doubts as to the advisability of building reservoirs in this valley. Leakage from these reservoirs that does not reappear a short distance downstream has heretofore been assumed to reach the Honolulu artesian basin, hence has not been considered a complete loss.⁸⁵ The writer believes that most of this water flows seaward through the Nuuanu volcanics and never reaches the Honolulu artesian basin.

Some of the ground water in the Nuuanu volcanics can be recovered by means of tunnels. The quantity of water recoverable will be less at higher altitudes than at lower altitudes, owing to a decrease in area of recharge above it.^{85A}

Should the need ever arise, the ground-water discharge at the mouth of Nuuanu Valley could be recovered by shallow wells or tunnels near sea level and be utilized for industrial purposes. Owing to the numerous cesspools in Nuuanu Valley this water supply would probably not be safe for domestic use.

The ash bed between the two flows gives rise to the spring that supplies Alewa Heights. This spring is at an altitude of about 750 feet and is situated just below reservoir 3. It yields from about 37,000 to 167,000 gallons daily.⁸⁶ Excavations at the spring in 1931 revealed a coarse pumice bed beneath aa basalt. That the supply of this spring is partly derived from leakage from reservoir 3 is shown by a decrease in flow when this reservoir is drained. A small spring, apparently derived from leakage from reservoir 2, issues from this same ash bed at the sharp bend in the road just below the dam. Several tunnels develop water at this ash horizon (see section "Nuuanu tunnels").

Keiliohia Spring issues from post-Koolau clinker and firefountain deposits on the east side of Makuku cinder cone in Nuuanu Reservoir 4, at an altitude of 975 feet. Kunesh⁸⁷ gives 11 measurements of it which range between 203,000 and 512,000 gallons daily. On April 17, 1931, after the reservoir had been dry for some time and most of the bank storage had drained out, the flow of this spring was estimated to be less than 100,000 gallons daily. It is frequently submerged by the water in the reservoir.

The low water flow of this spring is probably derived from the rainfall on Makuku cone and the small streams that sink near it. The underlying older alluvium probably perches the water.

Kanewai Spring issues from basalt of the Nuuanu formation at an altitude of 90 feet in Nuuanu Valley above School Street. Its dis-

⁸⁵ Honolulu Sewer and Water Comm., Rept., p. 105, Honolulu, 1929.

^{85A} Recent drilling shows that the ground-water conditions are very complicated and that several tunnels will probably be necessary.

⁸⁶ Kunesh, J. F. Surface water supply of the island of Oahu, 1909-1928: Honolulu Sewer and Water Comm. Rept., Suppl., p. 48, 1929.

⁸⁷ Idem, p. 240.

charge on December 6, 1929, was at the rate of 50,000 gallons a day.⁸⁸ The water is not used.

Pali Volcanics

Distribution and character.—The basalt of the Pali volcanics crops out along the road down the famous Nuuanu Pali, for which the formation is named (pl. 2). Like many other post-Koolau eruptions, it occurred practically on the crest of a divide at an altitude of about 1,600 feet. The cinders at this place were described as early as 1835 by Gairdner.⁸⁹ Dana⁹⁰ was probably the first to point out their relatively recent age. Hitchcock thought the basalt was a laccolith.⁹¹ Numerous fine exposures of the steep erosional unconformity separating the pyroclastic rocks of this formation from basalt of the Koolau volcanic series, like the one shown in plate 16, B, can be seen in the cuts along the Pali road. The products of the Pali eruption probably once mantled the entire cliff at this place, but subsequent erosion has left only long, narrow patches (pl. 2). The road cuts show that these patches of Pali eruptives fill former V-shaped valleys in the cliff. The displacement of the drainage causes the present streams to flow along former ridges.

The first outcrop of Pali pyroclastics encountered in descending the Pali road consists of 15 feet of lithic tuff grading upward into cinders. The tuff is in many places coarse enough to be called an agglomerate. It contains numerous fragments of Koolau basalt and indicates that steam blasts preceded the firefountains. Near the Pali vent the basalt of the Koolau series is cut by numerous dikes, which confine water. A perennial spring issues nearby. At the time of the eruption evidently sufficient water was stored near the surface to start it off as a phreatomagmatic explosion. The supply of water would soon have been exhausted, so that normal firefountains and flows would have naturally followed. Similar explosions preceded the Kalihi, Haiku, and Kaau eruptions, all of which broke through bodies of perched water near the surface. On the other hand, those which broke through nonsaturated rocks at the surface such as the Sugar Loaf, Tantalus, Kalama, Kaneohe, and Kaupo lavas, began as normal firefountains. The importance of ground water as a causal agent of volcanic explosions on Oahu is evident.

In the tuff, cinders, and lava of the Pali eruption are numerous nodules of olivine reaching 4 inches across. In some places the lava flow looks like a conglomerate because the nodules make up so large a percentage of it. At an altitude of about 925 feet and striking north

⁸⁸ Kunesh, J. F., Honolulu Board of Water Supply Rept., Suppl., p. 30, 1931.

⁸⁹ Gairdner, Meredith, Physicogeognostic sketch of the island of Oahu, one of the Sandwich group: Hawaiian Spectator, vol. 1, no. 2, p. 13, 1838. Reprinted in full from Edinburgh New Philos. Journal., July, 1835.

⁹⁰ Dana, J. D., op. cit., p. 260.

⁹¹ Hitchcock, C. H. Geology of Oahu; Geol. Soc. America Bull., vol. 11, p. 35, 1900.

and south across the Pali road is a 2-foot dike that probably fed the Pali eruption. It contains olivine nodules similar to those in the flows. They decrease in number toward the sides of the dike. The dike is full of vesicles, which are arranged irregularly instead of in zones, a condition usually found in the superficial part of a dike. Its trend practically coincides with post-Koolau fissures, most of the Koolau dikes trending more westerly. It is a basanite⁹² similar to Pali basalt. The fact that it is the only one of its kind found in the Koolau Range further indicates its post-Koolau age.

The cinders have a maximum thickness of about 40 feet and in places contain thin beds of flow lava. As they accumulated on the Pali wall the beds have dips as steep as 40°. Although flow lava makes up an appreciable part of the extruded material it shows as only narrow outcrops on plate 2, because it generally lies beneath the cinders in the bottoms of small valleys. In many places it exceeds 20 feet in thickness and is aa. Cinder xenoliths are common in it. Specimen F63 from this flow was determined under the microscope to be a basanite. Near the hairpin turn in the Pali road and at several other places a foot or two of soil occurs between the Koolau and Pali basalts. If this soil at the contact of the two formations had been exposed when Hitchcock described the lava he would not have called the Pali basalt an intrusive body.

Breccia at vent.—In the amphitheater at the head of the main mass of cinders there is a patch of breccia (pl. 2). It contains subangular blocks of green-gray aa, brown vesicular pahoehoe, coarse-textured red tuff, and olivine basalt as much as 3 feet in diameter. Associated with the breccia at one place is a light brownish-gray brittle laminated tuff having a subconchoidal fracture. The contacts of the breccia with Koolau basalt are steep, and dips of 80° were observed. The contact is irregular and lacks gouge or any other indication of faulting. It appears that this breccia represents the filling of the main Pali vent and is in part talus and in part the product of the early explosions. Probably not all of the Pali lava was erupted at this spot, because some of the flows head back to the crest farther northeast, as if the eruption took place along a north-south fissure.

Age relations.—Between altitudes of 500 to 600 feet on the west bank of the Pali road there are numerous large Koolau boulders in a matrix of cinders that looks like a landslide deposit. Elsewhere the cinders merge into older alluvium at the foot of the Pali, and if the lava flows from this vent were extensive they are now buried by the alluvium. The eruption occurred so close to the Pali, where erosion and fan building are active, that its age is difficult to determine. The cinders

⁹² Holmes, Arthur, *Nomenclature of petrology*, p. 43, 1920. Defines basanite as "a basaltic rock, generally porphyritic, containing plagioclase, augite, olivine, and a feldspathoid."

form the surface of the terrace in which Kaneohe cinders are intercalated; hence they are younger than Kaneohe basalt. In the Pali gap at the head of Nuuanu Valley they rest on older alluvium and are in turn buried by considerable alluvium. Fine pumice drifted by the wind during this eruption occurs in Nuuanu Reservoir 4, intercalated with thoroughly decomposed alluvium, which in turn rests on a basalt of the Nuuanu volcanics. The Pali eruption was therefore later than this basalt. The terraces at the foot of the Pali, which have Pali cinders in them, when traced seaward seem to be graded to the Kaena stand of the sea. The Pali eruption probably occurred near the end of that stand.

Water-bearing properties.—Prior to the construction of Nuuanu Reservoir 4 several springs issued below the present site of the dam and during the excavation for the dam springs were encountered. While the geology of the reservoir was being mapped in 1931 several small springs were noted issuing from this pumiceous tuff, but it was not until a few months later, when test pits were dug by the Board of Water Supply, that the important part played by this bed in the leakage of the reservoir was revealed. On October 8, 1931, a small excavation in this tuff at the base of the tower in the west bank of Nuuanu Stream yielded water at the rate of 300,000 gallons daily, and a pit on the opposite bank was pumped at the same rate. Permeability tests made on this tuff indicated a percolation rate as high as 3,099 gallons per square foot per day per foot of depth.⁹³ This intercalated tuff gives rise to innumerable springs and seeps along Nuuanu Stream, both above and below dam 4. Formerly, when the reservoir was full one leak below the dam discharged over 2,000,000 gallons daily from this bed.⁹⁴

Small springs above the reservoir that appear to issue from alluvium are probably dependent upon this tuff as an aquifer.

If the lava that cascaded down the Pali can be located by means of test borings in the flats below, interbedded with alluvium, it might yield a small supply of water.

Makawao Breccia

Distribution and character.—About 2½ miles south and a little west of Olomana Peak, in the Maunawili ranch, a patch of breccia half a mile long and a quarter of a mile wide crops out. It rests unconformably upon the dike complex of the Koolau volcanic series, and the contacts are invariably almost vertical. Although numerous dikes occur adjacent to this breccia, no dikes were observed in it; hence it appears to be younger than all Koolau dikes. It is firmly cemented and contains numerous large angular blocks of Koolau basalt, some of which exceed 3 feet in diameter. Except in one place bedding is absent. At an alti-

⁹³ Honolulu Board of Water Supply Rept., p. 193, 1933.

⁹⁴ Kunesh, J. F., Honolulu Sewer and Water Comm. Rept., Suppl., p. 239, 1929.

tude of about 600 feet in the bed of Makawao Stream two beds of extremely fine-grained laminated brown tuff occur, striking N. 20° W. and dipping 5° NE. The lower bed is 2 feet thick, and the other, 4 feet higher, is 4 inches thick. A small spring issues at this place. Specimen F215, from the lower bed, was found in this section to consist chiefly of glass fragments with scattered pieces of plagioclase and some particles with a moderate birefringence, probably augite. Some serpentinelike material is also present. In a few places palagonitized vesicular pieces of cinders were observed.

As a whole the breccia has a remarkably uniform dark-grey color and is so free from joints that it often breaks up into blocks 20 feet in diameter. The fragments usually protrude slightly from the matrix. Its thickness exceeds 200 feet. It is so well cemented at the surface that it looks impermeable, but this condition may not persist with depth. In the banks of Maunawili Stream near the Maunawili ranch several outcrops were observed that megascopically appear to be tuff or tuffaceous alluvium, and they may be correlative with the breccia.

Age relations.—The presence of tuff layers and scattered cinders in the breccia, together with its nearly vertical contacts, practically establishes the conclusion that this breccia fills a vent blasted through the dike complex of the Koolau series by an explosion. If the material in the banks of Maunawili Stream is tuff from this vent, it proves that this explosion occurred in post-Koolau time and probably during the Kaena stand of the sea, because the tuff is intercalated in alluvium underlying the Ainoni volcanics. However, for several miles along the top of the Pali, as shown in plate 2, and intercalated with Koolau basalt, is a bed of lithic tuff. This tuff thickens toward the Maunawili area, and although it could not be mapped all the way along the Pali, because of the steepness of the cliff, it is known to be present, because it occurs as blocks in the talus at the foot of the Pali. If the Makawao breccia was formed late in Koolau time, it seems likely that a few dikes would have been injected into it before the end of Koolau activity. In view of the absence of such dikes the breccia is tentatively considered of post-Koolau age and assigned to the Kaena stand of the sea.

Water-bearing properties.—The breccia is crossed by several streams, but leakage from them is probably not great. The breccia appears to fill a vertical pipe that cuts through the dike complex of the Koolau series. The water perched between these dikes probably descends toward sea level in the breccia if it is permeable. A large part of the daily flow of 12,000,000 gallons from a tunnel in Kahana Valley issues from a breccia similar to the Makawao breccia. In places the breccia of Kahana Valley is cemented like the Makawao breccia, but streaks of very loose, extremely permeable rubble occur in it. The

breccia of Kahana Valley is cut by several dikes and occurs in a region of heavy rainfall, which doubtless accounts in large measure for the high yield. About 500 feet north of the Makawao breccia is a tunnel that yields a strong flow of water. This tunnel could be continued southward to prospect the breccia for water.

Moku Manu Volcanics

Distribution and character.—Moku Manu consists of two islands of lithic tuff, basalt, and cinders (pl. 2), one 202 feet and the other 132 feet high, a little more than half a mile north of Mokapu Point. The south island is the larger and in its west side is exposed the rim of a crater with its inward-dipping and outward-dipping beds of tuff. These dips and the jointing of the overlying basalt indicate that the center of the crater lay approximately at the site of the north island. Resting on this tuff and forming the east half of the island is a massive columnar-jointed porphyritic nephelitic basalt containing clusters of augites about half a centimeter long (specimen F368). The broad flat on the top of this island may be either the result of marine erosion during some former high stand of the sea, or due to the resistance of this mass of basalt to subaerial denudation. The top of the basalt at the west side is highly scoriaceous and approaches spatter in texture. On the southwest side, at the contact of the lava with the tuff, is the largest sea cave noted in this investigation. The tuff is brown and contains numerous angular blocks of amygdaloidal basalt of the Kailua volcanic series and a small amount of marine calcareous material.

It is evident from the sequence of the deposits that the Moku Manu eruptions began with phreatomagmatic explosions, probably submarine, and ended with firefountains, which produced the cinders and associated crater fill of lava.

The north island consists of columnar-jointed basalt with a sag in its top over which lies about 40 feet of cinders and spatter. This lava has evidently been detached from that of the south island by marine erosion and is part of a crater fill.

Age relations.—The west and south side of the south island is fringed by a remarkably smooth wave-cut bench which reaches a maximum width of 200 feet and lies about 2 to 6 feet above sea level. From the east end of the bench to the northeast tip of the island there is a lava boulder beach, and on the north side of the island an impassable precipice. A few remnants of tuff project above the level of the bench, and one at the east end of the bench has a cap of lava cobbles cemented in a matrix of fossiliferous calcareous sand. This conglomerate is estimated to be about 12 feet above sea level and is a remnant of a beach laid down by a higher sea. On the northeast side waterworn lava cobbles were noted up to about 35 feet above sea level, evidently

laid down during the Waimanalo stand of the sea. On the evidence of these deposits the Moku Manu cone is believed to be as old as the Waimanalo stand, if not older. Its advanced state of erosion suggests that it is older than Ulupau Crater; hence it is tentatively assigned to the Kaena stand of the sea.

The islands are too small to contain fresh ground water.

Ulupau Tuff

Distribution and character.—The Ulupau cone forms the tip of Mokapu Point, the largest peninsula on the northeast coast of Oahu. The topographic form of the cone is well shown on plate 2. Its north coast is a sea-cut cliff 500 feet high, which in places is overhanging and which is said to be the highest vertical cliff on Oahu. The secondary character of this cone was recognized by Dana⁹⁵ in 1841. Wentworth⁹⁶ gives a detailed description of Ulupau Head and a geologic map.

The Ulupau cone is made up of gray and brown tuff containing considerable accidental ejecta. The east rim of the crater has been partly destroyed by erosion, so that only a horseshoe-shaped part of the rim is left. An 80-foot cliff on the east coast within the former crater is formed by a section of tuffaceous sediments extending below sea level. The bedding is well displayed in this cliff and in the gullies made by streams draining the adjacent slopes. Some of the beds between 30 and 40 feet above sea level show fine laminations, and only by careful study can the sediment be distinguished from a tuff. At its north and south end the deposit rests unconformably upon the Ulupau tuff and hence is distinctly younger. Near the sea the beds have dips of about 5°, and the material was evidently washed from the adjacent crater walls. The deposit is much more friable than the tuff, but if it were not for the conglomerate layers, the absence of bomb sags, and the field relations, this deposit might readily be confused with a primary subaqueous deposit of tuff.

Age relations.—A diagrammatic cross section along the coast of Ulupau Crater from Kii Point to an unnamed point about 1,200 feet southeast is shown in figure 10. The vertical scale is not exaggerated, but the horizontal has been distorted to take care of the curve in the coast. The size of the critical outcrops also has been exaggerated because they are small. Resting on the clean surface of the inward-dipping tuff beds on the north and south sides of the crater is a laminated, poorly consolidated white limestone containing numerous fossil oyster and barnacle shells. The laminations in the limestone diverge slightly from the bedding of the tuff. The lime deposit is wedge-shaped, attains

⁹⁵ Dana, J. D., *op. cit.*, pp. 248-249.

⁹⁶ Wentworth, C. K., *Pyroclastic geology of Oahu*: B. P. Bishop Mus. Bull. 30, pp. 85-90. 1926.

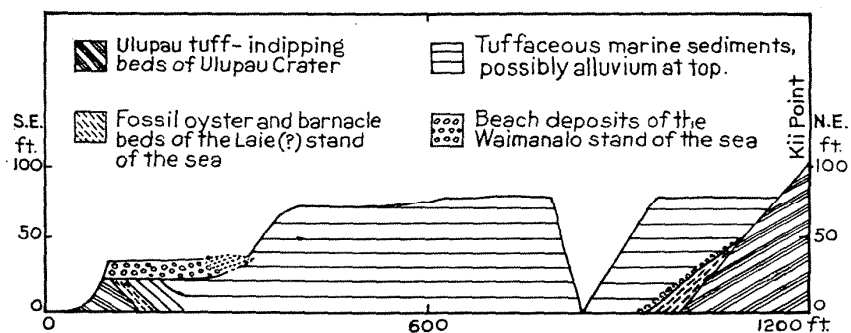

FIGURE 10.—Diagrammatic cross section along coast of Ulupau Crater.

a thickness of about 20 feet at water level, and apparently extends beneath the sea. On the Kii Point side it is overlain by a thin layer of angular tuff blocks in a fine dirt matrix, which is a slide deposit from the adjacent steep crater wall. On the opposite side the limestone is overlain by several beds of fine greenish-yellow silt, which lie conformably on it, as shown in plate 17, A. The nature of the contact of these beds with the adjacent nearly horizontal sediments is indefinite, but the uppermost of the steeply dipping beds seems to merge into the horizontal beds. At 22 feet above sea level, as shown in plate 17, A, the steeply dipping and nearly horizontal beds are overlain by a fossiliferous tuff-cobble conglomerate containing, near the bottom, heads of a coralline alga. Only water-worn coral was noted. The top of the conglomerate is 33 feet above estimated mean sea level. It changes northward into a typical lithified sand beach. Overlying this shore deposit is about 10 feet of stratified tuffaceous hill wash not shown in figure 10. Several angular blocks occur at the base of the conglomerate, as shown in plate 17, A, but a few feet north the underlying surface consists of fine-grained sediments filled with long tubular calcareous concretions, which look like root casts of vegetation that grew on the surface prior to the deposition of the conglomerate. The basal contact of the conglomerate dips gently southeastward.

In a little cove about 100 feet northeast of the oyster bed at Kii Point is a boulder conglomerate with a fossiliferous calcareous matrix, at 24 feet above estimated mean sea level as determined by a hand level.

As shown by the oyster bed at Kii Point, Ulupau Crater was occupied by a sea at least 45 feet higher than at present. The fact that the oyster bed rests on a clean surface of tuff suggests but does not prove that the oysters started growing there soon after the eruption ceased. If the slide deposit resting on this bed is subaerial it means that the sea fell lower after the growth of the oysters. If it is submarine it has no significance. The most plausible sequence of events is that these oysters grew in the Laie (70-foot) sea and that the tuffaceous sediments

slowly filled up the crater and killed off the oysters and barnacles. The top of the sediments is 80 feet above sea level, and as they occur on the coast within a crater that has not been cut back far by marine erosion, their height indicates that they were probably deposited in a sea about 70 feet higher than at present.

As the Waipio negative stand of the sea followed the Laie, it is likely that the concretions beneath the beach conglomerate are root casts of vegetation that grew during the Waipio stand. The beach conglomerate unconformably overlying these sediments appears to have been laid down during the Waimanalo stand. The top of the beach is about 35 feet above sea level, which is not too high for this beach to have been formed during this stand, as the beach deposits of the present sea on this reefless coast are well over 10 feet above sea level. Wentworth⁹⁷ believed, on the evidence of this conglomerate beach, that the eruption of Ulupau Head took place before or during the 40-foot stand of the sea. The excellent beach deposit described above with its top not more than 35 feet above sea level can hardly have been formed by a 40-foot sea. Furthermore on the sheltered southwest side of Ulupau Head several notches occur in which marine deposits occur at about the 25-foot level.

Between the east end of the recent dunes shown on plate 2 and Ulupau Head, a distinct marine cliff is cut in Ulupau tuff and alluvium which, according to the topographic map, is about 60 feet above sea level. This bench practically coincides with the level of the Laie sea, hence the Ulupau cone is assigned to the Laie stand.

Water-bearing properties.—The tuff is fairly impermeable and is located in so dry an area close to the sea that it is unlikely to contain potable water supplies.

Kaau Volcanics

Location of vent.—Kaau Crater is a circular depression about 1,600 feet in diameter, 900 feet from the Koolau crest at the head of Palolo Valley (pl. 2). The floor of the crater has an altitude of about 1,600 feet and is mostly covered by a swamp. The water from the crater discharges on the southeast side through a small gap and cascades 475 feet downward into Waiomao Stream. The crater can be reached either by climbing this cascade or by ascending the ridges from the south. At the end of volcanic activity the depression was probably undrained, but landslides, hill wash, and vegetation have aggraded the floor. The walls of the crater consist of Koolau flow lavas, hence it is evident that this crater was caused either by explosions blasting a hole in the Koolau dome, by collapse, or by both processes operating together.

⁹⁷ Wentworth, C. K., *op. cit.*, p. 90.

Tuff deposits.—Partly filling Pukele and Waiomao valleys to their confluence with Palolo Valley are mud-flow and tuff deposits. The deposits probably at one time continued down Palolo Valley and have since been eroded or hidden by later alluvium. No attempt has been made to differentiate the mud flow from the alluvium on plate 2. In most exposures the bedding is poor, and the material consists of what appear to be talus blocks from the adjacent valley walls in a matrix of tuff and explosion breccia. Some of the large blocks may have reached their present site by explosion, but the usual bomb sags were not found, and many of the blocks have weathered surfaces that are not usually found on angular fragments torn from a volcanic throat. Near the mouth of Waiomao the bedding in this deposit strikes east and dips 4° S. In most exposures the bedding has low dips. In places the deposit is firmly cemented, but in most of the outcrops it is considerably weathered. On the east bank of Pukele Stream the following section was measured:

*Geologic section at altitude of 550 feet on east bank of
Pukele Stream, about 60 feet downstream from wooden bridge*

	Feet
Unexposed.....	40
Brown pebbly tuffaceous alluvium (possibly mudflow).....	20
Dark-gray dense, hard fresh basalt containing olivine phenocrysts except for top foot, which is badly decomposed.....	13
Brown tuff containing numerous angular fragments 1 to 6 inches in diameter; definite contact at top.....	5
Light gray-brown firm, partly stratified tuff with a fine sandy-silt texture, well-developed vertical joints, conchoidal fracture, and many decomposed olivine crystals; contact not sharp at top.....	2
Brown friable sandy tuff with angular vesicular basalt fragments one-quarter to 1 inch in diameter, more or less decomposed, and one fragment 18 inches across; sharp contact at top.....	3
Dark-gray hard fresh, slightly to moderately vesicular basalt containing olivine phenocrysts; sharp contact at top and stream bed at base.....	2

85

Lava flows.—The basal basalt about 50 feet upstream rests unconformably on rotten Koolau talus, and about 1,000 feet downstream it rests unconformably on Koolau basalt. The basalt outcrops are discontinuous, owing to the cover of mud flow and tuff, hence no attempt has been made on plate 2 to differentiate the two lava flows. Both are assigned to the Kaau volcanics. Specimen F58, collected just above the main bridge on Pukele Stream, was determined microscopically as a nephelinite-melilite basalt containing numerous phenocrysts of olivine and a few microphenocrysts of melilite and pyroxene.

A fresh black jointed lava flow, unconformable on Koolau basalt, floors the east fork of Pukele Stream to a point within about 200 feet

of the rim of Kaau Crater. Small patches of tuff are found near the head of this stream. It appears that this lava flowed over the south rim of Kaau Crater and has since been severed from it by erosion. Exposures are poor owing to dense vegetation, and it is possible that a small stringer of basalt may reach back to the rim. The flow is about 20 feet thick in this east fork, and the stream has in places cut 10 to 15 feet into it. Specimen F59, from an altitude of 1,470 feet in this stream bed, is nephelite-melilite basalt with phenocrysts of olivine.

Large boulders of lava similar to Kaau basalt occur up to an altitude of 900 feet in the bed of the next fork of Pukele Stream to the west. As this stream heads on the west side of Kaau Crater, it appears that lava overflowed the crater on this side also and coursed down this stream. Subsequent erosion has removed practically all of this flow.

In Waiomao Stream basalt boulders of the Kaau type, as much as 10 feet in diameter, predominate over Koolau boulders up to an altitude of 800 feet. Above this point none were found. Near the end of the automobile road up the valley a wedge of Kaau basalt remains in place. Facing the stream at this point is a 25-foot cliff of columnar-jointed nephelite-melilite basalt. This flow may extend farther downstream under a cover of tuff and mud flow. Although the highest boulders in this stream are half a mile from Kaau Crater, it seems likely that the flow came from Kaau and has since been separated by erosion.

Sequence of eruptions.—The fact that all three valleys reaching Kaau Crater were flooded with basalt of the same petrologic type is good evidence that this crater was once occupied by a lake of lava that overflowed its rim. Apparently, from the geologic section given above, lava broke out at the site of Kaau Crater after these valleys had been carved in the Koolau dome. This eruption laid down the lower basalt flow of the Kaau formation. Then came a period of violent explosions, which blasted a vent through the Koolau dome and mantled the adjacent area with sufficient ash and accessory ejecta to make a deposit 10 feet thick a mile southwest of the vent. As the explosions died down lava filled the newly made crater pit and formed a lake similar to that in Halemaumau, at Kilauea Volcano. This lake overflowed the rim and poured lava down the adjacent valleys. A period of collapse appears to have ended the history of Kaau, because the floor of the crater is now 75 to 100 feet below the heads of two of the valleys that were inundated by lavas from this crater. Because sufficient time has elapsed for the flows to be nearly eroded away, the floor of the crater has probably been subsequently filled 25 to 100 feet by landslides and hill wash. Evidently soon after the ash and lava eruptions the loose mantle of ash on the steep slopes adjacent to the crater choked the streams and gave rise to extensive mud flows, which moved down into Palolo Valley and probably thence into the sea. The mud flow appears to

have a thickness of 20 to 60 feet in much of Pukele Valley at the present time.

At the time of the Kaau eruptions Palolo Stream probably entered the sea about a mile east of the point where it now joins Manoa Stream and nearly 2 miles farther inland than the present coast line southwest of Palolo Valley.

Age relations.—As described on page 137 a basalt similar petrologically to Kaau basalt is exposed in the Kapahulu quarry beneath conglomerate, Diamond Head tuff, and Kaimuki basalt. Wells 7C and 7D, nearby, indicate the existence of two flows, separated by 2 to 4 feet of clay, beneath the Diamond Head tuff and Kaimuki basalt. This intervening clay may be ash from Kaau Crater, separating the upper and lower flows in the same way as farther upstream. Thus Diamond Head and the Kaimuki dome apparently did not exist at the time of the Kaau eruptions. The Kaau tuff and basalt flows were erupted during a high stand of the sea preceding the Waipio stand, but no data are at hand to indicate which one.

Water-bearing properties.—At an altitude of about 935 feet on the east fork of Pukele Stream a 1-inch pipe diverts water from a pool at the foot of a waterfall. On July 15, 1931, the flow at this point was estimated to be 10 gallons a minute. The water is used to supply some residences downstream. In most places in this valley Kaau basalt is probably in contact with permeable Koolau basalt, hence it is likely that water sinking into Kaau basalt will pass downward to the main water table. Furthermore, the drainage area is small, hence conditions do not appear to be favorable for developing high-level water in this valley. If ash or soil occurs under the Kaau basalt, it might hold up perched water, and in that case a short tunnel to the base of the flow might recover sufficient water for a few residences too high in the valley to be supplied by city water.

About 6 feet above creek level on the west bank of Pukele Stream, at an altitude of about 370 feet, is Mahoe Spring. It issues from Kaau basalt and has a minimum flow of about 100,000 gallons daily. The water is occasionally used by local inhabitants for domestic supplies. The spring represents an overflow of the water perched in Kaau basalt. A tunnel contouring the base of the basalt in this valley at this level or slightly higher might develop some additional water. It would be in danger of pollution because of the settlement above the spring, but it is nevertheless a possible future supply for Honolulu.

Another tunnel to prospect for ground water under Kaau Crater is described in the section "Kaau tunnel." As only a few patches of lava from Kaau occur in the middle fork of Pukele Stream and in Wai-omao Stream, no opportunity exists for developing water from these flows.

It is reported that a 16-inch pump running all night in a 4-foot pit

in the bottom of the Kapahula quarry failed to lower the water level appreciably. The water comes from Kaau basalt near the mouth of the valley and may be suitable for industrial use. Its salt content is not known.

LAVAS AND PYROCLASTIC ROCKS OF THE WAIPIO (—60±-FOOT) AND WAIMANALO (+25-FOOT) STANDS OF THE SEA

Salt Lake and Makalapa Tuffs

Distribution.—The tuff from Salt Lake and that from Makalapa Crater were not differentiated in the field; hence both are described under one heading. In most places the Salt Lake tuff is readily distinguished from the Aliamanu tuff because of its stratigraphic position and sub-aerial character, but it has not been differentiated on plate 2. In fact, practically all the tuff shown on plate 2 in the Pearl Harbor area except a few streaks interbedded with noncalcareous deposits is Salt Lake tuff. The work done on this tuff by previous authors is cited on page 108.

The fact that the Salt Lake tuff has a maximum thickness of about 300 feet indicates that the eruption was smaller than those at Diamond Head and Koko Crater. The greater areal extent of the tuff on the southeast side of the vents indicates that trade winds were blowing during the eruption.

In the Army tunnels there occur, at the base of the upper tuff, beds of very friable granular and spiny nodules of dense basalt like the balls in the Sugar Loaf lava flows described on page 159 and megascopically similar to the post-Koolau nephelinite basalts. Wentworth and Pegau⁹⁸ report nepheline in the glass from these tuffs. Like much of the other post-Koolau magma, Salt Lake Crater ejected masses of dunite several inches across, some of which are reported to contain green garnet and biotite.⁹⁹

Age relations.—The geologic section given on page 105 and those described under Aliamanu tuff show that the Salt Lake tuff was sub-aerially deposited on the dissected Kaena terraces, which indicates that it was laid down during an erosional cycle following the Kaena stand of the sea. As described on page 49, the Salt Lake tuff, containing upright tree molds, passes beneath sea level, which indicates that it was laid down during the Waipio stand of the sea.

Further evidence of the age of the Salt Lake tuff is available in a road cut at the small outcrop of consolidated calcareous sediments shown on plate 2 just northwest of Mapunapuna Pond, near the mouth of Moanalua Stream. As illustrated in plate 12, an older tuff probably from Aliamanu is reworked and intercalated in horizontal sand and gravel deposits that are believed to be marine and laid down in

⁹⁸ Wentworth, C. K., Pyroclastic geology of Oahu: B. P. Bishop Mus. Bull. 30, p. 105, 1926.

⁹⁹ Hitchcock, C. H., Geology of Oahu: Geol. Soc. America Bull., vol. 11, p. 38, 1900.

quiet water. Erosion of this material during the Waipio stand of the sea left the irregular soil-covered forested surface on which the Salt Lake tuff was deposited. During the Waimanalo (25-foot) stand the sea advanced over these deposits. Coral grew about 50 feet offshore, and the waves undermined the upper tuff and incorporated angular blocks of it as much as 3 feet in diameter in the shore gravel. At this locality, as in many others in the adjacent Pearl Harbor Navy Yard, the coral of the Waimanalo sea is definitely younger than the Salt Lake tuff.

Dana¹ and Brigham² on sketch maps of Salt Lake Crater show a ledge of reef rock or limestone on the south side of the crater, but it was not found after a careful search. Instead, ledges coated with white deposits of caliche or secondary subaerial calcareous concentrates were found. Fragments of coral limestone occur with the caliche, but these fragments are angular and evidently ejecta. They occur in the tuff, and fragments weathered from the tuff are common on the surface nearby. About 200 feet east of the point where the road enters the gap on the south side of the main Salt Lake Crater the upper tuff rests on a small exposure of conglomerate, which is overlain in places by as much as 5 feet of soil. The dips in the tuff suggest that a small hill has been mantled at this place.

The Salt Lake drainage tunnel encountered numerous fossil trees and leaves, which included such trees as the koa, loulu palm, and ohia. Some 15 or more species of plants closely related to if not identical with species of present day were identified with absolute certainty.³ As these trees, especially the koa and loulu palm, grow only in the rain belt, their presence at sea level indicates that the climate at the time of the eruption of the tuff was wetter at sea level than at present. Thus the fossils give further support to the stratigraphic evidence that the eruption occurred during a glacial period when the rainbelt and ocean were lower.

A porphyritic basalt containing abundant feldspar crystals an inch or more in length occurs in the Koolau volcanic series on the crest of the Koolau Range at the head of Moanalua Stream. The presence of blocks of this basalt among the accessory ejecta in the tuff indicates that this flow passes beneath Salt Lake Crater.

Origin of the Salt Lake.—The origin of the salt lake in the crater has been variously accounted for. Dana proved that the lake, instead of being 50 fathoms deep, was only 16 inches deep in 1840 and 6 inches deep in 1841. Small springs, according to Dana, formerly supplied taro patches on a part of the crater floor and issued from the side near-

¹ Dana, J. D., *op. cit.*, p. 248.

² Brigham, W. T., *Notes on the volcanoes of the Hawaiian Islands: Boston Soc. Nat. History Mem.*, vol. 1, pt. 3, p. 362, 1868.

³ Lyon, H. S., *The flora of Moanalua 100,000 years ago [abstract]: B. P. Bishop Mus. Special Pub.* 16, pp. 6-7, 1930.

est the mountains. Both Dana⁴ and Brigham⁵ have shown that the lake has no direct connection with the ocean. Because the base of the crater is practically at mean sea level and indents the main water table, the springs in it were probably depressional springs. It seems likely that prior to the formation of the artificial lake that now occupies the crater the rise of the water table during rainy weather caused water to flow into the crater. Although this water was potable, it doubtless carried appreciable sodium chloride, like all other shallow ground water near the coast. This water apparently formed a shallow pond each spring and during the rest of the year was wholly or partly dried up by evaporation. The salt was thus concentrated, and repetition of this cycle throughout the long period of the crater's existence is adequate to account for all the salt observable. It is the same process that gives rise to the salt lakes of the Great Basin region of the United States, of which Great Salt Lake in Utah is typical.

Well 157 was drilled on the north shore of the lake in 1910 to make a fish pond of the crater. It penetrated Koolau basalt beneath the crater and obtained a strong flow of artesian water containing about 6.5 grains of salt a gallon (65 parts per million of chloride). As there was no natural outlet for this water and evaporation was no longer in excess of the inflow, the lake began to fill the crater and soon became too deep for raising mullet. A drainage tunnel was then constructed through the southeast side, at an altitude less than 10 feet above sea level. The surplus irrigation water from Aliamanu Crater is now drained into Salt Lake by means of a tunnel and thence to the sea by Salt Lake tunnel. Aliamanu formerly contained a pond.

Water-bearing properties.—The Salt Lake tuff has low permeability and as most of the tuff lies above the water table, it is not a likely source of ground water.

Ainoni Volcanics

Distribution and character.—About 1½ miles southwest of Olomana Peak, on the Maunawili ranch, is an unnamed hill composed of bedded cinders that lie unconformably on the dike complex of the Koolau volcanic series. On the northwest side is a breached crater 1,000 feet across, and on the east side is a well-defined swale that suggests another crater. Extending north for three-quarters of a mile is a lava flow about 100 feet thick and nearly half a mile wide. Specimen F370, from this flow, is a nephelite basalt. The basalt forms massive walls along Ainoni and Maunawili Streams and generally shows good columnar jointing. Its surface is soil-covered, and in places it is weathered to a depth of 15 feet. For convenience these rocks are

⁴ Dana, J. D., op. cit., p. 247.

⁵ Brigham, W. T., Notes on the volcanoes of the Hawaiian Islands: Boston Soc. Nat. History Mem., vol. 1, pt. 3, p. 363, 1868.

named "Ainoni volcanics," from Ainoni Spring, which issues from the east margin of the basalt.

Age relations.—At an altitude of about 370 feet just downstream from the swimming pool on Maunawili Stream the basalt rests unconformably on coarse conglomerate. At the swimming pool the joint columns in the basalt are nearly horizontal caused by the lava cooling against a former steep valley wall.

The basalt can be seen resting unconformably also on alluvium in two places along the north margin of the flow. About 900 feet downstream from the swimming pool 40 feet of columnar basalt is exposed containing numerous inclusions of rock fragments of diverse rock types, evidently belonging to the Koolau dike complex. Some of these fragments are feldspar-rich basalt, and others were weathered prior to being picked up by the lava flow.

The contacts exposed indicate that the basalt poured down a former valley carved at least in part in the alluvium now forming the terraces nearby. The sediments in these terraces when followed downstream connect with deposits believed to have been laid down during the 95-foot stand of the sea. As none of these deposits cap the basalt, the eruption probably took place during the Waipio stand of the sea, perhaps simultaneously with the Maunawili volcanics.

Water-bearing properties.—At an altitude of about 750 feet in the main crater depression of the source cone, a small spring issues from cinders overlying decomposed basalt. On October 29, 1931, it was discharging about 30,000 gallons daily, but Mr. Herd, manager of the Maunawili ranch, states that the discharge falls as low as 20,000 gallons daily in dry weather.

About 900 feet west of the Maunawili ranch, at an altitude of 250 feet, is Api Spring. Most of the water from this spring is piped to the Girls' Industrial School. Its average flow, according to Mr. Herd, is 65,000 gallons daily. The spring discharges from the contact of the basalt with a cobble conglomerate having a gray matrix, on the east side of Maunawili Valley. Water is oozing out of the ground for some distance upstream. These seeps appear to be supplied by this basalt also.

Ainoni Spring issues at an altitude of 376 feet about half a mile south of the Maunawili ranch and several feet above Ainoni Stream. The water comes from the basalt and is percolating through large talus blocks at the mouth of a caved-in tunnel near the base of the Ainoni basalt. A tunnel 22 feet above the spring formerly intercepted the entire flow of the spring. The low-water flow was 271,000 gallons on November 15, 1929, and the high-water flow was 391,000 gallons on March 14, 1927. The spring maintains an unusually uniform flow. It appears to be the outlet of the subterranean drainage buried by the

basalt. As the lava terminates at the Maunawili ranch, Api and Ainoni Springs must represent the total discharge of all water moving through this basalt. It seems feasible to drive a tunnel beneath the basalt farther upstream and capture this water at an altitude where it could be delivered into the Maunawili Ditch. If the entire flow of these springs is water collected only from rainfall on the lava flow and from losses into it from adjacent streams there will be no chance of recovering more water than is now discharged by these springs. However, in view of the sustained flow of Ainoni Spring in dry weather, a possibility exists that it is in part derived from the Koolau dike complex buried by the basalt. About a quarter of a mile west of the Ainoni vent is Pikoaukea Spring, which issues from the dike complex. A similar spring may have been buried by the basalt and now contributes to Ainoni Spring.

Maunawili Volcanics

Distribution and character.—On the Maunawili ranch, 2 miles west of Waimanalo a post-Koolau flow crops out along Makawao Stream (pl. 2). At the head of this flow and resting unconformably on the dike complex of the Koolau volcanic series on the crest on Aniani Nui Ridge is the remains of a cinder cone. Bedded cinders and bombs are well exposed in hill 858, about 1,000 feet north of the old Waimanalo road gap in Aniani Nui Ridge. This road has been cut for half a mile down Makawao Stream in the deeply weathered basalt from this cone. The flow is about 100 feet thick and appears to be filling a former valley. It may have formerly extended farther, because remnants of either this flow or of Ainoni basalt occur for more than half a mile downstream. Specimen F83, collected along the road near the Maunawili ranch gate, was determined under the microscope as nephelite basalt with phenocrysts of pyroxene and olivine.

Age relations.—The large remnant of columnar-jointed basalt along the road just north of the Maunawili ranch is about 15 feet thick and rests on 2 feet of brown soil which is underlain by thoroughly decomposed coarse conglomerate forming a terrace about 50 feet above the adjacent stream. Microscopically it does not resemble Ainoni basalt, hence it is correlated with Maunawili basalt. The terrace capped by this lava continues down Maunawili Stream toward the coast, where it is graded to the Kaena stand of the sea. As the basalt rests on soil covering this terrace, it was probably erupted during a period when these terraces were being dissected. Because of the extensive weathering of this flow it is tentatively assigned to the Waipio stand of the sea, though it may have been erupted at any time during the recession of the sea from the Kaena to the Waipio level.

Water-bearing properties.—Two small seeps discharge from the margins of the basalt, but because of the small drainage area tributary to the Maunawili volcanics it is believed that prospecting for water at these places is not advisable.

Training School Volcanics

Distribution and character.—About 2 miles northwest of Waimanalo on the north flank of Olomana Peak is a hill of bedded cinders lying unconformably upon the dike complex of the Koolau volcanic series. The cinders have been sufficiently eroded to make it difficult to determine whether or not a crater was formed at the time of the eruption. Spreading northward from the cone for nearly 1½ miles is a lava flow at least 50 feet thick. Near the source of the flow is the Maunawili Training School for Girls, and for convenience the rocks are called the "Training School volcanics." The flow is crossed by the main highway to Kailua and to Waimanalo but very little rock is exposed because of a soil cover about 10 feet thick.

Specimen F68, from an abandoned quarry on the north margin of the flow, was found under the microscope to be a nephelite basalt, with phenocrysts of olivine. Numerous olivine segregations occur in the rock. Among the cinders at the source were found balls of dense basalt similar to those around Sugar Loaf Crater, near Honolulu. Some of the smaller firefountain material has its glassy surfaces replaced by secondary limonite, which has restored most of the original iridescence.

Age relations.—A landslide in 1932 revealed about 10 feet of this basalt resting on 20 feet of thoroughly decomposed sandstone and conglomerate in the bank at the bend of the highway on the east side of Maunawili Stream. A decomposed sandstone occurs directly in contact with the basalt. About 1,400 feet north of this exposure, the basalt can be seen resting on conglomerate in the east bank of the highway. The configuration of this basalt suggests that it was spread over a partly dissected terrace graded to the Kaena stand of the sea. The north margin of the flow has been etched into cliffs by the Waimanalo sea, hence it seems likely that the basalt was poured out during the Waipio stand of the sea, at about the same time as the adjacent Maunawili and Ainoni basalts. The absence of soil beneath the basalt at the exposure described above may be accidental, but if it is not, this basalt must be older than the Maunawili and Ainoni volcanics.

Water-bearing properties.—The average annual precipitation falling on the basalt is probably about 50 inches. Although the total area covered by the flow is only about a square mile, yet a small pit dug at the site of the former seep less than half a mile from the head of the lava flow is pumped at the rate of 300,000 gallons daily, according to

Mr. Roderiques of the training school. It is reported that this pumping causes little draw-down and that the pit never goes dry. The water is used chiefly for irrigation because of possible contamination, and it supplements the supply from Api and Olomana Springs. As the basalt probably buried a former drainage system, this developed spring may be rain water and waste domestic and irrigation water from the school moving through the basalt along a buried stream channel. However, there is a possibility that the lava flow buried a spring issuing from the dike complex of the Koolau series.

Discharging from the south margin of the basalt at an altitude of about 90 feet is a spring that was yielding about 8,600 gallons daily on August 12, 1931. Another spring of the same magnitude discharges from the west margin of the flow at an altitude of about 50 feet, about 600 feet north of the Maunawili Stream highway bridge. Near this spring are some huge blocks of Training School basalt which show etched surfaces resembling those found on limestone. The joint cracks have been enlarged by solution until many of them are several inches deep and 1 or 2 inches wide. This solution is the result of rain water, because the blocks show it only on their exposed surfaces. Post-Koolau nephelite basalt commonly shows this feature.

Diamond Head Tuff

Distribution and character.—The distribution of Diamond Head tuff is shown on pl. 2. Gairdner⁶ described Diamond Head as a cone in 1835. Dana⁷ was apparently the first geologist to describe it as a tuff cone, and much has been written about it since that time. Wentworth⁸ recently described it and presented a geologic and structure map of the area. The cone consists of inward- and outward-dipping beds of palagonitized brown tuff containing large amounts of accessory and accidental ejecta. According to Wentworth⁸ the magmatic ejecta consist mostly of glass with olivine, nepheline, and magnetite in lesser amounts, cemented by secondary calcite. Evidently the exploding magma was a nephelite basalt. Much of the seaward side of the cone has been removed by marine and fluvatile erosion, so that inward-dipping beds form the outer rim in many places (pl. 1, B). At the base of the cone considerable talus breccia and hill wash has accumulated. Along the highway on the southwest side small lithified dunes occur, and on the east side extensive lithified dunes over 100 feet high can be seen (pl. 2).

Structure of crater.—A structure section of Diamond Head published by Wentworth¹⁰ is reproduced in figure 11, A. He states that the struc-

⁶ Gairdner, Meredith, *Hawaiian Spectator*, vol. 1, no. 2, p. 8, 1838.

⁷ Dana, J. D., *op. cit.*, pp. 243-245.

⁸ Wentworth, C. K., *Pyroclastic geology of Oahu*: B. P. Bishop Mus. Bull. 30, pp. 32-34, 1926.

⁹ *Idem*, p. 104.

¹⁰ *Idem*, fig. 13, p. 36.

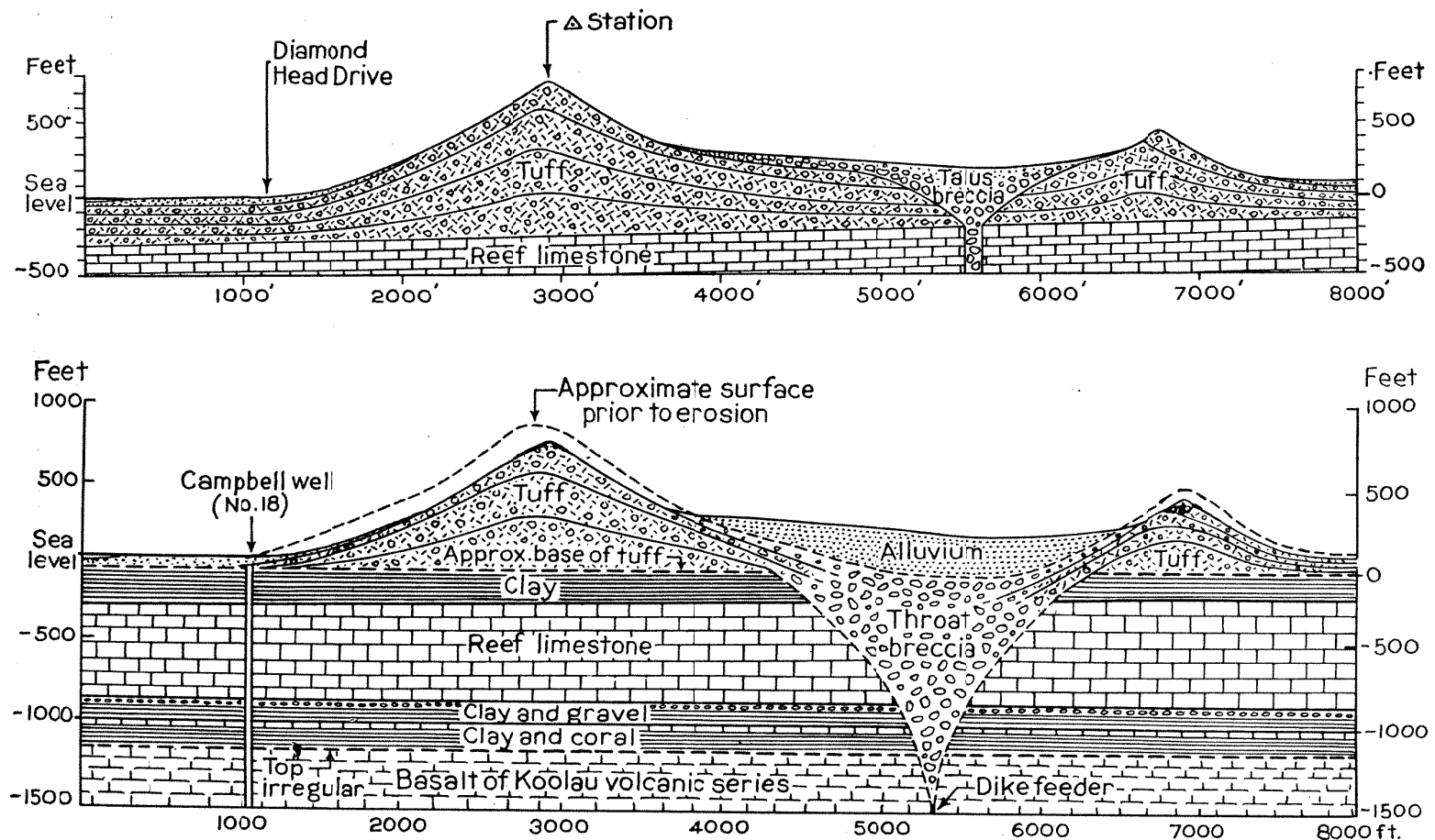

FIGURE 11. A (upper), Structure section of Diamond Head by C. K. Wentworth; B (lower), A different interpretation of the structure of Diamond Head based on the log of the Campbell well (no. 18).

ture of the reef limestone and of the filling of the vent is hypothetical. In figure 11, B, is given my structure section of Diamond Head, with the thickness of the underlying rocks based upon the log of well 18. The tuff of Diamond Head includes appreciable amounts of reef limestone and scattered fragments of Koolau basalt. It is reasonable to suppose that the bottom layers of tuff contain even greater amounts of these accidental and accessory ejecta, for the initial explosions probably did more blasting of foundation rocks than the later ones. The log of well 18 proves that Koolau basalt is 1,178 feet below the surface only a short distance from the apex of the explosion. It is very probable that the surface of the basalt is irregular; hence it may be somewhat closer to the surface under the vent than is indicated in the figure. It seems evident, however, because fragments of Koolau basalt are found in the tuff, that the foci of the explosions must have been in basalt, and if so it was deeper than shown by Wentworth. The abundant limestone ejecta indicate that a considerable quantity of reef rock was blown out of the vent, and this checks with the log of well 18.

The crater slopes have suffered appreciably from fluvial erosion, hence sedimentation has built up the original crater floor. The trade winds blowing at the time of the explosion doubtless account for the thicker deposits on the southwest side. In figure 11, B, bedded tuff with gentle dips is shown near the top of the throat breccia. The explosive energy toward the end of the eruption was probably insufficient to clear the crater throat completely; hence ash probably accumulated upon previously formed breccia. Observations on historic explosions support this assumption.

Cause and sequence of explosions.—The following order of events seems probable. The magma feeding this cone rose through rocks most of which were extremely permeable and saturated with water. The water near the magma was heated and formed steam. Under the weight of the overlying rocks this steam and some of the adjacent water became superheated. When the magma reached the upper part of the reef the abundant water available gave rise to great volumes of steam, which finally accumulated sufficient pressure to blast a vent. Immediately all of the superheated water in the vent flew into steam and added to the intensity of the explosion at the surface. The first blast may have been purely phreatic, unaccompanied by magmatic ejecta. After the first blast the sudden relief of pressure on the magma induced foaming, which, concurrent with the inrush of more water, led to magmatic explosions. Collapse of the funnel walls then probably formed talus plugs, which would retard the explosive forces intermittently and give rise to successive explosive spasms.

I agree with Wentworth and others in respect to the subaerial origin of the exposed part of Diamond Head and with Wentworth and Bishop in their belief that the eruption was short-lived. Both Bishop and Wentworth have computed mathematically the time required to build Diamond Head and came to the conclusion it was a matter of a few hours only. Wentworth¹¹ states: "The conclusion is drawn, therefore, that the duration of eruption of Diamond Head was of the order of 5 hours. The eruption may have been intermittent, with interruptions sufficient to extend the whole period of activity to as much as 5 days, but probably not more."

Wentworth,¹² like Bishop, based his whole computation on the belief "that the regularity, symmetry, and comparative sharpness of crest of the circular crater rims of the Diamond Head type postulate practically constant conditions of projection from the vent during a single brief episode. It seems unlikely that after any considerable interval a second episode would so nearly duplicate the first as to add with precision to the accumulated debris of a previous eruption." It is apparent that the argument of these writers fell into a vicious circle when they assumed constant projection to start with and ended with a period of a few hours for the duration of the eruption. Numerous symmetrical cones have been formed in historic time, some by explosions lasting a few hours and others by explosions lasting several months. The symmetrical ash cone of Bromo, in Java, has been active for many years. The explosions of Kilauea in 1924 began on May 11 and continued intermittently until May 27.¹³ They began as mild explosions, reached a maximum on May 18, and then slowly decreased in violence. They sent up ash-laden clouds 4 miles into the air at velocities of 75 to 100 feet a second from a crater about 3,000 feet in diameter. Although this activity lasted 16 days, the ash layers from the several explosions are not distinguishable from one another, and without observational records it would be impossible to tell whether the ash was deposited in one hour or in one year. The explosions that formed Diamond Head were probably of about the same magnitude as those at Kilauea, except that they carried out more solid material. Wentworth makes his computations on the basis of vent diameters of 50, 100 and 200 feet and hence gets high velocities. He also makes no allowance for rocks falling back into the crater and being reejected. There is reason to believe, as shown in figure 11, that the vent diameter was several times greater than 200 feet. It is evident that by changing the vent diameter or assuming a greater time interval between explosions, the building of Diamond Head can be estimated as a matter of a few hours or many

¹¹ Wentworth, C. K., *op. cit.*, p. 54.

¹² *Idem*, p. 49.

¹³ Stearns, H. T., The explosive phase of Kilauea Volcano, Hawaii, in 1924: *Bull. volcanologique*, 2 e ann., nos. 5 et 6, pp. 193-208, 1925.

days. Volcanoes have many habits not subject to mathematical analysis.

Age relations.—The relation of Diamond Head tuff to other rocks is well shown at the abandoned Kapahulu Quarry. This quarry is at the outcrop of tuff shown on plate 2 near the northwest corner of the area of Kaimuki basalt near St. Louis College. At this place the top layer consists of 4 to 8 feet of Kaimuki olivine pahoehoe basalt overlain by 1 to 2 feet of red soil. The basalt rests conformably on 4 to 8 feet of thin-bedded horizontal Diamond Head tuff. The upper surface of the tuff is baked for several inches by the basalt, and the lower part contains numerous remains of carbonized plants. Edward L. Caum, of the Hawaiian Sugar Planters' Association, reports that he could recognize blades of grass or sedge and leaves of a myrtaceous plant allied to the Ohia ha, *Eugenia (Syzygium) sandwicensis*, among fossils collected from this bed. One stem cast, an inch in diameter, extends 3 feet vertically into the tuff, indicating that the ash fell on land supporting vegetation. The tuff ranges from 2 to 5 feet in thickness and rests on a fine-grained brown silt except in the northwestern part of the quarry, where thoroughly decomposed Koolau gravel replaces the silt. These sediments range from 1 to 8 feet in thickness and rest on the ropy, hummocky surface of an olivine-nephelite pahoehoe that is believed to have come from Kaau Crater. On the east side of the quarry this basalt consists of 15 feet of dense columnar rock resting on 8 feet of clinkery lava. The base of this clinker is not exposed, but the flow is probably not much thicker, for wells 7C, D, and F, across the road, penetrated a maximum of 22 feet of this lava. In the west side of the quarry the columnar basalt is a jumbled mass of rough pillows and finely jointed masses radiating from various centers and was probably disrupted by steam caused by the lava flowing over wet ground or into water. At the entrance to the quarry consolidated calcareous beach material at an altitude of about 25 feet rests on this basalt. This limestone connects with an extensive outcrop of limestone that extends southward and overlies Kaimuki basalt (pl. 2). Wentworth¹⁴ thought that the reef rock at the quarry was older than Kaimuki basalt and Diamond Head tuff, because he could find no tuff fragments in the limestone.

I succeeded in finding pebbles of Kaimuki basalt in this limestone. In this same ledge of limestone 1,000 feet farther south along Kapahulu Road a cesspool that was being dug in 1932 exposed 1½ feet of soil and 7 feet of reef limestone resting on Kaimuki basalt, and 1,900 feet south of the quarry, near Kapahulu Road, a sewer excavation revealed limestone full of Diamond Head tuff pebbles. Thus there can

¹⁴ Wentworth, C. K., op. cit., p. 40.

be no doubt that the limestone at the Kapahulu quarry is younger than the Diamond Head and Kaimuki cones. According to plate 2, the limestone at the quarry is about 25 feet above sea level. It is a beach deposit and indicates that the Diamond Head and Kaimuki cones are older than the Waimanalo stand of the sea.

Near Kupikipikio Point Diamond Head tuff is overlain by Black Point basalt. About 200 feet west of the point the Diamond Head tuff rests on massive reef limestone 20 feet above sea level. The tuff is filled with calcareous casts of tree molds, showing that the reef supported vegetation when the tuff fell. Lying unconformably on the tuff is a lithified beach conglomerate containing numerous tuff pebbles that extends to about 30 feet above sea level and is correlative with the Waimanalo stand of the sea.

The fact that the older reef supported vegetation at 20 feet above present sea level indicates that the sea was lower than this altitude at the time of the eruption. Thus, Diamond Head could not have erupted during the Waimanalo stand. The fossil plant remains in the tuff are suggestive of a wet climate at this point at the time of the eruption. This fact, together with the subaerial character of the tuff at present sea level, indicates that it was erupted during the Waipio stand of the sea and at about the same time as the Salt Lake explosions. The extent of marine erosion since the Waipio stand can be gaged by the amount of material removed from the south side of Diamond Head. Kupikipiko Point is a remnant of Diamond Head preserved by a lava cap. The tip of this point is nearly a mile from the center of Diamond Head on the west side of the cone. It appears that about half a mile of the seaward side of Diamond Head has been removed by the ocean.

On the southwest slope of Diamond Head and well exposed in artificial cuts along Diamond Head Drive a black sand occurs underlain and overlain by tuff hill wash. Its origin is discussed on page 142.

Water-bearing properties.—The Diamond Head tuff is so well indurated in most places that it makes a poor aquifer. However, the joint cracks and bedding planes are sufficiently numerous to allow water to move slowly through the mass. The tuff is much less permeable than the basalt, limestone, and recent alluvium, hence it is probably more serviceable as a cap rock or retaining member in this area than as an aquifer.

Kaimuki Volcanics

Distribution and character.—The Kaimuki lava dome shown on plate 2 just north of Diamond Head was recognized by Dana¹⁵ in 1841 as a secondary cone. It has been described by several authors since that

¹⁵ Dana, J. D., op. cit., pp. 241-242.

time. Wentworth¹⁶ made a geologic map of the area covered by its flows and studied the lava in thin section. As shown in figure 1 this basalt forms a typical lava dome. It is surmounted by an undrained depression about 30 feet deep, elongated in a north-south direction. In the walls of the vent are some cinders and spatter and many thin layers of lava a few inches thick. The lava covers an area of about $1\frac{1}{2}$ square miles and is a vesicular olivine pahoehoe basalt. Its surface is usually covered with a few inches to 2 feet of bright-red soil. In most exposures the lava is broken into crude hexagonal joint blocks by shrinkage cracks formed during cooling. Its thickness may be 200 feet near the center, but near the margin, at the Kapahulu quarry, it is 4 to 8 feet thick, and in well 7C nearby it is 15 feet thick.

Age relations.—At this quarry the basalt rests on a baked surface of Diamond Head tuff. The top of the tuff is somewhat weathered, but it could not be definitely established that this weathering occurred prior to the Kaimuki eruption or was subsequently caused by percolating water. The contact was carefully searched for traces of vegetation, but none were found. It seems probable that the Kaimuki eruption followed soon after the formation of Diamond Head, but the petrologic difference between the tuff and the basalt indicates that they were probably not concurrently erupted. The fact that Mauumae cone, Kaimuki dome, and Diamond Head fall in line and are so close together suggests that the same fissure supplied the magma for them all. Jorullo Volcano,¹⁷ in Mexico, formed several tuff cones about like Diamond Head in a few weeks, and then a year later several lava flows poured out nearby from the same fissure. It would seem that winds or storms should have gullied or drifted Diamond Head ash soon after it was laid down, and the lack of such effects suggests that the Kaimuki eruption probably occurred very soon after that of Diamond Head.

In dug well 28, on the east side of Kaimuki dome (pl. 2), reef limestone rests directly on Kaimuki basalt and fills the crevices in it. The absence of soil at the contact indicates either that the lava was submerged soon after it was erupted or that the soil was washed off before the coral grew. The reef limestone grades upward into beach conglomerate with its top about 25 feet above sea level, and above this is about 15 feet of younger alluvium. Reef limestone likewise overlies the basalt on the west side of the dome. As these limestones belong to the Waimanalo stand of the sea and Kaimuki basalt rests conformably on Diamond Head tuff, the basalt was apparently erupted during the Waipio stand. Further evidence is found near dug well 31, where lithified dunes rest on Kaimuki basalt. These dunes must be of Waipio

¹⁶ Wentworth, C. K., op. cit., pp. 44, 91.

¹⁷ Gadow, Hans, Jorullo, pp. 2-5 Cambridge Univ. Press, 1930.

age, because this well pit exposes fossiliferous beach conglomerate resting unconformably upon a bench cut into the dunes by the Waimanalo sea.

Water-bearing properties.—The basalt of the Kaimuki volcanics is very permeable, but because most of it lies above the water table it is more valuable as an intake formation than as an aquifer. Practically all of it lies on the marine plain forming the cap rock of the Honolulu artesian basin, where much of the subjacent material is nearly impermeable. Water sinking into it will therefore probably not reach the artesian basin but remain as sea-level ground water. Dug wells 25, 27 and 28 and probably well 26 obtain sufficient water to irrigate truck farms from this basalt. The water level in these wells stands between 1 and 2 feet above sea level.

Mauumae Volcanics

Just north of the center of Kaimuki, on the crest of a Koolau spur, is the Mauumae cinder cone. It was recognized as a secondary cone as early as 1840 by Dana.¹⁸ It is made up entirely of firefountain products and small trickles of lava. As shown on plate 2, it forms a small hill about 50 feet high on the crest of the wall of Palolo Valley. Most of the ejecta rolled down into this valley and are now well exposed in a quarry on the west side of the cone. In the light of the history of fissure eruptions on Kilauea it seems likely that a crack opened from this point to Diamond Head, and that the copious flows from the Kaimuki vent covered up the spatter along the rest of the crack, this cone being preserved because it was too high to be covered. According to Wentworth¹⁹ the rock is porphyritic olivine basalt, hence is similar to the Kaimuki and Black Point basalts. Because of the lack of evidence to the contrary it is correlated with the Kaimuki volcanics and assigned to the Waipio stand of the sea. The deposits of this cone are very permeable but lie above the water table. However, the quarry hole would be a good place to sink a shaft to the basal water table to recover water from artesian area 5.

Black Point Basalt

Distribution and character.—On the southeast side of Diamond Head is the promontory shown on plate 2 as Kupikipikio Point. It is better known as "Black Point" and consists chiefly of basalt and tuff. The basalt contains phenocrysts of olivine and is indistinguishable megascopically from Kaimuki basalt.

Previous work.—Dana²⁰ was apparently the first to recognize the Black Point lava stream as a secondary volcanic feature. Hitchcock²¹ de-

¹⁸ Dana, J. D., *op. cit.*, p. 242.

¹⁹ Wentworth, C. K., *op. cit.* (B. P. Bishop Mus. Bull. 30), p. 92.

²⁰ Dana, J. D., *op. cit.*, p. 241.

²¹ Hitchcock, C. H., *Geology of Diamond Head, Oahu: Geol. Soc. America Bull.*, vol. 17, pp. 479-480, 1906.

scribed and gave a view of the dike cutting emerged reef rock shown on plate 2 and described the black sand in this region. Wentworth²² noted that some of the emerged reef is older than the basalt and some is younger, and concluded that the Diamond Head tuff was erupted when the sea was over 40 feet higher than at present and that the Black Point basalt was extruded during a later 12-foot stand of the sea. He also stated that the source of the black ash on the point and on Diamond Head is unknown but that the ash is probably contemporaneous with the basalt and most likely came from Mauumae Cone. Ostergaard,²³ not recognizing the pre-lava emerged reef, assumed a volcanic eruption after the end of the last emergence to account for the black ash.

Age relations.—The Black Point basalt was erupted during the Waipio stand of the sea, as shown by well-exposed stratigraphy along the coast. On the extreme point columnar-jointed vesicular Black Point basalt about 6 feet thick and underlain by about 2 to 10 inches of red clinker rests on even-bedded consolidated reddish-brown tuff striking 10° NW. and dipping 5° E. The tuff contains numerous small accessory, accidental, and essential ejecta in a fine matrix made up essentially of olivine grains, glass, and palagonite. It is typical Diamond Head tuff. The upper 2 to 6 inches of the tuff is distinctly red and owes its color to baking by the basalt. The contact is free of soil, although the red tuff is more friable than that below—a condition which may indicate a short period of weathering between the eruptions of the tuff and the lava. The presence of nepheline in Diamond Head tuff and its absence in the Black Point basalt indicates that the Black Point basalt is not a lava flow from Diamond Head.

Resting on the basalt at this place and filling joint cracks in the lava are consolidated calcareous beach sediments, which here and there reach a height of about 30 feet. The limestone contains coarse calcareous grains, fossil shells, and numerous well-rounded pebbles and cobbles of coral, coralline alga and Black Point basalt. In most places only a thin deposit of this limestone remains, suggesting that it has been partly removed by erosion. These are beach sediments of the 25-foot sea and show that the Black Point basalt is as old as the Waimanalo stand of the sea.

Along the shore westward a few hundred feet the Diamond Head tuff rises above sea level and its base rests on the clean surface of massive reef limestone, which reaches a height of about 25 feet above sea level. The reef contains no tuff or lava fragments and is the type that grows a considerable distance offshore. Although there is no soil between the reef and the tuff, numerous upright tree molds

²² Wentworth, C. K., *op. cit.*, pp. 44-45, 55.

²³ Ostergaard, J. M., Fossil marine mollusks of Oahu: B. P. Bishop Mus. Bull. 51, p. 12, 1928.

were found in the tuff, indicating that the reef was supporting vegetation when Diamond Head erupted. On the tuff and extending to about 30 feet above sea level is a beach limestone of the Waimanalo stand, which is similar to that resting on the basalt at the point but which at this place contains water-worn fragments of Diamond Head tuff. About 1,000 feet west of the point a vesicular basalt dike, brecciated in places, forms the wall of a swimming pool and cuts reef limestone that extends about 8 feet above sea level. This limestone is similar to that underlying the Diamond Head tuff near the point and is distinctly free from basalt or tuff fragments. About 700 feet farther northwest along the shore is another segment of dike, also very vesicular, which is believed to be a part or an offshoot of the dike described above. This rock is megascopically similar to the Black Point basalt and probably fed the flow.

Between these two dike segments there are several places where the ancient reef is overlain unconformably by the later emerged beach limestone. Also in this area, are dissected, partly consolidated dunes overlying the late beach limestones and overlain by recent beach deposits. These dunes exhibit cross-bedding typical of wind deposition. The grains are uniformly small and well sorted, although concretionary nodules occur here and there among them. This is unquestionably the material mistaken for black ash by early writers. The grains consist of olivine, glass, basalt, and limestone. The limestone grains make up from 5 to 10 percent of the mass and appear to have furnished the cement for the partial lithification of the dunes. The grains are rounded and are typical sand such as might be blown from a beach formed by waves beating against a basalt and tuff coast. As both of these rock types occur in place at Black Point, there is no need of invoking a later explosion to account for the material. The dunes can be traced northwestward up the slope of Diamond Head, where they are overlain by consolidated hill wash. As this material at the shore overlies emerged beach limestone which is known to overlie Black Point basalt, it is obvious that the sand is not contemporaneous with the basalt, as Wentworth suggested. In several places along the shore and about 10 feet above the present ocean the black-sand dunes rest on several inches of red soil, which accumulated on the emerged beach limestone of the 25-foot sea prior to the arrival of the dunes.

The order of events from oldest to youngest at Black Point based on this stratigraphy is as follows:

1. Growth of reef that now extends up to 25 feet above sea level (probably in the Kaena stand of the sea).
2. Emergence of this reef.
3. Diamond Head eruption and deposition of tuff during the Wai-pio stand.

4. Extrusion of Black Point basalt.
5. Submergence to 25-foot level and deposition of beach limestone during the Waimanalo stand of the sea.
6. Lowering of sea to present level or slightly lower.
7. Accumulation of black-sand dunes.
8. Partial lithification and cliffing of these dunes accompanying the recession of the coast line by marine erosion.

On plate 2 a small patch of Diamond Head tuff is shown about 500 feet north of Black Point at a place where the basalt is eroded away. It seems likely that the Mauumae, Kaimuki, and Black Point lavas were all extruded soon after the Diamond Head eruption. In any event, the Black Point basalt welled out of a crack and flowed down the slope of Diamond Head. During the erosional period that followed the eruption Diamond Head suffered heavily by erosion and its shore was eaten back about half a mile by wave cutting. The southeastern part of the Diamond Head cone was not cut back so far, however, owing to the capping of the tuff there by resistant Black Point basalt.

Water-bearing properties.—The Black Point basalt has no value as an aquifer because of its thinness and local character.

Kamanaiki Basalt

Distribution and character.—Southeast of Kamanaiki triangulation station at an altitude of 750 feet in Kamanaiki Valley, a tributary of Kalihi Valley, is a waterfall about 100 feet high (pl. 6, A). In this waterfall 40 feet of dense basalt fills a narrow V-shaped valley 40 feet deep carved in Koolau basalt. Well-developed columnar jointing occurs perpendicular to the walls and floor of this ancient valley. The V-shaped fill of basalt is fresh, dark gray, and slightly vesicular. It contains small olivine phenocrysts and resembles all other post-Koolau nephelinite basalts. Downstream, at an altitude of about 600 feet, a small remnant of this same basalt showing well-developed columnar jointing rests unconformably on older alluvium. As shown on plate 2, most of this basalt has been swept out of Kamanaiki Valley by subsequent erosion.

Resting unconformably on Koolau basalt on the south wall of Kalihi Valley three-quarters of a mile northeast of the waterfall described above is a similar dense basalt about 10 feet thick. These two patches of lava, shown on plate 2, are Kamanaiki basalt also and are parts of a dissected apron or cascade of basalt that must have come from the ridge above. As the vent that supplied this Kamanaiki basalt was high enough to pour lava into Kalihi Valley also, it must have been situated on the summit of the ridge between Kalihi and Kamanaiki Streams, or at an altitude of about 1,500 feet. A search was made for this vent, but it was not found. The ridge has a heavy cover of vegeta-

tion, but sufficient Koolau basalt crops out to suggest that if the vent was indicated by a cinder cone, all vestiges of such a cone have been removed by erosion.

On plate 2 the Kamanaiki flow is not differentiated from the Kalihi flow of basalt in the upper part of the valley, owing to the difficulty of separating them in the field. It is not known whether the Kalihi branch of the Kamanaiki lava flow was very extensive. The main flow, however, followed Kamanaiki Stream and thence went down Kalihi Valley and spread out fanwise at the mouth of Kalihi Valley.

Age relations.—In most places the lower end of the flow is overlain by noncalcareous sediments. About 225 feet north of the point where Kahauiki Stream crosses the highway, beneath the Fort Shafter stables, 10 feet or so of jointed vesicular aa basalt rests on 2 to 4 inches of brown vitric material and 1 to 3 feet of what appears to be soil. In most places this soil is baked red for several inches beneath the basalt. In places along this terrace beds of gravel and stream-laid firefountain deposits can be seen beneath this soil. Beneath one of the buildings near the stables the basalt appears to be banked against a terrace of alluvium containing about 8 feet of pumiceous gravel and capped with a consolidated mud flow. This pumice is believed to be the same as that described on page 105 and was probably produced by the Kalihi eruption. As stated on page 109, the mud flow above the Kalihi pumice may have been formed at the same time as the Aliamanu eruption. The basalt was not found in direct contact with the mud flow, but its relative position at this locality suggests that it probably came to rest later than the mud flow.

About 800 feet east of the mouth of Kahauiki Stream, behind the middle one of the three buildings shown at this place on plate 2, at an altitude of about 10 feet, the basalt is about 6 feet thick and rests on red soil a few inches to 4 feet thick. Beneath the soil is a marine silt containing considerable coarse calcareous sand. A few feet to the south this silt contains coral and shells. The calcareous material is greatly weathered, and much of it is nearly structureless. At the northern building an artificial cut exposes the same brown silt containing patches of white calcareous material so greatly weathered that all original structures are gone. The high degree of weathering of the calcareous marine sediments suggests that the scarcity of fossils in the conglomerates upstream may be due largely to their removal by solution. The soil underlying the basalt at the middle building must have formed during a period of emergence following a high stand of the sea. As this soil is now near present sea level, the sea during its formation must have stood as low as at present, or even lower.

Well 135, almost a mile southeast of this locality, penetrated 8 feet of reef rock above 26 feet of this basalt, and well 136 penetrated a

similar sequence of rocks. These wells are about 30 feet above sea level, and this emerged limestone belongs to the Waimanalo stand of the sea. As the Kamaikai basalt along Kahauiki Stream near Fort Shafter lies on the eroded soil-covered surface of sediments graded to or laid down by a high stand of the sea and is overlain by marine sediments of the Waimanalo stand, the basalt appears to have been extruded during the erosional period concurrent with the Waipio stand of the sea.

Water-bearing properties.—The remnants of basalt in Kamaikai Stream are too small to yield perched water. However, the part in Kalihi Valley is permeable aa and overlies nearly impermeable sediments, hence ground water is doubtless moving seaward through its basal portion. Somewhere beneath the basalt occurs the channel of Kalihi Stream that existed before the eruption. As the basalt is more than a mile in width at the mouth of the valley it would be a difficult matter to locate this channel and recover ground water from it with a tunnel. The presence of a large number of homes and numerous irrigated farms on the basalt means that the water in this rock is liable to be badly polluted. The water could be used industrially to relieve demands on potable water supplies, but so many other better prospects occur elsewhere, as described in this report, that this one can be neglected, at least for the present.

Castle Volcanics

About 3 miles west of Kailua and a quarter of a mile north of Ulumawao Peak there is a partly eroded cinder cone, as shown on plate 2. Bedded cinders, bombs, and spatter rest unconformably on older rocks on the southwest side of the cone. It is situated on the Castle ranch, from which it is named. A dense lava flow over 100 feet thick extends for half a mile from the cone. Its surface is covered with sufficient soil to permit farming and to conceal most of the rock. Under the microscope specimen F126, from this flow, was determined as a nephelinite basalt containing phenocrysts of pyroxene and olivine. The olivine is altered to iddingsite on the margins. The groundmass consists of pyroxene and nepheline with magnetite. The flow appears to have been etched into cliffs on the north by the Waimanalo sea, but other evidence of its age except the extensive amount of weathering is not available. It is sufficiently weathered to be as old as the Waipio stand of the sea, if not older, and is tentatively assigned to that stand. It is so small and lies in so dry an area that it is not likely to be a source of water.

Punchbowl Volcanics

Distribution and character.—The cone of Punchbowl, with its symmetrical crater, is near the center of Honolulu and was recognized as a vol-

canic crater as early as 1835.²⁴ (See pl. 2 for topographic form.) Dana was apparently the first geologist to note that it was a tuff cone. He describes two dikes on the southeast side, one 3 feet and the other 12 feet wide, visible for only a few rods, and also the lava on the summit and in the low gap.²⁵ The cone consists of inward-dipping and outward-dipping beds of palagonitized tuff rich in secondary calcite and containing many fragments of fossiliferous limestone and Koolau basalt. Some of the beds contain spiny nodules of dense lava similar to those blown out of Sugar Loaf and Tantalus. The symmetry of the cone indicates that strong trade winds were not blowing during its eruption.

Origin of black ash.—Practically all the geologists who have described this cone have attributed it to steam explosions. Hitchcock²⁶ was the first to ascribe Punchbowl as the source of some of the black sand in the vicinity of Honolulu. Wentworth²⁷ contributed a geologic map of Punchbowl, identified the lava as nephelite-olivine basalt, and amplified Hitchcock's idea of Punchbowl as the source of some of the black sand. However, I did not find any evidence that Punchbowl was the source of the black sand.

On plate 2 the areal distribution of the black sand on Punchbowl is shown. It is very difficult to map on the seaward side, because of artificial changes resulting from habitation and because it is used a great deal for grading lawns. The mapping is based on cuts where the sand could be observed and on data obtained from sewer trenches dug by the Honolulu Sewer and Water Commission.

In the excavations for target pits in the crater of Punchbowl, in ravines along Prospect Street, and in the gully draining the crater bedded black sand of the shard and nodule type can be seen resting unconformably on surfaces of Punchbowl tuff covered with soil and hill wash. The black sand in these exposures is extremely fresh and friable except at the surface, and to this extent it is very different from any of the material in Punchbowl Cone, which is either palagonitized or weathered and contains much secondary calcite. Furthermore, the black sand does not become coarser toward Punchbowl Crater but has the same size in the crater and on the outer slopes. If Punchbowl had been the source of this black sand the source cone should still be preserved in Punchbowl Crater. Firefountains intensive enough to form such widespread deposits of vitric ash always form cinder cones. The nearest cinder cones are Sugar Loaf and Tantalus, and the black-sand deposit maps in the form of a sector with the apex

²⁴ Gairdner, Meredith, Physico-geognostic sketch of the island of Oahu, one of the Sandwich group: *Hawaiian Spectator*, vol. 1, no. 2, pp. 1-18, 1838; reprinted from *Edinburgh New Philos. Jour.*, July, 1835.

²⁵ Dana, J. D., *Geology*, in U. S. Exploring Expedition, 1838-42, vol. 10, pp. 242-243, 1849.

²⁶ Hitchcock, C. H., *Hawaii and its volcanoes*, p. 35, Hawaiian Gazette Co., 1909.

²⁷ Wentworth, C. K., *Pyroclastic geology of Oahu*: B. P. Bishop Mus. Bull. 30, pp. 55-60, 1926.

at these cones and widening southwestward with the direction of the trade winds. Doubtless during the eruption of Sugar Loaf and Tantalus Punchbowl was completely mantled by this pumice, which was later washed off the steep slopes, reexposing the Punchbowl tuff. Wentworth recognized that the Tantalus and Sugar Loaf eruptions were much later than the main mass of Punchbowl, but he presented the following evidence²⁸ that Punchbowl had erupted again at a much later date to form some of this black ash :

Just outside the junction of the road loop on the south rim, black ash lies with in-dipping beds on the tuff. A few feet higher stratigraphically this black ash grades into droplet rhyoclastic material, and that in turn into true flow lava in fairly dense masses having the same in-dipping structure. It is quite clear that the black ash, rhyoclastic material, and flow lava are part of a closely contemporaneous series.

Similar relations in age and materials are shown by the resistant lip of the breach in the crater rim, where a mass of flow lava and rhyoclastic material lies in an erosion channel obviously cut since the Punchbowl tuff was deposited. These facts establish the considerable difference in age of the tuff and the black ash, which are in contact with apparent conformity at the road loop on the rim, and are in accord with the unconformable relations found between the black ash and the tuff on the lower flanks of the crater.

The first exposure near the summit can be interpreted differently. The ash just outside the junction of the road loop is unquestionably dipping inward toward the crater center, but it is yellow-brown, well cemented, and considerably weathered and differs considerably from the fresh black iridescent glassy lapilli from Tantalus and Sugar Loaf. In fact, there is only a foot or two of the same grade size as the typical black sand, and it then grades upward into spatter and lava undoubtedly ejected by Punchbowl. As the base of the rhyoclastic material under the flow lava is not exposed it is not possible to prove from this exposure that the lava and spatter are of later date than the Punchbowl volcanics; hence this locality has little significance. From their state of weathering, however, it would be inferred that they are of the same age as the subjacent Punchbowl tuff.

At the second locality described above by Wentworth the relations are clear. In the notch in the crater rim there is a vertical cliff about 25 feet high. In the northeast side of this cliff the lava flow is underlain by thin layers of gray tuff consisting of comminuted rock, olivine crystals, fine particles of glass, and accessory ejecta, cemented by a white substance that is probably calcium carbonate. This tuff rests conformably on and in places is welded or cemented to typical brown Punchbowl tuff. It is vastly different from the unconsolidated black pumice on the adjacent crater floor. On the southwest side of the cliff typical brown Punchbowl tuff grades upward into spatter and then into lava without any intervening soil or unconformity, indicating that the ejection of the spatter and lava immediately followed the

²⁸ Wentworth, C. K., *op. cit.*, pp. 58-59.

ejection of the brown tuff. Instead of lava filling a stream channel carved during a long period of quiescence, it is evident that the stream notched a formerly undrained crater, for all of this lava dips toward the crater and rests on inward-dipping tuff beds. The fresh, friable black sand is everywhere separated from Punchbowl tuff by soil, and the exposure at this cliff definitely proves that the spatter and lava were formed during the main Punchbowl eruption.

Sequence of eruptions.—The first blasts were steam explosions that disrupted the magma and made the brown tuff. Then the explosive force spent itself, and liquid lava rose into the crater, evidently forming a lava lake. Mild explosions immediately before the rise of the liquid lava produced the gray tuff, and as these explosions died down firefountains produced the spatter. If overflow from the lava lake occurred, the superfluent lava streams have since been removed by erosion. Then the lake subsided, leaving the thin flow on the highest point and a small patch in the bottom near the present gap. This subsidence was probably caused by the cone fissuring on the southwest side, for a dike is exposed at the city reservoir on Alapai near Crescent Street, from which lava has flowed southward under the present site on the Beretania pumping plant. Logs of wells 88A to 88F at this station show a lava flow about 15 feet thick resting on about 50 feet of Punchbowl tuff and overlain by 5 to 15 feet of reef and 10 feet of black sand. As samples from some of the holes check with the driller's logs, it is evident that this lava flow from Punchbowl is of the same age as that in the crater gap and hence considerably older than any of the friable black sand.

Age relations.—At well 98 Punchbowl tuff 47 feet thick is overlain by 13 feet of coral and 10 feet of black sand—a sequence which indicates that the lava flow was not wide enough to reach this locality or was removed by subsequent erosion. At this well the tuff overlies thick deposits of coral and clay. As reef belonging to the 25-foot stand of the sea overlies the tuff, the eruption must have taken place during or before the Waimanalo stand. The logs of wells 72 and 73 show that Kanaha Stream cut a valley at the site of these wells during the Waipio stand. As this stream was displaced to the site of these wells by the Punchbowl eruption, it is probable that Punchbowl erupted during the Waipio low stand of the sea.

Water-bearing properties.—The tuff has a low permeability and hence is of no value as a water bearer. A small seep that was reported never to go dry occurs in the low part of the crater. It seems to be supplied by rainfall on the crater floor. It was only a moist spot in the ground in April, 1931. The basalt flow on the south side is very permeable based on the samples from the Beretania Pumping Station wells.

LATEST PLEISTOCENE OR RECENT LAVAS AND PYROCLASTIC ROCKS
LAVAS AND PYROCLASTIC ROCKS ERUPTED AFTER THE WAIMANALO (+25-FOOT)
STAND OF THE SEA

The latest Pleistocene or Recent lavas and pyroclastic rocks consist of two groups of volcanic rocks, but as they do not overlap it is impossible to determine which of the two groups is the younger. Both, however, are later than the Waimanalo stand of the sea. The volcanic materials extruded from a fissure near the east point of Oahu comprise the Manana tuff, the Kaohikaipu volcanics, (basalt and firefountain deposits), the Kaupo basalt, the Kalama volcanics (basalt and firefountain deposits), and the Koko volcanics, all mapped as one unit on plate 2. They are referred to as the basalts and pyroclastic rocks of Koko fissure. The Manana tuff and the Kalama volcanics are sufficiently different petrologically to indicate that they were probably erupted at a slightly different time from the others. The lavas and pyroclastic rocks of Tantalus and Sugar Loaf, also of recent age, form a group distinct from the volcanic rocks of Koko fissure and are mapped as a separate unit on plate 2.

Basalts and Pyroclastic Rocks of Koko Fissure
Manana Tuff

Distribution and character.—Manana (Rabbit) Island is 1½ miles northwest of the east point of Oahu. It is composed of palagonitized gray to brown lithic tuff erupted from two vents (pl. 2). The highest point on the island is 361 feet above sea level. The tuff contains accidental, accessory, and magmatic ejecta, and the limestone blocks are fossiliferous. Wentworth²⁹ describes two thin sections of this tuff, both containing a mineral which he reports as melilite (?). Several joint planes cutting the tuff are slightly displaced. The tuff deposits from the two vents cannot be distinguished and doubtless were erupted concurrently. Alluvium more than 10 feet thick fills the west crater and mantles the southwest slope of the island. The waves striking the island pass around it and collide on the southwest side, where they are building out a sandbar. A few streaks of greenish-brown olivine sand occur, but otherwise the sand is calcareous. Around much of the island is a remarkably well developed bench, which appears to have been cut by the present sea. This bench is fully 150 feet wide on the northeast coast, where it bevels the inward-dipping concentric beds of the east vent.

Age relations.—Manana Island lies a little west of the direct line of the Koko fissure. If melilite is actually present the pyroclastic rocks are independent of the volcanic rocks of the Koko fissure, which do not contain identifiable melilite. Emerged reef is not present on the island, although living reef occurs between it and the mainland. The four patches of tuff on the main Koolau crest 1½ miles south of the

²⁹ Wentworth, C. K., op. cit., p. 107.

island shown on plate 2 are Manana tuff resting unconformably on Koolau basalt. On the mainland a mile southwest of the island tuff caps talus-covered emerged reef 6 feet above sea level believed to belong to the Waimanalo stand. It is not present on Kaohikaipu Island nor on the Kaupo basalt and hence is older. Facing Manana Island along the shore at the foot of the Pali, just below the road gap and about 20 feet above sea level, is a cave 5 feet high, 25 feet wide, and 15 feet long, in Koolau basalt. In this cave 3 feet of Manana tuff striking N. 70° W. and dipping 4° S. overlies well-rounded cobbles and angular blocks of basalt. This cave was evidently cut by the Waimanalo sea and left partly filled with beach cobbles. Then the sea receded to its present level and Manana tuff was deposited in the cave. Thus there is good evidence that this eruption was later than the Waimanalo stand and older than the Kaohikaipu eruption, hence is either latest Pleistocene or Recent.

Water-bearing properties.—This island has been considered as a possible prison site. The rainfall is low, and there is no source of fresh ground water, hence water would have to be transported from the mainland, if the island is so used.

Koko Volcanics

Location.—The Koko cones form a prominent chain of hills along the south coast near the east point of Oahu, as shown in plate 18, A. Puu Mai, the highest point of the group, is 1,204 feet above sea level, and as these cones were built up from sea level this height expresses about the maximum thickness of the tuff deposit. The topography and geology of these cones are shown on plate 2. The cones are alined along a fissure, and the vents on plate 2 indicate the most persistent centers of eruption.

Previous work.—The Koko craters have been recognized as such for a long time, but Dana³⁰ was apparently the first geologist to point out their secondary character. He also noted a lava flow from one of the craters. Brigham, Hitchcock, Dutton, Green, Bishop, Branner, Wentworth, and others have described these vents and Wentworth³¹ gives a geologic and structural map of them.

Distribution.—The areal extent of Koko tuff is shown on plate 2. It evidently mantled the ends of several of the Koolau ridges nearby but has now been mostly swept away. An outcrop of tuff in Niu Valley about 3 miles west of the cones is the outcrop farthest from the vents that was observed. Chart 4110 of the United States Coast and Geodetic Survey shows a distinct ridge for 3 miles southwest of Koko Head, which indicates that submarine eruptions also occurred along the fissure.

³⁰ Dana, J. D., *op. cit.*, pp. 243-245.

³¹ Wentworth, C. K., *op. cit.*, pp. 76-85, figs. 22 and 23.

Character.—The cones consist of well-bedded lithic gray to brown tuff like that shown in plate 3, A. In some beds the glass has turned to palagonite. Blocks of Koolau basalt and reef limestone are numerous. These two rocks underlie the vents at shallow depths. The cuts made for the new road along the south side of Koko Crater expose a very hard and brittle tan and black tuff that differs considerably from the normal tuff. Fractures pass through the fragments and matrix equally well, whereas in the normal tuff fractures do not break through the large fragments. Some of this tuff consists of fragments of very vesicular black glass as much as half an inch across in a fine-grained matrix. In other places small limestone fragments predominate. A thin section of the first type showed that the matrix consists of olivine phenocrysts in an amygdaloidal brown glass. The amygdules consisted of an undetermined zeolite, which may be largely the cause of the cementation of this particular tuff. In plate 17, B, is shown a streak of this compact variety. In most places tuff of this kind fills V-shaped valleys. Its jumbled character gives the impression that it originated as hot avalanches from the crater rim and that the fragments became welded before it had a chance to cool. Some occurrences may mark the site of fumaroles and thus they may be a local metamorphic effect. The few beds of this kind of tuff only about 3 inches thick may represent the fall of exceptionally hot showers of ash, which welded before cooling.

The tuff is the product of disruption of an olivine basalt. Nepheline and melilite were not present in the five thin sections studied by Wentworth, hence the Koko magma differed in this respect from most other post-Koolau magmas. The presence of euhedral augite crystals as much as half an inch in length embedded in the tuff is another unusual petrologic difference. Brigham³² early called attention to the abundance of augite crystals on the ridge east of Hanauma Bay.

Sequence of eruptions.—Wentworth recognized three different stages of tuff eruption but found it impracticable to map them separately. Striking unconformities occur in several places; probably none of them indicate any great time interval. Wentworth³³ expresses the view that Koko Head, because of its subdued topography, may be one of the oldest craters on Oahu. As it lay in the path of the trade winds blowing from the adjacent vents, the subdued topography is more likely the result of ash falls from the vents to the windward and not of its age. On the south side of Koko Crater only the north rim of a cone is left, the rest having been destroyed by the waves. A line of ash cones similar to the Koko group have been known to form in his-

³² Brigham, W. T., Notes on the volcanoes of the Hawaiian Islands: Boston Soc. Nat. History Mem., vol. 1, pt. 3, p. 359, 1868..

³³ Wentworth, C. K., op. cit., p. 81.

toric time within the period of a year. Several craters are sometimes active at the same time, resulting in very complicated overlapping and intimate mixtures of deposits and a crater may cease activity and in a few days be nearly buried by the deposits from adjacent vents; hence there is no reason why all the events that took place along the Koko fissure cannot be assigned to one epoch of volcanic activity. The history of Jorullo, in Mexico, which broke out in a plantation where no volcanoes were known and which built up a series of ash cones and poured out several lava flows in the course of 2 years, must have been practically a repetition of the events that occurred along the Koko fissure.

Lava flows.—Five small lava flows are associated with Koko tuff. A thin lens of basalt is intercalated in the tuff on the southwest side of Hanauma Bay. On the northeast side of the bay an unusual exposure occurs. Here a crack opened in the tuff, and mild firefountaining occurred while a small flow poured down the crater wall. Marine erosion has since carried away sufficient tuff to expose the dike feeder, without destroying the spatter or the flow. The pathway along the shore passes through a natural arch made by this lava. Lava broke out on this same crack on the outer slope of the rim about 100 feet to the northeast and flowed down the depression between the inner and outer crater rims around Hanauma Bay. Apparently at the same time lava broke out on the northeast rim of Kahauloa Crater nearby and flowed toward the sea, forming an aa flow only about 1 to 4 feet thick. In the highway cut this lava is resting on 2 to 6 inches of hill wash and 2 to 4 feet of partly consolidated dunes of black sand. These dunes contain sufficient calcareous grains to suggest that the sand drifted from a beach. The basalt is in many places overlain by about 6 feet of tuff, which indicates that it was extruded prior to the end of the Koko fissure explosions. Another firefountain produced spatter and lava on the northeast side of Koko Crater, as shown on plate 2. The detached patch of lava a few hundred feet to the northeast probably came from this vent.

Age relations.—The Koko volcanics must be of latest Pleistocene or Recent age because the tuff fell on soil-covered emerged reef belonging to the Waimanalo sea in the adjacent valleys. Soil-covered reef probably of Waimanalo age is exposed along the shore on the south side of Koko Crater about 15 feet above sea level, as shown in plate 3, A. The sea cliffs at the end of the Koolau ridges were made before the tuff was deposited, as shown by the steep unconformity between the tuff and and Koolau basalt on the north side of Koko Crater.

Water-bearing properties.—The rainfall on Koko tuff is slight, but Brigham³⁴ reports that in 1868 a small spring issuing near sea level at the

³⁴ Brigham, W. T., op. cit., p. 359.

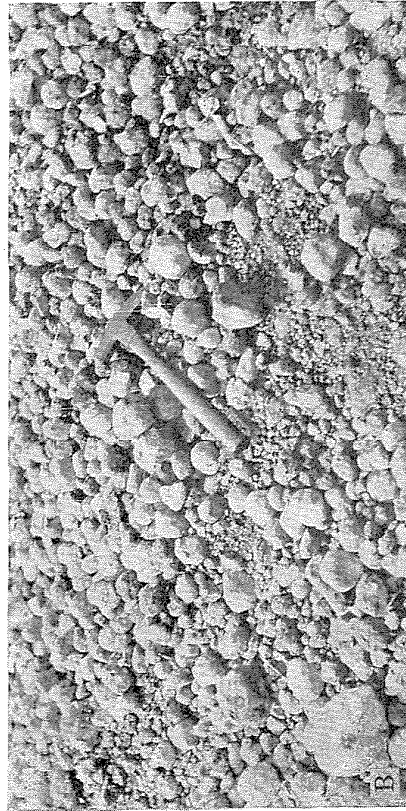

A, FIREFOUNTAIN DEPOSITS RESTING UNCONFORMABLY UPON SOIL-COVERED KOOLAU BASALT, ON SOUTHWEST SIDE OF TANTALUS; B, LAVA BALLS IN SUGAR LOAF LAVA FLOW; C, LAVA BALLS AMONG THE CLINKERS OF THE SUGAR LOAF LAVA.

Photographs by Harold T. Stearns



A, VIEW LOOKING SOUTHWEST OVER THE KOKO FISSURE GROUP OF CRATERS AND HANAUMA BAY.

The large crater in the right foreground is Koko Crater and the one farthest away is Koko Head. The hill on the left side of Koko Crater is the remains of an older tuff cone mantled by Koko volcanics and partly destroyed by the sea. Photograph by 11th Photo Section, Air Corps, Luke Field, T. H.

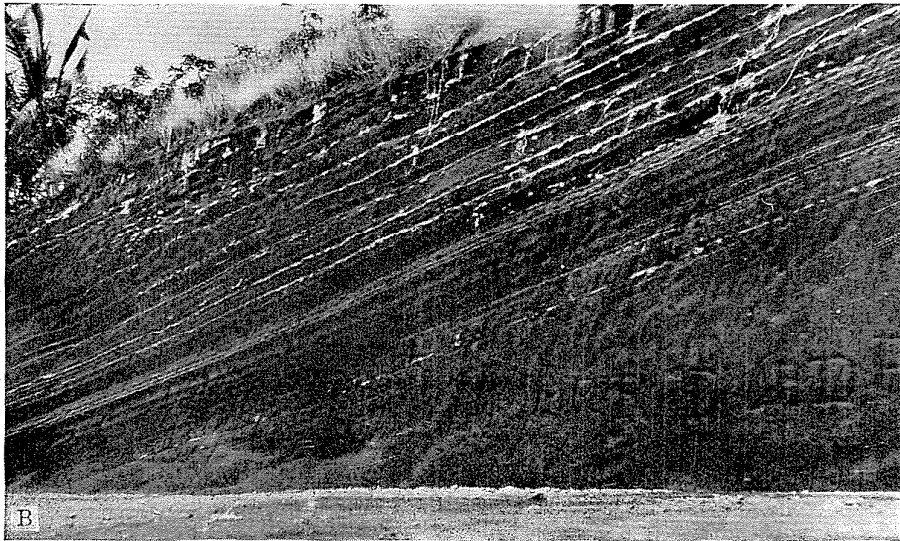

B

B, EVEN-BEDDED "BLACK SAND" OR FIREFOUNTAIN DEPOSITS.

From Sugar Loaf and Tantalus on the side of Round Top. Lime fills the cracks and bedding planes. Photograph by Harold T. Stearns.

head of Hanauma Bay was used for irrigating several taro patches along the shore. A well at the radio station at an altitude of about 30 feet, about 975 feet from Kuapa Pond, yields water with 28.9 grains of salt a gallon (301 parts per million of chloride). A windmill about 100 feet from the pond and 800 feet northwest of the radio station yields water with 416 parts per million of chloride. The Hahaione farm, on the north side of Kuapa Pond, pumps about 8,000,000 gallons annually from Koko tuff, which shows that the tuff is fairly permeable. At this place the tuff occurs as a narrow wedge probably about 50 feet or less in width, and the water is supplied to it from adjacent Koolau basalt.

Kalama Volcanics

Distribution and character.—Half a mile northeast of Koko Crater is Kalama Crater, a symmetrical crater 50 feet deep. As shown on plate 2, a ridge of spatter and cinders extends northeast of the crater, and a flow extends from the cone to the sea. It consists mostly of aa and forms a rocky shore line for a little over a mile. The surface of the flow is now considerably smoothed by sediments from the adjacent hills, but vesicular blocks still litter its surface. Its bottom is nowhere exposed; hence its thickness is unknown. Specimen F330 from the rim of the crater shows in thin section, olivine phenocrysts in an intergranular groundmass high in ferromagnesian minerals, low in feldspar and also a mineral of low birefringence possibly nephelite. Thus it is different petrologically from the Kaupo and Kaohikaipu lavas described in the following pages. It may or may not have been part of the same magma that produced the Koko volcanics. On the southwest slope of the cone there is several feet of even-bedded Koko tuff, which shows that the Kalama vent erupted before the end of the Koko explosions, possibly about the same time as the lava flows associated with the tuff cones.

Age relations.—Emerged reef of the Waimanalo stand was not found on the Kalama volcanics. The basalt of that formation is a suitable place for reef to have grown and have been subsequently preserved, hence it appears to be of post-Waimanalo or Recent age but older than the last Koko explosions.

Water-bearing properties.—The basalt of the Kalama volcanics is so permeable that water entering it must readily mix with sea water; consequently it is not a likely source of ground water.

Kaohikaipu Volcanics

Kaohikaipu Island lies three-quarters of a mile northwest of the east point of Oahu. The highest point of the island is 80 feet above sea level. The east side consists of bedded red cinders, spatter, and bombs cut by irregular dikes trending in general northeast. Black

pahoehoe containing phenocrysts of olivine makes up the rest of the island. On the central part of the island is a patch of lithified calcareous dune sand. Good cross-bedding can be seen at the east edge, where it has an exposed thickness of 5 feet. Root molds and casts are numerous in it, indicating that the island was probably once covered with shrubs or trees, but it now supports only a sparse growth of weeds and grass. A small spouting horn was observed on the east side. The small islets surrounding it consist of basalt belonging to this same eruption. The island is too small to contain potable ground water.

Kaupo Basalt

Distribution and character.—Southwest of Kaohikaipu Island, at the foot of the Pali, occurs another post-Koolau pahoehoe flow, which for convenience will be called the “Kaupo basalt,” from the name of the abandoned Hawaiian village on it. It issued from the talus at an altitude of about 200 feet (pl. 2), and a small heap of spatter now marks the site of the outbreak. The ocean is shallow between it and Kaohikaipu Island, which suggests that the two flows were once connected above sea level. Both eruptions probably occurred simultaneously along a northeast-southwest fissure. These two vents are alined with the Koko Craters, suggesting that they all belong to the same eruptive period. Wentworth was also impressed with this fact. Under the microscope the rock shows a peculiar mixed felty and ophitic texture and prominent olivine crystals in a groundmass of feldspar, pyroxene, and magnetite.

Age relations.—The surface of the flow is only sparsely covered with soil and vegetation and has unquestionably the most youthful appearance of all the flows on Oahu. It has no reef of the Waimanalo stand of the sea or indication of wave work at the 25-foot level; consequently both the Kaohikaipu and the Kaupo flows are believed to be of latest Pleistocene or Recent age. Tuff from Manana Island, although preserved on the older rocks nearby, is absent on these two flows; hence they are younger than Manana Island and rank with the Tantalus and Sugar Loaf lavas as being among the youngest flows on Oahu.

Water-bearing properties.—The flow is too small and occurs in too dry an area to be the source of any appreciable quantity of fresh ground water.

Basalts and Firefountain Deposits of Tantalus and Sugar Loaf

Firefountain Deposits

Distribution and character.—About 3½ miles northeast of Honolulu on the divide between Manoa and Pauoa Valleys is the Tantalus chain of craters. Tantalus Peak (Puu Ohio) is 2,013 feet above sea level, but only about 200 feet of this height is the product of the Tantalus eruption. The remaining part is Koolau basalt. Like many of the other post-Koolau eruptions, this one took place on the crest of a ridge.

Sugar Loaf (Puu Kakea) cone, with its two craters, is a mile south of Tantalus on the divide between Manoa and Makiki Valleys. As shown on plate 2, the alinement of these craters suggests that both eruptions occurred concurrently along a nearly north-south fissure. Both eruptive centers produced lava flows and great quantities of fire-fountain deposits. These deposits from the two vents have not been differentiated on plate 2 because they are so intimately intermingled, a fact further substantiating the simultaneity of the eruptions. The firefountain deposits from Tantalus and Sugar Loaf are locally known as "black sand," even though most of the material is coarser than sand. As shown on plate 2, they cover a triangular sector southwest of Tantalus and Sugar Loaf. A large part of the material consists of fragments of small vesicular glassy ribbons. Generally above this type and in places interbedded with it are spiny pellets and nodules of denser basalt, which reach walnut size and may properly be called lapilli. Near the vents the fine material gives way to cinders, bombs, and clots of glassy basalt. Balls of dense basalt about 4 inches in maximum diameter are not uncommon in the cones. Accidental and accessory ejecta are notably absent, hence it is evident that the eruption was accompanied by only the usual firefountains. Probably in part because the erupting magma consisted of nephelite-melilite basalt but largely because the eruptions took place on a high ridge exposed to strong trade winds, the firefountain deposits were drifted several miles southwestward and are more widespread than usual. In addition much coarse material rolled down the steep cliffs nearby and accumulated to depths of 50 feet or more at their base. The streams washed quantities of it onto the coral plain near Honolulu and into the sea. The symmetrical fan at the mouth of Makiki Stream was probably built mostly with this material immediately after the eruption. The deposit is now found almost entirely on the interstream divides and on the gentle slopes near Honolulu. Part of the deposit mapped on plate 2 has been transported to some extent by water, but where gravel and sand are obviously mixed with the deposit it is mapped as alluvium.

In many places the firefountain deposits, as shown in plate 18, B, are even-bedded and partly cemented by calcium carbonate. In other places they show cross-bedding as a result of being reworked by water. Although the wind transported the material from the vents, no dunes or other evidence was observed to indicate that wind drifted it after deposition. In many places the original glass is still fresh, bluish, and iridescent, but elsewhere the upper 2 or 3 feet is decomposed to a light-brown soil. Along the road near Sugar Loaf the glassy skin of the ribbons is replaced by limonite, so that the fragments, although they look extremely fresh, crumble into brown dust when handled.

Fornander³⁵ and Hunnewell³⁶ believed that because Hawaiian relics have been found in the "black sand" beneath limestone in Honolulu the "black sand" antedated the emerged limestone and indicated a great antiquity for man on Oahu. The coral limestone is full of caves, and as the Hawaiians buried their dead with their possessions in caves and the "black sand" is known to sift and wash into such caves, the finding of human relics in "black sand" beneath limestone is not adequate evidence that either man or the eruption that produced the "black sand" preceded the deposition of the coral limestone.

Previous work.—Hitchcock³⁷ was apparently the first geologist to mention Tantalus as a vent and ascribe the "black sand" to it. The presence of the deposit in this area was noted as early as 1868 by Brigham,³⁸ but he made no mention of its source. Later Hitchcock³⁹ described the deposit more fully and ascribed its source to Tantalus, Sugar Loaf, and Punchbowl. Bishop⁴⁰ thought that possibly Round Top had given vent to some of the "black sand." Wentworth⁴¹ followed Hitchcock in the belief that Tantalus, Sugar Loaf, and Punchbowl were the source of the "black sand" but stated that part was produced by an eruption of Punchbowl some time after the main cone was built. He also stated that Round Top is a vent. He presented a map showing the areal geology of the Tantalus-Round Top district⁴² but showed no lava flows from either Tantalus or Sugar Loaf. He presented no evidence to show why he believed Round Top to be a vent. No crater exists on Round Top, hence it may be simply a ridge of Koolau basalt mantled with the deposits from Sugar Loaf craters.

Age relations.—In several cuts along the Tantalus road the deposits can be seen resting on the steep soil-covered surface of Koolau basalt, as shown in plate 19, A. In Honolulu the "black sand" rests upon emerged reef of the Waimanalo stand of the sea. In some places the "black sand" has sifted down into crevices and caves in the limestone.

Water-bearing properties.—The "black sand" is extremely permeable and hence is a valuable intake formation. As it fell on a dissected and in places soil-covered Koolau surface, it gives rise to several springs, which are used by Honolulu. Makiki Springs rise in Kanealole Fork of Makiki Stream. The west spring is enclosed in a concrete box, and the water issues from coarse friable firefountain deposits at an altitude of 954 feet. For the year ending June 30, 1927, the discharge of both springs averaged 318,000 gallons daily. The east spring when

³⁵ Fornander, Abraham, An account of the Polynesian race, its origin and migrations, and the ancient history of the Hawaiian people to the times of Kamehameha I, vol. 1, pp. 164-165, London, Trubner & Co., 1878.

³⁶ Hunnewell, James, Early wells of Honolulu: Hawaiian Club Papers, p. 3, October, 1868.

³⁷ Hitchcock, C. H., Geology of Oahu: Geol. Soc. America Bull., vol. 11, pp. 41-42, 1900.

³⁸ Brigham, W. T., Notes on the volcanoes of the Hawaiian Islands: Boston Soc. Nat. History Mem., vol. 1, pt. 3, p. 355, 1868.

³⁹ Hitchcock, C. H., Hawaii and its volcanoes, 2d ed., pp. 34-36, Honolulu, 1911.

⁴⁰ Bishop, S. E., Geology of Oahu (revised reprint from the Hawaiian Annual), p. 12, 1901.

⁴¹ Wentworth, C. K., op. cit., pp. 72-75.

⁴² Idem, fig. 21.

visited was slightly larger than the west one. They vary considerably and are reported to go practically dry during droughts. On May 26, 1932, water was overflowing the intakes.

About 75 feet downstream from the west spring a ledge of partly consolidated "black sand" 6 feet thick occurs in the stream. Beneath this ledge is a tunnel 10 feet long which exposes 6 feet of compact red soil. About 50,000 gallons daily was escaping from the contact of the "black sand" and the soil on May 26, 1932. The soil perches the water, which is moving down a valley older than the "black sand." Numerous seeps issue along the creek bed below the spring. All of the water could be collected at this place by a tunnel driven along the soil bed across the bottom of this buried valley. As the soil is readily excavated with pick and shovel and the "black sand" is sufficiently consolidated to form a good roof, the cost of the tunnel should be low. The former valley is narrow, hence a tunnel probably not more than 100 feet long should be necessary.

An excellent geologic exposure occurs within a few feet of the east spring. As shown in figure 12, the present stream bed is east of the buried channel. The "black sand" forms a bluff 30 feet high, under

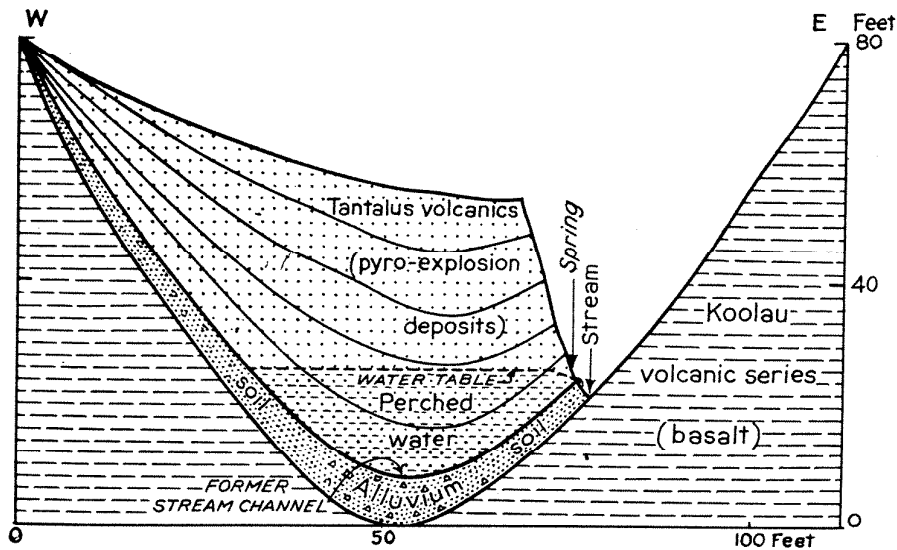

FIGURE 12.—Geologic conditions at Makiki Springs.

which occur soil and alluvium. Beneath the soil is permeable Koolau basalt. A few tree molds occur in the "black sand" and indicate that it fell on a surface supporting vegetation. A tunnel about 75 feet long driven to intercept the flow down this buried channel should be adequate to collect all the perched water at this locality, some of which is escaping below the concrete diversion box. The altitude of the east spring is 976 feet.⁴³

Herring springs consist of two main vents at altitudes of 970 and 977 feet⁴³ in the Moleka Fork of Makiki Stream. They have the same geologic setting as Makiki Springs. Small springs issue lower down that could be captured by a short tunnel crossing the adjacent buried valley. Like Makiki Springs, they are supplied by rainfall on the "black sand" close by, hence their discharge varies considerably with the local rainfall. For the two years ending July, 1930 their average flow was 59,000 gallons daily.⁴⁴

Sugar Loaf Basalt

Distribution and character.—A voluminous lava flow was poured out from Sugar Loaf Crater at the end of violent firefountaining. It flowed south into the saddle between Sugar Loaf and Round Top, cascaded down the 800-foot cliff of Koolau basalt bordering Manoa Valley, continued southeastward across the valley to the opposite wall, then spread southward $1\frac{1}{4}$ miles, covering the entire valley floor, and ended in a steep clinker margin about 40 feet high. One narrow tongue continued a third of a mile southward across emerged reef, and on it now lies Moiliili, a suburb of Honolulu. The area covered by this flow is shown on plate 2. It was not feasible, because of lawns and houses, to distinguish this flow from the lavas poured out from the cones of the Rocky Hill group except on the basis of topography.

On the west side of University Avenue, in a cut just south of the university gymnasium, firefountain debris of the ribbon type fills a few crevices in a hummock of aa in the Sugar Loaf flow. It is difficult to determine whether the deposit is alluvial or subaerial, but the dirt mixed with it suggests an alluvial origin.

On the Round Top road about 600 feet north of the south edge of the lava flow, at Moiliili quarry, and in a few other places masses of very vesicular spatter are associated with the flow. This spatter was caused by the splashing of the lava river feeding the flow, and similar spatter has been commonly observed in historic flows on Hawaii. Specimens of lava from the Moiliili quarry have been studied microscopically and analyzed.⁴⁵ According to Cross, nephelite-melilite basalt was first known on Oahu from specimens collected at this quarry. Hitchcock surmised that the lava in this quarry came from Rocky Hill.⁴⁶ Although some of the basalt to the northwest may have come from Rocky Hill, the particular rock in this quarry can be traced back to Sugar Loaf.

The basalt at the quarry is 40 feet thick and is a massive gray dense, roughly columnar-jointed basalt overlain with aa clinker. Many of the blocks contain primary veins as much as 8 inches wide and small

⁴³ Altitudes furnished by Honolulu Board of Water Supply.

⁴⁴ Kunesh, J. F., Water resources of the city of Honolulu, 1928-30, p. 24, 1931.

⁴⁵ Cross, Whitman, Lavas of Hawaii and their relations: U. S. Geol. Survey Prof. Paper 88, p. 20-23, 1915.

⁴⁶ Hitchcock, C. H., Geology of Oahu: Geol. Soc. America Bull., vol. 11, p. 47, 1900.

vugs partly filled with dull-white hexagonal nepheline crystals 1 to 2 millimeters in diameter and as much as 5 millimeters long. Interspersed with the nepheline are lustrous slender dark-green to black euhedral, somewhat bladed crystals of prismatic pyroxene as much as 1 centimeter long and short gray acicular crystals of apatite. The various minerals in this quarry have been determined by Dunham.⁴⁷ Along joint cracks near the top of the flow weathering has altered the normal gray basalt to a yellowish-brown rock rich in secondary minerals. The high mineralization of this rock may have been due to the lava flow passing over wet ground. The Kamaikai and Maunawili basalts show somewhat similar pegmatitoid phases, and these lava flows also fill valleys. However, they are also nephelinite basalts, and this lava may be commonly richer in volatiles than normal basalt at the time of extrusion.

Origin of ball lava.—The source end of the Sugar Loaf flow is characterized by peculiar nodules of dense basalt 6 inches or less in diameter with surfaces that appear to have been originally spiny or rough and later smoothed by rubbing against one another. On the west side of Manoa Valley these nodule deposits in many places exhibit crude and jumbled bedding with dips as steep as 65° and at the margin of the flow are banked against the lava in deposits 40 to 50 feet thick. A fine exposure of the nodules occurs in a quarry near the west end of Komaia Street (pl. 19, B). Plate 19, C, shows nodules and small clinker in the undisturbed bank of the quarry. In this quarry the nodules also occur mixed with heavy masses of dense flow lava and their relation to the lava is similar to the relation of the thick clinker deposits to the flow lava in the margins and on the surfaces of aa flows on Hawaii. It is possible at this quarry to find the nodules in all stages of attrition. Some have practically all their spines left, and others are smooth. The nodules are scarce on the surface of the flow on the valley bottom—a fact which suggests that the grinding was caused by the viscous clinker aa flow cascading down the 800-foot cliff. The nodules are rarely vesicular, and they lack the skin that is characteristic of bombs.

Sufficient milling must have occurred in Sugar Loaf Crater also, for nodules are present there. To the southwest of Sugar Loaf lapilli, or tiny spiny lumps, rest on firefountain deposits of the ribbon type, indicating that the firefountains produced the normal ribbon material first and nodular lapilli later. Some of the attrition may have occurred in the firefountains also. At first very frothy fluid magma supplied the fountains, which produced the normal vesicular bombs, lava ribbons, and pumice. Possibly the magma later contained lumps of

⁴⁷ Dunham, K. C., Crystal cavities in lavas from the Hawaiian Islands: *Am. Mineralogist*, vol. 18, no. 9, p. 372, 1933.

hard lava, of which the lighter lumps were blown out and carried southwestward by the wind while the heavier lumps remained and were churned about in the crater. That it is possible for magma to contain solid lumps in suspension when it arrives at the surface is shown by the flows, which consist of nodules of olivine in a matrix of basalt, a type of flow not uncommon in these islands. During the eruption at Nuuanu Pali nodules of olivine were not only floated out in the lava but were ejected with the cinders.

On the Round Top road at the south margin of the Sugar Loaf flow shown on plate 2, the contact of the flow lava, containing nodular aa and the underlying firefountain deposits, is well exposed. The contact strikes N. 13° W. and dips 58° NE. In the City and County quarry, on the north side of Round Top road 1,000 feet south of the triangulation station on the summit of Sugar Loaf, the nodular aa occurs mixed with heavy masses of flow basalt.

Because of its relief the lava cascade on the side of Manoa Valley can be seen readily from various places in the valley. On the southeast side of Manoa Road are two low hills which were probably caused by the accumulation of clinker at the foot of the cascade, although they may be due to irregularities in the surface over which the lava flowed.

Age relations.—Reef limestone correlated with the Waimanalo stand of the sea underlies the basalt at the Moiliili quarry. An excavation in the quarry floor in 1932 exposed the weathered surface of limestone, which indicates that the flow passed over emerged reef and hence was erupted after the Waimanalo sea had receded. Mr. Sam Ikuwa, foreman at the quarry, reports that the lava overlay a thin layer of gravel resting on coral at the entrance to the quarry, and that behind the quarry barns beach sand at an altitude of about 20 feet was encountered beneath the lava. The rough, clinkery surface of this flow is not yet entirely covered by soil, and although it is prehistoric it is quite evidently one of the features formed during the latest post-Koolau volcanic episodes on Oahu.

Displacement of Manoa Stream.—The Sugar Loaf flow greatly disturbed the hydrologic conditions in Manoa Valley. As can be seen on plate 2, Manoa Stream follows the axis of its wide valley until it reaches the north margin of the flow. At this place the stream is diverted by the lava dam and flows eastward along the north margin of the basalt to the contact of Sugar Loaf and Koolau basalts. It then follows this contact to the end of the Koolau spur, where it turns abruptly southward along the east margin of the lava flow. Evidently, before the eruption of the Sugar Loaf volcanics, Manoa Stream flowed along the axis of its valley and discharged into the sea farther west than at present.

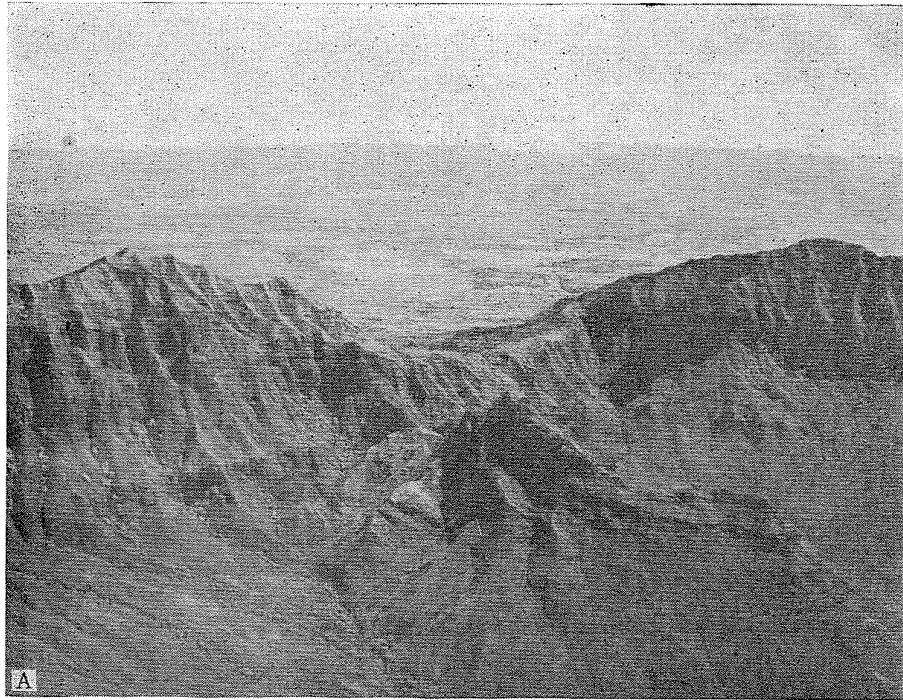

A, PUU KAILIO SYNCLINE AT THE ERUPTIVE CENTER OF THE
WAIANAE RANGE.

At the head of Lualualei Valley. Schofield Plateau and Koolau Range in background.

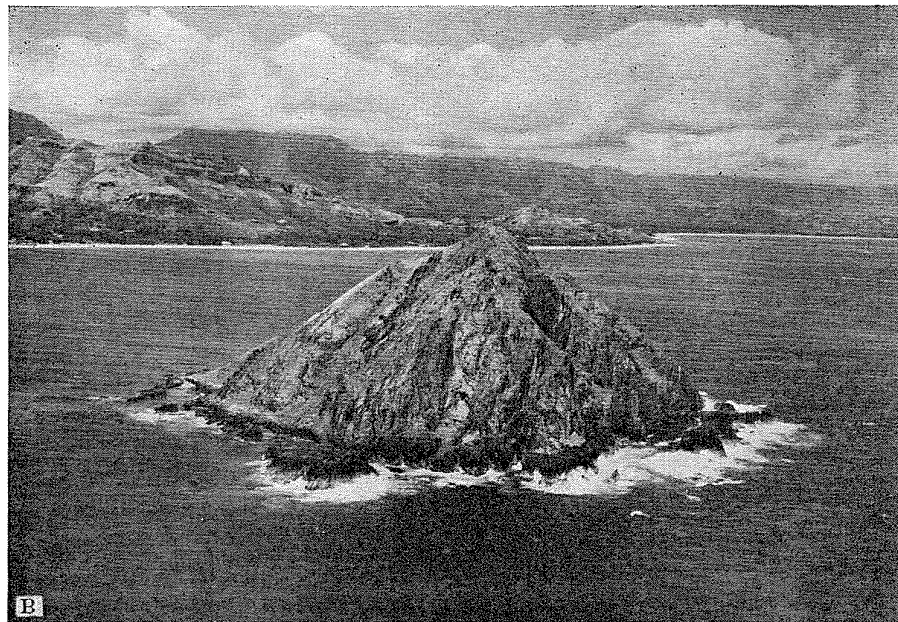

B, EAST LIMB OF THE LANIKAI SYNCLINE AND NORTH MOKULUA
ISLAND.

Island consists of Kailua dike complex.

Photographs by 11th Photo Section, Air Corps, Luke Field, T. H.

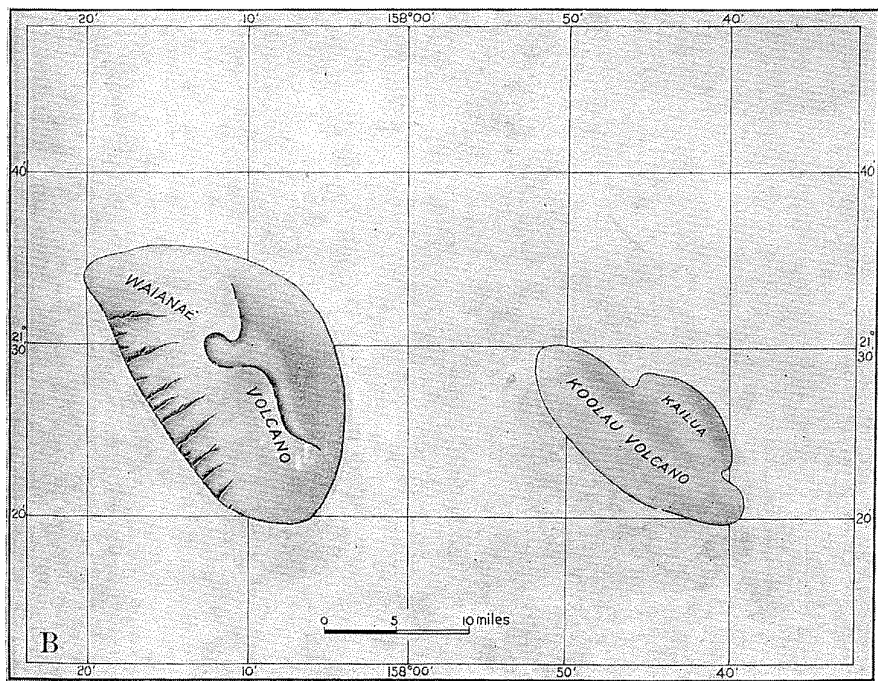
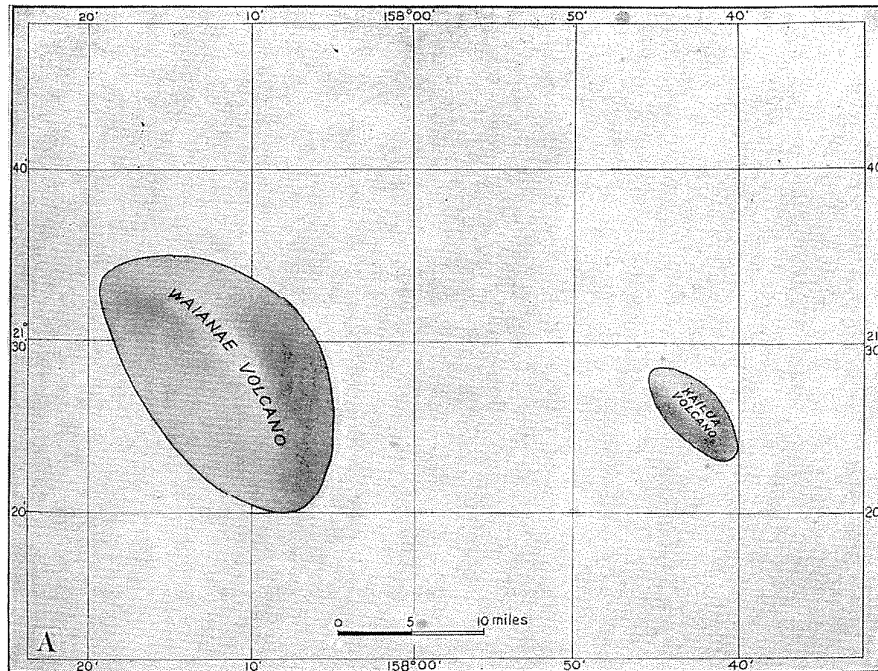

A, FIRST STAGE IN THE DEVELOPMENT OF OAHU.

Showing the completed domes of the lower lavas of the Waianae volcanic series and the lavas of the Kailua series.

B, SECOND STAGE IN THE DEVELOPMENT OF OAHU.

Showing the collapse of the dome of the lower lavas of the Waianae series, the development of drainage on its southwest slope, and the middle Waianae lavas banked against the cliffs. The Koolau volcano is shown in an early stage developing over the northwest-southeast fissure and flooding the Kailua dome with its lavas.

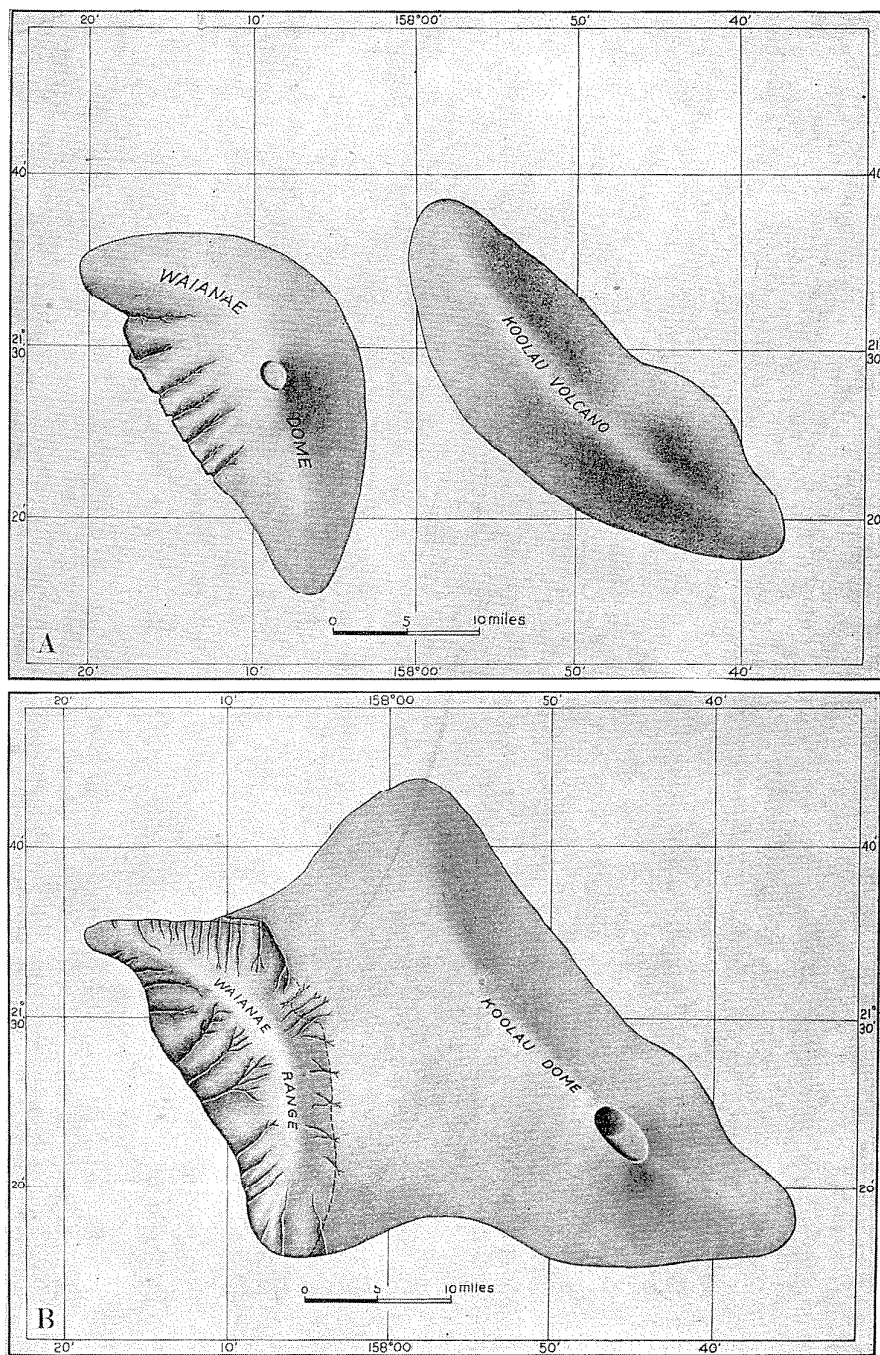

A, THIRD STAGE IN THE DEVELOPMENT OF OAHU.

Showing completion of the Waiaanae dome by the extrusion of the upper lavas, the caldera near the present site of Kolekole Pass, the deeply incised streams on the southwest flanks, and the receded southwest shore caused by marine erosion. The Koolau volcano has practically buried the Kailua dome.

B, FOURTH STAGE IN THE DEVELOPMENT OF OAHU.

Showing the fully developed drainage on the southwest side of the Waiaanae dome and the more youthful drainage on the windward side. Some of the streams are shown as sinking into the porous Koolau lavas. The Koolau dome is completed, with its caldera in the area between Kaneohe Bay and Olomana Peak.

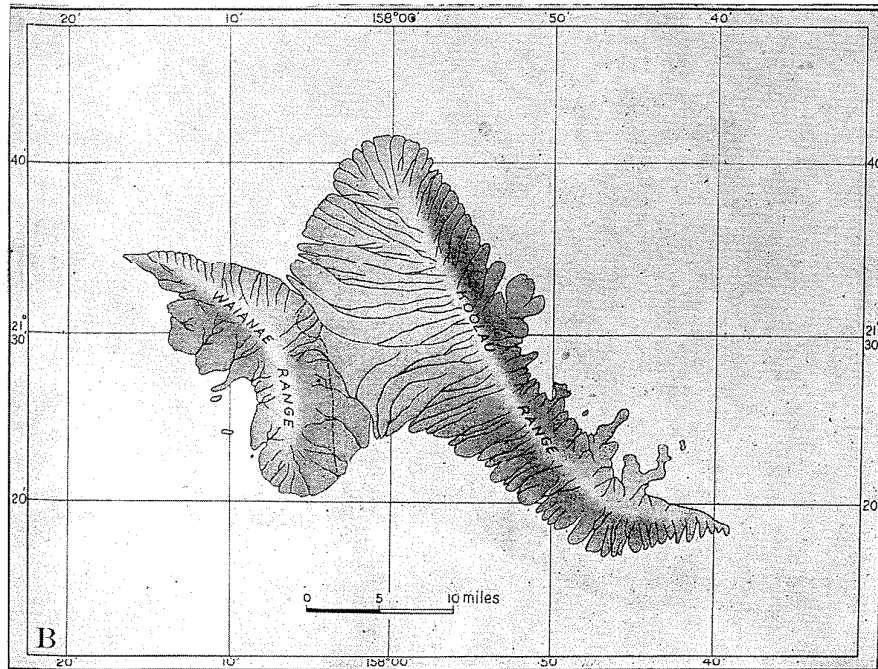
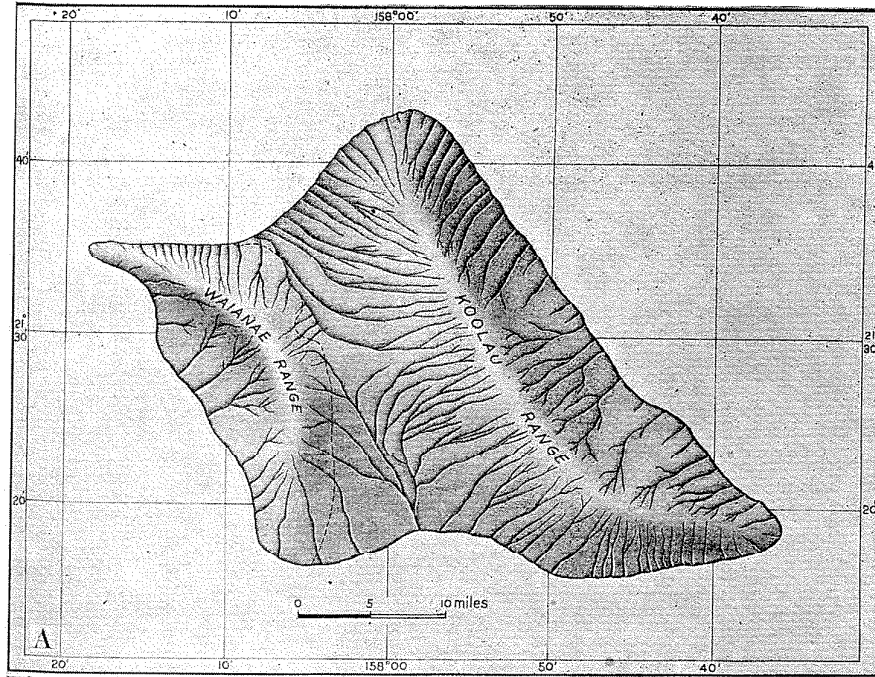

A, FIFTH STAGE IN THE DEVELOPMENT OF OAHU.
 Showing completed drainage pattern on both ranges.

B, SIXTH STAGE IN THE DEVELOPMENT OF OAHU.
 Showing submergence of Oahu by approximately 1,200 feet at the time of the Kaena stand of the sea about 95 feet above the present shore line.

Water-bearing properties.—The clinkery and jointed character of the Sugar Loaf basalt makes it an ideal water-bearer, hence Manoa Stream must lose heavily, especially in flood times in the part of the stream channel bordered by this lava. The seaward margin of the basalt is from 8 to 15 feet above sea level and everywhere rests on permeable coral or alluvium, hence water moving seaward through the basalt leaks downward into the underlying permeable materials and escapes to the sea. In very wet weather, however, quantities of water discharge from its base into the Moiliili quarry, which is 6 feet above sea level. As the water table lowers this water drains away through the coral.

During the quarrying operations a cavern about 25 feet wide and 10 to 15 feet high was found in the coral beneath the lava. This cavern must extend for some distance seaward, because the City and County sewer, built in 1928, encountered the cavern farther south along Waialae Road. At that time two pumps yielding 4,000,000 gallons daily did not appreciably lower the water surface in the cavern, which was about 3 feet above sea level. It is reported that mullet are caught in cesspools dug into the coral in this area, which indicates that the cavern connects with the sea. The City Bureau of Sewers pumping an excavation in emerged reef for several months during the fall of 1934 at the proposed intersection of Kapiolani Boulevard and University Avenue at the rate of 10,000,000 gallons a day dried up the springs in Moiliili and lowered the water table as far away as the cavern at the quarry.

The cavern is a solution channel made by the fresh water flowing from Manoa Valley underground to the sea. This ground water could be developed for industrial purposes should a need arise. If the cesspools in Manoa Valley were abandoned this water could be chlorinated and used for drinking, although contamination would doubtless continue in an area of such permeable rocks.

Several fresh-water springs southwest of the quarry discharge about 1,500,000 gallons daily; hence this area is a good site for developing shallow ground water.

Tantalus Basalt

Distribution and character.—Toward the end of the pyroexplosions or firefountains at Tantalus, a lava flow poured out of the north side of the cone and ran down Pauoa Valley for 1½ miles. Like the Sugar Loaf flow it is covered with a thick mantle of clinker and balls, especially where it cascaded down the east wall of Pauoa Valley. Pauoa Flat is caused by this lava damming Pauoa Stream. On the east side of the flat, at the source of Aihuahama Stream, the basalt rests unconformably upon alluvium. The great lava fill in Pauoa Valley is so permeable that Pauoa Stream has made little headway in cutting a new

channel in the upper part of the valley. However, between altitudes of 950 and 1,100 feet a narrow canyon, bounded by vertical cliffs in most places 100 feet high, has been carved out since the basalt was extruded. Most of the material is friable clinker and hence is easily removed. At an altitude of 950 feet in this valley the Tantalus flow rests on talus from the adjacent valley wall. Pauoa Stream flows along the west edge of the basalt from this point downstream and the east margin of the flow is obscured by talus and hill wash. Most of the lower stretch consists of dense, hard basalt. Specimen F69, from this flow, contains phenocrysts of olivine and microphenocrysts of melilite and smaller ones of nephelite.

Water-bearing properties.—As the Tantalus flow fills a buried drainage system, it serves as an efficient collecting formation. Some of the “black sand” is associated with it in the lower part of the valley, and this also aids in the collection of water. Apparently sufficient alluvium and soil underlie the basalt to prevent most of the water from percolating downward into Koolau basalt, as numerous springs issue between an altitude of about 800 feet and the end of the Tantalus flow. At an altitude of 775 feet Booth Spring, which is piped to Pacific Heights Reservoir and used by Honolulu, discharges an average of about 46,000 gallons daily.

About 40 feet lower and about 400 feet downstream from Booth Spring is Pump House Spring, where the water rises in an area about 10 feet in diameter in the bed of the stream. On May 24, 1911, Baldwin and Alexander,⁴⁸ by means of weirs placed in the stream above and below the spring, determined its flow to be 121,800 gallons. Measurements on April 6, 1911, by Mr. Martin, of the United States Geological Survey, indicate a higher yield, but it was evidently due largely to wetter weather. The flow of the spring is reported to decline considerably in dry weather.

At an altitude of 618 feet Kahuawai Spring delivers an average of about 280,000 gallons daily.⁴⁹ It is probably the finest high-level spring near Honolulu and is noted for its uniform flow. Monthly mean discharges varied only about 7 percent from the average in 1929 and 1930. Baldwin and Alexander state that it takes 2 days from the time of a heavy rain for the water to reach the spring.

About 320 feet above sea level a small spring issues from a cleft in Tantalus basalt. On May 19, 1911, the spring was yielding about 19,000 gallons daily, but it is reported to go dry at times. At an altitude of about 275 feet Kaaikahi Spring, which is the second largest in Pauoa Valley, issues near the end of the Tantalus lava flow. The water appears in the form of seepage over a considerable area. Baldwin and

⁴⁸ Honolulu Water Commission Rept. p. 289, 1917. A report on all the springs in Pauoa Valley by Baldwin and Alexander is given on pp. 287-292.

⁴⁹ Kunesch, J. F., Water resources of the city of Honolulu, 1928-30, p. 23, 1931.

Alexander show that it discharged about 255,000 gallons daily for several days in May, 1911. On April 13, 1910, it was flowing at the rate of 375,000 gallons daily, and on November 15, 1902, at the rate of 253,700 gallons daily. It is reported to vary considerably with the rainfall. The measurements indicate that the basalt and underlying black sand supply about 700,000 gallons of spring water in a distance of about a mile. Most of this water must be coming from upper drainage, because no perennial streams flow from the adjacent valley walls. Consequently, a tunnel contouring the base of the flow at the upper spring and at right angles to the main valley should recover most of this water with an effective head of about 750 feet. This valley appears to offer the best site near Honolulu for concentrating a large amount of water in one outlet at a high level with a short tunnel.

SUMMARY

In the foregoing pages 32 distinct post-Koolau eruptive centers or groups of vents are described. All the Koko explosion vents are considered as one eruptive group, because the eruptions were separated by no great time interval. Of these vents 13 have not been described before, and some of the remaining 19 have been only briefly noted by previous workers. Of the 36 lava flows erupted from these vents, 25 have not been previously recognized. Lithic tuff deposits were produced by 12 of the vents, and 4 of these deposits were formerly unknown. The eruptions from 8 of the 12 vents produced large tuff cones, all of which are within a few feet of sea level. They blasted their way through extremely permeable coral saturated with water and are believed to have been caused by phreatomagmatic explosions. The eruptions from the other 4 vents, producing lithic tuff, passed through Koolau basalt saturated practically to the surface with high-level ground water confined by dikes. It is believed that these explosions also were phreatomagmatic. Tuff cones were apparently not produced at these vents, because the quantity of ground water was inadequate and was soon exhausted. A study of the history of these volcanic rocks indicates that ordinarily the magma rises through rocks saturated with water but erupts without explosions unless the water is encountered close to the surface.

A striking fact regarding many of the post-Koolau eruptions is that they occurred on high narrow divides several hundred feet above adjacent valleys. Another striking fact is that all post-Koolau activity occurred in the southeastern part of the Koolau Range. Furthermore, as shown in figure 13, the vents fall on lines trending east of north and nearly at right angles to the main Koolau rift zone. Although the trend lines given in this figure could have been drawn somewhat differently on the basis of the dots alone, there can be little doubt that in

FIGURE 13.— Outline map of southeastern Oahu. Dots show all post-Koolau volcanic vents, and lines show dominant rift trends.

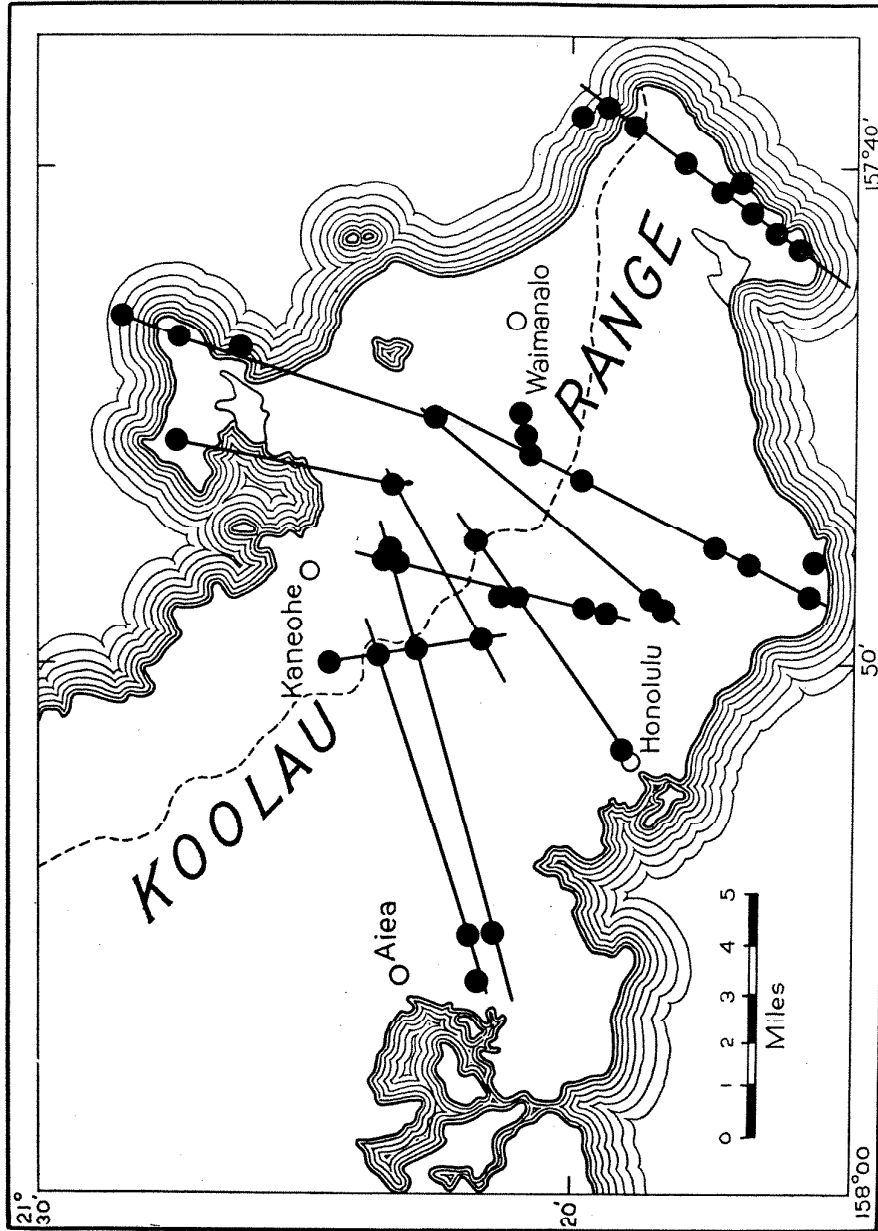

general they fall on lines running nearly at right angles to the crest of the Koolau Range, as shown by such prominent lines as pass through the Koko group or the Diamond Head-Kaimuki group of vents. Most of these lines are parallel to the trough that separates Molokai from Oahu. They also coincide in trend with the late Koolau dikes shown on plate 2 in this area. Most of these lines radiate from the throat breccia of the Koolau volcanic series, which is believed to mark the main center of eruption in the Koolau volcano.

A further interesting fact is that all of the post-Koolau volcanic rocks fall into two main types of basalt. About a third of the vents produced olivine basalt, whereas the other two-thirds produced nephelitic basalts, an ultrabasic lava generally believed to be a residual differentiation product of a lava reservoir. Both of these magmas produced phreatomagmatic explosions; hence tuff cones are not due to any particular rock type.

It appears that all of these post-Koolau eruptions occurred after the middle of Pleistocene time. It is conceivable that other post-Koolau eruptions occurred at earlier dates and that all vestiges of them have been removed by erosion or covered by sediments. However, with the possible exception of one well log there is no evidence that any post-Koolau flows not here described are intercalated in the thick sediments of the coastal plain. There is ample evidence that these eruptions occurred spasmodically every few thousand years up to Recent time. Consequently, there is reason to believe that these eruptive spasms will continue and that we are now living in one of the quiet intervals.

The geologic mapping of Maui has progressed far enough to show that a great erosional interval occurred on Haleakala during the Pleistocene, when great valleys were cut. Some of these valleys, especially Keanae Valley, are known to have been filled with gravel during the Kaena stand of the sea. After this period of relative quiescence Haleakala again became active and poured lava flows down these valleys. Some of the flows are correlative with the Waipio and Waimanalo stands of the sea and some are younger. It appears, therefore, that renewed activity on Haleakala was practically concurrent with the post-Koolau eruptions on Oahu. Late secondary cones are known on West Maui and on Kauai. When the age of these other cones is determined, it may be found that some force or combination of forces rekindled the volcanic fires of the entire Hawaiian group during the Kaena stand in late Pleistocene time. The period of renewed activity may have been concurrent with world-wide mid-Pleistocene crustal disturbances.

QUATERNARY SEDIMENTARY ROCKS

PLEISTOCENE SEDIMENTARY ROCKS

CONSOLIDATED CALCAREOUS MARINE SEDIMENTS

Distribution.—On plate 2 all the consolidated calcareous marine sediments above sea level on Oahu have been mapped as a unit. No attempt was made to distinguish beaches, marls, reef limestones, or deposits of the different stands of the sea on the map. This could be done readily in some localities, but in others they merge without apparent unconformities. It is believed, however, that many scientific data could be gathered by a specialist working on this problem. Perhaps

if extensive collections of fossils were made the reefs might be separated by the relative abundance of the various forms. Oahu, probably because of its stability and age, has more extensive emerged reefs than any other island of the Hawaiian group.

Fossils and climatic changes.—Both Pollock and Ostergaard have studied the reefs, but they did not do their work in relation to various shifts of the sea. Ostergaard⁵⁰ reached the important conclusion, however, that the ocean had a higher temperature during the formation of the emerged reefs than at present, because many species found only as fossils on Oahu are now thriving in the warmer Indo-Pacific waters. This conclusion further supports the theory that the emerged reefs of Oahu grew during warm interglacial periods. As under the glacial-control theory the height of the ocean is an index to temperature, the emerged reefs indicate a higher ocean level and likewise a warmer temperature than at present.

A few fossils were collected during the present investigation, in the hope that some from the higher reefs would prove to contain index fossils. W. C. Mansfield, paleontologist, of the United States Geological Survey, reports that most of the identifiable species in the subjoined list are now living in the Hawaiian Islands. Exceptions among the mollusks are *Arca fuscomarginata* Dunke, *Arca scapha* Chemnitz, and *Codakia punctata* Linne, which are now living elsewhere. He reports that there is a possibility that the fauna at site 12570 may be a little older than that at most of the other places. Field evidence indicates that the limestone at this locality probably belongs to the Waimanalo stand of the sea. He concludes that the fauna at no locality is older than late Pleistocene.

Fossils from Oahu

Determined by W. C. Mansfield

[Numbers are permanent U. S. Geological Survey numbers]

	12567	12568	12569	12570	12571	12572	12573	12574	12575	12576	12577	12578	12581	12582	12583	12585	Living in Hawaii
Gastropods																	
<i>Alectrion hirtus</i> Kiener.....				x	x												x x
<i>Clava sinensis</i> Gmelin.....		x															x x
<i>Columbella</i> cf. <i>C. varians</i> Sowerby (fragment).....									x								
<i>Conus</i> <i>distanis</i> Hwass? (fragments).....														x			
<i>Conus</i> cf. <i>C. abbreviatus</i> Reeve.....																	
<i>Conus</i> sp. (Corroded).....		x															
<i>Conus</i> sp. (Corroded).....	x																
<i>Conus</i> sp. (Corroded).....																	
<i>Cypraea caput - serpentis</i> Linne.....													x				x
<i>Cypraea puntulata</i> Gmelin.....													x	x			x
<i>Cypraea sulcidentata</i> Gray.....													x	x			x
<i>Cypraea vitillus</i> Linne.....																	x
<i>Cypraea madagascariensis</i> Gmelin.....		x					x						(?)				x

⁵⁰ Ostergaard, J. M., Fossil marine mollusks of Oahu: B. P. Bishop Mus. Bull. 51, p. 32, 1928.

Fossils from Oahu—Continued

Determined by W. C. Mansfield
 [Numbers are permanent U. S. Geological Survey numbers]

drina Dana.....	x	x																			
Pocillopera frondosa Ver- rill?																					
Pocillopera sp. undet.....																					
Cyphastrea ocellina Dana...																					
Fungia sp. Undet.....	x																				
Acropora sp. (not A. echi- nata, a Hawaiian species)																					
Montipora M. cf. flabellata Studer?																					
Porites compressa Dana.....																					
Porites lobata Dana?.....	x																				
Porites cf. P. lobata Dana?																					
Porites spp. undet.....																					
Callydon sp.....		x																			

- ¹ Living: Marshall Islands, North Queensland, Tuamotu Islands.
- ² Living: Fiji, Samoa, Philippines.
- ³ Recent: Fiji and East Indies.
- ⁴ Concentric sculpture more beaded than on Recent species.
- ⁵ Concentric sculpture slightly stronger than on Recent species.
- ⁶ Identified by Dr. Mary J. Rathbun, U. S. Nat. Mus.
- ⁷ Identified by J. W. Wells.
- ⁸ Identified by E. D. Reed, U. S. Nat. Mus.
- 12567. At 80 to 90 feet above sea level, 2,000 feet west of highest point on Ulupau Head.
- 12568. About 40 feet above sea level, 2,900 feet west of highest point on Ulupau Head.
- 12569. Marine sediments covered with talus breccia along the shore 1,900 feet west-northwest from Ulupau Head.
- 12570. Emerged reef 15 feet above sea level, 2,800 feet east of Puu Papaa, on Mokapu Peninsula.
- 12571. Marine mudstone 8 feet above sea level, in 35-foot terrace on southwest side of Heeia Pond at mouth of Haiku Valley.
- 12572. Emerged lithified conglomerate on Kaena Point, 81 feet above sea level.
- 12573. Emerged reef about 10 feet above sea level, on west side of north Mokulua Island near Kailua.
- 12574. Emerged deposits near Laie.
- 12575. Drainage ditch about 2 feet above sea level, 2,000 feet east-southeast from Mormon temple at Laie.
- 12576. About 60 feet above sea level, in limestone cliff in highway cut 1½ miles northwest of Kahuku.
- 12577. About 60 feet above sea level, in reef exposed beneath lithified dune 1 mile due west of Kahuku.
- 12578. Reef and underlying beach sediments 60 feet above sea level, 1½ miles northwest of Kahuku, at type locality of Kahuku stand of the sea.
- 12581. Emerged conglomerate about 15 feet above sea level, on west side of south Mokula Island.
- 12582. Emerged sandy beach deposit 30 feet above sea level, 1,200 feet south-southeast from Alala Point, at Lanikai.
- 12583. About 40 feet above sea level, in emerged reef at quarry at limekiln near Waianae.
- 12585. Emerged limestone 60 feet above sea level, on southeast side of reservoir 10, Ewa Plantation, three quarters of a mile northwest of Gilbert.

Beach sediments.—The consolidated beach sediments usually show good bedding planes and consist of cream-colored to white cemented water-worn grains of comminuted marine organisms, in most places containing a few shells and fragments of water-worn coral. The grains are distinctly coarser than those in lithified dune deposits and are mostly over half a millimeter in diameter. The older the deposits the more altered they become, owing to solution and the deposition of secondary calcite. The lithified beach deposits are exposed over a very small area on Oahu and have no importance as an aquifer. A few strips of lithified beach sediments that may be recent have been included on plate 2.

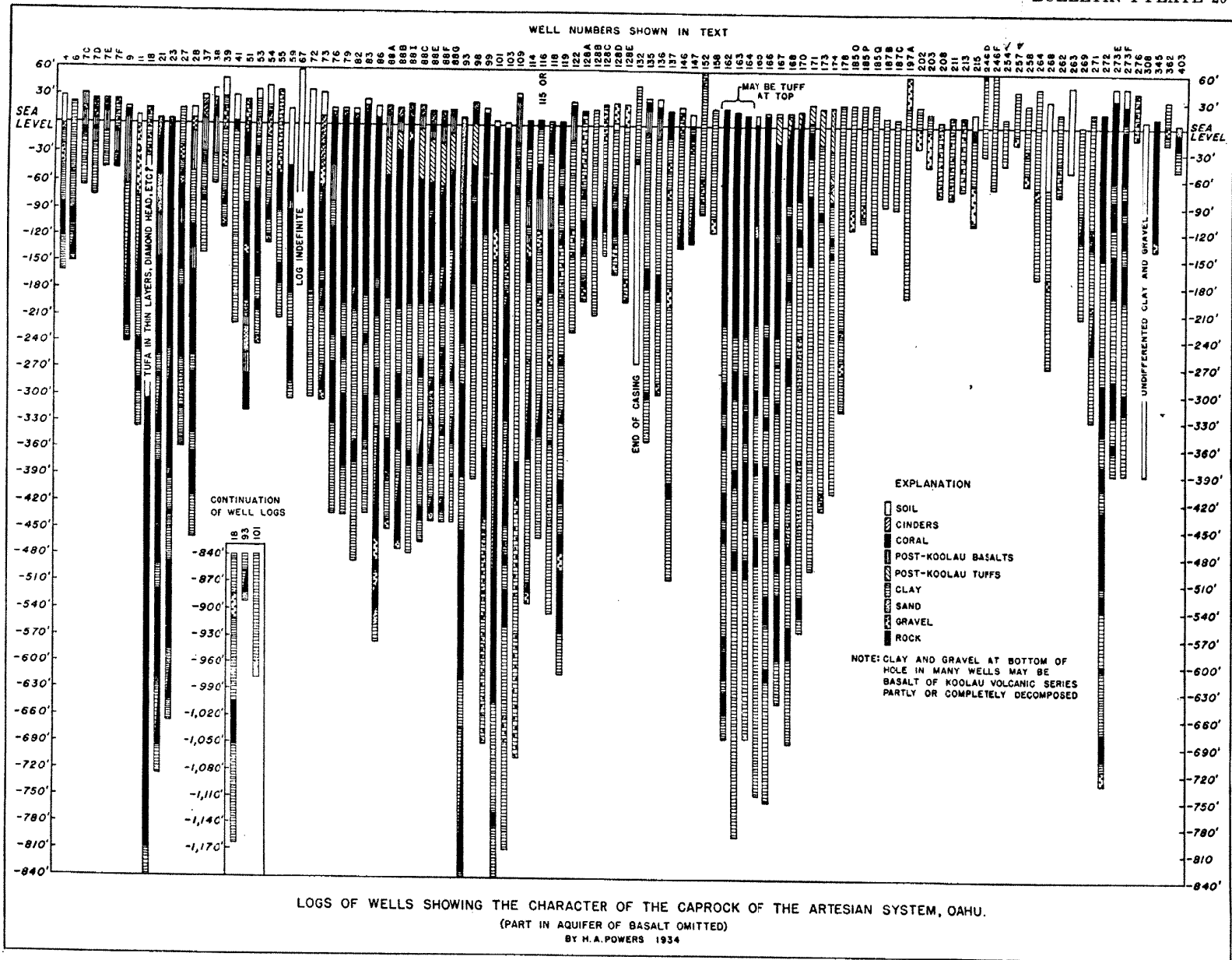

WELL LOGS OF OAHU PLOTTED GRAPHICALLY

NOTE THE ALTERNATION OF REEF WITH NONCALCAREOUS SEDIMENTS, INDICATING ALTERNATE PERIODS OF EMERGENCE AND SUBMERGENCE, AND ALSO THE NEARLY CONTINUOUS REEF ABOVE THE 300-FOOT LEVEL

Reef limestone.—The emerged reefs consist of coral heads and coralline algae cemented by a lime matrix. The maximum thickness of reef above sea level is 90 feet, but numerous thicker submerged reefs have been encountered in deep wells. The well logs plotted in plate 20 indicate that limestone extends down to a depth of at least 1,178 feet near Diamond Head, as shown by well 18. There is sufficient concordance in the buried reefs as shown in plate 20 to suggest that reef growth alternated with periods of sedimentation. These alternations may well have been caused by fluctuations in the level of the ocean coincident with world-wide glacial and interglacial stages.

Water-bearing properties.—The reef limestone contains numerous cavernous openings, in part caused by solution since emergence and in part original openings in the reef that were never filled. These cavities make the reef extremely permeable. Wells penetrating reef limestone usually obtain brackish water. Several wells, such as the one formerly used by the Waianae Plantation at the mouth of Lualualei Valley, became too salty to use because they were dug too deep. At the ends of some of the spurs in the Koolau Range springs with a low salt content discharge from reef rock. At these places the limestone forms a narrow outcrop, and the water is supplied to the springs from Koolau lavas a few feet away. Irrigation supplies are being recovered from wells and tunnels in reef rock on the Ewa and Waianae Plantations. The water in the Ewa Plantation appears to be largely return irrigation water from the higher lands, and the tunnels in Waianae Valley are supplied in part by return irrigation water and in part by ground water moving down Waianae Valley. Large supplies of brackish water have been encountered in the coral plain near Honolulu.

CONSOLIDATED CALCAREOUS DUNES

The consolidated calcareous dunes consist of thin-bedded and cross-bedded lithified calcareous sand drifted inland from ancient beaches. The character of the bedding almost always distinguishes them from lithified beaches, as shown in plate 11, A. Furthermore, the grains are usually under 1 millimeter in diameter and are distinctly more uniform in size than beach sand. The deposits still retain the form of dunes, as shown by the topography on plate 2. They extend to 280 feet above sea level back of Laie, but their maximum thickness is about 125 feet. Lithified dunes occur chiefly near Waimanalo, Kailua, Laie, Kahuku, and Diamond Head. They are all older than the Waimanalo stand of the sea and are mostly correlative with the Waipio stand, and hence probably of late Pleistocene age. As they lie mainly above the water table they are unimportant as aquifers. In general they contain sufficient solution channels to serve as intake formations. The area covered by lithified dunes is shown on plate 2.

CONSOLIDATED AND PARTLY CONSOLIDATED NONCALCAREOUS SEDIMENTS

Distribution and character.—The consolidated and partly consolidated noncalcareous sediments cover an appreciable area of Oahu (pl. 2). They include older alluvium, ancient talus and landslide deposits, and marine noncalcareous sediments. They fill valleys and form fans at the valley mouths that change seaward into delta deposits. Practically all these sediments mapped on plate 2 were laid down at higher stands of the sea, and most of them antedate the Waipio stand. They are characterized by rotted and partly decomposed friable red to brown poorly assorted lenticular conglomerates in the valleys and fans (pl. 13, A). Along the coast, where they become marine, fine brown stratified siltstones with scattered lenses of gravel predominate. Except in a very few places, as near Pearl Harbor, these deposits contain no fossils. The marine gravel is usually cleaner than the stream gravel, but this characteristic is not consistent enough to distinguish the two types.

In the arid valleys of the Waianae Range these deposits are much less rotted than in the rainy areas. The cementing material is apparently limonite in most places. At the head of Waianae Valley some of the ancient talus is a firmly cemented breccia.

Consolidated noncalcareous sediments similar to those described above extend 1,200 feet below sea level 2 miles inland in Lualualei Valley, as shown by the well logs. Black and red clay was reported at 1,251 feet below sea level in well 18 near Diamond Head. The epoch of sedimentation in which these thick deposits were laid down was concurrent with the erosion of the great valleys on Oahu. The total thickness of the consolidated and partly consolidated noncalcareous sediments is therefore not to be calculated only by their thickness above sea level, which amounts to about 200 feet, but to this figure should be added at least another 1,200 feet near the coast for their submerged part.

Water-bearing properties.—The noncalcareous sediments in general are not very permeable—in fact, they make up part of the cap rock of the artesian basins and hold up perched water where overlain by post-Koolau basalts. Water percolates slowly through them, as shown by the Gay tunnel, in Kalihi Valley, which penetrated them for about 2,000 feet and yielded only a few gallons a minute. In Waianae and Makaha Valleys, where the sediments are cleaner and less rotted, small irrigation supplies are obtained from them. A dug well near the mouth of Keaau Valley and a tunnel in Nanakuli Valley both obtain water from these sediments. Small supplies can probably be developed in the gravel beds in this formation in Lualualei Valley. A shaft connected with tunnels at right angles to a valley, similar to the one in Nanakuli Valley is the most efficient way to develop this water.

RECENT SEDIMENTARY ROCKS

UNCONSOLIDATED CALCAREOUS MARINE SEDIMENTS

The unconsolidated marine calcareous sediments shown on plate 2 consist chiefly of bedded cream-colored and light-tan beach sand made up of grains of water-worn coral, coralline algae, and shells with appreciable amounts of foraminifers and other calcareous marine organisms. In a few places lava detritus occurs sparingly; in some places coral pebbles and shell fragments predominate; and near tuff cones grains of olivine are conspicuous in these sediments. They have a variable thickness but rarely exceed 25 feet. They are very permeable and usually contain brackish or ocean water, except where they form barriers to fresh-water lagoons or cover the ends of lava ridges. In the barrier beach bordering Kawainui Swamp, near Kailua, wells yield water sufficiently fresh and in quantities adequate to irrigate small gardens. Fresh-water springs issue from these sediments at tide level where they lie at the ends of lava rock ridges that discharge large quantities of fresh water.

UNCONSOLIDATED CALCAREOUS DUNES

The unconsolidated calcareous dunes consist of fine-grained cream-colored sand blown inland from the present beach. They occur in sufficient size to be shown on plate 2 near Waimanalo, Mokapu Point, Kailua, Laie, and Kahuku.

On the north coast about 5 miles east of Kaena Point a narrow beach ridge 15 to 20 feet high capped by dune sand forms a distinct topographic feature a mile in length. A trench through this ridge shows that it is partly consolidated and contains beach sediments at the bottom near sea level. It has been included with recent deposits, however, because there is no evidence that it was laid down by a different sea from that of today. Fresh water is now drained through the ridge, suggesting that the partial lithification resulted from fresh water percolating through it.

The recent dunes are very permeable, and near sea level they usually contain brackish or sea water.

UNCONSOLIDATED NONCALCAREOUS SEDIMENTS

Distribution and character.—All deposits of unconsolidated noncalcareous sediments of appreciable size are shown on plate 2. They consist of younger alluvium, a black to brown fluvial deposit generally consisting of coarse detritus only slightly weathered and in many places subangular. In the valley bottoms near the sea this deposit consists of black sticky mud called "taro-patch clay," which is probably a slightly reworked sediment of the Waimanalo stand of the sea. Much of the younger alluvium is older alluvium reworked by streams. Talus composed of angular blocks, usually with brown interstitial

soil and forming aprons on steep slopes at the base of cliffs has also been mapped as part of the unconsolidated noncalcareous sediments. In the mountain areas much of the younger alluvium resembles, includes, and is in places inseparable from landslide deposits, because of the torrential character of the streams and the precipitous slope of the valley walls. Extensive mantles of hill wash are also included.

Water-bearing properties.—Most of these sediments are very permeable, especially the gravel and talus. They form an important intake formation because so large a part of them lies above the water table. Near the sea, where they lie in the zone of saturation they are finer-grained and yield water in small quantities but generally of good quality. They are relatively unimportant as aquifers. The thickness of the unconsolidated noncalcareous sediments, except where they consist of landslides, does not appear to exceed about 20 feet. They lie unconformably on the emerged reef near the sea and on the older alluvium in the valleys; hence they are of Recent age.

HISTORIC ARTIFICIAL FILLS OF MARINE SEDIMENTS

Areas of artificial fills sufficiently extensive to be shown on plate 2 occur near Honolulu and Pearl Harbor. They consist of brown to white marine muds containing shells, coral, and other calcareous marine organisms dredged from the ocean floor and used to fill up salt marshes and other low lands. Around Pearl Harbor the fills are mostly brown mud, in places containing numerous shells but very little coral. The coral fills are very permeable and yield brackish water at shallow depths, but the brown muds are almost impermeable. These fills rarely exceed 10 feet in thickness.

STRUCTURE

The major structural feature of each of the Waianae and Koolau domes in cross section is a gentle constructional arch with its axis coincident with the crest of the volcano. It is almost entirely the result of lava flows accumulating around a fissure vent. The intrusion of hundreds of dikes into the domes have probably caused a slight but doubtfully measurable change in the dip of the beds. The Hawaiian Volcano Observatory reports tumescence of Kilauea prior to an eruption, but probably most of such swelling is lost when the magma subsides. Dike rock occupies practically all of the heart of the Oahu rift zones. This means that the flow lavas have in part been displaced sidewise with each injection, partly carried upward as fragments and partly dropped into the magma reservoir and remelted. All these factors appear to play a part, but local melting at the edge of the dikes is practically everywhere insignificant. The graben depression

along the rift zone of Kilauea⁵¹ indicates that subsidence of the slivers of rock into depth, presumably by remelting from below, is an active process, probably as important as the actual crowding aside of the flow lavas by the injection of dike rock.

FAULTS

Waianae Range.—The buried cliffs and their associated breccia in the Waianae Range are described in detail on pages 80 to 86. They may have been caused by faulting. A fault breccia 6 to 12 inches wide marks a fault of unknown displacement parallel to one of these cliffs in the Keaau-Makaha Ridge, as shown on plate 2. Displacements of a few inches to several feet were noted in both ranges, but they are not large enough to justify individual description.

Koolau Range.—The only large fault seen in the Koolau Range crosses the winding road down Nuuanu Pali in two places, as shown on plate 2. At an altitude of 750 feet in the lower exposure, the fault strikes N. 70° E., dips 63° E., and consists of a platy shear zone 4 to 6 feet wide with 3 to 6 inches of clay gouge in the center. The amount of the displacement could not be determined, but the conspicuously bedded pahoehoe on the west side could not be matched with any of the rocks exposed in the cliff along the road. The rock on the east side is a massive amygdaloidal basalt that may be intrusive. Similar relations exist at an altitude of 950 feet. At 975 feet, where the fault crosses a small perennial stream, the dip decreases to 45° and the fault is accompanied by much clay gouge and a wide strip of breccia. In one place slightly displaced blocks in the breccia can be matched. The same gray intrusive (?) rock occurs at this place in contact with bedded pahoehoe.

About 300 feet up the road from the lower exposure of this fault an irregular dike is displaced slightly by two parallel faults striking N. 65° W. and dipping 32° NE.

Thin streaks of breccia indicative of faulting were seen in several of the Waiahole tunnels in association with dikes. In view of the repeated cracking and slipping concurrent with fissure eruptions in the major rift zone of a basaltic volcano of this type, such streaks of breccia have little significance.

Two faults are shown on plate 2 along the road between the Maunawili Training School and Waimanalo, and others occur in and near the Fault tunnel, in the Maunawili area. All of them cause only small displacements.

SYNCLINES

Two synclines occur on Oahu—one at Puu Kailio, at the center of the Waianae Volcano, and the other at Lanikai, near the eruptive center of the Koolau volcanic series.

⁵¹ Stearns, H. T., and Clark, W. O. Geology and water resources of the Kau District, Hawaii: U. S. Geol. Survey Water-Supply Paper 616, p. 87, 1930.

Kailio syncline.—The Kailio syncline forms Puu Kailio, near Kolekole Pass, at the head of Lualualei Valley (pl. 2). The rocks making up the syncline are the lower lavas of the Waianae volcanic series. The syncline occupies about three-quarters of a square mile at the eruptive center of the Waianae Volcano. The axis trends N. 70° E. The beds on the north side dip 28° S., and those on the south side dip 14° N., as shown in plate 21 A. The syncline is terminated on the east side by a nearly vertical cliff against which rests talus breccia cut by dikes.

Lanikai syncline.—The Lanikai syncline forms the hills adjacent to Lanikai, near Kailua, on the northeast shore of the Koolau Range (pl. 2). The rocks making up the syncline are Kailua amygdaloidal lavas cut by dikes. The axis trends N. 65° E., and plunges southwest away from the dike complex of the Kailua series, with the beds dipping toward it at angles of 5° to 10°. The south limb of the syncline can be discerned in plate 21 B.

Cause of synclines.—The fact that both the Lanikai and Kailio synclines occur at places of intense volcanic activity suggests that they are merely sags in the flows produced by local withdrawal of support. On Mauna Loa and Kilauea the jointed flows generally break rather than bend when support is withdrawn, as shown by the great number of narrow dropped blocks on these two volcanoes. However, at some depth below the surface, especially in their calderas, where the lavas may be either slightly plastic or rendered temporarily so by reheating, sagging rather than breaking would be expected if the support is slowly withdrawn.

GEOLOGIC HISTORY^{51A}

The geologic history of Oahu began with the first outpourings of lava from the great fractures in the ocean floor that underlie the 1,500-mile Hawaiian submarine ridge, of which Oahu is only an insignificant part that extends above sea level. These great fractures may have persisted since early geologic time. The first step of importance in the history of Oahu proper was the appearance of land at the site of this island. By comparison with other youthful volcanic islands, the first land was probably a tuff cone, because a submarine eruption close to the surface is usually explosive. The first cone may or may not have withstood wave attack, but successive eruptions must have followed with sufficient rapidity to build a small island. Then the explosions progressively decreased with the increase in height, because there was less chance of water coming into contact with the magma. Eventually the usual hard basalt flows veneered the island and protected it from rapid wave destruction. The site of the first island was probably either in the vicinity of Kolekole Pass, at the

^{51A} For a popular account of the Geology of Oahu see Stearns, Norah D., *An island is born*, 115 pages, 32 plates, 26 figures, Star-Bulletin, Honolulu, 1935.

head of Lualualei Valley, in the Waianae Range, or near the Mokulua Islands, between Kailua and Waimanalo Bays. The order of appearance above sea level of these two main vents is conjectural. To judge from physical appearances only, the basalt of the Kailua volcanic series is older than any other rocks on Oahu, but this appearance is mostly the result of hydrothermal alteration, which may have taken place relatively late in the history of Oahu. Perhaps a study of the radium content of the various lavas will shed some light on this question. In the absence of such data the Waianae Volcano is assumed to have appeared first, because it was the first of the two major volcanoes on Oahu to become extinct. However, time of extinction may have little significance, and the Koolau and Waianae Volcanoes may have been concurrently active until late in the history of the island. Consequently, the order of events before the first erosional unconformities were produced is speculative.

The first lavas that were poured out from the Waianae Volcano form the lower member of the Waianae volcanic series, and the lowest flows exposed at sea level near Kolekole Pass indicate that they were very viscous. The bottom flows are several hundred feet thick, and one is a hornblende-biotite trachyte. Then came thin flows of very fluid basalt, extruded quietly, like the flows of Kilauea, with scarcely any firefountains. The lower lavas of the Waianae volcanic series were extruded during this first phase, and a flat oval dome at least 3,000 feet high was built over two rifts intersecting near Kolekole Pass, as shown in plate 22, A. One of these rifts trends south-southeast, and the other northwest.

In view of the submergence of Oahu more than 1,200 feet in late geologic time the lowest exposed lavas in the heart of the two volcanoes are not necessarily indicative of the type of lava poured out above sea level in the beginning of the island. Additional submergence of which no record is now available may have occurred also.

A period of faulting (?) followed this first phase, and most of the northeastern part of the dome collapsed, leaving cliffs, some of which were 2,000 feet high, extending across what is now the head of Nanakuli and Lualualei Valleys and along the north side of Makaha Valley, as shown in plate 22, B. This period of collapse appears to have been nearly concurrent at all three places. It is not known whether it led to the formation of great calderas or great cliffs exposed to wave attack or both. In any event, the land to the south and west was free from inundation by flows during a period long enough for soil a foot or so thick to form and for erosion to expose dikes. During this cycle of erosion the ancestral streams of the large westward-draining valleys of the Waianae Range were started, as shown in plate 22, B.

After and perhaps concurrent with the period of collapse an additional 2,000 to 3,000 feet of lavas were poured out from the two rifts. These flows were ponded by the cliffs on the southwest, so that they spread mostly northeastward, as shown in plate 22, B. They were similar to the earlier basalts except that aa flows ceased to be scarce. Thus were the middle basalts of the Waianae volcanic series laid down. Finally they overtopped the earlier basalts near the present site of Makaha Valley and cascaded westward over an erosional slope, which exposed dikes that fed the lower basalt. The time interval between the flows that cascaded in this manner was long enough to allow some of the first cascading flows to be truncated by erosion also.

At this phase of lava extrusion began to wane less fluid lavas were extruded and the upper basalt of the Waianae series was laid down. Most of the late eruptions produced nephelite basalts. The upper basalt reached a thickness of about 2,500 feet and overtopped the lower basalts in many places, as shown in plate 23, A. These flows were mostly massive aa and were accompanied by strong firefountains. They built up the Waianae Volcano to a height of at least 5,000 feet, and the final eruptions studded it with cinder cones like Mauna Kea, in Hawaii. Thus the Waianae Volcano passed through three distinct phases in its growth above sea level—(1) extravasation of a few viscous and then only voluminous very fluid lavas in rapid succession, accompanied by an inappreciable number of firefountains, the youthful cone-building phase; (2) period of collapse and further extrusion of fluid lavas, with a few mild firefountains, the mature or collapse phase; (3) progressive slowing down of activity characterized by outpourings of massive more siliceous flows, mostly aa, accompanied by strong firefountains and ending with the extrusion of nephelite basalts, the old-age or cinder-cone phase.

Catastrophic explosions probably occurred less than a dozen times in the history of the Waianae Volcano, to judge from the number of lithic tuff beds observed. It was truly a Hawaiian type of volcano, characterized by relatively rapid lava extrusion, insignificant explosions, definite rift systems, fissure feeders only a few feet wide, and a dome or shield-shaped volcano consisting of thin- and even-bedded lava flows of pahoehoe and aa. The time involved in building the Waianae dome is unknown, but Tertiary time was sufficiently long for its development. With the cessation of activity an ephemeral stream pattern developed on the windward side in the massive lavas of the third phase. It seems likely that the streams that started on the west slope at the end of the first stage had carved deep canyons by the end of the third stage of volcanism. They had natural advantages over

those on the windward slope, because they were flowing across weaker rocks and, being more deeply incised, were supplied by ground water, which made them perennial.

If the Koolau-Kailua-volcano did not start at the same time as the Waianae Volcano it probably appeared above the ocean level soon afterward. At first these two volcanoes must have formed separate islands, as shown in plates 22, A, B, and 23, A. The early flows of the Kailua Volcano evidently issued from cracks running about N. 55° E. through the present site of the Mokulua Islands, near Kailua. The dips of the Kailua flows poured out of this rift indicate that a normal Hawaiian dome about 1,500 feet high was built, as shown in plate 22, A. Only the flows on the southwest side of the dome are now exposed.

The next event was a shift of the activity to a rift practically parallel to the Kailua rift and about a mile southwest of it, as shown in plate 22, B. This became the main rift of the Koolau Volcano, and most of the basalt was extruded from it. Another rift extending about S. 30° W. and intersecting with the main rift near Olomana Peak was the source of only a few flows. Thin fluid flows of pahoehoe and aa averaging about 30 feet in thickness were poured out in rapid succession from the main rift of the Koolau Volcano. The final result was a long inverted-canoe shaped dome, of about the same height but several times the bulk of the Waianae dome, with its center and caldera between Olomana Peak and Kaneohe, as shown in plate 23, B. The absence of soil layers exceeding a few inches in thickness and the presence of only a few deposits of lithic and vitric tuff indicate that the flows were laid down in rapid succession, with only occasional fire-fountains and only about a dozen catastrophic explosions.

The last Koolau flows overlie unconformably the eroded slopes of the Waianae Range and indicate that the Koolau Volcano ceased activity an appreciable time after the Waianae Volcano.

After this period of volcanic activity streams slowly became established on the Koolau dome. This cycle of erosion was not interrupted until a large part of the windward side of the dome had been eroded away, wide valleys several thousand feet deep had been carved in the leeward side, and coral reefs had become established on its peaceful shores (pl. 24, A). At first the streams on the east side of the Waianae dome sank into the porous Koolau lavas, as shown in plate 23, B, but gradually they silted up their channels and joined the Koolau streams, as shown in plate 24, A.

Next, the entire island was submerged by more than 1,200 feet and had the form shown in plate 24, B. During this time the valleys became filled with sediments. The presence of reef limestone intercalated with the sediments along the coast indicates that the submergence was

gradual. Before it was completed spasmodic eruptions began on the southeast end of the Koolau dome. These eruptions were accompanied either by strong firefountains or by catastrophic phreatomagmatic explosions. They continued intermittently until Recent time, but the legends of Hawaiian people do not record them. Most of these lavas are nephelite basalts. Thus the Koolau dome passed through essentially the same three stages as the Waianae Volcano. The main dome was built of fluid lava during the first stage, the second or collapse phase resulted in a caldera on its summit, and the third stage is represented by strong firefountains and phreatomagmatic explosions and short massive flows, chiefly nephelite basalts. The time interval between the second and third phases of the Koolau Volcano was longer, however, than that of the Waianae Volcano.

The first event definitely recorded after the deep submergence of Oahu is a stand of the sea about 55 feet above the present strand. This was followed by the emergence of Oahu by an unknown amount but perhaps about 300 feet, during which streams eroded the emerged marine deposits of the 55-foot sea. Then the sea rose 95 feet above present sea level and stood there long enough for most of the valleys to be graded to this level. Once more the sea slowly receded, with temporary halts at 70 feet and probably at 40 feet above present sea level. The decline continued to a level about 60 feet lower than the present sea. The sea remained at this low stage long enough for valleys to be cut to this depth and for extensive soils to form. Fossil plants in the Salt Lake and Diamond Head tuffs indicate that the climate became wetter near sea level at this time. Next the sea rose about 25 feet higher than the present level and remained in this position long enough for fringing reefs to grow but not long enough for the extensive alluvial deposits of Oahu to be entirely regraded to this level. Then the sea fell to its present stage as shown in plate 25, A. These oscillations in sea level were possibly correlative with the alternate withdrawal and return of water from the ocean in response to advances and recessions of the polar ice caps and to accompanying adjustments of the earth's crust.

The sequence of events in the geologic history of Oahu may be summarized as follows:

TERTIARY TIME

1. Building of a dome-shaped island about 3,000 feet high by the extrusion of the lower lavas of the Waianae volcanic series from southeast and northwest rifts, with the center of activity at their intersection near the present site of Kolekole Pass (pl. 22, A). Extrusion of basalt of the Kailua volcanic series from a rift passing through the site of the present Mokulua Islands, forming another island at about the same time (pl. 22, A).

2. Collapse of Waianae dome and extrusion of the middle basalt member of the Waianae volcanic series from the Waianae rifts. The cliffs formed by the collapse

ponded the middle basalt and forced most of it to flow north and east. Beginning of erosion to the west of these cliffs, starting the valleys of Nanakuli, Lualualei, Waianae, Makaha, Keaau, and Makua. Shift of volcanic activity a mile south of the Kailua rift, with the extrusion of the older layers in the Koolau volcanic series probably about this time (pl. 22, B).

3. Extrusion of the upper lavas of the Waianae volcanic series and continued erosion of the valleys named above. The main bulk of the Koolau basalts was probably extruded at this time (pl. 23, A).

4. Extinction of the Waianae Volcano and the beginning of erosion all over it (pl. 23, B). Continued extravasation of Koolau lava.

5. Overlapping of the Waianae dome by Koolau lavas, resulting in the partial filling of its eastern valleys and the joining of the two volcanoes to form a single island. Continued erosion of the leeward side of the Waianae dome (pl. 23, B).

EARLY (?) PLEISTOCENE TIME

6. Cessation of activity of the Koolau Volcano and beginning of erosion of it. Continued erosion of the Waianae dome (pl. 24, A).

7. Long cycle of erosion resulting in the sweeping away by streams of most of the windward (northeast) side of the Koolau dome and part of the leeward side of the Waianae dome. High cliffs formed on the end of interstream divides by marine abrasion. Coral started growing about this time, if not before.

8. Gradual submergence of Oahu by more than 1,200 feet, resulting in the drowning and sedimentation of the valleys and the formation of the Koolau Pali by the burial of interstream divides of great amphitheater-headed valleys. Continued marine abrasion on exposed headlands and growth of coral reefs (pl. 24, B).

MIDDLE (?) AND LATE PLEISTOCENE TIME

9. A halt of the sea at 55 feet above present sea level, known as the "Kahuku stand."

10. Recession of the sea to a level below 55 feet, known as the "Kahipa stand." Erosion of deposits of the previous stand of the sea.

11. Rise of the sea to 95 feet above present level, known as the "Kaena stand." Extrusion of some of the Honolulu basalts, vigorous growth of coral reef offshore, and grading of valley floors to this level (pl. 24, B).

12. Recession of the sea to 70 feet, known as the "Laie stand." More eruptions of the Honolulu basalts, growth of coral reef offshore, and continued erosion.

13. Halt of the sea at the 40-foot (?) level, known as the "Waialae stand."

14. Recession of the sea to about 60 feet below the present level, known as the "Waipio stand." Additional eruptions of the Honolulu basalts, dissection of all previous high-level deposits, vigorous wave attack on headlands, and possibly dying of corals.

15. Rise of the sea to about 25 feet above the present level, known as the "Waimanalo stand." Further eruptions of the Honolulu basalts, drowning of the mouths of valleys, renewed erosion of the higher deposits, and growth of coral offshore.

LATEST PLEISTOCENE OR RECENT TIME

16. Recession of the sea to the present level, conclusion of eruption of Honolulu basalts (Koko fissure, and Tantalus-Sugar Loaf eruptions), continued erosion, and growth of coral offshore (pl. 25, A).

PETROLOGY AND PETROGRAPHY

After a short time in the field it was recognized that most of the post-Koolau eruptions had produced a lava different both megascopically

and microscopically from the older flows. As this petrographic difference greatly facilitated the field mapping, slides were made of all these basalts not previously studied by others and this series of rocks is therefore fully represented. The petrographic difference will also greatly facilitate prospecting for water. Nephelite and nephelite-melilite basalts are such petrographic rarities that numerous articles have already been published about the occurrence of these rocks at a few localities on Oahu, but, as is shown below, these rocks are common on Oahu and make up a large percentage of the late eruptives of both the Waianae and Koolau Ranges.

No pillow lavas were noted in the Koolau, Kailua, or Waianae volcanic series. A few poorly developed pillows occur in the Kaau basalt at Kapahulu Quarry and a peculiar brecciated phase suggestive of pillow lavas occurs in the Haiku basalt along the coast. Stratigraphic evidence indicates that they formed beneath water. The complete absence of pillow lavas other than those noted indicates that they did not form subaerially on Oahu.

The systematic mapping of the island has made it possible to correlate stratigraphically the specimens heretofore studied by others, not all of whom knew the field relations. This correlation is based entirely on their published descriptions of the localities where the specimens were collected. It is hoped that the correlation of previously studied rocks, the geologic map (pl. 2), and the new slides of the rocks of the Waianae and Koolau volcanic series will prepare the way for an intensive systematic petrographic study of the rocks of Oahu.

I am greatly indebted to A. H. Koschmann and Howard A. Powers, of the United States Geological Survey, for aid in this petrographic study. Mr. Koschmann wrote descriptions of 41 of the 69 slides. Mr. Powers has carefully criticized this part of the report and both by discussion and by study of the slides has contributed a great deal toward it. His study of hundreds of slides of the flows on Hawaii during the last few years has made his contribution especially valuable. Both Mr. Koschmann and Mr. Powers should be considered joint authors of this section.

WAIANAË VOLCANIC SERIES

LOWER BASALT

The greatest variation occurs in the Waianae lavas, but the unusual rocks are limited to a few flows. Most of the lower rocks, to judge from their megascopic characteristics and habits of flow, consist of the usual basalts characteristic of the Hawaiian volcanoes. They occur chiefly as pahoehoe, vesicular and dense nonporphyritic basalts, and porphyritic olivine basalts with or without feldspar phenocrysts. A few flows are so rich in olivine that they may be pierite basalts. Some of the unusual flows were examined in thin section.

The petrographic descriptions of all the specimens examined in thin section, except the pyroclastic rocks, are given on page 189. Specimen F1 is the first reported occurrence of a hornblende-biotite trachyte in the Hawaiian Islands and the only occurrence of trachyte noted on Oahu. Trachyte on Maui, Molokai and Hawaii was erupted during the declining phase of the volcanoes which built these domes. It appears to differentiate from the basaltic magma during the long quiescent periods following the epoch of rapid outpourings of fluid basalt. Because the trachyte on Oahu is exposed at what appears to be the lowest stratigraphic position in the Waianae series, and because elsewhere in Hawaii it marks the dying phase of a basaltic volcano, it may indicate the summit of an older volcano buried by the Waianae lavas.

Specimen F5 came from a thick flow directly above F1 and is a porphyritic andesine basalt.⁵² It differs from the later flows of this member in being very massive and filled with feldspar laths 0.5 to 1 centimeter long.

Specimen F293 was collected from a massive bed in Puu Kailio, and the amount of soil cover makes it uncertain whether this rock is a sill or a flow. If a sill, its proximity to the eruptive center of the Waianae Range makes its stratigraphic position uncertain, as it could have been injected at any time during the building of the Waianae dome.

The lower basalt member of the Waianae volcanic series is represented by only a few slides in all previous publications. Hitchcock collected three specimens from the Makua cliffs, one from a flow and the other two from dikes. Doubtless the flow is lower Waianae, and possibly the dikes are also. Cross⁵³ describes the flow and one of the dikes as olivine-plagioclase basalts and the other dike as bronzite-bearing basalt. Among the rocks collected by Hitchcock are flow and dike specimens from Kaena Point. The flow is probably lower Waianae and is described by Cross as olivine-plagioclase basalt with a notable amount of biotite. The dike may have supplied any of the Waianae basalts, but it was most likely a feeder for a lower Waianae flow. It is described as olivine diabase by Cross and is probably from the same dike as specimen F137, described in the table. The lower lavas of the Waianae series contain hornblende-biotite trachyte, porphyritic andesine basalt, olivine-plagioclase basalt, olivine-biotite-plagioclase basalt, and bronzite-bearing basalt. Doubtless olivine-free plagioclase basalts will also be found. A careful search revealed no rocks identifiable megascopically as nephelite basalts, and it is thought that they will not be found in this member.

⁵² Washington, H. S., *Petrology of the Hawaiian Islands—1, Kohala and Mauna Kea, Hawaii*: Am. Jour. Sci., 5th Ser., vol. 5, pp. 468-474, 1923.

⁵³ Cross, Whitman, *Lavas of Hawaii and their relations*: U. S. Geol. Survey Prof. Paper 88, p. 19, 1915.

BRECCIA

Specimen F308, collected from a breccia outcrop near the head of Waianae Valley, although not quite typical of the Waianae series breccia because of its fine grain, was chosen for thin section because of its texture. It consists of angular fragments of several kinds of basalt cemented with a cryptocrystalline iron-stained material probably silica. This slide was cut to determine if possible the nature of the cementing material, which holds the fragments so securely that they project from the outcrops.

MIDDLE BASALT

Only specimens F307 and F295 came definitely from flows in the middle basalt member of the Waianae series. Specimens F226 and 228 came from dikes probably correlative with these lavas. Thus this member is poorly represented and awaits further petrographic study. Megascopically the rocks differ little in the field from the lower basalt, although they are commonly more massive and contain more aa. F295, collected from the wall of Nanakuli Valley, is the only specimen from a typical middle basalt flow. Except for a little olivine in the groundmass it does not appreciably differ from the other older basalts on Oahu. F307 was collected from a heavy flow at the head of Waianae Valley not typical of the middle basalt. It contains a pyroxene-plagioclase segregation showing some resorption and considerable magnetite. It is a porphyritic plagioclase basalt and is interesting chiefly because of the absence of olivine. F226 and F228 came from dikes cutting the middle basalt and are both porphyritic olivine plagioclase basalts with the olivine altered to iddingsite. No nephelite basalts were noted in this member, but several olivine-rich basalts, possibly picrite basalts, were seen. Graphic sections showing the type of phenocrysts present are given for two ridges in the Waianae Range in figure 7.

UPPER BASALT

Because the upper basalt of the Waianae series covers so much of the surface of the Waianae Range and because the late cones on its surface have attracted attention, this series is fairly well represented in previous collections. The olivine-plagioclase basalt rich in labradorite (Ab^3An^7) tablets 0.5 centimeter long with hyalo-ophitic texture described by Cross⁵⁴ and obtained from a ridge west of Schofield Barracks is probably from this series, as flows of this type are common. Cross describes two olivine-plagioclase basalts collected by Hitchcock from Ewa Church and the east boundary of the Ewa Plantation, on the Government road, and correlates them tentatively with the flows from the Laeloa Craters, on the south end of the Waianae Range. The latter

⁵⁴ Cross, Whitman, *op. cit.*, p. 19.

specimen is certainly from one of the Koolau flows and probably the former is also, as Koolau basalts underlie Ewa. Cross describes a bronzite-bearing basalt from the Waianae Range collected by Hitchcock from the highest point of the valley between the Waianae and Koolau Ranges.⁵⁴ Apparently this means that it was collected from the highest point of the Schofield Plateau, and if so it was certainly obtained from a Koolau flow. Cross⁵⁵ also describes a nephelite basalt collected by Hitchcock from Puu Kapuai, one of the late cones on the southeast end of the Waianac Range, and a nephelite basanite from Puu Kapolei, another one of these cones.

Specimen F187, from Kuua Cone, and F279, from Puu Kapuai, both contain a mineral of low birefringence that may be nephelite. Inasmuch as Cross classifies the rock of Puu Kapuai as nephelite basalt, both of these specimens may be nephelite-bearing basalts. If nephelite basalts, they are very different from the post-Koolau nephelite-bearing rocks.

Sidney Powers⁵⁶ reports nephelite (?) basalt from Puu Palailai and nephelite basalt from Puu Makakilo, two more of these cones. Specimen F81, collected at the City and County quarry on the south side of Puu Palailai, is a porphyritic olivine andesite. Specimen F249, from a remarkable feldspar basalt in Pohakea Pass, contains fractured gem feldspars reaching 5 inches in length and averaging about 1 inch. It is a vesicular rock and contains 10 percent of brown basaltic hornblende, a few crystals of which are euhedral. A similar porphyritic feldspar rock was obtained from a dike in Makua Valley that was probably a feeder to a flow of the upper basalt of the Waianae series. It is unusual because it likewise carries brown basaltic hornblende, a rare mineral in Hawaiian lavas.

The Waianae upper basalts usually contain feldspar phenocrysts, and a few of them have 20 to 30 percent of olivine phenocrysts. A few olivine phenocrysts are common in most of them, but pyroxene phenocrysts are rare. Some of them are probably andesites and, like specimen F81, when more fully studied in thin section will probably be found to differ from the middle and lower lavas of the Waianae series, chiefly in this respect. One of these massive flows on the summit of Kaala has numerous subangular yellow olivine segregations as much as 4 inches across containing many magnetite octahedrons. Similar segregations were noted in a flow northwest of Puu Kapuai and in the lava near the tops of Puu Makakilo and Puu Kapolei.

KAILUA VOLCANIC SERIES
AMYGDALOIDAL BASALT

The amygdaloidal basalt of the Kailua volcanic series is represented by specimen F73 only. It is from a flow that has been considerably

⁵⁵ *Idem*, p. 23.

⁵⁶ Powers, Sidney, Notes on Hawaiian petrology: *Am. Jour. Sci.*, 4th ser., vol. 50, p. 273, 1920.

mineralized and in this respect resembles the other flows of this series. In thin section it consists of plagioclase, very probably labradorite, and pyroxene in chlorite. The large amygdules are lined first with quartz and then with nontronite (?), and have a core of calcite. A core of one amygdule is heulandite. Calcite is common throughout the rock and replaces some plagioclase.

The cavities in these lavas are commonly lined with minerals which were deposited in the following order: quartz, epistilbite, nontronite, laumontite, heulandite, ptilolite, calcite, and aragonite.⁵⁷

KOOLAU VOLCANIC SERIES

BASALTS AND PYROCLASTIC ROCKS

The lavas of the Koolau volcanic series are well represented in previous reports. Cross⁵⁸ describes an olivine-plagioclase basalt from the Niu district, which is on the road to Hanauma Bay; another from a ridge northeast of Koko Crater; and one from the Pacific Heights spur, at the end of Judd Street in Honolulu. Two similar rocks found north of Pearl Harbor⁵⁹ also came from Koolau flows. Bronzite-bearing basalts are common. Cross⁵⁹ describes them from Niu, Manoa Valley, Kalihi Valley, the east base of Tantalus, the spur between Manoa and Nuuanu Valleys (several), the Pali, Waialua Plain, Waimea Gulch along the railroad, the cliffs back of Kahuku Plantation, Laie Point, Moanalua Valley (several), and the highest point of the Schofield Plateau. He also found some among the accessory ejecta at Makalapa and Aliamanu cones. The Dana⁶⁰ collection contained 11 bronzite-bearing basalts. The porphyritic olivine basalt in this collection from Kahuku Head is probably the same as F139 in the table on page 189.

In the specimens listed in the table, eight of the 12 Koolau rocks contain bronzite, and one other contains bastite (?) possibly after bronzite. The occurrence of bronzite as cores in the monoclinic pyroxene and as resorbed crystals indicates that it was formed at an early stage in the magma. It is certainly characteristic of the Koolau lavas so far studied.

Four aphanitic olivine-free plagioclase basalts from the Pali gap are described by Cross.⁶¹ Two were from dikes, and the others were not labeled as to whether they were flows or dikes. Cross thought they might belong to post-Koolau eruptions, but present field work definitely establishes them as being Koolau rocks, probably all from dikes. Four other similar basalts from the Oahu Plantation, the stratigraphic position of which Cross⁶¹ did not know, are definitely Koolau.

Specimens F71, 104, 119, 129, 139, 140 and 235 came from flows in

⁵⁷ Determined by the late A. S. Eakle. See Stearns, H. T., Memorial to Dr. Arthur Starr Eakle: *Pan Pacific Research Inst. Jour.*, vol. 6, no. 4, p. 3, October 1931. Order determined by Dunham, K. C., *Crystal cavities in lavas from the Hawaiian Islands: Am. Mineralogist*, vol. 18, no. 9, pp. 369-385, 1933.

⁵⁸ Cross, Whitman, *op. cit.*, p. 18.

⁵⁹ *Idem*, p. 19.

⁶⁰ *Idem*, p. 20.

⁶¹ *Op. cit.*, p. 20.

the Koolau series, and F6, 79A (?), 79B (?), 131, and 155 from dike feeders. F71 and 104 contain disseminated dark-brown needles of basaltic hornblende, a rare mineral in Hawaiian lavas. F235 is notable for the numerous feldspar phenocrysts, averaging nearly an inch in length, and which produce a peculiar slotted appearance where they weather out of the rock. This rock carries an unusual amount of apatite and also residual glass, commonly noted in these porphyries. F129 is a somewhat similar porphyry except that it has olivine phenocrysts also. It is exposed in Moanalua Valley also, and specimens apparently of this same basalt were found among the accessory ejecta at Aliamanu Crater.

F139 is a porphyritic olivine basalt chiefly interesting because it is one of the few flows in the Koolau series in which the vesicles are filled. Another flow with well-developed crystals in its cavities is exposed in the Dillingham quarry, north of Waipahu. F140 is very similar to F139 but is the only specimen from the Koolau series carrying zeolites.

Among the intrusive rocks F6 is interesting because of its coarse grain. It was collected from the boss at the Palolo quarry. Cutting across this boss are a few veins lined with feldspar and pyroxene crystals as much as half an inch in length. F79A and 79B also are coarse-grained basalts of Koolau age, blown out probably from an intrusive body. The agglomerate from which they were collected is intercalated in the upper part of the Koolau volcanic series. They are interesting because of the large amount of intersertal glass present. Possibly they were blown from an intrusive body that had only partly crystallized when it was fragmented and were then quickly chilled by their expulsion. F131 is a typical black dense basalt from one of the dikes of the dike complex of the Koolau series. Pyrite is present in the dikes at the quarry where this specimen was collected. F155 came from another similar dike.

The Koolau basalts include olivine-plagioclase basalts, porphyritic olivine basalts, bronzite-bearing basalts, and olivine-free plagioclase basalts. Bronzite-bearing basalts apparently predominate, and feldspathoid basalts are notably absent.

Eight slides of Koolau pyroclastic rocks were examined. None have previously been described.

F26 was collected from a bed of lithic vitric tuff 2 feet thick intercalated with Koolau basalts at the top of the Pali at the head of Kuliouou Valley, near the east end of the range. About one-third of the slide is palagonitized pumice; the other two-thirds consists of lithic fragments. F28 was collected from a block at the foot of a waterfall in the Pali back of Waimanalo. The tuff bed from which it came is developed feather-like incipient crystals, and in another sheaf-like pyroxene crystals occur. Most of the lithic pieces have ophitic texture

and from their fine grain and lack of phenocrysts appear to be fragments of dike rocks. In one fragment the feldspar crystals are oriented as if by flowage. Fresh crystals of augite, olivine, and feldspar are scattered through the palagonite. The usual vesicular and shard forms are present in the altered glass. The deposit was made by a catastrophic magmatic eruption.

F33 was collected at an altitude of 450 feet in the west wall of Manoa Valley from the top of a 3-foot bed of lithic tuff 20 feet below another one. The glass has altered to pale-yellow and orange-brown palagonite that is zoned in places. The pumice is vesicular, and some pieces contain microlites of feldspar in a groundmass of dusty iron oxide. Microphenocrysts of feldspar, olivine and pyroxene are scattered through the palagonite. The lithic fragments are ophitic basalts typical of Koolau dikes. About one-third of the specimen is lithic and two-thirds vitric. F34, from the base of the same bed as F33, is a vitric tuff with the pumice altered to palagonitelike material. A few tiny anhedral crystals of pyroxene and feldspar are scattered through the pumice. Evidently the explosion ejected pumice only at the start and then accessory ejecta, or else the blasts were directed so that at the beginning only the light pumice was drifted by the wind to this place.

F40 came from the top of a 5-foot bed of pahoehoe at an altitude of 1,250 feet in Niniko (formerly Maole) waterfall, a tributary to Nuuanu Stream. In thin section it is seen to be a very vesicular glassy rock with microlites of feldspar in a groundmass speckled with iron oxide. The vesicles are filled with a dust of glass shards altered to palagonite and microphenocrysts of plagioclase, pyroxene, and what appears to be iddingsite after olivine. Evidently, the specimen is a dust-filled crust of pahoehoe.

F41 was collected from a bed of vitric tuff about 35 feet above F40. This bed rests on clinkery aa and is variable in thickness but does not exceed 3 feet at any place. In the thicker parts it is finely laminated and shows cross-bedding typical of wind-drifted ash. The microscope shows that it is a vesicular pumiceous material with the shards dark and nearly opaque but with rims of clear-yellow palagonite. A few outlines of what may have been crystals of olivine occur. It is a typical weathered pumice deposit from a Koolau firefountain.

F62 was collected from a 1-foot bed of red vitric tuff intercalated with the Koolau lavas along the Nuuanu Pali road near the small stream that flows under a concrete bridge part way down the east side. It rests on pahoehoe and contains small angular rock fragments. In thin section it is composed almost entirely of orange-brown to black palagonitized glass shards and vesicular pumice. A few fragments show microlites of feldspar and a few tiny fragments of basalt, prob-

ably dike rock, occur also. The tuff is chiefly the product of a fire-fountain.

F122 is vitric tuff from a 3-foot bed resting on aa at an altitude of 650 feet in Moanalua Valley. It consists entirely of altered glassy pumice and is evidently a normal firefountain deposit.

BRECCIA

F116 was collected near the top of Ulumawao Peak, near Kaneohe, and is a fine breccia very much altered by chloritization with some silification.

F338 was collected near Kokokahi and is a coarser phase of the same breccia of the Koolau volcanic series. It consists of angular fragments of more or less altered basalt with a complex cement of chlorite, calcite, and a peculiar radiating fibrous blue-green mineral with oolitic development. Calcite and chlorite form a few veinlets.

HONOLULU VOLCANIC SERIES

BASALTS AND PYROCLASTIC ROCKS

The post-Koolau or Honolulu basalts comprise all the eruptive rocks unconformable upon the Koolau volcanic series. They were erupted during middle (?) and late Pleistocene and possibly during Recent time. In the table on page 189 a description is given of slides from every post-Koolau volcanic not represented in previous collections. A few have been duplicated. Cross⁶² describes in great detail and gives an analysis of the nephelite-melilite basalt from the Moiliili quarry, in Ma-noa Valley, and correlates it with the basalt of Rocky Hill. Field work during this investigation shows that this lava came from Sugar Loaf. Cross⁶² describes similar rocks from Rocky Hill, the north edge of Kalihi Valley, Gulick Stream, west of Kamehameha School, and half a mile east of Bishop Museum. He⁶³ also describes nephelite basalt from Punchbowl, Salt Lake Craters, and a dike in the Pali road. The dike he classifies as limburgite. The specimens from the north edge of Kalihi Valley, Gulick Stream, and near the Bishop Museum are all apparently from the same flow, which I have correlated tentatively with the Kama-naiki eruption. Cross reports olivine-plagioclase basalt from Kaimuki, Mauumae, and Koko Craters, and a basalt poor in plagioclase but rich in olivine and augite from Black Point, near Diamond Head.

Sidney Powers⁶⁴ also reports nephelite basalt from the Salt Lake Crater, and melilite-nephelite basalt from the northwest side of Mauumae Cone, Ulupau Crater, and Puu Hawaii-iloa. Powers' specimen from Mauumae Cone was evidently mislabeled, because Wentworth and Pegau, like Cross, describe specimens from this cone as normal olivine basalt.

⁶² Cross, Whitman, *op. cit.*, pp. 20-22.

⁶³ *Idem*, p. 23.

⁶⁴ Powers, Sidney, Notes on Hawaiian petrology: *Am. Jour. Sci.*, 4th ser., vol. 50, p. 273, 1920.

Wentworth and Pegau⁶⁵ describe olivine basalt with ophitic texture from two places on Kaimuki Cone, from the Black Point dike and flow, and from the Koko Crater dike, also a fine-grained olivine basalt from Mauumac Crater. They also describe nephelite basalt from two places on Punchbowl, the "Manoa dike" (one of the cones in the Rocky Hill group), the west side of Rocky Hill, and Puu Hawaiiiloa. The Rocky Hill specimen may contain melilite. They describe the tuff on Diamond Head and Salt Lake Craters as containing nephelite, that of Manana Island as containing melilite (?), and that of Koko Crater as normal basaltic tuff.

Five specimens of tuff were examined microscopically. F77 was collected from an indurated bed in the new road cut on the southeast side of Koko Crater. The hand specimen has a subconchoidal fracture and a dull-black, waxy appearance. Small patches of vesicles indicate fragments of pumice. Under the microscope it is found to be composed mostly of brown vesicular pumice fragments and a few black ones. Olivine phenocrysts are scattered through the glass, and the vesicles are filled with a zeolite, which may have caused the local hardening of the tuff.

F107 was collected from the 2-foot bed of gray-brown ash in the section described on page 124. It consists of a fine-grained lithic tuff, composed chiefly of weathered fragments of fine-grained basalt containing tiny crystals of feldspar, a few fragments of olivine partly altered to iddingsite, a very few shards of glass altered to palagonite, and specks of another mineral, probably augite.

F127, a lithic tuff produced by the Haiku eruption, was collected near the head of Haiku Valley. It consists of fragments of basalt, glass, and olivine cemented together by a zeolite. The fragments consist of olivine basalt, olivine feldspathoid basalt, and pumice with olivine phenocrysts.

F215 came from a thin brown lens in the Makawao breccia at an altitude of 650 feet in Makawao Stream. Megascopically it shows good laminations and looks like hardened brown dust. It consists chiefly of glass fragments with scattered pieces of plagioclase and some fragments having moderate birefringence, probably augite. Some serpentinelike material is also present. The crystal fragments may be derived from the comminution of Koolau basalt, which makes up the large blocks in the breccia.

SUMMARY

The following table shows the main petrographic features of all the specimens except the breccias and pyroclastic rocks. The localities at which the specimens were collected are shown on plate 2.

⁶⁵ Wentworth, C. K., *Pyroclastic geology of Oahu*: B. P. Bishop Mus. Bull. 30, pp. 91-112, 1926.

Petrographic character of rock specimens

Specimen No.	Rock Name	Locality	Texture and Structure						Phenocrysts			Groundmass							Remarks	Geologic Division
			Porphyritic	Nonporphyritic	Vesicular	Dense	Ophitic	Intergranular	Pyroxene	Olivine	Feldspar	Pyroxene	Olivine	Nephelite	Melilite	Feldspar	Magnetite	Apatite		
F1	Hornblende biotite trachyte	Kuwale Ridge between Lualualei and Waiaanae Valleys.	X			X		X			X				X	X	X		Euhedral phenocrysts of hornblende, biotite, and plagioclase in feldspathic groundmass containing very little magnetite and some cristobalite.	Lower basalt of Waiaanae series
F5	Andesine basalt	do.	X		X			X		X	X	X			X	X	X		Very fine-grained groundmass. Vesicles are filled with silica. Olivine partly altered to chlorite.	do.
F6	Coarse-grained basalt	Palolo quarry		X		X	X					X			X	X	X		Coarse-grained phase of boss. Partly resorbed bronzite cores with monoclinic pyroxene rims.	Dike in Koolau series
F35	Melilite-nephelite basalt	Foot of lava cascade, Manoa Valley	X		X			X		X			X	X		X		X	Hauynite (?) phenocrysts, much melilite and secondary calcite.	Basalt of Sugar Loaf volcanics
F38	Nephelite basalt	East end Judd St., Honolulu.	X			X		X		X		X			X	X			Euhedral olivine.	Lower basalt of Nuuanu volcanics
F58	Nephelite melilite basalt	Near mouth of Pukele Stream in Palolo Valley	X			X		X	X	X		X	X		X	X			Melilite crystals 0.05 mm long. Euhedral olivine. Very few pyroxene phenocrysts; zeolite sparingly present.	Basalt in Kaau volcanics
F59	do.	South side of Kaau Crater	X			X		X		X		X	X		X	X			Similar to F58 but no pyroxene crystals.	do.
F63	Nephelite (?) basalt	Nuuanu Pali	X			X		X		X		X		X	X				Green spinel or garnet in one inclusion. Zeolite present. An interstitial mineral of low birefringence, probably nephelite, occurs in the groundmass.	Basalt in Pali volcanics

Petrographic character of rock specimens—Continued

Specimen No.	Rock Name	Locality	Texture and Structure						Phenocrysts			Groundmass						Remarks	Geologic Division	
			Porphyritic	Nonporphyritic	Vesicular	Dense	Ophitic	Intergranular	Pyroxene	Olivine	Feldspar	Pyroxene	Olivine	Nephelite	Mellite	Feldspar	Magnetite			Apatite
F64	do.	Waiomao Stream near end of road	X		X			X			X			X	X		X	X	Phenocrysts of mellite and accessory perovskite. A zeolite and another isotropic secondary mineral with its index less than balsam, probably also a zeolite, abundant. A few grains of calcite.	Basalt of Waiomao branch of Kaau volcanics
F68	Nephelite basalt	City and County quarry, near Kailua radio station	X			X		X			X					X	X	Segregation of mellite crystals in one part. Zeolite fills vugs.	Basalt of Training School volcanics	
F69	Mellite nephelite basalt	Pauoa Valley	X		X			X			X		X	X		X		Mellite and a few nephelite phenocrysts, yellow interstitial glass. Vesicles filled with zeolite. Euhedral nephelite in groundmass.	Basalt of Tantalus volcanics	
F71	Olivine basalt	Floor of Manoa Valley	X		X			X	X	X	X				X	X	X	A few pyroxene phenocrysts, one of which is twinned. Disseminated dark-brown needles of basaltic hornblende.	Basalt of Koolau series	
F72	Nephelite basalt	Abandoned quarry near Kaneohe	X			X		X			X				X	X	X	A little calcite and a secondary iron alteration stain.	Basalt of Kaneohe volcanics	
F73	Amygdaloidal basalt	Quarry near Kailua radio station		X	X		X							X			X	Ophitic intergrowth of pyroxene and probably labradorite in chlorite. Amygdules have walls lined with quartz, then nontronite (?) and finally a core of calcite. Zeolite fills one cavity and calcite is common in the rock and replaces some plagioclase.	Basalt of Kailua series	

F79A	Coarse-grained basalt	Fragment in tuff bed intercalated with Koolau basalts near Wai-manalo		X		X	X								X			X		X	X	Ophitic intergrowth of labradorite, bronzite, and monoclinic pyroxene in brown glass. A few vesicles and cracks lined with partly altered glass.	Dike complex (?) of Koolau series
F79B	do.	do.		X		X	X								X			X	X	X	X	Very similar to 79A, but glass shows microlites, and bronzite forms resorbed cores in the monoclinic pyroxene.	do.
F81	Olivine andesite	City and County quarry on south side of Puu Palalai, near Ewa	X			X				X					X	X		X				Much apatite. One olivine phenocryst contains graphic intergrowth of magnetite.	Upper basalt of Waianae series
F83	Nephelite basalt	Maunawili ranch, near Olomana	X		X			X	X	X					X			X	X			Accessory perovskite. Augite is beautifully zoned. Secondary calcite, siderite, zeolite, and small areas of pale-green and brown secondary minerals.	Basalt of Maunawili volcanics
F84	Nephelite-melilite basalt	Near reservoir 2, Nuuanu Road	X			X		X	X	X					X	X		X	X			Zeolite fills cavities.	Upper basalt of Nuuanu volcanics
F85	Nephelite basalt	Mokapu Peninsula	X		X			X	X	X					X			X	X			Zeolite is present in a few vesicles. Pyroxenes are zoned. Abundant magnetite.	Mokapu basalt
F86	do.	Pyramid Rock, Mokapu Peninsula	X			X		X	X	X					X			X	X			Pyroxenes beautifully zoned. Similar to F85.	Basalt of Hawaii-loa volcanics
F101	Melilite-nephelite basalt	Kamanaiki Valley	X			X		X	X	X					X	X		X	X			Considerable apatite. Melilite occurs as faint yellow mineral. Zeolite is common, and an isotropic mineral with index less than balsam, probably also a zeolite.	Kamanaiki basalt
F104	Olivine basalt	Pukele Valley	X			X		X	X	X					X	X		X	X	X		Bronzite phenocrysts and rare tiny needles of brown basaltic hornblende.	Basalt of Koolau series
F119	Coarse-grained basalt	Waialae Nui Valley		X		X	X								X	X		X	X	X	X	A few olivines, needles of hematite, and intersertal glass. A few tiny colorless crystals of an isotropic substance with index less than balsam. Bronzite occurs as cores and resorbed crystals.	Basalt of Koolau series

Petrographic character of rock specimens—Continued

Specimen No.	Rock Name	Locality	Texture and Structure						Pheno-crysts			Groundmass						Remarks	Geologic Division	
			Porphyritic	Nonporphyritic	Vesicular	Dense	Ophitic	Intergranular	Pyroxene	Olivine	Feldspar	Pyroxene	Olivine	Nephelite	Melilite	Feldspar	Magnetite			Apatite
F126	Nephelite basalt	Near Ulumawao Peak	X			X		X	X	X			X		X	X			Olivine, mostly euhedral.	Basalt of Castle volcanics
F128	do.	South side of Haku Valley	X			X		X		X			X	X		X			Zeolite present in a few vugs. Only two or three melilite crystals present.	Haku volcanics (south basalt)
F129	Feldspar basalt porphyry	Manaiki Valley altitude 1,100 feet	X		X			X		X	X	X			X	X	X		Phenocrysts of labradorite 1/2-inch long. Veinlets of a colorless isotropic mineral with index less than balsam are present in the labrad-crite phenocrysts. Bronzite altered to brown bastite (?).	Basalt of Koolau series
F131	Basalt	Quarry near Heia Pond		X		X	X					X			X	X	X	X	Glass altered to chlorite-quartz veinlet with a little calcite, feldspar seamed with sericite.	Dike complex of Koolau series
F133	Nephelite basalt	From 44 feet below surface, bore hole 5, reservoir 4, Nuuanu Valley	X			X		X		X					X	X	X		Olivine marginally altered in part to magnetite. Some colorless isotropic material, index higher than balsam, probably glass. Zeolite fills vugs.	Lower basalt of Nuuanu volcanics
F135	Nephelite-analcite basalt	Upper Gay tunnel, Kalihi Valley	X		X			X		X					X	X			Considerable analcite and a pale-green soda variety of pyroxene. The olivines have been replaced by iron oxide. The nephelite is altering to analcite.	Basalt of Kalihi volcanics
F136	Olivine basalt	Kaupo flow, near Makapuu	X		X		X			X					X	X	X		Pyroxene titaniferous. Texture in part fine-grained felty.	Kaupo basalt

Petrographic character of rock specimens—Continued

Specimen No.	Rock Name	Locality	Texture and Structure						Phenocrysts			Groundmass								Remarks	Geologic Division		
			Porphyritic	Nonporphyritic	Vesicular	Dense	Ophitic	Intergranular	Pyroxene	Olivine	Feldspar	Pyroxene	Olivine	Nephelite	Melilite	Feldspar	Magnetite	Apatite	Glass				
F187	Olivine basalt	Kuua cone, Waianae Range	X		X				X			X							X	X	X	Some large olivines enclose poikilitically feldspar or magnetite. Calcite fills some cavities. A mineral with low birefringence possibly nephelite.	Upper basalt of Waianae series
F226	Feldspar basalt	Kaukonahua Gulch, near Schofield	X		X				X			X	X					X	X	X	Bronzite altered to bastite (?). Phenocrysts of bytownite. Small areas and vesicles filled with chlorite.	Dike in middle (?) of Waianae series	
F228	Feldspar-olivine basalt	do.	X			X	X				X	X	X					X	X	X	X	Plagioclase phenocrysts and altered intersertal glass.	do.
F235	Porphyritic basalt	do.	X			X	X				X	X	X					X	X	X	X	Considerable apatite. Phenocrysts of labradorite. Glass altered. Pyroxene is titaniferous.	Basalt of Koolau series
F249	do.	Pohakea Pass	X		X			X				X	X					X	X	X	Phenocrysts of labradorite and 10 percent of brown basaltic hornblende in the groundmass. Small amount of secondary mineral, possibly chlorite.	Upper basalt of Waianae series	
F279	Olivine basalt	Puu Kapuai cone	X		X				X	X	X							X	X	X	A mineral of low birefringence present, possibly nephelite.		

F293	Coarse-grained basalt	Puu Kailio, Lualuahi Valley	X			X	X		X	X	X	X	X			X	X	X	Olivine grains and intersertal glass completely altered to a chlorite mineral. Small patches of calcite.	Sill (?) in lower (?) part of Waianae series
F295	Olivine basalt	Nanakuli Valley	X			X		X	'X		X	'X				X	X	X	Much apatite. Some olivine in groundmass not altered.	Basalt of middle Waianae series
F296	Nephelite-melilitite basalt	Mokulea Rock, Kailua Bay	X			X		X	X	X		X		X	X		X	X	The phenocrysts are partly resorbed. The pyroxene is zoned like F85 and F86. Much melilitite.	Mokulea basalt
F307	Basalt	Altitude 1,730 feet in Waianae Valley	X			X		X				X				X	X	X	Pyroxene - plagioclase segregation showing some resorption. Much magnetite and a little hematite; accessory basaltic hornblende.	Middle basalt of Waianae series
F328	Porphyritic basalt	East side of Makua Valley	X			X	X				X	X				X	X	X	Large phenocrysts of plagioclase, titaniferous pyroxene, basaltic hornblende in small idiomorphic crystals disseminated at random.	Dike of upper (?) Waianae series
F330	Basalt	Kalama Crater	X		X			X	X	X		X				X	X	X	Exceedingly fine-grained and felty texture. Rock is low in feldspar. An interstitial mineral of low birefringence possibly nephelite, in the groundmass.	Basalt of Kalama series
F368	Nephelite basalt	Moku Manu Island	X			X			X	'X		X		X			X	X	Large nephelite crystals including the other minerals poikilitically. One shows twinning. The apatite is also abundant in large crystals. Pyroxene is beautifully zoned. A number of flakes of biotite.	Basalt of Moku Manu volcanics
F370	do.	Ainoni Spring, near Olomana Peak	X		X			X	X	'X		X		X			X	X	A yellow secondary isotropic mineral present in cavities.	Basalt of Ainoni volcanics
F373	Olivine basalt	Kahe Point	X		X		X		'X		X					X	X	X	Feldspar of low birefringence present.	Basalt of lower Waianae series
F376	Nephelite-melilitite basalt	Damon Road cut	X					X	X		X		X	X		X			Much melilitite and some zeolites present.	Basalt of Manaiki branch (?) of Kalihi volcanics

¹ Olivine partly or completely altered to iddingsite.

The following table summarizes the type of each post-Koolau eruptive.

Petrographic types of post-Koolau eruptives

Geologic formation	Type of basalt	Specimen No.	Reported by
Tantalus volcanics	Melilite-nephelite	F69	Stearns
Sugar Loaf volcanics	Melilite-nephelite	F35	Stearns and Cross
Firefountain deposits of Tantalus and Sugar Loaf	Melilite-nephelite		Cross
Kaupo basalt	Olivine	F136	Stearns, Wentworth-Pegau
Kaohikaipu volcanics	Olivine	F162	Stearns
Koko volcanics (tuff)	Olivine	F77	Stearns, Powers, and Wentworth-Pegau
Koko volcanics (basalt)	Olivine		Cross and Wentworth-Pegau
Kalama volcanics	Nephelite (?) (a)	F330	Stearns
Manana tuff	Melilite (?)		Wentworth-Pegau
Punchbowl volcanics (basalt)	Nephelite		Cross and Wentworth-Pegau
Moku Manu volcanics (basalt)	Nephelite	F368	Stearns
Castle volcanics	Nephelite	F126	Stearns
Rocky Hill volcanics	Nephelite (b)		Cross and Wentworth-Pegau
Kamanaiki basalt	Melilite-nephelite	F101	Stearns and Cross
Black Point basalt	Olivine		Cross, Wentworth-Pegau
Mauumae volcanics	Olivine		Cross, Wentworth-Pegau
Kaimuki volcanics	Olivine		Cross, Wentworth-Pegau
Diamond Head tuff	Nephelite		Wentworth-Pegau
Training School volcanics	Nephelite	F68	Stearns
Maunawili volcanics	Nephelite	F83	Stearns
Ainoni volcanics	Nephelite	F368	Stearns
Kaau volcanics (basalt), Waiomao Branch	Melilite-nephelite	F64	Stearns
Kaau volcanics (basalt), Pukele Branch	Melilite-nephelite	F58, 59	Stearns
Ulupau tuff	Melilite-nephelite		Powers and Wentworth-Pegau
Makawao breccia	(?)	F215	Stearns
Pali volcanics	Nephelite (?) (a)	F63	Stearns
Pali volcanics (dike feeder)	Nephelite (?) (a)	F146	Stearns and Cross
Nuuanu volcanics (upper basalt)	Nephelite-melilite	F84	Stearns
Nuuanu volcanics (lower basalt)	Nephelite	F38, 133	Stearns
Mokapu volcanics	Nephelite	F85	Stearns
Mokulea basalt	Nephelite-melilite	F296	Stearns
Hawaiiloa volcanics	Nephelite (c)	F86	Stearns, Powers, and Wentworth-Pegau
Kaneohe volcanics (basalt)	Nephelite	F72	Stearns

Petrographic types of post-Koolau eruptives—Continued

Salt Lake tuff	Nephelite		Cross, Powers, and Wentworth-Pegau
Haiku volcanics (north basalt)	Nephelite (d)	F154	Stearns
Haiku volcanics (south basalt)	Nephelite (d)	F128	Stearns
Haiku volcanics (tuff)	Nephelite	F127	Stearns
Kalihi volcanics	Nephelite	F135	Stearns

(a) Contains small amount of feldspar.

(b) Cross gives no description, but text seems to indicate that melilite is present.

(c) Sidney Powers reports melilite.

(d) Two or three crystals of melilite present.

Nephelite is present in all the post-Koolau or Honolulu eruptives except those at Black Point, Kaimuki, Mauumae, and in some of the Koko fissure. The Black Point, Kaimuki, and Mauumae lavas were apparently concurrently erupted from one fissure and for convenience are called the "Kaimuki eruptives."

Cross⁶⁶ from his study of Hawaiian rocks believes that extensive differentiation occurred during the long rest period between the parasitic eruption and the main cone lavas. Further, he does not believe,⁶⁷ as Daly does, that these alkalic rocks owe their unusual composition to the magmatic absorption of marine limestone. Daly's fundamental contention⁶⁸ that the limestones are interbedded with the older rocks is not supported by this investigation.

Sidney Powers pointed out that most of the tuff cones occur along the shore where limestone was available. The Koko group of tuff cones were erupted through limestone, but they are not nephelite basalts. The best proof that nephelite eruptions have nothing to do with limestone is their distribution as shown on plate 2. For example, feeding dikes of the Training School, Kaneohe, Maunawili, and Ainoni nephelite basalts rose through the center part of the dike complex of the Koolau volcanic series. In the vicinity of these post-Koolau vents flow rock is practically absent from the dike complex and since the dikes increase in number downward as shown in figure 5, A, any limestone as old as the Koolau volcano would have been replaced by dikes during the building of the Koolau Volcano and not be available for absorption by the youthful post-Koolau magma unless we "beg the question" and have the nephelite basalt dikes rise from magma reservoirs far afield and cut across half of the Koolau dike complex in order to erupt where they did. The chance of these younger feeding dikes cutting obliquely across hundreds of strong vertical Koolau dikes seems remote. For this reason, I agree with Cross that these ultrabasic

⁶⁶ Cross, Whitman, *op. cit.*, p. 93.

⁶⁷ *Idem.*, p. 90.

⁶⁸ Daly, R. A., Magmatic differentiation in Hawaii: *Jour. Geology*, vol. 19, p. 308, 1911.

rocks are differentiate lavas uncontaminated by limestone. Furthermore, the stratigraphic occurrence of these rocks indicates that a period of thousands of years was available for the differentiation to take place.

There remains to be explained, however, the Koko fissure and Kaimuki eruptives as normal basalts in the midst of the other alkalic lavas. When a chemical analysis is made of these rocks, it may be found that they are differentiated basalts. .

Some of the nephelite lavas arrived at the surface unusually high in mineralizers, as shown by the veins in the Moiliili quarry and in the Kamanaiki basalt. If, as seems likely, the zeolitization noted in the remaining nephelite basalts took place concurrent with the cooling of these lavas then they were all rich in volatiles. Perhaps the differentiation or concentration of the alkalies was accomplished by the rise of mineralizers in the magma chamber as suggested by Smyth.⁶⁹

The final eruptions of the Waianae Range also produced nephelite basalts—a fact which supports the contention that nephelite basalts are commonly the final differentiate of a Hawaiian magma reservoir. My recent field work indicates that nephelite basalts were erupted during the final phase of the West Maui Volcano also. The field relations of the nephelite rocks of the other volcanoes of the Hawaiian group are not yet fully known, but both Cross⁷⁰ and Powers⁷¹ believe that they are associated with only the late eruptives.

⁶⁹ Smyth, C. H., The chemical composition of the alkaline rocks and its significance as to their origin: *Am. Jour. Sci.*, 4th ser., vol. 36, pp. 33-46, 1913.

⁷⁰ Cross Whitman, *op. cit.*, p. 93.

⁷¹ Powers, Sidney, *op. cit.*, p. 280.

PART 2 — GROUND-WATER RESOURCES

By HAROLD T. STEARNS AND KNUTE N. VAKSVIK

Numerous reports are available describing artesian wells on Oahu, especially those in the Honolulu area, as shown by the titles listed in Bulletin 3. Repetition of this published material has been avoided as much as possible, and attention has been centered on the occurrences and development of ground water for which data have not already been printed. Practically complete records of the wells and tunnels on Oahu have been assembled for the first time, and also many new data regarding springs.

CLIMATE

By H. T. STEARNS

TEMPERATURE

The climate of Oahu is semitropical rather than tropical. It is stated that, owing to the drift of Bering Sea waters to this region, the temperature of the surrounding waters is about 10° lower than that of some other regions of equal latitude. At Honolulu the mean temperature is 74.7°, the absolute maximum 90°, and the absolute minimum 52°. The temperature at Aiea and Waialua has reached 97°. The lowest temperature varies with the altitude. In general there is an average decrease of about 4° in the mean temperature with each increase of 1,000 feet in altitude.

WIND

Oahu lies in the belt of the northeasterly trade winds, which are extremely persistent throughout most of the year. They are, however, occasionally interrupted by kona or southerly winds which seldom last longer than a few days at a time. Generally breezes blow during the warmer part of the day. Wind velocities at Honolulu average 9.7 miles an hour and have not exceeded 50 miles an hour during the period of record. The days may seem very hot on account of the high humidity, as on certain days with south winds the relative humidity reaches 95 percent.

RAINFALL

Areal distribution.—The distribution of rainfall is shown in plate 26. The average annual rainfall on the Koolau Range varies from less than 20 inches along the coast to about 250 inches on the crest above Kahana Valley. Because the Waianac Range lies to the leeward of the Koolau Range it receives much less rainfall, as shown by a variation from about 6 inches at the coast to about 110 inches on the summit. Voorhees'

¹ Voorhees, J. F., A quantitative study of the rainfall of the island of Oahu, p. 2. Honolulu, U. S. Weather Bureau, 1929.

has determined that the isohyets, or lines of equal rainfall, do not locally follow topographic contours but that distance from the crest is far more important. Thus a rainfall station in the bottom of a deep valley half a mile west of the Koolau crest will generally record the same precipitation as a station on the adjacent ridge.

The geographic distribution of the rainfall is particularly spotty, because much rain falls during kona storms, which are usually local. The distribution of the rain during the storm on November 18, 1930, as shown in the table below, illustrates how spotty the rainfall was even in the Honolulu district, where this storm centered. In some of the drier areas most of the rain commonly falls during one or two of these storms each year, so that even though the annual rainfall may be normal the area may suffer from drought most of the year. The rainfall and run-off during these heavy kona storms are exceedingly rapid, hence they probably do not contribute proportionally to the underground supplies.

Rainfall, in inches, on November 18, 1930, in the Honolulu district

(Recording stations of the Board of Water Supply and U. S. Geological Survey)
[Compiled by J. F. Kunesch]

Station	Altitude (feet above sea level)	Distance from capitol (miles)	Rainfall to noon	Rain started	12 to 1 p. m.	1 to 2	2 to 3	3 to 4
Palolo.....	900	5.5	1.2	Noon	0.2	2.4	1.9	1.5
Manoa.....	650	4.5	1.2	12:45	.2	1.8	2.3	2.4
Pauoa Flats.....	1800	4.0	1.3	Noon	.2	1.6	2.3	2.7
Nuuanu (Lower Luakaha.....	890	4.3	1.4	12:45	.3	2.6	2.5	4.4
Kalihi.....	900	4.4	1.2	1:00	.2	1.9	1.6	2.5
Moanalua (a).....	300	5.0	.7	2:30	.1	.1	.5	1.9
Halawa (c).....	300	5.2	.4	2:00	.2	.2	2.0	3.6

Station	4 to 5	5 to 6	6 to 7	7 to 8	8 to 9	9 to 10	10 to 11	11 to 12	Total
Palolo.....	0.0	0.4	0.4	0.9	0.1	0.2	0.1	0.0	9.3
Manoa.....	.2	1.5	.1	.4	.3	.1	.0	.1	10.6
Pauoa Flats.....	1.6	1.7	1.9	.3	.3	.3	.2	.0	14.4
Nuuanu (Lower Luakaha.....	2.6	3.0	2.9	.0	.0	.0	.0	.0	19.7
Kalihi.....	2.7	3.0	.2	.0	.1	.0	.0	.0	13.4
Moanalua (a).....	b5.0	b5.6	b4.6	2.0	.5	.1	.2	.1	21.4
Halawa (c).....	3.2	3.0	1.2	.0	.2	.0	.0	.0	14.0

^a In cooperation with the U. S. Geological Survey.

^b Severest storm intensity.

^c U. S. Geological Survey in cooperation with Bishop estate.

The annual precipitation at the various stations on Oahu is given in the following table:

Distribution in time.—The rainfall varies widely from year to year, and there is no well-marked rainy season in the regions of high rainfall. Droughts may come in the winter as well as in the summer. The comparative monthly distribution of rainfall in various parts of the Koolau

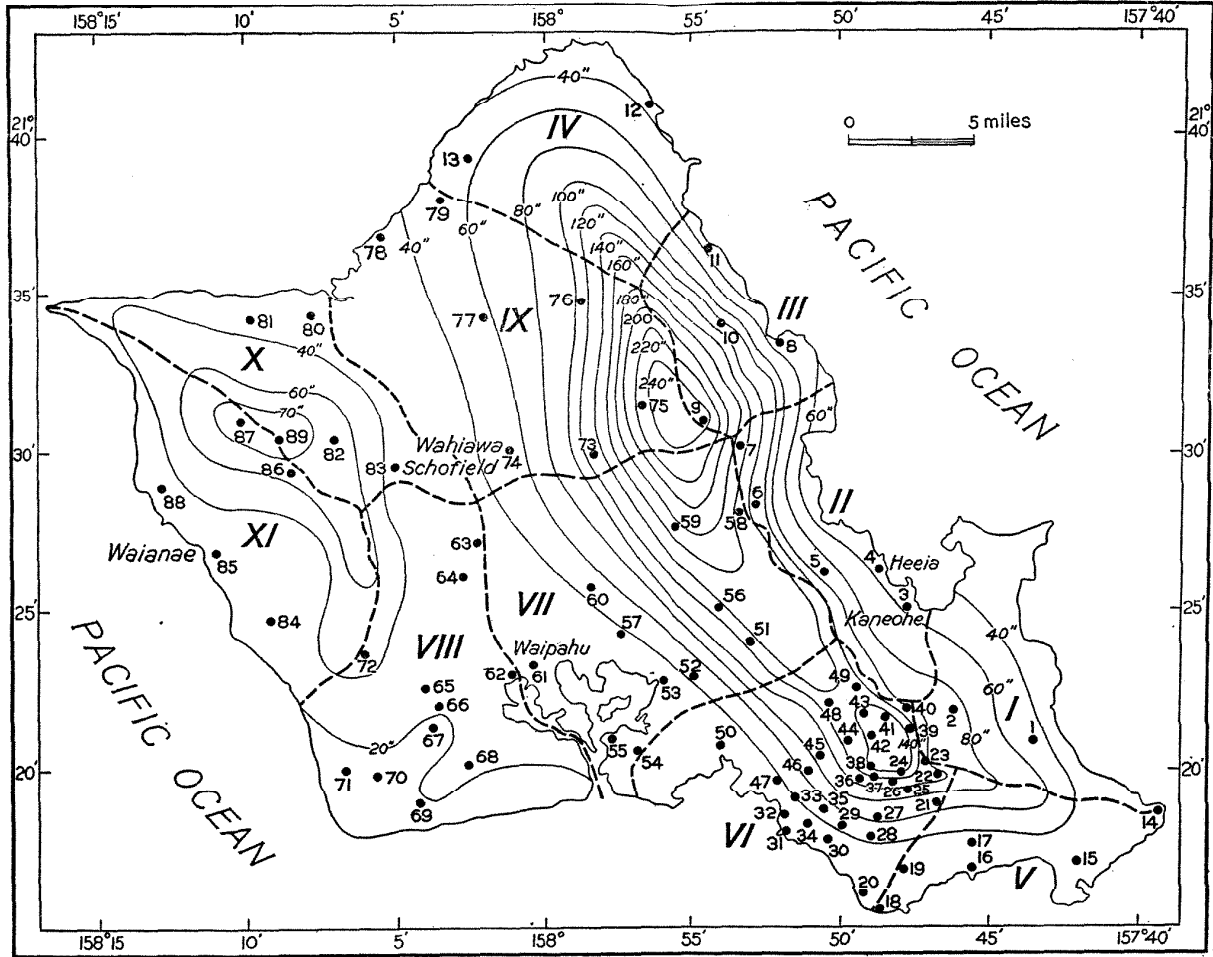

DISTRIBUTION OF RAINFALL ON OAHU AND LOCATION OF RAINFALL STATIONS
(After Voorhees)

KOOLAU RANGE

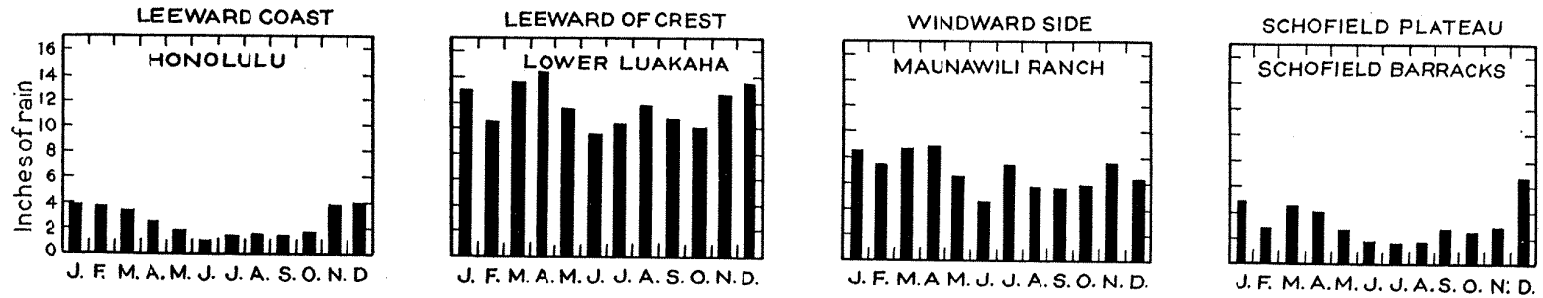

WAIANAE RANGE

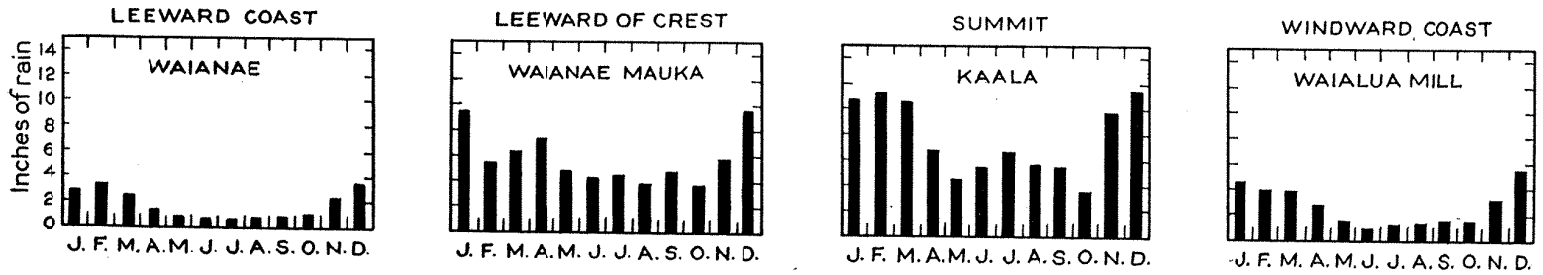

FIGURE 14.—Comparative monthly distribution of rainfall on Oahu.

and Waianae Ranges is shown in figure 14. Heavy downpours may greatly affect the total monthly rainfall. For example, Aiea station, at an altitude of 500 feet, received one-fifth of its annual rainfall on one day in November, 1930. At Kaukonahua station 33 inches fell on three days in February, 1932.

Quantity.—Voorhees² states that only 20 percent of the area of the island lies above the 100-inch isohyet and yet this area received 45 percent of the total, or more than double the average precipitation. In the dry year of 1926 the total rainfall was 40 percent less than the average, and in 1927, a wet year, it was 50 percent greater than the average. In a very wet year the total annual rainfall amounts to a cubic mile. He has computed the average annual rainfall as 68.4 inches, equivalent to 1,950 million gallons a day, or 3.26 million gallons a square mile. The average rainfall by districts (see pl. 26) is as follows:

Total annual average rainfall on Oahu
(Computed by J. F. Voorhees)

District (see pl. 26)	Area (square miles)	Annual rainfall		Average daily quantity (million gallons)	Average daily quantity per square mile (million gallons)
		Average depth (inches)	Average quantity (million gallons)		
I	34.71	36.2	34,000	93	2.68
II	32.96	91.2	53,406	146	4.43
III	27.63	135.0	65,000	178	6.45
IV	50.60	72.8	64,000	175	3.50
V	27.35	39.0	18,600	51	1.86
VI	54.54	74.7	71,000	194	3.56
VII	88.92	90.0	139,500	382	4.30
VIII	80.00	28.8	40,200	110	1.38
IX	93.43	90.0	146,500	401	4.28
X	47.10	46.8	38,500	105	2.23
XI	60.69	40.4	42,700	117	1.93
	598.00	68.4	713,400	1950	3.26

TRANSPIRATION AND EVAPORATION

It was evident at the beginning of the investigation that a thorough study of the disposal of the rainfall, especially in relation to ground water recharge, involved a study of transpiration and evaporation. No records of transpiration existed except for sugar cane, and that study had just been started. Some local engineers believed that transpiration is greater in areas where the annual rainfall is about 200 inches and dense jungle covers the surface than in areas where the rainfall is about 100 inches and the jungle is replaced by grasses and shrubs.

The United States Weather Bureau has recorded evaporation from a freewater surface at a point where the mean annual rainfall is about 100 inches, but no records of evaporation existed for the areas of

² Voorhees, J. F., *op. cit.* p. 3.

heavier rainfall. It was also found that during heavy downpours these records were not reliable, because of spatter or overflow. The Weather Bureau practice is to discard the records of the day of the rain, the day before, and the day after and to substitute for these records the mean daily evaporation for the remainder of the month. In a region of heavy rainfall the record for weeks at a time may be lost because of spatter. Further, the method of substituting a mean that includes the evaporation on sunny days for the evaporation on rainy days leads to a cumulative error that makes all the results too large. Consequently two stations were established at which the evaporation is measured volumetrically, as explained below, instead of daily with a hook gage, as is done by the Weather Bureau.

LOWER LUAKAHA STATION, IN NUUANU VALLEY

The lower Luakaha station was installed in November, 1930, by Mr. Vaksvik at an altitude of 890 feet on the west side of Nuuanu Stream, adjacent to the Lower Luakaha automatic rain gage, which is maintained by the Honolulu Board of Water Supply. The rain gage is on the roof of a small shed nearly level with the evaporation and transpiration pans. Both of these pans are on the leeward side of a bank, as shown by the topography (pl. 2) and somewhat sheltered from the high winds that blow through Nuuanu Gap. This site was chosen because it appeared to represent average weather conditions on the southwest (leeward) side of the Koolau Range at this altitude and because a long record of rainfall was available at this place.

The evaporation pan is of the standard Weather Bureau class A type and is set on 4-by-4-inch timbers on the ground. An overflow pipe with its bottom 3 inches below the rim connects with a storage tank equipped with an automatic water-stage recorder. Until April 29, 1932, the bottom of the overflow pipe was 2 inches below the rim, but because occasionally water was lost from the pan by spatter the pipe had to be lowered 1 inch. Rain falling in the pan not lost by evaporation overflows into a storage tank, where it is measured volumetrically by an automatic water-stage recorder. The difference between the overflow and the rainfall is the evaporation. During one or two dry spells the water surface has fallen about an inch below the overflow pipe. Thus, the water surface is consistently about 1 inch lower than in the evaporation pans of the United States Weather Bureau stations. A 3-cup anemometer at the same level records the wind movement. The station is visited weekly.

The transpiration pan is a circular galvanized-iron tank 4 feet in diameter and 5 feet deep, painted with asphalt to prevent corrosion and planted with panicum grass. In the bottom of the pan are the contents of one bag of No. 2 and three bags of No. 3 fine crushed rock,

and three bags of sand to a depth of 1 foot. Above this material is 3 feet of the residual clayey loam soil of the Nuuanu volcanics, dug from the hole in which the pan is set. A perforated 1 3/4-inch brass pipe 18 inches long in the bottom of the pan is connected to a storage tank where the surplus water is measured volumetrically by an automatic water-stage recorder. A tunnel leads from the storage-tank shelter to the transpiration pan, so that the pan can be inspected for leaks.

Although the pan projects 12 inches above the surface, this part is hidden from the sun by a dense mat of grass. The grass in and outside the pan intertwines and completely conceals it from view. On the adjacent hillside are scattered guava bushes with a dense undergrowth of panicum grass. The vegetation is so similar inside and outside the station that the position of the pan is not evident. The transpiration during the first few months when the grass was making its maximum growth was a little higher than normal. The loss from the transpiration pan, comprising both evaporation and transpiration, is known as "consumptive use," to distinguish it from losses by either transpiration or evaporation. The water collected in the storage tank is equivalent to the sum of run-off and deep percolation. The results obtained at this station are given in the table below:

Records of rainfall, evaporation, consumptive use, and wind movement at Lower Luakaha station, Nuuanu Valley

[Altitude 890 feet]

Week ending	Rainfall inches	Evaporation pan		Panicum pan		Anemometer miles
		Overflow inches	Loss inches	Overflow (a) inches	Loss (Consumptive use) inches	
1930						
Dec. 13	1.18	0.90	.280	0.65	0.53
20	4.32	3.47	.850	1.63	2.69
27	.73	.248	.482	1.50	— .77
	6.23	4.618	1.612	3.78	2.45
1931						
Jan. 3	.40	.279	.121	.079	.321
10	4.75	3.715	1.035	2.970	1.780
17	1.20	.734	.466	.423	.777
24	.28	.000	.280	.046	.234
31	.04	.000	.040	.000	.040
	6.67	4.728	1.942	3.518	3.152
Feb. 7	1.60	.445	1.155	.000	1.600
10	.50	.000	.500	.000	.500
16	2.65	1.855	.795	.000	2.650
21	.55	.129	.421	.000	.550
27	2.46	1.641	.819	.000	2.460
	7.76	4.070	3.690	.000	7.760
Mar 3	1.51	1.248	.262	1.135	.375
10	.61	.256	.354	.695	— .085
17	.32	.000	.320	.000	.320
21	.80	.000	.800	.000	.800
28	.88	.000	.880	.000	.880
	4.12	1.504	2.616	1.830	2.290

Records of rainfall, evaporation, consumptive use, and wind movement at
Lower Luakaha station, Nuuanu Valley—Continued

[Altitude 890 feet]

Week ending	Rainfall inches	Evaporation pan		Panicum pan		Anemometer miles
		Overflow inches	Loss inches	Overflow (a) inches	Loss (Consumptive use) inches	
Apr. 4	1.53	.918	.612	.000	1.530
11	1.92	.880	1.040	.000	1.920
18	1.50	.332	1.168	.000	1.500
25	2.28	1.810	.470	1.275	1.005
	7.23	3.940	3.290	1.275	5.955
May 2	.35	.000	.350	.000	.350
9	.70	.000	.700	.000	.700
16	2.03	.058	1.972	.000	2.030
21	3.05	2.078	.972	.450	2.600
28	1.17	.962	.208	1.630	.460
	7.30	3.098	4.202	2.080	5.220
June 6	1.15	.144	1.006	.162	.988
13	.13	.000	.130	.000	.130
20	2.10	.000	2.100	.000	2.100
27	2.20	.024	2.176	.000	2.200
	7.06	.168	5.412	.162	5.418
July 4	.92	.000	.920	.000	.920
11	3.25	1.758	1.492	.392	2.858
18	2.35	.702	1.648	1.900	.450
23	4.95	b.....	c 1.500	.576	4.374
25	.42	.375	.945	2.985	— 2.565
	11.89	6.505	5.853	6.037
Aug. 3	8.04	5.533	2.507	4.635	3.405
8	1.62	1.314	.306	2.176	— .556
13	2.60	1.708	.892	1.592	1.008
20	7.26	5.464	1.796	4.912	2.348
26	6.57	5.002	1.568	4.606	1.964
	26.09	19.021	7.069	17.921	8.169
Sept. 5	3.05	1.652	1.398	3.088	— .038
9	8.60	6.490	2.110	5.796	2.804
12	2.05	1.759	.291	4.011	— 1.961
19	6.33	5.074	1.256	5.741	.589
26	4.99	4.139	.851	4.154	.836
	25.02	19.114	5.906	22.790	2.230
Oct. 3	2.15	1.475	.675	1.644	.506
10	3.43	2.916	.514	3.142	.288
17	5.28	5.053	.227	6.356	— 1.076
24	3.53	2.622	.908	.237	1.143	242
31	1.36	.888	.472	1.429	— .069	85
	15.75	12.954	2.796	14.958	.792
Nov. 7	5.96	4.766	1.194	5.059	.901	173
14	4.02	3.322	.698	3.275	.745	154
21	6.08	5.344	.736	5.390	.690	81
28	1.29	1.200	.090	2.535	— 1.245	30
	17.35	14.632	2.718	16.259	1.091	438
Dec. 5	1.53	1.187	.343	1.058	.472	24
12	.95	.774	.176	.676	.274	29
19	3.23	2.784	.446	2.761	.469	192
26	2.76	2.274	.486	2.050	.710	350
	8.47	7.019	1.451	6.545	1.925	495
1932						
Jan. 2	1.62	1.232	.388	117
9	1.28	1.202	.078	9
16	3.07	2.790	.280	172
23	6.56	5.906	.654	25
30	4.01	3.480	.530	208
	16.54	14.610	1.930	531

Records of rainfall, evaporation, consumptive use, and wind movement at
Lower Luakaha station, Nuuanu Valley—Continued

[Altitude 890 feet]

Week ending	Rainfall inches	Evaporation pan		Panicum pan		Anemometer miles
		Overflow inches	Loss inches	Overflow (a) inches	Loss (Consumptive use) inches	
Feb. 6	5.70	4.686	1.014			
13	27.35	9.565				250
20	3.13	b 9.399+				594
27	5.35	4.282				648
	41.58	27.932	c 1.800			1492
Mar. 5	14.82	b 12.509+	c .300			88
12	.58	.258	.322			77
19	.95	.586	.364			75
26	2.16	1.311	.849			190
	18.51	14.664	1.835			430
Apr. 2	2.06	1.286	.774			227
9	3.44	2.654	.786			213
16	1.87	1.297	.573			200
23	2.91	1.618				70
30	13.52	d 4.059				150
	23.80	10.814	c 3.100			860
May 7	3.35	b 6.905+	c .700			140
14	1.89	.746	1.144			149
21	2.71	1.796	.914			191
28	2.62	2.028	.592			120
	10.57	11.475	3.350			600
June 4	3.38	2.634	.746			100
11	2.42	1.440	.980			92
18	1.18	.290	.890			118
25	1.26	.580	.680			43
	8.24	4.944	3.296			353
July 2	3.79	2.762	1.028			119
8	1.24	.386	.854			61
15	3.47	e 3.844	2.716			262
22	3.09					245
29	2.70	1.302	1.398			200
	14.29	8.294	5.996			887
Aug. 5	2.63	1.816	.814			120
12	3.45	2.318	1.132			183
19	3.40	2.566	.834			82
26	2.46	1.430	1.030			123
	11.94	8.130	3.810			508
Sept. 9	5.97	3.434	2.536			
16	1.56	1.408	.152			
23	.44	.000	.440			
30	.68	.000	.680			
	8.65	4.842	3.808			
Oct. 7	.28	.004	.276			
14	.17	.000	.170			
21	3.17	1.622	1.548			
28	2.73	2.052	.678			
	6.35	3.678	2.672			
Nov. 4	.43	.213	.217			
11	1.08	.683	.397			
18	2.77	2.610	.160			
25	2.16	1.945	.215			
	6.44	5.451	.989			

Records of rainfall, evaporation, consumptive use, and wind movement at
Lower Luakaha station, Nuuanu Valley—Continued

[Altitude 890 feet]

Week ending	Rainfall inches	Evaporation pan		Panicum pan		Anemometer miles
		Overflow inches	Loss inches	Overflow (a) inches	Loss (Consumptive use) inches	
Dec. 2	1.87	1.362	.508			
9	4.35	4.272	.078			
16	3.12	2.870	.250			
23	.84	.782	.058			
30	3.14	2.450	.690			
	13.32	11.736	1.584			
1933						
Jan. 6	4.27	4.140	.130			
13	.46	.315	.145			
20	3.24	2.604	.636			
27	2.06	1.594	.466			
	10.03	8.653	1.377		c 1.65	
Feb. 3	9.56	8.808	.752			
10	4.93	4.466	.464			
17	6.87	6.525	.345			
24	3.67	3.228	.442			
	25.03	23.027	2.003		c 2.40	
Mar. 4	8.46	6.945	1.515			
10	4.56	3.809	.751			
17	.22	.208	.012			
24	1.10	.174	.926			
31	.99	.304	.686			
	14.23	11.440	3.890		c 4.67	
Apr. 7	2.43	1.696	.734	1.486	.944	
14	.38	.000	.380	.148	.232	
21	.93	.050	.880	.007	.923	
28	.95	.000	.950	.005	.945	
30	.22	.000	.220	.000	.220	
	4.91	1.746	3.164	1.646	3.264	
May 5	.56	.000	.560	.000	.560	
12	1.54	1.121	.419	.175	1.365	
19	1.02	.555	.465	.260	.760	
26	.98	.000	.980	.135	.845	
31	.32	.000	.320	.040	.280	
	4.42	1.676	2.744	.610	3.810	
June 2	.96	.000	.960	.010	.950	
9	2.46	1.819	.641	1.102	1.358	
16	1.44	1.170	.270	1.159	.281	
23	.97	.000	.970	.064	.906	
30	2.37	1.351	1.019	.412	1.958	
	8.20	4.340	3.860	2.747	5.453	
July 7	1.82	.927	.893	1.017	.803	
14	.90	.256	.644	.306	.594	
21	1.29	.122	1.168	.096	1.194	
28	1.87	.706	1.164	.208	1.662	
31	1.12	.240	.880	.170	.950	
	7.00	2.251	4.749	1.797	5.203	
Aug. 4	.40	.354	.046	.260	.140	
11	1.19	.194	.996	.180	1.010	
18	1.05	.000	1.050	.041	1.009	
25	.94	.143	.797	.019	.921	
31	.98	.001	.979	.011	.969	
	4.56	.692	3.868	.511	4.049	
Sept. 1	.12	.032	.088	.001	.119	
8	2.07	1.092	.978	.146	1.924	
15	1.06	.550	.510	.509	.551	
22	1.32	.348	.972	.138	1.182	
29	.15	.004	.146	.062	.088	
30	.59	.000	.590	.003	.587	
	5.31	2.026	3.284	.859	4.451	

*Records of rainfall, evaporation, consumptive use, and wind movement at
Lower Luakaha station, Nuuanu Valley—Continued*

[Altitude 890 feet]

Week ending	Rainfall inches	Evaporation pan		Panicum pan		Anemometer miles
		Overflow inches	Loss inches	Overflow (a) inches	Loss (Consumptive use) inches	
Oct. 6	.76	.233	.527	.021	.739
14	.38	.005	.375	.000	.380
20	.12	.000	.120	.000	.120
27	.05	.000	.050	.000	.050
31	.73	.000	.730	.000	.730
	2.04	.238	1.802	.021	2.019
Nov. 3	.81	.550	.260	.000	.810
10	.61	.412	.198	.000	.610
17	.00	.000	.000	.000	.000
24	.10	.000	.100	.000	.100
30	1.28	.780	.500	.000	1.280
	2.80	1.742	1.058	.000	2.800
Dec. 1	.00	.000	.000	.000	.000
8	1.84	1.562	.278	.000	1.840
15	.39	.208	.182	.000	.390
22	2.36	1.560	.800	.000	2.360
29	3.78	3.540	.240	3.300	.480
31	.00	.000	.000	.058	.058
	8.37	6.870	1.500	3.358	5.012

(a) Overflow is what percolates through the pan to the measuring tank and is equivalent to deep percolation and direct run-off.

(b) Storage tank overflowed.

(c) Estimated.

(d) Outlet lowered 1 inch to prevent spatter.

(e) Small leak in union of overflow pipe from evaporation pan stopped. Leakage only during times of overflow and probably resulted from lowering outlet on April 30, 1932.

The following table summarizes the data:

Evaporation and transpiration, in inches, at Lower Luakaha (Nuuanu Valley) station

[Altitude 890 feet]

Month (a)	1931			1932		1933		
	Rain	Evaporation from free water surface	Consumptive use	Rain	Evaporation from free water surface	Rain	Evaporation from free water surface	Consumptive use (b)
Jan.	6.67	1.942	c 3.152	16.54	1.930	10.03	1.377	d 1.65
Feb.	7.76	3.690	c 7.760	41.58	1.800	25.03	2.003	d 2.40
Mar.	4.12	2.616	c 2.290	18.51	1.835	14.23	3.890	d e 4.67
Apr.	7.23	3.290	c 5.955	23.80	f 3.100	4.91	3.164	3.264
May	7.30	4.202	c 5.220	10.57	3.350	4.42	2.744	3.810
June	7.06	5.412	5.418	8.24	3.296	8.20	3.860	5.453
July	11.89	6.505	6.037	14.29	5.996	7.00	4.749	5.203
Aug.	26.09	7.069	8.169	11.94	3.810	4.56	3.868	4.049
Sept.	25.02	5.906	2.230	8.65	3.808	5.31	3.284	4.451
Oct.	15.75	2.797	.792	6.35	2.672	2.04	1.802	2.019
Nov.	17.35	2.718	1.091	6.44	.989	2.80	1.058	2.800
Dec.	8.47	1.451	1.925	13.32	1.584	8.37	1.500	g 5.012
	144.71	h 47.598	50.039	180.23	34.170	96.90	33.299	44.781

(a) Record is for a period approximating the month until April 1933.

(b) Consumptive use equals transpiration plus evaporation.

(c) Abnormally high transpiration due to plants being transplanted.

(d) Estimated on basis 1.2 times evaporation.

(e) Inflow over top of grass tank stopped.

(f) Some spatter prior to this date during heavy rains, so outlet was lowered 1 inch.

(g) Rainfall so low that no water passed through tank from Oct. 6 to Dec. 29, hence October and November losses appear in this figure.

(h) Evaporation too high, owing to a slight amount of spatter during heavy rains.

KAUKONAHUA STATION

The Kaukonahua station was installed in July 1931 by Mr. Vaksvik at an altitude of 1,250 feet on the south bank of the North Fork of Kaukonahua Stream near the Wahiawa intake rain gage, where almost the heaviest rainfall on Oahu is recorded. It consists of a rain gage, evaporation pan, panicum pan, and fern pan, all of which are connected to storage tanks equipped with automatic water-stage recorders. The tanks and pans were transported on a small boat to the station by the Wahiawa Water Co. through 2 miles of tunnel.

As the mean annual rainfall is about 250 inches at this station it is about 100 inches greater than at the Lower Luakaha station, and therefore this experiment gives a comparison between the consumptive use of panicum at places with very different rainfall. Panicum grass does not occur in the area and had to be brought in from lower down in the valley. It grew slowly after transplanting, because the climate is not as suitable as at Lower Luakaha, yet by 1933 it had become very dense, as shown in plate 27, A.

Another pan, similar in shape to the panicum pan, was installed to obtain the loss from ferns, which are common in this area. The annual loss by both pans was so nearly the same that transpiration is apparently quite uniform at this place.

The results given in the table below show that the loss by evaporation at this station is only about a third and the consumptive use only about half as great as at the Lower Luakaha station. This decrease in consumptive use with high rainfall appears to be due chiefly to the smaller number of hours of sunshine, with differences in temperature and wind as minor causes. The difference in mean temperature between the two stations is probably less than 5°. Recent unpublished studies by the Hawaiian Sugar Planters Experiment Station in Honolulu show a quantitatively measurable decrease in the rate of transpiration from sugar cane even when the sun is obscured by a cloud for only a few minutes.

Owing to the slow rate of percolation through the clayey soil, the rainfall of one month does not always reach the storage tanks by the end of the month. Slight inconsistencies in the monthly rate of loss in the two transpiration pans are caused in this manner. Losses during February 1932 had to be partly estimated, because all storage tanks overflowed when more than 33 inches of rain fell in one week. The following table gives the results obtained at Kaukonahua:

Records of rainfall, evaporation, consumptive use, and wind movement at
Kaukonahua station

[Altitude 1,250 feet]

Week ending	Rainfall (inches)	Evaporation pan		Fern pan		Panicum pan		Anemo-meter (miles)
		Overflow (inches) (a)	Loss (inches)	Overflow (inches)	Loss (inches)	Overflow (inches)	Loss (inches)	
1931								
August 29 to Sept. 20	27.515	26.486	1.029	25.696	1.819	25.912	1.603	
September 27	11.090	10.822	.268	8.408	2.682	9.266	1.824	
	38.605	37.308	1.297	34.104	4.501	35.178	3.427	
October 4	1.770	1.588	.182	3.626	-1.856	2.330	-.560	
11	3.795	3.660	.135	3.860	.065	3.522	.273	
18	5.445	4.860	.585	4.478	.967	4.654	.791	
25	5.185	4.764	.421	5.992	-.807	4.364	.821	
	16.195	14.872	1.323	17.956	-1.631	14.870	1.325	
November 1	3.065	2.620	.445	3.194	-.129	2.832	.233	
8	6.260	6.382	-.122	5.620	.640	6.116	.144	
15	12.000	11.464	.536	7.062	4.938	10.178	1.822	
22	6.090	6.156	-.066	7.532	-1.442	7.150	-1.060	
29	.485	.256	.229	1.846	-1.361	.688	-.203	
	27.900	26.878	1.022	25.254	2.646	26.964	.936	
December 6	1.420	1.162	.258	1.298	.122	.884	.536	
13	.830	.628	.202	.316	.514	.722	.108	
20	3.640	3.590	.050	3.734	-.094	3.068	.572	
27	3.550	3.780	-.230	3.716	-.166	3.316	.234	
	9.440	9.160	.280	9.064	.376	7.990	1.450	
1932								
January 3	4.095	3.696	.399	4.132	-.037	3.766	.329	
10	1.355	1.236	.119	1.368	-.013	1.254	.101	
17	3.250	3.574	-.324	3.408	-.158	3.094	.156	
24	12.880	12.530	.350	11.142	1.738	10.974	1.906	
31	9.260	8.746	.514	9.466	-.206	9.084	.176	
	30.840	29.782	1.058	29.516	1.324	28.172	2.668	
February 7	9.550	9.678	-.128	10.020	-.470	9.044	.506	189
14	b 40.980	c .467	271
21	5.705	5.220	.485	5.584	.121	5.192	.513	113
28	13.055	12.758	.297	11.482	1.573	11.338	1.717	196
	69.290	c .500	c .900	3.203	770
March 5	13.850	13.814	.036	14.318	-.468	14.418	-.568	105
13	.520	.146	.374	1.954	-1.434	1.736	-1.216	95
20	1.795	1.280	.515	1.498	.297	1.350	.445	129
27	2.820	2.226	.594	2.308	.512	2.084	.736	177
	18.985	17.466	1.519	20.078	-1.093	19.588	-.603	506
April 3	5.125	4.998	.127	4.468	.657	4.564	.561	275
10	7.835	7.716	.119	7.264	.571	7.496	.339	224
17	4.240	4.258	-.018	4.390	-.150	4.050	.190	239
24	9.320	8.622	.698	8.158	1.162	8.474	.846	198
	26.520	25.594	.926	24.280	2.240	24.584	1.936	936
May 1	7.975	7.442	.533	7.414	.561	7.616	.359	216
8	6.530	6.362	.168	6.552	-.022	6.492	.038	254
15	6.905	6.680	.225	6.206	.699	6.312	.593	203
22	3.655	3.658	-.003	3.554	.101	3.878	-.223	234
29	5.110	4.878	.232	4.472	.638	4.680	.430	105
	30.175	29.020	1.155	28.198	1.977	28.978	1.197	1012
June 5	5.995	5.432	.563	5.112	.883	5.408	.587	170
12	2.285	1.698	.587	1.488	.797	1.596	.689	219
19	4.920	4.498	.422	4.360	.560	4.432	.488	190
26	1.970	1.696	.274	1.858	.112	2.068	-.098	158
	15.170	13.324	1.846	12.818	2.352	13.504	1.666	737
July 3	5.895	5.108	.787	4.608	1.287	4.902	.993	123
10	2.730	2.080	.650	1.856	.874	1.962	.768	154
17	4.905	4.430	.475	4.194	.711	4.566	.339	125
24	8.330	7.658	.672	7.044	1.286	7.524	.806	198
31	4.830	4.364	.466	4.190	.640	4.536	.294	222
	26.690	23.640	3.050	21.892	4.798	23.490	3.200	822
August 7	4.710	4.260	.450	4.048	.662	4.212	.498	162
14	5.160	4.936	.224	4.526	.634	5.014	.146	67
21	2.420	2.050	.370	1.854	.566	1.786	.634	119
28	1.870	1.248	.622	1.164	.706	1.138	.732	106
	14.160	12.494	1.666	11.592	2.568	12.150	2.010	454

Records of rainfall, evaporation, consumptive use, and wind movement at
Kaukonahua station—Continued

[Altitude 1,250 feet]

Week ending	Rainfall (inches)	Evaporation pan		Fern pan		Panicum pan		Anemometer (miles)
		Overflow (inches) (a)	Loss (inches)	Overflow (inches)	Loss (inches)	Overflow (inches)	Loss (inches)	
September 4	2.960	2.172	.788	2.022	.938	2.020	.940	181
11	6.920	6.628	.292	6.304	.616	7.006	— .086	158
18	1.035	.584	.451	.736	.299	.566	.469	71
25	.255	.000	.255	1.198	— .943	.000	.255	64
	11.170	9.384	1.786	10.260	.910	9.592	1.578	474
October 2	.675	.000	.675	.080	.595	.000	.675	17
9	.750	.014	.736	.200	.550	.000	.750	53
16	.364	.348	.016	.296	.068	.000	.364	109
23	8.010	7.980	.030	6.544	1.466	7.202	.808	33
30	2.905	2.752	.153	3.148	— .243	2.574	.331	98
	12.704	11.094	1.610	10.268	2.436	9.776	2.928	310
November 6	.805	.474	.331	.350	.455	.152	.653	58
13	1.960	1.770	.190	1.728	.232	1.160	.800	31
20	7.545	7.010	.535	6.340	1.205	7.468	.077	54
27	4.220	4.164	.056	4.372	— .152	4.354	— .134	242
	14.530	13.418	1.112	12.790	1.740	13.134	1.396	385
December 4	9.705	9.380	.325	8.486	1.219	9.282	.423	108
11	.395	.240	.155	.884	— .489	.904	— .589	45
18	5.270	5.220	.050	4.808	.462	4.818	.452	77
24	2.200	2.204	— .004	1.950	.250	1.940	.260	47
30	6.060	5.958	.102	5.384	.676	5.952	.108	213
	23.630	23.002	.628	21.512	2.118	22.976	.654	490
(d) 1933								
April 2	2.105	2.096	.009	1.876	.229	2.050	.055
9	.250	.262	— .012	.338	— .088	.236	.014	49
16	2.155	1.584	.571	1.016	1.139	.786	1.369	84
23	2.110	2.062	.048	1.958	.152	2.120	— .010	129
30	e 4.410	4.379	.031	3.498	.912	3.708	.702	215
	11.030	10.383	f .647	8.686	f 2.344	8.900	f 2.130
May 7	3.188	2.577	.611	2.076	1.112	2.118	1.070	159
14	1.200	.790	.410	.808	.392	.858	.342	45
21	3.860	3.464	.396	2.786	1.074	2.770	1.090	285
28	1.345	.862	.483	.768	.577	.546	.799	144
31	1.065	.880	.185	.620	.445	.490	.575
	10.658	8.573	2.085	7.058	3.600	6.782	3.876
June 4	5.490	5.150	.340	4.514	.976	4.722	.768	141
10	4.575	4.658	— .083	4.390	.185	4.732	— .157	101
17	1.235	.958	.277	.676	.559	.738	.497	30
24	2.960	2.360	.600	1.794	1.166	1.788	1.172	176
30	5.590	5.874	— .284	4.774	.816	5.314	.276	171
	19.850	19.000	.850	16.148	3.702	17.294	2.556	619
July 1	1.020	.600	.420	.460	.560	.510	.510
8	4.480	4.454	.026	4.276	.204	3.850	.630	179
15	1.225	.656	.569	.392	.833	.382	.843	204
23	3.465	3.130	.335	2.486	.979	2.324	1.141	123
29	2.670	2.400	.270	2.222	.448	2.070	.600	201
31	1.540	1.700	— .160	1.690	— .150	1.620	.080
	14.400	12.940	1.460	11.526	2.874	10.756	3.644
August 6	3.195	2.814	.381	2.610	.585	2.652	.543	239
12	1.830	1.406	.424	1.436	.394	1.432	.398	91
19	2.125	1.512	.613	1.390	.735	1.306	.810	72
26	1.085	.552	.533	.590	.495	.564	.521	57
31	1.745	1.016	.729	.458	1.287	.364	1.381
	9.980	7.300	2.680	6.484	3.496	6.318	3.662
September 2	.790	.740	.050	.830	— .040	.620	.170	85
10	5.080	4.306	.774	4.480	.600	4.328	.752	130
17	4.030	3.986	.044	3.578	.452	3.220	.810	207
24	1.705	1.242	.463	.930	.775	.836	.869	124
30	.955	.572	.383	.378	.577	.320	.635	117
	12.560	10.846	1.714	10.196	2.364	9.324	3.236	665
October 1	.000	.004	— .004	.020	— .020	.020	— .020
8	2.065	1.602	.463	1.468	.597	.780	1.285	70
15	.655	.228	.427	.330	.325	.334	.321	192
22	.640	.452	.188	.174	.466	.202	.438	38
29	1.070	.386	.684	.048	1.022	.000	1.070
31	.130	.200	— .070	.304	— .174	.264	— .134
	4.560	2.872	1.688	2.344	2.216	1.600	2.960

212 GEOLOGY AND GROUND-WATER RESOURCES OF OAHU

Records of rainfall, evaporation, consumptive use, and wind movement at
Kaukonahua station—Continued

[Altitude 1,250 feet]

Week ending	Rainfall (inches)	Evaporation pan		Fern pan		Panicum pan		Anemo-meter (miles)
		Overflow (inches) (a)	Loss (inches)	Overflow (inches)	Loss (inches)	Overflow (inches)	Loss (inches)	
November 5	1.320	1.010	.310	.996	.324	.734	.586	161
12	.345	.226	.119	.396	— .051	.094	.251	28
18	.000	.042	— .042	.444	— .444	.000	.000	42
25	.235	.000	.235	.000	.235	.000	.235	6
30	2.595	2.344	.251	2.300	.295	2.016	.579	
	4.495	3.622	.873	4.136	.350	2.844	1.651	
December 3	.650	.380	.270	.088	.562	.014	.636	20
10	.950	1.032	— .082	1.056	— .106	1.000	— .050	39
17	.235	.026	.209	.178	.057	.000	.235	42
24	7.405	6.930	.475	6.570	.835	5.572	1.833	59
31	.135	.080	.055	.959	— .824	1.400	— 1.265	83
	9.375	8.448	.927	8.851	.524	7.986	1.389	243

(a) Overflow is what percolates through the pan to the measuring tank and is equivalent to deep percolation and direct run-off.

(b) Tanks overflowed after 33 inches had fallen; total obtained from rain gage a few hundred feet away.

(c) Partly estimated.

(d) Measuring tank overflowed week ending Jan. 8; leak evidently developed in rain-gage pipe during storm this week.

(e) Rain-gage pipe removed and leak soldered; reinstalled May 7. Rainfall for interval period from rain-gage at Wahiawa Water Company's intake, nearby.

(f) Perhaps slightly low owing to using Wahiawa Water Company's rainfall records.

The following table summarizes the data by months:

Rainfall, evaporation, and consumptive use, in inches, at
Kaukonahua station

[Altitude 1,250 feet]

	Rainfall	Evaporation	Consumptive use	
			Fern pan	Panicum pan
1931				
September	39.195	1.24	2.18	2.29
October	18.255	1.63	} a 3.13 }	2.28
November	24.970	.71		.98
December	10.605	.47	} a 2.00 }	1.56
1932				
January	31.085	.51	} b .90 }	2.48
February	69.290	b .50		a 2.60
March	13.135	1.59	} 1.38 }	
April	30.590	.93		1.95
May	22.970	1.24	2.15	1.31
June	19.580	2.14	3.09	2.07
July	21.975	2.60	4.21	2.63
August	14.570	1.89	2.57	2.41
Year ending August 31.....	316.22	15.45	23.56	22.28
September	11.185	2.04	1.34	1.66
October	12.184	1.18	2.07	2.54
November	17.105	1.20	2.20	1.48
December	25.725	.49	1.60	.47
Total for 1932	289.39	16.31	24.46	21.32
1933				
January	c 29.95	} b 1.70 }	b 3.00	b 2.50
February	c 26.00			
March	c 20.40	} d .647 }	d 2.344	d 2.130
April	11.030			
May	10.658	2.085	3.600	3.876
June	19.850	.850	3.702	2.556
July	14.400	1.460	2.874	3.644
August	9.980	2.680	3.496	3.662
Year ending August 31.....	208.47	14.33	26.23	24.52
September	12.560	1.714	2.444	3.236
October	4.560	1.688	2.216	2.960
November	4.495	.873	.359	1.651
December	9.375	.927	.524	1.389
Total for 1933	173.26	14.62	24.56	27.60

(a) No stopping point in record at end of month.

(b) Partly estimated.

(c) Rainfall at adjacent Wahiawa Water Company's rain-gage.

(d) Perhaps slightly low owing to use of Wahiawa Water Company's record.

EVAPORATION AT UPPER HOAEAE AND MAUNAWILI RANCH

Evaporation records at two United States Weather Bureau stations are given below. Upper Hoaeae is a few miles southwest of the Kaukonahua station, and Maunawili is a few miles northeast of the Luakaha station. The similarity of the rate of evaporation at the Maunawili and Luakaha stations, in spite of a difference of about 50 percent more rainfall at Luakaha, is due in part to the method of computation used by the Weather Bureau for the Maunawili record and in part to the fact that Maunawili is more exposed to the wind.

Evaporation at Upper Hoaeae and Maunawili ranch

(From records of United States Weather Bureau)

[Altitude: Upper Hoaeae, 705 feet; Maunawili, 250 feet]

Year	Upper Hoaeae			Maunawili		
	Rainfall (inches)	Evaporation		Rainfall (inches)	Evaporation	
		Inches	Percent of Rainfall		Inches	Percent of rainfall
1921	34.34	69.26	202	98.67	41.71	42
1922	25.16	61.80	246	66.34	43.60	66
1923	49.46	59.47	120	117.93	50.27	43
1924	60.44	73.57	48.13	65
1925	24.79	59.62	240	73.76	43.70	59
1926	22.06	62.36	44.26	71
1927	67.39	57.67	86	140.63	43.62	31
1928	24.13	57.29	237	62.41	46.34	74
1929	44.78	58.10	130	75.36	44.91	60
1930	37.14	60.11	162
1931	25.32	63.20	250

SURFACE WATER

By H. T. STEARNS

Run-off records.—Records of stream flow for the Hawaiian Islands are published in United States Geological Survey water-supply papers, and the records for Oahu have been compiled by Kunesh³ and need not be reprinted here. Additional records are still being obtained by the United States Geological Survey and the Honolulu Board of Water Supply and will be found in their publications. The streams are for the most part very flashy, and the greater number of them are ephemeral except those draining from the dike complexes of the Koolau and Waianae Ranges or from valleys floored with post-Koolau volcanics. In general, the ephemeral streams flow only a few hours after a rain except within the forest belt, where they may flow for several days.

Rate of run-off.—Extreme floods accompanying cloudbursts sometimes cause considerable property damage and even loss of life, as the flood of Kalihi in November, 1930, when the rate of run-off was about 4,220 second-feet from a drainage basin of only 2.7 square miles and the flood of the same stream on January 16, 1921, when the run-off was 4,350

³ Kunesh, J. F., Surface water supply of the Island of Oahu, 1909-28; Honolulu Sewer and Water Comm. Rept. for 1929, Suppl., 307 pp., 1929.

second-feet from the same area. On the latter date West Manoa Stream discharged at the rate of 3,520 second-feet from a drainage area of 1.1 square miles and East Manoa 3,090 second-feet from 1 square mile.⁴

Kunesh estimates that the surface run-off from all streams from Moanalua to Palolo in a year of average rainfall equals 42 million gallons daily. As the daily rainfall for the area tributary to these streams during an average year, as computed by Voorhees, is 194 million gallons, the run-off is about 22 percent of the rainfall.

Character of stream beds.—Except the streams back of Honolulu, which flow largely on late valley fills of basalt and contribute to perched water tables, the upper stretches of the streams are mostly on bare lava rock, and seepage water from them sinks to the basal water table. Here and there pockets and bars of loose gravel occur, and the water lost in the gravel that does not reappear downstream likewise descends to the basal water table. The lower stretches of the streams are usually in older alluvium, which generally has low permeability, but such water as seeps into this deposit is likely to percolate to the basal water table also. Seepage water from the streams where they cross the coastal plain, however, has little opportunity to reach the water in the basalt because of intervening impermeable sediments, hence it moves seaward usually at shallow depths. In ascending the various streams on the leeward side of Oahu all of the flow was observed to disappear permanently into the ground a short distance below the zone of heavy rainfall, except during heavy rains.

Debris transported by streams.—The amount of debris transported by the streams of Oahu during flood flows is very great. Several acres of closely packed boulders, mostly over a foot in diameter, were left strewn over the land adjacent to Kalihi Stream near King Street after the flood of 1930, and similar deposits were left on the coastal plain by most of the other streams in the Honolulu district. Such floods are not unusual and play an important part in the wearing down of the Oahu mountains and in filling up lagoons along the shore (pl. 27, B). By similar erosion and sedimentation, concurrent with the higher stands of the sea, the cap rock of the artesian basins was laid down.

IMPORTANCE OF GROUND WATER

By H. T. STEARNS

Reservoir sites to store surface water are scarce because of the steep gradients of the streams, and except for a few places such as Wahiawa, where the bed rock is deeply weathered reservoirs are impracticable because of the high permeability of the lava rocks. Because of this condition and the flashy character of the streams the water supply of

⁴ U. S. Geol. Survey Water-Supply Paper 695, pp. 35-36, 1929.

the island is obtained mainly from wells, tunnels, and springs. About 32 million gallons is pumped daily from artesian wells in the Honolulu area for municipal supplies, and in 1932 about 260 million gallons were pumped daily from wells on Oahu for public supplies and irrigation. The rainfall on most of the plantations is too low to grow sugar cane without irrigation, and even in areas of more rainfall the crop of cane is doubled by irrigation. Most of the water used for irrigation is obtained from the ground by means of wells and tunnels. All communities are supplied with ground water except Wahiawa and Schofield Barracks, which obtain water from the Wahiawa and Ku Tree Reservoirs. Water recovered from tunnels high in the mountain is used at Waianae for generating power.

Unlike regions in the United States where large supplies of water can be transported from adjacent regions, Oahu must base its future development upon the local water supply. Because of this fact and because of the high financial return for irrigation supplies, any new water that can be economically developed has great value.

BASAL GROUND WATER

By H. T. STEARNS

DEFINITION

The basal ground water on Oahu, as distinguished from high-level or perched ground water, is the great body of water that lies below the main water table of the island.⁵ It naturally falls into two divisions—(1) shallow water, usually without confining beds, occurring in the limestone, post-Koolau volcanics, gravel, and other permeable rocks that make up the coastal plain, and (2) water occurring in the Koolau and Waianae basalts, with or without confining beds, and near the coast supplying the artesian wells.

WATER IN THE ROCKS OF THE COASTAL PLAIN

OCCURRENCE

Permeability.—The rocks of the coastal plain comprise clay, silt, sand, and gravel; calcareous reef, beach, and dune deposits; and various types of post-Koolau volcanics. Because much of the sand and gravel shown on plate 2 as consolidated noncalcareous sediments is deeply weathered, indurated, and poorly sorted, it has low permeability and, like the clay and silt, yields only small supplies to domestic wells. However, where ribbons of saturated loose gravel and sand are encountered small irrigation supplies have been recovered—for example, in the Waianae area. The limestone, lava, cinders, and unconsolidated beach and dune sand are very permeable and yield larger supplies.

⁵ Meinzer, O. E., Ground water in the Hawaiian Islands: U. S. Geol. Survey Water-Supply Paper 616, p. 10, 1930.

Quality and head.—The water in the emerged delta deposits of the coastal plain usually stands not more than 10 feet above sea level and is generally potable. It stands only 1 to 3 feet above sea level in the more permeable rocks, and because there it can mix freely with sea water it is likely to be too brackish for human consumption, but at Ewa and Waianae it is used successfully for irrigation. Where the salt content is more than about 70 grains per gallon it is generally mixed with fresher supplies.

Some of the drillers' logs indicate that ground water under appreciable head exists in the deeper aquifers of the coastal plain. This water is generally encountered in volcanic rocks, gravel, or limestone and is confined in these rocks by beds of clay and silt. Little is known regarding the quality or quantity of this deep water, because it is cased off when drilling for the main artesian supply, but both potable and very brackish water have been reported. Probably in regions where water is scarce such supplies would be used but at present there is little demand for them on Oahu.

In making test borings for bridges the Hobart Engineering Co. has encountered flowing water in the coastal sediments in several places. On February 7, 1933, a hole that was bored by this company at the Bere-tania Street Bridge over Nuuanu Stream in Honolulu, penetrated 5.5 feet of compact sand and gravel beneath the river and then encountered 39 feet of soft material, mostly mud but containing a little decayed vegetation and streaks of sand and gravel. With the casing 9 feet from the bottom, water rose 11 feet above the river surface and overflowed the casing. In this particular well the flow was caused by swamp gas acting on the principle of an air lift as is shown by the fact that the gas was present in sufficient quantity to burn for several hours after being ignited.

This company reports a hole 177 feet deep about 1,100 feet northwest of Kailua Tavern which penetrated beach sand, coral, and coral mud. It obtained water too salty for use, and the salt content increased with depth. The company drilled a well also at an altitude of about 30 feet at Lanikai which encountered water just above sea level containing 50 grains of salt per gallon. The hole was drilled to a depth of 135 feet, but the water became saltier with depth, so it was plugged back to sea level. Mr. Hobart believes that the hole did not encounter basalt.

Drilled well 158 in Moanalua Valley encountered ground water in the coastal-plain silts at 9 feet below sea level which rose 3.5 feet above sea level and contained only 11.8 grains of salt per gallon. At 100 feet below sea level the salt decreased to 10.7 grains per gallon and the head increased to 5.7 feet, which seems to indicate artesian pressure in these sediments. At 112 feet the head fell to 2.66 feet, and a little

deeper, just above the contact of the coastal-plain sediments with Koolau basalt, the head fell to 2.5 feet, which points to a permeable bed with a lower head at this depth. However, drill cuttings in suspension could account for all the changes in head observed, and as these measurements were made while the well was being drilled, a possibility exists that some of these changes in head were caused by differences in the amount of suspended matter. Artesian water in Koolau basalt was obtained at 135 feet; no brackish or ocean water occurred between the water in the sediments and the basalts, and the artesian water was only slightly different in quality from the water in the sediments.

Good supplies of potable water with a head of only a foot or two above sea level are generally obtained where pervious rocks of the coastal plain rest against the ends of inter-valley spurs, especially in the Koolau Range. This water is escaping from the adjacent zone of saturation in the flow lavas. The irrigation supplies pumped from shallow wells in Wailupe, Niu, and the adjacent valleys are largely of this type.

In general, the lower the water table the higher the salt, and the higher the water table the lower the salt. Usually in the coastal plain a high head means a small supply, but a low head with a low salt content may mean a large supply if the water is found in coral, because such an occurrence means that considerable fresh water is moving seaward. Generally, the farther inland a well is dug the less will be the danger of contamination by sea water.

The largest supplies have been struck in cavernous reef limestone. At well 9 in Waianae Valley a cavern was struck which yielded so much water with 750 grains of salt per gallon that it could not be blocked off from the south tunnel, which was yielding 250,000 gallons daily with only 65 grains per gallon; hence the well had to be abandoned.

Tidal fluctuations.—The water table in the very permeable rocks usually fluctuates with the tide, whereas that in the finer-grained sediments does not. In figure 15, pronounced tidal fluctuations occurred in the sump at well 1B on November 19 and 20 when the pump was not operating, yet they did not occur in the well dug in silt and partly decomposed gravel 100 yards away. Tidal effects can also be detected between November 14 and 18 when the pump was operating.

Effect of draft on quality.—In most wells the salt content varies with the draft, indicating connection with sea water. In dug well 1-B, for example, the salt content doubles when the quantity pumped is doubled. In other wells the salt does not increase as rapidly, and in a few wells the salt has been known to decrease for short periods with increased draft, possibly because return irrigation water with a higher salt con-

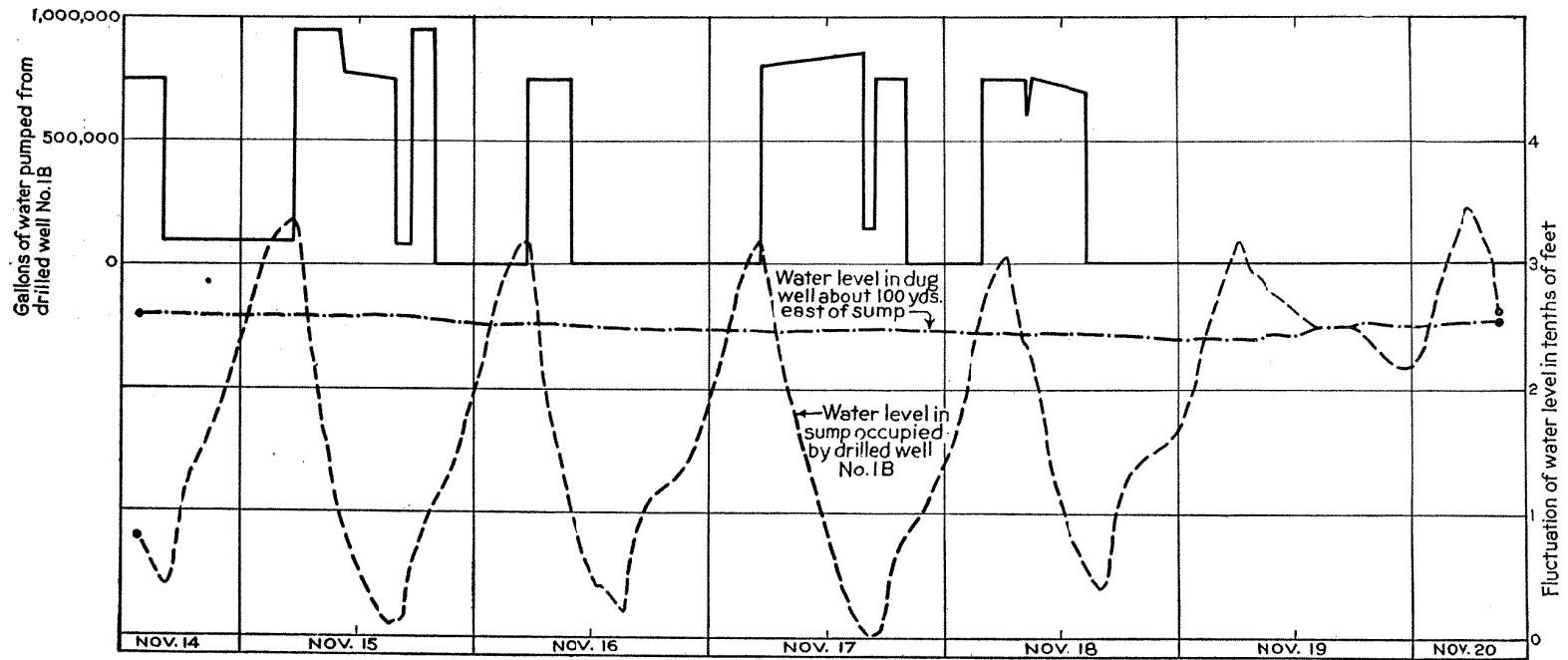

FIGURE 15.—Graph showing tidal effect on the water level of a well dug in coral (?) and its absence in a well dug in silt and gravel in November, 1933. Both wells in the Waialae golf course.

tent than the normal water of the well is stored near the top of the saturated zone that supplies the well.

Methods for recovery.—Wells and tunnels dug to recover ground water in the permeable coastal-plain sediments should be made as shallow as possible. In the less permeable formations such as the older valley fill, where the development is made some distance from the coast, tunnels are more effective if placed several feet below sea level. As shown by drilled well 158, the water in the valley fill is not generally floating on sea water, hence recovery is not a matter of skimming the fresh water off a body of sea water. It is really a difficult problem to develop irrigation supplies effectively in the coastal plain, because the formations are so variable in permeability and in continuity; hence test borings or pits should generally be made to determine the character of the aquifer and the quality of the water in it.

WELLS AND TUNNELS THAT YIELD WATER FROM THE ROCKS OF THE COASTAL PLAIN BORDERING THE WAIANAЕ RANGE

The wells and tunnels used for irrigation in the coastal plain bordering the Waianae Range are listed in the following table (Nos. 1 to 24), and records of the quantity and quality of the water pumped are given on pages 228-234. Wells 5 and 7 derive most of their water from the lower Waianae lavas but they are included here because they form an integral part of the coastal-plain water developments of the Waianae Plantation Co. The total pumpage in 1932 from the coastal-plain sediments bordering the Waianae Range, exclusive of the Waianae Mill pump, amounted to about 3,934,000,000 gallons, or an average of 10,750,000 gallons a day. Of this amount an average of about 300,000 gallons a day was derived directly from the lower Waianae lavas.

Plate 2 shows 21 dug wells between Makaha Valley and Kaena Point. They are dug a few feet below sea level and obtain brackish water from the sediments of the coastal plain. The salt content in every well but one exceeds 30 grains per gallon. Some are equipped with gasoline-driven pumps, but most of them are pumped by windmills. One well in Keaau Valley was formerly used for irrigation, but all are now used to water stock.

A noteworthy well owned by Fidus McKenzie at an altitude of 129 feet, near the center of Keaau Valley and 2,600 feet from the sea, is apparently supplied by underflow from the valley. It penetrates 115 feet of partly consolidated conglomerate (pl. 2), and water stands in it 20 feet above sea level.⁶ The owner reports that when pumped at the rate of 600 gallons an hour, the water contains only 4 grains of salt per gallon and the draw-down amounts to only about 1 foot.

⁶ Clark, W. O., unpublished report on investigation of ground water of Makua Valley, 1930.

Dug irrigation wells on Waianae coastal plain

No. on pl.	Valley or area	Owner	Year dug	Rocks Penetrated	Altitude (feet)	Depth (feet)	Altitude of water (feet)	Tunnels (a)			Number of Motors	Kind and Amount of Power	Number of pumps	Type (c)	Size (inches)	Capacity (gallons a minute)
								Number	Direction	Length (feet)						
d e 1	Waianae	Waianae Plantation Co.		Reef limestone	17.7	33.2	10.0	1	NW	500	1	E 30	1	VC	10	790
f 1-B	Makaha	do.	1917	Valley fill	24.8	34.6	6.0	2		1,200	1	D 15	1	HC	8	835
g 2	do.	do.	1919	do.	22.8	24.0	3.0	1		6	1	D 15	1	HC	5	375
h 3	Waianae	do.	1923	do.	24.4	37.0	7.5	1	(E N S)	395 500 178	1	E 20	1	VC	5	490
i 4	do.	do.	1923	Reef on valley fill	23.2	36.7	7.5	2	(N W)	369 130	1	E 20	1	VC	5	320
j 5	do.	do.	1924	Lower Waianae lavas	36.0	44.0	8.0	2	(E S)	80 150	1	E 7½	1	VC	3	90
k 6	do.	do.	1924	Valley fill	29.7	44.2	6.0	2	(N S)	190 90	1	E 7½	1	VC	6	230
l m 7	do.	do.	1923	Valley fill, reef, lower	27.7	39.5	4.0	3	(N NE S)	176 53 266	1	E 20	1	VC	8	745
n 9	do.	do.	1928	Waianae lavas Valley fill	o 20.0			2	(S)	250 10	0					
p 10	do.	do.	1929	do.	41.15	62.0	13.0	2	(N S)	317 125	1	E 15	1	VC	8	385
q 11	Lualualei	do.	1911	Reef limestone	o 30.00	37.0	Dry	0								
r 12	do.	do.	1912	do.	o 55.00	o 60.0	o 2.0	0								
s 13	do.	do.	1920	Reef 20 ft. then water-worn boulders	o 28.00	o 25.0	Dry	0								
t 14	do.	do.	1923	Black silty clay	o 47.00	10.0	o 40.0	0								
16	Nanakuli	Hawaiian Homes Commission		Valley fill	55.7	50.0	9.2	2	(NW SW)	200 700	1	E 15	1	T	7	160
v 20	Ewa	Ewa Plantation Co.	1930	Reef limestone	24.7	29.8	u 7	0			2	15	2	T	12	1,000
21	do.	do.	1930	do.	25.1	29.8	1.9	0			2	7½	2	T	12	750
22	do.	do.	1930	do.	23.0	28.8	u 1.6			95	2	7½	2	T	12	750
23	do.	do.	1931	do.	43.0	47.0	u 1.6			200	1	E 100	1	V		6,950
24	do.	do.	1932	do.	24.0	29.0	2.0			250	1	E 20	1	T		2,000

- (a) Tunnels are driven from the bottom of the well or shaft to increase yield of well.
- (b) E, electric; G, gas; D, Diesel engine.
- (c) VC, vertical centrifugal; HC, horizontal centrifugal; T, deep-well turbine; V, double-suction volute.
- (d) Record is for both Puko No. 1 and No. 2. Water in No. 2 comes from thin streak of gravel a little above sea level. Drainage water enters well at times. Pumps against a 56-foot head.
- (e) Data furnished by plantation. Numbering system for Makaha and Waianae Valleys the same as that used by the plantation.
- (f) Pumps against a 35-foot head.
- (g) Pumps against a 54-foot head. Dug in swampy spot.
- (h) Dug at site of spring. Pumps against a 59-foot head.
- (i) Pumps against a 45-foot head.
- (j) Pumps against a 105-foot head.
- (k) Dug at site of spring. Pumps against a 60-foot head.

- (m) North tunnel penetrates reef and valley fill and last 20 feet caved in; Northeast tunnel, reef; South tunnel, 50 feet of reef and 216 feet of lower basalt of Waianae volcanic series. Pumps against a 77-foot head.
- (n) Abandoned.
- (o) Approximate.
- (p) Pumps against a 72-foot head.
- (q) Two or three holes drilled to about 15 feet below sea level in bottom of pit. Well consists of two pits 10 feet square. Abandoned.
- (r) Yields 10,000 gallons daily with salt content of 120 grains per gallon. Used for wash water at camp.
- (s) Abandoned because water encountered contained 100 grains of salt per gallon.
- (t) Appears to be seepage water locally perched. Abandoned.
- (u) Pumping.
- (v) 17 to 19 omitted so as to make numbering system fit the one used by Ewa Plantation Co.

Dug irrigation wells on Koolau coastal plain

No. on pl. 2	Valley or area	Owner	Year dug	Rocks Penetrated	Altitude (feet)	Depth ((feet)	Altitude of water (feet)	Tunnels (a)			Number of Motors	Kind and Amount of Power	Number of pumps	Type (c)	Size (inches)	Capacity (gallons a minute)
								Number	Direction	Length (feet)						
d 25	Kaimuki	Salvation Army Punahou farm		Kaimuki basalt	e 40.0	45.0	1.7	0			1	E 25	1	2C		
f 26	do.	do.		do. ?												
g 27	do.	Carter estate		Valley fill 14 feet; Kaimuki basalt, 30 feet	e 40.0	44.0	1.8	1		20	2	E 5 D —	2	VC		
h 28	do.	Walter C. Love		Valley fill 15 feet; reef, 15 feet; Kaimuki basalt, 5 feet	e 31.0	35.0	1.7	0				E 15	1	HC	3	
i 29	do.	T. Nakano		Soil, beach, sand, reef	e 8.0	e 12.0	e 1.0	0			1	E 2	1	HC	1	
j 30	do.	U. Tokunaga		Reef limestone	e 10.0	e 13.0	e 1.5	0			1	E 2	1	HC	1	
k 31	do.	M. Murakami	1933	Fossiliferous beach gravels and dune limestone	e 22.0	e 27.0	e 2.0	0			1	E 5	1	HC	2	
l 32	do.	S. Surenaga	1933	Reef on boulders	e 22.0	24.0	e 2.0	1	W	40	1	D 6	1	HC	3	
m 33	Waialae	Waialae Dairy		Valley fill, reef limestone	8.2	e 14.0	6.0	0			1	E 10	1	HC	6	
n 34	Wallupe	Hind-Clark Dairy		Reef and Koolau basalt	26.2	27.7	1.5	1	N	e 145	3	(E 20 E 7½ E 10 E 10 E 20)	3	HC HC HC HC HC	9 e 6 e 4 6 8	
o 35	Niu			Reef limestone	e 10.0	e 14.0	e 1.0	1			1	E 10	1	HC	6	
36	do.	Niu Dairy	1928	Reef 6 feet, cobbles 1 foot, Koolau basalt	e 24.0	e 28.0	e 1.5	2		55 65	1	E 20	1	HC	8	
p 37	do.	do.		Reef limestone	e 8.0	e 12.0	e 1.0	0			1	E 5	1	HC	4	
q 38	Kaalakei	Bishop estate		Koolau basalt	e 6.0	e 9.0	e 1.0	0			1	G 10	1	HC	4	200
r 39	Hahaione	do.		Koko tuff	e 8.0	e 8.0	1.5	1	S	860	1	E 10	1	HC	4	

- (a) Tunnels are driven from the bottom of the well or shaft to increase yield of well.
- (b) E, electric; G, gas; D, Diesel engine.
- (c) VC, Vertical centrifugal; HC, horizontal centrifugal; T, deep-well turbine; V, double-suction volute.
- (d) Static level May 22, 1933. Salt 23 grains per gallon. Shallow drill-hole in bottom.
- (e) Approximate.
- (f) Locked.
- (g) Tunnel in Kaimuki basalt. Static level May 8, 1933. Salt 37.3 grains per gallon.
- (h) Supplies 20-acre truck garden with drawdown of 1 foot at reported rate of \$4.00 an acre.
- (i) Salt about 100 grains per gallon.
- (j) Salt less than 30 grains per gallon.
- (k) Can be pumped dry in 1 hour. Used chiefly for washing water.
- (l) Tunnel follows base of reef and not finished Oct. 29, 1932. Salt reported less than 40 grains per gallon.

- (m) Irrigates 20 acres. Most of water comes from buried spring piped to well.
- (n) Irrigates 32½ acres of grass. Salt Oct. 3, 1933, with one pump running, 71 gallons per gallon.
The first feet of tunnel in beach conglomerate the rest in Koolau basalt. Northwest lateral 25 feet long 80 feet from portal; East lateral 20 feet long 82 feet from portal; West lateral 20 feet long about 103 feet from portal.
- (o) Yields enough water for 32 acres of watermelons. Salt 48 grains per gallon.
- (p) Irrigates 4 acres of alfalfa.
- (q) At spring.
- (r) Tunnel is really a pipe line with open joints and at top of water table to skim fresh water. Irrigates 20 acres of forage grass. 8,400,000 gallons pumped during year ending July 1, 1931, and 8,000,000 gallons during year ending July 1, 1932. Salt from 55 to 80 grains per gallon. Draw-down 1 foot.

WELLS AND TUNNELS THAT YIELD WATER FROM THE ROCKS OF THE COASTAL PLAIN BORDERING THE KOOLAU RANGE

The irrigation wells in the coastal plain adjacent to the Koolau Range are listed on page 221 and their location is shown on plate 2. The domestic wells together with the salt content of those east of Kaimuki, are shown on plate 2 by different symbols.

The artesian wells entering Koolau basalt yield so copiously that little attention has been paid to the water supplies in the sediments and Honolulu volcanics making up the coastal plain bordering this range except in the more arid east end. The increase in Honolulu water rates in late years has encouraged gardeners in this area to put in small irrigation pumping plants drawing water from wells in these coastal-plain rocks. In the Kaimuki area the Kaimuki lava is the best aquifer where it lies at sea level, and between Honolulu and Kaimuki the "black sand" of the Tantalus volcanics is a good water-bearer. Much unused shallow ground water exists in Honolulu that could be utilized for certain industrial purposes to relieve the demand on the artesian wells. A few buildings within the city, where large flows have been encountered in excavating for the foundation, are equipped with pumps to utilize the water for fire protection.

Dug wells 34, 36, and 38 derive their supply from Koolau basalt but are included here for convenience. Most of the other wells east of Kaimuki are supplied by water percolating into the coastal-plain sediments from the adjacent Koolau spurs. Little attempt has been made east of Kaimuki to develop water from the valley fill, which should yield small amounts with fair quality.

The Waimanalo Plantation has a sump and open cut in the lithified dune north of the town that recovers considerable shallow water, much of which is return irrigation water. Slightly brackish water occurs in the adjacent beach deposits. In the valleys, chiefly those above the plantation, the channels of younger alluvium contain water at shallow depths. Drilled well 409 encountered a small quantity of water about 15 feet below the surface in coarse gravel. These supplies are so small that it is doubtful if irrigation supplies could be developed economically by the shaft and tunnel method from the alluvium. It is probable that no attempt will be made to recover this water, as larger supplies are available in the underlying lava rocks.

Several dug wells in the beach ridge at Kailua Bay obtain water fit for irrigation. This water appears to be seepage from the adjacent Kawainui Swamp. A few stock wells have been dug in the Mokapu coral plain but are little used now that better water has been piped to this area from the Luluku tunnel.

The coastal plain and valleys northwest of Kaneohe are abundantly watered by springs issuing near the base of the Pali, but dug wells should be successful in the valley bottoms and should recover water of good quality if the need arises.

An average of 27,400 gallons daily was pumped in 1931 by the Kahuku Plantation at pump 24. About 229,500 gallons daily during 1932 was pumped from a shallow ditch draining ground water from the emerged marine sediments southeast of the Mormon temple at Laie; this water is probably in large part return irrigation water. An average of about 3,000,000 gallons daily is pumped from a swamp in reef limestone near drilled well 341 by the Kahuku Plantation. This water, although coming from coastal-plain rocks, is largely overflow of basal water from the adjacent Koolau basalt.

The average daily pumpage from the sediments and Honolulu volcanics in the coastal plain bordering the Koolau Range is estimated as follows: From dug wells 34, 36, and 38, 1,200,000 gallons; from the remaining dug wells and drains, 1,800,000 gallons; from the swamp near well 341, 3,000,000 gallons—a total of about 6,000,000 gallons. Only about 1,000,000 gallons daily of this total is probably derived from recharge on the coastal-plain rocks; the remainder apparently comes from the basal zone of saturation in the Koolau lavas.

UNDEVELOPED SUPPLIES

Makaha Valley.—The underflow of Makaha Valley plus return irrigation water is doubtless substantially greater than the amount of water recovered from the two wells in the valley; hence if additional water is needed at this level similar shafts and tunnels could be driven at intervals across the valley floor.

The tunnel in well 2 could be extended if additional water is needed at that well. In 1922 a pit 10 feet deep, dug near the mouth of the valley, encountered water with 140 grains of salt to the gallon, which shows the need of digging wells as far inland as possible.

One of the most promising projects appears to be a shaft approximately to sea level at an altitude of about 80 feet on the north bank of Makaha Stream and a tunnel about 1,000 feet long running slightly east of north into the spur that projects into the valley southwest of Puu Keaau. This tunnel would encounter the middle flow lavas of the Waianae series in a distance of about 700 feet and would be far enough up the valley to be on the east side of the breccia shown on plate 2 north of dug well 1-B. The swarm of dikes and the breccia cutting the Keaau-Makaha ridge farther northeast will retard the movement of water seaward through this ridge, hence a large yield such as is obtained at the end of the adjacent Kamaileunu ridge need not be ex-

pected. Water of good quality should be encountered, because the shaft will be 3,500 feet from shore and because of the dikes and adjacent breccia shown on plate 2 northwest of well 1-B, which should serve to some extent in preventing the ready access of sea water laterally. However, as the rainfall on the ridge is small, the quantity recoverable may not be any greater than might be obtained by a similar expenditure for tunnels in the valley floor.

Waianae Valley.—Although well 1 yields half the total supply from dug wells in the Waianae Valley, the constancy of the salt content indicates that it is not being overpumped. However, the rise in salt content in 1932 in well 4 shows the effects of the heavy draft of that year and indicates that this well will not safely yield additional water. The low salt content of well 5 indicates that it is not being pumped to capacity. The north tunnel of well 7 when completed yielded water with 40 grains of salt per gallon; the northeast tunnel 45 grains; and the south tunnel, which entered basalt, 8 grains. This shows that the largest supply of fresh water is moving through the basalt ridge. From the fact that this well yielded twice as much water in 1932 as in 1931, with an average increase of only 5 grains of salt to the gallon, it is estimated that this well will yield safely about 200 million gallons a year.

A shaft at Waianac Mill dug 15 feet deep in reef in 1878, at an altitude of 6 feet, formerly yielded water containing only 20 grains of salt per gallon, but increased draft, amounting at present to 2 million gallons a day, increased the salt content to 800 grains per gallon. The experience with this well demonstrates the danger of overdraft in permeable rocks.

The present recovery in Waianae Valley, exclusive of the mill pump, is shown in the table below.

Total annual pumpage, in millions of gallons, from dug wells in Waianae Valley

Year	Well 1	Well 3	Well 4	Well 5	Well 6	Well 7	Well 10	Total
1928	132.80	53.75	34.71	5.66	18.17	186.54	431.63
1929	147.22	86.65	43.82	15.70	24.12	183.38	500.89
1930	135.20	67.77	47.96	a13.60	26.98	133.50	22.63	447.64
1931	126.66	69.25	39.19	b20.19	30.61	203.84	69.46	559.20
1932	119.01	77.81	54.36	38.33	35.99	104.55	65.60	495.65
Average	132.18	71.05	44.00	18.70	27.17	162.36	52.56	487.00
Average daily	.36	.19	.12	.05	.07	.44	.15	1.33

a Estimated from number of days in operation.

b May and June estimated.

The average daily rainfall in Waianae Valley amounts to somewhat more than 20 million gallons. The average daily yield of ground water is about 1,960,000 gallons from the high-level tunnels, about 2,500,000 gallons from the Kamaile pump, and about 1,330,000 gallons from the above wells, making the total quantity of ground water recovered



A, KAUKONAHUA TRANSPIRATION STATION.

Grass growing in panicum pan in foreground partly obscures anemometer and evaporation pan. Photograph by Henry Hopewell, Sept. 2, 1933.



B, AIR VIEW LOOKING SOUTHEAST TOWARD DIAMOND HEAD
SHOWING THE DELTA OF KALIHI STREAM.

Photograph by 11th Photo Section, Air Corps, Luke Field, T. H.

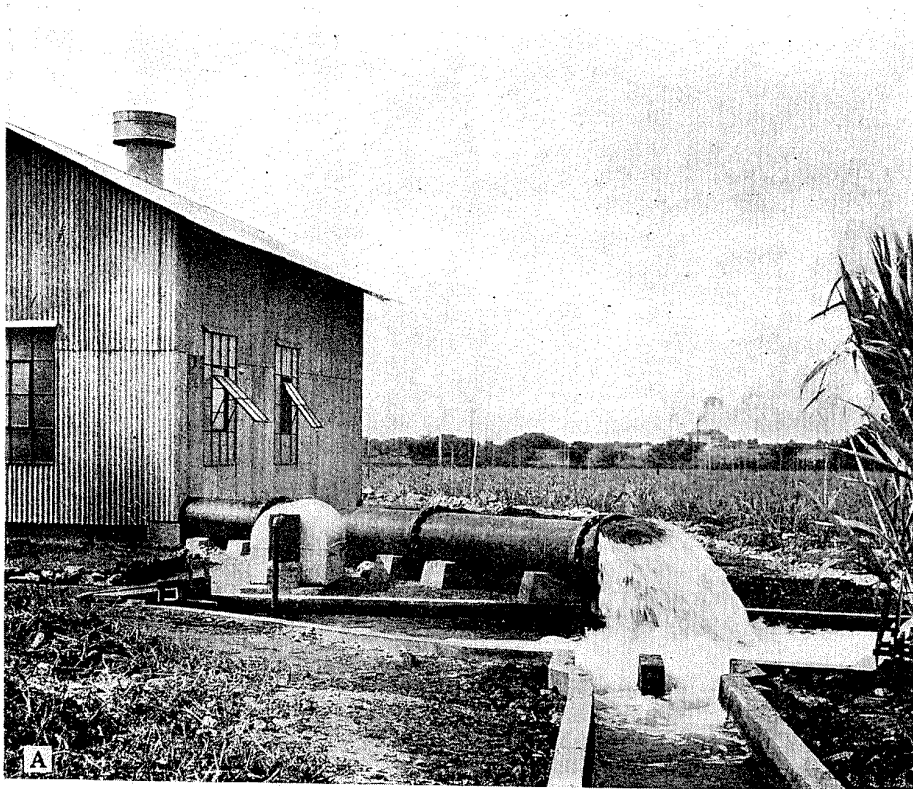

A

A, WELL 23, DUG IN REEF LIMESTONE AT EWA.

Pumping at the rate of 10,000,000 gallons a day. Courtesy of Ewa Plantation Co.

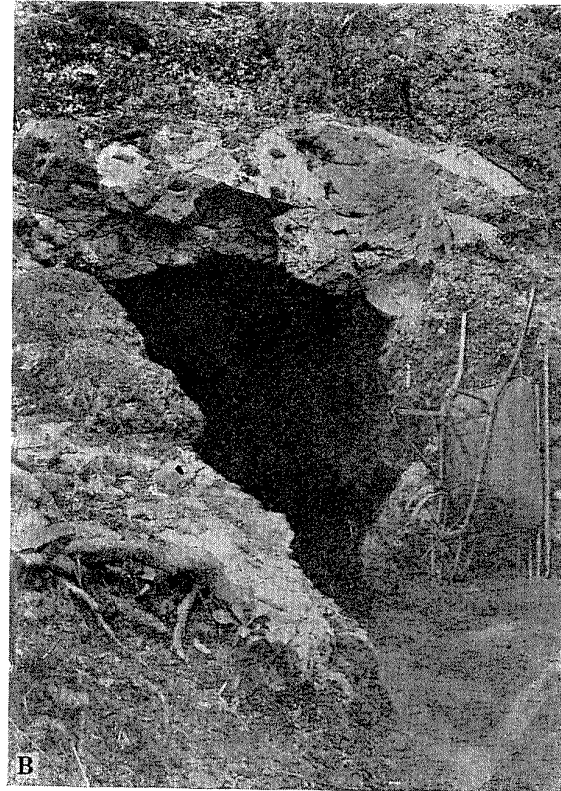

B

B, PALOLO TUNNEL IN KOOLAU AA

Photograph by Harold S. Palmer.

equal to about 21 percent of the annual rainfall, if it is assumed that half of the recovery from the Kamaile wells comes from rainfall on the Makaha Valley drainage basin. The mill pump yields a certain percentage of fresh water which would raise this figure to about 30 percent. Since part of the water from the shafts is return irrigation water, the actual percentage of recovery is somewhat less.

There is still room for a few more developments of the sea-level type in Waianae Valley, especially in the swale on the south side of the valley about 1,500 to 2,500 feet upstream from well 5. The Kamaile pump, because the battery of wells is too deep, does not recover the maximum amount of water with the least salt possible. If all these wells were plugged and a tunnel were driven through the nose of the ridge slightly below the water table, water of better quality could be obtained. However, as the station is only about 2,200 feet from the shore, where there is more contamination than farther inland, it would be preferable to abandon the Kamaile station when the present equipment is worn out and dig a shaft to sea level and a tunnel through the ridge as far inland as is economically practicable.

Lualualei Valley.—Well 11, or the old G-6 development, consists of two pits about 10 feet square dug in 1911 into reef limestone 4,200 feet from shore, at an altitude of about 30 feet. The pits were originally 37 feet deep but are now filled to a little above sea level. Two or three holes were drilled into the bottom of the pits, to a point about 15 feet below sea level. These holes were probably partly the cause of the abandonment of the well, because they doubtless tapped saltier water than the dug pits. From 1911 to 1920 these pits yielded about 1 million gallons daily, ranging in salt content from 174 to 208 grains per gallon. As the water pumped was about 10 percent sea water, at least 900,000 gallons of fresh water is moving seaward daily at this place. Probably a large part of this water is return irrigation water from the extensive irrigated fields above.

Wells 12 and 13 indicate that very little fresh water is escaping seaward near Puu o Hulu. Well 14 was dug in 1923 on the edge of a relatively impervious spot in a cane field where water stands after each irrigation. Water was standing 5 feet below the surface of the pit, or about 40 feet above sea level, on November 25, 1930. The water is apparently perched and supplied by seepage from the adjacent irrigated fields and possibly from the irrigation reservoirs nearby. Two 2-inch plunger pumps kept the pit dry during the excavation. Because the water contained 108 grains of salt per gallon it was abandoned. This salt probably results from concentration by evaporation and transpiration of the irrigation water, which contains as much as 70 grains of salt per gallon. The pit shows that relatively impermeable silts occur in the valley fill.

Because some water should be moving seaward through the more permeable streaks of the valley fill inland of the reef limestone in Lualualei, this area awaits development. Test borings should be made to determine the permeability and texture of the valley fill in the zone of saturation, in order to locate the tunnels at the most advantageous places. Lualualei Valley is nearly three times as wide near the mouth as Waianae Valley; hence the water moving seaward through the valley fill will be more diffused and probably more difficult to recover.

Several windmills lift water from the shallow wells in the homesteads near the coast, but this water is small in quantity and fit for only a few purposes because of its high salt content. These wells are shown by a distinguishing symbol on plate 2.

In the Honolulu Advertiser of June 16, 1934, J. S. McCandless reports that he and his brother, L. L. McCandless, drilled a well about 800 feet deep in the center of Mikilua Valley (Lualualei Valley) to obtain water for irrigating land of the Waianae Plantation. He reports that this well yielded perfectly fresh warm water of about blood temperature. The well was pumped for some time but did not yield enough water to justify further drilling and was abandoned. It is not unlikely that this notably higher temperature resulted from the natural thermal gradient in the valley fill rather than from an underlying body of hot rock. The mean annual temperature at Waianae is 75.7°F. This well shows that fresh water occurs at considerable depth in this valley.

Nanakuli Valley.—The water level at well 16 on September 18, 1930, after a week without pumping, was 46.5 feet below the top of the shaft, or 9.2 feet above sea level. The salt content slowly increased from 7½ grains per gallon in January 1933 to 21 grains in July 1933 and then declined during the remainder of the year. The tunnel yields an average of about 90 gallons a day per foot of length. A deep-well turbine pumps the water to a tank on the adjacent terrace, from which it is distributed to the homesteads lower down. Monthly pumpage and salt content is given on page 233. The supply is inadequate to meet all the domestic needs.

The tunnels were examined on December 8, 1930, and found to be entirely in valley fill, with about 75 percent in fine silty clay and the remainder consisting of streaks of coarse sand and gravel containing a few large boulders. In the southeast heading numerous large angular rocks with gravel between may be talus from the adjacent cliff. The operator states that most of the water enters from the Waianae side. This plant is designed correctly for developing water at the mouth of a valley on Oahu, because it is far enough from the sea and from coral to obtain good water. When examined there were several cave-ins, as

the valley fill is not sufficiently indurated in all places to stand up against the effects of the alternate lowering and filling of the tunnel. As these cave-ins probably reduce the yield of the tunnel they should be removed and the caving parts lined.

Ewa coral plain.—Five wells have been dug in the Ewa coral plain by the Ewa Plantation Co. since May 1930. (See pl. 28, A.) They all penetrate coral and have recovered large quantities of water suitable for irrigation, especially when mixed with artesian water. It is probable that a large part of this water is return irrigation water from the 75 million gallons pumped daily from the artesian wells and used on higher lands. The remainder is doubtless supplied by losses from ephemeral streams crossing the plantation and by direct penetration of rainfall. Contributions from these two sources must be small in view of the low rainfall and the intensive cultivation of the land. The average daily yield of the five wells for 1932 amounted to 9.09 million gallons.

Additional water is probably available in the plain west of these wells, because of the large amount of irrigated land above it.

Remaining areas.—Shallow wells dug close to the streams crossing the alluvium on the east side of the Waianae Range have been successful in places and yield small supplies of good quality for some of the pineapple camps. This water is held up by the more impermeable layers of the alluvium.

The coastal plain on the north side of the Waianae Range consists mostly of noncalcareous sediments. A water table exists in the sediments near sea level, sustained by return flow from the irrigated fields, from water escaping from the adjacent Waianae lavas, from rainfall, and from seepage from streams crossing the flats during heavy rains. No data are available regarding the quality or quantity of this water, but at the mouths of some of the large northward-draining valleys developments like the one in Nanakuli Valley should be successful if any need arises for the water. At present the area is amply supplied by artesian and high-level spring water.

RECORDS OF QUANTITY AND QUALITY OF WATER PUMPED

The following records give the quantity and quality of the water pumped from the coastal plain adjacent to the Waianae Range for irrigation and show the relation of draft to salt.

Pumpage, in gallons, from Makaha well 1-B

[Data furnished by Waianae Plantation Co.]

	1928	1929	1930	1931	1932
January.....	0	12,877,632	0	12,200,000	7,400,074
February.....	0	7,623,283	0	11,200,000	0
March.....	5,399,352	7,853,663	0	11,850,000	0
April.....	5,340,698	10,930,026	0	10,325,000	3,965,931
May.....	2,706,845	10,511,911	3,800,075	4,675,000	8,794,304
June.....	4,817,381	12,203,751	9,537,016	11,800,000	8,421,657
July.....	0	13,734,944	9,099,714	10,800,000	5,491,531
August.....	7,839,973	13,714,746	7,991,496	7,183,581	8,560,791
September.....	10,480,670	11,508,731	12,134,685	7,670,919	9,043,070
October.....	7,849,426	12,247,759	9,131,464	8,436,801	9,109,162
November.....	5,700,698	561,767	10,150,000	7,803,808	4,867,295
December.....	2,794,172	0	12,000,000	4,090,083	710,681
	50,929,215	113,768,213	73,844,450	108,035,192	66,364,496

Pumpage, in gallons, from Makaha well 2

[Data furnished by Waianae Plantation Co.]

	1928	1929	1930	1931	1932
January.....	0	5,276,250	0	5,535,000	5,197,500
February.....	2,721,418	4,860,000	0	5,310,000	2,846,250
March.....	4,930,059	5,422,500	1,125,000	5,557,500	0
April.....	5,014,340	5,535,000	0	3,105,000	2,992,500
May.....	2,474,735	5,985,000	1,327,500	2,429,000	5,996,250
June.....	4,100,844	5,535,000	2,880,000	3,217,500	5,451,250
July.....	0	5,692,500	5,670,000	4,680,000	4,387,500
August.....	2,475,000	5,905,000	5,512,500	5,950,750	6,243,850
September.....	5,467,500	4,837,500	4,947,500	5,242,500	5,861,250
October.....	5,881,250	5,985,000	4,421,450	3,037,500	5,883,250
November.....	1,530,000	225,000	4,995,000	5,265,000	3,214,425
December.....	1,507,500	0	4,815,000	2,261,250	0
	36,102,646	55,258,750	35,693,950	51,591,000	48,074,025

Average salt content, in grains per gallon, of water from Makaha wells 1B and 2

[Data furnished by Waianae Plantation Co.]

	1922		1923		1924		1925		1926		1927	
	1B	2	1B	2	1B	2	1B	2	1B	2	1B	2
January.....			108.06				57.4		138.4	74.6	70.9	
February.....		78.7			64.2		75.9		120.9	75.1	74.6	
March.....	79.2		40.7		99.2		102.3	68.3	137.8	81.8	86.6	77.9
April.....	79.0	79.7	51.8				120.1	68.9	132.6	87.5	69.9	63.5
May.....	96.4	83.3	79.4				128.0	73.0	148.2	86.8	51.2	77.2
June.....	101.5	87.6	101.2		73.9	63.7	132.8	77.9	144.9	89.1	58.0	82.8
July.....	103.0	80.4	105.4	74.7	100.1	66.0	136.0	82.6		84.0	69.7	87.7
August.....	105.3	85.4	113.4	74.6	109.1	66.5	136.6	83.2		84.0	75.9	91.5
September.....	104.1	92.4	118.7	76.3	116.6	67.9	139.8	82.2	113.3	83.9	80.8	91.3
October.....	106.0	91.1	116.0	76.6	113.0	66.2	141.2	81.8	80.7	88.4	89.2	96.1
November.....	107.3		124.7	75.6	120.4	66.2	138.9	82.3	64.7	92.4	105.4	93.6
December.....	107.9		122.6	76.4	123.1	69.3	137.7	79.9	74.2	95.9	105.6	89.8
Average.....	99.0	84.8	98.4	75.7	102.2	66.5	120.6	78.0	115.6	85.3	78.2	85.1

Average salt content, in grains pr gallon, of water from Makaha wells 1B and 2
—Continued

[Data furnished by Waianae Plantation Co.]

	1928		1929		1930		1931		1932	
	1B	2	1B	2	1B	2	1B	2	1B	2
January			75.3	81.4			108.3	75.9	89.9	68.0
February		80.7	91.0	86.8			117.6	76.7		62.3
March	50.1	80.7	93.1	89.8		58.4	121.8	74.5		
April	50.1	79.6	104.7	92.5	33.7		126.8	70.3	59.5	51.0
May	60.2	80.7	109.8	95.9	37.6	54.8	116.9	69.1	76.7	55.2
June	53.8	79.6	113.9	97.5	56.9	55.9	110.7	61.5	94.2	61.1
July			113.4	100.3	69.9	59.5	123.6	64.5	82.4	62.5
August	46.7	73.2	128.0	109.4	74.9	64.1	122.8	67.5	98.2	67.1
September	56.5	73.4	125.8	107.6	90.4	68.0	115.5	69.8	105.9	71.8
October	71.2	78.1	123.2	108.5	97.9	67.2	116.9	70.5	112.7	78.8
November	77.0	81.8			94.6	71.9	116.0	67.8	111.5	80.9
December	59.4	76.6			104.9	73.6	116.9	68.0	72.4	
Average	58.3	78.4	107.8	97.0	73.3	63.7	117.8	69.7	90.3	65.9

Pumpage, in gallons, from Puko well 1

[Data furnished by Waianae Plantation Co.]

	1928	1929	1930	1931	1932
January.....	0	12,824,667	12,898,633	6,179,930	9,524,714
February.....	6,194,889	14,314,510	14,439,293	13,884,379	7,537,218
March.....	14,678,777	13,525,533	8,928,097	9,773,890	10,611,102
April.....	13,394,496	17,122,726	13,551,468	9,555,260	16,611,102
May.....	14,572,839	19,741,446	13,676,948	7,441,497	11,378,659
June.....	13,387,859	12,214,870	11,817,594	12,217,103	8,864,309
July.....	12,010,275	15,194,527	12,104,576	11,253,822	9,949,102
August.....	14,362,755	13,166,873	11,632,936	10,892,746	9,881,261
September.....	12,824,439	10,069,126	10,529,978	13,563,995	7,718,258
October.....	14,112,678	11,716,616	8,434,655	11,493,417	8,078,461
November.....	10,545,544	4,330,240	5,126,550	11,469,216	9,192,354
December.....	6,719,331	2,994,929	12,054,596	8,934,910	9,667,367
	132,803,882	147,216,063	135,195,324	126,660,165	119,013,907

Average salt content, in grains per gallon, of water from Puko wells 1 and 2

[Data furnished by Waianae Plantation Co.]

	1922	1923	1924	1925	1926	1927	1928	1929	1930	1931	1932
Jan.....		42.7	50.2	63.4	59.7	56.3		57.3	58.4	55.0	58.1
Feb.....	57.2	42.1	52.8		51.1	61.0	65.7	56.2	64.7	56.8	52.1
Mar.....	56.4	54.9	55.9	48.8	55.9	62.1	60.6	55.7	58.0	52.7	51.1
Apr.....	54.0	58.4	47.2	50.8	53.3	59.0	58.1	57.1	58.7	53.7	64.2
May.....	52.0	67.1	56.4	58.1	53.0	70.6	57.9	52.9	58.1	51.0	58.6
June.....	50.4	54.9	55.4	57.4	55.7	68.1	57.5	55.4	57.1	52.5	56.3
July.....	48.4	54.4	55.2	51.1	51.7	69.1	57.1	57.1	56.6	52.6	57.0
Aug.....	45.5	45.3	47.1	44.5	53.1	66.2	57.4	55.4	57.7	52.8	57.0
Sept.....	46.7	48.8	47.2	45.2	52.3	60.2	57.4	56.2	58.1	52.7	57.1
Oct.....	46.2	47.0	46.5	49.1	55.4	59.1	59.1	56.7	54.6	53.6	58.6
Nov.....	45.9	45.4	46.6	50.2	59.2	57.9	60.5	54.8	56.4	54.9	56.5
Dec.....	44.8	47.7	47.5	52.9	59.0	57.1	62.3		56.2	56.2	55.4
Average ..	49.8	50.7	50.6	51.0	54.9	62.2	59.4	55.9	57.9	53.7	56.8

Pumpage, in gallons, from Lehano well 3

[Data furnished by Waianae Plantation Co.]

	1928	1929	1930	1931	1932
January.....	0	6,111,650	0	2,185,426	6,561,400
February.....	0	7,889,058	0	3,371,261	4,514,390
March.....	637,468	13,496,748	5,000,080	6,095,762	1,913,046
April.....	5,601,158	13,721,215	5,880,714	3,281,726	7,029,127
May.....	6,733,365	13,483,041	7,750,280	4,564,079	8,245,360
June.....	6,314,021	6,252,469	7,177,821	8,313,372	10,766,581
July.....	6,095,660	5,398,296	8,377,562	7,783,670	9,704,514
August.....	6,928,673	4,456,153	7,017,059	7,329,882	9,003,264
September.....	5,738,149	6,136,365	7,175,418	7,291,585	8,214,189
October.....	6,362,419	6,936,913	6,518,848	6,836,380	7,870,678
November.....	5,574,367	1,373,130	6,377,215	7,097,885	3,984,544
December.....	3,768,144	1,399,720	6,493,640	5,101,032	0
	53,753,424	86,654,758	67,768,637	69,252,060	77,807,093

Average salt content, in grains per gallon, of water from Lehano well 3

[Data furnished by Waianae Plantation Co.]

	1923	1924	1925	1926	1927	1928	1929	1930	1931	1932
January.....	63.2	39.8	-----	36.8	36.7	-----	38.3	-----	33.4	33.4
February.....	65.3	39.9	-----	36.6	37.3	-----	38.5	-----	30.1	33.8
March.....	55.0	39.9	-----	38.6	38.6	41.9	37.8	31.9	31.8	33.2
April.....	46.0	-----	39.6	36.5	44.0	38.7	34.8	34.1	32.1	33.7
May.....	42.5	-----	41.6	38.8	42.3	38.9	34.7	34.4	31.8	33.6
June.....	42.5	42.6	40.3	-----	43.8	39.5	37.1	34.4	32.6	32.3
July.....	42.2	41.9	40.5	-----	42.1	39.4	35.2	35.0	33.0	33.4
August.....	-----	41.0	40.9	-----	41.9	39.0	35.0	34.4	33.7	33.4
September.....	-----	40.7	40.3	33.2	40.8	38.8	38.8	34.1	33.8	33.7
October.....	-----	39.3	40.1	37.0	39.4	38.0	35.4	32.9	33.6	33.5
November.....	40.9	39.5	38.9	37.3	40.2	37.7	36.3	32.9	34.1	33.9
December.....	39.6	40.9	39.1	37.0	40.6	38.8	-----	32.6	33.5	-----
Average	48.6	40.5	40.1	36.9	40.6	39.1	36.5	33.7	32.8	33.4

Pumpage, in gallons, from Kuaiwa well 4

[Data furnished by Waianae Plantation Co.]

	1928	1929	1930	1931	1932
January.....	0	5,696,268	0	4,911,473	3,963,891
February.....	3,328,080	3,329,018	0	4,500,288	2,602,107
March.....	5,262,992	3,973,304	3,535,656	4,653,713	974,266
April.....	4,738,049	4,840,415	4,847,052	4,107,059	6,598,941
May.....	3,627,804	5,036,104	6,005,408	337,840	7,295,101
June.....	3,570,270	4,290,888	5,199,773	0	6,111,922
July.....	5,470,644	4,643,144	5,338,068	4,619,167	5,851,077
August.....	0	4,082,524	5,390,579	3,727,699	5,460,986
September.....	907,319	3,502,055	4,281,864	3,210,268	5,303,438
October.....	3,871,444	4,278,995	4,428,875	3,148,773	5,488,459
November.....	556,482	152,163	4,159,848	2,984,937	3,238,982
December.....	3,373,710	0	4,769,448	2,989,019	1,472,908
	34,706,794	43,824,878	47,956,571	39,190,236	54,362,078

Average salt content, in grains per gallon, of water from Kuaiwa well 4

[Data furnished by Waianae Plantation Co.]

	1924	1925	1926	1927	1928	1929	1930	1931	1932
January.....	75.6	65.3	66.0	73.0	67.3
February.....	76.9	60.9	77.0	72.8	68.6
March.....	76.9	64.0	81.8	77.4	66.5	78.9	71.9	87.0
April.....	76.3	65.2	102.9	73.9	66.0	77.5	72.4	98.2
May.....	75.8	67.3	74.2	74.2	68.8	73.7	59.4	85.4
June.....	73.3	69.1	71.8	69.6	66.9	68.8	72.4
July.....	83.2	71.3	68.1	72.2	70.0	65.9	70.4	68.5	74.5
August.....	67.9	77.9	67.0	71.3	64.3	69.8	68.3	74.9
September.....	63.9	71.1	67.3	70.5	64.3	65.4	70.8	67.6	75.7
October.....	66.6	70.9	70.8	72.3	66.8	65.6	72.4	66.0	76.6
November.....	73.1	67.6	72.6	69.8	67.3	63.3	71.9	67.0	65.0
December.....	72.7	66.8	81.5	67.9	74.1	67.1	61.1
Average	71.2	73.4	67.1	76.8	70.8	66.0	72.8	68.5	75.6

Pumpage, in gallons, from Paheehee well 5

[Data furnished by Waianae Plantation Co.]

	1928	1929	1930	1931	1932
January.....	0	0	0	0	3,030,480
February.....	0	296,231	0	0	2,726,670
March.....	0	1,557,298	0	0	1,446,771
April.....	0	1,718,499	0	0	1,955,380
May.....	0	2,246,298	0	2,141,667	3,894,741
June.....	0	3,048,887	0	2,379,630	4,145,650
July.....	0	3,309,503	0	2,170,775	4,191,571
August.....	1,521,905	2,938,128	2,210,403	2,459,266	3,965,390
September.....	1,922,252	581,684	3,490,110	2,502,055	3,850,160
October.....	1,924,550	0	3,606,447	2,806,190	4,083,310
November.....	306,488	0	3,490,110	2,725,390	3,347,200
December.....	0	0	814,359	3,005,130	1,691,610
	5,675,195	15,696,528	13,611,429	20,190,103	38,328,933

Average salt content, in grains per gallon, of water from Paheehee well 5

[Data furnished by Waianae Plantation Co.]

	1923	1924	1925	1926	1927	1928	1929	1930	1931	1932
January.....	18.5	16.7	13.3
February.....	20.9	27.7	29.8	15.9	13.4
March.....	24.6	25.7	31.7	24.6	16.3	12.5
April.....	23.2	24.6	27.5	35.6	21.1	24.4	15.6	14.2
May.....	21.5	23.4	23.3	37.6	25.1	15.6	15.0
June.....	24.7	21.5	20.7	40.8	23.7	15.5	14.3
July.....	24.2	20.2	19.3	40.5	21.0	15.4	13.7
August.....	21.7	19.5	19.6	39.5	22.0	19.7	14.6	14.4	14.6
September.....	21.4	18.8	19.1	36.6	21.9	20.5	15.4	13.9	13.9
October.....	27.7	20.8	17.8	20.8	34.5	21.0	16.7	13.6	13.6
November.....	28.9	21.4	20.6	21.4	36.0	19.8	20.5	16.9	13.4	13.6
December.....	28.6	22.2	16.3	36.3	17.2	13.4	13.0
Average	28.4	22.1	21.0	21.9	36.9	21.2	23.3	16.2	15.0	13.8

Pumpage, in gallons, from Keekee well 6

[Data furnished by Waianae Plantation Co.]

	1928	1929	1930	1931	1932
January.....	0	1,598,307	0	3,323,356	3,135,907
February.....	1,274,200	2,201,123	0	3,230,246	1,871,823
March.....	1,734,713	2,683,258	883,185	3,303,186	1,914,106
April.....	2,443,751	1,769,386	3,252,412	3,064,410	3,249,242
May.....	3,258,302	2,574,619	3,747,115	248,020	3,781,396
June.....	1,353,318	2,788,250	2,854,806	544,078	4,232,246
July.....	2,675,007	3,323,529	3,175,236	3,250,191	4,118,974
August.....	588,091	2,336,676	1,843,464	2,965,058	3,776,795
September.....	299,213	2,549,120	1,948,353	2,742,207	3,467,074
October.....	2,952,479	2,154,209	3,199,786	2,798,407	3,547,929
November.....	0	145,076	2,816,049	2,859,336	2,040,406
December.....	1,593,384	0	3,252,775	2,283,155	858,248
	18,172,458	24,123,553	26,973,181	30,611,650	35,994,146

Average salt content, in grains per gallon, of water from Keekee well 6

[Data furnished by Waianae Plantation Co.]

	1923	1924	1925	1926	1927	1928	1929	1930	1931	1932
January.....	72.6	75.2	80.2	72.5
February.....	74.9	66.8	84.3	87.0	81.4	72.4
March.....	76.0	73.1	67.3	89.9	84.9	78.5	82.2	75.1
April.....	76.7	74.6	65.2	87.0	85.8	81.3	80.3	76.6
May.....	77.4	74.9	65.2	90.6	83.8	82.0	80.5	78.5
June.....	78.4	73.7	74.1	93.5	84.1	84.3	84.8	78.5
July.....	84.1	78.9	76.1	78.8	93.3	84.5	83.2	79.7	78.7
August.....	89.8	80.5	85.8	72.1	79.6	90.4	82.3	83.2	80.0	78.8
September.....	86.2	76.7	77.9	69.9	79.5	87.6	81.9	82.3	77.5	79.1
October.....	74.8	71.2	77.4	72.6	79.7	88.8	81.7	81.4	74.8	78.8
November.....	80.3	72.8	75.7	73.3	78.1	88.4	81.4	74.1	74.4
December.....	79.7	72.6	74.9	77.5	86.6	81.5	73.6	81.3
Average	82.2	76.3	77.2	72.8	74.5	89.1	84.0	81.9	79.1	77.1

Pumpage, in gallons, from Pahoia well 7

[Data furnished by Waianae Plantation Co.]

	1928	1929	1930	1931	1932
January.....	0	8,897,213	0	24,862,166	5,248,739
February.....	0	6,731,673	0	17,919,532	4,722,322
March.....	11,933,816	11,015,872	2,947,301	26,235,943	0
April.....	11,119,722	19,068,002	5,345,963	18,808,821	3,132,000
May.....	13,844,642	30,333,969	14,130,825	11,436,391	12,686,270
June.....	19,471,343	25,579,879	13,613,522	25,945,814	12,986,882
July.....	26,187,118	14,786,359	21,114,535	28,354,548	14,282,266
August.....	29,052,497	18,268,570	24,516,425	14,467,480	14,042,555
September.....	28,974,214	25,198,019	17,245,428	10,861,416	13,655,054
October.....	30,076,887	22,480,738	7,733,026	10,817,886	15,553,725
November.....	15,883,322	1,021,105	13,649,160	9,473,824	8,238,631
December.....	0	0	13,207,387	4,651,544	0
	186,543,561	183,381,399	133,503,572	203,835,365	104,548,444

Average salt content in grains per gallon of water from Pahoa well 7

[Data furnished by Waianae Plantation Co.]

	1923	1924	1925	1926	1927	1928	1929	1930	1931	1932
January.....	47.5	24.3	69.1	78.0	57.4	70.3
February.....	47.0	28.4	65.3	67.0	57.9	59.6	62.9
March.....	46.6	34.5	65.3	59.5	51.5	51.9	47.6	61.6
April.....	39.4	67.3	59.7	45.3	63.0	38.4	66.1	52.5
May.....	42.2	65.5	40.3	40.6	73.5	42.3	69.2	59.1
June.....	41.9	47.1	68.0	46.5	46.8	78.2	41.7	67.7	62.6
July.....	37.5	49.4	68.5	53.5	64.8	77.2	47.4	77.6	64.9
August.....	34.7	53.9	66.8	59.3	66.5	79.0	57.3	79.7	65.8
September.....	30.5	57.2	63.9	56.2	72.0	85.3	60.2	77.5	69.2
October.....	81.0	26.4	58.7	73.7	62.6	76.9	88.1	44.5	76.7	72.7
November.....	50.8	28.0	67.0	73.1	64.5	76.6	50.3	77.0	73.2
December.....	44.0	27.9	63.9	71.3	62.4	51.6	79.7
Average.....	58.6	36.8	47.2	68.1	59.1	60.1	72.7	48.1	70.8	65.3

Pumpage, in gallons, from well 10 and average salt content in grains per gallon

[Data furnished by Waianae Plantation Co.]

	Pumpage			Salt content		
	1930	1931	1932	1930	1931	1932
January.....	0	4,514,600	6,008,173	30.2
February.....	0	6,947,700	3,717,160	32.5	30.3
March.....	0	8,183,300	0	33.0
April.....	0	3,674,020	4,643,453	32.7	33.3	27.9
May.....	0	3,483,400	7,930,447	30.6	33.1	30.0
June.....	0	6,135,600	8,487,726	28.9	32.3	30.3
July.....	0	6,817,844	8,518,891	28.9	34.7	30.6
August.....	1,702,800	6,670,824	8,348,204	28.4	32.7	30.1
September.....	6,775,200	5,872,088	7,190,040	28.5	31.5	30.1
October.....	4,200,000	6,485,941	3,756,645	27.5	31.2	30.1
November.....	4,497,200	6,205,639	0	29.1	30.6	30.1
December.....	5,452,300	4,468,639	0	30.4
	22,627,500	69,459,595	65,600,739	29.3	32.3	30.1

Pumpage, in gallons, and salt content, in grains per gallon, from Nanakuli well 16

[Data furnished by Hawaiian Homes Commission]

	1932		1933	
	Pumpage	Salt content	Pumpage	Salt content
January.....	1,380,950	7
February.....	1,254,530	18
March.....	1,194,740	15
April.....	1,851,130	13
May.....	2,435,670	16
June.....	2,522,250	17
July.....	12	2,277,920	21
August.....	1,826,671	2,148,520	17
September.....	1,803,409	12	2,149,000	18
October.....	1,785,350	1,929,900	17
November.....	1,633,030	8	2,124,480
December.....	1,377,960	8
	8,426,420		21,269,090	

234 GEOLOGY AND GROUND-WATER RESOURCES OF OAHU

Pumpage, in million gallons, and salt content, in grains per gallon, of water pumped from wells 20 to 24

[Records furnished by Ewa Plantation Co.]

	20		21		22		23	
	Pumpage	Salt	Pumpage	Salt	Pumpage	Salt	Pumpage	Salt
1930								
May.....					12.2	84.14		
June.....	23.2	82.53	15.2	82.53	11.9	84.10		
July.....	40.5	83.29	35.9	84.22	15.1	84.71		
August.....	58.1	85.27	54.2	86.70	30.8	85.81	176.5	86.33
September.....	27.3	85.13	31.3	86.56	15.4	86.07	142.5	83.52
October.....	26.4	86.29	29.9	88.70	12.4	86.50	139.1	82.94
November.....	27.5	87.20	23.0	88.55	9.7	87.55	91.1	84.25
December.....	38.7	87.87	34.8	89.86	17.6	88.54	96.0	83.41
Total	241.7		224.3		125.1		645.2	
Daily average	.66	85.37	.61	86.73	.34	84.93	1.77	84.09
1931								
January.....	21.6	87.83	23.7	91.04	13.5	88.58	77.1	80.29
February.....	18.1	87.27	24.4	90.28	14.4	89.72	6.8	71.41
March.....	30.9	88.35	32.3	90.52	15.1	89.24		
April.....	33.5	85.78	37.3	88.87	23.3	87.52	9.1	82.00
May.....	19.6	85.62	23.7	89.09	17.6	87.78	119.3	78.38
June.....	41.0	87.24	29.5	89.47	32.3	89.86	183.5	80.82
July.....	66.9	87.55	54.4	89.34	41.2	90.04	193.9	80.23
August.....	79.9	87.96	55.0	88.35	37.7	90.23	205.1	81.75
September.....	74.5	89.96	42.7	89.27	28.8	92.51	56.6	69.22
October.....	47.0	88.86	35.5	89.26	23.3	91.76	104.0	73.96
November.....	56.6	88.80	42.0	89.59	29.7	92.63	114.9	73.68
December.....	52.1	88.49	26.2	88.18	25.4	92.97	82.2	68.16
Total	541.7		426.7		302.3		1,152.5	
Daily average	1.48	87.81	1.14	89.44	.83	90.24	3.16	69.99
1932								
January.....	55.7	89.55	28.6	89.04	13.2	95.74	133.0	76.53
February.....	7.8	89.30	11.0	89.50		92.07	55.1	73.66
March.....	9.2	88.36	8.7	90.19	8.6	93.93	29.4	69.13
April.....	31.2	87.22	22.0	88.93	15.4	93.46	136.8	76.32
May.....	32.4	88.86	21.7	89.54	21.6	92.47	156.4	83.97
June.....	60.1	86.74	41.9	87.33	26.9	92.04	195.7	84.38
July.....	50.5	85.39	55.5	87.25	26.2	92.02	320.7	86.40
August.....	57.2	86.07	40.5	86.46	17.7	91.71	331.1	86.55
September.....	36.7	84.81	24.5	85.52	12.9	91.21	308.9	85.99
October.....	59.4	83.52	24.2	83.32	21.7	91.57	252.0	83.81
November.....	26.8	85.48	15.3	84.40	17.7	89.79	178.3	81.94
December.....	54.0	85.41	21.9	85.25	17.2	93.27	224.6	87.14
Total	481.0		315.8		197.1		2,322.0	
Daily average	1.32	86.73	.87	87.23	.58	92.44	6.36	81.32
1933								
January.....	34.7	83.62	17.8	84.40	13.1	93.02	251.9	86.34
February.....	12.5	82.30	12.8	83.48	5.0	91.80	104.5	80.47
March.....	25.9	80.37	12.6	83.48	13.0	92.04	163.4	79.67
April.....	36.7	85.09	4.7	85.77	11.0	94.72	295.9	86.26
May.....	63.1	85.67	29.9	84.70	12.4	93.75	321.9	86.16
June.....	84.7	87.84	44.2	84.65	20.6	96.32	309.7	84.65
July.....	79.3	59.44	53.0	82.41	29.6	93.11	322.3	81.93
August.....	92.0	85.50	52.0	83.18	29.0	95.53	319.2	81.64
September.....	78.9	85.75	50.7	82.35	16.7	94.76	298.4	83.97
October.....	79.7	86.43	44.5	82.77	28.5	92.98	285.2	83.25
November.....	61.6	85.40	39.8	83.16	18.9	91.17	274.6	83.16
December.....	49.2	85.93	15.7	85.83	13.0	93.44	162.6	76.55
Total	698.3		377.7		210.8		3,109.6	
Daily average	1.91	82.78	1.03	83.85	0.58	93.55	8.52	82.84

SPRINGS

The springs issuing from the rocks of the coastal plain are practically all supplied by overflow from the basal water table in the basalts. No known large springs occur along the shore of the Waianae Range. However, water trickles into the sea in many places, and definite springs occur at the end of most of the spurs of the Koolau Range east of Honolulu (pl.2). Their daily discharge which can be only roughly estimated, because most of them are at tide level, is as follows in gallons: Waialac, 63,000 (measured April 1932); Wailupe, 200,000; Kawaikui, 100,000; Lucas, 200,000; Kanewai, 200,000; Kaalakei, 250,000; Barrel, 100,000. These estimates indicate that about a million gallons daily flows into the sea from spurs east of Honolulu and, although issuing from basalt, talus or reef limestone in the coastal plain, is not supplied by rainfall on these rocks.

In the Moiliili district, in Honolulu, are the Kumalae Springs which when measured on February 20, 1928, discharged at the rate of 2.42 million gallons daily.⁷ These springs are in the reef limestone. Unlike the springs described above, they appear to discharge water that is largely collected in the sediments and from the Sugar Loaf basalt flooring Moana Valley. The Alawai Canal drains a considerable amount of water of similar origin from the Waikiki district. In spite of this large drain, springs apparently rise in the adjacent ocean floor.

Fresh water discharges at sea level in many places along the northeast coast. Springs were noted especially near Waimanalo Landing, Hauula, Laie, Kahuku, Kewalo Bay, Waialea Industrial School, Ashley station, and Waialua. These springs are largely discharge water from the basal water table of the Koolau basalts.

WATER IN THE BASALT MEMBER OF THE KOOLAU VOLCANIC SERIES OCCURRENCE

Permeability.—The cavities and crevices within and between the Koolau flow lavas form the greatest underground reservoir on Oahu. These crevices and cavities, named in order of their potential yield, are (1) interstitial spaces in clinker, (2) cavities between beds, (3) shrinkage cracks, (4) gas vesicles, (5) lava tubes, (6) cracks produced by mechanical forces after the flows have come to rest, (7) tree-mold holes.

The flow lavas exposed by erosion in the heart of the Koolau and Waianae Ranges appear to have been considerably compressed by the weight of the overlying rocks. In traversing recent lava flows, one is impressed with the great number of cavernous spaces that collapse under foot in the pahoehoe, and the very loose clinker piled

⁷ Honolulu Board of Water Supply. Rept. for 1929 Suppl., p. 251, 1929.

FIGURE 16.—Ground-water areas on Oahu.

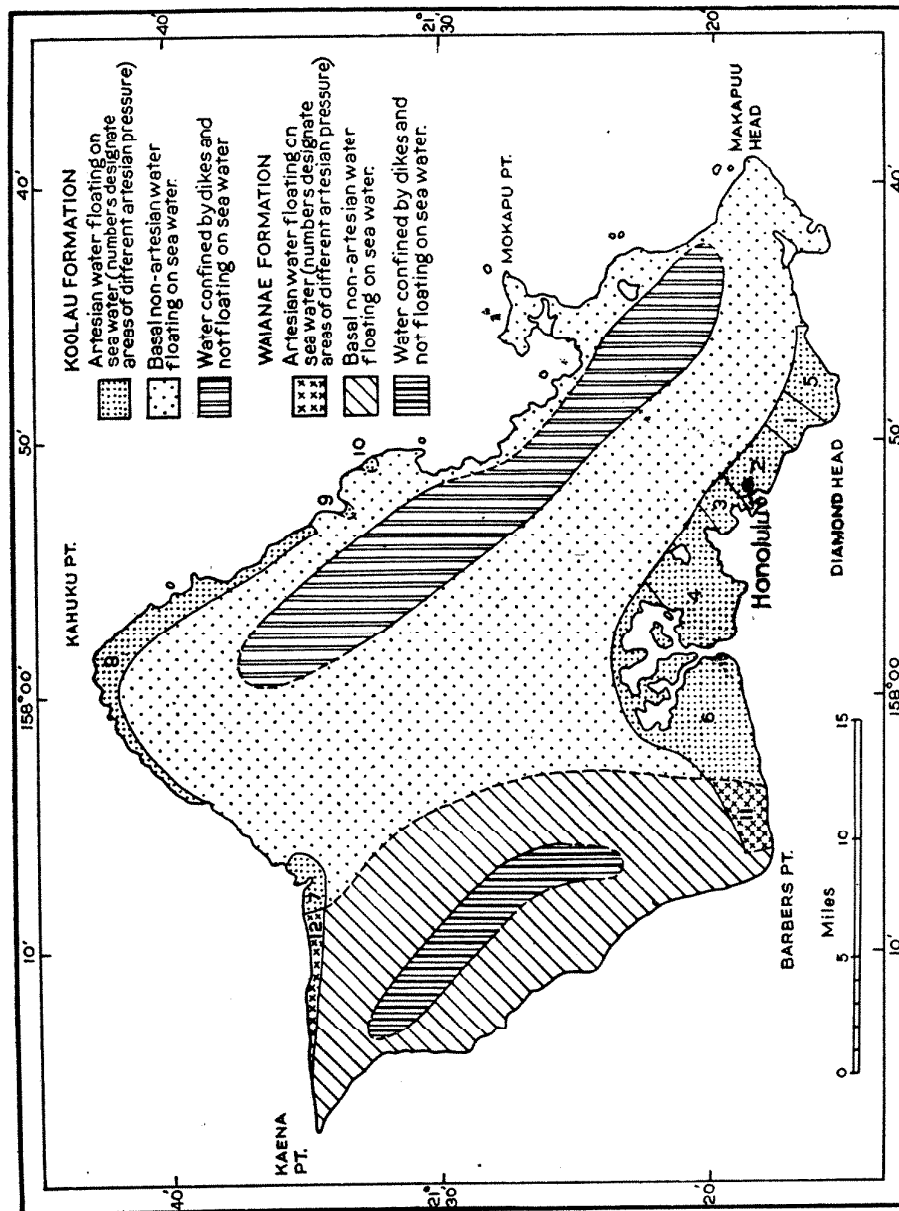

up in the aa. These openings are greatly reduced in number and size in the rocks at the base of cliffs 3,000 feet or more high apparently because of compaction by the weight of the overlying rocks.

Although some of the wells of Oahu are about 1,000 feet deep, most of their depth is in sedimentary rocks. The basalt penetrated generally consists of the surficial flows of the lava dome, hence its high degree of permeability.

Form of the water table.—The basal water table lies near sea level and is relatively flat. The gradient inland is only about 1 foot in the $1\frac{3}{4}$ miles between wells 248 and 251, and only 1.6 feet to the mile in the 6.7 miles between wells 292 and 341. In some places the gradient

reaches 3 feet to the mile. Such flat gradients are also characteristic of the basal water table in the other large islands and indicate that the rocks are exceedingly permeable.

Geologic studies, especially in connection with the occurrences of high-level ground water, indicate that the basal water table does not extend under the entire range but surrounds the dike complex, which contains confined water in many places several hundred feet above sea level. (See figs. 5, A, and 16.) The altitude of the basal water table next to the dike complex is not known, but because of its general flat gradient it is believed to be only a few feet higher there than along the shore.

Relation to underlying salt water.—The flow lavas are saturated for an unknown depth below sea level but not everywhere with fresh water, for various deep wells encountered increasingly saltier water with depth. For example, well 18, which is the deepest well in the Hawaiian Islands, reached water as salty as sea water about 1,500 feet below sea level.

Salt water probably filled the interstices in the rocks concurrently with the building of the volcano above sea level. Rain water percolating downward through the porous lava floated upon the salt water because of its lower specific gravity. When the island was small this rain water percolated laterally and quickly discharged into the sea, but as the island grew larger the friction increased in proportion to the distance the water had to move to reach the sea. Moreover, because the salt water in the interstices of the island is not a rigid body but is in hydrostatic equilibrium with the adjacent ocean level, the fresh water disturbed the equilibrium and caused the surface of the salt water to sag until the body of combined fresh and salt water in the rocks was in equilibrium with the sea.

Ghyben-Herzberg principle.—The Ghyben-Herzberg principle of the behavior of fresh water in contact with salt water in a pervious formation is stated by Brown⁸ as follows:

Wherever a coast is formed of pervious rocks containing ground water that receives continual additions from rainfall, this ground water must move downward and laterally toward the shore and mingle ultimately with the salt water of the sea. Such movements have long been a matter of common knowledge. Even on small porous, sandy islands fresh water can generally be found at an altitude slightly above mean sea level. It might be supposed that in such places the salt water surrounding the island would penetrate the sand to mean sea level and immediately absorb all the fresh water that might percolate downward to its surface. For several physical reasons this does not happen. Such islands are found, in reality, to contain a dome-shaped lens of fresh water floating upon a concave surface of salt water. The fresh water is enabled to float upon the salt water because it has a considerably smaller density. This principle was apparently first applied

⁸ Brown, J. S., A study of coastal ground water, with special reference to Connecticut; U. S. Geol. Supply Paper 537, pp. 16-17, fig. 2, 1925.

to the hydrology of seacoasts by Badon Ghyben,⁹ a Dutch captain of engineers, as the result of investigations made in Holland in 1887, but gained little notice from hydrologists at that time. It was also published about 1900 by Herzberg,¹⁰ of Berlin, who apparently had no knowledge of the work of Badon Ghyben. Herzberg found in drilling wells on the island of Norderney, one of the East Friesian islands off the coast of Germany, that the depth to salt water was roughly a function of the height of the water table above mean sea level and of the density of the water of the North Sea. Figure 17 shows the application of his theory.

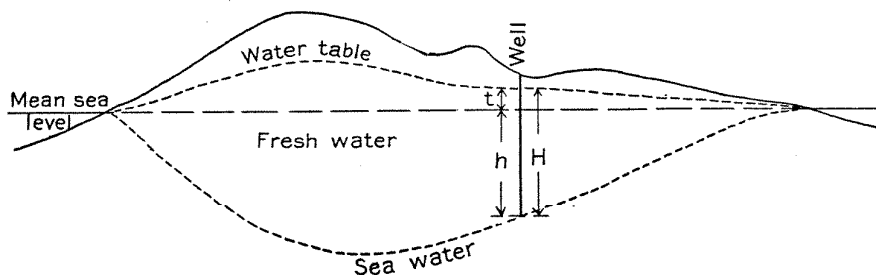

FIGURE 17.—Section of the island of Norderney, Germany, showing the application of the Baden Ghyben-Herzberg theory. (From Herzberg.)

Let H equal total thickness of fresh water.

h equal depth of fresh water below sea level.

t equal height of fresh water above mean sea level.

Then H equals h plus t .

But the column of fresh water H must be balanced by a column of salt water h in order to maintain equilibrium. Wherefore, if g is the specific gravity of sea water and the specific gravity of fresh water is assumed to be 1,

$H = h + t = hg$ whence

$$h = \frac{t}{g-1}$$

In any case $g-1$ will be the difference in specific gravity between the fresh water and the salt water. Herzberg gives the specific gravity of the North Sea as 1.027, whence h equals $37t$.

The average specific gravity of sea water off Oahu is 1.024. Thus on Oahu $h = 42t$. For example, if fresh water stands 2 feet above sea level in a well, the depth of fresh water below sea level will be theoretically 84 feet. Because of diffusion and mixing, the actual depth of fresh water is somewhat less than theoretical depth.

Areas along the coast without artesian water.—Cap rock is so scanty between the east points of Oahu and Wailupe Valley that artesian water does not occur (fig. 16). Instead, the water table is within 2 feet of sea level, and springs discharge from the ends of most of the spurs at tide level.

As the area between Kaneohe Bay and Kaaawa Valley is without drilled wells, the position of the water table is difficult to determine, but

⁹ Badon Ghyben, W., Nota in verband met de voorgenomen put boring nabij Amsterdam: K. inst. ing. Tijdschr., 1888-89, p. 21, The Hague, 1889.

¹⁰ Herzberg, Baurat, Die Wasserversorgung einiger Nordseebader: Jour. Gasbeleuchtung und Wasserversorgung, Jahrg. 44, Munich, 1901.

it is probably low, because the cap rock has two holes (pl. 2). Several dikes and a spring occur near the hole on the bay side. These dikes probably increase the friction at this discharge point, and if the Koolau basalt at sea level in the other hole is not too permeable artesian water with a low head may be found under the adjacent lowlands.

Between Waimea Canyon and Haleiwa Koolau basalt is exposed at sea level at so many places (pl.2) that artesian water does not exist. The static level of well 334 is about 3.75 feet, and according to the manager of the Waialua Agricultural Co., the water level fluctuates with the tide. The sedimentary deposits in the submerged Anahulu Valley extend below sea level and appear to be competent to form a partial ground-water barrier between this area without cap rock and the adjacent Waialua artesian area. However, the difference of about 6 feet in head between artesian area 7 and well 334 indicates an unusually steep gradient, which suggests that either the Anahulu fill extends farther inland than is suspected or else the rocks in this area are less permeable than usual.

ARTESIAN WATER

HISTORY OF ARTESIAN DEVELOPMENT

By K. N. VAKSVIK

EARLY SOURCES OF WATER SUPPLY

Prior to 1879 the only sources of water supply on Oahu were the shallow dug wells, the numerous small flashy streams, and the many springs large and small and at high and low altitudes. The dug wells were mainly in the lowlands of Honolulu and yielded water abundantly. The wells near the shore were reported to be slightly brackish, but those farther inland yielded good fresh water. The wells were not utilized to a very great extent and as the population of Honolulu grew the water became polluted and unfit for domestic consumption. People living at higher altitudes and those using large quantities of water were served mainly by diversions from streams. These diversions were limited to low-water flows, as the lack of good reservoir sites prevented the storage of the storm waters. Nearly all of the Nuuanu Stream was piped into the city mains, and most of the other streams on Oahu were used to irrigate rice and taro. To augment these supplies many of the springs on the island were developed. Those at high altitudes yielded only small quantities of water but had the advantage of gravity flow. Those at lower altitudes, particularly the Pearl Harbor Springs, yielded large quantities of water but could not be utilized on any except small areas of very low land without the use of pumps. As the cost of pumping was then generally considered prohibitive for purposes of irrigation, these low-altitude springs were not developed.

FIRST ATTEMPTS TO PROCURE ARTESIAN WATER

Several people in Honolulu began to think of various ways of obtaining water for irrigating the rather extensive arid lands outside of Honolulu. H. M. Whitney,¹¹ in 1875, prompted by the successful drilling of artesian wells in California, corresponded with a well driller in California regarding possibilities of obtaining artesian water on Oahu. In 1876 Charles Oester, a representative of a firm manufacturing well-boring tools, arrived in Honolulu with a drilling rig. A group of men in Honolulu offered to pay half the cost of drilling an experimental well, provided the Government would pay the other half. This the Government refused to do, whereupon Mr. Oester returned to California.

In 1879, while visiting in California, James Campbell, owner of a large tract of arid land west of Pearl Harbor, met a well driller named James Ashley, whom he brought back to Honolulu with a hand-operated well-boring rig. On June 26 of that year Mr. Ashley began boring a well on land belonging to Mr. Campbell near Honouliuli, on what is now the Ewa Plantation. This well (No. 267) was the first flowing well in the Hawaiian Islands.¹² It was therefore called the "Pioneer Well."

Upon the successful completion of this well on September 22, 1879, a great amount of enthusiasm was aroused regarding the possibility of obtaining water for a large acreage of arid lands elsewhere on the island. Mr. Ashley bored several other wells on different parts of Mr. Campbell's estate, but without obtaining artesian flows. He found that boring on land at high altitudes did not obtain flowing water and that his hand-operated tools could not penetrate the hardest rocks.

A. Marques was another man who had thought of the possibilities of obtaining artesian water. He resided on a tract of arid land at the mouth of Manoa Valley, on what is now Wilder Avenue near Metcalf Street. In 1880 Mr. Marques, G. W. Macfarlane, H. Cornwell, F. A. Schaefer, S. Parker, H. A. Widemann, and W. S. Green formed a company, who were to share the risk and expense of well drilling on their respective pieces of land. This company brought over A. D. Pierce, a well driller, from California. With a steam-operated well rig he began drilling a 6-inch well on the premises of Mr. Marques on February 25, 1880. Flowing artesian water was struck on April 28 at a depth of 273 feet, after drilling through soil, sand, coral, black basalt rock, clay, very hard basalt rock, another stratum of clay, and then more basalt rock, which contained the artesian water. As the drilling continued the flow from the well increased, until at a depth

¹¹ Whitney, H. M., Origin of artesian wells in the Hawaiian Islands: *Hawaiian Planters Monthly*, vol.17, pp. 486-491, 1898.

¹² McCully, L., Artesian wells: *Thrum's Hawaiian Annual*, 1882, pp. 41-46.

of 295 feet a flow of 96,000 gallons a day was obtained. At this point the drilling was stopped.¹³

This well, being easily accessible to the people of Honolulu, aroused even greater enthusiasm than the Pioneer well at Honouliuli. Hundreds came to view the fountain of clear, sparkling water that flowed from the well. Everyone began to see a new future for the thousands of acres of the then unproductive lands on Oahu.

The success of the Marques well encouraged King Kalakaua to have a well drilled on his property on the slope of Round Top. This well never yielded flowing artesian water, although it was eventually drilled down to 970 feet. Meanwhile two more well rigs had been sent for, and a little later drilling was begun for L. McCully and C. P. Ward.

Artesian water was first obtained for Judge McCully on his premises at what is now the corner of Beretania Street and Pawaa Lane. The well was completed September 15, 1880, and yielded a large flow at a depth of 418 feet. This was called the "Ontario well". Being still nearer the city than that of Mr. Marques, it renewed the enthusiasm of the people and hope of a new source of prosperity for the country.

After the Ontario well Mr. Pierce next struck flowing water on the premises of C. P. Ward on King Street, opposite Thomas Square on what is known as the "Old Plantation." Here, after drilling for about 6 months, a good flow of water was obtained at a depth of 540 feet. The Ward well was followed in a few months by a well on Kewalo Street. This probably is the one known as the "Loon Gawk well," located on the grounds of what is now the McKinley High School. The yield of water from this well greatly surpassed that from any previous well.

After the drilling of these wells others were drilled—namely No. 55 for B. F. Dillingham, near the Central Union Church; No. 64 for W. A. Widemann, on Punahou Street; No. 70 for the municipal water supply at the Makiki Reservoir; No. 48, called the "St. Lawrence well," for L. McCully on Artesian Street; No. 28 for Goo Kim, in Moiliili; No. 57 for Mr. Jaeger, on Beretania Street near Punahou Street; No. 72 for Captain Babcock and three other landowners, on Liholiho Street near Lunailo Street; and No. 61, called "Niagara well," for the municipal water supply on Kalakaua Avenue near King Street. By the beginning of 1882 there were 13 flowing artesian wells in Honolulu, all between central Honolulu and Kapahulu Road. This number does not include several wells which were then uncompleted in Honolulu nor two wells outside of the city—the Pio-

¹³ Marques, A., letter in Hawaiian Gazette, May 5, p. 3, 1880.

near well, at Honouliuli, and a flowing well near Kahuku, which made 15 flowing wells on the Island of Oahu.¹⁴

Of these 15 wells 13 were cased with the so-called "stove-pipe casing," which consisted of a thin sheet iron riveted to the shape of cylinders of the desired diameter and slightly cone-shaped so that the end of one length of casing could be fitted into the end of another. There was an inner lining of casing of this same type so placed that the joints of the inner casing alternated with those of the outer casing. The Jaeger well, (No. 57) was the first well on Oahu to be lined with heavy iron pipe with threaded joints. The Niagara well, (No. 61) was also lined in this manner. A few of the later wells were lined with the stove-pipe casing, but the large majority were lined with the more durable, heavy iron pipe or well casing. All the different types of casings were seated in the so-called "cap-rock" just above the water-bearing lava rock or in the top of the lava rock. The hole was then extended down an average of 80 to 100 feet into the aquifer without being cased.

According to the records kept by Mr. Ashley, the boring of the Pioneer well was done by means of augers and chisels fixed on the ends of jointed poles. With this apparatus he was able to penetrate only the relatively weak formations. Evidently he did not go far into the water-bearing lava rock for the well yielded only 60,000 gallons a day when it was finished, which was a very small flow compared with those of later wells.

Mr. Pierce was equipped with a much better apparatus when he drilled the first wells in Honolulu. He imported a steam-operated, cable-equipped well-drilling rig of the percussion type from California, which could penetrate any rock formation found in the islands. In the Marques well (No. 38) he penetrated 22 feet into the aquifer; in the Ontario well, 26 feet; and in the Ward well, 40 feet. Each of these wells yielded several times as much water as the Pioneer well did, even though they were drilled on higher ground. In recent years it has been the practice to drill even deeper into the aquifer, 100 feet or even more, resulting in flows as great as 3,500,000 gallons a day from a 12-inch well without the use of pumps. The power-operated cable rig of the percussion type has been used to drill all wells over 2 inches in diameter up to the present time.

The 2-inch wells have been drilled by a wash drilling rig that consists essentially of a bit fixed to the end of a hollow stem of 1-inch pipe. The rig is of the percussion type, and as the particles of rock at the bottom of the well are churned loose they are forced to the surface outside of the stem by a stream of water that flows down through the stem and out through the sides of the bit. The bit is

¹⁴ The King's well, included in this total was abandoned when flowing water was not obtained. The owner considered the well a failure.

small enough to pass through a 2-inch casing and as the drilling progresses the casing is forced down. When artesian water is obtained the casing is seated in its final position. Drills of this type will not penetrate hard rock, but in some locations on Oahu they have proved successful in developing small flows.

SUCCESSFUL WELLS

It was fortunate that when well drilling was begun on Oahu, experienced drillers were employed. Nearly 700 wells have been drilled on this island to date, with very few failures. Mr. Ashley, after successfully completing the Pioneer well at Honouliuli, at about 10 feet above sea level, moved his rig to another location on Mr. Campbell's land in Honouliuli, at a place called "Lihue," just east of Puu Kaua, in the Waianae Range. Boring was started at an altitude of about 700 feet but stopped after going down 240 feet without getting any water. He made several other attempts but was unable to get flowing artesian water above an altitude of 32 feet. The water in the first 13 wells in Honolulu rose uniformly to about 42 feet above sea level, so that prior to 1882 it became apparent to the well drillers that flowing wells were to be had only on the lowlands.¹⁵

Artesian wells drilled in Honolulu before February 1882

No. on pl. 2	Name	Altitude of land surface at well (feet)	Total depth (feet)	Depth below sea level (feet)	Static head of water in well above sea level (a) (feet)
	Flowing wells:				
77	Loong Gawk	5.91	610	604	----
82	C. P. Ward	13.36	510	497	----
61	Niagara	14.0	475	461	----
28	Goo Kim	15.0	430	415	----
48	St. Lawrence	25.0	318	293	42
51	Ontario	25.24	418	393	----
57	Jaeger	28.38	315	287	42.88
38 (b)	A. Marques	36.67	295	258	43.5
72	Capt. Babcock	37.38	375	338	41.96
55	B. F. Dillingham	38.72	300	261	42.0
	Nonflowing wells:				
64	H. A. Widemann	47.7	419	371	42.7
70	Makiki	150.0	900	750	42
60	King Kalakaua	200.0	970	770	42

(a) Measurements of static head made prior to 1882.

(b) Oldest artesian well in Honolulu. Flowing water struck April 25, 1880.

(c) Head measured on April 25, 1880.

UNSUCCESSFUL WELLS

A few wells were drilled without success. One of them was the Campbell well (No. 18), near the Diamond Head end of Kapiolani Park, which was the deepest hole drilled on the island. The hole was

¹⁵ McCully, L., op. cit., pp. 41-46.

drilled to a depth of 1,500 feet at a place 15 feet above sea level without encountering fresh water. The well driller reported that the water in the well was "saltier than sea water." The water rose only 1 foot higher than the water in an adjacent shallow dug well. The casing was withdrawn and the well abandoned. The exact location has been lost. Another unsuccessful well in Honolulu that did not reach artesian water was drilled somewhere near the mouth of Manoa Valley, in the vicinity of the Stadium, at an altitude of approximately 7 feet. Although 730 feet deep this well did not penetrate the water-bearing lava rock and was abandoned.

In the vicinity of Waianae two wells were drilled, one about 800 feet deep and the other about 1,000 feet deep, both of which failed to overflow and were abandoned. The unsuccessful wells in the Hono-liuli district drilled by Mr. Ashley have already been mentioned.

EFFECT UPON AGRICULTURE

In the days prior to the discovery of artesian water Oahu was not considered to be a "sugar" island. According to Bowser¹⁶ there were on Oahu in 1880 only a few small sugar plantations with comparatively small tracts planted in sugar cane. The following table gives data as to the extent of sugar cultivation on Oahu at that time:

Sugar plantations on Oahu in 1880

Name	Area planted in sugar cane (acres)	Estimated yield of 1880 crop (tons)
Waianae sugar plantation.....	250	500
Waiialua sugar plantation.....	400	600
Laie sugar plantation.....	200	100
Kaalaea plantation	160	200
Kahaluu plantation	50	75
Heeia sugar plantation.....	250	600
Parker's sugar plantation.....	75	120
Kaneohe sugar plantation.....	500	500
Waimanalo Sugar Mill & Plantation Co.	750	800
	2,635	3,495

The production in the Hawaiian Islands in 1880 was 28,386 tons,¹⁷ hence the production on Oahu was only about 12 percent of the total. The plantations enumerated above depended on rain and diversions from surface streams and springs for the irrigation of their crops. For that reason these plantations were located almost entirely on the northeast (windward) side of the island, in regions where the rainfall was fairly heavy and where there was considerable stream and spring water. The only exception was the Waianae Plantation, which was located in the lee of the Waianae Mountains, where the rainfall was light.

¹⁶ Bowser, George, An account of the sugar plantations and principal stock ranches of the Hawaiian Islands: The Hawaiian Kingdom, statistical and commercial directory, pp. 407-409, 1880-1881.

¹⁷ Paradise of the Pacific, vol. 32, p. 55, December 1919.

However, this plantation had already developed considerable water from tunnels in the Waianae Range. On windward Oahu the topography is such that the plantations were necessarily small. The amount of water available for irrigation on the Waialua and Waimanalo plantations was sufficient only for small areas.

About 1880, in a report concerning the possible future sugar production in Hawaii, the following statement was made about the sugar lands on Oahu:¹⁸

This island contains but a very small amount of land upon which cane can be raised. Three plantations of very moderate size and two very small ones comprise the whole of it. In the center of the island is a very extensive tract where the soil seems good and sufficient, but it is under the lee of the eastern mountain range and would have to be heavily irrigated, and there is no water except such as is already employed by existing cane fields. The total acreage at present cultivated is about 3,000 acres. The three existing large plantations may be capable of some slight enlargement.

This was the status of Oahu before the discovery of artesian water for irrigation on the island. The large areas of arid and semi-arid lands west of Salt Lake Crater and those between Hauula and Kawaihapai were considered to be of little value except for grazing. However, in the early eighties, after the success of the Pioneer well, artesian wells were drilled at different places on these lands. Several flowing wells were drilled at Laie, Kahuku, Waialua, and Mokuleia and on the shores of Pearl Harbor. The indications were that artesian wells could be drilled almost anywhere on the narrow strip of low land between the mountains and the sea.

Ewa plantation.— B. F. Dillingham, a business man in Honolulu began to investigate the possibilities of growing sugar cane on lands near Ewa to be irrigated with artesian water. He engaged two engineers to investigate the water supply for plantations at Honouliuli and at Kahuku. These engineers,¹⁹ were very optimistic about the probability of obtaining sufficient artesian water to irrigate such lands in Honouliuli and at Kahuku as Mr. Dillingham wished to plant in sugar cane. He interested capital in the venture, and 650 acres, on what is now the Ewa plantation,²⁰ was planted in cane in Honouliuli in 1890. At the same time drilling of artesian wells to obtain water for irrigation was begun. The following table shows the progress of well drilling on the Ewa plantation and the lands of its subsidiary, the Apokaa Sugar Co.

¹⁸ Spalding, Z. S., *Pacific Commercial Advertiser*, July 6, 1899, p. 1.

¹⁹ Schuyler, J. D., and Allardt, G. F., *Report on water supply for irrigation on the island of Oahu*, H. I., Aug. 26, 1889.

²⁰ Ewa plantation: *The Friend*, vol. 448, pp. 49-50, June 1890.

Progress of well drilling on Ewa plantation

Pumping stations	Number of wells drilled									Total in 1930
	1890	1891	1897	1899	1900	1908	1913	1921	1923	
1	6	2	8
2	2	1	3
3, 4.....	1	11	4	4	20
5, 6.....	12	12
7	6	6
Mill	2	2	2	2	8
10, 11, 12	7	2	2	11
Apokaa ..	1	1	2
	10	13	12	8	8	9	2	5	3	70

None of these 70 wells overflow, as they were drilled on land at altitudes above the static head of the water in the wells. The pumps on these wells in 1930, according to records of the Ewa Plantation Co., had a capacity of 110 million gallons a day. There are two other wells on this plantation that are not in use—the Pioneer well and a well drilled in Puuloa.

Kahuku plantation.— Soon after the Ewa plantation project began to show indications of success the Kahuku plantation project was begun. At first the operators depended on pumped spring water, stream water, and rain, but all this was found to be insufficient for the acreage of land available for sugar cane. The company purchased a drilling rig and in 1900 drilled eight artesian wells—six at pump 5 and two on the Laie side of the plantation. In 1901 two more wells were drilled at pump 5, two at pump 2, and one about a mile west of pump 2. In 1902 two wells were drilled in fields 5 and 13. In 1903 one well was drilled at Kaipapau.

In 1930, according to records of the Kahuku Plantation Co., a total of 34 artesian wells on this plantation yielded a maximum of 20 million gallons a day.

Oahu Sugar Co.—The next venture on Oahu was the Oahu Sugar Co., incorporated in 1897.²¹ Records of artesian-well drilling on this plantation are very meager. The annual reports of the company state that in 1901 \$33,000 was spent for artesian wells. Four wells were drilled in 1906; five in 1908; and 3 in 1910 and 1911. The Oahu Sugar Co. now has a total of 63 artesian wells on its land, with 60 of them at pumping plants and 3 yielding water by artesian flow at the rate of about 1 million gallons a day. The pumping-plant capacity in 1930 was 84.5 million gallons a day.

Waiialua Agricultural Co.—The Waiialua Agricultural Co. was organized in 1898. Parts of the lands of its plantation were then occupied by the Halstead plantation and by producers of rice and bananas. These lands were irrigated by all the available surface water and the yield of several artesian wells. The first of these wells was drill-

²¹ Evening Bulletin, February 22, 1912, industrial section, pp. 43-48.

ed in 1882,²² and by 1895 there were 19 wells between Haleiwa and Kawaihapai. On the lands that have been taken over by the Waialua Agricultural Co. there were 12 wells in 1898. The progress of well drilling is shown by the following table.

Progress of well drilling on the Waialua Agricultural Company's plantation

Pumping stations	Number of wells drilled											Total in 1930	
	1898	1899	1900	1902	1913	1915	1916	1917	1920	1923	1924		1927
1	3								2				5
2		7				3		3			1		14
3		5	6	6	3								20
4			15										15
5		1	5			1							a8
7					2					2			a5
8			1							1			2
11					1								1
13												12	12
Mill		3	1						1	2			7
	3	16	28	6	6	3	1	3	3	5	1	12	89

(a) Includes one well not drilled by the Waialua Agricultural Co. in existence prior to 1898.

Practically all of these 89 wells were at pumping plants which, according to records of the Waialua Agricultural Co., had a total capacity of 95.6 million gallons a day.

Honolulu plantation.—The Honolulu Plantation Co., organized in 1898, was the last of the large plantations to be formed on Oahu. In 1899 the company began drilling artesian wells to supply water for irrigating sugar cane. By 1900 three pumping plants were in operation—pump 1, with 14 wells; pump 2, with 20 wells; and pump 3, with 10 wells. Later, several flowing wells were drilled in the Halawa, Makalapa, and Puuloa areas. In 1904 nine wells were drilled at pump 4; in 1907 and 1908, five wells at pump 5; in 1926, four wells at pump 7; and in 1930, three additional wells at pump 1. As the company grew, it acquired new land on which there were already several flowing wells. By 1930 the Honolulu Plantation Co. had 87 artesian wells, mostly at pumping stations and the total capacity of the pumps, according to company records, was 85 million gallons a day.

Laie plantation.—Before any of the larger sugar plantations on Oahu had been organized, the Laie plantation was irrigating by means of artesian wells, some of which had been drilled in the early eighties. Information about these old wells is meager. They were drilled for irrigating both taro and sugar cane. In 1930 there were 24 artesian wells on the lands of the Laie plantation most of them on sufficiently low land to overflow. This plantation was absorbed into the Kahuku plantation in 1931.

Waianae plantation.—Several wells have been drilled on the Waianae plantation to augment the water supply derived from springs and

²² Pacific Commercial Advertiser, March 18, 1882, p. 3.

tunnels. At the Kamaile pump 27 wells, all about 300 feet deep, have been drilled. However, 11 of these wells had been sealed and abandoned by the end of 1928. The capacity of the pump is 5 million gallons a day. In the early days two other wells were drilled on the plantation. Fred Meyers, manager of the Waianae plantation from 1899 to 1919, reports that one well was drilled to a depth of about 800 feet without striking artesian water, and the other was drilled to about 1,000 feet and struck "pure Pacific Ocean."

Rice.— The numerous rice plantations on Oahu were formerly large users of artesian water. Probably about 60 or 65 artesian wells were drilled to obtain water for the irrigation of rice. A rice pest accidentally introduced on the island in 1927 caused so much damage that many rice fields were either abandoned or planted to other crops. Also in recent years California rice has been sold here at relatively low prices. There are now only about 12 artesian wells used by rice planters.

Bananas and taro.— Bananas and taro are in some places irrigated with artesian water, but lands devoted to these crops are gradually being absorbed by sugar plantations. Formerly about 35 wells were used to irrigate bananas, but only about 20 wells are used now. In 1930, five wells were used to irrigate taro.

Miscellaneous.—In addition to supplying the cane lands, some of the plantation pumps serve the mills with well water for the manufacture of sugar. The navy yard at Pearl Harbor uses the discharge from five wells. Artesian water also furnishes the supply for Fort Kamehameha, Watertown, Fords Island, Aiea, Pearl City, Waipahu, Honouliuli, Ewa, Mokuleia, Waialua, Haleiwa, Kahuku, Laie, Hauula, and most of the plantation camps and villages. About 25 wells are used to irrigate truck gardens and lawns, for stock and dairies, for supplying homes, and for fish ponds.

PROGRESS OF WELL DRILLING IN HONOLULU

The success that attended the drilling of the 13 artesian wells in Honolulu prior to 1882 led to the use of well water for municipal purposes. By 1884 five wells augmented the municipal water-supply system. King Kalakaua also caused the drilling of several wells in the early eighties. James Campbell, in spite of the failure of his well near Diamond Head, had four more wells drilled, all of which proved successful. Several other individuals, desiring an ample supply of pure water for domestic supply, irrigation, and stock, had wells drilled on their lands, so that by the end of 1884 there were 45 artesian wells in Honolulu. These wells helped materially in developing lands around the city. Land between Thomas Square and Diamond Head, which before 1880 had been comparatively barren, was placed

under irrigation, and Waikiki obtained good water to replace the previous poor supply.

Between 1884 and 1888 the demand for additional water slackened, and only 10 wells were finished, whereas in the preceding 4 years nearly four times as many wells were brought in. This decrease in demand is accounted for by the slight increase in population—from 20,487 in 1884 to 22,907 in 1890. Of the nine wells drilled in 1889, all but one were for dairies or rice fields in Moiliili, Kahauiki, or Moanalua. The 8 wells drilled in the next 2 years were mainly for rice fields. In 1892 none were drilled. In the following 3-year period 14 wells were drilled, including 2 at the present Beretania pumping station, which was started in 1895 as the result of droughts of 1889, 1891, 1893, and 1894 and an increase of several thousand in population since 1890. Some of the other wells drilled during this period were also for domestic supply.

By 1900 the population of Honolulu had increased to 39,306, and two more pumping stations were added to the municipal distributing system. The Kaimuki pumping station was started in 1898 with 2 wells, and the Kalihi pumping station was started in 1900 with 3 wells. In this period 12 other wells were finished, mainly for private domestic supply and for irrigating rice. The Honolulu Rapid Transit Co. and the Oahu Railway & Land Co. both had wells drilled for industrial purposes.

The next 10 years saw an increase in population in Honolulu from 39,306 to 52,183 and 25 wells were drilled. The capacity of the Beretania pumping station was increased in 1909 with the addition of 2 more wells. At least 7 of the others were drilled for industrial purposes, and the rest were for domestic supply and for irrigating truck gardens and sugar cane.

The next 10 years saw an increase in population in Honolulu from 52,183 to 83,327. In 1912 the Wilder Avenue pumping station, with 2 wells, was added to the city system, and 2 additional wells were brought in at the Kaimuki pumping station. Fifteen other wells were drilled, of which at least 10 were for industrial purposes.

From 1920 to 1930 the population rose from 83,327 to 132,000. This large increase again made it necessary to increase the artesian water supply at the city pumping stations. Of the 23 wells drilled during this period, 14 were at these plants. At the Kaimuki station 3 wells were drilled in 1925 and one in 1928. At the Beretania station one well was drilled in 1923, one in 1924, and three in 1926. At the Kalihi station four wells were drilled in 1926 and one in 1927. Of the other 9 wells four were drilled for industrial purposes, four for private and domestic supply, and one for stock.

A graph of the progress of artesian well drilling in Honolulu from 1879 to 1930 is shown in figure 18.

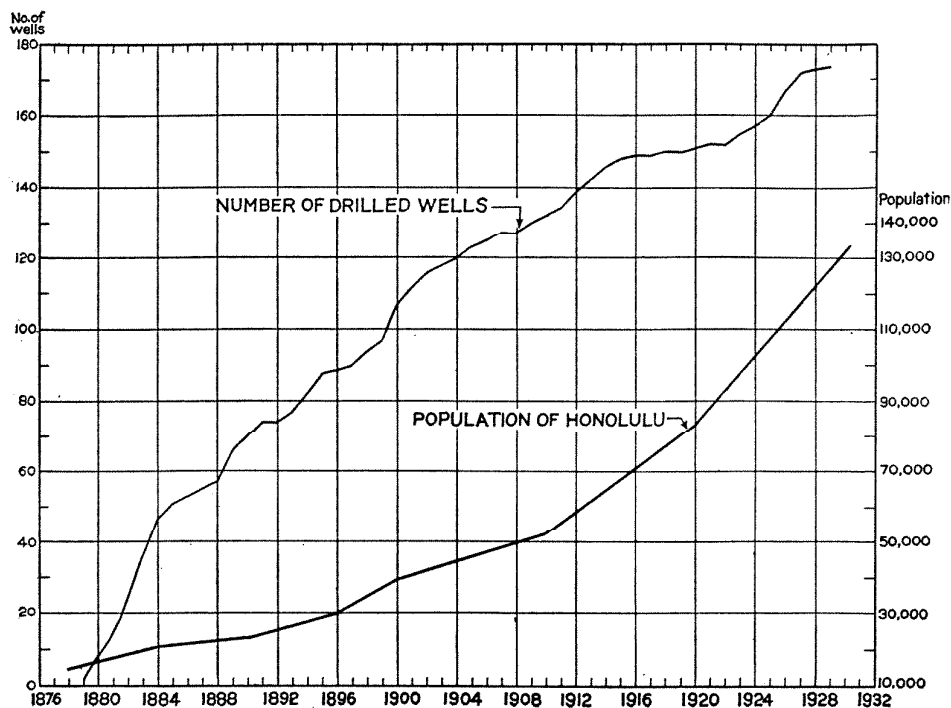

FIGURE 18.—Progress of well drilling in Honolulu.

OCCURRENCE

By H. T. STEARNS

RELATION OF ARTESIAN TO BASAL GROUND WATER

Where Koolau basalt passes beneath impermeable rocks of the coastal plain the basal water becomes confined under pressure, so that wells drilled through coastal sediments into the lava obtain water under pressure, which may or may not overflow the well casing. As shown in plate 25, B, both nonflowing and flowing wells entering Koolau basalt obtain their water from the same water-bearing basalt or aquifer and the same underground reservoir.

The locations of the drilled wells entering Koolau basalt are shown on plate 2, and it is planned to print their records in a later bulletin. Some of the wells are flowing, and most of the nonflowing wells contain water under pressure. For many years only flowing water was looked for and it was not generally recognized that wells penetrating Koolau basalt above the upper boundary of the cap rock and obtaining nonflowing water entered the same aquifer as the flowing wells. For this reason several nonflowing wells were abandoned. The practical application of this fact may be illustrated by well 71, at the

Roosevelt High School in Honolulu. This well had long been abandoned, and the rubbish was being cleaned out of the well in preparation for sealing it. After successfully cleaning out 50 feet of the well, the driller reported that he could not remove any more except at much additional expense, because he encountered a concrete plug. The geologic map (pl. 2) indicated that the well probably penetrated only Tantalus and Sugar Loaf "black sand" and Koolau basalt. If such was the case there would be no confining stratum and hence there would be no advantage in plugging the well. A 4-inch hole was bored next to the casing through the soft sand at only a small expense and no cap rock was found. Thus, it was not necessary to spend additional money cleaning out the well, because if the well was not artesian the plug placed in it would have no value in conserving artesian water. The well was therefore plugged near the surface, to prevent possible contamination of the basal water.

CHARACTER OF CAP ROCK

The character of the cap rock of the Honolulu artesian basin was correctly understood at an early date. Judge McCully in 1882 described it as follows:²³

From the borings it appears that the containing strata are composed of very compact clay, many feet in thickness. These are covered again by other strata of sand, coral, and clay, with overlying beds of lava. It seems to be a necessary inference that these strata were gradually and successively deposited upon the submarine slope of the slowly growing volcanic mountain as then existing. On all ocean beds slow deposition of sediment from the land is constantly accumulating, upon which near the shore sand is also deposited and coral grows. On this ancient volcanic coast lava has occasionally overflowed these lower strata, enlarging the area of the island.***

These strata now extend to a point far inland, but which must once have been the vicinity of the sea beach. They have a rapid slope in conformity with the normal contour of the ancient volcanic nucleus of the island. The upper and inner edge of these strata appear to be at a point which is now 42 feet above the sea level but which must at the period of original deposition have been just below the level of the sea in which the clay was deposited. Hence it is to be inferred that a later elevation of the region, at least 42 feet above sea level, took place at the early period in question.

The effective confining beds in the cap rock of the artesian basins of Oahu consist of lateritic soil (soil formed in humid tropical latitudes and notably high in red iron oxide), tuff deposits from post-Koolau eruptions, and the shales, sandstones, and conglomerates laid down beneath the sea by the streams draining Oahu, (pl. 20). Except for the tuff and soil these deposits represent the material eroded from the Koolau and Waianae Ranges and deposited in fans and as marine

²³ Thrum's Annual, 1882, p. 46.

sediments during former high stands of the sea. Where the coastal-plain sediments are thick the permeability of the lower fine-grained beds in the cap rock has probably been appreciably reduced through compression by the weight of the overlying rocks. The reefs and post-Koolau basalt flows included in the cap rock are too permeable to act as retaining beds.

Mapping of the cap rock has demonstrated that it is not essential for these deposits to make a continuous cover above sea level in order to obtain artesian water. If the holes in the cap rock are small in relation to the amount of water available, these holes simply become leaks or the sites of springs, as, for example, at Pearl Harbor. (pl. 25, B). If, however, the cap rock is scanty, as east of Wailupe Valley or between Waimea and Anahulu Valleys, little or no artesian pressure is found.

IMPORTANCE OF ANCIENT SOILS

Logs of many of the wells show that clay is penetrated just before water is recovered. Logs of wells 161 to 171, for instance, record several layers of soft rock and clay before reaching hard rock and strong flows of water. Because the drill penetrates these layers readily it is believed that the upper layers of the Koolau basalt are considerably decomposed. In some logs decomposed lava is actually reported, or else "red clay," which is probably lateritic soil.

Well 271 was drilled with a 2-inch bit by the wash-rod method, yet this drill cuts only a few inches a day in a solid unweathered basalt, as was demonstrated at the hole and again while making test borings at Nuuanu Dam. In spite of this fact, the Hobart Engineering Co has succeeded in drilling several artesian wells by this method, and in the logs the driller generally reports "mudrock" as the aquifer.

Because artesian water is generally found in basalt rather than in mudrock, Mr. Hobart kindly devised a scraper by which he could obtain unmixed samples from definite depths in well 271, to test this belief. The samples positively demonstrated that the water-bearing "mudrock" in this well is Koolau basalt, and that there is considerable decomposed Koolau basalt just below the coastal sediments.

In the wells recently drilled at Kahuku the samples for the first 50 feet or so were decomposed or partly decomposed basalt. In some wells the driller reports artesian water first in gravel or boulders on top of the basalt. Residual boulders in weathered soil would naturally drill like gravel and boulders. The evidence is accumulating to indicate that the Koolau lavas beneath the coastal plain sediments were deeply weathered before submergence and that the soil thus formed is one of the most effective parts of the cap rock.

ABSENCE OF LOWER CONFINING BED

The deepest wells on Oahu have penetrated only water-bearing flow lavas beneath the cap rock. Nowhere in the thick sections of Koolau basalt exposed in the canyons adjacent to the artesian areas are there any beds adequate to form a lower confining bed, and it is these basalts that dip beneath the cap rock and form the aquifer. Furthermore, deep wells have passed through the zone of fresh artesian water into salt water; hence there can be no doubt that a lower confining bed is absent from the artesian basins.

EFFECT OF GHYBEN-HERZBERG PRINCIPLE

As artesian water can pass freely into the sea around the lower end of the cap rock, it is also true that when artesian water is withdrawn in excess of the recharge the direction of movement of water is reversed and sea water can enter the aquifer. Thus the artesian water is essentially in hydrostatic equilibrium with the sea water, in a natural U-shaped tube.

If Oahu were an island in a lake instead of in an ocean both arms of the U-tube would be filled with fresh water of the same specific gravity. It follows that the static head of the wells in the artesian basin would then be only equal to the frictional resistance of the aquifer. On account of the great permeability of the basalts making up the aquifer, the frictional resistance is so small that the head of the artesian wells under such conditions would raise the water only slightly above lake level. McCombs²⁴ describes this condition as follows:

The action of the water beneath the confining bed on the island of Oahu follows this principle, but the effect is not the same as is shown in figure 17 for an island with uniform permeability. Consider an ideal section of a permeable formation along a seacoast, with an impervious vertical wall at the shore line extending to a depth of 1,500 feet below sea level but not to the bottom of the permeable formation. Assume further that the water in the permeable formation on the landward side of the wall is as salty as sea water and is standing at sea level. If water is pumped from the landward side, sea water will at once flow under the wall, and the water level on the landward side will, except for friction, remain the same.

If fresh water is added by rainfall on the land, the balance will be maintained, but the levels will not be the same; an amount of sea water equal in weight to the added fresh water but smaller in volume will be forced out under the wall, leaving the fresh-water level inside the wall higher than the sea-water level on the outside. As the process of adding fresh water continues, the zone of contact between the fresh and the salt water will sink lower and lower until one of two things happens—either the upper surface of the fresh water will reach the top of the wall and thenceforth any water added by rainfall will flow over the wall, or else the zone of contact between fresh and salt water will reach the bottom of the wall and fresh water will begin to flow out under the wall. In either case the zone of contact will thereafter remain stationary.

²⁴ McCombs, John, Methods of exploring and repairing leaky artesian wells on the island of Oahu, Hawaii: U. S. Geol. Survey Water-Supply Paper 596, pp. 7-8, fig. 2, 1927.

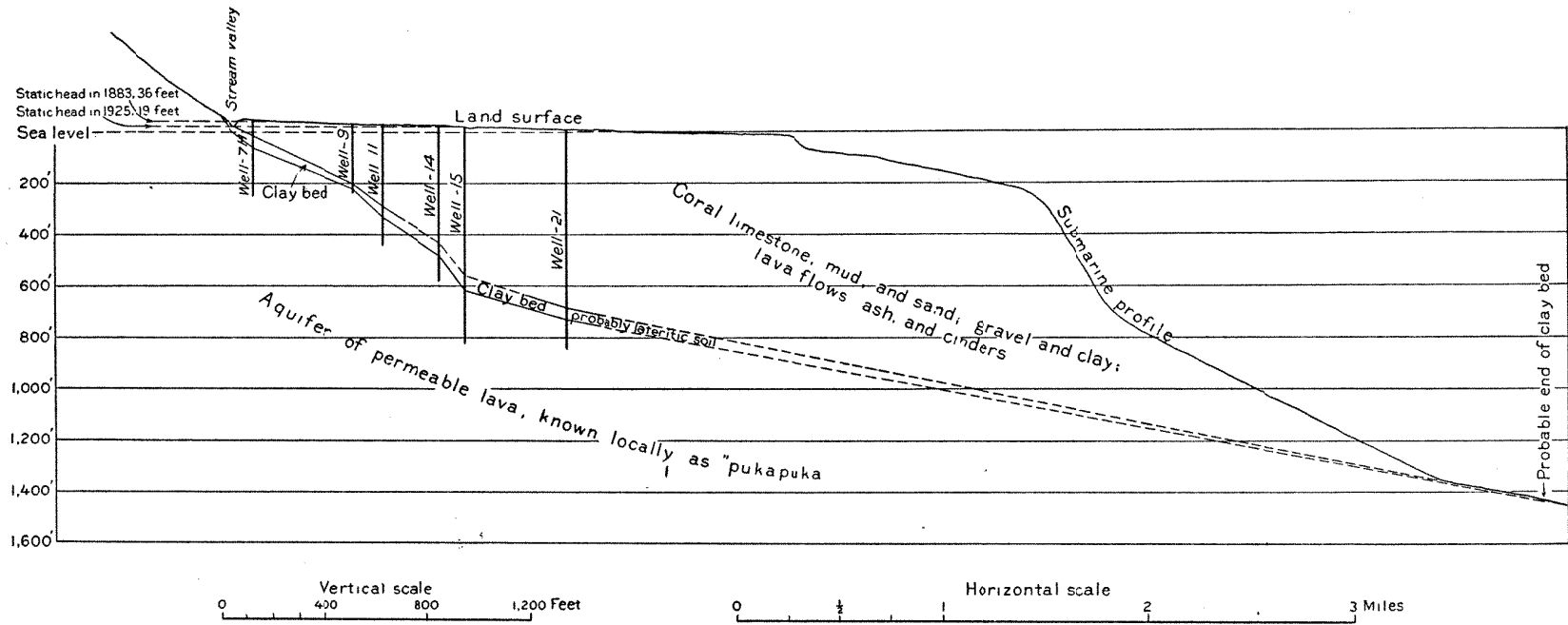

FIGURE 19.—Section of the Waikiki artesian area, Honolulu. The section extends from the junction of Waialae and Kapahula Avenues, in Honolulu, through Aina hau, to a point about 3½ miles offshore. Based on topography by U. S. Geological Survey, soundings by U. S. Coast and Geodetic Survey, and logs of artesian wells. In this area the artesian water originally rose to a height of 36 feet above sea level. (After McCombs).

An actual section in the Waikiki area is shown in figure 19. It illustrates conditions equivalent in their effect to those discussed above. The wall is present, not as a thin vertical structure but as a sloping sheet of impervious clay. This clay wall is overlain with many other materials, which, except for their weight, do not affect the result.

The average specific gravity of sea water at the surface off the coast of Oahu has been reported by Lyon ²⁵ as 1.024,²⁶ if that of ordinary water is rated as 1.

At greater depth the specific gravity may be somewhat higher. With sea water 1.024 times as heavy as fresh water, the difference in level between the fresh water in the aquifer and the salt water in the sea will increase about 1 foot for each 43 feet of fresh water added. If the wall extends 1,500 feet below sea level, the fresh water will stand about 36 feet above sea level, provided the wall rises to that height. The change in conditions behind this actual wall of impervious clay has gone much farther than in the ideal case outlined above. In 1883, when well 21²⁷ (see fig. 19) was drilled, the water in this well rose to a height of 36 feet above sea level and had a very low salt content. It is reasonable to suppose that at that time the fresh water was either flowing out under the confining bed or was flowing over the top of it.

As there are no physical evidences of large springs near the 36-foot level, the former supposition is more probably the correct one. By 1892 the head had declined to about 30 feet above sea level, and the water in well 54 had become too salty to drink. In September, 1925, the head was less than 19 feet above sea level and salt water had risen until it began to affect well 14 at a higher level.

The experience with these wells indicates that salt begins to appear in a well when the theoretical zone of contact between the fresh and salt water is still at a considerable depth below the bottom of the well. This condition may be due in part to the width of the actual contact zone and in part to the doming up of the salt water under a well that is discharging. Obviously there must be a contact zone of considerable width in which the water contains more salt than normal artesian water but less than sea water. Such an intermediate condition is undoubtedly developed by diffusion of the dissolved salt and by the mixing of salt and fresh water due to the alternate up and down movements of the water in the aquifer, as fluctuations in the head are caused by variations in rainfall, draft, and tide. At the upper limit of this zone the salt content is only slightly greater than that of normal fresh water, but it increases progressively with depth until at the lower limit it is equal to that of sea water. If the specific gravity of the sea water is greater than has been assumed, the contact between fresh and salt water will be theoretically higher and the transition zone correspondingly thinner.

The relation of pumpage to loss of static head and invasion by sea water, as outlined above, is the basis for the rather extensive conservation which has been planned and enforced by the division of hydrography. Most artesian basins in the United States have been overdeveloped and have suffered large losses in head. In most of them, however, the process of decline in artesian head is self-limiting, and the principal damage that results from overdevelopment and waste of artesian

²⁵ Lyon, H. L. (botanist, Hawaiian Sugar Planters Association), oral communication.

²⁶ W. D. Collins, of the United States Geological Survey, reports a specific gravity of 1.0222 at 24° C. (75.2° F.) for a sample collected from Pearl and Hermes Reef lagoon on August 22, 1930, and 1.0220 at 24°C for a sample collected October 30, 1930, outside of Pearl Harbor. Dr. Lyon reports orally May 4, 1932, that his determination was made on a sample collected 5 miles out of Honolulu and was made at a temperature lower than 24°C. As Collins' specific gravity of ocean water when corrected to 60°F. (15.56°C) is 1.0239 and at 50°F. (10°C) is 1.0246, it is evident that 1.024 is the practical figure to use for the water off Oahu.—H. T. S.

²⁷ Numbers of wells changed to agree with the present report.—H. T. S.

water is in making pumping necessary. On the island of Oahu the drop in artesian head produces more serious results. As the head is due to an equilibrium between fresh and salt water, a loss of 1 foot in artesian head will be accompanied by a rise of the salt water of about 42 feet. Thus the decline of head becomes of great significance, as it indicates loss of storage.

INDEPENDENT APPLICATION OF THE GHYBEN-HERZBERG PRINCIPLE ON OAHU

Because the artesian head in the central Honolulu district was more than 42 feet when the first wells were drilled, and only a small part of this head could be accounted for by the frictional resistance of the aquifer, Prof. W. D. Alexander and his son, A. C. Alexander, of Honolulu, came to the conclusion some time before 1908 that the seaward end of the aquifer was not covered, that the fresh water was in equilibrium with sea water, and that the head was caused by the difference in density between the sea and fresh water.

The Pacific Commercial Advertiser, on October 9, 1908, carried an article by Professor Alexander on the subject of Oahu artesian wells in which he concludes that "It may not be necessary to assume that 'the water-bearing rock must be separated by impervious strata from the surrounding ocean,'²⁸ in view of the slowness with which water percolates through rock or gravel, and also of the pressure of the sea water." Evidently Alexander believed at that time that the difference in density of fresh and sea water was an important factor.

Carl Andrews, now professor of physics at the University of Hawaii, was in the employ of A. C. Alexander in 1908 and wrote a master's thesis entitled "The structure of the southeastern portion of the Island of Oahu, Hawaiian Islands." This thesis was filed with the Rose Polytechnic Institute, Terre Haute, Indiana, in 1909. It has been widely distributed locally and apparently includes the first definite computation of the artesian head as produced by the difference in density of the sea and artesian water. Andrews²⁹ acknowledges that the Alexanders originated the idea. A. C. Alexander states that both he and his father were unfamiliar with any foreign publications on the subject; hence it is evident that the principle of salt-water balance was independently developed in regard to the Oahu artesian system by the Alexanders in 1908.

CHANGE IN HEAD AND DISCHARGE WITH DEPTH

The wells in each of the Honolulu artesian areas have depths ranging from a few feet to several hundred feet. The discharge is definitely known to increase with depth, the reason evidently being that with increased depth the well taps an increasing number of water-yielding openings. Moreover, with the low dips and thin bedding, the number of very permeable clinker beds encountered increases with depth.

²⁸ McCully, Lawrence, Artesian wells: Thrum's Annual, 1882, p. 46.

²⁹ Oral communication, May 4, 1932.

Quantitative data on changes of head with depth are meager, however, and should be obtained as new wells are drilled. The following valuable data were obtained at well 158, in Moanalua Valley, by the Honolulu Board of Water Supply. This well, at an altitude of 17 feet, after passing through 135 feet of fine-grained noncalcareous sediments, entered Koolau basalt. The static level of the water in the coastal sediments at that depth was 2.5 feet above sea level. Artesian water was struck in a 3-foot clinker bed beneath 3 feet of hard blue lava rock. The water rose to 17.7 feet and flowed over the casing at the rate of 3,000 gallons a day. Beneath the clinker occurred 18 feet of blue lava, followed by 16 feet of clinker, which yielded 272,000 gallons a day with a head of 22 feet. The next 20 feet was dense lava, and beneath this 8 feet of clinker, which yielded an additional 125,000 gallons a day with a head of 24.6 feet. Next came 38 feet of dense lava yielding little water, followed by a 4-foot clinker bed which added 35,000 gallons a day to the flow with an increase of 0.36 foot in head.

Several other water-bearing layers encountered between this point and the bottom increased the discharge to 1,065,000 gallons a day but increased the head only 0.4 foot. The two distinct increases in head at the beginning can hardly have been due to the difference in the altitude of the water table at the intake points of these beds but were probably due to upward percolation through confining beds that are not impermeable. The few tenths of a foot change in head in the remaining 100 feet of hole may be due to upward leakage or to heavier pumpage from upper strata. The salt content decreased from 9.4 to 6.2 grains per gallon from the top of the basalt to the bottom of the hole, but this difference in salt content is not sufficient to account for the change in head.

Geologic studies indicate that the basalt was cut by numerous canyons and gullies before submergence. There is, therefore, a good chance that the upper beds with the lower head are not continuous and either do not extend back to the intake area, or else suffer a local loss in head due to leakage into the overlying cap rock where they are eroded. More accurate data of the sort obtained at this well are needed before this condition can be fully understood.

ARTESIAN AREAS

By H. T. STEARNS

LOCATION

The following table lists the ten artesian areas underlain by Koolau basalt shown in figure 16.

Artesian areas in Koolau basalt

No.	Name	Boundary		Static level	
		East side	West side	Date	Feet above sea level
1	St. Louis Heights spur	Palolo Valley fill	Manoa Valley fill	Aug. 1932	27
2	Makiki-Pacific Heights spur	Manoa Valley fill	Nuuanu Valley fill	do	31.8
3	Kapalama spur	Nuuanu Valley fill	Kalihi Valley fill	do	31
a4	Moanalua spur	Kalihi Valley fill	Halawa Valley fill	do	28
b5	Wilhelmina Rise spur	Near Wailupe Valley	Palolo Valley fill	do	8.5
6	Pearl Harbor	Halawa Valley fill	Contact of Koolau and Waianae basalts between Ewa and Gilbert	Feb. 1932	23
7	Waialua	Anahulu Valley fill	Contact of Koolau and Waianae basalts near Mokuleia Camp	Jan. 1933	10-12
8	Kahuku	Punaluu Valley fill	Waimea Canyon and dikes	Jan. 1930	10-21
9	Kahana	(?)	(?)	Apr. 1935	17.6
10	Kaaawa	(?)	(?)	Jan. 1930	15

(a) By analogy with the existing areas a separate area should in all probability exist in the Red Hill spur between Moanalua and Halawa Valleys, but adequate data are not available to establish it.

(b) Area 5 should be area 1 in the systematic clockwise numbering of the areas about the Koolau Range, but the numbers of the first four areas were used in many reports before area 5 was recognized.

Several of the areas listed above are named from the mountain spurs, because the artesian water occurs in the underground extension of these spurs beneath the coastal plain sediments. There are no natural surface boundaries between these areas, and the wells are too few to determine the boundaries accurately. They are approximately bounded by the present courses of the surface streams that laid down the valley fills, except for the Palolo and Manoa Streams, which have been appreciably diverted from their former courses by late lava flows. An extension of the axes of these two valleys across the coastal plain, however, gives the approximate boundary of area 1.

CAUSE OF SEPARATE AREAS

The well drillers on Oahu have long recognized the fact that water rises to a certain level in all wells in one area and to a different height in another area. An area of equal artesian pressure in an artesian system is known as an isopiestic area. As all the isopiestic areas in the Koolau Range are supplied essentially from the same basal ground-water reservoir, the difference in head must be a function of

the height of the cap rock on the individual areas and the effectiveness of the barrier that retards lateral transfer between them.

Valley fills extending below the water table.—Palmer³⁰ has shown by a study of well logs that this barrier in Honolulu is caused by fills of cap-rock material extending far below sea level in the drowned valleys. Thus, he regarded each ridge between major valleys as a distinct isopiestic area.

Dikes.—Valley fills do not adequately account for all the differences noted. The difference in head in 1881 between areas 2 and 5 was about 25 feet, but this difference has been reduced by draft until in 1932 it was only about 19 feet. As the Koolau basalt floor of Palolo Valley rises inland, an opportunity exists for the water to move from one ridge to another at a less distance inland than is indicated by the valley fill shown on plate 2.

The usual water-table gradient in Koolau basalt is of the order of 1.3 feet to the mile, and as these areas are less than 2 miles apart, a difference of head in excess of about 3 feet must be due to some cause other than the frictional resistance of the flow lavas. On plate 2 several dikes are shown extending northward from Palolo Valley, and probably other dikes exist that are hidden by vegetation. As the number of dikes generally increases with depth, and as these dikes connect with the valley fill, it is probable that they retard the normal lateral transfer of ground water and cause the large differences in head between areas 2 and 5.

The original difference of head between areas 1 and 2 was 7 feet; in 1932 the difference was 5 feet. It is possible that this difference, which is somewhat higher than that between most of the other areas, is due to the less pervious character of the flow lavas in the intervening space, but as several dikes run northward from the head of Manoa Valley, it appears that dikes probably cause at least a part of this difference. Further evidence that dike rock forms barriers to the lateral movement of ground water is given in the section "Perched ground water."

Soil and sediments.—Neither dikes nor drowned valleys bound the west sides of areas 6 and 7. Instead, they appear to be bounded by sediments and soil laid down on the Waianae basalts prior to emplacement of the Koolau basalts in these areas.

METHOD USED TO ESTABLISH ARTESIAN AREAS

The artesian areas were determined by simultaneous readings of head in several wells in each area during times of little or no draft, except in areas 1 to 4 where there is continuous draft.

³⁰ Palmer, H. S., The geology of the Honolulu artesian system; Honolulu Sewer and Water Comm. Rept., Suppl., p. 40, 1927.

Areas 1 to 4.—Areas 1 to 4 are in part based upon records made about 1881, before heavy draft, and upon recent simultaneous surveys of head by the Honolulu Board of Water Supply³¹. The original heads about 1881 were: area 1, 35 feet; area 2, 42 feet; area 3, not known; area 4, 37 feet. The present difference in head, especially between areas 2 and 3, is very slight but is nevertheless distinct, as shown by surveys of the head.

The original difference in head between areas 2 and 6 was about 7 feet, equivalent to a hydraulic slope of 2 feet to the mile toward the nearest Pearl Harbor Springs, by the most direct route. Although the cap rock between the two areas is sufficiently low at a few points to allow some overflow, the main controlling leak in the whole system was apparently Kalauao Spring.

This means that surplus water probably flowed from the Manoa spur toward the Pearl Harbor Springs in wet years prior to artificial draft. This condition has an important bearing on future developments. (See section "Undeveloped ground-water supplies, area 4.")

Area 5.—Wells 1A and 1B are the only deep wells in area 5. The cap rock in this area slopes toward Wailupe Valley and at Wailupe Pond is largely replaced by permeable coral. A spring discharges at this point. Well 1B derives its supply from Koolau basalt. It was drilled in a concrete-walled pit or sump, which was dug sufficiently deep in coastal plain sediments to encounter water. Before May 1933 well 1B, together with some water that rose alongside the casing, discharged directly into the sump. A pipe near the bottom of the sump leads southward to an unknown point. A short distance east of the sump is well 1A, 131 feet deep, which formerly discharged through a pipe line into the sump also. This well was recased and disconnected from the sump in May, 1933. At this same time well 1B was repaired so as to stop the water rising outside its casing, and the pump was directly connected to the casing so as to shut out the water in the sump. As the sump was no longer needed it was filled with sand in May, 1934. Before it was filled a recorder was installed, and the graph shown in figure 15 was obtained. This graph shows conclusively that the water in the sump was still somewhat affected by the draft from well 1B, indicating that some water was probably still rising outside the casing of the drilled hole.

The other graph in figure 15 was obtained from a pit dug to the water table in very dirty gravel about 100 yards east of the sump. The water level in this pit did not fluctuate with the pumping of well 1B, a fact which proves that the ground water in this gravel does not show any immediate effects of pumpage from the underlying Koolau

³¹ Honolulu Board of Water Supply, Rept. for 1931-32, pp. 208-218, 1933.

basalt. Because the water level in the sump fluctuated with the tide, either the material it penetrated was sufficiently permeable to allow rapid movement of ground water, or else the tidal influence was transferred from the point at which the pipe leading south from the sump discharged.

John McCombs, who has measured the head of these wells on several occasions, reports that the water level in well 1B is generally about 8 inches higher than in the sump. On May 23, 1934, after the sump had been partly filled with sand, the head of well 1B was 8.22 feet above sea level, or 0.49 foot higher than the water in the sump. This difference may have been caused either by water still escaping to a lower point through the buried pipe or by the water table in the aquifer of the sump being naturally lower than the water in the Koolau basalt penetrated by well 1B.

The complications are so numerous that it is difficult to obtain satisfactory data on the hydrologic conditions in area 5. The data available indicate, however, that flowing water can be obtained at altitudes below 8 feet between this well and the sea provided the coastal sediments are not more than about 250 feet thick. Otherwise there is danger of encountering salty water in the Koolau basalt, according to the Ghyben-Herzberg principle. With only one well in this large area it is impossible to determine much about the artesian conditions. However, the cap rock rises rapidly toward Kaimuki, hence wells drilled at the end of the Wilhelmina Rise, in the center of Kaimuki, after passing through the Kaimuki basalt and coastal-plain sediments will enter Koolau basalt and doubtless find water of good quality with sufficient head to rise about 10 feet above sea level. This area awaits further development.

Area 6.—Early records indicate that the head in area 6 was about 32 feet, or about 5 feet lower than in the adjacent area 4. The present difference during times of no draft ranges from 2 to 3 feet and hence is little changed since the first wells were drilled.

A survey of the static level of wells around Pearl Harbor was made to determine the boundaries of isopiestic area 6, and the results are given in the subjoined table. Both sets of readings were made during a period of minimum draft, after a period of heavy rain. During the survey of 1932 the mill pump at Waipahu was operating at the rate of 7½ million gallons a day; pump 3 at Honolulu Plantation was operating on February 8 during the daytime only, at a rate of 7 million gallons a day; and all pumps at Ewa were shut down except one domestic pump delivering 1½ million gallons a day. The total draft from all wells in the area was probably not more than 12 million gallons daily on February 7 and 15 million gallons daily on

February 8, 1932. On February 15, 1933 the total draft from plantation wells amounted to about 16,500,000 gallons.

The ideal condition for a simultaneous survey of head is to have all draft from the basin stopped, but this is not possible in area 6. The draft at the time of the surveys, although only about 10 percent of the normal draft, is probably the cause of most of the differences in head not accounted for in other ways. The heads on February 15, 1933, of wells 239, 247, 248, and 249, belonging to the Oahu Sugar Co., were notably high, because this company had not pumped since November, 1932, and this shows that the artesian pressure can build up locally within a basin.

Static level of wells adjacent to Pearl Harbor in isopiestic area 6

[Wells 153, in area 4, and 276, in area 11, given for comparison]

Well no.	Static level (feet above sea level)		Remarks.
	1932 Feb. 5 (a), 6 (b), 7 (c), 8 (d), 9 (e)	1933 Feb. 15 (f), 16 (g)	
153	27.45	28.65 (g)	Measurement listed in first column made Feb. 18, 1932. Well in Moanalua (area 4)
177	23.08 (c)	20.96 a.m. 21.62 p.m.	
182	22.89 (c)		
185	24.40 (b)	24.80 (f)	Corrected 1.02 feet for bench mark.
186	23.40 (e)	24.40 (f)	Do.
187	23.20 (d)	20.46 (f)	U. S. Navy; pump shut down 1 minute before reading.
190	22.66 (c) 22.50 (d)	24.16 a.m. (f) 24.83 p.m. (f)	
192	21.86 (c)		Head reading low because overflow from box cannot be shut off.
193		22.55 (f)	
196	22.82 (e)	23.80 (f)	Corrected 0.68 feet for bench mark.
197	22.00 (a)	23.50 (f)	Corrected 0.69 feet for bench mark.
201	20.93 (c)	22.27 (g)	Head of this well has been low since 1923; bench mark was rechecked; probably leaking.
204	20.85 (c)		
208	19.52 (c)		2-inch hole, salt about 29 grains per gallon.
212	19.55 (d)		Salt may be from 40 to 220 grains per gallon. Recased 10-inches hole.
213	19.92 (d)		Salt about 110 grains (2-inch hole 126 feet deep).
214	20.17 (c)		High salt.
226	22.48 (c)		Previous tests show high salt.

Static level of wells adjacent to Pearl Harbor in isopiestic area 6—Continued

(Wells 153, in area 4, and 276, in area 11, given for comparison)

Well no.	Static level (feet above sea level)		Remarks
	1932 Feb. 5 (a), 6 (b), 7 (c), 8 (d), 9 (e)	1933 Feb. 15 (f), 16 (g)	
228	20.53	Salt ranges from 100 to 200 grains per gallon. High head due to no pumping in this locality since November 1932.
239	26.30 (f)	
241	24.16 (c)	Do. Do. Do. 6 a.m. and 6 p.m.
244	22.50 (c)	23.37 (f)	
247	25.40 (f)	
248	25.30 (f)	
249	25.20 (f)	
254	24.56 (f)	
256	22.67 (c)	
257	22.61 (c)	24.88 6 a.m. (f)	
	22.65 (d)	24.95 6 p.m. (f)	
259	22.51 (c)	24.76 6 a.m. (f)	
	22.51 (d)	24.85 6 p.m. (f)	
261	21.54 (d)	Pump 3 started 5:30 a.m. Measurements taken at 3 p. m. Head about 1 foot low; see measurement Feb. 7 of well 266.
263	22.46 (c)	24.61 6 a.m. (f)	Measurement Feb. 8, about 1 foot low; see note well 261.
	22.11 (d)	24.57 6 p.m. (f)	
264	22.63 (c)	24.93 6 p.m. (f)	
		24.94 6 p.m. (f)	
266	22.37 (c)	23.31 (f)	Average of 3 plants at Gilbert (area 11).
	21.17 (d)		
268	21.73 (c)	24.28 6 a.m. (f)	Area 11.
	22.15 (d)	24.31 6 p.m. (f)	
276	13.88 (c)	14.50 (f)	
	13.92 (d)		
274	Pumping	19.70 (f)	

The readings indicate that one isopiestic area extends from Halawa Gulch to Ewa, which means that the valley fills of the intervening small gulches are not extensive enough to prevent the lateral transfer of water. This condition has considerable economic significance, because it means that the Honolulu wells and those of the Oahu Sugar Co., being farther inland than those at Ewa, have first demand upon the water, and the Ewa Plantation gets what is left. Fortunately, there is a surplus of 50 million gallons daily wasting into the sea from this area, hence there is no danger of a water shortage unless the surplus is exported, new uses are found for the water, or it is tapped in adjacent areas.

The wells in the Pearl City Peninsula area listed in the table above have a head 2 to 3 feet below normal. These low heads are not due to leaky casings, because several of the wells are only a few years old,

and they cannot be due to pumping, because the draft from these wells is small. The salt content is about 100 grains per gallon, but only part of the subnormal head can be accounted for by increase in specific gravity caused by the salt. Some of the wells are only 126 feet deep, yet deeper wells nearer the sea have higher heads and less salt.

According to the Ghyben-Herzberg principle the depth to sea water under this peninsula should be about 800 feet. It is evident that some special condition causes the zone of mixture to extend far upward at this place. The only apparent reason is the discharge of about 50 million gallons a day from the adjacent Pearl Harbor Springs. Much of this water escapes at or close to sea level and constitutes a very great natural draft, which might well cause a local loss in head and an exceptional doming upward of the zone of mixture.

The survey also brings out a pronounced difference in head between the wells at pump 5 of the Oahu Sugar Co., the wells at Gilbert, and those in area 6. Plate 2 shows that the Gilbert and pump 5 wells penetrate the flow lavas of the Waianae Range and that the adjacent wells at Ewa, as shown by plate 23, B, penetrate Koolau lavas. The wells at pump 5 are only a few hundred feet from the Koolau lavas, which to the south pass under Ewa and supply the artesian wells there. Furthermore, it is about 3 miles inland, where the water table should stand higher rather than lower if the wells at the two places are supplied from the same reservoir. This difference apparently indicates a ground-water barrier between the Waianae and Koolau lavas. At the contact of the two lavas half a mile north of pump 5, 6 feet of soil occurs, and at lower levels considerable ancient consolidated alluvium may lie between the lavas. It appears from the head readings that this soil probably serves as the ground-water barrier between the basal water tables of the Koolau and Waianae lavas in this area.

The original difference in head was about 10 feet, but the difference is now usually only about 5 feet. Some percolation may occur into area 11 from area 6 through the soil bed, because a very water-tight dam is not required to cause this small difference in head.

Daily measurements by the Ewa Plantation from January 16 to 23, 1933, when both pumps were shut down, indicate that the head of well 276, in area 11, rose steadily, while the head of well 257, in area 7, fell. Figure 20 brings out forcibly the difference in static level at pump 5 of the Oahu Sugar Co. (well 274), in area 11, as compared to wells 239 and 247, in area 6. During the later part of February, 1930, as shown in this figure, the water level of well 274 did not decline with the water levels in the wells in area 6. Thus the hydrologic evidence supports the geologic observations that the water in the Waia-

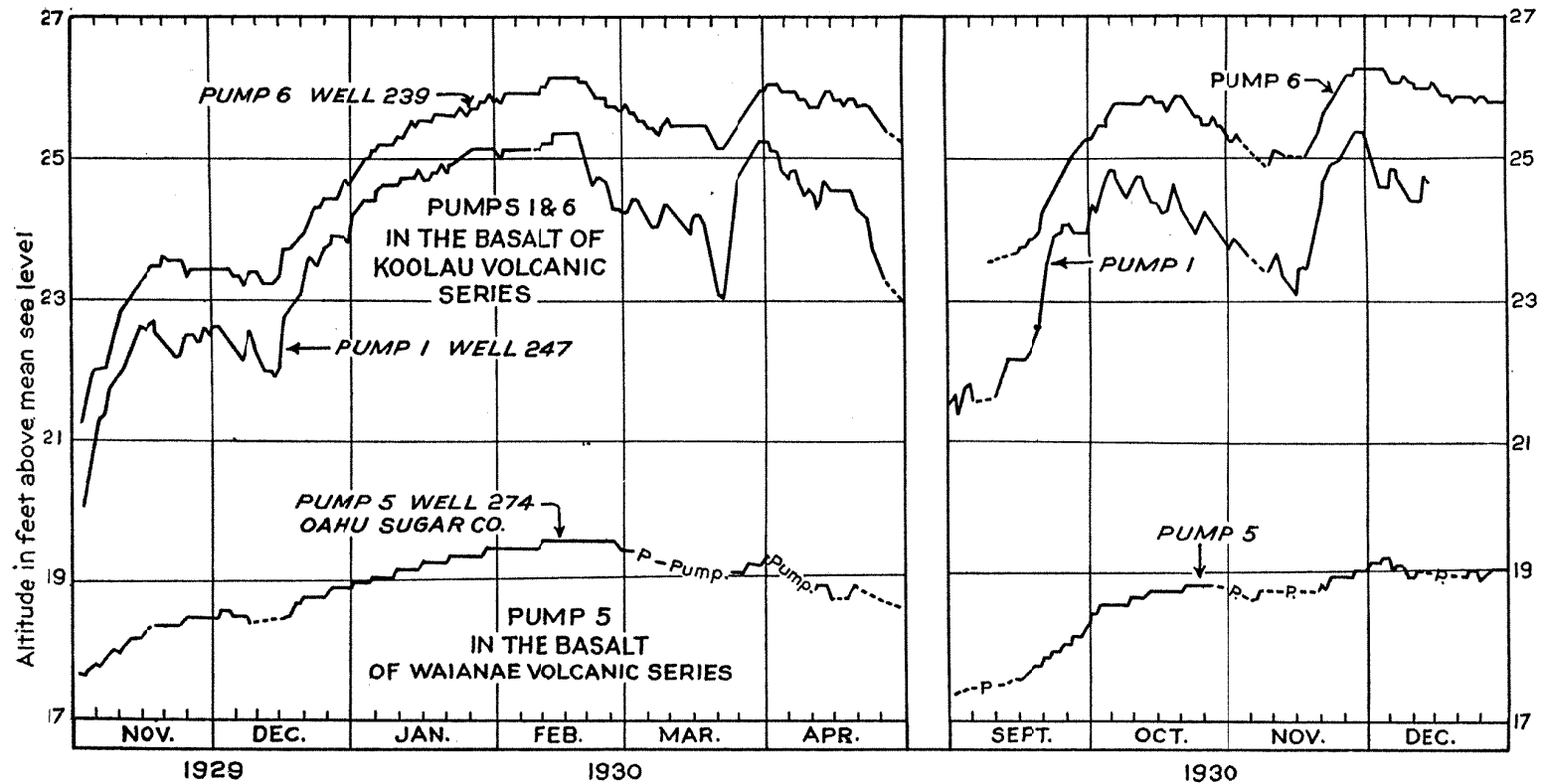

FIGURE 20.—Relation of the water level in the Oahu Sugar Co.'s wells at pump 5 in Waianae basalt, and at the adjacent pumps 1 and 6 in Koolau basalt. Based on daily measurements.

Simultaneous survey of the static level in drilled wells near Waialua

[Made when no irrigation pumps were operating. Records furnished by the Waialua Agricultural Co. for wells with pumps]

Pump no.	Well no.	1933		1932		1931		1930	
		Jan. 15 (m), 18 (n), 19 (p)		Mar. 12 (d), 14 (e), 15 (f)		Mar. 25 (g), 31 (h)		Oct. 3 (i), 7 (j), 8(k), 9 (l)	
		Time	Static (a) level (feet)	Time	Static (a) level (feet)	Time	Static (a) level (feet)	Time	Static (a) level (feet)
1	321	2:30 p.m.	12.34 (n)	11:45 a.m.	12.61 (e)	10:05 a.m.	11.31 (h)	10:15 a.m.	12.88 (j)
(b) 2	322	2:20 p.m.	12.40 (n)	3:15 p.m.	12.63 (e)	10:00 a.m.	11.43 (h)	10:00 a.m.	12.95 (j)
3-A	331	3:15 p.m.	11.46 (n)	2:50 p.m.	11.75 (e)	10:50 a.m.	10.80 (h)	3:45 p.m.	12.08 (j)
(b) 3-B		3:15 p.m.	11.37 (n)			11:00 a.m.	10.71 (h)	3:30 p.m.	12.00 (k)
(c) 4	334	3:45 p.m.	3.76 (n)	5:00 p.m.	3.48 (d)	2:45 p.m.	3.63 (h)	4:00 p.m.	4.26 (k)
5	285	1:50 p.m.	17.02 (n)	3:20 p.m.	17.31 (d)	4:00 p.m.	17.00 (h)	1:45 p.m.	17.40 (k)
7	324	2:40 p.m.	12.25 (n)	2:30 p.m.	12.52 (e)	11:50 a.m.	12.56 (h)	3:00 p.m.	12.87 (k)
8	329	3:30 p.m.	11.68 (n)					1:30 p.m.	12.24 (l)
9	327	3:20 p.m.	12.06 (n)	3:45 p.m.	12.40 (e)	11:35 a.m.	11.46 (h)	4:30 p.m.	12.83 (k)
(b) 10	323	2:50 p.m.	12.36 (n)	2:55 p.m.	12.27 (e)	3:20 p.m.	11.39 (h)	2:40 p.m.	12.27 (k)
(b) 11	296	2:00 p.m.	18.02 (n)	3:30 p.m.	18.33 (d)	3:40 p.m.	17.99 (h)	2:00 p.m.	18.45 (k)
12	332	8:30 a.m.	10.78 (p)	3:25 p.m.	10.87 (e)	11:15 a.m.	10.20 (h)	2:10 p.m.	11.20 (l)
13	323	4:05 p.m.	11.57 (n)	3:15 p.m.	11.80 (e)	11:25 a.m.	10.96 (h)	2:00 p.m.	12.20 (l)
	286		17.78 (m)		18.04 (f)		17.65 (g)		17.98 (i)
	326		12.27 (m)		12.45 (f)		11.25 (g)		12.64 (i)
	308		18.78 (m)		19.34 (f)		17.76 (g)		19.95 (i)

(a) All static levels are based on mean sea level benches, transferred by double turning points from bench marks in Waialua established by the U. S. Coast and Geodetic Survey, 1927.

(b) Pumps 2-A, 3-B, 10, and 11 had small domestic water pumps operating. (c) Non-artesian well entering Koolau basalt north of Waialua artesian area 7.

Simultaneous survey of the static level in drilled wells near Waialua, September 22, 1934 (a)

[All plantation pumps shut down on this date after heavy pumping season except No. 2 at well 322. Records furnished by Waialua Agricultural Co.]

Well no.	Static level	Hour of reading	Well no.	Static level	Hour of reading
279	Flowing		308	18.32	6:30 a.m.
281	15.15	9:20 a.m.	309	17.51	6:15 a.m.
285 A to H	16.21	2:58 p.m.	312	19.03	6:50 a.m.
286	16.72	10:40 a.m.	313	19.12	7:14 a.m.
288	17.25		314	b 13.34	7:03 a.m.
291	17.12	11:50 a.m.	315	19.11	7:25 a.m.
292	b 12.98	12:00 noon	316	18.88	7:34 a.m.
293	16.49	12:06 p.m.	321	11.05	2:10 p.m.
295	17.11	11:30 a.m.	323 A to L	11.17	2:00 p.m.
296 A & B	17.11	2:50 p.m.	324 A to F	10.44	11:10 a.m.
297	b 14.15	11:37 a.m.	326	10.94	8:25 a.m.
298	c 3.67	2:30 p.m.	327	11.13	10:50 a.m.
299	16.96	2:45 p.m.	328	10.51	9:25 a.m.
301	c 5.50	2:47 p.m.	329 A & B	10.89	9:45 a.m.
304	17.38	3:17 p.m.	331 A to T	10.51	3:30 p.m.
305	b 15.60	3:13 p.m.	332	9.74	9:02 a.m.
306	17.47		334	3.40	3:41 p.m.
307	17.67	6:37 a.m.			

(a) Wells 297, 307-316, and 326 measured on September 24. (b) Probably leaking. (c) Leaking.

nae lavas is separated by a barrier from the water in the Koolau lavas.

Area 7.—The survey on page 266 of the static level in the wells near Waialua when irrigation pumps were shut down indicates that the west boundary of area 7 is apparently between wells 317 and 321, probably about 1 mile west of Waialua. The east boundary is the fill in Anahulu Valley.

The piezometric slope of the Waialua artesian area is less than 1 foot to the mile toward Emerson Spring, at the mouth of Anahulu Stream, where surplus artesian water escapes at the lowest point of the cap rock. The western boundary of the Waialua artesian basin is apparently formed by soil or non-calcareous sediments between the Koolau and older Waianae basalts.

Area 8.—The following survey of static level was made in area 8 during a period of practically no pumping.

Survey of static level in drilled wells near Kahuku, 1930

[Records furnished by Kahuku Plantation Co.]

Well no.	Date	Static level (feet above sea level)	Distance from well 341 (miles)
337	Jan. 27	12.96	2.7 W.
341	Feb. 4	10.46	0.0
352	Feb. 4	14.17	1.3 SE.
348	Feb. 4	14.85	1.7 SE.
353	Feb. 4	15.65	2.1 SE.
354	Feb. 4	15.60	2.4 SE.
357	Feb. 4	16.74	2.8 SE.
361	Feb. 4	17.20	3.2 SE.
363	Feb. 5	17.47	3.8 SE.
392	Feb. 5	21.15	6.7 SE.
396	Jan. 27	21.75	8.1 SE.

This survey indicates a progressive downward slope of the piezometric surface from Punaluu Valley toward well 341 at the rate of 1.6 feet to the mile. This is typical of the flat gradients noted in the Koolau lavas elsewhere. The lowest point in the cap rock in this stretch is near well 341 (see plate 2), and the several springs nearby are evidently discharging from the artesian basin. Punahoolapa Swamp yields 4,500 gallons a minute.

Punaluu Valley has a deep valley fill, perhaps extending below sea level as far upstream as the dike complex, and it forms the south-east boundary of the Kahuku artesian area. In spite of the fact that overflow from the basin takes place at Waialeale Spring, the head of well 337, near this spring, indicates a hydraulic gradient toward well 341 of about 1 foot to the mile.

About 3½ miles southwest of well 337 a small outcrop of Koolau basalt occurs at sea level (pl. 2), and 4 miles away at Waimea Canyon the cap rock is entirely missing. The hydraulic gradient toward this canyon from well 337, on the assumption that the water table is at sea level at Waimea, is about 3 feet to the mile. Very massive basalt is exposed at sea level in the quarry at Waimea and it may prevent any great discharge of ground water at this point. This unusually high gradient may be caused in part also by the massive dikes near the well (pl. 2).

Area 9.—Little is known about area 9 because well 405, in Kahana Valley is the only one that has been drilled in it. This well is reported to have reached Koolau basalt at 177 feet and started to flow at 190 feet. The basalt in the ridge bounding the north side of Kahana Valley crops out at sea level (pl. 2), hence water in it can readily escape to the sea. The static head of 17.6 feet in well 405 is perhaps a local artesian condition that will be found only in the valley bottom. The salt content is 4.5 grains to the gallon.

Area 10.—Well 406, at the mouth of Kaaawa Valley, has a head of about 15 feet and flows continuously. The water has a salt content averaging about 22 grains to the gallon. The depth of the well is unknown, and it is plugged with debris not far below the surface. This rather high salt content may be caused either by a leak in the casing or by the too great depth of the well. It is not certainly known that the well obtains its supply from Koolau basalt, but the large flow makes that source seem probable. In the adjacent ridge Koolau basalt crops out at sea level at Puumahia Point; hence this head seems high to be supplied by a ridge with a direct outlet at sea level. It may be a local artesian condition confined to the valley bottom.

ARTESIAN WATER IN THE DIKE COMPLEX

By H. T. STEARNS

At Waimanalo Mill a 6-inch well, now pumped to supply the mill, was drilled to a depth of 999 feet, or about 969 feet below sea level, and obtained flowing water of good quality. A log does not exist, but because of its great depth below sea level and its low salt content (5.6 grains per gallon or 58 parts per million) its low yield, and the exposure of dikes nearby (pl.2), the water doubtless comes from the dike complex rather than from the basal water table and is held under pressure by a sedimentary cap rock (fig. 5,A). Further evidence that the water in the dike complex near Waimanalo is under considerable head is shown by well 409, drilled at an altitude of 310 feet southwest of Waimanalo in 1932. A study of the samples from this well indicates that the drill passed through alluvium at about 115 feet and

penetrated flow lavas and dike rock to the bottom at a depth of 400 feet. Water rose within a foot or two of the top, or about 308 feet above sea level. The driller was able to bail the water down to 40 feet, which indicates a low yield for the well, a condition to be expected in the dike complex.

Dike complex forms the shore of Kaneohe Bay to Moli Pond (pl. 2). Well 407 may obtain water from the dike complex, although the log is inconclusive. If wells in the low lands of this area tap the water confined in the dike complex they will probably yield small quantities, and whether or not they flow will depend on the height and permeability of the sedimentary cap rock.

FLUCTUATIONS IN WATER LEVEL

By H. T. STEARNS and K. N. VAKSVIK

The head of the artesian wells of Oahu fluctuates in response to changes in the amount of rainfall on the intake area, changes in draft, changes in barometric pressure, tides, and earthquakes.

Annual and secular fluctuations.—Annual fluctuations of artesian head occur in the various isopiestic areas and range from about 1 to 5 feet, depending upon the amount of draft and rainfall. As the rate of pumping decreases with increased rainfall, the rise in static head during wet weather is a function of both factors and not readily susceptible of separation. It is clear, however, that the immediate recovery at the beginning of a wet spell is caused by decreased pumpage rather than by recharge, because it takes place immediately, whereas if it were due to rainfall a lag would occur.

The annual peak usually occurs in the spring and the annual low in the fall, as shown by plates 29 and 30. A fluctuation also in response to rainfall and draft lasting over a period of several years is shown in these figures.

Fluctuations due to pumping.—The amount of the fluctuation of the water level in a well due to pumping varies with its proximity to the pump and with the quantity of water being pumped. If the well is close to the pump the water level drops precipitously for a short time, as shown in plate 31, and afterward declines slowly as the cone of draw-down slowly deepens. In some areas where there is slight draft, as in area 11, the cone of draw-down soon reaches virtual equilibrium and thereafter little or no further decline due to pumping occurs. When the pump is shut down (pl. 31) the water level rises rapidly for a few minutes and then very slowly for several hours. The usual

FIGURE 21.—Relation of static level in well 11 to pumpage from the city wells at Kaimuki station.

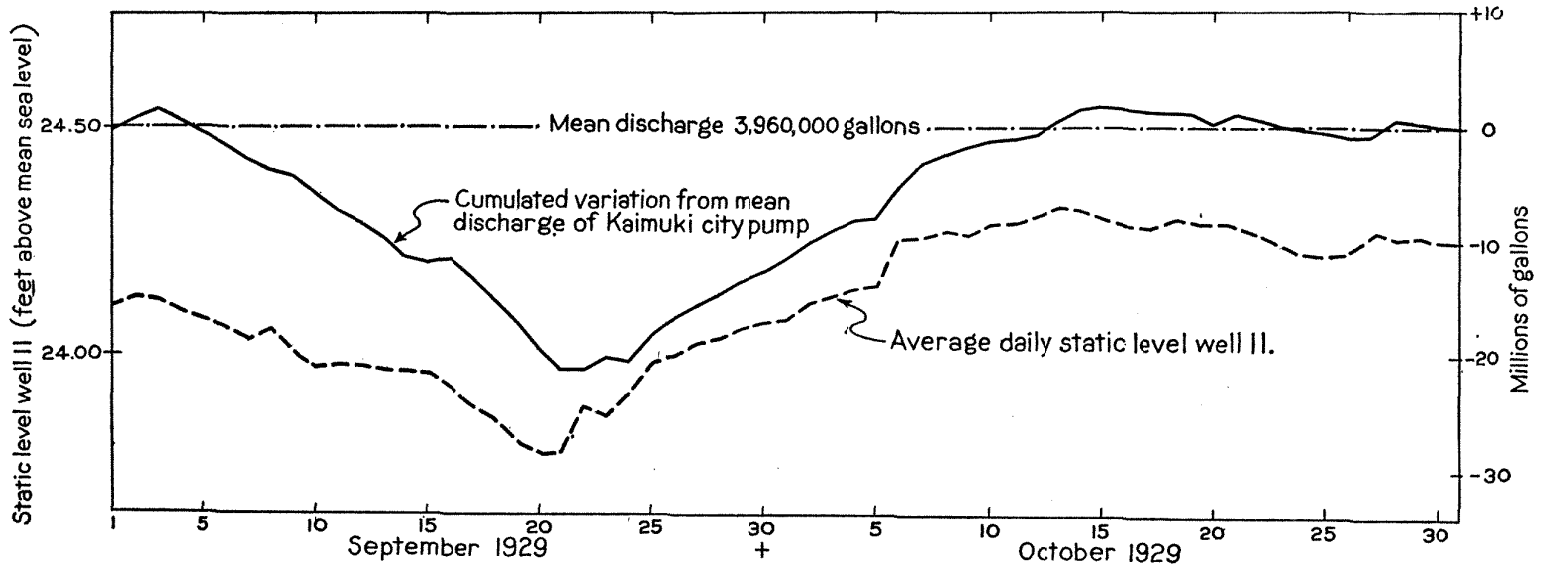

nightly and week-end recovery due to a reduction in draft in the whole basin at these times is shown in the same plate.

The cumulative effect of pumping in the basins during times when the draft is in excess of the recharge is to cause the average daily static level to decline. Sometimes, as shown in figure 21, nearly all the fluctuation is caused by pumpage.

Fluctuations due to barometric changes in pressure.— If the cap rock of an artesian aquifer is impervious and does not yield to changes in barometric pressure, the water in the well should be depressed and forced into the aquifer during times of high pressure, and it should rise during periods of low pressure. The specific gravity of mercury is 13.59, hence for each rise of 0.1 in a mercury barometer the water in the well should decline 0.113 foot. As shown in figure 22, the water level

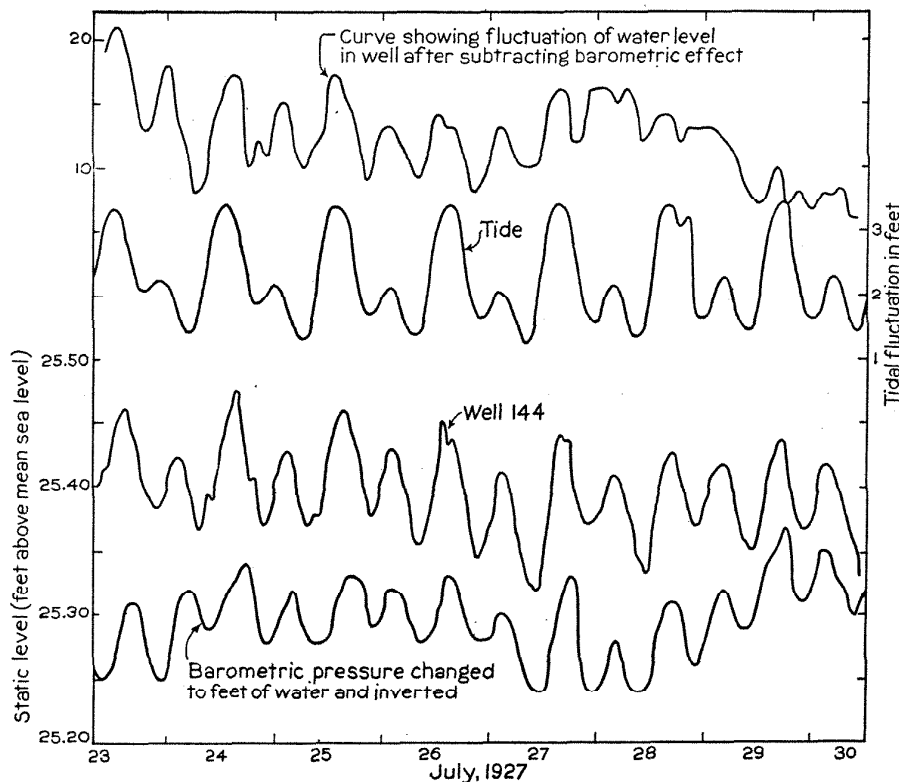

FIGURE 22.—Fluctuations of water level in artesian well 144 in relation to changes in barometric pressure and the tide.

in the wells shows distinct but somewhat dampened fluctuations resulting from barometric changes in pressure. The actual fluctuation is only about one-tenth of the calculated effect in well 319H and appears to indicate that the cap rock is not rigid but yields appreciably to these pressure changes.

Fluctuations due to tides.— The tidal range of the ocean about Oahu averages about 2 feet. This change in pressure on the cap rock apparently affects the water level in the artesian wells, as shown by the relation of the tidal curve in figure 22 to the curve made by subtracting the barometer effect. In this particular well the tide is less than 5 percent effective but its effect is more pronounced in well 319 H, in artesian area 7 (pl. 31). The rate of decline of the static level in well 319H (pl. 31) was decreased from 9 to 12 a. m. on December 13, probably as a result of both a rising tide and a falling barometer. At 7:30 p. m. on the 15th and 8:30 p. m. on the 16th, the water level reached a secondary low point with the tide and then started to rise with the tide, in spite of the fact that the barometer curve was still descending. At 10:30 p. m. on the 17th the low tide and the low of the barometer curve coincided, with only a single low resulting in the static-level curve.

Fluctuations due to earthquakes.—Fluctuations of the water level in artesian wells as a result of the compression of the aquifer by earthquakes were noted in California.³² In examining the automatic records of wells in the Honolulu area, numerous fluctuations produced by earthquakes were found, some amounting to a change of 1 foot in the water level. Between 1927 and 1931 the water levels of wells in Honolulu were affected by earthquakes in central China, Alaska, Japan, New Guinea, New Caledonia, Mexico, Peru, Fiji, Chile, the Philippine Islands, the Aleutian Islands, the Kurile Islands, New Zealand, Hawaii, the Caroline Islands, Burma, Nicaragua, the Solomon Islands, Bonin Island, Guam, and the Mariana Islands. Earthquakes in the Americas, exclusive of Alaska, affected the wells less often than those in Alaska, the South Seas, and Asia, possibly because they were less severe.

DRAFT

By H. T. STEARNS

AREAS 1 TO 4

The draft from areas 1 to 4 is given below. From 1930 to 1934 it averaged 30 million gallons a day.

³² Stearns, H. T., Record of earthquake made by automatic recorders on wells in California: Seismol. Soc. America Bull., vol. 18, no. 1, pp. 9-15, 1928.

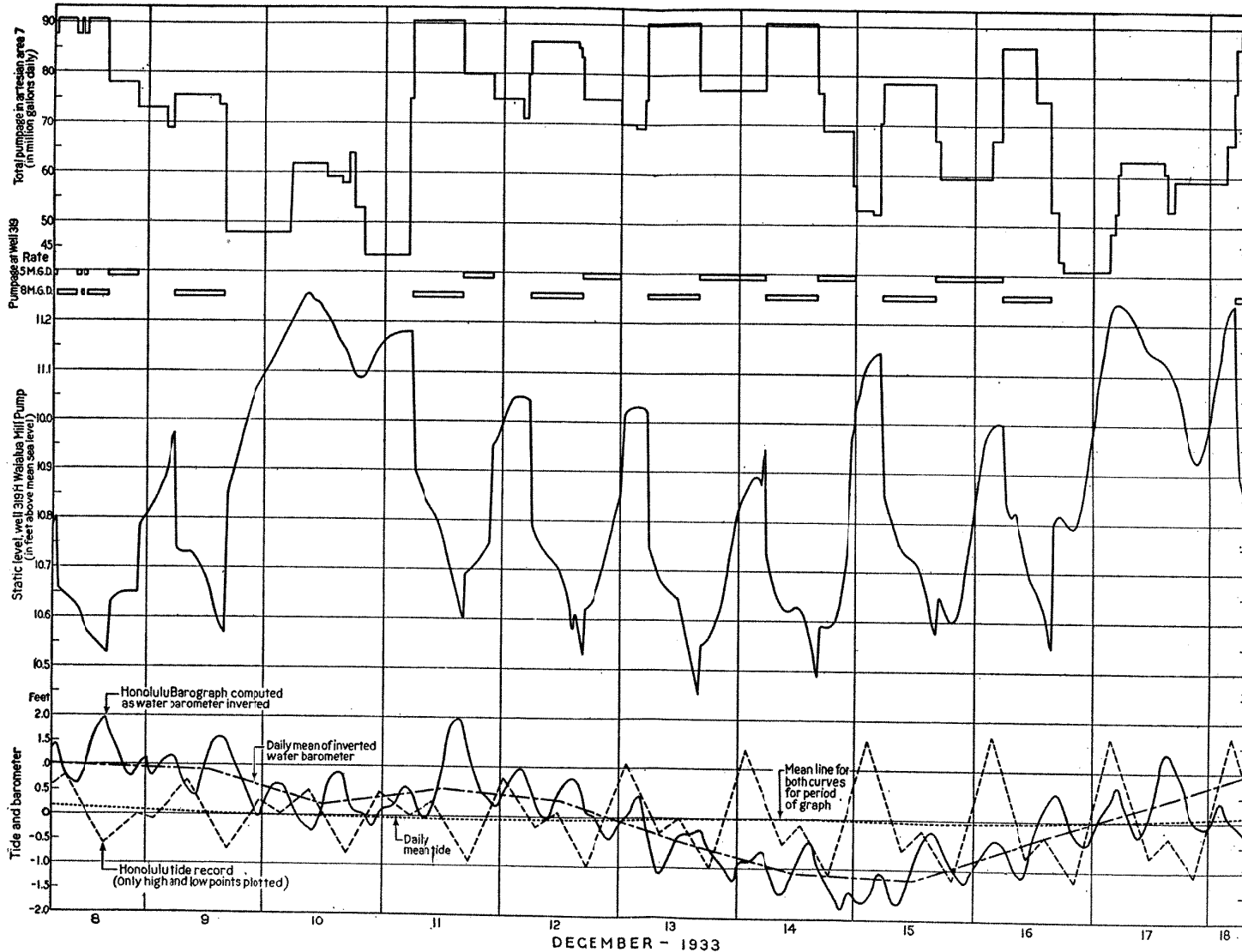

TIDAL, BAROMETRIC AND PUMPING FLUCTUATIONS IN WELL 319H

Total monthly, annual and average daily draft, in millions of gallons, from artesian wells in isopiestic areas 1 to 4 by use and ownership, 1928-34

[Records furnished by Honolulu Board of Water Supply]

Month	City	Private				GRAND TOTAL
	Irrigation Industrial Domestic	Domestic	Industrial	Irrigation	Total	
1928 (a)						
Annual	7,660	677	2,700	2,050	5,430	13,100
Average daily	20.9	1.85	7.3	5.6	14.8	35.7
1929						
July	764	45.1	258	142	445	1,210
August	722	40.9	226	128	395	1,120
September	696	40.2	192	132	364	1,060
October	654	39.4	180	138	357	1,010
November	578	36.1	185	132	353	931
December	582	35.8	191	117	344	926
Period	4,000	237	1,230	789	2,260	6,260
Average daily for period	21.7	1.29	6.68	4.28	12.3	34
1930						
January	554	33.9	192	139	365	919
February	507	36.0	181	139	356	863
March	562	33.4	196	187	416	978
April	562	34.9	182	180	397	950
May	639	45.5	193	173	412	1,050
June	568	45.1	167	146	358	926
July	647	49.6	309	153	512	1,160
August	647	50.4	264	179	493	1,140
September	540	42.5	176	160	378	918
October	501	39.6	175	121	336	837
November	546	36.5	168	103	308	854
December	480	3.50	171	107	313	793
Annual	6,750	482	2,370	1,790	4,640	11,400
Average daily	18.5	1.32	6.52	4.9	12.7	31.2
1931						
January	505	34.2	197	131	362	867
February	523	32.7	173	148	354	877
March	619	37.2	183	172	392	1,010
April	615	37.8	176	181	395	1,010
May	647	38.2	178	182	398	1,040
June	673	36.1	220	144	400	1,070
July	719	40.0	342	146	528	1,250
August	657	36.0	261	131	428	1,090
September	569	34.7	182	133	350	919
October	572	36.4	143	149	328	900
November	527	33.1	141	134	308	835
December	517	35.0	157	132	324	841
Annual	7,140	431	2,350	1,780	4,570	11,700
Average daily	19.6	1.18	6.44	4.89	12.5	32.1

(a) Estimated from one series of draft measurements made in November and December 1928.

274 GEOLOGY AND GROUND-WATER RESOURCES OF OAHU

Total monthly, annual and average daily draft, in millions of gallons, from artesian wells in isopiestic areas 1 to 4 by use and ownership, 1928-34—Continued

[Records furnished by Honolulu Board of Water Supply]

Month	City	Private				GRAND TOTAL
	Domestic Industrial Irrigation	Domestic	Industrial	Irrigation	Total	
1932						
January	547	30.3	164	150	344	891
February	435	16.9	145	146	308	743
March	492	21.6	162	189	373	865
April	497	21.1	147	186	354	851
May	533	21.1	139	186	346	879
June	583	23.3	179	187	389	972
July	602	23.0	278	180	481	1,080
August	583	21.8	150	190	362	945
September	587	20.2	162	203	385	972
October	604	21.1	147	195	363	967
November	537	19.6	126	154	300	837
December	536	18.2	127	147	292	828
Annual	6,540	258	1,930	2,110	4,300	10,800
Average daily	17.9	.7	5.26	5.78	11.7	29.6
1933						
January	479	19.0	132	171	322	801
February	392	15.3	123	158	296	688
March	447	17.8	131	174	323	770
April	483	18.2	127	188	333	816
May	539	19.2	134	198	351	890
June	539	22.0	139	188	349	888
July	558	20.4	194	184	398	956
August	590	22.6	197	203	423	1,010
September	564	20.4	157	180	357	921
October	594	25.1	164	178	367	961
November	525	25.0	179	174	378	903
December	492	19.5	197	154	371	863
Annual	6,200	244	1,870	2,150	4,270	10,500
Average daily	17.0	.67	5.13	5.89	11.17	28.7
1934						
January	474	19.5	151	150	320	794
February	414	16.8	179	141	337	751
March	521	20.4	150	177	347	868
April	511	21.0	133	167	321	832
May	563	19.0	146	165	330	893
June	531	17.9	197	151	366	897
July	608	23.2	244	172	439	1,050
August	590	24.6	207	171	403	993
September	505	19.2	193	154	366	871
October	525	19.5	170	165	354	879
November	483	19.2	176	129	324	807
December	480	19.8	155	147	322	802
Annual	6,200	240	2,100	1,890	4,230	10,400
Average daily	17.0	.66	5.76	5.18	11.6	28.6

AREA 5

Drilled well 1, in area 5, is pumped at a rate of about 300,000 gallons a day, or about 100 million gallons a year. Dug well 34 is listed with the wells in the coastal-plain sediments although its supply is obviously derived from Koolau basalt. The total daily draft from drilled well 1 and dug well 34 averages about 1,000,000 gallons a day.

AREA 6

HONOLULU PLANTATION CO.

Pumpage from the Honolulu Plantation Co.'s wells is given below. In addition to the pumpage, the yield of 14 flowing wells in use on this plantation is estimated at about 180 million gallons a year, or about 500,000 gallons a day.

*Artesian water pumped by Honolulu Plantation Co. from drilled wells,
1910-33, in millions of gallons*

Well no.	185	196	186	197	189	203	Total
Station no.	1	2	3	4	5	7	
Pump no.	1	1, 2	1, 2	4	5	7	
1910							
July	528	472	450	333	61		1,844
August	488	386	371	237	45		1,527
September	157	135	138	102	2		534
October	537	372	370	258	60		1,597
November	294	257	236	194	3		984
December	415	356	343	370	1		1,485
Period	2,419	1,978	1,908	1,494	172		7,971
Average daily for period	13.15	10.75	10.37	8.12	.94		43.3
1911							
January	52	3	151	20	0		226
February	32	21	180	58	2		293
March	35	26	251	79	0		391
April	201	154	376	326	4		1,061
May	374	319	364	360	54		1,471
June	455	367	403	383	15		1,623
July	560	371	476	351	0		1,758
August	588	500	482	358	0		1,928
September	431	406	405	334	0		1,576
October	553	440	449	352	0		1,794
November	0	0	0	0	0		0
December	263	189	277	97	0		826
Annual	3,544	2,796	3,814	2,718	75		12,947
Average daily	9.71	7.66	10.45	7.45	.21		35.5
1912							
January	309	255	437	119	0		1,120
February	240	238	359	140	0		977
March	316	208	314	97	0		935
April	261	305	336	97	0		999
May	533	501	454	228	0		1,716
June	551	592	473	382	19		2,017
July	537	509	478	376	75		1,975
August	575	501	488	387	77		2,028
September	511	469	447	352	68		1,847
October	512	415	362	274	50		1,613
November	486	185	178	45	0		894
December	137	0	169	20	0		326
Annual	4,968	4,178	4,495	2,517	289		16,447
Average daily	13.61	11.45	12.32	6.89	.79		44.9

*Artesian water pumped by Honolulu Plantation Co. from drilled wells,
1910-33, in millions of gallons—Continued*

Well no.	185	196	186	197	189	203	Total
Station no.	1	2	3	4	5	7	
Pump no.	1	1, 2	1, 2	4	5	7	
1913							
January	475	147	401	304			1,327
February	375	191	406	358			1,330
March	411	277	383	365			1,436
April	417	186	350	239			1,192
May	252	186	291	178			907
June	185	152	272	198			807
July	474	356	412	346			1,588
August	285	379	240	265	36		1,205
September	509	480	335	308	53		1,685
October	504	350	274	205			1,333
November	364	53	128	0			545
December	339	162	237	49			787
Annual	4,590	2,919	3,729	2,815	89		14,142
Average daily	12.58	8.00	10.22	7.71	.24		38.7
1914							
January	442	268	298	138			1,146
February	271	314	249	95			929
March	293	276	258	138			965
April	218	213	257	106			794
May	388	267	256	123			1,034
June	508	407	287	211			1,413
July	541	469	310	332	51		1,705
August	571	461	224	347	30		1,633
September	373	286	187	222	37		1,105
October	487	327	169	205	22		1,210
November	442	247	158	155	26		1,028
December	142	0	163	25	0		330
Annual	4,676	3,535	2,816	2,097	166		13,292
Average daily	12.80	9.68	7.73	5.75	.45		36.4
1915							
January	351	338	322	249			1,260
February	363	222	318	269			1,172
March	476	300	330	352			1,458
April	312	185	352	273			1,122
May	433	200	343	291			1,267
June	565	352	272	331			1,520
July	535	408	231	346			1,520
August	564	445	181	354			1,544
September	556	368	209	318	74		1,525
October	521	303	165	259	65		1,313
November	0	0	0	0	0		0
December	0	0	0	0	0		0
Annual	4,676	3,121	2,723	3,042	139		13,701
Average daily	12.80	8.55	7.46	8.34	.38		37.5
1916							
March	214	236	253	103	0		806
April	502	412	311	309	0		1,534
May	310	283	189	70	0		852
June	583	388	306	122	0		1,399
Period	1,609	1,319	1,059	604	0		4,591
Average daily for period	13.19	10.81	8.68	4.95	0		37.6

*Artesian water pumped by Honolulu Plantation Co. from drilled wells,
1910-33, in millions of gallons—Continued*

Well no.	185	196	186	197	189	203	Total
Station no.	1	2	3	4	5	7	
Pump no.	1	1, 2	1, 2	4	5	7	
1919 (a)							
January	451	98	363	189	0		1,101
February	423	145	381	190	0		1,139
March	497	210	368	256	0		1,331
April	447	339	409	283	0		1,478
May	519	388	422	320	0		1,601
June	518	378	399	306			
July	529	453	406	339			
August	534	438	419	310			
September	479	355	363	285	600		
October	371	336	335	270			
November	495	367	329	298			
December	484	387	327	287			
Annual	5,747	3,894	4,521	3,333	600		18,095
Average daily	15.75	10.67	12.39	9.13	1.64		49.6
1920							
January	111	44	131	93	50		429
February	0	13	0	36	124		173
March	279	66	37	118	155		655
April	371	95	231	168	150		1,015
May	474	95	310	228	155		1,262
June	437	133	292	259	149		1,270
July	500	252	323	302	150		1,527
August	496	261	322	304	150		1,533
September	496	312	330	331	145		1,614
October	512	274	345	346	150		1,627
November	438	160	0	199	0		797
December	136	0	0	0	0		136
Annual	4,250	1,705	2,321	2,384	1,378		12,038
Average daily	11.64	4.67	6.36	6.53	3.78		33.0
1921							
August	556	422	457	341	148		1,924
September	438	425	415	320	145		1,743
October	120	146	124	104	130		624
November	467	79	169	68	90		873
December	173	49	216	49	0		487
Period	1,754	1,121	1,381	882	513		5,651
Average daily for period	11.46	7.33	9.03	5.76	3.35		36.9
1922							
January	18	7	181	47	31		284
February	141	29	198	42	0		410
March	159	183	200	78	0		620
April	435	329	386	181	11		1,342
May	431	447	453	350	154		1,835
June	464	441	428	334	143		1,810
July	514	403	429	372	153		1,871
August	682	491	400	354	130		2,057
September	527	381	318	296	131		1,653
October	551	279	318	222	123		1,493
November	550	292	270	200	58		1,370
December	513	205	302	180	58		1,258
Annual	4,985	3,487	3,883	2,656	992		16,003
Average daily	13.66	9.55	10.64	7.28	2.72		43.8

(a) No record available from July 1, 1916 to Dec. 31, 1918.

*Artesian water pumped by Honolulu Plantation Co. from drilled wells,
1910-33, in millions of gallons—Continued*

Well no.	185	196	186	197	189	203	Total
Station no.	1	2	3	4	5	7	
Pump no.	1	1, 2	1, 2	4	5	7	
1923							
January	134	55	199	61	50		499
February	0	16	160	53	26		255
March	22	15	3	44	0		84
April	112	28	300	59	0		499
May	395	205	426	364	0		1,390
June	537	333	426	358	0		1,654
July	658	490	379	359	72		1,958
August	787	473	437	360	149		2,206
September	776	459	417	338	141		2,131
October	703	445	424	338	141		2,051
November	565	438	327	296	0		1,626
December	312	305	273	158	0		1,048
Annual	5,001	3,262	3,771	2,788	579		15,401
Average daily	13.70	8.94	10.33	7.62	1.59		42.2
1924							
January	228	64	197	148	7		644
February	432	310	203	250	111		1,306
March	445	267	160	237	56		1,165
April	67	81	214	68	0		430
May	452	268	274	252	0		1,246
June	709	446	424	366	32		1,977
July	778	340	418	314	132		1,982
August	771	463	455	365	152		2,206
September	712	455	442	350	145		2,104
October	595	350	323	201	120		1,589
November	494	301	358	169	0		1,322
December	191	132	304	137	0		764
Annual	5,874	3,477	3,772	2,857	755		16,735
Average daily	16.09	9.53	10.33	7.83	2.07		45.8
1925							
January	320	20	260	126	0		726
February	401	211	399	291	10		1,312
March	447	276	400	297	109		1,529
April	291	95	297	141	18		842
May	568	306	415	241	116		1,646
June	630	430	434	300	150		1,944
July	647	391	440	335	128		1,941
August	709	432	457	371	128		2,097
September	755	428	427	395	104		2,109
October	676	385	438	387	93		1,949
November	582	205	191	128	0		1,106
December	355	140	317	199	57		1,068
Annual	6,381	3,319	4,475	3,181	913		18,269
Average daily	17.48	9.09	12.26	8.72	2.50		50.0
1926							
March	639	399	258	303	138		1,737
April	610	409	277	363	135		1,794
May	678	446	283	390	137		1,934
June	454	273	216	207	135		1,285
July	740	426	401	320	138		2,025
August	735	420	401	316	138		2,010
September	622	410	351	271	129		1,783
October	396	364	323	273	130		1,486
November	435	295	334	265	135		1,464
December	146	199	289	208	121		963
Period	5,455	3,641	3,133	2,916	1,336		16,481
Average daily for period	17.83	11.90	10.24	9.53	4.37		53.9

*Artesian water pumped by Honolulu Plantation Co. from drilled wells,
1910-33, in millions of gallons—Continued*

Well no.	185	196	186	197	189	203	
Station no.	1	2	3	4	5	7	Total
Pump no.	1	1, 2	1, 2	4	5	7	
1927							
January	123	140	260	105	40	0	668
February	62	178	205	83	86	0	614
March	96	172	163	39	140	0	610
April	91	190	170	71	129	16	667
May	340	224	243	176	140	93	1,216
June	600	287	320	305	135	107	1,754
July	662	331	271	271	140	115	1,790
August	755	451	349	375	140	144	2,214
September	655	330	278	290	135	125	1,813
October	757	406	283	345	139	126	2,056
November	258	162	116	107	135	63	841
December	119	35	82	24	135	19	414
Annual	4,518	2,906	2,740	2,191	1,494	808	14,657
Average daily	12.37	7.96	7.51	6.00	4.09	2.21	40.2
1928							
January	238	60	153	77	140	50	718
February	496	324	289	292	127	97	1,625
March	341	317	320	308	140	87	1,513
April	348	303	269	192	134	68	1,314
May	450	396	345	314	139	41	1,685
June	577	410	362	367	134	39	1,889
July	418	278	312	270	139	46	1,463
August	698	371	397	330	138	60	1,994
September	578	448	480	388	134	92	2,120
October	775	266	454	403	139	115	2,152
November	194	74	82	81	129	25	585
December	374	139	156	193	132	64	1,058
Annual	5,487	3,386	3,619	3,215	1,625	784	18,116
Average daily	14.99	9.25	9.89	8.78	4.44	2.14	49.5
1929							
January	290	254	302	260	138	84	1,328
February	190	121	214	225	124	50	924
March	479	304	239	287	126	92	1,527
April	450	354	299	287	165	88	1,643
May	553	404	311	342	167	123	1,900
June	692	424	276	348	162	119	2,021
July	734	425	381	350	166	141	2,197
August	636	409	291	295	163	130	1,924
September	667	452	347	372	160	133	2,131
October	501	324	270	306	162	128	1,691
November	74	129	53	81	157	43	537
December	244	191	95	140	163	61	894
Annual	5,510	3,791	3,078	3,293	1,853	1,192	18,717
Average daily	15.10	10.39	8.43	9.02	5.08	3.27	51.3
1930							
January	0	0	55	1	165	0	221
February	60	4	128	37	147	1	377
March	174	198	191	175	152	32	922
April	137	260	238	195	123	55	1,008
May	501	437	374	396	180	114	2,002
June	484	434	331	358	167	111	1,885
July	465	417	351	336	167	99	1,835
August	525	395	346	312	180	109	1,867
September	267	233	192	168	170	76	1,106
October	249	188	182	213	154	64	1,050
November	296	230	146	159	69	60	960
December	430	317	96	248	124	107	1,322
Annual	3,588	3,113	2,630	2,598	1,798	828	14,555
Average daily	9.83	8.53	7.21	7.12	4.93	2.27	39.9

*Artesian water pumped by Honolulu Plantation Co. from drilled wells,
1910-33, in millions of gallons—Continued*

Well no.	185	196	186	197	189	203	Total
Station no.	1	2	3	4	5	7	
Pump no.	1	1, 2	1, 2	4	5	7	
1931							
January	674	443	230	341	165	130	1,983
February	576	306	231	293	135	106	1,647
March	582	332	260	330	168	117	1,789
April	580	360	264	334	163	121	1,822
May	320	195	192	206	161	70	1,144
June	542	440	355	371	166	132	2,006
July	634	407	350	339	143	130	2,003
August	335	294	315	223	182	64	1,413
September	325	301	252	212	178	64	1,332
October	381	301	246	256	162	107	1,453
November	464	225	149	166	145	90	1,239
December	391	284	161	247	131	97	1,311
Annual	5,804	3,888	3,005	3,318	1,899	1,228	19,142
Average daily	15.90	10.65	8.23	9.09	5.20	3.36	52.4
1932							
January	396	283	133	214	132	87	1,245
February	27	50	66	21	143	19	326
March	95	95	89	79	158	29	545
April	406	293	213	210	152	86	1,360
May	507	357	221	222	163	110	1,580
June	553	353	247	250	160	90	1,653
July	584	395	283	241	157	109	1,769
August	502	285	248	248	173	104	1,560
September	540	415	302	288	170	120	1,835
October	560	416	304	327	168	115	1,890
November	248	182	83	147	81	53	794
December	463	291	107	165	104	95	1,225
Annual	4,881	3,415	2,296	2,412	1,761	1,017	15,782
Average daily	13.34	9.33	6.27	6.59	4.81	2.78	43.1
1933							
January	362	280	192	167	132	91	1,224
February	126	66	86	42	135	23	478
March	251	255	228	172	155	70	1,131
April	339	372	302	253	142	88	1,496
May	508	430	378	352	166	117	1,951
June	546	456	367	361	159	134	2,023
July	523	466	332	364	153	122	1,960
August	669	442	403	406	158	113	2,191
September	668	456	396	406	188	129	2,243
October	710	444	381	403	175	130	2,243
November	556	403	264	337	113	114	1,787
December	384	270	84	227	98	79	1,142
Annual	5,642	4,340	3,413	3,490	1,774	1,210	19,869
Average daily	15.46	11.89	9.35	9.56	4.86	3.31	54.4

OAHU SUGAR CO.

The pumpage of ground water by the Oahu Sugar Co. in 1905-33 is given below. Artesian flow from two wells used by this company amounts to about 100,000 gallons a day.

Water pumped by Oahu Sugar Co. from wells and tunnels, 1905-33, in millions of gallons

Well no.	247	249	248	Tunnel	274	239	246	Total (a)	
Pump no.	1	2, 3	4	4-B	5	5-B	6, 6-B	7 (b)	
1905									
January	176	397	172	185	183	1,113
February	182	459	167	195	174	1,177
March	193	464	199	217	174	1,247
April	276	465	186	231	180	1,338
May	244	548	194	228	239	1,453
June	272	543	203	223	286	1,527
July	296	553	202	234	321	1,606
August	263	535	203	235	283	1,519
September	285	531	202	235	343	1,596
October	308	563	210	225	430	1,736
November	144	326	128	143	258	999
December	99	367	165	163	235	1,029
Annual	2,738	5,751	2,231	2,514	3,106	16,340
Average daily	7.50	15.76	6.11	6.89	8.51	44.77
1906									
January	117	253	74	64	142	650
February	252	493	151	157	334	1,387
March	295	544	197	209	467	1,712
April	304	547	204	230	465	1,750
May	313	563	210	241	489	1,816
June	304	535	200	235	479	1,753
July	306	549	204	225	479	1,763
August	307	562	192	242	485	1,788
September	299	542	199	229	479	1,748
October	312	557	211	247	469	1,796
November	0	0	0	0	0	0
December	0	0	0	0	0	0
Annual	2,809	5,145	1,842	2,079	4,288	16,163
Average daily	7.70	14.10	5.05	5.70	11.75	44.28

(a) Fractions of million gallons omitted from 1905 to 1917
 (b) No record available prior to 1921. Installed about 1900.

Water pumped by Oahu Sugar Co. from wells and tunnels, 1905-33, in millions of gallons—Continued

Well no.	247	249	248	Tunnel	274		239	246	Total
Pump no.	1	2, 3	4	4-B	5	5-B	6, 6-B	7	
1907									
January	0	0	0	0	0	0
February	30	60	120	136	43	389
March	160	220	110	137	202	829
April	296	444	203	216	487	1,646
May	253	503	211	230	485	1,682
June	259	538	199	220	447	1,663
July	304	537	207	230	485	1,763
August	242	535	197	231	445	1,650
September	239	511	169	106	191	405	1,621
October	0	0	0	0	0	0	0
November	272	460	164	128	177	373	1,574
December	219	333	124	93	146	279	1,194
Annual	2,274	4,141	1,704	327	1,914	3,651	14,011
Average daily	6.23	11.35	4.67	.90	5.24	10.00	38.39
1908									
January	245	367	160	88	181	304	1,345
February	183	282	113	103	140	217	1,038
March	134	204	89	75	100	149	751
April	211	317	120	169	158	249	1,224
May	317	571	205	216	234	492	2,035
June	305	550	201	208	224	443	1,931
July	304	528	202	209	224	476	1,943
August	317	541	211	209	231	488	1,997
September	277	529	170	170	220	428	1,794
October	316	566	200	206	217	490	1,995
November	274	507	189	190	210	430	1,800
December	235	450	197	199	211	254	1,546
Annual	3,118	5,412	2,057	2,042	2,350	4,420	19,399
Average daily	8.52	14.79	5.62	5.58	6.42	12.08	53.00

Water pumped by Oahu Sugar Co. from wells and tunnels, 1905-33, in millions of gallons—Continued

Well no.	247	249	248	Tunnel	274		239	246	Total
Pump no.	1	2, 3	4	4-B	5	5-B	6, 6-B	7	
1909									
January	111	183	73	103	62	126	658
February	46	89	75	78	11	53	352
March	16	231	124	128	72	87	658
April	361	454	187	202	161	285	1,650
May	285	498	189	168	168	461	1,769
June	299	540	195	205	217	503	1,959
July	306	532	198	201	177	444	1,858
August	315	562	207	207	208	531	2,030
September	307	540	203	201	194	515	1,960
October	311	560	208	191	200	483	1,953
November	307	536	199	192	228	403	1,865
December	224	399	160	159	181	332	1,455
Annual	2,888	5,124	2,018	2,035	1,879	4,223	18,167
Average daily	7.91	14.04	5.53	5.58	5.15	11.57	49.77
1910									
January	16	91	37	41	80	25	290
February	95	390	163	165	155	301	1,269
March	256	551	206	208	232	505	1,958
April	258	516	178	201	226	453	1,832
May	289	521	200	195	227	544	1,976
June	267	527	197	196	201	447	1,835
July	286	520	199	201	206	527	1,939
August	275	558	210	206	217	507	1,971
September	170	367	123	127	159	276	1,222
October	281	545	184	202	223	530	1,965
November	213	403	148	146	132	382	1,424
December	244	485	188	189	188	463	1,757
Annual	2,650	5,472	2,033	2,077	2,246	4,960	19,438
Average daily	7.26	14.99	5.57	5.69	6.15	13.59	53.25

Water pumped by Oahu Sugar Co. from wells and tunnels, 1905-33, in millions of gallons—Continued

Well no.	247	249	248	Tunnel	274		239	246	Total
Pump no.	1	2, 3	4	4-B	5	5-B	6, 6-B	7	
1911									
January	34	81	27	30	0		23		195
February	14	188	52	30	86		95		465
March	13	174	113	107	0		135		542
April	98	400	171	176	27		374		1,246
May	239	545	211	205	264		491		1,955
June	294	533	201	192	250		488		1,958
July	294	540	205	190	238		467		1,934
August	301	555	211	189	211		556		2,023
September	273	517	207	202	262		546		2,007
October	301	522	202	192	241		484		1,942
November	281	489	195	188	234		506		1,893
December	207	517	201	193	238		488		1,844
Annual	2,349	5,061	1,996	1,894	2,051		4,653		18,004
Average daily	6.44	13.87	5.47	5.19	5.62		12.75		49.33
1912									
January	244	541	198	196	208		390		1,777
February	199	391	143	131	138		347		1,349
March	217	510	212	198	254		423		1,814
April	230	484	180	155	197		503		1,749
May	299	569	210	180	220		535		2,013
June	293	554	200	195	213		524		1,979
July	291	550	204	197	250		520		2,012
August	296	571	209	202	230		513		2,021
September	275	531	197	187	222		487		1,899
October	276	562	211	194	240		510		1,993
November	285	516	200	193	252		491		1,937
December	169	194	142	141	235		301		1,182
Annual	3,074	5,973	2,306	2,169	2,659		5,544		21,725
Average daily	8.40	16.32	6.30	5.93	7.27		15.15		59.36

Water pumped by Oahu Sugar Co. from wells and tunnels, 1905-33, in millions of gallons—Continued

Well no.	247	249	248	Tunnel	274		239	246	Total
Pump no.	1	2, 3	4	4-B	5	5-B	6, 6-B	7	
1913									
January	132	443	206	186	185	373	1,525
February	189	388	173	170	88	408	1,416
March	292	498	211	202	188	537	1,928
April	223	457	204	196	164	496	1,740
May	154	326	162	153	131	374	1,300
June	158	309	156	144	104	258	1,129
July	269	497	202	196	247	482	1,893
August	269	556	212	199	233	424	1,893
September	281	548	204	161	254	478	1,826
October	274	544	200	188	237	490	1,933
November	113	390	190	182	216	303	1,394
December	158	369	188	163	222	333	1,433
Annual	2,512	5,325	2,208	2,140	2,269	4,956	19,410
Average daily	6.88	14.59	6.32	5.86	6.22	13.58	53.18
1914									
January	254	432	204	193	207	333	1,623
February	246	345	172	168	188	211	1,330
March	189	307	137	132	162	281	1,208
April	100	268	82	0	133	232	815
May	130	439	163	8	216	358	1,314
June	220	526	183	152	221	401	1,703
July	381	553	189	154	214	437	1,928
August	260	566	191	136	228	514	1,895
September	120	406	154	111	195	302	1,288
October	262	515	186	154	205	453	1,775
November	252	536	204	195	199	452	1,838
December	64	123	46	43	23	109	408
Annual	2,478	5,016	1,911	1,446	2,191	4,083	17,125
Average daily	6.79	13.74	5.24	3.96	6.00	11.19	46.92

DRAFT FROM ARTESIAN AREAS

Water pumped by Oahu Sugar Co. from wells and tunnels, 1905-33, in millions of gallons—Continued

Well no.	247	249	248	Tunnel	274	239	246	Total	
Pump no.	1	2, 3	4	4-B	5	5-B	6, 6-B	7	
1915									
January	263	524	190	185	200	484	1,846
February	240	466	183	176	198	347	1,610
March	294	555	211	186	204	543	1,993
April	210	488	196	150	212	388	1,644
May	210	420	156	149	162	380	1,477
June	258	536	201	196	210	481	1,882
July	266	556	202	196	213	218	1,651
August	288	578	210	201	203	492	1,972
September	279	558	203	195	191	462	1,888
October	256	543	208	194	184	417	1,802
November	13	100	53	50	87	22	325
December	131	344	149	124	148	209	1,105
Annual	2,708	5,668	2,162	2,002	2,212	4,443	19,195
Average daily	7.42	15.53	5.92	5.48	6.06	12.17	52.59
1916									
		Pump 2	Pump 3				Pump 6	Pump 6-B	
January	0	0	0	0	0	0	0	0
February	22	23	18	13	0	8	18	0	102
March	171	201	113	120	73	163	216	0	1,057
April	254	273	206	179	172	219	292	131	1,726
May	101	226	122	111	0	249	260	81	1,150
June	231	297	241	97	12	250	219	138	1,485
July	266	293	232	174	157	241	317	160	1,840
August	254	308	251	162	143	253	318	144	1,833
September	293	308	236	203	197	247	337	173	1,994
October	231	307	234	196	174	258	338	168	1,906
November	129	189	149	22	121	195	228	71	1,104
December	4	4	5	0	0	45	10	5	73
Annual	1,956	2,429	1,807	1,277	1,049	2,128	2,553	1,071	14,270
Average daily	5.34	6.64	4.95	3.49	2.87	5.79	6.98	2.93	38.99

Water pumped by Oahu Sugar Co. from wells and tunnels, 1905-33, in millions of gallons—Continued

Well no.	247	249		248	Tunnel	274		239		246	Total
Pump no.	1	2	3	4	4-B	5	5-B	6	6-B	7	
1917											
January	0	0	0	0	0	0		0	0		0
February	0	0	0	0	0	0		0	0		0
March	0	0	0	31.13	0	16.51		0	0		47.64
April	40.96	117.19	12.08	68.54	39.63	158.74		0	3.76		440.90
May	99.65	173.03	34.87	115.54	119.86	196.08		0	64.90		803.93
June	204.69	270.79	148.34	193.38	189.33	196.06		92.25	125.00		1,419.84
July	283.38	268.24	230.27	199.68	198.95	248.74		296.28	179.64		1,905.18
August	301.56	302.85	242.47	209.00	204.96	252.19		343.66	182.02		2,038.71
September	271.17	297.41	220.48	203.12	197.81	249.46		333.34	146.28		1,919.07
October	297.03	299.07	235.51	205.81	200.20	247.94		344.71	175.55		2,005.82
November	175.50	272.42	144.00	162.34	169.83	226.31		165.39	84.10		1,399.99
December	0	46.26	0	31.97	31.02	38.56		0	0		147.81
Annual	1,674.04	2,047.26	1,268.02	1,420.51	1,351.59	1,830.59		1,575.63	961.25		12,128.89
Average daily	4.59	5.61	3.47	3.89	3.70	5.02		4.32	2.63		33.20
1918											
January	0	0	0	0	0	0		0	0		0
February	0	0	0	0	0	0		0	0		0
March	0	0	0	0	0	0		0	0		0
April	0	0	3.84	0	0	6.75		0	0		10.59
May	92.29	198.36	133.35	0	0	219.34		0	83.69		727.03
June	245.14	268.76	227.39	156.27	59.49	236.56		255.40	159.02		1,608.03
July	295.21	284.45	245.43	206.17	199.80	242.96		342.53	171.23		1,987.88
August	261.96	308.40	201.18	202.57	196.43	260.56		327.94	177.32		1,936.36
September	293.89	298.87	237.36	206.51	200.16	248.84		339.34	192.67		2,017.64
October	274.82	277.75	221.68	190.95	186.37	239.13		316.91	172.41		1,880.02
November	213.78	214.05	162.37	142.47	121.87	199.34		231.78	124.69		1,410.35
December	33.26	30.20	0	0	3.61	19.31		0	0		86.35
Annual	1,710.35	1,880.84	1,432.60	1,104.94	967.73	1,672.79		1,813.90	1,081.03		11,664.25
Average daily	4.69	5.15	3.92	3.03	2.65	4.58		4.97	2.96		31.95

DRAFT FROM ARTESIAN AREAS

Water pumped by Oahu Sugar Co. from wells and tunnels, 1905-33, in millions of gallons—Continued

Well no.	247	249		248	* Tunnel	274		239		246	Total
Pump no.	1	2	3	4	4-B	5	5-B	6	6-B	7	
1919											
January	249.48	193.53	113.46	117.84	129.32	122.89	109.06	20.71	1,056.29
February	264.96	206.74	139.58	139.08	170.54	209.43	237.48	108.79	1,476.60
March	200.78	264.63	148.88	202.05	201.41	215.78	342.15	123.89	1,699.57
April	146.92	298.75	149.47	186.34	183.80	233.58	314.71	148.42	1,661.99
May	238.55	301.95	123.77	197.50	188.76	245.37	304.53	137.94	1,738.37
June	226.94	284.38	203.51	189.26	174.34	230.07	307.31	161.48	1,777.29
July	282.88	292.03	221.20	194.13	181.98	237.25	265.22	169.99	1,844.68
August	273.74	301.35	230.50	199.39	188.15	244.46	345.83	182.98	1,966.40
September	234.65	290.61	197.88	172.25	174.90	235.31	322.36	157.48	1,785.44
October	213.31	292.31	184.64	176.24	182.26	239.87	262.29	151.08	1,702.00
November	251.72	248.80	197.85	173.32	171.42	220.73	198.90	166.15	1,628.89
December	255.66	215.75	207.81	152.48	148.72	215.75	294.23	176.45	1,666.85
Annual	2,839.59	3,190.83	2,118.55	2,099.88	2,095.60	2,650.49	3,304.07	1,705.86	20,004.37
Average daily	7.78	8.74	5.80	5.75	5.74	7.26	9.05	4.67	54.80
1920											
January	113.17	50.95	64.75	62.64	15.47	68.61	124.47	81.83	581.89
February	18.59	0	17.38	0	0	14.70	0	18.34	69.01
March	86.66	48.46	70.28	0	0	218.27	0	27.31	450.98
April	100.94	114.70	86.42	0	0	177.55	54.15	32.37	566.13
May	266.94	267.09	182.09	47.38	0	205.07	276.11	135.15	1,380.70
June	259.56	241.48	185.61	165.70	0	217.02	297.61	152.68	1,519.66
July	256.20	283.27	217.28	164.64	112.00	230.98	299.02	175.59	1,738.98
August	266.52	290.99	227.74	189.99	167.94	225.80	308.95	184.64	1,862.57
September	266.88	276.17	221.55	188.20	166.00	233.16	303.35	177.13	1,832.44
October	267.88	269.85	226.43	194.74	165.55	244.90	289.24	185.77	1,844.37
November	187.33	230.81	173.59	152.82	118.34	226.31	283.15	176.55	1,548.90
December	58.29	82.18	48.82	64.80	51.07	91.49	77.16	38.50	512.31
Annual	2,148.96	2,155.95	1,721.94	1,230.91	796.37	2,153.86	2,313.22	1,385.86	13,907.94
Average daily	5.89	5.90	4.74	3.37	2.18	5.90	6.32	3.79	38.00

Water pumped by Oahu Sugar Co. from wells and tunnels, 1905-33, in millions of gallons—Continued

Well no.	247	249		248	Tunnel	274		239		246	Total
Pump no.	1	2	3	4	4-B	5	5-B	6	6-B	7	
1921											
January	0	0	0	0	0	0	0	0	0	0
February	22.34	0	0	0	0	0	0	0	0	22.34
March	158.86	0	0	0	40.53	27.53	0	0	210.00	436.92
April	237.95	73.13	41.84	79.64	130.97	250.89	0	0	0	814.42
May	250.87	277.73	199.70	184.38	179.89	176.33	0	44.20	232.00	1,545.10
June	279.96	234.25	223.67	188.02	173.87	230.16	202.83	146.22	210.00	1,938.98
July	276.64	278.84	223.79	183.85	179.37	165.86	296.32	163.72	232.00	2,000.39
August	277.65	292.13	234.95	194.31	190.81	182.08	334.59	179.13	232.00	2,117.65
September ..	272.07	277.51	230.68	189.43	184.15	227.83	316.28	170.46	237.00	2,105.41
October	181.89	195.90	137.11	148.95	144.17	138.00	194.74	92.94	0	1,233.70
November ..	276.74	268.29	231.29	192.86	186.38	226.20	315.19	173.78	0	1,870.73
December ..	117.67	159.86	106.40	99.77	95.38	160.92	153.15	100.49	217.00	1,210.64
Annual	2,352.64	2,107.64	1,629.43	1,461.21	1,505.52	1,785.80	1,813.10	1,070.94	1,570.00	15,296.28
Average daily	6.45	5.77	4.46	4.00	4.12	4.89	4.97	2.93	4.30	41.91
1922											
January	2.56	0	0	0	0	6.66	0	0	0	219.22	224.44
February	25.63	33.88	57.76	57.02	15.29	82.25	0	0	24.70	210.00	556.53
March	80.84	175.15	97.80	45.40	28.20	111.39	0	0	48.67	210.00	797.45
April	251.49	256.47	172.08	121.22	0	222.63	0	160.22	48.40	210.00	1,442.51
May	295.77	299.12	238.00	194.41	0	206.25	0	335.41	149.92	217.00	1,935.88
June	278.72	204.66	222.25	163.90	41.60	202.66	0	320.71	153.07	210.00	1,797.57
July	279.65	284.67	230.82	187.12	76.42	194.04	0	312.29	183.19	217.00	1,965.20
August	278.84	290.01	235.82	193.16	173.72	234.00	0	330.04	179.88	285.00	2,200.47
September ..	232.08	221.96	218.26	145.44	117.53	223.00	0	325.02	176.55	285.00	1,944.84
October	265.98	254.26	228.90	165.32	121.48	193.55	46.57	300.27	182.36	279.00	2,037.69
November ..	199.09	235.64	191.18	124.75	118.12	204.61	14.40	227.48	135.35	279.00	1,729.62
December ..	85.01	197.90	158.67	121.60	70.56	180.38	6.81	71.31	83.38	279.00	1,254.62
Annual	2,275.66	2,503.72	2,051.54	1,519.34	762.92	2,061.42	67.78	2,382.75	1,365.47	2,900.22	17,890.82
Average daily	6.23	6.86	5.62	4.16	2.08	5.65	.19	6.53	3.74	7.95	49.01

DRAFT FROM ARTESIAN AREAS

Water pumped by Oahu Sugar Co. from wells and tunnels, 1905-33, in millions of gallons—Continued

Well no.	247	249		248	Tunnel	274		239		246	Total
Pump no.	1	2	3	4	4-B	5	5-B	6	6-B	7	
1923											
January	57.92	61.70	74.01	53.52	13.15	84.02	1.78	44.76	52.94	279.00	722.80
February	0	0	0	0	0	0	0	0	0	221.20	221.20
March	4.90	57.52	8.59	18.86	0	102.70	0	15.66	34.06	279.00	521.29
April	3.75	38.95	0	52.68	0	108.02	0	0	18.01	279.00	500.41
May	216.97	261.76	143.99	195.79	185.38	183.75	18.96	165.75	133.54	279.00	1,784.89
June	179.84	292.63	211.65	193.22	186.18	219.22	44.00	313.39	182.08	270.00	2,092.22
July	230.51	291.09	230.72	195.02	185.03	234.27	54.60	321.59	183.53	270.00	2,196.36
August	272.02	301.60	234.84	199.51	188.33	222.32	58.50	322.57	190.25	279.00	2,268.94
September	269.30	297.46	220.24	194.05	177.41	227.28	77.00	305.64	188.66	270.00	2,227.04
October	269.20	297.23	240.74	199.96	186.28	218.50	9.62	259.06	198.05	279.20	2,157.84
November	232.45	277.48	171.40	159.93	157.67	168.50	3.50	272.00	126.98	260.90	1,830.81
December	93.22	140.55	55.04	71.22	57.48	81.93	0	152.30	54.07	265.00	970.81
Annual	1,830.08	2,317.97	1,591.22	1,533.76	1,336.91	1,850.51	267.96	2,172.72	1,362.18	3,231.30	17,494.61
Average daily	5.01	6.35	4.36	4.20	3.66	5.07	.73	5.95	3.73	8.85	47.93
1924											
January	4.20	7.89	72.79	0	0	7.00	18.50	35.99	40.77	278.39	465.53
February	248.09	72.48	178.61	0	0	76.00	23.00	250.93	144.73	278.29	1,272.23
March	269.34	201.06	177.38	64.23	0	126.00	32.00	308.12	158.03	278.39	1,615.05
April	50.56	50.91	0	8.98	0	0	35.00	54.11	28.88	239.79	468.33
May	202.94	0	98.99	0	0	53.30	55.50	250.84	83.35	275.00	1,019.92
June	285.11	189.63	215.66	129.61	28.79	174.78	24.75	303.23	177.13	270.00	1,798.69
July	285.72	288.70	235.64	188.95	133.77	213.80	14.50	307.62	187.65	279.00	2,135.35
August	255.35	284.68	243.80	195.45	187.47	215.50	74.80	313.72	193.03	278.60	2,242.40
September	286.48	291.43	235.89	189.46	182.07	224.20	73.50	302.04	177.53	272.00	2,234.60
October	253.67	287.61	215.89	182.91	155.78	225.00	80.00	284.33	137.10	277.90	2,100.19
November	236.07	259.60	173.27	133.80	155.02	180.00	70.00	201.20	93.60	251.90	1,754.46
December	104.20	106.12	71.63	62.08	66.34	78.20	37.10	96.07	48.73	272.25	942.72
Annual	2,482.33	2,040.11	1,919.55	1,155.47	909.24	1,573.78	538.65	2,708.20	1,470.53	3,251.61	18,049.47
Average daily	6.78	5.57	5.24	3.16	2.48	4.30	1.47	7.40	4.02	8.88	49.32

Water pumped by Oahu Sugar Co. from wells and tunnels, 1905-33, in millions of gallons—Continued

Well no.	247	249		248	Tunnel	274		239		246	Total
Pump no.	1	2	3	4	4-B	5	5-B	6	6-B	7	
1925											
January	0	0	0	0	0	4.59	13.20	0	0	245.00	267.79
February	103.29	158.44	66.56	124.35	62.32	190.90	.92	94.51	0	238.00	1,039.29
March	215.59	264.07	0	163.48	151.16	188.48	15.20	261.79	21.56	238.00	1,519.33
April	58.72	211.31	0	105.21	98.38	79.99	6.15	96.00	85.56	238.50	979.82
May	194.54	300.77	86.85	185.77	189.63	199.80	0	270.15	218.02	272.00	1,917.53
June	185.90	290.72	157.30	188.12	163.01	202.50	37.93	306.18	224.11	245.00	2,000.77
July	245.41	235.98	230.60	184.73	167.99	218.30	63.00	296.31	218.63	253.00	2,163.94
August	255.90	295.19	243.43	193.68	173.14	222.00	126.00	305.77	223.72	275.50	2,314.33
September	249.56	278.46	229.71	183.70	159.62	199.80	135.60	297.12	203.92	268.00	2,205.49
October	256.06	210.55	169.22	143.47	143.59	159.84	38.50	301.97	190.30	275.00	1,888.50
November	77.59	63.25	0	25.01	25.75	82.33	3.08	248.45	100.31	230.00	855.77
December	123.57	0	0	0	0	102.86	.90	173.02	54.11	284.79	739.25
Annual	1,966.13	2,358.74	1,183.67	1,497.51	1,334.59	1,851.39	445.48	2,651.27	1,540.24	3,062.79	17,891.81
Average daily	5.39	6.46	3.24	4.10	3.66	5.07	1.22	7.26	4.22	8.39	49.02
1926											
January	233.59	0	0	0	46.75	170.25	.01	13.56	70.87	284.79	819.82
February	226.39	32.09	13.78	30.65	65.31	167.20	9.62	162.40	67.53	240.00	1,014.97
March	276.35	226.24	163.16	156.47	93.69	190.00	12.00	304.17	144.94	265.00	1,832.02
April	267.44	227.00	128.57	150.61	108.70	197.60	1.75	304.17	173.95	264.00	1,823.79
May	256.13	270.54	184.60	193.05	144.13	198.50	69.92	311.09	218.75	269.00	2,115.71
June	145.80	163.78	120.48	115.28	105.92	111.70	39.70	255.88	151.84	275.00	1,485.38
July	247.24	279.20	221.34	184.27	182.66	231.26	81.22	304.50	215.04	279.00	2,225.73
August	229.61	236.13	234.76	191.88	189.11	237.41	209.95	341.12	217.27	279.00	2,416.24
September	195.30	253.37	210.93	170.13	169.87	214.81	183.31	281.80	188.90	261.00	2,129.42
October	166.21	199.68	78.47	140.13	115.24	168.67	85.12	180.75	82.43	270.00	1,486.70
November	150.30	155.71	71.38	97.91	76.85	170.62	6.42	196.93	76.80	263.97	1,266.89
December	143.23	129.64	24.05	96.27	80.04	94.80	3.50	161.81	98.54	276.00	1,107.88
Annual	2,537.59	2,223.38	1,451.52	1,526.65	1,378.27	2,152.82	702.52	2,818.18	1,706.86	3,226.76	19,724.55
Average daily	6.95	6.09	3.98	4.18	3.78	5.90	1.92	7.72	4.68	8.84	54.00

DRAFT FROM ARTESIAN AREAS

Water pumped by Oahu Sugar Co. from wells and tunnels, 1905-33, in millions of gallons—Continued

Well no.	247	249		248	Tunnel	274		239		246	Total
Pump no.	1	2	3	4	4-B	5	5-B	6	6-B	7	
1927											
January	16.82	41.17	0	0	0	3.90	2.04	0	6.65	270.00	340.58
February	6.50	20.23	0	0	0	4.87	1.17	0	11.05	250.50	294.32
March	41.90	84.27	0	54.35	45.64	0	8.46	51.76	0	276.75	563.13
April	12.06	36.57	0	6.56	15.15	16.90	13.42	45.61	0	267.75	414.02
May	83.11	121.74	0	70.29	76.58	70.58	3.50	161.86	57.74	279.00	924.40
June	206.80	215.86	0	103.94	74.15	175.83	12.54	219.80	145.13	270.00	1,424.05
July	233.37	259.09	153.65	179.06	168.65	220.35	85.17	296.43	176.73	279.00	2,052.00
August	250.55	281.81	216.08	189.81	191.53	220.68	170.33	304.52	230.62	270.00	2,325.93
September	176.72	256.98	160.86	78.69	152.24	213.84	44.04	279.48	193.48	270.00	1,826.34
October	182.96	267.44	97.47	57.02	57.26	215.80	7.88	277.68	193.76	275.22	1,632.49
November ..	27.34	30.43	29.88	0	0	104.33	.58	49.71	47.22	267.39	556.88
December ..	0	0	0	0	0	18.52	.58	0	0	279.00	298.10
Annual	1,238.63	1,615.59	657.94	739.72	781.20	1,265.61	349.71	1,686.85	1,062.38	3,254.61	12,652.24
Average daily	3.39	4.43	1.80	2.03	2.14	3.47	.96	4.62	2.91	8.90	34.66
1928											
January	0	0	0	0	0	5.85	15.46	0	0	279.00	300.31
February	0	140.40	0	85.51	0	167.05	26.00	157.23	18.79	259.87	854.85
March	69.13	205.23	17.14	90.98	54.87	226.85	4.08	252.51	0	279.00	1,199.79
April69	172.07	3.52	73.93	79.48	174.12	2.33	152.28	0	270.00	928.42
May	113.59	155.97	0	95.16	40.54	221.65	35.29	227.42	88.59	279.00	1,257.21
June	233.10	210.17	125.09	178.25	141.77	218.72	158.08	293.00	225.51	270.00	2,053.79
July	185.60	240.07	217.27	166.28	169.57	220.03	167.13	283.83	187.68	279.00	2,116.46
August	183.49	263.55	208.92	180.96	180.71	214.48	147.58	253.07	170.53	279.00	2,109.39
September	201.25	242.87	204.09	169.41	173.86	210.92	151.38	245.03	155.35	262.80	2,016.96
October	223.67	235.87	188.31	175.27	179.84	192.40	136.50	238.13	143.35	279.00	1,992.34
November ..	0	0	0	0	0	0	1.75	0	0	267.30	269.05
December ..	0	0	0	0	0	0	1.46	0	0	279.00	280.46
Annual	1,210.52	1,866.20	964.34	1,215.75	1,020.64	1,879.07	847.04	2,102.50	990.00	3,282.97	15,379.03
Average daily	3.31	5.10	2.63	3.32	2.79	5.13	2.31	5.74	2.70	8.97	42.02

Water pumped by Oahu Sugar Co. from wells and tunnels, 1905-33, in millions of gallons—Continued

Well no.	247	249		248	Tunnel	274		239		246	Total
Pump no.	1	2	3	4	4-B	5	5-B	6	6-B	7	
1929											
January	236.17	2.67	0	112.36	68.16	163.47	14.87	206.95	20.84	279.00	1,104.49
February	119.44	71.44	0	50.90	43.10	62.40	12.54	96.86	61.40	252.00	770.08
March	104.96	184.85	49.82	102.49	98.31	180.70	5.20	137.89	71.57	279.00	1,214.79
April	188.23	204.66	42.14	166.63	109.19	172.25	40.67	214.43	150.61	270.00	1,558.81
May	254.14	265.83	98.35	180.82	172.71	221.00	44.33	292.47	199.41	279.00	2,008.06
June	251.79	256.78	148.28	172.55	175.41	218.73	89.33	295.52	188.08	267.37	2,063.84
July	262.62	266.83	197.44	183.93	185.92	228.80	186.33	305.20	219.06	271.12	2,307.25
August	256.36	284.79	211.27	181.46	182.61	239.20	251.47	311.10	217.84	274.12	2,410.22
September	224.85	244.78	155.40	152.73	148.83	209.62	186.89	268.12	194.14	267.39	2,052.75
October	212.90	225.06	33.10	166.10	91.17	221.07	41.00	272.80	193.61	278.25	1,735.06
November	13.13	13.90	0	9.22	9.01	11.70	30.41	15.62	10.72	264.00	377.71
December	0	0	0	0	0	42.90	21.53	0	0	276.00	340.43
Annual	2,124.59	2,021.59	935.80	1,479.19	1,284.42	1,971.84	924.57	2,416.96	1,527.28	3,257.25	17,943.49
Average daily	5.82	5.54	2.56	4.05	3.52	5.40	2.53	6.62	4.18	8.92	49.16
1930											
January	0	0	0	0	0	0	3.76	0	0	279.00	282.76
February	0	0	0	0	0	11.70	1.71	0	0	252.00	265.41
March	0	22.53	21.86	8.57	21.77	152.73	5.13	0	0	279.00	511.59
April	36.91	7.39	0	40.47	36.22	193.04	6.83	26.78	8.67	270.00	626.31
May	269.76	153.73	11.34	182.10	169.13	228.77	239.85	316.36	103.99	279.00	1,954.03
June	242.41	261.79	92.26	182.10	175.30	234.37	246.00	287.43	190.22	267.38	2,179.26
July	247.91	256.85	134.53	179.37	174.14	216.59	240.53	302.78	211.83	279.00	2,243.53
August	207.88	266.52	211.06	172.09	175.69	219.70	242.58	270.68	217.98	279.00	2,263.18
September	35.47	3.84	0	42.49	15.51	116.67	6.83	0	77.58	266.63	565.02
October	0	0	0	0	0	42.25	5.81	0	0	276.00	324.06
November	26.06	54.62	0	.42	0	90.20	1.03	0	53.54	264.75	490.62
December	0	0	0	0	0	112.12	8.54	0	0	279.00	399.66
Annual	1,066.40	1,027.27	471.05	807.61	767.76	1,618.14	1,008.60	1,204.03	863.81	3,270.76	12,105.43
Average daily	2.92	2.81	1.29	2.21	2.10	4.43	2.76	3.30	2.37	8.96	33.17

DRAFT FROM ARTESIAN AREAS

Water pumped by Oahu Sugar Co. from wells and tunnels, 1905-33, in millions of gallons—Continued

Well no.	247	249		248	Tunnel	274		239		246	Total
Pump no.	1	2	3	4	4-B	5	5-B	6	6-B	7	
1931											
January	0	0	0	46.32	0	198.00	1.37	95.43	169.56	279.00	789.68
February	47.77	147.71	0	145.06	83.69	196.50	18.45	277.33	209.79	252.00	1,378.30
March	79.12	265.50	139.64	169.82	161.32	229.05	6.50	297.89	233.83	279.00	1,861.67
April	155.79	156.83	102.48	119.92	115.81	195.00	13.00	274.51	211.42	270.00	1,614.76
May	160.57	171.40	83.99	130.53	105.76	143.32	11.28	232.31	152.65	279.00	1,470.81
June	256.64	248.61	57.22	184.24	172.74	209.67	102.84	306.05	218.19	270.00	2,026.20
July	237.02	269.16	155.39	169.96	153.77	239.17	226.87	286.24	219.24	278.62	2,235.44
August	220.36	164.33	56.38	47.74	22.93	221.75	112.75	197.86	190.47	279.00	1,513.57
September	58.55	50.19	20.41	23.79	0	177.45	21.18	110.68	52.81	267.00	782.06
October	49.02	48.32	0	29.88	0	196.12	.68	78.92	26.43	276.37	705.74
November	0	0	0	0	0	156.48	9.57	0	0	266.63	432.68
December	93.60	0	0	0	20.96	137.36	3.07	0	0	279.00	533.99
Annual	1,358.44	1,522.05	615.51	1,067.26	836.98	2,299.87	527.56	2,157.22	1,684.39	3,275.62	15,344.90
Average daily	3.72	4.17	1.69	2.92	2.29	6.30	1.45	5.91	4.61	8.97	42.04
1932											
January	29.70	0	0	0	0	165.65	1.02	0	0	279.00	475.37
February	0	0	0	0	0	32.74	1.03	0	0	261.00	294.77
March	0	0	0	0	0	31.47	2.05	0	0	279.00	312.52
April	46.88	24.14	0	1.88	0	146.00	1.02	39.14	0	270.00	529.06
May	138.98	115.46	0	0	0	201.24	1.37	21.02	0	279.00	757.07
June	209.43	268.70	20.49	100.19	67.74	226.00	2.05	266.34	185.78	270.00	1,616.72
July	205.67	259.65	111.84	139.12	79.08	228.33	68.67	257.40	200.21	279.00	1,828.97
August	231.86	291.80	191.99	191.04	178.83	252.53	48.86	306.59	236.41	279.00	2,208.91
September	215.44	245.91	174.30	143.16	143.06	226.80	61.16	219.44	221.28	270.00	1,920.55
October	194.43	278.06	1.67	101.11	28.19	247.00	1.03	166.13	184.26	276.00	1,477.88
November	108.29	87.88	0	66.16	0	99.78	.68	0	77.30	269.25	709.34
December	0	0	0	0	0	0	1.37	0	0	279.00	280.37
Annual	1,380.68	1,571.60	500.29	742.66	496.90	1,857.54	190.31	1,276.06	1,105.24	3,290.25	12,411.53
Average daily	3.77	4.29	1.37	2.03	1.36	5.08	.52	3.49	3.02	8.99	34.18

Water pumped by Oahu Sugar Co. from wells and tunnels, 1905-33, in millions of gallons—Continued

Well no.	247	249		248	Tunnel	274		239		246	Total
Pump no.	1	2	3	4	4-B	5	5-B	6	6-B	7	
1933											
January	0	0	0	0	0	0	1.71	0	0	279.00	280.71
February	0	0	0	0	0	0	2.05	0	0	252.00	254.05
March	0	0	0	0	0	0	2.05	0	0	279.00	281.05
April	96.90	95.40	0	18.54	0	56.33	1.36	74.26	0	270.00	612.79
May	236.73	267.72	11.86	149.88	9.49	231.33	1.37	300.60	19.71	279.00	1,507.69
June	177.64	225.82	7.85	155.87	15.93	210.60	49.20	265.35	199.36	270.00	1,577.62
July	185.23	256.67	0	153.77	83.88	228.66	4.00	207.03	195.54	279.00	1,593.78
August	287.82	293.50	6.18	190.98	194.94	254.86	159.19	305.87	223.75	279.00	2,196.09
September	225.84	239.64	175.43	156.35	133.80	213.11	36.87	256.71	185.47	267.37	1,890.59
October	242.64	246.03	173.32	131.73	153.84	199.14	1.04	230.87	179.89	276.38	1,834.88
November	193.86	137.34	52.51	37.92	32.81	152.44	.69	220.45	112.12	267.75	1,207.89
December	153.95	104.48	0	21.01	0	108.57	1.04	160.54	36.96	279.00	865.55
Annual	1,800.61	1,866.60	427.15	1,016.05	624.69	1,655.04	260.57	2,021.68	1,152.80	3,277.50	14,102.69
Average daily	4.93	5.11	1.17	2.78	1.71	4.53	.71	5.54	3.16	8.98	38.64

DRAFT FROM ARTESIAN AREAS

To arrive at pumpage from drilled wells alone on this plantation, the discharge of pump 4B should be subtracted, because it pumps from a sea-level tunnel and sump. It taps the same underground supply, however. Pumps 5 and 5B at well 274, listed above, are in area 11; hence their discharge must be subtracted from the totals to give quantities of water pumped from the Koolau basalt in area 6. These quantities are shown in the following table:

Annual pumpage by Oahu Sugar Co. from Koolau basalt in area 6, in millions of gallons, 1905-33

Year	Total	Average daily	Year	Total	Average daily
1905	13,826	37.9	1920	11,754	32.1
1906	13,084	35.8	1920	13,510	37.0
1907	12,097	33.1	1922	15,761	43.2
1908	14,979	40.9	1923	15,376	42.1
1909	16,288	44.6	1924	15,937	43.5
1910	17,192	47.1	1925	15,595	42.7
1911	15,953	43.7	1926	16,869	46.2
1912	19,066	52.2	1927	11,037	30.2
1913	17,141	47.0	1928	12,653	34.6
1914	14,934	40.9	1929	15,047	41.2
1915	16,983	46.5	1930	9,478	26.0
1916	12,142	33.2	1931	12,517	34.3
1917	10,298	28.2	1932	10,364	28.3
1918	9,991	27.4	1933	12,187	33.4
1919	17,354	47.5			

EWA PLANTATION CO.

The total pumpage from drilled wells on the Ewa plantation is given below. No artesian flow from wells is used. The quantity of water pumped from the wells dug in coral is given on page 234.

Water pumped by Ewa Plantation from drilled wells, 1901-33, in millions of gallons

Well no.	268	257	264		259		263	270	273					276			254		
Pump no.	1	2	3	4	5	6a	7	8b	9Ac	9B	9C	9D	9E	10	11	12	13	(d)	Total
1901																			
July	246	62	143	177	266	233	192	1,319
August	279	78	104	184	279	277	316	1,517
September	250	71	138	170	259	257	306	1,451
October	188	49	84	107	173	216	186	1,003
November	145	25	81	93	117	139	211	811
December	103	32	42	48	59	99	124	507
Period	1,211	317	592	779	1,153	1,221	1,335	6,608
Average daily	6.58	1.72	3.22	4.23	6.27	6.64	7.26	35.91
1902																			
January	175	38	62	77	155	194	208	0.7	0 910
February	186	42	60	71	88	212	202	1.0	14 876
March	107	16	11	23	103	98	115	.8	8 482
April	122	24	16	19	121	137	161	1.0	10 611
May	254	63	65	81	211	290	292	.5	34 1,301
June	328	22	21	99	290	286	313	1.9	20 1,381
July	333	29	95	153	307	295	350	2.2	39 1,603
August	326	59	124	168	319	299	350	2.0	40 1,687
September	330	62	124	150	296	293	328	1.9	45 1,630
October	350	66	131	157	322	309	361	2.8	41 1,750
November	135	33	52	63	111	100	213	1.8	15 724
December	14	11	0	0	32	36	22	.0	5 120
Annual	2,680	465	761	1,061	2,355	2,549	2,915	16.6	271 13,075
Average daily	7.34	1.27	2.08	2.91	6.45	6.98	7.99	.04574 35.82

(a) Starting with September 1923 includes both pumps 6-A and 6-B. (b) At well 270 from 1902 to 1905. In 1923 a new pump 8 was installed at well 263 for domestic purposes. (c) Five Blake pumps not equipped with meters from 1915 to 1927; annual pumpage estimated from pump displacement. (d) Apokaa Sugar Co., subsidiary of Ewa Plantation. Pumpage for January 1906 probably incorrect.

Water pumped by Ewa Plantation from drilled wells, 1901-33, in millions of gallons—Continued

Well no.	268	257	264		259		263	270	273					276				254		
Pump no.	1	2	3	4	5	6a	7	8b	9Ac	9B	9C	9D	9E	10	11	12	13	(d)	Total	
1903																				
January	206	48	58	0	174	168	184	1.0											29	868
February	186	47	58	0	196	156	161	1.3											13	818
March	261	79	118	0	325	303	300	1.7											37	1,425
April	213	75	113	0	280	254	258	1.9											43	1,238
May	283	89	43	170	305	283	270	1.9											48	1,492
June	287	99	160	192	305	283	272	.1											46	1,644
July	294	98	129	221	312	294	340	1.3											61	1,750
August	326	105	132	293	333	314	359	2.4											59	1,923
September	297	98	125	286	313	295	339	2.4											52	1,807
October	277	93	108	278	291	310	314	2.2											39	1,712
November	240	71	80	146	233	250	240	2.5											31	1,294
December	238	41	0	177	265	249	280	2.0											41	1,293
Annual	3,108	943	1,124	1,763	3,332	3,159	3,317	20.7											499	17,264
Average daily	8.52	2.58	3.08	4.83	9.13	8.65	9.09	.06											1.37	47.29
1904																				
January	261	15	0	110	289	266	306	1.7											24	1,273
February	2	0	0	40	0	50	65	.3											1	158
March	0	0	0	0	0	0	0	.0											0	0
April	140	3	0	73	143	143	105	.1											16	623
May	295	12	135	235	308	292	332	2.1											28	1,639
June	271	13	203	251	301	279	324	2.2											33	1,677
July	299	14	224	257	318	302	350	2.2											53	1,819
August	327	18	238	285	329	312	358	2.3											38	1,907
September	298	46	211	257	302	286	343	2.1											51	1,796
October	303	55	223	246	292	291	306	.0											52	1,768
November	249	45	184	227	256	246	295	.0											38	1,540
December	149	25	0	110	135	124	126	.0											16	685
Annual	2,594	246	1,418	2,091	2,673	2,591	2,910	13.0											350	14,886
Average daily	7.09	.67	3.87	5.71	7.30	7.08	7.95	.03											.96	40.67

Water pumped by Ewa Plantation from drilled wells, 1901-33, in millions of gallons—Continued

Well no.	268	257	264		259		263	270	273					276				254	Total
Pump no.	1	2	3	4	5	6a	7	8b	9Ac	9B	9C	9D	9E	10	11	12	13	(d)	Total
1905																			
January	201	54	0	241	273	264	322	.0	40	1,395
February	197	55	0	213	249	235	269	.0	45	1,263
March	222	75	0	267	291	265	298	.0	58	1,476
April	319	79	0	267	314	249	338	.0	57	1,623
May	329	84	216	237	329	314	360	.0	68	1,937
June	312	85	196	266	288	285	326	.0	59	1,817
July	306	89	185	247	309	295	329	1.7	69	1,831
August	316	96	213	278	319	298	340	2.9	66	1,929
September	305	101	185	256	309	294	330	2.6	69	1,852
October	327	107	216	286	328	312	364	2.5	76	2,018
November	309	95	197	259	299	282	332	2.4	61	1,836
December	209	32	87	183	198	198	131	.0	31	1,069
Annual	3,352	952	1,495	3,000	3,506	3,291	3,739	12.1	599	20,046
Average daily	9.18	2.61	4.10	8.22	9.61	9.02	10.24	.033	1.92	54.92
1906																			
January	156	31	100	138	119	26	171	241	982
February	289	58	58	198	226	233	251	35	1,348
March	307	62	150	258	293	285	290	33	1,678
April	318	44	208	279	299	294	339	57	1,838
May	322	40	192	283	319	312	351	62	1,881
June	310	38	203	265	303	291	327	65	1,802
July	320	49	190	279	318	294	331	53	1,834
August	329	82	203	283	324	309	357	64	1,951
September	329	82	203	283	324	309	356	64	1,950
October	329	82	203	283	324	309	356	64	1,950
November	295	85	140	248	291	276	313	59	1,707
December	0	7	0	18	0	31	40	4	100
Annual	3,304	660	1,850	2,815	3,140	2,969	3,482	801	19,021
Average daily	9.05	1.81	5.07	7.71	8.60	8.13	9.54	2.19	52.11

DRAFT FROM ARTESIAN AREAS

Water pumped by Ewa Plantation from drilled wells, 1901-33, in millions of gallons—Continued

Well no.	268	257	264		259		263	270	273					276				254	Total
Pump no.	1	2	3	4	5	6a	7	8b	9Ac	9B	9C	9D	9E	10	11	12	13	(d)	
1907																			
January	0	0	0	0	0	0	0	0	0
February	0	0	0	0	0	0	0	0	0
March	210	67	0	82	190	205	260	40	1,054
April	318	101	161	279	320	307	310	69	1,865
May	322	101	187	229	324	317	350	70	1,900
June	302	100	187	236	317	306	330	69	1,847
July	315	100	189	235	319	306	340	69	1,873
August	321	106	187	238	329	316	350	61	1,908
September	311	93	180	225	310	298	330	67	1,814
October	329	105	194	238	330	316	350	69	1,931
November	298	94	166	198	301	295	250	66	1,668
December	264	71	134	171	268	254	290	56	1,508
Annual	2,990	938	1,585	2,131	3,008	2,920	3,160	636	17,368
Average daily	8.19	2.57	4.34	5.84	8.24	8.00	8.66	1.74	47.58
1908																			
January	309	74	0	232	236	306	341	0	52	1,550
February	270	61	165	133	229	215	246	0	28	1,347
March	136	33	59	18	140	144	149	0	27	706
April	269	22	153	86	267	268	294	0	26	1,385
May	330	43	211	219	330	315	351	0	33	1,832
June	309	46	203	249	312	298	329	0	47	1,793
July	319	78	207	255	319	307	341	35	57	1,918
August	329	81	208	262	330	315	353	55	67	2,000
September	307	81	200	246	305	294	327	60	70	1,890
October	330	104	204	261	329	310	350	72	76	2,036
November	300	89	197	243	303	287	320	45	66	1,850
December	316	100	216	247	313	310	338	37	73	1,950
Annual	3,524	812	2,023	2,451	3,413	3,369	3,739	304	622	20,257
Average daily	9.63	2.22	5.53	6.70	9.33	9.20	10.22	1.33	1.70	55.35

Water pumped by Ewa Plantation from drilled wells, 1901-33, in millions of gallons—Continued

Well no.	268	257	264		259		263	270	273					276				254	
Pump no.	1	2	3	4	5	6a	7	8b	9Ac	9B	9C	9D	9E	10	11	12	13	(d)	Total
1909																			
January	238	72	150	195	163	91	256							16	0			51	1,232
February	195	56	112	169	63	0	222							113	0			27	957
March	246	77	162	189	27	204	242							151	0			38	1,336
April	263	103	108	202	277	330	336							219	0			57	1,895
May	157	82	137	122	267	254	256							180	0			42	1,497
June	302	102	199	232	327	322	331							226	55			59	2,155
July	317	101	197	230	329	329	343							242	139			57	2,284
August	327	105	214	233	339	342	353							246	128			60	2,347
September	305	100	196	219	321	319	332							246	137			56	2,231
October	325	105	195	237	344	341	354							263	147			62	2,373
November	298	95	150	214	319	323	332							236	120			56	2,143
December	185	22	130	144	208	207	205							159	38			34	1,332
Annual	3,158	1,020	1,950	2,386	2,984	3,062	3,562							2,297	764			599	21,782
Average daily	8.65	2.79	5.34	6.54	8.18	8.39	9.76							6.29	2.09			1.64	59.68
1910																			
January	154	17	0	132	163	185	14							140	55			4	864
February	233	96	177	72	306	252	272							224	97			17	1,746
March	177	68	213	59	333	343	354							259	121			52	1,979
April	186	99	206	223	333	332	343							240	103			53	2,118
May	281	104	203	236	343	338	346							247	177			60	2,335
June	295	99	196	223	313	316	332							210	81			54	2,119
July	312	99	205	229	320	332	342							240	40			55	2,174
August	324	105	178	236	344	343	353							243	143			61	2,330
September	147	53	113	121	138	187	203							134	86			30	1,212
October	324	106	214	237	270	313	353							248	174			61	2,300
November	203	69	134	132	187	218	237							154	80			38	1,452
December	174	93	186	202	249	282	308							195	92			49	1,830
Annual	2,810	1,008	2,025	2,102	3,299	3,441	3,457							2,534	1,249			534	22,459
Average daily	7.70	2.76	5.55	5.76	9.04	9.43	9.47							6.94	3.42			1.46	61.53

Water pumped by Ewa Plantation from drilled wells, 1901-33, in millions of gallons

Well no.	268	257	264		259		263	270	273					276			254		
Pump no.	1	2	3	4	5	6a	7	8b	9Ac	9B	9C	9D	9E	10	11	12	13	(d)	Total
1911																			
January	0	8	22	8	0	31	41	12	3	5	130
February	44	46	67	21	0	98	192	87	41	18	614
March	120	95	122	160	140	0	269	188	106	26	1,226
April	187	100	195	218	171	183	317	188	103	54	1,716
May	260	105	129	214	251	314	351	181	169	59	2,033
June	263	100	164	218	290	319	319	239	156	51	2,119
July	317	104	208	219	330	333	335	231	175	58	2,310
August	318	105	211	237	342	340	354	237	187	59	2,390
September	305	99	202	317	317	309	330	236	176	55	2,346
October	301	53	183	225	307	319	329	206	146	60	2,129
November	382	68	188	190	282	303	310	220	146	52	2,141
December	244	66	48	165	193	270	266	204	136	50	1,642
Annual	2,741	949	1,739	2,192	2,623	2,819	3,413	2,229	1,544	547	20,796
Average daily	7.51	2.60	4.76	6.01	7.19	7.72	9.35	6.11	4.23	1.50	56.98
1912																			
January	300	87	162	174	96	334	343	229	114	53	1,892
February	138	49	105	87	63	65	219	90	3	15	834
March	347	94	204	238	278	176	353	207	0	15	1,912
April	170	86	182	196	191	256	278	166	22	20	1,567
May	253	105	215	238	295	342	347	217	66	25	2,103
June	206	100	201	234	322	322	330	172	0	22	1,909
July	309	104	190	226	286	310	341	202	11	26	2,005
August	329	71	207	236	341	342	353	248	83	27	2,237
September	330	69	194	222	333	316	248	225	125	49	2,111
October	331	70	213	238	340	345	354	248	130	54	2,323
November	261	66	177	198	278	278	288	191	109	9	1,855
December	208	44	139	153	16	228	238	158	118	26	1,328
Annual	3,182	945	2,189	2,440	2,839	3,314	3,692	2,353	781	341	22,076
Average daily	8.69	2.58	5.98	6.67	7.76	9.05	10.09	6.43	2.1393	60.32

Water pumped by Ewa Plantation from drilled wells, 1901-33, in millions of gallons—Continued

Well no.	268	257	264		259		263	270	273					276				254	Total
Pump no.	1	2	3	4	5	6a	7	8b	9Ac	9B	9C	9D	9E	10	11	12	13	(d)	
1913																			
January	320	69	18	225	271	263	332	202	120	0	33	1,853
February	234	53	35	158	191	231	208	134	61	0	28	1,333
March	312	41	91	210	269	323	333	218	151	0	34	1,982
April	320	5	94	231	286	313	341	212	154	0	32	1,988
May	210	2	84	131	189	209	209	144	31	0	1	1,210
June	209	4	159	81	89	214	342	140	68	0	32	1,338
July	298	2	98	210	290	309	339	239	174	0	43	2,002
August	258	11	146	211	262	304	281	193	123	0	48	1,837
September	308	62	200	223	289	321	230	227	172	0	54	2,086
October	328	60	204	237	323	320	348	240	172	19	57	2,308
November	264	40	168	191	281	275	264	200	140	121	48	1,992
December	234	48	0	172	205	241	196	172	26	57	30	1,381
Annual	3,295	397	1,297	2,280	2,945	3,323	3,423	2,321	1,392	197	440	21,310
Average daily	9.03	1.09	3.55	6.25	8.07	9.10	9.38	6.36	3.81	0.54	1.21	58.38
1914																			
January	220	41	20	146	141	186	184	153	50	3	40	1,184
February	210	54	110	0	226	234	186	162	0	62	33	1,277
March	194	47	145	31	183	179	255	156	43	88	37	1,358
April	209	85	132	78	196	217	189	165	10	18	14	1,313
May	289	115	199	214	292	263	110	221	64	111	36	1,914
June	320	120	208	230	310	311	343	231	102	140	28	2,343
July	320	119	203	230	323	323	343	237	162	154	49	2,463
August	331	124	214	232	323	323	353	245	162	168	62	2,537
September	281	107	179	201	291	281	327	210	143	142	52	2,214
October	331	124	215	239	344	344	355	244	172	162	59	2,589
November	309	106	194	220	323	323	331	214	113	131	57	2,321
December	110	38	32	22	114	121	71	84	20	43	17	672
Annual	3,124	1,080	1,851	1,843	3,066	3,105	3,047	2,322	1,041	1,222	484	22,185
Average daily	8.56	2.96	5.07	5.05	8.40	8.51	8.35	6.36	2.85	3.35	1.32	60.78

DRAFT FROM ARTESIAN AREAS

Water pumped by Ewa Plantation from drilled wells, 1901-33, in millions of gallons—Continued

Well no.	268	257	264		259		263	270	273					276				254	
Pump no.	1	2	3	4	5	6a	7	8b	9A ^c	9B	9C	9D.	9E	10	11	12	13	(d)	Total
1915																			
January	308	110	24	156	328	281	236							226	124	101		57	1,951
February	265	93	88	21	272	282	241							204	95	95		50	1,706
March	330	112	182	161	322	315	292							248	113	154		61	2,290
April	375	90	157	88	277	277	257							212	88	75		46	1,942
May	303	86	103	172	265	193	282							199	19	116		44	1,782
June	319	110	208	145	330	317	327							240	58	138		50	2,242
July	319	81	206	197	333	333	341							227	141	151		47	2,376
August	326	73	208	231	343	343	355							248	148	120		59	2,454
September	296	74	194	214	309	323	307							165	131	108		52	2,173
October	331	92	213	237	319	335	355							248	152	136		62	2,480
November	104	7	57	53	95	68	97							91	36	39		7	654
December	201	67	97	0	158	109	200							143	61	16		22	1,074
Annual	3,477	995	1,737	1,675	3,351	3,176	3,290						2,340	2,451	1,166	1,249		557	25,464
Average daily	9.53	2.73	4.76	4.59	9.18	8.70	9.01						6.41	6.72	3.19	3.42		1.53	69.76
1916																			
January	0	0	0	0	0	0	25							0	0	0		0	25
February	41	5	17	32	0	48	81							28	0	4		2	258
March	196	21	145	167	41	195	238							178	37	102		43	1,363
April	302	57	193	216	280	307	328							234	94	113		52	2,176
May	326	76	212	225	322	324	355							239	124	151		61	2,415
June	318	70	205	225	333	333	345							240	143	143		60	2,415
July	319	79	195	215	323	323	331							233	142	123		58	2,341
August	331	89	215	235	343	345	353							248	133	132		62	2,486
September	310	73	199	221	322	322	330							232	114	128		58	2,309
October	328	77	213	237	324	324	354							242	133	129		60	2,421
November	319	116	125	216	300	310	315							238	132	122		58	2,251
December	217	77	0	142	207	136	217							166	54	46		38	1,300
Annual	3,007	740	1,719	2,131	2,795	2,967	3,272						2,279	2,278	1,106	1,193		552	24,039
Average daily	8.22	2.02	4.70	5.82	7.64	8.11	8.94						6.23	6.22	3.02	3.26		1.51	65.68

Water pumped by Ewa Plantation from drilled wells, 1901-33, in millions of gallons—Continued

Well no.	268	257	264		259		263	270	273					275				254	
Pump no.	1	2	3	4	5	6a	7	8b	9Ac	9B	9C	9D	9E	10	11	12	13	(d)	Total
1917																			
January	0	0	0	0	0	0	24							0	0	0		0	24
February	122	35	0	32	0	77	160							81	0	0		4	511
March	155	62	0	79	0	125	162							105	0	27		15	730
April	285	81	0	211	182	307	334							186	103	67		31	1,787
May	314	98	0	184	292	241	328							236	138	61		48	1,940
June	291	99	67	191	288	301	310							217	136	85		59	2,044
July	307	108	175	218	321	322	335							227	139	139		60	2,351
August	325	116	214	231	332	333	347							248	155	144		62	2,507
September	304	48	197	304	311	310	325							228	140	134		58	2,359
October	325	45	205	218	322	322	346							244	147	137		57	2,368
November	310	44	189	208	284	310	324							231	136	106		56	2,198
December	95	33	22	38	73	77	69							63	22	2		20	514
Annual	2,833	769	1,069	1,914	2,405	2,725	3,064							2,084	2,066	1,116	902	470	21,417
Average daily	7.76	2.11	2.93	5.24	6.59	7.47	8.39							5.71	5.66	3.06	2.47	1.29	58.68
1918																			
January	18	5	3	3	10	15	48							8	0	0		0	110
February	56	26	0	0	68	86	122							67	12	0		0	437
March	33	40	0	0	125	64	157							108	37	21		0	585
April	30	15	0	0	38	39	64							33	14	11		0	244
May	281	120	141	123	336	336	345							248	120	97		47	2,194
June	315	120	166	218	329	329	336							240	144	145		57	2,399
July	314	120	198	218	329	329	335							240	132	120		59	2,394
August	323	115	205	224	313	315	343							248	134	143		62	2,425
September	316	120	197	223	314	313	331							232	135	124		60	2,365
October	325	121	201	229	326	322	340							240	146	146		60	2,456
November	250	94	156	173	247	247	270							169	117	114		46	1,883
December	134	26	0	0	54	115	134							53	5	0		25	546
Annual	2,395	922	1,267	1,411	2,489	2,510	2,825							1,960	1,886	996	921	416	19,998
Average daily	6.56	2.53	3.47	3.87	6.82	6.88	7.74							5.37	5.17	2.73	2.52	1.14	54.79

DRAFT FROM ARTESIAN AREAS

Water pumped by Ewa Plantation from drilled wells, 1901-33, in millions of gallons—Continued

Well no.	268	257	264		259		263	270	273					276				254	
Pump no.	1	2	3	4	5	6a	7	8b	9Ac	9B	9C	9D	9E	10	11	12	13	(d)	Total
1919																			
January	267	88	68	101	198	263	285	160	76	14	48	1,568
February	292	107	117	172	270	274	301	212	114	90	53	2,002
March	325	124	205	228	316	315	346	248	153	116	52	2,428
April	314	119	191	178	306	306	336	240	143	22	43	2,198
May	322	122	203	230	314	281	344	246	153	47	42	2,304
June	304	71	143	117	293	293	323	232	96	37	37	1,946
July	315	59	193	222	305	305	335	237	127	122	47	2,267
August	312	109	206	229	317	316	347	347	155	154	46	2,538
September	305	115	183	215	295	293	322	232	144	137	53	2,294
October	311	104	192	209	287	268	320	225	138	119	57	2,230
November	303	74	193	216	295	295	323	229	143	138	55	2,264
December	303	75	192	216	168	284	308	231	143	137	43	2,100
Annual	3,673	1,167	2,086	2,333	3,364	3,493	3,890	3,408	2,839	1,585	1,133	576	29,547
Average daily	10.06	3.20	5.72	6.39	9.22	9.57	10.66	9.34	7.78	4.34	3.10	1.58	80.95
1920																			
January	126	29	67	82	0	100	129	98	50	27	13	721
February	175	46	97	117	71	221	12	95	38	31	29	932
March	302	61	181	218	320	297	130	229	97	98	29	1,962
April	313	53	186	224	284	306	189	239	130	107	34	2,065
May	325	95	202	232	316	315	316	248	155	109	45	2,358
June	290	115	198	222	306	306	336	238	150	140	59	2,360
July	291	99	198	223	306	274	333	239	145	149	60	2,317
August	302	110	203	231	306	290	347	248	155	101	52	2,345
September	291	102	201	223	297	280	331	240	140	150	40	2,295
October	301	110	206	230	307	284	346	248	144	144	62	2,382
November	278	94	192	214	261	261	322	231	144	147	52	2,196
December	133	45	99	111	106	127	163	137	75	66	36	1,098
Annual	3,127	959	2,030	2,327	2,880	3,061	2,954	3,337	2,490	1,423	1,269	511	26,368
Average daily	8.54	2.62	5.55	6.36	7.87	8.36	8.07	9.12	6.80	3.87	3.47	1.40	72.04

Water pumped by Ewa Plantation from drilled wells, 1901-33, in millions of gallons—Continued

Well no.	268	257	264		259		263	270	273					276			254	Total		
Pump no.	1	2	3	4	5	6a	7	8b	9Ac	9B	9C	9D	9E	10	11	12	13		(d)	
1921																				
January	0	0	0	0	30	0	0	0	0	0	5	35	
February	80	4	22	8	74	59	16	37	15	0	14	329	
March	304	30	139	148	315	306	228	240	135	25	41	1,911	
April	313	54	194	222	333	306	328	238	146	125	47	2,306	
May	325	81	206	185	339	320	346	247	155	154	48	2,406	
June	301	91	200	223	332	310	333	240	156	150	54	2,390	
July	306	105	200	223	298	263	334	235	147	147	55	2,313	
August	301	108	205	222	317	316	347	248	156	155	60	2,435	
September	292	106	198	220	309	307	335	239	150	149	58	2,363	
October	234	54	123	144	177	198	204	219	130	48	35	1,566	
November	271	98	193	200	277	283	307	231	132	116	53	2,161	
December	153	66	136	137	190	181	205	155	95	65	39	1,422	
Annual	2,880	797	1,816	1,932	2,991	2,849	2,983	4,254	2,329	1,417	1,134	509	25,891	
Average daily	7.84	2.18	4.98	5.29	8.19	7.81	8.17	11.65	6.38	3.88	3.11	1.39	70.93	
1922																				
January	0	0	60	10	58	77	69	148	60	19	9	510	
February	0	0	141	130	177	163	236	224	103	72	39	1,285	
March	294	0	175	195	274	252	288	210	128	111	53	1,980	
April	343	84	198	195	293	293	329	240	150	143	56	2,324	
May	353	136	206	224	313	299	346	237	148	128	62	2,452	
June	347	139	197	222	307	291	317	240	145	129	60	2,394	
July	349	90	188	223	309	293	336	240	150	136	59	2,373	
August	352	56	182	232	318	299	347	245	153	152	59	2,395	
September	345	56	167	222	300	283	335	240	150	150	58	2,306	
October	360	71	195	231	296	291	345	244	153	150	60	2,396	
November	326	86	185	206	263	221	305	212	132	122	55	2,113	
December	296	82	131	151	241	197	126	175	109	93	47	1,648	
Annual	3,365	800	2,025	2,241	3,149	2,959	3,379	2,199	2,655	1,581	1,405	617	26,375
Average daily	9.22	2.19	5.55	6.14	8.64	8.11	9.26	6.02	7.27	4.33	3.85	1.69	72.26

DRAFT FROM ARTESIAN AREAS

Water pumped by Ewa Plantation from drilled wells, 1901-33, in millions of gallons—Continued

Well no.	268	257	264		259		263	270	273					276				254		
Pump no.	1	2	3	4	5	6a	7	8b	9Ac	9B	9C	9D	9E	10	11	12	13	(d)	Total	
1923																				
January	142	32	0	0	125	114	0	12	80	48	32	19	604	
February	57	15	0	0	38	36	0	13	8	1	0	4	172	
March	188	52	209	44	150	151	1	16	130	59	48	11	1,059	
April	202	63	220	49	153	171	104	7	113	43	38	33	2,196	
May	305	127	365	39	298	284	254	0	240	115	108	53	2,188	
June	310	144	359	280	218	284	331	9	239	149	146	59	2,528	
July	343	143	358	323	287	283	329	32	228	143	135	60	2,664	
August	346	145	363	351	389	149	340	30	241	148	145	60	2,707	
September	327	141	347	329	296	282	324	30	231	134	131	59	2,631	
October	345	150	339	331	307	311	330	29	244	150	150	62	2,748	
November	125	140	285	174	279	304	313	0	231	145	144	58	2,198	
December	23	98	242	121	178	202	241	14	155	90	67	42	1,473	
Annual	2,713	1,250	3,087	2,041	2,718	2,571	2,567	192	2,570	2,140	1,225	1,144	520	24,738
Average daily	7.43	3.45	8.46	5.59	7.45	7.04	7.03	.53	7.04	5.86	3.36	3.13	1.42	67.77
1924																				
January	0	59	166	73	37	109	170	18	117	0	0	13	762	
February	0	41	306	182	112	250	283	7	176	47	93	47	1,544	
March	186	25	334	183	186	281	318	3	153	159	89	22	1,939	
April	39	6	95	28	47	65	66	35	37	24	22	6	470	
May	148	56	378	136	240	288	324	3	216	144	47	52	2,032	
June	269	94	366	296	274	298	334	1	239	167	109	58	2,505	
July	347	118	367	359	296	307	336	18	239	181	121	58	2,747	
August	363	110	377	374	304	319	342	23	240	214	125	60	2,851	
September	335	138	349	349	275	295	324	23	233	201	116	56	2,694	
October	323	147	373	351	284	318	341	23	241	169	95	61	2,726	
November	213	111	280	252	160	227	306	26	179	131	26	46	1,957	
December	64	47	117	88	83	95	117	33	79	58	0	19	800	
Annual	2,287	952	3,508	2,671	2,298	2,852	3,261	213	2,418	2,149	1,495	843	498	25,445
Average daily	6.25	2.60	9.58	7.30	6.28	7.81	8.91	.58	6.61	5.87	4.08	2.30	1.36	69.52

Water pumped by Ewa Plantation from drilled wells, 1901-33, in millions of gallons—Continued

Well no.	268	257	264		259		263	270	273					276				254	Total	
Pump no.	1	2	3	4	5	6a	7	8b	9Ac	9B	9C	9D	9E	10	11	12	13	(d)	Total	
1925																				
January	0	43	184	132	142	149	211	16	157	0	65	14	1,113	
February	22	137	343	333	253	265	310	0	227	140	63	34	2,127	
March	144	130	365	330	199	276	335	1	241	118	43	36	2,218	
April	136	143	365	326	217	297	332	0	242	149	49	42	2,298	
May	159	142	376	362	306	317	339	0	251	200	71	56	2,579	
June	290	133	363	351	295	318	328	0	243	155	130	56	2,662	
July	272	137	361	353	289	317	335	1	245	112	143	54	2,619	
August	274	137	362	341	283	311	325	18	244	168	131	55	2,649	
September	283	128	358	355	290	310	320	36	234	185	145	53	2,697	
October	241	113	361	342	248	289	318	28	220	146	103	49	2,458	
November	7	36	272	265	139	236	252	10	188	61	57	43	1,566	
December	0	5	183	178	148	160	170	21	123	41	46	29	1,104	
Annual	1,828	1,284	3,893	3,668	2,809	3,245	3,575	131	2,419	2,615	1,475	1,046	521	28,509
Average daily	5.01	3.32	10.67	10.05	7.70	8.89	9.79	.36	6.63	7.16	4.04	2.87	1.43	78.11
1926																				
January	0	4	332	257	169	258	272	9	196	75	83	28	1,683	
February	19	78	337	309	195	251	265	6	192	75	47	27	1,802	
March	247	65	369	344	255	319	303	1	231	135	133	34	2,437	
April	0	64	314	266	211	266	271	6	211	113	68	47	1,837	
May	131	120	366	352	282	323	343	0	223	139	44	55	2,378	
June	66	65	277	244	149	218	272	12	97	71	50	32	1,553	
July	290	143	352	341	279	312	336	33	182	175	140	54	2,637	
August	324	141	353	342	275	308	334	41	185	181	140	53	2,677	
September	319	138	351	328	275	300	319	40	219	189	119	52	2,649	
October	258	110	296	294	217	247	230	41	189	118	92	43	2,135	
November	0	116	283	273	222	249	262	9	94	79	121	31	1,739	
December	112	118	294	268	214	275	100	35	140	81	111	36	1,784	
Annual	1,766	1,162	3,924	3,618	2,743	3,326	3,307	233	1,839	2,159	1,433	1,148	492	27,150
Average daily	4.84	3.18	10.77	9.91	7.51	9.13	9.06	.64	5.04	5.91	3.93	3.15	1.35	74.38

DRAFT FROM ARTESIAN AREAS

Water pumped by Ewa Plantation from drilled wells, 1901-33, in millions of gallons—Continued

Well no.	268	257	264		259		263	270	273					276				254	Total
Pump no.	1	2	3	4	5	6a	7	8b	9Ac	9B	9C	9D	9E	10	11	12	13	(d)	
1927																			
January	0	87	257	221	136	205	145	36						71	78	86		19	1,341
February	0	37	208	174	107	152	106	25						44	64	64		22	1,003
March	33	49	249	241	165	210	234	17						60	96	92		24	1,470
April	17	0	210	141	115	170	124	26						63	62	60		21	1,000
May	150	15	369	363	236	331	285	5						185	167	123		46	2,275
June	288	46	359	354	267	316	331	2						286	199	116		54	2,618
July	304	20	364	352	284	359	335	1						297	209	144		55	2,724
August	348	38	369	362	294	372	346	1						306	219	156		56	2,867
September	325	63	347	337	277	346	325	44						283	204	147		53	2,751
October	282	77	370	360	285	361	355	24						294	211	126		51	2,776
November	127	47	287	256	186	247	232	12						144	125	83		26	1,772
December	18	12	65	66	34	51	56	39						33	32	13		7	426
Annual	1,892	491	3,445	3,227	2,386	3,120	2,854	232					2,138	2,066	1,666	1,210		434	25,161
Average daily	5.18	1.35	9.44	8.84	6.54	8.55	7.82	.64					5.86	5.66	4.56	3.32		1.19	68.93
1928																			
January	5	41	185	174	102	180	166	24						128	53	51		28	1,137
February	83	55	310	307	206	299	263	7						167	125	60		50	1,932
March	105	73	320	321	234	331	297	7	528					213	134	31		48	2,114
April	111	84	343	356	230	360	306	2	60	0	149	0	44	259	133	75		54	2,556
May	195	102	374	374	277	387	347	29	67	0	150	12	46	285	167	61		57	2,930
June	313	115	360	346	276	367	334	45	63	0	145	7	44	282	157	127		55	3,036
July	344	115	366	369	280	368	335	47	61	0	146	8	43	283	130	112		50	3,057
August	354	122	372	375	288	384	344	43	48	0	132	45	42	297	175	144		59	3,224
September	327	120	357	347	279	358	310	45	17	99	60	60	37	288	183	131		52	3,070
October	311	103	367	368	275	376	332	45	0	199	0	45	42	297	175	118		49	3,102
November	66	64	253	240	148	152	192	20	6	88	16	0	35	164	98	40		27	1,609
December	0	58	275	259	118	188	219	16	30	0	93	0	38	192	102	0		25	1,613
Annual	2,214	1,052	3,882	3,836	2,713	3,759	3,445	330	e 352	e 386	e 891	e 177	e 371	2,855	1,632	950		554	29,918
Average daily	6.05	2.87	10.61	10.49	7.41	10.30	9.41	.90	.96	1.05	2.46	.48	1.01	7.80	4.46	2.60		1.51	81.74

Water pumped by Ewa Plantation from drilled wells, 1901-33, in millions of gallons—Continued

Well no.	268	257	264		259		263	270	273					276				254	
Pump no.	1	2	3	4	5	6a	7	8b	9Ac	9B	9C	9D	9E	10	11	12	13	(d)	Total
1929																			
January	139	38	329	291	195	280	267	11	60	0	116	0	41	187	142	74	0	41	2,211
February	0	17	145	126	90	128	94	26	48	0	101	0	38	76	46	14	0	12	961
March	83	35	303	302	195	251	237	10	63	0	109	7	42	240	138	38	1	36	2,090
April	332	26	370	362	247	368	330	0	62	0	109	6	40	294	152	40	0	48	2,786
May	348	56	380	370	272	386	345	0	65	0	107	62	41	308	181	114	0	41	3,076
June	336	68	366	354	275	373	334	0	54	0	100	45	37	293	181	113	0	45	2,974
July	328	92	370	359	277	375	331	33	47	0	110	53	36	299	173	57	0	54	2,994
August	338	102	375	363	281	380	342	46	47	22	94	49	41	308	195	115	0	56	3,154
September	320	102	363	344	266	362	323	45	2	157	0	50	39	292	193	122	0	53	3,033
October	190	80	298	272	208	283	247	20	0	113	0	33	41	228	136	88	0	40	2,277
November	14	37	142	128	66	140	102	29	0	7	0	2	20	89	45	23	1	18	863
December	76	44	147	141	113	159	104	28	9	0	43	0	32	121	61	25	1	20	1,124
Annual	2,504	697	3,588	3,412	2,485	3,485	3,056	248	457	299	889	307	448	2,735	1,643	823	3	464	27,543
Average daily	6.86	1.91	9.83	9.35	6.81	9.55	8.37	.68	1.25	.82	2.44	.84	1.23	7.49	4.50	2.25	1.27	75.46
1930																			
January	0	2	5	0	0	0	0	46	32	0	98	0	43	8	0	0	1	0	235
February	5	37	39	91	58	123	101	27	27	0	101	0	37	95	34	23	1	17	816
March	95	70	226	199	152	229	203	19	49	0	103	0	42	177	104	68	1	25	1,762
April	87	104	338	300	227	324	264	7	46	0	113	2	40	257	104	86	0	43	2,342
May	347	139	376	378	295	398	346	0	60	0	124	11	41	307	201	116	0	56	3,195
June	341	134	398	363	284	383	335	1	59	0	143	10	40	296	189	144	0	55	3,175
July	329	127	403	357	276	372	327	3	67	0	113	46	42	292	191	133	0	53	3,131
August	353	119	425	374	292	393	347	0	67	0	107	40	41	306	204	147	0	54	3,269
September	217	67	312	259	205	283	235	11	43	8	85	42	40	222	139	103	0	34	2,305
October	195	84	337	276	205	280	229	13	0	134	0	8	40	218	147	99	0	35	2,300
November	168	59	240	214	134	181	152	23	3	96	0	27	41	137	87	63	1	25	1,651
December	219	79	330	293	211	281	232	14	11	34	74	0	40	211	140	85	0	34	2,288
Annual	2,356	1,021	3,429	3,104	2,339	3,247	2,771	164	464	272	1,061	186	487	2,526	1,540	1,067	4	431	26,469
Average daily	6.45	2.80	9.39	8.51	6.41	8.90	7.59	.45	1.27	.75	2.91	.51	1.33	6.92	4.22	2.92	1.18	72.51

DRAFT FROM ARTESIAN AREAS

Water pumped by Ewa Plantation from drilled wells, 1901-33, in millions of gallons—Continued

Well no.	268	257	264		259		263	270	273					276				254	Total
Pump no.	1	2	3	4	5	6a	7	8b	9Ac	9B	9C	9D	9E	10	11	12	13	(d)	
1931																			
January	214	79	356	308	185	316	281	9	37	0	114	9	41	236	137	55	37	2,414
February	144	45	335	271	220	303	255	7	55	0	113	9	37	211	139	76	28	2,248
March	281	39	419	358	227	327	289	8	41	0	125	7	41	244	166	93	29	2,694
April	299	70	399	354	222	370	321	1	51	0	121	37	40	269	183	64	46	2,847
May	121	79	331	228	198	301	265	11	36	0	119	8	41	231	153	67	42	2,231
June	210	109	410	361	269	332	331	0	45	0	115	1	40	290	192	103	55	2,913
July	328	136	413	363	274	377	329	41	47	0	115	1	41	295	204	147	54	3,165
August	292	136	420	370	283	393	342	40	39	0	132	0	40	297	210	145	55	3,194
September	206	130	398	332	267	365	309	32	10	0	140	0	39	282	190	120	52	2,872
October	267	103	340	320	234	320	275	23	1	84	34	1	40	240	163	122	46	2,618
November	259	83	357	314	223	289	254	17	0	116	0	0	39	236	144	112	43	2,486
December	184	67	285	244	175	243	211	27	15	66	39	0	33	200	126	62	39	2,016
Annual	2,805	1,076	4,463	3,823	2,777	3,986	3,462	216	377	266	1,167	73	472	3,031	2,012	1,166	3	526	31,701
Average daily	7.68	2.95	12.23	10.47	7.61	10.92	9.48	.59	1.03	.73	3.20	.20	1.29	8.30	5.51	3.19	1.44	86.85
1932																			
January	160	65	340	292	193	308	237	31	37	0	99	3	40	220	134	62	42	2,263
February	8	27	125	112	71	112	120	28	30	0	86	0	38	95	39	19	13	923
March	30	27	116	85	72	86	83	37	26	0	99	1	40	73	30	32	15	852
April	238	132	415	367	258	355	330	4	50	0	114	0	39	291	173	112	52	2,930
May	225	129	416	334	256	366	331	10	52	0	118	0	40	286	170	132	50	2,915
June	342	141	406	354	270	281	337	0	52	0	114	0	39	291	197	135	51	3,010
July	337	139	412	364	281	392	326	28	48	0	116	0	40	287	195	142	49	3,156
August	356	126	423	374	289	392	345	46	47	0	125	0	40	298	197	145	38	3,241
September	295	105	411	357	279	379	310	31	46	0	148	0	39	279	171	133	28	3,011
October	274	104	371	314	229	393	268	27	62	0	138	21	38	252	168	113	29	2,801
November	145	38	232	205	152	203	179	42	2	33	51	0	38	162	107	54	20	1,668
December	155	30	318	282	191	250	214	40	0	120	0	0	34	191	133	62	33	2,053
Annual	2,565	1,063	3,985	3,440	2,541	3,522	3,080	324	452	153	1,208	25	465	2,725	1,714	1,141	4	420	28,827
Average daily	7.01	2.90	10.89	9.40	6.94	9.62	8.42	.89	1.23	.42	3.30	.07	1.27	7.45	4.68	3.12	1.15	78.76

Water pumped by Ewa Plantation from drilled wells, 1901-33, in millions of gallons—Continued

Well no.	268	257	264		259		263	270	273					276				254	Total
Pump no.	1	2	3	4	5	6a	7	8b	9 A ^c	9B	9C	9D	9E	10	11	12	13	(d)	
1933																			
January	96	26	364	286	175	298	241	14	44	55	87	0	38	180	133	32	34	2,103
February	0	26	164	144	56	147	101	23	0	0	101	0	37	108	82	23	12	1,024
March	6	59	228	167	124	204	190	16	0	0	152	24	41	153	105	6	27	1,502
April	66	75	399	325	222	360	320	1	0	0	177	17	40	246	187	73	39	2,547
May	179	97	426	393	220	384	344	0	0	0	191	18	41	280	203	65	49	2,890
June	272	127	409	384	262	366	338	10	0	0	175	57	39	289	200	98	50	3,076
July	347	140	421	396	279	367	339	31	0	0	178	59	41	290	210	146	53	3,297
August	353	150	416	392	289	374	350	28	0	0	158	59	41	294	213	139	57	3,313
September	323	139	405	372	263	353	319	34	0	0	161	56	39	282	146	100	52	3,044
October	288	120	405	373	231	311	281	53	0	43	106	31	37	256	177	126	42	2,880
November	236	103	390	365	198	271	188	89	0	140	0	0	37	226	126	100	44	2,513
December	130	71	236	200	117	178	155	23	0	107	0	0	10	129	77	56	27	1,516
Annual	2,296	1,133	4,263	3,797	2,436	3,613	3,166	322	44	345	1,486	321	441	2,733	1,859	964	2	486	29,707
Average daily	6.29	3.10	11.68	10.40	6.67	9.90	8.67	.88	.12	.95	4.07	.88	1.21	7.49	5.09	2.64	1.33	81.36

DRAFT FROM ARTESIAN AREAS

Pumps 10, 11 and 12 at well 276 draw from Waianae basalt in area 11. In the table below this draft is deducted.

Annual pumpage by Ewa Plantation Co. from Koolau basalt in area 6, in millions of gallons, 1901-33

Year	Total	Average daily	Year	Total	Average daily
1901	6,608	18.1	1918	16,195	44.4
1902	13,139	36.0	1919	23,990	65.7
1903	17,262	47.3	1920	21,186	57.9
1904	14,886	40.7	1921	21,011	57.6
1905	20,046	54.9	1922	20,734	56.8
1906	19,021	52.1	1923	20,037	54.9
1907	17,368	47.6	1924	20,958	57.3
1908	19,953	54.5	1925	23,373	64.0
1909	18,721	51.3	1926	22,410	61.4
1910	18,676	51.2	1927	20,219	55.4
1911	17,023	46.6	1928	24,481	66.9
1912	18,942	51.8	1929	22,339	61.3
1913	17,400	47.7	1930	21,332	58.4
1914	17,600	48.2	1931	25,489	69.8
1915	20,598	56.4	1932	23,243	63.5
1916	19,462	53.2	1933	24,151	66.2
1917	17,333	47.5			

PRIVATE AND PUBLIC WELLS

The pumpage from the Navy wells at Aiea used to supply the Pearl Harbor navy yard and Fort Kamehameha is listed below.

Pumpage from Navy wells at Aiea, 1924-33, in millions of gallons

1924.....	117.8	1929.....	675.7
1925.....	373.1	1930.....	711.7
1926.....	623.4	1931.....	804.2
1927.....	522.6	1932.....	1,042.1
1928.....	653.1	1933.....	937.3

Measurements are not available for the draft from the remaining wells in this area. It is roughly estimated to be 1,277.5 million gallons a year, or 3,500,000 gallons a day.

TOTAL DRAFT, AREA 6

The table below summarizes total draft from area 6.

Total draft from wells and tunnels entering Koolau basalt in area 6, in millions of gallons, 1925-33

	1925	1926	1927	1928	1929
Honolulu Plantation Co. (a).....	18,449	16,661	14,837	18,296	18,897
Oahu Sugar Co. (b).....	15,595	16,869	11,037	12,253	15,047
Ewa Plantation Co.....	23,373	22,410	20,219	24,481	22,339
Others (c).....	1,650	1,900	1,800	1,830	1,850
	59,067	57,840	47,893	57,260	58,133
Average daily.....	161.83	158.47	131.21	156.45	159.27
	1930	1931	1932	1933	
Honolulu Plantation Co. (a).....	14,735	19,332	15,962	20,049	
Oahu Sugar Co. (b).....	9,478	12,517	10,364	12,187	
Ewa Plantation Co.....	21,332	25,489	23,243	24,151	
Others (c).....	1,990	2,080	2,320	2,220	
	47,535	59,418	51,889	58,607	
Average daily.....	130.23	162.79	141.77	160.57	

- (a) Includes estimated gravity flow from wells of 180 million gallons a year.
 (b) Does not include negligible gravity flow.
 (c) Largely estimated.

AREA 7

WAIALUA AGRICULTURAL CO.

Pumpage from the Waialua Agricultural Co.'s wells is given below. No records are available for 1912, 1913 and from 1917-23.

Water pumped by Waialua Agricultural Co. from wells, 1910-33, in millions of gallons

Well no.	321	322	331	334	285	324	329	327	323	296	332	319	328	
Pump no.	1	2	3	4	5	7	8	9	10	11	12	Mill	13	Total
1910														
January														11
February														389
March														933
April														937
May														1,220
June														798
July														1,420
August														1,440
September														1,390
October														1,020
November														236
December														268
Annual														10,062
Average daily														27.57
1911														
January														29
February														77
March														24
April														642
May														1,200
June														1,260
July														1,520
August														1,630
September														1,390
October														1,340
November														886
December														384
Annual														10,382
Average daily														28.44
1914														
January	0	125	25		54	0	0	0		1	5			210
February	0	165	134		65	0	0	11		0	7			382
March	9	177	175		54	10	5	10		0	5			445
April	43	563	523		220	19	14	40		1	19			1,462
May	37	220	216		126	13	15	14		0	7			648
June	151	287	338		203	13	37	31		17	7			1,084
July	146	252	374		193	0	50	35		32	18			1,100
August	148	266	354		219	0	46	37		35	18			1,123
September	66	134	225		141	0	24	24		21	14			649
October	19	126	257		82	0	17	24		13	9			547
November	99	188	277		71	0	7	23		7	7			679
December	12	100	0		34	0	0	0		0	0			146
Annual	730	2,623	2,898		1,462	55	215	249		127	116			8,475
Average daily	2.00	7.19	7.94		4.01	.15	.59	.08		.35	.32			23.22
1915														
January	122	52	229		38	6	0	11		0	0			458
February	87	218	327		36	41	0	19		0	0			728
March	143	258	501		39	55	0	29		0	0			1,025
April	155	270	267		44	35	0	16		0	0			787
May	127	245	370		45	5	0	0		4	0			796
June	186	298	538		83	52	0	9		30	0			1,196
July	188	298	541		165	41	0	0		37	1			1,271
August	193	310	563		162	56	43	37		44	25			1,433
September	156	303	577		297	61	40	39		44	24			1,541
October	182	315	566		163	62	38	24		46	21			1,417
November	39	62	51		42	2	2	3		8	1			210
December	121	2	30		48	0	3	12		0	2			218
Annual	1,699	2,631	4,560		1,162	416	126	199		213	74			11,080
Average daily	4.65	7.21	12.49		3.18	1.14	.35	.55		.58	.20			30.36

316 GEOLOGY AND GROUND-WATER RESOURCES OF OAHU

Water pumped by Waialua Agricultural Co. from wells, 1910-33, in millions of gallons—Continued

Well no.	321	322	331	334	285	324	329	327	323	296	332	310	328	
Pump no.	1	2	3	4	5	7	8	9	10	11	12	Mill	13	Total
1916														
January	0	0	0	0	0	0	0	0	0
February	0	0	69	7	0	10	7	6	99
March	45	0	224	69	0	25	27	15	405
April	65	251	501	100	22	35	27	24	1,025
May	0	98	109	99	0	5	36	11	358
June	49	262	387	147	0	19	30	23	917
Period	159	611	1,290	422	22	94	127	79	2,804
Average daily ..	.87	3.35	7.09	2.3252	.6943	15.41
1924														
January	0	153	158	0	42	0	0	11	0	0	232	596
February	62	224	545	31	72	20	8	12	0	0	216	1,190
March	1	294	369	7	71	21	24	18	0	0	242	1,047
April	0	1	44	0	0	2	0	0	0	0	225	272
May	45	273	188	15	90	31	22	15	0	0	232	911
June	92	407	545	127	189	27	31	20	0	1	225	1,664
July	139	433	414	259	173	71	15	16	0	1	0	1,521
August	194	518	582	300	200	82	33	19	2	1	0	1,931
September	191	513	588	292	195	111	19	35	15	3	0	1,962
October	154	279	286	118	81	41	21	10	8	0	0	998
November	121	205	162	0	42	16	0	0	0	0	0	546
December	0	105	84	0	14	7	0	0	0	0	0	210
Annual	999	3,405	3,965	1,149	1,169	429	173	156	25	6	1,372	12,848
Average daily ..	2.73	9.30	10.83	3.14	3.19	1.17	.47	.4307	3.75	35.10
1925														
January	0	18	18	1	3	0	0	0	0	0	40
February	0	99	151	15	3	0	0	0	0	0	268
March	14	238	254	10	3	0	0	0	0	0	519
April	63	255	166	63	25	0	0	0	0	0	572
May	80	380	361	94	55	0	0	10	0	0	980
June	107	422	565	97	86	23	6	3	0	0	1,309
July	186	475	560	103	104	32	15	19	0	0	1,494
August	188	511	546	201	105	59	22	20	0	0	1,652
September	186	413	509	121	99	47	19	23	0	210	1,627
October	149	406	527	81	34	40	16	17	0	210	1,480
November	0	115	81	57	3	14	8	5	0	210	493
December	0	18	17	1	3	7	2	6	0	26	80
Annual	973	3,350	3,755	844	523	222	88	103	656	10,514
Average daily ..	2.67	9.18	10.29	2.31	1.43	.61	.2428	1.80	28.81
1926														
January	0	23	108	0	3	16	8	0	0	217	375
February	0	237	321	45	4	24	16	0	0	196	843
March	80	489	588	112	73	33	19	0	0	210	1,604
April	78	355	561	161	145	33	19	1	6	210	1,569
May	110	328	601	196	150	33	19	1	19	217	1,674
June	81	143	434	705	48	13	10	3	5	210	1,652
July	154	355	584	162	102	56	22	8	8	217	1,668
August	178	390	594	174	191	57	26	11	8	217	1,846
September	161	429	563	143	151	62	22	21	11	210	1,773
October	134	357	457	121	123	52	20	21	8	217	1,510
November	82	320	365	39	59	37	0	1	0	210	1,123
December	59	280	266	29	54	19	2	1	2	20	732
Annual	1,117	3,716	5,442	1,887	1,103	435	183	68	67	2,351	16,369
Average daily ..	3.06	10.18	14.91	5.17	3.02	1.19	.5019	.18	6.44	44.85
1927														
January	0	71	18	0	0	4	0	0	1	0	216	310
February	0	32	16	0	0	8	5	0	1	0	202	264
March	0	30	18	0	4	3	0	0	1	0	223	279
April	0	26	17	0	0	3	0	0	1	0	216	263
May	0	253	20	0	56	565	9	0	3	8	223	1,137
June	85	362	159	13	73	51	30	4	3	19	216	1,015
July	170	445	475	139	107	15	66	17	24	23	223	1,704
August	196	536	608	228	145	71	64	29	25	31	223	2,156
September	108	156	198	152	87	43	29	13	25	14	216	1,041
October	59	509	214	256	128	81	40	23	16	12	223	1,561
November	9	71	55	21	16	12	8	3	3	5	0	203
December	0	27	18	0	1	3	0	0	0	0	0	49
Annual	627	2,518	1,816	809	617	859	251	89	103	112	2,181	9,982
Average daily ..	1.72	6.90	4.98	2.22	1.69	2.35	.69	.2428	.31	5.98	27.35

Water pumped by Waialua Agricultural Co. from wells, 1910-33, in millions of gallons—Continued

Well no.	321	322	331	334	285	324	329	327	323	296	332	319	328	Total	
Pump no.	1	2	3	4	5	7	8	9	10	11	12	Mill	13		
1928															
January	0	35	18	0	17	3	1	7	0	0	3	183	267	
February	0	202	186	58	94	9	11	16	0	1	10	196	783	
March	0	217	407	191	75	45	35	16	0	1	12	229	1,228	
April	0	150	178	95	76	62	10	14	35	0	1	224	845	
May	0	241	92	132	92	35	16	12	0	5	10	218	853	
June	0	512	550	292	166	96	42	39	133	14	18	225	2,087	
July	120	459	316	195	162	85	36	23	124	4	0	225	1,749	
August	182	456	280	188	166	62	34	25	116	16	0	232	1,757	
September	150	493	452	287	150	44	20	42	61	19	12	166	1,896	
October	80	567	388	202	101	92	40	26	195	19	12	229	1,951	
November	0	30	17	0	3	0	2	0	2	0	0	0	54	
December	0	27	18	0	1	0	0	0	1	0	0	0	47	
Annual	532	3,389	2,902	1,640	1,103	533	247	220	667	79	78	2,127	13,517	
Average daily ..	1.45	9.26	7.93	4.48	3.01	1.46	.67	.60	1.82	.22	.21	5.81	36.93	
1929															
January	0	227	18	0	44	0	34	53	0	15	190	0	581	
February	0	115	60	31	13	0	10	39	0	8	37	0	313	
March	0	423	148	56	45	71	8	93	1	11	69	7	932	
April	0	399	438	133	49	61	28	202	2	9	210	7	1,538	
May	76	579	594	283	130	83	48	311	15	17	232	16	2,384	
June	110	545	570	279	107	132	46	317	31	12	225	14	2,388	
July	149	571	586	302	129	136	51	363	20	18	207	11	2,543	
August	164	655	664	282	122	95	56	345	38	15	216	13	2,455	
September	168	555	577	284	135	127	63	348	39	18	225	20	2,559	
October	104	574	587	296	109	126	52	343	25	11	194	12	2,433	
November	5	76	62	15	9	19	2	29	2	1	24	2	246	
December	0	27	18	0	1	0	0	0	0	0	0	0	46	
Annual	766	4,646	4,222	1,961	893	850	398	2,443	173	135	1,829	102	18,418	
Average daily ..	2.10	12.73	11.58	5.37	2.45	2.33	1.09	6.69	.47	.37	5.01	.28	50.46	
1930															
January	0	26	18	0	0	0	0	1	0	0	75	0	120	
February	2	27	16	0	0	1	0	1	0	0	197	0	244	
March	26	50	18	0	21	6	3	10	7	0	249	2	392	
April	31	106	17	0	69	6	4	10	2	0	240	4	490	
May	28	284	361	104	151	88	17	20	3	4	232	8	1,304	
June	70	510	544	231	136	100	44	23	3	1	225	17	1,914	
July	77	493	565	202	129	105	37	24	3	1	232	20	1,901	
August	80	532	422	160	144	102	37	32	3	4	229	22	1,779	
September	88	460	333	89	89	54	20	11	2	0	12	98	1,270	
October	45	254	186	71	67	3	13	3	2	0	9	47	708	
November	54	194	240	75	63	0	10	1	1	0	6	28	678	
December	0	27	18	0	0	0	18	0	1	0	8	0	80	
Annual	501	2,963	2,738	932	669	465	203	134	29	10	75	1,052	10,880	
Average daily ..	1.37	8.12	7.50	2.55	2.38	1.27	.5637	.08	.03	.21	5.07	29.86	
1931															
January	64	384	274	64	108	24	24	1	208	5	10	158	11	1,335
February	41	476	514	209	85	5	36	9	281	15	16	164	18	1,869
March	22	380	325	67	73	47	16	17	262	13	9	173	9	1,413
April	64	473	449	156	123	74	32	15	268	17	11	176	13	1,871
May	36	516	519	249	100	61	35	22	291	19	17	213	18	2,096
June	35	565	581	291	173	146	51	32	339	17	20	217	23	2,490
July	110	566	582	288	148	153	66	37	330	23	21	222	26	2,572
August	64	507	341	144	146	85	41	20	235	19	17	197	20	1,896
September	122	440	158	34	129	84	43	23	19	17	18	80	23	1,190
October	80	235	112	0	69	51	25	15	4	6	10	52	14	673
November	75	155	17	0	78	40	13	1	0	9	50	17	468	
December	17	74	18	0	34	3	3	6	1	0	0	25	6	187
Annual	730	4,831	3,690	1,502	1,266	773	385	210	2,239	151	158	1,727	198	16,060
Average daily ..	2.00	13.24	10.66	4.12	3.47	2.12	1.0558	6.13	.41	.43	4.73	.54	49.48
1932															
January	0	118	18	0	15	0	3	12	19	0	0	216	6	407
February	0	31	15	0	1	0	0	0	1	0	0	232	0	280
March	1	30	31	0	22	0	0	5	2	0	0	238	0	329
April	2	94	17	0	64	3	2	13	2	2	0	236	3	438
May	38	224	18	0	117	13	8	22	5	6	0	0	8	459
June	83	275	17	6	118	39	16	23	38	5	7	69	9	705
July	83	309	17	0	111	21	20	16	89	7	11	47	12	743
August	140	502	18	17	146	38	22	25	146	18	11	54	12	1,155
September	147	454	276	204	147	59	37	23	251	15	15	103	16	1,747
October	151	442	512	276	155	83	45	13	275	18	16	147	21	2,154
November	64	258	222	148	77	43	20	3	148	9	9	49	11	1,061
December	0	68	18	0	6	0	5	0	0	0	10	0	9	116
Annual	715	2,805	1,179	651	979	299	178	155	976	80	79	1,391	107	9,594
Average daily ..	1.95	7.66	3.22	1.78	2.67	.82	.4942	2.67	.22	.22	3.80	.29	26.21

Water pumped by Waialua Agricultural Co. from wells, 1910-33, in millions of gallons—Continued

Well no.	321	322	331	334	285	324	329	327	323	296	332	319	328	
Pump no.	1	2	3	4	5	7	8	9	10	11	12	Mill	13	Total
1933														
January	0	32	18	0	11	0	2	0	2	1	6	3	6	81
February	0	57	16	0	36	0	5	0	1	0	7	3	7	132
March	0	91	18	0	60	0	6	11	2	9	5	6	6	214
April	15	282	67	58	120	19	32	19	134	14	18	23	17	818
May	60	463	529	258	155	82	62	24	330	18	25	78	21	2,105
June	119	476	534	279	147	74	60	18	303	17	25	29	21	2,102
July	146	525	558	268	162	115	71	17	332	18	28	32	23	*2,320
August	172	589	597	298	157	152	71	19	366	19	28	50	24	*2,573
September	145	551	549	285	158	157	69	12	350	16	26	131	25	*2,499
October	145	583	597	302	158	179	71	12	376	18	27	182	24	*2,707
November	128	507	571	287	101	120	48	12	345	8	16	162	16	*2,351
December	86	308	405	203	27	85	35	8	263	0	10	85	10	*1,544
Annual	1,016	4,464	4,459	2,238	1,292	983	532	152	2,804	138	221	784	200	*19,446
Average daily ..	2.78	12.23	12.22	6.13	3.54	2.69	1.46	.42	7.68	.38	.61	2.15	.55	53.28

* Includes Hesper Farm pumps 14, B, C, on wells 298, 299, 301, as follows, in million gallons a day: July, 25; August, 31; September, 25; October, 33; November, 30; December, 19; total, 163.

Well 334 is neither artesian nor in area 7. Wells 285, 296, and the Hesper Farm pumps listed in the table draw water from the Waianae lavas in area 12. Deducting the pumpage by these four plants leaves the annual draft by this company from area 7, together with the estimated draft from the other wells in the area, as given below. In addition to the amount of water pumped as shown in the preceding table, this plantation uses the artesian flow of most of the wells in area 12.

Annual draft from Koolau basalt in area 7, in millions of gallons, 1914-33

Year	Waialua Agricultural Co.	City and County well 333	Wells 325 and 326 a	Total	Average daily
1914	6,890	(b)	(b)	6,890	18.9
1915	9,705	(b)	(b)	9,705	26.6
1924	10,506	(b)	(b)	10,506	28.8
1925	9,567	(b)	(b)	9,567	26.2
1926	14,414	(b)	(b)	14,414	39.5
1927	8,453	(b)	(b)	8,453	23.2
1928	10,695	(b)	(b)	10,695	29.2
1929	15,391	(b)	(b)	15,391	42.2
1930	9,069	(b)	(b)	9,069	24.8
1931	15,141	66	300	15,507	42.5
1932	7,884	89	300	8,273	22.6
1933	15,615	73	300	15,988	43.8

(a) Estimated on basis of one measurement in 1933.

(b) No record.

AREA 8

KAHUKU PLANTATION CO.

Pumpage from the Kahuku Plantation Co.'s wells is given below. No data are available for the wells formerly used by the Laie Plantation Co. until September 1931, when this company was merged with the Kahuku Co. and records started.

Water pumped by Kahuku Plantation Co. from wells, 1926-33, in millions of gallons^a

[Data furnished by Kahuku Plantation Co.]

Well no.	353	341	362	352	392	363	357	361	338	348 (b)	362	377	387	373	398	
Pump no.	1	2 (c)	3	5	6 (d)	7	8	12	14 (e)	15	17	20 (f)	23 (f)	25 (f)	27 (fg)	Total
1926																
January	60	19	69	20	10	5	0	183
February	84	37	91	26	14	9	0	261
March	123	43	116	48	19	3	0	352
April	118	48	137	47	18	28	0	396
May	130	53	181	229	18	48	0	659
June	77	36	113	126	11	22	0	385
July	106	59	152	202	16	28	0	563
August	116	51	162	239	14	28	0	610
September	119	62	182	276	21	25	25	710
October	86	46	166	194	7	19	19	537
November	50	47	122	143	0	22	17	401
December	h 0	32	50	70	0	21	15	188
Annual	1,069	533	1,541	1,620	148	258	76	5,245
Average daily ..	2.93	1.46	4.22	4.44	.41	.7121	14.37
1927																
January	12	8	20	17	0	15	2	74
February	28	15	24	20	0	11	1	99
March	8	9	38	15	0	14	4	88
April	11	6	22	15	0	16	0	70
May	25	18	55	37	0	14	7	156
June	50	36	108	101	0	38	24	357
July	80	54	162	170	3	37	20	526
August	104	60	208	189	20	41	19	641
September	92	45	163	127	20	21	9	477
October	92	11	103	42	19	8	2	277
November	8	7	27	7	1	0	0	50
December	0	0	16	0	1	0	0	17
Annual	510	269	946	740	64	215	88	2,832
Average daily ..	1.4	.74	2.59	2.03	.18	.5824	7.76

^a Total pumpage shown to the nearest million gallons; where pumping was less than 500,000 gallons in any month it was not recorded. ^b Well 351 after 1932. ^c (After recomputing.) Total water pumped by this plant was four times this amount, but only one-quarter of the total is from wells; the remainder is from swamp. ^d Now called pump 26. ^e Domestic. ^f These pumps on former Lale lands. No record available before September 1931. ^g Pump 27 finished July 1932, but not run until September 1932. ^h Pumpage less than 500,000 gallons.

Water pumped by Kahuku Plantation Co. from wells, 1926-33, in millions of gallons*

[Data furnished by Kahuku Plantation Co.]

Well no.	353	341	362	352	392	363	357	361	338	348 (b)	362	377	387	373	398	
Pump no.	1	2 (c)	3	5	6 (d)	7	8	12	14 (e)	15	17	20 (f)	23 (f)	25 (f)	27 (fg)	Total
1930																
January	0	0	0	0	0	0	0	0	0	0	0					0
February	15	10	18	19	12	5	13	3	2	0	0					97
March	24	15	53	17	13	7	19	2	2	0	0					152
April	67	30	127	48	25	22	32	14	2	0	0					367
May	127	51	212	145	58	74	63	26	7	4	0					767
June	128	67	220	160	68	72	65	28	6	0	19					833
July	105	52	217	149	77	69	67	19	8	3	19					785
August	132	62	218	181	77	61	78	25	10	24	22					890
September	33	24	74	29	0	10	28	7	4	6	4					219
October	74	27	46	54	0	0	22	3	5	14	0					245
November	63	23	57	58	0	0	23	0	4	11	0					239
December	19	13	44	39	0	5	4	0	0	5	0					129
Annual	787	374	1,286	899	330	325	414	127	50	67	64					4,723
Average daily ..	2.16	1.02	3.52	2.46	.90	.89	1.13	.33	.14	.18	.18					12.94
1931																
January	75	33	157	76	0	22	38	0	8	9	4	0	0	0		422
February	83	53	182	118	25	15	39	0	9	15	0	0	0	0		539
March	52	26	174	92	2	21	36	0	9	8	8	0	0	0		428
April	85	40	151	149	0	26	42	7	9	13	10	0	0	0		532
May	61	27	111	111	0	19	34	10	5	8	10	0	0	0		396
June	125	61	216	192	21	48	61	23	10	22	19	0	0	0		798
July	136	74	231	205	31	58	71	25	10	24	20	0	0	0		885
August	101	62	238	201	13	60	69	18	9	11	18	0	0	0		800
September	103	51	164	141	13	55	52	15	6	2	14	23	5	4		648
October	56	37	123	98	19	34	40	10	4	0	11	51	7	4		494
November	5	1	16	62	0	1	2	0	h 0	0	h 0	0	0	0		87
December	26	17	138	19	0	17	23	2	0	2	5	0	0	0		249
Annual	908	482	1,901	1,464	124	376	507	110	79	114	119	74	12	8		6,278
Average daily ..	2.49	1.32	5.21	4.01	.34	1.03	1.39	.30	.22	.31	.33	.20	.03	.02		17.20

DRAFT FROM ARTESIAN AREAS

*Water pumped by Kahuku Plantation Co. from wells, 1926-33, in millions of gallons**

[Data furnished by Kahuku Plantation Co.]

Well no.	353	341	362	352	392	363	357	361	338	348 (b)	362	377	387	373	398	
Pump no.	1	2 (c)	3	5	6 (d)	7	8	12	14 (e)	15	17	20 (f)	23 (f)	25 (f)	27 (fg)	Total
1932																
January	45	9	68	20	72	8	18	6	h 0	8	5	0	0	0	0	259
February	2	0	0	0	0	0	0	0	0	0	0	0	0	0	0	2
March	46	15	94	25	0	10	15	0	3	7	4	12	0	2	0	233
April	101	40	158	45	0	14	24	3	9	16	7	67	0	3	0	487
May	107	37	158	77	0	0	8	0	9	0	8	62	0	0	0	466
June	126	53	216	131	0	51	39	6	13	17	15	102	7	2	0	778
July	121	51	202	94	0	40	53	8	10	10	16	54	11	0	0	670
August	126	74	229	141	0	30	48	23	13	21	20	101	15	3	0	844
September	125	49	211	160	38	43	52	18	20	23	17	110	22	2	38	928
October	130	63	232	172	47	49	68	19	12	15	18	112	23	4	47	1,011
November	64	22	116	83	26	20	22	12	4	10	10	53	12	4	26	484
December	0	0	0	0	0	0	0	0	0	0	0	0	0	0	0	0
Annual	993	413	1,684	948	183	265	347	95	93	127	120	673	90	20	111	6,162
Average daily ..	2.71	1.13	4.60	2.59	.50	.72	.95	.26	.24	.35	.33	1.84	.25	.05	.30	16.84
1933																
January	42	14	134	55	12	18	29	10	5	0	4	15	5	4	0	347
February	3	4	52	3	h 0	3	11	0	2	0	3	2	0	h 0	0	83
March	50	20	98	71	14	11	16	10	5	0	4	15	5	4	0	347
April	84	34	210	147	38	26	36	22	6	2	16	95	12	0	7	735
May	90	43	189	139	33	25	34	15	9	4	15	84	5	0	13	698
June	127	75	229	179	41	29	44	25	11	14	19	128	13	8	18	960
July	83	56	229	99	33	10	18	9	10	18	15	99	20	14	34	747
August	77	72	237	168	44	27	0	0	15	21	12	146	31	18	97	965
September	88	64	249	180	33	50	38	13	15	17	13	105	25	15	68	973
October	145	79	241	209	31	45	54	22	11	14	20	149	30	16	82	1,148
November	61	26	133	89	5	21	26	9	5	6	11	48	13	2	15	470
December	32	23	73	42	0	8	13	h 0	2	4	5	18	6	0	0	226
Annual	882	510	2,074	1,381	284	273	319	130	92	100	138	935	170	77	334	7,699
Average daily ..	2.42	1.40	5.68	3.78	.78	.75	.87	.36	.25	.27	.38	2.56	.47	.21	.92	21.09

Approximate rate of artesian flow from wells on Kahuku plantation, in gallons per minute

[Data furnished by Kahuku Plantation Co.]

Well 364.....	800	Well 405.....	1,000	Well 376.....	900
358.....	600	395.....	1,000	368.....	700
348.....	400	393.....	800	365.....	800
347.....	800	388.....	900	366.....	800
346.....	800	384.....	700		
341.....	1,500	374.....	900	Total.....	13,400

The average daily artesian flow of wells belonging to the plantation has been estimated by the company engineer at about 9 million gallons, because they are used only about half of the year. The discharge of other wells in the area is estimated at 1.6 million gallons a day throughout the year. In 1932, the only year with practically complete records, both pumping and artesian flow amounted to about 27 million gallons a day from the Koolau basalt in area 8.

AREAS 9 AND 10

The discharge of well 405, in area 9, is about 1,000 gallons a minute, but it is not used continually. Well 406, in area 10 overflows constantly at the rate of about 200 gallons a minute. The total draft from these two areas is estimated at 300,000 gallons daily.

NONARTESIAN AREAS

Only well 334 draws water from Koolau basalt in the area between Haleiwa and Waimea. The pumpage from this well is given on page 315. In the area east of isopiestic area 5 only dug wells 36 and 38 definitely draw their supply from Koolau basalt, although it is evident that some of the others entering coastal-plain sediments are supplied from it. The average draft from dug wells 36 and 38 is roughly estimated at 200,000 gallons a day.

TOTAL DRAFT

The total draft from the artesian and nonartesian areas in Koolau basalt in the years for which records are fairly complete is given in the table below. Probably over 90 percent of the water listed as pumped from the various areas is artesian. However, the separation of the two types of water is not significant, as they are both supplied by the same aquifer.

Total draft from Koolau basalt, 1928-33, in millions of gallons

Area	1928	1929	1930	1931	1932	1933
1.....	a 2,970	a 2,100	2,110	2,110	2,370	2,600
2.....	a 5,860	a 5,340	4,260	4,240	3,570	3,220
3.....	a 2,880	a 3,780	3,400	3,510	2,970	2,840
4.....	a 1,370	a 1,280	1,620	1,840	1,930	1,800
5.....	a 360	a 360	a 360	a 360	a 360	a 400
6.....	57,260	58,130	47,530	59,420	51,890	58,600
7.....	b 11,070	b 15,760	b 9,500	d 15,510	d 8,270	d 15,990
c 8.....	9,200	9,600	9,700	10,100	9,900	11,500
9.....	0	0	0	0	a 10	a 20
10.....	a 100	a 100	a 100	a 100	a 100	a 100
Outside these areas.....	1,700	2,050	1,000	1,550	700	2,300
	92,770	98,500	79,580	98,740	82,070	99,370
Average daily.....	253	270	218	271	224	272

(a) Mostly estimated.

(b) Includes an estimate for the discharge of wells 325, 326, and 333.

(c) Draft for Late Plantation estimated prior to September 1931.

(d) Includes estimate for discharge of wells 325 and 326.

The average daily draft from the Koolau basalt from 1928 to 1933 was 251 million gallons. The Laie plantation used only a small amount of water; hence any error in estimating its draft does not appreciably affect the total for the other years.

SAFE YIELD OF THE ARTESIAN AREAS

By H. T. STEARNS

Effect of salt and type of well on the safe yield.—The term "safe yield" as defined by Meinzer³³ designates the rate at which water can be withdrawn from an aquifer for human use without depleting the supply to such an extent that withdrawal at this rate is no longer economically feasible. The economic limit of withdrawal of artesian water on Oahu depends more on the salt content of the water than on the pumping lift.

During the last decade more and more wells in the Honolulu area have been plugged because of defective casings or abandoned because of salt. By abandoning virtually all the rest of the wells and sinking wells of the Maui type into Koolau basalt at the ends of the spurs adjacent to Honolulu it would be possible to increase the safe yield of the basin without appreciably increasing the pumping lift.

The Maui type of well consists of either a vertical or an inclined shaft, driven a few feet below the water table, with one or more horizontal tunnels driven from the bottom of the shaft to skim fresh water from the upper part of the zone of saturation. Although it is not essential for the shaft to be in water-bearing rock, the tunnels are always driven into permeable basalt, the location of which is often predetermined by test holes. The most effective direction to drive these tunnels is generally at right angles to the strike and inland across the dip of the lavas. Where the zone of fresh water is thick, as it is under most of Oahu, tunnels may be unnecessary. The pumping machinery is placed in a chamber at the bottom of the shaft, and the shaft is locally deepened to provide a sump for the suction pipes. The well is usually dug at the altitude from which the water is to be distributed, thereby saving pipe line. The shaft is either lined or unlined according to the character of the materials encountered, but the tunnels are not lined. A well of the Maui type encounters a much greater amount of pervious rock than a drilled well, but the essential difference is that the Maui well skims the fresh water from the top of the zone of saturation, whereas the drilled well passes through many feet of non-water-bearing rock and then must penetrate deep into the zone of saturation in order to have an effective yield. The

³³ Meinzer, O. E., Outline of ground-water hydrology: U. S. Geol. Survey Water-Supply Paper 494, p. 55, 1923.

drilled well therefore derives its supply from the lower part of the zone of fresh water rather than from the upper part (fig. 5A).

With wells of the Maui type it is safe to lower the water level either to or a little below sea level, and because the aquifers are highly permeable the cone of influence is greatly extended. This lowering of head would decrease the natural discharge from the basin now occurring through overflow and upward percolation through the confining beds. Because of the low gradients of the water table this lowering of the head would greatly increase the flow into the pumped area. Thus water would flow into the Honolulu area from adjacent regions, so that the net result would be to increase the size of the recharge area.

As it costs less to build a well of the Maui type than to drill a battery of artesian wells, the safe yield of the basin can be increased economically. The Maui wells will likewise recover greater amounts of water safely in the areas being pumped by the plantations. In Honolulu the danger from salt is far greater in times of drought than in the other artesian areas because the draft from areas outside of Honolulu is not as great in proportion to the supply.

Areas 1 to 4.—The yield of the Honolulu artesian basin for a period in which the head is exactly the same at the end as at the beginning can be approximately computed for that head by measuring the draft. The recharge for the period amounts to this yield plus the natural discharge from the artesian basin. As the leakage from certain defective wells has been stopped in recent years, the amount of this leakage can be added to the recoverable yield of the area. Because the cone of influence widens progressively as the head is lowered and because the natural leakage from the artesian basin is simultaneously reduced, it follows that with the same rate of recharge the yield will be greater for low heads than for high heads.

The safe yield of isopiestic areas 1 to 4 of the Honolulu area has been estimated by McCombs²⁴ and Kunesh²⁵ as about 42 million gallons a day. A comparison of their results for the various areas follows:

Safe yields of areas 1 to 4, in million gallons a day

Area no.	McCombs		Kunesh	
	Intake method	Water-level method	Intake method	Water-level method
1	10	10	} Not computed separately	9
2	21	6		19
3	a 12	15.4		9
4		a 12		4
	43	43.4	42	41

(a) Estimated by comparison of areas.

²⁴ McCombs, John, Methods of estimating safe yield of Honolulu artesian area: Honolulu Sewer and Water Comm. Rept. for 1926, pp. 55-65.

²⁵ Kunesh, J. F., Honolulu Sewer and Water Comm. Rept. for 1929 pls. F and 13, 1929.

The loss from leaky wells repaired since 1928 amounts to 2.8 million gallons daily, of which 2.2 million gallons is in area 2. This brings the present safe yield as calculated by Kunesh by the water-level method up to 43.8 million gallons daily. A total leakage of 3.8 million gallons daily has been stopped since McCombs made his calculations; hence the safe yield by his water-level method would be 47.2 million gallons daily. Although the totals computed by McCombs and Kunesh are nearly the same, there is a wide discrepancy for the individual areas. The chief error in computing safe yield by the water-level method lies in the quantity of water pumped out for the period used. Kunesh recognized this error and on July 1, 1929, started measuring the draft from each well in Honolulu. Monthly records of draft are given on page 273. With these new draft data the following results were obtained.

Yield of areas 1 to 4 for given static levels

Area	Period		Well no.	Static level (feet)		Draft (million gallons a day)	
	Start	End		Start	End	Measured	Average
1	Oct. 24, 1929	Aug. 25, 1931	9	24.41	24.41	5.1	[5.5
	Nov. 2, 1931	Mar. 17, 1932	9	26.65	26.64	5.8	
	Dec. 31, 1929	Apr. 1, 1931	11	25.50	25.50	5.7	
2	Mar. 29, 1930	Apr. 1, 1931	83	29.40	29.40	11.6	[12.1
	May 15, 1929	June 1, 1931	83	28.66	28.66	12.7	
3	June 25, 1929	Oct. 6, 1931	119	27.22	27.22	9.8	[9.85
	May 21, 1929	May 30, 1931	132	28.83	28.83	9.9	
4	Dec. 29, 1929	May 31, 1931	144	26.97	26.97	4.7	[4.55
	June 22, 1929	Sept. 31, 1931	144	25.82	25.80	4.4	
						32.00	

Leakage from wells in area 2 during these periods, since stopped, amounts to 1.1 million gallons daily, which, when added to the average yield, gives a recharge for the four isopicstic areas of about 33 million gallons daily for these particular periods. As the pumping records used were determined by meters, the error is probably not more than 5 per cent. The recharge rate will vary for any period according to the rainfall on the intake area; hence the variations in the results obtained do not indicate errors. They were averaged, however, to iron out lag in the response of the static level to rainfall in the mountains. If the rainfall was normal for the periods involved, it follows that about 33 million gallons daily is the safe yield for these static levels in these four areas. Various factors make it difficult to determine whether the periods used were normal, because the amount of recharge varies with the distribution and intensity of the rainfall as well as with the amount, and because a sufficient number of stations to determine the rainfall accurately did not then exist in the recharge areas. A rough calculation suggests that the absorption was nearly normal and therefore 33 million gallons daily seems to be a close estimate of the safe yield of the four Honolulu artesian areas if the head is to remain at these levels. The total draft from these areas in

1932 amounted to 29.6 million gallons daily, which leaves a daily increase in storage of about 3.4 million gallons. As 1932 was a wet year, the increase in absorption combined with the decrease in draft caused a marked recovery in artesian head.

On page 260 it was pointed out that area 2 prior to development probably discharged westward toward the Pearl Harbor Springs. Obviously for each foot the head is lowered the cone of influence widens. If the head is lowered sufficiently to cause a hydraulic slope toward these areas from outside areas the yield will increase proportionately. Thus, the yield of these areas will vary for different heads, even though the rainfall on the recharge area remains constant. For example, in the section "Undeveloped water supplies-area 4," a method is described for increasing the yield of area 4 from about 5 million to about 20 million gallons daily by drawing water from area 6.

Area 5.—The yield of area 5 can be estimated on the basis of the intake method. Koolau basalt in the intake area of area 5 covers 4,323 acres, and the average daily rainfall amounts to about 17,000,000 gallons according to the isohyetal map of Oahu.³⁶ The annual rainfall ranges from 20 inches near the coast to over 100 inches near the summit.

The adjacent Kaimuki area (area 1) has been computed to have a safe yield of about 5,500,000 gallons daily. This area has an intake area of 2,640 acres and an average daily rainfall of about 16,700,000 gallons. However, area 5 has 1,688 acres in which the average annual rainfall is less than 30 inches, as compared with 228 acres in area 1. A more conservative comparison for the purpose of determining recharge is made by computing the average daily rainfall exclusive of these areas of low rainfall, which then amounts to about 16,200,000 gallons for area 1 and about 13,200,000 gallons for area 5. The safe yield of area 1 is about 33 percent of this rainfall. Applying this percentage to the corresponding rainfall in area 5 indicates a safe yield of about 4,500,000 gallons daily. As the present draft in area 5 does not exceed about 1,000,000 gallons daily, there is apparently about 3,500,000 gallons that may be recoverable.

Area 6.—The changes resulting from draft in area 6 from 1910 to 1933 are illustrated in plates 29 and 30 by the static level of wells 190, 193, 201, 244 and 266. The static level of wells 190 and 193 indicates a decline of possibly 6 inches since 1910 near Aiea but this difference may be caused by using two different wells for which there may have been an initial difference of this amount. Well 201 indicates a drop of about 3 feet in the static level near Pearl City but because fragmentary records on other wells in this area do not

³⁶ Honolulu Sewer and Water Comm. Rept. for 1929, pl. A, 1929.

show an equal decline, this well may have sprung a slight leak about 1923. Well 244 near Waipahu and well 266 near Ewa do not show any appreciable decline in static level since 1910. Consequently, there does not appear to be appreciable overdraft in this artesian area. The average draft from area 6 from 1928 to 1933 was 152 million gallons a day. Besides this draft, overflow from the basin at the Pearl Harbor Springs amounts to about 83.5 million gallons a day, which when added to the draft gives the safe yield of this area at the existing head as about 235 million gallons a day.

Area 7.— The artesian head in area 7, as shown by well 326 (pl. 29) has not declined since 1911, indicating that the average daily recovery of about 33 million gallons is not causing overdraft. As this area is supplied by the great reservoir of ground water extending under the Schofield Plateau to Pearl Harbor, there is no great danger of overdraft. The head in this area is 10 feet lower than in area 6. A further decline in head ^{in area} 7 should simply drain to it water that is now moving southward to Pearl Harbor. Because the head of area 7 is lower than that of area 6, the crest of the ground-water divide between the two areas is probably south of the topographic divide, so that the water table in the Koolau basalts in the vicinity of Wahiawa may be about 20 feet above sea level.

Area 8.— The static level of wells 337, 356, and 396 illustrates the changes resulting from draft in area 8 since 1910 (pls. 29 and 30). No record exists of wells 356 and 396 between 1918 and 1923 and during this time there appears to have been a decline of about 1 foot. However since 1923 there is no evidence of further decline; hence the average daily recovery of about 27 million gallons is not causing overdraft. This basin has a very wet recharge area and a narrow coastal plain where very little additional water can be used; hence there is no danger of overdraft at present. The area can stand further development.

Areas 9 and 10.—The intake region behind areas 9 and 10 is adequate to supply a much greater quantity of water than is used at present. It is believed, however, that because of incomplete cap rock, new development on a large scale should be effected by tunnels a little above sea level rather than by drilled wells:

CURTAILMENT OF WASTE AND LOSSES OF ARTESIAN WATER

By K. N. VAKSVIK

UNDERGROUND LEAKAGE IN ARTESIAN WELLS

The detection of underground leakage in artesian wells on Oahu has been confined mainly to the four artesian or isopiestic areas in Honolulu. As many of the wells in these areas were drilled prior to

1890, the casings in some of them have given way in recent years and allowed artesian water to escape into porous strata between the cap rock and the land surface. In most wells these leakages occurred in coral formations, which are so porous and contain water under so little hydrostatic pressure that the artesian water readily flows through them and wastes into the sea. The coral formations below sea level contain water of high chloride content, which is very corrosive, so that most of the leaks, in the casings occur in those strata.

DETECTION OF LEAKS

Bench marks referred to mean sea level have been established on all wells in Honolulu so that the static level on them can be measured. As stated elsewhere in this report, the static level in all wells that do not leak in any isopiestic area should be nearly the same. Automatic water-stage recorders are maintained in continuous operation on certain unused nonflowing artesian wells in each of the four areas, so that the normal static level in any area can be determined by referring to the automatic recorder installed in that area.

These recorders are checked once each month by readings of static level on other wells near them. The static levels of all the wells in Honolulu, except a few inaccessible wells used for industrial purposes, are measured periodically. The results are compared with the readings on the automatic recorders, and if the static level of one of them should be less than normal the well is suspected of being defective.

A subnormal head in a well does not, in itself, constitute positive proof of a defective casing. Several measurements made on well 23 showed that it had a static level only half as high above sea level as the normal for the area. At first it was thought to be leaking, but later investigation proved that the low static level was due to the high chloride content and consequently high specific gravity of the water in the well. Being 810 feet deep, it was so seriously contaminated by sea water that a sample of water taken while it was being pumped in 1926 had a salt content of 1,097 grains a gallon (11,400 p.p.m. of chloride) and over 1,250 grains in 1928. Sea water has a salt content of about 2,020 grains a gallon. The water from this well therefore had a specific gravity of 1.012, compared with 1.024 for sea water and 1 for artesian water, and as the head above mean sea level is caused by the differences in the specific gravity of artesian and sea water the measured static level on well 23 was computed to be correct.

An examination of the well by means of a deep-well meter did not disclose any leak in the casing. The subnormal heads on several other wells were found to be caused by specific gravity higher than that of fresh artesian water. However, a subnormal head on a well that

yields fresh water may be regarded as almost unmistakable proof of a leak, providing there is not heavy draft close by.

To obtain definite proof of a leak in a casing it is necessary to introduce into the well an instrument that will indicate flow or movement of water. The device used at present is the 3-inch deep-well meter, which is fully described by Fiedler.³⁷ The practice in Hawaii is to cut off all flow at the surface of a well to be tested, in case it is a flowing well, by means of a standpipe, and to have the well open so that a meter can be lowered in it. Then, if the casing is not leaking, there will be no movement of water in the well. The meter is lowered from the top a short distance, and a measurement of velocity is made with the meter at rest. When the measurement is recorded the meter is lowered a short distance farther and another measurement is made. This procedure continues downward at regular intervals to the bottom of the well. Care is taken throughout the test to be assured that the meter is operating properly, by listening at the ear phones while the meter is being lowered through the water. While in motion the meter will record velocity, but while at rest and if no leak has been encountered it will record zero velocity.

When it is lowered to a point below a leak, a movement of water will be detected as the water flows upward to it. In this manner the location of the leak is determined. If the meter has been rated, a fair estimate of the discharge through the leak can be made. An accurate measurement of discharge cannot be made, as the insides of the older well casings are coated with scale, which may be as much as an inch thick, so that an exact cross-sectioned area cannot be determined unless the well has been cleaned out or "swedged" beforehand. This is usually done after the meter test has been made, as it is an expensive operation and weakens the casings so that there is danger of losing the meter by a cave-in if it is inserted after the swedging has been completed.

RECASING WELLS

Under the laws of the Territory of Hawaii the owner of an artesian well that has been found defective must repair it or allow it to be permanently sealed by the city and county authorities. If the owner desires to continue using the water from the well after a leak is found some distance below the ground surface, he must engage an expert well driller to recase it. This work consists essentially of inserting a new casing within the old one, the result being a new well of smaller diameter. The work is done under the strict supervision of the chief hydrographer of the Territory and must be so carefully done that only an experienced well driller with adequate equipment

³⁷ Fiedler, A. G., The Au deep-well current meter: U. S. Geol. Survey Water Supply Paper 596, pp. 24-32, 1928.

should undertake it. A good description of the methods used in recasing wells in Honolulu is given by McCombs.³⁸

The following table shows wells in Honolulu that have been recased and the quantities of water saved thereby. Several wells have also been recased on Oahu outside of Honolulu, but very little is known as to the amount of waste that was curtailed.

Wells recased in Honolulu and waste stopped

Well no.	Date recased	Loss in head (feet)	Original diameter (inches)	Diameter after recasing (inches)	Underground loss stopped by recasing (million gallons a day)
38	1907	(?)	6	3	(?)
102	July 1917	10	12	10	0.50
14	Feb. 1920	9.0	8	6	.55
94	June 1920	15.8	10	8	.65
101	Aug. 1920	14.0	10	8	.50
148	Sept. 1920	10	8	.20
85	Feb. 1924	4.8	10	8	.10
64	Aug. 1924	0.0	6	4	.00
83	Sept. 1924	18	8	6	.75
96	June 1925	2.7	10	8	.20
33	Feb. 1926	1.5	8	6	.10
97	Dec. 1926	13.67	7	5	.60
99	Feb. 1928	5.5	8	4	.30
141	May 1928	0.0	8	6	.00
24	June 1928	2.8	6	4	.20
					4.65

The figures in the column showing underground losses in the above table are estimated mostly by computing the discharge through the leaks on the basis of the losses in head and the estimated cross-sectional area. In view of the uncertainties in the method used, the results stated are conservative.

SEALING WELLS

The laws of the Territory of Hawaii provide that the owner of a well which has become defective may relieve himself of the liability of making the necessary repairs by allowing the City and County of Honolulu to seal it without cost to him. Also those who have wells for which they have no further use may get rid of them in the same manner. To take advantage of this law the owners must relinquish all rights to drill any more artesian wells in the district in which were located the wells that had been turned over to the city and county. However, this provision in the laws did not exist prior to April 1925, so that some of the wells were sealed at the expense of the owners. Well 129 was sealed subsequent to 1925 at the owners' expense, as they did not wish to give up their right to develop more artesian water. In 1928, beginning with well 67, the Honolulu Sewer and Water Commissioner undertook a program of sealing in Honolulu. This commission sealed 22 wells. Only 3 of these had been re-

³⁸ McCombs, John, Methods of exploring and repairing leaky artesian wells on the Island of Oahu, Hawaii: U. S. Geol. Survey Water-Supply Paper 596, pp.15-17, 1928.

ported defective; the other 19 were in good condition but were of no use to the owners and represented potential sources of underground leakage if their casings should give out. By the end of 1930 there had been 39 wells sealed on Oahu, all but 2 of them in Honolulu.

The permanent plugging of these 39 wells required a considerable variety in the methods used. Those wells that still had casings in good condition offered no particular problems and were sealed by a standard method that has been evolved here. The first step in this method is the cleaning out of the well. This is done by lowering swedges of various sizes down into it, beginning with one of small diameter. When the smallest one has been lowered to the bottom of the well and withdrawn one of a slightly larger diameter is lowered. This is in turn replaced by a larger one, and so on until the last swedge which will be about an inch less in diameter than the inside of the casing. Great care must be exercised in lowering these swedges, particularly the last one, as in many wells the casings are old and may collapse if injured. This danger necessitates the use of a set of jars with each swedge that goes into the well. Obstructions in a casing such as rocks or other debris are knocked down into the well below the casing by the swedges, as a rule, without much difficulty, although in so doing there is again danger of causing a collapse of the casing. If there is an accumulation of mud or other soft material at the bottom of the well it is removed by means of a sand bailer.

Drillers' logs or complete descriptions did not exist for some of the wells sealed in Honolulu. These wells were explored with the deep-well meter to determine the location of the bottom of the casing or the top of the aquifer. A uniform flow of water from the top of the well was obtained by leaving it open if it flowed naturally or by means of a pump if it was nonflowing. Then the meter was lowered into the well, and readings of velocity of flow were taken at regular intervals. The meter should register a uniform velocity throughout the casing if it was of the same diameter from top to bottom. If the well is not leaking the meter should register the same velocity down to a certain point and then show an increased velocity which continued downward uniformly for some distance, a reduction in size of casing was indicated. This was easily verified by means of the swedges. As soon as the meter began to show less velocity which decreased down to or nearly to zero, it was obvious that the meter had passed the bottom of the casing. The casings are generally seated in the cap rock, and it is in this formation that the plug must be placed. As a rule the location of the bottom of the casing was checked by "fishing" with a bolt, slightly shorter than the diameter of the casing, fixed horizontally on the end of a well tool.

When it is known where the plug is to be placed, all flow from the well is stopped, a standpipe being used if necessary, and the sealing operations are begun. The plug is made of neat cement. Concrete has been used successfully in the past, when deposited by a dump bucket, but neat cement has the advantage of being more fluid, so that it can be deposited through a 2-inch pipe and can penetrate any cracks or openings in the cap rock and pass up around the bottom end of the casing if there are leaks at that point. Also there need be no worry about separation of aggregate. The only disadvantage is that more cement is required. However, to decrease the amount of cement used to make the plug the lower part of the hole or the portion that is in the aquifer is filled by other material. Recently it has been the practice to use iron turnings or punchings for this purpose whether or not there is movement in the water, although where the water is not in motion sand or small-sized crushed rock would serve just as well. In a few wells the velocity at the bottom was so high that crushed rock would not remain in place, making the use of iron necessary. Even lead had to be used in one well.

The iron is lowered to the bottom of the well by means of a dump bucket.³⁹ The part of the well that is in the aquifer is nearly filled with this material, as it has been found to be much cheaper than cement, and nothing is gained by having the plug extend very far down into the water-bearing formation.

When the iron fill is in place the cement plug is placed above it. This is done by first lowering a string of 2-inch pipe so that it extends from the top of the well down to a point a few feet above the iron. Enough water is mixed with the cement to make a grout. This is poured into the 2-inch pipe through a sieve to prevent any lumps entering the pipe to clog it. Usually the cement goes down by its own weight, but if it does not a rotary pump is used to force it down. At intervals while the cement is being poured in, the string of pipe is raised so that the lower end will be above the cement fill.

It is difficult to determine whether or not the lower end of the pipe is entirely free of the fill, but the ease with which the pipe will turn indicates whether or not it is very far into the cement. The filling is continued until it is 10 feet or more up into the well casing, so that if there is an opening outside the casing some of the cement can come up outside, thereby forming a seal both outside and inside of the casing. When the cement has been allowed to set for about 4 days, a test is made to determine the effectiveness of the plug by lowering the water level in the well about 20 feet or more with either a pump or a bailer. If after the pumping or bailing is stopped the water level re-

³⁹ McCombs, John. *op. cit.*, p. 18.

mains at the same level for about half an hour the well is considered properly sealed. The remainder of the hole is then filled with sand or other similar material, and the well can be forgotten, as this type of seal is permanent.

Defective wells usually required variations in this method of sealing, although it has been followed in a general way in most wells since early in 1926. Prior to that time wells were sealed in a manner described by McCombs, in his paper already cited. As a rule, defective wells, particularly those in which the casings had caved in or were liable to cave in, were temporarily recased with a smaller pipe, so that the sealing operations could be carried on without danger of the well tools being caught by cave-ins, and also to cut off a portion of the leakage, so that material deposited at the bottom of the well would not be carried out through the leak by the high velocities that existed in the water below the leaks in several of the defective wells.

As the smallest dump bucket used was about 3 inches in diameter, it was desirable to use 6-inch pipe for the temporary casing, although 4-inch pipe has been used successfully. To get it down to the proper depth the well had to be cleared of obstructions and cave-ins by means of swedges. The 6-inch pipe was then inserted and lowered into the well, one section at a time, until it extended from the top to a level below the lowest danger point. Usually this pipe would go down by its own weight. However, if it did not, turning the pipe with wrenches would generally obtain the desired result.

Great care was exercised to avoid forcing the pipe down, so that the old casing would not be damaged more than was necessary. Tearing the casing would increase the leakage that would have to be cut off and would make it more difficult to lower the temporary pipe into place. A few of the wells to be sealed were found to be filled with dirt, gravel, and other debris, which had to be cleaned out by means of the small wash-boring drill before the pipe could be lowered into the well. When the pipe was in place the sealing of the well by the standard method proceeded with little or no difficulty. When the job was completed the 6-inch pipe was removed from the well, to be used again on some other well.

Although the method of sealing defective wells in Honolulu is now fairly standardized, exactly the same procedure cannot be used in each well, because of the variations in the types and extent of the leaks and obstructions found in them. Some wells have only one leak, which can easily be cased off. Others may have several leaks or cave-ins or may be filled with debris. Several unsuccessful attempts by unskilled men to seal wells added considerably to the work and expense of sealing them properly. To give a better idea of the procedure

in sealing defective wells in Honolulu detailed descriptions of the methods used on several wells are given below.

An example of the method now used in Honolulu was the sealing of well 76, on Birch Street. (fig. 23). It was a 6-inch well and one of

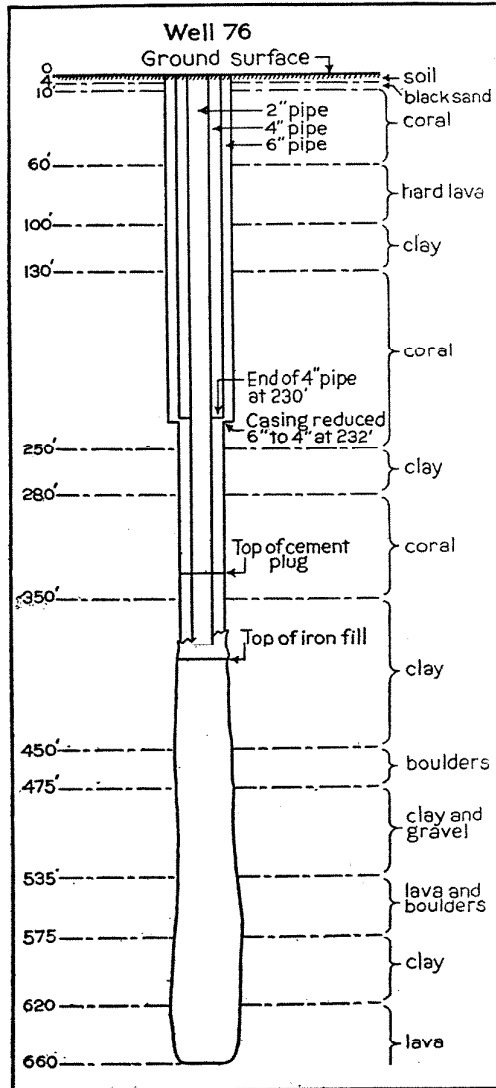

FIGURE 23.—Log and character of plug in well 76.

the first in Honolulu, having been drilled in 1881, but was abandoned prior to 1918 because of a defective casing. As the owner had no further use for the well, when funds for sealing the well became available in 1926 he turned it over to the City and County of Honolulu, and the work was started in October of that year. The driller found the well to be in very bad condition. The hole was obstructed with debris from the surface to a depth of 240 feet, which was cleaned out by means of a 1-inch water-jet drill operated inside a 2-inch casing. The water in the well then stood at about 8 feet above mean sea level; the standard for the locality at that time was 23.65 feet. When the debris was cleaned out the 1-inch water-jet drill was removed, and other tools were lowered into the well to determine the length of casing and the depth. The friction of these tools on the side of the casing caused a cave-in at a depth of 107 feet

in a stratum of clay, and while the operator was trying to drill through this obstruction a second cave-in occurred above the 43-foot depth, which jammed the tools to such an extent that they were withdrawn only after considerable difficulty and with pieces of the casing adhering to them. To avoid further cave-ins, a temporary casing of 4-inch pipe was inserted into the well and lowered to the first cave-in.

Then a percussion drill that would just pass through the 4-inch pipe was lowered into the well and the obstruction was drilled through, the 4-inch pipe following closely behind, so that the drill was never more than 2 feet beyond the pipe. The pipe was finally stopped at a depth of 230 feet, and as the original well casing was reduced from 6 inches in diameter to 4 inches at a depth of 232 feet the 4-inch drill was removed, and the 1-inch water-jet drill with its 2-inch casing was inserted and continued on downward beyond the 4-inch pipe through crumpled-up casing at 334 feet and other obstructions down to a depth of 382 feet. From this point the well was found to be clear to the bottom at 656 feet. The 1-inch drill was then taken out, but the 2-inch casing was left in place, so that the materials used in making the seal could be passed through it, and the placing of the plug was then begun. The static level had risen from 8 feet to 19 feet, indicating that most of the underground leakage had been stopped, thereby considerably reducing the velocity in the well.

Through the 2-inch pipe 2,680 pounds of iron filings and punchings, which had been obtained from a local machine shop and from which the larger pieces had been carefully removed, were passed to the bottom of the well by dropping a few pieces at a time into the tip of the 2-inch pipe. This was necessarily a tedious operation, as it was found that when the workmen became a little impatient and dropped in whole handfuls at a time the iron would bridge and clog the pipe. The 1-inch water-jet drill then had to be inserted to clear the pipe, causing a delay of perhaps several hours each time this occurred. Of course the dump-bucket method of depositing the iron is much more rapid, but it could not be used in this well as it is not practicable to use a bucket small enough to pass through a 2-inch pipe.

When the iron fill had been built up from the bottom to 390 feet, or a total of 266 feet, the top of it was well into the clay cap rock. The cement plug was then placed on the iron fill by pouring a rather sloppy mixture of neat cement into the top of the 2-inch pipe. The cement was mixed in several tubs, so that as one tub was emptied pouring was started from another, thus making the placing of the cement plug one continuous operation. The cement was poured in until the plug extended from 390 feet up to 334 feet, or a total of 56 feet. The 2-inch pipe, part of which had been taken out during the filling operation, was then entirely removed from the hole. After the cement had been allowed to set for 4 days the water in the hole was bailed out until it stood at about sea level. As the water surface did not rise after 20 minutes, the well was pronounced permanently sealed, the 4-inch temporary casing was removed, and the remainder of the hole was filled with sand and debris.

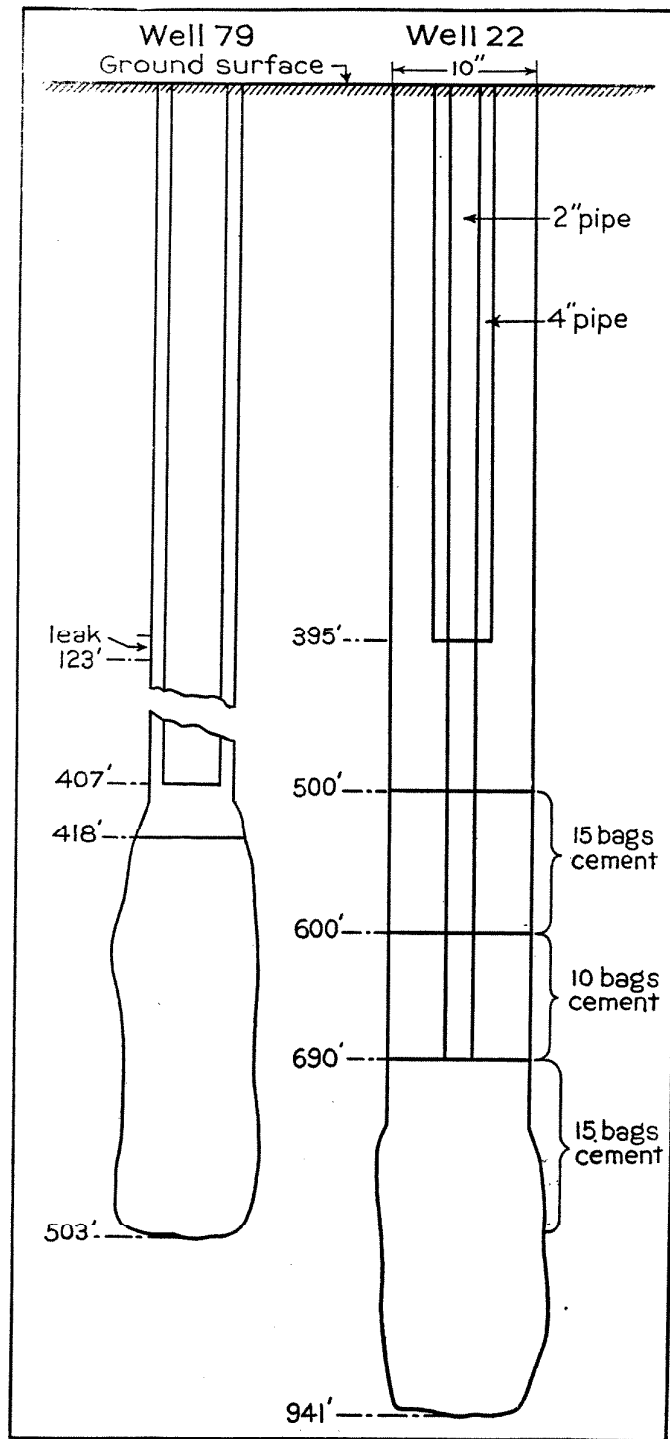

FIGURE 24.—Plugs in wells 22 and 79.

Early in 1927 well 79, known as the "Vida Villa well," on South King Street, was sealed (fig. 24). It was 6 inches in diameter, was drilled in 1884, and was known to have been defective prior to 1918. Other than that no description of the well was available. In January

1927 the owners turned the well over to the City and County of Honolulu for sealing, and work was started in February. As the well was found to be 503 feet deep and free of obstructions, a test was made with a deep-well meter to determine the location of the leak. This was found at 123 feet below the ground surface. To avoid cave-ins and to cut off as much of the leak as possible a 4-inch temporary casing was inserted into the well to a depth of 407 feet. This reduced the leakage so much that the static level in the well rose from 12.05 feet to 24.35 feet; the standard for the vicinity was 24.86 feet. The sealing operations were then begun.

As the 4-inch temporary casing permitted the use of a dump bucket, all the iron was placed by this method. About 7,500 pounds of iron fill was placed that extended from the bottom at 503 feet up to 418 feet. When the iron fill reached 418 feet practically all the flow of water from the top of the well had ceased indicating that that part of the hole which was in the aquifer was entirely filled with iron. Then the same dump bucket was used to place the plug on top of the iron.

Ten bags of cement made a plug of neat cement 143 feet long, which extended from 418 feet up to 275 feet. Lengths of the temporary casing were withdrawn, so that the lower end was always above the cement that was being deposited. After the plug had been allowed to set for several days the water in the hole was bailed out to about sea level, at which point the water surface remained stationary for about 20 minutes. The deep-well meter was then lowered into the hole just above the plug and registered zero velocity. The well was then considered permanently sealed, the remaining temporary casing was taken out, and the rest of the hole was filled with debris.

Well 22 (fig. 24), at the corner of Kalakaua and Liliuokalani Avenue, was a very difficult one to seal. It was drilled in 1894 for municipal supply but within a year the water from it was too brackish to use and it was therefore abandoned. A few years later, when Kalakaua Avenue was widened and paved, the engineer in charge of the work had the well filled with sand, crushed rock, and concrete in an attempt to seal the well permanently. However, this job was not considered a thorough one, so when funds became available in 1927 an expert well driller was engaged to seal it properly. Ten weeks was required to do this work. All that was known about the well was that it was 10 inches in diameter and was drilled 941 feet deep.

When the driller started work he found the top of the well filled to a depth of 4 feet with concrete. When this was penetrated by a 6-inch drill the water was found to be standing at about 6 inches above mean sea level. Then a 4-inch temporary casing was started down through the crushed rock and sand with which the hole was filled. The 1-inch water-jet drill operating in a 2-inch pipe was used to clean out the material encountered by the 4-inch pipe.

By this method the 4-inch pipe was extended downward until it was finally stopped at a depth of 395 feet. The 2-inch pipe was continued downward, however, to the depth of 690 feet. By this time the friction between the 2-inch pipe and the materials surrounding it was so great that there was danger of collapsing the pipe if it was forced farther down. About 300 yards away was well 21, for which a driller's log was available. According to the log this well was 850 feet deep with the top of the water-bearing rock at 728 feet and the top of the cap rock at 700 feet. It was therefore assumed that the cap rock in well 22 was only a few feet below the end of the 2-inch pipe. As it was

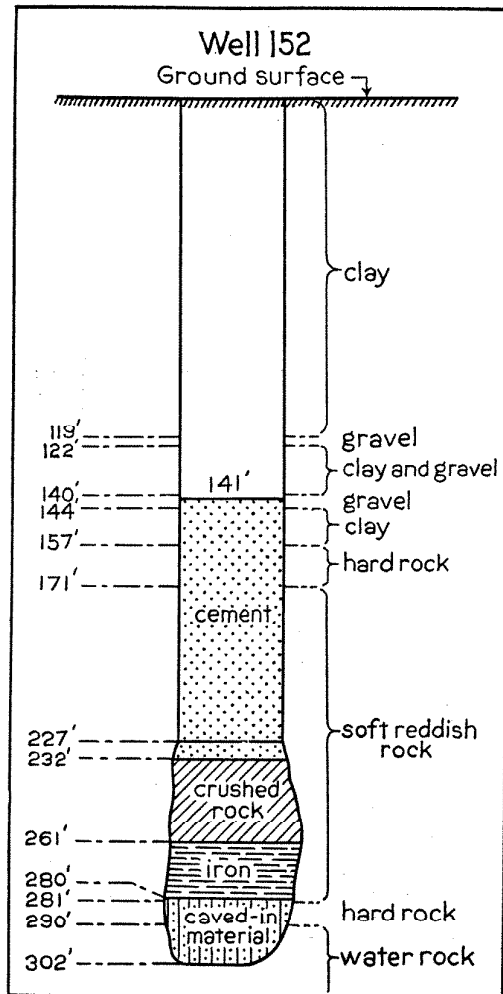

FIGURE 25.— Log and character of plug in well 152

Well 152, at Fort Shafter, was sealed in January 1929, by the Honolulu Sewer and Water Commission (fig. 25). All the measurements of static level and a meter test showed that there was no underground leakage. It was 12 inches in diameter and was drilled in 1906 to a depth

not considered practicable to try to clean out the well farther, the driller began to deposit neat cement in the well, using the 2-inch pipe as a tremie. With the tremie at 690 feet 15 bags of cement was deposited. The tremie was then gradually raised from 690 feet to 600 feet as an additional 10 bags of cement was deposited.

Between 600 and 500 feet 15 bags of cement was deposited as the tremie was raised gradually. Thus 40 bags of cement, making about 40 cubic feet of neat-cement grout, was placed in the well below the depth of 500 feet, of which 15 bags was below 690 feet, so there was a reasonable certainty that much of the cement penetrated down into the portion of the hole that was in the cap rock, making a plug in that formation which was effective in sealing the well.

of 302 feet, according to the driller's log, with the casing ending at 226 feet. The driller who did the work sounded the well and found it to be 280 feet deep, indicating that there had been cave-ins near the bottom.

Swedges were lowered into the well to make sure that the casings were clear for its entire length. Then iron punchings and chips were lowered in a dump-bottom bucket until there was an iron fill from a depth of 280 feet up to 261 feet, and as the supply of iron ran out No.3 crushed rock was deposited in the same manner until the fill had been raised to 232 feet, or 6 feet below the end of the casing. When this was completed the 2-inch tremie was inserted into the well, and the neat-cement grout was poured in so that a fill was deposited that extended from the top of the crushed rock at 232 feet up to 141 feet. After the cement had been allowed to set for a few days the bailing test was made, and as there was no inflow of water the remainder of the hole was filled with black sand.

Cost of sealing artesian wells on Oahu

Well no.	Date sealed	Depth (feet)		Cement		Iron		Crew of 4 men and rig ^a		Extras ^b	Total cost
		Well	To top of plug	No. of bags	Cost	Lbs.	Cost	Days	Cost		
209	July 1924	230	40								\$1,195.77
78	Oct. 1924	497	442								2,614.57
106	Sept. 1925										1,125.00
16	Oct. 1925	746	623	18	\$ 13.95	6,600	\$13.20	22	\$1,870.00	\$1,016.57	2,913.72
17	Dec. 1925	825	568	10	8.00	6,955	13.91	23	1,955.00	^c 723.53	2,700.44
15	Jan. 1926	860	268	10	8.63	7,400	14.80	31¼	2,656.25	^d 1,107.66	3,787.34
4	Mar. 1926	286	162	10	9.00	9,100	18.20	14	1,190.00	633.03	1,850.23
72		340	207								1,295.00
135		600	197								1,820.00
76	Jan. 1927	656	334	10	7.38	2,680	6.70	^e 35½	3,026.50	524.06	3,564.64
79	Feb. 1927	503	275								1,975.00
21	do.	856	710								1,965.00
139	do.	600	175								1,860.00
129	Apr. 1927	346	167								2,000.00
22	July 1927	941	500	40	29.60	0	0	62	4,650.01	1,746.40	6,426.01
217	June 1928	309	128	65		17,500					^a 1,315.13
12	do.	513	388	14	10.36	6,450	16.13	14¾	1,314.45	83.96	1,424.90
67	do.	194	76	17	12.58	16,150	40.38	7½	635.12	70.29	758.37
56	July 1928	383	277	61	45.14	4,950	12.38	9½	846.83	44.33	948.68
49	do.	281	210	19	14.06	1,400	3.50	7	623.98	62.63	704.17
13	do.	586	424	24	17.76	4,550	11.38	13	1,158.82	18.86	1,206.82
14	Aug. 1928	738	400	97	71.78	800	2.00	20½	1,827.37	137.33	2,038.48
3	Sept. 1928	250	59	73	54.02	0	0	9	802.26	9.25	865.53
19	do.	666	78	155	114.70	3,100	7.25	15	1,337.10	33.94	1,492.99
23	Oct. 1928	810	625	94	69.56	2,450	6.13	13	1,158.82	127.96	1,362.47
34	do.	500	285	54	39.96	4,900	12.25	10	891.40	33.13	976.74
65	Nov. 1928	277	153	120	88.80	9,900	24.75	12	1,069.68	47.39	1,230.62
57	do.	291	200	20	14.80	1,100	2.75	8	713.12	2.63	733.30
138	Dec. 1928	500	284	140	103.60	0	0	12	1,069.68	152.85	1,326.13
84	do.	486	358	25	18.50	2,040	5.10	9	802.26	3.54	829.40
145	do.	212	107	15	11.10	1,700	4.25	8	713.12	2.30	730.77
152	Jan. 1929	281	141	90	66.60	7,410	18.53	17	1,515.38	22.80	1,623.31
123	do.	118	31	40	29.60	0	0	9	802.26	2.84	834.70
46	Feb. 1929	374	250	70	51.80	2,000	5.00	11	980.54	20.94	1,058.28
39	do.	210	56	25	18.50	840	2.10	9	802.26	3.09	825.95
147	June 1929			362	267.88	0	0	88	7,844.32	835.30	8,947.50
41	do.	242	3	39	28.86	1,760	4.40	8	713.12	4.99	751.37
5	May 1930	162	50	65	48.10	2,690	6.73	9½	813.40	8.12	876.35

- (a) After July 1927, hire of truck included.
 (b) Includes contractor's and watchman's time, additional labor, machine work, overhead, etc.
 (c) Includes 200 pounds of No. 8 lead shot at \$15 per 100 pounds.
 (d) Includes 1 cubic yard of crushed rock No. 3, at \$4.50.
 (e) Small rig nine and one-half days at \$75. Larger rig 26 days at \$39.

MAGNETIC METHOD FOR LOCATING LOST WELLS

During 1933 J. F. Kunesh, of the Board of Water Supply, successfully located several "lost" wells that were known to exist but had been covered so that no evidence of them was visible at the surface. Most of them were wasting artesian water, and the Board of Water Supply is sealing them as rapidly as they are found. By interviewing people who know about the wells and by tracing down old records and photographs, Kunesh obtains the approximate location of the well. Then with a compass he walks systematically over the area until he finds a point that attracts the compass needle. A well casing, because it extends far into the ground, is strongly negative at the upper end. One well was located by finding an old pipe that formerly led away from it. The well itself was under a building. Another well was located a few inches from the foundation of a house. The building and foundation were badly cracked from settling at the corner nearest the well. When the well was cleaned out a bad leak was found, which was causing the settling of the ground.

With any considerable increase in head some of the lost wells may start to overflow again, thereby indicating their location.

SURFACE WASTE

As early as 1884, only 5 years after the first well in Hawaii had been drilled, some people became alarmed concerning the quantities of artesian water that flowed continuously night and day from the wells and, fearing that the supply might be endangered thereby, caused a law to be passed which required that all wells must be capped and that artesian water could not be used to drive machinery unless it was used later for irrigation or other useful purposes. Apparently this law was enforced to some extent in the early days, because most well owners complied with it. However, it was not until about 1910, after there had been a considerable drop in the static levels of the wells and some wells had become unfit for use owing to high salt content, that measures were taken toward the conservation of this water supply. The Public Works Department began the active enforcement of the law of 1884, which was continued until 1917 and resulted in the conservation of considerable water at the surface and the rousing of public sentiment to such an extent that in 1917 the law of 1884 was repealed and a more effective law was passed which aimed at the curtailment of surface waste of water. This law clearly defined an artesian well and what constituted waste of artesian water. At the same time more funds were appropriated for the enforcement of this law.

Much of the waste had been stopped by the considerable drop in static level, so that some flowing wells ceased to flow and others that

had yielded large quantities of water had their discharges reduced. Still there were many flowing wells with discharges ranging from 200,000 to 2,000,000 gallons a day from which large quantities were permitted to go to waste. The ignorance or indifference on the part of some of the well owners was the principal cause of this waste as they were convinced that the artesian supply was unlimited, and, therefore, permitted their wells to run wide open day or night, regardless of weather conditions, whether the wells were equipped with valves or not. On many wells the valves were broken or lacking entirely, so that all the flow from them could not be shut off. On others the valves were so located and in such a condition as not to be conducive to proper manipulation by the users of the water. The discharges from a few wells were used solely in the operation of water wheels or hydraulic rams.

The enactment and enforcement of the artesian-well law proved to be a good step forward in conservation of this important supply, considerable water being saved that would otherwise have gone to waste.

It is impossible to arrive at a definite figure as to the amount of water conserved in this manner but data accumulated as steps were taken from time to time to enforce the laws in particular cases indicate that the quantity probably exceeded 8 million gallons a day, about three-fourths of which was in the District of Honolulu, where the need of careful use of the artesian water was the greatest. It was in Honolulu that the law was enforced with the greatest vigor, for as the city grew in population with great rapidity the static level of the wells continued to decrease, so that it became imperative that the draft be reduced to only necessary requirements.

Another means by which artesian water was conserved was by the metering of the services of all who used water from the city pumping plants. Until a few years ago the prevailing method of selling the water from the city mains was at flat rates. Obviously this was not conducive to careful use of water, as the people paid the same amount regardless of the quantity of water they used. Attempts were made to regulate the irrigation of lawns by ordinance, but even when several inspectors were employed to enforce the ordinance and also to see that broken and leaky fittings were repaired, an excessively large quantity of water per capita, estimated to have been as high as 350 gallons a day, was consumed.

This led to the adoption of metering, which was begun in 1912 and reached 100 percent in 1930. The following tabulation shows the wisdom of this policy.

Progress of metering services in Honolulu

Year	Popula- tion	Consumers				Water-supplied daily to the municipal water mains (average)			
		Metered	Un- metered	Total	Percent metered	Artesian wells (m.g.d.)	Moun- tain tunnels (m.g.d.)	Total (m.g.d.)	Per cap- ita (gals.)
1915	68,000	897	5,843	6,740	13.3	12.99	3.27	16.26	239
1916	72,000	1,678	5,623	7,301	23.0	12.61	3.43	16.04	223
1917	75,000	1,863	5,691	7,554	24.7	15.26	3.44	18.70	249
1918	78,000	1,965	5,982	7,947	24.7	15.13	3.45	18.58	238
1919	81,000			8,340		17.97	3.45	21.42	264
1920	85,000	2,140	6,711	8,851	24.2	21.47	2.80	24.27	285
1921	90,000			9,040		20.66	3.17	23.83	265
1922	96,000	2,458	7,810	10,268	23.9	19.64	3.63	23.27	243
1923	101,000			11,250		20.96	5.09	26.05	258
1924	106,000	2,400	9,600	12,000	20.0	21.86	2.77	24.63	232
1925	112,000	4,950	7,950	12,900	38.4	22.93	2.30	25.23	225
1926	117,000	6,150	6,575	13,275	46.3	23.65	2.43	26.08	223
1927	122,000	8,450	5,200	13,650	61.9	22.44	3.71	26.15	214
1928	128,000	13,900	500	14,400	96.5	21.12	3.05	24.17	189
1929	133,000	16,340	133	16,463	99.4	20.91	2.42	23.33	175
1930	139,000	17,032	1	17,033	100.0	18.50	3.62	22.12	159
1931	143,000	17,505	1	17,506	100	19.58	2.02	21.60	151
1932	143,000	17,912	1	17,913	100	17.86	1.99	19.85	139
1933	142,000	18,191	1	18,192	100	15.64	1.48	17.12	121

The records prior to 1925, although not as accurate as those of the present time, were probably within 15 percent of being correct, so that the data can be used. It is noteworthy that although there was from 1920 to 1930 an increase of nearly 64 percent in population, in the same period there was a decrease of about 9 percent in the total consumption of city water in Honolulu. The figures given for per capita consumption of water are based on the total population of Honolulu. It has been estimated that in 1920 only 85 percent of the people were supplied by city water,⁴⁰ so that the amounts shown as the per capita consumption should be higher. The percentage of the population having private sources of water supply has decreased considerably within recent years, as a result of the lowering of static level in the wells. However, nearly all the large users of water still have their own sources of supply.

In 1928, when 96.5 percent of the consumers' services were metered, the quantities of water delivered to the city mains and the quantities consumed by the people were compared for the first time, and an alarming condition was disclosed. During the months of August, September, and October of that year a total of 2,379 million gallons was delivered to the mains.

During the same period only 1,452 million gallons was actually consumed, leaving 927 million gallons, or 10 million gallons a day, which

⁴⁰ Larrison, G. K., Honolulu's water supply, p. 35, 1923.

could not be accounted for.⁴¹ This represented a loss of water delivered to the mains of 39 percent, most of which had been pumped from artesian wells. The Honolulu Sewer and Water Commission, which became the Board of Water Supply in 1929, began investigations to determine the causes of the "unaccounted for" water and found that it was due to underground leakage in mains and services; under-registration of meters; services of which there were no records in the waterworks office; fires; flushing of hydrants, mains, and reservoirs; breaks; reservoir overflow and leakage; and pump slippage. Some of these causes are of course legitimate and proper, but the fact remained that the total of "unaccounted for" water was too high. The Board of Water Supply undertook to eliminate the unnecessary losses and succeeded in reducing them considerably. For the year ending September 30, 1930, the amount delivered to the mains was 8,242 million gallons, and the amount actually consumed was 6,126 million gallons, leaving 2,116 millions of gallons actually not accounted for, which was 25.7 percent of the total delivered.⁴² This is equivalent to 5.8 million gallons a day, as compared with 10 million gallons a day "unaccounted for" during the 3-month period ending October 31, 1928, a saving of 4.2 million gallons a day. By the end of 1933 the loss had been reduced to 16.2 percent.

QUALITY

By K. N. VAKSVIK

In the Hawaiian Islands the saltiness of water is generally expressed as sodium chloride (NaCl) in grains per gallon, all chloride being computed as sodium chloride. Strictly, this is not correct, as salt in natural waters includes, in addition to sodium chloride, potassium chloride (KCl) and sometimes magnesium chloride, (MgCl₂) and calcium chloride (CaCl₂) in measurable quantities. As numerous chemical analyses have shown that sodium chloride is by far the predominant one of these salts, however, the assumption that all the chlorides in water are sodium chloride is very nearly correct. The making of a complete chemical analysis of a sample of water is a tedious and complicated operation, so that usually only the chloride content is determined. This is done by titration and, in a well-equipped laboratory, can be accomplished in a few minutes, the result being expressed in parts of chloride per million parts of water, or just parts per million. If it is assumed that all the salt in the water is sodium chloride (NaCl) the quantity in grains per gallon is computed by dividing the amount of chlorides as expressed in parts per million by 10.39.

⁴¹ Larrison, G. K., Water supply: Honolulu Sewer and Water Comm. Rept., for 1929, p. 44, 1929.

⁴² Honolulu Board of Water Supply Rept. for 1931, pp. 98-103, 1931.

Oahu is fortunate in having a large supply of generally good ground water. The sugar plantations, which use by far the largest amount of the artesian water on this island, have developed supplies that, although locally somewhat brackish, are entirely satisfactory for irrigation. Very little of the developed ground water contains more than 1,000 parts per million of chlorides, and most of it contains less than 300 parts per million. Although excessive chloride content of water has a bad effect on sugar cane, the amount that it will tolerate varies with the type of soil, the terrane, and the quantity of water applied to the fields. Several plantation officials have mentioned figures ranging from 700 to 900 parts per million of chlorides as the maximum permissible without impairing the yield of sugar. On one plantation it was found that best results were obtained when the water discharged from a group of wells containing as high as 850 parts per million of chloride was mixed with high-level spring and tunnel water very low in chlorides. On another plantation brackish water from spring-fed sea-level ponds is used for the reason that for certain fields it is the only water available.

Although most people can detect the presence of salt when the chloride content exceeds 200 parts per million, water containing considerably higher quantities of chloride can be consumed by human beings without harmful effect. People who are accustomed to drinking water containing as high as 350 parts per million of chloride have stated that they prefer their own water to that of the Honolulu municipal supply (chloride content from 45 to 72 parts per million), which they consider tasteless. Several families of Japanese living on the west side of the entrance to Pearl Harbor use water from a sea-level spring and several shallow dug wells that have a chloride content of 950 to 1,100 parts per ^{million} gallon.

EFFECT OF OCEAN SPRAY

All natural waters on Oahu have been found to contain salt. As no point on the island is more than 12 miles from the ocean, all of it is reached by fine ocean spray or minute particles of salt that remain suspended in the air when the spray evaporates. This material is blown over the land, and some of it is brought down by the rains. Below is given a table of chloride determinations of rain water at different points on the island.

Chloride determinations of rain water on Oahu, in parts per million

[By H. S. Palmer]

Date	Location	Chloride	Remarks
April 18, 1920	University of Hawaii campus, Honolulu	9	No information given
April 28, 1920	U. S. Coast and Geodetic Survey magnetic observatory near Sisal	10	Single shower of 0.25 inch
May 23, 1920	do.	10	Single shower
May 22, 1920	Manoa Valley, Honolulu	6.5	Single shower of 0.37 inch
June 22, 1920	do.	6	Single shower of 0.33 inch
June 22, 1920	do.	6	Single shower of 0.34 inch
April 2, 1920	Roof of Alexander Young Hotel, Honolulu	11.5	Composite sample of several rains
July 13, 1920	do.	11	Single shower
July 17, 1920	do.	29	do.
Aug. 3, 1920	do.	42	No information given
Aug. 14, 1920	do.	6	do.

All the points at which the samples of rain water were taken are at low altitudes on the leeward side of the island 0.4 to 1.6 miles from the coast. As some of the rain water is lost through evaporation and transpiration before percolating into the rocks, a concentrating effect takes place so that water from high-level springs and tunnels will contain somewhat larger quantities of chlorides. The lowest amount found in the natural waters on Oahu was 18 parts per million in a sample taken from the Waiahole collecting ditch, on the northeast (windward) side of the Koolau Range, at an altitude of 750 feet. Numerous other samples from different sources contained less than 30 parts per million of chlorides. The chlorides found in samples from artesian wells range from 27 to 14,560 parts per million. It is obvious that these large quantities of salt must be due to the incursion of sea water rather than to spray.

CONTAMINATION OF GROUND WATER BY DIRECT CONTACT WITH SEA WATER

Of far greater significance is the contamination that results from direct contact with sea water. The drilling of artesian wells on Oahu has shown that the danger with regard to the encroachment of sea water here is the same as has been encountered in many other localities. Geologists and engineers have known for a long time that in a porous rock formation fresh water, owing to its lower specific gravity, will float on salt water without mixing with it to any large extent and that when water from such a source is pumped faster than it can be replenished the salinity of the water will increase. Lindgren,⁴³ in his studies of the ground waters on Molokai, found that there was a sheet of fresh water floating on underlying sea water and that even moderate pumping on wells drilled below sea level caused the chloride content of the water to increase rapidly. He makes a vague reference to

⁴³ Lindgren, Waldemar. The water resources of Molokai: U. S. Geol. Survey Water-Supply Paper 77, p. 27, 1903.

the counter pressure of sea water, but the Alexanders were the first to develop a clear concept of the relation of sea water to fresh ground water. (See p. 256). On Maui the same situation exists. Several of the plantations on that island originally developed ground water by drilling wells down into saturated rock, but when the water was pumped the salt content rose so high as to render it unfit for use. They found that by sinking a shaft only a few feet below the water table and driving tunnels that would skim off only the top, water of much better quality was obtained.

Along the coast of Florida Sanford⁴⁴ also found a sheet of fresh water floating on sea water. He noted that there was a zone of diffusion between the two waters and that the more open-textured the rock the greater the admixture of salt with fresh water. On the coast of Maine and on adjacent small islands Clapp⁴⁵ found that some wells drilled into water-bearing rock first struck fresh water but when drilled deeper struck salt water. He also stated that in some wells fresh water was obtained at first but continued pumping rendered them salty. Thompson⁴⁶ states that what he believes to be a continuous sand formation lying at a depth of 800 feet at Atlantic City yielded excellent water, whereas at Lewes, Del., about 55 miles away, at depths of 891 to 950 feet, the formation contained water that was too salty for use. Brown⁴⁷ found that along the Connecticut coast near New Haven if wells were drilled too deep contamination by sea water would result. Also he found that continued draft on some wells that originally yielded water of good quality caused the salinity of the water from them to increase so much that many had to be abandoned. Spear,⁴⁸ in his description of the Brooklyn water supply on Long Island, stated that a group of deep wells near the shore became seriously contaminated by sea water after continued heavy pumping but that other groups of wells similarly situated, some of which were used only a few months each year during dry weather and the rest pumped continuously but rather lightly, continued to yield good water.

CONTAMINATION OF ARTESIAN WELLS

Most of the ground-water developments on Oahu consist of artesian wells drilled down into the water-bearing basalt that forms the main body of the island. The depth of these wells ranges from 97 to

⁴⁴ Matson, G. C., and Sanford, Samuel, *Geology and ground waters of Florida*: U. S. Geol. Survey Water-Supply Paper 319, p. 261, 1913.

⁴⁵ Clapp, F. G., *Underground waters of southern Maine*: U. S. Geol. Survey Water-Supply Paper 223, p. 67, 1909.

⁴⁶ Thompson, D. G., *Ground-water supplies of the Atlantic City region*: New Jersey Dept. Cons. and Devel. Bull. 30, p. 116, 1928.

⁴⁷ Brown, J. S., *A study of coastal ground water, with special reference to Connecticut*: U. S. Geol. Survey Water-Supply Paper 537, pp. 21-34, 1925.

⁴⁸ Spear, W. B., *Long Island sources of an additional supply of water for the city of New York*, pp. 144-149, New York Board of Water Supply, 1912.

1,500 feet, depending on location. As the top of the water-bearing basalt or aquifer dips toward the sea, wells drilled near the shore must pass through considerable thicknesses of alluvium and marine deposits before striking the top of the aquifer. In some localities the logs of wells have shown that the underlying aquifer is 700 or more feet below the ground surface and that even the top of it contains brackish water. In well 18 only sea water was obtained. The exact location of this well is not known but is said to be at the base of Diamond Head near Kapiolani Park, at an altitude of 15 feet. The drillers of this well penetrated 1,178 feet of various strata of sand, tuff, and marine deposits before reaching the aquifer. Apparently they found only sea water, as they continued to a depth of 1,500 feet in the hope of finding fresh water but without success. They reported that the water stood about 1 foot above the water level in an adjacent dug well and that the water was "saltier than the ocean." It would seem from this report that the bottom of the zone of mixture of fresh and sea water was less than 1,500 feet below the ground surface.

That other wells were drilled near or into sea water seems reasonably certain. The four wells drilled in Waikiki on the seaward side of the present drainage canal all yielded brackish water. One of these on Kalakaua Avenue (Well 22) was drilled to a depth of 936 feet below sea level, but as no log was kept the depth to the top of the aquifer is unknown. This well was drilled in 1894 for the municipal supply of Honolulu, but the water was reported unpleasantly brackish at the outset and too brackish for use within a year. In 1927, when the well was sealed, water from it was apparently almost as salty as sea water. Well 21 is drilled to a depth of 850 feet below sea level about 300 yards inland from well 22. The log of well 21 indicates that the top of the aquifer was at a depth of 730 feet. When the well was drilled the fresh-water zone extended down below 730 feet, as in 1886, when the static level for the area was reported to be about 35 feet above sea level, the water from the well contained only 76 parts per million of chlorides. In 1927, after the static level had fallen to less than 21 feet, thereby causing the depth of fresh water to decrease, the chloride content had risen to 14,600 parts per million, or about three-fourths that of sea water. Well 19, about 300 yards farther inland and about 200 yards west of well 21, was drilled to a depth of 661 feet below sea level. No log is available for this well, but a deep-well meter test showed the end of the casing to be 608 feet below the ground surface. The earliest recorded chloride content was in 1910, when, with a static level for the area of about 25 feet, it was 493 parts per million. In September 1928, when the static level was about 21.5 feet, the chloride content had increased to 1,510 parts per million, indicating

that the top of the zone of mixture of fresh and salt water had risen considerably. The fourth well of this group, well 23, about 150 yards west of well 19 and about 50 yards nearer to the shore, was drilled to a depth of 806 feet below sea level. Although the log shows the top of the aquifer to be at 716 feet, the well driller who sealed the well and a deep-well meter test determined the end of the casing to be at a depth of 779 feet. In 1921, with a static level for the area of about 21.5 feet the chloride content was 10,530 parts per million, and in 1928, with a static level of 21.2 feet, it was 13,300 parts per million. This well was drilled in 1914 and evidently yielded very brackish water from the outset, as in 1916 the owners drilled a shallower well, which yielded water of much better quality about 800 yards farther from the sea.

At the Territorial Fair Grounds, about 700 yards east of the Waikiki wells and about 50 yards farther than well 19 from the main Koolau ridge, is a group of three wells, only a few yards apart, which have about the same history. One of them, well 16, was drilled to a depth of 742 feet below sea level and reached the top of the aquifer at 626 feet. This well was reported to be in use to some extent in 1918, when the static level for the area was about 24 feet, but in September, 1925, when the static level had fallen to about 18.5 feet, the chloride content had increased to 8,000 parts per million. Well 17 was drilled to a depth of 821 feet below sea level and struck flowing water at 593 feet, or more than 30 feet higher than in well 16. Although the water was brackish, it was still in use for the irrigation of rice in 1918, when the static level for the area was about 24 feet, but in 1924, when the static level had fallen to about 22.5 feet, the chloride content had risen to 3,400 parts per million. Well 15 extended 856 feet below sea level and reached the top of the aquifer at about 646 feet. The water which it yielded had 285 parts per million of chloride in 1918 and 7,400 parts in 1924. Whether or not these wells yielded fresh water when they were drilled in 1883 is not known. Presumably they did, for, as recently as 1918, when the static level for the area had fallen several feet from the original level and the water had become somewhat brackish, the wells were still in use for stock and irrigation. It was not until the static level had fallen another 18 inches that the wells became seriously contaminated by the rise of the zone of mixture of fresh and salt water resulting from the depletion of the fresh water.

The wells that are nearer to the Koolau ridge are considerably less contaminated by sea water than the Waikiki or Fair Grounds wells; those that are nearest have shown no trace of contamination. About 500 yards inland from the Fair Grounds wells is well 14, which extends 514 feet below sea level. There is no log of this well, but a deep-well meter test indicated that the end of the casing was at 507 feet.

In 1910, when the static level for the area was about 25 feet, the chloride content was only 59 parts per million. In 1926, when the static level had fallen to 22.4 feet, the chloride content had risen to 190 parts per million. Although slight contamination was indicated, the extent was far less than in the Fair Grounds wells, as the bottom of well 14 is almost 100 feet above the top of the aquifer at well 17.

Well 13, which is about the same distance from the ridge as well 14 and about 100 yards east of it, was drilled to a depth of 578 feet below sea level and reached the top of the aquifer at 510 feet, as estimated by the results of a deep-well meter test. This well was drilled farther down into the aquifer than well 14 and showed somewhat more contamination—364 parts per million of chloride as compared with 169 parts per million in July 1926—but considerably less than well 17, where the top of the aquifer is lower than the bottom of well 13.

About 100 yards nearer the ridge than either well 14 or well 13 and about 50 yards east of well 13 is well 12. The data on record for this well show that the depth below sea level is 501 feet and that the top of the aquifer is at 450 feet below sea level, according to the results of a deep-well meter test. In 1928, when the static level was 24.1 feet, the chloride content was only 125 parts per million, which, although still indicating the presence of a slight amount of sea water, was less than that of any well farther from the main ridge. Well 24, which is about 300 yards farther inland and about 400 yards west of well 12, extends 400 feet below sea level and reached the top of the aquifer between 350 feet and 360 feet below sea level, as estimated from the results of a deep-well meter test. Here, owing to the lesser depth as compared with the wells nearer the sea, the water contains still less salt, the chloride ranging from 48 to 63 parts per million. Well 11, which is about 400 yards nearer the Koolau ridge than well 12, is of unknown depth, but the log states that flowing water was struck at 337 feet below sea level. The chloride content ranges from 48 to 54 parts per million indicating little or no contamination by sea water. Well 9, which is about 100 yards farther inland than well 11, was drilled to a depth of 254 feet below sea level and struck the top of the aquifer at 240 feet below sea level. The chloride content ranges between 51 and 56 parts per million. The average chloride content is slightly higher than in well 11, probably because well 11 is only an emergency supply and is seldom used, whereas well 9 is in almost constant use.

Well 6 is about 400 yards nearer the ridge than well 9 and about 300 yards farther west. The log shows that the bottom is 255 feet and the top of the aquifer at 152 feet, below sea level. Al-

though there is a continuous draft on this well, the salt content is very low, the chloride ranging from 22 to 25 parts per million. At the Kaimuki pump there are eight wells (7A to 7F), which serve the municipal water system of Honolulu. These wells average about 280 feet in depth below sea level, but the average depth to the aquifer is only about 70 feet. As they were to have a capacity of almost 2,000,000 gallons a day each, they were drilled about 200 feet into the water-bearing rock, in order not to cause excessive draw-down. As a result of the greater depth below sea level than well 6, which is farther from the main ridge, the chloride content is slightly higher, ranging from 34 parts per million during periods of comparatively light draft and high static level to 57 parts per million when the draft per well is heavier and the static level lower. Well 5, which is about 50 yards nearer the ridge than the Kaimuki pump and about 200 yards farther west has a depth of 140 feet below sea level, and the top of the aquifer is at about 100 feet as estimated from the results of a deep-well meter test. Although the top of the aquifer is lower by about 30 feet than at the Kaimuki pump, the water was of a slightly better quality, as the chloride content ranged from 26 to 34 parts per million. This difference is probably due to the fact that the bottom of well 5 is about 180 feet higher than the bottoms of the wells at the Kaimuki pump and also possibly to a lesser draft. About 200 yards nearer the main ridge and about 150 yards seaward from the ridge that comes down from the main ridge between Palolo and Manoa Streams is well 3, the bottom of which is only 130 feet below sea level and the top of the aquifer at 75 feet. Water from this well had not been used for many years prior to the time when it was sealed, so that nothing is known concerning the quality of the water. Undoubtedly the well was free from contamination, being the shallowest, relative to sea level, of all the wells of known depth in the Moiliili area.

With only a few exceptions, which may be due to inequalities in the slope of the top of the aquifer, the depth to the aquifer below sea level becomes less inland (fig. 19).

It is also noteworthy that, in general, as the distance to the top of the aquifer below sea level decreases the chloride in the water that occurs in it also decreases. Figure 26 is a somewhat distorted cross section of a typical artesian area on Oahu with wells drilled through the cap rock into the aquifer. It shows the different qualities of water found in the aquifer, beginning with fresh water at the top and grading downward through water of increasing brackishness until pure sea water is reached at the bottom of the transition zone. As the salinity of the water varies vertically but remains fairly uniform horizontally, wells driven deeper than others in the same area will yield

FIGURE 26.—Increase in chloride content of the water in artesian wells with increase in depth

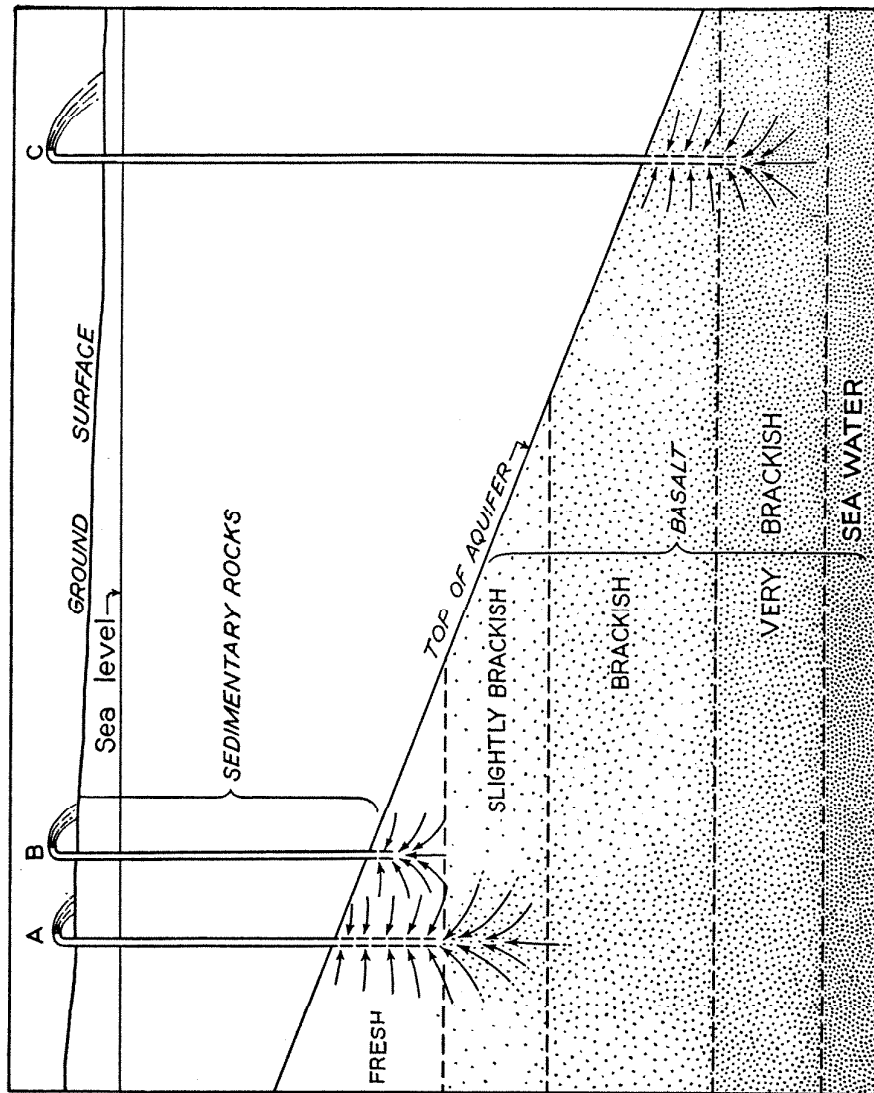

water of a higher chloride content. Thus well C in figure 26, which in the Moiliili area is representative of any of those in Waikiki, will yield only brackish water, whereas well B, which represents the wells nearer the main Koolau ridge, will yield fresh water. As can be seen in the sketch, the point at which well C passes into the aquifer is below the top of the zone of diffusion, so that even the small quantity of water that first flowed from the top of the well was brackish, and as a larger flow was desired, the well was continued downward through increasingly brackish water so that as the discharge increased the chloride content also increased. On the other hand, fresh water flowed from well B, at the beginning and continued to flow after the well was completed, as both the top of the

aquifer at the well and the bottom of the hole are above the top of the zone of mixture.

The contamination by sea water progresses upward from beneath rather than laterally from the shore line, and therefore wells that are drilled too deep will yield brackish water even though they are at considerable distances from the shore. Such is the case with the wells in the upper portion of Moiliili area. The average depth of the wells at the Kaimuki pump is 280 feet below sea level, and these wells yield water that ranges from 34 to 57 parts per million of chloride. Well 46A, which is about 50 yards farther from the main ridge and has a depth of 255 feet below sea level, yields water of slightly better quality, the chloride content ranging from 22 to 25 parts per million. However, as the bottom of well 46A is about 25 feet higher than that of the wells at the Kaimuki pump, that portion of the well which is in the water-bearing formation remains in the fresh-water zone, whereas the Kaimuki wells, which undoubtedly pass through the same kind of water as well 46A, also go farther down, near or possibly into the top of the zone mixture. Therefore, the water that comes from the wells at the Kaimuki pump includes not only the kind that is yielded by well 46A but also a slightly brackish water from a lower level.

The experiences on the plantations in drilling groups of wells at pumping plants further illustrate this principle. It has been found that in a group of several wells within a radius of 50 yards, or even less, at locations that may be a mile or more from tidewater, the salt content may not be uniform. Some of the wells in the group may be deeper than others, and usually the deepest wells will have the highest chloride content. An example of this is pump 4, (well 334) on the Waiialua Agricultural Co.'s plantation. At this plant seven wells ranging from 42 to 50 feet in depth are now yielding water which, although somewhat brackish, is suitable for irrigation. A few feet from this group are several deeper wells that yielded water that was too brackish for use.⁴⁹ At this same plant a well was drilled to a depth of 420 feet, but as the water became more brackish with increasing depth, it was finally abandoned. The Honolulu Plantation Co. also found that wells drilled too deep yielded highly brackish water.

At two of its pumping plants in Waimalu—pump 2 (well 196) and pump 4 (well 197)—wells that were considerably deeper than others only a few feet on each side were found to yield water of such high chloride content that they had to be shut off and abandoned.

A few records of the quality of water flowing from wells as they reached various depths during the drilling are available and indicate

⁴⁹ Goodale, W. W., Report on artesian wells to the Waiialua Agricultural Co.

that the water became increasingly brackish as greater depths were attained. An example is the record on well 167, in the Puuloa section, which is one of several wells in that locality that were abandoned because of the high salinity of their water. The data are not complete for the entire distance that the well penetrated the aquifer nor are they uniformly consistent. However, the general trend is conclusive, as shown in the following table:

Quality of water flowing from well 167 during drilling

Depth (feet)	Chlorides (Parts per million)	Depth (feet)	Chlorides (Parts per million)
950	2,600	980	5,830
955	2,730	981	4,220
958	2,240	983	4,680
960	3,440	990	4,810
962	3,440	992	5,090
963	4,850	996	5,020
967	5,190	998	4,880
970	5,090	1,006	4,950
973	4,880	1,008	6,010
975	4,950	1,022	4,780
976	4,820	1,030	5,550
978	4,850		

The data from well 271 (see page 355 and fig. 27), on the naval reservation on the East Loch of Pearl Harbor, show the same trend and are tabulated below:

Quality of water flowing from well 271 during drilling

Depth (feet)	Chlorides (parts per million)	Depth (feet)	Chlorides (parts per million)
292	646	364	871
312	665	367	987
330	626	379	1,167
332.1	661	383	1,216
332.6	655	399	1,503
344	646		

Data from well 158, which was drilled in Moanalua to a depth of 283 feet below the ground surface, indicated the reverse condition—that is, the water became less salty as the well went deeper. However, as the well is comparatively shallow and the chloride content low, it probably never reached the zone of mixture.

Often the depth at which drilling is stopped is determined by the amount of chloride in the water. Samples of water are taken frequently during the drilling operations, and when the salinity approaches the limit beyond which the water would not be usable for

the purpose for which it is intended the work is stopped. Unfortunately, except for the two wells cited above, no records of the levels where brackish water was struck were kept, and I have had to rely on statements by well drillers and owners.

IMPROVEMENT OF QUALITY BY REDUCING DEPTH OF WELLS

That the depth of a well has an influence on the quality of the water has been conclusively proved by the experiences gained in reducing the chloride content in the water flowing from artesian wells. Many wells on Oahu have been drilled too deep, so that some of them actually entered the zone of mixture at the time of drilling, yielding brackish water at the outset, or their bottoms were so close to it that when the zone of mixture rose, as a result of depletion of the overlying fresh water with the resultant loss of static level, the lower portions of the wells were in water of greater salinity than at the time when they were drilled.

The method used in improving the quality of the yield is to reduce the depth by filling the lower portion of the well, so that only water from the upper part of the zone of mixture, which is less brackish, will enter the well. The filling consists of iron punchings, lead, crushed rock, concrete, or neat cement. Often several of these materials are combined. The methods used in depositing the materials at the bottom of the wells are the same as those used in sealing wells except that in a few wells the materials have been dumped in at the top. The amount of chloride in the water is determined both before and after the lower part of the well is plugged, in order to find out where the filling should stop. In well 256 the plug was placed in eight layers, with chloride determinations after each layer. After each fill a decrease in the chloride content was noted—a fact which, incidentally helps to prove that below the fresh water there is a transition zone between the fresh and sea water that gradually increases in salinity with increasing depths.

A typical example of freshening of water in wells by decreasing the depth is afforded by well 271 (fig. 27). When this well was drilled brackish water containing 646 parts per million of chloride was encountered at the outset, and the water continued to be of about the same degree of brackishness until the top of the main aquifer was reached at a depth of 330 feet below sea level. Then it was decided to continue downward, in the hope of obtaining potable water, because the driller's log showed mudrock and there was a possibility that the main aquifer had not been reached. However, as the hole went deeper into the aquifer the water flowing from the well became increasingly brackish, until at a depth of 399 feet below sea level the water con-

tained 1,503 parts per million of chloride with a discharge of 65,500 gallons a day, increasing later to 76,700 gallons. As this was more brackish than was desirable, particularly as the chloride later in-

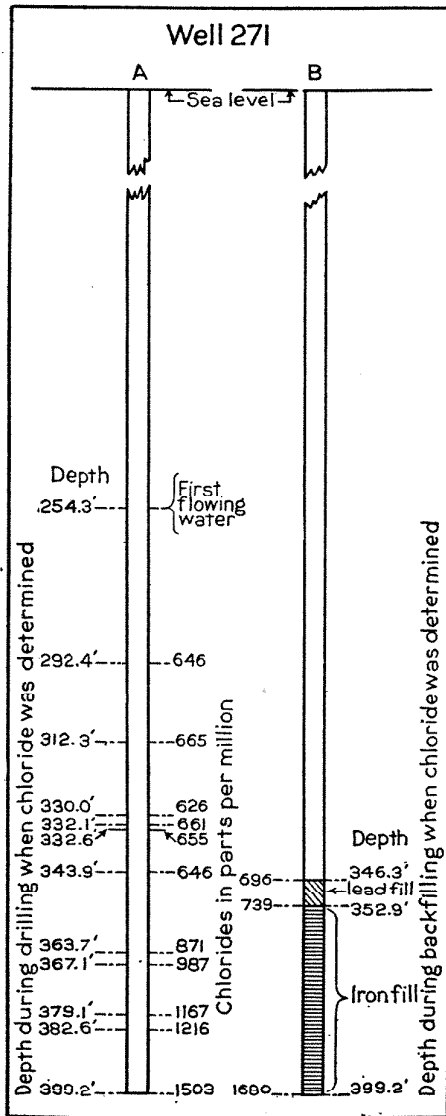

FIGURE 27.—Increase of chloride with depth in well 271 and the freshening of the water by backfilling the well

creased to 1,680 parts per million, it was decided to fill the bottom to shut off the saltiest water, so that the final flow could be used for at least some purposes. The well was filled from the bottom at 399 feet up to 354 feet with small pieces of iron, dropped in at the top, as the well was only 2 inches in diameter. The iron was carefully tamped, and then on top of it about a foot of lead wool was placed and tamped. The raising of the bottom of the well by 46 feet resulted in decreasing the chloride content from 1,680 to 739 parts per million. As the quality of the water was still unsatisfactory, an additional fill of 6 feet of iron and 6 inches of lead wool was placed in the well, which raised the bottom to 246½ feet. The chloride then decreased from 739 to 696 parts per million. As the artesian discharge had decreased from 76,700 to 25,600 gallons a day, no further work was done. Section A in figure 27 shows the well as originally drilled and indicates that flowing water first occurred at a depth of 254 feet

below sea level. Section B in the same figure shows that the plugging of that portion of the bottom that is in the zone of most brackish water effectively reduced the chloride content in the water flowing from the well. An additional result of the plugging was the reduction of the exposed aquifer in the well, so that the discharge decreased 67 percent.

Below is given a table of wells on Oahu which were partly filled. With only one exception, the quality of the water was improved by decreasing the depths.

Effect of reducing depths of wells to improve quality of water

Well no.	Depth (feet)			Chloride content (Parts per million)			Remarks	
	Original	Fill	Final	Original	Final	Decrease		
112	1,010	214	796	479	53	426	Flow reduced 95 percent	
196E	1,000	480	520	1,760	374	1,386		
209	220	90	130	1,430	748	682		
248D	615	115	500	495	226	269		
248E	640	140	500	1,660	169	1,491		
248F	630	130	500	1,060	287	773		
248G	580	80	500	1,130	155	975		
248H	645	500		
248I	600	500	842	301		
248J	500		
256	600	20	580	779	779	0		With a uniform discharge the draw-down at original depth was 1.0 foot. At final depth it increased to 6.2 feet
	580	10	570	779	764	15		
	570	9	561	784	696	68		
	561	23	538	696	634	62		
	538	40	498	634	540	94		
	498	28	470	540	504	36		
	470	8	462	504	457	47		
462	26	436	457	407	50			
271	399	46	353	1,680	739	941	Flow reduced 67 percent	
	353	7	346	739	696	43		
273B	593	76	517	2,540	1,410	1,130		
273C	592	76	516	1,500	977	523		
273D	567	47	520	1,490	883	607		
273E	590	41	549	1,270	1,160	110		
273F	607	69	538	1,070	696	374		
273G	596	98	498	1,530	1,140	390		
273H	596	99	497	2,240	1,140	1,100		
308	542	24	518	582	145	437		Flow reduced 50 percent
319A	299	19	280	1,060	1,060	0		No improvement

In addition to the wells listed above 27 wells were drilled at the Kamaile pump, near Waianae, to a depth of about 300 feet. These wells yielded water so brackish that 11 of them were abandoned and the depths of the remaining 16 were reduced by filling with about 25 feet of iron. There is no record of the results, but according to the plantation officials there was an improvement in quality.

EFFECT OF DRAFT ON QUALITY

Another factor that affects the salinity of water is the intensity of draft on a well. In a well that penetrates the transition or mixture zone the chloride content of the water will increase with the rate of discharge. The removal of water surrounding a well when discharging will cause a reduction in hydrostatic pressure in its immediate vicinity, even in a very permeable aquifer, and this will cause the formation of a protuberance or cone of the more brackish water below the bottom of the well, which will rise into the well, thereby increasing the salinity. The distance to the top of the cone from the bottom of the well is dependent on the rate of discharge from the well. In many wells that show only slight contamination or none at

all the effect of the cone of brackish water is not noticeable, because of comparatively light drafts or distances greater than the height of the cones between the top of the zone of mixture and the bottom of the wells. The manner in which a well becomes contaminated by this method is illustrated by figure 28, based upon actual observations.

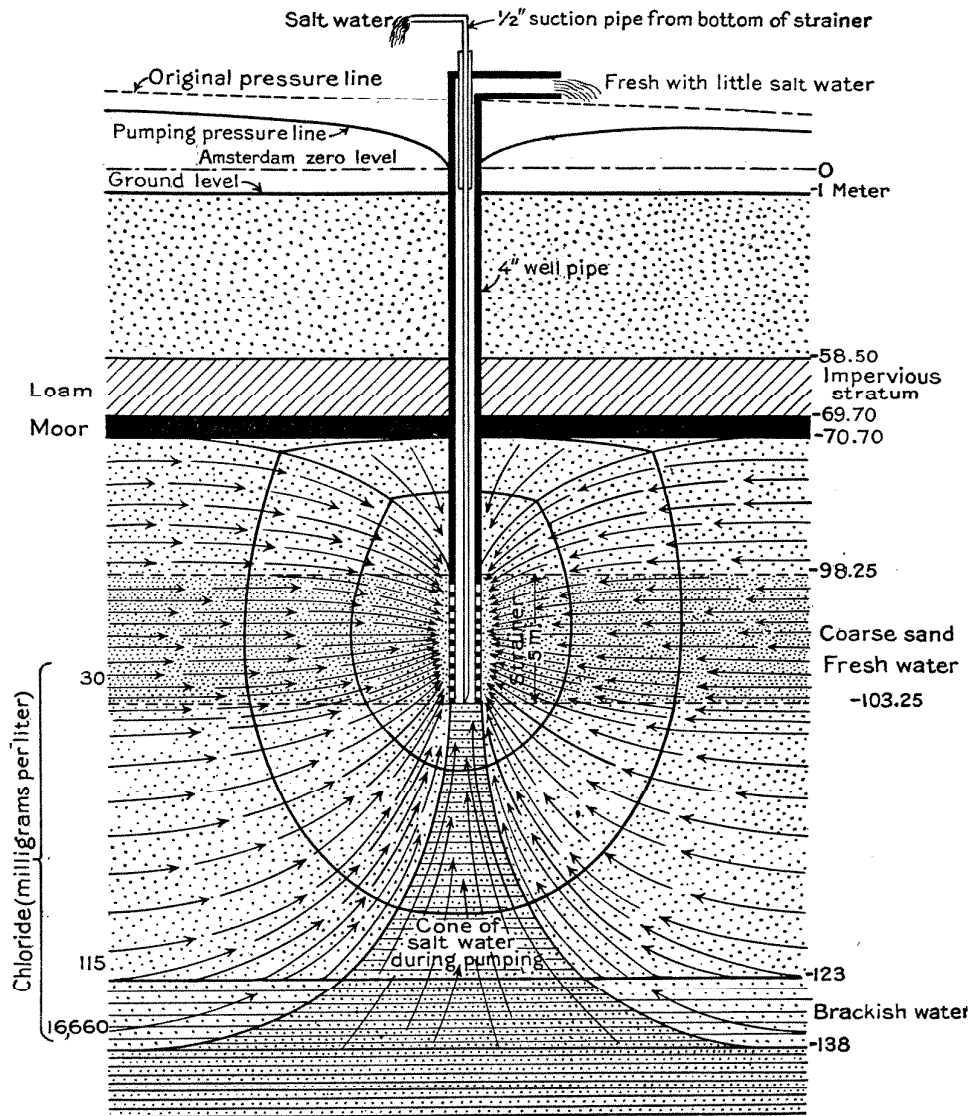

FIGURE 28.—Cone of salt water induced by pumping overlying fresh water. (From Pennink, J.M.K., Am. Soc. Civil Eng. Proc., vol. 54, pt. 4, p. 179, 1905.) Pumping at the rate of 1,200 cubic meters daily. Strainer placed about 35 meters above the level of water having a density equal to sea water. Salinity of sea water approximately 17,000 parts per million of chloride. Zero level of Amsterdam, 0.2 meter above mean sea level.

On Molokai Lindgren⁵⁰ found that in well 3 at Kawela, the salinity increased markedly with pumping. This well is 14 inches in diameter and drilled to a depth of 45 feet below sea level. It was pumped steadily at the rate of 2.5 million gallons a day for 30 days, March 1-30, 1900, during which the water level fell 8 feet and the salinity rose as follows:

	Chloride (parts per million)
March 2	197
March 7	343
March 16	332
March 20	436
March 24	572
March 28	644
March 30	665

On Oahu a notable example of increase in salinity due to the rising of a cone of salt water is afforded by well 101, in Honolulu. This well is 8 inches in diameter, 1,151.5 feet deep, and cased to a depth of 1,091 feet, leaving 60.5 feet of exposed aquifer in it. After the well had been unused for several years the Honolulu Board of Water Supply made a series of tests during December, 1928, and January, October, and November 1929,⁵¹ which proved that with a heavy draft the salinity of the water flowing from a well will increase considerably above that of the water in the portion of the aquifer actually penetrated by the hole. During December, 1928, and on January 2, 1929, with no water flowing, a series of samples were taken from the well at different depths by means of a bucket and also through a 1-inch pipe. The maximum salinity, which was at the top of the well, was found to be 777 parts per million of chloride; the maximum at the bottom was 693 parts per million. On January 2 the valve on the well was opened after having been closed for several years, so that the water flowed from it at the rate of 430,000 gallons a day. The following morning the chlorides had increased to 3,900 parts per million. On January 4 the valve was closed, and on January 7, with the valve still closed and after no flow for 3 days, several samples of water were taken from different depths near the bottom through a 1-inch pipe. The sample showing the highest salinity, taken about 3 feet above the bottom, contained only 438 parts per million of chloride. The next day, January 8, the well was again allowed to flow at the rate of 430,000 gallons a day, and samples of water taken in the same manner as on the previous

⁵⁰ Lindgren, Waldemar, The water resources of Molokai: U. S. Geol. Survey Water-Supply Paper 77, p. 44, 1903.

⁵¹ Kunesh, J. F., Honolulu Board of Water Supply, Rept. for 1931, Suppl., pp. 98-105, 1931.

day showed that there had been a marked increase in salinity. At 65 minutes after opening, the chlorides had increased from 378 to 3,860 parts per million, with the lower end of the 1-inch sampling pipe at a depth of 1,076 feet.

After the end of the pipe had been lowered to a depth of 1,097 feet and the well had been open for 2½ hours, the chloride content was found to be 4,500 parts per million. There was no appreciable variation from this figure at greater depths, nor after the well had been open for several hours longer. Another significant feature of the test was the drop in static level from 28.35 feet prior to the opening of the well on January 2 to 22.6 feet on January 8, or 5.75 feet, which indicated that the column of water in the well had gained considerably in specific gravity as a result of brackish water getting into it.

During the later part of October, 1929, another test was made on this well. On October 29 the well was opened after having been closed since January 11 of the same year. Water from the well discharged at the rate of 430,000 gallons a day, and all samples were taken from the top of the well. The results are given below.

Relation of salinity to discharge in well 101

Date 1929	Time	Static level (feet above sea level)	Chlorides (parts per million)	Draft (million gallons per day)	Normal static level for area (feet above sea level)
Oct. 29	1:24 p. m.	24.37		0	
	1:38		146	.43	26.12
	1:44	21.27	140	.43	26.12
	1:59	19.02	3,150	.43	26.13
	2:38 p. m.	18.82	3,730	.43	26.13
	4:38	18.42	3,890	.42	26.10
	9:08	18.12	3,970	.42	26.00
Oct. 30	9:33 a. m.	17.82	3,990	.42	26.02
	1:15 p. m.	18.17	4,110	.42	26.09
	5:20 p. m.	18.20	4,100	.43	26.09
Oct. 31	9:08 a. m.	18.00	4,050	.40	26.04

CHEMICAL ANALYSES OF OAHU WATER

The following tables give the chemical analysis of water from various wells, tunnels, springs, streams and the surrounding ocean and expresses in general the chemical quality of Oahu waters, in parts per million.

Analyses of spring, tunnel, stream, and ocean water

	Silica (SiO ₂)	Iron (Fe) or Fe ₂ O ₃ + Al ₂ O ₃	Calcium (Ca)	Magnesium (Mg)	Sodium (Na) or sodium and potassium (Na+K)	Potassium (K)	Loss on ignition	Sulphate radicle (SO ₄)	Chloride radicle (Cl) and nitrate radicle (NO ₃)	Total solids	Total hardness (calculated)	Date of collection	Analyst ^a
Kalihi Stream at U. S. G. S. gaging station	26	0.43	4.2	3.8	12	0.9	30	5.1	16	86	26	Aug. 16, 1928	F
Kalauao Springs	49	.55	18	16	43	3.3	56	17	69	274	111	Dec. 27, 1929	P
Nuuanu Tunnel		1.8	4.0	4.4	7.8	3.0	6.3	11	19	58	28	Nov. 20, 1926	P
Waiahole Tunnel	74		25	16	57		31	25	123		128	May 1920	D
Tunnel 4-E, Oahu Sugar Co.	36	1.2	18	15	97		37	34	156	400	106	Sept. 1929	D
Tunnel 8, Oahu Sugar Co.	35	1.2	26	12	96		49	36	145	406	114	Sept. 1929	D
Pacific Ocean mid- way between Oahu and Molokai	8	1.2	427	973	12,535		73	2,852	20,713	37,700	4,934	Dec. 31, 1929	D
Pacific Ocean 1½ miles southeast of Oahu	40	6.0	585	1,193	10,823	456	T.	2,734	19,646	35,492	6,354	Nov. 16, 1929	P
Pacific Ocean in Ha- nauma Bay	4.0	6.0	507	1,258	10,821	493	T.	2,729	19,681	35,507	6,425	Nov. 18, 1929	P
Waikane tunnel 1	24	1.9	8.6	4.8	8.7	3.7	16	4.7	17				Da
Waikane tunnel 2	14	1.4	7.0	2.8	8.9	3.3	12	4.3	14				Da
Kahana tunnel 1	13	1.8	7.2	4.5	6.5	3.1	13	4.3	15				Da

^a See footnote (a) of following table.

Analyses of well water, Oahu

Well no.	Depth	Silica (SiO ₂)	Iron (Fe) or Fe ₂ O ₃ + Al ₂ O ₃	Calcium (Ca)	Magnesium (Mg)	Sodium (Na) or sodium and potassium (Na+K)	Potassium (K)	Carbonate radicle (CO ₃)	Bicarbonate radicle (HCO ₃)	Sulphate radicle (SO ₄)	Chloride radicle (Cl) and nitrate radicle (NO ₃)	Total dissolved solids at 180° C.	Total hardness (calculated)	Date of collection	Analyst*
33	520	35	1.6	27	29	158	3.8	83		43	246	629	186	Jan. 9, 1930	P
36-A	395	26	1.6	4.0	5.2	30	21	23		12	51	178	31	Nov. 20, 1926	P
		31	1.0	6.5	6.6	44	5.8	37		11	51	196	43	Dec. 1928	P
75	650	26	1.1	29	4.8	57		45		21	85	92	Jan. 25, 1926	P	
9	270	67	.08	4.0	1.4	64	2.4	12	63	18	51	252	16	Feb. 13, 1928	H
7-G & H	240-260	16	5.4	5.4	2.4	57		34		11	56	190	23	Apr. 28, 1914	D
7-A to H	240-260	35	1.3	4.4	5.2	30	19	23		14	48	183	32	Nov. 20, 1926	P
7-A to H	240-300	40	.45	2.8	2.8	51	4.3	35		11	49	199	18	Dec. 1929	P
		34	1.0	5.0	5.5	47	4.8	36		13	48	195	35	Dec. 1928	P
5	162?	41	.08	2.4	2.8	45	1.6		87	8.4	29	168	17	Apr. 29, 1930	L
5	162?	34	.50	1.8	1.8	15	4.2	63		6.7	28	157	12	May 2, 1930	P
29	600?	27	3.4	1.4	1.4	84		34		15	83	250	9.2	June 18, 1917	D
		3	2.8	16	17	180		52		61	247	582	110	Apr. 22, 1925	D
23	720	40	11	1,158	1,430	3,460		15		1,376	10,527	18,050	8,780	Apr. 20, 1921	D
37	302	48	.08	7.6	6.7	48	6.5	3.0	104	12	39	231	46	Mar. 15, 1928	H
		12	3.2	7.3	6.4	26	18	26		14	46	161	44	Nov. 20, 1926	P
88-A to I	580-616 533-636	34	1.2	21	5.8	62		78		4.4	53	260	76	July 19, 1927	P
		36	1.1	7.5	7.7	36	3.8	35		15	44	189	50	Dec. 1928	P
		38	1.2	7.1	7.4	36	4.4	35		11	46	189	48	Dec. 1929	
		36	.80	11	11	43	3.3	37		13	69	226	72	Dec. 1929	
87	-----	22	7.6	13	9.3	50		41		8.0	75	232	71	June 23, 1910	D
		28	2.2	13	9.5	46		42		9.1	66	220	71	Apr. 25, 1912	D
		26	3.8	8.6	10	44		38		4.5	67	67	62	Dec. 29, 1921	D
89	887	28	10	15	14	69		56		15	95	304	95	May 13, 1910	D
		23	3.3	12	13	55		50		10	78	246	83	June 12, 1911	D
		23	1.6	13	16	55		45		15	95	266	98	Apr. 20, 1921	D
89	887	31	1.2	22	12	78		57		15	116	332	104	Mar. 9, 1926	D
		20	1.2	21	14	60		68		11	81	277	110	Feb. 18, 1927	D

95		28	9.4	13	11	70		54		16	89	298	78	Dec. 30, 1907	D	
93	1,015	17	6.2	11	14	70		50		14	103	288	85	Apr. 27, 1914	D	
101	1,152	46	16	598	299	2,526	45	1,225		452	4,084	9,296	2,720	Oct. 29, 1929	P	
		33	5.2	489	663	500	40	3,368		274	3,234	8,611	3,960	Dec. 28, 1930	P	
		31	8.0	436	599	460	35	3,624		294	2,922	8,385	3,550	Dec. 29, 1930	P	
102		38	5.0	6.4	8.7	54		37		11	67	228	52	Aug. 3, 1908	D	
		16	12	37	19	94		100		4.2	144		170	June 9, 1925	D	
		40	5.5	125	424	325	28	1,017		85	746	2,799	2,050	Oct. 29, 1929	P	
		32	3.0	38	37	27	68	280		31	248	738	247	Dec. 28, 1930	P	
		30	4.4	33	36	34	28	210		23	216	618	230	Dec. 29, 1930	P	
103	1,150	9.8	4.0	8.7	7.0	37		29		5.6	55	158	50	June 9, 1911	D	
		17	12	22	12	100		61		19	141		100	June 9, 1925	D	
		36	.80	10	11	54	3.7	66		13	77	276	70	Oct. 29, 1929	P	
		32	3.6	12	8.5	62	6.5	16		13	89	244	65	Dec. 27, 1930	P	
		31	3.4	9.9	7.8	72	7.7	60		12	78	284	57	Dec. 29, 1930	P	
104		17	1.6	7.1	8.5	56		48		8.2	62	208	53	June 18, 1917	D	
		26	1.2	15	14	52		46		16	81	252	95	Oct. 8, 1926	D	
113	707	21	8.2	42	31	61		36		42	187		230	Jan. 29, 1909	D	
		10	2.6	13	9.8	51		35		18	74	214	73	Oct. 17, 1910	D	
		20	5.2	20	8.8	50		44		12	78			May 18, 1926	D	
117		59	.21	18	22	123	6.1		78	33	*220	522	135	Aug. 9, 1928	F	
		9.1	5.1	16	15	126		37		30	200	440	101	Apr. 28, 1914	D	
118	549	28	2.4	8.6	8.0	50	14	12		20	99	244	54	Dec. 2, 1926	P	
119	682	30	1.8	11	9.8	52	22	19		21	110	279	68	Dec. 2, 1926	P	
124	150	17	4.8	26	18	157		42		33	266	564	139	Dec. 10, 1923	D	
		53	.08	36	33	138	12		74	43	*305	707	225	Mar. 14, 1928	H	
128-A to H	401-490	10	.28	15	5.5	67	4.2		27	19	*118	261	60	Aug. 9, 1928	F	
		24	1.2	11	9.4	25		17		15	71	193	66	Nov. 20, 1926	P	
138	500	30	.70	11	12	44	16	39		13	69	224	77	Dec. 1928	P	
		19	3.6	18	16	72		31		24	134	320	111	Nov. 17, 1910	D	
134		16	2.6	18	19	61		31		17	130	296	123	Aug. 7, 1914	D	
		45	.21	24	26	68	4.0		63	26	^h 170	417	167	Aug. 7, 1928	F	
144	500	15	1.8	6.6	1.4	80		37		13	85	240	22	Apr. 27, 1909	D	
152	302	30	2.2	17	15	46		29		28	89	283	104	Nov. 1917	P	
153		22	2.8	9.7	10	42		34		11	64	198	65	Mar. 2, 1909	D	
155		63	.08	17	12	38	3.1		84	15	'63	255	92	Mar. 6, 1928	H	
		15	3.8	18	10	50		40		12	85	236	86	Dec. 13, 1909	D	
156	726	7	8.6	13	11	47		39		14	70	212	78	Feb. 13, 1913	D	
		31	2.2	13	10	38		39		11	56		74	Oct. 15, 1915	D	
		35	2.6	14	12	43		34		12	79		84	Apr. 1920	D	
		8	1.0	13	8.6	21	18	21		14	70	177	68	Nov. 20, 1926	P	
		36	.55	8.5	13	41		2.5	42		11	67	224	74	Dec. 1928	P
		39	.65	12	12	41		4.5	35		12	67	224	79	Nov. 18, 1929	P

QUALITY

Analyses of well water, Oahu—Continued

Well no.	Depth	SiO ₂	Fe or Fe ₂ O ₃ + Al ₂ O ₃	Ca	Mg	Na or Na + K	K	CO ₃	HCO ₃	SO ₄	Cl + NO ₃	Total solids 180°C	Total hardness	Date	Analyst ^a
187-B	173	16	3.6	28	21	71		50		33	138	362	156	Feb. 27, 1923	D
202	197	21	8.2	42	31	61		36		42	187	430	232	Jan. 29, 1909	P
		16	2.4	37	29	60		28		38	180	389	211	Nov. 17, 1910	D
202-C	140	25	5.2	31	18	98		36		32	192		151	May 18, 1926	D
239	577-739	34	8.0	46	47	231		26		59	501	954	308	Nov. 4, 1908	D
239-A to E	582-739	4.3	1.2	35	28	161		26		48	326	643	202	Sept. 1929	D
239-F to N	577-707	33	3.2	54	43	254		27		83	519	1,030	312	Sept. 1929	D
246	400-430	28	1.4	20	17	80		26		30	155	360	120	Nov. 1921	D
		44	2.4	26	17	55		30		25	127	328	135	Nov. 4, 1908	D
247	400-498	74		21	11	52		1.8		42	113	396	98	May 1920	D
		16	1.2	24	1.4	76		36		30	99	286	66	Sept. 1929	D
248	500	50	5.0	24	19	51		28		21	129	328	138	Nov. 4, 1908	D
		30	1.2	57	43	282		29		89	559	1,094	319	Sept. 1929	D
248-E	500	25	1.2	20	15	59		32		25	114	292	112	Sept. 1929	D
249	400-439	36	9.4	23	19	52		27		24	127	322	135	Nov. 4, 1908	D
249-A to F	400-425	24	1.2	35	22	127		42		52	234	539	178	Sept. 1929	D
249-G to L	400-439	23	1.2	38	28	138		30		49	284	598	210	Sept. 1929	D
254-A	175	4.2	2.8	42	40	70		23		43	241	468	269	June 8, 1911	D
251	-----	56	14	27	31	76		115		4.5	121		195	May 18, 1926	D
274-A to F	158-246	50	12	39	31	88		58		27	206	512	225	Nov. 4, 1908	D
274	158-246	1.5	.99	23	27	88		37		25	194	398	168	Oct. 26, 1911	D
		53	3.8	29	36	100		66		32	212	546	220	Aug. 1921	D
		25	1.2	31	21	106		67		29	181	467	164	Sept. 1929	D
257	230	2	6.7	12	10	23		16		14	58	142	71	June 8, 1911	D
259	306	1	1.1	10	8.9	24		8.5		17	58	130	62	June 8, 1911	D
263	475	1.2	1.6	11	9.7	29		6.5		16	72	150	67	June 8, 1911	D
264	326-444	2.6	1.8	52	55	94		20		52	334	615	356	June 8, 1911	D
268	470	12	1.6	16	15	88		58		16	126	322	102	June 8, 1911	D
276	160	1.2	1.6	13	13	106		91		14	104	343	86	June 8, 1911	D
285	487-550	28	2.4	56	51	82		30		46	304	606	349	Aug. 6, 1914	D
		30	3.0	32	29	70		40		24	185		199	Dec. 29, 1921	D
331	400	56	4.8	13	10	63		50		22	74		74	Dec. 30, 1921	D
334	50	34	8.8	16	7.2	113		41		30	152		70	Dec. 30, 1921	D

^a D. Dearborn Chemical Co., Chicago, Ill.; Da, L. E. Davis, Hawaiian Sugar Planters' Experiment Station; F, Margaret D. Foster, U. S. Geological Survey; H, C. S. Howard, U. S. Geological Survey; L, S. K. Love, U. S. Geological Survey; P, Pacific Guano & Fertilizer Co., Honolulu.
^b NO₃ = 0.60 ^c NO₃ = 1.4 ^d NO₃ = 0.90 ^e NO₃ = 1.7 ^f NO₃ = 1.0 ^g NO₃ = .05 ^h NO₃ = 1.5 ⁱ NO₃ = .41

TUNNELS RECOVERING BASAL GROUND WATER IN THE BASALT
MEMBER OF THE KOOLAU VOLCANIC SERIES

By H. T. STEARNS

Four tunnels have been driven to recover basal ground water in Koolau basalt. Two of them are described under dug wells 34 and 36, and the other two are on the east bank of Waikele Stream at Waipahu (See pl. 2).

Tunnel 4B, at well pumping plant 248, was started in January 1906 and finished in the early autumn of the same year. It is 3 feet above sea level and was driven 1,140 feet into flat-lying Koolau flow lavas. The draft from this tunnel is given on page 282. During construction it was kept dewatered by a pump, but it is reported that so large a volume of water was encountered suddenly at the heading that the workmen barely escaped with their lives. At first the salt content was 64 grains a gallon (665 p.p.m.) but it later decreased to 15 grains a gallon (156 p.p.m.). An analysis of this water is given on page 361.

A similar tunnel was started at pump 8 in the fall of 1906 and completed in the spring of 1907. It is 7 feet above sea level and 290 feet long and is reported to have yielded about 10,000,000 gallons a day, but it had to be blocked off because it depleted the supply of tunnel 4B. Doubtless the freshening of the water in tunnel 4B was caused by the damming of this tunnel. An analysis of this water is given on page 361.

These tunnels were driven at and near Waikele Springs and show conclusively that the spring group is discharging from the basal zone of saturation in the Koolau lavas. They further demonstrate that water can be developed in this basalt by tunnels extending away from shafts, as in the Maui type of well recommended on page 324.

BASAL SPRINGS SUPPLIED BY THE BASALT MEMBER OF THE KOOLAU
VOLCANIC SERIES

By H. T. STEARNS

HONOLULU AND VICINITY

The springs issuing from the end of the Koolau spurs east of Honolulu have been described on page 235. Ah Yin or Kapalama Spring, on the south side of School Street, on the west side of Nuuanu Valley, was discharging at the rate of 550,000 gallons a day when measured on September 15, 1911. Its close proximity to the adjacent outcrop of Koolau basalt (pl.2) suggests that it is overflow of the basal water in this basalt, but its altitude is slightly higher than that of the water in the adjacent artesian wells, hence it may be supplied by basalt of the Nuuanu volcanics.

PEARL HARBOR SPRINGS

Location.—The Pearl Harbor Springs comprise five large springs along the north shore of Pearl Harbor between Aiea and Waipahu.

show any direct relationship with the tide, and not enough data are available to show how much of the chloride present is due to return irrigation well water in which the chloride has been concentrated by evaporation and transpiration. Except in Waiawa and Loko Kukona, the salt content is not appreciably different from that of the water pumped from the adjacent plantation wells. The extreme variations of salinity, based on monthly determination of the measured springs since 1931, are given below, and a chemical analysis of Kalauao Spring is given on page 361.

Minimum and maximum salinity of the Pearl Harbor Springs

Name	Minimum		Date	Maximum		Date
	Parts per million	Grains per gallon		Parts per million	Grains per gallon	
Kalauao.....	114	11	Feb. 8, 1932 Sept. 17, 1932	229	22	Nov. 5, 1931
Waiawa.....	384	37	Feb. 8, 1932	551	53	[Dec. 6, 1932 Jan. 10, 1933
Waiuu.....	125	12	Feb. 10, 1932	145	14	
Waimanu:						
Loko Kukona.....	603	58	Dec. 11, 1931	873	84	Jan. 12, 1933
Puukapu.....	239	23	Nov. 6, 1931	384	37	May 9, 1932
Kaluaopu.....	145	14	Oct. 12, 1932	166	16	Jan. 8, 1932
Waikele.....	83	8	Various dates	156	15	Various dates

Quantity.—Monthly measurements of the Pearl Harbor springs for 1932 and 1933 made by the United States Geological Survey in cooperation with the Honolulu Board of Water Supply, are given below, and the location of the measuring stations is shown in figure 29.

Monthly discharge of Pearl Harbor Springs in millions of gallons, (a)

Month	Waiuu		Kalauao				Waimanu	
	1932	1933	Unused		Diverted ^b		Puukapu	
	1932	1933	1932	1933	1932	1933	1932	1933
January	241	298	506	567	149	133	129	176
February	251	274	622	620	21.7	26.0	141	163
March	292	306	684	634	27.4	92.2	167	177
April	260	287	586	525	81.3	156	156	163
May	266	270	550	496	144	187	169	153
June	240	^d 249	515	428	145	197	170	148
July	236	253	642	431	38.6	202	166	152
August	279	239	631	397	47.4	215	164	148
September	267	219	516	373	119	191	154	134
October	274	^d 214	513	394	119	185	140	124
November	276	208	563	400	72.8	174	158	129
December	300	^d 217	571	516	110	93.5	170	147
	3,182	3,034	6,899	5,781	1,075	1,852	1,884	1,814
	8.69	8.31	18.8	15.8	2.94	5.07	5.15	4.97

(a) A few small diversions adjacent to the springs not measured.
 (b) Diverted by pump 6, Honolulu Plantation Co.

Monthly discharge of Pearl Harbor Springs in millions of gallons, (a)—Continued

	Waimanu—Cont.				Waiawa			
	Kaluaoopu		Loko Kukona		Unused		Diverted ^c	
	1932	1933	1932	1933	1932	1933	1932	1933
January	598	651	97.1	^d 102	422	468	0	0
February	593	605	94.5	^d 93.5	428	438	0	0
March	679	667	120	^d 108	511	511	0	0
April	639	622	109	103	476	451	0	.60
May	679	619	113	95.0	476	427	0	13.9
June	621	^d 568	109	91.3	407	365	60.7	59.4
July	613	580	105	92.3	459	360	13.0	72.1
August	601	567	98.6	86.4	386	271	78.6	150
September	574	538	90.2	84.0	380	363	56.6	32.4
October	586	543	93.4	82.0	377	402	88.6	0
November	589	521	92.6	77.0	427	375	38.7	0
December	638	562	102	87.1	480	409	0	0
Average daily	7,410	7,043	1,225	1,102	5,229	4,840	336	308
	20.2	19.3	3.35	3.02	14.3	13.3	.92	.84

(c) Diverted by pump 9, Oahu Sugar Co.

(d) Partly estimated.

Some additional unmeasured water issues from Waiiau and Waiawa Springs, and occasional measurements indicate that about 3,000,000 gallons a day that does not pass the Waimanu gage is discharged by Waimanu Spring. Waikele Spring is not equipped with a continuous recorder, but numerous measurements indicate that its average flow amounts to about 8,000,000 gallons a day, of which about 2,400,000 gallons is diverted for irrigation by the Oahu Sugar Co.⁵² Thus the total discharge of the Pearl Harbor Springs amounted to about 85,450,000 gallons a day in 1932 and about 81,650,000 gallons a day in 1933. The unused flow wastes into the sea.

Relation to artesian water.—All the large springs issue from Koolau basalt. Noncalcareous sediments probably marine are exposed at Waiawa Spring, but a 15-foot excavation exposed the basalt; hence the water at the main openings probably issues directly from the basalt. The geologic map (pl.2) shows that these springs issue at the low points in the cap rock and hence represent leaks or outlets in the artesian structure (pl. 25, B). Palmer⁵³ anticipated that this was the case from his study of the Honolulu area. That these springs are at low points in the cap rock and are really nothing but spillways for this great underground reservoir is shown by the fact that the discharge of the springs varies directly with the static level in the adjacent artesian wells (fig. 30).

As the spring openings are all lower than the level of the adjacent reservoir, these leaks must be carrying their full capacity for any given head. This means that any enlargement of the spring vents will

⁵² Kunesch, J. F., Honolulu Board of Water Supply Rept. Suppl., p. 47, 1931.⁵³ Palmer, H. S., The geology of the Honolulu artesian system: Honolulu Sewer and Water Comm. Rept., Suppl., p. 43, 1927.

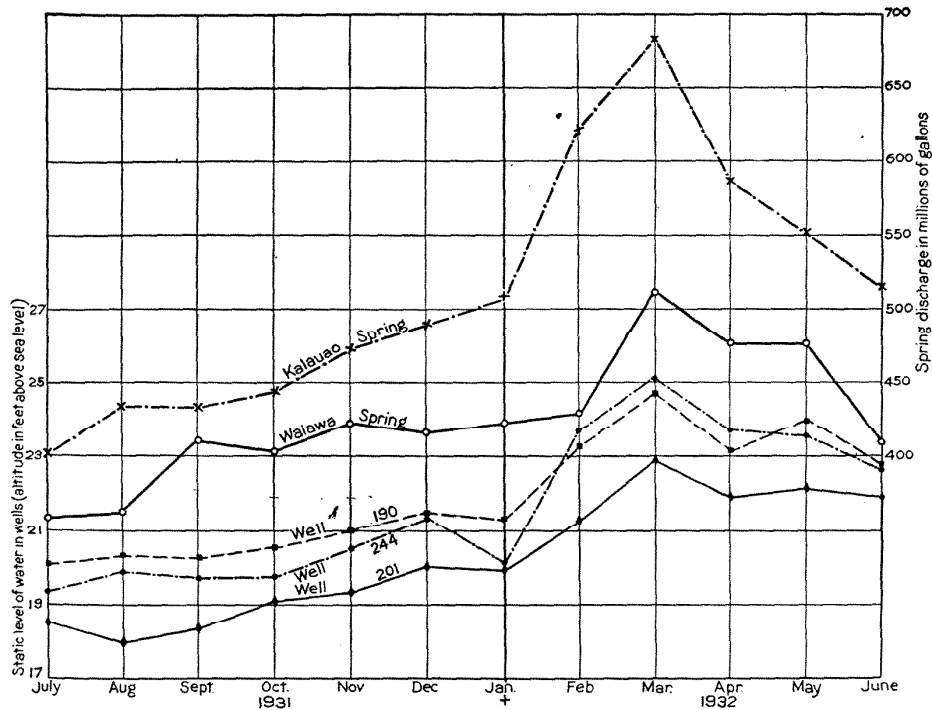

FIGURE 30.—Relation of discharge of Pearl Harbor Springs to static level in adjacent artesian wells.

increase the discharge of the springs and if large enough will lower the static level in artesian area 6. In fact, this relationship has already been demonstrated by the tunnel at Waikele Spring, which so lowered the head in tunnel 4B that the Waikele tunnel had to be plugged.

Discharge affected by pumping from wells.—Robert Fricke reports that prior to the heavy pumpage from the adjacent wells the springs in Waikela Gulch discharged from the bank about 20 feet above their present level, and that the present dry bank of the railroad cut near the bridge across this stream at Waipahu was formerly covered with trickling water.

It is not definitely known whether the other springs have decreased with the increase in pumpage from wells in area 6. It would be difficult to detect any change, because the springs issue in low swampy spots and are affected by the tides. Furthermore, they discharge large volumes of water, and any decrease caused by draft from wells would have been so gradual as to be scarcely noticeable.

However, with a draft of about 160 million gallons a day from area 6, their discharge must have declined, because much of the amount pumped would have overflowed from the basin. The return flow from the irrigation water imported through the Waiahole system repre-

sents an addition to the basin, but its contribution is small compared with this draft.

Possibility of springs in Pearl Harbor Lochs.—The geologic history of the Pearl Harbor area as described on page 48 shows that part of the caprock was laid down as marine sediments in the high seas preceding the Waipio stand of the sea. The Waipio stand was one of stream erosion, during which much of the cap rock was cut away. The subsequent Waimanalo stand of the sea restored part of the cap rock previously destroyed, but it did not effectively cover up all of the exposed basalt below the 25-foot level, as shown by the leaks where the Pearl Harbor Springs issue.

Probably there are other places below present sea level where the cap rock is either absent or scanty and where ground water can escape unnoticed. Soundings made by the United States Navy indicate small depressions in East Loch, which may be places where springs issue. In one of these depressions about midway between Waiau Springs and Fords Island, J. F. Kunesh and K. N. Vaksvik collected a sample of water with only 17,000 parts per million of chloride, which was appreciably less than that of the water at the surface. The bottom of this depression was 75 feet below sea level, or only 10 feet above the level at which Koolau basalt was encountered in well 208, on the Pearl City peninsula.

Methods for recovery.—It has been proposed to divert some of the water from Pearl Harbor Springs to Honolulu through a pipe line.⁵⁴ On page 327 it is pointed out that an appreciable part of this water could be recovered from wells in the Honolulu area by a reversal of the water-table gradient, thereby saving the long pipe line to the springs. Unless diverted, these springs insure the plantations in area 6 a perpetual water supply. However, in any comprehensive development of the water resources of Oahu this great quantity of water wasting into Pearl Harbor should be conserved. The water can be used in area 6 either by diverting the flow of the springs directly by means of collection ditches, or by replacing the artesian pumping plants on the plantations by wells of the Maui type dug as far inland as possible, so that the static level of the basal water in area 6 can be lowered safely. By the use of Maui wells, as the static level was lowered there would be a progressive decrease in the discharge, both visible and submarine, of the Pearl Harbor Springs. If the discharge of the submarine springs is now large, this method would result in a substantially larger net yield from the area than could possibly be recovered by diverting the springs directly.

⁵⁴ Honolulu Sewer and Water Comm. Rept. for 1929, p.117, 1929.

WINDWARD SPRINGS

Numerous springs issue from Koolau basalt on the windward side of the range. One group similar in origin to the Pearl Harbor Springs issues from the southwest bank of Anahulu Stream at the lowest point in the cap rock of artesian area 7. Emerson Spring (pl. 2), formerly used by the railroad, is the largest in the group and discharges about 1,000,000 gallons a day. The total discharge of these springs is difficult to estimate, because much of the water rises in tidal sloughs, although some springs issue as high as about 7 feet above sea level.

Kawailoa Spring, a mile northeast of Emerson Spring, issues from Koolau basalt and is now largely diverted by the Waialua Agricultural Co. Before it was dammed the discharge amounted to about 5,000,000 gallons a day, according to C. H. Bischoff, engineer for this company. At present about 2,000,000 gallons a day rises in the swamp below the pumping station and wastes into the sea.

About a mile northeast of Kawailoa Spring is Laniakea Spring, which discharges at tide level. Other springs doubtless discharge below ocean level where Koolau lava is exposed along the coast near Waimea Bay. Springs also issue from Koolau basalt near the Waialeale Industrial School, Kewalo Bay, Kahuku, Laie, and Hauula. The total discharge of all visible springs issuing from Koolau basalt along the windward coast is roughly estimated to be 12,000,000 gallons a day.

QUANTITY OF BASAL GROUND WATER DERIVED FROM THE BASALT MEMBER OF THE KOOLAU VOLCANIC SERIES

By H. T. STEARNS

The total quantity of basal ground water recovered from wells and tunnels and discharged from springs in Koolau basalt is computed to have been 117,998,400,000 gallons in 1932, a year of practically normal rainfall, subdivided as follows:

Quantity of basal ground water derived from Koolau basalt in 1932, in gallons a day

Water pumped from drilled wells.....	221,000,000
Water pumped from dug wells and tunnels.....	2,500,000
Water discharged by Pearl Harbor Springs.....	85,400,000
Water discharged by remaining springs (estimated)....	13,500,000
	322,400,000

WATER IN THE BASALT OF THE WAIANAЕ VOLCANIC SERIES

By H. T. STEARNS

OCCURRENCE

Basal water occurs in essentially the same way in the Waianae lavas as in the Koolau lavas, but because of a smaller rainfall and less continuous cap rock the quantity is much less. The high zone of saturation in the dike complex of the Waianae series indicates that basal water does not extend under the entire range. The area where basal ground water occurs is shown in figure 16. There are certain areas along the coast—as, for example, at Kaena Point—where this layer of fresh ground water may be so thin that it would be impossible to recover potable supplies from it. The water table had a slope of only 1.4 feet to the mile in the 4 miles between wells 274 and 276 on January 6, 1933, and a gradient of 1 foot to the mile was found between the wells on the north side of the range, indicating that the Waianae basalt is similar to the Koolau in permeability. Areas along the Waianae coast with and without artesian water are shown in figure 16.

ARTESIAN AREAS

Area 11.—Area 11, or the Gilbert area, is tapped by a battery of wells (wells 276 A to K, pumps 10, 11, and 12, Ewa Plantation), and logs of these wells show that the cap rock consists of 11 feet of soil, 9 feet of gravel and clay, and 38 feet of red earth and clay, lying on water-bearing basalt. The red earth may be either marine sediments or lateritic soil or both. As shown on plate 2, this locality is on the southeast end of the Waianae Range; hence there can be little doubt that these wells obtain their water from the upper basalt of the Waianae series. Because the draw-down averages only 6 inches when the pumps are running at a capacity of 21 million gallons a day, a large supply must be available.

The difference in head between these wells and those at Ewa was 10 feet on February 7, 1932, during a period of no pumping. The distance between them is $3\frac{1}{2}$ miles, indicating a hydraulic slope of slightly less than 3 feet to the mile. Although this gradient is not steeper than has been observed in some places in Koolau basalt, there is both geologic and hydrologic evidence which points to an artesian area separate from area 6 (see p. 264), but positive proof awaits further drilling in the area between Ewa and Gilbert. Although wells 274 and 275 are not artesian and not in area 11, they are described in the following pages because they draw from the same aquifer as wells 276 and shed light on the occurrence of water in area 11.

Pumping plant 5 of the Oahu Sugar Co., at well 274, consists of a shaft through the upper basalt of the Waianae series to the basal water

table and several tunnels in the upper part of the zone of saturation connecting a battery of wells. The water level at this plant is usually about 19 feet above sea level, and it fluctuates annually only about 2 feet and daily usually less than a tenth of a foot (fig. 20). When the wells are pumped at the rate of 16 million gallons daily the draw-down is only 0.25 foot. The salt content ranges from about 14 to 19 grains a gallon and is remarkably constant. The water is not artesian, because no cap rock is present. The well is 3 miles inland from well 273, at Ewa, yet its head is constantly 6 feet lower. It is believed that this unusual condition is not essentially caused by a downward hydraulic slope, but that the water in the Koolau lavas of area 6 is probably separated from that in the Waianae lavas by a ground-water barrier consisting of a soil bed between the Waianae and Koolau basalts. This soil bed is exposed at the contact of the two rocks 3,000 feet north of well 274.

Between Gilbert and well 274 is the recently drilled well 275, at Puu Kapolei, one of the last cones of the Waianae Range to erupt. The hole penetrates 147 feet of lava and cinders from this cone and probably enters the underlying flows of the upper basalt of the Waianae series, because it ends 60 feet below sea level. The salt content increased from 45 grains a gallon at 10 feet above sea level to 49 grains a gallon at the bottom.

When pumped at the rate of 465 gallons a minute the draw-down amounted to only 6 inches and the salt content increased to only 50 grains a gallon. The water level on January 6, 1933, was reported to be 19.2 feet above mean sea level. As the well did not pass through any cap rock the water is nonartesian. It is supplied from the same reservoir as wells 276A to K.

The average head at the Gilbert wells on January 6, 1933, was 13.71 feet with all pumps running, and as the draw-down amounts to about 6 inches, the adjusted static level was about 14.20 feet, or about 5.3 feet lower than in well 275. On this same date the head of well 274 was 19.5 feet, which indicates a gradient of about 1.4 feet to the mile for the 4 miles between wells 274 and 276. This gradient is similar to the gradient in the Koolau basalts.

At Kahe Point, 2 miles northwest of Gilbert, the lower lavas crop out along the shore and the cap rock disappears (pl.2). For some distance toward Gilbert from this outcrop the coastal-plain deposits consist of very permeable reef limestone only; hence the cap rock does not extend even to this exposure. A hydraulic gradient of 14 feet in a distance of less than 2 miles is not compatible with the observed slope of the basal water table elsewhere and requires a ground-water dam. Very permeable lavas form continuous exposures between Gilbert and this outcrop, and the only observed possible barrier is the thin

soil bed shown on plate 2 a quarter of a mile northwest of Gilbert, between the lower and upper Waianae lavas.

This bed may thicken downward or be sufficiently baked to form either a partial or complete ground-water dam between the Gilbert wells and the Kahe outcrop. As shown on plate 2, this soil bed connects with the talus breccia near the head of Nanakuli Valley, which is also believed to be a partial or complete barrier to ground-water movement. Pumpage from the Gilbert wells is given on page 297, and this is the only artesian draft from area 11. For convenience, the draft from the nonartesian wells in the tributary area is included in the summary below. Monthly draft for well 274 is given on page 281.

Well 275, drilled in January 1933, will pump about 300,000 gallons daily. In spite of an average daily draft of about 22 million gallons from the Waianae basalts, the head in this area has not declined—a fact indicating that the maximum safe yield has not yet been reached.

Annual draft from wells 274 and 276, in millions of gallons, 1905-33

Year	274	276	Total	Year	274	276	Total
1905	2,514	2,514	1920	2,154	5,282	7,436
1906	2,079	2,079	1921	1,786	4,880	6,666
1907	1,914	1,914	1922	2,129	5,641	7,770
1908	2,350	304	2,654	1923	2,118	4,509	6,627
1909	1,879	3,061	4,940	1924	2,112	4,487	6,599
1910	2,246	3,783	6,029	1925	2,297	5,136	7,433
1911	2,051	3,773	5,824	1926	2,855	4,740	7,595
1912	2,659	3,134	5,793	1927	1,615	4,942	6,557
1913	2,269	3,910	6,179	1928	2,726	5,437	8,163
1914	2,191	4,585	6,776	1929	2,896	5,201	8,097
1915	2,212	4,866	7,078	1930	2,627	5,133	7,760
1916	2,128	4,567	6,695	1931	2,827	6,209	9,036
1917	1,831	4,084	5,915	1932	2,048	5,584	7,632
1918	1,673	3,803	5,476	1933	1,916	5,558	7,474
1919	2,650	5,557	8,207				

Area 12.—From Kaena Point eastward along the north coast for 4½ miles, no wells have been drilled, but, as shown on plate 2, sediments are present that make either a partial or complete cap rock, because well 278 is artesian. A simultaneous survey of static level in the wells between 278 and Waialua shows that there are two isopiestic areas, with the boundary roughly a north-south line between wells 317 and 319. The artesian area west of well 317 is in Waianae basalt (pl. 2), and because a piezometric slope of 1.2 feet to the mile occurs between wells 315 and 281, the discharge point for this area is toward the west. As shown on plate 2, the caprock is low at the point of lava just west of well 278 and is absent at Kaena Point.

The geologic history of Oahu, as illustrated by plate 23,B, shows that the Koolau lavas should overlap the Waianae basalts near the east boundary of area 12. If the alluvium reported as encountered in the following log of well 308 at 412 feet is really alluvium, then this

well penetrated the overlapping contact of the Waianae and Koolau lavas, and it is this sedimentary deposit that serves as the ground-water barrier between areas 7 and 12.

Log of Well 308

Driller's description	Geologic interpretation	Thickness (feet)	Depth (feet)
Alternating layers of coral, sand, and alluvial deposits	Coastal-plain sediments (cap rock)	396	396
Hard rock	Koolau basalt (?)	16	412
Alluvial deposit	Alluvium or soil at contact (?)	20	432
Hard solidified lava rock	Waianae basalt	116	548

Except for the records of pumpage from wells 285 and 296 given on page 315 no accurate draft data exist. All except wells 278, 279, 283, 284, 288-293, 295, and 307 in this area are being used by the Waialua Agricultural Co. From a single round of discharge measurements made in January 1934 by the Waialua Agricultural Co., it is roughly estimated that the average daily draft for 1933 was 14 million gallons, including pumpage from wells 285 and 296. The head in the area is not declining, as shown by well 308 in plate 30, hence the safe yield has probably not been reached. In the unexplored west end of the coastal plain the sediments may be so thick that potable water will not be encountered in drilled wells; if so, water could be developed by a shaft connected to a tunnel into Waianae basalt a few feet above sea level. The recharge area of these wells is large, as it consists of the whole northern part of the Waianae Range. A sufficient number of dikes were found in Waianae basalt in Kaukonahua Gulch to retard rapid movement of water from the range south of Schofield.

AREAS ALONG THE COAST WITHOUT ARTESIAN WATER

BETWEEN AREA 11 AND KAENA POINT

Between Gilbert and Waianae.—On pages 81-7 ground-water barriers are described that probably separate the water in the middle and upper Waianae lavas of area 11 from the lower Waianae lavas to the west. Because of these ground-water dams, because of the sea-level outcrops of basalt between Kahe and Puu Paheehee where water can escape freely, and because of the low rainfall in this area, it is believed that only meager supplies of basal ground water exist in the lower Waianae lavas between Nanakuli and Waianae.

Three wells in Lualualei Valley shed light on the occurrence of water in the basalt beneath the coastal sediments. Their precise locations are not known, but the following descriptions are given by Bryan:⁵⁵

⁵⁵ Bryan, W. A., Evidence of the deep subsidence of the Waianae Range: Thrum's Annual, 1916, pp. 117-118.

The first of these, situated 10,000 feet almost due east of the mill between the mountain end of Maililili and the present pump, was driven 800 feet. Soft earth and boulders were passed through for 60 feet; the remainder of the depth was through "river bed gravel and sand." The second well in the basin was near the geographical center of the valley, 17,000 feet in an easterly direction from the mill. It was 1,200 feet deep; the first 300 feet penetrated soft earth, the remaining 900 feet in "river bed gravel and sand." The third well was at the foot of Puu Kaua, 25,000 feet distant from the mill in a direct line. It was drilled for the 300 feet of its depth in "solid lava rock." None of the wells in the Lualualei region furnished fresh artesian water.

There are evidently many places along the coast between Nanakuli and Makaha, as shown by these wells, where the coastal-plain sediments and valley fill extend so deep that, in accordance with the Ghyben-Herzberg principle, fresh water does not exist in the underlying Waianae basalt. It was impossible to show these areas in figures 16 because of lack of data.

Dug wells 5 and 7, near Waianae, pump water from Waianae basalt and they indicate only a relatively small amount of fresh water moving seaward through Paheehee Ridge, a condition to be expected in view of its small size and low rainfall.

Kamaileunu spur.—Because Kamaileunu Ridge, between Waianae and Makaha Valleys, extends back to the wettest part of the Waianae Range, it yields a good supply. Formerly at the point of the ridge a spring issued, but it has been dried up by the draft at Kamaile pumping station (277, pl. 2). This station consisted originally of a battery of 27 wells 260 to 300 feet deep which according to Bryan⁵⁶ penetrated 75 feet of soft earth and boulders and then entered basalt. The wells, which may be subartesian, are connected by a tunnel below ground surface, and 14 of them have been partly or completely sealed because of their high salt content. The plant consists of a 250 horsepower motor 6 feet above sea level connected to a horizontal centrifugal pump with a capacity of 2,500 gallons a minute. The wells are pumped at the rate of 5 million gallons a day against a 173-foot head, with a draw-down ranging from 5 to 17 feet, depending upon the season. The static level recovers to about 6 feet above sea level after 3 or 4 months without pumping, and the salt content decreases from 85 to 45 grains in a gallon.

A method to improve the recovery of water in this ridge is given on page 225. The quantity of water pumped is listed on the next page.

Kaau-Makaha spur.—The Kaau-Makaha Ridge is crossed in two places by breccia (pl. 2) that probably obstructs the flow of water toward the coast. Permeable coral separates the basalt in the south tip of this spur from the ocean and practically spoils the chances of recovering artesian water. In fact, if the breccia forms a fairly tight barrier

⁵⁶ Idem, p. 116.

it is doubtful if any potable ground water will be found in the upper basalt of the Waianae series near the coast between Makaha and Keaau Valleys.

Pumpage from well 277, in gallons a month, 1928-32

[Records furnished by Waianae Plantation Co.]

	1928	1929	1930	1931	1932
January	Shutdown	70,677,084	Shutdown	107,618,811	73,422,937
February	53,833,922	41,171,475	Shutdown	97,612,373	39,981,917
March	63,716,903	55,893,222	11,789,289	106,533,727	Shutdown
April	45,948,247	79,113,136	35,654,617	89,449,358	58,483,739
May	74,883,815	102,382,376	112,097,077	62,352,522	83,203,273
June	95,053,993	107,938,144	104,405,919	111,180,444	90,472,530
July	102,724,528	111,955,884	88,696,839	114,898,319	91,381,648
August	112,013,520	113,132,210	72,575,763	100,802,008	101,430,621
September	109,078,622	106,733,512	45,178,632	92,094,469	95,620,970
October	119,365,734	113,878,406	69,000,000	79,348,678	98,175,646
November	69,008,721	8,853,372	88,459,519	88,894,091	54,097,734
December	28,072,063	Shutdown	111,815,773	55,176,352	50,041,388
	873,700,068	911,728,821	739,673,428	1,105,961,152	836,312,403
Average daily..	2,387,158	2,497,887	2,026,502	3,030,030	2,285,006

Keaau-Makua spur.—The Keaau-Makua Ridge is full of dikes, striking chiefly toward the coast. Only coral caps the end of this ridge; hence ground water that is able to find its way through this maze of dikes can readily escape seaward. Although a steep water table would normally be expected in a ridge so full of dikes, the recharge area is very dry; hence recoverable quantities will be small.

Between Makua and Kaena Point.—The extreme aridity of the region west of Makua Valley, the number of outcrops of Waianae basalt at sea level (pl. 2), and the presence of dikes parallel to the coast cutting off supplies from the wetter mountain region probably mean scanty supplies of brackish or barely potable water along this coast. This does not mean, however, that water cannot be recovered in Makua Valley. (See page 70).

QUANTITY OF BASAL GROUND WATER DERIVED FROM THE BASALT MEMBERS OF THE WAIANAE VOLCANIC SERIES

Ground water is probably percolating into the sea at several points along the Waianae coast, but no large springs comparable to those along the Koolau coast are known. Small springs were noted at Brown's Camp and near Mokuleia, but the total quantity is small and difficult to estimate.

The total draft from the basal zone of saturation in the Waianae basalts for 1928-32 is given on the next page.

The total draft of basal water from the Waianae lavas is only 14 percent of the amount recovered from the Koolau lavas. This great difference is due primarily to the low rainfall on the Waianae Range. The static level of wells in these rocks has not declined because of this draft; hence more water can be developed safely in certain places. For example, a well at Schofield Barracks would encounter this reservoir

Draft from Waianae basalts, 1928-32, in millions of gallons

Year	Drilled wells				Dug wells or sea level tunnels		Total
	274	Area 12 ^a	276	277	5	7 ^b	
1928	2,726	4,700	5,437	874	6	187	13,930
1929	2,896	4,400	5,201	912	16	183	13,608
1930	2,627	4,100	5,133	740	14	134	12,748
1931	2,827	5,000	6,209	1,106	20	204	15,366
1932	2,048	3,500	5,584	836	38	105	12,111
Average daily	7.18	11.9	15.1	2.45	0.05	0.44	37.09

(a) Partly estimated.

(b) Includes an unknown amount from the coastal plain rocks.

probably about 25 feet above sea level, or a shaft at the head of Lualualei Valley connected to a sea-level tunnel cutting through the dike complex and tapping the reservoir under Schofield would yield large quantities of water.

PERCHED GROUND WATER

By H. T. STEARNS

OCCURRENCE

Perched or high-level ground water is exceedingly valuable on Oahu. It is used to irrigate lands too high to be economically supplied by pumped water, to supplement low-level ground-water supplies where they are insufficient, to generate power, and to dilute brackish low-level pumped water, thereby increasing the water supply and hence the irrigable acreage. It is utilized also for domestic supplies and is the cheapest water used in Honolulu. On Oahu it has no value for fluming sugar cane as on the island of Hawaii, because the land is flat enough for the cane to be transported to the mills by railroads.

Below are described the four types of occurrences of perched ground water on Oahu. As already pointed out by Meinzer,⁵⁷ they are (1) water confined by intrusive rocks, (2) water perched on ash or tuff beds, (3) water perched on soil beds, (4) water perched on alluvium. They are all the known quantitatively important occurrences of high-level ground water in the basalts of the Hawaiian Islands. The puddles of water perched on ice in the cracks and caves on Mauna Loa are too small to be included in this generalization. Whenever high-level water occurs in Oahu, intrusive rocks, ash or tuff beds, soil beds, or alluvium should be looked for as the restraining member. No occurrence is known on Oahu where flow lavas by themselves serve to collect and perch perennial ground water. However, in the areas of high rainfall on Maui the andesitic mantle covering the basalts of Haleakala is sufficiently impermeable to hold up perched water in the valleys cut in it which were subsequently filled with basalt and some of the andesitic clinker beds are sufficiently cemented by secondary minerals to perch small bodies of water.

⁵⁷ Meinzer, O. E., Ground water in the Hawaiian Islands: U. S. Geol. Survey Water-Supply Paper 616, p. 21, 1930.

WATER CONFINED BY INTRUSIVE ROCKS

Dikes, sills, and bosses constitute the intrusive rocks on Oahu. No water is known to be perched by bosses and the sills are so small and so few that they serve as restraining members in a few places only. To account for the large springs on the east side of the Koolau Range between altitudes of 550 and 750 feet, Palmer⁵⁸ postulated an extensive sill or zone of sills, or a zone of decayed and impervious ash extending through the Koolau Range between these altitudes and acting as a negative restraining member to prevent downward percolation of the water. The conception of ground water occurring in reservoirs of permeable flow lavas confined on the sides by dikes and on the bottom by sills or ash beds has become general. On Oahu, however, such structures are not found necessary in conjunction with the dike systems to hold the water at high levels, as the indefinite floor of the reservoir may be formed by the dike complex itself.

A large part of the field work during the investigation consisted of climbing stream beds and ascending the Pali where continuous exposures were available from the vicinity of sea level to the mountain top. Only here and there were thin sills and lenticular tuff beds encountered, and they are conspicuously absent in the area along the Pali where high-level ground water is most abundant. Consequently the word "perched" has been purposely omitted from the above heading and "confined" used in its place. Field observations indicate that a vertical zone of saturation extends from a level near the surface in the dike complex to a depth where dikes become so numerous as to replace all permeable extrusive lavas (fig. 5A). This depth along the Pali is probably well below sea level, but near the heart of the dike complex it is apparently in places above sea level. Thus, in driving a tunnel to develop high-level ground water in the dike complex along the Pali there is little danger of encountering dry rock caused by some overlying impermeable floor. On the contrary, the tunnel should always be located as low as practicable, for there is danger of being too near the surface and hence above the saturated zone.

The springs issuing at the base of the Pali (pl. 2) have no particular lower limit of altitude. Most of them, however, occur within a narrow belt extending along the base of the Pali. This condition is due in part to the extensive blanket of nearly impermeable older alluvium that covers the dike complex to the foot of the Pali, as shown on plate 2 and in figure 5A, and in part to the fact that the dikes near the Pali face are the only ones that are both cut through by erosion and have sufficient recharge area above them to provide water for overflow in the form of perennial springs.

⁵⁸ Palmer, H. S., Manuscript report on the possible occurrences of high-level ground water in the Honolulu region, p. 78, 1921.

The water entering this vertical zone of saturation is disposed of in several ways. A large part overflows as springs; some reaches the sea by flowing at the base of the alluvium; and the remainder leaks through joint cracks the dikes along the margin of the rift zone and joins the basal zone of saturation supplying the artesian basins. Thus deep percolation and overflow account for all the water.

In a general way, the dikes in the rift zone are roughly parallel and nearly vertical, so that a tunnel driven at right angles to them drains the water confined by them for a considerable distance on each side and above the tunnel. The main Waiahole bore completely drained the rock for more than 2,000 feet on each side. In areas such as the head of Waianae Valley, where there are numerous dikes with low dips and irregular trends, the volume of rock drained by a single tunnel or its area of influence is less than in the Koolau Range, because dikes may closely parallel the tunnel without being punctured and thus retard the percolation of water toward the tunnel. For instance, tunnel 6 in Waianae Valley did not completely dry up springs situated almost directly over it.

Dikes are not sufficiently impermeable to prevent some percolation through them. Thus a spring at the base of the Pali may be supplied from water between dikes on the south side of the divide. This requires a water table sloping toward the spring at nearly right angles to the dikes, a condition that was demonstrated by the main Waiahole bore. The north portal was started at a spring discharging about 4,700,000 gallons a day, but it dried up springs having a discharge of about 5,700,000 gallons a day. At the present time only about 2,000,000 gallons a day enters the tunnel between the portal and the point where the tunnel passes under the Koolau divide. The remaining 3,700,000 gallons a day formerly supplying these springs enters the tunnel south of the divide which indicates that this water formerly moved northward through several dikes to reach the springs. This fact has considerable economic importance, because it means that a tunnel not only drains the rock above and on each side of it but also drains water for some distance ahead of it. Thus, to drain all the water confined by a set of dikes, it may not be necessary to drive a tunnel far enough to cut through the last dike.

In the Koolau and Waianae Ranges, except near their respective eruptive centers, the dikes are nearly vertical and extend longitudinally for considerable distances. However, it takes more than such an arrangement of dikes to make a tunnel successful. Areas where practically nothing but dike rock occurs should be avoided.

There are many such places along the axis of the dike complexes of the Kailua and Koolau volcanic series at low altitudes, such as Puu

Pueo, near Waikane, and Wailea Point, near Lanikai. Tunneling for water will be unsuccessful also where the intake area above the dikes to be punctured is either small or arid. Thus, the low narrow ridges between the Pali and the north coast in the area between Waimanalo and Kahana are for the most part too small. Ridges in the Waianae Range such as Puu Hulu, although full of dikes, receive too low a rainfall to make high-level tunneling successful. Another important precaution is to avoid tunneling through dikes that have obviously been cut and drained by erosion at lower levels. Many of the ridges in the Waianae Range and most of the spurs along the Pali do not yield high-level water for this reason, although dikes are abundant.

Near the northwest end of the Koolau Range the dikes are divergent rather than parallel or intersecting; hence water has an opportunity to escape seaward from the ends of the intervening slices of flow rock. High-level ground water will probably not be found in this area.

To summarize, on Oahu ground water is confined between dikes in prisms of permeable extrusive rock which are usually saturated to great depth, and almost invariably the lower the tunnel the more successful it will be. However, areas consisting only of dikes, those with small intake, those of low recharge, and those where the dikes have been cut through by erosion at lower levels than the projected tunnel should be avoided. Largest yields per foot of tunnel will be obtained by driving at right angles to the prevailing dike trend and under the highest and wettest mountain mass. If possible, tunnels should be driven in dike areas below springs, which indicate that a water table is present.

By far the largest quantities of high-level ground water on Oahu are yielded by the dike complexes. Tunnels obtain annually about 12,250 million gallons from them, and springs supplied by them discharge about 19,800 million gallons. Thus the tunnels and springs together have an average daily discharge of nearly 88 million gallons, or 4.5 percent of the total average annual rainfall on Oahu. More ground water confined by dikes is awaiting development than all other high-level possibilities combined.

WATER PERCHED ON ASH BEDS

Although ash beds were found to be the most effective agent for perching water in the Kau district, Hawaii, they are much less effective on Oahu. This difference is due to their thinness and their small extent on this island. However, the ash on Oahu is invariably compacted to a tuff and altered or partly altered to palagonite, and because of this compaction a foot of tuff on Oahu is many times more effective for perching water than a foot of the Pahala ash in Kau.

In addition to the alteration by the weathering of the glass to palagonite, most of the tuffs intercalated with basalts have been baked by the heat of the lavas that overflowed them.

Although large areas of post-Koolau lithic tuff, as shown on plate 2, occur in southeastern Oahu, these tuffs do not perch water, because they overlie water-bearing rocks. Tuff must be intercalated between permeable rocks in rainy areas to perch water. In the Koolau and Waianae Ranges a few beds of lithic tuff are interbedded with lava, but only small springs issue from them. In places seeps were observed, but the tuff rarely exceeded a foot in thickness and thinned out at short intervals. These holes in the tuff blanket are caused by its deposition on an uneven surface and its subsequent removal by wind and rain from the high spots. It is through these holes that perched water escapes. One bed of lithic tuff in the Pali south of Waimanalo is unusually continuous, but when traced northward it appeared to split into several beds, no one of which was thick enough to form a good restraining member.

In the northeast corner of Manoa Valley several springs issue from the older alluvium a short distance from bedrock. It is evident that the water comes from the Koolau lavas, but the perching structure was not located. The east group of springs form Waaloa Stream and issue at the head of some water-cress paddies at an altitude of about 550 feet. Their discharge is reported to be very uniform and seldom to fall much below 400,000 gallons a day. Several springs also issue in the adjacent Waiakeakua Valley at about the same altitude. The upper ones issue from Koolau basalt, and the lower ones from older alluvium. Tunnels 1 and 2 have been driven at the site of the upper springs, but they did not reveal the perching structure. Both dikes and ash beds occur in this area; hence this water may be perched by either or by a combination of both. The similarity in altitude of the two groups of springs and the absence of outcrops of dikes close by points toward an ash bed as being the perching formation. These fine springs in close proximity to Honolulu justify exploration, because additional water might be developed there. The thick cover of alluvium downstream conceals all bedrock geology; hence core drilling or a pit dug near the springs will probably be necessary to determine whether an ash bed exists.

Deposits of vitric tuff of post-Koolau age are in general too permeable to perch water. Thus the "black sand" of Tantalus and Sugar Loaf is an aquifer, and to that from the Pali eruption is due in large measure the former leakage under Nuuanu dam 4. The older tuff underlying the upper basalt of the Nuuanu volcanics appears to be sufficiently impermeable to perch water for several of the City

and County tunnels in Nuuanu Valley, and it has caused the spring at the bend in the road below reservoir 2 and the Alewa Heights Spring. Some parts of this layer, however, are very permeable.

The older deposits of vitric tuff in the Koolau Range are much more impermeable but are thin and not extensive. Seeps have been noted issuing from some of them, but water is not scarce enough to justify tunneling along them for the small quantities recoverable. Locally, as in Manoa and Palolo Valleys, it may pay to tunnel along one of these deposits in order to take advantage of the softer rock in connection with obtaining water confined by dikes and at the same time to recover any water that might be perched by them. .

In the Waianae Range firefountains have taken place on a grand scale, and deposits of vitric tuff are numerous, fairly continuous, and thick. Unfortunately they are more permeable than those in the Koolau Range and occur almost entirely in the arid areas. Three tunnels recover water on the southeast slope of the Waianae Range from the top of deposits of vitric tuff, but as the tunnels were driven without scientific direction, they are not as effective as they might be. Tunnels along ash or tuff beds should be driven along the strike of the deposit, at right angles to its dip. The tuff mantles old surfaces; hence a tunnel should contour this old surface, with the rock forming the roof. The floor of the tunnel and as much as possible of the walls should be in the tuff.

An excellent spring horizon, caused by a zone of fairly continuous beds of vitric tuff in the cliff on the north side of the Waianae Range, extends for several miles west of Waialua. Tunneling along these tuff beds will yield valuable domestic supplies of water when the beach lots in this area are built up. The spring at an altitude of about 3,800 feet on the Schofield-Kaala trail discharges from the surface of a 25-foot tuff deposit. About 20 feet consists of yellow-brown decomposed cinders, and 5 feet is a fine-grained lithic tuff. Another small spring occurs on the trail to the Von Holt place, at an altitude of 1,950 feet, at the head of Kaloi Gulch. This spring discharges less than (a pint a minute.) Other small seeps in Makua Valley issue from the surface of a tuff bed. Although beds of vitric tuff are numerous on the southeast slope of the Waianae Range, for the most part they lie too close to the surface and in too dry an area for tunneling on them to be economically successful.

The total daily yield from all tunnels in the Koolau and Waianae ranges developing water on tuff is less than 1,000,000 gallons. The total discharge from springs perched on tuff in both ranges amounts to only a few hundred thousand gallons a day, an insignificant fraction of the high-level ground water of Oahu.

WATER PERCHED ON SOIL

The Koolau volcano spread flows over its surface so frequently that appreciable deposits of soil did not accumulate on one flow before burial by the next. Streaks of soil a few inches thick were noted at several horizons in the Koolau Range, but none were of sufficient extent or thickness to justify prospecting for water. Several feet of soil occurs on the Waianae rocks where they are in contact with Koolau lavas.

Because the Waianae Range had developed a drainage pattern prior to being overlapped by Koolau flows, probably most of the water is not moving down the soil-covered interstream surfaces but down the former stream channels. If these former streams were flowing on bedrock at the time of their burial the water would probably percolate directly through the bedrock to sea level, and tunneling along the unconformity would fail to recover perched water. If, on the other hand, the channels were floored with aluvium that has since decomposed, like that exposed in *Kaukonahua Gulch*, small underground streams might be encountered.

The Waianae-Koolau unconformity, as shown on plate 2, is exposed up *Kaukonahua Gulch* as far as *Haleanau Gulch*, about 2 miles northwest of *Schofield Barracks*. As far as this gulch the soil horizon is high in a canyon wall, where it has no opportunity to collect water. However, a tunnel contouring this surface southward from the gulch toward *Schofield* would probably recover some water, but the character of the area tributary to it would make the economic success of such a tunnel doubtful, especially in view of the fact that several of the streams in this area are already diverted for use at times by *Schofield*.

Several feet of soil was observed at the *Waianae-Koolau contact* south of *Schofield*, near pump 5 of the Oahu Sugar Co. The drainage area above this locality is fairly dry; hence a tunnel started at this point and driven toward *Schofield* would probably have too low a yield per foot of tunnel to be economically successful. This soil horizon, however, may be worth prospecting at some time in the future, should the need arise.

The Waianae Range, like the Koolau Range, lacks good soil horizons within its mass. The tuffaceous soil between the lower and upper lavas of the Waianae series gives rise to numerous small seeps. Several such seeps issue from it on the southeast side of *Nanakuli Valley*, but the rainfall on the overlying rocks is too small for water to be recovered in large quantities. Tunnels driven on this contact may yield sufficient water for livestock. The same holds true for the bed of ashy soil on the north side of *Makua Valley*.

Soil beds reaching 6 feet in thickness are exposed beneath the fire-fountain deposits of Tantalus and Sugar Loaf in Makiki Valley. They effectively perch water and give rise to Makiki and Herring Springs. However, because the overlying deposits have so small an intake area these springs go nearly dry in times of drought. Opportunities for developing water by a tunnel on these soil beds are described on page 157. Elsewhere the firefountain deposits lie mostly on slopes so steep that before burial they were not covered with soil.

Soil beds occur beneath the post-Koolau basalts, but as most of these basalts flowed down valleys filled with alluvium, the water perched in them is probably held up by alluvial deposits.

The total average daily discharge of springs perched on soil beds is estimated to be about 400,000 gallons. No tunnels on Oahu are known to recover water from soil beds, but on Maui 4,000,000 gallons a day is now being recovered by tunnels driven on such beds.

WATER PERCHED ON ALLUVIUM

No alluvium intercalated with the flows of the Koolau and Waianae Ranges is known. A small patch of alluvium was observed at the contact of the Koolau and Waianae basalt in Kaukonahua Gulch, and other similar deposits may exist under Schofield but are concealed. Tunneling along this contact has been discussed in preceding pages.

Considerable older alluvium sufficiently impermeable to perch water is known to occur beneath many of the post-Koolau flows where they floor valleys. This occurrence of perched water is believed to have considerable importance for Honolulu, and tunnels have been recommended in the description of the Tantalus, Nuuanu, and Kalihi basalts. Possibilities exist also for recovering water in the Ainoni, Kaneohe, and Haiku flows where they rest on alluvium. It is impossible to make a reliable estimate of the quantity of ground water perched on alluvium in these flows, but the Tantalus basalt alone yields about 700,000 gallons daily, and Ainoni basalt about 400,000 gallons daily. Hence, several millions of gallons a day is probably flowing into the sea unutilized.

It seems paradoxical to expect deposits of bouldery gravel to perch water, but the boulders and sand in the older alluvium are in most places so rotted that they have become compacted into a deposit approaching clay in texture. In the rain belt particularly these deposits are generally almost impermeable. Thus the main Gay tunnel in Kalihi Valley yields only a few gallons a minute from 769 feet of older alluvium. One of the tunnels in Nuuanu Valley recovers water from a gravel streak in the alluvium. In the Waianae Range

the older alluvium is not everywhere rotted, and water percolates through the unfilled interstices. Several of the tunnels in Waianae and Makaha Valleys recover considerable water from it.

At first thought it would seem that perched water could be recovered from the younger alluvium where it is underlain by older alluvium. In some places water occurs in this manner, but the deposits of younger alluvium in the upper parts of the valleys are too small in area and occur practically only in the stream bed. It is only near sea level that the younger alluvium widens out, and there water can be developed more readily from the basal water table.

TUNNELS

Only the tunnels driven to develop high-level or perched ground water are described in the following pages. Numerous other tunnels have been made for transporting water, but they are not included except two that are driven through rock for 2 or 3 miles and are instructive because they develop no water. They forcibly illustrate the fact that ground water can not be recovered by random tunneling.

TUNNELS IN THE KOOLAU RANGE

The tunnels are described below in clockwise order, starting at the east point of the island and progressing around the Koolau Range. A few tunnels may have escaped notice, especially those that were unsuccessful or have long been abandoned. Holes blasted a few feet into the rock at a spring site are not considered tunnels and are not included herein.

PALOLO TUNNEL

Palolo tunnel, on the west bank of Palolo Stream, about 35 feet above Waiomao Fork at an altitude of 987 feet, is 180 feet long (pl. 2). According to Palmer,⁵⁹ W. A. Wall, former city engineer of Honolulu, drove this tunnel at this site in the fall of 1920, at the suggestion of O. E. Meinzer. Formerly Waiomao Springs issued at this place, but their discharge is not known. The tunnel (pl. 28,B) penetrates considerable loose Koolau aa clinker and one dike 4 feet thick about 50 feet from the portal. The dike trends a little east of north, like most of the others in this area. About 950 feet upstream in the falls from Kaau Crater several dikes occur parallel to the one in the tunnel. Unless they pinch out toward the tunnel, these dikes should be encountered by driving the tunnel westward about 300 feet, and more water may be obtained by puncturing them. Palmer has already recommended this procedure.⁶⁰

⁵⁹ Palmer, H. S., Manuscript report on the possible occurrence of high-level ground water in the Honolulu region, p. 54, 1921.

⁶⁰ Idem, p. 73.

As an alternative development, a tunnel could be driven under Kaau Crater from the base of the falls. It would puncture these dikes with certainty in a distance of less than 500 feet and prospect a new area, as described more fully in the section "Kaau tunnel."

The discharge from the tunnel is variable and fluctuates according to the rainfall. When excavated the tunnel yielded about 1½ million gallons daily, but this flow lasted only a few months. For the months of record since 1925 its mean monthly discharge has ranged from 152,000 gallons daily in August 1925 to 562,000 gallons daily in May 1932. The average daily discharge from July 1, 1927, to June 30, 1930, was 292,000 gallons.⁶¹ During 1932 it was 408,000 gallons.⁶² The water from the tunnel is conducted through a pipe line to Honolulu, but when the discharge is greater than the capacity of the pipe line the water wastes into the adjacent stream. This is the most successful high-level water tunnel in the Honolulu area.

KAEA TUNNELS

Kaea Valley heads on the southwest side of Kaau Crater and is a branch of Pukele Fork of Palolo Stream. Two tunnels were driven in the east wall of this valley about 1910 by A. F. Cooke. One at an altitude of about 1,130 feet bears N. 60° E. and is 100 feet long. About halfway in, a branch tunnel runs off to the north. It was driven through rather dense Koolau lava broken by numerous joints, and its maximum yield according to Mr. Cooke was about 100,000 gallons daily. In April 1920 the portal was partly clogged with debris, and only a small trickle of water was coming from the tunnel. The yield must have been negligible most of the time, because the Milton Ditch, built up this valley to use the water from the tunnel, is abandoned.

The other tunnel, at an altitude of about 870 feet is 120 feet long and bears S. 80° E. A tunnel 25 feet long branches off to the northeast 70 feet from the portal. The entire length is in dense Koolau basalt, which is deeply rotted at the mouth but firm at the end. No water was developed.

The description of these tunnels was furnished by H. S. Palmer. They were looked for in 1932 but were not found. The object of the tunnels is said to have been to tap Kaau Crater water. If so, they stopped about 700 feet short of the crater.

MANOA TUNNELS

Five tunnels have been dug in Waiakeakua Valley, which is the easternmost tributary at the head of Manoa Valley. The tunnels were constructed by the Honolulu Waterworks Department under the direction of W. A. Wall about 1923.

⁶¹ Kunesh, J. F., Surface water supply of the island of Oahu, 1909-28; p. 96, Honolulu, 1929; Water resources of the city of Honolulu, 1928-30, p. 33, Honolulu, 1931.

⁶² Honolulu Board of Water Supply, Rept. for 1933, p. 157.

Tunnel 1.—In the south bank of Waiakeakua Stream at an altitude of 550 feet and about 4 feet above the stream is tunnel 1 (pl. 2). It is about 4 feet wide and 7 feet high and trends S. 40° E. It is 72 feet long by pacing and is driven nearly parallel to and less than 25 feet from the stream, in Koolau pahoehoe and aa basalt. The water issues in the tunnel floor from the surface of a bed of ropy pahoehoe. The largest single inflow comes from the stream side of the tunnel. W. O. Clark, who saw the stream practically dry in July 1931, reports that between 30 and 50 gallons a minute of spring water discharges from the plunge pool adjacent to the tunnel.

Palmer in his manuscript report on the high-level water possibilities for Honolulu shows a photograph dated March 14, 1921, of a spring at the side of this tunnel issuing from a small lava tube about 4 feet above the stream bed. When examined on July 21, 1931, the spring was dry, evidently having been intercepted by the tunnel. Most of the spring water that formerly discharged at this place has been captured by the tunnel. In fact, because the tunnel is driven so close to the stream and because it did not penetrate a dike or other geologic feature that would store water, it is exceedingly doubtful if the tunnel developed any appreciable amount of water that did not normally discharge into the stream at this place.

About 1,500 feet downstream several springs issue from alluvium and probably have the same origin as the springs at tunnel 1. A search was made of the valley near tunnel 1, but the formation on which the water is perched could not be found. From experience elsewhere it is believed that this water is either perched on an ash bed intercalated with Koolau basalt or held at this altitude by intrusive rocks.

This area seems a good place to prospect for water, but no advantage is to be gained by continuing the present tunnel with the meager knowledge at hand. First a detailed geologic examination should be made of the area after the vegetation has been cleared at the critical points, so that outcrops can be studied. Then, if dikes or other restraining members are not discovered a prospecting shaft should be dug near the mouth of the tunnel to determine whether an ash bed exists. The springs lower down, if perched by the same structure, indicate that more water should be obtained by driving a tunnel lower than the present tunnel.

Records kept by the Honolulu Board of Water Supply indicate that the discharge of this tunnel drops in dry years as low as 23,000 gallons daily, and in wet periods it reaches 319,000 gallons daily. The mean daily discharge from July 1, 1926, to June 30, 1930, was 150,000 gallons, but for the period January 1, 1931, to December

31, 1932, it was 176,000 gallons.⁶³ The water is piped to Honolulu.

Tunnel 2.—On the opposite bank from tunnel 1 and running N. 60° E. is tunnel 2, 9 feet long by pacing (pl. 2). It penetrates Koolau pahoehoe basalt, and two small trickles of water discharge from the surface of a red ropy pahoehoe flow at the heading of the tunnel. The rock is apparently the same as that in tunnel 1. Tunnel 2 is about 5 feet higher than tunnel 1, and this probably accounts in large part for its failure. The flow from the tunnel is carried by a 2-inch pipe to the adjacent city pipe line. The tunnel went dry in June 1929 and during April, May and June 1931. The average discharge is about 39,000 gallons daily, according to the records of the Honolulu Board of Water Supply.

Tunnel 3.—Tunnel 3 is in a gulch tributary to Waiakeakua Stream from the east, about 900 feet upstream from tunnel 1, at an altitude of 760 feet (pl. 2). It starts in a cliff near the top of a waterfall, the site of a former spring, according to local residents. It consists of a main tunnel and two branches, the main tunnel 81 feet long by pacing, with a trend of S. 45°E. The water is piped to Honolulu.

This tunnel is driven through Koolau pahoehoe and aa clinker. Both kinds of lava occur at the entrance, but most of the water comes from pahoehoe. A dense dike 2½ feet wide, striking N. 80°W. and nearly vertical, crosses the main tunnel at a point 66 feet from the portal. Another dike 36 feet from the portal, strikes S. 50°W. and dips 72 E. It is 3 feet wide, is tightly jointed and it has one parallel offshoot 4 inches thick. The selvage of glass is well developed.

A branching tunnel starting at about 42 feet from the portal of the main tunnel turns S. 45°W. and extends 15 feet to a point beneath the top of the waterfall. Like the main tunnel beyond the point of forking, it is completely dry. An 8-inch dike runs nearly parallel to this branch and dies out in the south wall of the main tunnel in a little stringer of glass.

Another branch turns N. 65° E. and extends 93 feet from a point about 51 feet from the portal of the main tunnel. All the water comes from this tunnel, mostly from the northwest side. It issues from pahoehoe apparently from behind the outermost dike crossing the main tunnel. A considerable part of this water must have formerly discharged into the adjacent stream, for the dikes have been cut by the stream. One other dike crosses the stream 600 feet to the east, but dikes are so few and far between that further prospecting for water at this site does not seem advisable.

The daily discharge of the tunnel fluctuates from 133,000 to 370,000 gallons, according to the rainfall. Records of the Honolulu Board

⁶³ Honolulu Board of Water Supply Rept., p. 175, 1933.

of Water Supply show an average daily discharge of 211,000 gallons for the period from July 1, 1926, to June 30, 1930. During 1932 its yield averaged 301,000 gallons a day.⁶⁴

Tunnel 4.—A tunnel about 100 feet long was driven about 1923 into the west bank of Waiakeakua Stream at an altitude of about 850 feet, (pl. 2). On July 21, 1931, about 1 pint a minute issued from it. A vertical dike striking N. 75° E. crosses the stream at the mouth of the tunnel. It shows platy jointing parallel to the strike and is very vesicular in the center. The tunnel starts in a direction away from the stream but turns around and stops directly beneath a plunge pool. When examined it was found to be walled up at the heading with large rocks. Among these rocks were several tiny water-worn pebbles which appeared to have been washed in from the stream. Consequently, W. O. Clark and I moved the rocks and found the water seeping in through inclined drill holes. These were later cleaned out and found to open into the bed of Waiakeakua Stream. When the dirt was removed the entire low-water flow of the stream could be diverted through the holes into the tunnel. Mr. Wall laid 1,000 feet of wood-stave pipe line to this tunnel. The flow from the tunnel is no longer used by the city.

Tunnel 5.—Tunnel 5 is about 25 feet long and was driven in the bank 24 feet downstream from tunnel 4 but failed to develop water. It runs S. 45° W. and is all in pahoehoe according to W. O. Clark, who examined it.

Woodlawn tunnel.—A tunnel driven about 1925 for the Woodlawn Dairy and Stock Co., by W. A. Wall, occurs at an altitude of about 525 feet, just below a small concrete dam on the southeast bank of Alamihikawai, a small stream tributary to Manoa. The tunnel extends N. 70° E. from a 15-foot open cut for about 120 feet. It starts on a 6-inch red ash bed interstratified with Koolau basalt but soon goes above the ash into aa basalt. On October 4, 1934 the tunnel was discharging at the rate of about 3 gallons a minute. The stream just above this point was discharging on this same date about 5 gallons a minute and the basalt for some distance above this ash layer was saturated. This ash layer may extend up Manoa Valley and perch the water in tunnels 1 and 2. A small supply might be developed at this place by contouring the surface of the ash bed with a tunnel.

Tantalus tunnel 1.—A tunnel driven about 1927 for A. Campbell by W. A. Wall occurs at an altitude of about 1,215 feet just below a wet spot in the trail on the southeast side of Tantalus. The tunnel extends N. 30° W. for about 30 feet and then runs N. 20° E. for about 50 feet. It penetrated only coarse stratified firefountain deposits from Tantalus vent and is dry.

⁶⁴ Honolulu Board of Water Supply Rept., p. 173, 1933.

Tantalus tunnel 2.—A tunnel driven about 1927 for A. Campbell by W. A. Wall occurs at an altitude of about 1,175 feet in a ravine on the east side of the southernmost Tantalus crater. The tunnel extends N. 35° W. through coarse cinders for about 130 feet and then for about 120 feet through hard Tantalus basalt. The cinders dip toward the crater indicating the basalt is a crater fill. According to Mr. Tada, the foreman, the purpose of this tunnel was to drain the swamp in the crater. Since the tunnel did not develop any water, a shaft was dug 20 feet deep in the bottom of the crater to drain the water into the tunnel, but this did not succeed.

NUUANU TUNNELS

Dowsett tunnel.—A tunnel was driven south-southeast into the east wall of Nuuanu Valley at an altitude of 775 feet upon the recommendation and under the direction of W. A. Wall, to obtain water for the Dowsett tract. It is shown on plate 2 about 2¾ miles southwest of the gap at the head of Nuuanu Valley, and a plan is given in figure 31. It is driven through Koolau pahoehoe and aa basalt. No

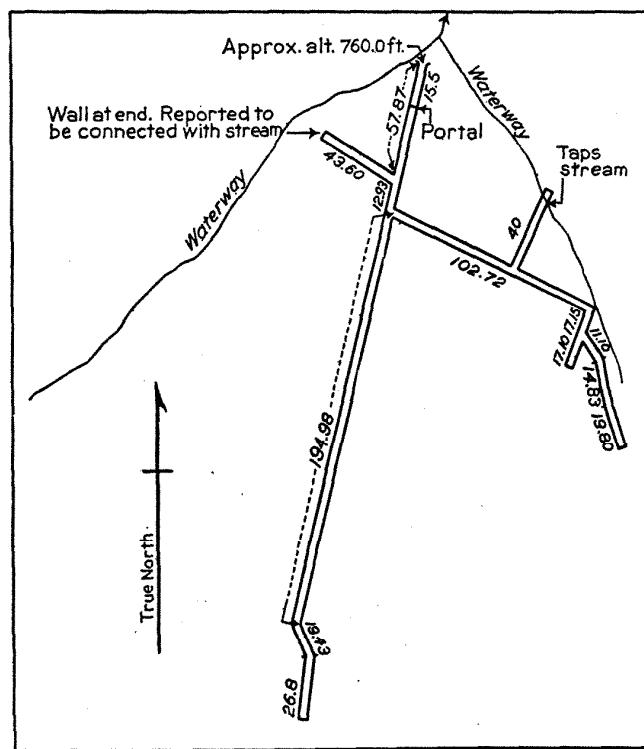

FIGURE 31.—Plan of Alexander Dowsett tunnel, in Nuuanu Valley.
(After a survey by Fred Harvey.)

dikes or other geologic structural features for perching water occur nearby. As would be expected under the circumstances, the tunnel

did not develop any ground water. Two laterals were driven underneath and within a few feet of the two adjacent stream beds. On May 15, 1932, about 10 gallons a minute, or the entire flow of one of the streams, was dropping through the roof at the point indicated in figure 31. The other stream was dry.

City and County tunnel 3.—Tunnel 3, as shown on plate 2, is at 810 feet above sea level⁶⁵ on the northwest edge of the floor of Nuuanu Valley about 500 feet upstream from Dam 3. The water is piped to Honolulu, and the tunnel was driven under the direction of W. A. Wall at a cost of \$3,753.50. It is 554 feet long and consists of one main tunnel with two laterals.

It runs N. 30° W. for the first 160 feet (determined by pacing) of which the first 110 feet is younger alluvium and the last 40 feet brown vitric tuff. The tuff at the end of this section strikes north and dips 13° W. For the next 120 feet the tunnel runs N. 10° E. and is in similar tuff. At this point a lateral runs N. 32° through aa basalt for about 35 feet. The remaining 239 feet of the tunnel runs N. 60° E. The first 75 feet of this part penetrates tuff and aa lava. At this point a lateral runs N. 5° E. for 30 feet in aa. The next 30 feet of the main tunnel is aa, and the remainder is all brown vitric tuff except for 5 feet of aa between 90 and 95 feet from the last lateral. All the tuff and lava is post-Koolau and apparently came from the Makuku cone, half a mile to the northeast. Most of the water comes out from the last 50 feet of the tunnel, where lava overlies the tuff, which strikes N. 21° E. and dips 8° NW. The yield of the tunnel is variable. Its flow was 170,000 gallons daily for September and October 1929 and reached 760,000 gallons daily in June 1930. Kunesh⁶⁶ believes it to be largely seepage from reservoir 4. The mean discharge for the period June 9 to December 31, 1932, when there was no backwater effect, was about 250,000 gallons daily.⁶⁷

City and County tunnel 3A.—Tunnel 3A is about 1,300 feet northeast of tunnel 3, at an altitude of about 900 feet (pl. 2). It was driven under the direction of W. A. Wall at a cost of \$1,509.20. It is 314 feet long and starts east and then veers to S. 70° E. at the end. The entire tunnel is in partly decomposed jointed Nuuanu basalt containing a little clinker. The main inflow occurs in the last 20 feet. Its yield on January 14, 1930, was 476,000 gallons, but on March 28, 1933, it was yielding only about 20,000 gallons daily, and Kunesh⁶⁸ reports that this is about the normal flow. It may also benefit from leakage from reservoir 4.

⁶⁵ Lengths, altitudes, and locations of Nuuanu municipal tunnels furnished by the Honolulu Board of Water Supply unless otherwise noted.

⁶⁶ Kunesh, J. F., Water resources of the city of Honolulu, island of Oahu, p. 18, 1931.

⁶⁷ Honolulu Board of Water Supply Rept., p. 162, 1933.

⁶⁸ Kunesh, J. F., op. cit., p. 39.

City and County tunnel 3B.—Tunnel 3B is about 600 feet north north-east of tunnel 3A (pl. 2). It was driven under the direction of W. A. Wall at a cost of \$576. It is 128.5 feet long and runs N. 5° E. The first 18 feet is lined with rock; the next 30 or 40 feet is in red-brown friable vitric tuff, and the remainder is in partly decomposed dark-gray vesicular Nuuanu basalt. The contact of the basalt and tuff strikes N. 20° W. and dips 5° NE. The discharge of this tunnel on January 14, 1930, was 192,999 gallons,⁶⁸ but on March 28, 1933, it was dry. It is no longer used, because it flows only for a short time after each rain, and the pipe line is frequently washed away where it crosses the adjacent stream.

City and County tunnel 4.—Tunnel 4 is near the upper end of reservoir no. 4, half a mile down Nuuanu Stream from the Pali Gap at an altitude of 1,027 feet. (See pl. 2). It was driven under the direction of W. A. Wall at a cost of \$8,989.50. It was started at a place where several small springs issued. All of the tunnel is in firm to friable brown pebbly clay and clayey conglomerate, with the pebbles thoroughly decomposed, indicating that it is older alluvium. Water from this tunnel is piped to Honolulu. The main tunnel runs about 190 feet N. 50° E. A branch runs about 420 feet S. 58° E. Another branch runs N. 40° W. for about 40 feet, where the only water in the tunnel is seen. The water enters through two 1-foot wooden pipes at the base of the boarded-up end. The tunnel has caved in for 30 feet, and the pipes conduct water through this part. The tunnel then continues for about 150 feet in the same direction and is walled up at the end with stone, through which a 3-foot wooden pipe brings into the tunnel all the water discharging at its mouth. It is reported that this pipe connects with a perforated pipe laid in the gravel bed of the adjacent Nuuanu Stream. Some concrete on the bank of the stream just above the tunnel suggests that a dam formerly diverted all the stream water into this pipe, as at City and County tunnel 1 in Kalihi Valley. The discharge of the tunnel is turbid during storms. Its open part is about 830 feet long, although it is reported to be 1,799 feet long. The discharge of this tunnel averaged 320,000 gallons daily for the year ending June 30, 1930,⁷⁰ but it is not known how much of this is ground water.

City and County tunnel 4B.—Tunnel 4B is on the east bank of Nuuanu Stream about 550 feet downstream from the dam of reservoir 4, at an altitude of 968 feet (pl. 2). It cost \$934.80 and was driven under the direction of W. A. Wall. It extends S. 85° E. for 228 feet in brown friable conglomerate. At the end of the tunnel brown clayey silt underlies the conglomerate, and at the portal brown friable vitric

⁷⁰ Kunesh, J. F., *op. cit.*, p. 14.

tuff overlies it. The water enters the tunnel through many small holes in the conglomerate. The roof is filled with roots, and the water may be percolating downward from the overlying permeable ash. A similar condition was found in test pits at reservoir 4. The discharge of the tunnel on March 28, 1933, was about 25,000 gallons daily. The water may be partly supplied by percolation from the adjacent stream and from Nuuanu reservoir 4.

City and County tunnel 4C.—Tunnel 4C is on the bank of Nuuanu Stream 800 feet southwest of tunnel 4B, at an altitude of 937 feet (pl. 2). It was driven N. 28°E. about 136 feet, through blocky jointed, moderately vesicular dark-gray Nuuanu aa basalt. The water enters through the roof between 50 and 90 feet from the portal. The last 46 feet is relatively unproductive. The yield was estimated on May 26, 1932, at 100,000 gallons daily. The tunnel was driven under the direction of W. A. Wall at a cost of \$854.

PAUOA TUNNEL

Directly beneath the road about 50 feet upstream and at a point about 15 feet higher than the Booth Spring is a tunnel driven for the city under the direction of W. A. Wall. It starts in the bedded ball-clinker marginal phase of the Tantalus aa flow. At 15 feet from the portal it enters dense Tantalus basalt, and thence it runs eastward although in a slightly curved line for about 100 feet in this rock. In the floor of the tunnel at the heading a hole about 1 foot across yields about 30 gallons a minute. A good stream of water can be heard flowing past this hole. The tunnel evidently encounters at this point the upper surface of the body of perched water that supplies the springs below, because the tunnel goes dry first. It is reported that the tunnel was stopped because it endangered the flow of Booth Spring. A tunnel at the base of this lava as described in the section "Undeveloped ground-water supplies—Pauoa tunnel" should be successful.

KALIHI TUNNELS

Gay tunnel.—The main Gay tunnel is about 3,000 feet long. It was constructed by W. A. Wall for the late Francis Gay. It starts at an altitude of 502 feet in the east bank of a small tributary that enters Kalihi Stream at Kalihi Orphanage (pl. 2). The first 95 feet is in red vitric tuff, probably from the Kamaikai eruption, which took place about a mile to the east. For the next 769 feet the tunnel is chiefly in thoroughly decomposed older alluvium with a few streaks of red tuff. Then the tunnel enters thoroughly and partly decomposed Kalihi basalt, which persists for 553 feet to a small creek bed. Crossing this creek and connecting the parts of the tunnel on the two banks is 57 feet of wood-stave pipe line. The next stretch of tunnel starts

in rotten Kalihi basalt but soon penetrates good fresh rock. Then there is about 75 feet of pipe line connecting this tunnel to the upper unit. The upper part is 1,310 feet long and starts in younger alluvium, which consists of fairly clean coarse sand and boulders, evidently the fan of the small creek that passes the mouth of the tunnel. The alluvium yields a little water at all times but large quantities during heavy rains. It continues for about 400 feet, and then the tunnel enters decomposed Kalihi basalt containing a few hard, dense residual blocks, which grades into fresh rock. The tunnel is nowhere very far beneath the surface, much of it less than 20 feet, which accounts for the fact that so much of this post-Koolau basalt in the tunnel is decomposed. On March 2, 1931, the upper 631 feet was yielding only 8.85 gallons a minute, or 12,744 gallons a day. On March 1, 1931, the lower 1,054 feet was discharging only 2.85 gallons a minute, or 4,104 gallons a day. This stretch of tunnel, of which about 800 feet is in decomposed older alluvium, is excellent proof of the impermeability of this material. On March 2, 1931, the middle portion of the tunnel, up to the cave-in, was yielding only 16.75 gallons a minute, or 24,120 gallons a day. In April 1932 the caved-in part was reexcavated. A weir installed and read by John McCombs just above the pipe-line diversion for the period April 16 to July 13, 1932, showed an average flow of 88,000 gallons daily. On May 1, 1932, the flow was 200,000 gallons, and on June 25, 1932 it was 38,000 gallons, indicating that the tunnel is sensitive to variations in rainfall.

A large part of the high yields comes from the gravel section, which underlies abandoned taro patches. McCombs reports that at one of the points where the water from one taro patch empties into another he found an artificial rock drain connecting the tunnel to the surface. Through this drain a large stream of water enters the tunnel during each rain. According to Mr. Wall the lower 1,054 feet of the tunnel was built for a transportation tunnel. At the present time a 4-inch pipe line diverts water from an adit at exactly this distance from the lower end for supplying the Gay estate. The region is too thickly inhabited and the tunnel too shallow to make this water safe for domestic use without chlorination. Surface streams during heavy rains enter some of the adits above the diversion point of this water, hence the danger of pollution is great.

Mr. Wall reports that he drove a tunnel 67 feet long toward the valley wall a few hundred feet above the main tunnel, but it did not develop any water and so was abandoned.

Gay mauka tunnel.—At an altitude of 650 feet on the northwest side of Kalihi Valley half a mile above the upper end of the main Gay tunnel is the Gay mauka tunnel (pl. 2). It was started January

17, 1927, and completed May 15, 1928. Like the main Gay tunnel, it was driven under the direction of W. A. Wall with the purpose of developing ground water to sell to the city of Honolulu. It starts in a northerly direction in a gulch and at 150 feet from the portal turns northeast for 286 feet and stops under the bed of the same stream that passes the entrance. One hole in the roof of the tunnel is within 5 feet of the bed of the stream but does not tap the stream. The tunnel starts in decomposed Kalihi basalt but ends in sound rock filled with many joints, through which the water enters the tunnel.

A branch tunnel turns southwest 35 feet from the entrance and runs in this direction for 350 feet through decomposed Kalihi basalt. It then turns northwest for 285 feet through cavernous slaggy Kalihi pahoehoe, which was practically dry in March 1931. The total length of this whole tunnel system is 1,202.5 feet according to a map by Mr. Wall. On March 1, 1931, this tunnel was yielding 17.65 gallons a minute, or 25,416 gallons a day. The west branch yielded only 4 gallons a minute of this total.

Between March 25 and July 16, 1932, the maximum daily discharge of this tunnel as recorded by John McCombs was 64,000 gallons and the minimum 36,000 gallons.

Kalihi Orphanage tunnels.—The Kalihi Orphanage tunnels are about 600 feet above sea level on the southeast bank of Kalihi Stream about 100 feet above the water surface (pl. 2). It is reported that they were driven about 1905. The south tunnel is about 50 feet long and starts due south. The middle tunnel is about 75 feet long and starts S 45° E. The north tunnel is about 125 feet long and starts S. 70° E. The south and middle tunnels yield about equal amounts of water, but the north tunnel is nearly dry. The tunnels discharge into a trench 15 feet long, from which the flow is led to a reservoir nearby. On September 4, 1932, the flow was estimated at about 20 gallons a minute, but the tunnels go virtually dry in times of drought. At the portals of the tunnels 2½ feet of post-Koolau basalt is exposed resting on compact older alluvium. The contact plunges beneath the floors a short distance from the portals, so that the tunnels are mostly in the basalt instead of under it. More water might be developed here by driving a tunnel at the contact of the basalt and the alluvium. As water issues about 100 feet above Kalihi Stream, the water escaping here is probably seepage from tributaries on the south canyon wall rather than from the stream. Consequently, the prospect is not favorable for developing much additional water at this site.

City and County tunnel 1.—Tunnel 1 of the City and County of Honolulu is about 800 feet up Kalihi Valley from the Gay mauka tunnel, at an altitude of about 720 feet (pl. 2). The tunnel was driven by the

City Waterworks Department under the direction of W. A. Wall. The tunnel starts in the north bank of a small creek and runs 20 feet north directly away from it, then turns N. 60° E. for 300 feet. The entire flow of the tunnel pours through loose rock at the head of the tunnel. The tunnel starts in decomposed Kalihi basalt but ends in fresh dense rock. A traverse up the adjacent stream bed, which was dry at the mouth of the tunnel, revealed a small concrete dam in the stream bed. At this point the entire flow of the stream sinks into the boulders at the head of the tunnel. It is evident that none of the flow of this tunnel is ground water. It would have been better to divert the water directly from the stream, and save the city the cost of the tunnel. The operator in the valley reports that the water from this tunnel cannot be used on rainy days because it is so muddy.

City and County tunnel 2.—Tunnel 2 is at an altitude of about 740 feet, about 100 feet east of tunnel 1 (pl. 2). It was also driven by W. A. Wall. It is about 225 feet long (by pacing) and runs N. 45° E. through fresh Kalihi basalt. On March 9, 1931, the yield of this tunnel was about 3 gallons a minute, practically all of which enters through a boarded-over hole in the roof of the tunnel about 50 feet from the portal. Examination showed that this hole is in the bottom of a small creek bed and covered by gravel. The operator states that muddy water flows from this tunnel every time it rains.

City and County tunnel 3.—Tunnel 3 is about 1,200 feet upstream from tunnel 2, at an altitude of about 800 feet. The tunnel is driven S. 50° E. for about 240 feet and then turns S. 15° E. for 110 feet. A pipe from the upper tunnels discharges into its upper end. On September 24, 1931, after considerable rain, about 10 gallons a minute was entering the tunnel 80 feet from the portal from small lava tubes in very vesicular pahoehoe. This tunnel may dry up soon after rains stop. Most of the tunnel is in thoroughly decomposed Kalihi basalt crossed by streaks of a black mineral, possibly manganese dioxide, and containing cavities filled with a pale-yellow soapy substance that is probably montmorillonite. About 54 feet of the tunnel, in the curving part is in firm fresh dense Kalihi basalt. The decomposed part stops in places against fresh lava with a striking sharpness, not uncommonly observed in the post-Koolau nephelitic basalts. The amount of water developed by this tunnel could not be determined because of the inflow from the pipe at the end, but it is evidently not large.

City and County tunnel 4.— Tunnel 4, about 380 feet long, is at an altitude of about 810 feet about 500 feet upstream from tunnel 3 (pl. 2). It starts N. 5° E. but curves toward the east. Some water enters the tunnel about 240 feet from the portal, but most of the water tumbles into the end, apparently from a pipe line that is covered up. The tunnel

is entirely in Kalihi basalt and may have been driven by Mr. Wall to transport water from the diversion dam farther up in Kalihi Stream. The water from this tunnel is reported to enter tunnel 3 through a pipe.

City and County tunnel 5.—Tunnel 5 starts at an altitude of about 835 feet on the south side of Kalihi Stream and runs about 300 feet in a direction S. 16° E. through a brown clayey material. The water enters from the far end, which nearly underlies a small stream bed.

City and County tunnel 6.—Tunnel 6 is only a few feet north of tunnel 5. It starts N. 63° E., and at 100 feet it turns about 10° toward the north. It is about 260 feet long and ends in decomposed older alluvium. Water enters at 100 feet from the portal and also at the heading.

According to the records of the Honolulu Board of Water Supply obtained at a venturi meter at an altitude of 500 feet in the pipe line below all Kalihi City and County tunnels, all the tunnels frequently go completely dry. They show a maximum daily flow of 1,410,000 gallons, but a large part of this flow is surface water. It is doubtful if the average yield of ground water from all these City and County tunnels, which have a total length of about 1,835 feet, exceeds 50,000 gallons daily.

SOUTH HALAWA TUNNEL

At an altitude of about 780 feet on the northwest bank and only about 2 feet above South Halawa Stream is a tunnel driven about 1900 by the Honolulu Plantation Co. (pl. 2). On September 3, 1932, it was discharging about 15,000 gallons daily. The main tunnel runs N. 20° W. for about 380 feet. At about 125 feet from the portal a branch starts N. 55° E. and curves gradually until at its heading it runs due north. This branch is about 630 feet long. About 65 feet from the heading a lateral runs N. 60° E. for 20 feet. The tunnel was in excellent condition when examined, although some mud washed in from South Halawa Stream covered the floor near the portal. It penetrates the partly decomposed clinker phase of an aa flow. Its surface is sufficiently weathered to account for all the water perched in this tunnel. It is reported never to go dry. The low yield of this tunnel, considering the fact that it penetrates Koolau lava for about 1,030 feet, is ample proof that random tunneling without locating geologic structures favorable for perching water is likely to be unsuccessful.

NORTH HALAWA TUNNEL

At an altitude of about 680 feet on the northwest bank and about 10 feet above North Halawa Stream is a tunnel driven about 1901 by the Honolulu Plantation Co. to develop water (pl. 2). The tunnel starts N. 10° E. near a small dry stream bed, in weathered basalt, but

it is plugged at the entrance so that water fills it nearly to the roof. It was not examined. John Pregill, who visited the tunnel regularly during its construction, states that it runs north about 300 feet and then forks. One branch is about 2,000 feet long, and the other is shorter. The yield on August 31, 1932, was about 30,000 gallons daily.

Its flow is reported to be very uniform. A thin layer of soil intercalated in Koolau lava is exposed at about the level of the tunnel in the adjacent dry waterfall, hence it is likely that the water discharged by this tunnel is perched on this soil.

AIEA TUNNEL

At an altitude of about 650 feet on the northwest bank and about 6 feet above the bed of Aiea Stream is a tunnel driven about 1898 by the Honolulu Plantation Co. to develop water (pl. 2). It starts N. 5° W. and runs for about 375 feet into the canyon wall in the clinker base of a massive aa flow. It was dry on August 31, 1932, and does not appear to have ever discharged any water. It lends additional support to the belief that Koolau flow lavas do not perch water.

WAIAHOLE TUNNEL SYSTEM

The Waiahole tunnel starts at an altitude of 724 feet in the north bank of Waiawa Stream about 6½ miles northeast of Waipahu and runs N. 72° E. for 14,567 feet to Waiahole Valley through the main Koolau divide. (pl. 2). Construction was started in February 1913 from both ends to transport the flow of the eastern streams to the west side of the range to irrigate the high lands of the Oahu Sugar Co. It is owned by the Waiahole Water Co., Ltd., of Waipahu, a subsidiary of the Oahu Sugar Co., and work was started by H. K. Bishop, engineer for this company. In October 1913 Mr. Bishop resigned, and the work was finished by J. Jorgensen, a contracting engineer. H. Olstad, who is now superintendent of the company, has an excellent knowledge of the whole system and was superintendent in charge of most of the construction. A fine description of the project is given by Kleugel.⁷¹

Contouring the Pali north of the north portal is 24,621 feet of collection tunnel consisting of 27 units and 30 intakes, one at each gulch to admit surface water. The units range from 280 to 2,332 feet in length and the grade is 1.3 feet in 1,000 feet. The intake end of the tunnel is 790 feet above sea level.

Much of the surface water is derived from springs issuing from Koolau lavas where dikes have been cut by stream erosion. At some of the springs, such as the one shown in plate 32, A, the water squirts out under considerable pressure. The tunnel is close to the Pali face except

⁷¹ Kleugel, C. H., Engineering features of the Waiahole water project of the Waiahole Water Co., island of Oahu, T. H., Hawaiian Eng. Assoc. Press Bull. 53, June 1916.

where it passes through ridges between drainage divides. A similar collection tunnel consisting of two units with a total length of 745 feet extends south from the north portal. It starts 20 feet higher than the main tunnel and connects water-development tunnel A to the main tunnel.

Main Waiahole tunnel.—The main Waiahole tunnel is 8 feet wide and 8 feet high and built on a grade of 2 feet in 1,000 feet, at a cost of \$28.60 a foot.⁷² This cost included all the expense of drainage except the cost of drainage tunnel R and its prorated part of the general overhead account. The tunnel was all lined except where water enters, at an additional cost of \$6.20 a foot. A cross section of the Koolau Range along the tunnel line is shown in figure 32. Probably a few more dikes

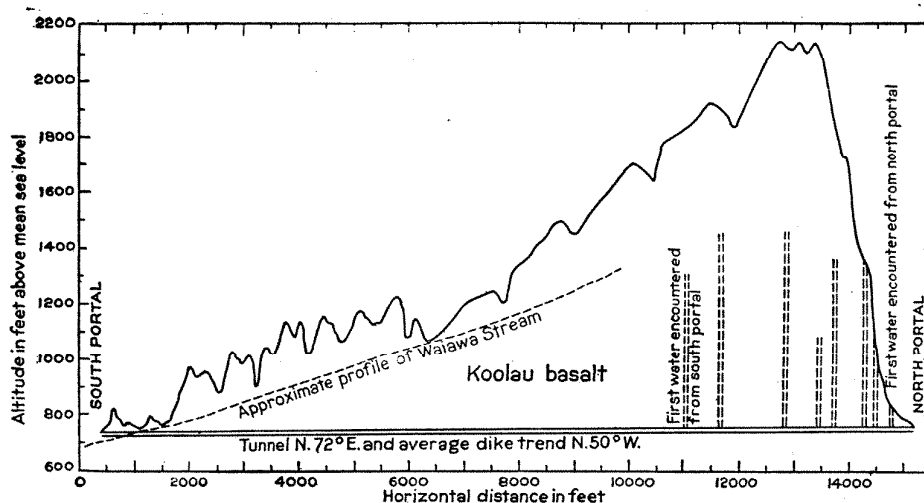

FIGURE 32.—Cross section of Koolau Range above main Waiahole bore. Vertical broken lines indicate dikes. (After J. Jorgensen.)

were cut than are shown in this figure as indicated by the survey of tunnel R, but those shown probably released large flows when cut. The entire tunnel was driven through Koolau basalt at a somewhat lower angle than the dip of the lava flows.

Work was carried on from the south portal for 10,518 feet before the first dike and water were encountered. J. Jorgensen informed me that he drove the first 2 miles from the south side at an average rate of 21 feet a day at a cost of \$12 a foot, exclusive of depreciation of machinery. Tunneling was carried on continuously by three 8-hour shifts, with three men working at the face of the tunnel. Electric, gas, and cable cars were used at various times for hauling. When the first dike was drilled the holes were plugged and the tracks raised on timbers about a foot above the floor, to allow the water to drain out beneath

⁷² Letter from H. Olstad, dated April 18, 1932.



A, SPRING ISSUING FROM AA.

Where dike has been cut through by erosion near intake 29, Waiahole System.

Photograph by Harold T. Stearns.

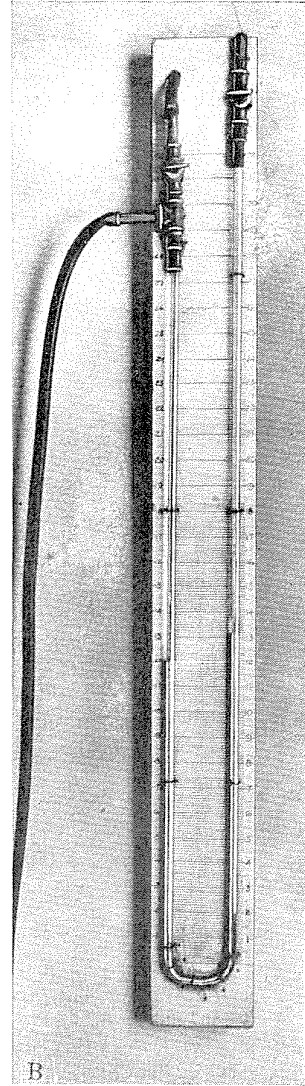

B, PIEZOMETER TUBE.

Board is 35 inches by 3/4 inches by 3/4 inch. Records static level of artesian wells in feet direct. Photograph by H. F. Hill Studio.

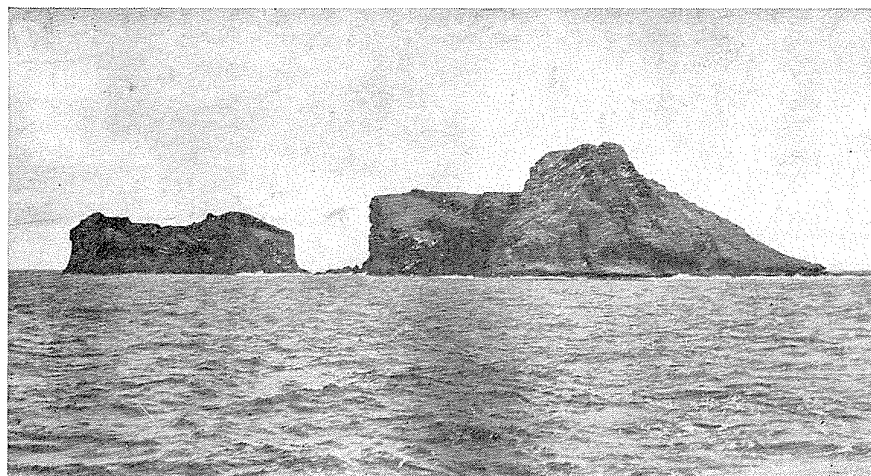

C, MOKU MANU OR BIRD ISLAND.

A tuff cone partly destroyed by marine erosion. Courtesy of Mid-Pacific Magazine.

them. Pressures of 67 pounds to the square inch developed in the drill holes, indicating that water was standing in the rocks at least 150 feet above the tunnel, or 900 feet above sea level. A maximum daily flow of 17,000,000 gallons was developed in this heading. Progress became much slower because of the difficulty of working in so much water, and specially devised tubes had to be made for placing dynamite charges.

Work on the north heading began at one of the Waiahole Springs, which were discharging about 4,100,000 gallons daily. As water was expected and as the natural slope of the tunnel was downward into the mountain, the floor of the tunnel was lowered an extra 3 feet, so that water could run out of the tunnel by gravity.

The first dike was penetrated at about 200 feet and yielded 2,000,000 gallons daily. At 600 feet a dike about 8 feet thick was penetrated, and by 900 feet the flow had increased to 26,000,000 gallons daily and the floor was lowered an additional 2 feet. Because of the hardship involved in men working waist-deep in cold water for 8 hours at a time, four shifts per day of 6 hours each were used in the north heading.

The temperature of the water in the tunnel was approximately 66° F., 8 degrees colder than Honolulu artesian water, or somewhat less than 1° for each 100 feet in altitude above the artesian water beneath Honolulu.

As shown in figure 32, by the time the tunnel penetrated 1,400 feet it had cut four dikes and was yielding about 35,000,000 gallons daily. Work was temporarily stopped at this time, and two siphons 16 inches and 22 inches in diameter were installed. They soon proved inadequate, so another parallel tunnel known as "drainage tunnel R" was driven a little higher. When the main bore passed south of the intersection of these two tunnels the water was pumped to the upper bore by means of a large centrifugal pump. Mr. Jorgensen states that the average cost of the north end of the main tunnel was about \$100 a foot, owing to the expense of drainage. The two bores met at 11,679 feet from the south portal on December 13, 1915. The Oahu Plantation was in dire need of the water at the time; otherwise a good deal of money could have been saved by allowing much of the stored water to drain out by gravity.

The rate at which the ground water stored between the dikes drained out is shown by the following records, based on miscellaneous measurements by H. A. Austin.⁷⁸

⁷⁸ From report by H. Olstad to J. B. Thompson, October 22, 1923, p. 3.

Average daily ground-water discharge of main Waiahole tunnel in millions of gallons

Month	North end	South end	Total
1913			
August.....	16		16
September.....	21		21
October.....	17		17
1914			
April.....	15		15
May.....	20		20
June.....	38		38
August.....	36		36
October.....	40		40
November.....	30		30
1915			
January.....	29		29
February.....	28		28
March.....	30	10	40
April.....	31	12	43
May.....	25	13	38
June.....	20	15	35
September.....	12	12	24
November.....	8.5	9	17.5
December.....	8.3	6.1	14.4
1916			
January.....			13.8
April.....			12.2
June.....			8.6
October.....			8.7
December.....			8.6

The records of the Waiahole gaging station do not indicate any change in discharge until August 1913. Evidently the water encountered before this date did not increase the discharge of the Waiahole Springs. The curve shown in figure 33 is based upon Austin's measure-

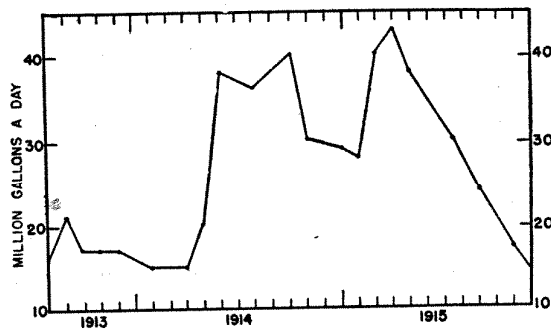

FIGURE 33.—Ground-water discharge from Waiahole tunnel during construction.

ments except for the period November 1913 to March 1914, which is estimated from the flow past the Waiahole gaging station. Between April 1915, when the peak flow was reached, and the completion of the tunnel, there was a progressive decrease in discharge as stored water was drained out. The constant flow of 8,600,000 to 8,700,000

gallons daily, as determined in June, October, and December 1916, seems to indicate that most of the stored water was drained out by June 1916. Thus it took just a little over a year for the stored water to drain out. Tunnel R, which is much shorter, drained out in 10 months.

During June and July 1911 weir measurements were made of three springs in Waiahole Valley at altitudes of about 750 feet. Their discharge was 4,700,000, 1,004,000, and 2,400,000 gallons a day.⁷⁴ According to Olstad, the first two of these springs were dried up by the main Waiahole bore, so that about 5,700,000 gallons daily of spring water was diverted. The flow of the Waiahole tunnel is measured continuously where it passes under the Koolau divide, at the junction of tunnel R and the main bore, and it is also measured at the south portal. The average daily discharge at these two stations, the ground-water gain between the two stations, and the rainfall at Waiawa are given in the table below.

Average daily flow of the main Waiahole tunnel at the boundary and south portal stations, ground-water gain between the stations, and annual rainfall at Waiawa, 1916-32

[Records furnished by Waiahole Water Co.]

Year	Average daily flow (million gals.)		Ground-water gain (main tunnel) (million gallons)	Rainfall in Waiawa (inches)
	Boundary Station	South portal adit 8		
1916	23.35	29.61	6.26	.56
1917	23.17	29.39	6.10	.36
1918	27.96	35.53	5.81	.44
1919	22.20	28.42	5.51	.29
1920	17.92	23.79	5.06	.38
1921	21.43	28.07	6.11	.37
1922	20.96	28.90	6.57	.41
1923	24.06	32.07	6.51	.60
1924	19.50	26.98	6.60	.43
1925	19.13	27.37	7.05	.51
1926	17.63	23.47	5.27	.35
1927	28.28	37.11	6.29	.85
1928	26.14	33.90	6.26	.64
1929	24.75	31.55	5.84	.40
1930	35.08	41.34	*4.62	.41
1931	34.21	39.89	*3.90	.34
1932	35.72	42.68	5.41	.50
1916-32 (6,062 days)	24.83	31.91	5.82	.46

* In view of previous records this gain appears too small.—H. T. S.

In addition to the average daily ground-water gain of 5,820,000 gallons between the two gaging stations, the measurements by Austin indicate about 3,000,000 gallons daily ground-water gain between the

⁷⁴ Lippincott, J. B., unpublished report on the feasibility of bringing the waters of the Waiahole, Waikane, and Kahana Streams through the Koolau Range to the lands of the Oahu Sugar Co., August 19, 1911.

north portal and the boundary station. Mr. Olstad reports that during dry weather this gain drops to 1,500,000 gallons. Thus, the total ground-water gain in the Waiahole main bore is about 8,000,000 gallons daily, or about 2,300,000 gallons daily in excess of the flow of the springs dried up. It is noteworthy that most of the spring flow is now recovered on the south side of the Pali. The water gained in excess of the spring flow must have formerly escaped elsewhere. Probably most of it leaked through fissures in the dikes and entered the Pearl Harbor artesian basin.

According to Olstad,⁷⁵ 27,088,000,000 gallons of water drained out of the main bore between August 1913 and December 31, 1916. Deducting the average daily percolation of 8,600,000 gallons, or 10,740,000,000 gallons for the period, leaves 16,348,000,000 gallons, which must have been stored between the dikes. This is equal to 15,800,000 gallons daily for the period August 1913 to May 31, 1916, when the flow from storage ceased. On the assumption that the rock has a porosity of 10 percent, this water would saturate 21,855,615,000 cubic feet, or a little less than one-sixth of a cubic mile of rock.

Drainage tunnel R.—Tunnel R was driven just above the north portal of the main bore for drainage, and except for one flow of pahoehoe it is all in aa basalt. It was completed in June 1915 with a length of 1,663 feet and went dry 10 months later. Its peak flow of 9,000,000 gallons daily was reached in May 1915. The following table gives the description of the dikes crossed by this tunnel. Their distances from the portal were determined by pacing from the stations marked each 100 feet.

Dikes in Waiahole drainage tunnel R

Distance from portal (feet)	Trend	Thickness (feet)	Remarks
250	N. 55° W.	7	Small sill offshoot
370	N. 50° W.	8	Multiple dike
550	N. 50° W.	6	Irregular and very vesicular in loose clinker
660	N. 50° W.	8	
950	N. 55° W.	6	
1,470	N. 50° W.	8	
1,550	N. 70° W.	7	
1,550	N. 25° W.	3	

The trend of most of the dikes is N. 50°-55°W. The average trend of dikes in the adjacent dike complex is about N. 35° W.; hence the dikes encountered had strikes sufficiently divergent to carry them out of the main dike complex.

⁷⁵ Olstad, H., *Op. cit.*, p. 3.

Lippincott⁷⁶ believed that the water was held up by a great sill, which he described as cropping out between Waiahole and Kahana, and everyone writing on the subject subsequently has followed Lippincott. The massive rock outcrop he noted is not a sill, however, but consists of the sides of several thick dikes partly exposed by erosion. The vertical contacts on both sides of these dikes were found. Field observations indicate that the water is not perched by a sill but continues downward between the dikes for an unknown distance, probably to the point where dikes become so numerous that the permeable flow lavas are absent and the whole mass is practically impermeable. The water in the slices of flow lavas between the dikes is confined on the southeast by the main dike complex of the range and is probably shut off on the northwest by other dikes sufficiently divergent from the main swarm to intersect them like the dike under the main divide striking N. 70° W.

In addition to the main Waiahole tunnel and collection system, six tunnels have been driven from the collection tunnel into the Pali to develop ground water.

Tunnel A.—Tunnel A, 735 feet south of the main tunnel, was driven S. 13° W. for 1,011 feet (pl. 2). It was completed in January 1915, when a peak flow of 3,000,000 gallons daily was developed. Three months later it was permanently dried up, apparently by the main bore, because it was started about 21 feet higher than the adjacent portal of the main Waiahole bore, and its heading is about 26 feet above the main bore to the north.

Tunnel B.—Development tunnel B was driven N. 76° W. for 1,260 feet into the Pali, on a grade of 3 feet in 1,000 feet, 1,400^{feet} north of the main tunnel. Its entrance is about 5.7 feet above the main tunnel under the Koolau crest, and its heading is about 8.3 feet above the same point. It was dry from the start, and work on it was stopped in May 1915. It failed to dry up a small spring several hundred feet above and slightly to one side of it, on the Pali. The lack of success of this tunnel is also attributed to its proximity to the main tunnel. The main bore has evidently completely drained the rocks for more than 2,000 feet on each side, if the failure of these tunnels is correctly interpreted. The fact that these tunnels are less than 30 feet higher than the main tunnel demonstrates the flat gradient of the water table in this part of the complex and likewise the high degree of permeability of the rocks enclosed by the dikes in this particular area.

Uwau tunnel.—The Uwau tunnel was started May 20, 1932, at intake 27 of the main collection tunnel, in Uwau Valley 6,700 feet north of the

⁷⁶ Lippincott, J. B., manuscript report on the feasibility of bringing the waters of the Waiahole, Waikane, and Kahana Streams through the Koolau Range to the lands of the Oahu Sugar Co., Ltd., p. 4, August 19, 1911.

north portal. It is driven into the Pali S. 65° W. on a grade of 3 feet in 1,000 feet. On August 15, 1932, water was first encountered with a flow of 250,000 gallons a day. On May 16, 1933, with the tunnel incomplete but 1,104 feet long, the discharge had gradually increased to 6,400,000 gallons a day. The tunnel penetrates the dike complex of the Koolau series.

Waikane tunnel 1.—Development tunnel 1 in Waikane Valley was started in January 1925 at intake 22 of the Waiahole collection tunnel, 500 feet north of Waikane Camp, at an altitude of about 800 feet, and was driven 2,635 feet into the Pali under the direction of H. Olstad (pl. 2). It runs N. 70° W. for 507 feet and S. 35° W. for 2,128 feet. It was completed May 9, 1927. It is 5 feet wide and 6 feet high and was built on a 2 percent grade at a cost of \$13.09 a foot. The work was done under contract by Japanese, who netted about \$3 a foot for labor alone, according to Mr. Olstad. From 3 to 4 feet of tunnel was made on each shift, in spite of the fact that considerable water and very hard rock were encountered.

About 260 dikes from a few inches to 12 feet in width were cut through. The widest single dikes in the Koolau Range were observed in this tunnel.

Many multiple dikes occur, and a few slickensides were noted along the dikes but these were due practically everywhere to very slight movement. Several sheared dikes and thin breccia streaks, however, indicate that faults cross the tunnel. In a few places water pours through vertical joint planes in the dikes. A thick dike occurs at the end of the tunnel, and a good stream of water pours out from the clinker in front of it. Practically all the dikes strike between N. 30° W. and N. 45° W. and vary only a few degrees from the vertical. About half of the rock penetrated by the tunnel is dike rock; the remainder is Koolau flow lava. It is believed that if the tunnel were continued farther into the mountain it would yield more water.

Curves in plate 33 show the relation of discharge to tunnel progress. The progressive decline in the discharge of this tunnel indicates that stored water is still draining out 6 years after the completion of the tunnel. This condition is probably due to the great number of dikes penetrated by this tunnel and consequently the great number of thin wedges of flow lava, which yield their stored water only very slowly. A comparison of the discharge and rainfall curves in plate 33 indicates that about a month is required for rainfall to percolate through to the tunnel.

Waikane tunnel 2.—Tunnel 2 in Waikane Valley was started in June 1927 at intake 25 of the Waiahole collection tunnel, half a mile south of Waikane Camp, at an altitude of about 800 feet, and was driven

2,342 feet westward into the Pali, under the direction of H. Olstad (pl. 2). It was completed February 18, 1929, even though considerable water and very hard rock were encountered. It is 5 feet wide and 6 feet high and was driven on a 2 percent grade at a cost of \$13.79 a foot, by Japanese labor. The machinery had to be packed in pieces on muleback from Waikane Camp.

The dike rock in this tunnel appears to exceed the flow rock by about 5 percent: 126 dikes were counted in the first 1,200 feet. Between 300 and 400 feet from the portal several thin breccia zones associated with the dikes indicate faults, and at 400 feet a sheared zone striking N. 10° E. occurs. One short thin sill was noted. The discharge of the tunnel is shown in plate 33.

The progressive decline of the minima of each year, in spite of rainfall above normal in 1932, indicates that stored water is still being drained from the tunnel. The tunnel discharge lags 1 month behind the rainfall (pl. 33).

Kahana tunnel 1.—Tunnel 1 in Kahana Valley was started April 26, 1929, at intake 9, three-quarters of a mile from the end of the Waiahole collection tunnel, at an altitude of about 800 feet, and was driven S. 66° W. 1,975 feet into the Pali, under the direction of H. Olstad (pl. 2). It was completed January 16, 1931. It is 5 feet wide and 6 feet high, and was driven on a 2 percent grade at a cost of \$12.77 a foot, by Japanese labor. The machinery had to be packed in pieces on muleback from Waikane Camp over a 1,250-foot ridge.

About 120 dikes were cut by the tunnel, and between 1,300 and 1,800 feet from the portal a breccia containing blocks as much as 2 feet in diameter was penetrated. Many of the fragments in the breccia consist of dike rock, and bedding is absent. Although in some places the breccia is well cemented and impermeable, there are streaks and zones of loose rubble without any fine matrix from which water pours in great quantities. A big stream of water pours out of Koolau basalt at the end of the tunnel, but by far the largest part of the water is recovered in the breccia.

The presence of the breccia was not known prior to the construction of the tunnel, but this tunnel has demonstrated the great value of breccias in the rift zone as water bearers. Breccias are known at many other places on Oahu, and the experience gained in connection with this tunnel may be applicable to some of the other areas of this rock.

Most breccias on the surface are so well cemented that they look practically impermeable, but this tunnel shows that the cementation may not extend downward.

A breccia in this position within the rift zone of the Koolau Range might be a crater fill, a fault breccia, a talus breccia, or an explosive deposit. The fragments are too angular and fresh to have accumulated as alluvium. The tunnel demonstrates that the breccia is 500 feet wide along an east-west line. Only seven dikes cut the breccia, whereas they make up about a third of the rock mass on both sides of it. This breccia is bounded by abrupt and nearly vertical contacts on each side; hence it does not appear to be a mantling agglomeratic deposit left by explosion on the surface of a dome.

The steep contacts fit a fault breccia, but gouge, shear zones, and slickensides characteristic of faults of this magnitude are absent. These features might be absent from a wall-crack fill along a fault, but the deposit appears to be too wide to be a fill of this sort, and the great preponderance of dike fragments in it seem to rule out a normal talus breccia. As an erosional unconformity does not occur in this part of the Koolau Range, a cliff to shed a talus would have been formed by a fault. A fault cliff sufficiently high to form a talus apron 500 feet across before the cessation of Koolau activity would have given rise to a profound unconformity, which could hardly have been overlooked.

A crater fill, probably caused by an explosion blasting its way up through the volcanic dome late in its history, best accounts for the breccia. As the explosions would have broken through the dike complex, a large number of dike fragments in the throat is to be expected. The fact that only seven dikes penetrate the breccia indicate that it was formed toward the end of Koolau activity in this area. At an altitude of about 1,300 feet on the Schofield-Waikane trail, 1 mile southeast of this tunnel, a breccia 5 feet thick containing angular and subangular fragments of dikes and Koolau flows as much as 8 inches in diameter crops out. It may be the explosive debris that fell on the surface of the dome at the time of the explosion that formed the breccia in the tunnel.

It is interesting to note that the tunnel dried up a spring yielding a million gallons daily about 2,000 feet to the south but did not affect springs to the north. If the breccia were a fault breccia with linear form, it would probably have affected springs on both sides of the tunnel. The discharge of this tunnel plotted in relation to rainfall (pl. 33) indicates that it takes about 1 month for the rain water to percolate to it, a lag which has a very beneficial effect, because the minimum discharge of the tunnels does not occur until so long after a dry spell starts. Plate 33 shows that water is still draining out of storage. However, its exceptionally high initial yield must be due to

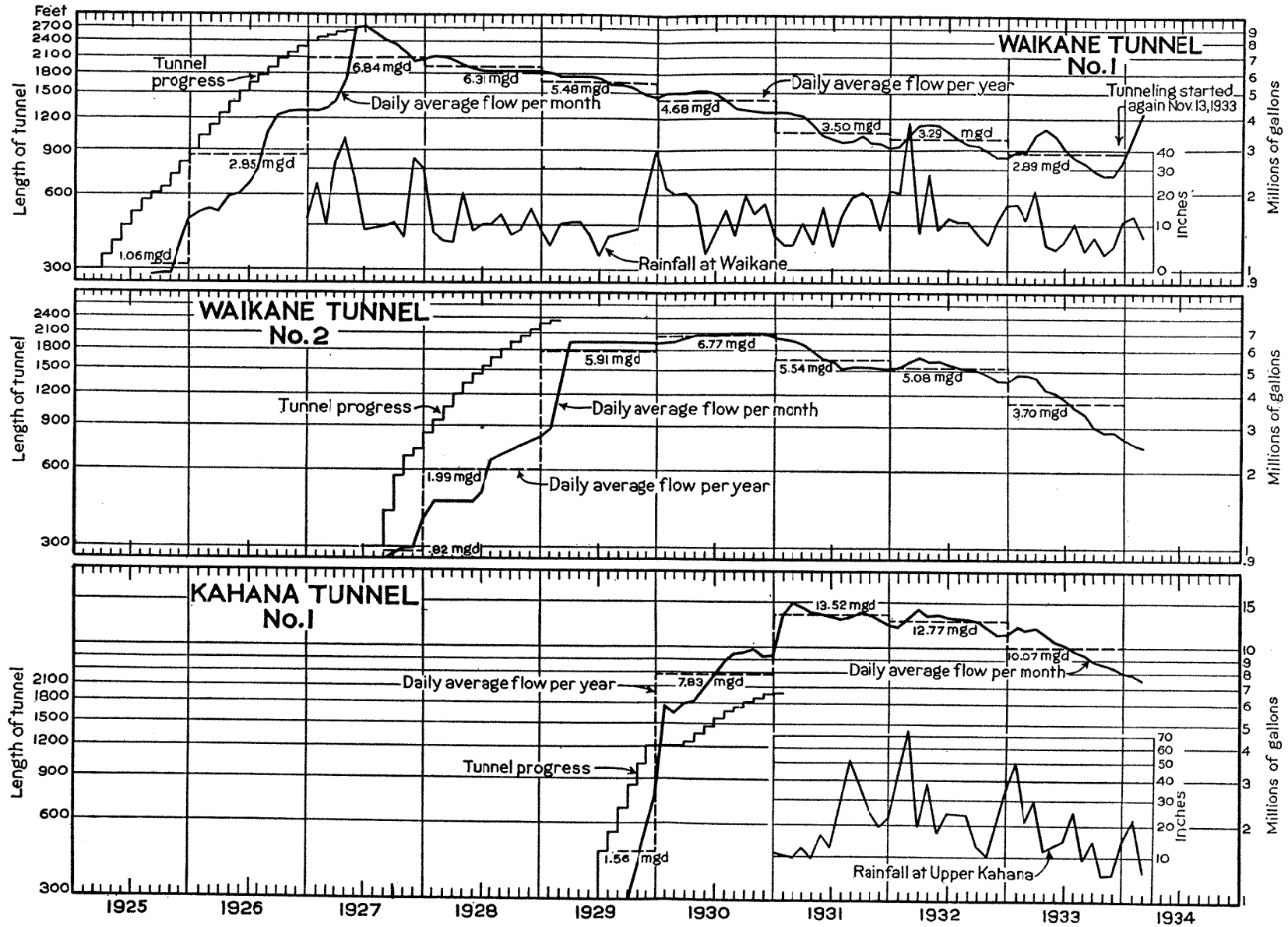

DISCHARGE OF KAHANA AND WAIKANE TUNNELS IN RELATION TO RAINFALL AND TUNNEL PROGRESS

(Courtesy of H. Olstad)

the breccia, which fills a vertical pipe like a rock-filled pit, thereby draining a large area of dike complex.

Before this tunnel was driven many of the prisms of permeable Koolau rock between the dikes were bounded on one end by this very permeable breccia, and as this breccia had no underground outlet, there was probably a tendency for the water to escape through the dikes that confined the other sides of the prisms. The tunnel, however, changed this hydrologic condition and allowed the water to drain into the breccia from the adjacent saturated Koolau prisms. Thus this tunnel has an area of influence corresponding to the size of the breccia rather than to the size of the tunnel as in the Waikane tunnels.

The large stream pouring from the heading of the tunnel indicates that more water can be obtained by continuing the tunnel.

WAIKAKALAU TUNNELS

About 1900 two tunnels were driven by the Oahu Sugar Co. into Koolau basalt at an altitude of about 750 feet in Waikakalaua Gulch just above the company's ditch intake, for the purpose of developing ground water (pl. 2). One is 1,000 feet long and the other 3,000 feet, but neither developed any water except a little seepage from the stream during rains. These two tunnels demonstrate that high-level ground water cannot be developed by tunneling at random in Koolau basalt unless a geologic structure favorable to perched water is present. The 4 miles of transportation tunnels of the Oahu Sugar Co. through Koolau basalt in the foothills of Waiawa did not develop any ground water.⁷⁷

KAUKONAHUA TUNNELS

The Kaukonahua tunnels were driven to transport water and do not develop high-level ground water, but they are described here to indicate the difference between water transportation and development tunnels. The upper Kaukonahua tunnel starts at an altitude of 1,200 feet in the north fork of Kaukonahua Stream, continues in a westerly direction for a little over 2 miles, and ends at an altitude of about 1,175 feet. It then continues in a series of tunnels and ditches for about 1½ miles farther and discharges into a reservoir that supplies the Waialua Agricultural Co. Only the upper 2-mile stretch from tunnel 16 to tunnel 37 was examined. Not a single dike was cut in the whole 2 miles of tunnels, and it loses rather than gains water, even though much of it is driven through weathered rock. From a point 50 feet east of unit 32 to a point about 200 feet from the west end of unit 31 an unusual lava is exposed. It consists of feldspar phenocrysts, mostly from half

⁷⁷ Olstad, H., manuscript report to J. B. Thomson, mgr., Oahu Sugar Co., October 22, 1923.

an inch to 1 inch in length in a sparse matrix of fine-grained vesicular basalt. The abundant feldspars give the rock a crumbly fracture and make it difficult to obtain hand specimens. The feldspars are oriented and concentrated in zones in which the matrix is almost absent. In units 30 and 29 an olivine-rich basalt occurs with phenocrysts as much as 1 centimeter across. In units 24 and 23 a basalt containing abundant small phenocrysts of olivines and feldspar occurs. The remaining rocks are either deeply weathered or were fine-grained basalts. Although a few clinker beds occur, dense to very vesicular pahoehoe is dominant.

Water from the Wahiawa Reservoir is transported part of the way to Waialua through a tunnel near the east bank of Kaukonahua Stream. The tunnel was entered near the point where the Kamehameha Highway crosses it, at an altitude of about 740 feet, and was traversed for about 2 miles. The tunnel starts in lateritic soil but soon enters fresh pahoehoe containing short vertical joints, thin layering, and ropy structure near its top. This flow is passed through at the middle of unit 12, where an aa flow that extends to the end of unit 10 was penetrated. The tunnel is partly lined to prevent leakage.

HENRY TUNNEL

A mile southwest of Kaneohe, at an altitude of about 250 feet, on a tributary of Kaneohe Stream and about 100 feet from Keaahala Spring, is ex-Sheriff Henry's tunnel. It is caved in and could not be examined but is reported to have been driven into the Koolau dike complex for about 50 feet. Taylor⁷⁸ gives its discharge in February 1916 as 140,000 gallons daily. This site is a good place to develop water by tunneling.

LULUKU TUNNELS

About $2\frac{1}{4}$ miles southwest of Kaneohe are two tunnels at an altitude of 570 feet, at the base of a waterfall in Mamalahoa branch of Luluku Fork of Kaneohe Stream (pl. 2). One tunnel about 20 feet long was driven N. 37° W. through vesicular Koolau pahoehoe. It is filled with rocks within 3 feet of the top, and the water pours down from the roof. On February 16, 1919, Taylor⁷⁹ recorded 69,000 gallons over a weir near the mouth of the tunnel of which about one-third came from a spring and two-thirds from the tunnel.

He further states that the measurement was made under unfavorable conditions and the flow of water was above normal. The water from this tunnel is in part used to supply Kailua and Lanikai.

The other tunnel runs nearly straight south for about 80 feet, and about three-quarters of the flow enters at the end. At about 40 feet

⁷⁸ Taylor, J. T., Honolulu Water Comm. Rept. for 1917, p. 101, 1918.

⁷⁹ Idem, p. 100.

from the portal a lateral tunnel runs 10 feet west. The first 40 feet was driven through a dike, and the last 40 feet is in vesicular Koolau basalt with the dike in the east wall. The yield of this tunnel on February 16, 1916, was 273,000 gallons daily, according to a measurement by Taylor.⁸⁰ The water is piped to Kailua and Lanikai and is leased from Harold Castle.

On May 16, 1932, the waterfall above the tunnels was practically dry, and a spring yielding about 12 gallons a minute was discharging from the lower part of the falls. A larger spring issued here prior to the driving of the tunnels, but it is not known how much ground water was actually developed by the tunnels. It seems probable that the tunnels were driven by following the water, or one of the tunnels would not have been driven 80 feet along the dike. Further tunneling here should be rewarded with success, but the tunnel should be started a little lower and should be driven about S. 80° W., or practically at right angles to the trend of the dikes in this area to be most effective.

GIRLS INDUSTRIAL SCHOOL TUNNEL

About three-quarters of a mile northwest of Olomana Park, on a small tributary to Maunawili Stream, at an altitude of 100 feet, is the Girls' Industrial School tunnel (pl. 2), which runs N. 40° E. for about 100 feet. It was driven about 1928 and is lined with wood, but older alluvium is exposed in the heading. Most of the water enters the first part of the tunnel which on August 28, 1931, was yielding about 6,000 gallons daily. Two automatic electric 15-horsepower motors connected to four pumps having a capacity of 75 gallons a minute each lift the water from a sump at the portal of the tunnel over Olomana Ridge to the Girls' Industrial School. The tunnel was driven at the site of a small spring and it is doubtful if much water was developed. The spring is probably supplied from the adjacent dike complex, because the area of alluvium is small at this place.

MAUNAWILI TUNNELS

Six tunnels have been driven in the Maunawili ranch area, between Olomana Peak and the Pali, to develop high-level ground water, mostly for the Waimanalo Plantation.

O'Shaughnessy tunnel.— A 449-foot tunnel was driven about 1893 at the base of one of the deepest stream grooves in the pali, at an altitude of about 750 feet, near the head of Omao Stream, 1½ miles southwest of the Maunawili ranch, at a site chosen by M. M. O'Shaughnessy (pl. 2). The tunnel was driven through Koolau basalt under Puu Konahuanui, the highest peak in the Koolau Range. In 1931 the tunnel was nearly filled with mud washed in from the adjacent stream. W. O.

⁸⁰ Idem, p. 100.

Clark, who examined it about 1922, states that it follows a small dike part of the way but does not cut any dikes and that it was abandoned because it failed to yield water. Inspection of plate 2 shows that this tunnel was driven too far away from the dike complex. A few dikes occur in this area, but they strike at nearly right angles to the main rift system and are in general thin, irregular, short, and widely spaced. Thus the geologic structure of this mountain is not very favorable for developing water.

Kunesh⁸¹ points out that the possible yield of underground water from the entire Konahuanui mountain mass above 750 feet would be only about 3,100,000 gallons daily. Thus, in view of the low recharge and the unfavorable geologic structure, it is believed that a tunnel through this mountain would be an economic failure, because it would recover so small an amount of ground water in proportion to its length.

Cooke tunnel.—The Cooke tunnel is on the north bank of Omao Stream about $1\frac{3}{4}$ miles west of the Maunawili ranch, at an altitude of about 500 feet. It was started in September 1926 under the supervision of W. O. Clark, at the site of a spring which at that time was discharging 19,388 gallons daily.

The tunnel is 130 feet long and was driven into the Koolau dike complex. The first 83 feet is reported to be in loose alluvium and rotten rock and is lined with cut-stone masonry. The remaining 47 feet is in Koolau basalt and runs along the south side of a dike that strikes N. 50° W. A dike was formerly exposed 1,000 feet upstream. The ground is still swampy around the portal, indicating that all the confined water was not captured by the tunnel.

The discharge of the tunnel when finished was 252,000 gallons daily, but as soon as stored water drained out the discharge fell to an average of about 150,000 gallons daily, or nearly eight times the former spring flow. About 28,800 gallons daily is diverted through a $1\frac{1}{4}$ -inch pipe to the Cooke ranch, and the remainder is flumed to the Waimanalo plantation. The tunnel was driven for Mr. Cooke, and as soon as he was satisfied that sufficient water was obtained for his use tunneling was stopped. The indications are favorable for continuing this tunnel.

Clark tunnel.—The Clark tunnel is at an altitude of about 550 feet on the middle fork of Maunawili Stream, a little over a mile south-southwest of the Maunawili ranch house, near Pikoaukea Spring (pl. 2). Formerly numerous seeps issued below the spring, and this tunnel was started in 1922 under the direction of W. O. Clark to develop additional water for the Waimanalo plantation. Tunneling was carried on intermittently for several years until March 13, 1926. A map of the

⁸¹ Kunesh, J. F., Honolulu Sewer and Water Comm. Rept. for 1929, p. 111, 1929.

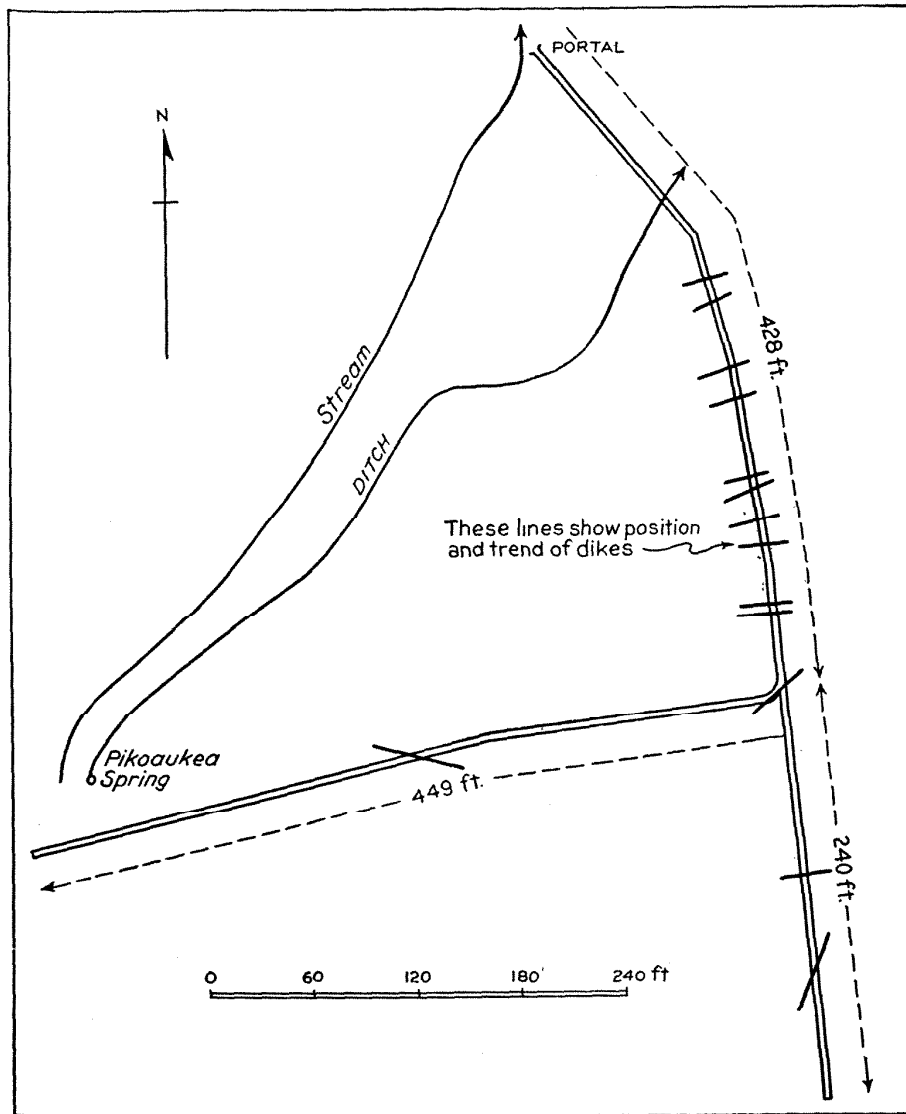

FIGURE 34.—Plan of Clark tunnel, on middle fork of Maunawili Stream, showing position of dikes. (After a survey by Waimanalo Plantation Co.)

tunnel and the dikes encountered is given in figure 34. Its entire length of 1,117 feet is in Koolau basalt and dikes. The average discharge of the tunnel is about 600,000 gallons daily.

A considerable amount of this water formerly discharged in the swampy area below Pikoaukea Spring, as shown by the following data, but records are too inadequate to determine the actual amount of water developed.

*Comparison of total discharge of Pikoaukea Spring, Clark tunnel, and swamp,
in gallons*

[Records furnished by Waimanalo Plantation Co.]

Location of weir	June 1-30, 1924	June 1-30, 1925	May 1-31, 1926
Pikoaukea Spring.....	25,611,000	13,553,000	6,502,000
Clark tunnel.....	^a 4,427,000	^b 16,598,000	^c 18,197,000
Swamp at tunnel mouth.....	8,775,000	381,000	212,000
	38,813,000	30,532,000	^d 24,911,000

^a Tunnel 300 feet long. ^b Tunnel 428 feet long. ^c Tunnel 1,037 feet long.
^d The apparent decline is due to changes in rainfall.

Ainoni tunnel.— The Ainoni tunnel is at an altitude of 376 feet at Ainoni Spring, on the west bank of Ainoni Stream half a mile south of the Maunawili ranch house (pl. 2). In the spring of 1926 an attempt was made to capture the flow of Ainoni Spring at a level high enough to deliver the water into the ditch above. A tunnel was driven 25 feet west, 30 feet southwest, and 20 feet west. It is now caved in, but excavated material indicates that it passed through talus into Ainoni basalt.

A short tunnel was then driven 22 feet above the lower tunnel into the basalt and captured the entire flow of Ainoni Spring. A third tunnel was driven still higher, but it was dry. All the tunnels are now caved in, and the spring issues from the lower tunnel again, with its flow not increased. Doubtless this spring could be captured at the desired level as described on page 131.

Fault tunnel.— Three-quarters of a mile south-southeast of the Maunawili ranch house at an altitude of about 450 feet, is the Fault tunnel (pl. 2), which is 350 feet long and runs in a southerly direction through greenish-gray vesicular Koolau basalt. The water is flumed to the Maunawili Ditch and used on the Waimanalo plantation. About 40 feet from the portal a good flow comes from a shear zone in the west wall about 4½ feet above the floor, and at 230 feet more water issues from jointed Koolau basalt in the west wall. The first 180 feet shows several shear zones, and at 190 feet there is a 6-foot zone of shearing which is badly caved in. Two prominent slickensided surfaces occur: one trends N. 30° E. and dips 63° NW.; the other, 6 feet away, trends N. 50° E. and dips 62° NW. The rock at this place is decomposed red clay fault gouge. For 100 feet beyond there is more Koolau basalt showing shear zones, a prominent one striking east and dipping 47° S. The last 90 feet is unsheared vesicular Koolau basalt. It is apparent that this tunnel penetrates a fault zone, but the origin of the water is not so evident. As the tunnel is driven into the dike complex, dikes are more than likely the source of this high-level water.

The tunnel is reported to have been made about 1900 at the site of a spring. No reason is known why work was stopped, except possibly because of the danger of caving. It is unlined, and the shearing causes the rock to be unusually loose, which must have made work in it during blasting very hazardous. George Chalmers, Jr., manager of the Waimanalo plantation, reports that its average yield is 364,000 gallons daily and that it has a remarkably uniform flow. It looks like a reasonable prospect to continue the tunnel south, because the breccia of the Ainoni volcanics and some dikes lie not far away.

Korean tunnel.—About 1,200 feet southeast of the Fault tunnel, on a tributary to Makawao Stream at an altitude of about 535 feet, is the Korean tunnel (pl. 2), which was driven into Koolau basalt in 1923. It is so badly caved that no attempt was made to examine it. Mr. Chalmers reports its average daily discharge as 185,000 gallons, although on November 9, 1931, it was discharging only a fraction of this amount. A map furnished by the Waimanalo Plantation Co. shows that it was started in an old landslide at an altitude of 526 feet, but later, work was shifted to an altitude of 535 feet, where it was driven S. 17° W. from the end of a 25-foot open cut for about 110 feet. It then turned southeast for about 50 feet, which would make the length about 160 feet. A 4-foot dike was encountered at the portal, and another about 70 feet farther in, striking 53° E. The tunnel was driven under a spring that issued at an altitude of 574 feet.

WAIMANALO TUNNELS

Four tunnels have been driven near the base of the Pali nearly 2 miles southwest of Waimanalo. The following data regarding them have been furnished by W. O. Clark and the Waimanalo Sugar Co. Their location as shown on plate 2 is that furnished by the Waimanalo Sugar Co. and is slightly different from that shown by Mr. Clark.

Waimanalo Sugar Co.'s tunnel 1.—The Waimanalo Sugar Co.'s tunnel 1 is at an altitude of 415 feet near the base of the Pali. It is about 125 feet long and was driven S. 25° W. into weathered Koolau basalt about 1888. No water could be seen entering the tunnel walls except a little seepage at the end. Occasional measurements by the plantation officials indicate that its discharge is about 250,000 gallons daily. The water is piped to Waimanalo for domestic supply.

Waimanalo Sugar Co.'s tunnel 2.—Tunnel 2 of the Waimanalo Sugar Co. is about a quarter of a mile northwest of tunnel 1, at an altitude of about 425 feet. It was started in 1922 at the site of a spring that discharged between 40,000 and 50,000 gallons daily. It was driven 50 feet through hard rock, probably Koolau dike complex, and was finished in 1926. The discharge of this tunnel is about 100,000 gallons

daily, hence about 50,000 gallons of the flow was developed by the tunnel. The water is piped to Waimanalo for domestic purposes.

Waimanalo Sugar Co.'s tunnel 3.— Tunnel 3 of the Waimanalo Sugar Co. is about 1,000 feet west of tunnel 2, at an altitude of 462 feet, and was driven S. 10° E. through Koolau basalt for about 60 feet. About 8 feet from the portal a 2½-foot dike trending N. 85° E. is cut, and the water enters from shear cracks behind this dike. The heading of the tunnel is practically dry. The combined discharge of this tunnel and the adjacent City and County tunnel averaged about 60,000 gallons daily in July 1931.⁸² The water is piped to the Waimanalo beach lots.

City and County tunnel.— A tunnel belonging to the City and County of Honolulu is 500 feet southeast of the Waimanalo Sugar Co.'s tunnel 3, at about the same altitude (pl. 2). It is caved in, so that nothing could be definitely ascertained about it, although it probably develops water from structural features similar to those that supply tunnel 3. Its discharge is piped with that of tunnel 3 to the Waimanalo beach lots. George Chalmers, Jr., reports that in 1929 this tunnel discharged about 150,000 gallons daily, but measurements by Larrison in July 1931 indicate only a small fraction of this amount.

TUNNELS IN THE WAIANAE RANGE

Tunnels driven in the Waianae Range to develop perched ground water are described in clockwise order around the range starting at Kaena Point, the west point of Oahu. A few may have been missed, but all that were known to residents in the region were examined.

ANDREWS TUNNEL

A short water-development tunnel known as the "Andrews tunnel," not found by me, is reported to exist at an altitude of about 1,200 feet near the head of Manini Gulch, about 3 miles east of Kaena Point. It is reported that the tunnel goes nearly dry in dry weather and that its discharge is a mere trickle.

SCHOFIELD TUNNELS

Three tunnels reported to have been driven about 20 years ago to develop water for the Oahu Sugar Co. occur about a mile west of Schofield Barracks (pl. 2). All three appear to derive their main supply from the underflow moving downstream through younger alluvium of the stream beds under which they are driven. The water is apparently perched on older alluvium and soil. The lengths and discharge were furnished by the United States Army.

North Schofield tunnel.—At an altitude of about 1,040 feet in Haleanau Gulch is a tunnel 900 feet long, the water from which is piped to a

⁸² Larrison, G. K., Domestic water supply for proposed Hawaiian Homes Commission house lots at Waimanalo, Oahu, T. H. (manuscript report) p. 4, Aug. 15, 1931.

concrete reservoir and then pumped to Schofield Barracks. Except for an 8-foot lateral at 191 feet the tunnel runs nearly due west for 387 feet before a lateral takes off. This stretch of tunnel passes through Waianae basalt, mostly vesicular pahoehoe, yielding no water. It is half filled with crushed rock, placed there as if to filter the water. At about 300 feet from the portal older alluvium consisting of friable brown clay and pebbly conglomerate rests on the basalt. At 387 feet from the portal a dry lateral runs northwest for about 40 feet in pahoehoe. At 18 feet from this lateral another lateral 15 feet long leads off. Crossing the end of this lateral and also the main tunnel is a nearly vertical fault striking almost due north. About an inch of clay gouge occurs along the fault, and water percolates into the tunnel from it. The main tunnel continues another 76 feet without forking, through pahoehoe with some dripping bouldery younger alluvium in the roof. Then a lateral, poorly timbered, runs about 100 feet west through dripping bouldery younger alluvium, and the main tunnel turns southwest for 108 feet through similar material and ends at a 30-foot masonry shaft leading to the surface about 50 feet from Haleanau Stream. Two forks, badly caved in but partly filled with broken rock, lead from the shaft under the stream bed. The western fork is 97 feet long and the northwestern one 61 feet long. From March 1 to June 30, 1931, the average yield was 151,000 gallons daily, but in very dry weather the yield is about half this amount. The water has not been used since July 12, 1931.

Middle Schofield tunnel.—Schofield middle or center pump is in a small gulch tributary to Mahiakea Stream at an altitude of about 1,087 feet, a mile south of the north tunnel. It is supplied by two tunnels, one of which runs west and then northwest for 243 feet from the concrete shaft 22 feet deep. The other extends southwest for 870 feet and has a 20-foot lateral running northwest 438 feet from the portal. It is connected by a pipe line to the shaft and starts at an altitude of 1,097 feet in older alluvium about 500 feet from the pump. It is half filled with roots and dirt, and no attempt was made to enter it. The yield on June 4, 1932, was about 25 gallons a minute. Until July 12, 1931, the water was pumped to Schofield Barracks. From March 1 to June 30, 1931, its average yield was 88,000 gallons a day.

South Schofield tunnel.—Schofield south tunnel is at an altitude of 1,070 feet in Waieli Gulch, about half a mile south of the middle tunnel. The tunnel is 90 feet long and starts S. 35° W. but halfway from the portal turns N. 75° W. The tunnel is partly in younger and partly in older alluvium, and the younger alluvium contains boulders as much as 2 feet in diameter between which roots enter the tunnel.

Water trickling in through this material aggregated about 5 gallons a minute on May 12, 1932. Until July 12, 1931, the water was pumped to Schofield Barracks. From March 1 to June 30, 1931, its average yield was 189,000 gallons a day, but in dry weather the yield is only about half this amount, according to the United States Army.

Kaala tunnel.— At an altitude of about 2,700 feet on the south bank of the gulch draining the southeast slope of Kaala is a dry tunnel 20 feet long, excavated in decomposed basalt (pl. 2).

KALOI TUNNELS

Upper Kaloi tunnel.— At an altitude of 1,925 feet in Kaloi Gulch, on the southeast slope of the Waianae Range 3 miles east of Nanakuli station, is the Upper Kaloi tunnel, which runs in a northerly direction for 50 feet in clinkery Waianae aa basalt. On December 16, 1931, the tunnel was dry, but a nearby trough full of water is apparently supplied from the tunnel. Doubtless after rains this tunnel yields a little water; otherwise a pipe line would not have been built to it. Probably a small seep here invited tunneling. If the water is perched the perching formation is probably the vitric tuff beds, which are exposed close by.

Lower Kaloi tunnel.— At an altitude of about 1,610 feet, 1,800 feet south east of the upper tunnel, is the Lower Kaloi tunnel, which runs straight into the gulch bank for about 80 feet. About 30 feet from the portal a lateral branches to the south for about 30 feet. In this lateral, about 10 feet from the fork, a small spring delivering about a pint a minute issues from fractured platy Waianae aa resting on about 2 feet of red to yellow coarse vitric tuff striking N. 40° E. and dipping 30° SE. The tunnel exposes this contact throughout, but in some places it shows the base of the tuff resting on basalt that contains feldspar phenocrysts as much as half an inch across.

About 100 feet south of the tunnel and a little higher is a covered spring, which was yielding a pint a minute on January 12, 1932. The water trickles from fractured Waianae lava overlying 2 feet of coarse yellow vitric tuff, which in turn overlies vesicular lava. The water from this spring runs into a collecting basin in the tunnel and then is piped to the adjacent pineapple camps and to cattle-watering troughs. The Kaloi tunnels belong to the Dillingham ranch. Water collected from this tunnel on January 12, 1932, was titrated by H. S. Palmer, who reports 5 grains of salt per gallon, a chloride content similar to that of the best of the artesian waters. Sufficient ocean spray is blown inland to account for this small amount of salt. This tunnel, if extended along the strike of the ash bed, might develop more water.

MAKAKILO TUNNEL

Half a mile northwest of the summit of Puu Makakilo and 1½ miles southeast of the Lower Kaloï tunnel, at an altitude of about 840 feet, is the Makakilo tunnel, belonging to the Dillingham ranch. It is about 100 feet long and is driven entirely in coarse red and yellow vitric tuff. On January 11, 1932, after about 6 months of dry weather, the water was entering from the roof at the heading, and the tunnel was yielding a little less than 1 gallon a minute. Its flow is reported to increase rapidly after a rain, but it is said never to go dry. It was dug at the site of a small spring about 1929 by the Dillingham Ranch Co. The tunnel is improperly constructed, because it is now established that to develop water from tuff or ash beds the tunnel should be at the top of the tuff and instead of running straight into the mountain should contour the slope. More water could probably be recovered here by a properly constructed tunnel, in view of the facts that the tuff bed is more than 10 feet thick and that several seeps occur in the gulch near the tunnel. A sample of water collected January 11, 1932, and titrated by H. S. Palmer showed 95 grains of salt per gallon, the highest salt content known in perched ground water on Oahu. It is reported that no water was present at this place before the pineapple fields were cultivated above it. If so, the tilling of the ground has increased the amount of deep percolation, and the salt may result from the slow leaching of soil saturated for centuries with salt spray, because the land above is exposed to heavy winds sweeping off the ocean. The Honolulu Advertiser of September 26, 1929, reports that a sample collected from this tunnel by Fred Harvey contained 110 grains of salt per gallon. Perhaps the water is leaching out an ancient fumarole deposit, as it is close to a large cinder cone, yet it seems likely that salts from such a fumarole would have been washed away in the thousands of years since this cone became extinct. A complete chemical analysis of the water would shed light on this hypothesis.

MUTUAL RADIO TUNNEL

A tunnel belonging to the Dillingham Ranch Co. and used to supply a water trough for cattle and also the adjacent Mutual Telephone Co.'s radio station is at an altitude of about 1,600 feet in Lumaloa Gulch, a little over a mile west of the Lower Kaloï tunnel. (pl. 2). It is driven through Waianae aa for about 180 feet, with the first 100 feet running a little east of north and the last 80 feet nearly north. A bed of vitric tuff 3 to 6 inches thick, baked red at the top, perches the water. One trickle near the end on the west side supplies most of the water. On January 11, 1932, the flow was a pint a minute, and a sample collected on this date and titrated by H. S. Palmer contained slightly less

than 5 grains of salt per gallon. He states that the water gave off a strong odor of hydrogen sulphide when the bottle was opened for analysis, several months after collection.

LUALUALEI TUNNEL

A tunnel important in its bearing on the occurrence of ground water in the dike complex, is under construction by the U. S. Navy in Lualualei Valley. The tunnel was driven into the Waianae dike complex at a site selected by me at altitude 1,500 feet on the north bank of Puhawai Stream. It was started in pahoehoe from which water oozed indicating saturation, but low permeability below a 2-foot nearly horizontal sill. Puhawai Spring which had an estimated flow ranging from 20,000 to 60,000 gallons a day depending on the rainfall issued 168 feet upstream from the site at an altitude of 1,630 feet. According to previous theories regarding the occurrence of water in the dike complex, this tunnel would have been a failure because it was driven below a sill and below the spring level. Based on the theory set forth on page 379, it was anticipated that this tunnel would dry up the spring and develop some additional water from the dike complex supplying it.

The tunnel penetrated rock with low permeability for about 390 feet from the portal and yielded only 40,000 gallons a day at this point. The next few feet of tunnel increased the discharge to 85,000 gallons a day and at this time the first appreciable decrease was noted in the flow of the spring. At a point 500 feet from the portal the flow increased to 300,000 gallons a day and the spring practically dried up. At 800 feet the flow had increased to 450,000 gallons a day. On March 31, 1935 the tunnel was 900 feet long and had cut 47 dikes, many of which had low inclination. It is planned to drive the tunnel 1000 feet and then place a concrete plug equipped with a valve at a dike about 450 feet from the portal. It is hoped that because of this plugging considerable water can be stored in the dike complex during the months when the flow is not needed, as described on page 435. The driving of this tunnel directly below a sill, the final drying up the spring above it, and the recovering of 450,000 gallons a day, indicate that the dike complex is saturated and that springs merely indicate favorable outlets or spillways. Because of the construction of the plug it will probably be impossible to determine the amount of ground water actually developed by this tunnel in excess of the former discharge of the spring. Much of the flow at present is water draining from storage.

The tunnel was driven by the Kalihi Contracting Co., under a contract calling for the first 1000 feet at \$9.15 a foot, and an optional ad-

ditional 1000 feet at \$9.20 a foot. The tunnel was started on June 4, 1934 and driven N. 20° E. on a grade of 2 feet in 1000 feet.

WAIANAE VALLEY TUNNELS

There are 16 high-level water-development tunnels in Waianae Valley, which supply water used for irrigating sugar cane of the Waianae plantation, for domestic purposes, and for the homesteaders in Lualualei Valley. Clark's report⁸³ has been drawn on heavily in the following descriptions of the tunnels, and he gives plans of tunnels 2, 4, 6, 6A, 9, 11, and 15, showing the position of dikes present. All the tunnels except 17 are shown on plate 2, although tunnels 16 and 18 are not located as accurately as the others. No tunnels 5, 10, 12, or 13 exist, although springs occur at the reported sites of tunnels 12 and 13 and were probably at one time slightly excavated. The numbers used herein are those used by the Waianae Plantation Co. The lengths and altitudes were furnished by the Waianae Plantation Co. from recent surveys. Discharge records based on miscellaneous measurements by the United States Geological Survey are given below. Weirs were installed in December 1932 by the Waianae Plantation Co. and weekly readings are now available.

Discharge of tunnels in Waianae Valley, in million gallons per day

[Measurements by U. S. Geological Survey.]

Date	1	2	3	4	6	7	8
1925							
May 14-15	0.023	0.711	0.039	0.131	0.646	0.043	0.021
April 15-16010	.716	.010	.020	.454	.018	.031
March 4-5014	.745	.024	.031	.51	.024	.041
January 28-29015	.811	.039	.039	.524	.027	.083
1924							
October 15-16018	.724	.041	.034	.524	.023	.112
September 13, 16022	.73	.033	.038	.50	.046	.093
1923							
August 2938		
March 2761		
March 749		
Average017	.740	.031	.049	.515	.030	.064
Date	9	11	14	15	16	18	Total
1925							
May 14-15	0.140	0.034	0.053	0.327	.039	0.070	2.277
April 15-16058	.020	.058	.229	.024	.029	1.677
March 4-5083	.039	.039	.20	.027	.034	1.811
January 28-29008	.058	.090	.249	.030	.048	2.021
1924							
October 15-16018	.145	.053	.184	.001	.043	1.920
September 13,16029	.102	.056	.30	.005	.034	1.988
1923							
March 2721			
March 722			
Average056	.066	.058	.240	.021	.043	1.95

(a) Subsequent records indicate these measurements are too low and may not represent this tunnel.

⁸³ Clark, W. O., Ground water of a portion of Waianae Valley (manuscript report to the attorney general of the Territory of Hawaii, September, 1930).

Tunnel 1.— Tunnel 1, at an altitude of about 1,425 feet, is on the easternmost tributary to the west fork of Waianae Stream that heads at the Pali. It runs N. 88° E. for 63 feet through a heavy bed of Waianae aa, and most of it is in jointed massive rock, although some clinker is present. Except for one ledge of rock similar to that in the tunnel, no other bedrock is exposed between the tunnel and the Pali. In the adjacent valley 400 feet to the north are numerous dikes trending toward tunnel 1. Hence it is believed that the water discharged by this tunnel is held at high levels by dikes. Several small springs issue downstream from the tunnel, and a tunnel driven a little lower than the lowest spring might concentrate the flow of all the springs in this area and possibly develop an appreciable additional amount. Tunnel 1 appears to have been driven at the site of a former spring. Its discharge is about 17,000 gallons daily, but the combined discharge of the springs and tunnels between December 7, 1932, and November 1, 1933, did not fall below 51,000 gallons daily.

Tunnel 2.— Tunnel 2 is at an altitude of 1,426 feet, 2,000 feet northwest of tunnel 1. It is 700 feet long and has the highest yield of all the high-level tunnels in Waianae Valley except tunnel 19 which is still draining stored water. The yield of tunnel 2 is very steady, as shown by the way it held up during the drought of 1933. Its discharge slowly decreased from 647,000 gallons a day on December 7, 1932, to 549,000 gallons on November 1, 1933. It is nearly semi-circular in plan, starting northeastward and turning until at its heading it is running northwest. All except the last 50 feet is in older alluvium, consisting of a coarse angular and subangular boulder conglomerate. The last 50 feet is in Waianae basalt and at the heading there is a dike not cut by the tunnel. All the water issues from the alluvium within 100 feet of the heading. Five streams of water enter from the west side, and most of the water comes from an area within a few feet of the contact of the alluvium and the bed rock. Thus it appears that the water recovered is held in the bedrock by dikes and escapes at this point because the dikes have been cut through during a cycle of erosion antedating the deposition of the conglomerate. Considerable soft creamy material similar to that identified as montmorillonite in tunnel 6 has been deposited in the joints in the rock of this tunnel by percolating water. Possibly more ground water could be recovered in this area by extending this tunnel farther along the contact of the alluvium and bedrock, because more points where ground water is escaping from the bedrock may occur beneath the alluvium.

Tunnel 3.— Tunnel 3 is northeast of tunnel 2, near the site of the old mountain house, at an altitude of 1,565 feet. About 10 feet of tunnel

has been excavated in loose hill wash, probably at the site of a former spring. Weekly weir readings between December 7, 1932, and November 1, 1933, indicate that the discharge was above 41,000 gallons a day except for three readings when its flow decreased to 25,000 gallons. As there are numerous dikes in the adjacent region the water in this tunnel may be held at this level by dikes in Waianae basalt.

Tunnel 4.—Tunnel 4 is only a few feet north of tunnel 3, at an altitude of 1,567 feet. It is driven in a northeasterly direction through Waianae basalt for 140 feet. Near the portal the tunnel cuts a 1-foot dike striking N. 10° W. and a sill-like offshoot. Near the heading a 2-foot dike dipping 30° SW., an 8-inch dike, and a 1-foot dike striking N. 76° W. are cut. Most of the water issues below the 2-foot dike, but a good stream enters from a crack in the last dike and from the floor near the dike. The minimum yield of the tunnel between December 7, 1932 and September 20, 1933, was 51,000 gallons a day. On September 27, 1933, it began to dry up as a result of being drained by new tunnel 19, adjacent to it. On October 25, 1933, it went completely dry. This tunnel could have been made to develop additional water if continued in a northeasterly direction toward the Pali, because more dikes would have been penetrated, but the new tunnel has now tapped the same reservoir.

Tunnel 6.—About 400 feet east of tunnel 3 is tunnel 6, at an altitude of 1,525 feet. It is 696 feet long and penetrates Waianae basalt and dikes. It is the second best producer of high-level ground water in Waianae Valley yielding on the average about 550,000 gallons daily. As a result of the drought in 1933 the discharge fell on October 25 to 371,369 gallons a day. A soapy creamy deposit in this tunnel was determined by the late Professor Eakle as montmorillonite.

The trend and thickness of the 15 dikes penetrated by this tunnel, in order according to their distance from the portal, are given below:

Dikes in tunnel 6

No.	Strike	Thickness Feet	No.	Strike	Thickness Feet
1	N. 3° E.	1.5	9	N. 85° E.	1
2	N. 55° W.	2	10	N. 10° E.	.5
3	N. 70° E.	1.5	11	N. 10° E.	.5
4	N. 10° W.	4	12	N. 72° E.	.7
5	N. 45° W.	3	13	N. 40° W.	4
6	N. 25° E.	.5	14	N. 10° W.	1
7	N. (?) W.	* 12	15	N. 79° E.	3
8	N. 20° W.	2			

* Compound dike.

The tunnel runs nearly east but has one branch about 80 feet from the portal that runs north for about 90 feet and another branch 55

feet long that runs southeast from a point about 170 feet from the heading. A good stream of water comes around the end of dike 4, and in one place where the tunnel parallels a dike water is under sufficient pressure to squirt halfway across the tunnel. This tunnel could have been driven farther toward the Pali, because it would doubtless encounter more dikes and water, but now that tunnel 19 is being driven nearby it will probably not be expedient to do so. The dikes in this tunnel, instead of being practically vertical and straight like those in the Waiahole tunnels, are irregular and have low dips, which make it possible for the tunnel to pass beneath isolated bodies of saturated rock. However, the fact that the water squirts through the joint cracks of a dike paralleled by this tunnel indicates that considerable water might reach the tunnel from such a superior saturated rock prism through cracks in the confining dikes.

Tunnel 6A.—Tunnel 6A is about 40 feet lower than tunnel 6 and about 50 feet distant. The tunnel runs due north for 107 feet and has one lateral 55 feet long that runs northwest from a point about 45 feet from the heading. It is 162 feet long, and its minimum flow from December 7, 1932, to November 1, 1933, was 18,600 gallons a day. It penetrates Waianae basalt and one 5-inch dike striking N. 47° W., which appears to be an offshoot from a 1-foot sill exposed by the tunnel between the dike and the heading. Two springs with a daily discharge of 29,000 gallons issue about 75 feet above the tunnel, not far from tunnel 6 and the end of this tunnel. It seems that if tunnel 6A had been driven a little farther it would have drained at least one of these springs and would have developed some water. If continued far enough it probably would drain part of the water now entering tunnel 6.

Tunnel 7.—Tunnel 7, at an altitude of 1,409 feet, is about 200 feet south of tunnel 6A and runs N. 65° W. for 15 feet from the end of an open cut 18 feet long. A small sill is exposed in the cut, but the tunnel is in Waianae basalt.

The average discharge is about 25,000 gallons daily, but several times between December 7, 1932, and November 1, 1933, the discharge fell to 18,600 gallons. Considerable water issues from the basalt nearby.

Tunnel 8.—Tunnel 8 runs 350 feet northeast through Waianae basalt and 10 dikes a little downstream from tunnel 7, at an altitude of 1,385. The average discharge is about 122,000 gallons daily, but between December 7, 1932, and November 1, 1933, its discharge fell as low as 105,100 gallons a day. The fourth dike from the portal is considerably cracked, and much water issues from it. Two thin streaks of breccia cross the tunnel not far from the portal and probably indi-

cate faults. Although containing a little montmorillonite it is strikingly free from mineral deposits as compared with the adjacent tunnel 9.

Tunnel 9.—Tunnel 9, just across the gulch from tunnel 8, consists of a main tunnel 237 feet long driven northwest into Waianae basalt and dikes, and one lateral running north, 43 feet long. Its total length is 280 feet and its minimum discharge from December 7, 1932, to November 1, 1933, was 41,200 gallons a day. The floor is ankle-deep with a mushy precipitate, probably montmorillonite, which occurs on the walls also. Limonitic stalactites 4 inches long hang from the roof in places. Six dikes are exposed in the tunnel, three at the mouth, two at the forks, and one 6-inch dike farther in. The incrustation on the walls may conceal other dikes.

Tunnel 11.—Tunnel 11 is 1,764 feet above sea level and about 2,000 feet northwest of tunnel 6A. It runs northeast for 388 feet and penetrates Waianae basalt and nine dikes, most of which trend northwest. Two have such flat dips that they approach sills in form. The average discharge is about 200,000 gallons a day, but the minimum between December 7, 1932, and November 1, 1933, was 105,100 gallons a day.

Tunnel 14.—Tunnel 14, about 400 feet west of tunnel 11, at an altitude of 1,709 feet, runs northwest through Waianae basalt and dikes. Its total length is 397 feet, and its average discharge about 150,000 gallons daily, with a recorded minimum between December 7, 1932, and October 18, 1933, of 144,500 gallons a day. The tunnel runs nearly parallel to a dike striking N. 30° W. but finally cuts through it. A lateral about 43 feet long stops at a dike believed to be the same one as is cut by the main tunnel. Most of the water enters the floor of the tunnel near the lateral.

Tunnel 15.—Tunnel 15 is about 1,400 feet south of tunnel 14, at an altitude of 1,399 feet, about 8 feet above the east bank of a fork of Waianae Stream. The tunnel starts N. 30° E. but soon curves around to the northwest. Two dikes occur near the mouth of the tunnel; the first one is 3 feet thick, strikes N. 45° W., and is vertical; the other is 4 feet thick, strikes N. 50° W., and dips 83° SW. The tunnel is 310 feet long, and the average discharge is about 240,000 gallons daily. Between December 7, 1932, and November 1, 1933, the minimum flow was 183,650 gallons a day.

At about 60 feet from the portal the tunnel passes from Waianae basalt into an overlying breccia which consists of large blocks and which is believed to be a slightly older talus than that at the foot of the present cliffs. About 200 feet from the portal a strong flow of water enters the southwest side of the tunnel, and 10 feet farther another stream enters.

The water may be leakage from the stream beneath which the tunnel passes. The breccia is uncemented and the interstices are open where the water discharges from it, but in the exposures in the stream bed it is firmly cemented. Thus there is reason to believe that cementing of breccia may be to a certain extent a surficial process. If the water entering this tunnel is not leakage from the adjacent stream it doubtless is leakage from the adjacent dike.

Tunnel 16.—Tunnel 16 is about 1,075 feet above sea level three-quarters of a mile southwest of tunnel 15. It runs nearly east for about 297 feet through coarse older alluvium and discharges about 21,000 gallons daily.

Tunnel 17.—Tunnel 17 is about an eighth of a mile northwest of tunnel 16 and about 175 feet higher. It is so caved in that it could not be examined.

Tunnel 18.—Tunnel 18 is not quite $1\frac{1}{2}$ miles southwest of tunnel 6, about 460 feet above sea level and connected to the north bank of Waianae Stream by an open cut. It runs northwest for about 84 feet through coarse older alluvium. Its yield decreased from 51,200 gallons a day on April 19, 1933, to nothing on October 4, 1933.

Tunnel 19.—Tunnel 19 is a short distance east of tunnel 3, at an altitude of 1,515 feet. It runs about N. 30° E. and penetrates about 450 feet of partly consolidated bouldery older alluvium and then enters Waianae basalt. Water was encountered as soon as the first dike was cut. On August 10, 1933, the tunnel was 560 feet long and was yielding 1,500,000 gallons a day. Four dikes had been cut, and the tunnel was still being extended. On November 1, 1933, its yield was 2,450,000 gallons a day.

MAKAHA TUNNELS

Little is known about the history or discharge of the 11 tunnels in Makaha Valley described below. Tunnel 10 was evidently a wildcat tunnel, because it is so dry and so long and the report that this tunnel was started to drain the swamp on Kaala Mountain seem credible. The other tunnels were probably driven at the site of former springs, but how much they increased the spring discharge is unknown. In any event the older alluvium is saturated in the middle of Makaha Valley, a condition not found in any other valley filled only with alluvium in the Waianae Range. The fact that tunnel 6 found water in bedrock rules out the possibility that this water is simply the reappearance of water that sinks in the adjacent gulches. Definite geologic structures are necessary to hold water in the bedrock penetrated by tunnel 6. Plate 2 shows that an unusually large number of dikes head toward the tunnel from the ridge on the northwest side of the valley and that a pronounced angular unconformity between the middle and lower

basalt of the Waianae volcanic series becomes buried beneath alluvium in this part of the valley. In view of the geology it seems an inevitable conclusion that the water is held at this level by dikes and that the tunnels penetrated rocks saturated with the overflow from this dike complex. There is a good chance that considerable water is escaping seaward through the older alluvium that could be recovered by one or more tunnels placed in critical positions. The selection of the tunnel sites requires more intensive geologic study than was made during this investigation. Possibly some test holes to bedrock in the axis of the valley in connection with such a special study would help determine the cheapest method to recover the water.

Tunnel 1.—About 100 feet upstream from the pipe-line intake on the west bank of Makaha Stream, at an altitude of about 750 feet, is tunnel 1. It starts N. 20° W. and is driven about 30 feet through older alluvium consisting of bouldery conglomerate. On January 19, 1932, it was discharging at the rate of about 3,000 gallons daily. Springs nearby yield about 20,000 gallons daily.

Tunnel 2.—About 75 feet northeast of tunnel 1 and 40 feet above Mahaka Stream in the northwest bank, at an altitude of about 780 feet, is tunnel 2. It is 70 feet long by pacing and bears N. 70° W. at the portal and N. 80° W. at the heading. It penetrates older alluvium consisting of brown friable unsorted bouldery conglomerate. On July 12, 1932, its discharge was estimated at 70,000 gallons daily. The water issues mostly from a point about 40 feet from the portal and is flumed to the Makaha Stream.

Tunnel 3.—About 100 feet northeast of tunnel 2 and 60 feet above Makaha Stream, in the northwest bank, at an altitude of about 810 feet, is tunnel 3. By pacing it is about 80 feet long. It bears N. 80° W. at the portal and S. 70° W. at the heading. The water seeps into the tunnel along its entire length, and its discharge and geology are similar to those of tunnel 2.

Tunnel 3A.—On the west bank of a tributary about 150 feet northwest of Makaha Stream and 400 feet northeast of tunnel 3 is tunnel 3A, at an altitude of about 835 feet. It penetrates older alluvium consisting of friable brown unsorted bouldery conglomerate for about 40 feet. On March 21, 1932, it was yielding about 25,000 gallons daily. The tunnel at the portal bears N. 70° W. and at the heading N. 55° W. Most of the water issues from a point about 5 feet from the heading.

Tunnel 4.—Tunnel 4 is about 2,200 feet upstream from tunnel 3A, a little east of Makaha Stream, at an altitude of about 1,000 feet. It starts S. 60° E. and at about 90 feet forks, one branch going northeast for about 65 feet and the other southeast for about 90 feet. The entire tunnel is in feldspar basalt. On January 19, 1932, it was dis-

charging at the rate of about 70,000 gallons daily. A collapsed tunnel 50 feet to the northeast is dry, and another caved-in tunnel about 50 feet to the south was yielding about 7,000 gallons daily on July 12, 1932.

Tunnel 5.—At an altitude of about 1,025 feet on the east bank of Makaha Stream is tunnel 5. It is driven N. 70° E. for about 50 feet through older alluvium consisting of bouldery conglomerate. The discharge on January 19, 1932, was about a pint a minute.

Tunnel 6.—Tunnel 6 is at an altitude of about 1,125 feet in a small tributary to Makaha Stream about 400 feet northwest of tunnel 5. The tunnel starts S. 75° W. and curves toward the west. It penetrates older alluvium for about 475 feet. On January 19, 1932, it was delivering about 28,000 gallons daily.

Tunnel 7.—About 250 feet upstream from tunnel 6 and 50 feet higher on the northeast bank is tunnel 7. It starts N. 35° E. and runs for about 70 feet through older alluvium consisting of bouldery conglomerate. On January 19, 1932, it was delivering about a quart a minute.

Tunnel 8.—About 600 feet upstream from tunnel 7 and 75 feet higher is tunnel 8, which starts N. 10° W. and runs for about 150 feet before it branches. The west fork is about 80 feet long, and the north fork about 250 feet long. All the tunnel is in older alluvium consisting of conglomerate that contains boulders as much as 4 feet across. It was yielding water at the rate of about 43,000 gallons daily on January 19, 1932.

Tunnel 9.—About 700 feet northeast of tunnel 5 and 100 feet east of Makaha Stream, at an altitude of about 1,100 feet, is tunnel 9. By pacing, it is 60 feet long. It runs N. 75° E. through older alluvium consisting of friable brown unsorted bouldery conglomerate. The tunnel was discharging about 1,000 gallons daily on July 12, 1932. A boggy area nearby yields about 10,000 gallons daily, and the water from the marsh and tunnel is conducted to Makaha Stream through a ditch.

Tunnel 10.—Tunnel 10 is about half a mile from the head of Makaha Valley, at an altitude of about 2,100 feet (pl. 2). It is driven about 1,400 feet through Waianae basalt. Considerable aa clinker is cut by the tunnel, and four dikes and an irregular sill-like intrusive occur in the first 100 feet. The tunnel starts N. 72° E. but curves so that at the end it trends N. 20° E. The dikes range in thickness from 18 inches to 4 feet and in trend from N. 10° E. to N. 45° W. The tunnel was yielding only a gallon a minute on January 19, 1932. It is reported to be dry except during heavy rains. Too few dikes and a low recharge rate on the rocks above the tunnel probably account for its failure to develop water. It is reported that the tunnel was started with the idea of draining the swamp on Kaala Mountain.

MAKUA TUNNELS

Clark examined a tunnel on the south side of Makua Valley and reports⁸⁴ that it cuts two small dikes and that a trickle of water escapes from behind each of them. The two tunnels are reported to go practically dry in times of drought.

QUANTITY OF PERCHED GROUND WATER RECOVERED BY TUNNELS

KOOLAU RANGE

The 60 tunnels in the Koolau Range develop about 33,000,000 gallons daily (1932) exclusive of the yield of the unfinished tunnel in Uwau Valley. Of this total 95 percent or about 31,400,000 gallons daily, is recovered by about 13,500 feet of tunnels penetrating the dike complex of the Koolau series. An additional 540,000 gallons daily is recovered from 346 feet of tunnels where the perching geologic formation is not definitely known but is probably either dikes or tuff. Outcrops of dikes near two of the tunnels having a combined length of 200 feet indicate that probably 350,000 gallons daily of the 540,000 gallons is perched by dikes rather than by tuff. Older alluvium or soil which in all but two tunnels is associated with post-Koolau lava flows, perches about 190,000 gallons daily, which is recovered by a total of 8,339 feet of tunnel. Post-Koolau tuff perches about 250,000 gallons daily, and an additional 145,000 gallons daily is probably due also to tuff. About 1,032 feet of tunnels were dug to recover this water.

The doubt regarding the source of some of the perched water is due to the collapse of the tunnels, which prevents examination, or to the fact that the tunnels do not penetrate far enough to reveal the perching geologic structures. All the water recovered by the tunnels is not "new water," because most of them were driven where springs formerly issued. It is probable, however, that about 23,000,000 gallons daily of the total is "new water."

The recovery from all except the dry tunnels is given in the table below.

Average yield per foot of Koolau tunnels in relation to geologic structure

Cause of perched water	Total water recovered per day (gallons)	Total length of tunnels (feet)	Average yield per foot per day (gallons)
Alluvium or soil.....	190,000	8,339	23
Post-Koolau tuff.....	250,000	554	451
do. (?).....	145,000	478	304
Dikes or tuff.....	539,000	346	1,558
Dikes.....	31,461,000	^a 13,500	2,330
	32,585,000	23,217	1,403

(a) 272 feet added for two tunnels of unknown length.

⁸⁴ Clark, W. O., manuscript report on investigation of ground water of Makua Valley, Oahu, to the Governor's Advisory Committee on Leprosy, April 30, 1930.

This table bring out forcibly the fact that tunnels penetrating dike structures have the highest yield per foot. This yield if expressed in new or developed water would greatly increase the dominance of dike water over that of any other source, because most of the other tunnels started at springs. All tunnels penetrating dikes recovered water except tunnels A and B of the Waiahole system. These two tunnels apparently failed because the main bore was lower and drained them.

The dry tunnels were driven into either alluvium or Koolau flow lavas. These unsuccessful tunnels indicate that high level water cannot be obtained on Oahu without the presence of a perching geologic structure. All the important data relating to the Koolau tunnels are given in the table on page 431.

WAIANAE RANGE

The 35 tunnels in the Waianae Range (not including tunnel 19, in Waianae Valley, or the Lualualei tunnel now being dug) develop about 2,400,000 gallons daily (1932). Of this total 86 percent, or about 2,060,600 gallons, is recovered by 3,544 feet of tunnel supplied by dike complex, and 8 percent, or about 199,600 gallons, is recovered by 1,600 feet of tunnels and is believed to be perched water largely held up by concealed dikes. About 360 feet of tunnels in tuff develop only 1,800 gallons daily. A tunnel 285 long in alluvium in which the perching formation is unknown or is some fine-textured bed in the alluvium, recovers 21,000 gallons daily. About 205,000 gallons daily is recovered from three tunnels that run under stream beds and yield water from younger alluvium perched on older alluvium or soil. A certain part of the water recovered formerly issued as springs.

Average yield per foot of Waianae tunnels in relation to geologic structure

Cause of perched water	Total water recovered per day (gallons)	Total length of tunnels (feet)	Average yield per foot per day (gallons)
Tuff.....	1,800	360	5
Alluvium or soil.....	* 186,000	*1,185	158
Dikes.....	2,060,600	3,544	581
Dikes (?).....	199,600	1,600	125
	2,448,000	6,689	380

(a) Does not include Middle Schofield tunnel, length of which is unknown.

In the Waianae Range, as in the Koolau Range, the greater yields are produced by dikes. The lower yield per foot as compared with the Koolau Range is due largely to the lower rainfall on the Waianae Range. The dry 1,400-foot tunnel driven into Waianae basalt is another illustration of the impossibility of finding water in any quantity in flow lavas except where water is perched.

Tunnels driven for perched ground water in Oahu.—Continued

Name	Valley	Length (feet) ^a	Rocks penetrated	Cause of perched water	Average daily discharge (gallons) ^b
City and County 4.....	do.....	380	do.....	do.....	None
City and County 5.....	do.....	300	Alluvium	do.....	None ?
City and County 6.....	do.....	260	do.....	do.....	None ?
South Halawa.....	South Halawa	1,030	Koolau volcanic series (basalt)....	Soil	15,000
North Halawa.....	North Halawa	2,500 (?)	do.....	Soil (?)	30,000
Aiea.....	Aiea	375	do.....	None	None
Waikakalaua (2 tunnels).....	Waikakalaua	4,000	do.....	None	None
Waiahole.....	Waiawa	14,567	Koolau volcanic series (basalt and dikes).....	Dikes	8,000,000
Waiahole tunnel B.....	Waiahole	1,260	do.....	do.....	^a None
Waiahole tunnel A.....	do.....	1,011	do.....	do.....	^a None
Waiahole Uwau 1.....	Uwau	do.....	do.....	Not completed
Waiahole Waikane 1.....	Waikane	2,635	Koolau volcanic series (dike com- plex)	Dikes	3,230,000
Waiahole Waikane 2.....	do.....	2,342	do.....	do.....	5,030,000
Waiahole Kahana 1.....	Kahana	1,975	Koolau volcanic series (dike com- plex and breccia).....	do.....	12,770,000
Henry.....	Kaneohe	50	do.....	do.....	140,000
Luluku (north).....	do.....	20	Koolau volcanic series (dike com- plex)	do.....	40,000
Luluku (south).....	do.....	80	do.....	do.....	273,000
Girls' Industrial School.....	Maunawili	100	Older alluvium	do. (?)	6,000
Maunawili:					
O'Shaughnessy.....	do.....	449	Koolau volcanic series (basalt and one dike).....	None	None
Cooke.....	do.....	130	Koolau volcanic series (dike com- plex)	Dikes	150,000
Clark.....	do.....	1,117	do.....	do.....	600,000
Ainoni (3 tunnels).....	do.....	105	Ainoni volcanics (basalt).....	Older alluvium	No new water
Fault.....	do.....	350	Koolau volcanic series (basalt)	Dikes (?)	384,000
Korean.....	do.....	do.....	Dikes	185,000

Tunnels driven for perched ground water in Oahu.—Continued

Name	Valley	Length (feet) ^a	Rocks penetrated	Cause of perched water	Average daily discharge (gallons) ^b
Waimanalo:					
Waimanalo Sugar Co. 1.....	Waimanalo	125	do.....	Dikes (?)	250,000
Waimanalo Sugar Co. 2.....	do.....	50	do.....	do.	100,000
Waimanalo Sugar Co. 3.....	do.....	60	Koolau volcanic series (basalt and dike)	Dikes	50,000
City and County.....	do.....	(?)	(?)		

WAIANAË TUNNELS

Andrews.....	Manini	(?)	(?)	Soil (?) or tuff (?)	Mere trickle
North Schofield.....	Haleanau	780	Older and younger alluvium and basalt of Waianae volcanic series	Older alluvium and soil (?)	^e 75,000
Middle Schofield.....	Mahiakea	Caved in	Older and younger (?) alluvium	do.	^e 40,000
South Schofield.....	Waieli	120	Younger and older alluvium	do.	^e 90,000
Upper Kaloi.....	Kaloi	50	Basalt of Waianae volcanic series	Tuff bed (?)	^f Dry
Lower Kaloi.....	do.....	80	Basalt of Waianae volcanic series and vitric tuff	Tuff	200
Makakilo.....	Makakilo	100	Vitric tuff	do.	1,400
Mutual Radio.....	Lumaloa	180	Basalt and vitric tuff of Waianae volcanic series	do.	200
Waianae 1.....	Waianae	63	Basalt of Waianae volcanic series	Dikes	17,000
Waianae 2.....	do.....	720	Older alluvium and basalt of Waianae volcanic series	do.	600,000
Waianae 3.....	do.....	10	Younger alluvium	do.	41,000
Waianae 4.....	do.....	144	Basalt and dikes of Waianae volcanic series	do.	^g 51,000
Waianae 6.....	do.....	696	do.....	do.	550,000
Waianae 6A.....	do.....	198	do.....	do.	18,600
Waianae 7.....	do.....	15	do.....	do.	25,000
Waianae 8.....	do.....	350	do.....	do.	122,000
Waianae 9.....	do.....	280	do.....	do.	45,000

Tunnels driven for perched ground water in Oahu

KOOLAU TUNNELS

Name	Valley	Length (feet) ^a	Rocks penetrated	Cause of perched water	Average daily discharge (gallons) ^b
Palolo.....	Palolo	180	Koolau volcanic series (basalt and dike)	Dikes	292,000
Kaea (upper).....	Kaea	100	Koolau volcanic series (basalt)	None (?)	None
Kaea (lower).....	do.	120	do.....	None	None
Tunnel 1.....	Manoa	72	do.....	Dikes or tuff (?)....	150,000
Tunnel 2.....	do.	99	do.....	do.	39,000
Tunnel 3.....	do.	189	Koolau volcanic series (basalt and dikes)	Dikes	211,000
Tunnel 4.....	do.	100	do.....	None	None
Tunnel 5.....	do.	25	do.....	do.	None
Dowsett.....	Nuuanu	589	do.....	do.	None
City and County 3.....	do.	554	Younger alluvium, Nuuanu volcanics (basalt and tuff).....	Tuff	250,000
City and County 3A.....	do.	214	Nuuanu volcanics (basalt)	Tuff (?)	20,000
City and County 3B.....	do.	128	Nuuanu volcanics (basalt and tuff)	Tuff (?)	^c 50,000
City and County 4.....	do.	830	Older alluvium	(?)	(?)
City and County 4B.....	do.	228	Older alluvium beneath tuff.....	Older alluvium ...	25,000
City and County 4C.....	do.	136	Nuuanu volcanics (basalt)	Older alluvium or tuff	75,000
Pauoa.....	Pauoa	100	Tantalus basalt	Older alluvium and soil (?)	21,000
Gay.....	Kalihi	3,000	Younger and older alluvium; Kalihi volcanics (basalt and tuff)	Older alluvium (?)	50,000 (?)
Abandoned Gay.....	do.	67	Basalt of Koolau volcanic series	None	None
Gay mauka.....	do.	1,202	Basalt of Kalihi volcanics	Older alluvium (?)	25,000
Orphanage (3 tunnels).....	do.	250	do.....	Alluvium	25,000
City and County 1.....	do.	300	do.....	None	None
City and County 2.....	do.	225	do.....	do.....	None
City and County 3.....	do.	350	do.....	do.....	None ?

QUANTITY OF PERCHED GROUND WATER

Tunnels driven for perched ground water in Oahu.—Continued

Name	Valley	Length (feet) ^a	Rocks penetrated	Cause of perched water	Average daily discharge (gallons) ^b
Waianae 11.....	do.....	378	do.....	do.....	200,000
Waianae 14.....	do.....	334	do.....	do.....	150,000
Waianae 15.....	do.....	306	Basalt and dikes of Waianae volcanic series and talus breccia	240,000
Waianae 16.....	do.....	285	Older alluvium	21,000
Waianae 17.....	do.....	Caved in	do.....
Waianae 18.....	do.....	84	do.....	^c 20,000
Waianae 19.....	do.....	Not finished	Basalt of Waianae volcanic series	Dikes	2,500,000
Makaha 1.....	Makaha	30	Older alluvium	Dikes (?)	2,000
Makaha 2.....	do.....	70	do.....	do.....	40,000
Makaha 3.....	do.....	80	do.....	do.....	40,000
Makaha 3A.....	do.....	40	do.....	do.....	15,000
Makaha 4.....	do.....	245	Basalt of Waianae volcanic series	do.....	45,000
Makaha 5.....	do.....	50	Older alluvium	do.....	200
Makaha 6.....	do.....	475	do.....	Dikes (?)	20,000
Makaha 7.....	do.....	70	do.....	do.....	400
Makaha 8.....	do.....	480	do.....	do.....	35,000
Makaha 9.....	do.....	60	do.....	do.....	1,000
Makaha 10.....	do.....	1,400	Basalt and dikes of Waianae volcanic series	None	None
Makua.....	Makua	(?)	do.....	Dikes	1,000 (?)

- (a) Approximate only for some tunnels.
- (b) Estimated only for some tunnels and no discharge given where water is simply diverted from adjacent stream. Discharge of Waikane, Kahana, and Waianae 19 tunnels have decreased since this table was prepared.
- (c) Dry part of the time.
- (d) Drained by main Waiahole bore.
- (e) Probably all underflow down streambeds.
- (f) Probably some flow in wet weather.
- (g) Dried up in October 1933 by tunnel No. 19.

METHOD FOR CONSERVING WATER DEVELOPED BY TUNNELS IN THE
DIKE COMPLEX

The curves of discharge of the water-development tunnels of the Waiahole system (pl. 33) show that large quantities of water were drained from ground storage during the several years following the construction of the tunnels. As the Waiahole system collects surface water also, there are many days in the year when there is no need for either the natural flow or the stored water issuing from these tunnels; hence they are virtually wasted. It is believed that much of this wasted water could be stored underground by properly constructed control gates placed at one or more critical points in the tunnel. If these gates were so placed as to connect thick impermeable dikes cut by the tunnel, then original conditions for storing water in the dikes complex would be partly restored.

If the right dikes are selected, large volumes of water could be stored. It may be more difficult than would appear at first to place these checks successfully, because of the longitudinal variation in the permeability of these dikes. Thus a thick dike in the tunnel may pinch out a short distance beyond or be cut by numerous joints. However, surface exposures in the Waiahole area indicate that many of the dikes are thick and continuous. Consultation of the construction records or with the tunnel men should greatly help in the choice of the proper dikes, because those which yielded large flows when penetrated should be good dikes to rebuild. Gates placed too close to the portal of the tunnel will probably not be generally as successful as those placed farther in, because of the danger of leaks through the outermost dikes due to erosion. Most of the tunnel-construction records show that little or no water was encountered behind the first few dikes.

It is believed that if such a method of conservation of the dike water proves to be practicable it should be made mandatory, because it is just as essential in many places to conserve the dike water as it is to conserve artesian water. In the future as more and more dike water is developed it will become more and more apparent that such conservation is a wise measure.^{84a}

^{84a} As this report goes to press, the Waiahole Water Co. report that they have recently placed a plug of concrete 5 feet thick under the direction of W. O. Clark at a dike 1,100 feet from the portal of Waikane No. 2 tunnel. The plug was set in a groove cut 2 feet deep and the outlet is controlled by a 24-inch valve. The yield of the tunnel between the plug and the heading is about 2,200,000 gallons a day. Twenty-two days after closing the valve the pressure reached 32 lbs. per square inch. The valve was then opened for 8 days and 40,000,000 gallons released. The pressure dropped to 6 pounds per square inch at the end of 8 days. Because of no further need for the water the valve was again closed. During the time the valve was closed the inflow did not increase in the stretch of the tunnel between the plug and the portal indicating that the plug is an effective seal. The pressure when the valve is closed is not nearly as great as the original pressure must have been. It might pay to build two plugs in the future, one nearer the heading so as to restore a dike extending higher into the mountain and another nearer the portal. A trap door or discharge pipe sufficiently large to admit a man would have to be placed in the outer plug so that the inner plug valve could be opened after all the water has drained from storage between the plugs unless some automatic device could be arranged.

The success of this first trial plug means that the Kalihi-Waiahole tunnel system proposed for Honolulu if equipped with a series of plugs could be made to yield more water per foot of tunnel, thereby reducing the cost per gallon.

HIGH LEVEL SPRINGS

KOOLAU RANGE

Numerous high-level springs issue from the post-Koolau basalts and pyroclastics rocks described in the section on latest Pleistocene or Recent volcanic rocks, in connection with various flows causing them. Some high-level springs have been captured by tunnels and are described in the preceding pages. Only the springs not heretofore mentioned are described below.

LEEWARD SPRINGS

Small springs and seeps discharging not more than a gallon a minute were noted in the heads of most of the valleys between Pearl Harbor and Hahaione. As they were visited only once, it is not known how many of them are perennial, but all are too small to warrant individual description. Most of them were clearly perched by either dikes or tuff beds. A sill about 300 feet long and 4 feet thick crops out at an altitude of about 700 feet in Waiomao Fork of Palolo Valley, along the trail to Palolo tunnel. Numerous small perennial seeps issue from the top of this sill, but the quantity is too small to invite prospecting.

A group of springs issue between altitudes of 450 and 550 feet in Waaloa and Waiakeakua Forks of East Manoa Stream. Some of the water issues from well-defined springs, but some issues from swampy ground; hence it is difficult to estimate the total discharge, but it is probably about 500,000 gallons daily. Waaloa Spring issues from the coarse older alluvium 150 feet from olivine-rich Koolau basalt at an altitude of about 550 feet. The water is evidently discharging from a saturated zone in the basalt—probably because of its proximity and altitude, the same zone that supplies the adjacent City and County tunnels 1 and 2. On August 11, 1933, the total spring water flow of Waaloa Fork as measured by a weir near its mouth amounted to 372,000 gallons a day. The springs below tunnels 1 and 2 in Waiakeakua Fork likewise issue from coarse alluvium and appear to be from the same saturated zone. As several parallel dikes in the canyon farther upstream were noted striking toward the springs, (pl. 2) and as several tuff beds are intercalated with the basalt in the vicinity of the springs, either one or a combination of these confining structures probably holds up the perched water at this place. It appears to be a good place to prospect for water.

Waihi, the westernmost tributary to Manoa Valley, carries spring water but it amounts to very little in dry weather. Both intrusive rock and tuff beds are exposed in the valley and probably cause these perched springs, but the inaccessibility of the valley since the trail was dynamited made an intensive study of this water impracticable.

A small perennial spring issues at an altitude of about 1,850 feet on the east side of Nuuanu Valley about a mile from the gap. It forms a conspicuous waterfall about 400 feet high but goes nearly dry in times of drought. Several tuff beds intercalated with Koolau basalt crop out in the cliff below the spring, and they may serve to perch the water, although a few dikes also occur in this area.

Small seeps issue from the top of a bed of vitric tuff in Moanalua Valley but are too small to invite prospecting. The extensive area northwest of Moanalua Valley with its numerous canyons is not known to contain perennial springs that warrant description.

WINDWARD SPRINGS

In every major valley that extends back to the Pali between Kahuku and Waimanalo perennial springs issue. With only one exception, all the springs examined other than those associated with the post-Koolau eruptives owe their origin to dikes. Many of them issue from Koolau basalt behind dikes under considerable pressure, such as the one shown in plate 32, A, and they are so numerous and so similar that they do not justify individual description. The fact that most of them discharge at the foot of the Pali has been cited by some as evidence that they issue from the top of a sill extending from one end of the Pali to the other. As shown on plate 2, these springs occur chiefly at the upper edge of the older alluvium at the base of the Pali. The blanket of older alluvium serves as a sort of cap rock, so that water in the dike complex generally escapes at the low points in its upper edge. The discharge of these springs is given in various water-supply papers of the U. S. Geological Survey, in the report of the Honolulu Water Commission for 1917, in the supplement to the report of the Honolulu Sewer and Water Commission for 1929, and in the supplement to the report of the Honolulu Board of Water supply for 1931.

Waihoi Spring, unlike the others, discharges from breccia at an altitude of 590 feet on the west wall of Punaluu Valley, and its height above the adjacent valley gives it a potential value for power. The water issues from two forks above the gaging station, and their mean discharge from July, 1915 to June, 1917, was 3.77 million gallons daily.⁸⁵ An exposure of breccia about 200 feet wide and at least 50 feet thick is exposed in the south branch. It is sufficiently resistant to form a waterfall, and the water issues in an area about 50 feet across at the top of the breccia. Scattered outcrops of bedded Koolau flow lavas are exposed in the dense vegetation, and the breccia near the contact with the basalt contains diverse types of rock fragments but farther away consists mostly of one kind of lava. The north

⁸⁵ Kunesh, J. F., Honolulu Sewer and Water Comm., Rept. for 1929, Suppl., p. 193, 1929.

branch was not examined, but John McCombs, who is familiar with it, reports that the water issues from the same kind of rock. Considerable field work and cleaning away of vegetation would have to be done to work out the nature of this breccia, but its general lack of diverse fragments except near the contact is suggestive of fault breccia.

WAIANAЕ RANGE

The Waianae Range receives so much less rainfall than the Koolau Range that in spite of perching geologic structures it has relatively few springs. A few small seeps issue from the soil bed at the contact of the lower and upper basalts of the Waianae volcanic series, but their combined discharge in dry weather is probably only a gallon a minute.

LEEWARD SPRINGS

Lualualei Valley.—Eight springs, with a combined discharge in the fall of 1930 of about 130,000 gallons a day, issue in the head of Lualualei Valley, but in times of drought some of them go nearly dry (pl. 2). The largest one issues in the northwest corner of the valley at an altitude of 1,630 feet and is used by the United States Navy. All except the southernmost one, Pohakea Spring, are held at these high levels by intrusive rocks. Pohakea Spring issues from talus close to the dike complex and hence is probably perched by dikes. The remaining springs issue from a more or less saturated zone of bedrock about 4,000 feet long between Kolekole Pass and the divide between Waianae and Lualualei Valleys. Several short tunnels or two long ones driven northeastward into this zone through the dike complex would probably drain most of this saturated zone and recover some new water. As this is the volcanic center of the Waianae Range, the dikes intersect at various angles and do not fall into one definite system, as in the rift zones radiating from it. Consequently it will probably take more tunnels to drain the saturated zone than would be necessary if there was less crisscrossing of dikes.

Waianae Valley.—The same saturated zone at the head of Lualualei Valley extends northwestward into the head of Waianae Valley, and about 30 springs with a combined discharge of about 250,000 gallons daily issue from it between altitudes of 1,000 and 2,000 feet. Most of the tunnels in this valley were driven at points where springs formerly issue. Most of the springs issue behind dikes in the middle basalt of the Waianae series, and the larger ones are shown on plate 2. Some, however, issue from older alluvium but are close enough to dike-intruded bedrock to make it fairly certain that they are supplied by dikes. In a few issuing from the alluvium some distance from

bedrock the perching formation is not evident. Several springs issuing in the valleys near tunnels 11 and 14 escape from the dike complex of the Waianae volcanic series at the contact with the older alluvium. Like the springs at the foot of the Koolau Pali, these springs issue at the low points in the boundary between the alluvium and dike complex because the alluvium serves as an imperfect cap rock. The springs issuing from the valley fill lower down are believed to be leaks where the water confined in the dike complex escapes through this cap rock, as appears to be demonstrated by tunnel 2 in this valley.

In view of the continuous zone of saturation in the dike complex extending across the head of Waianae Valley, from which these springs discharge, it is believed that two or three long tunnels at the lowest economical altitude driven in a northeast direction through the dike complex would drain this saturated zone more effectively than a larger number of short tunnels near the top of the zone of saturation similar to those in existence. The dikes are not as thick nor is their trend as parallel as in the dike complex of the Koolau series; hence the area of influence of each tunnel will be probably smaller.

Makaha Valley.—In the adjacent Makaha Valley tunnels have been driven at the points where most of the springs issued. A spring near tunnel 1 was discharging about 20,000 gallons daily, and a boggy area near tunnel 9 about 10,000 gallons daily when visited. Makaha Stream gains a little spring water below an altitude of 1,250 feet. The high-level springs in Makaha Valley issue from older alluvium between altitudes of 750 and 1,200 feet, or in general lower than those in Waianae Valley. It is believed that this high-level water only incidentally discharges from the alluvium and is perched at this level by dikes.

Makua Valley.—Several small seeps were noted issuing from the dikes in the south side of the Makua Valley and from the tuffaceous soil bed shown on plate 2 on the north side of the valley. Their combined average flow is probably not more than 10,000 gallons daily.

WINDWARD SPRINGS

A nearly continuous spring zone occurs in the windward cliff of the Waianae Range, perched by a series of beds of vitric tuff as shown on plate 2. It extends for about 4 miles eastward of a point $2\frac{1}{4}$ miles east of Kaena Point and varies from 200 to 600 feet in altitude. The discharge of individual springs in this zone is small and difficult to estimate, but they probably have a combined discharge of about 70,000 gallons daily. Several springs yielding from a pint to a gallon a minute discharge from tuff layers exposed in the gulches south of the cliff. About 20,000 gallons daily is perched by a tuff bed at an altitude of 3,800 feet on the trail from Schofield to the top of Kaala

Peak. A spring discharging less than one pint a minute issues from the top of a bed of vitric tuff at an altitude of 1,950 feet on the trail to the Von Holt place, at the head of Kaloi Gulch.

The combined flow of all springs discharging from tuff layers in the Waianae Range is estimated at about 100,000 gallons daily. Although such springs occurring in the Koolau Range would hardly justify description, perennial water is so scarce in the Waianae Range that these springs when properly developed will be of considerable value for domestic and stock supplies.

QUANTITY OF HIGH LEVEL SPRING WATER

KOOLAU RANGE

The quantity of high-level or perched spring water in the Koolau Range, exclusive of spring water captured by tunnels, can be roughly estimated from miscellaneous measurements and observations made during this investigation. The following table lists the principal springs that issue from the post-Koolau eruptives:

High-level springs issuing from post-Koolau eruptives

Name of spring	Altitude above sea level (feet)	Name of eruptive	Discharge per day (gallons)
Mahoe	370	Kaau volcanics	100,000
Punahou	100	Rocky Hill volcanics	350,000
Mid-Pacific	120	do. (?)	100,000
Makiki	976	Tantalus and Sugar Loaf volcanics	318,000
Herring	970	do.	59,000
Booth	775	Tantalus volcanics	46,000
Pump House	735	do.	122,000
Kahuawai	618	do.	280,000
No name	320	do.	19,000
Kaaikahi	275	do.	250,000
Keiliohia	975	Nuuanu volcanics	300,000
Near dam 4	950	Pali volcanics	500,000
Alewa Heights	750	Nuuanu volcanics	100,000
Below dam 2	700	do.	2,000
Kanewai	90	do.	50,000
Manaiki	2,150	Kalihi volcanics	15,000
Haiku	150	Haiku volcanics	25,000
Crater	750	Ainoni volcanics	25,000
Ainoni	376	do.	300,000
Api	250	do.	65,000
Unnamed	90	Training School volcanics	8,000
Training School	140	do.	300,000
Unnamed	90	do.	8,000
			3,342,000

An estimate of the total minimum discharge of springs issuing from the dike complex of the Koolau volcanic series between Waimanalo and Kahuku, based on the low-water flow of streams draining this area, is 54,000,000 gallons daily.⁸⁶ An additional 1,000,000 gallons

⁸⁶ Kunesch, J. F., Honolulu Sewer and Water Comm. Rept. for 1929, Suppl., pp. 103-212, 1929.

is estimated as the total discharge of all springs issuing at high levels from the basalt of the Koolau series on the leeward side of the range. The total low-water flow of all high-level springs in the Koolau Range is estimated to be about 58,500,000 gallons daily.

WAIANAE RANGE

The quantity of high-level or perched ground water in the Waianae Range, exclusive of spring water captured by tunnels, is estimated to be about 535,000 gallons daily, of which about 435,000 gallons is perched by intrusive rocks and the remaining 100,000 gallons by tuff deposits.

QUALITY OF PERCHED GROUND WATER

The perched water on Oahu as a whole is of excellent quality except that in one tunnel in the Waianae Range and a few in Nuuanu Valley. The rainfall on Oahu usually carries only 1 or 2 grains of salt per gallon as a result of ocean spray blown inland. An analysis of Kaaikahi Spring, in Pauoa Valley, showed only 19 parts per million of chloride (less than 2 grains of salt a gallon) and 175 parts per million of dissolved solids. Kahuawai Spring, in the same valley, contains only 15 parts per million of chloride (1.4 grains of salt a gallon) and 150 parts per million of solids⁸⁷. The high-level spring water has a lower chloride content than any artesian water on Oahu for which analyses are available.

The analyses below show the character of the water in the dike complex of the Koolau series.

Analyses of water from the dike complex of the Koolau volcanic series

[Furnished by Waiahole Water Co.; analysis by L. E. Davis, Hawaiian Sugar Planters' Experiment Station]

	Waikane Tunnel 1		Waikane Tunnel 2		Kahana Tunnel 1	
	Parts per million	Grains per gallon	Parts per million	Grains per gallon	Parts per million	Grains per gallon
Silica (SiO ₂)	23.8	1.39	14.4	0.84	13.4	0.78
Iron (Fe)	1.9	.11	1.4	.08	1.8	.11
Calcium (Ca)	8.6	.50	7.0	.41	7.2	.42
Magnesium (Mg)	4.8	.28	2.8	.16	4.5	.26
Sodium (Na)	8.7	.51	8.9	.52	6.5	.38
Potassium (K)	3.7	.22	3.3	.19	3.1	.18
Chlorides (Cl)	16.8	.98	14.2	.83	15.1	.88
Bicarbonates (HCO ₃)	44.2	2.58	34.3	2.00	35.1	2.05
Sulphates (SO ₄)	4.7	.27	4.3	.25	4.3	.25
Loss on ignition	16.0	.94	12.0	.70	13.0	.76

The shallow tunnels in Nuuanu Valley carry sufficient carbon dioxide to cause rusty water because of oxidation of the pipe line. The Honolulu Board of Water Supply has greatly reduced this carbon

⁸⁷ Shorey, E. C., Honolulu Water Comm. Rept. for 1917, p.279, 1918.

dioxide content by a simple aerator. The high gas content is apparently caused by decaying vegetation, because the tunnels drain swampy ground, and roots were noted in some of the tunnels. An analysis of Nuuanu tunnel water is given on page 361.

Analyses of the tunnel water in Waianae Valley are not available, but the total solids are probably higher than in the Pauoa Springs, as montmorillonite, a hydrous aluminum silicate, is being deposited in the tunnels. The water from the lower Kaloi tunnel, in the Waianae Range, carries 4.9 grains of salt a gallon, and the adjacent Makakilo tunnel 95.2 grains a gallon. The latter tunnel is the only one on Oahu discharging high-level water unfit for man.

QUANTITY OF GROUND WATER ON OAHU

By H. T. STEARNS

The following table summarizes the quantity of ground water discharged by wells, tunnels, and springs on Oahu in relation to the geologic structure.

Average daily discharge of ground water on Oahu, in gallons

	Koolau Range	Waianae Range
Basal water pumped from drilled wells entering basalt	^a 251,000,000	^b 37,100,000
Basal water pumped from dug wells and tunnels entering basalt	^c 1,200,000	500,000
Basal water pumped from dug wells, tunnels and drains in the coastal plain sediments	4,800,000	11,000,000
Basal water discharged as springs above sea level from basalt, including those issuing from coastal plain sediments but obviously supplied by basalt.....	^a 97,000,000	Negligible
Basal water discharged as springs above sea level from coastal plain sediments, excluding those obviously supplied by adjacent basalt	2,500,000	Negligible
Perched and confined water discharged from tunnels	33,000,000	2,400,000
Perched water discharged in springs.....	58,500,000	500,000
	448,000,000	51,500,000

(a) Includes draft from tunnel 4B, Oahu Sugar Co., and is average for 1928-33.

(b) Average, 1928-32.

(c) Does not include tunnel 4B, listed above.

(d) Average, 1932-33.

The average annual quantity of ground water discharged, based on the above table, is nearly 182,500,000,000 gallons or sufficient to supply a city of 3,800,000 inhabitants based on the per capita consumption of Honolulu in 1934. There must be considerable ground water escaping as submarine springs that is not measured and can still be in part recovered. The salt content of the well water shows that

between 10,000,000 and 15,000,000 gallons of the daily total is sea water that has been mixed with the fresh ground water in the zone of saturation. Further, an unknown amount of the total is return irrigation water pumped from wells and thus is measured twice. This amount is not large, however, because the lands irrigated are not very permeable, and the methods of irrigation are considered very efficient.

The average annual quantity of ground water, as given above, is 25.6 percent of the average annual rainfall on Oahu as determined from existing records. It may be that the high percentage is caused by poor records of rainfall in the areas of high precipitation. Nevertheless, for its size the island of Oahu is probably outstanding for the content and utilization of its ground-water reservoir.

UNDEVELOPED GROUND-WATER SUPPLIES

By H. T. STEARNS

KOOLAU RANGE

SUPPLIES AVAILABLE FOR HONOLULU

The Honolulu water supply is derived chiefly from artesian wells but in part from springs and tunnels. One of the chief purposes of this investigation was to find additional ground-water supplies that can be developed when needed for the city of Honolulu.

In 1929 it was estimated⁸⁸ that twice as much water will be needed for the public water supply of Honolulu by 1950 as was used in 1928, to meet the increase in population and use. The rate of increase in population has declined recently from 6,000 to 2,600 a year, owing apparently to economic conditions,⁸⁹ but this decreased rate may not be permanent. It is obvious that a growing city such as Honolulu will require more and more water. At the present time the supply is adequate, owing to an increase in water rates, the economic depression, and measures of conservation effected by the Board of Water Supply.

During the dry years 1925 and 1926 the water level in the artesian wells in Honolulu fell to the lowest stage on record, and the community became alarmed for fear the well water would become salty. During 1926 the water level in one area fell to an altitude of only a little more than 23 feet, which represents a decline of about 20 feet from the maximum. The information here given as to feasible projects for increasing the water supply should be useful in effective planning for the future. Moreover, several of the minor projects described herein would relieve somewhat the cost of pumping to high residential districts in Honolulu.

⁸⁸ Honolulu Sewer and Water Comm. Rept. for 1929, p. 2, 1929.

⁸⁹ Honolulu Board of Water Supply Rept. for 1933, p. 15, 1933.

Since 1926 there has been a notable recovery of the artesian head in the Honolulu district, owing to the application of effective measures of conservation and also to a succession of wet years. Thus in 1932 the head in the area mentioned above had risen to an altitude of 32 foot. As a result of the unfavorable conditions first recognized in 1917, more effective legislation to prevent the waste of artesian water was enacted, and several government agencies cooperated in repairing or sealing leaky and abandoned wells. It is estimated that through this work a waste of 9,350,000 gallons a day of artesian water was eliminated of which 5,700,000 gallons daily was prevented by sealing and 3,650,000 gallons daily was prevented by recasing.⁹⁰ In addition, the Honolulu Sewer and Water Commission⁹¹ found that during August, September, and October, 1928, a total of 927,130,000 gallons, or about 39 percent of the total Honolulu water supply, was wasted or unaccounted for. Practically all of this loss was due to leakage in the distribution system or to unrecorded outlets. By checking the outlets and leaks, the Board of Water Supply reduced the loss in 1934 to only 18 percent.⁹² It has also greatly reduced waste of water by the installation of a meter system.

The Board of Water Supply has repaired the dam at the Nuuanu Reservoir 4 and has made plans for future use of this reservoir. In addition, bonds have been authorized for building a plant to filter the flow of the Nuuanu Stream, but the Board of Water Supply does not intend to build the plant until there is need for it.⁹⁴

The possibilities of extensive storage of surface water have in the past been thoroughly investigated, and these investigations have shown that because of leakage and lack of adequate reservoir sites, extensive storage would be impracticable. Therefore projects utilizing ground water delivered by springs, wells, or tunnels are the only economically feasible source of large additional water supplies for Honolulu. During the present investigation, all possible ground-water supplies were carefully studied, and the conclusion was reached that there are several sources of excellent water supply that can be developed at a reasonable cost.

PROPOSED KALIHI-WAIAHOLE GROUND-WATER TUNNEL SYSTEM

Original Kalihi-Waihole tunnel project.—In 1917 Jorgen Jorgensen⁹⁵ recommended a project to supply Honolulu with water through a tunnel extending from the altitude of 600 feet in Kalihi Valley to the Pali on the northeast side, and thence as a collection tunnel along the Pali to Waihee Valley, with intakes to collect the surface streams along

⁹⁰ Honolulu Board of Water Supply Rept. for 1933, p. 18, 1933.

⁹¹ Honolulu Sewer and Water Comm. Rept. for 1929, p. 44, 1929.

⁹² Honolulu Board of Water Supply Rept. for 1934, p. 16, 1935.

⁹⁴ *Idem* (1933 rept.) p. 6.

⁹⁵ Honolulu Water Comm. Rept. for 1917, pp. 92-97, 1918.

the Pali. In addition he proposed several water-development tunnels into the Pali, which would be tributary to the enclosed ditch system—a plan similar to the Waiahole system of the Oahu Sugar Co. In 1921 H. S. Palmer made a report⁹⁶ on the high-level waters in the vicinity of Honolulu in which this project was given favorable consideration. In 1929 the Honolulu Sewer and Water Commission⁹⁷ reviewed this project and because of uncertain geologic and drainage conditions estimated that the cost would be high. The commission pointed out as its chief²¹¹ advantage a high cost for chlorination and filtration.⁹⁸

Ground-water tunnel project based on present investigation.—The field work that has been done during the present investigation has removed many of the uncertainties regarding the geology of this area in relation to the occurrence of the ground water, the nature of the rock to be encountered in the tunnels, and the problems of draining the tunnels. The work consisted largely in making a careful study of the system of dikes that holds up the water in the Koolau Range. Thus the geologic information that has been obtained makes it possible to plan a revised project that will reduce the cost and increase the quantity of water recovered and moreover will eliminate the cost of chlorination and filtration by making it entirely a ground-water project.

A proposed tunnel system has been laid out that will intersect the greatest number of dikes at the lowest feasible levels on a route from Waiahole and yet will deliver the water in Kalihi Valley, Honolulu, at an altitude of 500 feet. It differs from the plan proposed by Jorgensen in that it will recover only ground water. It is believed that by penetrating water-bearing rocks of favorable geologic structure, this system will yield more water during dry weather than would be obtained by the original Jorgensen project.

It would not be necessary to complete the entire project at one time, as the tunnel system could be extended toward Waiahole as the demand for water increased. The tunnel system of this revised project, which may be called the “Kalihi-Waiahole ground-water tunnel system,” is shown on plate 2.

The following table gives the lengths of the several units of the proposed tunnel system as scaled from the latest Geological Survey topographic maps:

⁹⁶ Manuscript report of the U. S. Geological Survey transmitted to the mayor of Honolulu.

⁹⁷ Honolulu Sewer and Water Comm. Rept. for 1929, p. 132, 1929.

⁹⁸ *Idem*, p. 134.

Proposed Kalihi-Waiahole ground-water tunnel system

Unit	From	To	Altitude (feet)	Length (feet)
A	Alt. 500 ft., Kalihi Valley	Luluku Valley	512	12,000
B	Luluku Valley	Haiku Valley	519.7	7,700
C	Haiku Valley	Iolekaa Valley	523.2	3,500
D	Iolekaa Valley	Ahuimanu Valley	528.8	5,600
D-1	Tunnel D	Side of dike system	1,400
E	Ahuimanu Valley	Kahaluu Valley	533.1	4,300
E-1	Tunnel E	Side of dike system	1,600
F	Kahaluu Valley	South side Waihee Valley	538.6	5,500
F-1	Tunnel F	Side of dike system	1,400
G	S. side Waihee Valley	Middle Waihee Valley	539.8	1,200
G-1	Tunnel G	Side of dike system	1,700
H	Middle Waihee Valley	Kaalaea Valley	544.3	4,500
I	Kaalaea Valley	Waiahole Valley	549.7	5,400
I-1	Tunnel I	Side of dike system	2,000
	Kalihi	Waiahole with laterals		57,800

Conditions controlling the water supply.—The dike complex of the Koolau volcanic series is the denuded rift zone of the Koolau Volcano, and its boundary, as shown on plate 2, is the approximate edge of the zone in which dikes are so numerous that they cannot be individually plotted on the scale of the Geological Survey topographic map. The heart of the dike complex lies a mile or more northeast of the Pali. A study of all the tunnels on Oahu indicates that the greatest volumes of high-level water are encountered in the marginal zone of the dike complex, where the ratio of permeable flow lavas to the nearly impermeable dike rock is in the right proportion.

Ground water is confined in the permeable flow lavas between the nearly impermeable dikes in the dike complex. Field observations indicate that in the area of the dike complex a vertical zone of saturation extends from rocks near the surface to a depth where the dikes become so numerous as to replace all extrusive or flow lavas (fig. 5A). This depth is probably well below sea level in the vicinity of the Pali but is possibly above sea level at some places near the heart of the dike complex. In a few places small bodies of ground water are perched locally by a set of intersecting dikes. However, observation of the tunnels of the Waiahole system indicates that a water table exists in the dike complex of the Koolau series and that as a rule the lower the tunnel the greater will be its cone of influence and yield. The proposed system will penetrate the dike complex below the water table, because it is lower than the springs, which are at points where water discharges from the zone of saturation.

The dikes of the main dike system trend about N. 30°-50° W. Numerous dikes occur as much as 1,000 feet southwest of the boundary shown on the map. These are strays, or dikes with trends somewhat

divergent from the main dike system. All the water encountered by the main Waiahole bore was developed between a few stray dikes southwest of the main dike complex.

Not all of the overflow of the water confined between the dikes southwest of the heart of the dike complex is discharged through the springs on the northeast side, at the foot of the Pali, for a part percolates toward the south coast. The purpose of the proposed laterals is to penetrate dikes that will not be cut by the main tunnel units and thus to draw in water that would otherwise escape toward the south.

Numerous springs discharge between altitudes of 500 and 700 feet in each of the valleys between the north portal of the tunnel that will extend from Kalihi Valley through the Koolau Range (unit A) and the head of the tunnel system in Waiahole. The discharge of these springs is about 7,500,000 gallons daily, according to measurements by Taylor.⁹⁹ Kunesh¹ lists two springs at altitudes of 605 and 680 feet in Kahaluu Valley with an aggregate average discharge of about 3,800,000 gallons daily, of which apparently only part was measured by Taylor. The total flow of all the springs along the proposed tunnel line, excluding those in Waiahole Valley, may therefore be nearer 9,000,000 than 7,500,000 gallons daily, but until further measurements of these springs are made the more conservative figure of 7,500,000 gallons daily should be used. All these springs are supplied by overflow from the dike complex, which will probably in large part be captured by the proposed tunnel.

The average annual rainfall is 132 inches at the head of Kalihi Valley, but it increases northwestward along the crest of the Pali until on Waiahole Ridge above the end of the proposed tunnel system it is 158 inches. Although the average annual rainfall over the drainage area of the proposed tunnel system southeast of Waiahole is about 50 inches less than the average over the drainage area of the Waiahole tunnel, the total volume of rainfall on the two areas is about the same, owing to the larger drainage area of the proposed system. The ground-water recharge is probably less in the drainage area of the proposed system, because the total consumption by the vegetation is probably greater. The minimum daily flow of the Waiahole system in 1932 amounted to 33,300,000 gallons and the lowest mean daily flow for any month was 36,100,000 gallons. The rainfall in 1932 was about normal, but an unusually long dry spell occurred which caused a low daily minimum. All of the low flow of the system comes from springs and tunnels, yet some additional ground water can still be

⁹⁹ Taylor, J. T., Honolulu Water Comm. Rept. for 1917, p. 97, 1918.

¹ Kunesh, J. F., Honolulu Sewer and Water Comm. Rept. for 1929, suppl., p. 260, 1929.

recovered, because development tunnels have not yet been driven at the heads of all the valleys, hence 33,300,000 gallons daily probably does not represent the total recoverable ground water from the drainage area of the Waiahole system.

The proposed Kalihi-Waiahole system may recover as much ground water as the Waiahole system, but conservative estimates should be based on a substantially lower recovery. Several million gallons daily should be developed by the 8,100 feet of proposed laterals, to judge from the yield of the adjacent Waikane and Kahana development tunnels of the Waiahole system, because the laterals will penetrate dikes not cut by the main tunnel units. About 25,000 feet of the main units will pass through water-bearing rocks, but these units will penetrate the dikes obliquely and will therefore not cut nearly as many dikes per linear foot as the laterals, and moreover they will not be far from the face of the Pali. These two conditions will reduce their yield, but they will probably develop some water in addition to the spring flow that they will capture.

The Waiahole drainage basin belongs to the Territory of Hawaii. In 1912, when the Territory granted the Waiahole Water Co. the right to tunnel through the Koolau Range in this valley, it reserved the right to take 4,000,000 gallons daily of government water from 1942 to 1952, 6,000,000 gallons daily of government water from 1952 to 1962, and any additional government water up to 15,000,000 gallons daily in 1962, and thereafter.² It may be that sufficient water can be obtained southeast of Waiahole so that it will not be necessary to take any ground water of the Waiahole drainage basin. In the event that it should become necessary to divert some of this water to Honolulu it will not necessarily endanger the Oahu Sugar Co.'s supply, as considerable undeveloped ground water is still within reach of the Waiahole tunnel system.

This Kalihi-Waiahole tunnel system will not in any way deplete the present supply of the Honolulu artesian water. It will probably cut off a part of the supply of the artesian basin around Pearl Harbor, probably amounting to only a small part of the quantity now wasting into the sea by overflow from the basin.

The high-level water is clear and low in mineral content. It is doubtless free from organic pollution and can never be contaminated by sea water. The water in the Waiahole tunnel is about 6° to 8° cooler than the Honolulu artesian water. Another significant factor is that the return flow from such amounts of this water as are used for irrigating lawns or as otherwise percolate into the ground above the upper edge of the cap rock will make an addition to the Honolulu artesian-water supply.

² Honolulu Sewer and Water Comm. Rept. for 1929, pp. 127-128, 1929.

The flow of such tunnels is nearly uniform once the water stored between the dikes is drained out and, as shown by the Waiahole system, the lag between rainfall and discharge is several weeks, which means a corresponding length of time before the tunnel reflects a drought.

Conditions controlling the tunnel work.—Wherever the tunnels will not be developing ground water they will have to be lined to prevent leakage. It is estimated that in the entire system bottom and side lining will be required for about 30,000 feet. Most of the first 20,000 feet of tunnel will be essentially a conduit because it will intersect few dikes. The basalt of the post-Koolau Kalihi volcanics, which is similar to the excellent rock at Moiliili quarry, crops out near the Kalihi portal and can be readily quarried and crushed for use in lining unit A. Rock excavated from the other units, because of the dike rock present, should be found satisfactory for concrete lining. The tunnel can be made the smallest size feasible to work in, or about 5 by 6 feet on a grade of 1 foot per thousand feet, similar to the more recently constructed water tunnels in the Territory.

The main Waiahole tunnel, which is an 8-by 8-foot bore 14,567 feet long, was worked from two headings only at an average cost, exclusive of lining, of \$28.60 a foot.³ This cost, however, included expensive drainage. J. Jorgensen, the contracting engineer who finished the Waiahole tunnel, states that the first 2 miles of tunnel from the south portal, in which water was not encountered, was driven at the rate of 21 feet a day, at an average cost of \$12 a foot exclusive of the cost of the machinery, etc. he acquired when he took over the contract from his predecessor.

The north heading of the Waiahole tunnel was started at a spring yielding about 6,000,000 gallons daily, and as much as 35,000,000 gallons daily had to be drained from the tunnel by pumps and siphons, the tunnel having been driven on a down grade into the mountain. The cost of tunneling at this heading was about \$100 a foot, owing to the expensive drainage, and it was largely this cost that raised the average cost of the Waiahole tunnel to \$28.60 a foot.

The proposed unit A will penetrate the same vesicular flow lavas of the Koolau Range as were encountered in the main Waiahole tunnel, and similarly it will also cut through a few dikes near the Pali. The proposed north heading of unit A is at a lower level than Luluku Springs, which discharge at an altitude of about 570 feet. Two tunnels have been driven into the Pali at Luluku Springs, and both yield water. The total discharge of the tunnels and Luluku Springs is slightly less than 1,000,000 gallons daily, or less than one-sixth of the

³ Letter from H. Olstad, manager Waiahole Water Co., dated April 18, 1932.

discharge of the Waiahole Springs prior to the driving of the main Waiahole tunnel. At most, therefore, only about one-sixth as much water is likely to be encountered in the north heading of unit A as was encountered in the north heading of the Waiahole tunnel. By lowering one side of the floor of this heading so that it will slope northward, all the water developed can be drained out by gravity. Some dikes will probably be cut that will yield strong flows temporarily. Work could be carried on alternately on the south heading of unit B and the north heading of unit A, thereby avoiding delay at times of strong flow in unit A.

The Waiahole tunnel is about 250 feet higher in the Pali than the proposed tunnel and was less accessible to existing roads than the proposed tunnel will be. A road already passes the proposed Kalihi portal at 500 feet, and on the Pali side roads to the several adits can be built without difficulty in the alluvium. In fact, abandoned roads to former pineapple fields or county roads now extend up each of the valleys nearly to the desired level.

In the nearby Waikane and Kahana Valleys, in the period from 1925 to 1930, the Waiahole Water Co. drove the following tunnels through rock of which hard dikes composed 30 to 50 percent. Waikane tunnel 1 is 2,635 feet long, 5 by 6 feet in cross section, and cost \$13.09 a foot. Waikane tunnel 2 is 2,342 feet long, 5 by 6 feet in cross section, and cost \$13.79 a foot. Kahana tunnel 1 is 1,975 feet long, and cost \$12.77 a foot. The machinery for constructing these tunnels had to be packed in pieces on the backs of mules over mountain trails.

The following additional data regarding the cost of similar water-development tunnels on Maui have been kindly furnished by C. A. Brown, engineer for the Pioneer Mill Co., Ltd., of Lahaina.

A section of the Honokahau tunnel system was extended 452 feet in 1926 at a cost of \$7.16 a foot, divided as follows: Labor \$5.50, explosives \$1.42, miscellaneous \$0.24. The wages for labor ranged from \$3 to \$3.50 a day, and the transportation was expensive, as the tunnel was in the mountains 20 miles from Lahaina. The drilling was done by hand. The Kahoma tunnel, driven 5,580 feet in 1903 to 1905 by compressed air drilling, cost \$6.82 a foot. A tunnel 4,024 feet long in Kauaula Valley, driven in 1928 and 1929, 5 by 6 feet in cross section, cost \$7.82 a foot, not including the cost of a hoist, a portable air compressor, and the rails. Everything had to be packed in on mules; drilling was done by compressed air. This tunnel was lined with 4-inch concrete at \$2.90 a foot, exclusive of the cost of equipment. The height of the wall lining was 3 feet 6 inches, or the same as will be necessary for the proposed system. The Crater tunnel at Lahaina,

744 feet long, recently lined, part of which is arching, cost \$3.44 a foot, and the concrete had to be hoisted up an incline.

J. H. Foss reports that the entire Honokahau tunnel system, driven through lava rock in the West Maui Mountains, is 36,000 feet long, has a cross section 6 by 7 feet, and did not encounter water. Its longest unit is 5,000 feet, and ventilation was helped by air currents through the cracks and tubes in the lava rock. The average cost of this tunnel, including a concrete floor and plaster sides of poor materials, was \$8 a foot with labor about \$1.75 a day. After 10 years the tunnels were relined with good concrete at a cost of about \$6 a foot, but this cost included rerouting the water. Mr. Foss states that the rock was much more easily removed because of its weak character than the lava rock he encounters in tunnels on East Maui.

It is evident from the costs cited above that the proposed Kalihi tunnel should cost less than the Waiahole tunnel. Most of the land to be crossed by the proposed tunnel is not government-owned; hence the water rights and right of way will have to be procured. As the proposed tunnel system will be entirely underground and in rock it will have but little depreciation and will be easily maintained.

Further investigation and prospecting.—It is recommended that all the springs at the foot of the Pali between the Pali road and Waiahole be measured for a period sufficiently long to establish the amount of their flow. If it is desired to prospect a part of this area before undertaking the main project, lateral E-1 and the 2,000 feet of unit E necessary to reach the lateral could be driven as a test tunnel. By installing plugs in the tunnels as described on page 435 a larger yield should be obtainable per foot of tunnel.

MINOR HIGH-LEVEL PROJECTS

The cheapest water used by the city of Honolulu is obtained from short high-level tunnels.⁴ In Nuuanu Valley 3,060 feet of tunnels have been driven at an average cost of \$5.43 a foot.⁵ Therefore, a careful study was made of the areas in the vicinity of Honolulu where the geologic structure indicates that high-level water might be obtained.

Lava flows erupted late in the history of Oahu have coursed down Kalihi, Nuuanu, Pauoa, and Pukele Valley, in each valley displacing the stream. These permeable lavas rest in most places on a relatively impermeable basement of hill wash and alluvium, so that water sinking to the bottom of the lava percolates seaward through the base of the flows. Part of this water can be recovered by tunnels contouring the base of these lava flows. The valleys of two branches of Makiki Stream are partly filled with "black sand" or ash erupted from the

⁴ Honolulu Sewer and Water Comm. Rept. for 1929, p. 115, 1929.

⁵ *Idem*, p. 113.

Tantalus and Sugar Loaf vents, and water is perched in this permeable ash by the soil beneath the ash. The water confined by dikes at high levels near the head of the Waiomao branch of Palolo Valley also awaits further development. A prospect for high-level water in Manoa Valley is described on page 388. The following proposed tunnels would prospect these water-bearing materials.

Kalihi Valley tunnel.—The basalt of the Kalihi volcanics floors Kalihi Valley from the vicinity of its head nearly to its confluence with Kamaikai Stream. Its total thickness is unknown but is probably less than 100 feet, because at the Kalihi Orphanage and near City and County tunnel 3 its contact with alluvium is exposed. Probably the most effective and economical way to recover water from this basalt is to drive a tunnel through the soft alluvium from the contact of the lava and the valley wall to the bottom of the buried stream channel. Experience elsewhere has shown that it is usually unnecessary to tunnel back along the contact on the opposite side of the valley, because the water drains completely out of the basalt as soon as the tunnel reaches the lowest point of the lava fill, providing the base of the lava plaster is not too tight. The farther downstream the tunnel is driven the more water it will probably yield, but settlement and pollution necessitate that the tunnel be driven in the upper part of the valley. The particular site chosen will depend upon the requirements of the Honolulu Board of Water Supply and should be determined by test borings. The amount of water that can be developed by such a tunnel depends largely upon the altitude of the chosen site, but recovery will not be large, owing to the small drainage area tributary to the basalt and to its weathered condition. Furthermore, several tunnels have already been driven, and they develop part of the water.

Nuuanu tunnels.—The Nuuanu volcanics consist of lava flows and pumice which carry perched ground water as shown by the tunnels penetrating them. The Honolulu Board of Water Supply is studying the ground-water conditions in this valley intensively by test holes and observations of the water-table fluctuations, hence the location of tunnels to recover the perched water in this valley awaits the completion of this study. The water leaking from the Nuuanu reservoirs not now recovered by tunnels percolates seaward thru the Nuuanu volcanics and adds appreciably to the supply that can be intercepted by tunnels.

Pauoa tunnel.—An extremely permeable clinker lava flow, which was erupted from Tantalus Crater, fills Pauoa Valley to a point a little below the bridge where the main road crosses Pauoa Stream, at an

altitude of about 280 feet. At an altitude of 775 feet Booth Spring discharges an average of about 46,000 gallons daily, which is piped to Pacific Heights Reservoir and used by Honolulu. Measurements by Baldwin and Alexander⁶ indicate that the total discharge of springs issuing from the basalt of the Tantalus volcanics in this valley is about 700,000 gallons daily. Kunesh⁷ found a net gain of 833,000 gallons from springs between altitudes of 820 and 430 feet on August 13, 1928. Practically all of this water can be recovered by a relatively short tunnel along the base of the basalt at Booth Spring, where it can be led directly into the present city pipe line. It is the most favorable minor project.

Makiki tunnels.—The city of Honolulu already pipes the water from Makiki and Herring Springs, at altitudes of 954 and 970 feet respectively, in Makiki Valley. The springs issue from the "black sand" or tuff of the Tantalus and Sugar Loaf volcanics, which partly fills Makiki Valley and its tributaries, and the water is perched on the soil which covered this area prior to the eruption of these volcanics (fig. 12). Two tunnels are proposed, both to follow this soil to the bottom of the "black sand," one at each of the springs. The tunnels would be only a few hundred feet long and would mainly improve the collection system of the present springs, which is subject to destruction by floods. On May 26, 1932, several seeps and springs were observed below the present spring intakes. During normal weather they discharge about 100,000 gallons daily, and this water could readily be recovered by means of the two tunnels. Both Makiki and Herring Springs go dry in times of drought; hence the tunnels also would probably dry up at such times.

Pukele tunnel.—Several lava flows have spilled out of Kaau Crater, near the summit of the Koolau Range, and have partly filled the various tributaries of Palolo Stream (pl. 2). Two of these flows are exposed in Pukele Valley, and Mahoe Spring, with a minimum flow of about 100,000 gallons daily, issues from Kaau basalt at an altitude of 370 feet near the bridge crossing this stream. This and probably some additional water can be recovered from the basalt by a tunnel driven at the base of the lava at a slightly higher altitude, and it could be used to supply high-level consumers on the adjacent spur slopes.

Kaau tunnel.—About 1,000 feet south of Kaau Crater, a City and County tunnel recovers about 170,000 gallons daily, perched in basalt of the Koolau series by a system of intrusive rocks and ash beds. Eight dikes and five thin beds of ash or tuff were observed in the stream bed between Waiomao Stream and Kaau Crater. Most of

⁶ Honolulu Water Comm. Rept. for 1917, p. 289, 1918.

⁷ Kunesh, J. F., Honolulu Board of Water Supply Rept. for 1931, Suppl., p. 40, 1931.

the dikes and tuff beds are about 1 foot thick, and the average trend of the dikes is N. 10° E. Although the intrusions and tuff beds are sufficiently numerous to perch ground water, the large number of tuff beds present in any vertical section makes prospecting difficult, because it is possible that some of the upper tuff beds would prevent the water from entering a tunnel driven beneath them.

On March 30, 1911, the overflow of surface water from Kaau Crater was 250,000 gallons.⁸ The flow is variable, depending upon rainfall. The overflow from the crater is unfit for the city supply because of its dark color, popularly supposed to be caused by decaying vegetation. The presence of a swamp in the crater and this overflow indicate that the floor of the crater is probably not very permeable. The bottom of the crater at the end of its activity may have been floored by lava, like the present Halemaumau, at Kilauea Volcano, or it may have been filled with talus, but in either case the floor would have been porous. The low permeability at present is doubtless produced by dirt washed into the crater, and the swamp suggests that a lake formerly existed but has since been filled.

In spite of the fact that the water in the crater floor is probably perched, a tunnel driven under the crater from Waiomao Stream appears to be a reasonable prospect. An 800-foot tunnel driven toward the crater from the base of the falls would probably reach talus breccia, which probably fills the crater throat. This breccia may be firmly cemented, but it is likely to have some poorly cemented streaks of high permeability, because an older breccia penetrated in the Kahana tunnel of the Waiahole System yielded copious flows of water from such partly consolidated streaks. The tunnel would cut through about eight dikes in the first 500 feet, and probably sufficient water would be recovered in this stretch to pay for this part of the tunnel.

The numerous dikes exposed in the stream beds near Kaau Crater suggest that many more exist in the adjacent Koolau basalt than were mapped. As this crater was caused by the blasting of a vent through the dikes and basalt, all the dikes will terminate at the throat breccia. The water perched by the dike system adjacent to the crater must drain downward through the throat breccia if permeable passages exist in it. The objective of the proposed tunnel is to intercept this water. Water was successfully intercepted in the Kahana tunnel in this manner, but the geologic structure is more favorable there than at Kaau.

If the breccia is permeable but contains no water the tunnel should not be driven farther, but if the breccia is tightly cemented the tunnel should be driven some distance into it to determine whether

⁸ Kunesh, J. F., Surface water supply of the island of Oahu, 1909-28: Honolulu Sewer and Water Comm. Rept. for 1929, Suppl., p. 252, 1929.

this impermeable condition prevails throughout the mass. A lateral tunnel contouring the contact of the breccia and basalt around the wall of the crater throat might recover water moving from the adjacent dike system down the contact.

As an alternative, the adjacent City and County tunnel might be continued in a northwesterly direction to intercept additional dikes, as recommended by Palmer.⁹ This prospect has an advantage over the proposed Kaau tunnel in that the water will be at a City and County pipe-line intake, and the project will take advantage of the existing length of tunnel and will start at a point where perched water is in evidence. It will, however, miss the opportunity to test out Kaau Crater.

ARTESIAN WATER SUPPLIES

Areas 1, 2, and 3.—Artesian areas 1, 2, and 3 lie between areas 4 and 5 and comprise the lands in the more thickly settled part of Honolulu. The artesian water in the Koolau lavas in these areas is now pumped from wells ending several hundred feet below sea level, near the bottom of the fresh-water zone. This same artesian water could be tapped by shafts 50 to 100 feet deep at the seaward end of the intervalley spurs in the city—as, for example, near St. Louis College, near Punahou College, at the foot of Pacific Heights, or at the old insane asylum on School Street (fig. 5, A).

As artesian areas 1, 2, and 3 are now drawn on virtually to capacity by the deep artesian wells, these shafts would not encounter new supplies. However, by proper construction any one of them might be made to yield a supply as large as is now used by Honolulu, thereby enabling the pumping to be centralized if that is ever considered advisable. Pumpage from such shafts, if greatly in excess of the present draft, would gradually cause the artesian wells within Honolulu to go brackish, but because the shafts would be drawing water from the top of the fresh-water reservoir they would still yield fresh water. However, the great advantage of the shaft method of recovery over the present well method is that by lowering the static head more water would enter these areas from outside areas, thereby saving the city from going outside of its confines for water, and if the static level were lowered it would greatly decrease any underground leakage from areas 1, 2 and 3 that now occurs.

The shaft and tunnel method of development in these areas hinges upon many factors and may not be desirable until present pumping equipment becomes obsolete or until more of the private wells within the city are abandoned.

⁹Palmer, H. S., manuscript report on the possible occurrences of high-level ground water in the Honolulu region, p. 74, 1921.

Area 4.—Area 4, between Kalihi and Halawa Streams, is not being pumped for municipal supply, but the private draft amounts to about 5,000,000 gallons daily, or about the safe yield without further lowering the static head. On February 7, 1932, the static level was about 3.5 feet higher in this area than in the Pearl Harbor area 6. The hydraulic gradient between the two areas is slightly over 1 foot to the mile, suggesting that the aquifer consists of very permeable rocks. At the present time surplus water from area 4 flows into area 6 and discharges at the Pearl Harbor Springs.

Honolulu has contemplated diverting the Pearl Harbor Springs for municipal supply through a pipe line, but it is possible to divert a large part of the flow of these springs without going outside of Honolulu. This could be accomplished by pumping from a shaft about 30 feet deep at the lowest point of the Koolau spur east of Moanalua Stream, 1,100 feet north of the road intersection at Salt Lake Crater. A collecting tunnel driven in a northerly direction about 5 feet above sea level from the bottom of the shaft would also be necessary, or else a battery of shallow wells drilled in the bottom of the shaft. As soon as the water level in this shaft had been lowered by pumping about 6 feet, it would reverse the hydraulic slope toward area 6 and cause the water to flow from area 6 to the shaft. If the head in area 4 were lowered from its present level of about 26 feet above sea level to only 8 feet above sea level, it would create a gradient of about 7 feet to the mile from area 6 toward area 4. Such a steep gradient should cause large quantities of water to flow from area 6 to area 4, with the result that the shaft would probably yield 10 to 20 million gallons a day of potable water. The disadvantage of so large a development would be that it would gradually cause the water in most of the wells in area 4 to become brackish, and it might after several years seriously increase the salt content of the wells about Aiea.

Area 5.—Area 5 is not being used by Honolulu. The Kaimuki and Waialae districts of Honolulu are now supplied by water pumped from wells at the Kaimuki station, near the mouth of Palolo Valley, and the water is distributed to the residences on the southwest side of the Kaimuki Ridge by a pipe line that passes over the ridge at an altitude of about 75 feet. This district has been growing rapidly in the last few years, and it is probably only a question of time before something will have to be done to increase the capacity of the pipe line. A pipe line contouring Diamond Head near sea level has been contemplated to relieve the condition.

The coastal plain and its subjacent cap rock, which causes the artesian head, ends near Wailupe Valley, where a spring of good

size discharges into the sea. It is very difficult to estimate the amount of water escaping as overflow from the lavas at this place, because of duck ponds and swamps, but it appears to be several hundred thousand gallons daily.

Another spring representing overflow of artesian water occurs a few feet below the Waialae road at an altitude of about 9 feet, 1,100 feet northeast of well 1 in the Waialae Golf Course. In April 1932 it was discharging at the rate of 63,000 gallons daily of water with a salt content¹⁰ of 7.8 grains a gallon. The Bishop estate has kindly furnished the following data regarding this spring:

Salt content of Waialae Spring in 1925

Date	Remarks	Salt	Chloride
		Grains per gallon	Parts per million
June 13		8.3	86.24
15		8.0	83.12
16		8.3	86.24
17		8.3	86.24
18	Pumping at rate of 900,000 gallons per day:		
	8 a. m.....	7.9	82.08
	Noon	8.1	84.16
	4 p. m.....	7.9	82.08
19	Pumping at rate of 900,000 gallons per day:		
	8 a. m.....	7.9	82.08
	Noon	7.9	82.08
	4 p. m.....	8.0	83.12

Because the salt content of the water did not appreciably change during this pumping test, considerable potable water is apparently escaping underground here.

As extensive areas of permeable rocks occur between this spring and Palolo Valley, much additional water is probably escaping underground into the sea from this artesian area.

Well 1B at the Waialae Golf Course had a head of 8.57 feet above mean sea level on April 18, 1933, and a salt content of 17.8 grains per gallon, but on September 28, 1933, after several dry months, it was only 13.5 grains per gallon.¹¹ The well is 114 feet deep and is pumped at a rate of about 300,000 gallons a day. Except for the draft from the Hind-Clarke Dairy well, which is not measured but is used for dairy supplies and to irrigate 82½ acres of grass land, the water in the basalt of the Koolau series in this area is at present not used. The low cap rock makes it undesirable to develop water by artesian wells because of the danger of contamination by sea water. However, a shaft sunk to sea level on the north side of the Waialae road near the point

¹⁰ All chlorides determined by titration and then computed to NaCl.

¹¹ Data furnished by Honolulu Board of Water Supply.

where Waialaenui Stream debouches upon the coastal plain, connecting with a tunnel driven through the basalt a few feet above sea level near the top of the zone of saturation, should encounter water of good quality. The site is a mile from the sea, and hence direct contamination by sea water is unlikely.

Estimates of the recharge based on rainfall are given on page 327 and indicate that about 3,500,000 gallons daily may be recoverable.

Methods for recharging the artesian areas.—At the meeting of the Honolulu chapter of the American Association of Engineers in November 1924 Harold Lyon proposed to recharge the Honolulu artesian system by tunnels adjacent to the streams, into which excess water could be diverted to sink into the permeable lava rock. At this meeting I described the success obtained by sinking surface water by means of wells in the lava rocks of Idaho and stated that many of the reservoirs there leaked badly and contributed to the recharge. L. L. McCandless¹² has since suggested a series of barrages in the streams back of Honolulu for this same purpose.

On the Minidoka irrigation project, in Idaho, a shaft about 100 feet deep blasted in basalt drains a continuous flow of 15,000,000 gallons a day of dirty waste water. It has to be cleaned only once or twice a year. The Oahu Sugar Co. dumps waste irrigation and stream water into tunnel 4B at Waipahu, thereby increasing the artesian supply.

One of the difficulties of sinking flood waters on Oahu is that the streams in flood carry so much debris that they would soon fill up the holes, tunnels, or reservoirs. This difficulty could be at least partly overcome by properly screening the pits or tunnels, or the pits could be back-filled with coarse rock and the top covered with crushed rock. But owing to the flashy character of the streams there seems to be little chance of sinking the major part of the great floods, and recharge pits would probably be most successful in sinking the unused low flow. As most of these valleys are floored with late lava flows, resting on relatively impervious alluvium, most of the water entering them from reservoirs produced by barrages or from shallow pits or tunnels would probably not percolate to the artesian basin. Such structures might, however, be satisfactory at places where the valleys are floored with lavas or with coarse gravel resting directly on these lavas.

Recharging the artesian basins by sinking surface water should doubtless be considered in any comprehensive plan to conserve the water of Oahu. A good location for an experiment would be at the nose of the spur between the confluence of Pauoa and Nuuanu

¹² Honolulu Advertiser, June 1926.

Streams. By blasting pits 20 to 30 feet deep into the clinker beds or into the particular pahoehoe flows that are full of tubes, a considerable part of the unused flow of these streams might be made to percolate into the artesian reservoir.

Conservation of water by any recharge method might involve some danger of pollution because of the rapidity of the recharge. Therefore, sanitary studies should be made in connection with recharge tests.

SUMMARY

The minor tunnel projects in the vicinity of Honolulu will probably recover only about 2,000,000 gallons of water daily, but such water will be valuable to supply residential districts at high levels where pumping is expensive or to supplement supplies now inadequate. About 3,000,000 gallons daily of artesian water can probably be safely recovered from shafts and tunnels at sea level in the Waialae area. Small additional surface water supplies can also be utilized by filtration, as proposed by the Board of Water Supply. Ultimately, however, the city will probably need a larger additional supply than can be furnished from these sources.

A report describing the possibility of obtaining water from the Pearl Harbor Springs was released by the Geological Survey in manuscript form and was published in the Honolulu Star-Bulletin August 13, 1931. The cost of obtaining this water for Honolulu through a pipe line leading from the springs is given in plate M of the Honolulu Sewer and Water Commission's report for 1929. It is shown in the present report that about 10 to 20 million gallons of this spring water could probably be recovered daily through a shaft and tunnel at Moanalua, thereby saving considerable pipe line, but that such a development might seriously damage the wells in the area in which the shaft and tunnel would be located. It is also pointed out that by pumping from similar shafts and tunnels within Honolulu it would probably be unnecessary to import water from areas beyond the city limits, but that such a method of recovery virtually means the gradual abandonment of the deep wells and the present pumping plants.

The proposed Kalihi-Waiahole ground-water tunnel will deliver a large gravity supply at a lower cost than that of pumping water from the Pearl Harbor Springs, and it is the most economical large additional supply within reach of Honolulu unless the artesian wells are abandoned and replaced by shafts.

AREA EAST OF HONOLULU

The springs discharging from the ends of the spurs east of Honolulu shown on plate 2 indicate that surplus ground water is moving

through these ridges into the sea. A considerable part of this water could be recovered by tunneling into the ridges slightly below the water table as far inland as possible. The water could be used to irrigate the land at the mouths of these valleys.

PEARL HARBOR AREA

Large low-level undeveloped water supplies exist in this area, as shown by the great amount wasted into the sea annually from the Pearl Harbor Springs. The salt content of the water used in the Ewa district might be improved by a change in the method of recovery of the ground water. The Ewa plantation is supplied chiefly by artesian water and to a lesser extent by water pumped from reef limestone. The latter is believed to be chiefly return irrigation water from the higher fields supplied by artesian water. The salt content of the artesian water reaches about 70 grains per gallon. Transpiration and evaporation losses concentrate the salt in the water that percolates toward the shallow wells in the limestone. If water with a lower salt content could be used in the upper fields it would decrease the salt content in the shallow wells. This could be accomplished by plugging the artesian wells whenever the present pumping equipment wears out and replacing them by shafts almost to sea level and by tunnels extending away from the shafts just below the water table in the lava rocks as far inland as possible. The artesian wells of this plantation extend several hundred feet below sea level, into the upper part of the zone of mixture (fig. 5,A). The proposed shafts and tunnels, or wells of the Maui type, would not even reach sea level and would skim off the very freshest water at the top of the zone of saturation. In addition to the fresher water obtained they would save the cost of the pipe lines that now convey the water from the wells to the reservoirs at the upper levels of the plantations. The water from the proposed shafts could be pumped directly into these reservoirs.

The Honolulu plantation can also develop a large gravity supply for irrigating its high lands by tunneling through the Koolau Ridge at the head of Moanalua Valley and carrying out the proposed Kalihi-Waiahole tunnel system described on page 444. This project would save the cost of the relatively unproductive unit B. Muddy water would not cause trouble for irrigation; hence if the system was not used to supply Honolulu it should be modified to collect surface water also.

WINDWARD COAST

The windward side of Oahu is as a whole well watered, and except in a few places the supply exceeds the demands. The Waimanalo plantation can develop additional water to meet its requirements in

several ways. Wells 408 and 409 indicate that the dike complex is saturated with water below the sedimentary cover. A tunnel could be driven toward the Pali into the dike complex from various points behind Waimanalo. If driven at a low altitude it would be much longer than if driven at a high altitude but would recover more water. However, to have much value most of the water would have to be pumped to the main ditch at an altitude of about 300 feet near well 409. This would require pumps and a pipe line. By sinking a shaft to about sea level in the vicinity of well 409, and then driving a tunnel toward the Pali from the bottom of the shaft, the pipe line would not be required, and a much shorter tunnel would be sufficient to develop the same amount of water. The shaft would have another advantage over the gravity tunnel because ground water would be stored during times of no pumpage, whereas it would have to waste from the gravity tunnel unless some kind of shut-off gates could be installed.

It is not believed that a battery of wells in the vicinity of well 409 would develop enough water for irrigation, owing to the small number of dikes cut by a vertical hole as compared with a tunnel, but small supplies might be obtained in this region for domestic purposes.

The beach lots in this area can be supplied from wells or a shaft in this same general vicinity. The tunnels penetrating the dike complex above the Waimanalo plantation might also be driven farther under the Pali, but not if the shaft is to be excavated, because it may drain these tunnels.

The gravity supply of the Waimanalo plantation can also be augmented by a tunnel under the basalt of the Ainoni volcanics, described on page 131.

Additional water can probably be developed by tunneling into the Pali at Lulukū Springs to meet increased demands in the Mokapu Point-Kailua beach areas. Small supplies for this area can be developed by tunnels or shafts at the springs shown on plate 2 in the lower part of Kahanaiki and Maunawili Valleys.

From Kaneohe to Punaluu a surplus of high-level water exists. Should additional water be needed, it can be developed by tunnels into the dike complex at the head of the valleys and below the springs. The possibility of developing Waihoi Spring for power has been described on page 437.

The Kahuku plantation has successfully met the need for additional water for the lands between Punaluu and Waialeale by drilling artesian wells. There is apparently a large surplus of artesian water in this region because of the large drainage area behind it and the small area of coastal land on which the water can be used.

From Waialeale to Haleiwa water can be developed for the beach lots by wells of the Maui type. The Waialua Agricultural Co. should

use the Maui wells as far inland as possible when developing additional large supplies of basal water. It could use to great advantage high-level water. Dikes are not numerous, however, in the upper stretches of the streams flowing toward the plantation, owing to the slight dissection of the rift zone in this area. Furthermore, the dikes are divergent, and there is an opportunity for the water to escape seaward toward the north point of the island. Both of these factors lead to a lower water table. To develop such water will require a long tunnel because of the gradual slope of the valleys that drain the area. It would be worth while, however, to drill a few test holes near the summit in the area, to determine the height of the water table in the dike complex. A small portable diamond-drill machine could be transported into the jungle for this test.

WAIANA E RANGE

The relatively low rainfall on the Waianae Range makes prospecting for water much more difficult there than in the Koolau Range.

On page 73 an inclined shaft to the basal water table in Heleakala Ridge is recommended for developing additional water in Lualualei Valley. This water could be used to supply the Nanakuli or Lualualei homesteads. The present tunnel at the Nanakuli pump could probably also be extended with advantage. Test boring to determine whether it is feasible to develop water in the floor of Lualualei Valley has been suggested on page 226. Several short tunnels at the site of the springs or at somewhat lower levels should meet with success in the dike complex at the head of Lualualei Valley. A few such small prospects exist in Waianae Valley, but it is believed that one or two long tunnels as low as economically possible and driven several thousand feet under the divide at the head of this valley would be the best way to develop high-level water in this valley. A sea-level tunnel to replace the Kamaile wells is described on page 225.

A few borings to determine the depth of bedrock and the altitude of the perched water table in Makaha Valley are essential to further understanding of the source of supply of the high-level tunnels in this valley. If this water is forced to the surface here by a ground-water dam of dikes, then a tunnel puncturing them should develop additional water. More water awaits development near the mouth of the valley, as pointed out on page 223.

When the beach lots are settled along the north coast of the Waianae Range, a gravity water supply can be obtained by a series of tunnels contouring the ash beds in the north-coast cliff, as described on page 383, or it can be pumped from area 12 (See p. 375). The possibilities of developing water by tunneling along the Koolau-Waianae unconformity beneath the Schofield Plateau are described on page 384.

NUMBERING SYSTEM FOR DRILLED WELLS

By H. T. STEARNS

Records of all the drilled wells on Oahu have been compiled and it is planned to publish them in a later bulletin. Most of the readings of the static level were made with the mercury U-tube shown in Plate 32, B. The numbers for drilled wells on Oahu used in previous reports are so lacking in system that all wells have been renumbered starting on the east point of the island and proceeding clockwise around the island. The following tables show both the old numbers and the numbers used in the present report and shown on Plate 2. When new wells are drilled on Oahu and there are no new numbers specifically left for new wells in the area where the new well is drilled, the new well should be numbered with a "-1" following the number of the nearest well. For example, a new well drilled near 62 would be numbered 62-1, and if 2 wells are drilled nearby, the second should be numbered 62-2. New wells drilled at pumping stations where a well already exists should be designated by a letter. For example, a new well drilled at station 185 would be numbered 185-R, since wells 185-A to Q already exist.

Table giving old and new numbers of drilled wells

Old No.	New No.	Old No.	New No.	Old No.	New No.	Old No.	New No.
1	18	24	79	47	4	71½	71
1-A, and B	1-A, and 1-B	24½	81	48	3	72	88-A
2	16	25	82	49	2	73	88-B
3	17	26	83	50	32	74	88-C
4	22	27	97	51	31	75	88-D
5	61	28	106	51-A	29	76	88-E
5½	59	29	99	51½	34	77	88-F
6	28	30	108	52	35	77-A	88-G
7	33	31	109	52½	27	78	84
8	40	31-A	111	53	19	79	88-H
9	38	32	147	54	21	80	88-I
9½	36-A	33	121	54½	23	81	87
9¾	36-B	34	49	55	42	82	86
10	48	35	78	56	43	83	91
11	51	36	15	57	44	84	85
12	53	37	14	58	47	84-A	89
12½	55	38	13	59	45	85	92
13	52	39	12	60	46	86	95
14	54	40	24	61	41	87	94
15	64	40½	11	62	39	87½	93
16	57	41	25	62½	37	88	101
17	60	41½	9	63	56	88-A	105
18	70	42	26	64	58	89	102
19	72	43	8	65	62	89½	103
20	73	44	7-G	66	63	90	104
21	74	45	7-H	67	65	* *	* *
22	76	45-A	7-A	68	67	92	96
22½	75	to F	to F	69	68	93	107
23	77	46	5	70	66	94	98
		46-A	6	71	69	95	113

* * No old no. 91.

Table giving old and new numbers of drilled wells

Old No.	New No.	Old No.	New No.	Old No.	New No.	Old No.	New No.
95-A	114	138	223	190	238	233	281
95-B	118	139	224	191	241	234	282
95-C	119	140	171	192	242	235	283
95-D	116	141	176	193	243	236	284
95-E	115	142	172	194	244	237-A	285-A
95½	117	143	173	195	245	to H	to H
96	112	144	174	196-A	246-A	238	286
96-A	122	145	175	to H	to H	239	287
97	124	146	177	197	253	240	288
98	125	147	178	198	234	241	289
99	126	148	179	199	232	242	292
100	127	149	180	199-1	233	243	291
100½	123	150	182	200	231	244	293
101	128-F	151	183	201	229	245	294
101-A	128-A	152	181	202	228	246	295
101-B	128-B	153-A	185-A	203	227	247-A	296-A
101-C	128-C	to Q	to Q	204	226	and R	and R
101-D	128-D	154-A	186-A	205-A	247-A	248	297
101-E	128-E	to H	to H	to J	to J	249	298
102	128-G	155	184	206-A	248-A	250	299
102½	128-H	156-A	187-A	to J	to J	251	301
103	129	to C	to C	207-A	249-A	252	303
104	132	157	188	to L	to L	252-1	302
105	131	158-A	189-A	208	252	253	305
106	133	to E	to E	209-A	254-A	254	304
107	136	159	190	and B	and B	255	306
108	135	160	191	210	255	256	307
109	138	161	192	211	256	257	308
110	142	162	193	211-1	269	258	309
110-A	137	163	194	212	251	259	311
110-B	134	164	195	213-A	274-A	260	312
111	139	165-A	196-A	to F	to F	261	313
112	141	to T	to T	214-A	257-A	262	314
113	143	166-A	197-A	to C	to C	263	316
114	144	to I	to I	215	261	264	315
115	145	167	198	216	258	265	317
115½	151	168	199	216-1	262	266	318
116	152	169	200	217	265	267-A	319-A
116½	146	170	201	218	266	to G	to G
117	148	171-A	202-A	219-A	259-A	268-A	321-A
118	149	to C	to C	to L	to L	to E	to E
119	153	172	205	220-A	263-A	269-A	322-A
120	154	173	206	to F	to F	to N	to N
120-A	158	174	207	221-A	264-A	270-A	324-A
121	155	175	208	to T	to T	to E	to E
122	157	176	209	222	267	271-A	323-A
122½	156	177	212	223-A	268-A	to L	to L
123	159	178	217	to H	to H	272	325
124	161	179	213	224	270	273	327
125	162	180	215	224-1	271	274	326
126	163	181	214	224-2	273-I	275	328
127	164	182	216	225-A	273-A	276-A	329-A
128	165	183	218	to I	to I	and B	and B
129	166	184	211	226	272	277-A	331-A
130	167	185-A	203-A	227	225	to T	to T
131	168	to D	to D	228-A	276-A	278	332
132	169	186	204	to K	to K	279	333
133	170	187-A	239-A	228-1	275	280-A	334-A
134	219	to N	to N	229	277	to O	to O
135	220	188	235	230	278-A	281	335
136	221	188-1	236	231	278-B	282	336
137	222	189	237	232	279	283	337

Table giving old and new numbers of drilled wells

Old No.	New No.	Old No.	New No.	Old No.	New No.	Old No.	New No.
284	338	294	355	309	374	322	392
285-A	341-A	295	356	310	376	323	393
and B	and B	296	357	311	375	324	394
286	342	297	361	312-A	377-A	325	395
286-1	345	298-A	362-A	to G	to G	326	396
287	343	to F	to F	313	Not on	327	397
287-1	344	299	358		map	327-1	398-A
288-A	352-A	300	363	314	381		and B
to H	to H	301	364	315	382	328	401
289	348	302	371	316	383	329	402
289-1	351	303	367	317	378	330	403
290	347	304	368	318	384	331	404
291	346	305	365	319	385	331-1	405
292-A	353-A	306	366	320	386	332	406
to C	to C	307	373	320-1	387	333	407
293	354	308	372	321	388	334	408
				321-1	391	335	409

Table giving new and old numbers of drilled wells

New No.	Old No.	New No.	Old No.	New No.	Old No.	New No.	Old No.
1-A	1-A	33	7	68	69	96	92
and 1-B	and 1-B	34	51½	69	71	97	27
2	49	35	52	70	18	98	94
3	48	36-A	9½	71	71½	99	29
4	47	36-B	9¾	72	19	100	* *
5	46	37	62½	73	20	101	88
6	46-A	38	9	74	21	102	89
7-A	45-A	39	62	75	22½	103	89½
to F	to F	40	8	76	22	104	90
7-G	44	41	61	77	23	105	88-A
7-H	45	42	55	78	35	106	28
8	43	43	56	79	24	107	93
9	41½	44	57	80	* *	108	30
10	* *	45	59	81	24½	109	31
11	40½	46	60	82	25	110	* *
12	39	47	58	83	26	111	31-A
13	38	48	10	84	78	112	96
14	37	49	34	85	84	113	95
15	36	50	* *	86	82	114	95-A
16	2	51	11	87	81	115	95-E
17	3	52	13	88-A	72	116	95-D
18	1	53	12	88-B	73	117	95½
19	53	54	14	88-C	74	118	95-B
20	* *	55	12½	88-D	75	119	95C
21	54	56	63	88-E	76	120	* *
22	4	57	16	88-F	77	121	33
23	54½	58	64	88-G	77-A	122	96-A
24	40	59	5½	88-H	79	123	100½
25	41	60	17	88-I	80	124	97
26	42	61	5	89	84-A	125	98
27	52½	62	65	90	* *	126	99
28	6	63	66	91	83	128-D	100
29	51-A	64	15	92	85	127	101-A
30	* *	65	67	93	87½	128-A	101-B
31	51	66	70	94	87	128-B	101-C
32	50	67	68	95	86	128-C	101-D

* * Left for new well.

Table giving new and old numbers of drilled wells

New No.	Old No.	New No.	Old No.	New No.	Old No.	New No.	Old No.
128-E	101-E	184	155	234	198	278-A	230
128-F	101	185-A	153-A	235	188	278-B	231
128-G	102	to Q	to Q	236	188-1	279	232
128-H	102½	186-A	154-A	237	189	280	* *
129	103	to H	to H	238	190	281	233
130	* *	187-A	156-A	239-A	187-A	282	234
131	105	to C	to C	to N	to N	283	235
132	104	188	157	240	* *	284	236
133	106	189-A	158-A	241	191	285-A	237-A
134	110-B	to E	to E	242	192	to H	to H
135	108	190	159	243	193	286	238
136	107	191	160	244	194	287	239
137	110-A	192	161	245	195	288	240
138	109	193	162	246-A	196-A	289	241
139	111	194	163	to H	to H	290	* *
140	* *	195	164	247-A	205-A	291	243
141	112	196-A	165-A	to J	to J	292	242
142	110	to T	to T	248-A	206-A	293	244
143	113	197-A	166-A	to J	to J	294	245
144	114	to I	to I	249-A	207-A	295	246
145	115	197-1		to L	to L	296-A	247-A
146	116½	198	167	250	* *	and B	and B
147	32	199	168	251	212	297	248
148	117	200	169	252	208	298	249
149	118	201	170	253	197	299	250
150	* *	202-A	171-A	254-A	209-A	300	* *
151	115½	to C	to C	and B	and B	301	251
152	116	203-A	185-A	255	210	302	252-1
153	119	to D	to D	256	211	303	252
154	120	204	186	257-A	214-A	304	254
155	121	205	172	to C	to C	305	253
156	122½	206	173	258	216	306	255
157	122	207	174	259-A	219-A	307	256
158	120-A	208	175	to L	to L	308	257
159	123	209	176	260	* *	309	258
160	* *	210	* *	261	215	310	* *
161	124	211	184	262	216-1	311	259
162	125	212	177	263-A	220-A	312	260
163	126	213	179	to F	to F	313	261
164	127	214	181	264-A	221-A	314	262
165	128	215	180	to T	to T	315	264
166	129	216	182	265	217	316	263
167	130	217	178	266	218	317	265
168	131	218	183	267	222	318	266
169	132	219	134	268-A	223-A	319-A	267-A
170	133	220	135	to H	to H	to I	to I
171	140	221	136	269	211-1	320	* *
172	142	222	137	270	224	321-A	268-A
173	143	223	138	271	224-1	to E	to E
174	144	224	139	272	226	322-A	269-A
175	145	225	227	273-A	225-A	to N	to N
176	141	226	204	to I	to I	323-A	271-A
177	146	227	203	273-I	224-2	to L	to L
178	147	228	202	274-A	213-A	324-A	270-A
179	148	229	* *	to F	to F	to E	to E
180	149	230	201	275	228-1	325	272
181	152	231	200	276-A	228-A	326	274
182	150	232	199	to K	to K	327	273
183	151	233	199-1	277	229	328	275

* * Left for new well.

NUMBERING SYSTEM FOR DRILLED WELLS

467

Table giving new and old numbers of drilled wells

New No.	Old No.	New No.	Old No.	New No.	Old No.	New No.	Old No.
329-A	276-A	348	289	368	304	389	* *
and B	and B	349	* *	369	* *	390	* *
330	* *	350	* *	370	* *	391	321-1
331-A	277-A	351	289-1	371	302	392	322
to T	to T	352-A	288-A	372	308	393	323
332	278	to H	to H	373-A	307-A	394	324
333	279	353-A	292-A	and B	and B	395	325
334-A	280-A	to C	to C	374	309	396	326
to O	to O	354	293	375	311	397	327
335	281	355	294	376	310	398-A	327-1
336	282	356	295	377-A	312-A	and B	
337	283	357	296	to G	to G	399	* *
338	284	358	299	378	317	400	* *
339	* *	359	* *	379	* *	401	328
340	* *	360	* *	380	* *	402	329
341-A	285-A	361	297	381	314	403	330
and B	and B	362-A	298-A	382	315	404	331
342	286	to F	to F	383	316	405	331-1
343	287	363	300	384	318	406	332
344	287-1	364	301	385	319	407	333
345	286-1	365	305	386	320	408	334
346	291	366	306	387	320-1	409	335
347	290	367	303	388	321		

* * Left for new well.

PAGE 468
(BLANK)

INDEX

	Page		Page
Aa, definition and formation of.....	18	Artesian water—Cont.	
Abrasion, rates of.....	47	history of artesian development.....	239
Abstract	1	importance of ancient soils.....	252
Achatinellidae	6	independent application of Ghyben- Herzberg principle on Oahu.....	256
Acknowledgments	10	Koolau basalt, in.....	257-364
Age of rocks, general.....	66, 67	occurrence	250
Agriculture, effect of artesian wells on...	244	relation to basal ground water.....	250
Aiea tunnel	399	unusual, on Oahu.....	64
Ainoni, spring	130, 440	used on plantations.....	254-248
tunnel	414	used on other crops.....	248
volcanics	129-131	Waianae basalts, in.....	372-375
Alapena plunge pool.....	113	Artesian wells	243, 248, 328, 347
Alewa Heights Spring.....	115, 440	chloride increased with depth.....	347
Aliamanu tuff	108-111	contamination of	347
Altitude, former, of Oahu.....	24	drilled in Honolulu, prior to Feb. 1882	243
Amphitheater-headed valleys	24	drilling progress (fig. 18).....	248-250
views of (pls. 6, B; 7, A).....	16	leakage underground	328
Amygdaloidal basalt, Kailua	88-90	Ash, definition of and use of term.....	17
Amygdaloidal breccia, Koolau	97	and soil beds, as perching members	66
Amygdaloidal tuff, Koko volcanics.....	151	Augite, crystals in Koko volcanics.....	151
Amygdules, definition of.....	18	Ball lava	99, 127, 132, 146, 155, 159, 161
Koko volcanics	151	Barking sands	56
Anahula Stream, profile (fig. 2).....	35	Barnacle, fossil shells, Ulupau Crater..	121, 122
Analcite-nephelite basalt, Kalihi vol- canics	104	Barometric changes in pressure and fluctuations in water level (fig. 22)	271
Analyses, chemical	361-364, 441	Barometric fluctuation, well 319 H (graph, Pl. 31).....	272
Ancient caldera, Waianae.....	85	Barrel Spring	235
land mass, Waianae.....	85	Basal ground water	215, 365, 371
Waianae vent	35	coastal plain rocks, in.....	215
Andrews tunnel	416	definition of	215
Api Spring	130, 440	quantity in Koolau basalt.....	371
Aragonite	88, 184	quantity in Waianae basalt.....	377-378
Area of Oahu.....	3	recovered by tunnels	365
Artesian area, section of Waikiki (fig. 19)	254	springs supplied by.....	365
Artesian areas	260-268	Basal water table.....	236
cause of	258	Basalt, definition of.....	12
draft	273-324	Basaltic hornblende	185
establishment of	259	Basanite	117
location	257	Baskerville Springs	108
map of (fig. 16).....	236	Bastite	184
recharge	458	Beach conglomerate, view (pl. 12, C)...	56
safe yield of.....	324-328	Beaches	39-41
Artesian basin, block diagram (pl. 25, B)	176	Benches	43
Artesian water	239-364, 372-375	Bidens, specialization of.....	6
absence of lower confining bed.....	255	Biotite, in Salt Lake tuff.....	127
change in head and discharge, with depth	256	Black Point basalt	140
character of cap rock.....	251	"Black sand"	146, 159
curtailment of waste and losses.....	328-344	Diamond Head	138, 141-143
dike complex, in.....	268-269	Hawaiian relics in.....	156
effect of Ghyben-Herzberg principle on	253	origin of	146
effect on agriculture.....	244	view (pl. 18, B).....	152
fluctuations see Fluctuations.....			
first attempts to secure.....	240		

	Page		Page
Blowhole	46	Cinders, definition of	14
Bomb sags	106, 110	City and County tunnels. 392-394, 396-398, 416	
Bombs, definition of	14	Clark tunnel (fig. 34).....	412
Booth Spring	162, 440	Climate	199-213
Bosses and plugs	21	rainfall	199-202
Palolo Valley, view, (pl. 4, A).....	16	temperature	199
Waianae Range	21	time of Salt Lake eruption.....	128
Bottomless Falls	94	wind	199
Boulder trains	62	Coastal plain, description of.....	35
Branner, J. C., on Pearl Harbor.....	48	terraces	36
on lithified beaches.....	41	thickness of sediments in.....	36
Breccia, Koolau crater.....	98	wells and tunnels in.....	219-223
Kolealili Spur (Waianae).....	83	Coastal-plain rocks, permeability.....	215
Makawao	118-119	water in	215-227
Pali	117	Coastal-plain water, effect of draft on	
Ulumawao Ridge	97	quality	217
Breccia, talus	70-72, 80-86	head	216
as ground-water dam	82	methods for recovery.....	219
geologic section, Waianae (fig. 8)....	81	occurrence	216
Kahana tunnel 1, (Waiahole).....	407	quality	216
Keaau and Makaha Valleys.....	84	tidal fluctuations	217
Lualualei and Waianae Valleys.....	83	undeveloped supplies	223, 227
Nanakuli Valley	80	yields	215
North Mokulua Island (pl. 11, C)....	48	Cones, cinder	13
Breccia, throat (Koolau).....	97	lava	14
Bronzite	184	secondary	13
Brown, J. S., quoted	237	tuff	15
Bryan, W. A., quoted	378	types	13
		Waianae	32
Calcareous, concentrates, secondary (Salt Lake Crater)	128	confining bed, absence of lower, in artesian basins	64, 253
concretions, tubular (Ulupau Crater)	122	Confining formation, Koolau dike complex	97
dunes, consolidated	167	Conservation of dike complex water in tunnels by plug	435
dunes, unconsolidated	171	Consolidated and partly consolidated noncalcareous sediments	170
marine sediments, consolidated.....	165	Consolidated calcareous dunes	119
marine sediments, unconsolidated..	171	Consolidated calcareous marine sediments	165-169
sediments, consolidated dunes.....	169	Consumptive use, Lower Luakaha Station	204
Calcite	89, 97, 104	Kaukonahua Station	210
Caldera, effect on Pali.....	29	Contamination of artesian wells.....	347
Koolau	29	of ground water by sea water.....	346
Waianae	31	Cooke tunnel	412
Caliche	50, 61, 128	Corals, fossil	167
Campbell well (No. 18).....	248	Cost, of sealing wells (table).....	340
Cap rock of artesian basins.....	251	of tunnels	450-451
Castle volcanics	145	Crater breccia, Koolau	98
Catastrophic eruptions	19	Crater spring	440
Cavern, Moiliili Quarry	161	Crustacean, fossil	167
Change in head and discharge of wells with depth	256	Crystals in cavities at Dillingham Quarry	185
Character and water-bearing properties of Oahu rocks, table.....	68	Curtailment of waste and losses of artesian water	328-344
Character of rocks, general.....	66	Damon road cut, geologic section.....	105
Chemical analyses	361-364, 441	Debris, transported by streams.....	214
Chemical weathering	58	Depth, change in head and discharge with, in wells	256
Chloride determinations of rain water....	346	increase of chloride with (fig. 26)....	352
Chloride, increase with depth in artesian wells (fig. 26).....	352		
Chlorite	97		
Cinder cone phase of volcanism.....	76		
Cinder cones, definition and character of	13, 14		
Waianae	32, 79		

	Page		Page
Diamond Head, view (pl. 1, B)..... frontispiece		Enamel-like coating	46
cause and sequence of explosions. 135-137		Epistilbite	88, 184
structure of crater (fig. 11).....	134	Erosion cycle, Koolau	98
tuff	133-138	Erosional unconformity, between Koolau	
Differentiation	198-199	and Honolulu series	98
Dike complex, artesian water in.....	268-269	between lower and middle Waianae	
dam to ground water	79, 82, 84	basalts	70
exposed in North Mokulua Island....	90	between Waianae and Koolau	
Kailua volcanic series.....	90	basalts	91
Koolau volcanic series.....	95	Eruptions, catastrophic	19
Waianae volcanic series	77	Eruptive center, Koolau	22
Dike system, Koolau secondary.....	97	Waianae	31
Waianae	78	Eustatic bench	43
Dikes, character, in dike complex of		Evaporation	202
Waianae	77	Kaukonahua station	210
character of rock in	20	Lower Luakaha station	204
effect on streams	63	Maunawili Ranch station	213
exposed in North Mokulua Island....	90	Upper Hoaeae station	213
exposed in Waimanalo transporta-		Ewa Plantation Co., pumpage from drill-	
tion tunnel	90	ed wells	296-314
formation	20	wells on	245
in breccia at Puu Kailio (pl. 3, A)	16	Explosions	19
Kailua volcanics	90	due to ground water	107, 135
Schofield-Waikane trail	96	phreatic	19, 135
separating artesian areas	259	phreatomagmatic	15, 107
size on Oahu	20	steam	19
typical, view (pl. 3, B).....	20	Extrusive rocks	17-18
Waiahole drainage tunnel R.....	404	Falls, formation of	25
Waiahole tunnels	96	Fauna, of Oahu	5
Waianae Valley, tunnel 6.....	423	Fault cliffs	82
water confining, exposure of, by		Fault tunnel	173, 414
erosion of Fall	29	Faults	173
Dillingham Quarry, crystals in cavities	185	Fills	172
Discharge, ground water, from Wai-		Fire fountain deposits, "black sand",	
hole tunnel (fig. 33).....	402, 403	view (pl. 18, B).....	152
Discharge, relation to salinity, well 101	360	Koolau	93
Dowsett tunnel (fig. 31).....	391	Tantalus and Sugar Loaf	154
Draft, artesian areas 1 to 10.....	272-324	Tantalus, view (pl. 19, A).....	152
effect on quality	217	Waianae	79-80
effect on quality (fig. 28).....	358	Flora of Oahu	6
Ewa Plantation Co.....	296-314	relation to age of Oahu.....	67
Honolulu Plantation Co.....	275-280	Flow-slope facets	23
Kahuku Plantation Co.	318	Fluctuations of water level.....	269-272
Koolau basalt	323	annual and secular	269
Navy wells at Aiea	314	barometer graph (pl. 31).....	272
nonartesian areas	323	barometric (fig. 22)	271
Oahu Sugar Co.	280-295	earthquake	272
private and public wells.....	314	pumping	269
total	442	pumping graph (pl. 31).....	272
Waianae basalts	378	tidal (fig. 22)	217, 218, 271
wells in Waianae coastal plain.....	228	tidal graph (pl. 31)	272
Drilled wells, numbering system for....	463-467	well 319 H, graph (pl. 31)	272
Dunes	56-57	wells 153, 201, 244, 326, 377, graph	
lithified	57	(pl. 29)	272
Dunite in Salt Lake tuff.....	127	wells 190, 193, 266, 308, 356 and	
Early sources of water supply.....	239	396, graph (pl. 30).....	272
Earthquakes, and fluctuations in water		Fluves	62
level	272	Fluviatile vs. marine abrasion	47
Ejecta, classification by Johnston-Lavis	15	Fossils	166
of steam explosions	19	absence in lavas	66
Emerged shore lines	47-48	barnacle shells Ulupau Crater.....	121, 122
Emerson Spring	371	climatic changes	166

Fossils—Cont.	Page		Page
corals	167	Haiku volcanics	106-108
crustacean	167	Halawa Falls, Molokai, view (pl. 7, A)....	24
gastropod	166	Halawa tunnels	398
in beach limestones	66	Hanauma Bay, view (pl. 18, A).....	152
in emerged reef	66	Hawaiian relics, in "black sand" under limestone	156
leaves	110, 128	Hawaiiioa, Puu	99
list of	166-128	volcanics	99-100
oyster shells, Ulupau Crater.....	121-122	Head, static, in rocks of coastal plain...	216
plants, Diamond Head tuff.....	137	Heleakala Ridge, geologic section of breccia (fig. 8)	81
shells, Laie (?) stand of the sea....	121, 122	Henry tunnel	410
trees, Salt Lake	128	Herring Springs	158, 440
wood, Aliamanu mud flow.....	109	Heulandite	88, 184
Fretwork weathering	46	High level springs	436-442
view of, (pl. 11, B).....	48	Koolau leeward	436
Garnet	127	Koolau windward	437
Gastropod, fossil	166	quantity discharged from post-Koo- lau eruptives (table)	440
Gay tunnels	394-395	Waianae leeward	438
Gem feldspar, Pohakea Pass	76	Waianae windward	439
Gems, semiprecious	88	High level water, quantity of.....	440-441
Geodes, quartz	88	Historic artificial fills of marine sedi- ments	172
Geography	3	Historical sketch of Oahu.....	3
Geologic history	174-179	History of artesian development.....	239
sequence of events	178-179	History of investigation	7-10
Geologic section, Damon road cut	105	Honokohau Valley, Maui, view (pl. 6, B)	16
half mile south Waipahu station....	53	Honolulu volcanic series	98-165
Kaau volcanics	124	Hydrothermal action	91
Kamaileunu and Keaau-Makaha ridges (fig. 7).....	74	Hydrothermal alteration	80, 90, 97
near Aiea railroad station.....	110	Iddingsite	145
Geology	64-198	Importance of ground water.....	214-215
effect on movement and recharge of ground water	64	Industries, Oahu	4-5
Geomorphic forms, minor	55	Intercalated soil, Waianae	86
Geomorphic provinces of Oahu.....	22	Introduction	3-12
Geomorphology	22-64	Intrusive rock, dikes and sills.....	20
Ghyben-Herzberg principle	65, 237	Palolo Quarry boss, petrography of	105
Brown, J. S., quoted	237	Investigations, previous	11
effect on artesian basins	253	Isopiestic areas	257-268
independent application of, on Oahu	256	Kaakahi Spring	162, 440
section of island of Norderney (fig. 17)	238	Kaala, Mount, origin of.....	30
Gilbert artesian area, area 11	372	tunnel	418
Girls Industrial School tunnel	411	view, (pl. 4, B).....	16
Grooves, formation Pali	62	Kaalakei Spring	235
lapies	59	Kaau volcanics	123-126
Ground water, areas of Oahu (fig. 16)...	236	Kaea tunnel	387
basal	215	Kaena (+95-foot) stand of the sea.....	48
dam or barrier	79, 82, 84, 88, 92	lavas and pyroclastic rocks of.....	99
dike complex	65	Kahana station, rainfall, graph (pl. 33)	408
effect on formation of Koolau Pali	29	Kahana tunnel, discharge and tunnel progress graph (pl. 33).....	407, 408
high level	65	breccia	94
importance of	21	Kahipa shore line	48, 100
movement	64	Kahuawai Spring	162, 440
perched	378	Kahuku Plantation Co., draft from wells	318-323
recharge, affected by geology	64	rate of artesian flow	323
recovery of, in relation to erosion of Koolau Pali	29	Kahuku shore line	48
relation of recharge of, to rainfall	64		
resources	199-463		
Haiku Spring	440		

	Page		Page
Kaaliio, Puu, former highest part of Waia- anae Range	83	Koolau Range	22-23
site of summit caldera of Waiaanae..	31	cross section above main Waiahole bore (fig. 32)	400
view of breccia in (pl. 14, C).....	72	description of	22
Kaaliio syncline	174	original form of	22
view (pl. 21, A)	176	position of eruptive center of.....	22-23
Kallua volcanic series	88-92	stage of dissection of	23
amygdaloidal basalt	88	Koolau volcanic series	92-98
dike complex	90-91	basalt	93
Kaimuki lava dome	139	breccia	97
volcanics	138-140	dike complex	95
Kalama volcanics	153	tuff	93-95
Kalihi gap, view (pl. 6, A).....	17	water in	235-236
Kalihi Orphanage tunnel.....	396	Koolau-Waiaanae erosional unconformity	91-92
Kalihi Stream delta, view (pl. 27, B)....	224	Korean tunnel	415
Kalihi Valley, tunnels in.....	304-308	Kumalae Springs	235
Kalihi volcanics	103-106	Kupipikio Point (also Black Point).....	140
Kaloi tunnels	418	Kuua, Puu	32, 79
Kamaileunu Ridge (Waiaanae) graphic section of	74	Kuwale Ridge, unusual flows in.....	68
Kamanaiiki basalt	143-145	Laelo craters (Waiaanae)	182
Kaneohe Bay, coral	36	Laie marine sediments, Ulupau Crater....	100
Kaneohe volcanics	111-112	Laie (+70-foot) stand of the sea.....	48
geologic cross section (fig. 9).....	112	lavas and pyroclastic rocks of.....	99
Kanewai Spring	115, 235, 440	Land snails, relation to age of Oahu....	67
Kaohikaipu volcanics	153	Landslide boulder trains (Nanakuli)....	62
Kapahulu Quarry, Kaaui volcanics in....	126	Landslides	25
Kapena plunge-pool	113	Laniakea Spring	371
Kapolei, Puu o	32, 79	Lanikai syncline	174
nephelite-basanite flow from	183	view (pl. 21, B).....	176
Kapua, Puu	32, 79	Lapies	59
Kaukonahua station	209	view of, near Waimea (pl. 14, C)....	72
view (pl. 27, A)	224	Laterite	60, 251
Kaukonahua Stream, profile (fig. 2).....	35	Latest Pleistocene or Recent lavas and pyroclastic rocks	149
Kaukonahua tunnel	409	Laumontite	88, 184
Kauopuu Ridge (Waiaanae) breccia.....	83	Lava balls, views (pl. 19) see also ball lava	153
Kaupo basalt	154	Lava cavern, Mahalo and Judd Sts.....	18
Kawaikuhi Spring	235	Lava cones or dome (Kaimuki).....	14, 139
Kawailoa Spring	371	Lava tube or cave	18
Kawiwi, Puu, cinders	79	Leakage, Nuuanu reservoirs	114
Keaahala Stream, diverted	44	Leakage, underground, in artesian wells detection of	328
Keaau-Makaha Ridge (Waiaanae) graphic section of	74	Limestone, relation to tuff.....	198
Keahiakahoe, Puu, source of Haiku basalt	106	weathering effects	61
Kelliohia Spring	115, 440	Limonite, Sugar Loaf	155
Kii Point, oyster bed (Ulupau)	122	stalactites, in tunnel 9, Waiaanae Valley	425
Kipuka, definition	86	Training School volcanics	132
Koko fissure basalts and pyroclastics....	149-153	Literature, previous geologic and hydrologic	11
Koko fissure, view of craters (pl. 18, A)	152	Lithic tuff, mantling emerged reef limestone (pl. 3, B)	16
Koko volcanics	150-152	Lithified beaches	41-42
sequence of eruptions	151	Lithified dunes	57
Kolealiili Spur (Waiaanae) breccia.....	83	view of near Waimanalo (pl. 11, A)	49
Koolau basalt	93	Lithothamnium ridge	36, 37
areas along coast without artesian water	238	Location of Oahu	3
permeability	235	Logs, well, graphic (pl. 20).....	168
relation to underlying salt water.....	237	Loon Gawk Well	241
total draft	314, 323	Losses, curtailment, of artesian water....	328
water in	235, 239	Lost wells, locating	341
Koolau breccia (crater)	97-98		
Koolau caldera, site of.....	98		
Koolau dike complex	95-97		

	Page		Page
Lower Luakaha station	203	Mud flow, Aliamanu	109
Luakaha cinder cone, now Makuku.....	112	criteria for distinguishing deposit of	19
Luualualei Valley, breccia in.....	82	Kaau	24
cause of large size	31	Palolo Valley	19
depth of sediments in	30	Metering, progress of, Honolulu.....	342-343
dry shaft in, (footnote).....	75	Middle (?) and Late Pleistocene lavas	
high-level springs in	438	and pyroclastic rocks	99
tunnel in	490	Mid-Pacific Spring	440
undeveloped ground-water supplies		Mikilua Camp, wells at.....	70
in	225	Mineralization, of basalt, Moiliili Quarry	159
view of tributary to (pl. 7, B).....	24	Minerals, order of deposition in cavities	
Lucas Spring	235	of Kailua amygdaloidal basalt..	184
Luluku tunnels	410	origin of, in Kailua basalt	88
		Moiliili Quarry cavern	161
Magnetic method for locating lost wells	341	minerals	159
Mahoe Spring	126, 440	primary veins	158
Makaha Ridge, view (pl. 13, B).....	72	Mokapu basalt	101
Makaha Valley, high level springs in....	439	Mokolii Island, a stack	46
local unconformity in lower Wai-		Moku Manu, view (pl. 32, C).....	400
anae basalt	69	volcanics	120
tunnels in	426-428	Mokulua, basalt	101
undeveloped ground-water supplies		Island (North) dikes	90
in	223	Island (North), view (pl. 21, B).....	176
Makakilo, Puu	32, 79	Montmorillonite	423, 425
tunnel	419	Mount Kaala (see Kaala).....	
Makalapa crater and tuff	127	Movement of ground water, affected by	
Makapuu Head, view (pl. 12, B).....	56	geology	64
Makawao breccia	118-119	Mutual Radio tunnel	419
Makiki Springs	156, 440		
geologic conditions, diagram (fig.		Nanakuli Valley, ancient cliff.....	82
12)	157	breccia and ground-water movement	
Makua Valley, high-level springs in....	439	in	80-82
tunnels in	429	undeveloped ground water supplies..	226
Makuku cinder cone (formerly Luakaha)	112	Natural bridges	46
Manaiki branch, Kalihi volcanics.....	104	Nepheline, crystals, Moiliili Quarry.....	159
Manaiki Spring	440	Nephelite basalts, a differentiate.....	198
Manana tuff	149-150	table	196
Manoa, dike	101	Waianae	183
geology of valley	158-161	Niagara well	241
stream displaced	160	Noncalcareous sediments	170-172
tunnels	387-391	Nontronite	184
Mansfield, W. C., determined fossils		Norderney, section of island of (fig. 17)	238
from Oahu	166	Numbering system of drilled wells.....	463-67
Marine, abrasion	28, 47	Nuuanu Reservoir 4, leakage	114
cliff, Waianae Range, view (pl. 10,		Nuuanu Valley, tunnels in.....	391-394
A)	48	view (pl. 5, A)	16
cliffs	46	Nuuanu volcanics	112-114
features	36		
reef	36	Oahu, development of, diagrams (pls.	
sediments, calcareous consolidated	165-169	22 to 25, A)	176
sediments, calcareous unconsolidated	171	Ocean, profiles of floor (fig. 3).....	37
sediments, historic fills.....	172	spray, effect on quality of water....	345
shelves	37	water, chemical analyses	364
Main type of well	324-325	Olivine, nodules in Pali volcanics.....	116
Maunawili, evaporation and rainfall		segregation, Hawaitoia	99
station	213	segregation, Kaala, Kapolei, Ka-	
tunnels	411-415	pua, Makakilo	183
volcanics	131-132	Olowalu shore line	48
Mauumae cone	140	Ontario well	241
volcanics	140	Opal	88
McCombs, John, quoted	253-256	Oscillations of sea level	178
McCully, Judge, quoted	251	O'Shaughnessy tunnel	411
		Ostergaard, J. M., on fossils.....	41, 166

	Page		Page
Oyster, fossil shells, Ulupau Crater.....	121, 122	Pneumatomagmatic explosions	15, 107
Waipio Peninsula	53	Picrite basalts	182
Paheehoe, Puu, sea level tunnel in.....	69	Piezometer tube, view (pl. 32, B).....	400
Pahoehoe, definition and formation of....	17	Pikoaukea Spring	131
flows, character of	18	Pillow lavas	180
Palailai, Puu	32, 79	Pioneer well	240, 242
Pali Kilo	99	Pleistocene, sedimentary rocks	165-170
Pali, definition of	26	volcanic rocks	99, 165
development of, block diagrams		Plug, concrete, to conserve water (also	
(pl. 8)	24	see sealing)	435
grooves, origin	62	Plugs and bosses	21
relation to dike complex	96	Plunge-pool action	25
road unconformity, view (pl. 16, B)	88	Pohakea Pass, gem feldspar from.....	76
southeast end, view (pl. 9, B).....	25	view (pl. 7, B)	24
theories of origin	26	Pohakea Spring	438
volcanics	118	Pollock, J. B. on corals.....	36
Waianae	30	on fossils	166
west of Kaneohe, view (pl. 9, A).....	25	on Pearl Harbor	48
Palmer, H. S., quoted	59	Population, Oahu	4
Palolo tunnel, view (pl. 28, B).....	224, 386	Post-Koolau eruptives, summary	163-165
Pauoa Valley, geology	161	age and types of	165
springs	162	effects on stream forms.....	63-64
tunnel	394	location and number of vents of....	163
Pearl Harbor	48	rift trends (fig. 13).....	164
artesian springs of	55	springs issuing from	440
geologic history of	50	table, petrographic character	196
origin of	48	Pothole	63
relation to ground water	55	Previous investigations	11
Pearl Harbor Springs	365-370	Proposed Kaliki-Waihole ground-water	
discharge of, affected by pumping of		tunnel system	444-450
wells	369	Pseudo dike	94
gaging stations, map (fig. 29).....	366	Ptilolite	88, 184
location of	365	Pueo, Puu, view showing dikes (pl. 16, A)	88
methods of recovery from.....	370	Pukapuka rock	18
possibility of springs in the lochs....	370	Pumice, definition of.....	14
quantity (table)	367	Pump House Springs	102, 162, 440
relation to artesian water (fig 30) 368, 369		Pumpage, see draft	
salinity (table)	367	Pumping and fluctuations in water level	269
Pelecypod, fossil	167	Pumping fluctuations, well 319 H, graph,	
Pele's hair and tears	17	(pl. 31)	272
Penguin Bank, off Molokai.....	39	Punahou Spring	103, 440
Perched ground water	378-386	Punchbowl volcanics	145-148
occurrence	378-386	Purpose of investigation	7
quality	441	Pyramid Rock	99
relation to basal water (fig. 5A)....	65	Quality of water	216, 344-364, 441
tunnels	386-434	effect of draft on (fig. 28).....	358
types of	378	improvement in, by reducing depth	
water confined by intrusive rocks....	379	of wells	355
water perched on alluvium.....	385	in coastal plain rocks	216
water perched on ash beds.....	381	in Waianae coastal plain	227-234
water perched on soil beds.....	384	perched	441
Permeability, of coastal plain rocks.....	215	Quantity	227-234, 377-378, 429-434, 440-443
Koolau volcanic series	235	basal ground water, Waianae	
Petrographic tables	189-197	basalt	377-378
Petrology and Petrography	179-198	ground water, Oahu	442-443
Honolulu volcanic series	187-188	perched ground water recovered by	
Kailua volcanic series	183-184	tunnels	426
Koolau volcanic series	184-187	records of water pumped from Wai-	
rock specimens	189-198	anae coastal plain	227-234
summary	188	relation to geologic structure, table	442
tables of petrographic character of		Quartz	88, 184
Waianae volcanic series	180-183		

	Page		Page
Submerged shore lines, table of.....	47-48	Waianae, and table	219-220
Submergence, effect on Koolau Pali.....	28	Tunnels recovering basal ground water	
effect on Waianae Pali	30	in Koolau basalt	365
Oahu	24, 28, 30, 47, 98, 175, 177, 178	Tunnels recovering perched ground wa-	
Sugar Loaf basalt	158-161	ter, table	431-434
Sugar Loaf, see also Tantalus and		average yield per foot	429-430
Sugar Loaf		Tunnels, Koolau Range	386-416
Summary, of Post-Koolau eruptives....	163-165	Aiea	399
table, petrographic character of		Ainoni	414
post-Koolau eruptives	196-197	City and County (Kalihi) 1 to 6....	396-398
undeveloped ground-water supplies		City and County (Nuuanu) 3 to 4C	392-394
east of Honolulu	459	City and County (Waimanalo)	416
undeveloped ground-water supplies		Clark (fig. 34)	412
in Koolau Range	459-462	Cooke	412
undeveloped ground-water supplies		Dowsett (fig. 31)	391
Pearl Harbor area	460	Drainage tunnel R (Waiahole)	404
Superfluent discharge of lavas vs. rift....	96	Fault	414
Surface waste of artesian wells.....	341	Gay	394
Surface water	213-214	Gay mauka	395
Synclines	173-174	Girls Industrial School	411
Tachylite	81	Henry	410
Talus breccia (see also breccia).....	80-86	Halawa, see North Halawa, South	
Tantalus and Sugar Loaf, basalts and		Halawa	
firefountain deposits	154-163	Kaea	387
Tantalus basalt and volcanics	161-163	Kahana 1 (Waiahole)	407
Tantalus tunnels	390-391	Kalihi	394-398
Temperature	199	Kalihi Orphanage	396
Terraces	43-45	Kaukonahua	409
profiles of (fig. 5).....	45	Korean	415
Tertiary and early Pleistocene (?) vol-		Luluku	410
canic rocks	67-98	Main Waiahole	400
Troat breccia, Koolau (see also crater		Maunawili	411-413
breccia)	97	Manoa, 1 to 5	387-391
Tidal fluctuations, artesian wells, graph		North Halawa	398
(fig. 22)	272	Nuuanu	391-394
in wells of coastal-plain rocks	217	O'Shaughnessy	411
sump of drilled well 1 (fig. 15).....	218	Palolo	386
well 319H, graph (pl. 31).....	272	Pauoa	394
Tachyte	181	South Halawa	398
Trade wind, change of direction.....	24	Tantalus 1	390
Training School Spring	440	Tantalus 2	391
Training School volcanics	132	Tunnel A, (Waiahole)	405
Transpiration	202-212	Tunnel B (Waiahole)	405
Kaukonahua station	209-212	Uwau	405
Kaukonahua station, view (pl. 27,		Waiahole system	399-409
A)	224	Waikakalau	409
Lower Luakaha station	203-208	Waikane 1	406
Tuff	16-17	Waikane 2	406
Koko Crater, view (pl. 17, B).....	89	Waimanalo	415-416
relation to ash	17	Waimanalo Sugar Co.'s 1 to 3.....	415-416
relation to water	16	Tunnels, Waianae Range	416-429
Tuff cones	15	Andrews	416
Tree molds, below sea level.....	127	Kaala	418
calcareous casts of	138	Kaloi, lower and upper	418
Diamond Head tuff	138	Lualualei	420
Pearl Harbor	50-52	Makaha, 1 to 10	426-428
Salt Lake tuff	110, 127	Makakilo	419
upright	127, 141	Makua	429
Tunnel at Pump 5, Oahu Sugar Co.,		Middle Schofield	417
view (pl. 15, A).....	72	Mutual Radio	419
Tunnel water, chemical analyses	364	North Schofield	416
Tunnels and wells, Koolau coastal		Schofield	416-417
plain	220-221	South Schofield	417
		Waianae Valley, 1 to 19.....	421-426

	Page		Page
Unconformity, angular, Waianae, (fig. 8)	81	Waialae Spring	235
erosional, between Honolulu and Koolau volcanic series	98	Waialua Agricultural Co., draft from wells of	315
erosional, between Waianae and Koolau volcanic series	91-92	Waianae, ancient land mass	
erosional, effect on ground water movement	92	artesian areas 11 and 12	372
erosional, north of Schofield Barracks	91	basalt, water in	371
erosional, south of Schofield Barracks	92	cinder cones	
erosional, time significance of	92	dike complex	77
local, in lower Waianae basalt	69	fireountain deposits	79
Mokapu Peninsula, view (pl. 17, A)	88	intercalated soil	86
Pali Road, view (pl. 16, B)	88	Koolau erosional unconformity	91
Waianae	31	lower basalt	67
Waianae, lower and middle basalts (see also fig. 6)	70-72	middle basalt	72
Unconsolidated calcareous dunes	171	nonartesian areas along coast	375-3
Unconsolidated calcareous marine sediments	171	north coast precipice	
Unconsolidated noncalcareous sediments	171-172	pali	30-31
Undeveloped ground-water supplies	223-227, 443-462	quantity of water in basalt	377-37
area east of Honolulu, summary	459	unconformity (also figs. 6 and 8)	31, 9
artesian water, areas 1 to 5	455-458	upper basalt	75-7
available for Honolulu	443	volcanic series	67-8
coastal-plain rocks, in	223-227	Waianae Range, ancient marine cliffs of	3
Kaaui tunnel	453	cause of convex shape	3
Kalihi Valley tunnel	452	description of	2
Kalihi-Waihole ground-water tunnel system	444	eruptive source	3
Koolau Range	443-461	north coast precipice	3
minor high-level projects	451-455	tunnels in	416-42
Makiki tunnels	453	Waianae valley, breccia in	82-8
Nuuanu tunnels	452	high-level springs in	43
Pauoa tunnel	452	pumpage from dug wells in	22
Pearl Harbor area, summary	460	tunnels	421-42
proposed Kalihi-Waihole ground-water tunnel system	444	undeveloped ground-water supplies in	22
Pukele tunnel	453	Waihoi Spring	43
summary, Koolau	459-462	Waikakalaua tunnel	40
Waianae Range	223-227, 462	Waikane rainfall station, graph (pl. 33)	406
windward Koolau coast	460	Waikane tunnels 1 and 2, discharge and tunnel progress, graphs (pl. 33)	408
Ulumawao Ridge, breccia	97	Waikiki artesian area, section of (fig. 19)	254
Ulupau Crater, diagram (fig. 10)	122	Wailupe Spring	235
Ulupau Head	99, 100	Waimanalo beach deposits, Ulupau Crater	122, 123
Ulupau tuff	121-123	Waimanalo (+25-foot) stand of the sea, lavas and pyroclastic rocks of	127
Unsuccessful artesian wells	243	lavas and pyroclastic rocks erupted after	149
Upper Hoaeae station	213	Waimanalo, tunnels	415-416
Uwau tunnel	405	water-transportation tunnel	89
Valley fills, separating artesian areas	259	Waimea River, view (pl. 5, B)	16
Valleys	24	Waipio (-60±-foot) stand of the sea, lavas and pyroclastic rocks of	127
Veins, primary, Mollili Quarry	158	Warm water, Lualualei	226
Vida Villa well (79)	337	Waste, curtailment of artesian water	328
Volcanic domes, gradient of slopes of	13	artesian wells	341
Volcanic processes and products	12-21	Water, conserving dike-complex water, method	435
Waihole tunnel system	399-409	need of	9
dikes	404	recovery from coastal plain, method	219
discharge of ground water (fig. 33)	402-403	Water table, form	236
Waialae shore line (?)	48	Weathering	58-62
		Well drilling, progress of	246-250
		Well logs, graph (pl. 20)	168
		Well numbers, old and new	463-467
		Well, type of, effect on safe yield	324

INDEX

479

	Page		Page
Well water, chemical analyses of.....	361-363	Well 18—Cont.	
Well 18, submerged reef limestone in.....	169	356, fluctuation in, graph (pl. 30)....	272
22, plug in (fig. 24).....	337	377, fluctuation in, graph (pl. 29)....	272
23, (dug at Ewa) view (pl. 28, A)....	224	396, fluctuation in, graph (pl. 30)....	272
76, log and character of plug (fig. 23)	335	Wells and tunnels, coastal plain.....	219
79, plug in (fig. 24).....	337	dug irrigation, table, Koolau	221
101, relation of salinity to discharge of	360	dug irrigation, table, Waianae	220
152, log and character of plug in (fig. 25)	339	Koolau	222
153, fluctuation in, graph (pl. 29)....	272	Waianae	219
167, quality during drilling.....	354	Wells, drilled, numbering system	463-467
190, fluctuation in, graph (pl. 30)....	272	Mikilua Camp	70
193, fluctuation in, graph (pl. 30)....	272	table of new and old	465
201, fluctuation in, graph (pl. 29)....	272	table of old and new.....	463
244, fluctuation in, graph (pl. 29)....	272	Wells recased in Honolulu	331
266, fluctuation in, graph (pl. 30)....	272	Wells, recasing and sealing of	330-331
271, freshening by back filling (fig. 27)	356	Wentworth, C. K., quoted	147
271, increase of chloride with depth	355	Wind	199
271, quality during drilling.....	354	etching	58
274, draft from	374	records, Lower Luakaha station.....	204
276, draft from	374	records, Kaukonahua station.....	210
308, fluctuation in, graph (pl. 30)....	272	scars	57
308, log of	375	Yield per foot of tunnels.....	429-430
326, fluctuation in, graph (pl. 29)....	272	Zeolites	91, 106, 185
		Zeolitization	89, 98, 198