

REBUILD HAWAII

Energy \$mart Schools Program Maui

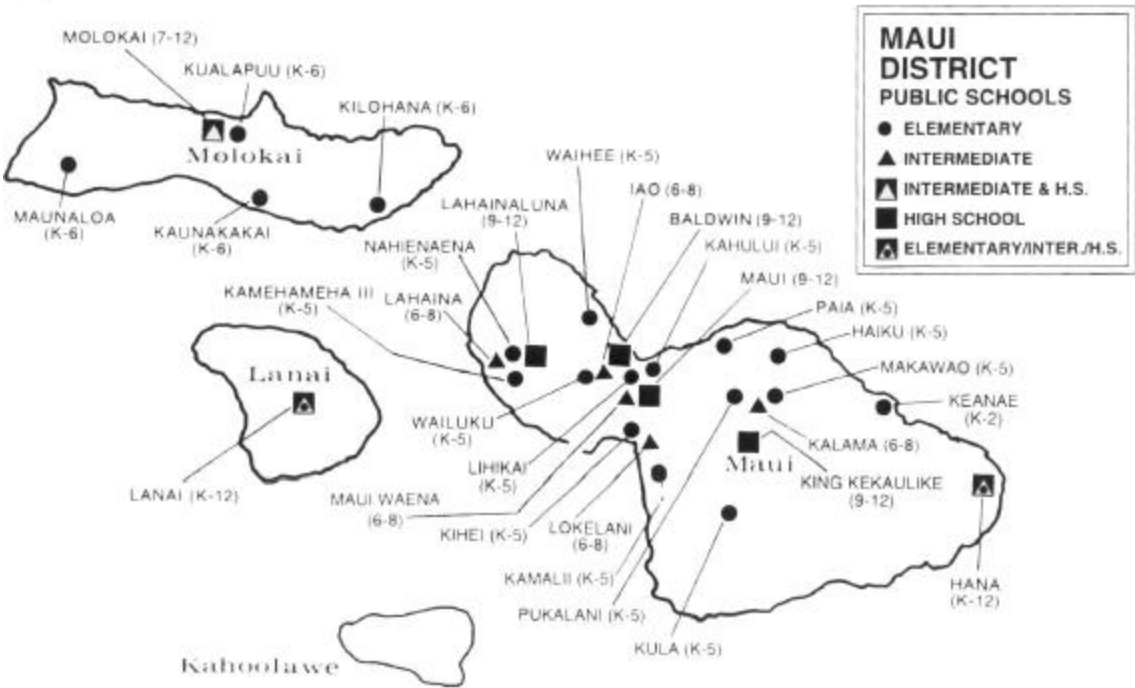

Maui County Public Schools Lighting Audit

Prepared for:
Department of Business, Economic Development and Tourism

Prepared By:
Hawaiian Electric Company, Inc.
PO Box 2750, Honolulu, HI 96840
808-543-4790

In association with:
Pacific Energy Services, Company
Maui Community College
Academic Capital Group

Date
June 30, 2001

TABLE OF CONTENTS

Executive Summary 3

Introduction 7

 Results of Lighting Engineering Study 9

 Current and Proposed Energy Use 10

 Financial Summary 12

 Lighting Levels and Recommendations 14

 Financial Analysis 15

 Recommendations 17

 Comments 17

Base Case Conditions 18

 Lighting Fixtures 19

 Operation Hours 21

 Standard Energy Wattages 22

 Utility Incentives 22

 Budget Estimates 22

 Electricity Rate 23

 Payback 23

 Site Conditions 24

Benchmark Analysis 31

 Project Information 32

 Energy Utilization Index 32

 Maui Schools Benchmark Criteria 33

 Listing by School Name 34

 Listing by Square Footage 35

 Listing by EUI 36

 Listing by Operating Costs 37

 Listing by Electric Rates 38

 Listing by Population 39

 Listing by Energy Savings 40

 Listing by Project Costs 41

 Listing by Payback 42

 Listing by Light Calculation 43

Individual Summary School Compilation 44

 Background 45

Product Specification and Selection 46

General O&M Manuals 47

REBUILD HAWAII

Energy Smart Schools Program Maui

Executive Summary

EXECUTIVE SUMMARY

The purpose of the Energy Smart Schools Maui Lighting Retrofit Program is to give the Department of Education (DOE) and Department of Accounting and General Services (DAGS) a comprehensive report detailing Maui County's 32 public schools' lighting usage. The report recommends the schools retrofit the existing T12 fluorescent lighting fixtures energized with magnetic ballasts to T8 lamps utilizing electronic ballasts. Generally speaking, this type of lighting retrofit can reduce the lighting portion of the electric bill by 34% and increase lighting levels by 3 to 10 percent.

The project entailed identifying the existing fluorescent lamps and fixtures in each of the 32 schools including existing fixture quantities and types, operating hours, the baseline energy consumption of the existing T12 lighting systems, the energy savings of the proposed T8 lighting systems, the cost to install the retrofitted lighting systems and payback periods. This report also suggests financing alternatives and implementation strategies.

The Maui Public School District is composed of 32 schools ranging from kindergarten to the 12th grade. The schools occupy approximately 1,998,000 total square feet and have a total student population of 21,474. The schools consume about 12,301,000 kilowatt-hours of electricity each year which places the Maui School District as the 6th largest electricity user for Maui Electric Company (MECO). Of the total electricity, fluorescent lighting in classrooms currently accounts for about 5,389,000 kWh/year or 44 percent. The opportunities arising in this report will result in a reduction of about 1,834,000 kWh/year or 34 percent of current lighting energy consumption. The energy reductions from this project will save the schools approximately \$369,000 per year. Upon completion of the retrofits, the utility rebate is estimated to be \$233,400, which will reduce the simple payback to about 5.7 years.

LIGHTING ENGINEERING STUDY

- The average school square footage is 62,358. The schools range in size from 3,770 to 149,744 square feet and total 1,838,285 square feet.
- Total energy consumption averages 375,805 kWh/year. Energy consumption varies from 24,128 at Keanae Elementary to 1,302,000 at Maui High School.
- Operating costs for electric energy averages \$72,367 per year. The operating costs range from \$4,750 at Keanae Elementary to \$229,454 at Maui High School.
- Electric utility costs average 20.11 cents per kWh. It ranges from 17.60 cents per kWh to 27.1 cents per kWh. This includes service, demand, energy and power adjustment charges. The schools located on Molokai and Lanai have the highest electric rates on the average.
- Energy savings estimates average \$11,529.05 kWh/year and ranges from \$243.86 kWh/year to \$30,729.47 kWh/year.

This lighting audit also determined existing lighting levels by taking foot-candle measurements (which averaged between 40 to 60 foot candles) and documenting general lighting conditions. This report provides recommended foot-candle levels by the Illuminating Engineering Society (IES).

For further details, refer to the Engineering Study and Benchmark Analysis sections.

FINANCIAL ANALYSIS

There are various financing options available to DOE to fund this lighting retrofit project.

A. Municipal Lease/Purchasing Program

This method provides the lowest interest rate and a method to fund the project through the construction phase. Two types of Municipal Financing were evaluated:

1. Finance the schools as a total project

Financing the schools as a total project would cost about \$2,087,899 (after MECO lighting rebates and at an interest rate of 6.25% over 60 months). This method would result in an annual expenditure of \$368,928 for the first two years (\$579,444 annual expenditure for the balance of the term). Estimated energy savings for the entire 5 years is approximately \$368,929 per year.

2. Financing the schools individually.

Financing the schools individually is much more expensive from an interest and term standpoint due to the small size of the projects.

B. Alternative Financing and Implementation Strategies.

Other financing methods include, internal financing, debt financing and the use of an Energy Saving Performance Contract (ESPC).

CONCLUSIONS

Rebuild Hawaii encourages its Rebuild Partners to collaborate on projects to promote energy efficiency measures in the state. The Energy Smart Schools Maui Program involved the local utilities, Hawaiian Electric Company, Inc. (HECO) and Maui Electric Company (MECO), the community schools, Maui Community College and Maui Public Schools, DOE, DAGS and Rebuild Business Partners, Pacific Energy Services and Academic Capital Group.

The study shows that the Maui schools will achieve substantial energy savings as well as reduced electrical costs by retrofitting from the T12 lighting systems to T8's. The savings begin immediately with the first school's retrofit.

Stemming from meetings between all the parties involved, it is agreed that the improved lighting and financial savings are beneficial to the schools and retrofitting should take place.

RECOMMENDATIONS

The most cost effective method for retrofitting the lighting at the 32 schools is to finance the schools as a total project. If this is done, the schools should be retrofitted in a geographical pattern by location.

If a total project approach cannot be taken and financial allocations require having to determine which school should be retrofitted first, the logical method would be to utilize the benchmarking data and weight the different school retrofit projects by categories (i.e. fastest payback, highest electrical costs, or as determined most important to DOE/DAGS).

The most direct approach would be to begin on the schools that would stand to save the most money by retrofitting and retrofit those first.

REBUILD HAWAII

Energy Smart Schools Program Maui

Introduction

INTRODUCTION

The purpose of the Energy Smart Schools Maui Lighting Retrofit Program is to give the Department of Education (DOE) and Department of Accounting and General Services (DAGS) a comprehensive report detailing Maui County's 32 public schools' lighting usage. The report recommends the schools retrofit the existing T12 fluorescent lighting fixtures energized with magnetic ballasts to T8 lamps utilizing electronic ballasts. Generally speaking, this type of lighting retrofit can reduce the lighting portion of the electric bill by 34% and increase lighting levels by 3 to 10 percent.

Rebuild Hawaii encourages its Rebuild Partners to collaborate on projects to promote energy efficiency measures in the state. The Energy Smart Schools Maui program involved the local utilities, Hawaiian Electric Company (HECO), Maui Electric Company (MECO), the community schools, Maui Community College, Maui Public Schools, DOE and DAGS and Rebuild Business Partners including Pacific Energy Services and Academic Capital Group. All dollars spent on this project remained within the State Of Hawaii.

The information provided by the lighting audit included:

- Identify existing lamps, fixtures and conditions in each room in all 32 schools including exiting fixture quantities, operating hours, fixture types by school, room and location.
- Determine the energy consumption of the existing T12 lighting systems.
- Determine the energy consumption of the proposed T8 lighting systems.
- Determine the energy savings of the proposed T8 lighting designs.
- Determine the cost to install the new lighting systems and payback periods.
- Determine financing alternatives and implementation strategies.
- Determine benchmark data including, square footage, energy usage per square foot (energy utilization index or EUI), operating costs per square foot, cost of electricity per school (cents/kWh), population (number of students), project costs, energy savings opportunities, and payback.

The Maui Public School District is composed of 32 schools ranging from kindergarten to the 12th grade varying in use from elementary, intermediate, and high school. The schools occupy a total of about 1,998,000 total square feet and have a total student population of 21,474 students. The schools consume about 12,301,000 kilowatt-hours of electricity each year which places the Maui School District as the 6th largest electricity user for MECO. Of the total electricity, fluorescent lighting uses for classrooms currently accounts for about 5,389,000 kWh/year or 44 percent. The opportunities arising from this project will result in a reduction of about 1,834,000 kWh/year or 34 percent of current lighting energy consumption. The energy savings from this project with in utility operation costs savings of about \$368,929 per year. The utility rebate is estimated to be \$233,398 and will reduce the simple payback to about 5.7 years.

RESULTS OF LIGHTING ENGINEERING STUDY

- The average school square footage is 62,358. The schools range in size from 3,770 to 149,744 square feet and total 1,838,285 square feet.
- Total energy consumption averages 375,805 kWh/year. Energy consumption varies from
- 24,128 at Keanae Elementary to 1,302,000 at Maui High School.
- Operating costs for electric energy averages \$72,367 per year. The operating costs range from \$4,750 at Keanae Elementary to \$229,454 at Maui High School.
- Electric utility costs average 20.11 cents per kWh. It ranges from 17.60 cents per kWh to 27.1 cents per kWh. This includes service, demand, energy and power adjustment charges. The schools located on Molokai and Lanai have the highest electric rates on the average.
- Energy savings estimates average \$11,529.05 kWh/year and ranges from \$243.86 kWh/year to \$30,729.47 kWh/year.
- The engineering study and benchmark data sections reveal other interesting findings and are reported in the engineering and benchmark studies.

CURRENT AND PROPOSED ENERGY USE

Table 1 represents the current electric lighting energy consumption and the proposed energy savings opportunities if the evaluated lighting retrofit measures implemented.

TABLE 1 – EXISTING AND PROPOSED LIGHTING ENERGY CONSUMPTION (kWh)

	Schools	Existing (kWh)	Proposed (kWh)
1	Maui High School	475,029	318,584
2	Baldwin High School	468,165	308,557
3	King Kekaulike High School	435,264	288,061
4	Lahaina Luna High School	362,827	243,270
5	Wailuku Elementary School	271,028	180,633
6	Lanai Elementary and High School	233,486	154,202
7	Hana High and Elementary School	217,671	142,089
8	Lihikai Elementary School	212,378	140,969
9	Lokelani Intermediate School	206,277	137,170
10	Maui Waena Intermediate School	205,745	135,673
11	Kihei Elementary School	187,169	124,063
12	Kahului Elementary School	173,852	115,670
13	Iao Elementary School	167,296	111,688
14	Kalama Intermediate School	161,085	105,109
15	Waihee Elementary School	160,618	106,553
16	Molokai Intermediate and High School	156,183	103,594
17	Lahaina Intermediate School	149,996	99,279
18	Princess Nahienaena Elementary School	136,588	90,897
19	Pukalani Elementary School	121,906	81,088
20	Kula Elementary School	119,162	79,124
21	Haiku Elementary School	114,646	75,620
22	Makawao Elementary School	108,465	71,953
23	Kamalii Elementary School	107,828	70,825
24	Kaunakakai Elementary School	101,179	67,246
25	Kualapuu Elementary School	75,826	31,149
26	Mauna Loa Elementary School	55,529	36,726
27	Paia Elementary School	54,911	36,333
28	Kilohana Elementary School	44,686	29,585
29	King Kamehameha III Elementary School	40,106	26,251
30	Puunene Elementary and Intermediate School	36,054	23,861
31	Maui Community School for Adults	25,071	16,582
32	Keanae Elementary School	3,549	2,347

Maui High School currently consumes the most electric energy of all schools in the Maui County Public School District.

The total identified kWh savings for all Maui Public Schools is 1,834,827 kWh. This represents a reduction 34% of the current annual electric consumption.

Graph 2 graphically demonstrates the current and proposed annual electric consumption of the schools if the evaluated Lighting Retrofit Measures are implemented.

GRAPH 2 – ENERGY SAVINGS COMPARISON

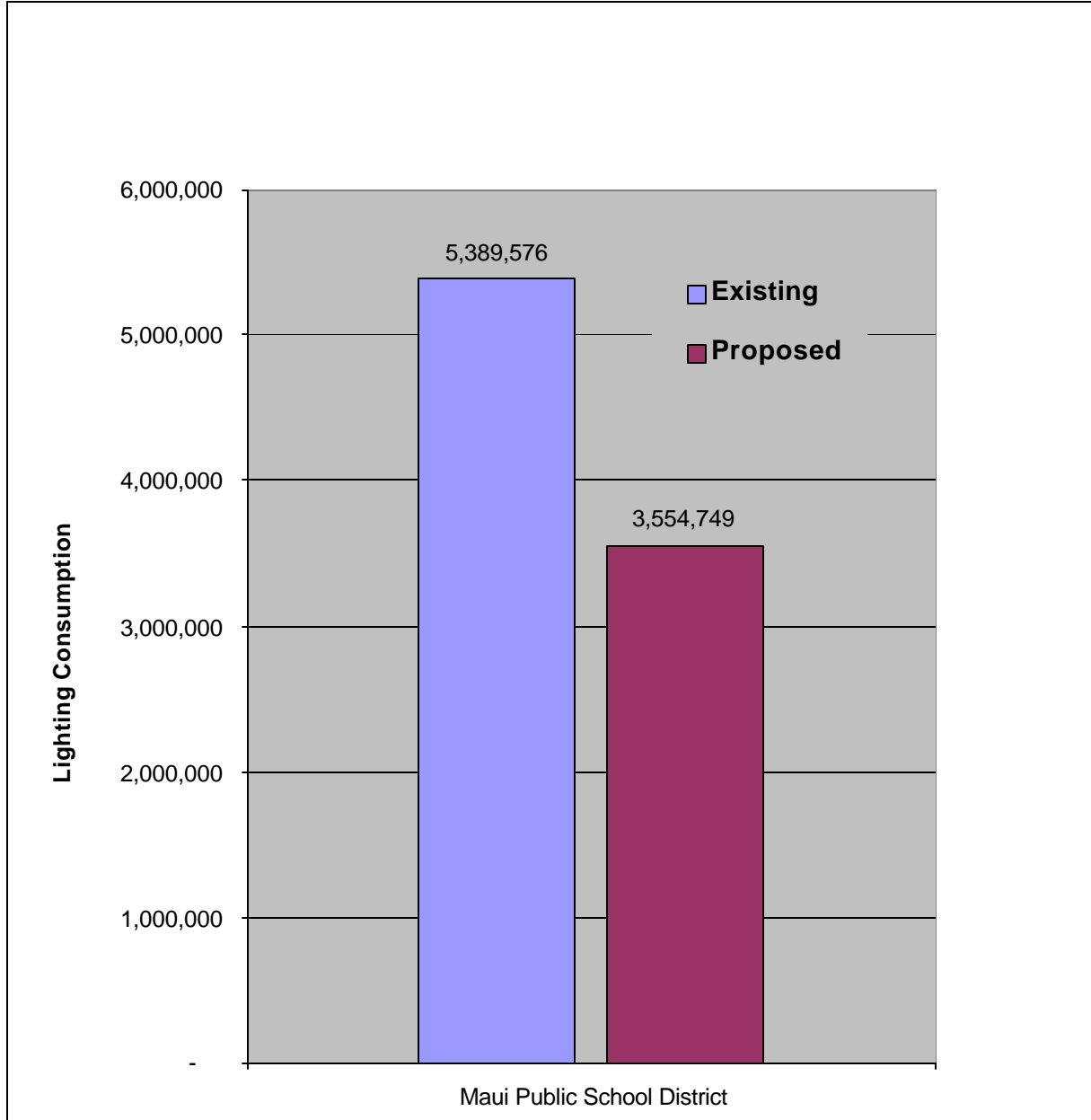

FINANCIAL SUMMARY

Table 3 displays a summary of the evaluated their established implementation budgets, projected electric-energy cost savings and associated simple payback periods. Schools are listed in order of shortest payback.

TABLE 3 – FINANCIAL ANALYSIS

ID No.	Location Island	Schools	Cost (\$)	Rebate (\$)	Cost After Rebate (\$)	Savings (\$/year)	Payback (years)
1	Maui	Baldwin High School	\$161,290	\$18,816	\$ 142,474	\$30,729	4.6
2	Maui	Haiku Elementary School	\$ 41,330	\$ 4,342	\$ 36,988	\$ 6,321	5.9
3	Maui	Hana High and Elementary School	\$ 71,890	\$ 8,103	\$ 63,787	\$14,270	4.5
4	Maui	Iao Elementary School	\$ 69,285	\$ 6,933	\$ 62,352	\$10,786	5.8
5	Maui	Kahului Elementary School	\$ 60,165	\$ 7,916	\$ 52,249	\$11,599	4.5
6	Maui	Kalama Intermediate School	\$ 87,409	\$11,569	\$ 75,841	\$12,360	6.1
7	Maui	Kamalii Elementary School	\$ 56,830	\$ 7,836	\$ 48,994	\$ 7,701	6.4
8	Maui	King Kamehameha III Elementary School	\$ 16,760	\$ 1,613	\$ 15,147	\$ 2,654	5.7
9	Molokai	Kaunakakai Elementary School	\$ 49,335	\$ 4,055	\$ 45,280	\$ 8,763	5.2
10	Maui	Keanae Elementary School	\$ 2,880	\$ 202	\$ 2,678	\$ 244	11.0
11	Maui	Kihei Elementary School	\$ 60,480	\$ 8,949	\$ 51,531	\$12,538	4.1
12	Molokai	Kilohana Elementary School	\$ 19,870	\$ 1,999	\$ 17,871	\$ 4,034	4.4
13	Maui	King Kekaulike High School	\$106,839	\$13,301	\$ 93,538	\$22,865	4.1
14	Molokai	Kualapuu Elementary School	\$ 66,135	\$ 4,278	\$ 61,857	\$12,475	5.0
15	Maui	Kula Elementary School	\$ 60,830	\$ 6,766	\$ 54,064	\$ 8,320	6.5
16	Maui	Lahaina Intermediate School	\$ 49,265	\$ 7,148	\$ 42,117	\$ 9,957	4.2
17	Maui	Lahaina Luna High School	\$106,113	\$12,872	\$ 93,241	\$22,350	4.2
18	Lanai	Lanai Elementary and High School	\$119,909	\$10,020	\$ 109,890	\$21,796	5.0
19	Maui	Lihikai Elementary School	\$105,350	\$ 8,790	\$ 96,560	\$13,946	6.9
20	Maui	Lokelani Intermediate School	\$ 59,810	\$ 8,401	\$ 51,409	\$13,326	3.9
21	Maui	Makawao Elementary School	\$ 37,930	\$ 5,477	\$ 32,453	\$ 7,300	4.4
22	Maui	Maui Community School for Adults	\$ 4,410	\$ 706	\$ 3,704	\$ 1,534	2.4
23	Maui	Maui High School	\$258,641	\$22,099	\$ 236,542	\$30,664	7.7
24	Maui	Maui Waena Intermediate School	\$ 86,185	\$ 9,568	\$ 76,617	\$13,958	5.5
25	Molokai	Mauna Loa Elementary School	\$ 15,270	\$ 2,083	\$ 13,187	\$ 4,786	2.8
26	Molokai	Molokai Intermediate and High School	\$ 90,750	\$ 7,648	\$ 83,102	\$13,325	6.2
27	Maui	Paia Elementary School	\$ 27,015	\$ 2,495	\$ 24,520	\$ 3,623	6.8
28	Maui	Princess Nahienaena Elementary School	\$ 77,425	\$ 5,608	\$ 71,817	\$ 8,759	8.2
29	Maui	Pukalani Elementary School	\$113,570	\$ 6,891	\$ 106,679	\$ 8,400	12.7
30	Maui	Puunene Elementary and Intermediate School	\$ 19,725	\$ 1,816	\$ 17,909	\$ 2,460	7.3
31	Maui	Waihee Elementary School	\$ 56,295	\$ 6,233	\$ 50,062	\$10,346	4.8
32	Maui	Wailuku Elementary School	\$108,930	\$ 8,867	\$ 100,063	\$16,738	6.0

Maui Community School for Adults has the fastest payback at 2.4 years, while Pukalani Elementary has a payback of 12.7 years. The average payback for the Maui Public School District is 5.7 years.

The total identified dollar savings for the entire Maui Public Schools is \$368,929.46.

The total identified net cost (cost after utility rebate) for entire Maui Public Schools is \$2,034,524.00

School Ranking – Schools listed by lighting retrofit energy savings opportunity.

Rank	School Name	Savings/Year	Rank	School Name	Savings/Year
1	Baldwin High School	\$ 30,729.47	17	Waihee Elementary School	\$10,346.12
2	Maui High School	\$ 30,664.49	18	Lahaina Intermediate School	\$ 9,957.33
3	King Kekaulike High School	\$ 22,865.11	19	Kaunakakai Elementary School	\$ 8,762.69
4	Lahaina Luna High School	\$ 22,350.19	20	Princess Nahienaena Elementary School	\$ 8,758.66
5	Lanai Elementary and High School	\$ 21,795.94	21	Pukalani Elementary School	\$ 8,400.39
6	Wailuku Elementary School	\$ 16,738.03	22	Kula Elementary School	\$ 8,320.36
7	Hana High and Elementary School	\$ 14,270.19	23	Kamalii Elementary School	\$ 7,701.48
8	Maui Waena Intermediate School	\$ 13,957.59	24	Makawao Elementary School	\$ 7,300.30
9	Lihikai Elementary School	\$ 13,945.82	25	Haiku Elementary School	\$ 6,320.69
10	Lokelani Intermediate School	\$ 13,326.26	26	Mauna Loa Elementary School	\$ 4,786.10
11	Molokai Intermediate and High School	\$ 13,324.90	27	Kilohana Elementary School	\$ 4,034.24
12	Kihei Elementary School	\$ 12,537.88	28	Paia Elementary School	\$ 3,623.47
13	Kualapuu Elementary School	\$ 12,475.17	29	King Kamehameha III Elementary School	\$ 2,654.30
14	Kalama Intermediate School	\$ 12,359.94	30	Puunene Elementary and Intermediate School	\$ 2,459.53
15	Kahului Elementary School	\$ 11,599.19	31	Maui Community School for Adults	\$ 1,533.74
16	Iao Elementary School	\$ 10,786.04	32	Keanae Elementary School	\$ 243.86

School Ranking: Energy Savings Opportunity

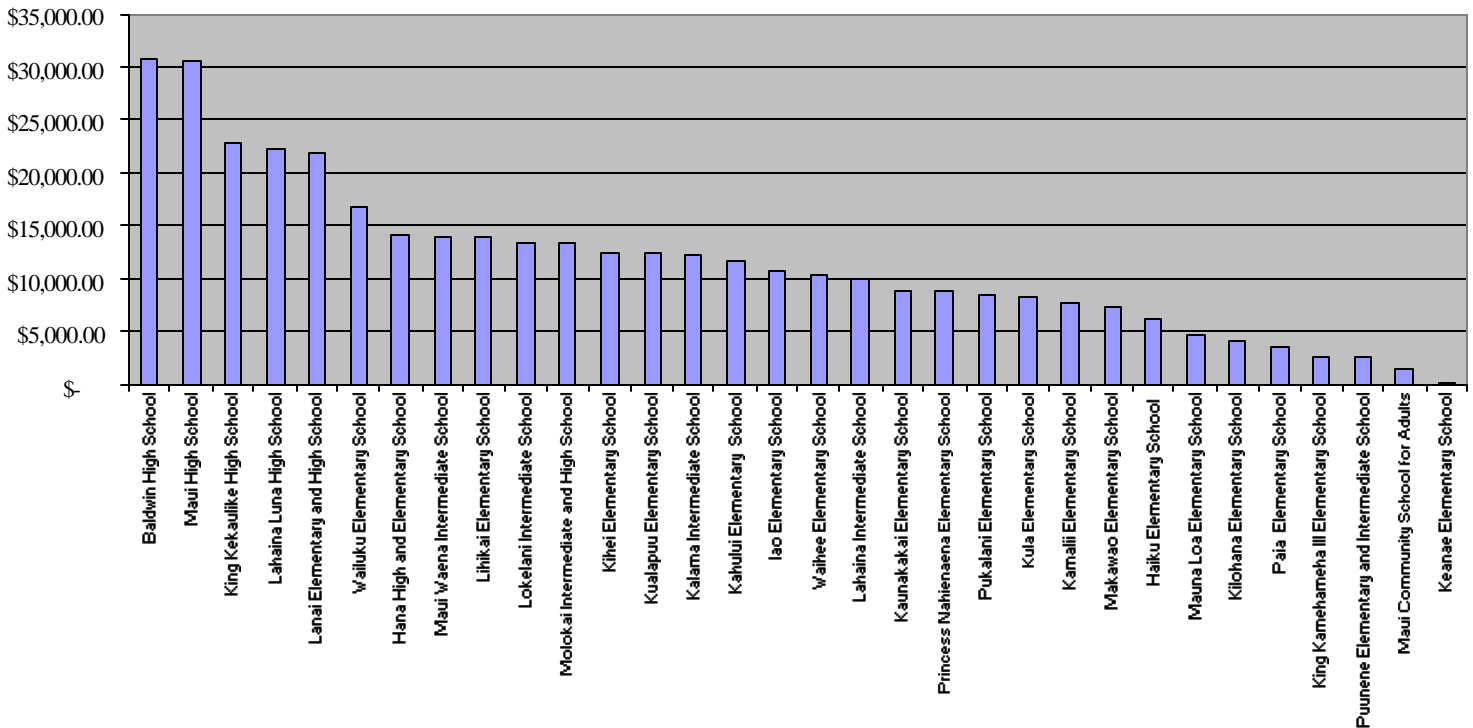

LIGHTING LEVELS AND RECOMMENDATIONS

This project also determined existing lighting levels, foot-candle levels and general lighting conditions. The recommended foot-candle levels for schools should range between 20 and 100 depending on the specific task. For general reading areas, the lighting levels should be between 30 and 70 foot-candles. Laboratories, drafting and sewing classrooms rooms should be lit to about 100 foot-candles. These are the recommended foot-candle levels by the Illuminating Engineering Society (IES).

The lighting levels observed in each school varied considerably by room and school. The study indicated measured lighting levels that ranged between 20 and 200 foot-candles. The foot-candle level depends upon the room orientation, location, lamps, fixtures, wall, ceiling and floor reflectance, age, cleanliness, and the location (in the room) where the measurement was taken. On the average, the lighting levels ranged between 40 and 60 foot-candles. Below are a few recorded levels.

School Name	Room 1	Room 2	Room 3
Kamali'i	48-65	55-70	60-75
Kamehameha III	42-68	65-71	40-65
King Kekaulike	65-77	70-72	50-69
Iao	65-100	80-200	50-75
Maui High School	39-46	41-45	37-40
Waihee	35-50	46-55	43-50

While it is generally accepted that higher lighting levels (50 to 100 foot-candles) improve a child's ability to learn. This is not always the case. Too much, improperly designed or mis-directed light can create reflection and glare problems. This inhibits a child's ability to learn. To specify an average of 75 foot-candles for all educational facilities is not recommended by IES and will nullify energy saving opportunities. Lighting levels should be specified and maintained by the type of learning or "tasks" required by the space, where possible. For example, computer rooms require between 20-30 foot-candles because students focus on the computers rather than reading assignments.

There are three additional items that should be considered when establishing and maintaining proper lighting levels:

- 1) Provide light colored surfaces that reflect light from walls, ceiling and floor onto the workspace. The reflectance from clean, light colored surfaces can increase lighting levels by about 10 percent.
- 2) Provide and maintain clean fixtures and lamps. Dirty lamps and fixtures can have a considerable amount of impact on the amount of light delivered to the work plane. Keeping lamps and lenses clean can affect lighting levels by about 15 percent.

- 3) Group re-lamp programs maintain high lighting levels and help to reduce operating and maintenance costs. Lamp lumen levels decrease with lamp life. Replacing all the lamps on a regular scheduled basis (about every five to seven years for schools depending upon operating hours) maintains a high lighting level, ensures energy savings and reduces overall maintenance costs.

FINANCIAL ANALYSIS

The objective of the financial analysis was to provide DOE and DAGS with financing and implementation strategies. There are numerous ways in which DOE could implement the project and secure funding. One method is through the use of a “Municipal Lease/Purchasing” program. Other methods include, internal financing, debt financing and the use of an Energy Saving Performance Contract (ESPC). Each method has advantages and disadvantages and are outlined in the attached materials provided by Rebuild America.

A. Municipal Lease/Purchasing Program

This method provides the lowest interest rate and a method to fund the project through the construction phase. Two methods of Municipal Financing were evaluated:

1. Finance the schools as a total project

Financing the schools as a total project requires the development of a work schedule (an example has been prepared in the financial section). This method includes assigning the utility rebate directly to the lighting contractor to reduce the loan amount. As soon as the school is retrofitted and the rebate is released it goes directly to the contractor. The loan amount has a set interest rate for the entire term. This report currently shows 6.25%. The draw on the escrow takes place two times per month over the course of the retrofit installation period (8-9 months) and covers the contractors’ material and labor costs.

Financing the schools as a total project would cost about \$2,087,899 (after MECO lighting rebates and at an interest rate of 6.25% over 60 months). This method would result in an annual expenditure of \$368,928 for the first two years (\$579,444 annual expenditure for the balance of the term). Estimated energy savings for the entire 5 years is approximately \$368,929 per year.

2. Financing the schools individually.

Financing the schools individually is much more expensive from an interest and term standpoint due to the small size of the projects. A spreadsheet showing the individual interest rates for each school is provided. The rates are higher and only add cost to the overall project.

B. Alternative Financing and Implementation Strategies.

There are other mechanisms that are available to finance energy efficiency projects. These include internal financing, debt financing and Energy Savings Performance Contracts (ESPC).

1. Internal Financing

Internally financed energy-efficiency improvements are paid directly with available cash drawn from an organization's current operating budget or capital funds. One attraction of internal financing is it allows the organization to retain all energy-cost savings and any benefits from the depreciation of the equipment. It also allows quick project implementation by avoiding complex contract negotiations or transaction delays often associated with other financing mechanisms. However, available internal funds are commonly constrained by budget limitations and competing operating and capital investment project needs. One method to appropriate funding for each school would be to prioritize funding using the benchmark data to determine the most cost-effective (highest electric rates, lowest payback, etc.) locations to implement the lighting retrofit projects.

2. Debt Financing

Capital is acquired through simple loans, bonds or other debt instruments. Debt principal and interest are repaid incrementally over an agreed upon period and guaranteed by the full faith and credit of the borrowing organization and/or by revenues derived from energy-cost savings.

3. Energy Saving Performance Contract (ESPC)

An ESPC is an agreement between a facility owner and a performance contractor. Energy conservation measures (ECMs) are designed and installed by the contractor who guarantees their performances. Performance contracts are structured so that the cost of implementing ECMs is recovered from savings created by those measures. Performance contracts can be used to reduce energy use and costs in existing equipment, upgrade capital equipment, improve the maintenance of existing facilities. The term of an ESPC commonly ranges from five to ten years. Performance contracts in which the performance contractor directly finances improvements typically involve only the facility owner and the performance contractor as parties of the agreement. Choosing a performance contractor should be done carefully. While most performance contracting firms provide similar services, their offerings can vary significantly in scope and approach. Performance contractors have a great deal of flexibility when negotiating contractual agreements. This flexibility enables building owners to have their site-specific needs met. Performance contracts are essential to organizations that:

- Lack necessary technical expertise
- Need to free up in-house resources for other priorities
- Lack the time to supervise or manage the project
- Are unwilling or unable to finance the initial costs of the ECMs.

DOE has not found this financing method favorable in the past, however it should be continually re-evaluated. Both Oregon and the State of Washington use ESPCs regularly to fund energy efficiency projects at electric rates that are one-third that of Hawaii.

RECOMMENDATIONS

1. Lighting systems at the Maui Schools District should be retrofitted (or replaced as necessary) with energy saving T8 lighting systems. This will save about \$368,929 per year and provide a payback period of 5.7 years. It will also improve lighting levels.
2. DOE needs to initiate financing that will insure implementation of the retrofits either through municipal lease program, internal financing, debt financing or ESPCs.
3. A regular maintenance lighting program needs to be implemented to insure lighting levels are maintained at the utmost highest level. This can be done through regular lighting maintenance programs designed to clean lamps, lenses and fixtures on a scheduled basis. Group re-lamp programs need to be instituted to insure high lighting levels are maintained, insure energy savings and reduce overall maintenance costs.
4. DOE should establish a no-cost, low-cost program that encourages moving classroom functions to rooms where recommended IES lighting levels can be achieved for that specific task.

CONCLUSIONS

The results of this investigation indicate that cost-effective opportunities to implement energy measures exist at the Maui School District. Combined with the current utility rebate incentive from MECO and unique financing options available, the lighting retrofit projects as detailed should be conducted.

REBUILD HAWAII

Energy Smart Schools Program Maui

BASE CASE CONDITIONS

BASE CASE CONDITIONS

In the preparation of this engineering study, much of the information contained is factual and, quantifiable based on data gathered during the school energy audits. However some assumptions are required to complete the engineering study. The assumptions based upon the best available information at the time of the audit. In all cases, the conservative approach has been taken to best portray both risks and potential benefits for the implementation of this project.

2.1 Lighting Fixtures



Wrap: Displayed is a 4-foot T-12, 2-lamp wrap fixture with one 2-lamp magnetic ballast mounted in the fixture and the fixture is surface mounted. The retrofit for this type of fixture is 2-T8 lamps and one 2-lamp low wattage electronic ballast. The current condition as displayed in this digital photograph is typical of T12-lamp Magnetic ballast burnout. In a magnetic ballasted fixture as one lamp goes bad the other lamp automatically cuts out. Electronic fixtures will allow the still working lamp to stay illuminated.

Strips: Displayed is a 4-foot T-12, 2-lamp strip fixture with one 2-lamp magnetic ballast mounted in the fixture. These fixtures are mounted back to back on a uni-strut beam is hung by a pendant stem secured to the ceiling of this classroom. The retrofit for this type of fixture is 2-T8 lamps and one 2-lamp low wattage electronic ballast.

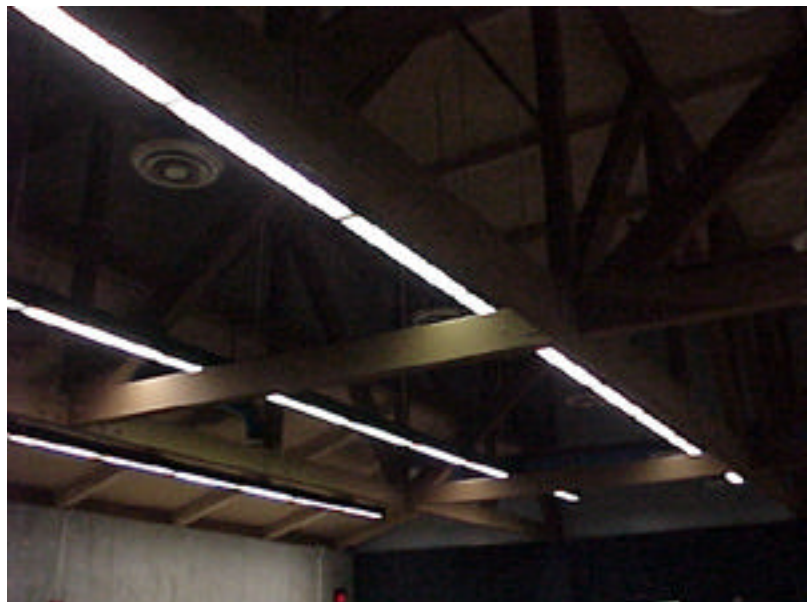



Troffer: Displayed is a 4-foot T-12, 2x4 4-lamp lay-in troffer. It is designed to “lay” into a drop or suspended ceiling. The retrofit for this type of fixture is 4-T8 lamps and one 4-lamp low wattage electronic ballast.

Vapor: Displayed is a 4-foot T-12, 2-lamp strip fixture with one 2-lamp magnetic ballast mounted in the fixture. This fixture has a vapor tight enclosure designed to resist moisture. This type of fixture will most commonly be found in locker rooms and in exterior applications. The retrofit for this fixture is 2-T8 lamps and one 2-lamp low wattage electronic ballast.



4 Foot Ice Fixture: Displayed is a 4-foot T-12, 4-lamp schoolhouse fixture with two 2-lamp magnetic ballasts. This fixture is hung by a pendant stem secured to the ceiling of this classroom. The term “Ice” fixture has been designated by the Maui Community College surveyors to this fixture because of its appearance to an ice-tray. This fixture is recommended for replacement by a 4-foot T-8, 4-lamp wrap fixture with one 4-lamp low wattage electronic ballast.

8 Foot Ice Fixture: Displayed is a 8-foot T-12 8-foot magnetic ballasts mounted in the fixture and is hung by a pendant stem secured to the ceiling of this classroom. This fixture is recommended for replacement by a 8foot bng T-8, four foot 4-lamp wrap fixture with one 4-lamp low wattage electronic ballast.

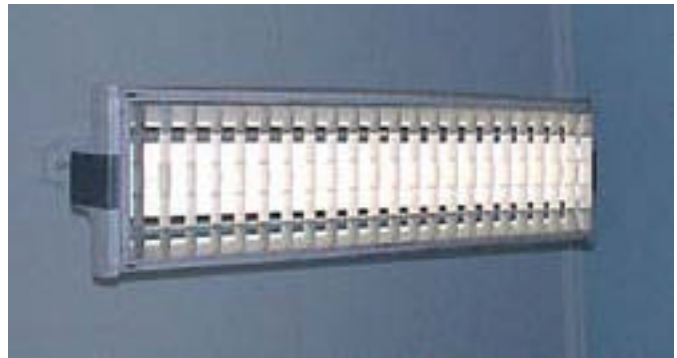

Electronic 4 Lamp Troffers: Displayed is a 4-foot T-8, 2x4 4-lamp surface mount troffer. By design this fixture is mounted to a solid surface. This fixture is typical of those found in most new portable structures. The fixture displayed is already energy efficient and requires no further retrofit.

2x2 Fixture: Displayed is a 4-foot T-12, 2-lamp U-bend fixture with one 2-lamp magnetic ballast mounted in the fixture. The retrofit for this fixture is 2-T8 lamps and one 2-lamp low wattage electronic ballast.



2.2 OPERATION HOURS

In effort for accuracy this study utilizes the actual operational hours per each individual school as based upon data provided by officials at each school. The base data for a general school year in a non-year round school operation cycle is 163 teacher school days and summer (if applicable) based on 25 teacher school days. This represents a total of 188 days possible of the 365 days in the calendar year. This information was acquired from interviews with the principals and officials at the various schools in the Maui Public School District.

2.3 STANDARD ENERGY WATTAGES

To identify the energy standard wattages for Maui Public Schools, an onsite facility audit was conducted in which data was acquired from the use of FLUKE 39 POWER METERS. The meters measured actual wattages consumed by the different types of light fixtures noted. Thus actual wattage data has been used as the baseline power consumption for energy calculations and reflects true energy saving opportunities.

MAGNETIC BALLAST CALCS			LOW WATTAGE ELECTRONIC BALLAST		
4' 1 Lamp	45.6	Watts	4' 1 Lamp	31	Watts
4' 2 Lamp	75.6	Watts	4' 2 Lamp	51	Watts
4' 3 Lamp	121.2	Watts	4' 3 Lamp	77	Watts
4' 4 Lamp	151.2	Watts	4' 4 Lamp	100	Watts
8' 1 Lamp	69	Watts	8' 1L	55	Watts
8' 2 Lamp	158	Watts	8' 2L	110	Watts
8' 1L HO Lamp	125	Watts	8' 1L HO	85.2	Watts
8' 2L HO Lamp	227	Watts	8' 2L HO	170.5	Watts

2.4 UTILITY INCENTIVES

The lighting retrofit project qualifies for the Maui Electric Company, Inc. (MECO) lighting rebate incentive program. The rebate sums are prescriptive based upon each type of lamp and ballast system installed. Rebate sums per applicable project fixtures are listed in chart below.

2.5 BUDGET ESTIMATES AND MECO LIGHTING REBATES

For purposes of creating budgets for use in this report, simulated estimates were created to reflect a typical cost structure in a solicited bid situation. The unit costs and its applicable rebates are as follows:

Fixture Type	Lamps per Fixture	Utility Rebate	Installed Cost Per Fixture
Fixture replacement w/ 4' 4 Lamp Fixture (a conversion from 8' 2 Lamp Fixtures "ice fixture")	4 Lamps	\$ 11.20	\$ 160.00
Fixture replacement w/ 4' 2 Lamp Fixture (a conversion from 8' 1 Lamp Fixtures "ice fixture")	2 Lamps	\$ 5.60	\$ 135.00
Fixture Retrofit with 8 foot fluorescent lamps	2 lamps	\$ 7.20	\$ 80.00
	1 lamp	\$ 3.60	\$ 75.00
Fixture Retrofit with 4 foot fluorescent lamps	4 lamps	\$ 11.20	\$ 70.00
	3 lamps	\$ 8.40	\$ 65.00
	2 lamps	\$ 5.60	\$ 60.00
	1 lamp	\$ 2.80	\$ 55.00

2.6 ELECTRICITY RATE

The electricity rate used in this report is based upon each individual schools 12-month load profile as provided by MECO. The baseline kW demand rate for schedule “J” customers of \$5.75 was used to calculate kW-Demand charge. The kWh energy consumption rate was derived from the following formula:

$$\frac{\text{Total Energy Charge for 12 month period} + \text{Fuel Oil Adjustment for 12 month period}}{\text{Energy Use (kWh) for 12 month period}} = \text{Cents kWh}$$

Calculating electrical-energy consumption by using demand and energy consumption charges separately will provide an accurate account for energy use in each individual school and will assist in providing an accurate portrayal of energy savings opportunities.

2.7 SIMPLE PAYBACK

It is extremely important to note that the payback as displayed in this analysis represents the retrofit and replacement of fixtures inventoried. The simple payback was calculated by determining the cost to upgrade lighting fixtures (both retrofit and replacement) divided by the energy savings (\$dollars per year). The simple payback identified ranges between 2.4 to 12.7 years. Certain schools included in this analysis such as Keanae Elementary and Intermediate School reflect 11 year paybacks simply because all the fixtures in this school are a recommended replacement measure.

2.8 SITE CONDITION

SCHOOLS ARE LISTED IN ALPHABETICAL ORDER.

The following information is a compilation of observation reports provided by the MCC Energy Management Surveyors as they conducted the physical inventories of each school and interviewed school officials from each different campus. All data was acquired at time of survey.

Baldwin High School

Operating Hours School Year	7:00 AM to 4:30 PM	Summer	7:00 AM to 4:30 PM
Number of Students School Year	1,700	Summer	600
Total Operating Hours:	1,786	Ave. kWh/12 mo	0.15
Year round school?	No		
Does the school have a full kitchen?	Yes	Water Heater Fuel	Gas
Surveyor's Notes:			
<ol style="list-style-type: none"> (1) Older lighting fixtures (2) Lower lighting levels. (3) Chicken wire on windows. (4) School fixtures are missing lens' – should be replaced. 			

Haiku Elementary School

Operating Hours School Year	7:00 AM to 5:30 PM	Summer	7:30 AM to 4:30 PM
Number of Students School Year	458	Summer	15
Total Operating Hours:	1,936	Ave. kWh/12 mo	0.16
Year round school?	No		
Does the school have a full kitchen?	Yes	Water Heater Fuel	Electric
Surveyor's Notes:			
<ol style="list-style-type: none"> 1. Older school built circa 1952. 2. 60% of this school is below the reasonable lighting levels. 			

Hana High and Elementary School

Operating Hours School Year	7:00 AM to 5:30 PM	Summer	7:00 AM to 5:30 PM
Number of Students School Year	400	Summer	150
Total Operating Hours:	1,974	Ave. kWh/12 mo	0.15
Year round school?	No		
Does the school have a full kitchen?	Yes	Water Heater Fuel	Gas
Surveyor's Notes:			
<ol style="list-style-type: none"> 1. Built circa 1960. 2. T8 found in libraries. 3. Gym is new. 			

Iao Elementary School

Operating Hours School Year	7:00 AM to 4:30 PM	Summer	7:00 AM to 4:30 PM
Number of Students School Year	885	Summer	200
Total Operating Hours:	1,548	Ave. kWh/12 mo	0.15
Year round school?	No		
Does the school have a full kitchen?	Yes	Water Heater Fuel	Gas and Electricity
Surveyor's Notes:			
<ol style="list-style-type: none"> 1. None 			

Kahului Elementary School

Operating Hours School Year	7:00 AM to 4:30 PM	Summer	None
Number of Students School Year	888	Summer	None
Total Operating Hours:	1,548	Ave. kWh/12 mo	0.15
Does the school have a full kitchen?	Yes	Water Heater Fuel	Gas
Surveyor's Notes:			
<ol style="list-style-type: none"> 1. Many "Ice" type fixtures hanging on pendant. 2. Was reported that a bank of fixtures fell to the ground. 4. School has begun to replace "Ice" fixtures. Some replacement fixtures T12. 			

Kalama Intermediate School

Operating Hours School Year	7:45 AM to 2:00 PM	Summer	Only 2 classrooms
Number of Students School Year	1,150	Summer	10
Total Operating Hours:	1,002	Ave. kWh/12 mo (cents)	0.15
Does the school have a full kitchen?	Yes	Water Heater Fuel	Gas and Electric
Surveyor's Notes:			
<ol style="list-style-type: none"> 1. Only about 12 years old. 2. ½ of school T8, ½ T12. 			

Kamalii Elementary School

Operating Hours School Year	8:30 AM to 2:45 PM	Summer	None
Number of Students School Year	860	Summer	None
Total Operating Hours:	1,002	Ave. kWh/12 mo	0.14
Does the school have a full kitchen?	Yes	Water Heater Fuel	Electric
Surveyor's Notes:			
<ol style="list-style-type: none"> 1. Built Circa 1994 2. School is equipped with all T8 lamps and electronic ballasts. 			

King Kamehameha III Elementary School

Operating Hours School Year	7:00 AM to 4:30 PM	Summer	7:00 AM to 4:30 PM
Number of Students School Year	630	Summer	150
Total Operating Hours:	1,786	Ave. kWh/12 mo	0.15
Does the school have a full kitchen?	No	Water Heater Fuel	Gas
Surveyor's Notes:			
<ol style="list-style-type: none"> 1. School is in the process of retrofitting to T8 lamps. 2. A lot of portables found. 3. Some fixtures are being replaced 			

Kaunakakai Elementary School

Operating Hours School Year	7:00 AM to 4:30 PM	Summer	7:00 AM to 4:30 PM
Number of Students School Year	380	Summer	40
Total Operating Hours:	1,786	Ave. kWh/12 mo	0.22
Does the school have a full kitchen?	Yes	Water Heater Fuel	Gas
Surveyor's Notes:			
<ol style="list-style-type: none"> 1. Fixtures "Ice" type – recommend a replacement. 			

Keanae Elementary School

Operating Hours School Year	7:00 AM to 3:00 PM	Summer	None		
Number of Students School Year	3	Summer	None		
Total Operating Hours:	1,304	Ave. kWh/12 mo	0.15	Year round school?	No
Does the school have a full kitchen?	No	Water Heater Fuel	Electric		
Surveyor's Notes: 1. No note.					

Kihei Elementary School

Operating Hours School Year	7:00 AM to 4:30 PM	Summer	None		
Number of Students School Year	768	Summer	None		
Total Operating Hours:	1,548	Ave. kWh/12 mo	0.15	Year round school?	No
Does the school have a full kitchen?	Yes	Water Heater Fuel	Gas		
Surveyor's Notes: 1. Retrofit highly recommended. 2. Fixtures are mostly T12.					

Kilohana Elementary School

Operating Hours School Year	6:30 AM to 4:30 PM	Summer	None		
Number of Students School Year	125	Summer	None		
Total Operating Hours:	1,630	Ave. kWh/12 mo	0.22	Year round school?	No
Does the school have a full kitchen?	Yes	Water Heater Fuel	Gas		
Surveyor's Notes: 1. About ½ of school has been retrofitted. 2. School seems to be in process of complete retrofit.					

King Kekaulike High School

Operating Hours School Year	6:00 AM to 7:00 PM	Summer	6:00 AM to 4:30 PM		
Number of Students School Year	1,400	Summer	500		
Total Operating Hours:	2,381	Ave. kWh/12 mo	0.16	Year round school?	No
Does the school have a full kitchen?	Yes	Water Heater Fuel	Electric		
Surveyor's Notes: 1. New school. 2. All T8's in school.					

Kualapuu Elementary School

Operating Hours School Year	8:00 AM to 4:00 PM	Summer	None		
Number of Students School Year	414	Summer	None		
Total Operating Hours:	1,304	Ave. kWh/12 mo	0.23	Year round school?	No
Does the school have a full kitchen?	Yes	Water Heater Fuel	Electric		
Surveyor's Notes: 1. Built circa 1949. 2. Very small school. 3. Some walls in classrooms have been painted lighter colors which help FC readings.					

Kula Elementary School

Operating Hours School Year	7:00 AM to 5:30 PM	Summer	7:30 AM to 4:00 PM
Number of Students School Year	460	Summer	150
Total Operating Hours:	1,304	Ave. kWh/12 mo	0.15
Does the school have a full kitchen?	Yes	Water Heater Fuel	Gas
Surveyor's Notes:			
<ol style="list-style-type: none"> Built circa 1951. T8's in portables. 			

Lahaina Intermediate School

Operating Hours School Year	7:00 AM to 4:30 PM	Summer	None
Number of Students School Year	641	Summer	None
Total Operating Hours:	1,548	Ave. kWh/12 mo	0.15
Does the school have a full kitchen?	Yes	Water Heater Fuel	Gas
Surveyor's Notes:			
<ol style="list-style-type: none"> Built circa 1979 Newer facilities – good candidate for retrofit. 			

Lahaina Luna High School

Operating Hours School Year	7:00 AM to 6:00 PM	Summer	7:00 AM to 3:00 PM
Number of Students School Year	889	Summer	40-80
Total Operating Hours:	1,993	Ave. kWh/12 mo	0.15
Does the school have a full kitchen?	Yes	Water Heater Fuel	Gas
Surveyor's Notes:			
<ol style="list-style-type: none"> Oldest school West of Rockies. Excellent candidate for lighting retrofit. Dorms on campus allow for housing nearly year round. 			

Lanai Elementary and High School

Operating Hours School Year	7:45 AM to 4:30 PM	Summer	7:45 AM to 4:30 PM
Number of Students School Year	690	Summer	35
Total Operating Hours:	1,692	Ave. kWh/12 mo	0.23
Does the school have a full kitchen?	Yes	Water Heater Fuel	Gas
Surveyor's Notes:			
<ol style="list-style-type: none"> Built circa 1944. Added new library and new cafeteria over past 5 years. Lots of windows may help to increase Foot Candle readings. 			

Lihikai Elementary School

Operating Hours School Year	7:00 AM to 4:00 PM	Summer	7:00 M to 4:00 PM
Number of Students School Year	1,156	Summer	74
Total Operating Hours:	1,467	Ave. kWh/12 mo	0.15
Does the school have a full kitchen?	Yes	Water Heater Fuel	Gas
Surveyor's Notes:			
<ol style="list-style-type: none"> Built circa 1963. Only ¼ of school T8 (3 new buildings) Some fixtures were missing lenses. Noted a lot of 8' "Fin" Fixtures 			

Lokelani Intermediate School

Operating Hours School Year	6:30 AM to 5:30 PM	Summer	None
Number of Students School Year	678	Summer	None
Total Operating Hours:	1,793	Ave. kWh/12 mo	0.15
Does the school have a full kitchen?	Yes	Water Heater Fuel	Gas
Surveyor's Notes:			
<ol style="list-style-type: none"> 1. New school – built circa 1995. 2. New cafeteria – built 2000. 3. Although a newer campus, the lighting is T12 and remains a very good candidate for retrofit. 4. Adult Education at night. 			

Makawao Elementary School

Operating Hours School Year	7:30 AM to 4:30 PM	Summer	None
Number of Students School Year	540	Summer	None
Total Operating Hours:	1,467	Ave. kWh/12 mo	0.15
Does the school have a full kitchen?	Yes	Water Heater Fuel	Gas
Surveyor's Notes:			
<ol style="list-style-type: none"> 1. Built circa 1947. 2. Mostly T12 lighting. 3. Wood Louvers painted brown reduced light levels. 			

Maui Community School for Adults

Operating Hours School Year	7:30 AM to 9:30 PM	Summer	7:30 AM to 9:30 PM
Number of Students School Year	80	Summer	80
Total Operating Hours:	2,632	Ave. kWh/12 mo	0.15
Does the school have a full kitchen?	No	Water Heater Fuel	Electric
Surveyor's Notes:			
<ol style="list-style-type: none"> 1. Very small school. 2. School for adults – operates into nights 			

Maui High School

Operating Hours School Year	7:30 AM to 4:00 PM	Summer	None
Number of Students School Year	1,709	Summer	None
Total Operating Hours:	1,548	Ave. kWh/12 mo	0.15
Does the school have a full kitchen?	Yes	Water Heater Fuel	Gas
Surveyor's Notes:			
<ol style="list-style-type: none"> 1. Very large school. 2. Possibly the best candidate for retrofit because of size and student quantity. 3. Mostly T12 lighting. 			

Maui Waena Intermediate School

Operating Hours School Year	7:00 AM to 4:30 PM	Summer	None
Number of Students School Year	979	Summer	None
Total Operating Hours:	1,548	Ave. kWh/12 mo)	0.15
Does the school have a full kitchen?	Yes	Water Heater Fuel	Gas
Surveyor's Notes:			
<ol style="list-style-type: none"> 1. Built circa 1978. 2. Mostly T12 inefficient lighting. 3. Maintenance and replacement is a major concern of the school. 			

Mauna Loa Elementary School

Operating Hours School Year	6:30 AM to 5:00 PM	Summer	8:00 AM to 12:00 PM
Number of Students School Year	70	Summer	15
Total Operating Hours:	1,974	Ave. kWh/12 mo	0.22
Does the school have a full kitchen?	Yes	Water Heater Fuel	Gas
Surveyor's Notes:			
<ol style="list-style-type: none"> Built circa 1940. Are in the process of retrofitting. 			

Molokai Intermediate and High School

Operating Hours School Year	7:00 AM to 4:00 PM	Summer	None
Number of Students School Year	755	Summer	None
Total Operating Hours:	1,467	Ave. kWh/12 mo	0.21
Does the school have a full kitchen?	Yes	Water Heater Fuel	Gas
Surveyor's Notes:			
<ol style="list-style-type: none"> Recently added 2 buildings. Very light colors on walls help FC readings. Retrofit is about ½ complete. 			

Paia Elementary School

Operating Hours School Year	7:45 AM to 5:30 PM	Summer	None
Number of Students School Year	225	Summer	None
Total Operating Hours:	1,630	Ave. kWh/12 mo	0.15
Does the school have a full kitchen?	Yes	Water Heater Fuel	Gas
Surveyor's Notes:			
<ol style="list-style-type: none"> Built circa 1938. Mostly T12 lamps and is a good candidate for retrofit. Used by military. 			

Princess Nahienaena Elementary School

Operating Hours School Year	7:00 AM to 4:30 PM	Summer	7:30 AM to 4:30 PM
Number of Students School Year	125	Summer	20
Total Operating Hours:	1,773	Ave. kWh/12 mo	0.15
Does the school have a full kitchen?	No	Water Heater Fuel	N/A
Surveyor's Notes:			
<ol style="list-style-type: none"> Built circa 1981. 			

Pukalani Elementary School

Operating Hours School Year	7:50 AM to 4:30 PM	Summer	None
Number of Students School Year	516	Summer	None
Total Operating Hours:	1,304	Ave. kWh/12 mo	0.15
Does the school have a full kitchen?	Yes	Water Heater Fuel	Gas
Surveyor's Notes:			
<ol style="list-style-type: none"> Built circa 1954. T8's in portables and a majority of campus appears to be retrofitted. 			

Puunene Elementary and Intermediate School

Operating Hours School Year	7:30 AM to 4:30 PM	Summer	None
Number of Students School Year	24	Summer	None
Total Operating Hours:	1,467	Ave. kWh/12 mo	0.15
Does the school have a full kitchen?	Yes	Water Heater Fuel	Electric
Surveyor's Notes:			
<ol style="list-style-type: none"> 1. Very old school in poor condition. 2. Mental Health use. 3. Possibly demo. Of school in near future? 			

Waihee Elementary School

Operating Hours School Year	7:30 AM to 5:30 PM	Summer	7:30 AM to 5:30 PM
Number of Students School Year	856	Summer	200
Total Operating Hours:	1,880	Ave. kWh/12 mo	0.15
Does the school have a full kitchen?	Yes	Water Heater Fuel	Gas
Surveyor's Notes:			
<ol style="list-style-type: none"> 1. None. 			

Wailuku Elementary School

Operating Hours School Year	6:00 AM to 6:00 PM	Summer	6:00 AM to 6:00 PM
Number of Students School Year	1,000	Summer	6000
Total Operating Hours:	2,256	Ave. kWh/12 mo	0.15
Does the school have a full kitchen?	Yes	Water Heater Fuel	Gas
Surveyor's Notes:			
<ol style="list-style-type: none"> 1. Built circa 1953 2. Good candidate for retrofit. 			

REBUILD HAWAII

Energy Smart Schools Program Maui

Benchmark Analysis

BENCHMARK ANALYSIS

PROJECT INFORMATION

The Maui School District is located in the County of Maui, Hawaii and spans the Islands of Maui, Molokai and Lanai. The general lay out of the facilities consists of typical school structures with portable classrooms, typical classroom buildings (constructed in phases), band rooms, cafeterias, locker room facilities, and offices. The quantity and detail of these structures vary between Elementary, Intermediate and High School use.

ENERGY UTILIZATION INDEX (EUI)

The benchmark normally used to measure the effectiveness of a building's energy efficiency is the Energy Utilization Index (EUI). The EUI is normally expressed as:

KBtus per square-foot per year (kBtus/sq.ft.-yr)

However, most of the energy consumed at the schools is all electric (some schools have gas cooking and water heating) the index as used for this study is:

kWh per square foot per year (kWh/Sq.ft.-yr)

Typical EUI's vary by commercial sector. The table below provides "typical" energy usage per square feet for various business functions in Hawaii. These numbers were compiled from HECO's database on energy utilization indices.

Typical EUI's by Business Sector

Description	KWh/sq.ft.-yr	KBtu/sq.ft.-yr
Offices	22	75
Retail	25	85
Restaurant	70-120	238-410
Schools (Maui)	7.4	25

MAUI SCHOOLS BENCHMARK CRITERIA

EUI's of the schools audited ranged from 3.0 to 11.5 kWh/sq.ft.-yr (10.4 to 39.3 kBtus/sq.ft.-yr). The attached sheets describe the results of the Benchmarking Analysis.

- 1) Description by Alphabetical Listing by School Name and Location
- 2) Description of Schools by Square Footage
- 3) Description of Schools by EUI.
- 4) Description of Schools by Operating Costs.
- 5) Description of Schools by Electric Rates.
- 6) Description of Schools by Population
- 7) Description of Schools by Energy Savings
- 8) Description of Schools by Payback
- 9) Description of Schools by Costs and Rebates
- 10) Description of Schools by Lighting Load.

DESCRIPTION BY ALPHABETICAL LISTING BY SCHOOL NAME

(Ranked in alphabetical order A-Z)

ID No.	Location Island	Schools	Size (Sq. Ft.)
1	Maui	Baldwin High School	143,940
2	Maui	Haiku Elementary School	31,259
3	Maui	Hana High and Elementary School	66,794
4	Maui	Iao Elementary School	62,224
5	Maui	Kahului Elementary School	63,173
6	Maui	Kalama Intermediate School	91,260
7	Maui	Kamalii Elementary School	72,248
8	Maui	King Kamehameha III Elementary School	42,022
9	Molokai	Kaunakakai Elementary School	31,446
10	Maui	Kearnae Elementary School	3,770
11	Maui	Kihei Elementary School	70,628
12	Molokai	Kilohana Elementary School	18,874
13	Maui	King Kekaulike High School	117,775
14	Molokai	Kualapuu Elementary School	28,711
15	Maui	Kula Elementary School	34,862
16	Maui	Lahaina Intermediate School	57,064
17	Maui	Lahaina Luna High School	149,744
18	Lanai	Lanai Elementary and High School	89,981
19	Maui	Lihikai Elementary School	68,644
20	Maui	Lokelani Intermediate School	56,999
21	Maui	Makawao Elementary School	39,332
22	Maui	Maui Community School for Adults	6,845
23	Maui	Maui High School	176,292
24	Maui	Maui Waena Intermediate School	91,055
25	Molokai	Mauna Loa Elementary School	10,076
26	Molokai	Molokai Intermediate and High School	108,599
27	Maui	Paia Elementary School	30,914
28	Maui	Princess Nahienaena Elementary School	44,830
29	Maui	Pukalani Elementary School	45,658
30	Maui	Puunene Elementary and Intermediate School	29,291
31	Maui	Waihee Elementary School	37,754
32	Maui	Wailuku Elementary School	73,024

DESCRIPTION OF SCHOOLS BY SQUARE FOOTAGE

(Ranked in order of largest square footage to smallest)

ID No.	Location Island	Schools	Size (Sq. Ft.)
23	Maui	Maui High School	176,292
17	Maui	Lahaina Luna High School	149,744
1	Maui	Baldwin High School	143,940
13	Maui	King Kekaulike High School	117,775
26	Molokai	Molokai Intermediate and High School	108,599
6	Maui	Kalama Intermediate School	91,260
24	Maui	Maui Waena Intermediate School	91,055
18	Lanai	Lanai Elementary and High School	89,981
32	Maui	Wailuku Elementary School	73,024
7	Maui	Kamalii Elementary School	72,248
11	Maui	Kihei Elementary School	70,628
19	Maui	Lihikai Elementary School	68,644
3	Maui	Hana High and Elementary School	66,794
5	Maui	Kahului Elementary School	63,173
4	Maui	Iao Elementary School	62,224
16	Maui	Lahaina Intermediate School	57,064
20	Maui	Lokelani Intermediate School	56,999
29	Maui	Pukalani Elementary School	45,658
28	Maui	Princess Nahienaena Elementary School	44,830
8	Maui	King Kamehameha III Elementary School	42,022
21	Maui	Makawao Elementary School	39,332
31	Maui	Waihee Elementary School	37,754
15	Maui	Kula Elementary School	34,862
9	Molokai	Kaunakakai Elementary School	31,446
2	Maui	Haiku Elementary School	31,259
27	Maui	Paia Elementary School	30,914
30	Maui	Puunene Elementary and Intermediate School	29,291
14	Molokai	Kualapuu Elementary School	28,711
12	Molokai	Kilohana Elementary School	18,874
25	Molokai	Mauna Loa Elementary School	10,076
22	Maui	Maui Community School for Adults	6,845
10	Maui	Keanae Intermediate School	3,770

DESCRIPTION OF SCHOOLS BY ENERGY UTILIZATION INDEX.

(Ranked in order of highest EUI-kWh to lowest)

ID NO.	Location Island	Schools	EUIs (kWh)	EUI's (kBtus)
27	Maui	Paia Elementary School	11.52	11.39
15	Maui	Kula Elementary School	8.63	13.66
5	Maui	Kahului Elementary School	8.15	14.43
18	Lanai	Lanai Elementary and High School	8.07	14.78
32	Maui	Wailuku Elementary School	7.79	14.96
29	Maui	Pukalani Elementary School	7.72	15.22
21	Maui	Makawao Elementary School	7.39	15.63
17	Maui	Lahaina Luna High School	7.36	15.68
12	Molokai	Kilohana Elementary School	7.23	16.22
4	Maui	Iao Elementary School	7.13	17.44
14	Molokai	Kualapuu Elementary School	7.03	17.74
19	Maui	Lihikai Elementary School	6.95	17.98
11	Maui	Kihei Elementary School	6.48	18.03
8	Maui	King Kamehameha III Elementary School	6.40	18.08
1	Maui	Baldwin High School	6.34	18.09
28	Maui	Princess Nahienaena Elementary School	6.23	21.25
31	Maui	Waihee Elementary School	5.30	21.65
10	Maui	Keanae Elementary School	5.30	21.84
3	Maui	Hana High and Elementary School	5.28	22.10
26	Molokai	Molokai Intermediate and High School	5.27	23.73
24	Maui	Maui Waena Intermediate School	5.20	23.99
20	Maui	Lokelani Intermediate School	5.11	24.32
16	Maui	Lahaina Intermediate School	4.75	24.68
6	Maui	Kalama Intermediate School	4.60	25.12
23	Maui	Maui High School	4.58	25.21
25	Molokai	Mauna Loa Elementary School	4.46	26.36
9	Molokai	Kaunakakai Elementary School	4.38	26.57
22	Maui	Maui Community School for Adults	4.33	27.54
2	Maui	Haiku Elementary School	4.23	27.80
13	Maui	King Kekaulike High School	4.00	29.44
7	Maui	Kamalii Elementary School	3.34	39.32
30	Maui	Puunene Elementary and Intermediate School	3.05	10.39

DESCRIPTION OF SCHOOLS BY OPERATING COSTS.

(Ranked in order of highest yearly operating cost to lowest)

ID No.	Location Island	School	Operating Costs (\$/year)
22	Maui	Maui Community School for Adults	\$229,454
25	Molokai	Mauna Loa Elementary School	\$182,021
12	Molokai	Kilohana Elementary School	\$163,746
14	Molokai	Kualapuu Elementary School	\$155,972
30	Maui	Puunene Elementary and Intermediate School	\$143,419
27	Maui	Paia Elementary School	\$132,949
2	Maui	Haiku Elementary School	\$121,994
9	Molokai	Kaunakakai Elementary School	\$120,281
15	Maui	Kula Elementary School	\$79,246
31	Maui	Waihee Elementary School	\$78,508
21	Maui	Makawao Elementary School	\$74,264
8	Maui	King Kamehameha III Elementary School	\$70,099
28	Maui	Princess Nahienaena Elementary School	\$69,753
29	Maui	Pukalani Elementary School	\$62,387
20	Maui	Lokelani Intermediate School	\$60,537
16	Maui	Lahaina Intermediate School	\$59,097
4	Maui	Iao Elementary School	\$51,799
5	Maui	Kahului Elementary School	\$51,517
3	Maui	Hana High and Elementary School	\$50,401
19	Maui	Lihikai Elementary School	\$45,844
11	Maui	Kihei Elementary School	\$42,304
7	Maui	Kamalii Elementary School	\$39,216
32	Maui	Wailuku Elementary School	\$39,142
18	Lanai	Lanai Elementary and High School	\$34,390
24	Maui	Maui Waena Intermediate School	\$29,704
6	Maui	Kalama Intermediate School	\$29,575
26	Molokai	Molokai Intermediate and High School	\$24,315
13	Maui	King Kekaulike High School	\$20,671
1	Maui	Baldwin High School	\$19,940
17	Maui	Lahaina Luna High School	\$17,522
23	Maui	Maui High School	\$10,922
10	Maui	Keanae Elementary School	\$4,750

DESCRIPTION OF SCHOOLS BY ELECTRIC RATES.

(Ranked in order of highest kWh cost to lowest)

ID No.	Location Island	School	Cost (cents/kWh)
22	Maui	Maui Community School for Adults	\$27.1
25	Molokai	Mauna Loa Elementary School	\$26.6
12	Molokai	Kilohana Elementary School	\$26.2
14	Molokai	Kualapuu Elementary School	\$25.5
30	Maui	Puunene Elementary and Intermediate School	\$21.7
27	Maui	Paia Elementary School	\$21.3
2	Maui	Haiku Elementary School	\$20.9
9	Molokai	Kaunakakai Elementary School	\$20.4
10	Maui	Keanae Elementary School	\$19.7
15	Maui	Kula Elementary School	\$19.6
31	Maui	Waihee Elementary School	\$19.6
21	Maui	Makawao Elementary School	\$19.3
8	Maui	King Kamehameha III Elementary School	\$19.3
28	Maui	Princess Nahienaena Elementary School	\$19.3
29	Maui	Pukalani Elementary School	\$19.3
20	Maui	Lokelani Intermediate School	\$19.3
16	Maui	Lahaina Intermediate School	\$19.3
4	Maui	Iao Elementary School	\$19.2
5	Maui	Kahului Elementary School	\$19.1
3	Maui	Hana High and Elementary School	\$19.1
19	Maui	Lihikai Elementary School	\$19.0
11	Maui	Kihei Elementary School	\$18.8
7	Maui	Kamalii Elementary School	\$18.8
32	Maui	Wailuku Elementary School	\$18.8
18	Lanai	Lanai Elementary and High School	\$18.7
24	Maui	Maui Waena Intermediate School	\$18.6
6	Maui	Kalama Intermediate School	\$18.6
26	Molokai	Molokai Intermediate and High School	\$18.3
13	Maui	King Kekaulike High School	\$18.3
1	Maui	Baldwin High School	\$18.2
17	Maui	Lahaina Luna High School	\$18.0
23	Maui	Maui High School	\$17.6

DESCRIPTION OF SCHOOLS BY POPULATION

(Ranked in order of largest student population to smallest)

ID No.	Location Island	Schools	Students (Number)
23	Maui	Maui High School	1709
1	Maui	Baldwin High School	1700
13	Maui	King Kekaulike High School	1400
19	Maui	Lihikai Elementary School	1156
6	Maui	Kalama Intermediate School	1150
32	Maui	Wailuku Elementary School	1000
24	Maui	Maui Waena Intermediate School	979
17	Maui	Lahaina Luna High School	889
5	Maui	Kahului Elementary School	888
4	Maui	Iao Elementary School	885
7	Maui	Kamalii Elementary School	860
31	Maui	Waihee Elementary School	856
26	Molokai	Molokai Intermediate and High School	775
11	Maui	Kihei Elementary School	768
18	Lanai	Lanai Elementary and High School	690
20	Maui	Lokelani Intermediate School	678
16	Maui	Lahaina Intermediate School	641
8	Maui	King Kamehameha III Elementary School	630
21	Maui	Makawao Elementary School	540
29	Maui	Pukalani Elementary School	516
15	Maui	Kula Elementary School	460
2	Maui	Haiku Elementary School	458
14	Molokai	Kualapuu Elementary School	414
3	Maui	Hana High and Elementary School	400
9	Molokai	Kaunakakai Elementary School	380
27	Maui	Paia Elementary School	225
12	Molokai	Kilohana Elementary School	125
28	Maui	Princess Nahienaena Elementary School	125
22	Maui	Maui Community School for Adults	80
25	Molokai	Mauna Loa Elementary School	70
30	Maui	Puunene Elementary and Intermediate School	24
10	Maui	Keanae Elementary School	3

DESCRIPTION OF SCHOOLS BY ENERGY SAVINGS

(Ranked in order of highest energy savings per year to lowest)

ID No.	Location Island	Schools	Savings (\$/year)
1	Maui	Baldwin High School	\$30,729.47
23	Maui	Maui High School	\$30,664.49
13	Maui	King Kekaulike High School	\$22,865.11
17	Maui	Lahaina Luna High School	\$22,350.19
18	Lanai	Lanai Elementary and High School	\$21,795.94
32	Maui	Wailuku Elementary School	\$16,738.03
3	Maui	Hana High and Elementary School	\$14,270.19
24	Maui	Maui Waena Intermediate School	\$13,957.59
19	Maui	Lihikai Elementary School	\$13,945.82
20	Maui	Lokelani Intermediate School	\$13,326.26
26	Molokai	Molokai Intermediate and High School	\$13,324.90
11	Maui	Kihei Elementary School	\$12,537.88
14	Molokai	Kualapuu Elementary School	\$12,475.17
6	Maui	Kalama Intermediate School	\$12,359.94
5	Maui	Kahului Elementary School	\$11,599.19
4	Maui	Iao Elementary School	\$10,786.04
31	Maui	Waihee Elementary School	\$10,346.12
16	Maui	Lahaina Intermediate School	\$ 9,957.33
9	Molokai	Kaunakakai Elementary School	\$ 8,762.69
28	Maui	Princess Nahienaena Elementary School	\$ 8,758.66
29	Maui	Pukalani Elementary School	\$ 8,400.39
15	Maui	Kula Elementary School	\$ 8,320.36
7	Maui	Kamalii Elementary School	\$ 7,701.48
21	Maui	Makawao Elementary School	\$ 7,300.30
2	Maui	Haiku Elementary School	\$ 6,320.69
25	Molokai	Mauna Loa Elementary School	\$ 4,786.10
12	Molokai	Kilohana Elementary School	\$ 4,034.24
27	Maui	Paia Elementary School	\$ 3,623.47
8	Maui	King Kamehameha III Elementary School	\$ 2,654.30
30	Maui	Puunene Elementary and Intermediate School	\$ 2,459.53
22	Maui	Maui Community School for Adults	\$ 1,533.74
10	Maui	Keanae Elementary School	\$ 243.86

DESCRIPTION OF SCHOOLS BY OVERALL PROJECT COSTS

All schools listed alphabetic

ID No.	Location Island	Schools	Cost (\$)	Rebate (\$)	Cost After Rebate (\$)	Savings (\$/year)	Payback (years)
1	Maui	Baldwin High School	\$ 161,290.00	\$ 18,816.40	\$ 142,473.60	\$ 30,729.47	4.6
2	Maui	Haiku Elementary School	\$ 41,330.00	\$ 4,341.60	\$ 36,988.40	\$ 6,320.69	5.9
3	Maui	Hana High and Elementary School	\$ 71,890.00	\$ 8,103.20	\$ 63,786.80	\$ 14,270.19	4.5
4	Maui	Iao Elementary School	\$ 69,285.00	\$ 6,932.80	\$ 62,352.20	\$ 10,786.04	5.8
5	Maui	Kahului Elementary School	\$ 60,165.00	\$ 7,915.60	\$ 52,249.40	\$ 11,599.19	4.5
6	Maui	Kalama Intermediate School	\$ 87,409.30	\$ 11,568.80	\$ 75,840.50	\$ 12,359.94	6.1
7	Maui	Kamalii Elementary School	\$ 56,830.00	\$ 7,836.00	\$ 48,994.00	\$ 7,701.48	6.4
8	Maui	King Kamehameha III Elementary School	\$ 16,760.00	\$ 1,612.80	\$ 15,147.20	\$ 2,654.30	5.7
9	Molokai	Kaunakakai Elementary School	\$ 49,335.00	\$ 4,054.80	\$ 45,280.20	\$ 8,762.69	5.2
10	Maui	Keanae Elementary School	\$ 2,880.00	\$ 201.60	\$ 2,678.40	\$ 243.86	11.0
11	Maui	Kihei Elementary School	\$ 60,480.00	\$ 8,948.80	\$ 51,531.20	\$ 12,537.88	4.1
12	Molokai	Kilohana Elementary School	\$ 19,870.00	\$ 1,999.20	\$ 17,870.80	\$ 4,034.24	4.4
13	Maui	King Kekaulike High School	\$ 106,839.40	\$ 13,301.20	\$ 93,538.20	\$ 22,865.11	4.1
14	Molokai	Kualapuu Elementary School	\$ 66,135.00	\$ 4,278.40	\$ 61,856.60	\$ 12,475.17	5.0
15	Maui	Kula Elementary School	\$ 60,830.00	\$ 6,765.60	\$ 54,064.40	\$ 8,320.36	6.5
16	Maui	Lahaina Intermediate School	\$ 49,265.00	\$ 7,147.60	\$ 42,117.40	\$ 9,957.33	4.2
17	Maui	Lahaina Luna High School	\$ 106,113.00	\$ 12,872.40	\$ 93,240.60	\$ 22,350.19	4.2
18	Lanai	Lanai Elementary and High School	\$ 119,909.30	\$ 10,019.60	\$ 109,889.70	\$ 21,795.94	5.0
19	Maui	Lihikai Elementary School	\$ 105,350.00	\$ 8,790.40	\$ 96,559.60	\$ 13,945.82	6.9
20	Maui	Lokelani Intermediate School	\$ 59,810.00	\$ 8,401.20	\$ 51,408.80	\$ 13,326.26	3.9
21	Maui	Makawao Elementary School	\$ 37,930.00	\$ 5,476.80	\$ 32,453.20	\$ 7,300.30	4.4
22	Maui	Maui Community School for Adults	\$ 4,410.00	\$ 705.60	\$ 3,704.40	\$ 1,533.74	2.4
23	Maui	Maui High School	\$ 258,641.00	\$ 22,099.20	\$ 236,541.80	\$ 30,664.49	7.7
24	Maui	Maui Waena Intermediate School	\$ 86,185.00	\$ 9,567.60	\$ 76,617.40	\$ 13,957.59	5.5
25	Molokai	Mauna Loa Elementary School	\$ 15,270.00	\$ 2,083.20	\$ 13,186.80	\$ 4,786.10	2.8
26	Molokai	Molokai Intermediate and High School	\$ 90,750.00	\$ 7,648.00	\$ 83,102.00	\$ 13,324.90	6.2
27	Maui	Paia Elementary School	\$ 27,015.00	\$ 2,494.80	\$ 24,520.20	\$ 3,623.47	6.8
28	Maui	Princess Nahienaena Elementary School	\$ 77,425.00	\$ 5,608.40	\$ 71,816.60	\$ 8,758.66	8.2
29	Maui	Pukalani Elementary School	\$ 113,570.00	\$ 6,890.80	\$ 106,679.20	\$ 8,400.39	12.7
30	Maui	Puunene Elementary and Intermediate School	\$ 19,725.00	\$ 1,816.00	\$ 17,909.00	\$ 2,459.53	7.3
31	Maui	Waihee Elementary School	\$ 56,295.00	\$ 6,232.80	\$ 50,062.20	\$ 10,346.12	4.8
32	Maui	Wailuku Elementary School	\$ 108,930.00	\$ 8,866.80	\$ 100,063.20	\$ 16,738.03	6.0

DESCRIPTION OF SCHOOLS BY PAYBACK

(Ranked in order of shortest payback to longest)

ID No.	Location Island	Schools	Payback (years)
22	Maui	Maui Community School for Adults	2.4
25	Molokai	Mauna Loa Elementary School	2.8
20	Maui	Lokelani Intermediate School	3.9
13	Maui	King Kekaulike High School	4.1
11	Maui	Kihei Elementary School	4.1
17	Maui	Lahaina Luna High School	4.2
16	Maui	Lahaina Intermediate School	4.2
12	Molokai	Kilohana Elementary School	4.4
21	Maui	Makawao Elementary School	4.4
3	Maui	Hana High and Elementary School	4.5
5	Maui	Kahului Elementary School	4.5
1	Maui	Baldwin High School	4.6
31	Maui	Waihee Elementary School	4.8
14	Molokai	Kualapuu Elementary School	5.0
18	Lanai	Lanai Elementary and High School	5.0
9	Molokai	Kaunakakai Elementary School	5.2
24	Maui	Maui Waena Intermediate School	5.5
8	Maui	King Kamehameha III Elementary School	5.7
4	Maui	Iao Elementary School	5.8
2	Maui	Haiku Elementary School	5.9
32	Maui	Wailuku Elementary School	6.0
6	Maui	Kalama Intermediate School	6.1
26	Molokai	Molokai Intermediate and High School	6.2
7	Maui	Kamalii Elementary School	6.4
15	Maui	Kula Elementary School	6.5
27	Maui	Paia Elementary School	6.8
19	Maui	Lihikai Elementary School	6.9
30	Maui	Puunene Elementary and Intermediate School	7.3
23	Maui	Maui High School	7.7
28	Maui	Princess Nahienaena Elementary School	8.2
10	Maui	Keanae Elementary School	11.0
29	Maui	Pukalani Elementary School	12.7

DESCRIPTION OF SCHOOLS BY LIGHTING CALCULATIONS

(Ranked in order of highest light quantity per school to least)

ID No.	Location Island	Schools	Light Load (%)	Light Density (kWh/sq.ft -yr.)
15	Maui	Kula Elementary School	85%	3.42
32	Maui	Wailuku Elementary School	85%	3.71
25	Molokai	Mauna Loa Elementary School	71%	5.51
31	Maui	Waihee Elementary School	67%	4.25
5	Maui	Kahului Elementary School	65%	2.75
1	Maui	Baldwin High School	61%	3.25
21	Maui	Makawao Elementary School	60%	2.76
18	Lanai	Lanai Elementary and High School	60%	2.59
29	Maui	Pukalani Elementary School	60%	2.67
19	Maui	Lihikai Elementary School	59%	3.09
27	Maui	Paia Elementary School	53%	1.78
17	Maui	Lahaina Luna High School	53%	2.42
4	Maui	Iao Elementary School	53%	2.69
14	Molokai	Kualapuu Elementary School	51%	2.64
20	Maui	Lokelani Intermediate School	51%	3.62
3	Maui	Hana High and Elementary School	50%	3.26
11	Maui	Kihei Elementary School	50%	2.65
12	Molokai	Kilohana Elementary School	50%	2.37
28	Maui	Princess Nahienaena Elementary School	49%	3.05
22	Maui	Maui Community School for Adults	45%	3.66
2	Maui	Haiku Elementary School	45%	3.67
13	Maui	King Kekaulike High School	43%	3.70
9	Molokai	Kaunakakai Elementary School	41%	3.22
30	Maui	Puunene Elementary and Intermediate School	40%	1.23
23	Maui	Maui High School	36%	2.69
16	Maui	Lahaina Intermediate School	36%	2.63
24	Maui	Maui Waena Intermediate School	32%	2.26
6	Maui	Kalama Intermediate School	24%	1.77
26	Molokai	Molokai Intermediate and High School	21%	1.44
8	Maui	King Kamehameha III Elementary School	18%	0.95
10	Maui	Keanae Elementary School	15%	0.94
7	Maui	Kamalii Elementary School	13%	1.49

REBUILD HAWAII

Energy Smart Schools Program Maui

Individual Schools Summary Compilation

School Map

Foot Candle Reports

Actual Fixture Inventory

Energy Analysis

Individual Schools Summary Compilation

BACKGROUND

Pacific Energy Services Company working in cooperation with the Maui Community College Energy Management program conducted comprehensive facility lighting inventories of the Maui Public Schools. Provided in the following sections include the physical lighting audits, the energy savings reports, the applicable rebate sums, the estimated budget costs per line item and the foot candle reports for each school.

BALDWIN HIGH SCHOOL

ALMA MATER
 Hail to thee, Maroon and Blue,
 Alma Mater fair and true,
 Mighty sons and daughters we,
 Loyally serve thee and love thee
 We'll proclaim thee near and far.
 Thou shalt be our guiding star.
 May thy light forever shine,
 With united hearts we praise thee
 Much as we shall always love thee
 Now and forever be true.

VISION STATEMENT
 Henry Perrine Baldwin High School
 will provide a caring and dynamic
 learning environment where all will
 strive to achieve their fullest potential.

MISSION STATEMENT
 The mission of Henry Perrine
 Baldwin High School is to provide all
 members of the school community with
 a variety of opportunities to acquire
 knowledge, academic and social skills
 to become responsible and productive
 citizens.

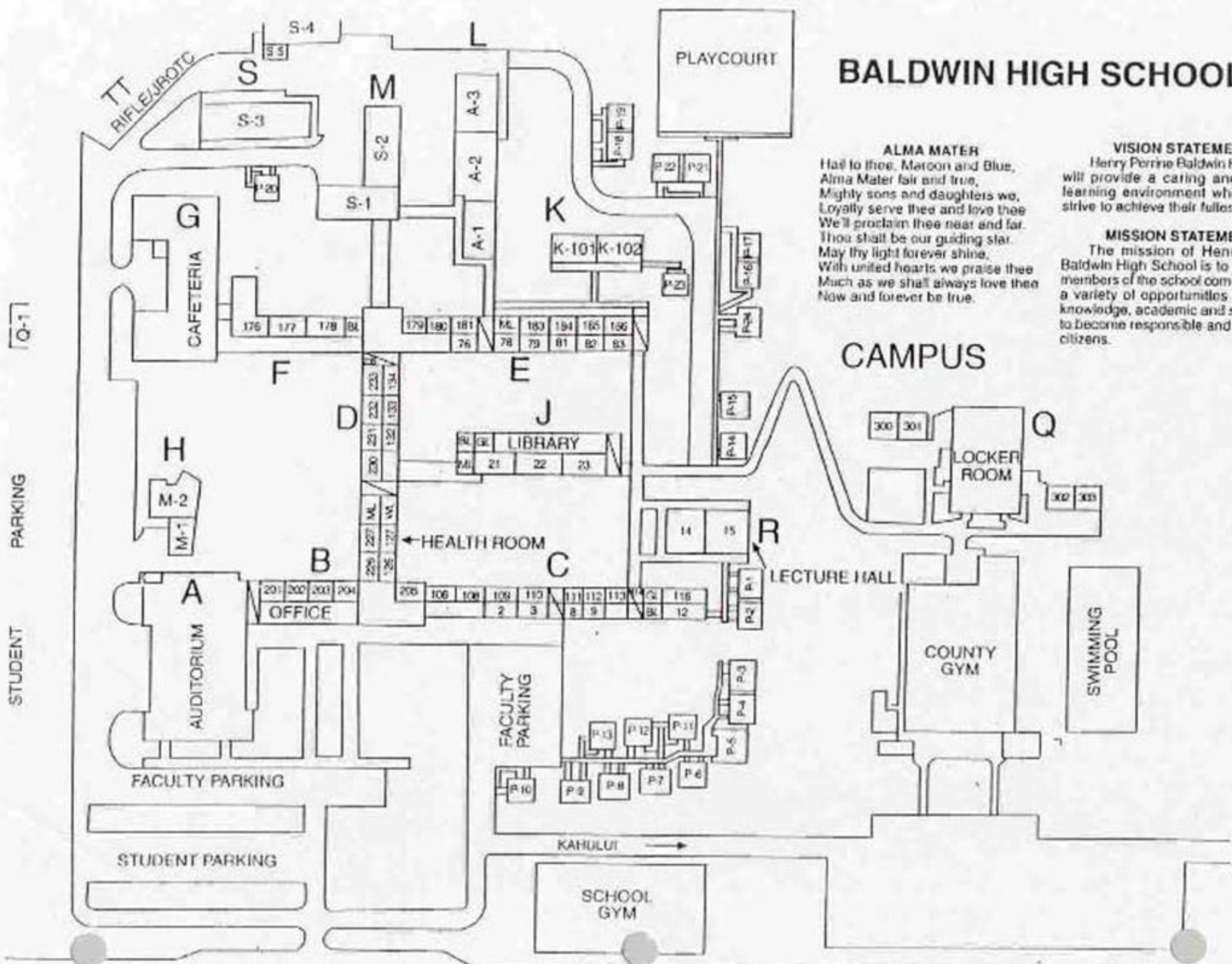

CAMPUS

[Q-1]

PARKING

STUDENT

FACULTY PARKING

STUDENT PARKING

KAHULUI →

SCHOOL GYM

COUNTY GYM

SWIMMING POOL

LOCKER ROOM

LECTURE HALL

HEALTH ROOM

LIBRARY

CAFETERIA

PLAYCOURT

Foot Candle Readings

School: Baldwin High School

Room: Bldg. A - Rm. A-2

Ceiling height: 12'

Light fixture height: 9'

Fixture type: ICE TRAY

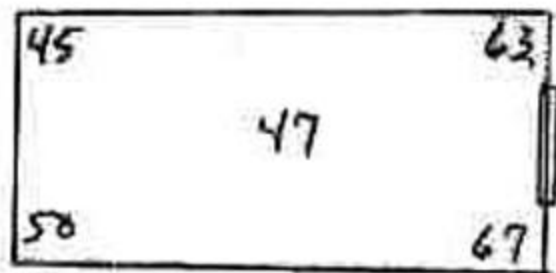

Room: BLDG. E - 186 - 2nd fl.

Ceiling height: 10'

Light fixture height: 8'

Fixture type: TRAFFER

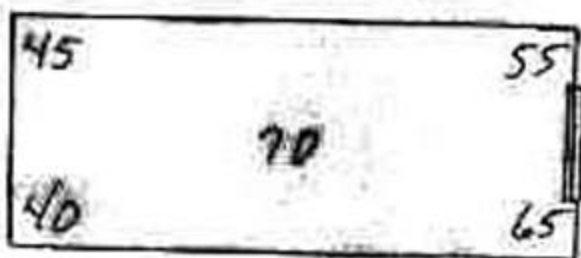

Room: Portable P-18

Ceiling height: 10'

Light fixture height: 10'

Fixture type: WRAP





CUSTOMER INFORMATION		
NAME Baldwin High School	DATE 1/25/2001	
STREET ADDRESS 1650 Kaahumanu Avenue Wailuku, HI 96793	OPERATIONAL HOURS 1,786	
POINT OF CONTACT Wallace Fujii	PHONE 984-5656	FAX 120V
AUDITOR Maui Community College Auditors		

LOCATION	EXISTING EQUIPMENT						PROPOSED			REBATES		COSTS		COMMENTS
Location (Rm Name, Rm. #, Area, Zone, etc.)	Floor	Quantity	Lamp Type	Lamps Per Fixture	Type of Fixture	Ballast Type	Lamps Per Fixture	Reflectors	Ballast Type	Per Single	Extended	Per Single	Extended	Comments
BUILDING A														
<i>Auditorium</i>														
<i>Downstairs Lobby</i>	N/A	3	4' T12	4	Troffer	Magnetic	4	N	Electronic	\$ 11.20	\$ 33.60	\$ 70.00	\$ 210.00	Excellent Opportunity for retrofit
	N/A	1	4' T12	4	Troffer	Magnetic	4	N	Electronic	\$ 11.20	\$ 11.20	\$ 70.00	\$ 70.00	Excellent Opportunity for retrofit
<i>Upstairs Lobby</i>	N/A	6	4' T12	4	Troffer	Magnetic	4	N	Electronic	\$ 11.20	\$ 67.20	\$ 70.00	\$ 420.00	Excellent Opportunity for retrofit
BUILDING B														
<i>Registrar Office</i>	N/A	12	4' T12	4	Wrap	Magnetic	4	N	Electronic	\$ 11.20	\$ 134.40	\$ 70.00	\$ 840.00	Excellent Opportunity for retrofit
	N/A	1	4' T12	4	Troffer	Magnetic	4	N	Electronic	\$ 11.20	\$ 11.20	\$ 70.00	\$ 70.00	Excellent Opportunity for retrofit
<i>Registrar room</i>	N/A	8	4' T12	4	Wrap	Magnetic	4	N	Electronic	\$ 11.20	\$ 89.60	\$ 70.00	\$ 560.00	Excellent Opportunity for retrofit
<i>Attendance</i>	N/A	6	4' T12	4	Wrap	Magnetic	4	N	Electronic	\$ 11.20	\$ 67.20	\$ 70.00	\$ 420.00	Excellent Opportunity for retrofit
<i>Admittance</i>	N/A	22	4' T12	4	Troffer	Magnetic	4	N	Electronic	\$ 11.20	\$ 246.40	\$ 70.00	\$ 1,540.00	Excellent Opportunity for retrofit
<i>Secretary</i>	N/A	8	4' T12	4	Wrap	Magnetic	4	N	Electronic	\$ 11.20	\$ 89.60	\$ 70.00	\$ 560.00	Excellent Opportunity for retrofit
<i>Principal</i>	N/A	8	4' T12	4	Wrap	Magnetic	4	N	Electronic	\$ 11.20	\$ 89.60	\$ 70.00	\$ 560.00	Excellent Opportunity for retrofit
<i>Printing Room</i>	N/A	2	4' T12	4	Wrap	Magnetic	4	N	Electronic	\$ 11.20	\$ 22.40	\$ 70.00	\$ 140.00	Excellent Opportunity for retrofit
	N/A	1	4' T12	4	Ice	Magnetic	4	N	Electronic	\$ 11.20	\$ 11.20	\$ 160.00	\$ 160.00	Excellent Opportunity for retrofit
<i>B - 201</i>	N/A	15	4' T12	3	Troffer	Magnetic	3	N	Electronic	\$ 8.40	\$ 126.00	\$ 65.00	\$ 975.00	Excellent Opportunity for retrofit
<i>B - 201 A</i>	N/A	15	4' T12	3	Troffer	Magnetic	3	N	Electronic	\$ 8.40	\$ 126.00	\$ 65.00	\$ 975.00	Excellent Opportunity for retrofit
<i>B - 202</i>	N/A	15	4' T12	3	Troffer	Magnetic	3	N	Electronic	\$ 8.40	\$ 126.00	\$ 65.00	\$ 975.00	Excellent Opportunity for retrofit
<i>B - 203</i>	N/A	15	4' T12	3	Troffer	Magnetic	3	N	Electronic	\$ 8.40	\$ 126.00	\$ 65.00	\$ 975.00	Excellent Opportunity for retrofit
<i>B - 204</i>	N/A	10	4' T12	3	Troffer	Magnetic	3	N	Electronic	\$ 8.40	\$ 84.00	\$ 65.00	\$ 650.00	Excellent Opportunity for retrofit
<i>B - 205</i>	N/A	21	4' T12	3	Troffer	Magnetic	3	N	Electronic	\$ 8.40	\$ 176.40	\$ 65.00	\$ 1,365.00	Excellent Opportunity for retrofit
	N/A	2	4' T12	4	Wrap	Magnetic	4	N	Electronic	\$ 11.20	\$ 22.40	\$ 70.00	\$ 140.00	Excellent Opportunity for retrofit
BUILDING C														
<i>C - 106</i>	N/A	15	4' T12	4	Ice	Magnetic	4	N	Electronic	\$ 11.20	\$ 168.00	\$ 160.00	\$ 2,400.00	Replace fixture & mount hardware
<i>C - 108</i>	N/A	15	4' T12	4	Ice	Magnetic	4	N	Electronic	\$ 11.20	\$ 168.00	\$ 160.00	\$ 2,400.00	Replace fixture & mount hardware
<i>C - 109</i>	N/A	15	4' T12	4	Ice	Magnetic	4	N	Electronic	\$ 11.20	\$ 168.00	\$ 160.00	\$ 2,400.00	Replace fixture & mount hardware
<i>C - 110</i>	N/A	15	4' T12	4	Ice	Magnetic	4	N	Electronic	\$ 11.20	\$ 168.00	\$ 160.00	\$ 2,400.00	Replace fixture & mount hardware
<i>C - 111</i>	N/A	15	4' T12	4	Ice	Magnetic	4	N	Electronic	\$ 11.20	\$ 168.00	\$ 160.00	\$ 2,400.00	Replace fixture & mount hardware
<i>C - 112</i>	N/A	15	4' T12	4	Ice	Magnetic	4	N	Electronic	\$ 11.20	\$ 168.00	\$ 160.00	\$ 2,400.00	Replace fixture & mount hardware
<i>C - 113</i>	N/A	15	4' T12	4	Ice	Magnetic	4	N	Electronic	\$ 11.20	\$ 168.00	\$ 160.00	\$ 2,400.00	Replace fixture & mount hardware
<i>C - 116</i>	N/A	15	4' T12	4	Ice	Magnetic	4	N	Electronic	\$ 11.20	\$ 168.00	\$ 160.00	\$ 2,400.00	Replace fixture & mount hardware
<i>Girls' Restroom</i>	N/A	4	4' T12	2	Wrap	Magnetic	2	N	Electronic	\$ 5.60	\$ 22.40	\$ 60.00	\$ 240.00	Excellent Opportunity for retrofit
<i>Boys' Restroom</i>	N/A	4	4' T12	2	Wrap	Magnetic	2	N	Electronic	\$ 5.60	\$ 22.40	\$ 60.00	\$ 240.00	Excellent Opportunity for retrofit

LOCATION	EXISTING EQUIPMENT						PROPOSED			REBATES		COSTS		COMMENTS
Location (Rm Name, Rm. #, Area, Zone, etc.)	Floor	Quantity	Lamp Type	Lamps Per Fixture	Type of Fixture	Ballast Type	Lamps Per Fixture	Reflectors	Ballast Type	Per Single	Extended	Per Single	Extended	Comments
C - 2	N/A	18	4' T12	4	Troffer	Magnetic	4	N	Electronic	\$ 11.20	\$ 201.60	\$ 70.00	\$ 1,260.00	Excellent Opportunity for retrofit
C - 3	N/A	18	4' T12	4	Troffer	Magnetic	4	N	Electronic	\$ 11.20	\$ 201.60	\$ 70.00	\$ 1,260.00	Excellent Opportunity for retrofit
C - 8	N/A	18	4' T12	4	Troffer	Magnetic	4	N	Electronic	\$ 11.20	\$ 201.60	\$ 70.00	\$ 1,260.00	Excellent Opportunity for retrofit
C - 9	N/A	18	4' T12	4	Troffer	Magnetic	4	N	Electronic	\$ 11.20	\$ 201.60	\$ 70.00	\$ 1,260.00	Excellent Opportunity for retrofit
C - 12	N/A	18	4' T12	4	Troffer	Magnetic	4	N	Electronic	\$ 11.20	\$ 201.60	\$ 70.00	\$ 1,260.00	Excellent Opportunity for retrofit
BUILDING D														
D - 126	N/A	18	4' T12	4	Troffer	Magnetic	4	N	Electronic	\$ 11.20	\$ 201.60	\$ 70.00	\$ 1,260.00	Excellent Opportunity for retrofit
D - 127	N/A	18	4' T12	4	Troffer	Magnetic	4	N	Electronic	\$ 11.20	\$ 201.60	\$ 70.00	\$ 1,260.00	Excellent Opportunity for retrofit
D - 132	N/A	18	4' T12	4	Troffer	Magnetic	4	N	Electronic	\$ 11.20	\$ 201.60	\$ 70.00	\$ 1,260.00	Excellent Opportunity for retrofit
D - 133	N/A	18	4' T12	4	Troffer	Magnetic	4	N	Electronic	\$ 11.20	\$ 201.60	\$ 70.00	\$ 1,260.00	Excellent Opportunity for retrofit
D - 134	N/A	18	4' T12	4	Troffer	Magnetic	4	N	Electronic	\$ 11.20	\$ 201.60	\$ 70.00	\$ 1,260.00	Excellent Opportunity for retrofit
Girls' Restroom	N/A	4	4' T12	2	Wrap	Magnetic	2	N	Electronic	\$ 5.60	\$ 22.40	\$ 60.00	\$ 240.00	Excellent Opportunity for retrofit
Boys' Restroom	N/A	1	4' T12	2	Wrap	Magnetic	2	N	Electronic	\$ 5.60	\$ 5.60	\$ 60.00	\$ 60.00	Excellent Opportunity for retrofit
Staff Rest Room	N/A	2	4' T12	4	Troffer	Magnetic	4	N	Electronic	\$ 11.20	\$ 22.40	\$ 70.00	\$ 140.00	Excellent Opportunity for retrofit
D -226	N/A	15	4' T12	3	Troffer	Magnetic	3	N	Electronic	\$ 8.40	\$ 126.00	\$ 65.00	\$ 975.00	Excellent Opportunity for retrofit
D -227	N/A	15	4' T12	4	Troffer	Magnetic	4	N	Electronic	\$ 11.20	\$ 168.00	\$ 70.00	\$ 1,050.00	Excellent Opportunity for retrofit
D -228	N/A	6	4' T12	3	Wrap	Magnetic	3	N	Electronic	\$ 8.40	\$ 50.40	\$ 65.00	\$ 390.00	Excellent Opportunity for retrofit
D -230	N/A	18	4' T12	4	Wrap	Magnetic	4	N	Electronic	\$ 11.20	\$ 201.60	\$ 70.00	\$ 1,260.00	Excellent Opportunity for retrofit
D -231	N/A	18	4' T12	4	Wrap	Magnetic	4	N	Electronic	\$ 11.20	\$ 201.60	\$ 70.00	\$ 1,260.00	Excellent Opportunity for retrofit
D -232	N/A	18	4' T12	4	Wrap	Magnetic	4	N	Electronic	\$ 11.20	\$ 201.60	\$ 70.00	\$ 1,260.00	Excellent Opportunity for retrofit
D -233	N/A	18	4' T12	4	Wrap	Magnetic	4	N	Electronic	\$ 11.20	\$ 201.60	\$ 70.00	\$ 1,260.00	Excellent Opportunity for retrofit
D -234	N/A	3	4' T12	4	Wrap	Magnetic	4	N	Electronic	\$ 11.20	\$ 33.60	\$ 70.00	\$ 210.00	Excellent Opportunity for retrofit
	N/A	1	4' T12	2	Wrap	Magnetic	2	N	Electronic	\$ 5.60	\$ 5.60	\$ 60.00	\$ 60.00	Excellent Opportunity for retrofit
BUILDING E														
E - 76	N/A	18	4' T12	4	Troffer	Magnetic	4	N	Electronic	\$ 11.20	\$ 201.60	\$ 70.00	\$ 1,260.00	Excellent Opportunity for retrofit
E - 78	N/A	18	4' T12	4	Troffer	Magnetic	4	N	Electronic	\$ 11.20	\$ 201.60	\$ 70.00	\$ 1,260.00	Excellent Opportunity for retrofit
E - 79	N/A	18	4' T12	4	Troffer	Magnetic	4	N	Electronic	\$ 11.20	\$ 201.60	\$ 70.00	\$ 1,260.00	Excellent Opportunity for retrofit
E - 81	N/A	18	4' T12	4	Troffer	Magnetic	4	N	Electronic	\$ 11.20	\$ 201.60	\$ 70.00	\$ 1,260.00	Excellent Opportunity for retrofit
E -82	N/A	18	4' T12	4	Troffer	Magnetic	4	N	Electronic	\$ 11.20	\$ 201.60	\$ 70.00	\$ 1,260.00	Excellent Opportunity for retrofit
E - 83	N/A	18	4' T12	4	Troffer	Magnetic	4	N	Electronic	\$ 11.20	\$ 201.60	\$ 70.00	\$ 1,260.00	Excellent Opportunity for retrofit
E -179	N/A	15	4' T12	3	Troffer	Magnetic	3	N	Electronic	\$ 8.40	\$ 126.00	\$ 65.00	\$ 975.00	Excellent Opportunity for retrofit
E - 180	N/A	15	4' T12	3	Troffer	Magnetic	3	N	Electronic	\$ 8.40	\$ 126.00	\$ 65.00	\$ 975.00	Excellent Opportunity for retrofit
E - 181	N/A	15	4' T12	3	Troffer	Magnetic	3	N	Electronic	\$ 8.40	\$ 126.00	\$ 65.00	\$ 975.00	Excellent Opportunity for retrofit
E - 183	N/A	21	4' T12	4	Troffer	Magnetic	4	N	Electronic	\$ 11.20	\$ 235.20	\$ 70.00	\$ 1,470.00	Excellent Opportunity for retrofit
E - 184	N/A	18	4' T12	3	Troffer	Magnetic	3	N	Electronic	\$ 8.40	\$ 151.20	\$ 65.00	\$ 1,170.00	Excellent Opportunity for retrofit
E - 185	N/A	18	4' T12	3	Wrap	Magnetic	3	N	Electronic	\$ 8.40	\$ 151.20	\$ 65.00	\$ 1,170.00	Excellent Opportunity for retrofit
E - 186	N/A	18	4' T12	3	Wrap	Magnetic	3	N	Electronic	\$ 8.40	\$ 151.20	\$ 65.00	\$ 1,170.00	Excellent Opportunity for retrofit
Girls' Rest Room	N/A	2	4' T12	4	Wrap	Magnetic	4	N	Electronic	\$ 11.20	\$ 22.40	\$ 70.00	\$ 140.00	Excellent Opportunity for retrofit

LOCATION	EXISTING EQUIPMENT						PROPOSED			REBATES		COSTS		COMMENTS
Location (Rm Name, Rm. #, Area, Zone, etc.)	Floor	Quantity	Lamp Type	Lamps Per Fixture	Type of Fixture	Ballast Type	Lamps Per Fixture	Reflectors	Ballast Type	Per Single	Extended	Per Single	Extended	Comments
Boys' Restroom	N/A	1	4' T12	4	Wrap	Magnetic	4	N	Electronic	\$ 11.20	\$ 11.20	\$ 70.00	\$ 70.00	Excellent Opportunity for retrofit
BUILDING F														
F-176	N/A	8	4' T12	2	Ice	Magnetic	2	N	Electronic	\$ 5.60	\$ 44.80	\$ 135.00	\$ 1,080.00	Replace fixture & mount hardware
	N/A	4	4' T12	2	Wrap	Magnetic	2	N	Electronic	\$ 5.60	\$ 22.40	\$ 60.00	\$ 240.00	Excellent Opportunity for retrofit
	N/A	1	4' T12	4	Ice	Magnetic	4	N	Electronic	\$ 11.20	\$ 11.20	\$ 160.00	\$ 160.00	Replace fixture & mount hardware
F-177	N/A	27	4' T12	2	Wrap	Magnetic	2	N	Electronic	\$ 5.60	\$ 151.20	\$ 60.00	\$ 1,620.00	Excellent Opportunity for retrofit
Hall Office	N/A	2	4' T12	4	Wrap	Magnetic	4	N	Electronic	\$ 11.20	\$ 22.40	\$ 70.00	\$ 140.00	Excellent Opportunity for retrofit
F-178	N/A	27	4' T12	2	Wrap	Magnetic	2	N	Electronic	\$ 5.60	\$ 151.20	\$ 60.00	\$ 1,620.00	Excellent Opportunity for retrofit
Girls' Restroom	N/A	4	4' T12	2	Wrap	Magnetic	2	N	Electronic	\$ 5.60	\$ 22.40	\$ 60.00	\$ 240.00	Excellent Opportunity for retrofit
Boys' Restroom	N/A	1	4' T12	4	Wrap	Magnetic	4	N	Electronic	\$ 11.20	\$ 11.20	\$ 70.00	\$ 70.00	Excellent Opportunity for retrofit
BUILDING G														
Cafeteria														
Dining Room A	N/A	13	4' T12	4	Wrap	Magnetic	4	N	Electronic	\$ 11.20	\$ 145.60	\$ 70.00	\$ 910.00	Excellent Opportunity for retrofit
	N/A	10	8' T12	2	Wrap	Magnetic	2	N	Electronic	\$ 7.20	\$ 72.00	\$ 80.00	\$ 800.00	Excellent Opportunity for retrofit
Kitchen	N/A	16	8' T12	2	Ice	Magnetic	2	N	Electronic	\$ 11.20	\$ 179.20	\$ 160.00	\$ 2,560.00	Replace fixture & mount hardware
Office	N/A	6	4' T12	2	Wrap	Magnetic	2	N	Electronic	\$ 5.60	\$ 33.60	\$ 60.00	\$ 360.00	Excellent Opportunity for retrofit
Dining Room B	N/A	11	4' T12	4	Troffer	Magnetic	4	N	Electronic	\$ 11.20	\$ 123.20	\$ 70.00	\$ 770.00	Excellent Opportunity for retrofit
	N/A	6	4' T12	4	Wrap	Magnetic	4	N	Electronic	\$ 11.20	\$ 67.20	\$ 70.00	\$ 420.00	Excellent Opportunity for retrofit
BUILDING H														
M-1	N/A	2	4' T12	4	Wrap	Magnetic	4	N	Electronic	\$ 11.20	\$ 22.40	\$ 70.00	\$ 140.00	Excellent Opportunity for retrofit
M-2	N/A	3	8' T12	2	Ice	Magnetic	2	N	Electronic	\$ 7.20	\$ 21.60	\$ 160.00	\$ 480.00	Replace fixture & mount hardware
BUILDING J														
Library	N/A	33	8' T12	2	Ice	Magnetic	2	N	Electronic	\$ 11.20	\$ 369.60	\$ 160.00	\$ 5,280.00	Replace fixture & mount hardware
Store Room	N/A	3	8' T12	1	Ice	Magnetic	1	N	Electronic	\$ 5.60	\$ 16.80	\$ 135.00	\$ 405.00	Replace fixture & mount hardware
J-21	N/A	15	8' T12	2	Ice	Magnetic	2	N	Electronic	\$ 11.20	\$ 168.00	\$ 160.00	\$ 2,400.00	Replace fixture & mount hardware
J-22	N/A	15	8' T12	2	Ice	Magnetic	2	N	Electronic	\$ 11.20	\$ 168.00	\$ 160.00	\$ 2,400.00	Replace fixture & mount hardware
J-23	N/A	15	8' T12	2	Ice	Magnetic	2	N	Electronic	\$ 11.20	\$ 168.00	\$ 160.00	\$ 2,400.00	Replace fixture & mount hardware
Store Room	N/A	2	8' T12	1	Ice	Magnetic	1	N	Electronic	\$ 5.60	\$ 11.20	\$ 135.00	\$ 270.00	Replace fixture & mount hardware
Girls' Restroom	N/A	4	4' T12	2	Wrap	Magnetic	2	N	Electronic	\$ 5.60	\$ 22.40	\$ 60.00	\$ 240.00	Excellent Opportunity for retrofit
Boys' Restroom	N/A	1	4' T12	4	Wrap	Magnetic	4	N	Electronic	\$ 11.20	\$ 11.20	\$ 70.00	\$ 70.00	Excellent Opportunity for retrofit
Men's Rest Room	N/A	1	4' T12	4	Wrap	Magnetic	4	N	Electronic	\$ 11.20	\$ 11.20	\$ 70.00	\$ 70.00	Excellent Opportunity for retrofit
BUILDING K														
K-101	N/A	25	4' T12	4	Troffer	Magnetic	4	N	Electronic	\$ 11.20	\$ 280.00	\$ 70.00	\$ 1,750.00	Excellent Opportunity for retrofit
K-102	N/A	16	4' T12	4	Troffer	Magnetic	4	N	Electronic	\$ 11.20	\$ 179.20	\$ 70.00	\$ 1,120.00	Excellent Opportunity for retrofit
BUILDING L														
A-1	N/A	18	8' T12	2	Ice	Magnetic	2	N	Electronic	\$ 11.20	\$ 201.60	\$ 160.00	\$ 2,880.00	Replace fixture & mount hardware
	N/A	6	4' T12	2	Ice	Magnetic	2	N	Electronic	\$ 5.60	\$ 33.60	\$ 135.00	\$ 810.00	Replace fixture & mount hardware
A-2	N/A	18	8' T12	2	Ice	Magnetic	2	N	Electronic	\$ 11.20	\$ 201.60	\$ 160.00	\$ 2,880.00	Replace fixture & mount hardware

LOCATION	EXISTING EQUIPMENT						PROPOSED			REBATES		COSTS		COMMENTS
Location (Rm Name, Rm. #, Area, Zone, etc.)	Floor	Quantity	Lamp Type	Lamps Per Fixture	Type of Fixture	Ballast Type	Lamps Per Fixture	Reflectors	Ballast Type	Per Single	Extended	Per Single	Extended	Comments
	N/A	6	4' T12	2	Ice	Magnetic	2	N	Electronic	\$ 5.60	\$ 33.60	\$ 135.00	\$ 810.00	Replace fixture & mount hardware
A - 3	N/A	38	8' T12	2	Ice	Magnetic	2	N	Electronic	\$ 5.60	\$ 212.80	\$ 135.00	\$ 5,130.00	Replace fixture & mount hardware
	N/A	16	4' T12	2	Ice	Magnetic	2	N	Electronic	\$ 5.60	\$ 89.60	\$ 135.00	\$ 2,160.00	Replace fixture & mount hardware
BUILDING M														
S - 1														
Drafting	N/A	60	4' T12	4	Wrap	Magnetic	4	N	Electronic	\$ 11.20	\$ 672.00	\$ 70.00	\$ 4,200.00	Excellent Opportunity for retrofit
Mini Lab	N/A	4	4' T12	2	Wrap	Magnetic	2	N	Electronic	\$ 5.60	\$ 22.40	\$ 60.00	\$ 240.00	Excellent Opportunity for retrofit
Hall	N/A	1	4' T12	2	Wrap	Magnetic	2	N	Electronic	\$ 5.60	\$ 5.60	\$ 60.00	\$ 60.00	Excellent Opportunity for retrofit
Office	N/A	4	4' T12	2	Wrap	Magnetic	2	N	Electronic	\$ 5.60	\$ 22.40	\$ 60.00	\$ 240.00	Excellent Opportunity for retrofit
S - 2														
Theatre	N/A	30	4' T12	2	Wrap	Magnetic	2	N	Electronic	\$ 5.60	\$ 168.00	\$ 60.00	\$ 1,800.00	Excellent Opportunity for retrofit
Office	N/A	6	4' T12	4	Wrap	Magnetic	4	N	Electronic	\$ 11.20	\$ 67.20	\$ 70.00	\$ 420.00	Excellent Opportunity for retrofit
Class	N/A	6	4' T12	4	Wrap	Magnetic	4	N	Electronic	\$ 11.20	\$ 67.20	\$ 70.00	\$ 420.00	Excellent Opportunity for retrofit
BUILDING R														
R - 14	N/A	45	4' T12	4	Troffer	Magnetic	4	N	Electronic	\$ 11.20	\$ 504.00	\$ 70.00	\$ 3,150.00	Excellent Opportunity for retrofit
R - 15	N/A	30	4' T12	4	Troffer	Magnetic	4	N	Electronic	\$ 11.20	\$ 336.00	\$ 70.00	\$ 2,100.00	Excellent Opportunity for retrofit
Conference	N/A	2	4' T12	4	Troffer	Magnetic	4	N	Electronic	\$ 11.20	\$ 22.40	\$ 70.00	\$ 140.00	Excellent Opportunity for retrofit
Teachers' Room	N/A	2	4' T12	4	Troffer	Magnetic	4	N	Electronic	\$ 11.20	\$ 22.40	\$ 70.00	\$ 140.00	Excellent Opportunity for retrofit
Dressing Room	N/A	1	4' T12	4	Troffer	Magnetic	4	N	Electronic	\$ 11.20	\$ 11.20	\$ 70.00	\$ 70.00	Excellent Opportunity for retrofit
Girls' Restroom	N/A	1	4' T12	2	Vanity	Magnetic	2	N	Electronic	\$ 5.60	\$ 5.60	\$ 60.00	\$ 60.00	Excellent Opportunity for retrofit
Boys' Restroom	N/A	1	4' T12	2	Vanity	Magnetic	2	N	Electronic	\$ 5.60	\$ 5.60	\$ 60.00	\$ 60.00	Excellent Opportunity for retrofit
BUILDING S														
S - 3														
Auto-shop	N/A	34	8' T12	2	Ice	Magnetic	2	N	Electronic	\$ 11.20	\$ 380.80	\$ 160.00	\$ 5,440.00	Replace fixture & mount hardware
Class	N/A	20	4' T12	4	Ice	Magnetic	4	N	Electronic	\$ 11.20	\$ 224.00	\$ 160.00	\$ 3,200.00	Replace fixture & mount hardware
Office	N/A	1	4' T12	4	Wrap	Magnetic	4	N	Electronic	\$ 11.20	\$ 11.20	\$ 70.00	\$ 70.00	Excellent Opportunity for retrofit
S - 4	N/A										\$ -		\$ -	
Wood-Shop	N/A	24	8' T12	2	Wrap	Magnetic	2	N	Electronic	\$ 7.20	\$ 172.80	\$ 80.00	\$ 1,920.00	Excellent Opportunity for retrofit
Class	N/A	10	4' T12	4	Ice	Magnetic	4	N	Electronic	\$ 11.20	\$ 112.00	\$ 160.00	\$ 1,600.00	Replace fixture & mount hardware
Office	N/A	2	4' T12	4	Wrap	Magnetic	4	N	Electronic	\$ 11.20	\$ 22.40	\$ 70.00	\$ 140.00	Excellent Opportunity for retrofit
BUILDING TT														
JROTC														
Office	N/A	3	4' T12	4	Wrap	Magnetic	4	N	Electronic	\$ 11.20	\$ 33.60	\$ 70.00	\$ 210.00	Excellent Opportunity for retrofit
Outside Lanai	N/A	8	4' T8	1	Impact	Electronic					\$ -		\$ -	T8 Lamps/Elec. Ballast, No Retrofit

LOCATION Location (Rm Name, Rm. #, Area, Zone, etc.)	EXISTING EQUIPMENT						PROPOSED			REBATES		COSTS		COMMENTS Comments
	Floor	Quantity	Lamp Type	Lamps Per Fixture	Type of Fixture	Ballast Type	Lamps Per Fixture	Reflectors	Ballast Type	Per Single	Extended	Per Single	Extended	
Office	N/A	8	4' T8	4	Wrap	Electronic					\$ -		\$ -	T8 Lamps/Elec. Ballast, No Retrofit
Arms Room	N/A	1	4' T8	4	Wrap	Electronic					\$ -		\$ -	T8 Lamps/Elec. Ballast, No Retrofit
Bathroom	N/A	1	4' T8	4	Wrap	Electronic					\$ -		\$ -	T8 Lamps/Elec. Ballast, No Retrofit
Class	N/A	6	4' T8	4	Wrap	Electronic					\$ -		\$ -	T8 Lamps/Elec. Ballast, No Retrofit
Supplay Room	N/A	1	4' T8	4	Wrap	Electronic					\$ -		\$ -	T8 Lamps/Elec. Ballast, No Retrofit
Class	N/A	6	4' T8	4	Wrap	Electronic					\$ -		\$ -	T8 Lamps/Elec. Ballast, No Retrofit
Hall	N/A	1	4' T8	2	Wrap	Electronic					\$ -		\$ -	T8 Lamps/Elec. Ballast, No Retrofit
Locker Room	N/A	3	4' T8	4	Wrap	Electronic					\$ -		\$ -	T8 Lamps/Elec. Ballast, No Retrofit
PORTABLES														
P - 1	N/A	16	4' T12	4	Wrap	Magnetic	4	N	Electronic	\$ 11.20	\$ 179.20	\$ 70.00	\$ 1,120.00	Excellent Opportunity for retrofit
P - 2	N/A	16	4' T12	4	Wrap	Magnetic	4	N	Electronic	\$ 11.20	\$ 179.20	\$ 70.00	\$ 1,120.00	Excellent Opportunity for retrofit
P - 3	N/A	16	4' T12	4	Wrap	Magnetic	4	N	Electronic	\$ 11.20	\$ 179.20	\$ 70.00	\$ 1,120.00	Excellent Opportunity for retrofit
P - 4	N/A	16	4' T12	4	Wrap	Magnetic	4	N	Electronic	\$ 11.20	\$ 179.20	\$ 70.00	\$ 1,120.00	Excellent Opportunity for retrofit
P - 5	N/A	16	4' T12	4	Wrap	Magnetic	4	N	Electronic	\$ 11.20	\$ 179.20	\$ 70.00	\$ 1,120.00	Excellent Opportunity for retrofit
P - 6	N/A	16	4' T12	4	Wrap	Magnetic	4	N	Electronic	\$ 11.20	\$ 179.20	\$ 70.00	\$ 1,120.00	Excellent Opportunity for retrofit
P - 7	N/A	16	4' T12	4	Wrap	Magnetic	4	N	Electronic	\$ 11.20	\$ 179.20	\$ 70.00	\$ 1,120.00	Excellent Opportunity for retrofit
P - 8	N/A	16	4' T12	4	Wrap	Magnetic	4	N	Electronic	\$ 11.20	\$ 179.20	\$ 70.00	\$ 1,120.00	Excellent Opportunity for retrofit
P - 9	N/A	16	4' T12	4	Wrap	Magnetic	4	N	Electronic	\$ 11.20	\$ 179.20	\$ 70.00	\$ 1,120.00	Excellent Opportunity for retrofit
P - 10	N/A	16	4' T12	4	Wrap	Magnetic	4	N	Electronic	\$ 11.20	\$ 179.20	\$ 70.00	\$ 1,120.00	Excellent Opportunity for retrofit
P - 11	N/A	16	4' T12	4	Wrap	Magnetic	4	N	Electronic	\$ 11.20	\$ 179.20	\$ 70.00	\$ 1,120.00	Excellent Opportunity for retrofit
P - 12	N/A	16	4' T12	4	Wrap	Magnetic	4	N	Electronic	\$ 11.20	\$ 179.20	\$ 70.00	\$ 1,120.00	Excellent Opportunity for retrofit
P - 13	N/A	16	4' T12	4	Wrap	Magnetic	4	N	Electronic	\$ 11.20	\$ 179.20	\$ 70.00	\$ 1,120.00	Excellent Opportunity for retrofit
P - 14	N/A	16	4' T12	4	Wrap	Magnetic	4	N	Electronic	\$ 11.20	\$ 179.20	\$ 70.00	\$ 1,120.00	Excellent Opportunity for retrofit
P - 15	N/A	16	4' T12	4	Wrap	Magnetic	4	N	Electronic	\$ 11.20	\$ 179.20	\$ 70.00	\$ 1,120.00	Excellent Opportunity for retrofit
P - 16	N/A	16	4' T12	4	Wrap	Magnetic	4	N	Electronic	\$ 11.20	\$ 179.20	\$ 70.00	\$ 1,120.00	Excellent Opportunity for retrofit
P - 17	N/A	16	4' T12	4	Wrap	Magnetic	4	N	Electronic	\$ 11.20	\$ 179.20	\$ 70.00	\$ 1,120.00	Excellent Opportunity for retrofit
P - 18	N/A	16	4' T12	4	Wrap	Magnetic	4	N	Electronic	\$ 11.20	\$ 179.20	\$ 70.00	\$ 1,120.00	Excellent Opportunity for retrofit
P - 19	N/A	12	4' T12	4	Wrap	Magnetic	4	N	Electronic	\$ 11.20	\$ 134.40	\$ 70.00	\$ 840.00	Excellent Opportunity for retrofit
P - 20 A	N/A	6	4' T12	4	Wrap	Magnetic	4	N	Electronic	\$ 11.20	\$ 67.20	\$ 70.00	\$ 420.00	Excellent Opportunity for retrofit
P - 20 B	N/A	6	4' T12	4	Wrap	Magnetic	4	N	Electronic	\$ 11.20	\$ 67.20	\$ 70.00	\$ 420.00	Excellent Opportunity for retrofit
P - 21	N/A	12	4' T12	4	Wrap	Magnetic	4	N	Electronic	\$ 11.20	\$ 134.40	\$ 70.00	\$ 840.00	Excellent Opportunity for retrofit
P - 22	N/A	12	4' T12	4	Wrap	Magnetic	4	N	Electronic	\$ 11.20	\$ 134.40	\$ 70.00	\$ 840.00	Excellent Opportunity for retrofit
P - 23	N/A	12	4' T12	4	Wrap	Magnetic	4	N	Electronic	\$ 11.20	\$ 134.40	\$ 70.00	\$ 840.00	Excellent Opportunity for retrofit
P - 24	N/A	12	4' T12	4	Wrap	Magnetic	4	N	Electronic	\$ 11.20	\$ 134.40	\$ 70.00	\$ 840.00	Excellent Opportunity for retrofit
Total Rebates										\$	18,816.40			
Total Costs										\$	161,290.00			

LOCATION	QTY	EXISTING TYPE	QTY	RETROFIT		Existing	Actual			Proposed			
						Watt/unit	Op. Hours	kWh	kW-D	Watt/unit	Op. Hours	kWh	kW-D
E - 82	18	4' 4L Fixture	18	Lamp & Low Watt Ballast	Excellent Opportunity for retrofit	151.2	1,786	4,860.8	2.7216	100	1,786	3,214.8	1.8
E - 83	18	4' 4L Fixture	18	Lamp & Low Watt Ballast	Excellent Opportunity for retrofit	151.2	1,786	4,860.8	2.7216	100	1,786	3,214.8	1.8
E - 179	15	4' 3L Fixture	15	Lamp & Low Watt Ballast	Excellent Opportunity for retrofit	121.2	1,786	3,246.9	1.818	77	1,786	2,062.8	1.155
E - 180	15	4' 3L Fixture	15	Lamp & Low Watt Ballast	Excellent Opportunity for retrofit	121.2	1,786	3,246.9	1.818	77	1,786	2,062.8	1.155
E - 181	15	4' 3L Fixture	15	Lamp & Low Watt Ballast	Excellent Opportunity for retrofit	121.2	1,786	3,246.9	1.818	77	1,786	2,062.8	1.155
E - 183	21	4' 4L Fixture	21	Lamp & Low Watt Ballast	Excellent Opportunity for retrofit	151.2	1,786	5,670.9	3.1752	100	1,786	3,750.6	2.1
E - 184	18	4' 3L Fixture	18	Lamp & Low Watt Ballast	Excellent Opportunity for retrofit	121.2	1,786	3,896.3	2.1816	77	1,786	2,475.4	1.386
E - 185	18	4' 3L Fixture	18	Lamp & Low Watt Ballast	Excellent Opportunity for retrofit	121.2	1,786	3,896.3	2.1816	77	1,786	2,475.4	1.386
E - 186	18	4' 3L Fixture	18	Lamp & Low Watt Ballast	Excellent Opportunity for retrofit	121.2	1,786	3,896.3	2.1816	77	1,786	2,475.4	1.386
Girls' Rest Room	2	4' 4L Fixture	2	Lamp & Low Watt Ballast	Excellent Opportunity for retrofit	151.2	1,786	540.1	0.3024	100	1,786	357.2	0.2
Boys' Restroom	1	4' 4L Fixture	1	Lamp & Low Watt Ballast	Excellent Opportunity for retrofit	151.2	1,786	270.0	0.1512	100	1,786	178.6	0.1
BUILDING F	0		0		0		1,786	0.0	0		1,786	0.0	0
F - 176	8	4' 2L Fixture	8	Lamp & Low Watt Ballast	Replace fixture & mount hardware	75.6	1,786	1,080.2	0.6048	51	1,786	728.7	0.408
0	4	4' 2L Fixture	4	Lamp & Low Watt Ballast	Excellent Opportunity for retrofit	75.6	1,786	540.1	0.3024	51	1,786	364.3	0.204
0	1	4' 4L Fixture	1	Lamp & Low Watt Ballast	Replace fixture & mount hardware	151.2	1,786	270.0	0.1512	100	1,786	178.6	0.1
F - 177	27	4' 2L Fixture	27	Lamp & Low Watt Ballast	Excellent Opportunity for retrofit	75.6	1,786	3,645.6	2.0412	51	1,786	2,459.3	1.377
Hall Office	2	4' 4L Fixture	2	Lamp & Low Watt Ballast	Excellent Opportunity for retrofit	151.2	1,786	540.1	0.3024	100	1,786	357.2	0.2
F - 178	27	4' 2L Fixture	27	Lamp & Low Watt Ballast	Excellent Opportunity for retrofit	75.6	1,786	3,645.6	2.0412	51	1,786	2,459.3	1.377
Girls' Restroom	4	4' 2L Fixture	4	Lamp & Low Watt Ballast	Excellent Opportunity for retrofit	75.6	1,786	540.1	0.3024	51	1,786	364.3	0.204
Boys' Restroom	1	4' 4L Fixture	1	Lamp & Low Watt Ballast	Excellent Opportunity for retrofit	151.2	1,786	270.0	0.1512	100	1,786	178.6	0.1
BUILDING G	0		0		0		1,786	0.0	0		1,786	0.0	0
Cafeteria	0		0		0		1,786	0.0	0		1,786	0.0	0
Dining Room A	13	4' 4L Fixture	13	Lamp & Low Watt Ballast	Excellent Opportunity for retrofit	151.2	1,786	3,510.6	1.9656	100	1,786	2,321.8	1.3
0	10	8' 2L Fixture	10	Lamp & Ballast Retrofit	Excellent Opportunity for retrofit	158	1,786	2,821.9	1.58	110	1,786	1,964.6	1.1
Kitchen	16	8' 2L Fixture	16	Lamp & Ballast Retrofit	Replace fixture & mount hardware	158	1,786	4,515.0	2.528	102	1,786	2,914.8	1.632
Office	6	4' 2L Fixture	6	Lamp & Low Watt Ballast	Excellent Opportunity for retrofit	75.6	1,786	810.1	0.4536	51	1,786	546.5	0.306
Dining Room B	11	4' 4L Fixture	11	Lamp & Low Watt Ballast	Excellent Opportunity for retrofit	151.2	1,786	2,970.5	1.6632	100	1,786	1,964.6	1.1
0	6	4' 4L Fixture	6	Lamp & Low Watt Ballast	Excellent Opportunity for retrofit	151.2	1,786	1,620.3	0.9072	100	1,786	1,071.6	0.6
BUILDING H	0		0		0		1,786	0.0	0		1,786	0.0	0
M - 1	2	4' 4L Fixture	2	Lamp & Low Watt Ballast	Excellent Opportunity for retrofit	151.2	1,786	540.1	0.3024	100	1,786	357.2	0.2
M - 2	3	8' 2L Fixture	3	Lamp & Ballast Retrofit	Replace fixture & mount hardware	158	1,786	846.6	0.474	102	1,786	546.5	0.306
BUILDING J	0		0		0		1,786	0.0	0		1,786	0.0	0
Library	33	8' 2L Fixture	33	Lamp & Ballast Retrofit	Replace fixture & mount hardware	158	1,786	9,312.2	5.214	102	1,786	6,011.7	3.366
Store Room	3	8' 1L Fixture	3	Lamp & Ballast Retrofit	Replace fixture & mount hardware	69	1,786	369.7	0.207	62	1,786	332.2	0.186
J - 21	15	8' 2L Fixture	15	Lamp & Ballast Retrofit	Replace fixture & mount hardware	158	1,786	4,232.8	2.37	102	1,786	2,732.6	1.53
J - 22	15	8' 2L Fixture	15	Lamp & Ballast Retrofit	Replace fixture & mount hardware	158	1,786	4,232.8	2.37	102	1,786	2,732.6	1.53
J - 23	15	8' 2L Fixture	15	Lamp & Ballast Retrofit	Replace fixture & mount hardware	158	1,786	4,232.8	2.37	102	1,786	2,732.6	1.53
Store Room	2	8' 1L Fixture	2	Lamp & Ballast Retrofit	Replace fixture & mount hardware	69	1,786	246.5	0.138	62	1,786	221.5	0.124
Girls' Restroom	4	4' 2L Fixture	4	Lamp & Low Watt Ballast	Excellent Opportunity for retrofit	75.6	1,786	540.1	0.3024	51	1,786	364.3	0.204
Boys' Restroom	1	4' 4L Fixture	1	Lamp & Low Watt Ballast	Excellent Opportunity for retrofit	151.2	1,786	270.0	0.1512	100	1,786	178.6	0.1
Men's Rest Room	1	4' 4L Fixture	1	Lamp & Low Watt Ballast	Excellent Opportunity for retrofit	151.2	1,786	270.0	0.1512	100	1,786	178.6	0.1
BUILDING K	0		0		0		1,786	0.0	0		1,786	0.0	0
K - 101	25	4' 4L Fixture	25	Lamp & Low Watt Ballast	Excellent Opportunity for retrofit	151.2	1,786	6,751.1	3.78	100	1,786	4,465.0	2.5
K - 102	16	4' 4L Fixture	16	Lamp & Low Watt Ballast	Excellent Opportunity for retrofit	151.2	1,786	4,320.7	2.4192	100	1,786	2,857.6	1.6
BUILDING L	0		0		0		1,786	0.0	0		1,786	0.0	0
A - 1	18	8' 2L Fixture	18	Lamp & Ballast Retrofit	Replace fixture & mount hardware	158	1,786	5,079.4	2.844	110	1,786	3,536.3	1.98
0	6	4' 2L Fixture	6	Lamp & Low Watt Ballast	Replace fixture & mount hardware	75.6	1,786	810.1	0.4536	51	1,786	546.5	0.306
A - 2	18	8' 2L Fixture	18	Lamp & Ballast Retrofit	Replace fixture & mount hardware	158	1,786	5,079.4	2.844	102	1,786	3,279.1	1.836
0	6	4' 2L Fixture	6	Lamp & Low Watt Ballast	Replace fixture & mount hardware	75.6	1,786	810.1	0.4536	51	1,786	546.5	0.306
A - 3	38	8' 2L Fixture	38	Lamp & Ballast Retrofit	Replace fixture & mount hardware	158	1,786	10,723.1	6.004	102	1,786	6,922.5	3.876
0	16	4' 2L Fixture	16	Lamp & Low Watt Ballast	Replace fixture & mount hardware	75.6	1,786	2,160.3	1.2096	51	1,786	1,457.4	0.816
BUILDING M	0		0		0		1,786	0.0	0		1,786	0.0	0
S - 1	0		0		0		1,786	0.0	0		1,786	0.0	0
Drafting	60	4' 4L Fixture	60	Lamp & Low Watt Ballast	Excellent Opportunity for retrofit	151.2	1,786	16,202.6	9.072	100	1,786	10,716.0	6
Mini Lab	4	4' 2L Fixture	4	Lamp & Low Watt Ballast	Excellent Opportunity for retrofit	75.6	1,786	540.1	0.3024	51	1,786	364.3	0.204
Hall	1	4' 2L Fixture	1	Lamp & Low Watt Ballast	Excellent Opportunity for retrofit	75.6	1,786	135.0	0.0756	51	1,786	91.1	0.051
Office	4	4' 2L Fixture	4	Lamp & Low Watt Ballast	Excellent Opportunity for retrofit	75.6	1,786	540.1	0.3024	51	1,786	364.3	0.204
S - 2	0		0		0		1,786	0.0	0		1,786	0.0	0
Theatre	30	4' 2L Fixture	30	Lamp & Low Watt Ballast	Excellent Opportunity for retrofit	75.6	1,786	4,050.6	2.268	51	1,786	2,732.6	1.53
Office	6	4' 4L Fixture	6	Lamp & Low Watt Ballast	Excellent Opportunity for retrofit	151.2	1,786	1,620.3	0.9072	100	1,786	1,071.6	0.6

LOCATION	QTY	EXISTING TYPE	QTY	RETROFIT		Actual				Proposed			
						Existing Watt/unit	Op. Hours	kWh	kW-D	Watt/unit	Op. Hours	kWh	kW-D
<i>Class</i>	6	4' 4L Fixture	6	Lamp & Low Watt Ballast	Excellent Opportunity for retrofit	151.2	1,786	1,620.3	0.9072	100	1,786	1,071.6	0.6
BUILDING R	0		0		0		1,786	0.0	0		1,786	0.0	0
<i>R - 14</i>	45	4' 4L Fixture	45	Lamp & Low Watt Ballast	Excellent Opportunity for retrofit	151.2	1,786	12,151.9	6.804	100	1,786	8,037.0	4.5
<i>R - 15</i>	30	4' 4L Fixture	30	Lamp & Low Watt Ballast	Excellent Opportunity for retrofit	151.2	1,786	8,101.3	4.536	100	1,786	5,358.0	3
<i>Conference</i>	2	4' 4L Fixture	2	Lamp & Low Watt Ballast	Excellent Opportunity for retrofit	151.2	1,786	540.1	0.3024	100	1,786	357.2	0.2
<i>Teachers' Room</i>	2	4' 4L Fixture	2	Lamp & Low Watt Ballast	Excellent Opportunity for retrofit	151.2	1,786	540.1	0.3024	100	1,786	357.2	0.2
<i>Dressing Room</i>	1	4' 4L Fixture	1	Lamp & Low Watt Ballast	Excellent Opportunity for retrofit	151.2	1,786	270.0	0.1512	100	1,786	178.6	0.1
<i>Girls' Restroom</i>	1	4' 2L Fixture	1	Lamp & Low Watt Ballast	Excellent Opportunity for retrofit	75.6	1,786	135.0	0.0756	51	1,786	91.1	0.051
<i>Boys' Restroom</i>	1	4' 2L Fixture	1	Lamp & Low Watt Ballast	Excellent Opportunity for retrofit	75.6	1,786	135.0	0.0756	51	1,786	91.1	0.051
BUILDING S	0		0		0		1,786	0.0	0		1,786	0.0	0
<i>S - 3</i>	0		0		0		1,786	0.0	0		1,786	0.0	0
<i>Auto-shop</i>	34	8' 2L Fixture	34	Lamp & Ballast Retrofit	Replace fixture & mount hardware	158	1,786	9,594.4	5.372	102	1,786	6,193.8	3.468
<i>Class</i>	20	4' 4L Fixture	20	Lamp & Low Watt Ballast	Replace fixture & mount hardware	151.2	1,786	5,400.9	3.024	100	1,786	3,572.0	2
<i>Office</i>	1	4' 4L Fixture	1	Lamp & Low Watt Ballast	Excellent Opportunity for retrofit	151.2	1,786	270.0	0.1512	100	1,786	178.6	0.1
<i>S - 4</i>	0		0		0		1,786	0.0	0		1,786	0.0	0
<i>Wood-Shop</i>	24	8' 2L Fixture	24	Lamp & Ballast Retrofit	Excellent Opportunity for retrofit	158	1,786	6,772.5	3.792	110	1,786	4,715.0	2.64
<i>Class</i>	10	4' 4L Fixture	10	Lamp & Low Watt Ballast	Replace fixture & mount hardware	151.2	1,786	2,700.4	1.512	100	1,786	1,786.0	1
<i>Office</i>	2	4' 4L Fixture	2	Lamp & Low Watt Ballast	Excellent Opportunity for retrofit	151.2	1,786	540.1	0.3024	100	1,786	357.2	0.2
BUILDING TT	0		0		0		1,786	0.0	0		1,786	0.0	0
<i>JROTC</i>	0		0		0		1,786	0.0	0		1,786	0.0	0
<i>Office</i>	3	4' 4L Fixture	3	Lamp & Low Watt Ballast	Excellent Opportunity for retrofit	151.2	1,786	810.1	0.4536	100	1,786	535.8	0.3
<i>Outside Lanai</i>	8		0		T8 Lamps/Elec. Ballast, No Retrofit		1,786	0.0	0		1,786	0.0	0
<i>Office</i>	8		0		T8 Lamps/Elec. Ballast, No Retrofit		1,786	0.0	0		1,786	0.0	0
<i>Arms Room</i>	1		0		T8 Lamps/Elec. Ballast, No Retrofit		1,786	0.0	0		1,786	0.0	0
<i>Bathroom</i>	1		0		T8 Lamps/Elec. Ballast, No Retrofit		1,786	0.0	0		1,786	0.0	0
<i>Class</i>	6		0		T8 Lamps/Elec. Ballast, No Retrofit		1,786	0.0	0		1,786	0.0	0
<i>Supplay Room</i>	1		0		T8 Lamps/Elec. Ballast, No Retrofit		1,786	0.0	0		1,786	0.0	0
<i>Class</i>	6		0		T8 Lamps/Elec. Ballast, No Retrofit		1,786	0.0	0		1,786	0.0	0
<i>Hall</i>	1		0		T8 Lamps/Elec. Ballast, No Retrofit		1,786	0.0	0		1,786	0.0	0
<i>Locker Room</i>	3		0		T8 Lamps/Elec. Ballast, No Retrofit		1,786	0.0	0		1,786	0.0	0
PORTABLES	0		0		0		1,786	0.0	0		1,786	0.0	0
<i>P - 1</i>	16	4' 4L Fixture	16	Lamp & Low Watt Ballast	Excellent Opportunity for retrofit	151.2	1,786	4,320.7	2.4192	100	1,786	2,857.6	1.6
<i>P - 2</i>	16	4' 4L Fixture	16	Lamp & Low Watt Ballast	Excellent Opportunity for retrofit	151.2	1,786	4,320.7	2.4192	100	1,786	2,857.6	1.6
<i>P - 3</i>	16	4' 4L Fixture	16	Lamp & Low Watt Ballast	Excellent Opportunity for retrofit	151.2	1,786	4,320.7	2.4192	100	1,786	2,857.6	1.6
<i>P - 4</i>	16	4' 4L Fixture	16	Lamp & Low Watt Ballast	Excellent Opportunity for retrofit	151.2	1,786	4,320.7	2.4192	100	1,786	2,857.6	1.6
<i>P - 5</i>	16	4' 4L Fixture	16	Lamp & Low Watt Ballast	Excellent Opportunity for retrofit	151.2	1,786	4,320.7	2.4192	100	1,786	2,857.6	1.6
<i>P - 6</i>	16	4' 4L Fixture	16	Lamp & Low Watt Ballast	Excellent Opportunity for retrofit	151.2	1,786	4,320.7	2.4192	100	1,786	2,857.6	1.6
<i>P - 7</i>	16	4' 4L Fixture	16	Lamp & Low Watt Ballast	Excellent Opportunity for retrofit	151.2	1,786	4,320.7	2.4192	100	1,786	2,857.6	1.6
<i>P - 8</i>	16	4' 4L Fixture	16	Lamp & Low Watt Ballast	Excellent Opportunity for retrofit	151.2	1,786	4,320.7	2.4192	100	1,786	2,857.6	1.6
<i>P - 9</i>	16	4' 4L Fixture	16	Lamp & Low Watt Ballast	Excellent Opportunity for retrofit	151.2	1,786	4,320.7	2.4192	100	1,786	2,857.6	1.6
<i>P - 10</i>	16	4' 4L Fixture	16	Lamp & Low Watt Ballast	Excellent Opportunity for retrofit	151.2	1,786	4,320.7	2.4192	100	1,786	2,857.6	1.6
<i>P - 11</i>	16	4' 4L Fixture	16	Lamp & Low Watt Ballast	Excellent Opportunity for retrofit	151.2	1,786	4,320.7	2.4192	100	1,786	2,857.6	1.6
<i>P - 12</i>	16	4' 4L Fixture	16	Lamp & Low Watt Ballast	Excellent Opportunity for retrofit	151.2	1,786	4,320.7	2.4192	100	1,786	2,857.6	1.6
<i>P - 13</i>	16	4' 4L Fixture	16	Lamp & Low Watt Ballast	Excellent Opportunity for retrofit	151.2	1,786	4,320.7	2.4192	100	1,786	2,857.6	1.6
<i>P - 14</i>	16	4' 4L Fixture	16	Lamp & Low Watt Ballast	Excellent Opportunity for retrofit	151.2	1,786	4,320.7	2.4192	100	1,786	2,857.6	1.6
<i>P - 15</i>	16	4' 4L Fixture	16	Lamp & Low Watt Ballast	Excellent Opportunity for retrofit	151.2	1,786	4,320.7	2.4192	100	1,786	2,857.6	1.6
<i>P - 16</i>	16	4' 4L Fixture	16	Lamp & Low Watt Ballast	Excellent Opportunity for retrofit	151.2	1,786	4,320.7	2.4192	100	1,786	2,857.6	1.6
<i>P - 17</i>	16	4' 4L Fixture	16	Lamp & Low Watt Ballast	Excellent Opportunity for retrofit	151.2	1,786	4,320.7	2.4192	100	1,786	2,857.6	1.6
<i>P - 18</i>	16	4' 4L Fixture	16	Lamp & Low Watt Ballast	Excellent Opportunity for retrofit	151.2	1,786	4,320.7	2.4192	100	1,786	2,857.6	1.6
<i>P - 19</i>	12	4' 4L Fixture	12	Lamp & Low Watt Ballast	Excellent Opportunity for retrofit	151.2	1,786	3,240.5	1.8144	100	1,786	2,143.2	1.2
<i>P - 20 A</i>	6	4' 4L Fixture	6	Lamp & Low Watt Ballast	Excellent Opportunity for retrofit	151.2	1,786	1,620.3	0.9072	100	1,786	1,071.6	0.6
<i>P - 20B</i>	6	4' 4L Fixture	6	Lamp & Low Watt Ballast	Excellent Opportunity for retrofit	151.2	1,786	1,620.3	0.9072	100	1,786	1,071.6	0.6
<i>P - 21</i>	12	4' 4L Fixture	12	Lamp & Low Watt Ballast	Excellent Opportunity for retrofit	151.2	1,786	3,240.5	1.8144	100	1,786	2,143.2	1.2
<i>P - 22</i>	12	4' 4L Fixture	12	Lamp & Low Watt Ballast	Excellent Opportunity for retrofit	151.2	1,786	3,240.5	1.8144	100	1,786	2,143.2	1.2
<i>P - 23</i>	12	4' 4L Fixture	12	Lamp & Low Watt Ballast	Excellent Opportunity for retrofit	151.2	1,786	3,240.5	1.8144	100	1,786	2,143.2	1.2
<i>P - 24</i>	12	4' 4L Fixture	12	Lamp & Low Watt Ballast	Excellent Opportunity for retrofit	151.2	1,786	3,240.5	1.8144	100	1,786	2,143.2	1.2

Existing Qty. 1884 Proposed Qty. 1849

ENERGY CALCULATIONS			468,165	262	308,557	173
Description	kW-Demand	kWh				
Existing Use	262.13	468,165				
Proposed Use	172.76	308,557				
Difference - Savings	89.37	159,608				
Electrical Utility Cost	\$5.75	\$0.15390				
Savings per Year	\$6,166.27	\$24,563.20	Total Yearly Energy Savings		\$30,729.47	

Haiku Elementary School
 105 Pauwela Road
 Haiku, Maui, Hawaii 96708

Phone: 575-3000
 FAX: 575-3003

CAMPUS MAP

P-2
Toddy

C-5
Owens

C-4
Daly

C-3
Porter

C-2
Grayden

C-1
Knovlton

boys/girls
restrooms

D-4
Walter

D-3
Young, B.

D-2

boys/girls
restrooms

D-1
Beppu

D-1A
Akashi

Therapy Room
P-10
Jones

Conference RM
P-9---
Armstrong, P.

PSAP
...P-3
Gintling

Cafeteria

P-4
Kuba

Smith P13

P14
Pascher

Squires P15

Head
Start
Preschool

P-11
Bowman

ESL1
P-12
Holt
Gamposia

P-7
Chow

PARENT Gen.
P-6
PCNC
21st

Work room	Principal	Tech. Hub	Health Room	Shimizu/ Yamamura Library
Clerk	SASA	Makua's Lounge	Study	

Glass Area
Parking

P-8
Haines

E-3 delos Sanford	E-1 Nakahaahi
E-4 Kelly	E-2 Brown
Counselor Kakiuchi	
boys' restroom	girls' restroom

Maui Smart Schools Program
Foot Candle Readings

School: Haiku Elementary School

Room: P-13 Head start
Ceiling height: 9'
Light fixture height: 7'
Fixture type: ICE TRAY

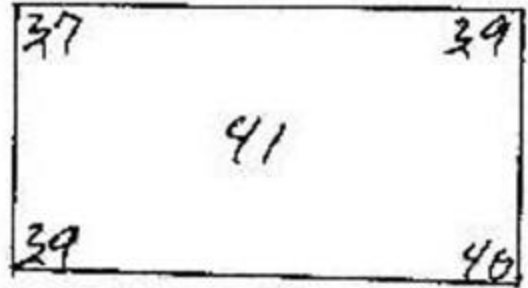

Room: Bldg. G - G-104
Ceiling height: 9'
Light fixture height: 7'
Fixture type: Ice TRAY

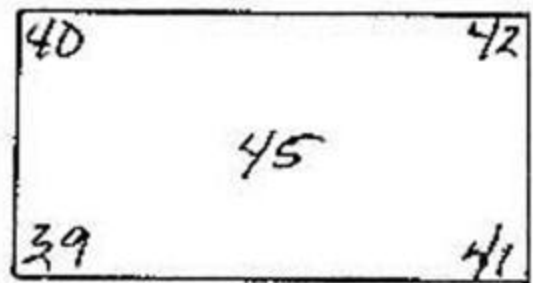

Room: Bldg. C - C-3
Ceiling height: 9'
Light fixture height: 7'
Fixture type: Ice TRAY

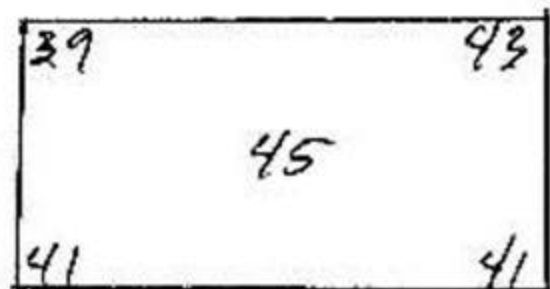



SCHOOL INFORMATION		
NAME	Haiku Elementary School	DATE 2/8/2001
STREET ADDRESS	105 Pauwela Road Haiku, HI 96708	
POINT OF CONTACT	PHONE	FAX
Fern Markgraf	575-3000	
AUDITOR	VOLTAGE	
Maui Community College Auditors	120V	

LOCATION <small>(Rm Name, Rm. #, Area, Zone, etc.)</small>	EXISTING EQUIPMENT						PROPOSED			REBATES		COSTS		COMMENTS <small>SurvivorComments</small>
	Floor	Quantity	Lamp Type	Lamps Per Fixture	Type of Fixture	Ballast Type	Lamps Per Fixture	Reflectors	Ballast Type	Per Single	Extended	Per Single	Extended	
Head Start		16	4' T12	4	Wrap	Magnetic	4	N	Electronic	\$ 11.20	\$ 179.20	\$ 70.00	\$ 1,120.00	Excellent Opportunity for retrofit
P 13		16	4' T12	4	Troffer	Magnetic	4	N	Electronic	\$ 11.20	\$ 179.20	\$ 70.00	\$ 1,120.00	Excellent Opportunity for retrofit
P 14		16	4' T12	4	Troffer	Magnetic	4	N	Electronic	\$ 11.20	\$ 179.20	\$ 70.00	\$ 1,120.00	Excellent Opportunity for retrofit
P 15		16	4' T12	4	Troffer	Magnetic	4	N	Electronic	\$ 11.20	\$ 179.20	\$ 70.00	\$ 1,120.00	Excellent Opportunity for retrofit
P 4		16	4' T12	4	Wrap	Magnetic	4	N	Electronic	\$ 11.20	\$ 179.20	\$ 70.00	\$ 1,120.00	Excellent Opportunity for retrofit
P 3		12	4' T12	4	Wrap	Magnetic	4	N	Electronic	\$ 11.20	\$ 134.40	\$ 70.00	\$ 840.00	Excellent Opportunity for retrofit
P 9		12	4' T12	4	Wrap	Magnetic	4	N	Electronic	\$ 11.20	\$ 134.40	\$ 70.00	\$ 840.00	Excellent Opportunity for retrofit
P 10		12	4' T12	4	Wrap	Magnetic	4	N	Electronic	\$ 11.20	\$ 134.40	\$ 70.00	\$ 840.00	Excellent Opportunity for retrofit
BUILDING D														
D 4		9	4' T12	4	Ice	Magnetic	4	N	Electronic	\$ 11.20	\$ 100.80	\$ 160.00	\$ 1,440.00	Replace fixture & mount hardware
D 3		9	4' T12	4	Ice	Magnetic	4	N	Electronic	\$ 11.20	\$ 100.80	\$ 160.00	\$ 1,440.00	Replace fixture & mount hardware
D 2		9	4' T12	4	Ice	Magnetic	4	N	Electronic	\$ 11.20	\$ 100.80	\$ 160.00	\$ 1,440.00	Replace fixture & mount hardware
Boys' Restroom		2	4' T12	2	Wrap	Magnetic	2	N	Electronic	\$ 5.60	\$ 11.20	\$ 60.00	\$ 120.00	Excellent Opportunity for retrofit
Girls' Restroom		2	4' T12	2	Wrap	Magnetic	2	N	Electronic	\$ 5.60	\$ 11.20	\$ 60.00	\$ 120.00	Excellent Opportunity for retrofit
D 1		5	4' T12	4	Ice	Magnetic	4	N	Electronic	\$ 11.20	\$ 56.00	\$ 160.00	\$ 800.00	Replace fixture & mount hardware
Bathroom		1	4' T12	2	Wrap	Magnetic	2	N	Electronic	\$ 5.60	\$ 5.60	\$ 60.00	\$ 60.00	Excellent Opportunity for retrofit
BUILDING C														
Boys' Restroom		2	4' T12	2	Wrap	Magnetic	2	N	Electronic	\$ 5.60	\$ 11.20	\$ 60.00	\$ 120.00	Excellent Opportunity for retrofit
Girls' Restroom		2	4' T12	2	Wrap	Magnetic	2	N	Electronic	\$ 5.60	\$ 11.20	\$ 60.00	\$ 120.00	Excellent Opportunity for retrofit
C 1		9	4' T12	4	Ice	Magnetic	4	N	Electronic	\$ 11.20	\$ 100.80	\$ 160.00	\$ 1,440.00	Replace fixture & mount hardware
C 2		9	4' T12	4	Ice	Magnetic	4	N	Electronic	\$ 11.20	\$ 100.80	\$ 160.00	\$ 1,440.00	Replace fixture & mount hardware
C 3		9	4' T12	4	Ice	Magnetic	4	N	Electronic	\$ 11.20	\$ 100.80	\$ 160.00	\$ 1,440.00	Replace fixture & mount hardware
C 4		9	4' T12	4	Ice	Magnetic	4	N	Electronic	\$ 11.20	\$ 100.80	\$ 160.00	\$ 1,440.00	Replace fixture & mount hardware
C 5		9	4' T12	4	Ice	Magnetic	4	N	Electronic	\$ 11.20	\$ 100.80	\$ 160.00	\$ 1,440.00	Replace fixture & mount hardware
P 2		16	4' T12	4	Wrap	Magnetic	4	N	Electronic	\$ 11.20	\$ 179.20	\$ 160.00	\$ 2,560.00	Excellent Opportunity for retrofit
Library		23	4' T12	3	Troffer	Magnetic	3	N	Electronic	\$ 8.40	\$ 193.20	\$ 65.00	\$ 1,495.00	Excellent Opportunity for retrofit
Teachers' Lounge		15	4' T12	3	Troffer	Magnetic	3	N	Electronic	\$ 8.40	\$ 126.00	\$ 65.00	\$ 975.00	Excellent Opportunity for retrofit
Office		14	4' T12	3	Troffer	Magnetic	3	N	Electronic	\$ 8.40	\$ 117.60	\$ 65.00	\$ 910.00	Excellent Opportunity for retrofit
Toilet		1	4' T12	4	Wrap	Magnetic	4	N	Electronic	\$ 11.20	\$ 11.20	\$ 70.00	\$ 70.00	Excellent Opportunity for retrofit
BUILDING E														
E 1		20	4' T12	2	Wrap	Magnetic	2	N	Electronic	\$ 5.60	\$ 112.00	\$ 60.00	\$ 1,200.00	Excellent Opportunity for retrofit
E 3		20	4' T12	2	Wrap	Magnetic	2	N	Electronic	\$ 5.60	\$ 112.00	\$ 60.00	\$ 1,200.00	Excellent Opportunity for retrofit
E 4		20	4' T12	2	Wrap	Magnetic	2	N	Electronic	\$ 5.60	\$ 112.00	\$ 60.00	\$ 1,200.00	Excellent Opportunity for retrofit

LOCATION (Rm Name, Rm. #, Area, Zone, etc.)	EXISTING EQUIPMENT						PROPOSED			REBATES		COSTS		COMMENTS SurveyorsCo mments
	Floor	Quantity	Lamp Type	Lamps Per Fixture	Type of Fixture	Ballast Type	Lamps Per Fixture	Reflectors	Ballast Type	Per Single	Extended	Per Single	Extended	
Boys' Restroom		2	4' T12	2	Wrap	Magnetic	2	N	Electronic	\$ 5.60	\$ 11.20	\$ 60.00	\$ 120.00	Excellent Opportunity for retrofit
Girls' Restroom		2	4' T12	2	Wrap	Magnetic	2	N	Electronic	\$ 5.60	\$ 11.20	\$ 60.00	\$ 120.00	Excellent Opportunity for retrofit
Teachers' Restroom		3	4' T12	2	Wrap	Magnetic	2	N	Electronic	\$ 5.60	\$ 16.80	\$ 60.00	\$ 180.00	Excellent Opportunity for retrofit
E 2		20	4' T12	2	Wrap	Magnetic	2	N	Electronic	\$ 5.60	\$ 112.00	\$ 60.00	\$ 1,200.00	Excellent Opportunity for retrofit
PORTABLES														
P 6		16	4' T12	4	Wrap	Magnetic	4	N	Electronic	\$ 11.20	\$ 179.20	\$ 70.00	\$ 1,120.00	Excellent Opportunity for retrofit
P 12		16	4' T12	4	Wrap	Magnetic	4	N	Electronic	\$ 11.20	\$ 179.20	\$ 70.00	\$ 1,120.00	Excellent Opportunity for retrofit
P 11		16	4' T12	3	Troffer	Magnetic	3	N	Electronic	\$ 8.40	\$ 134.40	\$ 65.00	\$ 1,040.00	Excellent Opportunity for retrofit
P 7		16	4' T12	4	Wrap	Magnetic	4	N	Electronic	\$ 11.20	\$ 179.20	\$ 70.00	\$ 1,120.00	Excellent Opportunity for retrofit
P 8		16	4' T12	4	ICE	Magnetic	4	N	Electronic	\$ 11.20	\$ 179.20	\$ 160.00	\$ 2,560.00	Replace fixture & mount hardware
CAFETERIA														
Dining Room		10	4' T12	4	ICE	Magnetic	4	N	Electronic	\$ 11.20	\$ 112.00	\$ 160.00	\$ 1,600.00	Replace fixture & mount hardware
Kitchen		8	4' T12	2	Open	Magnetic	2	N	Electronic	\$ 5.60	\$ 44.80	\$ 60.00	\$ 480.00	Excellent Opportunity for retrofit
		1	8' T12	2	Open	Magnetic	2	N	Electronic	\$ 7.20	\$ 7.20	\$ 80.00	\$ 80.00	Excellent Opportunity for retrofit
Total Rebates										\$	4,341.60			
Total Costs										\$	41,330.00			

Haiku Elementary School

LOCATION	QTY	EXISTING TYPE	QTY	RETROFIT	SURVEYORS COMMENTS	Existing				Proposed			
						Watt/unit	Op. Hours	kWh	kW-D	Watt/unit	Op. Hours	kWh	kW-D
Head Start	16	4' 4L Fixture	16	Lamp & Low Watt Ballast	Excellent Opportunity for retrofit	151.2	1,937	4,684.8	2,4192	100	1,937	3,098.4	1.6
P 13	16	4' 4L Fixture	16	Lamp & Low Watt Ballast	Excellent Opportunity for retrofit	151.2	1,937	4,684.8	2,4192	100	1,937	3,098.4	1.6
P 14	16	4' 4L Fixture	16	Lamp & Low Watt Ballast	Excellent Opportunity for retrofit	151.2	1,937	4,684.8	2,4192	100	1,937	3,098.4	1.6
P 15	16	4' 4L Fixture	16	Lamp & Low Watt Ballast	Excellent Opportunity for retrofit	151.2	1,937	4,684.8	2,4192	100	1,937	3,098.4	1.6
P 4	16	4' 4L Fixture	16	Lamp & Low Watt Ballast	Excellent Opportunity for retrofit	151.2	1,937	4,684.8	2,4192	100	1,937	3,098.4	1.6
P 3	12	4' 4L Fixture	12	Lamp & Low Watt Ballast	Excellent Opportunity for retrofit	151.2	1,937	3,513.6	1,8144	100	1,937	2,323.8	1.2
P 9	12	4' 4L Fixture	12	Lamp & Low Watt Ballast	Excellent Opportunity for retrofit	151.2	1,937	3,513.6	1,8144	100	1,937	2,323.8	1.2
P 10	12	4' 4L Fixture	12	Lamp & Low Watt Ballast	Excellent Opportunity for retrofit	151.2	1,937	3,513.6	1,8144	100	1,937	2,323.8	1.2
BUILDING D	0		0		0		1,937	0.0	0		1,937	0.0	0
D 4	9	4' 4L Fixture	9	Lamp & Low Watt Ballast	Replace fixture & mount hardware	151.2	1,937	2,635.2	1,3608	100	1,937	1,742.9	0.9
D 3	9	4' 4L Fixture	9	Lamp & Low Watt Ballast	Replace fixture & mount hardware	151.2	1,937	2,635.2	1,3608	100	1,937	1,742.9	0.9
D 2	9	4' 4L Fixture	9	Lamp & Low Watt Ballast	Replace fixture & mount hardware	151.2	1,937	2,635.2	1,3608	100	1,937	1,742.9	0.9
Boys' Restroom	2	4' 2L Fixture	2	Lamp & Low Watt Ballast	Excellent Opportunity for retrofit	75.6	1,937	292.8	0.1512	51	1,937	197.5	0.102
Girls' Restroom	2	4' 2L Fixture	2	Lamp & Low Watt Ballast	Excellent Opportunity for retrofit	75.6	1,937	292.8	0.1512	51	1,937	197.5	0.102
D 1	5	4' 4L Fixture	5	Lamp & Low Watt Ballast	Replace fixture & mount hardware	151.2	1,937	1,464.0	0.756	100	1,937	968.3	0.5
Bathroom	1	4' 2L Fixture	1	Lamp & Low Watt Ballast	Excellent Opportunity for retrofit	75.6	1,937	146.4	0.0756	51	1,937	98.8	0.051
BUILDING C	0		0		0		1,937	0.0	0		1,937	0.0	0
Boys' Restroom	2	4' 2L Fixture	2	Lamp & Low Watt Ballast	Excellent Opportunity for retrofit	75.6	1,937	292.8	0.1512	51	1,937	197.5	0.102
Girls' Restroom	2	4' 2L Fixture	2	Lamp & Low Watt Ballast	Excellent Opportunity for retrofit	75.6	1,937	292.8	0.1512	51	1,937	197.5	0.102
C 1	9	4' 4L Fixture	9	Lamp & Low Watt Ballast	Replace fixture & mount hardware	151.2	1,937	2,635.2	1,3608	100	1,937	1,742.9	0.9
C 2	9	4' 4L Fixture	9	Lamp & Low Watt Ballast	Replace fixture & mount hardware	151.2	1,937	2,635.2	1,3608	100	1,937	1,742.9	0.9
C 3	9	4' 4L Fixture	9	Lamp & Low Watt Ballast	Replace fixture & mount hardware	151.2	1,937	2,635.2	1,3608	100	1,937	1,742.9	0.9
C 4	9	4' 4L Fixture	9	Lamp & Low Watt Ballast	Replace fixture & mount hardware	151.2	1,937	2,635.2	1,3608	100	1,937	1,742.9	0.9
C 5	9	4' 4L Fixture	9	Lamp & Low Watt Ballast	Replace fixture & mount hardware	151.2	1,937	2,635.2	1,3608	100	1,937	1,742.9	0.9
P 2	16	4' 4L Fixture	16	Lamp & Low Watt Ballast	Excellent Opportunity for retrofit	151.2	1,937	4,684.8	2,4192	100	1,937	3,098.4	1.6
Library	23	4' 3L Fixture	23	Lamp & Low Watt Ballast	Excellent Opportunity for retrofit	121.2	1,937	5,398.2	2,7876	77	1,937	3,429.5	1.771
Teachers' Lounge	15	4' 3L Fixture	15	Lamp & Low Watt Ballast	Excellent Opportunity for retrofit	121.2	1,937	3,520.6	1,818	77	1,937	2,236.7	1.155
Office	14	4' 3L Fixture	14	Lamp & Low Watt Ballast	Excellent Opportunity for retrofit	121.2	1,937	3,285.9	1,6968	77	1,937	2,087.5	1.078
Toilet	1	4' 4L Fixture	1	Lamp & Low Watt Ballast	Excellent Opportunity for retrofit	151.2	1,937	292.8	0.1512	100	1,937	193.7	0.1
BUILDING E	0		0		0		1,937	0.0	0		1,937	0.0	0
E 1	20	4' 2L Fixture	20	Lamp & Low Watt Ballast	Excellent Opportunity for retrofit	75.6	1,937	2,928.0	1,512	51	1,937	1,975.2	1.02
E 3	20	4' 2L Fixture	20	Lamp & Low Watt Ballast	Excellent Opportunity for retrofit	75.6	1,937	2,928.0	1,512	51	1,937	1,975.2	1.02
E 4	20	4' 2L Fixture	20	Lamp & Low Watt Ballast	Excellent Opportunity for retrofit	75.6	1,937	2,928.0	1,512	51	1,937	1,975.2	1.02
Boys' Restroom	2	4' 2L Fixture	2	Lamp & Low Watt Ballast	Excellent Opportunity for retrofit	75.6	1,937	292.8	0.1512	51	1,937	197.5	0.102
Girls' Restroom	2	4' 2L Fixture	2	Lamp & Low Watt Ballast	Excellent Opportunity for retrofit	75.6	1,937	292.8	0.1512	51	1,937	197.5	0.102
Teachers' Restroom	3	4' 2L Fixture	3	Lamp & Low Watt Ballast	Excellent Opportunity for retrofit	75.6	1,937	439.2	0.2268	51	1,937	296.3	0.153
E 2	20	4' 2L Fixture	20	Lamp & Low Watt Ballast	Excellent Opportunity for retrofit	75.6	1,937	2,928.0	1,512	51	1,937	1,975.2	1.02
PORTABLES	0		0		0		1,937	0.0	0		1,937	0.0	0
P 6	16	4' 4L Fixture	16	Lamp & Low Watt Ballast	Excellent Opportunity for retrofit	151.2	1,937	4,684.8	2,4192	100	1,937	3,098.4	1.6
P 12	16	4' 4L Fixture	16	Lamp & Low Watt Ballast	Excellent Opportunity for retrofit	151.2	1,937	4,684.8	2,4192	100	1,937	3,098.4	1.6
P 11	16	4' 3L Fixture	16	Lamp & Low Watt Ballast	Excellent Opportunity for retrofit	121.2	1,937	3,755.3	1,9392	77	1,937	2,385.8	1.232
P 7	16	4' 4L Fixture	16	Lamp & Low Watt Ballast	Excellent Opportunity for retrofit	151.2	1,937	4,684.8	2,4192	100	1,937	3,098.4	1.6
P 8	16	4' 4L Fixture	16	Lamp & Low Watt Ballast	Replace fixture & mount hardware	151.2	1,937	4,684.8	2,4192	100	1,937	3,098.4	1.6
CAFETERIA	0		0		0		1,937	0.0	0		1,937	0.0	0
Dining Room	10	4' 4L Fixture	10	Lamp & Low Watt Ballast	Replace fixture & mount hardware	151.2	1,937	2,928.0	1,512	100	1,937	1,936.5	1
Kitchen	8	4' 2L Fixture	8	Lamp & Low Watt Ballast	Excellent Opportunity for retrofit	75.6	1,937	1,171.2	0.6048	51	1,937	790.1	0.408
0	1	8' 2L Fixture	1	Lamp & Ballast Retrofit	Excellent Opportunity for retrofit	158	1,937	306.0	0.158	110	1,937	213.0	0.11

Existing 457 Proposed 457

ENERGY CALCULATIONS			114,646	59.20	75,620	39.05
Description	kW-Demand	kWh				
Existing Use	59.20	114,646				
Proposed Use	39.05	75,620				
Difference - Savings	20.15	39,026				
Electrical Utility Cost	\$5.75	\$0.16188				
Savings per Year	\$3.00	\$6,317.69				
			Total Yearly Energy Savings		\$6,320.69	

Hana High & Elementary School

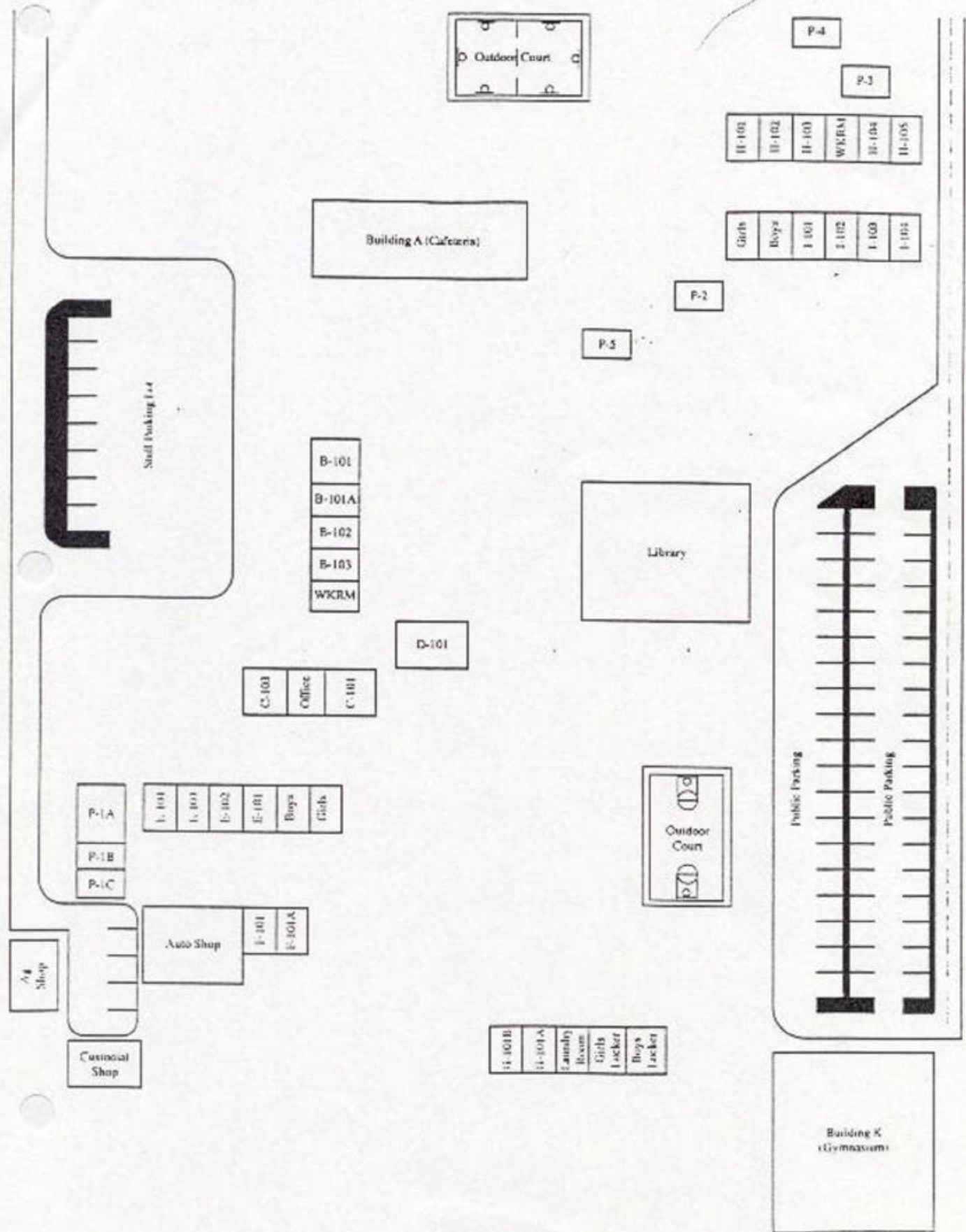

Maui Smart Schools Program
Foot Candle Readings

School: Hana High + Elementary School

Room: Bldg. H H-102

Ceiling height: 9'

Light fixture height: 8'

Fixture type: WRAP

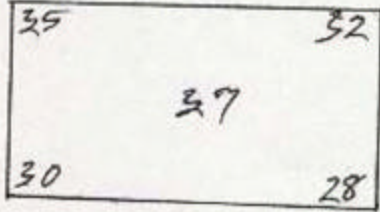

Room: G-101-B

Ceiling height: 9'

Light fixture height: 8'

Fixture type: WRAP

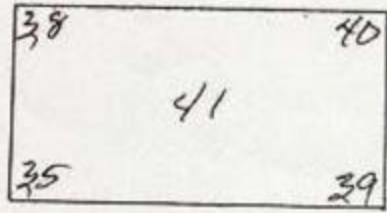

Room: Bldg. E E-102

Ceiling height: 9'

Light fixture height: 8'

Fixture type: WRAP

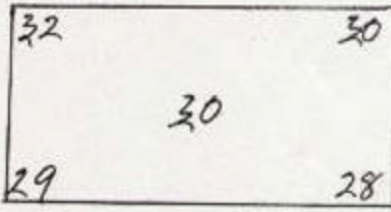



SCHOOL INFORMATION					
NAME Hana High & Elementary School				DATE 2/9/2001	
STREET ADDRESS P. O. Box 128 Hana, HI 96713				OPERATIONAL HOURS 1,974	
POINT OF CONTACT Melanie Coates		PHONE 248-4815	FAX		VOLTAGE 120V
AUDITOR Maui Community College Auditors					

LOCATION (Rm Name, Rm. #, Area, Zone, etc.)	EXISTING EQUIPMENT						PROPOSED			REBATES		COSTS		COMMENTS Surveyors Comments
	Floor	Quantity	Lamp Type	Lamps Per Fixture	Type of Fixture	Ballast Type	Lamps Per Fixture	Reflectors	Ballast Type	Per Single	Extended	Per Single	Extended	
P 5A		6	4' T12	4	Wrap	Magnetic	4	N	Electronic	\$ 11.20	\$ 67.20	\$ 70.00	\$ 420.00	Excellent Opportunity for Retrofit
P 5B		6	4' T12	4	Wrap	Magnetic	4	N	Electronic	\$ 11.20	\$ 67.20	\$ 70.00	\$ 420.00	Excellent Opportunity for Retrofit
P 2A		8	4' T12	4	Wrap	Magnetic	4	N	Electronic	\$ 11.20	\$ 89.60	\$ 70.00	\$ 560.00	Excellent Opportunity for Retrofit
P 2B		8	4' T12	4	Wrap	Magnetic	4	N	Electronic	\$ 11.20	\$ 89.60	\$ 70.00	\$ 560.00	Excellent Opportunity for Retrofit
BUILDING I														
Girls' Restroom		5	4' T12	2	Wrap	Magnetic	2	N	Electronic	\$ 5.60	\$ 28.00	\$ 60.00	\$ 300.00	Excellent Opportunity for Retrofit
Janitor		1	4' T12	1	Wire	Magnetic	1	N	Electronic	\$ 2.80	\$ 2.80	\$ 55.00	\$ 55.00	Excellent Opportunity for Retrofit
Boys' Restroom		5	4' T12	2	Wrap	Magnetic	2	N	Electronic	\$ 5.60	\$ 28.00	\$ 60.00	\$ 300.00	Excellent Opportunity for Retrofit
I 101		24	4' T12	2	Wrap	Magnetic	2	N	Electronic	\$ 5.60	\$ 134.40	\$ 60.00	\$ 1,440.00	Excellent Opportunity for Retrofit
I 102		24	4' T12	2	Wrap	Magnetic	2	N	Electronic	\$ 5.60	\$ 134.40	\$ 60.00	\$ 1,440.00	Excellent Opportunity for Retrofit
I 103		24	4' T12	2	Wrap	Magnetic	2	N	Electronic	\$ 5.60	\$ 134.40	\$ 60.00	\$ 1,440.00	Excellent Opportunity for Retrofit
I 104		24	4' T12	2	Wrap	Magnetic	2	N	Electronic	\$ 5.60	\$ 134.40	\$ 60.00	\$ 1,440.00	Excellent Opportunity for Retrofit
BUILDING H														
H 101		24	4' T12	2	Wrap	Magnetic	2	N	Electronic	\$ 5.60	\$ 134.40	\$ 60.00	\$ 1,440.00	Excellent Opportunity for Retrofit
Janitor		1	4' T12	1	Wire	Magnetic	1	N	Electronic	\$ 2.80	\$ 2.80	\$ 55.00	\$ 55.00	Excellent Opportunity for Retrofit
H 102		22	4' T12	2	Wrap	Magnetic	2	N	Electronic	\$ 5.60	\$ 123.20	\$ 60.00	\$ 1,320.00	Excellent Opportunity for Retrofit
Girls' Restroom		2	4' T12	1	Van	Magnetic	1	N	Electronic	\$ 2.80	\$ 5.60	\$ 55.00	\$ 110.00	Excellent Opportunity for Retrofit
Boys' Restroom		2	4' T12	1	Van	Magnetic	1	N	Electronic	\$ 2.80	\$ 5.60	\$ 55.00	\$ 110.00	Excellent Opportunity for Retrofit
H 103		22	4' T12	2	Wrap	Magnetic	2	N	Electronic	\$ 5.60	\$ 123.20	\$ 60.00	\$ 1,320.00	Excellent Opportunity for Retrofit
Teachers' Restroom		1	4' T12	2	Van	Magnetic	2	N	Electronic	\$ 2.80	\$ 2.80	\$ 55.00	\$ 55.00	Excellent Opportunity for Retrofit
Work Room		10	4' T12	2	Wrap	Magnetic	2	N	Electronic	\$ 5.60	\$ 56.00	\$ 60.00	\$ 600.00	Excellent Opportunity for Retrofit
H 104		22	4' T12	2	Wrap	Magnetic	2	N	Electronic	\$ 5.60	\$ 123.20	\$ 60.00	\$ 1,320.00	Excellent Opportunity for Retrofit
Girls' Restroom		2	4' T12	2	Van	Magnetic	2	N	Electronic	\$ 5.60	\$ 11.20	\$ 60.00	\$ 120.00	Excellent Opportunity for Retrofit
Boys' Restroom		2	4' T12	2	Van	Magnetic	2	N	Electronic	\$ 5.60	\$ 11.20	\$ 60.00	\$ 120.00	Excellent Opportunity for Retrofit
H 105		24	4' T12	2	Wrap	Magnetic	2	N	Electronic	\$ 5.60	\$ 134.40	\$ 60.00	\$ 1,440.00	Excellent Opportunity for Retrofit
P 3		12	4' T12	4	Wrap	Magnetic	4	N	Electronic	\$ 11.20	\$ 134.40	\$ 70.00	\$ 840.00	Excellent Opportunity for Retrofit
P 4		12	4' T12	4	Wrap	Magnetic	4	N	Electronic	\$ 11.20	\$ 134.40	\$ 70.00	\$ 840.00	Excellent Opportunity for Retrofit
LIBRARY		128	4' T12	3	Troffer	Magnetic	3	N	Electronic	\$ 8.40	\$ 1,075.20	\$ 65.00	\$ 8,320.00	Excellent Opportunity for Retrofit
		10	4' T12	2	Troffer	Magnetic	2	N	Electronic	\$ 5.60	\$ 56.00	\$ 60.00	\$ 600.00	Excellent Opportunity for Retrofit
		8	U T12	2	Troffer	Magnetic	2	N	Electronic	\$ 5.60	\$ 44.80	\$ 60.00	\$ 480.00	Excellent Opportunity for Retrofit
		4	4' T12	1	Troffer	Magnetic	1	N	Electronic	\$ 2.80	\$ 11.20	\$ 55.00	\$ 220.00	Excellent Opportunity for Retrofit
		2	4' T12	2	Van	Magnetic	2	N	Electronic	\$ 5.60	\$ 11.20	\$ 60.00	\$ 120.00	Excellent Opportunity for Retrofit
PORTABLES														
P 1A		8	4' T12	4	Wrap	Magnetic	4	N	Electronic	\$ 11.20	\$ 89.60	\$ 70.00	\$ 560.00	3 no lens Excellent opportunity for retro-fit
P 1B		8	4' T12	4	Wrap	Magnetic	4	N	Electronic	\$ 11.20	\$ 89.60	\$ 70.00	\$ 560.00	3 no covers Excellent opportunity for retro-fit

LOCATION Location (Rm Name, Rm. #, Area, Zone, etc.)	EXISTING EQUIPMENT						PROPOSED			REBATES		COSTS		COMMENTS Surveyors Comments
	Floor	Quantity	Lamp Type	Lamps Per Fixture	Type of Fixture	Ballast Type	Lamps Per Fixture	Reflectors	Ballast Type	Per Single	Extended	Per Single	Extended	
P 6		16	4' T12	3	Troffer	Magnetic	3	N	Electronic	\$ 8.40	\$ 134.40	\$ 65.00	\$ 1,040.00	3 no covers Excellent opportunity for retro-fit
Maintenance		1	4' T12	2	Wrap	Magnetic	2	N	Electronic	\$ 5.60	\$ 5.60	\$ 60.00	\$ 60.00	3 no covers Excellent opportunity for retro-fit
BUILDING D														
Counselor		6	4' T12	2	Wrap	Magnetic	2	N	Electronic	\$ 5.60	\$ 33.60	\$ 60.00	\$ 360.00	Excellent Opportunity for Retrofit
Hallway		2	4' T12	4	Wrap	Magnetic	4	N	Electronic	\$ 11.20	\$ 22.40	\$ 70.00	\$ 140.00	Excellent Opportunity for Retrofit
Office		2	4' T12	4	Wrap	Magnetic	4	N	Electronic	\$ 11.20	\$ 22.40	\$ 70.00	\$ 140.00	Excellent Opportunity for Retrofit
Band Room		36	4' T12	2	Wrap	Magnetic	2	N	Electronic	\$ 5.60	\$ 201.60	\$ 60.00	\$ 2,160.00	3 no covers Excellent opportunity for retro-fit
Bath Room		2	4' T12	4	Wrap	Magnetic	4	N	Electronic	\$ 11.20	\$ 22.40	\$ 70.00	\$ 140.00	3 no covers Excellent opportunity for retro-fit
A/C Room		2	4' T12	4	Wrap	Magnetic	4	N	Electronic	\$ 11.20	\$ 22.40	\$ 70.00	\$ 140.00	Café - 2 no covers Excellent opportunity for retro-fit
BUILDING A														
		48	4' T12	4	Wrap	Magnetic	4	N	Electronic	\$ 11.20	\$ 537.60	\$ 70.00	\$ 3,360.00	Excellent Opportunity for Retrofit
Kitchen		34	4' T12	4	Wrap	Magnetic	4	N	Electronic	\$ 11.20	\$ 380.80	\$ 70.00	\$ 2,380.00	Excellent Opportunity for Retrofit
Storage		3	4' T12	2	Wrap	Magnetic	2	N	Electronic	\$ 5.60	\$ 16.80	\$ 60.00	\$ 180.00	Excellent Opportunity for Retrofit
BUILDING B														
B 101A		34	4' T12	2	Wrap	Magnetic	2	N	Electronic	\$ 5.60	\$ 190.40	\$ 60.00	\$ 2,040.00	Excellent Opportunity for Retrofit
B 101B		12	4' T12	2	Wrap	Magnetic	2	N	Electronic	\$ 5.60	\$ 67.20	\$ 60.00	\$ 720.00	Excellent Opportunity for Retrofit
B 102		16	4' T12	2	Wrap	Magnetic	2	N	Electronic	\$ 5.60	\$ 89.60	\$ 60.00	\$ 960.00	2 no lens Excellent opportunity for retro-fit
B 103		16	4' T12	4	Wrap	Magnetic	4	N	Electronic	\$ 11.20	\$ 179.20	\$ 70.00	\$ 1,120.00	2 no lens Excellent opportunity for retro-fit
Storage		4	4' T12	2	Wrap	Magnetic	2	N	Electronic	\$ 5.60	\$ 22.40	\$ 60.00	\$ 240.00	Excellent Opportunity for Retrofit
Girls' Restroom		3	4' T12	1	Vanity	Magnetic	1	N	Electronic	\$ 2.80	\$ 8.40	\$ 55.00	\$ 165.00	Excellent Opportunity for Retrofit
Boys' Restroom		3	4' T12	1	Vanity	Magnetic	1	N	Electronic	\$ 2.80	\$ 8.40	\$ 55.00	\$ 165.00	Excellent Opportunity for Retrofit
Teachers' Restroom		8	4' T12	2	Wrap	Magnetic	2	N	Electronic	\$ 5.60	\$ 44.80	\$ 60.00	\$ 480.00	Excellent Opportunity for Retrofit
BUILDING C														
C 101		36	4' T12	4	Wrap	Magnetic	4	N	Electronic	\$ 11.20	\$ 403.20	\$ 70.00	\$ 2,520.00	Excellent Opportunity for Retrofit
C 102		21	4' T12	2	Wrap	Magnetic	2	N	Electronic	\$ 5.60	\$ 117.60	\$ 60.00	\$ 1,260.00	Excellent Opportunity for Retrofit
C 103		20	4' T12	2	Wrap	Magnetic	2	N	Electronic	\$ 5.60	\$ 112.00	\$ 60.00	\$ 1,200.00	Excellent Opportunity for Retrofit
BUILDING G														
G 101		12	4' T12	2	Wrap	Magnetic	2	N	Electronic	\$ 5.60	\$ 67.20	\$ 60.00	\$ 720.00	Broken lens Excellent opportunity for retro-fit
Health Physician		12	4' T12	4	Wrap	Magnetic	4	N	Electronic	\$ 11.20	\$ 134.40	\$ 70.00	\$ 840.00	No lens Excellent opportunity for retro-fit
BUILDING E														
E 104		28	4' T12	2	Wrap	Magnetic	2	N	Electronic	\$ 5.60	\$ 156.80	\$ 60.00	\$ 1,680.00	Excellent Opportunity for Retrofit
E 103		28	4' T12	2	Wrap	Magnetic	2	N	Electronic	\$ 5.60	\$ 156.80	\$ 60.00	\$ 1,680.00	Missing lens Excellent opportunity for retro-fit
E 102		28	4' T12	2	Wrap	Magnetic	2	N	Electronic	\$ 5.60	\$ 156.80	\$ 60.00	\$ 1,680.00	Excellent Opportunity for Retrofit
E 101		28	4' T12	2	Wrap	Magnetic	2	N	Electronic	\$ 5.60	\$ 156.80	\$ 60.00	\$ 1,680.00	Excellent Opportunity for Retrofit
Boys' Restroom		5	4' T12	2	Wrap	Magnetic	2	N	Electronic	\$ 5.60	\$ 28.00	\$ 60.00	\$ 300.00	Excellent Opportunity for Retrofit
Girls' Restroom		4	4' T12	2	Wrap	Magnetic	2	N	Electronic	\$ 5.60	\$ 22.40	\$ 60.00	\$ 240.00	Loose lens Excellent opportunity for retro-fit
BUILDING F														
F 101		28	4' T12	2	Wrap	Magnetic	2	N	Electronic	\$ 5.60	\$ 156.80	\$ 60.00	\$ 1,680.00	Excellent Opportunity for Retrofit
F 102		49	4' T12	2	Wire	Magnetic	2	N	Electronic	\$ 5.60	\$ 274.40	\$ 60.00	\$ 2,940.00	Excellent Opportunity for Retrofit
		8	4' T12	2	Ice	Magnetic	2	N	Electronic	\$ 5.60	\$ 44.80	\$ 60.00	\$ 480.00	Replace fixture and mount hardware

LOCATION <small>(Rm Name, Rm. #, Area, Zone, etc.)</small>	EXISTING EQUIPMENT						PROPOSED			REBATES		COSTS		COMMENTS <small>Surveyors Comments</small>	
	Floor	Quantity	Lamp Type	Lamps Per Fixture	Type of Fixture	Ballast Type	Lamps Per Fixture	Reflectors	Ballast Type	Per Single	Extended	Per Single	Extended		
<i>Paintshop</i>		1	4' T12	2	Wrap	Magnetic	2	N	Electronic	\$ 5.60	\$ 5.60	\$ 60.00	\$ 60.00	Special bulb Excellent opportunity for retro-fit	
<i>Compression</i>		1	60W Inc			Magnetic			Electronic		\$ -	\$ -	\$ -	No Retrofit	
<i>Boys' Restroom</i>		4	4' T12	1	Wrap	Magnetic	1	N	Electronic	\$ 2.80	\$ 11.20	\$ 55.00	\$ 220.00	Wall mount Excellent opportunity for retro-fit	
<i>Girls' Restroom</i>		2	4' T12	1	Wrap	Magnetic	1	N	Electronic	\$ 2.80	\$ 5.60	\$ 55.00	\$ 110.00	Wall mount Excellent opportunity for retro-fit	
<i>Supplies</i>		2	4' T12	1	Wrap	Magnetic	1	N	Electronic	\$ 2.80	\$ 5.60	\$ 55.00	\$ 110.00	No lens Excellent opportunity for retro-fit	
<i>Auto body</i>		10	4' T12	2	Wrap	Magnetic	2	N	Electronic	\$ 5.60	\$ 56.00	\$ 60.00	\$ 600.00	No lens Excellent opportunity for retro-fit	
<i>Tool Room</i>		4	4' T12	2	Wire	Magnetic	2	N	Electronic	\$ 5.60	\$ 22.40	\$ 60.00	\$ 240.00	No lens Excellent opportunity for retro-fit	
<i>Equipment Room</i>		6	4' T12	2	Wire	Magnetic	2	N	Electronic	\$ 5.60	\$ 33.60	\$ 60.00	\$ 360.00	No lens Excellent opportunity for retro-fit	
GYMNASIUM															
		8	4' T12	2	Wrap	Magnetic	2	N	Electronic	\$ 5.60	\$ 44.80	\$ 60.00	\$ 480.00	Excellent Opportunity for Retrofit	
		24	HID	1		0		0	0		\$ -	\$ -	\$ -	No Retrofit	
<i>A. Dineda</i>		4	4' T12	1	Wrap	Magnetic	1	N	Electronic	\$ 2.80	\$ 11.20	\$ 55.00	\$ 220.00	No Retrofit	
<i>Boys/Girls' RR</i>		6	4' T12	2	Wrap	Magnetic	2	N	Electronic	\$ 5.60	\$ 33.60	\$ 60.00	\$ 360.00	No Retrofit	
<i>Custodian</i>		2	60W Inc	1		0		0	0		\$ -	\$ -	\$ -	No Retrofit	
<i>Electrical Room</i>		2	60W Inc	1		Magnetic			Electronic		\$ -	\$ -	\$ -	No Retrofit	
<i>Wrestling Room</i>		14	4' T12	4	Troffer	Magnetic	4	N	Electronic	\$ 11.20	\$ 156.80	\$ 70.00	\$ 980.00	Outside Troffer Excellent opportunity for retro-fit	
		1	4' T12	1	Troffer	Magnetic	1	N	Electronic	\$ 2.80	\$ 2.80	\$ 55.00	\$ 55.00	Excellent Opportunity for Retrofit	
		4	4' T12	4	Wrap	Magnetic	4	N	Electronic	\$ 11.20	\$ 44.80	\$ 70.00	\$ 280.00	Excellent Opportunity for Retrofit	
<i>Weight Room</i>		6	4' T12	4	Wrap	Magnetic	4	N	Electronic	\$ 11.20	\$ 67.20	\$ 70.00	\$ 420.00	Excellent Opportunity for Retrofit	
<i>Hallways</i>		7	4' T12	2	Wrap	Magnetic	2	N	Electronic	\$ 5.60	\$ 39.20	\$ 60.00	\$ 420.00	Excellent Opportunity for Retrofit	
<i>Equipment Room</i>		1	4' T12	1	Wrap	Magnetic	1	N	Electronic	\$ 2.80	\$ 2.80	\$ 55.00	\$ 55.00	Excellent Opportunity for Retrofit	
<i>Exterior</i>		10	HID	1		0		0	0		\$ -	\$ -	\$ -	No Retrofit	
<i>General Office</i>		4	4' T12	4	Troffer	Magnetic	4	N	Electronic	\$ 11.20	\$ 44.80	\$ 70.00	\$ 280.00	Flat Panel Excellent opportunity for retro-fit	
<i>Boys' Locker Room</i>		3	4' T12	2	Wrap	Magnetic	2	N	Electronic	\$ 5.60	\$ 16.80	\$ 60.00	\$ 180.00	Flat Panel Excellent opportunity for retro-fit	
		8	4' T12	2	Ice	Magnetic	2	N	Electronic	\$ 11.20	\$ 89.60	\$ 60.00	\$ 480.00	Replace fixture and mount hardware	
<i>Teacher</i>		3	4' T12	2	Wrap	Magnetic	2	N	Electronic	\$ 5.60	\$ 16.80	\$ 60.00	\$ 180.00	Excellent Opportunity for Retrofit	
<i>Restroom</i>		2	4' T12	2	Wrap	Magnetic	2	N	Electronic	\$ 5.60	\$ 11.20	\$ 135.00	\$ 270.00	No lens Excellent opportunity for retro-fit	
<i>Hall</i>		3	4' T12	1	Wrap	Magnetic	1	N	Electronic	\$ 2.80	\$ 8.40	\$ 55.00	\$ 165.00	No lens Excellent opportunity for retro-fit	
<i>Laundry</i>		2	60W Inc	1		0		0	0		\$ -	\$ -	\$ -	No Retrofit	
<i>Girls' Locker Room</i>		8	4' T12	1	Wrap	Magnetic	1	N	Electronic	\$ 2.80	\$ 22.40	\$ 55.00	\$ 440.00	Excellent Opportunity for Retrofit	
		6	4' T12	2	Ice	Magnetic	2	N	Electronic	\$ 5.60	\$ 33.60	\$ 135.00	\$ 810.00	Replace fixture and mount hardware	
		2	4' T12	2	Wrap	Magnetic	2	N	Electronic	\$ 5.60	\$ 11.20	\$ 60.00	\$ 120.00	Excellent Opportunity for Retrofit	
<i>Teacher</i>		3	4' T12	2	Wrap	Magnetic	2	N	Electronic	\$ 5.60	\$ 16.80	\$ 60.00	\$ 180.00	No lens Excellent opportunity for retro-fit	
Total Rebates										\$	8,103.20				
Total Costs										\$	71,890.00				

LOCATION	QTY	EXISTING TYPE	QTY	RETROFIT	SURVEYORS COMMENTS	Existing				Actual				Proposed			
						Watt/unit	Op. Hours	kWh	kW-D	Watt/unit	Op. Hours	kWh	kW-D	Watt/unit	Op. Hours	kWh	kW-D
P 5A	6	4' 4L Fixture	6	Lamp & Low Watt Ballast	Excellent Opportunity for Retrofit	151.2	1,974	1,790.8	0.9072	100	1,974	1,184.4	0.6				
P 5B	6	4' 4L Fixture	6	Lamp & Low Watt Ballast	Excellent Opportunity for Retrofit	151.2	1,974	1,790.8	0.9072	100	1,974	1,184.4	0.6				
P 2A	8	4' 4L Fixture	8	Lamp & Low Watt Ballast	Excellent Opportunity for Retrofit	151.2	1,974	2,387.8	1.2096	100	1,974	1,579.2	0.8				
P 2B	8	4' 4L Fixture	8	Lamp & Low Watt Ballast	Excellent Opportunity for Retrofit	151.2	1,974	2,387.8	1.2096	100	1,974	1,579.2	0.8				
BUILDING I	0		0		0		1,974	0.0	0		1,974	0.0	0				
Girls' Restroom	5	4' 2L Fixture	5	Lamp & Low Watt Ballast	Excellent Opportunity for Retrofit	75.6	1,974	746.2	0.378	51	1,974	503.4	0.255				
Janitor	1	4' 1L Fixture	1	Lamp & Low Watt Ballast	Excellent Opportunity for Retrofit	45.6	1,974	90.0	0.0456	31	1,974	61.2	0.031				
Boys' Restroom	5	4' 2L Fixture	5	Lamp & Low Watt Ballast	Excellent Opportunity for Retrofit	75.6	1,974	746.2	0.378	51	1,974	503.4	0.255				
I 101	24	4' 2L Fixture	24	Lamp & Low Watt Ballast	Excellent Opportunity for Retrofit	75.6	1,974	3,581.6	1.8144	51	1,974	2,416.2	1.224				
I 102	24	4' 2L Fixture	24	Lamp & Low Watt Ballast	Excellent Opportunity for Retrofit	75.6	1,974	3,581.6	1.8144	51	1,974	2,416.2	1.224				
I 103	24	4' 2L Fixture	24	Lamp & Low Watt Ballast	Excellent Opportunity for Retrofit	75.6	1,974	3,581.6	1.8144	51	1,974	2,416.2	1.224				
I 104	24	4' 2L Fixture	24	Lamp & Low Watt Ballast	Excellent Opportunity for Retrofit	75.6	1,974	3,581.6	1.8144	51	1,974	2,416.2	1.224				
BUILDING H	0		0		0		1,974	0.0	0		1,974	0.0	0				
H 101	24	4' 2L Fixture	24	Lamp & Low Watt Ballast	Excellent Opportunity for Retrofit	75.6	1,974	3,581.6	1.8144	51	1,974	2,416.2	1.224				
Janitor	1	4' 1L Fixture	1	Lamp & Low Watt Ballast	Excellent Opportunity for Retrofit	45.6	1,974	90.0	0.0456	31	1,974	61.2	0.031				
H 102	22	4' 2L Fixture	22	Lamp & Low Watt Ballast	Excellent Opportunity for Retrofit	75.6	1,974	3,283.2	1.6632	51	1,974	2,214.8	1.122				
Girls' Restroom	2	4' 1L Fixture	2	Lamp & Low Watt Ballast	Excellent Opportunity for Retrofit	45.6	1,974	180.0	0.0912	31	1,974	122.4	0.062				
Boys' Restroom	2	4' 1L Fixture	2	Lamp & Low Watt Ballast	Excellent Opportunity for Retrofit	45.6	1,974	180.0	0.0912	31	1,974	122.4	0.062				
H 103	22	4' 2L Fixture	22	Lamp & Low Watt Ballast	Excellent Opportunity for Retrofit	75.6	1,974	3,283.2	1.6632	51	1,974	2,214.8	1.122				
Teachers' Restroom	1	4' 2L Fixture	1	Lamp & Low Watt Ballast	Excellent Opportunity for Retrofit	75.6	1,974	149.2	0.0756	51	1,974	100.7	0.051				
Work Room	10	4' 2L Fixture	10	Lamp & Low Watt Ballast	Excellent Opportunity for Retrofit	75.6	1,974	1,492.3	0.756	51	1,974	1,006.7	0.51				
H 104	22	4' 2L Fixture	22	Lamp & Low Watt Ballast	Excellent Opportunity for Retrofit	75.6	1,974	3,283.2	1.6632	51	1,974	2,214.8	1.122				
Girls' Restroom	2	4' 2L Fixture	2	Lamp & Low Watt Ballast	Excellent Opportunity for Retrofit	75.6	1,974	298.5	0.1512	51	1,974	201.3	0.102				
Boys' Restroom	2	4' 2L Fixture	2	Lamp & Low Watt Ballast	Excellent Opportunity for Retrofit	75.6	1,974	298.5	0.1512	51	1,974	201.3	0.102				
H 105	24	4' 2L Fixture	24	Lamp & Low Watt Ballast	Excellent Opportunity for Retrofit	75.6	1,974	3,581.6	1.8144	51	1,974	2,416.2	1.224				
P 3	12	4' 4L Fixture	12	Lamp & Low Watt Ballast	Excellent Opportunity for Retrofit	151.2	1,974	3,581.6	1.8144	100	1,974	2,368.8	1.2				
P 4	12	4' 4L Fixture	12	Lamp & Low Watt Ballast	Excellent Opportunity for Retrofit	151.2	1,974	3,581.6	1.8144	100	1,974	2,368.8	1.2				
LIBRARY	128	4' 3L Fixture	128	Lamp & Low Watt Ballast	Excellent Opportunity for Retrofit	121.2	1,974	30,623.8	15.5136	77	1,974	19,455.7	9.856				
0	10	4' 2L Fixture	10	Lamp & Low Watt Ballast	Excellent Opportunity for Retrofit	75.6	1,974	1,492.3	0.756	51	1,974	1,006.7	0.51				
0	8	2x2 2U Fixture	8	Lamp & Low Watt Ballast	Excellent Opportunity for Retrofit	75.6	1,974	1,193.9	0.6048	51	1,974	805.4	0.408				
0	4	4' 1L Fixture	4	Lamp & Low Watt Ballast	Excellent Opportunity for Retrofit	45.6	1,974	360.1	0.1824	31	1,974	244.8	0.124				
0	2	4' 2L Fixture	2	Lamp & Low Watt Ballast	Excellent Opportunity for Retrofit	75.6	1,974	298.5	0.1512	51	1,974	201.3	0.102				
PORTABLES	0		0		0		1,974	0.0	0		1,974	0.0	0				
P 1A	8	4' 4L Fixture	8	Lamp & Low Watt Ballast	3 no lens Excellent opportunity for retro-fit	151.2	1,974	2,387.8	1.2096	100	1,974	1,579.2	0.8				
P 1B	8	4' 4L Fixture	8	Lamp & Low Watt Ballast	3 no covers Excellent opportunity for retro-fit	151.2	1,974	2,387.8	1.2096	100	1,974	1,579.2	0.8				
P 6	16		0	Lamp & Low Watt Ballast	3 no covers Excellent opportunity for retro-fit	121.2	1,974	3,828.0	1.9392	77	1,974	0.0	0				
Maintenance	1	4' 2L Fixture	1	Lamp & Low Watt Ballast	3 no covers Excellent opportunity for retro-fit	75.6	1,974	149.2	0.0756	51	1,974	100.7	0.051				
BUILDING D	0		0		0		1,974	0.0	0		1,974	0.0	0				
Counselor	6	4' 2L Fixture	6	Lamp & Low Watt Ballast	Excellent Opportunity for Retrofit	75.6	1,974	895.4	0.4536	51	1,974	604.0	0.306				
Hallway	2	4' 4L Fixture	2	Lamp & Low Watt Ballast	Excellent Opportunity for Retrofit	151.2	1,974	596.9	0.3024	100	1,974	394.8	0.2				
Office	2	4' 4L Fixture	2	Lamp & Low Watt Ballast	Excellent Opportunity for Retrofit	151.2	1,974	596.9	0.3024	100	1,974	394.8	0.2				
Band Room	36	4' 2L Fixture	36	Lamp & Low Watt Ballast	3 no covers Excellent opportunity for retro-fit	75.6	1,974	5,372.4	2.7216	51	1,974	3,624.3	1.836				
Bath Room	2	4' 4L Fixture	2	Lamp & Low Watt Ballast	3 no covers Excellent opportunity for retro-fit	151.2	1,974	596.9	0.3024	100	1,974	394.8	0.2				
A/C Room	2	4' 4L Fixture	2	Lamp & Low Watt Ballast	Café - 2 no covers Excellent opportunity for retro-fit	151.2	1,974	596.9	0.3024	100	1,974	394.8	0.2				
BUILDING A	0		0		0		1,974	0.0	0		1,974	0.0	0				
0	48	4' 4L Fixture	48	Lamp & Low Watt Ballast	Excellent Opportunity for Retrofit	151.2	1,974	14,326.5	7.2576	100	1,974	9,475.2	4.8				
Kitchen	34	4' 4L Fixture	34	Lamp & Low Watt Ballast	Excellent Opportunity for Retrofit	151.2	1,974	10,147.9	5.1408	100	1,974	6,711.6	3.4				
Storage	3	4' 2L Fixture	3	Lamp & Low Watt Ballast	Excellent Opportunity for Retrofit	75.6	1,974	447.7	0.2268	51	1,974	302.0	0.153				
BUILDING B	0		0		0		1,974	0.0	0		1,974	0.0	0				
B 101A	34	4' 2L Fixture	34	Lamp & Low Watt Ballast	Excellent Opportunity for Retrofit	75.6	1,974	5,074.0	2.5704	51	1,974	3,422.9	1.734				
B 101B	12	4' 2L Fixture	12	Lamp & Low Watt Ballast	Excellent Opportunity for Retrofit	75.6	1,974	1,790.8	0.9072	51	1,974	1,208.1	0.612				
B 102	16	4' 2L Fixture	16	Lamp & Low Watt Ballast	2 no lens Excellent opportunity for retro-fit	75.6	1,974	2,387.8	1.2096	51	1,974	1,610.8	0.816				
B 103	16	4' 4L Fixture	16	Lamp & Low Watt Ballast	2 no lens Excellent opportunity for retro-fit	151.2	1,974	4,775.5	2.4192	100	1,974	3,158.4	1.6				
Storage	4	4' 2L Fixture	4	Lamp & Low Watt Ballast	Excellent Opportunity for Retrofit	75.6	1,974	596.9	0.3024	51	1,974	402.7	0.204				
Girls' Restroom	3	4' 1L Fixture	3	Lamp & Low Watt Ballast	Excellent Opportunity for Retrofit	45.6	1,974	270.0	0.1368	31	1,974	183.6	0.093				
Boys' Restroom	3	4' 1L Fixture	3	Lamp & Low Watt Ballast	Excellent Opportunity for Retrofit	45.6	1,974	270.0	0.1368	31	1,974	183.6	0.093				
Teachers' Restroom	8	4' 2L Fixture	8	Lamp & Low Watt Ballast	Excellent Opportunity for Retrofit	75.6	1,974	1,193.9	0.6048	51	1,974	805.4	0.408				
BUILDING C	0		0		0		1,974	0.0	0		1,974	0.0	0				
C 101	36	4' 4L Fixture	36	Lamp & Low Watt Ballast	Excellent Opportunity for Retrofit	151.2	1,974	10,744.9	5.4432	100	1,974	7,106.4	3.6				
C 102	21	4' 2L Fixture	21	Lamp & Low Watt Ballast	Excellent Opportunity for Retrofit	75.6	1,974	3,133.9	1.5876	51	1,974	2,114.2	1.071				
C 103	20	4' 2L Fixture	20	Lamp & Low Watt Ballast	Excellent Opportunity for Retrofit	75.6	1,974	2,984.7	1.512	51	1,974	2,013.5	1.02				
BUILDING G	0		0		0		1,974	0.0	0		1,974	0.0	0				
G 101	12	4' 2L Fixture	12	Lamp & Low Watt Ballast	Broken lens Excellent opportunity for retro-fit	75.6	1,974	1,790.8	0.9072	51	1,974	1,208.1	0.612				
Health Physician	12	4' 4L Fixture	12	Lamp & Low Watt Ballast	No lens Excellent opportunity for retro-fit	151.2	1,974	3,581.6	1.8144	100	1,974	2,368.8	1.2				

LOCATION	QTY	EXISTING TYPE	QTY	RETROFIT	SURVEYORS COMMENTS	Existing Watt/unit	Actual			Proposed			
							Op. Hours	kWh	kW-D	Watt/unit	Op. Hours	kWh	kW-D
BUILDING E	0		0		0		1,974	0.0	0		1,974	0.0	0
E 104	28	4' 2L Fixture	28	Lamp & Low Watt Ballast	Excellent Opportunity for Retrofit	75.6	1,974	4,178.6	2.1168	51	1,974	2,818.9	1.428
E 103	28	4' 2L Fixture	28	Lamp & Low Watt Ballast	Missing lens Excellent opportunity for retro-fit	75.6	1,974	4,178.6	2.1168	51	1,974	2,818.9	1.428
E 102	28	4' 2L Fixture	28	Lamp & Low Watt Ballast	Excellent Opportunity for Retrofit	75.6	1,974	4,178.6	2.1168	51	1,974	2,818.9	1.428
E 101	28	4' 2L Fixture	28	Lamp & Low Watt Ballast	Excellent Opportunity for Retrofit	75.6	1,974	4,178.6	2.1168	51	1,974	2,818.9	1.428
Boys' Restroom	5	4' 2L Fixture	5	Lamp & Low Watt Ballast	Excellent Opportunity for Retrofit	75.6	1,974	746.2	0.378	51	1,974	503.4	0.255
Girls' Restroom	4	4' 2L Fixture	4	Lamp & Low Watt Ballast	Loose lens Excellent opportunity for retro-fit	75.6	1,974	596.9	0.3024	51	1,974	402.7	0.204
BUILDING F	0		0		0		1,974	0.0	0		1,974	0.0	0
F 101	28	4' 2L Fixture	28	Lamp & Low Watt Ballast	Excellent Opportunity for Retrofit	75.6	1,974	4,178.6	2.1168	51	1,974	2,818.9	1.428
F 102	49	4' 2L Fixture	49	Lamp & Low Watt Ballast	Excellent Opportunity for Retrofit	75.6	1,974	7,312.5	3.7044	51	1,974	4,933.0	2.499
0	8	4' 2L Fixture	8	Lamp & Low Watt Ballast	Replace fixture and mount hardware	75.6	1,974	1,193.9	0.6048	51	1,974	805.4	0.408
Paintshop	1	4' 2L Fixture	1	Lamp & Low Watt Ballast	Special bulb Excellent opportunity for retro-fit	75.6	1,974	149.2	0.0756	51	1,974	100.7	0.051
Compression	1	60W Inc	0		No Retrofit		1,974	0.0	0		1,974	0.0	0
Boys' Restroom	4	4' 1L Fixture	4	Lamp & Low Watt Ballast	Wall mount Excellent opportunity for retro-fit	45.6	1,974	360.1	0.1824	31	1,974	244.8	0.124
Girls' Restroom	2	4' 1L Fixture	2	Lamp & Low Watt Ballast	Wall mount Excellent opportunity for retro-fit	45.6	1,974	180.0	0.0912	31	1,974	122.4	0.062
Supplies	2	4' 1L Fixture	2	Lamp & Low Watt Ballast	No lens Excellent opportunity for retro-fit	45.6	1,974	180.0	0.0912	31	1,974	122.4	0.062
Auto body	10	4' 2L Fixture	10	Lamp & Low Watt Ballast	No lens Excellent opportunity for retro-fit	75.6	1,974	1,492.3	0.756	51	1,974	1,006.7	0.51
Tool Room	4	4' 2L Fixture	4	Lamp & Low Watt Ballast	No lens Excellent opportunity for retro-fit	75.6	1,974	596.9	0.3024	51	1,974	402.7	0.204
Equipment Room	6	4' 2L Fixture	6	Lamp & Low Watt Ballast	No lens Excellent opportunity for retro-fit	75.6	1,974	895.4	0.4536	51	1,974	604.0	0.306
GYMNASIUM	0		0		0		1,974	0.0	0		1,974	0.0	0
0	8	4' 2L Fixture	8	Lamp & Low Watt Ballast	Excellent Opportunity for Retrofit	75.6	1,974	1,193.9	0.6048	51	1,974	805.4	0.408
0	24	HID	0		No Retrofit		1,974	0.0	0		1,974	0.0	0
A. Dineda	4	4' 1L Fixture	4	Lamp & Low Watt Ballast	No Retrofit	45.6	1,974	360.1	0.1824	31	1,974	244.8	0.124
Boys'/Girls' RR	6	4' 2L Fixture	6	Lamp & Low Watt Ballast	No Retrofit	75.6	1,974	895.4	0.4536	51	1,974	604.0	0.306
Custodian	2	60W Inc	0		No Retrofit	0	1,974	0.0	0	0	1,974	0.0	0
Electrical Room	2	60W Inc	0		No Retrofit	0	1,974	0.0	0	0	1,974	0.0	0
Wrestling Room	14	4' 4L Fixture	14	Lamp & Low Watt Ballast	Outside Troffer Excellent opportunity for retro-fit	151.2	1,974	4,178.6	2.1168	100	1,974	2,763.6	1.4
0	1	4' 1L Fixture	1	Lamp & Low Watt Ballast	Excellent Opportunity for Retrofit	45.6	1,974	90.0	0.0456	31	1,974	61.2	0.031
0	4	4' 4L Fixture	4	Lamp & Low Watt Ballast	Excellent Opportunity for Retrofit	151.2	1,974	1,193.9	0.6048	100	1,974	789.6	0.4
Weight Room	6	4' 4L Fixture	6	Lamp & Low Watt Ballast	Excellent Opportunity for Retrofit	151.2	1,974	1,790.8	0.9072	100	1,974	1,184.4	0.6
Hallways	7	4' 2L Fixture	7	Lamp & Low Watt Ballast	Excellent Opportunity for Retrofit	75.6	1,974	1,044.6	0.5292	51	1,974	704.7	0.357
Equipment Room	1	4' 1L Fixture	1	Lamp & Low Watt Ballast	Excellent Opportunity for Retrofit	45.6	1,974	90.0	0.0456	31	1,974	61.2	0.031
Exterior	10	HID	0		No Retrofit	0	1,974	0.0	0	0	1,974	0.0	0
General Office	4	4' 4L Fixture	4	Lamp & Low Watt Ballast	Flat Panel Excellent opportunity for retro-fit	151.2	1,974	1,193.9	0.6048	100	1,974	789.6	0.4
Boys' Locker Room	3	4' 2L Fixture	3	Lamp & Low Watt Ballast	Flat Panel Excellent opportunity for retro-fit	75.6	1,974	447.7	0.2268	51	1,974	302.0	0.153
0	8	4' 2L Fixture	8	Lamp & Low Watt Ballast	Replace fixture and mount hardware	75.6	1,974	1,193.9	0.6048	51	1,974	805.4	0.408
Teacher	3	4' 2L Fixture	3	Lamp & Low Watt Ballast	Excellent Opportunity for Retrofit	75.6	1,974	447.7	0.2268	51	1,974	302.0	0.153
Restroom	2	4' 2L Fixture	2	Lamp & Low Watt Ballast	No lens Excellent opportunity for retro-fit	75.6	1,974	298.5	0.1512	51	1,974	201.3	0.102
Hall	3	4' 1L Fixture	3	Lamp & Low Watt Ballast	No lens Excellent opportunity for retro-fit	45.6	1,974	270.0	0.1368	31	1,974	183.6	0.093
Laundry	2	60W Inc	0		No Retrofit	0	1,974	0.0	0	0	1,974	0.0	0
Girls' Locker Room	8	4' 1L Fixture	8	Lamp & Low Watt Ballast	Excellent Opportunity for Retrofit	45.6	1,974	720.1	0.3648	31	1,974	489.6	0.248
0	6	4' 2L Fixture	6	Lamp & Low Watt Ballast	Replace fixture and mount hardware	75.6	1,974	895.4	0.4536	51	1,974	604.0	0.306
0	2	4' 2L Fixture	2	Lamp & Low Watt Ballast	Excellent Opportunity for Retrofit	75.6	1,974	298.5	0.1512	51	1,974	201.3	0.102
Teacher	3	4' 2L Fixture	3	Lamp & Low Watt Ballast	No lens Excellent opportunity for retro-fit	75.6	1,974	447.7	0.2268	51	1,974	302.0	0.153

Existing 1179 Proposed 1122

ENERGY CALCULATIONS			217,671	110	142,089	72
Description	kW-Demand	kWh				
Existing Use	110.27	217,671				
Proposed Use	71.98	142,089				
Difference - Savings	38.29	75,583				
Electrical Utility Cost	\$5.75	\$0.15385				
Savings per Year	\$2,641.95	\$11,628.23			Total Yearly Energy Savings	\$14,270.19

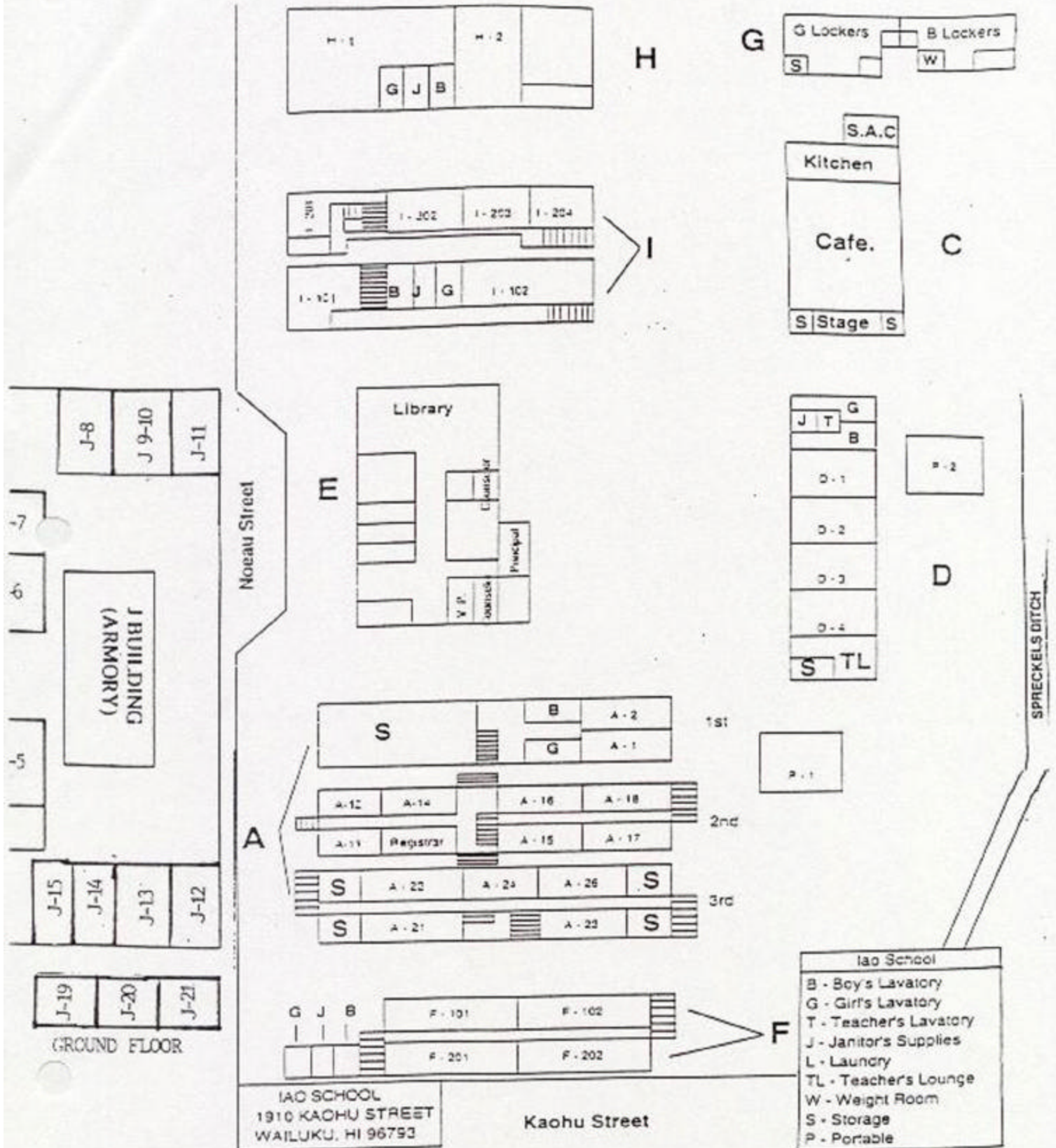

Maui Smart Schools Program
Foot Candle Readings

School: IAD Elementary School

Room: Bldg. C - C-22

Ceiling height: 9'

Light fixture height: 7'

Fixture type: wrap

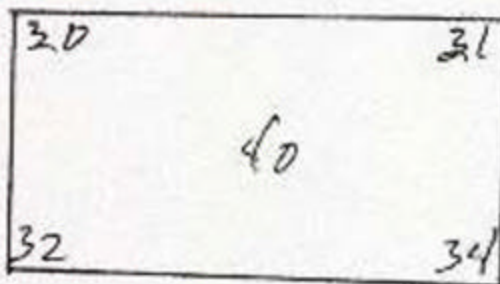

Room: Principles Office

Ceiling height: 9'

Light fixture height: 8'

Fixture type: wrap

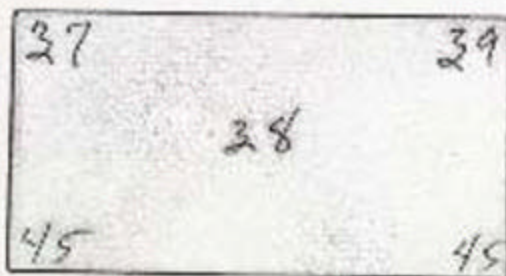

Room: Library-Library

Ceiling height: 12'

Light fixture height: 10'

Fixture type: wrap

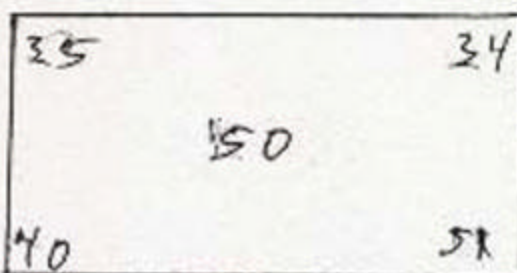



SCHOOL INFORMATION										
NAME lao Elementary School										DATE 1/5/2001
STREET ADDRESS 1910 Kaohu Street Wailuku, HI 96793										OPERATIONAL HOURS 1,786
POINT OF CONTACT DR. Elizabeth Ayson					PHONE 984-5610			FAX		VOLTAGE 120V
AUDITOR Maui Community College Auditors										

LOCATION Location (Rm Name, Rm. #, Area, Zone, etc.)	EXISTING EQUIPMENT						PROPOSED			REBATES		COSTS		COMMENTS Surveyors Comments
	Floor	Quantity	Lamp Type	Lamps Per Fixture	Type of Fixture	Ballast Type	Lamps Per Fixture	Reflectors	Ballast Type	Per Single	Extended	Per Single	Extended	
BUILDING E														
Front Office	1	8	4' T12	2	Wrap	Magnetic	2	N	Electronic	\$ 5.60	\$ 44.80	\$ 60.00	\$ 480.00	No Lens Excellent opportunity for retro-fit
	1	3	4' T12	2	Wrap	Magnetic	2	N	Electronic	\$ 5.60	\$ 16.80	\$ 60.00	\$ 180.00	Excellent Opportunity for Retro-fit
Vice Principal	1	4	4' T12	2	Wrap	Magnetic	2	N	Electronic	\$ 5.60	\$ 22.40	\$ 60.00	\$ 240.00	Excellent Opportunity for Retro-fit
Health	1	4	4' T12	2	Wrap	Magnetic	2	N	Electronic	\$ 5.60	\$ 22.40	\$ 60.00	\$ 240.00	Excellent Opportunity for Retro-fit
Counselor	1	2	4' T12	2	Wrap	Magnetic	2	N	Electronic	\$ 5.60	\$ 11.20	\$ 60.00	\$ 120.00	Excellent Opportunity for Retro-fit
Principal	1	2	4' T12	2	Wrap	Magnetic	2	N	Electronic	\$ 5.60	\$ 11.20	\$ 60.00	\$ 120.00	Excellent Opportunity for Retro-fit
Private	1	2	4' T12	2	Wrap	Magnetic	2	N	Electronic	\$ 5.60	\$ 11.20	\$ 60.00	\$ 120.00	Excellent Opportunity for Retro-fit
Hall	1	2	4' T12	2	Wrap	Magnetic	2	N	Electronic	\$ 5.60	\$ 11.20	\$ 60.00	\$ 120.00	No Lens Excellent opportunity for retro-fit
Restrooms	1	2	4' T12	2	Wrap	Magnetic	2	N	Electronic	\$ 5.60	\$ 11.20	\$ 60.00	\$ 120.00	No Lens Excellent opportunity for retro-fit
Workroom	1	9	4' T12	2	Wrap	Magnetic	2	N	Electronic	\$ 5.60	\$ 50.40	\$ 60.00	\$ 540.00	Excellent Opportunity for Retro-fit
List and Viewing	1	2	4' T12	2	Wrap	Magnetic	2	N	Electronic	\$ 5.60	\$ 11.20	\$ 60.00	\$ 120.00	Excellent Opportunity for Retro-fit
Staff	1	2	4' T12	2	Wrap	Magnetic	2	N	Electronic	\$ 5.60	\$ 11.20	\$ 60.00	\$ 120.00	Excellent Opportunity for Retro-fit
Library	1	60	4' T12	2	Wrap	Magnetic	2	N	Electronic	\$ 5.60	\$ 336.00	\$ 60.00	\$ 3,600.00	Excellent Opportunity for Retro-fit
	1	6	4' T12	2	Wrap	Magnetic	2	N	Electronic	\$ 5.60	\$ 33.60	\$ 60.00	\$ 360.00	Excellent Opportunity for Retro-fit
BUILDING A														
Hall	2	4	4' T12	2	Wrap	Magnetic	2	N	Electronic	\$ 5.60	\$ 22.40	\$ 60.00	\$ 240.00	Excellent Opportunity for Retro-fit
	2	1	4' T12	4	Wrap	Magnetic	4	N	Electronic	\$ 11.20	\$ 11.20	\$ 70.00	\$ 70.00	Excellent Opportunity for Retro-fit
Class 23	2	12	4' T12	4	Wrap	Magnetic	4	N	Electronic	\$ 11.20	\$ 134.40	\$ 70.00	\$ 840.00	Excellent Opportunity for Retro-fit
Class 26	2	9	4' T12	4	Wrap	Magnetic	4	N	Electronic	\$ 11.20	\$ 100.80	\$ 70.00	\$ 630.00	Excellent Opportunity for Retro-fit
Class 24	2	9	4' T12	4	Wrap	Magnetic	4	N	Electronic	\$ 11.20	\$ 100.80	\$ 70.00	\$ 630.00	Excellent Opportunity for Retro-fit
Class 22	2	9	4' T12	4	Wrap	Magnetic	4	N	Electronic	\$ 11.20	\$ 100.80	\$ 70.00	\$ 630.00	Excellent Opportunity for Retro-fit
Counselor	2	12	4' T12	4	Wrap	Magnetic	4	N	Electronic	\$ 11.20	\$ 134.40	\$ 70.00	\$ 840.00	Excellent Opportunity for Retro-fit
Hall	1	7	4' T12	4	Wrap	Magnetic	4	N	Electronic	\$ 11.20	\$ 78.40	\$ 70.00	\$ 490.00	Excellent Opportunity for Retro-fit
BSS.	1	2	4' T12	2	Wrap	Magnetic	2	N	Electronic	\$ 5.60	\$ 11.20	\$ 60.00	\$ 120.00	Excellent Opportunity for Retro-fit
	1	1	4' T12	4	Wrap	Magnetic	4	N	Electronic	\$ 11.20	\$ 11.20	\$ 70.00	\$ 70.00	Excellent Opportunity for Retro-fit
A 17	1	9	4' T12	2	Wrap	Magnetic	2	N	Electronic	\$ 5.60	\$ 50.40	\$ 60.00	\$ 540.00	Excellent Opportunity for Retro-fit
A 18	1	9	4' T12	4	Wrap	Magnetic	4	N	Electronic	\$ 11.20	\$ 100.80	\$ 70.00	\$ 630.00	Excellent Opportunity for Retro-fit
A 15	1	12	4' T12	4	Wrap	Magnetic	4	N	Electronic	\$ 11.20	\$ 134.40	\$ 70.00	\$ 840.00	Excellent Opportunity for Retro-fit
A 16	1	12	4' T12	4	Wrap	Magnetic	4	N	Electronic	\$ 11.20	\$ 134.40	\$ 70.00	\$ 840.00	Excellent Opportunity for Retro-fit

LOCATION	EXISTING EQUIPMENT						PROPOSED			REBATES		COSTS		COMMENTS
Location (Rm Name, Rm. #, Area, Zone, etc.)	Floor	Quantity	Lamp Type	Lamps Per Fixture	Type of Fixture	Ballast Type	Lamps Per Fixture	Reflectors	Ballast Type	Per Single	Extended	Per Single	Extended	Surveyors Comments
A 14	1	12	4' T12	4	Wrap	Magnetic	4	N	Electronic	\$ 11.20	\$ 134.40	\$ 70.00	\$ 840.00	Excellent Opportunity for Retro-fit
A 12	1	9	4' T12	4	Wrap	Magnetic	4	N	Electronic	\$ 11.20	\$ 100.80	\$ 70.00	\$ 630.00	Excellent Opportunity for Retro-fit
A 11	1	9	4' T12	4	Wrap	Magnetic	4	N	Electronic	\$ 11.20	\$ 100.80	\$ 70.00	\$ 630.00	Excellent Opportunity for Retro-fit
Registrar	1	4	4' T12	4	Wrap	Magnetic	4	N	Electronic	\$ 11.20	\$ 44.80	\$ 70.00	\$ 280.00	Excellent Opportunity for Retro-fit
Restrooms	B	8	4' T12	2	Wrap	Magnetic	2	N	Electronic	\$ 5.60	\$ 44.80	\$ 60.00	\$ 480.00	Excellent Opportunity for Retro-fit
Hall	B	3	4' T12	2	Wrap	Magnetic	2	N	Electronic	\$ 5.60	\$ 16.80	\$ 60.00	\$ 180.00	Excellent Opportunity for Retro-fit
A 2	B	11	4' T12	4	Wrap	Magnetic	4	N	Electronic	\$ 11.20	\$ 123.20	\$ 70.00	\$ 770.00	Excellent Opportunity for Retro-fit
A 1 Class	B	11	4' T12	4	Wrap	Magnetic	4	N	Electronic	\$ 11.20	\$ 123.20	\$ 70.00	\$ 770.00	Excellent Opportunity for Retro-fit
BUILDING F														
F 202	2	33	4' T12	2	Wrap	Magnetic	2	N	Electronic	\$ 5.60	\$ 184.80	\$ 60.00	\$ 1,980.00	Excellent Opportunity for Retro-fit
Kitchen	2	3	4' T12	2	Wrap	Magnetic	2	N	Electronic	\$ 5.60	\$ 16.80	\$ 60.00	\$ 180.00	Excellent Opportunity for Retro-fit
F 201	2	33	4' T12	2	Wrap	Magnetic	2	N	Electronic	\$ 5.60	\$ 184.80	\$ 60.00	\$ 1,980.00	Excellent Opportunity for Retro-fit
Storage	2	3	4' T12	2	Wrap	Magnetic	2	N	Electronic	\$ 5.60	\$ 16.80	\$ 60.00	\$ 180.00	Excellent Opportunity for Retro-fit
Girls' Restroom	1	4	4' T12	2	Vapor	Magnetic	2	N	Electronic	\$ 5.60	\$ 22.40	\$ 60.00	\$ 240.00	No Comment
Boys' Restroom	1	4	4' T12	2	Vapor	Magnetic	2	N	Electronic	\$ 5.60	\$ 22.40	\$ 60.00	\$ 240.00	No Comment
F 101	1	30	4' T12	2	Wrap	Magnetic	2	N	Electronic	\$ 5.60	\$ 168.00	\$ 60.00	\$ 1,800.00	Excellent Opportunity for Retro-fit
	1	4	4' T12	2	Wrap	Magnetic	2	N	Electronic	\$ 5.60	\$ 22.40	\$ 60.00	\$ 240.00	Excellent Opportunity for Retro-fit
F 102	1	33	4' T12	2	Wrap	Magnetic	2	N	Electronic	\$ 5.60	\$ 184.80	\$ 60.00	\$ 1,980.00	Excellent Opportunity for Retro-fit
Storage	1	3	4' T12	2	Wrap	Magnetic	2	N	Electronic	\$ 5.60	\$ 16.80	\$ 60.00	\$ 180.00	Excellent Opportunity for Retro-fit
PORTABLE 2035														
Portable	1	12	4' T12	4	Ice	Magnetic	4	N	Electronic	\$ 11.20	\$ 134.40	\$ 70.00	\$ 840.00	No Comment
Storage	1	2	4' T12	4	Wrap	Magnetic	4	N	Electronic	\$ 11.20	\$ 22.40	\$ 70.00	\$ 140.00	Excellent Opportunity for Retro-fit
BUILDING D														
Workroom	1	6	4' T12	2	Ice	Magnetic	2	N	Electronic	\$ 5.60	\$ 33.60	\$ 135.00	\$ 810.00	Replace Fixture and mount hardware
	1	1	4' T12	2	Ice	Magnetic	2	N	Electronic	\$ 5.60	\$ 5.60	\$ 135.00	\$ 135.00	Replace Fixture and mount hardware
D 4	1	28	4' T12	2	Ice	Magnetic	2	N	Electronic	\$ 5.60	\$ 156.80	\$ 135.00	\$ 3,780.00	Replace Fixture and mount hardware
D 3	1	28	4' T12	2	Ice	Magnetic	2	N	Electronic	\$ 5.60	\$ 156.80	\$ 135.00	\$ 3,780.00	Replace Fixture and mount hardware
D 2	1	28	4' T12	2	Ice	Magnetic	2	N	Electronic	\$ 5.60	\$ 156.80	\$ 135.00	\$ 3,780.00	Replace Fixture and mount hardware
D 1	1	28	4' T12	2	Ice	Magnetic	2	N	Electronic	\$ 5.60	\$ 156.80	\$ 135.00	\$ 3,780.00	Replace Fixture and mount hardware
Detention	1	2	4' T12	2	Ice	Magnetic	2	N	Electronic	\$ 5.60	\$ 11.20	\$ 135.00	\$ 270.00	Replace Fixture and mount hardware
BUILDING C														
Main Room	1	14	4' T12	4	Ice	Magnetic	4	N	Electronic	\$ 11.20	\$ 156.80	\$ 160.00	\$ 2,240.00	Replace Fixture and mount hardware
Kitchen	1	17	60W Inc			Magnetic			Electronic	\$ -		\$ -		No Comment
Office	1	1	4' T12	4	Ice	Magnetic	4	N	Electronic	\$ 11.20	\$ 11.20	\$ 160.00	\$ 160.00	Replace Fixture and mount hardware
Snack Shack	1	2	4' T12	4	Wrap	Magnetic	4	N	Electronic	\$ 11.20	\$ 22.40	\$ 160.00	\$ 320.00	Excellent Opportunity for Retro-fit

LOCATION	EXISTING EQUIPMENT						PROPOSED			REBATES		COSTS		COMMENTS
Location (Rm Name, Rm. #, Area, Zone, etc.)	Floor	Quantity	Lamp Type	Lamps Per Fixture	Type of Fixture	Ballast Type	Lamps Per Fixture	Reflectors	Ballast Type	Per Single	Extended	Per Single	Extended	Surveyors Comments
BUILDING G														
<i>Girls' Locker Room</i>	1	18	4' T12	2	Wrap	Magnetic	2	N	Electronic	\$ 5.60	\$ 100.80	\$ 60.00	\$ 1,080.00	Excellent Opportunity for Retro-fit
<i>Boys' Locker Room</i>	1	22	4' T12	2	Wrap	Magnetic	2	N	Electronic	\$ 5.60	\$ 123.20	\$ 60.00	\$ 1,320.00	Excellent Opportunity for Retro-fit
<i>Weight Room</i>	1	2	4' T12	4	Wrap	Magnetic	4	N	Electronic	\$ 11.20	\$ 22.40	\$ 70.00	\$ 140.00	Excellent Opportunity for Retro-fit
		6	4' T12	2	Wrap	Magnetic	2	N	Electronic	\$ 5.60	\$ 33.60	\$ 60.00	\$ 360.00	Excellent Opportunity for Retro-fit
BUILDING H														
<i>Main Ceiling</i>	1	47	4' T12	2	Exp PRF	Magnetic	2	N	Electronic	\$ 5.60	\$ 263.20	\$ 60.00	\$ 2,820.00	No Comment
<i>Class</i>	1	9	4' T12	2	Troffer	Magnetic	2	N	Electronic	\$ 5.60	\$ 50.40	\$ 60.00	\$ 540.00	Excellent Opportunity for Retro-fit
<i>Office</i>	1	2	4' T12	3	Troffer	Magnetic	3	N	Electronic	\$ 8.40	\$ 16.80	\$ 65.00	\$ 130.00	Excellent Opportunity for Retro-fit
	1	2	4' T12	2	Wrap	Magnetic	2	N	Electronic	\$ 5.60	\$ 11.20	\$ 60.00	\$ 120.00	Excellent Opportunity for Retro-fit
<i>Cage</i>	1	2	4' T12	2	Wrap	Magnetic	2	N	Electronic	\$ 5.60	\$ 11.20	\$ 60.00	\$ 120.00	Excellent Opportunity for Retro-fit
<i>Boys</i>	1	2	4' T12	2	Wrap	Magnetic	2	N	Electronic	\$ 5.60	\$ 11.20	\$ 60.00	\$ 120.00	Excellent Opportunity for Retro-fit
<i>Girls</i>	1	2	4' T12	2	Wrap	Magnetic	2	N	Electronic	\$ 5.60	\$ 11.20	\$ 60.00	\$ 120.00	Excellent Opportunity for Retro-fit
<i>Restrooms</i>	1	8	4' T12	2	Wrap	Magnetic	2	N	Electronic	\$ 5.60	\$ 44.80	\$ 60.00	\$ 480.00	Excellent Opportunity for Retro-fit
<i>Electrical Room</i>	1	2	4' T12	1	Strip	Magnetic	1	N	Electronic	\$ 2.80	\$ 5.60	\$ 55.00	\$ 110.00	Excellent Opportunity for Retro-fit
BAND ROOM														
<i>Hall</i>	1	2	4' T12	2	Troffer	Magnetic	2	N	Electronic	\$ 5.60	\$ 11.20	\$ 60.00	\$ 120.00	Excellent Opportunity for Retro-fit
<i>Office</i>	1	4	4' T12	2	Troffer	Magnetic	2	N	Electronic	\$ 5.60	\$ 22.40	\$ 60.00	\$ 240.00	Excellent Opportunity for Retro-fit
<i>Repair Room</i>	1	6	4' T12	3	Troffer	Magnetic	3	N	Electronic	\$ 8.40	\$ 50.40	\$ 65.00	\$ 390.00	Excellent Opportunity for Retro-fit
<i>Main Room</i>	1	40	4' T12	2	Troffer	Magnetic	2	N	Electronic	\$ 5.60	\$ 224.00	\$ 60.00	\$ 2,400.00	Excellent Opportunity for Retro-fit
<i>Practice Room</i>	1	6	4' T12	2	Troffer	Magnetic	2	N	Electronic	\$ 5.60	\$ 33.60	\$ 60.00	\$ 360.00	Excellent Opportunity for Retro-fit
<i>Practice Room (5)</i>	1	5	4' T12	2	Troffer	Magnetic	2	N	Electronic	\$ 5.60	\$ 28.00	\$ 60.00	\$ 300.00	Excellent Opportunity for Retro-fit
BUILDING I														
<i>Typing 201</i>	2	12	4' T12	4	Troffer	Magnetic	4	N	Electronic	\$ 11.20	\$ 134.40	\$ 70.00	\$ 840.00	Excellent Opportunity for Retro-fit
<i>Storage</i>	2	3	4' T12	4	Troffer	Magnetic	4	N	Electronic	\$ 11.20	\$ 33.60	\$ 70.00	\$ 210.00	Excellent Opportunity for Retro-fit
	2	1	U T12	2	2x2	Magnetic	2	N	Electronic	\$ 5.60	\$ 5.60	\$ 60.00	\$ 60.00	No Comment
<i>Electrical Room</i>	2	1	4' T12	2	Wrap	Magnetic	2	N	Electronic	\$ 5.60	\$ 5.60	\$ 60.00	\$ 60.00	Excellent Opportunity for Retro-fit
<i>Faculty Workroom</i>	2	8	4' T12	4	Troffer	Magnetic	4	N	Electronic	\$ 11.20	\$ 89.60	\$ 70.00	\$ 560.00	Excellent Opportunity for Retro-fit
<i>Restrooms</i>	2	2	4' T12	2	Vanity	Magnetic	2	N	Electronic	\$ 5.60	\$ 11.20	\$ 60.00	\$ 120.00	Excellent Opportunity for Retro-fit
<i>202</i>	2	16	4' T12	4	Troffer	Magnetic	4	N	Electronic	\$ 11.20	\$ 179.20	\$ 70.00	\$ 1,120.00	Excellent Opportunity for Retro-fit
<i>203</i>	2	16	4' T12	4	Troffer	Magnetic	4	N	Electronic	\$ 11.20	\$ 179.20	\$ 70.00	\$ 1,120.00	Excellent Opportunity for Retro-fit
<i>204</i>	2	16	4' T12	4	Troffer	Magnetic	4	N	Electronic	\$ 11.20	\$ 179.20	\$ 70.00	\$ 1,120.00	Excellent Opportunity for Retro-fit
<i>102</i>	1	29	4' T12	4	Troffer	Magnetic	4	N	Electronic	\$ 11.20	\$ 324.80	\$ 70.00	\$ 2,030.00	Excellent Opportunity for Retro-fit
<i>Laundry</i>	1	2	4' T12	2	Wrap	Magnetic	2	N	Electronic	\$ 5.60	\$ 11.20	\$ 60.00	\$ 120.00	Excellent Opportunity for Retro-fit
<i>Storage</i>	1	1	4' T12	2	Wrap	Magnetic	2	N	Electronic	\$ 5.60	\$ 5.60	\$ 60.00	\$ 60.00	Excellent Opportunity for Retro-fit

LOCATION	EXISTING EQUIPMENT						PROPOSED			REBATES		COSTS		COMMENTS
Location (Rm Name, Rm. #, Area, Zone, etc.)	Floor	Quantity	Lamp Type	Lamps Per Fixture	Type of Fixture	Ballast Type	Lamps Per Fixture	Reflectors	Ballast Type	Per Single	Extended	Per Single	Extended	Surveyors Comments
Storage	1	2	4' T12	2	Wrap	Magnetic	2	N	Electronic	\$ 5.60	\$ 11.20	\$ 60.00	\$ 120.00	Excellent Opportunity for Retro-fit
Womens' Restroom	1	6	4' T12	2	Wrap	Magnetic	2	N	Electronic	\$ 5.60	\$ 33.60	\$ 60.00	\$ 360.00	Excellent Opportunity for Retro-fit
Mens' Restroom	1	8	4' T12	2	Wrap	Magnetic	2	N	Electronic	\$ 5.60	\$ 44.80	\$ 60.00	\$ 480.00	Excellent Opportunity for Retro-fit
Elevator	1	1	4' T12	2	Wrap	Magnetic	2	N	Electronic	\$ 5.60	\$ 5.60	\$ 60.00	\$ 60.00	Excellent Opportunity for Retro-fit
101	1	6	4' T12	4	Troffer	Magnetic	4	N	Electronic	\$ 11.20	\$ 67.20	\$ 70.00	\$ 420.00	Excellent Opportunity for Retro-fit
	1	21	4' T12	4	Troffer	Magnetic	4	N	Electronic	\$ 11.20	\$ 235.20	\$ 70.00	\$ 1,470.00	Excellent Opportunity for Retro-fit
	1	3	U T12	2	2x2	Magnetic	2	N	Electronic	\$ 5.60	\$ 16.80	\$ 60.00	\$ 180.00	No Comment
Total Rebates										\$	6,932.80			
Total Costs										\$	69,285.00			

LOCATION	QTY	EXISTING TYPE	QTY	RETROFIT	SURVEYORS COMMENTS	Actual				Proposed			
						Existing Watt/unit	Op. Hours	kWh	kW-D	Watt/unit	Op. Hours	kWh	kW-D
BUILDING E	0		0		0		1,786	0.0	0		1,786	0.0	0
Front Office	8	4' 2L Fixture	8	Lamp & Low Watt Ballast	No Lens Excellent opportunity for retro-fit	75.6	1,786	1,080.2	0.6048	51	1,786	728.7	0.408
0	3	4' 2L Fixture	3	Lamp & Low Watt Ballast	Excellent Opportunity for Retro-fit	75.6	1,786	405.1	0.2268	51	1,786	273.3	0.153
Vice Principal	4	4' 2L Fixture	4	Lamp & Low Watt Ballast	Excellent Opportunity for Retro-fit	75.6	1,786	540.1	0.3024	51	1,786	364.3	0.204
Health	4	4' 2L Fixture	4	Lamp & Low Watt Ballast	Excellent Opportunity for Retro-fit	75.6	1,786	540.1	0.3024	51	1,786	364.3	0.204
Counselor	2	4' 2L Fixture	2	Lamp & Low Watt Ballast	Excellent Opportunity for Retro-fit	75.6	1,786	270.0	0.1512	51	1,786	182.2	0.102
Principal	2	4' 2L Fixture	2	Lamp & Low Watt Ballast	Excellent Opportunity for Retro-fit	75.6	1,786	270.0	0.1512	51	1,786	182.2	0.102
Private	2	4' 2L Fixture	2	Lamp & Low Watt Ballast	Excellent Opportunity for Retro-fit	75.6	1,786	270.0	0.1512	51	1,786	182.2	0.102
Hall	2	4' 2L Fixture	2	Lamp & Low Watt Ballast	No Lens Excellent opportunity for retro-fit	75.6	1,786	270.0	0.1512	51	1,786	182.2	0.102
Restrooms	2	4' 2L Fixture	2	Lamp & Low Watt Ballast	No Lens Excellent opportunity for retro-fit	75.6	1,786	270.0	0.1512	51	1,786	182.2	0.102
Workroom	9	4' 2L Fixture	9	Lamp & Low Watt Ballast	Excellent Opportunity for Retro-fit	75.6	1,786	1,215.2	0.6804	51	1,786	819.8	0.459
List and Viewing	2	4' 2L Fixture	2	Lamp & Low Watt Ballast	Excellent Opportunity for Retro-fit	75.6	1,786	270.0	0.1512	51	1,786	182.2	0.102
Staff	2	4' 2L Fixture	2	Lamp & Low Watt Ballast	Excellent Opportunity for Retro-fit	75.6	1,786	270.0	0.1512	51	1,786	182.2	0.102
Library	60	4' 2L Fixture	60	Lamp & Low Watt Ballast	Excellent Opportunity for Retro-fit	75.6	1,786	8,101.3	4.536	51	1,786	5,465.2	3.06
0	6	4' 2L Fixture	6	Lamp & Low Watt Ballast	Excellent Opportunity for Retro-fit	75.6	1,786	810.1	0.4536	51	1,786	546.5	0.306
BUILDING A	0		0		0		1,786	0.0	0		1,786	0.0	0
Hall	4	4' 2L Fixture	4	Lamp & Low Watt Ballast	Excellent Opportunity for Retro-fit	75.6	1,786	540.1	0.3024	51	1,786	364.3	0.204
0	1	4' 4L Fixture	1	Lamp & Low Watt Ballast	Excellent Opportunity for Retro-fit	151.2	1,786	270.0	0.1512	100	1,786	178.6	0.1
Class 23	12	4' 4L Fixture	12	Lamp & Low Watt Ballast	Excellent Opportunity for Retro-fit	151.2	1,786	3,240.5	1.8144	100	1,786	2,143.2	1.2
Class 26	9	4' 4L Fixture	9	Lamp & Low Watt Ballast	Excellent Opportunity for Retro-fit	151.2	1,786	2,430.4	1.3608	100	1,786	1,607.4	0.9
Class 24	9	4' 4L Fixture	9	Lamp & Low Watt Ballast	Excellent Opportunity for Retro-fit	151.2	1,786	2,430.4	1.3608	100	1,786	1,607.4	0.9
Class 22	9	4' 4L Fixture	9	Lamp & Low Watt Ballast	Excellent Opportunity for Retro-fit	151.2	1,786	2,430.4	1.3608	100	1,786	1,607.4	0.9
Counselor	12	4' 4L Fixture	12	Lamp & Low Watt Ballast	Excellent Opportunity for Retro-fit	151.2	1,786	3,240.5	1.8144	100	1,786	2,143.2	1.2
Hall	7	4' 4L Fixture	7	Lamp & Low Watt Ballast	Excellent Opportunity for Retro-fit	151.2	1,786	1,890.3	1.0584	100	1,786	1,250.2	0.7
BSS.	2	4' 2L Fixture	2	Lamp & Low Watt Ballast	Excellent Opportunity for Retro-fit	75.6	1,786	270.0	0.1512	51	1,786	182.2	0.102
0	1	4' 4L Fixture	1	Lamp & Low Watt Ballast	Excellent Opportunity for Retro-fit	151.2	1,786	270.0	0.1512	100	1,786	178.6	0.1
A 17	9	4' 2L Fixture	9	Lamp & Low Watt Ballast	Excellent Opportunity for Retro-fit	75.6	1,786	1,215.2	0.6804	51	1,786	819.8	0.459
A 18	9	4' 4L Fixture	9	Lamp & Low Watt Ballast	Excellent Opportunity for Retro-fit	151.2	1,786	2,430.4	1.3608	100	1,786	1,607.4	0.9
A 15	12	4' 4L Fixture	12	Lamp & Low Watt Ballast	Excellent Opportunity for Retro-fit	151.2	1,786	3,240.5	1.8144	100	1,786	2,143.2	1.2
A 16	12	4' 4L Fixture	12	Lamp & Low Watt Ballast	Excellent Opportunity for Retro-fit	151.2	1,786	3,240.5	1.8144	100	1,786	2,143.2	1.2
A 14	12	4' 4L Fixture	12	Lamp & Low Watt Ballast	Excellent Opportunity for Retro-fit	151.2	1,786	3,240.5	1.8144	100	1,786	2,143.2	1.2
A 12	9	4' 4L Fixture	9	Lamp & Low Watt Ballast	Excellent Opportunity for Retro-fit	151.2	1,786	2,430.4	1.3608	100	1,786	1,607.4	0.9
A 11	9	4' 4L Fixture	9	Lamp & Low Watt Ballast	Excellent Opportunity for Retro-fit	151.2	1,786	2,430.4	1.3608	100	1,786	1,607.4	0.9
Registrar	4	4' 4L Fixture	4	Lamp & Low Watt Ballast	Excellent Opportunity for Retro-fit	151.2	1,786	1,080.2	0.6048	100	1,786	714.4	0.4
Restrooms	8	4' 2L Fixture	8	Lamp & Low Watt Ballast	Excellent Opportunity for Retro-fit	75.6	1,786	1,080.2	0.6048	51	1,786	728.7	0.408
Hall	3	4' 2L Fixture	3	Lamp & Low Watt Ballast	Excellent Opportunity for Retro-fit	75.6	1,786	405.1	0.2268	51	1,786	273.3	0.153
A 2	11	4' 4L Fixture	11	Lamp & Low Watt Ballast	Excellent Opportunity for Retro-fit	151.2	1,786	2,970.5	1.6632	100	1,786	1,964.6	1.1
A 1 Class	11	4' 4L Fixture	11	Lamp & Low Watt Ballast	Excellent Opportunity for Retro-fit	151.2	1,786	2,970.5	1.6632	100	1,786	1,964.6	1.1
BUILDING F	0		0		0		1,786	0.0	0		1,786	0.0	0
F 202	33	4' 2L Fixture	33	Lamp & Low Watt Ballast	Excellent Opportunity for Retro-fit	75.6	1,786	4,455.7	2.4948	51	1,786	3,005.8	1.683
Kitchen	3	4' 2L Fixture	3	Lamp & Low Watt Ballast	Excellent Opportunity for Retro-fit	75.6	1,786	405.1	0.2268	51	1,786	273.3	0.153
F 201	33	4' 2L Fixture	33	Lamp & Low Watt Ballast	Excellent Opportunity for Retro-fit	75.6	1,786	4,455.7	2.4948	51	1,786	3,005.8	1.683
Storage	3	4' 2L Fixture	3	Lamp & Low Watt Ballast	Excellent Opportunity for Retro-fit	75.6	1,786	405.1	0.2268	51	1,786	273.3	0.153
Girls' Restroom	4	4' 2L Fixture	4	Lamp & Low Watt Ballast	No Comment	75.6	1,786	540.1	0.3024	51	1,786	364.3	0.204
Boys' Restroom	4	4' 2L Fixture	4	Lamp & Low Watt Ballast	No Comment	75.6	1,786	540.1	0.3024	51	1,786	364.3	0.204
F 101	30	4' 2L Fixture	30	Lamp & Low Watt Ballast	Excellent Opportunity for Retro-fit	75.6	1,786	4,050.6	2.268	51	1,786	2,732.6	1.53
0	4	4' 2L Fixture	4	Lamp & Low Watt Ballast	Excellent Opportunity for Retro-fit	75.6	1,786	540.1	0.3024	51	1,786	364.3	0.204
F 102	33	4' 2L Fixture	33	Lamp & Low Watt Ballast	Excellent Opportunity for Retro-fit	75.6	1,786	4,455.7	2.4948	51	1,786	3,005.8	1.683
Storage	3	4' 2L Fixture	3	Lamp & Low Watt Ballast	Excellent Opportunity for Retro-fit	75.6	1,786	405.1	0.2268	51	1,786	273.3	0.153
PORTABLE 2035	0		0		0		1,786	0.0	0		1,786	0.0	0
Portable	12	4' 4L Fixture	12	Lamp & Low Watt Ballast	No Comment	151.2	1,786	3,240.5	1.8144	100	1,786	2,143.2	1.2
Storage	2	4' 4L Fixture	2	Lamp & Low Watt Ballast	Excellent Opportunity for Retro-fit	151.2	1,786	540.1	0.3024	100	1,786	357.2	0.2
BUILDING D	0		0		0		1,786	0.0	0		1,786	0.0	0
Workroom	6	4' 2L Fixture	6	Lamp & Low Watt Ballast	Replace Fixture and mount hardware	75.6	1,786	810.1	0.4536	51	1,786	546.5	0.306
0	1	4' 2L Fixture	1	Lamp & Low Watt Ballast	Replace Fixture and mount hardware	75.6	1,786	135.0	0.0756	51	1,786	91.1	0.051
D 4	28	4' 2L Fixture	28	Lamp & Low Watt Ballast	Replace Fixture and mount hardware	75.6	1,786	3,780.6	2.1168	51	1,786	2,550.4	1.428
D 3	28	4' 2L Fixture	28	Lamp & Low Watt Ballast	Replace Fixture and mount hardware	75.6	1,786	3,780.6	2.1168	51	1,786	2,550.4	1.428
D 2	28	4' 2L Fixture	28	Lamp & Low Watt Ballast	Replace Fixture and mount hardware	75.6	1,786	3,780.6	2.1168	51	1,786	2,550.4	1.428
D 1	28	4' 2L Fixture	28	Lamp & Low Watt Ballast	Replace Fixture and mount hardware	75.6	1,786	3,780.6	2.1168	51	1,786	2,550.4	1.428
Detention	2	4' 2L Fixture	2	Lamp & Low Watt Ballast	Replace Fixture and mount hardware	75.6	1,786	270.0	0.1512	51	1,786	182.2	0.102
BUILDING C	0		0		0		1,786	0.0	0		1,786	0.0	0
Main Room	14	4' 4L Fixture	14	Lamp & Low Watt Ballast	Replace Fixture and mount hardware	151.2	1,786	3,780.6	2.1168	100	1,786	2,500.4	1.4
Kitchen	17	60W Inc	0		No Comment		1,786	0.0	0		1,786	0.0	0
Office	1	4' 4L Fixture	1	Lamp & Low Watt Ballast	Replace Fixture and mount hardware	151.2	1,786	270.0	0.1512	100	1,786	178.6	0.1
Snack Shack	2	4' 4L Fixture	2	Lamp & Low Watt Ballast	Excellent Opportunity for Retro-fit	151.2	1,786	540.1	0.3024	100	1,786	357.2	0.2
BUILDING G	0		0		0		1,786	0.0	0		1,786	0.0	0
Girls' Locker Room	18	4' 2L Fixture	18	Lamp & Low Watt Ballast	Excellent Opportunity for Retro-fit	75.6	1,786	2,430.4	1.3608	51	1,786	1,639.5	0.918

LOCATION	QTY	EXISTING TYPE	QTY	RETROFIT	SURVEYORS COMMENTS	Existing				Proposed			
						Watt/unit	Op. Hours	kWh	kW-D	Watt/unit	Op. Hours	kWh	kW-D
Boys' Locker Room	22	4' 2L Fixture	22	Lamp & Low Watt Ballast	Excellent Opportunity for Retro-fit	75.6	1,786	2,970.5	1.6632	51	1,786	2,003.9	1.122
Weight Room	2	4' 4L Fixture	2	Lamp & Low Watt Ballast	Excellent Opportunity for Retro-fit	151.2	1,786	540.1	0.3024	100	1,786	357.2	0.2
0	6	4' 2L Fixture	6	Lamp & Low Watt Ballast	Excellent Opportunity for Retro-fit	75.6	1,786	810.1	0.4536	51	1,786	546.5	0.306
BUILDING H	0		0		0		1,786	0.0	0		1,786	0.0	0
Main Ceiling	47	4' 2L Fixture	47	Lamp & Low Watt Ballast	No Comment	75.6	1,786	6,346.0	3.5532	51	1,786	4,281.0	2.397
Class	9	4' 2L Fixture	9	Lamp & Low Watt Ballast	Excellent Opportunity for Retro-fit	75.6	1,786	1,215.2	0.6804	51	1,786	819.8	0.459
Office	2	4' 3L Fixture	2	Lamp & Low Watt Ballast	Excellent Opportunity for Retro-fit	121.2	1,786	432.9	0.2424	77	1,786	275.0	0.154
0	2	4' 2L Fixture	2	Lamp & Low Watt Ballast	Excellent Opportunity for Retro-fit	75.6	1,786	270.0	0.1512	51	1,786	182.2	0.102
Cage	2	4' 2L Fixture	2	Lamp & Low Watt Ballast	Excellent Opportunity for Retro-fit	75.6	1,786	270.0	0.1512	51	1,786	182.2	0.102
Boys	2	4' 2L Fixture	2	Lamp & Low Watt Ballast	Excellent Opportunity for Retro-fit	75.6	1,786	270.0	0.1512	51	1,786	182.2	0.102
Girls	2	4' 2L Fixture	2	Lamp & Low Watt Ballast	Excellent Opportunity for Retro-fit	75.6	1,786	270.0	0.1512	51	1,786	182.2	0.102
Restrooms	8	4' 2L Fixture	8	Lamp & Low Watt Ballast	Excellent Opportunity for Retro-fit	75.6	1,786	1,080.2	0.6048	51	1,786	728.7	0.408
Electrical Room	2	4' 1L Fixture	2	Lamp & Low Watt Ballast	Excellent Opportunity for Retro-fit	45.6	1,786	162.9	0.0912	31	1,786	110.7	0.062
BAND ROOM	0		0		0		1,786	0.0	0		1,786	0.0	0
Hall	2	4' 2L Fixture	2	Lamp & Low Watt Ballast	Excellent Opportunity for Retro-fit	75.6	1,786	270.0	0.1512	51	1,786	182.2	0.102
Office	4	4' 2L Fixture	4	Lamp & Low Watt Ballast	Excellent Opportunity for Retro-fit	75.6	1,786	540.1	0.3024	51	1,786	364.3	0.204
Repair Room	6	4' 3L Fixture	6	Lamp & Low Watt Ballast	Excellent Opportunity for Retro-fit	121.2	1,786	1,298.8	0.7272	77	1,786	825.1	0.462
Main Room	40	4' 2L Fixture	40	Lamp & Low Watt Ballast	Excellent Opportunity for Retro-fit	75.6	1,786	5,400.9	3.024	51	1,786	3,643.4	2.04
Practice Room	6	4' 2L Fixture	6	Lamp & Low Watt Ballast	Excellent Opportunity for Retro-fit	75.6	1,786	810.1	0.4536	51	1,786	546.5	0.306
Practice Room (5)	5	4' 2L Fixture	5	Lamp & Low Watt Ballast	Excellent Opportunity for Retro-fit	75.6	1,786	675.1	0.378	51	1,786	455.4	0.255
BUILDING I	0		0		0		1,786	0.0	0		1,786	0.0	0
Typing 201	12	4' 4L Fixture	12	Lamp & Low Watt Ballast	Excellent Opportunity for Retro-fit	151.2	1,786	3,240.5	1.8144	100	1,786	2,143.2	1.2
Storage	3	4' 4L Fixture	3	Lamp & Low Watt Ballast	Excellent Opportunity for Retro-fit	151.2	1,786	810.1	0.4536	100	1,786	535.8	0.3
0	1	2x2 2U Fixture	1	Lamp & Low Watt Ballast	No Comment	75.6	1,786	135.0	0.0756	51	1,786	91.1	0.051
Electrical Room	1	4' 2L Fixture	1	Lamp & Low Watt Ballast	Excellent Opportunity for Retro-fit	75.6	1,786	135.0	0.0756	51	1,786	91.1	0.051
Faculty Workroom	8	4' 4L Fixture	8	Lamp & Low Watt Ballast	Excellent Opportunity for Retro-fit	151.2	1,786	2,160.3	1.2096	100	1,786	1,428.8	0.8
Restrooms	2	4' 2L Fixture	2	Lamp & Low Watt Ballast	Excellent Opportunity for Retro-fit	75.6	1,786	270.0	0.1512	51	1,786	182.2	0.102
202	16	4' 4L Fixture	16	Lamp & Low Watt Ballast	Excellent Opportunity for Retro-fit	151.2	1,786	4,320.7	2.4192	100	1,786	2,857.6	1.6
203	16	4' 4L Fixture	16	Lamp & Low Watt Ballast	Excellent Opportunity for Retro-fit	151.2	1,786	4,320.7	2.4192	100	1,786	2,857.6	1.6
204	16	4' 4L Fixture	16	Lamp & Low Watt Ballast	Excellent Opportunity for Retro-fit	151.2	1,786	4,320.7	2.4192	100	1,786	2,857.6	1.6
102	29	4' 4L Fixture	29	Lamp & Low Watt Ballast	Excellent Opportunity for Retro-fit	151.2	1,786	7,831.3	4.3848	100	1,786	5,179.4	2.9
Laundry	2	4' 2L Fixture	2	Lamp & Low Watt Ballast	Excellent Opportunity for Retro-fit	75.6	1,786	270.0	0.1512	51	1,786	182.2	0.102
Storage	1	4' 2L Fixture	1	Lamp & Low Watt Ballast	Excellent Opportunity for Retro-fit	75.6	1,786	135.0	0.0756	51	1,786	91.1	0.051
Storage	2	4' 2L Fixture	2	Lamp & Low Watt Ballast	Excellent Opportunity for Retro-fit	75.6	1,786	270.0	0.1512	51	1,786	182.2	0.102
Womens' Restroom	6	4' 2L Fixture	6	Lamp & Low Watt Ballast	Excellent Opportunity for Retro-fit	75.6	1,786	810.1	0.4536	51	1,786	546.5	0.306
Mens' Restroom	8	4' 2L Fixture	8	Lamp & Low Watt Ballast	Excellent Opportunity for Retro-fit	75.6	1,786	1,080.2	0.6048	51	1,786	728.7	0.408
Elevator	1	4' 2L Fixture	1	Lamp & Low Watt Ballast	Excellent Opportunity for Retro-fit	75.6	1,786	135.0	0.0756	51	1,786	91.1	0.051
101	6	4' 4L Fixture	6	Lamp & Low Watt Ballast	Excellent Opportunity for Retro-fit	151.2	1,786	1,620.3	0.9072	100	1,786	1,071.6	0.6
0	21	4' 4L Fixture	21	Lamp & Low Watt Ballast	Excellent Opportunity for Retro-fit	151.2	1,786	5,670.9	3.1752	100	1,786	3,750.6	2.1
0	3	2x2 2U Fixture	3	Lamp & Low Watt Ballast	No Comment	75.6	1,786	405.1	0.2268	51	1,786	273.3	0.153

Existing 943 Proposed 926

ENERGY CALCULATIONS			167,296	94	111,688	63
Description	kW-Demand	kWh				
Existing Use	93.67	167,296				
Proposed Use	62.54	111,688				
Difference - Savings	31.14	55,609				
Electrical Utility Cost	\$5.75	\$0.15533				
Savings per Year	\$2,148.37	\$8,637.67				
			Total Yearly Energy Savings			
				\$10,786.04		

Kahului Elementary School Campus

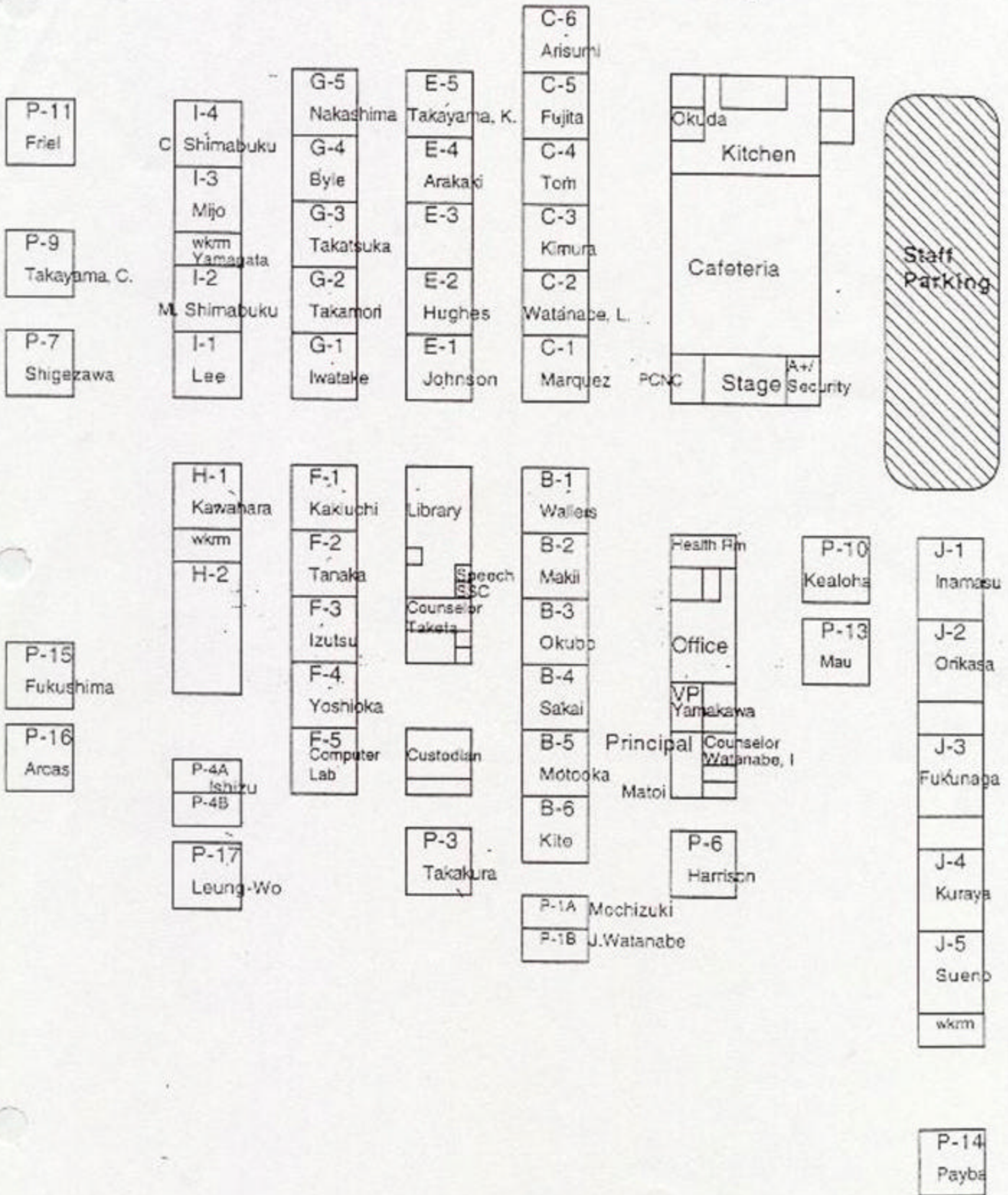

Maui Smart Schools Program
Foot Candle Readings

School: Kahului Elementary School

Room: <u>P-14</u>	60	62
Ceiling Height: <u>8 Feet</u>		62
Light Fixture Height: <u>7 Feet</u>		
Fixture Type: <u>Wrap</u>	67	63

Room: <u>Bldg. J-3</u>	41	47
Ceiling Height: <u>11 Feet</u>		45
Light Fixture Height: <u>8 Feet</u>		
Fixture Type: <u>Wrap</u>	50	41

Room: <u>Bldg B-5</u>	31	47
Ceiling Height: <u>10 Feet</u>		42
Light Fixture Height: <u>9 Feet</u>		
Fixture Type: <u>Wrap</u>	39	44



CUSTOMER INFORMATION		DATE
NAME Kahului Elementary School		7/2/2000
STREET ADDRESS 410 South Hina Avenue Kahului, HI 96732		OPERATIONAL HOURS 1,549
POINT OF CONTACT Gary Motoi	PHONE 873-3055	FAX 873-3062
AUDITOR		VOLTAGE 120V

LOCATION (Rm Name, Rm. #, Area, Zone, etc.)	EXISTING EQUIPMENT						PROPOSED			REBATES		COSTS		COMMENTS
	Floor	Quantity	Lamp Type	Lamps Per Fixture	Type of Fixture	Ballast Type	Lamps Per Fixture	Reflectors	Ballast Type	Per Single	Extended	Per Single	Extended	
PORTABLES											\$ -		\$ -	
P14		16	4' T12	4	Wrap	Magnetic	4	N	Electronic	\$ 11.20	\$ 179.20	\$ 70.00	\$ 1,120.00	Retrofit Recommended
Exterior		2	Inc								\$ -		\$ -	None
P13		16	4' T12	4	Wrap	Magnetic	4	N	Electronic	\$ 11.20	\$ 179.20	\$ 70.00	\$ 1,120.00	Retrofit Recommended
Exterior		2	Inc								\$ -	\$ -	\$ -	None
P10		16	4' T12	4	Wrap	Magnetic	4	N	Electronic	\$ 11.20	\$ 179.20	\$ 70.00	\$ 1,120.00	Retrofit Recommended
Exterior		2	Inc								\$ -	\$ -	\$ -	None
P6		16	4' T12	4	Wrap	Magnetic	4	N	Electronic	\$ 11.20	\$ 179.20	\$ 70.00	\$ 1,120.00	Retrofit Recommended
Exterior		2	Inc								\$ -	\$ -	\$ -	None
P1A		4	4' T12	4	Fixture	Magnetic	4	N	Electronic	\$ 11.20	\$ 44.80	\$ 70.00	\$ 280.00	Retrofit Recommended
Exterior		2	4' T12	2	Fixture	Magnetic	2	N	Electronic	\$ 5.60	\$ 11.20	\$ 60.00	\$ 120.00	Retrofit Recommended
P1B		4	4' T12	4	Fixture	Magnetic	4	N	Electronic	\$ 11.20	\$ 44.80	\$ 70.00	\$ 280.00	Retrofit Recommended
Exterior		2	4' T12	2	Fixture	Magnetic	2	N	Electronic	\$ 5.60	\$ 11.20	\$ 60.00	\$ 120.00	Retrofit Recommended
P3		16	4' T12	4	Wrap	Magnetic	4	N	Electronic	\$ 11.20	\$ 179.20	\$ 70.00	\$ 1,120.00	Retrofit Recommended
Exterior		2	Inc								\$ -	\$ -	\$ -	None
P4		16	4' T12	4	Fixture	Magnetic	4	N	Electronic	\$ 11.20	\$ 179.20	\$ 70.00	\$ 1,120.00	Retrofit Recommended
Exterior		2	Inc								\$ -	\$ -	\$ -	None
P17		16	4' T12	4	Fixture	Magnetic	4	N	Electronic	\$ 11.20	\$ 179.20	\$ 70.00	\$ 1,120.00	Retrofit Recommended
Exterior		2	Inc								\$ -	\$ -	\$ -	None
Bath		2	Inc								\$ -	\$ -	\$ -	None
P16		16	4' T12	4	Fixture	Magnetic	4	N	Electronic	\$ 11.20	\$ 179.20	\$ 70.00	\$ 1,120.00	Retrofit Recommended
Exterior		2	Inc								\$ -	\$ -	\$ -	None
P15		16	4' T12	4	Wrap	Magnetic	4	N	Electronic	\$ 11.20	\$ 179.20	\$ 70.00	\$ 1,120.00	Retrofit Recommended
		2	Inc								\$ -	\$ -	\$ -	None
P7		16	4' T12	4	Wrap	Magnetic	4	N	Electronic	\$ 11.20	\$ 179.20	\$ 70.00	\$ 1,120.00	Retrofit Recommended
Bath		1	Inc								\$ -	\$ -	\$ -	None
Bath		1	Inc								\$ -	\$ -	\$ -	None
Exit		2	Inc								\$ -	\$ -	\$ -	None
P9		16	4' T12	4	Wrap	Magnetic	4	N	Electronic	\$ 11.20	\$ 179.20	\$ 70.00	\$ 1,120.00	Retrofit Recommended
Exit		1	Inc								\$ -	\$ -	\$ -	None

LOCATION	EXISTING EQUIPMENT						PROPOSED			REBATES		COSTS		COMMENTS
Location (Rm. Name, Rm. #, Area, Zone, etc.)	Floor	Quantity	Lamp Type	Lamps Per Fixture	Type of Fixture	Ballast Type	Lamps Per Fixture	Reflectors	Ballast Type	Per Single	Extended	Per Single	Extended	Comments
<i>P11</i>		16	4' T12	4	Wrap	Magnetic	4	N	Electronic	\$ 11.20	\$ 179.20	\$ 70.00	\$ 1,120.00	Retrofit Recommended
<i>Exit</i>		1	Inc								\$ -	\$ -	\$ -	None
BUILDING J											\$ -		\$ -	
<i>Tower</i>		1	4' T12	4	Wrap	Magnetic	4	N	Electronic	\$ 11.20	\$ 11.20	\$ 70.00	\$ 70.00	Retrofit Recommended
		1	Inc								\$ -	\$ -	\$ -	None
<i>J5</i>		2	Inc								\$ -	\$ -	\$ -	None
		15	4' T12	4	Wrap	Magnetic	4	N	Electronic	\$ 11.20	\$ 168.00	\$ 70.00	\$ 1,050.00	Retrofit Recommended
<i>J4</i>		15	4' T12	4	Wrap	Magnetic	4	N	Electronic	\$ 11.20	\$ 168.00	\$ 70.00	\$ 1,050.00	Retrofit Recommended
		1	Inc	2							\$ -		\$ -	None
<i>Janitor</i>		2	Inc								\$ -	\$ -	\$ -	None
<i>J3</i>		15	4' T12	4	Wrap	Magnetic	4	N	Electronic	\$ 11.20	\$ 168.00	\$ 70.00	\$ 1,050.00	Retrofit Recommended
		1	Inc	2							\$ -	\$ -	\$ -	None
<i>J2</i>		15	4' T12	4	Wrap	Magnetic	4	N	Electronic	\$ 11.20	\$ 168.00	\$ 70.00	\$ 1,050.00	Retrofit Recommended
		1	Inc	2							\$ -	\$ -	\$ -	None
<i>Janitor</i>		2	Inc								\$ -	\$ -	\$ -	None
<i>J1</i>		15	4' T12	4	Wrap	Magnetic	4	N	Electronic	\$ 11.20	\$ 168.00	\$ 70.00	\$ 1,050.00	Retrofit Recommended
		1	Inc	2							\$ -	\$ -	\$ -	None
<i>Exterior</i>		8	Inc								\$ -	\$ -	\$ -	None
CAFETERIA											\$ -		\$ -	
		1	4' T12	4	Ice	Magnetic	4	N	Electronic	\$ 11.20	\$ 11.20	\$ 160.00	\$ 160.00	Fixture Replacement
		1	4' T12	2	Fixture	Magnetic	2	N	Electronic	\$ 5.60	\$ 5.60	\$ 60.00	\$ 60.00	Retrofit Recommended
<i>Stage</i>		2	4' T12	4	Ice	Magnetic	4	N	Electronic	\$ 11.20	\$ 22.40	\$ 160.00	\$ 320.00	Fixture Replacement
<i>Exterior</i>		3	Inc								\$ -	\$ -	\$ -	None
<i>Cafeteria</i>		28	4' T12	4	Wrap	Magnetic	4	N	Electronic	\$ 11.20	\$ 313.60	\$ 70.00	\$ 1,960.00	Retrofit Recommended
		1	4' T12	4	Ice	Magnetic	4	N	Electronic	\$ 11.20	\$ 11.20	\$ 160.00	\$ 160.00	Fixture Replacement
		4			Exit Sign						\$ -		\$ -	None
<i>Girls' Restroom</i>		1	4' T12	2	Fixture	Magnetic	2	N	Electronic	\$ 5.60	\$ 5.60	\$ 60.00	\$ 60.00	Retrofit Recommended
<i>Exterior</i>		19	Inc								\$ -	\$ -	\$ -	None
<i>Boys' Restroom</i>		1	4' T12	2	Fixture	Magnetic	2	N	Electronic	\$ 5.60	\$ 5.60	\$ 60.00	\$ 60.00	Retrofit Recommended
<i>Men's Restroom</i>		1	Inc								\$ -	\$ -	\$ -	None
<i>Stu</i>		1	Inc								\$ -	\$ -	\$ -	None
<i>Heater</i>		1	Inc								\$ -	\$ -	\$ -	None
<i>Kitchen</i>		2	4' T12	4	Fixture	Magnetic	4	N	Electronic	\$ 11.20	\$ 22.40	\$ 70.00	\$ 140.00	Retrofit Recommended
		8	4' T12	2	Fixture	Magnetic	2	N	Electronic	\$ 5.60	\$ 44.80	\$ 60.00	\$ 480.00	Retrofit Recommended
		8	4' T12	4	Fixture	Magnetic	4	N	Electronic	\$ 11.20	\$ 89.60	\$ 70.00	\$ 560.00	Retrofit Recommended
<i>Side Office</i>		1	4' T12	4	Fixture	Magnetic	4	N	Electronic	\$ 11.20	\$ 11.20	\$ 70.00	\$ 70.00	Retrofit Recommended

LOCATION (Rm Name, Rm. #, Area, Zone, etc.)	EXISTING EQUIPMENT						PROPOSED			REBATES		COSTS		COMMENTS
	Floor	Quantity	Lamp Type	Lamps Per Fixture	Type of Fixture	Ballast Type	Lamps Per Fixture	Reflectors	Ballast Type	Per Single	Extended	Per Single	Extended	
		1	4' T12	4	Wrap	Magnetic	4	N	Electronic	\$ 11.20	\$ 11.20	\$ 70.00	\$ 70.00	Retrofit Recommended
OFFICE											\$ -		\$ -	
Health Room		2	4' T12	4	Fixture	Magnetic	4	N	Electronic	\$ 11.20	\$ 22.40	\$ 70.00	\$ 140.00	Retrofit Recommended
		2	Inc	2							\$ -	\$ -	\$ -	None
Office		1	4' T12	4	Fixture	Magnetic	4	N	Electronic	\$ 11.20	\$ 11.20	\$ 70.00	\$ 70.00	Retrofit Recommended
Main Office		13	4' T12	4	Wrap	Magnetic	4	N	Electronic	\$ 11.20	\$ 145.60	\$ 70.00	\$ 910.00	Retrofit Recommended
Office		1	4' T12	4	Wrap	Magnetic	4	N	Electronic	\$ 11.20	\$ 11.20	\$ 70.00	\$ 70.00	Retrofit Recommended
Supply Room		1	4' T12	4	Fixture	Magnetic	4	N	Electronic	\$ 11.20	\$ 11.20	\$ 70.00	\$ 70.00	Retrofit Recommended
Hallway		2	4' T12	2	Fixture	Magnetic	2	N	Electronic	\$ 5.60	\$ 11.20	\$ 60.00	\$ 120.00	Retrofit Recommended
Bash		1	Inc								\$ -	\$ -	\$ -	None
Councilor		1	4' T12	4	Fixture	Magnetic	4	N	Electronic	\$ 11.20	\$ 11.20	\$ 70.00	\$ 70.00	Retrofit Recommended
Conference Room		2	4' T12	4	Wrap	Magnetic	4	N	Electronic	\$ 11.20	\$ 22.40	\$ 70.00	\$ 140.00	Retrofit Recommended
Custodial		2	Inc								\$ -	\$ -	\$ -	None
BUILDING B											\$ -		\$ -	
Exterior		5	Inc								\$ -	\$ -	\$ -	None
Girls' Restroom		6	Inc								\$ -	\$ -	\$ -	None
B6		9	4' T12	4	Fixture	Magnetic	4	N	Electronic	\$ 11.20	\$ 100.80	\$ 70.00	\$ 630.00	Retrofit Recommended
		1	4' T12	2	Fixture	Magnetic	2	N	Electronic	\$ 5.60	\$ 5.60	\$ 60.00	\$ 60.00	Retrofit Recommended
Boys' Restroom		1	Inc								\$ -	\$ -	\$ -	None
B5		9	4' T12	4	Fixture	Magnetic	4	N	Electronic	\$ 11.20	\$ 100.80	\$ 70.00	\$ 630.00	Retrofit Recommended
		1	4' T12	2	Fixture	Magnetic	2	N	Electronic	\$ 5.60	\$ 5.60	\$ 60.00	\$ 60.00	Retrofit Recommended
B4		9	4' T12	4	Fixture	Magnetic	4	N	Electronic	\$ 11.20	\$ 100.80	\$ 70.00	\$ 630.00	Retrofit Recommended
		1	4' T12	2	Fixture	Magnetic	2	N	Electronic	\$ 5.60	\$ 5.60	\$ 60.00	\$ 60.00	Retrofit Recommended
B3		9	4' T12	4	Fixture	Magnetic	4	N	Electronic	\$ 11.20	\$ 100.80	\$ 70.00	\$ 630.00	Retrofit Recommended
		1	4' T12	2	Fixture	Magnetic	2	N	Electronic	\$ 5.60	\$ 5.60	\$ 60.00	\$ 60.00	Retrofit Recommended
B2		9	4' T12	4	Fixture	Magnetic	4	N	Electronic	\$ 11.20	\$ 100.80	\$ 70.00	\$ 630.00	Retrofit Recommended
		1	4' T12	2	Fixture	Magnetic	2	N	Electronic	\$ 5.60	\$ 5.60	\$ 60.00	\$ 60.00	Retrofit Recommended
B1		9	4' T12	4	Fixture	Magnetic	4	N	Electronic	\$ 11.20	\$ 100.80	\$ 70.00	\$ 630.00	Retrofit Recommended
		1	4' T12	2	Fixture	Magnetic	2	N	Electronic	\$ 5.60	\$ 5.60	\$ 60.00	\$ 60.00	Retrofit Recommended
BUILDING C											\$ -		\$ -	
Teacher's Restroom		1	4' T12	2	Fixture	Magnetic	2	N	Electronic	\$ 5.60	\$ 5.60	\$ 60.00	\$ 60.00	Retrofit Recommended
Handi Restroom		1	4' T12	2	Fixture	Magnetic	2	N	Electronic	\$ 5.60	\$ 5.60	\$ 60.00	\$ 60.00	Retrofit Recommended
Boys' Restroom		1	4' T12	2	Fixture	Magnetic	2	N	Electronic	\$ 5.60	\$ 5.60	\$ 60.00	\$ 60.00	Retrofit Recommended
Restroom		7	Inc								\$ -	\$ -	\$ -	None
Exterior		7	Inc								\$ -	\$ -	\$ -	None
C1		9	4' T12	4	Fixture	Magnetic	4	N	Electronic	\$ 11.20	\$ 100.80	\$ 70.00	\$ 630.00	Retrofit Recommended

LOCATION	EXISTING EQUIPMENT						PROPOSED			REBATES		COSTS		COMMENTS
Location (Rm. Name, Rm. #, Area, Zone, etc.)	Floor	Quantity	Lamp Type	Lamps Per Fixture	Type of Fixture	Ballast Type	Lamps Per Fixture	Reflectors	Ballast Type	Per Single	Extended	Per Single	Extended	Comments
		1	4' T12	2	Fixture	Magnetic	2	N	Electronic	\$ 5.60	\$ 5.60	\$ 60.00	\$ 60.00	Retrofit Recommended
C2		9	4' T12	4	Fixture	Magnetic	4	N	Electronic	\$ 11.20	\$ 100.80	\$ 70.00	\$ 630.00	Retrofit Recommended
		1	4' T12	2	Fixture	Magnetic	2	N	Electronic	\$ 5.60	\$ 5.60	\$ 60.00	\$ 60.00	Retrofit Recommended
C3		9	4' T12	4	Fixture	Magnetic	4	N	Electronic	\$ 11.20	\$ 100.80	\$ 70.00	\$ 630.00	Retrofit Recommended
		1	4' T12	2	Fixture	Magnetic	2	N	Electronic	\$ 5.60	\$ 5.60	\$ 60.00	\$ 60.00	Retrofit Recommended
C4		9	4' T12	4	Fixture	Magnetic	4	N	Electronic	\$ 11.20	\$ 100.80	\$ 70.00	\$ 630.00	Retrofit Recommended
		1	4' T12	2	Fixture	Magnetic	2	N	Electronic	\$ 5.60	\$ 5.60	\$ 60.00	\$ 60.00	Retrofit Recommended
C5		9	4' T12	4	Fixture	Magnetic	4	N	Electronic	\$ 11.20	\$ 100.80	\$ 70.00	\$ 630.00	Retrofit Recommended
		1	4' T12	2	Fixture	Magnetic	2	N	Electronic	\$ 5.60	\$ 5.60	\$ 60.00	\$ 60.00	Retrofit Recommended
C6		9	4' T12	4	Fixture	Magnetic	4	N	Electronic	\$ 11.20	\$ 100.80	\$ 70.00	\$ 630.00	Retrofit Recommended
		1	4' T12	2	Fixture	Magnetic	2	N	Electronic	\$ 5.60	\$ 5.60	\$ 60.00	\$ 60.00	Retrofit Recommended
BUILDING E												\$ -	\$ -	
E5		9	4' T12	4	Fixture	Magnetic	4	N	Electronic	\$ 11.20	\$ 100.80	\$ 70.00	\$ 630.00	Retrofit Recommended
		1	4' T12	2	Fixture	Magnetic	2	N	Electronic	\$ 5.60	\$ 5.60	\$ 60.00	\$ 60.00	Retrofit Recommended
Exterior		6	Inc								\$ -	\$ -	\$ -	None
E4		9	4' T12	4	Fixture	Magnetic	4	N	Electronic	\$ 11.20	\$ 100.80	\$ 70.00	\$ 630.00	Retrofit Recommended
		1	4' T12	2	Fixture	Magnetic	2	N	Electronic	\$ 5.60	\$ 5.60	\$ 60.00	\$ 60.00	Retrofit Recommended
E3		9	4' T12	4	Fixture	Magnetic	4	N	Electronic	\$ 11.20	\$ 100.80	\$ 70.00	\$ 630.00	Retrofit Recommended
		1	4' T12	2	Fixture	Magnetic	2	N	Electronic	\$ 5.60	\$ 5.60	\$ 60.00	\$ 60.00	Retrofit Recommended
E2		9	4' T12	4	Fixture	Magnetic	4	N	Electronic	\$ 11.20	\$ 100.80	\$ 70.00	\$ 630.00	Retrofit Recommended
		1	4' T12	2	Fixture	Magnetic	2	N	Electronic	\$ 5.60	\$ 5.60	\$ 60.00	\$ 60.00	Retrofit Recommended
E1		9	4' T12	4	Fixture	Magnetic	4	N	Electronic	\$ 11.20	\$ 100.80	\$ 70.00	\$ 630.00	Retrofit Recommended
		1	4' T12	2	Fixture	Magnetic	2	N	Electronic	\$ 5.60	\$ 5.60	\$ 60.00	\$ 60.00	Retrofit Recommended
Storage		1	4' T12	2	Fixture	Magnetic	2	N	Electronic	\$ 5.60	\$ 5.60	\$ 60.00	\$ 60.00	Retrofit Recommended
Shower		1	4' T12	2	Fixture	Magnetic	2	N	Electronic	\$ 5.60	\$ 5.60	\$ 60.00	\$ 60.00	Retrofit Recommended
Boys' Restroom		1	4' T12	2	Fixture	Magnetic	2	N	Electronic	\$ 5.60	\$ 5.60	\$ 60.00	\$ 60.00	Retrofit Recommended
Janitor's Closet		1	Inc								\$ -	\$ -	\$ -	None
Girls' Restroom		1	4' T12	2	Fixture	Magnetic	2	N	Electronic	\$ 5.60	\$ 5.60	\$ 60.00	\$ 60.00	Retrofit Recommended
		2	Inc								\$ -	\$ -	\$ -	None
Teacher		1	Inc								\$ -	\$ -	\$ -	None
Boys' Restroom		2	Inc								\$ -	\$ -	\$ -	None
Handi Restroom		1	4' T12	2	Fixture	Magnetic	2	N	Electronic	\$ 5.60	\$ 5.60	\$ 60.00	\$ 60.00	Retrofit Recommended
Handi 2		1	4' T12	2	Fixture	Magnetic	2	N	Electronic	\$ 5.60	\$ 5.60	\$ 60.00	\$ 60.00	Retrofit Recommended
Handi 3		1	4' T12	2	Fixture	Magnetic	2	N	Electronic	\$ 5.60	\$ 5.60	\$ 60.00	\$ 60.00	Retrofit Recommended
LIBRARY												\$ -	\$ -	
Exterior		4	Inc								\$ -	\$ -	\$ -	None

LOCATION	EXISTING EQUIPMENT						PROPOSED			REBATES		COSTS		COMMENTS
	Location (Rm Name, Rm. #, Area, Zone, etc.)	Floor	Quantity	Lamp Type	Lamps Per Fixture	Type of Fixture	Ballast Type	Lamps Per Fixture	Reflectors	Ballast Type	Per Single	Extended	Per Single	
<i>Reading</i>		20	4' T12	4	Fixture	Magnetic	4	N	Electronic	\$ 11.20	\$ 224.00	\$ 70.00	\$ 1,400.00	Retrofit Recommended
		2	4' T12	2	Fixture	Magnetic	2	N	Electronic	\$ 5.60	\$ 11.20	\$ 60.00	\$ 120.00	Retrofit Recommended
<i>Commucation Room</i>		1	4' T12	4	Wrap	Magnetic	4	N	Electronic	\$ 11.20	\$ 11.20	\$ 70.00	\$ 70.00	Retrofit Recommended
<i>Speech</i>		5	4' T12	4	Wrap	Magnetic	4	N	Electronic	\$ 11.20	\$ 56.00	\$ 70.00	\$ 350.00	Retrofit Recommended
<i>Back Office</i>		8	4' T12	4	Wrap	Magnetic	4	N	Electronic	\$ 11.20	\$ 89.60	\$ 70.00	\$ 560.00	Retrofit Recommended
<i>Office</i>		2	4' T12	2	Ice	Magnetic	2	N	Electronic	\$ 5.60	\$ 11.20	\$ 135.00	\$ 270.00	Fixture Replacement
<i>Restroom</i>		1	Inc								\$ -	\$ -	\$ -	None
<i>Teacher's Restroom</i>		3	4' T12	4	Wrap	Magnetic	4	N	Electronic	\$ 11.20	\$ 33.60	\$ 70.00	\$ 210.00	Retrofit Recommended
<i>Lounge</i>		4	4' T12	4	Wrap	Magnetic	4	N	Electronic	\$ 11.20	\$ 44.80	\$ 70.00	\$ 280.00	Retrofit Recommended
<i>Restroom</i>		2	Inc								\$ -	\$ -	\$ -	None
<i>Custodian</i>		3	4' T12	4	Ice	Magnetic	4	N	Electronic	\$ 11.20	\$ 33.60	\$ 160.00	\$ 480.00	Fixture Replacement
		1	4' T12	2	Fixture	Magnetic	2	N	Electronic	\$ 5.60	\$ 5.60	\$ 60.00	\$ 60.00	Retrofit Recommended
<i>Gas</i>		1	4' T12	4	Wrap	Magnetic	4	N	Electronic	\$ 11.20	\$ 11.20	\$ 70.00	\$ 70.00	Retrofit Recommended
BUILDING F											\$ -		\$ -	
<i>F5</i>		9	4' T12	4	Fixture	Magnetic	4	N	Electronic	\$ 11.20	\$ 100.80	\$ 70.00	\$ 630.00	Retrofit Recommended
		1	4' T12	2	Fixture	Magnetic	2	N	Electronic	\$ 5.60	\$ 5.60	\$ 60.00	\$ 60.00	Retrofit Recommended
<i>Exterior</i>		5	Inc								\$ -	\$ -	\$ -	None
<i>F4</i>		9	4' T12	4	Fixture	Magnetic	4	N	Electronic	\$ 11.20	\$ 100.80	\$ 70.00	\$ 630.00	Retrofit Recommended
		1	4' T12	2	Fixture	Magnetic	2	N	Electronic	\$ 5.60	\$ 5.60	\$ 60.00	\$ 60.00	Retrofit Recommended
<i>F3</i>		9	4' T12	4	Fixture	Magnetic	4	N	Electronic	\$ 11.20	\$ 100.80	\$ 70.00	\$ 630.00	Retrofit Recommended
		1	4' T12	2	Fixture	Magnetic	2	N	Electronic	\$ 5.60	\$ 5.60	\$ 60.00	\$ 60.00	Retrofit Recommended
<i>F2</i>		9	4' T12	4	Fixture	Magnetic	4	N	Electronic	\$ 11.20	\$ 100.80	\$ 70.00	\$ 630.00	Retrofit Recommended
		1	4' T12	2	Fixture	Magnetic	2	N	Electronic	\$ 5.60	\$ 5.60	\$ 60.00	\$ 60.00	Retrofit Recommended
<i>F1</i>		9	4' T12	4	Fixture	Magnetic	4	N	Electronic	\$ 11.20	\$ 100.80	\$ 70.00	\$ 630.00	Retrofit Recommended
		1	4' T12	2	Fixture	Magnetic	2	N	Electronic	\$ 5.60	\$ 5.60	\$ 60.00	\$ 60.00	Retrofit Recommended
<i>Girls' Restroom</i>		2	Inc								\$ -	\$ -	\$ -	None
<i>Teacher's Restroom</i>		1	Inc								\$ -	\$ -	\$ -	None
<i>Boys' Restroom</i>		2	Inc								\$ -	\$ -	\$ -	None
<i>Janitor's Closet</i>		1	Inc								\$ -	\$ -	\$ -	None
BUILDING G											\$ -		\$ -	
<i>HCC Room 1</i>		1	4' T12	2	Fixture	Magnetic	2	N	Electronic	\$ 5.60	\$ 5.60	\$ 60.00	\$ 60.00	Retrofit Recommended
<i>HCC Room 2</i>		1	4' T12	2	Fixture	Magnetic	2	N	Electronic	\$ 5.60	\$ 5.60	\$ 60.00	\$ 60.00	Retrofit Recommended
<i>HCC Room 3</i>		1	4' T12	2	Fixture	Magnetic	2	N	Electronic	\$ 5.60	\$ 5.60	\$ 60.00	\$ 60.00	Retrofit Recommended
<i>Exterior</i>		5	Inc								\$ -	\$ -	\$ -	None
<i>Boys' Restroom</i>		2	Inc								\$ -	\$ -	\$ -	None
<i>Janitor's Closet</i>		1	Inc								\$ -	\$ -	\$ -	None

LOCATION	EXISTING EQUIPMENT						PROPOSED			REBATES		COSTS		COMMENTS
	Floor	Quantity	Lamp Type	Lamps Per Fixture	Type of Fixture	Ballast Type	Lamps Per Fixture	Reflectors	Ballast Type	Per Single	Extended	Per Single	Extended	
<i>Teacher's Restroom</i>		1	Inc								\$ -	\$ -	\$ -	None
<i>Girls' Restroom</i>		2	Inc								\$ -	\$ -	\$ -	None
G1		9	4' T12	4	Fixture	Magnetic	4	N	Electronic	\$ 11.20	\$ 100.80	\$ 70.00	\$ 630.00	Retrofit Recommended
		1	4' T12	2	Fixture	Magnetic	2	N	Electronic	\$ 5.60	\$ 5.60	\$ 60.00	\$ 60.00	Retrofit Recommended
G2		9	4' T12	4	Fixture	Magnetic	4	N	Electronic	\$ 11.20	\$ 100.80	\$ 70.00	\$ 630.00	Retrofit Recommended
		1	4' T12	2	Fixture	Magnetic	2	N	Electronic	\$ 5.60	\$ 5.60	\$ 60.00	\$ 60.00	Retrofit Recommended
G3		9	4' T12	4	Fixture	Magnetic	4	N	Electronic	\$ 11.20	\$ 100.80	\$ 70.00	\$ 630.00	Retrofit Recommended
		1	4' T12	2	Fixture	Magnetic	2	N	Electronic	\$ 5.60	\$ 5.60	\$ 60.00	\$ 60.00	Retrofit Recommended
G4		9	4' T12	4	Fixture	Magnetic	4	N	Electronic	\$ 11.20	\$ 100.80	\$ 70.00	\$ 630.00	Retrofit Recommended
		1	4' T12	2	Fixture	Magnetic	2	N	Electronic	\$ 5.60	\$ 5.60	\$ 60.00	\$ 60.00	Retrofit Recommended
G5		9	4' T12	4	Fixture	Magnetic	4	N	Electronic	\$ 11.20	\$ 100.80	\$ 70.00	\$ 630.00	Retrofit Recommended
		1	4' T12	2	Fixture	Magnetic	2	N	Electronic	\$ 5.60	\$ 5.60	\$ 60.00	\$ 60.00	Retrofit Recommended
BUILDING I											\$ -		\$ -	
<i>Hallway</i>		12	Inc								\$ -	\$ -	\$ -	None
I4		3	4' T12	2	Ice	Magnetic	2	N	Electronic	\$ 5.60	\$ 16.80	\$ 135.00	\$ 405.00	Fixture Replacement
		8	8' T12	2	Ice	Magnetic	2	N	Electronic	\$ 5.60	\$ 44.80	\$ 135.00	\$ 1,080.00	Fixture Replacement
		1	4' T12	4	Fixture	Magnetic	4	N	Electronic	\$ 11.20	\$ 11.20	\$ 70.00	\$ 70.00	Retrofit Recommended
I3		9	8' T12	2	Ice	Magnetic	2	N	Electronic	\$ 5.60	\$ 50.40	\$ 135.00	\$ 1,215.00	Fixture Replacement
		3	4' T12	2	Ice	Magnetic	2	N	Electronic	\$ 5.60	\$ 16.80	\$ 135.00	\$ 405.00	Fixture Replacement
<i>Teacher's Work Room</i>		3	8' T12	2	Ice	Magnetic	2	N	Electronic	\$ 5.60	\$ 16.80	\$ 135.00	\$ 405.00	Fixture Replacement
		3	4' T12	2	Ice	Magnetic	2	N	Electronic	\$ 5.60	\$ 16.80	\$ 135.00	\$ 405.00	Fixture Replacement
I2		9	8' T12	2	Ice	Magnetic	2	N	Electronic	\$ 5.60	\$ 50.40	\$ 135.00	\$ 1,215.00	Fixture Replacement
		3	4' T12	2	Ice	Magnetic	2	N	Electronic	\$ 5.60	\$ 16.80	\$ 135.00	\$ 405.00	Fixture Replacement
I1		9	8' T12	2	Ice	Magnetic	2	N	Electronic	\$ 5.60	\$ 50.40	\$ 135.00	\$ 1,215.00	Fixture Replacement
		3	4' T12	2	Ice	Magnetic	2	N	Electronic	\$ 5.60	\$ 16.80	\$ 135.00	\$ 405.00	Fixture Replacement
<i>Girls' Restroom</i>		3	4' T12	1	Fixture	Magnetic	1	N	Electronic	\$ 2.80	\$ 8.40	\$ 55.00	\$ 165.00	Retrofit Recommended
		2	Inc								\$ -	\$ -	\$ -	None
<i>Teacher's Restroom</i>		1	Inc								\$ -	\$ -	\$ -	None
<i>Boys' Restroom</i>		3	4' T12	1	Fixture	Magnetic	1	N	Electronic	\$ 2.80	\$ 8.40	\$ 55.00	\$ 165.00	Retrofit Recommended
		2	Inc								\$ -	\$ -	\$ -	None
<i>Janitor's Closet</i>		1	Inc								\$ -	\$ -	\$ -	None
<i>Handi Restroom 1</i>		1	4' T12	2	Fixture	Magnetic	2	N	Electronic	\$ 5.60	\$ 5.60	\$ 60.00	\$ 60.00	Retrofit Recommended
<i>Handi Restroom 2</i>		1	4' T12	2	Fixture	Magnetic	2	N	Electronic	\$ 5.60	\$ 5.60	\$ 60.00	\$ 60.00	Retrofit Recommended
<i>Handi Restroom 3</i>		1	4' T12	2	Fixture	Magnetic	2	N	Electronic	\$ 5.60	\$ 5.60	\$ 60.00	\$ 60.00	Retrofit Recommended
BUILDING H											\$ -		\$ -	
H1		9	8' T12	2	Ice	Magnetic	2	N	Electronic	\$ 5.60	\$ 50.40	\$ 135.00	\$ 1,215.00	Fixture Replacement

LOCATION	EXISTING EQUIPMENT						PROPOSED			REBATES		COSTS		COMMENTS
	Floor	Quantity	Lamp Type	Lamps Per Fixture	Type of Fixture	Ballast Type	Lamps Per Fixture	Reflectors	Ballast Type	Per Single	Extended	Per Single	Extended	
		2	4' T12	4	Wrap	Magnetic	4	N	Electronic	\$ 11.20	\$ 22.40	\$ 70.00	\$ 140.00	Retrofit Recommended
<i>Exterior</i>		6	Inc								\$ -	\$ -	\$ -	None
<i>Storage</i>		3	8' T12	2	Ice	Magnetic	2	N	Electronic	\$ 5.60	\$ 16.80	\$ 135.00	\$ 405.00	Fixture Replacement
		1	4' T12	1	Fixture	Magnetic	1	N	Electronic	\$ 2.80	\$ 2.80	\$ 55.00	\$ 55.00	Retrofit Recommended
<i>H2</i>		15	8' T12	2	Ice	Magnetic	2	N	Electronic	\$ 5.60	\$ 84.00	\$ 135.00	\$ 2,025.00	Fixture Replacement
<i>Storage</i>		1	4' T12	2	Fixture	Magnetic	2	N	Electronic	\$ 5.60	\$ 5.60	\$ 60.00	\$ 60.00	Retrofit Recommended
<i>Electrical Room</i>		1	Inc								\$ -	\$ -	\$ -	None
		1	Inc								\$ -	\$ -	\$ -	None

Total Rebates \$ 7,915.60
Total Costs \$ 60,165.00

LOCATION	QTY	EXISTING TYPE	QTY	RETROFIT		Existing	Actual			Proposed			
						Watt/unit	Op. Hours	kWh	kW-D	Watt/unit	Op. Hours	kWh	kW-D
PORTABLES	0		0			0	1,549	0.0	0	100	1,549	0.0	0
<i>P14</i>	16	4' 4L Fixture	16	Lamp & Low Watt Ballast	Retrofit Recommended	151.2	1,549	3,746.1	2.4192	100	1,549	2,477.6	1.6
<i>Exterior</i>	2	60W Incandescent	0		None	0	1,549	0.0	0	0	1,549	0.0	0
<i>P13</i>	16	4' 4L Fixture	16	Lamp & Low Watt Ballast	Retrofit Recommended	151.2	1,549	3,746.1	2.4192	100	1,549	2,477.6	1.6
<i>Exterior</i>	2	60W Incandescent	0	0	None	0	1,549	0.0	0	0	1,549	0.0	0
<i>P10</i>	16	4' 4L Fixture	16	Lamp & Low Watt Ballast	Retrofit Recommended	151.2	1,549	3,746.1	2.4192	100	1,549	2,477.6	1.6
<i>Exterior</i>	2	60W Incandescent	0	0	None	0	1,549	0.0	0	0	1,549	0.0	0
<i>P6</i>	16	4' 4L Fixture	16	Lamp & Low Watt Ballast	Retrofit Recommended	151.2	1,549	3,746.1	2.4192	100	1,549	2,477.6	1.6
<i>Exterior</i>	2	60W Incandescent	0	0	None	0	1,549	0.0	0	0	1,549	0.0	0
<i>P1A</i>	4	4' 4L Fixture	4	Lamp & Low Watt Ballast	Retrofit Recommended	151.2	1,549	936.5	0.6048	100	1,549	619.4	0.4
<i>Exterior</i>	2	4' 2L Fixture	2	Lamp & Low Watt Ballast	Retrofit Recommended	75.6	1,549	234.1	0.1512	51	1,549	157.9	0.102
<i>P1B</i>	4	4' 4L Fixture	4	Lamp & Low Watt Ballast	Retrofit Recommended	151.2	1,549	936.5	0.6048	100	1,549	619.4	0.4
<i>Exterior</i>	2	4' 2L Fixture	2	Lamp & Low Watt Ballast	Retrofit Recommended	75.6	1,549	234.1	0.1512	51	1,549	157.9	0.102
<i>P3</i>	16	4' 4L Fixture	16	Lamp & Low Watt Ballast	Retrofit Recommended	151.2	1,549	3,746.1	2.4192	100	1,549	2,477.6	1.6
<i>Exterior</i>	2	60W Incandescent	0	0	None	0	1,549	0.0	0	0	1,549	0.0	0
<i>P4</i>	16	4' 4L Fixture	16	Lamp & Low Watt Ballast	Retrofit Recommended	151.2	1,549	3,746.1	2.4192	100	1,549	2,477.6	1.6
<i>Exterior</i>	2	60W Incandescent	0	0	None	0	1,549	0.0	0	0	1,549	0.0	0
<i>P17</i>	16	4' 4L Fixture	16	Lamp & Low Watt Ballast	Retrofit Recommended	151.2	1,549	3,746.1	2.4192	100	1,549	2,477.6	1.6
<i>Exterior</i>	2	60W Incandescent	0	0	None	0	1,549	0.0	0	0	1,549	0.0	0
<i>Bath</i>	2	60W Incandescent	0	0	None	0	1,549	0.0	0	0	1,549	0.0	0
<i>P16</i>	16	4' 4L Fixture	16	Lamp & Low Watt Ballast	Retrofit Recommended	151.2	1,549	3,746.1	2.4192	100	1,549	2,477.6	1.6
<i>Exterior</i>	2	60W Incandescent	0	0	None	0	1,549	0.0	0	0	1,549	0.0	0
<i>P15</i>	16	4' 4L Fixture	16	Lamp & Low Watt Ballast	Retrofit Recommended	151.2	1,549	3,746.1	2.4192	100	1,549	2,477.6	1.6
<i>0</i>	2	60W Incandescent	0	0	None	0	1,549	0.0	0	0	1,549	0.0	0
<i>P7</i>	16	4' 4L Fixture	16	Lamp & Low Watt Ballast	Retrofit Recommended	151.2	1,549	3,746.1	2.4192	100	1,549	2,477.6	1.6
<i>Bath</i>	1	60W Incandescent	0	0	None	0	1,549	0.0	0	0	1,549	0.0	0
<i>Bath</i>	1	60W Incandescent	0	0	None	0	1,549	0.0	0	0	1,549	0.0	0
<i>Exit</i>	2	60W Incandescent	0	0	None	0	1,549	0.0	0	0	1,549	0.0	0
<i>P9</i>	16	4' 4L Fixture	16	Lamp & Low Watt Ballast	Retrofit Recommended	151.2	1,549	3,746.1	2.4192	100	1,549	2,477.6	1.6
<i>Exit</i>	1	60W Incandescent	0	0	None	0	1,549	0.0	0	0	1,549	0.0	0
<i>P11</i>	16	4' 4L Fixture	16	Lamp & Low Watt Ballast	Retrofit Recommended	151.2	1,549	3,746.1	2.4192	100	1,549	2,477.6	1.6
<i>Exit</i>	1	60W Incandescent	0	0	None	0	1,549	0.0	0	0	1,549	0.0	0
BUILDING J	0		0			0	1,549	0.0	0	100	1,549	0.0	0
<i>Tower</i>	1	4' 4L Fixture	1	Lamp & Low Watt Ballast	Retrofit Recommended	151.2	1,549	234.1	0.1512	100	1,549	154.9	0.1
<i>0</i>	1	60W Incandescent	0	0	None	0	1,549	0.0	0	0	1,549	0.0	0
<i>J5</i>	2	60W Incandescent	0	0	None	0	1,549	0.0	0	0	1,549	0.0	0
<i>0</i>	15	4' 4L Fixture	15	Lamp & Low Watt Ballast	Retrofit Recommended	151.2	1,549	3,512.0	2.268	100	1,549	2,322.8	1.5
<i>J4</i>	15	4' 4L Fixture	15	Lamp & Low Watt Ballast	Retrofit Recommended	151.2	1,549	3,512.0	2.268	100	1,549	2,322.8	1.5
<i>0</i>	1	2L 60W Incandescent	0		None	0	1,549	0.0	0	0	1,549	0.0	0
<i>Janitor</i>	2	60W Incandescent	0	0	None	0	1,549	0.0	0	0	1,549	0.0	0
<i>J3</i>	15	4' 4L Fixture	15	Lamp & Low Watt Ballast	Retrofit Recommended	151.2	1,549	3,512.0	2.268	100	1,549	2,322.8	1.5
<i>0</i>	1	2L 60W Incandescent	0	0	None	0	1,549	0.0	0	0	1,549	0.0	0
<i>J2</i>	15	4' 4L Fixture	15	Lamp & Low Watt Ballast	Retrofit Recommended	151.2	1,549	3,512.0	2.268	100	1,549	2,322.8	1.5
<i>0</i>	1	2L 60W Incandescent	0	0	None	0	1,549	0.0	0	0	1,549	0.0	0
<i>Janitor</i>	2	60W Incandescent	0	0	None	0	1,549	0.0	0	0	1,549	0.0	0
<i>J1</i>	15	4' 4L Fixture	15	Lamp & Low Watt Ballast	Retrofit Recommended	151.2	1,549	3,512.0	2.268	100	1,549	2,322.8	1.5
<i>0</i>	1	2L 60W Incandescent	0	0	None	0	1,549	0.0	0	0	1,549	0.0	0
<i>Exterior</i>	8	60W Incandescent	0	0	None	0	1,549	0.0	0	0	1,549	0.0	0
CAFETERIA	0		0			0	1,549	0.0	0	100	1,549	0.0	0
<i>0</i>	1	4' 4L Fixture	1	Lamp & Low Watt Ballast	Fixture Replacement	151.2	1,549	234.1	0.1512	100	1,549	154.9	0.1
<i>0</i>	1	4' 2L Fixture	1	Lamp & Low Watt Ballast	Retrofit Recommended	75.6	1,549	117.1	0.0756	51	1,549	79.0	0.051
<i>Stage</i>	2	4' 4L Fixture	2	Lamp & Low Watt Ballast	Fixture Replacement	151.2	1,549	468.3	0.3024	100	1,549	309.7	0.2
<i>Exterior</i>	3	60W Incandescent	0	0	None	0	1,549	0.0	0	0	1,549	0.0	0
<i>Cafeteria</i>	28	4' 4L Fixture	28	Lamp & Low Watt Ballast	Retrofit Recommended	151.2	1,549	6,555.7	4.2336	100	1,549	4,335.8	2.8
<i>0</i>	1	4' 4L Fixture	1	Lamp & Low Watt Ballast	Fixture Replacement	151.2	1,549	234.1	0.1512	100	1,549	154.9	0.1
<i>0</i>	4	Exit Sign	0		None	0	1,549	0.0	0	0	1,549	0.0	0
<i>Girls' Restroom</i>	1	4' 2L Fixture	1	Lamp & Low Watt Ballast	Retrofit Recommended	75.6	1,549	117.1	0.0756	51	1,549	79.0	0.051

LOCATION	QTY	EXISTING TYPE	QTY	RETROFIT		Existing				Actual				Proposed			
						Watt/unit	Op. Hours	kWh	kW-D	Watt/unit	Op. Hours	kWh	kW-D				
Exterior	19	60W Incandescent	0	0	None	0	1,549	0.0	0	0	1,549	0.0	0	0			
Boys' Restroom	1	4' 2L Fixture	1	Lamp & Low Watt Ballast	Retrofit Recommended	75.6	1,549	117.1	0.0756	51	1,549	79.0	0.051				
Men's Restroom	1	60W Incandescent	0	0	None	0	1,549	0.0	0	0	1,549	0.0	0				
Stu	1	60W Incandescent	0	0	None	0	1,549	0.0	0	0	1,549	0.0	0				
Heater	1	60W Incandescent	0	0	None	0	1,549	0.0	0	0	1,549	0.0	0				
Kitchen	2	4' 4L Fixture	2	Lamp & Low Watt Ballast	Retrofit Recommended	151.2	1,549	468.3	0.3024	100	1,549	309.7	0.2				
0	8	4' 2L Fixture	8	Lamp & Low Watt Ballast	Retrofit Recommended	75.6	1,549	936.5	0.6048	51	1,549	631.8	0.408				
0	8	4' 4L Fixture	8	Lamp & Low Watt Ballast	Retrofit Recommended	151.2	1,549	1,873.1	1.2096	100	1,549	1,238.8	0.8				
Side Office	1	4' 4L Fixture	1	Lamp & Low Watt Ballast	Retrofit Recommended	151.2	1,549	234.1	0.1512	100	1,549	154.9	0.1				
0	1	4' 4L Fixture	1	Lamp & Low Watt Ballast	Retrofit Recommended	151.2	1,549	234.1	0.1512	100	1,549	154.9	0.1				
OFFICE	0		0		0		1,549	0.0	0		1,549	0.0	0				
Health Room	2	4' 4L Fixture	2	Lamp & Low Watt Ballast	Retrofit Recommended	151.2	1,549	468.3	0.3024	100	1,549	309.7	0.2				
0	2	2L 60W Incandescent	0	0	None	0	1,549	0.0	0	0	1,549	0.0	0				
Office	1	4' 4L Fixture	1	Lamp & Low Watt Ballast	Retrofit Recommended	151.2	1,549	234.1	0.1512	100	1,549	154.9	0.1				
Main Office	13	4' 4L Fixture	13	Lamp & Low Watt Ballast	Retrofit Recommended	151.2	1,549	3,043.7	1.9656	100	1,549	2,013.1	1.3				
Office	1	4' 4L Fixture	1	Lamp & Low Watt Ballast	Retrofit Recommended	151.2	1,549	234.1	0.1512	100	1,549	154.9	0.1				
Supply Room	1	4' 4L Fixture	1	Lamp & Low Watt Ballast	Retrofit Recommended	151.2	1,549	234.1	0.1512	100	1,549	154.9	0.1				
Hallway	2	4' 2L Fixture	2	Lamp & Low Watt Ballast	Retrofit Recommended	75.6	1,549	234.1	0.1512	51	1,549	157.9	0.102				
Bash	1	60W Incandescent	0	0	None	0	1,549	0.0	0	0	1,549	0.0	0				
Councilor	1	4' 4L Fixture	1	Lamp & Low Watt Ballast	Retrofit Recommended	151.2	1,549	234.1	0.1512	100	1,549	154.9	0.1				
Conference Room	2	4' 4L Fixture	2	Lamp & Low Watt Ballast	Retrofit Recommended	151.2	1,549	468.3	0.3024	100	1,549	309.7	0.2				
Custodial	2	60W Incandescent	0	0	None	0	1,549	0.0	0	0	1,549	0.0	0				
BUILDING B	0		0		0		1,549	0.0	0		1,549	0.0	0				
Exterior	5	60W Incandescent	0	0	None	0	1,549	0.0	0	0	1,549	0.0	0				
Girls' Restroom	6	60W Incandescent	0	0	None	0	1,549	0.0	0	0	1,549	0.0	0				
B6	9	4' 4L Fixture	9	Lamp & Low Watt Ballast	Retrofit Recommended	151.2	1,549	2,107.2	1.3608	100	1,549	1,393.7	0.9				
0	1	4' 2L Fixture	1	Lamp & Low Watt Ballast	Retrofit Recommended	75.6	1,549	117.1	0.0756	51	1,549	79.0	0.051				
Boys' Restroom	1	60W Incandescent	0	0	None	0	1,549	0.0	0	0	1,549	0.0	0				
B5	9	4' 4L Fixture	9	Lamp & Low Watt Ballast	Retrofit Recommended	151.2	1,549	2,107.2	1.3608	100	1,549	1,393.7	0.9				
0	1	4' 2L Fixture	1	Lamp & Low Watt Ballast	Retrofit Recommended	75.6	1,549	117.1	0.0756	51	1,549	79.0	0.051				
B4	9	4' 4L Fixture	9	Lamp & Low Watt Ballast	Retrofit Recommended	151.2	1,549	2,107.2	1.3608	100	1,549	1,393.7	0.9				
0	1	4' 2L Fixture	1	Lamp & Low Watt Ballast	Retrofit Recommended	75.6	1,549	117.1	0.0756	51	1,549	79.0	0.051				
B3	9	4' 4L Fixture	9	Lamp & Low Watt Ballast	Retrofit Recommended	151.2	1,549	2,107.2	1.3608	100	1,549	1,393.7	0.9				
0	1	4' 2L Fixture	1	Lamp & Low Watt Ballast	Retrofit Recommended	75.6	1,549	117.1	0.0756	51	1,549	79.0	0.051				
B2	9	4' 4L Fixture	9	Lamp & Low Watt Ballast	Retrofit Recommended	151.2	1,549	2,107.2	1.3608	100	1,549	1,393.7	0.9				
0	1	4' 2L Fixture	1	Lamp & Low Watt Ballast	Retrofit Recommended	75.6	1,549	117.1	0.0756	51	1,549	79.0	0.051				
B1	9	4' 4L Fixture	9	Lamp & Low Watt Ballast	Retrofit Recommended	151.2	1,549	2,107.2	1.3608	100	1,549	1,393.7	0.9				
0	1	4' 2L Fixture	1	Lamp & Low Watt Ballast	Retrofit Recommended	75.6	1,549	117.1	0.0756	51	1,549	79.0	0.051				
BUILDING C	0		0		0		1,549	0.0	0		1,549	0.0	0				
Teacher's Restroom	1	4' 2L Fixture	1	Lamp & Low Watt Ballast	Retrofit Recommended	75.6	1,549	117.1	0.0756	51	1,549	79.0	0.051				
Handi Restroom	1	4' 2L Fixture	1	Lamp & Low Watt Ballast	Retrofit Recommended	75.6	1,549	117.1	0.0756	51	1,549	79.0	0.051				
Boys' Restroom	1	4' 2L Fixture	1	Lamp & Low Watt Ballast	Retrofit Recommended	75.6	1,549	117.1	0.0756	51	1,549	79.0	0.051				
Restroom	7	60W Incandescent	0	0	None	0	1,549	0.0	0	0	1,549	0.0	0				
Exterior	7	60W Incandescent	0	0	None	0	1,549	0.0	0	0	1,549	0.0	0				
C1	9	4' 4L Fixture	9	Lamp & Low Watt Ballast	Retrofit Recommended	151.2	1,549	2,107.2	1.3608	100	1,549	1,393.7	0.9				
0	1	4' 2L Fixture	1	Lamp & Low Watt Ballast	Retrofit Recommended	75.6	1,549	117.1	0.0756	51	1,549	79.0	0.051				
C2	9	4' 4L Fixture	9	Lamp & Low Watt Ballast	Retrofit Recommended	151.2	1,549	2,107.2	1.3608	100	1,549	1,393.7	0.9				
0	1	4' 2L Fixture	1	Lamp & Low Watt Ballast	Retrofit Recommended	75.6	1,549	117.1	0.0756	51	1,549	79.0	0.051				
C3	9	4' 4L Fixture	9	Lamp & Low Watt Ballast	Retrofit Recommended	151.2	1,549	2,107.2	1.3608	100	1,549	1,393.7	0.9				
0	1	4' 2L Fixture	1	Lamp & Low Watt Ballast	Retrofit Recommended	75.6	1,549	117.1	0.0756	51	1,549	79.0	0.051				
C4	9	4' 4L Fixture	9	Lamp & Low Watt Ballast	Retrofit Recommended	151.2	1,549	2,107.2	1.3608	100	1,549	1,393.7	0.9				
0	1	4' 2L Fixture	1	Lamp & Low Watt Ballast	Retrofit Recommended	75.6	1,549	117.1	0.0756	51	1,549	79.0	0.051				
C5	9	4' 4L Fixture	9	Lamp & Low Watt Ballast	Retrofit Recommended	151.2	1,549	2,107.2	1.3608	100	1,549	1,393.7	0.9				
0	1	4' 2L Fixture	1	Lamp & Low Watt Ballast	Retrofit Recommended	75.6	1,549	117.1	0.0756	51	1,549	79.0	0.051				
C6	9	4' 4L Fixture	9	Lamp & Low Watt Ballast	Retrofit Recommended	151.2	1,549	2,107.2	1.3608	100	1,549	1,393.7	0.9				
0	1	4' 2L Fixture	1	Lamp & Low Watt Ballast	Retrofit Recommended	75.6	1,549	117.1	0.0756	51	1,549	79.0	0.051				
BUILDING E	0		0		0		1,549	0.0	0		1,549	0.0	0				
E5	9	4' 4L Fixture	9	Lamp & Low Watt Ballast	Retrofit Recommended	151.2	1,549	2,107.2	1.3608	100	1,549	1,393.7	0.9				

LOCATION	QTY	EXISTING TYPE	QTY	RETROFIT		Existing				Actual				Proposed			
						Watt/unit	Op. Hours	kWh	kW-D	Watt/unit	Op. Hours	kWh	kW-D	Watt/unit	Op. Hours	kWh	kW-D
0	1	4' 2L Fixture	1	Lamp & Low Watt Ballast	Retrofit Recommended	75.6	1,549	117.1	0.0756	51	1,549	79.0	0.051				
Exterior	6	60W Incandescent	0	0	None	0	1,549	0.0	0	0	1,549	0.0	0				
E4	9	4' 4L Fixture	9	Lamp & Low Watt Ballast	Retrofit Recommended	151.2	1,549	2,107.2	1.3608	100	1,549	1,393.7	0.9				
0	1	4' 2L Fixture	1	Lamp & Low Watt Ballast	Retrofit Recommended	75.6	1,549	117.1	0.0756	51	1,549	79.0	0.051				
E3	9	4' 4L Fixture	9	Lamp & Low Watt Ballast	Retrofit Recommended	151.2	1,549	2,107.2	1.3608	100	1,549	1,393.7	0.9				
0	1	4' 2L Fixture	1	Lamp & Low Watt Ballast	Retrofit Recommended	75.6	1,549	117.1	0.0756	51	1,549	79.0	0.051				
E2	9	4' 4L Fixture	9	Lamp & Low Watt Ballast	Retrofit Recommended	151.2	1,549	2,107.2	1.3608	100	1,549	1,393.7	0.9				
0	1	4' 2L Fixture	1	Lamp & Low Watt Ballast	Retrofit Recommended	75.6	1,549	117.1	0.0756	51	1,549	79.0	0.051				
E1	9	4' 4L Fixture	9	Lamp & Low Watt Ballast	Retrofit Recommended	151.2	1,549	2,107.2	1.3608	100	1,549	1,393.7	0.9				
0	1	4' 2L Fixture	1	Lamp & Low Watt Ballast	Retrofit Recommended	75.6	1,549	117.1	0.0756	51	1,549	79.0	0.051				
Storage	1	4' 2L Fixture	1	Lamp & Low Watt Ballast	Retrofit Recommended	75.6	1,549	117.1	0.0756	51	1,549	79.0	0.051				
Shower	1	4' 2L Fixture	1	Lamp & Low Watt Ballast	Retrofit Recommended	75.6	1,549	117.1	0.0756	51	1,549	79.0	0.051				
Boys' Restroom	1	4' 2L Fixture	1	Lamp & Low Watt Ballast	Retrofit Recommended	75.6	1,549	117.1	0.0756	51	1,549	79.0	0.051				
Janitor's Closet	1	60W Incandescent	0	0	None	0	1,549	0.0	0	0	1,549	0.0	0				
Girls' Restroom	1	4' 2L Fixture	1	Lamp & Low Watt Ballast	Retrofit Recommended	75.6	1,549	117.1	0.0756	51	1,549	79.0	0.051				
0	2	60W Incandescent	0	0	None	0	1,549	0.0	0	0	1,549	0.0	0				
Teacher	1	60W Incandescent	0	0	None	0	1,549	0.0	0	0	1,549	0.0	0				
Boys' Restroom	2	60W Incandescent	0	0	None	0	1,549	0.0	0	0	1,549	0.0	0				
Handi Restroom	1	4' 2L Fixture	1	Lamp & Low Watt Ballast	Retrofit Recommended	75.6	1,549	117.1	0.0756	51	1,549	79.0	0.051				
Handi 2	1	4' 2L Fixture	1	Lamp & Low Watt Ballast	Retrofit Recommended	75.6	1,549	117.1	0.0756	51	1,549	79.0	0.051				
Handi 3	1	4' 2L Fixture	1	Lamp & Low Watt Ballast	Retrofit Recommended	75.6	1,549	117.1	0.0756	51	1,549	79.0	0.051				
LIBRARY	0		0		0		1,549	0.0	0		1,549	0.0	0				
Exterior	4	60W Incandescent	0	0	None	0	1,549	0.0	0	0	1,549	0.0	0				
Reading	20	4' 4L Fixture	20	Lamp & Low Watt Ballast	Retrofit Recommended	151.2	1,549	4,682.7	3.024	100	1,549	3,097.0	2				
0	2	4' 2L Fixture	2	Lamp & Low Watt Ballast	Retrofit Recommended	75.6	1,549	234.1	0.1512	51	1,549	157.9	0.102				
Commucation Room	1	4' 4L Fixture	1	Lamp & Low Watt Ballast	Retrofit Recommended	151.2	1,549	234.1	0.1512	100	1,549	154.9	0.1				
Speech	5	4' 4L Fixture	5	Lamp & Low Watt Ballast	Retrofit Recommended	151.2	1,549	1,170.7	0.756	100	1,549	774.3	0.5				
Back Office	8	4' 4L Fixture	8	Lamp & Low Watt Ballast	Retrofit Recommended	151.2	1,549	1,873.1	1.2096	100	1,549	1,238.8	0.8				
Office	2	4' 2L Fixture	2	Lamp & Low Watt Ballast	Fixture Replacement	75.6	1,549	234.1	0.1512	51	1,549	157.9	0.102				
Restroom	1	60W Incandescent	0	0	None	0	1,549	0.0	0	0	1,549	0.0	0				
Teacher's Restroom	3	4' 4L Fixture	3	Lamp & Low Watt Ballast	Retrofit Recommended	151.2	1,549	702.4	0.4536	100	1,549	464.6	0.3				
Lounge	4	4' 4L Fixture	4	Lamp & Low Watt Ballast	Retrofit Recommended	151.2	1,549	936.5	0.6048	100	1,549	619.4	0.4				
Restroom	2	60W Incandescent	0	0	None	0	1,549	0.0	0	0	1,549	0.0	0				
Custodian	3	4' 4L Fixture	3	Lamp & Low Watt Ballast	Fixture Replacement	151.2	1,549	702.4	0.4536	100	1,549	464.6	0.3				
0	1	4' 2L Fixture	1	Lamp & Low Watt Ballast	Retrofit Recommended	75.6	1,549	117.1	0.0756	51	1,549	79.0	0.051				
Gas	1	4' 4L Fixture	1	Lamp & Low Watt Ballast	Retrofit Recommended	151.2	1,549	234.1	0.1512	100	1,549	154.9	0.1				
BUILDING F	0		0		0		1,549	0.0	0		1,549	0.0	0				
F5	9	4' 4L Fixture	9	Lamp & Low Watt Ballast	Retrofit Recommended	151.2	1,549	2,107.2	1.3608	100	1,549	1,393.7	0.9				
0	1	4' 2L Fixture	1	Lamp & Low Watt Ballast	Retrofit Recommended	75.6	1,549	117.1	0.0756	51	1,549	79.0	0.051				
Exterior	5	60W Incandescent	0	0	None	0	1,549	0.0	0	0	1,549	0.0	0				
F4	9	4' 4L Fixture	9	Lamp & Low Watt Ballast	Retrofit Recommended	151.2	1,549	2,107.2	1.3608	100	1,549	1,393.7	0.9				
0	1	4' 2L Fixture	1	Lamp & Low Watt Ballast	Retrofit Recommended	75.6	1,549	117.1	0.0756	51	1,549	79.0	0.051				
F3	9	4' 4L Fixture	9	Lamp & Low Watt Ballast	Retrofit Recommended	151.2	1,549	2,107.2	1.3608	100	1,549	1,393.7	0.9				
0	1	4' 2L Fixture	1	Lamp & Low Watt Ballast	Retrofit Recommended	75.6	1,549	117.1	0.0756	51	1,549	79.0	0.051				
F2	9	4' 4L Fixture	9	Lamp & Low Watt Ballast	Retrofit Recommended	151.2	1,549	2,107.2	1.3608	100	1,549	1,393.7	0.9				
0	1	4' 2L Fixture	1	Lamp & Low Watt Ballast	Retrofit Recommended	75.6	1,549	117.1	0.0756	51	1,549	79.0	0.051				
F1	9	4' 4L Fixture	9	Lamp & Low Watt Ballast	Retrofit Recommended	151.2	1,549	2,107.2	1.3608	100	1,549	1,393.7	0.9				
0	1	4' 2L Fixture	1	Lamp & Low Watt Ballast	Retrofit Recommended	75.6	1,549	117.1	0.0756	51	1,549	79.0	0.051				
Girls' Restroom	2	60W Incandescent	0	0	None	0	1,549	0.0	0	0	1,549	0.0	0				
Teacher's Restroom	1	60W Incandescent	0	0	None	0	1,549	0.0	0	0	1,549	0.0	0				
Boys' Restroom	2	60W Incandescent	0	0	None	0	1,549	0.0	0	0	1,549	0.0	0				
Janitor's Closet	1	60W Incandescent	0	0	None	0	1,549	0.0	0	0	1,549	0.0	0				
BUILDING G	0		0		0		1,549	0.0	0		1,549	0.0	0				
HCC Room 1	1	4' 2L Fixture	1	Lamp & Low Watt Ballast	Retrofit Recommended	75.6	1,549	117.1	0.0756	51	1,549	79.0	0.051				
HCC Room 2	1	4' 2L Fixture	1	Lamp & Low Watt Ballast	Retrofit Recommended	75.6	1,549	117.1	0.0756	51	1,549	79.0	0.051				
HCC Room 3	1	4' 2L Fixture	1	Lamp & Low Watt Ballast	Retrofit Recommended	75.6	1,549	117.1	0.0756	51	1,549	79.0	0.051				
Exterior	5	60W Incandescent	0	0	None	0	1,549	0.0	0	0	1,549	0.0	0				
Boys' Restroom	2	60W Incandescent	0	0	None	0	1,549	0.0	0	0	1,549	0.0	0				

LOCATION	QTY	EXISTING TYPE	QTY	RETROFIT		Existing				Actual				Proposed			
						Watt/unit	Op. Hours	kWh	kW-D	Watt/unit	Op. Hours	kWh	kW-D				
Janitor's Closet	1	60W Incandescent	0	0	None	0	1,549	0.0	0	0	1,549	0.0	0	0	1,549	0.0	0
Teacher's Restroom	1	60W Incandescent	0	0	None	0	1,549	0.0	0	0	1,549	0.0	0	0	1,549	0.0	0
Girls' Restroom	2	60W Incandescent	0	0	None	0	1,549	0.0	0	0	1,549	0.0	0	0	1,549	0.0	0
G1	9	4' 4L Fixture	9	Lamp & Low Watt Ballast	Retrofit Recommended	151.2	1,549	2,107.2	1.3608	100	1,549	1,393.7	0.9				
0	1	4' 2L Fixture	1	Lamp & Low Watt Ballast	Retrofit Recommended	75.6	1,549	117.1	0.0756	51	1,549	79.0	0.051				
G2	9	4' 4L Fixture	9	Lamp & Low Watt Ballast	Retrofit Recommended	151.2	1,549	2,107.2	1.3608	100	1,549	1,393.7	0.9				
0	1	4' 2L Fixture	1	Lamp & Low Watt Ballast	Retrofit Recommended	75.6	1,549	117.1	0.0756	51	1,549	79.0	0.051				
G3	9	4' 4L Fixture	9	Lamp & Low Watt Ballast	Retrofit Recommended	151.2	1,549	2,107.2	1.3608	100	1,549	1,393.7	0.9				
0	1	4' 2L Fixture	1	Lamp & Low Watt Ballast	Retrofit Recommended	75.6	1,549	117.1	0.0756	51	1,549	79.0	0.051				
G4	9	4' 4L Fixture	9	Lamp & Low Watt Ballast	Retrofit Recommended	151.2	1,549	2,107.2	1.3608	100	1,549	1,393.7	0.9				
0	1	4' 2L Fixture	1	Lamp & Low Watt Ballast	Retrofit Recommended	75.6	1,549	117.1	0.0756	51	1,549	79.0	0.051				
G5	9	4' 4L Fixture	9	Lamp & Low Watt Ballast	Retrofit Recommended	151.2	1,549	2,107.2	1.3608	100	1,549	1,393.7	0.9				
0	1	4' 2L Fixture	1	Lamp & Low Watt Ballast	Retrofit Recommended	75.6	1,549	117.1	0.0756	51	1,549	79.0	0.051				
BUILDING I	0		0		0		1,549	0.0	0		1,549	0.0	0		1,549	0.0	0
Hallway	12	60W Incandescent	0	0	None	0	1,549	0.0	0	0	1,549	0.0	0	0	1,549	0.0	0
I4	3	4' 2L Fixture	3	Lamp & Low Watt Ballast	Fixture Replacement	75.6	1,549	351.2	0.2268	51	1,549	236.9	0.153				
0	8	8' 2L Fixture	8	Lamp & Ballast Retrofit	Fixture Replacement	158	1,549	1,957.3	1.264	110	1,549	1,362.7	0.88				
0	1	4' 4L Fixture	1	Lamp & Low Watt Ballast	Retrofit Recommended	151.2	1,549	234.1	0.1512	100	1,549	154.9	0.1				
I3	9	8' 2L Fixture	9	Lamp & Ballast Retrofit	Fixture Replacement	158	1,549	2,202.0	1.422	110	1,549	1,533.0	0.99				
0	3	4' 2L Fixture	3	Lamp & Low Watt Ballast	Fixture Replacement	75.6	1,549	351.2	0.2268	51	1,549	236.9	0.153				
Teacher's Work Room	3	8' 2L Fixture	3	Lamp & Ballast Retrofit	Fixture Replacement	158	1,549	734.0	0.474	110	1,549	511.0	0.33				
0	3	4' 2L Fixture	3	Lamp & Low Watt Ballast	Fixture Replacement	75.6	1,549	351.2	0.2268	51	1,549	236.9	0.153				
I2	9	8' 2L Fixture	9	Lamp & Ballast Retrofit	Fixture Replacement	158	1,549	2,202.0	1.422	110	1,549	1,533.0	0.99				
0	3	4' 2L Fixture	3	Lamp & Low Watt Ballast	Fixture Replacement	75.6	1,549	351.2	0.2268	51	1,549	236.9	0.153				
I1	9	8' 2L Fixture	9	Lamp & Ballast Retrofit	Fixture Replacement	158	1,549	2,202.0	1.422	110	1,549	1,533.0	0.99				
0	3	4' 2L Fixture	3	Lamp & Low Watt Ballast	Fixture Replacement	75.6	1,549	351.2	0.2268	51	1,549	236.9	0.153				
Girls' Restroom	3	4' 1L Fixture	3	Lamp & Low Watt Ballast	Retrofit Recommended	45.6	1,549	211.8	0.1368	31	1,549	144.0	0.093				
0	2	60W Incandescent	0	0	None	0	1,549	0.0	0	0	1,549	0.0	0	0	1,549	0.0	0
Teacher's Restroom	1	60W Incandescent	0	0	None	0	1,549	0.0	0	0	1,549	0.0	0	0	1,549	0.0	0
Boys' Restroom	3	4' 1L Fixture	3	Lamp & Low Watt Ballast	Retrofit Recommended	45.6	1,549	211.8	0.1368	31	1,549	144.0	0.093				
0	2	60W Incandescent	0	0	None	0	1,549	0.0	0	0	1,549	0.0	0	0	1,549	0.0	0
Janitor's Closet	1	60W Incandescent	0	0	None	0	1,549	0.0	0	0	1,549	0.0	0	0	1,549	0.0	0
Handi Restroom 1	1	4' 2L Fixture	1	Lamp & Low Watt Ballast	Retrofit Recommended	75.6	1,549	117.1	0.0756	51	1,549	79.0	0.051				
Handi Restroom 2	1	4' 2L Fixture	1	Lamp & Low Watt Ballast	Retrofit Recommended	75.6	1,549	117.1	0.0756	51	1,549	79.0	0.051				
Handi Restroom 3	1	4' 2L Fixture	1	Lamp & Low Watt Ballast	Retrofit Recommended	75.6	1,549	117.1	0.0756	51	1,549	79.0	0.051				
BUILDING H	0		0		0		1,549	0.0	0		1,549	0.0	0		1,549	0.0	0
H1	9	8' 2L Fixture	9	Lamp & Ballast Retrofit	Fixture Replacement	158	1,549	2,202.0	1.422	110	1,549	1,533.0	0.99				
0	2	4' 4L Fixture	2	Lamp & Low Watt Ballast	Retrofit Recommended	151.2	1,549	468.3	0.3024	100	1,549	309.7	0.2				
Exterior	6	60W Incandescent	0	0	None	0	1,549	0.0	0	0	1,549	0.0	0	0	1,549	0.0	0
Storage	3	8' 2L Fixture	3	Lamp & Ballast Retrofit	Fixture Replacement	158	1,549	734.0	0.474	110	1,549	511.0	0.33				
0	1	4' 1L Fixture	1	Lamp & Low Watt Ballast	Retrofit Recommended	45.6	1,549	70.6	0.0456	31	1,549	48.0	0.031				
H2	15	8' 2L Fixture	15	Lamp & Ballast Retrofit	Fixture Replacement	158	1,549	3,669.9	2.37	110	1,549	2,555.0	1.65				
Storage	1	4' 2L Fixture	1	Lamp & Low Watt Ballast	Retrofit Recommended	75.6	1,549	117.1	0.0756	51	1,549	79.0	0.051				
Electrical Room	1	60W Incandescent	0	0	None	0	1,549	0.0	0	0	1,549	0.0	0	0	1,549	0.0	0
0	1	60W Incandescent	0	0	None	0	1,549	0.0	0	0	1,549	0.0	0	0	1,549	0.0	0
Existing	957		Proposed	785													

ENERGY CALCULATIONS

			173,852	112			115,670	75
Description	kW-Demand	kWh						
Existing Use	112.27	173,852						
Proposed Use	74.70	115,670						
Difference - Savings	37.57	58,182						
Electrical Utility Cost	\$5.75	\$0.15480						
Savings per Year	\$2,592.55	\$9,006.63						
			Total Yearly Energy Savings					
			\$11,599.19					

Exit ← "Blue Street" →



"Silver Street"
Bus Stop

Exit
Entrance
Two Way Traffic

Q-204	Q-205	Q-202	Q-201
Williams	Bellevue	Amakawa	Adams
Q-104	Q-103	Q-102	Q-101
Farr	Makani	Bur	Brown

Hawaiian Intermediate

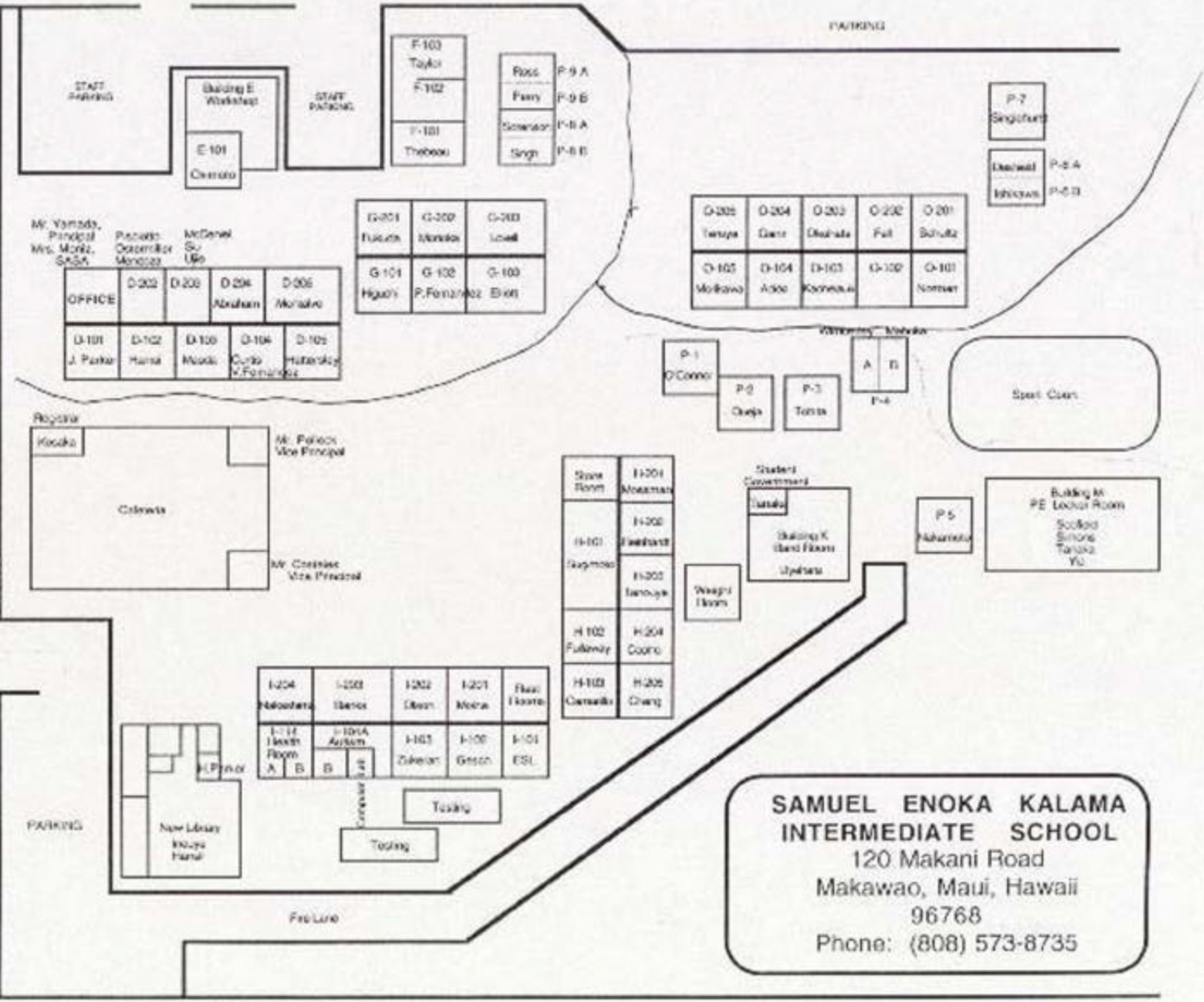

**SAMUEL ENOKA KALAMA
INTERMEDIATE SCHOOL**
120 Makani Road
Makawao, Maui, Hawaii
96768
Phone: (808) 573-8735

Maui Smart Schools Program
Foot Candle Readings

School: KALAMA INTERMEDIATE SCHOOL

Room: Bldg. H - 2nd Fl. - H203

Ceiling height: 9'

Light fixture height: 8'

Fixture type: TROFFER

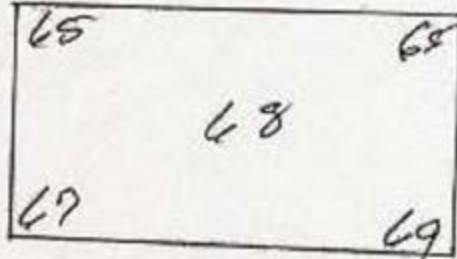

Room: Bldg. Q - Q-103

Ceiling height: 9'

Light fixture height: 8'

Fixture type: TROFFER

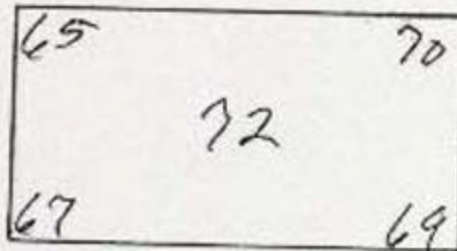

Room: Bldg. G - G-202

Ceiling height: 9'

Light fixture height: 8'

Fixture type: TROFFER

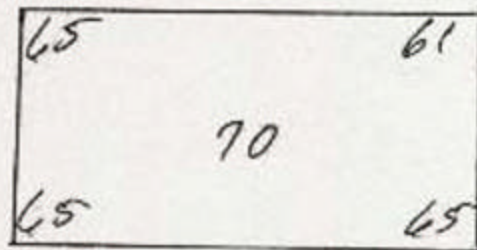



SCHOOL INFORMATION			DATE	
NAME Kalama Intermediate School			2/8/2001	
STREET ADDRESS 120 Makani Road Makawao, HI 96768			OPERATIONAL HOURS 1,002	
POINT OF CONTACT Stephen Yamada		PHONE 573-8735	FAX	
AUDITOR Maui Community College Auditors			VOLTAGE 120V	

LOCATION (Rm Name, Rm. #, Area, Zone, etc.)	EXISTING EQUIPMENT						PROPOSED			REBATES		COSTS		COMMENTS Surveyors Comments
	Floor	Quantity	Lamp Type	Lamps Per Fixture	Type of Fixture	Ballast Type	Lamps Per Fixture	Reflectors	Ballast Type	Per Single	Extended	Per Single	Extended	
BUILDING M														
Office		2	4' T12	3	Troffer	Magnetic	3	N	Electronic	\$ 8.40	\$ 16.80	\$ 65.00	\$ 130.00	Excellent Opportunity for Retro-fit
Boys' Locker Room		22	4' T12	2	Impact	Magnetic	2	N	Electronic	\$ 5.60	\$ 123.20	\$ 60.00	\$ 1,320.00	Excellent Opportunity for Retro-fit
Boys		4	4' T12	2	Wrap	Magnetic	2	N	Electronic	\$ 5.60	\$ 22.40	\$ 60.00	\$ 240.00	Excellent Opportunity for Retro-fit
Towel Room		2	4' T12	2	Wrap	Magnetic	2	N	Electronic	\$ 5.60	\$ 11.20	\$ 60.00	\$ 120.00	Excellent Opportunity for Retro-fit
Office		2	4' T12	3	Troffer	Magnetic	3	N	Electronic	\$ 8.40	\$ 16.80	\$ 65.00	\$ 130.00	Excellent Opportunity for Retro-fit
Faculty		2	4' T12	2	Troffer	Magnetic	2	N	Electronic	\$ 5.60	\$ 11.20	\$ 60.00	\$ 120.00	Excellent Opportunity for Retro-fit
Girls' Locker Room		20	4' T12	2	Impact	Magnetic	2	N	Electronic	\$ 5.60	\$ 112.00	\$ 60.00	\$ 1,200.00	Excellent Opportunity for Retro-fit
Girls		5	4' T12	2	Troffer	Magnetic	2	N	Electronic	\$ 5.60	\$ 28.00	\$ 60.00	\$ 300.00	Excellent Opportunity for Retro-fit
Office		2	4' T12	3	Troffer	Magnetic	3	N	Electronic	\$ 8.40	\$ 16.80	\$ 65.00	\$ 130.00	Excellent Opportunity for Retro-fit
Towel Room		2	4' T12	2	Wrap	Magnetic	2	N	Electronic	\$ 5.60	\$ 11.20	\$ 60.00	\$ 120.00	Excellent Opportunity for Retro-fit
P 5		12	4' T12	4	Troffer	Magnetic	4	N	Electronic	\$ 11.20	\$ 134.40	\$ 70.00	\$ 840.00	Excellent Opportunity for Retro-fit
P 4B		6	4' T12	4	Troffer	Magnetic	4	N	Electronic	\$ 11.20	\$ 67.20	\$ 70.00	\$ 420.00	Excellent Opportunity for Retro-fit
P 4A		6	4' T12	4	Troffer	Magnetic	4	N	Electronic	\$ 11.20	\$ 67.20	\$ 70.00	\$ 420.00	Excellent Opportunity for Retro-fit
P 3		16	4' T12	4	Wrap	Magnetic	4	N	Electronic	\$ 11.20	\$ 179.20	\$ 70.00	\$ 1,120.00	Excellent Opportunity for Retro-fit
P 2		16	4' T12	4	Wrap	Magnetic	4	N	Electronic	\$ 11.20	\$ 179.20	\$ 70.00	\$ 1,120.00	Excellent Opportunity for Retro-fit
P 1		16	4' T12	4	Wrap	Magnetic	4	N	Electronic	\$ 11.20	\$ 179.20	\$ 70.00	\$ 1,120.00	Excellent Opportunity for Retro-fit
BUILDING K														
		5	U T12	2	Troffer	Magnetic	2	N	Electronic	\$ 5.60	\$ 28.00	\$ 60.00	\$ 300.00	No Comment
Girls		4	2' T12	2	Troffer	Magnetic	2	N	Electronic	\$ 4.80	\$ 19.20	\$ 60.00	\$ 240.00	Excellent Opportunity for Retro-fit
Boys		4	4' T12	4	Troffer	Magnetic	4	N	Electronic	\$ 11.20	\$ 44.80	\$ 70.00	\$ 280.00	Excellent Opportunity for Retro-fit
Ensemble		4	4' T12	4	Troffer	Magnetic	4	N	Electronic	\$ 11.20	\$ 44.80	\$ 70.00	\$ 280.00	Excellent Opportunity for Retro-fit
Room 1		1	U T12	2	Troffer	Magnetic	2	N	Electronic	\$ 5.60	\$ 5.60	\$ 60.00	\$ 60.00	No Comment
Room 2		1	U T12	2	Troffer	Magnetic	2	N	Electronic	\$ 5.60	\$ 5.60	\$ 60.00	\$ 60.00	No Comment
Room 3		1	U T12	2	Troffer	Magnetic	2	N	Electronic	\$ 5.60	\$ 5.60	\$ 60.00	\$ 60.00	No Comment
Room 4		1	U T12	2	Troffer	Magnetic	2	N	Electronic	\$ 5.60	\$ 5.60	\$ 60.00	\$ 60.00	No Comment
Room 5		1	U T12	2	Troffer	Magnetic	2	N	Electronic	\$ 5.60	\$ 5.60	\$ 60.00	\$ 60.00	No Comment
Repair Storage		6	4' T12	3	Troffer	Magnetic	3	N	Electronic	\$ 8.40	\$ 50.40	\$ 65.00	\$ 390.00	Excellent Opportunity for Retro-fit
		4	4' T12	2	Wrap	Magnetic	2	N	Electronic	\$ 5.60	\$ 22.40	\$ 60.00	\$ 240.00	Excellent Opportunity for Retro-fit
Weight Room		8	4' T12	2	Troffer	Magnetic	2	N	Electronic	\$ 5.60	\$ 44.80	\$ 60.00	\$ 480.00	Excellent Opportunity for Retro-fit

LOCATION	EXISTING EQUIPMENT						PROPOSED			REBATES		COSTS		COMMENTS
Location (Rm Name, Rm. #, Area, Zone, etc.)	Floor	Quantity	Lamp Type	Lamps Per Fixture	Type of Fixture	Ballast Type	Lamps Per Fixture	Reflectors	Ballast Type	Per Single	Extended	Per Single	Extended	Surveyors Comments
BUILDING H														
Boys	1	6	4' T12	2	Troffer	Magnetic	2	N	Electronic	\$ 5.60	\$ 33.60	\$ 60.00	\$ 360.00	Excellent Opportunity for Retro-fit
Girls	1	6	4' T12	2	Troffer	Magnetic	2	N	Electronic	\$ 5.60	\$ 33.60	\$ 60.00	\$ 360.00	Excellent Opportunity for Retro-fit
Storage	1	7	4' T12	2	Wrap	Magnetic	2	N	Electronic	\$ 5.60	\$ 39.20	\$ 60.00	\$ 420.00	Excellent Opportunity for Retro-fit
H 101	1	24	4' T12	3	Troffer	Magnetic	3	N	Electronic	\$ 8.40	\$ 201.60	\$ 65.00	\$ 1,560.00	Excellent Opportunity for Retro-fit
H 102	1	16	4' T12	3	Troffer	Magnetic	3	N	Electronic	\$ 8.40	\$ 134.40	\$ 65.00	\$ 1,040.00	Excellent Opportunity for Retro-fit
H 103	2	16	4' T12	3	Troffer	Magnetic	3	N	Electronic	\$ 8.40	\$ 134.40	\$ 65.00	\$ 1,040.00	Excellent Opportunity for Retro-fit
H 205	2	16	4' T12	3	Troffer	Magnetic	3	N	Electronic	\$ 8.40	\$ 134.40	\$ 65.00	\$ 1,040.00	Excellent Opportunity for Retro-fit
H 204	2	16	4' T12	3	Troffer	Magnetic	3	N	Electronic	\$ 8.40	\$ 134.40	\$ 65.00	\$ 1,040.00	Excellent Opportunity for Retro-fit
H 203	2	16	4' T12	3	Troffer	Magnetic	3	N	Electronic	\$ 8.40	\$ 134.40	\$ 65.00	\$ 1,040.00	Excellent Opportunity for Retro-fit
H 202	2	16	4' T12	3	Troffer	Magnetic	3	N	Electronic	\$ 8.40	\$ 134.40	\$ 65.00	\$ 1,040.00	Excellent Opportunity for Retro-fit
H 201	2	12	4' T12	3	Troffer	Magnetic	3	N	Electronic	\$ 8.40	\$ 100.80	\$ 65.00	\$ 780.00	Excellent Opportunity for Retro-fit
	2	1	U T12	2	Troffer	Magnetic	2	N	Electronic	\$ 5.60	\$ 5.60	\$ 60.00	\$ 60.00	No Comment
BUILDING I														
Boys	2	6	4' T12	2	Wrap	Magnetic	2	N	Electronic	\$ 5.60	\$ 33.60	\$ 60.00	\$ 360.00	Excellent Opportunity for Retro-fit
Girls	2	6	4' T12	2	Wrap	Magnetic	2	N	Electronic	\$ 5.60	\$ 33.60	\$ 60.00	\$ 360.00	Excellent Opportunity for Retro-fit
I 201	2	15	4' T12	3	Troffer	Magnetic	3	N	Electronic	\$ 8.40	\$ 126.00	\$ 65.00	\$ 975.00	Excellent Opportunity for Retro-fit
I 202	2	15	4' T12	3	Troffer	Magnetic	3	N	Electronic	\$ 8.40	\$ 126.00	\$ 65.00	\$ 975.00	Excellent Opportunity for Retro-fit
I 203	2	32	4' T12	3	Troffer	Magnetic	3	N	Electronic	\$ 8.40	\$ 268.80	\$ 65.00	\$ 2,080.00	Excellent Opportunity for Retro-fit
I 204	2	15	4' T12	3	Troffer	Magnetic	3	N	Electronic	\$ 8.40	\$ 126.00	\$ 65.00	\$ 975.00	Excellent Opportunity for Retro-fit
LIBRARY														
		16	4' T8	4	Troffer	Electronic					\$ -		\$ -	T8 Lamps No Retro-fit
		16	4' T8	4	Troffer	Electronic					\$ -		\$ -	T8 Lamps No Retro-fit
		64	4' T8	4	Ice	Electronic					\$ -		\$ -	T8 Lamps No Retro-fit
		12	4' T8	4	Troffer	Electronic					\$ -		\$ -	T8 Lamps No Retro-fit
Staff		21	4' T8	4	Troffer	Electronic					\$ -		\$ -	T8 Lamps No Retro-fit
GLNU	1	4	4' T12	2	Wrap	Magnetic	2	N	Electronic	\$ 5.60	\$ 5.60	\$ 60.00	\$ 60.00	Excellent Opportunity for Retro-fit
Hall		4	4' T12	2	Troffer	Magnetic	2	N	Electronic	\$ 5.60	\$ 22.40	\$ 60.00	\$ 240.00	Excellent Opportunity for Retro-fit
Storage		4	4' T12	4	Troffer	Magnetic	4	N	Electronic	\$ 11.20	\$ 44.80	\$ 70.00	\$ 280.00	Excellent Opportunity for Retro-fit
Storage		4	4' T12	4	Troffer	Magnetic	4	N	Electronic	\$ 11.20	\$ 44.80	\$ 70.00	\$ 280.00	Excellent Opportunity for Retro-fit
Office		6	4' T12	3	Troffer	Magnetic	3	N	Electronic	\$ 8.40	\$ 50.40	\$ 65.00	\$ 390.00	Excellent Opportunity for Retro-fit
Mech		2	4' T12	3	Troffer	Magnetic	3	N	Electronic	\$ 8.40	\$ 16.80	\$ 65.00	\$ 130.00	Excellent Opportunity for Retro-fit
Video		3	4' T12	4	Troffer	Magnetic	4	N	Electronic	\$ 11.20	\$ 33.60	\$ 70.00	\$ 210.00	Excellent Opportunity for Retro-fit
Room		4	4' T12	3	Troffer	Magnetic	3	N	Electronic	\$ 8.40	\$ 33.60	\$ 65.00	\$ 260.00	Excellent Opportunity for Retro-fit
BUILDING Q														
Boys	1	4	4' T12	2	Wrap	Magnetic	2	N	Electronic	\$ 5.60	\$ 22.40	\$ 60.00	\$ 240.00	Excellent Opportunity for Retro-fit

LOCATION	EXISTING EQUIPMENT						PROPOSED			REBATES		COSTS		COMMENTS
Location (Rm Name, Rm. #, Area, Zone, etc.)	Floor	Quantity	Lamp Type	Lamps Per Fixture	Type of Fixture	Ballast Type	Lamps Per Fixture	Reflectors	Ballast Type	Per Single	Extended	Per Single	Extended	Surveyors Comments
Mech	1	2	4' T12	1	Wrap	Magnetic	1	N	Electronic	\$ 2.80	\$ 5.60	\$ 55.00	\$ 110.00	Excellent Opportunity for Retro-fit
Girls	1	4	4' T12	2	Wrap	Magnetic	2	N	Electronic	\$ 5.60	\$ 22.40	\$ 60.00	\$ 240.00	Excellent Opportunity for Retro-fit
Janitor	1	1	4' T12	1	Wrap	Magnetic	1	N	Electronic	\$ 2.80	\$ 2.80	\$ 55.00	\$ 55.00	Excellent Opportunity for Retro-fit
Q 101	1	16	4' T12	4	Wrap	Magnetic	4	N	Electronic	\$ 11.20	\$ 179.20	\$ 70.00	\$ 1,120.00	Excellent Opportunity for Retro-fit
Q 102	1	16	4' T12	4	Wrap	Magnetic	4	N	Electronic	\$ 11.20	\$ 179.20	\$ 70.00	\$ 1,120.00	Excellent Opportunity for Retro-fit
Q 103	1	16	4' T12	4	Wrap	Magnetic	4	N	Electronic	\$ 11.20	\$ 179.20	\$ 70.00	\$ 1,120.00	Excellent Opportunity for Retro-fit
Q 104	1	12	4' T12	4	Wrap	Magnetic	4	N	Electronic	\$ 11.20	\$ 134.40	\$ 70.00	\$ 840.00	Excellent Opportunity for Retro-fit
Electrical	1	1	4' T12	2	Wrap	Magnetic	2	N	Electronic	\$ 5.60	\$ 5.60	\$ 60.00	\$ 60.00	Excellent Opportunity for Retro-fit
Q 204	2	16	4' T12	4	Wrap	Magnetic	4	N	Electronic	\$ 11.20	\$ 179.20	\$ 70.00	\$ 1,120.00	Excellent Opportunity for Retro-fit
Q 203	2	16	4' T12	4	Wrap	Magnetic	4	N	Electronic	\$ 11.20	\$ 179.20	\$ 70.00	\$ 1,120.00	Excellent Opportunity for Retro-fit
Q 202	2	16	4' T12	4	Wrap	Magnetic	4	N	Electronic	\$ 11.20	\$ 179.20	\$ 70.00	\$ 1,120.00	Excellent Opportunity for Retro-fit
Q 201	2	16	4' T12	4	Wrap	Magnetic	4	N	Electronic	\$ 11.20	\$ 179.20	\$ 70.00	\$ 1,120.00	Excellent Opportunity for Retro-fit
Faculty	2	7	4' T12	4	Wrap	Magnetic	4	N	Electronic	\$ 11.20	\$ 78.40	\$ 70.00	\$ 490.00	Excellent Opportunity for Retro-fit
Boys	2	1	4' T12	4	Wrap	Magnetic	4	N	Electronic	\$ 11.20	\$ 11.20	\$ 70.00	\$ 70.00	Excellent Opportunity for Retro-fit
Girls	2	1	4' T12	4	Wrap	Magnetic	4	N	Electronic	\$ 11.20	\$ 11.20	\$ 70.00	\$ 70.00	Excellent Opportunity for Retro-fit
Stairs	2	3	4' T12	4	Wrap	Magnetic	4	N	Electronic	\$ 11.20	\$ 33.60	\$ 70.00	\$ 210.00	Excellent Opportunity for Retro-fit
CAFETERIA														
Office		2	4' T12	4	Troffer	Magnetic	4	N	Electronic	\$ 11.20	\$ 22.40	\$ 70.00	\$ 140.00	Excellent Opportunity for Retro-fit
Utility		4	4' T12	4	Troffer	Magnetic	4	N	Electronic	\$ 11.20	\$ 44.80	\$ 70.00	\$ 280.00	Excellent Opportunity for Retro-fit
Kitchen		50	4' T12	2	Impact	Magnetic	2	N	Electronic	\$ 5.60	\$ 280.00	\$ 60.00	\$ 3,000.00	Excellent Opportunity for Retro-fit
Storage		4	4' T12	1	Impact	Magnetic	1	N	Electronic	\$ 2.80	\$ 11.20	\$ 55.00	\$ 220.00	Excellent Opportunity for Retro-fit
Electrical		1	4' T12	2	Impact	Magnetic	2	N	Electronic	\$ 5.60	\$ 5.60	\$ 60.00	\$ 60.00	Excellent Opportunity for Retro-fit
Storage		4	4' T12	1	Impact	Magnetic	1	N	Electronic	\$ 2.80	\$ 11.20	\$ 55.00	\$ 220.00	Excellent Opportunity for Retro-fit
Locker A		1	4' T12	2	Impact	Magnetic	2	N	Electronic	\$ 5.60	\$ 5.60	\$ 60.00	\$ 60.00	Excellent Opportunity for Retro-fit
Toilet		1	4' T12	1	Vanity	Magnetic	1	N	Electronic	\$ 2.80	\$ 2.80	\$ 55.00	\$ 55.00	Excellent Opportunity for Retro-fit
Locker B		1	4' T12	2	Vanity	Magnetic	2	N	Electronic	\$ 5.60	\$ 5.60	\$ 60.00	\$ 60.00	Excellent Opportunity for Retro-fit
Toilet		1	2' T12	1	Vanity	Magnetic	1	N	Electronic	\$ 2.40	\$ 2.40	\$ 49.30	\$ 49.30	Excellent Opportunity for Retro-fit
Faculty		7	4' T12	2	Troffer	Magnetic	2	N	Electronic	\$ 5.60	\$ 39.20	\$ 60.00	\$ 420.00	Excellent Opportunity for Retro-fit
		22	4' T12	3	Troffer	Magnetic	3	N	Electronic	\$ 8.40	\$ 184.80	\$ 65.00	\$ 1,430.00	Excellent Opportunity for Retro-fit
		22	4' T12	3	Troffer	Magnetic	3	N	Electronic	\$ 8.40	\$ 184.80	\$ 65.00	\$ 1,430.00	Excellent Opportunity for Retro-fit
Vice Principal		2	4' T12	2	Wrap	Magnetic	2	N	Electronic	\$ 5.60	\$ 11.20	\$ 60.00	\$ 120.00	Excellent Opportunity for Retro-fit
DRTSI A		4	4' T12	2	Wrap	Magnetic	2	N	Electronic	\$ 5.60	\$ 22.40	\$ 60.00	\$ 240.00	Excellent Opportunity for Retro-fit
PA		1	4' T12	2	Wrap	Magnetic	2	N	Electronic	\$ 5.60	\$ 5.60	\$ 60.00	\$ 60.00	Excellent Opportunity for Retro-fit
Refridgerator		2	4' T12	2	Wrap	Magnetic	2	N	Electronic	\$ 5.60	\$ 11.20	\$ 60.00	\$ 120.00	Excellent Opportunity for Retro-fit
BUILDING D														
Men's Restroom		5	4' T12	4	Troffer	Magnetic	4	N	Electronic	\$ 11.20	\$ 56.00	\$ 70.00	\$ 350.00	Excellent Opportunity for Retro-fit

LOCATION	EXISTING EQUIPMENT						PROPOSED			REBATES		COSTS		COMMENTS
Location (Rm Name, Rm. #, Area, Zone, etc.)	Floor	Quantity	Lamp Type	Lamps Per Fixture	Type of Fixture	Ballast Type	Lamps Per Fixture	Reflectors	Ballast Type	Per Single	Extended	Per Single	Extended	Surveyors Comments
Women's Rsetroom		5	4' T12	4	Troffer	Magnetic	4	N	Electronic	\$ 11.20	\$ 56.00	\$ 70.00	\$ 350.00	Excellent Opportunity for Retro-fit
Administration Office		11	4' T12	4	Troffer	Magnetic	4	N	Electronic	\$ 11.20	\$ 123.20	\$ 70.00	\$ 770.00	Excellent Opportunity for Retro-fit
D 202		12	4' T12	3	Troffer	Magnetic	3	N	Electronic	\$ 8.40	\$ 100.80	\$ 65.00	\$ 780.00	Excellent Opportunity for Retro-fit
Office		4	4' T12	2	Troffer	Magnetic	2	N	Electronic	\$ 5.60	\$ 22.40	\$ 60.00	\$ 240.00	Excellent Opportunity for Retro-fit
D 203		16	4' T12	3	Troffer	Magnetic	3	N	Electronic	\$ 8.40	\$ 134.40	\$ 65.00	\$ 1,040.00	Excellent Opportunity for Retro-fit
D 204		16	4' T12	3	Troffer	Magnetic	3	N	Electronic	\$ 8.40	\$ 134.40	\$ 65.00	\$ 1,040.00	Excellent Opportunity for Retro-fit
D 205		27	4' T12	4	Troffer	Magnetic	4	N	Electronic	\$ 11.20	\$ 302.40	\$ 70.00	\$ 1,890.00	Excellent Opportunity for Retro-fit
D 105		32	4' T12	3	Troffer	Magnetic	3	N	Electronic	\$ 8.40	\$ 268.80	\$ 65.00	\$ 2,080.00	Excellent Opportunity for Retro-fit
D 104		9	4' T12	3	Troffer	Magnetic	3	N	Electronic	\$ 8.40	\$ 75.60	\$ 65.00	\$ 585.00	Excellent Opportunity for Retro-fit
D 103		12	4' T12	3	Troffer	Magnetic	3	N	Electronic	\$ 8.40	\$ 100.80	\$ 65.00	\$ 780.00	Excellent Opportunity for Retro-fit
D 102		12	4' T12	3	Troffer	Magnetic	3	N	Electronic	\$ 8.40	\$ 100.80	\$ 65.00	\$ 780.00	Excellent Opportunity for Retro-fit
D 101		16	4' T12	3	Troffer	Magnetic	3	N	Electronic	\$ 8.40	\$ 134.40	\$ 65.00	\$ 1,040.00	Excellent Opportunity for Retro-fit
Girls' Restroom		4	4' T12	2	Troffer	Magnetic	2	N	Electronic	\$ 5.60	\$ 22.40	\$ 60.00	\$ 240.00	Excellent Opportunity for Retro-fit
Boys' Restroom		4	4' T12	2	Troffer	Magnetic	2	N	Electronic	\$ 5.60	\$ 22.40	\$ 60.00	\$ 240.00	Excellent Opportunity for Retro-fit
BUILDING E														
E 101		36	4' T12	2	Troffer	Magnetic	2	N	Electronic	\$ 5.60	\$ 201.60	\$ 60.00	\$ 2,160.00	Excellent Opportunity for Retro-fit
Office		4	4' T12	4	Troffer	Magnetic	4	N	Electronic	\$ 11.20	\$ 44.80	\$ 70.00	\$ 280.00	Excellent Opportunity for Retro-fit
Storage Room		3	4' T12	2	Troffer	Magnetic	2	N	Electronic	\$ 5.60	\$ 16.80	\$ 60.00	\$ 180.00	Excellent Opportunity for Retro-fit
Storage		4	4' T12	2	Troffer	Magnetic	2	N	Electronic	\$ 5.60	\$ 22.40	\$ 60.00	\$ 240.00	Excellent Opportunity for Retro-fit
Finishing Room		2	4' T12	4	Troffer	Magnetic	4	N	Electronic	\$ 11.20	\$ 22.40	\$ 70.00	\$ 140.00	Excellent Opportunity for Retro-fit
BUILDING F														
		6	4' T12	4	Troffer	Magnetic	4	N	Electronic	\$ 11.20	\$ 67.20	\$ 70.00	\$ 420.00	Excellent Opportunity for Retro-fit
F 101		17	4' T12	3	Troffer	Magnetic	3	N	Electronic	\$ 8.40	\$ 142.80	\$ 65.00	\$ 1,105.00	Excellent Opportunity for Retro-fit
TB 101		8	4' T12	3	Troffer	Magnetic	3	N	Electronic	\$ 8.40	\$ 67.20	\$ 65.00	\$ 520.00	Excellent Opportunity for Retro-fit
TB 102		8	4' T12	3	Troffer	Magnetic	3	N	Electronic	\$ 8.40	\$ 67.20	\$ 65.00	\$ 520.00	Excellent Opportunity for Retro-fit
TB 103		8	4' T12	3	Troffer	Magnetic	3	N	Electronic	\$ 8.40	\$ 67.20	\$ 65.00	\$ 520.00	Excellent Opportunity for Retro-fit
BUILDING G														
Boys' Restroom	1	4	4' T12	2	Troffer	Magnetic	2	N	Electronic	\$ 5.60	\$ 22.40	\$ 60.00	\$ 240.00	Excellent Opportunity for Retro-fit
Storage	1	1	4' T12	1	Troffer	Magnetic	1	N	Electronic	\$ 2.80	\$ 2.80	\$ 55.00	\$ 55.00	Excellent Opportunity for Retro-fit
Girls' Restroom	1	4	4' T12	2	Troffer	Magnetic	2	N	Electronic	\$ 5.60	\$ 22.40	\$ 60.00	\$ 240.00	Excellent Opportunity for Retro-fit
G 101	1	16	4' T12	2	Troffer	Magnetic	2	N	Electronic	\$ 5.60	\$ 89.60	\$ 60.00	\$ 960.00	Excellent Opportunity for Retro-fit
G 102	1	16	4' T12	3	Troffer	Magnetic	3	N	Electronic	\$ 8.40	\$ 134.40	\$ 65.00	\$ 1,040.00	Excellent Opportunity for Retro-fit
G 103	1	33	4' T12	3	Troffer	Magnetic	3	N	Electronic	\$ 8.40	\$ 277.20	\$ 65.00	\$ 2,145.00	Excellent Opportunity for Retro-fit
G 203	2	33	4' T12	3	Troffer	Magnetic	3	N	Electronic	\$ 8.40	\$ 277.20	\$ 65.00	\$ 2,145.00	Excellent Opportunity for Retro-fit
G 202	2	16	4' T12	3	Troffer	Magnetic	3	N	Electronic	\$ 8.40	\$ 134.40	\$ 65.00	\$ 1,040.00	Excellent Opportunity for Retro-fit
Girls' Restroom	2	4	4' T12	2	Troffer	Magnetic	2	N	Electronic	\$ 5.60	\$ 22.40	\$ 60.00	\$ 240.00	Excellent Opportunity for Retro-fit

LOCATION Location (Rm. Name, Rm. #, Area, Zone, etc.)	EXISTING EQUIPMENT						PROPOSED			REBATES		COSTS		COMMENTS Surveyors Comments
	Floor	Quantity	Lamp Type	Lamps Per Fixture	Type of Fixture	Ballast Type	Lamps Per Fixture	Reflectors	Ballast Type	Per Single	Extended	Per Single	Extended	
Boys' Restroom	2	4	4' T12	2	Troffer	Magnetic	2	N	Electronic	\$ 5.60	\$ 22.40	\$ 60.00	\$ 240.00	Excellent Opportunity for Retro-fit
PORTABLES														
		6	4' T12	3	Troffer	Magnetic	3	N	Electronic	\$ 8.40	\$ 50.40	\$ 65.00	\$ 390.00	Excellent Opportunity for Retro-fit
P 6A		6	4' T12	3	Troffer	Magnetic	3	N	Electronic	\$ 8.40	\$ 50.40	\$ 65.00	\$ 390.00	Excellent Opportunity for Retro-fit
P 6B		6	4' T12	3	Troffer	Magnetic	3	N	Electronic	\$ 8.40	\$ 50.40	\$ 65.00	\$ 390.00	Excellent Opportunity for Retro-fit
P 7		12	4' T12	3	Troffer	Magnetic	3	N	Electronic	\$ 8.40	\$ 100.80	\$ 65.00	\$ 780.00	Excellent Opportunity for Retro-fit
BUILDING O														
O 105	1	16	4' T12	4	Troffer	Magnetic	4	N	Electronic	\$ 11.20	\$ 179.20	\$ 70.00	\$ 1,120.00	Excellent Opportunity for Retro-fit
O 104	1	16	4' T12	4	Troffer	Magnetic	4	N	Electronic	\$ 11.20	\$ 179.20	\$ 70.00	\$ 1,120.00	Excellent Opportunity for Retro-fit
O 103	1	16	4' T12	4	Troffer	Magnetic	4	N	Electronic	\$ 11.20	\$ 179.20	\$ 70.00	\$ 1,120.00	Excellent Opportunity for Retro-fit
Boys' Restroom	1	3	4' T12	2	Troffer	Magnetic	2	N	Electronic	\$ 5.60	\$ 16.80	\$ 60.00	\$ 180.00	Excellent Opportunity for Retro-fit
Girls' Restroom	1	3	4' T12	2	Troffer	Magnetic	2	N	Electronic	\$ 5.60	\$ 16.80	\$ 60.00	\$ 180.00	Excellent Opportunity for Retro-fit
O 102	1	16	4' T12	4	Troffer	Magnetic	4	N	Electronic	\$ 11.20	\$ 179.20	\$ 70.00	\$ 1,120.00	Excellent Opportunity for Retro-fit
O 101	1	16	4' T12	4	Troffer	Magnetic	4	N	Electronic	\$ 11.20	\$ 179.20	\$ 70.00	\$ 1,120.00	Excellent Opportunity for Retro-fit
O 201	2	16	4' T12	4	Troffer	Magnetic	4	N	Electronic	\$ 11.20	\$ 179.20	\$ 70.00	\$ 1,120.00	Excellent Opportunity for Retro-fit
O 202	2	16	4' T12	4	Troffer	Magnetic	4	N	Electronic	\$ 11.20	\$ 179.20	\$ 70.00	\$ 1,120.00	Excellent Opportunity for Retro-fit
Boys' Restroom	2	3	4' T12	2	Troffer	Magnetic	2	N	Electronic	\$ 5.60	\$ 16.80	\$ 60.00	\$ 180.00	Excellent Opportunity for Retro-fit
Girls' Restroom	2	3	4' T12	2	Troffer	Magnetic	2	N	Electronic	\$ 5.60	\$ 16.80	\$ 60.00	\$ 180.00	Excellent Opportunity for Retro-fit
O 203	2	16	4' T12	4	Troffer	Magnetic	4	N	Electronic	\$ 11.20	\$ 179.20	\$ 70.00	\$ 1,120.00	Excellent Opportunity for Retro-fit
O 204	2	16	4' T12	4	Troffer	Magnetic	4	N	Electronic	\$ 11.20	\$ 179.20	\$ 70.00	\$ 1,120.00	Excellent Opportunity for Retro-fit
O 205	2	16	4' T12	4	Troffer	Magnetic	4	N	Electronic	\$ 11.20	\$ 179.20	\$ 70.00	\$ 1,120.00	Excellent Opportunity for Retro-fit
Total Rebates										\$	11,568.80			
Total Costs										\$	87,409.30			

LOCATION	QTY	EXISTING TYPE	QTY	RETROFIT	SURVEYORS COMMENTS	Existing		Actual		Proposed			
						Watt/unit	Op. Hours	kWh	kW-D	Watt/unit	Op. Hours	kWh	kW-D
BUILDING M	0		0		0		1,002	0.0	0		1,002	0.0	0
Office	2	4' 3L Fixture	2	Lamp & Low Watt Ballast	Excellent Opportunity for Retro-fit	121.2	1,002	243.0	0.2424	77	1,002	154.4	0.154
Boys' Locker Room	22	4' 2L Fixture	22	Lamp & Low Watt Ballast	Excellent Opportunity for Retro-fit	75.6	1,002	1,667.3	1.6632	51	1,002	1,124.7	1.122
Boys	4	4' 2L Fixture	4	Lamp & Low Watt Ballast	Excellent Opportunity for Retro-fit	75.6	1,002	303.1	0.3024	51	1,002	204.5	0.204
Towel Room	2	4' 2L Fixture	2	Lamp & Low Watt Ballast	Excellent Opportunity for Retro-fit	75.6	1,002	151.6	0.1512	51	1,002	102.2	0.102
Office	2	4' 3L Fixture	2	Lamp & Low Watt Ballast	Excellent Opportunity for Retro-fit	121.2	1,002	243.0	0.2424	77	1,002	154.4	0.154
Faculty	2	4' 2L Fixture	2	Lamp & Low Watt Ballast	Excellent Opportunity for Retro-fit	75.6	1,002	151.6	0.1512	51	1,002	102.2	0.102
Girls' Locker Room	20	4' 2L Fixture	20	Lamp & Low Watt Ballast	Excellent Opportunity for Retro-fit	75.6	1,002	1,515.7	1.512	51	1,002	1,022.5	1.02
Girls	5	4' 2L Fixture	5	Lamp & Low Watt Ballast	Excellent Opportunity for Retro-fit	75.6	1,002	378.9	0.378	51	1,002	255.6	0.255
Office	2	4' 3L Fixture	2	Lamp & Low Watt Ballast	Excellent Opportunity for Retro-fit	121.2	1,002	243.0	0.2424	77	1,002	154.4	0.154
Towel Room	2	4' 2L Fixture	2	Lamp & Low Watt Ballast	Excellent Opportunity for Retro-fit	75.6	1,002	151.6	0.1512	51	1,002	102.2	0.102
P 5	12	4' 4L Fixture	12	Lamp & Low Watt Ballast	Excellent Opportunity for Retro-fit	151.2	1,002	1,818.8	1.8144	100	1,002	1,202.9	1.2
P 4B	6	4' 4L Fixture	6	Lamp & Low Watt Ballast	Excellent Opportunity for Retro-fit	151.2	1,002	909.4	0.9072	100	1,002	601.5	0.6
P 4A	6	4' 4L Fixture	6	Lamp & Low Watt Ballast	Excellent Opportunity for Retro-fit	151.2	1,002	909.4	0.9072	100	1,002	601.5	0.6
P 3	16	4' 4L Fixture	16	Lamp & Low Watt Ballast	Excellent Opportunity for Retro-fit	151.2	1,002	2,425.1	2.4192	100	1,002	1,603.9	1.6
P 2	16	4' 4L Fixture	16	Lamp & Low Watt Ballast	Excellent Opportunity for Retro-fit	151.2	1,002	2,425.1	2.4192	100	1,002	1,603.9	1.6
P 1	16	4' 4L Fixture	16	Lamp & Low Watt Ballast	Excellent Opportunity for Retro-fit	151.2	1,002	2,425.1	2.4192	100	1,002	1,603.9	1.6
BUILDING K	0		0		0		1,002	0.0	0		1,002	0.0	0
Girls	5	2x2 2U Fixture	5	Lamp & Low Watt Ballast	No Comment	75.6	1,002	378.9	0.378	51	1,002	255.6	0.255
Boys	4	2' 2L Fixture	4	Lamp & Low Watt Ballast	Excellent Opportunity for Retro-fit	55.4	1,002	222.1	0.2216	55.4	1,002	222.1	0.2216
Boys	4	4' 4L Fixture	4	Lamp & Low Watt Ballast	Excellent Opportunity for Retro-fit	151.2	1,002	606.3	0.6048	100	1,002	401.0	0.4
Ensemble	4	4' 4L Fixture	4	Lamp & Low Watt Ballast	Excellent Opportunity for Retro-fit	151.2	1,002	606.3	0.6048	100	1,002	401.0	0.4
Room 1	1	2x2 2U Fixture	1	Lamp & Low Watt Ballast	No Comment	75.6	1,002	75.8	0.0756	51	1,002	51.1	0.051
Room 2	1	2x2 2U Fixture	1	Lamp & Low Watt Ballast	No Comment	75.6	1,002	75.8	0.0756	51	1,002	51.1	0.051
Room 3	1	2x2 2U Fixture	1	Lamp & Low Watt Ballast	No Comment	75.6	1,002	75.8	0.0756	51	1,002	51.1	0.051
Room 4	1	2x2 2U Fixture	1	Lamp & Low Watt Ballast	No Comment	75.6	1,002	75.8	0.0756	51	1,002	51.1	0.051
Room 5	1	2x2 2U Fixture	1	Lamp & Low Watt Ballast	No Comment	75.6	1,002	75.8	0.0756	51	1,002	51.1	0.051
Repair Storage	6	4' 3L Fixture	6	Lamp & Low Watt Ballast	Excellent Opportunity for Retro-fit	121.2	1,002	729.0	0.7272	77	1,002	463.1	0.462
Weight Room	4	4' 2L Fixture	4	Lamp & Low Watt Ballast	Excellent Opportunity for Retro-fit	75.6	1,002	303.1	0.3024	51	1,002	204.5	0.204
Weight Room	8	4' 2L Fixture	8	Lamp & Low Watt Ballast	Excellent Opportunity for Retro-fit	75.6	1,002	606.3	0.6048	51	1,002	409.0	0.408
BUILDING H	0		0		0		1,002	0.0	0		1,002	0.0	0
Boys	6	4' 2L Fixture	6	Lamp & Low Watt Ballast	Excellent Opportunity for Retro-fit	75.6	1,002	454.7	0.4536	51	1,002	306.7	0.306
Girls	6	4' 2L Fixture	6	Lamp & Low Watt Ballast	Excellent Opportunity for Retro-fit	75.6	1,002	454.7	0.4536	51	1,002	306.7	0.306
Storage	7	4' 2L Fixture	7	Lamp & Low Watt Ballast	Excellent Opportunity for Retro-fit	75.6	1,002	530.5	0.5292	51	1,002	357.9	0.357
H 101	24	4' 3L Fixture	24	Lamp & Low Watt Ballast	Excellent Opportunity for Retro-fit	121.2	1,002	2,915.9	2.9088	77	1,002	1,852.5	1.848
H 102	16	4' 3L Fixture	16	Lamp & Low Watt Ballast	Excellent Opportunity for Retro-fit	121.2	1,002	1,944.0	1.9392	77	1,002	1,235.0	1.232
H 103	16	4' 3L Fixture	16	Lamp & Low Watt Ballast	Excellent Opportunity for Retro-fit	121.2	1,002	1,944.0	1.9392	77	1,002	1,235.0	1.232
H 205	16	4' 3L Fixture	16	Lamp & Low Watt Ballast	Excellent Opportunity for Retro-fit	121.2	1,002	1,944.0	1.9392	77	1,002	1,235.0	1.232
H 204	16	4' 3L Fixture	16	Lamp & Low Watt Ballast	Excellent Opportunity for Retro-fit	121.2	1,002	1,944.0	1.9392	77	1,002	1,235.0	1.232
H 203	16	4' 3L Fixture	16	Lamp & Low Watt Ballast	Excellent Opportunity for Retro-fit	121.2	1,002	1,944.0	1.9392	77	1,002	1,235.0	1.232
H 202	16	4' 3L Fixture	16	Lamp & Low Watt Ballast	Excellent Opportunity for Retro-fit	121.2	1,002	1,944.0	1.9392	77	1,002	1,235.0	1.232
H 201	12	4' 3L Fixture	12	Lamp & Low Watt Ballast	Excellent Opportunity for Retro-fit	121.2	1,002	1,458.0	1.4544	77	1,002	926.3	0.924
	1	2x2 2U Fixture	1	Lamp & Low Watt Ballast	No Comment	75.6	1,002	75.8	0.0756	51	1,002	51.1	0.051
BUILDING I	0		0		0		1,002	0.0	0		1,002	0.0	0
Boys	6	4' 2L Fixture	6	Lamp & Low Watt Ballast	Excellent Opportunity for Retro-fit	75.6	1,002	454.7	0.4536	51	1,002	306.7	0.306
Girls	6	4' 2L Fixture	6	Lamp & Low Watt Ballast	Excellent Opportunity for Retro-fit	75.6	1,002	454.7	0.4536	51	1,002	306.7	0.306
I 201	15	4' 3L Fixture	15	Lamp & Low Watt Ballast	Excellent Opportunity for Retro-fit	121.2	1,002	1,822.5	1.818	77	1,002	1,157.8	1.155
I 202	15	4' 3L Fixture	15	Lamp & Low Watt Ballast	Excellent Opportunity for Retro-fit	121.2	1,002	1,822.5	1.818	77	1,002	1,157.8	1.155
I 203	32	4' 3L Fixture	32	Lamp & Low Watt Ballast	Excellent Opportunity for Retro-fit	121.2	1,002	3,887.9	3.8784	77	1,002	2,470.0	2.464
I 204	15	4' 3L Fixture	15	Lamp & Low Watt Ballast	Excellent Opportunity for Retro-fit	121.2	1,002	1,822.5	1.818	77	1,002	1,157.8	1.155
LIBRARY	0		0		0		1,002	0.0	0		1,002	0.0	0
	16	0	0	0	T8 Lamps No Retro-fit	0	1,002	0.0	0	0	1,002	0.0	0
	16	0	0	0	T8 Lamps No Retro-fit	0	1,002	0.0	0	0	1,002	0.0	0
	64	0	0	0	T8 Lamps No Retro-fit	0	1,002	0.0	0	0	1,002	0.0	0
	12	0	0	0	T8 Lamps No Retro-fit	0	1,002	0.0	0	0	1,002	0.0	0
Staff	21	0	0	0	T8 Lamps No Retro-fit	0	1,002	0.0	0	0	1,002	0.0	0
GLNU	1	4' 2L Fixture	1	Lamp & Low Watt Ballast	Excellent Opportunity for Retro-fit	75.6	1,002	75.8	0.0756	51	1,002	51.1	0.051
Hall	4	4' 2L Fixture	4	Lamp & Low Watt Ballast	Excellent Opportunity for Retro-fit	75.6	1,002	303.1	0.3024	51	1,002	204.5	0.204

LOCATION	QTY	EXISTING TYPE	QTY	RETROFIT	SURVEYORS COMMENTS	Existing	Actual			Proposed			
						Watt/unit	Op. Hours	kWh	kW-D	Watt/unit	Op. Hours	kWh	kW-D
Storage	4	4' 4L Fixture	4	Lamp & Low Watt Ballast	Excellent Opportunity for Retro-fit	151.2	1,002	606.3	0.6048	100	1,002	401.0	0.4
Storage	4	4' 4L Fixture	4	Lamp & Low Watt Ballast	Excellent Opportunity for Retro-fit	151.2	1,002	606.3	0.6048	100	1,002	401.0	0.4
Office	6	4' 3L Fixture	6	Lamp & Low Watt Ballast	Excellent Opportunity for Retro-fit	121.2	1,002	729.0	0.7272	77	1,002	463.1	0.462
Mech	2	4' 3L Fixture	2	Lamp & Low Watt Ballast	Excellent Opportunity for Retro-fit	121.2	1,002	243.0	0.2424	77	1,002	154.4	0.154
Video	3	4' 4L Fixture	3	Lamp & Low Watt Ballast	Excellent Opportunity for Retro-fit	151.2	1,002	454.7	0.4536	100	1,002	300.7	0.3
Room	4	4' 3L Fixture	4	Lamp & Low Watt Ballast	Excellent Opportunity for Retro-fit	121.2	1,002	486.0	0.4848	77	1,002	308.8	0.308
BUILDING Q	0		0		0		1,002	0.0	0		1,002	0.0	0
Boys	4	4' 2L Fixture	4	Lamp & Low Watt Ballast	Excellent Opportunity for Retro-fit	75.6	1,002	303.1	0.3024	51	1,002	204.5	0.204
Mech	2	2' 1L Fixture	2	Lamp & Low Watt Ballast	Excellent Opportunity for Retro-fit	45.6	1,002	91.4	0.0912	31	1,002	62.2	0.062
Girls	4	4' 2L Fixture	4	Lamp & Low Watt Ballast	Excellent Opportunity for Retro-fit	75.6	1,002	303.1	0.3024	51	1,002	204.5	0.204
Janitor	1	2' 1L Fixture	1	Lamp & Low Watt Ballast	Excellent Opportunity for Retro-fit	45.6	1,002	45.7	0.0456	31	1,002	31.1	0.031
Q 101	16	4' 4L Fixture	16	Lamp & Low Watt Ballast	Excellent Opportunity for Retro-fit	151.2	1,002	2,425.1	2.4192	100	1,002	1,603.9	1.6
Q 102	16	4' 4L Fixture	16	Lamp & Low Watt Ballast	Excellent Opportunity for Retro-fit	151.2	1,002	2,425.1	2.4192	100	1,002	1,603.9	1.6
Q 103	16	4' 4L Fixture	16	Lamp & Low Watt Ballast	Excellent Opportunity for Retro-fit	151.2	1,002	2,425.1	2.4192	100	1,002	1,603.9	1.6
Q 104	12	4' 4L Fixture	12	Lamp & Low Watt Ballast	Excellent Opportunity for Retro-fit	151.2	1,002	1,818.8	1.8144	100	1,002	1,202.9	1.2
Electrical	1	4' 2L Fixture	1	Lamp & Low Watt Ballast	Excellent Opportunity for Retro-fit	75.6	1,002	75.8	0.0756	51	1,002	51.1	0.051
Q 204	16	4' 4L Fixture	16	Lamp & Low Watt Ballast	Excellent Opportunity for Retro-fit	151.2	1,002	2,425.1	2.4192	100	1,002	1,603.9	1.6
Q 203	16	4' 4L Fixture	16	Lamp & Low Watt Ballast	Excellent Opportunity for Retro-fit	151.2	1,002	2,425.1	2.4192	100	1,002	1,603.9	1.6
Q 202	16	4' 4L Fixture	16	Lamp & Low Watt Ballast	Excellent Opportunity for Retro-fit	151.2	1,002	2,425.1	2.4192	100	1,002	1,603.9	1.6
Q 201	16	4' 4L Fixture	16	Lamp & Low Watt Ballast	Excellent Opportunity for Retro-fit	151.2	1,002	2,425.1	2.4192	100	1,002	1,603.9	1.6
Faculty	7	4' 4L Fixture	7	Lamp & Low Watt Ballast	Excellent Opportunity for Retro-fit	151.2	1,002	1,061.0	1.0584	100	1,002	701.7	0.7
Boys	1	4' 4L Fixture	1	Lamp & Low Watt Ballast	Excellent Opportunity for Retro-fit	151.2	1,002	151.6	0.1512	100	1,002	100.2	0.1
Girls	1	4' 4L Fixture	1	Lamp & Low Watt Ballast	Excellent Opportunity for Retro-fit	151.2	1,002	151.6	0.1512	100	1,002	100.2	0.1
Stairs	3	4' 4L Fixture	3	Lamp & Low Watt Ballast	Excellent Opportunity for Retro-fit	151.2	1,002	454.7	0.4536	100	1,002	300.7	0.3
CAFETERIA	0		0		0		1,002	0.0	0		1,002	0.0	0
Office	2	4' 4L Fixture	2	Lamp & Low Watt Ballast	Excellent Opportunity for Retro-fit	151.2	1,002	303.1	0.3024	100	1,002	200.5	0.2
Utility	4	4' 4L Fixture	4	Lamp & Low Watt Ballast	Excellent Opportunity for Retro-fit	151.2	1,002	606.3	0.6048	100	1,002	401.0	0.4
Kitchen	50	4' 2L Fixture	50	Lamp & Low Watt Ballast	Excellent Opportunity for Retro-fit	75.6	1,002	3,789.3	3.78	51	1,002	2,556.2	2.55
Storage	4	2' 1L Fixture	4	Lamp & Low Watt Ballast	Excellent Opportunity for Retro-fit	45.6	1,002	182.8	0.1824	31	1,002	124.3	0.124
Electrical	1	4' 2L Fixture	1	Lamp & Low Watt Ballast	Excellent Opportunity for Retro-fit	75.6	1,002	75.8	0.0756	51	1,002	51.1	0.051
Storage	4	2' 1L Fixture	4	Lamp & Low Watt Ballast	Excellent Opportunity for Retro-fit	45.6	1,002	182.8	0.1824	31	1,002	124.3	0.124
Locker A	1	4' 2L Fixture	1	Lamp & Low Watt Ballast	Excellent Opportunity for Retro-fit	75.6	1,002	75.8	0.0756	51	1,002	51.1	0.051
Toilet	1	2' 1L Fixture	1	Lamp & Low Watt Ballast	Excellent Opportunity for Retro-fit	45.6	1,002	45.7	0.0456	31	1,002	31.1	0.031
Locker B	1	4' 2L Fixture	1	Lamp & Low Watt Ballast	Excellent Opportunity for Retro-fit	75.6	1,002	75.8	0.0756	51	1,002	51.1	0.051
Toilet	1	4' 1L Fixture	1	Lamp & Low Watt Ballast	Excellent Opportunity for Retro-fit	27.7	1,002	27.8	0.0277	18	1,002	18.0	0.018
Faculty	7	4' 2L Fixture	7	Lamp & Low Watt Ballast	Excellent Opportunity for Retro-fit	75.6	1,002	530.5	0.5292	51	1,002	357.9	0.357
	22	4' 3L Fixture	22	Lamp & Low Watt Ballast	Excellent Opportunity for Retro-fit	121.2	1,002	2,672.9	2.6664	77	1,002	1,698.2	1.694
	22	4' 3L Fixture	22	Lamp & Low Watt Ballast	Excellent Opportunity for Retro-fit	121.2	1,002	2,672.9	2.6664	77	1,002	1,698.2	1.694
Vice Principal	2	4' 2L Fixture	2	Lamp & Low Watt Ballast	Excellent Opportunity for Retro-fit	75.6	1,002	151.6	0.1512	51	1,002	102.2	0.102
DRTSI A	4	4' 2L Fixture	4	Lamp & Low Watt Ballast	Excellent Opportunity for Retro-fit	75.6	1,002	303.1	0.3024	51	1,002	204.5	0.204
PA	1	4' 2L Fixture	1	Lamp & Low Watt Ballast	Excellent Opportunity for Retro-fit	75.6	1,002	75.8	0.0756	51	1,002	51.1	0.051
Refridgerator	2	4' 2L Fixture	2	Lamp & Low Watt Ballast	Excellent Opportunity for Retro-fit	75.6	1,002	151.6	0.1512	51	1,002	102.2	0.102
BUILDING D	0		0		0		1,002	0.0	0		1,002	0.0	0
Men's Restroom	5	4' 4L Fixture	5	Lamp & Low Watt Ballast	Excellent Opportunity for Retro-fit	151.2	1,002	757.9	0.756	100	1,002	501.2	0.5
Women's Restroom	5	4' 4L Fixture	5	Lamp & Low Watt Ballast	Excellent Opportunity for Retro-fit	151.2	1,002	757.9	0.756	100	1,002	501.2	0.5
Administration Office	11	4' 4L Fixture	11	Lamp & Low Watt Ballast	Excellent Opportunity for Retro-fit	151.2	1,002	1,667.3	1.6632	100	1,002	1,102.7	1.1
D 202	12	4' 3L Fixture	12	Lamp & Low Watt Ballast	Excellent Opportunity for Retro-fit	121.2	1,002	1,458.0	1.4544	77	1,002	926.3	0.924
Office	4	4' 2L Fixture	4	Lamp & Low Watt Ballast	Excellent Opportunity for Retro-fit	75.6	1,002	303.1	0.3024	51	1,002	204.5	0.204
D 203	16	4' 3L Fixture	16	Lamp & Low Watt Ballast	Excellent Opportunity for Retro-fit	121.2	1,002	1,944.0	1.9392	77	1,002	1,235.0	1.232
D 204	16	4' 3L Fixture	16	Lamp & Low Watt Ballast	Excellent Opportunity for Retro-fit	121.2	1,002	1,944.0	1.9392	77	1,002	1,235.0	1.232
D 205	27	4' 4L Fixture	27	Lamp & Low Watt Ballast	Excellent Opportunity for Retro-fit	151.2	1,002	4,092.4	4.0824	100	1,002	2,706.6	2.7
D 105	32	4' 3L Fixture	32	Lamp & Low Watt Ballast	Excellent Opportunity for Retro-fit	121.2	1,002	3,887.9	3.8784	77	1,002	2,470.0	2.464
D 104	9	4' 3L Fixture	9	Lamp & Low Watt Ballast	Excellent Opportunity for Retro-fit	121.2	1,002	1,093.5	1.0908	77	1,002	694.7	0.693
D 103	12	4' 3L Fixture	12	Lamp & Low Watt Ballast	Excellent Opportunity for Retro-fit	121.2	1,002	1,458.0	1.4544	77	1,002	926.3	0.924
D 102	12	4' 3L Fixture	12	Lamp & Low Watt Ballast	Excellent Opportunity for Retro-fit	121.2	1,002	1,458.0	1.4544	77	1,002	926.3	0.924
D 101	16	4' 3L Fixture	16	Lamp & Low Watt Ballast	Excellent Opportunity for Retro-fit	121.2	1,002	1,944.0	1.9392	77	1,002	1,235.0	1.232
Girls' Restroom	4	4' 2L Fixture	4	Lamp & Low Watt Ballast	Excellent Opportunity for Retro-fit	75.6	1,002	303.1	0.3024	51	1,002	204.5	0.204
Boys' Restroom	4	4' 2L Fixture	4	Lamp & Low Watt Ballast	Excellent Opportunity for Retro-fit	75.6	1,002	303.1	0.3024	51	1,002	204.5	0.204
BUILDING E	0		0		0		1,002	0.0	0		1,002	0.0	0

LOCATION	QTY	EXISTING TYPE	QTY	RETROFIT	SURVEYORS COMMENTS	Actual				Proposed			
						Existing Watt/unit	Op. Hours	kWh	kW-D	Watt/unit	Op. Hours	kWh	kW-D
E 101	36	4' 2L Fixture	36	Lamp & Low Watt Ballast	Excellent Opportunity for Retro-fit	75.6	1,002	2,728.3	2.7216	51	1,002	1,840.5	1.836
Office	4	4' 4L Fixture	4	Lamp & Low Watt Ballast	Excellent Opportunity for Retro-fit	151.2	1,002	606.3	0.6048	100	1,002	401.0	0.4
Storage Room	3	4' 2L Fixture	3	Lamp & Low Watt Ballast	Excellent Opportunity for Retro-fit	75.6	1,002	227.4	0.2268	51	1,002	153.4	0.153
Storage	4	4' 2L Fixture	4	Lamp & Low Watt Ballast	Excellent Opportunity for Retro-fit	75.6	1,002	303.1	0.3024	51	1,002	204.5	0.204
Finishing Room	2	4' 4L Fixture	2	Lamp & Low Watt Ballast	Excellent Opportunity for Retro-fit	151.2	1,002	303.1	0.3024	100	1,002	200.5	0.2
BUILDING F	0		0		0		1,002	0.0	0		1,002	0.0	0
	6	4' 4L Fixture	6	Lamp & Low Watt Ballast	Excellent Opportunity for Retro-fit	151.2	1,002	909.4	0.9072	100	1,002	601.5	0.6
F 101	17	4' 3L Fixture	17	Lamp & Low Watt Ballast	Excellent Opportunity for Retro-fit	121.2	1,002	2,065.4	2.0604	77	1,002	1,312.2	1.309
TB 101	8	4' 3L Fixture	8	Lamp & Low Watt Ballast	Excellent Opportunity for Retro-fit	121.2	1,002	972.0	0.9696	77	1,002	617.5	0.616
TB 102	8	4' 3L Fixture	8	Lamp & Low Watt Ballast	Excellent Opportunity for Retro-fit	121.2	1,002	972.0	0.9696	77	1,002	617.5	0.616
TB 103	8	4' 3L Fixture	8	Lamp & Low Watt Ballast	Excellent Opportunity for Retro-fit	121.2	1,002	972.0	0.9696	77	1,002	617.5	0.616
BUILDING G	0		0		0		1,002	0.0	0		1,002	0.0	0
Boys' Restroom	4	4' 2L Fixture	4	Lamp & Low Watt Ballast	Excellent Opportunity for Retro-fit	75.6	1,002	303.1	0.3024	51	1,002	204.5	0.204
Storage	1	2' 1L Fixture	1	Lamp & Low Watt Ballast	Excellent Opportunity for Retro-fit	45.6	1,002	45.7	0.0456	31	1,002	31.1	0.031
Girls' Restroom	4	4' 2L Fixture	4	Lamp & Low Watt Ballast	Excellent Opportunity for Retro-fit	75.6	1,002	303.1	0.3024	51	1,002	204.5	0.204
G 101	16	4' 2L Fixture	16	Lamp & Low Watt Ballast	Excellent Opportunity for Retro-fit	75.6	1,002	1,212.6	1.2096	51	1,002	818.0	0.816
G 102	16	4' 3L Fixture	16	Lamp & Low Watt Ballast	Excellent Opportunity for Retro-fit	121.2	1,002	1,944.0	1.9392	77	1,002	1,235.0	1.232
G 103	33	4' 3L Fixture	33	Lamp & Low Watt Ballast	Excellent Opportunity for Retro-fit	121.2	1,002	4,009.4	3.9996	77	1,002	2,547.2	2.541
G 203	33	4' 3L Fixture	33	Lamp & Low Watt Ballast	Excellent Opportunity for Retro-fit	121.2	1,002	4,009.4	3.9996	77	1,002	2,547.2	2.541
G 202	16	4' 3L Fixture	16	Lamp & Low Watt Ballast	Excellent Opportunity for Retro-fit	121.2	1,002	1,944.0	1.9392	77	1,002	1,235.0	1.232
Girls' Restroom	4	4' 2L Fixture	4	Lamp & Low Watt Ballast	Excellent Opportunity for Retro-fit	75.6	1,002	303.1	0.3024	51	1,002	204.5	0.204
Boys' Restroom	4	4' 2L Fixture	4	Lamp & Low Watt Ballast	Excellent Opportunity for Retro-fit	75.6	1,002	303.1	0.3024	51	1,002	204.5	0.204
PORTABLES	0		0		0		1,002	0.0	0		1,002	0.0	0
	6	4' 3L Fixture	6	Lamp & Low Watt Ballast	Excellent Opportunity for Retro-fit	121.2	1,002	729.0	0.7272	77	1,002	463.1	0.462
P 6A	6	4' 3L Fixture	6	Lamp & Low Watt Ballast	Excellent Opportunity for Retro-fit	121.2	1,002	729.0	0.7272	77	1,002	463.1	0.462
P 6B	6	4' 3L Fixture	6	Lamp & Low Watt Ballast	Excellent Opportunity for Retro-fit	121.2	1,002	729.0	0.7272	77	1,002	463.1	0.462
P 7	12	4' 3L Fixture	12	Lamp & Low Watt Ballast	Excellent Opportunity for Retro-fit	121.2	1,002	1,458.0	1.4544	77	1,002	926.3	0.924
BUILDING O	0		0		0		1,002	0.0	0		1,002	0.0	0
O 105	16	4' 4L Fixture	16	Lamp & Low Watt Ballast	Excellent Opportunity for Retro-fit	151.2	1,002	2,425.1	2.4192	100	1,002	1,603.9	1.6
O 104	16	4' 4L Fixture	16	Lamp & Low Watt Ballast	Excellent Opportunity for Retro-fit	151.2	1,002	2,425.1	2.4192	100	1,002	1,603.9	1.6
O 103	16	4' 4L Fixture	16	Lamp & Low Watt Ballast	Excellent Opportunity for Retro-fit	151.2	1,002	2,425.1	2.4192	100	1,002	1,603.9	1.6
Boys' Restroom	3	4' 2L Fixture	3	Lamp & Low Watt Ballast	Excellent Opportunity for Retro-fit	75.6	1,002	227.4	0.2268	51	1,002	153.4	0.153
Girls' Restroom	3	4' 2L Fixture	3	Lamp & Low Watt Ballast	Excellent Opportunity for Retro-fit	75.6	1,002	227.4	0.2268	51	1,002	153.4	0.153
O 102	16	4' 4L Fixture	16	Lamp & Low Watt Ballast	Excellent Opportunity for Retro-fit	151.2	1,002	2,425.1	2.4192	100	1,002	1,603.9	1.6
O 101	16	4' 4L Fixture	16	Lamp & Low Watt Ballast	Excellent Opportunity for Retro-fit	151.2	1,002	2,425.1	2.4192	100	1,002	1,603.9	1.6
O 201	16	4' 4L Fixture	16	Lamp & Low Watt Ballast	Excellent Opportunity for Retro-fit	151.2	1,002	2,425.1	2.4192	100	1,002	1,603.9	1.6
O 202	16	4' 4L Fixture	16	Lamp & Low Watt Ballast	Excellent Opportunity for Retro-fit	151.2	1,002	2,425.1	2.4192	100	1,002	1,603.9	1.6
Boys' Restroom	3	4' 2L Fixture	3	Lamp & Low Watt Ballast	Excellent Opportunity for Retro-fit	75.6	1,002	227.4	0.2268	51	1,002	153.4	0.153
Girls' Restroom	3	4' 2L Fixture	3	Lamp & Low Watt Ballast	Excellent Opportunity for Retro-fit	75.6	1,002	227.4	0.2268	51	1,002	153.4	0.153
O 203	16	4' 4L Fixture	16	Lamp & Low Watt Ballast	Excellent Opportunity for Retro-fit	151.2	1,002	2,425.1	2.4192	100	1,002	1,603.9	1.6
O 204	16	4' 4L Fixture	16	Lamp & Low Watt Ballast	Excellent Opportunity for Retro-fit	151.2	1,002	2,425.1	2.4192	100	1,002	1,603.9	1.6
O 205	16	4' 4L Fixture	16	Lamp & Low Watt Ballast	Excellent Opportunity for Retro-fit	151.2	1,002	2,425.1	2.4192	100	1,002	1,603.9	1.6
Existing	1464		Proposed	1335	ENERGY CALCULATIONS				161,085	161			
Description						kW-Demand	kWh						
Existing Use						160.69	161,085						
Proposed Use						104.85	105,109						
Difference - Savings						55.84	55,976						
Electrical Utility Cost						\$5.75	\$0.15198						
Savings per Year						\$3,852.90	\$8,507.04		Total Yearly Energy Savings \$12,359.94				
									105,109				
									105				

Existing 1464 Proposed 1335

ENERGY CALCULATIONS		
Description	kW-Demand	kWh
Existing Use	160.69	161,085
Proposed Use	104.85	105,109
Difference - Savings	55.84	55,976
Electrical Utility Cost	\$5.75	\$0.15198
Savings per Year	\$3,852.90	\$8,507.04
		Total Yearly Energy Savings \$12,359.94

Kamali'i Elementary School

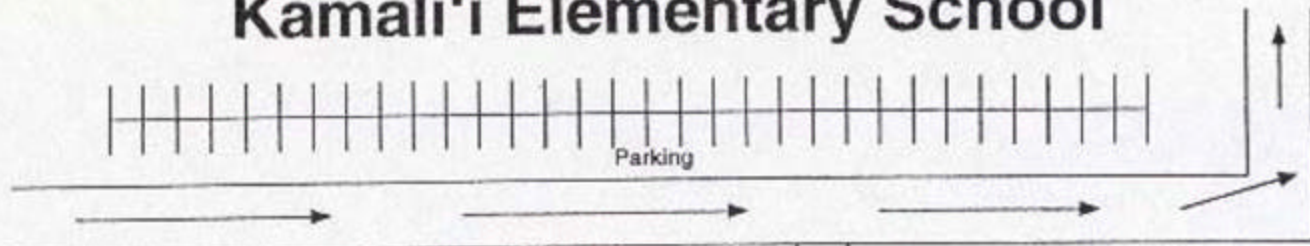

A-4 Brown	A-3 Farnham	Teacher Station 1	Hensor	A-2 Tohulin	A-1 Callahan	PCNC	Office
A-8 Valentine	A-7 Echeverri	Teacher Station 2	Mechanical Area	A-6 Williams	A-5 King	Resource Center	

D-1 Ohashi	D-2 Zemetra	Web	Mechanical Area	D-3 Shannon	D-4 Bisera	● Girls
D-5 Lussler	D-6 Tompkins	Teacher Station 2	Mechanical Area	D-7 Moniz	D-8 Kobayashi	● Boys

● Girls	B-2 Cabatu	B-1 Kalehuawe	Resource Room	Library Valery	Production Workroom- Authoring Lab
● Boys	B-5 Ross	B-4 Evans	Teacher Station	Mechanical Area	B-3 Computer Lab - Mac

● Girls	E-1 Fujimoto	E-2 Osomo	Teacher Station 2	Faculty Center	E-3 Sakamoto	E-4 Parriera
● Boys	E-5 Matsuura	E-6 Halford	Mechanical Area	Teacher Station 1	E-7 Clapper	E-8 Yamaoka

F-1 Thorne Balinbin	F-2 Salcido	Resource Room	Resource Room	Hoover Mugs	F-3 Kaopuki	F-4 Hicks	● Girls
F-5 Barroga	F-6 Lafey	Resource Room	Resource Room Hanoy	Mechanical Area	F-7 Gaston	F-8 Hart	● Boys

- Restrooms
- ⊠ Teacher Stations
- ⊞ Resource Center
- ⊠ Faculty Center
- ⊞ Mechanical Area

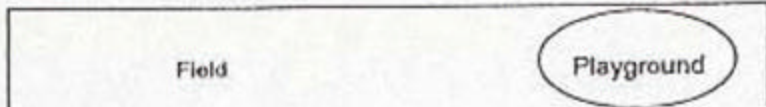

Basketball Court

FIRE LANE

Health Room

Cafeteria

Maui Smart Schools Program Foot Candle Readings

School: Kamali'i Elementary School

Room: Bldg. B – Computer room

Ceiling Height: 12'

Light Fixture Height: 8'

Fixture Type: Troffer

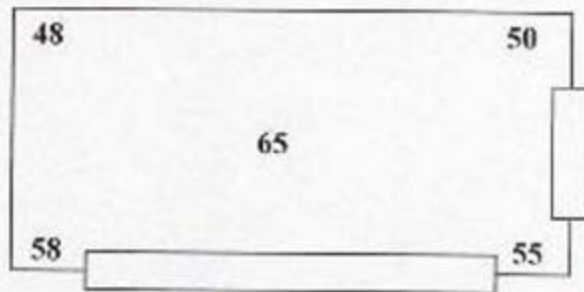

Room: Bldg. E E-4

Ceiling Height: 12'

Light Fixture Height: 8'

Fixture Type: Troffer

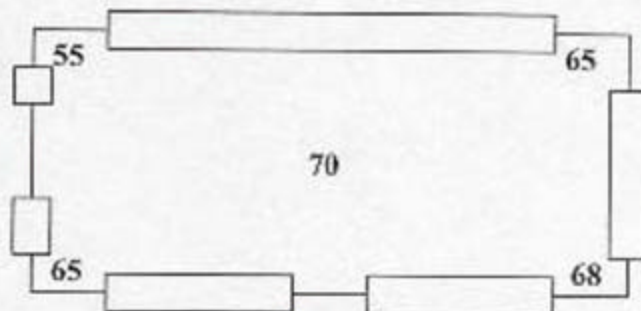

Room: Bldg. – F F-8

Ceiling Height: 12'

Light Fixture Height: 8'

Fixture Type: Troffer

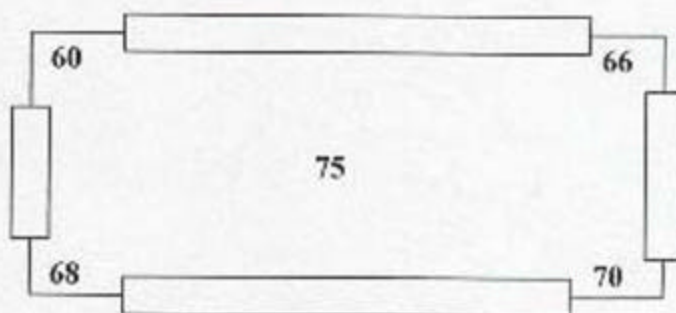



SCHOOL INFORMATION														
NAME Kamalii Elementary School											DATE 3/30/2001			
STREET ADDRESS 180 Kealii Alanui Kihei											OPERATIONAL HOURS 1,002			
POINT OF CONTACT Sandra Showhan					PHONE 875-6840			FAX		VOLTAGE 120V				
AUDITOR Maui Community College Auditors														
LOCATION		EXISTING EQUIPMENT					PROPOSED			REBATES		COSTS		COMMENTS
Location (Rm Name, Rm. #, Area, Zone, etc.)	Floor	Quantity	Lamp Type	Lamps Per Fixture	Type of Fixture	Ballast Type	Lamps Per Fixture	Reflectors	Ballast Type	Per Single	Extended	Per Single	Extended	Surveyors Comments
BUILDING A	1	6	4T12	4	Troffer	Magnetic	4	N	Electronic	\$ 11.20	\$ 67.20	\$ 70.00	\$ 420.00	excellent opportunity for retro-fit
A - 1	1	12	4T12	4	Troffer	Magnetic	4	N	Electronic	\$ 11.20	\$ 134.40	\$ 70.00	\$ 840.00	excellent opportunity for retro-fit
A - 2	1	12	4T12	4	Troffer	Magnetic	4	N	Electronic	\$ 11.20	\$ 134.40	\$ 70.00	\$ 840.00	excellent opportunity for retro-fit
Elec./Comm.	1	4	4T12	1	Open	Magnetic	1	N	Electronic	\$ 2.80	\$ 11.20	\$ 55.00	\$ 220.00	replace fixture and mount hardware
Teacher Station 1	1	9	4T12	4	Troffer	Magnetic	4	N	Electronic	\$ 11.20	\$ 100.80	\$ 70.00	\$ 630.00	excellent opportunity for retro-fit
Staff Restroom	1	1	4T12	2	Wrap	Magnetic	2	N	Electronic	\$ 5.60	\$ 5.60	\$ 60.00	\$ 60.00	excellent opportunity for retro-fit
A - 3	1	12	4T12	4	Troffer	Magnetic	4	N	Electronic	\$ 11.20	\$ 134.40	\$ 60.00	\$ 720.00	excellent opportunity for retro-fit
A - 4	1	12	4T12	4	Troffer	Magnetic	4	N	Electronic	\$ 11.20	\$ 134.40	\$ 70.00	\$ 840.00	excellent opportunity for retro-fit
A - 8	1	12	4T12	4	Troffer	Magnetic	4	N	Electronic	\$ 11.20	\$ 134.40	\$ 70.00	\$ 840.00	excellent opportunity for retro-fit
A - 7	1	12	4T12	4	Troffer	Magnetic	4	N	Electronic	\$ 11.20	\$ 134.40	\$ 70.00	\$ 840.00	excellent opportunity for retro-fit
Staff Restroom	1	1	4T12	2	Wrap	Magnetic	2	N	Electronic	\$ 5.60	\$ 5.60	\$ 60.00	\$ 60.00	excellent opportunity for retro-fit
Teacher Station 2	1	5	4T12	4	Troffer	Magnetic	4	N	Electronic	\$ 11.20	\$ 56.00	\$ 70.00	\$ 350.00	excellent opportunity for retro-fit
A - 6	1	12	4T12	4	Troffer	Magnetic	4	N	Electronic	\$ 11.20	\$ 134.40	\$ 70.00	\$ 840.00	excellent opportunity for retro-fit
A - 5	1	12	4T12	4	Troffer	Magnetic	4	N	Electronic	\$ 11.20	\$ 134.40	\$ 70.00	\$ 840.00	excellent opportunity for retro-fit
Resource Center	1	15	4T12	3	Troffer	Magnetic	3	N	Electronic	\$ 8.40	\$ 126.00	\$ 65.00	\$ 975.00	excellent opportunity for retro-fit
ADMIN. BUILDING														
General Utility	1	1	4T12	1	Open	Magnetic	1	N	Electronic	\$ 2.80	\$ 2.80	\$ 55.00	\$ 55.00	replace fixture and mount hardware
Counselor	1	2	4T12	3	Troffer	Magnetic	3	N	Electronic	\$ 8.40	\$ 16.80	\$ 65.00	\$ 130.00	excellent opportunity for retro-fit
Staff	1	2	4T12	3	Troffer	Magnetic	3	N	Electronic	\$ 8.40	\$ 16.80	\$ 65.00	\$ 130.00	excellent opportunity for retro-fit
Staff Lounge	1	2	4T12	3	Troffer	Magnetic	3	N	Electronic	\$ 8.40	\$ 16.80	\$ 65.00	\$ 130.00	excellent opportunity for retro-fit
Counselor	1	2	4T12	3	Troffer	Magnetic	3	N	Electronic	\$ 8.40	\$ 16.80	\$ 65.00	\$ 130.00	excellent opportunity for retro-fit
Counselor	1	2	4T12	3	Troffer	Magnetic	3	N	Electronic	\$ 8.40	\$ 16.80	\$ 65.00	\$ 130.00	excellent opportunity for retro-fit
Student Services	1	2	4T12	3	Troffer	Magnetic	3	N	Electronic	\$ 8.40	\$ 16.80	\$ 65.00	\$ 130.00	excellent opportunity for retro-fit
Conference Room 2	1	6	4T12	3	Troffer	Magnetic	3	N	Electronic	\$ 8.40	\$ 50.40	\$ 65.00	\$ 390.00	excellent opportunity for retro-fit
Conference Room 1	1	6	4T12	3	Troffer	Magnetic	3	N	Electronic	\$ 8.40	\$ 50.40	\$ 65.00	\$ 390.00	excellent opportunity for retro-fit
Restroom	1	1	4T12	2	Wrap	Magnetic	2	N	Electronic	\$ 5.60	\$ 5.60	\$ 60.00	\$ 60.00	excellent opportunity for retro-fit
BUILDING F														
F 1	1	12	4T12	4	Troffer	Magnetic	4	N	Electronic	\$ 11.20	\$ 134.40	\$ 70.00	\$ 840.00	excellent opportunity for retro-fit
F 2	1	12	4T12	4	Troffer	Magnetic	4	N	Electronic	\$ 11.20	\$ 134.40	\$ 70.00	\$ 840.00	excellent opportunity for retro-fit
F 3	1	12	4T12	4	Troffer	Magnetic	4	N	Electronic	\$ 11.20	\$ 134.40	\$ 70.00	\$ 840.00	excellent opportunity for retro-fit
F 4	1	12	4T12	4	Troffer	Magnetic	4	N	Electronic	\$ 11.20	\$ 134.40	\$ 70.00	\$ 840.00	excellent opportunity for retro-fit
F 5	1	12	4T12	4	Troffer	Magnetic	4	N	Electronic	\$ 11.20	\$ 134.40	\$ 70.00	\$ 840.00	excellent opportunity for retro-fit

LOCATION	EXISTING EQUIPMENT						PROPOSED			REBATES		COSTS		COMMENTS
Location (Rm Name, Rm. #, Area, Zone, etc.)	Floor	Quantity	Lamp Type	Lamps Per Fixture	Type of Fixture	Ballast Type	Lamps Per Fixture	Reflectors	Ballast Type	Per Single	Extended	Per Single	Extended	Surveyors Comments
F 6	1	12	4T12	4	Troffer	Magnetic	4	N	Electronic	\$ 11.20	\$ 134.40	\$ 70.00	\$ 840.00	excellent opportunity for retro-fit
F 7	1	12	4T12	4	Troffer	Magnetic	4	N	Electronic	\$ 11.20	\$ 134.40	\$ 70.00	\$ 840.00	excellent opportunity for retro-fit
F 8	1	12	4T12	4	Troffer	Magnetic	4	N	Electronic	\$ 11.20	\$ 134.40	\$ 70.00	\$ 840.00	excellent opportunity for retro-fit
Boys	1	6	4T12	2	Wrap	Magnetic	2	N	Electronic	\$ 5.60	\$ 33.60	\$ 60.00	\$ 360.00	excellent opportunity for retro-fit
General Utility	1	1	4T12	1	Open	Magnetic	1	N	Electronic	\$ 2.80	\$ 2.80	\$ 55.00	\$ 55.00	replace fixture and mount hardware
BUILDING C														
Boys	1	1	4T12	2	Wrap	Magnetic	2	N	Electronic	\$ 5.60	\$ 5.60	\$ 60.00	\$ 60.00	excellent opportunity for retro-fit
Girls	1	1	4T12	2	Wrap	Magnetic	2	N	Electronic	\$ 5.60	\$ 5.60	\$ 60.00	\$ 60.00	excellent opportunity for retro-fit
Cafeteria	1	54	4T12	2	Wrap	Magnetic	2	N	Electronic	\$ 5.60	\$ 302.40	\$ 60.00	\$ 3,240.00	excellent opportunity for retro-fit
Stage	1	8	4T12	2	Wrap	Magnetic	2	N	Electronic	\$ 5.60	\$ 44.80	\$ 60.00	\$ 480.00	excellent opportunity for retro-fit
Dress Room 1	1	2	4T12	3	Troffer	Magnetic	3	N	Electronic	\$ 8.40	\$ 16.80	\$ 65.00	\$ 130.00	excellent opportunity for retro-fit
Dress Room 2	1	2	4T12	3	Troffer	Magnetic	3	N	Electronic	\$ 8.40	\$ 16.80	\$ 65.00	\$ 130.00	excellent opportunity for retro-fit
Storage	1	1	4T12	1	Troffer	Magnetic	1	N	Electronic	\$ 2.80	\$ 2.80	\$ 55.00	\$ 55.00	excellent opportunity for retro-fit
P.A	1	2	4T12	2	Troffer	Magnetic	2	N	Electronic	\$ 5.60	\$ 11.20	\$ 60.00	\$ 120.00	excellent opportunity for retro-fit
Kitchen	1	22	4T12	3	Troffer	Magnetic	3	N	Electronic	\$ 8.40	\$ 184.80	\$ 65.00	\$ 1,430.00	excellent opportunity for retro-fit
Laundry	1	1	4T12	3	Troffer	Magnetic	3	N	Electronic	\$ 8.40	\$ 8.40	\$ 65.00	\$ 65.00	excellent opportunity for retro-fit
Office	1	2	4T12	3	Troffer	Magnetic	3	N	Electronic	\$ 8.40	\$ 16.80	\$ 65.00	\$ 130.00	excellent opportunity for retro-fit
Mens Locker	1	2	4T12	2	Wrap	Magnetic	2	N	Electronic	\$ 5.60	\$ 11.20	\$ 60.00	\$ 120.00	excellent opportunity for retro-fit
Womens Locker	1	2	4T12	2	Wrap	Magnetic	2	N	Electronic	\$ 5.60	\$ 11.20	\$ 60.00	\$ 120.00	excellent opportunity for retro-fit
Store Room	1	6	4T12	2	Troffer	Magnetic	2	N	Electronic	\$ 5.60	\$ 33.60	\$ 60.00	\$ 360.00	excellent opportunity for retro-fit
Staff Dining	1	6	4T12	3	Troffer	Magnetic	3	N	Electronic	\$ 8.40	\$ 50.40	\$ 65.00	\$ 390.00	excellent opportunity for retro-fit
Tool Room	1	3	4T12	2	Wrap	Magnetic	2	N	Electronic	\$ 5.60	\$ 16.80	\$ 60.00	\$ 180.00	excellent opportunity for retro-fit
Tool Room	1	2	4T12	4	Troffer	Magnetic	4	N	Electronic	\$ 11.20	\$ 22.40	\$ 70.00	\$ 140.00	excellent opportunity for retro-fit
Electrical	1	2	4T12	1	Open	Magnetic	1	N	Electronic	\$ 2.80	\$ 5.60	\$ 55.00	\$ 110.00	replace fixture and mount hardware
BUILDING D														
General Utility	1	1	4T12	1	Open	Magnetic	1	N	Electronic	\$ 2.80	\$ 2.80	\$ 55.00	\$ 55.00	replace fixture and mount hardware
Girls	1	4	4T12	2	Wrap	Magnetic	2	N	Electronic	\$ 5.60	\$ 22.40	\$ 60.00	\$ 240.00	excellent opportunity for retro-fit
D- 4	1	12	4T12	4	Troffer	Magnetic	4	N	Electronic	\$ 11.20	\$ 134.40	\$ 70.00	\$ 840.00	excellent opportunity for retro-fit
D -3	1	12	4T12	4	Troffer	Magnetic	4	N	Electronic	\$ 11.20	\$ 134.40	\$ 70.00	\$ 840.00	excellent opportunity for retro-fit
Electrical/Comm.	1	2	4T12	1	Open	Magnetic	1	N	Electronic	\$ 2.80	\$ 5.60	\$ 55.00	\$ 110.00	replace fixture and mount hardware
Teachers Station 1	1	9	4T12	3	Troffer	Magnetic	3	N	Electronic	\$ 8.40	\$ 75.60	\$ 65.00	\$ 585.00	excellent opportunity for retro-fit
Staff Restroom	1	1	4T12	2	Wrap	Magnetic	2	N	Electronic	\$ 5.60	\$ 5.60	\$ 60.00	\$ 60.00	excellent opportunity for retro-fit
D -2	1	12	4T12	4	Troffer	Magnetic	4	N	Electronic	\$ 11.20	\$ 134.40	\$ 70.00	\$ 840.00	excellent opportunity for retro-fit
D -1	1	12	4T12	4	Troffer	Magnetic	4	N	Electronic	\$ 11.20	\$ 134.40	\$ 70.00	\$ 840.00	excellent opportunity for retro-fit
D -5	1	12	4T12	4	Troffer	Magnetic	4	N	Electronic	\$ 11.20	\$ 134.40	\$ 70.00	\$ 840.00	excellent opportunity for retro-fit
D -6	1	12	4T12	4	Troffer	Magnetic	4	N	Electronic	\$ 11.20	\$ 134.40	\$ 70.00	\$ 840.00	excellent opportunity for retro-fit
Staff Restroom	1	1	4T12	2	Wrap	Magnetic	2	N	Electronic	\$ 5.60	\$ 5.60	\$ 60.00	\$ 60.00	excellent opportunity for retro-fit

LOCATION	EXISTING EQUIPMENT						PROPOSED			REBATES		COSTS		COMMENTS
Location (Rm Name, Rm. #, Area, Zone, etc.)	Floor	Quantity	Lamp Type	Lamps Per Fixture	Type of Fixture	Ballast Type	Lamps Per Fixture	Reflectors	Ballast Type	Per Single	Extended	Per Single	Extended	Surveyors Comments
Teachers Station 2	1	5	4T12	3	Troffer	Magnetic	3	N	Electronic	\$ 8.40	\$ 42.00	\$ 65.00	\$ 325.00	excellent opportunity for retro-fit
D -7	1	12	4T12	4	Troffer	Magnetic	4	N	Electronic	\$ 11.20	\$ 134.40	\$ 70.00	\$ 840.00	excellent opportunity for retro-fit
D -8	1	12	4T12	4	Troffer	Magnetic	4	N	Electronic	\$ 11.20	\$ 134.40	\$ 70.00	\$ 840.00	excellent opportunity for retro-fit
Boys	1	5	4T12	2	Wrap	Magnetic	2	N	Electronic	\$ 5.60	\$ 28.00	\$ 60.00	\$ 300.00	excellent opportunity for retro-fit
General Utility	1	1	4T12	1	Open	Magnetic	1	N	Electronic	\$ 2.80	\$ 2.80	\$ 55.00	\$ 55.00	replace fixture and mount hardware
BUILDING E														
E -4	1	12	4T12	4	Troffer	Magnetic	4	N	Electronic	\$ 11.20	\$ 134.40	\$ 70.00	\$ 840.00	excellent opportunity for retro-fit
E -3	1	12	4T12	4	Troffer	Magnetic	4	N	Electronic	\$ 11.20	\$ 134.40	\$ 70.00	\$ 840.00	excellent opportunity for retro-fit
Mens Locker	1	1	4T12	1	Wrap	Magnetic	1	N	Electronic	\$ 2.80	\$ 2.80	\$ 55.00	\$ 55.00	excellent opportunity for retro-fit
Womens Locker	1	1	4T12	1	Wrap	Magnetic	1	N	Electronic	\$ 2.80	\$ 2.80	\$ 55.00	\$ 55.00	excellent opportunity for retro-fit
Storage	1	2	4T12	2	Wrap	Magnetic	2	N	Electronic	\$ 5.60	\$ 11.20	\$ 60.00	\$ 120.00	excellent opportunity for retro-fit
Hall	1	3	2T12	2	Troffer	Magnetic	2	N	Electronic	\$ 4.80	\$ 14.40	\$ 60.00	\$ 180.00	excellent opportunity for retro-fit
Teachers Station 2	1	13	4T12	3	Troffer	Magnetic	3	N	Electronic	\$ 8.40	\$ 109.20	\$ 65.00	\$ 845.00	excellent opportunity for retro-fit
Elec./Comm.	1	4	4T12	1	Open	Magnetic	1	N	Electronic	\$ 2.80	\$ 11.20	\$ 55.00	\$ 220.00	replace fixture and mount hardware
E -2	1	12	4T12	4	Troffer	Magnetic	4	N	Electronic	\$ 11.20	\$ 134.40	\$ 70.00	\$ 840.00	excellent opportunity for retro-fit
E -1	1	12	4T12	4	Troffer	Magnetic	4	N	Electronic	\$ 11.20	\$ 134.40	\$ 70.00	\$ 840.00	excellent opportunity for retro-fit
Girls	1	4	4T12	2	Wrap	Magnetic	2	N	Electronic	\$ 5.60	\$ 22.40	\$ 60.00	\$ 240.00	excellent opportunity for retro-fit
General Utility	1	1	4T12	1	Open	Magnetic	1	N	Electronic	\$ 2.80	\$ 2.80	\$ 55.00	\$ 55.00	replace fixture and mount hardware
General Utility	1	1	4T12	1	Open	Magnetic	1	N	Electronic	\$ 2.80	\$ 2.80	\$ 55.00	\$ 55.00	replace fixture and mount hardware
Boys	1	5	4T12	2	Wrap	Magnetic	2	N	Electronic	\$ 5.60	\$ 28.00	\$ 60.00	\$ 300.00	excellent opportunity for retro-fit
E -5	1	12	4T12	4	Troffer	Magnetic	4	N	Electronic	\$ 11.20	\$ 134.40	\$ 70.00	\$ 840.00	excellent opportunity for retro-fit
E -6	1	12	4T12	4	Troffer	Magnetic	4	N	Electronic	\$ 11.20	\$ 134.40	\$ 70.00	\$ 840.00	excellent opportunity for retro-fit
Teachers Station 1	1	5	4T12	4	Troffer	Magnetic	4	N	Electronic	\$ 11.20	\$ 56.00	\$ 70.00	\$ 350.00	excellent opportunity for retro-fit
Faculty Center	1	6	4T12	3	Troffer	Magnetic	3	N	Electronic	\$ 8.40	\$ 50.40	\$ 65.00	\$ 390.00	excellent opportunity for retro-fit
E -7	1	12	4T12	4	Troffer	Magnetic	4	N	Electronic	\$ 11.20	\$ 134.40	\$ 70.00	\$ 840.00	excellent opportunity for retro-fit
E -8	1	12	4T12	4	Troffer	Magnetic	4	N	Electronic	\$ 11.20	\$ 134.40	\$ 70.00	\$ 840.00	excellent opportunity for retro-fit
BUILDING B														
Workroom	1	1	4T12	2	Troffer	Magnetic	2	N	Electronic	\$ 5.60	\$ 5.60	\$ 60.00	\$ 60.00	excellent opportunity for retro-fit
Computer Room	1	19	4T12	2	Troffer	Magnetic	2	N	Electronic	\$ 5.60	\$ 106.40	\$ 60.00	\$ 1,140.00	excellent opportunity for retro-fit
General Utility	1	1	4T12	2	Troffer	Magnetic	2	N	Electronic	\$ 5.60	\$ 5.60	\$ 60.00	\$ 60.00	excellent opportunity for retro-fit
Signal Projection	1	2	4T12	3	Troffer	Magnetic	3	N	Electronic	\$ 8.40	\$ 16.80	\$ 65.00	\$ 130.00	excellent opportunity for retro-fit
Media Center	1	6	4T12	1	Troffer	Magnetic	1	N	Electronic	\$ 2.80	\$ 16.80	\$ 55.00	\$ 330.00	excellent opportunity for retro-fit
Library Office	1	6	4T12	2	Troffer	Magnetic	2	N	Electronic	\$ 5.60	\$ 33.60	\$ 60.00	\$ 360.00	excellent opportunity for retro-fit
Library	1	59	4T12	3	Troffer	Magnetic	3	N	Electronic	\$ 8.40	\$ 495.60	\$ 65.00	\$ 3,835.00	excellent opportunity for retro-fit
Conference Room	1	6	4T12	2	Troffer	Magnetic	2	N	Electronic	\$ 5.60	\$ 33.60	\$ 60.00	\$ 360.00	excellent opportunity for retro-fit
Elec./Comm.	1	4	4T12	1	Troffer	Magnetic	1	N	Electronic	\$ 2.80	\$ 11.20	\$ 55.00	\$ 220.00	excellent opportunity for retro-fit
Faculty Center	1	11	4T12	3	Troffer	Magnetic	3	N	Electronic	\$ 8.40	\$ 92.40	\$ 65.00	\$ 715.00	excellent opportunity for retro-fit

LOCATION	EXISTING EQUIPMENT						PROPOSED			REBATES		COSTS		COMMENTS	
Location (Rm Name, Rm. #, Area, Zone, etc.)	Floor	Quantity	Lamp Type	Lamps Per Fixture	Type of Fixture	Ballast Type	Lamps Per Fixture	Reflectors	Ballast Type	Per Single	Extended	Per Single	Extended	Surveyors Comments	
Hall	1	2	2T12	2	Troffer	Magnetic	2	N	Electronic	\$ 4.80	\$ 9.60	\$ 60.00	\$ 120.00	excellent opportunity for retro-fit	
Mens Restrooms	1	1	4T12	2	Troffer	Magnetic	2	N	Electronic	\$ 5.60	\$ 5.60	\$ 60.00	\$ 60.00	excellent opportunity for retro-fit	
Womens Restrooms	1	1	4T12	2	Troffer	Magnetic	2	N	Electronic	\$ 5.60	\$ 5.60	\$ 60.00	\$ 60.00	excellent opportunity for retro-fit	
Storage	1	2	4T12	2	Troffer	Magnetic	2	N	Electronic	\$ 5.60	\$ 11.20	\$ 60.00	\$ 120.00	excellent opportunity for retro-fit	
B -11	1	12	4T12	4	Troffer	Magnetic	4	N	Electronic	\$ 8.40	\$ 100.80	\$ 65.00	\$ 780.00	excellent opportunity for retro-fit	
B -2	1	12	4T12	4	Troffer	Magnetic	4	N	Electronic	\$ 11.20	\$ 134.40	\$ 70.00	\$ 840.00	excellent opportunity for retro-fit	
General Utility	1	1	4T12	2	Troffer	Magnetic	2	N	Electronic	\$ 5.60	\$ 5.60	\$ 60.00	\$ 60.00	excellent opportunity for retro-fit	
Girls Restroom	1	8	4T12	2	Wrap	Magnetic	2	N	Electronic	\$ 5.60	\$ 44.80	\$ 60.00	\$ 480.00	excellent opportunity for retro-fit	
Boys Restroom	1	8	4T12	2	Wrap	Magnetic	2	N	Electronic	\$ 5.60	\$ 44.80	\$ 60.00	\$ 480.00	excellent opportunity for retro-fit	
General Utility	1	1	4T12	2	Wrap	Magnetic	2	N	Electronic	\$ 5.60	\$ 5.60	\$ 60.00	\$ 60.00	excellent opportunity for retro-fit	
B -5	1	12	4T12	4	Troffer	Magnetic	4	N	Electronic	\$ 11.20	\$ 134.40	\$ 70.00	\$ 840.00	excellent opportunity for retro-fit	
B -4	1	12	4T12	4	Troffer	Magnetic	4	N	Electronic	\$ 11.20	\$ 134.40	\$ 70.00	\$ 840.00	excellent opportunity for retro-fit	
Teacher Station	1	8	4T12	4	Troffer	Magnetic	4	N	Electronic	\$ 11.20	\$ 89.60	\$ 70.00	\$ 560.00	excellent opportunity for retro-fit	
B -3	1	12	4T12	3	Troffer	Magnetic	3	N	Electronic	\$ 8.40	\$ 100.80	\$ 65.00	\$ 780.00	excellent opportunity for retro-fit	
Total Rebates										\$	7,836.00				
Total Costs										\$	56,830.00				

LOCATION	QTY	EXISTING TYPE	QTY	RETROFIT	SURVEYORS COMMENTS	Existing		Actual		Proposed			
						Watt/unit	Op. Hours	kWh	kW-D	Watt/unit	Op. Hours	kWh	kW-D
BUILDING A	6	4' 4L Fixture	6	Lamp & Low Watt Ballast	excellent opportunity for retro-fit	151.2	1,002	909.4	0.9072	100	1,002	601.5	0.6
A - 1	12	4' 4L Fixture	12	Lamp & Low Watt Ballast	excellent opportunity for retro-fit	151.2	1,002	1,818.8	1.8144	100	1,002	1,202.9	1.2
A - 2	12	4' 4L Fixture	12	Lamp & Low Watt Ballast	excellent opportunity for retro-fit	151.2	1,002	1,818.8	1.8144	100	1,002	1,202.9	1.2
Elec./Comm.	4	4' 1L Fixture	4	Lamp & Low Watt Ballast	replace fixture and mount hardware	45.6	1,002	182.8	0.1824	31	1,002	124.3	0.124
Teacher Station 1	9	4' 4L Fixture	9	Lamp & Low Watt Ballast	excellent opportunity for retro-fit	151.2	1,002	1,364.1	1.3608	100	1,002	902.2	0.9
Staff Restroom	1	4' 2L Fixture	1	Lamp & Low Watt Ballast	excellent opportunity for retro-fit	75.6	1,002	75.8	0.0756	51	1,002	51.1	0.051
A - 3	12	4' 4L Fixture	12	Lamp & Low Watt Ballast	excellent opportunity for retro-fit	151.2	1,002	1,818.8	1.8144	100	1,002	1,202.9	1.2
A - 4	12	4' 4L Fixture	12	Lamp & Low Watt Ballast	excellent opportunity for retro-fit	151.2	1,002	1,818.8	1.8144	100	1,002	1,202.9	1.2
A - 8	12	4' 4L Fixture	12	Lamp & Low Watt Ballast	excellent opportunity for retro-fit	151.2	1,002	1,818.8	1.8144	100	1,002	1,202.9	1.2
A - 7	12	4' 4L Fixture	12	Lamp & Low Watt Ballast	excellent opportunity for retro-fit	151.2	1,002	1,818.8	1.8144	100	1,002	1,202.9	1.2
Staff Restroom	1	4' 2L Fixture	1	Lamp & Low Watt Ballast	excellent opportunity for retro-fit	75.6	1,002	75.8	0.0756	51	1,002	51.1	0.051
Teacher Station 2	5	4' 4L Fixture	5	Lamp & Low Watt Ballast	excellent opportunity for retro-fit	151.2	1,002	757.9	0.756	100	1,002	501.2	0.5
A - 6	12	4' 4L Fixture	12	Lamp & Low Watt Ballast	excellent opportunity for retro-fit	151.2	1,002	1,818.8	1.8144	100	1,002	1,202.9	1.2
A - 5	12	4' 4L Fixture	12	Lamp & Low Watt Ballast	excellent opportunity for retro-fit	151.2	1,002	1,818.8	1.8144	100	1,002	1,202.9	1.2
Resource Center	15	4' 3L Fixture	15	Lamp & Low Watt Ballast	excellent opportunity for retro-fit	121.2	1,002	1,822.5	1.818	77	1,002	1,157.8	1.155
ADMIN. BUILDING	0		0		0		1,002				1,002		
General Utility	1	4' 1L Fixture	1	Lamp & Low Watt Ballast	replace fixture and mount hardware	45.6	1,002	45.7	0.0456	31	1,002	31.1	0.031
Counselor	2	4' 3L Fixture	2	Lamp & Low Watt Ballast	excellent opportunity for retro-fit	121.2	1,002	243.0	0.2424	77	1,002	154.4	0.154
Staff	2	4' 3L Fixture	2	Lamp & Low Watt Ballast	excellent opportunity for retro-fit	121.2	1,002	243.0	0.2424	77	1,002	154.4	0.154
Staff Lounge	2	4' 3L Fixture	2	Lamp & Low Watt Ballast	excellent opportunity for retro-fit	121.2	1,002	243.0	0.2424	77	1,002	154.4	0.154
Counselor	2	4' 3L Fixture	2	Lamp & Low Watt Ballast	excellent opportunity for retro-fit	121.2	1,002	243.0	0.2424	77	1,002	154.4	0.154
Counselor	2	4' 3L Fixture	2	Lamp & Low Watt Ballast	excellent opportunity for retro-fit	121.2	1,002	243.0	0.2424	77	1,002	154.4	0.154
Student Services	2	4' 3L Fixture	2	Lamp & Low Watt Ballast	excellent opportunity for retro-fit	121.2	1,002	243.0	0.2424	77	1,002	154.4	0.154
Conference Room 2	6	4' 3L Fixture	6	Lamp & Low Watt Ballast	excellent opportunity for retro-fit	121.2	1,002	729.0	0.7272	77	1,002	463.1	0.462
Conference Room 1	6	4' 3L Fixture	6	Lamp & Low Watt Ballast	excellent opportunity for retro-fit	121.2	1,002	729.0	0.7272	77	1,002	463.1	0.462
Restroom	1	4' 2L Fixture	1	Lamp & Low Watt Ballast	excellent opportunity for retro-fit	75.6	1,002	75.8	0.0756	51	1,002	51.1	0.051
BUILDING F	0		0		0		1,002				1,002		
F 1	12	4' 4L Fixture	12	Lamp & Low Watt Ballast	excellent opportunity for retro-fit	151.2	1,002	1,818.8	1.8144	100	1,002	1,202.9	1.2
F 2	12	4' 4L Fixture	12	Lamp & Low Watt Ballast	excellent opportunity for retro-fit	151.2	1,002	1,818.8	1.8144	100	1,002	1,202.9	1.2
F 3	12	4' 4L Fixture	12	Lamp & Low Watt Ballast	excellent opportunity for retro-fit	151.2	1,002	1,818.8	1.8144	100	1,002	1,202.9	1.2
F 4	12	4' 4L Fixture	12	Lamp & Low Watt Ballast	excellent opportunity for retro-fit	151.2	1,002	1,818.8	1.8144	100	1,002	1,202.9	1.2
F 5	12	4' 4L Fixture	12	Lamp & Low Watt Ballast	excellent opportunity for retro-fit	151.2	1,002	1,818.8	1.8144	100	1,002	1,202.9	1.2
F 6	12	4' 4L Fixture	12	Lamp & Low Watt Ballast	excellent opportunity for retro-fit	151.2	1,002	1,818.8	1.8144	100	1,002	1,202.9	1.2
F 7	12	4' 4L Fixture	12	Lamp & Low Watt Ballast	excellent opportunity for retro-fit	151.2	1,002	1,818.8	1.8144	100	1,002	1,202.9	1.2
F 8	12	4' 4L Fixture	12	Lamp & Low Watt Ballast	excellent opportunity for retro-fit	151.2	1,002	1,818.8	1.8144	100	1,002	1,202.9	1.2
Boys	6	4' 2L Fixture	6	Lamp & Low Watt Ballast	excellent opportunity for retro-fit	75.6	1,002	454.7	0.4536	51	1,002	306.7	0.306
General Utility	1	4' 1L Fixture	1	Lamp & Low Watt Ballast	replace fixture and mount hardware	45.6	1,002	45.7	0.0456	31	1,002	31.1	0.031
BUILDING C	0		0		0		1,002				1,002		
Boys	1	4' 2L Fixture	1	Lamp & Low Watt Ballast	excellent opportunity for retro-fit	75.6	1,002	75.8	0.0756	51	1,002	51.1	0.051
Girls	1	4' 2L Fixture	1	Lamp & Low Watt Ballast	excellent opportunity for retro-fit	75.6	1,002	75.8	0.0756	51	1,002	51.1	0.051
Cafeteria	54	4' 2L Fixture	54	Lamp & Low Watt Ballast	excellent opportunity for retro-fit	75.6	1,002	4,092.4	4.0824	51	1,002	2,760.7	2.754
Stage	8	4' 2L Fixture	8	Lamp & Low Watt Ballast	excellent opportunity for retro-fit	75.6	1,002	606.3	0.6048	51	1,002	409.0	0.408
Dress Room 1	2	4' 3L Fixture	2	Lamp & Low Watt Ballast	excellent opportunity for retro-fit	121.2	1,002	243.0	0.2424	77	1,002	154.4	0.154
Dress Room 2	2	4' 3L Fixture	2	Lamp & Low Watt Ballast	excellent opportunity for retro-fit	121.2	1,002	243.0	0.2424	77	1,002	154.4	0.154
Storage	1	4' 1L Fixture	1	Lamp & Low Watt Ballast	excellent opportunity for retro-fit	45.6	1,002	45.7	0.0456	31	1,002	31.1	0.031
P.A	2	4' 2L Fixture	2	Lamp & Low Watt Ballast	excellent opportunity for retro-fit	75.6	1,002	151.6	0.1512	51	1,002	102.2	0.102
Kitchen	22	4' 3L Fixture	22	Lamp & Low Watt Ballast	excellent opportunity for retro-fit	121.2	1,002	2,672.9	2.6664	77	1,002	1,698.2	1.694
Laundry	1	4' 3L Fixture	1	Lamp & Low Watt Ballast	excellent opportunity for retro-fit	121.2	1,002	121.5	0.1212	77	1,002	77.2	0.077
Office	2	4' 3L Fixture	2	Lamp & Low Watt Ballast	excellent opportunity for retro-fit	121.2	1,002	243.0	0.2424	77	1,002	154.4	0.154
Mens Locker	2	4' 2L Fixture	2	Lamp & Low Watt Ballast	excellent opportunity for retro-fit	75.6	1,002	151.6	0.1512	51	1,002	102.2	0.102
Womens Locker	2	4' 2L Fixture	2	Lamp & Low Watt Ballast	excellent opportunity for retro-fit	75.6	1,002	151.6	0.1512	51	1,002	102.2	0.102
Store Room	6	4' 2L Fixture	6	Lamp & Low Watt Ballast	excellent opportunity for retro-fit	75.6	1,002	454.7	0.4536	51	1,002	306.7	0.306
Staff Dining	6	4' 3L Fixture	6	Lamp & Low Watt Ballast	excellent opportunity for retro-fit	121.2	1,002	729.0	0.7272	77	1,002	463.1	0.462
Tool Room	3	4' 2L Fixture	3	Lamp & Low Watt Ballast	excellent opportunity for retro-fit	75.6	1,002	227.4	0.2268	51	1,002	153.4	0.153
Tool Room	2	4' 4L Fixture	2	Lamp & Low Watt Ballast	excellent opportunity for retro-fit	151.2	1,002	303.1	0.3024	100	1,002	200.5	0.2
Electrical	2	4' 1L Fixture	2	Lamp & Low Watt Ballast	replace fixture and mount hardware	45.6	1,002	91.4	0.0912	31	1,002	62.2	0.062
BUILDING D	0		0		0		1,002				1,002		
General Utility	1	4' 1L Fixture	1	Lamp & Low Watt Ballast	replace fixture and mount hardware	45.6	1,002	45.7	0.0456	31	1,002	31.1	0.031
Girls	4	4' 2L Fixture	4	Lamp & Low Watt Ballast	excellent opportunity for retro-fit	75.6	1,002	303.1	0.3024	51	1,002	204.5	0.204
D - 4	12	4' 4L Fixture	12	Lamp & Low Watt Ballast	excellent opportunity for retro-fit	151.2	1,002	1,818.8	1.8144	100	1,002	1,202.9	1.2
D - 3	12	4' 4L Fixture	12	Lamp & Low Watt Ballast	excellent opportunity for retro-fit	151.2	1,002	1,818.8	1.8144	100	1,002	1,202.9	1.2
Electrical/Comm.	2	4' 1L Fixture	2	Lamp & Low Watt Ballast	replace fixture and mount hardware	45.6	1,002	91.4	0.0912	31	1,002	62.2	0.062

LOCATION	QTY	EXISTING TYPE	QTY	RETROFIT	SURVEYORS COMMENTS	Existing		Actual			Proposed		
						Watt/unit	Op. Hours	kWh	kW-D	Watt/unit	Op. Hours	kWh	kW-D
Teachers Station 1	9	4' 3L Fixture	9	Lamp & Low Watt Ballast	excellent opportunity for retro-fit	121.2	1,002	1,093.5	1.0908	77	1,002	694.7	0.693
Staff Restroom	1	4' 2L Fixture	1	Lamp & Low Watt Ballast	excellent opportunity for retro-fit	75.6	1,002	75.8	0.0756	51	1,002	51.1	0.051
D-2	12	4' 4L Fixture	12	Lamp & Low Watt Ballast	excellent opportunity for retro-fit	151.2	1,002	1,818.8	1.8144	100	1,002	1,202.9	1.2
D-1	12	4' 4L Fixture	12	Lamp & Low Watt Ballast	excellent opportunity for retro-fit	151.2	1,002	1,818.8	1.8144	100	1,002	1,202.9	1.2
D-5	12	4' 4L Fixture	12	Lamp & Low Watt Ballast	excellent opportunity for retro-fit	151.2	1,002	1,818.8	1.8144	100	1,002	1,202.9	1.2
D-6	12	4' 4L Fixture	12	Lamp & Low Watt Ballast	excellent opportunity for retro-fit	151.2	1,002	1,818.8	1.8144	100	1,002	1,202.9	1.2
Staff Restroom	1	4' 2L Fixture	1	Lamp & Low Watt Ballast	excellent opportunity for retro-fit	75.6	1,002	75.8	0.0756	51	1,002	51.1	0.051
Teachers Station 2	5	4' 3L Fixture	5	Lamp & Low Watt Ballast	excellent opportunity for retro-fit	121.2	1,002	607.5	0.606	77	1,002	385.9	0.385
D-7	12	4' 4L Fixture	12	Lamp & Low Watt Ballast	excellent opportunity for retro-fit	151.2	1,002	1,818.8	1.8144	100	1,002	1,202.9	1.2
D-8	12	4' 4L Fixture	12	Lamp & Low Watt Ballast	excellent opportunity for retro-fit	151.2	1,002	1,818.8	1.8144	100	1,002	1,202.9	1.2
Boys	5	4' 2L Fixture	5	Lamp & Low Watt Ballast	excellent opportunity for retro-fit	75.6	1,002	378.9	0.378	51	1,002	255.6	0.255
General Utility	1	4' 1L Fixture	1	Lamp & Low Watt Ballast	replace fixture and mount hardware	45.6	1,002	45.7	0.0456	31	1,002	31.1	0.031
BUILDING E	0		0		0		1,002				1,002		
E-4	12	4' 4L Fixture	12	Lamp & Low Watt Ballast	excellent opportunity for retro-fit	151.2	1,002	1,818.8	1.8144	100	1,002	1,202.9	1.2
E-3	12	4' 4L Fixture	12	Lamp & Low Watt Ballast	excellent opportunity for retro-fit	151.2	1,002	1,818.8	1.8144	100	1,002	1,202.9	1.2
Mens Locker	1	4' 1L Fixture	1	Lamp & Low Watt Ballast	excellent opportunity for retro-fit	45.6	1,002	45.7	0.0456	31	1,002	31.1	0.031
Womens Locker	1	4' 1L Fixture	1	Lamp & Low Watt Ballast	excellent opportunity for retro-fit	45.6	1,002	45.7	0.0456	31	1,002	31.1	0.031
Storage	2	4' 2L Fixture	2	Lamp & Low Watt Ballast	excellent opportunity for retro-fit	75.6	1,002	151.6	0.1512	51	1,002	102.2	0.102
Hall	3	2' 2L Fixture	3	Lamp & Low Watt Ballast	excellent opportunity for retro-fit	55.4	1,002	166.6	0.1662	29	1,002	87.2	0.087
Teachers Station 2	13	4' 3L Fixture	13	Lamp & Low Watt Ballast	excellent opportunity for retro-fit	121.2	1,002	1,579.5	1.5756	77	1,002	1,003.5	1.001
Elec./Comm.	4	4' 1L Fixture	4	Lamp & Low Watt Ballast	excellent opportunity for retro-fit	45.6	1,002	182.8	0.1824	31	1,002	124.3	0.124
E-2	12	4' 4L Fixture	12	Lamp & Low Watt Ballast	replace fixture and mount hardware	151.2	1,002	1,818.8	1.8144	100	1,002	1,202.9	1.2
E-1	12	4' 4L Fixture	12	Lamp & Low Watt Ballast	excellent opportunity for retro-fit	151.2	1,002	1,818.8	1.8144	100	1,002	1,202.9	1.2
Girls	4	4' 2L Fixture	4	Lamp & Low Watt Ballast	excellent opportunity for retro-fit	75.6	1,002	303.1	0.3024	51	1,002	204.5	0.204
General Utility	1	4' 1L Fixture	1	Lamp & Low Watt Ballast	excellent opportunity for retro-fit	45.6	1,002	45.7	0.0456	31	1,002	31.1	0.031
General Utility	1	4' 1L Fixture	1	Lamp & Low Watt Ballast	replace fixture and mount hardware	45.6	1,002	45.7	0.0456	31	1,002	31.1	0.031
Boys	5	4' 2L Fixture	5	Lamp & Low Watt Ballast	replace fixture and mount hardware	75.6	1,002	378.9	0.378	51	1,002	255.6	0.255
E-5	12	4' 4L Fixture	12	Lamp & Low Watt Ballast	excellent opportunity for retro-fit	151.2	1,002	1,818.8	1.8144	100	1,002	1,202.9	1.2
E-6	12	4' 4L Fixture	12	Lamp & Low Watt Ballast	excellent opportunity for retro-fit	151.2	1,002	1,818.8	1.8144	100	1,002	1,202.9	1.2
Teachers Station 1	5	4' 4L Fixture	5	Lamp & Low Watt Ballast	excellent opportunity for retro-fit	151.2	1,002	757.9	0.756	100	1,002	501.2	0.5
Faculty Center	6	4' 3L Fixture	6	Lamp & Low Watt Ballast	excellent opportunity for retro-fit	121.2	1,002	729.0	0.7272	77	1,002	463.1	0.462
E-7	12	4' 4L Fixture	12	Lamp & Low Watt Ballast	excellent opportunity for retro-fit	151.2	1,002	1,818.8	1.8144	100	1,002	1,202.9	1.2
E-8	12	4' 4L Fixture	12	Lamp & Low Watt Ballast	excellent opportunity for retro-fit	151.2	1,002	1,818.8	1.8144	100	1,002	1,202.9	1.2
BUILDING B	0		0		0		1,002				1,002		
Workroom	1	4' 2L Fixture	1	Lamp & Low Watt Ballast	excellent opportunity for retro-fit	75.6	1,002	75.8	0.0756	51	1,002	51.1	0.051
Computer Room	19	4' 2L Fixture	19	Lamp & Low Watt Ballast	excellent opportunity for retro-fit	75.6	1,002	1,439.9	1.4364	51	1,002	971.4	0.969
General Utility	1	4' 2L Fixture	1	Lamp & Low Watt Ballast	excellent opportunity for retro-fit	75.6	1,002	75.8	0.0756	51	1,002	51.1	0.051
Signal Projection	2	4' 3L Fixture	2	Lamp & Low Watt Ballast	excellent opportunity for retro-fit	121.2	1,002	243.0	0.2424	77	1,002	154.4	0.154
Media Center	6	4' 1L Fixture	6	Lamp & Low Watt Ballast	excellent opportunity for retro-fit	45.6	1,002	274.3	0.2736	31	1,002	186.5	0.186
Library Office	6	4' 2L Fixture	6	Lamp & Low Watt Ballast	excellent opportunity for retro-fit	75.6	1,002	454.7	0.4536	51	1,002	306.7	0.306
Library	59	4' 3L Fixture	59	Lamp & Low Watt Ballast	excellent opportunity for retro-fit	121.2	1,002	7,168.3	7.1508	77	1,002	4,554.1	4.543
Conference Room	6	4' 2L Fixture	6	Lamp & Low Watt Ballast	excellent opportunity for retro-fit	75.6	1,002	454.7	0.4536	51	1,002	306.7	0.306
Elec./Comm.	4	4' 1L Fixture	4	Lamp & Low Watt Ballast	excellent opportunity for retro-fit	45.6	1,002	182.8	0.1824	31	1,002	124.3	0.124
Faculty Center	11	4' 3L Fixture	11	Lamp & Low Watt Ballast	excellent opportunity for retro-fit	121.2	1,002	1,336.5	1.3332	77	1,002	849.1	0.847
Hall	2	2' 2L Fixture	2	Lamp & Low Watt Ballast	excellent opportunity for retro-fit	55.4	1,002	111.1	0.1108	29	1,002	58.1	0.058
Mens Restrooms	1	4' 2L Fixture	1	Lamp & Low Watt Ballast	excellent opportunity for retro-fit	75.6	1,002	75.8	0.0756	51	1,002	51.1	0.051
Womens Restrooms	1	4' 2L Fixture	1	Lamp & Low Watt Ballast	excellent opportunity for retro-fit	75.6	1,002	75.8	0.0756	51	1,002	51.1	0.051
Storage	2	4' 2L Fixture	2	Lamp & Low Watt Ballast	excellent opportunity for retro-fit	75.6	1,002	151.6	0.1512	51	1,002	102.2	0.102
B-11	12	4' 3L Fixture	12	Lamp & Low Watt Ballast	excellent opportunity for retro-fit	121.2	1,002	1,458.0	1.4544	77	1,002	926.3	0.924
B-2	12	4' 4L Fixture	12	Lamp & Low Watt Ballast	excellent opportunity for retro-fit	151.2	1,002	1,818.8	1.8144	100	1,002	1,202.9	1.2
General Utility	1	4' 2L Fixture	1	Lamp & Low Watt Ballast	excellent opportunity for retro-fit	75.6	1,002	75.8	0.0756	51	1,002	51.1	0.051
Girls Restroom	8	4' 2L Fixture	8	Lamp & Low Watt Ballast	excellent opportunity for retro-fit	75.6	1,002	606.3	0.6048	51	1,002	409.0	0.408
Boys Restroom	8	4' 2L Fixture	8	Lamp & Low Watt Ballast	excellent opportunity for retro-fit	75.6	1,002	606.3	0.6048	51	1,002	409.0	0.408
General Utility	1	4' 2L Fixture	1	Lamp & Low Watt Ballast	excellent opportunity for retro-fit	75.6	1,002	75.8	0.0756	51	1,002	51.1	0.051
B-5	12	4' 4L Fixture	12	Lamp & Low Watt Ballast	excellent opportunity for retro-fit	151.2	1,002	1,818.8	1.8144	100	1,002	1,202.9	1.2
B-4	12	4' 4L Fixture	12	Lamp & Low Watt Ballast	excellent opportunity for retro-fit	151.2	1,002	1,818.8	1.8144	100	1,002	1,202.9	1.2
Teacher Station	8	4' 4L Fixture	8	Lamp & Low Watt Ballast	excellent opportunity for retro-fit	151.2	1,002	1,212.6	1.2096	100	1,002	802.0	0.8
B-3	12	4' 3L Fixture	12	Lamp & Low Watt Ballast	excellent opportunity for retro-fit	121.2	1,002	1,458.0	1.4544	77	1,002	926.3	0.924

Existing 859 Proposed 859

ENERGY CALCULATIONS		
Description	kW-Demand	kWh
Existing Use	107.56	107,828
Proposed Use	70.65	70,825
Difference - Savings	36.91	37,003
Electrical Utility Cost	\$5.75	\$0.13930
Savings per Year	\$2,546.94	\$5,154.54

107,828 108 70,825 71

Total Yearly Energy Savings	
\$7,701.48	

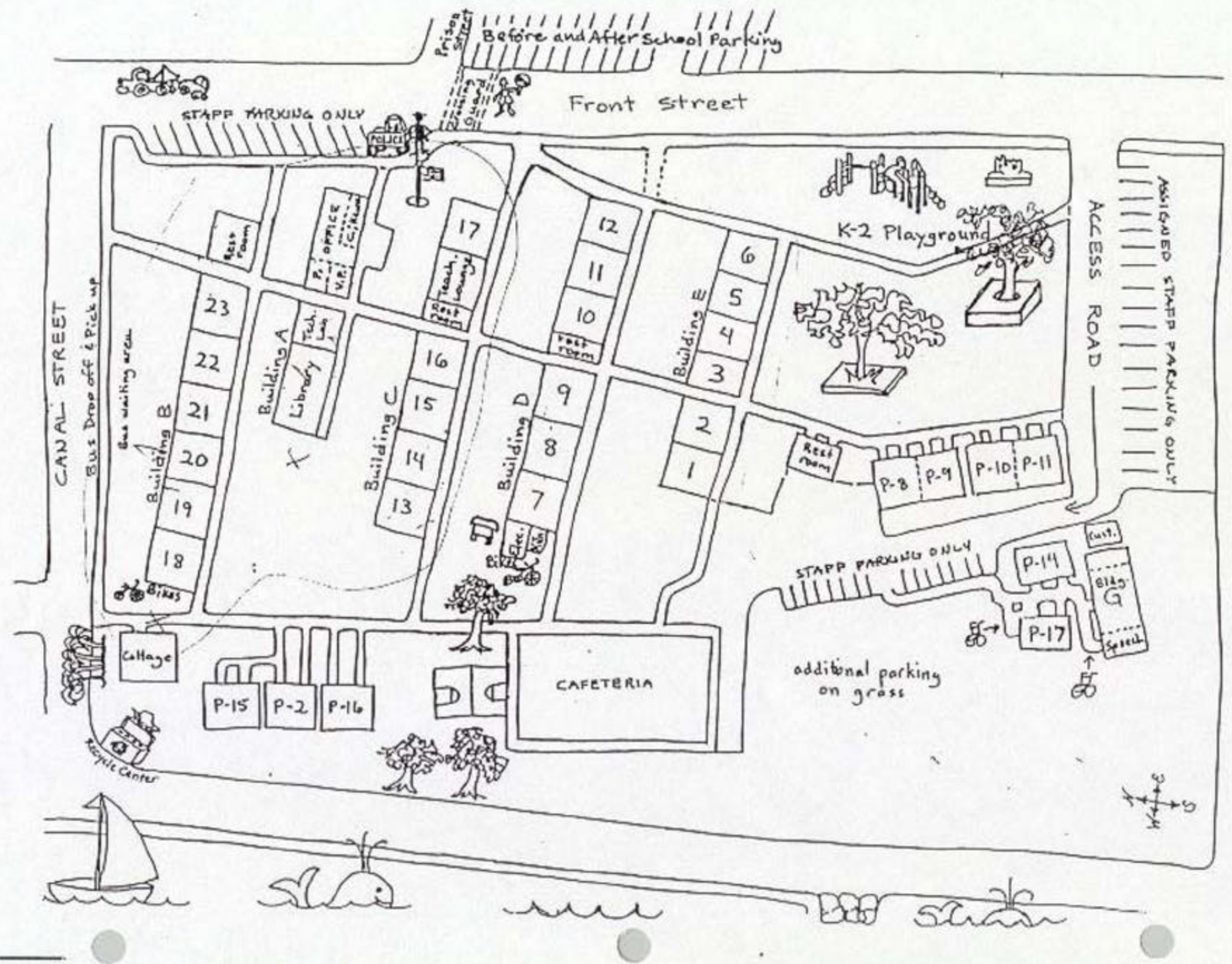

KING KAMSHAMWA III

Maui Smart Schools Program Foot Candle Readings

School: Kamehameha III School

Room: Bldg. C C-15

Ceiling Height: 10'

Light Fixture Height: 8'

Fixture Type: Ice Tray & Troffer
One half of classroom has been replaced

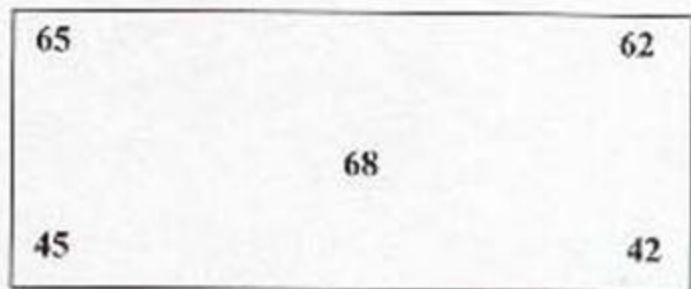

Room: Portable P-15

Ceiling Height: 10'

Light Fixture Height: 8'

Fixture Type: Troffer

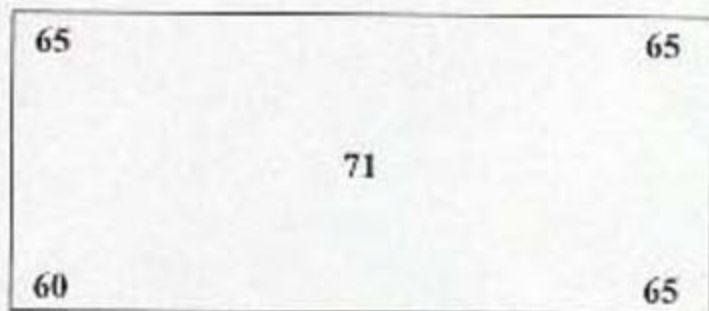

Room: Bldg. E E-2

Ceiling Height: 10'

Light Fixture Height: 8'

Fixture Type: Troffer & Ice Tray
One half of class room has been replaced

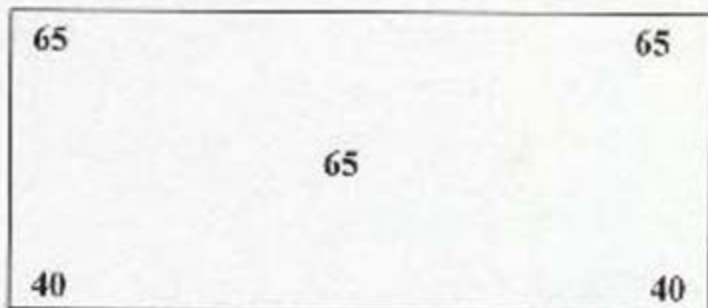



SCHOOL INFORMATION			
NAME King Kamehameha III Elementary School			DATE 3/2/2001
STREET ADDRESS 611 Front St. Lahaina, HI 96761			OPERATIONAL HOURS 1,786
POINT OF CONTACT Richard Paul		PHONE 662-3955	FAX 120V
AUDITOR Maui Community College Auditors			

LOCATION Location (Rm Name, Rm. #, Area, Zone, etc.)	EXISTING EQUIPMENT						PROPOSED			REBATES		COSTS		COMMENTS Surveyors Comments
	Floor	Quantity	Lamp Type	Lamps Per Fixture	Type of Fixture	Ballast Type	Lamps Per Fixture	Reflectors	Ballast Type	Per Single	Extended	Per Single	Extended	
BUILDING A														
<i>Building - A - Library</i>	1	10	4T8	3	Ice	Electronic						\$ -	\$ -	T8 Lamps, No Retrofit
<i>Building - A - Tech Lab</i>	1	5	4T8	3	Ice	Electronic						\$ -	\$ -	T8 Lamps, No Retrofit
<i>Building - A - Tech Lab</i>	1	2	8T12	2	Ice	Magnetic	2	N	Electronic	\$ 11.20	\$ 22.40	\$ 160.00	\$ 320.00	replace fixture and mount hardware
<i>Building - A - Tech Lab</i>	1	1	4T12	2	Ice	Magnetic	2	N	Electronic	\$ 5.60	\$ 5.60	\$ 135.00	\$ 135.00	replace fixture and mount hardware
<i>Storage Room</i>	1	1	4T12	2	Ice	Magnetic	2	N	Electronic	\$ 5.60	\$ 5.60	\$ 135.00	\$ 135.00	replace fixture and mount hardware
<i>Nurse Room</i>	1	2	8T12	2	Ice	Magnetic	2	N	Electronic	\$ 11.20	\$ 22.40	\$ 160.00	\$ 320.00	replace fixture and mount hardware
<i>Counselor Office</i>	1	1	4T12	4	Wrap	Magnetic	4	N	Electronic	\$ 11.20	\$ 11.20	\$ 70.00	\$ 70.00	excellent opportunity for retro-fit
<i>Counselor Office</i>	1	8	4T12	4	Wrap	Magnetic	4	N	Electronic	\$ 11.20	\$ 89.60	\$ 70.00	\$ 560.00	excellent opportunity for retro-fit
<i>Principal Office</i>	1	2	4T12	4	Wrap	Magnetic	4	N	Electronic	\$ 11.20	\$ 22.40	\$ 70.00	\$ 140.00	excellent opportunity for retro-fit
<i>Vice-principal Office</i>	1	3	4T12	4	Wrap	Magnetic	4	N	Electronic	\$ 11.20	\$ 33.60	\$ 70.00	\$ 210.00	excellent opportunity for retro-fit
<i>Storage Room</i>	1	1	4T12	4	Ice	Magnetic	4	N	Electronic	\$ 11.20	\$ 11.20	\$ 70.00	\$ 70.00	replace fixture and mount hardware
BUILDING B														
<i>Room #18</i>	1	6	4T8	3	Ice	Electronic						\$ -	\$ -	T8 Lamps, No Retrofit
<i>Room #18</i>	1	3	8T12	2	Ice	Magnetic	2	N	Electronic	\$ 11.20	\$ 33.60	\$ 160.00	\$ 480.00	replace fixture and mount hardware
<i>Room #19</i>	1	6	4T8	3	Ice	Electronic						\$ -	\$ -	T8 Lamps, No Retrofit
<i>Room #19</i>	1	3	8T12	2	Ice	Magnetic	2	N	Electronic	\$ 11.20	\$ 33.60	\$ 160.00	\$ 480.00	replace fixture and mount hardware
<i>Room #20</i>	1	6	4T8	3	Ice	Electronic						\$ -	\$ -	T8 Lamps, No Retrofit
<i>Room #20</i>	1	3	8T12	2	Ice	Magnetic	2	N	Electronic	\$ 11.20	\$ 33.60	\$ 160.00	\$ 480.00	replace fixture and mount hardware
<i>Room #21</i>	1	6	4T8	3	Ice	Electronic						\$ -	\$ -	T8 Lamps, No Retrofit
<i>Room #21</i>	1	3	8T12	2	Ice	Magnetic	2	N	Electronic	\$ 11.20	\$ 33.60	\$ 160.00	\$ 480.00	replace fixture and mount hardware
<i>Room #22</i>	1	6	4T8	3	Ice	Electronic						\$ -	\$ -	T8 Lamps, No Retrofit
<i>Room #22</i>	1	3	8T12	2	Ice	Magnetic	2	N	Electronic	\$ 11.20	\$ 33.60	\$ 160.00	\$ 480.00	replace fixture and mount hardware
<i>Room #23</i>	1	6	4T8	3	Ice	Electronic						\$ -	\$ -	T8 Lamps, No Retrofit
<i>Room #23</i>	1	3	8T12	2	Ice	Magnetic	2	N	Electronic	\$ 11.20	\$ 33.60	\$ 160.00	\$ 480.00	replace fixture and mount hardware
<i>Girls Rest Room</i>	1	3	4T8	4	Ice	Electronic						\$ -	\$ -	T8 Lamps, No Retrofit
<i>Boys rest room</i>	1	3	4T8	4	Ice	Electronic						\$ -	\$ -	T8 Lamps, No Retrofit
BUILDING C														
<i>Room # 13</i>	1	3	8T12	2	Ice	Magnetic	2	N	Electronic	\$ 11.20	\$ 33.60	\$ 160.00	\$ 480.00	replace fixture and mount hardware
<i>Room # 13</i>	1	6	4T8	3	Ice	Electronic						\$ -	\$ -	T8 Lamps, No Retrofit
<i>Room # 14</i>	1	3	8T12	2	Ice	Magnetic	2	N	Electronic	\$ 11.20	\$ 33.60	\$ 160.00	\$ 480.00	replace fixture and mount hardware
<i>Room # 14</i>	1	6	4T8	3	Ice	Electronic						\$ -	\$ -	T8 Lamps, No Retrofit

LOCATION	EXISTING EQUIPMENT						PROPOSED			REBATES		COSTS		COMMENTS
Location (Rm Name, Rm. #, Area, Zone, etc.)	Floor	Quantity	Lamp Type	Lamps Per Fixture	Type of Fixture	Ballast Type	Lamps Per Fixture	Reflectors	Ballast Type	Per Single	Extended	Per Single	Extended	Surveyors Comments
Room # 15	1	3	8T12	2	Ice	Magnetic	2	N	Electronic	\$ 11.20	\$ 33.60	\$ 160.00	\$ 480.00	replace fixture and mount hardware
Room #15	1	6	4T8	3	Ice	Electronic					\$ -		\$ -	T8 Lamps, No Retrofit
Room # 16	1	3	8T12	2	Ice	Magnetic	2	N	Electronic	\$ 11.20	\$ 33.60	\$ 160.00	\$ 480.00	replace fixture and mount hardware
Room # 16	1	6	4T8	3	Ice	Electronic					\$ -		\$ -	T8 Lamps, No Retrofit
BUILDING D														
Room # 7	1	3	8T12	2	Ice	Magnetic	2	N	Electronic	\$ 11.20	\$ 33.60	\$ 160.00	\$ 480.00	replace fixture and mount hardware
Room # 7	1	6	4T8	3	Ice	Electronic					\$ -		\$ -	T8 Lamps, No Retrofit
Room # 8	1	3	8T12	2	Ice	Magnetic	2	N	Electronic	\$ 11.20	\$ 33.60	\$ 160.00	\$ 480.00	replace fixture and mount hardware
Room # 8	1	6	4T8	3	Ice	Electronic					\$ -		\$ -	T8 Lamps, No Retrofit
Room # 9	1	3	8T12	2	Ice	Magnetic	2	N	Electronic	\$ 11.20	\$ 33.60	\$ 160.00	\$ 480.00	replace fixture and mount hardware
Room # 9	1	6	4T8	3	Ice	Electronic					\$ -		\$ -	T8 Lamps, No Retrofit
Room # 10	1	3	8T12	2	Ice	Magnetic	2	N	Electronic	\$ 11.20	\$ 33.60	\$ 160.00	\$ 480.00	replace fixture and mount hardware
Room # 10	1	6	4T8	3	Ice	Electronic					\$ -		\$ -	T8 Lamps, No Retrofit
Room # 11	1	3	8T12	2	Ice	Magnetic	2	N	Electronic	\$ 11.20	\$ 33.60	\$ 160.00	\$ 480.00	replace fixture and mount hardware
Room # 11	1	6	4T8	3	Ice	Electronic					\$ -		\$ -	T8 Lamps, No Retrofit
Room #12	1	3	8T12	2	Ice	Magnetic	2	N	Electronic	\$ 11.20	\$ 33.60	\$ 160.00	\$ 480.00	replace fixture and mount hardware
Room #12	1	6	4T8	3	Ice	Electronic					\$ -		\$ -	T8 Lamps, No Retrofit
BUILDING E														
Room #1	1	3	8T12	3	Ice	Magnetic	2	N	Electronic	\$ 11.20	\$ 33.60	\$ 160.00	\$ 480.00	replace fixture and mount hardware
Room #1	1	3	8T12	2	Ice	Magnetic	2	N	Electronic	\$ 11.20	\$ 33.60	\$ 160.00	\$ 480.00	replace fixture and mount hardware
Room #2	1	12	4T12	4	Wrap	Magnetic	4	N	Electronic	\$ 11.20	\$ 134.40	\$ 70.00	\$ 840.00	excellent opportunity for retro-fit
Room #3	1	3	8T12	2	Ice	Magnetic	2	N	Electronic	\$ 11.20	\$ 33.60	\$ 160.00	\$ 480.00	replace fixture and mount hardware
Room #3	1	6	4T8	3	Ice	Electronic					\$ -		\$ -	T8 Lamps, No Retrofit
Room #4	1	3	8T12	2	Ice	Magnetic	2	N	Electronic	\$ 11.20	\$ 33.60	\$ 160.00	\$ 480.00	replace fixture and mount hardware
Room #4	1	6	4T8	3	Ice	Electronic					\$ -		\$ -	T8 Lamps, No Retrofit
Room #5	1	3	8T12	2	Ice	Magnetic	2	N	Electronic	\$ 11.20	\$ 33.60	\$ 160.00	\$ 480.00	replace fixture and mount hardware
Room #5	1	6	4T8	3	Ice	Electronic					\$ -		\$ -	T8 Lamps, No Retrofit
Room #6	1	3	8T12	2	Ice	Magnetic	2	N	Electronic	\$ 11.20	\$ 33.60	\$ 160.00	\$ 480.00	replace fixture and mount hardware
Room #6	1	6	4T8	3	Ice	Electronic					\$ -		\$ -	T8 Lamps, No Retrofit
Boys rest room	1	2	4T12	4	Ice	Magnetic	4	N	Electronic	\$ 11.20	\$ 22.40	\$ 160.00	\$ 320.00	excellent opportunity for retro-fit
PORTABLES														
P - 2	1	16	4T8	3	Troffer	Electronic					\$ -		\$ -	T8 Lamps, No Retrofit
P - 15	1	16	4T8	3	Troffer	Electronic					\$ -		\$ -	T8 Lamps, No Retrofit
P - 16	1	16	4T8	3	Troffer	Electronic					\$ -		\$ -	T8 Lamps, No Retrofit
P - 8	1	16	4T8	3	Troffer	Electronic					\$ -		\$ -	T8 Lamps, No Retrofit
P - 9	1	16	4T8	3	Troffer	Electronic					\$ -		\$ -	T8 Lamps, No Retrofit
P - 10	1	16	4T8	3	Troffer	Electronic					\$ -		\$ -	T8 Lamps, No Retrofit

LOCATION	EXISTING EQUIPMENT						PROPOSED			REBATES		COSTS		COMMENTS	
	Location (Rm Name, Rm. #, Area, Zone, etc.)	Floor	Quantity	Lamp Type	Lamps Per Fixture	Type of Fixture	Ballast Type	Lamps Per Fixture	Reflectors	Ballast Type	Per Single	Extended	Per Single		Extended
<i>P - 11</i>	1	16	4T8	3	Troffer	Electronic					\$ -		\$ -		T8 Lamps, No Retrofit
<i>P - 14</i>	1	16	4T8	3	Troffer	Electronic					\$ -		\$ -		T8 Lamps, No Retrofit
<i>P - 17 - A</i>	1	8	4T8	3	Troffer	Electronic					\$ -		\$ -		T8 Lamps, No Retrofit
<i>P - 17 - B</i>	1	8	4T8	3	Troffer	Electronic					\$ -		\$ -		T8 Lamps, No Retrofit
BUILDING G															
<i>G - A</i>	1	2	4T12	4	Wrap	Magnetic	4	N	Electronic	\$ 11.20	\$ 22.40	\$ 70.00	\$ 140.00		excellent opportunity for retro-fit
<i>G - B</i>	1	6	4T12	4	Wrap	Magnetic	4	N	Electronic	\$ 11.20	\$ 67.20	\$ 70.00	\$ 420.00		excellent opportunity for retro-fit
<i>G - C</i>	1	2	4T12	4	Wrap	Magnetic	4	N	Electronic	\$ 11.20	\$ 22.40	\$ 70.00	\$ 140.00		excellent opportunity for retro-fit
CAFETERIA															
<i>Dining Room</i>	1	18	4T12	4	Ice	Magnetic	4	N	Electronic	\$ 11.20	\$ 201.60	\$ 70.00	\$ 1,260.00		replace fixture and mount hardware
<i>Kitchen</i>	1	10	4T12	4	Wrap	Magnetic	4	N	Electronic	\$ 11.20	\$ 112.00	\$ 70.00	\$ 700.00		excellent opportunity for retro-fit
<i>Storage Room</i>	1	4	4T12	4	troffer	Magnetic	4	N	Electronic	\$ 11.20	\$ 44.80	\$ 70.00	\$ 280.00		excellent opportunity for retro-fit
<i>Office</i>	1	1	4T12	4	Troffer	Magnetic	4	N	Electronic	\$ 11.20	\$ 11.20	\$ 70.00	\$ 70.00		excellent opportunity for retro-fit
<i>Storage Room</i>	1	1	4T12	4	Troffer	Magnetic	4	N	Electronic	\$ 11.20	\$ 11.20	\$ 70.00	\$ 70.00		excellent opportunity for retro-fit
Total Rebates										\$	1,612.80				
Total Costs										\$	16,760.00				

LOCATION	QTY	EXISTING TYPE	QTY	RETROFIT	SURVEYORS COMMENTS	Existing	Actual			Proposed			
						Watt/unit	Op. Hours	kWh	kW-D	Watt/unit	Op. Hours	kWh	kW-D
BUILDING A	0		0		0		1,786	0.0	0		1,786	0.0	0
<i>Building - A - Library</i>	10		0		T8 Lamps, No Retrofit		1,786	0.0	0		1,786	0.0	0
<i>Building - A - Tech Lab</i>	5		0		T8 Lamps, No Retrofit		1,786	0.0	0		1,786	0.0	0
<i>Building - A - Tech Lab</i>	2	8' 2L Fixture	2	Lamp & Ballast Retrofit	replace fixture and mount hardware	158	1,786	564.4	0.316	102	1,786	364.3	0.204
<i>Building - A - Tech Lab</i>	1	4' 2L Fixture	1	Lamp & Low Watt Ballast	replace fixture and mount hardware	75.6	1,786	135.0	0.0756	51	1,786	91.1	0.051
<i>Storage Room</i>	1	4' 2L Fixture	1	Lamp & Low Watt Ballast	replace fixture and mount hardware	75.6	1,786	135.0	0.0756	51	1,786	91.1	0.051
<i>Nurse Room</i>	2	8' 2L Fixture	2	Lamp & Ballast Retrofit	replace fixture and mount hardware	158	1,786	564.4	0.316	102	1,786	364.3	0.204
<i>Counselor Office</i>	1	4' 4L fixture	1	Lamp & Low Watt Ballast	excellent opportunity for retro-fit	151.2	1,786	270.0	0.1512	100	1,786	178.6	0.1
<i>Counselor Office</i>	8	4' 4L fixture	8	Lamp & Low Watt Ballast	excellent opportunity for retro-fit	151.2	1,786	2,160.3	1.2096	100	1,786	1,428.8	0.8
<i>Principal Office</i>	2	4' 4L fixture	2	Lamp & Low Watt Ballast	excellent opportunity for retro-fit	151.2	1,786	540.1	0.3024	100	1,786	357.2	0.2
<i>Vice-principal Office</i>	3	4' 4L fixture	3	Lamp & Low Watt Ballast	excellent opportunity for retro-fit	151.2	1,786	810.1	0.4536	100	1,786	535.8	0.3
<i>Storage Room</i>	1	4' 4L fixture	1	Lamp & Low Watt Ballast	replace fixture and mount hardware	151.2	1,786	270.0	0.1512	100	1,786	178.6	0.1
BUILDING B	0		0		0		1,786	0.0	0		1,786	0.0	0
<i>Room #18</i>	6		0		T8 Lamps, No Retrofit		1,786	0.0	0		1,786	0.0	0
<i>Room #18</i>	3	8' 2L Fixture	3	Lamp & Ballast Retrofit	replace fixture and mount hardware	158	1,786	846.6	0.474	102	1,786	546.5	0.306
<i>Room #19</i>	6		0		T8 Lamps, No Retrofit		1,786	0.0	0		1,786	0.0	0
<i>Room #19</i>	3	8' 2L Fixture	3	Lamp & Ballast Retrofit	replace fixture and mount hardware	158	1,786	846.6	0.474	102	1,786	546.5	0.306
<i>Room #20</i>	6		0		T8 Lamps, No Retrofit		1,786	0.0	0		1,786	0.0	0
<i>Room #20</i>	3	8' 2L Fixture	3	Lamp & Ballast Retrofit	replace fixture and mount hardware	158	1,786	846.6	0.474	102	1,786	546.5	0.306
<i>Room #21</i>	6		0		T8 Lamps, No Retrofit		1,786	0.0	0		1,786	0.0	0
<i>Room #21</i>	3	8' 2L Fixture	3	Lamp & Ballast Retrofit	replace fixture and mount hardware	158	1,786	846.6	0.474	102	1,786	546.5	0.306
<i>Room #22</i>	6		0		T8 Lamps, No Retrofit		1,786	0.0	0		1,786	0.0	0
<i>Room #22</i>	3	8' 2L Fixture	3	Lamp & Ballast Retrofit	replace fixture and mount hardware	158	1,786	846.6	0.474	102	1,786	546.5	0.306
<i>Room #23</i>	6		0		T8 Lamps, No Retrofit		1,786	0.0	0		1,786	0.0	0
<i>Room #23</i>	3	8' 2L Fixture	3	Lamp & Ballast Retrofit	replace fixture and mount hardware	158	1,786	846.6	0.474	102	1,786	546.5	0.306
<i>Girls Rest Room</i>	3		0		T8 Lamps, No Retrofit		1,786	0.0	0		1,786	0.0	0
<i>Boys rest room</i>	3		0		T8 Lamps, No Retrofit		1,786	0.0	0		1,786	0.0	0
BUILDING C	0		0		0		1,786	0.0	0		1,786	0.0	0
<i>Room #13</i>	3	8' 2L Fixture	3	Lamp & Ballast Retrofit	replace fixture and mount hardware	158	1,786	846.6	0.474	102	1,786	546.5	0.306
<i>Room #13</i>	6		0		T8 Lamps, No Retrofit		1,786	0.0	0		1,786	0.0	0
<i>Room #14</i>	3	8' 2L Fixture	3	Lamp & Ballast Retrofit	replace fixture and mount hardware	158	1,786	846.6	0.474	102	1,786	546.5	0.306
<i>Room #14</i>	6		0		T8 Lamps, No Retrofit		1,786	0.0	0		1,786	0.0	0
<i>Room #15</i>	3	8' 2L Fixture	3	Lamp & Ballast Retrofit	replace fixture and mount hardware	158	1,786	846.6	0.474	102	1,786	546.5	0.306
<i>Room #15</i>	6		0		T8 Lamps, No Retrofit		1,786	0.0	0		1,786	0.0	0
<i>Room #16</i>	3	8' 2L Fixture	3	Lamp & Ballast Retrofit	replace fixture and mount hardware	158	1,786	846.6	0.474	102	1,786	546.5	0.306
<i>Room #16</i>	6		0		T8 Lamps, No Retrofit		1,786	0.0	0		1,786	0.0	0
BUILDING D	0		0		0		1,786	0.0	0		1,786	0.0	0
<i>Room #7</i>	3	8' 2L Fixture	3	Lamp & Ballast Retrofit	replace fixture and mount hardware	158	1,786	846.6	0.474	102	1,786	546.5	0.306
<i>Room #7</i>	6		0		T8 Lamps, No Retrofit		1,786	0.0	0		1,786	0.0	0
<i>Room #8</i>	3	8' 2L Fixture	3	Lamp & Ballast Retrofit	replace fixture and mount hardware	158	1,786	846.6	0.474	102	1,786	546.5	0.306
<i>Room #8</i>	6		0		T8 Lamps, No Retrofit		1,786	0.0	0		1,786	0.0	0
<i>Room #9</i>	3	8' 2L Fixture	3	Lamp & Ballast Retrofit	replace fixture and mount hardware	158	1,786	846.6	0.474	102	1,786	546.5	0.306
<i>Room #9</i>	6		0		T8 Lamps, No Retrofit		1,786	0.0	0		1,786	0.0	0
<i>Room #10</i>	3	8' 2L Fixture	3	Lamp & Ballast Retrofit	replace fixture and mount hardware	158	1,786	846.6	0.474	102	1,786	546.5	0.306
<i>Room #10</i>	6		0		T8 Lamps, No Retrofit		1,786	0.0	0		1,786	0.0	0
<i>Room #11</i>	3	8' 2L Fixture	3	Lamp & Ballast Retrofit	replace fixture and mount hardware	158	1,786	846.6	0.474	102	1,786	546.5	0.306
<i>Room #11</i>	6		0		T8 Lamps, No Retrofit		1,786	0.0	0		1,786	0.0	0
<i>Room #12</i>	3	8' 2L Fixture	3	Lamp & Ballast Retrofit	replace fixture and mount hardware	158	1,786	846.6	0.474	102	1,786	546.5	0.306
<i>Room #12</i>	6		0		T8 Lamps, No Retrofit		1,786	0.0	0		1,786	0.0	0
BUILDING E	0		0		0		1,786	0.0	0		1,786	0.0	0
<i>Room #1</i>	3	8' 3L Fixture	3	Lamp & Ballast Retrofit	replace fixture and mount hardware	227	1,786	1,216.3	0.681	154	1,786	825.1	0.462
<i>Room #1</i>	3	8' 2L Fixture	3	Lamp & Ballast Retrofit	replace fixture and mount hardware	158	1,786	846.6	0.474	102	1,786	546.5	0.306
<i>Room #2</i>	12	4' 4L fixture	12	Lamp & Low Watt Ballast	excellent opportunity for retro-fit	151.2	1,786	3,240.5	1.8144	100	1,786	2,143.2	1.2
<i>Room #3</i>	3	8' 2L Fixture	3	Lamp & Ballast Retrofit	replace fixture and mount hardware	158	1,786	846.6	0.474	102	1,786	546.5	0.306
<i>Room #3</i>	6		0		T8 Lamps, No Retrofit		1,786	0.0	0		1,786	0.0	0
<i>Room #4</i>	3	8' 2L Fixture	3	Lamp & Ballast Retrofit	replace fixture and mount hardware	158	1,786	846.6	0.474	102	1,786	546.5	0.306
<i>Room #4</i>	6		0		T8 Lamps, No Retrofit		1,786	0.0	0		1,786	0.0	0
<i>Room #5</i>	3	8' 2L Fixture	3	Lamp & Ballast Retrofit	replace fixture and mount hardware	158	1,786	846.6	0.474	102	1,786	546.5	0.306
<i>Room #5</i>	6		0		T8 Lamps, No Retrofit		1,786	0.0	0		1,786	0.0	0
<i>Room #6</i>	3	8' 2L Fixture	3	Lamp & Ballast Retrofit	replace fixture and mount hardware	158	1,786	846.6	0.474	102	1,786	546.5	0.306
<i>Room #6</i>	6		0		T8 Lamps, No Retrofit		1,786	0.0	0		1,786	0.0	0

LOCATION	QTY	EXISTING TYPE	QTY	RETROFIT	SURVEYORS COMMENTS	Existing Watt/unit	Actual			Proposed			
							Op. Hours	kWh	kW-D	Watt/unit	Op. Hours	kWh	kW-D
<i>Boys rest room</i>	2	4' 4L fixture	2	Lamp & Low Watt Ballast	excellent opportunity for retro-fit	151.2	1,786	540.1	0.3024	100	1,786	357.2	0.2
PORTABLES	0		0		0		1,786	0.0	0		1,786	0.0	0
<i>P - 2</i>	16		0		T8 Lamps, No Retrofit		1,786	0.0	0		1,786	0.0	0
<i>P - 15</i>	16		0		T8 Lamps, No Retrofit		1,786	0.0	0		1,786	0.0	0
<i>P - 16</i>	16		0		T8 Lamps, No Retrofit		1,786	0.0	0		1,786	0.0	0
<i>P - 8</i>	16		0		T8 Lamps, No Retrofit		1,786	0.0	0		1,786	0.0	0
<i>P - 9</i>	16		0		T8 Lamps, No Retrofit		1,786	0.0	0		1,786	0.0	0
<i>P - 10</i>	16		0		T8 Lamps, No Retrofit		1,786	0.0	0		1,786	0.0	0
<i>P - 11</i>	16		0		T8 Lamps, No Retrofit		1,786	0.0	0		1,786	0.0	0
<i>P - 14</i>	16		0		T8 Lamps, No Retrofit		1,786	0.0	0		1,786	0.0	0
<i>P - 17 - A</i>	8		0		T8 Lamps, No Retrofit		1,786	0.0	0		1,786	0.0	0
<i>P - 17 - B</i>	8		0		T8 Lamps, No Retrofit		1,786	0.0	0		1,786	0.0	0
BUILDING G	0		0		0		1,786	0.0	0		1,786	0.0	0
<i>G - A</i>	2	4' 4L fixture	2	Lamp & Low Watt Ballast	excellent opportunity for retro-fit	151.2	1,786	540.1	0.3024	100	1,786	357.2	0.2
<i>G - B</i>	6	4' 4L fixture	6	Lamp & Low Watt Ballast	excellent opportunity for retro-fit	151.2	1,786	1,620.3	0.9072	100	1,786	1,071.6	0.6
<i>G - C</i>	2	4' 4L fixture	2	Lamp & Low Watt Ballast	excellent opportunity for retro-fit	151.2	1,786	540.1	0.3024	100	1,786	357.2	0.2
CAFETERIA	0		0		0		1,786	0.0	0		1,786	0.0	0
<i>Dining Room</i>	18	4' 4L fixture	18	Lamp & Low Watt Ballast	replace fixture and mount hardware	151.2	1,786	4,860.8	2.7216	100	1,786	3,214.8	1.8
<i>Kitchen</i>	10	4' 4L fixture	10	Lamp & Low Watt Ballast	excellent opportunity for retro-fit	151.2	1,786	2,700.4	1.512	100	1,786	1,786.0	1
<i>Storage Room</i>	4	4' 4L fixture	4	Lamp & Low Watt Ballast	excellent opportunity for retro-fit	151.2	1,786	1,080.2	0.6048	100	1,786	714.4	0.4
<i>Office</i>	1	4' 4L fixture	1	Lamp & Low Watt Ballast	excellent opportunity for retro-fit	151.2	1,786	270.0	0.1512	100	1,786	178.6	0.1
<i>Storage Room</i>	1	4' 4L fixture	1	Lamp & Low Watt Ballast	excellent opportunity for retro-fit	151.2	1,786	270.0	0.1512	100	1,786	178.6	0.1

Existing 430 Proposed 145

ENERGY CALCULATIONS			40,106	22	26,251	15
Description	kW-Demand	kWh				
Existing Use	22.46	40,106				
Proposed Use	14.70	26,251				
Difference - Savings	7.76	13,855				
Electrical Utility Cost	\$5.75	\$0.15294				
Savings per Year	\$535.29	\$2,119.01				
			Total Yearly			
			Energy Savings			
			\$2,654.30			

KAUNAKAKAI SCHOOL FIRE EXIT PLAN

REV. 10/15/93

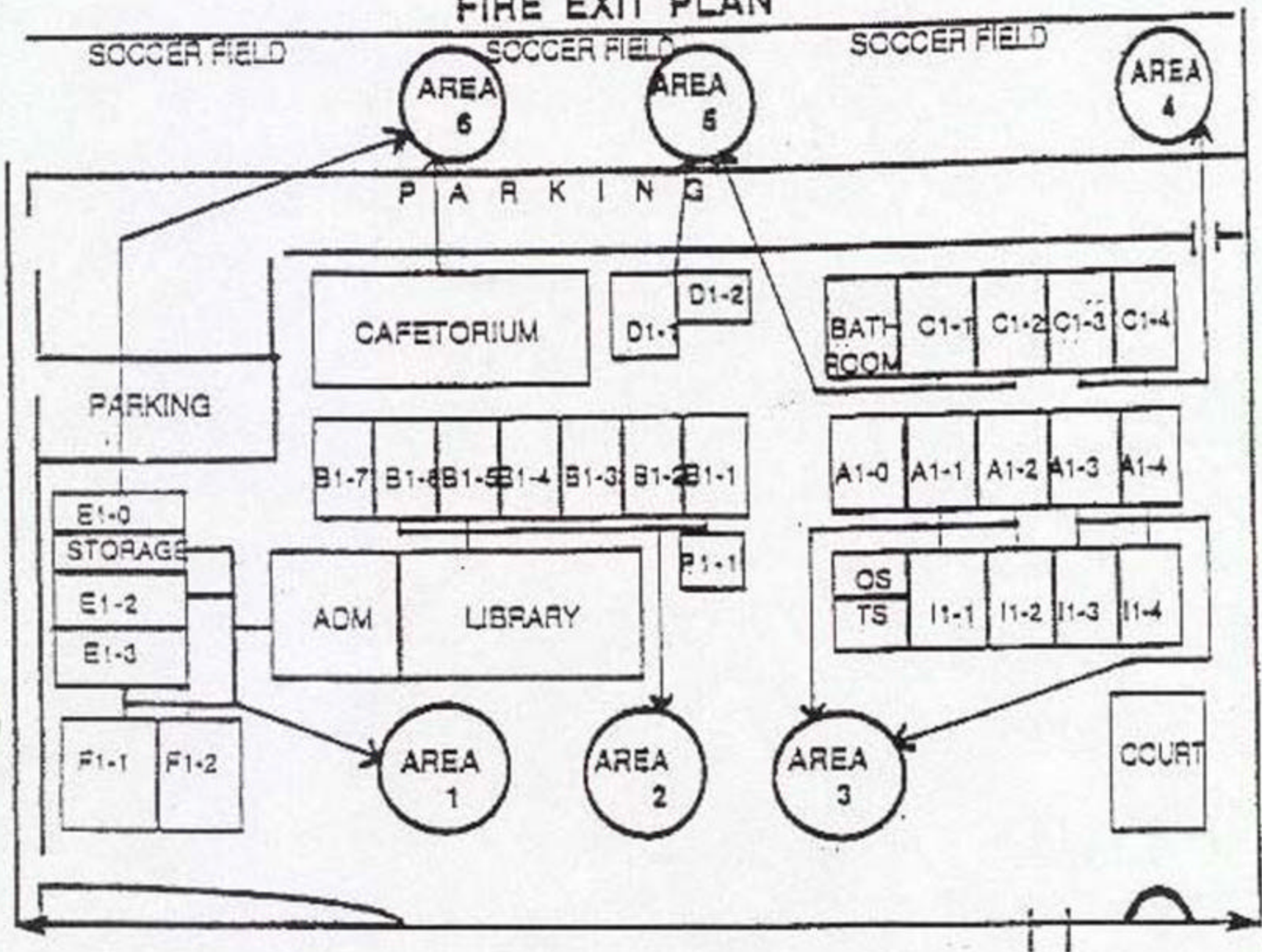

Maui Smart Schools Program
Foot Candle Readings

School: Kaanakakai Elementary School

Room: Bldg. B - B-101

Ceiling height: 9'

Light fixture height: 8'

Fixture type: Ice tray

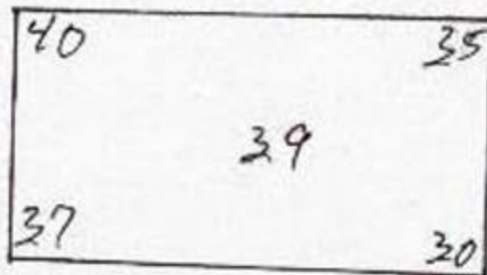

Room: Bldg. G - Dining Room

Ceiling height: 10'

Light fixture height: 8'

Fixture type: ICE TRAY

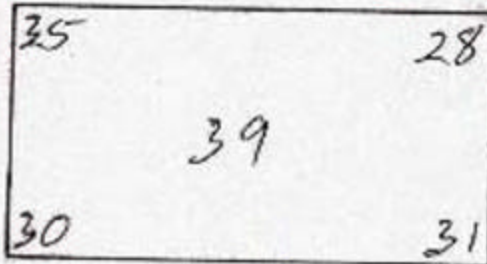

Room: Bldg. F - F-101

Ceiling height: 9'

Light fixture height: 8'

Fixture type: ICE TRAY

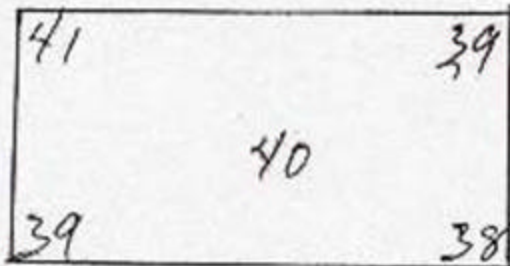



SCHOOL INFORMATION			
NAME Kaunakakai Elementary School		DATE 2/23/2001	
STREET ADDRESS P. O. Box 1950 Kaunakakai, HI 96748		OPERATIONAL HOURS 1,786	
POINT OF CONTACT Joyce Bellino	PHONE 553-1730	FAX	VOLTAGE 120V
AUDITOR Maui Community College Auditors			

LOCATION <small>(Rm Name, Rm. #, Area, Zone, etc.)</small>	EXISTING EQUIPMENT						PROPOSED			REBATES		COSTS		COMMENTS <small>Surveyors Comments</small>
	Floor	Quantity	Lamp Type	Lamps Per Fixture	Type of Fixture	Ballast Type	Lamps Per Fixture	Reflectors	Ballast Type	Per Single	Extended	Per Single	Extended	
BUILDING B														
B 108	1	6	4' T12	4	Ice	Magnetic	4	N	Electronic	\$ 11.20	\$ 67.20	\$ 160.00	\$ 960.00	Replace fixture and mount hardware
B 107	1	6	4' T12	4	Ice	Magnetic	4	N	Electronic	\$ 11.20	\$ 67.20	\$ 160.00	\$ 960.00	Replace fixture and mount hardware
B 106	1	6	4' T12	4	Ice	Magnetic	4	N	Electronic	\$ 11.20	\$ 67.20	\$ 160.00	\$ 960.00	Replace fixture and mount hardware
B 105	1	6	4' T12	4	Ice	Magnetic	4	N	Electronic	\$ 11.20	\$ 67.20	\$ 160.00	\$ 960.00	Replace fixture and mount hardware
B 104	1	6	4' T12	4	Ice	Magnetic	4	N	Electronic	\$ 11.20	\$ 67.20	\$ 160.00	\$ 960.00	Replace fixture and mount hardware
B 103	1	3	4' T12	4	Ice	Magnetic	4	N	Electronic	\$ 11.20	\$ 33.60	\$ 160.00	\$ 480.00	Replace fixture and mount hardware
B 101	1	9	4' T12	4	Ice	Magnetic	4	N	Electronic	\$ 11.20	\$ 100.80	\$ 160.00	\$ 1,440.00	Replace fixture and mount hardware
BUILDING A														
A 105	1	4	4' T12	4	Wrap	Magnetic	4	N	Electronic	\$ 11.20	\$ 44.80	\$ 70.00	\$ 280.00	Excellent opportunity for retro-fit
A 104	1	4	4' T12	4	Ice	Magnetic	4	N	Electronic	\$ 11.20	\$ 44.80	\$ 160.00	\$ 640.00	Replace fixture and mount hardware
A 103	1	6	4' T12	4	Ice	Magnetic	4	N	Electronic	\$ 11.20	\$ 67.20	\$ 160.00	\$ 960.00	Replace fixture and mount hardware
A 102	1	6	4' T12	4	Ice	Magnetic	4	N	Electronic	\$ 11.20	\$ 67.20	\$ 160.00	\$ 960.00	Replace fixture and mount hardware
A 101	1	8	4' T12	4	Ice	Magnetic	4	N	Electronic	\$ 11.20	\$ 89.60	\$ 160.00	\$ 1,280.00	Replace fixture and mount hardware
BUILDING I														
I 107	1	16	4' T12	4	Wrap	Magnetic	4	N	Electronic	\$ 11.20	\$ 179.20	\$ 70.00	\$ 1,120.00	Excellent opportunity for retro-fit
I 106	1	4	4' T12	4	Wrap	Magnetic	4	N	Electronic	\$ 11.20	\$ 44.80	\$ 70.00	\$ 280.00	Excellent opportunity for retro-fit
Girls' Restroom	1	4	4' T12	4	Wrap	Magnetic	4	N	Electronic	\$ 11.20	\$ 44.80	\$ 70.00	\$ 280.00	Excellent opportunity for retro-fit
I 102	1	16	4' T12	4	Wrap	Magnetic	4	N	Electronic	\$ 11.20	\$ 179.20	\$ 70.00	\$ 1,120.00	Excellent opportunity for retro-fit
I 101	1	16	4' T12	4	Wrap	Magnetic	4	N	Electronic	\$ 11.20	\$ 179.20	\$ 70.00	\$ 1,120.00	Excellent opportunity for retro-fit
Storage	1	16	4' T12	4	Wrap	Magnetic	4	N	Electronic	\$ 11.20	\$ 179.20	\$ 70.00	\$ 1,120.00	Excellent opportunity for retro-fit
BUILDING G														
Custodial	1	3	4' T12	1	Wrap	Magnetic	1	N	Electronic	\$ 2.80	\$ 8.40	\$ 55.00	\$ 165.00	Excellent opportunity for retro-fit
Kitchen	1	6	4' T12	2	Wrap	Magnetic	2	N	Electronic	\$ 5.60	\$ 33.60	\$ 60.00	\$ 360.00	Excellent opportunity for retro-fit
	1	7	8' T12	2	Wrap	Magnetic	2	N	Electronic	\$ 7.20	\$ 50.40	\$ 80.00	\$ 560.00	Excellent opportunity for retro-fit
Office	1	1	8' T12	2	Wrap	Magnetic	2	N	Electronic	\$ 7.20	\$ 7.20	\$ 80.00	\$ 80.00	Excellent opportunity for retro-fit
Storage	1	2	8' T12	1	Wrap	Magnetic	1	N	Electronic	\$ 3.60	\$ 7.20	\$ 75.00	\$ 150.00	Excellent opportunity for retro-fit
Dining Room	1	36	4' T12	2	Wrap	Magnetic	2	N	Electronic	\$ 2.80	\$ 100.80	\$ 80.00	\$ 2,880.00	Excellent opportunity for retro-fit
BUILDING D														
D 101	1	6	4' T12	4	Ice	Magnetic	4	N	Electronic	\$ 11.20	\$ 67.20	\$ 160.00	\$ 960.00	Replace fixture and mount hardware
D 102	1	6	4' T12	4	Ice	Magnetic	4	N	Electronic	\$ 11.20	\$ 67.20	\$ 160.00	\$ 960.00	Replace fixture and mount hardware
BUILDING C														

LOCATION (Rm Name, Rm. #, Area, Zone, etc.)	EXISTING EQUIPMENT						PROPOSED			REBATES		COSTS		COMMENTS Surveyors Comments
	Floor	Quantity	Lamp Type	Lamps Per Fixture	Type of Fixture	Ballast Type	Lamps Per Fixture	Reflectors	Ballast Type	Per Single	Extended	Per Single	Extended	
Teachers' Restroom	1	1	4' T12	2	Wrap	Magnetic	2	N	Electronic	\$ 5.60	\$ 5.60	\$ 60.00	\$ 60.00	Excellent opportunity for retro-fit
Boys' Restroom	1	2	4' T12	2	Wrap	Magnetic	2	N	Electronic	\$ 5.60	\$ 11.20	\$ 60.00	\$ 120.00	Excellent opportunity for retro-fit
Girls' Restroom	1	2	4' T12	2	Wrap	Magnetic	2	N	Electronic	\$ 5.60	\$ 11.20	\$ 60.00	\$ 120.00	Excellent opportunity for retro-fit
C 101	1	18	4' T12	2	Ice	Magnetic	2	N	Electronic	\$ 5.60	\$ 100.80	\$ 60.00	\$ 1,080.00	Replace fixture and mount hardware
C 102	1	18	4' T12	2	Ice	Magnetic	2	N	Electronic	\$ 5.60	\$ 100.80	\$ 60.00	\$ 1,080.00	Replace fixture and mount hardware
C 103	1	18	4' T12	2	Ice	Magnetic	2	N	Electronic	\$ 5.60	\$ 100.80	\$ 60.00	\$ 1,080.00	Replace fixture and mount hardware
C 104	1	18	4' T12	2	Ice	Magnetic	2	N	Electronic	\$ 5.60	\$ 100.80	\$ 60.00	\$ 1,080.00	Replace fixture and mount hardware
BUILDING F														
F 102	1	6	4' T12	4	Ice	Magnetic	4	N	Electronic	\$ 11.20	\$ 67.20	\$ 160.00	\$ 960.00	Replace fixture and mount hardware
F 101	1	6	4' T12	4	Ice	Magnetic	4	N	Electronic	\$ 11.20	\$ 67.20	\$ 160.00	\$ 960.00	Replace fixture and mount hardware
BUILDING E														
E 102	1	9	4' T12	4	Ice	Magnetic	4	N	Electronic	\$ 11.20	\$ 100.80	\$ 160.00	\$ 1,440.00	Replace fixture and mount hardware
E 101	1	9	4' T12	4	Ice	Magnetic	4	N	Electronic	\$ 11.20	\$ 100.80	\$ 160.00	\$ 1,440.00	Replace fixture and mount hardware
E 103	1	9	4' T12	4	Ice	Magnetic	4	N	Electronic	\$ 11.20	\$ 100.80	\$ 160.00	\$ 1,440.00	Replace fixture and mount hardware
Library	1	54	4' T12	4	Ice	Magnetic	4	N	Electronic	\$ 11.20	\$ 604.80	\$ 160.00	\$ 8,640.00	Replace fixture and mount hardware
Office	1	1	4' T12	4	Ice	Magnetic	4	N	Electronic	\$ 11.20	\$ 11.20	\$ 160.00	\$ 160.00	Replace fixture and mount hardware
Portables														
P - 1	1	16	4' T12	4	Ice	Magnetic	4	N	Electronic	\$ 11.20	\$ 179.20	\$ 160.00	\$ 2,560.00	Replace fixture and mount hardware
BUILDING I	1	21	4' T12	4	Ice	Magnetic	4	N	Electronic	\$ 11.20	\$ 235.20	\$ 160.00	\$ 3,360.00	Replace fixture and mount hardware
Total Rebates										\$		\$	4,054.80	
Total Costs										\$		\$	49,335.00	

LOCATION	QTY	EXISTING TYPE	QTY	RETROFIT	SURVEYORS COMMENTS	Existing	Actual			Proposed			
						Watt/unit	Op. Hours	kWh	kW-D	Watt/unit	Op. Hours	kWh	kW-D
BUILDING B	0		0		0		1,786	0.0	0		1,786	0.0	0
B 108	6	4' 4L Fixture	6	Lamp & Low Watt Ballast	Replace fixture and mount hardware	151.2	1,786	1,620.3	0.9072	100	1,786	1,071.6	0.6
B 107	6	4' 4L Fixture	6	Lamp & Low Watt Ballast	Replace fixture and mount hardware	151.2	1,786	1,620.3	0.9072	100	1,786	1,071.6	0.6
B 106	6	4' 4L Fixture	6	Lamp & Low Watt Ballast	Replace fixture and mount hardware	151.2	1,786	1,620.3	0.9072	100	1,786	1,071.6	0.6
B 105	6	4' 4L Fixture	6	Lamp & Low Watt Ballast	Replace fixture and mount hardware	151.2	1,786	1,620.3	0.9072	100	1,786	1,071.6	0.6
B 104	6	4' 4L Fixture	6	Lamp & Low Watt Ballast	Replace fixture and mount hardware	151.2	1,786	1,620.3	0.9072	100	1,786	1,071.6	0.6
B 103	3	4' 4L Fixture	3	Lamp & Low Watt Ballast	Replace fixture and mount hardware	151.2	1,786	810.1	0.4536	100	1,786	535.8	0.3
B 101	9	4' 4L Fixture	9	Lamp & Low Watt Ballast	Replace fixture and mount hardware	151.2	1,786	2,430.4	1.3608	100	1,786	1,607.4	0.9
BUILDING A	4	4' 4L Fixture	4	Lamp & Low Watt Ballast	Replace fixture and mount hardware	151.2	1,786	1,080.2	0.6048	100	1,786	714.4	0.4
A 105	4	4' 4L Fixture	4	Lamp & Low Watt Ballast	Excellent opportunity for retro-fit	151.2	1,786	1,080.2	0.6048	100	1,786	714.4	0.4
A 104	4	4' 4L Fixture	4	Lamp & Low Watt Ballast	Replace fixture and mount hardware	151.2	1,786	1,080.2	0.6048	100	1,786	714.4	0.4
A 103	6	4' 4L Fixture	6	Lamp & Low Watt Ballast	Replace fixture and mount hardware	151.2	1,786	1,620.3	0.9072	100	1,786	1,071.6	0.6
A 102	6	4' 4L Fixture	6	Lamp & Low Watt Ballast	Replace fixture and mount hardware	151.2	1,786	1,620.3	0.9072	100	1,786	1,071.6	0.6
A 101	8	4' 4L Fixture	8	Lamp & Low Watt Ballast	Replace fixture and mount hardware	151.2	1,786	2,160.3	1.2096	100	1,786	1,428.8	0.8
BUILDING I	16	4' 4L Fixture	16	Lamp & Low Watt Ballast	Excellent opportunity for retro-fit	151.2	1,786	4,320.7	2.4192	100	1,786	2,857.6	1.6
I 107	16	4' 4L Fixture	16	Lamp & Low Watt Ballast	Excellent opportunity for retro-fit	151.2	1,786	4,320.7	2.4192	100	1,786	2,857.6	1.6
I 106	4	4' 4L Fixture	4	Lamp & Low Watt Ballast	Excellent opportunity for retro-fit	151.2	1,786	1,080.2	0.6048	100	1,786	714.4	0.4
Girls' Restroom	4	4' 4L Fixture	4	Lamp & Low Watt Ballast	Excellent opportunity for retro-fit	151.2	1,786	1,080.2	0.6048	100	1,786	714.4	0.4
I 102	16	4' 4L Fixture	16	Lamp & Low Watt Ballast	Excellent opportunity for retro-fit	151.2	1,786	4,320.7	2.4192	100	1,786	2,857.6	1.6
I 101	16	4' 4L Fixture	16	Lamp & Low Watt Ballast	Excellent opportunity for retro-fit	151.2	1,786	4,320.7	2.4192	100	1,786	2,857.6	1.6
Storage	16	4' 4L Fixture	16	Lamp & Low Watt Ballast	Excellent opportunity for retro-fit	151.2	1,786	4,320.7	2.4192	100	1,786	2,857.6	1.6
BUILDING G	0		0		0		1,786	0.0	0		1,786	0.0	0
Custodial	3	4' 1L Fixture	3	Lamp & Low Watt Ballast	Excellent opportunity for retro-fit	45.6	1,786	244.3	0.1368	31	1,786	166.1	0.093
Kitchen	6	4' 2L Fixture	6	Lamp & Low Watt Ballast	Excellent opportunity for retro-fit	75.6	1,786	810.1	0.4536	51	1,786	546.5	0.306
0	7	8' 2L Fixture	7	Lamp & Ballast Retrofit	Excellent opportunity for retro-fit	158	1,786	1,975.3	1.106	110	1,786	1,375.2	0.77
Office	1	8' 2L Fixture	1	Lamp & Ballast Retrofit	Excellent opportunity for retro-fit	158	1,786	282.2	0.158	110	1,786	196.5	0.11
Storage	2	8' 2L Fixture	2	Lamp & Ballast Retrofit	Excellent opportunity for retro-fit	69	1,786	246.5	0.138	55	1,786	196.5	0.11
Dining Room	36	4' 1L Fixture	36	Lamp & Low Watt Ballast	Excellent opportunity for retro-fit	75.6	1,786	4,860.8	2.7216	51	1,786	3,279.1	1.836
BUILDING D	0		0		0		1,786	0.0	0		1,786	0.0	0
D 101	6	4' 4L Fixture	6	Lamp & Low Watt Ballast	Replace fixture and mount hardware	151.2	1,786	1,620.3	0.9072	100	1,786	1,071.6	0.6
D 102	6	4' 4L Fixture	6	Lamp & Low Watt Ballast	Replace fixture and mount hardware	151.2	1,786	1,620.3	0.9072	100	1,786	1,071.6	0.6
BUILDING C	0		0		0		1,786	0.0	0		1,786	0.0	0
Teachers' Restroom	1	4' 2L Fixture	1	Lamp & Low Watt Ballast	Excellent opportunity for retro-fit	75.6	1,786	135.0	0.0756	51	1,786	91.1	0.051
Boys' Restroom	2	8' 2L Fixture	2	Lamp & Ballast Retrofit	Excellent opportunity for retro-fit	75.6	1,786	270.0	0.1512	51	1,786	182.2	0.102
Girls' Restroom	2	8' 2L Fixture	2	Lamp & Ballast Retrofit	Excellent opportunity for retro-fit	75.6	1,786	270.0	0.1512	51	1,786	182.2	0.102
C 101	18	8' 2L Fixture	18	Lamp & Ballast Retrofit	Replace fixture and mount hardware	75.6	1,786	2,430.4	1.3608	51	1,786	1,639.5	0.918
C 102	18	4' 1L Fixture	18	Lamp & Low Watt Ballast	Replace fixture and mount hardware	75.6	1,786	2,430.4	1.3608	51	1,786	1,639.5	0.918
C 103	18	4' 1L Fixture	18	Lamp & Low Watt Ballast	Replace fixture and mount hardware	75.6	1,786	2,430.4	1.3608	51	1,786	1,639.5	0.918
C 104	18	4' 1L Fixture	18	Lamp & Low Watt Ballast	Replace fixture and mount hardware	75.6	1,786	2,430.4	1.3608	51	1,786	1,639.5	0.918
BUILDING F	0		0		0		1,786	0.0	0		1,786	0.0	0
F 102	6	4' 4L Fixture	6	Lamp & Low Watt Ballast	Replace fixture and mount hardware	151.2	1,786	1,620.3	0.9072	100	1,786	1,071.6	0.6
F 101	6	4' 4L Fixture	6	Lamp & Low Watt Ballast	Replace fixture and mount hardware	151.2	1,786	1,620.3	0.9072	100	1,786	1,071.6	0.6
BUILDING E	0		0		0		1,786	0.0	0		1,786	0.0	0
E 102	9	4' 4L Fixture	9	Lamp & Low Watt Ballast	Replace fixture and mount hardware	151.2	1,786	2,430.4	1.3608	100	1,786	1,607.4	0.9
E 101	9	4' 4L Fixture	9	Lamp & Low Watt Ballast	Replace fixture and mount hardware	151.2	1,786	2,430.4	1.3608	100	1,786	1,607.4	0.9
E 103	9	4' 4L Fixture	9	Lamp & Low Watt Ballast	Replace fixture and mount hardware	151.2	1,786	2,430.4	1.3608	100	1,786	1,607.4	0.9
Library	54	4' 4L Fixture	54	Lamp & Low Watt Ballast	Replace fixture and mount hardware	151.2	1,786	14,582.3	8.1648	100	1,786	9,644.4	5.4
Office	1	4' 4L Fixture	1	Lamp & Low Watt Ballast	Replace fixture and mount hardware	151.2	1,786	270.0	0.1512	100	1,786	178.6	0.1
Portables	0		0		0		1,786	0.0	0		1,786	0.0	0
P - 1	16	4' 4L Fixture	16	Lamp & Low Watt Ballast	Replace fixture and mount hardware	151.2	1,786	4,320.7	2.4192	100	1,786	2,857.6	1.6
BUILDING I	21	4' 4L Fixture	21	Lamp & Low Watt Ballast	Replace fixture and mount hardware	151.2	1,786	5,670.9	3.1752	100	1,786	3,750.6	2.1
Existing						437	Proposed						437

ENERGY CALCULATIONS		
Description	kW-Demand	kWh
Existing Use	56.65	101,179
Proposed Use	37.65	67,246
Difference - Savings	19.00	33,933
Electrical Utility Cost	\$5.75	\$0.21960
Savings per Year	\$1,310.94	\$7,451.75

Total Yearly Energy Savings	\$8,762.69
------------------------------------	-------------------

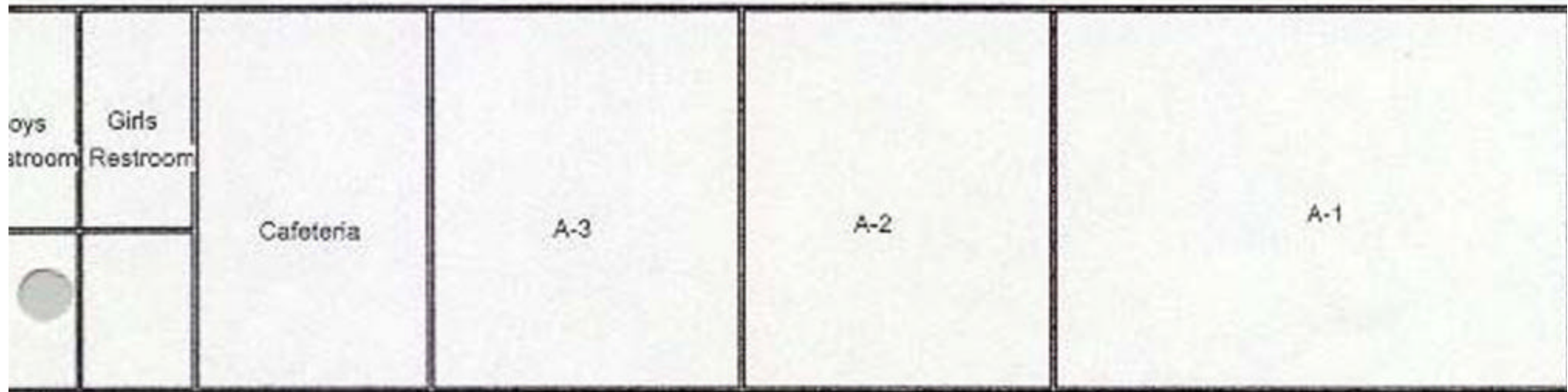

Keanae School
3770 sqft

Maui Smart Schools Program Foot Candle Readings

School: Keanae School

Room: Main Room

Ceiling Height: 10'

Light Fixture Height: 8'

Fixture Type: Ice Tray

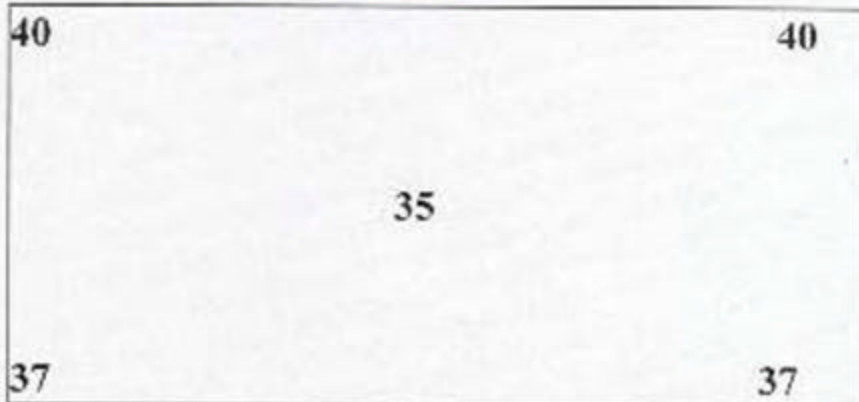



SCHOOL INFORMATION		
NAME Keanae Elementary and Intermediate School	DATE 2/9/2001	
STREET ADDRESS P. O. Box 128 Hana, HI 96713		OPERATIONAL HOURS 1,304
POINT OF CONTACT (Vacant)	PHONE 248-4841	FAX 120V
AUDITOR Maui Community College Auditors		

LOCATION <small>(Rm Name, Rm. #, Area, Zone, etc.)</small>	EXISTING EQUIPMENT						PROPOSED			REBATES		COSTS		COMMENTS <small>Surveyors Comments</small>	
	Floor	Quantity	Lamp Type	Lamps Per Fixture	Type of Fixture	Ballast Type	Lamps Per Fixture	Reflectors	Ballast Type	Per Single	Extended	Per Single	Extended		
Room 1		6	4' T12	4	Ice	Magnetic	4	N	Electronic	\$ 11.20	\$ 67.20	\$ 160.00	\$ 960.00	Replace fixture and mount hardware	
Room 2		4	4' T12	4	Ice	Magnetic	4	N	Electronic	\$ 11.20	\$ 44.80	\$ 160.00	\$ 640.00	Replace fixture and mount hardware	
Room 3		4	4' T12	4	Ice	Magnetic	4	N	Electronic	\$ 11.20	\$ 44.80	\$ 160.00	\$ 640.00	Replace fixture and mount hardware	
Room 4		4	4' T12	4	Ice	Magnetic	4	N	Electronic	\$ 11.20	\$ 44.80	\$ 160.00	\$ 640.00	Replace fixture and mount hardware	
Total Rebates \$										201.60					
Total Costs \$										2,880.00					

Kanae Elementary

LOCATION	QTY	EXISTING TYPE	QTY	RETROFIT	SURVEYORS COMMENTS	Existing				Proposed			
						Watt/unit	Op. Hours	kWh	kW-D	Watt/unit	Op. Hours	kWh	kW-D
Room 1	6	4' 4L Fixture	6	Lamp & Low Watt Ballast	Replace fixture and mount hardware	151.2	1,304	1,183.0	0.9072	100	1,304	782.4	0.6
Room 2	4	4' 4L Fixture	4	Lamp & Low Watt Ballast	Replace fixture and mount hardware	151.2	1,304	788.7	0.6048	100	1,304	521.6	0.4
Room 3	4	4' 4L Fixture	4	Lamp & Low Watt Ballast	Replace fixture and mount hardware	151.2	1,304	788.7	0.6048	100	1,304	521.6	0.4
Room 4	4	4' 4L Fixture	4	Lamp & Low Watt Ballast	Replace fixture and mount hardware	151.2	1,304	788.7	0.6048	100	1,304	521.6	0.4

Existing 18 Proposed 18

ENERGY CALCULATIONS			3,549	2.72	2,347	1.80
Description	kW-Demand	kWh				
Existing Use	2.72	3,549				
Proposed Use	1.80	2,347				
Difference - Savings	0.92	1,202				
Electrical Utility Cost	\$5.75	\$0.15000				
Savings per Year	\$63.59	\$180.26				
					Total Yearly Energy Savings	\$243.86

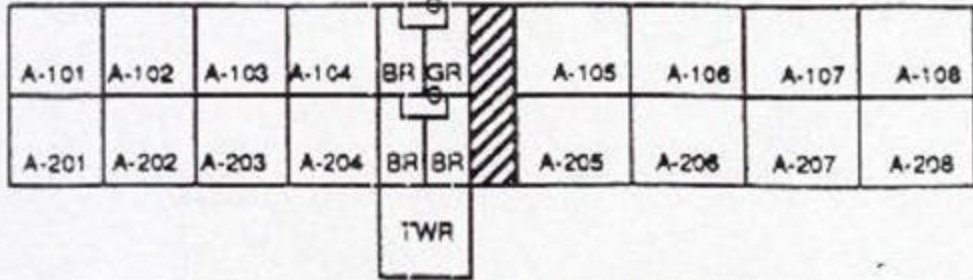
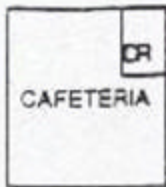

60017042

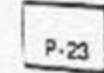
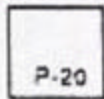
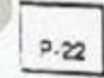
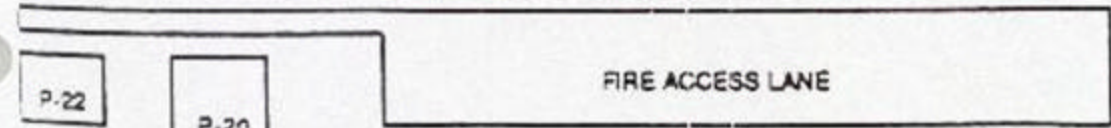
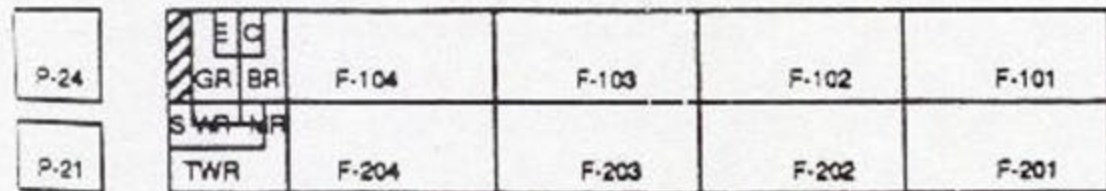
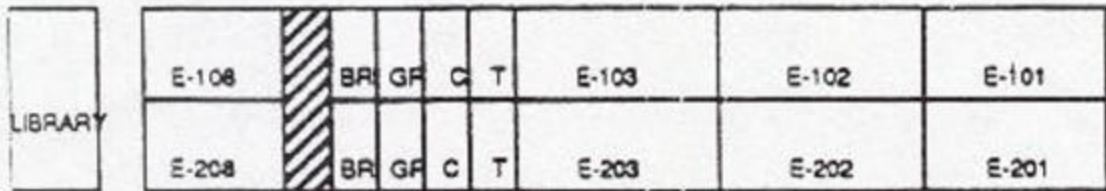
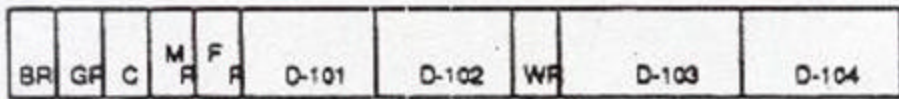
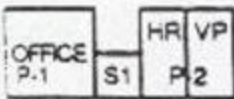
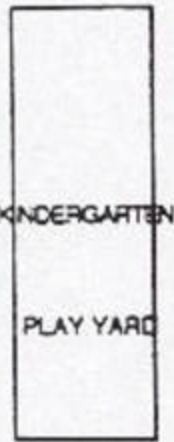
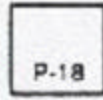
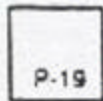

- LEGEND:
- DR=DRAWING ROOM
 - BR=BOYS RESTRM.
 - GR=GIRLS RESTRM.
 - C=CUSTODIANS
 - TWR=TEACHERS W/
 - HR=HEALTH ROOM
 - VP=VICE PRINCIPAL
 - MR=MEN'S RESTRM
 - FR=FEMALE RESTRM
 - WR=WORK ROOM
 - E=ELECTRIC ROOM
 -
 BREZEWAY

KIH EI ELEMENTARY

Maui Smart Schools Program
Foot Candle Readings

School: Kihei Elementary School

Room: <u>A-201</u>	37	40
Ceiling Height: <u>14 Feet</u>	37	
Light Fixture Height: <u>10 Feet</u>		
Fixture Type: <u>Wrap-Tandem Style</u>	38	43

Room: <u>Bldg B-101</u>	38	40
Ceiling Height: <u>13 Feet</u>	39	
Light Fixture Height: <u>10 Feet</u>		
Fixture Type: <u>Wrap</u>	41	41

Room: <u>Bldg D-103</u>	31	47
Ceiling Height: <u>14 Feet</u>	42	
Light Fixture Height: <u>10 Feet</u>		
Fixture Type: <u>Wrap</u>	39	44



CUSTOMER INFORMATION		
NAME Kihei Elementary School	DATE 8/2/2000	
STREET ADDRESS 250 East Lipoa Street Kihei, HI 96753		OPERATIONAL HOURS 1,549
POINT OF CONTACT Alvin Shima	PHONE 875-6818	FAX 875-6825
AUDITOR		VOLTAGE 120V

LOCATION <small>(Rm Name, Rm. #, Area, Zone, etc.)</small>	EXISTING EQUIPMENT						PROPOSED			REBATES		COSTS		COMMENTS
	Floor	Quantity	Lamp Type	Lamps Per Fixture	Type of Fixture	Ballast Type	Lamps Per Fixture	Reflectors	Ballast Type	Per Single	Extended	Per Single	Extended	
PORTABLES											\$ -		\$ -	
P12	1	12	4' T12	4	Fixture	Magnetic	4	N	Electronic	\$ 11.20	\$ 134.40	\$ 70.00	\$ 840.00	Retrofit Recommended
	1	2	Inc								\$ -		\$ -	None
S2	1	2	4' T12	4	Fixture	Magnetic	4	N	Electronic	\$ 11.20	\$ 22.40	\$ 70.00	\$ 140.00	Retrofit Recommended
P13	1	16	4' T12	4	Fixture	Magnetic	4	N	Electronic	\$ 11.20	\$ 179.20	\$ 70.00	\$ 1,120.00	Retrofit Recommended
Bathroom	1	2	Inc								\$ -	\$ -	\$ -	None
Exterior	1	2	Inc								\$ -	\$ -	\$ -	None
P14	1	16	4' T12	4	Fixture	Magnetic	4	N	Electronic	\$ 11.20	\$ 179.20	\$ 70.00	\$ 1,120.00	Retrofit Recommended
Bathroom	1	2	Inc								\$ -	\$ -	\$ -	None
Exterior	1	2	Inc								\$ -	\$ -	\$ -	None
P19	1	12	4' T12	4	Fixture	Magnetic	4	N	Electronic	\$ 11.20	\$ 134.40	\$ 70.00	\$ 840.00	Retrofit Recommended
P18	1	12	4' T12	4	Fixture	Magnetic	4	N	Electronic	\$ 11.20	\$ 134.40	\$ 70.00	\$ 840.00	Retrofit Recommended
P1	1	14	4' T12	4	Fixture	Magnetic	4	N	Electronic	\$ 11.20	\$ 156.80	\$ 70.00	\$ 980.00	Retrofit Recommended
Restroom	1	2	Inc								\$ -	\$ -	\$ -	None
Exterior	1	2	Inc								\$ -	\$ -	\$ -	None
P2A	2	8	4' T12	4	Fixture	Magnetic	4	N	Electronic	\$ 11.20	\$ 89.60	\$ 70.00	\$ 560.00	Retrofit Recommended
P2B	2	8	4' T12	4	Fixture	Magnetic	4	N	Electronic	\$ 11.20	\$ 89.60	\$ 70.00	\$ 560.00	Retrofit Recommended
P24	2	12	4' T12	4	Wrap	Magnetic	4	N	Electronic	\$ 11.20	\$ 134.40	\$ 70.00	\$ 840.00	Retrofit Recommended
P2	2	12	4' T12	4	Wrap	Magnetic	4	N	Electronic	\$ 11.20	\$ 134.40	\$ 70.00	\$ 840.00	Retrofit Recommended
P20	2	12	4' T12	4	Wrap	Magnetic	4	N	Electronic	\$ 11.20	\$ 134.40	\$ 70.00	\$ 840.00	Retrofit Recommended
P22	2	12	4' T12	4	Wrap	Magnetic	4	N	Electronic	\$ 11.20	\$ 134.40	\$ 70.00	\$ 840.00	Retrofit Recommended
P23	2	12	4' T12	4	Wrap	Magnetic	4	N	Electronic	\$ 11.20	\$ 134.40	\$ 70.00	\$ 840.00	Retrofit Recommended
BUILDING A											\$ -		\$ -	Retrofit Recommended
Mech Room	1	2	Inc								\$ -	\$ -	\$ -	None
Exterior Lower	1	12	Inc								\$ -	\$ -	\$ -	None
A101	1	9	4' T12	4	Fixture	Magnetic	4	N	Electronic	\$ 11.20	\$ 100.80	\$ 70.00	\$ 630.00	Retrofit Recommended
Storage	1	1	Inc								\$ -	\$ -	\$ -	None
A102	1	9	4' T12	4	Fixture	Magnetic	4	N	Electronic	\$ 11.20	\$ 100.80	\$ 70.00	\$ 630.00	Retrofit Recommended
Storage	1	1	Inc								\$ -	\$ -	\$ -	None
A103	1	9	4' T12	4	Fixture	Magnetic	4	N	Electronic	\$ 11.20	\$ 100.80	\$ 70.00	\$ 630.00	Retrofit Recommended
Storage	1	1	Inc								\$ -	\$ -	\$ -	None

LOCATION	EXISTING EQUIPMENT						PROPOSED			REBATES		COSTS		COMMENTS
Location (Rm Name, Rm. #, Area, Zone, etc.)	Floor	Quantity	Lamp Type	Lamps Per Fixture	Type of Fixture	Ballast Type	Lamps Per Fixture	Reflectors	Ballast Type	Per Single	Extended	Per Single	Extended	Comments
A104	1	8	4' T12	4	Fixture	Magnetic	4	N	Electronic	\$ 11.20	\$ 89.60	\$ 70.00	\$ 560.00	Retrofit Recommended
C Office	1	1	4' T12	2	Fixture	Magnetic	2	N	Electronic	\$ 5.60	\$ 5.60	\$ 60.00	\$ 60.00	Retrofit Recommended
Boys' Restroom	1	5	4' T12	2	Fixture	Magnetic	2	N	Electronic	\$ 5.60	\$ 28.00	\$ 60.00	\$ 300.00	Retrofit Recommended
Custodial	1	1	Inc								\$ -	\$ -	\$ -	None
Elevator	1	4	4' T12	1	Strip	Magnetic	1	N	Electronic	\$ 2.80	\$ 11.20	\$ 55.00	\$ 220.00	Retrofit Recommended
Girls' Restroom	1	5	4' T12	4	Fixture	Magnetic	4	N	Electronic	\$ 11.20	\$ 56.00	\$ 70.00	\$ 350.00	Retrofit Recommended
Storage	1	1	Inc								\$ -	\$ -	\$ -	None
A105	1	9	4' T12	4	Fixture	Magnetic	4	N	Electronic	\$ 11.20	\$ 100.80	\$ 70.00	\$ 630.00	Retrofit Recommended
	1	3	4' T12	2	Fixture	Magnetic	2	N	Electronic	\$ 5.60	\$ 16.80	\$ 60.00	\$ 180.00	Retrofit Recommended
A 106	1	9	4' T12	4	Fixture	Magnetic	4	N	Electronic	\$ 11.20	\$ 100.80	\$ 70.00	\$ 630.00	Retrofit Recommended
	1	3	4' T12	2	Fixture	Magnetic	2	N	Electronic	\$ 5.60	\$ 16.80	\$ 60.00	\$ 180.00	Retrofit Recommended
A107	1	9	4' T12	4	Fixture	Magnetic	4	N	Electronic	\$ 11.20	\$ 100.80	\$ 70.00	\$ 630.00	Retrofit Recommended
	1	3	4' T12	2	Fixture	Magnetic	2	N	Electronic	\$ 5.60	\$ 16.80	\$ 60.00	\$ 180.00	Retrofit Recommended
A108	1	9	4' T12	4	Fixture	Magnetic	4	N	Electronic	\$ 11.20	\$ 100.80	\$ 70.00	\$ 630.00	Retrofit Recommended
	1	3	4' T12	2	Fixture	Magnetic	2	N	Electronic	\$ 5.60	\$ 16.80	\$ 60.00	\$ 180.00	Retrofit Recommended
Stairway		1	Inc								\$ -	\$ -	\$ -	None
Exterior	2	15	Inc								\$ -	\$ -	\$ -	None
A208	2	9	4' T12	4	Fixture	Magnetic	4	N	Electronic	\$ 11.20	\$ 100.80	\$ 70.00	\$ 630.00	Retrofit Recommended
	2	3	4' T12	2	Fixture	Magnetic	2	N	Electronic	\$ 5.60	\$ 16.80	\$ 60.00	\$ 180.00	Retrofit Recommended
A207	2	9	4' T12	4	Fixture	Magnetic	4	N	Electronic	\$ 11.20	\$ 100.80	\$ 70.00	\$ 630.00	Retrofit Recommended
	2	3	4' T12	2	Fixture	Magnetic	2	N	Electronic	\$ 5.60	\$ 16.80	\$ 60.00	\$ 180.00	Retrofit Recommended
A206	2	9	4' T12	4	Fixture	Magnetic	4	N	Electronic	\$ 11.20	\$ 100.80	\$ 70.00	\$ 630.00	Retrofit Recommended
	2	3	4' T12	2	Fixture	Magnetic	2	N	Electronic	\$ 5.60	\$ 16.80	\$ 60.00	\$ 180.00	Retrofit Recommended
A205	2	9	4' T12	4	Fixture	Magnetic	4	N	Electronic	\$ 11.20	\$ 100.80	\$ 70.00	\$ 630.00	Retrofit Recommended
	2	3	4' T12	2	Fixture	Magnetic	2	N	Electronic	\$ 5.60	\$ 16.80	\$ 60.00	\$ 180.00	Retrofit Recommended
Girls' Restroom	2	5	4' T12	2	Fixture	Magnetic	2	N	Electronic	\$ 5.60	\$ 28.00	\$ 60.00	\$ 300.00	Retrofit Recommended
Janitor's Closet	2	1	Inc								\$ -	\$ -	\$ -	None
Boys' Restroom	2	5	4' T12	2	Fixture	Magnetic	2	N	Electronic	\$ 5.60	\$ 28.00	\$ 60.00	\$ 300.00	Retrofit Recommended
A204	2	9	4' T12	4	Fixture	Magnetic	4	N	Electronic	\$ 11.20	\$ 100.80	\$ 70.00	\$ 630.00	Retrofit Recommended
Storage	2	1	Inc								\$ -	\$ -	\$ -	None
A203	2	9	4' T12	4	Fixture	Magnetic	4	N	Electronic	\$ 11.20	\$ 100.80	\$ 70.00	\$ 630.00	Retrofit Recommended
Storage	2	1	Inc								\$ -	\$ -	\$ -	None
A202	2	9	4' T12	4	Fixture	Magnetic	4	N	Electronic	\$ 11.20	\$ 100.80	\$ 70.00	\$ 630.00	Retrofit Recommended
Storage	2	1	Inc								\$ -	\$ -	\$ -	None
A201	2	9	4' T12	4	Fixture	Magnetic	4	N	Electronic	\$ 11.20	\$ 100.80	\$ 70.00	\$ 630.00	Retrofit Recommended
Storage	2	1	Inc								\$ -	\$ -	\$ -	None

LOCATION (Rm Name, Rm. #, Area, Zone, etc.)	EXISTING EQUIPMENT						PROPOSED			REBATES		COSTS		COMMENTS
	Floor	Quantity	Lamp Type	Lamps Per Fixture	Type of Fixture	Ballast Type	Lamps Per Fixture	Reflectors	Ballast Type	Per Single	Extended	Per Single	Extended	
Teacher	2	8	4' T12	4	Fixture	Magnetic	4	N	Electronic	\$ 11.20	\$ 89.60	\$ 70.00	\$ 560.00	Retrofit Recommended
	2	4	4' T12	2	Fixture	Magnetic	2	N	Electronic	\$ 5.60	\$ 22.40	\$ 60.00	\$ 240.00	Retrofit Recommended
Restroom	2	2	Inc								\$ -	\$ -	\$ -	None
BUILDING B											\$ -		\$ -	
B104	1	12	4' T12	4	Fixture	Magnetic	4	N	Electronic	\$ 11.20	\$ 134.40	\$ 70.00	\$ 840.00	Retrofit Recommended
B103	1	12	4' T12	4	Fixture	Magnetic	4	N	Electronic	\$ 11.20	\$ 134.40	\$ 70.00	\$ 840.00	Retrofit Recommended
Teacher's Room	1	5	4' T12	4	Fixture	Magnetic	4	N	Electronic	\$ 11.20	\$ 56.00	\$ 70.00	\$ 350.00	Retrofit Recommended
Restroom	1	1	Inc								\$ -	\$ -	\$ -	None
Girls' Restroom	1	3	4' T12	4	Fixture	Magnetic	4	N	Electronic	\$ 11.20	\$ 33.60	\$ 70.00	\$ 210.00	Retrofit Recommended
Custodian	1	1	Inc								\$ -	\$ -	\$ -	None
Boys' Restroom	1	3	4' T12	4	Fixture	Magnetic	4	N	Electronic	\$ 11.20	\$ 33.60	\$ 70.00	\$ 210.00	Retrofit Recommended
B102	1	12	4' T12	4	Fixture	Magnetic	4	N	Electronic	\$ 11.20	\$ 134.40	\$ 70.00	\$ 840.00	Retrofit Recommended
B101	1	12	4' T12	4	Fixture	Magnetic	4	N	Electronic	\$ 11.20	\$ 134.40	\$ 70.00	\$ 840.00	Retrofit Recommended
CAFETERIA	1	45	4' T12	4	Fixture	Magnetic	4	N	Electronic	\$ 11.20	\$ 504.00	\$ 70.00	\$ 3,150.00	Retrofit Recommended
Office	1	2	4' T12	2	Fixture	Magnetic	2	N	Electronic	\$ 5.60	\$ 11.20	\$ 60.00	\$ 120.00	Retrofit Recommended
Stage	1	6	4' T12	2	Fixture	Magnetic	2	N	Electronic	\$ 5.60	\$ 33.60	\$ 60.00	\$ 360.00	Retrofit Recommended
Office	1	3	4' T12	2	Fixture	Magnetic	2	N	Electronic	\$ 5.60	\$ 16.80	\$ 60.00	\$ 180.00	Retrofit Recommended
Sound Equipment	1	1	Inc								\$ -	\$ -	\$ -	None
Kitchen	1	6	4' T12	4	Fixture	Magnetic	4	N	Electronic	\$ 11.20	\$ 67.20	\$ 70.00	\$ 420.00	Retrofit Recommended
	1	25	4' T12	2	Hood	Magnetic	2	N	Electronic	\$ 5.60	\$ 140.00	\$ 60.00	\$ 1,500.00	Retrofit Recommended
Office	1	2	4' T12	4	Fixture	Magnetic	4	N	Electronic	\$ 11.20	\$ 22.40	\$ 70.00	\$ 140.00	Retrofit Recommended
Women's Restroom	1	1	4' T12	2	Fixture	Magnetic	2	N	Electronic	\$ 5.60	\$ 5.60	\$ 60.00	\$ 60.00	Retrofit Recommended
	1	1	Inc								\$ -	\$ -	\$ -	None
Dining Area	1	10	4' T12	2	Fixture	Magnetic	2	N	Electronic	\$ 5.60	\$ 56.00	\$ 60.00	\$ 600.00	Retrofit Recommended
Custodian	1	2	4' T12	2	Fixture	Magnetic	2	N	Electronic	\$ 5.60	\$ 11.20	\$ 60.00	\$ 120.00	Retrofit Recommended
Men's Restroom	1	1	Inc								\$ -	\$ -	\$ -	None
Pump Station	1	2	Inc								\$ -	\$ -	\$ -	None
Heater Room	1	2	Inc								\$ -	\$ -	\$ -	None
Electric Room	1	2	Inc								\$ -	\$ -	\$ -	None
Girls' restroom	1	1	Inc								\$ -	\$ -	\$ -	None
Boys' Restroom	1	1	Inc								\$ -	\$ -	\$ -	None
Custodian	1	1	Inc								\$ -	\$ -	\$ -	None
BUILDING D											\$ -		\$ -	
Boys' Restroom	1	5	4' T12	2	Fixture	Magnetic	2	N	Electronic	\$ 5.60	\$ 28.00	\$ 60.00	\$ 300.00	Retrofit Recommended
Custodian	1	1	Inc								\$ -	\$ -	\$ -	None
Men's Restroom	1	1	Inc								\$ -	\$ -	\$ -	None

LOCATION	EXISTING EQUIPMENT						PROPOSED			REBATES		COSTS		COMMENTS
Location (Rm Name, Rm. #, Area, Zone, etc.)	Floor	Quantity	Lamp Type	Lamps Per Fixture	Type of Fixture	Ballast Type	Lamps Per Fixture	Reflectors	Ballast Type	Per Single	Extended	Per Single	Extended	Comments
Women's Restroom	1	1	Inc								\$ -	\$ -	\$ -	None
Girls' Restroom	1	5	4' T12	2	Fixture	Magnetic	2	N	Electronic	\$ 5.60	\$ 28.00	\$ 60.00	\$ 300.00	Retrofit Recommended
D101	1	16	4' T12	4	Fixture	Magnetic	4	N	Electronic	\$ 11.20	\$ 179.20	\$ 70.00	\$ 1,120.00	Retrofit Recommended
D102	1	15	4' T12	4	Fixture	Magnetic	4	N	Electronic	\$ 11.20	\$ 168.00	\$ 70.00	\$ 1,050.00	Retrofit Recommended
Exterior	1	3	4' T12	2	Fixture	Magnetic	2	N	Electronic	\$ 5.60	\$ 16.80	\$ 60.00	\$ 180.00	Retrofit Recommended
Bathroom	1	1	4' T12	2	Fixture	Magnetic	2	N	Electronic	\$ 5.60	\$ 5.60	\$ 60.00	\$ 60.00	Retrofit Recommended
Bathroom	1	1	4' T12	2	Fixture	Magnetic	2	N	Electronic	\$ 5.60	\$ 5.60	\$ 60.00	\$ 60.00	Retrofit Recommended
Storage	1	2	4' T12	4	Fixture	Magnetic	4	N	Electronic	\$ 11.20	\$ 22.40	\$ 70.00	\$ 140.00	Retrofit Recommended
D103	1	16	4' T12	4	Fixture	Magnetic	4	N	Electronic	\$ 11.20	\$ 179.20	\$ 70.00	\$ 1,120.00	Retrofit Recommended
Closet	1	2	4' T12	4	Fixture	Magnetic	4	N	Electronic	\$ 11.20	\$ 22.40	\$ 70.00	\$ 140.00	Retrofit Recommended
D104	1	18	4' T12	4	Fixture	Magnetic	4	N	Electronic	\$ 11.20	\$ 201.60	\$ 70.00	\$ 1,260.00	Retrofit Recommended
		6	4' T12	2	Fixture	Magnetic	2	N	Electronic	\$ 5.60	\$ 33.60	\$ 60.00	\$ 360.00	Retrofit Recommended
BUILDING E											\$ -		\$ -	
Library	1	38	4' T12	4	Wrap	Magnetic	4	N	Electronic	\$ 11.20	\$ 425.60	\$ 70.00	\$ 2,660.00	Retrofit Recommended
E108	1	12	4' T12	4	Fixture	Magnetic	4	N	Electronic	\$ 11.20	\$ 134.40	\$ 70.00	\$ 840.00	Retrofit Recommended
	1	3	4' T12	2	Fixture	Magnetic	2	N	Electronic	\$ 5.60	\$ 16.80	\$ 60.00	\$ 180.00	Retrofit Recommended
Boys'	1	1	Inc								\$ -	\$ -	\$ -	None
Atrium	1	1	Inc								\$ -	\$ -	\$ -	None
Shower	1	1	Inc								\$ -	\$ -	\$ -	None
Bath	1	1	Inc								\$ -	\$ -	\$ -	None
Store	1	1	4' T12	1	Fixture	Magnetic	1	N	Electronic	\$ 2.80	\$ 2.80	\$ 55.00	\$ 55.00	Retrofit Recommended
Custodian	1	1	Inc								\$ -	\$ -	\$ -	None
Boys' Restroom	1	3	4' T12	2	Fixture	Magnetic	2	N	Electronic	\$ 5.60	\$ 16.80	\$ 60.00	\$ 180.00	Retrofit Recommended
Teacher's Restroom	1	1	Inc	2							\$ -		\$ -	None
Custodian	1	2	Inc								\$ -	\$ -	\$ -	None
Girls'	1	4	4' T12	2	Fixture	Magnetic	2	N	Electronic	\$ 5.60	\$ 22.40	\$ 60.00	\$ 240.00	Retrofit Recommended
E103	1	9	4' T12	4	Fixture	Magnetic	4	N	Electronic	\$ 11.20	\$ 100.80	\$ 70.00	\$ 630.00	Retrofit Recommended
	1	3	4' T12	2	Fixture	Magnetic	2	N	Electronic	\$ 5.60	\$ 16.80	\$ 60.00	\$ 180.00	Retrofit Recommended
E102	1	9	4' T12	4	Fixture	Magnetic	4	N	Electronic	\$ 11.20	\$ 100.80	\$ 70.00	\$ 630.00	Retrofit Recommended
	1	3	4' T12	2	Fixture	Magnetic	2	N	Electronic	\$ 5.60	\$ 16.80	\$ 60.00	\$ 180.00	Retrofit Recommended
E101	1	9	4' T12	4	Fixture	Magnetic	4	N	Electronic	\$ 11.20	\$ 100.80	\$ 70.00	\$ 630.00	Retrofit Recommended
	1	3	4' T12	2	Fixture	Magnetic	2	N	Electronic	\$ 5.60	\$ 16.80	\$ 60.00	\$ 180.00	Retrofit Recommended
Storage	1	1	Inc								\$ -	\$ -	\$ -	None
E201	2	9	4' T12	4	Fixture	Magnetic	4	N	Electronic	\$ 11.20	\$ 100.80	\$ 70.00	\$ 630.00	Retrofit Recommended
	2	3	4' T12	2	Fixture	Magnetic	2	N	Electronic	\$ 5.60	\$ 16.80	\$ 60.00	\$ 180.00	Retrofit Recommended
E202	2	9	4' T12	4	Fixture	Magnetic	4	N	Electronic	\$ 11.20	\$ 100.80	\$ 70.00	\$ 630.00	Retrofit Recommended

LOCATION (Rm Name, Rm. #, Area, Zone, etc.)	EXISTING EQUIPMENT						PROPOSED			REBATES		COSTS		COMMENTS
	Floor	Quantity	Lamp Type	Lamps Per Fixture	Type of Fixture	Ballast Type	Lamps Per Fixture	Reflectors	Ballast Type	Per Single	Extended	Per Single	Extended	
	2	3	4' T12	2	Fixture	Magnetic	2	N	Electronic	\$ 5.60	\$ 16.80	\$ 60.00	\$ 180.00	Retrofit Recommended
E203	2	9	4' T12	4	Fixture	Magnetic	4	N	Electronic	\$ 11.20	\$ 100.80	\$ 70.00	\$ 630.00	Retrofit Recommended
	2	3	4' T12	2	Fixture	Magnetic	2	N	Electronic	\$ 5.60	\$ 16.80	\$ 60.00	\$ 180.00	Retrofit Recommended
Girls' Restroom	2	4	4' T12	2	Fixture	Magnetic	2	N	Electronic	\$ 5.60	\$ 22.40	\$ 60.00	\$ 240.00	Retrofit Recommended
Custodian	2	2	Inc							\$ -	\$ -	\$ -	\$ -	None
Boys' Restroom	2	3	4' T12	2	Fixture	Magnetic	2	N	Electronic	\$ 5.60	\$ 16.80	\$ 60.00	\$ 180.00	Retrofit Recommended
Teacher's Restroom	2	1	Inc	2						\$ -	\$ -	\$ -	\$ -	None
E208	2	9	4' T12	4	Fixture	Magnetic	4	N	Electronic	\$ 11.20	\$ 100.80	\$ 70.00	\$ 630.00	Retrofit Recommended
	2	3	4' T12	2	Fixture	Magnetic	2	N	Electronic	\$ 5.60	\$ 16.80	\$ 60.00	\$ 180.00	Retrofit Recommended
BUILDING F											\$ -		\$ -	
Teacher's Lounge	2	6	4' T12	4	Fixture	Magnetic	4	N	Electronic	\$ 11.20	\$ 67.20	\$ 70.00	\$ 420.00	Retrofit Recommended
	2	2	4' T12	2	Fixture	Magnetic	2	N	Electronic	\$ 5.60	\$ 11.20	\$ 60.00	\$ 120.00	Retrofit Recommended
Men's Restroom	2	1	4' T12	2	Fixture	Magnetic	2	N	Electronic	\$ 5.60	\$ 5.60	\$ 60.00	\$ 60.00	Retrofit Recommended
Women's Restroom	2	1	4' T12	2	Fixture	Magnetic	2	N	Electronic	\$ 5.60	\$ 5.60	\$ 60.00	\$ 60.00	Retrofit Recommended
F204	2	12	4' T12	4	Fixture	Magnetic	4	N	Electronic	\$ 11.20	\$ 134.40	\$ 70.00	\$ 840.00	Retrofit Recommended
F203	2	12	4' T12	4	Fixture	Magnetic	4	N	Electronic	\$ 11.20	\$ 134.40	\$ 70.00	\$ 840.00	Retrofit Recommended
Janitor	2	1	4' T12	1	Fixture	Magnetic	1	N	Electronic	\$ 2.80	\$ 2.80	\$ 55.00	\$ 55.00	Retrofit Recommended
F202	2	12	4' T12	4	Fixture	Magnetic	4	N	Electronic	\$ 11.20	\$ 134.40	\$ 70.00	\$ 840.00	Retrofit Recommended
F201	2	12	4' T12	4	Fixture	Magnetic	4	N	Electronic	\$ 11.20	\$ 134.40	\$ 70.00	\$ 840.00	Retrofit Recommended
Hall	2	2			CFL Exit					\$ -		\$ -	\$ -	None
Storage	2	1	4' T12	2	Fixture	Magnetic	2	N	Electronic	\$ 5.60	\$ 5.60	\$ 60.00	\$ 60.00	Retrofit Recommended
F101	1	12	4' T12	4	Fixture	Magnetic	4	N	Electronic	\$ 11.20	\$ 134.40	\$ 70.00	\$ 840.00	Retrofit Recommended
F102	1	12	4' T12	4	Fixture	Magnetic	4	N	Electronic	\$ 11.20	\$ 134.40	\$ 70.00	\$ 840.00	Retrofit Recommended
F103	1	12	4' T12	4	Fixture	Magnetic	4	N	Electronic	\$ 11.20	\$ 134.40	\$ 70.00	\$ 840.00	Retrofit Recommended
Mech Room	1	2	4' T12	1	Fixture	Magnetic	1	N	Electronic	\$ 2.80	\$ 5.60	\$ 55.00	\$ 110.00	Retrofit Recommended
Electric Room	1	1	4' T12	2	Fixture	Magnetic	2	N	Electronic	\$ 5.60	\$ 5.60	\$ 60.00	\$ 60.00	Retrofit Recommended
F104	1	12	4' T12	4	Fixture	Magnetic	4	N	Electronic	\$ 11.20	\$ 134.40	\$ 70.00	\$ 840.00	Retrofit Recommended
Boys' Restroom	1	4	4' T12	2	Fixture	Magnetic	2	N	Electronic	\$ 5.60	\$ 22.40	\$ 60.00	\$ 240.00	Retrofit Recommended
Electric Room	1	1	4' T12	2	Fixture	Magnetic	2	N	Electronic	\$ 5.60	\$ 5.60	\$ 60.00	\$ 60.00	Retrofit Recommended
Custodian	1	1	4' T12	2	Fixture	Magnetic	2	N	Electronic	\$ 5.60	\$ 5.60	\$ 60.00	\$ 60.00	Retrofit Recommended
Girls' Restroom	1	5	4' T12	2	Fixture	Magnetic	2	N	Electronic	\$ 5.60	\$ 28.00	\$ 60.00	\$ 300.00	Retrofit Recommended
Storage	1	1	4' T12	2	Fixture	Magnetic	2	N	Electronic	\$ 5.60	\$ 5.60	\$ 60.00	\$ 60.00	Retrofit Recommended
Total Rebates										\$	8,948.80			
Total Costs										\$	60,480.00			

LOCATION	QTY	EXISTING TYPE	QTY	RETROFIT		Existing		Actual			Proposed			
						Watt/unit	Op. Hours	kWh	kW-D	Watt/unit	Op. Hours	kWh	kW-D	
PORTABLES	0		0		0			1,549	0.0	0		1,549	0.0	0
P12	12	4' 4L Fixture	12	Lamp & Low Watt Ballast	Retrofit Recommended	151.2	1,549	2,809.6	1,814.4	100	1,549	1,858.2	1.2	
0	2	60W Inc	0		None		1,549	0.0	0		1,549	0.0	0	
S2	2	4' 4L Fixture	2	Lamp & Low Watt Ballast	Retrofit Recommended	151.2	1,549	468.3	0.3024	100	1,549	309.7	0.2	
P13	16	4' 4L Fixture	16	Lamp & Low Watt Ballast	Retrofit Recommended	151.2	1,549	3,746.1	2,419.2	100	1,549	2,477.6	1.6	
Bathroom	2	60W Inc	0	0	None	0	1,549	0.0	0	0	1,549	0.0	0	
Exterior	2	60W Inc	0	0	None	0	1,549	0.0	0	0	1,549	0.0	0	
P14	16	4' 4L Fixture	16	Lamp & Low Watt Ballast	Retrofit Recommended	151.2	1,549	3,746.1	2,419.2	100	1,549	2,477.6	1.6	
Bathroom	2	60W Inc	0	0	None	0	1,549	0.0	0	0	1,549	0.0	0	
Exterior	2	60W Inc	0	0	None	0	1,549	0.0	0	0	1,549	0.0	0	
P19	12	4' 4L Fixture	12	Lamp & Low Watt Ballast	Retrofit Recommended	151.2	1,549	2,809.6	1,814.4	100	1,549	1,858.2	1.2	
P18	12	4' 4L Fixture	12	Lamp & Low Watt Ballast	Retrofit Recommended	151.2	1,549	2,809.6	1,814.4	100	1,549	1,858.2	1.2	
P1	14	4' 4L Fixture	14	Lamp & Low Watt Ballast	Retrofit Recommended	151.2	1,549	3,277.9	2,116.8	100	1,549	2,167.9	1.4	
Restroom	2	60W Inc	0	0	None	0	1,549	0.0	0	0	1,549	0.0	0	
Exterior	2	60W Inc	0	0	None	0	1,549	0.0	0	0	1,549	0.0	0	
P2A	8	4' 4L Fixture	8	Lamp & Low Watt Ballast	Retrofit Recommended	151.2	1,549	1,873.1	1,209.6	100	1,549	1,238.8	0.8	
P2B	8	4' 4L Fixture	8	Lamp & Low Watt Ballast	Retrofit Recommended	151.2	1,549	1,873.1	1,209.6	100	1,549	1,238.8	0.8	
P24	12	4' 4L Fixture	12	Lamp & Low Watt Ballast	Retrofit Recommended	151.2	1,549	2,809.6	1,814.4	100	1,549	1,858.2	1.2	
P2	12	4' 4L Fixture	12	Lamp & Low Watt Ballast	Retrofit Recommended	151.2	1,549	2,809.6	1,814.4	100	1,549	1,858.2	1.2	
P20	12	4' 4L Fixture	12	Lamp & Low Watt Ballast	Retrofit Recommended	151.2	1,549	2,809.6	1,814.4	100	1,549	1,858.2	1.2	
P22	12	4' 4L Fixture	12	Lamp & Low Watt Ballast	Retrofit Recommended	151.2	1,549	2,809.6	1,814.4	100	1,549	1,858.2	1.2	
P23	12	4' 4L Fixture	12	Lamp & Low Watt Ballast	Retrofit Recommended	151.2	1,549	2,809.6	1,814.4	100	1,549	1,858.2	1.2	
BUILDING A	0		0		Retrofit Recommended		1,549	0.0	0		1,549	0.0	0	
Mech Room	2	60W Inc	0	0	None	0	1,549	0.0	0	0	1,549	0.0	0	
Exterior Lower	12	60W Inc	0	0	None	0	1,549	0.0	0	0	1,549	0.0	0	
A101	9	4' 4L Fixture	9	Lamp & Low Watt Ballast	Retrofit Recommended	151.2	1,549	2,107.2	1,360.8	100	1,549	1,393.7	0.9	
Storage	1	60W Inc	0	0	None	0	1,549	0.0	0	0	1,549	0.0	0	
A102	9	4' 4L Fixture	9	Lamp & Low Watt Ballast	Retrofit Recommended	151.2	1,549	2,107.2	1,360.8	100	1,549	1,393.7	0.9	
Storage	1	60W Inc	0	0	None	0	1,549	0.0	0	0	1,549	0.0	0	
A103	9	4' 4L Fixture	9	Lamp & Low Watt Ballast	Retrofit Recommended	151.2	1,549	2,107.2	1,360.8	100	1,549	1,393.7	0.9	
Storage	1	60W Inc	0	0	None	0	1,549	0.0	0	0	1,549	0.0	0	
A104	8	4' 4L Fixture	8	Lamp & Low Watt Ballast	Retrofit Recommended	151.2	1,549	1,873.1	1,209.6	100	1,549	1,238.8	0.8	
C Office	1	4' 2L Fixture	1	Lamp & Low Watt Ballast	Retrofit Recommended	75.6	1,549	117.1	0.0756	51	1,549	79.0	0.051	
Boys' Restroom	5	4' 2L Fixture	5	Lamp & Low Watt Ballast	Retrofit Recommended	75.6	1,549	585.3	0.378	51	1,549	394.9	0.255	
Custodial	1	60W Inc	0	0	None	0	1,549	0.0	0	0	1,549	0.0	0	
Elevator	4	4' 1L Fixture	4	Lamp & Low Watt Ballast	Retrofit Recommended	45.6	1,549	282.4	0.1824	31	1,549	192.0	0.124	
Girls' Restroom	5	4' 4L Fixture	5	Lamp & Low Watt Ballast	Retrofit Recommended	151.2	1,549	1,170.7	0.756	100	1,549	774.3	0.5	
Storage	1	60W Inc	0	0	None	0	1,549	0.0	0	0	1,549	0.0	0	
A105	9	4' 4L Fixture	9	Lamp & Low Watt Ballast	Retrofit Recommended	151.2	1,549	2,107.2	1,360.8	100	1,549	1,393.7	0.9	
0	3	4' 2L Fixture	3	Lamp & Low Watt Ballast	Retrofit Recommended	75.6	1,549	351.2	0.2268	51	1,549	236.9	0.153	
A 106	9	4' 4L Fixture	9	Lamp & Low Watt Ballast	Retrofit Recommended	151.2	1,549	2,107.2	1,360.8	100	1,549	1,393.7	0.9	
0	3	4' 2L Fixture	3	Lamp & Low Watt Ballast	Retrofit Recommended	75.6	1,549	351.2	0.2268	51	1,549	236.9	0.153	
A107	9	4' 4L Fixture	9	Lamp & Low Watt Ballast	Retrofit Recommended	151.2	1,549	2,107.2	1,360.8	100	1,549	1,393.7	0.9	
0	3	4' 2L Fixture	3	Lamp & Low Watt Ballast	Retrofit Recommended	75.6	1,549	351.2	0.2268	51	1,549	236.9	0.153	
A108	9	4' 4L Fixture	9	Lamp & Low Watt Ballast	Retrofit Recommended	151.2	1,549	2,107.2	1,360.8	100	1,549	1,393.7	0.9	
0	3	4' 2L Fixture	3	Lamp & Low Watt Ballast	Retrofit Recommended	75.6	1,549	351.2	0.2268	51	1,549	236.9	0.153	
Stairway	1	60W Inc	0	0	None	0	1,549	0.0	0	0	1,549	0.0	0	
Exterior	15	60W Inc	0	0	None	0	1,549	0.0	0	0	1,549	0.0	0	
A208	9	4' 4L Fixture	9	Lamp & Low Watt Ballast	Retrofit Recommended	151.2	1,549	2,107.2	1,360.8	100	1,549	1,393.7	0.9	
0	3	4' 2L Fixture	3	Lamp & Low Watt Ballast	Retrofit Recommended	75.6	1,549	351.2	0.2268	51	1,549	236.9	0.153	
A207	9	4' 4L Fixture	9	Lamp & Low Watt Ballast	Retrofit Recommended	151.2	1,549	2,107.2	1,360.8	100	1,549	1,393.7	0.9	
0	3	4' 2L Fixture	3	Lamp & Low Watt Ballast	Retrofit Recommended	75.6	1,549	351.2	0.2268	51	1,549	236.9	0.153	
A206	9	4' 4L Fixture	9	Lamp & Low Watt Ballast	Retrofit Recommended	151.2	1,549	2,107.2	1,360.8	100	1,549	1,393.7	0.9	
0	3	4' 2L Fixture	3	Lamp & Low Watt Ballast	Retrofit Recommended	75.6	1,549	351.2	0.2268	51	1,549	236.9	0.153	
A205	9	4' 4L Fixture	9	Lamp & Low Watt Ballast	Retrofit Recommended	151.2	1,549	2,107.2	1,360.8	100	1,549	1,393.7	0.9	
0	3	4' 2L Fixture	3	Lamp & Low Watt Ballast	Retrofit Recommended	75.6	1,549	351.2	0.2268	51	1,549	236.9	0.153	
Girls' Restroom	5	4' 2L Fixture	5	Lamp & Low Watt Ballast	Retrofit Recommended	75.6	1,549	585.3	0.378	51	1,549	394.9	0.255	
Janitor's Closet	1	60W Inc	0	0	None	0	1,549	0.0	0	0	1,549	0.0	0	
Boys' Restroom	5	4' 2L Fixture	5	Lamp & Low Watt Ballast	Retrofit Recommended	75.6	1,549	585.3	0.378	51	1,549	394.9	0.255	
A204	9	4' 4L Fixture	9	Lamp & Low Watt Ballast	Retrofit Recommended	151.2	1,549	2,107.2	1,360.8	100	1,549	1,393.7	0.9	

LOCATION	QTY	EXISTING TYPE	QTY	RETROFIT		Existing				Proposed			
						Watt/unit	Op. Hours	kWh	kW-D	Watt/unit	Op. Hours	kWh	kW-D
<i>Storage</i>	1	60W Inc	0	0	None	0	1,549	0.0	0	0	1,549	0.0	0
<i>A203</i>	9	4' 4L Fixture	9	Lamp & Low Watt Ballast	Retrofit Recommended	151.2	1,549	2,107.2	1.3608	100	1,549	1,393.7	0.9
<i>Storage</i>	1	60W Inc	0	0	None	0	1,549	0.0	0	0	1,549	0.0	0
<i>A202</i>	9	4' 4L Fixture	9	Lamp & Low Watt Ballast	Retrofit Recommended	151.2	1,549	2,107.2	1.3608	100	1,549	1,393.7	0.9
<i>Storage</i>	1	60W Inc	0	0	None	0	1,549	0.0	0	0	1,549	0.0	0
<i>A201</i>	9	4' 4L Fixture	9	Lamp & Low Watt Ballast	Retrofit Recommended	151.2	1,549	2,107.2	1.3608	100	1,549	1,393.7	0.9
<i>Storage</i>	1	60W Inc	0	0	None	0	1,549	0.0	0	0	1,549	0.0	0
<i>Teacher</i>	8	4' 4L Fixture	8	Lamp & Low Watt Ballast	Retrofit Recommended	151.2	1,549	1,873.1	1.2096	100	1,549	1,238.8	0.8
<i>0</i>	4	4' 2L Fixture	4	Lamp & Low Watt Ballast	Retrofit Recommended	75.6	1,549	468.3	0.3024	51	1,549	315.9	0.204
<i>Restroom</i>	2	60W Inc	0	0	None	0	1,549	0.0	0	0	1,549	0.0	0
BUILDING B	0		0		0		1,549	0.0	0		1,549	0.0	0
<i>B104</i>	12	4' 4L Fixture	12	Lamp & Low Watt Ballast	Retrofit Recommended	151.2	1,549	2,809.6	1.8144	100	1,549	1,858.2	1.2
<i>B103</i>	12	4' 4L Fixture	12	Lamp & Low Watt Ballast	Retrofit Recommended	151.2	1,549	2,809.6	1.8144	100	1,549	1,858.2	1.2
<i>Teacher's Room</i>	5	4' 4L Fixture	5	Lamp & Low Watt Ballast	Retrofit Recommended	151.2	1,549	1,170.7	0.756	100	1,549	774.3	0.5
<i>Restroom</i>	1	60W Inc	0	0	None	0	1,549	0.0	0	0	1,549	0.0	0
<i>Girls' Restroom</i>	3	4' 4L Fixture	3	Lamp & Low Watt Ballast	Retrofit Recommended	151.2	1,549	702.4	0.4536	100	1,549	464.6	0.3
<i>Custodian</i>	1	60W Inc	0	0	None	0	1,549	0.0	0	0	1,549	0.0	0
<i>Boys' Restroom</i>	3	4' 4L Fixture	3	Lamp & Low Watt Ballast	Retrofit Recommended	151.2	1,549	702.4	0.4536	100	1,549	464.6	0.3
<i>B102</i>	12	4' 4L Fixture	12	Lamp & Low Watt Ballast	Retrofit Recommended	151.2	1,549	2,809.6	1.8144	100	1,549	1,858.2	1.2
<i>B101</i>	12	4' 4L Fixture	12	Lamp & Low Watt Ballast	Retrofit Recommended	151.2	1,549	2,809.6	1.8144	100	1,549	1,858.2	1.2
<i>CAFETERIA</i>	45	4' 4L Fixture	45	Lamp & Low Watt Ballast	Retrofit Recommended	151.2	1,549	10,536.0	6.804	100	1,549	6,968.3	4.5
<i>Office</i>	2	4' 2L Fixture	2	Lamp & Low Watt Ballast	Retrofit Recommended	75.6	1,549	234.1	0.1512	51	1,549	157.9	0.102
<i>Stage</i>	6	4' 2L Fixture	6	Lamp & Low Watt Ballast	Retrofit Recommended	75.6	1,549	702.4	0.4536	51	1,549	473.8	0.306
<i>Office</i>	3	4' 2L Fixture	3	Lamp & Low Watt Ballast	Retrofit Recommended	75.6	1,549	351.2	0.2268	51	1,549	236.9	0.153
<i>Sound Equipment</i>	1	60W Inc	0	0	None	0	1,549	0.0	0	0	1,549	0.0	0
<i>Kitchen</i>	6	4' 4L Fixture	6	Lamp & Low Watt Ballast	Retrofit Recommended	151.2	1,549	1,404.8	0.9072	100	1,549	929.1	0.6
<i>0</i>	25	4' 2L Fixture	25	Lamp & Low Watt Ballast	Retrofit Recommended	75.6	1,549	2,926.7	1.89	51	1,549	1,974.3	1.275
<i>Office</i>	2	4' 4L Fixture	2	Lamp & Low Watt Ballast	Retrofit Recommended	151.2	1,549	468.3	0.3024	100	1,549	309.7	0.2
<i>Women's Restroom</i>	1	4' 2L Fixture	1	Lamp & Low Watt Ballast	Retrofit Recommended	75.6	1,549	117.1	0.0756	51	1,549	79.0	0.051
<i>0</i>	1	60W Inc	0	0	None	0	1,549	0.0	0	0	1,549	0.0	0
<i>Dining Area</i>	10	4' 2L Fixture	10	Lamp & Low Watt Ballast	Retrofit Recommended	75.6	1,549	1,170.7	0.756	51	1,549	789.7	0.51
<i>Custodian</i>	2	4' 2L Fixture	2	Lamp & Low Watt Ballast	Retrofit Recommended	75.6	1,549	234.1	0.1512	51	1,549	157.9	0.102
<i>Men's Restroom</i>	1	60W Inc	0	0	None	0	1,549	0.0	0	0	1,549	0.0	0
<i>Pump Station</i>	2	60W Inc	0	0	None	0	1,549	0.0	0	0	1,549	0.0	0
<i>Heater Room</i>	2	60W Inc	0	0	None	0	1,549	0.0	0	0	1,549	0.0	0
<i>Electric Room</i>	2	60W Inc	0	0	None	0	1,549	0.0	0	0	1,549	0.0	0
<i>Girls' restroom</i>	1	60W Inc	0	0	None	0	1,549	0.0	0	0	1,549	0.0	0
<i>Boys' Restroom</i>	1	60W Inc	0	0	None	0	1,549	0.0	0	0	1,549	0.0	0
<i>Custodian</i>	1	60W Inc	0	0	None	0	1,549	0.0	0	0	1,549	0.0	0
BUILDING D	0		0		0		1,549	0.0	0		1,549	0.0	0
<i>Boys' Restroom</i>	5	4' 2L Fixture	5	Lamp & Low Watt Ballast	Retrofit Recommended	75.6	1,549	585.3	0.378	51	1,549	394.9	0.255
<i>Custodian</i>	1	60W Inc	0	0	None	0	1,549	0.0	0	0	1,549	0.0	0
<i>Men's Restroom</i>	1	60W Inc	0	0	None	0	1,549	0.0	0	0	1,549	0.0	0
<i>Women's Restroom</i>	1	60W Inc	0	0	None	0	1,549	0.0	0	0	1,549	0.0	0
<i>Girls' Restroom</i>	5	4' 2L Fixture	5	Lamp & Low Watt Ballast	Retrofit Recommended	75.6	1,549	585.3	0.378	51	1,549	394.9	0.255
<i>D101</i>	16	4' 4L Fixture	16	Lamp & Low Watt Ballast	Retrofit Recommended	151.2	1,549	3,746.1	2.4192	100	1,549	2,477.6	1.6
<i>D102</i>	15	4' 4L Fixture	15	Lamp & Low Watt Ballast	Retrofit Recommended	151.2	1,549	3,512.0	2.268	100	1,549	2,322.8	1.5
<i>Exterior</i>	3	4' 2L Fixture	3	Lamp & Low Watt Ballast	Retrofit Recommended	75.6	1,549	351.2	0.2268	51	1,549	236.9	0.153
<i>Bathroom</i>	1	4' 2L Fixture	1	Lamp & Low Watt Ballast	Retrofit Recommended	75.6	1,549	117.1	0.0756	51	1,549	79.0	0.051
<i>Bathroom</i>	1	4' 2L Fixture	1	Lamp & Low Watt Ballast	Retrofit Recommended	75.6	1,549	117.1	0.0756	51	1,549	79.0	0.051
<i>Storage</i>	2	4' 4L Fixture	2	Lamp & Low Watt Ballast	Retrofit Recommended	151.2	1,549	468.3	0.3024	100	1,549	309.7	0.2
<i>D103</i>	16	4' 4L Fixture	16	Lamp & Low Watt Ballast	Retrofit Recommended	151.2	1,549	3,746.1	2.4192	100	1,549	2,477.6	1.6
<i>Closet</i>	2	4' 4L Fixture	2	Lamp & Low Watt Ballast	Retrofit Recommended	151.2	1,549	468.3	0.3024	100	1,549	309.7	0.2
<i>D104</i>	18	4' 4L Fixture	18	Lamp & Low Watt Ballast	Retrofit Recommended	151.2	1,549	4,214.4	2.7216	100	1,549	2,787.3	1.8
<i>0</i>	6	4' 2L Fixture	6	Lamp & Low Watt Ballast	Retrofit Recommended	75.6	1,549	702.4	0.4536	51	1,549	473.8	0.306
BUILDING E	0		0		0		1,549	0.0	0		1,549	0.0	0
<i>Library</i>	38	4' 4L Fixture	38	Lamp & Low Watt Ballast	Retrofit Recommended	151.2	1,549	8,897.1	5.7456	100	1,549	5,884.3	3.8
<i>E108</i>	12	4' 4L Fixture	12	Lamp & Low Watt Ballast	Retrofit Recommended	151.2	1,549	2,809.6	1.8144	100	1,549	1,858.2	1.2
<i>0</i>	3	4' 2L Fixture	3	Lamp & Low Watt Ballast	Retrofit Recommended	75.6	1,549	351.2	0.2268	51	1,549	236.9	0.153
<i>Boys'</i>	1	60W Inc	0	0	None	0	1,549	0.0	0	0	1,549	0.0	0
<i>Atrium</i>	1	60W Inc	0	0	None	0	1,549	0.0	0	0	1,549	0.0	0
<i>Shower</i>	1	60W Inc	0	0	None	0	1,549	0.0	0	0	1,549	0.0	0
<i>Bath</i>	1	60W Inc	0	0	None	0	1,549	0.0	0	0	1,549	0.0	0

LOCATION	QTY	EXISTING TYPE	QTY	RETROFIT		Existing		Actual			Proposed		
						Watt/unit	Op. Hours	kWh	kW-D	Watt/unit	Op. Hours	kWh	kW-D
Store	1	4' 1L Fixture	1	Lamp & Low Watt Ballast	Retrofit Recommended	45.6	1,549	70.6	0.0456	31	1,549	48.0	0.031
Custodian	1	60W Inc	0	0	None	0	1,549	0.0	0	0	1,549	0.0	0
Boys' Restroom	3	4' 2L Fixture	3	Lamp & Low Watt Ballast	Retrofit Recommended	75.6	1,549	351.2	0.2268	51	1,549	236.9	0.153
Teacher's Restroom	1	2L 60W Inc	0	0	None	0	1,549	0.0	0	0	1,549	0.0	0
Custodian	2	60W Inc	0	0	None	0	1,549	0.0	0	0	1,549	0.0	0
Girls'	4	4' 2L Fixture	4	Lamp & Low Watt Ballast	Retrofit Recommended	75.6	1,549	468.3	0.3024	51	1,549	315.9	0.204
E103	9	4' 4L Fixture	9	Lamp & Low Watt Ballast	Retrofit Recommended	151.2	1,549	2,107.2	1.3608	100	1,549	1,393.7	0.9
0	3	4' 2L Fixture	3	Lamp & Low Watt Ballast	Retrofit Recommended	75.6	1,549	351.2	0.2268	51	1,549	236.9	0.153
E102	9	4' 4L Fixture	9	Lamp & Low Watt Ballast	Retrofit Recommended	151.2	1,549	2,107.2	1.3608	100	1,549	1,393.7	0.9
0	3	4' 2L Fixture	3	Lamp & Low Watt Ballast	Retrofit Recommended	75.6	1,549	351.2	0.2268	51	1,549	236.9	0.153
E101	9	4' 4L Fixture	9	Lamp & Low Watt Ballast	Retrofit Recommended	151.2	1,549	2,107.2	1.3608	100	1,549	1,393.7	0.9
0	3	4' 2L Fixture	3	Lamp & Low Watt Ballast	Retrofit Recommended	75.6	1,549	351.2	0.2268	51	1,549	236.9	0.153
Storage	1	60W Inc	0	0	None	0	1,549	0.0	0	0	1,549	0.0	0
E201	9	4' 4L Fixture	9	Lamp & Low Watt Ballast	Retrofit Recommended	151.2	1,549	2,107.2	1.3608	100	1,549	1,393.7	0.9
0	3	4' 2L Fixture	3	Lamp & Low Watt Ballast	Retrofit Recommended	75.6	1,549	351.2	0.2268	51	1,549	236.9	0.153
E202	9	4' 4L Fixture	9	Lamp & Low Watt Ballast	Retrofit Recommended	151.2	1,549	2,107.2	1.3608	100	1,549	1,393.7	0.9
0	3	4' 2L Fixture	3	Lamp & Low Watt Ballast	Retrofit Recommended	75.6	1,549	351.2	0.2268	51	1,549	236.9	0.153
E203	9	4' 4L Fixture	9	Lamp & Low Watt Ballast	Retrofit Recommended	151.2	1,549	2,107.2	1.3608	100	1,549	1,393.7	0.9
0	3	4' 2L Fixture	3	Lamp & Low Watt Ballast	Retrofit Recommended	75.6	1,549	351.2	0.2268	51	1,549	236.9	0.153
Girls' Restroom	4	4' 2L Fixture	4	Lamp & Low Watt Ballast	Retrofit Recommended	75.6	1,549	468.3	0.3024	51	1,549	315.9	0.204
Custodian	2	60W Inc	0	0	None	0	1,549	0.0	0	0	1,549	0.0	0
Boys' Restroom	3	4' 2L Fixture	3	Lamp & Low Watt Ballast	Retrofit Recommended	75.6	1,549	351.2	0.2268	51	1,549	236.9	0.153
Teacher's Restroom	1	60W Inc	0	0	None	0	1,549	0.0	0	0	1,549	0.0	0
E208	9	4' 4L Fixture	9	Lamp & Low Watt Ballast	Retrofit Recommended	151.2	1,549	2,107.2	1.3608	100	1,549	1,393.7	0.9
0	3	4' 2L Fixture	3	Lamp & Low Watt Ballast	Retrofit Recommended	75.6	1,549	351.2	0.2268	51	1,549	236.9	0.153
BUILDING F	0		0		0		1,549	0.0	0		1,549	0.0	0
Teacher's Lounge	6	4' 4L Fixture	6	Lamp & Low Watt Ballast	Retrofit Recommended	151.2	1,549	1,404.8	0.9072	100	1,549	929.1	0.6
0	2	4' 2L Fixture	2	Lamp & Low Watt Ballast	Retrofit Recommended	75.6	1,549	234.1	0.1512	51	1,549	157.9	0.102
Men's Restroom	1	4' 2L Fixture	1	Lamp & Low Watt Ballast	Retrofit Recommended	75.6	1,549	117.1	0.0756	51	1,549	79.0	0.051
Women's Restroom	1	4' 2L Fixture	1	Lamp & Low Watt Ballast	Retrofit Recommended	75.6	1,549	117.1	0.0756	51	1,549	79.0	0.051
F204	12	4' 4L Fixture	12	Lamp & Low Watt Ballast	Retrofit Recommended	151.2	1,549	2,809.6	1.8144	100	1,549	1,858.2	1.2
F203	12	4' 4L Fixture	12	Lamp & Low Watt Ballast	Retrofit Recommended	151.2	1,549	2,809.6	1.8144	100	1,549	1,858.2	1.2
Janitor	1	4' 1L Fixture	1	Lamp & Low Watt Ballast	Retrofit Recommended	45.6	1,549	70.6	0.0456	31	1,549	48.0	0.031
F202	12	4' 4L Fixture	12	Lamp & Low Watt Ballast	Retrofit Recommended	151.2	1,549	2,809.6	1.8144	100	1,549	1,858.2	1.2
F201	12	4' 4L Fixture	12	Lamp & Low Watt Ballast	Retrofit Recommended	151.2	1,549	2,809.6	1.8144	100	1,549	1,858.2	1.2
Hall	2	CFL Exit Sign	0		None		1,549	0.0	0		1,549	0.0	0
Storage	1	4' 2L Fixture	1	Lamp & Low Watt Ballast	Retrofit Recommended	75.6	1,549	117.1	0.0756	51	1,549	79.0	0.051
F101	12	4' 4L Fixture	12	Lamp & Low Watt Ballast	Retrofit Recommended	151.2	1,549	2,809.6	1.8144	100	1,549	1,858.2	1.2
F102	12	4' 4L Fixture	12	Lamp & Low Watt Ballast	Retrofit Recommended	151.2	1,549	2,809.6	1.8144	100	1,549	1,858.2	1.2
F103	12	4' 4L Fixture	12	Lamp & Low Watt Ballast	Retrofit Recommended	151.2	1,549	2,809.6	1.8144	100	1,549	1,858.2	1.2
Mech Room	2	4' 1L Fixture	2	Lamp & Low Watt Ballast	Retrofit Recommended	45.6	1,549	141.2	0.0912	31	1,549	96.0	0.062
Electric Room	1	4' 2L Fixture	1	Lamp & Low Watt Ballast	Retrofit Recommended	75.6	1,549	117.1	0.0756	51	1,549	79.0	0.051
F104	12	4' 4L Fixture	12	Lamp & Low Watt Ballast	Retrofit Recommended	151.2	1,549	2,809.6	1.8144	100	1,549	1,858.2	1.2
Boys' Restroom	4	4' 2L Fixture	4	Lamp & Low Watt Ballast	Retrofit Recommended	75.6	1,549	468.3	0.3024	51	1,549	315.9	0.204
Electric Room	1	4' 2L Fixture	1	Lamp & Low Watt Ballast	Retrofit Recommended	75.6	1,549	117.1	0.0756	51	1,549	79.0	0.051
Custodian	1	4' 2L Fixture	1	Lamp & Low Watt Ballast	Retrofit Recommended	75.6	1,549	117.1	0.0756	51	1,549	79.0	0.051
Girls' Restroom	5	4' 2L Fixture	5	Lamp & Low Watt Ballast	Retrofit Recommended	75.6	1,549	585.3	0.378	51	1,549	394.9	0.255
Storage	1	4' 2L Fixture	1	Lamp & Low Watt Ballast	Retrofit Recommended	75.6	1,549	117.1	0.0756	51	1,549	79.0	0.051
Existing						977	Proposed						890

ENERGY CALCULATIONS		
Description	kW-Demand	kWh
Existing Use	120.87	187,169
Proposed Use	80.12	124,063
Difference - Savings	40.75	63,106
Electrical Utility Cost	\$5.75	\$0.15412
Savings per Year	\$2,811.97	\$9,725.91
Total Yearly Energy Savings		\$12,537.88

Kilohana Elementary School Map

Boys' Bathrooms	WK. RM.	Girls' Bathrooms
-----------------	---------	------------------

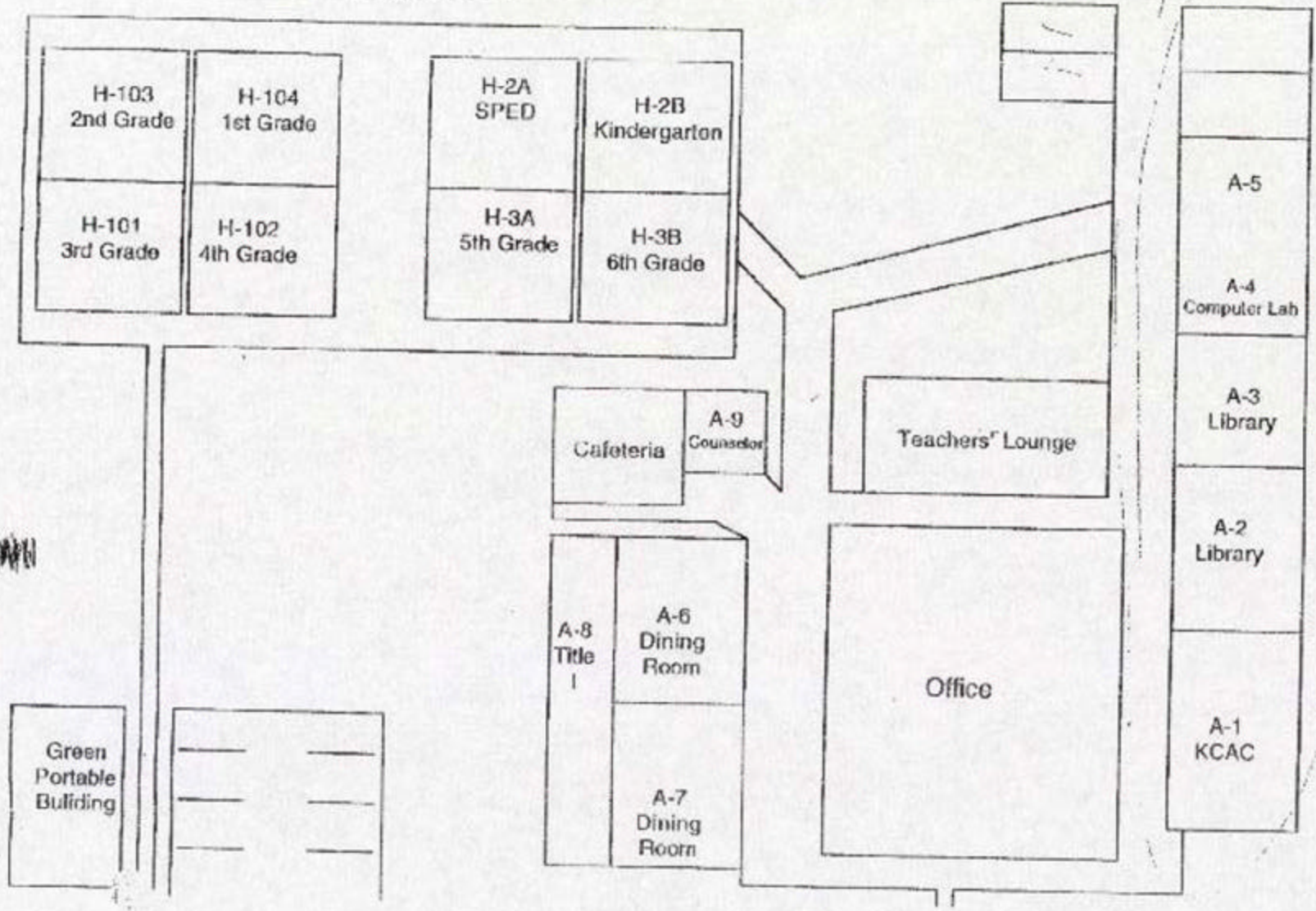

Maui Smart Schools Program
Foot Candle Readings

Kilohana

School

Room: Bldg. H H-102

Ceiling height: 9'

Light fixture height: 7'

Fixture type: TROFFER

25	30
	33
31	27

Room: Bldg. A A-4

Ceiling height: 9'

Light fixture height: 7'

Fixture type: TROFFER

28	30
	39
34	32

Room: Bldg. A A6+7

Ceiling height: 15'

Light fixture height: 10'

Fixture type: WRAP

35	30
	39
32	31



SCHOOL INFORMATION			
NAME Kilohana Elementary School			DATE 2/23/2001
STREET ADDRESS H C 01, Box 334 Kaunakakai, HI 96748-9701			OPERATIONAL HOURS 1,630
POINT OF CONTACT Allen Ashitomi		PHONE 558-2200	FAX 120V
AUDITOR Maui Community College Auditors			

LOCATION Location (Rm Name, Rm. #, Area, Zone, etc.)	EXISTING EQUIPMENT						PROPOSED			REBATES		COSTS		COMMENTS Surveyors Comments
	Floor	Quantity	Lamp Type	Lamps Per Fixture	Type of Fixture	Ballast Type	Lamps Per Fixture	Reflectors	Ballast Type	Per Single	Extended	Per Single	Extended	
Girls' Restroom	1	3	4' T12	2	Wrap	Magnetic	2	N	Electronic	\$ 5.60	\$ 16.80	\$ 60.00	\$ 180.00	excellent opportunity for retro-fit
	1	4	4' T12	4	Troffer	Magnetic	4	N	Electronic	\$ 11.20	\$ 44.80	\$ 70.00	\$ 280.00	excellent opportunity for retro-fit
	1	1	4' T12	4	Wrap	Magnetic	4	N	Electronic	\$ 11.20	\$ 11.20	\$ 70.00	\$ 70.00	excellent opportunity for retro-fit
Boys' Restroom	1	4	4' T12	2	Wrap	Magnetic	2	N	Electronic	\$ 5.60	\$ 22.40	\$ 60.00	\$ 240.00	excellent opportunity for retro-fit
H 104	1	3	4' T12	2	Wrap	Magnetic	2	N	Electronic	\$ 5.60	\$ 16.80	\$ 60.00	\$ 180.00	excellent opportunity for retro-fit
	1	9	4' T12	4	Troffer	Magnetic	4	N	Electronic	\$ 11.20	\$ 100.80	\$ 70.00	\$ 630.00	excellent opportunity for retro-fit
H 103	1	2	4' T12	2	Troffer	Magnetic	2	N	Electronic	\$ 5.60	\$ 11.20	\$ 60.00	\$ 120.00	excellent opportunity for retro-fit
	1	9	4' T12	4	Troffer	Magnetic	4	N	Electronic	\$ 11.20	\$ 100.80	\$ 70.00	\$ 630.00	excellent opportunity for retro-fit
H 2A	1	9	4' T12	4	Troffer	Magnetic	4	N	Electronic	\$ 11.20	\$ 100.80	\$ 70.00	\$ 630.00	excellent opportunity for retro-fit
	1	3	4' T12	2	Troffer	Magnetic	2	N	Electronic	\$ 5.60	\$ 16.80	\$ 60.00	\$ 180.00	excellent opportunity for retro-fit
H 2B	1	9	4' T12	4	Troffer	Magnetic	4	N	Electronic	\$ 11.20	\$ 100.80	\$ 70.00	\$ 630.00	excellent opportunity for retro-fit
	1	2	4' T12	2	Troffer	Magnetic	2	N	Electronic	\$ 5.60	\$ 11.20	\$ 60.00	\$ 120.00	excellent opportunity for retro-fit
H 3A	1	9	4' T12	4	Troffer	Magnetic	4	N	Electronic	\$ 11.20	\$ 100.80	\$ 70.00	\$ 630.00	excellent opportunity for retro-fit
	1	2	4' T12	2	Troffer	Magnetic	2	N	Electronic	\$ 5.60	\$ 11.20	\$ 60.00	\$ 120.00	excellent opportunity for retro-fit
H 3B	1	9	4' T12	4	Troffer	Magnetic	4	N	Electronic	\$ 11.20	\$ 100.80	\$ 70.00	\$ 630.00	excellent opportunity for retro-fit
	1	3	4' T12	2	Troffer	Magnetic	2	N	Electronic	\$ 5.60	\$ 16.80	\$ 60.00	\$ 180.00	excellent opportunity for retro-fit
H 102	1	2	4' T12	2	Troffer	Magnetic	2	N	Electronic	\$ 5.60	\$ 11.20	\$ 60.00	\$ 120.00	excellent opportunity for retro-fit
	1	9	4' T12	4	Troffer	Magnetic	4	N	Electronic	\$ 11.20	\$ 100.80	\$ 70.00	\$ 630.00	excellent opportunity for retro-fit
H 101	1	9	4' T12	4	Troffer	Magnetic	4	N	Electronic	\$ 11.20	\$ 100.80	\$ 70.00	\$ 630.00	excellent opportunity for retro-fit
	1	3	4' T12	2	Troffer	Magnetic	2	N	Electronic	\$ 5.60	\$ 16.80	\$ 60.00	\$ 180.00	excellent opportunity for retro-fit
A 1	1	6	4' T12	4	Ice	Magnetic	4	N	Electronic	\$ 11.20	\$ 67.20	\$ 160.00	\$ 960.00	Replace fixture and mount hardware
A 2	1	9	4' T12	4	Ice	Magnetic	4	N	Electronic	\$ 11.20	\$ 100.80	\$ 160.00	\$ 1,440.00	Replace fixture and mount hardware
A 3	1	9	4' T12	4	Ice	Magnetic	4	N	Electronic	\$ 11.20	\$ 100.80	\$ 160.00	\$ 1,440.00	Replace fixture and mount hardware
A 4	1	9	4' T12	4	Ice	Magnetic	4	N	Electronic	\$ 11.20	\$ 100.80	\$ 160.00	\$ 1,440.00	Replace fixture and mount hardware
A 5	1	9	4' T12	4	Ice	Magnetic	4	N	Electronic	\$ 11.20	\$ 100.80	\$ 160.00	\$ 1,440.00	Replace fixture and mount hardware
Teachers' Lounge	1	4	4' T12	4	Ice	Magnetic	4	N	Electronic	\$ 11.20	\$ 44.80	\$ 160.00	\$ 640.00	Replace fixture and mount hardware
Office A/J	1	4	4' T12	4	Ice	Magnetic	4	N	Electronic	\$ 11.20	\$ 44.80	\$ 160.00	\$ 640.00	Replace fixture and mount hardware
Health Room	1	7	8' T12	2	Ice	Magnetic	2	N	Electronic	\$ 7.20	\$ 50.40	\$ 160.00	\$ 1,120.00	Replace fixture and mount hardware
	1	1	4' T12	4	Ice	Magnetic	4	N	Electronic	\$ 11.20	\$ 11.20	\$ 160.00	\$ 160.00	Replace fixture and mount hardware
A 7														
Dining Room	1	12	4' T12	4	Ice	Magnetic	4	N	Electronic	\$ 11.20	\$ 134.40	\$ 160.00	\$ 1,920.00	Replace fixture and mount hardware
A 9 Counselor	1	4	4' T12	4	Troffer	Magnetic	4	N	Electronic	\$ 11.20	\$ 44.80	\$ 70.00	\$ 280.00	Excellent opportunity for retro-fit

LOCATION	EXISTING EQUIPMENT						PROPOSED			REBATES		COSTS		COMMENTS	
Location (Rm Name, Rm. #, Area, Zone, etc.)	Floor	Quantity	Lamp Type	Lamps Per Fixture	Type of Fixture	Ballast Type	Lamps Per Fixture	Reflectors	Ballast Type	Per Single	Extended	Per Single	Extended	Surveyors Comments	
Cafeteria	1	7	4' T12	2	Wrap	Magnetic	2	N	Electronic	\$ 5.60	\$ 39.20	\$ 60.00	\$ 420.00	Excellent opportunity for retro-fit	
	1	2	4' T12	2	Troffer	Magnetic	2	N	Electronic	\$ 5.60	\$ 11.20	\$ 60.00	\$ 120.00	Excellent opportunity for retro-fit	
	1	4	4' T12	4	Troffer	Magnetic	4	N	Electronic	\$ 11.20	\$ 44.80	\$ 70.00	\$ 280.00	Excellent opportunity for retro-fit	
Title	1	8	4' T12	4	Ice	Magnetic	4	N	Electronic	\$ 11.20	\$ 89.60	\$ 70.00	\$ 560.00	Replace fixture and mount hardware	
Total Rebates										\$	1,999.20				
Total Costs										\$	19,870.00				

LOCATION	QTY	EXISTING TYPE	QTY	RETROFIT	SURVEYORS COMMENTS	Existing				Actual				Proposed			
						Watt/unit	Op. Hours	kWh	kW-D	Watt/unit	Op. Hours	kWh	kW-D	Watt/unit	Op. Hours	kWh	kW-D
<i>Girls' Restroom</i>	3	4' 2L Fixture	3	Lamp & Low Watt Ballast	excellent opportunity for retro-fit	75.6	1,630	369.7	0.2268	51	1,630	249.4	0.153				
<i>0</i>	4	4' 4L Fixture	4	Lamp & Low Watt Ballast	excellent opportunity for retro-fit	151.2	1,630	985.8	0.6048	100	1,630	652.0	0.4				
<i>0</i>	1	4' 4L Fixture	1	Lamp & Low Watt Ballast	excellent opportunity for retro-fit	151.2	1,630	246.5	0.1512	100	1,630	163.0	0.1				
<i>Boys' Restroom</i>	4	4' 2L Fixture	4	Lamp & Low Watt Ballast	excellent opportunity for retro-fit	75.6	1,630	492.9	0.3024	51	1,630	332.5	0.204				
<i>H 104</i>	3	4' 2L Fixture	3	Lamp & Low Watt Ballast	excellent opportunity for retro-fit	75.6	1,630	369.7	0.2268	51	1,630	249.4	0.153				
<i>0</i>	9	4' 4L Fixture	9	Lamp & Low Watt Ballast	excellent opportunity for retro-fit	151.2	1,630	2,218.1	1.3608	100	1,630	1,467.0	0.9				
<i>H 103</i>	2	4' 2L Fixture	2	Lamp & Low Watt Ballast	excellent opportunity for retro-fit	75.6	1,630	246.5	0.1512	51	1,630	166.3	0.102				
<i>0</i>	9	4' 4L Fixture	9	Lamp & Low Watt Ballast	excellent opportunity for retro-fit	151.2	1,630	2,218.1	1.3608	100	1,630	1,467.0	0.9				
<i>H 2A</i>	9	4' 4L Fixture	9	Lamp & Low Watt Ballast	excellent opportunity for retro-fit	151.2	1,630	2,218.1	1.3608	100	1,630	1,467.0	0.9				
<i>0</i>	3	4' 2L Fixture	3	Lamp & Low Watt Ballast	excellent opportunity for retro-fit	75.6	1,630	369.7	0.2268	51	1,630	249.4	0.153				
<i>H 2B</i>	9	4' 4L Fixture	9	Lamp & Low Watt Ballast	excellent opportunity for retro-fit	151.2	1,630	2,218.1	1.3608	100	1,630	1,467.0	0.9				
<i>0</i>	2	4' 2L Fixture	2	Lamp & Low Watt Ballast	excellent opportunity for retro-fit	75.6	1,630	246.5	0.1512	51	1,630	166.3	0.102				
<i>H 3A</i>	9	4' 4L Fixture	9	Lamp & Low Watt Ballast	excellent opportunity for retro-fit	151.2	1,630	2,218.1	1.3608	100	1,630	1,467.0	0.9				
<i>0</i>	2	4' 2L Fixture	2	Lamp & Low Watt Ballast	excellent opportunity for retro-fit	75.6	1,630	246.5	0.1512	51	1,630	166.3	0.102				
<i>H 3B</i>	9	4' 4L Fixture	9	Lamp & Low Watt Ballast	excellent opportunity for retro-fit	151.2	1,630	2,218.1	1.3608	100	1,630	1,467.0	0.9				
<i>0</i>	3	4' 2L Fixture	3	Lamp & Low Watt Ballast	excellent opportunity for retro-fit	75.6	1,630	369.7	0.2268	51	1,630	249.4	0.153				
<i>H 102</i>	2	4' 2L Fixture	2	Lamp & Low Watt Ballast	excellent opportunity for retro-fit	75.6	1,630	246.5	0.1512	51	1,630	166.3	0.102				
<i>0</i>	9	4' 4L Fixture	9	Lamp & Low Watt Ballast	excellent opportunity for retro-fit	151.2	1,630	2,218.1	1.3608	100	1,630	1,467.0	0.9				
<i>H 101</i>	9	4' 4L Fixture	9	Lamp & Low Watt Ballast	excellent opportunity for retro-fit	151.2	1,630	2,218.1	1.3608	100	1,630	1,467.0	0.9				
<i>0</i>	3	4' 2L Fixture	3	Lamp & Low Watt Ballast	excellent opportunity for retro-fit	75.6	1,630	369.7	0.2268	51	1,630	249.4	0.153				
<i>A 1</i>	6	4' 4L Fixture	6	Lamp & Low Watt Ballast	Replace fixture and mount hardware	151.2	1,630	1,478.7	0.9072	100	1,630	978.0	0.6				
<i>A 2</i>	9	4' 4L Fixture	9	Lamp & Low Watt Ballast	Replace fixture and mount hardware	151.2	1,630	2,218.1	1.3608	100	1,630	1,467.0	0.9				
<i>A 3</i>	9	4' 4L Fixture	9	Lamp & Low Watt Ballast	Replace fixture and mount hardware	151.2	1,630	2,218.1	1.3608	100	1,630	1,467.0	0.9				
<i>A 4</i>	9	4' 4L Fixture	9	Lamp & Low Watt Ballast	Replace fixture and mount hardware	151.2	1,630	2,218.1	1.3608	100	1,630	1,467.0	0.9				
<i>A 5</i>	9	4' 4L Fixture	9	Lamp & Low Watt Ballast	Replace fixture and mount hardware	151.2	1,630	2,218.1	1.3608	100	1,630	1,467.0	0.9				
<i>Teachers' Lounge</i>	4	4' 4L Fixture	4	Lamp & Low Watt Ballast	Replace fixture and mount hardware	151.2	1,630	985.8	0.6048	100	1,630	652.0	0.4				
<i>Office A/J</i>	4	4' 4L Fixture	4	Lamp & Low Watt Ballast	Replace fixture and mount hardware	151.2	1,630	985.8	0.6048	100	1,630	652.0	0.4				
<i>Health Room</i>	7	8' 2L Fixture	7	Lamp & Ballast Retrofit	Replace fixture and mount hardware	158	1,630	1,802.8	1.106	102	1,630	1,163.8	0.714				
<i>0</i>	1	4' 4L Fixture	1	Lamp & Low Watt Ballast	Replace fixture and mount hardware	151.2	1,630	246.5	0.1512	100	1,630	163.0	0.1				
<i>A 7</i>	0		0		0		1,630	0.0	0		1,630	0.0	0				
<i>Dining Room</i>	12	4' 4L Fixture	12	Lamp & Low Watt Ballast	Replace fixture and mount hardware	151.2	1,630	2,957.5	1.8144	100	1,630	1,956.0	1.2				
<i>A 9 Counselor</i>	4	4' 4L Fixture	4	Lamp & Low Watt Ballast	Excellent opportunity for retro-fit	151.2	1,630	985.8	0.6048	100	1,630	652.0	0.4				
<i>Cafeteria</i>	7	4' 2L Fixture	7	Lamp & Low Watt Ballast	Excellent opportunity for retro-fit	75.6	1,630	862.6	0.5292	51	1,630	581.9	0.357				
<i>0</i>	2	4' 2L Fixture	2	Lamp & Low Watt Ballast	Excellent opportunity for retro-fit	75.6	1,630	246.5	0.1512	51	1,630	166.3	0.102				
<i>0</i>	4	4' 4L Fixture	4	Lamp & Low Watt Ballast	Excellent opportunity for retro-fit	151.2	1,630	985.8	0.6048	100	1,630	652.0	0.4				
<i>Title</i>	8	4' 4L Fixture	8	Lamp & Low Watt Ballast	Replace fixture and mount hardware	151.2	1,630	1,971.6	1.2096	100	1,630	1,304.0	0.8				

Existing 199 Proposed 199

ENERGY CALCULATIONS			44,686	27	29,585	18
Description	kW-Demand	kWh				
Existing Use	27.41	44,686				
Proposed Use	18.15	29,585				
Difference - Savings	9.26	15,102				
Electrical Utility Cost	\$5.75	\$0.22481				
Savings per Year	\$639.27	\$3,394.97				Total Yearly Energy Savings \$4,034.24

King Kekaulike High School
 121 Kula Highway
 Pukalani, Maui, Hawaii 96768
 (808) 573-8710

Bldg. Q
Construction Technology

Bldg. O
Automotive Technology

Ag Ag Ag

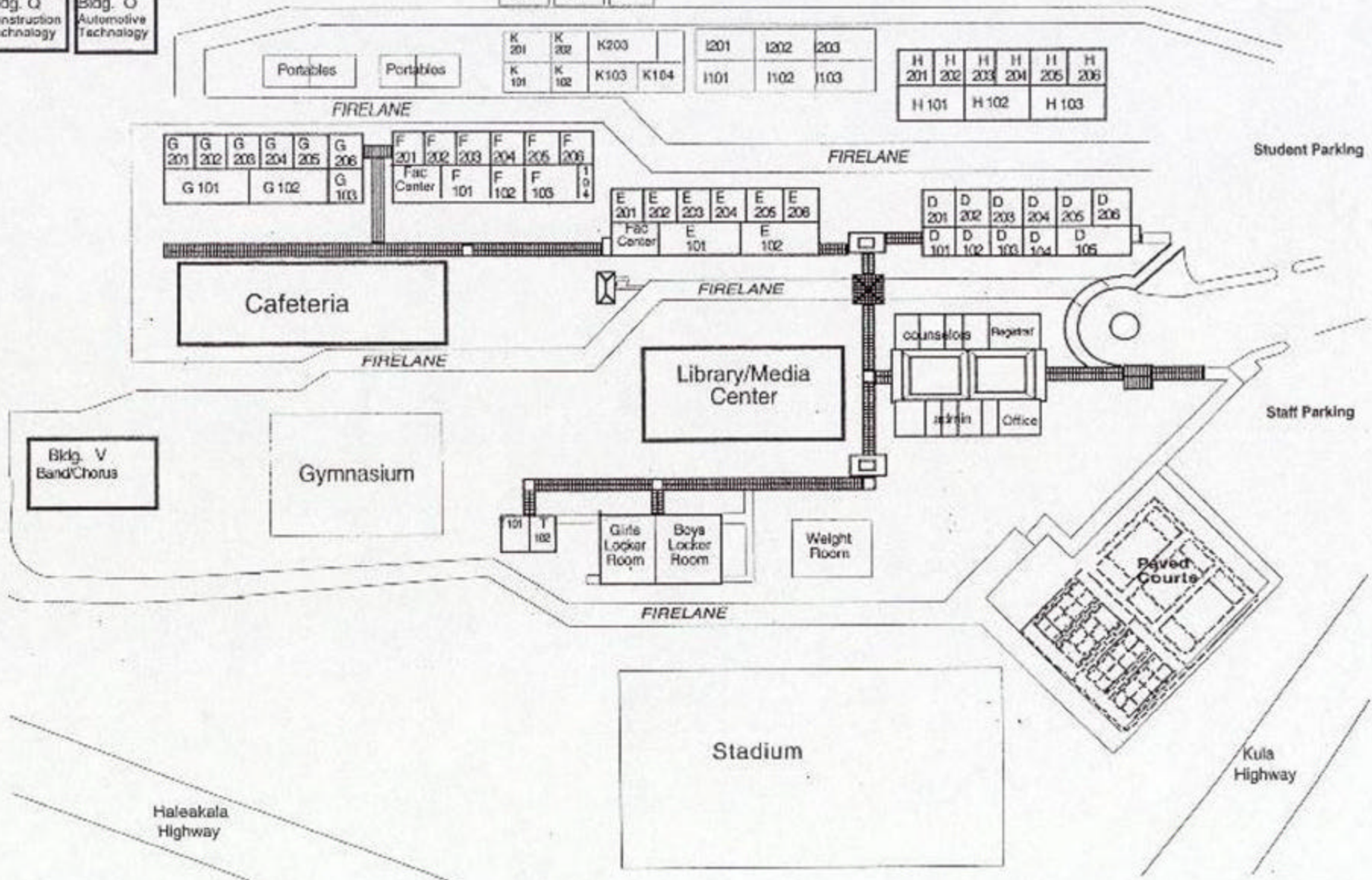

Maui Smart Schools Program
Foot Candle Readings

School: King Kekaulike High School

Room: Bldg. B - Media Control

Ceiling height: 12'

Light fixture height: 9'

Fixture type: Troffer

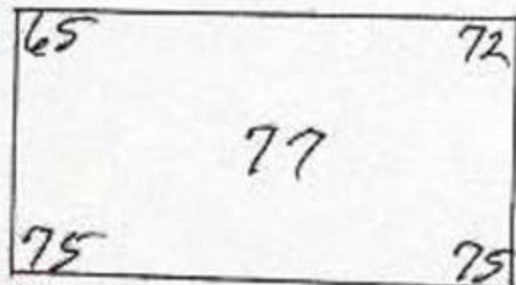

Room: Bldg. G - 2nd fl. G-201

Ceiling height: 10'

Light fixture height: 9'

Fixture type: TROFFER

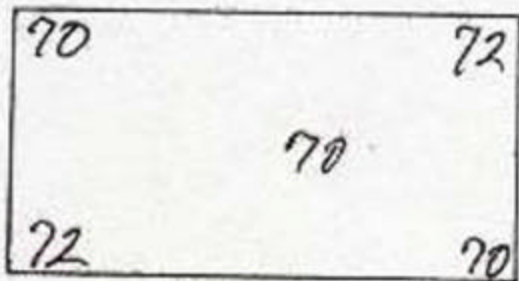

Room: Ag. Bldgs.

Ceiling height: 12'

Light fixture height: 10'

Fixture type: TROFFER

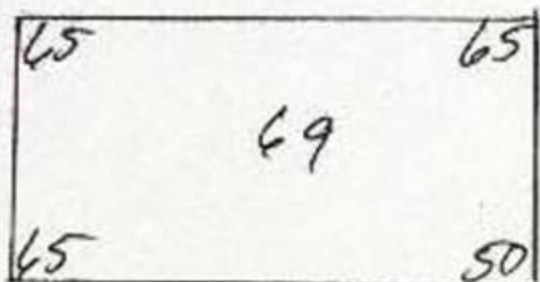



SCHOOL INFORMATION		
NAME King Kekaulike High School	DATE 2/2/2001	
STREET ADDRESS 121 Kula Highway Pukalani, HI 96768	OPERATIONAL HOURS 2,382	
POINT OF CONTACT Susan Scofield	PHONE 573-8710	FAX 120V
AUDITOR Maui Community College Auditors		

LOCATION Location (Rm Name, Rm. #, Area, Zone, etc.)	EXISTING EQUIPMENT						PROPOSED			REBATES		COSTS		COMMENTS Surveyors Comments
	Floor	Quantity	Lamp Type	Lamps Per Fixture	Type of Fixture	Ballast Type	Lamps Per Fixture	Reflectors	Ballast Type	Per Single	Extended	Per Single	Extended	
BUILDING A											\$ -		\$ -	
<i>Staff Lounge</i>	1	4	4' T12	2	Troffer	Magnetic	2	N	Electronic	\$ 5.60	\$ 22.40	\$ 60.00	\$ 240.00	Excellent opportunity for retro-fit
<i>Counselor 1</i>	1	3	4' T12	2	Troffer	Magnetic	2	N	Electronic	\$ 5.60	\$ 16.80	\$ 60.00	\$ 180.00	Excellent opportunity for retro-fit
<i>Counselor 2</i>	1	3	4' T12	2	Troffer	Magnetic	2	N	Electronic	\$ 5.60	\$ 16.80	\$ 60.00	\$ 180.00	Excellent opportunity for retro-fit
<i>Conference Room</i>	1	6	4' T12	2	Troffer	Magnetic	2	N	Electronic	\$ 5.60	\$ 33.60	\$ 60.00	\$ 360.00	Excellent opportunity for retro-fit
<i>Counselor 3</i>	1	3	4' T12	2	Troffer	Magnetic	2	N	Electronic	\$ 5.60	\$ 16.80	\$ 60.00	\$ 180.00	Excellent opportunity for retro-fit
<i>Counselor 4</i>	1	3	4' T12	2	Troffer	Magnetic	2	N	Electronic	\$ 5.60	\$ 16.80	\$ 60.00	\$ 180.00	Excellent opportunity for retro-fit
	1	2	4' T12	2	Troffer	Magnetic	2	N	Electronic	\$ 5.60	\$ 11.20	\$ 60.00	\$ 120.00	Excellent opportunity for retro-fit
<i>Registrar</i>	1	6	4' T12	2	Troffer	Magnetic	2	N	Electronic	\$ 5.60	\$ 33.60	\$ 60.00	\$ 360.00	Excellent opportunity for retro-fit
	1	6	4' T12	2	Troffer	Magnetic	2	N	Electronic	\$ 5.60	\$ 33.60	\$ 60.00	\$ 360.00	Excellent opportunity for retro-fit
<i>Ms. Cabral</i>	1	6	4' T12	2	Troffer	Magnetic	2	N	Electronic	\$ 5.60	\$ 33.60	\$ 60.00	\$ 360.00	Excellent opportunity for retro-fit
<i>Health Center</i>	1	4	4' T12	4	Troffer	Magnetic	4	N	Electronic	\$ 11.20	\$ 44.80	\$ 70.00	\$ 280.00	Excellent opportunity for retro-fit
<i>Office</i>	1	4	4' T12	4	Troffer	Magnetic	4	N	Electronic	\$ 11.20	\$ 44.80	\$ 70.00	\$ 280.00	Excellent opportunity for retro-fit
<i>Vice Principal</i>	1	4	4' T12	4	Troffer	Magnetic	4	N	Electronic	\$ 11.20	\$ 44.80	\$ 70.00	\$ 280.00	Excellent opportunity for retro-fit
<i>Conference Room</i>	1	6	4' T12	2	Troffer	Magnetic	2	N	Electronic	\$ 5.60	\$ 33.60	\$ 60.00	\$ 360.00	Excellent opportunity for retro-fit
<i>Principial Office</i>	1	6	4' T12	2	Troffer	Magnetic	2	N	Electronic	\$ 5.60	\$ 33.60	\$ 60.00	\$ 360.00	Excellent opportunity for retro-fit
<i>Dup. Room</i>	1	4	4' T12	2	Troffer	Magnetic	2	N	Electronic	\$ 5.60	\$ 22.40	\$ 60.00	\$ 240.00	Excellent opportunity for retro-fit
<i>Storage</i>	1	3	4' T12	4	Troffer	Magnetic	4	N	Electronic	\$ 11.20	\$ 33.60	\$ 70.00	\$ 210.00	Excellent opportunity for retro-fit
<i>Tele Center</i>	1	2	4' T12	2	Troffer	Magnetic	2	N	Electronic	\$ 5.60	\$ 11.20	\$ 60.00	\$ 120.00	Excellent opportunity for retro-fit
<i>Office</i>	1	11	4' T12	2	Troffer	Magnetic	2	N	Electronic	\$ 5.60	\$ 61.60	\$ 60.00	\$ 660.00	Excellent opportunity for retro-fit
BUILDING B											\$ -		\$ -	
<i>Library</i>	1	112	4' T8	2	Troffer	Electronic				\$ 5.60	\$ 627.20	\$ 60.00	\$ 6,720.00	F40 Biax Lamps No Comment
<i>Main Room</i>	1	68	4' T8	4	Troffer	Electronic					\$ -		\$ -	T8 Lamps, no retrofit measure
<i>Storage</i>	1	23	4' T8	3	Troffer	Electronic					\$ -		\$ -	T8 Lamps, no retrofit measure
<i>Office</i>	1	6	4' T8	2	Troffer	Electronic					\$ -		\$ -	T8 Lamps, no retrofit measure
<i>Mens Restroom</i>	1	1	4' T8	2	Troffer	Electronic				\$ -	\$ -	\$ -	\$ -	T8 Lamps, no retrofit measure
<i>Womens Restroom</i>	1	1	4' T8	2	Troffer	Electronic				\$ -	\$ -	\$ -	\$ -	T8 Lamps, no retrofit measure
<i>Media Control</i>	1	10	4' T8	2	Troffer	Electronic				\$ -	\$ -	\$ -	\$ -	T8 Lamps, no retrofit measure
<i>Conference</i>	1	4	4' T12	4	Troffer	Magnetic	4	N	Electronic	\$ 11.20	\$ 44.80	\$ 70.00	\$ 280.00	Excellent opportunity for retro-fit
<i>Video</i>	1	2	4' T12	4	Troffer	Magnetic	4	N	Electronic	\$ 11.20	\$ 22.40	\$ 70.00	\$ 140.00	Excellent opportunity for retro-fit
<i>Utility</i>	1	1	4' T12	2	Troffer	Magnetic	2	N	Electronic	\$ 5.60	\$ 5.60	\$ 60.00	\$ 60.00	Excellent opportunity for retro-fit
<i>Electrical</i>	1	3	4' T12	2	Wire Wrap	Magnetic	2	N	Electronic	\$ 5.60	\$ 16.80	\$ 60.00	\$ 180.00	Excellent opportunity for retro-fit
BUILDING C											\$ -		\$ -	

LOCATION	EXISTING EQUIPMENT						PROPOSED			REBATES		COSTS		COMMENTS
Location (Rm Name, Rm. #, Area, Zone, etc.)	Floor	Quantity	Lamp Type	Lamps Per Fixture	Type of Fixture	Ballast Type	Lamps Per Fixture	Reflectors	Ballast Type	Per Single	Extended	Per Single	Extended	Surveyors Comments
Tool Room	1	1	4' T12	2	Wrap	Magnetic	2	N	Electronic	\$ 5.60	\$ 5.60	\$ 60.00	\$ 60.00	Excellent opportunity for retro-fit
Custodial	1	4	4' T12	2	Wrap	Magnetic	2	N	Electronic	\$ 5.60	\$ 22.40	\$ 60.00	\$ 240.00	Excellent opportunity for retro-fit
Locker	1	1	4' T12	2	Wrap	Magnetic	2	N	Electronic	\$ 5.60	\$ 5.60	\$ 60.00	\$ 60.00	Excellent opportunity for retro-fit
Electrical	1	2	4' T12	1	Wire Wrap	Magnetic	1	N	Electronic	\$ 2.80	\$ 5.60	\$ 55.00	\$ 110.00	Excellent opportunity for retro-fit
Manager	1	3	4' T8	2	Troffer	Electronic				\$ -	\$ -	\$ -	\$ -	T8 Lamps, no retrofit measure
Gen Utility	1	2	4' T8	2	Wrap	Electronic				\$ -	\$ -	\$ -	\$ -	T8 Lamps, no retrofit measure
Storage	1	4	4' T12	2	Wrap	Magnetic	2	N	Electronic	\$ 5.60	\$ 22.40	\$ 60.00	\$ 240.00	Excellent opportunity for retro-fit
Mens Restroom	1	1	4' T12	2	Wrap	Magnetic	2	N	Electronic	\$ 5.60	\$ 5.60	\$ 60.00	\$ 60.00	Excellent opportunity for retro-fit
Toilet	1	1	4' T8	2	Vanity	Electronic				\$ -	\$ -	\$ -	\$ -	T8 Lamps, no retrofit measure
Womens Restroom	1	1	4' T12	2	Wrap	Magnetic	2	N	Electronic	\$ 5.60	\$ 5.60	\$ 60.00	\$ 60.00	Excellent opportunity for retro-fit
Toilet	1	1	4' T12	2	Vanity	Magnetic	2	N	Electronic	\$ 5.60	\$ 5.60	\$ 60.00	\$ 60.00	Excellent opportunity for retro-fit
Staff Dining	1	8	4' T8	2	Troffer	Electronic				\$ -	\$ -	\$ -	\$ -	T8 Lamps, no retrofit measure
Main Kitchen	1	14	4' T12	2	Troffer	Magnetic	2	N	Electronic	\$ 5.60	\$ 78.40	\$ 60.00	\$ 840.00	Excellent opportunity for retro-fit
	1	28	4' T12	2	Troffer	Magnetic	2	N	Electronic	\$ 5.60	\$ 156.80	\$ 60.00	\$ 1,680.00	Excellent opportunity for retro-fit
	1	2	U T12	2	Troffer	Magnetic	2	N	Electronic	\$ 5.60	\$ 11.20	\$ 60.00	\$ 120.00	Excellent opportunity for retro-fit
Can Wash	1	3	4' T12	2	Wrap	Magnetic	2	N	Electronic	\$ 5.60	\$ 16.80	\$ 60.00	\$ 180.00	Excellent opportunity for retro-fit
Storage	1	1	4' T12	2	Wrap	Magnetic	2	N	Electronic	\$ 5.60	\$ 5.60	\$ 60.00	\$ 60.00	Excellent opportunity for retro-fit
Main Dining	1	30	4' T8	2	Troffer	Electronic				\$ -	\$ -	\$ -	\$ -	T8 Lamps, no retrofit measure
	1	54	4' T12	2	Troffer	Magnetic	2	N	Electronic	\$ 5.60	\$ 302.40	\$ 60.00	\$ 3,240.00	Excellent opportunity for retro-fit
	1	14	4' T12	2	Troffer	Magnetic	2	N	Electronic	\$ 5.60	\$ 78.40	\$ 60.00	\$ 840.00	Excellent opportunity for retro-fit
Stage	1	4	4' T12	2	Troffer	Magnetic	2	N	Electronic	\$ 5.60	\$ 22.40	\$ 60.00	\$ 240.00	Excellent opportunity for retro-fit
Girls' Dressing	1	2	4' T12	2	Wrap	Magnetic	2	N	Electronic	\$ 5.60	\$ 11.20	\$ 60.00	\$ 120.00	Excellent opportunity for retro-fit
Boys' Dressing	1	2	4' T12	2	Wrap	Magnetic	2	N	Electronic	\$ 5.60	\$ 11.20	\$ 60.00	\$ 120.00	Excellent opportunity for retro-fit
EXIT	1	6			Exit Sign					\$ -	\$ -	\$ -	\$ -	
BUILDING D										\$ -	\$ -	\$ -	\$ -	
D 105A	1	12	4' T12	2	Troffer	Magnetic	2	N	Electronic	\$ 5.60	\$ 67.20	\$ 60.00	\$ 720.00	Excellent opportunity for retro-fit
D 105B	1	15	4' T12	2	Troffer	Magnetic	2	N	Electronic	\$ 5.60	\$ 84.00	\$ 60.00	\$ 900.00	Excellent opportunity for retro-fit
Storage	1	4	4' T12	4	Troffer	Magnetic	4	N	Electronic	\$ 11.20	\$ 44.80	\$ 70.00	\$ 280.00	Excellent opportunity for retro-fit
D 104 Restroom	1	15	4' T12	2	Troffer	Magnetic	2	N	Electronic	\$ 5.60	\$ 84.00	\$ 60.00	\$ 900.00	Excellent opportunity for retro-fit
D 103	1	15	4' T12	2	Troffer	Magnetic	2	N	Electronic	\$ 5.60	\$ 84.00	\$ 60.00	\$ 900.00	Excellent opportunity for retro-fit
D 102	1	15	4' T12	2	Troffer	Magnetic	2	N	Electronic	\$ 5.60	\$ 84.00	\$ 60.00	\$ 900.00	Excellent opportunity for retro-fit
D 101	1	15	4' T12	2	Troffer	Magnetic	2	N	Electronic	\$ 5.60	\$ 84.00	\$ 60.00	\$ 900.00	Excellent opportunity for retro-fit
Girls' Restroom	1	3	4' T12	2	Troffer	Magnetic	2	N	Electronic	\$ 5.60	\$ 16.80	\$ 60.00	\$ 180.00	Excellent opportunity for retro-fit
Electrical	1	2	4' T12	4	Wrap	Magnetic	4	N	Electronic	\$ 11.20	\$ 22.40	\$ 70.00	\$ 140.00	Excellent opportunity for retro-fit
Gen Utility	1	1	4' T12	1	Wrap	Magnetic	1	N	Electronic	\$ 2.80	\$ 2.80	\$ 55.00	\$ 55.00	Excellent opportunity for retro-fit
Boys' Restroom	1	3	4' T12	2	Wrap	Magnetic	2	N	Electronic	\$ 5.60	\$ 16.80	\$ 60.00	\$ 180.00	Excellent opportunity for retro-fit
Boys' Restroom	2	3	4' T12	2	Wrap	Magnetic	2	N	Electronic	\$ 5.60	\$ 16.80	\$ 60.00	\$ 180.00	Excellent opportunity for retro-fit
Elect. Storage	2	2	4' T12	2	Wrap	Magnetic	2	N	Electronic	\$ 5.60	\$ 11.20	\$ 60.00	\$ 120.00	Excellent opportunity for retro-fit

LOCATION	EXISTING EQUIPMENT						PROPOSED			REBATES		COSTS		COMMENTS
Location (Rm Name, Rm. #, Area, Zone, etc.)	Floor	Quantity	Lamp Type	Lamps Per Fixture	Type of Fixture	Ballast Type	Lamps Per Fixture	Reflectors	Ballast Type	Per Single	Extended	Per Single	Extended	Surveyors Comments
<i>Electrical</i>	2	2	4' T12	2	Wrap	Magnetic	2	N	Electronic	\$ 5.60	\$ 11.20	\$ 60.00	\$ 120.00	Excellent opportunity for retro-fit
<i>Girls' Restroom</i>	2	3	4' T12	2	Wrap	Magnetic	2	N	Electronic	\$ 5.60	\$ 16.80	\$ 60.00	\$ 180.00	Excellent opportunity for retro-fit
<i>D 201</i>	2	15	4' T12	2	Wrap	Magnetic	2	N	Electronic	\$ 5.60	\$ 84.00	\$ 60.00	\$ 900.00	Excellent opportunity for retro-fit
<i>D 202</i>	2	15	4' T12	2	Wrap	Magnetic	2	N	Electronic	\$ 5.60	\$ 84.00	\$ 60.00	\$ 900.00	Excellent opportunity for retro-fit
<i>D 203</i>	2	15	4' T12	2	Wrap	Magnetic	2	N	Electronic	\$ 5.60	\$ 84.00	\$ 60.00	\$ 900.00	Excellent opportunity for retro-fit
<i>D 204</i>	2	15	4' T12	2	Wrap	Magnetic	2	N	Electronic	\$ 5.60	\$ 84.00	\$ 60.00	\$ 900.00	Excellent opportunity for retro-fit
<i>D 205</i>	2	15	4' T12	2	Wrap	Magnetic	2	N	Electronic	\$ 5.60	\$ 84.00	\$ 60.00	\$ 900.00	Excellent opportunity for retro-fit
<i>D 205</i>	2	15	4' T12	2	Wrap	Magnetic	2	N	Electronic	\$ 5.60	\$ 84.00	\$ 60.00	\$ 900.00	Excellent opportunity for retro-fit
<i>D 206</i>	2	15	4' T12	2	Wrap	Magnetic	2	N	Electronic	\$ 5.60	\$ 84.00	\$ 60.00	\$ 900.00	Excellent opportunity for retro-fit
BUILDING I											\$ -		\$ -	
<i>Area of Reserve</i>	2	1	4' T12	2	Wrap	Magnetic	2	N	Electronic	\$ 5.60	\$ 5.60	\$ 60.00	\$ 60.00	Excellent opportunity for retro-fit
<i>H 206</i>	2	15	4' T12	4	Troffer	Magnetic	4	N	Electronic	\$ 11.20	\$ 168.00	\$ 70.00	\$ 1,050.00	Excellent opportunity for retro-fit
<i>H 205</i>	2	15	4' T12	4	Troffer	Magnetic	4	N	Electronic	\$ 11.20	\$ 168.00	\$ 70.00	\$ 1,050.00	Excellent opportunity for retro-fit
<i>H 204</i>	2	15	4' T12	4	Troffer	Magnetic	4	N	Electronic	\$ 11.20	\$ 168.00	\$ 70.00	\$ 1,050.00	Excellent opportunity for retro-fit
<i>H 203</i>	2	15	4' T12	4	Troffer	Magnetic	4	N	Electronic	\$ 11.20	\$ 168.00	\$ 70.00	\$ 1,050.00	Excellent opportunity for retro-fit
<i>H 202</i>	2	15	4' T12	4	Troffer	Magnetic	4	N	Electronic	\$ 11.20	\$ 168.00	\$ 70.00	\$ 1,050.00	Excellent opportunity for retro-fit
<i>H 201</i>	2	20	4' T12	4	Troffer	Magnetic	4	N	Electronic	\$ 11.20	\$ 224.00	\$ 70.00	\$ 1,400.00	Excellent opportunity for retro-fit
<i>Snack Shop</i>	2	3	4' T12	4	Troffer	Magnetic	4	N	Electronic	\$ 11.20	\$ 33.60	\$ 70.00	\$ 210.00	Excellent opportunity for retro-fit
<i>Duplicating</i>	2	2	4' T12	4	Troffer	Magnetic	4	N	Electronic	\$ 11.20	\$ 22.40	\$ 70.00	\$ 140.00	Excellent opportunity for retro-fit
<i>Faculty Center</i>	2	11	4' T12	4	Troffer	Magnetic	4	N	Electronic	\$ 11.20	\$ 123.20	\$ 70.00	\$ 770.00	Excellent opportunity for retro-fit
<i>Staff Restroom</i>	2	2	4' T12	2	Wrap	Magnetic	2	N	Electronic	\$ 5.60	\$ 11.20	\$ 60.00	\$ 120.00	Excellent opportunity for retro-fit
<i>General Utility</i>	2	2	4' T12	2	Wrap	Magnetic	2	N	Electronic	\$ 5.60	\$ 11.20	\$ 60.00	\$ 120.00	Excellent opportunity for retro-fit
<i>Electrical</i>	2	4	4' T12	2	Wrap	Magnetic	2	N	Electronic	\$ 5.60	\$ 22.40	\$ 60.00	\$ 240.00	Excellent opportunity for retro-fit
<i>Restroom B/G</i>	2	10	4' T8	2	Wrap	Electronic				\$ 5.60	\$ 56.00	\$ 60.00	\$ 600.00	T8 Lamps, no retrofit measure
<i>Electrical</i>	2	4	4' T8	2	Wire	Electronic				\$ 5.60	\$ 22.40	\$ 60.00	\$ 240.00	T8 Lamps, no retrofit measure
<i>Restroom B/G</i>	2	8	4' T12	2	Troffer	Magnetic	2	N	Electronic	\$ 5.60	\$ 44.80	\$ 60.00	\$ 480.00	Excellent opportunity for retro-fit
<i>General Utility</i>	2	2	4' T12	2	Wire	Magnetic	2	N	Electronic	\$ 5.60	\$ 11.20	\$ 60.00	\$ 120.00	Excellent opportunity for retro-fit
<i>I 203</i>	2	12	4' T12	4	Troffer	Magnetic	4	N	Electronic	\$ 11.20	\$ 134.40	\$ 70.00	\$ 840.00	Excellent opportunity for retro-fit
<i>I 202</i>	2	24	4' T12	4	Troffer	Magnetic	4	N	Electronic	\$ 11.20	\$ 268.80	\$ 70.00	\$ 1,680.00	Excellent opportunity for retro-fit
<i>Prep Room</i>	2	2	4' T12	2	Troffer	Magnetic	2	N	Electronic	\$ 5.60	\$ 11.20	\$ 60.00	\$ 120.00	Excellent opportunity for retro-fit
	2	2	4' T12	4	Troffer	Magnetic	4	N	Electronic	\$ 11.20	\$ 22.40	\$ 70.00	\$ 140.00	Excellent opportunity for retro-fit
<i>I 201</i>	2	12	4' T12	4	Troffer	Magnetic	4	N	Electronic	\$ 11.20	\$ 134.40	\$ 70.00	\$ 840.00	Excellent opportunity for retro-fit
BUILDING I + H	1										\$ -		\$ -	
<i>I 101</i>	1	12	4' T12	4	Troffer	Magnetic	4	N	Electronic	\$ 11.20	\$ 134.40	\$ 70.00	\$ 840.00	Excellent opportunity for retro-fit
<i>I 101</i>	1	24	4' T12	4	Troffer	Magnetic	4	N	Electronic	\$ 11.20	\$ 268.80	\$ 70.00	\$ 1,680.00	Excellent opportunity for retro-fit
<i>I 102</i>	1	2	4' T12	2	Troffer	Magnetic	2	N	Electronic	\$ 5.60	\$ 11.20	\$ 60.00	\$ 120.00	Excellent opportunity for retro-fit
<i>Prep Room</i>	1	2	4' T12	4	Troffer	Magnetic	4	N	Electronic	\$ 11.20	\$ 22.40	\$ 70.00	\$ 140.00	Excellent opportunity for retro-fit
<i>I 103</i>	1	12	4' T12	4	Troffer	Magnetic	4	N	Electronic	\$ 11.20	\$ 134.40	\$ 70.00	\$ 840.00	Excellent opportunity for retro-fit

LOCATION	EXISTING EQUIPMENT						PROPOSED			REBATES		COSTS		COMMENTS
Location (Rm Name, Rm. #, Area, Zone, etc.)	Floor	Quantity	Lamp Type	Lamps Per Fixture	Type of Fixture	Ballast Type	Lamps Per Fixture	Reflectors	Ballast Type	Per Single	Extended	Per Single	Extended	Surveyors Comments
<i>Electrical Utility</i>	1	2	4' T12	2	Wire	Magnetic	2	N	Electronic	\$ 5.60	\$ 11.20	\$ 60.00	\$ 120.00	Excellent opportunity for retro-fit
<i>Restroom B/G</i>	1	8	4' T12	4	Troffer	Magnetic	4	N	Electronic	\$ 11.20	\$ 89.60	\$ 70.00	\$ 560.00	Excellent opportunity for retro-fit
<i>Electrical</i>	1	4	4' T12	2	Wire	Magnetic	2	N	Electronic	\$ 5.60	\$ 22.40	\$ 60.00	\$ 240.00	Excellent opportunity for retro-fit
<i>Electrical Elevator RM.</i>	1	1	4' T12	2	Wrap	Magnetic	2	N	Electronic	\$ 5.60	\$ 5.60	\$ 60.00	\$ 60.00	Excellent opportunity for retro-fit
<i>Restroom B/G</i>	1	10	4' T12	2	Wrap	Magnetic	2	N	Electronic	\$ 5.60	\$ 56.00	\$ 60.00	\$ 600.00	Excellent opportunity for retro-fit
<i>Electrical Comm.</i>	1	4	4' T12	2	Wrap	Magnetic	2	N	Electronic	\$ 5.60	\$ 22.40	\$ 60.00	\$ 240.00	Excellent opportunity for retro-fit
<i>General Utility</i>	1	2	4' T12	2	Wrap	Magnetic	2	N	Electronic	\$ 5.60	\$ 11.20	\$ 60.00	\$ 120.00	Excellent opportunity for retro-fit
<i>H 101</i>	1	32	4' T12	4	Troffer	Magnetic	4	N	Electronic	\$ 11.20	\$ 358.40	\$ 70.00	\$ 2,240.00	Excellent opportunity for retro-fit
<i>Teacher Prep</i>	1	18	4' T12	4	Troffer	Magnetic	4	N	Electronic	\$ 11.20	\$ 201.60	\$ 70.00	\$ 1,260.00	Excellent opportunity for retro-fit
<i>H 102</i>	1	29	4' T12	4	Troffer	Magnetic	4	N	Electronic	\$ 11.20	\$ 324.80	\$ 70.00	\$ 2,030.00	Excellent opportunity for retro-fit
<i>H 103</i>	1	29	4' T12	4	Troffer	Magnetic	4	N	Electronic	\$ 11.20	\$ 324.80	\$ 70.00	\$ 2,030.00	Excellent opportunity for retro-fit
<i>Kiln</i>	1	2	4' T12	2	Wire	Magnetic	2	N	Electronic	\$ 5.60	\$ 11.20	\$ 60.00	\$ 120.00	Excellent opportunity for retro-fit
BUILDING K											\$ -		\$ -	
<i>Electrical</i>	2	4	4' T12	2	Wire	Magnetic	2	N	Electronic	\$ 5.60	\$ 22.40	\$ 60.00	\$ 240.00	Excellent opportunity for retro-fit
<i>Restroom B/G</i>	2	8	4' T12	2	Troffer	Magnetic	2	N	Electronic	\$ 5.60	\$ 44.80	\$ 60.00	\$ 480.00	Excellent opportunity for retro-fit
<i>General Utility</i>	2	2	4' T12	2	Wire	Magnetic	2	N	Electronic	\$ 5.60	\$ 11.20	\$ 60.00	\$ 120.00	Excellent opportunity for retro-fit
<i>Model Store</i>	2	10	4' T12	3	Troffer	Magnetic	3	N	Electronic	\$ 8.40	\$ 84.00	\$ 63.80	\$ 638.00	Excellent opportunity for retro-fit
<i>K 203</i>	2	13	4' T12	4	Troffer	Magnetic	4	N	Electronic	\$ 11.20	\$ 145.60	\$ 70.00	\$ 910.00	Excellent opportunity for retro-fit
<i>K 202</i>	2	20	4' T12	4	Troffer	Magnetic	4	N	Electronic	\$ 11.20	\$ 224.00	\$ 70.00	\$ 1,400.00	Excellent opportunity for retro-fit
<i>K 201 Electrical</i>	2	39	4' T12	4	Troffer	Magnetic	4	N	Electronic	\$ 11.20	\$ 436.80	\$ 70.00	\$ 2,730.00	Excellent opportunity for retro-fit
<i>S Cage</i>	2	10	4' T12	2	Wire	Magnetic	2	N	Electronic	\$ 5.60	\$ 56.00	\$ 60.00	\$ 600.00	Excellent opportunity for retro-fit
<i>Restroom</i>	2	1	4' T12	3	Troffer	Magnetic	3	N	Electronic	\$ 8.40	\$ 8.40	\$ 65.00	\$ 65.00	Excellent opportunity for retro-fit
<i>Staff Restroom</i>	1	1	4' T12	3	Troffer	Magnetic	3	N	Electronic	\$ 8.40	\$ 8.40	\$ 65.00	\$ 65.00	Excellent opportunity for retro-fit
<i>K 101</i>	1	46	4' T12	4	Troffer	Magnetic	4	N	Electronic	\$ 11.20	\$ 515.20	\$ 70.00	\$ 3,220.00	Excellent opportunity for retro-fit
<i>Supply Room</i>	1	2	4' T12	2	Wire	Magnetic	2	N	Electronic	\$ 5.60	\$ 11.20	\$ 60.00	\$ 120.00	Excellent opportunity for retro-fit
<i>K 102</i>	1	12	4' T12	4	Troffer	Magnetic	4	N	Electronic	\$ 11.20	\$ 134.40	\$ 70.00	\$ 840.00	Excellent opportunity for retro-fit
<i>K 103</i>	1	12	4' T12	4	Troffer	Magnetic	4	N	Electronic	\$ 11.20	\$ 134.40	\$ 70.00	\$ 840.00	Excellent opportunity for retro-fit
<i>K 104</i>	1	12	4' T12	4	Troffer	Magnetic	4	N	Electronic	\$ 11.20	\$ 134.40	\$ 70.00	\$ 840.00	Excellent opportunity for retro-fit
<i>Utility</i>	1	2	4' T12	2	Wire	Magnetic	2	N	Electronic	\$ 5.60	\$ 11.20	\$ 60.00	\$ 120.00	Excellent opportunity for retro-fit
<i>Restroom B/G</i>	1	8	4' T12	2	Troffer	Magnetic	2	N	Electronic	\$ 5.60	\$ 44.80	\$ 60.00	\$ 480.00	Excellent opportunity for retro-fit
<i>Electrical</i>	1	4	4' T12	2	Wire	Magnetic	2	N	Electronic	\$ 5.60	\$ 22.40	\$ 60.00	\$ 240.00	Excellent opportunity for retro-fit
PORTABLES											\$ -		\$ -	
<i>P 1</i>	1	8	4' T12	3	Troffer	Magnetic	3	N	Electronic	\$ 8.40	\$ 67.20	\$ 65.00	\$ 520.00	Excellent opportunity for retro-fit
<i>P 1A</i>	1	8	4' T12	3	Troffer	Magnetic	3	N	Electronic	\$ 8.40	\$ 67.20	\$ 65.00	\$ 520.00	Excellent opportunity for retro-fit
<i>P 2</i>	1	8	4' T12	3	Troffer	Magnetic	3	N	Electronic	\$ 8.40	\$ 67.20	\$ 65.00	\$ 520.00	Excellent opportunity for retro-fit
<i>P 2A</i>	1	8	4' T12	3	Troffer	Magnetic	3	N	Electronic	\$ 8.40	\$ 67.20	\$ 65.00	\$ 520.00	Excellent opportunity for retro-fit
<i>P 3</i>	1	8	4' T12	3	Troffer	Magnetic	3	N	Electronic	\$ 8.40	\$ 67.20	\$ 65.00	\$ 520.00	Excellent opportunity for retro-fit
<i>P 3A</i>	1	8	4' T12	3	Troffer	Magnetic	3	N	Electronic	\$ 8.40	\$ 67.20	\$ 65.00	\$ 520.00	Excellent opportunity for retro-fit

LOCATION	EXISTING EQUIPMENT						PROPOSED			REBATES		COSTS		COMMENTS
Location (Rm Name, Rm. #, Area, Zone, etc.)	Floor	Quantity	Lamp Type	Lamps Per Fixture	Type of Fixture	Ballast Type	Lamps Per Fixture	Reflectors	Ballast Type	Per Single	Extended	Per Single	Extended	Surveyors Comments
P 4	1	8	4' T12	3	Troffer	Magnetic	3	N	Electronic	\$ 8.40	\$ 67.20	\$ 65.00	\$ 520.00	Excellent opportunity for retro-fit
P 4A	1	8	4' T8	3	Troffer	Electronic				\$ -	\$ -	\$ -	\$ -	T8 Lamps, no retrofit measure
BUILDING M											\$ -		\$ -	
M 101	1	22	4' T12	4	Troffer	Magnetic	4	N	Electronic	\$ 11.20	\$ 246.40	\$ 70.00	\$ 1,540.00	Excellent opportunity for retro-fit
Restroom B/G	1	4	4' T12	3	Troffer	Magnetic	3	N	Electronic	\$ 8.40	\$ 33.60	\$ 65.00	\$ 260.00	Excellent opportunity for retro-fit
	1	2	4' T12	4	Troffer	Magnetic	4	N	Electronic	\$ 11.20	\$ 22.40	\$ 70.00	\$ 140.00	Excellent opportunity for retro-fit
	1	12								\$ -	\$ -	\$ -	\$ -	Halogen Lamps
Green House	1	6	4' T12	2	Wrap	Magnetic	2	N	Electronic	\$ 5.60	\$ 33.60	\$ 60.00	\$ 360.00	Excellent opportunity for retro-fit
Storage	1	13	4' T12	2	Wrap	Magnetic	2	N	Electronic	\$ 5.60	\$ 72.80	\$ 60.00	\$ 780.00	Excellent opportunity for retro-fit
GYMNASIUM											\$ -		\$ -	
Home Boys' L/S											\$ -		\$ -	
Locker	1	4	4' T12	4	Troffer	Magnetic	4	N	Electronic	\$ 11.20	\$ 44.80	\$ 70.00	\$ 280.00	Excellent opportunity for retro-fit
Shower	1	8	4' T8	2	Wrap	Electronic				\$ -	\$ -	\$ -	\$ -	T8 Lamps, no retrofit measure
Restroom	1	2	4' T12	4	Troffer	Magnetic	4	N	Electronic	\$ 11.20	\$ 22.40	\$ 70.00	\$ 140.00	Excellent opportunity for retro-fit
Hall	1	8	4' T12	2	Troffer	Magnetic	2	N	Electronic	\$ 5.60	\$ 44.80	\$ 60.00	\$ 480.00	Excellent opportunity for retro-fit
Electrical	1	1	4' T12	4	Troffer	Magnetic	4	N	Electronic	\$ 5.60	\$ 5.60	\$ 60.00	\$ 60.00	Excellent opportunity for retro-fit
Staff Restroom	1	2	4' T12	4	Troffer	Magnetic	4	N	Electronic	\$ 11.20	\$ 22.40	\$ 70.00	\$ 140.00	Excellent opportunity for retro-fit
Utility	1	1	4' T12	4	Troffer	Magnetic	4	N	Electronic	\$ 11.20	\$ 11.20	\$ 70.00	\$ 70.00	Excellent opportunity for retro-fit
Hall	1	4	4' T12	2	Troffer	Magnetic	2	N	Electronic	\$ 5.60	\$ 22.40	\$ 60.00	\$ 240.00	Excellent opportunity for retro-fit
Storage	1	2	4' T12	2	Troffer	Magnetic	2	N	Electronic	\$ 5.60	\$ 11.20	\$ 60.00	\$ 120.00	Excellent opportunity for retro-fit
Wrestling	1	24	4' T12	4	Troffer	Magnetic	4	N	Electronic	\$ 11.20	\$ 268.80	\$ 70.00	\$ 1,680.00	Excellent opportunity for retro-fit
Visitor Girls	1	1	4' T12	2	Troffer	Magnetic	2	N	Electronic	\$ 5.60	\$ 5.60	\$ 60.00	\$ 60.00	Excellent opportunity for retro-fit
Restroom	1	2	4' T12	4	Troffer	Magnetic	4	N	Electronic	\$ 11.20	\$ 22.40	\$ 70.00	\$ 140.00	Excellent opportunity for retro-fit
Locker	1	4	4' T12	4	Troffer	Magnetic	4	N	Electronic	\$ 11.20	\$ 44.80	\$ 70.00	\$ 280.00	Excellent opportunity for retro-fit
Shower	1	8	4' T12	2	Wrap	Magnetic	2	N	Electronic	\$ 5.60	\$ 44.80	\$ 60.00	\$ 480.00	Excellent opportunity for retro-fit
Upstairs Hall	2	36	4' T12	4	Troffer	Magnetic	4	N	Electronic	\$ 11.20	\$ 403.20	\$ 70.00	\$ 2,520.00	Excellent opportunity for retro-fit
Mens Restroom	2	5	4' T12	4	Troffer	Magnetic	4	N	Electronic	\$ 11.20	\$ 56.00	\$ 70.00	\$ 350.00	Excellent opportunity for retro-fit
Office	2	2	4' T12	4	Troffer	Magnetic	4	N	Electronic	\$ 11.20	\$ 22.40	\$ 70.00	\$ 140.00	Excellent opportunity for retro-fit
Kitchen	2	4	4' T12	4	Troffer	Magnetic	4	N	Electronic	\$ 11.20	\$ 44.80	\$ 70.00	\$ 280.00	Excellent opportunity for retro-fit
BUILDING O											\$ -		\$ -	
Electrical	1	2	4' T8	2	Wire Wrap	Electronic				\$ -	\$ -	\$ -	\$ -	T8 Lamps, no retrofit measure
Class Room	1	16	4' T8	4	Troffer	Electronic				\$ -	\$ -	\$ -	\$ -	T8 Lamps, no retrofit measure
Office	1	3	4' T8	4	Troffer	Electronic				\$ -	\$ -	\$ -	\$ -	T8 Lamps, no retrofit measure
Shop Area	1	35	8' T12	2	Wrap	Magnetic	2	N	Electronic	\$ 7.20	\$ 252.00	\$ 80.00	\$ 2,800.00	Excellent opportunity for retro-fit
Spray Booth	1	6	8' T12	2	Wrap	Magnetic	2	N	Electronic	\$ 7.20	\$ 43.20	\$ 80.00	\$ 480.00	Excellent opportunity for retro-fit
EXIT											\$ -		\$ -	
Boys Restroom	1	6	4' T12	2	Wrap	Magnetic	2	N	Electronic	\$ 5.60	\$ 33.60	\$ 60.00	\$ 360.00	Excellent opportunity for retro-fit
Girls Restroom	1	6	4' T12	2	Wrap	Magnetic	2	N	Electronic	\$ 5.60	\$ 33.60	\$ 60.00	\$ 360.00	Excellent opportunity for retro-fit

LOCATION	EXISTING EQUIPMENT						PROPOSED			REBATES		COSTS		COMMENTS
Location (Rm Name, Rm. #, Area, Zone, etc.)	Floor	Quantity	Lamp Type	Lamps Per Fixture	Type of Fixture	Ballast Type	Lamps Per Fixture	Reflectors	Ballast Type	Per Single	Extended	Per Single	Extended	Surveyors Comments
BUILDING Q											\$ -		\$ -	
<i>Material Storage</i>	1	4	4' T8	2	Wrap	Electronic				\$ -	\$ -	\$ -	\$ -	T8 Lamps, no retrofit measure
<i>Project Storage 5</i>	1	2	4' T12	2	Wrap	Magnetic	2	N	Electronic	\$ 5.60	\$ 11.20	\$ 60.00	\$ 120.00	Excellent opportunity for retro-fit
<i>Project Storage 4</i>	1	2	4' T12	2	Wrap	Magnetic	2	N	Electronic	\$ 5.60	\$ 11.20	\$ 60.00	\$ 120.00	Excellent opportunity for retro-fit
<i>Project Storage 3</i>	1	2	4' T12	2	Wrap	Magnetic	2	N	Electronic	\$ 5.60	\$ 11.20	\$ 60.00	\$ 120.00	Excellent opportunity for retro-fit
<i>Project Storage 2</i>	1	2	4' T12	2	Wrap	Magnetic	2	N	Electronic	\$ 5.60	\$ 11.20	\$ 60.00	\$ 120.00	Excellent opportunity for retro-fit
<i>Wash Area</i>	1	2	4' T12	2	Wrap	Magnetic	2	N	Electronic	\$ 5.60	\$ 11.20	\$ 60.00	\$ 120.00	Excellent opportunity for retro-fit
<i>Project Storage 1</i>	1	2	4' T12	2	Wrap	Magnetic	2	N	Electronic	\$ 5.60	\$ 11.20	\$ 60.00	\$ 120.00	Excellent opportunity for retro-fit
<i>Tools</i>	1	2	4' T12	2	Wrap	Magnetic	2	N	Electronic	\$ 5.60	\$ 11.20	\$ 60.00	\$ 120.00	Excellent opportunity for retro-fit
<i>Boys Restroom</i>	1	1	4' T12	2	Wrap	Magnetic	2	N	Electronic	\$ 5.60	\$ 5.60	\$ 60.00	\$ 60.00	Excellent opportunity for retro-fit
<i>Girls Restroom</i>	1	1	4' T12	2	Wrap	Magnetic	2	N	Electronic	\$ 5.60	\$ 5.60	\$ 60.00	\$ 60.00	Excellent opportunity for retro-fit
<i>Class Room</i>	1	15	4' T12	4	Troffer	Magnetic	4	N	Electronic	\$ 11.20	\$ 168.00	\$ 70.00	\$ 1,050.00	Excellent opportunity for retro-fit
<i>Office</i>	1	3	4' T12	3	Troffer	Magnetic	3	N	Electronic	\$ 8.40	\$ 25.20	\$ 63.80	\$ 191.40	Excellent opportunity for retro-fit
<i>Supply Parts</i>	1	2	4' T12	4	Troffer	Magnetic	4	N	Electronic	\$ 11.20	\$ 22.40	\$ 70.00	\$ 140.00	Excellent opportunity for retro-fit
<i>Office Bathroom</i>	1	1	4' T12	2	Wrap	Magnetic	2	N	Electronic	\$ 5.60	\$ 5.60	\$ 60.00	\$ 60.00	Excellent opportunity for retro-fit
<i>Main Shop</i>	1	41	4' T12	2	Wrap	Magnetic	2	N	Electronic	\$ 5.60	\$ 229.60	\$ 60.00	\$ 2,460.00	Excellent opportunity for retro-fit
EXIT	1	2			Exit Sign					\$ -	\$ -	\$ -	\$ -	
<i>Electrical</i>	1	1	4' T12	3	Wrap	Magnetic	3	N	Electronic	\$ 8.40	\$ 8.40	\$ 65.00	\$ 65.00	Excellent opportunity for retro-fit
BUILDING T											\$ -		\$ -	
<i>T 101</i>	1	15	4' T8	2	Troffer	Electronic				\$ -	\$ -	\$ -	\$ -	T8 Lamps, no retrofit measure
<i>T 102</i>	1	1	4' T12	2	Troffer	Magnetic	2	N	Electronic	\$ 5.60	\$ 5.60	\$ 60.00	\$ 60.00	Excellent opportunity for retro-fit
BUILDING X											\$ -		\$ -	
<i>X 101</i>	1	20	4' T8	3	Troffer	Electronic				\$ -	\$ -	\$ -	\$ -	T8 Lamps, no retrofit measure
BUILDING S											\$ -		\$ -	
<i>Girls Locker</i>	1	14	4' T12	2	Wrap	Magnetic	2	N	Electronic	\$ 5.60	\$ 78.40	\$ 60.00	\$ 840.00	Excellent opportunity for retro-fit
<i>Shower</i>	1	6	4' T12	2	Wrap	Magnetic	2	N	Electronic	\$ 5.60	\$ 33.60	\$ 60.00	\$ 360.00	Excellent opportunity for retro-fit
<i>Tower</i>	1	4	U T12	2	Troffer	Magnetic	2	N	Electronic	\$ 5.60	\$ 22.40	\$ 60.00	\$ 240.00	Excellent opportunity for retro-fit
<i>Toilet</i>	11	2	4' T12	2	Wrap	Magnetic	2	N	Electronic	\$ 5.60	\$ 11.20	\$ 60.00	\$ 120.00	Excellent opportunity for retro-fit
<i>Office</i>	1	4	U T12	2	Troffer	Magnetic	2	N	Electronic	\$ 5.60	\$ 22.40	\$ 60.00	\$ 240.00	Excellent opportunity for retro-fit
<i>Toilet</i>	1	1	4' T12	2	Wrap	Magnetic	2	N	Electronic	\$ 5.60	\$ 5.60	\$ 60.00	\$ 60.00	Excellent opportunity for retro-fit
<i>Office</i>	1	4	U T12	2	Troffer	Magnetic	2	N	Electronic	\$ 5.60	\$ 22.40	\$ 60.00	\$ 240.00	Excellent opportunity for retro-fit
<i>Toilet</i>	1	1	4' T12	2	Wrap	Magnetic	2	N	Electronic	\$ 5.60	\$ 5.60	\$ 60.00	\$ 60.00	Excellent opportunity for retro-fit
<i>Boys Locker</i>	1	12	4' T8	2	Wrap	Electronic				\$ -	\$ -	\$ -	\$ -	T8 Lamps, no retrofit measure
<i>Toilet</i>	1	2	4' T12	2	Wrap	Magnetic	2	N	Electronic	\$ 5.60	\$ 11.20	\$ 60.00	\$ 120.00	Excellent opportunity for retro-fit
<i>Shower</i>	1	6	4' T12	2	Wrap	Magnetic	2	N	Electronic	\$ 5.60	\$ 33.60	\$ 60.00	\$ 360.00	Excellent opportunity for retro-fit
<i>Towel</i>	1	4	U T12	2	Troffer	Magnetic	2	N	Electronic	\$ 5.60	\$ 22.40	\$ 60.00	\$ 240.00	Excellent opportunity for retro-fit
BUILDING V											\$ -		\$ -	
<i>V 101 Band</i>											\$ -		\$ -	

LOCATION	EXISTING EQUIPMENT						PROPOSED			REBATES		COSTS		COMMENTS
Location (Rm Name, Rm. #, Area, Zone, etc.)	Floor	Quantity	Lamp Type	Lamps Per Fixture	Type of Fixture	Ballast Type	Lamps Per Fixture	Reflectors	Ballast Type	Per Single	Extended	Per Single	Extended	Surveyors Comments
Rehearsal Room	1	22	4' T8	2	Troffer	Electronic				\$ -	\$ -	\$ -	\$ -	T8 Lamps, no retrofit measure
	1	30	4' T8	4	Troffer	Electronic				\$ -	\$ -	\$ -	\$ -	T8 Lamps, no retrofit measure
Practice 1	1	2	4' T12	3	Troffer	Magnetic	3	N	Electronic	\$ 8.40	\$ 16.80	\$ 65.00	\$ 130.00	Excellent opportunity for retro-fit
Practice 2	1	2	4' T12	3	Troffer	Magnetic	3	N	Electronic	\$ 8.40	\$ 16.80	\$ 65.00	\$ 130.00	Excellent opportunity for retro-fit
Practice 3	1	2	4' T12	3	Troffer	Magnetic	3	N	Electronic	\$ 8.40	\$ 16.80	\$ 65.00	\$ 130.00	Excellent opportunity for retro-fit
Ensemble	1	5	4' T12	4	Troffer	Magnetic	4	N	Electronic	\$ 11.20	\$ 56.00	\$ 70.00	\$ 350.00	Excellent opportunity for retro-fit
Repair/Storage	1	5	4' T8	3	Troffer	Electronic				\$ -	\$ -	\$ -	\$ -	T8 Lamps, no retrofit measure
Office	1	3	4' T8	3	Troffer	Electronic				\$ -	\$ -	\$ -	\$ -	T8 Lamps, no retrofit measure
EXIT	1	2			Exit Sign					\$ -	\$ -	\$ -	\$ -	
Girls Restroom	1	3	4' T12	3	Troffer	Magnetic	3	N	Electronic	\$ 8.40	\$ 25.20	\$ 65.00	\$ 195.00	Excellent opportunity for retro-fit
Boys Restroom	1	3	4' T12	3	Troffer	Magnetic	3	N	Electronic	\$ 8.40	\$ 25.20	\$ 65.00	\$ 195.00	Excellent opportunity for retro-fit
Gen Utility	1	1	4' T8	2	Troffer	Electronic				\$ -	\$ -	\$ -	\$ -	T8 Lamps, no retrofit measure
V 102 Choral											\$ -		\$ -	
Rehearsal Room	1	30	4' T12	4	Troffer	Magnetic	4	N	Electronic	\$ 11.20	\$ 336.00	\$ 70.00	\$ 2,100.00	Excellent opportunity for retro-fit
	1	16	4' T12	2	Troffer	Magnetic	2	N	Electronic	\$ 5.60	\$ 89.60	\$ 60.00	\$ 960.00	Excellent opportunity for retro-fit
Office	1	3	4' T8	3	Troffer	Electronic				\$ -	\$ -	\$ -	\$ -	T8 Lamps, no retrofit measure
Storage	1	3	4' T12	4	Troffer	Magnetic	4	N	Electronic	\$ 11.20	\$ 33.60	\$ 70.00	\$ 210.00	Excellent opportunity for retro-fit
EXIT	1	2			Exit Sign					\$ -	\$ -	\$ -	\$ -	
BUILDING G											\$ -		\$ -	
Concession	1	9	4' T12	2	Troffer	Magnetic	2	N	Electronic	\$ 5.60	\$ 50.40	\$ 60.00	\$ 540.00	Excellent opportunity for retro-fit
RadioRoom	1	3	4' T12	2	Troffer	Magnetic	2	N	Electronic	\$ 5.60	\$ 16.80	\$ 60.00	\$ 180.00	Excellent opportunity for retro-fit
Guest	1	4	4' T12	2	Troffer	Magnetic	2	N	Electronic	\$ 5.60	\$ 22.40	\$ 60.00	\$ 240.00	Excellent opportunity for retro-fit
Broadcast	1	8	4' T12	2	Troffer	Magnetic	2	N	Electronic	\$ 5.60	\$ 44.80	\$ 60.00	\$ 480.00	Excellent opportunity for retro-fit
Home	1	4	4' T12	2	Troffer	Magnetic	2	N	Electronic	\$ 5.60	\$ 22.40	\$ 60.00	\$ 240.00	Excellent opportunity for retro-fit
Score Board	1	3	4' T12	2	Troffer	Magnetic	2	N	Electronic	\$ 5.60	\$ 16.80	\$ 60.00	\$ 180.00	Excellent opportunity for retro-fit
	1980													
										Total Rebates	\$	13,301.20		
										Total Costs	\$	106,839.40		

LOCATION	QTY	EXISTING TYPE	QTY	RETROFIT	SURVEYORS COMMENTS	Existing	Actual			Proposed			
						Watt/unit	Op. Hours	kWh	kW-D	Watt/unit	Op. Hours	kWh	kW-D
BUILDING A	0		0		0		2,382	0.0	0		2,382	0.0	0
Staff Lounge	4	4' 2L Fixture	4	Lamp & Low Watt ballast	Excellent opportunity for retro-fit	75.6	2,382	720.2	0.3024	51	2,382	485.8	0.204
Counselor 1	3	4' 2L Fixture	3	Lamp & Low Watt ballast	Excellent opportunity for retro-fit	75.6	2,382	540.1	0.2268	51	2,382	364.4	0.153
Counselor 2	3	4' 2L Fixture	3	Lamp & Low Watt ballast	Excellent opportunity for retro-fit	75.6	2,382	540.1	0.2268	51	2,382	364.4	0.153
Conference Room	6	4' 2L Fixture	6	Lamp & Low Watt ballast	Excellent opportunity for retro-fit	75.6	2,382	1,080.2	0.4536	51	2,382	728.7	0.306
Counselor 3	3	4' 2L Fixture	3	Lamp & Low Watt ballast	Excellent opportunity for retro-fit	75.6	2,382	540.1	0.2268	51	2,382	364.4	0.153
Counselor 4	3	4' 2L Fixture	3	Lamp & Low Watt ballast	Excellent opportunity for retro-fit	75.6	2,382	540.1	0.2268	51	2,382	364.4	0.153
	2	4' 2L Fixture	2	Lamp & Low Watt ballast	Excellent opportunity for retro-fit	75.6	2,382	360.1	0.1512	51	2,382	242.9	0.102
Registrar	6	4' 2L Fixture	6	Lamp & Low Watt ballast	Excellent opportunity for retro-fit	75.6	2,382	1,080.2	0.4536	51	2,382	728.7	0.306
	6	4' 2L Fixture	6	Lamp & Low Watt ballast	Excellent opportunity for retro-fit	75.6	2,382	1,080.2	0.4536	51	2,382	728.7	0.306
Ms. Cabral	6	4' 2L Fixture	6	Lamp & Low Watt ballast	Excellent opportunity for retro-fit	75.6	2,382	1,080.2	0.4536	51	2,382	728.7	0.306
Health Center	4	4' 4L Fixture	4	Lamp & Low Watt ballast	Excellent opportunity for retro-fit	151.2	2,382	1,440.3	0.6048	100	2,382	952.6	0.4
Office	4	4' 4L Fixture	4	Lamp & Low Watt ballast	Excellent opportunity for retro-fit	151.2	2,382	1,440.3	0.6048	100	2,382	952.6	0.4
Vice Principal	4	4' 4L Fixture	4	Lamp & Low Watt ballast	Excellent opportunity for retro-fit	151.2	2,382	1,440.3	0.6048	100	2,382	952.6	0.4
Conference Room	6	4' 2L Fixture	6	Lamp & Low Watt ballast	Excellent opportunity for retro-fit	75.6	2,382	1,080.2	0.4536	51	2,382	728.7	0.306
Principal Office	6	4' 2L Fixture	6	Lamp & Low Watt ballast	Excellent opportunity for retro-fit	75.6	2,382	1,080.2	0.4536	51	2,382	728.7	0.306
Dup. Room	4	4' 2L Fixture	4	Lamp & Low Watt ballast	Excellent opportunity for retro-fit	75.6	2,382	720.2	0.3024	51	2,382	485.8	0.204
Storage	3	4' 4L Fixture	3	Lamp & Low Watt ballast	Excellent opportunity for retro-fit	151.2	2,382	1,080.2	0.4536	100	2,382	714.5	0.3
Tele Center	2	4' 2L Fixture	2	Lamp & Low Watt ballast	Excellent opportunity for retro-fit	75.6	2,382	360.1	0.1512	51	2,382	242.9	0.102
Office	11	4' 2L Fixture	11	Lamp & Low Watt ballast	Excellent opportunity for retro-fit	75.6	2,382	1,980.5	0.8316	51	2,382	1,336.0	0.561
BUILDING B	0		0		0		2,382	0.0	0		2,382	0.0	0
Library	112	2x2 2U Fixture	112	Lamp & Low Watt ballast	F40 Biax Lamps No Comment	75.6	2,382	20,164.6	8.4672	51	2,382	13,603.1	5.712
Main Room	68		0		T8 Lamps, no retrofit measure		2,382	0.0	0		2,382	0.0	0
Storage	23		0		T8 Lamps, no retrofit measure		2,382	0.0	0		2,382	0.0	0
Office	6		0		T8 Lamps, no retrofit measure		2,382	0.0	0		2,382	0.0	0
Mens Restroom	1	0	0	0	T8 Lamps, no retrofit measure	0	2,382	0.0	0	0	2,382	0.0	0
Womens Restroom	1	0	0	0	T8 Lamps, no retrofit measure	0	2,382	0.0	0	0	2,382	0.0	0
Media Control	10	0	0	0	T8 Lamps, no retrofit measure	0	2,382	0.0	0	0	2,382	0.0	0
Conference	4	4' 4L Fixture	4	Lamp & Low Watt ballast	Excellent opportunity for retro-fit	151.2	2,382	1,440.3	0.6048	100	2,382	952.6	0.4
Video	2	4' 4L Fixture	2	Lamp & Low Watt ballast	Excellent opportunity for retro-fit	151.2	2,382	720.2	0.3024	100	2,382	476.3	0.2
Utility	1	4' 2L Fixture	1	Lamp & Low Watt ballast	Excellent opportunity for retro-fit	75.6	2,382	180.0	0.0756	51	2,382	121.5	0.051
Electrical	3	4' 2L Fixture	3	Lamp & Low Watt ballast	Excellent opportunity for retro-fit	75.6	2,382	540.1	0.2268	51	2,382	364.4	0.153
BUILDING C	0		0		0		2,382	0.0	0		2,382	0.0	0
Tool Room	1	4' 2L Fixture	1	Lamp & Low Watt ballast	Excellent opportunity for retro-fit	75.6	2,382	180.0	0.0756	51	2,382	121.5	0.051
Custodial	4	4' 2L Fixture	4	Lamp & Low Watt ballast	Excellent opportunity for retro-fit	75.6	2,382	720.2	0.3024	51	2,382	485.8	0.204
Locker	1	4' 2L Fixture	1	Lamp & Low Watt ballast	Excellent opportunity for retro-fit	75.6	2,382	180.0	0.0756	51	2,382	121.5	0.051
Electrical	2	4' 1L Fixture	2	Lamp & Low Watt ballast	Excellent opportunity for retro-fit	45.6	2,382	217.2	0.0912	31	2,382	147.7	0.062
Manager	3	0	0	0	T8 Lamps, no retrofit measure	0	2,382	0.0	0	0	2,382	0.0	0
Gen Utility	2	0	0	0	T8 Lamps, no retrofit measure	0	2,382	0.0	0	0	2,382	0.0	0
Storage	4	4' 2L Fixture	4	Lamp & Low Watt ballast	Excellent opportunity for retro-fit	75.6	2,382	720.2	0.3024	51	2,382	485.8	0.204
Mens Restroom	1	4' 2L Fixture	1	Lamp & Low Watt ballast	Excellent opportunity for retro-fit	75.6	2,382	180.0	0.0756	51	2,382	121.5	0.051
Toilet	1	0	0	0	T8 Lamps, no retrofit measure	0	2,382	0.0	0	0	2,382	0.0	0
Womens Restroom	1	4' 2L Fixture	1	Lamp & Low Watt ballast	Excellent opportunity for retro-fit	75.6	2,382	180.0	0.0756	51	2,382	121.5	0.051
Toilet	1	4' 2L Fixture	1	Lamp & Low Watt ballast	Excellent opportunity for retro-fit	75.6	2,382	180.0	0.0756	51	2,382	121.5	0.051
Staff Dining	8	0	0	0	T8 Lamps, no retrofit measure	0	2,382	0.0	0	0	2,382	0.0	0
Main Kitchen	14	4' 2L Fixture	14	Lamp & Low Watt ballast	Excellent opportunity for retro-fit	75.6	2,382	2,520.6	1.0584	51	2,382	1,700.4	0.714
	28	4' 2L Fixture	28	Lamp & Low Watt ballast	Excellent opportunity for retro-fit	75.6	2,382	5,041.2	2.1168	51	2,382	3,400.8	1.428
	2	2x2 2U Fixture	2	Lamp & Low Watt ballast	Excellent opportunity for retro-fit	75.6	2,382	360.1	0.1512	51	2,382	242.9	0.102
Can Wash	3	4' 2L Fixture	3	Lamp & Low Watt ballast	Excellent opportunity for retro-fit	75.6	2,382	540.1	0.2268	51	2,382	364.4	0.153
Storage	1	4' 2L Fixture	1	Lamp & Low Watt ballast	Excellent opportunity for retro-fit	75.6	2,382	180.0	0.0756	51	2,382	121.5	0.051
Main Dining	30	0	0	0	T8 Lamps, no retrofit measure	0	2,382	0.0	0	0	2,382	0.0	0
	54	4' 2L Fixture	54	Lamp & Low Watt ballast	Excellent opportunity for retro-fit	75.6	2,382	9,722.2	4.0824	51	2,382	6,558.7	2.754
	14	4' 2L Fixture	14	Lamp & Low Watt ballast	Excellent opportunity for retro-fit	75.6	2,382	2,520.6	1.0584	51	2,382	1,700.4	0.714
Stage	4	4' 2L Fixture	4	Lamp & Low Watt ballast	Excellent opportunity for retro-fit	75.6	2,382	720.2	0.3024	51	2,382	485.8	0.204
Girls' Dressing	2	4' 2L Fixture	2	Lamp & Low Watt ballast	Excellent opportunity for retro-fit	75.6	2,382	360.1	0.1512	51	2,382	242.9	0.102
Boys' Dressing	2	4' 2L Fixture	2	Lamp & Low Watt ballast	Excellent opportunity for retro-fit	75.6	2,382	360.1	0.1512	51	2,382	242.9	0.102
EXIT	6		6		0		2,382	0.0	0		2,382	0.0	0

LOCATION	QTY	EXISTING TYPE	QTY	RETROFIT	SURVEYORS COMMENTS	Existing	Actual			Proposed			
						Watt/unit	Op. Hours	kWh	kW-D	Watt/unit	Op. Hours	kWh	kW-D
BUILDING D	0		0		0		2,382	0.0	0	2,382	0.0	0	0
<i>D 105A</i>	12	4' 2L Fixture	12	Lamp & Low Watt ballast	Excellent opportunity for retro-fit	75.6	2,382	2,160.5	0.9072	51	2,382	1,457.5	0.612
<i>D 105B</i>	15	4' 2L Fixture	15	Lamp & Low Watt ballast	Excellent opportunity for retro-fit	75.6	2,382	2,700.6	1.134	51	2,382	1,821.8	0.765
Storage	4	4' 4L Fixture	4	Lamp & Low Watt ballast	Excellent opportunity for retro-fit	151.2	2,382	1,440.3	0.6048	100	2,382	952.6	0.4
<i>D 104 Restroom</i>	15	4' 2L Fixture	15	Lamp & Low Watt ballast	Excellent opportunity for retro-fit	75.6	2,382	2,700.6	1.134	51	2,382	1,821.8	0.765
<i>D 103</i>	15	4' 2L Fixture	15	Lamp & Low Watt ballast	Excellent opportunity for retro-fit	75.6	2,382	2,700.6	1.134	51	2,382	1,821.8	0.765
<i>D 102</i>	15	4' 2L Fixture	15	Lamp & Low Watt ballast	Excellent opportunity for retro-fit	75.6	2,382	2,700.6	1.134	51	2,382	1,821.8	0.765
<i>D 101</i>	15	4' 2L Fixture	15	Lamp & Low Watt ballast	Excellent opportunity for retro-fit	75.6	2,382	2,700.6	1.134	51	2,382	1,821.8	0.765
Girls' Restroom	3	4' 2L Fixture	3	Lamp & Low Watt ballast	Excellent opportunity for retro-fit	75.6	2,382	540.1	0.2268	51	2,382	364.4	0.153
Electrical	2	4' 4L Fixture	2	Lamp & Low Watt ballast	Excellent opportunity for retro-fit	151.2	2,382	720.2	0.3024	100	2,382	476.3	0.2
Gen Utility	1	4' 1L Fixture	1	Lamp & Low Watt ballast	Excellent opportunity for retro-fit	45.6	2,382	108.6	0.0456	31	2,382	73.8	0.031
Boys' Restroom	3	4' 2L Fixture	3	Lamp & Low Watt ballast	Excellent opportunity for retro-fit	75.6	2,382	540.1	0.2268	51	2,382	364.4	0.153
Boys' Restroom	3	4' 2L Fixture	3	Lamp & Low Watt ballast	Excellent opportunity for retro-fit	75.6	2,382	540.1	0.2268	51	2,382	364.4	0.153
Elect. Storage	2	4' 2L Fixture	2	Lamp & Low Watt ballast	Excellent opportunity for retro-fit	75.6	2,382	360.1	0.1512	51	2,382	242.9	0.102
Electrical	2	4' 2L Fixture	2	Lamp & Low Watt ballast	Excellent opportunity for retro-fit	75.6	2,382	360.1	0.1512	51	2,382	242.9	0.102
Girls' Restroom	3	4' 2L Fixture	3	Lamp & Low Watt ballast	Excellent opportunity for retro-fit	75.6	2,382	540.1	0.2268	51	2,382	364.4	0.153
<i>D 201</i>	15	4' 2L Fixture	15	Lamp & Low Watt ballast	Excellent opportunity for retro-fit	75.6	2,382	2,700.6	1.134	51	2,382	1,821.8	0.765
<i>D 202</i>	15	4' 2L Fixture	15	Lamp & Low Watt ballast	Excellent opportunity for retro-fit	75.6	2,382	2,700.6	1.134	51	2,382	1,821.8	0.765
<i>D 203</i>	15	4' 2L Fixture	15	Lamp & Low Watt ballast	Excellent opportunity for retro-fit	75.6	2,382	2,700.6	1.134	51	2,382	1,821.8	0.765
<i>D 204</i>	15	4' 2L Fixture	15	Lamp & Low Watt ballast	Excellent opportunity for retro-fit	75.6	2,382	2,700.6	1.134	51	2,382	1,821.8	0.765
<i>D 205</i>	15	4' 2L Fixture	15	Lamp & Low Watt ballast	Excellent opportunity for retro-fit	75.6	2,382	2,700.6	1.134	51	2,382	1,821.8	0.765
<i>D 205</i>	15	4' 2L Fixture	15	Lamp & Low Watt ballast	Excellent opportunity for retro-fit	75.6	2,382	2,700.6	1.134	51	2,382	1,821.8	0.765
<i>D 206</i>	15	4' 2L Fixture	15	Lamp & Low Watt ballast	Excellent opportunity for retro-fit	75.6	2,382	2,700.6	1.134	51	2,382	1,821.8	0.765
BUILDING I	0		0		0		2,382	0.0	0	2,382	0.0	0	0
Area of Reserve	1	4' 2L Fixture	1	Lamp & Low Watt ballast	Excellent opportunity for retro-fit	75.6	2,382	180.0	0.0756	51	2,382	121.5	0.051
<i>H 206</i>	15	4' 4L Fixture	15	Lamp & Low Watt ballast	Excellent opportunity for retro-fit	151.2	2,382	5,401.2	2.268	100	2,382	3,572.3	1.5
<i>H 205</i>	15	4' 4L Fixture	15	Lamp & Low Watt ballast	Excellent opportunity for retro-fit	151.2	2,382	5,401.2	2.268	100	2,382	3,572.3	1.5
<i>H 204</i>	15	4' 4L Fixture	15	Lamp & Low Watt ballast	Excellent opportunity for retro-fit	151.2	2,382	5,401.2	2.268	100	2,382	3,572.3	1.5
<i>H 203</i>	15	4' 4L Fixture	15	Lamp & Low Watt ballast	Excellent opportunity for retro-fit	151.2	2,382	5,401.2	2.268	100	2,382	3,572.3	1.5
<i>H 202</i>	15	4' 4L Fixture	15	Lamp & Low Watt ballast	Excellent opportunity for retro-fit	151.2	2,382	5,401.2	2.268	100	2,382	3,572.3	1.5
<i>H 201</i>	20	4' 4L Fixture	20	Lamp & Low Watt ballast	Excellent opportunity for retro-fit	151.2	2,382	7,201.7	3.024	100	2,382	4,763.0	2
Snack Shop	3	4' 4L Fixture	3	Lamp & Low Watt ballast	Excellent opportunity for retro-fit	151.2	2,382	1,080.2	0.4536	100	2,382	714.5	0.3
Duplicating	2	4' 4L Fixture	2	Lamp & Low Watt ballast	Excellent opportunity for retro-fit	151.2	2,382	720.2	0.3024	100	2,382	476.3	0.2
Faculty Center	11	4' 4L Fixture	11	Lamp & Low Watt ballast	Excellent opportunity for retro-fit	151.2	2,382	3,960.9	1.6632	100	2,382	2,619.7	1.1
Staff Restroom	2	4' 2L Fixture	2	Lamp & Low Watt ballast	Excellent opportunity for retro-fit	75.6	2,382	360.1	0.1512	51	2,382	242.9	0.102
General Utility	2	4' 2L Fixture	2	Lamp & Low Watt ballast	Excellent opportunity for retro-fit	75.6	2,382	360.1	0.1512	51	2,382	242.9	0.102
Electrical	4	4' 2L Fixture	4	Lamp & Low Watt ballast	Excellent opportunity for retro-fit	75.6	2,382	720.2	0.3024	51	2,382	485.8	0.204
Restroom B/G	10	2x2 2U Fixture	0	Lamp & Low Watt ballast	T8 Lamps, no retrofit measure	75.6	2,382	1,800.4	0.756	51	2,382	0.0	0
Electrical	4	2x2 2U Fixture	0	Lamp & Low Watt ballast	T8 Lamps, no retrofit measure	75.6	2,382	720.2	0.3024	51	2,382	0.0	0
Restroom B/G	8	4' 2L Fixture	8	Lamp & Low Watt ballast	Excellent opportunity for retro-fit	75.6	2,382	1,440.3	0.6048	51	2,382	971.7	0.408
General Utility	2	4' 2L Fixture	2	Lamp & Low Watt ballast	Excellent opportunity for retro-fit	75.6	2,382	360.1	0.1512	51	2,382	242.9	0.102
<i>I 203</i>	12	4' 4L Fixture	12	Lamp & Low Watt ballast	Excellent opportunity for retro-fit	151.2	2,382	4,321.0	1.8144	100	2,382	2,857.8	1.2
<i>I 202</i>	24	4' 4L Fixture	24	Lamp & Low Watt ballast	Excellent opportunity for retro-fit	151.2	2,382	8,642.0	3.6288	100	2,382	5,715.6	2.4
Prep Room	2	4' 2L Fixture	2	Lamp & Low Watt ballast	Excellent opportunity for retro-fit	75.6	2,382	360.1	0.1512	51	2,382	242.9	0.102
	2	4' 4L Fixture	2	Lamp & Low Watt ballast	Excellent opportunity for retro-fit	151.2	2,382	720.2	0.3024	100	2,382	476.3	0.2
<i>I 201</i>	12	4' 4L Fixture	12	Lamp & Low Watt ballast	Excellent opportunity for retro-fit	151.2	2,382	4,321.0	1.8144	100	2,382	2,857.8	1.2
BUILDING I + H	0		0		0		2,382	0.0	0	2,382	0.0	0	0
<i>I 101</i>	12	4' 4L Fixture	12	Lamp & Low Watt ballast	Excellent opportunity for retro-fit	151.2	2,382	4,321.0	1.8144	100	2,382	2,857.8	1.2
<i>I 101</i>	24	4' 4L Fixture	24	Lamp & Low Watt ballast	Excellent opportunity for retro-fit	151.2	2,382	8,642.0	3.6288	100	2,382	5,715.6	2.4
<i>I 102</i>	2	4' 2L Fixture	2	Lamp & Low Watt ballast	Excellent opportunity for retro-fit	75.6	2,382	360.1	0.1512	51	2,382	242.9	0.102
Prep Room	2	4' 4L Fixture	2	Lamp & Low Watt ballast	Excellent opportunity for retro-fit	151.2	2,382	720.2	0.3024	100	2,382	476.3	0.2
<i>I 103</i>	12	4' 4L Fixture	12	Lamp & Low Watt ballast	Excellent opportunity for retro-fit	151.2	2,382	4,321.0	1.8144	100	2,382	2,857.8	1.2
Electrical Utility	2	4' 2L Fixture	2	Lamp & Low Watt ballast	Excellent opportunity for retro-fit	75.6	2,382	360.1	0.1512	51	2,382	242.9	0.102
Restroom B/G	8	4' 4L Fixture	8	Lamp & Low Watt ballast	Excellent opportunity for retro-fit	151.2	2,382	2,880.7	1.2096	100	2,382	1,905.2	0.8
Electrical	4	4' 2L Fixture	4	Lamp & Low Watt ballast	Excellent opportunity for retro-fit	75.6	2,382	720.2	0.3024	51	2,382	485.8	0.204
Electrical Elevator RM.	1	4' 2L Fixture	1	Lamp & Low Watt ballast	Excellent opportunity for retro-fit	75.6	2,382	180.0	0.0756	51	2,382	121.5	0.051
Restroom B/G	10	4' 2L Fixture	10	Lamp & Low Watt ballast	Excellent opportunity for retro-fit	75.6	2,382	1,800.4	0.756	51	2,382	1,214.6	0.51
Electrical Comm.	4	4' 2L Fixture	4	Lamp & Low Watt ballast	Excellent opportunity for retro-fit	75.6	2,382	720.2	0.3024	51	2,382	485.8	0.204

LOCATION	QTY	EXISTING TYPE	QTY	RETROFIT	SURVEYORS COMMENTS	Existing	Actual				Proposed			
						Watt/unit	Op. Hours	kWh	kW-D	Watt/unit	Op. Hours	kWh	kW-D	
General Utility	2	4' 2L Fixture	2	Lamp & Low Watt ballast	Excellent opportunity for retro-fit	75.6	2,382	360.1	0.1512	51	2,382	242.9	0.102	
H 101	32	4' 4L Fixture	32	Lamp & Low Watt ballast	Excellent opportunity for retro-fit	151.2	2,382	11,522.6	4.8384	100	2,382	7,620.8	3.2	
Teacher Prep	18	4' 4L Fixture	18	Lamp & Low Watt ballast	Excellent opportunity for retro-fit	151.2	2,382	6,481.5	2.7216	100	2,382	4,286.7	1.8	
H 102	29	4' 4L Fixture	29	Lamp & Low Watt ballast	Excellent opportunity for retro-fit	151.2	2,382	10,442.4	4.3848	100	2,382	6,906.4	2.9	
H 103	29	4' 4L Fixture	29	Lamp & Low Watt ballast	Excellent opportunity for retro-fit	151.2	2,382	10,442.4	4.3848	100	2,382	6,906.4	2.9	
Kiln	2	4' 2L Fixture	2	Lamp & Low Watt ballast	Excellent opportunity for retro-fit	75.6	2,382	360.1	0.1512	51	2,382	242.9	0.102	
BUILDING K	0		0		0		2,382	0.0	0		2,382	0.0	0	
Electrical	4	4' 2L Fixture	4	Lamp & Low Watt ballast	Excellent opportunity for retro-fit	75.6	2,382	720.2	0.3024	51	2,382	485.8	0.204	
Restroom B/G	8	4' 2L Fixture	8	Lamp & Low Watt ballast	Excellent opportunity for retro-fit	75.6	2,382	1,440.3	0.6048	51	2,382	971.7	0.408	
General Utility	2	4' 2L Fixture	2	Lamp & Low Watt ballast	Excellent opportunity for retro-fit	75.6	2,382	360.1	0.1512	51	2,382	242.9	0.102	
Model Store	10	4' 3L Fixture	10	Lamp & Low Watt ballast	Excellent opportunity for retro-fit	121.2	2,382	2,886.4	1.212	77	2,382	1,833.8	0.77	
K 203	13	4' 4L Fixture	13	Lamp & Low Watt ballast	Excellent opportunity for retro-fit	151.2	2,382	4,681.1	1.9656	100	2,382	3,096.0	1.3	
K 202	20	4' 4L Fixture	20	Lamp & Low Watt ballast	Excellent opportunity for retro-fit	151.2	2,382	7,201.7	3.024	100	2,382	4,763.0	2	
K 201 Electrical	39	4' 4L Fixture	39	Lamp & Low Watt ballast	Excellent opportunity for retro-fit	151.2	2,382	14,043.2	5.8968	100	2,382	9,287.9	3.9	
S Cage	10	4' 2L Fixture	10	Lamp & Low Watt ballast	Excellent opportunity for retro-fit	75.6	2,382	1,800.4	0.756	51	2,382	1,214.6	0.51	
Restroom	1	4' 3L Fixture	1	Lamp & Low Watt ballast	Excellent opportunity for retro-fit	121.2	2,382	288.6	0.1212	77	2,382	183.4	0.077	
Staff Restroom	1	4' 3L Fixture	1	Lamp & Low Watt ballast	Excellent opportunity for retro-fit	121.2	2,382	288.6	0.1212	77	2,382	183.4	0.077	
K 101	46	4' 4L Fixture	46	Lamp & Low Watt ballast	Excellent opportunity for retro-fit	151.2	2,382	16,563.8	6.9552	100	2,382	10,954.9	4.6	
Supply Room	2	4' 2L Fixture	2	Lamp & Low Watt ballast	Excellent opportunity for retro-fit	75.6	2,382	360.1	0.1512	51	2,382	242.9	0.102	
K 102	12	4' 4L Fixture	12	Lamp & Low Watt ballast	Excellent opportunity for retro-fit	151.2	2,382	4,321.0	1.8144	100	2,382	2,857.8	1.2	
K 103	12	4' 4L Fixture	12	Lamp & Low Watt ballast	Excellent opportunity for retro-fit	151.2	2,382	4,321.0	1.8144	100	2,382	2,857.8	1.2	
K 104	12	4' 4L Fixture	12	Lamp & Low Watt ballast	Excellent opportunity for retro-fit	151.2	2,382	4,321.0	1.8144	100	2,382	2,857.8	1.2	
Utility	2	4' 2L Fixture	2	Lamp & Low Watt ballast	Excellent opportunity for retro-fit	75.6	2,382	360.1	0.1512	51	2,382	242.9	0.102	
Restroom B/G	8	4' 2L Fixture	8	Lamp & Low Watt ballast	Excellent opportunity for retro-fit	75.6	2,382	1,440.3	0.6048	51	2,382	971.7	0.408	
Electrical	4	4' 2L Fixture	4	Lamp & Low Watt ballast	Excellent opportunity for retro-fit	75.6	2,382	720.2	0.3024	51	2,382	485.8	0.204	
PORTABLES	0		0		0		2,382	0.0	0		2,382	0.0	0	
P 1	8	4' 3L Fixture	8	Lamp & Low Watt ballast	Excellent opportunity for retro-fit	121.2	2,382	2,309.1	0.9696	77	2,382	1,467.0	0.616	
P 1A	8	4' 3L Fixture	8	Lamp & Low Watt ballast	Excellent opportunity for retro-fit	121.2	2,382	2,309.1	0.9696	77	2,382	1,467.0	0.616	
P 2	8	4' 3L Fixture	8	Lamp & Low Watt ballast	Excellent opportunity for retro-fit	121.2	2,382	2,309.1	0.9696	77	2,382	1,467.0	0.616	
P 2A	8	4' 3L Fixture	8	Lamp & Low Watt ballast	Excellent opportunity for retro-fit	121.2	2,382	2,309.1	0.9696	77	2,382	1,467.0	0.616	
P 3	8	4' 3L Fixture	8	Lamp & Low Watt ballast	Excellent opportunity for retro-fit	121.2	2,382	2,309.1	0.9696	77	2,382	1,467.0	0.616	
P 3A	8	4' 3L Fixture	8	Lamp & Low Watt ballast	Excellent opportunity for retro-fit	121.2	2,382	2,309.1	0.9696	77	2,382	1,467.0	0.616	
P 4	8	4' 3L Fixture	8	Lamp & Low Watt ballast	Excellent opportunity for retro-fit	121.2	2,382	2,309.1	0.9696	77	2,382	1,467.0	0.616	
P 4A	8	0	0	0	T8 Lamps, no retrofit measure	0	2,382	0.0	0	0	2,382	0.0	0	
BUILDING M	0		0		0		2,382	0.0	0		2,382	0.0	0	
M 101	22	4' 4L Fixture	22	Lamp & Low Watt ballast	Excellent opportunity for retro-fit	151.2	2,382	7,921.8	3.3264	100	2,382	5,239.3	2.2	
Restroom B/G	4	4' 3L Fixture	4	Lamp & Low Watt ballast	Excellent opportunity for retro-fit	121.2	2,382	1,154.6	0.4848	77	2,382	733.5	0.308	
	2	4' 4L Fixture	2	Lamp & Low Watt ballast	Excellent opportunity for retro-fit	151.2	2,382	720.2	0.3024	100	2,382	476.3	0.2	
	12	0	0	0	Halogen Lamps	0	2,382	0.0	0	0	2,382	0.0	0	
Green House	6	4' 2L Fixture	6	Lamp & Low Watt ballast	Excellent opportunity for retro-fit	75.6	2,382	1,080.2	0.4536	51	2,382	728.7	0.306	
Storage	13	4' 2L Fixture	13	Lamp & Low Watt ballast	Excellent opportunity for retro-fit	75.6	2,382	2,340.5	0.9828	51	2,382	1,578.9	0.663	
GYMNASIUM	0		0		0		2,382	0.0	0		2,382	0.0	0	
Home Boys' L/S	0		0		0		2,382	0.0	0		2,382	0.0	0	
Locker	4	4' 4L Fixture	4	Lamp & Low Watt ballast	Excellent opportunity for retro-fit	151.2	2,382	1,440.3	0.6048	100	2,382	952.6	0.4	
Shower	8	0	0	0	T8 Lamps, no retrofit measure	0	2,382	0.0	0	0	2,382	0.0	0	
Restroom	2	4' 4L Fixture	2	Lamp & Low Watt ballast	Excellent opportunity for retro-fit	151.2	2,382	720.2	0.3024	100	2,382	476.3	0.2	
Hall	8	4' 2L Fixture	8	Lamp & Low Watt ballast	Excellent opportunity for retro-fit	75.6	2,382	1,440.3	0.6048	51	2,382	971.7	0.408	
Electrical	1	4' 2L Fixture	1	Lamp & Low Watt ballast	Excellent opportunity for retro-fit	75.6	2,382	180.0	0.0756	51	2,382	121.5	0.051	
Staff Restroom	2	4' 4L Fixture	2	Lamp & Low Watt ballast	Excellent opportunity for retro-fit	151.2	2,382	720.2	0.3024	100	2,382	476.3	0.2	
Utility	1	4' 4L Fixture	1	Lamp & Low Watt ballast	Excellent opportunity for retro-fit	151.2	2,382	360.1	0.1512	100	2,382	238.2	0.1	
Hall	4	4' 2L Fixture	4	Lamp & Low Watt ballast	Excellent opportunity for retro-fit	75.6	2,382	720.2	0.3024	51	2,382	485.8	0.204	
Storage	2	4' 2L Fixture	2	Lamp & Low Watt ballast	Excellent opportunity for retro-fit	75.6	2,382	360.1	0.1512	51	2,382	242.9	0.102	
Wrestling	24	4' 4L Fixture	24	Lamp & Low Watt ballast	Excellent opportunity for retro-fit	151.2	2,382	8,642.0	3.6288	100	2,382	5,715.6	2.4	
Visitor Girls	1	4' 2L Fixture	1	Lamp & Low Watt ballast	Excellent opportunity for retro-fit	75.6	2,382	180.0	0.0756	51	2,382	121.5	0.051	
Restroom	2	4' 4L Fixture	2	Lamp & Low Watt ballast	Excellent opportunity for retro-fit	151.2	2,382	720.2	0.3024	100	2,382	476.3	0.2	
Locker	4	4' 4L Fixture	4	Lamp & Low Watt ballast	Excellent opportunity for retro-fit	151.2	2,382	1,440.3	0.6048	100	2,382	952.6	0.4	
Shower	8	4' 2L Fixture	8	Lamp & Low Watt ballast	Excellent opportunity for retro-fit	75.6	2,382	1,440.3	0.6048	51	2,382	971.7	0.408	
Upstairs Hall	36	4' 4L Fixture	36	Lamp & Low Watt ballast	Excellent opportunity for retro-fit	151.2	2,382	12,963.0	5.4432	100	2,382	8,573.4	3.6	

LOCATION	QTY	EXISTING TYPE	QTY	RETROFIT	SURVEYORS COMMENTS	Existing Watt/unit	Actual				Proposed			
							Op. Hours	kWh	kW-D	Watt/unit	Op. Hours	kWh	kW-D	
<i>Mens Restroom</i>	5	4' 4L Fixture	5	Lamp & Low Watt ballast	Excellent opportunity for retro-fit	151.2	2,382	1,800.4	0.756	100	2,382	1,190.8	0.5	
<i>Office</i>	2	4' 4L Fixture	2	Lamp & Low Watt ballast	Excellent opportunity for retro-fit	151.2	2,382	720.2	0.3024	100	2,382	476.3	0.2	
<i>Kitchen</i>	4	4' 4L Fixture	4	Lamp & Low Watt ballast	Excellent opportunity for retro-fit	151.2	2,382	1,440.3	0.6048	100	2,382	952.6	0.4	
BUILDING O	0		0		0		2,382	0.0	0		2,382	0.0	0	
<i>Electrical</i>	2	0	0	0	T8 Lamps, no retrofit measure	0	2,382	0.0	0	0	2,382	0.0	0	
<i>Class Room</i>	16	0	0	0	T8 Lamps, no retrofit measure	0	2,382	0.0	0	0	2,382	0.0	0	
<i>Office</i>	3	0	0	0	T8 Lamps, no retrofit measure	0	2,382	0.0	0	0	2,382	0.0	0	
<i>Shop Area</i>	35	8' 2L Fixture	35	Lamp & Ballast Retrofit	Excellent opportunity for retro-fit	158	2,382	13,169.7	5.53	110	2,382	9,168.8	3.85	
<i>Spray Booth</i>	6	8' 2L Fixture	6	Lamp & Ballast Retrofit	Excellent opportunity for retro-fit	158	2,382	2,257.7	0.948	110	2,382	1,571.8	0.66	
<i>EXIT</i>	3	0	3	0	0	0	2,382	0.0	0	0	2,382	0.0	0	
<i>Boys Restroom</i>	6	4' 2L Fixture	6	Lamp & Low Watt ballast	Excellent opportunity for retro-fit	75.6	2,382	1,080.2	0.4536	51	2,382	728.7	0.306	
<i>Girls Restroom</i>	6	4' 2L Fixture	6	Lamp & Low Watt ballast	Excellent opportunity for retro-fit	75.6	2,382	1,080.2	0.4536	51	2,382	728.7	0.306	
BUILDING Q	0		0		0		2,382	0.0	0		2,382	0.0	0	
<i>Material Storage</i>	4	0	0	0	T8 Lamps, no retrofit measure	0	2,382	0.0	0	0	2,382	0.0	0	
<i>Project Storage 5</i>	2	4' 2L Fixture	2	Lamp & Low Watt ballast	Excellent opportunity for retro-fit	75.6	2,382	360.1	0.1512	51	2,382	242.9	0.102	
<i>Project Storage 4</i>	2	4' 2L Fixture	2	Lamp & Low Watt ballast	Excellent opportunity for retro-fit	75.6	2,382	360.1	0.1512	51	2,382	242.9	0.102	
<i>Project Storage 3</i>	2	4' 2L Fixture	2	Lamp & Low Watt ballast	Excellent opportunity for retro-fit	75.6	2,382	360.1	0.1512	51	2,382	242.9	0.102	
<i>Project Storage 2</i>	2	4' 2L Fixture	2	Lamp & Low Watt ballast	Excellent opportunity for retro-fit	75.6	2,382	360.1	0.1512	51	2,382	242.9	0.102	
<i>Wash Area</i>	2	4' 2L Fixture	2	Lamp & Low Watt ballast	Excellent opportunity for retro-fit	75.6	2,382	360.1	0.1512	51	2,382	242.9	0.102	
<i>Project Storage 1</i>	2	4' 2L Fixture	2	Lamp & Low Watt ballast	Excellent opportunity for retro-fit	75.6	2,382	360.1	0.1512	51	2,382	242.9	0.102	
<i>Tools</i>	2	4' 2L Fixture	2	Lamp & Low Watt ballast	Excellent opportunity for retro-fit	75.6	2,382	360.1	0.1512	51	2,382	242.9	0.102	
<i>Boys Restroom</i>	1	4' 2L Fixture	1	Lamp & Low Watt ballast	Excellent opportunity for retro-fit	75.6	2,382	180.0	0.0756	51	2,382	121.5	0.051	
<i>Girls Restroom</i>	1	4' 2L Fixture	1	Lamp & Low Watt ballast	Excellent opportunity for retro-fit	75.6	2,382	180.0	0.0756	51	2,382	121.5	0.051	
<i>Class Room</i>	15	4' 4L Fixture	15	Lamp & Low Watt ballast	Excellent opportunity for retro-fit	151.2	2,382	5,401.2	2.268	100	2,382	3,572.3	1.5	
<i>Office</i>	3	4' 3L Fixture	3	Lamp & Low Watt ballast	Excellent opportunity for retro-fit	121.2	2,382	865.9	0.3636	77	2,382	550.1	0.231	
<i>Supply Parts</i>	2	4' 4L Fixture	2	Lamp & Low Watt ballast	Excellent opportunity for retro-fit	151.2	2,382	720.2	0.3024	100	2,382	476.3	0.2	
<i>Office Bathroom</i>	1	4' 2L Fixture	1	Lamp & Low Watt ballast	Excellent opportunity for retro-fit	75.6	2,382	180.0	0.0756	51	2,382	121.5	0.051	
<i>Main Shop</i>	41	4' 2L Fixture	41	Lamp & Low Watt ballast	Excellent opportunity for retro-fit	75.6	2,382	7,381.7	3.0996	51	2,382	4,979.7	2.091	
<i>EXIT</i>	2	0	2	0	0	0	2,382	0.0	0	0	2,382	0.0	0	
<i>Electrical</i>	1	4' 3L Fixture	1	Lamp & Low Watt ballast	Excellent opportunity for retro-fit	121.2	2,382	288.6	0.1212	77	2,382	183.4	0.077	
BUILDING T	0		0		0		2,382	0.0	0		2,382	0.0	0	
<i>T 101</i>	15	0	0	0	T8 Lamps, no retrofit measure	0	2,382	0.0	0	0	2,382	0.0	0	
<i>T 102</i>	1	4' 2L Fixture	1	Lamp & Low Watt ballast	Excellent opportunity for retro-fit	75.6	2,382	180.0	0.0756	51	2,382	121.5	0.051	
BUILDING X	0		0		0		2,382	0.0	0		2,382	0.0	0	
<i>X 101</i>	20	0	0	0	T8 Lamps, no retrofit measure	0	2,382	0.0	0	0	2,382	0.0	0	
BUILDING S	0		0		0		2,382	0.0	0		2,382	0.0	0	
<i>Girls Locker</i>	14	4' 2L Fixture	14	Lamp & Low Watt ballast	Excellent opportunity for retro-fit	75.6	2,382	2,520.6	1.0584	51	2,382	1,700.4	0.714	
<i>Shower</i>	6	4' 2L Fixture	6	Lamp & Low Watt ballast	Excellent opportunity for retro-fit	75.6	2,382	1,080.2	0.4536	51	2,382	728.7	0.306	
<i>Tower</i>	4	2x2 2U Fixture	4	Lamp & Low Watt ballast	Excellent opportunity for retro-fit	75.6	2,382	720.2	0.3024	51	2,382	485.8	0.204	
<i>Toilet</i>	2	4' 2L Fixture	2	Lamp & Low Watt ballast	Excellent opportunity for retro-fit	75.6	2,382	360.1	0.1512	51	2,382	242.9	0.102	
<i>Office</i>	4	2x2 2U Fixture	4	Lamp & Low Watt ballast	Excellent opportunity for retro-fit	75.6	2,382	720.2	0.3024	51	2,382	485.8	0.204	
<i>Toilet</i>	1	4' 2L Fixture	1	Lamp & Low Watt ballast	Excellent opportunity for retro-fit	75.6	2,382	180.0	0.0756	51	2,382	121.5	0.051	
<i>Office</i>	4	2x2 2U Fixture	4	Lamp & Low Watt ballast	Excellent opportunity for retro-fit	75.6	2,382	720.2	0.3024	51	2,382	485.8	0.204	
<i>Toilet</i>	1	4' 2L Fixture	1	Lamp & Low Watt ballast	Excellent opportunity for retro-fit	75.6	2,382	180.0	0.0756	51	2,382	121.5	0.051	
<i>Boys Locker</i>	12	0	0	0	T8 Lamps, no retrofit measure	0	2,382	0.0	0	0	2,382	0.0	0	
<i>Toilet</i>	2	4' 2L Fixture	2	Lamp & Low Watt ballast	Excellent opportunity for retro-fit	75.6	2,382	360.1	0.1512	51	2,382	242.9	0.102	
<i>Shower</i>	6	4' 2L Fixture	6	Lamp & Low Watt ballast	Excellent opportunity for retro-fit	75.6	2,382	1,080.2	0.4536	51	2,382	728.7	0.306	
<i>Towel</i>	4	2x2 2U Fixture	4	Lamp & Low Watt ballast	Excellent opportunity for retro-fit	75.6	2,382	720.2	0.3024	51	2,382	485.8	0.204	
BUILDING V	0		0		0		2,382	0.0	0		2,382	0.0	0	
<i>V 101 Band</i>	0		0		0		2,382	0.0	0		2,382	0.0	0	
<i>Rehearsal Room</i>	22	0	0	0	T8 Lamps, no retrofit measure	0	2,382	0.0	0	0	2,382	0.0	0	
	30	0	0	0	T8 Lamps, no retrofit measure	0	2,382	0.0	0	0	2,382	0.0	0	
<i>Practice 1</i>	2	4' 3L Fixture	2	Lamp & Low Watt ballast	Excellent opportunity for retro-fit	121.2	2,382	577.3	0.2424	77	2,382	366.8	0.154	
<i>Practice 2</i>	2	4' 3L Fixture	2	Lamp & Low Watt ballast	Excellent opportunity for retro-fit	121.2	2,382	577.3	0.2424	77	2,382	366.8	0.154	
<i>Practice 3</i>	2	4' 3L Fixture	2	Lamp & Low Watt ballast	Excellent opportunity for retro-fit	121.2	2,382	577.3	0.2424	77	2,382	366.8	0.154	
<i>Ensemble</i>	5	4' 4L Fixture	5	Lamp & Low Watt ballast	Excellent opportunity for retro-fit	151.2	2,382	1,800.4	0.756	100	2,382	1,190.8	0.5	
<i>Repair/Storage</i>	5	0	0	0	T8 Lamps, no retrofit measure	0	2,382	0.0	0	0	2,382	0.0	0	
<i>Office</i>	3	0	0	0	T8 Lamps, no retrofit measure	0	2,382	0.0	0	0	2,382	0.0	0	

LOCATION	QTY	EXISTING TYPE	QTY	RETROFIT	SURVEYORS COMMENTS	Existing				Actual				Proposed			
						Watt/unit	Op. Hours	kWh	kW-D	Watt/unit	Op. Hours	kWh	kW-D	Watt/unit	Op. Hours	kWh	kW-D
<i>EXIT</i>	2	0	2	0	0	0	2,382	0.0	0	0	0	2,382	0.0	0	0	0	0
<i>Girls Restroom</i>	3	4' 3L Fixture	3	Lamp & Low Watt ballast	Excellent opportunity for retro-fit	121.2	2,382	865.9	0.3636	77	2,382	550.1	0.231				
<i>Boys Restroom</i>	3	4' 3L Fixture	3	Lamp & Low Watt ballast	Excellent opportunity for retro-fit	121.2	2,382	865.9	0.3636	77	2,382	550.1	0.231				
<i>Gen Utility</i>	1	0	0	0	T8 Lamps, no retrofit measure	0	2,382	0.0	0	0	2,382	0.0	0				
<i>V 102 Choral</i>	0		0		0		2,382	0.0	0		2,382	0.0	0				
<i>Rehersal Room</i>	30	4' 4L Fixture	30	Lamp & Low Watt ballast	Excellent opportunity for retro-fit	151.2	2,382	10,802.5	4.536	100	2,382	7,144.5	3				
	16	4' 2L Fixture	16	Lamp & Low Watt ballast	Excellent opportunity for retro-fit	75.6	2,382	2,880.7	1.2096	51	2,382	1,943.3	0.816				
<i>Office</i>	3	0	3	0	T8 Lamps, no retrofit measure	0	2,382	0.0	0	0	2,382	0.0	0				
<i>Storage</i>	3	4' 4L Fixture	3	Lamp & Low Watt ballast	Excellent opportunity for retro-fit	151.2	2,382	1,080.2	0.4536	100	2,382	714.5	0.3				
<i>EXIT</i>	2	0	0	0	0	0	2,382	0.0	0	0	2,382	0.0	0				
<i>BUILDING G</i>	0		0		0		2,382	0.0	0		2,382	0.0	0				
<i>Concession</i>	9	4' 2L Fixture	9	Lamp & Low Watt ballast	Excellent opportunity for retro-fit	75.6	2,382	1,620.4	0.6804	51	2,382	1,093.1	0.459				
<i>RadioRoom</i>	3	4' 2L Fixture	3	Lamp & Low Watt ballast	Excellent opportunity for retro-fit	75.6	2,382	540.1	0.2268	51	2,382	364.4	0.153				
<i>Guest</i>	4	4' 2L Fixture	4	Lamp & Low Watt ballast	Excellent opportunity for retro-fit	75.6	2,382	720.2	0.3024	51	2,382	485.8	0.204				
<i>Broadcast</i>	8	4' 2L Fixture	8	Lamp & Low Watt ballast	Excellent opportunity for retro-fit	75.6	2,382	1,440.3	0.6048	51	2,382	971.7	0.408				
<i>Home</i>	4	4' 2L Fixture	4	Lamp & Low Watt ballast	Excellent opportunity for retro-fit	75.6	2,382	720.2	0.3024	51	2,382	485.8	0.204				
<i>Score Board</i>	3	4' 2L Fixture	3	Lamp & Low Watt ballast	Excellent opportunity for retro-fit	75.6	2,382	540.1	0.2268	51	2,382	364.4	0.153				
Existing	1980		Proposed	1650				435,264	183			288,061	121				

ENERGY CALCULATIONS		
Description	kW-Demand	kWh
Existing Use	182.77	435,264
Proposed Use	120.96	288,061
Difference - Savings	61.81	147,202
Electrical Utility Cost	\$5.75	\$0.15533
Savings per Year	\$0.16	\$22,864.95
		Total Yearly Energy Savings \$22,865.11

KUALAPUU SCHOOL SY2000-2001

P-4 Phys.Ed. PSAP	P-3 HLIP-1/2 Kim Johnston	P-2 Grade 1 Leah Nakayama	P-1 Grade 1 Morry Klyan	P-5 HLIP-2/3 Henry Pali	P-6 HLIP-4 Kaoo Kawaa	P-7 TBA
-------------------------	------------------------------------	------------------------------------	----------------------------------	----------------------------------	--------------------------------	------------

Portables

F-1 HLIP-5 Karnalu Poopoo	F-2 HLIP-6 Sarah Kawaa	F-3 Grade 4 Janet Anderson	F-4 Grade 4 Scott O'Brien	TB-1 SPED L.Mizumoto C. Helm L. Ela
------------------------------------	---------------------------------	-------------------------------------	------------------------------------	---

Building F

P-8 HLIP-K	E-4 Grade 2 Penny Puleloa	E-3 Grade 3 Amy Quach	E-2 Grade 3 Earlina Iaea	E-1 Grade 2 Julie Bykowiecki	Boys' B Rm.	Girls' B Rm.	Counselor Steve Clark
---------------	------------------------------------	--------------------------------	-----------------------------------	---------------------------------------	----------------	-----------------	--------------------------

Building E

Girls' B Rm.	Boys' B Rm.	D-1 Grade 5/5 Dora Lukonen	D-2 Grade 5/5 Vicki Newberry	D-3 Grade 5/6 Keith Hoakema	D-4 Grade 5/6 Pualani Akaka
-----------------	----------------	-------------------------------------	---------------------------------------	--------------------------------------	--------------------------------------

Building D

SSC An Seguid	Library	Office	PCNC Toni Manuad
---------------------	---------	--------	------------------------

Building C - Administration

B-2 K Michelle Maioho	B-1 K Kathy Bennett
--------------------------------	------------------------------

Building B

Cafeteria	Kitchen
-----------	---------

Building A - Cafeteria

Maui Smart Schools Program
Foot Candle Readings

School: KUALAPUUA School

Room: Bldg. F F-4

Ceiling height: 12'

Light fixture height: 9'

Fixture type: ICE TRAY

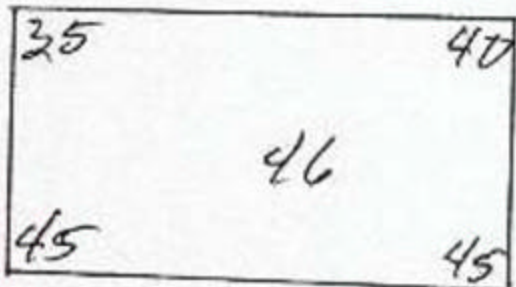

Room: P-4 Phys. Ed.

Ceiling height: 9'

Light fixture height: 7'

Fixture type: WRAP

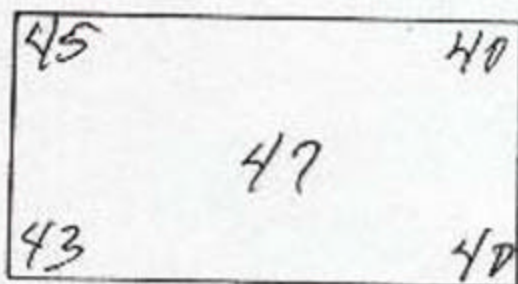

Room: Bldg. D D-4

Ceiling height: 9'

Light fixture height: 7'

Fixture type: ICE TRAY

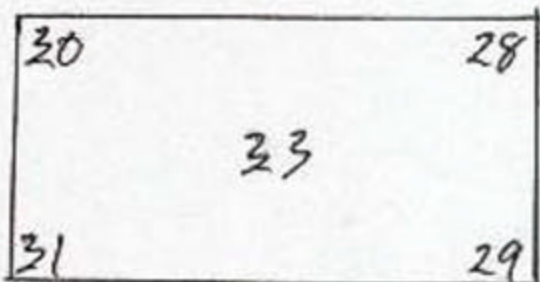



SCHOOL INFORMATION			
NAME Kualapuu Elementary School			DATE 2/23/2001
STREET ADDRESS P. O. Box 260 Kualapuu, HI 96757			OPERATIONAL HOURS 1,304
POINT OF CONTACT Lydia Trinidad		PHONE 567-6900	FAX 120V
AUDITOR Maui Community College Auditors			

LOCATION <small>(Rm Name, Rm. #, Area, Zone, etc.)</small>	EXISTING EQUIPMENT						PROPOSED			REBATES		COSTS		COMMENTS <small>Surveyors Comments</small>
	Floor	Quantity	Lamp Type	Lamps Per Fixture	Type of Fixture	Ballast Type	Lamps Per Fixture	Reflectors	Ballast Type	Per Single	Extended	Per Single	Extended	
BUILDING A	1	28	4' T12	2	Ice	Magnetic	2	N	Electronic	\$ 5.60	\$ 156.80	\$ 135.00	\$ 3,780.00	Replace fixture and mount hardware
B 2	1	28	4' T12	2	Ice	Magnetic	2	N	Electronic	\$ 5.60	\$ 156.80	\$ 135.00	\$ 3,780.00	Replace fixture and mount hardware
CAFETERIA														
Kitchen	1	20	4' T12	1	Ice	Magnetic	1	N	Electronic	\$ 2.80	\$ 56.00	\$ 55.00	\$ 1,100.00	Replace fixture and mount hardware
Dining Room	1	24	4' T12	1	Wrap	Magnetic	1	N	Electronic	\$ 2.80	\$ 67.20	\$ 55.00	\$ 1,320.00	Excellent opportunity for retro-fit
Office	1	2	4' T12	1	Wrap	Magnetic	1	N	Electronic	\$ 2.80	\$ 5.60	\$ 55.00	\$ 110.00	Excellent opportunity for retro-fit
Storage	1	9	4' T12	2	Ice	Magnetic	2	N	Electronic	\$ 5.60	\$ 50.40	\$ 135.00	\$ 1,215.00	Replace fixture and mount hardware
	1	4	4' T12	1	Open	Magnetic	1	N	Electronic	\$ 2.80	\$ 11.20	\$ 55.00	\$ 220.00	Replace fixture and mount hardware
Dispensary	1	2	4' T12	4	Ice	Magnetic	4	N	Electronic	\$ 11.20	\$ 22.40	\$ 160.00	\$ 320.00	Replace fixture and mount hardware
Administration Office	1	23	4' T12	2	Ice	Magnetic	2	N	Electronic	\$ 5.60	\$ 128.80	\$ 135.00	\$ 3,105.00	Replace fixture and mount hardware
BUILDING D														
Teachers' Lounge	1	4	4' T12	2	Ice	Magnetic	2	N	Electronic	\$ 5.60	\$ 22.40	\$ 135.00	\$ 540.00	Replace fixture and mount hardware
Boys-Girls	1	3	4' T12	4	Wrap	Magnetic	4	N	Electronic	\$ 11.20	\$ 33.60	\$ 70.00	\$ 210.00	Excellent opportunity for retro-fit
D 1	1	24	4' T12	2	Ice	Magnetic	2	N	Electronic	\$ 5.60	\$ 134.40	\$ 135.00	\$ 3,240.00	Replace fixture and mount hardware
D 2	1	24	4' T12	2	Ice	Magnetic	2	N	Electronic	\$ 5.60	\$ 134.40	\$ 135.00	\$ 3,240.00	Replace fixture and mount hardware
D 3	1	24	4' T12	2	Ice	Magnetic	2	N	Electronic	\$ 5.60	\$ 134.40	\$ 135.00	\$ 3,240.00	Replace fixture and mount hardware
D 4	1	24	4' T12	2	Ice	Magnetic	2	N	Electronic	\$ 5.60	\$ 134.40	\$ 135.00	\$ 3,240.00	Replace fixture and mount hardware
BUILDING E														
Counselor	1	3	4' T12	2	Ice	Magnetic	2	N	Electronic	\$ 5.60	\$ 16.80	\$ 135.00	\$ 405.00	Replace fixture and mount hardware
E 1	1	24	4' T12	2	Ice	Magnetic	2	N	Electronic	\$ 5.60	\$ 134.40	\$ 135.00	\$ 3,240.00	Replace fixture and mount hardware
E 2	1	24	4' T12	2	Ice	Magnetic	2	N	Electronic	\$ 5.60	\$ 134.40	\$ 135.00	\$ 3,240.00	Replace fixture and mount hardware
E 3	1	24	4' T12	2	Ice	Magnetic	2	N	Electronic	\$ 5.60	\$ 134.40	\$ 135.00	\$ 3,240.00	Replace fixture and mount hardware
E 4	1	24	4' T12	2	Ice	Magnetic	2	N	Electronic	\$ 5.60	\$ 134.40	\$ 135.00	\$ 3,240.00	Replace fixture and mount hardware
TB 1	1	16	4' T12	4	Troffer	Magnetic	4	N	Electronic	\$ 11.20	\$ 179.20	\$ 70.00	\$ 1,120.00	Excellent opportunity for retro-fit
Building - F														
F 4	1	24	4' T12	4	Ice	Magnetic	4	N	Electronic	\$ 11.20	\$ 268.80	\$ 160.00	\$ 3,840.00	Replace fixture and mount hardware
F 3	1	24	4' T12	4	Ice	Magnetic	4	N	Electronic	\$ 11.20	\$ 268.80	\$ 160.00	\$ 3,840.00	Replace fixture and mount hardware
F 2	1	24	4' T12	4	Ice	Magnetic	4	N	Electronic	\$ 11.20	\$ 268.80	\$ 160.00	\$ 3,840.00	Replace fixture and mount hardware
F 1	1	24	4' T12	4	Ice	Magnetic	4	N	Electronic	\$ 11.20	\$ 268.80	\$ 160.00	\$ 3,840.00	Replace fixture and mount hardware
PORTABLES														
P 4	1	12	4' T12	4	Wrap	Magnetic	4	N	Electronic	\$ 11.20	\$ 134.40	\$ 70.00	\$ 840.00	Excellent opportunity for retro-fit
P 3	1	12	4' T12	4	Troffer	Magnetic	4	N	Electronic	\$ 11.20	\$ 134.40	\$ 70.00	\$ 840.00	Excellent opportunity for retro-fit

LOCATION	EXISTING EQUIPMENT						PROPOSED			REBATES		COSTS		COMMENTS
Location (Rm Name, Rm. #, Area, Zone, etc.)	Floor	Quantity	Lamp Type	Lamps Per Fixture	Type of Fixture	Ballast Type	Lamps Per Fixture	Reflectors	Ballast Type	Per Single	Extended	Per Single	Extended	Surveyors Comments
P 2	1	12	4' T12	4	Troffer	Magnetic	4	N	Electronic	\$ 11.20	\$ 134.40	\$ 70.00	\$ 840.00	Excellent opportunity for retro-fit
P 1	1	12	4' T12	4	Troffer	Magnetic	4	N	Electronic	\$ 11.20	\$ 134.40	\$ 70.00	\$ 840.00	Excellent opportunity for retro-fit
P 5	1	16	4' T12	4	Troffer	Magnetic	4	N	Electronic	\$ 11.20	\$ 179.20	\$ 70.00	\$ 1,120.00	Excellent opportunity for retro-fit
P 6	1	12	4' T12	4	Troffer	Magnetic	4	N	Electronic	\$ 11.20	\$ 134.40	\$ 70.00	\$ 840.00	Excellent opportunity for retro-fit
P 7	1	12	4' T12	4	Troffer	Magnetic	4	N	Electronic	\$ 11.20	\$ 134.40	\$ 70.00	\$ 840.00	Excellent opportunity for retro-fit
P 8	1	21	4' T12	4	Troffer	Magnetic	4	N	Electronic	\$ 11.20	\$ 235.20	\$ 70.00	\$ 1,470.00	Excellent opportunity for retro-fit
Total Rebates										\$	4,278.40			
Total Costs										\$	66,135.00			

LOCATION	QTY	EXISTING TYPE	QTY	RETROFIT	SURVEYORS COMMENTS	Existing				Actual				Proposed			
						Watt/unit	Op. Hours	kWh	kW-D	Watt/unit	Op. Hours	kWh	kW-D	Watt/unit	Op. Hours	kWh	kW-D
BUILDING A	28	4' 2L Fixture	28	Lamp & Low Watt Ballast	Replace fixture and mount hardware	75.6	1,304	2,760.3	2.1168	51	1,304	1,862.1	1.428				
B 2	28	4' 2L Fixture	28	Lamp & Low Watt Ballast	Replace fixture and mount hardware	75.6	1,304	2,760.3	2.1168	51	1,304	1,862.1	1.428				
CAFETERIA	0		0		0		1,304	0.0	0		1,304	0.0	0				
Kitchen	20	4' 1L Fixture	20	Lamp & Low Watt Ballast	Replace fixture and mount hardware	45.6	1,304	1,189.2	0.912	31	1,304	808.5	0.62				
Dining Room	24	4' 1L Fixture	24	Lamp & Low Watt Ballast	Excellent opportunity for retro-fit	45.6	1,304	1,427.1	1.0944	31	1,304	970.2	0.744				
Office	2	4' 1L Fixture	2	Lamp & Low Watt Ballast	Excellent opportunity for retro-fit	45.6	1,304	118.9	0.0912	31	1,304	80.8	0.062				
Storage	9	4' 2L Fixture	9	Lamp & Low Watt Ballast	Replace fixture and mount hardware	75.6	1,304	887.2	0.6804	51	1,304	598.5	0.459				
0	4	4' 1L Fixture	4	Lamp & Low Watt Ballast	Replace fixture and mount hardware	45.6	1,304	237.8	0.1824	31	1,304	161.7	0.124				
Dispensary	2	4' 4L Fixture	2	Lamp & Low Watt Ballast	Replace fixture and mount hardware	151.2	1,304	394.3	0.3024	100	1,304	260.8	0.2				
Administration Office	23	4' 2L Fixture	23	Lamp & Low Watt Ballast	Replace fixture and mount hardware	75.6	1,304	2,267.4	1.7388	51	1,304	1,529.6	1.173				
BUILDING D	0		0		0		1,304	0.0	0		1,304	0.0	0				
Teachers' Lounge	4	4' 2L Fixture	4	Lamp & Low Watt Ballast	Replace fixture and mount hardware	75.6	1,304	394.3	0.3024	51	1,304	266.0	0.204				
Boys-Girls	3	4' 4L Fixture	3	Lamp & Low Watt Ballast	Excellent opportunity for retro-fit	151.2	1,304	591.5	0.4536	100	1,304	391.2	0.3				
D 1	24	4' 2L Fixture	24	Lamp & Low Watt Ballast	Replace fixture and mount hardware	75.6	1,304	2,366.0	1.8144	51	1,304	1,596.1	1.224				
D 2	24	4' 2L Fixture	24	Lamp & Low Watt Ballast	Replace fixture and mount hardware	75.6	1,304	2,366.0	1.8144	51	1,304	1,596.1	1.224				
D 3	24	4' 2L Fixture	24	Lamp & Low Watt Ballast	Replace fixture and mount hardware	75.6	1,304	2,366.0	1.8144	51	1,304	1,596.1	1.224				
D 4	24	4' 2L Fixture	24	Lamp & Low Watt Ballast	Replace fixture and mount hardware	75.6	1,304	2,366.0	1.8144	51	1,304	1,596.1	1.224				
BUILDING E	0		0		0		1,304	0.0	0		1,304	0.0	0				
Counselor	3	4' 2L Fixture	3	Lamp & Low Watt Ballast	Replace fixture and mount hardware	75.6	1,304	295.7	0.2268	51	1,304	199.5	0.153				
E 1	24	4' 2L Fixture	24	Lamp & Low Watt Ballast	Replace fixture and mount hardware	75.6	1,304	2,366.0	1.8144	51	1,304	1,596.1	1.224				
E 2	24	4' 2L Fixture	24	Lamp & Low Watt Ballast	Replace fixture and mount hardware	75.6	1,304	2,366.0	1.8144	51	1,304	1,596.1	1.224				
E 3	24	4' 2L Fixture	24	Lamp & Low Watt Ballast	Replace fixture and mount hardware	75.6	1,304	2,366.0	1.8144	51	1,304	1,596.1	1.224				
E 4	24	4' 2L Fixture	24	Lamp & Low Watt Ballast	Replace fixture and mount hardware	75.6	1,304	2,366.0	1.8144	51	1,304	1,596.1	1.224				
TB 1	16	4' 4L Fixture	16	Lamp & Low Watt Ballast	Excellent opportunity for retro-fit	151.2	1,304	3,154.6	2.4192		1,304	0.0	0				
Building - F	0		0		0		1,304	0.0	0	100	1,304	0.0	0				
F 4	24	4' 4L Fixture	24	Lamp & Low Watt Ballast	Replace fixture and mount hardware	151.2	1,304	4,732.0	3.6288	100	1,304	3,129.6	2.4				
F 3	24	4' 4L Fixture	24	Lamp & Low Watt Ballast	Replace fixture and mount hardware	151.2	1,304	4,732.0	3.6288	100	1,304	3,129.6	2.4				
F 2	24	4' 4L Fixture	24	Lamp & Low Watt Ballast	Replace fixture and mount hardware	151.2	1,304	4,732.0	3.6288	100	1,304	3,129.6	2.4				
F 1	24	4' 4L Fixture	24	Lamp & Low Watt Ballast	Replace fixture and mount hardware	151.2	1,304	4,732.0	3.6288		1,304	0.0	0				
PORTABLES	0		0		0		1,304	0.0	0		1,304	0.0	0				
P 4	12	4' 4L Fixture	12	Lamp & Low Watt Ballast	Excellent opportunity for retro-fit	151.2	1,304	2,366.0	1.8144	0	1,304	0.0	0				
P 3	12	4' 4L Fixture	12	Lamp & Low Watt Ballast	Excellent opportunity for retro-fit	151.2	1,304	2,366.0	1.8144	0	1,304	0.0	0				
P 2	12	4' 4L Fixture	12	Lamp & Low Watt Ballast	Excellent opportunity for retro-fit	151.2	1,304	2,366.0	1.8144	0	1,304	0.0	0				
P 1	12	4' 4L Fixture	12	Lamp & Low Watt Ballast	Excellent opportunity for retro-fit	151.2	1,304	2,366.0	1.8144	0	1,304	0.0	0				
P 5	16	4' 4L Fixture	16	Lamp & Low Watt Ballast	Excellent opportunity for retro-fit	151.2	1,304	3,154.6	2.4192	0	1,304	0.0	0				
P 6	12	4' 4L Fixture	12	Lamp & Low Watt Ballast	Excellent opportunity for retro-fit	151.2	1,304	2,366.0	1.8144	0	1,304	0.0	0				
P 7	12	4' 4L Fixture	12	Lamp & Low Watt Ballast	Excellent opportunity for retro-fit	151.2	1,304	2,366.0	1.8144	0	1,304	0.0	0				
P 8	21	4' 4L Fixture	21	Lamp & Low Watt Ballast	Excellent opportunity for retro-fit	151.2	1,304	4,140.5	3.1752	0	1,304	0.0	0				

Existing 563 Proposed 563

ENERGY CALCULATIONS			75,826	58	31,149	24
Description	kW-Demand	kWh				
Existing Use	58.15	75,826				
Proposed Use	23.89	31,149				
Difference - Savings	34.26	44,677				
Electrical Utility Cost	\$5.75	\$0.22632				
Savings per Year	\$2,364.04	\$10,111.13				
			Total Yearly Energy Savings	\$12,475.17		

KULA ELEMENTARY SCHOOL

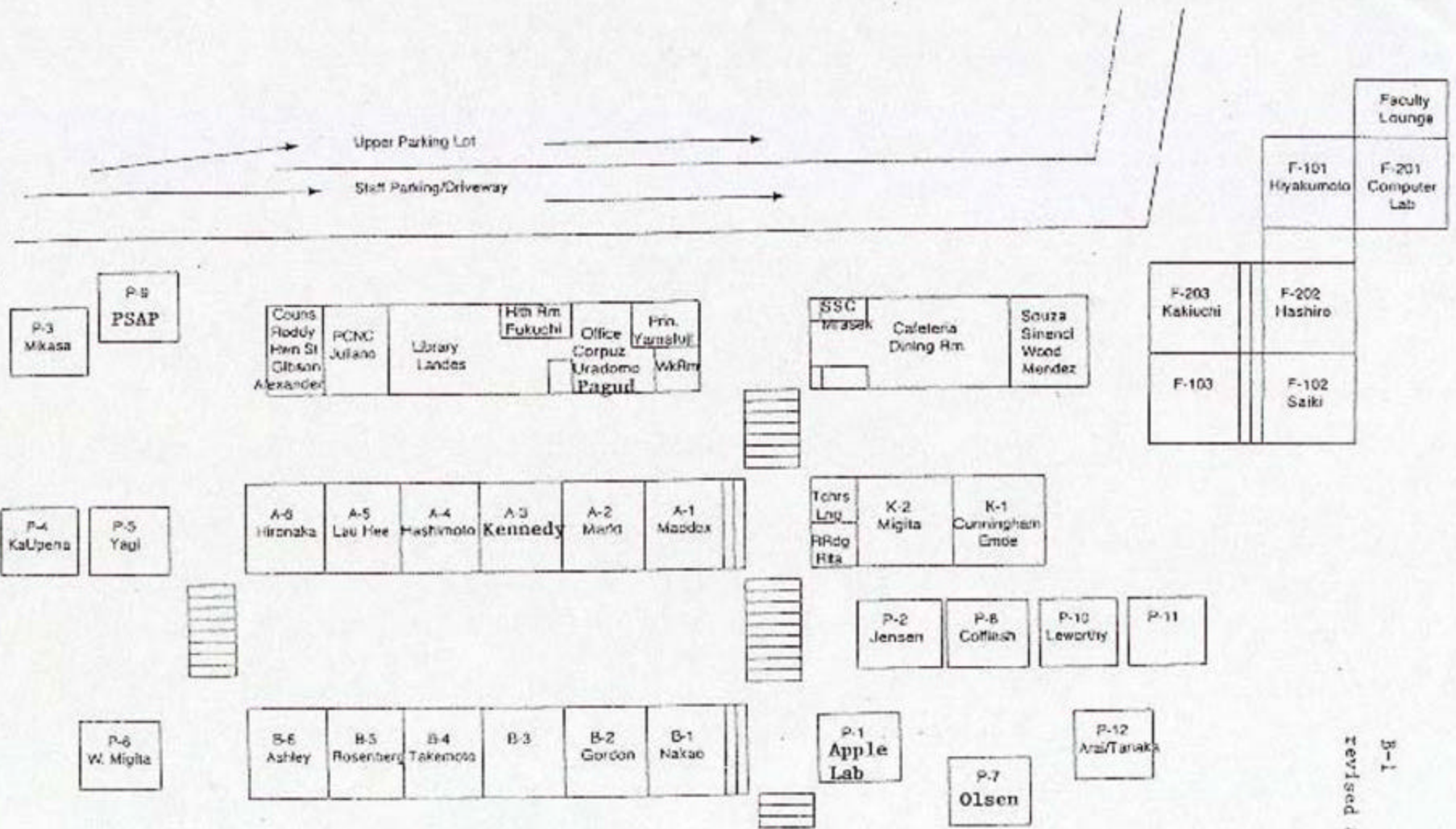

00/8 Pastrez
T-8

Maui Smart Schools Program
Foot Candle Readings

School: Kula Elementary School

Room: Bldg. B - E-3

Ceiling height: 9'

Light fixture height: 8'

Fixture type: WRAP

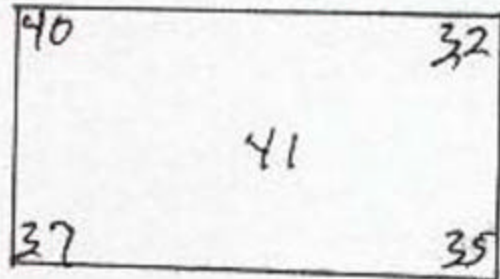

Room: BLDG. F F-203

Ceiling height: 9'

Light fixture height: 8'

Fixture type: TROFFER

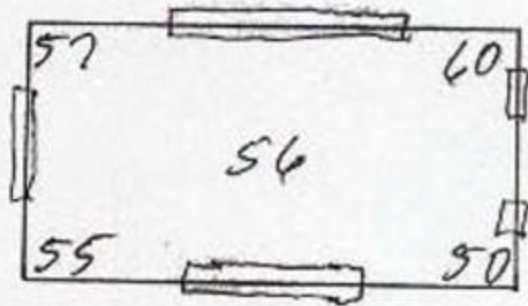

Room: Portables - P-4

Ceiling height: 9'

Light fixture height: 8'

Fixture type: TROFFER

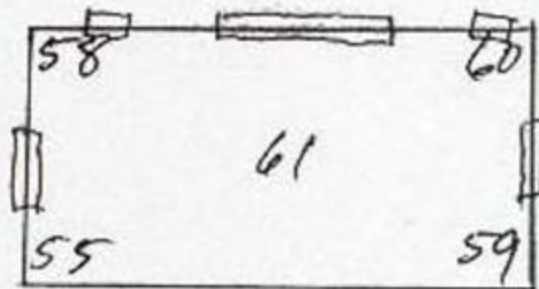



SCHOOL INFORMATION			DATE	
NAME Kula Elementary School			2/2/2001	
STREET ADDRESS 299 Kula Highway Kula, HI 96790			OPERATIONAL HOURS 1,304	
POINT OF CONTACT Rene Yamafuji		PHONE 867-7610	FAX	
AUDITOR Maui Community College Auditors			VOLTAGE 120V	

LOCATION <small>(Rm Name, Rm. #, Area, Zone, etc.)</small>	EXISTING EQUIPMENT						PROPOSED			REBATES		COSTS		COMMENTS <small>Surveyors Comments</small>
	Floor	Quantity	Lamp Type	Lamps Per Fixture	Type of Fixture	Ballast Type	Lamps Per Fixture	Reflectors	Ballast Type	Per Single	Extended	Per Single	Extended	
BUILDING A														
Restroom B/G	1	6	4' T12	2	Ice	Magnetic	2	N	Electronic	\$ 5.60	\$ 33.60	\$ 135.00	\$ 810.00	Replace fixture and mount hardware
Janitor	1	6	4' T12	2	Ice	Magnetic	2	N	Electronic	\$ 5.60	\$ 33.60	\$ 135.00	\$ 810.00	Replace fixture and mount hardware
Restroom / Utility	1	6	4' T12	2	Ice	Magnetic	2	N	Electronic	\$ 5.60	\$ 33.60	\$ 135.00	\$ 810.00	Replace fixture and mount hardware
A 1	1	14	4' T12	2	Wrap	Magnetic	2	N	Electronic	\$ 5.60	\$ 78.40	\$ 60.00	\$ 840.00	Excellent opportunity for retro-fit
	1	7	4' T12	4	Wrap	Magnetic	4	N	Electronic	\$ 11.20	\$ 78.40	\$ 70.00	\$ 490.00	Excellent opportunity for retro-fit
A 2	1	14	4' T12	2	Wrap	Magnetic	2	N	Electronic	\$ 5.60	\$ 78.40	\$ 60.00	\$ 840.00	Excellent opportunity for retro-fit
	1	7	4' T12	4	Wrap	Magnetic	4	N	Electronic	\$ 11.20	\$ 78.40	\$ 70.00	\$ 490.00	Excellent opportunity for retro-fit
A 3	1	14	4' T12	2	Wrap	Magnetic	2	N	Electronic	\$ 5.60	\$ 78.40	\$ 60.00	\$ 840.00	Excellent opportunity for retro-fit
	1	7	4' T12	4	Wrap	Magnetic	4	N	Electronic	\$ 11.20	\$ 78.40	\$ 70.00	\$ 490.00	Excellent opportunity for retro-fit
A 4	1	14	4' T12	2	Wrap	Magnetic	2	N	Electronic	\$ 5.60	\$ 78.40	\$ 60.00	\$ 840.00	Excellent opportunity for retro-fit
	1	7	4' T12	4	Wrap	Magnetic	4	N	Electronic	\$ 11.20	\$ 78.40	\$ 70.00	\$ 490.00	Excellent opportunity for retro-fit
A 5	1	14	4' T12	2	Wrap	Magnetic	2	N	Electronic	\$ 5.60	\$ 78.40	\$ 60.00	\$ 840.00	Excellent opportunity for retro-fit
	1	7	4' T12	4	Wrap	Magnetic	4	N	Electronic	\$ 11.20	\$ 78.40	\$ 70.00	\$ 490.00	Excellent opportunity for retro-fit
A 6	1	14	4' T12	2	Wrap	Magnetic	2	N	Electronic	\$ 5.60	\$ 78.40	\$ 60.00	\$ 840.00	Excellent opportunity for retro-fit
	1	7	4' T12	4	Wrap	Magnetic	4	N	Electronic	\$ 11.20	\$ 78.40	\$ 70.00	\$ 490.00	Excellent opportunity for retro-fit
BUILDING B														
B 6		14	4' T12	2	Wrap	Magnetic	2	N	Electronic	\$ 5.60	\$ 78.40	\$ 60.00	\$ 840.00	Excellent opportunity for retro-fit
		7	4' T12	2	Wrap	Magnetic	2	N	Electronic	\$ 5.60	\$ 39.20	\$ 60.00	\$ 420.00	Excellent opportunity for retro-fit
B 5		14	4' T12	2	Wrap	Magnetic	2	N	Electronic	\$ 5.60	\$ 78.40	\$ 60.00	\$ 840.00	Excellent opportunity for retro-fit
		7	4' T12	2	Wrap	Magnetic	2	N	Electronic	\$ 5.60	\$ 39.20	\$ 60.00	\$ 420.00	Excellent opportunity for retro-fit
B 4		14	4' T12	2	Wrap	Magnetic	2	N	Electronic	\$ 5.60	\$ 78.40	\$ 60.00	\$ 840.00	Excellent opportunity for retro-fit
		7	4' T12	2	Wrap	Magnetic	2	N	Electronic	\$ 5.60	\$ 39.20	\$ 60.00	\$ 420.00	Excellent opportunity for retro-fit
B 3		14	4' T12	2	Wrap	Magnetic	2	N	Electronic	\$ 5.60	\$ 78.40	\$ 60.00	\$ 840.00	Excellent opportunity for retro-fit
		7	4' T12	2	Wrap	Magnetic	2	N	Electronic	\$ 5.60	\$ 39.20	\$ 60.00	\$ 420.00	Excellent opportunity for retro-fit
B 2		14	4' T12	2	Wrap	Magnetic	2	N	Electronic	\$ 5.60	\$ 78.40	\$ 60.00	\$ 840.00	Excellent opportunity for retro-fit
		7	4' T12	2	Wrap	Magnetic	2	N	Electronic	\$ 5.60	\$ 39.20	\$ 60.00	\$ 420.00	Excellent opportunity for retro-fit
B 1		14	4' T12	2	Wrap	Magnetic	2	N	Electronic	\$ 5.60	\$ 78.40	\$ 60.00	\$ 840.00	Excellent opportunity for retro-fit
		7	4' T12	2	Wrap	Magnetic	2	N	Electronic	\$ 5.60	\$ 39.20	\$ 60.00	\$ 420.00	Excellent opportunity for retro-fit
Restroom B/G		6	4' T12	2	Wrap	Magnetic	2	N	Electronic	\$ 5.60	\$ 33.60	\$ 60.00	\$ 360.00	Excellent opportunity for retro-fit
Janitor		6	4' T12	2	Wrap	Magnetic	2	N	Electronic	\$ 5.60	\$ 33.60	\$ 60.00	\$ 360.00	Excellent opportunity for retro-fit
Utility		6	4' T12	2	Wrap	Magnetic	2	N	Electronic	\$ 5.60	\$ 33.60	\$ 60.00	\$ 360.00	Excellent opportunity for retro-fit

LOCATION	EXISTING EQUIPMENT						PROPOSED			REBATES		COSTS		COMMENTS
Location (Rm Name, Rm. #, Area, Zone, etc.)	Floor	Quantity	Lamp Type	Lamps Per Fixture	Type of Fixture	Ballast Type	Lamps Per Fixture	Reflectors	Ballast Type	Per Single	Extended	Per Single	Extended	Surveyors Comments
CAFETERIA														
<i>Dining Room</i>		36	4' T12	2	Troffer	Magnetic	2	N	Electronic	\$ 5.60	\$ 201.60	\$ 60.00	\$ 2,160.00	Excellent opportunity for retro-fit
<i>Kitchen</i>		15	4' T12	1	Troffer	Magnetic	1	N	Electronic	\$ 2.80	\$ 42.00	\$ 55.00	\$ 825.00	Excellent opportunity for retro-fit
<i>Sinks</i>		3	4' T12	2	Troffer	Magnetic	2	N	Electronic	\$ 5.60	\$ 16.80	\$ 60.00	\$ 180.00	Excellent opportunity for retro-fit
<i>Stoves</i>		15	4' T12	2	Troffer	Magnetic	2	N	Electronic	\$ 5.60	\$ 84.00	\$ 60.00	\$ 900.00	Excellent opportunity for retro-fit
<i>Office</i>		2	4' T12	2	Troffer	Magnetic	2	N	Electronic	\$ 5.60	\$ 11.20	\$ 60.00	\$ 120.00	Excellent opportunity for retro-fit
<i>Cooler</i>		1	4' T12	2	Troffer	Magnetic	2	N	Electronic	\$ 5.60	\$ 5.60	\$ 60.00	\$ 60.00	Excellent opportunity for retro-fit
<i>Office</i>		1	4' T12	2	Troffer	Magnetic	2	N	Electronic	\$ 5.80	\$ 5.60	\$ 60.00	\$ 60.00	Excellent opportunity for retro-fit
ADMINISTRATION														
<i>Computer Room</i>		4	4' T12	4	Troffer	Magnetic	4	N	Electronic	\$ 11.20	\$ 44.80	\$ 70.00	\$ 280.00	Excellent opportunity for retro-fit
<i>Office</i>		8	4' T12	2	Ice	Magnetic	2	N	Electronic	\$ 5.60	\$ 44.80	\$ 135.00	\$ 1,080.00	Replace fixture and mount hardware
<i>Office</i>		14	4' T12	2	Ice	Magnetic	2	N	Electronic	\$ 5.60	\$ 78.40	\$ 135.00	\$ 1,890.00	Replace fixture and mount hardware
<i>Office</i>		2	4' T12	2	Ice	Magnetic	2	N	Electronic	\$ 5.60	\$ 11.20	\$ 135.00	\$ 270.00	Replace fixture and mount hardware
<i>Health Room</i>		5	4' T12	2	Ice	Magnetic	2	N	Electronic	\$ 5.60	\$ 28.00	\$ 135.00	\$ 675.00	Replace fixture and mount hardware
<i>Hallway</i>		3	4' T12	2	Ice	Magnetic	2	N	Electronic	\$ 5.60	\$ 16.80	\$ 135.00	\$ 405.00	Replace fixture and mount hardware
<i>Library</i>		30	4' T12	2	Ice	Magnetic	2	N	Electronic	\$ 5.60	\$ 168.00	\$ 135.00	\$ 4,050.00	Replace fixture and mount hardware
<i>PTA 1</i>		15	4' T12	1	Ice	Magnetic	1	N	Electronic	\$ 2.80	\$ 42.00	\$ 135.00	\$ 2,025.00	Replace fixture and mount hardware
		2	4' T12	2	Ice	Magnetic	2	N	Electronic	\$ 5.60	\$ 11.20	\$ 135.00	\$ 270.00	Replace fixture and mount hardware
<i>Counselor</i>		3	4' T12	4	Ice	Magnetic	4	N	Electronic	\$ 11.20	\$ 33.60	\$ 160.00	\$ 480.00	Replace fixture and mount hardware
BUILDING F														
<i>F 103</i>		14	4' T12	4	Troffer	Magnetic	4	N	Electronic	\$ 11.20	\$ 156.80	\$ 70.00	\$ 980.00	Excellent opportunity for retro-fit
<i>Boys' Restroom</i>		4	2' T12	2	Troffer	Magnetic	2	N	Electronic	\$ 4.80	\$ 19.20	\$ 60.00	\$ 240.00	Excellent opportunity for retro-fit
<i>General Utility</i>		1	4' T12	4	Troffer	Magnetic	4	N	Electronic	\$ 11.20	\$ 11.20	\$ 70.00	\$ 70.00	Excellent opportunity for retro-fit
<i>Girls' Restroom</i>		4	2' T12	2	Troffer	Magnetic	2	N	Electronic	\$ 4.80	\$ 19.20	\$ 60.00	\$ 240.00	Excellent opportunity for retro-fit
<i>F 102</i>		15	4' T12	4	Troffer	Magnetic	4	N	Electronic	\$ 11.20	\$ 168.00	\$ 70.00	\$ 1,050.00	Excellent opportunity for retro-fit
<i>Mech Room</i>		1	4' T12	4	Troffer	Magnetic	4	N	Electronic	\$ 11.20	\$ 11.20	\$ 70.00	\$ 70.00	Excellent opportunity for retro-fit
<i>F 101</i>		15	4' T12	4	Troffer	Magnetic	4	N	Electronic	\$ 11.20	\$ 168.00	\$ 70.00	\$ 1,050.00	Excellent opportunity for retro-fit
		4	2' T12	2	Troffer	Magnetic	2	N	Electronic	\$ 4.80	\$ 19.20	\$ 60.00	\$ 240.00	Excellent opportunity for retro-fit
<i>Electrical Room</i>		2	4' T12	4	Troffer	Magnetic	4	N	Electronic	\$ 11.20	\$ 22.40	\$ 70.00	\$ 140.00	Excellent opportunity for retro-fit
<i>F 202</i>		15	4' T12	4	Troffer	Magnetic	4	N	Electronic	\$ 11.20	\$ 168.00	\$ 70.00	\$ 1,050.00	Excellent opportunity for retro-fit
<i>Girls' Restroom</i>		4	2' T12	2	Troffer	Magnetic	2	N	Electronic	\$ 4.80	\$ 19.20	\$ 60.00	\$ 240.00	Excellent opportunity for retro-fit
<i>Gen Utility</i>		1	4' T12	4	Troffer	Magnetic	4	N	Electronic	\$ 11.20	\$ 11.20	\$ 70.00	\$ 70.00	Excellent opportunity for retro-fit
<i>Boys' Restroom</i>		4	2' T12	2	Troffer	Magnetic	2	N	Electronic	\$ 4.80	\$ 19.20	\$ 60.00	\$ 240.00	Excellent opportunity for retro-fit
<i>F 203</i>		15	4' T12	4	Troffer	Magnetic	4	N	Electronic	\$ 11.20	\$ 168.00	\$ 70.00	\$ 1,050.00	Excellent opportunity for retro-fit
<i>F 201</i>		15	4' T12	4	Troffer	Magnetic	4	N	Electronic	\$ 11.20	\$ 168.00	\$ 70.00	\$ 1,050.00	Excellent opportunity for retro-fit
<i>Computer Room</i>		15	4' T12	4	Troffer	Magnetic	4	N	Electronic	\$ 11.20	\$ 168.00	\$ 70.00	\$ 1,050.00	Excellent opportunity for retro-fit
<i>Faculty Center</i>		13	4' T12	4	Troffer	Magnetic	4	N	Electronic	\$ 11.20	\$ 145.60	\$ 70.00	\$ 910.00	Excellent opportunity for retro-fit

LOCATION	EXISTING EQUIPMENT						PROPOSED			REBATES		COSTS		COMMENTS
Location (Rm Name, Rm. #, Area, Zone, etc.)	Floor	Quantity	Lamp Type	Lamps Per Fixture	Type of Fixture	Ballast Type	Lamps Per Fixture	Reflectors	Ballast Type	Per Single	Extended	Per Single	Extended	Surveyors Comments
Boiler Room		1	4' T12	4	Troffer	Magnetic	4	N	Electronic	\$ 11.20	\$ 11.20	\$ 70.00	\$ 70.00	Excellent opportunity for retro-fit
P 11		12	4' T12	4	Wrap	Magnetic	4	N	Electronic	\$ 11.20	\$ 134.40	\$ 70.00	\$ 840.00	Excellent opportunity for retro-fit
P 10		16	4' T12	4	Troffer	Magnetic	4	N	Electronic	\$ 11.20	\$ 179.20	\$ 70.00	\$ 1,120.00	Excellent opportunity for retro-fit
P 8		12	4' T12	4	Wrap	Magnetic	4	N	Electronic	\$ 11.20	\$ 134.40	\$ 70.00	\$ 840.00	Excellent opportunity for retro-fit
P 2		16	4' T12	4	Wrap	Magnetic	4	N	Electronic	\$ 11.20	\$ 179.20	\$ 70.00	\$ 1,120.00	Excellent opportunity for retro-fit
P 12		16	4' T12	4	Troffer	Magnetic	4	N	Electronic	\$ 11.20	\$ 179.20	\$ 70.00	\$ 1,120.00	Excellent opportunity for retro-fit
P 7		16	4' T12	4	Wrap	Magnetic	4	N	Electronic	\$ 11.20	\$ 179.20	\$ 70.00	\$ 1,120.00	Excellent opportunity for retro-fit
P 1		16	4' T12	4	Wrap	Magnetic	4	N	Electronic	\$ 11.20	\$ 179.20	\$ 70.00	\$ 1,120.00	Excellent opportunity for retro-fit
P 6		16	4' T12	4	Wrap	Magnetic	4	N	Electronic	\$ 11.20	\$ 179.20	\$ 70.00	\$ 1,120.00	Excellent opportunity for retro-fit
P 5		16	4' T12	4	Wrap	Magnetic	4	N	Electronic	\$ 11.20	\$ 179.20	\$ 70.00	\$ 1,120.00	Excellent opportunity for retro-fit
P 4		16	4' T12	4	Wrap	Magnetic	4	N	Electronic	\$ 11.20	\$ 179.20	\$ 70.00	\$ 1,120.00	Excellent opportunity for retro-fit
P 3		16	4' T12	4	Wrap	Magnetic	4	N	Electronic	\$ 11.20	\$ 179.20	\$ 70.00	\$ 1,120.00	Excellent opportunity for retro-fit
P 9		12	4' T12	4	Troffer	Magnetic	4	N	Electronic	\$ 11.20	\$ 134.40	\$ 70.00	\$ 840.00	Excellent opportunity for retro-fit
BUILDING K														
Teachers' Lounge		2	4' T12	4	Troffer	Magnetic	4	N	Electronic	\$ 11.20	\$ 22.40	\$ 70.00	\$ 140.00	Excellent opportunity for retro-fit
Reading Room		2	4' T12	4	Troffer	Magnetic	4	N	Electronic	\$ 11.20	\$ 22.40	\$ 70.00	\$ 140.00	Excellent opportunity for retro-fit
K 2		16	4' T12	4	Wrap	Magnetic	4	N	Electronic	\$ 11.20	\$ 179.20	\$ 70.00	\$ 1,120.00	Excellent opportunity for retro-fit
		8	4' T12	4	Wrap	Magnetic	4	N	Electronic	\$ 11.20	\$ 89.60	\$ 70.00	\$ 560.00	Excellent opportunity for retro-fit
K 1		16	4' T12	4	Wrap	Magnetic	4	N	Electronic	\$ 11.20	\$ 179.20	\$ 70.00	\$ 1,120.00	Excellent opportunity for retro-fit
		8	4' T12	4	Wrap	Magnetic	4	N	Electronic	\$ 11.20	\$ 89.60	\$ 70.00	\$ 560.00	Excellent opportunity for retro-fit
Total Rebates										\$	6,765.60			
Total Costs										\$	60,830.00			

LOCATION	QTY	EXISTING TYPE	QTY	RETROFIT	SURVEYORS COMMENTS	Existing	Actual			Proposed			
						Watt/unit	Op. Hours	kWh	kW-D	Watt/unit	Op. Hours	kWh	kW-D
BUILDING A	0		0		0		1,304	0.0	0		1,304	0.0	0
Restroom B/G	6	4' 2L Fixture	6	Lamp & Low Watt Ballast	Replace fixture and mount hardware	75.6	1,304	591.5	0.4536	51	1,304	399.0	0.306
Janitor	6	4' 2L Fixture	6	Lamp & Low Watt Ballast	Replace fixture and mount hardware	75.6	1,304	591.5	0.4536	51	1,304	399.0	0.306
Restroom / Utility	6	4' 2L Fixture	6	Lamp & Low Watt Ballast	Replace fixture and mount hardware	75.6	1,304	591.5	0.4536	51	1,304	399.0	0.306
A 1	14	4' 2L Fixture	14	Lamp & Low Watt Ballast	Excellent opportunity for retro-fit	75.6	1,304	1,380.2	1.0584	51	1,304	931.1	0.714
	7	4' 4L Fixture	7	Lamp & Low Watt Ballast	Excellent opportunity for retro-fit	151.2	1,304	1,380.2	1.0584	100	1,304	912.8	0.7
A 2	14	4' 2L Fixture	14	Lamp & Low Watt Ballast	Excellent opportunity for retro-fit	75.6	1,304	1,380.2	1.0584	51	1,304	931.1	0.714
	7	4' 4L Fixture	7	Lamp & Low Watt Ballast	Excellent opportunity for retro-fit	151.2	1,304	1,380.2	1.0584	100	1,304	912.8	0.7
A 3	14	4' 2L Fixture	14	Lamp & Low Watt Ballast	Excellent opportunity for retro-fit	75.6	1,304	1,380.2	1.0584	51	1,304	931.1	0.714
	7	4' 4L Fixture	7	Lamp & Low Watt Ballast	Excellent opportunity for retro-fit	151.2	1,304	1,380.2	1.0584	100	1,304	912.8	0.7
A 4	14	4' 2L Fixture	14	Lamp & Low Watt Ballast	Excellent opportunity for retro-fit	75.6	1,304	1,380.2	1.0584	51	1,304	931.1	0.714
	7	4' 4L Fixture	7	Lamp & Low Watt Ballast	Excellent opportunity for retro-fit	151.2	1,304	1,380.2	1.0584	100	1,304	912.8	0.7
A 5	14	4' 2L Fixture	14	Lamp & Low Watt Ballast	Excellent opportunity for retro-fit	75.6	1,304	1,380.2	1.0584	51	1,304	931.1	0.714
	7	4' 4L Fixture	7	Lamp & Low Watt Ballast	Excellent opportunity for retro-fit	151.2	1,304	1,380.2	1.0584	100	1,304	912.8	0.7
A 6	14	4' 2L Fixture	14	Lamp & Low Watt Ballast	Excellent opportunity for retro-fit	75.6	1,304	1,380.2	1.0584	51	1,304	931.1	0.714
	7	4' 4L Fixture	7	Lamp & Low Watt Ballast	Excellent opportunity for retro-fit	151.2	1,304	1,380.2	1.0584	100	1,304	912.8	0.7
BUILDING B	0		0		0		1,304	0.0	0		1,304	0.0	0
B 6	14	4' 2L Fixture	14	Lamp & Low Watt Ballast	Excellent opportunity for retro-fit	75.6	1,304	1,380.2	1.0584	51	1,304	931.1	0.714
	7	4' 2L Fixture	7	Lamp & Low Watt Ballast	Excellent opportunity for retro-fit	75.6	1,304	690.1	0.5292	51	1,304	465.5	0.357
B 5	14	4' 2L Fixture	14	Lamp & Low Watt Ballast	Excellent opportunity for retro-fit	75.6	1,304	1,380.2	1.0584	51	1,304	931.1	0.714
	7	4' 2L Fixture	7	Lamp & Low Watt Ballast	Excellent opportunity for retro-fit	75.6	1,304	690.1	0.5292	51	1,304	465.5	0.357
B 4	14	4' 2L Fixture	14	Lamp & Low Watt Ballast	Excellent opportunity for retro-fit	75.6	1,304	1,380.2	1.0584	51	1,304	931.1	0.714
	7	4' 2L Fixture	7	Lamp & Low Watt Ballast	Excellent opportunity for retro-fit	75.6	1,304	690.1	0.5292	51	1,304	465.5	0.357
B 3	14	4' 2L Fixture	14	Lamp & Low Watt Ballast	Excellent opportunity for retro-fit	75.6	1,304	1,380.2	1.0584	51	1,304	931.1	0.714
	7	4' 2L Fixture	7	Lamp & Low Watt Ballast	Excellent opportunity for retro-fit	75.6	1,304	690.1	0.5292	51	1,304	465.5	0.357
B 2	14	4' 2L Fixture	14	Lamp & Low Watt Ballast	Excellent opportunity for retro-fit	75.6	1,304	1,380.2	1.0584	51	1,304	931.1	0.714
	7	4' 2L Fixture	7	Lamp & Low Watt Ballast	Excellent opportunity for retro-fit	75.6	1,304	690.1	0.5292	51	1,304	465.5	0.357
B 1	14	4' 2L Fixture	14	Lamp & Low Watt Ballast	Excellent opportunity for retro-fit	75.6	1,304	1,380.2	1.0584	51	1,304	931.1	0.714
	7	4' 2L Fixture	7	Lamp & Low Watt Ballast	Excellent opportunity for retro-fit	75.6	1,304	690.1	0.5292	51	1,304	465.5	0.357
Restroom B/G	6	4' 2L Fixture	6	Lamp & Low Watt Ballast	Excellent opportunity for retro-fit	75.6	1,304	591.5	0.4536	51	1,304	399.0	0.306
Janitor	6	4' 2L Fixture	6	Lamp & Low Watt Ballast	Excellent opportunity for retro-fit	75.6	1,304	591.5	0.4536	51	1,304	399.0	0.306
Utility	6	4' 2L Fixture	6	Lamp & Low Watt Ballast	Excellent opportunity for retro-fit	75.6	1,304	591.5	0.4536	51	1,304	399.0	0.306
CAFETERIA	0		0		0		1,304	0.0	0		1,304	0.0	0
Dining Room	36	4' 2L Fixture	36	Lamp & Low Watt Ballast	Excellent opportunity for retro-fit	75.6	1,304	3,549.0	2.7216	51	1,304	2,394.1	1.836
Kitchen	15	4' 1L Fixture	15	Lamp & Low Watt Ballast	Excellent opportunity for retro-fit	45.6	1,304	891.9	0.684	31	1,304	606.4	0.465
Sinks	3	4' 2L Fixture	3	Lamp & Low Watt Ballast	Excellent opportunity for retro-fit	75.6	1,304	295.7	0.2268	51	1,304	199.5	0.153
Stoves	15	4' 2L Fixture	15	Lamp & Low Watt Ballast	Excellent opportunity for retro-fit	75.6	1,304	1,478.7	1.134	51	1,304	997.6	0.765
Office	2	4' 2L Fixture	2	Lamp & Low Watt Ballast	Excellent opportunity for retro-fit	75.6	1,304	197.2	0.1512	51	1,304	133.0	0.102
Cooler	1	4' 2L Fixture	1	Lamp & Low Watt Ballast	Excellent opportunity for retro-fit	75.6	1,304	98.6	0.0756	51	1,304	66.5	0.051
Office	1	4' 2L Fixture	1	Lamp & Low Watt Ballast	Excellent opportunity for retro-fit	75.6	1,304	98.6	0.0756	51	1,304	66.5	0.051
ADMINISTRATION	0		0		0		1,304	0.0	0		1,304	0.0	0
Computer Room	4	4' 4L Fixture	4	Lamp & Low Watt Ballast	Excellent opportunity for retro-fit	151.2	1,304	788.7	0.6048	100	1,304	521.6	0.4
Office	8	4' 2L Fixture	8	Lamp & Low Watt Ballast	Replace fixture and mount hardware	75.6	1,304	788.7	0.6048	51	1,304	532.0	0.408
Office	14	4' 2L Fixture	14	Lamp & Low Watt Ballast	Replace fixture and mount hardware	75.6	1,304	1,380.2	1.0584	51	1,304	931.1	0.714
Office	2	4' 2L Fixture	2	Lamp & Low Watt Ballast	Replace fixture and mount hardware	75.6	1,304	197.2	0.1512	51	1,304	133.0	0.102
Health Room	5	4' 2L Fixture	5	Lamp & Low Watt Ballast	Replace fixture and mount hardware	75.6	1,304	492.9	0.378	51	1,304	332.5	0.255
Hallway	3	4' 2L Fixture	3	Lamp & Low Watt Ballast	Replace fixture and mount hardware	75.6	1,304	295.7	0.2268	51	1,304	199.5	0.153
Library	30	4' 2L Fixture	30	Lamp & Low Watt Ballast	Replace fixture and mount hardware	75.6	1,304	2,957.5	2.268	51	1,304	1,995.1	1.53
PTA 1	15	4' 1L Fixture	15	Lamp & Low Watt Ballast	Replace fixture and mount hardware	45.6	1,304	891.9	0.684	31	1,304	606.4	0.465
	2	4' 2L Fixture	2	Lamp & Low Watt Ballast	Replace fixture and mount hardware	75.6	1,304	197.2	0.1512	51	1,304	133.0	0.102
Counselor	3	4' 4L Fixture	3	Lamp & Low Watt Ballast	Replace fixture and mount hardware	151.2	1,304	591.5	0.4536	100	1,304	391.2	0.3
BUILDING F	0		0		0		1,304	0.0	0		1,304	0.0	0

LOCATION	QTY	EXISTING TYPE	QTY	RETROFIT	SURVEYORS COMMENTS	Existing	Actual			Proposed			
						Watt/unit	Op. Hours	kWh	kW-D	Watt/unit	Op. Hours	kWh	kW-D
<i>F 103</i>	14	4' 4L Fixture	14	Lamp & Low Watt Ballast	Excellent opportunity for retro-fit	151.2	1,304	2,760.3	2.1168	100	1,304	1,825.6	1.4
<i>Boys' Restroom</i>	4	2' 2L Fixture	4	Lamp & Low Watt Ballast	Excellent opportunity for retro-fit	55.4	1,304	289.0	0.2216	29	1,304	151.3	0.116
<i>General Utility</i>	1	4' 4L Fixture	1	Lamp & Low Watt Ballast	Excellent opportunity for retro-fit	151.2	1,304	197.2	0.1512	100	1,304	130.4	0.1
<i>Girls' Restroom</i>	4	2' 2L Fixture	4	Lamp & Low Watt Ballast	Excellent opportunity for retro-fit	55.4	1,304	289.0	0.2216	29	1,304	151.3	0.116
<i>F 102</i>	15	4' 4L Fixture	15	Lamp & Low Watt Ballast	Excellent opportunity for retro-fit	151.2	1,304	2,957.5	2.268	100	1,304	1,956.0	1.5
<i>Mech Room</i>	1	4' 4L Fixture	1	Lamp & Low Watt Ballast	Excellent opportunity for retro-fit	151.2	1,304	197.2	0.1512	100	1,304	130.4	0.1
<i>F 101</i>	15	4' 4L Fixture	15	Lamp & Low Watt Ballast	Excellent opportunity for retro-fit	151.2	1,304	2,957.5	2.268	100	1,304	1,956.0	1.5
	4	2' 2L Fixture	4	Lamp & Low Watt Ballast	Excellent opportunity for retro-fit	55.4	1,304	289.0	0.2216	29	1,304	151.3	0.116
<i>Electrical Room</i>	2	4' 4L Fixture	2	Lamp & Low Watt Ballast	Excellent opportunity for retro-fit	151.2	1,304	394.3	0.3024	100	1,304	260.8	0.2
<i>F 202</i>	15	4' 4L Fixture	15	Lamp & Low Watt Ballast	Excellent opportunity for retro-fit	151.2	1,304	2,957.5	2.268	100	1,304	1,956.0	1.5
<i>Girls' Restroom</i>	4	2' 2L Fixture	4	Lamp & Low Watt Ballast	Excellent opportunity for retro-fit	55.4	1,304	289.0	0.2216	29	1,304	151.3	0.116
<i>Gen Utility</i>	1	4' 4L Fixture	1	Lamp & Low Watt Ballast	Excellent opportunity for retro-fit	151.2	1,304	197.2	0.1512	100	1,304	130.4	0.1
<i>Boys' Restroom</i>	4	2' 2L Fixture	4	Lamp & Low Watt Ballast	Excellent opportunity for retro-fit	55.4	1,304	289.0	0.2216	29	1,304	151.3	0.116
<i>F 203</i>	15	4' 4L Fixture	15	Lamp & Low Watt Ballast	Excellent opportunity for retro-fit	151.2	1,304	2,957.5	2.268	100	1,304	1,956.0	1.5
<i>F 201</i>	15	4' 4L Fixture	15	Lamp & Low Watt Ballast	Excellent opportunity for retro-fit	151.2	1,304	2,957.5	2.268	100	1,304	1,956.0	1.5
<i>Computer Room</i>	15	4' 4L Fixture	15	Lamp & Low Watt Ballast	Excellent opportunity for retro-fit	151.2	1,304	2,957.5	2.268	100	1,304	1,956.0	1.5
<i>Faculty Center</i>	13	4' 4L Fixture	13	Lamp & Low Watt Ballast	Excellent opportunity for retro-fit	151.2	1,304	2,563.1	1.9656	100	1,304	1,695.2	1.3
<i>Boiler Room</i>	1	4' 4L Fixture	1	Lamp & Low Watt Ballast	Excellent opportunity for retro-fit	151.2	1,304	197.2	0.1512	100	1,304	130.4	0.1
<i>P 11</i>	12	4' 4L Fixture	12	Lamp & Low Watt Ballast	Excellent opportunity for retro-fit	151.2	1,304	2,366.0	1.8144	100	1,304	1,564.8	1.2
<i>P 10</i>	16	4' 4L Fixture	16	Lamp & Low Watt Ballast	Excellent opportunity for retro-fit	151.2	1,304	3,154.6	2.4192	100	1,304	2,086.4	1.6
<i>P 8</i>	12	4' 4L Fixture	12	Lamp & Low Watt Ballast	Excellent opportunity for retro-fit	151.2	1,304	2,366.0	1.8144	100	1,304	1,564.8	1.2
<i>P 2</i>	16	4' 4L Fixture	16	Lamp & Low Watt Ballast	Excellent opportunity for retro-fit	151.2	1,304	3,154.6	2.4192	100	1,304	2,086.4	1.6
<i>P 12</i>	16	4' 4L Fixture	16	Lamp & Low Watt Ballast	Excellent opportunity for retro-fit	151.2	1,304	3,154.6	2.4192	100	1,304	2,086.4	1.6
<i>P 7</i>	16	4' 4L Fixture	16	Lamp & Low Watt Ballast	Excellent opportunity for retro-fit	151.2	1,304	3,154.6	2.4192	100	1,304	2,086.4	1.6
<i>P 1</i>	16	4' 4L Fixture	16	Lamp & Low Watt Ballast	Excellent opportunity for retro-fit	151.2	1,304	3,154.6	2.4192	100	1,304	2,086.4	1.6
<i>P 6</i>	16	4' 4L Fixture	16	Lamp & Low Watt Ballast	Excellent opportunity for retro-fit	151.2	1,304	3,154.6	2.4192	100	1,304	2,086.4	1.6
<i>P 5</i>	16	4' 4L Fixture	16	Lamp & Low Watt Ballast	Excellent opportunity for retro-fit	151.2	1,304	3,154.6	2.4192	100	1,304	2,086.4	1.6
<i>P 4</i>	16	4' 4L Fixture	16	Lamp & Low Watt Ballast	Excellent opportunity for retro-fit	151.2	1,304	3,154.6	2.4192	100	1,304	2,086.4	1.6
<i>P 3</i>	16	4' 4L Fixture	16	Lamp & Low Watt Ballast	Excellent opportunity for retro-fit	151.2	1,304	3,154.6	2.4192	100	1,304	2,086.4	1.6
<i>P 9</i>	12	4' 4L Fixture	12	Lamp & Low Watt Ballast	Excellent opportunity for retro-fit	151.2	1,304	2,366.0	1.8144	100	1,304	1,564.8	1.2
BUILDING K	0		0		0		1,304	0.0	0		1,304	0.0	0
<i>Teachers' Lounge</i>	2	4' 4L Fixture	2	Lamp & Low Watt Ballast	Excellent opportunity for retro-fit	151.2	1,304	394.3	0.3024	100	1,304	260.8	0.2
<i>Reading Room</i>	2	4' 4L Fixture	2	Lamp & Low Watt Ballast	Excellent opportunity for retro-fit	151.2	1,304	394.3	0.3024	100	1,304	260.8	0.2
<i>K 2</i>	16	4' 4L Fixture	16	Lamp & Low Watt Ballast	Excellent opportunity for retro-fit	151.2	1,304	3,154.6	2.4192	100	1,304	2,086.4	1.6
	8	4' 4L Fixture	8	Lamp & Low Watt Ballast	Excellent opportunity for retro-fit	151.2	1,304	1,577.3	1.2096	100	1,304	1,043.2	0.8
<i>K 1</i>	16	4' 4L Fixture	16	Lamp & Low Watt Ballast	Excellent opportunity for retro-fit	151.2	1,304	3,154.6	2.4192	100	1,304	2,086.4	1.6
	8	4' 4L Fixture	8	Lamp & Low Watt Ballast	Excellent opportunity for retro-fit	151.2	1,304	1,577.3	1.2096	100	1,304	1,043.2	0.8
Existing	822		Proposed	822				119,162	91			79,124	61

ENERGY CALCULATIONS		
Description	kW-Demand	kWh
Existing Use	91.38	119,162
Proposed Use	60.68	79,124
Difference - Savings	30.70	40,037
Electrical Utility Cost	\$5.75	\$0.15490
Savings per Year	\$2,118.55	\$6,201.81
		Total Yearly Energy Savings \$8,320.36

L
A
H
A
I
N
A
L
U
N
A
R
O
A
D

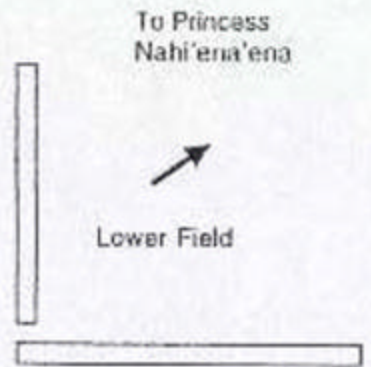
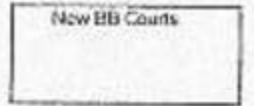
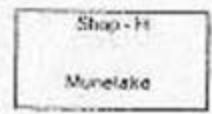
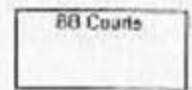
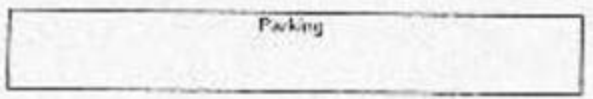
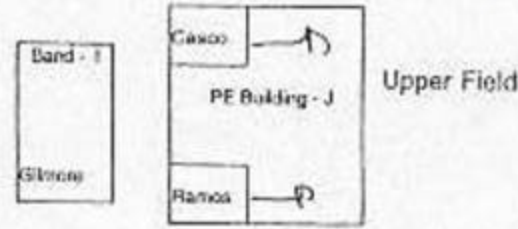
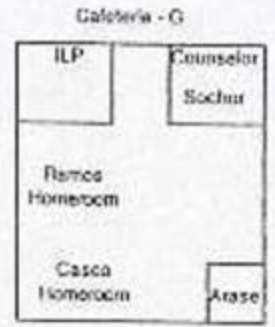
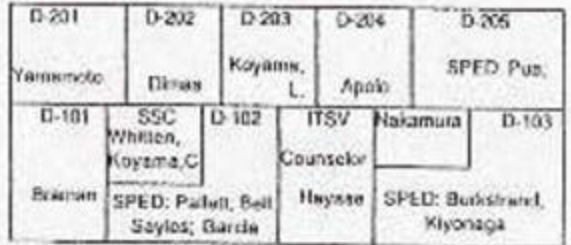
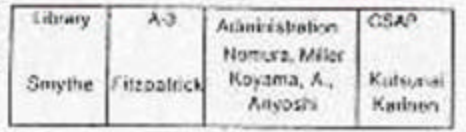
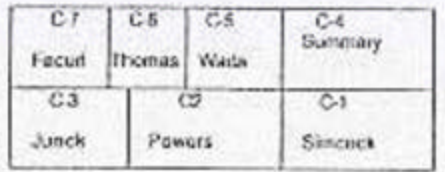
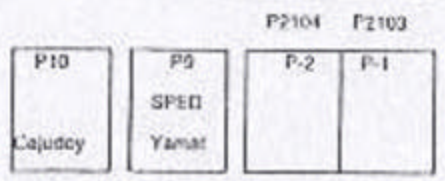
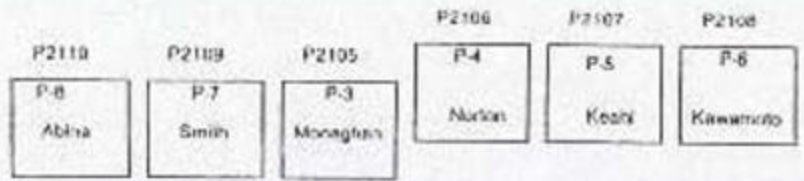

Lahaina Intermediate School

871 LAHAINALUNA ROAD
LAHAINA, HAWAII 96761
(808) 662-3965

KENNETH NOMURA, PRINCIPAL
MARSHA NAKAMUHA, VICE-PRINCIPAL
KAIPO MILLER, VICE-PRINCIPAL

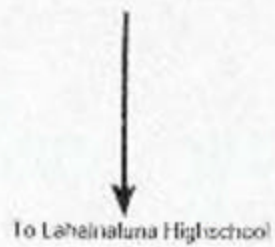

Maui Smart Schools Program
Foot Candle Readings

School: Lahaina Intermediate School

Room: <u>Portable 2</u>	<table border="1"><tr><td>51</td><td>57</td></tr><tr><td></td><td>59</td></tr><tr><td>54</td><td>57</td></tr></table>	51	57		59	54	57
51		57					
		59					
54		57					
Ceiling Height: <u>8 Feet</u>							
Light Fixture Height: <u>7 Feet</u>							
Fixture Type: <u>Wrap</u>							

Room: <u>Music Classroom</u>	<table border="1"><tr><td></td><td>55</td></tr><tr><td></td><td></td></tr><tr><td>59</td><td>63</td></tr></table>		55			59	63
		55					
59		63					
Ceiling Height: <u>8 Feet</u>							
Light Fixture Height: <u>7 Feet</u>							
Fixture Type: <u>Troffer</u>							

Room: <u>Bldg D-205</u>	<table border="1"><tr><td>50</td><td>54</td></tr><tr><td></td><td>51</td></tr><tr><td>57</td><td>52</td></tr></table>	50	54		51	57	52
50		54					
		51					
57		52					
Ceiling Height: <u>8 Feet</u>							
Light Fixture Height: <u>7 Feet</u>							
Fixture Type: <u>Troffer</u>							



CUSTOMER INFORMATION		
NAME	Lahaina Intermediate School	DATE 8/1/2000
STREET ADDRESS	871 Lahainaluna Road Lahaina, HI 96761	OPERATIONAL HOURS 1,549
POINT OF CONTACT	PHONE 667-6638	FAX 120V
AUDITOR		

LOCATION <small>(Rm Name, Rm. #, Area, Zone, etc.)</small>	EXISTING EQUIPMENT						PROPOSED			REBATES		COSTS		COMMENTS
	Floor	Quantity	Lamp Type	Lamps Per Fixture	Type of Fixture	Ballast Type	Lamps Per Fixture	Reflectors	Ballast Type	Per Single	Extended	Per Single	Extended	
BUILDING A											\$ -		\$ -	
Telephone Cabinet	1	1	4' T12	2	Vapor	Magnetic	2	N	Electronic	\$ 5.60	\$ 5.60	\$ 60.00	\$ 60.00	Retrofit Recommended
A1	1	16	4' T12	2	Wrap	Magnetic	2	N	Electronic	\$ 5.60	\$ 89.60	\$ 60.00	\$ 960.00	Retrofit Recommended
Women's Restroom	1	1	4' T12	2	Wrap	Magnetic	2	N	Electronic	\$ 5.60	\$ 5.60	\$ 60.00	\$ 60.00	Retrofit Recommended
Men's Restroom	1	1	Inc	2							\$ -		\$ -	None
A2	1	32	4' T12	2	Wrap	Magnetic	2	N	Electronic	\$ 5.60	\$ 179.20	\$ 60.00	\$ 1,920.00	Retrofit Recommended
Principal	1	3	4' T12	4	Wrap	Magnetic	4	N	Electronic	\$ 11.20	\$ 33.60	\$ 70.00	\$ 210.00	Retrofit Recommended
Conference Room	1	4	4' T12	2	Wrap	Magnetic	2	N	Electronic	\$ 5.60	\$ 22.40	\$ 60.00	\$ 240.00	Retrofit Recommended
Storage	1	4	4' T12	2	Wrap	Magnetic	2	N	Electronic	\$ 5.60	\$ 22.40	\$ 60.00	\$ 240.00	Retrofit Recommended
Registrar	1	4	4' T12	2	Wrap	Magnetic	2	N	Electronic	\$ 5.60	\$ 22.40	\$ 60.00	\$ 240.00	Retrofit Recommended
A3	1	25	4' T12	2	Wrap	Magnetic	2	N	Electronic	\$ 5.60	\$ 140.00	\$ 60.00	\$ 1,500.00	Retrofit Recommended
Storage	1	3	4' T12	2	Wrap	Magnetic	2	N	Electronic	\$ 5.60	\$ 16.80	\$ 60.00	\$ 180.00	Retrofit Recommended
Library	1	14	4' T12	4	Fixture	Magnetic	4	N	Electronic	\$ 11.20	\$ 156.80	\$ 70.00	\$ 980.00	Retrofit Recommended
A5	1	14	4' T12	4	Fixture	Magnetic	4	N	Electronic	\$ 11.20	\$ 156.80	\$ 70.00	\$ 980.00	Retrofit Recommended
A5	1	2			Exit Sign						\$ -		\$ -	None
Girls' Restroom	1	2	4' T12	4	Fixture	Magnetic	4	N	Electronic	\$ 11.20	\$ 22.40	\$ 70.00	\$ 140.00	Retrofit Recommended
Janitor	1	1	4' T12	2	Fix	Magnetic	2	N	Electronic	\$ 5.60	\$ 5.60	\$ 60.00	\$ 60.00	Retrofit Recommended
Boys' Restroom	1	2	4' T12	4	Fixture	Magnetic	4	N	Electronic	\$ 11.20	\$ 22.40	\$ 70.00	\$ 140.00	Retrofit Recommended
BUILDING B											\$ -		\$ -	
Boys' Restroom	1	2	4' T12	4	Fixture	Magnetic	4	N	Electronic	\$ 11.20	\$ 22.40	\$ 70.00	\$ 140.00	Retrofit Recommended
Janitor's Room	1	1	4' T12	2	Fix	Magnetic	2	N	Electronic	\$ 5.60	\$ 5.60	\$ 60.00	\$ 60.00	Retrofit Recommended
Girls' Restroom	1	2	4' T12	4	Fixture	Magnetic	4	N	Electronic	\$ 11.20	\$ 22.40	\$ 70.00	\$ 140.00	Retrofit Recommended
Men/Women Restroom	1	2	4' T12	4	Fixture	Magnetic	4	N	Electronic	\$ 11.20	\$ 22.40	\$ 70.00	\$ 140.00	Retrofit Recommended
B5	1	17	4' T12	4	Fixture	Magnetic	4	N	Electronic	\$ 11.20	\$ 190.40	\$ 70.00	\$ 1,190.00	Retrofit Recommended
B4	1	14	4' T12	4	Fixture	Magnetic	4	N	Electronic	\$ 11.20	\$ 156.80	\$ 70.00	\$ 980.00	Retrofit Recommended
B3	1	14	4' T12	4	Fixture	Magnetic	4	N	Electronic	\$ 11.20	\$ 156.80	\$ 70.00	\$ 980.00	Retrofit Recommended
B2	1	14	4' T12	4	Fixture	Magnetic	4	N	Electronic	\$ 11.20	\$ 156.80	\$ 70.00	\$ 980.00	Retrofit Recommended
B1	1	14	4' T12	4	Fixture	Magnetic	4	N	Electronic	\$ 11.20	\$ 156.80	\$ 70.00	\$ 980.00	Retrofit Recommended
BUILDING C											\$ -		\$ -	
Men's Restroom	1	1	Inc	2							\$ -	\$ -	\$ -	None

LOCATION	EXISTING EQUIPMENT						PROPOSED			REBATES		COSTS		COMMENTS
Location (Rm Name, Rm. #, Area, Zone, etc.)	Floor	Quantity	Lamp Type	Lamps Per Fixture	Type of Fixture	Ballast Type	Lamps Per Fixture	Reflectors	Ballast Type	Per Single	Extended	Per Single	Extended	Comments
<i>Girls' Restroom</i>	1	2	4' T12	4	Fixture	Magnetic	4	N	Electronic	\$ 11.20	\$ 22.40	\$ 70.00	\$ 140.00	Retrofit Recommended
<i>Janitor's Room</i>	1	1	4' T12	2	Fix	Magnetic	2	N	Electronic	\$ 5.60	\$ 5.60	\$ 60.00	\$ 60.00	Retrofit Recommended
<i>Boys' Restroom</i>	1	2	4' T12	4	Fixture	Magnetic	4	N	Electronic	\$ 11.20	\$ 22.40	\$ 70.00	\$ 140.00	Retrofit Recommended
<i>C1</i>	1	21	4' T12	4	Fixture	Magnetic	4	N	Electronic	\$ 11.20	\$ 235.20	\$ 70.00	\$ 1,470.00	Retrofit Recommended
<i>C1</i>	1	6	4' T12	2	Fix	Magnetic	2	N	Electronic	\$ 5.60	\$ 33.60	\$ 60.00	\$ 360.00	Retrofit Recommended
<i>C2</i>	1	21	4' T12	4	Fixture	Magnetic	4	N	Electronic	\$ 11.20	\$ 235.20	\$ 70.00	\$ 1,470.00	Retrofit Recommended
<i>C2</i>	1	6	4' T12	2	Fix	Magnetic	2	N	Electronic	\$ 5.60	\$ 33.60	\$ 60.00	\$ 360.00	Retrofit Recommended
<i>C3</i>	1	4	4' T12	4	Fixture	Magnetic	4	N	Electronic	\$ 11.20	\$ 44.80	\$ 70.00	\$ 280.00	Retrofit Recommended
<i>Women's Restroom</i>	1	1	4' T12	2	Fix	Magnetic	2	N	Electronic	\$ 5.60	\$ 5.60	\$ 60.00	\$ 60.00	Retrofit Recommended
<i>C7</i>	2	14	4' T12	4	Fixture	Magnetic	4	N	Electronic	\$ 11.20	\$ 156.80	\$ 70.00	\$ 980.00	Retrofit Recommended
<i>C6</i>	2	14	4' T12	4	Fixture	Magnetic	4	N	Electronic	\$ 11.20	\$ 156.80	\$ 70.00	\$ 980.00	Retrofit Recommended
<i>C5</i>	2	14	4' T12	4	Fixture	Magnetic	4	N	Electronic	\$ 11.20	\$ 156.80	\$ 70.00	\$ 980.00	Retrofit Recommended
<i>C4</i>	2	23	4' T12	4	Fixture	Magnetic	4	N	Electronic	\$ 11.20	\$ 257.60	\$ 70.00	\$ 1,610.00	Retrofit Recommended
<i>C4</i>	2	7	4' T12	2	Fixture	Magnetic	2	N	Electronic	\$ 5.60	\$ 39.20	\$ 60.00	\$ 420.00	Retrofit Recommended
<i>Boys' Restroom</i>	2	2	4' T12	4	Fixture	Magnetic	4	N	Electronic	\$ 11.20	\$ 22.40	\$ 70.00	\$ 140.00	Retrofit Recommended
<i>Janitor's Room</i>	2	1	4' T12	2	Fix	Magnetic	2	N	Electronic	\$ 5.60	\$ 5.60	\$ 60.00	\$ 60.00	Retrofit Recommended
<i>Girls' Restroom</i>	2	2	4' T12	4	Fixture	Magnetic	4	N	Electronic	\$ 11.20	\$ 22.40	\$ 70.00	\$ 140.00	Retrofit Recommended
<i>Rescue Area (Stairs)</i>	2	1	4' T12	4	Fix	Magnetic	4	N	Electronic	\$ 11.20	\$ 11.20	\$ 70.00	\$ 70.00	Retrofit Recommended
<i>Electrical Room</i>	2	1	Inc								\$ -		\$ -	None
<i>Mechanical Room</i>	2	1	Inc								\$ -	\$ -	\$ -	None
<i>Elevator</i>	2	1	4' T12	2	Fix	Magnetic	2	N	Electronic	\$ 5.60	\$ 5.60	\$ 60.00	\$ 60.00	Retrofit Recommended
PORTABLES											\$ -		\$ -	
<i>P1</i>	1	8	4' T12	4	Fix	Magnetic	4	N	Electronic	\$ 11.20	\$ 89.60	\$ 70.00	\$ 560.00	Retrofit Recommended
<i>P1</i>	1	7	4' T12	2	Fix	Magnetic	2	N	Electronic	\$ 5.60	\$ 39.20	\$ 60.00	\$ 420.00	Retrofit Recommended
<i>Storage</i>	1	3	Inc								\$ -	\$ -	\$ -	None
<i>Exterior</i>	1	4	Inc								\$ -	\$ -	\$ -	None
<i>P2</i>	1	8	4' T12	4	Fix	Magnetic	4	N	Electronic	\$ 11.20	\$ 89.60	\$ 70.00	\$ 560.00	Retrofit Recommended
<i>P2</i>	1	7	4' T12	2	Fix	Magnetic	2	N	Electronic	\$ 5.60	\$ 39.20	\$ 60.00	\$ 420.00	Retrofit Recommended
<i>P8</i>	1	12	4' T12	4	Wrap	Magnetic	4	N	Electronic	\$ 11.20	\$ 134.40	\$ 70.00	\$ 840.00	Retrofit Recommended
<i>P7</i>	1	12	4' T12	4	Wrap	Magnetic	4	N	Electronic	\$ 11.20	\$ 134.40	\$ 70.00	\$ 840.00	Retrofit Recommended
<i>Exterior</i>	1	4	Inc								\$ -	\$ -	\$ -	None
<i>P3</i>	1	12	4' T12	4	Wrap	Magnetic	4	N	Electronic	\$ 11.20	\$ 134.40	\$ 70.00	\$ 840.00	Retrofit Recommended
<i>P4</i>	1	16	4' T12	4	Wrap	Magnetic	4	N	Electronic	\$ 11.20	\$ 179.20	\$ 70.00	\$ 1,120.00	Retrofit Recommended
<i>Bathroom</i>	1	2	Inc								\$ -	\$ -	\$ -	None
<i>Exterior</i>	1	6	Inc								\$ -	\$ -	\$ -	None
<i>P5</i>	1	16	4' T12	4	Wrap	Magnetic	4	N	Electronic	\$ 11.20	\$ 179.20	\$ 70.00	\$ 1,120.00	Retrofit Recommended

LOCATION	EXISTING EQUIPMENT						PROPOSED			REBATES		COSTS		COMMENTS
Location (Rm Name, Rm. #, Area, Zone, etc.)	Floor	Quantity	Lamp Type	Lamps Per Fixture	Type of Fixture	Ballast Type	Lamps Per Fixture	Reflectors	Ballast Type	Per Single	Extended	Per Single	Extended	Comments
P6	1	16	4' T12	4	Wrap	Magnetic	4	N	Electronic	\$ 11.20	\$ 179.20	\$ 70.00	\$ 1,120.00	Retrofit Recommended
INDUSTRIAL											\$ -		\$ -	
Warehouse/Classroom	1	33	4' T12	3	Vapor	Magnetic	3	N	Electronic	\$ 8.40	\$ 277.20	\$ 65.00	\$ 2,145.00	Retrofit Recommended
Finishing Room	1	2	4' T12	2	Fix	Magnetic	2	N	Electronic	\$ 5.60	\$ 11.20	\$ 60.00	\$ 120.00	Retrofit Recommended
Boys' Restroom	1	2	4' T12	1	Fix	Magnetic	1	N	Electronic	\$ 2.80	\$ 5.60	\$ 55.00	\$ 110.00	Retrofit Recommended
Custodian	1	1	4' T12	1	Fix	Magnetic	1	N	Electronic	\$ 2.80	\$ 2.80	\$ 55.00	\$ 55.00	Retrofit Recommended
Girls' Restroom	1	2	4' T12	1	Fix	Magnetic	1	N	Electronic	\$ 2.80	\$ 5.60	\$ 55.00	\$ 110.00	Retrofit Recommended
Classroom	1	12	4' T12	4	Fix	Magnetic	4	N	Electronic	\$ 11.20	\$ 134.40	\$ 70.00	\$ 840.00	Retrofit Recommended
Office	1	2	4' T12	4	Fix	Magnetic	4	N	Electronic	\$ 11.20	\$ 22.40	\$ 70.00	\$ 140.00	Retrofit Recommended
Bathroom	1	1	4' T12	1	Fix	Magnetic	1	N	Electronic	\$ 2.80	\$ 2.80	\$ 55.00	\$ 55.00	Retrofit Recommended
Storage	1	1	4' T12	2	Fix	Magnetic	2	N	Electronic	\$ 5.60	\$ 5.60	\$ 60.00	\$ 60.00	Retrofit Recommended
MUSIC											\$ -		\$ -	
Music Classroom	1	2	4' T12	2	Fix	Magnetic	2	N	Electronic	\$ 5.60	\$ 11.20	\$ 60.00	\$ 120.00	Retrofit Recommended
Music Classroom	1	15	4' T12	4	Fix	Magnetic	4	N	Electronic	\$ 11.20	\$ 168.00	\$ 70.00	\$ 1,050.00	Retrofit Recommended
Practice Room	1	4	4' T12	4	Fix	Magnetic	4	N	Electronic	\$ 11.20	\$ 44.80	\$ 70.00	\$ 280.00	Retrofit Recommended
Practice Room	1	2			Exit Sign						\$ -	\$ -	\$ -	None
Band Room	1	6	4' T12	4	Fix	Magnetic	4	N	Electronic	\$ 11.20	\$ 67.20	\$ 70.00	\$ 420.00	Retrofit Recommended
Office	1	6	4' T12	1	Fix	Magnetic	1	N	Electronic	\$ 2.80	\$ 16.80	\$ 55.00	\$ 330.00	Retrofit Recommended
Girls' Restroom	1	2	4' T12	1	Fix	Magnetic	1	N	Electronic	\$ 2.80	\$ 5.60	\$ 55.00	\$ 110.00	Retrofit Recommended
Hallway	1	2	4' T12	4	Fix	Magnetic	4	N	Electronic	\$ 11.20	\$ 22.40	\$ 70.00	\$ 140.00	Retrofit Recommended
Hallway	1	1			Exit Sign						\$ -	\$ -	\$ -	None
Janitor	1	1	4' T12	2	Fix	Magnetic	2	N	Electronic	\$ 5.60	\$ 5.60	\$ 60.00	\$ 60.00	Retrofit Recommended
Boys' Restroom	1	2	4' T12	1	Fix	Magnetic	1	N	Electronic	\$ 2.80	\$ 5.60	\$ 55.00	\$ 110.00	Retrofit Recommended
BUILDING D											\$ -		\$ -	
Storage	1	1	Inc								\$ -	\$ -	\$ -	None
D103	1	25	4' T12	4	Fix	Magnetic	4	N	Electronic	\$ 11.20	\$ 280.00	\$ 70.00	\$ 1,750.00	Retrofit Recommended
Bathroom	1	2	Inc								\$ -	\$ -	\$ -	None
Back Classroom	1	6	4' T12	4	Fix	Magnetic	4	N	Electronic	\$ 11.20	\$ 67.20	\$ 70.00	\$ 420.00	Retrofit Recommended
Storage	1	6	4' T12	4	Fix	Magnetic	4	N	Electronic	\$ 11.20	\$ 67.20	\$ 70.00	\$ 420.00	Retrofit Recommended
Storage	1	2	4' T12	2	Fix	Magnetic	2	N	Electronic	\$ 5.60	\$ 11.20	\$ 60.00	\$ 120.00	Retrofit Recommended
Toilet	1	1	Inc								\$ -	\$ -	\$ -	None
D102	1	23	4' T12	4	Fix	Magnetic	4	N	Electronic	\$ 11.20	\$ 257.60	\$ 70.00	\$ 1,610.00	Retrofit Recommended
Women's Restroom	1	1	2' T12	1	Fix	Magnetic	1	N	Electronic	\$ 2.40	\$ 2.40	\$ 55.00	\$ 55.00	Retrofit Recommended
Men's Restroom	1	1	2' T12	1	Fix	Magnetic	1	N	Electronic	\$ 2.40	\$ 2.40	\$ 55.00	\$ 55.00	Retrofit Recommended
Storage	1	1	4' T12	2	Fix	Magnetic	2	N	Electronic	\$ 5.60	\$ 5.60	\$ 60.00	\$ 60.00	Retrofit Recommended
Storage	1	1	Inc								\$ -	\$ -	\$ -	None

LOCATION (Rm Name, Rm. #, Area, Zone, etc.)	EXISTING EQUIPMENT						PROPOSED			REBATES		COSTS		COMMENTS
	Floor	Quantity	Lamp Type	Lamps Per Fixture	Type of Fixture	Ballast Type	Lamps Per Fixture	Reflectors	Ballast Type	Per Single	Extended	Per Single	Extended	
<i>D101</i>	1	16	4' T12	4	Fixture	Magnetic	4	N	Electronic	\$ 11.20	\$ 179.20	\$ 70.00	\$ 1,120.00	Retrofit Recommended
<i>Girls Restroom</i>	1	2	4' T12	4	Fixture	Magnetic	4	N	Electronic	\$ 11.20	\$ 22.40	\$ 70.00	\$ 140.00	Retrofit Recommended
<i>Janitor</i>	1	1	Inc								\$ -	\$ -	\$ -	None
<i>Boys' Restroom</i>	1	2	4' T12	4	Fixture	Magnetic	4	N	Electronic	\$ 11.20	\$ 22.40	\$ 70.00	\$ 140.00	Retrofit Recommended
<i>Mech. Room</i>	1	1	4' T12	2	Fix	Magnetic	2	N	Electronic	\$ 5.60	\$ 5.60	\$ 60.00	\$ 60.00	Retrofit Recommended
<i>Electrical Room</i>	1	1	Inc								\$ -	\$ -	\$ -	None
<i>Elevator</i>	1	1	4' T12	2	Fix	Magnetic	2	N	Electronic	\$ 5.60	\$ 5.60	\$ 60.00	\$ 60.00	Retrofit Recommended
<i>Corridor</i>	2	2			Exit Sign						\$ -	\$ -	\$ -	None
<i>Boys' Restroom</i>	2	2	4' T12	4	Fixture	Magnetic	4	N	Electronic	\$ 11.20	\$ 22.40	\$ 70.00	\$ 140.00	Retrofit Recommended
<i>Janitor's Closet</i>	2	1			Exit Sign						\$ -	\$ -	\$ -	None
<i>Girls' Restroom</i>	2	2	4' T12	4	Fixture	Magnetic	4	N	Electronic	\$ 11.20	\$ 22.40	\$ 70.00	\$ 140.00	Retrofit Recommended
<i>D201</i>	2	16	4' T12	4	Fixture	Magnetic	4	N	Electronic	\$ 11.20	\$ 179.20	\$ 70.00	\$ 1,120.00	Retrofit Recommended
<i>D202</i>	2	16	4' T12	4	Fixture	Magnetic	4	N	Electronic	\$ 11.20	\$ 179.20	\$ 70.00	\$ 1,120.00	Retrofit Recommended
<i>D203</i>	2	16	4' T12	4	Fixture	Magnetic	4	N	Electronic	\$ 11.20	\$ 179.20	\$ 70.00	\$ 1,120.00	Retrofit Recommended
<i>D204</i>	2	16	4' T12	4	Fixture	Magnetic	4	N	Electronic	\$ 11.20	\$ 179.20	\$ 70.00	\$ 1,120.00	Retrofit Recommended
<i>D205</i>	2	16	4' T12	4	Fixture	Magnetic	4	N	Electronic	\$ 11.20	\$ 179.20	\$ 70.00	\$ 1,120.00	Retrofit Recommended
Total Rebates										\$		\$	7,147.60	
Total Costs										\$		\$	49,265.00	

LOCATION	QTY	EXISTING TYPE	QTY	RETROFIT		Existing Watt/unit	Actual			Proposed			
							Op. Hours	kWh	kW-D	Watt/unit	Op. Hours	kWh	kW-D
BUILDING A	0		0		0		1,549	0.0	0		1,549	0.0	0
Telephone Cabinet	1	4' 2L Fixture	1	Lamp & Low Watt Ballast	Retrofit Recommended	75.6	1,549	117.1	0.0756	51	1,549	79.0	0.051
A1	16	4' 2L Fixture	16	Lamp & Low Watt Ballast	Retrofit Recommended	75.6	1,549	1,873.1	1.2096	51	1,549	1,263.6	0.816
Women's Restroom	1	4' 2L Fixture	1	Lamp & Low Watt Ballast	Retrofit Recommended	75.6	1,549	117.1	0.0756	51	1,549	79.0	0.051
Men's Restroom	1	2L 60W Incandescent	0		None		1,549	0.0	0		1,549	0.0	0
A2	32	4' 2L Fixture	32	Lamp & Low Watt Ballast	Retrofit Recommended	75.6	1,549	3,746.1	2.4192	51	1,549	2,527.2	1.632
Principal	3	4' 4L Fixture	3	Lamp & Low Watt Ballast	Retrofit Recommended	151.2	1,549	702.4	0.4536	100	1,549	464.6	0.3
Conference Room	4	4' 2L Fixture	4	Lamp & Low Watt Ballast	Retrofit Recommended	75.6	1,549	468.3	0.3024	51	1,549	315.9	0.204
Storage	4	4' 2L Fixture	4	Lamp & Low Watt Ballast	Retrofit Recommended	75.6	1,549	468.3	0.3024	51	1,549	315.9	0.204
Registrar	4	4' 2L Fixture	4	Lamp & Low Watt Ballast	Retrofit Recommended	75.6	1,549	468.3	0.3024	51	1,549	315.9	0.204
A3	25	4' 2L Fixture	25	Lamp & Low Watt Ballast	Retrofit Recommended	75.6	1,549	2,926.7	1.89	51	1,549	1,974.3	1.275
Storage	3	4' 2L Fixture	3	Lamp & Low Watt Ballast	Retrofit Recommended	75.6	1,549	351.2	0.2268	51	1,549	236.9	0.153
Library	14	4' 4L Fixture	14	Lamp & Low Watt Ballast	Retrofit Recommended	151.2	1,549	3,277.9	2.1168	100	1,549	2,167.9	1.4
A5	14	4' 4L Fixture	14	Lamp & Low Watt Ballast	Retrofit Recommended	151.2	1,549	3,277.9	2.1168	100	1,549	2,167.9	1.4
A5	2	Exit Sign	0		None		1,549	0.0	0		1,549	0.0	0
Girls' Restroom	2	4' 4L Fixture	2	Lamp & Low Watt Ballast	Retrofit Recommended	151.2	1,549	468.3	0.3024	100	1,549	309.7	0.2
Janitor	1	4' 2L Fixture	1	Lamp & Low Watt Ballast	Retrofit Recommended	75.6	1,549	117.1	0.0756	51	1,549	79.0	0.051
Boys' Restroom	2	4' 4L Fixture	2	Lamp & Low Watt Ballast	Retrofit Recommended	151.2	1,549	468.3	0.3024	100	1,549	309.7	0.2
BUILDING B	0		0		0		1,549	0.0	0		1,549	0.0	0
Boys' Restroom	2	4' 4L Fixture	2	Lamp & Low Watt Ballast	Retrofit Recommended	151.2	1,549	468.3	0.3024	100	1,549	309.7	0.2
Janitor's Room	1	4' 2L Fixture	1	Lamp & Low Watt Ballast	Retrofit Recommended	75.6	1,549	117.1	0.0756	51	1,549	79.0	0.051
Girls' Restroom	2	4' 4L Fixture	2	Lamp & Low Watt Ballast	Retrofit Recommended	151.2	1,549	468.3	0.3024	100	1,549	309.7	0.2
Men/Women Restroom	2	4' 4L Fixture	2	Lamp & Low Watt Ballast	Retrofit Recommended	151.2	1,549	468.3	0.3024	100	1,549	309.7	0.2
B5	17	4' 4L Fixture	17	Lamp & Low Watt Ballast	Retrofit Recommended	151.2	1,549	3,980.3	2.5704	100	1,549	2,632.5	1.7
B4	14	4' 4L Fixture	14	Lamp & Low Watt Ballast	Retrofit Recommended	151.2	1,549	3,277.9	2.1168	100	1,549	2,167.9	1.4
B3	14	4' 4L Fixture	14	Lamp & Low Watt Ballast	Retrofit Recommended	151.2	1,549	3,277.9	2.1168	100	1,549	2,167.9	1.4
B2	14	4' 4L Fixture	14	Lamp & Low Watt Ballast	Retrofit Recommended	151.2	1,549	3,277.9	2.1168	100	1,549	2,167.9	1.4
B1	14	4' 4L Fixture	14	Lamp & Low Watt Ballast	Retrofit Recommended	151.2	1,549	3,277.9	2.1168	100	1,549	2,167.9	1.4
BUILDING C	0		0		0		1,549	0.0	0		1,549	0.0	0
Men's Restroom	1	2L 60W Incandescent	0		None	0	1,549	0.0	0	0	1,549	0.0	0
Girls' Restroom	2	4' 4L Fixture	2	Lamp & Low Watt Ballast	Retrofit Recommended	151.2	1,549	468.3	0.3024	100	1,549	309.7	0.2
Janitor's Room	1	4' 2L Fixture	1	Lamp & Low Watt Ballast	Retrofit Recommended	75.6	1,549	117.1	0.0756	51	1,549	79.0	0.051
Boys' Restroom	2	4' 4L Fixture	2	Lamp & Low Watt Ballast	Retrofit Recommended	151.2	1,549	468.3	0.3024	100	1,549	309.7	0.2
C1	21	4' 4L Fixture	21	Lamp & Low Watt Ballast	Retrofit Recommended	151.2	1,549	4,916.8	3.1752	100	1,549	3,251.9	2.1
C1	6	4' 2L Fixture	6	Lamp & Low Watt Ballast	Retrofit Recommended	75.6	1,549	702.4	0.4536	51	1,549	473.8	0.306
C2	21	4' 4L Fixture	21	Lamp & Low Watt Ballast	Retrofit Recommended	151.2	1,549	4,916.8	3.1752	100	1,549	3,251.9	2.1
C2	6	4' 2L Fixture	6	Lamp & Low Watt Ballast	Retrofit Recommended	75.6	1,549	702.4	0.4536	51	1,549	473.8	0.306
C3	4	4' 4L Fixture	4	Lamp & Low Watt Ballast	Retrofit Recommended	151.2	1,549	936.5	0.6048	100	1,549	619.4	0.4
Women's Restroom	1	4' 2L Fixture	1	Lamp & Low Watt Ballast	Retrofit Recommended	75.6	1,549	117.1	0.0756	51	1,549	79.0	0.051
C7	14	4' 4L Fixture	14	Lamp & Low Watt Ballast	Retrofit Recommended	151.2	1,549	3,277.9	2.1168	100	1,549	2,167.9	1.4
C6	14	4' 4L Fixture	14	Lamp & Low Watt Ballast	Retrofit Recommended	151.2	1,549	3,277.9	2.1168	100	1,549	2,167.9	1.4
C5	14	4' 4L Fixture	14	Lamp & Low Watt Ballast	Retrofit Recommended	151.2	1,549	3,277.9	2.1168	100	1,549	2,167.9	1.4
C4	23	4' 4L Fixture	23	Lamp & Low Watt Ballast	Retrofit Recommended	151.2	1,549	5,385.1	3.4776	100	1,549	3,561.6	2.3
C4	7	4' 2L Fixture	7	Lamp & Low Watt Ballast	Retrofit Recommended	75.6	1,549	819.5	0.5292	51	1,549	552.8	0.357
Boys' Restroom	2	4' 4L Fixture	2	Lamp & Low Watt Ballast	Retrofit Recommended	151.2	1,549	468.3	0.3024	100	1,549	309.7	0.2
Janitor's Room	1	4' 2L Fixture	1	Lamp & Low Watt Ballast	Retrofit Recommended	75.6	1,549	117.1	0.0756	51	1,549	79.0	0.051
Girls' Restroom	2	4' 4L Fixture	2	Lamp & Low Watt Ballast	Retrofit Recommended	151.2	1,549	468.3	0.3024	100	1,549	309.7	0.2
Rescue Area (Stairs)	1	4' 4L Fixture	1	Lamp & Low Watt Ballast	Retrofit Recommended	151.2	1,549	234.1	0.1512	100	1,549	154.9	0.1
Electrical Room	1	60W Incandescent	0		None		1,549	0.0	0		1,549	0.0	0
Mechanical Room	1	60W Incandescent	0		None	0	1,549	0.0	0	0	1,549	0.0	0
Elevator	1	4' 2L Fixture	1	Lamp & Low Watt Ballast	Retrofit Recommended	75.6	1,549	117.1	0.0756	51	1,549	79.0	0.051
PORTABLES	0		0		0		1,549	0.0	0		1,549	0.0	0
P1	8	4' 4L Fixture	8	Lamp & Low Watt Ballast	Retrofit Recommended	151.2	1,549	1,873.1	1.2096	100	1,549	1,238.8	0.8
P1	7	4' 2L Fixture	7	Lamp & Low Watt Ballast	Retrofit Recommended	75.6	1,549	819.5	0.5292	51	1,549	552.8	0.357
Storage	3	60W Incandescent	0		None	0	1,549	0.0	0	0	1,549	0.0	0
Exterior	4	60W Incandescent	0		None	0	1,549	0.0	0	0	1,549	0.0	0
P2	8	4' 4L Fixture	8	Lamp & Low Watt Ballast	Retrofit Recommended	151.2	1,549	1,873.1	1.2096	100	1,549	1,238.8	0.8

LOCATION	QTY	EXISTING TYPE	QTY	RETROFIT		Existing				Actual				Proposed			
						Watt/unit	Op. Hours	kWh	kW-D	Watt/unit	Op. Hours	kWh	kW-D	Watt/unit	Op. Hours	kWh	kW-D
P2	7	4' 2L Fixture	7	Lamp & Low Watt Ballast	Retrofit Recommended	75.6	1,549	819.5	0.5292	51	1,549	552.8	0.357				
P8	12	4' 4L Fixture	12	Lamp & Low Watt Ballast	Retrofit Recommended	151.2	1,549	2,809.6	1.8144	100	1,549	1,858.2	1.2				
P7	12	4' 4L Fixture	12	Lamp & Low Watt Ballast	Retrofit Recommended	151.2	1,549	2,809.6	1.8144	100	1,549	1,858.2	1.2				
Exterior	4	60W Incandescent	0	0	None	0	1,549	0.0	0	0	1,549	0.0	0				
P3	12	4' 4L Fixture	12	Lamp & Low Watt Ballast	Retrofit Recommended	151.2	1,549	2,809.6	1.8144	100	1,549	1,858.2	1.2				
P4	16	4' 4L Fixture	16	Lamp & Low Watt Ballast	Retrofit Recommended	151.2	1,549	3,746.1	2.4192	100	1,549	2,477.6	1.6				
Bathroom	2	60W Incandescent	0	0	None	0	1,549	0.0	0	0	1,549	0.0	0				
Exterior	6	60W Incandescent	0	0	None	0	1,549	0.0	0	0	1,549	0.0	0				
P5	16	4' 4L Fixture	16	Lamp & Low Watt Ballast	Retrofit Recommended	151.2	1,549	3,746.1	2.4192	100	1,549	2,477.6	1.6				
P6	16	4' 4L Fixture	16	Lamp & Low Watt Ballast	Retrofit Recommended	151.2	1,549	3,746.1	2.4192	100	1,549	2,477.6	1.6				
INDUSTRIAL	0		0		0		1,549	0.0	0		1,549	0.0	0				
Warehouse/Classroom	33	4' 3L Fixture	33	Lamp & Low Watt Ballast	Retrofit Recommended	121.2	1,549	6,193.4	3.9996	77	1,549	3,934.7	2.541				
Finishing Room	2	4' 2L Fixture	2	Lamp & Low Watt Ballast	Retrofit Recommended	75.6	1,549	234.1	0.1512	51	1,549	157.9	0.102				
Boys' Restroom	2	4' 1L Fixture	2	Lamp & Low Watt Ballast	Retrofit Recommended	45.6	1,549	141.2	0.0912	31	1,549	96.0	0.062				
Custodian	1	4' 1L Fixture	1	Lamp & Low Watt Ballast	Retrofit Recommended	45.6	1,549	70.6	0.0456	31	1,549	48.0	0.031				
Girls' Restroom	2	4' 1L Fixture	2	Lamp & Low Watt Ballast	Retrofit Recommended	45.6	1,549	141.2	0.0912	31	1,549	96.0	0.062				
Classroom	12	4' 4L Fixture	12	Lamp & Low Watt Ballast	Retrofit Recommended	151.2	1,549	2,809.6	1.8144	100	1,549	1,858.2	1.2				
Office	2	4' 4L Fixture	2	Lamp & Low Watt Ballast	Retrofit Recommended	151.2	1,549	468.3	0.3024	100	1,549	309.7	0.2				
Bathroom	1	4' 1L Fixture	1	Lamp & Low Watt Ballast	Retrofit Recommended	45.6	1,549	70.6	0.0456	31	1,549	48.0	0.031				
Storage	1	4' 2L Fixture	1	Lamp & Low Watt Ballast	Retrofit Recommended	75.6	1,549	117.1	0.0756	51	1,549	79.0	0.051				
MUSIC	0		0		0		1,549	0.0	0		1,549	0.0	0				
Music Classroom	2	4' 2L Fixture	2	Lamp & Low Watt Ballast	Retrofit Recommended	75.6	1,549	234.1	0.1512	51	1,549	157.9	0.102				
Music Classroom	15	4' 4L Fixture	15	Lamp & Low Watt Ballast	Retrofit Recommended	151.2	1,549	3,512.0	2.268	100	1,549	2,322.8	1.5				
Practice Room	4	4' 4L Fixture	4	Lamp & Low Watt Ballast	Retrofit Recommended	151.2	1,549	936.5	0.6048	100	1,549	619.4	0.4				
Practice Room	2	Exit Sign	0	0	None	0	1,549	0.0	0	0	1,549	0.0	0				
Band Room	6	4' 4L Fixture	6	Lamp & Low Watt Ballast	Retrofit Recommended	151.2	1,549	1,404.8	0.9072	100	1,549	929.1	0.6				
Office	6	4' 1L Fixture	6	Lamp & Low Watt Ballast	Retrofit Recommended	45.6	1,549	423.7	0.2736	31	1,549	288.0	0.186				
Girls' Restroom	2	4' 1L Fixture	2	Lamp & Low Watt Ballast	Retrofit Recommended	45.6	1,549	141.2	0.0912	31	1,549	96.0	0.062				
Hallway	2	4' 4L Fixture	2	Lamp & Low Watt Ballast	Retrofit Recommended	151.2	1,549	468.3	0.3024	100	1,549	309.7	0.2				
Hallway	1	Exit Sign	0	0	None	0	1,549	0.0	0	0	1,549	0.0	0				
Janitor	1	4' 2L Fixture	1	Lamp & Low Watt Ballast	Retrofit Recommended	75.6	1,549	117.1	0.0756	51	1,549	79.0	0.051				
Boys' Restroom	2	4' 1L Fixture	2	Lamp & Low Watt Ballast	Retrofit Recommended	45.6	1,549	141.2	0.0912	31	1,549	96.0	0.062				
BUILDING D	0		0		0		1,549	0.0	0		1,549	0.0	0				
Storage	1	60W Incandescent	0	0	None	0	1,549	0.0	0	0	1,549	0.0	0				
D103	25	4' 4L Fixture	25	Lamp & Low Watt Ballast	Retrofit Recommended	151.2	1,549	5,853.3	3.78	100	1,549	3,871.3	2.5				
Bathroom	2	60W Incandescent	0	0	None	0	1,549	0.0	0	0	1,549	0.0	0				
Back Classroom	6	4' 4L Fixture	6	Lamp & Low Watt Ballast	Retrofit Recommended	151.2	1,549	1,404.8	0.9072	100	1,549	929.1	0.6				
Storage	6	4' 4L Fixture	6	Lamp & Low Watt Ballast	Retrofit Recommended	151.2	1,549	1,404.8	0.9072	100	1,549	929.1	0.6				
Storage	2	4' 2L Fixture	2	Lamp & Low Watt Ballast	Retrofit Recommended	75.6	1,549	234.1	0.1512	51	1,549	157.9	0.102				
Toilet	1	60W Incandescent	0	0	None	0	1,549	0.0	0	0	1,549	0.0	0				
D102	23	4' 4L Fixture	23	Lamp & Low Watt Ballast	Retrofit Recommended	151.2	1,549	5,385.1	3.4776	100	1,549	3,561.6	2.3				
Women's Restroom	1	2' 1L Fixture	1	Lamp & Low Watt Ballast	Retrofit Recommended	27.7	1,549	42.9	0.0277	18	1,549	27.9	0.018				
Men's Restroom	1	2' 1L Fixture	1	Lamp & Low Watt Ballast	Retrofit Recommended	27.7	1,549	42.9	0.0277	18	1,549	27.9	0.018				
Storage	1	4' 2L Fixture	1	Lamp & Low Watt Ballast	Retrofit Recommended	75.6	1,549	117.1	0.0756	51	1,549	79.0	0.051				
Storage	1	60W Incandescent	0	0	None	0	1,549	0.0	0	0	1,549	0.0	0				
D101	16	4' 4L Fixture	16	Lamp & Low Watt Ballast	Retrofit Recommended	151.2	1,549	3,746.1	2.4192	100	1,549	2,477.6	1.6				
Girls Restroom	2	4' 4L Fixture	2	Lamp & Low Watt Ballast	Retrofit Recommended	151.2	1,549	468.3	0.3024	100	1,549	309.7	0.2				
Janitor	1	60W Incandescent	0	0	None	0	1,549	0.0	0	0	1,549	0.0	0				
Boys' Restroom	2	4' 4L Fixture	2	Lamp & Low Watt Ballast	Retrofit Recommended	151.2	1,549	468.3	0.3024	100	1,549	309.7	0.2				
Mech. Room	1	4' 2L Fixture	1	Lamp & Low Watt Ballast	Retrofit Recommended	75.6	1,549	117.1	0.0756	51	1,549	79.0	0.051				
Electrical Room	1	60W Incandescent	0	0	None	0	1,549	0.0	0	0	1,549	0.0	0				
Elevator	1	4' 2L Fixture	1	Lamp & Low Watt Ballast	Retrofit Recommended	75.6	1,549	117.1	0.0756	51	1,549	79.0	0.051				
Corridor	2	Exit Sign	0	0	None	0	1,549	0.0	0	0	1,549	0.0	0				
Boys' Restroom	2	4' 4L Fixture	2	Lamp & Low Watt Ballast	Retrofit Recommended	151.2	1,549	468.3	0.3024	100	1,549	309.7	0.2				
Janitor's Closet	1	Exit Sign	0	0	None	0	1,549	0.0	0	0	1,549	0.0	0				
Girls' Restroom	2	4' 4L Fixture	2	Lamp & Low Watt Ballast	Retrofit Recommended	151.2	1,549	468.3	0.3024	100	1,549	309.7	0.2				
D201	16	4' 4L Fixture	16	Lamp & Low Watt Ballast	Retrofit Recommended	151.2	1,549	3,746.1	2.4192	100	1,549	2,477.6	1.6				
D202	16	4' 4L Fixture	16	Lamp & Low Watt Ballast	Retrofit Recommended	151.2	1,549	3,746.1	2.4192	100	1,549	2,477.6	1.6				

LOCATION	QTY	EXISTING TYPE	QTY	RETROFIT		Existing		Actual		Proposed			
						Watt/unit	Op. Hours	kWh	kW-D	Watt/unit	Op. Hours	kWh	kW-D
D203	16	4' 4L Fixture	16	Lamp & Low Watt Ballast	Retrofit Recommended	151.2	1,549	3,746.1	2.4192	100	1,549	2,477.6	1.6
D204	16	4' 4L Fixture	16	Lamp & Low Watt Ballast	Retrofit Recommended	151.2	1,549	3,746.1	2.4192	100	1,549	2,477.6	1.6
D205	16	4' 4L Fixture	16	Lamp & Low Watt Ballast	Retrofit Recommended	151.2	1,549	3,746.1	2.4192	100	1,549	2,477.6	1.6

Existing 768 Proposed 730

ENERGY CALCULATIONS			149,996	97	99,279	64
Description	kW-Demand	kWh				
Existing Use	96.87	149,996				
Proposed Use	64.11	99,279				
Difference - Savings	32.75	50,717				
Electrical Utility Cost	\$5.75	\$0.15177				
Savings per Year	\$2,259.92	\$7,697.42				
					Total Yearly Energy Savings	\$9,957.33

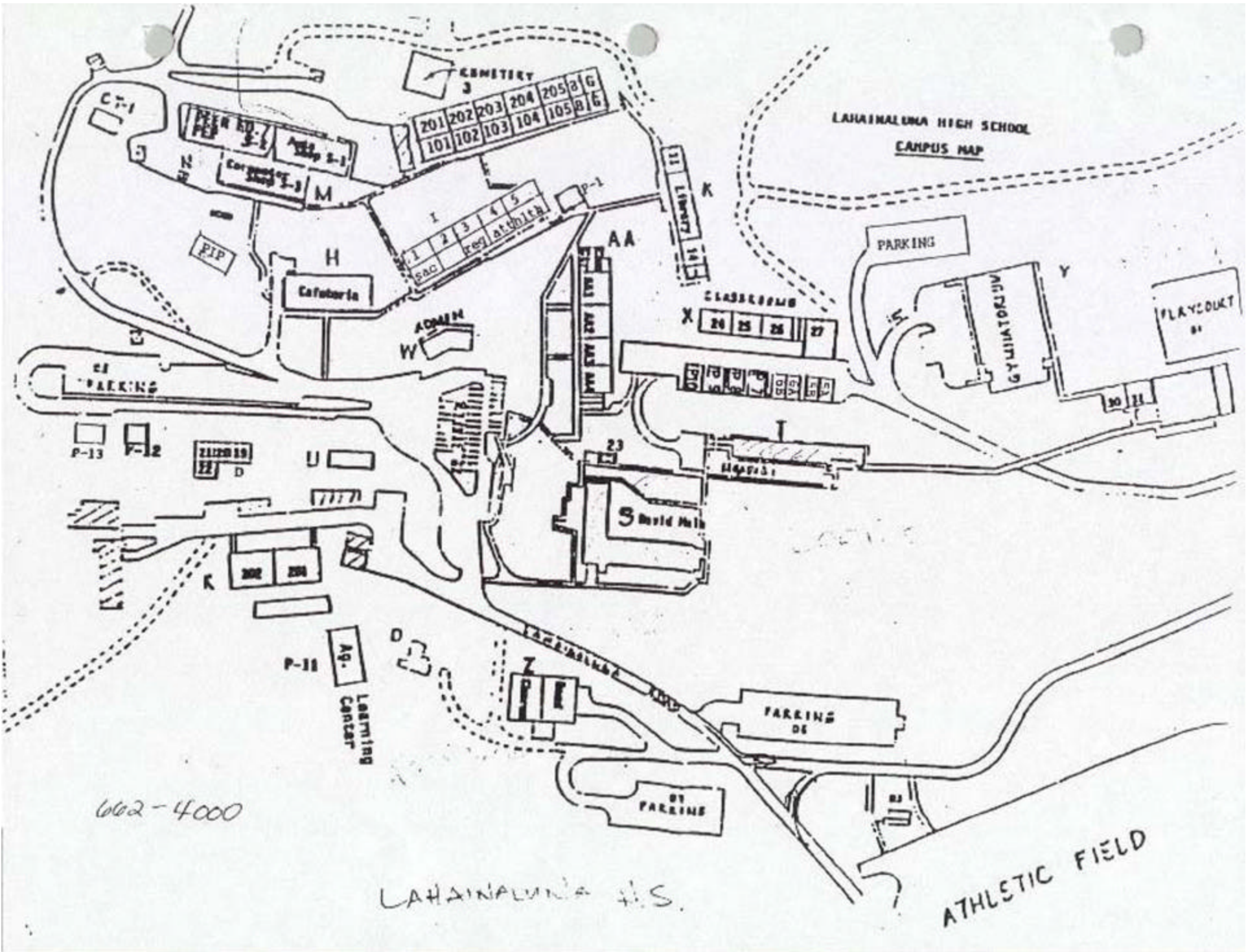

Maui Smart Schools Program
Foot Candle Readings

School: Lahaina Luna High School

Room: <u>J 205</u>	42	47
Ceiling Height: <u>12 Feet</u>	39	
Light Fixture Height: <u>8 Feet</u>		
Fixture Type: <u>Wrap</u>	45	41

Room: <u>Bldg K 201</u>	60	64
Ceiling Height: <u>10 Feet</u>	61	
Light Fixture Height: <u>8 Feet</u>		
Fixture Type: <u>Wrap</u>	62	61

Room: <u>X-26</u>	45	50
Ceiling Height: <u>9 Feet</u>	40	
Light Fixture Height: <u>8 Feet</u>		
Fixture Type: <u>Wrap</u>	41	46



CUSTOMER INFORMATION			DATE	
NAME Lahaina Luna High School			7/25/2000	
STREET ADDRESS 980 Lahaina Luna Road Lahaina, HI 96761			OPERATIONAL HOURS 1,993	
POINT OF CONTACT		PHONE 661-0313	FAX	VOLTAGE 120V
AUDITOR				

LOCATION <small>(Rm Name, Rm. #, Area, Zone, etc.)</small>	EXISTING EQUIPMENT						PROPOSED			REBATES		COSTS		COMMENTS
	Floor	Quantity	Lamp Type	Lamps Per Fixture	Type of Fixture	Ballast Type	Lamps Per Fixture	Reflectors	Ballast Type	Per Single	Extended	Per Single	Extended	
PORTABLES											\$ -		\$ -	
Building P1		1	4' T12	4	Wrap	Magnetic	4	N	Electronic	\$ 11.20	\$ 11.20	\$ 70.00	\$ 70.00	Retrofit Recommended
Room 1		1	4' T12	4	Wrap	Magnetic	4	N	Electronic	\$ 11.20	\$ 11.20	\$ 70.00	\$ 70.00	Retrofit Recommended
P2113		1	4' T12	4	Wrap	Magnetic	4	N	Electronic	\$ 11.20	\$ 11.20	\$ 70.00	\$ 70.00	Retrofit Recommended
Room 2											\$ -		\$ -	None
Building P23		3	4' T12	2	Strip	Magnetic	2	N	Electronic	\$ 5.60	\$ 16.80	\$ 60.00	\$ 180.00	Retrofit Recommended
Room 3		3	4' T12	2	Strip	Magnetic	2	N	Electronic	\$ 5.60	\$ 16.80	\$ 60.00	\$ 180.00	Retrofit Recommended
Building P10		12	4' T12	4	Wrap	Magnetic	4	N	Electronic	\$ 11.20	\$ 134.40	\$ 70.00	\$ 840.00	Retrofit Recommended
Building P9		12	4' T12	4	Wrap	Magnetic	4	N	Electronic	\$ 11.20	\$ 134.40	\$ 70.00	\$ 840.00	Retrofit Recommended
Building P8		12	4' T12	4	Wrap	Magnetic	4	N	Electronic	\$ 11.20	\$ 134.40	\$ 70.00	\$ 840.00	Retrofit Recommended
Building P7		12	4' T12	4	Wrap	Magnetic	4	N	Electronic	\$ 11.20	\$ 134.40	\$ 70.00	\$ 840.00	Retrofit Recommended
Building P6A		6	4' T12	4	Wrap	Magnetic	4	N	Electronic	\$ 11.20	\$ 67.20	\$ 70.00	\$ 420.00	Retrofit Recommended
Building P6B		6	4' T12	4	Wrap	Magnetic	4	N	Electronic	\$ 11.20	\$ 67.20	\$ 70.00	\$ 420.00	Retrofit Recommended
Building P5A		6	4' T12	4	Wrap	Magnetic	4	N	Electronic	\$ 11.20	\$ 67.20	\$ 70.00	\$ 420.00	Retrofit Recommended
Building P5B		6	4' T12	4	Wrap	Magnetic	4	N	Electronic	\$ 11.20	\$ 67.20	\$ 70.00	\$ 420.00	Retrofit Recommended
Building PIP		6	4' T12	4	Wrap	Magnetic	4	N	Electronic	\$ 11.20	\$ 67.20	\$ 70.00	\$ 420.00	Retrofit Recommended
Room 8		6	Inc								\$ -		\$ -	None
Building P13		6	4' T12	4	Fix	Magnetic	4	N	Electronic	\$ 11.20	\$ 67.20	\$ 70.00	\$ 420.00	Retrofit Recommended
Room 9		7	4' T12	4	Fix	Magnetic	4	N	Electronic	\$ 11.20	\$ 78.40	\$ 70.00	\$ 490.00	Retrofit Recommended
P2121		1	4' T12	4	Fix	Magnetic	4	N	Electronic	\$ 11.20	\$ 11.20	\$ 70.00	\$ 70.00	Retrofit Recommended
Room 10		6	4' T12	4	Fix	Magnetic	4	N	Electronic	\$ 11.20	\$ 67.20	\$ 70.00	\$ 420.00	Retrofit Recommended
P2122		16	4' T12	4	Para	Magnetic	4	N	Electronic	\$ 11.20	\$ 179.20	\$ 70.00	\$ 1,120.00	Retrofit Recommended
Building P12		12	4' T12	4	Para	Magnetic	4	N	Electronic	\$ 11.20	\$ 134.40	\$ 70.00	\$ 840.00	Retrofit Recommended
Building P11			4' T12	4	Wrap	Magnetic	4	N	Electronic	\$ 11.20	\$ -	\$ 70.00	\$ -	None
BUILDING AA														
Teacher's Work Room		1	4' T12	2	Wrap	Magnetic	2	N	Electronic	\$ 5.60	\$ 5.60	\$ 60.00	\$ 60.00	Retrofit Recommended
AA-101		24	4' T12	3	Wrap	Magnetic	3	N	Electronic	\$ 8.40	\$ 201.60	\$ 65.00	\$ 1,560.00	Retrofit Recommended
AA-102		24	4' T12	3	Wrap	Magnetic	3	N	Electronic	\$ 8.40	\$ 201.60	\$ 65.00	\$ 1,560.00	Retrofit Recommended
Trans Duplicate Room		6	4' T12	4	Wrap	Magnetic	4	N	Electronic	\$ 11.20	\$ 67.20	\$ 70.00	\$ 420.00	Retrofit Recommended
Storage		2	4' T12	2	Wrap	Magnetic	2	N	Electronic	\$ 5.60	\$ 11.20	\$ 60.00	\$ 120.00	Retrofit Recommended
AA-103		24	4' T12	4	Wrap	Magnetic	4	N	Electronic	\$ 11.20	\$ 268.80	\$ 70.00	\$ 1,680.00	Retrofit Recommended

LOCATION	EXISTING EQUIPMENT						PROPOSED			REBATES		COSTS		COMMENTS
	Floor	Quantity	Lamp Type	Lamps Per Fixture	Type of Fixture	Ballast Type	Lamps Per Fixture	Reflectors	Ballast Type	Per Single	Extended	Per Single	Extended	
Storage		8	4' T12	2	Wrap	Magnetic	2	N	Electronic	\$ 5.80	\$ 44.80	\$ 60.00	\$ 480.00	Retrofit Recommended
AA-104		24	4' T12	4	Wrap	Magnetic	4	N	Electronic	\$ 11.20	\$ 268.80	\$ 70.00	\$ 1,680.00	Retrofit Recommended
Women's Restroom		5	4' T12	1	Strip	Magnetic	1	N	Electronic	\$ 2.80	\$ 14.00	\$ 55.00	\$ 275.00	Retrofit Recommended
Custodian		2	4' T12	1	Strip	Magnetic	1	N	Electronic	\$ 2.80	\$ 5.60	\$ 55.00	\$ 110.00	Retrofit Recommended
Men's Restroom		5	4' T12	1	Strip	Magnetic	1	N	Electronic	\$ 2.80	\$ 14.00	\$ 55.00	\$ 275.00	Retrofit Recommended
Teacher's Work Room		6	4' T12	4	Wrap	Magnetic	4	N	Electronic	\$ 11.20	\$ 67.20	\$ 70.00	\$ 420.00	Retrofit Recommended
Storage		4	Inc								\$ -	\$ -	\$ -	None
Night Lite		10	Inc								\$ -	\$ -	\$ -	None
BUILDING X														
X-27 Kitchen		24	4' T12	4	Wrap	Magnetic	4	N	Electronic	\$ 11.20	\$ 268.80	\$ 70.00	\$ 1,680.00	Retrofit Recommended
X-27 Computer Room		14	4' T12	4	Wrap	Magnetic	4	N	Electronic	\$ 11.20	\$ 156.80	\$ 70.00	\$ 980.00	Retrofit Recommended
Women's Restroom		8	Inc								\$ -	\$ -	\$ -	None
Janitor		2	Inc								\$ -	\$ -	\$ -	None
Men's Restroom		8	Inc								\$ -	\$ -	\$ -	None
X-26		12	4' T12	4	Wrap	Magnetic	4	N	Electronic	\$ 11.20	\$ 134.40	\$ 70.00	\$ 840.00	Retrofit Recommended
		6	4' T12	2	Wrap	Magnetic	2	N	Electronic	\$ 5.60	\$ 33.60	\$ 60.00	\$ 360.00	Retrofit Recommended
X-25		12	4' T12	4	Wrap	Magnetic	4	N	Electronic	\$ 11.20	\$ 134.40	\$ 70.00	\$ 840.00	Retrofit Recommended
		6	4' T12	2	Wrap	Magnetic	2	N	Electronic	\$ 5.60	\$ 33.60	\$ 60.00	\$ 360.00	Retrofit Recommended
X-24		21	4' T12	4	Wrap	Magnetic	4	N	Electronic	\$ 11.20	\$ 235.20	\$ 70.00	\$ 1,470.00	Retrofit Recommended
Storage		4	4' T12	2	Wrap	Magnetic	2	N	Electronic	\$ 5.60	\$ 22.40	\$ 60.00	\$ 240.00	Retrofit Recommended
Kiln Room		1	4' T12	2	Wrap	Magnetic	2	N	Electronic	\$ 5.60	\$ 5.60	\$ 60.00	\$ 60.00	Retrofit Recommended
LIBRARY - BLDG K														
K-14		15	8' T12	2	Louver	Magnetic	2	N	Electronic	\$ 11.20	\$ 168.00	\$ 160.00	\$ 2,400.00	Retrofit Recommended
Library		33	8' T12	2	Louver	Magnetic	2	N	Electronic	\$ 11.20	\$ 369.60	\$ 160.00	\$ 5,280.00	Retrofit Recommended
		3			Exit Sign						\$ -	\$ -	\$ -	None
K-12		16	4' T8	3	Fix	Electronic					\$ -	\$ -	\$ -	None
Storage		1	8' T12	2	Louver	Magnetic	2	N	Electronic	\$ 11.20	\$ 11.20	\$ 160.00	\$ 160.00	Retrofit Recommended
MEN'S DORM														
Common (Hall)	1	8	4' T12	2	Strip	Magnetic	2	N	Electronic	\$ 5.60	\$ 44.80	\$ 60.00	\$ 480.00	Retrofit Recommended
Reception	1	2	4' T12	2	Wrap	Magnetic	2	N	Electronic	\$ 5.60	\$ 11.20	\$ 60.00	\$ 120.00	Retrofit Recommended
Mail Array	1	2	4' T12	2	Fix	Magnetic	2	N	Electronic	\$ 5.60	\$ 11.20	\$ 60.00	\$ 120.00	Retrofit Recommended
	1	1	4' T12	2	Tandem	Magnetic	2	N	Electronic	\$ 5.60	\$ 5.60	\$ 60.00	\$ 60.00	Retrofit Recommended
Lobby	1	10	4' T12	4	Wrap	Magnetic	4	N	Electronic	\$ 11.20	\$ 112.00	\$ 70.00	\$ 700.00	Retrofit Recommended
Kitchen	1	4	4' T12	4	Wrap	Magnetic	4	N	Electronic	\$ 11.20	\$ 44.80	\$ 70.00	\$ 280.00	Retrofit Recommended
Office	1	2	4' T12	2	Fix	Magnetic	2	N	Electronic	\$ 5.60	\$ 11.20	\$ 60.00	\$ 120.00	Retrofit Recommended
Women's Restroom	1	3	4' T12	2	Strip	Magnetic	2	N	Electronic	\$ 5.60	\$ 16.80	\$ 60.00	\$ 180.00	Retrofit Recommended
Stairs Closet	1	1	Inc								\$ -	\$ -	\$ -	None

LOCATION	EXISTING EQUIPMENT						PROPOSED			REBATES		COSTS		COMMENTS
Location (Rm Name, Rm. #, Area, Zone, etc.)	Floor	Quantity	Lamp Type	Lamps Per Fixture	Type of Fixture	Ballast Type	Lamps Per Fixture	Reflectors	Ballast Type	Per Single	Extended	Per Single	Extended	Comments
Stair Case	1	2	4' T12	1	Strip	Magnetic	1	N	Electronic	\$ 2.80	\$ 5.60	\$ 55.00	\$ 110.00	Retrofit Recommended
	1	1	2' T12	2	Strip	Magnetic	2	N	Electronic	\$ 2.40	\$ 2.40	\$ 60.00	\$ 60.00	Retrofit Recommended
	1	1	2' T12	2	Strip	Magnetic	2	N	Electronic	\$ 2.40	\$ 2.40	\$ 60.00	\$ 60.00	Retrofit Recommended
											\$ -		\$ -	None
	2	5	4' T12	2	Fix	Magnetic	2	N	Electronic	\$ 5.60	\$ 28.00	\$ 60.00	\$ 300.00	Retrofit Recommended
Stairwell	2	1	4' T12	2	Fix	Magnetic	2	N	Electronic	\$ 5.60	\$ 5.60	\$ 60.00	\$ 60.00	Retrofit Recommended
	2	1	4' T12	2	Fix	Magnetic	2	N	Electronic	\$ 5.60	\$ 5.60	\$ 60.00	\$ 60.00	Retrofit Recommended
	2	8	4' T12	2	Fix	Magnetic	2	N	Electronic	\$ 5.60	\$ 44.80	\$ 60.00	\$ 480.00	Retrofit Recommended
WOMEN'S DORM														
Hall	1	9	4' T12	2	Wrap	Magnetic	2	N	Electronic	\$ 5.60	\$ 50.40	\$ 60.00	\$ 540.00	Retrofit Recommended
Lobby	1	3	4' T12	2	Wrap	Magnetic	2	N	Electronic	\$ 5.60	\$ 16.80	\$ 60.00	\$ 180.00	Retrofit Recommended
Counselor Room	1	4	4' T12	2	Wrap	Magnetic	2	N	Electronic	\$ 5.60	\$ 22.40	\$ 60.00	\$ 240.00	Retrofit Recommended
Storage Room	1	3	4' T12	2	Wrap	Magnetic	2	N	Electronic	\$ 5.60	\$ 16.80	\$ 60.00	\$ 180.00	Retrofit Recommended
											\$ -		\$ -	None
Lobby	2	1	4' T12	2	Wrap	Magnetic	2	N	Electronic	\$ 5.60	\$ 5.60	\$ 60.00	\$ 60.00	Retrofit Recommended
Storage Room	2	1	4' T12	2	Wrap	Magnetic	2	N	Electronic	\$ 5.60	\$ 5.60	\$ 60.00	\$ 60.00	Retrofit Recommended
Hall	2	9	4' T12	2	Wrap	Magnetic	2	N	Electronic	\$ 5.60	\$ 50.40	\$ 60.00	\$ 540.00	Retrofit Recommended
BUILDING W														
Vice Principal		4	4' T12	4	Wrap	Magnetic	4	N	Electronic	\$ 11.20	\$ 44.80	\$ 70.00	\$ 280.00	Retrofit Recommended
		1	4' T12	2	Wrap	Magnetic	2	N	Electronic	\$ 5.60	\$ 5.60	\$ 60.00	\$ 60.00	Retrofit Recommended
		2	Inc								\$ -	\$ -	\$ -	None
Copy Room		21	4' T12	4	Fix	Magnetic	4	N	Electronic	\$ 11.20	\$ 235.20	\$ 70.00	\$ 1,470.00	Retrofit Recommended
Storage		1	Inc								\$ -	\$ -	\$ -	None
Reception		14	4' T12	4	Fix	Magnetic	4	N	Electronic	\$ 11.20	\$ 156.80	\$ 70.00	\$ 980.00	Retrofit Recommended
Storage		11	4' T12	2	Fix	Magnetic	2	N	Electronic	\$ 5.60	\$ 61.60	\$ 60.00	\$ 660.00	Retrofit Recommended
Principal		2	4' T12	4	Fix	Magnetic	4	N	Electronic	\$ 11.20	\$ 22.40	\$ 70.00	\$ 140.00	Retrofit Recommended
Janitor		1	Inc								\$ -	\$ -	\$ -	None
Hallway		1	4' T12	2	Fix	Magnetic	2	N	Electronic	\$ 5.60	\$ 5.60	\$ 60.00	\$ 60.00	Retrofit Recommended
Women's Restroom		2	Inc								\$ -	\$ -	\$ -	None
Copy Room 2		2	4' T12	4	Wrap	Magnetic	4	N	Electronic	\$ 11.20	\$ 22.40	\$ 70.00	\$ 140.00	Retrofit Recommended
Conference Room		3	4' T12	2	Fix	Magnetic	2	N	Electronic	\$ 11.20	\$ 33.60	\$ 160.00	\$ 480.00	Retrofit Recommended
Men's Restroom		2	Inc								\$ -	\$ -	\$ -	None
Women's Restroom		2	Inc								\$ -	\$ -	\$ -	None
Vice Principal		3	4' T12	2	Fix	Magnetic	2	N	Electronic	\$ 5.60	\$ 16.80	\$ 60.00	\$ 180.00	Retrofit Recommended
Vice Principal 2		3	4' T12	2	Fix	Magnetic	2	N	Electronic	\$ 5.60	\$ 16.80	\$ 60.00	\$ 180.00	Retrofit Recommended
Hallway		5	4' T12	2	Fix	Magnetic	2	N	Electronic	\$ 5.60	\$ 28.00	\$ 60.00	\$ 300.00	Retrofit Recommended
		2	4' T12	2	Fix	Magnetic	2	N	Electronic	\$ 5.60	\$ 11.20	\$ 60.00	\$ 120.00	Retrofit Recommended

LOCATION	EXISTING EQUIPMENT						PROPOSED			REBATES		COSTS		COMMENTS
	Floor	Quantity	Lamp Type	Lamps Per Fixture	Type of Fixture	Ballast Type	Lamps Per Fixture	Reflectors	Ballast Type	Per Single	Extended	Per Single	Extended	
Counselor 2		3	4' T12	2	Fix	Magnetic	2	N	Electronic	\$ 5.60	\$ 16.80	\$ 60.00	\$ 180.00	Retrofit Recommended
Councilor 1		3	4' T12	2	Fix	Magnetic	2	N	Electronic	\$ 5.60	\$ 16.80	\$ 60.00	\$ 180.00	Retrofit Recommended
Lounge		5	4' T12	2	Wrap	Magnetic	2	N	Electronic	\$ 5.60	\$ 28.00	\$ 60.00	\$ 300.00	Retrofit Recommended
Storage		1	4' T12	2	Wrap	Magnetic	2	N	Electronic	\$ 5.60	\$ 5.60	\$ 60.00	\$ 60.00	Retrofit Recommended
Room1		2	4' T12	2	Wrap	Magnetic	2	N	Electronic	\$ 5.60	\$ 11.20	\$ 60.00	\$ 120.00	Retrofit Recommended
Stairwell		1	4' T12	2	Fix	Magnetic	2	N	Electronic	\$ 5.60	\$ 5.60	\$ 60.00	\$ 60.00	Retrofit Recommended
Stock Room		7	4' T12	2	Wrap	Magnetic	2	N	Electronic	\$ 5.60	\$ 39.20	\$ 60.00	\$ 420.00	Retrofit Recommended
BUILDING I														
Student Art Director	1	1	4' T12	4	Wrap	Magnetic	4	N	Electronic	\$ 11.20	\$ 11.20	\$ 70.00	\$ 70.00	Retrofit Recommended
Registrar	1	2	4' T12	4	Fix	Magnetic	4	N	Electronic	\$ 11.20	\$ 22.40	\$ 70.00	\$ 140.00	Retrofit Recommended
Conference Room	1	2	4' T12	4	Fix	Magnetic	4	N	Electronic	\$ 11.20	\$ 22.40	\$ 70.00	\$ 140.00	Retrofit Recommended
Lobby	1	1	4' T12	4	Wrap	Magnetic	4	N	Electronic	\$ 11.20	\$ 11.20	\$ 70.00	\$ 70.00	Retrofit Recommended
Cashier	1	1	8' T12	2	Fix	Magnetic	2	N	Electronic	\$ 11.20	\$ 11.20	\$ 160.00	\$ 160.00	Retrofit Recommended
Guidance	1	1	8' T12	2	Fix	Magnetic	2	N	Electronic	\$ 11.20	\$ 11.20	\$ 160.00	\$ 160.00	Retrofit Recommended
	1	3	Inc								\$ -	\$ -	\$ -	None
Hallway	1	3	Inc								\$ -	\$ -	\$ -	None
Yearbook	1	2	4' T12	4	Wrap	Magnetic	4	N	Electronic	\$ 11.20	\$ 22.40	\$ 70.00	\$ 140.00	Retrofit Recommended
											\$ -	\$ -	\$ -	None
I 1	2	8	4' T12	4	Fix	Magnetic	4	N	Electronic	\$ 11.20	\$ 89.60	\$ 70.00	\$ 560.00	Retrofit Recommended
I 2	2	8	4' T12	4	Fix	Magnetic	4	N	Electronic	\$ 11.20	\$ 89.60	\$ 70.00	\$ 560.00	Retrofit Recommended
I 3	2	8	4' T12	4	Fix	Magnetic	4	N	Electronic	\$ 11.20	\$ 89.60	\$ 70.00	\$ 560.00	Retrofit Recommended
I 4	2	8	4' T12	4	Fix	Magnetic	4	N	Electronic	\$ 11.20	\$ 89.60	\$ 70.00	\$ 560.00	Retrofit Recommended
	2	6	4' T12	4	Fix	Magnetic	4	N	Electronic	\$ 11.20	\$ 67.20	\$ 70.00	\$ 420.00	Retrofit Recommended
Girls' Restroom	2	4	4' T12	2	Fix	Magnetic	2	N	Electronic	\$ 5.60	\$ 22.40	\$ 60.00	\$ 240.00	Retrofit Recommended
Boys' Restroom	2	4	4' T12	2	Fix	Magnetic	2	N	Electronic	\$ 5.60	\$ 22.40	\$ 60.00	\$ 240.00	Retrofit Recommended
BUILDING J														
J 101		15	4' T12	4	Fix	Magnetic	4	N	Electronic	\$ 11.20	\$ 168.00	\$ 70.00	\$ 1,050.00	Retrofit Recommended
J 102		15	4' T12	4	Fix	Magnetic	4	N	Electronic	\$ 11.20	\$ 168.00	\$ 70.00	\$ 1,050.00	Retrofit Recommended
J 103		15	4' T12	4	Fix	Magnetic	4	N	Electronic	\$ 11.20	\$ 168.00	\$ 70.00	\$ 1,050.00	Retrofit Recommended
J 104		15	4' T12	4	Fix	Magnetic	4	N	Electronic	\$ 11.20	\$ 168.00	\$ 70.00	\$ 1,050.00	Retrofit Recommended
J 105		60	4' T12	4	Fix	Magnetic	4	N	Electronic	\$ 11.20	\$ 672.00	\$ 70.00	\$ 4,200.00	Retrofit Recommended
Electrical Room		8	4' T12	2	Fix	Magnetic	2	N	Electronic	\$ 5.60	\$ 44.80	\$ 60.00	\$ 480.00	Retrofit Recommended
Storage		4	4' T12	2	Fix	Magnetic	2	N	Electronic	\$ 5.60	\$ 22.40	\$ 60.00	\$ 240.00	Retrofit Recommended
Boys' Restroom		6	4' T12	2	Fix	Magnetic	2	N	Electronic	\$ 5.60	\$ 33.60	\$ 60.00	\$ 360.00	Retrofit Recommended
Girls' Restroom		10	4' T12	2	Fix	Magnetic	2	N	Electronic	\$ 5.60	\$ 56.00	\$ 60.00	\$ 600.00	Retrofit Recommended
Storage		2	Inc								\$ -	\$ -	\$ -	None
J 205		24	4' T12	4	Fix	Magnetic	4	N	Electronic	\$ 11.20	\$ 268.80	\$ 70.00	\$ 1,680.00	Retrofit Recommended

LOCATION	EXISTING EQUIPMENT						PROPOSED			REBATES		COSTS		COMMENTS
	Floor	Quantity	Lamp Type	Lamps Per Fixture	Type of Fixture	Ballast Type	Lamps Per Fixture	Reflectors	Ballast Type	Per Single	Extended	Per Single	Extended	
<i>J 204</i>		14	4' T12	4	Wrap	Magnetic	4	N	Electronic	\$ 11.20	\$ 156.80	\$ 70.00	\$ 980.00	Retrofit Recommended
<i>J 203</i>		14	4' T12	4	Wrap	Magnetic	4	N	Electronic	\$ 11.20	\$ 156.80	\$ 70.00	\$ 980.00	Retrofit Recommended
<i>J 202</i>		14	4' T12	4	Wrap	Magnetic	4	N	Electronic	\$ 11.20	\$ 156.80	\$ 70.00	\$ 980.00	Retrofit Recommended
<i>J 201</i>		14	4' T12	4	Wrap	Magnetic	4	N	Electronic	\$ 11.20	\$ 156.80	\$ 70.00	\$ 980.00	Retrofit Recommended
		2			Exit Sign						\$ -	\$ -	\$ -	None
<i>Plus Office</i>		6	4' T12	2	Fix	Magnetic	2	N	Electronic	\$ 5.60	\$ 33.60	\$ 60.00	\$ 360.00	Retrofit Recommended
<i>Electrical Room</i>		8	4' T12	2	Fix	Magnetic	2	N	Electronic	\$ 5.60	\$ 44.80	\$ 60.00	\$ 480.00	Retrofit Recommended
<i>CAFETERIA</i>														
		12	Inc								\$ -	\$ -	\$ -	None
		17	4' T12	4	Fix	Magnetic	4	N	Electronic	\$ 11.20	\$ 190.40	\$ 70.00	\$ 1,190.00	Retrofit Recommended
		4			Exit Sign						\$ -	\$ -	\$ -	None
		9	4' T12	3	Fix	Magnetic	3	N	Electronic	\$ 8.40	\$ 75.60	\$ 65.00	\$ 585.00	Retrofit Recommended
		2	4' T12	4	Fix	Magnetic	4	N	Electronic	\$ 11.20	\$ 22.40	\$ 70.00	\$ 140.00	Retrofit Recommended
<i>Manager's Office</i>		1	4' T12	4	Fix	Magnetic	4	N	Electronic	\$ 11.20	\$ 11.20	\$ 70.00	\$ 70.00	Retrofit Recommended
		4	Inc								\$ -	\$ -	\$ -	None
<i>Cold Storage</i>		1	4' T12	2	Fix	Magnetic	2	N	Electronic	\$ 5.60	\$ 5.60	\$ 60.00	\$ 60.00	Retrofit Recommended
<i>Women's & Men's RR</i>		4	4' T12	2	Fix	Magnetic	2	N	Electronic	\$ 5.60	\$ 22.40	\$ 60.00	\$ 240.00	Retrofit Recommended
<i>BUILDING K</i>														
<i>Boys' & Girls' RR</i>		2	4' T12	1	Fix	Magnetic	1	N	Electronic	\$ 2.80	\$ 5.60	\$ 55.00	\$ 110.00	Retrofit Recommended
<i>201</i>		21	4' T12	2	Fix	Magnetic	2	N	Electronic	\$ 5.80	\$ 117.60	\$ 60.00	\$ 1,260.00	Retrofit Recommended
<i>202</i>		213	4' T12	2	Fix	Magnetic	2	N	Electronic	\$ 5.60	\$ 1,192.80	\$ 60.00	\$ 12,780.00	Retrofit Recommended
<i>Tool Room</i>		1	Inc								\$ -	\$ -	\$ -	None
<i>1st Floor Side Office</i>		2	4' T12	2	Fix	Magnetic	2	N	Electronic	\$ 5.60	\$ 11.20	\$ 60.00	\$ 120.00	Retrofit Recommended
<i>2nd Office</i>		4	4' T12	2	Fix	Magnetic	2	N	Electronic	\$ 5.60	\$ 22.40	\$ 60.00	\$ 240.00	Retrofit Recommended
<i>Side Sotrage</i>		1	Inc								\$ -	\$ -	\$ -	None
<i>Locker Room</i>		4	4' T12	2	Fix	Magnetic	2	N	Electronic	\$ 5.60	\$ 22.40	\$ 60.00	\$ 240.00	Retrofit Recommended
<i>Storage</i>		3	Inc								\$ -	\$ -	\$ -	None
<i>VARIOUS MAINT.</i>														
		8	4' T12	2	Fix	Magnetic	2	N	Electronic	\$ 5.60	\$ 44.80	\$ 60.00	\$ 480.00	Retrofit Recommended
<i>AUDITORIUM & GYM</i>														
<i>PB 30</i>		12	8' T12	2	Fix	Magnetic	2	N	Electronic	\$ 11.20	\$ 134.40	\$ 160.00	\$ 1,920.00	Retrofit Recommended
<i>Weight Room</i>		18	4' T12	2	Fix	Magnetic	2	N	Electronic	\$ 5.60	\$ 100.80	\$ 60.00	\$ 1,080.00	Retrofit Recommended
<i>Men's Restroom</i>		27	4' T12	2	Fix	Magnetic	2	N	Electronic	\$ 5.60	\$ 151.20	\$ 60.00	\$ 1,620.00	Retrofit Recommended
<i>Office</i>		4	4' T12	2	Fix	Magnetic	2	N	Electronic	\$ 5.60	\$ 22.40	\$ 60.00	\$ 240.00	Retrofit Recommended
<i>Women's Restroom</i>		4	4' T12	2	Fix	Magnetic	2	N	Electronic	\$ 5.60	\$ 22.40	\$ 60.00	\$ 240.00	Retrofit Recommended
<i>P31</i>		9	8' T12	2	Fix	Magnetic	2	N	Electronic	\$ 11.20	\$ 100.80	\$ 80.00	\$ 720.00	Retrofit Recommended
		3	4' T12	2	Fix	Magnetic	2	N	Electronic	\$ 7.20	\$ 21.60	\$ 60.00	\$ 180.00	Retrofit Recommended

LOCATION <small>(Rm Name, Rm. #, Area, Zone, etc.)</small>	EXISTING EQUIPMENT						PROPOSED			REBATES		COSTS		COMMENTS
	Floor	Quantity	Lamp Type	Lamps Per Fixture	Type of Fixture	Ballast Type	Lamps Per Fixture	Reflectors	Ballast Type	Per Single	Extended	Per Single	Extended	
Auditorium Building Z											\$ -		\$ -	
Office		6	4' T12	2	Fix	Magnetic	2	N	Electronic	\$ 5.60	\$ 33.60	\$ 60.00	\$ 360.00	Retrofit Recommended
Auditorium		40	4' T12	2	Fix	Magnetic	2	N	Electronic	\$ 5.60	\$ 224.00	\$ 60.00	\$ 2,400.00	Retrofit Recommended
High Ceiling		22	4' T12	4	Fix	Magnetic	4	N	Electronic	\$ 11.20	\$ 246.40	\$ 70.00	\$ 1,540.00	Retrofit Recommended
Practice Room 1		1	4' T12	4	Fix	Magnetic	4	N	Electronic	\$ 11.20	\$ 11.20	\$ 70.00	\$ 70.00	Retrofit Recommended
Practice Room 2		1	4' T12	4	Fix	Magnetic	4	N	Electronic	\$ 11.20	\$ 11.20	\$ 70.00	\$ 70.00	Retrofit Recommended
Practice Room 3		1	4' T12	4	Fix	Magnetic	4	N	Electronic	\$ 11.20	\$ 11.20	\$ 70.00	\$ 70.00	Retrofit Recommended
Practice Room 4		1	4' T12	4	Fix	Magnetic	4	N	Electronic	\$ 11.20	\$ 11.20	\$ 70.00	\$ 70.00	Retrofit Recommended
Boys' Restroom		3	4' T12	2	Fix	Magnetic	2	N	Electronic	\$ 5.60	\$ 16.80	\$ 60.00	\$ 180.00	Retrofit Recommended
Girls' Restroom		3	4' T12	2	Fix	Magnetic	2	N	Electronic	\$ 5.60	\$ 16.80	\$ 60.00	\$ 180.00	Retrofit Recommended
Wst.		2	Inc								\$ -	\$ -	\$ -	None
Auditorium 2		16	4' T12	2	Fix	Magnetic	2	N	Electronic	\$ 5.60	\$ 89.60	\$ 60.00	\$ 960.00	Retrofit Recommended
High Ceiling		18	4' T12	4	Fix	Magnetic	4	N	Electronic	\$ 11.20	\$ 201.60	\$ 70.00	\$ 1,260.00	Retrofit Recommended
Office		6	4' T12	2	Fix	Magnetic	2	N	Electronic	\$ 5.60	\$ 33.60	\$ 60.00	\$ 360.00	Retrofit Recommended
Ensemble		2	4' T12	4	Fix	Magnetic	4	N	Electronic	\$ 11.20	\$ 22.40	\$ 70.00	\$ 140.00	Retrofit Recommended
Front		5	Inc								\$ -	\$ -	\$ -	None
Mechanical		6	4' T12	2	Fix	Magnetic	2	N	Electronic	\$ 5.60	\$ 33.60	\$ 60.00	\$ 360.00	Retrofit Recommended
Gymnasium											\$ -		\$ -	None
		6	Inc								\$ -	\$ -	\$ -	None
Hallway		12	4' T12	2	Fix	Magnetic	2	N	Electronic	\$ 5.60	\$ 67.20	\$ 60.00	\$ 720.00	Retrofit Recommended
		2	4' T12	4	Fix	Magnetic	4	N	Electronic	\$ 11.20	\$ 22.40	\$ 70.00	\$ 140.00	Retrofit Recommended
Office 1		4	4' T12	2	Fix	Magnetic	2	N	Electronic	\$ 5.60	\$ 22.40	\$ 60.00	\$ 240.00	Retrofit Recommended
Women's Restroom		5	4' T12	2	Fix	Magnetic	2	N	Electronic	\$ 5.60	\$ 28.00	\$ 60.00	\$ 300.00	Retrofit Recommended
Men's Restroom		5	4' T12	2	Fix	Magnetic	2	N	Electronic	\$ 5.60	\$ 28.00	\$ 60.00	\$ 300.00	Retrofit Recommended
Middle Office		5	4' T12	4	Fix	Magnetic	4	N	Electronic	\$ 11.20	\$ 56.00	\$ 70.00	\$ 350.00	Retrofit Recommended
Office 2		4	4' T12	2	Fix	Magnetic	2	N	Electronic	\$ 5.60	\$ 22.40	\$ 60.00	\$ 240.00	Retrofit Recommended
Stairwell		2	4' T12	2	Fix	Magnetic	2	N	Electronic	\$ 5.60	\$ 11.20	\$ 60.00	\$ 120.00	Retrofit Recommended
Upper Level High		30	4' T12	4	Fix	Magnetic	4	N	Electronic	\$ 11.20	\$ 336.00	\$ 70.00	\$ 2,100.00	Retrofit Recommended
Odd Location		6	4' T12	4	Fix	Magnetic	4	N	Electronic	\$ 11.20	\$ 67.20	\$ 70.00	\$ 420.00	Retrofit Recommended
Restroom 1		3	4' T12	2	Fix	Magnetic	2	N	Electronic	\$ 5.60	\$ 16.80	\$ 60.00	\$ 180.00	Retrofit Recommended
Restroom 2		3	4' T12	2	Fix	Magnetic	2	N	Electronic	\$ 5.60	\$ 16.80	\$ 60.00	\$ 180.00	Retrofit Recommended
2nd Level Office		4	4' T12	4	Fix	Magnetic	4	N	Electronic	\$ 11.20	\$ 44.80	\$ 70.00	\$ 280.00	Retrofit Recommended
Super High Fixture		40	8' HO T12	2	Fix	HO	2	N	Electronic	\$ 7.20	\$ 288.00	\$ 110.20	\$ 4,408.00	Retrofit Recommended
Total Rebates										\$	12,872.40			
Total Costs										\$	106,113.00			

LOCATION	QTY	EXISTING TYPE	QTY	RETROFIT		Existing				Actual			Proposed		
						Watt/unit	Op. Hours	kWh	kW-D	Watt/unit	Op. Hours	kWh	kW-D		
PORTABLES	0		0		0		1,993	0.0	0		1,993	0.0	0		
<i>Building P1</i>	1	4' 4L Fixture	1	Lamp & Low Watt Ballast	Retrofit Recommended	151.2	1,993	301.3	0.1512	100	1,993	199.3	0.1		
<i>Room 1</i>	1	4' 4L Fixture	1	Lamp & Low Watt Ballast	Retrofit Recommended	151.2	1,993	301.3	0.1512	100	1,993	199.3	0.1		
<i>P2113</i>	1	4' 4L Fixture	1	Lamp & Low Watt Ballast	Retrofit Recommended	151.2	1,993	301.3	0.1512	100	1,993	199.3	0.1		
<i>Room 2</i>	0		0		None		1,993	0.0	0		1,993	0.0	0		
<i>Building P23</i>	3	4' 2L Fixture	3	Lamp & Low Watt Ballast	Retrofit Recommended	75.6	1,993	452.0	0.2268	51	1,993	304.9	0.153		
<i>Room 3</i>	3	4' 2L Fixture	3	Lamp & Low Watt Ballast	Retrofit Recommended	75.6	1,993	452.0	0.2268	51	1,993	304.9	0.153		
<i>Building P10</i>	12	4' 4L Fixture	12	Lamp & Low Watt Ballast	Retrofit Recommended	151.2	1,993	3,616.1	1.8144	100	1,993	2,391.6	1.2		
<i>Building P9</i>	12	4' 4L Fixture	12	Lamp & Low Watt Ballast	Retrofit Recommended	151.2	1,993	3,616.1	1.8144	100	1,993	2,391.6	1.2		
<i>Building P8</i>	12	4' 4L Fixture	12	Lamp & Low Watt Ballast	Retrofit Recommended	151.2	1,993	3,616.1	1.8144	100	1,993	2,391.6	1.2		
<i>Building P7</i>	12	4' 4L Fixture	12	Lamp & Low Watt Ballast	Retrofit Recommended	151.2	1,993	3,616.1	1.8144	100	1,993	2,391.6	1.2		
<i>Building P6A</i>	6	4' 4L Fixture	6	Lamp & Low Watt Ballast	Retrofit Recommended	151.2	1,993	1,808.0	0.9072	100	1,993	1,195.8	0.6		
<i>Building P6B</i>	6	4' 4L Fixture	6	Lamp & Low Watt Ballast	Retrofit Recommended	151.2	1,993	1,808.0	0.9072	100	1,993	1,195.8	0.6		
<i>Building P5A</i>	6	4' 4L Fixture	6	Lamp & Low Watt Ballast	Retrofit Recommended	151.2	1,993	1,808.0	0.9072	100	1,993	1,195.8	0.6		
<i>Building P5B</i>	6	4' 4L Fixture	6	Lamp & Low Watt Ballast	Retrofit Recommended	151.2	1,993	1,808.0	0.9072	100	1,993	1,195.8	0.6		
<i>Building PIP</i>	6	4' 4L Fixture	6	Lamp & Low Watt Ballast	Retrofit Recommended	151.2	1,993	1,808.0	0.9072	100	1,993	1,195.8	0.6		
<i>Room 8</i>	6		6		None		1,993	0.0	0		1,993	0.0	0		
<i>Building P13</i>	6	4' 4L Fixture	6	Lamp & Low Watt Ballast	Retrofit Recommended	151.2	1,993	1,808.0	0.9072	100	1,993	1,195.8	0.6		
<i>Room 9</i>	7	4' 4L Fixture	7	Lamp & Low Watt Ballast	Retrofit Recommended	151.2	1,993	2,109.4	1.0584	100	1,993	1,395.1	0.7		
<i>P2121</i>	1	4' 4L Fixture	1	Lamp & Low Watt Ballast	Retrofit Recommended	151.2	1,993	301.3	0.1512	100	1,993	199.3	0.1		
<i>Room 10</i>	6	4' 4L Fixture	6	Lamp & Low Watt Ballast	Retrofit Recommended	151.2	1,993	1,808.0	0.9072	100	1,993	1,195.8	0.6		
<i>P2122</i>	16	4' 4L Fixture	16	Lamp & Low Watt Ballast	Retrofit Recommended	151.2	1,993	4,821.5	2.4192	100	1,993	3,188.8	1.6		
<i>Building P12</i>	12	4' 4L Fixture	12	Lamp & Low Watt Ballast	Retrofit Recommended	151.2	1,993	3,616.1	1.8144	100	1,993	2,391.6	1.2		
<i>Building P11</i>	0	4' 4L Fixture	0	Lamp & Low Watt Ballast	None	151.2	1,993	0.0	0	100	1,993	0.0	0		
BUILDING AA	0		0		0		1,993	0.0	0		1,993	0.0	0		
<i>Teacher's Work Room</i>	1	4' 2L Fixture	1	Lamp & Low Watt Ballast	Retrofit Recommended	75.6	1,993	150.7	0.0756	51	1,993	101.6	0.051		
<i>AA-101</i>	24	4' 3L Fixture	24	Lamp & Low Watt Ballast	Retrofit Recommended	121.2	1,993	5,797.2	2.9088	77	1,993	3,683.1	1.848		
<i>AA-102</i>	24	4' 3L Fixture	24	Lamp & Low Watt Ballast	Retrofit Recommended	121.2	1,993	5,797.2	2.9088	77	1,993	3,683.1	1.848		
<i>Trans Duplicate Room</i>	6	4' 4L Fixture	6	Lamp & Low Watt Ballast	Retrofit Recommended	151.2	1,993	1,808.0	0.9072	100	1,993	1,195.8	0.6		
<i>Storage</i>	2	4' 2L Fixture	2	Lamp & Low Watt Ballast	Retrofit Recommended	75.6	1,993	301.3	0.1512	51	1,993	203.3	0.102		
<i>AA-103</i>	24	4' 4L Fixture	24	Lamp & Low Watt Ballast	Retrofit Recommended	151.2	1,993	7,232.2	3.6288	100	1,993	4,783.2	2.4		
<i>Storage</i>	8	4' 2L Fixture	8	Lamp & Low Watt Ballast	Retrofit Recommended	75.6	1,993	1,205.4	0.6048	51	1,993	813.1	0.408		
<i>AA-104</i>	24	4' 4L Fixture	24	Lamp & Low Watt Ballast	Retrofit Recommended	151.2	1,993	7,232.2	3.6288	100	1,993	4,783.2	2.4		
<i>Women's Restroom</i>	5	4' 1L Fixture	5	Lamp & Low Watt Ballast	Retrofit Recommended	45.6	1,993	454.4	0.228	31	1,993	308.9	0.155		
<i>Custodian</i>	2	4' 1L Fixture	2	Lamp & Low Watt Ballast	Retrofit Recommended	45.6	1,993	181.8	0.0912	31	1,993	123.6	0.062		
<i>Men's Restroom</i>	5	4' 1L Fixture	5	Lamp & Low Watt Ballast	Retrofit Recommended	45.6	1,993	454.4	0.228	31	1,993	308.9	0.155		
<i>Teacher's Work Room</i>	6	4' 4L Fixture	6	Lamp & Low Watt Ballast	Retrofit Recommended	151.2	1,993	1,808.0	0.9072	100	1,993	1,195.8	0.6		
<i>Storage</i>	4	60W Incandescent	0		None		1,993	0.0	0		1,993	0.0	0		
<i>Night Lite</i>	10	60W Incandescent	0	0	None	0	1,993	0.0	0	0	1,993	0.0	0		
BUILDING X	0		0		0		1,993	0.0	0		1,993	0.0	0		
<i>X-27 Kitchen</i>	24	4' 4L Fixture	24	Lamp & Low Watt Ballast	Retrofit Recommended	151.2	1,993	7,232.2	3.6288	100	1,993	4,783.2	2.4		
<i>X-27 Computer Room</i>	14	4' 4L Fixture	14	Lamp & Low Watt Ballast	Retrofit Recommended	151.2	1,993	4,218.8	2.1168	100	1,993	2,790.2	1.4		
<i>Women's Restroom</i>	8	60W Incandescent	0	0	None	0	1,993	0.0	0	0	1,993	0.0	0		
<i>Janitor</i>	2	60W Incandescent	0	0	None	0	1,993	0.0	0	0	1,993	0.0	0		
<i>Men's Restroom</i>	8	60W Incandescent	0	0	None	0	1,993	0.0	0	0	1,993	0.0	0		
<i>X-26</i>	12	4' 4L Fixture	12	Lamp & Low Watt Ballast	Retrofit Recommended	151.2	1,993	3,616.1	1.8144	100	1,993	2,391.6	1.2		
<i>0</i>	6	4' 2L Fixture	6	Lamp & Low Watt Ballast	Retrofit Recommended	75.6	1,993	904.0	0.4536	51	1,993	609.9	0.306		
<i>X-25</i>	12	4' 4L Fixture	12	Lamp & Low Watt Ballast	Retrofit Recommended	151.2	1,993	3,616.1	1.8144	100	1,993	2,391.6	1.2		
<i>0</i>	6	4' 2L Fixture	6	Lamp & Low Watt Ballast	Retrofit Recommended	75.6	1,993	904.0	0.4536	51	1,993	609.9	0.306		
<i>X-24</i>	21	4' 4L Fixture	21	Lamp & Low Watt Ballast	Retrofit Recommended	151.2	1,993	6,328.2	3.1752	100	1,993	4,185.3	2.1		
<i>Storage</i>	4	4' 2L Fixture	4	Lamp & Low Watt Ballast	Retrofit Recommended	75.6	1,993	602.7	0.3024	51	1,993	406.6	0.204		
<i>Kiln Room</i>	1	4' 2L Fixture	1	Lamp & Low Watt Ballast	Retrofit Recommended	75.6	1,993	150.7	0.0756	51	1,993	101.6	0.051		
LIBRARY - BLDG K	0		0		0		1,993	0.0	0		1,993	0.0	0		
<i>K-14</i>	15	8' 2L Fixture	15	Lamp & Ballast Retrofit	Retrofit Recommended	158	1,993	4,723.4	2.37	110	1,993	3,288.5	1.65		
<i>Library</i>	33	8' 2L Fixture	33	Lamp & Ballast Retrofit	Retrofit Recommended	158	1,993	10,391.5	5.214	110	1,993	7,234.6	3.63		
<i>0</i>	3	Exit Sign	0		None		1,993	0.0	0		1,993	0.0	0		
<i>K-12</i>	16		16		None		1,993	0.0	0		1,993	0.0	0		

LOCATION	QTY	EXISTING TYPE	QTY	RETROFIT		Existing	Actual			Proposed			
						Watt/unit	Op. Hours	kWh	kW-D	Watt/unit	Op. Hours	kWh	kW-D
Storage	1	8' 2L Fixture	1	Lamp & Ballast Retrofit	Retrofit Recommended	158	1,993	314.9	0.158	110	1,993	219.2	0.11
MEN'S DORM	0		0		0		1,993	0.0	0		1,993	0.0	0
Common (Hall)	8	4' 2L Fixture	8	Lamp & Low Watt Ballast	Retrofit Recommended	75.6	1,993	1,205.4	0.6048	51	1,993	813.1	0.408
Reception	2	4' 2L Fixture	2	Lamp & Low Watt Ballast	Retrofit Recommended	75.6	1,993	301.3	0.1512	51	1,993	203.3	0.102
Mail Array	2	4' 2L Fixture	2	Lamp & Low Watt Ballast	Retrofit Recommended	75.6	1,993	301.3	0.1512	51	1,993	203.3	0.102
0	1	4' 2L Fixture	1	Lamp & Low Watt Ballast	Retrofit Recommended	75.6	1,993	150.7	0.0756	51	1,993	101.6	0.051
Lobby	10	4' 4L Fixture	10	Lamp & Low Watt Ballast	Retrofit Recommended	151.2	1,993	3,013.4	1.512	100	1,993	1,993.0	1
Kitchen	4	4' 4L Fixture	4	Lamp & Low Watt Ballast	Retrofit Recommended	151.2	1,993	1,205.4	0.6048	100	1,993	797.2	0.4
Office	2	4' 2L Fixture	2	Lamp & Low Watt Ballast	Retrofit Recommended	75.6	1,993	301.3	0.1512	51	1,993	203.3	0.102
Women's Restroom	3	4' 2L Fixture	3	Lamp & Low Watt Ballast	Retrofit Recommended	75.6	1,993	452.0	0.2268	51	1,993	304.9	0.153
Stairs Closet	1	60W Incandescent	0	0	None	0	1,993	0.0	0	0	1,993	0.0	0
Stair Case	2	4' 1L Fixture	2	Lamp & Low Watt Ballast	Retrofit Recommended	45.6	1,993	181.8	0.0912	31	1,993	123.6	0.062
0	1	2' 2L Fixture	1	Lamp & Low Watt Ballast	Retrofit Recommended	55.4	1,993	110.4	0.0554	29	1,993	57.8	0.029
0	1	2' 2L Fixture	1	Lamp & Low Watt Ballast	Retrofit Recommended	55.4	1,993	110.4	0.0554	29	1,993	57.8	0.029
0	0		0		None		1,993	0.0	0		1,993	0.0	0
0	5	4' 2L Fixture	5	Lamp & Low Watt Ballast	Retrofit Recommended	75.6	1,993	753.4	0.378	51	1,993	508.2	0.255
Stairwell	1	4' 2L Fixture	1	Lamp & Low Watt Ballast	Retrofit Recommended	75.6	1,993	150.7	0.0756	51	1,993	101.6	0.051
0	1	4' 2L Fixture	1	Lamp & Low Watt Ballast	Retrofit Recommended	75.6	1,993	150.7	0.0756	51	1,993	101.6	0.051
0	8	4' 2L Fixture	8	Lamp & Low Watt Ballast	Retrofit Recommended	75.6	1,993	1,205.4	0.6048	51	1,993	813.1	0.408
WOMEN'S DORM	0		0		0		1,993	0.0	0		1,993	0.0	0
Hall	9	4' 2L Fixture	9	Lamp & Low Watt Ballast	Retrofit Recommended	75.6	1,993	1,356.0	0.6804	51	1,993	914.8	0.459
Lobby	3	4' 2L Fixture	3	Lamp & Low Watt Ballast	Retrofit Recommended	75.6	1,993	452.0	0.2268	51	1,993	304.9	0.153
Counselor Room	4	4' 2L Fixture	4	Lamp & Low Watt Ballast	Retrofit Recommended	75.6	1,993	602.7	0.3024	51	1,993	406.6	0.204
Storage Room	3	4' 2L Fixture	3	Lamp & Low Watt Ballast	Retrofit Recommended	75.6	1,993	452.0	0.2268	51	1,993	304.9	0.153
0	0		0		None		1,993	0.0	0		1,993	0.0	0
Lobby	1	4' 2L Fixture	1	Lamp & Low Watt Ballast	Retrofit Recommended	75.6	1,993	150.7	0.0756	51	1,993	101.6	0.051
Storage Room	1	4' 2L Fixture	1	Lamp & Low Watt Ballast	Retrofit Recommended	75.6	1,993	150.7	0.0756	51	1,993	101.6	0.051
Hall	9	4' 2L Fixture	9	Lamp & Low Watt Ballast	Retrofit Recommended	75.6	1,993	1,356.0	0.6804	51	1,993	914.8	0.459
BUILDING W	0		0		0		1,993	0.0	0		1,993	0.0	0
Vice Principal	4	4' 4L Fixture	4	Lamp & Low Watt Ballast	Retrofit Recommended	151.2	1,993	1,205.4	0.6048	100	1,993	797.2	0.4
0	1	4' 2L Fixture	1	Lamp & Low Watt Ballast	Retrofit Recommended	75.6	1,993	150.7	0.0756	51	1,993	101.6	0.051
0	2	60W Incandescent	0	0	None	0	1,993	0.0	0	0	1,993	0.0	0
Copy Room	21	4' 4L Fixture	21	Lamp & Low Watt Ballast	Retrofit Recommended	151.2	1,993	6,328.2	3.1752	100	1,993	4,185.3	2.1
Storage	1	60W Incandescent	0	0	None	0	1,993	0.0	0	0	1,993	0.0	0
Reception	14	4' 4L Fixture	14	Lamp & Low Watt Ballast	Retrofit Recommended	151.2	1,993	4,218.8	2.1168	100	1,993	2,790.2	1.4
Storage	11	4' 2L Fixture	11	Lamp & Low Watt Ballast	Retrofit Recommended	75.6	1,993	1,657.4	0.8316	51	1,993	1,118.1	0.561
Principal	2	4' 4L Fixture	2	Lamp & Low Watt Ballast	Retrofit Recommended	151.2	1,993	602.7	0.3024	100	1,993	398.6	0.2
Janitor	1	60W Incandescent	0	0	None	0	1,993	0.0	0	0	1,993	0.0	0
Hallway	1	4' 2L Fixture	1	Lamp & Low Watt Ballast	Retrofit Recommended	75.6	1,993	150.7	0.0756	51	1,993	101.6	0.051
Women's Restroom	2	60W Incandescent	0	0	None	0	1,993	0.0	0	0	1,993	0.0	0
Copy Room 2	2	4' 4L Fixture	2	Lamp & Low Watt Ballast	Retrofit Recommended	151.2	1,993	602.7	0.3024	100	1,993	398.6	0.2
Conference Room	3	2x4 6L Fixture	3	Lamp & Low Watt Ballast	Retrofit Recommended	226.8	1,993	1,356.0	0.6804	151	1,993	902.8	0.453
Men's Restroom	2	60W Incandescent	0	0	None	0	1,993	0.0	0	0	1,993	0.0	0
Women's Restroom	2	60W Incandescent	0	0	None	0	1,993	0.0	0	0	1,993	0.0	0
Vice Principal	3	2x4 6L Fixture	3	Lamp & Low Watt Ballast	Retrofit Recommended	226.8	1,993	1,356.0	0.6804	151	1,993	902.8	0.453
Vice Principal 2	3	2x4 6L Fixture	3	Lamp & Low Watt Ballast	Retrofit Recommended	226.8	1,993	1,356.0	0.6804	151	1,993	902.8	0.453
Hallway	5	4' 2L Fixture	5	Lamp & Low Watt Ballast	Retrofit Recommended	75.6	1,993	753.4	0.378	51	1,993	508.2	0.255
0	2	4' 2L Fixture	2	Lamp & Low Watt Ballast	Retrofit Recommended	75.6	1,993	301.3	0.1512	51	1,993	203.3	0.102
Counselor 2	3	2x4 6L Fixture	3	Lamp & Low Watt Ballast	Retrofit Recommended	226.8	1,993	1,356.0	0.6804	151	1,993	902.8	0.453
Councilor 1	3	2x4 6L Fixture	3	Lamp & Low Watt Ballast	Retrofit Recommended	226.8	1,993	1,356.0	0.6804	151	1,993	902.8	0.453
Lounge	5	4' 2L Fixture	5	Lamp & Low Watt Ballast	Retrofit Recommended	75.6	1,993	753.4	0.378	51	1,993	508.2	0.255
Storage	1	4' 2L Fixture	1	Lamp & Low Watt Ballast	Retrofit Recommended	75.6	1,993	150.7	0.0756	51	1,993	101.6	0.051
Room1	2	4' 2L Fixture	2	Lamp & Low Watt Ballast	Retrofit Recommended	75.6	1,993	301.3	0.1512	51	1,993	203.3	0.102
Stairwell	1	4' 2L Fixture	1	Lamp & Low Watt Ballast	Retrofit Recommended	75.6	1,993	150.7	0.0756	51	1,993	101.6	0.051
Stock Room	7	4' 2L Fixture	7	Lamp & Low Watt Ballast	Retrofit Recommended	75.6	1,993	1,054.7	0.5292	51	1,993	711.5	0.357
BUILDING I	0		0		0		1,993	0.0	0		1,993	0.0	0
Student Art Director	1	4' 4L Fixture	1	Lamp & Low Watt Ballast	Retrofit Recommended	151.2	1,993	301.3	0.1512	100	1,993	199.3	0.1
Registrar	2	4' 4L Fixture	2	Lamp & Low Watt Ballast	Retrofit Recommended	151.2	1,993	602.7	0.3024	100	1,993	398.6	0.2

LOCATION	QTY	EXISTING TYPE	QTY	RETROFIT		Existing	Actual			Proposed			
						Watt/unit	Op. Hours	kWh	kW-D	Watt/unit	Op. Hours	kWh	kW-D
Conference Room	2	4' 4L Fixture	2	Lamp & Low Watt Ballast	Retrofit Recommended	151.2	1,993	602.7	0.3024	100	1,993	398.6	0.2
Lobby	1	4' 4L Fixture	1	Lamp & Low Watt Ballast	Retrofit Recommended	151.2	1,993	301.3	0.1512	100	1,993	199.3	0.1
Cashier	1	8' 2L Fixture	1	Lamp & Ballast Retrofit	Retrofit Recommended	158	1,993	314.9	0.158	110	1,993	219.2	0.11
Guidance	1	8' 2L Fixture	1	Lamp & Ballast Retrofit	Retrofit Recommended	158	1,993	314.9	0.158	110	1,993	219.2	0.11
0	3	60W Incandescent	0	0	None	0	1,993	0.0	0	0	1,993	0.0	0
Hallway	3	60W Incandescent	0	0	None	0	1,993	0.0	0	0	1,993	0.0	0
Yearbook	2	4' 4L Fixture	2	Lamp & Low Watt Ballast	Retrofit Recommended	151.2	1,993	602.7	0.3024	100	1,993	398.6	0.2
0	0		0		None	0	1,993	0.0	0	0	1,993	0.0	0
I 1	8	4' 4L Fixture	8	Lamp & Low Watt Ballast	Retrofit Recommended	151.2	1,993	2,410.7	1.2096	100	1,993	1,594.4	0.8
I 2	8	4' 4L Fixture	8	Lamp & Low Watt Ballast	Retrofit Recommended	151.2	1,993	2,410.7	1.2096	100	1,993	1,594.4	0.8
I 3	8	4' 4L Fixture	8	Lamp & Low Watt Ballast	Retrofit Recommended	151.2	1,993	2,410.7	1.2096	100	1,993	1,594.4	0.8
I 4	8	4' 4L Fixture	8	Lamp & Low Watt Ballast	Retrofit Recommended	151.2	1,993	2,410.7	1.2096	100	1,993	1,594.4	0.8
0	6	4' 4L Fixture	6	Lamp & Low Watt Ballast	Retrofit Recommended	151.2	1,993	1,808.0	0.9072	100	1,993	1,195.8	0.6
Girls' Restroom	4	4' 2L Fixture	4	Lamp & Low Watt Ballast	Retrofit Recommended	75.6	1,993	602.7	0.3024	51	1,993	406.6	0.204
Boys' Restroom	4	4' 2L Fixture	4	Lamp & Low Watt Ballast	Retrofit Recommended	75.6	1,993	602.7	0.3024	51	1,993	406.6	0.204
BUILDING J	0		0		0	0	1,993	0.0	0	0	1,993	0.0	0
J 101	15	4' 4L Fixture	15	Lamp & Low Watt Ballast	Retrofit Recommended	151.2	1,993	4,520.1	2.268	100	1,993	2,989.5	1.5
J 102	15	4' 4L Fixture	15	Lamp & Low Watt Ballast	Retrofit Recommended	151.2	1,993	4,520.1	2.268	100	1,993	2,989.5	1.5
J 103	15	4' 4L Fixture	15	Lamp & Low Watt Ballast	Retrofit Recommended	151.2	1,993	4,520.1	2.268	100	1,993	2,989.5	1.5
J 104	15	4' 4L Fixture	15	Lamp & Low Watt Ballast	Retrofit Recommended	151.2	1,993	4,520.1	2.268	100	1,993	2,989.5	1.5
J 105	60	4' 4L Fixture	60	Lamp & Low Watt Ballast	Retrofit Recommended	151.2	1,993	18,080.5	9.072	100	1,993	11,958.0	6
Electrical Room	8	4' 2L Fixture	8	Lamp & Low Watt Ballast	Retrofit Recommended	75.6	1,993	1,205.4	0.6048	51	1,993	813.1	0.408
Storage	4	4' 2L Fixture	4	Lamp & Low Watt Ballast	Retrofit Recommended	75.6	1,993	602.7	0.3024	51	1,993	406.6	0.204
Boys' Restroom	6	4' 2L Fixture	6	Lamp & Low Watt Ballast	Retrofit Recommended	75.6	1,993	904.0	0.4536	51	1,993	609.9	0.306
Girls' Restroom	10	4' 2L Fixture	10	Lamp & Low Watt Ballast	Retrofit Recommended	75.6	1,993	1,506.7	0.756	51	1,993	1,016.4	0.51
Storage	2	60W Incandescent	0	0	None	0	1,993	0.0	0	0	1,993	0.0	0
J 205	24	4' 4L Fixture	24	Lamp & Low Watt Ballast	Retrofit Recommended	151.2	1,993	7,232.2	3.6288	100	1,993	4,783.2	2.4
J 204	14	4' 4L Fixture	14	Lamp & Low Watt Ballast	Retrofit Recommended	151.2	1,993	4,218.8	2.1168	100	1,993	2,790.2	1.4
J 203	14	4' 4L Fixture	14	Lamp & Low Watt Ballast	Retrofit Recommended	151.2	1,993	4,218.8	2.1168	100	1,993	2,790.2	1.4
J 202	14	4' 4L Fixture	14	Lamp & Low Watt Ballast	Retrofit Recommended	151.2	1,993	4,218.8	2.1168	100	1,993	2,790.2	1.4
J 201	14	4' 4L Fixture	14	Lamp & Low Watt Ballast	Retrofit Recommended	151.2	1,993	4,218.8	2.1168	100	1,993	2,790.2	1.4
0	2	Exit Sign	0	0	None	0	1,993	0.0	0	0	1,993	0.0	0
Plus Office	6	4' 2L Fixture	6	Lamp & Low Watt Ballast	Retrofit Recommended	75.6	1,993	904.0	0.4536	51	1,993	609.9	0.306
Electrical Room	8	4' 2L Fixture	8	Lamp & Low Watt Ballast	Retrofit Recommended	75.6	1,993	1,205.4	0.6048	51	1,993	813.1	0.408
CAFETERIA	0		0		0	0	1,993	0.0	0	0	1,993	0.0	0
0	12	60W Incandescent	0	0	None	0	1,993	0.0	0	0	1,993	0.0	0
0	17	4' 4L Fixture	17	Lamp & Low Watt Ballast	Retrofit Recommended	151.2	1,993	5,122.8	2.5704	100	1,993	3,388.1	1.7
0	4	Exit Sign	0	0	None	0	1,993	0.0	0	0	1,993	0.0	0
0	9	4' 3L Fixture	9	Lamp & Low Watt Ballast	Retrofit Recommended	121.2	1,993	2,174.0	1.0908	77	1,993	1,381.1	0.693
0	2	4' 4L Fixture	2	Lamp & Low Watt Ballast	Retrofit Recommended	151.2	1,993	602.7	0.3024	100	1,993	398.6	0.2
Manager's Office	1	4' 4L Fixture	1	Lamp & Low Watt Ballast	Retrofit Recommended	151.2	1,993	301.3	0.1512	100	1,993	199.3	0.1
0	4	60W Incandescent	0	0	None	0	1,993	0.0	0	0	1,993	0.0	0
Cold Storage	1	4' 2L Fixture	1	Lamp & Low Watt Ballast	Retrofit Recommended	75.6	1,993	150.7	0.0756	51	1,993	101.6	0.051
Women's & Men's RR	4	4' 2L Fixture	4	Lamp & Low Watt Ballast	Retrofit Recommended	75.6	1,993	602.7	0.3024	51	1,993	406.6	0.204
BUILDING K	0		0		0	0	1,993	0.0	0	0	1,993	0.0	0
Boys' & Girls' RR	2	4' 1L Fixture	2	Lamp & Low Watt Ballast	Retrofit Recommended	45.6	1,993	181.8	0.0912	31	1,993	123.6	0.062
201	21	4' 2L Fixture	21	Lamp & Low Watt Ballast	Retrofit Recommended	75.6	1,993	3,164.1	1.5876	51	1,993	2,134.5	1.071
202	213	4' 2L Fixture	213	Lamp & Low Watt Ballast	Retrofit Recommended	75.6	1,993	32,092.9	16.1028	51	1,993	21,650.0	10.863
Tool Room	1	60W Incandescent	0	0	None	0	1,993	0.0	0	0	1,993	0.0	0
1st Floor Side Office	2	4' 2L Fixture	2	Lamp & Low Watt Ballast	Retrofit Recommended	75.6	1,993	301.3	0.1512	51	1,993	203.3	0.102
2nd Office	4	4' 2L Fixture	4	Lamp & Low Watt Ballast	Retrofit Recommended	75.6	1,993	602.7	0.3024	51	1,993	406.6	0.204
Side Storage	1	60W Incandescent	0	0	None	0	1,993	0.0	0	0	1,993	0.0	0
Locker Room	4	4' 2L Fixture	4	Lamp & Low Watt Ballast	Retrofit Recommended	75.6	1,993	602.7	0.3024	51	1,993	406.6	0.204
Storage	3	60W Incandescent	0	0	None	0	1,993	0.0	0	0	1,993	0.0	0
VARIOUS MAINT.	0		0		0	0	1,993	0.0	0	0	1,993	0.0	0
0	8	4' 2L Fixture	8	Lamp & Low Watt Ballast	Retrofit Recommended	75.6	1,993	1,205.4	0.6048	51	1,993	813.1	0.408
AUDITORIUM & GYM	0		0		0	0	1,993	0.0	0	0	1,993	0.0	0
PB 30	12	8' 2L Fixture	12	Lamp & Ballast Retrofit	Retrofit Recommended	158	1,993	3,778.7	1.896	110	1,993	2,630.8	1.32

LOCATION	QTY	EXISTING TYPE	QTY	RETROFIT		Existing				Actual				Proposed			
						Watt/unit	Op. Hours	kWh	kW-D	Watt/unit	Op. Hours	kWh	kW-D	Watt/unit	Op. Hours	kWh	kW-D
Weight Room	18	4' 2L Fixture	18	Lamp & Low Watt Ballast	Retrofit Recommended	75.6	1,993	2,712.1	1.3608	51	1,993	1,829.6	0.918				
Men's Restroom	27	4' 2L Fixture	27	Lamp & Low Watt Ballast	Retrofit Recommended	75.6	1,993	4,068.1	2.0412	51	1,993	2,744.4	1.377				
Office	4	4' 2L Fixture	4	Lamp & Low Watt Ballast	Retrofit Recommended	75.6	1,993	602.7	0.3024	51	1,993	406.6	0.204				
Women's Restroom	4	4' 2L Fixture	4	Lamp & Low Watt Ballast	Retrofit Recommended	75.6	1,993	602.7	0.3024	51	1,993	406.6	0.204				
P31	9	8' 2L Fixture	9	Lamp & Ballast Retrofit	Retrofit Recommended	158	1,993	2,834.0	1.422	110	1,993	1,973.1	0.99				
0	3	4' 2L Fixture	3	Lamp & Low Watt Ballast	Retrofit Recommended	75.6	1,993	452.0	0.2268	51	1,993	304.9	0.153				
Auditorium Building Z	0		0		0		1,993	0.0	0		1,993	0.0	0				
Office	6	4' 2L Fixture	6	Lamp & Low Watt Ballast	Retrofit Recommended	75.6	1,993	904.0	0.4536	51	1,993	609.9	0.306				
Auditorium	40	4' 2L Fixture	40	Lamp & Low Watt Ballast	Retrofit Recommended	75.6	1,993	6,026.8	3.024	51	1,993	4,065.7	2.04				
High Ceiling	22	4' 4L Fixture	22	Lamp & Low Watt Ballast	Retrofit Recommended	151.2	1,993	6,629.5	3.3264	100	1,993	4,384.6	2.2				
Practice Room 1	1	4' 4L Fixture	1	Lamp & Low Watt Ballast	Retrofit Recommended	151.2	1,993	301.3	0.1512	100	1,993	199.3	0.1				
Practice Room 2	1	4' 4L Fixture	1	Lamp & Low Watt Ballast	Retrofit Recommended	151.2	1,993	301.3	0.1512	100	1,993	199.3	0.1				
Practice Room 3	1	4' 4L Fixture	1	Lamp & Low Watt Ballast	Retrofit Recommended	151.2	1,993	301.3	0.1512	100	1,993	199.3	0.1				
Practice Room 4	1	4' 4L Fixture	1	Lamp & Low Watt Ballast	Retrofit Recommended	151.2	1,993	301.3	0.1512	100	1,993	199.3	0.1				
Boys' Restroom	3	4' 2L Fixture	3	Lamp & Low Watt Ballast	Retrofit Recommended	75.6	1,993	452.0	0.2268	51	1,993	304.9	0.153				
Girls' Restroom	3	4' 2L Fixture	3	Lamp & Low Watt Ballast	Retrofit Recommended	75.6	1,993	452.0	0.2268	51	1,993	304.9	0.153				
Wst.	2	60W Incandescent	0	0	None	0	1,993	0.0	0	0	1,993	0.0	0				
Auditorium 2	16	4' 2L Fixture	16	Lamp & Low Watt Ballast	Retrofit Recommended	75.6	1,993	2,410.7	1.2096	51	1,993	1,626.3	0.816				
High Ceiling	18	4' 4L Fixture	18	Lamp & Low Watt Ballast	Retrofit Recommended	151.2	1,993	5,424.1	2.7216	100	1,993	3,587.4	1.8				
Office	6	4' 2L Fixture	6	Lamp & Low Watt Ballast	Retrofit Recommended	75.6	1,993	904.0	0.4536	51	1,993	609.9	0.306				
Ensemble	2	4' 4L Fixture	2	Lamp & Low Watt Ballast	Retrofit Recommended	151.2	1,993	602.7	0.3024	100	1,993	398.6	0.2				
Front	5	60W Incandescent	0	0	None	0	1,993	0.0	0	0	1,993	0.0	0				
Mechanical	6	4' 2L Fixture	6	Lamp & Low Watt Ballast	Retrofit Recommended	75.6	1,993	904.0	0.4536	51	1,993	609.9	0.306				
Gymnasium	0		0		None		1,993	0.0	0		1,993	0.0	0				
0	6	60W Incandescent	0	0	None	0	1,993	0.0	0	0	1,993	0.0	0				
Hallway	12	4' 2L Fixture	12	Lamp & Low Watt Ballast	Retrofit Recommended	75.6	1,993	1,808.0	0.9072	51	1,993	1,219.7	0.612				
0	2	4' 4L Fixture	2	Lamp & Low Watt Ballast	Retrofit Recommended	151.2	1,993	602.7	0.3024	100	1,993	398.6	0.2				
Office 1	4	4' 2L Fixture	4	Lamp & Low Watt Ballast	Retrofit Recommended	75.6	1,993	602.7	0.3024	51	1,993	406.6	0.204				
Women's Restroom	5	4' 2L Fixture	5	Lamp & Low Watt Ballast	Retrofit Recommended	75.6	1,993	753.4	0.378	51	1,993	508.2	0.255				
Men's Restroom	5	4' 2L Fixture	5	Lamp & Low Watt Ballast	Retrofit Recommended	75.6	1,993	753.4	0.378	51	1,993	508.2	0.255				
Middle Office	5	4' 4L Fixture	5	Lamp & Low Watt Ballast	Retrofit Recommended	151.2	1,993	1,506.7	0.756	100	1,993	996.5	0.5				
Office 2	4	4' 2L Fixture	4	Lamp & Low Watt Ballast	Retrofit Recommended	75.6	1,993	602.7	0.3024	51	1,993	406.6	0.204				
Stairwell	2	4' 2L Fixture	2	Lamp & Low Watt Ballast	Retrofit Recommended	75.6	1,993	301.3	0.1512	51	1,993	203.3	0.102				
Upper Level High	30	4' 4L Fixture	30	Lamp & Low Watt Ballast	Retrofit Recommended	151.2	1,993	9,040.2	4.536	100	1,993	5,979.0	3				
Odd Location	6	4' 4L Fixture	6	Lamp & Low Watt Ballast	Retrofit Recommended	151.2	1,993	1,808.0	0.9072	100	1,993	1,195.8	0.6				
Restroom 1	3	4' 2L Fixture	3	Lamp & Low Watt Ballast	Retrofit Recommended	75.6	1,993	452.0	0.2268	51	1,993	304.9	0.153				
Restroom 2	3	4' 2L Fixture	3	Lamp & Low Watt Ballast	Retrofit Recommended	75.6	1,993	452.0	0.2268	51	1,993	304.9	0.153				
2nd Level Office	4	4' 4L Fixture	4	Lamp & Low Watt Ballast	Retrofit Recommended	151.2	1,993	1,205.4	0.6048	100	1,993	797.2	0.4				
Super High Fixture	40	8' 2L HO Fixture	40	Lamp & Ballast Retrofit	Retrofit Recommended	227	1,993	18,096.4	9.08	170.5	1,993	13,592.3	6.82				

Existing 1620 Proposed 1526

ENERGY CALCULATIONS

Description	kW-Demand	kWh	362,827	182	243,270	122
Existing Use	182.05	362,827				
Proposed Use	122.06	243,270				
Difference - Savings	59.99	119,558	Total Yearly Energy Savings			
Electrical Utility Cost	\$5.75	\$0.15232				
Savings per Year	\$4,139.23	\$18,210.96				

LA HIGH & ELEM SCHOOL

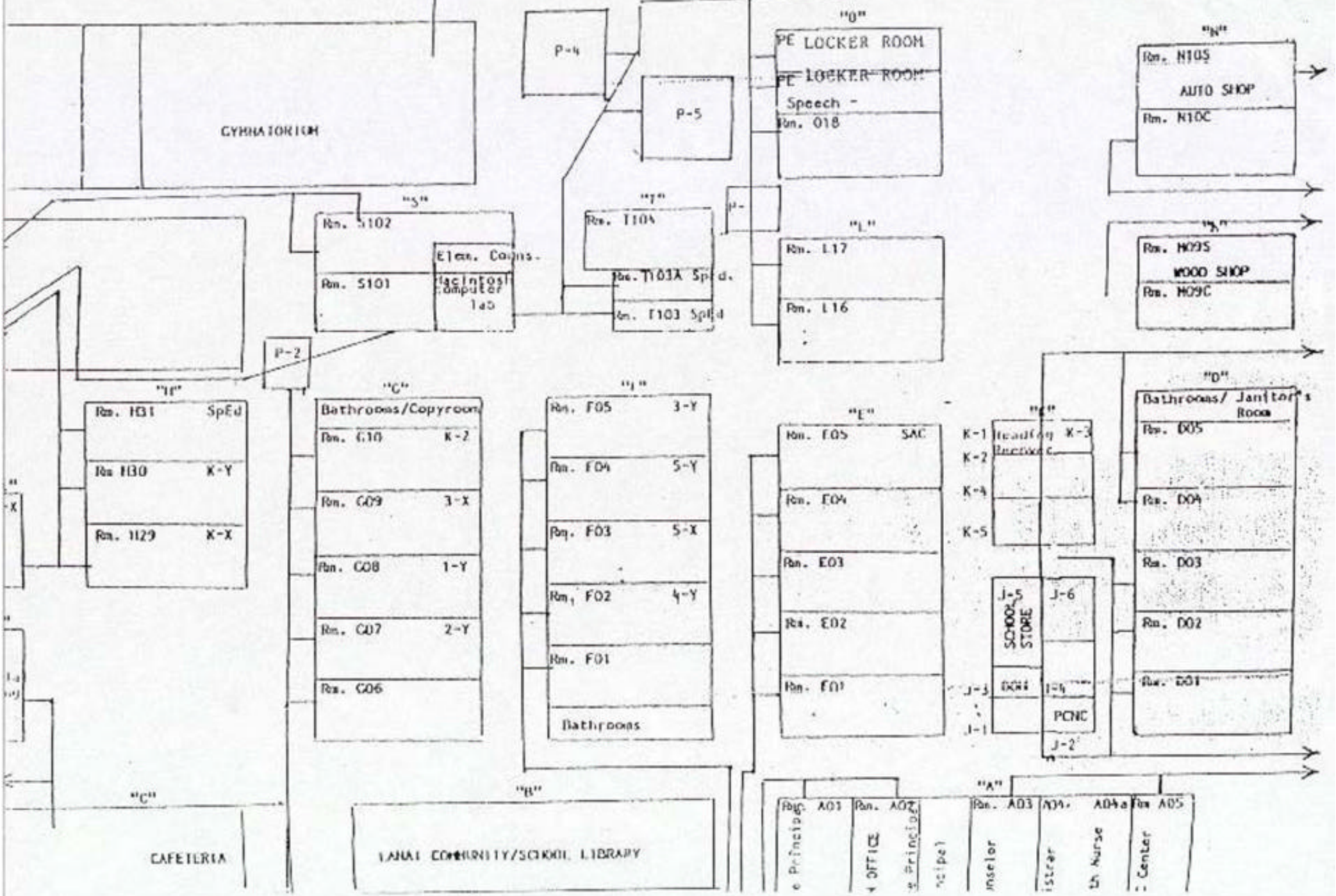

Maui Smart Schools Program
Foot Candle Readings

School: Lanai High + Elementary School

Room: Bldg. h #16
Ceiling height: 9'
Light fixture height: 7'
Fixture type: ICE TRAY

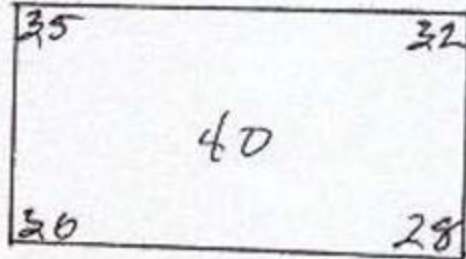

Room: Bldg. D D-3
Ceiling height: 9'
Light fixture height: 7'
Fixture type: ICE TRAY

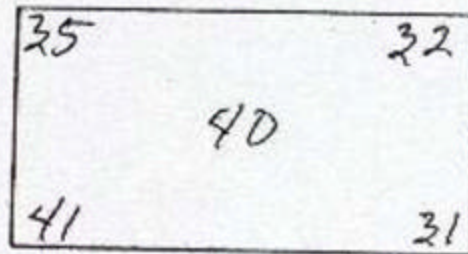

Room: Bldg. F - F-2
Ceiling height: 9'
Light fixture height: 7'
Fixture type: ICE TRAY

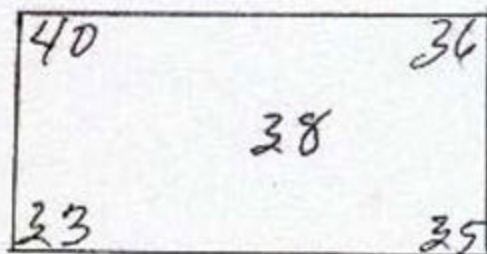



SCHOOL INFORMATION			
NAME Lanai Elementary & High School			DATE 2/15/2001
STREET ADDRESS P. O. Box 757 Lanai City, HI 96763			OPERATIONAL HOURS 1,692
POINT OF CONTACT Pierce Myers		PHONE 565-7900	FAX 120V
AUDITOR Maui Community College Auditors			

LOCATION <small>(Rm Name, Rm. #, Area, Zone, etc.)</small>	EXISTING EQUIPMENT						PROPOSED			REBATES		COSTS		COMMENTS <small>Surveyors Comments</small>
	Floor	Quantity	Lamp Type	Lamps Per Fixture	Type of Fixture	Ballast Type	Lamps Per Fixture	Reflectors	Ballast Type	Per Single	Extended	Per Single	Extended	
BUILDING E														
E 1		6	8' T12	2	Ice	Magnetic	2	N	Electronic	\$ 11.20	\$ 67.20	\$ 160.00	\$ 960.00	Replace fixture and mount hardware
E 2		6	8' T12	2	Ice	Magnetic	2	N	Electronic	\$ 11.20	\$ 67.20	\$ 160.00	\$ 960.00	Replace fixture and mount hardware
E 3		6	8' T12	2	Ice	Magnetic	2	N	Electronic	\$ 11.20	\$ 67.20	\$ 160.00	\$ 960.00	Replace fixture and mount hardware
E 4		6	8' T12	2	Ice	Magnetic	2	N	Electronic	\$ 11.20	\$ 67.20	\$ 160.00	\$ 960.00	Replace fixture and mount hardware
BUILDING L														
L 16		18	8' T12	2	Ice	Magnetic	2	N	Electronic	\$ 11.20	\$ 201.60	\$ 160.00	\$ 2,880.00	Replace fixture and mount hardware
L 17		15	8' T12	2	Ice	Magnetic	2	N	Electronic	\$ 11.20	\$ 168.00	\$ 160.00	\$ 2,400.00	Replace fixture and mount hardware
Boys' Restroom		2	4' T12	2	Wrap	Magnetic	2	N	Electronic	\$ 5.60	\$ 11.20	\$ 60.00	\$ 120.00	Excellent opportunity for retro-fit
Girls' Restroom		2	4' T12	2	Wrap	Magnetic	2	N	Electronic	\$ 5.60	\$ 11.20	\$ 60.00	\$ 120.00	Excellent opportunity for retro-fit
TB 1		16	4' T12	3	Troffer	Magnetic	3	N	Electronic	\$ 8.40	\$ 134.40	\$ 65.00	\$ 1,040.00	Excellent opportunity for retro-fit
BUILDING O														
O 18		21	4' T12	2	Ice	Magnetic	2	N	Electronic	\$ 5.60	\$ 117.60	\$ 135.00	\$ 2,835.00	Replace fixture and mount hardware
GIRLS' LOCKER ROOM														
Office		3	4' T12	3	Troffer	Magnetic	3	N	Electronic	\$ 8.40	\$ 25.20	\$ 65.00	\$ 195.00	Excellent opportunity for retro-fit
		18	4' T12	1	Impact	Magnetic	1	N	Electronic	\$ 2.80	\$ 50.40	\$ 55.00	\$ 990.00	Excellent opportunity for retro-fit
		3	4' T12	2	Impact	Magnetic	2	N	Electronic	\$ 5.60	\$ 16.80	\$ 60.00	\$ 180.00	Excellent opportunity for retro-fit
		6	4' T12	2	Impact	Magnetic	2	N	Electronic	\$ 5.60	\$ 33.60	\$ 60.00	\$ 360.00	Excellent opportunity for retro-fit
BOYS' LOCKER ROOM														
Office		3	4' T12	3	Troffer	Magnetic	3	N	Electronic	\$ 8.40	\$ 25.20	\$ 65.00	\$ 195.00	Excellent opportunity for retro-fit
		18	4' T12	1	Troffer	Magnetic	1	N	Electronic	\$ 2.80	\$ 50.40	\$ 55.00	\$ 990.00	Excellent opportunity for retro-fit
		3	4' T12	2	Troffer	Magnetic	2	N	Electronic	\$ 5.60	\$ 16.80	\$ 60.00	\$ 180.00	Excellent opportunity for retro-fit
		6	4' T12	2	Impact	Magnetic	2	N	Electronic	\$ 5.60	\$ 33.60	\$ 60.00	\$ 360.00	Excellent opportunity for retro-fit
TB 5		16	4' T12	3	Troffer	Magnetic	3	N	Electronic	\$ 8.40	\$ 134.40	\$ 65.00	\$ 1,040.00	Excellent opportunity for retro-fit
TB 4		16	4' T12	3	Troffer	Magnetic	3	N	Electronic	\$ 8.40	\$ 134.40	\$ 65.00	\$ 1,040.00	Excellent opportunity for retro-fit
T 104 Storage		6	4' T12	4	Troffer	Magnetic	4	N	Electronic	\$ 11.20	\$ 67.20	\$ 70.00	\$ 420.00	Excellent opportunity for retro-fit
		21	4' T12	4	Troffer	Magnetic	4	N	Electronic	\$ 11.20	\$ 235.20	\$ 70.00	\$ 1,470.00	Excellent opportunity for retro-fit
T 103		8	4' T12	4	Troffer	Magnetic	4	N	Electronic	\$ 11.20	\$ 89.60	\$ 70.00	\$ 560.00	Excellent opportunity for retro-fit
T 103A		8	4' T12	4	Troffer	Magnetic	4	N	Electronic	\$ 11.20	\$ 89.60	\$ 70.00	\$ 560.00	Excellent opportunity for retro-fit
Boys' Restroom		1	4' T12	2	Troffer	Magnetic	2	N	Electronic	\$ 5.60	\$ 5.60	\$ 60.00	\$ 60.00	Excellent opportunity for retro-fit
		1	4' T12	2	Vanity	Magnetic	2	N	Electronic	\$ 5.60	\$ 5.60	\$ 60.00	\$ 60.00	Excellent opportunity for retro-fit
Girls' Restroom		1	4' T12	2	Troffer	Magnetic	2	N	Electronic	\$ 5.60	\$ 5.60	\$ 60.00	\$ 60.00	Excellent opportunity for retro-fit

LOCATION	EXISTING EQUIPMENT						PROPOSED			REBATES		COSTS		COMMENTS
Location (Rm Name, Rm. #, Area, Zone, etc.)	Floor	Quantity	Lamp Type	Lamps Per Fixture	Type of Fixture	Ballast Type	Lamps Per Fixture	Reflectors	Ballast Type	Per Single	Extended	Per Single	Extended	Surveyors Comments
		1	4' T12	2	Vanity	Magnetic	2	N	Electronic	\$ 5.60	\$ 5.60	\$ 60.00	\$ 60.00	Excellent opportunity for retro-fit
GYM		86	4' T12	2	Wrap	Magnetic	2	N	Electronic	\$ 5.60	\$ 481.60	\$ 60.00	\$ 5,160.00	Excellent opportunity for retro-fit
Weight Room		9	4' T12	1	Wrap	Magnetic	1	N	Electronic	\$ 2.80	\$ 25.20	\$ 55.00	\$ 495.00	Excellent opportunity for retro-fit
LIBRARY														
Meeting Room		10	4' T12	4	Wrap	Magnetic	4	N	Electronic	\$ 11.20	\$ 112.00	\$ 70.00	\$ 700.00	Excellent opportunity for retro-fit
Staff Prep		4	4' T12	2	Wrap	Magnetic	2	N	Electronic	\$ 5.60	\$ 22.40	\$ 60.00	\$ 240.00	Excellent opportunity for retro-fit
Production		10	4' T12	2	Wrap	Magnetic	2	N	Electronic	\$ 5.60	\$ 56.00	\$ 60.00	\$ 600.00	Excellent opportunity for retro-fit
Recording		4	4' T12	2	Wrap	Magnetic	2	N	Electronic	\$ 5.60	\$ 22.40	\$ 60.00	\$ 240.00	Excellent opportunity for retro-fit
		2	4' T12	1	Vanity	Magnetic	1	N	Electronic	\$ 2.80	\$ 5.60	\$ 55.00	\$ 110.00	Excellent opportunity for retro-fit
Conference		8	U T12	2	Troffer	Magnetic	2	N	Electronic	\$ 5.60	\$ 44.80	\$ 60.00	\$ 480.00	No Comment
Main		10	U T12	2	Troffer	Magnetic	2	N	Electronic	\$ 5.60	\$ 56.00	\$ 60.00	\$ 600.00	No Comment
		75	4' T12	2	Troffer	Magnetic	2	N	Electronic	\$ 5.60	\$ 420.00	\$ 60.00	\$ 4,500.00	Excellent opportunity for retro-fit
BUILDING J														
J 2		2	4' T12	2	Wrap	Magnetic	2	N	Electronic	\$ 5.60	\$ 11.20	\$ 60.00	\$ 120.00	Excellent opportunity for retro-fit
J 4		4	4' T12	2	Wrap	Magnetic	2	N	Electronic	\$ 5.60	\$ 22.40	\$ 60.00	\$ 240.00	Excellent opportunity for retro-fit
J 6		4	4' T12	2	Wrap	Magnetic	2	N	Electronic	\$ 5.60	\$ 22.40	\$ 60.00	\$ 240.00	Excellent opportunity for retro-fit
J 7		4	4' T12	2	Wrap	Magnetic	2	N	Electronic	\$ 5.60	\$ 22.40	\$ 60.00	\$ 240.00	Excellent opportunity for retro-fit
		2	4' T12	2	Wrap	Magnetic	2	N	Electronic	\$ 5.60	\$ 11.20	\$ 60.00	\$ 120.00	Excellent opportunity for retro-fit
J 3		2	4' T12	2	Wrap	Magnetic	2	N	Electronic	\$ 5.60	\$ 11.20	\$ 60.00	\$ 120.00	Excellent opportunity for retro-fit
J 5		2	4' T12	2	Wrap	Magnetic	2	N	Electronic	\$ 5.60	\$ 11.20	\$ 60.00	\$ 120.00	Excellent opportunity for retro-fit
Hall		5	4' T12	2	Wrap	Magnetic	2	N	Electronic	\$ 5.60	\$ 28.00	\$ 60.00	\$ 300.00	Excellent opportunity for retro-fit
BUILDING T		6	4' T12	2	Wrap	Magnetic	2	N	Electronic	\$ 5.60	\$ 33.60	\$ 60.00	\$ 360.00	Excellent opportunity for retro-fit
		8	4' T12	2	Wrap	Magnetic	2	N	Electronic	\$ 5.60	\$ 44.80	\$ 60.00	\$ 480.00	Excellent opportunity for retro-fit
		6	4' T12	2	Wrap	Magnetic	2	N	Electronic	\$ 5.60	\$ 33.60	\$ 60.00	\$ 360.00	Excellent opportunity for retro-fit
T 107		2	4' T12	2	Wrap	Magnetic	2	N	Electronic	\$ 5.60	\$ 11.20	\$ 60.00	\$ 120.00	Excellent opportunity for retro-fit
T 109		2	4' T12	2	Wrap	Magnetic	2	N	Electronic	\$ 5.60	\$ 11.20	\$ 60.00	\$ 120.00	Excellent opportunity for retro-fit
BUILDING D														
D 1		6	8' T12	2	Ice	Magnetic	2	N	Electronic	\$ 11.20	\$ 67.20	\$ 160.00	\$ 960.00	Replace fixture and mount hardware
D 2		6	8' T12	2	Ice	Magnetic	2	N	Electronic	\$ 11.20	\$ 67.20	\$ 160.00	\$ 960.00	Replace fixture and mount hardware
D 3		7	8' T12	2	Ice	Magnetic	2	N	Electronic	\$ 11.20	\$ 78.40	\$ 160.00	\$ 1,120.00	Replace fixture and mount hardware
D 4		4	8' T12	2	Ice	Magnetic	2	N	Electronic	\$ 11.20	\$ 44.80	\$ 160.00	\$ 640.00	Replace fixture and mount hardware
D 5		5	8' T12	2	Ice	Magnetic	2	N	Electronic	\$ 11.20	\$ 56.00	\$ 160.00	\$ 800.00	Replace fixture and mount hardware
Men's Bathroom		3	4' T12	2	Wrap	Magnetic	2	N	Electronic	\$ 5.60	\$ 16.80	\$ 60.00	\$ 180.00	Excellent opportunity for retro-fit
Women's Bathroom		3	4' T12	2	Wrap	Magnetic	2	N	Electronic	\$ 5.60	\$ 16.80	\$ 60.00	\$ 180.00	Excellent opportunity for retro-fit
INDUSTRIAL		6	8' T12	2	Ice	Magnetic	2	N	Electronic	\$ 11.20	\$ 67.20	\$ 160.00	\$ 960.00	Replace fixture and mount hardware
Wood		25	200W Inc	1						\$ -		\$ -		Replace fixture and mount hardware
AUTOSHOP		15	4' T12	2	Ice	Magnetic	2	N	Electronic	\$ 5.60	\$ 84.00	\$ 135.00	\$ 2,025.00	Replace fixture and mount hardware

LOCATION	EXISTING EQUIPMENT						PROPOSED			REBATES		COSTS		COMMENTS
Location (Rm Name, Rm. #, Area, Zone, etc.)	Floor	Quantity	Lamp Type	Lamps Per Fixture	Type of Fixture	Ballast Type	Lamps Per Fixture	Reflectors	Ballast Type	Per Single	Extended	Per Single	Extended	Surveyors Comments
Office		3	4' T12	2	Ice	Magnetic	2	N	Electronic	\$ 5.60	\$ 16.80	\$ 135.00	\$ 405.00	Replace fixture and mount hardware
SHOP		34	4' T12	4	Wrap	Magnetic	4	N	Electronic	\$ 11.20	\$ 380.80	\$ 70.00	\$ 2,380.00	Excellent opportunity for retro-fit
Outside Shop		16	4' T12	4	Wrap	Magnetic	4	N	Electronic	\$ 11.20	\$ 179.20	\$ 70.00	\$ 1,120.00	Excellent opportunity for retro-fit
		14	4' T12	2	Wrap	Magnetic	2	N	Electronic	\$ 5.60	\$ 78.40	\$ 60.00	\$ 840.00	Excellent opportunity for retro-fit
Compression		1	4' T12	2	Wrap	Magnetic	2	N	Electronic	\$ 5.60	\$ 5.60	\$ 60.00	\$ 60.00	Excellent opportunity for retro-fit
Spray Booth		6	4' T12	1	Wrap	Magnetic	1	N	Electronic	\$ 2.80	\$ 16.80	\$ 55.00	\$ 330.00	Excellent opportunity for retro-fit
Greenhouse		4	4' T12	2	Wrap	Magnetic	2	N	Electronic	\$ 5.60	\$ 22.40	\$ 60.00	\$ 240.00	Excellent opportunity for retro-fit
BUILDING A														
A 233		4	4' T12	2	Ice	Magnetic	2	N	Electronic	\$ 5.60	\$ 22.40	\$ 135.00	\$ 540.00	Replace fixture and mount hardware
		3	4' T12	2	Ice	Magnetic	2	N	Electronic	\$ 5.60	\$ 16.80	\$ 135.00	\$ 405.00	Replace fixture and mount hardware
		3	4' T12	4	Wrap	Magnetic	4	N	Electronic	\$ 11.20	\$ 33.60	\$ 70.00	\$ 210.00	Excellent opportunity for retro-fit
		4	4' T12	2	Wrap	Magnetic	2	N	Electronic	\$ 5.60	\$ 22.40	\$ 60.00	\$ 240.00	Excellent opportunity for retro-fit
Health Room		5	8' T12	2	Ice	Magnetic	2	N	Electronic	\$ 11.20	\$ 56.00	\$ 160.00	\$ 800.00	Replace fixture and mount hardware
		1	60W Inc							\$ -		\$ -		Replace fixture and mount hardware
Office		2	4' T12	2	Ice	Magnetic	2	N	Electronic	\$ 5.60	\$ 11.20	\$ 160.00	\$ 320.00	Replace fixture and mount hardware
		2	4' T12	2	Wrap	Magnetic	2	N	Electronic	\$ 5.60	\$ 11.20	\$ 60.00	\$ 120.00	Excellent opportunity for retro-fit
Main Office		1	4' T12	4	Wrap	Magnetic	4	N	Electronic	\$ 11.20	\$ 11.20	\$ 70.00	\$ 70.00	Excellent opportunity for retro-fit
Admin Main Office		3	8' T12	2	Ice	Magnetic	2	N	Electronic	\$ 11.20	\$ 33.60	\$ 160.00	\$ 480.00	Replace fixture and mount hardware
Office		1	4' T12	2	Ice	Magnetic	2	N	Electronic	\$ 5.60	\$ 5.60	\$ 135.00	\$ 135.00	Replace fixture and mount hardware
		1	4' T12	4	Ice	Magnetic	4	N	Electronic	\$ 11.20	\$ 11.20	\$ 160.00	\$ 160.00	Replace fixture and mount hardware
		1	4' T12	4	Wrap	Magnetic	4	N	Electronic	\$ 11.20	\$ 11.20	\$ 70.00	\$ 70.00	Excellent opportunity for retro-fit
Office AOI		2	4' T12	2	Ice	Magnetic	2	N	Electronic	\$ 5.60	\$ 11.20	\$ 135.00	\$ 270.00	Replace fixture and mount hardware
Office		8	4' T12	4	Wrap	Magnetic	4	N	Electronic	\$ 11.20	\$ 89.60	\$ 70.00	\$ 560.00	Excellent opportunity for retro-fit
		4	U T12	2	Troffer	Magnetic	2	N	Electronic	\$ 5.60	\$ 22.40	\$ 60.00	\$ 240.00	No Comment
Vanity		1	2' T12	1	Troffer	Magnetic	1	N	Electronic	\$ 2.40	\$ 2.40	\$ 49.30	\$ 49.30	Excellent opportunity for retro-fit
Employees		4	U T12	2	Troffer	Magnetic	2	N	Electronic	\$ 5.60	\$ 22.40	\$ 60.00	\$ 240.00	No Comment
Women's Restroom		1	4' T12	4	Troffer	Magnetic	4	N	Electronic	\$ 11.20	\$ 11.20	\$ 70.00	\$ 70.00	Excellent opportunity for retro-fit
Men's Restroom		1	4' T12	4	Troffer	Magnetic	4	N	Electronic	\$ 11.20	\$ 11.20	\$ 70.00	\$ 70.00	Excellent opportunity for retro-fit
Storage		1	4' T12	2	Troffer	Magnetic	2	N	Electronic	\$ 5.60	\$ 5.60	\$ 60.00	\$ 60.00	Excellent opportunity for retro-fit
BUILDING A														
Office		2	8' T12	2	Ice	Magnetic	2	N	Electronic	\$ 11.20	\$ 22.40	\$ 160.00	\$ 320.00	Replace fixture and mount hardware
F - 4A		6	4' T12	4	Troffer	Magnetic	4	N	Electronic	\$ 11.20	\$ 67.20	\$ 70.00	\$ 420.00	Excellent opportunity for retro-fit
F - 4B		6	8' T12	2	Ice	Magnetic	2	N	Electronic	\$ 11.20	\$ 67.20	\$ 160.00	\$ 960.00	Replace fixture and mount hardware
		18	4' T12	2	Ice	Magnetic	2	N	Electronic	\$ 5.60	\$ 100.80	\$ 135.00	\$ 2,430.00	Replace fixture and mount hardware
Computer Room		20	4' T12	2	Wrap	Magnetic	2	N	Electronic	\$ 5.60	\$ 112.00	\$ 60.00	\$ 1,200.00	Excellent opportunity for retro-fit
Choral		16	4' T12	2	Wrap	Magnetic	2	N	Electronic	\$ 5.60	\$ 89.60	\$ 60.00	\$ 960.00	Excellent opportunity for retro-fit
Ensemble		11	2' T12	2	Wrap	Magnetic	2	N	Electronic	\$ 4.80	\$ 52.80	\$ 60.00	\$ 660.00	Excellent opportunity for retro-fit

LOCATION	EXISTING EQUIPMENT						PROPOSED			REBATES		COSTS		COMMENTS
Location (Rm Name, Rm. #, Area, Zone, etc.)	Floor	Quantity	Lamp Type	Lamps Per Fixture	Type of Fixture	Ballast Type	Lamps Per Fixture	Reflectors	Ballast Type	Per Single	Extended	Per Single	Extended	Surveyors Comments
Band		40	4' T12	4	Wrap	Magnetic	4	N	Electronic	\$ 11.20	\$ 448.00	\$ 70.00	\$ 2,800.00	Excellent opportunity for retro-fit
Storage		4	4' T12	2	Wrap	Magnetic	2	N	Electronic	\$ 5.60	\$ 22.40	\$ 60.00	\$ 240.00	Excellent opportunity for retro-fit
Uniform		6	4' T12	4	Wrap	Magnetic	4	N	Electronic	\$ 11.20	\$ 67.20	\$ 70.00	\$ 420.00	Excellent opportunity for retro-fit
GYMNASIUM														
Carter Court		48	8' T12	2	Wrap	Magnetic	2	N	Electronic	\$ 11.20	\$ 537.60	\$ 160.00	\$ 7,680.00	Replace fixture and mount hardware
Rear Hallway		14	4' T12	2	Wrap	Magnetic	2	N	Electronic	\$ 5.60	\$ 78.40	\$ 60.00	\$ 840.00	Excellent opportunity for retro-fit
Office		4	4' T12	4	Wrap	Magnetic	4	N	Electronic	\$ 11.20	\$ 44.80	\$ 70.00	\$ 280.00	Excellent opportunity for retro-fit
Storage		3	4' T12	2	Wrap	Magnetic	2	N	Electronic	\$ 5.60	\$ 16.80	\$ 60.00	\$ 180.00	Excellent opportunity for retro-fit
Women's Restroom		3	4' T12	2	Wrap	Magnetic	2	N	Electronic	\$ 5.60	\$ 16.80	\$ 60.00	\$ 180.00	Excellent opportunity for retro-fit
Men's Restroom		3	4' T12	2	Wrap	Magnetic	2	N	Electronic	\$ 5.60	\$ 16.80	\$ 60.00	\$ 180.00	Excellent opportunity for retro-fit
Weight Room		9	4' T12	2	Wrap	Magnetic	2	N	Electronic	\$ 5.60	\$ 50.40	\$ 60.00	\$ 540.00	Excellent opportunity for retro-fit
Gym		48	4'T12	2	Wrap	Magnetic	2	N	Electronic	\$ 5.60	\$ 268.80	\$ 60.00	\$ 2,880.00	Excellent opportunity for retro-fit
Gymnastics		29	4' T12	4	Wrap	Magnetic	4	N	Electronic	\$ 11.20	\$ 324.80	\$ 70.00	\$ 2,030.00	Excellent opportunity for retro-fit
Hallway		6	4' T12	2	Wrap	Magnetic	2	N	Electronic	\$ 5.60	\$ 33.60	\$ 60.00	\$ 360.00	Excellent opportunity for retro-fit
Locker Room		18	4' T12	2	Wrap	Magnetic	2	N	Electronic	\$ 5.60	\$ 100.80	\$ 60.00	\$ 1,080.00	Excellent opportunity for retro-fit
Custodial		4	4' T12	2	Open	Magnetic	2	N	Electronic	\$ 5.60	\$ 22.40	\$ 60.00	\$ 240.00	Excellent opportunity for retro-fit
Portable 1		12	4' T12	4	Troffer	Magnetic	4	N	Electronic	\$ 11.20	\$ 134.40	\$ 70.00	\$ 840.00	Excellent opportunity for retro-fit
BUILDING H														
H 1		18	4' T12	3	Wrap	Magnetic	3	N	Electronic	\$ 8.40	\$ 151.20	\$ 65.00	\$ 1,170.00	Excellent opportunity for retro-fit
H 2		22	4' T12	3	Wrap	Magnetic	3	N	Electronic	\$ 8.40	\$ 184.80	\$ 65.00	\$ 1,430.00	Excellent opportunity for retro-fit
H 3		16	4' T12	3	Wrap	Magnetic	3	N	Electronic	\$ 8.40	\$ 134.40	\$ 65.00	\$ 1,040.00	Excellent opportunity for retro-fit
BUILDING R 2		16	4' T12	3	Ice	Std.	3	N	120LW	\$ 8.40	\$ 134.40	\$ 160.00	\$ 2,560.00	Replace fixture and mount hardware
BUILDING G											\$ -			
G 10		21	4' T12	2	Ice	Magnetic	2	N	Electronic	\$ 5.60	\$ 117.60	\$ 135.00	\$ 2,835.00	Replace fixture and mount hardware
G 9		21	4' T12	2	Ice	Magnetic	2	N	Electronic	\$ 5.60	\$ 117.60	\$ 135.00	\$ 2,835.00	Replace fixture and mount hardware
G 8		21	4' T12	2	Ice	Magnetic	2	N	Electronic	\$ 5.60	\$ 117.60	\$ 135.00	\$ 2,835.00	Replace fixture and mount hardware
G 7		21	4' T12	2	Ice	Magnetic	2	N	Electronic	\$ 5.60	\$ 117.60	\$ 135.00	\$ 2,835.00	Replace fixture and mount hardware
G 6		21	4' T12	2	Ice	Magnetic	2	N	Electronic	\$ 5.60	\$ 117.60	\$ 135.00	\$ 2,835.00	Replace fixture and mount hardware
CAFETERIA														
Stage		3	8' T12	2	Open	Magnetic	2	N	Electronic	\$ 11.20	\$ 33.60	\$ 160.00	\$ 480.00	Replace fixture and mount hardware
Dining Room		29	4' T12	2	Ice	Magnetic	2	N	Electronic	\$ 5.60	\$ 162.40	\$ 135.00	\$ 3,915.00	Replace fixture and mount hardware
Kitchen		23	4' T12	4	Wrap	Magnetic	4	N	Electronic	\$ 11.20	\$ 257.60	\$ 70.00	\$ 1,610.00	Excellent opportunity for retro-fit
Office		2	4' T12	2	Troffer	Magnetic	2	N	Electronic	\$ 5.60	\$ 11.20	\$ 60.00	\$ 120.00	Excellent opportunity for retro-fit
Storage		8	4' T12	2	Open	Magnetic	2	N	Electronic	\$ 5.60	\$ 44.80	\$ 60.00	\$ 480.00	Replace fixture and mount hardware
Store Room		3	4' T12	2	Open	Magnetic	2	N	Electronic	\$ 5.60	\$ 16.80	\$ 60.00	\$ 180.00	Replace fixture and mount hardware
BUILDING F											\$ -			
Boys' Restroom		3	8' T12	1	Open	Magnetic	1	N	Electronic	\$ 3.60	\$ 10.80	\$ 75.00	\$ 225.00	Replace fixture and mount hardware

LOCATION	EXISTING EQUIPMENT						PROPOSED			REBATES		COSTS		COMMENTS
Location (Rm Name, Rm. #, Area, Zone, etc.)	Floor	Quantity	Lamp Type	Lamps Per Fixture	Type of Fixture	Ballast Type	Lamps Per Fixture	Reflectors	Ballast Type	Per Single	Extended	Per Single	Extended	Surveyors Comments
<i>Girls' Restroom</i>		3	8' T12	1	Open	Magnetic	1	N	Electronic	\$ 3.60	\$ 10.80	\$ 75.00	\$ 225.00	Replace fixture and mount hardware
<i>F 1</i>		18	8' T12	2	Ice	Magnetic	2	N	Electronic	\$ 11.20	\$ 201.60	\$ 160.00	\$ 2,880.00	Replace fixture and mount hardware
<i>F 2</i>		18	8' T12	2	Ice	Magnetic	2	N	Electronic	\$ 11.20	\$ 201.60	\$ 160.00	\$ 2,880.00	Replace fixture and mount hardware
<i>F 3</i>		18	4' T12	2	Ice	Magnetic	2	N	Electronic	\$ 5.60	\$ 100.80	\$ 135.00	\$ 2,430.00	Replace fixture and mount hardware
Total Rebates										\$		\$	10,019.60	
Total Costs										\$		\$	119,909.30	

LOCATION	QTY	EXISTING TYPE	QTY	RETROFIT	SURVEYORS COMMENTS	Existing	Actual			Proposed			
						Watt/unit	Op. Hours	kWh	kW-D	Watt/unit	Op. Hours	kWh	kW-D
BUILDING E	0		0		0		1,692	0.0	0		1,692	0.0	0
E 1	6	8' 2L Fixture	6	Lamp & Ballast Retrofit	Replace fixture and mount hardware	158	1,692	1,604.0	0.948	102	1,692	1,035.5	0.612
E 2	6	8' 2L Fixture	6	Lamp & Ballast Retrofit	Replace fixture and mount hardware	158	1,692	1,604.0	0.948	102	1,692	1,035.5	0.612
E 3	6	8' 2L Fixture	6	Lamp & Ballast Retrofit	Replace fixture and mount hardware	158	1,692	1,604.0	0.948	102	1,692	1,035.5	0.612
E 4	6	8' 2L Fixture	6	Lamp & Ballast Retrofit	Replace fixture and mount hardware	158	1,692	1,604.0	0.948	102	1,692	1,035.5	0.612
BUILDING L	0		0		0		1,692	0.0	0		1,692	0.0	0
L 16	18	8' 2L Fixture	18	Lamp & Ballast Retrofit	Replace fixture and mount hardware	158	1,692	4,812.0	2.844	102	1,692	3,106.5	1.836
L 17	15	8' 2L Fixture	15	Lamp & Ballast Retrofit	Replace fixture and mount hardware	158	1,692	4,010.0	2.37	102	1,692	2,588.8	1.53
Boys' Restroom	2	4' 2L Fixture	2	Lamp & Low Watt Ballast	Excellent opportunity for retro-fit	75.6	1,692	255.8	0.1512	51	1,692	172.6	0.102
Girls' Restroom	2	4' 2L Fixture	2	Lamp & Low Watt Ballast	Excellent opportunity for retro-fit	75.6	1,692	255.8	0.1512	51	1,692	172.6	0.102
TB 1	16	4' 3L Fixture	16	Lamp & Low Watt Ballast	Excellent opportunity for retro-fit	121.2	1,692	3,281.1	1.9392	77	1,692	2,084.5	1.232
BUILDING O	0		0		0		1,692	0.0	0		1,692	0.0	0
O 18	21	4' 2L Fixture	21	Lamp & Low Watt Ballast	Replace fixture and mount hardware	75.6	1,692	2,686.2	1.5876	51	1,692	1,812.1	1.071
GIRLS' LOCKER ROOM	0		0		0		1,692	0.0	0		1,692	0.0	0
Office	3	4' 3L Fixture	3	Lamp & Low Watt Ballast	Excellent opportunity for retro-fit	121.2	1,692	615.2	0.3636	77	1,692	390.9	0.231
0	18	4' 1L Fixture	18	Lamp & Low Watt Ballast	Excellent opportunity for retro-fit	45.6	1,692	1,388.8	0.8208	31	1,692	944.1	0.558
0	3	4' 2L Fixture	3	Lamp & Low Watt Ballast	Excellent opportunity for retro-fit	75.6	1,692	383.7	0.2268	51	1,692	258.9	0.153
0	6	4' 2L Fixture	6	Lamp & Low Watt Ballast	Excellent opportunity for retro-fit	75.6	1,692	767.5	0.4536	51	1,692	517.8	0.306
BOYS' LOCKER ROOM	0		0		0		1,692	0.0	0		1,692	0.0	0
Office	3	4' 3L Fixture	3	Lamp & Low Watt Ballast	Excellent opportunity for retro-fit	121.2	1,692	615.2	0.3636	77	1,692	390.9	0.231
0	18	4' 1L Fixture	18	Lamp & Low Watt Ballast	Excellent opportunity for retro-fit	45.6	1,692	1,388.8	0.8208	31	1,692	944.1	0.558
0	3	4' 2L Fixture	3	Lamp & Low Watt Ballast	Excellent opportunity for retro-fit	75.6	1,692	383.7	0.2268	51	1,692	258.9	0.153
0	6	4' 2L Fixture	6	Lamp & Low Watt Ballast	Excellent opportunity for retro-fit	75.6	1,692	767.5	0.4536	51	1,692	517.8	0.306
TB 5	16	4' 3L Fixture	16	Lamp & Low Watt Ballast	Excellent opportunity for retro-fit	121.2	1,692	3,281.1	1.9392	77	1,692	2,084.5	1.232
TB 4	16	4' 3L Fixture	16	Lamp & Low Watt Ballast	Excellent opportunity for retro-fit	121.2	1,692	3,281.1	1.9392	77	1,692	2,084.5	1.232
T 104 Storage	6	4' 4L Fixture	6	Lamp & Low Watt Ballast	Excellent opportunity for retro-fit	151.2	1,692	1,535.0	0.9072	100	1,692	1,015.2	0.6
0	21	4' 4L Fixture	21	Lamp & Low Watt Ballast	Excellent opportunity for retro-fit	151.2	1,692	5,372.4	3.1752	100	1,692	3,553.2	2.1
T 103	8	4' 4L Fixture	8	Lamp & Low Watt Ballast	Excellent opportunity for retro-fit	151.2	1,692	2,046.6	1.2096	100	1,692	1,353.6	0.8
T 103A	8	4' 4L Fixture	8	Lamp & Low Watt Ballast	Excellent opportunity for retro-fit	151.2	1,692	2,046.6	1.2096	100	1,692	1,353.6	0.8
Boys' Restroom	1	4' 2L Fixture	1	Lamp & Low Watt Ballast	Excellent opportunity for retro-fit	75.6	1,692	127.9	0.0756	51	1,692	86.3	0.051
0	1	4' 2L Fixture	1	Lamp & Low Watt Ballast	Excellent opportunity for retro-fit	75.6	1,692	127.9	0.0756	51	1,692	86.3	0.051
Girls' Restroom	1	4' 2L Fixture	1	Lamp & Low Watt Ballast	Excellent opportunity for retro-fit	75.6	1,692	127.9	0.0756	51	1,692	86.3	0.051
0	1	4' 2L Fixture	1	Lamp & Low Watt Ballast	Excellent opportunity for retro-fit	75.6	1,692	127.9	0.0756	51	1,692	86.3	0.051
GYM	86	4' 2L Fixture	86	Lamp & Low Watt Ballast	Excellent opportunity for retro-fit	75.6	1,692	11,000.7	6.5016	51	1,692	7,421.1	4.386
Weight Room	9	4' 1L Fixture	9	Lamp & Low Watt Ballast	Excellent opportunity for retro-fit	45.6	1,692	694.4	0.4104	31	1,692	472.1	0.279
LIBRARY	0		0		0		1,692	0.0	0		1,692	0.0	0
Meeting Room	10	4' 4L Fixture	10	Lamp & Low Watt Ballast	Excellent opportunity for retro-fit	151.2	1,692	2,558.3	1.512	100	1,692	1,692.0	1
Staff Prep	4	4' 2L Fixture	4	Lamp & Low Watt Ballast	Excellent opportunity for retro-fit	75.6	1,692	511.7	0.3024	51	1,692	345.2	0.204
Production	10	4' 2L Fixture	10	Lamp & Low Watt Ballast	Excellent opportunity for retro-fit	75.6	1,692	1,279.2	0.756	51	1,692	862.9	0.51
Recording	4	4' 2L Fixture	4	Lamp & Low Watt Ballast	Excellent opportunity for retro-fit	75.6	1,692	511.7	0.3024	51	1,692	345.2	0.204
0	2	4' 1L Fixture	2	Lamp & Low Watt Ballast	Excellent opportunity for retro-fit	45.6	1,692	154.3	0.0912	31	1,692	104.9	0.062
Conference	8	2x2 2U Fixture	8	Lamp & Low Watt Ballast	No Comment	75.6	1,692	1,023.3	0.6048	51	1,692	690.3	0.408
Main	10	2x2 2U Fixture	10	Lamp & Low Watt Ballast	No Comment	75.6	1,692	1,279.2	0.756	51	1,692	862.9	0.51
0	75	4' 2L Fixture	75	Lamp & Low Watt Ballast	Excellent opportunity for retro-fit	75.6	1,692	9,593.6	5.67	51	1,692	6,471.9	3.825
BUILDING J	0		0		0		1,692	0.0	0		1,692	0.0	0
J 2	2	4' 2L Fixture	2	Lamp & Low Watt Ballast	Excellent opportunity for retro-fit	75.6	1,692	255.8	0.1512	51	1,692	172.6	0.102
J 4	4	4' 2L Fixture	4	Lamp & Low Watt Ballast	Excellent opportunity for retro-fit	75.6	1,692	511.7	0.3024	51	1,692	345.2	0.204
J 6	4	4' 2L Fixture	4	Lamp & Low Watt Ballast	Excellent opportunity for retro-fit	75.6	1,692	511.7	0.3024	51	1,692	345.2	0.204
J 7	4	4' 2L Fixture	4	Lamp & Low Watt Ballast	Excellent opportunity for retro-fit	75.6	1,692	511.7	0.3024	51	1,692	345.2	0.204
0	2	4' 2L Fixture	2	Lamp & Low Watt Ballast	Excellent opportunity for retro-fit	75.6	1,692	255.8	0.1512	51	1,692	172.6	0.102
J 3	2	4' 2L Fixture	2	Lamp & Low Watt Ballast	Excellent opportunity for retro-fit	75.6	1,692	255.8	0.1512	51	1,692	172.6	0.102
J 5	2	4' 2L Fixture	2	Lamp & Low Watt Ballast	Excellent opportunity for retro-fit	75.6	1,692	255.8	0.1512	51	1,692	172.6	0.102
Hall	5	4' 2L Fixture	5	Lamp & Low Watt Ballast	Excellent opportunity for retro-fit	75.6	1,692	639.6	0.378	51	1,692	431.5	0.255
BUILDING T	6	4' 2L Fixture	6	Lamp & Low Watt Ballast	Excellent opportunity for retro-fit	75.6	1,692	767.5	0.4536	51	1,692	517.8	0.306
0	8	4' 2L Fixture	8	Lamp & Low Watt Ballast	Excellent opportunity for retro-fit	75.6	1,692	1,023.3	0.6048	51	1,692	690.3	0.408
0	6	4' 2L Fixture	6	Lamp & Low Watt Ballast	Excellent opportunity for retro-fit	75.6	1,692	767.5	0.4536	51	1,692	517.8	0.306
T 107	2	4' 2L Fixture	2	Lamp & Low Watt Ballast	Excellent opportunity for retro-fit	75.6	1,692	255.8	0.1512	51	1,692	172.6	0.102
T 109	2	4' 2L Fixture	2	Lamp & Low Watt Ballast	Excellent opportunity for retro-fit	75.6	1,692	255.8	0.1512	51	1,692	172.6	0.102
BUILDING D	0		0		0		1,692	0.0	0		1,692	0.0	0
D 1	6	8' 2L Fixture	6	Lamp & Ballast Retrofit	Replace fixture and mount hardware	158	1,692	1,604.0	0.948	102	1,692	1,035.5	0.612
D 2	6	8' 2L Fixture	6	Lamp & Ballast Retrofit	Replace fixture and mount hardware	158	1,692	1,604.0	0.948	102	1,692	1,035.5	0.612

LOCATION	QTY	EXISTING TYPE	QTY	RETROFIT	SURVEYORS COMMENTS	Existing				Actual				Proposed			
						Watt/unit	Op. Hours	kWh	kW-D	Watt/unit	Op. Hours	kWh	kW-D	Watt/unit	Op. Hours	kWh	kW-D
D 3	7	8' 2L Fixture	7	Lamp & Ballast Retrofit	Replace fixture and mount hardware	158	1,692	1,871.4	1.106	102	1,692	1,208.1	0.714				
D 4	4	8' 2L Fixture	4	Lamp & Ballast Retrofit	Replace fixture and mount hardware	158	1,692	1,069.3	0.632	102	1,692	690.3	0.408				
D 5	5	8' 2L Fixture	5	Lamp & Ballast Retrofit	Replace fixture and mount hardware	158	1,692	1,336.7	0.79	102	1,692	862.9	0.51				
Men's Bathroom	3	4' 2L Fixture	3	Lamp & Low Watt Ballast	Excellent opportunity for retro-fit	75.6	1,692	383.7	0.2268	51	1,692	258.9	0.153				
Women's Bathroom	3	4' 2L Fixture	3	Lamp & Low Watt Ballast	Excellent opportunity for retro-fit	75.6	1,692	383.7	0.2268	51	1,692	258.9	0.153				
INDUSTRIAL	6	8' 2L Fixture	6	Lamp & Ballast Retrofit	Replace fixture and mount hardware	158	1,692	1,604.0	0.948	102	1,692	1,035.5	0.612				
Wood	25	200W Incandescent	0		Replace fixture and mount hardware		1,692	0.0	0		1,692	0.0	0				
AUTOSHOP	15	4' 2L Fixture	15	Lamp & Low Watt Ballast	Replace fixture and mount hardware	75.6	1,692	1,918.7	1.134	51	1,692	1,294.4	0.765				
Office	3	4' 2L Fixture	3	Lamp & Low Watt Ballast	Replace fixture and mount hardware	75.6	1,692	383.7	0.2268	51	1,692	258.9	0.153				
SHOP	34	4' 4L Fixture	34	Lamp & Low Watt Ballast	Excellent opportunity for retro-fit	151.2	1,692	8,698.2	5.1408	100	1,692	5,752.8	3.4				
Outside Shop	16	4' 4L Fixture	16	Lamp & Low Watt Ballast	Excellent opportunity for retro-fit	151.2	1,692	4,093.3	2.4192	100	1,692	2,707.2	1.6				
0	14	4' 2L Fixture	14	Lamp & Low Watt Ballast	Excellent opportunity for retro-fit	75.6	1,692	1,790.8	1.0584	51	1,692	1,208.1	0.714				
Compression	1	4' 2L Fixture	1	Lamp & Low Watt Ballast	Excellent opportunity for retro-fit	75.6	1,692	127.9	0.0756	51	1,692	86.3	0.051				
Spray Booth	6	4' 1L Fixture	6	Lamp & Low Watt Ballast	Excellent opportunity for retro-fit	45.6	1,692	462.9	0.2736	31	1,692	314.7	0.186				
Greenhouse	4	4' 2L Fixture	4	Lamp & Low Watt Ballast	Excellent opportunity for retro-fit	75.6	1,692	511.7	0.3024	51	1,692	345.2	0.204				
BUILDING A	0		0		0		1,692	0.0	0		1,692	0.0	0				
A 233	4	4' 2L Fixture	4	Lamp & Low Watt Ballast	Replace fixture and mount hardware	75.6	1,692	511.7	0.3024	51	1,692	345.2	0.204				
0	3	4' 2L Fixture	3	Lamp & Low Watt Ballast	Replace fixture and mount hardware	75.6	1,692	383.7	0.2268	51	1,692	258.9	0.153				
0	3	4' 4L Fixture	3	Lamp & Low Watt Ballast	Excellent opportunity for retro-fit	151.2	1,692	767.5	0.4536	100	1,692	507.6	0.3				
0	4	4' 2L Fixture	4	Lamp & Low Watt Ballast	Excellent opportunity for retro-fit	75.6	1,692	511.7	0.3024	51	1,692	345.2	0.204				
Health Room	5	8' 2L Fixture	5	Lamp & Ballast Retrofit	Replace fixture and mount hardware	158	1,692	1,336.7	0.79	102	1,692	862.9	0.51				
0	1	60W Incandescent	0		Replace fixture and mount hardware		1,692	0.0	0		1,692	0.0	0				
Office	2	4' 2L Fixture	2	Lamp & Low Watt Ballast	Replace fixture and mount hardware	75.6	1,692	255.8	0.1512	51	1,692	172.6	0.102				
0	2	4' 2L Fixture	2	Lamp & Low Watt Ballast	Excellent opportunity for retro-fit	75.6	1,692	255.8	0.1512	51	1,692	172.6	0.102				
Main Office	1	4' 4L Fixture	1	Lamp & Low Watt Ballast	Excellent opportunity for retro-fit	151.2	1,692	255.8	0.1512	100	1,692	169.2	0.1				
Admin Main Office	3	8' 2L Fixture	3	Lamp & Ballast Retrofit	Replace fixture and mount hardware	158	1,692	802.0	0.474	102	1,692	517.8	0.306				
Office	1	4' 2L Fixture	1	Lamp & Low Watt Ballast	Replace fixture and mount hardware	75.6	1,692	127.9	0.0756	51	1,692	86.3	0.051				
0	1	4' 4L Fixture	1	Lamp & Low Watt Ballast	Replace fixture and mount hardware	151.2	1,692	255.8	0.1512	100	1,692	169.2	0.1				
0	1	4' 4L Fixture	1	Lamp & Low Watt Ballast	Excellent opportunity for retro-fit	151.2	1,692	255.8	0.1512	100	1,692	169.2	0.1				
Office AOI	2	4' 2L Fixture	2	Lamp & Low Watt Ballast	Replace fixture and mount hardware	75.6	1,692	255.8	0.1512	51	1,692	172.6	0.102				
Office	8	4' 4L Fixture	8	Lamp & Low Watt Ballast	Excellent opportunity for retro-fit	151.2	1,692	2,046.6	1.2096	100	1,692	1,353.6	0.8				
0	4	2x2 2U Fixture	4	Lamp & Low Watt Ballast	No Comment	75.6	1,692	511.7	0.3024	51	1,692	345.2	0.204				
Vanity	1	2' 1L Fixture	1	Lamp & Low Watt Ballast	Excellent opportunity for retro-fit	27.7	1,692	46.9	0.0277	18	1,692	30.5	0.018				
Employees	4	2x2 2U Fixture	4	Lamp & Low Watt Ballast	No Comment	75.6	1,692	511.7	0.3024	51	1,692	345.2	0.204				
Women's Restroom	1	4' 4L Fixture	1	Lamp & Low Watt Ballast	Excellent opportunity for retro-fit	151.2	1,692	255.8	0.1512	100	1,692	169.2	0.1				
Men's Restroom	1	4' 4L Fixture	1	Lamp & Low Watt Ballast	Excellent opportunity for retro-fit	151.2	1,692	255.8	0.1512	100	1,692	169.2	0.1				
Storage	1	4' 2L Fixture	1	Lamp & Low Watt Ballast	Excellent opportunity for retro-fit	75.6	1,692	127.9	0.0756	51	1,692	86.3	0.051				
BUILDING A	0		0		0		1,692	0.0	0		1,692	0.0	0				
Office	2	8' 2L Fixture	2	Lamp & Ballast Retrofit	Replace fixture and mount hardware	158	1,692	534.7	0.316	102	1,692	345.2	0.204				
F - 4A	6	4' 4L Fixture	6	Lamp & Low Watt Ballast	Excellent opportunity for retro-fit	151.2	1,692	1,535.0	0.9072	100	1,692	1,015.2	0.6				
F - 4B	6	8' 2L Fixture	6	Lamp & Ballast Retrofit	Replace fixture and mount hardware	158	1,692	1,604.0	0.948	102	1,692	1,035.5	0.612				
0	18	4' 2L Fixture	18	Lamp & Low Watt Ballast	Replace fixture and mount hardware	75.6	1,692	2,302.5	1.3608	51	1,692	1,553.3	0.918				
Computer Room	20	4' 2L Fixture	20	Lamp & Low Watt Ballast	Excellent opportunity for retro-fit	75.6	1,692	2,558.3	1.512	51	1,692	1,725.8	1.02				
Choral	16	4' 2L Fixture	16	Lamp & Low Watt Ballast	Excellent opportunity for retro-fit	75.6	1,692	2,046.6	1.2096	51	1,692	1,380.7	0.816				
Ensemble	11	2' 2L Fixture	11	Lamp & Low Watt Ballast	Excellent opportunity for retro-fit	55.4	1,692	1,031.1	0.6094	29	1,692	539.7	0.319				
Band	40	4' 4L Fixture	40	Lamp & Low Watt Ballast	Excellent opportunity for retro-fit	151.2	1,692	10,233.2	6.048	100	1,692	6,768.0	4				
Storage	4	4' 2L Fixture	4	Lamp & Low Watt Ballast	Excellent opportunity for retro-fit	75.6	1,692	511.7	0.3024	51	1,692	345.2	0.204				
Uniform	6	4' 4L Fixture	6	Lamp & Low Watt Ballast	Excellent opportunity for retro-fit	151.2	1,692	1,535.0	0.9072	100	1,692	1,015.2	0.6				
GYMNASIUM	0		0		0		1,692	0.0	0		1,692	0.0	0				
Carter Court	48	8' 2L Fixture	48	Lamp & Ballast Retrofit	Replace fixture and mount hardware	158	1,692	12,832.1	7.584	102	1,692	8,284.0	4.896				
Rear Hallway	14	4' 2L Fixture	14	Lamp & Low Watt Ballast	Excellent opportunity for retro-fit	75.6	1,692	1,790.8	1.0584	51	1,692	1,208.1	0.714				
Office	4	4' 4L Fixture	4	Lamp & Low Watt Ballast	Excellent opportunity for retro-fit	151.2	1,692	1,023.3	0.6048	100	1,692	676.8	0.4				
Storage	3	4' 2L Fixture	3	Lamp & Low Watt Ballast	Excellent opportunity for retro-fit	75.6	1,692	383.7	0.2268	51	1,692	258.9	0.153				
Women's Restroom	3	4' 2L Fixture	3	Lamp & Low Watt Ballast	Excellent opportunity for retro-fit	75.6	1,692	383.7	0.2268	51	1,692	258.9	0.153				
Men's Restroom	3	4' 2L Fixture	3	Lamp & Low Watt Ballast	Excellent opportunity for retro-fit	75.6	1,692	383.7	0.2268	51	1,692	258.9	0.153				
Weight Room	9	4' 2L Fixture	9	Lamp & Low Watt Ballast	Excellent opportunity for retro-fit	75.6	1,692	1,151.2	0.6804	51	1,692	776.6	0.459				
Gym	48	4' 2L Fixture	48	Lamp & Low Watt Ballast	Excellent opportunity for retro-fit	75.6	1,692	6,139.9	3.6288	51	1,692	4,142.0	2.448				
Gymnastics	29	4' 4L Fixture	29	Lamp & Low Watt Ballast	Excellent opportunity for retro-fit	151.2	1,692	7,419.1	4.3848	100	1,692	4,906.8	2.9				
Hallway	6	4' 2L Fixture	6	Lamp & Low Watt Ballast	Excellent opportunity for retro-fit	75.6	1,692	767.5	0.4536	51	1,692	517.8	0.306				
Locker Room	18	4' 2L Fixture	18	Lamp & Low Watt Ballast	Excellent opportunity for retro-fit	75.6	1,692	2,302.5	1.3608	51	1,692	1,553.3	0.918				
Custodial	4	4' 2L Fixture	4	Lamp & Low Watt Ballast	Excellent opportunity for retro-fit	75.6	1,692	511.7	0.3024	51	1,692	345.2	0.204				
Portable 1	12	4' 4L Fixture	12	Lamp & Low Watt Ballast	Excellent opportunity for retro-fit	151.2	1,692	3,070.0	1.8144	100	1,692	2,030.4	1.2				

LOCATION	QTY	EXISTING TYPE	QTY	RETROFIT	SURVEYORS COMMENTS	Existing Watt/unit	Actual			Proposed						
							Op. Hours	kWh	kW-D	Watt/unit	Op. Hours	kWh	kW-D			
BUILDING H	0		0		0		1,692	0.0	0		1,692	0.0	0			
H 1	18	4' 3L Fixture	18	Lamp & Low Watt Ballast	Excellent opportunity for retro-fit	121.2	1,692	3,691.3	2.1816	77	1,692	2,345.1	1.386			
H 2	22	4' 3L Fixture	22	Lamp & Low Watt Ballast	Excellent opportunity for retro-fit	121.2	1,692	4,511.5	2.6664	77	1,692	2,866.2	1.694			
H 3	16	4' 3L Fixture	16	Lamp & Low Watt Ballast	Excellent opportunity for retro-fit	121.2	1,692	3,281.1	1.9392	77	1,692	2,084.5	1.232			
BUILDING R 2	16	4' 3L Fixture	16	Lamp & Low Watt Ballast	Replace fixture and mount hardware	121.2	1,692	3,281.1	1.9392	77	1,692	2,084.5	1.232			
BUILDING G	0		0		0		1,692	0.0	0		1,692	0.0	0			
G 10	21	4' 2L Fixture	21	Lamp & Low Watt Ballast	Replace fixture and mount hardware	75.6	1,692	2,686.2	1.5876	51	1,692	1,812.1	1.071			
G 9	21	4' 2L Fixture	21	Lamp & Low Watt Ballast	Replace fixture and mount hardware	75.6	1,692	2,686.2	1.5876	51	1,692	1,812.1	1.071			
G 8	21	4' 2L Fixture	21	Lamp & Low Watt Ballast	Replace fixture and mount hardware	75.6	1,692	2,686.2	1.5876	51	1,692	1,812.1	1.071			
G 7	21	4' 2L Fixture	21	Lamp & Low Watt Ballast	Replace fixture and mount hardware	75.6	1,692	2,686.2	1.5876	51	1,692	1,812.1	1.071			
G 6	21	4' 2L Fixture	21	Lamp & Low Watt Ballast	Replace fixture and mount hardware	75.6	1,692	2,686.2	1.5876	51	1,692	1,812.1	1.071			
CAFETERIA	0		0		0		1,692	0.0	0		1,692	0.0	0			
Stage	3	8' 2L Fixture	3	Lamp & Ballast Retrofit	Replace fixture and mount hardware	158	1,692	802.0	0.474	102	1,692	517.8	0.306			
Dining Room	29	4' 2L Fixture	29	Lamp & Low Watt Ballast	Replace fixture and mount hardware	75.6	1,692	3,709.5	2.1924	51	1,692	2,502.5	1.479			
Kitchen	23	4' 4L Fixture	23	Lamp & Low Watt Ballast	Excellent opportunity for retro-fit	151.2	1,692	5,884.1	3.4776	100	1,692	3,891.6	2.3			
Office	2	4' 2L Fixture	2	Lamp & Low Watt Ballast	Excellent opportunity for retro-fit	75.6	1,692	255.8	0.1512	51	1,692	172.6	0.102			
Storage	8	4' 2L Fixture	8	Lamp & Low Watt Ballast	Replace fixture and mount hardware	75.6	1,692	1,023.3	0.6048	51	1,692	690.3	0.408			
Store Room	3	4' 2L Fixture	3	Lamp & Low Watt Ballast	Replace fixture and mount hardware	75.6	1,692	383.7	0.2268	51	1,692	258.9	0.153			
BUILDING F	0		0		0		1,692	0.0	0		1,692	0.0	0			
Boys' Restroom	3	8' 1L Fixture	3	Lamp & Ballast Retrofit	Replace fixture and mount hardware	69	1,692	350.2	0.207	62	1,692	314.7	0.186			
Girls' Restroom	3	8' 1L Fixture	3	Lamp & Ballast Retrofit	Replace fixture and mount hardware	69	1,692	350.2	0.207	62	1,692	314.7	0.186			
F 1	18	8' 2L Fixture	18	Lamp & Ballast Retrofit	Replace fixture and mount hardware	158	1,692	4,812.0	2.844	102	1,692	3,106.5	1.836			
F 2	18	8' 2L Fixture	18	Lamp & Ballast Retrofit	Replace fixture and mount hardware	158	1,692	4,812.0	2.844	102	1,692	3,106.5	1.836			
F 3	18	4' 2L Fixture	18	Lamp & Low Watt Ballast	Replace fixture and mount hardware	75.6	1,692	2,302.5	1.3608	51	1,692	1,553.3	0.918			
Existing 1350 Proposed 1324							ENERGY CALCULATIONS			233,486		138		154,202		91

Description	kW-Demand	kWh	Total Yearly Energy Savings
Existing Use	137.99	233,486	
Proposed Use	91.14	154,202	
Difference - Savings	46.86	79,284	
Electrical Utility Cost	\$5.75	\$0.23413	
Savings per Year	\$3,233.22	\$18,562.71	\$21,795.94

Lihikai School Map & Phone Ext. 2000-01

Revised: 07/28/00

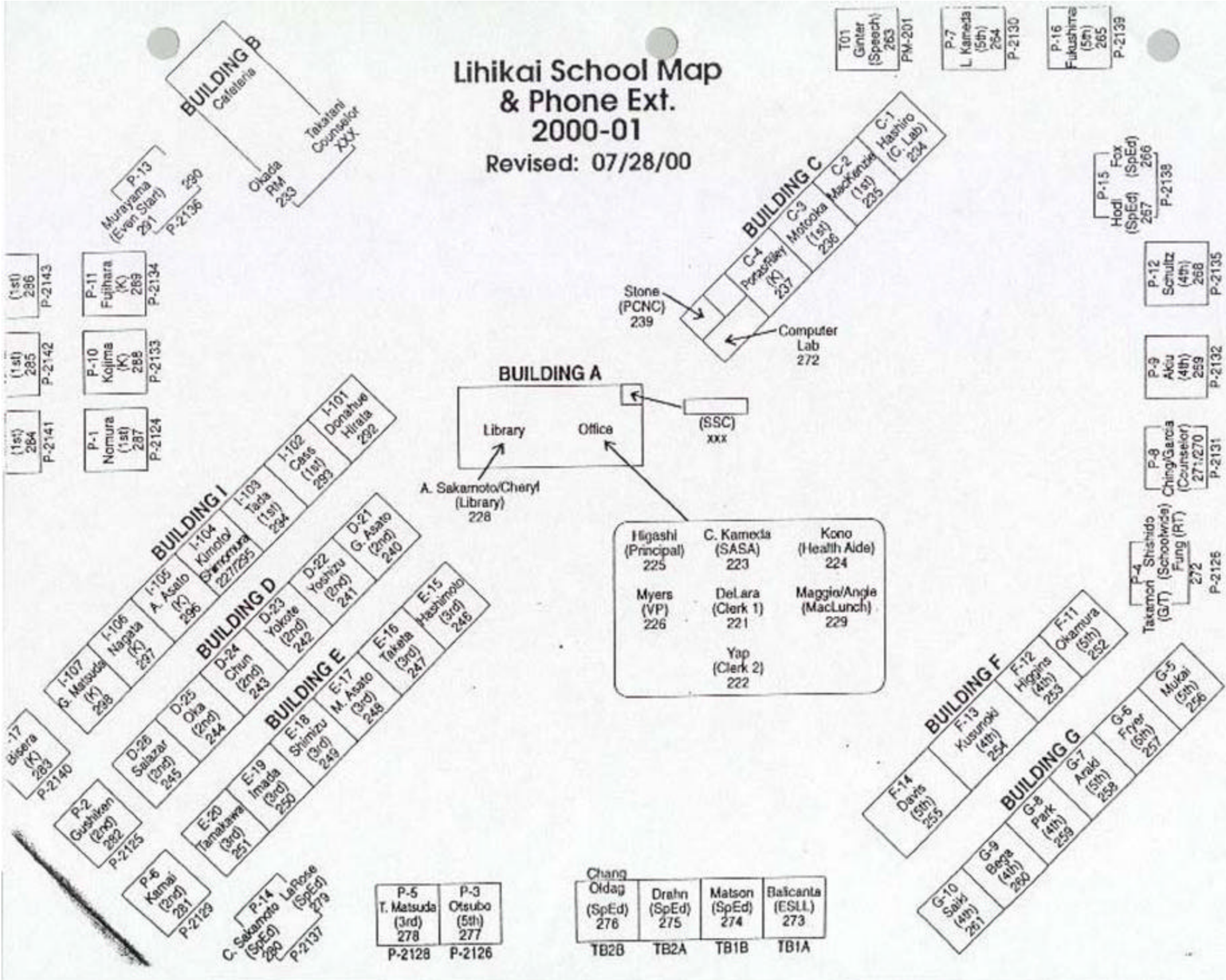

(1st) 284 P-2141
(1st) 285 P-2142
(1st) 286 P-2143

P-1 Normura (K) 287 P-2124
P-10 Kojima (K) 288 P-2133
P-11 Fujihara (K) 289 P-2134

BUILDING I
I-107 G. Matsuda (K) 298
I-105 A. Asato (K) 296
I-104 Kimetol (K) 227/225
I-103 Tada (1st) 284
I-102 Cass (1st) 285
I-101 Domahue Hiraia 292

BUILDING D
D-25 Saizai (2nd) 245
D-24 Chun (2nd) 243
D-23 Yokone (2nd) 242
D-22 Yoshizu (2nd) 241
D-21 G. Asato (2nd) 240

BUILDING E
E-20 Tamakawa (3rd) 251
E-19 Imada (3rd) 250
E-18 Shimizu (3rd) 249
E-17 M. Asato (3rd) 248
E-16 Takaha (3rd) 247
E-15 Hashimoto (3rd) 246

P-5 T. Matsuda (3rd) 278 P-2128
P-3 Otsubo (5th) 277 P-2126

Chang
Oldag (SpEd) 276 TB28
Drahn (SpEd) 275 TB2A
Matson (SpEd) 274 TB1B
Baicanta (ESLL) 273 TB1A

Higashi (Principal) 225	C. Kameda (SASA) 223	Kono (Health Aide) 224
Myers (VP) 226	DeLara (Clerk 1) 221	Maggio/Angle (MacLunch) 229
	Yap (Clerk 2) 222	

T01 Ginter (Speech) 263 PM-201

P-7 L. Kameda (5th) 264 P-2130

P-16 Fukushima (5th) 265 P-2139

P-15 Fox (SpEd) 266
Hodi (SpEd) 267 P-2138

P-12 Scultz (4th) 268 P-2135

P-9 Akiu (4th) 259 P-2132

P-8 Ching/Garcia (Counselor) 271/270 P-2131

P-4 Takamori Shitido (G/T) (Schoolwide) Fung (RT) 272 P-2125

BUILDING F
F-14 Davis (5th) 255
F-13 Kusunoki (4th) 254
F-12 Higgins (4th) 253
F-11 Okamura (5th) 252

BUILDING G
G-10 Saki (4th) 251
G-9 Baga (4th) 250
G-8 Park (4th) 259
G-7 Anaki (5th) 258
G-6 Fryer (5th) 257
G-5 Mukai (5th) 256

P-13 Murayama (Even Start) 290 P-2136

Okada RM 233
Takahashi Counselor xxx

Stone (PCNC) 239
Computer Lab 272

BUILDING A
Library
Office
(SSC) xxx
A. Sakamoto/Cheryl (Library) 228

Maul Smart Schools Program
Foot Candle Readings

School: Lihikai School

Room: Bldg. E #E-17

Ceiling height: 10'

Light fixture height: 8'

Fixture type: ICE TRAY

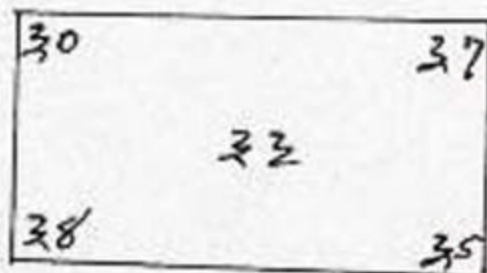

Room: Portable P-14

Ceiling height: 10'

Light fixture height: 8'

Fixture type: ICE TRAY

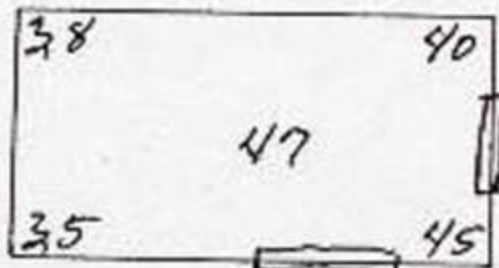

Room: Portable P-201

Ceiling height: 10'

Light fixture height: 8'

Fixture type: Warp

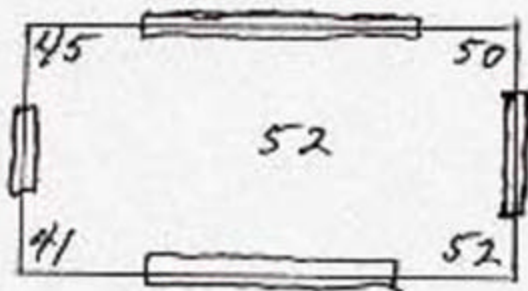



SCHOOL INFORMATION			DATE	
NAME Lihikai Elementary School			1/25/2001	
STREET ADDRESS 335 S Papa			OPERATIONAL HOURS 1,692	
POINT OF CONTACT Richard Higashi	PHONE 873-3033	FAX	VOLTAGE 120V	
AUDITOR Maui Community College Auditors				

LOCATION <small>(Rm Name, Rm. #, Area, Zone, etc.)</small>	EXISTING EQUIPMENT						PROPOSED			REBATES		COSTS		COMMENTS <small>Surveyors Comments</small>
	Floor	Quantity	Lamp Type	Lamps Per Fixture	Type of Fixture	Ballast Type	Lamps Per Fixture	Reflectors	Ballast Type	Per Single	Extended	Per Single	Extended	
BUILDING A														
<i>Library</i>	1	32	8'T12	2	Ice	Magnetic	2	N	Electronic	\$ 11.20	\$ 358.40	\$ 160.00	\$ 5,120.00	Replace Fixture and Mount Hardware
<i>Library</i>	1	6	4'T12	2	Ice	Magnetic	2	N	Electronic	\$ 5.60	\$ 33.60	\$ 135.00	\$ 810.00	Replace Fixture and Mount Hardware
<i>Office</i>	1	21	4'T12	2	Ice	Magnetic	2	N	Electronic	\$ 5.60	\$ 117.60	\$ 135.00	\$ 2,835.00	Replace Fixture and Mount Hardware
<i>Front Desk Area</i>	1	6	4'T12	2	Ice	Magnetic	2	N	Electronic	\$ 5.60	\$ 33.60	\$ 135.00	\$ 810.00	Replace Fixture and Mount Hardware
BUILDING B														
<i>Cafeteria Dining Area</i>	1	30	8'T12	2	Ice	Magnetic	2	N	Electronic	\$ 11.20	\$ 336.00	\$ 160.00	\$ 4,800.00	Replace Fixture and Mount Hardware
<i>Kitchen Hall</i>	1	5	8'T12	2	wrap	Magnetic	2	N	Electronic	\$ 7.20	\$ 36.00	\$ 80.00	\$ 400.00	missing lens
<i>Kitchen</i>	1	12	8'T12	2	wrap	Magnetic	2	N	Electronic	\$ 7.20	\$ 86.40	\$ 80.00	\$ 960.00	No Comment
<i>Kitchen</i>	1	7	4'T12	2	wrap	Magnetic	2	N	Electronic	\$ 5.60	\$ 39.20	\$ 60.00	\$ 420.00	Fixture in Fair Condition
<i>Laundry Room</i>	1	1	8'T12	2	wrap	Magnetic	2	N	Electronic	\$ 7.20	\$ 7.20	\$ 80.00	\$ 80.00	Replace Fixture and Mount Hardware
<i>Hall</i>	1	3	4'T12	2	wrap	Magnetic	2	N	Electronic	\$ 5.60	\$ 16.80	\$ 60.00	\$ 180.00	missing lens
<i>Office</i>	1	1	8'T12	2	wrap	Magnetic	2	N	Electronic	\$ 7.20	\$ 7.20	\$ 80.00	\$ 80.00	Replace Fixture and Mount Hardware
<i>Store Room</i>	1	4	8'T12	2	wrap	Magnetic	2	N	Electronic	\$ 7.20	\$ 28.80	\$ 80.00	\$ 320.00	Replace Fixture and Mount Hardware
<i>Women's Room</i>	1	1	8'T12	2	wrap	Magnetic	2	N	Electronic	\$ 7.20	\$ 7.20	\$ 80.00	\$ 80.00	Replace Fixture and Mount Hardware
<i>Men's Room</i>	1	1	8'T12	2	wrap	Magnetic	2	N	Electronic	\$ 7.20	\$ 7.20	\$ 80.00	\$ 80.00	Replace Fixture and Mount Hardware
BUILDING C														
<i>C-1</i>	1	6	8'T12	2	wrap	Magnetic	2	N	Electronic	\$ 7.20	\$ 43.20	\$ 80.00	\$ 480.00	Replace Fixture and Mount Hardware
<i>C-1</i>	1	12	4'T12	2	wrap	Magnetic	2	N	Electronic	\$ 5.60	\$ 67.20	\$ 60.00	\$ 720.00	Excellent retro-fit opportunity
<i>C-1</i>	1	10	4'T12	2	wrap	Magnetic	2	N	Electronic	\$ 5.60	\$ 56.00	\$ 60.00	\$ 600.00	Excellent retro-fit opportunity
<i>C-2</i>	1	6	8'T12	2	wrap	Magnetic	2	N	Electronic	\$ 7.20	\$ 43.20	\$ 80.00	\$ 480.00	Replace Fixture and Mount Hardware
<i>C-2</i>	1	12	4'T12	2	wrap	Magnetic	2	N	Electronic	\$ 5.60	\$ 67.20	\$ 60.00	\$ 720.00	Excellent retro-fit opportunity
<i>C-3</i>	1	6	8'T12	2	wrap	Magnetic	2	N	Electronic	\$ 7.20	\$ 43.20	\$ 80.00	\$ 480.00	Replace Fixture and Mount Hardware
<i>C-3</i>	1	12	4'T12	1	wrap	Magnetic	1	N	Electronic	\$ 2.80	\$ 33.60	\$ 55.00	\$ 660.00	no lens cover
<i>C-4</i>	1	6	8'T12	2	wrap	Magnetic	2	N	Electronic	\$ 7.20	\$ 43.20	\$ 80.00	\$ 480.00	Replace Fixture and Mount Hardware
<i>C-4</i>	1	12	4'T12	1	wrap	Magnetic	1	N	Electronic	\$ 2.80	\$ 33.60	\$ 55.00	\$ 660.00	no lens covers
<i>Girls' Restroom</i>	1	5	4'T12	1	wrap	Magnetic	1	N	Electronic	\$ 2.80	\$ 14.00	\$ 55.00	\$ 275.00	Excellent retro-fit opportunity
<i>Boys' Restroom</i>	1	5	4'T12	1	wrap	Magnetic	1	N	Electronic	\$ 2.80	\$ 14.00	\$ 55.00	\$ 275.00	Excellent retro-fit opportunity
<i>Computer Lab</i>	1	12	4'T12	2	wrap	Magnetic	2	N	Electronic	\$ 5.60	\$ 67.20	\$ 60.00	\$ 720.00	Excellent retro-fit opportunity
<i>PCNC</i>	1	6	8'T12	2	wrap	Magnetic	2	N	Electronic	\$ 7.20	\$ 43.20	\$ 80.00	\$ 480.00	Replace Fixture and Mount Hardware
BUILDING D														

LOCATION	EXISTING EQUIPMENT						PROPOSED			REBATES		COSTS		COMMENTS
Location (Rm Name, Rm. #, Area, Zone, etc.)	Floor	Quantity	Lamp Type	Lamps Per Fixture	Type of Fixture	Ballast Type	Lamps Per Fixture	Reflectors	Ballast Type	Per Single	Extended	Per Single	Extended	Surveyors Comments
D-21	1	12	4'T12	2	Ice	Magnetic	2	N	Electronic	\$ 5.60	\$ 67.20	\$ 135.00	\$ 1,620.00	Replace Fixture and Mount Hardware
D-21	1	12	4'T12	1	Vanity	Magnetic	1	N	Electronic	\$ 2.80	\$ 33.60	\$ 55.00	\$ 660.00	Excellent retro-fit opportunity
D-22	1	12	4'T12	2	Ice	Magnetic	2	N	Electronic	\$ 5.60	\$ 67.20	\$ 55.00	\$ 660.00	Replace Fixture and Mount Hardware
D-22	1	12	4'T12	1	Vanity	Magnetic	1	N	Electronic	\$ 2.80	\$ 33.60	\$ 55.00	\$ 660.00	Excellent retro-fit opportunity
D-23	1	12	4'T12	2	Ice	Magnetic	2	N	Electronic	\$ 5.60	\$ 67.20	\$ 135.00	\$ 1,620.00	Replace Fixture and Mount Hardware
D-23	1	12	4'T12	1	Vanity	Magnetic	1	N	Electronic	\$ 2.80	\$ 33.60	\$ 55.00	\$ 660.00	Excellent retro-fit opportunity
D-24	1	12	4'T12	2	Ice	Magnetic	2	N	Electronic	\$ 5.60	\$ 67.20	\$ 135.00	\$ 1,620.00	Replace Fixture and Mount Hardware
D-24	1	12	4'T12	1	Vanity	Magnetic	1	N	Electronic	\$ 2.80	\$ 33.60	\$ 55.00	\$ 660.00	Excellent retro-fit opportunity
D-25	1	12	4'T12	2	Ice	Magnetic	2	N	Electronic	\$ 5.60	\$ 67.20	\$ 135.00	\$ 1,620.00	Replace Fixture and Mount Hardware
D-25	1	12	4'T12	1	Vanity	Magnetic	1	N	Electronic	\$ 2.80	\$ 33.60	\$ 55.00	\$ 660.00	Excellent retro-fit opportunity
D-26	1	12	4'T12	2	Ice	Magnetic	2	N	Electronic	\$ 5.60	\$ 67.20	\$ 135.00	\$ 1,620.00	Replace Fixture and Mount Hardware
D-26	1	12	4'T12	1	Vanity	Magnetic	1	N	Electronic	\$ 2.80	\$ 33.60	\$ 55.00	\$ 660.00	Excellent retro-fit opportunity
Teachers' Room	1	3	8'T12	2	Ice	Magnetic	2	N	Electronic	\$ 11.20	\$ 33.60	\$ 160.00	\$ 480.00	Replace Fixture and Mount Hardware
Girls' Restroom	1	5	4'T12	1	wrap	Magnetic	1	N	Electronic	\$ 2.80	\$ 14.00	\$ 55.00	\$ 275.00	No Comment
Boys' Restroom	1	5	4'T12	1	wrap	Magnetic	1	N	Electronic	\$ 2.80	\$ 14.00	\$ 55.00	\$ 275.00	No Comment
BUILDING E														
E-15	1	1	8'T12	2	Ice	Magnetic	2	N	Electronic	\$ 11.20	\$ 11.20	\$ 160.00	\$ 160.00	Replace Fixture and Mount Hardware
E-15	1	12	4'T12	2	wrap	Magnetic	2	N	Electronic	\$ 5.60	\$ 67.20	\$ 60.00	\$ 720.00	Missing Lens cover
E-15	1	12	4'T12	2	Ice	Magnetic	2	N	Electronic	\$ 5.60	\$ 67.20	\$ 135.00	\$ 1,620.00	Replace Fixture and Mount Hardware
E-16	1	12	4'T12	2	Ice	Magnetic	2	N	Electronic	\$ 5.60	\$ 67.20	\$ 135.00	\$ 1,620.00	Replace Fixture and Mount Hardware
E-16	1	12	4'T12	1	Vanity	Magnetic	1	N	Electronic	\$ 2.80	\$ 33.60	\$ 55.00	\$ 660.00	Replace Fixture and Mount Hardware
E-17	1	12	4'T12	2	Ice	Magnetic	2	N	Electronic	\$ 5.60	\$ 67.20	\$ 135.00	\$ 1,620.00	Replace Fixture and Mount Hardware
E-17	1	12	4'T12	1	Vanity	Magnetic	1	N	Electronic	\$ 2.80	\$ 33.60	\$ 55.00	\$ 660.00	Replace Fixture and Mount Hardware
E-18	1	12	4'T12	2	Ice	Magnetic	2	N	Electronic	\$ 5.60	\$ 67.20	\$ 135.00	\$ 1,620.00	Replace Fixture and Mount Hardware
E-18	1	12	4'T12	1	Vanity	Magnetic	1	N	Electronic	\$ 2.80	\$ 33.60	\$ 55.00	\$ 660.00	Replace Fixture and Mount Hardware
E-19	1	12	4'T12	2	Ice	Magnetic	2	N	Electronic	\$ 5.60	\$ 67.20	\$ 135.00	\$ 1,620.00	Replace Fixture and Mount Hardware
E-19	1	12	4'T12	1	Vanity	Magnetic	1	N	Electronic	\$ 2.80	\$ 33.60	\$ 55.00	\$ 660.00	Replace Fixture and Mount Hardware
E-20	1	12	4'T12	2	Ice	Magnetic	2	N	Electronic	\$ 5.60	\$ 67.20	\$ 135.00	\$ 1,620.00	Replace Fixture and Mount Hardware
E-20	1	12	4'T12	1	Vanity	Magnetic	1	N	Electronic	\$ 2.80	\$ 33.60	\$ 55.00	\$ 660.00	Replace Fixture and Mount Hardware
Girls' Restroom	1	5	4'T12	1	wrap	Magnetic	1	N	Electronic	\$ 2.80	\$ 14.00	\$ 55.00	\$ 275.00	Replace Fixture and Mount Hardware
Boys' Restroom	1	5	4'T12	1	wrap	Magnetic	1	N	Electronic	\$ 2.80	\$ 14.00	\$ 55.00	\$ 275.00	Replace Fixture and Mount Hardware
BUILDING F														
Teachers' Room	1	1	8'T12	2	Ice	Magnetic	2	N	Electronic	\$ 11.20	\$ 11.20	\$ 160.00	\$ 160.00	Replace Fixture and Mount hardware
Teachers' Room	1	1	4'T12	2	Ice	Magnetic	2	N	Electronic	\$ 5.60	\$ 5.60	\$ 135.00	\$ 135.00	Excellent retro-fit opportunity
F-11	1	3	8'T12	2	Ice	Magnetic	2	N	Electronic	\$ 11.20	\$ 33.60	\$ 160.00	\$ 480.00	Replace Fixture and Mount hardware
F-11	1	12	4'T12	1	wrap	Magnetic	1	N	Electronic	\$ 2.80	\$ 33.60	\$ 55.00	\$ 660.00	Excellent retro-fit opportunity

LOCATION	EXISTING EQUIPMENT						PROPOSED			REBATES		COSTS		COMMENTS
Location (Rm Name, Rm. #, Area, Zone, etc.)	Floor	Quantity	Lamp Type	Lamps Per Fixture	Type of Fixture	Ballast Type	Lamps Per Fixture	Reflectors	Ballast Type	Per Single	Extended	Per Single	Extended	Surveyors Comments
<i>F-12</i>	1	3	8'T12	2	Ice	Magnetic	2	N	Electronic	\$ 11.20	\$ 33.60	\$ 160.00	\$ 480.00	Replace Fixture and Mount hardware
<i>F-12</i>	1	12	4'T12	1	wrap	Magnetic	1	N	Electronic	\$ 2.80	\$ 33.60	\$ 55.00	\$ 660.00	Missing Lens Cover
<i>F-13</i>	1	10	8'T12	2	Ice	Magnetic	2	N	Electronic	\$ 11.20	\$ 112.00	\$ 160.00	\$ 1,600.00	Replace Fixture and Mount hardware
<i>F-13</i>	1	18	4'T12	1	wrap	Magnetic	1	N	Electronic	\$ 2.80	\$ 50.40	\$ 55.00	\$ 990.00	Excellent retro-fit opportunity
<i>F-14</i>	1	10	8'T12	2	Ice	Magnetic	2	N	Electronic	\$ 11.20	\$ 112.00	\$ 160.00	\$ 1,600.00	Replace Fixture and Mount hardware
<i>F-14</i>	1	18	4'T12	1	wrap	Magnetic	1	N	Electronic	\$ 2.80	\$ 50.40	\$ 55.00	\$ 990.00	Excellent retro-fit opportunity
<i>Girls' Restroom</i>	1	5	4'T12	1	wrap	Magnetic	1	N	Electronic	\$ 2.80	\$ 14.00	\$ 55.00	\$ 275.00	Excellent retro-fit opportunity
<i>Boys' Restroom</i>	1	5	4'T12	1	wrap	Magnetic	1	N	Electronic	\$ 2.80	\$ 14.00	\$ 55.00	\$ 275.00	Excellent retro-fit opportunity
BUILDING G														
<i>Teachers' Room</i>	1	1	8'T12	2	wrap	Magnetic	2	N	Electronic	\$ 11.20	\$ 11.20	\$ 80.00	\$ 80.00	Replace Fixture and Mount Hardware
<i>Teachers' Room</i>	1	1	4'T12	2	wrap	Magnetic	2	N	Electronic	\$ 5.60	\$ 5.60	\$ 60.00	\$ 60.00	Excellent retro-fit opportunity
<i>G-5</i>	1	6	8'T12	2	Ice	Magnetic	2	N	Electronic	\$ 11.20	\$ 67.20	\$ 160.00	\$ 960.00	Replace Fixture and Mount Hardware
<i>G-5</i>	1	12	4'T12	2	wrap	Magnetic	2	N	Electronic	\$ 5.60	\$ 67.20	\$ 135.00	\$ 1,620.00	Classroom has dark louvers
<i>G-6</i>	1	6	8'T12	2	Ice	Magnetic	2	N	Electronic	\$ 11.20	\$ 67.20	\$ 160.00	\$ 960.00	Replace Fixture and Mount Hardware
<i>G-6</i>	1	12	4'T12	1	wrap	Magnetic	1	N	Electronic	\$ 2.80	\$ 33.60	\$ 55.00	\$ 660.00	Missing Lens Cover
<i>G-7</i>	1	6	8'T12	2	Ice	Magnetic	2	N	Electronic	\$ 11.20	\$ 67.20	\$ 160.00	\$ 960.00	Replace Fixture and Mount Hardware
<i>G-7</i>	1	12	4'T12	1	wrap	Magnetic	1	N	Electronic	\$ 2.80	\$ 33.60	\$ 55.00	\$ 660.00	Excellent retro-fit opportunity
<i>G-8</i>	1	6	8'T12	2	Ice	Magnetic	2	N	Electronic	\$ 11.20	\$ 67.20	\$ 160.00	\$ 960.00	Replace Fixture and Mount Hardware
<i>G-8</i>	1	12	4'T12	1	wrap	Magnetic	1	N	Electronic	\$ 2.80	\$ 33.60	\$ 55.00	\$ 660.00	Excellent retro-fit opportunity
<i>G-9</i>	1	6	8'T12	2	Ice	Magnetic	2	N	Electronic	\$ 11.20	\$ 67.20	\$ 160.00	\$ 960.00	Replace Fixture and Mount Hardware
<i>G-9</i>	1	12	4'T12	1	wrap	Magnetic	1	N	Electronic	\$ 2.80	\$ 33.60	\$ 55.00	\$ 660.00	Excellent retro-fit opportunity
<i>G-10</i>	1	6	8'T12	2	Ice	Magnetic	2	N	Electronic	\$ 11.20	\$ 67.20	\$ 160.00	\$ 960.00	Replace Fixture and Mount Hardware
<i>G-10</i>	1	12	4'T12	1	wrap	Magnetic	1	N	Electronic	\$ 2.80	\$ 33.60	\$ 55.00	\$ 660.00	Excellent retro-fit opportunity
<i>Girls' Restroom</i>	1	5	4'T12	1	wrap	Magnetic	1	N	Electronic	\$ 2.80	\$ 14.00	\$ 55.00	\$ 275.00	Excellent retro-fit opportunity
<i>Boys' Restroom</i>	1	5	4'T12	1	wrap	Magnetic	1	N	Electronic	\$ 2.80	\$ 14.00	\$ 55.00	\$ 275.00	Excellent retro-fit opportunity
BUILDING I														
<i>I-101</i>	1	25	4'T12	2	wrap	Magnetic	2	N	Electronic	\$ 5.60	\$ 140.00	\$ 60.00	\$ 1,500.00	Excellent opportunity for retro-fit
<i>I-102</i>	1	25	4'T12	2	wrap	Magnetic	2	N	Electronic	\$ 5.60	\$ 140.00	\$ 60.00	\$ 1,500.00	Excellent opportunity for retro-fit
<i>I-103</i>	1	25	4'T12	2	wrap	Magnetic	2	N	Electronic	\$ 5.60	\$ 140.00	\$ 60.00	\$ 1,500.00	Excellent opportunity for retro-fit
<i>I-104</i>	1	16	4'T12	2	wrap	Magnetic	2	N	Electronic	\$ 5.60	\$ 89.60	\$ 60.00	\$ 960.00	Excellent opportunity for retro-fit
<i>I-104 storage room</i>	1	4	4'T12	2	wrap	Magnetic	2	N	Electronic	\$ 5.60	\$ 22.40	\$ 60.00	\$ 240.00	Excellent opportunity for retro-fit
<i>I-105</i>	1	25	4'T12	2	wrap	Magnetic	2	N	Electronic	\$ 5.60	\$ 140.00	\$ 60.00	\$ 1,500.00	Excellent opportunity for retro-fit
<i>I-106</i>	1	25	4'T12	2	wrap	Magnetic	2	N	Electronic	\$ 5.60	\$ 140.00	\$ 60.00	\$ 1,500.00	Excellent opportunity for retro-fit
<i>I-107</i>	1	25	4'T12	2	wrap	Magnetic	2	N	Electronic	\$ 5.60	\$ 140.00	\$ 60.00	\$ 1,500.00	Excellent opportunity for retro-fit
<i>Girls' Restroom</i>	1	5	4'T12	1	wrap	Magnetic	1	N	Electronic	\$ 2.80	\$ 14.00	\$ 55.00	\$ 275.00	Excellent opportunity for retro-fit
<i>Boys' Restroom</i>	1	5	4'T12	1	wrap	Magnetic	1	N	Electronic	\$ 2.80	\$ 14.00	\$ 55.00	\$ 275.00	Excellent opportunity for retro-fit

LOCATION	EXISTING EQUIPMENT						PROPOSED			REBATES		COSTS		COMMENTS
Location (Rm Name, Rm. #, Area, Zone, etc.)	Floor	Quantity	Lamp Type	Lamps Per Fixture	Type of Fixture	Ballast Type	Lamps Per Fixture	Reflectors	Ballast Type	Per Single	Extended	Per Single	Extended	Surveyors Comments
PORTABLES														
P-1	1	12	4'T12	4	wrap	Magnetic	4	N	Electronic	\$ 11.20	\$ 134.40	\$ 70.00	\$ 840.00	Excellent opportunity for retro-fit
P-2	1	16	4'T12	4	wrap	Magnetic	4	N	Electronic	\$ 11.20	\$ 179.20	\$ 70.00	\$ 1,120.00	Excellent opportunity for retro-fit
P-3	1	16	4'T12	4	wrap	Magnetic	4	N	Electronic	\$ 11.20	\$ 179.20	\$ 70.00	\$ 1,120.00	Excellent opportunity for retro-fit
P-4 - A	1	8	4'T12	4	wrap	Magnetic	4	N	Electronic	\$ 11.20	\$ 89.60	\$ 70.00	\$ 560.00	Excellent opportunity for retro-fit
P-4 - B	1	8	4'T12	4	wrap	Magnetic	4	N	Electronic	\$ 11.20	\$ 89.60	\$ 70.00	\$ 560.00	Excellent opportunity for retro-fit
P-5	1	16	4'T12	4	wrap	Magnetic	4	N	Electronic	\$ 11.20	\$ 179.20	\$ 70.00	\$ 1,120.00	Excellent opportunity for retro-fit
P-6	1	16	4'T12	4	wrap	Magnetic	4	N	Electronic	\$ 11.20	\$ 179.20	\$ 70.00	\$ 1,120.00	Excellent opportunity for retro-fit
P-7	1	16	4'T12	4	Troffer	Magnetic	4	N	Electronic	\$ 11.20	\$ 179.20	\$ 70.00	\$ 1,120.00	Excellent opportunity for retro-fit
P-8	1	16	4'T12	4	wrap	Magnetic	4	N	Electronic	\$ 11.20	\$ 179.20	\$ 70.00	\$ 1,120.00	Excellent opportunity for retro-fit
P-9	1	16	4'T12	4	wrap	Magnetic	4	N	Electronic	\$ 11.20	\$ 179.20	\$ 70.00	\$ 1,120.00	Excellent opportunity for retro-fit
P-10	1	12	4'T12	4	wrap	Magnetic	4	N	Electronic	\$ 11.20	\$ 134.40	\$ 70.00	\$ 840.00	Excellent opportunity for retro-fit
P-11	1	12	4'T12	4	Ice	Magnetic	4	N	Electronic	\$ 11.20	\$ 134.40	\$ 70.00	\$ 840.00	Excellent opportunity for retro-fit
P-12	1	12	4'T12	4	wrap	Magnetic	4	N	Electronic	\$ 11.20	\$ 134.40	\$ 70.00	\$ 840.00	Excellent opportunity for retro-fit
P-13	1	12	4'T12	4	wrap	Magnetic	4	N	Electronic	\$ 11.20	\$ 134.40	\$ 70.00	\$ 840.00	Excellent opportunity for retro-fit
P-14	1	16	4'T12	4	Troffer	Magnetic	4	N	Electronic	\$ 11.20	\$ 179.20	\$ 70.00	\$ 1,120.00	Excellent opportunity for retro-fit
P-15	1	16	4'T12	4	Troffer	Magnetic	4	N	Electronic	\$ 11.20	\$ 179.20	\$ 70.00	\$ 1,120.00	Excellent opportunity for retro-fit
P-16	1	16	4'T12	4	Troffer	Magnetic	4	N	Electronic	\$ 11.20	\$ 179.20	\$ 70.00	\$ 1,120.00	Excellent opportunity for retro-fit
P-17	1	16	4'T12	4	wrap	Magnetic	4	N	Electronic	\$ 11.20	\$ 179.20	\$ 70.00	\$ 1,120.00	Excellent opportunity for retro-fit
T01	1	10	4'T12	2	wrap	Magnetic	2	N	Electronic	\$ 5.60	\$ 56.00	\$ 60.00	\$ 600.00	Excellent opportunity for retro-fit
TB1A	1	16	4'T12	4	Troffer	Magnetic	4	N	Electronic	\$ 11.20	\$ 179.20	\$ 70.00	\$ 1,120.00	Excellent opportunity for retro-fit
TB1B	1	16	4'T12	4	Troffer	Magnetic	4	N	Electronic	\$ 11.20	\$ 179.20	\$ 70.00	\$ 1,120.00	Excellent opportunity for retro-fit
TB2A	1	16	4'T12	4	Troffer	Magnetic	4	N	Electronic	\$ 11.20	\$ 179.20	\$ 70.00	\$ 1,120.00	Excellent opportunity for retro-fit
TB2B	1	16	4'T12	4	Troffer	Magnetic	4	N	Electronic	\$ 11.20	\$ 179.20	\$ 70.00	\$ 1,120.00	Excellent opportunity for retro-fit
Total Rebates										\$	8,790.40			
Total Costs										\$	105,350.00			

LOCATION	QTY	EXISTING TYPE	QTY	RETROFIT	SURVEYORS COMMENTS	Actual				Proposed			
						Existing Watt/unit	Op. Hours	kWh	kW-D	Watt/unit	Op. Hours	kWh	kW-D
Building A	0		0		0		1,692	0	0		1,692	0	0
Library	32	8' 2L Fixture	32	Lamp & Ballast Retrofit	replace fixture and mount hardware	158	1,692	8,554.8	5.056	102	1,692	5,522.7	3.264
Library	6	4' 2L Fixture	6	Lamp & Low Watt Ballast	replace fixture and mount hardware	75.6	1,692	767.5	0.4536	51	1,692	517.8	0.306
Office	21	4' 2L Fixture	21	Lamp & Low Watt Ballast	replace fixture and mount hardware	75.6	1,692	2,686.2	1.5876	51	1,692	1,812.1	1.071
Front Desk Area	6	4' 2L Fixture	6	Lamp & Low Watt Ballast	replace fixture and mount hardware	75.6	1,692	767.5	0.4536	51	1,692	517.8	0.306
BUILDING B	0		0		0		1,692	0.0	0		1,692	0.0	0
Cafeteria Dining Area	30	8' 2L Fixture	30	Lamp & Ballast Retrofit	replace fixture and mount hardware	158	1,692	8,020.1	4.74	102	1,692	5,177.5	3.06
Kitchen Hall	5	8' 2L Fixture	5	Lamp & Ballast Retrofit	missing lens	158	1,692	1,336.7	0.79	110	1,692	930.6	0.55
Kitchen	12	8' 2L Fixture	12	Lamp & Ballast Retrofit	replace fixture and mount hardware	158	1,692	3,208.0	1.896	102	1,692	2,071.0	1.224
Kitchen	7	4' 2L Fixture	7	Lamp & Low Watt Ballast	no comment	75.6	1,692	895.4	0.5292	51	1,692	604.0	0.357
Laundry Room	1	8' 2L Fixture	1	Lamp & Ballast Retrofit	replace fixture and mount hardware	158	1,692	267.3	0.158	102	1,692	172.6	0.102
Hall	3	4' 2L Fixture	3	Lamp & Low Watt Ballast	missing lens	75.6	1,692	383.7	0.2268	51	1,692	258.9	0.153
Office	1	8' 2L Fixture	1	Lamp & Ballast Retrofit	replace fixture and mount hardware	158	1,692	267.3	0.158	102	1,692	172.6	0.102
Store Room	4	8' 2L Fixture	4	Lamp & Ballast Retrofit	replace fixture and mount hardware	158	1,692	1,069.3	0.632	102	1,692	690.3	0.408
Women's Room	1	8' 2L Fixture	1	Lamp & Ballast Retrofit	replace fixture and mount hardware	158	1,692	267.3	0.158	102	1,692	172.6	0.102
Men's Room	1	8' 2L Fixture	1	Lamp & Ballast Retrofit	replace fixture and mount hardware	158	1,692	267.3	0.158	102	1,692	172.6	0.102
BUILDING C	0		0		0		1,692	0.0	0		1,692	0.0	0
C-1	6	8' 2L Fixture	6	Lamp & Ballast Retrofit	replace fixture and mount hardware	158	1,692	1,604.0	0.948	102	1,692	1,035.5	0.612
C-1	12	4' 2L Fixture	12	Lamp & Low Watt Ballast	Excellent retro-fit opportunity	75.6	1,692	1,535.0	0.9072	51	1,692	1,035.5	0.612
C-1	10	4' 2L Fixture	10	Lamp & Low Watt Ballast	Excellent retro-fit opportunity	75.6	1,692	1,279.2	0.756	51	1,692	862.9	0.51
C-2	6	8' 2L Fixture	6	Lamp & Ballast Retrofit	replace fixture and mount hardware	158	1,692	1,604.0	0.948	102	1,692	1,035.5	0.612
C-2	12	4' 2L Fixture	12	Lamp & Low Watt Ballast	Excellent retro-fit opportunity	75.6	1,692	1,535.0	0.9072	51	1,692	1,035.5	0.612
C-3	6	8' 2L Fixture	6	Lamp & Ballast Retrofit	replace fixture and mount hardware	158	1,692	1,604.0	0.948	102	1,692	1,035.5	0.612
C-3	12	4' 1L Fixture	12	Lamp & Low Watt Ballast	no lens cover	45.6	1,692	925.9	0.5472	31	1,692	629.4	0.372
C-4	6	8' 2L Fixture	6	Lamp & Ballast Retrofit	replace fixture and mount hardware	158	1,692	1,604.0	0.948	102	1,692	1,035.5	0.612
C-4	12	4' 1L Fixture	12	Lamp & Low Watt Ballast	no lens covers	45.6	1,692	925.9	0.5472	31	1,692	629.4	0.372
Girls' Restroom	5	4' 1L Fixture	5	Lamp & Low Watt Ballast	Excellent retro-fit opportunity	45.6	1,692	385.8	0.228	31	1,692	262.3	0.155
Boys' Restroom	5	4' 1L Fixture	5	Lamp & Low Watt Ballast	Excellent retro-fit opportunity	45.6	1,692	385.8	0.228	31	1,692	262.3	0.155
Computer Lab	12	4' 2L Fixture	12	Lamp & Low Watt Ballast	Excellent retro-fit opportunity	75.6	1,692	1,535.0	0.9072	51	1,692	1,035.5	0.612
PCNC	6	8' 2L Fixture	6	Lamp & Ballast Retrofit	replace fixture and mount hardware	158	1,692	1,604.0	0.948	102	1,692	1,035.5	0.612
BUILDING D	0		0		0		1,692	0.0	0		1,692	0.0	0
D-21	12	4' 2L Fixture	12	Lamp & Low Watt Ballast	replace fixture and mount hardware	75.6	1,692	1,535.0	0.9072	51	1,692	1,035.5	0.612
D-21	12	4' 1L Fixture	12	Lamp & Low Watt Ballast	Excellent retro-fit opportunity	45.6	1,692	925.9	0.5472	31	1,692	629.4	0.372
D-22	12	4' 2L Fixture	12	Lamp & Low Watt Ballast	replace fixture and mount hardware	75.6	1,692	1,535.0	0.9072	51	1,692	1,035.5	0.612
D-22	12	4' 1L Fixture	12	Lamp & Low Watt Ballast	Excellent retro-fit opportunity	45.6	1,692	925.9	0.5472	31	1,692	629.4	0.372
D-23	12	4' 2L Fixture	12	Lamp & Low Watt Ballast	replace fixture and mount hardware	75.6	1,692	1,535.0	0.9072	51	1,692	1,035.5	0.612
D-23	12	4' 1L Fixture	12	Lamp & Low Watt Ballast	Excellent retro-fit opportunity	45.6	1,692	925.9	0.5472	31	1,692	629.4	0.372
D-24	12	4' 2L Fixture	12	Lamp & Low Watt Ballast	replace fixture and mount hardware	75.6	1,692	1,535.0	0.9072	51	1,692	1,035.5	0.612
D-24	12	4' 1L Fixture	12	Lamp & Low Watt Ballast	Excellent retro-fit opportunity	45.6	1,692	925.9	0.5472	31	1,692	629.4	0.372
D-25	12	4' 2L Fixture	12	Lamp & Low Watt Ballast	replace fixture and mount hardware	75.6	1,692	1,535.0	0.9072	51	1,692	1,035.5	0.612
D-25	12	4' 1L Fixture	12	Lamp & Low Watt Ballast	Excellent retro-fit opportunity	45.6	1,692	925.9	0.5472	31	1,692	629.4	0.372
D-26	12	4' 2L Fixture	12	Lamp & Low Watt Ballast	replace fixture and mount hardware	75.6	1,692	1,535.0	0.9072	51	1,692	1,035.5	0.612
D-26	12	4' 1L Fixture	12	Lamp & Low Watt Ballast	Excellent retro-fit opportunity	45.6	1,692	925.9	0.5472	31	1,692	629.4	0.372
Teachers' Room	3	8' 2L Fixture	3	Lamp & Ballast Retrofit	replace fixture and mount hardware	158	1,692	802.0	0.474	102	1,692	517.8	0.306
Girls' Restroom	5	4' 1L Fixture	5	Lamp & Low Watt Ballast	No Comment	45.6	1,692	385.8	0.228	31	1,692	262.3	0.155
Boys' Restroom	5	4' 1L Fixture	5	Lamp & Low Watt Ballast	No Comment	45.6	1,692	385.8	0.228	31	1,692	262.3	0.155
BUILDING E	0		0		0		1,692	0.0	0		1,692	0.0	0
E-15	1	8' 2L Fixture	1	Lamp & Ballast Retrofit	replace fixture and mount hardware	158	1,692	267.3	0.158	102	1,692	172.6	0.102
E-15	12	4' 2L Fixture	12	Lamp & Low Watt Ballast	missing lens	75.6	1,692	1,535.0	0.9072	51	1,692	1,035.5	0.612
E-15	12	4' 2L Fixture	12	Lamp & Low Watt Ballast	replace fixture and mount hardware	75.6	1,692	1,535.0	0.9072	51	1,692	1,035.5	0.612
E-16	12	4' 2L Fixture	12	Lamp & Low Watt Ballast	replace fixture and mount hardware	75.6	1,692	1,535.0	0.9072	51	1,692	1,035.5	0.612
E-16	12	4' 1L Fixture	12	Lamp & Low Watt Ballast	replace fixture and mount hardware	45.6	1,692	925.9	0.5472	31	1,692	629.4	0.372
E-17	12	4' 2L Fixture	12	Lamp & Low Watt Ballast	replace fixture and mount hardware	75.6	1,692	1,535.0	0.9072	51	1,692	1,035.5	0.612
E-17	12	4' 1L Fixture	12	Lamp & Low Watt Ballast	replace fixture and mount hardware	45.6	1,692	925.9	0.5472	31	1,692	629.4	0.372
E-18	12	4' 2L Fixture	12	Lamp & Low Watt Ballast	replace fixture and mount hardware	75.6	1,692	1,535.0	0.9072	51	1,692	1,035.5	0.612
E-18	12	4' 1L Fixture	12	Lamp & Low Watt Ballast	replace fixture and mount hardware	45.6	1,692	925.9	0.5472	31	1,692	629.4	0.372
E-19	12	4' 2L Fixture	12	Lamp & Low Watt Ballast	replace fixture and mount hardware	75.6	1,692	1,535.0	0.9072	51	1,692	1,035.5	0.612
E-19	12	4' 1L Fixture	12	Lamp & Low Watt Ballast	replace fixture and mount hardware	45.6	1,692	925.9	0.5472	31	1,692	629.4	0.372

LOCATION	QTY	EXISTING TYPE	QTY	RETROFIT	SURVEYORS COMMENTS	Existing	Actual			Proposed			
						Watt/unit	Op. Hours	kWh	kW-D	Watt/unit	Op. Hours	kWh	kW-D
E-20	12	4' 2L Fixture	12	Lamp & Low Watt Ballast	replace fixture and mount hardware	75.6	1,692	1,535.0	0.9072	51	1,692	1,035.5	0.612
E-20	12	4' 1L Fixture	12	Lamp & Low Watt Ballast	replace fixture and mount hardware	45.6	1,692	925.9	0.5472	31	1,692	629.4	0.372
Girls' Restroom	5	4' 1L Fixture	5	Lamp & Low Watt Ballast	replace fixture and mount hardware	45.6	1,692	385.8	0.228	31	1,692	262.3	0.155
Boys' Restroom	5	4' 1L Fixture	5	Lamp & Low Watt Ballast	replace fixture and mount hardware	45.6	1,692	385.8	0.228	31	1,692	262.3	0.155
BUILDING F	0		0		0		1,692	0.0	0		1,692	0.0	0
Teachers' Room	1	8' 2L Fixture	1	Lamp & Ballast Retrofit	replace fixture and mount hardware	158	1,692	267.3	0.158	102	1,692	172.6	0.102
Teachers' Room	1	4' 2L Fixture	1	Lamp & Low Watt Ballast	Excellent retro-fit opportunity	75.6	1,692	127.9	0.0756	51	1,692	86.3	0.051
F-11	3	8' 2L Fixture	3	Lamp & Ballast Retrofit	replace fixture and mount hardware	158	1,692	802.0	0.474	102	1,692	517.8	0.306
F-11	12	4' 1L Fixture	12	Lamp & Low Watt Ballast	Excellent retro-fit opportunity	45.6	1,692	925.9	0.5472	31	1,692	629.4	0.372
F-12	3	8' 2L Fixture	3	Lamp & Ballast Retrofit	replace fixture and mount hardware	158	1,692	802.0	0.474	102	1,692	517.8	0.306
F-12	12	4' 1L Fixture	12	Lamp & Low Watt Ballast	Excellent retro-fit opportunity	45.6	1,692	925.9	0.5472	31	1,692	629.4	0.372
F-13	10	8' 2L Fixture	10	Lamp & Ballast Retrofit	replace fixture and mount hardware	158	1,692	2,673.4	1.58	102	1,692	1,725.8	1.02
F-13	18	4' 1L Fixture	18	Lamp & Low Watt Ballast	missing lens	45.6	1,692	1,388.8	0.8208	31	1,692	944.1	0.558
F-14	10	8' 2L Fixture	10	Lamp & Ballast Retrofit	replace fixture and mount hardware	158	1,692	2,673.4	1.58	102	1,692	1,725.8	1.02
F-14	18	4' 1L Fixture	18	Lamp & Low Watt Ballast	Excellent retro-fit opportunity	45.6	1,692	1,388.8	0.8208	31	1,692	944.1	0.558
Girls' Restroom	5	4' 1L Fixture	5	Lamp & Low Watt Ballast	Excellent retro-fit opportunity	45.6	1,692	385.8	0.228	31	1,692	262.3	0.155
Boys' Restroom	5	4' 1L Fixture	5	Lamp & Low Watt Ballast	Excellent retro-fit opportunity	45.6	1,692	385.8	0.228	31	1,692	262.3	0.155
BUILDING G	0		0		0		1,692	0.0	0		1,692	0.0	0
Teachers' Room	1	8' 2L Fixture	1	Lamp & Ballast Retrofit	replace fixture and mount hardware	158	1,692	267.3	0.158	102	1,692	172.6	0.102
Teachers' Room	1	4' 2L Fixture	1	Lamp & Low Watt Ballast	Excellent retro-fit opportunity	75.6	1,692	127.9	0.0756	51	1,692	86.3	0.051
G-5	6	8' 2L Fixture	6	Lamp & Ballast Retrofit	replace fixture and mount hardware	158	1,692	1,604.0	0.948	102	1,692	1,035.5	0.612
G-5	12	4' 2L Fixture	12	Lamp & Low Watt Ballast	Excellent retro-fit opportunity	75.6	1,692	1,535.0	0.9072	51	1,692	1,035.5	0.612
G-6	6	8' 2L Fixture	6	Lamp & Ballast Retrofit	replace fixture and mount hardware	158	1,692	1,604.0	0.948	102	1,692	1,035.5	0.612
G-6	12	4' 1L Fixture	12	Lamp & Low Watt Ballast	Excellent retro-fit opportunity	45.6	1,692	925.9	0.5472	31	1,692	629.4	0.372
G-7	6	8' 2L Fixture	6	Lamp & Ballast Retrofit	replace fixture and mount hardware	158	1,692	1,604.0	0.948	102	1,692	1,035.5	0.612
G-7	12	4' 1L Fixture	12	Lamp & Low Watt Ballast	missing lens	45.6	1,692	925.9	0.5472	31	1,692	629.4	0.372
G-8	6	8' 2L Fixture	6	Lamp & Ballast Retrofit	replace fixture and mount hardware	158	1,692	1,604.0	0.948	102	1,692	1,035.5	0.612
G-8	12	4' 1L Fixture	12	Lamp & Low Watt Ballast	Excellent retro-fit opportunity	45.6	1,692	925.9	0.5472	31	1,692	629.4	0.372
G-9	6	8' 2L Fixture	6	Lamp & Ballast Retrofit	replace fixture and mount hardware	158	1,692	1,604.0	0.948	102	1,692	1,035.5	0.612
G-9	12	4' 1L Fixture	12	Lamp & Low Watt Ballast	Excellent retro-fit opportunity	45.6	1,692	925.9	0.5472	31	1,692	629.4	0.372
G-10	6	8' 2L Fixture	6	Lamp & Ballast Retrofit	replace fixture and mount hardware	158	1,692	1,604.0	0.948	102	1,692	1,035.5	0.612
G-10	12	4' 1L Fixture	12	Lamp & Low Watt Ballast	Excellent retro-fit opportunity	45.6	1,692	925.9	0.5472	31	1,692	629.4	0.372
Girls' Restroom	5	4' 1L Fixture	5	Lamp & Low Watt Ballast	Excellent retro-fit opportunity	45.6	1,692	385.8	0.228	31	1,692	262.3	0.155
Boys' Restroom	5	4' 1L Fixture	5	Lamp & Low Watt Ballast	Excellent retro-fit opportunity	45.6	1,692	385.8	0.228	31	1,692	262.3	0.155
BUILDING I	0		0		0		1,692	0.0	0		1,692	0.0	0
I-101	25	4' 2L Fixture	25	Lamp & Low Watt Ballast	Excellent retro-fit opportunity	75.6	1,692	3,197.9	1.89	51	1,692	2,157.3	1.275
I-102	25	4' 2L Fixture	25	Lamp & Low Watt Ballast	Excellent retro-fit opportunity	75.6	1,692	3,197.9	1.89	51	1,692	2,157.3	1.275
I-103	25	4' 2L Fixture	25	Lamp & Low Watt Ballast	Excellent retro-fit opportunity	75.6	1,692	3,197.9	1.89	51	1,692	2,157.3	1.275
I-104	16	4' 2L Fixture	16	Lamp & Low Watt Ballast	Excellent retro-fit opportunity	75.6	1,692	2,046.6	1.2096	51	1,692	1,380.7	0.816
I-104 storage room	4	4' 2L Fixture	4	Lamp & Low Watt Ballast	Excellent retro-fit opportunity	75.6	1,692	511.7	0.3024	51	1,692	345.2	0.204
I-105	25	4' 2L Fixture	25	Lamp & Low Watt Ballast	Excellent retro-fit opportunity	75.6	1,692	3,197.9	1.89	51	1,692	2,157.3	1.275
I-106	25	4' 2L Fixture	25	Lamp & Low Watt Ballast	Excellent retro-fit opportunity	75.6	1,692	3,197.9	1.89	51	1,692	2,157.3	1.275
I-107	25	4' 2L Fixture	25	Lamp & Low Watt Ballast	Excellent retro-fit opportunity	75.6	1,692	3,197.9	1.89	51	1,692	2,157.3	1.275
Girls' Restroom	5	4' 1L Fixture	5	Lamp & Low Watt Ballast	Excellent retro-fit opportunity	45.6	1,692	385.8	0.228	31	1,692	262.3	0.155
Boys' Restroom	5	4' 1L Fixture	5	Lamp & Low Watt Ballast	Excellent retro-fit opportunity	45.6	1,692	385.8	0.228	31	1,692	262.3	0.155
PORTABLES	0		0		0		1,692	0.0	0		1,692	0.0	0
P-1	12	4' 4L Fixture	12	Lamp & Low Watt Ballast	Excellent retro-fit opportunity	151.2	1,692	3,070.0	1.8144	100	1,692	2,030.4	1.2
P-2	16	4' 4L Fixture	16	Lamp & Low Watt Ballast	Excellent retro-fit opportunity	151.2	1,692	4,093.3	2.4192	100	1,692	2,707.2	1.6
P-3	16	4' 4L Fixture	16	Lamp & Low Watt Ballast	Excellent retro-fit opportunity	151.2	1,692	4,093.3	2.4192	100	1,692	2,707.2	1.6
P-4 - A	8	4' 4L Fixture	8	Lamp & Low Watt Ballast	Excellent retro-fit opportunity	151.2	1,692	2,046.6	1.2096	100	1,692	1,353.6	0.8
P-4 - B	8	4' 4L Fixture	8	Lamp & Low Watt Ballast	Excellent retro-fit opportunity	151.2	1,692	2,046.6	1.2096	100	1,692	1,353.6	0.8
P-5	16	4' 4L Fixture	16	Lamp & Low Watt Ballast	Excellent retro-fit opportunity	151.2	1,692	4,093.3	2.4192	100	1,692	2,707.2	1.6
P-6	16	4' 4L Fixture	16	Lamp & Low Watt Ballast	Excellent retro-fit opportunity	151.2	1,692	4,093.3	2.4192	100	1,692	2,707.2	1.6
P-7	16	4' 4L Fixture	16	Lamp & Low Watt Ballast	Excellent retro-fit opportunity	151.2	1,692	4,093.3	2.4192	100	1,692	2,707.2	1.6
P-8	16	4' 4L Fixture	16	Lamp & Low Watt Ballast	Excellent retro-fit opportunity	151.2	1,692	4,093.3	2.4192	100	1,692	2,707.2	1.6
P-9	16	4' 4L Fixture	16	Lamp & Low Watt Ballast	Excellent retro-fit opportunity	151.2	1,692	4,093.3	2.4192	100	1,692	2,707.2	1.6
P-10	12	4' 4L Fixture	12	Lamp & Low Watt Ballast	Excellent retro-fit opportunity	151.2	1,692	3,070.0	1.8144	100	1,692	2,030.4	1.2
P-11	12	4' 4L Fixture	12	Lamp & Low Watt Ballast	Excellent retro-fit opportunity	151.2	1,692	3,070.0	1.8144	100	1,692	2,030.4	1.2

LOCATION	QTY	EXISTING TYPE	QTY	RETROFIT	SURVEYORS COMMENTS	Actual				Proposed				
						Existing Watt/unit	Op. Hours	kWh	kW-D	Watt/unit	Op. Hours	kWh	kW-D	
P-12	12	4' 4L Fixture	12	Lamp & Low Watt Ballast	Excellent retro-fit opportunity	151.2	1,692	3,070.0	1.8144	100	1,692	2,030.4	1.2	
P-13	12	4' 4L Fixture	12	Lamp & Low Watt Ballast	Excellent retro-fit opportunity	151.2	1,692	3,070.0	1.8144	100	1,692	2,030.4	1.2	
P-14	16	4' 4L Fixture	16	Lamp & Low Watt Ballast	Excellent retro-fit opportunity	151.2	1,692	4,093.3	2.4192	100	1,692	2,707.2	1.6	
P-15	16	4' 4L Fixture	16	Lamp & Low Watt Ballast	Excellent retro-fit opportunity	151.2	1,692	4,093.3	2.4192	100	1,692	2,707.2	1.6	
P-16	16	4' 4L Fixture	16	Lamp & Low Watt Ballast	Excellent retro-fit opportunity	151.2	1,692	4,093.3	2.4192	100	1,692	2,707.2	1.6	
P-17	16	4' 4L Fixture	16	Lamp & Low Watt Ballast	Excellent retro-fit opportunity	151.2	1,692	4,093.3	2.4192	100	1,692	2,707.2	1.6	
T01	10	4' 2L Fixture	10	Lamp & Low Watt Ballast	Excellent retro-fit opportunity	75.6	1,692	1,279.2	0.756	51	1,692	862.9	0.51	
TB1A	16	4' 4L Fixture	16	Lamp & Low Watt Ballast	Excellent retro-fit opportunity	151.2	1,692	4,093.3	2.4192	100	1,692	2,707.2	1.6	
TB1B	16	4' 4L Fixture	16	Lamp & Low Watt Ballast	Excellent retro-fit opportunity	151.2	1,692	4,093.3	2.4192	100	1,692	2,707.2	1.6	
TB2A	16	4' 4L Fixture	16	Lamp & Low Watt Ballast	Excellent retro-fit opportunity	151.2	1,692	4,093.3	2.4192	100	1,692	2,707.2	1.6	
TB2B	16	4' 4L Fixture	16	Lamp & Low Watt Ballast	Excellent retro-fit opportunity	151.2	1,692	4,093.3	2.4192	100	1,692	2,707.2	1.6	
Existing 1276 Proposed 1276						ENERGY CALCULATIONS				212,378	126			

Description	kW-Demand	kWh	
Existing Use	125.52	212,378	
Proposed Use	83.32	140,969	
Difference - Savings	42.20	71,410	Total Yearly Energy Savings
Electrical Utility Cost	\$5.75	\$0.15451	
Savings per Year	\$2,912.09	\$11,033.73	

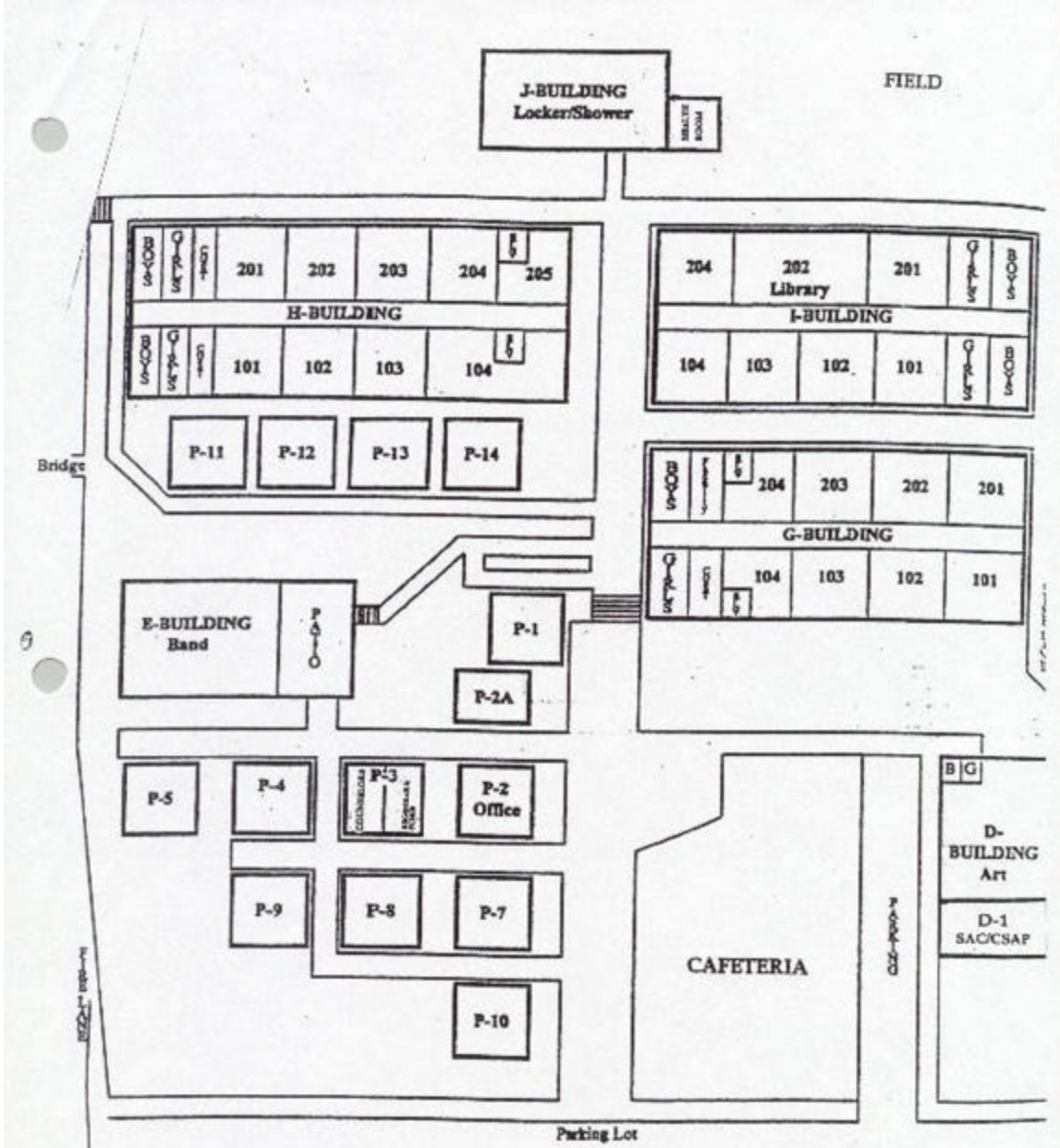

Lokelani Intermediate School
 Kihei, Maui, Hawaii
 Campus Map



Maui Smart Schools Program
Foot Candle Readings

School: Lokelani Intermediate School

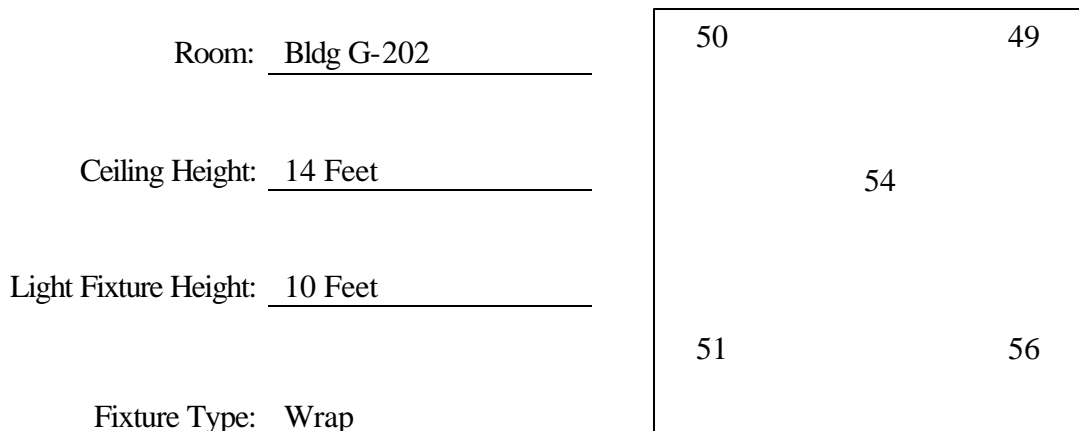
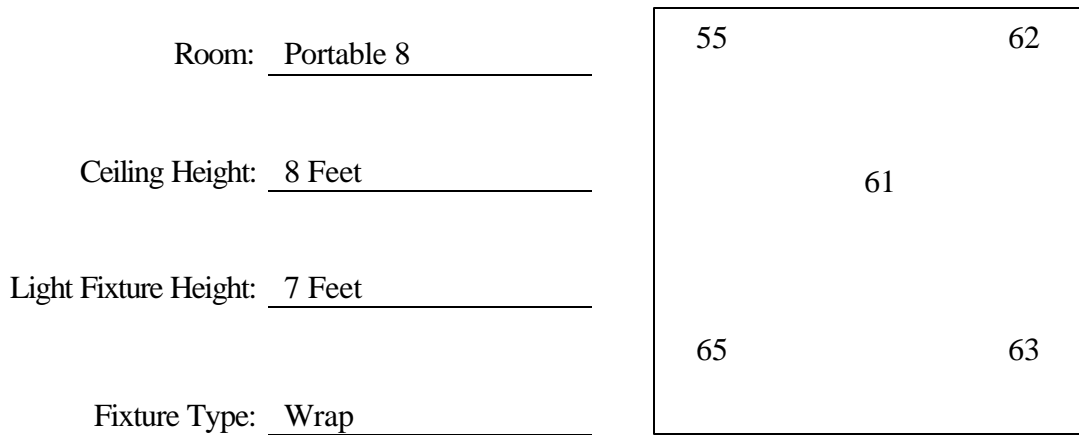
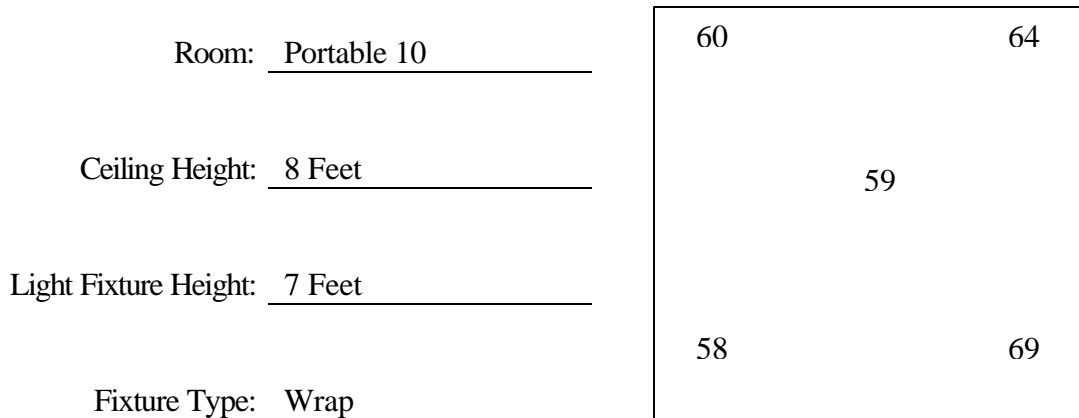



CUSTOMER INFORMATION										
NAME Lokelani Intermediate School										DATE 7/22/2000
STREET ADDRESS 250 East Lipoa Street Kihei, HI 96753										OPERATIONAL HOURS 1,793
POINT OF CONTACT					PHONE 875-6800	FAX 875-6835			VOLTAGE 120V	
AUDITOR										

LOCATION <small>(Rm Name, Rm. #, Area, Zone, etc.)</small>	EXISTING EQUIPMENT						PROPOSED			REBATES		COSTS		COMMENTS
	Floor	Quantity	Lamp Type	Lamps Per Fixture	Type of Fixture	Ballast Type	Lamps Per Fixture	Reflectors	Ballast Type	Per Single	Extended	Per Single	Extended	
PORTABLES											\$ -		\$ -	
P10	1	12	4' T12	4	Wrap	Magnetic	4	N	Electronic	\$ 11.20	\$ 134.40	\$ 70.00	\$ 840.00	Retrofit Recommended
Elec. Bldg	1	4	4' T12	2	Strip	Magnetic	2	N	Electronic	\$ 5.60	\$ 22.40	\$ 60.00	\$ 240.00	Retrofit Recommended
P9	1	12	4' T12	4	Wrap	Magnetic	4	N	Electronic	\$ 11.20	\$ 134.40	\$ 70.00	\$ 840.00	Retrofit Recommended
P8	1	12	4' T12	4	Wrap	Magnetic	4	N	Electronic	\$ 11.20	\$ 134.40	\$ 70.00	\$ 840.00	Retrofit Recommended
P7	1	12	4' T12	4	Wrap	Magnetic	4	N	Electronic	\$ 11.20	\$ 134.40	\$ 70.00	\$ 840.00	Retrofit Recommended
Office	1	10	4' T12	4	Wrap	Magnetic	4	N	Electronic	\$ 11.20	\$ 112.00	\$ 70.00	\$ 700.00	Retrofit Recommended
P3	1	13	4' T12	4	Wrap	Magnetic	4	N	Electronic	\$ 11.20	\$ 145.60	\$ 70.00	\$ 910.00	Retrofit Recommended
P4	1	12	4' T12	4	Wrap	Magnetic	4	N	Electronic	\$ 11.20	\$ 134.40	\$ 70.00	\$ 840.00	Retrofit Recommended
P5	1	12	4' T12	4	Wrap	Magnetic	4	N	Electronic	\$ 11.20	\$ 134.40	\$ 70.00	\$ 840.00	Retrofit Recommended
Ext Portable	1	8	Inc								\$ -		\$ -	None
P2A	1	5	4' T12	4	Wrap	Magnetic	4	N	Electronic	\$ 11.20	\$ 56.00	\$ 70.00	\$ 350.00	Retrofit Recommended
P1	1	12	4' T12	4	Para	Magnetic	4	N	Electronic	\$ 11.20	\$ 134.40	\$ 70.00	\$ 840.00	Retrofit Recommended
P11	1	12	4' T12	4	Fixture	Magnetic	4	N	Electronic	\$ 11.20	\$ 134.40	\$ 70.00	\$ 840.00	Retrofit Recommended
P12	1	12	4' T12	4	Fixture	Magnetic	4	N	Electronic	\$ 11.20	\$ 134.40	\$ 70.00	\$ 840.00	Retrofit Recommended
P13	1		T8			Electronic					\$ -		\$ -	T8 Lamps, No Retrofit
P14	1		T8			Electronic					\$ -		\$ -	T8 Lamps, No Retrofit
BUILDING D											\$ -		\$ -	
Boys' Restroom	1	1	8' T12	1	Fixture	Magnetic	1	N	Electronic	\$ 3.60	\$ 3.60	\$ 75.00	\$ 75.00	Retrofit Recommended
Girls' Restroom	1	1	8' T12	1	Fixture	Magnetic	1	N	Electronic	\$ 3.60	\$ 3.60	\$ 75.00	\$ 75.00	Retrofit Recommended
Material	1	2	8' T12	2	Fixture	Magnetic	2	N	Electronic	\$ 7.20	\$ 14.40	\$ 80.00	\$ 160.00	Retrofit Recommended
Custodian	1	1	8' T12	2	Fixture	Magnetic	2	N	Electronic	\$ 7.20	\$ 7.20	\$ 80.00	\$ 80.00	Retrofit Recommended
Shop Area	1	18	8' T12	2	Fixture	Magnetic	2	N	Electronic	\$ 7.20	\$ 129.60	\$ 80.00	\$ 1,440.00	Retrofit Recommended
Cage	1	5	8' T12	2	Fixture	Magnetic	2	N	Electronic	\$ 7.20	\$ 36.00	\$ 80.00	\$ 400.00	Retrofit Recommended
Office	1	2	4' T12	4	Fixture	Magnetic	4	N	Electronic	\$ 11.20	\$ 22.40	\$ 70.00	\$ 140.00	Retrofit Recommended
Supply	1	2	4' T12	4	Fixture	Magnetic	4	N	Electronic	\$ 11.20	\$ 22.40	\$ 70.00	\$ 140.00	Retrofit Recommended
Classroom	1	12	4' T12	4	Fixture	Magnetic	4	N	Electronic	\$ 11.20	\$ 134.40	\$ 70.00	\$ 840.00	Retrofit Recommended
Ext	1	4	4' T12	4	Fixture	Magnetic	4	N	Electronic	\$ 11.20	\$ 44.80	\$ 70.00	\$ 280.00	Retrofit Recommended
BUILDING G											\$ -		\$ -	
Girls' Restroom	1	6	4' T12	2	Fixture	Magnetic	2	N	Electronic	\$ 5.60	\$ 33.60	\$ 60.00	\$ 360.00	Retrofit Recommended
Custodian	1	1	4' T12	2	Fixture	Magnetic	2	N	Electronic	\$ 5.60	\$ 5.60	\$ 60.00	\$ 60.00	Retrofit Recommended

LOCATION (Rm Name, Rm. #, Area, Zone, etc.)	EXISTING EQUIPMENT						PROPOSED			REBATES		COSTS		COMMENTS
	Floor	Quantity	Lamp Type	Lamps Per Fixture	Type of Fixture	Ballast Type	Lamps Per Fixture	Reflectors	Ballast Type	Per Single	Extended	Per Single	Extended	
Mech.	1	1	4' T12	2	Fixture	Magnetic	2	N	Electronic	\$ 5.60	\$ 5.60	\$ 60.00	\$ 60.00	Retrofit Recommended
Elec	1	1	4' T12	2	Fixture	Magnetic	2	N	Electronic	\$ 5.60	\$ 5.60	\$ 60.00	\$ 60.00	Retrofit Recommended
G104	1	26	4' T12	4	Fixture	Magnetic	4	N	Electronic	\$ 11.20	\$ 291.20	\$ 70.00	\$ 1,820.00	Retrofit Recommended
Crafts	1	6	4' T12	4	Fixture	Magnetic	4	N	Electronic	\$ 11.20	\$ 67.20	\$ 70.00	\$ 420.00	Retrofit Recommended
Bathroom	1	1	4' T12	4	Fixture	Magnetic	4	N	Electronic	\$ 11.20	\$ 11.20	\$ 70.00	\$ 70.00	Retrofit Recommended
G103	1	16	4' T12	2	Fixture	Magnetic	2	N	Electronic	\$ 5.60	\$ 89.60	\$ 60.00	\$ 960.00	Retrofit Recommended
G102	1	16	4' T12	2	Fixture	Magnetic	2	N	Electronic	\$ 5.60	\$ 89.60	\$ 60.00	\$ 960.00	Retrofit Recommended
G101	1	16	4' T12	4	Fixture	Magnetic	4	N	Electronic	\$ 11.20	\$ 179.20	\$ 70.00	\$ 1,120.00	Retrofit Recommended
Storage	1	1	4' T12	2	Fixture	Magnetic	2	N	Electronic	\$ 5.60	\$ 5.60	\$ 60.00	\$ 60.00	Retrofit Recommended
G201	1	16	4' T12	4	Fixture	Magnetic	4	N	Electronic	\$ 11.20	\$ 179.20	\$ 70.00	\$ 1,120.00	Retrofit Recommended
G202	1	16	4' T12	4	Fixture	Magnetic	4	N	Electronic	\$ 11.20	\$ 179.20	\$ 70.00	\$ 1,120.00	Retrofit Recommended
G203	1	16	4' T12	4	Fixture	Magnetic	4	N	Electronic	\$ 11.20	\$ 179.20	\$ 70.00	\$ 1,120.00	Retrofit Recommended
G204	1	16	4' T12	4	Fixture	Magnetic	4	N	Electronic	\$ 11.20	\$ 179.20	\$ 70.00	\$ 1,120.00	Retrofit Recommended
Faculty	1	1	4' T12	2	Fixture	Magnetic	2	N	Electronic	\$ 5.60	\$ 5.60	\$ 60.00	\$ 60.00	Retrofit Recommended
Storage	1	4	4' T12	4	Fixture	Magnetic	4	N	Electronic	\$ 11.20	\$ 44.80	\$ 70.00	\$ 280.00	Retrofit Recommended
Men's Restroom	1	1	4' T12	2	Fixture	Magnetic	2	N	Electronic	\$ 5.60	\$ 5.60	\$ 60.00	\$ 60.00	Retrofit Recommended
Women's Restroom	1	1	4' T12	2	Fixture	Magnetic	2	N	Electronic	\$ 5.60	\$ 5.60	\$ 60.00	\$ 60.00	Retrofit Recommended
Custodian	1	1	4' T12	2	Fixture	Magnetic	2	N	Electronic	\$ 5.60	\$ 5.60	\$ 60.00	\$ 60.00	Retrofit Recommended
Boys' Restroom	1	6	4' T12	2	Fixture	Magnetic	2	N	Electronic	\$ 5.60	\$ 33.60	\$ 60.00	\$ 360.00	Retrofit Recommended
Hall	1	2			Exit Sign						\$ -		\$ -	None
Elevator	1	2	4' T12	2	Fixture	Magnetic	2	N	Electronic	\$ 5.60	\$ 11.20	\$ 60.00	\$ 120.00	Retrofit Recommended
BUILDING H											\$ -		\$ -	
Elevator Room	1	1	4' T12	2	Fixture	Magnetic	2	N	Electronic	\$ 5.60	\$ 5.60	\$ 60.00	\$ 60.00	Retrofit Recommended
Elevator	1	2	4' T12	2	Fixture	Magnetic	2	N	Electronic	\$ 5.60	\$ 11.20	\$ 60.00	\$ 120.00	Retrofit Recommended
Home Ec	1	33	4' T12	4	Fixture	Magnetic	4	N	Electronic	\$ 11.20	\$ 369.60	\$ 70.00	\$ 2,310.00	Retrofit Recommended
Storage	1	3	4' T12	2	Fixture	Magnetic	2	N	Electronic	\$ 5.60	\$ 16.80	\$ 60.00	\$ 180.00	Retrofit Recommended
Dressing	1	1	Inc	2							\$ -		\$ -	None
H103	1	16	4' T12	4	Fixture	Magnetic	4	N	Electronic	\$ 11.20	\$ 179.20	\$ 70.00	\$ 1,120.00	Retrofit Recommended
H102	1	16	4' T12	4	Fixture	Magnetic	4	N	Electronic	\$ 11.20	\$ 179.20	\$ 70.00	\$ 1,120.00	Retrofit Recommended
H101	1	16	4' T12	4	Fixture	Magnetic	4	N	Electronic	\$ 11.20	\$ 179.20	\$ 70.00	\$ 1,120.00	Retrofit Recommended
Girls' Restroom	1	6	4' T12	2	Fixture	Magnetic	2	N	Electronic	\$ 5.60	\$ 33.60	\$ 60.00	\$ 360.00	Retrofit Recommended
Elec Room	1	2	4' T12	2	Fixture	Magnetic	2	N	Electronic	\$ 5.60	\$ 11.20	\$ 60.00	\$ 120.00	Retrofit Recommended
Boys' Restroom	1	5	4' T12	2	Fixture	Magnetic	2	N	Electronic	\$ 5.60	\$ 28.00	\$ 60.00	\$ 300.00	Retrofit Recommended
Men's Restroom	2	5	4' T12	2	Fixture	Magnetic	2	N	Electronic	\$ 5.60	\$ 28.00	\$ 60.00	\$ 300.00	Retrofit Recommended
Custodian	2	2	4' T12	2	Fixture	Magnetic	2	N	Electronic	\$ 5.60	\$ 11.20	\$ 60.00	\$ 120.00	Retrofit Recommended
Women's Restroom	2	6	4' T12	2	Fixture	Magnetic	2	N	Electronic	\$ 5.60	\$ 33.60	\$ 60.00	\$ 360.00	Retrofit Recommended

LOCATION	EXISTING EQUIPMENT						PROPOSED			REBATES		COSTS		COMMENTS
Location (Rm Name, Rm. #, Area, Zone, etc.)	Floor	Quantity	Lamp Type	Lamps Per Fixture	Type of Fixture	Ballast Type	Lamps Per Fixture	Reflectors	Ballast Type	Per Single	Extended	Per Single	Extended	Comments
H201	2	12	4' T12	4	Fixture	Magnetic	4	N	Electronic	\$ 11.20	\$ 134.40	\$ 70.00	\$ 840.00	Retrofit Recommended
H202	2	12	4' T12	4	Fixture	Magnetic	4	N	Electronic	\$ 11.20	\$ 134.40	\$ 70.00	\$ 840.00	Retrofit Recommended
H203	2	12	4' T12	4	Fixture	Magnetic	4	N	Electronic	\$ 11.20	\$ 134.40	\$ 70.00	\$ 840.00	Retrofit Recommended
H204	2	20	4' T12	4	Fixture	Magnetic	4	N	Electronic	\$ 11.20	\$ 224.00	\$ 70.00	\$ 1,400.00	Retrofit Recommended
Office	2	2	4' T12	4	Fixture	Magnetic	4	N	Electronic	\$ 11.20	\$ 22.40	\$ 70.00	\$ 140.00	Retrofit Recommended
H205	2	9	4' T12	4	Fixture	Magnetic	4	N	Electronic	\$ 11.20	\$ 100.80	\$ 70.00	\$ 630.00	Retrofit Recommended
Men's Restroom	2	1	4' T12	2	Fixture	Magnetic	2	N	Electronic	\$ 5.60	\$ 5.60	\$ 60.00	\$ 60.00	Retrofit Recommended
Women's Restroom	2	1	4' T12	2	Fixture	Magnetic	2	N	Electronic	\$ 5.60	\$ 5.60	\$ 60.00	\$ 60.00	Retrofit Recommended
BUILDING I														
I204	2	26	4' T12	4	Fixture	Magnetic	4	N	Electronic	\$ 11.20	\$ 291.20	\$ 70.00	\$ 1,820.00	Retrofit Recommended
Teacher's Office	2	3	4' T12	4	Fixture	Magnetic	4	N	Electronic	\$ 11.20	\$ 33.60	\$ 70.00	\$ 210.00	Retrofit Recommended
I203	2	28	4' T12	4	Fixture	Magnetic	4	N	Electronic	\$ 11.20	\$ 313.60	\$ 70.00	\$ 1,960.00	Retrofit Recommended
	2	6	4' T12	4	Fixture	Magnetic	4	N	Electronic	\$ 11.20	\$ 67.20	\$ 70.00	\$ 420.00	Retrofit Recommended
	2	7	4' T12	4	Fixture	Magnetic	4	N	Electronic	\$ 11.20	\$ 78.40	\$ 70.00	\$ 490.00	Retrofit Recommended
I201	2	16	4' T12	4	Fixture	Magnetic	4	N	Electronic	\$ 11.20	\$ 179.20	\$ 70.00	\$ 1,120.00	Retrofit Recommended
Girls' Restroom	2	6	4' T12	2	Fixture	Magnetic	2	N	Electronic	\$ 5.60	\$ 33.60	\$ 60.00	\$ 360.00	Retrofit Recommended
Boy's Restroom	2	6	4' T12	2	Fixture	Magnetic	2	N	Electronic	\$ 5.60	\$ 33.60	\$ 60.00	\$ 360.00	Retrofit Recommended
Custodian	2	3	4' T12	2	Fixture	Magnetic	2	N	Electronic	\$ 5.60	\$ 16.80	\$ 60.00	\$ 180.00	Retrofit Recommended
Boy's Restroom	1	6	4' T12	2	Fixture	Magnetic	2	N	Electronic	\$ 5.60	\$ 33.60	\$ 60.00	\$ 360.00	Retrofit Recommended
Custodian	1	3	4' T12	2	Fixture	Magnetic	2	N	Electronic	\$ 5.60	\$ 16.80	\$ 60.00	\$ 180.00	Retrofit Recommended
Girls' Restroom	1	6	4' T12	2	Fixture	Magnetic	2	N	Electronic	\$ 5.60	\$ 33.60	\$ 60.00	\$ 360.00	Retrofit Recommended
I101	1	13	4' T12	4	Fixture	Magnetic	4	N	Electronic	\$ 11.20	\$ 145.60	\$ 70.00	\$ 910.00	Retrofit Recommended
I102	1	13	4' T12	4	Fixture	Magnetic	4	N	Electronic	\$ 11.20	\$ 145.60	\$ 70.00	\$ 910.00	Retrofit Recommended
I103	1	13	4' T12	4	Fixture	Magnetic	4	N	Electronic	\$ 11.20	\$ 145.60	\$ 70.00	\$ 910.00	Retrofit Recommended
	1	24	4' T12	4	Fixture	Magnetic	4	N	Electronic	\$ 11.20	\$ 268.80	\$ 70.00	\$ 1,680.00	Retrofit Recommended
	1	2	4' T12	4	Fixture	Magnetic	4	N	Electronic	\$ 11.20	\$ 22.40	\$ 70.00	\$ 140.00	Retrofit Recommended
Teacher's Office	1	3	4' T12	4	Fixture	Magnetic	4	N	Electronic	\$ 11.20	\$ 33.60	\$ 70.00	\$ 210.00	Retrofit Recommended
PE														
Storage	1	1	4' T12	2	Ice	Magnetic	2	N	Electronic	\$ 5.60	\$ 5.60	\$ 60.00	\$ 135.00	Fixture Replacement
First Aid	1	1	4' T12	4	Fixture	Magnetic	4	N	Electronic	\$ 11.20	\$ 11.20	\$ 70.00	\$ 70.00	Retrofit Recommended
Boys' Locker	1	42	4' T12	2	Fixture	Magnetic	2	N	Electronic	\$ 5.60	\$ 235.20	\$ 60.00	\$ 2,520.00	Retrofit Recommended
Office	1	2	4' T12	4	Fixture	Magnetic	4	N	Electronic	\$ 11.20	\$ 22.40	\$ 70.00	\$ 140.00	Retrofit Recommended
Girls' Locker	1	42	4' T12	2	Fixture	Magnetic	2	N	Electronic	\$ 5.60	\$ 235.20	\$ 60.00	\$ 2,520.00	Retrofit Recommended
Office	1	2	4' T12	4	Fixture	Magnetic	4	N	Electronic	\$ 11.20	\$ 22.40	\$ 70.00	\$ 140.00	Retrofit Recommended
Utility	1	2	4' T12	2	Fixture	Magnetic	2	N	Electronic	\$ 5.60	\$ 11.20	\$ 60.00	\$ 120.00	Retrofit Recommended
Weight Room	1	2	4' T12	2	Fixture	Magnetic	2	N	Electronic	\$ 5.60	\$ 11.20	\$ 60.00	\$ 120.00	Retrofit Recommended

LOCATION Location (Rm Name, Rm. #, Area, Zone, etc.)	EXISTING EQUIPMENT						PROPOSED			REBATES		COSTS		COMMENTS Comments
	Floor	Quantity	Lamp Type	Lamps Per Fixture	Type of Fixture	Ballast Type	Lamps Per Fixture	Reflectors	Ballast Type	Per Single	Extended	Per Single	Extended	
Elec Room	1	2	4' T12	2	Fixture	Magnetic	2	N	Electronic	\$ 5.60	\$ 11.20	\$ 60.00	\$ 120.00	Retrofit Recommended
ARAKAWA														
Band Building	1	3	4' T12	2	Fixture	Magnetic	2	N	Electronic	\$ 5.60	\$ 16.80	\$ 60.00	\$ 180.00	Retrofit Recommended
Custodian	1	1	4' T12	1	Fixture	Magnetic	1	N	Electronic	\$ 2.80	\$ 2.80	\$ 55.00	\$ 55.00	Retrofit Recommended
Boys' Restroom	1	3	4' T12	2	Fixture	Magnetic	2	N	Electronic	\$ 5.60	\$ 16.80	\$ 60.00	\$ 180.00	Retrofit Recommended
Storage	1	6	U T12	2	Fixture	Magnetic	2	N	Electronic	\$ 5.60	\$ 33.60	\$ 60.00	\$ 360.00	Retrofit Recommended
Band Room High	1	15	4' T12	6	Fixture	Magnetic	6	N	Electronic	\$ 16.80	\$ 252.00	\$ 120.00	\$ 1,800.00	Retrofit Recommended
Band Room High	1	8	4' T12	2	Fixture	Magnetic	2	N	Electronic	\$ 5.60	\$ 44.80	\$ 60.00	\$ 480.00	Retrofit Recommended
Practice Rooms	1	5	4' T12	4	Wrap	Magnetic	4	N	Electronic	\$ 11.20	\$ 56.00	\$ 70.00	\$ 350.00	Retrofit Recommended
Storage	1	2	4' T12	4	Fixture	Magnetic	4	N	Electronic	\$ 11.20	\$ 22.40	\$ 70.00	\$ 140.00	Retrofit Recommended
Office	1	4	4' T12	4	Fixture	Magnetic	4	N	Electronic	\$ 11.20	\$ 44.80	\$ 70.00	\$ 280.00	Retrofit Recommended
Inst Rep.	1	4	4' T12	2	Fixture	Magnetic	2	N	Electronic	\$ 5.60	\$ 22.40	\$ 60.00	\$ 240.00	Retrofit Recommended
Inst Rep.	1	1	4' T12	2	Fixture	Magnetic	2	N	Electronic	\$ 5.60	\$ 5.60	\$ 60.00	\$ 60.00	Retrofit Recommended

Total Rebates \$ 8,401.20
Total Costs \$ 59,810.00

LOCATION	QTY	EXISTING TYPE	QTY	RETROFIT		Existing			Actual			Proposed		
						Watt/unit	Op. Hours	kWh	kW-D	Watt/unit	Op. Hours	kWh	kW-D	
PORTABLES	0		0				1,793	0.0	0		1,793	0.0	0	
<i>P10</i>	12	4' 4L Fixture	12	Lamp & Low Watt Ballast	Retrofit Recommended	151.2	1,793	3,253.2	1.8144	100	1,793	2,151.6	1.2	
Elec. Bldg	4	4' 2L Fixture	4	Lamp & Low Watt Ballast	Retrofit Recommended	75.6	1,793	542.2	0.3024	51	1,793	365.8	0.204	
<i>P9</i>	12	4' 4L Fixture	12	Lamp & Low Watt Ballast	Retrofit Recommended	151.2	1,793	3,253.2	1.8144	100	1,793	2,151.6	1.2	
<i>P8</i>	12	4' 4L Fixture	12	Lamp & Low Watt Ballast	Retrofit Recommended	151.2	1,793	3,253.2	1.8144	100	1,793	2,151.6	1.2	
<i>P7</i>	12	4' 4L Fixture	12	Lamp & Low Watt Ballast	Retrofit Recommended	151.2	1,793	3,253.2	1.8144	100	1,793	2,151.6	1.2	
Office	10	4' 4L Fixture	10	Lamp & Low Watt Ballast	Retrofit Recommended	151.2	1,793	2,711.0	1.512	100	1,793	1,793.0	1	
<i>P3</i>	13	4' 4L Fixture	13	Lamp & Low Watt Ballast	Retrofit Recommended	151.2	1,793	3,524.3	1.9656	100	1,793	2,330.9	1.3	
<i>P4</i>	12	4' 4L Fixture	12	Lamp & Low Watt Ballast	Retrofit Recommended	151.2	1,793	3,253.2	1.8144	100	1,793	2,151.6	1.2	
<i>P5</i>	12	4' 4L Fixture	12	Lamp & Low Watt Ballast	Retrofit Recommended	151.2	1,793	3,253.2	1.8144	100	1,793	2,151.6	1.2	
Ext Portable	8	60W Incandescent	0		None		1,793	0.0	0		1,793	0.0	0	
<i>P2A</i>	5	4' 4L Fixture	5	Lamp & Low Watt Ballast	Retrofit Recommended	151.2	1,793	1,355.5	0.756	100	1,793	896.5	0.5	
<i>P1</i>	12	4' 4L Fixture	12	Lamp & Low Watt Ballast	Retrofit Recommended	151.2	1,793	3,253.2	1.8144	100	1,793	2,151.6	1.2	
<i>P11</i>	12	4' 4L Fixture	12	Lamp & Low Watt Ballast	Retrofit Recommended	151.2	1,793	3,253.2	1.8144	100	1,793	2,151.6	1.2	
<i>P12</i>	12	4' 4L Fixture	12	Lamp & Low Watt Ballast	Retrofit Recommended	151.2	1,793	3,253.2	1.8144	100	1,793	2,151.6	1.2	
<i>P13</i>	0		0		T8 Lamps, No Retrofit		1,793	0.0	0		1,793	0.0	0	
<i>P14</i>	0		0		T8 Lamps, No Retrofit		1,793	0.0	0		1,793	0.0	0	
BUILDING D	0		0				1,793	0.0	0		1,793	0.0	0	
Boys' Restroom	1	8' 1L Fixture	1	Lamp & Ballast Retrofit	Retrofit Recommended	69	1,793	123.7	0.069	55	1,793	98.6	0.055	
Girls' Restroom	1	8' 1L Fixture	1	Lamp & Ballast Retrofit	Retrofit Recommended	69	1,793	123.7	0.069	55	1,793	98.6	0.055	
Material	2	8' 2L Fixture	2	Lamp & Ballast Retrofit	Retrofit Recommended	158	1,793	566.6	0.316	110	1,793	394.5	0.22	
Custodian	1	8' 2L Fixture	1	Lamp & Ballast Retrofit	Retrofit Recommended	158	1,793	283.3	0.158	110	1,793	197.2	0.11	
Shop Area	18	8' 2L Fixture	18	Lamp & Ballast Retrofit	Retrofit Recommended	158	1,793	5,099.3	2.844	110	1,793	3,550.1	1.98	
Cage	5	8' 2L Fixture	5	Lamp & Ballast Retrofit	Retrofit Recommended	158	1,793	1,416.5	0.79	110	1,793	986.2	0.55	
Office	2	4' 4L Fixture	2	Lamp & Low Watt Ballast	Retrofit Recommended	151.2	1,793	542.2	0.3024	100	1,793	358.6	0.2	
Supply	2	4' 4L Fixture	2	Lamp & Low Watt Ballast	Retrofit Recommended	151.2	1,793	542.2	0.3024	100	1,793	358.6	0.2	
Classroom	12	4' 4L Fixture	12	Lamp & Low Watt Ballast	Retrofit Recommended	151.2	1,793	3,253.2	1.8144	100	1,793	2,151.6	1.2	
Ext	4	4' 4L Fixture	4	Lamp & Low Watt Ballast	Retrofit Recommended	151.2	1,793	1,084.4	0.6048	100	1,793	717.2	0.4	
BUILDING G	0		0				1,793	0.0	0		1,793	0.0	0	
Girls' Restroom	6	4' 2L Fixture	6	Lamp & Low Watt Ballast	Retrofit Recommended	75.6	1,793	813.3	0.4536	51	1,793	548.7	0.306	
Custodian	1	4' 2L Fixture	1	Lamp & Low Watt Ballast	Retrofit Recommended	75.6	1,793	135.6	0.0756	51	1,793	91.4	0.051	
Mech.	1	4' 2L Fixture	1	Lamp & Low Watt Ballast	Retrofit Recommended	75.6	1,793	135.6	0.0756	51	1,793	91.4	0.051	
Elec	1	4' 2L Fixture	1	Lamp & Low Watt Ballast	Retrofit Recommended	75.6	1,793	135.6	0.0756	51	1,793	91.4	0.051	
G104	26	4' 4L Fixture	26	Lamp & Low Watt Ballast	Retrofit Recommended	151.2	1,793	7,048.6	3.9312	100	1,793	4,661.8	2.6	
Crafts	6	4' 4L Fixture	6	Lamp & Low Watt Ballast	Retrofit Recommended	151.2	1,793	1,626.6	0.9072	100	1,793	1,075.8	0.6	
Bathroom	1	4' 4L Fixture	1	Lamp & Low Watt Ballast	Retrofit Recommended	151.2	1,793	271.1	0.1512	100	1,793	179.3	0.1	
G103	16	4' 2L Fixture	16	Lamp & Low Watt Ballast	Retrofit Recommended	75.6	1,793	2,168.8	1.2096	51	1,793	1,463.1	0.816	
G102	16	4' 2L Fixture	16	Lamp & Low Watt Ballast	Retrofit Recommended	75.6	1,793	2,168.8	1.2096	51	1,793	1,463.1	0.816	
G101	16	4' 4L Fixture	16	Lamp & Low Watt Ballast	Retrofit Recommended	151.2	1,793	4,337.6	2.4192	100	1,793	2,868.8	1.6	
Storage	1	4' 2L Fixture	1	Lamp & Low Watt Ballast	Retrofit Recommended	75.6	1,793	135.6	0.0756	51	1,793	91.4	0.051	
G201	16	4' 4L Fixture	16	Lamp & Low Watt Ballast	Retrofit Recommended	151.2	1,793	4,337.6	2.4192	100	1,793	2,868.8	1.6	
G202	16	4' 4L Fixture	16	Lamp & Low Watt Ballast	Retrofit Recommended	151.2	1,793	4,337.6	2.4192	100	1,793	2,868.8	1.6	
G203	16	4' 4L Fixture	16	Lamp & Low Watt Ballast	Retrofit Recommended	151.2	1,793	4,337.6	2.4192	100	1,793	2,868.8	1.6	
G204	16	4' 4L Fixture	16	Lamp & Low Watt Ballast	Retrofit Recommended	151.2	1,793	4,337.6	2.4192	100	1,793	2,868.8	1.6	
Faculty	1	4' 2L Fixture	1	Lamp & Low Watt Ballast	Retrofit Recommended	75.6	1,793	135.6	0.0756	51	1,793	91.4	0.051	
Storage	4	4' 4L Fixture	4	Lamp & Low Watt Ballast	Retrofit Recommended	151.2	1,793	1,084.4	0.6048	100	1,793	717.2	0.4	
Men's Restroom	1	4' 2L Fixture	1	Lamp & Low Watt Ballast	Retrofit Recommended	75.6	1,793	135.6	0.0756	51	1,793	91.4	0.051	
Women's Restroom	1	4' 2L Fixture	1	Lamp & Low Watt Ballast	Retrofit Recommended	75.6	1,793	135.6	0.0756	51	1,793	91.4	0.051	
Custodian	1	4' 2L Fixture	1	Lamp & Low Watt Ballast	Retrofit Recommended	75.6	1,793	135.6	0.0756	51	1,793	91.4	0.051	
Boys' Restroom	6	4' 2L Fixture	6	Lamp & Low Watt Ballast	Retrofit Recommended	75.6	1,793	813.3	0.4536	51	1,793	548.7	0.306	
Hall	2	Exit Sign	0		None		1,793	0.0	0		1,793	0.0	0	
Elevator	2	4' 2L Fixture	2	Lamp & Low Watt Ballast	Retrofit Recommended	75.6	1,793	271.1	0.1512	51	1,793	182.9	0.102	
BUILDING H	0		0				1,793	0.0	0		1,793	0.0	0	
Elevator Room	1	4' 2L Fixture	1	Lamp & Low Watt Ballast	Retrofit Recommended	75.6	1,793	135.6	0.0756	51	1,793	91.4	0.051	
Elevator	2	4' 2L Fixture	2	Lamp & Low Watt Ballast	Retrofit Recommended	75.6	1,793	271.1	0.1512	51	1,793	182.9	0.102	
Home Ec	33	4' 4L Fixture	33	Lamp & Low Watt Ballast	Retrofit Recommended	151.2	1,793	8,946.4	4.9896	100	1,793	5,916.9	3.3	
Storage	3	4' 2L Fixture	3	Lamp & Low Watt Ballast	Retrofit Recommended	75.6	1,793	406.7	0.2268	51	1,793	274.3	0.153	
Dressing	1	2L 60 Incandescent	0		None		1,793	0.0	0		1,793	0.0	0	
H103	16	4' 4L Fixture	16	Lamp & Low Watt Ballast	Retrofit Recommended	151.2	1,793	4,337.6	2.4192	100	1,793	2,868.8	1.6	
H102	16	4' 4L Fixture	16	Lamp & Low Watt Ballast	Retrofit Recommended	151.2	1,793	4,337.6	2.4192	100	1,793	2,868.8	1.6	

LOCATION	QTY	EXISTING TYPE	QTY	RETROFIT		Actual			Proposed				
						Existing Watt/unit	Op. Hours	kWh	kW-D	Watt/unit	Op. Hours	kWh	kW-D
H101	16	4' 4L Fixture	16	Lamp & Low Watt Ballast	Retrofit Recommended	151.2	1,793	4,337.6	2.4192	100	1,793	2,868.8	1.6
Girls' Restroom	6	4' 2L Fixture	6	Lamp & Low Watt Ballast	Retrofit Recommended	75.6	1,793	813.3	0.4536	51	1,793	548.7	0.306
Elec Room	2	4' 2L Fixture	2	Lamp & Low Watt Ballast	Retrofit Recommended	75.6	1,793	271.1	0.1512	51	1,793	182.9	0.102
Boys' Restroom	5	4' 2L Fixture	5	Lamp & Low Watt Ballast	Retrofit Recommended	75.6	1,793	677.8	0.378	51	1,793	457.2	0.255
Men's Restroom	5	4' 2L Fixture	5	Lamp & Low Watt Ballast	Retrofit Recommended	75.6	1,793	677.8	0.378	51	1,793	457.2	0.255
Custodian	2	4' 2L Fixture	2	Lamp & Low Watt Ballast	Retrofit Recommended	75.6	1,793	271.1	0.1512	51	1,793	182.9	0.102
Women's Restroom	6	4' 2L Fixture	6	Lamp & Low Watt Ballast	Retrofit Recommended	75.6	1,793	813.3	0.4536	51	1,793	548.7	0.306
H201	12	4' 4L Fixture	12	Lamp & Low Watt Ballast	Retrofit Recommended	151.2	1,793	3,253.2	1.8144	100	1,793	2,151.6	1.2
H202	12	4' 4L Fixture	12	Lamp & Low Watt Ballast	Retrofit Recommended	151.2	1,793	3,253.2	1.8144	100	1,793	2,151.6	1.2
H203	12	4' 4L Fixture	12	Lamp & Low Watt Ballast	Retrofit Recommended	151.2	1,793	3,253.2	1.8144	100	1,793	2,151.6	1.2
H204	20	4' 4L Fixture	20	Lamp & Low Watt Ballast	Retrofit Recommended	151.2	1,793	5,422.0	3.024	100	1,793	3,586.0	2
Office	2	4' 4L Fixture	2	Lamp & Low Watt Ballast	Retrofit Recommended	151.2	1,793	542.2	0.3024	100	1,793	358.6	0.2
H205	9	4' 4L Fixture	9	Lamp & Low Watt Ballast	Retrofit Recommended	151.2	1,793	2,439.9	1.3608	100	1,793	1,613.7	0.9
Men's Restroom	1	4' 2L Fixture	1	Lamp & Low Watt Ballast	Retrofit Recommended	75.6	1,793	135.6	0.0756	51	1,793	91.4	0.051
Women's Restroom	1	4' 2L Fixture	1	Lamp & Low Watt Ballast	Retrofit Recommended	75.6	1,793	135.6	0.0756	51	1,793	91.4	0.051
BUILDING I	0		0			0	1,793	0.0	0		1,793	0.0	0
I204	26	4' 4L Fixture	26	Lamp & Low Watt Ballast	Retrofit Recommended	151.2	1,793	7,048.6	3.9312	100	1,793	4,661.8	2.6
Teacher's Office	3	4' 4L Fixture	3	Lamp & Low Watt Ballast	Retrofit Recommended	151.2	1,793	813.3	0.4536	100	1,793	537.9	0.3
I203	28	4' 4L Fixture	28	Lamp & Low Watt Ballast	Retrofit Recommended	151.2	1,793	7,590.8	4.2336	100	1,793	5,020.4	2.8
0	6	4' 4L Fixture	6	Lamp & Low Watt Ballast	Retrofit Recommended	151.2	1,793	1,626.6	0.9072	100	1,793	1,075.8	0.6
0	7	4' 4L Fixture	7	Lamp & Low Watt Ballast	Retrofit Recommended	151.2	1,793	1,897.7	1.0584	100	1,793	1,255.1	0.7
I201	16	4' 4L Fixture	16	Lamp & Low Watt Ballast	Retrofit Recommended	151.2	1,793	4,337.6	2.4192	100	1,793	2,868.8	1.6
Girls' Restroom	6	4' 2L Fixture	6	Lamp & Low Watt Ballast	Retrofit Recommended	75.6	1,793	813.3	0.4536	51	1,793	548.7	0.306
Boys' Restroom	6	4' 2L Fixture	6	Lamp & Low Watt Ballast	Retrofit Recommended	75.6	1,793	813.3	0.4536	51	1,793	548.7	0.306
Custodian	3	4' 2L Fixture	3	Lamp & Low Watt Ballast	Retrofit Recommended	75.6	1,793	406.7	0.2268	51	1,793	274.3	0.153
Boys' Restroom	6	4' 2L Fixture	6	Lamp & Low Watt Ballast	Retrofit Recommended	75.6	1,793	813.3	0.4536	51	1,793	548.7	0.306
Custodian	3	4' 2L Fixture	3	Lamp & Low Watt Ballast	Retrofit Recommended	75.6	1,793	406.7	0.2268	51	1,793	274.3	0.153
Girls' Restroom	6	4' 2L Fixture	6	Lamp & Low Watt Ballast	Retrofit Recommended	75.6	1,793	813.3	0.4536	51	1,793	548.7	0.306
I101	13	4' 4L Fixture	13	Lamp & Low Watt Ballast	Retrofit Recommended	151.2	1,793	3,524.3	1.9656	100	1,793	2,330.9	1.3
I102	13	4' 4L Fixture	13	Lamp & Low Watt Ballast	Retrofit Recommended	151.2	1,793	3,524.3	1.9656	100	1,793	2,330.9	1.3
I103	13	4' 4L Fixture	13	Lamp & Low Watt Ballast	Retrofit Recommended	151.2	1,793	3,524.3	1.9656	100	1,793	2,330.9	1.3
0	24	4' 4L Fixture	24	Lamp & Low Watt Ballast	Retrofit Recommended	151.2	1,793	6,506.4	3.6288	100	1,793	4,303.2	2.4
0	2	4' 4L Fixture	2	Lamp & Low Watt Ballast	Retrofit Recommended	151.2	1,793	542.2	0.3024	100	1,793	358.6	0.2
Teacher's Office	3	4' 4L Fixture	3	Lamp & Low Watt Ballast	Retrofit Recommended	151.2	1,793	813.3	0.4536	100	1,793	537.9	0.3
PE	0		0			0	1,793	0.0	0		1,793	0.0	0
Storage	1	4' 2L Fixture	1	Lamp & Low Watt Ballast	Fixture Replacement	75.6	1,793	135.6	0.0756	51	1,793	91.4	0.051
First Aid	1	4' 4L Fixture	1	Lamp & Low Watt Ballast	Retrofit Recommended	151.2	1,793	271.1	0.1512	100	1,793	179.3	0.1
Boys' Locker	42	4' 2L Fixture	42	Lamp & Low Watt Ballast	Retrofit Recommended	75.6	1,793	5,693.1	3.1752	51	1,793	3,840.6	2.142
Office	2	4' 4L Fixture	2	Lamp & Low Watt Ballast	Retrofit Recommended	151.2	1,793	542.2	0.3024	100	1,793	358.6	0.2
Girls' Locker	42	4' 2L Fixture	42	Lamp & Low Watt Ballast	Retrofit Recommended	75.6	1,793	5,693.1	3.1752	51	1,793	3,840.6	2.142
Office	2	4' 4L Fixture	2	Lamp & Low Watt Ballast	Retrofit Recommended	151.2	1,793	542.2	0.3024	100	1,793	358.6	0.2
Utility	2	4' 2L Fixture	2	Lamp & Low Watt Ballast	Retrofit Recommended	75.6	1,793	271.1	0.1512	51	1,793	182.9	0.102
Weight Room	2	4' 2L Fixture	2	Lamp & Low Watt Ballast	Retrofit Recommended	75.6	1,793	271.1	0.1512	51	1,793	182.9	0.102
Elec Room	2	4' 2L Fixture	2	Lamp & Low Watt Ballast	Retrofit Recommended	75.6	1,793	271.1	0.1512	51	1,793	182.9	0.102
ARAKAWA	0		0			0	1,793	0.0	0		1,793	0.0	0
Band Building	3	4' 2L Fixture	3	Lamp & Low Watt Ballast	Retrofit Recommended	75.6	1,793	406.7	0.2268	51	1,793	274.3	0.153
Custodian	1	4' 1L Fixture	1	Lamp & Low Watt Ballast	Retrofit Recommended	45.6	1,793	81.8	0.0456	30	1,793	53.8	0.03
Boys' Restroom	3	4' 2L Fixture	3	Lamp & Low Watt Ballast	Retrofit Recommended	75.6	1,793	406.7	0.2268	51	1,793	274.3	0.153
Storage	6	2x2 2U Fixture	6	Lamp & Low Watt Ballast	Retrofit Recommended	75.6	1,793	813.3	0.4536	51	1,793	548.7	0.306
Band Room High	15	2x4 6L Fixture	15	Lamp & Low Watt Ballast	Retrofit Recommended	226.8	1,793	6,099.8	3.402	151	1,793	4,061.1	2.265
Band Room High	8	4' 2L Fixture	8	Lamp & Low Watt Ballast	Retrofit Recommended	75.6	1,793	1,084.4	0.6048	51	1,793	731.5	0.408
Practice Rooms	5	4' 4L Fixture	5	Lamp & Low Watt Ballast	Retrofit Recommended	151.2	1,793	1,355.5	0.756	100	1,793	896.5	0.5
Storage	2	4' 4L Fixture	2	Lamp & Low Watt Ballast	Retrofit Recommended	151.2	1,793	542.2	0.3024	100	1,793	358.6	0.2
Office	4	4' 4L Fixture	4	Lamp & Low Watt Ballast	Retrofit Recommended	151.2	1,793	1,084.4	0.6048	100	1,793	717.2	0.4
Inst Rep.	4	4' 2L Fixture	4	Lamp & Low Watt Ballast	Retrofit Recommended	75.6	1,793	542.2	0.3024	51	1,793	365.8	0.204
Inst Rep.	1	4' 2L Fixture	1	Lamp & Low Watt Ballast	Retrofit Recommended	75.6	1,793	135.6	0.0756	51	1,793	91.4	0.051

Existing 884 Proposed 873

ENERGY CALCULATIONS			206,277	115	137,170	77
Description	kW-Demand	kWh				
Existing Use	115.05	206,277				
Proposed Use	76.50	137,170				
Difference - Savings	38.54	69,107				
Electrical Utility Cost	\$5.75	\$0.15435				
Savings per Year	\$2,659.44	\$10,666.82				Total Yearly Energy Savings \$13,326.26

Makawao School Campus Map SY1999-2000

Boy's Lav.
 Girl's Lav.
 11 Shishido 5
 H Baker
 1
 12 Kalaokamalle Computer
 13 DAVIS 5
 14 Nagata 5
 15 Suchiro SPED
 F Health Room
 G
 V.P. E
 McCarthy
 D
 OFFICE
 Alfonsi Bangasan
PRINCIPAL
 Anderson

0	9	8	7	6	5	4	3
Tavares 4		Boelter 4	Matsumoto 3	Wilhelm 3	Dalyon 3	Ono 3	Suzuki

2C Makua	2B Kinoshita	2A K. Smith	1B Rivers	1A Harper 2	P13 Kiteuki 2
----------	--------------	-------------	-----------	----------------	------------------

P6 Gibeon-Kekiwi 4	P5 Ball 4	P4 L. Shaw Sp. Ed.	P10 Germaine	P12 Ludwig 1
-----------------------	--------------	--------------------	--------------	-----------------

P7 Hashiro 2	P8 Kawal 2	P9 Palmer 1	P11 Kubota 1	P14 Conlan 1
-----------------	---------------	----------------	-----------------	-----------------

Frerking

B101 Dean K	B103 Fujimoto K	COUNSELORS	Girl's Lav.
B102 Kim K	B104 Kajihara K		Boy's Lav.

16A Arakaki
17A Tanaka

16C	16A	16B	Girl's Lav.	17A SPEECH	17 Broad-cast Room 17B Good Beginings	18 T. Shaw 5	LIBRARY Costales	19 Livingaton K-1
-----	-----	-----	-------------	------------	--	-----------------	------------------	----------------------

CAFETERIA
O
Connally

LOUNGE
Custodian
Fernandez

Maui Smart Schools Program
Foot Candle Readings

School: Makawao Elementary School

Room: Bldg. B- B-101
Ceiling height: 10'
Light fixture height: 8'
Fixture type: WRAP

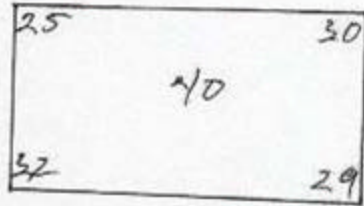

Room: # 8
Ceiling height: 9'
Light fixture height: 8'
Fixture type: WRAP

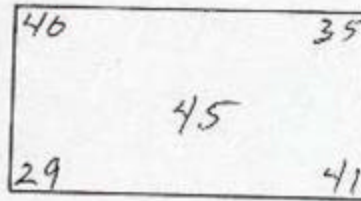

Room: Portable P-4
Ceiling height: 9'
Light fixture height: 8'
Fixture type: TROFFER

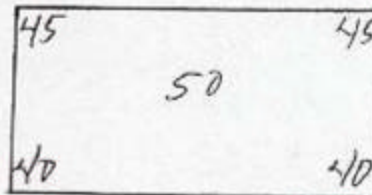



SCHOOL INFORMATION			DATE
NAME Makawao Elementary School		2/2/2001	
STREET ADDRESS 3542 Baldwin Avenue Makawao, HI 96768		OPERATIONAL HOURS 1,467	
POINT OF CONTACT Bruce Anderson	PHONE 573-8770	FAX	VOLTAGE 120V
AUDITOR Maui Community College Auditors			

LOCATION (Rm Name, Rm. #, Area, Zone, etc.)	EXISTING EQUIPMENT					PROPOSED			REBATES		COSTS		COMMENTS Surveyors Comments	
	Floor	Quantity	Lamp Type	Lamps Per Fixture	Type of Fixture	Ballast Type	Lamps Per Fixture	Reflectors	Ballast Type	Per Single	Extended	Per Single		Extended
BUILDING G														
Office		7	4' T12	4	Troffer	Magnetic	4	N	Electronic	\$ 11.20	\$ 78.40	\$ 70.00	\$ 490.00	Excellent opportunity for retro-fit
		4	4' T12	2	Troffer	Magnetic	2	N	Electronic	\$ 5.60	\$ 22.40	\$ 60.00	\$ 240.00	Excellent opportunity for retro-fit
Office		4	4' T12	4	Troffer	Magnetic	4	N	Electronic	\$ 11.20	\$ 44.80	\$ 70.00	\$ 280.00	Excellent opportunity for retro-fit
15		6	4' T12	4	Troffer	Magnetic	4	N	Electronic	\$ 11.20	\$ 67.20	\$ 70.00	\$ 420.00	Excellent opportunity for retro-fit
14		6	4' T12	4	Troffer	Magnetic	4	N	Electronic	\$ 11.20	\$ 67.20	\$ 70.00	\$ 420.00	Excellent opportunity for retro-fit
13		6	4' T12	4	Troffer	Magnetic	4	N	Electronic	\$ 11.20	\$ 67.20	\$ 70.00	\$ 420.00	Excellent opportunity for retro-fit
12		6	4' T12	4	Troffer	Magnetic	4	N	Electronic	\$ 11.20	\$ 67.20	\$ 70.00	\$ 420.00	Excellent opportunity for retro-fit
Mrs. Kehanu		2	4' T12	4	Troffer	Magnetic	4	N	Electronic	\$ 11.20	\$ 22.40	\$ 70.00	\$ 140.00	Excellent opportunity for retro-fit
Mr. Baker		2	4' T12	4	Troffer	Magnetic	4	N	Electronic	\$ 11.20	\$ 22.40	\$ 70.00	\$ 140.00	Excellent opportunity for retro-fit
Mr. Shishide		6	4' T12	4	Troffer	Magnetic	4	N	Electronic	\$ 11.20	\$ 67.20	\$ 70.00	\$ 420.00	Excellent opportunity for retro-fit
Girls' Restroom		4	4' T12	4	Troffer	Magnetic	4	N	Electronic	\$ 11.20	\$ 44.80	\$ 70.00	\$ 280.00	Excellent opportunity for retro-fit
Boys' Restroom		4	4' T12	4	Troffer	Magnetic	4	N	Electronic	\$ 11.20	\$ 44.80	\$ 70.00	\$ 280.00	Excellent opportunity for retro-fit
PORTABLES														
P 6		16	4' T12	4	Troffer	Magnetic	4	N	Electronic	\$ 11.20	\$ 179.20	\$ 70.00	\$ 1,120.00	Excellent opportunity for retro-fit
P 5		16	4' T12	4	Troffer	Magnetic	4	N	Electronic	\$ 11.20	\$ 179.20	\$ 70.00	\$ 1,120.00	Excellent opportunity for retro-fit
P 4		20	4' T12	2	Troffer	Magnetic	2	N	Electronic	\$ 5.60	\$ 112.00	\$ 60.00	\$ 1,200.00	Excellent opportunity for retro-fit
P 10		20	4' T12	4	Troffer	Magnetic	4	N	Electronic	\$ 11.20	\$ 224.00	\$ 70.00	\$ 1,400.00	Excellent opportunity for retro-fit
P 12		20	4' T12	2	Troffer	Magnetic	2	N	Electronic	\$ 5.60	\$ 112.00	\$ 60.00	\$ 1,200.00	Excellent opportunity for retro-fit
P 14		12	4' T12	4	Troffer	Magnetic	4	N	Electronic	\$ 11.20	\$ 134.40	\$ 70.00	\$ 840.00	Excellent opportunity for retro-fit
P 11		12	4' T12	4	Troffer	Magnetic	4	N	Electronic	\$ 11.20	\$ 134.40	\$ 70.00	\$ 840.00	Excellent opportunity for retro-fit
P 9		16	4' T12	4	Troffer	Magnetic	4	N	Electronic	\$ 11.20	\$ 179.20	\$ 70.00	\$ 1,120.00	Excellent opportunity for retro-fit
P 8		16	4' T12	4	Troffer	Magnetic	4	N	Electronic	\$ 11.20	\$ 179.20	\$ 70.00	\$ 1,120.00	Excellent opportunity for retro-fit
P 7		16	4' T12	4	Troffer	Magnetic	4	N	Electronic	\$ 11.20	\$ 179.20	\$ 70.00	\$ 1,120.00	Excellent opportunity for retro-fit
BUILDING B														
B 102		24	4' T12	2	Wrap	Magnetic	2	N	Electronic	\$ 5.60	\$ 134.40	\$ 60.00	\$ 1,440.00	Excellent opportunity for retro-fit
B 101		24	4' T12	2	Wrap	Magnetic	2	N	Electronic	\$ 5.60	\$ 134.40	\$ 60.00	\$ 1,440.00	Excellent opportunity for retro-fit
B 103		24	4' T12	2	Wrap	Magnetic	2	N	Electronic	\$ 5.60	\$ 134.40	\$ 60.00	\$ 1,440.00	Excellent opportunity for retro-fit
Counselor		4	4' T12	2	Wrap	Magnetic	2	N	Electronic	\$ 5.60	\$ 22.40	\$ 60.00	\$ 240.00	Excellent opportunity for retro-fit
Counselor		4	4' T12	2	Wrap	Magnetic	2	N	Electronic	\$ 5.60	\$ 22.40	\$ 60.00	\$ 240.00	Excellent opportunity for retro-fit
B 104		24	4' T12	2	Wrap	Magnetic	2	N	Electronic	\$ 5.60	\$ 134.40	\$ 60.00	\$ 1,440.00	Excellent opportunity for retro-fit
BUILDING N														
		8	4' T12	4	Ice	Magnetic	4	N	Electronic	\$ 11.20	\$ 89.60	\$ 70.00	\$ 560.00	Replace fixture and mount hardware

LOCATION (Rm Name, Rm. #, Area, Zone, etc.)	EXISTING EQUIPMENT						PROPOSED			REBATES		COSTS		COMMENTS Surveyors Comments
	Floor	Quantity	Lamp Type	Lamps Per Fixture	Type of Fixture	Ballast Type	Lamps Per Fixture	Reflectors	Ballast Type	Per Single	Extended	Per Single	Extended	
		6	4' T12	4	Ice	Magnetic	4	N	Electronic	\$ 11.20	\$ 67.20	\$ 70.00	\$ 420.00	Replace fixture and mount hardware
10		16	4' T12	4	Wrap	Magnetic	4	N	Electronic	\$ 11.20	\$ 179.20	\$ 70.00	\$ 1,120.00	Excellent opportunity for retro-fit
9		16	4' T12	4	Wrap	Magnetic	4	N	Electronic	\$ 11.20	\$ 179.20	\$ 70.00	\$ 1,120.00	Excellent opportunity for retro-fit
8		16	4' T12	4	Wrap	Magnetic	4	N	Electronic	\$ 11.20	\$ 179.20	\$ 70.00	\$ 1,120.00	Excellent opportunity for retro-fit
7		16	4' T12	4	Wrap	Magnetic	4	N	Electronic	\$ 11.20	\$ 179.20	\$ 70.00	\$ 1,120.00	Excellent opportunity for retro-fit
6		16	4' T12	4	Wrap	Magnetic	4	N	Electronic	\$ 11.20	\$ 179.20	\$ 70.00	\$ 1,120.00	Excellent opportunity for retro-fit
5		16	4' T12	4	Wrap	Magnetic	4	N	Electronic	\$ 11.20	\$ 179.20	\$ 70.00	\$ 1,120.00	Excellent opportunity for retro-fit
4		16	4' T12	4	Wrap	Magnetic	4	N	Electronic	\$ 11.20	\$ 179.20	\$ 70.00	\$ 1,120.00	Excellent opportunity for retro-fit
3		16	4' T12	4	Wrap	Magnetic	4	N	Electronic	\$ 11.20	\$ 179.20	\$ 70.00	\$ 1,120.00	Excellent opportunity for retro-fit
1		1	4' T12	4	Ice	Magnetic	4	N	Electronic	\$ 11.20	\$ 11.20	\$ 70.00	\$ 70.00	Replace fixture and mount hardware
2B		14	4' T12	4	Wrap	Magnetic	4	N	Electronic	\$ 11.20	\$ 156.80	\$ 70.00	\$ 980.00	Excellent opportunity for retro-fit
2A		14	4' T12	4	Wrap	Magnetic	4	N	Electronic	\$ 11.20	\$ 156.80	\$ 70.00	\$ 980.00	Excellent opportunity for retro-fit
1B		14	4' T12	4	Wrap	Magnetic	4	N	Electronic	\$ 11.20	\$ 156.80	\$ 70.00	\$ 980.00	Excellent opportunity for retro-fit
1A		16	4' T12	4	Wrap	Magnetic	4	N	Electronic	\$ 11.20	\$ 179.20	\$ 70.00	\$ 1,120.00	Excellent opportunity for retro-fit
P 13		12	4' T12	4	Wrap	Magnetic	4	N	Electronic	\$ 11.20	\$ 134.40	\$ 70.00	\$ 840.00	Excellent opportunity for retro-fit
CAFETERIA														
Dining Room		14	4' T12	4	Ice	Magnetic	4	N	Electronic	\$ 11.20	\$ 156.80	\$ 70.00	\$ 980.00	Replace fixture and mount hardware
Kitchen		10	4' T12	4	Troffer	Magnetic	4	N	Electronic	\$ 11.20	\$ 112.00	\$ 70.00	\$ 700.00	No comment
Room		1	4' T12	4	Troffer	Magnetic	4	N	Electronic	\$ 11.20	\$ 11.20	\$ 70.00	\$ 70.00	No comment
Total Rebates										\$	5,476.80			
Total Costs										\$	37,930.00			

LOCATION	QTY	EXISTING TYPE	QTY	RETROFIT	SURVEYORS COMMENTS	Existing				Actual				Proposed			
						Watt/unit	Op. Hours	kWh	kW-D	Watt/unit	Op. Hours	kWh	kW-D	Watt/unit	Op. Hours	kWh	kW-D
BUILDING G	0		0		0		1,467	0.0	0		1,467	0.0	0		1,467	0.0	0
<i>Office</i>	7	4' 4L Fixture	7	Lamp & Low Watt Ballast	Excellent opportunity for retro-fit	151.2	1,467	1,552.7	1.0584	100	1,467	1,026.9	0.7		1,467	299.3	0.204
	4	4' 2L Fixture	4	Lamp & Low Watt Ballast	Excellent opportunity for retro-fit	75.6	1,467	443.6	0.3024	51	1,467	299.3	0.204		1,467	586.8	0.4
<i>Office</i>	4	4' 4L Fixture	4	Lamp & Low Watt Ballast	Excellent opportunity for retro-fit	151.2	1,467	887.2	0.6048	100	1,467	586.8	0.4		1,467	880.2	0.6
<i>15</i>	6	4' 4L Fixture	6	Lamp & Low Watt Ballast	Excellent opportunity for retro-fit	151.2	1,467	1,330.9	0.9072	100	1,467	880.2	0.6		1,467	880.2	0.6
<i>14</i>	6	4' 4L Fixture	6	Lamp & Low Watt Ballast	Excellent opportunity for retro-fit	151.2	1,467	1,330.9	0.9072	100	1,467	880.2	0.6		1,467	880.2	0.6
<i>13</i>	6	4' 4L Fixture	6	Lamp & Low Watt Ballast	Excellent opportunity for retro-fit	151.2	1,467	1,330.9	0.9072	100	1,467	880.2	0.6		1,467	880.2	0.6
<i>12</i>	6	4' 4L Fixture	6	Lamp & Low Watt Ballast	Excellent opportunity for retro-fit	151.2	1,467	1,330.9	0.9072	100	1,467	880.2	0.6		1,467	293.4	0.2
<i>Mrs. Kehanu</i>	2	4' 4L Fixture	2	Lamp & Low Watt Ballast	Excellent opportunity for retro-fit	151.2	1,467	443.6	0.3024	100	1,467	293.4	0.2		1,467	293.4	0.2
<i>Mr. Baker</i>	2	4' 4L Fixture	2	Lamp & Low Watt Ballast	Excellent opportunity for retro-fit	151.2	1,467	443.6	0.3024	100	1,467	293.4	0.2		1,467	880.2	0.6
<i>Mr. Shishide</i>	6	4' 4L Fixture	6	Lamp & Low Watt Ballast	Excellent opportunity for retro-fit	151.2	1,467	1,330.9	0.9072	100	1,467	880.2	0.6		1,467	880.2	0.4
<i>Girls' Restroom</i>	4	4' 4L Fixture	4	Lamp & Low Watt Ballast	Excellent opportunity for retro-fit	151.2	1,467	887.2	0.6048	100	1,467	586.8	0.4		1,467	586.8	0.4
<i>Boys' Restroom</i>	4	4' 4L Fixture	4	Lamp & Low Watt Ballast	Excellent opportunity for retro-fit	151.2	1,467	887.2	0.6048	100	1,467	586.8	0.4		1,467	0.0	0
PORTABLES	0		0		0		1,467	0.0	0		1,467	0.0	0		1,467	2,347.2	1.6
<i>P 6</i>	16	4' 4L Fixture	16	Lamp & Low Watt Ballast	Excellent opportunity for retro-fit	151.2	1,467	3,549.0	2.4192	100	1,467	2,347.2	1.6		1,467	2,347.2	1.6
<i>P 5</i>	16	4' 4L Fixture	16	Lamp & Low Watt Ballast	Excellent opportunity for retro-fit	151.2	1,467	3,549.0	2.4192	100	1,467	2,347.2	1.6		1,467	1,496.3	1.02
<i>P 4</i>	20	4' 2L Fixture	20	Lamp & Low Watt Ballast	Excellent opportunity for retro-fit	75.6	1,467	2,218.1	1.512	51	1,467	1,496.3	1.02		1,467	2,934.0	2
<i>P 10</i>	20	4' 4L Fixture	20	Lamp & Low Watt Ballast	Excellent opportunity for retro-fit	151.2	1,467	4,436.2	3.024	100	1,467	2,934.0	2		1,467	1,496.3	1.02
<i>P 12</i>	20	4' 2L Fixture	20	Lamp & Low Watt Ballast	Excellent opportunity for retro-fit	75.6	1,467	2,218.1	1.512	51	1,467	1,496.3	1.02		1,467	1,760.4	1.2
<i>P 14</i>	12	4' 4L Fixture	12	Lamp & Low Watt Ballast	Excellent opportunity for retro-fit	151.2	1,467	2,661.7	1.8144	100	1,467	1,760.4	1.2		1,467	1,760.4	1.2
<i>P 11</i>	12	4' 4L Fixture	12	Lamp & Low Watt Ballast	Excellent opportunity for retro-fit	151.2	1,467	2,661.7	1.8144	100	1,467	1,760.4	1.2		1,467	2,347.2	1.6
<i>P 9</i>	16	4' 4L Fixture	16	Lamp & Low Watt Ballast	Excellent opportunity for retro-fit	151.2	1,467	3,549.0	2.4192	100	1,467	2,347.2	1.6		1,467	2,347.2	1.6
<i>P 8</i>	16	4' 4L Fixture	16	Lamp & Low Watt Ballast	Excellent opportunity for retro-fit	151.2	1,467	3,549.0	2.4192	100	1,467	2,347.2	1.6		1,467	2,347.2	1.6
<i>P 7</i>	16	4' 4L Fixture	16	Lamp & Low Watt Ballast	Excellent opportunity for retro-fit	151.2	1,467	3,549.0	2.4192	100	1,467	2,347.2	1.6		1,467	0.0	0
BUILDING B	0		0		0		1,467	0.0	0		1,467	0.0	0		1,467	1,795.6	1.224
<i>B 102</i>	24	4' 2L Fixture	24	Lamp & Low Watt Ballast	Excellent opportunity for retro-fit	75.6	1,467	2,661.7	1.8144	51	1,467	1,795.6	1.224		1,467	1,795.6	1.224
<i>B 101</i>	24	4' 2L Fixture	24	Lamp & Low Watt Ballast	Excellent opportunity for retro-fit	75.6	1,467	2,661.7	1.8144	51	1,467	1,795.6	1.224		1,467	299.3	0.204
<i>B 103</i>	24	4' 2L Fixture	24	Lamp & Low Watt Ballast	Excellent opportunity for retro-fit	75.6	1,467	2,661.7	1.8144	51	1,467	1,795.6	1.224		1,467	299.3	0.204
<i>Counselor</i>	4	4' 2L Fixture	4	Lamp & Low Watt Ballast	Excellent opportunity for retro-fit	75.6	1,467	443.6	0.3024	51	1,467	299.3	0.204		1,467	299.3	0.204
<i>Counselor</i>	4	4' 2L Fixture	4	Lamp & Low Watt Ballast	Excellent opportunity for retro-fit	75.6	1,467	443.6	0.3024	51	1,467	299.3	0.204		1,467	1,795.6	1.224
<i>B 104</i>	24	4' 2L Fixture	24	Lamp & Low Watt Ballast	Excellent opportunity for retro-fit	75.6	1,467	2,661.7	1.8144	51	1,467	1,795.6	1.224		1,467	0.0	0
BUILDING N	0		0		0		1,467	0.0	0		1,467	0.0	0		1,467	1,173.6	0.8
	8	4' 4L Fixture	8	Lamp & Low Watt Ballast	Replace fixture and mount hardware	151.2	1,467	1,774.5	1.2096	100	1,467	1,173.6	0.8		1,467	880.2	0.6
	6	4' 4L Fixture	6	Lamp & Low Watt Ballast	Replace fixture and mount hardware	151.2	1,467	1,330.9	0.9072	100	1,467	880.2	0.6		1,467	2,347.2	1.6
<i>10</i>	16	4' 4L Fixture	16	Lamp & Low Watt Ballast	Excellent opportunity for retro-fit	151.2	1,467	3,549.0	2.4192	100	1,467	2,347.2	1.6		1,467	2,347.2	1.6
<i>9</i>	16	4' 4L Fixture	16	Lamp & Low Watt Ballast	Excellent opportunity for retro-fit	151.2	1,467	3,549.0	2.4192	100	1,467	2,347.2	1.6		1,467	2,347.2	1.6
<i>8</i>	16	4' 4L Fixture	16	Lamp & Low Watt Ballast	Excellent opportunity for retro-fit	151.2	1,467	3,549.0	2.4192	100	1,467	2,347.2	1.6		1,467	2,347.2	1.6
<i>7</i>	16	4' 4L Fixture	16	Lamp & Low Watt Ballast	Excellent opportunity for retro-fit	151.2	1,467	3,549.0	2.4192	100	1,467	2,347.2	1.6		1,467	2,347.2	1.6
<i>6</i>	16	4' 4L Fixture	16	Lamp & Low Watt Ballast	Excellent opportunity for retro-fit	151.2	1,467	3,549.0	2.4192	100	1,467	2,347.2	1.6		1,467	2,347.2	1.6
<i>5</i>	16	4' 4L Fixture	16	Lamp & Low Watt Ballast	Excellent opportunity for retro-fit	151.2	1,467	3,549.0	2.4192	100	1,467	2,347.2	1.6		1,467	2,347.2	1.6
<i>4</i>	16	4' 4L Fixture	16	Lamp & Low Watt Ballast	Excellent opportunity for retro-fit	151.2	1,467	3,549.0	2.4192	100	1,467	2,347.2	1.6		1,467	2,347.2	1.6
<i>3</i>	16	4' 4L Fixture	16	Lamp & Low Watt Ballast	Excellent opportunity for retro-fit	151.2	1,467	3,549.0	2.4192	100	1,467	2,347.2	1.6		1,467	2,347.2	1.6
<i>1</i>	1	4' 4L Fixture	1	Lamp & Low Watt Ballast	Replace fixture and mount hardware	151.2	1,467	221.8	0.1512	100	1,467	146.7	0.1		1,467	3,105.3	2.1168
<i>2B</i>	14	4' 4L Fixture	14	Lamp & Low Watt Ballast	Excellent opportunity for retro-fit	151.2	1,467	3,105.3	2.1168	100	1,467	2,053.8	1.4		1,467	3,105.3	2.1168
<i>2A</i>	14	4' 4L Fixture	14	Lamp & Low Watt Ballast	Excellent opportunity for retro-fit	151.2	1,467	3,105.3	2.1168	100	1,467	2,053.8	1.4		1,467	2,053.8	1.4
<i>1B</i>	14	4' 4L Fixture	14	Lamp & Low Watt Ballast	Excellent opportunity for retro-fit	151.2	1,467	3,105.3	2.1168	100	1,467	2,053.8	1.4		1,467	2,347.2	1.6
<i>1A</i>	16	4' 4L Fixture	16	Lamp & Low Watt Ballast	Excellent opportunity for retro-fit	151.2	1,467	3,549.0	2.4192	100	1,467	2,347.2	1.6		1,467	1,760.4	1.2
<i>P 13</i>	12	4' 4L Fixture	12	Lamp & Low Watt Ballast	Excellent opportunity for retro-fit	151.2	1,467	2,661.7	1.8144	100	1,467	1,760.4	1.2		1,467	0.0	0
CAFETERIA	0		0		0		1,467	0.0	0		1,467	0.0	0		1,467	2,053.8	1.4
<i>Dining Room</i>	14	4' 4L Fixture	14	Lamp & Low Watt Ballast	Replace fixture and mount hardware	151.2	1,467	3,105.3	2.1168	100	1,467	2,053.8	1.4		1,467	1,467.0	1
<i>Kitchen</i>	10	4' 4L Fixture	10	Lamp & Low Watt Ballast	No comment	151.2	1,467	2,218.1	1.512	100	1,467	1,467.0	1		1,467	146.7	0.1
<i>Room</i>	1	4' 4L Fixture	1	Lamp & Low Watt Ballast	No comment	151.2	1,467	221.8	0.1512	100	1,467	146.7	0.1		1,467		

Existing 563 Proposed 563

ENERGY CALCULATIONS			108,465	74	71,953	49
Description	kW-Demand	kWh				
Existing Use	73.94	108,465				
Proposed Use	49.05	71,953				
Difference - Savings	24.89	36,512				
Electrical Utility Cost	\$5.75	\$0.15291				
Savings per Year	\$1,717.33	\$5,582.98				Total Yearly Energy Savings \$7,300.30

Maui Community School for Adults (Kahului Annex)

179 Kaahumanu Avenue, Kahului, HI 96732

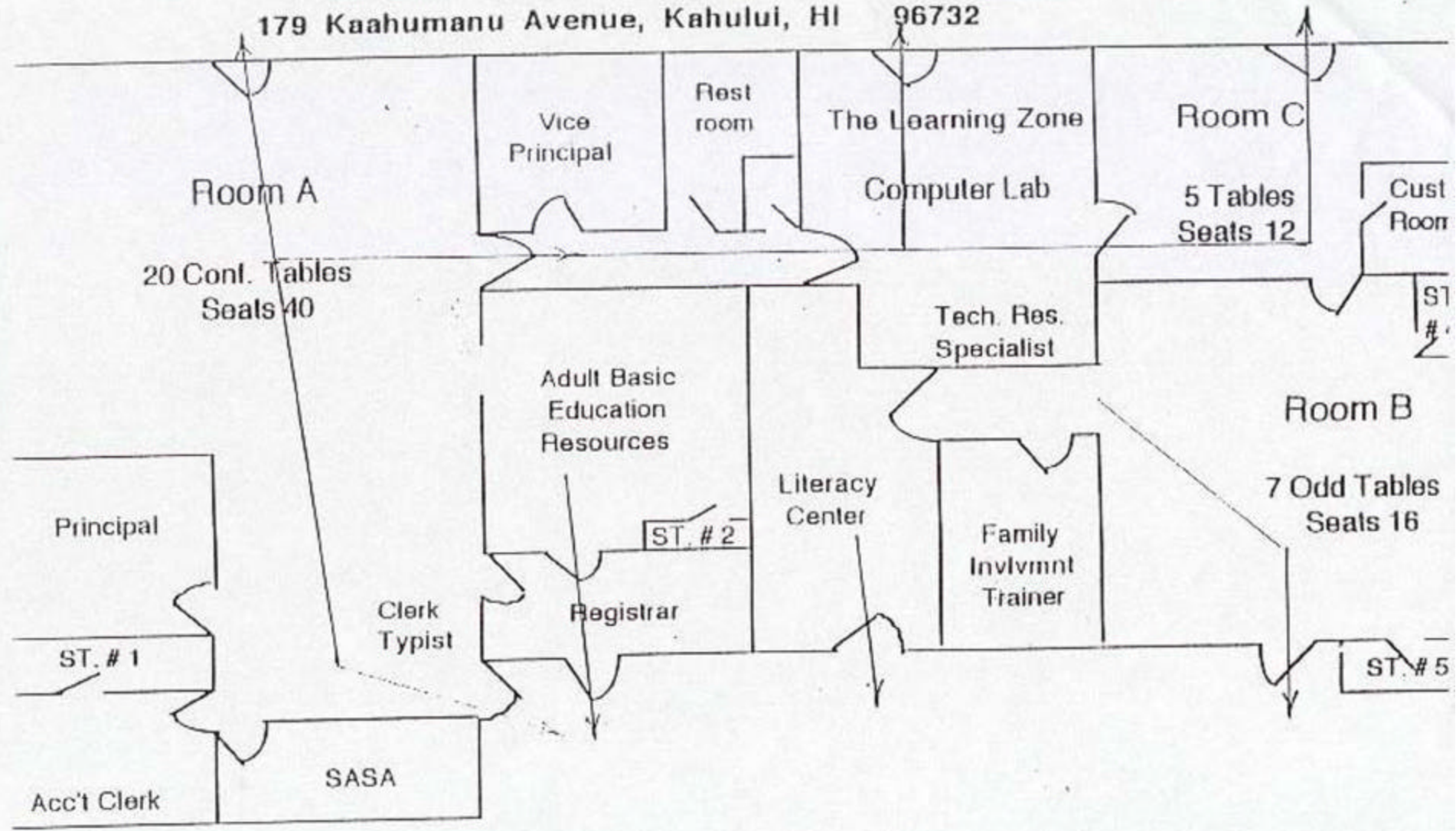

MauI Smart Schools Program
Foot Candle Readings

School: MauI School for Adults

Room: A
Ceiling height: 12'
Light fixture height: 10'
Fixture type: WRAP

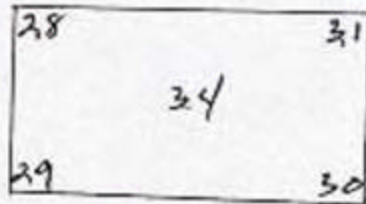

Room: ANNEX C
Ceiling height: 12'
Light fixture height: 10'
Fixture type: WRAP

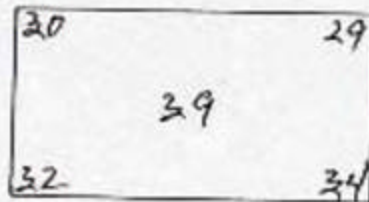

Room: Tutoring Room
Ceiling height: 12'
Light fixture height: 10'
Fixture type: WRAP

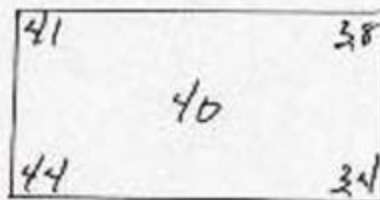



SCHOOL INFORMATION	
NAME Maui Community School for Adults	DATE 3/30/2001
STREET ADDRESS 179 Kaahumanu Ave. Kahului, HI 96732	
POINT OF CONTACT Gwen Ueoka	OPERATIONAL HOURS 2,632
PHONE 873-3082	VOLTAGE 120 Volts
FAX	
AUDITOR Maui Community College Auditors	

LOCATION Location (Rm Name, Rm. #, Area, Zone, etc.)	EXISTING EQUIPMENT						PROPOSED			REBATES		COSTS		COMMENTS Surveyors Comments
	Floor	Quantity	Lamp Type	Lamps Per Fixture	Type of Fixture	Ballast Type	Lamps Per Fixture	Reflectors	Ballast Type	Per Single	Extended	Per Single	Extended	
Business	1	14	4T12	4	Wrap	Magnetic	4	N	Electronic	\$ 11.20	\$ 156.80	\$ 70.00	\$ 980.00	excellent opportunity for retro-fit
Principal	1	3	4T12	4	Wrap	Magnetic	4	N	Electronic	\$ 11.20	\$ 33.60	\$ 70.00	\$ 210.00	excellent opportunity for retro-fit
Business	1	3	4T12	4	Wrap	Magnetic	4	N	Electronic	\$ 11.20	\$ 33.60	\$ 70.00	\$ 210.00	excellent opportunity for retro-fit
Registrar	1	2	4T12	4	Wrap	Magnetic	4	N	Electronic	\$ 11.20	\$ 22.40	\$ 70.00	\$ 140.00	excellent opportunity for retro-fit
Middle Office	1	3	4T12	4	Wrap	Magnetic	4	N	Electronic	\$ 11.20	\$ 33.60	\$ 70.00	\$ 210.00	excellent opportunity for retro-fit
Hallway	1	2	4T12	4	Wrap	Magnetic	4	N	Electronic	\$ 11.20	\$ 22.40	\$ 70.00	\$ 140.00	excellent opportunity for retro-fit
Vice Principle	1	2	4T12	4	Wrap	Magnetic	4	N	Electronic	\$ 11.20	\$ 22.40	\$ 70.00	\$ 140.00	excellent opportunity for retro-fit
Men's Restroom	1	2	4T12	4	Wrap	Magnetic	4	N	Electronic	\$ 11.20	\$ 22.40	\$ 70.00	\$ 140.00	excellent opportunity for retro-fit
Women's Restroom	1	1	4T12	4	Wrap	Magnetic	4	N	Electronic	\$ 11.20	\$ 11.20	\$ 70.00	\$ 70.00	excellent opportunity for retro-fit
Computer Lab	1	6	4T12	4	Wrap	Magnetic	4	N	Electronic	\$ 11.20	\$ 67.20	\$ 70.00	\$ 420.00	excellent opportunity for retro-fit
Annex C	1	7	4T12	4	Wrap	Magnetic	4	N	Electronic	\$ 11.20	\$ 78.40	\$ 70.00	\$ 490.00	excellent opportunity for retro-fit
Annex B	1	11	4T12	4	Wrap	Magnetic	4	N	Electronic	\$ 11.20	\$ 123.20	\$ 70.00	\$ 770.00	excellent opportunity for retro-fit
Annex B	1	2	4T12	4	Ice	Magnetic	4	N	Electronic	\$ 11.20	\$ 22.40	\$ 70.00	\$ 140.00	Replace fixture and mount hardware
Tutoring Room	1	2	4T12	4	Wrap	Magnetic	4	N	Electronic	\$ 11.20	\$ 22.40	\$ 70.00	\$ 140.00	excellent opportunity for retro-fit
Literacy Room	1	3	4T12	4	Wrap	Magnetic	4	N	Electronic	\$ 11.20	\$ 33.60	\$ 70.00	\$ 210.00	excellent opportunity for retro-fit
Total Rebates										\$	705.60			
Total Costs										\$	4,410.00			

Maui Community School for Adults

LOCATION	QTY	EXISTING TYPE	QTY	RETROFIT	SURVEYORS COMMENTS	Existing	Actual				Proposed			
						Watt/unit	Op. Hours	kWh	kW-D	Watt/unit	Op. Hours	kWh	kW-D	
<i>Business</i>	14	4' 4L Fixture	14	Lamp & Low Watt Ballast	excellent opportunity for retro-fit	151.2	2,632	5,571.4	2.1168	100	2,632	3,684.8	1.4	
<i>Principal</i>	3	4' 4L Fixture	3	Lamp & Low Watt Ballast	excellent opportunity for retro-fit	151.2	2,632	1,193.9	0.4536	100	2,632	789.6	0.3	
<i>Business</i>	3	4' 4L Fixture	3	Lamp & Low Watt Ballast	excellent opportunity for retro-fit	151.2	2,632	1,193.9	0.4536	100	2,632	789.6	0.3	
<i>Registrar</i>	2	4' 4L Fixture	2	Lamp & Low Watt Ballast	excellent opportunity for retro-fit	151.2	2,632	795.9	0.3024	100	2,632	526.4	0.2	
<i>Middle Office</i>	3	4' 4L Fixture	3	Lamp & Low Watt Ballast	excellent opportunity for retro-fit	151.2	2,632	1,193.9	0.4536	100	2,632	789.6	0.3	
<i>Hallway</i>	2	4' 4L Fixture	2	Lamp & Low Watt Ballast	excellent opportunity for retro-fit	151.2	2,632	795.9	0.3024	100	2,632	526.4	0.2	
<i>Vice Principle</i>	2	4' 4L Fixture	2	Lamp & Low Watt Ballast	excellent opportunity for retro-fit	151.2	2,632	795.9	0.3024	100	2,632	526.4	0.2	
<i>Men's Restroom</i>	2	4' 4L Fixture	2	Lamp & Low Watt Ballast	excellent opportunity for retro-fit	151.2	2,632	795.9	0.3024	100	2,632	526.4	0.2	
<i>Women's Restroom</i>	1	4' 4L Fixture	1	Lamp & Low Watt Ballast	excellent opportunity for retro-fit	151.2	2,632	398.0	0.1512	100	2,632	263.2	0.1	
<i>Computer Lab</i>	6	4' 4L Fixture	6	Lamp & Low Watt Ballast	excellent opportunity for retro-fit	151.2	2,632	2,387.8	0.9072	100	2,632	1,579.2	0.6	
<i>Annex C</i>	7	4' 4L Fixture	7	Lamp & Low Watt Ballast	excellent opportunity for retro-fit	151.2	2,632	2,785.7	1.0584	100	2,632	1,842.4	0.7	
<i>Annex B</i>	11	4' 4L Fixture	11	Lamp & Low Watt Ballast	excellent opportunity for retro-fit	151.2	2,632	4,377.5	1.6632	100	2,632	2,895.2	1.1	
<i>Annex B</i>	2	4' 4L Fixture	2	Lamp & Low Watt Ballast	Replace fixture and mount hardware	151.2	2,632	795.9	0.3024	100	2,632	526.4	0.2	
<i>Tutoring Room</i>	2	4' 4L Fixture	2	Lamp & Low Watt Ballast	excellent opportunity for retro-fit	151.2	2,632	795.9	0.3024	100	2,632	526.4	0.2	
<i>Literacy Room</i>	3	4' 4L Fixture	3	Lamp & Low Watt Ballast	excellent opportunity for retro-fit	151.2	2,632	1,193.9	0.4536	100	2,632	789.6	0.3	

Existing 63 Proposed 63

ENERGY CALCULATIONS

		25,071	9.53		16,582	6.30
Description	kW-Demand	kWh				
Existing Use	9.53	25,071				
Proposed Use	6.30	16,582				
Difference - Savings	3.23	8,490		Total Yearly		
Electrical Utility Cost	\$5.75	\$0.15444		Energy Savings		
Savings per Year	\$222.57	\$1,311.17		\$1,533.74		

Maui Smart Schools Program
Foot Candle Readings

School: Maui High School

Room: <u>Bldg C-101</u>	39	47
Ceiling Height: <u>10 Feet</u>	46	
Light Fixture Height: <u>9 Feet</u>		
Fixture Type: <u>Wrap</u>	41	42

Room: <u>Bldg A-112</u>	41	47
Ceiling Height: <u>14 Feet</u>	41	
Light Fixture Height: <u>10 Feet</u>		
Fixture Type: <u>Ice Tray</u>	47	45

Room: <u>Bldg A-101</u>	34	31
Ceiling Height: <u>10 Feet</u>	37	
Light Fixture Height: <u>8 Feet</u>		
Fixture Type: <u>Troffer</u>	38	40



CUSTOMER INFORMATION										
NAME Maui High School										DATE 8/23/2000
STREET ADDRESS 660 South Lono Avenue Kahului, HI 96732										OPERATIONAL HOURS 1,549
POINT OF CONTACT					PHONE 877-7311			FAX		VOLTAGE 120V
AUDITOR										

LOCATION <small>(Rm Name, Rm. #, Area, Zone, etc.)</small>	EXISTING EQUIPMENT						PROPOSED			REBATES		COSTS		COMMENTS
	Floor	Quantity	Lamp Type	Lamps Per Fixture	Type of Fixture	Ballast Type	Lamps Per Fixture	Reflectors	Ballast Type	Per Single	Extended	Per Single	Extended	
P11	N/A	12	4' T12	4	Wrap	Magnetic	4	N	Electronic	\$ 11.20	\$ 134.40	\$ 70.00	\$ 840.00	Retrofit Recommended
P10	N/A	12	4' T12	4	Wrap	Magnetic	4	N	Electronic	\$ 11.20	\$ 134.40	\$ 70.00	\$ 840.00	Retrofit Recommended
P9	N/A	20	4' T12	2	Wrap	Magnetic	2	N	Electronic	\$ 5.60	\$ 112.00	\$ 60.00	\$ 1,200.00	Retrofit Recommended
P8 1/2A	N/A	6	4' T12	4	Para	Magnetic	4	N	Electronic	\$ 11.20	\$ 67.20	\$ 70.00	\$ 420.00	Retrofit Recommended
P8 1/2B	N/A	6	4' T12	4	Para	Magnetic	4	N	Electronic	\$ 11.20	\$ 67.20	\$ 70.00	\$ 420.00	Retrofit Recommended
P7	N/A	16	4' T12	4	Wrap	Magnetic	4	N	Electronic	\$ 11.20	\$ 179.20	\$ 70.00	\$ 1,120.00	Retrofit Recommended
P6	N/A	16	4' T12	4	Wrap	Magnetic	4	N	Electronic	\$ 11.20	\$ 179.20	\$ 70.00	\$ 1,120.00	Retrofit Recommended
P5 1/2A	N/A	8	4' T12	4	Wrap	Magnetic	4	N	Electronic	\$ 11.20	\$ 89.60	\$ 70.00	\$ 560.00	Retrofit Recommended
P5 1/2B	N/A	8	4' T12	4	Wrap	Magnetic	4	N	Electronic	\$ 11.20	\$ 89.60	\$ 70.00	\$ 560.00	Retrofit Recommended
P4	N/A	16	4' T12	4	Wrap	Magnetic	4	N	Electronic	\$ 11.20	\$ 179.20	\$ 70.00	\$ 1,120.00	Retrofit Recommended
P3	N/A	16	4' T12	4	Wrap	Magnetic	4	N	Electronic	\$ 11.20	\$ 179.20	\$ 70.00	\$ 1,120.00	Retrofit Recommended
P2	N/A	16	4' T12	4	Wrap	Magnetic	4	N	Electronic	\$ 11.20	\$ 179.20	\$ 70.00	\$ 1,120.00	Retrofit Recommended
P1	N/A	16	4' T12	4	Wrap	Magnetic	4	N	Electronic	\$ 11.20	\$ 179.20	\$ 70.00	\$ 1,120.00	Retrofit Recommended
L - 108	N/A	28	4' T12	2	Wrap	Magnetic	2	N	Electronic	\$ 5.60	\$ 156.80	\$ 60.00	\$ 1,680.00	Retrofit Recommended
Storage	N/A	6	4' T12	2	Ice	Magnetic	2	N	Electronic	\$ 5.60	\$ 33.60	\$ 135.00	\$ 810.00	Fixture Replacement
Office	N/A	4	4' T12	2	Ice	Magnetic	2	N	Electronic	\$ 5.60	\$ 22.40	\$ 135.00	\$ 540.00	Fixture Replacement
L - 107	N/A	32	4' T12	2	Ice	Magnetic	2	N	Electronic	\$ 5.60	\$ 179.20	\$ 135.00	\$ 4,320.00	Fixture Replacement
L - 106	N/A	32	4' T12	2	Ice	Magnetic	2	N	Electronic	\$ 5.60	\$ 179.20	\$ 135.00	\$ 4,320.00	Fixture Replacement
Storage	N/A	8	4' T12	2	Ice	Magnetic	2	N	Electronic	\$ 5.60	\$ 44.80	\$ 135.00	\$ 1,080.00	Fixture Replacement
L - 105	N/A	32	4' T12	2	Ice	Magnetic	2	N	Electronic	\$ 5.60	\$ 179.20	\$ 135.00	\$ 4,320.00	Fixture Replacement
L - 103	N/A	48	4' T12	2	Ice	Magnetic	2	N	Electronic	\$ 5.60	\$ 268.80	\$ 135.00	\$ 6,480.00	Fixture Replacement
L - 104	N/A	50	4' T12	2	Ice	Magnetic	2	N	Electronic	\$ 5.60	\$ 280.00	\$ 135.00	\$ 6,750.00	Fixture Replacement
L - 102	N/A	41	4' T12	2	Ice	Magnetic	2	N	Electronic	\$ 5.60	\$ 229.60	\$ 135.00	\$ 5,535.00	Fixture Replacement
L - 101	N/A	36	4' T12	2	Ice	Magnetic	2	N	Electronic	\$ 5.60	\$ 201.60	\$ 135.00	\$ 4,860.00	Fixture Replacement
L - Girls	N/A	8	4' T12	2	Ice	Magnetic	2	N	Electronic	\$ 5.60	\$ 44.80	\$ 135.00	\$ 1,080.00	Fixture Replacement
L - Women	N/A	1	Inc.								\$ -		\$ -	None
L - Utility	N/A	1	Inc.								\$ -	\$ -	\$ -	None
L - Men	N/A	1	Inc.								\$ -	\$ -	\$ -	None
L - Boys	N/A	5	4' T12	2	Ice	Magnetic	2	N	Electronic	\$ 5.60	\$ 28.00	\$ 135.00	\$ 675.00	Fixture Replacement
L - Electrical	N/A	4	Inc.								\$ -	\$ -	\$ -	None
E - 104	N/A	13	4' T12	2	Industrial	Magnetic	2	N	Electronic	\$ 5.60	\$ 72.80	\$ 60.00	\$ 780.00	Retrofit Recommended
E - 104	N/A	2	8' T12	2	Industrial	Magnetic	2	N	Electronic	\$ 7.20	\$ 14.40	\$ 80.00	\$ 160.00	Retrofit Recommended
E - 101	N/A	27	8' T12	2	Industrial	Magnetic	2	N	Electronic	\$ 7.20	\$ 194.40	\$ 80.00	\$ 2,160.00	Retrofit Recommended

LOCATION	EXISTING EQUIPMENT						PROPOSED			REBATES		COSTS		COMMENTS
Location (Rm Name, Rm. #, Area, Zone, etc.)	Floor	Quantity	Lamp Type	Lamps Per Fixture	Type of Fixture	Ballast Type	Lamps Per Fixture	Reflectors	Ballast Type	Per Single	Extended	Per Single	Extended	Comments
E - 101 Girls	N/A	1	4' T12	1	Fixture	Magnetic	1	N	Electronic	\$ 2.80	\$ 2.80	\$ 55.00	\$ 55.00	Retrofit Recommended
Classroom	N/A	5	4' T12	3	Fixture	Magnetic	3	N	Electronic	\$ 8.40	\$ 42.00	\$ 65.00	\$ 325.00	Retrofit Recommended
Office	N/A	2	4' T12	3	Fixture	Magnetic	3	N	Electronic	\$ 8.40	\$ 16.80	\$ 65.00	\$ 130.00	Retrofit Recommended
Storage	N/A	1	4' T12	2	Industrial	Magnetic	2	N	Electronic	\$ 5.60	\$ 5.60	\$ 60.00	\$ 60.00	Retrofit Recommended
Parti	N/A	2	4' T12	2	Industrial	Magnetic	2	N	Electronic	\$ 5.60	\$ 11.20	\$ 60.00	\$ 120.00	Retrofit Recommended
E - 102	N/A	5	4' T12	2	Industrial	Magnetic	2	N	Electronic	\$ 5.60	\$ 28.00	\$ 60.00	\$ 300.00	Retrofit Recommended
E - 102	N/A	17	4' T12	1	Fixture	Magnetic	1	N	Electronic	\$ 2.80	\$ 47.60	\$ 55.00	\$ 935.00	Retrofit Recommended
	N/A	33	8' T12	2	Industrial	Magnetic	2	N	Electronic	\$ 7.20	\$ 237.60	\$ 80.00	\$ 2,640.00	Retrofit Recommended
Office	N/A	2	4' T12	2	Ice	Magnetic	2	N	Electronic	\$ 5.60	\$ 11.20	\$ 135.00	\$ 270.00	Fixture Replacement
Restrooms	N/A	5	4' T12	2	Wrap	Magnetic	2	N	Electronic	\$ 5.60	\$ 28.00	\$ 60.00	\$ 300.00	Retrofit Recommended
Office	N/A	2	4' T12	2	Ice	Magnetic	2	N	Electronic	\$ 5.60	\$ 11.20	\$ 135.00	\$ 270.00	Fixture Replacement
E - 102	N/A	30	8' HO T12	2	HO	Magnetic	2	N	Electronic	\$ 7.20	\$ 216.00	\$ 110.20	\$ 3,306.00	Retrofit Recommended
E - 102	N/A	4	4' T12	2	Industrial	Magnetic	2	N	Electronic	\$ 5.60	\$ 22.40	\$ 60.00	\$ 240.00	Retrofit Recommended
E - 102	N/A	15	4' T12	1	Strip	Magnetic	1	N	Electronic	\$ 2.80	\$ 42.00	\$ 55.00	\$ 825.00	Retrofit Recommended
F - 103	N/A	24	4' T12	2	Ice	Magnetic	2	N	Electronic	\$ 5.60	\$ 134.40	\$ 135.00	\$ 3,240.00	Retrofit Recommended
F - 102	N/A	19	4' T12	2	Ice	Magnetic	2	N	Electronic	\$ 5.60	\$ 106.40	\$ 135.00	\$ 2,565.00	Fixture Replacement
Office	N/A	4	4' T12	2	Ice	Magnetic	2	N	Electronic	\$ 5.60	\$ 22.40	\$ 135.00	\$ 540.00	Fixture Replacement
F - 101	N/A	40	4' T12	2	Ice	Magnetic	2	N	Electronic	\$ 5.60	\$ 224.00	\$ 135.00	\$ 5,400.00	Fixture Replacement
Boys & Girls RR	N/A	2	4' T12	2	Wrap	Magnetic	2	N	Electronic	\$ 5.60	\$ 11.20	\$ 60.00	\$ 120.00	Retrofit Recommended
BUILDING D	N/A	86	4' T12	2	Industrial	Magnetic	2	N	Electronic	\$ 5.60	\$ 481.60	\$ 60.00	\$ 5,160.00	Retrofit Recommended
	N/A	169	4' T12	2	Surface	Magnetic	2	N	Electronic	\$ 5.60	\$ 946.40	\$ 60.00	\$ 10,140.00	Retrofit Recommended
	N/A	4			Exit Sign						\$ -		\$ -	None
P 26	N/A	16	4' T12	4	Wrap	Magnetic	4	N	Electronic	\$ 11.20	\$ 179.20	\$ 70.00	\$ 1,120.00	Retrofit Recommended
P 17	N/A	12	4' T12	4	Para	Magnetic	4	N	Electronic	\$ 11.20	\$ 134.40	\$ 70.00	\$ 840.00	Retrofit Recommended
P 16	N/A	12	4' T12	4	Para	Magnetic	4	N	Electronic	\$ 11.20	\$ 134.40	\$ 70.00	\$ 840.00	Retrofit Recommended
P 15	N/A	12	4' T12	4	Para	Magnetic	4	N	Electronic	\$ 11.20	\$ 134.40	\$ 70.00	\$ 840.00	Retrofit Recommended
P 25	N/A	16	4' T12	4	Wrap	Magnetic	4	N	Electronic	\$ 11.20	\$ 179.20	\$ 70.00	\$ 1,120.00	Retrofit Recommended
P 28	N/A	20	4' T12	4	Wrap	Magnetic	4	N	Electronic	\$ 11.20	\$ 224.00	\$ 70.00	\$ 1,400.00	Retrofit Recommended
P 27	N/A	16	4' T12	4	Wrap	Magnetic	4	N	Electronic	\$ 11.20	\$ 179.20	\$ 70.00	\$ 1,120.00	Retrofit Recommended
K - 101	N/A	14	4' T12	2	Ice	Magnetic	2	N	Electronic	\$ 5.60	\$ 78.40	\$ 135.00	\$ 1,890.00	Retrofit Recommended
K - 102	N/A	14	4' T12	2	Ice	Magnetic	2	N	Electronic	\$ 5.60	\$ 78.40	\$ 135.00	\$ 1,890.00	Fixture Replacement
Storage 2 Sides	N/A	8	4' T12	2	Ice	Magnetic	2	N	Electronic	\$ 5.60	\$ 44.80	\$ 135.00	\$ 1,080.00	Fixture Replacement
Laundry	N/A	4	4' T12	2	Ice	Magnetic	2	N	Electronic	\$ 5.60	\$ 22.40	\$ 135.00	\$ 540.00	Fixture Replacement
Boys' Locker	N/A	4	4' T12	2	Ice	Magnetic	2	N	Electronic	\$ 5.60	\$ 22.40	\$ 135.00	\$ 540.00	Fixture Replacement
	N/A	4	4' T12	2	Hood	Magnetic	2	N	Electronic	\$ 5.60	\$ 22.40	\$ 60.00	\$ 240.00	Retrofit Recommended
	N/A	45	4' T12	2	Fix	Magnetic	2	N	Electronic	\$ 5.60	\$ 252.00	\$ 60.00	\$ 2,700.00	Retrofit Recommended
Towel - DND											\$ -		\$ -	None
Team Locker	N/A	4	4' T12	2	Ice	Magnetic	2	N	Electronic	\$ 5.60	\$ 22.40	\$ 135.00	\$ 540.00	Fixture Replacement

LOCATION	EXISTING EQUIPMENT						PROPOSED			REBATES		COSTS		COMMENTS
Location (Rm Name, Rm. #, Area, Zone, etc.)	Floor	Quantity	Lamp Type	Lamps Per Fixture	Type of Fixture	Ballast Type	Lamps Per Fixture	Reflectors	Ballast Type	Per Single	Extended	Per Single	Extended	Comments
	N/A	11	4' T12	2	Hood	Magnetic	2	N	Electronic	\$ 5.60	\$ 61.60	\$ 60.00	\$ 660.00	Retrofit Recommended
	N/A	35	4' T12	2	Dimmer	Magnetic	2	N	Electronic	\$ 5.60	\$ 196.00	\$ 60.00	\$ 2,100.00	Retrofit Recommended
Towel Storage - DND											\$ -		\$ -	None
First AID - DND											\$ -		\$ -	None
Girls' Locker	N/A	23	4' T12	2	Fix	Magnetic	2	N	Electronic	\$ 5.60	\$ 128.80	\$ 60.00	\$ 1,380.00	Retrofit Recommended
	N/A	69	4' T12	2	Dimmer	Magnetic	2	N	Electronic	\$ 5.60	\$ 386.40	\$ 60.00	\$ 4,140.00	Retrofit Recommended
GYM	N/A	3	UBend	2	Fix	Magnetic	2	N	Electronic	\$ 5.60	\$ 16.80	\$ 60.00	\$ 180.00	None
	N/A	5			Exit Sign						\$ -	\$ -	\$ -	None
	N/A	6	4' T12	2	Fix	Magnetic	2	N	Electronic	\$ 5.60	\$ 33.60	\$ 60.00	\$ 360.00	Retrofit Recommended
Girls' Restroom	N/A	59	4' T12	2	Wrap	Magnetic	2	N	Electronic	\$ 5.60	\$ 330.40	\$ 60.00	\$ 3,540.00	Retrofit Recommended
Boys' Restroom	N/A	6	4' T12	2	Wrap	Magnetic	2	N	Electronic	\$ 5.60	\$ 33.60	\$ 60.00	\$ 360.00	Retrofit Recommended
Weight Room	N/A	3	4' T12	4	Fix	Magnetic	4	N	Electronic	\$ 11.20	\$ 33.60	\$ 70.00	\$ 210.00	Retrofit Recommended
Court	N/A	8			Exit Sign	Magnetic					\$ -	\$ -	\$ -	None
Stairwell	N/A	24	4' T12	1	Fix	Magnetic	1	N	Electronic	\$ 2.80	\$ 67.20	\$ 55.00	\$ 1,320.00	Retrofit Recommended
Team Room 1	N/A	18	4' T12	2	Fix	Magnetic	2	N	Electronic	\$ 5.60	\$ 100.80	\$ 60.00	\$ 1,080.00	Retrofit Recommended
	N/A	1			Exit Sign						\$ -	\$ -	\$ -	None
Tumbling Room	N/A	32	4' T12	2	Fix	Magnetic	2	N	Electronic	\$ 5.60	\$ 179.20	\$ 60.00	\$ 1,920.00	Retrofit Recommended
Team Room 2	N/A	18	4' T12	2	Fix	Magnetic	2	N	Electronic	\$ 5.60	\$ 100.80	\$ 60.00	\$ 1,080.00	Retrofit Recommended
	N/A	1			Exit Sign						\$ -	\$ -	\$ -	None
Store Room	N/A	8	4' T12	2	Fix	Magnetic	2	N	Electronic	\$ 5.60	\$ 44.80	\$ 60.00	\$ 480.00	Retrofit Recommended
Office	N/A	8	4' T12	2	Fix	Magnetic	2	N	Electronic	\$ 5.60	\$ 44.80	\$ 60.00	\$ 480.00	Retrofit Recommended
Storage	N/A	6	4' T12	2	Fix	Magnetic	2	N	Electronic	\$ 5.60	\$ 33.60	\$ 60.00	\$ 360.00	Retrofit Recommended
Storage Room	N/A	8	4' T12	2	Fix	Magnetic	2	N	Electronic	\$ 5.60	\$ 44.80	\$ 60.00	\$ 480.00	Retrofit Recommended
	N/A	2	UBend	2	Fix	Magnetic	2	N	Electronic	\$ 5.60	\$ 11.20	\$ 60.00	\$ 120.00	None
P20	N/A	12	4' T12	4	Para	Magnetic	4	N	Electronic	\$ 11.20	\$ 134.40	\$ 70.00	\$ 840.00	Retrofit Recommended
Band	N/A	4	4' T12	2	Wrap	Magnetic	2	N	Electronic	\$ 5.60	\$ 22.40	\$ 60.00	\$ 240.00	Retrofit Recommended
Hallway	N/A	4	4' T12	2	Wrap	Magnetic	2	N	Electronic	\$ 5.60	\$ 22.40	\$ 60.00	\$ 240.00	Retrofit Recommended
	N/A	23	4' T12	4	Para	Magnetic	4	N	Electronic	\$ 11.20	\$ 257.60	\$ 70.00	\$ 1,610.00	Retrofit Recommended
Band Continued	N/A	32	4' T12	4	Surface	Magnetic	4	N	Electronic	\$ 11.20	\$ 358.40	\$ 70.00	\$ 2,240.00	Retrofit Recommended
Repair	N/A	2	4' T12	4	Fix	Magnetic	4	N	Electronic	\$ 11.20	\$ 22.40	\$ 70.00	\$ 140.00	Retrofit Recommended
Practice 1	N/A	1	4' T12	4	Fix	Magnetic	4	N	Electronic	\$ 11.20	\$ 11.20	\$ 70.00	\$ 70.00	Retrofit Recommended
Practice 2	N/A	1	4' T12	4	Fix	Magnetic	4	N	Electronic	\$ 11.20	\$ 11.20	\$ 70.00	\$ 70.00	Retrofit Recommended
Practice 3	N/A	1	4' T12	4	Fix	Magnetic	4	N	Electronic	\$ 11.20	\$ 11.20	\$ 70.00	\$ 70.00	Retrofit Recommended
Practice 4	N/A	1	4' T12	4	Fix	Magnetic	4	N	Electronic	\$ 11.20	\$ 11.20	\$ 70.00	\$ 70.00	Retrofit Recommended
	N/A	4			Exit Sign						\$ -	\$ -	\$ -	None
Ensemble	N/A	6	4' T12	4	Fix	Magnetic	4	N	Electronic	\$ 11.20	\$ 67.20	\$ 70.00	\$ 420.00	Retrofit Recommended
Office 1	N/A	2	4' T12	4	Fix	Magnetic	4	N	Electronic	\$ 11.20	\$ 22.40	\$ 70.00	\$ 140.00	Retrofit Recommended
Office 2	N/A	2	4' T12	4	Fix	Magnetic	4	N	Electronic	\$ 11.20	\$ 22.40	\$ 70.00	\$ 140.00	Retrofit Recommended

LOCATION	EXISTING EQUIPMENT						PROPOSED			REBATES		COSTS		COMMENTS
Location (Rm Name, Rm. #, Area, Zone, etc.)	Floor	Quantity	Lamp Type	Lamps Per Fixture	Type of Fixture	Ballast Type	Lamps Per Fixture	Reflectors	Ballast Type	Per Single	Extended	Per Single	Extended	Comments
BUILDING G	N/A	10	4' T12	1	Strip	Magnetic	1	N	Electronic	\$ 2.80	\$ 28.00	\$ 55.00	\$ 550.00	Retrofit Recommended
P 21	N/A	16	4' T12	4	Wrap	Magnetic	4	N	Electronic	\$ 11.20	\$ 179.20	\$ 70.00	\$ 1,120.00	Retrofit Recommended
P 22	N/A	16	4' T12	4	Wrap	Magnetic	4	N	Electronic	\$ 11.20	\$ 179.20	\$ 70.00	\$ 1,120.00	Retrofit Recommended
P 29			N/A								\$ -		\$ -	None
P 23	N/A	16	4' T12	4	Wrap	Magnetic	4	N	Electronic	\$ 11.20	\$ 179.20	\$ 70.00	\$ 1,120.00	Retrofit Recommended
P 24	N/A	16	4' T12	4	Wrap	Magnetic	4	N	Electronic	\$ 11.20	\$ 179.20	\$ 70.00	\$ 1,120.00	Retrofit Recommended
P 12	N/A	12	4' T12	4	Wrap	Magnetic	4	N	Electronic	\$ 11.20	\$ 134.40	\$ 70.00	\$ 840.00	Retrofit Recommended
P13	N/A	12	4' T12	4	Wrap	Magnetic	4	N	Electronic	\$ 11.20	\$ 134.40	\$ 70.00	\$ 840.00	Retrofit Recommended
P14	N/A	12	4' T12	4	Wrap	Magnetic	4	N	Electronic	\$ 11.20	\$ 134.40	\$ 70.00	\$ 840.00	Retrofit Recommended
P 18	N/A	16	4' T12	3	Para	Magnetic	3	N	Electronic	\$ 8.40	\$ 134.40	\$ 65.00	\$ 1,040.00	Retrofit Recommended
BUILDING B	N/A	3	4' T12	2	Ice	Magnetic	2	N	Electronic	\$ 5.60	\$ 16.80	\$ 135.00	\$ 405.00	Fixture Replacement
101	N/A	32	4' T12	2	Ice	Magnetic	2	N	Electronic	\$ 5.60	\$ 179.20	\$ 135.00	\$ 4,320.00	Fixture Replacement
102	N/A	32	4' T12	2	Ice	Magnetic	2	N	Electronic	\$ 5.60	\$ 179.20	\$ 135.00	\$ 4,320.00	Fixture Replacement
103	N/A	24	4' T12	2	Ice	Magnetic	2	N	Electronic	\$ 5.60	\$ 134.40	\$ 135.00	\$ 3,240.00	Fixture Replacement
104	N/A	24	4' T12	2	Ice	Magnetic	2	N	Electronic	\$ 5.60	\$ 134.40	\$ 135.00	\$ 3,240.00	Fixture Replacement
105	N/A	24	4' T12	2	Ice	Magnetic	2	N	Electronic	\$ 5.60	\$ 134.40	\$ 135.00	\$ 3,240.00	Fixture Replacement
106	N/A	20	4' T12	2	Ice	Magnetic	2	N	Electronic	\$ 5.60	\$ 112.00	\$ 135.00	\$ 2,700.00	Fixture Replacement
107	N/A	20	4' T12	2	Ice	Magnetic	2	N	Electronic	\$ 5.60	\$ 112.00	\$ 135.00	\$ 2,700.00	Fixture Replacement
108	N/A	20	4' T12	2	Ice	Magnetic	2	N	Electronic	\$ 5.60	\$ 112.00	\$ 135.00	\$ 2,700.00	Fixture Replacement
109	N/A	20	4' T12	2	Ice	Magnetic	2	N	Electronic	\$ 5.60	\$ 112.00	\$ 135.00	\$ 2,700.00	Fixture Replacement
110	N/A	20	4' T12	2	Ice	Magnetic	2	N	Electronic	\$ 5.60	\$ 112.00	\$ 135.00	\$ 2,700.00	Fixture Replacement
111	N/A	20	4' T12	2	Ice	Magnetic	2	N	Electronic	\$ 5.60	\$ 112.00	\$ 135.00	\$ 2,700.00	Fixture Replacement
112	N/A	20	4' T12	2	Ice	Magnetic	2	N	Electronic	\$ 5.60	\$ 112.00	\$ 135.00	\$ 2,700.00	Fixture Replacement
100	N/A	16	4' T12	2	Ice	Magnetic	2	N	Electronic	\$ 5.60	\$ 89.60	\$ 135.00	\$ 2,160.00	Fixture Replacement
100	N/A	5	4' T12	2	Ice	Magnetic	2	N	Electronic	\$ 5.60	\$ 28.00	\$ 135.00	\$ 675.00	Fixture Replacement
100 A	N/A	4	4' T12	4	Ice	Magnetic	4	N	Electronic	\$ 11.20	\$ 44.80	\$ 135.00	\$ 540.00	Fixture Replacement
100 B	N/A	4	4' T12	4	Ice	Magnetic	4	N	Electronic	\$ 11.20	\$ 44.80	\$ 135.00	\$ 540.00	Fixture Replacement
100 C	N/A	2	4' T12	4	Ice	Magnetic	4	N	Electronic	\$ 11.20	\$ 22.40	\$ 135.00	\$ 270.00	Fixture Replacement
Work Room	N/A	2	4' T12	4	Ice	Magnetic	4	N	Electronic	\$ 11.20	\$ 22.40	\$ 135.00	\$ 270.00	Fixture Replacement
Work Room	N/A	5	4' T12	2	Ice	Magnetic	2	N	Electronic	\$ 5.60	\$ 28.00	\$ 135.00	\$ 675.00	Fixture Replacement
Work Room	N/A	1	4' T12	4	Ice	Magnetic	4	N	Electronic	\$ 11.20	\$ 11.20	\$ 135.00	\$ 135.00	Fixture Replacement
Girls' Restroom	N/A	4	4' T12	2	Ice	Magnetic	2	N	Electronic	\$ 5.60	\$ 22.40	\$ 135.00	\$ 540.00	Fixture Replacement
BUILDING N														
104	N/A	28	4' T12	2	Wrap	Magnetic	2	N	Electronic	\$ 5.60	\$ 156.80	\$ 60.00	\$ 1,680.00	Retrofit Recommended
103	N/A	28	4' T12	2	Wrap	Magnetic	2	N	Electronic	\$ 5.60	\$ 156.80	\$ 60.00	\$ 1,680.00	Retrofit Recommended
102	N/A	28	4' T12	2	Wrap	Magnetic	2	N	Electronic	\$ 5.60	\$ 156.80	\$ 60.00	\$ 1,680.00	Retrofit Recommended
101	N/A	28	4' T12	2	Wrap	Magnetic	2	N	Electronic	\$ 5.60	\$ 156.80	\$ 60.00	\$ 1,680.00	Retrofit Recommended
Women's Restroom	N/A	6	4' T12	2	Wrap	Magnetic	2	N	Electronic	\$ 5.60	\$ 33.60	\$ 60.00	\$ 360.00	Retrofit Recommended

LOCATION Location (Rm Name, Rm. #, Area, Zone, etc.)	EXISTING EQUIPMENT						PROPOSED			REBATES		COSTS		COMMENTS Comments
	Floor	Quantity	Lamp Type	Lamps Per Fixture	Type of Fixture	Ballast Type	Lamps Per Fixture	Reflectors	Ballast Type	Per Single	Extended	Per Single	Extended	
Boys' Restroom	N/A	6	4' T12	2	Wrap	Magnetic	2	N	Electronic	\$ 5.60	\$ 33.60	\$ 60.00	\$ 360.00	Retrofit Recommended
BUILDING O	N/A	28	4' T12	2	Wrap	Magnetic	2	N	Electronic	\$ 5.60	\$ 156.80	\$ 60.00	\$ 1,680.00	Retrofit Recommended
101	N/A	4	4' T12	2	Wrap	Magnetic	2	N	Electronic	\$ 5.60	\$ 22.40	\$ 60.00	\$ 240.00	Retrofit Recommended
102	N/A	22	4' T12	2	Wrap	Magnetic	2	N	Electronic	\$ 5.60	\$ 123.20	\$ 60.00	\$ 1,320.00	Retrofit Recommended
103	N/A	12	4' T12	2	Wrap	Magnetic	2	N	Electronic	\$ 5.60	\$ 67.20	\$ 60.00	\$ 720.00	Retrofit Recommended
103	N/A	14	4' T12	2	Wrap	Magnetic	2	N	Electronic	\$ 5.60	\$ 78.40	\$ 60.00	\$ 840.00	Retrofit Recommended
	N/A	2	4' T12	2	Wrap	Magnetic	2	N	Electronic	\$ 5.60	\$ 11.20	\$ 60.00	\$ 120.00	Retrofit Recommended
104	N/A	35	4' T12	2	Wrap	Magnetic	2	N	Electronic	\$ 5.60	\$ 196.00	\$ 60.00	\$ 2,100.00	Retrofit Recommended
BUILDING M														
Counselor	N/A	2	4' T12	4	Surface	Magnetic	4	N	Electronic	\$ 11.20	\$ 22.40	\$ 70.00	\$ 140.00	Retrofit Recommended
Transition Center	N/A	2	4' T12	4	Surface	Magnetic	4	N	Electronic	\$ 11.20	\$ 22.40	\$ 70.00	\$ 140.00	Retrofit Recommended
Office	N/A	4	4' T12	3	Surface	Magnetic	3	N	Electronic	\$ 8.40	\$ 33.60	\$ 65.00	\$ 260.00	Retrofit Recommended
Vice Principal	N/A	2	4' T12	4	Surface	Magnetic	4	N	Electronic	\$ 11.20	\$ 22.40	\$ 70.00	\$ 140.00	Retrofit Recommended
Vice Principal	N/A	4	4' T12	2	Wrap	Magnetic	2	N	Electronic	\$ 5.60	\$ 22.40	\$ 60.00	\$ 240.00	Retrofit Recommended
Office	N/A	4	4' T12	2	Wrap	Magnetic	2	N	Electronic	\$ 5.60	\$ 22.40	\$ 60.00	\$ 240.00	Retrofit Recommended
Main Office	N/A	1	4' T12	2	Wrap	Magnetic	2	N	Electronic	\$ 5.60	\$ 5.60	\$ 60.00	\$ 60.00	Retrofit Recommended
	N/A	17	4' T12	4	Wrap	Magnetic	4	N	Electronic	\$ 11.20	\$ 190.40	\$ 70.00	\$ 1,190.00	Retrofit Recommended
Health Room	N/A	4	4' T12	3	Wrap	Magnetic	3	N	Electronic	\$ 8.40	\$ 33.60	\$ 65.00	\$ 260.00	Retrofit Recommended
Restroom	N/A	1	4' T12	2	Fix	Magnetic	2	N	Electronic	\$ 5.60	\$ 5.60	\$ 60.00	\$ 60.00	Retrofit Recommended
Staff Lounge	N/A	2	4' T12	4	Fix	Magnetic	4	N	Electronic	\$ 11.20	\$ 22.40	\$ 70.00	\$ 140.00	Retrofit Recommended
Principal	N/A	4	4' T12	4	Fix	Magnetic	4	N	Electronic	\$ 11.20	\$ 44.80	\$ 70.00	\$ 280.00	Retrofit Recommended
Conference	N/A	4	4' T12	4	Fix	Magnetic	4	N	Electronic	\$ 11.20	\$ 44.80	\$ 70.00	\$ 280.00	Retrofit Recommended
Copy Room	N/A	6	4' T12	4	Fix	Magnetic	4	N	Electronic	\$ 11.20	\$ 67.20	\$ 70.00	\$ 420.00	Retrofit Recommended
PA Room	N/A	4	4' T12	2	Fix	Magnetic	2	N	Electronic	\$ 5.60	\$ 22.40	\$ 60.00	\$ 240.00	Retrofit Recommended
Telephone Room	N/A	1	4' T12	2	Fix	Magnetic	2	N	Electronic	\$ 5.60	\$ 5.60	\$ 60.00	\$ 60.00	Retrofit Recommended
Men's & Women's RR	N/A	2	4' T12	2	Fix	Magnetic	2	N	Electronic	\$ 5.60	\$ 11.20	\$ 60.00	\$ 120.00	Retrofit Recommended
Office nxt to Conf Rm	N/A	2	4' T12	4	Fix	Magnetic	4	N	Electronic	\$ 11.20	\$ 22.40	\$ 70.00	\$ 140.00	Retrofit Recommended
Counselor	N/A	2	4' T12	4	Wrap	Magnetic	4	N	Electronic	\$ 11.20	\$ 22.40	\$ 70.00	\$ 140.00	Retrofit Recommended
Office	N/A	4	4' T12	4	Wrap	Magnetic	4	N	Electronic	\$ 11.20	\$ 44.80	\$ 70.00	\$ 280.00	Retrofit Recommended
Office	N/A	2	4' T12	4	Wrap	Magnetic	4	N	Electronic	\$ 11.20	\$ 22.40	\$ 70.00	\$ 140.00	Retrofit Recommended
Office	N/A	2	4' T12	4	Wrap	Magnetic	4	N	Electronic	\$ 11.20	\$ 22.40	\$ 70.00	\$ 140.00	Retrofit Recommended
Counselor	N/A	2	4' T12	4	Wrap	Magnetic	4	N	Electronic	\$ 11.20	\$ 22.40	\$ 70.00	\$ 140.00	Retrofit Recommended
BUILDING C														
C - 102	N/A	16	4' T12	4	Fix	Magnetic	4	N	Electronic	\$ 11.20	\$ 179.20	\$ 70.00	\$ 1,120.00	Retrofit Recommended
C - 101	N/A	16	4' T12	4	Fix	Magnetic	4	N	Electronic	\$ 11.20	\$ 179.20	\$ 70.00	\$ 1,120.00	Retrofit Recommended
Hallway	N/A	5	4' T12	4	Fix	Magnetic	4	N	Electronic	\$ 11.20	\$ 56.00	\$ 70.00	\$ 350.00	Retrofit Recommended
C - 104	N/A	12	4' T12	4	Fix	Magnetic	4	N	Electronic	\$ 11.20	\$ 134.40	\$ 70.00	\$ 840.00	Retrofit Recommended
C - 105	N/A	20	4' T12	2	Wrap	Magnetic	2	N	Electronic	\$ 5.60	\$ 112.00	\$ 60.00	\$ 1,200.00	Retrofit Recommended

LOCATION	EXISTING EQUIPMENT						PROPOSED			REBATES		COSTS		COMMENTS
Location (Rm Name, Rm. #, Area, Zone, etc.)	Floor	Quantity	Lamp Type	Lamps Per Fixture	Type of Fixture	Ballast Type	Lamps Per Fixture	Reflectors	Ballast Type	Per Single	Extended	Per Single	Extended	Comments
Hallway	N/A	5			Exit Sign						\$ -	\$ -	\$ -	None
C - 103	N/A	15	4' T12	4	Fix	Magnetic	4	N	Electronic	\$ 11.20	\$ 168.00	\$ 70.00	\$ 1,050.00	Retrofit Recommended
C - 106	N/A	24	4' T12	2	Fix	Magnetic	2	N	Electronic	\$ 5.60	\$ 134.40	\$ 60.00	\$ 1,440.00	Retrofit Recommended
Library	N/A	102	4' T12	4	Fix	Magnetic	4	N	Electronic	\$ 11.20	\$ 1,142.40	\$ 70.00	\$ 7,140.00	Retrofit Recommended
Meeting Room 1	N/A	6	4' T12	2	Fix	Magnetic	2	N	Electronic	\$ 5.60	\$ 33.60	\$ 60.00	\$ 360.00	Retrofit Recommended
Meeting Room2	N/A	6	4' T12	2	Fix	Magnetic	2	N	Electronic	\$ 5.60	\$ 33.60	\$ 60.00	\$ 360.00	Retrofit Recommended
Records Room	N/A	4	4' T12	2	Fix	Magnetic	2	N	Electronic	\$ 5.60	\$ 22.40	\$ 60.00	\$ 240.00	Retrofit Recommended
Lib	N/A	1			Exit Sign						\$ -	\$ -	\$ -	None
General Office	N/A	4	4' T12	2	Fix	Magnetic	2	N	Electronic	\$ 5.60	\$ 22.40	\$ 60.00	\$ 240.00	Retrofit Recommended
C - 106	N/A	4	4' T12	2	Fix	Magnetic	2	N	Electronic	\$ 5.60	\$ 22.40	\$ 60.00	\$ 240.00	Retrofit Recommended
Girls Restroom	N/A	3	4' T12	2	Fix	Magnetic	2	N	Electronic	\$ 5.60	\$ 16.80	\$ 60.00	\$ 180.00	Retrofit Recommended
Boys Restroom	N/A	2	4' T12	2	Ice	Magnetic	2	N	Electronic	\$ 5.60	\$ 11.20	\$ 135.00	\$ 270.00	Retrofit Recommended
Tax Center	N/A	15	4' T12	2	Fix	Magnetic	2	N	Electronic	\$ 5.60	\$ 84.00	\$ 60.00	\$ 900.00	Retrofit Recommended
TV Studio	N/A	15	4' T12	4	Fix	Magnetic	4	N	Electronic	\$ 11.20	\$ 168.00	\$ 70.00	\$ 1,050.00	Retrofit Recommended
Control Room	N/A	4	4' T12	2	Wrap	Magnetic	2	N	Electronic	\$ 5.60	\$ 22.40	\$ 60.00	\$ 240.00	Retrofit Recommended
BUILDING A														
Girls Restroom	N/A	8	4' T12	2	Ice	Magnetic	2	N	Electronic	\$ 5.60	\$ 44.80	\$ 135.00	\$ 1,080.00	Fixture Replacement
Boys Restroom	N/A	4	4' T12	2	Ice	Magnetic	2	N	Electronic	\$ 5.60	\$ 22.40	\$ 135.00	\$ 540.00	Fixture Replacement
	N/A	2	4' T12	2	Fix	Magnetic	2	N	Electronic	\$ 5.60	\$ 11.20	\$ 60.00	\$ 120.00	Retrofit Recommended
A - 112	N/A	24	4' T12	2	Ice	Magnetic	2	N	Electronic	\$ 5.60	\$ 134.40	\$ 135.00	\$ 3,240.00	Fixture Replacement
A - 111	N/A	24	4' T12	2	Fix	Magnetic	2	N	Electronic	\$ 5.60	\$ 134.40	\$ 60.00	\$ 1,440.00	Retrofit Recommended
A - 110	N/A	24	4' T12	4	Fix	Magnetic	4	N	Electronic	\$ 11.20	\$ 268.80	\$ 70.00	\$ 1,680.00	Retrofit Recommended
A - 109	N/A	24	4' T12	4	Fix	Magnetic	4	N	Electronic	\$ 11.20	\$ 268.80	\$ 70.00	\$ 1,680.00	Retrofit Recommended
A - 108	N/A	24	4' T12	4	Fix	Magnetic	4	N	Electronic	\$ 11.20	\$ 268.80	\$ 70.00	\$ 1,680.00	Retrofit Recommended
A - 107	N/A	24	4' T12	4	Fix	Magnetic	4	N	Electronic	\$ 11.20	\$ 268.80	\$ 70.00	\$ 1,680.00	Retrofit Recommended
A - 106	N/A	24	4' T12	4	Fix	Magnetic	4	N	Electronic	\$ 11.20	\$ 268.80	\$ 70.00	\$ 1,680.00	Retrofit Recommended
A - 105	N/A	24	4' T12	4	Fix	Magnetic	4	N	Electronic	\$ 11.20	\$ 268.80	\$ 70.00	\$ 1,680.00	Retrofit Recommended
Classroom	N/A	12	4' T12	2	Ice	Magnetic	2	N	Electronic	\$ 5.60	\$ 67.20	\$ 135.00	\$ 1,620.00	Fixture Replacement
Faculty Lounge	N/A	4	4' T12	2	Fix	Magnetic	2	N	Electronic	\$ 5.60	\$ 22.40	\$ 60.00	\$ 240.00	Retrofit Recommended
Men's Restroom	N/A	1	4' T12	2	Ice	Magnetic	2	N	Electronic	\$ 5.60	\$ 5.60	\$ 135.00	\$ 135.00	Fixture Replacement
Women's Restroom	N/A	1	4' T12	2	Ice	Magnetic	2	N	Electronic	\$ 5.60	\$ 5.60	\$ 135.00	\$ 135.00	Fixture Replacement
ATR	N/A	28	4' T12	2	Ice	Magnetic	2	N	Electronic	\$ 5.60	\$ 156.80	\$ 135.00	\$ 3,780.00	Fixture Replacement
Teachers Office	N/A	6	4' T12	2	Ice	Magnetic	2	N	Electronic	\$ 5.60	\$ 33.60	\$ 135.00	\$ 810.00	Fixture Replacement
Building A continued														
											\$ -		\$ -	None
A - 104	N/A	16	4' T12	2	Ice	Magnetic	2	N	Electronic	\$ 5.60	\$ 89.60	\$ 135.00	\$ 2,160.00	Fixture Replacement
A - 104A	N/A	24	4' T12	4	Fix	Magnetic	4	N	Electronic	\$ 11.20	\$ 268.80	\$ 70.00	\$ 1,680.00	Retrofit Recommended
Storage	N/A	2	4' T12	2	Ice	Magnetic	2	N	Electronic	\$ 5.60	\$ 11.20	\$ 135.00	\$ 270.00	Fixture Replacement
A - 103	N/A	2	4' T12	2	Ice	Magnetic	2	N	Electronic	\$ 5.60	\$ 11.20	\$ 135.00	\$ 270.00	Fixture Replacement

LOCATION (Rm Name, Rm. #, Area, Zone, etc.)	EXISTING EQUIPMENT						PROPOSED			REBATES		COSTS		COMMENTS
	Floor	Quantity	Lamp Type	Lamps Per Fixture	Type of Fixture	Ballast Type	Lamps Per Fixture	Reflectors	Ballast Type	Per Single	Extended	Per Single	Extended	
A - 103L	N/A	4	4' T12	4	Fix	Magnetic	4	N	Electronic	\$ 11.20	\$ 44.80	\$ 70.00	\$ 280.00	Retrofit Recommended
A - 103	N/A	8	4' T12	4	Fix	Magnetic	4	N	Electronic	\$ 11.20	\$ 89.60	\$ 70.00	\$ 560.00	Retrofit Recommended
A - 102	N/A	8	4' T12	4	Fix	Magnetic	4	N	Electronic	\$ 11.20	\$ 89.60	\$ 70.00	\$ 560.00	Retrofit Recommended
A - 102L	N/A	4	4' T12	4	Fix	Magnetic	4	N	Electronic	\$ 11.20	\$ 44.80	\$ 70.00	\$ 280.00	Retrofit Recommended
Storage	N/A	8	4' T12	4	Fix	Magnetic	4	N	Electronic	\$ 11.20	\$ 89.60	\$ 70.00	\$ 560.00	Retrofit Recommended
A - 101L	N/A	8	4' T12	4	Fix	Magnetic	4	N	Electronic	\$ 11.20	\$ 89.60	\$ 70.00	\$ 560.00	Retrofit Recommended
Storage	N/A	8	4' T12	4	Fix	Magnetic	4	N	Electronic	\$ 11.20	\$ 89.60	\$ 70.00	\$ 560.00	Retrofit Recommended
A - 101	N/A	4	4' T12	4	Fix	Magnetic	4	N	Electronic	\$ 11.20	\$ 44.80	\$ 70.00	\$ 280.00	Retrofit Recommended
Total Rebates										\$	22,099.20			
Total Costs										\$	258,641.00			

LOCATION	QTY	EXISTING TYPE	QTY	RETROFIT		Existing				Actual				Proposed			
						Watt/unit	Op. Hours	kWh	kW-D	Watt/unit	Op. Hours	kWh	kW-D	Watt/unit	Op. Hours	kWh	kW-D
P11	12	4' 4L Fixture	12	Lamp & Low Watt Ballast	Retrofit Recommended	151.2	1,549	2,809.6	1.8144	100	1,549	1,858.2	1.2				
P10	12	4' 4L Fixture	12	Lamp & Low Watt Ballast	Retrofit Recommended	151.2	1,549	2,809.6	1.8144	100	1,549	1,858.2	1.2				
P9	20	4' 2L Fixture	20	Lamp & Low Watt Ballast	Retrofit Recommended	75.6	1,549	2,341.3	1.512	51	1,549	1,579.5	1.02				
P8 1/2A	6	4' 4L Fixture	6	Lamp & Low Watt Ballast	Retrofit Recommended	151.2	1,549	1,404.8	0.9072	100	1,549	929.1	0.6				
P8 1/2B	6	4' 4L Fixture	6	Lamp & Low Watt Ballast	Retrofit Recommended	151.2	1,549	1,404.8	0.9072	100	1,549	929.1	0.6				
P7	16	4' 4L Fixture	16	Lamp & Low Watt Ballast	Retrofit Recommended	151.2	1,549	3,746.1	2.4192	100	1,549	2,477.6	1.6				
P6	16	4' 4L Fixture	16	Lamp & Low Watt Ballast	Retrofit Recommended	151.2	1,549	3,746.1	2.4192	100	1,549	2,477.6	1.6				
P5 1/2A	8	4' 4L Fixture	8	Lamp & Low Watt Ballast	Retrofit Recommended	151.2	1,549	1,873.1	1.2096	100	1,549	1,238.8	0.8				
P5 1/2B	8	4' 4L Fixture	8	Lamp & Low Watt Ballast	Retrofit Recommended	151.2	1,549	1,873.1	1.2096	100	1,549	1,238.8	0.8				
P4	16	4' 4L Fixture	16	Lamp & Low Watt Ballast	Retrofit Recommended	151.2	1,549	3,746.1	2.4192	100	1,549	2,477.6	1.6				
P3	16	4' 4L Fixture	16	Lamp & Low Watt Ballast	Retrofit Recommended	151.2	1,549	3,746.1	2.4192	100	1,549	2,477.6	1.6				
P2	16	4' 4L Fixture	16	Lamp & Low Watt Ballast	Retrofit Recommended	151.2	1,549	3,746.1	2.4192	100	1,549	2,477.6	1.6				
P1	16	4' 4L Fixture	16	Lamp & Low Watt Ballast	Retrofit Recommended	151.2	1,549	3,746.1	2.4192	100	1,549	2,477.6	1.6				
L - 108	28	4' 2L Fixture	28	Lamp & Low Watt Ballast	Retrofit Recommended	75.6	1,549	3,277.9	2.1168	51	1,549	2,211.3	1.428				
Storage	6	4' 2L Fixture	6	Lamp & Low Watt Ballast	Fixture Replacement	75.6	1,549	702.4	0.4536	51	1,549	473.8	0.306				
Office	4	4' 2L Fixture	4	Lamp & Low Watt Ballast	Fixture Replacement	75.6	1,549	468.3	0.3024	51	1,549	315.9	0.204				
L - 107	32	4' 2L Fixture	32	Lamp & Low Watt Ballast	Fixture Replacement	75.6	1,549	3,746.1	2.4192	51	1,549	2,527.2	1.632				
L - 106	32	4' 2L Fixture	32	Lamp & Low Watt Ballast	Fixture Replacement	75.6	1,549	3,746.1	2.4192	51	1,549	2,527.2	1.632				
Storage	8	4' 2L Fixture	8	Lamp & Low Watt Ballast	Fixture Replacement	75.6	1,549	936.5	0.6048	51	1,549	631.8	0.408				
L - 105	32	4' 2L Fixture	32	Lamp & Low Watt Ballast	Fixture Replacement	75.6	1,549	3,746.1	2.4192	51	1,549	2,527.2	1.632				
L - 103	48	4' 2L Fixture	48	Lamp & Low Watt Ballast	Fixture Replacement	75.6	1,549	5,619.2	3.6288	51	1,549	3,790.7	2.448				
L - 104	50	4' 2L Fixture	50	Lamp & Low Watt Ballast	Fixture Replacement	75.6	1,549	5,853.3	3.78	51	1,549	3,948.7	2.55				
L - 102	41	4' 2L Fixture	41	Lamp & Low Watt Ballast	Fixture Replacement	75.6	1,549	4,799.7	3.0996	51	1,549	3,237.9	2.091				
L - 101	36	4' 2L Fixture	36	Lamp & Low Watt Ballast	Fixture Replacement	75.6	1,549	4,214.4	2.7216	51	1,549	2,843.0	1.836				
L - Girls	8	4' 2L Fixture	8	Lamp & Low Watt Ballast	Fixture Replacement	75.6	1,549	936.5	0.6048	51	1,549	631.8	0.408				
L - Women	1	75W Incandescent	0		None		1,549	0.0	0		1,549	0.0	0				
L - Utility	1	75W Incandescent	0	0	None	0	1,549	0.0	0	0	1,549	0.0	0				
L - Men	1	75W Incandescent	0	0	None	0	1,549	0.0	0	0	1,549	0.0	0				
L - Boys	5	4' 2L Fixture	5	Lamp & Low Watt Ballast	Fixture Replacement	75.6	1,549	585.3	0.378	51	1,549	394.9	0.255				
L - Electrical	4	75W Incandescent	0	0	None	0	1,549	0.0	0	0	1,549	0.0	0				
E - 104	13	4' 2L Fixture	13	Lamp & Low Watt Ballast	Retrofit Recommended	75.6	1,549	1,521.9	0.9828	51	1,549	1,026.7	0.663				
E - 104	2	8' 2L Fixture	2	Lamp & Ballast Retrofit	Retrofit Recommended	158	1,549	489.3	0.316	110	1,549	340.7	0.22				
E - 101	27	8' 2L Fixture	27	Lamp & Ballast Retrofit	Retrofit Recommended	158	1,549	6,605.9	4.266	110	1,549	4,599.0	2.97				
E - 101 Girls	1	4' 1L Fixture	1	Lamp & Low Watt Ballast	Retrofit Recommended	45.6	1,549	70.6	0.0456	31	1,549	48.0	0.031				
Classroom	5	4' 3L Fixture	5	Lamp & Low Watt Ballast	Retrofit Recommended	121.2	1,549	938.4	0.606	77	1,549	596.2	0.385				
Office	2	4' 3L Fixture	2	Lamp & Low Watt Ballast	Retrofit Recommended	121.2	1,549	375.4	0.2424	77	1,549	238.5	0.154				
Storage	1	4' 2L Fixture	1	Lamp & Low Watt Ballast	Retrofit Recommended	75.6	1,549	117.1	0.0756	51	1,549	79.0	0.051				
Parti	2	4' 2L Fixture	2	Lamp & Low Watt Ballast	Retrofit Recommended	75.6	1,549	234.1	0.1512	51	1,549	157.9	0.102				
E - 102	5	4' 2L Fixture	5	Lamp & Low Watt Ballast	Retrofit Recommended	75.6	1,549	585.3	0.378	51	1,549	394.9	0.255				
E - 102	17	4' 1L Fixture	17	Lamp & Low Watt Ballast	Retrofit Recommended	45.6	1,549	1,200.4	0.7752	31	1,549	816.1	0.527				
0	33	8' 2L Fixture	33	Lamp & Ballast Retrofit	Retrofit Recommended	158	1,549	8,073.9	5.214	110	1,549	5,621.1	3.63				
Office	2	4' 2L Fixture	2	Lamp & Low Watt Ballast	Fixture Replacement	75.6	1,549	234.1	0.1512	51	1,549	157.9	0.102				
Restrooms	5	4' 2L Fixture	5	Lamp & Low Watt Ballast	Retrofit Recommended	75.6	1,549	585.3	0.378	51	1,549	394.9	0.255				
Office	2	4' 2L Fixture	2	Lamp & Low Watt Ballast	Fixture Replacement	75.6	1,549	234.1	0.1512	51	1,549	157.9	0.102				
E - 102	30	8' 2L HO Fixture	30	Lamp & Ballast Retrofit	Retrofit Recommended	227	1,549	10,545.3	6.81	170.5	1,549	7,920.6	5.115				
E - 102	4	4' 2L Fixture	4	Lamp & Low Watt Ballast	Retrofit Recommended	75.6	1,549	468.3	0.3024	51	1,549	315.9	0.204				
E - 102	15	4' 1L Fixture	15	Lamp & Low Watt Ballast	Retrofit Recommended	45.6	1,549	1,059.2	0.684	31	1,549	720.1	0.465				
F - 103	24	4' 2L Fixture	24	Lamp & Low Watt Ballast	Retrofit Recommended	75.6	1,549	2,809.6	1.8144	51	1,549	1,895.4	1.224				
F - 102	19	4' 2L Fixture	19	Lamp & Low Watt Ballast	Fixture Replacement	75.6	1,549	2,224.3	1.4364	51	1,549	1,500.5	0.969				
Office	4	4' 2L Fixture	4	Lamp & Low Watt Ballast	Fixture Replacement	75.6	1,549	468.3	0.3024	51	1,549	315.9	0.204				
F - 101	40	4' 2L Fixture	40	Lamp & Low Watt Ballast	Fixture Replacement	75.6	1,549	4,682.7	3.024	51	1,549	3,158.9	2.04				
Boys & Girls RR	2	4' 2L Fixture	2	Lamp & Low Watt Ballast	Retrofit Recommended	75.6	1,549	234.1	0.1512	51	1,549	157.9	0.102				
BUILDING D	86	4' 2L Fixture	86	Lamp & Low Watt Ballast	Retrofit Recommended	75.6	1,549	10,067.7	6.5016	51	1,549	6,791.7	4.386				
0	169	4' 2L Fixture	169	Lamp & Low Watt Ballast	Retrofit Recommended	75.6	1,549	19,784.3	12.7764	51	1,549	13,346.5	8.619				
0	4	Exit Sign	0		None		1,549	0.0	0		1,549	0.0	0				
P 26	16	4' 4L Fixture	16	Lamp & Low Watt Ballast	Retrofit Recommended	151.2	1,549	3,746.1	2.4192	100	1,549	2,477.6	1.6				
P 17	12	4' 4L Fixture	12	Lamp & Low Watt Ballast	Retrofit Recommended	151.2	1,549	2,809.6	1.8144	100	1,549	1,858.2	1.2				
P 16	12	4' 4L Fixture	12	Lamp & Low Watt Ballast	Retrofit Recommended	151.2	1,549	2,809.6	1.8144	100	1,549	1,858.2	1.2				
P 15	12	4' 4L Fixture	12	Lamp & Low Watt Ballast	Retrofit Recommended	151.2	1,549	2,809.6	1.8144	100	1,549	1,858.2	1.2				

LOCATION	QTY	EXISTING TYPE	QTY	RETROFIT		Existing Watt/unit	Actual			Proposed			
							Op. Hours	kWh	kW-D	Watt/unit	Op. Hours	kWh	kW-D
P 25	16	4' 4L Fixture	16	Lamp & Low Watt Ballast	Retrofit Recommended	151.2	1,549	3,746.1	2.4192	100	1,549	2,477.6	1.6
P 28	20	4' 4L Fixture	20	Lamp & Low Watt Ballast	Retrofit Recommended	151.2	1,549	4,682.7	3.024	100	1,549	3,097.0	2
P 27	16	4' 4L Fixture	16	Lamp & Low Watt Ballast	Retrofit Recommended	151.2	1,549	3,746.1	2.4192	100	1,549	2,477.6	1.6
K - 101	14	4' 2L Fixture	14	Lamp & Low Watt Ballast	Retrofit Recommended	75.6	1,549	1,638.9	1.0584	51	1,549	1,105.6	0.714
K - 102	14	4' 2L Fixture	14	Lamp & Low Watt Ballast	Fixture Replacement	75.6	1,549	1,638.9	1.0584	51	1,549	1,105.6	0.714
Storage 2 Sides	8	4' 2L Fixture	8	Lamp & Low Watt Ballast	Fixture Replacement	75.6	1,549	936.5	0.6048	51	1,549	631.8	0.408
Laundry	4	4' 2L Fixture	4	Lamp & Low Watt Ballast	Fixture Replacement	75.6	1,549	468.3	0.3024	51	1,549	315.9	0.204
Boys' Locker	4	4' 2L Fixture	4	Lamp & Low Watt Ballast	Fixture Replacement	75.6	1,549	468.3	0.3024	51	1,549	315.9	0.204
0	4	4' 2L Fixture	4	Lamp & Low Watt Ballast	Retrofit Recommended	75.6	1,549	468.3	0.3024	51	1,549	315.9	0.204
0	45	4' 2L Fixture	45	Lamp & Low Watt Ballast	Retrofit Recommended	75.6	1,549	5,268.0	3.402	51	1,549	3,553.8	2.295
Towel - DND	0		0		None		1,549	0.0	0		1,549	0.0	0
Team Locker	4	4' 2L Fixture	4	Lamp & Low Watt Ballast	Fixture Replacement	75.6	1,549	468.3	0.3024	51	1,549	315.9	0.204
0	11	4' 2L Fixture	11	Lamp & Low Watt Ballast	Retrofit Recommended	75.6	1,549	1,287.7	0.8316	51	1,549	868.7	0.561
0	35	4' 2L Fixture	35	Lamp & Low Watt Ballast	Retrofit Recommended	75.6	1,549	4,097.3	2.646	51	1,549	2,764.1	1.785
Towel Storage - DND	0		0		None		1,549	0.0	0		1,549	0.0	0
First Aid - DND	0		0		None		1,549	0.0	0		1,549	0.0	0
Girls' Locker	23	4' 2L Fixture	23	Lamp & Low Watt Ballast	Retrofit Recommended	75.6	1,549	2,692.5	1.7388	51	1,549	1,816.4	1.173
0	69	4' 2L Fixture	69	Lamp & Low Watt Ballast	Retrofit Recommended	75.6	1,549	8,077.6	5.2164	51	1,549	5,449.2	3.519
GYM	3	2x2 2U Fixture	3	Lamp & Low Watt Ballast	None	75.6	1,549	351.2	0.2268	51	1,549	236.9	0.153
0	5	Exit Sign	0	0	None	0	1,549	0.0	0	0	1,549	0.0	0
0	6	4' 2L Fixture	6	Lamp & Low Watt Ballast	Retrofit Recommended	75.6	1,549	702.4	0.4536	51	1,549	473.8	0.306
Girls' Restroom	59	4' 2L Fixture	59	Lamp & Low Watt Ballast	Retrofit Recommended	75.6	1,549	6,906.9	4.4604	51	1,549	4,659.4	3.009
Boys' Restroom	6	4' 2L Fixture	6	Lamp & Low Watt Ballast	Retrofit Recommended	75.6	1,549	702.4	0.4536	51	1,549	473.8	0.306
Weight Room	3	4' 4L Fixture	3	Lamp & Low Watt Ballast	Retrofit Recommended	151.2	1,549	702.4	0.4536	100	1,549	464.6	0.3
Court	8	Exit Sign	0	0	None	0	1,549	0.0	0	0	1,549	0.0	0
Stairwell	24	4' 1L Fixture	24	Lamp & Low Watt Ballast	Retrofit Recommended	45.6	1,549	1,694.7	1.0944	31	1,549	1,152.1	0.744
Team Room 1	18	4' 2L Fixture	18	Lamp & Low Watt Ballast	Retrofit Recommended	75.6	1,549	2,107.2	1.3608	51	1,549	1,421.5	0.918
0	1	Exit Sign	0	0	None	0	1,549	0.0	0	0	1,549	0.0	0
Tumbling Room	32	4' 2L Fixture	32	Lamp & Low Watt Ballast	Retrofit Recommended	75.6	1,549	3,746.1	2.4192	51	1,549	2,527.2	1.632
Team Room 2	18	4' 2L Fixture	18	Lamp & Low Watt Ballast	Retrofit Recommended	75.6	1,549	2,107.2	1.3608	51	1,549	1,421.5	0.918
0	1	Exit Sign	0	0	None	0	1,549	0.0	0	0	1,549	0.0	0
Store Room	8	4' 2L Fixture	8	Lamp & Low Watt Ballast	Retrofit Recommended	75.6	1,549	936.5	0.6048	51	1,549	631.8	0.408
Office	8	4' 2L Fixture	8	Lamp & Low Watt Ballast	Retrofit Recommended	75.6	1,549	936.5	0.6048	51	1,549	631.8	0.408
Storage	6	4' 2L Fixture	6	Lamp & Low Watt Ballast	Retrofit Recommended	75.6	1,549	702.4	0.4536	51	1,549	473.8	0.306
Storage Room	8	4' 2L Fixture	8	Lamp & Low Watt Ballast	Retrofit Recommended	75.6	1,549	936.5	0.6048	51	1,549	631.8	0.408
0	2	2x2 2U Fixture	2	Lamp & Low Watt Ballast	None	75.6	1,549	234.1	0.1512	51	1,549	157.9	0.102
P20	12	4' 4L Fixture	12	Lamp & Low Watt Ballast	Retrofit Recommended	151.2	1,549	2,809.6	1.8144	100	1,549	1,858.2	1.2
Band	4	4' 2L Fixture	4	Lamp & Low Watt Ballast	Retrofit Recommended	75.6	1,549	468.3	0.3024	51	1,549	315.9	0.204
Hallway	4	4' 2L Fixture	4	Lamp & Low Watt Ballast	Retrofit Recommended	75.6	1,549	468.3	0.3024	51	1,549	315.9	0.204
0	23	4' 4L Fixture	23	Lamp & Low Watt Ballast	Retrofit Recommended	151.2	1,549	5,385.1	3.4776	100	1,549	3,561.6	2.3
Band Continued	32	4' 4L Fixture	32	Lamp & Low Watt Ballast	Retrofit Recommended	151.2	1,549	7,492.3	4.8384	100	1,549	4,955.2	3.2
Repair	2	4' 4L Fixture	2	Lamp & Low Watt Ballast	Retrofit Recommended	151.2	1,549	468.3	0.3024	100	1,549	309.7	0.2
Practice 1	1	4' 4L Fixture	1	Lamp & Low Watt Ballast	Retrofit Recommended	151.2	1,549	234.1	0.1512	100	1,549	154.9	0.1
Practice 2	1	4' 4L Fixture	1	Lamp & Low Watt Ballast	Retrofit Recommended	151.2	1,549	234.1	0.1512	100	1,549	154.9	0.1
Practice 3	1	4' 4L Fixture	1	Lamp & Low Watt Ballast	Retrofit Recommended	151.2	1,549	234.1	0.1512	100	1,549	154.9	0.1
Practice 4	1	4' 4L Fixture	1	Lamp & Low Watt Ballast	Retrofit Recommended	151.2	1,549	234.1	0.1512	100	1,549	154.9	0.1
0	4	Exit Sign	0	0	None	0	1,549	0.0	0	0	1,549	0.0	0
Ensemble	6	4' 4L Fixture	6	Lamp & Low Watt Ballast	Retrofit Recommended	151.2	1,549	1,404.8	0.9072	100	1,549	929.1	0.6
Office 1	2	4' 4L Fixture	2	Lamp & Low Watt Ballast	Retrofit Recommended	151.2	1,549	468.3	0.3024	100	1,549	309.7	0.2
Office 2	2	4' 4L Fixture	2	Lamp & Low Watt Ballast	Retrofit Recommended	151.2	1,549	468.3	0.3024	100	1,549	309.7	0.2
BUILDING G	10	4' 1L Fixture	10	Lamp & Low Watt Ballast	Retrofit Recommended	45.6	1,549	706.1	0.456	31	1,549	480.0	0.31
P 21	16	4' 4L Fixture	16	Lamp & Low Watt Ballast	Retrofit Recommended	151.2	1,549	3,746.1	2.4192	100	1,549	2,477.6	1.6
P 22	16	4' 4L Fixture	16	Lamp & Low Watt Ballast	Retrofit Recommended	151.2	1,549	3,746.1	2.4192	100	1,549	2,477.6	1.6
P 29	0		0		None		1,549	0.0	0		1,549	0.0	0
P 23	16	4' 4L Fixture	16	Lamp & Low Watt Ballast	Retrofit Recommended	151.2	1,549	3,746.1	2.4192	100	1,549	2,477.6	1.6
P 24	16	4' 4L Fixture	16	Lamp & Low Watt Ballast	Retrofit Recommended	151.2	1,549	3,746.1	2.4192	100	1,549	2,477.6	1.6
P 12	12	4' 4L Fixture	12	Lamp & Low Watt Ballast	Retrofit Recommended	151.2	1,549	2,809.6	1.8144	100	1,549	1,858.2	1.2
P13	12	4' 4L Fixture	12	Lamp & Low Watt Ballast	Retrofit Recommended	151.2	1,549	2,809.6	1.8144	100	1,549	1,858.2	1.2
P14	12	4' 4L Fixture	12	Lamp & Low Watt Ballast	Retrofit Recommended	151.2	1,549	2,809.6	1.8144	100	1,549	1,858.2	1.2
P 18	16	4' 3L Fixture	16	Lamp & Low Watt Ballast	Retrofit Recommended	121.2	1,549	3,002.9	1.9392	77	1,549	1,907.8	1.232

LOCATION	QTY	EXISTING TYPE	QTY	RETROFIT	Existing Watt/unit	Actual			Proposed				
						Op. Hours	kWh	kW-D	Watt/unit	Op. Hours	kWh	kW-D	
BUILDING B	3	4' 2L Fixture	3	Lamp & Low Watt Ballast	Fixture Replacement	75.6	1,549	351.2	0.2268	51	1,549	236.9	0.153
101	32	4' 2L Fixture	32	Lamp & Low Watt Ballast	Fixture Replacement	75.6	1,549	3,746.1	2.4192	51	1,549	2,527.2	1.632
102	32	4' 2L Fixture	32	Lamp & Low Watt Ballast	Fixture Replacement	75.6	1,549	3,746.1	2.4192	51	1,549	2,527.2	1.632
103	24	4' 2L Fixture	24	Lamp & Low Watt Ballast	Fixture Replacement	75.6	1,549	2,809.6	1.8144	51	1,549	1,895.4	1.224
104	24	4' 2L Fixture	24	Lamp & Low Watt Ballast	Fixture Replacement	75.6	1,549	2,809.6	1.8144	51	1,549	1,895.4	1.224
105	24	4' 2L Fixture	24	Lamp & Low Watt Ballast	Fixture Replacement	75.6	1,549	2,809.6	1.8144	51	1,549	1,895.4	1.224
106	20	4' 2L Fixture	20	Lamp & Low Watt Ballast	Fixture Replacement	75.6	1,549	2,341.3	1.512	51	1,549	1,579.5	1.02
107	20	4' 2L Fixture	20	Lamp & Low Watt Ballast	Fixture Replacement	75.6	1,549	2,341.3	1.512	51	1,549	1,579.5	1.02
108	20	4' 2L Fixture	20	Lamp & Low Watt Ballast	Fixture Replacement	75.6	1,549	2,341.3	1.512	51	1,549	1,579.5	1.02
109	20	4' 2L Fixture	20	Lamp & Low Watt Ballast	Fixture Replacement	75.6	1,549	2,341.3	1.512	51	1,549	1,579.5	1.02
110	20	4' 2L Fixture	20	Lamp & Low Watt Ballast	Fixture Replacement	75.6	1,549	2,341.3	1.512	51	1,549	1,579.5	1.02
111	20	4' 2L Fixture	20	Lamp & Low Watt Ballast	Fixture Replacement	75.6	1,549	2,341.3	1.512	51	1,549	1,579.5	1.02
112	20	4' 2L Fixture	20	Lamp & Low Watt Ballast	Fixture Replacement	75.6	1,549	2,341.3	1.512	51	1,549	1,579.5	1.02
100	16	4' 2L Fixture	16	Lamp & Low Watt Ballast	Fixture Replacement	75.6	1,549	1,873.1	1.2096	51	1,549	1,263.6	0.816
100	5	4' 2L Fixture	5	Lamp & Low Watt Ballast	Fixture Replacement	75.6	1,549	585.3	0.378	51	1,549	394.9	0.255
100 A	4	4' 4L Fixture	4	Lamp & Low Watt Ballast	Fixture Replacement	151.2	1,549	936.5	0.6048	100	1,549	619.4	0.4
100 B	4	4' 4L Fixture	4	Lamp & Low Watt Ballast	Fixture Replacement	151.2	1,549	936.5	0.6048	100	1,549	619.4	0.4
100 C	2	4' 4L Fixture	2	Lamp & Low Watt Ballast	Fixture Replacement	151.2	1,549	468.3	0.3024	100	1,549	309.7	0.2
Work Room	2	4' 4L Fixture	2	Lamp & Low Watt Ballast	Fixture Replacement	151.2	1,549	468.3	0.3024	100	1,549	309.7	0.2
Work Room	5	4' 2L Fixture	5	Lamp & Low Watt Ballast	Fixture Replacement	75.6	1,549	585.3	0.378	51	1,549	394.9	0.255
Work Room	1	4' 4L Fixture	1	Lamp & Low Watt Ballast	Fixture Replacement	151.2	1,549	234.1	0.1512	100	1,549	154.9	0.1
Girls' Restroom	4	4' 2L Fixture	4	Lamp & Low Watt Ballast	Fixture Replacement	75.6	1,549	468.3	0.3024	51	1,549	315.9	0.204
BUILDING N	0		0			0	1,549	0.0	0	51	1,549	0.0	0
104	28	4' 2L Fixture	28	Lamp & Low Watt Ballast	Retrofit Recommended	75.6	1,549	3,277.9	2.1168	51	1,549	2,211.3	1.428
103	28	4' 2L Fixture	28	Lamp & Low Watt Ballast	Retrofit Recommended	75.6	1,549	3,277.9	2.1168	51	1,549	2,211.3	1.428
102	28	4' 2L Fixture	28	Lamp & Low Watt Ballast	Retrofit Recommended	75.6	1,549	3,277.9	2.1168	51	1,549	2,211.3	1.428
101	28	4' 2L Fixture	28	Lamp & Low Watt Ballast	Retrofit Recommended	75.6	1,549	3,277.9	2.1168	51	1,549	2,211.3	1.428
Women's Restroom	6	4' 2L Fixture	6	Lamp & Low Watt Ballast	Retrofit Recommended	75.6	1,549	702.4	0.4536	51	1,549	473.8	0.306
Boys' Restroom	6	4' 2L Fixture	6	Lamp & Low Watt Ballast	Retrofit Recommended	75.6	1,549	702.4	0.4536	51	1,549	473.8	0.306
BUILDING O	28	4' 2L Fixture	28	Lamp & Low Watt Ballast	Retrofit Recommended	75.6	1,549	3,277.9	2.1168	51	1,549	2,211.3	1.428
101	4	4' 2L Fixture	4	Lamp & Low Watt Ballast	Retrofit Recommended	75.6	1,549	468.3	0.3024	51	1,549	315.9	0.204
102	22	4' 2L Fixture	22	Lamp & Low Watt Ballast	Retrofit Recommended	75.6	1,549	2,575.5	1.6632	51	1,549	1,737.4	1.122
103	12	4' 2L Fixture	12	Lamp & Low Watt Ballast	Retrofit Recommended	75.6	1,549	1,404.8	0.9072	51	1,549	947.7	0.612
103	14	4' 2L Fixture	14	Lamp & Low Watt Ballast	Retrofit Recommended	75.6	1,549	1,638.9	1.0584	51	1,549	1,105.6	0.714
0	2	4' 2L Fixture	2	Lamp & Low Watt Ballast	Retrofit Recommended	75.6	1,549	234.1	0.1512	51	1,549	157.9	0.102
104	35	4' 2L Fixture	35	Lamp & Low Watt Ballast	Retrofit Recommended	75.6	1,549	4,097.3	2.646	51	1,549	2,764.1	1.785
BUILDING M	0		0			0	1,549	0.0	0	51	1,549	0.0	0
Counselor	2	4' 4L Fixture	2	Lamp & Low Watt Ballast	Retrofit Recommended	151.2	1,549	468.3	0.3024	100	1,549	309.7	0.2
Transition Center	2	4' 4L Fixture	2	Lamp & Low Watt Ballast	Retrofit Recommended	151.2	1,549	468.3	0.3024	100	1,549	309.7	0.2
Office	4	4' 3L Fixture	4	Lamp & Low Watt Ballast	Retrofit Recommended	121.2	1,549	750.7	0.4848	77	1,549	476.9	0.308
Vice Principal	2	4' 4L Fixture	2	Lamp & Low Watt Ballast	Retrofit Recommended	151.2	1,549	468.3	0.3024	100	1,549	309.7	0.2
Vice Principal	4	4' 2L Fixture	4	Lamp & Low Watt Ballast	Retrofit Recommended	75.6	1,549	468.3	0.3024	51	1,549	315.9	0.204
Office	4	4' 2L Fixture	4	Lamp & Low Watt Ballast	Retrofit Recommended	75.6	1,549	468.3	0.3024	51	1,549	315.9	0.204
Main Office	1	4' 2L Fixture	1	Lamp & Low Watt Ballast	Retrofit Recommended	75.6	1,549	117.1	0.0756	51	1,549	79.0	0.051
0	17	4' 4L Fixture	17	Lamp & Low Watt Ballast	Retrofit Recommended	151.2	1,549	3,980.3	2.5704	100	1,549	2,632.5	1.7
Health Room	4	4' 3L Fixture	4	Lamp & Low Watt Ballast	Retrofit Recommended	121.2	1,549	750.7	0.4848	77	1,549	476.9	0.308
Restroom	1	4' 2L Fixture	1	Lamp & Low Watt Ballast	Retrofit Recommended	75.6	1,549	117.1	0.0756	51	1,549	79.0	0.051
Staff Lounge	2	4' 4L Fixture	2	Lamp & Low Watt Ballast	Retrofit Recommended	151.2	1,549	468.3	0.3024	100	1,549	309.7	0.2
Principal	4	4' 4L Fixture	4	Lamp & Low Watt Ballast	Retrofit Recommended	151.2	1,549	936.5	0.6048	100	1,549	619.4	0.4
Conference	4	4' 4L Fixture	4	Lamp & Low Watt Ballast	Retrofit Recommended	151.2	1,549	936.5	0.6048	100	1,549	619.4	0.4
Copy Room	6	4' 4L Fixture	6	Lamp & Low Watt Ballast	Retrofit Recommended	151.2	1,549	1,404.8	0.9072	100	1,549	929.1	0.6
PA Room	4	4' 2L Fixture	4	Lamp & Low Watt Ballast	Retrofit Recommended	75.6	1,549	468.3	0.3024	51	1,549	315.9	0.204
Telephone Room	1	4' 2L Fixture	1	Lamp & Low Watt Ballast	Retrofit Recommended	75.6	1,549	117.1	0.0756	51	1,549	79.0	0.051
Men's & Women's RR	2	4' 2L Fixture	2	Lamp & Low Watt Ballast	Retrofit Recommended	75.6	1,549	234.1	0.1512	51	1,549	157.9	0.102
Office nxt to Conf Rm	2	4' 4L Fixture	2	Lamp & Low Watt Ballast	Retrofit Recommended	151.2	1,549	468.3	0.3024	100	1,549	309.7	0.2
Counselor	2	4' 4L Fixture	2	Lamp & Low Watt Ballast	Retrofit Recommended	151.2	1,549	468.3	0.3024	100	1,549	309.7	0.2
Office	4	4' 4L Fixture	4	Lamp & Low Watt Ballast	Retrofit Recommended	151.2	1,549	936.5	0.6048	100	1,549	619.4	0.4
Office	2	4' 4L Fixture	2	Lamp & Low Watt Ballast	Retrofit Recommended	151.2	1,549	468.3	0.3024	100	1,549	309.7	0.2
Office	2	4' 4L Fixture	2	Lamp & Low Watt Ballast	Retrofit Recommended	151.2	1,549	468.3	0.3024	100	1,549	309.7	0.2
Counselor	2	4' 4L Fixture	2	Lamp & Low Watt Ballast	Retrofit Recommended	151.2	1,549	468.3	0.3024	100	1,549	309.7	0.2
BUILDING C	0		0			0	1,549	0.0	0	51	1,549	0.0	0

LOCATION	QTY	EXISTING TYPE	QTY	RETROFIT		Existing Watt/unit	Actual			Proposed			
							Op. Hours	kWh	kW-D	Watt/unit	Op. Hours	kWh	kW-D
C - 102	16	4' 4L Fixture	16	Lamp & Low Watt Ballast	Retrofit Recommended	151.2	1,549	3,746.1	2,4192	100	1,549	2,477.6	1.6
C - 101	16	4' 4L Fixture	16	Lamp & Low Watt Ballast	Retrofit Recommended	151.2	1,549	3,746.1	2,4192	100	1,549	2,477.6	1.6
Hallway	5	4' 4L Fixture	5	Lamp & Low Watt Ballast	Retrofit Recommended	151.2	1,549	1,170.7	0.756	100	1,549	774.3	0.5
C - 104	12	4' 4L Fixture	12	Lamp & Low Watt Ballast	Retrofit Recommended	151.2	1,549	2,809.6	1.8144	100	1,549	1,858.2	1.2
C - 105	20	4' 2L Fixture	20	Lamp & Low Watt Ballast	Retrofit Recommended	75.6	1,549	2,341.3	1.512	51	1,549	1,579.5	1.02
Hallway	5	Exit Sign	0	0	None	0	1,549	0.0	0	0	1,549	0.0	0
C - 103	15	4' 4L Fixture	15	Lamp & Low Watt Ballast	Retrofit Recommended	151.2	1,549	3,512.0	2.268	100	1,549	2,322.8	1.5
C - 106	24	4' 2L Fixture	24	Lamp & Low Watt Ballast	Retrofit Recommended	75.6	1,549	2,809.6	1.8144	51	1,549	1,895.4	1.224
Library	102	4' 4L Fixture	102	Lamp & Low Watt Ballast	Retrofit Recommended	151.2	1,549	23,881.6	15,4224	100	1,549	15,794.7	10.2
Meeting Room 1	6	4' 2L Fixture	6	Lamp & Low Watt Ballast	Retrofit Recommended	75.6	1,549	702.4	0.4536	51	1,549	473.8	0.306
Meeting Room2	6	4' 2L Fixture	6	Lamp & Low Watt Ballast	Retrofit Recommended	75.6	1,549	702.4	0.4536	51	1,549	473.8	0.306
Records Room	4	4' 2L Fixture	4	Lamp & Low Watt Ballast	Retrofit Recommended	75.6	1,549	468.3	0.3024	51	1,549	315.9	0.204
Lib	1	Exit Sign	0	0	None	0	1,549	0.0	0	0	1,549	0.0	0
General Office	4	4' 2L Fixture	4	Lamp & Low Watt Ballast	Retrofit Recommended	75.6	1,549	468.3	0.3024	51	1,549	315.9	0.204
C - 106	4	4' 2L Fixture	4	Lamp & Low Watt Ballast	Retrofit Recommended	75.6	1,549	468.3	0.3024	51	1,549	315.9	0.204
Girls Restroom	3	4' 2L Fixture	3	Lamp & Low Watt Ballast	Retrofit Recommended	75.6	1,549	351.2	0.2268	51	1,549	236.9	0.153
Boys Restroom	2	4' 2L Fixture	2	Lamp & Low Watt Ballast	Retrofit Recommended	75.6	1,549	234.1	0.1512	51	1,549	157.9	0.102
Tax Center	15	4' 2L Fixture	15	Lamp & Low Watt Ballast	Retrofit Recommended	75.6	1,549	1,756.0	1.134	51	1,549	1,184.6	0.765
TV Studio	15	4' 4L Fixture	15	Lamp & Low Watt Ballast	Retrofit Recommended	151.2	1,549	3,512.0	2.268	100	1,549	2,322.8	1.5
Control Room	4	4' 2L Fixture	4	Lamp & Low Watt Ballast	Retrofit Recommended	75.6	1,549	468.3	0.3024	51	1,549	315.9	0.204
BUILDING A	0		0		0		1,549	0.0	0		1,549	0.0	0
Girls Restroom	8	4' 2L Fixture	8	Lamp & Low Watt Ballast	Fixture Replacement	75.6	1,549	936.5	0.6048	51	1,549	631.8	0.408
Boys Restroom	4	4' 2L Fixture	4	Lamp & Low Watt Ballast	Fixture Replacement	75.6	1,549	468.3	0.3024	51	1,549	315.9	0.204
0	2	4' 2L Fixture	2	Lamp & Low Watt Ballast	Retrofit Recommended	75.6	1,549	234.1	0.1512	51	1,549	157.9	0.102
A - 112	24	4' 2L Fixture	24	Lamp & Low Watt Ballast	Fixture Replacement	75.6	1,549	2,809.6	1.8144	51	1,549	1,895.4	1.224
A - 111	24	4' 2L Fixture	24	Lamp & Low Watt Ballast	Retrofit Recommended	75.6	1,549	2,809.6	1.8144	51	1,549	1,895.4	1.224
A - 110	24	4' 4L Fixture	24	Lamp & Low Watt Ballast	Retrofit Recommended	151.2	1,549	5,619.2	3.6288	100	1,549	3,716.4	2.4
A - 109	24	4' 4L Fixture	24	Lamp & Low Watt Ballast	Retrofit Recommended	151.2	1,549	5,619.2	3.6288	100	1,549	3,716.4	2.4
A - 108	24	4' 4L Fixture	24	Lamp & Low Watt Ballast	Retrofit Recommended	151.2	1,549	5,619.2	3.6288	100	1,549	3,716.4	2.4
A - 107	24	4' 4L Fixture	24	Lamp & Low Watt Ballast	Retrofit Recommended	151.2	1,549	5,619.2	3.6288	100	1,549	3,716.4	2.4
A - 106	24	4' 4L Fixture	24	Lamp & Low Watt Ballast	Retrofit Recommended	151.2	1,549	5,619.2	3.6288	100	1,549	3,716.4	2.4
A - 105	24	4' 4L Fixture	24	Lamp & Low Watt Ballast	Retrofit Recommended	151.2	1,549	5,619.2	3.6288	100	1,549	3,716.4	2.4
Classroom	12	4' 2L Fixture	12	Lamp & Low Watt Ballast	Fixture Replacement	75.6	1,549	1,404.8	0.9072	51	1,549	947.7	0.612
Faculty Lounge	4	4' 2L Fixture	4	Lamp & Low Watt Ballast	Retrofit Recommended	75.6	1,549	468.3	0.3024	51	1,549	315.9	0.204
Men's Restroom	1	4' 2L Fixture	1	Lamp & Low Watt Ballast	Fixture Replacement	75.6	1,549	117.1	0.0756	51	1,549	79.0	0.051
Women's Restroom	1	4' 2L Fixture	1	Lamp & Low Watt Ballast	Fixture Replacement	75.6	1,549	117.1	0.0756	51	1,549	79.0	0.051
ATR	28	4' 2L Fixture	28	Lamp & Low Watt Ballast	Fixture Replacement	75.6	1,549	3,277.9	2.1168	51	1,549	2,211.3	1.428
Teachers Office	6	4' 2L Fixture	6	Lamp & Low Watt Ballast	Fixture Replacement	75.6	1,549	702.4	0.4536	51	1,549	473.8	0.306
Building A continued	0		0		None		1,549	0.0	0		1,549	0.0	0
A - 104	16	4' 2L Fixture	16	Lamp & Low Watt Ballast	Fixture Replacement	75.6	1,549	1,873.1	1.2096	51	1,549	1,263.6	0.816
A - 104A	24	4' 4L Fixture	24	Lamp & Low Watt Ballast	Retrofit Recommended	151.2	1,549	5,619.2	3.6288	100	1,549	3,716.4	2.4
Storage	2	4' 2L Fixture	2	Lamp & Low Watt Ballast	Fixture Replacement	75.6	1,549	234.1	0.1512	51	1,549	157.9	0.102
A - 103	2	4' 2L Fixture	2	Lamp & Low Watt Ballast	Fixture Replacement	75.6	1,549	234.1	0.1512	51	1,549	157.9	0.102
A - 103L	4	4' 4L Fixture	4	Lamp & Low Watt Ballast	Retrofit Recommended	151.2	1,549	936.5	0.6048	100	1,549	619.4	0.4
A - 103	8	4' 4L Fixture	8	Lamp & Low Watt Ballast	Retrofit Recommended	151.2	1,549	1,873.1	1.2096	100	1,549	1,238.8	0.8
A - 102	8	4' 4L Fixture	8	Lamp & Low Watt Ballast	Retrofit Recommended	151.2	1,549	1,873.1	1.2096	100	1,549	1,238.8	0.8
A - 102L	4	4' 4L Fixture	4	Lamp & Low Watt Ballast	Retrofit Recommended	151.2	1,549	936.5	0.6048	100	1,549	619.4	0.4
Storage	8	4' 4L Fixture	8	Lamp & Low Watt Ballast	Retrofit Recommended	151.2	1,549	1,873.1	1.2096	100	1,549	1,238.8	0.8
A - 101L	8	4' 4L Fixture	8	Lamp & Low Watt Ballast	Retrofit Recommended	151.2	1,549	1,873.1	1.2096	100	1,549	1,238.8	0.8
Storage	8	4' 4L Fixture	8	Lamp & Low Watt Ballast	Retrofit Recommended	151.2	1,549	1,873.1	1.2096	100	1,549	1,238.8	0.8
A - 101	4	4' 4L Fixture	4	Lamp & Low Watt Ballast	Retrofit Recommended	151.2	1,549	936.5	0.6048	100	1,549	619.4	0.4

Existing 3069 Proposed 3033

ENERGY CALCULATIONS

Description	kW-Demand	kWh	
Existing Use	306.77	475,029	
Proposed Use	205.74	318,584	
Difference - Savings	101.03	156,445	Total Yearly Energy Savings
Electrical Utility Cost	\$5.75	\$0.15145	
Savings per Year	\$6,971.08	\$23,693.41	

475,029 307 318,584 206

Maui Waena Intermedia

795 Onehee Ave.
Kahului, HI 96732
Phone: 873-3070

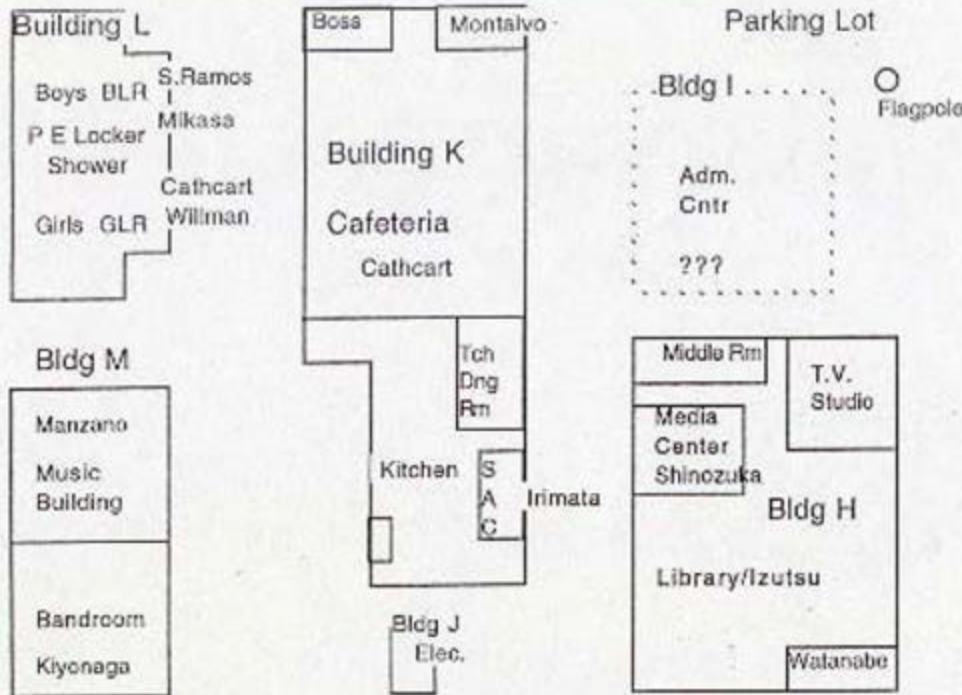

Building A

Office 101 Kaneshina	Yap 102	Takahashi Nishimitsu Shiozawa 103
----------------------------	------------	--

Building B

Kurokawa 201	Pua 202	Newell/ Tua 203	204 Wilson A Omura
Coulter/ Street 101A	Ishii 101B	Soderholm 102	

Building C

Reynon 201	Nunez 202	White 203	Browning 204
Kihara 101	Felipe 102	Rodriguez 103	

Building D

Aiwohi 201	Kutsunai 202	Magee 203	Fukami 204	Matoi 205	Kawahara 206
Guerin 101	Ballanger 102		Lai-Cortez 103A	Takakura 103B	104 A

Building E

Prais 201	Takano 202	Kawamura 203	Sakamoto 204
101	Ogata	102	Fujii-Pacheco

Building G

Sylva 201	Tomoso 202	Cabaice- Alakai 203	Giamenelli 204
Szymczyk 101	Shiraishi 102	LAB 103	Suzuki 104

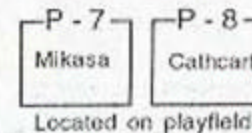
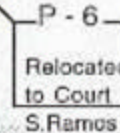
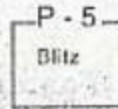
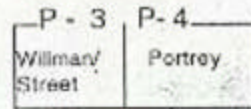
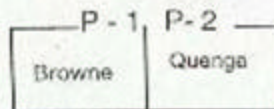
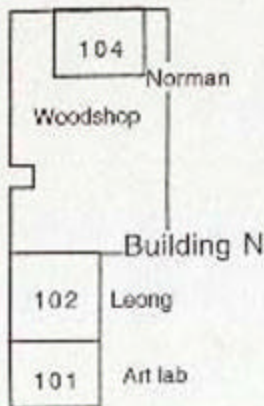

DeMello Tch. Aides

Maul Smart Schools Program
Foot Candle Readings

School: Maui Waiana Intermediate

Room: Bldg. C - C 203

Ceiling height: 10'

Light fixture height: 8'

Fixture type: TRUSS

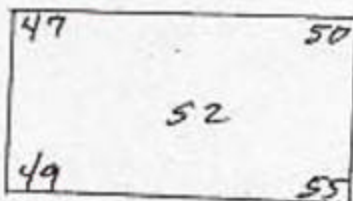

Room: Portable - P-16

Ceiling height: 10

Light fixture height: 8'

Fixture type: TRUSS

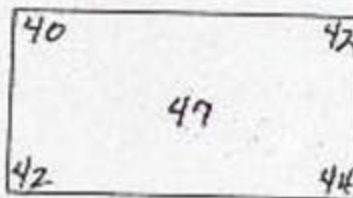

Room: Bldg. E E-202

Ceiling height: 10'

Light fixture height: 8'

Fixture type: WAP

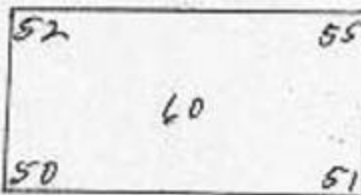



SCHOOL INFORMATION													
NAME Maui Waena Intermediate School											DATE 1/26/2001		
STREET ADDRESS 795 Onehee Street Kahului, HI 96732											OPERATIONAL HOURS 1,549		
POINT OF CONTACT Donna Whitford					PHONE 873-3070			FAX		VOLTAGE 120V			
AUDITOR Maui Community College Auditors													

LOCATION <small>(Rm Name, Rm. #, Area, Zone, etc.)</small>	EXISTING EQUIPMENT						PROPOSED			REBATES		COSTS		COMMENTS <small>Surveyors Comments</small>
	Floor	Quantity	Lamp Type	Lamps Per Fixture	Type of Fixture	Ballast Type	Lamps Per Fixture	Reflectors	Ballast Type	Per Single	Extended	Per Single	Extended	
BUILDING A											\$ -		\$ -	
<i>Girls' Restroom</i>	1	3	4' T12	1	Vanity	Magnetic	1	N	Electronic	\$ 2.80	\$ 8.40	\$ 55.00	\$ 165.00	Excellent opportunity for retro-fit
<i>Boys' Restroom</i>	1	3	4' T12	1	Vanity	Magnetic	1	N	Electronic	\$ 2.80	\$ 8.40	\$ 55.00	\$ 165.00	Excellent opportunity for retro-fit
<i>Office - 101</i>	1	6	4' T12	4	Troffer	Magnetic	4	N	Electronic	\$ 11.20	\$ 67.20	\$ 70.00	\$ 420.00	Excellent opportunity for retro-fit
<i>Principal</i>	1	14	4' T12	2	Wrap	Magnetic	2	N	Electronic	\$ 5.60	\$ 78.40	\$ 60.00	\$ 840.00	Excellent opportunity for retro-fit
<i>Health Room</i>	1	4	4' T12	4	Troffer	Magnetic	4	N	Electronic	\$ 11.20	\$ 44.80	\$ 70.00	\$ 280.00	Excellent opportunity for retro-fit
<i>102</i>	1	12	4' T12	4	Wrap	Magnetic	4	N	Electronic	\$ 11.20	\$ 134.40	\$ 70.00	\$ 840.00	Excellent opportunity for retro-fit
<i>Vice-Principal</i>	1	4	4' T12	4	Wrap	Magnetic	4	N	Electronic	\$ 11.20	\$ 44.80	\$ 70.00	\$ 280.00	Excellent opportunity for retro-fit
<i>103</i>	1	24	4' T12	2	Wrap	Magnetic	2	N	Electronic	\$ 5.60	\$ 134.40	\$ 60.00	\$ 1,440.00	Excellent opportunity for retro-fit
<i>Girls' Restroom</i>	1	3	4' T12	1	Vanity	Magnetic	1	N	Electronic	\$ 2.80	\$ 8.40	\$ 55.00	\$ 165.00	Excellent opportunity for retro-fit
<i>Boys' Restroom</i>	1	3	4' T12	1	Vanity	Magnetic	1	N	Electronic	\$ 2.80	\$ 8.40	\$ 55.00	\$ 165.00	Excellent opportunity for retro-fit
BUILDING B											\$ -		\$ -	
<i>Girls' Restroom</i>	1	5	4' T12	1	Vanity	Magnetic	1	N	Electronic	\$ 2.80	\$ 14.00	\$ 55.00	\$ 275.00	Excellent opportunity for retro-fit
<i>Boys' Restroom</i>	1	7	4' T12	1	Vanity	Magnetic	1	N	Electronic	\$ 2.80	\$ 19.60	\$ 55.00	\$ 385.00	Excellent opportunity for retro-fit
<i>101 - A</i>	1	15	4' T8	3	Troffer	Electronic					\$ -		\$ -	T8 Lamps, No Retrofit
<i>101 - B</i>	1	12	4' T8	3	Troffer	Electronic					\$ -		\$ -	T8 Lamps, No Retrofit
<i>102</i>	1	24	4' T8	3	Troffer	Electronic					\$ -		\$ -	T8 Lamps, No Retrofit
<i>Hall</i>	1	1	4' T12	2	Troffer	Magnetic	2	N	Electronic	\$ 5.60	\$ 5.60	\$ 60.00	\$ 60.00	Excellent opportunity for retro-fit
<i>Laundry</i>	1	2	4' T12	2	Troffer	Magnetic	2	N	Electronic	\$ 5.60	\$ 11.20	\$ 60.00	\$ 120.00	Excellent opportunity for retro-fit
<i>Storage Room</i>	1	2	4' T12	4	Troffer	Magnetic	4	N	Electronic	\$ 11.20	\$ 22.40	\$ 70.00	\$ 140.00	Excellent opportunity for retro-fit
<i>Girls' Restroom</i>	2	5	4' T12	1	Vanity	Magnetic	1	N	Electronic	\$ 2.80	\$ 14.00	\$ 55.00	\$ 275.00	Excellent opportunity for retro-fit
<i>Boys' Restroom</i>	2	7	4' T12	1	Vanity	Magnetic	1	N	Electronic	\$ 2.80	\$ 19.60	\$ 55.00	\$ 385.00	Excellent opportunity for retro-fit
<i>201</i>	2	24	4' T12	2	Wrap	Magnetic	2	N	Electronic	\$ 5.60	\$ 134.40	\$ 60.00	\$ 1,440.00	Excellent opportunity for retro-fit
<i>202</i>	2	24	4' T12	2	Wrap	Magnetic	2	N	Electronic	\$ 5.60	\$ 134.40	\$ 60.00	\$ 1,440.00	Excellent opportunity for retro-fit
<i>203</i>	2	24	4' T12	2	Wrap	Magnetic	2	N	Electronic	\$ 5.60	\$ 134.40	\$ 60.00	\$ 1,440.00	Excellent opportunity for retro-fit
<i>204</i>	2	10	4' T12	2	Wrap	Magnetic	2	N	Electronic	\$ 5.60	\$ 56.00	\$ 60.00	\$ 600.00	Excellent opportunity for retro-fit
<i>Storage Room</i>	2	3	4' T8	3	Troffer	Electronic					\$ -		\$ -	T8 Lamps, No Retrofit
BUILDING C											\$ -		\$ -	
<i>Girls' Restroom</i>	1	5	4' T12	1	Vanity	Magnetic	1	N	Electronic	\$ 2.80	\$ 14.00	\$ 55.00	\$ 275.00	Excellent opportunity for retro-fit
<i>Boys' Restroom</i>	1	5	4' T12	1	Vanity	Magnetic	1	N	Electronic	\$ 2.80	\$ 14.00	\$ 55.00	\$ 275.00	Excellent opportunity for retro-fit
<i>101</i>	1	22	4' T12	4	Troffer	Magnetic	4	N	Electronic	\$ 11.20	\$ 246.40	\$ 70.00	\$ 1,540.00	Excellent opportunity for retro-fit
<i>102</i>	1	16	4' T12	4	Troffer	Magnetic	4	N	Electronic	\$ 11.20	\$ 179.20	\$ 70.00	\$ 1,120.00	Excellent opportunity for retro-fit
<i>103</i>	1	24	4' T12	4	Troffer	Magnetic	4	N	Electronic	\$ 11.20	\$ 268.80	\$ 70.00	\$ 1,680.00	Excellent opportunity for retro-fit
<i>201</i>	2	36	4' T12	2	Wrap	Magnetic	2	N	Electronic	\$ 5.60	\$ 201.60	\$ 60.00	\$ 2,160.00	Excellent opportunity for retro-fit

LOCATION	EXISTING EQUIPMENT						PROPOSED			REBATES		COSTS		COMMENTS
Location (Rm Name, Rm. #, Area, Zone, etc.)	Floor	Quantity	Lamp Type	Lamps Per Fixture	Type of Fixture	Ballast Type	Lamps Per Fixture	Reflectors	Ballast Type	Per Single	Extended	Per Single	Extended	Surveyors Comments
202	2	24	4' T12	2	Wrap	Magnetic	2	N	Electronic	\$ 5.60	\$ 134.40	\$ 60.00	\$ 1,440.00	Excellent opportunity for retro-fit
203	2	24	4' T12	2	Wrap	Magnetic	2	N	Electronic	\$ 5.60	\$ 134.40	\$ 60.00	\$ 1,440.00	Excellent opportunity for retro-fit
204	2	24	4' T12	2	Wrap	Magnetic	2	N	Electronic	\$ 5.60	\$ 134.40	\$ 60.00	\$ 1,440.00	Excellent opportunity for retro-fit
Girls' Restroom	2	5	4' T12	1	Vanity	Magnetic	1	N	Electronic	\$ 2.80	\$ 14.00	\$ 55.00	\$ 275.00	Excellent opportunity for retro-fit
Boys' Restroom	2	5	4' T12	1	Vanity	Magnetic	1	N	Electronic	\$ 2.80	\$ 14.00	\$ 55.00	\$ 275.00	Excellent opportunity for retro-fit
BUILDING D											\$ -		\$ -	
Girls' Restroom	1	17	4' T12	1	Wrap	Magnetic	1	N	Electronic	\$ 2.80	\$ 47.60	\$ 55.00	\$ 935.00	Excellent opportunity for retro-fit
Boys' Restroom	1	17	4' T12	1	Wrap	Magnetic	1	N	Electronic	\$ 2.80	\$ 47.60	\$ 55.00	\$ 935.00	Excellent opportunity for retro-fit
101	1	16	4' T12	3	Troffer	Magnetic	3	N	Electronic	\$ 8.40	\$ 134.40	\$ 65.00	\$ 1,040.00	Excellent opportunity for retro-fit
102	1	23	4' T12	3	Troffer	Magnetic	3	N	Electronic	\$ 8.40	\$ 193.20	\$ 65.00	\$ 1,495.00	Excellent opportunity for retro-fit
103-A	1	14	4' T12	3	Troffer	Magnetic	3	N	Electronic	\$ 8.40	\$ 117.60	\$ 65.00	\$ 910.00	Excellent opportunity for retro-fit
103-B	1	12	4' T12	3	Troffer	Magnetic	3	N	Electronic	\$ 8.40	\$ 100.80	\$ 65.00	\$ 780.00	Excellent opportunity for retro-fit
104	1	8	4' T12	3	Troffer	Magnetic	3	N	Electronic	\$ 8.40	\$ 67.20	\$ 65.00	\$ 520.00	Excellent opportunity for retro-fit
BUILDING E											\$ -		\$ -	
Girls' Restroom	1	3	4' T12	2	Troffer	Magnetic	2	N	Electronic	\$ 5.60	\$ 16.80	\$ 60.00	\$ 180.00	Excellent opportunity for retro-fit
Boys' Restroom	1	3	4' T12	2	Troffer	Magnetic	2	N	Electronic	\$ 5.60	\$ 16.80	\$ 60.00	\$ 180.00	Excellent opportunity for retro-fit
101	1	23	4' T12	3	Troffer	Magnetic	3	N	Electronic	\$ 5.60	\$ 128.80	\$ 60.00	\$ 1,380.00	Excellent opportunity for retro-fit
101	1	3	4' T12	2	Troffer	Magnetic	2	N	Electronic	\$ 5.60	\$ 16.80	\$ 60.00	\$ 180.00	Excellent opportunity for retro-fit
Staff Restroom	1	1	4' T12	2	Vanity	Magnetic	2	N	Electronic	\$ 5.60	\$ 5.60	\$ 60.00	\$ 60.00	Excellent opportunity for retro-fit
General Utility Room	1	1	4' T12	1	Wrap	Magnetic	1	N	Electronic	\$ 2.80	\$ 2.80	\$ 55.00	\$ 55.00	Excellent opportunity for retro-fit
102	1	23	4' T12	3	Troffer	Magnetic	3	N	Electronic	\$ 8.40	\$ 193.20	\$ 65.00	\$ 1,495.00	Excellent opportunity for retro-fit
Girls' Restroom	2	3	4' T12	2	Troffer	Magnetic	2	N	Electronic	\$ 5.60	\$ 16.80	\$ 60.00	\$ 180.00	Excellent opportunity for retro-fit
Boys' Restroom	2	3	4' T12	2	Troffer	Magnetic	2	N	Electronic	\$ 5.60	\$ 16.80	\$ 60.00	\$ 180.00	Excellent opportunity for retro-fit
201	2	24	4' T12	2	Wrap	Magnetic	2	N	Electronic	\$ 5.60	\$ 134.40	\$ 60.00	\$ 1,440.00	Excellent opportunity for retro-fit
202	2	24	4' T12	2	Wrap	Magnetic	2	N	Electronic	\$ 5.60	\$ 134.40	\$ 60.00	\$ 1,440.00	Excellent opportunity for retro-fit
203	2	24	4' T12	2	Wrap	Magnetic	2	N	Electronic	\$ 5.60	\$ 134.40	\$ 60.00	\$ 1,440.00	Excellent opportunity for retro-fit
204	2	24	4' T12	2	Wrap	Magnetic	2	N	Electronic	\$ 5.60	\$ 134.40	\$ 60.00	\$ 1,440.00	Excellent opportunity for retro-fit
BUILDING G											\$ -		\$ -	
101	1	16	4' T12	3	Troffer	Magnetic	3	N	Electronic	\$ 8.40	\$ 134.40	\$ 65.00	\$ 1,040.00	Excellent opportunity for retro-fit
102	1	16	4' T12	3	Troffer	Magnetic	3	N	Electronic	\$ 8.40	\$ 134.40	\$ 65.00	\$ 1,040.00	Excellent opportunity for retro-fit
103	1	16	4' T12	3	Troffer	Magnetic	3	N	Electronic	\$ 8.40	\$ 134.40	\$ 65.00	\$ 1,040.00	Excellent opportunity for retro-fit
104	1	16	4' T12	3	Troffer	Magnetic	3	N	Electronic	\$ 8.40	\$ 134.40	\$ 65.00	\$ 1,040.00	Excellent opportunity for retro-fit
Girls' Restroom	1	2	4' T12	2	Vanity	Magnetic	2	N	Electronic	\$ 5.60	\$ 11.20	\$ 60.00	\$ 120.00	Excellent opportunity for retro-fit
Boys' Restroom	1	2	4' T12	2	Vanity	Magnetic	2	N	Electronic	\$ 5.60	\$ 11.20	\$ 60.00	\$ 120.00	Excellent opportunity for retro-fit
201	2	24	4' T12	2	Wrap	Magnetic	2	N	Electronic	\$ 5.60	\$ 134.40	\$ 60.00	\$ 1,440.00	Excellent opportunity for retro-fit
202	2	24	4' T12	2	Wrap	Magnetic	2	N	Electronic	\$ 5.60	\$ 134.40	\$ 60.00	\$ 1,440.00	Excellent opportunity for retro-fit
203	2	24	4' T12	2	Wrap	Magnetic	2	N	Electronic	\$ 5.60	\$ 134.40	\$ 60.00	\$ 1,440.00	Excellent opportunity for retro-fit
204	2	24	4' T12	2	Wrap	Magnetic	2	N	Electronic	\$ 5.60	\$ 134.40	\$ 60.00	\$ 1,440.00	Excellent opportunity for retro-fit

LOCATION	EXISTING EQUIPMENT						PROPOSED			REBATES		COSTS		COMMENTS
Location (Rm Name, Rm. #, Area, Zone, etc.)	Floor	Quantity	Lamp Type	Lamps Per Fixture	Type of Fixture	Ballast Type	Lamps Per Fixture	Reflectors	Ballast Type	Per Single	Extended	Per Single	Extended	Surveyors Comments
Girls' Restroom	2	2	4' T12	2	Vanity	Magnetic	2	N	Electronic	\$ 5.60	\$ 11.20	\$ 60.00	\$ 120.00	Excellent opportunity for retro-fit
Boys' Restroom	2	2	4' T12	2	Vanity	Magnetic	2	N	Electronic	\$ 5.60	\$ 11.20	\$ 60.00	\$ 120.00	Excellent opportunity for retro-fit
BUILDING H												\$ -	\$ -	
Library	1	94	4' T8	3	Troffer	Electronic					\$ -		\$ -	T8 Lamps, No Retrofit
General Purpose Room	1	3	4' T8	3	Troffer	Electronic					\$ -		\$ -	T8 Lamps, No Retrofit
Work Room	1	20	4' T8	3	Troffer	Electronic					\$ -		\$ -	T8 Lamps, No Retrofit
Storage Room	1	4	4' T8	3	Troffer	Electronic					\$ -		\$ -	T8 Lamps, No Retrofit
Office	1	6	4' T8	3	Troffer	Electronic					\$ -		\$ -	T8 Lamps, No Retrofit
Student Conference Room	1	9	4' T8	3	Troffer	Electronic					\$ -		\$ -	T8 Lamps, No Retrofit
Media Control Room	1	9	4' T8	3	Troffer	Electronic					\$ -		\$ -	T8 Lamps, No Retrofit
Men's Room	1	1	4' T8	2	Troffer	Electronic					\$ -		\$ -	T8 Lamps, No Retrofit
General Utility Room	1	1	4' T8	2	Troffer	Electronic					\$ -		\$ -	T8 Lamps, No Retrofit
Faculty Center	1	8	4' T8	3	Troffer	Electronic					\$ -		\$ -	T8 Lamps, No Retrofit
Storage Room	1	6	4' T8	3	Troffer	Electronic					\$ -		\$ -	T8 Lamps, No Retrofit
Women's Room	1	1	4' T8	2	Troffer	Electronic					\$ -		\$ -	T8 Lamps, No Retrofit
BUILDING K												\$ -	\$ -	
Cafeteria	1	32	4' T12	1	Wrap	Magnetic	1	N	Electronic	\$ 2.80	\$ 89.60	\$ 55.00	\$ 1,760.00	Excellent opportunity for retro fit
Cafeteria	1	38	4' T12	2	Wrap	Magnetic	2	N	Electronic	\$ 5.60	\$ 212.80	\$ 60.00	\$ 2,280.00	Excellent opportunity for retro fit
Stage	1	12	4' T12	2	Troffer	Magnetic	2	N	Electronic	\$ 5.60	\$ 67.20	\$ 60.00	\$ 720.00	Excellent opportunity for retro fit
Stage	1	17	4' T12	1	Troffer	Magnetic	1	N	Electronic	\$ 2.80	\$ 47.60	\$ 55.00	\$ 935.00	Excellent opportunity for retro fit
Office	1	5	4' T12	2	Troffer	Magnetic	2	N	Electronic	\$ 5.60	\$ 28.00	\$ 60.00	\$ 300.00	Excellent opportunity for retro fit
Storage Room	1	1	4' T12	1	Wrap	Magnetic	1	N	Electronic	\$ 2.80	\$ 2.80	\$ 55.00	\$ 55.00	Excellent opportunity for retro fit
Storage Room	1	4	4' T12	2	Wrap	Magnetic	2	N	Electronic	\$ 5.60	\$ 22.40	\$ 60.00	\$ 240.00	Excellent opportunity for retro fit
Storage Room	1	2	4' T12	4	Wrap	Magnetic	4	N	Electronic	\$ 11.20	\$ 22.40	\$ 70.00	\$ 140.00	Excellent opportunity for retro fit
Kitchen	1	32	4' T12	3	Wrap	Magnetic	3	N	Electronic	\$ 8.40	\$ 268.80	\$ 65.00	\$ 2,080.00	Excellent opportunity for retro fit
Hoods	1	6	4' T12	2	Wrap	Magnetic	2	N	Electronic	\$ 5.60	\$ 33.60	\$ 60.00	\$ 360.00	Excellent opportunity for retro fit
Faculty Dining Room	1	6	4' T12	3	Wrap	Magnetic	3	N	Electronic	\$ 8.40	\$ 50.40	\$ 65.00	\$ 390.00	Excellent opportunity for retro fit
BUILDING L												\$ -	\$ -	
Boys Locker Room	1	27	4' T12	2	Wrap	Magnetic	2	N	Electronic	\$ 5.60	\$ 151.20	\$ 60.00	\$ 1,620.00	Excellent opportunity for retro-fit
Office	1	4	4' T12	2	Wrap	Magnetic	2	N	Electronic	\$ 5.60	\$ 22.40	\$ 60.00	\$ 240.00	Excellent opportunity for retro-fit
Girls Locker Room	1	27	4' T12	2	Wrap	Magnetic	2	N	Electronic	\$ 5.60	\$ 151.20	\$ 60.00	\$ 1,620.00	Excellent opportunity for retro-fit
Office	1	4	4' T12	2	Wrap	Magnetic	2	N	Electronic	\$ 5.60	\$ 22.40	\$ 60.00	\$ 240.00	Excellent opportunity for retro-fit
BUILDING M												\$ -	\$ -	
Music Building Entry Hall	1	8	4' T12	3	Ice	Magnetic	3	N	Electronic	\$ 8.40	\$ 67.20	\$ 65.00	\$ 520.00	Replace fixture and mount hardware
Girls' Restroom	1	4	4' T12	2	Wrap	Magnetic	2	N	Electronic	\$ 5.60	\$ 22.40	\$ 60.00	\$ 240.00	Excellent opportunity for retro-fit
Boys' Restroom	1	4	4' T12	2	Wrap	Magnetic	2	N	Electronic	\$ 5.60	\$ 22.40	\$ 60.00	\$ 240.00	Excellent opportunity for retro-fit
M - 101	1	36	4' T12	3	Ice	Magnetic	3	N	Electronic	\$ 8.40	\$ 302.40	\$ 65.00	\$ 2,340.00	Replace fixture and mount hardware
Office	1	3	4' T12	3	Ice	Magnetic	3	N	Electronic	\$ 8.40	\$ 25.20	\$ 65.00	\$ 195.00	Replace fixture and mount hardware

LOCATION (Rm Name, Rm. #, Area, Zone, etc.)	EXISTING EQUIPMENT						PROPOSED			REBATES		COSTS		COMMENTS Surveyors Comments
	Floor	Quantity	Lamp Type	Lamps Per Fixture	Type of Fixture	Ballast Type	Lamps Per Fixture	Reflectors	Ballast Type	Per Single	Extended	Per Single	Extended	
Storage Room	1	6	4' T12	3	Ice	Magnetic	3	N	Electronic	\$ 8.40	\$ 50.40	\$ 65.00	\$ 390.00	Replace fixture and mount hardware
Robe Storage	1	2	4' T12	3	Ice	Magnetic	3	N	Electronic	\$ 8.40	\$ 16.80	\$ 65.00	\$ 130.00	Replace fixture and mount hardware
Band Room	1	48	4' T12	3	Ice	Magnetic	3	N	Electronic	\$ 8.40	\$ 403.20	\$ 65.00	\$ 3,120.00	Replace fixture and mount hardware
Office	1	3	4' T12	3	Ice	Magnetic	3	N	Electronic	\$ 8.40	\$ 25.20	\$ 65.00	\$ 195.00	Replace fixture and mount hardware
Uniform Storage	1	6	4' T12	3	Ice	Magnetic	3	N	Electronic	\$ 8.40	\$ 50.40	\$ 65.00	\$ 390.00	Replace fixture and mount hardware
Ensemble Room	1	4	4' T12	3	Ice	Magnetic	3	N	Electronic	\$ 8.40	\$ 33.60	\$ 65.00	\$ 260.00	Replace fixture and mount hardware
Practice Room - 1	1	1	4' T12	3	Ice	Magnetic	3	N	Electronic	\$ 8.40	\$ 8.40	\$ 65.00	\$ 65.00	Replace fixture and mount hardware
Practice Room - 2	1	1	4' T12	3	Ice	Magnetic	3	N	Electronic	\$ 8.40	\$ 8.40	\$ 65.00	\$ 65.00	Replace fixture and mount hardware
Practice Room - 3	1	1	4' T12	3	Ice	Magnetic	3	N	Electronic	\$ 8.40	\$ 8.40	\$ 65.00	\$ 65.00	Replace fixture and mount hardware
Practice Room - 4	1	1	4' T12	3	Ice	Magnetic	3	N	Electronic	\$ 8.40	\$ 8.40	\$ 65.00	\$ 65.00	Replace fixture and mount hardware
Practice Room - 5	1	1	4' T12	3	Ice	Magnetic	3	N	Electronic	\$ 8.40	\$ 8.40	\$ 65.00	\$ 65.00	Replace fixture and mount hardware
General Utility Room	1	1	4' T12	2	Wrap	Magnetic	2	N	Electronic	\$ 5.60	\$ 5.60	\$ 60.00	\$ 60.00	Excellent opportunity for retro-fit
BUILDING N											\$ -		\$ -	
101	1	15	4' T12	3	Troffer	Magnetic	3	N	Electronic	\$ 8.40	\$ 126.00	\$ 65.00	\$ 975.00	Excellent opportunity for -retro-fit
102	1	21	4' T12	2	Wrap	Magnetic	2	N	Electronic	\$ 5.60	\$ 117.60	\$ 60.00	\$ 1,260.00	Excellent opportunity for -retro-fit
Wood shop	1	50	4' T12	2	Wrap	Magnetic	2	N	Electronic	\$ 5.60	\$ 280.00	\$ 60.00	\$ 3,000.00	Excellent opportunity for -retro-fit
104	1	12	4' T12	4	Troffer	Magnetic	4	N	Electronic	\$ 11.20	\$ 134.40	\$ 70.00	\$ 840.00	Excellent opportunity for -retro-fit
Office	1	2	4' T12	4	Troffer	Magnetic	4	N	Electronic	\$ 11.20	\$ 22.40	\$ 70.00	\$ 140.00	Excellent opportunity for -retro-fit
Girls' Restroom	1	6	4' T12	4	Vanity	Magnetic	4	N	Electronic	\$ 11.20	\$ 67.20	\$ 70.00	\$ 420.00	Excellent opportunity for -retro-fit
Boys' Restroom	1	6	4' T12	4	Vanity	Magnetic	4	N	Electronic	\$ 11.20	\$ 67.20	\$ 70.00	\$ 420.00	Excellent opportunity for -retro-fit
PORTABLES											\$ -		\$ -	
P - 1	1	16	4' T12	4	Wrap	Magnetic	4	N	Electronic	\$ 11.20	\$ 179.20	\$ 70.00	\$ 1,120.00	Excellent opportunity for retro-fit
P - 2	1	16	4' T12	4	Wrap	Magnetic	4	N	Electronic	\$ 11.20	\$ 179.20	\$ 70.00	\$ 1,120.00	Excellent opportunity for retro-fit
P - 3	1	16	4' T12	4	Wrap	Magnetic	4	N	Electronic	\$ 11.20	\$ 179.20	\$ 70.00	\$ 1,120.00	Excellent opportunity for retro-fit
P - 4	1	16	4' T12	4	Wrap	Magnetic	4	N	Electronic	\$ 11.20	\$ 179.20	\$ 70.00	\$ 1,120.00	Excellent opportunity for retro-fit
P - 5	1	12	4' T12	4	Troffer	Magnetic	4	N	Electronic	\$ 11.20	\$ 134.40	\$ 70.00	\$ 840.00	Excellent opportunity for retro-fit
P - 6	1	12	4' T12	4	Troffer	Magnetic	4	N	Electronic	\$ 11.20	\$ 134.40	\$ 70.00	\$ 840.00	Excellent opportunity for retro-fit
P - 7	1	12	4' T12	4	Troffer	Magnetic	4	N	Electronic	\$ 11.20	\$ 134.40	\$ 70.00	\$ 840.00	Excellent opportunity for retro-fit
P - 8	1	12	4' T12	4	Troffer	Magnetic	4	N	Electronic	\$ 11.20	\$ 134.40	\$ 70.00	\$ 840.00	Excellent opportunity for retro-fit
Total Rebates										\$		\$	9,567.60	
Total Costs										\$		\$	86,185.00	

LOCATION	QTY	EXISTING TYPE	QTY	RETROFIT	SURVEYORS COMMENTS	Existing		Actual			Proposed		
						Watt/unit	Op. Hours	kWh	kW-D	Watt/unit	Op. Hours	kWh	kW-D
BUILDING A	0		0		0		1,549	0	0		1,549	0	0
<i>Girls' Restroom</i>	3	4' 1L Fixture	3	Lamp & Low Watt Ballast	Excellent opportunity for retro-fit	45.6	1,549	211.8348	0.1368	31	1,549	144.0105	0.093
<i>Boys' Restroom</i>	3	4' 1L Fixture	3	Lamp & Low Watt Ballast	Excellent opportunity for retro-fit	45.6	1,549	211.8	0.1368	31	1,549	144.0	0.093
Office - 101	6	4' 4L Fixture	6	Lamp & Low Watt Ballast	Excellent opportunity for retro-fit	151.2	1,549	1,404.8	0.9072	100	1,549	929.1	0.6
<i>Principal</i>	14	4' 2L Fixture	14	Lamp & Low Watt Ballast	Excellent opportunity for retro-fit	75.6	1,549	1,638.9	1.0584	51	1,549	1,105.6	0.714
<i>Health Room</i>	4	4' 4L Fixture	4	Lamp & Low Watt Ballast	Excellent opportunity for retro-fit	151.2	1,549	936.5	0.6048	100	1,549	619.4	0.4
102	12	4' 4L Fixture	12	Lamp & Low Watt Ballast	Excellent opportunity for retro-fit	151.2	1,549	2,809.6	1.8144	100	1,549	1,858.2	1.2
<i>Vice-Principal</i>	4	4' 4L Fixture	4	Lamp & Low Watt Ballast	Excellent opportunity for retro-fit	151.2	1,549	936.5	0.6048	100	1,549	619.4	0.4
103	24	4' 2L Fixture	24	Lamp & Low Watt Ballast	Excellent opportunity for retro-fit	75.6	1,549	2,809.6	1.8144	51	1,549	1,895.4	1.224
<i>Girls' Restroom</i>	3	4' 1L Fixture	3	Lamp & Low Watt Ballast	Excellent opportunity for retro-fit	45.6	1,549	211.8	0.1368	31	1,549	144.0	0.093
<i>Boys' Restroom</i>	3	4' 1L Fixture	3	Lamp & Low Watt Ballast	Excellent opportunity for retro-fit	45.6	1,549	211.8	0.1368	31	1,549	144.0	0.093
BUILDING B	0		0		0		1,549	0.0	0		1,549	0.0	0
<i>Girls' Restroom</i>	5	4' 1L Fixture	5	Lamp & Low Watt Ballast	Excellent opportunity for retro-fit	45.6	1,549	353.1	0.228	31	1,549	240.0	0.155
<i>Boys' Restroom</i>	7	4' 1L Fixture	7	Lamp & Low Watt Ballast	Excellent opportunity for retro-fit	45.6	1,549	494.3	0.3192	31	1,549	336.0	0.217
101 - A	15		0		T8 Lamps, No Retrofit		1,549	0.0	0		1,549	0.0	0
101 - B	12		0		T8 Lamps, No Retrofit		1,549	0.0	0		1,549	0.0	0
102	24		0		T8 Lamps, No Retrofit		1,549	0.0	0		1,549	0.0	0
<i>Hall</i>	1	4' 2L Fixture	1	Lamp & Low Watt Ballast	Excellent opportunity for retro-fit	75.6	1,549	117.1	0.0756	51	1,549	79.0	0.051
<i>Laundry</i>	2	4' 2L Fixture	2	Lamp & Low Watt Ballast	Excellent opportunity for retro-fit	75.6	1,549	234.1	0.1512	51	1,549	157.9	0.102
<i>Storage Room</i>	2	4' 4L Fixture	2	Lamp & Low Watt Ballast	Excellent opportunity for retro-fit	151.2	1,549	468.3	0.3024	100	1,549	309.7	0.2
<i>Girls' Restroom</i>	5	4' 1L Fixture	5	Lamp & Low Watt Ballast	Excellent opportunity for retro-fit	45.6	1,549	353.1	0.228	31	1,549	240.0	0.155
<i>Boys' Restroom</i>	7	4' 1L Fixture	7	Lamp & Low Watt Ballast	Excellent opportunity for retro-fit	45.6	1,549	494.3	0.3192	31	1,549	336.0	0.217
201	24	4' 2L Fixture	24	Lamp & Low Watt Ballast	Excellent opportunity for retro-fit	75.6	1,549	2,809.6	1.8144	51	1,549	1,895.4	1.224
202	24	4' 2L Fixture	24	Lamp & Low Watt Ballast	Excellent opportunity for retro-fit	75.6	1,549	2,809.6	1.8144	51	1,549	1,895.4	1.224
203	24	4' 2L Fixture	24	Lamp & Low Watt Ballast	Excellent opportunity for retro-fit	75.6	1,549	2,809.6	1.8144	51	1,549	1,895.4	1.224
204	10	4' 2L Fixture	10	Lamp & Low Watt Ballast	Excellent opportunity for retro-fit	75.6	1,549	1,170.7	0.756	51	1,549	789.7	0.51
<i>Storage Room</i>	3		0		T8 Lamps, No Retrofit		1,549	0.0	0		1,549	0.0	0
BUILDING C	0		0		0		1,549	0.0	0		1,549	0.0	0
<i>Girls' Restroom</i>	5	4' 1L Fixture	5	Lamp & Low Watt Ballast	Excellent opportunity for retro-fit	45.6	1,549	353.1	0.228	31	1,549	240.0	0.155
<i>Boys' Restroom</i>	5	4' 1L Fixture	5	Lamp & Low Watt Ballast	Excellent opportunity for retro-fit	45.6	1,549	353.1	0.228	31	1,549	240.0	0.155
101	22	4' 4L Fixture	22	Lamp & Low Watt Ballast	Excellent opportunity for retro-fit	151.2	1,549	5,150.9	3.3264	100	1,549	3,406.7	2.2
102	16	4' 4L Fixture	16	Lamp & Low Watt Ballast	Excellent opportunity for retro-fit	151.2	1,549	3,746.1	2.4192	100	1,549	2,477.6	1.6
103	24	4' 4L Fixture	24	Lamp & Low Watt Ballast	Excellent opportunity for retro-fit	151.2	1,549	5,619.2	3.6288	100	1,549	3,716.4	2.4
201	36	4' 2L Fixture	36	Lamp & Low Watt Ballast	Excellent opportunity for retro-fit	75.6	1,549	4,214.4	2.7216	51	1,549	2,843.0	1.836
202	24	4' 2L Fixture	24	Lamp & Low Watt Ballast	Excellent opportunity for retro-fit	75.6	1,549	2,809.6	1.8144	51	1,549	1,895.4	1.224
203	24	4' 2L Fixture	24	Lamp & Low Watt Ballast	Excellent opportunity for retro-fit	75.6	1,549	2,809.6	1.8144	51	1,549	1,895.4	1.224
204	24	4' 2L Fixture	24	Lamp & Low Watt Ballast	Excellent opportunity for retro-fit	75.6	1,549	2,809.6	1.8144	51	1,549	1,895.4	1.224
<i>Girls' Restroom</i>	5	4' 1L Fixture	5	Lamp & Low Watt Ballast	Excellent opportunity for retro-fit	45.6	1,549	353.1	0.228	31	1,549	240.0	0.155
<i>Boys' Restroom</i>	5	4' 1L Fixture	5	Lamp & Low Watt Ballast	Excellent opportunity for retro-fit	45.6	1,549	353.1	0.228	31	1,549	240.0	0.155
BUILDING D	0		0		0		1,549	0.0	0		1,549	0.0	0
<i>Girls' Restroom</i>	17	4' 1L Fixture	17	Lamp & Low Watt Ballast	Excellent opportunity for retro-fit	45.6	1,549	1,200.4	0.7752	31	1,549	816.1	0.527
<i>Boys' Restroom</i>	17	4' 1L Fixture	17	Lamp & Low Watt Ballast	Excellent opportunity for retro-fit	45.6	1,549	1,200.4	0.7752	31	1,549	816.1	0.527
101	16	4' 3L Fixture	16	Lamp & Low Watt Ballast	Excellent opportunity for retro-fit	121.2	1,549	3,002.9	1.9392	77	1,549	1,907.8	1.232
102	23	4' 3L Fixture	23	Lamp & Low Watt Ballast	Excellent opportunity for retro-fit	121.2	1,549	4,316.6	2.7876	77	1,549	2,742.4	1.771
103-A	14	4' 3L Fixture	14	Lamp & Low Watt Ballast	Excellent opportunity for retro-fit	121.2	1,549	2,627.5	1.6968	77	1,549	1,669.3	1.078
103-B	12	4' 3L Fixture	12	Lamp & Low Watt Ballast	Excellent opportunity for retro-fit	121.2	1,549	2,252.1	1.4544	77	1,549	1,430.8	0.924
104	8	4' 3L Fixture	8	Lamp & Low Watt Ballast	Excellent opportunity for retro-fit	121.2	1,549	1,501.4	0.9696	77	1,549	953.9	0.616
BUILDING E	0		0		0		1,549	0.0	0		1,549	0.0	0
<i>Girls' Restroom</i>	3	4' 2L Fixture	3	Lamp & Low Watt Ballast	Excellent opportunity for retro-fit	75.6	1,549	351.2	0.2268	51	1,549	236.9	0.153
<i>Boys' Restroom</i>	3	4' 2L Fixture	3	Lamp & Low Watt Ballast	Excellent opportunity for retro-fit	75.6	1,549	351.2	0.2268	51	1,549	236.9	0.153
101	23	4' 2L Fixture	23	Lamp & Low Watt Ballast	Excellent opportunity for retro-fit	75.6	1,549	2,692.5	1.7388	51	1,549	1,816.4	1.173
101	3	4' 2L Fixture	3	Lamp & Low Watt Ballast	Excellent opportunity for retro-fit	75.6	1,549	351.2	0.2268	51	1,549	236.9	0.153
<i>Staff Restroom</i>	1	4' 2L Fixture	1	Lamp & Low Watt Ballast	Excellent opportunity for retro-fit	75.6	1,549	117.1	0.0756	51	1,549	79.0	0.051
<i>General Utility Room</i>	1	4' 1L Fixture	1	Lamp & Low Watt Ballast	Excellent opportunity for retro-fit	45.6	1,549	70.6	0.0456	31	1,549	48.0	0.031
102	23	4' 3L Fixture	23	Lamp & Low Watt Ballast	Excellent opportunity for retro-fit	121.2	1,549	4,316.6	2.7876	77	1,549	2,742.4	1.771
<i>Girls' Restroom</i>	3	4' 2L Fixture	3	Lamp & Low Watt Ballast	Excellent opportunity for retro-fit	75.6	1,549	351.2	0.2268	51	1,549	236.9	0.153
<i>Boys' Restroom</i>	3	4' 2L Fixture	3	Lamp & Low Watt Ballast	Excellent opportunity for retro-fit	75.6	1,549	351.2	0.2268	51	1,549	236.9	0.153
201	24	4' 2L Fixture	24	Lamp & Low Watt Ballast	Excellent opportunity for retro-fit	75.6	1,549	2,809.6	1.8144	51	1,549	1,895.4	1.224
202	24	4' 2L Fixture	24	Lamp & Low Watt Ballast	Excellent opportunity for retro-fit	75.6	1,549	2,809.6	1.8144	51	1,549	1,895.4	1.224
203	24	4' 2L Fixture	24	Lamp & Low Watt Ballast	Excellent opportunity for retro-fit	75.6	1,549	2,809.6	1.8144	51	1,549	1,895.4	1.224
204	24	4' 2L Fixture	24	Lamp & Low Watt Ballast	Excellent opportunity for retro-fit	75.6	1,549	2,809.6	1.8144	51	1,549	1,895.4	1.224

LOCATION	QTY	EXISTING TYPE	QTY	RETROFIT	SURVEYORS COMMENTS	Existing	Actual			Proposed			
						Watt/unit	Op. Hours	kWh	kW-D	Watt/unit	Op. Hours	kWh	kW-D
BUILDING G	0		0		0		1,549	0.0	0		1,549	0.0	0
101	16	4' 3L Fixture	16	Lamp & Low Watt Ballast	Excellent opportunity for retro-fit	121.2	1,549	3,002.9	1.9392	77	1,549	1,907.8	1.232
102	16	4' 3L Fixture	16	Lamp & Low Watt Ballast	Excellent opportunity for retro-fit	121.2	1,549	3,002.9	1.9392	77	1,549	1,907.8	1.232
103	16	4' 3L Fixture	16	Lamp & Low Watt Ballast	Excellent opportunity for retro-fit	121.2	1,549	3,002.9	1.9392	77	1,549	1,907.8	1.232
104	16	4' 3L Fixture	16	Lamp & Low Watt Ballast	Excellent opportunity for retro-fit	121.2	1,549	3,002.9	1.9392	77	1,549	1,907.8	1.232
Girls' Restroom	2	4' 2L Fixture	2	Lamp & Low Watt Ballast	Excellent opportunity for retro-fit	75.6	1,549	234.1	0.1512	51	1,549	157.9	0.102
Boys' Restroom	2	4' 2L Fixture	2	Lamp & Low Watt Ballast	Excellent opportunity for retro-fit	75.6	1,549	234.1	0.1512	51	1,549	157.9	0.102
201	24	4' 2L Fixture	24	Lamp & Low Watt Ballast	Excellent opportunity for retro-fit	75.6	1,549	2,809.6	1.8144	51	1,549	1,895.4	1.224
202	24	4' 2L Fixture	24	Lamp & Low Watt Ballast	Excellent opportunity for retro-fit	75.6	1,549	2,809.6	1.8144	51	1,549	1,895.4	1.224
203	24	4' 2L Fixture	24	Lamp & Low Watt Ballast	Excellent opportunity for retro-fit	75.6	1,549	2,809.6	1.8144	51	1,549	1,895.4	1.224
204	24	4' 2L Fixture	24	Lamp & Low Watt Ballast	Excellent opportunity for retro-fit	75.6	1,549	2,809.6	1.8144	51	1,549	1,895.4	1.224
Girls' Restroom	2	4' 2L Fixture	2	Lamp & Low Watt Ballast	Excellent opportunity for retro-fit	75.6	1,549	234.1	0.1512	51	1,549	157.9	0.102
Boys' Restroom	2	4' 2L Fixture	2	Lamp & Low Watt Ballast	Excellent opportunity for retro-fit	75.6	1,549	234.1	0.1512	51	1,549	157.9	0.102
BUILDING H	0		0		0		1,549	0.0	0		1,549	0.0	0
Library	94		0		T8 Lamps, No Retrofit		1,549	0.0	0		1,549	0.0	0
General Purpose Room	3		0		T8 Lamps, No Retrofit		1,549	0.0	0		1,549	0.0	0
Work Room	20		0		T8 Lamps, No Retrofit		1,549	0.0	0		1,549	0.0	0
Storage Room	4		0		T8 Lamps, No Retrofit		1,549	0.0	0		1,549	0.0	0
Office	6		0		T8 Lamps, No Retrofit		1,549	0.0	0		1,549	0.0	0
Student Conference Room	9		0		T8 Lamps, No Retrofit		1,549	0.0	0		1,549	0.0	0
Media Control Room	9		0		T8 Lamps, No Retrofit		1,549	0.0	0		1,549	0.0	0
Men's Room	1		0		T8 Lamps, No Retrofit		1,549	0.0	0		1,549	0.0	0
General Utility Room	1		0		T8 Lamps, No Retrofit		1,549	0.0	0		1,549	0.0	0
Faculty Center	8		0		T8 Lamps, No Retrofit		1,549	0.0	0		1,549	0.0	0
Storage Room	6		0		T8 Lamps, No Retrofit		1,549	0.0	0		1,549	0.0	0
Women's Room	1		0		T8 Lamps, No Retrofit		1,549	0.0	0		1,549	0.0	0
BUILDING K	0		0		0		1,549	0.0	0		1,549	0.0	0
Cafeteria	32	4' 1L Fixture	32	Lamp & Low Watt Ballast	Excellent opportunity for retro fit	45.6	1,549	2,259.6	1.4592	31	1,549	1,536.1	0.992
Cafeteria	38	4' 2L Fixture	38	Lamp & Low Watt Ballast	Excellent opportunity for retro fit	75.6	1,549	4,448.5	2.8728	51	1,549	3,001.0	1.938
Stage	12	4' 2L Fixture	12	Lamp & Low Watt Ballast	Excellent opportunity for retro fit	75.6	1,549	1,404.8	0.9072	51	1,549	947.7	0.612
Stage	17	4' 1L Fixture	17	Lamp & Low Watt Ballast	Excellent opportunity for retro fit	45.6	1,549	1,200.4	0.7752	31	1,549	816.1	0.527
Office	5	4' 2L Fixture	5	Lamp & Low Watt Ballast	Excellent opportunity for retro fit	75.6	1,549	585.3	0.378	51	1,549	394.9	0.255
Storage Room	1	4' 1L Fixture	1	Lamp & Low Watt Ballast	Excellent opportunity for retro fit	45.6	1,549	70.6	0.0456	31	1,549	48.0	0.031
Storage Room	4	4' 2L Fixture	4	Lamp & Low Watt Ballast	Excellent opportunity for retro fit	75.6	1,549	468.3	0.3024	51	1,549	315.9	0.204
Storage Room	2	4' 4L Fixture	2	Lamp & Low Watt Ballast	Excellent opportunity for retro fit	151.2	1,549	468.3	0.3024	100	1,549	309.7	0.2
Kitchen	32	4' 3L Fixture	32	Lamp & Low Watt Ballast	Excellent opportunity for retro fit	121.2	1,549	6,005.7	3.8784	77	1,549	3,815.5	2.464
Hoods	6	4' 2L Fixture	6	Lamp & Low Watt Ballast	Excellent opportunity for retro fit	75.6	1,549	702.4	0.4536	51	1,549	473.8	0.306
Faculty Dining Room	6	4' 3L Fixture	6	Lamp & Low Watt Ballast	Excellent opportunity for retro fit	121.2	1,549	1,126.1	0.7272	77	1,549	715.4	0.462
BUILDING L	0		0		0		1,549	0.0	0		1,549	0.0	0
Boys Locker Room	27	4' 2L Fixture	27	Lamp & Low Watt Ballast	Excellent opportunity for retro-fit	75.6	1,549	3,160.8	2.0412	51	1,549	2,132.3	1.377
Office	4	4' 2L Fixture	4	Lamp & Low Watt Ballast	Excellent opportunity for retro-fit	75.6	1,549	468.3	0.3024	51	1,549	315.9	0.204
Girls Locker Room	27	4' 2L Fixture	27	Lamp & Low Watt Ballast	Excellent opportunity for retro-fit	75.6	1,549	3,160.8	2.0412	51	1,549	2,132.3	1.377
Office	4	4' 2L Fixture	4	Lamp & Low Watt Ballast	Excellent opportunity for retro-fit	75.6	1,549	468.3	0.3024	51	1,549	315.9	0.204
BUILDING M	0		0		0		1,549	0.0	0		1,549	0.0	0
Music Building Entry Hall	8	4' 3L Fixture	8	Lamp & Low Watt Ballast	Replace fixture and mount hardware	121.2	1,549	1,501.4	0.9696	77	1,549	953.9	0.616
Girls' Restroom	4	4' 2L Fixture	4	Lamp & Low Watt Ballast	Excellent opportunity for retro-fit	75.6	1,549	468.3	0.3024	51	1,549	315.9	0.204
Boys' Restroom	4	4' 2L Fixture	4	Lamp & Low Watt Ballast	Excellent opportunity for retro-fit	75.6	1,549	468.3	0.3024	51	1,549	315.9	0.204
M - 101	36	4' 3L Fixture	36	Lamp & Low Watt Ballast	Replace fixture and mount hardware	121.2	1,549	6,756.4	4.3632	77	1,549	4,292.4	2.772
Office	3	4' 3L Fixture	3	Lamp & Low Watt Ballast	Replace fixture and mount hardware	121.2	1,549	563.0	0.3636	77	1,549	357.7	0.231
Storage Room	6	4' 3L Fixture	6	Lamp & Low Watt Ballast	Replace fixture and mount hardware	121.2	1,549	1,126.1	0.7272	77	1,549	715.4	0.462
Robe Storage	2	4' 3L Fixture	2	Lamp & Low Watt Ballast	Replace fixture and mount hardware	121.2	1,549	375.4	0.2424	77	1,549	238.5	0.154
Band Room	48	4' 3L Fixture	48	Lamp & Low Watt Ballast	Replace fixture and mount hardware	121.2	1,549	9,008.6	5.8176	77	1,549	5,723.3	3.696
Office	3	4' 3L Fixture	3	Lamp & Low Watt Ballast	Replace fixture and mount hardware	121.2	1,549	563.0	0.3636	77	1,549	357.7	0.231
Uniform Storage	6	4' 3L Fixture	6	Lamp & Low Watt Ballast	Replace fixture and mount hardware	121.2	1,549	1,126.1	0.7272	77	1,549	715.4	0.462
Ensemble Room	4	4' 3L Fixture	4	Lamp & Low Watt Ballast	Replace fixture and mount hardware	121.2	1,549	750.7	0.4848	77	1,549	476.9	0.308
Practice Room - 1	1	4' 3L Fixture	1	Lamp & Low Watt Ballast	Replace fixture and mount hardware	121.2	1,549	187.7	0.1212	77	1,549	119.2	0.077
Practice Room - 2	1	4' 3L Fixture	1	Lamp & Low Watt Ballast	Replace fixture and mount hardware	121.2	1,549	187.7	0.1212	77	1,549	119.2	0.077
Practice Room - 3	1	4' 3L Fixture	1	Lamp & Low Watt Ballast	Replace fixture and mount hardware	121.2	1,549	187.7	0.1212	77	1,549	119.2	0.077
Practice Room - 4	1	4' 3L Fixture	1	Lamp & Low Watt Ballast	Replace fixture and mount hardware	121.2	1,549	187.7	0.1212	77	1,549	119.2	0.077
Practice Room - 5	1	4' 3L Fixture	1	Lamp & Low Watt Ballast	Replace fixture and mount hardware	121.2	1,549	187.7	0.1212	77	1,549	119.2	0.077
General Utility Room	1	4' 2L Fixture	1	Lamp & Low Watt Ballast	Excellent opportunity for retro-fit	75.6	1,549	117.1	0.0756	51	1,549	79.0	0.051

LOCATION	QTY	EXISTING TYPE	QTY	RETROFIT	SURVEYORS COMMENTS	Existing	Actual			Proposed			
						Watt/unit	Op. Hours	kWh	kW-D	Watt/unit	Op. Hours	kWh	kW-D
BUILDING N	0		0		0		1,549	0.0	0		1,549	0.0	0
101	15	4' 3L Fixture	15	Lamp & Low Watt Ballast	Excellent opportunity for -retro-fit	121.2	1,549	2,815.2	1.818	77	1,549	1,788.5	1.155
102	21	4' 2L Fixture	21	Lamp & Low Watt Ballast	Excellent opportunity for -retro-fit	75.6	1,549	2,458.4	1.5876	51	1,549	1,658.4	1.071
Wood shop	50	4' 2L Fixture	50	Lamp & Low Watt Ballast	Excellent opportunity for -retro-fit	75.6	1,549	5,853.3	3.78	51	1,549	3,948.7	2.55
104	12	4' 4L Fixture	12	Lamp & Low Watt Ballast	Excellent opportunity for -retro-fit	151.2	1,549	2,809.6	1.8144	100	1,549	1,858.2	1.2
Office	2	4' 4L Fixture	2	Lamp & Low Watt Ballast	Excellent opportunity for -retro-fit	151.2	1,549	468.3	0.3024	100	1,549	309.7	0.2
Girls' Restroom	6	4' 4L Fixture	6	Lamp & Low Watt Ballast	Excellent opportunity for -retro-fit	151.2	1,549	1,404.8	0.9072	100	1,549	929.1	0.6
Boys' Restroom	6	4' 4L Fixture	6	Lamp & Low Watt Ballast	Excellent opportunity for -retro-fit	151.2	1,549	1,404.8	0.9072	100	1,549	929.1	0.6
PORTABLES	0		0		0		1,549	0.0	0		1,549	0.0	0
P - 1	16	4' 4L Fixture	16	Lamp & Low Watt Ballast	Excellent opportunity for retro-fit	151.2	1,549	3,746.1	2.4192	100	1,549	2,477.6	1.6
P - 2	16	4' 4L Fixture	16	Lamp & Low Watt Ballast	Excellent opportunity for retro-fit	151.2	1,549	3,746.1	2.4192	100	1,549	2,477.6	1.6
P - 3	16	4' 4L Fixture	16	Lamp & Low Watt Ballast	Excellent opportunity for retro-fit	151.2	1,549	3,746.1	2.4192	100	1,549	2,477.6	1.6
P - 4	16	4' 4L Fixture	16	Lamp & Low Watt Ballast	Excellent opportunity for retro-fit	151.2	1,549	3,746.1	2.4192	100	1,549	2,477.6	1.6
P - 5	12	4' 4L Fixture	12	Lamp & Low Watt Ballast	Excellent opportunity for retro-fit	151.2	1,549	2,809.6	1.8144	100	1,549	1,858.2	1.2
P - 6	12	4' 4L Fixture	12	Lamp & Low Watt Ballast	Excellent opportunity for retro-fit	151.2	1,549	2,809.6	1.8144	100	1,549	1,858.2	1.2
P - 7	12	4' 4L Fixture	12	Lamp & Low Watt Ballast	Excellent opportunity for retro-fit	151.2	1,549	2,809.6	1.8144	100	1,549	1,858.2	1.2
P - 8	12	4' 4L Fixture	12	Lamp & Low Watt Ballast	Excellent opportunity for retro-fit	151.2	1,549	2,809.6	1.8144	100	1,549	1,858.2	1.2
Existing	1598	Proposed	1382	ENERGY CALCULATIONS				205,745	133			135,673	88

Description	kW-Demand	kWh	
Existing Use	132.87	205,745	
Proposed Use	87.62	135,673	
Difference - Savings	45.25	70,072	
Electrical Utility Cost	\$5.75	\$0.15463	
Savings per Year	\$3,122.36	\$10,835.23	Total Yearly Energy Savings \$13,957.59

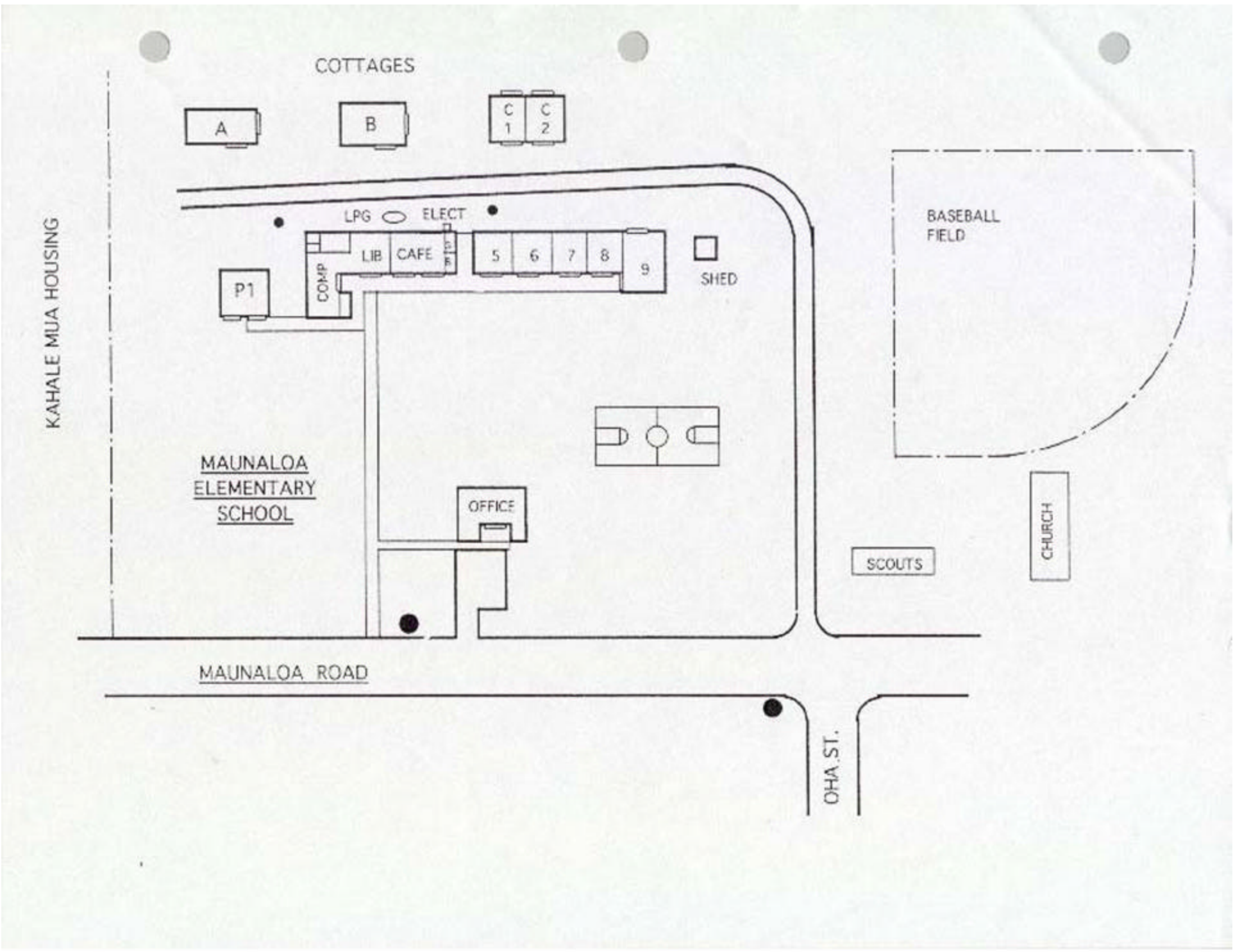

COTTAGES

A

B

C
1 2

KAHALE MUA HOUSING

LPG ELECT

P1

COMP

LIB

CAFE

5

6

7

8

9

SHED

BASEBALL
FIELD

MAUNALOA
ELEMENTARY
SCHOOL

OFFICE

SCOUTS

CHURCH

MAUNALOA ROAD

OHA ST.

Maui Smart Schools Program
Foot Candle Readings

School: Mannaloa Elementary School

Room: Cottage A-
Ceiling height: 9'
Light fixture height: 8'
Fixture type: WRAP

45		97
	50	
48		45

Room: Bldg. A- = 3A
Ceiling height: 9'
Light fixture height: 8'
Fixture type: WRAP

35		37
	38	
40		32

Room: Cafeteria
Ceiling height: 10'
Light fixture height: 8'
Fixture type: WRAP

37		40
	40	
47		44



SCHOOL INFORMATION		DATE
NAME Mauna Loa Elementary School		8/29/2000
STREET ADDRESS P. O. Box 128 Maunaloa, HI 96770		OPERATIONAL HOURS 1,975
POINT OF CONTACT Joe Yamamoto	PHONE 552-2000	FAX 120V
AUDITOR Maui Community College Auditors		

LOCATION <small>(Rm Name, Rm. #, Area, Zone, etc.)</small>	EXISTING EQUIPMENT						PROPOSED			REBATES		COSTS		COMMENTS <small>Surveyors Comments</small>
	Floor	Quantity	Lamp Type	Lamps Per Fixture	Type of Fixture	Ballast Type	Lamps Per Fixture	Reflectors	Ballast Type	Per Single	Extended	Per Single	Extended	
BUILDING A	1	15	4' T12	4	Ice	Magnetic	4	N	Electronic	\$ 11.20	\$ 168.00	\$ 160.00	\$ 2,400.00	replace fixture and mount hardware
Office	1	2	4' T12	4	Ice	Magnetic	4	N	Electronic	\$ 11.20	\$ 22.40	\$ 160.00	\$ 320.00	replace fixture and mount hardware
Conference Room	1	10	4' T12	4	Wrap	Magnetic	4	N	Electronic	\$ 11.20	\$ 112.00	\$ 70.00	\$ 700.00	excellent opportunity for retro-fit
Cafeteria	1	18	4' T12	4	Wrap	Magnetic	4	N	Electronic	\$ 11.20	\$ 201.60	\$ 70.00	\$ 1,260.00	excellent opportunity for retro-fit
Kitchen	1	5	4' T12	4	Wrap	Magnetic	4	N	Electronic	\$ 11.20	\$ 56.00	\$ 70.00	\$ 350.00	excellent opportunity for retro-fit
Boys Restroom	1	2	4' T12	4	Wrap	Magnetic	4	N	Electronic	\$ 11.20	\$ 22.40	\$ 70.00	\$ 140.00	excellent opportunity for retro-fit
	1	15	4' T12	4	Wrap	Magnetic	4	N	Electronic	\$ 11.20	\$ 168.00	\$ 70.00	\$ 1,050.00	excellent opportunity for retro-fit
	1	15	4' T12	4	Wrap	Magnetic	4	N	Electronic	\$ 11.20	\$ 168.00	\$ 70.00	\$ 1,050.00	excellent opportunity for retro-fit
	1	15	4' T12	4	Wrap	Magnetic	4	N	Electronic	\$ 11.20	\$ 168.00	\$ 70.00	\$ 1,050.00	excellent opportunity for retro-fit
Office	1	14	4' T12	4	Wrap	Magnetic	4	N	Electronic	\$ 11.20	\$ 156.80	\$ 70.00	\$ 980.00	excellent opportunity for retro-fit
Girls' Restroom	1	2	4' T12	4	Wrap	Magnetic	4	N	Electronic	\$ 11.20	\$ 22.40	\$ 70.00	\$ 140.00	excellent opportunity for retro-fit
	1	15	4' T12	4	Wrap	Magnetic	4	N	Electronic	\$ 11.20	\$ 168.00	\$ 70.00	\$ 1,050.00	excellent opportunity for retro-fit
	1	15	4' T12	4	Wrap	Magnetic	4	N	Electronic	\$ 11.20	\$ 168.00	\$ 70.00	\$ 1,050.00	excellent opportunity for retro-fit
Cottage C	1	8	4' T12	4	Wrap	Magnetic	4	N	Electronic	\$ 11.20	\$ 89.60	\$ 70.00	\$ 560.00	excellent opportunity for retro-fit
Office	1	7	4' T12	4	Ice	Magnetic	4	N	Electronic	\$ 11.20	\$ 78.40	\$ 160.00	\$ 1,120.00	replace fixture and mount hardware
Storage	1	1	4' T12	4	Ice	Magnetic	4	N	Electronic	\$ 11.20	\$ 11.20	\$ 160.00	\$ 160.00	replace fixture and mount hardware
Health Room	1	2	4' T12	4	Wrap	Magnetic	4	N	Electronic	\$ 11.20	\$ 22.40	\$ 70.00	\$ 140.00	excellent opportunity for retro-fit
Cottage A	1	3	4' T12	4	Wrap	Magnetic	4	N	Electronic	\$ 11.20	\$ 33.60	\$ 70.00	\$ 210.00	excellent opportunity for retro-fit
Library	1	1	4' T12	4	Wrap	Magnetic	4	N	Electronic	\$ 11.20	\$ 11.20	\$ 70.00	\$ 70.00	excellent opportunity for retro-fit
Restroom	1	1	4' T12	4	Wrap	Magnetic	4	N	Electronic	\$ 11.20	\$ 11.20	\$ 70.00	\$ 70.00	excellent opportunity for retro-fit
Cottage B	1	2	4' T12	4	Wrap	Magnetic	4	N	Electronic	\$ 11.20	\$ 22.40	\$ 70.00	\$ 140.00	excellent opportunity for retro-fit
Office 1	1	1	4' T12	4	Wrap	Magnetic	4	N	Electronic	\$ 11.20	\$ 11.20	\$ 70.00	\$ 70.00	excellent opportunity for retro-fit
Office 2	1	1	4' T12	4	Wrap	Magnetic	4	N	Electronic	\$ 11.20	\$ 11.20	\$ 70.00	\$ 70.00	excellent opportunity for retro-fit
Office 3	1	1	4' T12	4	Wrap	Magnetic	4	N	Electronic	\$ 11.20	\$ 11.20	\$ 70.00	\$ 70.00	excellent opportunity for retro-fit
Total Rebates										\$	2,083.20			
Total Costs										\$	15,270.00			

LOCATION	QTY	EXISTING TYPE	QTY	RETROFIT	SURVEYORS COMMENTS	Existing		Actual			Proposed		
						Watt/unit	Op. Hours	kWh	kW-D	Watt/unit	Op. Hours	kWh	kW-D
BUILDING A	15	4' 4L Fixture	15	Lamp & Low Watt Ballast	replace fixture and mount hardware	151.2	1,975	4,478.2	2.268	100	1,975	2,961.8	1.5
<i>Office</i>	2	4' 4L Fixture	2	Lamp & Low Watt Ballast	replace fixture and mount hardware	151.2	1,975	597.1	0.3024	100	1,975	394.9	0.2
Conference Room	10	4' 4L Fixture	10	Lamp & Low Watt Ballast	excellent opportunity for retro-fit	151.2	1,975	2,985.4	1.512	100	1,975	1,974.5	1
<i>Cafeteria</i>	18	4' 4L Fixture	18	Lamp & Low Watt Ballast	excellent opportunity for retro-fit	151.2	1,975	5,373.8	2.7216	100	1,975	3,554.1	1.8
<i>Kitchen</i>	5	4' 4L Fixture	5	Lamp & Low Watt Ballast	excellent opportunity for retro-fit	151.2	1,975	1,492.7	0.756	100	1,975	987.3	0.5
Boys Restroom	2	4' 4L Fixture	2	Lamp & Low Watt Ballast	excellent opportunity for retro-fit	151.2	1,975	597.1	0.3024	100	1,975	394.9	0.2
	15	4' 4L Fixture	15	Lamp & Low Watt Ballast	excellent opportunity for retro-fit	151.2	1,975	4,478.2	2.268	100	1,975	2,961.8	1.5
	15	4' 4L Fixture	15	Lamp & Low Watt Ballast	excellent opportunity for retro-fit	151.2	1,975	4,478.2	2.268	100	1,975	2,961.8	1.5
	15	4' 4L Fixture	15	Lamp & Low Watt Ballast	excellent opportunity for retro-fit	151.2	1,975	4,478.2	2.268	100	1,975	2,961.8	1.5
<i>Office</i>	14	4' 4L Fixture	14	Lamp & Low Watt Ballast	excellent opportunity for retro-fit	151.2	1,975	4,179.6	2.1168	100	1,975	2,764.3	1.4
Girls' Restroom	2	4' 4L Fixture	2	Lamp & Low Watt Ballast	excellent opportunity for retro-fit	151.2	1,975	597.1	0.3024	100	1,975	394.9	0.2
	15	4' 4L Fixture	15	Lamp & Low Watt Ballast	excellent opportunity for retro-fit	151.2	1,975	4,478.2	2.268	100	1,975	2,961.8	1.5
	15	4' 4L Fixture	15	Lamp & Low Watt Ballast	excellent opportunity for retro-fit	151.2	1,975	4,478.2	2.268	100	1,975	2,961.8	1.5
	15	4' 4L Fixture	15	Lamp & Low Watt Ballast	excellent opportunity for retro-fit	151.2	1,975	4,478.2	2.268	100	1,975	2,961.8	1.5
Cottage C	8	4' 4L Fixture	8	Lamp & Low Watt Ballast	excellent opportunity for retro-fit	151.2	1,975	2,388.4	1.2096	100	1,975	1,579.6	0.8
<i>Office</i>	7	4' 4L Fixture	7	Lamp & Low Watt Ballast	replace fixture and mount hardware	151.2	1,975	2,089.8	1.0584	100	1,975	1,382.2	0.7
Storage	1	4' 4L Fixture	1	Lamp & Low Watt Ballast	replace fixture and mount hardware	151.2	1,975	298.5	0.1512	100	1,975	197.5	0.1
Health Room	2	4' 4L Fixture	2	Lamp & Low Watt Ballast	excellent opportunity for retro-fit	151.2	1,975	597.1	0.3024	100	1,975	394.9	0.2
Cottage A	3	4' 4L Fixture	3	Lamp & Low Watt Ballast	excellent opportunity for retro-fit	151.2	1,975	895.6	0.4536	100	1,975	592.4	0.3
<i>Library</i>	1	4' 4L Fixture	1	Lamp & Low Watt Ballast	excellent opportunity for retro-fit	151.2	1,975	298.5	0.1512	100	1,975	197.5	0.1
Restroom	1	4' 4L Fixture	1	Lamp & Low Watt Ballast	excellent opportunity for retro-fit	151.2	1,975	298.5	0.1512	100	1,975	197.5	0.1
Cottage B	2	4' 4L Fixture	2	Lamp & Low Watt Ballast	excellent opportunity for retro-fit	151.2	1,975	597.1	0.3024	100	1,975	394.9	0.2
<i>Office 1</i>	1	4' 4L Fixture	1	Lamp & Low Watt Ballast	excellent opportunity for retro-fit	151.2	1,975	298.5	0.1512	100	1,975	197.5	0.1
<i>Office 2</i>	1	4' 4L Fixture	1	Lamp & Low Watt Ballast	excellent opportunity for retro-fit	151.2	1,975	298.5	0.1512	100	1,975	197.5	0.1
<i>Office 3</i>	1	4' 4L Fixture	1	Lamp & Low Watt Ballast	excellent opportunity for retro-fit	151.2	1,975	298.5	0.1512	100	1,975	197.5	0.1

Existing 186 Proposed 186

ENERGY CALCULATIONS			55,529	28.12	36,726	18.60
Description	kW-Demand	kWh				
Existing Use	28.12	55,529				
Proposed Use	18.60	36,726				
Difference - Savings	9.52	18,804				
Electrical Utility Cost	\$5.75	\$0.21959				
Savings per Year	\$657.10	\$4,129.00	Total Yearly Energy Savings \$4,786.10			

MOLOKAI HIGH AND INTERMEDIATE SCHOOL CAMPUS MAP 1999 - 2000

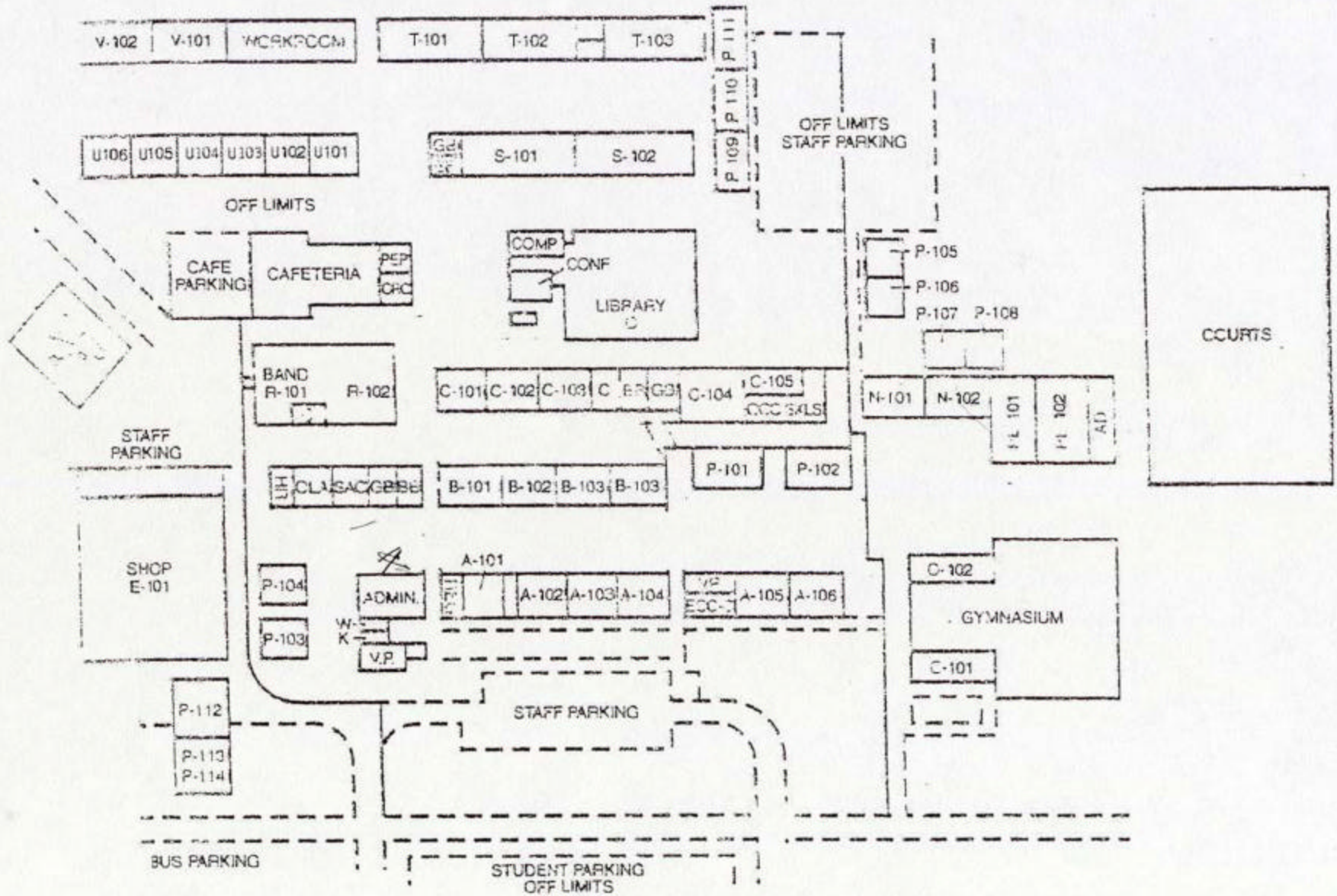

Maui Smart Schools Program
Foot Candle Readings

School: Malakai High + Intermediate School

Room: Bldg A A-103
Ceiling height: 9'
Light fixture height: 7'
Fixture type: ICE TRAY

30	30
	39
42	41

Room: Bldg S S-102
Ceiling height: 9'
Light fixture height: 7'
Fixture type: WRAP

28	31
	39
27	35

Room: Portable P-110
Ceiling height: 10'
Light fixture height: 7'
Fixture type: TROFFER

40	35
	50
45	42



SCHOOL INFORMATION			
NAME Molokai High & Intermediate School			DATE 2/23/2001
STREET ADDRESS P. O. Box 158 Hoolehua, HI 96729			OPERATIONAL HOURS 1,467
POINT OF CONTACT Linda Puleloa		PHONE 567-6950	FAX 120V
AUDITOR Maui Community College Auditors			

LOCATION Location (Rm Name, Rm. #, Area, Zone, etc.)	EXISTING EQUIPMENT						PROPOSED			REBATES		COSTS		COMMENTS Surveyors Comments
	Floor	Quantity	Lamp Type	Lamps Per Fixture	Type of Fixture	Ballast Type	Lamps Per Fixture	Reflectors	Ballast Type	Per Single	Extended	Per Single	Extended	
Band Room		36	4' T12	2	Wrap	Magnetic	2	N	Electronic	\$ 5.60	\$ 201.60	\$ 60.00	\$ 2,160.00	Excellent opportunity for retro-fit
BUILDING G											\$ -		\$ -	
G 1		1	4' T12	2	Wrap	Magnetic	2	N	Electronic	\$ 5.60	\$ 5.60	\$ 60.00	\$ 60.00	Excellent opportunity for retro-fit
G 2		1	4' T12	2	Wrap	Magnetic	2	N	Electronic	\$ 5.60	\$ 5.60	\$ 60.00	\$ 60.00	Excellent opportunity for retro-fit
G 3		1	4' T12	2	Wrap	Magnetic	2	N	Electronic	\$ 5.60	\$ 5.60	\$ 60.00	\$ 60.00	Excellent opportunity for retro-fit
G 4		1	4' T12	2	Wrap	Magnetic	2	N	Electronic	\$ 5.60	\$ 5.60	\$ 60.00	\$ 60.00	Excellent opportunity for retro-fit
G 5		1	4' T12	2	Wrap	Magnetic	2	N	Electronic	\$ 5.60	\$ 5.60	\$ 60.00	\$ 60.00	Excellent opportunity for retro-fit
Storage		2	4' T12	2	Wrap	Magnetic	2	N	Electronic	\$ 5.60	\$ 11.20	\$ 60.00	\$ 120.00	Excellent opportunity for retro-fit
Storage Office		4	4' T12	1	Wrap	Magnetic	1	N	Electronic	\$ 2.80	\$ 11.20	\$ 55.00	\$ 220.00	Excellent opportunity for retro-fit
BUILDING H											\$ -		\$ -	
H 1		18	4' T12	2	Wrap	Magnetic	2	N	Electronic	\$ 5.60	\$ 100.80	\$ 60.00	\$ 1,080.00	Excellent opportunity for retro-fit
H 2		18	4' T12	2	Wrap	Magnetic	2	N	Electronic	\$ 5.60	\$ 100.80	\$ 60.00	\$ 1,080.00	Excellent opportunity for retro-fit
Janitor		6	4' T12	2	Impact	Magnetic	2	N	Electronic	\$ 5.60	\$ 33.60	\$ 60.00	\$ 360.00	Excellent opportunity for retro-fit
		17	4' T12	2	Impact	Magnetic	2	N	Electronic	\$ 5.60	\$ 95.20	\$ 60.00	\$ 1,020.00	Excellent opportunity for retro-fit
		26	4' T12	2	Impact	Magnetic	2	N	Electronic	\$ 5.60	\$ 145.60	\$ 60.00	\$ 1,560.00	Excellent opportunity for retro-fit
BUILDING N											\$ -		\$ -	
N 101		3	4' T12	2	Troffer	Magnetic	2	N	Electronic	\$ 5.60	\$ 16.80	\$ 60.00	\$ 180.00	Excellent opportunity for retro-fit
		3	8' T12	2	Ice	Magnetic	2	N	Electronic	\$ 7.20	\$ 21.60	\$ 160.00	\$ 480.00	Replace fixture and mount hardware
N 102		3	4' T12	2	Troffer	Magnetic	2	N	Electronic	\$ 5.60	\$ 16.80	\$ 60.00	\$ 180.00	Excellent opportunity for retro-fit
		3	8' T12	2	Ice	Magnetic	2	N	Electronic	\$ 7.20	\$ 21.60	\$ 160.00	\$ 480.00	Replace fixture and mount hardware
Boys' Locker		26	4' T12	1	Troffer	Magnetic	1	N	Electronic	\$ 2.80	\$ 72.80	\$ 55.00	\$ 1,430.00	Excellent opportunity for retro-fit
Girls' Locker		26	4' T12	1	Troffer	Magnetic	1	N	Electronic	\$ 2.80	\$ 72.80	\$ 55.00	\$ 1,430.00	Excellent opportunity for retro-fit
P 7		12	4' T12	4	Troffer	Magnetic	4	N	Electronic	\$ 11.20	\$ 134.40	\$ 70.00	\$ 840.00	Excellent opportunity for retro-fit
P 8		12	4' T12	4	Troffer	Magnetic	4	N	Electronic	\$ 11.20	\$ 134.40	\$ 70.00	\$ 840.00	Excellent opportunity for retro-fit
P 5		16	4' T12	2	Troffer	Magnetic	2	N	Electronic	\$ 5.60	\$ 89.60	\$ 60.00	\$ 960.00	Excellent opportunity for retro-fit
P 6A		8	4' T12	2	Troffer	Magnetic	2	N	Electronic	\$ 5.60	\$ 44.80	\$ 60.00	\$ 480.00	Excellent opportunity for retro-fit
P 6B		8	4' T12	2	Troffer	Magnetic	2	N	Electronic	\$ 5.60	\$ 44.80	\$ 60.00	\$ 480.00	Excellent opportunity for retro-fit
BUILDING T 104		2	4' T12	2	Ice	Magnetic	2	N	Electronic	\$ 5.60	\$ 11.20	\$ 135.00	\$ 270.00	Replace fixture and mount hardware
		10	8' T12	2	Ice	Magnetic	2	N	Electronic	\$ 7.20	\$ 72.00	\$ 160.00	\$ 1,600.00	Replace fixture and mount hardware
P 109		16	4' T12	3	Ice	Magnetic	3	N	Electronic	\$ 8.40	\$ 134.40	\$ 160.00	\$ 2,560.00	Replace fixture and mount hardware
P 110		16	4' T12	3	Ice	Magnetic	3	N	Electronic	\$ 8.40	\$ 134.40	\$ 160.00	\$ 2,560.00	Replace fixture and mount hardware
P 111		12	4' T12	4	Ice	Magnetic	4	N	Electronic	\$ 11.20	\$ 134.40	\$ 160.00	\$ 1,920.00	Replace fixture and mount hardware

LOCATION	EXISTING EQUIPMENT						PROPOSED			REBATES		COSTS		COMMENTS
Location (Rm. Name, Rm. #, Area, Zone, etc.)	Floor	Quantity	Lamp Type	Lamps Per Fixture	Type of Fixture	Ballast Type	Lamps Per Fixture	Reflectors	Ballast Type	Per Single	Extended	Per Single	Extended	Surveyors Comments
Library		61	4' T12	4	Troffer	Magnetic	4	N	Electronic	\$ 11.20	\$ 683.20	\$ 70.00	\$ 4,270.00	Excellent opportunity for retro-fit
Conference		10	4' T12	4	Troffer	Magnetic	4	N	Electronic	\$ 11.20	\$ 112.00	\$ 70.00	\$ 700.00	Excellent opportunity for retro-fit
Faculty		8	4' T12	4	Troffer	Magnetic	4	N	Electronic	\$ 11.20	\$ 89.60	\$ 70.00	\$ 560.00	Excellent opportunity for retro-fit
Storage		8	4' T12	4	Troffer	Magnetic	4	N	Electronic	\$ 11.20	\$ 89.60	\$ 70.00	\$ 560.00	Excellent opportunity for retro-fit
Lab		14	4' T12	4	Troffer	Magnetic	4	N	Electronic	\$ 11.20	\$ 156.80	\$ 70.00	\$ 980.00	Excellent opportunity for retro-fit
BUILDING A											\$ -		\$ -	
A 101		18	4' T12	2	Wrap	Magnetic	2	N	Electronic	\$ 5.60	\$ 100.80	\$ 60.00	\$ 1,080.00	Excellent opportunity for retro-fit
A 102		6	4' T12	4	Ice	Magnetic	4	N	Electronic	\$ 11.20	\$ 67.20	\$ 160.00	\$ 960.00	Replace fixture and mount hardware
A 103		9	8' T12	2	Ice	Magnetic	2	N	Electronic	\$ 11.20	\$ 100.80	\$ 160.00	\$ 1,440.00	Replace fixture and mount hardware
A 104		9	8' T12	2	Ice	Magnetic	2	N	Electronic	\$ 11.20	\$ 100.80	\$ 160.00	\$ 1,440.00	Replace fixture and mount hardware
Office		2	4' T12	2	Wrap	Magnetic	2	N	Electronic	\$ 5.60	\$ 11.20	\$ 60.00	\$ 120.00	Excellent opportunity for retro-fit
A 105		9	8' T12	2	Wrap	Magnetic	2	N	Electronic	\$ 7.20	\$ 64.80	\$ 80.00	\$ 720.00	Replace fixture and mount hardware
A 106		9	8' T12	2	Wrap	Magnetic	2	N	Electronic	\$ 7.20	\$ 64.80	\$ 80.00	\$ 720.00	Replace fixture and mount hardware
GYM		16	4' T12	2	Wrap	Magnetic	2	N	Electronic	\$ 5.60	\$ 89.60	\$ 60.00	\$ 960.00	Excellent opportunity for retro-fit
		16	4' T12	2	Wrap	Magnetic	2	N	Electronic	\$ 5.60	\$ 89.60	\$ 60.00	\$ 960.00	Excellent opportunity for retro-fit
Weight Room		7	4' T12	2	Wrap	Magnetic	2	N	Electronic	\$ 5.60	\$ 39.20	\$ 60.00	\$ 420.00	Excellent opportunity for retro-fit
Boys' Restroom		4	4' T12	2	Wrap	Magnetic	2	N	Electronic	\$ 5.60	\$ 22.40	\$ 60.00	\$ 240.00	Excellent opportunity for retro-fit
Girls' Restroom		4	4' T12	2	Wrap	Magnetic	2	N	Electronic	\$ 5.60	\$ 22.40	\$ 60.00	\$ 240.00	Excellent opportunity for retro-fit
Office		2	4' T12	2	Wrap	Magnetic	2	N	Electronic	\$ 5.60	\$ 11.20	\$ 60.00	\$ 120.00	Excellent opportunity for retro-fit
Office		2	4' T12	2	Wrap	Magnetic	2	N	Electronic	\$ 5.60	\$ 11.20	\$ 60.00	\$ 120.00	Excellent opportunity for retro-fit
PORTABLES		16	4' T12	4	Wrap	Magnetic	4	N	Electronic	\$ 11.20	\$ 179.20	\$ 70.00	\$ 1,120.00	Excellent opportunity for retro-fit
		16	4' T12	4	Wrap	Magnetic	4	N	Electronic	\$ 11.20	\$ 179.20	\$ 70.00	\$ 1,120.00	Excellent opportunity for retro-fit
BUILDING B		6	4' T12	4	Ice	Magnetic	4	N	Electronic	\$ 11.20	\$ 67.20	\$ 160.00	\$ 960.00	Replace fixture and mount hardware
B 103		6	4' T12	4	Ice	Magnetic	4	N	Electronic	\$ 11.20	\$ 67.20	\$ 160.00	\$ 960.00	Replace fixture and mount hardware
B 102		6	4' T12	4	Ice	Magnetic	4	N	Electronic	\$ 11.20	\$ 67.20	\$ 160.00	\$ 960.00	Replace fixture and mount hardware
B 101		6	4' T12	4	Ice	Magnetic	4	N	Electronic	\$ 11.20	\$ 67.20	\$ 160.00	\$ 960.00	Replace fixture and mount hardware
Boys' Restroom		2	4' T12	4	Wrap	Magnetic	4	N	Electronic	\$ 11.20	\$ 22.40	\$ 70.00	\$ 140.00	Excellent opportunity for retro-fit
Girls' Restroom		2	4' T12	4	Wrap	Magnetic	4	N	Electronic	\$ 11.20	\$ 22.40	\$ 70.00	\$ 140.00	Excellent opportunity for retro-fit
		8	4' T12	2	Ice	Magnetic	2	N	Electronic	\$ 5.60	\$ 44.80	\$ 135.00	\$ 1,080.00	Replace fixture and mount hardware
B 105		12	8' T12	2	Ice	Magnetic	2	N	Electronic	\$ 11.20	\$ 134.40	\$ 160.00	\$ 1,920.00	Replace fixture and mount hardware
Health Room		3	4' T12	2	Wrap	Magnetic	2	N	Electronic	\$ 5.60	\$ 16.80	\$ 60.00	\$ 180.00	Excellent opportunity for retro-fit
V 102		18	4' T12	2	Ice	Magnetic	2	N	Electronic	\$ 5.60	\$ 100.80	\$ 135.00	\$ 2,430.00	Replace fixture and mount hardware
Teacher Prep		6	4' T12	2	Wrap	Magnetic	2	N	Electronic	\$ 5.60	\$ 33.60	\$ 60.00	\$ 360.00	Excellent opportunity for retro-fit
V 101		18	4' T12	2	Ice	Magnetic	2	N	Electronic	\$ 5.60	\$ 100.80	\$ 135.00	\$ 2,430.00	Replace fixture and mount hardware
Teacher Prep		6	4' T12	2	Wrap	Magnetic	2	N	Electronic	\$ 5.60	\$ 33.60	\$ 60.00	\$ 360.00	Excellent opportunity for retro-fit
Boys' Restroom		4	4' T12	2	Wrap	Magnetic	2	N	Electronic	\$ 5.60	\$ 22.40	\$ 60.00	\$ 240.00	Excellent opportunity for retro-fit
Girls' Restroom		4	4' T12	2	Wrap	Magnetic	2	N	Electronic	\$ 5.60	\$ 22.40	\$ 60.00	\$ 240.00	Excellent opportunity for retro-fit

LOCATION (Rm Name, Rm. #, Area, Zone, etc.)	EXISTING EQUIPMENT						PROPOSED			REBATES		COSTS		COMMENTS Surveyors Comments
	Floor	Quantity	Lamp Type	Lamps Per Fixture	Type of Fixture	Ballast Type	Lamps Per Fixture	Reflectors	Ballast Type	Per Single	Extended	Per Single	Extended	
<i>Counselor</i>		2	4' T12	2	Wrap	Magnetic	2	N	Electronic	\$ 5.60	\$ 11.20	\$ 60.00	\$ 120.00	Excellent opportunity for retro-fit
<i>Faculty</i>		12	4' T12	2	Wrap	Magnetic	2	N	Electronic	\$ 5.60	\$ 67.20	\$ 60.00	\$ 720.00	Excellent opportunity for retro-fit
<i>Hall</i>		1	4' T12	2	Wrap	Magnetic	2	N	Electronic	\$ 5.60	\$ 5.60	\$ 60.00	\$ 60.00	Excellent opportunity for retro-fit
<i>Boys' Restroom</i>		1	4' T12	2	Wrap	Magnetic	2	N	Electronic	\$ 5.60	\$ 5.60	\$ 60.00	\$ 60.00	Excellent opportunity for retro-fit
<i>Girls' Restroom</i>		1	4' T12	2	Wrap	Magnetic	2	N	Electronic	\$ 5.60	\$ 5.60	\$ 60.00	\$ 60.00	Excellent opportunity for retro-fit
BUILDING I											\$ -		\$ -	
<i>I 101</i>		34	4' T12	2	Wrap	Magnetic	2	N	Electronic	\$ 5.60	\$ 190.40	\$ 60.00	\$ 2,040.00	Excellent opportunity for retro-fit
<i>Storage</i>		2	4' T12	2	Wrap	Magnetic	2	N	Electronic	\$ 5.60	\$ 11.20	\$ 60.00	\$ 120.00	Excellent opportunity for retro-fit
<i>I 102</i>		33	4' T12	2	Wrap	Magnetic	2	N	Electronic	\$ 5.60	\$ 184.80	\$ 60.00	\$ 1,980.00	Excellent opportunity for retro-fit
<i>Storage</i>		8	4' T12	2	Wrap	Magnetic	2	N	Electronic	\$ 5.60	\$ 44.80	\$ 60.00	\$ 480.00	Excellent opportunity for retro-fit
<i>I 103</i>		33	4' T12	2	Wrap	Magnetic	2	N	Electronic	\$ 5.60	\$ 184.80	\$ 60.00	\$ 1,980.00	Excellent opportunity for retro-fit
BUILDING S											\$ -		\$ -	
<i>S 102</i>		30	4' T12	2	Wrap	Magnetic	2	N	Electronic	\$ 5.60	\$ 168.00	\$ 60.00	\$ 1,800.00	Excellent opportunity for retro-fit
<i>Storage</i>		1	4' T12	2	Wrap	Magnetic	2	N	Electronic	\$ 5.60	\$ 5.60	\$ 60.00	\$ 60.00	Excellent opportunity for retro-fit
<i>S 101</i>		40	4' T12	2	Wrap	Magnetic	2	N	Electronic	\$ 5.60	\$ 224.00	\$ 60.00	\$ 2,400.00	Excellent opportunity for retro-fit
<i>Girls' Restroom</i>		3	4' T12	2	Wrap	Magnetic	2	N	Electronic	\$ 5.60	\$ 16.80	\$ 60.00	\$ 180.00	Excellent opportunity for retro-fit
<i>Boys' Restroom</i>		3	4' T12	2	Wrap	Magnetic	2	N	Electronic	\$ 5.60	\$ 16.80	\$ 60.00	\$ 180.00	Excellent opportunity for retro-fit
BUILDING U											\$ -		\$ -	
<i>U 101</i>		16	4' T12	4	Ice	Magnetic	4	N	Electronic	\$ 11.20	\$ 179.20	\$ 160.00	\$ 2,560.00	Replace fixture and mount hardware
<i>U 102</i>		16	4' T12	4	Ice	Magnetic	4	N	Electronic	\$ 11.20	\$ 179.20	\$ 160.00	\$ 2,560.00	Replace fixture and mount hardware
<i>U 103</i>		16	4' T12	4	Ice	Magnetic	4	N	Electronic	\$ 11.20	\$ 179.20	\$ 160.00	\$ 2,560.00	Replace fixture and mount hardware
<i>U 104</i>		16	4' T12	4	Ice	Magnetic	4	N	Electronic	\$ 11.20	\$ 179.20	\$ 160.00	\$ 2,560.00	Replace fixture and mount hardware
<i>U 105</i>		16	4' T12	4	Ice	Magnetic	4	N	Electronic	\$ 11.20	\$ 179.20	\$ 160.00	\$ 2,560.00	Replace fixture and mount hardware
<i>U 106</i>		16	4' T12	4	Ice	Magnetic	4	N	Electronic	\$ 11.20	\$ 179.20	\$ 160.00	\$ 2,560.00	Replace fixture and mount hardware
CAFETERIA											\$ -		\$ -	
<i>Office</i>		1	4' T12	2	Ice	Magnetic	2	N	Electronic	\$ 5.60	\$ 5.60	\$ 135.00	\$ 135.00	Replace fixture and mount hardware
<i>Kitchen</i>		16	8' T12	2	Ice	Magnetic	2	N	Electronic	\$ 11.20	\$ 179.20	\$ 160.00	\$ 2,560.00	Replace fixture and mount hardware
<i>Faculty Dining Room</i>		1	4' T12	2	Ice	Magnetic	2	N	Electronic	\$ 5.60	\$ 5.60	\$ 135.00	\$ 135.00	
<i>Dining Room</i>		22	8' T12	2	Ice	Magnetic	2	N	Electronic	\$ 11.20	\$ 246.40	\$ 160.00	\$ 3,520.00	Replace fixture and mount hardware
Total Rebates										\$	7,648.00			
Total Costs										\$	90,750.00			

LOCATION	QTY	EXISTING TYPE	QTY	RETROFIT	SURVEYORS COMMENTS	Actual				Proposed			
						Existing Watt/unit	Op. Hours	kWh	kW-D	Watt/unit	Op. Hours	kWh	kW-D
Band Room	36	4' 2L Fixture	36	Lamp & Low Watt Ballast	Excellent opportunity for retro-fit	75.6	1,467	3,992.6	2.7216	51	1,467	2,693.4	1.836
BUILDING G	0		0		0		1,467	0.0	0		1,467	0.0	0
G 1	1	4' 2L Fixture	1	Lamp & Low Watt Ballast	Excellent opportunity for retro-fit	75.6	1,467	110.9	0.0756	51	1,467	74.8	0.051
G 2	1	4' 2L Fixture	1	Lamp & Low Watt Ballast	Excellent opportunity for retro-fit	75.6	1,467	110.9	0.0756	51	1,467	74.8	0.051
G 3	1	4' 2L Fixture	1	Lamp & Low Watt Ballast	Excellent opportunity for retro-fit	75.6	1,467	110.9	0.0756	51	1,467	74.8	0.051
G 4	1	4' 2L Fixture	1	Lamp & Low Watt Ballast	Excellent opportunity for retro-fit	75.6	1,467	110.9	0.0756	51	1,467	74.8	0.051
G 5	1	4' 2L Fixture	1	Lamp & Low Watt Ballast	Excellent opportunity for retro-fit	75.6	1,467	110.9	0.0756	51	1,467	74.8	0.051
Storage	2	4' 2L Fixture	2	Lamp & Low Watt Ballast	Excellent opportunity for retro-fit	75.6	1,467	221.8	0.1512	51	1,467	149.6	0.102
Storage Office	4	4' 1L Fixture	4	Lamp & Low Watt Ballast	Excellent opportunity for retro-fit	45.6	1,467	267.6	0.1824	31	1,467	181.9	0.124
BUILDING H	0		0		0		1,467	0.0	0		1,467	0.0	0
H 1	18	4' 2L Fixture	18	Lamp & Low Watt Ballast	Excellent opportunity for retro-fit	75.6	1,467	1,996.3	1.3608	51	1,467	1,346.7	0.918
H 2	18	4' 2L Fixture	18	Lamp & Low Watt Ballast	Excellent opportunity for retro-fit	75.6	1,467	1,996.3	1.3608	51	1,467	1,346.7	0.918
Janitor	6	4' 2L Fixture	6	Lamp & Low Watt Ballast	Excellent opportunity for retro-fit	75.6	1,467	665.4	0.4536	51	1,467	448.9	0.306
	17	4' 2L Fixture	17	Lamp & Low Watt Ballast	Excellent opportunity for retro-fit	75.6	1,467	1,885.4	1.2852	51	1,467	1,271.9	0.867
	26	4' 2L Fixture	26	Lamp & Low Watt Ballast	Excellent opportunity for retro-fit	75.6	1,467	2,883.5	1.9656	51	1,467	1,945.2	1.326
BUILDING N	0		0		0		1,467	0.0	0		1,467	0.0	0
N 101	3	4' 2L Fixture	3	Lamp & Low Watt Ballast	Excellent opportunity for retro-fit	75.6	1,467	332.7	0.2268	51	1,467	224.5	0.153
	3	8' 2L Fixture	3	Lamp & Ballast Retrofit	Replace fixture and mount hardware	158	1,467	695.4	0.474	102	1,467	448.9	0.306
N 102	3	4' 2L Fixture	3	Lamp & Low Watt Ballast	Excellent opportunity for retro-fit	75.6	1,467	332.7	0.2268	51	1,467	224.5	0.153
	3	8' 2L Fixture	3	Lamp & Ballast Retrofit	Replace fixture and mount hardware	158	1,467	695.4	0.474	102	1,467	448.9	0.306
Boys' Locker	26	4' 1L Fixture	26	Lamp & Low Watt Ballast	Excellent opportunity for retro-fit	45.6	1,467	1,739.3	1.1856	31	1,467	1,182.4	0.806
Girls' Locker	26	4' 1L Fixture	26	Lamp & Low Watt Ballast	Excellent opportunity for retro-fit	45.6	1,467	1,739.3	1.1856	31	1,467	1,182.4	0.806
P 7	12	4' 4L Fixture	12	Lamp & Low Watt Ballast	Excellent opportunity for retro-fit	151.2	1,467	2,661.7	1.8144	100	1,467	1,760.4	1.2
P 8	12	4' 4L Fixture	12	Lamp & Low Watt Ballast	Excellent opportunity for retro-fit	151.2	1,467	2,661.7	1.8144	100	1,467	1,760.4	1.2
P 5	16	4' 2L Fixture	16	Lamp & Low Watt Ballast	Excellent opportunity for retro-fit	75.6	1,467	1,774.5	1.2096	51	1,467	1,197.1	0.816
P 6A	8	4' 2L Fixture	8	Lamp & Low Watt Ballast	Excellent opportunity for retro-fit	75.6	1,467	887.2	0.6048	51	1,467	598.5	0.408
P 6B	8	4' 2L Fixture	8	Lamp & Low Watt Ballast	Excellent opportunity for retro-fit	75.6	1,467	887.2	0.6048	51	1,467	598.5	0.408
BUILDING T 104	2	4' 2L Fixture	2	Lamp & Low Watt Ballast	Replace fixture and mount hardware	75.6	1,467	221.8	0.1512	51	1,467	149.6	0.102
	10	8' 2L Fixture	10	Lamp & Ballast Retrofit	Replace fixture and mount hardware	158	1,467	2,317.9	1.58	102	1,467	1,496.3	1.02
P 109	16	4' 3L Fixture	16	Lamp & Low Watt Ballast	Replace fixture and mount hardware	121.2	1,467	2,844.8	1.9392	77	1,467	1,807.3	1.232
P 110	16	4' 3L Fixture	16	Lamp & Low Watt Ballast	Replace fixture and mount hardware	121.2	1,467	2,844.8	1.9392	77	1,467	1,807.3	1.232
P 111	12	4' 4L Fixture	12	Lamp & Low Watt Ballast	Replace fixture and mount hardware	151.2	1,467	2,661.7	1.8144	100	1,467	1,760.4	1.2
Library	61	4' 4L Fixture	61	Lamp & Low Watt Ballast	Excellent opportunity for retro-fit	151.2	1,467	13,530.4	9.2232	100	1,467	8,948.7	6.1
Conference	10	4' 4L Fixture	10	Lamp & Low Watt Ballast	Excellent opportunity for retro-fit	151.2	1,467	2,218.1	1.512	100	1,467	1,467.0	1
Faculty	8	4' 4L Fixture	8	Lamp & Low Watt Ballast	Excellent opportunity for retro-fit	151.2	1,467	1,774.5	1.2096	100	1,467	1,173.6	0.8
Storage	8	4' 4L Fixture	8	Lamp & Low Watt Ballast	Excellent opportunity for retro-fit	151.2	1,467	1,774.5	1.2096	100	1,467	1,173.6	0.8
Lab	14	4' 4L Fixture	14	Lamp & Low Watt Ballast	Excellent opportunity for retro-fit	151.2	1,467	3,105.3	2.1168	100	1,467	2,053.8	1.4
BUILDING A	0		0		0		1,467	0.0	0		1,467	0.0	0
A 101	18	4' 2L Fixture	18	Lamp & Low Watt Ballast	Excellent opportunity for retro-fit	75.6	1,467	1,996.3	1.3608	51	1,467	1,346.7	0.918
A 102	6	4' 4L Fixture	6	Lamp & Low Watt Ballast	Replace fixture and mount hardware	151.2	1,467	1,330.9	0.9072	100	1,467	880.2	0.6
A 103	9	8' 2L Fixture	9	Lamp & Ballast Retrofit	Replace fixture and mount hardware	158	1,467	2,086.1	1.422	102	1,467	1,346.7	0.918
A 104	9	8' 2L Fixture	9	Lamp & Ballast Retrofit	Replace fixture and mount hardware	158	1,467	2,086.1	1.422	102	1,467	1,346.7	0.918
Office	2	4' 2L Fixture	2	Lamp & Low Watt Ballast	Excellent opportunity for retro-fit	75.6	1,467	221.8	0.1512	51	1,467	149.6	0.102
A 105	9	8' 2L Fixture	9	Lamp & Ballast Retrofit	Replace fixture and mount hardware	158	1,467	2,086.1	1.422	102	1,467	1,346.7	0.918
A 106	9	8' 2L Fixture	9	Lamp & Ballast Retrofit	Replace fixture and mount hardware	158	1,467	2,086.1	1.422	102	1,467	1,346.7	0.918
GYM	16	4' 2L Fixture	16	Lamp & Low Watt Ballast	Excellent opportunity for retro-fit	75.6	1,467	1,774.5	1.2096	51	1,467	1,197.1	0.816
	16	4' 2L Fixture	16	Lamp & Low Watt Ballast	Excellent opportunity for retro-fit	75.6	1,467	1,774.5	1.2096	51	1,467	1,197.1	0.816
Weight Room	7	4' 2L Fixture	7	Lamp & Low Watt Ballast	Excellent opportunity for retro-fit	75.6	1,467	776.3	0.5292	51	1,467	523.7	0.357
Boys' Restroom	4	4' 2L Fixture	4	Lamp & Low Watt Ballast	Excellent opportunity for retro-fit	75.6	1,467	443.6	0.3024	51	1,467	293.3	0.204
Girls' Restroom	4	4' 2L Fixture	4	Lamp & Low Watt Ballast	Excellent opportunity for retro-fit	75.6	1,467	443.6	0.3024	51	1,467	293.3	0.204
Office	2	4' 2L Fixture	2	Lamp & Low Watt Ballast	Excellent opportunity for retro-fit	75.6	1,467	221.8	0.1512	51	1,467	149.6	0.102
Office	2	4' 2L Fixture	2	Lamp & Low Watt Ballast	Excellent opportunity for retro-fit	75.6	1,467	221.8	0.1512	51	1,467	149.6	0.102
PORTABLES	16	4' 4L Fixture	16	Lamp & Low Watt Ballast	Excellent opportunity for retro-fit	151.2	1,467	3,549.0	2.4192	100	1,467	2,347.2	1.6
	16	4' 4L Fixture	16	Lamp & Low Watt Ballast	Excellent opportunity for retro-fit	151.2	1,467	3,549.0	2.4192	100	1,467	2,347.2	1.6
BUILDING B	6	4' 4L Fixture	6	Lamp & Low Watt Ballast	Replace fixture and mount hardware	151.2	1,467	1,330.9	0.9072	100	1,467	880.2	0.6
B 103	6	4' 4L Fixture	6	Lamp & Low Watt Ballast	Replace fixture and mount hardware	151.2	1,467	1,330.9	0.9072	100	1,467	880.2	0.6
B 102	6	4' 4L Fixture	6	Lamp & Low Watt Ballast	Replace fixture and mount hardware	151.2	1,467	1,330.9	0.9072	100	1,467	880.2	0.6
B 101	6	4' 4L Fixture	6	Lamp & Low Watt Ballast	Replace fixture and mount hardware	151.2	1,467	1,330.9	0.9072	100	1,467	880.2	0.6
Boys' Restroom	2	4' 4L Fixture	2	Lamp & Low Watt Ballast	Excellent opportunity for retro-fit	151.2	1,467	443.6	0.3024	100	1,467	293.4	0.2
Girls' Restroom	2	4' 4L Fixture	2	Lamp & Low Watt Ballast	Excellent opportunity for retro-fit	151.2	1,467	443.6	0.3024	100	1,467	293.4	0.2

LOCATION	QTY	EXISTING TYPE	QTY	RETROFIT	SURVEYORS COMMENTS	Existing	Actual			Proposed			
						Watt/unit	Op. Hours	kWh	kW-D	Watt/unit	Op. Hours	kWh	kW-D
	8	4' 2L Fixture	8	Lamp & Low Watt Ballast	Replace fixture and mount hardware	75.6	1,467	887.2	0.6048	51	1,467	598.5	0.408
B 105	12	8' 2L Fixture	12	Lamp & Ballast Retrofit	Replace fixture and mount hardware	158	1,467	2,781.4	1.896	102	1,467	1,795.6	1.224
Health Room	3	4' 2L Fixture	3	Lamp & Low Watt Ballast	Excellent opportunity for retro-fit	75.6	1,467	332.7	0.2268	51	1,467	224.5	0.153
V 102	18	4' 2L Fixture	18	Lamp & Low Watt Ballast	Replace fixture and mount hardware	75.6	1,467	1,996.3	1.3608	51	1,467	1,346.7	0.918
Teacher Prep	6	4' 2L Fixture	6	Lamp & Low Watt Ballast	Excellent opportunity for retro-fit	75.6	1,467	665.4	0.4536	51	1,467	448.9	0.306
V 101	18	4' 2L Fixture	18	Lamp & Low Watt Ballast	Replace fixture and mount hardware	75.6	1,467	1,996.3	1.3608	51	1,467	1,346.7	0.918
Teacher Prep	6	4' 2L Fixture	6	Lamp & Low Watt Ballast	Excellent opportunity for retro-fit	75.6	1,467	665.4	0.4536	51	1,467	448.9	0.306
Boys' Restroom	4	4' 2L Fixture	4	Lamp & Low Watt Ballast	Excellent opportunity for retro-fit	75.6	1,467	443.6	0.3024	51	1,467	299.3	0.204
Girls' Restroom	4	4' 2L Fixture	4	Lamp & Low Watt Ballast	Excellent opportunity for retro-fit	75.6	1,467	443.6	0.3024	51	1,467	299.3	0.204
Counselor	2	4' 2L Fixture	2	Lamp & Low Watt Ballast	Excellent opportunity for retro-fit	75.6	1,467	221.8	0.1512	51	1,467	149.6	0.102
Faculty	12	4' 2L Fixture	12	Lamp & Low Watt Ballast	Excellent opportunity for retro-fit	75.6	1,467	1,330.9	0.9072	51	1,467	897.8	0.612
Hall	1	4' 2L Fixture	1	Lamp & Low Watt Ballast	Excellent opportunity for retro-fit	75.6	1,467	110.9	0.0756	51	1,467	74.8	0.051
Boys' Restroom	1	4' 2L Fixture	1	Lamp & Low Watt Ballast	Excellent opportunity for retro-fit	75.6	1,467	110.9	0.0756	51	1,467	74.8	0.051
Girls' Restroom	1	4' 2L Fixture	1	Lamp & Low Watt Ballast	Excellent opportunity for retro-fit	75.6	1,467	110.9	0.0756	51	1,467	74.8	0.051
BUILDING I	0		0		0		1,467	0.0	0		1,467	0.0	0
I 101	34	4' 2L Fixture	34	Lamp & Low Watt Ballast	Excellent opportunity for retro-fit	75.6	1,467	3,770.8	2.5704	51	1,467	2,543.8	1.734
Storage	2	4' 2L Fixture	2	Lamp & Low Watt Ballast	Excellent opportunity for retro-fit	75.6	1,467	221.8	0.1512	51	1,467	149.6	0.102
I 102	33	4' 2L Fixture	33	Lamp & Low Watt Ballast	Excellent opportunity for retro-fit	75.6	1,467	3,659.9	2.4948	51	1,467	2,469.0	1.683
Storage	8	4' 2L Fixture	8	Lamp & Low Watt Ballast	Excellent opportunity for retro-fit	75.6	1,467	887.2	0.6048	51	1,467	598.5	0.408
I 103	33	4' 2L Fixture	33	Lamp & Low Watt Ballast	Excellent opportunity for retro-fit	75.6	1,467	3,659.9	2.4948	51	1,467	2,469.0	1.683
BUILDING S	0		0		0		1,467	0.0	0		1,467	0.0	0
S 102	30	4' 2L Fixture	30	Lamp & Low Watt Ballast	Excellent opportunity for retro-fit	75.6	1,467	3,327.2	2.268	51	1,467	2,244.5	1.53
Storage	1	4' 2L Fixture	1	Lamp & Low Watt Ballast	Excellent opportunity for retro-fit	75.6	1,467	110.9	0.0756	51	1,467	74.8	0.051
S 101	40	4' 2L Fixture	40	Lamp & Low Watt Ballast	Excellent opportunity for retro-fit	75.6	1,467	4,436.2	3.024	51	1,467	2,992.7	2.04
Girls' Restroom	3	4' 2L Fixture	3	Lamp & Low Watt Ballast	Excellent opportunity for retro-fit	75.6	1,467	332.7	0.2268	51	1,467	224.5	0.153
Boys' Restroom	3	4' 2L Fixture	3	Lamp & Low Watt Ballast	Excellent opportunity for retro-fit	75.6	1,467	332.7	0.2268	51	1,467	224.5	0.153
BUILDING U	0		0		0		1,467	0.0	0		1,467	0.0	0
U 101	16	4' 4L Fixture	16	Lamp & Low Watt Ballast	Replace fixture and mount hardware	151.2	1,467	3,549.0	2.4192	100	1,467	2,347.2	1.6
U 102	16	4' 4L Fixture	16	Lamp & Low Watt Ballast	Replace fixture and mount hardware	151.2	1,467	3,549.0	2.4192	100	1,467	2,347.2	1.6
U 103	16	4' 4L Fixture	16	Lamp & Low Watt Ballast	Replace fixture and mount hardware	151.2	1,467	3,549.0	2.4192	100	1,467	2,347.2	1.6
U 104	16	4' 4L Fixture	16	Lamp & Low Watt Ballast	Replace fixture and mount hardware	151.2	1,467	3,549.0	2.4192	100	1,467	2,347.2	1.6
U 105	16	4' 4L Fixture	16	Lamp & Low Watt Ballast	Replace fixture and mount hardware	151.2	1,467	3,549.0	2.4192	100	1,467	2,347.2	1.6
U 106	16	4' 4L Fixture	16	Lamp & Low Watt Ballast	Replace fixture and mount hardware	151.2	1,467	3,549.0	2.4192	100	1,467	2,347.2	1.6
CAFETERIA	0		0		0		1,467	0.0	0		1,467	0.0	0
Office	1	4' 2L Fixture	1	Lamp & Low Watt Ballast	Replace fixture and mount hardware	75.6	1,467	110.9	0.0756	51	1,467	74.8	0.051
Kitchen	16	8' 2L Fixture	16	Lamp & Ballast Retrofit	Replace fixture and mount hardware	158	1,467	3,708.6	2.528	102	1,467	2,394.1	1.632
Faculty Dining Room	1	4' 2L Fixture	1	Lamp & Low Watt Ballast	Replace fixture and mount hardware	75.6	1,467	110.9	0.0756	51	1,467	74.8	0.051
Dining Room	22	8' 2L Fixture	22	Lamp & Ballast Retrofit	Replace fixture and mount hardware	158	1,467	5,099.3	3.476	102	1,467	3,291.9	2.244

Existing 1001 Proposed 1001

ENERGY CALCULATIONS			156,183	106
Description	kW-Demand	kWh		
Existing Use	106.46	156,183		
Proposed Use	70.62	103,594		
Difference - Savings	35.85	52,589		
Electrical Utility Cost	\$5.75	\$0.20634		
Savings per Year	\$2,473.51	\$10,851.39	Total Yearly	Energy Savings
				\$13,324.90

Pa'ia School

955 Baldwin Avenue
Pa'ia, Hawaii 96779

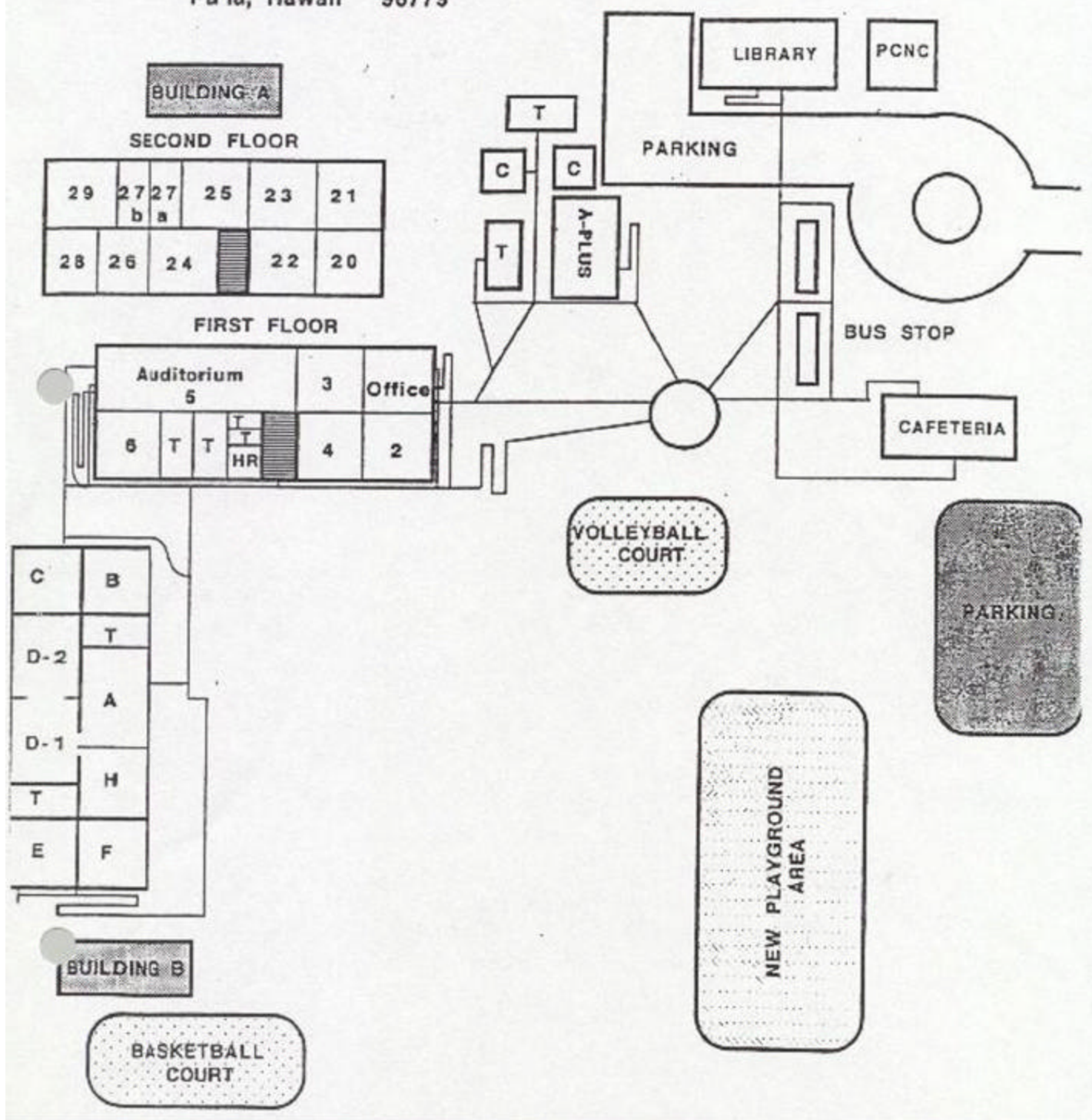

BUILDING A

SECOND FLOOR

29	27	27	25	23	21
	b	a			
28	26	24		22	20

FIRST FLOOR

Auditorium 5			3	Office
6	T	T	T	HR
			4	2

C	B
D-2	T
	A
D-1	H
T	
E	F

BUILDING B

BASKETBALL COURT

VOLLEYBALL COURT

NEW PLAYGROUND AREA

PARKING

LIBRARY **PCNC**

PARKING

BUS STOP

CAFETERIA

T
C **C**
T **A-PLUS**

Maui Smart Schools Program
Foot Candle Readings

School: Pa'ia School

Room: Bldg. A 2nd Floor #22

Ceiling height: 12'

Light fixture height: 10'

Fixture type: ICE TRAY

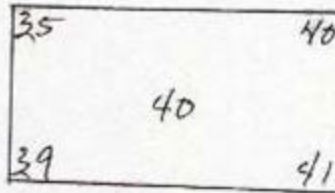

Room: Bldg. B D-2

Ceiling height: 12'

Light fixture height: 10'

Fixture type: ICE TRAY

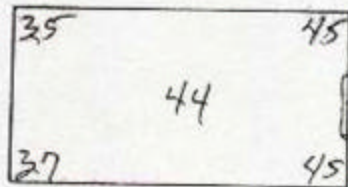

Room: LIBRARY

Ceiling height: 12'

Light fixture height: 10'

Fixture type: TROFFER

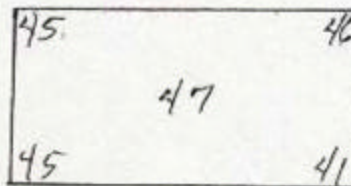



SCHOOL INFORMATION		
NAME	Paia Elementary School	DATE 2/8/2001
STREET ADDRESS	955 Baldwin Avenue Paia, HI 96779	OPERATIONAL HOURS 1,630
POINT OF CONTACT	Ione Isobe	PHONE 579-2100
AUDITOR	Maui Community College Auditors	FAX 120V

LOCATION <small>(Rm Name, Rm. #, Area, Zone, etc.)</small>	EXISTING EQUIPMENT						PROPOSED			REBATES		COSTS		COMMENTS <small>Surveyors Comments</small>
	Floor	Quantity	Lamp Type	Lamps Per Fixture	Type of Fixture	Ballast Type	Lamps Per Fixture	Reflectors	Ballast Type	Per Single	Extended	Per Single	Extended	
BUILDING A											\$ -		\$ -	
A 1	1	1	4' T12	1	Wrap	Magnetic	1	N	Electronic	\$ 2.80	\$ 2.80	\$ 55.00	\$ 55.00	Excellent opportunity for retro-fit
	1	4	4' T12	4	Ice	Magnetic	4	N	Electronic	\$ 11.20	\$ 44.80	\$ 160.00	\$ 640.00	Replace fixture and mount hardware
A 2	1	4	4' T12	4	Ice	Magnetic	4	N	Electronic	\$ 11.20	\$ 44.80	\$ 160.00	\$ 640.00	Replace fixture and mount hardware
A 4	1	4	4' T12	4	Ice	Magnetic	4	N	Electronic	\$ 11.20	\$ 44.80	\$ 160.00	\$ 640.00	Replace fixture and mount hardware
A 3	1	8	4' T12	4	Ice	Magnetic	4	N	Electronic	\$ 11.20	\$ 89.60	\$ 160.00	\$ 1,280.00	Replace fixture and mount hardware
AUDITORIUM	1	22	4' T12	4	Wrap	Magnetic	4	N	Electronic	\$ 11.20	\$ 246.40	\$ 70.00	\$ 1,540.00	Tandem Excellent opportunity for retro-fit
S Stage	1	2	4' T12	4	Wrap	Magnetic	4	N	Electronic	\$ 11.20	\$ 22.40	\$ 70.00	\$ 140.00	Excellent opportunity for retro-fit
Teachers' Lounge	1	6	4' T12	4	Ice	Magnetic	4	N	Electronic	\$ 11.20	\$ 67.20	\$ 160.00	\$ 960.00	Replace fixture and mount hardware
Girls' Restroom	1	4	4' T12	2	Wrap	Magnetic	2	N	Electronic	\$ 5.60	\$ 22.40	\$ 60.00	\$ 240.00	Excellent opportunity for retro-fit
Boys' Restroom	1	4	4' T12	2	Wrap	Magnetic	2	N	Electronic	\$ 5.60	\$ 22.40	\$ 60.00	\$ 240.00	Excellent opportunity for retro-fit
Health Room	1	1	4' T12	4	Wrap	Magnetic	4	N	Electronic	\$ 11.20	\$ 11.20	\$ 70.00	\$ 70.00	Excellent opportunity for retro-fit
21	2	4	4' T12	4	Ice	Magnetic	4	N	Electronic	\$ 11.20	\$ 44.80	\$ 160.00	\$ 640.00	Replace fixture and mount hardware
20	2	4	4' T12	4	Ice	Magnetic	4	N	Electronic	\$ 11.20	\$ 44.80	\$ 160.00	\$ 640.00	Replace fixture and mount hardware
23	2	4	4' T12	4	Ice	Magnetic	4	N	Electronic	\$ 11.20	\$ 44.80	\$ 160.00	\$ 640.00	Replace fixture and mount hardware
22	2	4	4' T12	4	Ice	Magnetic	4	N	Electronic	\$ 11.20	\$ 44.80	\$ 160.00	\$ 640.00	Replace fixture and mount hardware
25	2	4	4' T12	4	Ice	Magnetic	4	N	Electronic	\$ 11.20	\$ 44.80	\$ 160.00	\$ 640.00	Replace fixture and mount hardware
27 A	2	2	4' T12	4	Ice	Magnetic	4	N	Electronic	\$ 11.20	\$ 22.40	\$ 160.00	\$ 320.00	Replace fixture and mount hardware
27B	2	2	4' T12	4	Ice	Magnetic	4	N	Electronic	\$ 11.20	\$ 22.40	\$ 160.00	\$ 320.00	Replace fixture and mount hardware
26	2	4	4' T12	4	Ice	Magnetic	4	N	Electronic	\$ 11.20	\$ 44.80	\$ 160.00	\$ 640.00	Replace fixture and mount hardware
27	2	4	4' T12	4	Ice	Magnetic	4	N	Electronic	\$ 11.20	\$ 44.80	\$ 160.00	\$ 640.00	Replace fixture and mount hardware
28	2	6	4' T12	4	Ice	Magnetic	4	N	Electronic	\$ 11.20	\$ 67.20	\$ 160.00	\$ 960.00	Replace fixture and mount hardware
BUILDING B											\$ -		\$ -	
A	1	5	4' T12	4	Ice	Magnetic	4	N	Electronic	\$ 11.20	\$ 56.00	\$ 160.00	\$ 800.00	Replace fixture and mount hardware
	1	1	4' T12	4	Wrap	Magnetic	4	N	Electronic	\$ 11.20	\$ 11.20	\$ 70.00	\$ 70.00	Excellent opportunity for retro-fit
B	1	6	4' T12	4	Ice	Magnetic	4	N	Electronic	\$ 11.20	\$ 67.20	\$ 160.00	\$ 960.00	Replace fixture and mount hardware
C	1	4	4' T12	4	Ice	Magnetic	4	N	Electronic	\$ 11.20	\$ 44.80	\$ 160.00	\$ 640.00	Replace fixture and mount hardware
	1	2	4' T12	4	Ice	Magnetic	4	N	Electronic	\$ 11.20	\$ 22.40	\$ 160.00	\$ 320.00	Replace fixture and mount hardware
D 2	1	6	4' T12	4	Ice	Magnetic	4	N	Electronic	\$ 11.20	\$ 67.20	\$ 160.00	\$ 960.00	Replace fixture and mount hardware
D 1	1	6	4' T12	4	Ice	Magnetic	4	N	Electronic	\$ 11.20	\$ 67.20	\$ 160.00	\$ 960.00	Replace fixture and mount hardware
Girls' Restroom	1	1	4' T12	4	Ice	Magnetic	4	N	Electronic	\$ 11.20	\$ 11.20	\$ 160.00	\$ 160.00	Replace fixture and mount hardware
Boys' Restroom	1	2	4' T12	4	Ice	Magnetic	4	N	Electronic	\$ 11.20	\$ 22.40	\$ 160.00	\$ 320.00	Replace fixture and mount hardware

LOCATION	EXISTING EQUIPMENT						PROPOSED			REBATES		COSTS		COMMENTS	
Location (Rm Name, Rm. #, Area, Zone, etc.)	Floor	Quantity	Lamp Type	Lamps Per Fixture	Type of Fixture	Ballast Type	Lamps Per Fixture	Reflectors	Ballast Type	Per Single	Extended	Per Single	Extended	Surveyors Comments	
Hall	1	1	4' T12	2	Ice	Magnetic	2	N	Electronic	\$ 5.60	\$ 5.60	\$ 60.00	\$ 60.00	Replace fixture and mount hardware	
H	1	6	4' T12	4	Ice	Magnetic	4	N	Electronic	\$ 11.20	\$ 67.20	\$ 160.00	\$ 960.00	Replace fixture and mount hardware	
Hall	1	4	4' T12	4	Ice	Magnetic	4	N	Electronic	\$ 11.20	\$ 44.80	\$ 160.00	\$ 640.00	Replace fixture and mount hardware	
F	1	6	4' T12	4	Wrap	Magnetic	4	N	Electronic	\$ 11.20	\$ 67.20	\$ 70.00	\$ 420.00	Excellent opportunity for retro-fit	
E	1	6	4' T12	4	Ice	Magnetic	4	N	Electronic	\$ 11.20	\$ 67.20	\$ 160.00	\$ 960.00	Replace fixture and mount hardware	
BUILDING G											\$ -		\$ -		
Girls' Restroom	1	4	4' T12	4	Troffer	Magnetic	4	N	Electronic	\$ 11.20	\$ 44.80	\$ 70.00	\$ 280.00	Excellent opportunity for retro-fit	
Janitor	1	1	4' T12	4	Wrap	Magnetic	4	N	Electronic	\$ 11.20	\$ 11.20	\$ 70.00	\$ 70.00	Excellent opportunity for retro-fit	
Boys' Restroom	1	4	4' T12	4	Troffer	Magnetic	4	N	Electronic	\$ 11.20	\$ 44.80	\$ 70.00	\$ 280.00	Excellent opportunity for retro-fit	
Store Room	1	4	4' T12	4	Ice	Magnetic	4	N	Electronic	\$ 11.20	\$ 44.80	\$ 160.00	\$ 640.00	Replace fixture and mount hardware	
BUILDING E	1	18	4' T12	4	Wrap	Magnetic	4	N	Electronic	\$ 11.20	\$ 201.60	\$ 70.00	\$ 1,260.00	Excellent opportunity for retro-fit	
BUILDING C	1	8	4' T12	4	Ice	Magnetic	4	N	Electronic	\$ 11.20	\$ 89.60	\$ 160.00	\$ 1,280.00	Replace fixture and mount hardware	
BUILDING H	1	5	4' T12	4	Wrap	Magnetic	4	N	Electronic	\$ 11.20	\$ 56.00	\$ 70.00	\$ 350.00	Excellent opportunity for retro-fit	
	1	3	4' T12	4	Wrap	Magnetic	4	N	Electronic	\$ 11.20	\$ 33.60	\$ 70.00	\$ 210.00	Excellent opportunity for retro-fit	
BUILDING D											\$ -		\$ -		
Cafeteria	1	9	4' T12	4	Impact	Magnetic	4	N	Electronic	\$ 11.20	\$ 100.80	\$ 70.00	\$ 630.00	Excellent opportunity for retro-fit	
Kitchen	1	18	4' T12	4	Wrap	Magnetic	4	N	Electronic	\$ 11.20	\$ 201.60	\$ 70.00	\$ 1,260.00	Excellent opportunity for retro-fit	
Total Rebates										\$	2,494.80				
Total Costs										\$	27,015.00				

LOCATION	QTY	EXISTING TYPE	QTY	RETROFIT	SURVEYORS COMMENTS	Actual			Proposed				
						Existing Watt/unit	Op. Hours	kWh	kW-D	Watt/unit	Op. Hours	kWh	kW-D
BUILDING A	0		0		0		1,630	0.0	0		1,630	0.0	0
A 1	1	4' 1L Fixture	1	Lamp & Low Watt Ballast	Excellent opportunity for retro-fit	45.6	1,630	74.3	0.0456	31	1,630	50.5	0.031
0	4	4' 4L Fixture	4	Lamp & Low Watt Ballast	Replace fixture and mount hardware	151.2	1,630	985.8	0.6048	100	1,630	652.0	0.4
A 2	4	4' 4L Fixture	4	Lamp & Low Watt Ballast	Replace fixture and mount hardware	151.2	1,630	985.8	0.6048	100	1,630	652.0	0.4
A 4	4	4' 4L Fixture	4	Lamp & Low Watt Ballast	Replace fixture and mount hardware	151.2	1,630	985.8	0.6048	100	1,630	652.0	0.4
A 3	8	4' 4L Fixture	8	Lamp & Low Watt Ballast	Replace fixture and mount hardware	151.2	1,630	1,971.6	1.2096	100	1,630	1,304.0	0.8
AUDITORIUM	22	4' 4L Fixture	22	Lamp & Low Watt Ballast	Tandem Excellent opportunity for retro-fit	151.2	1,630	5,422.0	3.3264	100	1,630	3,586.0	2.2
S Stage	2	4' 4L Fixture	2	Lamp & Low Watt Ballast	Excellent opportunity for retro-fit	151.2	1,630	492.9	0.3024	100	1,630	326.0	0.2
Teachers' Lounge	6	4' 4L Fixture	6	Lamp & Low Watt Ballast	Replace fixture and mount hardware	151.2	1,630	1,478.7	0.9072	100	1,630	978.0	0.6
Girls' Restroom	4	4' 2L Fixture	4	Lamp & Low Watt Ballast	Excellent opportunity for retro-fit	75.6	1,630	492.9	0.3024	51	1,630	332.5	0.204
Boys' Restroom	4	4' 2L Fixture	4	Lamp & Low Watt Ballast	Excellent opportunity for retro-fit	75.6	1,630	492.9	0.3024	51	1,630	332.5	0.204
Health Room	1	4' 4L Fixture	1	Lamp & Low Watt Ballast	Excellent opportunity for retro-fit	151.2	1,630	246.5	0.1512	100	1,630	163.0	0.1
21	4	4' 4L Fixture	4	Lamp & Low Watt Ballast	Replace fixture and mount hardware	151.2	1,630	985.8	0.6048	100	1,630	652.0	0.4
20	4	4' 4L Fixture	4	Lamp & Low Watt Ballast	Replace fixture and mount hardware	151.2	1,630	985.8	0.6048	100	1,630	652.0	0.4
23	4	4' 4L Fixture	4	Lamp & Low Watt Ballast	Replace fixture and mount hardware	151.2	1,630	985.8	0.6048	100	1,630	652.0	0.4
22	4	4' 4L Fixture	4	Lamp & Low Watt Ballast	Replace fixture and mount hardware	151.2	1,630	985.8	0.6048	100	1,630	652.0	0.4
25	4	4' 4L Fixture	4	Lamp & Low Watt Ballast	Replace fixture and mount hardware	151.2	1,630	985.8	0.6048	100	1,630	652.0	0.4
27 A	2	4' 4L Fixture	2	Lamp & Low Watt Ballast	Replace fixture and mount hardware	151.2	1,630	492.9	0.3024	100	1,630	326.0	0.2
27B	2	4' 4L Fixture	2	Lamp & Low Watt Ballast	Replace fixture and mount hardware	151.2	1,630	492.9	0.3024	100	1,630	326.0	0.2
26	4	4' 4L Fixture	4	Lamp & Low Watt Ballast	Replace fixture and mount hardware	151.2	1,630	985.8	0.6048	100	1,630	652.0	0.4
27	4	4' 4L Fixture	4	Lamp & Low Watt Ballast	Replace fixture and mount hardware	151.2	1,630	985.8	0.6048	100	1,630	652.0	0.4
28	6	4' 4L Fixture	6	Lamp & Low Watt Ballast	Replace fixture and mount hardware	151.2	1,630	1,478.7	0.9072	100	1,630	978.0	0.6
BUILDING B	0		0		0		1,630	0.0	0		1,630	0.0	0
A	5	4' 4L Fixture	5	Lamp & Low Watt Ballast	Replace fixture and mount hardware	151.2	1,630	1,232.3	0.756	100	1,630	815.0	0.5
0	1	4' 4L Fixture	1	Lamp & Low Watt Ballast	Excellent opportunity for retro-fit	151.2	1,630	246.5	0.1512	100	1,630	163.0	0.1
B	6	4' 4L Fixture	6	Lamp & Low Watt Ballast	Replace fixture and mount hardware	151.2	1,630	1,478.7	0.9072	100	1,630	978.0	0.6
C	4	4' 4L Fixture	4	Lamp & Low Watt Ballast	Replace fixture and mount hardware	151.2	1,630	985.8	0.6048	100	1,630	652.0	0.4
0	2	4' 4L Fixture	2	Lamp & Low Watt Ballast	Replace fixture and mount hardware	151.2	1,630	492.9	0.3024	100	1,630	326.0	0.2
D 2	6	4' 4L Fixture	6	Lamp & Low Watt Ballast	Replace fixture and mount hardware	151.2	1,630	1,478.7	0.9072	100	1,630	978.0	0.6
D 1	6	4' 4L Fixture	6	Lamp & Low Watt Ballast	Replace fixture and mount hardware	151.2	1,630	1,478.7	0.9072	100	1,630	978.0	0.6
Girls' Restroom	1	4' 4L Fixture	1	Lamp & Low Watt Ballast	Replace fixture and mount hardware	151.2	1,630	246.5	0.1512	100	1,630	163.0	0.1
Boys' Restroom	2	4' 4L Fixture	2	Lamp & Low Watt Ballast	Replace fixture and mount hardware	151.2	1,630	492.9	0.3024	100	1,630	326.0	0.2
Hall	1	4' 2L Fixture	1	Lamp & Low Watt Ballast	Replace fixture and mount hardware	75.6	1,630	123.2	0.0756	51	1,630	83.1	0.051
H	6	4' 4L Fixture	6	Lamp & Low Watt Ballast	Replace fixture and mount hardware	151.2	1,630	1,478.7	0.9072	100	1,630	978.0	0.6
Hall	4	4' 4L Fixture	4	Lamp & Low Watt Ballast	Replace fixture and mount hardware	151.2	1,630	985.8	0.6048	100	1,630	652.0	0.4
F	6	4' 4L Fixture	6	Lamp & Low Watt Ballast	Excellent opportunity for retro-fit	151.2	1,630	1,478.7	0.9072	100	1,630	978.0	0.6
E	6	4' 4L Fixture	6	Lamp & Low Watt Ballast	Replace fixture and mount hardware	151.2	1,630	1,478.7	0.9072	100	1,630	978.0	0.6
BUILDING G	0		0		0		1,630	0.0	0		1,630	0.0	0
Girls' Restroom	4	4' 4L Fixture	4	Lamp & Low Watt Ballast	Excellent opportunity for retro-fit	151.2	1,630	985.8	0.6048	100	1,630	652.0	0.4
Janitor	1	4' 4L Fixture	1	Lamp & Low Watt Ballast	Excellent opportunity for retro-fit	151.2	1,630	246.5	0.1512	100	1,630	163.0	0.1
Boys' Restroom	4	4' 4L Fixture	4	Lamp & Low Watt Ballast	Excellent opportunity for retro-fit	151.2	1,630	985.8	0.6048	100	1,630	652.0	0.4
Store Room	4	4' 4L Fixture	4	Lamp & Low Watt Ballast	Replace fixture and mount hardware	151.2	1,630	985.8	0.6048	100	1,630	652.0	0.4
BUILDING E	18	4' 4L Fixture	18	Lamp & Low Watt Ballast	Excellent opportunity for retro-fit	151.2	1,630	4,436.2	2.7216	100	1,630	2,934.0	1.8
BUILDING C	8	4' 4L Fixture	8	Lamp & Low Watt Ballast	Replace fixture and mount hardware	151.2	1,630	1,971.6	1.2096	100	1,630	1,304.0	0.8
BUILDING H	5	4' 4L Fixture	5	Lamp & Low Watt Ballast	Excellent opportunity for retro-fit	151.2	1,630	1,232.3	0.756	100	1,630	815.0	0.5
0	3	4' 4L Fixture	3	Lamp & Low Watt Ballast	Excellent opportunity for retro-fit	151.2	1,630	739.4	0.4536	100	1,630	489.0	0.3
BUILDING D	0		0		0		1,630	0.0	0		1,630	0.0	0
Cafeteria	9	4' 4L Fixture	9	Lamp & Low Watt Ballast	Excellent opportunity for retro-fit	151.2	1,630	2,218.1	1.3608	100	1,630	1,467.0	0.9
Kitchen	18	4' 4L Fixture	18	Lamp & Low Watt Ballast	Excellent opportunity for retro-fit	151.2	1,630	4,436.2	2.7216	100	1,630	2,934.0	1.8
Existing	228		Proposed	228	ENERGY CALCULATIONS				54,911	34		36,333	22.29
Description						kW-Demand	kWh						
Existing Use						33.69	54,911						
Proposed Use						22.29	36,333						
Difference - Savings						11.40	18,578						
Electrical Utility Cost						\$5.75	\$0.15271						
Savings per Year						\$786.43	\$2,837.04		Total Yearly Energy Savings \$3,623.47				

Princess Nahi'ena'ena Elementary School Classroom Designation Map

SY 2000 - 2001

	C204 Mrs. G Watanabe Gr. 2	C203 Mrs. J. Kupau Gr. 2	C202 Mrs. J. Acopan Gr. 2	C201 Ms. M. Tamayo Gr. 2
C105 Ms. R. Brooks Rem. Rdg.	C104 Mrs. L. Anchela Gr. K	C103 Ms. J. Santos Gr. 2	C102 Mrs. M. Golls Gr. 1	C101 Mrs. A. Silva Gr. 1

E 201 Mrs. S. Cabanilla Computer	E202 Mr. B. Santillo Gr. 5	E203 Ms. K. Williams Gr. 5	E204 Ms. C. Nelson Gr.5
E101 Ms. J Kubota Gr. 1	E102 Mrs. L. Matsui Gr. 1	E103 Mrs. P. Kaniho Gr. 5	E104 Mr. T. Hubble ESL

E105
Mrs. S.
Gramuglia
Gr. Pre

B204 Gr. 4	B203 Ms. P. Ferrelra Gr. 4	B202 Mrs. A. Nagasako Gr. 4	B201 Mrs. T. Kua'ana Gr. 4
B104 Mrs. C Mizomi Gr. 4	B103 Mrs. M. Barbosa Library	B102 Mr. D. Kiyomoto SSC	B101 OFFICE

Mr. S. Yanagi, SAS

Kristy
TAYLOR

P-1 Mrs. P. Miller SPED	P-2 Mrs. M. Marchand SPED	P-7 Mrs. V. Peterson SPED
--	------------------------------------	------------------------------------

Mrs. E. Snyder, Principal
Mrs. B. Takahata, VP
Mrs. I. Tihada, SASA
Ms. D. Sonomura, Clerk
Ms. S. Cameron, Health Aide

A204 Ms. F. Corrales Gr. 3	A203 Ms. L. Kaufman Gr. 3	A202 Mrs. K. Murphy Gr. 3	A201 Mr. D Nakamura Gr. 3
A104 Ms. F. Hudock Gr. K	A103 Mrs. A. Tumpap Gr. K	A102 Ms. D. Oshiro Gr. K	A101 LEINALA KUROKOYO Hawaiian Immersion

P-5 Mrs. R. Ligenza SPED	P-4 Mrs. L. Baker GT, ESL	P-3 ANN KURASCH
-----------------------------------	------------------------------------	-----------------------

Ms. D. Yoshitake, Remedial Reading

Mrs. L. Casicas PCNC
CAFETERIA
Mrs. C. Lewicki Speech Therapist
Ms. W. Johannson Ms. A. Katz Counselors

Maui Smart Schools Program
Foot Candle Readings

School: Princess Nahi'ewa'ewa

Room: Bldg. C C-202

Ceiling height: 12'

Light fixture height: 9'

Fixture type: Warp

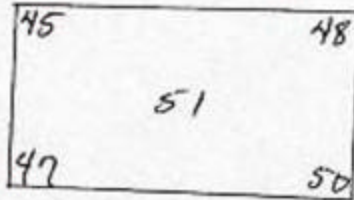

Room: Bldg. A A-102

Ceiling height: 12'

Light fixture height: 9'

Fixture type: Warp

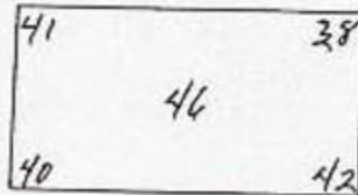

Room: Bldg. E -E-203

Ceiling height: 12'

Light fixture height: 9'

Fixture type: Warp

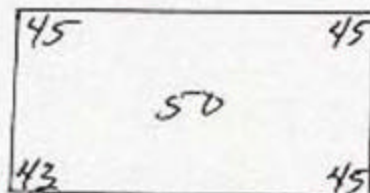



SCHOOL INFORMATION			
NAME Princess Nahi'ena'ena Elementary		DATE 3/2/2001	
STREET ADDRESS 816 Niheu St. Lahaina, Hawaii 96761		OPERATIONAL HOURS 1,774	
POINT OF CONTACT Edwina Wilson-Snyder	PHONE 622-4020	FAX	VOLTAGE 120V
AUDITOR Maui Community College Auditors			

LOCATION Location (Mr. Name, Rm. #, Area, Zone, etc.)	EXISTING EQUIPMENT						PROPOSED			REBATES		COSTS		COMMENTS Surveyors Comments
	Floor	Quantity	Lamp Type	Lamps Per Fixture	Type of Fixture	Ballast Type	Lamps Per Fixture	Reflectors	Ballast Type	Per Single	Extended	Per Single	Extended	
BUILDING A											\$ -		\$ -	
A - 101	1	30	4T12	2	Ice	Magnetic	2	N	Electronic	\$ 5.60	\$ 168.00	\$ 135.00	\$ 4,050.00	replace fixture and mount hardware
Faculty Room	1	20	4T12	2	Ice	Magnetic	2	N	Electronic	\$ 5.60	\$ 112.00	\$ 135.00	\$ 2,700.00	replace fixture and mount hardware
Boys' Restroom	1	3	4T12	2	Troffer	Magnetic	2	N	Electronic	\$ 5.60	\$ 16.80	\$ 60.00	\$ 180.00	excellent opportunity for retro-fit
Girls' Restroom	1	3	4T12	2	Troffer	Magnetic	2	N	Electronic	\$ 5.60	\$ 16.80	\$ 60.00	\$ 180.00	excellent opportunity for retro-fit
A - 102	1	30	4T12	2	Ice	Magnetic	2	N	Electronic	\$ 5.60	\$ 168.00	\$ 135.00	\$ 4,050.00	replace fixture and mount hardware
A - 103	1	30	4T12	2	Ice	Magnetic	2	N	Electronic	\$ 5.60	\$ 168.00	\$ 135.00	\$ 4,050.00	replace fixture and mount hardware
A - 104	1	30	4T12	2	Ice	Magnetic	2	N	Electronic	\$ 5.60	\$ 168.00	\$ 135.00	\$ 4,050.00	replace fixture and mount hardware
A - 201	2	30	4T12	2	Ice	Magnetic	2	N	Electronic	\$ 5.60	\$ 168.00	\$ 135.00	\$ 4,050.00	replace fixture and mount hardware
A - 202	2	30	4T12	2	Ice	Magnetic	2	N	Electronic	\$ 5.60	\$ 168.00	\$ 135.00	\$ 4,050.00	replace fixture and mount hardware
A - 203	2	30	4T12	2	Ice	Magnetic	2	N	Electronic	\$ 5.60	\$ 168.00	\$ 135.00	\$ 4,050.00	replace fixture and mount hardware
A - 204	2	30	4T12	2	Ice	Magnetic	2	N	Electronic	\$ 5.60	\$ 168.00	\$ 135.00	\$ 4,050.00	replace fixture and mount hardware
Boys' Restroom	2	3	4T12	2	Troffer	Magnetic	2	N	Electronic	\$ 5.60	\$ 16.80	\$ 60.00	\$ 180.00	excellent opportunity for retro-fit
Girls' Restroom	2	3	4T12	2	Troffer	Magnetic	2	N	Electronic	\$ 5.60	\$ 16.80	\$ 60.00	\$ 180.00	excellent opportunity for retro-fit
Store Room	2	1	4T12	2	Vanity	Magnetic	2	N	Electronic	\$ 5.60	\$ 5.60	\$ 60.00	\$ 60.00	excellent opportunity for retro-fit
Machine room	2	1	4T12	2	Vanity	Magnetic	2	N	Electronic	\$ 5.60	\$ 5.60	\$ 60.00	\$ 60.00	excellent opportunity for retro-fit
Custodian	2	1	4T12	2	Vanity	Magnetic	2	N	Electronic	\$ 5.60	\$ 5.60	\$ 60.00	\$ 60.00	excellent opportunity for retro-fit
BUILDING B											\$ -		\$ -	
B - 101 - Office	1	12	4T12	2	Wrap	Magnetic	2	N	Electronic	\$ 5.60	\$ 67.20	\$ 60.00	\$ 720.00	excellent opportunity for retro-fit
B - 101 - Custodian	1	1	4T12	2	Wrap	Magnetic	2	N	Electronic	\$ 5.60	\$ 5.60	\$ 60.00	\$ 60.00	excellent opportunity for retro-fit
B - 101 - Vice-principal	1	2	4T12	2	Wrap	Magnetic	2	N	Electronic	\$ 5.60	\$ 11.20	\$ 60.00	\$ 120.00	excellent opportunity for retro-fit
B - 101 - Principal	1	2	4T12	2	Wrap	Magnetic	2	N	Electronic	\$ 5.60	\$ 11.20	\$ 60.00	\$ 120.00	excellent opportunity for retro-fit
B - 101 - A	1	2	4T12	2	Wrap	Magnetic	2	N	Electronic	\$ 5.60	\$ 11.20	\$ 60.00	\$ 120.00	excellent opportunity for retro-fit
Girls' Restroom	1	5	4T12	1	Wrap	Magnetic	1	N	Electronic	\$ 2.80	\$ 14.00	\$ 55.00	\$ 275.00	excellent opportunity for retro-fit
Boys' Restroom	1	5	4T12	1	Wrap	Magnetic	1	N	Electronic	\$ 2.80	\$ 14.00	\$ 55.00	\$ 275.00	excellent opportunity for retro-fit
Teachers' Room	1	1	4T12	1	Wrap	Magnetic	1	N	Electronic	\$ 2.80	\$ 2.80	\$ 55.00	\$ 55.00	excellent opportunity for retro-fit
B - 102	1	20	4T12	2	Wrap	Magnetic	2	N	Electronic	\$ 5.60	\$ 112.00	\$ 60.00	\$ 1,200.00	excellent opportunity for retro-fit
B - 102 - Office	1	2	4T12	2	Wrap	Magnetic	2	N	Electronic	\$ 5.60	\$ 11.20	\$ 60.00	\$ 120.00	excellent opportunity for retro-fit
B - 103	1	24	4T12	2	Wrap	Magnetic	2	N	Electronic	\$ 5.60	\$ 134.40	\$ 60.00	\$ 1,440.00	excellent opportunity for retro-fit
B - 104	1	24	4T12	2	Wrap	Magnetic	2	N	Electronic	\$ 5.60	\$ 134.40	\$ 60.00	\$ 1,440.00	excellent opportunity for retro-fit
Store Room	1	1	4T12	2	Wrap	Magnetic	2	N	Electronic	\$ 5.60	\$ 5.60	\$ 60.00	\$ 60.00	excellent opportunity for retro-fit
B - 201	2	24	4T12	2	Wrap	Magnetic	2	N	Electronic	\$ 5.60	\$ 134.40	\$ 60.00	\$ 1,440.00	excellent opportunity for retro-fit

LOCATION	EXISTING EQUIPMENT						PROPOSED			REBATES		COSTS		COMMENTS
Location (Mr. Name, Rm. #, Area, Zone, etc.)	Floor	Quantity	Lamp Type	Lamps Per Fixture	Type of Fixture	Ballast Type	Lamps Per Fixture	Reflectors	Ballast Type	Per Single	Extended	Per Single	Extended	Surveyor's Comments
B - 202	2	24	4T12	2	Wrap	Magnetic	2	N	Electronic	\$ 5.60	\$ 134.40	\$ 60.00	\$ 1,440.00	excellent opportunity for retro-fit
B - 203	2	24	4T12	2	Wrap	Magnetic	2	N	Electronic	\$ 5.60	\$ 134.40	\$ 60.00	\$ 1,440.00	excellent opportunity for retro-fit
B - 204	2	24	4T12	2	Wrap	Magnetic	2	N	Electronic	\$ 5.60	\$ 134.40	\$ 60.00	\$ 1,440.00	excellent opportunity for retro-fit
Store Room	2	1	4T12	2	Wrap	Magnetic	2	N	Electronic	\$ 5.60	\$ 5.60	\$ 60.00	\$ 60.00	excellent opportunity for retro-fit
Custodian	2	1	4T12	2	Wrap	Magnetic	2	N	Electronic	\$ 5.60	\$ 5.60	\$ 60.00	\$ 60.00	excellent opportunity for retro-fit
Teachers' Room	2	1	4T12	1	Wrap	Magnetic	1	N	Electronic	\$ 2.80	\$ 2.80	\$ 55.00	\$ 55.00	excellent opportunity for retro-fit
Girls' Restroom	2	5	4T12	1	Wrap	Magnetic	1	N	Electronic	\$ 2.80	\$ 14.00	\$ 55.00	\$ 275.00	excellent opportunity for retro-fit
Boys' Restroom	2	5	4T12	1	Wrap	Magnetic	1	N	Electronic	\$ 2.80	\$ 14.00	\$ 55.00	\$ 275.00	excellent opportunity for retro-fit
BUILDING C											\$ -		\$ -	
C - 101	1	16	4T12	3	Troffer	Magnetic	3	N	Electronic	\$ 8.40	\$ 134.40	\$ 65.00	\$ 1,040.00	no comment
C - 102	1	16	4T12	3	Troffer	Magnetic	3	N	Electronic	\$ 8.40	\$ 134.40	\$ 65.00	\$ 1,040.00	no comment
C - 103	1	16	4T12	3	Troffer	Magnetic	3	N	Electronic	\$ 8.40	\$ 134.40	\$ 65.00	\$ 1,040.00	no comment
C - 104	1	16	4T12	3	Troffer	Magnetic	3	N	Electronic	\$ 8.40	\$ 134.40	\$ 65.00	\$ 1,040.00	no comment
C - 105	1	6	4T12	3	Troffer	Magnetic	3	N	Electronic	\$ 8.40	\$ 50.40	\$ 65.00	\$ 390.00	no comment
Girls' Restroom	1	4	4T12	2	Troffer	Magnetic	2	N	Electronic	\$ 5.60	\$ 22.40	\$ 60.00	\$ 240.00	excellent opportunity for retro-fit
Boys' Restroom	1	4	4T12	2	Troffer	Magnetic	2	N	Electronic	\$ 5.60	\$ 22.40	\$ 60.00	\$ 240.00	excellent opportunity for retro-fit
Staff Room	1	2	4T12	2	Troffer	Magnetic	2	N	Electronic	\$ 5.60	\$ 11.20	\$ 60.00	\$ 120.00	excellent opportunity for retro-fit
Utility	1	2	4T12	2	Troffer	Magnetic	2	N	Electronic	\$ 5.60	\$ 11.20	\$ 60.00	\$ 120.00	excellent opportunity for retro-fit
C -201	2	16	4T12	3	Troffer	Magnetic	3	N	Electronic	\$ 8.40	\$ 134.40	\$ 65.00	\$ 1,040.00	no comment
C -202	2	16	4T12	3	Troffer	Magnetic	3	N	Electronic	\$ 8.40	\$ 134.40	\$ 65.00	\$ 1,040.00	no comment
C -203	2	16	4T12	3	Troffer	Magnetic	3	N	Electronic	\$ 8.40	\$ 134.40	\$ 65.00	\$ 1,040.00	no comment
C -204	2	16	4T12	3	Troffer	Magnetic	3	N	Electronic	\$ 8.40	\$ 134.40	\$ 65.00	\$ 1,040.00	no comment
Utility	2	1	4T12	2	Troffer	Magnetic	2	N	Electronic	\$ 5.60	\$ 5.60	\$ 60.00	\$ 60.00	excellent opportunity for retro-fit
Store Room	2	2	4T12	2	Troffer	Magnetic	2	N	Electronic	\$ 5.60	\$ 11.20	\$ 60.00	\$ 120.00	excellent opportunity for retro-fit
Girls' Restroom	2	4	4T12	2	Troffer	Magnetic	2	N	Electronic	\$ 5.60	\$ 22.40	\$ 60.00	\$ 240.00	excellent opportunity for retro-fit
Boys' Restroom	2	4	4T12	2	Troffer	Magnetic	2	N	Electronic	\$ 5.60	\$ 22.40	\$ 60.00	\$ 240.00	excellent opportunity for retro-fit
Store Room	2	2	4T12	2	Wrap	Magnetic	2	N	Electronic	\$ 5.60	\$ 11.20	\$ 60.00	\$ 120.00	replace fixture and mount hardware
BUILDING E											\$ -		\$ -	
E -101	1	24	4T12	2	Wrap	Magnetic	2	N	Electronic	\$ 5.60	\$ 134.40	\$ 60.00	\$ 1,440.00	excellent opportunity for retro-fit
E -102	1	24	4T12	2	Wrap	Magnetic	2	N	Electronic	\$ 5.60	\$ 134.40	\$ 60.00	\$ 1,440.00	excellent opportunity for retro-fit
E - 103	1	24	4T12	2	Wrap	Magnetic	2	N	Electronic	\$ 5.60	\$ 134.40	\$ 60.00	\$ 1,440.00	excellent opportunity for retro-fit
E -104 - A	1	8	4T12	2	Wrap	Magnetic	2	N	Electronic	\$ 5.60	\$ 44.80	\$ 60.00	\$ 480.00	excellent opportunity for retro-fit
E - 104 -B	1	8	4T12	2	Wrap	Magnetic	2	N	Electronic	\$ 5.60	\$ 44.80	\$ 60.00	\$ 480.00	excellent opportunity for retro-fit
E - 105	1	24	4T12	2	Wrap	Magnetic	2	N	Electronic	\$ 5.60	\$ 134.40	\$ 60.00	\$ 1,440.00	excellent opportunity for retro-fit
Girls' Restroom	1	6	4T12	1	Wrap	Magnetic	1	N	Electronic	\$ 2.80	\$ 16.80	\$ 55.00	\$ 330.00	excellent opportunity for retro-fit
Boys' Restroom	1	5	4T12	1	Wrap	Magnetic	1	N	Electronic	\$ 2.80	\$ 14.00	\$ 55.00	\$ 275.00	excellent opportunity for retro-fit
Custodian	1	2	4T12	2	Wrap	Magnetic	2	N	Electronic	\$ 5.60	\$ 11.20	\$ 60.00	\$ 120.00	excellent opportunity for retro-fit

LOCATION (Mr. Name, Rm. #, Area, Zone, etc.)	EXISTING EQUIPMENT						PROPOSED			REBATES		COSTS		COMMENTS Surveyor's Comments
	Floor	Quantity	Lamp Type	Lamps Per Fixture	Type of Fixture	Ballast Type	Lamps Per Fixture	Reflectors	Ballast Type	Per Single	Extended	Per Single	Extended	
Store Room	1	2	4T12	2	Wrap	Magnetic	2	N	Electronic	\$ 5.60	\$ 11.20	\$ 60.00	\$ 120.00	excellent opportunity for retro-fit
E - 201	2	24	4T12	2	Wrap	Magnetic	2	N	Electronic	\$ 5.60	\$ 134.40	\$ 60.00	\$ 1,440.00	excellent opportunity for retro-fit
E - 202	2	24	4T12	2	Wrap	Magnetic	2	N	Electronic	\$ 5.60	\$ 134.40	\$ 60.00	\$ 1,440.00	excellent opportunity for retro-fit
E - 203	2	24	4T12	2	Wrap	Magnetic	2	N	Electronic	\$ 5.60	\$ 134.40	\$ 60.00	\$ 1,440.00	excellent opportunity for retro-fit
E - 204	2	24	4T12	2	Wrap	Magnetic	2	N	Electronic	\$ 5.60	\$ 134.40	\$ 60.00	\$ 1,440.00	excellent opportunity for retro-fit
Store Room	2	1	4T12	2	Wrap	Magnetic	2	N	Electronic	\$ 5.60	\$ 5.60	\$ 60.00	\$ 60.00	excellent opportunity for retro-fit
Girls' Restroom	2	5	4T12	2	Wrap	Magnetic	2	N	Electronic	\$ 5.60	\$ 28.00	\$ 60.00	\$ 300.00	excellent opportunity for retro-fit
Boys' Restroom	2	6	4T12	2	Wrap	Magnetic	2	N	Electronic	\$ 5.60	\$ 33.60	\$ 60.00	\$ 360.00	excellent opportunity for retro-fit
PORTABLES											\$ -		\$ -	
P - 1	1	16	4" T8	3	Troffer	Electronic					\$ -		\$ -	T8 Lamps, No Retrofit
P - 2	1	16	4" T8	3	Troffer	Electronic					\$ -		\$ -	T8 Lamps, No Retrofit
P - 7	1	16	4" T8	3	Troffer	Electronic					\$ -		\$ -	T8 Lamps, No Retrofit
P - 3	1	12	4T12	4	Ice	Magnetic	4	N	Electronic	\$ 11.20	\$ 134.40	\$ 160.00	\$ 1,920.00	replace fixture and mount hardware
P - 4	1	12	4T12	4	Ice	Magnetic	4	N	Electronic	\$ 11.20	\$ 134.40	\$ 160.00	\$ 1,920.00	replace fixture and mount hardware
P - 5	1	12	4T12	4	Wrap	Electronic	4	N	Electronic	\$ 11.20	\$ 134.40	\$ 70.00	\$ 840.00	excellent opportunity for retro-fit
CAFETERIA											\$ -		\$ -	
Kitchen	1	20	4" T8	3	Troffer	Electronic					\$ -		\$ -	T8 Lamps, No Retrofit
Store Room	1	1	4" T8	3	Troffer	Electronic					\$ -		\$ -	T8 Lamps, No Retrofit
Total Rebates										\$	5,608.40			
Total Costs										\$	77,425.00			

LOCATION	QTY	EXISTING TYPE	QTY	RETROFIT	SURVEYORS COMMENTS	Existing		Actual			Proposed		
						Watt/unit	Op. Hours	kWh	kW-D	Watt/unit	Op. Hours	kWh	kW-D
BUILDING A	0		0		0		1,774	0.0	0		1,774	0.0	0
A - 101	30	4' 2L Fixture	30	Lamp & Low Watt Ballast	replace fixture and mount hardware	75.6	1,774	4,022.3	2.268	51	1,774	2,713.5	1.53
Faculty Room	20	4' 2L Fixture	20	Lamp & Low Watt Ballast	replace fixture and mount hardware	75.6	1,774	2,681.5	1.512	51	1,774	1,809.0	1.02
Boys' Restroom	3	4' 2L Fixture	3	Lamp & Low Watt Ballast	excellent opportunity for retro-fit	75.6	1,774	402.2	0.2268	51	1,774	271.3	0.153
Girls' Restroom	3	4' 2L Fixture	3	Lamp & Low Watt Ballast	excellent opportunity for retro-fit	75.6	1,774	402.2	0.2268	51	1,774	271.3	0.153
A - 102	30	4' 2L Fixture	30	Lamp & Low Watt Ballast	replace fixture and mount hardware	75.6	1,774	4,022.3	2.268	51	1,774	2,713.5	1.53
A - 103	30	4' 2L Fixture	30	Lamp & Low Watt Ballast	replace fixture and mount hardware	75.6	1,774	4,022.3	2.268	51	1,774	2,713.5	1.53
A - 104	30	4' 2L Fixture	30	Lamp & Low Watt Ballast	replace fixture and mount hardware	75.6	1,774	4,022.3	2.268	51	1,774	2,713.5	1.53
A - 201	30	4' 2L Fixture	30	Lamp & Low Watt Ballast	replace fixture and mount hardware	75.6	1,774	4,022.3	2.268	51	1,774	2,713.5	1.53
A - 202	30	4' 2L Fixture	30	Lamp & Low Watt Ballast	replace fixture and mount hardware	75.6	1,774	4,022.3	2.268	51	1,774	2,713.5	1.53
A - 203	30	4' 2L Fixture	30	Lamp & Low Watt Ballast	replace fixture and mount hardware	75.6	1,774	4,022.3	2.268	51	1,774	2,713.5	1.53
A - 204	30	4' 2L Fixture	30	Lamp & Low Watt Ballast	replace fixture and mount hardware	75.6	1,774	4,022.3	2.268	51	1,774	2,713.5	1.53
Boys' Restroom	3	4' 2L Fixture	3	Lamp & Low Watt Ballast	excellent opportunity for retro-fit	75.6	1,774	402.2	0.2268	51	1,774	271.3	0.153
Girls' Restroom	3	4' 2L Fixture	3	Lamp & Low Watt Ballast	excellent opportunity for retro-fit	75.6	1,774	402.2	0.2268	51	1,774	271.3	0.153
Store Room	1	4' 2L Fixture	1	Lamp & Low Watt Ballast	excellent opportunity for retro-fit	75.6	1,774	134.1	0.0756	51	1,774	90.4	0.051
Machine room	1	4' 2L Fixture	1	Lamp & Low Watt Ballast	excellent opportunity for retro-fit	75.6	1,774	134.1	0.0756	51	1,774	90.4	0.051
Custodian	1	4' 2L Fixture	1	Lamp & Low Watt Ballast	excellent opportunity for retro-fit	75.6	1,774	134.1	0.0756	51	1,774	90.4	0.051
BUILDING B	0		0		0		1,774	0.0	0		1,774	0.0	0
B - 101 - Office	12	4' 2L Fixture	12	Lamp & Low Watt Ballast	excellent opportunity for retro-fit	75.6	1,774	1,608.9	0.9072	51	1,774	1,085.4	0.612
B - 101 - Custodian	1	4' 2L Fixture	1	Lamp & Low Watt Ballast	excellent opportunity for retro-fit	75.6	1,774	134.1	0.0756	51	1,774	90.4	0.051
B - 101 - Vice-principal	2	4' 2L Fixture	2	Lamp & Low Watt Ballast	excellent opportunity for retro-fit	75.6	1,774	268.2	0.1512	51	1,774	180.9	0.102
B - 101 - Principal	2	4' 2L Fixture	2	Lamp & Low Watt Ballast	excellent opportunity for retro-fit	75.6	1,774	268.2	0.1512	51	1,774	180.9	0.102
B - 101 - A	2	4' 2L Fixture	2	Lamp & Low Watt Ballast	excellent opportunity for retro-fit	75.6	1,774	268.2	0.1512	51	1,774	180.9	0.102
Girls' Restroom	5	4' 1L Fixture	5	Lamp & Low Watt Ballast	excellent opportunity for retro-fit	45.6	1,774	404.4	0.228	31	1,774	274.9	0.155
Boys' Restroom	5	4' 1L Fixture	5	Lamp & Low Watt Ballast	excellent opportunity for retro-fit	45.6	1,774	404.4	0.228	31	1,774	274.9	0.155
Teachers' Room	1	4' 1L Fixture	1	Lamp & Low Watt Ballast	excellent opportunity for retro-fit	45.6	1,774	80.9	0.0456	31	1,774	55.0	0.031
B - 102	20	4' 2L Fixture	20	Lamp & Low Watt Ballast	excellent opportunity for retro-fit	75.6	1,774	2,681.5	1.512	51	1,774	1,809.0	1.02
B - 102 - Office	2	4' 2L Fixture	2	Lamp & Low Watt Ballast	excellent opportunity for retro-fit	75.6	1,774	268.2	0.1512	51	1,774	180.9	0.102
B - 103	24	4' 2L Fixture	24	Lamp & Low Watt Ballast	excellent opportunity for retro-fit	75.6	1,774	3,217.8	1.8144	51	1,774	2,170.8	1.224
B - 104	24	4' 2L Fixture	24	Lamp & Low Watt Ballast	excellent opportunity for retro-fit	75.6	1,774	3,217.8	1.8144	51	1,774	2,170.8	1.224
Store Room	1	4' 2L Fixture	1	Lamp & Low Watt Ballast	excellent opportunity for retro-fit	75.6	1,774	134.1	0.0756	51	1,774	90.4	0.051
B - 201	24	4' 2L Fixture	24	Lamp & Low Watt Ballast	excellent opportunity for retro-fit	75.6	1,774	3,217.8	1.8144	51	1,774	2,170.8	1.224
B - 202	24	4' 2L Fixture	24	Lamp & Low Watt Ballast	excellent opportunity for retro-fit	75.6	1,774	3,217.8	1.8144	51	1,774	2,170.8	1.224
B - 203	24	4' 2L Fixture	24	Lamp & Low Watt Ballast	excellent opportunity for retro-fit	75.6	1,774	3,217.8	1.8144	51	1,774	2,170.8	1.224
B - 204	24	4' 2L Fixture	24	Lamp & Low Watt Ballast	excellent opportunity for retro-fit	75.6	1,774	3,217.8	1.8144	51	1,774	2,170.8	1.224
Store Room	1	4' 2L Fixture	1	Lamp & Low Watt Ballast	excellent opportunity for retro-fit	75.6	1,774	134.1	0.0756	51	1,774	90.4	0.051
Custodian	1	4' 2L Fixture	1	Lamp & Low Watt Ballast	excellent opportunity for retro-fit	75.6	1,774	134.1	0.0756	51	1,774	90.4	0.051
Teachers' Room	1	4' 1L Fixture	1	Lamp & Low Watt Ballast	excellent opportunity for retro-fit	45.6	1,774	80.9	0.0456	31	1,774	55.0	0.031
Girls' Restroom	5	4' 1L Fixture	5	Lamp & Low Watt Ballast	excellent opportunity for retro-fit	45.6	1,774	404.4	0.228	31	1,774	274.9	0.155
Boys' Restroom	5	4' 1L Fixture	5	Lamp & Low Watt Ballast	excellent opportunity for retro-fit	45.6	1,774	404.4	0.228	31	1,774	274.9	0.155
BUILDING C	0		0		0		1,774	0.0	0		1,774	0.0	0
C - 101	16	4' 3L Fixture	16	Lamp & Low Watt Ballast	no comment	121.2	1,774	3,439.2	1.9392	77	1,774	2,185.0	1.232
C - 102	16	4' 3L Fixture	16	Lamp & Low Watt Ballast	no comment	121.2	1,774	3,439.2	1.9392	77	1,774	2,185.0	1.232
C - 103	16	4' 3L Fixture	16	Lamp & Low Watt Ballast	no comment	121.2	1,774	3,439.2	1.9392	77	1,774	2,185.0	1.232
C - 104	16	4' 3L Fixture	16	Lamp & Low Watt Ballast	no comment	121.2	1,774	3,439.2	1.9392	77	1,774	2,185.0	1.232
C - 105	6	4' 3L Fixture	6	Lamp & Low Watt Ballast	no comment	121.2	1,774	1,289.7	0.7272	77	1,774	819.4	0.462
Girls' Restroom	4	4' 2L Fixture	4	Lamp & Low Watt Ballast	excellent opportunity for retro-fit	75.6	1,774	536.3	0.3024	51	1,774	361.8	0.204
Boys' Restroom	4	4' 2L Fixture	4	Lamp & Low Watt Ballast	excellent opportunity for retro-fit	75.6	1,774	536.3	0.3024	51	1,774	361.8	0.204
Staff Room	2	4' 2L Fixture	2	Lamp & Low Watt Ballast	excellent opportunity for retro-fit	75.6	1,774	268.2	0.1512	51	1,774	180.9	0.102
Utility	2	4' 2L Fixture	2	Lamp & Low Watt Ballast	excellent opportunity for retro-fit	75.6	1,774	268.2	0.1512	51	1,774	180.9	0.102
C-201	16	4' 3L Fixture	16	Lamp & Low Watt Ballast	no comment	121.2	1,774	3,439.2	1.9392	77	1,774	2,185.0	1.232
C-202	16	4' 3L Fixture	16	Lamp & Low Watt Ballast	no comment	121.2	1,774	3,439.2	1.9392	77	1,774	2,185.0	1.232
C-203	16	4' 3L Fixture	16	Lamp & Low Watt Ballast	no comment	121.2	1,774	3,439.2	1.9392	77	1,774	2,185.0	1.232
C-204	16	4' 3L Fixture	16	Lamp & Low Watt Ballast	no comment	121.2	1,774	3,439.2	1.9392	77	1,774	2,185.0	1.232
Utility	1	4' 2L Fixture	1	Lamp & Low Watt Ballast	excellent opportunity for retro-fit	75.6	1,774	134.1	0.0756	51	1,774	90.4	0.051
Store Room	2	4' 2L Fixture	2	Lamp & Low Watt Ballast	excellent opportunity for retro-fit	75.6	1,774	268.2	0.1512	51	1,774	180.9	0.102
Girls' Restroom	4	4' 2L Fixture	4	Lamp & Low Watt Ballast	excellent opportunity for retro-fit	75.6	1,774	536.3	0.3024	51	1,774	361.8	0.204
Boys' Restroom	4	4' 2L Fixture	4	Lamp & Low Watt Ballast	excellent opportunity for retro-fit	75.6	1,774	536.3	0.3024	51	1,774	361.8	0.204
Store Room	2	4' 2L Fixture	2	Lamp & Low Watt Ballast	replace fixture and mount hardware	75.6	1,774	268.2	0.1512	51	1,774	180.9	0.102
BUILDING E	0		0		0		1,774	0.0	0		1,774	0.0	0

LOCATION	QTY	EXISTING TYPE	QTY	RETROFIT	SURVEYORS COMMENTS	Existing	Actual			Proposed			
						Watt/unit	Op. Hours	kWh	kW-D	Watt/unit	Op. Hours	kWh	kW-D
E -101	24	4' 2L Fixture	24	Lamp & Low Watt Ballast	excellent opportunity for retro-fit	75.6	1,774	3,217.8	1.8144	51	1,774	2,170.8	1.224
E -102	24	4' 2L Fixture	24	Lamp & Low Watt Ballast	excellent opportunity for retro-fit	75.6	1,774	3,217.8	1.8144	51	1,774	2,170.8	1.224
E - 103	24	4' 2L Fixture	24	Lamp & Low Watt Ballast	excellent opportunity for retro-fit	75.6	1,774	3,217.8	1.8144	51	1,774	2,170.8	1.224
E -104 - A	8	4' 2L Fixture	8	Lamp & Low Watt Ballast	excellent opportunity for retro-fit	75.6	1,774	1,072.6	0.6048	51	1,774	723.6	0.408
E - 104 -B	8	4' 2L Fixture	8	Lamp & Low Watt Ballast	excellent opportunity for retro-fit	75.6	1,774	1,072.6	0.6048	51	1,774	723.6	0.408
E - 105	24	4' 2L Fixture	24	Lamp & Low Watt Ballast	excellent opportunity for retro-fit	75.6	1,774	3,217.8	1.8144	51	1,774	2,170.8	1.224
Girls' Restroom	6	4' 1L Fixture	6	Lamp & Low Watt Ballast	excellent opportunity for retro-fit	45.6	1,774	485.2	0.2736	31	1,774	329.9	0.186
Boys' Restroom	5	4' 1L Fixture	5	Lamp & Low Watt Ballast	excellent opportunity for retro-fit	45.6	1,774	404.4	0.228	31	1,774	274.9	0.155
Custodian	2	4' 2L Fixture	2	Lamp & Low Watt Ballast	excellent opportunity for retro-fit	75.6	1,774	268.2	0.1512	51	1,774	180.9	0.102
Store Room	2	4' 2L Fixture	2	Lamp & Low Watt Ballast	excellent opportunity for retro-fit	75.6	1,774	268.2	0.1512	51	1,774	180.9	0.102
E - 201	24	4' 2L Fixture	24	Lamp & Low Watt Ballast	excellent opportunity for retro-fit	75.6	1,774	3,217.8	1.8144	51	1,774	2,170.8	1.224
E - 202	24	4' 2L Fixture	24	Lamp & Low Watt Ballast	excellent opportunity for retro-fit	75.6	1,774	3,217.8	1.8144	51	1,774	2,170.8	1.224
E - 203	24	4' 2L Fixture	24	Lamp & Low Watt Ballast	excellent opportunity for retro-fit	75.6	1,774	3,217.8	1.8144	51	1,774	2,170.8	1.224
E -204	24	4' 2L Fixture	24	Lamp & Low Watt Ballast	excellent opportunity for retro-fit	75.6	1,774	3,217.8	1.8144	51	1,774	2,170.8	1.224
Store Room	1	4' 2L Fixture	1	Lamp & Low Watt Ballast	excellent opportunity for retro-fit	75.6	1,774	134.1	0.0756	51	1,774	90.4	0.051
Girls' Restroom	5	4' 2L Fixture	5	Lamp & Low Watt Ballast	excellent opportunity for retro-fit	75.6	1,774	670.4	0.378	51	1,774	452.2	0.255
Boys' Restroom	6	4' 2L Fixture	6	Lamp & Low Watt Ballast	excellent opportunity for retro-fit	75.6	1,774	804.5	0.4536	51	1,774	542.7	0.306
PORTABLES	0		0		0		1,774	0.0	0		1,774	0.0	0
P -1	16		0		T8 Lamps, No Retrofit		1,774	0.0	0		1,774	0.0	0
P -2	16		0		T8 Lamps, No Retrofit		1,774	0.0	0		1,774	0.0	0
P - 7	16		0		T8 Lamps, No Retrofit		1,774	0.0	0		1,774	0.0	0
P -3	12	4' 4L Fixture	12	Lamp & Low Watt Ballast	replace fixture and mount hardware	151.2	1,774	3,217.8	1.8144	100	1,774	2,128.2	1.2
P - 4	12	4' 4L Fixture	12	Lamp & Low Watt Ballast	replace fixture and mount hardware	151.2	1,774	3,217.8	1.8144	100	1,774	2,128.2	1.2
P - 5	12	4' 4L Fixture	12	Lamp & Low Watt Ballast	excellent opportunity for retro-fit	151.2	1,774	3,217.8	1.8144	100	1,774	2,128.2	1.2
CAFETERIA	0		0		0		1,774	0.0	0		1,774	0.0	0
Kitchen	20		0		T8 Lamps, No Retrofit		1,774	0.0	0		1,774	0.0	0
Store Room	1		0		T8 Lamps, No Retrofit		1,774	0.0	0		1,774	0.0	0

Existing 984 Proposed 915

ENERGY CALCULATIONS			136,588	77	90,897	51
Description	kW-Demand	kWh				
Existing Use	77.02	136,588				
Proposed Use	51.25	90,897				
Difference - Savings	25.76	45,691	Total Yearly Energy Savings			
Electrical Utility Cost	\$5.75	\$0.15279				
Savings per Year	\$1,777.65	\$6,981.01	\$8,758.66			

PUKALANI ELEMENTARY SCHOOL
 2945 Iolani Street Pukalani, HI 96768
 Telephone: 573-8760

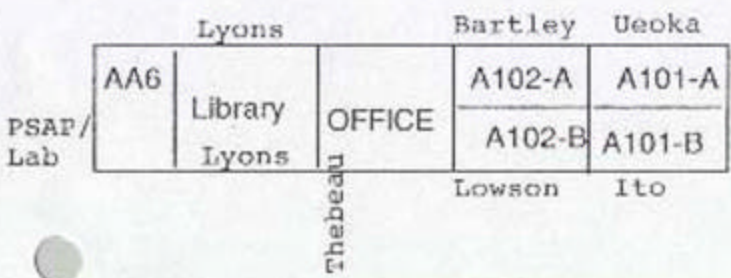
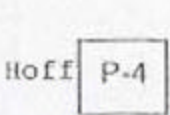
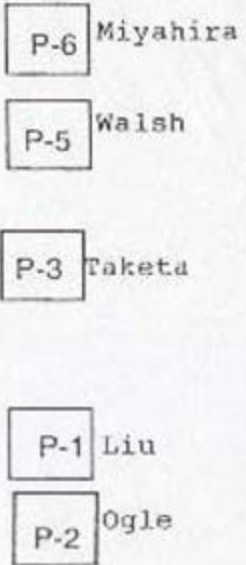
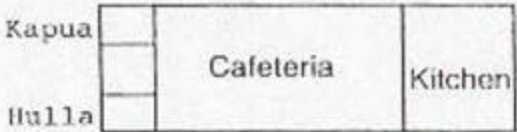
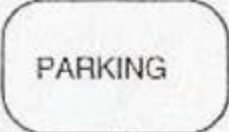
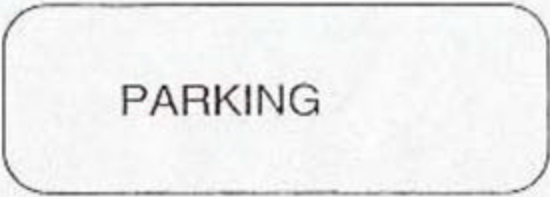
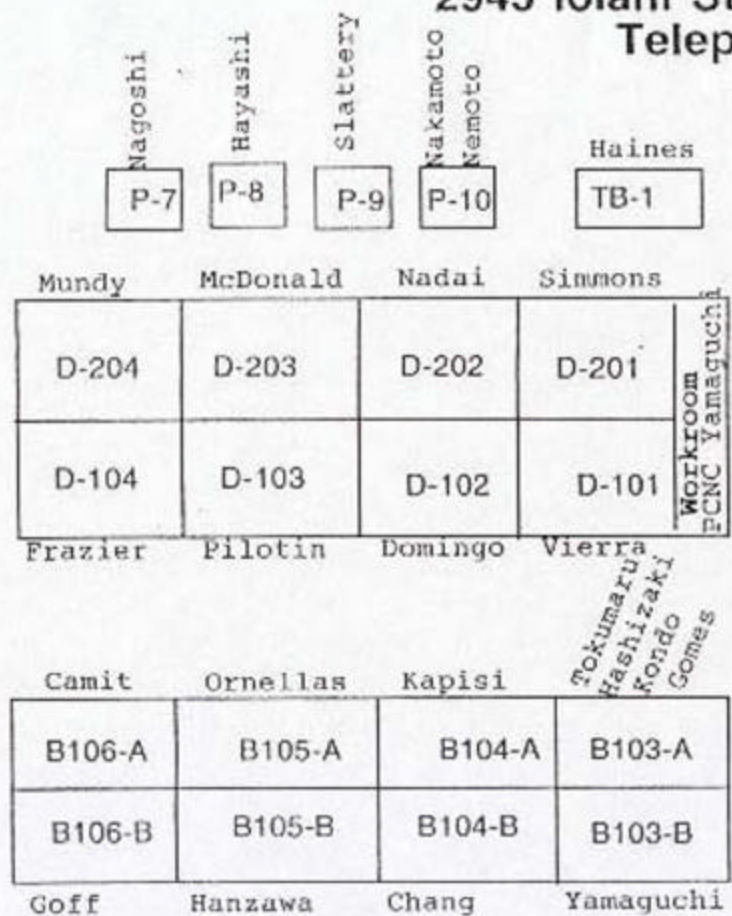

Maui Smart Schools Program
Foot Candle Readings

School: Pukalani Elementary School

Room: Bldg. A - Library
Ceiling height: 15'
Light fixture height: 12'
Fixture type: Troffer

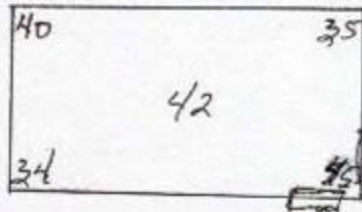

Room: Bldg. D Rm. D-104
Ceiling height: 12'
Light fixture height: 9'
Fixture type: Ice Tray

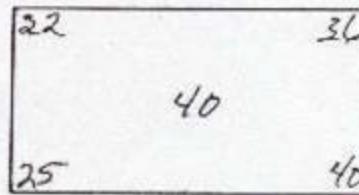

Room: Portable - P-6
Ceiling height: 9'
Light fixture height: 8'
Fixture type: Troffer

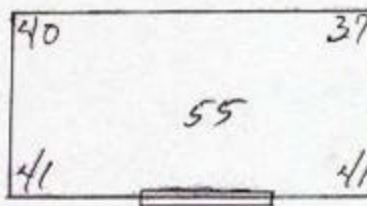



SCHOOL INFORMATION			
NAME Pukalani Elementary School			DATE 2/1/2001
STREET ADDRESS 2945 Iolani Street Pukalani, HI 96768			OPERATIONAL HOURS 1,304
POINT OF CONTACT Helen Orikasa		PHONE 573-8760	FAX 120V
AUDITOR Maui Community College Auditors			

LOCATION (Rm Name, Rm. #, Area, Zone, etc.)	EXISTING EQUIPMENT						PROPOSED			REBATES		COSTS		COMMENTS Surveyors Comments
	Floor	Quantity	Lamp Type	Lamps Per Fixture	Type of Fixture	Ballast Type	Lamps Per Fixture	Reflectors	Ballast Type	Per Single	Extended	Per Single	Extended	
BUILDING B											\$ -		\$ -	
B 103B	2	16	4' T12	4	Ice	Magnetic	4	N	Electronic	\$ 11.20	\$ 179.20	\$ 160.00	\$ 2,560.00	Replace fixture and mount hardware
B 104B	2	16	4' T12	4	Ice	Magnetic	4	N	Electronic	\$ 11.20	\$ 179.20	\$ 160.00	\$ 2,560.00	Replace fixture and mount hardware
Girls	2	4	4' T12	2	Ice	Magnetic	2	N	Electronic	\$ 5.60	\$ 22.40	\$ 135.00	\$ 540.00	Replace fixture and mount hardware
Boys	2	4	4' T12	2	Ice	Magnetic	2	N	Electronic	\$ 5.60	\$ 22.40	\$ 135.00	\$ 540.00	Replace fixture and mount hardware
B 105B	2	16	4' T12	4	Ice	Magnetic	4	N	Electronic	\$ 11.20	\$ 179.20	\$ 160.00	\$ 2,560.00	Replace fixture and mount hardware
B 106B	2	16	4' T12	4	Ice	Magnetic	4	N	Electronic	\$ 11.20	\$ 179.20	\$ 160.00	\$ 2,560.00	Replace fixture and mount hardware
B 106A	1	16	4' T12	4	Ice	Magnetic	4	N	Electronic	\$ 11.20	\$ 179.20	\$ 160.00	\$ 2,560.00	Replace fixture and mount hardware
B 105A	1	16	4' T12	4	Ice	Magnetic	4	N	Electronic	\$ 11.20	\$ 179.20	\$ 160.00	\$ 2,560.00	Replace fixture and mount hardware
B 104A	1	16	4' T12	4	Ice	Magnetic	4	N	Electronic	\$ 11.20	\$ 179.20	\$ 160.00	\$ 2,560.00	Replace fixture and mount hardware
B 103A	1	16	4' T12	4	Ice	Magnetic	4	N	Electronic	\$ 11.20	\$ 179.20	\$ 160.00	\$ 2,560.00	Replace fixture and mount hardware
BUILDING D											\$ -		\$ -	
Teachers' Work Room	1	17	4' T12	2	Ice	Magnetic	2	N	Electronic	\$ 5.60	\$ 95.20	\$ 135.00	\$ 2,295.00	Replace fixture and mount hardware
D 101	1	28	4' T12	2	Ice	Magnetic	2	N	Electronic	\$ 5.60	\$ 156.80	\$ 135.00	\$ 3,780.00	Replace fixture and mount hardware
D 102	1	28	4' T12	2	Ice	Magnetic	2	N	Electronic	\$ 5.60	\$ 156.80	\$ 135.00	\$ 3,780.00	Replace fixture and mount hardware
Girls	1	6	4' T12	1	Wrap	Magnetic	1	N	Electronic	\$ 2.80	\$ 16.80	\$ 55.00	\$ 330.00	Excellent opportunity for retro-fit
Boys	1	7	4' T12	1	Wrap	Magnetic	1	N	Electronic	\$ 2.80	\$ 19.60	\$ 55.00	\$ 385.00	Excellent opportunity for retro-fit
D 103	1	28	4' T12	2	Ice	Magnetic	2	N	Electronic	\$ 5.60	\$ 156.80	\$ 135.00	\$ 3,780.00	Replace fixture and mount hardware
D 104	1	28	4' T12	2	Ice	Magnetic	2	N	Electronic	\$ 5.60	\$ 156.80	\$ 135.00	\$ 3,780.00	Replace fixture and mount hardware
Stairs		2	4' T12	1	Ice	Magnetic	1	N	Electronic	\$ 2.80	\$ 5.60	\$ 135.00	\$ 270.00	Replace fixture and mount hardware
D 204	2	28	4' T12	2	Ice	Magnetic	2	N	Electronic	\$ 5.60	\$ 156.80	\$ 135.00	\$ 3,780.00	Replace fixture and mount hardware
D 203	2	28	4' T12	2	Ice	Magnetic	2	N	Electronic	\$ 5.60	\$ 156.80	\$ 135.00	\$ 3,780.00	Replace fixture and mount hardware
Boys	2	6	4' T12	1	Wrap	Magnetic	1	N	Electronic	\$ 2.80	\$ 16.80	\$ 55.00	\$ 330.00	Excellent opportunity for retro-fit
Girls	2	6	4' T12	1	Wrap	Magnetic	1	N	Electronic	\$ 2.80	\$ 16.80	\$ 55.00	\$ 330.00	Excellent opportunity for retro-fit
D 202	2	28	4' T12	2	Ice	Magnetic	2	N	Electronic	\$ 5.60	\$ 156.80	\$ 135.00	\$ 3,780.00	Replace fixture and mount hardware
D 201	2	28	4' T12	2	Ice	Magnetic	2	N	Electronic	\$ 5.60	\$ 156.80	\$ 135.00	\$ 3,780.00	Replace fixture and mount hardware
BUILDING C											\$ -		\$ -	
Cafeteria	1	96	4' T12	2	Ice	Magnetic	2	N	Electronic	\$ 5.60	\$ 537.60	\$ 135.00	\$ 12,960.00	Replace fixture and mount hardware
Girls' Dressing	1	2	4' T12	2	Ice	Magnetic	2	N	Electronic	\$ 5.60	\$ 11.20	\$ 135.00	\$ 270.00	Replace fixture and mount hardware
Store	1	10	4' T12	2	Ice	Magnetic	2	N	Electronic	\$ 5.60	\$ 56.00	\$ 135.00	\$ 1,350.00	Replace fixture and mount hardware
Boys	1	2	4' T12	2	Ice	Magnetic	2	N	Electronic	\$ 5.60	\$ 11.20	\$ 135.00	\$ 270.00	Replace fixture and mount hardware
Kitchen	1	35	4' T12	2	Ice	Magnetic	2	N	Electronic	\$ 5.60	\$ 196.00	\$ 135.00	\$ 4,725.00	Replace fixture and mount hardware

LOCATION		EXISTING EQUIPMENT					PROPOSED			REBATES		COSTS		COMMENTS
Location (Rm Name, Rm. #, Area, Zone, etc.)	Floor	Quantity	Lamp Type	Lamps Per Fixture	Type of Fixture	Ballast Type	Lamps Per Fixture	Reflectors	Ballast Type	Per Single	Extended	Per Single	Extended	Surveyors Comments
Laundry	1	4	4' T12	2	Ice	Magnetic	2	N	Electronic	\$ 5.60	\$ 22.40	\$ 135.00	\$ 540.00	Replace fixture and mount hardware
Storage	1	6	4' T12	2	Wrap	Magnetic	2	N	Electronic	\$ 5.60	\$ 33.60	\$ 60.00	\$ 360.00	Excellent opportunity for retro-fit
Staff Ding	1	9	4' T12	2	Ice	Magnetic	2	N	Electronic	\$ 5.60	\$ 50.40	\$ 135.00	\$ 1,215.00	Replace fixture and mount hardware
Office	1	4	4' T12	2	Ice	Magnetic	2	N	Electronic	\$ 5.60	\$ 22.40	\$ 135.00	\$ 540.00	Replace fixture and mount hardware
BUILDING A											\$ -	\$ -		
A 101B	1	16	4' T12	4	Ice	Magnetic	4	N	Electronic	\$ 11.20	\$ 179.20	\$ 160.00	\$ 2,560.00	Replace fixture and mount hardware
A 102B	1	16	4' T12	4	Ice	Magnetic	4	N	Electronic	\$ 11.20	\$ 179.20	\$ 160.00	\$ 2,560.00	Replace fixture and mount hardware
A 101A	1	16	4' T12	4	Ice	Magnetic	4	N	Electronic	\$ 11.20	\$ 179.20	\$ 160.00	\$ 2,560.00	Replace fixture and mount hardware
A 102A	1	16	4' T12	4	Ice	Magnetic	4	N	Electronic	\$ 11.20	\$ 179.20	\$ 160.00	\$ 2,560.00	Replace fixture and mount hardware
Teachers	1	8	4' T12	4	Ice	Magnetic	4	N	Electronic	\$ 11.20	\$ 89.60	\$ 160.00	\$ 1,280.00	Replace fixture and mount hardware
Library	1	32	4' T12	4	Ice	Magnetic	4	N	Electronic	\$ 11.20	\$ 358.40	\$ 160.00	\$ 5,120.00	Replace fixture and mount hardware
Office	1	24	4' T12	4	Ice	Magnetic	4	N	Electronic	\$ 11.20	\$ 268.80	\$ 160.00	\$ 3,840.00	Replace fixture and mount hardware
PORTABLES											\$ -	\$ -		
P 1	1	16	4' T12	4	Troffer	Magnetic	4	N	Electronic	\$ 11.20	\$ 179.20	\$ 70.00	\$ 1,120.00	Replace fixture and mount hardware
P 2	1	16	4' T12	4	Wrap	Magnetic	4	N	Electronic	\$ 11.20	\$ 179.20	\$ 70.00	\$ 1,120.00	Excellent opportunity for retro-fit
P 3	1	16	4' T12	4	Wrap	Magnetic	4	N	Electronic	\$ 11.20	\$ 179.20	\$ 70.00	\$ 1,120.00	Excellent opportunity for retro-fit
P 4	1	16	4' T12	4	Wrap	Magnetic	4	N	Electronic	\$ 11.20	\$ 179.20	\$ 70.00	\$ 1,120.00	Excellent opportunity for retro-fit
P 5	1	12	4' T12	4	Troffer	Magnetic	4	N	Electronic	\$ 11.20	\$ 134.40	\$ 70.00	\$ 840.00	Excellent opportunity for retro-fit
P 6	1	12	4' T12	4	Troffer	Magnetic	4	N	Electronic	\$ 11.20	\$ 134.40	\$ 70.00	\$ 840.00	Excellent opportunity for retro-fit
P 7	1	12	4' T12	4	Wrap	Magnetic	4	N	Electronic	\$ 11.20	\$ 134.40	\$ 70.00	\$ 840.00	Excellent opportunity for retro-fit
P 8	1	12	4' T12	4	Wrap	Magnetic	4	N	Electronic	\$ 11.20	\$ 134.40	\$ 70.00	\$ 840.00	Excellent opportunity for retro-fit
P 9	1	16	4' T12	3	Ice	Magnetic	3	N	Electronic	\$ 8.40	\$ 134.40	\$ 160.00	\$ 2,560.00	Replace fixture and mount hardware
P 10	1	16	4' T12	3	Ice	Magnetic	3	N	Electronic	\$ 8.40	\$ 134.40	\$ 160.00	\$ 2,560.00	Replace fixture and mount hardware
TB 1	1	16	4' T12	2	Ice	Magnetic	2	N	Electronic	\$ 5.60	\$ 89.60	\$ 135.00	\$ 2,160.00	Replace fixture and mount hardware
Total Rebates										\$	6,890.80			
Total Costs										\$	113,570.00			

LOCATION	QTY	EXISTING TYPE	QTY	RETROFIT	SURVEYORS COMMENTS	Existing				Proposed			
						Watt/unit	Op. Hours	kWh	kW-D	Watt/unit	Op. Hours	kWh	kW-D
BUILDING B	0		0		0		1,304				1,304		
B 103B	16	4' 4L Fixture	16	Lamp & Low Watt Ballast	Replace fixture and mount hardware	151.2	1,304	3,154.6	2,4192	100	1,304	2,086.4	1.6
B 104B	16	4' 4L Fixture	16	Lamp & Low Watt Ballast	Replace fixture and mount hardware	151.2	1,304	3,154.6	2,4192	100	1,304	2,086.4	1.6
Girls	4	4' 2L Fixture	4	Lamp & Low Watt Ballast	Replace fixture and mount hardware	75.6	1,304	394.3	0.3024	51	1,304	266.0	0.204
Boys	4	4' 2L Fixture	4	Lamp & Low Watt Ballast	Replace fixture and mount hardware	75.6	1,304	394.3	0.3024	51	1,304	266.0	0.204
B 105B	16	4' 4L Fixture	16	Lamp & Low Watt Ballast	Replace fixture and mount hardware	151.2	1,304	3,154.6	2,4192	100	1,304	2,086.4	1.6
B 106B	16	4' 4L Fixture	16	Lamp & Low Watt Ballast	Replace fixture and mount hardware	151.2	1,304	3,154.6	2,4192	100	1,304	2,086.4	1.6
B 106A	16	4' 4L Fixture	16	Lamp & Low Watt Ballast	Replace fixture and mount hardware	151.2	1,304	3,154.6	2,4192	100	1,304	2,086.4	1.6
B 105A	16	4' 4L Fixture	16	Lamp & Low Watt Ballast	Replace fixture and mount hardware	151.2	1,304	3,154.6	2,4192	100	1,304	2,086.4	1.6
B 104A	16	4' 4L Fixture	16	Lamp & Low Watt Ballast	Replace fixture and mount hardware	151.2	1,304	3,154.6	2,4192	100	1,304	2,086.4	1.6
B 103A	16	4' 4L Fixture	16	Lamp & Low Watt Ballast	Replace fixture and mount hardware	151.2	1,304	3,154.6	2,4192	100	1,304	2,086.4	1.6
BUILDING D	0		0		0		1,304				1,304		
Teachers' Work Room	17	4' 2L Fixture	17	Lamp & Low Watt Ballast	Replace fixture and mount hardware	75.6	1,304	1,675.9	1,2852	51	1,304	1,130.6	0.867
D 101	28	4' 2L Fixture	28	Lamp & Low Watt Ballast	Replace fixture and mount hardware	75.6	1,304	2,760.3	2,1168	51	1,304	1,862.1	1.428
D 102	28	4' 2L Fixture	28	Lamp & Low Watt Ballast	Replace fixture and mount hardware	75.6	1,304	2,760.3	2,1168	51	1,304	1,862.1	1.428
Girls	6	4' 1L Fixture	6	Lamp & Low Watt Ballast	Excellent opportunity for retro-fit	45.6	1,304	356.8	0.2736	31	1,304	242.5	0.186
Boys	7	4' 1L Fixture	7	Lamp & Low Watt Ballast	Excellent opportunity for retro-fit	45.6	1,304	416.2	0.3192	31	1,304	283.0	0.217
D 103	28	4' 2L Fixture	28	Lamp & Low Watt Ballast	Replace fixture and mount hardware	75.6	1,304	2,760.3	2,1168	51	1,304	1,862.1	1.428
D 104	28	4' 2L Fixture	28	Lamp & Low Watt Ballast	Replace fixture and mount hardware	75.6	1,304	2,760.3	2,1168	51	1,304	1,862.1	1.428
Stairs	2	4' 1L Fixture	2	Lamp & Low Watt Ballast	Replace fixture and mount hardware	45.6	1,304	118.9	0.0912	31	1,304	80.8	0.062
D 204	28	4' 2L Fixture	28	Lamp & Low Watt Ballast	Replace fixture and mount hardware	75.6	1,304	2,760.3	2,1168	51	1,304	1,862.1	1.428
D 203	28	4' 2L Fixture	28	Lamp & Low Watt Ballast	Replace fixture and mount hardware	75.6	1,304	2,760.3	2,1168	51	1,304	1,862.1	1.428
Boys	6	4' 1L Fixture	6	Lamp & Low Watt Ballast	Excellent opportunity for retro-fit	45.6	1,304	356.8	0.2736	31	1,304	242.5	0.186
Girls	6	4' 1L Fixture	6	Lamp & Low Watt Ballast	Excellent opportunity for retro-fit	45.6	1,304	356.8	0.2736	31	1,304	242.5	0.186
D 202	28	4' 2L Fixture	28	Lamp & Low Watt Ballast	Replace fixture and mount hardware	75.6	1,304	2,760.3	2,1168	51	1,304	1,862.1	1.428
D 201	28	4' 2L Fixture	28	Lamp & Low Watt Ballast	Replace fixture and mount hardware	75.6	1,304	2,760.3	2,1168	51	1,304	1,862.1	1.428
BUILDING C	0		0		0		1,304				1,304		
Cafeteria	96	4' 2L Fixture	96	Lamp & Low Watt Ballast	Replace fixture and mount hardware	75.6	1,304	9,463.9	7,2576	51	1,304	6,384.4	4.896
Girls' Dressing	2	4' 2L Fixture	2	Lamp & Low Watt Ballast	Replace fixture and mount hardware	75.6	1,304	197.2	0.1512	51	1,304	133.0	0.102
Store	10	4' 2L Fixture	10	Lamp & Low Watt Ballast	Replace fixture and mount hardware	75.6	1,304	985.8	0.756	51	1,304	665.0	0.51
Boys	2	4' 2L Fixture	2	Lamp & Low Watt Ballast	Replace fixture and mount hardware	75.6	1,304	197.2	0.1512	51	1,304	133.0	0.102
Kitchen	35	4' 2L Fixture	35	Lamp & Low Watt Ballast	Replace fixture and mount hardware	75.6	1,304	3,450.4	2.646	51	1,304	2,327.6	1.785
Laundry	4	4' 2L Fixture	4	Lamp & Low Watt Ballast	Replace fixture and mount hardware	75.6	1,304	394.3	0.3024	51	1,304	266.0	0.204
Storage	6	4' 2L Fixture	6	Lamp & Low Watt Ballast	Excellent opportunity for retro-fit	75.6	1,304	591.5	0.4536	51	1,304	399.0	0.306
Staff Ding	9	4' 2L Fixture	9	Lamp & Low Watt Ballast	Replace fixture and mount hardware	75.6	1,304	887.2	0.6804	51	1,304	598.5	0.459
Office	4	4' 2L Fixture	4	Lamp & Low Watt Ballast	Replace fixture and mount hardware	75.6	1,304	394.3	0.3024	51	1,304	266.0	0.204
BUILDING A	0		0		0		1,304				1,304		
A 101B	16	4' 4L Fixture	16	Lamp & Low Watt Ballast	Replace fixture and mount hardware	151.2	1,304	3,154.6	2,4192	100	1,304	2,086.4	1.6
A 102B	16	4' 4L Fixture	16	Lamp & Low Watt Ballast	Replace fixture and mount hardware	151.2	1,304	3,154.6	2,4192	100	1,304	2,086.4	1.6
A 101A	16	4' 4L Fixture	16	Lamp & Low Watt Ballast	Replace fixture and mount hardware	151.2	1,304	3,154.6	2,4192	100	1,304	2,086.4	1.6
A 102A	16	4' 4L Fixture	16	Lamp & Low Watt Ballast	Replace fixture and mount hardware	151.2	1,304	3,154.6	2,4192	100	1,304	2,086.4	1.6
Teachers	8	4' 4L Fixture	8	Lamp & Low Watt Ballast	Replace fixture and mount hardware	151.2	1,304	1,577.3	1,2096	100	1,304	1,043.2	0.8
Library	32	4' 4L Fixture	32	Lamp & Low Watt Ballast	Replace fixture and mount hardware	151.2	1,304	6,309.3	4,8384	100	1,304	4,172.8	3.2
Office	24	4' 4L Fixture	24	Lamp & Low Watt Ballast	Replace fixture and mount hardware	151.2	1,304	4,732.0	3,6288	100	1,304	3,129.6	2.4
PORTABLES	0		0		0		1,304				1,304		
P 1	16	4' 4L Fixture	16	Lamp & Low Watt Ballast	Replace fixture and mount hardware	151.2	1,304	3,154.6	2,4192	100	1,304	2,086.4	1.6
P 2	16	4' 4L Fixture	16	Lamp & Low Watt Ballast	Excellent opportunity for retro-fit	151.2	1,304	3,154.6	2,4192	100	1,304	2,086.4	1.6
P 3	16	4' 4L Fixture	16	Lamp & Low Watt Ballast	Excellent opportunity for retro-fit	151.2	1,304	3,154.6	2,4192	100	1,304	2,086.4	1.6
P 4	16	4' 4L Fixture	16	Lamp & Low Watt Ballast	Excellent opportunity for retro-fit	151.2	1,304	3,154.6	2,4192	100	1,304	2,086.4	1.6
P 5	12	4' 4L Fixture	12	Lamp & Low Watt Ballast	Excellent opportunity for retro-fit	151.2	1,304	2,366.0	1,8144	100	1,304	1,564.8	1.2
P 6	12	4' 4L Fixture	12	Lamp & Low Watt Ballast	Excellent opportunity for retro-fit	151.2	1,304	2,366.0	1,8144	100	1,304	1,564.8	1.2
P 7	12	4' 4L Fixture	12	Lamp & Low Watt Ballast	Excellent opportunity for retro-fit	151.2	1,304	2,366.0	1,8144	100	1,304	1,564.8	1.2
P 8	12	4' 4L Fixture	12	Lamp & Low Watt Ballast	Excellent opportunity for retro-fit	151.2	1,304	2,366.0	1,8144	100	1,304	1,564.8	1.2
P 9	16	4' 3L Fixture	16	Lamp & Low Watt Ballast	Replace fixture and mount hardware	121.2	1,304	2,528.7	1,9392	77	1,304	1,606.5	1.232
P 10	16	4' 3L Fixture	16	Lamp & Low Watt Ballast	Replace fixture and mount hardware	121.2	1,304	2,528.7	1,9392	77	1,304	1,606.5	1.232
TB 1	16	4' 2L Fixture	16	Lamp & Low Watt Ballast	Replace fixture and mount hardware	75.6	1,304	1,577.3	1,2096	51	1,304	1,064.1	0.816

Existing 860

Proposed 860

ENERGY CALCULATIONS			121,906	93	81,088	62
Description	kW-Demand	kWh				
Existing Use	93.49	121,906				
Proposed Use	62.18	81,088				
Difference - Savings	31.30	40,818				
Electrical Utility Cost	\$5.75	\$0.15289				
Savings per Year	\$2,159.84	\$6,240.55	Total Yearly Energy Savings		\$8,400.39	

BUILDING EVACUATION PLAN

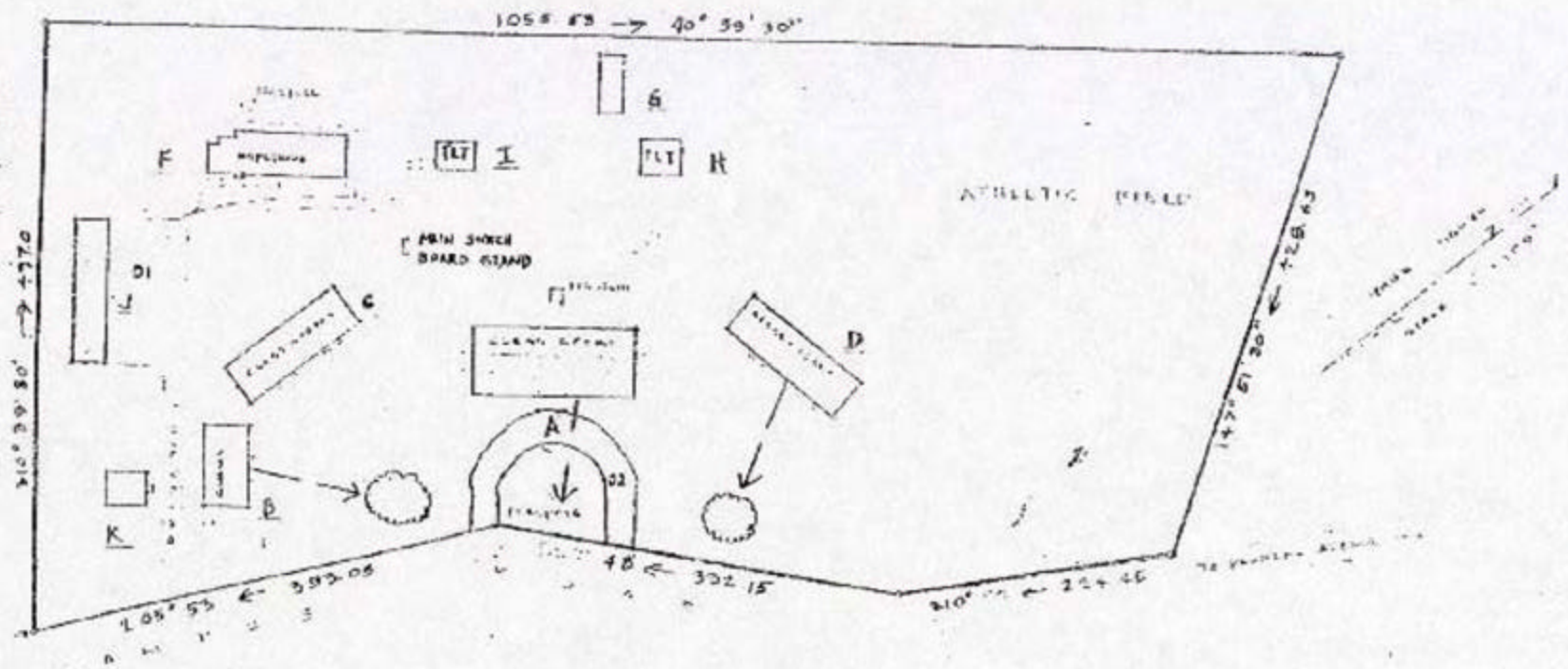

BLDG A: MEET IN CIRCLE
 BLDG B: MEET AT TREE
 BLDG D: MEET AT TREE

SCHOOL
 TRK. 3-8-66108 10.0 ACRES STATE PROP. 1910
TEACHERS COTTAGES
 TRK. 3-5-74107 1.005 ACRES STATE PROP. 1910

PŪNENE SCHOOL
 WAIKUKU DISTRICT
 E-2 423-6 REVISER AUG. 1990 2-27

09/03/01 THU 09:33 FAX 509 543 4722 HECO ENERGY SVCS DEPT

0004

Maul Smart Schools Program
Foot Candle Readings

School: Punahoa School

Room: Bldg. A #5
Ceiling height: 12'
Light fixture height: 10'
Fixture type: Ice

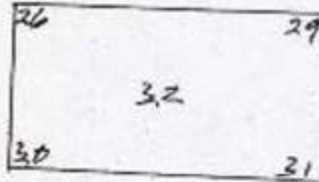

Room: Bldg. F #1
Ceiling height: 12'
Light fixture height: 10'
Fixture type: Ice

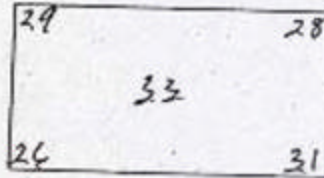

Room: Bldg. D
Ceiling height: 12'
Light fixture height: 10'
Fixture type: Ice

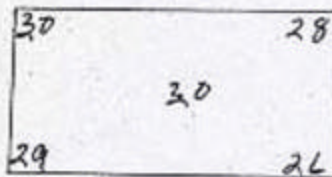



SCHOOL INFORMATION			DATE	
NAME Puunene Elementary & Intermediate School			3/29/2001	
STREET ADDRESS Puunene			OPERATIONAL HOURS 1,467	
POINT OF CONTACT Eillen Muraoka	PHONE 873-3520	FAX	VOLTAGE 120V	
AUDITOR Maui Community College Auditors				

LOCATION (Rm Name, Rm. #, Area, Zone, etc.)	EXISTING EQUIPMENT						PROPOSED			REBATES		COSTS		COMMENTS Surveyors Comments
	Floor	Quantity	Lamp Type	Lamps Per Fixture	Type of Fixture	Ballast Type	Lamps Per Fixture	Reflectors	Ballast Type	Per Single	Extended	Per Single	Extended	
BUILDING F											\$ -		\$ -	
Kitchen / Cafeteria	1	10	4' T12	4	Ice	Magnetic	4	N	Electronic	\$ 11.20	\$ 112.00	\$ 160.00	\$ 1,600.00	Replace Fixture and mount hardware
	1	5	4' T12	2	Troffer	Magnetic	2	N	Electronic	\$ 5.60	\$ 28.00	\$ 65.00	\$ 325.00	Excellent opportunity for retro-fit
BUILDING C											\$ -		\$ -	
Storage	1	20	4' T12	4	Ice	Magnetic	4	N	Electronic	\$ 11.20	\$ 224.00	\$ 160.00	\$ 3,200.00	Replace fixture and mount hardware
Building A											\$ -		\$ -	
Room #4	1	4	4' T12	4	Ice	Magnetic	4	N	Electronic	\$ 11.20	\$ 44.80	\$ 160.00	\$ 640.00	Replace fixture and mount hardware
Room #5	1	4	4' T12	4	Wrap	Magnetic	4	N	Electronic	\$ 11.20	\$ 44.80	\$ 70.00	\$ 280.00	Excellent opportunity for retro-fit
Room#3	1	5	4' T12	4	Ice	Magnetic	4	N	Electronic	\$ 11.20	\$ 56.00	\$ 160.00	\$ 800.00	Replace fixture and mount hardware
Room#6 Library	1	8	4' T12	4	Ice	Magnetic	4	N	Electronic	\$ 11.20	\$ 89.60	\$ 160.00	\$ 1,280.00	Replace fixture and mount hardware
Office	1	2	4' T12	4	Ice	Magnetic	4	N	Electronic	\$ 11.20	\$ 22.40	\$ 160.00	\$ 320.00	Replace fixture and mount hardware
Room#2	1	4	4' T12	4	Ice	Magnetic	4	N	Electronic	\$ 11.20	\$ 44.80	\$ 160.00	\$ 640.00	Replace fixture and mount hardware
Room#8	1	4	4' T12	4	Ice	Magnetic	4	N	Electronic	\$ 11.20	\$ 44.80	\$ 160.00	\$ 640.00	Replace fixture and mount hardware
Room#9	1	4	4' T12	4	Wrap	Magnetic	4	N	Electronic	\$ 11.20	\$ 44.80	\$ 70.00	\$ 280.00	Excellent opportunity for retro-fit
Room#7	1	4	4' T12	4	Ice	Magnetic	4	N	Electronic	\$ 11.20	\$ 44.80	\$ 160.00	\$ 640.00	Replace fixture and mount hardware
Room#10	2	4	4' T12	4	Ice	Magnetic	4	N	Electronic	\$ 11.20	\$ 44.80	\$ 160.00	\$ 640.00	Replace fixture and mount hardware
Room#11	2	4	4' T12	4	Ice	Magnetic	4	N	Electronic	\$ 11.20	\$ 44.80	\$ 160.00	\$ 640.00	Replace fixture and mount hardware
Room#12	2	4	4' T12	4	Wrap	Magnetic	4	N	Electronic	\$ 11.20	\$ 44.80	\$ 70.00	\$ 280.00	Excellent opportunity for retro-fit
Room#13	2	6	4' T12	4	Ice	Magnetic	4	N	Electronic	\$ 11.20	\$ 67.20	\$ 160.00	\$ 960.00	Replace fixture and mount hardware
Room#14	2	4	4' T12	4	Ice	Magnetic	4	N	Electronic	\$ 11.20	\$ 44.80	\$ 160.00	\$ 640.00	Replace fixture and mount hardware
Room#15	2	4	4' T12	4	Ice	Magnetic	4	N	Electronic	\$ 11.20	\$ 44.80	\$ 160.00	\$ 640.00	Replace fixture and mount hardware
Room#16	2	4	4' T12	4	Ice	Magnetic	4	N	Electronic	\$ 11.20	\$ 44.80	\$ 160.00	\$ 640.00	Replace fixture and mount hardware
Room#17	2	4	4' T12	4	Ice	Magnetic	4	N	Electronic	\$ 11.20	\$ 44.80	\$ 160.00	\$ 640.00	replace fixture and mount hardware
BUILDING K											\$ -		\$ -	
Community Room	1	1	8' T12	2	Wrap	Magnetic	2	N	Electronic	\$ 7.20	\$ 7.20	\$ 80.00	\$ 80.00	excellent opportunity for retro-fit
Workday Room	1	4	4' T12	4	Wrap	Magnetic	4	N	Electronic	\$ 11.20	\$ 44.80	\$ 70.00	\$ 280.00	excellent opportunity for retro-fit
Office	1	1	4' T12	4	Wrap	Magnetic	4	N	Electronic	\$ 11.20	\$ 11.20	\$ 70.00	\$ 70.00	excellent opportunity for retro-fit
Kitchen	1	2	4' T12	4	Wrap	Magnetic	4	N	Electronic	\$ 11.20	\$ 22.40	\$ 70.00	\$ 140.00	excellent opportunity for retro-fit
Back office	1	1	4' T12	4	Wrap	Magnetic	4	N	Electronic	\$ 11.20	\$ 11.20	\$ 70.00	\$ 70.00	excellent opportunity for retro-fit
BUILDING B											\$ -		\$ -	
Room#1	1	2	4' T12	4	Wrap	Magnetic	4	N	Electronic	\$ 11.20	\$ 22.40	\$ 70.00	\$ 140.00	Excellent opportunity for retro-fit

LOCATION (Rm. Name, Rm. #, Area, Zone, etc.)	EXISTING EQUIPMENT						PROPOSED			REBATES		COSTS		COMMENTS Surveyors Comments
	Floor	Quantity	Lamp Type	Lamps Per Fixture	Type of Fixture	Ballast Type	Lamps Per Fixture	Reflectors	Ballast Type	Per Single	Extended	Per Single	Extended	
Room#2	1	8	4' T12	4	Ice	Magnetic	4	N	Electronic	\$ 11.20	\$ 89.60	\$ 70.00	\$ 560.00	Replace fixture and mount hardware
BUILDING D											\$ -		\$ -	
Room#1	1	6	4' T12	4	Troffer	Magnetic	4	N	Electronic	\$ 11.20	\$ 67.20	\$ 70.00	\$ 420.00	Excellent opportunity for retro-fit
Room#2	1	32	4' T12	4	Wrap	Magnetic	4	N	Electronic	\$ 11.20	\$ 358.40	\$ 70.00	\$ 2,240.00	Excellent opportunity for retro-fit
Total Rebates										\$	1,816.00			
Total Costs										\$	19,725.00			

LOCATION	QTY	EXISTING TYPE	QTY	RETROFIT	SURVEYORS COMMENTS	Actual				Proposed			
						Existing Watt/unit	Op. Hours	kWh	kW-D	Watt/unit	Op. Hours	kWh	kW-D
BUILDING F	0		0		0		1,467	0.0	0		1,467	0.0	0
Kitchen / Cafeteria	10	4' 4L Fixture	10	Lamp & Low Watt Bllast	Replace Fixture and mount hardware	151.2	1,467	2,218.1	1.512	100	1,467	1,467.0	1
	5	4' 2L Fixture	5	Lamp & Low Watt Bllast	Excellent opportunity for retro-fit	75.6	1,467	554.5	0.378	51	1,467	374.1	0.255
BUILDING C	0		0		0		1,467	0.0	0		1,467	0.0	0
Storage	20	4' 4L Fixture	20	Lamp & Low Watt Bllast	Replace fixture and mount hardware	151.2	1,467	4,436.2	3.024	100	1,467	2,934.0	2
Building A	0		0		0		1,467	0.0	0		1,467	0.0	0
Room #4	4	4' 4L Fixture	4	Lamp & Low Watt Bllast	Replace fixture and mount hardware	151.2	1,467	887.2	0.6048	100	1,467	586.8	0.4
Room #5	4	4' 4L Fixture	4	Lamp & Low Watt Bllast	Excellent opportunity for retro-fit	151.2	1,467	887.2	0.6048	100	1,467	586.8	0.4
Room#3	5	4' 4L Fixture	5	Lamp & Low Watt Bllast	Replace fixture and mount hardware	151.2	1,467	1,109.1	0.756	100	1,467	733.5	0.5
Room#6 Library	8	4' 4L Fixture	8	Lamp & Low Watt Bllast	Replace fixture and mount hardware	151.2	1,467	1,774.5	1.2096	100	1,467	1,173.6	0.8
Office	2	4' 4L Fixture	2	Lamp & Low Watt Bllast	Replace fixture and mount hardware	151.2	1,467	443.6	0.3024	100	1,467	293.4	0.2
Room#2	4	4' 4L Fixture	4	Lamp & Low Watt Bllast	Replace fixture and mount hardware	151.2	1,467	887.2	0.6048	100	1,467	586.8	0.4
Room#8	4	4' 4L Fixture	4	Lamp & Low Watt Bllast	Replace fixture and mount hardware	151.2	1,467	887.2	0.6048	100	1,467	586.8	0.4
Room#9	4	4' 4L Fixture	4	Lamp & Low Watt Bllast	Excellent opportunity for retro-fit	151.2	1,467	887.2	0.6048	100	1,467	586.8	0.4
Room#7	4	4' 4L Fixture	4	Lamp & Low Watt Bllast	Replace fixture and mount hardware	151.2	1,467	887.2	0.6048	100	1,467	586.8	0.4
Room#10	4	4' 4L Fixture	4	Lamp & Low Watt Bllast	Replace fixture and mount hardware	151.2	1,467	887.2	0.6048	100	1,467	586.8	0.4
Room#11	4	4' 4L Fixture	4	Lamp & Low Watt Bllast	Replace fixture and mount hardware	151.2	1,467	887.2	0.6048	100	1,467	586.8	0.4
Room#12	4	4' 4L Fixture	4	Lamp & Low Watt Bllast	Excellent opportunity for retro-fit	151.2	1,467	887.2	0.6048	100	1,467	586.8	0.4
Room#13	6	4' 4L Fixture	6	Lamp & Low Watt Bllast	Replace fixture and mount hardware	151.2	1,467	1,330.9	0.9072	100	1,467	880.2	0.6
Room#14	4	4' 4L Fixture	4	Lamp & Low Watt Bllast	Replace fixture and mount hardware	151.2	1,467	887.2	0.6048	100	1,467	586.8	0.4
Room#15	4	4' 4L Fixture	4	Lamp & Low Watt Bllast	Replace fixture and mount hardware	151.2	1,467	887.2	0.6048	100	1,467	586.8	0.4
Room#16	4	4' 4L Fixture	4	Lamp & Low Watt Bllast	Replace fixture and mount hardware	151.2	1,467	887.2	0.6048	100	1,467	586.8	0.4
Room#17	4	4' 4L Fixture	4	Lamp & Low Watt Bllast	replace fixture and mount hardware	151.2	1,467	887.2	0.6048	100	1,467	586.8	0.4
BUILDING K	0		0		0		1,467	0.0	0		1,467	0.0	0
Community Room	1	8' 2L Fixture	1	Lamp & Ballast Retrofit	excellent opportunity for retro-fit	158	1,467	231.8	0.158	110	1,467	161.4	0.11
Workday Room	4	4' 4L Fixture	4	Lamp & Low Watt Bllast	excellent opportunity for retro-fit	151.2	1,467	887.2	0.6048	100	1,467	586.8	0.4
Office	1	4' 4L Fixture	1	Lamp & Low Watt Bllast	excellent opportunity for retro-fit	151.2	1,467	221.8	0.1512	100	1,467	146.7	0.1
Kitchen	2	4' 4L Fixture	2	Lamp & Low Watt Bllast	excellent opportunity for retro-fit	151.2	1,467	443.6	0.3024	100	1,467	293.4	0.2
Back office	1	4' 4L Fixture	1	Lamp & Low Watt Bllast	excellent opportunity for retro-fit	151.2	1,467	221.8	0.1512	100	1,467	146.7	0.1
BUILDING B	0		0		0		1,467	0.0	0		1,467	0.0	0
Room#1	2	4' 4L Fixture	2	Lamp & Low Watt Bllast	Excellent opportunity for retro-fit	151.2	1,467	443.6	0.3024	100	1,467	293.4	0.2
Room#2	8	4' 4L Fixture	8	Lamp & Low Watt Bllast	Replace fixture and mount hardware	151.2	1,467	1,774.5	1.2096	100	1,467	1,173.6	0.8
BUILDING D	0		0		0		1,467	0.0	0		1,467	0.0	0
Room#1	6	4' 4L Fixture	6	Lamp & Low Watt Bllast	Excellent opportunity for retro-fit	151.2	1,467	1,330.9	0.9072	100	1,467	880.2	0.6
Room#2	32	4' 4L Fixture	32	Lamp & Low Watt Bllast	Excellent opportunity for retro-fit	151.2	1,467	7,097.9	4.8384	100	1,467	4,694.4	3.2

Existing 165 Proposed 165

ENERGY CALCULATIONS			36,054	25	23,861	16
Description	kW-Demand	kWh				
Existing Use	24.58	36,054				
Proposed Use	16.27	23,861				
Difference - Savings	8.31	12,193				
Electrical Utility Cost	\$5.75	\$0.15467				
Savings per Year	\$573.51	\$1,886.01				
				Total Yearly Energy Savings		
				\$2,459.53		

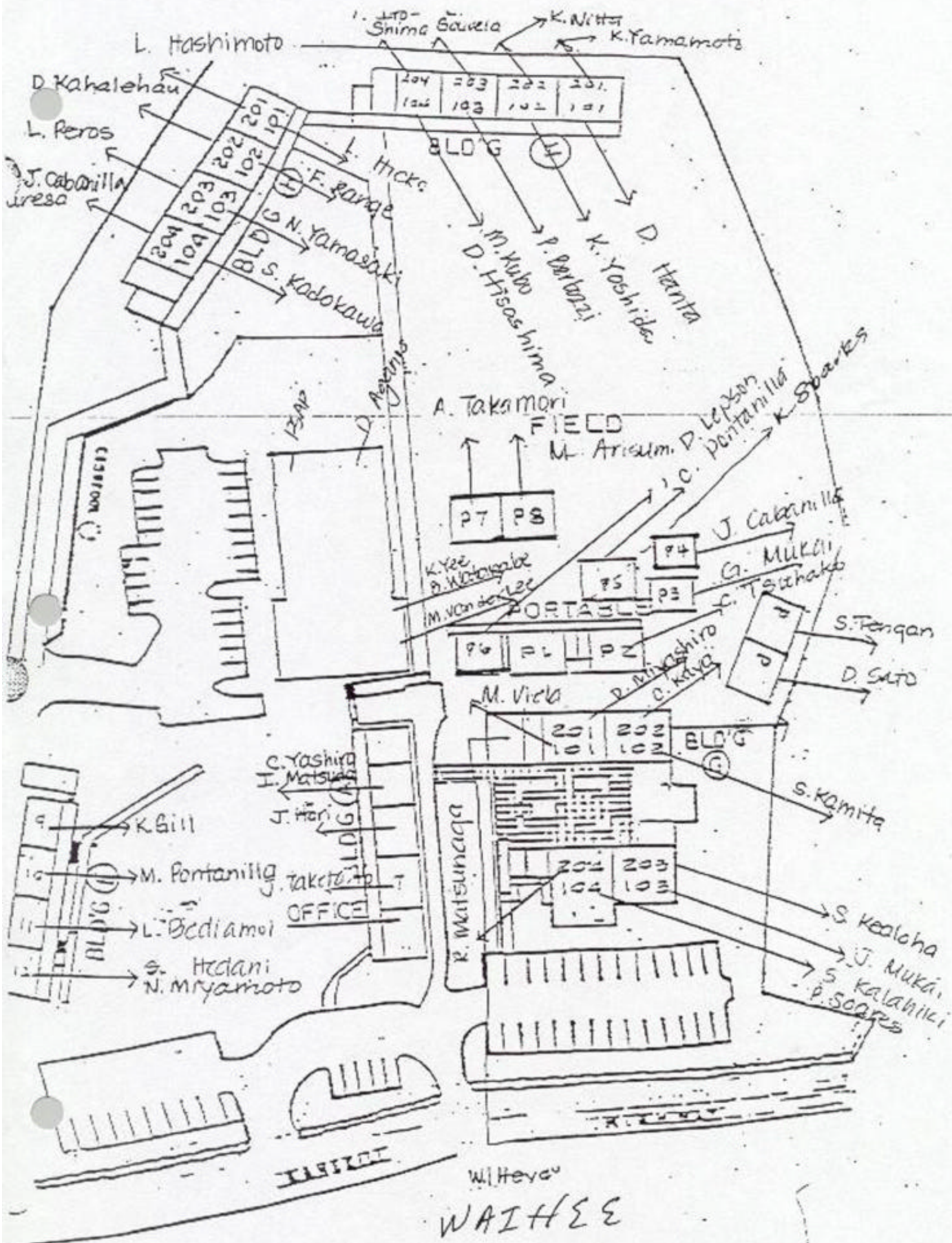

Maui Smart Schools Program

Foot Candle Readings

School: Waihe'e School

Room: Bldg. G G-203

Ceiling height: 10'

Light Fixture Height: 8'

Fixture Type: Wrap

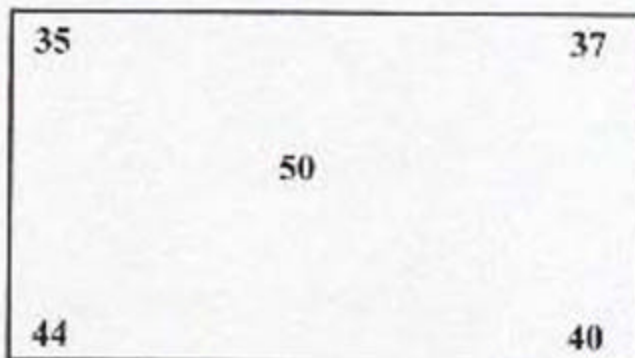

Room: Portable P-3

Ceiling Height: 10'

Light Fixture Height: 8'

Fixture Type: Troffer

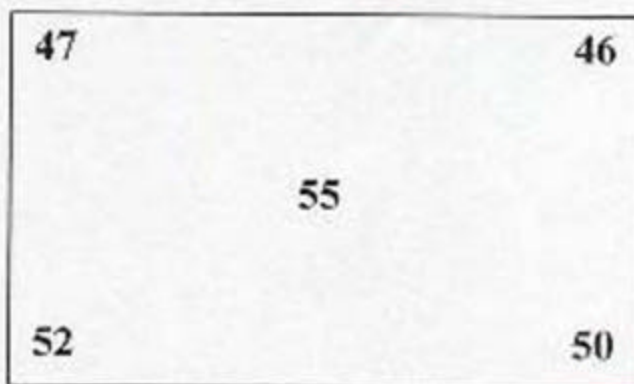

Room: Portable P-7

Ceiling Height: 10'

Light Fixture Height: 8'

Fixture Type: Troffer

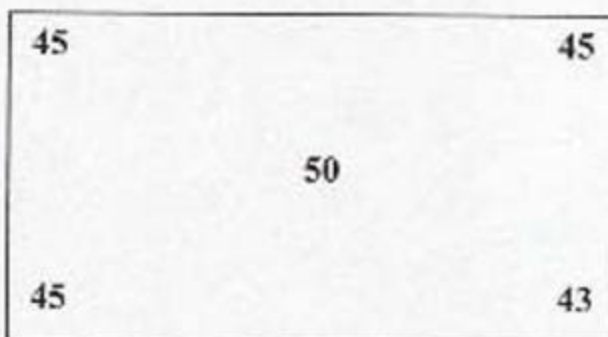



SCHOOL INFORMATION			
NAME Waihee Elementary School			DATE 1/19/2001
STREET ADDRESS 2125 Kahekili Highway Wailuku, HI 96793			OPERATIONAL HOURS 1,880
POINT OF CONTACT Lawrence Joyo		PHONE 984-5644	FAX 120V
AUDITOR Maui Community College Auditors			

LOCATION Location (Rm Name, Rm. #, Area, Zone, etc.)	EXISTING EQUIPMENT						PROPOSED			REBATES		COSTS		COMMENTS Surveyors Comments
	Floor	Quantity	Lamp Type	Lamps Per Fixture	Type of Fixture	Ballast Type	Lamps Per Fixture	Reflectors	Ballast Type	Per Single	Extended	Per Single	Extended	
BUILDING E											\$ -		\$ -	
E - 25	1	8	4'T12	4	Ice	Magnetic	4	N	Electronic	\$ 11.20	\$ 89.60	\$ 320.00	\$ 2,560.00	Replace fixture and mount Hardware
E - 26	1	8	4' T12	4	Ice	Magnetic	4	N	Electronic	\$ 11.20	\$ 89.60	\$ 320.00	\$ 2,560.00	Replace fixture and mount Hardware
E - 27	1	8	4' T12	4	Ice	Magnetic	4	N	Electronic	\$ 11.20	\$ 89.60	\$ 320.00	\$ 2,560.00	Replace fixture and mount Hardware
E - 28	1	8	4' T12	4	Ice	Magnetic	4	N	Electronic	\$ 11.20	\$ 89.60	\$ 320.00	\$ 2,560.00	Replace fixture and mount Hardware
BUILDING A											\$ -		\$ -	
Boys' Restroom	1	3	4' T12	2	Wrap	Magnetic	2	N	Electronic	\$ 5.60	\$ 16.80	\$ 60.00	\$ 180.00	Excellent opportunity for retro-fit
Girls' Restroom	1	3	4' T12	2	Wrap	Magnetic	2	N	Electronic	\$ 5.60	\$ 16.80	\$ 60.00	\$ 180.00	Excellent opportunity for retro-fit
Office	1	2	8' T12	2	Ice	Magnetic	2	N	Electronic	\$ 7.20	\$ 14.40	\$ 160.00	\$ 320.00	Replace fixture and mount hardware
Office	1	1	4' T12	4	Wrap	Magnetic	4	N	Electronic	\$ 11.20	\$ 11.20	\$ 70.00	\$ 70.00	Excellent opportunity for retro-fit
Main Office	1	1	4' T12	2	Ice	Magnetic	2	N	Electronic	\$ 5.60	\$ 5.60	\$ 135.00	\$ 135.00	Replace fixture and mount hardware
Yashiro	1	1	8' T12	2	Ice	Magnetic	2	N	Electronic	\$ 7.20	\$ 7.20	\$ 160.00	\$ 160.00	Replace fixture and mount hardware
Library	1	6	8' T12	2	Ice	Magnetic	2	N	Electronic	\$ 7.20	\$ 43.20	\$ 160.00	\$ 960.00	Tandem Replace fixture and hardware
Taketa	1	6	8' T12	2	Ice	Magnetic	2	N	Electronic	\$ 7.20	\$ 43.20	\$ 160.00	\$ 960.00	Tandem Replace fixture and hardware
Main Office	1	6	8' T12	2	Ice	Magnetic	2	N	Electronic	\$ 7.20	\$ 43.20	\$ 160.00	\$ 960.00	Tandem Replace fixture and hardware
Main Office	1	2	4' T12	2	Wrap	Magnetic	2	N	Electronic	\$ 5.60	\$ 11.20	\$ 60.00	\$ 120.00	Excellent opportunity for retro-fit
BUILDING G											\$ -		\$ -	
G - 204	2	12	4'T12	4	Troffer	Magnetic	4	N	Electronic	\$ 11.20	\$ 134.40	\$ 70.00	\$ 840.00	Excellent opportunity for retro-fit
G - 203	2	12	4' T12	4	Troffer	Magnetic	4	N	Electronic	\$ 11.20	\$ 134.40	\$ 70.00	\$ 840.00	Excellent opportunity for retro-fit
Girls' Restroom	2	4	4' T12	2	Wrap	Magnetic	2	N	Electronic	\$ 5.60	\$ 22.40	\$ 60.00	\$ 240.00	Excellent opportunity for retro-fit
Boys' Restroom	2	4	4' T12	2	Wrap	Magnetic	2	N	Electronic	\$ 5.60	\$ 22.40	\$ 60.00	\$ 240.00	Excellent opportunity for retro-fit
G - 202	2	12	4' T12	4	Troffer	Magnetic	4	N	Electronic	\$ 11.20	\$ 134.40	\$ 70.00	\$ 840.00	Excellent opportunity for retro-fit
G - 201	2	12	4' T12	4	Troffer	Magnetic	4	N	Electronic	\$ 11.20	\$ 134.40	\$ 70.00	\$ 840.00	Excellent opportunity for retro-fit
G - 101	1	12	4' T12	4	Wrap	Magnetic	4	N	Electronic	\$ 11.20	\$ 134.40	\$ 70.00	\$ 840.00	Excellent opportunity for retro-fit
G - 102	1	12	4' T12	4	Wrap	Magnetic	4	N	Electronic	\$ 11.20	\$ 134.40	\$ 70.00	\$ 840.00	Excellent opportunity for retro-fit
G - 103	1	12	4' T12	4	Wrap	Magnetic	4	N	Electronic	\$ 11.20	\$ 134.40	\$ 70.00	\$ 840.00	Excellent opportunity for retro-fit
G - 104	1	16	4' T12	4	Wrap	Magnetic	4	N	Electronic	\$ 11.20	\$ 179.20	\$ 70.00	\$ 1,120.00	Excellent opportunity for retro-fit
Girls' Restroom	2	4	4' T12	2	Wrap	Magnetic	2	N	Electronic	\$ 5.60	\$ 22.40	\$ 60.00	\$ 240.00	Excellent opportunity for retro-fit
Boys' Restroom	2	4	4' T12	2	Wrap	Magnetic	2	N	Electronic	\$ 5.60	\$ 22.40	\$ 60.00	\$ 240.00	Excellent opportunity for retro-fit
PORTABLES											\$ -		\$ -	
P - 14	1	16	4T12	4	Troffer	Magnetic	4	N	Electronic	\$ 11.20	\$ 179.20	\$ 70.00	\$ 1,120.00	Excellent opportunity for retro-fit
P - 9	1	16	4' T12	4	Troffer	Magnetic	4	N	Electronic	\$ 11.20	\$ 179.20	\$ 70.00	\$ 1,120.00	Excellent opportunity for retro-fit

LOCATION	EXISTING EQUIPMENT						PROPOSED			REBATES		COSTS		COMMENTS
Location (Rm Name, Rm. #, Area, Zone, etc.)	Floor	Quantity	Lamp Type	Lamps Per Fixture	Type of Fixture	Ballast Type	Lamps Per Fixture	Reflectors	Ballast Type	Per Single	Extended	Per Single	Extended	Surveyors Comments
P-2211-3	1	12	4' T12	4	Wrap	Magnetic	4	N	Electronic	\$ 11.20	\$ 134.40	\$ 70.00	\$ 840.00	Excellent opportunity for retro-fit
P - 2	1	12	4' T12	4	Wrap	Magnetic	4	N	Electronic	\$ 11.20	\$ 134.40	\$ 70.00	\$ 840.00	Excellent opportunity for retro-fit
P - 1	1	12	4' T12	4	Wrap	Magnetic	4	N	Electronic	\$ 11.20	\$ 134.40	\$ 70.00	\$ 840.00	Excellent opportunity for retro-fit
P - 6	1	12	4' T12	4	Wrap	Magnetic	4	N	Electronic	\$ 11.20	\$ 134.40	\$ 70.00	\$ 840.00	Excellent opportunity for retro-fit
P - 7	1	12	4' T12	4	Wrap	Magnetic	4	N	Electronic	\$ 11.20	\$ 134.40	\$ 70.00	\$ 840.00	Excellent opportunity for retro-fit
P - 8	1	12	4' T12	4	Wrap	Magnetic	4	N	Electronic	\$ 11.20	\$ 134.40	\$ 70.00	\$ 840.00	Excellent opportunity for retro-fit
P - 5	1	12	4' T12	4	Wrap	Magnetic	4	N	Electronic	\$ 11.20	\$ 134.40	\$ 70.00	\$ 840.00	Excellent opportunity for retro-fit
P - 4	1	12	4' T12	4	Wrap	Magnetic	4	N	Electronic	\$ 11.20	\$ 134.40	\$ 70.00	\$ 840.00	Excellent opportunity for retro-fit
BUILDING H											\$ -		\$ -	
H - 101	1	24	4' T12	2	Wrap	Magnetic	2	N	Electronic	\$ 5.60	\$ 134.40	\$ 60.00	\$ 1,440.00	Tandem Excellent for retro-fit
H - 102	1	24	4' T12	2	Wrap	Magnetic	2	N	Electronic	\$ 5.60	\$ 134.40	\$ 60.00	\$ 1,440.00	Tandem Excellent for retro-fit
H - 103	1	24	4' T12	2	Wrap	Magnetic	2	N	Electronic	\$ 5.60	\$ 134.40	\$ 60.00	\$ 1,440.00	Tandem Excellent for retro-fit
Girls' Restroom	1	3	4' T12	2	Wrap	Magnetic	2	N	Electronic	\$ 5.60	\$ 16.80	\$ 60.00	\$ 180.00	Excellent opportunity for retro-fit
Janitor	1	1	4' T12	2	Wrap	Magnetic	2	N	Electronic	\$ 5.60	\$ 5.60	\$ 60.00	\$ 60.00	Excellent opportunity for retro-fit
Teachers	1	1	4' T12	2	Wrap	Magnetic	2	N	Electronic	\$ 5.60	\$ 5.60	\$ 60.00	\$ 60.00	Excellent opportunity for retro-fit
Boys' Restroom	1	3	4' T12	2	Wrap	Magnetic	2	N	Electronic	\$ 5.60	\$ 16.80	\$ 60.00	\$ 180.00	Excellent opportunity for retro-fit
Machine	1	1	4' T12	2	Wrap	Magnetic	2	N	Electronic	\$ 5.60	\$ 5.60	\$ 60.00	\$ 60.00	Excellent opportunity for retro-fit
H - 201	2	12	4' T12	4	Troffer	Magnetic	4	N	Electronic	\$ 11.20	\$ 134.40	\$ 70.00	\$ 840.00	Excellent opportunity for retro-fit
H - 202	2	12	4' T12	4	Troffer	Magnetic	4	N	Electronic	\$ 11.20	\$ 134.40	\$ 70.00	\$ 840.00	Excellent opportunity for retro-fit
H - 203	2	12	4' T12	4	Troffer	Magnetic	4	N	Electronic	\$ 11.20	\$ 134.40	\$ 70.00	\$ 840.00	Excellent opportunity for retro-fit
H - 204	2	12	4' T12	4	Troffer	Magnetic	4	N	Electronic	\$ 11.20	\$ 134.40	\$ 70.00	\$ 840.00	Excellent opportunity for retro-fit
Girls' Restroom	2	3	4' T12	2	Wrap	Magnetic	2	N	Electronic	\$ 5.60	\$ 16.80	\$ 60.00	\$ 180.00	Excellent opportunity for retro-fit
Janitor	2	1	4' T12	2	Wrap	Magnetic	2	N	Electronic	\$ 5.60	\$ 5.60	\$ 60.00	\$ 60.00	Excellent opportunity for retro-fit
Teachers	2	1	4' T12	2	Wrap	Magnetic	2	N	Electronic	\$ 5.60	\$ 5.60	\$ 60.00	\$ 60.00	Excellent opportunity for retro-fit
Boys' Restroom	2	3	4' T12	2	Wrap	Magnetic	2	N	Electronic	\$ 5.60	\$ 16.80	\$ 60.00	\$ 180.00	Excellent opportunity for retro-fit
Electrical	2	1	4' T12	2	Wrap	Magnetic	2	N	Electronic	\$ 5.60	\$ 5.60	\$ 60.00	\$ 60.00	Excellent opportunity for retro-fit
BUILDING I											\$ -		\$ -	
I - 208	2	8	4' T12	2	Troffer	Magnetic	2	N	Electronic	\$ 5.60	\$ 44.80	\$ 60.00	\$ 480.00	Excellent opportunity for retro-fit
I - 207	2	1	4' T12	2	Wrap	Magnetic	2	N	Electronic	\$ 5.60	\$ 5.60	\$ 60.00	\$ 60.00	Excellent opportunity for retro-fit
I - 206	2	1	4' T12	2	Wrap	Magnetic	2	N	Electronic	\$ 5.60	\$ 5.60	\$ 60.00	\$ 60.00	Excellent opportunity for retro-fit
General Storage	2	2	4' T12	2	Troffer	Magnetic	2	N	Electronic	\$ 5.60	\$ 11.20	\$ 60.00	\$ 120.00	Excellent opportunity for retro-fit
I - 204	2	12	4' T12	4	Troffer	Magnetic	4	N	Electronic	\$ 11.20	\$ 134.40	\$ 70.00	\$ 840.00	Excellent opportunity for retro-fit
I - 203	2	12	4' T12	4	Troffer	Magnetic	4	N	Electronic	\$ 11.20	\$ 134.40	\$ 70.00	\$ 840.00	Excellent opportunity for retro-fit
I - 202	2	12	4' T12	4	Troffer	Magnetic	4	N	Electronic	\$ 11.20	\$ 134.40	\$ 70.00	\$ 840.00	Excellent opportunity for retro-fit
I - 201	2	12	4' T12	4	Troffer	Magnetic	4	N	Electronic	\$ 11.20	\$ 134.40	\$ 70.00	\$ 840.00	Excellent opportunity for retro-fit
I - 101	1	12	4' T12	4	Troffer	Magnetic	4	N	Electronic	\$ 11.20	\$ 134.40	\$ 70.00	\$ 840.00	Excellent opportunity for retro-fit
I - 102	1	12	4' T12	4	Troffer	Magnetic	4	N	Electronic	\$ 11.20	\$ 134.40	\$ 70.00	\$ 840.00	Excellent opportunity for retro-fit

LOCATION (Rm Name, Rm. #, Area, Zone, etc.)	EXISTING EQUIPMENT						PROPOSED			REBATES		COSTS		COMMENTS Surveyors Comments
	Floor	Quantity	Lamp Type	Lamps Per Fixture	Type of Fixture	Ballast Type	Lamps Per Fixture	Reflectors	Ballast Type	Per Single	Extended	Per Single	Extended	
<i>I - 103</i>	1	12	4' T12	4	Troffer	Magnetic	4	N	Electronic	\$ 11.20	\$ 134.40	\$ 70.00	\$ 840.00	Excellent opportunity for retro-fit
<i>I - 104</i>	1	12	4' T12	4	Troffer	Magnetic	4	N	Electronic	\$ 11.20	\$ 134.40	\$ 70.00	\$ 840.00	Excellent opportunity for retro-fit
<i>Girls' Restroom</i>	1	4	4' T12	2	Wrap	Magnetic	2	N	Electronic	\$ 5.60	\$ 22.40	\$ 60.00	\$ 240.00	Excellent opportunity for retro-fit
<i>Electrical</i>	1	1	4' T12	2	Wrap	Magnetic	2	N	Electronic	\$ 5.60	\$ 5.60	\$ 60.00	\$ 60.00	Excellent opportunity for retro-fit
<i>Janitor</i>	1	1	4' T12	2	Wrap	Magnetic	2	N	Electronic	\$ 5.60	\$ 5.60	\$ 60.00	\$ 60.00	Excellent opportunity for retro-fit
<i>Boys' Restroom</i>	1	4	4' T12	2	Wrap	Magnetic	2	N	Electronic	\$ 5.60	\$ 22.40	\$ 60.00	\$ 240.00	Excellent opportunity for retro-fit
<i>General Storage</i>	2	2	4' T12	2	Troffer	Magnetic	2	N	Electronic	\$ 5.60	\$ 11.20	\$ 60.00	\$ 120.00	Excellent opportunity for retro-fit
CAFETERIA														
<i>Diningroom</i>	1	63	4' T12	2	Wrap	Magnetic	2	N	Electronic	\$ 5.60	\$ 352.80	\$ 60.00	\$ 3,780.00	Excellent opportunity for retro-fit
<i>Stage</i>	1	6	4' T12	2	Wrap	Magnetic	2	N	Electronic	\$ 5.60	\$ 33.60	\$ 60.00	\$ 360.00	Excellent opportunity for retro-fit
<i>Kitchen</i>	1	52	4' T12	2	Wrap	Magnetic	2	N	Electronic	\$ 5.60	\$ 291.20	\$ 60.00	\$ 3,120.00	Impact Lens retro-fit
<i>Hall</i>	1	1	4' T12	2	Vanity	Magnetic	2	N	Electronic	\$ 5.60	\$ 5.60	\$ 60.00	\$ 60.00	Excellent opportunity for retro-fit
<i>Men's Restroom</i>	1	1	4' T12	2	Vanity	Magnetic	2	N	Electronic	\$ 5.60	\$ 5.60	\$ 60.00	\$ 60.00	Excellent opportunity for retro-fit
<i>Women's Restroom</i>	1	1	4' T12	2	Vanity	Magnetic	2	N	Electronic	\$ 5.60	\$ 5.60	\$ 60.00	\$ 60.00	Excellent opportunity for retro-fit
<i>Faculty Dining</i>	1	6	4' T12	2	Wrap	Magnetic	2	N	Electronic	\$ 5.60	\$ 33.60	\$ 60.00	\$ 360.00	Excellent opportunity for retro-fit
<i>Office</i>	1	2	4' T12	3	Wrap	Magnetic	3	N	Electronic	\$ 8.40	\$ 16.80	\$ 65.00	\$ 130.00	Excellent opportunity for retro-fit
<i>Storage</i>	1	4	4' T12	2	Wrap	Magnetic	2	N	Electronic	\$ 5.60	\$ 22.40	\$ 60.00	\$ 240.00	Excellent opportunity for retro-fit
Total Rebates										\$	6,232.80			
Total Costs										\$	56,295.00			

LOCATION	QTY	EXISTING TYPE	QTY	RETROFIT	SURVEYOR'S COMMENTS	Existing	Actual			Proposed			
						Watt/unit	Op. Hours	kWh	kW-D	Watt/unit	Op. Hours	kWh	kW-D
BUILDING E	0		0				1,880	0.0	0		1,880	0.0	0
E - 25	8	4' 4L Fixture	8	Lamp & Low Watt Ballast	Replace fixture and mount Hardware	151.2	1,880	2,274.0	1.2096	100	1,880	1,504.0	0.8
E - 26	8	4' 4L Fixture	8	Lamp & Low Watt Ballast	Replace fixture and mount Hardware	151.2	1,880	2,274.0	1.2096	100	1,880	1,504.0	0.8
E - 27	8	4' 4L Fixture	8	Lamp & Low Watt Ballast	Replace fixture and mount Hardware	151.2	1,880	2,274.0	1.2096	100	1,880	1,504.0	0.8
E - 28	8	4' 4L Fixture	8	Lamp & Low Watt Ballast	Replace fixture and mount Hardware	151.2	1,880	2,274.0	1.2096	100	1,880	1,504.0	0.8
BUILDING A	0		0				1,880	0.0	0		1,880	0.0	0
Boys' Restroom	3	4' 2L Fixture	3	Lamp & Low Watt Ballast	Excellent opportunity for retro-fit	75.6	1,880	426.4	0.2268	51	1,880	287.6	0.153
Girls' Restroom	3	4' 2L Fixture	3	Lamp & Low Watt Ballast	Excellent opportunity for retro-fit	75.6	1,880	426.4	0.2268	51	1,880	287.6	0.153
Office	2	8' 2L Fixture	2	Lamp & Ballast Retrofit	Replace fixture and mount hardware	158	1,880	594.1	0.316	100	1,880	376.0	0.2
Office	1	4' 4L Fixture	1	Lamp & Low Watt Ballast	Excellent opportunity for retro-fit	151.2	1,880	284.3	0.1512	100	1,880	188.0	0.1
Main Office	1	4' 2L Fixture	1	Lamp & Low Watt Ballast	Replace fixture and mount hardware	75.6	1,880	142.1	0.0756	51	1,880	95.9	0.051
Yashiro	1	8' 2L Fixture	1	Lamp & Ballast Retrofit	Replace fixture and mount hardware	158	1,880	297.0	0.158	100	1,880	188.0	0.1
Library	6	8' 2L Fixture	6	Lamp & Ballast Retrofit	Tandem Replace fixture and hardware	158	1,880	1,782.2	0.948	100	1,880	1,128.0	0.6
Taketa	6	8' 2L Fixture	6	Lamp & Ballast Retrofit	Tandem Replace fixture and hardware	158	1,880	1,782.2	0.948	100	1,880	1,128.0	0.6
Main Office	6	8' 2L Fixture	6	Lamp & Ballast Retrofit	Tandem Replace fixture and hardware	158	1,880	1,782.2	0.948	100	1,880	1,128.0	0.6
Main Office	2	4' 2L Fixture	2	Lamp & Low Watt Ballast	Excellent opportunity for retro-fit	75.6	1,880	284.3	0.1512	51	1,880	191.8	0.102
BUILDING G	0		0				1,880	0.0	0		1,880	0.0	0
G - 204	12	4' 4L Fixture	12	Lamp & Low Watt Ballast	Excellent opportunity for retro-fit	151.2	1,880	3,411.1	1.8144	100	1,880	2,256.0	1.2
G - 203	12	4' 4L Fixture	12	Lamp & Low Watt Ballast	Excellent opportunity for retro-fit	151.2	1,880	3,411.1	1.8144	100	1,880	2,256.0	1.2
Girls' Restroom	4	4' 2L Fixture	4	Lamp & Low Watt Ballast	Excellent opportunity for retro-fit	75.6	1,880	568.5	0.3024	51	1,880	383.5	0.204
Boys' Restroom	4	4' 2L Fixture	4	Lamp & Low Watt Ballast	Excellent opportunity for retro-fit	75.6	1,880	568.5	0.3024	51	1,880	383.5	0.204
G - 202	12	4' 4L Fixture	12	Lamp & Low Watt Ballast	Excellent opportunity for retro-fit	151.2	1,880	3,411.1	1.8144	100	1,880	2,256.0	1.2
G - 201	12	4' 4L Fixture	12	Lamp & Low Watt Ballast	Excellent opportunity for retro-fit	151.2	1,880	3,411.1	1.8144	100	1,880	2,256.0	1.2
G - 101	12	4' 4L Fixture	12	Lamp & Low Watt Ballast	Excellent opportunity for retro-fit	151.2	1,880	3,411.1	1.8144	100	1,880	2,256.0	1.2
G - 102	12	4' 4L Fixture	12	Lamp & Low Watt Ballast	Excellent opportunity for retro-fit	151.2	1,880	3,411.1	1.8144	100	1,880	2,256.0	1.2
G - 103	12	4' 4L Fixture	12	Lamp & Low Watt Ballast	Excellent opportunity for retro-fit	151.2	1,880	3,411.1	1.8144	100	1,880	2,256.0	1.2
G - 104	16	4' 4L Fixture	16	Lamp & Low Watt Ballast	Excellent opportunity for retro-fit	151.2	1,880	4,548.1	2.4192	100	1,880	3,008.0	1.6
Girls' Restroom	4	4' 2L Fixture	4	Lamp & Low Watt Ballast	Excellent opportunity for retro-fit	75.6	1,880	568.5	0.3024	51	1,880	383.5	0.204
Boys' Restroom	4	4' 2L Fixture	4	Lamp & Low Watt Ballast	Excellent opportunity for retro-fit	75.6	1,880	568.5	0.3024	51	1,880	383.5	0.204
PORTABLES	0		0				1,880	0.0	0		1,880	0.0	0
P - 14	16	4' 4L Fixture	16	Lamp & Low Watt Ballast	Excellent opportunity for retro-fit	151.2	1,880	4,548.1	2.4192	100	1,880	3,008.0	1.6
P - 9	16	4' 4L Fixture	16	Lamp & Low Watt Ballast	Excellent opportunity for retro-fit	151.2	1,880	4,548.1	2.4192	100	1,880	3,008.0	1.6
P -2211 -3	12	4' 4L Fixture	12	Lamp & Low Watt Ballast	Excellent opportunity for retro-fit	151.2	1,880	3,411.1	1.8144	100	1,880	2,256.0	1.2
P - 2	12	4' 4L Fixture	12	Lamp & Low Watt Ballast	Excellent opportunity for retro-fit	151.2	1,880	3,411.1	1.8144	100	1,880	2,256.0	1.2
P - 1	12	4' 4L Fixture	12	Lamp & Low Watt Ballast	Excellent opportunity for retro-fit	151.2	1,880	3,411.1	1.8144	100	1,880	2,256.0	1.2
P - 6	12	4' 4L Fixture	12	Lamp & Low Watt Ballast	Excellent opportunity for retro-fit	151.2	1,880	3,411.1	1.8144	100	1,880	2,256.0	1.2
P - 7	12	4' 4L Fixture	12	Lamp & Low Watt Ballast	Excellent opportunity for retro-fit	151.2	1,880	3,411.1	1.8144	100	1,880	2,256.0	1.2
P - 8	12	4' 4L Fixture	12	Lamp & Low Watt Ballast	Excellent opportunity for retro-fit	151.2	1,880	3,411.1	1.8144	100	1,880	2,256.0	1.2
P - 5	12	4' 4L Fixture	12	Lamp & Low Watt Ballast	Excellent opportunity for retro-fit	151.2	1,880	3,411.1	1.8144	100	1,880	2,256.0	1.2
P - 4	12	4' 4L Fixture	12	Lamp & Low Watt Ballast	Excellent opportunity for retro-fit	151.2	1,880	3,411.1	1.8144	100	1,880	2,256.0	1.2
BUILDING H	0		0				1,880	0.0	0		1,880	0.0	0
H - 101	24	4' 2L Fixture	24	Lamp & Low Watt Ballast	Tandem Excellent for retro-fit	75.6	1,880	3,411.1	1.8144	51	1,880	2,301.1	1.224
H - 102	24	4' 2L Fixture	24	Lamp & Low Watt Ballast	Tandem Excellent for retro-fit	75.6	1,880	3,411.1	1.8144	51	1,880	2,301.1	1.224
H - 103	24	4' 2L Fixture	24	Lamp & Low Watt Ballast	Tandem Excellent for retro-fit	75.6	1,880	3,411.1	1.8144	51	1,880	2,301.1	1.224
Girls' Restroom	3	4' 2L Fixture	3	Lamp & Low Watt Ballast	Excellent opportunity for retro-fit	75.6	1,880	426.4	0.2268	51	1,880	287.6	0.153
Janitor	1	4' 2L Fixture	1	Lamp & Low Watt Ballast	Excellent opportunity for retro-fit	75.6	1,880	142.1	0.0756	51	1,880	95.9	0.051
Teachers	1	4' 2L Fixture	1	Lamp & Low Watt Ballast	Excellent opportunity for retro-fit	75.6	1,880	142.1	0.0756	51	1,880	95.9	0.051
Boys' Restroom	3	4' 2L Fixture	3	Lamp & Low Watt Ballast	Excellent opportunity for retro-fit	75.6	1,880	426.4	0.2268	51	1,880	287.6	0.153
Machine	1	4' 2L Fixture	1	Lamp & Low Watt Ballast	Excellent opportunity for retro-fit	75.6	1,880	142.1	0.0756	51	1,880	95.9	0.051
H - 201	12	4' 4L Fixture	12	Lamp & Low Watt Ballast	Excellent opportunity for retro-fit	151.2	1,880	3,411.1	1.8144	100	1,880	2,256.0	1.2
H - 202	12	4' 4L Fixture	12	Lamp & Low Watt Ballast	Excellent opportunity for retro-fit	151.2	1,880	3,411.1	1.8144	100	1,880	2,256.0	1.2
H - 203	12	4' 4L Fixture	12	Lamp & Low Watt Ballast	Excellent opportunity for retro-fit	151.2	1,880	3,411.1	1.8144	100	1,880	2,256.0	1.2
H - 204	12	4' 4L Fixture	12	Lamp & Low Watt Ballast	Excellent opportunity for retro-fit	151.2	1,880	3,411.1	1.8144	100	1,880	2,256.0	1.2
Girls' Restroom	3	4' 2L Fixture	3	Lamp & Low Watt Ballast	Excellent opportunity for retro-fit	75.6	1,880	426.4	0.2268	51	1,880	287.6	0.153
Janitor	1	4' 2L Fixture	1	Lamp & Low Watt Ballast	Excellent opportunity for retro-fit	75.6	1,880	142.1	0.0756	51	1,880	95.9	0.051
Teachers	1	4' 2L Fixture	1	Lamp & Low Watt Ballast	Excellent opportunity for retro-fit	75.6	1,880	142.1	0.0756	51	1,880	95.9	0.051
Boys' Restroom	3	4' 2L Fixture	3	Lamp & Low Watt Ballast	Excellent opportunity for retro-fit	75.6	1,880	426.4	0.2268	51	1,880	287.6	0.153
Electrical	1	4' 2L Fixture	1	Lamp & Low Watt Ballast	Excellent opportunity for retro-fit	75.6	1,880	142.1	0.0756	51	1,880	95.9	0.051

LOCATION	QTY	EXISTING TYPE	QTY	RETROFIT	SURVEYOR'S COMMENTS	Existing Watt/unit	Actual			Proposed			
							Op. Hours	kWh	kW-D	Watt/unit	Op. Hours	kWh	kW-D
BUILDING I	0		0				1,880	0.0	0		1,880	0.0	0
<i>I - 208</i>	8	4' 2L Fixture	8	Lamp & Low Watt Ballast	Excellent opportunity for retro-fit	75.6	1,880	1,137.0	0.6048	51	1,880	767.0	0.408
<i>I - 207</i>	1	4' 2L Fixture	1	Lamp & Low Watt Ballast	Excellent opportunity for retro-fit	75.6	1,880	142.1	0.0756	51	1,880	95.9	0.051
<i>I - 206</i>	1	4' 2L Fixture	1	Lamp & Low Watt Ballast	Excellent opportunity for retro-fit	75.6	1,880	142.1	0.0756	51	1,880	95.9	0.051
General Storage	2	4' 2L Fixture	2	Lamp & Low Watt Ballast	Excellent opportunity for retro-fit	75.6	1,880	284.3	0.1512	51	1,880	191.8	0.102
<i>I - 204</i>	12	4' 4L Fixture	12	Lamp & Low Watt Ballast	Excellent opportunity for retro-fit	151.2	1,880	3,411.1	1.8144	100	1,880	2,256.0	1.2
<i>I - 203</i>	12	4' 4L Fixture	12	Lamp & Low Watt Ballast	Excellent opportunity for retro-fit	151.2	1,880	3,411.1	1.8144	100	1,880	2,256.0	1.2
<i>I - 202</i>	12	4' 4L Fixture	12	Lamp & Low Watt Ballast	Excellent opportunity for retro-fit	151.2	1,880	3,411.1	1.8144	100	1,880	2,256.0	1.2
<i>I - 201</i>	12	4' 4L Fixture	12	Lamp & Low Watt Ballast	Excellent opportunity for retro-fit	151.2	1,880	3,411.1	1.8144	100	1,880	2,256.0	1.2
<i>I - 101</i>	12	4' 4L Fixture	12	Lamp & Low Watt Ballast	Excellent opportunity for retro-fit	151.2	1,880	3,411.1	1.8144	100	1,880	2,256.0	1.2
<i>I - 102</i>	12	4' 4L Fixture	12	Lamp & Low Watt Ballast	Excellent opportunity for retro-fit	151.2	1,880	3,411.1	1.8144	100	1,880	2,256.0	1.2
<i>I - 103</i>	12	4' 4L Fixture	12	Lamp & Low Watt Ballast	Excellent opportunity for retro-fit	151.2	1,880	3,411.1	1.8144	100	1,880	2,256.0	1.2
<i>I - 104</i>	12	4' 4L Fixture	12	Lamp & Low Watt Ballast	Excellent opportunity for retro-fit	151.2	1,880	3,411.1	1.8144	100	1,880	2,256.0	1.2
Girls' Restroom	4	4' 2L Fixture	4	Lamp & Low Watt Ballast	Excellent opportunity for retro-fit	75.6	1,880	568.5	0.3024	51	1,880	383.5	0.204
Electrical	1	4' 2L Fixture	1	Lamp & Low Watt Ballast	Excellent opportunity for retro-fit	75.6	1,880	142.1	0.0756	51	1,880	95.9	0.051
Janitor	1	4' 2L Fixture	1	Lamp & Low Watt Ballast	Excellent opportunity for retro-fit	75.6	1,880	142.1	0.0756	51	1,880	95.9	0.051
Boys' Restroom	4	4' 2L Fixture	4	Lamp & Low Watt Ballast	Excellent opportunity for retro-fit	75.6	1,880	568.5	0.3024	51	1,880	383.5	0.204
General Storage	2	4' 2L Fixture	2	Lamp & Low Watt Ballast	Excellent opportunity for retro-fit	75.6	1,880	284.3	0.1512	51	1,880	191.8	0.102
CAFETERIA	0		0				1,880	0.0	0		1,880	0.0	0
Diningroom	63	4' 2L Fixture	63	Lamp & Low Watt Ballast	Excellent opportunity for retro-fit	75.6	1,880	8,954.1	4.7628	51	1,880	6,040.4	3.213
Stage	6	4' 2L Fixture	6	Lamp & Low Watt Ballast	Excellent opportunity for retro-fit	75.6	1,880	852.8	0.4536	51	1,880	575.3	0.306
Kitchen	52	4' 2L Fixture	52	Lamp & Low Watt Ballast	Impact Lens retro-fit	75.6	1,880	7,390.7	3.9312	51	1,880	4,985.8	2.652
Hall	1	4' 2L Fixture	1	Lamp & Low Watt Ballast	Excellent opportunity for retro-fit	75.6	1,880	142.1	0.0756	51	1,880	95.9	0.051
Men's Restroom	1	4' 2L Fixture	1	Lamp & Low Watt Ballast	Excellent opportunity for retro-fit	75.6	1,880	142.1	0.0756	51	1,880	95.9	0.051
Women's Restroom	1	4' 2L Fixture	1	Lamp & Low Watt Ballast	Excellent opportunity for retro-fit	75.6	1,880	142.1	0.0756	51	1,880	95.9	0.051
Faculty Dining	6	4' 2L Fixture	6	Lamp & Low Watt Ballast	Excellent opportunity for retro-fit	75.6	1,880	852.8	0.4536	51	1,880	575.3	0.306
Office	2	4' 3L Fixture	2	Lamp & Low Watt Ballast	Excellent opportunity for retro-fit	121.2	1,880	455.7	0.2424	77	1,880	289.5	0.154
Storage	4	4' 2L Fixture	4	Lamp & Low Watt Ballast	Excellent opportunity for retro-fit	75.6	1,880	568.5	0.3024	51	1,880	383.5	0.204

Existing 701 Proposed 701

ENERGY CALCULATIONS			160,618	85
Description	kW-Demand	kWh		
Existing Use	85.44	160,618		
Proposed Use	56.68	106,553		
Difference - Savings	28.76	54,065		
Electrical Utility Cost	\$5.75	\$0.15466		
Savings per Year	\$1,984.32	\$8,361.80	Total Yearly Energy Savings	\$10,346.12

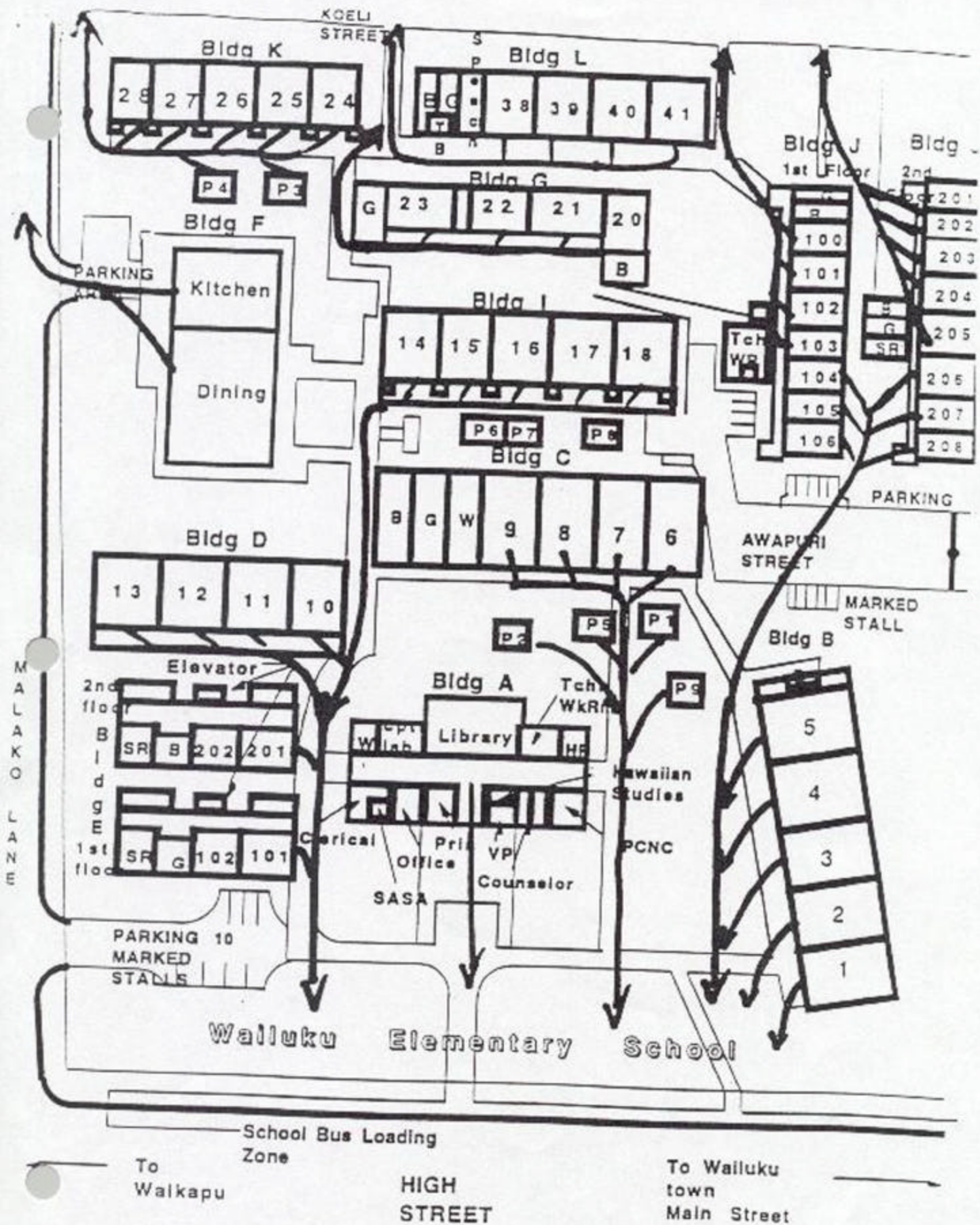

Walluku Elementary School

HIGH STREET

Maui Smart Schools Program
Foot Candle Readings

School: Wailuku Elementary

Room: Bldg. K K-26
Ceiling height: 10'
Light fixture height: 8'
Fixture type: WAAP

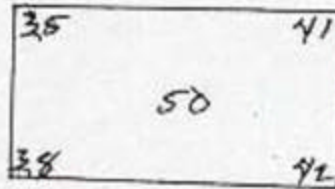

Room: Bldg. B B-3
Ceiling height: 12'
Light fixture height: 8'
Fixture type: ICE TRAY

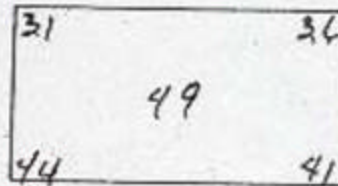

Room: Bldg. J J-206
Ceiling height: 10'
Light fixture height: 8'
Fixture type: TRAFEEB

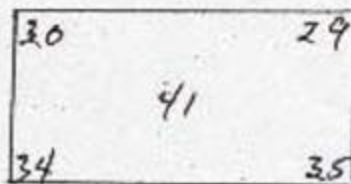



SCHOOL INFORMATION			
NAME Wailuku Elementary School			DATE 3/30/2001
STREET ADDRESS 255 High St.			OPERATIONAL HOURS 2,256
POINT OF CONTACT Beverly Stanich		PHONE 984-5622	FAX 120V
AUDITOR Maui Community College Auditors			

LOCATION Location (Rm Name, Rm. #, Area, Zone, etc.)	EXISTING EQUIPMENT						PROPOSED			REBATES		COSTS		COMMENTS Surveyors Comments
	Floor	Quantity	Lamp Type	Lamps Per Fixture	Type of Fixture	Ballast Type	Lamps Per Fixture	Reflectors	Ballast Type	Per Single	Extended	Per Single	Extended	
BUILDING K											\$ -		\$ -	
28	1	8	4' T12	4	Wrap	Magnetic	4	N	Electronic	\$ 11.20	\$ 89.60	\$ 160.00	\$ 1,280.00	excellent opportunity for retro-fit
28	1	4	4' T12	2	Wrap	Magnetic	2	N	Electronic	\$ 5.60	\$ 22.40	\$ 60.00	\$ 240.00	excellent opportunity for retro-fit
27	1	12	4' T12	2	Wrap	Magnetic	2	N	Electronic	\$ 5.60	\$ 67.20	\$ 60.00	\$ 720.00	excellent opportunity for retro-fit
26	1	12	4' T12	2	Wrap	Magnetic	2	N	Electronic	\$ 5.60	\$ 67.20	\$ 60.00	\$ 720.00	excellent opportunity for retro-fit
25	1	12	4' T12	2	Wrap	Magnetic	2	N	Electronic	\$ 5.60	\$ 67.20	\$ 60.00	\$ 720.00	excellent opportunity for retro-fit
24	1	12	4' T12	2	Wrap	Magnetic	2	N	Electronic	\$ 5.60	\$ 67.20	\$ 60.00	\$ 720.00	excellent opportunity for retro-fit
BUILDING L											\$ -		\$ -	
Teachers	1	1	4' T12	2	Ice	Magnetic	2	N	Electronic	\$ 5.60	\$ 5.60	\$ 135.00	\$ 135.00	replace fixture and mount hardware
Workroom	1	10	4' T12	2	Ice	Magnetic	2	N	Electronic	\$ 5.60	\$ 56.00	\$ 135.00	\$ 1,350.00	Tandem retro-fit
38	1	24	4' T12	2	Ice	Magnetic	2	N	Electronic	\$ 5.60	\$ 134.40	\$ 135.00	\$ 3,240.00	Tandem retro-fit
39	1	24	4' T12	2	Ice	Magnetic	2	N	Electronic	\$ 5.60	\$ 134.40	\$ 135.00	\$ 3,240.00	replace fixture and mount hardware
40	1	24	4' T12	2	Ice	Magnetic	2	N	Electronic	\$ 5.60	\$ 134.40	\$ 135.00	\$ 3,240.00	replace fixture and mount hardware
41	1	24	4' T12	2	Ice	Magnetic	2	N	Electronic	\$ 5.60	\$ 134.40	\$ 135.00	\$ 3,240.00	replace fixture and mount hardware
BUILDING J											\$ -		\$ -	
Staff	1	13	4' T12	2	Ice	Magnetic	2	N	Electronic	\$ 5.60	\$ 72.80	\$ 135.00	\$ 1,755.00	excellent opportunity for retro-fit
J - 101	1	18	4' T12	2	Ice	Magnetic	2	N	Electronic	\$ 5.60	\$ 100.80	\$ 135.00	\$ 2,430.00	replace fixture and mount hardware
J - 102	1	22	4' T12	2	Ice	Magnetic	2	N	Electronic	\$ 5.60	\$ 123.20	\$ 135.00	\$ 2,970.00	replace fixture and mount hardware
J - 102	1	1	8' T12	2	Ice	Magnetic	2	N	Electronic	\$ 11.20	\$ 11.20	\$ 160.00	\$ 160.00	replace fixture and mount hardware
J - 103	1	12	4' T12	4	Troffer	Magnetic	4	N	Electronic	\$ 11.20	\$ 134.40	\$ 70.00	\$ 840.00	excellent opportunity for retro-fit
Faculty Center	1	8	4' T12	4	Troffer	Magnetic	4	N	Electronic	\$ 11.20	\$ 89.60	\$ 70.00	\$ 560.00	excellent opportunity for retro-fit
Faculty Center	1	1	4' T12	4	Troffer	Magnetic	4	N	Electronic	\$ 11.20	\$ 11.20	\$ 70.00	\$ 70.00	excellent opportunity for retro-fit
Storage	1	1	4' T12	2	Wrap	Magnetic	2	N	Electronic	\$ 5.60	\$ 5.60	\$ 60.00	\$ 60.00	excellent opportunity for retro-fit
Men's Restroom	1	2	4' T12	2	Vanity	Magnetic	2	N	Electronic	\$ 5.60	\$ 11.20	\$ 60.00	\$ 120.00	excellent opportunity for retro-fit
Women's Restroom	1	2	4' T12	2	Vanity	Magnetic	2	N	Electronic	\$ 5.60	\$ 11.20	\$ 60.00	\$ 120.00	excellent opportunity for retro-fit
Elevator Room	1	1	4' T12	2	Wrap	Magnetic	2	N	Electronic	\$ 5.60	\$ 5.60	\$ 60.00	\$ 60.00	excellent opportunity for retro-fit
J - 104	1	12	4' T12	4	Troffer	Magnetic	4	N	Electronic	\$ 11.20	\$ 134.40	\$ 70.00	\$ 840.00	excellent opportunity for retro-fit
J - 105	1	12	4' T12	4	Troffer	Magnetic	4	N	Electronic	\$ 11.20	\$ 134.40	\$ 70.00	\$ 840.00	excellent opportunity for retro-fit
J - 106	1	12	4' T12	4	Troffer	Magnetic	4	N	Electronic	\$ 11.20	\$ 134.40	\$ 70.00	\$ 840.00	excellent opportunity for retro-fit
J - 208	2	12	4' T12	4	Troffer	Magnetic	4	N	Electronic	\$ 11.20	\$ 134.40	\$ 70.00	\$ 840.00	excellent opportunity for retro-fit
J - 207	2	12	4' T12	4	Troffer	Magnetic	4	N	Electronic	\$ 11.20	\$ 134.40	\$ 70.00	\$ 840.00	excellent opportunity for retro-fit

LOCATION	EXISTING EQUIPMENT						PROPOSED			REBATES		COSTS		COMMENTS
Location (Rm Name, Rm. #, Area, Zone, etc.)	Floor	Quantity	Lamp Type	Lamps Per Fixture	Type of Fixture	Ballast Type	Lamps Per Fixture	Reflectors	Ballast Type	Per Single	Extended	Per Single	Extended	Surveyors Comments
<i>J - 206</i>	2	12	4' T12	4	Troffer	Magnetic	4	N	Electronic	\$ 11.20	\$ 134.40	\$ 70.00	\$ 840.00	excellent opportunity for retro-fit
<i>Storage</i>	2	1	4' T12	4	Troffer	Magnetic	4	N	Electronic	\$ 11.20	\$ 11.20	\$ 70.00	\$ 70.00	excellent opportunity for retro-fit
<i>J - 205</i>	2	12	4' T12	4	Troffer	Magnetic	4	N	Electronic	\$ 11.20	\$ 134.40	\$ 70.00	\$ 840.00	excellent opportunity for retro-fit
<i>Storage</i>	2	6	4' T12	2	Wrap	Magnetic	2	N	Electronic	\$ 5.60	\$ 33.60	\$ 60.00	\$ 360.00	excellent opportunity for retro-fit
<i>Girls</i>	2	4	4' T12	2	Wrap	Magnetic	2	N	Electronic	\$ 5.60	\$ 22.40	\$ 60.00	\$ 240.00	excellent opportunity for retro-fit
<i>Boys</i>	2	4	4' T12	2	Wrap	Magnetic	2	N	Electronic	\$ 5.60	\$ 22.40	\$ 60.00	\$ 240.00	excellent opportunity for retro-fit
<i>J - 204</i>	2	24	4' T12	4	Ice	Magnetic	4	N	Electronic	\$ 11.20	\$ 268.80	\$ 160.00	\$ 3,840.00	replace fixture and mount hardware
<i>J - 203</i>	2	24	4' T12	4	Ice	Magnetic	4	N	Electronic	\$ 11.20	\$ 268.80	\$ 160.00	\$ 3,840.00	replace fixture and mount hardware
<i>J - 202</i>	2	24	4' T12	4	Ice	Magnetic	4	N	Electronic	\$ 11.20	\$ 268.80	\$ 160.00	\$ 3,840.00	replace fixture and mount hardware
<i>J - 201</i>	2	24	4' T12	4	Ice	Magnetic	4	N	Electronic	\$ 11.20	\$ 268.80	\$ 160.00	\$ 3,840.00	replace fixture and mount hardware
BUILDING A											\$ -		\$ -	
<i>Health Room</i>	1	2	4' T12	4	Ice	Magnetic	4	N	Electronic	\$ 11.20	\$ 22.40	\$ 160.00	\$ 320.00	replace fixture and mount hardware
<i>Hall</i>	1	1	4' T12	4	Ice	Magnetic	4	N	Electronic	\$ 11.20	\$ 11.20	\$ 160.00	\$ 160.00	replace fixture and mount hardware
<i>Hall</i>	1	5	4' T12	4	Wrap	Magnetic	4	N	Electronic	\$ 11.20	\$ 56.00	\$ 70.00	\$ 350.00	excellent opportunity for retro-fit
<i>Mr. Bass</i>	1	4	4' T12	4	Wrap	Magnetic	4	N	Electronic	\$ 11.20	\$ 44.80	\$ 70.00	\$ 280.00	excellent opportunity for retro-fit
<i>Mr. Paul</i>	1	2	4' T12	4	Ice	Magnetic	4	N	Electronic	\$ 11.20	\$ 22.40	\$ 160.00	\$ 320.00	replace fixture and mount hardware
<i>Ms. Funakoshi</i>	1	2	4' T12	4	Ice	Magnetic	4	N	Electronic	\$ 11.20	\$ 22.40	\$ 160.00	\$ 320.00	replace fixture and mount hardware
<i>Makua Mills</i>	1	1	4' T12	4	Ice	Magnetic	4	N	Electronic	\$ 11.20	\$ 11.20	\$ 160.00	\$ 160.00	replace fixture and mount hardware
<i>Vice Principal</i>	1	1	4' T12	4	Ice	Magnetic	4	N	Electronic	\$ 11.20	\$ 11.20	\$ 160.00	\$ 160.00	replace fixture and mount hardware
<i>Office</i>	1	1	4' T12	4	Wrap	Magnetic	4	N	Electronic	\$ 11.20	\$ 11.20	\$ 70.00	\$ 70.00	excellent opportunity for retro-fit
<i>Office</i>	1	2	4' T12	4	Ice	Magnetic	4	N	Electronic	\$ 11.20	\$ 22.40	\$ 160.00	\$ 320.00	replace fixture and mount hardware
<i>Principal</i>	1	2	4' T12	4	Wrap	Magnetic	4	N	Electronic	\$ 11.20	\$ 22.40	\$ 70.00	\$ 140.00	excellent opportunity for retro-fit
<i>Purdy</i>	1	6	4' T12	4	Wrap	Magnetic	4	N	Electronic	\$ 11.20	\$ 67.20	\$ 160.00	\$ 960.00	excellent opportunity for retro-fit
<i>Computer Room</i>	1	6	4' T12	4	Ice	Magnetic	4	N	Electronic	\$ 11.20	\$ 67.20	\$ 160.00	\$ 960.00	replace fixture and mount hardware
<i>Library</i>	1	9	4' T12	4	Ice	Magnetic	4	N	Electronic	\$ 11.20	\$ 100.80	\$ 160.00	\$ 1,440.00	replace fixture and mount hardware
<i>Pcnc</i>	1	6	4' T12	4	Ice	Magnetic	4	N	Electronic	\$ 11.20	\$ 67.20	\$ 160.00	\$ 960.00	replace fixture and mount hardware
BUILDING E											\$ -		\$ -	
<i>E-101</i>	1	16	4' T12	4	Troffer	Magnetic	4	N	Electronic	\$ 11.20	\$ 179.20	\$ 70.00	\$ 1,120.00	excellent opportunity for retro-fit
<i>E - 102</i>	1	16	4' T12	4	Troffer	Magnetic	4	N	Electronic	\$ 11.20	\$ 179.20	\$ 70.00	\$ 1,120.00	excellent opportunity for retro-fit
<i>Girls</i>	1	5	4' T12	2	Wrap	Magnetic	2	N	Electronic	\$ 5.60	\$ 28.00	\$ 60.00	\$ 300.00	excellent opportunity for retro-fit
<i>Custodian</i>	1	1	4' T12	2	Vanity	Magnetic	2	N	Electronic	\$ 5.60	\$ 5.60	\$ 60.00	\$ 60.00	excellent opportunity for retro-fit
<i>Storage</i>	1	1	4' T12	2	Vanity	Magnetic	2	N	Electronic	\$ 5.60	\$ 5.60	\$ 60.00	\$ 60.00	excellent opportunity for retro-fit
<i>Boys</i>	1	5	4' T12	2	Wrap	Magnetic	2	N	Electronic	\$ 5.60	\$ 28.00	\$ 60.00	\$ 300.00	excellent opportunity for retro-fit
<i>E - 202</i>	1	16	4' T12	4	Troffer	Magnetic	4	N	Electronic	\$ 11.20	\$ 179.20	\$ 70.00	\$ 1,120.00	excellent opportunity for retro-fit
<i>E - 203</i>	1	16	4' T12	4	Troffer	Magnetic	4	N	Electronic	\$ 11.20	\$ 179.20	\$ 70.00	\$ 1,120.00	excellent opportunity for retro-fit
BUILDING C											\$ -		\$ -	
<i>Room 6</i>	1	18	4' T12	2	Ice	Magnetic	2	N	Electronic	\$ 5.60	\$ 100.80	\$ 135.00	\$ 2,430.00	replace fixture and mount hardware

LOCATION	EXISTING EQUIPMENT						PROPOSED			REBATES		COSTS		COMMENTS
Location (Rm Name, Rm. #, Area, Zone, etc.)	Floor	Quantity	Lamp Type	Lamps Per Fixture	Type of Fixture	Ballast Type	Lamps Per Fixture	Reflectors	Ballast Type	Per Single	Extended	Per Single	Extended	Surveyors Comments
Room 7	1	18	4' T12	2	Ice	Magnetic	2	N	Electronic	\$ 5.60	\$ 100.80	\$ 135.00	\$ 2,430.00	replace fixture and mount hardware
Room 8	1	18	4' T12	2	Ice	Magnetic	2	N	Electronic	\$ 5.60	\$ 100.80	\$ 135.00	\$ 2,430.00	replace fixture and mount hardware
Room 9	1	18	4' T12	2	Ice	Magnetic	2	N	Electronic	\$ 5.60	\$ 100.80	\$ 135.00	\$ 2,430.00	replace fixture and mount hardware
Women's Locker	1	3	4' T12	2	Ice	Magnetic	2	N	Electronic	\$ 5.60	\$ 16.80	\$ 135.00	\$ 405.00	replace fixture and mount hardware
BUILDING D											\$ -		\$ -	
Room 10	1	6	8' T12	2	Ice	Magnetic	2	N	Electronic	\$ 11.20	\$ 67.20	\$ 160.00	\$ 960.00	replace fixture and mount hardware
Room 11	1	6	8' T12	2	Ice	Magnetic	2	N	Electronic	\$ 11.20	\$ 67.20	\$ 160.00	\$ 960.00	replace fixture and mount hardware
Room 12	1	6	8' T12	2	Ice	Magnetic	2	N	Electronic	\$ 11.20	\$ 67.20	\$ 160.00	\$ 960.00	replace fixture and mount hardware
Room 13	1	6	8' T12	2	Ice	Magnetic	2	N	Electronic	\$ 11.20	\$ 67.20	\$ 160.00	\$ 960.00	replace fixture and mount hardware
BUILDING B											\$ -		\$ -	
Office	1	18	4' T12	3	Troffer	Magnetic	3	N	Electronic	\$ 8.20	\$ 147.60	\$ 65.00	\$ 1,170.00	excellent opportunity for retro-fit
Office	1	9	4' T12	2	Ice	Magnetic	2	N	Electronic	\$ 5.60	\$ 50.40	\$ 135.00	\$ 1,215.00	replace fixture and mount hardware
Room 4	1	6	4' T12	2	Ice	Magnetic	2	N	Electronic	\$ 5.60	\$ 33.60	\$ 135.00	\$ 810.00	replace fixture and mount hardware
Room 5	1	12	4' T12	2	Ice	Magnetic	2	N	Electronic	\$ 5.60	\$ 67.20	\$ 135.00	\$ 1,620.00	replace fixture and mount hardware
Room 3	1	6	4' T12	2	Ice	Magnetic	2	N	Electronic	\$ 5.60	\$ 33.60	\$ 135.00	\$ 810.00	replace fixture and mount hardware
Room 2	1	18	4' T12	2	Ice	Magnetic	2	N	Electronic	\$ 5.60	\$ 100.80	\$ 135.00	\$ 2,430.00	replace fixture and mount hardware
Room 1	1	18	4' T12	2	Ice	Magnetic	2	N	Electronic	\$ 5.60	\$ 100.80	\$ 135.00	\$ 2,430.00	replace fixture and mount hardware
BUILDING G											\$ -		\$ -	
Room 20	1	9	4' T12	4	Wrap	Magnetic	4	N	Electronic	\$ 11.20	\$ 100.80	\$ 70.00	\$ 630.00	Excellent opportunity for retro-fit
Room 21	1	9	4' T12	4	Wrap	Magnetic	4	N	Electronic	\$ 11.20	\$ 100.80	\$ 70.00	\$ 630.00	Excellent opportunity for retro-fit
Room 22	1	9	4' T12	4	Wrap	Magnetic	4	N	Electronic	\$ 11.20	\$ 100.80	\$ 70.00	\$ 630.00	Excellent opportunity for retro-fit
Room 23	1	9	4' T12	4	Wrap	Magnetic	4	N	Electronic	\$ 11.20	\$ 100.80	\$ 70.00	\$ 630.00	Excellent opportunity for retro-fit
Girls' Restroom	1	4	4' T12	2	Wrap	Magnetic	2	N	Electronic	\$ 5.60	\$ 22.40	\$ 60.00	\$ 240.00	Excellent opportunity for retro-fit
BUILDING I											\$ -		\$ -	
Room 14	1	12	4' T12	2	Wrap	Magnetic	2	N	Electronic	\$ 5.60	\$ 67.20	\$ 60.00	\$ 720.00	Excellent opportunity for retro fit
Room 15	1	12	4' T12	2	Wrap	Magnetic	2	N	Electronic	\$ 5.60	\$ 67.20	\$ 60.00	\$ 720.00	Excellent opportunity for retro fit
Room 16	1	12	4' T12	2	Wrap	Magnetic	2	N	Electronic	\$ 5.60	\$ 67.20	\$ 60.00	\$ 720.00	Excellent opportunity for retro fit
Room 17	1	12	4' T12	2	Wrap	Magnetic	2	N	Electronic	\$ 5.60	\$ 67.20	\$ 60.00	\$ 720.00	Excellent opportunity for retro fit
Room 18	1	12	4' T12	2	Wrap	Magnetic	2	N	Electronic	\$ 5.60	\$ 67.20	\$ 60.00	\$ 720.00	Excellent opportunity for retro fit
Kitchen	1	12	4' T12	3	Ice	Magnetic	3	N	Electronic	\$ 5.60	\$ 67.20	\$ 60.00	\$ 720.00	Replace fixture and mount hardware
Office	1	1	4' T12	2	Ice	Magnetic	2	N	Electronic	\$ 5.60	\$ 5.60	\$ 60.00	\$ 60.00	Replace fixture and mount hardware
Dining Room	1	66	4' T12	2	Ice	Magnetic	2	N	Electronic	\$ 5.60	\$ 369.60	\$ 60.00	\$ 3,960.00	Replace fixture and mount hardware
PORTABLES											\$ -		\$ -	
P - 4	1	16	4' T12	4	Wrap	Magnetic	4	N	Electronic	\$ 11.20	\$ 179.20	\$ 70.00	\$ 1,120.00	Excellent opportunity for retro-fit
P - 3	1	16	4' T12	4	Wrap	Magnetic	4	N	Electronic	\$ 11.20	\$ 179.20	\$ 70.00	\$ 1,120.00	Excellent opportunity for retro-fit
P - 6	1	12	4' T12	4	Ice	Magnetic	4	N	Electronic	\$ 11.20	\$ 134.40	\$ 160.00	\$ 1,920.00	Replace fixture and mount hardware
P - 7	1	16	4' T12	4	Wrap	Magnetic	4	N	Electronic	\$ 11.20	\$ 179.20	\$ 70.00	\$ 1,120.00	Excellent opportunity for retro-fit

LOCATION	EXISTING EQUIPMENT						PROPOSED			REBATES		COSTS		COMMENTS
Location (Rm Name, Rm. #, Area, Zone, etc.)	Floor	Quantity	Lamp Type	Lamps Per Fixture	Type of Fixture	Ballast Type	Lamps Per Fixture	Reflectors	Ballast Type	Per Single	Extended	Per Single	Extended	Surveyors Comments
P - 8	1	12	4' T12	4	Wrap	Magnetic	4	N	Electronic	\$ 11.20	\$ 134.40	\$ 70.00	\$ 840.00	Excellent opportunity for retro-fit
P - 9	1	12	4' T12	4	Wrap	Magnetic	4	N	Electronic	\$ 11.20	\$ 134.40	\$ 70.00	\$ 840.00	Excellent opportunity for retro-fit
P - 1	1	16	4' T12	4	Wrap	Magnetic	4	N	Electronic	\$ 11.20	\$ 179.20	\$ 70.00	\$ 1,120.00	Excellent opportunity for retro-fit
P - 5	1	12	4' T12	4	Ice	Magnetic	4	N	Electronic	\$ 11.20	\$ 134.40	\$ 160.00	\$ 1,920.00	Replace fixture and mount hardware
P - 2	1	16	4' T12	4	Troffer	Magnetic	4	N	Electronic	\$ 11.20	\$ 179.20	\$ 70.00	\$ 1,120.00	Excellent opportunity for retro-fit
Total Rebates										\$	8,866.80			
Total Costs										\$	108,930.00			

LOCATION	QTY	EXISTING TYPE	QTY	RETROFIT	SURVEYORS COMMENTS	Existing Watt/unit	Actual			Proposed			
							Op. Hours	kWh	kW-D	Watt/unit	Op. Hours	kWh	kW-D
BUILDING K	0		0		0		2,256	0	0	2,256	0	0	
28	8	4' 4L Fixture	8	Lamp & Low Watt Ballast	excellent opportunity for retro-fit	151.2	2,256	2,728.9	1.2096	100	2,256	1,804.8	0.8
28	4	4' 2L Fixture	4	Lamp & Low Watt Ballast	excellent opportunity for retro-fit	75.6	2,256	682.2	0.3024	51	2,256	460.2	0.204
27	12	4' 2L Fixture	12	Lamp & Low Watt Ballast	excellent opportunity for retro-fit	75.6	2,256	2,046.6	0.9072	51	2,256	1,380.7	0.612
26	12	4' 2L Fixture	12	Lamp & Low Watt Ballast	excellent opportunity for retro-fit	75.6	2,256	2,046.6	0.9072	51	2,256	1,380.7	0.612
25	12	4' 2L Fixture	12	Lamp & Low Watt Ballast	excellent opportunity for retro-fit	75.6	2,256	2,046.6	0.9072	51	2,256	1,380.7	0.612
24	12	4' 2L Fixture	12	Lamp & Low Watt Ballast	excellent opportunity for retro-fit	75.6	2,256	2,046.6	0.9072	51	2,256	1,380.7	0.612
BUILDING L	0		0		0		2,256	0.0	0	2,256	0.0	0	
teachers	2	4' 2L Fixture	2	Lamp & Low Watt Ballast	replace fixture and mount hardware	75.6	2,256	341.1	0.1512	51	2,256	230.1	0.102
Workroom	10	4' 2L Fixture	10	Lamp & Low Watt Ballast	Tandem retro-fit	75.6	2,256	1,705.5	0.756	51	2,256	1,150.6	0.51
38	24	4' 2L Fixture	24	Lamp & Low Watt Ballast	Tandem retro-fit	75.6	2,256	4,093.3	1.8144	51	2,256	2,761.3	1.224
39	24	4' 2L Fixture	24	Lamp & Low Watt Ballast	replace fixture and mount hardware	75.6	2,256	4,093.3	1.8144	51	2,256	2,761.3	1.224
40	24	4' 2L Fixture	24	Lamp & Low Watt Ballast	replace fixture and mount hardware	75.6	2,256	4,093.3	1.8144	51	2,256	2,761.3	1.224
41	24	4' 2L Fixture	24	Lamp & Low Watt Ballast	replace fixture and mount hardware	75.6	2,256	4,093.3	1.8144	51	2,256	2,761.3	1.224
BUILDING J	0		0		0		2,256	0.0	0	2,256	0.0	0	
Staff	13	4' 2L Fixture	13	Lamp & Low Watt Ballast	excellent opportunity for retro-fit	75.6	2,256	2,217.2	0.9828	51	2,256	1,495.7	0.663
J - 101	18	4' 2L Fixture	18	Lamp & Low Watt Ballast	replace fixture and mount hardware	75.6	2,256	3,070.0	1.3608	51	2,256	2,071.0	0.918
J - 102	22	4' 2L Fixture	22	Lamp & Low Watt Ballast	replace fixture and mount hardware	75.6	2,256	3,752.2	1.6632	51	2,256	2,531.2	1.122
J - 102	1	8' 2L Fixture	1	Lamp & Ballast Retrofit	replace fixture and mount hardware	158	2,256	356.4	0.158	110	2,256	248.2	0.11
J - 103	12	4' 4L Fixture	12	Lamp & Low Watt Ballast	excellent opportunity for retro-fit	151.2	2,256	4,093.3	1.8144	100	2,256	2,707.2	1.2
Faculty Center	8	4' 4L Fixture	8	Lamp & Low Watt Ballast	excellent opportunity for retro-fit	151.2	2,256	2,728.9	1.2096	100	2,256	1,804.8	0.8
Faculty Center	1	4' 4L Fixture	1	Lamp & Low Watt Ballast	excellent opportunity for retro-fit	151.2	2,256	341.1	0.1512	100	2,256	225.6	0.1
Storage	1	4' 2L Fixture	1	Lamp & Low Watt Ballast	excellent opportunity for retro-fit	75.6	2,256	170.6	0.0756	51	2,256	115.1	0.051
Men's Restroom	2	4' 2L Fixture	2	Lamp & Low Watt Ballast	excellent opportunity for retro-fit	75.6	2,256	341.1	0.1512	51	2,256	230.1	0.102
Women's Restroom	2	4' 2L Fixture	2	Lamp & Low Watt Ballast	excellent opportunity for retro-fit	75.6	2,256	341.1	0.1512	51	2,256	230.1	0.102
Elevator Room	1	4' 2L Fixture	1	Lamp & Low Watt Ballast	excellent opportunity for retro-fit	75.6	2,256	170.6	0.0756	51	2,256	115.1	0.051
J - 104	12	4' 4L Fixture	12	Lamp & Low Watt Ballast	excellent opportunity for retro-fit	151.2	2,256	4,093.3	1.8144	100	2,256	2,707.2	1.2
J - 105	12	4' 4L Fixture	12	Lamp & Low Watt Ballast	excellent opportunity for retro-fit	151.2	2,256	4,093.3	1.8144	100	2,256	2,707.2	1.2
J - 106	12	4' 4L Fixture	12	Lamp & Low Watt Ballast	excellent opportunity for retro-fit	151.2	2,256	4,093.3	1.8144	100	2,256	2,707.2	1.2
J - 208	12	4' 4L Fixture	12	Lamp & Low Watt Ballast	excellent opportunity for retro-fit	151.2	2,256	4,093.3	1.8144	100	2,256	2,707.2	1.2
J - 207	12	4' 4L Fixture	12	Lamp & Low Watt Ballast	excellent opportunity for retro-fit	151.2	2,256	4,093.3	1.8144	100	2,256	2,707.2	1.2
J - 206	12	4' 4L Fixture	12	Lamp & Low Watt Ballast	excellent opportunity for retro-fit	151.2	2,256	4,093.3	1.8144	100	2,256	2,707.2	1.2
Storage	1	4' 4L Fixture	1	Lamp & Low Watt Ballast	excellent opportunity for retro-fit	151.2	2,256	341.1	0.1512	100	2,256	225.6	0.1
J - 205	12	4' 4L Fixture	12	Lamp & Low Watt Ballast	excellent opportunity for retro-fit	151.2	2,256	4,093.3	1.8144	100	2,256	2,707.2	1.2
Storage	6	4' 2L Fixture	6	Lamp & Low Watt Ballast	excellent opportunity for retro-fit	75.6	2,256	1,023.3	0.4536	51	2,256	690.3	0.306
Girls	4	4' 2L Fixture	4	Lamp & Low Watt Ballast	excellent opportunity for retro-fit	75.6	2,256	682.2	0.3024	51	2,256	460.2	0.204
Boys	4	4' 2L Fixture	4	Lamp & Low Watt Ballast	excellent opportunity for retro-fit	75.6	2,256	682.2	0.3024	51	2,256	460.2	0.204
J - 204	24	4' 4L Fixture	24	Lamp & Low Watt Ballast	replace fixture and mount hardware	151.2	2,256	8,186.6	3.6288	100	2,256	5,414.4	2.4
J - 203	24	4' 4L Fixture	24	Lamp & Low Watt Ballast	replace fixture and mount hardware	151.2	2,256	8,186.6	3.6288	100	2,256	5,414.4	2.4
J - 202	24	4' 4L Fixture	24	Lamp & Low Watt Ballast	replace fixture and mount hardware	151.2	2,256	8,186.6	3.6288	100	2,256	5,414.4	2.4
J - 201	24	4' 4L Fixture	24	Lamp & Low Watt Ballast	replace fixture and mount hardware	151.2	2,256	8,186.6	3.6288	100	2,256	5,414.4	2.4
BUILDING A	0		0		0		2,256	0.0	0	2,256	0.0	0	
Health Room	2	4' 4L Fixture	2	Lamp & Low Watt Ballast	replace fixture and mount hardware	151.2	2,256	682.2	0.3024	100	2,256	451.2	0.2
Hall	1	4' 4L Fixture	1	Lamp & Low Watt Ballast	replace fixture and mount hardware	151.2	2,256	341.1	0.1512	100	2,256	225.6	0.1
Hall	5	4' 4L Fixture	5	Lamp & Low Watt Ballast	excellent opportunity for retro-fit	151.2	2,256	1,705.5	0.756	100	2,256	1,128.0	0.5
Mr. Bass	4	4' 4L Fixture	4	Lamp & Low Watt Ballast	excellent opportunity for retro-fit	151.2	2,256	1,364.4	0.6048	100	2,256	902.4	0.4
Mr. Paul	2	4' 4L Fixture	2	Lamp & Low Watt Ballast	replace fixture and mount hardware	151.2	2,256	682.2	0.3024	100	2,256	451.2	0.2
Ms. Funakoshi	2	4' 4L Fixture	2	Lamp & Low Watt Ballast	replace fixture and mount hardware	151.2	2,256	682.2	0.3024	100	2,256	451.2	0.2
Makua Mills	1	4' 4L Fixture	1	Lamp & Low Watt Ballast	replace fixture and mount hardware	151.2	2,256	341.1	0.1512	100	2,256	225.6	0.1
Vice Principal	1	4' 4L Fixture	1	Lamp & Low Watt Ballast	replace fixture and mount hardware	151.2	2,256	341.1	0.1512	100	2,256	225.6	0.1
Office	1	4' 4L Fixture	1	Lamp & Low Watt Ballast	excellent opportunity for retro-fit	151.2	2,256	341.1	0.1512	100	2,256	225.6	0.1
Office	2	4' 4L Fixture	2	Lamp & Low Watt Ballast	replace fixture and mount hardware	151.2	2,256	682.2	0.3024	100	2,256	451.2	0.2
Principal	2	4' 4L Fixture	2	Lamp & Low Watt Ballast	excellent opportunity for retro-fit	151.2	2,256	682.2	0.3024	100	2,256	451.2	0.2
Purdy	6	4' 4L Fixture	6	Lamp & Low Watt Ballast	excellent opportunity for retro-fit	151.2	2,256	2,046.6	0.9072	100	2,256	1,353.6	0.6
Computer Room	6	4' 4L Fixture	6	Lamp & Low Watt Ballast	replace fixture and mount hardware	151.2	2,256	2,046.6	0.9072	100	2,256	1,353.6	0.6
Library	9	4' 4L Fixture	9	Lamp & Low Watt Ballast	replace fixture and mount hardware	151.2	2,256	3,070.0	1.3608	100	2,256	2,030.4	0.9
Pcnc	6	4' 4L Fixture	6	Lamp & Low Watt Ballast	replace fixture and mount hardware	151.2	2,256	2,046.6	0.9072	100	2,256	1,353.6	0.6

LOCATION	QTY	EXISTING TYPE	QTY	RETROFIT	SURVEYORS COMMENTS	Existing Watt/unit	Actual			Proposed			
							Op. Hours	kWh	kW-D	Watt/unit	Op. Hours	kWh	kW-D
BUILDING E	0		0		0		2,256	0.0	0		2,256	0.0	0
<i>E-101</i>	16	4' 4L Fixture	16	Lamp & Low Watt Ballast	excellent opportunity for retro-fit	151.2	2,256	5,457.7	2.4192	100	2,256	3,609.6	1.6
<i>E - 102</i>	16	4' 4L Fixture	16	Lamp & Low Watt Ballast	excellent opportunity for retro-fit	151.2	2,256	5,457.7	2.4192	100	2,256	3,609.6	1.6
<i>Girls</i>	5	4' 2L Fixture	5	Lamp & Low Watt Ballast	excellent opportunity for retro-fit	75.6	2,256	852.8	0.378	51	2,256	575.3	0.255
<i>Custodian</i>	1	4' 2L Fixture	1	Lamp & Low Watt Ballast	excellent opportunity for retro-fit	75.6	2,256	170.6	0.0756	51	2,256	115.1	0.051
<i>Storage</i>	1	4' 2L Fixture	1	Lamp & Low Watt Ballast	excellent opportunity for retro-fit	75.6	2,256	170.6	0.0756	51	2,256	115.1	0.051
<i>Boys</i>	5	4' 2L Fixture	5	Lamp & Low Watt Ballast	excellent opportunity for retro-fit	75.6	2,256	852.8	0.378	51	2,256	575.3	0.255
<i>E - 202</i>	16	4' 4L Fixture	16	Lamp & Low Watt Ballast	excellent opportunity for retro-fit	151.2	2,256	5,457.7	2.4192	100	2,256	3,609.6	1.6
<i>E - 203</i>	16	4' 4L Fixture	16	Lamp & Low Watt Ballast	excellent opportunity for retro-fit	151.2	2,256	5,457.7	2.4192	100	2,256	3,609.6	1.6
BUILDING C	0		0		0		2,256	0.0	0		2,256	0.0	0
<i>Room 6</i>	18	4' 2L Fixture	18	Lamp & Low Watt Ballast	replace fixture and mount hardware	75.6	2,256	3,070.0	1.3608	51	2,256	2,071.0	0.918
<i>Room 7</i>	18	4' 2L Fixture	18	Lamp & Low Watt Ballast	replace fixture and mount hardware	75.6	2,256	3,070.0	1.3608	51	2,256	2,071.0	0.918
<i>Room 8</i>	18	4' 2L Fixture	18	Lamp & Low Watt Ballast	replace fixture and mount hardware	75.6	2,256	3,070.0	1.3608	51	2,256	2,071.0	0.918
<i>Room 9</i>	18	4' 2L Fixture	18	Lamp & Low Watt Ballast	replace fixture and mount hardware	75.6	2,256	3,070.0	1.3608	51	2,256	2,071.0	0.918
<i>Women's Locker</i>	3	4' 2L Fixture	3	Lamp & Low Watt Ballast	replace fixture and mount hardware	75.6	2,256	511.7	0.2268	51	2,256	345.2	0.153
BUILDING D	0		0		0		2,256	0.0	0		2,256	0.0	0
<i>Room 10</i>	6	8' 2L Fixture	6	Lamp & Ballast Retrofit	replace fixture and mount hardware	158	2,256	2,138.7	0.948	110	2,256	1,489.0	0.66
<i>Room 11</i>	6	8' 2L Fixture	6	Lamp & Ballast Retrofit	replace fixture and mount hardware	158	2,256	2,138.7	0.948	110	2,256	1,489.0	0.66
<i>Room 12</i>	6	8' 2L Fixture	6	Lamp & Ballast Retrofit	replace fixture and mount hardware	158	2,256	2,138.7	0.948	110	2,256	1,489.0	0.66
<i>Room 13</i>	6	8' 2L Fixture	6	Lamp & Ballast Retrofit	replace fixture and mount hardware	158	2,256	2,138.7	0.948	110	2,256	1,489.0	0.66
BUILDING B	0		0		0		2,256	0.0	0		2,256	0.0	0
<i>Office</i>	18	4' 3L Fixture	18	Lamp & Low Watt Ballast	excellent opportunity for retro-fit	121.2	2,256	4,921.7	2.1816	77	2,256	3,126.8	1.386
<i>Office</i>	9	4' 2L Fixture	9	Lamp & Low Watt Ballast	replace fixture and mount hardware	75.6	2,256	1,535.0	0.6804	51	2,256	1,035.5	0.459
<i>Room 4</i>	6	4' 2L Fixture	6	Lamp & Low Watt Ballast	replace fixture and mount hardware	75.6	2,256	1,023.3	0.4536	51	2,256	690.3	0.306
<i>Room 5</i>	12	4' 2L Fixture	12	Lamp & Low Watt Ballast	replace fixture and mount hardware	75.6	2,256	2,046.6	0.9072	51	2,256	1,380.7	0.612
<i>Room 3</i>	6	4' 2L Fixture	6	Lamp & Low Watt Ballast	replace fixture and mount hardware	75.6	2,256	1,023.3	0.4536	51	2,256	690.3	0.306
<i>Room 2</i>	18	4' 2L Fixture	18	Lamp & Low Watt Ballast	replace fixture and mount hardware	75.6	2,256	3,070.0	1.3608	51	2,256	2,071.0	0.918
<i>Room 1</i>	18	4' 2L Fixture	18	Lamp & Low Watt Ballast	replace fixture and mount hardware	75.6	2,256	3,070.0	1.3608	51	2,256	2,071.0	0.918
BUILDING G	0		0		0		2,256	0.0	0		2,256	0.0	0
<i>Room 20</i>	9	4' 4L Fixture	9	Lamp & Low Watt Ballast	Excellent opportunity for retro-fit	151.2	2,256	3,070.0	1.3608	100	2,256	2,030.4	0.9
<i>Room 21</i>	9	4' 4L Fixture	9	Lamp & Low Watt Ballast	Excellent opportunity for retro-fit	151.2	2,256	3,070.0	1.3608	100	2,256	2,030.4	0.9
<i>Room 22</i>	9	4' 4L Fixture	9	Lamp & Low Watt Ballast	Excellent opportunity for retro-fit	151.2	2,256	3,070.0	1.3608	100	2,256	2,030.4	0.9
<i>Room 23</i>	9	4' 4L Fixture	9	Lamp & Low Watt Ballast	Excellent opportunity for retro-fit	151.2	2,256	3,070.0	1.3608	100	2,256	2,030.4	0.9
<i>Girls' Restroom</i>	4	4' 2L Fixture	4	Lamp & Low Watt Ballast	Excellent opportunity for retro-fit	75.6	2,256	682.2	0.3024	51	2,256	460.2	0.204
BUILDING I	0		0		0		2,256	0.0	0		2,256	0.0	0
<i>Room 14</i>	12	4' 2L Fixture	12	Lamp & Low Watt Ballast	Excellent opportunity for retro fit	75.6	2,256	2,046.6	0.9072	51	2,256	1,380.7	0.612
<i>Room 15</i>	12	4' 2L Fixture	12	Lamp & Low Watt Ballast	Excellent opportunity for retro fit	75.6	2,256	2,046.6	0.9072	51	2,256	1,380.7	0.612
<i>Room 16</i>	12	4' 2L Fixture	12	Lamp & Low Watt Ballast	Excellent opportunity for retro fit	75.6	2,256	2,046.6	0.9072	51	2,256	1,380.7	0.612
<i>Room 17</i>	12	4' 2L Fixture	12	Lamp & Low Watt Ballast	Excellent opportunity for retro fit	75.6	2,256	2,046.6	0.9072	51	2,256	1,380.7	0.612
<i>Room 18</i>	12	4' 2L Fixture	12	Lamp & Low Watt Ballast	Excellent opportunity for retro fit	75.6	2,256	2,046.6	0.9072	51	2,256	1,380.7	0.612
<i>Kitchen</i>	12	4' 2L Fixture	12	Lamp & Low Watt Ballast	Replace fixture and mount hardware	75.6	2,256	2,046.6	0.9072	51	2,256	1,380.7	0.612
<i>Office</i>	1	4' 2L Fixture	1	Lamp & Low Watt Ballast	Replace fixture and mount hardware	75.6	2,256	170.6	0.0756	51	2,256	115.1	0.051
<i>Dining Room</i>	66	4' 2L Fixture	66	Lamp & Low Watt Ballast	Replace fixture and mount hardware	75.6	2,256	11,256.5	4.9896	51	2,256	7,593.7	3.366
PORTABLES	0		0		0		2,256	0.0	0		2,256	0.0	0
<i>P - 4</i>	16	4' 4L Fixture	16	Lamp & Low Watt Ballast	Excellent opportunity for retro-fit	151.2	2,256	5,457.7	2.4192	100	2,256	3,609.6	1.6
<i>P - 3</i>	16	4' 4L Fixture	16	Lamp & Low Watt Ballast	Excellent opportunity for retro-fit	151.2	2,256	5,457.7	2.4192	100	2,256	3,609.6	1.6
<i>P - 6</i>	12	4' 4L Fixture	12	Lamp & Low Watt Ballast	Replace fixture and mount hardware	151.2	2,256	4,093.3	1.8144	100	2,256	2,707.2	1.2
<i>P - 7</i>	16	4' 4L Fixture	16	Lamp & Low Watt Ballast	Excellent opportunity for retro-fit	151.2	2,256	5,457.7	2.4192	100	2,256	3,609.6	1.6
<i>P - 8</i>	12	4' 4L Fixture	12	Lamp & Low Watt Ballast	Excellent opportunity for retro-fit	151.2	2,256	4,093.3	1.8144	100	2,256	2,707.2	1.2
<i>P - 9</i>	12	4' 4L Fixture	12	Lamp & Low Watt Ballast	Excellent opportunity for retro-fit	151.2	2,256	4,093.3	1.8144	100	2,256	2,707.2	1.2
<i>P - 1</i>	16	4' 4L Fixture	16	Lamp & Low Watt Ballast	Excellent opportunity for retro-fit	151.2	2,256	5,457.7	2.4192	100	2,256	3,609.6	1.6
<i>P - 5</i>	12	4' 4L Fixture	12	Lamp & Low Watt Ballast	Replace fixture and mount hardware	151.2	2,256	4,093.3	1.8144	100	2,256	2,707.2	1.2
<i>P - 2</i>	16	4' 4L Fixture	16	Lamp & Low Watt Ballast	Excellent opportunity for retro-fit	151.2	2,256	5,457.7	2.4192	100	2,256	3,609.6	1.6

Existing 1063 Proposed 1063

ENERGY CALCULATIONS			271,028	120
Description	kW-Demand	kWh		
Existing Use	120.14	271,028		
Proposed Use	80.07	180,633		
Difference - Savings	40.07	90,394		
Electrical Utility Cost	\$5.75	\$0.15458		
Savings per Year	\$2,764.72	\$13,973.31	Total Yearly Energy Savings	\$16,738.03

Product Specification and Selection

REQUEST FOR PROPOSAL: SAMPLE

GENERAL WRITEN SPECIFICATIONS AND PROVISIONS: **LIGHTING RETROFIT OF EXISTING FLUORESCENT FIXTURES AT SAMPLE**

SECTION 1: GENERAL PROVISIONS

Section 1 Part 1 Introduction

1. The scope of work generally consists of contractor performing lighting T12/Magnetic Ballast removal and retrofit of T8/Electronic Ballast. All work shall be in accordance with the EPA guidelines. All work performed by contractor shall be in accordance with lighting retrofit measures provided.
2. This project qualifies for a Hawaiian Electric Company utility rebate. Contractor is responsible for attaining all rebates in accordance with the HECO Energy Solutions™ program. Contractor is responsible for attaining all building permits to perform work.
3. Light levels after lighting retrofit is complete must comply with the Illuminating Engineering Society of North America and OSHA/HIOSH prescribed light levels.

Section 1 Part 2 Contractor Licensing

1. All bidders and proposes responding to this Request for Proposal shall be licensed and be of good standing with the following classification of license in the State of Hawaii.

C-13 Hawaii Electrical Contractor
2. All work to be performed must be in accordance with the National Electric Code NEC 1999.

Section 1 Part 3 Specialty Contractor Qualifications

1. All parties responding to this RFP must be certified or hold qualified personnel by at least one of the following regulatory agencies.
EPA – Green Lights Ally, Surveyor Ally, Partner, Buildings Partner.
IES – Lighting Certified
AEE – Certified Energy Manager
2. Contractors intending to propose must submit proof of experience in this specialized field with at least 5 previous similar projects within the past 3 years involving lighting retrofits in the State of Hawaii. At least 1 of project shall be over \$100,000 in value. Projects shall be fully functioning and trouble free. Submittal shall include contact name, address, and phone number with date of installation for each project.
3. Contractor found at any time to have misrepresented its qualifications or background in any way during proposal assessment or project implementation shall be immediately terminated from services.

SECTION 2: MATERIALS

Section 2 Part 1: General Specifications Materials

1. New and UL Labeled Materials: All materials and equipment to be installed by contractor shall be new and free from defect and suited for intended use; and be listed by Underwriter's Laboratories, Inc.
2. Product Consistency: All lamps and ballast used on this project shall be of one compatible system, and must be of the same manufacturer. All other materials such as wire connectors, new fixtures and lighting controls shall be the same through out this project.

Section 2 Part 2: Lamps

1. The following is a listing of approved lamp vendors. No substitutions shall be accepted.
 - Sylvania
 - Philips
 - General Electric
2. All linear fluorescent lamps used on this project shall be of T-8 designation with its electronic ballast partner. Lamps shall be listed with a color rendition index (CRI) of not less than 86. Lamps shall have an average rated life of 20,000 hours and have a lumen maintenance of 90% through out life.

Section 2 Part 3: Ballasts

1. The following is a listing of approved ballast manufacturers. No substitutions shall be accepted.
 - Sylvania
 - Advance/Philips
 - General Electric
2. All ballasts used on this project shall be electronic. Shall have a power factor of not less than .93 for 1 Lamp Ballast, not less than .96 for 2 Lamp Ballast, and not less than .98 for 3 and 4 Lamp Ballast.
3. All ballast shall have a THD of not less than .32 for 1 Lamp Ballast, and .20 for 2 Lamp, 3 Lamp and 4 Lamp ballast.
4. All ballasts must be CBM certified.
5. All ballast must be covered by a manufacturer's warranty for labor and materials for a period of not less than 5 years from date of installation.
6. All ballast must be of low wattage designation.

Section 2 Part 6: Lamp Sockets

1. Contractor will be required to replace broken or cracked lamp sockets. Price should be included with proposal.

SECTION 3: WARRANTY AND GUARANTEES

1. All work shall be warranted by contractor for a period of 1 year after project completion.
2. All materials shall be covered by manufacturer warranty. Lamp and Ballast combination shall maintain a general warranty Ballast 5 year, LampT8 3 years under normal use.

SECTION 4: CLEAN UP/PROJECT CLOSE OUT

1. All lamps are to be disposed of in accordance with all applicable federal and state guidelines.
2. All ballasts PCB or Non-PCB are to be disposed of in accordance with all applicable federal and state guidelines.
3. All equipment and excess materials must be removed from property within 1 week of completion of installation. Failure to comply may result in the assessment of penalties by property.
4. Contractor will be required to provide property with an excess surplus of lamps/ballast and other materials as detailed on Design Specification Attachments.

APPLICATION and PERFORMANCE SPECIFICATION

Description: High frequency electronic ballast for 1 or 2 F32T8 lamps (and others as indicated below).
Also equivalent U-shaped lamps.

- Line Voltage: 120vac, $\pm 10\%$, 60Hz
- Parallel Lamp Operation
- Instant Start
- Passive Power Factor Correction

Lamps		Input Watts	Nominal Line Amps	Power Factor	Ballast Factor	Ballast Efficacy Factor	Harmonic Total	Crest Factor
Type	#							
F32T8	2	51	0.44	> .95	.78	1.53	< 20%	< 1.7
F32T8	1	33	0.29	> .90	.96	2.91	< 32%	< 1.7
F25T8	2	43	0.37	> .95	.78	1.81	< 20%	< 1.7
F17T8	2	30	0.27	> .90	.85	2.83	< 32%	< 1.7
F40T8	1	40	0.34	> .95	.91	2.28	< 25%	< 1.7
F25T12	2	43	0.35	> .95	.78	1.81	< 20%	< 1.7

Application and Performance Specification Information Subject to Change without Notification.

Performance:

- Meets ANSI Standard C82.11-1993
- Meets ANSI Standard C62.41-1991
- Meets FCC Part 18 (Class A) for EMI and RFI
Non-Consumer Limits
- Meets CSA Standard 654 for Ballast Efficiency

Safety:

- No PCB's
- UL listed (Class P, Type 1 Outdoor)
- CSA Certified

Application:

- Minimum Starting Temperature: 0° F, -18° C
- Maximum Ambient Temperature: 105° F, 40° C
- Sound Rated: A
- Remote Mounting: 18 ft. max. lead length, 18 AWG
- Compatible with "Powerline Carrier" (PLC) Systems
and/or infrared systems

Physical Parameters:

- Length: 9.50"
- Width: 1.70"
- Height: 1.18"
- Weight: 1.70 lbs.
- Lead Length: White, Black 25" ($\pm 1"$)
- Red 48" ($\pm 1"$)
- Blue 31" ($\pm 1"$)

Warranty:

MagneTek, Inc., warrants to the purchaser that each electronic ballast will be free from defects in material or workmanship for a period of 5 years from date of manufacture when properly installed and under normal conditions of use. Call **1-800-BALLAST** for service.

Energy Engineered™

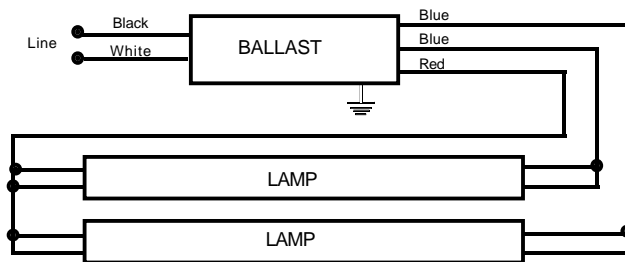

TWO LAMP APPLICATION

Manufactured in North America

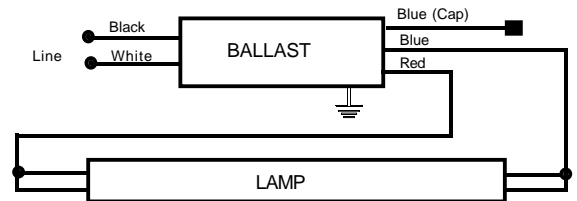

ONE LAMP APPLICATION
Cap any blue lead, insulate to 600 volts

Ballast Must be Grounded

APPLICATION and PERFORMANCE SPECIFICATION

Description: High frequency electronic ballasts for 3 F32T8 lamps (and others as indicated below).
Also equivalent U-shaped lamps.

- Line Voltage: 120vac, ±10%, 60Hz
- Parallel Lamp Operation
- Instant Start
- Passive Power Factor Correction

Lamps		Input Watts	Nominal Line Amps	Power Factor	Ballast Factor	Ballast Efficacy Factor	Harmonic Total	Crest Factor
Type	#							
F32T8	3	77	0.66	> .98	.78	1.01	< 15%	< 1.7
F32T8	2	58	0.53	> .95	.86	1.48	< 20%	< 1.7
F25T8	3	62	0.54	> .95	.80	1.29	< 20%	< 1.7
F17T8	3	43	0.43	> .90	.80	1.86	< 20%	< 1.7
F40T8	2	70	0.62	> .95	.86	1.23	< 20%	< 1.7
F25T12	3	61	0.57	> .95	.68	1.11	< 20%	< 1.7

Application and Performance Specification Information Subject to Change without Notification.

Performance:

- Meets ANSI Standard C82.11-1993
- Meets ANSI Standard C62.41-1991
- Meets FCC Part 18 (Class A) for EMI and RFI
Non-Consumer Limits
- Meets CSA Standard 654 for Ballast Efficiency

Safety:

- No PCB's
- UL listed (Class P, Type 1 Outdoor)
- CSA Certified

Application:

- Minimum Starting Temperature: 0° F, -18° C
- Maximum Ambient Temperature: 105° F, 40° C
- Sound Rated: A
- Remote Mounting: 18 ft. max. lead length, 18 AWG
- Compatible with "Powerline Carrier" (PLC) Systems
and/or infrared systems

Physical Parameters

- Length: 9.50"
- Width: 2.40"
- Height: 1.55"
- Weight: 2.70 lbs.
- Lead Length: White, Black 25" (± 1")
- Red 48" (± 1")
- Blue 31" (± 1")

Warranty:

MagneTek, Inc., warrants to the purchaser that each electronic ballast will be free from defects in material or workmanship for a period of 5 years from date of manufacture when properly installed and under normal conditions of use. Call **1-800-BALLAST** for service.

Energy Engineered™

Manufactured in North America

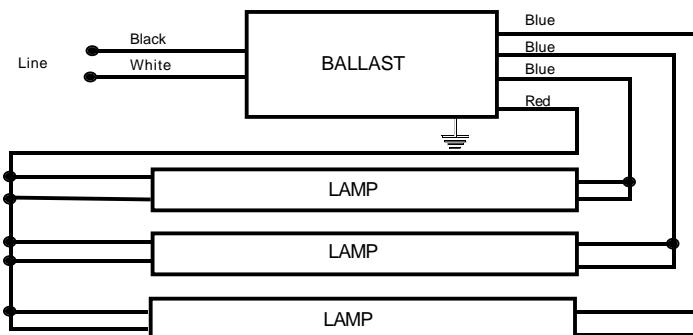

Note: For two lamp application, cap any blue lead, insulate to 600 volts

Ballast Must be Grounded

APPLICATION and PERFORMANCE SPECIFICATION

Description: High frequency electronic ballasts for 4 F32T8 lamps (and others as indicated below).
 Also equivalent U-shaped lamps.

- Line Voltage: 120vac, ±10%, 60Hz
- Parallel Lamp Operation
- Instant Start
- Passive Power Factor Correction

Lamps		Input Watts	Nominal Line Amps	Power Factor	Ballast Factor	Ballast Efficacy Factor	Harmonic Total	Crest Factor
Type	#							
F32T8	4	100	0.85	> .98	.78	0.78	< 20%	< 1.7
F32T8	3	83	0.70	> .97	.86	1.04	< 20%	< 1.7
F25T8	4	80	0.69	> .95	.82	1.03	< 20%	< 1.7
F17T8	4	56	0.51	> .90	.82	1.46	< 32%	< 1.7
F25T12	4	80	0.70	> .95	.68	0.85	< 20%	< 1.7

Application and Performance Specification Information Subject to Change without notification.

Performance:

- Meets ANSI Standard C82.11-1993
- Meets ANSI Standard C62.41-1991
- Meets FCC Part 18 (Class A) for EMI and RFI
 Non-Consumer Limits

Safety:

- No PCB's
- UL listed (Class P, Type 1 Outdoor)
- CSA Certified

Application:

- Minimum Starting Temperature: 50° F, 10° C
- Maximum Ambient Temperature: 105° F, 40° C
- Sound Rated: A
- Remote Mounting: 18 ft. max. lead length, 18 AWG

Physical Parameters

- Length: 9.50"
- Width: 2.40"
- Height: 1.55"
- Weight: 2.70 lbs.
- Lead Length: White, Black 25" (± 1")
- Red 31" (± 1")
- Blue 31" (± 1")
- Yellow 39" (± 1")

Warranty:

MagneTek, Inc., warrants to the purchaser that each electronic ballast will be free from defects in material or workmanship for a period of 5 years from date of manufacture when properly installed and under normal conditions of use. Call **1-800-BALLAST** for service.

Energy Engineered™

Manufactured in North America

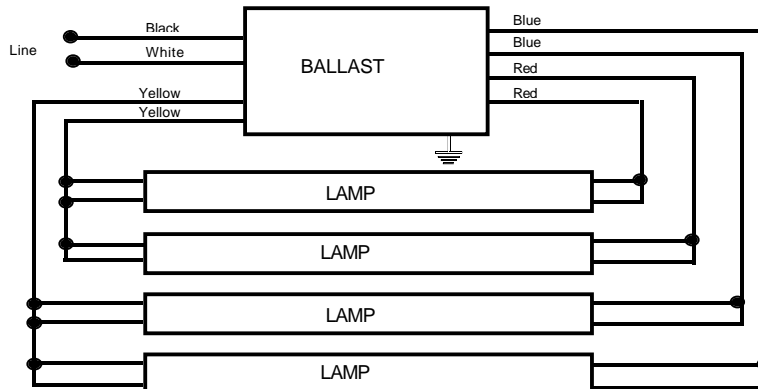

Note: For three lamp operation, cap any blue lead, insulate to 600 volts

Ballast Must be Grounded

TRIAD® B259I120RH & B259I277RH

APPLICATION and PERFORMANCE SPECIFICATION

Description: High frequency electronic ballast for (1 or 2) F96T8 lamps

- Line Voltage: 120vac or 277vac, ±10%, 60Hz
- Parallel Lamp Operation
- Instant Start
- Passive Power Factor Correction

Model	Line Volts	Lamp #	Input Watts	Nominal Line Amps	Power Factor	Ballast Factor	Ballast Efficacy Factor	Harmonic Total	Crest Factor
F96T8	120	2	112	0.95	> .98	.88	0.79	< 20%	<1.7
F96T8	120	1	68	0.62	> .97	1.05	1.54	< 25%	<1.7
F96T8	277	2	112	0.41	> .98	.88	0.79	< 20%	<1.7
F96T8	277	1	68	0.26	> .97	1.05	1.54	< 20%	<1.7

Application and Performance Specification Information Subject to Change without Notification.

Performance:

- Meets ANSI Standard C82.11-1993
- Meets ANSI Standard C62.41-1991
- Meets FCC Part 18 (Class A) for EMI and RFI Non-Consumer Limits

Safety:

- No PCB's
- UL listed (Class P, Type 1 Outdoor)
- CSA Certified

Application:

- Minimum Starting Temperature: 50° F, 10° C
- Maximum Ambient Temperature: 105° F, 40° C
- Sound Rated: A
- Remote Mounting: 18 ft. max. lead length, 18 AWG

Physical Parameters

- Length: 9.50"
- Width: 2.40"
- Height: 1.55"
- Weight: 2.70 lbs.
- Lead Length: White, Black 25" (± 1")
Red 66" (± 1")
Blue 58" (± 1")

Warranty:

MagneTek, Inc., warrants to the purchaser that each electronic ballast will be free from defects in material or workmanship for a period of 5 years from date of manufacture when properly installed and under normal conditions of use. Call **1-800-BALLAST** for service.

Manufactured in North America

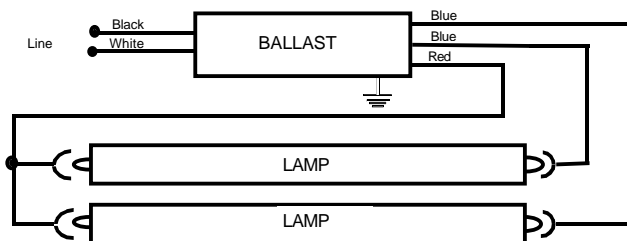

TWO LAMP APPLICATION

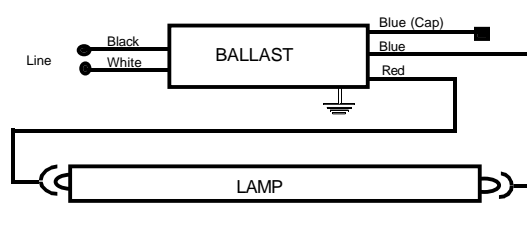

ONE LAMP APPLICATION
Cap any blue lead, insulate to 600 volts

Ballast Must be Grounded

LONGEST LIFE. BEST COLOR.
MOST LIGHT OVER LIFE.

THE ULTIMATE REDUCED
MERCURY T8 LAMP.

Ecolux^{XL}
WITH STARCOAT[™]

Reduced mercury lighting has never been more economical...because now there's GE Ecolux XL[™] with Starcoat[™], the longest lasting reduced mercury T8 lamp. At 24,000 hours it lasts an impressive 20% longer than standard T8s. That extends the relamping cycle by up to one year* for reduced lamp replacement costs, and lower disposal costs.

And ecological...the added life of Ecolux XL[™] results in less lamp disposal—up to 25% less over time. And GE Ecolux lamps consistently pass the EPA Toxicity Characteristic Leaching Procedure (TCLP) test for reduced disposal costs, where applicable.

Starcoat[™] puts your business in the best possible light. All GE Ecolux XL[™] T8 lamps feature Starcoat[™] technology, a proprietary coating technology that gives GE Ecolux XL[™] T8 lamps the best color rendering (up to 86 CRI) and highest maintained light output (95%) of any reduced mercury lamp. That means more light over life and the highest color quality to put your business in a better light.

A wide variety of colors. GE Ecolux XL[™] T8 lamps are available in popular SP color (78 CRI) quality or even better SPX color (86 CRI) for superior lumen output and color rendering. A wide variety of color temperatures, from warm to cool, are available to let you create just the right atmosphere. Choose the color option that best meets your lighting needs.

GE has a full family of Ecolux[™] products which include 4-foot T8 SP and SPX with Starcoat[™], 4-foot T12 CW/Watt-Miser[®], SP, and SPX and 8-foot T12 CW/Watt-Miser[®], SP, and SPX lamps.

* Operating 4,000 hours a year.



GE Lighting



GE Ecolux XL Fluorescent Lamps

GE Ecolux XL™ T8 Lamps with



Performance Data*

■ BEST COLOR

■ EXTRA LIFE°

PRODUCT CODE	DESCRIPTION	NOMINAL WATTS	MOL IN.	CRI/COLOR TEMPERATURE	LUMENS		LIFE		CASE QTY.
					INITIAL	MEAN†	3HRS/START	12HRS/START	
27619	F32T8/XL/SPX30/ECO	32	48	86 @ 3000K	2950	2800	24,000	30,000	36
27620	F32T8/XL/SPX35/ECO	32	48	86 @ 3500K	2950	2800	24,000	30,000	36
27621	F32T8/XL/SPX41/ECO	32	48	86 @ 4100K	2950	2800	24,000	30,000	36
27616	F32T8/XL/SP30/ECO	32	48	78 @ 3000K	2850	2710	24,000	30,000	36
27617	F32T8/XL/SP35/ECO	32	48	78 @ 3500K	2850	2710	24,000	30,000	36
27618	F32T8/XL/SP41/ECO	32	48	78 @ 4100K	2850	2710	24,000	30,000	36

* All data is based on a reference ballast of 60Hz, except life, which is based on a high frequency electronic ballast.

° 20% extra life at 3 hours/start, 25% extra life at 12 hours/start

† Mean lumens calculated at 40% of rated life.

GE Ecolux XL™ with Starcoat™ T8 The right solution to reduce your total cost of light.

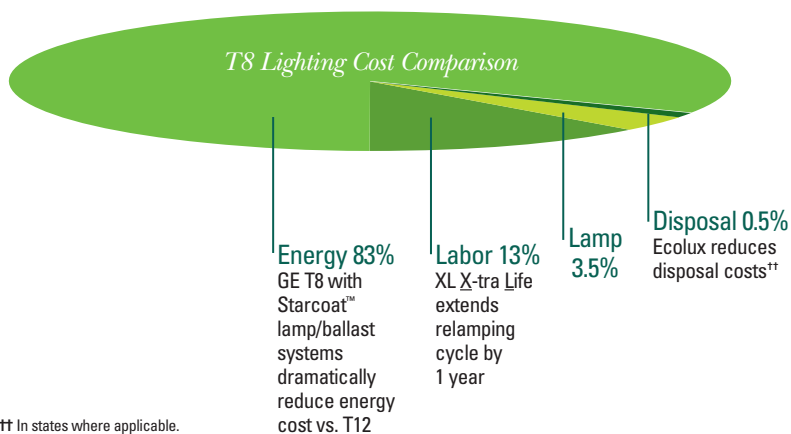

** In states where applicable.

System Comparison

ECOLUX XL™ WITH STARCOAT™ T8 4-LAMP 2X4 TROFFER

LAMP REPLACED	ENERGY-SAVING REPLACEMENT	CRI	PERCENTAGE WATT REDUCTION	RELATIVE LIGHT OUTPUT	ENERGY** SAVINGS
F40T12/CW/WM ELECTROMAGNETIC	F32T8/XL/SPX/ECO ELECTRONIC	62 vs. 86	38%	98%	\$163.50

** \$10 Per KWH over lamp life.

LUMEN MAINTENANCE

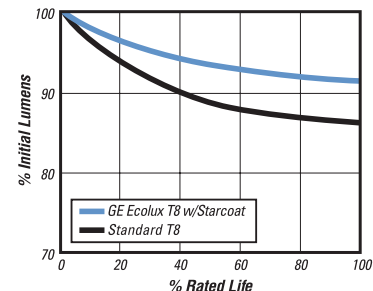

LAMP MORTALITY

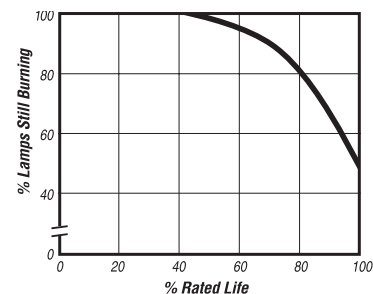

GE Lighting

FEATURES

- Choice of high impact, vandal-resistant acrylic, prismatic diffuser or Holophane® #7101-A injection-molded acrylic diffuser.
- End of diffuser includes decorative white injection-molded end caps.
- Pyramidal prisms minimize lamp image.
- Spring pin diffuser support prevents accidental opening and simplifies maintenance.
- Channel includes hemmed edges.
- Ballast cover secured by 1/4 turn fasteners; no tools required.
- Twist and lock anti-vibration lampholders.
- Available in tandem-wired lengths.
- High-gloss, baked white enamel finish.
- Guaranteed for one year against mechanical defects in manufacture.

SPECIFICATIONS

BALLAST — Thermally protected, resetting, Class P, HPF, non-PCB, UL listed, CSA certified ballast is standard. Sound rated A. Standard combinations are CBM approved and conform to UL 935.

WIRING & ELECTRICAL — Fixture conforms to UL 1570 and is suitable for damp locations. AWM, TFN or THHN wire used throughout rated for required temperatures.

MATERIALS — Metal parts are die-formed from code gauge steel. Diffuser is 100% acrylic. No asbestos used in this product.

FINISH — Five-stage, iron-phosphate pretreatment ensures superior paint adhesion and rust resistance. Painted parts finished with high-gloss, baked white enamel.

LISTING — UL listed and labeled. Listed and labeled to comply with Canadian Standards (see options). Listed and labeled to comply with Mexican Standards (see options).

Specifications subject to change without notice.

PHOTOMETRICS

CLM 1 32

Report LTL 6998 - Lumens per lamp = 2850

S/MH (along) 1.3 (across) 1.6

Coefficient of Utilization

Ceiling Wall	80%			70%			50%		
	70%	50%	30%	70%	50%	30%	50%	30%	10%
0	89	89	89	86	86	86	80	80	80
1	81	78	75	78	75	73	71	69	67
2	75	69	64	72	67	63	63	59	56
3	69	62	56	66	60	55	57	52	49
4	63	55	49	61	54	48	51	46	42
5	58	49	43	56	48	42	45	40	36
6	54	44	38	52	43	37	41	36	32
7	50	40	34	48	39	33	37	32	28
8	46	36	30	44	35	29	33	28	24
9	42	32	26	41	31	26	30	25	21
10	39	29	23	38	29	23	27	22	19

Zonal Lumens Summary

Zone	Lumens	%Lamp	%Fixture
0-30	494	17.3	20.7
0-40	846	29.7	35.4
0-60	1463	51.3	61.1
0-90	1912	67.1	79.9
90-180	480	16.9	20.1
0-180	2392	83.9	100.0

CLM 2 32

Report LTL 7085 - Lumens per lamp = 2850

S/MH (along) 1.3 (across) 1.5

Coefficient of Utilization

Ceiling Wall	80%			70%			50%		
	70%	50%	30%	70%	50%	30%	50%	30%	10%
0	102	102	102	98	98	98	90	90	90
1	92	87	83	87	83	79	76	73	71
2	83	75	69	79	72	67	67	62	58
3	76	66	59	72	64	57	59	53	49
4	70	59	51	66	57	49	52	46	42
5	64	53	45	61	51	43	47	41	36
6	59	47	40	56	46	38	42	36	32
7	55	43	35	52	41	34	39	32	28
8	51	39	32	49	38	31	35	29	25
9	48	36	29	45	35	28	32	27	22
10	44	33	26	43	32	25	30	24	20

Zonal Lumens Summary

Zone	Lumens	%Lamp	%Fixture
0-30	1089	19.1	21.5
0-40	1831	32.1	36.2
0-60	3122	54.8	61.6
0-90	4148	72.8	81.9
90-180	915	16.1	18.1
0-180	5164	88.8	100.0

CLM 2 32 IM

Report LTL 7084 - Lumens per lamp = 2850

S/MH (along) 1.3 (across) 1.7

Coefficient of Utilization

Ceiling Wall	80%			70%			50%		
	70%	50%	30%	70%	50%	30%	50%	30%	10%
0	101	101	101	97	97	97	89	89	89
1	92	88	84	88	84	81	78	75	73
2	84	77	72	80	74	69	68	64	61
3	77	68	62	73	66	60	61	56	52
4	71	61	54	67	59	52	54	49	44
5	65	54	47	62	52	46	49	43	39
6	60	49	42	57	47	40	44	38	34
7	56	44	37	53	43	36	40	34	30
8	52	40	33	50	39	32	37	31	27
9	48	37	30	46	36	29	34	28	24
10	45	34	27	43	33	27	31	25	22

Zonal Lumens Summary

Zone	Lumens	%Lamp	%Fixture
0-30	1152	20.2	23.0
0-40	2001	35.1	39.9
0-60	3396	59.6	67.8
0-90	4078	71.5	81.4
90-180	934	16.4	18.6
0-180	5011	87.9	100.0

Type

Catalog number

.....
.....
.....

Wraparound

CLM

4' and 8' Lengths
1, 2 and 3 Lamps

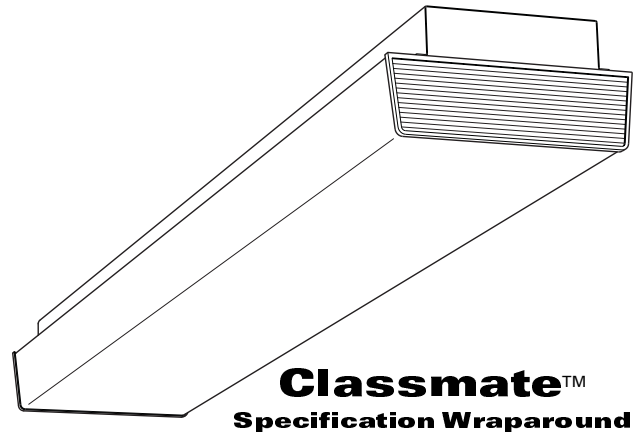

ENERGY

- Luminaire Efficacy Rating (LER) and Annual Energy Cost: Two-lamp LER.FW = 77. Annual Energy Cost = \$3.12. Based on 32W T8 lamp, 2850 lumens and energy saving electronic ballast. Ballast factor = .88, input watts = 58.

Calculated in accordance with NEMA standard LE-5.

CLM Wraparound

MOUNTING DATA

For unit or row installation, surface or stem mounting.

Unit installation — Two single-stem hangers required.

Row installation — One hanger per fixture plus one per row required.

See ACCESSORIES below for hanging devices.

DIMENSIONS

Inches (centimeters). Subject to change without notice.

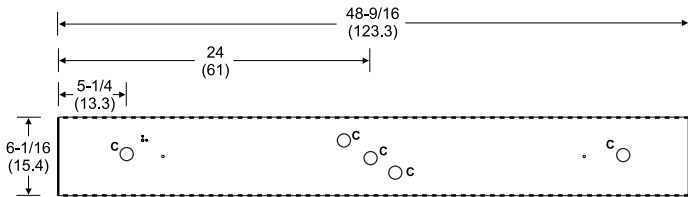
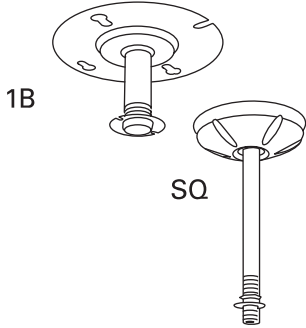
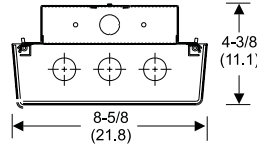

C = 7/8 (2.2) diameter K.O.

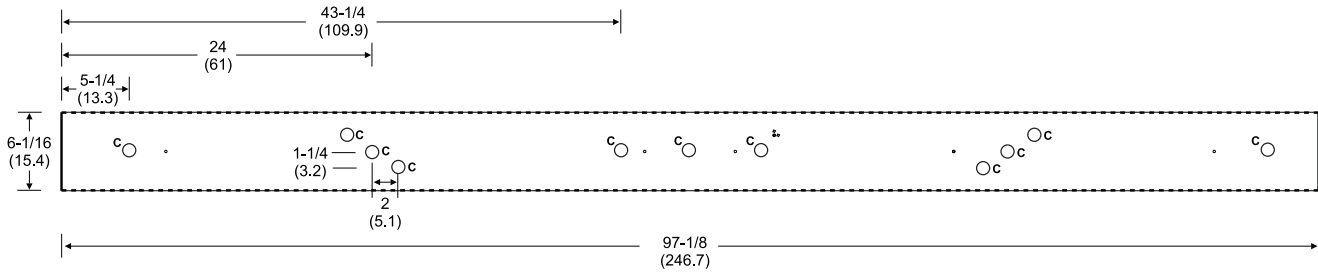

ORDERING INFORMATION

Example: **TCLM 2 32 277 1/4 GEB**

CLM					
Series	Number of lamps	Lamp type	Diffuser type*	Voltage	Options
CLM 8-5/8" wide For tandem, double-length unit, add prefix T . Example: TCLM . Two 4" diffusers provided on 8' units.	1, 2, 3 Not included.	32 32W T8 (48") 40 40W T12 (48")	(blank) High impact prismatic IM Injection-molded Holophane #7101	120, 277, 347 Others available.	GEB Electronic ballast, ≤ 20% THD GEB10 Electronic ballast, ≤ 10% THD 1/3 One 3-lamp ballast 1/4 One 4-lamp ballast 2/3 Two 3-lamp ballasts EL Self-contained emergency inverter CSA Listed and labeled to comply with Canadian Standards NOM Listed and labeled to comply with Mexican Standards

Accessories

Order as separate item.

- SQ** Swivel-stem hanger (specify length in 2" increments).
1B Ceiling spacer adjusts from 1-1/2" to 2-1/2" from ceiling.

NOTES:

* Diffuser ships separate from fixture.

CLM

©2000 Lithonia Lighting 3/00
CLM.P65



GENERAL FLUORESCENT LIGHTING

ONE LITHONIA WAY, CONYERS, GEORGIA 30012, TELEPHONE 770-922-9000, FAX 770-929-8789
www.lithonia.com • IN CANADA: 1100 50TH AVE., LACHINE, QUEBEC H8T 2V3

FEATURES

- Flat-bottom acrylic prismatic diffuser with sonic-welded, injection-molded, luminous ends.
- Diffuser hinges open from either side for easy maintenance.
- Available in tandem-wired lengths.
- Optional high-impact-resistant diffuser available — stronger than standard acrylic.
- For surface or stem mounting, individual or row installation.
- Available with black body or in special colors. Contact Lithonia representative.
- Guaranteed for one year against mechanical defects in manufacture.

SPECIFICATIONS

BALLAST — Thermally protected, resetting, Class P, HPF, non-PCB, UL listed, CSA-certified ballast is standard. Ballasts are sound rated A. Standard combinations are CBM approved and conform to UL 935.

WIRING & ELECTRICAL — Fixture conforms to UL 1570 and is suitable for damp locations. AWM, TFN or THHN wire used throughout. Rated for required temperatures. All ballast leads extend a minimum of 6" through access plate.

MATERIALS — Metal parts die-formed from code-gauge steel. Diffuser is 100% acrylic. No asbestos is used in this product.

FINISH — Five-stage, iron-phosphate pretreatment ensures superior paint adhesion and rust resistance. High-gloss, baked white enamel finish. All parts painted after fabrication.

LISTING — UL listed and labeled. Listed and labeled to comply with Canadian and Mexican Standards (see Options).

Specifications subject to change without notice.

Type

Catalog number

.....
.....
.....

Architectural Wraparound

AW

Narrow Body

4' and 8' length
2 lamps

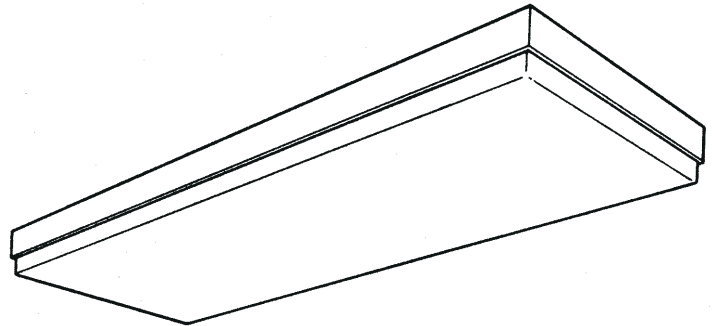

ENERGY

- Luminaire Efficacy Rating (LER) and Annual Energy Cost:
Two-lamp LER.FW = 59. Annual Energy Cost = \$4.07.
Based on 32W T8 lamp, 2850 lumens, and energy-saving electronic ballast. Ballast factor = .88, input watts = 61.
Calculated in accordance with NEMA standard NEMA LE-5.

PHOTOMETRICS

Calculated using the zonal cavity method in accordance with IESNA LM41 procedures. Floor reflectances are 20%. Lamp configurations shown are typical. Full photometric data on these and other configurations available upon request.

AW 2 32

Report LTL 6569— Lumens per lamp = 2900

S/MH (along) 1.3 (across) 1.5

Coefficient of Utilization

Ceiling	80%			70%			50%			0%
	70%	50%	30%	70%	50%	30%	50%	30%	10%	
0	84	84	84	82	82	82	78	78	78	69
1	77	74	71	75	72	69	69	66	64	58
2	71	65	60	68	63	59	60	57	54	49
3	65	57	52	63	56	51	54	49	46	42
4	59	51	45	57	50	44	48	43	39	36
5	55	46	39	53	45	39	43	38	34	31
6	50	41	35	49	40	35	39	34	30	27
7	47	37	31	45	37	31	35	30	26	24
8	44	34	28	42	34	28	32	27	24	22
9	41	31	26	40	31	25	30	25	21	20
10	38	29	23	37	28	23	28	23	19	18

Zonal Lumens Summary

Zone	Lumens	%Lamp	%Fixture
0-30	1149	19.8	27.8
0-40	1934	33.4	46.9
0-60	3313	57.1	80.2
0-90	3987	68.8	96.6
90-180	142	2.5	3.4
0-180	4129	71.2	100.0

AW 2 40

Report LTL 6567— Lumens per lamp = 3150

S/MH (along) 1.3 (across) 1.4

Coefficient of Utilization

Ceiling	80%			70%			50%			0%
	70%	50%	30%	70%	50%	30%	50%	30%	10%	
0	79	79	79	77	77	77	73	73	73	64
1	72	69	67	70	68	65	64	62	60	54
2	66	61	57	64	59	55	57	53	51	46
3	61	54	49	59	53	48	50	46	43	39
4	56	48	42	54	47	42	45	40	37	34
5	51	43	37	50	42	37	40	36	32	29
6	47	39	33	46	38	33	37	32	28	26
7	44	35	29	43	35	29	33	28	25	23
8	41	32	27	40	32	26	30	26	22	20
9	38	29	24	37	29	24	28	23	20	18
10	36	27	22	35	27	22	26	21	18	17

Zonal Lumens Summary

Zone	Lumens	%Lamp	%Fixture
0-30	1184	18.8	28.1
0-40	1979	31.4	47.0
0-60	3374	53.6	80.1
0-90	4061	64.5	96.4
90-180	149	2.4	3.6
0-180	4211	66.9	100.0

AW Architectural Wraparound, Narrow Body

MOUNTING DATA

For unit or row installation. Surface or stem mounting.
Two hanging devices per fixture required.

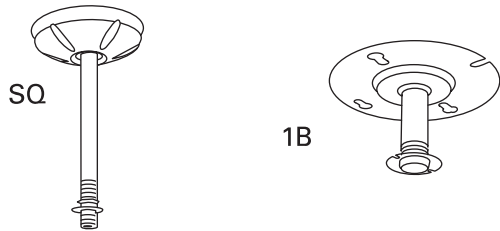

B = 1/4 x 1/2 (.635 x 1.27) K.O.
C = 7/8 (2.22) Dia.K.O.
K = 2 x 2-1/2 (5.1 x 6.37)
Square K.O.
L = 3/8 x 1/2 (.95 x 1.27) slot
M = 3/8 (.95) Dia. hole

DIMENSIONS

Inches (centimeters). Subject to change without notice.

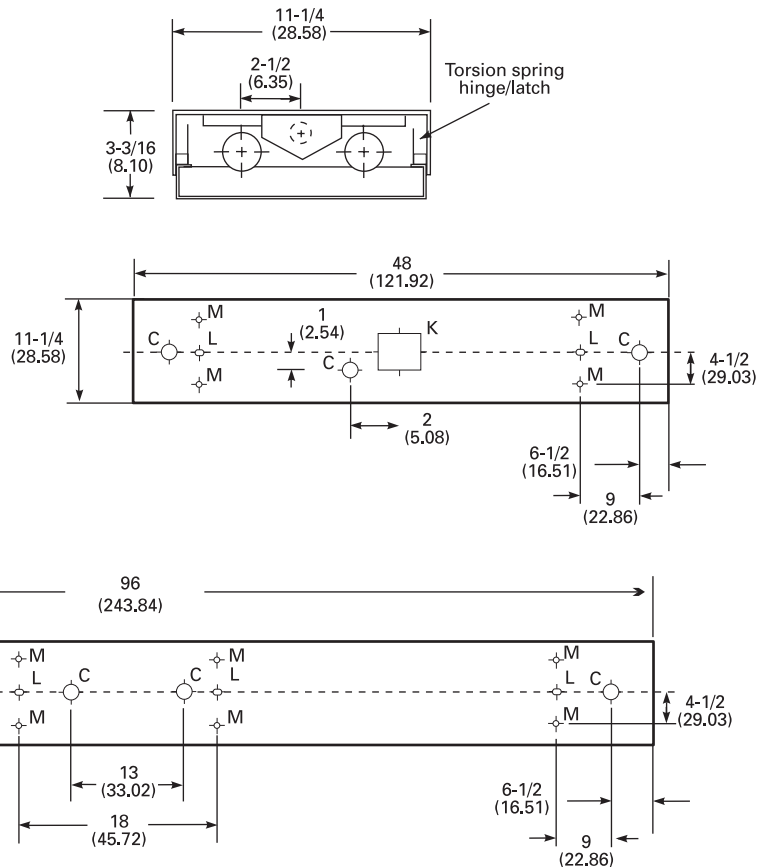

ORDERING INFORMATION

Example: **AW 2 32 AR 120 GEB**

Series	Number of Lamps	Lamp Type	Diffuser	Voltage	Options
AW 2-lamp, 11-1/4" wide For tandem double length unit, add prefix T . Example: TAW	2 Not included	32 32W T8 (48") 40 40W T12 (48")	(blank) Prismatic acrylic AR High-impact prismatic acrylic (50% DR)	120, 277, 347 Others available	ES Energy-saving ballasts (40W lamps only). GEB Electronic ballasts, ≤ 20% THD. GEB10 Electronic ballast, ≤10% THD. EL Emergency battery pack (nominal 300 lumens; See Life Safety Section). GLR Internal fast-blow fuse. GMF Internal slow-blow fuse. RIF1 Radio interference filter (1 per fixture). CSA Listed and labeled to comply with Canadian Standards. NOM Listed and labeled to comply with Mexican Standards.

Accessories

Order as separate catalog number.

- SQ** Swivel stem hanger (specify length in 2" increments).
1B Ceiling spacer (1-1/2" to 2-1/2" from ceiling).

STATE OF HAWAII
DEPARTMENT OF ACCOUNTING AND GENERAL SERVICES
MAUI DISTRICT OFFICE
P.O. BOX 1030
WAILUKU, HI 96793
Phone: (808) 877-3305
Fax: (808) 243-5771

FAX COVER SHEET

TO: DAGS - Central Services
fax no.: 9-1-808-831-6750

Date: December 21, 2000

ATTN: Francis

Total No. of Pages
Including This Page: 6

FROM: Wade Shimabukuro

SUBJECT: Fluorescent Fixtures and Tubes

ITEMS BEING TRANSMITTED: Various sheets

COMMENTS:

These are the type of T8 fixtures we are using. The tubes are T8, medium bi-pin rapid start, 32 watt lamps. An example of a 4' long Sylvania model number is "F032/741".

METALUX®



WSERIES

2', 4' or 8' Surface

SURFACE WRAPAROUND

- Equipped with energy saving ballasts/complies with federal energy efficiency standards
- Low profile
- Low brightness/extruded acrylic refractor
- Heavy gauge end plates with embossed light seal
- Baked white enamel finish
- Lift and shift refractor for ease of re-lamping
- Surface or stem mounting, single or continuous row⁽¹⁾
- Also available in tandem 8' lengths
- Luminaire Efficacy Rating LEP=PW-73
Catalog Number W-232A
- UL Listed, CSA Certified and IBEW Labeled

DESCRIPTION

The W Series wraparound features economy and energy efficient performance. The luminaire's characteristic clean, low profile design is both appealing and practically functional. The W Series utilizes a clear, low brightness, extruded acrylic refractor and a heavy gauge steel end plate with embossed light seal for dependable performance and good looks. The efficient and economical W Series is the perfect wraparound for commercial spaces, schools, dormitories, offices and retail areas.

DIMENSIONS



LAMP	A	B	C	D
2 Lamp	8 1/2" (216mm)	2 5/8" (67mm)	8 1/4" (210mm)	7 1/4" (184mm)
3/4 Lamp	14" (356mm)	2 5/8" (67mm)	13 3/4" (348mm)	12 3/4" (324mm)

ORDERING INFORMATION

SAMPLE NUMBER: W-232A-120V-2081-U

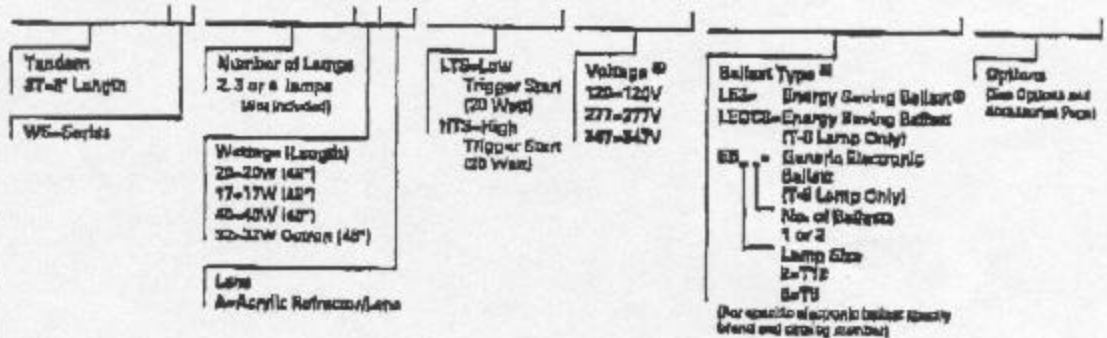

PRODUCT INFORMATION

Catalog Number	Lamp Type	Normal Size	Shipping Wt.
W-517A	2F77	2'	8 lbs. (3.6kg)
W-232A	2F32	4'	17 lbs. (7.7kg)
8TW-232A	4F32	8'	33 lbs. (14.9kg)
W-232A ⁽¹⁾	2F32	4'	25 lbs. (11.3kg)
8TW-232A ⁽¹⁾	4F32	8'	49 lbs. (22.1kg)
W-417A	4F77	2'	13 lbs. (5.9kg)
W-432A	2F32	4'	28 lbs. (12.7kg)
8TW-432A	4F32	8'	57 lbs. (25.8kg)

METALUX™



G SERIES

1' x 4', 2' x 2',
2' x 4' Troffer
2, 3 or 4 Lamp

LOW PROFILE
COMMERCIAL RECESSED
STATIC TROFFER

- Equipped with energy saving ballasts/complies with federal energy efficiency standards
- Reinforced flat white steel door, mitered corners
- Full length mechanical light trap and positive end light seal
- Cam latch/safety integral hinge
- One piece die embossed housing
- Unibody housing/end plates mechanically secured
- Four auxiliary fixture end suspension points provided
- End plate grid-lock feature
- Luminaire Efficacy Rating LER=FL-70
Catalog Number: 2G-332A
- U.L. Listed, CSA Certified and IESW Labeled

DESCRIPTION

The G Series features a nominal 3-3/4" deep low profile fixture housing with a premium finish for optimum performance. The finish provides 86% minimum reflectance. The series also features recessed aesthetics and the latest in energy efficient technology. Luminaires are compatible with today's popular ceiling systems and are available with a number of options and accessories for application versatility. The G Series is an excellent choice for commercial office spaces, schools, hospitals or retail merchandising areas.

DIMENSIONS



NOMINAL SIZE	A	B
1' x 4'	11 3/4" (298mm)	3 3/4" (95mm)
2' x 2'	23 3/4" (603mm)	3 3/4" (95mm)
2' x 4'	23 3/4" (603mm)	3 3/4" (95mm)

ORDERING INFORMATION

SAMPLE NUMBER: 2G-332A-120V-5987-M

Grid Width Blank-1' Width	Number of Lamps 2, 3, or 4 Lamps (Not Included)	Voltage W 120V-120V 277-277V 347-347V	Ballast Type (N) LBS= Energy Saving Ballast LECS= Energy Saving Ballast (7-8 Lamp Only) GS= General Electronic Ballast No. of Ballasts 1 or 2 Lamp Size 8-T12 8-T8	Options (See Options and Accessories Page)
Door Flat White Steel Door Standard	Wastage (Length) 60-40W (60") 32-30W T8 (60") 20-20W (24") 17-17W T8 (24") 13-40W (24") 16-40W (24") 18T8-32W (24")			
Trim Type G=Grid/Lay-in - Standard Compatible (Name Branding is (G/L)) Type-features can be field converted by adding trim kit. See Conversion Section.	And 12 Premium Acrylic AT25=12 Premium Acrylic (.125" Thick)			
	LTS=Low Trippler Start (20 Wires) HTS=High Trippler Start (20 Wires) to			

(For specific electronic ballast options brand and catalog number)

PRODUCT INFORMATION

Catalog Number	Lamp Type	Nominal Size	Shipping Wt.
G-332A	3F32	1' x 4'	18 lbs. (8.2kg)
2G-417	3F17	2' x 2'	18 lbs. (8.1kg)
2G-3473A	4F17	2' x 2'	31 lbs. (14.1kg)
2G-3473A	2F44	2' x 2'	18 lbs. (8.1kg)
2G-3473A	2F44	2' x 2'	18 lbs. (8.1kg)
2G-3473A	2F44	2' x 2'	18 lbs. (8.1kg)
2G-332A	2F40	2' x 4'	28 lbs. (12.7kg)
2G-332A	3F40	2' x 4'	31 lbs. (14.1kg)
2G-432A	4F40	2' x 4'	32 lbs. (14.5kg)

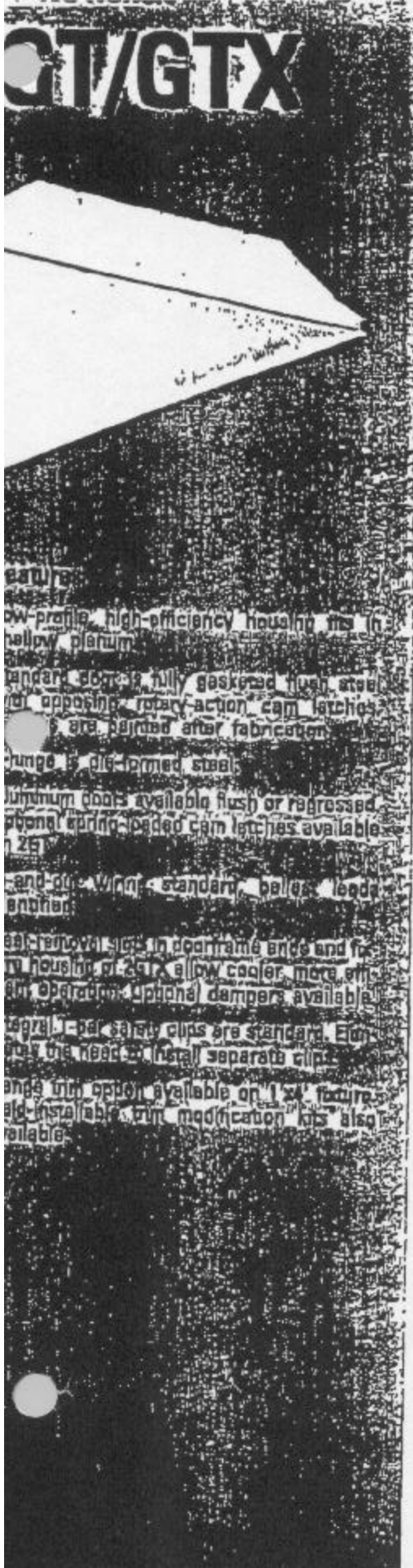

Static Troffers Heat-Removal Grid Troffers

Catalog Number

Example: 2GT 2 32 A12 120 GEB

Series	Number of lamps	Lamp type	Options
GT 1' wide 2GT 2' wide 2GTX 2' wide heat-removal grid troffer	1, 2, 3, 4 Not included.	32 32W T8 (48") 40 40W T12 (48")	For options & accessories, see page 33.
Trim type (blank) Grid F Flanged*			Voltage 120, 277, 347 Others available.
*Available on 1x4 fixtures only.		Frame type	Diffuser type
		(blank) Flush steel, white FN Flush aluminum, natural FM Flush aluminum, matte black FW Flush aluminum, white RM Regressed aluminum, natural RM Regressed aluminum, matte black RW Regressed aluminum, white	A12 #12 pattern acrylic A12T29 #12 pattern acrylic, .125" thick A19 #19 pattern acrylic, .150" thick K20 #20 pattern acrylic, .140" thick B4V Halophane B224 with overlay AC Dropped dish, matte white acrylic (n/a 2GTX)

PRODUCT AVAILABILITY

Nominal Size	Series	Number of Lamps	Lamp Type	Height in.(cm)
1x4	GT	1, 2	32, 40	4 5/8 (12.4)
2x4	2GT, 2GTX	2, 3, 4	32, 40	9 1/4 (23.3)

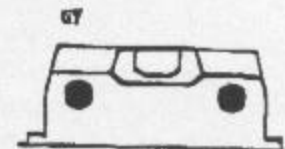
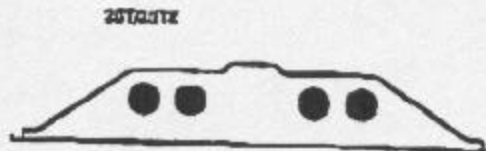

REBUILD HAWAII

Energy Smart Schools Program Maui

General O&M Manuals

General

Operational and Maintenance Measures

Energy Conservation Measures

- ❑ Schedule operating and maintenance work during daytime, if possible. Clean buildings during day shift instead of at night.
- ❑ Have plant protection forces check utility usage, and shut down unused equipment during non-working hours. Train protection personnel in proper machinery shut down procedures.
- ❑ Schedule elevator use to conserve energy.
- ❑ Operate trash compactor inside building to eliminate frequent door openings.
- ❑ Shut down boilers during spring and fall when air conditioning equipment is off and temperature control is not needed.
- ❑ If hot water boilers must be operated during spring, summer, and fall, consider shutting down any applicable hot water pumps that could cause hot water valve leakage into air handling hot water coils. Such leakage can increase heating requirements.
- ❑ Leave one to two boilers off during most of the winter heating season, and perhaps for the entire season, if one boiler is capable of carrying the entire load under design conditions. (A single boiler carrying building heating load will operate at higher annual efficiency than two boilers dividing the load.)
- ❑ Operate only one space heating water pump during spring and fall (and possibly entire year). Consider adjusting time-clock to permit heating pump to operate fewer hours on day cycle.
- ❑ Replace broken or cracked window panes.
- ❑ Replace worn or broken weather-stripping; install weather-stripping where non exists.
- ❑ Periodically calibrate the sensors controlling louvers and dampers on buildings. Repair faulty louvers and dampers.
- ❑ Clean or replace air filters regularly.
- ❑ Eliminate unused roof openings or abandoned stacks.

- ❑ Conserve energy by efficient use of water coolers and vending machines.
- ❑ Post signs next to all operable windows instructing occupants not to open window while building is being heated or cooled.
- ❑ Post signs next to all doors leading to exterior or unconditioned spaces advising occupants to keep doors closed at all times when not in use.
- ❑ Post signs on exterior walls near delivery doors instructing personnel on the operation of doors.
- ❑ Inform office managers and building operators of possible savings by closing drapes and shades at night.
- ❑ Instruct personnel to wear warm clothing in winter and cool clothing in summer.
- ❑ Insulate all pipes and ducts.
- ❑ Reduce heat gain by using window tinting.
- ❑ Caulk, gasket, or otherwise weather-strip all exterior joints, such as those between wall and foundation or wall and roof, and between wall panels.
- ❑ Caulk, gasket, or otherwise weather-strip all openings, such as those provided for entrance of electrical conduits, piping, through-the-wall cooling and other units, and outside air louvers.
- ❑ Size air handling grills, ducts, and coils to minimize air resistance.
- ❑ Where practical, cover all windows and through-the-wall cooling units when not in use.
- ❑ Remove unneeded utility service lines to eliminate potential leaks. Consider installing an automatic, tamper-proof door closer on all exterior building entrance/exit doors, as well as installing automatic door closer on all doors leading to the exterior or unconditioned spaces.
- ❑ If building has a garage, but not a garage door, consider installing one, preferably motorized to enable easier opening and closing.

Consider use of card, or radio frequency-operated garage doors that stay closed except when in use.

Lighting Equipment

Description

Lighting equipment is highly dependent upon customer's facility but generally consumes about 20-35% of the total energy.

Equipment

Lamps

Ballasts

Controls

Energy Conservation Measures

- ❑ Turn off lighting systems when not in use. Turning off equipment (use only when it is needed) can save about 10 percent or more of the lighting energy requirements.
- ❑ Reduce or eliminate general lighting where natural light provides sufficient illumination. Limit higher lighting levels to task areas only. On sunny days, turn off office light switches to take advantage of outside natural lighting.
- ❑ Raise blinds and turn off lights in offices that have one full wall of windows.
- ❑ Turn off lights whenever a room is unoccupied. In general, considering fluorescent tube life expectancy, energy savings, and group relamping cost, the "lights-on lights-off" break-even point is about 4 to 7 minutes.
- ❑ Turn off all lights when cafeteria/lunchroom areas are unoccupied. Switch on by sections when cleaning or for coffee breaks. If possible, arrange coffee breaks close to vending machines.
- ❑ If cleaning is done by contract personnel, insist on a clause requiring cleaning personnel to operate lights only in the section being cleaned and to turn off all lights in areas which have been completed.
- ❑ Locate energy conservation reminders, such as posters and individual decals, next to light switches and on bulletin boards to alert personnel that turning off lights is their responsibility.
- ❑ Eliminate inefficient electric lamps from plant stocks and catalogs.
- ❑ Replace burned out lamps as soon as possible to avoid ballast damage.
- ❑ Reduce exterior building and grounds illumination to minimum safe level.

- ❑ Keep outside windows clean.
- ❑ When refurbishing office areas, use light-colored paint on walls and ceilings and light-colored tile or carpet on floors.
- ❑ Install timers or occupancy sensors on light switches in little-used areas.
- ❑ Lower light fixtures in high ceiling areas.
- ❑ Convert to fluorescent, mercury, sodium, or high intensity discharge (HID) lighting.
- ❑ Use separate switches on perimeter lighting that may be turned off when natural light is available.
- ❑ Minimize illuminated signage hours by using time switches to shut down sign lighting at night after street/highway traffic has decreased.
- ❑ Consider installing improved switching capability in offices so that small groups of lights can be used as needed.
- ❑ If feasible, install two-level switching to achieve reduced lighting levels during low- or non-use periods.
- ❑ Use high efficiency reflectors and lenses in luminaries.
- ❑ Investigate feasibility of using automatic light level meter control of fluorescent or mercury vapor wattage to reduce fixture wattage on sunny days and increase it at night.

HVAC Equipment

Description

Weather and temperature dependent, generally between 35-50% of total energy

Equipment

Air conditioning equipment
Ventilation exhausters for bathrooms/other
Kitchen exhaust ventilation systems
Make-up air recovery systems

Energy Conservation Measures

- ❑ Insure efficient operation of A/C equipment through proper maintenance schedules program. Insure refrigerant systems are kept properly charged. This will insure efficient operation of the A.C equipment.
- ❑ Clean condenser coils regularly. This permits proper airflow across coils.
- ❑ Clean evaporator coils regularly. This permits proper airflow across coils.
- ❑ Keep fan belt drive and motor properly aligned and lubricated. This will extend the life of the motor and belts.
- ❑ Reduce ventilation levels to a minimum. For all air that is exhausted, it must be replaced with “air-conditioned” air.
- ❑ Adjust thermostat controls to maintain a minimum comfortable level. Install lock out covers to prevent customers and employees from tampering with the thermostat. For every 1-degree you can raise the setpoint temperature you can save about 3 percent on you're A/C energy operating costs.
- ❑ Increase thermostat temperatures (80 degrees) or turn off HVAC equipment at night during unoccupied periods. This will reduce air conditioning costs between 5 and 10 percent.
- ❑ Replace inefficient A/C equipment with more efficient units as cost effective. See attached guidelines for new high efficient A/C units and applicable HECO energy rebates.
- ❑ Install heat recovery systems. This will reduce the load on the A/C system.

- ❑ When appropriate, consider closing supply registers and radiators, reducing thermostat settings, and/or turning off the A/C in lobbies, corridors, and vestibules.
- ❑ Keep heat transfer surfaces of all A/C units clean and unobstructed. Keep air movement in and out of such units unobstructed.
- ❑ Inspect A/C controls, and, as applicable, fans on a periodic basis to ensure proper functioning.
- ❑ Cool office building no lower than 74 degrees Fahrenheit when occupied. Do not utilize mechanical cooling when unoccupied.
- ❑ Begin precooling operations so that building temperature is 80 degrees Fahrenheit when occupants arrive, and complete cool-down during first hour of occupancy.
- ❑ Investigate energy savings by lowering centrifugal compressor condenser temperatures. The lower refrigerant pressures will lower power consumption.
- ❑ Reduce internal heat generation as much as possible during cooling season. Typical sources of heat generation include: lighting, people, machines, and cooking equipment.
- ❑ During cooling season evening and night hours, flush building with cooler outdoor air.
- ❑ Inspect condition of indoor shading devices such as drapes and blinds, which can reduce heat gain as much as 50%. Keep indoor shading devices clean and in good repair.
- ❑ Turn on self-contained units, such as window and through-the-wall units, only when needed. Turn them off when space is unoccupied for several hours.
- ❑ In mild weather, decrease cooling effect by operating room cooling fans at lower speeds.
- ❑ Supply chilled water at highest possible temperature that will maintain building comfort; temperatures lower than necessary require larger energy inputs. Set demand limiter on chiller at lowest setting that will maintain building temperature.
- ❑ Clean air conditioning refrigerant condensers to reduce compressor horsepower; check cooling water treatment.
- ❑ Avoid introducing high-moisture exhaust air into air conditioning system.
- ❑ Allow natural humidity variations from 20% to 60% in occupied spaces.
- ❑ Turn off humidifiers whenever building is closed for extended periods of time, except when process or equipment requirements take precedence.

- ❑ Evaluate necessity for humidification system and curtail humidification for areas such as hallways, equipment rooms, lobbies, laundry areas, and similar spaces.
- ❑ Reduce use of heating and cooling systems in spaces used infrequently or only for short periods of time.
- ❑ Keep daily records that plot degree-days against steam or chiller capacity used. These records will pinpoint unnecessary heating or cooling.
- ❑ Close outdoor air dampers during warm-up or cool-down periods each day.
- ❑ Reduce building exhausts and thus make-up air for cooling.
- ❑ Use minimum number of boilers or chillers. It is far better to operate one unit at 90% capacity than two at 45%.
- ❑ Eliminate or reduce use of systems, which require simultaneous heating and cooling. (Systems that use energy to cool a specific volume of delivered air, and then reheat it for purposes of sophisticated control are wasteful.)
- ❑ Periodically calibrate sensors controlling louvers and dampers on buildings.
- ❑ Consider closing outside air dampers during first and last hours of occupancy and during peak hours.
- ❑ Use opaque or translucent insulating materials to block off and thermally seal all unused windows.
- ❑ Where roof insulation is not practical, consider insulating top floor ceiling. This can be done easily with blown insulation. (Use of CFCs is prohibited in San Jose.) In most cases, ceiling insulation also will require a vapor barrier placed on warm side of ceiling – if not integral with insulation – to prevent structural damage caused by rot, corrosion, or expansion of freezing water.
- ❑ If remodeling or modernizing is being considered, add insulation to all exterior walls, as well as those which separate conditioned and non-conditioned spaces. Refer to ASHRAE Standard 90.1 for insulation guidelines.
- ❑ Add or improve insulation under floors, over garages or other conditioned areas. Refer to ASHRAE Standard 90.1 for insulation guidelines.
- ❑ Plant trees or shrubs near windows to shield sunlight.
- ❑ Consider adding reflective and/or heat absorbing film to glazing to reduce solar heat gains by as much as 80% during summer season. (Such films however, will substantially reduce benefits of natural lighting.)

- ❑ Consider adding reflective materials to window side of draperies to reflect solar heat when draperies are drawn.
- ❑ Install indoor shading devices where none exists, even if exterior shading devices are used. Use light-colored, opaque materials.
- ❑ Inspect all outdoor air dampers; they should be as airtight as possible when closed. Check operation of position indicators for accuracy. Install, repair, or replace position indicators as needed.
- ❑ Reduce outdoor air to minimum required to balance exhaust requirements, and maintain a slight positive pressure to retard infiltration-caused heat losses and heat gains.
- ❑ Establish a ventilation operation schedule so that exhaust system operates only when most needed.
- ❑ Reduce exhaust air quantities as practical.
- ❑ Turn off all non-critical exhaust fans.
- ❑ Use direct air supply to exhaust hoods.
- ❑ If food preparation area exhaust hood is oversized, adjust it so that no more than necessary is exhausted. This can be done easily by blocking off a portion of the hood, reducing fan speed, lowering hood, or by a combination of these techniques in compliance with applicable health regulations.
- ❑ Inspect filters carefully. If necessary, create a filter replacement schedule. Utilize high efficiency, low-cost filters.
- ❑ Supply ventilated air to parking garages to levels indicated by CO2 monitoring system.
- ❑ Reduce or eliminate need for using outdoor air for odor control by installing chemical or activated charcoal odor-absorbing devices.
- ❑ Use exhaust hoods in food preparation and laboratory areas only while operations are underway. Add control dampers or gravity dampers to keep air path in exhaust duct closed when fan is not operating.
- ❑ Consider cutting off direct outdoor supply to toilet rooms and other potentially “odorous” areas. Permit air from other areas through door grilles to be exhausted.
- ❑ Consider adding controls to shut down ventilation system whenever building is closed for an extended period, such as evenings or weekends – except when economizer cycle is in use.

- ❑ If a large occupant load is involved, consider installing remotely adjustable outside air dampers. These permit outside air volume to be adjusted proportionally to current occupancy.
- ❑ Size air handling grills, ducts, and coils to minimize air resistance.
- ❑ Centralize control of exhaust fans to ensure their shutdown.

Domestic Hot Water Equipment

Description

Loads are dependent upon customer counts but generally is about 1-8% of total energy

Equipment

Electric or gas water heater
Water heating heat pump
Storage tank(s)
Booster heater for dishwasher
Dishwasher system

Energy Conservation Measures

- * Inspect water supply system and insulation and repair all leaks.
- * Inspect water heater controls. If necessary regulate, repair or replace.
- * Increase insulation on hot water pipes and storage tanks.
- * Reduce temperature of hot water at faucets to 110 degrees if possible. Where special applications require hotter water, provide local booster heating rather than heating all water to meet special circumstances.
- * Hot water circulation systems should be time clocked. Hot water circulated during unoccupied periods is a waste of energy. Install a time clock control device to turn off circulating pumps during unoccupied periods.
- * Install water heating heat recovery equipment to preheat water.
- * Install refrigeration heat recovery equipment off the A/C or refrigeration equipment to preheat water.

Motors Equipment

Description

Weather and temperature dependent, generally between 5-20% of total energy

Equipment

Air conditioning equipment

Pumps, fans, miscellaneous motors

Ventilation exhausters for bathrooms/other

Kitchen exhaust ventilation systems

Make-up air recovery systems

Energy Conservation Measures

- Locate causes of electrical power demand charges, and reschedule plant operations to avoid peaks. Limit equipment start-up or operation to off-peak hours, if possible. For instance, a fuel storage tank may be filled at night rather than during the day.
- Shut down all elevators but one after normal working hours, or install sequential elevator controls.
- Prohibit and remove all personal coffeepots, fans, heaters, and unnecessary lamps.
- Reduce standby generating plant weekly test time as much as feasible.
- Use power for water temperature control during off-peak periods. Store heated/cooled water for use during peak demand periods.
- Check accuracy of power meter.
- De-energize excess transformer capacity.
- Reduce load on electric conductors to reduce heating losses.
- Balance three-phase power sources to motors. (Imbalance can cause motor to operate inefficiently and use more energy.)
- Check for packing wear that can cause excessive leakage. Repack to avoid excessive water waste and shaft erosion.
- Check for loose connections and bad contacts on a regular basis. Correct as necessary.
- Check alignment of motor to equipment drive. Align and tighten as necessary.

- ❑ Check for over-voltage or low voltage condition on motors. Correct as necessary. (Operating at only 10% over-voltage can reduce motor operating efficiency by 5% to 6%.)
- ❑ Lubricate motor and drive bearings on a regular basis to help reduce friction and excessive torque (and related overheating and power losses).
- ❑ Replace worn bearings.
- ❑ Check for overheating, which can indicate a functional problem or lack of adequate ventilation.
- ❑ Check for excessive noise and vibration. Determine cause and correct as necessary.
- ❑ Inspect bearings and drive belts. Adjust or replace as necessary to ensure proper operation. Proper belt tension is critical. Tighten belts and pulleys to eliminate excessive losses.
- ❑ Inspect inlet and discharge screens on fans; keep free of dirt and debris at all times.
- ❑ Keep fan blades clean.
- ❑ Keep motors clean.
- ❑ Investigate use of time switches to limit water cooler operation and vending machine illumination to normal occupancy building hours.
- ❑ Use photocell controls rather than time clocks on security lights.
- ❑ Reduce load on electric conductors by reducing resistance and inductance whenever possible to reduce heating losses.
- ❑ Increase electrical conductor size to reduce distribution losses.
- ❑ Check all magnetic contractors for dropout voltage. Utility voltage reductions may cause some contractors to drop out, thus requiring both time-and power-wasting restarts. Most contractor manufacturers can provide “blowout-proof” coils.
- ❑ Consider power loss, as well as initial loads and load growth, in sizing transformers.
- ❑ Correlate motor size with load to improve power factor and efficiency.
- ❑ Optimize plant power factor.

Refrigeration Equipment

Description

Steady consistent load generally between 1-10% of total energy

Equipment

Walk in Freezer

Walk in Cooler

Multiple Reach in cases

Reach in freezer

Ice makers(s)

Energy Conservation Measures

- ❑ Insure efficient operation of refrigeration systems by regularly maintaining systems to insure proper refrigerant levels, pressures and temperatures are maintained. This insures the system is running efficiently.
- ❑ Replace seals to insure tight fit. This prevents refrigerant air from leaking.
- ❑ Install plastic strip curtains on freezers and coolers. This reduces air leakage when doors are opened and closed.
- ❑ Clean condenser coils regularly. This permits proper airflow across coils.
- ❑ Clean evaporator coils regularly. This permits proper airflow across coils.
- ❑ Increase refrigeration temperatures if possible. This will reduce loads on the compressor and save energy.
- ❑ Install heat recovery systems. This will reduce the load on the refrigeration system.
- ❑ Install more efficient refrigeration equipment and controls as economically feasible.