

# INTERSTATE INTERCHANGES AND REST AREAS

Siskiyou Summit – Exit 1

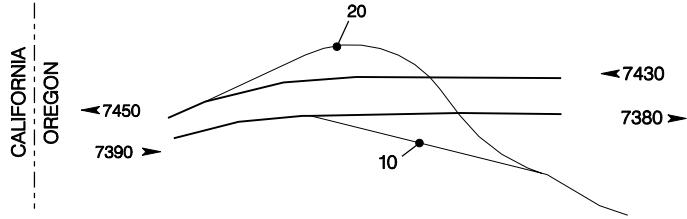

Siskiyou Hwy. – Exit 5

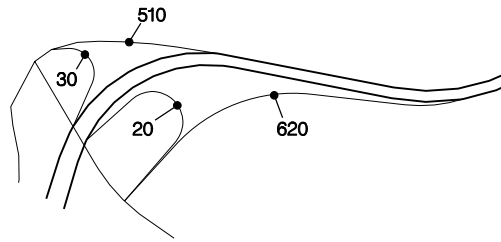

15-002  
Neil Creek ATR  
MP 11.03  
◀ 7910  
7980 ▶

South Ashland – Exit 11

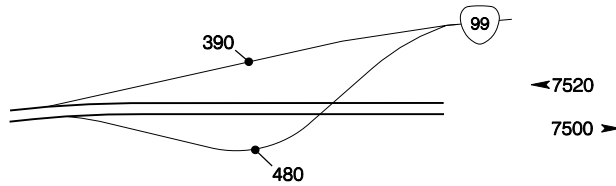

Green Springs – Exit 14

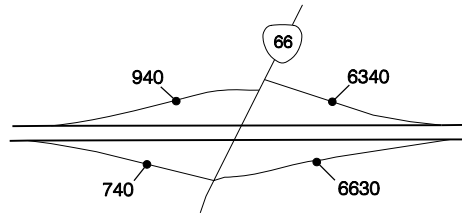

North Ashland – Exit 19

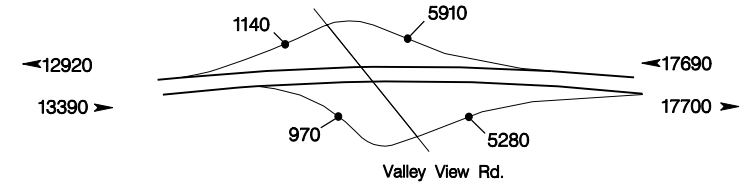

West Valley View – Exit 21

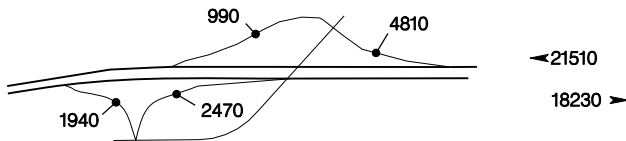

Suncrest Rest Area – Exit 22



Phoenix – Exit 24

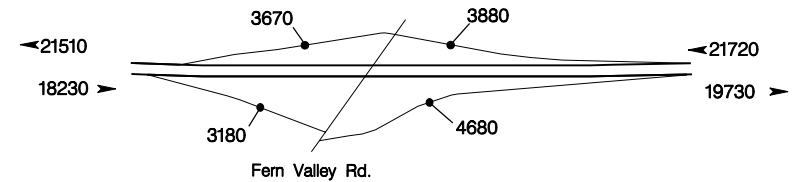

# INTERSTATE INTERCHANGES AND REST AREAS

Barnett Road – Exit 27

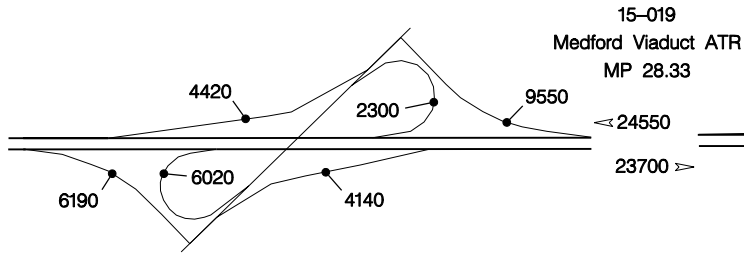

Crater Lake Hwy. – Exit 30

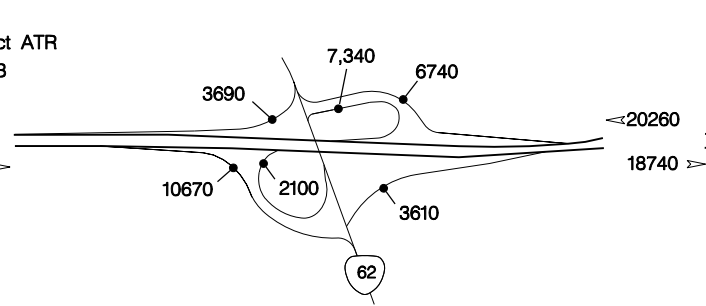

Central Point – Exit 32

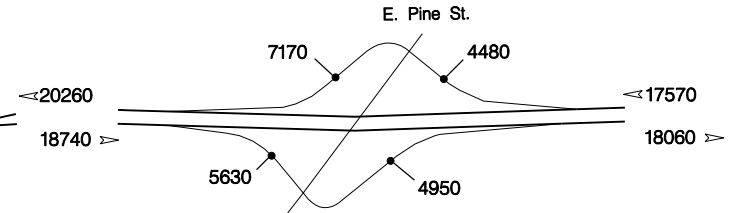

Seven Oaks – Exit 35

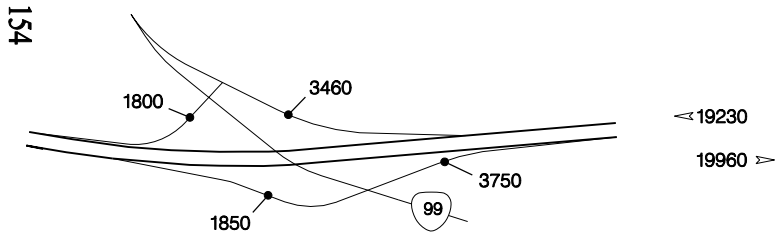

Kane Creek – Exit 40

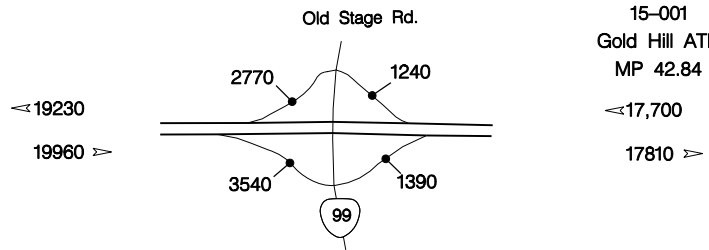

Rock Point – Exit 43

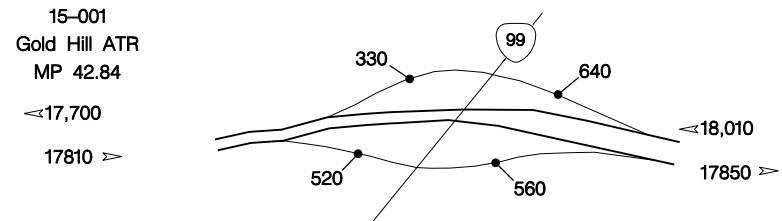

Homestead – Exit 45A

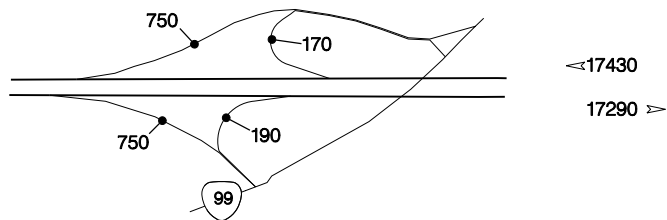

Valley Of The Rogue Rest Area – Exit 45B

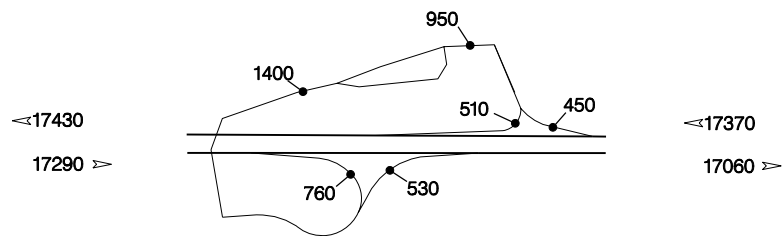

# INTERSTATE INTERCHANGES AND REST AREAS

Roque River – Exit 48

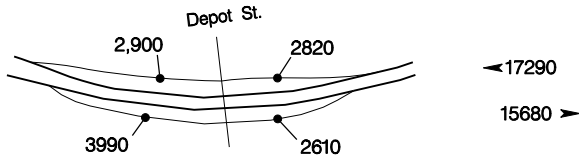

East Grants Pass – Exit 55

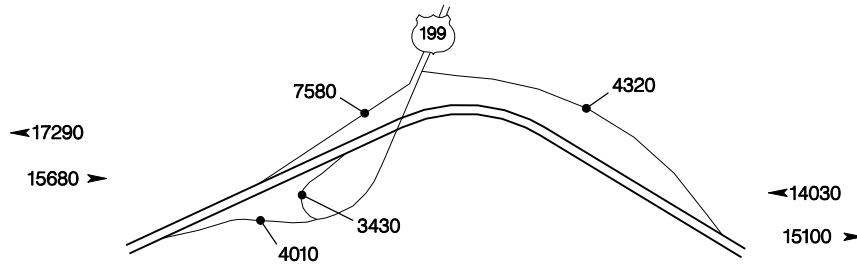

North Grants Pass – Exit 58

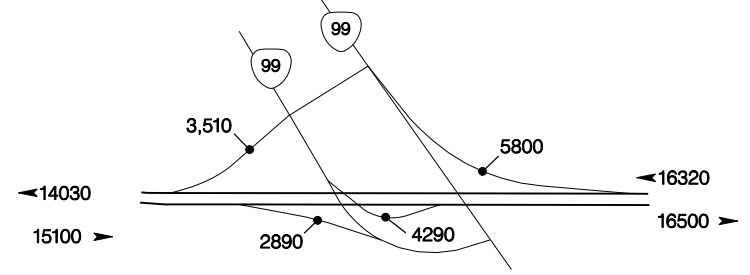

Louse Creek – Exit 61

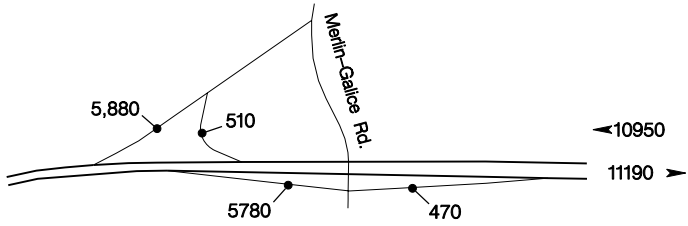

Manzanita Rest Area – Exit 62A, 62B

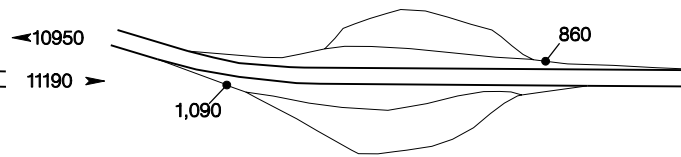

Jumpoff Joe – Exit 66

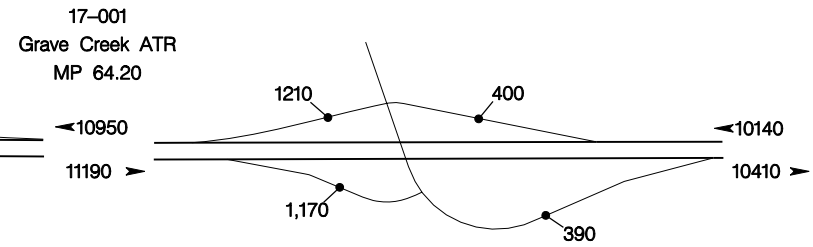

Sunny Valley – Exit 71

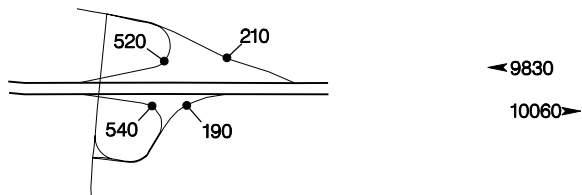

South Wolf Creek – Exit 76A



North Wolf Creek – Exit 76B

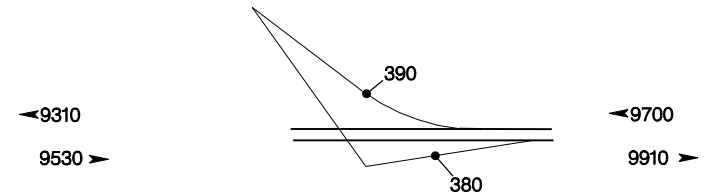

155

# INTERSTATE INTERCHANGES AND REST AREAS

Speaker Road – Exit 78

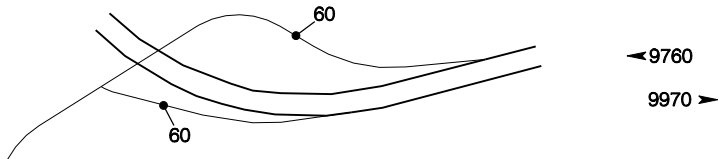

Glendale – Exit 80

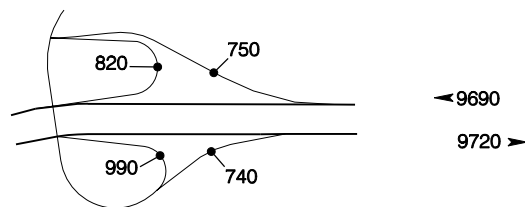

Cow Creek Rest Area – Exit 81

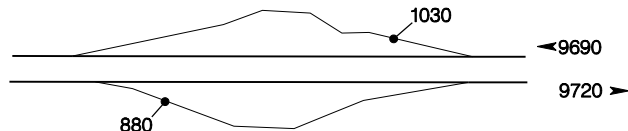

Barton Road – Exit 83

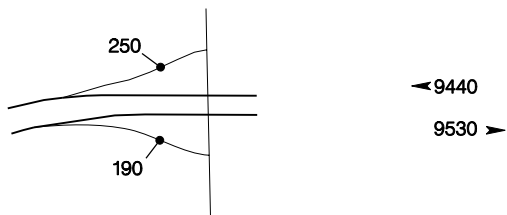

Quines Creek – Exit 86

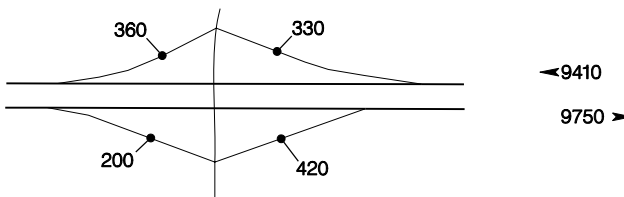

Azalea – Exit 88

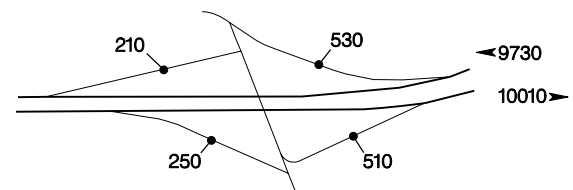

West Fork – Exit 95

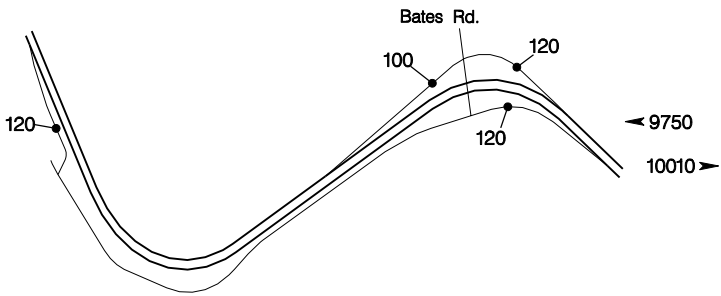

Canyonville – Exit 98

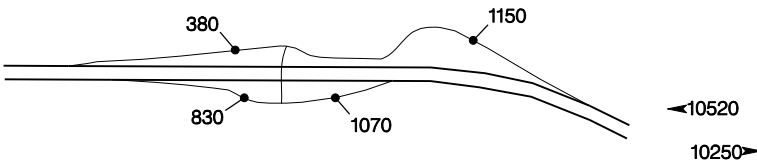

156

# INTERSTATE INTERCHANGES AND REST AREAS

North Canyonville – Exit 99

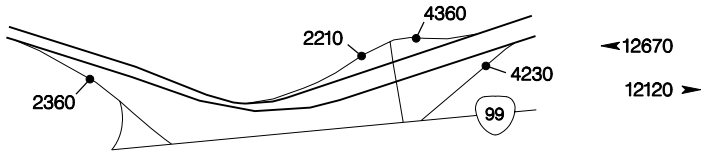

Yokum Road – Exit 101A

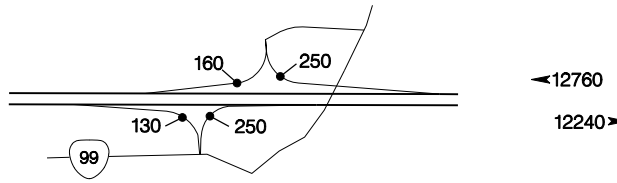

Gazely Road – Exit 101B

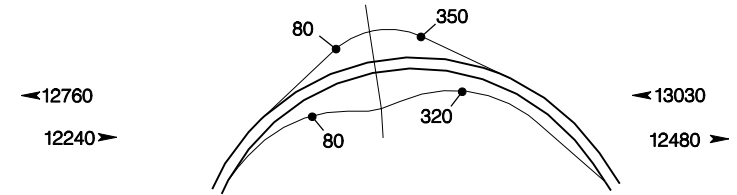

Riddle Road – Exit 103

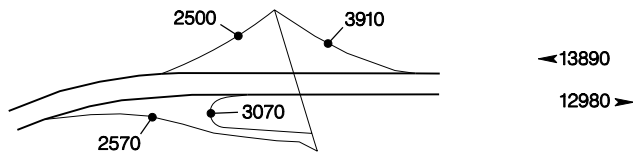

Weaver Road – Exit 106

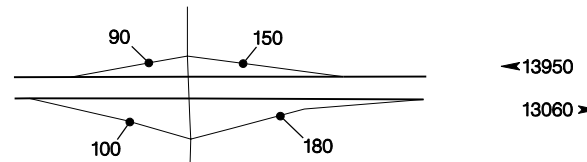

Myrtle Creek – Exit 108

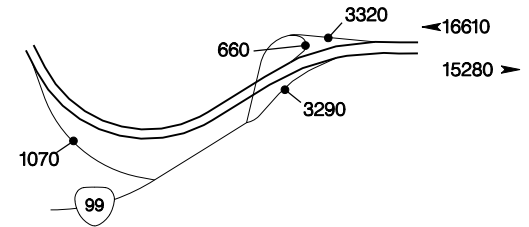

Boomer Hill Road – Exit 110

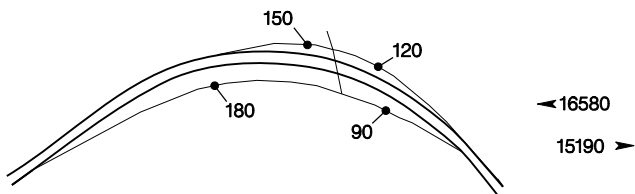

South Umpqua Rest Area – Exit 111B

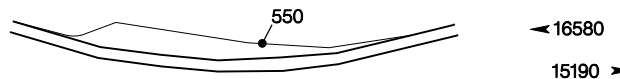

Dillard Hwy. – Exit 112

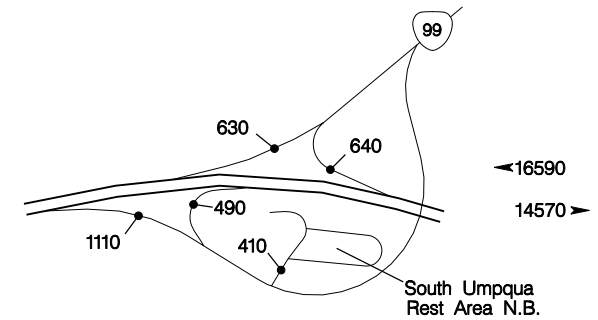

# INTERSTATE INTERCHANGES AND REST AREAS

Clarks Branch – Exit 113

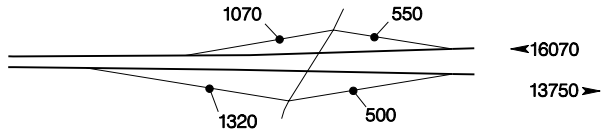

Coos Bay – Roseburg Hwy. – Exit 119

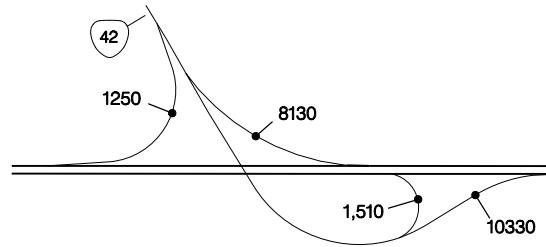

Oakland – Shady Hwy. – Exit 120

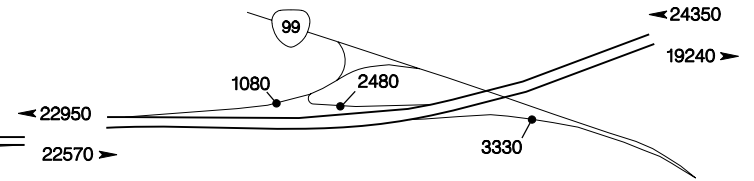

McLain Ave. – Exit 121



Fairgrounds – Exit 123

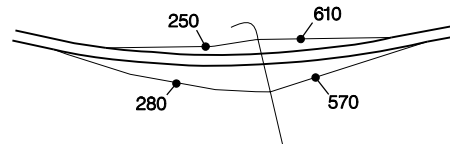

Harvard – Exit 124

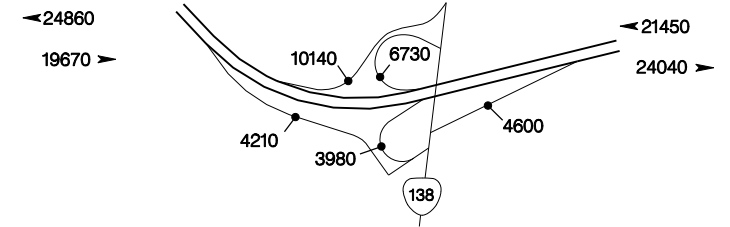

Garden Valley – Exit 125

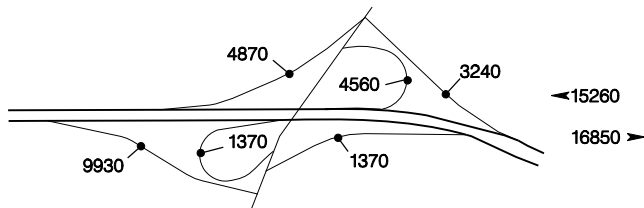

North Roseburg – Exit 127

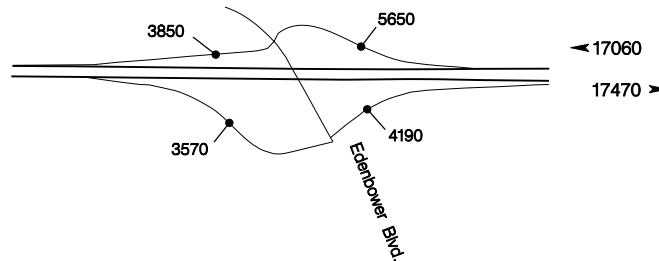

# INTERSTATE



# INTERCHANGES AND REST AREAS

### Winchester – Exit 129

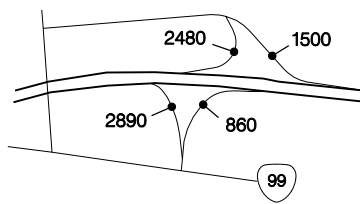

10-005  
Roseburg ATR  
MP 129.75

←16080  
15440 →

### Deady – Exit 135

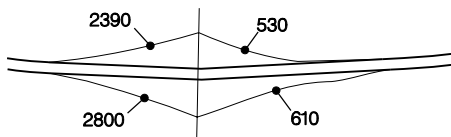

←14220  
13250 →

### Sutherlin – Exit 136

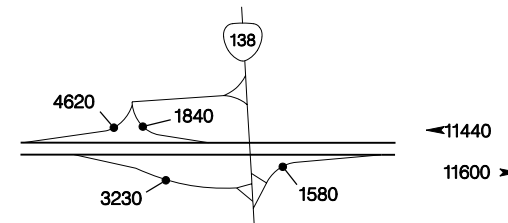

←11440  
11600 →

### South Oakland – Exit 138

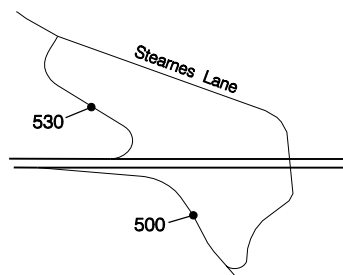

159

### North Oakland – Exit 140

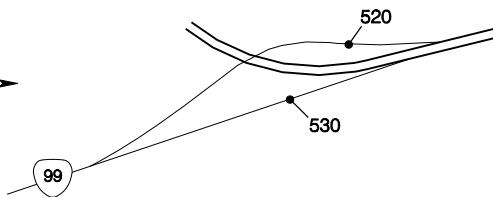

←10910  
11100 →

### Metz Hill – Exit 142A

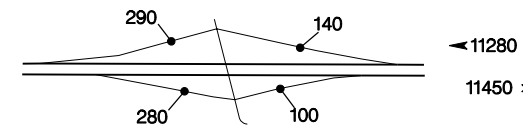

←11430  
11630 →

### Cabin Creek Rest Area NB – Exit 142B



←11280  
11450 →

### Cabin Creek Rest Area SB – Exit 143



10-007  
Oakland ATR  
MP 145.39

←11280  
11450 →

### South Rice Hill – Exit 146

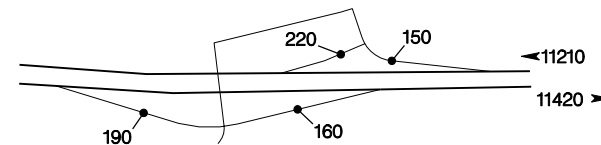

←11210  
11420 →

# INTERSTATE INTERCHANGES AND REST AREAS

Rice Hill – Exit 148

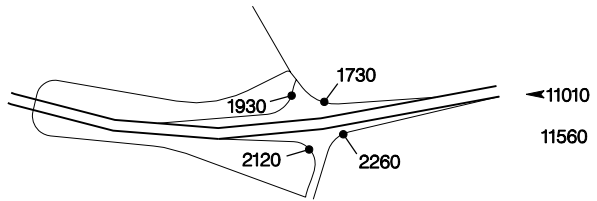

Yoncalla – Exit 150

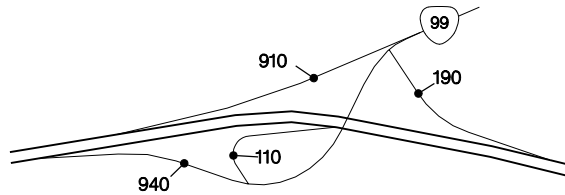

Elkhead Road – Exit 154

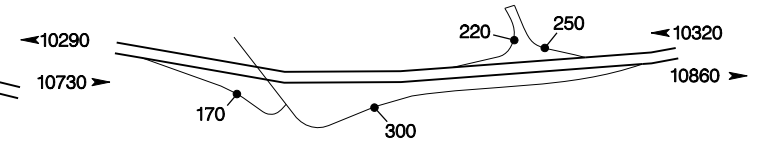

Elk Creek / Cox Road – Exit 159

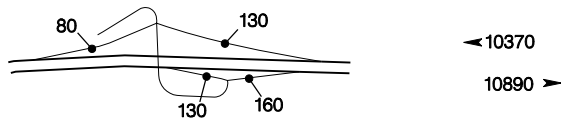

Salt Springs Road – Exit 160

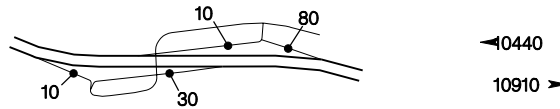

Buck Creek – Exit 161

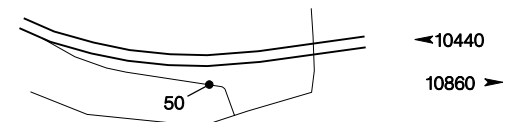

Umpqua Hwy. – Exit 162

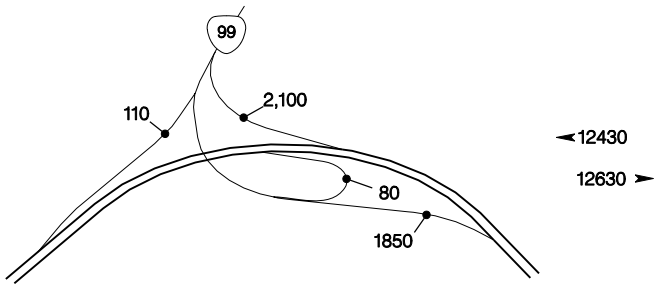

Curtin – Exit 163

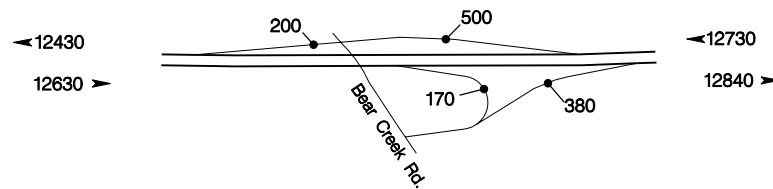

160



# INTERSTATE INTERCHANGES AND REST AREAS

Goshen – Divide Highway – Exit 168

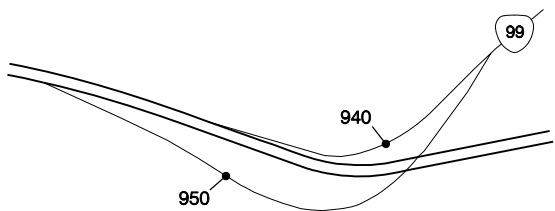

20-020  
Martins Creek ATR  
MP 169.20

←11790  
11890 →

London Road – Exit 172

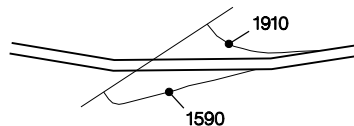

←13700  
13480 →

Cottage Grove – Exit 174

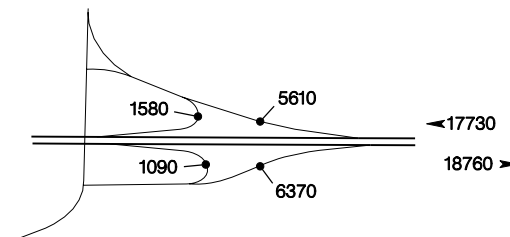

←17730  
18760 →

Saginaw – Exit 176

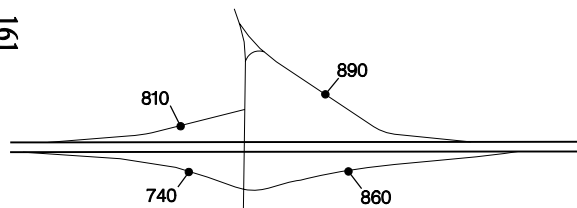

←17810  
18880 →

Gettings Creek Rest Area – Exit 177, 178

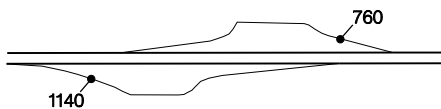

←17810  
18880 →

Creswell – Exit 182

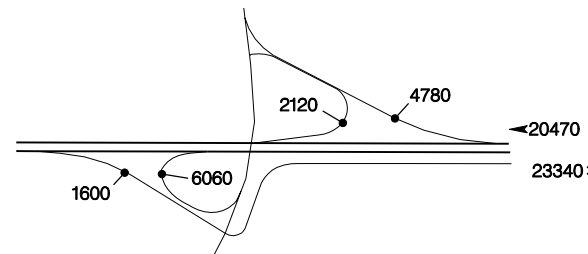

←20470  
23340 →

Dillard Road – Exit 186

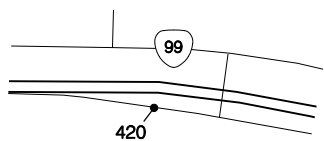

←20470  
22920 →

Goshen – Exit 188

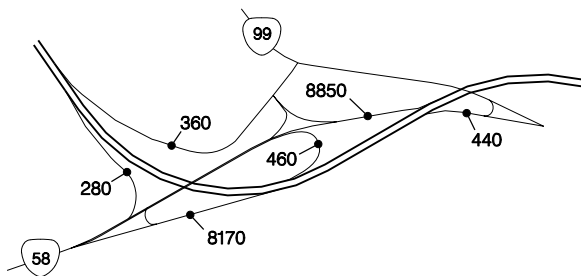

←28500  
30370 →

Bonneville Power – Exit 189

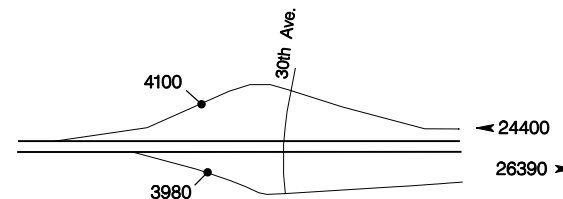

←24400  
26390 →

161

# INTERSTATE 5 INTERCHANGES AND REST AREAS

McVay Hwy. – Exit 190

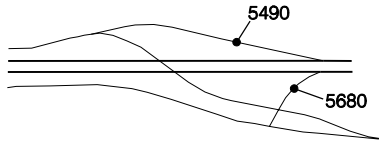

Judkins Point – Exit 191

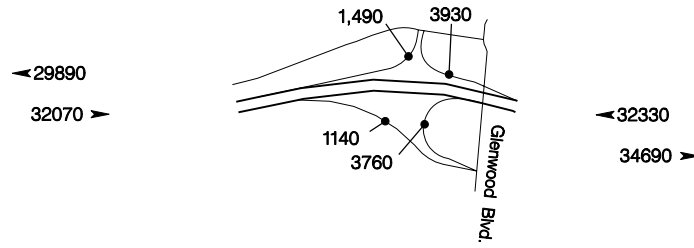

Pacific Hwy. West – Exit 192

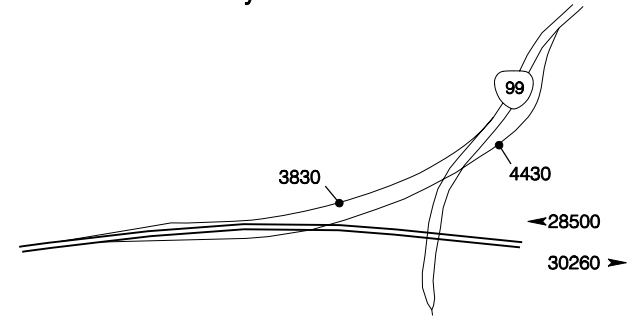

"Q" Street – Exit 194

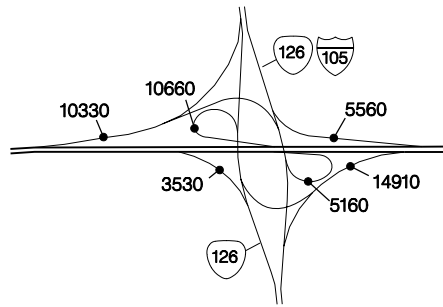

Belt Line Hwy. – Exit 195

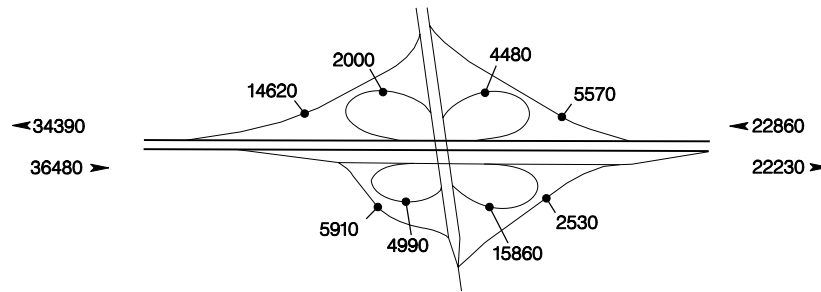

Van Duyn Road – Exit 199

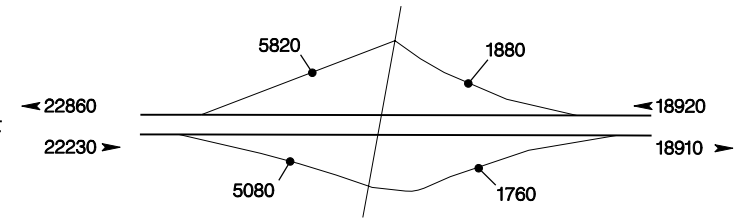

Oak Grove Rest Area – Exit 206B

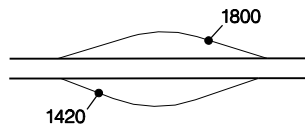

Diamond Hill – Exit 209

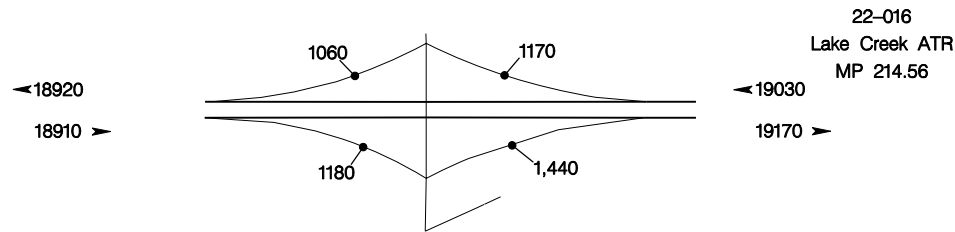

# INTERSTATE INTERCHANGES AND REST AREAS

Halsey – Sweethome – Exit 216

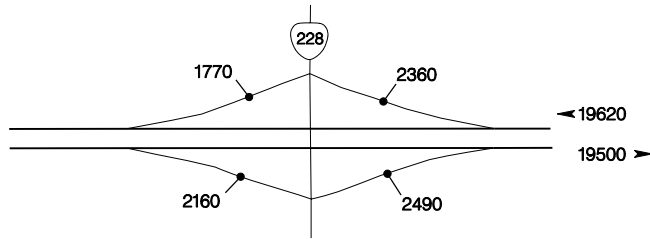

Corvallis – Lebanon Hwy. – Exit 228

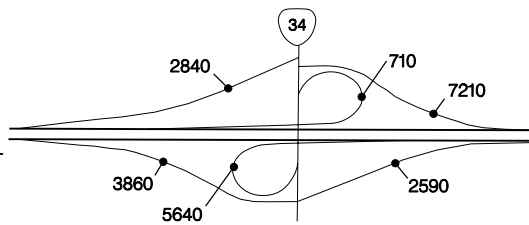

Santiam Hwy. – Exit 233

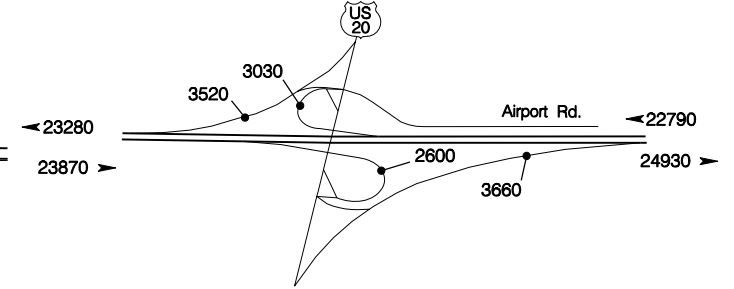

North Albany – Exit 234

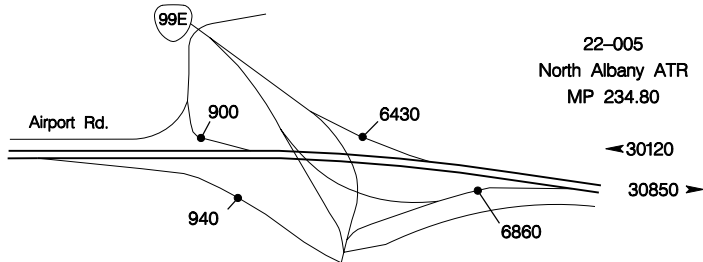

Murder Creek – Exit 235

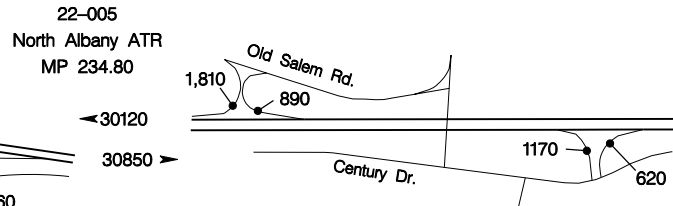

Viewcrest – Exit 237

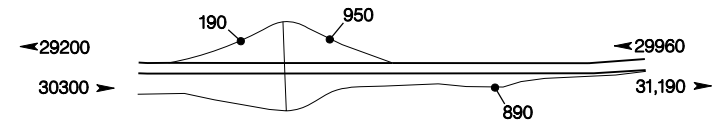

South Jefferson – Exit 238

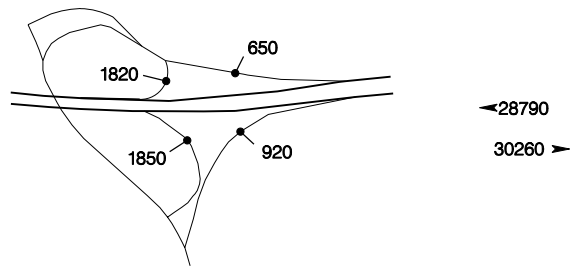

Dever Road – Exit 239

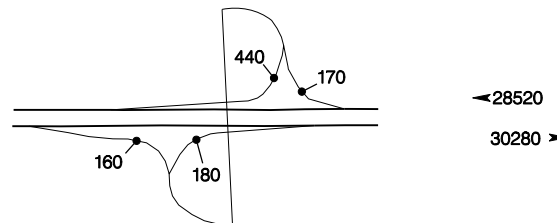

# INTERSTATE INTERCHANGES AND REST AREAS

Santiam Rest Area – Exit 241

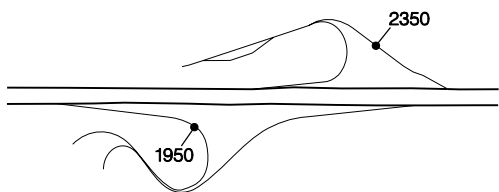

Talbot Road – Exit 242

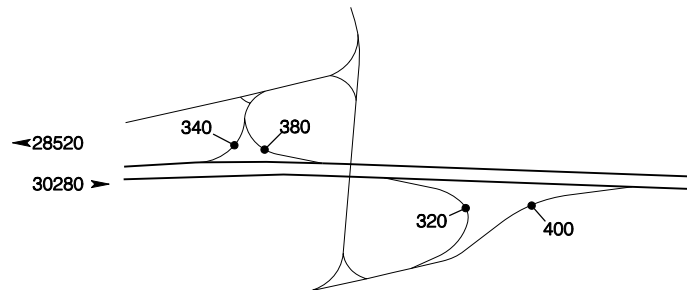

Ankeny Hill – Exit 243

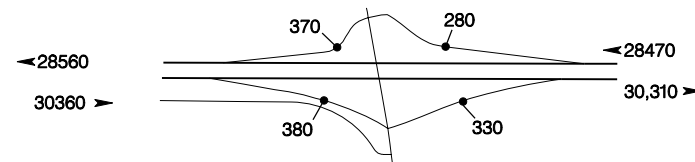

Jefferson Hwy. – Exit 244

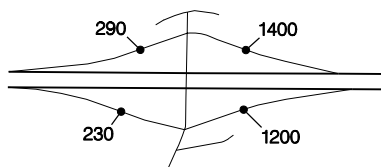

Battle Creek – Exit 248

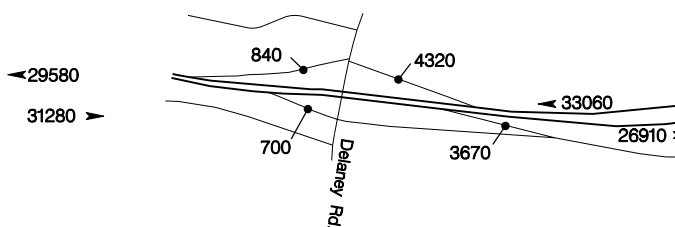

Commerical Street – Exit 249

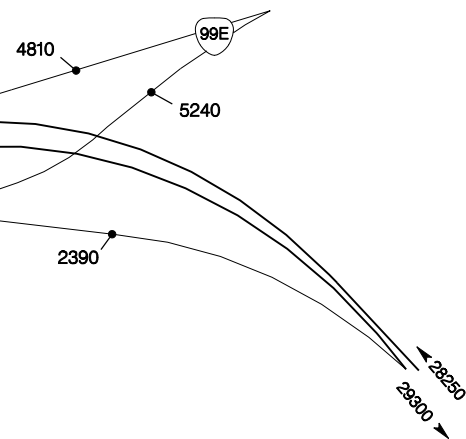

Kuebler – Exit 252

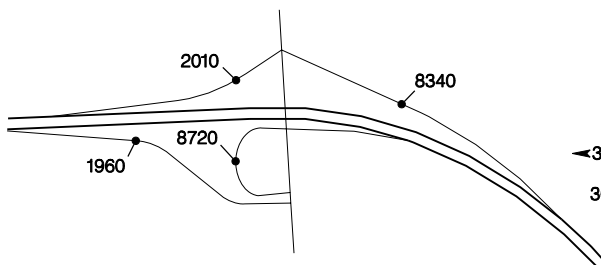

North Santiam – Exit 253

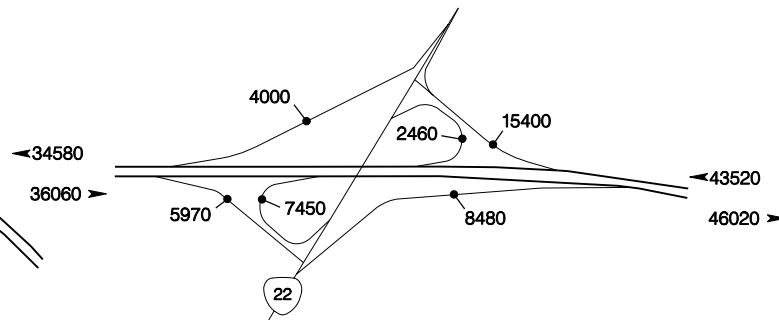

# INTERSTATE INTERCHANGES AND REST AREAS

Market Street – Exit 256

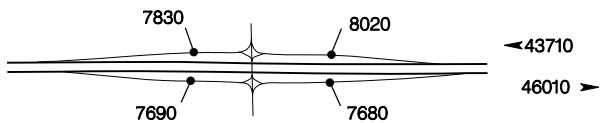

Hayesville – Exit 258

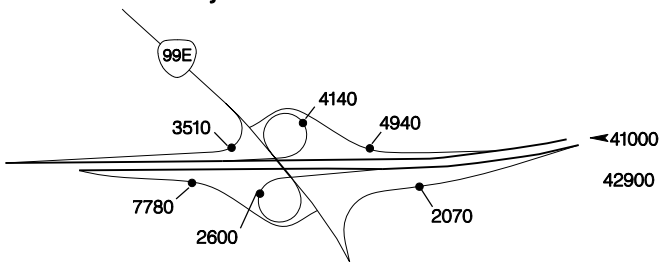

Chemawa Road – Exit 260

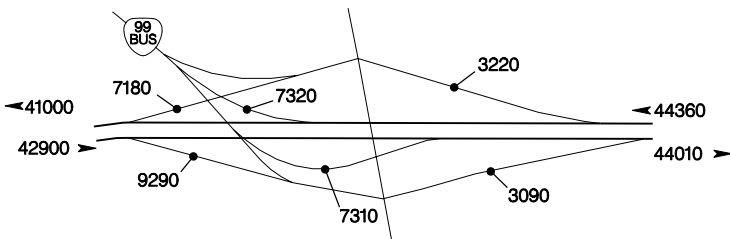

Brooks – Exit 263

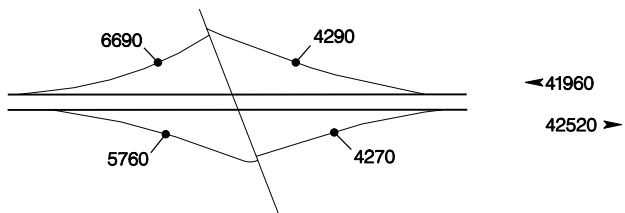

Woodburn – Exit 271

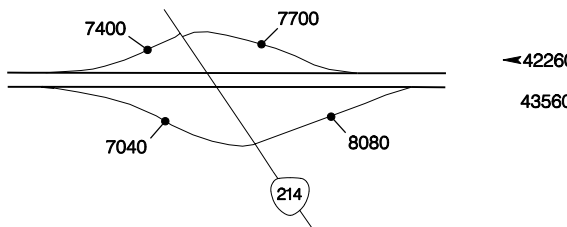

Fargo Road – Exit 278

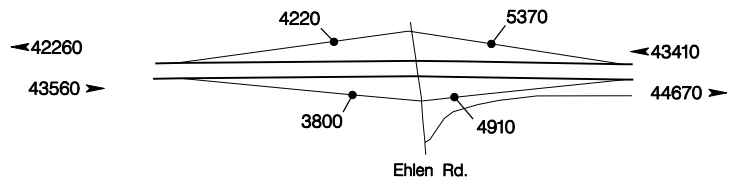

Baldock Rest Area – Exit 281B

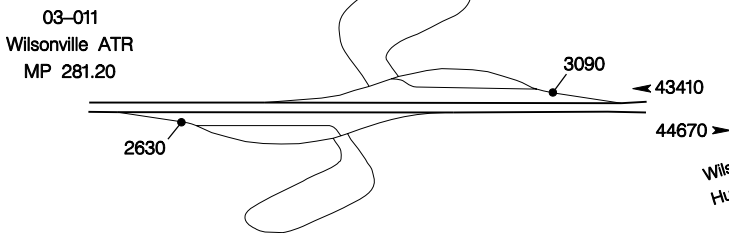

Hubbard – Exit 282

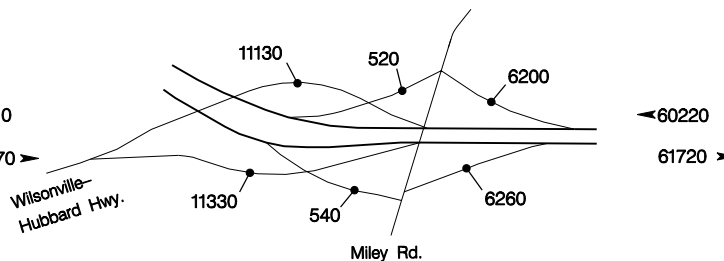

Wilsonville – Exit 283

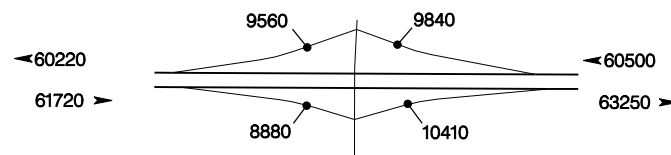

165

# INTERSTATE INTERCHANGES AND REST AREAS

Stafford Road – Exit 286

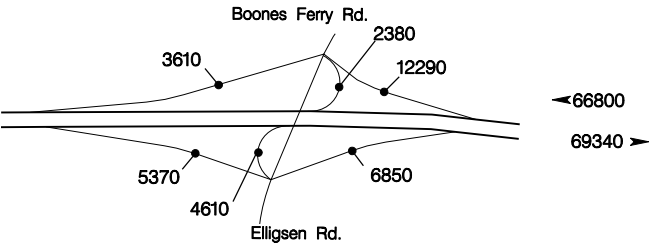

East Portland Freeway – Exit 288

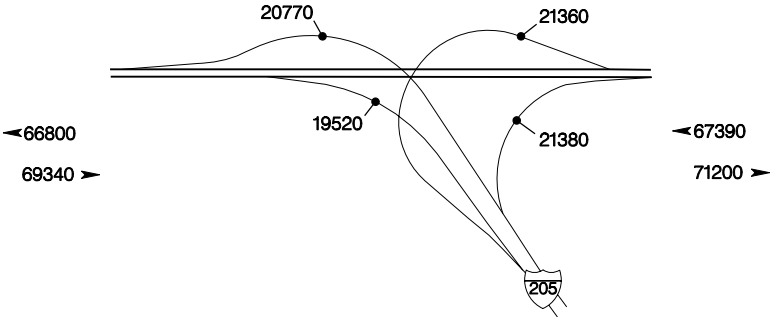

Nyberg Road – Exit 289

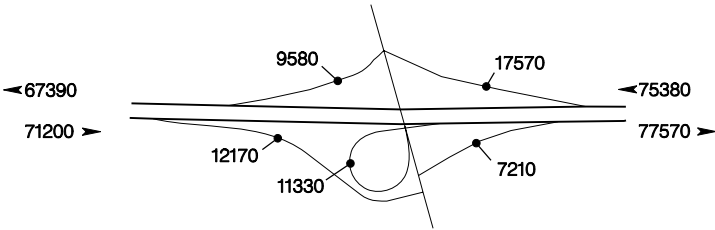

Lower Boones Ferry Road – Exit 290

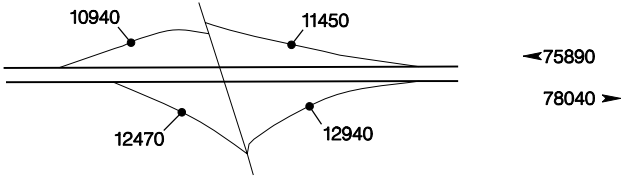

Upper Boones Ferry Road – Exit 291

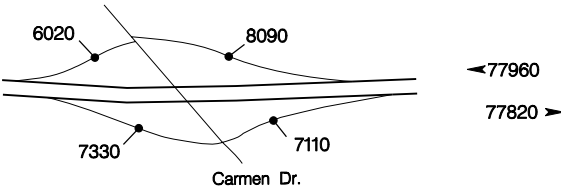

South Tigard – Exit 292

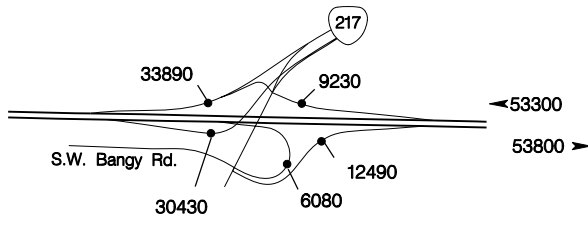

166

Haines Road – Exit 293

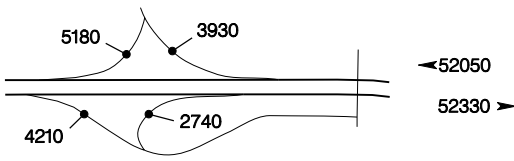

North Tigard – Exit 294

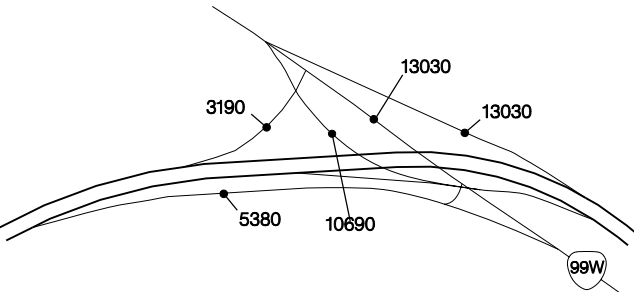

Capitol Highway – Exit 295A

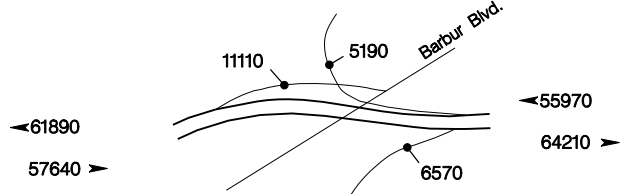

# INTERSTATE INTERCHANGES AND REST AREAS

Taylor's Ferry Road – Exit 295B

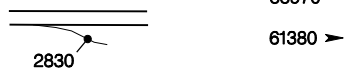

Spring Garden

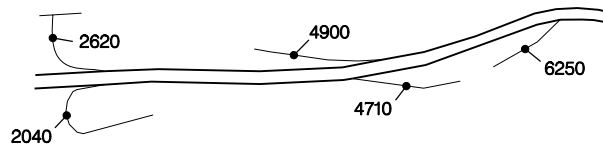

Multnomah Blvd. – Exit 296

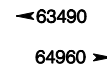

Terwilliger Blvd. – Exit 297

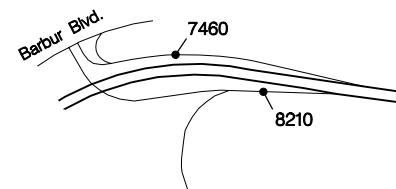

26-016  
Iowa ATR  
MP 298.24

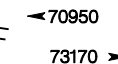

Corbett Avenue – Exit 298

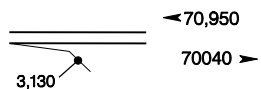

West Marquam – Exit 300

Oswego Highway – Exit 299

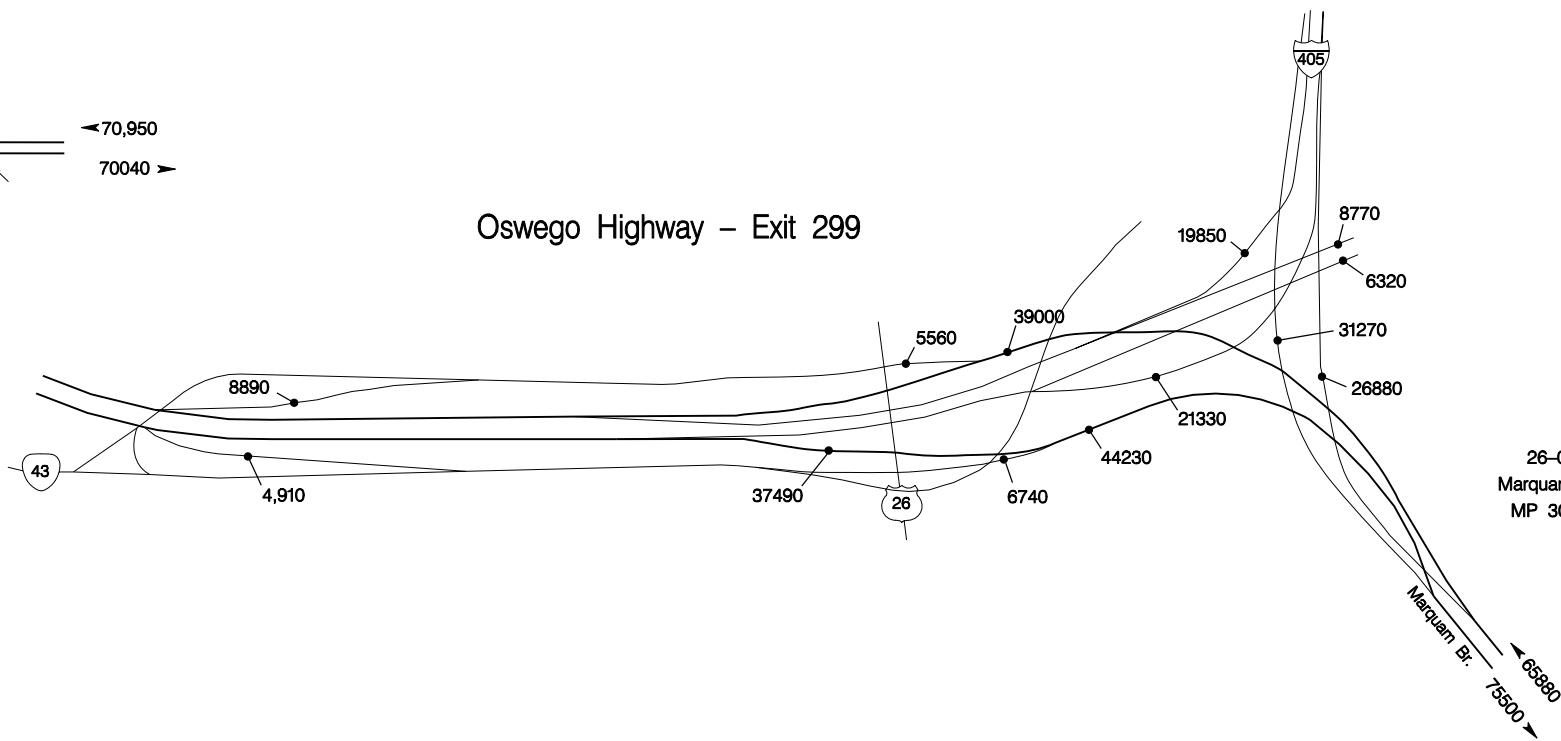

26-026  
Marquam ATR  
MP 300.37

# INTERSTATE INTERCHANGES AND REST AREAS

Columbia River Highway – Exit 301

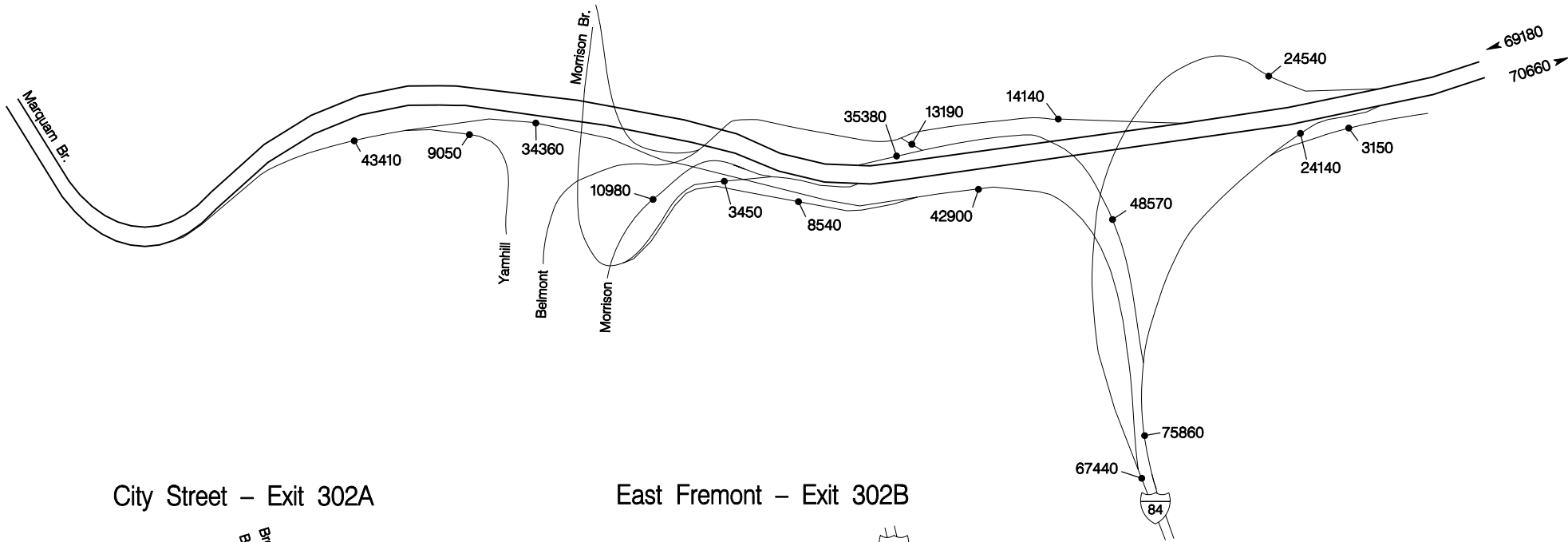

City Street – Exit 302A

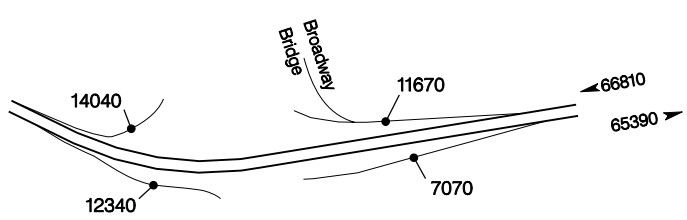

East Fremont – Exit 302B

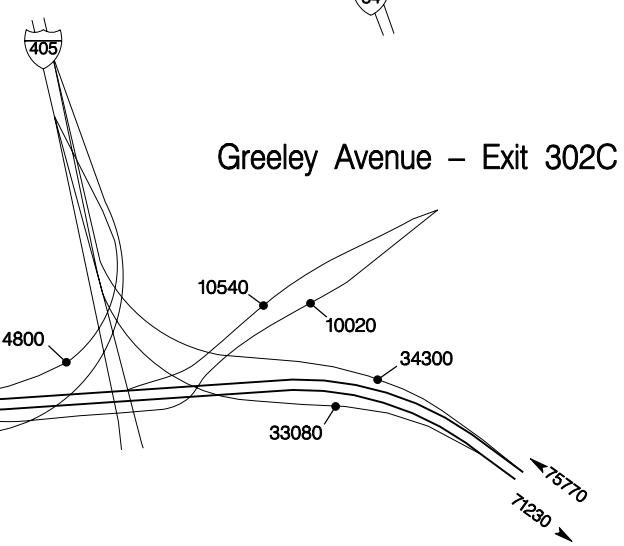

Greeley Avenue – Exit 302C

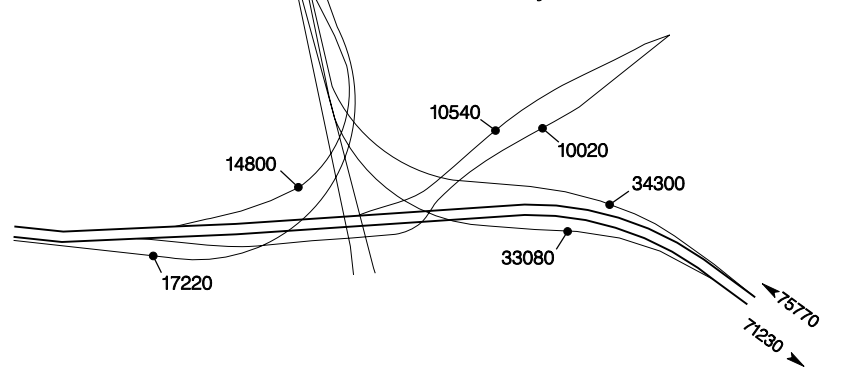



# INTERSTATE INTERCHANGES AND REST AREAS

Going Street – Exit 303

Minnesota Avenue – Exit 304A

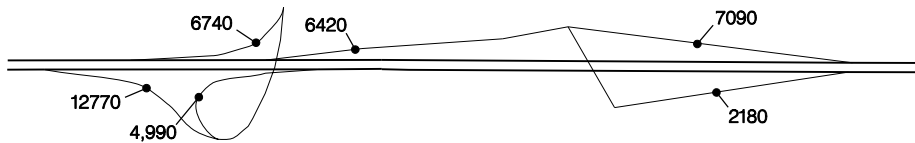

26-019  
Minnesota ATR  
MP 304.66

← 69700  
65630 →

Portland Blvd. – Exit 304B

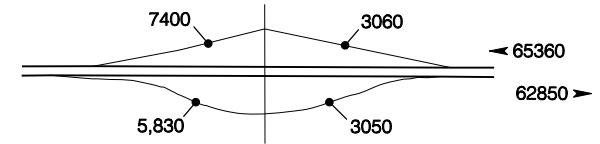

N.E. Portland – Exit 305A

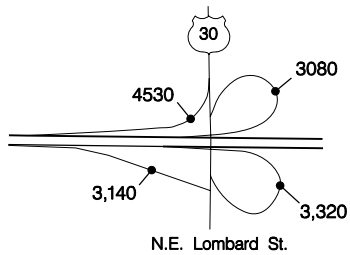

← 57750  
56390 →

Columbia Blvd. – Exit 305B

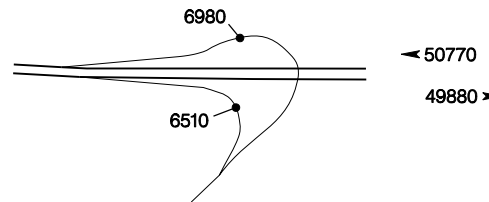

169

Delta Park – Exit 306

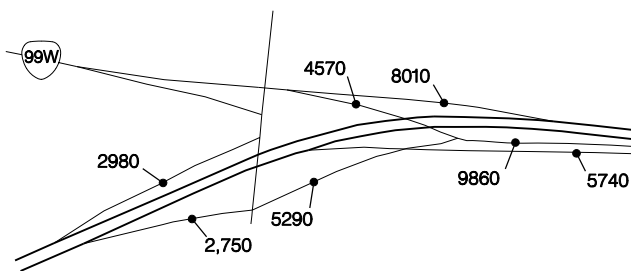

Swift-Union – Exit 307

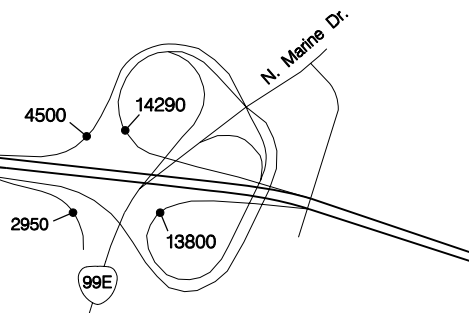

Jantzen Beach – Exit 308

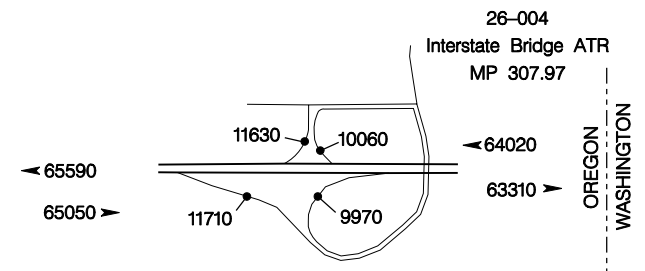

26-004

Interstate Bridge ATR  
MP 307.97

# INTERSTATE INTERCHANGES AND REST AREAS

Pacific Hwy. Exit 0

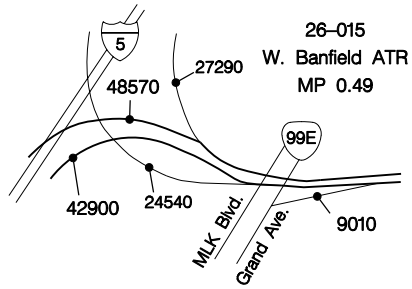

← 75860  
76450 ➤

NE Holladay St. – Exit 1A

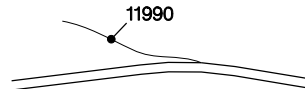

← 87850  
76450 ➤

NE 16th Ave. – Exit 1B

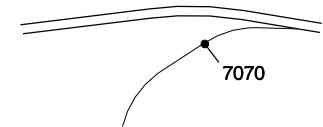

← 87850  
83520 ➤

NE 33rd Ave. – Exit 2A

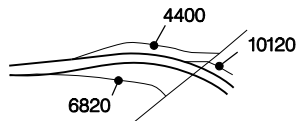

← 73330  
76700 ➤

NE 39th Ave. – Exit 2B

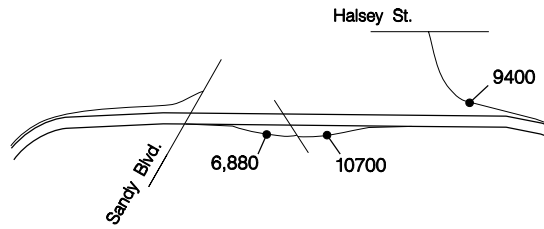

← 82730  
80520 ➤

NE Glisan St. – Exit 3

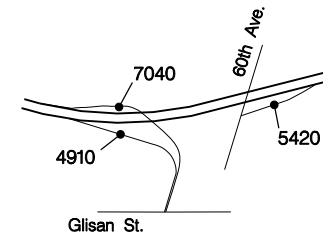

← 75690  
81030 ➤

NE 68th Ave. – Exit 4



← 75690  
77680 ➤

Cascade Hwy. – Exit 5A

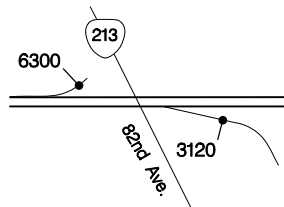

← 69390  
74560 ➤

# INTERSTATE INTERCHANGES AND REST AREAS

Hwy. 64 – Exit 5B

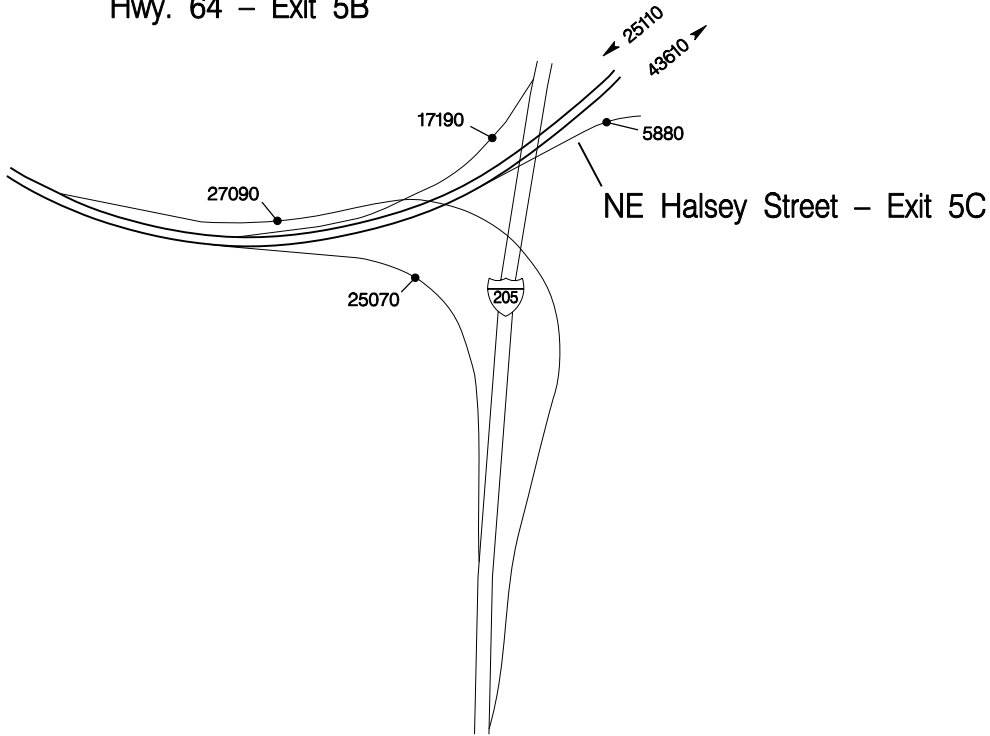

North Banfield – Exit 6A

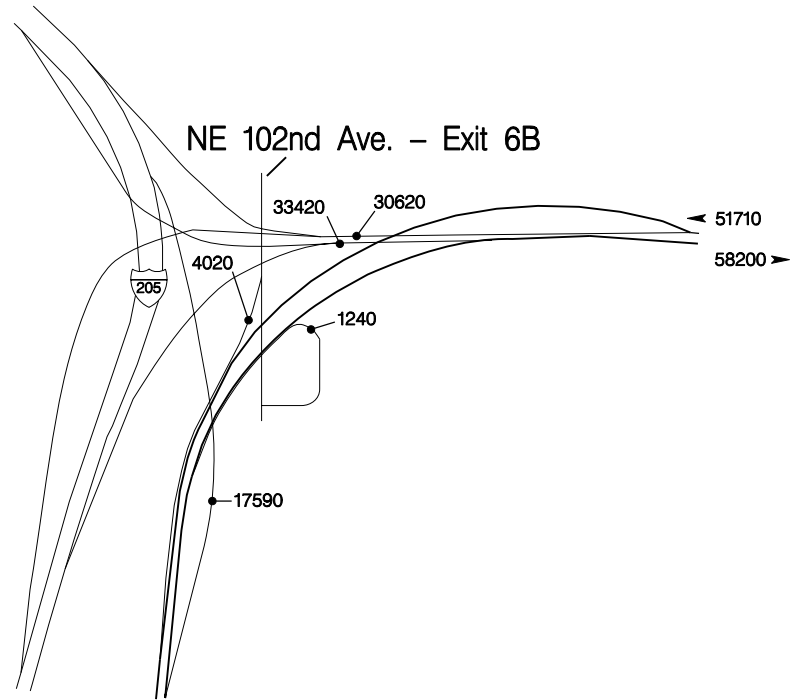

NE 122nd Ave. – Exit 10

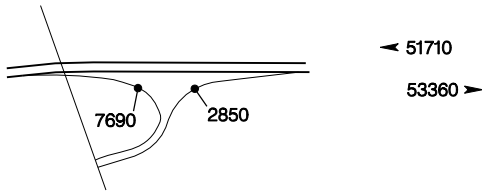

NE 181st Ave. – Exit 13

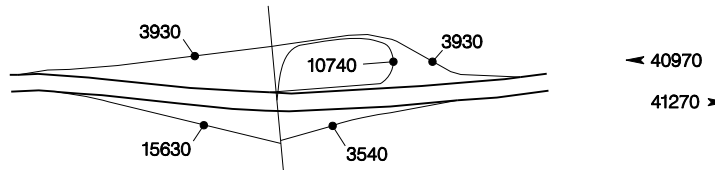

# INTERSTATE INTERCHANGES AND REST AREAS

NE 207th Ave. – Exit 14

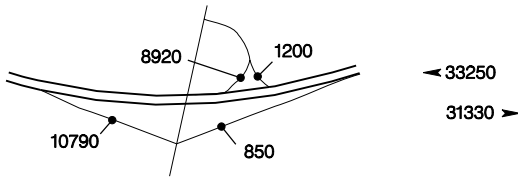

NE 238th Ave. – Exit 16A

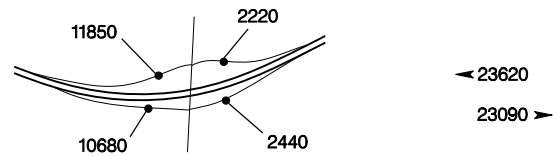

NE Marine Drive – Exit 17

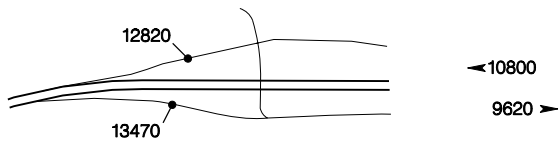

Troutdale – Exit 17

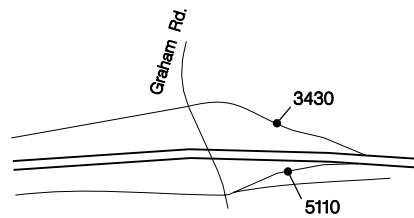

26-001  
Troutdale ATR  
MP 17.71

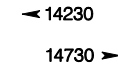

Jordan – Exit 18

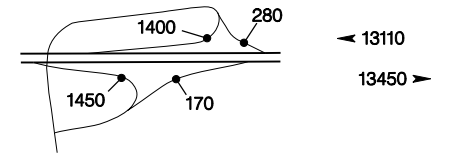

Corbett – Exit 22

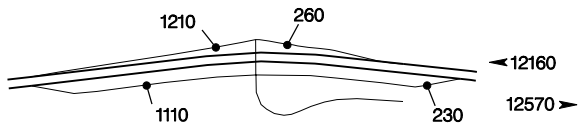

Rooster Rock – Exit 24

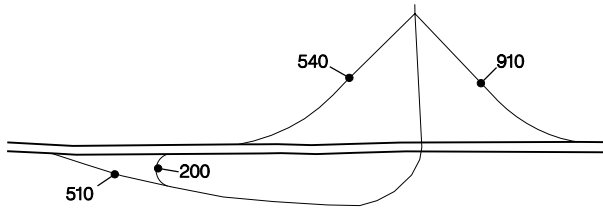

Bridal Veil – Exit 28

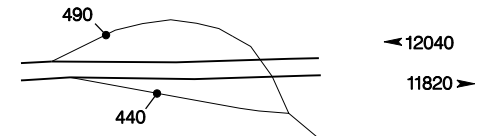

# INTERSTATE INTERCHANGES AND REST AREAS

Multnomah Falls – Exit 31

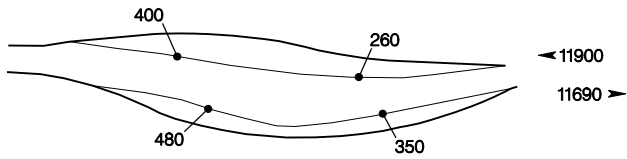

Historic Col. River Hwy. – Exit 35A

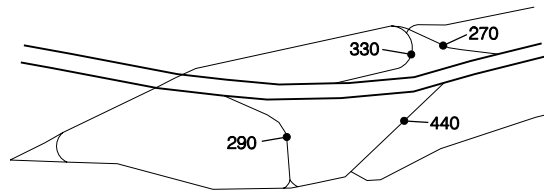

Warrendale O'King – Exit 37

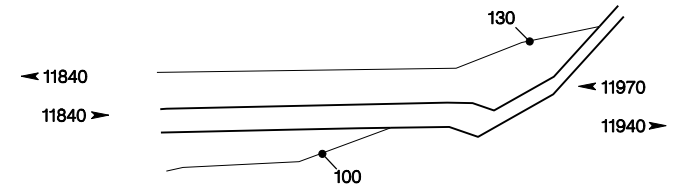

Bonneville Dam – Exit 40

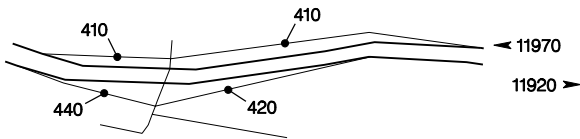

West Cascade Locks – Exit 43

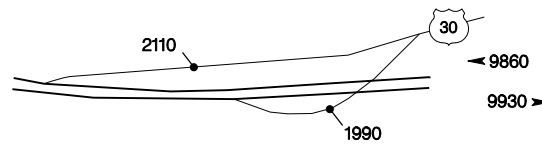

East Cascade Locks – Exit 45

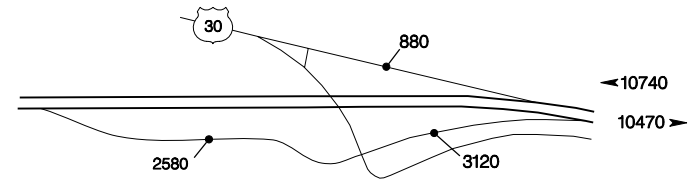

Herman Creek – Exit 47

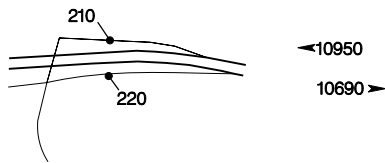

Wyeth – Exit 50

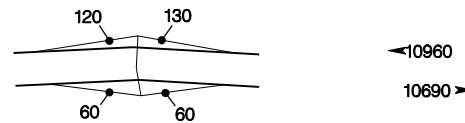

Starvation Creek State Park – Exit 54

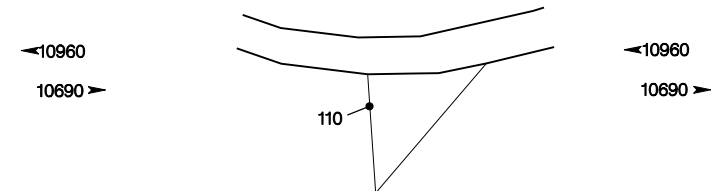

# INTERSTATE INTERCHANGES AND REST AREAS

Viento State Park – Exit 56

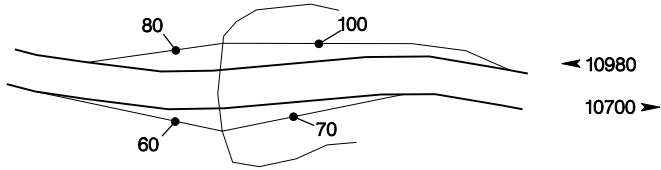

Mitchell Point – Exit 58

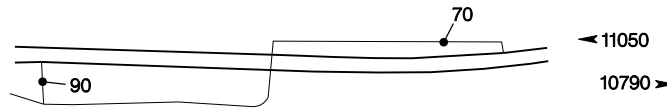

West Hood River – Exit 62

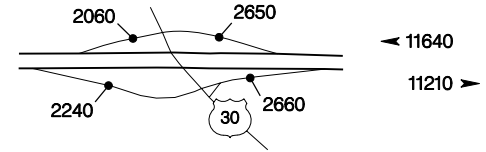

2nd Street – Exit 63

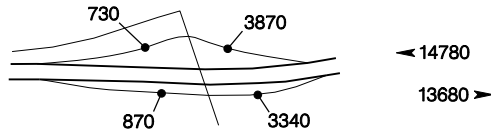

East Hood River – Exit 64

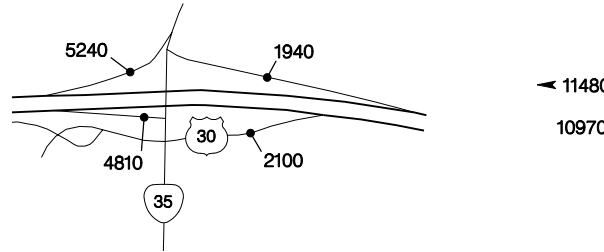

Mosier – Exit 69

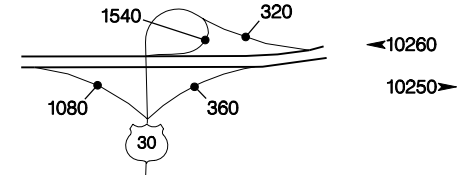

Memaloose Rest Area – Exit 72, 73

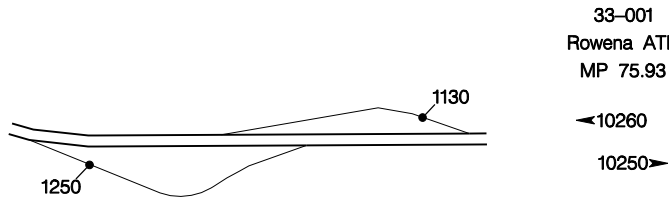

33-001  
Rowena ATR  
MP 75.93

Rowena – Exit 76

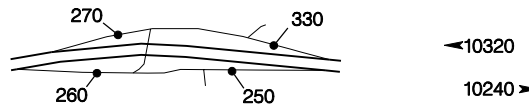

Chenoweth – Exit 82

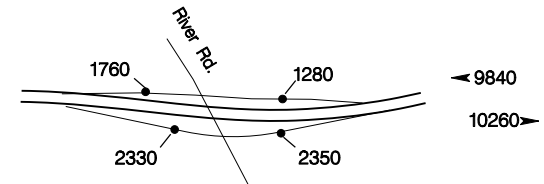

# INTERSTATE INTERCHANGES AND REST AREAS

West The Dalles – Exit 83

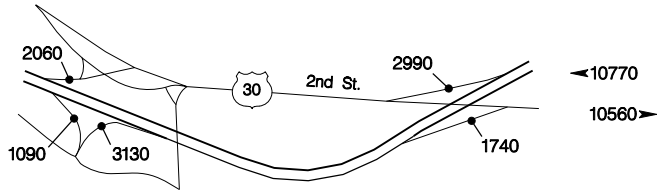

Brewery Grade – Exit 85

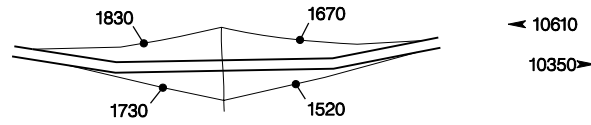

The Dalles Bridge – Exit 87

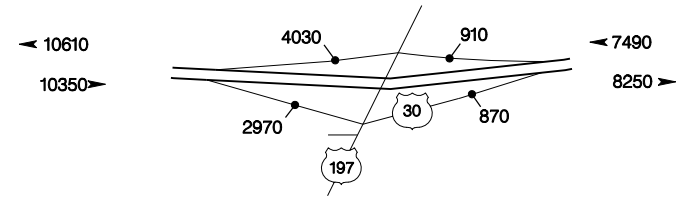

The Dalles Dam – Exit 88

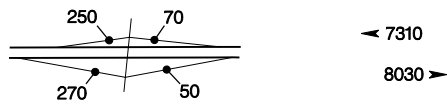

Celilo–Wasco Hwy. – Exit 97

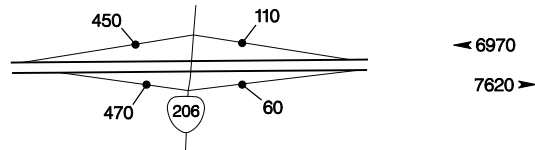

Biggs Jct. – Exit 104

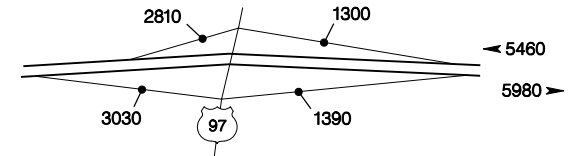

Rufus – Exit 109

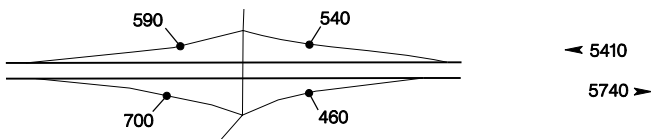

West John Day – Exit 114

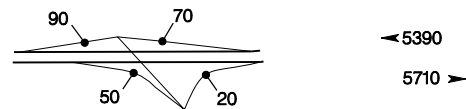

# INTERSTATE INTERCHANGES AND REST AREAS

Philippi Canyon – Exit 123

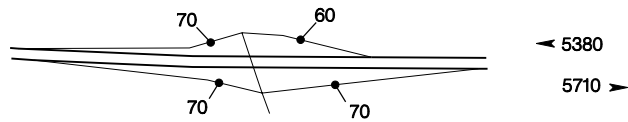

Blalock – Exit 129

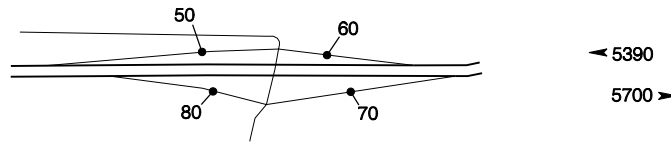

Woelpern – Exit 131

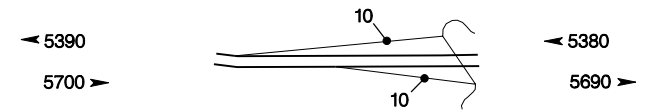

Arlington – Exit 137

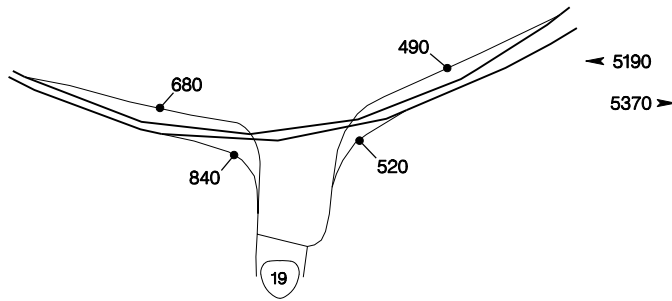

Heppner Jct. – Exit 147

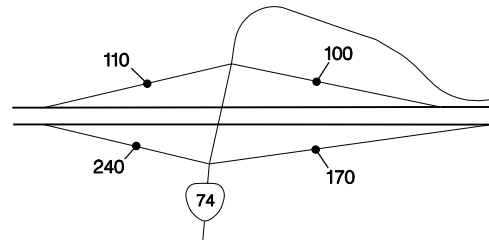

11-009  
Heppner Jct. ATR  
MP 147.60

Threemile Canyon – Exit 151

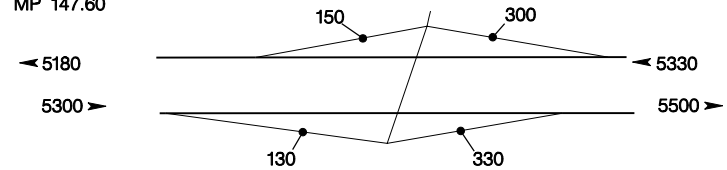

Tower Road – Exit 159

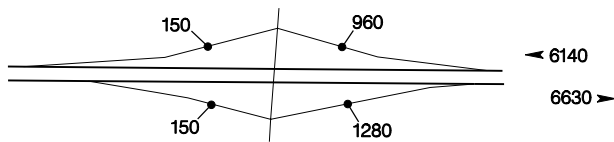

Boardman Rest Area – Exit 160

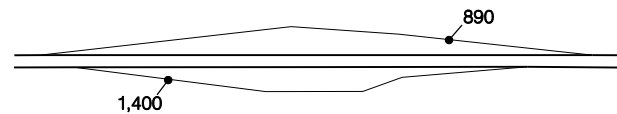

Boardman – Exit 164

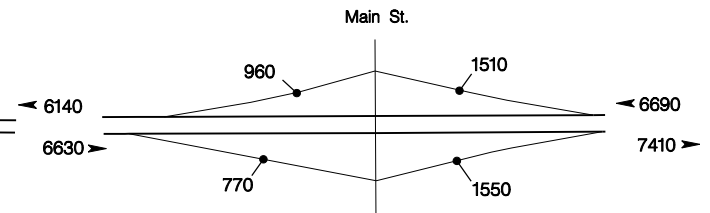



# INTERSTATE INTERCHANGES AND REST AREAS

Port Of Morrow – Exit 165

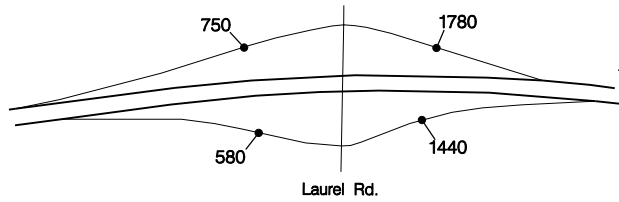

Boardman Jct. – Exit 168

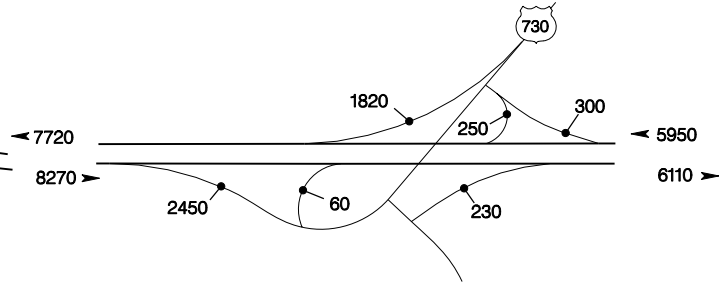

Paterson Ferry Road – Exit 171

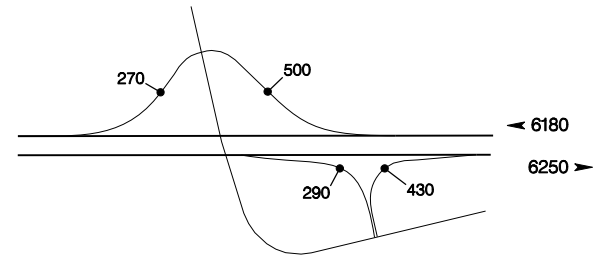

Ordnance – Exit 177

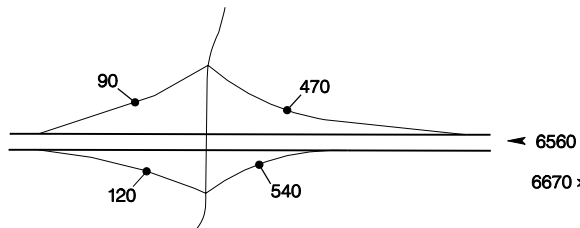

McNary Highway – Exit 179

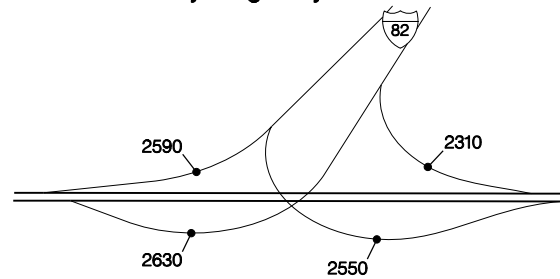

Westland Road – Exit 180

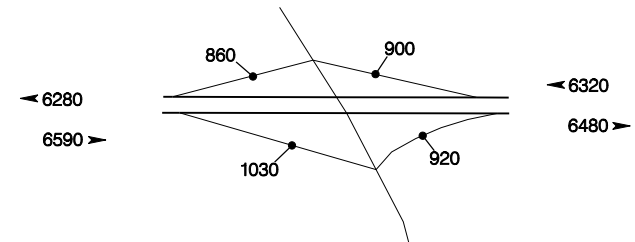

Hermiston – Exit 182

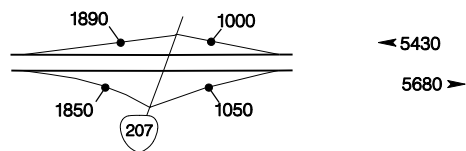

Stanfield Rest Area – Exit 186A, 186B

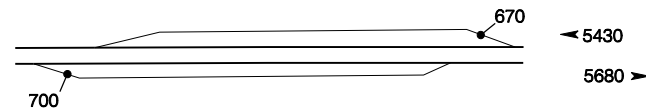

180

# INTERSTATE INTERCHANGES AND REST AREAS

Stanfield Jct. – Exit 188

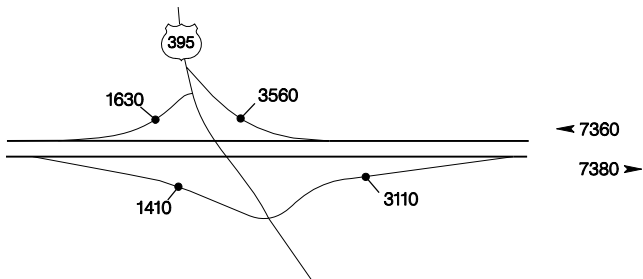

Echo Jct. – Exit 193

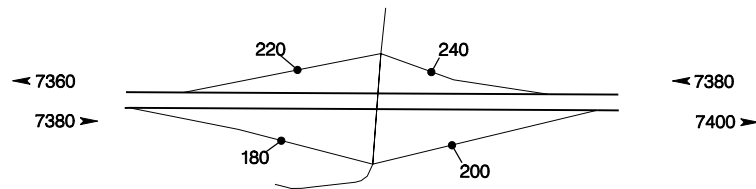

Rew Elevator – Exit 198

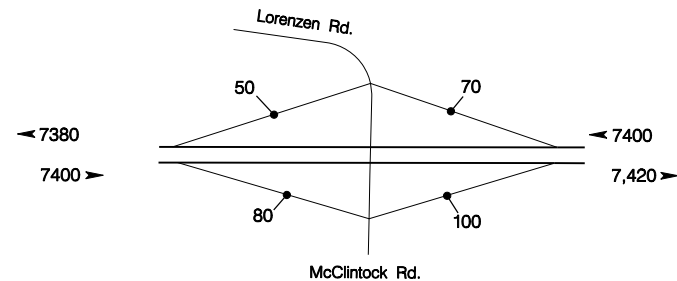

Yoakum Road – Exit 199

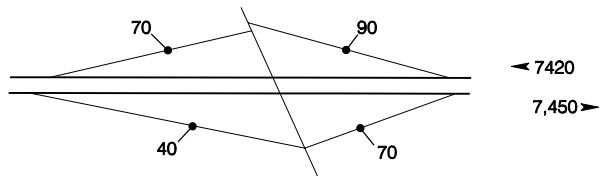

Barnhart – Exit 202

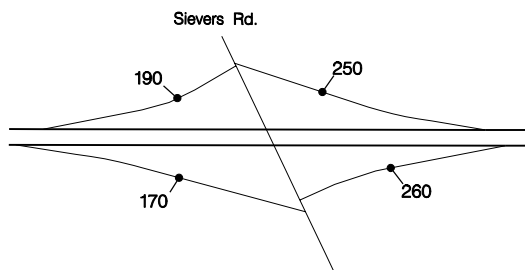

West Pendleton – Exit 207

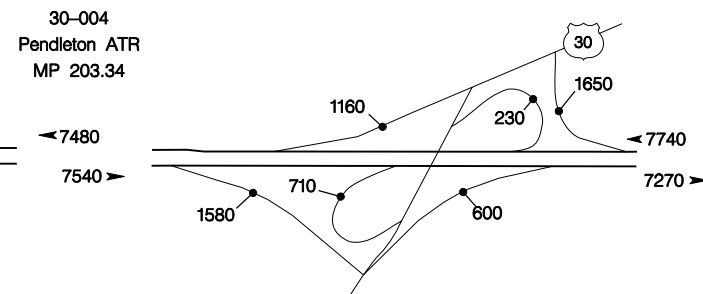

Emigrant Avenue – Exit 209

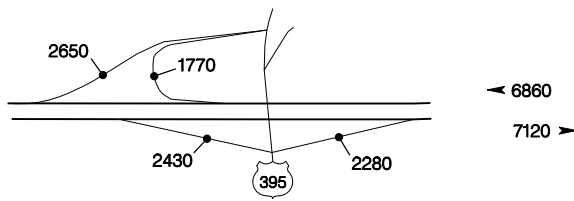

South Pendleton – Exit 211

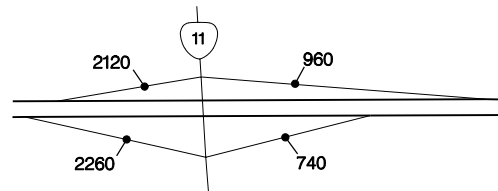

East Pendleton – Exit 213

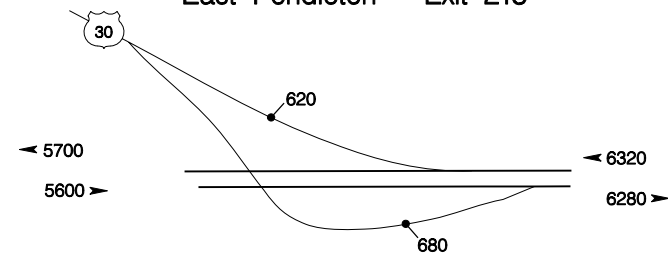

# INTERSTATE INTERCHANGES AND REST AREAS

Mission Jct. – Exit 215

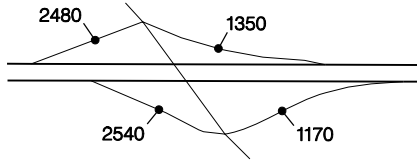

Emigrant Hill – Exit 224

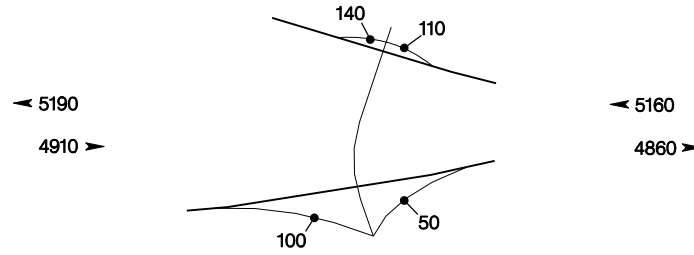

Deadman's Pass – Exit 228

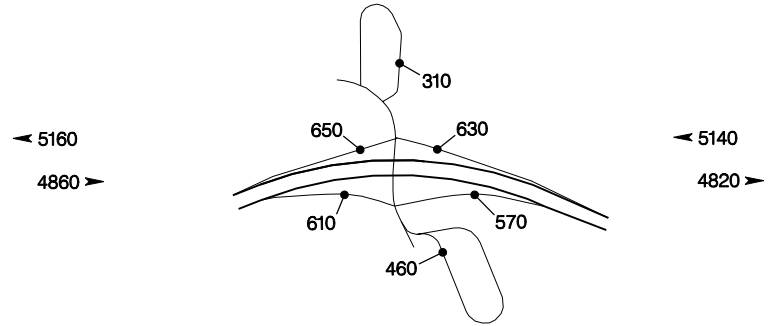

West Emigrant Park – Exit 233

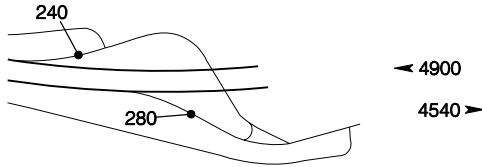

East Emigrant Park – Exit 235

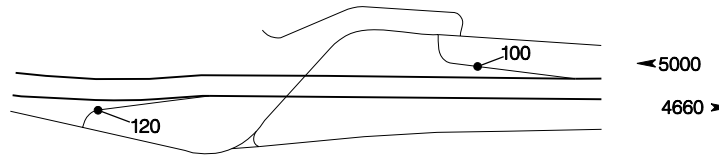

Meacham – Exit 238

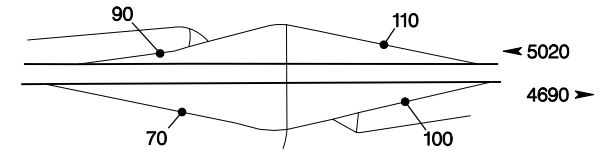

Kamela – Exit 243

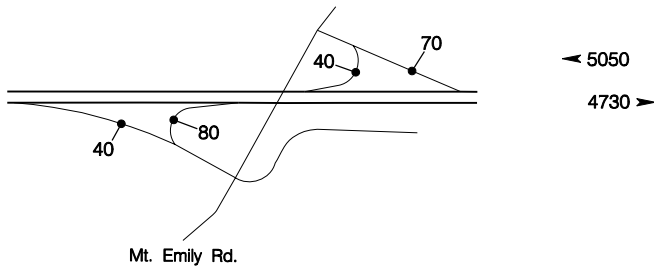

Glover – Exit 248

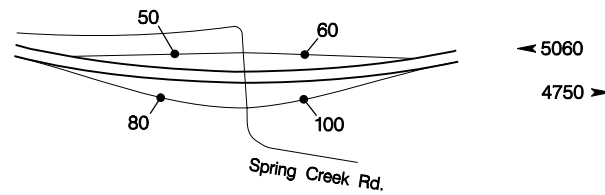

# INTERSTATE



# INTERCHANGES AND REST AREAS

Ukiah-Hilgard – Exit 252

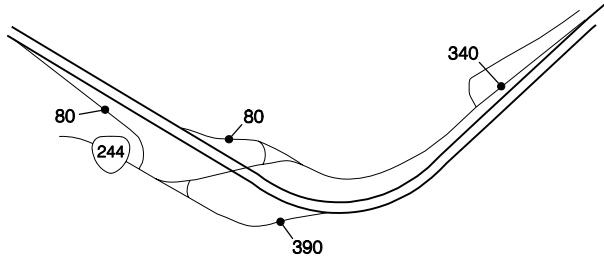

Upper Perry – Exit 256

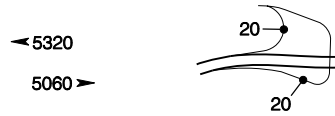

Lower Perry – Exit 257

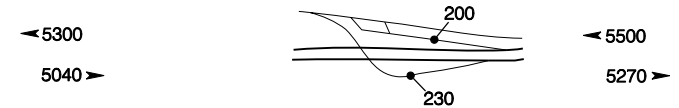

North LaGrande – Exit 259

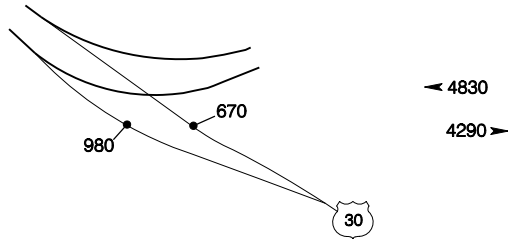

Wallowa Lake – Exit 261

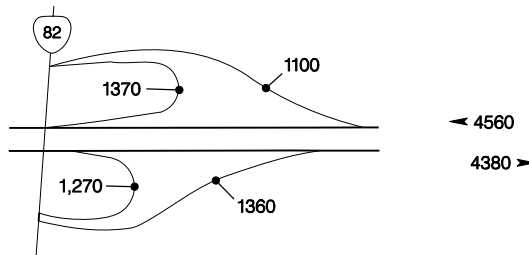

South LaGrande – Exit 264

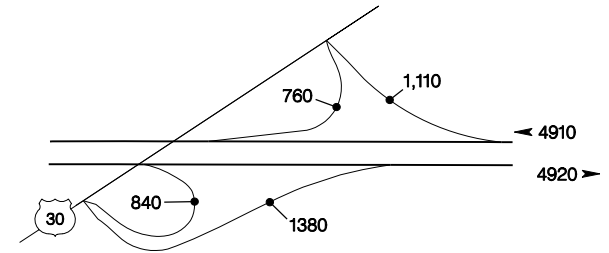

Foothill Road – Exit 268A

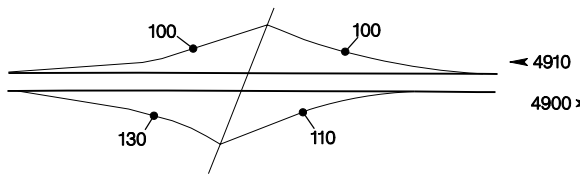

Ladd Canyon Rest Area – Exit 268B

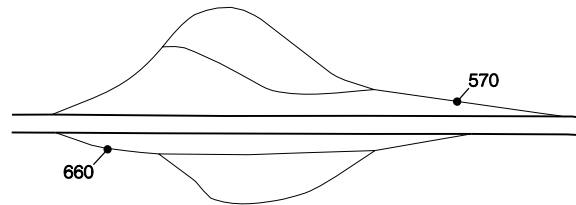

Ladd Creek – Exit 270

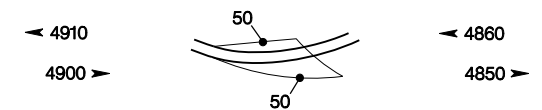

# INTERSTATE INTERCHANGES AND REST AREAS

Ladd Canyon – Exit 273

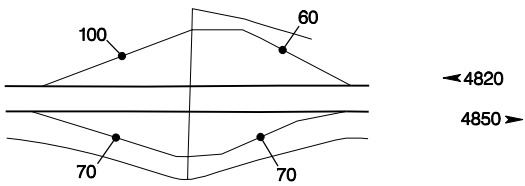

Clover Creek – Exit 278

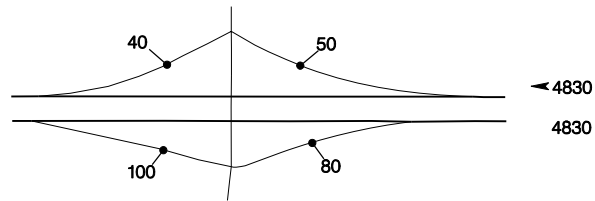

Wolf Creek – Exit 283

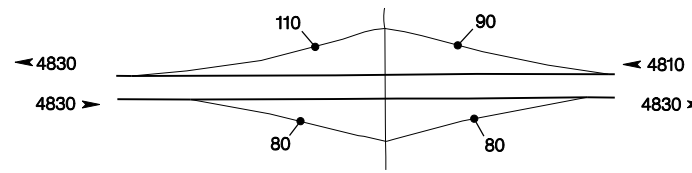

North Powder – Exit 285

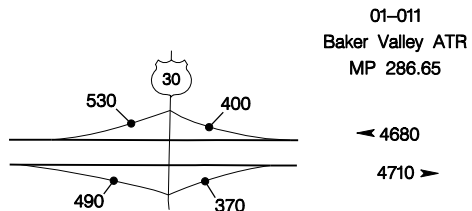

01-011  
Baker Valley ATR  
MP 286.65

Baker Valley Rest Area – Exit 294

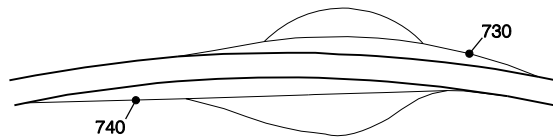

Chandler Lane – Exit 298

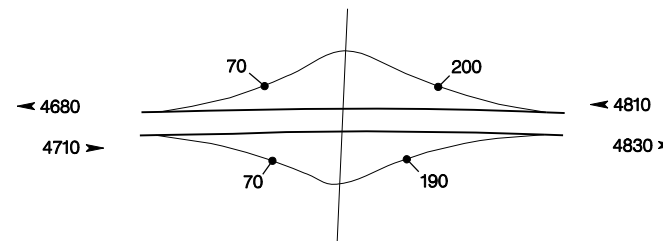

Richland – Exit 302

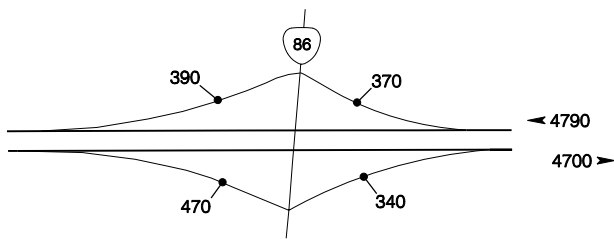

Campbell Street – Exit 304

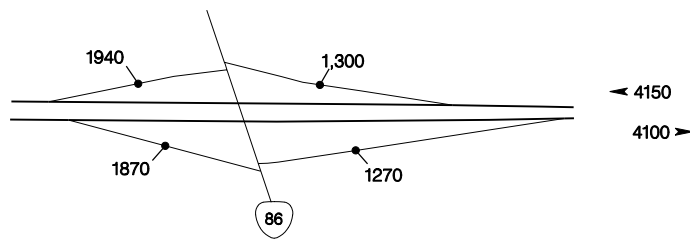

# INTERSTATE INTERCHANGES AND REST AREAS

South Baker – Exit 306

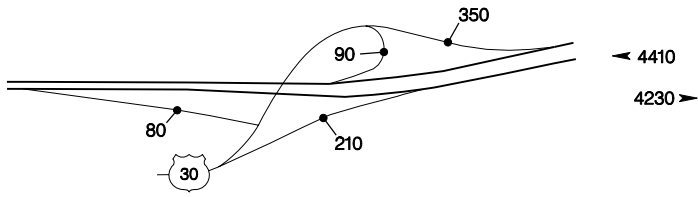

Encina – Exit 313

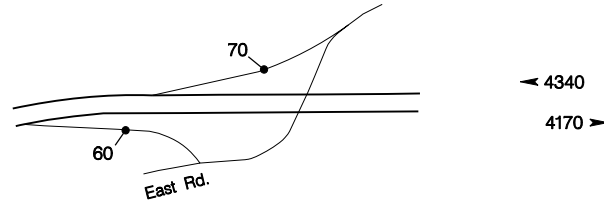

Pleasant Valley – Exit 317

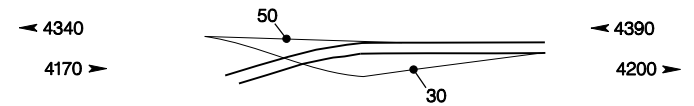

Durkee – Exit 327

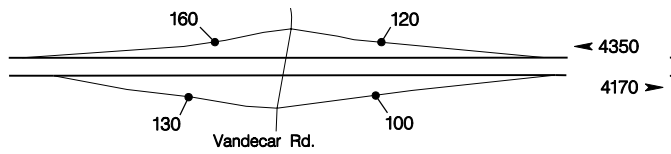

Nelson – Exit 330

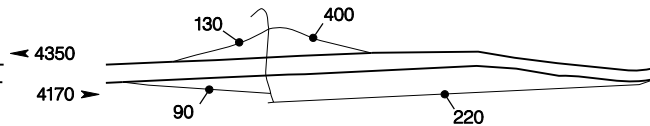

Weatherby – Exit 335

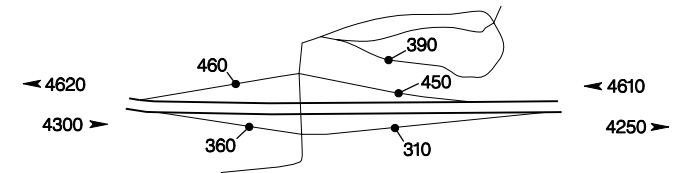

Jordan Creek – Exit 338

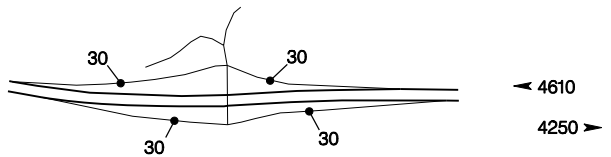

Dixie – Exit 340

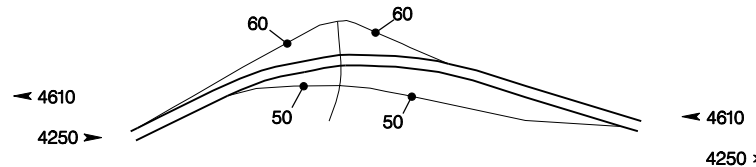

Lime – Exit 343

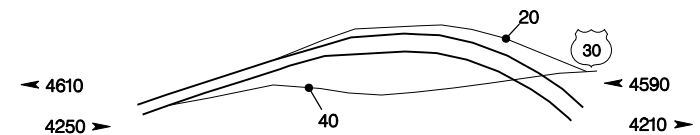

# INTERSTATE INTERCHANGES AND REST AREAS

North Huntington – Exit 345

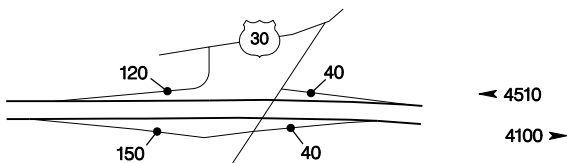

Benson – Exit 352

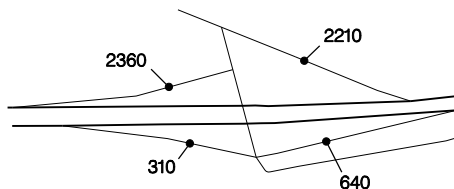

Olds Ferry – Exit 356

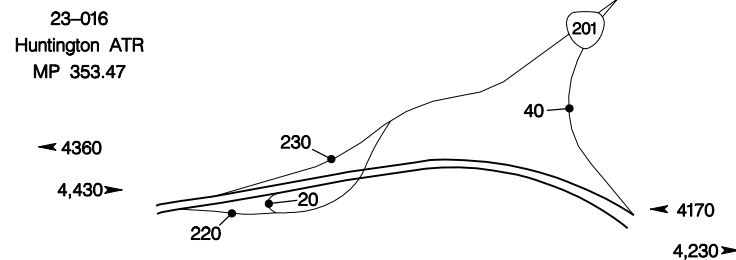

Moore's Hollow – Exit 362

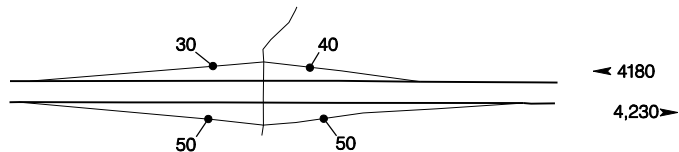

Stanton Blvd. – Exit 371

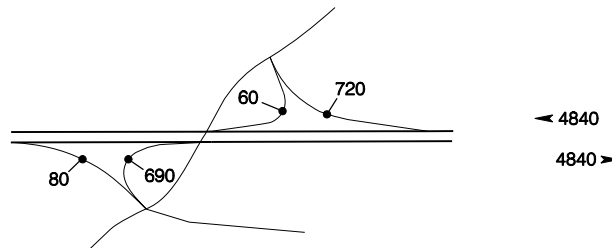

North Ontario – Exit 374

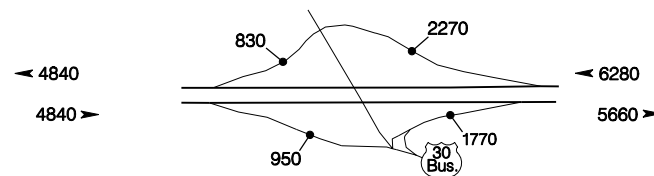

Idaho Avenue – Exit 376

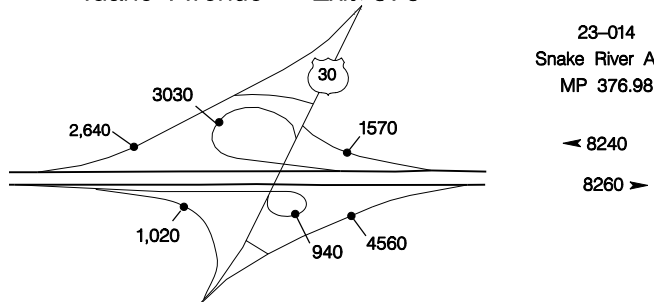

Ontario Rest Area – Exit 377

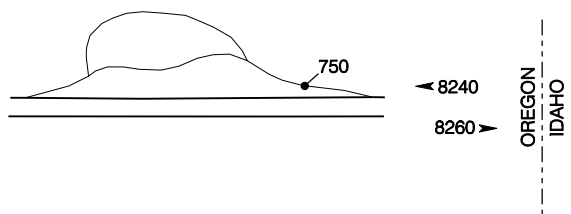

# US INTERCHANGES

McKenzie-Bend Hwy. – Exit 135A

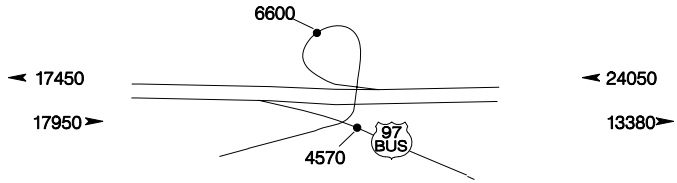

Empire Blvd. – Exit 135B

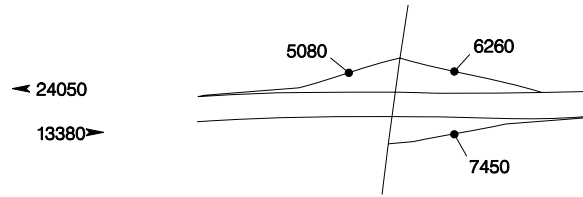

Butler Market Rd. – Exit 136

09-007  
Bend-Empire ATR  
MP 135.95

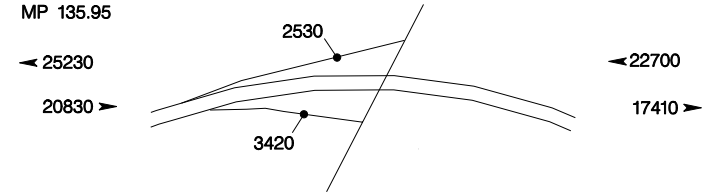

US20 – 3rd St

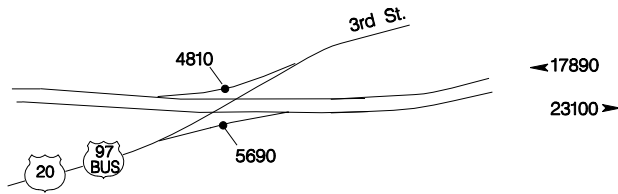

Revere Ave. – Exit 137

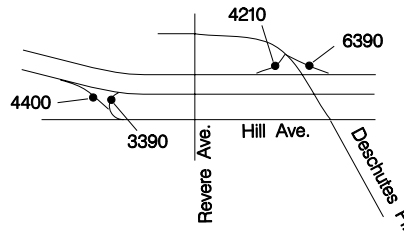

09-009  
Bend-Revere ATR  
MP 137.36

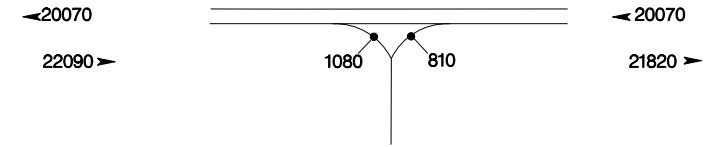

Hawthorne Ave.

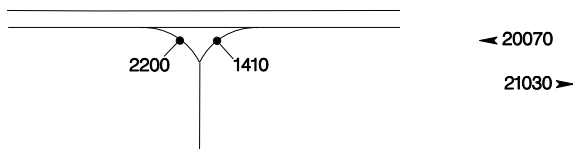

Colorado Ave. – Exit 138

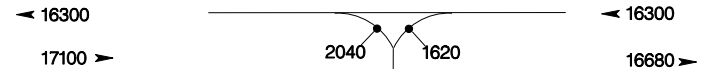
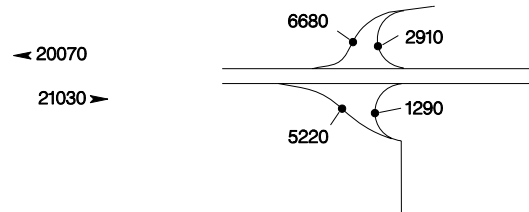

Truman Ave.



# US INTERCHANGES

Reed Market Rd. – Exit 139

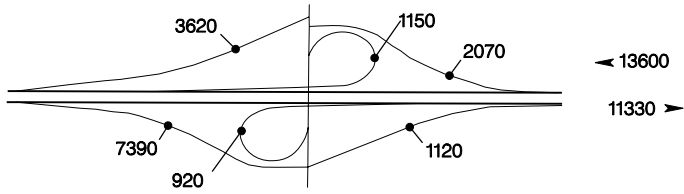

Reed Rd.

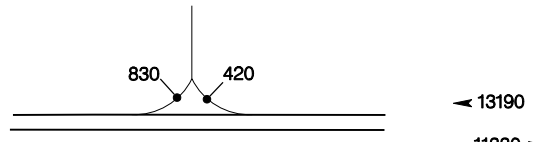

Powers Rd. – Exit 140

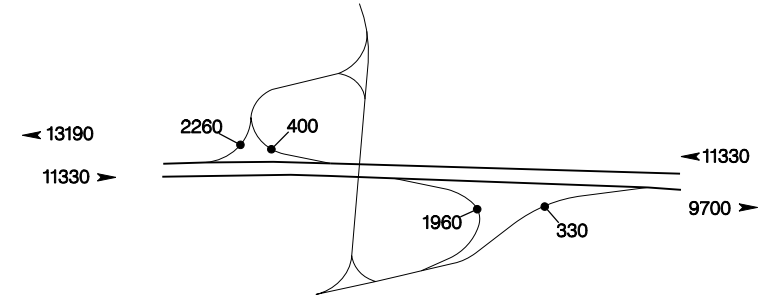

Badger Rd.

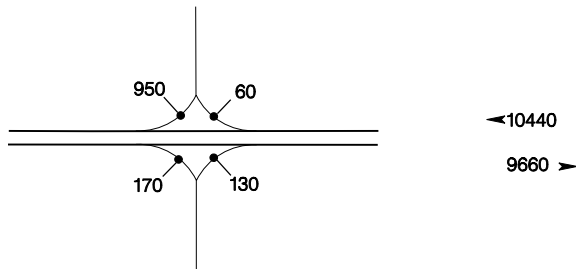

Pinebrook Blvd.

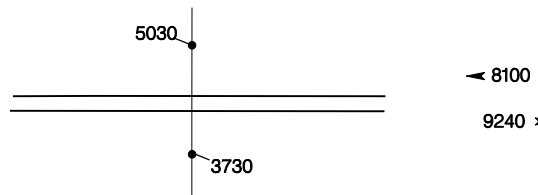

South End of Parkway

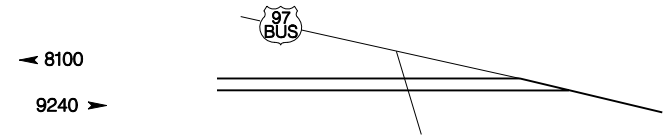

# US INTERCHANGES

Wilson River Hwy. – Exit 53A

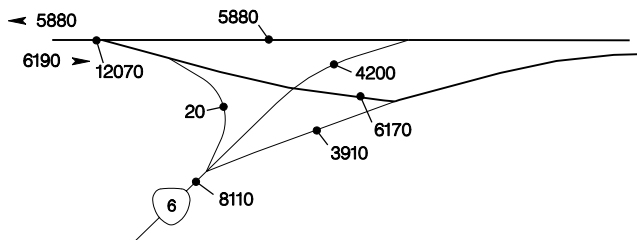

Dersham Road – Exit 55

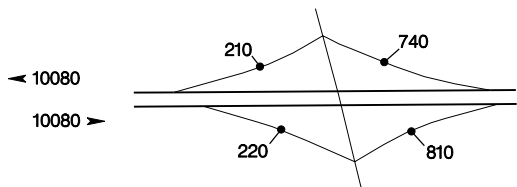

North Plains – Exit 57

34-007  
North Plains ATR  
MP 56.23

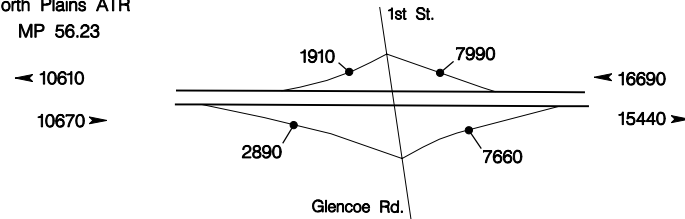

Jackson Road – Exit 58

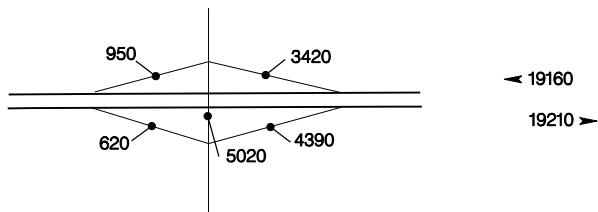

Helvetia Road – Exit 61

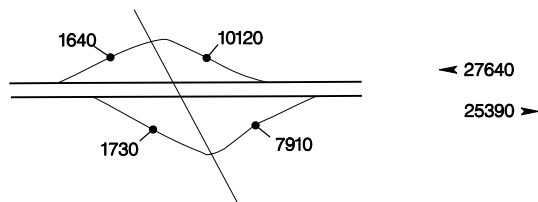

Cornelius Pass Rd. – Exit 62

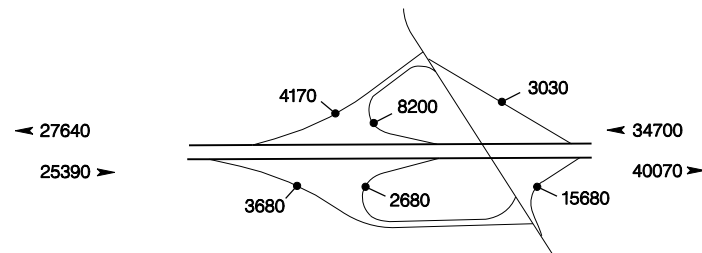

185th Ave. – Exit 64B

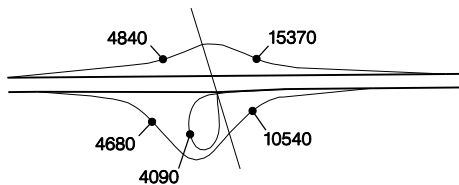

Cornell Road – Exit 65

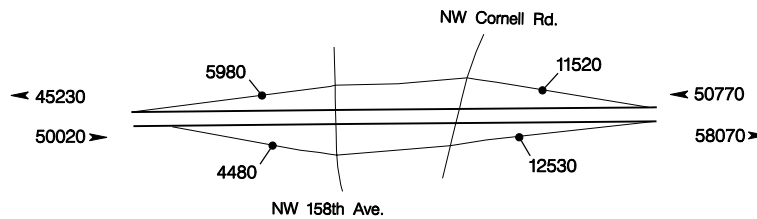

Murray Blvd. – Exit 67

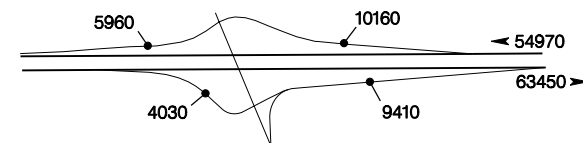

# US INTERCHANGES

Cedar Hills Blvd. – Exit 68

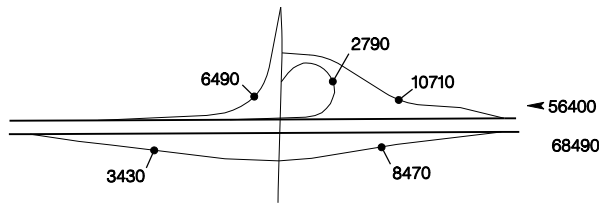

Beaverton – Tigard – Exit 69

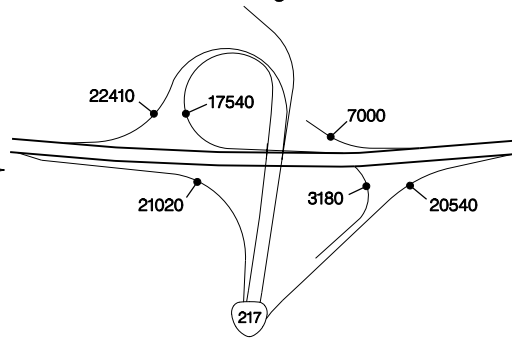

Sunset Hills – Exit 70B

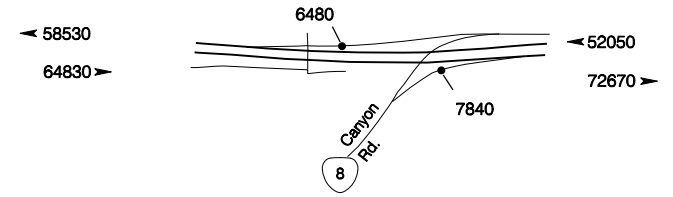

Sylvan – Exit 71

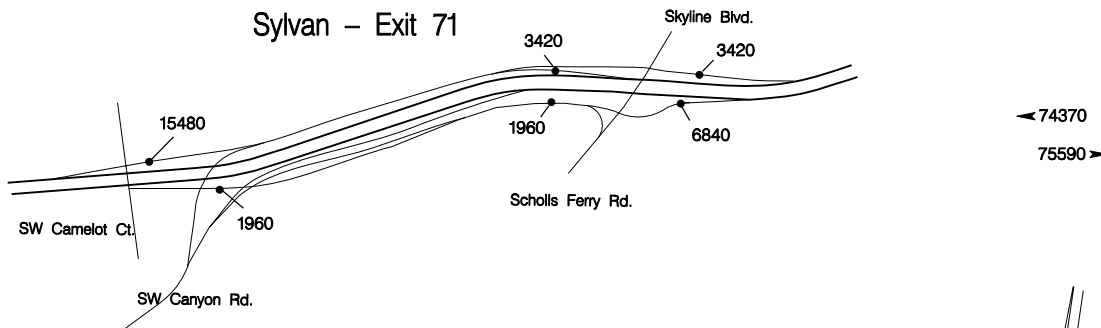

Highlands – Exit 72

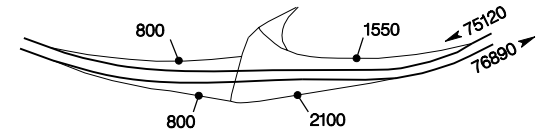

Jefferson St. – Exit 73B

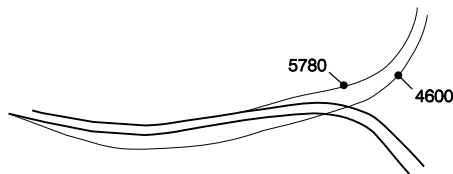

Stadium Freeway. – Exit 73C

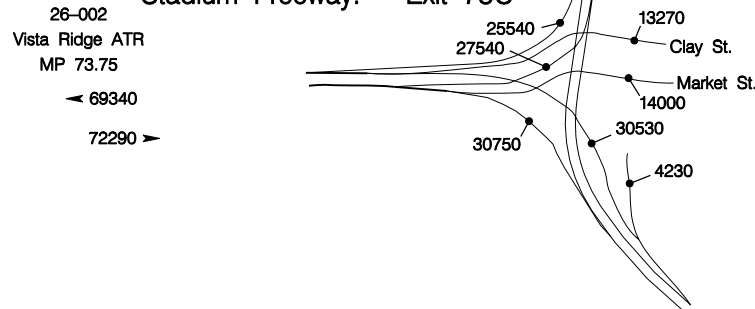

# INTERSTATE 405 INTERCHANGES

W. Marquam – Exit 0A

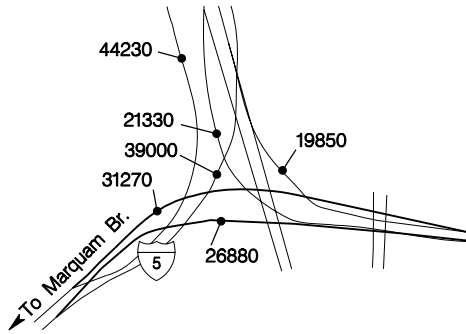

Broadway – Exit 0B

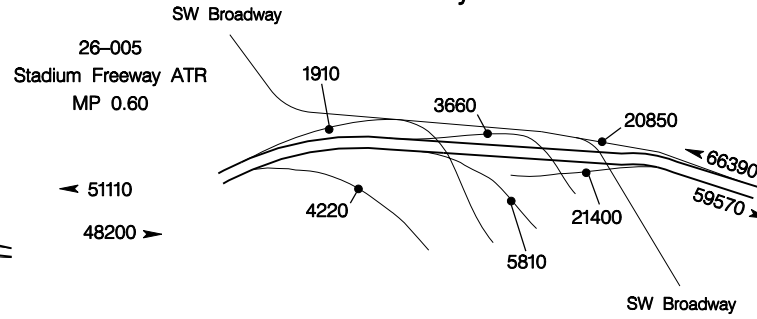

Sunset – Exit 1

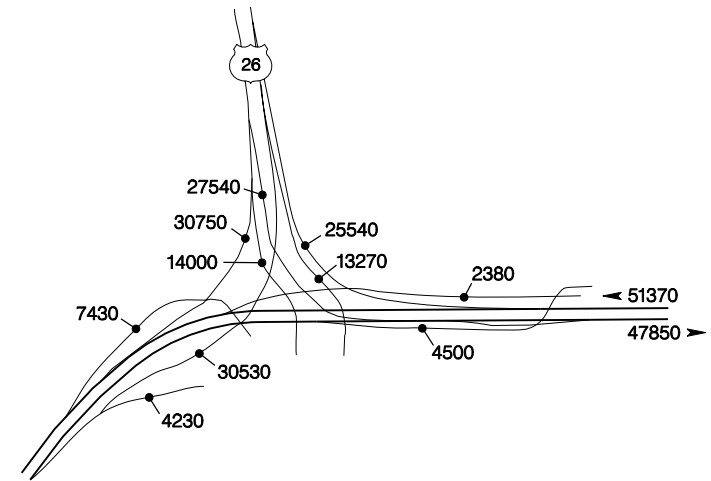

Burnside – Exit 2

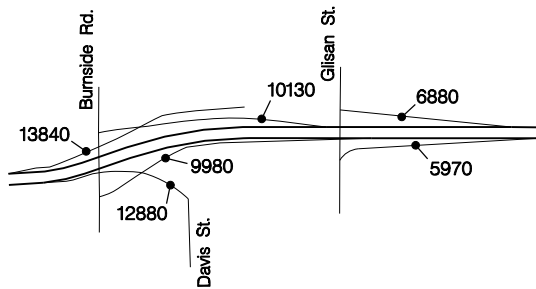

W. Fremont – Exit 3A

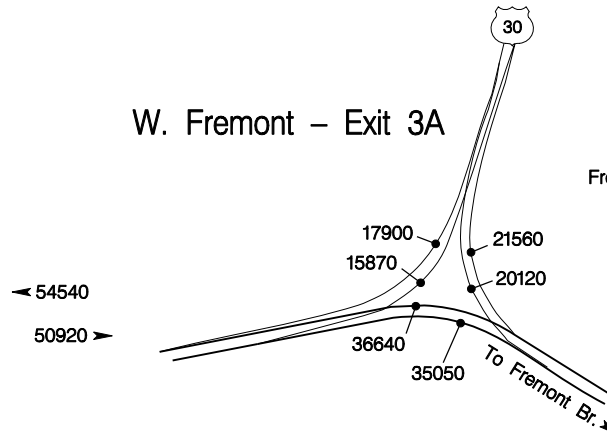

E. Fremont – Exit 3B

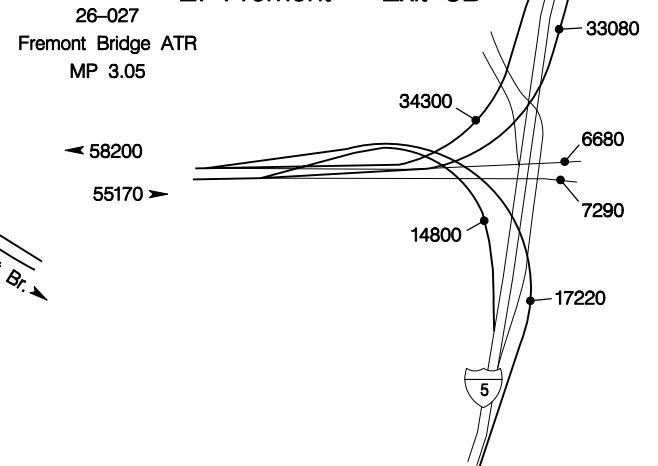

# INTERSTATE 205 INTERCHANGES AND REST AREAS

Pacific Hwy. Exit 1

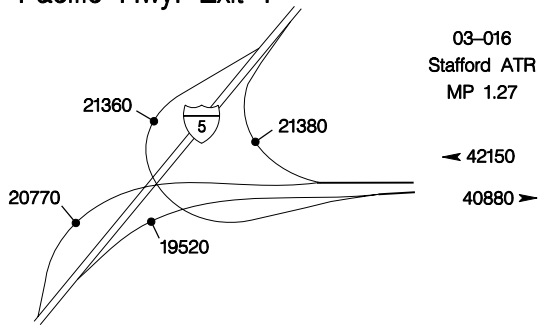

Wankers Corner - Exit 3

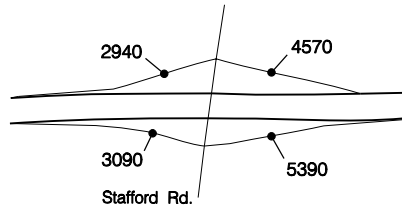

S. West Linn - Exit 6

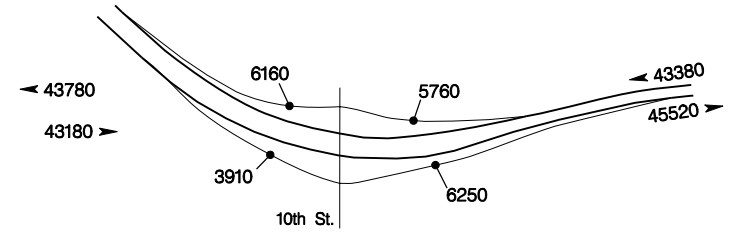

Willamette Falls Viewpoint - Exit 8A

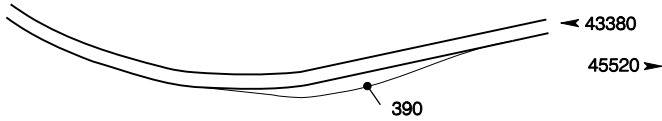

West Linn - Exit 8B

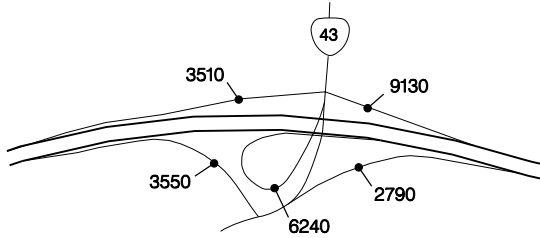

Oregon City - Exit 9

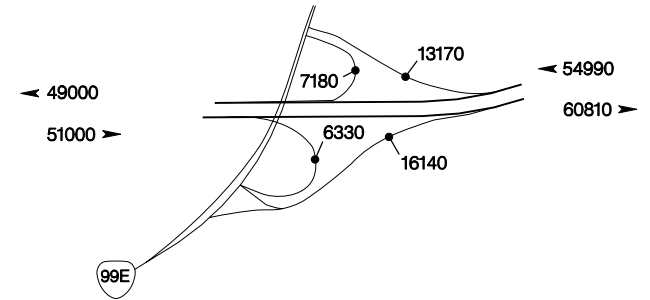

Park Place - Exit 10

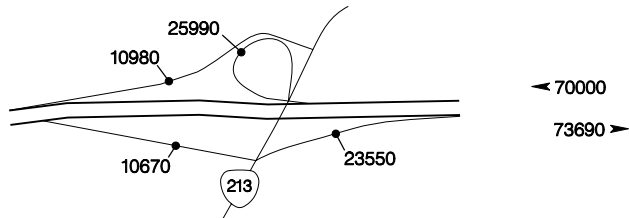

Gladstone - Exit 11

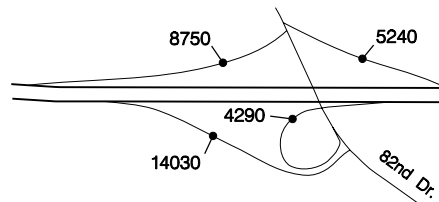

Clackamas - Exit 12

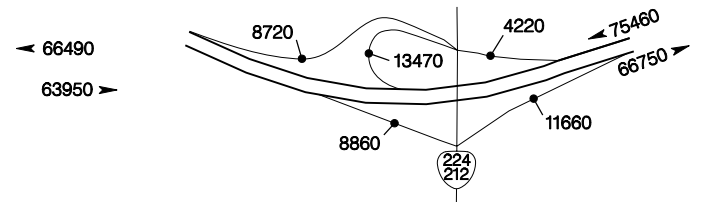

# INTERSTATE 205 INTERCHANGES AND REST AREAS



Lake Road – Exit 13

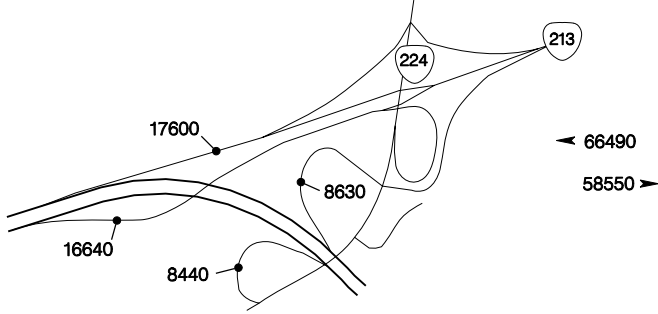

Sunnyside Rd. – Exit 14

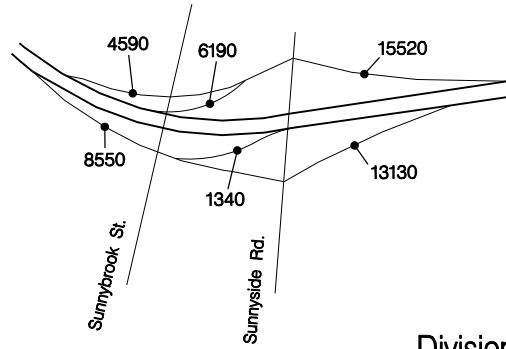

Johnson Cr. Blvd. – Exit 16

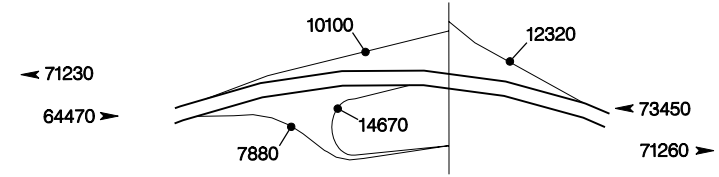

Foster & Woodstock – Exit 17

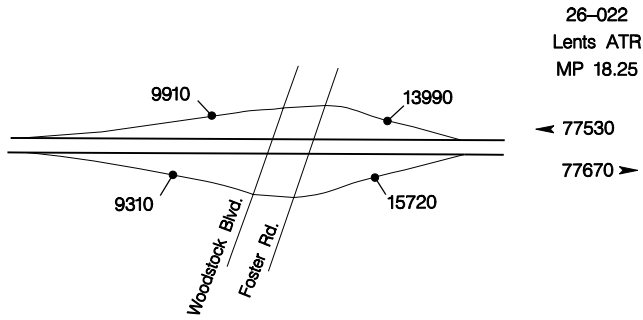

Division & Powell – Exit 19

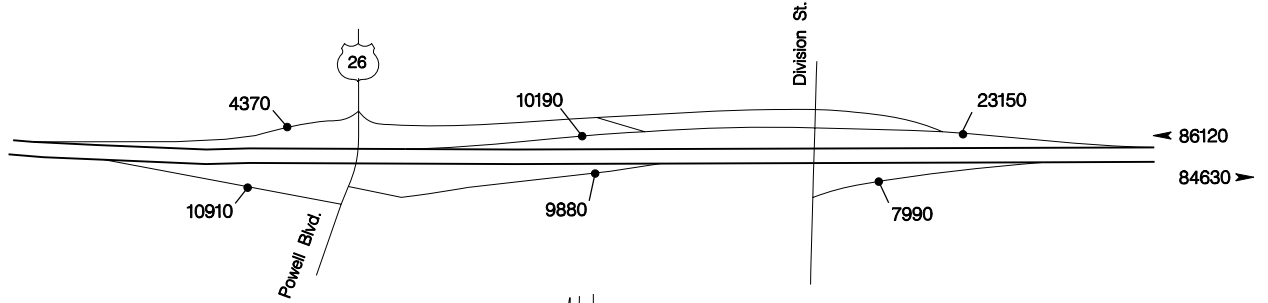

Stark–Washington St. – Exit 20B

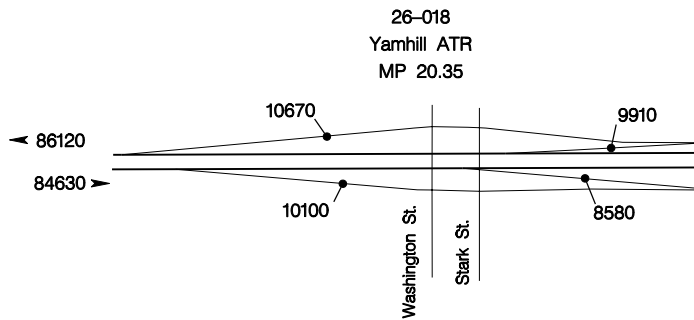

N.E. Glisan St. – Exit 20C

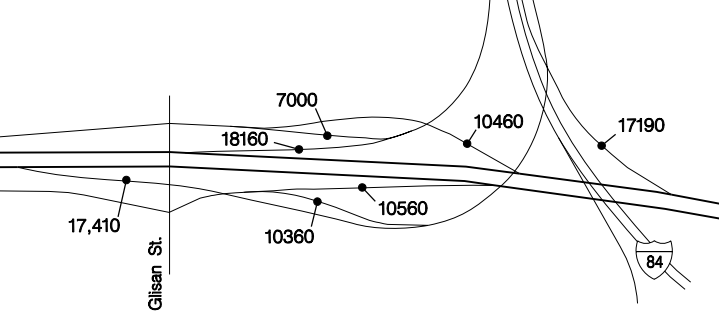

S. Banfield – Exit 20D

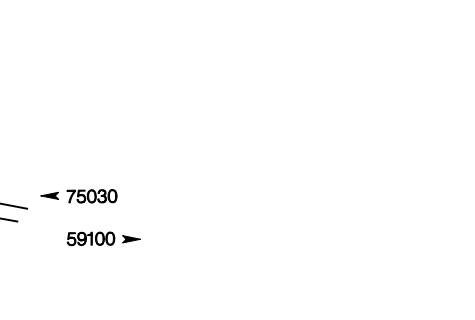

202

# INTERSTATE 205 INTERCHANGES AND REST AREAS

N. Banfield – Exit 22

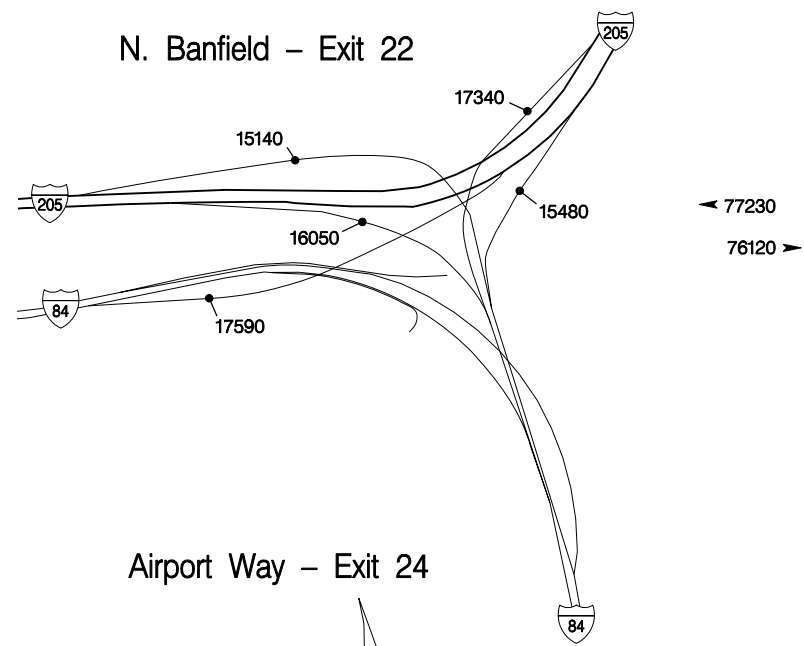

Sandy Blvd. – Exit 23A

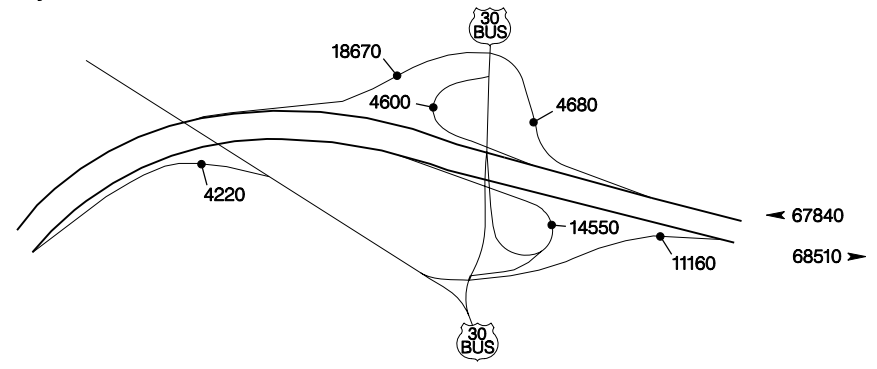

Columbia Blvd. – Exit 23B

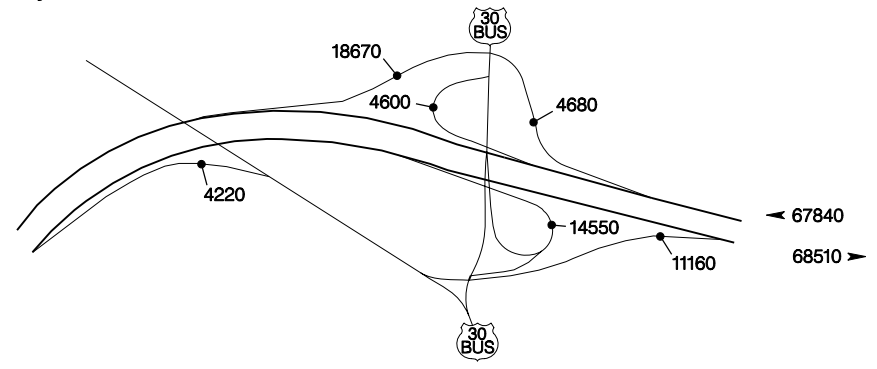

Airport Way – Exit 24

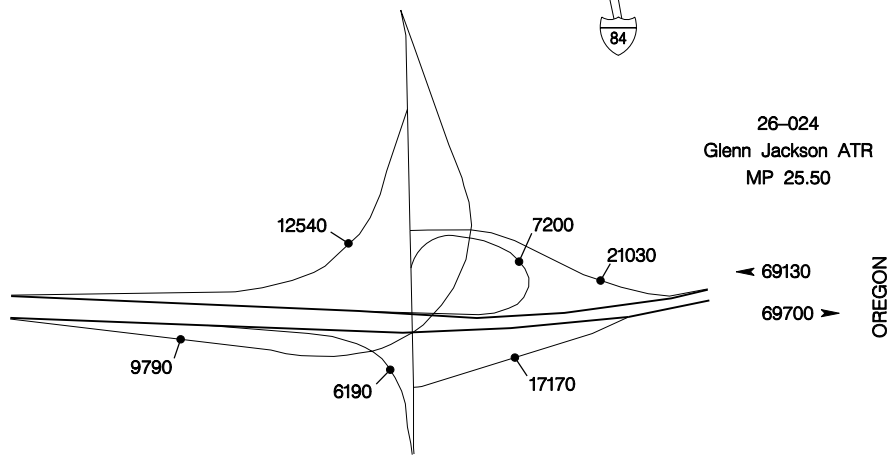

26-024  
Glenn Jackson ATR  
MP 25.50

# BELTLINE HIGHWAY NO. 569 INTERCHANGES (OR569)

Barger Dr. – Exit 5

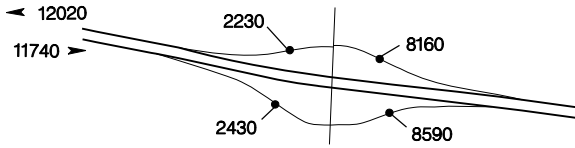

Pacific Hwy. West – Exit 6A

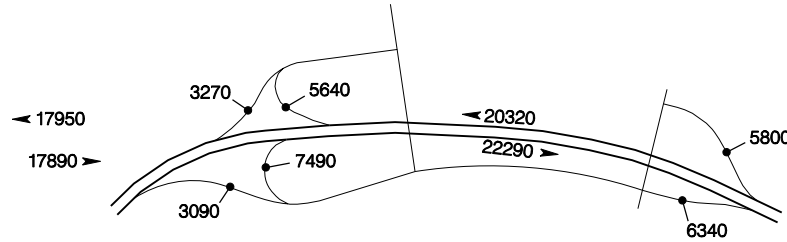

Prairie Road – Exit 6B

N. W. Expressway – Exit 7

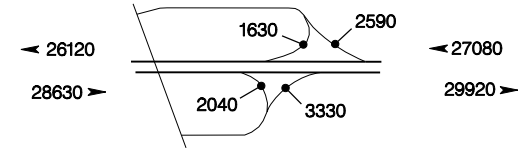

River Road – Exit 8

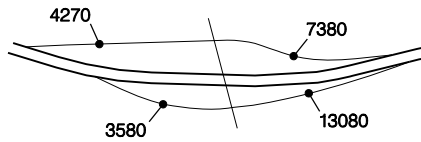

River Ave. – Exit 9

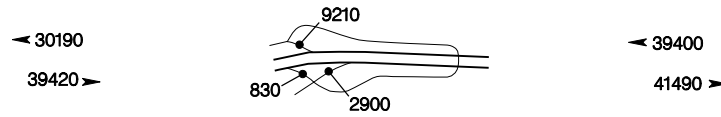

Delta Hwy. – Exit 9A

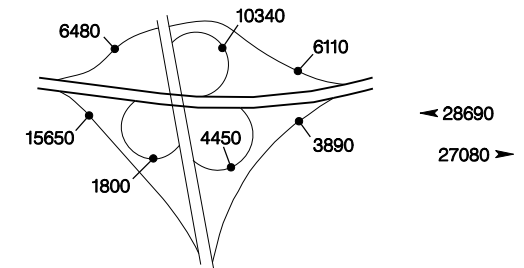

Coburg Road – Exit 11

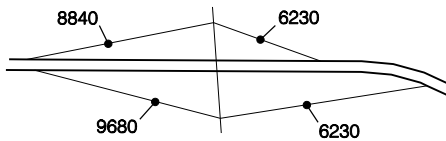

Pacific Hwy. – Exit 12

20-011  
Beltline ATR  
MP 12.00

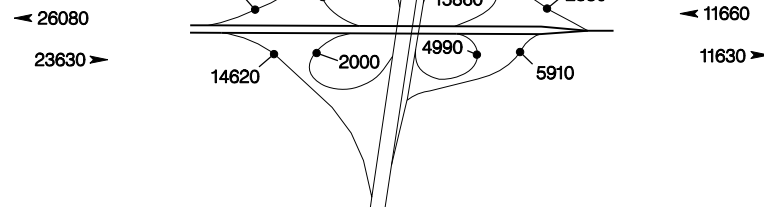



# INTERSTATE INTERCHANGES

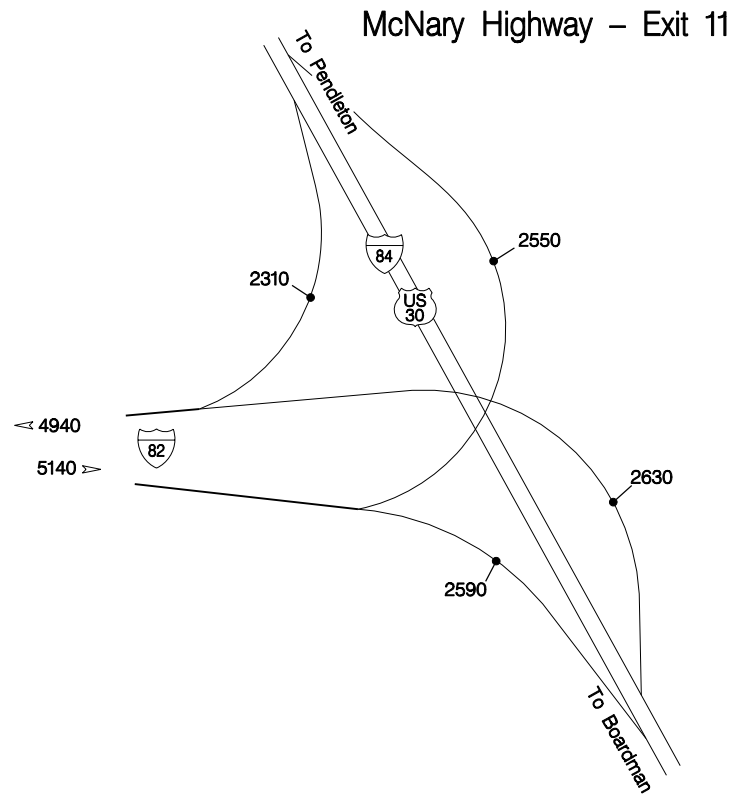
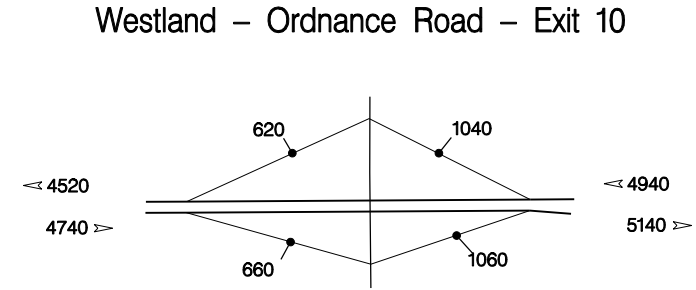
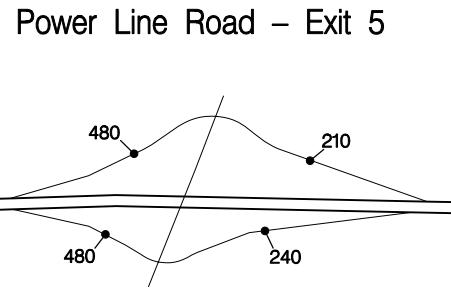
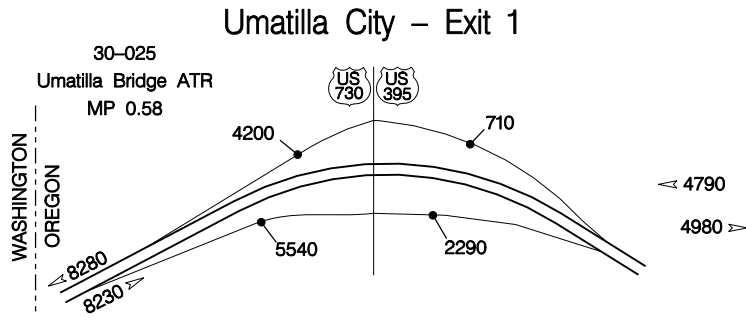

# OR 217 INTERCHANGES

Sunset Hwy. – Exit 0A

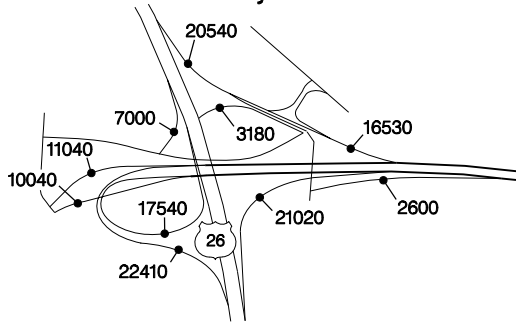

Walker Road – Exit 0B

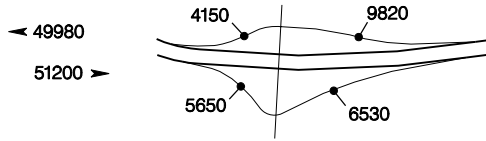

East Beaverton – Exit 1

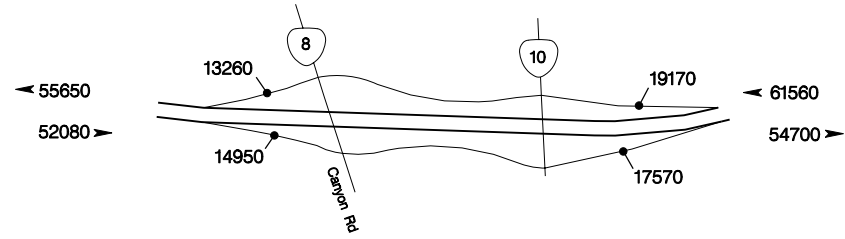

Allen Blvd. – Exit 2

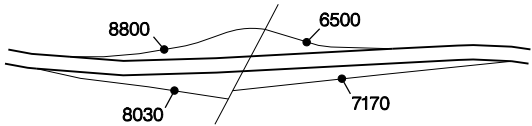

Denney Road – Exit 3A

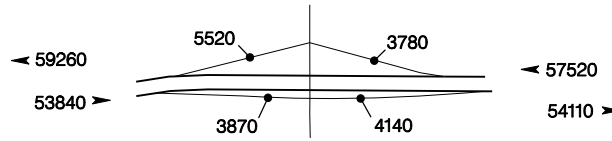

Beaverton-Tualatin Hwy. – Exit 3B

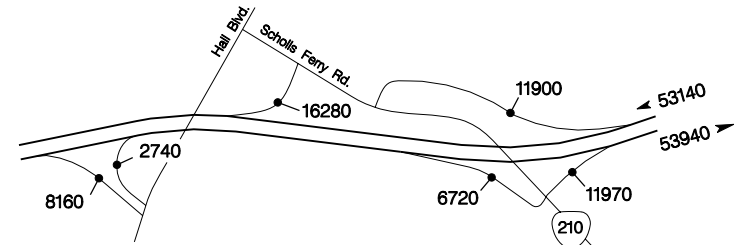

Progress – Exit 4A

Greenburg Road – Exit 4B

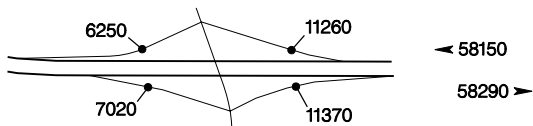

Tigard – Exit 5

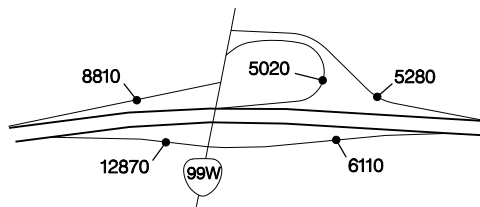

SW 72nd Ave. – Exit 6

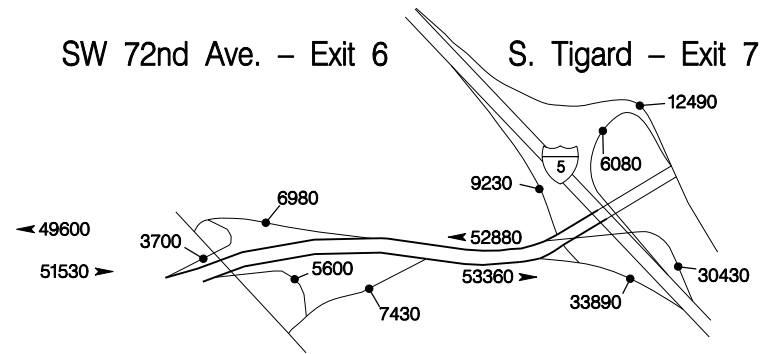

S. Tigard – Exit 7

# OR 22 INTERCHANGES

North Santiam – Exit 1

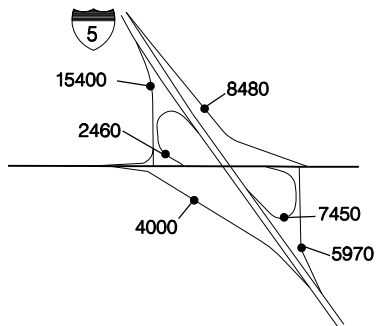

Lancaster Dr. – Exit 2

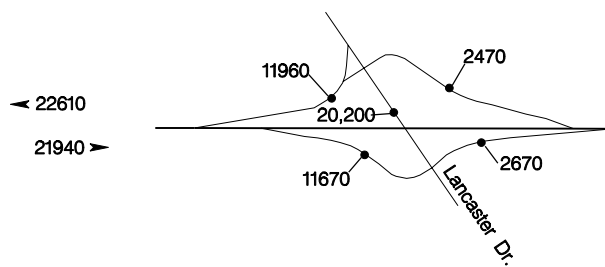

24-004  
N. Santiam ATR  
MP 2.82  
← 13120  
12940 ➤

Deer Park Dr. – Exit 4

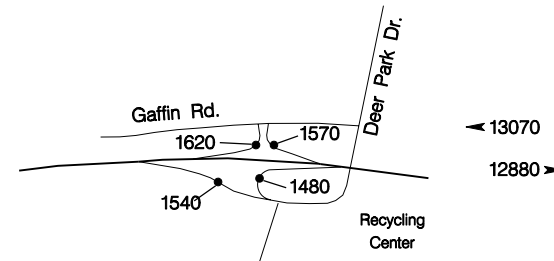

Joseph St. – Exit 5

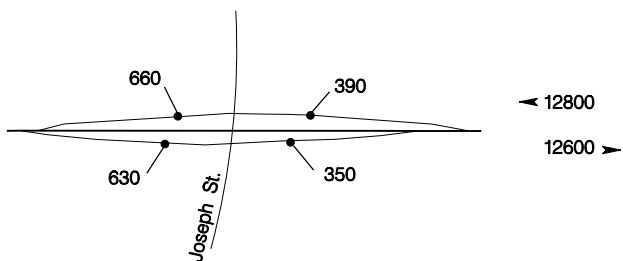

Silver Cr. Falls Hwy. – Exit 7

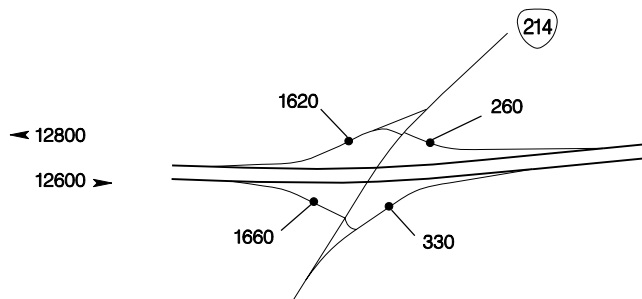

Shaw – Aumsville – Exit 9

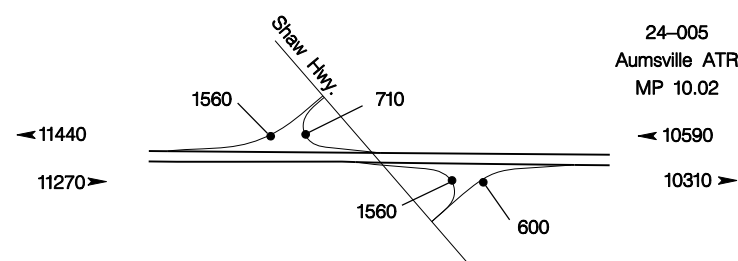

24-005  
Aumsville ATR  
MP 10.02  
← 10590  
10310 ➤

Golf Club Rd. – Exit 12

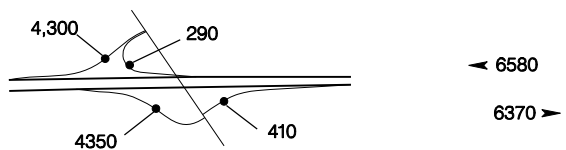

Stayton – Sublimity

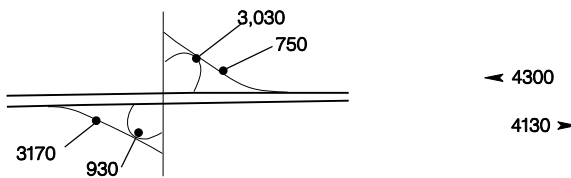

# INTERSTATE INTERCHANGES

6th & 7th Ave. – Exit 0A

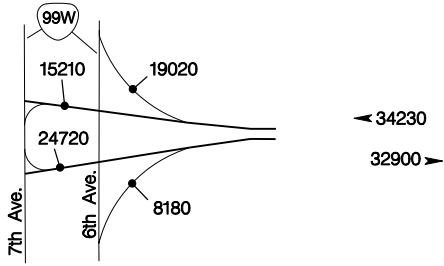

Delta Highway – Exit 0B

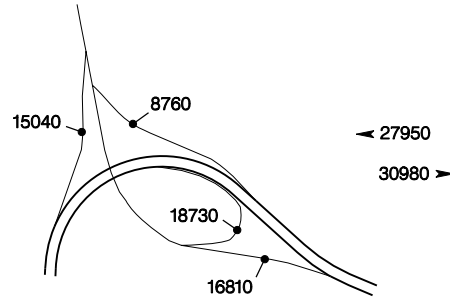

Country Club Rd. – Exit 1A

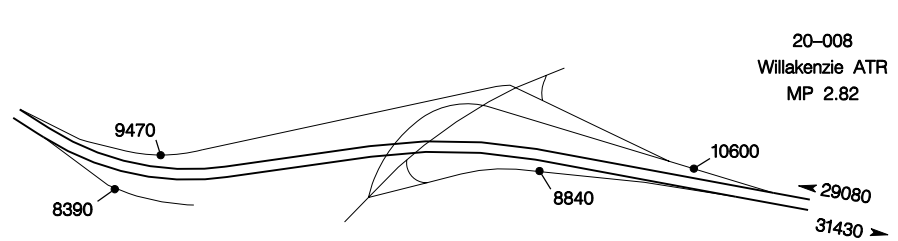

Coburg Road – Exit 1B

20-008  
Willakenzie ATR  
MP 2.82

"Q" Street – Exit 3

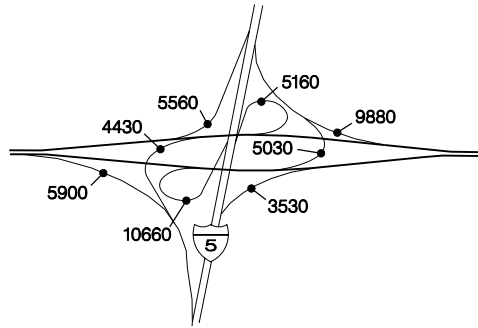

Springfield Hwy. – Exit 4

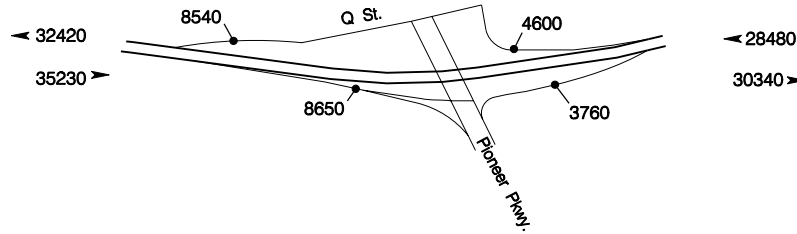

Mohawk Blvd. – Exit 6

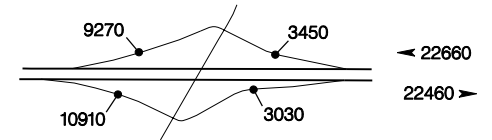

42nd Street – Exit 7

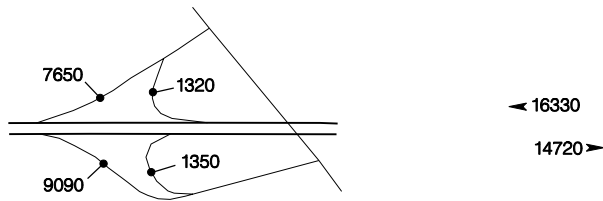

52nd Street – Exit 8



McKenzie Hwy. – Exit 10

