

NATIONAL WEATHER SERVICE MANUAL 10-1315

APRIL 18, 2007

Operations and Services

Surface Observing Program (Land), NDSPD 10-13

Cooperative Station Observations

NOTICE: This publication is available at: <http://www.nws.noaa.gov/directives/>.

OPR: OS7 (J.Newkirk)

Certified by: OS7 (D. McCarthy)

Type of Issuance: Emergency

SUMMARY OF REVISIONS: This Directive supersedes National Weather Service Manual, Cooperative Station Observations, dated September 21, 2006. Re-wrote section 4.1 page A-6, added M for missing data section 4 page D-15 and section 10 page E-6. Moved winterizing Universal Gage out of the F&P Section to the Universal Section. Minor word changes.

Signed

April 4, 2007

Dennis McCarthy

Date

Director, Office of Climate

Water and Weather Services

Cooperative Station Observations

<u>Table of Contents:</u>	<u>Page</u>
1 Purpose.....	3
2. Definition of a Cooperative Station.....	3
3. Reporting Elements.....	3
3.1 Precipitation.....	3
3.2 Air Temperature.....	3
3.3 River Stage.....	3
3.4 Evaporation, Wind Movement and Water Temperature.....	3
3.5 Soil Temperature.....	4
3.6 Atmospheric Phenomena.....	4
3.7 Flash Flooding.....	4
4. Establishing, Maintaining, and Inspecting Stations.....	4
4.1 Observer Training.....	4
4.2 Maintenance.....	4
4.3 Requesting Supplies.....	4
4.4 Reporting Equipment or Instrument Problems.....	5
5. Preferred Time for Taking Observations.....	5
6. Resetting Instruments.....	5
7. Forms.....	5
7.1 Legibility.....	5
7.2 Disposition of Forms.....	5
8. Paperless Data Transmission.....	5
9. Figures.....	6
 Appendices	
A. Precipitation.....	A-1
B. Air Temperature.....	B-1
C. River Stages and Related Precipitation Observations.....	C-1
D. Evaporation Station Observations.....	D-1
E. Soil Temperature Stations.....	E-1
F. Atmospheric Phenomena.....	F-1
G. Flash Flooding.....	G-1

1. Purpose. The purpose of this manual is to provide guidelines for taking and reporting climate and weather observations at cooperative observer program stations. The instructions pertain to the exposure, operation, maintenance of instruments, and equipment used by the cooperative observer.

2. Definition of a Cooperative Station. A cooperative weather observing station, under the direction of the National Weather Service (NWS), is a location at which weather observations are taken or other services rendered by private citizens, institutions or by other government agencies. Services rendered usually consist of taking instrumental or visual observations, recording data and transmitting reports. The equipment is usually owned by the NWS, but may be owned by an individual company, another government agency, or privately owned by the cooperative observer.

3. Reporting Elements. Although the majority of cooperative stations record precipitation amounts and maximum and minimum temperatures, each station is unique. For example, one station may record precipitation only, while another station may record precipitation, temperature, and evaporation. One or more of the following elements may be reported:

- | | |
|--------------------|--------------------------|
| a. Precipitation | f. Water Temperature |
| b. Air temperature | g. Soil Temperature |
| c. River stage | h. Atmospheric Phenomena |
| d. Evaporation | i. Flash Flooding |
| e. Wind Movement | |

3.1 Precipitation. Measurements are made for the amount of rainfall, snowfall (new snow), the depth of snow, and other forms of precipitation. Records are kept of the character, type, and time of occurrence. Each station is usually furnished with a non-recording or a weighing-type recording gauge.

3.2 Air Temperature. Measurements of the current air temperature and the maximum and minimum temperatures between observations are taken and recorded daily. Cooperative stations are provided with maximum and minimum thermometers and an instrument shelter for housing the thermometers, or an Electronic Thermometer System (ET).

3.3 River Stage. Some stations take daily observations of river stages. These stations generally record precipitation, weather conditions, depth of snow or ice, and the status of the river (rising or falling). Each is furnished with an appropriate river gauge for the station.

3.4 Evaporation, Wind Movement and Water Temperature. Daily measurements are made by the amount of evaporation in an open, freely exposed pan. Measurements are made of wind movement over the pan, temperature of the water, and at some stations, wet and dry-bulb temperatures of the air. The stations are provided with:

- a. An evaporation pan with stilling well and evaporation gauge.
- b. A totalizing anemometer.

c. Six's style maximum and minimum thermometer.

3.5 Soil Temperature. Selected stations record the soil temperatures daily. These stations are provided with soil thermometers or sensing elements to be installed under undisturbed bare or grass-covered soil at selected depths.

3.6 Atmospheric Phenomena. Weather occurrences such as rain, cloud cover, hail, and thunderstorms are considered to be atmospheric phenomena. Phenomena of severe enough nature to threaten life and property are usually reported when they take place, rather than waiting to report them at the scheduled time of observation.

3.7 Flash Flooding. In areas where flash flooding may occur, observations of the conditions which cause flash flooding are reported promptly. These conditions include heavy rainfall, river or creek stage, and the formation or breakup of ice jams.

4. Establishing, Maintaining, and Inspecting Stations. The National Weather Service Representative (NWSREP) is responsible for the installation of all furnished instruments and equipment. Hourly precipitation data, evaporation and soil temperature stations should be visited semi-annually. All other sites should be visited annually. In the cooperative program, the NWSREP is usually the Data Acquisition Program Manager (DAPM), Observing Program Leader (OPL) or the Hydrometeorological Technician (HMT). At times, other staff such as Service Hydrologist, Intern, Meteorologist in Charge, Meteorologist, regional and national personnel, etc operating within the scope of the cooperative program are considered an NWSREP.

4.1 Observer Training. When establishing a station, the NWSREP will instruct the observer in established techniques of weather observing, recording data, safety and environmental work practices as outlined in NWSM 50-1115 and NWSM 50-5116, and caring for instruments and equipment. During all site visits, the NWSREP should discuss any problems when observing and recording weather data with the cooperative observer; as well as inspecting and maintaining the instruments and equipment.

4.2 Maintenance. Instruments and equipment furnished to the station should be maintained in accordance with instructions for each instrument. Instruments and equipment should not be moved or relocated without the approval of the NWSREP. If immediate action is necessary to prevent damage, the cooperative observer should notify the NWSREP promptly. The observer may install replacement parts if authorized by the NWSREP. The cooperative observer should also inform the NWSREP when the growth of vegetation, trees, shrubs, or other changes affect the exposure of instruments or equipment.

4.3 Requesting Supplies. Instruments and equipment, report forms, envelopes, and all other supplies are furnished by the NWSREP. The cooperative observer should advise the NWSREP promptly when any forms, supplies, or services are needed. This may be communicated by letter, phone call, through the internet, or a note attached to the monthly data form mailed to the Weather Forecast Office (WFO).

4.4 Reporting Equipment or Instrument Problems. NWS equipment and instrument problems should be reported to the NWSREP, who will then arrange for the repair or replacement. Any boxes and shipping material in which thermometers, chart drives, and other delicate instruments are packed should be saved by the observer or NWSREP. The shipping items can be used when returning replaced parts. The parts should be carefully packed in the same manner as they were received.

5. Preferred Time for Taking Observations. Observations at precipitation stations should be taken at 7 a.m. local time, however any time between 6 a.m. and 8 am is usually acceptable if coordinated and approved by the NWSREP. Observations should be taken at the same time every day throughout the year if at all possible using standard time in the winter and daylight saving time in the summer if applicable.

Stations reporting both precipitation and temperature should report at a time agreed to with the NWSREP. Unless otherwise directed, precipitation and temperature should be observed at the same time each day. Evaporation and soil temperature stations should observe all elements in the morning.

6. Resetting Instruments. The maximum and minimum thermometers and MMTS/NIMBUS will be reset once every 24 hours, immediately after they have been read at the official time of observation. Non-recording precipitation gauges should be emptied after being read once each 24 hours. Thermometers and other temperature instruments should be reset only at the official time of observation. Instruments may be read at intermediate times, but they should not be reset.

7. Forms. The NWS will furnish all forms needed for recording weather data. The cover page for each pad of forms contains the reporting instructions. The cooperative observer should be instructed to enter their station name, county, state, month and year, time of observation, etc., on all forms.

7.1 Legibility. A legible record adds credibility to the historical record. A form that is difficult to read loses value. Use a black ball-point pen. Carbon paper located at the back of the pad should be replaced when it no longer makes a dark legible copy. The observer should draw a single line through erroneous entries. The correct entry can be written above, below, to the right or left of the line. If more space is needed, enter data in the remarks column for that day.

7.2 Disposition of Forms. The original and copy(s) if prescribed by the NWSREP, must be mailed promptly at the close of the period of record (usually monthly). The observer should keep the first carbon copy as it is the most readable and can be used to make copies if the original is lost. The carbon copy should be kept until the original is officially certified by NCDC. The NWS will furnish postage-paid envelopes for mailing forms.

8. Paperless Data Transmission. Paperless data transmission modes through PC and web-based, touch tone telephones or other approved National Oceanic and Atmospheric Administration (NOAA) supported paperless systems will follow the format prescribed by the NWS and National Climatic Data Center (NCDC).

9. Figures. Some pictures in this document are for display purposes and do not necessarily meet siting or suggested criteria.

APPENDIX A – Precipitation

<u>Table of Contents:</u>	<u>Page</u>
1. Introduction.....	A-3
2. Precipitation Gauges.....	A-4
3. Exposure of Gauges.....	A-4
4. Types of Precipitation Gauges.....	A-6
4.1 Eight-Inch Non-Recording Standard Precipitation Gauge.....	A-6
4.1.1 Installation.....	A-8
4.1.2 Maintenance.....	A-8
4.2 Four-Inch Non-Recording Gauge.....	A-8
4.2.1 Installation.....	A-9
4.2.2 Maintenance.....	A-9
4.3 Weighing Recording Gauge.....	A-9
4.3.1 Universal Weighing Precipitation Gauge.....	A-11
4.3.1.1 Calibration and Equipment Problems.....	A-11
4.3.1.2 Gaining Access to Bucket and Chart Mechanism.....	A-11
4.3.1.3 Preparation of Charts.....	A-12
4.3.1.4 Installing and Removing Charts.....	A-12
4.3.1.5 Changing Charts on Gauges.....	A-12
4.3.1.6 Completing the Charts.....	A-13
4.3.2 Fischer & Porter Punch Tape Gauge.....	A-14
4.3.2.1 Operation and Maintenance.....	A-14
4.3.2.2 Setting the Tape to the Correct Time.....	A-15
4.3.2.3 Winter Operation.....	A-16
4.3.2.4 Routine Maintenance.....	A-17
4.3.3 Fischer & Porter Upgrade (FPU) Gauge.....	A-17
4.3.3.1 Equipment Cluster.....	A-19
4.3.3.1.1 Data Logger Enclosure.....	A-19
4.3.3.1.2 Data Logger Display.....	A-20
4.3.3.2 Routine Checks.....	A-21
4.3.3.2.1 Rain Parameter.....	A-21
4.3.3.2.2 24-Hour Rain Difference Parameter (24RainDiff).....	A-22
4.3.3.3 Notation Codes Instead of “ON/OFF” Times.....	A-22
4.3.3.3.1 Notation Code List for Observer.....	A-23
4.3.3.3.2 How to Add a Notation.....	A-23
4.3.3.3.3 Checking Date or Time.....	A-24
4.3.3.4 Monthly Data Retrieval.....	A-25
4.3.3.4.1 Insert Data Key.....	A-25

<u>Table of Contents:</u>	<u>Page</u>
4.3.3.4.2 Monitor the Display	A-25
4.3.3.4.3 Verify the Start of Download.....	A-26
4.3.3.4.4 Remove Key.....	A-26
4.3.3.4.5 Mail the Data Key.....	A-27
4.3.3.5 FPU Bucket Draining.....	A-27
4.3.3.6 Inspect the Hardware and Visual Check List.....	A-27
4.3.3.7 NWSREP Seasonal Maintenance	A-27
4.3.3.7.1 Winterizing the FPU	A-29
4.3.3.7.2 Summerizing the FPU.....	A-29
 5. Gauge Supplies	 A-30
 6. How to Measure Rainfall	 A-30
6.1 Fischer & Porter Gauge	A-30
6.2 Universal Weighing Gauge.....	A-30
6.3 Four-Inch Non-Recording Gauge	A-30
6.4 Eight-Inch Non-Recording Gauge.....	A-30
 7. Measuring the Depth of Frozen Precipitation.....	 A-31
7.1 Definition	A-32
7.2 Snow Measurement Stick	A-32
7.3 Measuring New Snow Falling on Top of Old Snow.....	A-33
7.4 Snow Measurement Boards	A-34
7.5 Snow Measurement Stakes	A-35
 8. Measuring the Water Equivalent of Snowfall.....	 A-35
 9. Obtaining Core Samples of Snow.....	 A-36
 10. Measuring Snow Pack Water Equivalent	 A-36
 11. Keeping and Mailing Records	 A-37
11.1 Purpose.....	A-37
11.2 WS FORM B-82, “Official Weather Observer’s Record”.....	A-38
11.3 WS FORM B-91, “Record of River and Climatological Observations”	A-39
 12. Real-Time Reporting of Precipitation, Temperatures, and Hazardous Weather Events	 A-40
 Figures	
A-1 Wind Shield	A-4
A-2 Eight Inch Gauge	A-5

Figures	Page
A-3 Fischer&Porter Gauge Mounted on a Snow Tower with Wind Shield	A-6
A-4 Eight-Inch Precipitation Gauge Components	A-7
A-5 Measuring Stick Close Up	A-7
A-6 Eight-Inch Gauge	A-8
A-7 Four-Inch Plastic Gauge	A-8
A-8 Four-Inch Measuring Tube Closeup	A-9
A-9 Universal Weighing Recording Gauge	A-10
A-10 Fischer & Porter Recording Gauge	A-10
A-11 Front Open View of Universal Gauge	A-11
A-12 Fischer & Porter Recorder Components View with Cover Removed	A-16
A-13 Fischer & Porter Equipment Cluster	A-18
A-14 Upgraded F&P Gauge with Cover Removed	A-18
A-15 FPU Front View of Load Cell	A-19
A-16 Data Logger Box	A-19
A-17 Components - Data Logger Box	A-20
A-18 Data Logger	A-21
A-19 Rain Parameter	A-21
A-20 24-Hour Rain Difference Parameter	A-22
A-21 Data Logger Keypad	A-23
A-22 New Sensor Notation	A-24
A-23 Value Accepted	A-24
A-24 Date and Time	A-24
A-25 Datakey Receptacle	A-25
A-26 Datakey Activated	A-25
A-27 Datakey Insertion	A-26
A-28 Transfer Data	A-26
A-29 Download Complete	A-26
A-30 Eight-Inch Gauge with Measuring Stick Inserted	A-31
A-31 Measuring Tube with Funnel on Top	A-31
A-32 20 and 40 Inch Snow Sticks	A-33
A-33 Snow Stick Graduated Scale to a Tenth of an Inch	A-33
A-34 Snow Measurement Board (size and material may vary)	A-34
A-35 Snow Measurement Board	A-34
A-36 Snow Measurement Stake	A-35
A-37 WS Form B-82	A-38
A-38 WS Form B-91	A-39

1. Introduction. There are two basic types of precipitation; liquid and solid. Liquid precipitation includes rain and drizzle. Since precipitation, by definition, falls to the ground, dew (which forms on surfaces) is not precipitation. Solid precipitation includes snow, hail, ice pellets (sleet), etc. Precipitation is measured in terms of its accumulation:

- a. Liquid (including the water equivalent of solid precipitation which has melted) precipitation is measured to the nearest hundredth of an inch.
 - b. Solid precipitation is measured to the nearest tenth of an inch.
2. Precipitation Gauges. In its simplest form, a precipitation gauge is an open-mouthed can with straight sides, installed with the open end upward and sides vertical. Precipitation gauges are commonly called rain gauges. Recording gauges record the amount of precipitation falling per unit time on a chart (a punch tape or rotating drum) or electronically. See Section 4 page A-6.
3. Exposure of Gauges. The proper exposure of a precipitation gauge is essential for obtaining accurate and consistent measurements. Gauges should not be located close to obstructions such as trees and buildings, which may deflect precipitation due to turbulence. Gauges should not be located in wide-open spaces or on elevated sites, such as tops of buildings because of wind and the resulting turbulence. The best location is where the gauge is uniformly protected in all directions, such as an opening in a grove of trees.

As a general rule, the windier the gauge location, the greater the under catch. Gauge catch should be maximized by assuring it is unobstructed. Buildings, trees or any object that obstruct catch create a bias in the amount. Optimally when siting a precipitation gauge, the height of the protection should not exceed twice its distance from the gauge.

Wind shields, also known as snow shields (Figure A-1), can minimize under catch. Because of its light weight and propensity to blow about more easily than raindrops, snow is prone to under catch more than rain. Figure A-2 page A-5 is an 8 inch gauge without the wind shield.



Figure A-1. Wind Shield



Figure A-2. Eight Inch Gauge

Areas where heavy snowfall occurs; e.g., mountainous areas in the western U.S., gauges may be mounted on towers at a height considerably above the maximum level to which snow accumulates, but at or somewhat below the level of tree tops. (See Figure A-3 page A-6).

Good exposures are not always permanent. Man-made alterations to the area and the growth of vegetation may change an excellent exposure to an unsatisfactory one in a very short time. This necessitates the moving of precipitation gauges to locations with better exposures. Try to avoid this by anticipating changes when selecting a site.



Figure A-3. Fischer & Porter Gauge
Mounted on a Snow Tower with Wind
Shield

4. Types of Precipitation Gauges. The specific types of gauges approved for measuring precipitation are:

- | | | | |
|----|-----------------------------|----|----------------------------|
| a. | Non-recording | b. | Recording (weighing type) |
| | (1) eight-inch gauge | | (1) Fischer & Porter gauge |
| | (2) four-inch plastic gauge | | (2) Universal gauge |

4.1 Eight-Inch Non-Recording Standard Precipitation Gauge. This gauge (Figure A-4 page A-7) consists of a support, large diameter overflow can, measuring stick, smaller diameter measuring tube inside the overflow can, a funnel that connects the overflow can and measuring tube. The overflow can and top of the funnel are eight inches in diameter. The funnel directs precipitation into the measuring tube, which is 2.53 inches in diameter. The reduction in area from 8 inch diameter of the funnel to 2.53 inches diameter of the tube results in one to ten multiplication in the height of the volume. Therefore, 2 inches of rain entering the funnel will occupy 20 linear inches in the measuring tube, making it possible and practical to read rainfall amounts to the nearest hundredth, scaled inch. The measuring stick is marked to indicate this expansion; 20 linear inches on the stick equals 2 inches of rainfall. Therefore the smallest increments on the measuring stick, the 0.01 inch rainfall tick marks, are actually 1/10th linear inch apart, (See Figure A- 5). The inner measuring tube is 20 inches tall and holds exactly 2 inches of rainfall. Rainfall which overflows the measuring tube can be measured by pouring the

excess liquid from the overflow can into the measuring tube with the funnel attached, as shown, once the initial two inches has been emptied.



Figure A-4. Eight-Inch Precipitation Gauge Components



Figure A-5.
Measuring
Stick Close
Up

4.1.1 Installation. The metal support (Figure A-6) for the eight-inch standard precipitation gauge must be firmly installed to prevent it from being overturned. The top of the gauge must be level. This should be checked by laying a level across the open top of the gauge in two directions, one crossing the other at right angles.



Figure A-6. Eight-Inch Gauge

4.1.2 Maintenance. If the cooperative observer re-levels the gauge, the observer should add a note to the observation form giving the date the defect was discovered and the date corrected. Leaks in the measuring tube or overflow should be reported immediately to the NWSREP. In areas that receive frozen precipitation, the funnel and inner measuring tube should be removed before any frozen precipitation event. The funnel should be inspected and cleaned before each precipitation event to ensure an accurate catch.

4.2 Four-Inch Non-Recording Gauge. The four-inch non-recording gauge (Figure A-7) consists of the outer overflow tube (lower center), measuring tube (left), a funnel (top) that catches the precipitation and directs it into the inner measuring tube, and a mounting bracket with screws (lower right). The gauge is made of clear plastic. No measuring stick is needed because the transparent inner measuring tube (Figure A-8 page A-9) is graduated to hundredths of an inch. The inner measuring tube holds one inch of precipitation. Additional amounts will flow into the overflow tube and can be measured by pouring the excess into the measuring tube with the funnel attached once it has been emptied of the first inch.



Figure A-7. Four-Inch Plastic Gauge



Figure A-8. Four-Inch Measuring Tube Closeup

4.2.1 Installation. The installation of the four-inch plastic gauge should follow the same guidelines as the standard eight-inch rain gauge. The gauge is installed on a bracket provided with the gauge and is held in place with screws driven into a post or similar permanent mount. The top of the funnel should be well above the top of the post or similar mount for optimum exposure.

4.2.2 Maintenance. Little maintenance of the plastic gauge is needed. The measuring tube should be easy to read. If the plastic becomes “clouded” from exposure, the measuring tube or the gauge should be replaced. In areas that receive frozen precipitation, the funnel and inner measuring tube should be removed before any frozen precipitation event.

4.3 Weighing Recording Gauge. The weighing-type recording gauge is designed to record the amount of precipitation in a capture bucket at periodic intervals; F&P usually every 15 minutes and the Universal to the nearest minute. From this time series record of gain or loss, rate and accumulation can be calculated. The precipitation mass is measured in hundredths (Universal) or tenths (F&P) of an inch per unit time. These gauges consist of a receiver with an inside diameter of exactly eight inches that funnels precipitation into a collector mounted on a weighing mechanism. There are two types of weighing gauges approved by the NWS:

- a. The Universal Gauge (Figure A-9 page A-10), and
- b. The punched tape type Fischer & Porter (Figure A-10 page A-10).



Figure A-9. Universal Weighing Recording Gauge



Figure A-10. Fischer & Porter Recording Gauge

4.3.1 Universal Weighing Precipitation Gauge. Precipitation falls into the Universal gauge funnel and into a collector mounted on a weighing mechanism. The weight of the precipitation in the collector compresses a spring, which is connected to a pen arm. Ink from the pen leaves a trace on a paper chart, which is wrapped around a clock-driven cylinder. The cylinder rotates continuously, making one revolution hourly, daily, weekly or monthly based on the gears of the clock. Ink tracings on the chart provide a “history” of precipitation amounts over time.

Charts are graduated to the nearest .05 inch and may be estimated to the nearest .01 inch by interpolating between the graduations. The total capacity of the gauge varies from 2.4, 6 or 12 inches, depending on the model. Each type of gauge uses a different chart graduated for its specific range

4.3.1.1 Calibration and Equipment Problems. The Universal gauge requires calibration and other adjustments semi-annually. This is completed by the NWSREP with special equipment. Clock failure, or any trouble that cannot be corrected by the cooperative observer, should be reported immediately to the NWSREP.

4.3.1.2 Gaining Access to Bucket and Chart Mechanism. Access to the chart and bucket is necessary in order to read or change the chart, wind the clock, or empty the bucket. Most universal gauges have an inspection door large enough to provide access to the clock and chart. See Figure A-11.



Figure A-11. Front Open View of Universal Gauge

4.3.1.3 Preparation of Charts. The following information is entered into the spaces provided on the chart before placing the chart on the cylinder:

- a. Station name and station number as specified by the NWSREP.
- b. Date and local time, to the nearest minute, the pen will be placed on the new chart.

Indicate A.M. or P.M. as appropriate. When Daylight Saving Time is used locally, a “D” is entered following A.M. or P.M. For example, if the chart is changed in the morning, A.M.D. is entered.

4.3.1.4 Installing and Removing Charts. Charts should be changed on all of the following occasions:

- a. At the end of the chart (Usually once a week).
- b. On the first day of each month, and
- c. Within 24 hours after the ending of any precipitation.

Charts should not be changed during rain that is heavy enough to wet the trace and cause the ink to spread. Rather than changing the chart, the bucket should be emptied during heavy rain when it may overflow or the capacity of the chart may be exceeded.

When charts are installed or removed, a vertical mark should be inserted about 1/4 inch long on the chart (trace). This is accomplished by gently touching the weighing mechanism which moves the pen. This mark serves as a time check. If the pen does not produce a trace on the chart, a small dot should be placed on the chart to mark the position of the pen. A circle should be drawn around the dot for identification, and a note of explanation entered on the chart (e.g., “chart removed”).

4.3.1.5 Changing Charts on Gauges.

- a. Raise the sliding door and make a time check on the chart.
- b. Remove the pen from the chart by shifting the pen bar forward.
- c. Remove the upper portion of the case that includes the funnel. This is called the receiver. Also, remove the funnel for winter season.
- d. Empty and replace the bucket (this is based on the best judgment of the observer and NWSREP). Recharge with antifreeze and oil as directed by the NWSREP. The pen on the universal gauge should rest between the one and two inch lines after antifreeze and oil has been added.

- e. Remove the chart drum retaining nut.
- f. Grasp the cylinder at the top and gently lift it over the spindle.
- g. Release the clip holding the chart. Avoid touching or storing the chart in a way that will cause the trace to be smeared before it dries.
- h. Wind the clock. **Caution:** The clock may stop if wound too tight.
- i. Wrap the new chart around the cylinder, so it fits smoothly and snugly on the cylinder and uniformly against the flange on the bottom.
- j. The clip is a replaceable item and should be replaced if it fails to hold the end of the paper. Ensure the corresponding ends of each “inch” line coincide where they meet. The exposed end of the chart must extend 1/4 inch to the right of the clip.
- k. The cylinder can be reinstalled. It should be lowered gently over the spindle until the gears mesh and replace the retaining nut.
- l. If necessary, re-ink the pen or replace it with a gas-line type pen. Return the pen almost to the surface of the chart. Ensure it reads within .025 inch of the last reading on the previous chart. The chart should read zero if the bucket is empty.
- m. With the pen almost touching the chart, the cylinder should be turned until it reads three hours fast, and then turned back so it reads the correct time. Write the start time on the chart.
- n. Return the pen to the chart. Make a time check. The weighing mechanism should be touched to make a 1/4 inch vertical time mark on the chart. The shield and receiver can be reinstalled.

4.3.1.6 Completing the Charts. After the chart has been removed from the gauge, verify the following has been entered on the chart:

- a. Station name.
- b. The local time and date of removal. (See Section 4.3.1.3 page A-12)
- c. The time check mark was made when the chart was installed and removed.
- d. Notes that will explain unusual or missing parts of the trace. The gauge should be inspected daily to ensure the clock is running and the pen is making a trace. If the clock has stopped and cannot be restarted, the cylinder should be turned forward ½ inch each day until the clock is replaced. The chart should be replaced in accordance with Section 4.3.1.4 page A-12 or when the chart drive is replaced. The cooperative observer should contact the NWSREP promptly for a

replacement of the chart drive.

4.3.2 Fischer & Porter Punch Tape Gauge. Belfort Instrument Company took over manufacturing of this gauge in the early 1980's. Precipitation amounts are recorded at 0.1 inch increments. The maximum capacity is approximately 22 inches, however 19.5 inches is the maximum recorded. The F&P punches holes in a paper tape on a moving scroll every 15 minutes. Although the punch tape is designed for automatic machine processing, it may be read visually by summing the values of the holes punched. Punches are made for the following values: 0.1, 0.2, 0.4, 0.8, 1.0, 2.0, 4.0, 8.0, and 10.0 inches. For a precipitation amount of 3.7 inches, the following punches would be made: 2.0, 1.0, 0.4, 0.2 and 0.1 inches, the sum of which equals 3.7 inches.

An illustrated instruction bulletin is provided with each instrument. It should be consulted for details on any specified model. The Fischer & Porter gauge shown in Figure A-10 page A-10 is powered by a 6 volt DC battery. The battery is recharged in the field by a solar panel. The measuring device consists of:

- a. a collection bucket for captured precipitation,
- b. a weighing device, and
- c. an indicator dial showing the amount of precipitation collected

4.3.2.1 Operation and Maintenance. The NWSREP will place the gauge in operation and explain its operation to the observer. The cooperative observer should be instructed to do the following:

- a. Inspect the gauge weekly to ensure that the tape is positioned at the proper time. Figures on the left side of the tape indicate the days. Make a dial reading and enter it on the tape. If the time indicated on the tape is in error by more than an hour (4 spaces) from local time, reset it to the correct time. Annotate the time correction on the tape. Refer to Section 4.3.2.2 page A-15 for instructions on setting the tape to the correct time. Do not force manual punches before adjusting or removing the tape.
- b. If the reading on the indicator dial is near or exceeds 10 inches, remove the upper hood. Either *remove and empty the collector or unhook the plastic drain tube from the rim of the collector bucket and lower it to drain. The fluid should be collected in a container and must be retained for collection in accordance with instructions provided by the NWSREP. *Replace the collector on the force post or replace the drain tube on the collector. In warmer weather, add oil (supplied by the NWSREP) to the collector. During the time of year when snow or freezing temperatures can be expected, you must remove the funnel and add antifreeze (supplied by the NWSREP) to the collector. Replace the hood. Write the date and time on the tape along with a note indicating the bucket had been emptied, and that oil/antifreeze has been added. **Contact the NWSREP for instructions.**

- * Be especially careful when removing or replacing the collector. Too much force will damage equipment.
- c. As soon as possible after the beginning of each month, remove the punched portion of the tape from the black take-up spool. Before removing the tape, draw a line along the top of the punch block for a gauge time versus local time reference. Annotate the tape with station name and number, date and time information as instructed by the NWSREP. Advance the tape to provide 20 inches of blank tape following the punched portion. Tear or cut the tape above the punch block and remove by slipping it off the end of the black take-up spool. Include any other information that may be helpful in processing the tape.
- d. Check the amount of tape remaining on the spool. Install a new roll of tape when necessary. Thread the loose end of the tape from the supply roll under the tension spring, through the punch block behind the guide bar, and onto the take-up spool. The printed side of the tape should face you and be properly threaded through the punch block and paper guides.
- e. Set the tape to the correct time (Section 4.3.2.2 below) and mark the station name, station number, start time, date and month on the tape.
- f. Remove, empty, and replace the Chad tray.
- g. Close and fasten the door with both latches to keep out dust and moisture. Insert the latch cover in its retainer on the base of the gauge. The slot near the top should be over the padlock eye on the hood. The latch cover need not be installed if it is not necessary to lock the gauge.
- h. Put the punched tape for the past month in one of the mailers supplied by the NWSREP and mail by the 5th of the month. A mailing address should be stamped on the mailer. If not, obtain the address from the NWSREP and request new mailers properly addressed.

4.3.2.2 Setting the Tape to the Correct Time. The electronic timer (Figure A-12 page A-16) will trigger the gauge to punch every 15 minutes. The power switch must be “ON”. The best time to change the tape is immediately after a routine punch. This will allow 15 minutes to change the tape without missing any readings. The Model III timer has two buttons and a window on the front face. The window allows the observer to see the LED timer. The right button is pressed to light the LED while the left button is pressed to advance the time. The timer should be set to the number of minutes past the last scheduled punch time.

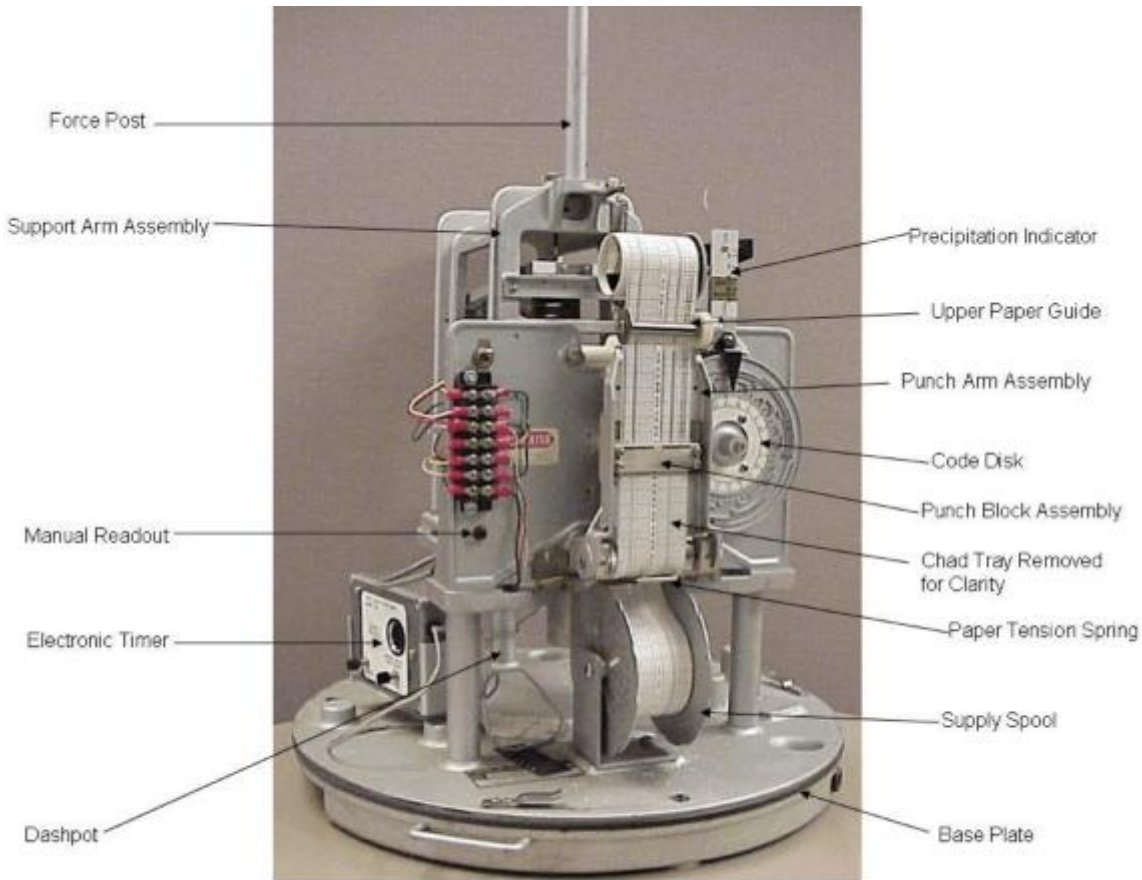

Figure A-12. Fischer & Porter Recorder Components View with Cover Removed

Set the tape to the correct time, as follows:

- a. With the power switch “OFF,” feed the tape through the punch block onto the take-up spool. Continue feeding the tape until the first time line to appear above the punch block reads two hours before the current time. (See Figure A-12 page A-16).
- b. Turn the power switch to the “ON” position and push the button to advance the tape eight punches or until the time line on the tape corresponding to the next 15-minute time interval is lined up with the holes in the punch block. Next, draw a line across the tape just above the punching block, using a felt tip pen. Write the date and time on the tape above the punch block. This reference will determine the actual start of the record. The next punch should occur at the next 15-minute clock interval and it should agree with the time shown by the tape within 15 minutes. Hold the button down 5 seconds for each punch.

4.3.2.3 Winter Operation. During the season when frozen precipitation (except hail) or freezing temperatures are likely to occur; recording gauges need to be winterized, as described below:

- a. At the start of winter, remove the funnel from the collector. Store in base of gauge.
- b. Empty the collector and replace it in the gauge. Remove and replace the collector very slowly to avoid damaging the mechanism. A full bucket can weigh 40 pounds. If there is any doubt about your ability to slowly handle this weight, use the drain tube to empty the collector. **Contact the NWSREP for instructions.**
- c. As instructed by the NWSREP, pour one or two quarts of antifreeze (supplied by the NWSREP) into the bucket. Do not use commercial antifreeze or add water.

In certain areas of the country significant evaporation can occur during periods of low relative humidity and windy conditions. The NWSREP may recommend to also add one quart of antifreeze and one quart of oil (supplied by the NWSREP).

- d. Make no adjustments to the gauge after antifreeze and/or oil has been added. The dial on the F&P gauge should read between one and three inches.
- e. Enter a note on the tape identifying the time and date the gauge was charged with antifreeze and/or oil.

4.3.2.4 Routine Maintenance. The following actions should be taken during the year:

- a. Empty or drain the F& P gauge when 10-inches are reached. The new indicated gauge level should not be adjusted. Follow the management of waste procedures in NWSM 50-5116 Section 2 (2.11.2b). **Contact the NWSREP for instructions.**
- b. Change tapes on the F&P gauge on or after the first of each month (never change the tape before the first of the month).
 - (1) The observer should notify the NWSREP when additional antifreeze/oil or other materials are needed.
 - (2) Charts or tapes should be mailed as instructed by the NWSREP.

4.3.3 Fischer & Porter Upgrade (FPU) Gauge. This equipment replaces the paper tape mechanism and provides an electronic data record. The upgrade is comprised of three components; the new precipitation sensor located in the base of the gauge; the data logger inside the stainless steel box; and the solar power panel also mounted to the new pole (Figure A-13). The weighing sensor (load cell) is to the right with inside pictures (Figures A-14, A-15). The weighing sensor is the small block at the bottom of the frame.



Figure A-13. Fischer & Porter Equipment Cluster



Figure A-14. Upgraded F&P Gauge with Cover Removed



Figure A-15. FPU Front View of Load Cell



Figure A-16. Data Logger Box

4.3.3.1 Equipment Cluster.

4.3.3.1.1 Data Logger Enclosure. A stainless steel box, that houses the data logger, battery, and the data key receptacle, see Figure A-16. To open the box, unfasten the spring clip located on the right-hand side of the enclosure's front panel. Your NWSREP will affix a reference card showing the notation codes to the inside of the door panel. The components of the Data Logger are highlighted in Figure A-17.

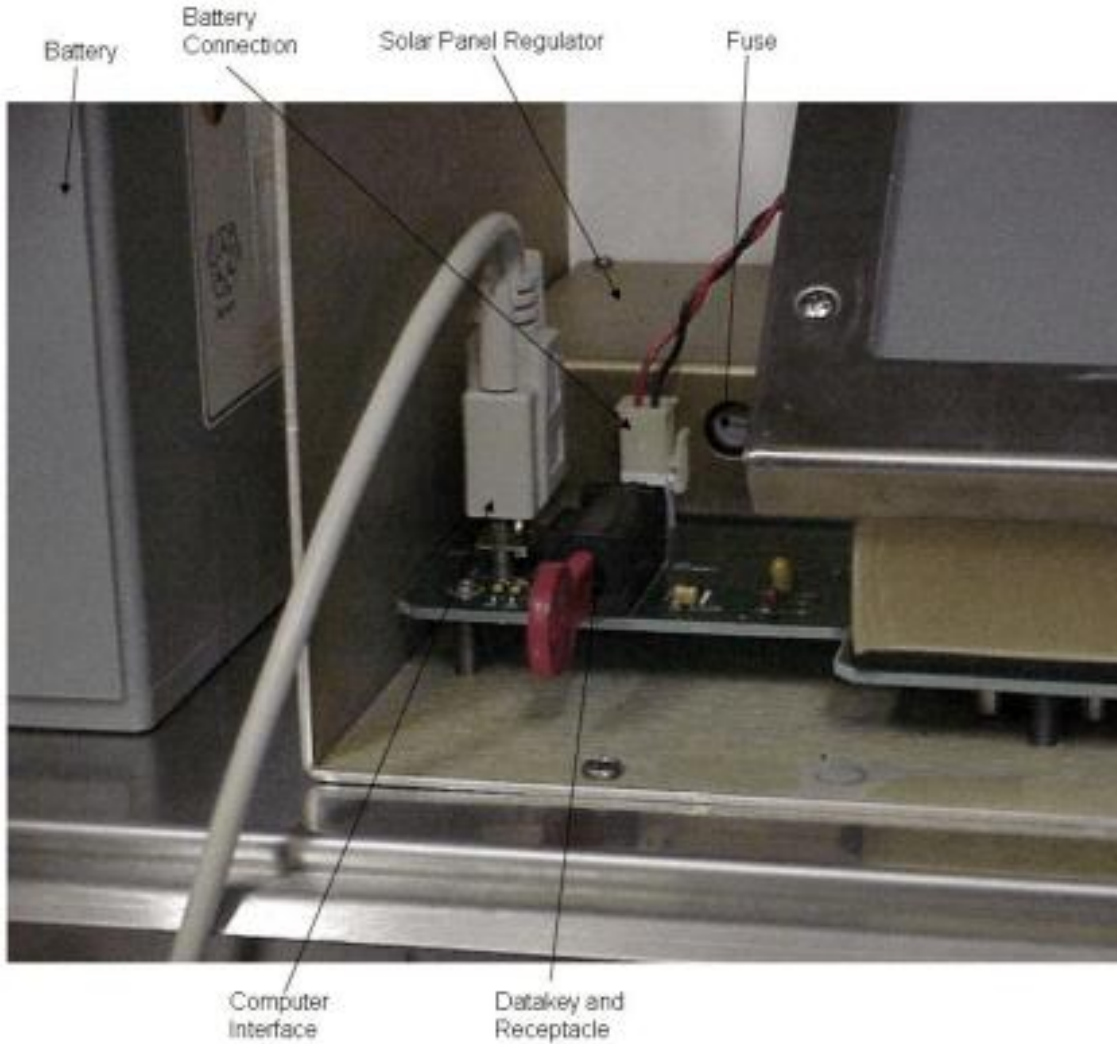

Figure A-17. Components - Data Logger Box

4.3.3.1.2 Data Logger Display. Press the <ENT> button on the data logger's keypad to wake-up the green fluorescent display. The user display (Figure A-18), is situated together with the data logger's 16-button pad. The keypad's user commands are called-up by pressing the <Up-arrow> and <Down-arrow> buttons.



Figure A-18. Data Logger

The keypad menus let you: change the date and time, change the displayed units of measurement, and enter a note into the data similar to when you drew a line and entered the “ON date/time” to an F&P paper tape. To return to the default data display, continue pressing the <Up-arrow> button until the current readings appear.

Data is displayed for five seconds at a time in an alternating pattern to show the current bucket level and then the precipitation for the 24 hours ending at midnight. If the keypad is not used for 5 minutes, it will return to the ‘sleep mode’, and the green fluorescent characters will not appear on the display – the screen goes dark.

4.3.3.2 Routine Checks.

4.3.3.2.1 Rain Parameter. This is the current level of liquid in the bucket, not just precipitation, from whenever the bucket was last serviced. The display (Figure A-19) updates every 10 seconds.

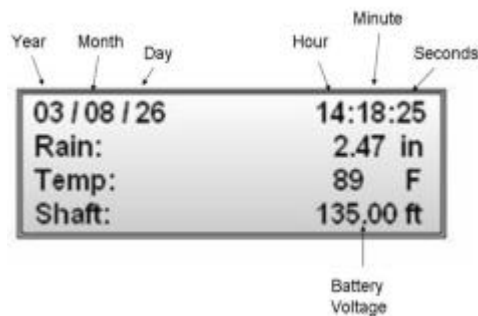

Figure A-19 Rain Parameter

Note: The **Rain** parameter gives the total amount of liquid in the bucket, including any antifreeze or oil. Special instructions apply if you have emptied the gauge bucket in the middle of the month. See Section 4.3.3.5 page A-27, ‘FPU Bucket Draining’.

4.3.3.2.2 24-Hour Rain Difference Parameter (24RainDiff). This is the difference between the rain reading of the most recent midnight, and the Rain reading from the preceding day’s midnight. The **24RainDiff** display (Figure A-20) is a data reading that updates once every 24 hours.

03 / 08 / 26	14:18:25
24RainDiff:	0.04 in
Temp:	89 F
Shaft:	135.00 ft

Figure A-20 24-Hour Rain Difference Parameter

Caution: Never use the **24RainDiff** parameter when entering data on the B-91 report, because midnight is invalid as your station’s standard observation time. Also, there are several conditions when the **24RainDiff** will not be valid (i.e., bucket drained on same day).

4.3.3.3 Notation Codes Instead of “ON/OFF” Times. Previously, any time you suspended the F&P gauge from its 15-minute timer or each month when you removed the Punch Tape from the sprockets, you were required to write down the ‘OFF Date/Time’, as well as your Station ID (i.e., 23-4652), your Station Name (i.e., Lake City), and your State (i.e., MO) in felt tip marker to your Punch Tape. You then had to draw a straight line (i.e., a “time line”) across the width of the Punch Tape, to stand as an unmistakable reference to show where the interruption began.

With the FPU however, the data logger continues to run un-interrupted while you perform the critical monthly task of downloading precipitation data to the red plastic data key. Therefore, you do not need to personally account for an “OFF” time, and “ON” when you collect the data. While the FPU has no Punch Tape for you to enter “ON/OFF” times, it does have a user interface, the keypad, where you may enter a 3-digit code for the record, to remark how a certain action interrupted the continuity of the data record!

There are FPU actions you may take, upon the direction of the NWSREP, that will affect the weight of the collection bucket, or somehow interrupt the logging of valid data. For example, any type of bucket draining or adding of antifreeze or oil will interrupt the continuity of data. For these actions you must first enter code 100, ‘End of Valid Data,’ prior to the task. This is analogous to the “OFF Date/Time” notation you entered on the F&P Punch Tape. When your task(s), are concluded you must always enter code 140, ‘Start of Valid Data’. This is analogous to the “ON Date/Time” notation.

In addition, your NWSREP will enter a Notation Code when he conducts a maintenance visit.

For example, when the NWSREP partially drains the bucket, code 162, ‘partially drained bucket’ is entered but for the observer the code is 116 ‘partially emptied’. Likewise, when antifreeze is added, code “164” is entered, but for the observer 118, and when oil is added, code “163” is entered, but the observer enters 117. See FPU Manual for complete list.

When a Notation Code is entered to the keypad, a valuable, unchangeable, and permanent note is entered into the electronic record. The National Climatic Data Center (NCDC) archives the Notation Code as it is embedded with the precipitation data.

4.3.3.3.1 Notation Code List For Observer. To review your list of appropriate 3-digit codes follow these descriptions for codes 100 to 140:

Value Meaning of value

100	End of Valid Data	117	Added Oil to bucket
103	Time is more than 15 minutes fast/slow	118	Added Antifreeze to bucket
104	Routine Gauge Check	125	Installed funnel
115	Emptied bucket - bucket completely emptied	126	Removed funnel
116	Partially emptied bucket - some liquid left in bucket	140	Start of Valid Data

4.3.3.3.2 How to Add a Notation. To enter a notation, access the FPU data logger’s keypad (Figure A-21) and press <ENT> button in lower-right corner. This wakes up the display.



Figure A-21. Data Logger Keypad

Now press either <Up-arrow> or <Down-arrow> buttons to cycle through the four menus (Sensor Notation, Current Date & Time, Current Units, Data Readings Status) until you reach the one labeled “New Sensor Notation:”. See Figure A-22.

For example: If you open the data logger enclosure to check on the health of the system, you should enter Code 104, ‘Routine Gauge Check’



Figure A-22. New Sensor Notation

Press the buttons < 1 >, < 0 >, < 4 >, and observe the numbers appear in the display. Press <ENT> button, the display will show, 'Value Accepted'. See Figure A-23.



Figure A-23. Value Accepted

This notation now becomes a permanent, irrevocable record embedded into the data file sent to the NWS and NCDC.

Notice you did not have to enter a date and time like you did on the Punch Tape, because the FPU appends date/time to every sensor notation before each is stored to memory. To return to the data readings display, a few presses of the <Up-arrow> button will cycle you back.

4.3.3.3.3 Checking Date or Time. At the keypad illustrated in Figure A-21, wake up the green florescent display by pressing the <ENT> button. View the current readings of precipitation. The precipitation appears underneath a date and time heading (Figure A-24). The time is always kept in **Standard** time, also known as 'sun time'. Do not adjust to daylight savings time. If you notice the **minutes** are off by more than 10 minutes, phone your NWSREP. The NWSREP will analyze the system to correct the problem.

Caution: The date format is **YEAR / Month / Day**. Data will become useless if you accidentally input the wrong format. See Figure A-19.

Example:

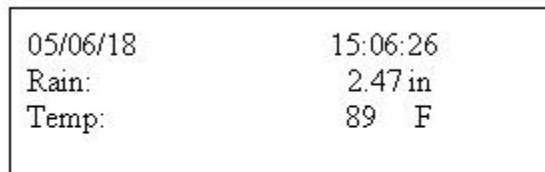

Figure A-24. Date and Time

Explanation: In the above example, **05/06/18**, is the proper display for June 18th, 2005. Specifically, the **05/** signifies year 2005; the **/06/** signifies month of June; and the **/18**, signifies the 18th day of June. The time, **15:06:26**, this is the proper display for 3:06 pm local Standard

time in the 24 hour convention.

4.3.3.4 Monthly Data Retrieval. In the first five days of each month (**but never before the first day of the month!**) on a day that is rain-free and snow-free, open the data logger housing's door, and wake up the keypad's green fluorescent display, then insert the red plastic Data Key into the key receptacle (Figure A-25) and turn 1/4 turn clockwise until it stops. Follow the prompts that appear on the user display and then remove key when prompted. This outdoor procedure could take up to 5 minutes.

4.3.3.4.1 Insert Data Key. Insert red plastic data key into the Data Key receptacle (Figure A-25 page A-27) while the green fluorescent display is active. Turn the data key clockwise one-quarter turn (Figure A-26).



Datakey

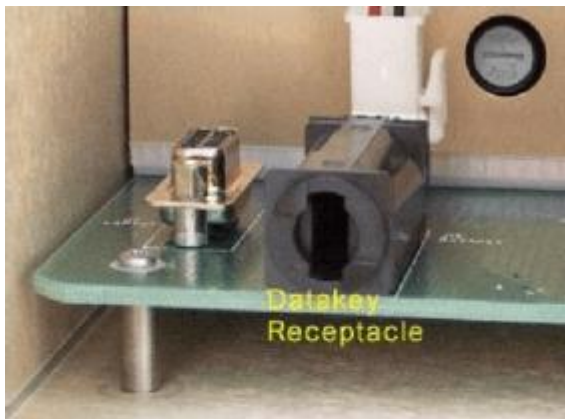

Red datakey (above) is inserted into the datakey receptacle and turned to the right in order to transfer the rain data from the Gauge Modification Assembly (GMA) into the datakey.

Figure A-25. Datakey Receptacle

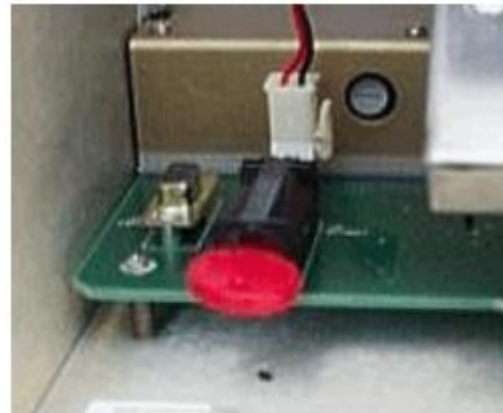

Red datakey remains in the receptacle for several minutes until data logger download completes. When keypad instructs "Please Remove Data Key" turn key to left and remove it.

Figure A-26. Datakey Activated

4.3.3.4.2 Monitor the Display. When the system recognizes that the Data Key has been inserted (Figure A-27) and turned, it automatically loads the data to it.



Figure A-27. Datakey Insertion

If the user display fails to give the message in Figure A-27 ‘data key insertion detected’, remove the red data key and wipe it clean with a paper towel, and then reinsert to the receptacle.

Note: If you entered the data key to the tumbler without having awakened the keypad display, remove the key, and then press the <ENT> button to wake up the display. Now reinsert the data key and turn the key one quarter turn to the right.

4.3.3.4.3 Verify the Start of Download. Monitor the display to verify a successful download to the data key. The display gives a running percentage (Figure A-28) of the portion of data copied to the data key until 100% complete. This process might require three-five minutes to complete.



Figure A-28. Transfer Data

4.3.3.4.4 Remove Key. Monitor the display for a notice that key download is completed and that it requests removal of the data key (Figure A-29).



Figure A-29. Download Complete

Note: After download has completed and if you forget to remove the data key from the receptacle and 5 minutes have elapsed, you will notice the display times-out and goes dark. You will also realize that pressing the <ENT> in this state will not wake-up the display. So, first remove the data key, then press <ENT> to wake-up the display. Finally, confirm that alternating readings of rain and **24RainDiff** appear every five seconds.

4.3.3.4.5 Mail the Data Key. By the 5th day of the month mail the red plastic Data Key to your NWSREP in the envelope provided you from the WFO.

Note: You should keep the primary Data Key inside the data logger enclosure, so it is readily available at time of download. Never leave the datakey inserted in the receptacle. If you are missing your data key, phone your NWSREP.

4.3.3.5 FPU Bucket Draining. The same bucket is used for FPU as the F&P Punch Tape system. It holds the same volume of fluids, with a capacity to 22 inches. Measurement range is 0-19.5 inches of precipitation (or 4.9 gallons). When you observe that your daily rain readings exceed 10.00 inches, go to the keypad and enter Notation Code 100 (End of Valid Data). Follow instructions outlined in paragraph 4.3.2.1.b page A-14 excluding annotations. **Contact NWSREP for instructions.**

4.3.3.6 Inspect the Hardware and Visual Check List. Periodic inspection of hardware is a best practice that will help ensure good system performance and quality representation of precipitation data. Ensure there are no obstructions that block the aperture of the gauge bucket and that all access doors and their hinges, latches, and locks, are working properly. After clearing obstructions, use a damp cloth or paper towel with gloves to wipe clean exterior surfaces.

- a FPU Hood, Funnel and Bucket: each free and clear of debris.
- b. Data Logger Access Door, hinges, latch, and lock is functional.
- c. Solar Panel, fastened tight, free and clear of debris. Ensure the cable and cable plugs are properly positioned and appear in good physical condition. Ensure the solar panel is not covered by dust, bird droppings, snow, or obstructed by any shaded objects.

4.3.3.7 NWSREP Seasonal Maintenance. Your NWSREP will plan seasonal maintenance for your site and coordinate with you in advance of his/her visit.

Note: The FPU Observer should not open the door to the lower bucket assembly where the gauge weighing sensor is located unless instructed by the NWSREP.

FPU SEMIANNUAL CHECK BY OBSERVER

What to Check	How to Check	Precautions and Remarks
1. Overall Appearance	Observe paint finish, or evidence of vandalism.	Clean oil film from the outside of gauge using GSA nonflammable liquid detergent.
2. Weather Stripping around	Check for breaks or general	Notify NWSREP.

<p>Base Plate and Cylindrical Door.</p>	<p>deterioration. Weather stripping is used around Base Plate of the Model 1558 and 1559 gauges only.</p>	
<p>3. Collection Bucket</p>	<p>The collection bucket is to be emptied whenever the keypad Rain display gives a reading in excess of 10.00 inches. Follow NWSREP instructions.</p>	<p>Enter notation 100, 'End of Valid Data,' before servicing collection bucket. Remove any foreign material in the collection bucket and clean. Enter 140 'Start of Valid Data' when actions are completed.</p>
<p>a. Emptying and charging collection bucket.</p>	<p>Collection bucket is charged for warm weather operation by adding approximately one half quart of SAE 10 non-detergent or multi viscosity oil to retard evaporation supplied by NWSREP..</p>	<p>SAE10, non-detergent oil available. Enter notation 100 'End of Valid Data'. Complete the actions. Enter notation 115 'Bucket completely emptied'; or enter 116, 'Partially drained bucket'. Then enter notation 117, 'Added oil to bucket'. Finally, enter notation 140, 'Start of Valid Data,' if you completed all actions with the bucket.</p>
<p>b. Charging Collection Bucket, Cold Weather Operation.</p>	<p>When collection bucket is emptied and charged for cold weather operation, add two quarts of pre-mixed antifreeze and oil supplied by NWSREP.</p>	<p>Antifreeze, propylene glycol base. Less antifreeze may be required in climatologically mild areas. Enter notation 'End of Valid Data'. Complete the actions. Enter</p>

<p>4. Funnel</p>	<p>During the period of year when snow or freezing weather is expected, remove funnel from the conical upper housing and store.</p>	<p>notation 118, 'Added antifreeze to bucket', and then enter notation 117, 'Added oil to bucket.'</p> <p>Then enter notation 140, 'Start of Valid Data', when you have completed all re-charging actions with the bucket.</p> <p>Enter notation 126, 'Removed Funnel'. Reinstall funnel after cold weather season ends. Enter notation 125, 'Installed funnel'.</p>
------------------	---	--

4.3.3.7.1 Winterizing the FPU. Partially drain the FPU bucket into the dispenser provided by the NWSREP (code 116), so as to retain the oil layer in the bucket. Remember to recharge with two quarts of antifreeze (code 118). Then if necessary, add oil (code 117). You do not need more than ¼ inch surface oil layer in the Fischer Porter’s 14 inch diameter bucket. Add one half quart of oil when completely replacing the charge.

Remove funnel: Remove the cone-shaped hood (Figure A-10 page A-10), tip it upside down and set it down. Rotate the funnel so its slots allow it to slide free from the three pins located on the base of the hood assembly. Enter notation 126, 'Removed Funnel.'

Further Considerations: Snowfall and high-rate rainfall events can lead to a layer of snow, ice, or fresh rainwater that rests on top of the oil layer. For these events stir the bucket with a mixing stick. This will prevent freezing and possible equipment damage.

4.3.3.7.2 Summerizing the FPU. Remove the cone-shaped hood and inspect the contents of the bucket with a mixing stick (i.e., paint stirrer). Remove and properly dispose of any leaves or debris that might have collected when the funnel was removed at start of winter season. Then with the stick, ensure there is still a ¼ inch film of oil on the surface to inhibit evaporation. If the **Rain** value exceeds **10.00 inches** on the day you are installing the funnel then perform a partial draining of the bucket by keeping the oil from running out the drain tube. Add antifreeze if local conditions require. Drain the contents into the dispenser provided by the NWSREP.

Install the funnel: Remove the conical housing, turn it upside down, and fasten the funnel by rotating its three slots onto the three pins of the cone shaped hood. Return this hood assembly to the gauge (Figure A-10 page A-10). Enter operator notation 125, 'Installed Funnel.' and enter code 140 'Start of Valid Data'.

5. Gauge Supplies. These quantities will vary as a function of the amount of precipitation a site receives in a given season. Please contact your NWSREP if you are responsible for keeping any of these items at your cooperative observer station.

- a. One quart of oil.
- b. A two-quart container of Propylene Glycol antifreeze.
- c. One 5 gallon sealable plastic container available to discard bucket fluids.

6. How to Measure Rainfall.

6.1 Fischer & Porter Gauge. See Section 4.3.2 page A-14 for instructions on reading the F&P gauge.

6.2 Universal Weighing Gauge. The Universal weighing gauge is read directly from the Trace on the drum. If the gauge did not read zero at the last observation time, the previous reading must be subtracted from the current reading.

6.3. Four-Inch Non-Recording Gauge. The four-inch clear plastic gauge (Figure A-7 page A-8) may be read directly by observing the marks etched on the measuring tube. The measuring tube holds up to one inch of water. If more than an inch of rain fell, the water in the measuring tube must be emptied, and the water in the overflow cylinder is poured into the measuring tube. Measure the additional water poured into the measuring tube and add this to the amount originally measured. This should be repeated if more than two inches fell. When finished, place the measuring tube back inside the overflow cylinder and replace the funnel.

6.4 Eight-Inch Non-Recording Gauge. This gauge is also known as the eight-inch Standard Rain Gauge (SRG). The funnel is designed to insert the measuring stick into the top of the measuring tube (Figure A-30) when receiving precipitation less than 2 inches. Slide the stick into the gauge, **do not bounce**, and leave it in place for two or three seconds. The water will darken the stick. Remove the stick and read the rainfall amount from the top of the darkened part of the stick. Replacement sticks are available from the NWSREP.



Figure A-30. Eight-Inch Gauge with Measuring Stick Inserted

For amounts of more than 2 inches when the measuring tube is full (indicating at least two inches of rain), carefully remove the funnel and empty the measuring tube to avoid spilling water back into the overflow can. Allow a few seconds for all the water to drain from the tube. Place the funnel over the measuring tube (Figure A-31) and pour the water from the overflow can into the measuring tube. Measure this amount and add it to the two inches already emptied. This procedure should be repeated if necessary.



Figure A-31. Measuring Tube with Funnel on Top

7. Measuring the Depth of Frozen Precipitation. A “Measuring Snow” video tape on the proper procedure for observing and measuring snow was produced for the NWS by the Department of Atmospheric Science at Colorado State University. Each Weather Forecast

Office was provided a copy from the Regional Headquarters. Cooperative observers required to take snow observations should be provided a copy. Copies of the snow measurement video must be ordered through the Regional Cooperative Program Manager (RCPM).

Snow measurement guidelines can also be accessed at:
www.nws.noaa.gov/om/coop/training.htm.

7.1 Definition. Although frozen precipitation includes snow, ice pellets, hail, the following text will use the word “snow” for all in this paragraph.

Two types of snow measurements are reported:

- a. Snowfall- The depth of newly fallen snow (snow having fallen since the previous scheduled time of observation), reported in inches and tenths.
- b. Snow Depth- The total depth of snow on the ground (new and old), reported to the nearest whole inch.

7.2 Snow Measurement Stick. Specially designed snow measuring sticks are available from the National Logistics Supply Center (NLSC). Figure A-32 illustrates two sizes available: a 20 inch measuring stick for areas that climatologically receive small amounts of snow and a 40 inch stick for heavier amounts. The snow measuring stick is graduated to tenths of an inch, Figure A-33.

To measure snow with this stick, find a location where the snow appears to be near its average depth. This may be difficult if the snow has drifted. Look for a flat, somewhat open area away from buildings and trees. Some trees in the distance may be helpful in breaking the wind, preventing drifting, and thus providing for a more even distribution of the snow.

Measure the depth with the snow measuring stick. Measure the depth at several locations and use an average depth if drifting has occurred.

When snow has fallen between observation times and has been melting, measure its greatest depth on the ground while it is snowing. This greatest depth measurement is considered the snowfall for the observation period. If all snow melted as it fell, enter a trace for the snowfall on the observing form.



Figure A-32.
20 and 40 Inch
Snow Sticks



Figure A-33. Snow Stick
Graduated Scale to a Tenth of an
Inch

7.3 Measuring New Snow Falling on Top of Old Snow. When fresh snow has fallen on old snow, it is necessary to measure the depth of the new snow (tenths of inches) and the total depth of all snow (whole inches). Snow boards (Section 7.4) provide the best method of taking measurements in this case. If a snow board is not available, and if the old snow has settled or partially melted enough to develop a crust or to be noticeably denser than the new snow, it may be possible to insert a snow stick until it meets the greater resistance of the crust of old snow, and to use this depth as the amount of new snow that fell.

Sometimes pollution or partial melting will give the old snow a darker color than the new snow. If so, cut a vertical core through the snow down to the ground. Measure the new (whitest) snow depth to the nearest tenth of an inch, and the total snow depth to the nearest inch. Some cooperative observers may be asked to provide 6-hour snowfall amounts other than their scheduled time of observation.

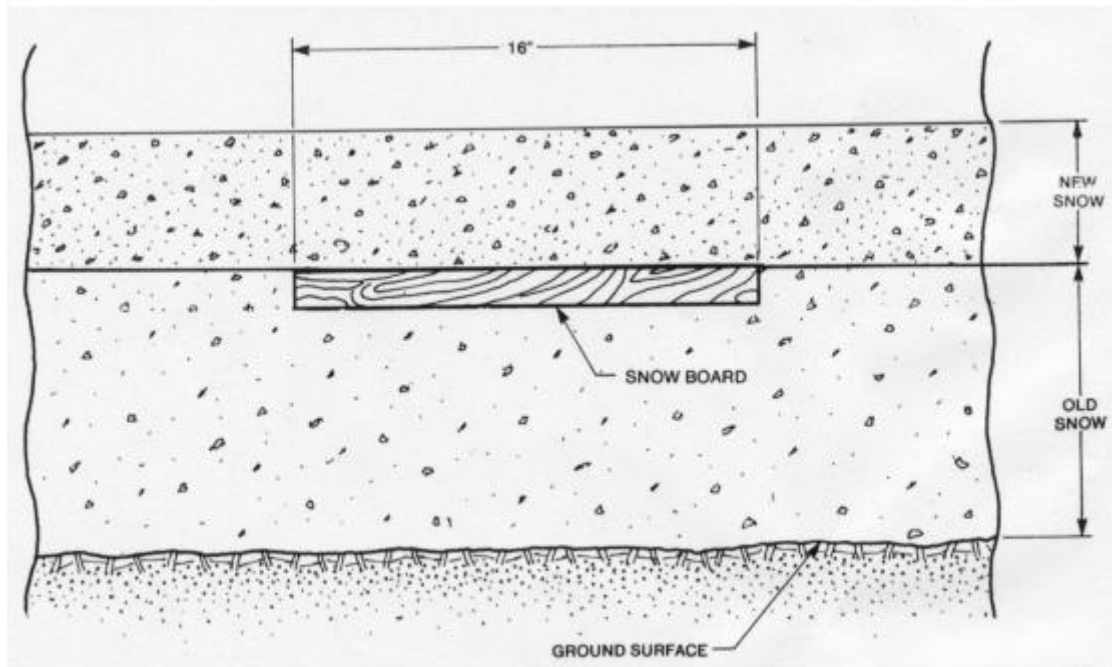

Figure A-34. Snow Measurement Board (size and material may vary)

7.4 Snow Measurement Boards. Snow boards provide a standard surface for measuring fresh snowfall. Inconsistent measurement surfaces from station to station, or even at the same location for different snowfalls, contribute to inaccurate and incompatible snowfall measurements and an inconsistent database.

Snow boards are laid on top of the old snow (Figure A-34) when there is any possibility of new snow falling. The snow board may be comprised of thin lumber or other light material that will not sink into the snow, yet be heavy enough not to blow away. The board should be painted white. Push the board into the snow just far enough that the top of the board is level with the top of the snow. A 16" X 16" snow board will allow cutting more than one snow sample.



Figure A-35. Snow Measurement Board

Usually the NWS provided snow board (Figure A-35) is the best surface and tool used to measure snowfall. The NWS snow board measures 16 inches by 24 inches, is eight millimeters

thick, and is made of the polyvinylchloride. These snow boards are available from NLSC.

After each observation, the snow board should be cleaned and placed in a new location. Because of evaporation or drifting, the board may need adjusting daily to ensure that the top of the board remains flush with the old snow.



Figure A-36. Snow Measurement Stake

7.5 Snow Measurement Stakes. Snow stakes are routinely used in geographical areas with deep snowfalls, as in the western mountains and to the lee of the Great Lakes. Stakes should be graduated in whole inches, with numerals inscribed at 10-inch intervals. Stakes should be sturdy, water-resistant, and painted white to minimize snow melt around them. The example (Figure A-36) is a snow stake in the Eastern U.S. with numerals inscribed at 2-inch intervals.

If possible, the stake should be located on level ground where the snow depth is typical of the area. In hilly areas, select a northerly exposure in a level area if possible. The area around the stake should be free from trees, buildings and other obstructions that could seriously affect the wind flow around the stake. Low, leafless bushes, however, can be beneficial in reducing drifting. If possible, several snow stakes may be used to represent the snow depth.

8. Measuring the Water Equivalent of Snowfall. The F&P and Universal weighing gauges measure precipitation by weight. Thus, snow falling into these gauges is automatically melted and measured. For non-recording gauges, remove the funnel and measuring tube from the outer overflow can during winter or whenever snow is likely to fall. The water equivalent of frozen precipitation that has fallen into the gauge can be determined by the following:

- a. Bring the overflow container that contains the snow into a warm building.

- b. Wait for the snow to melt.
- c. Pour the melted snow into the measuring tube.
- d. Measure as you would measure rain.

Melting the snow can be accelerated by carefully measuring an amount of warm water in the measuring tube, and then pour the warm water into the overflow can with the snow. Next, let the snow melt. Once melted, pour the water into the measuring tube and measure the total amount of water. Subtract the amount of added warm water to determine the water equivalent of snow.

Do not leave water standing in the gauge if temperatures are expected to drop below freezing.

9. Obtaining Core Samples of Snow. In cases where strong winds or drifting snow prevent the gauge from receiving the correct amount of snow, or when snow overflows the gauge or clings to the top to block snow from falling inside, the measurement will likely be inaccurate. Often the best solution in these cases is to take a core sample:

- a. Find an area where drifting is minimal. This will usually be a flat area away from obstructions such as trees and buildings, although obstructions at some distance can help minimize drifting.
- b. Invert the overflow can and force it down through the snow. The rim will cut a cylindrical vertical sample. If the snow is very deep, it may be necessary to push the can part way to the ground. Then, remove and empty the snow into a container and insert the can in the same hole to obtain the rest of the snow.

Caution! Do not push the can through snow that was measured at the previous observation, or its water equivalent will be counted in both measurements.

- c. Slip a piece of sheet metal or thin wood beneath the mouth of the can to prevent the snow from falling out of the can.
- d. Take the snow indoors, melt it, and obtain the water equivalent as described in Section 8.
- e. If there is a question about the accuracy of the water equivalent of snow measured directly in the can, compare it with the amount determined by a core sample and use the larger of the two readings.

10. Measuring Snow Pack Water Equivalent. Runoff from winter snow pack has the potential to produce flooding during warm spells or spring thaw. Measurement of the water equivalent helps the NWS forecast river stages and flooding potential during rapid runoff. The water equivalent can be determined by the following:

- a. Determine the average snow depth as described in Section 7, for example; your

morning observation snow depth measurement.

- b. Invert the overflow can at the point of the determined snow depth and force the can down through the snow. The rim will cut a cylindrical vertical sample. If the snow is very deep, it may be necessary to push the can part way to the ground. Then, remove and empty the snow into a container and insert the can in the same hole and obtain the remaining snow.

This procedure is also covered in the “Measuring Snow” video.

- c. Slip a piece of sheet metal or thin wood beneath the mouth of the can to prevent the snow from falling out of the can.
- d. Bring the overflow container that contains the snow into a warm building.
- e. Wait for the snow to melt. Melting the snow can be accelerated by carefully measuring an amount of warm water in the measuring tube, and then pour the water into the overflow can with the snow. Let the snow melt. Once melted, pour the water into the measuring tube and measure the total amount of water. Subtract the amount of added warm water to determine the water equivalent of snow.
Caution; be very careful not to overfill the tube. The tube will fill quickly with high water content and overflow losing some of the water content.
- f. The water content is measured to the nearest hundredth of an inch (.01) but in this case, it is reported to the nearest tenth of an inch (.1)

When measuring to the nearest hundredth of an inch and converting to the nearest tenth of an inch for reporting purposes, average up if the amount is .05 or more and average down if less than .05, for example:

(1) If you measure .65 then you will report (.7)

(2) If you measure .73 then you will report (.7)

If you have any questions call your NWSREP.

11. Keeping and Mailing Records.

11.1 Purpose. The cooperative observer is to record precipitation and other data on forms that are mailed directly by the observer or through the NWSREP, to the National Climatic Data Center (NCDC). NCDC archives, quality controls and publishes these records, which comprise the major part of the climate history of the U.S. The monthly forms, charts, and tapes are sent to the designated NWS Office. The forms used most often by cooperative observers are WS Form B-82 and WS Form B-91. These are described in section 11.2 and 11.3.

11.2 WS FORM B-82 “Official Weather Observer’s Record”. The purpose of this handy pocket-sized pad of forms (Figure A-37) is to record observations while reading the instruments. Information recorded on WS Form B-82 is then transferred to the official permanent record, WS Form B-91 or the approved NOAA paperless systems. Each pad of WS Form B-82 is intended to last one month. WS Form B-82 contains complete instructions for recording observations. This form is not to be mailed and may be retained by the observer.

DATE _____, 20____ DAY OF WEEK _____

TEMPERATURE °F			PRECIPITATION																													
24 Hrs. ending at Observation		AT. OBSN.	DRAW A STRAIGHT LINE (——) THROUGH HOURS PRECIPITATION WAS OBSERVED. AND A WAVED LINE (~~~~) THROUGH HOURS PRECIPITATION PROBABLY OCCURRED BUT WAS NOT OBSERVED.																													
MAX.	MIN.		A.M.												P.M.										Midnight							
			1	2	3	4	5	6	7	8	9	10	11	Noon	1	2	3	4	5	6	7	8	9	10	11							
								
PRECIPITATION		SNOW, ICE PELLETS, HAIL, ICE on ground at Obsn. (Inches)	WEATHER					REMARKS AND NOTES																								
24 Hr. Amounts AT OBSN.			Mark "X" for all types that occur during the calendar day																													
RAIN, MELTED SNOW, Etc. (Inches and Hundredths)	SNOW, ICE PELLETS, HAIL (Inches and tenths)		Fog	Ice Pellets	Glaze	Thunder	Hail	Damaging Wind																								
.....																															

ENTER ADDITIONAL NOTES ON REVERSE SIDE

Figure A-37. WS Form B-82

11.3 WS FORM B-91, "Record of River and Climatological Observations". The information on one page of WS Form B-82 is transferred to one line of WS Form B-91 (Figure A-38). For example, information for March 23rd on WS Form B-82 is transferred to the line designated for the 23rd day of the month on the WS Form B-91. Each WS Form B-91 contains space for an entire month's observations. Daily entries are recorded on the WS Form B-91 for the observational day (24 hours ending at the official time of observation) rather than calendar day (midnight to midnight). The NWSREP will instruct the cooperative observer on how many carbon copies are required, and to where the copies will be sent. The forms should be mailed as soon as possible, but no later than the fifth day of the following month. Instructions for filling out the WS Form B-91 are contained on the cover pages of the form. If data is missing, **M** will be entered in the appropriate column(s) for the day(s).

STATION (Climatological)		(River Station, if different)		MONTH	YEAR	WS FORM B-91 (12-64)												U.S. DEPARTMENT OF COMMERCE NATIONAL OCEANIC AND ATMOSPHERIC ADMINISTRATION NATIONAL WEATHER SERVICE					
STATE		COUNTY		RIVER		RECORD OF RIVER AND CLIMATOLOGICAL OBSERVATIONS																	
TIME (zone) OF OBSERVATION		TEMPERATURE		PRECIPITATION																STANDARD TIME IN USE			
TYPE OF RIVER GAGE		ELEVATION OF RIVER GAGE ZERO		FLOOD STAGE		NORMAL FLOOD STAGE																	
TEMPERATURE, F.		24 HOURS ENDING AT OBSERVATION		PRECIPITATION		WEATHER (Celestial Day)		RIVER STAGE															
MAX		MIN		AM		NOON		PM		Gage Reading at AM		Tendency		STATION INDEX NO.									
1																							
2																							
3																							
4																							
5																							
6																							
7																							
8																							
9																							
10																							
11																							
12																							
13																							
14																							
15																							
16																							
17																							
18																							
19																							
20																							
21																							
22																							
23																							
24																							
25																							
26																							
27																							
28																							
29																							
30																							
31																							
SUM		CHECK BAR (for wire-weight)		NORMAL CHECK BAR		Observer		SUPERVISING OFFICE		STATION INDEX NO.													

Figure A-38. WS Form B-91

12. Real-Time Reporting of Precipitation, Temperatures, and Hazardous Weather Events. Many cooperative observers may be requested to report precipitation (and in some cases temperature) values to an NWS office every day or whenever a certain minimum amount of precipitation has fallen. If the cooperative observer agrees, the information will be vital to the NWS river and flood forecast and warning program. During the winter, the observer may be requested to measure and report the water content (water equivalent) of snow on the ground twice a week. This information helps the NWS forecast the amount of runoff and potential flooding from snow melt during warm spells or the spring thaw. Some observers maintain precipitation gauges from which the data are automatically interrogated by telephone or satellite.

The NWSREP may also ask the cooperative observer to report immediately by telephone any severe weather event that may endanger life and property. This information will aid in determining the need for warnings of severe weather. If the cooperative observer agrees to participate in this program, the observer should be asked to report one or more of the following types of events.

- a. Flash flooding (observer should provide the time of the observation and state if the water level is rising or falling).
- b. Severe thunderstorms with damaging winds (58 mph or stronger) or 3/4 inch or larger hail.
- c. Excessive rain; i.e., 0.50 or 1.00 inch or more per hour.
- d. Unusual snow accumulation (4 inches or more, or as instructed).

This special reporting is entirely voluntary and is not intended to interfere with the regular weather duties agreed to by the cooperative observer with the NWS. However, these extra reports can be a valuable means of saving lives and minimizing the destruction of property.

APPENDIX B – Air Temperature

<u>Table of Contents:</u>	<u>Page</u>
1. Definition	B-2
2. Types of Thermometers	B-2
3. Instrument Shelters	B-3
3.1 Shelter Placement	B-3
3.2 Shelter Maintenance	B-4
4. Liquid-in-Glass Maximum/Minimum Thermometers	B-4
4.1 Mercury Clean-Up	B-4
4.2 Maximum Thermometer - How It Works	B-4
4.3 Minimum Thermometer - How It Works	B-5
4.4 Mounting and Maintaining the Thermometer Support	B-6
4.5 Mounting the Thermometers	B-6
4.6 How to Read and Record Temperatures	B-6
4.6.1 Reading and Setting the Maximum Thermometer	B-8
4.6.2 Reading and Setting the Minimum Thermometer	B-10
4.6.3 Reading the Current Temperature	B-10
5. Correcting Thermometer Errors	B-10
5.1 Correcting Maximum Thermometers	B-10
5.2 Correcting Minimum Thermometers	B-11
6. Electronic Thermometers	B-12
6.1 Initial Checkout of Instrument	B-13
6.2 Calibration	B-14
6.3 Operation	B-14
6.4 Identifying and Correcting Erroneous Maximum/Minimum Temperatures	B-15
6.5 “Help” and Blinking Displays	B-15
7. Entry of Temperature Readings on WS Form B-91	B-16
8. Common Errors to Avoid	B-17

Figures

B-1 Liquid-in-Glass Maximum and Minimum Thermometers	B-3
B-2 Instrument Shelters - Cotton Region Shelter and Two MMTS Shelters	B-3
B-3 ET Shelter	B-4
B-4 Liquid-in-Glass Maximum Thermometer	B-5
B-5 Index on Minimum Thermometer	B-5
B-6 Townsend Support for Maximum/Minimum Thermometers	B-6

Figures	Page
B-7 Reading and Setting Thermometers.....	B-7
B-8 Reading Thermometers.....	B-8
B-9 Maximum Thermometer in Reading Position.....	B-9
B-10 Maximum Thermometer Before and After Whirling.....	B-9
B-11 Minimum Thermometer in Vertical Position During Resetting of Index.....	B-10
B-12 Joining the Alcohol Column Tapping Method	B-11
B-13 C450-1 Original	B-13
B-14 C450-7 Upgrade.....	B-13
B-15 C451-N1 Nimbus PL-2	B-13
B-16 MMTS “Help” Display	B-13
B-17 WS Form B-91, Temperature Entries	B-18

1. Definitions. The word temperature as used in this appendix refers only to the air temperature. Temperature readings are taken from maximum and minimum thermometers, or from the digital displays of an Electronic Thermometer.

The minimum temperature is the lowest temperature to have occurred since the minimum thermometer or ET was last read and reset.

The maximum temperature is the highest temperature since the maximum thermometer or ET was last read and reset.

The current temperature is the temperature at the time the thermometer or ET is read. This is read from the maximum thermometer while in a vertical position after it has been whirled.

2. Types of Thermometers. There are two types of temperature sensors approved at cooperative stations; the liquid-in-glass maximum and minimum thermometers (Figure B-1 page B-3) and the ET’s shown in Figure B-2 page B-3 behind the Cotton Region Shelter (CRS). Figure B-1 shows the liquid-in-glass maximum and minimum thermometers in their correct operating or measuring positions.

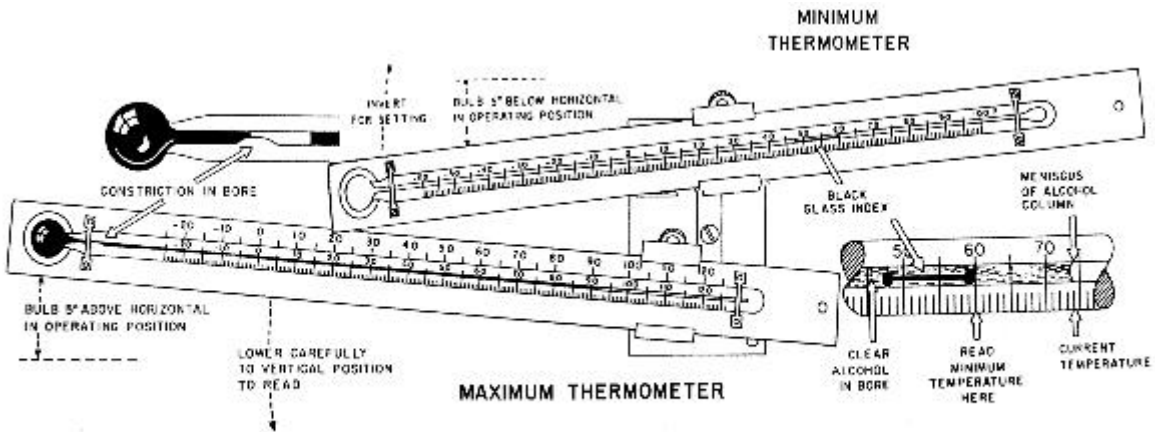

Figure B-1 - Liquid-in-Glass Maximum and Minimum Thermometers

3. Instrument Shelters. Thermometers must be enclosed in shelters, which act to shield the sensor from the sun, rain, snow, and other sources of light, heat, or cold which can cause erroneous readings. Shelters are designed to allow the maximum possible free flow of air. Ventilation is accomplished by louvers which slope downward from the inside to the outside of the shelter. Figure B-2 shows the medium-sized cotton region shelter used most often for liquid-in-glass maximum and minimum thermometers. Liquid-in-glass thermometers are mounted on a horizontal board located in the upper middle part of the shelter. The ET shelters are shown behind the cotton region shelter in Figure B-2.

3.1 Shelter Placement. The ground over which the shelter is located should be typical of the surrounding area. A level, open clearing is desirable so the thermometers are freely ventilated by the flow of air. Do not install on a steep slope or in a sheltered hollow unless it is typical of the area, or unless data from that type of topographic location is desired. When possible, the shelter should be no closer than four times the estimated height of any obstruction (tree, fence, building, etc.). Optimally it should be at least 100 feet from any paved or concrete surface. Under no circumstances should a shelter be placed on the roof of a building as this may result in extreme temperature biases.



Figure B-2 - Instrument Shelters Cotton Region Shelter and Two MMTS Shelters

All shelter supports or poles should be mounted securely enough into the earth or a concrete slab to eliminate vibrations. Strong winds can cause vibrations that will displace the indices on maximum and minimum thermometers, causing erroneous readings. The wooden shelter door must face “North” to prevent the sun from shining on the thermometers when the door is open.

3.2 Shelter Maintenance. Dust the inside of the cotton region shelter occasionally with a dry cloth. Inspect supports for a secure mounting. The cooperative observer should report any defects or changes to the NWSREP. The NWSREP is responsible for painting the cotton region shelter when needed.

Remove insect nests and other matter restricting air flow through the ET shelter (Figure B-3) when needed. The NWSREP should periodically disassemble the ET shelter and clean the plastic louvers with mild soap and water. The sensor should be cleaned with a non-abrasive cloth. Reassemble the plastic louvers in the same location before it was disassembled. Not all the plastic louvers are the same size. **Caution:** Plastic louvers have sharp edges that may cause injury.



Figure B-3 - ET Shelter

4. Liquid-in-Glass Maximum/Minimum Thermometers.

4.1 Mercury Clean-Up. Each cooperative observing site with mercurial thermometers will be supplied a mercury clean-up kit for each mercury thermometer. The NWSREP will instruct the cooperative observer on its use. The cooperative observer will provide the NWSREP with the used mercury clean-up kit for proper disposal. Follow instructions in NWSM 50-5116.

As the temperature rises, some of the expanding mercury in the bulb is forced to pass through the constricted portion into the graduated portion. As soon as the temperature falls, the column of mercury breaks at the constriction leaving the thread of mercury in the graduated portion indicating its highest reading. The thermometer is turned vertical for reading. The top of the mercury column indicates the highest temperature reached. Once the maximum temperature is read, the max thermometer is spun in its mount to force the mercury in the graduated tube past the constriction until it joins the mercury in the bulb. When joined, the maximum thermometer will indicate the current air temperature.

4.2 Maximum Thermometer - How It Works. The maximum thermometer has a mercury filled bulb sensing element. It is exposed in a nearly horizontal position (Figure B-1). Graduations at one degree intervals are etched on the stem. The bore is constricted between the graduated portion of the stem and the bulb, as shown in Figure B-4.

As the temperature rises, some of the expanding mercury in the bulb is forced to pass through the constricted portion into the graduated portion. As soon as the temperature falls, the column of mercury breaks at the constriction leaving the thread of mercury in the graduated portion indicating its highest reading. The thermometer is turned vertical for reading. The top of the mercury column indicates the highest temperature reached. Once the maximum temperature is read, the max thermometer is spun in its mount to force the mercury in the graduated tube past

the constriction until it joins the mercury in the bulb. When joined, the maximum thermometer will indicate the current air temperature.

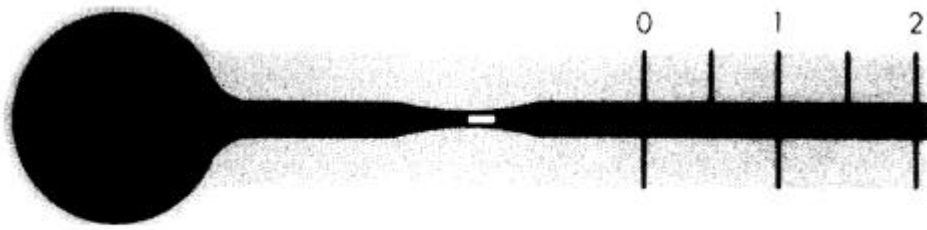

Figure B-4 - Liquid-in-Glass Maximum Thermometer

4.3 Minimum Thermometer - How It Works. The minimum thermometer has a spirit-filled bulb, graduated at one degree intervals, and exposed as shown in Figure B-1. The spirit is often colored to make it easier to read. The bore contains a dark dumbbell-shaped object called an index (Figure B-5). As the temperature rises, the spirit expands and flows around the index without displacing it. The bore contains a dark dumbbell-shaped object called an index (Figure B-5). As the temperature rises, the spirit expands and flows around the index without displacing it. Part A of Figure B-5 shows the top of the spirit column some distance to the right of the index. In Part B, the spirit column has retreated with falling temperatures until the top just touches the index. Further cooling moves the index nearer the bulb (to the left). As the temperature rises again, the spirit column moves toward the right without moving the index. Part C shows an incorrect reading with the index trapped in the broken spirit column. Correcting this problem is described in Section 5.2 page B-11.

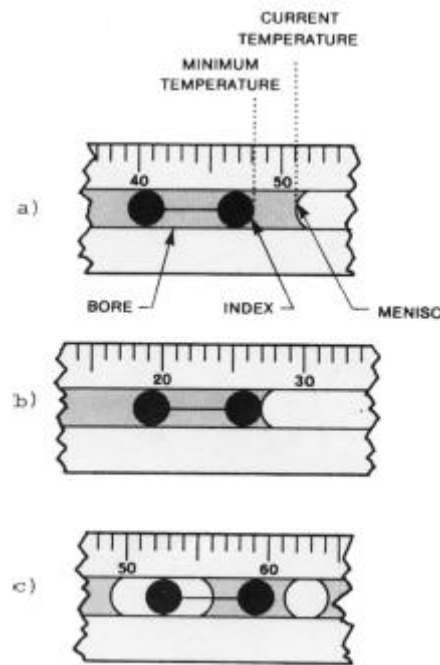

Figure B-5 - Index on Minimum Thermometer

4.4 Mounting and Maintaining the Thermometer Support. Thermometers are mounted in instrument shelters on supports such as the one shown in Figure B-6. This support is known as the “Townsend Support”. The support makes it easy to read and reset the thermometers to the current temperature at the time of observation.

The support consists of two metal shafts fastened to a metal base plate. Clamps, which hold the thermometers, are attached to the end of the shafts. The longer shaft holds the maximum thermometer, while the shorter shaft holds the minimum thermometer. The maximum thermometer may be spun (rotated) by hand to reset the mercury column to the current temperature. A pin in the minimum thermometer shaft prevents it from rotating more than a quarter turn (about 90°). It is reset by rotating it to the vertical position.

4.5 Mounting the Thermometers. Clamp the metal back of the maximum thermometer to the lower (longer) shaft of the support at a point 3.5 inches from the high-temperature end of the back. The bulb end will be to the left when the thermometer is set.

Clamp the metal back of the minimum thermometer to the upper (shorter) shaft. The back should be clamped at a point slightly closer to the high temperature end than the bulb end. The bulb end should be to the left when the thermometer is set.

The bulbs should not touch any object when rotated or tilted vertically. If properly installed and set, the bulb end of the minimum thermometer will be slightly (about 5°) above the horizontal (Figure B-1).

4.6 How to Read and Record Temperatures. Thermometers are read and recorded to the nearest whole degree Fahrenheit. Readings are usually recorded on WS Form B-82, and WS Form B-91, or WS Form B-92. Temperatures below zero are recorded with a minus (-) sign to the left of the digits; i.e., -15°F for 15°F below zero. The thermometers should be reset after they are read, as described in Sections 4.6.1, 4.6.2 and Figure B-7.

CAUTION! Stand as far from the thermometers as possible to prevent body heat from changing the readings. This is particularly important in cold weather. The bulbs of the thermometers should not be touched.

The line of sight from the top of the mercury or spirit column should be level to the eyes. If not, the reading will be too high or too low, as illustrated in Figure B-8.

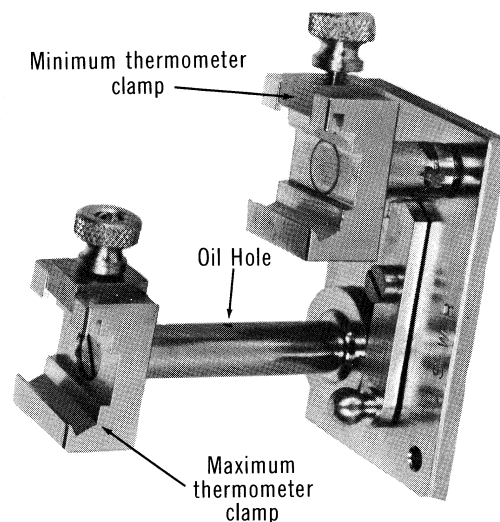
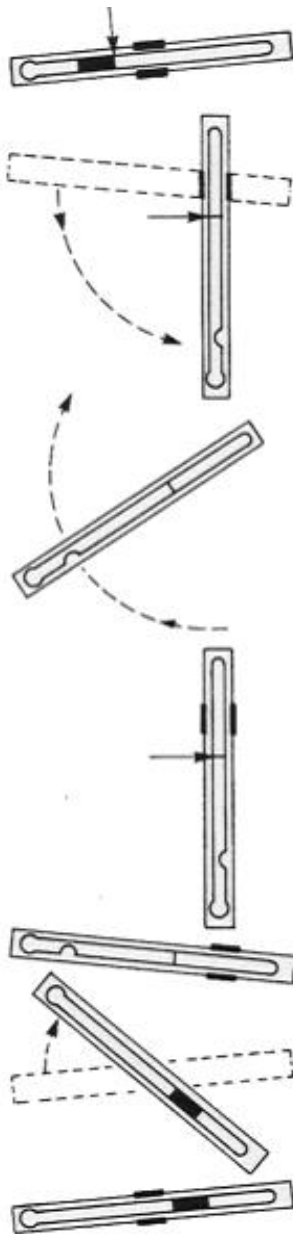

Figure B-6 - Townsend Support for Maximum/Minimum Thermometers



- a. Read the right end of the index on the minimum thermometer.
- b. Unlock and slowly lower the maximum and read the top of the mercury column.
- c. Whirl the maximum thermometer until its reading agrees (within 1°F) with the reading at the top of the spirit column on the minimum thermometer. When the two thermometers differ by more than 1°F, this should be reported to the NWSREP.
- d. Read the current ambient temperature from the maximum thermometer after it has been whirled, except at evaporation stations.
- e. Rotate the bulb end to the left near horizontal and lock the maximum thermometer in its set position.
- f. Invert the minimum thermometer until the index drops to the end of the spirit column.
- g. Return the minimum thermometer to its nearly horizontal position.

Figure B-7 - Reading and Setting Thermometers

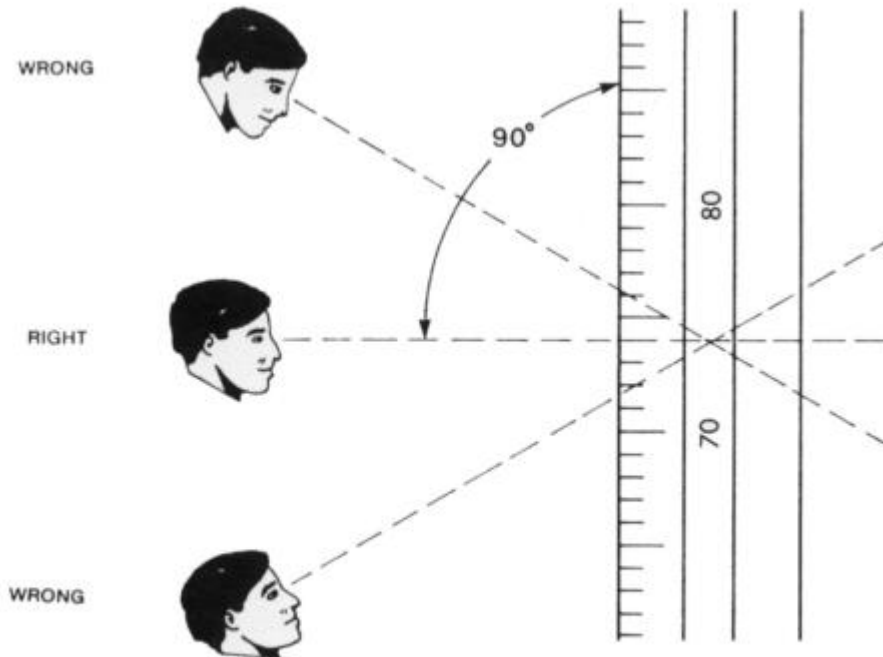

Figure B-8 - Reading Thermometers

4.6.1 Reading and Setting the Maximum Thermometer. The highest temperature occurring since the maximum temperature was previously reset is the reading at the top of the mercury column, taken with the bulb end lowered. Release the support catch on the back of the clamp and carefully lower the bulb end of the thermometer. See Figure B-9.

To reset the maximum thermometer, start with the bulb end lowered and whirl it rapidly, allowing it to spin freely until it comes to rest. Repeat the whirling if necessary until the mercury will not retreat farther into the bulb; i.e., until the column is no longer separated at or below the constriction. See Figure B-10.

Next, move the catch on the support until it touches the longer shaft. Carefully elevate the bulb end of the thermometer until the catch locks the shaft in place on the support. The thermometer is now “set” to indicate the maximum temperature that occurs before it is set again.



Figure B-9 - Maximum Thermometer
in Reading Position

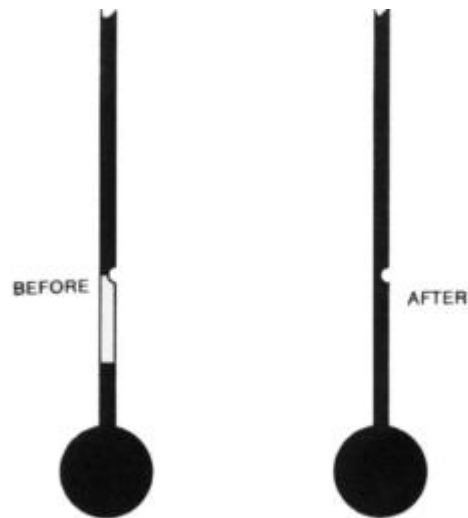

Figure B-10 - Maximum Thermometer
Before and After Whirling

4.6.2 Reading and Setting the Minimum Thermometer. The minimum temperature is the reading at the end of the index farthest from the bulb (not the reading on the spirit column). Read the thermometer before moving it from the almost horizontal position in which it was set at the time of the last observation.

To reset the minimum thermometer, point the bulb end upward (Figure B-11). Allow the index to fall to the end of the spirit column. Then turn the thermometer counterclockwise until it stops. The bulb end will now be slightly lower than horizontal.



Figure B-11 - Minimum Thermometer
in Vertical Position During Resetting of Index

4.6.3 Reading the Current Temperature. Read the current temperature from the maximum thermometer while it is in a vertical position after spinning. Read the temperature at the end of the mercury column farthest from the bulb. Read it immediately after resetting it. The current temperature should be within 1 degree of the minimum thermometer. If the current and minimum temperatures are not within 1 degree notify the NWSREP.

5. Correcting Thermometer Errors. Sometimes there may be breaks in the mercury or spirit columns, the thermometer may be too difficult to reset, or it will reset itself between readings. The following instructions explain how to correct some of these problems. If a correction is impossible, the cooperative observer should request a replacement from the NWSREP.

5.1 Correcting Maximum Thermometers. The constriction shown in Figure B-4 may not be small enough in some thermometers to prevent the mercury from withdrawing into the bulb when the temperature falls after reaching its maximum value. Sometimes rough handling will cause this problem. To test for this defect, place the thermometer in a vertical position. If the mercury withdraws into the bulb without spinning the thermometer, it must be replaced. This

defect should be reported to the NWSREP promptly.

If the constriction is too small, it may require many spins of the thermometer to get the mercury to return to the bulb, especially during low temperatures. This should be reported to the NWSREP.

Sometimes a small amount of mercury will lodge in the upper end of the bore. To correct this problem, hold the thermometer vertically with the bulb upward. Tap the metal back of the thermometer gently with a finger until the column joins the mercury at the bottom. Lower the bulb, allowing the column to slide slowly down the bore to the constriction. When the mercury cannot be united as above, remove the thermometer from its support and swing it as in Method II of Section 5.2.

5.2 Correcting Minimum Thermometers. Sometimes the spirit column of a minimum thermometer separates into small parts, causing incorrect readings. Separations may appear as small bubbles, making the column too long and readings too high, and trapping the index. Some spirits may separate completely and remain in the upper portion of the bore, resulting in readings too low. The thermometer should be inspected regularly for these problems. The methods described below may have to be repeated several times, taking 15 to 20 minutes, before the column can be joined. The thermometer should be kept in a vertical position for several hours after parts of the column have been joined, in order that spirit clinging to the sides of the bore will drain down. When repeated attempts fail to join the spirit column, the minimum thermometer must be replaced.

METHOD I: TAPPING

Grasp the thermometer slightly below the middle with the bulb end down. Strike the edge of the metal back sharply against the palm of your hand as shown in Figure B-12. Repeat this procedure several times. The thermometer must not be held so that your fingers or any part of your hand presses against the stem. Figure B-12 Joining the Alcohol Column Tapping Method against the stem.

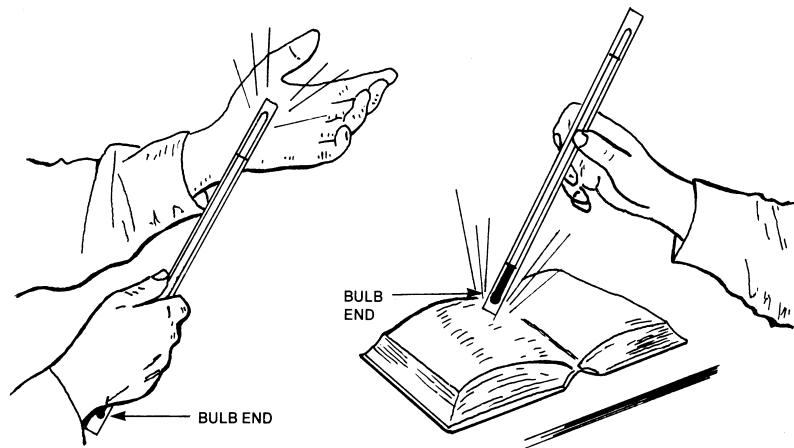
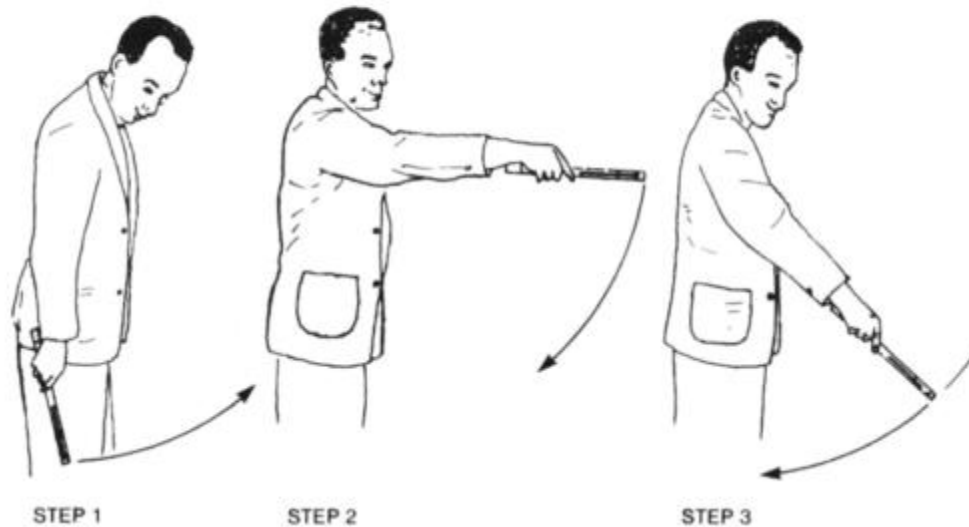

Figure B-12. Joining the Alcohol Column Tapping Method

The bulb end may also be tapped on an open book.

METHOD II: CENTRIFUGAL FORCE



A short, quick swing of the arm is often effective in forcing the index toward the bulb and reuniting segments of the alcohol column. Grasp the thermometer firmly by the edges of the metal back a little above the midpoint. Avoid pressure on the back. With the arm extended upward, quickly swing the thermometer downward through an arc of 3 or 4 feet, stopping the motion suddenly when the thermometer is vertical. Sometimes it will be necessary to repeat this operation several times.

The thermometer can also be whirled on a short cord. Pass a strong cord through the hole in the top of the metal back of the thermometer. Firmly grasp the cord 6 to 8 inches from the thermometer and whirl it rapidly. Stand clear of all objects the thermometer might strike while whirling. It may take considerable practice to spin the thermometer rapidly and stop it safely. This method will often bring down an entrapped index and unite detached segments of the column. Ensure the cord is not cut by the thermometer back as it is whirled.

6. Electronic Thermometers. The ET measures the current temperature over a range from -55°F to $+125^{\circ}\text{F}$ and compares it to the highest and lowest values stored in the memory of a microcomputer. If the current temperature exceeds the previous highest or lowest reading, then it becomes the newest maximum or minimum temperature.

6.1 Initial Checkout of Instrument. The NWS has 3 types of approved electronic thermometers, the NWS designed C450-1, the newer C450-7, and a commercial off the shelf unit, the Nimbus PL-2. The Nimbus unit will be referred to as the C451-N1 in this manual.

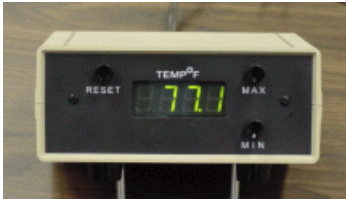

Figure B-13 - C450-1 Original



Figure B-14 - C450-7, Upgrade



Figure B-15 - C451-N1, Nimbus PL-2

Important: Always turn the electronic display unit power switch “off” on the C450-1 and C450-7 when the unit is not plugged in. If the power switch is “on” and the unit is unplugged, the battery supplying the emergency backup power will severely discharge, “permanently damaging” the system. The C451-N1 does not have an on/off switch. When not in use, the AC adapter and the 9 Volt battery must be removed to power down the unit.

- a. Connect the instrument shelter to the display unit with the fabricated cable.
- b. C450-1 and C450-7 Plug the AC power cord of the display unit into an AC outlet.

C451-N1 Plug the AC adapter into an AC outlet and into the back of the unit. Install a 9 Volt Alkaline battery into the rear compartment.
- c. C450-1 and C450-7 Turn on the power switch located on the rear panel of the display unit.

C451-N1 The unit is on when either the AC adapter or battery are connected.
- d. C450-1 and C450-7 Allow one hour for the backup nickel cadmium battery to charge and then turn the display unit off and back on to reset it.

C451-N1 No action required.
- e. C450-1 and C450-7 Observe if the display shows the message “HELP”. This indicates the microcomputer is functioning properly. Figure B-16 shows the display reading “HELP.”



Figure B-16 - MMTS “Help” Display

- C451-N1 No action required. The unit will display the current temperature.
- f. C450-1 and C450-7 Depress the button labeled “RESET”. The message “HELP” will be replaced by the current temperature; e.g., 66.3.
- C451-N1 Depress and hold the “CLEAR” button until the display reads “E2E2”. This takes about 6 seconds. Then release the button. The unit will display the current temperature.
- g. C450-1 and C450-7 Press and hold the “MAX” and “MIN” buttons simultaneously to test the fluorescent display for missing segments. All segments that are not already illuminated will flash intermittently.
- C451-N1 No action required.
- h. C450-1 and C450-7 The message “LO” or “HI” may appear indicating an open or shorted sensor or bad cable, or less likely, a temperature colder than -55°F or hotter than $+125^{\circ}\text{F}$.
- i. C451-N1 The display “-99.9” or “255.5” may appear indicating an open or shorted sensor or bad cable, or less likely, a temperature colder than -55°F or hotter than $+125^{\circ}\text{F}$.

6.2 Calibration. No calibration is necessary due to the design of the ET’s. To verify proper operation, some cooperative observers may be given accuracy verification equipment by the NWSREP, who will provide instructions on its use. Temperature sensors used with all three ET’s are accurate within 0.4°F between -40°F and $+104^{\circ}\text{F}$, and within 0.7°F for temperatures between -40°F and -55°F and between $+104^{\circ}\text{F}$ and 125°F if working properly.

6.3 Operation. The current temperature is displayed if no buttons are pressed.

To view the Maximum or Minimum Temperature:

- a. C450-1 and C450-7 Depress the “MAX” button to display the maximum temperature that occurred since the unit was last reset. Depress the “MIN” button to do the same for the minimum temperature.
- b. C451-N1 Verify the “MEMORY” switch is “OFF”. Depress and hold the “RECALL” button. The display will toggle back and forth showing the maximum and minimum temperatures while the button is depressed.

To reset the Maximum or Minimum Temperature:

- a. C450-1 and C450-7 Simultaneously press the “RESET” and “MAX” buttons to reset the stored maximum temperature. Do the same with the “RESET” and “MIN” buttons to reset the minimum temperature.
- b. C451-N1 Verify the “MEMORY” switch is “OFF”. Depress and hold the “CLEAR” button until the display reads “E2E2”. This takes about 6 seconds. Then release the button.

Do not reset the maximum or minimum temperatures between the scheduled times of observation. Resetting the temperatures at unscheduled times is a common cause of errors.

Record the maximum, minimum, and current temperatures on WS Form B91 or WS Form B-92 to the nearest whole degree, even though the readings are displayed to the nearest tenth degree. If the last digit is a 5 or higher (e.g., 43.5), round the temperature upward to the next higher whole degree (i.e., 44). If the last digit is 4 or lower (43.4) round the temperature downward to the whole degree (i.e., 43)

6.4 Identifying and Correcting Erroneous Maximum/Minimum Temperatures. Today's maximum temperature must be at least as high as the higher of today's or yesterday's temperatures at the time of their respective observations. For example, if the temperature at observation time yesterday was 64°F, and today's maximum temperature is displayed as 62°F, today's maximum temperature must be raised to 64°F. See Section 8 page B-17 for a description of the most frequently occurring errors.

Similarly, today's minimum temperature must be at least as low as the lowest of today's or yesterday's current temperature. If not, lower it to the lower of the two readings. For example, if yesterday's observation time temperature was 64 degrees and today's minimum is 65 degrees, the minimum temperature must be lowered to 64 degrees. Improper resetting between observation times creates more errors than all other causes combined. Persistent errors from other causes (i.e., vibrations) should be reported to the NWSREP.

6.5 “Help” and Blinking Displays. If the “HELP” message appears on the display, press the “RESET” button to clear it and to show the current temperature.

- a. C450-1 When the AC power line voltage is interrupted on a C450-1 unit; the microcomputer enters a “power down” condition in which the internal backup battery is used to preserve the maximum and minimum values stored in memory. These values are stored a minimum of two hours without power. However, no updating of new maximum and minimum temperatures occurs during the power interruption. The user must determine if the stored readings are still valid,

based on the length of the outage.

- b. C450-7
When the AC power line voltage is interrupted on a C450-7 unit, the display is blanked to preserve battery power, but the unit continues to measure the maximum and minimum values and update them to memory. Operation of the unit will continue for several hours without AC power and is indicated by a lit decimal point in the display. If power returns before the battery is depleted, the unit will NOT display “HELP”, and no action is required of the user as the data record is continuous through the outage. If the outage is long enough to deplete the battery, the decimal point will disappear from the display. The unit will display “HELP” when the AC power returns. The user must understand, any stored maximum or minimum values are not valid and they should log the daily readings accordingly. These units are identified by the markings “(ASN) C450-7” on the lower left of the front panel.

- c. C451-N1
This unit does not display “HELP” as it continues full operation on either AC power or battery. It will operate for more than 2 weeks on a fresh battery in the absence of AC power.

BLINKING:

- a. C450-1 and C450-7
Blinking of the tenths (right-most) digit on the display indicates the internal backup battery is charging. If the blinking persists and is not caused by power outages, the battery is probably defective, and the NWSREP should be informed.

- b. C451-N1
An “L” blinking on the left side of the display indicates the battery is low and should be replaced. Replace it with a 9 Volt Alkaline battery. This unit does not recharge the battery.

7. Entry of Temperature Readings on WS Form B-91. Maximum, minimum, and current temperatures are recorded to the nearest whole degree on WS Form B-91 (See Figure A-38). WS Form B-82 (Figure A-37) is designed to record readings taken outdoors, so as not to forget the values between the time the instruments are read and the time the readings are recorded on WS Form B-91. Since the ET is read indoors, WS Form B-82 may be needed only for recording precipitation.

8. Common Errors to Avoid. Maximum and minimum temperature data are keyed into computers at NCDC. Data which are inconsistent must either be rejected or corrected. Observations are flagged most commonly for the following types of errors:

- a. Maximum temperature lower than the time-of-observation temperature at the previous observation (24 hours earlier). This error is most frequently committed by observers taking observations in the afternoon or evening.
- b. Minimum temperature higher than the time-of-observation temperature at the previous observation (24 hours earlier). This error is most frequent among morning observers.
- c. Maximum (and occasionally the minimum) temperature entered on the WS Form B-91 on the day it occurred rather than on the day the thermometers were read and reset. For example, a morning observer records high and low temperatures for the past 24 hours at 7 a.m. on the 25th as being 88 and 62. The observer knows the maximum of 88 occurred on the 24th (the previous afternoon), so the observer records the high temperature on the WS Form B-91 for the 24th. It should have been recorded on the 25th; because this is the day the instruments were read and reset.

The most common cause of errors a. and b. is resetting the ET or the maximum and/or minimum thermometers between times of observation. The maximum temperature for the past 24 hours must be at least as high as the time-of-observation temperature both today and 24 hours earlier, and the minimum at least as low as today's and 24 hours ago. This error appears to be committed because; the afternoon observer wants to record this afternoon's maximum temperature when it is lower than yesterday's afternoon maximum.

This situation usually arises when it was warmer yesterday than today. Today's maximum should be recorded in the REMARKS column. For example, "PM MAX 48" or "TODAY'S MAX 48," and last night's minimum as "AM MIN 36." Figure B-17 page B-18 shows the correct method of recording minima for the past night that is higher than the 24-hour minima (see the REMARKS entries on the 3rd and 4th) and 24-hour maxima that is lower than the previous afternoon's maximum (see the REMARKS entry on the 5th). Figure B-17 illustrates the date, temperature, and remarks columns associated with WS Form B-91. The scheduled time of observation for this cooperative observer is 8 A.M.

DATE	TEMPERATURE F.		AT OBSN.	REMARKS (Special observations, etc.)
	24 HRS. ENDING AT OBSERVATION			
	MAX.	MIN.		
1				
2			28	
3	44	28	39	AM MIN 36
4	65	38	62	AM MIN 55
5	62	35	35	PM MAX 58
6				

Figure B-17 - WS Form B-91, Temperature Entries

APPENDIX C - River Stages and Related Precipitation Observations

<u>Table of Contents:</u>	<u>Page</u>
1. Introduction.....	C-1
2. Staff River Gauge	C-2
3. Wire Weight Gauge	C-2
3.1 Description.....	C-2
3.2 Installation	C-3
3.3 Re-Installing a Wire Weight at an Established Site.....	C-6
3.4 Replacement of a Lost Weight.....	C-7
4. Profile Gauge	C-8
5. River Gauge Location.....	C-9
6. Relocating River Gauges	C-9
7. When to Report.....	C-9
8. What to Report.....	C-10
9. Report Forms	C-11

Figures

C-1 Staff Gauge	C-2
C-2 Left Front View of Wire Weight Gauge Components.....	C-4
C-3 Top View of Wire Weight Gauge Components.....	C-5
C-4 Installing Brass Weight Visual Instructions	C-7

1. **Introduction.** The term “stage” is the height of the water surface above an established datum or reference elevation. The term “gauge height” is used for readings from a gauge, but stage and gauge height are often used interchangeably. The datum may be a recognized elevation such as mean sea level or an arbitrary datum chosen for convenience. In either case, the gauge is adjusted for positive gauge heights. This is accomplished by setting the lowest possible gauge height (the case of no stream flow) to a value of zero. The elevation of the zero gauge height is referenced to the datum by running levels to a reference mark which has a known elevation relative to the datum. It is important that an elevation reference mark for the datum be located (or established) that is permanent even if the gauge is destroyed.

River stages are affected by many factors. Precipitation and temperature are the most commonly

known causes of rises and falls in river stages, but river stages may also be affected by the release of water from upstream reservoirs.

Precipitation readings at river cooperative stations are taken with the four- or eight-inch non-recording gauges (Appendix A). River stages are read using a staff, wire weight, or profile gauge, as described below.

2. Staff River Gauge. The staff river gauge (Figure C-1) is a fixed scale that can be in the form of porcelain-enameled iron sections, a wooden plank, or may be printed on available structures such as a bridge, pier, or wall. The gauge may be mounted vertically or inclined with graduations for vertical depth. The inclined gauge is used where ice or debris will not permit a permanent vertical staff to be installed. It usually consists of a heavy timber installed on the incline of the bank. The scale of the staff gauge must be set so a reading can be taken at zero flow in the low-water channel. Readings are made to the nearest tenth of a foot. The staff gauge will usually have a gauge datum that will be the elevation of its zero reading referenced to mean sea level. The gauge sections should be set so the readings are heights above the datum.

If vertical movement of the supporting structure occurs, such as settling, erroneous observations from the staff gauge will result unless levels are run from a reference of known elevation and the staff scale is reset.

If the gauge has been set with a scale that has graduations above and below zero, the below zero readings must be recorded on the report form with a minus sign; e.g., -0.3 . If possible, the gauge should be set so as to avoid negative values.

3. Wire Weight Gauge.

3.1 Description. The wire weight gauge (Figures C-2 page C-4, C-3 page C-5) is permanently mounted inside a lockable cast metal box attached to a bridge or similar structure. The gauge consists of a drum wound with a single layer of stainless steel cable, a bronze or brass weight attached to the end of the graduated disc, and a counter. The drum's disk is graduated in tenths and hundredths of a foot and is connected to the counter which advances by one with each full revolution of the drum. The cable is made of 0.015 inch stainless steel wire, geometrically wound, and is guided to smoothly fill the drum by means of a threaded sheave. The wire weight reel assembly is equipped with a ratchet used to lock the drum and cable in any position by means of a pawl.



Figure C-1.
Staff Gauge

In order to check the check bar reading of the wire weight gauge, slide the check bar at the bottom fully forward toward the drum. When in this position, the cable weight when released can rest on the check bar. When the weight is resting on the bar with no slack in the cable, the combined reading from the counter and the number of graduations on the graduated disk equals the current Check-Bar reading.

The cable drum is fastened to the handle and shaft assembly by a friction clamp which, when loosened, allows the handle and shaft attached to the counter to turn independently of the cable drum. This allows the cable, weight and drum to be held in place on the check bar while the handle is turned to obtain the desired check bar reading on the counter and graduated disk. When the handle shaft assembly is released from the drum cable assembly the cable drum must be held in place by hand to keep the weight from free falling.

3.2 Installation. It is important to note that the NWSREP is only responsible for the installation and maintenance of NWS owned wire weight river gauges. Gauges owned by another agency are the responsibility of that agency. The wire weight river gauge is traditionally mounted on the upstream side of a bridge above the main channel of the river or stream.

The wire weight can be attached to the bridge using several methods. In some cases, the gauge is mounted to the bridge with bolts or it can be mounted using straps which secure the gage to the railing. The method of mounting is dictated by the owner of the bridge.

Many newer bridges have a concrete barrier on each side of the bridge which necessitates the use of a hanger strap that can be fashioned for the particular bridge. Consult with the owner of the bridge targeted for installation of a wire weight gauge to solicit approved methods of mounting the gauge. Never mount a wire weight gauge on a bridge without help. It is a 2 person job.

Get approval in writing from the bridge owner before installing gage.*

When the gauge is mounted on the bridge, levels have to be run for the gauge. Consult with the owner for benchmark/reference elevations. Often the owner will agree to run a level for the wire weight's check bar. This will save considerable work for the NWSREP. The ultimate objective of running a level on the new gauge is to develop a Check Bar setting. The process of determining the check bar elevations is calculated from the "gauge zero". Follow safety considerations outlined on page C9 Section 5.e

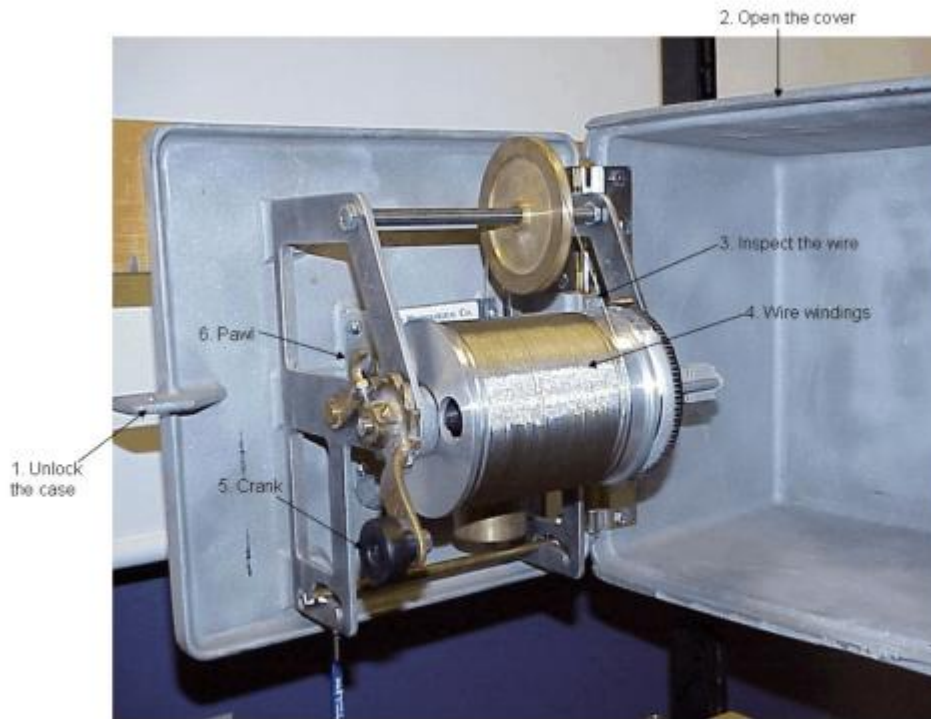

Figure C-2. Left Front View of Wire Weight Gauge Components

Take the readings as follows:

- a. Unlock the case at (1) and gently open the cover (2). If the cover jams and will not swing freely, do not force it open. Close, relock, and submit a repair order. Inspect the wire (3) on the drum (4) for even windings that touch each other.
- b. Grasp the crank handle (5) and release the pawl (6).

Caution: If the handle is released when the lock is not engaged the unit will backlash. Severe damage to the equipment or injury is possible.

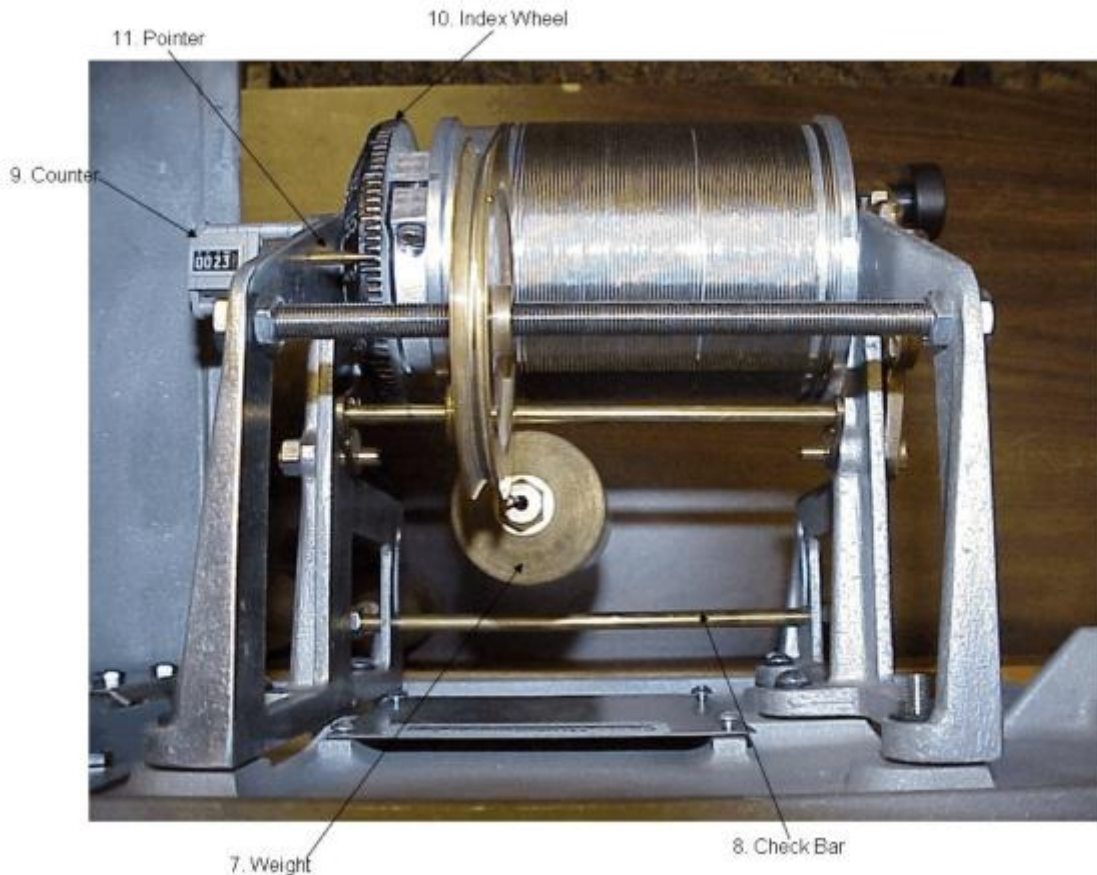

Figure C-3. Top View of Wire Weight Gauge Components

- c. Lower the weight (7) to just touch the check bar (8), which is read while in the forward position. Read the check bar elevation and record it. Enter this reading at the beginning, middle, and end of each month on WS Form B-91. The counter (9) displays units of feet. The index wheel (10) displays units of tenths and hundredths of a foot and is read at the pointer (11).
- d. Raise the weight and slide the check bar to the rear position. Lower the weight to the water surface and read this elevation just as the weight touches the water while descending. Average the peaks and troughs of elevation if the water surface is rough. Repeat this process at least once. If the point of contact with the water surface is difficult to determine, it may be necessary to strum the cable or to swing the weight in a pendulum motion up and downstream to obtain an accurate reading.
- e. Every day, record the reading obtained in step “c” in the "GAUGE READING AT" column on WS Form B-91 (Figure A-38).

- f. Engage the pawl and crank the weight to its original position within the gauge. Slide the check bar to the forward notch. The crank handle should now be located in the rear position. This will allow the cover to close without touching the outer tip of the crank handle.
- g. Close the cover and lock the case.

3.3 Re-Installing a Wire Weight at an Established Site. When installing a wire weight gauge at an established site, the gauge zero is established. If acceptable, the established gauge zero is simply subtracted from the surveyed elevation of the newly installed wire weight's check bar. This is the distance in feet, tenths and hundredths of a foot the check bar is above the gauge zero. The distance becomes the CHECK BAR READING for the newly installed gauge. The new check bar reading should be documented on the SIR in CSSA. The new check bar setting should be immediately made available to the Service Hydrologist (SH) or focal point, The River Forecast Center (RFC) and the Cooperative Observer.

When the wire weight's observed check bar reading differs by 0.03 feet or more from the official check bar established for the station, the check bar reading of the gage must be brought back within tolerance. Assuming adjustment is necessary:

Important. Never adjust the gauge of another agency. Report errors to the owner of the gage.

- a. Note the difference upon inspection.
- b. Rest the weight upon the check bar assuring the cable is taught.
- c. While holding the cable and drum, loosen the 2 large screws which secure the cable drum to the graduated disk.
- d. Turn the crank handle until the counter and graduated disk indicate the desired check bar reading.
- e. Tighten the 2 large screws. Do not let go of the cable drum until both screws are tightened.
- f. Recheck starting at b. Readjust as necessary.
- g. Lock the drum with the ratchet pawl.
- h. Move the check bar to the rear to allow the weight to be lowered.
- i. Lower weight to water level and rewind.
- j. Verify correct check bar reading of gauge.
- k. When the correct check bar reading is obtained, the gage crank handle may

require adjustment to permit closing of the gauge cover. This is accomplished by loosening the two small bolts which secure the handle to the shaft and repositioning the handle to allow closure of the cover. Re-tighten both bolts when repositioned.

- l. Lock gauge.
- m. Notify the SH of wire weight check bar readings before and after adjustment.

3.4 Replacement of a Lost Weight. When a weight is lost from a wire weight river gauge, The amount of cable remaining on the drum must be determined before deciding on the correct method of repair. This can be determined by winding the remaining cable on the drum and counting the number of feet of cable left. One complete revolution equates to one foot of cable. The condition of the remaining cable must be evaluated. If frayed or kinked, cable replacement should be considered.

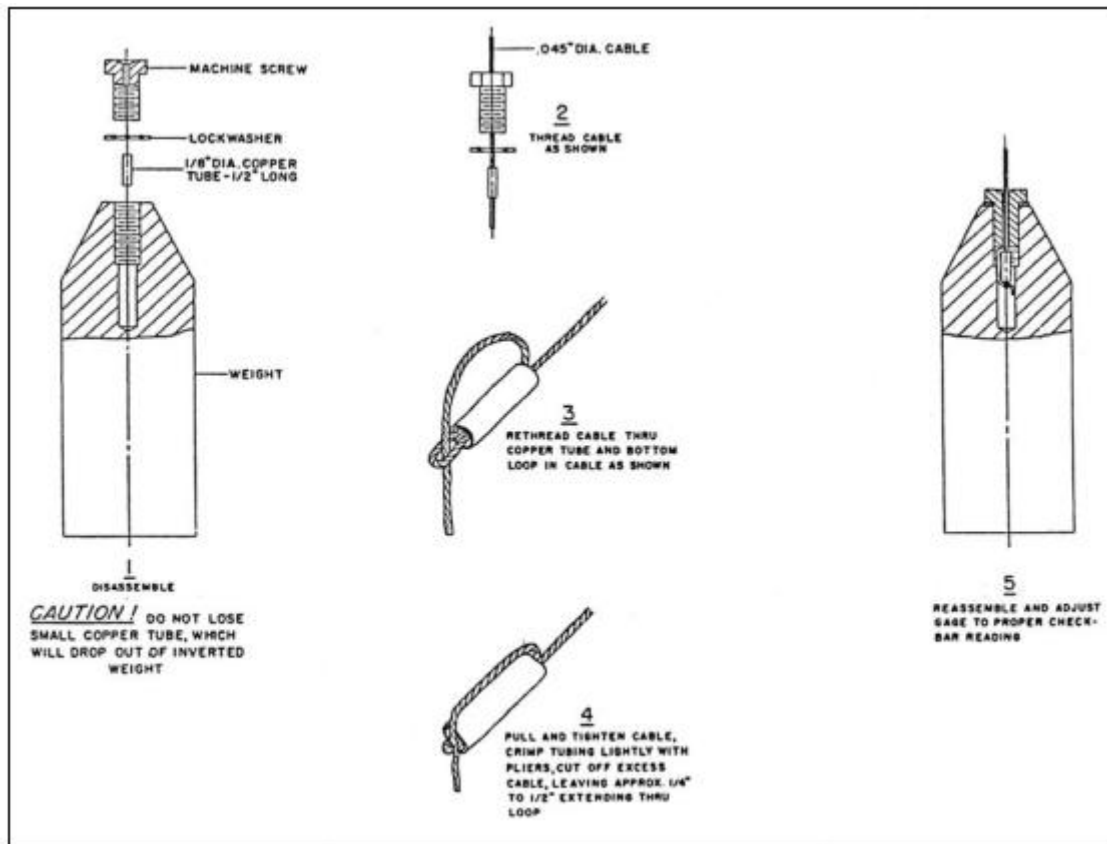

Figure C-4. Installing Brass Weight Visual Instructions

If the remaining cable on the wire weight is in acceptable condition and sufficient cable remains on the drum to allow the weight to extend several feet below gauge zero, a new brass weight can be installed on the existing cable. (See Figure C-4)

If the remaining cable on the wire weight is unacceptable or if it is too short to extend several feet below gage zero, the cable must be replaced. When considering installation of a new cable, it is suggested that the drum be filled to near capacity (100 feet) regardless of the amount required to attain the necessary length. This process of installing a full drum of cable could allow several future weights to be replaced without adding new cable.

Cable replacement begins with the removal of the old cable. It can be easily unwound. **Note how the old cable is secured to the drum.** Attach the new cable in a similar manner. When attached to the drum, move the guide wheel on the threaded shaft to where it is directly above the point on the drum where the new cable is attached. Route new cable over the brass guide wheel.

While continuing to hold the cable taut as it extends from the drum across the guide wheel, use the gauges crank handle and wind new cable onto the drum assuring that it fills the drum smoothly and evenly.

When sufficient cable is wound onto the drum, the weight can be installed. Tension applied while winding the cable should not be released. If the cable is released, the cable may loosen on the drum and become tangled. Keeping tension on the cable, install the new weight. When installed, route the weight between the guide wheel and gage mounting base to the normal weight position. Keep tension against cable until the weight takes over and provides tension to the cable.

The gauge should be back in operation. Lower the weight to the water level and rewind. The cable should rewind evenly on the drum. After successful installation of the new cable and weight, the wire weight's check bar reading must be set, and then the gauge is operational. Routine use/reading of the wire weight river gauge:

- a. While holding the crank handle, release the latch pawl which locks the drum in place.
- b. Assure the check bar is moved completely to the rear (toward you).
- c. Using the crank handle, lower the weight slowly to the surface of the water so the weight is just touching the surface. See caution on page C-4.
- d. Read the counter for whole feet. Add hundredths of feet from the graduated wheel on the drum.

Rough water- if the surface is rough, average the peaks and troughs.

- e. This is the current river reading.

4. Profile Gauge. On some rivers, especially where man-made structures such as bridges are rare and where vertical or staff gauges can be damaged by ice jams and breakup, profile gauges are used. These consist of a marker, usually a brass cap benchmark, anchored in the bank

above the levels of ice movement. The profile of the bank is surveyed to determine elevations to the nearest tenth of a foot and plotted on a graph. The cooperative observer, using a long surveyor's tape measure, determines the distance from the reference marker to the water's edge. From the graph, the slope distance is converted to a vertical stage. The observer always reports the slope distance to the NWS office.

5. River Gauge Location. Consider the following factors when selecting a site for the river gauge:

- a. The gauge should be located so river stages will best reflect flooding in the area of maximum damage potential.
- b. There should be access to the gauge during high water, if at all possible.
- c. The gauge should not be located in the backwater of a reservoir or of a main stem river, if possible.
- d. The river banks at the gauge site should be stable.
- e. Safety considerations require if a wire weight gauge is located on a bridge, the railing will be no lower than 42 inches. There should also be enough room for the observers to perform their job without having to worry about traffic. If either of these situations exists, the gauge should be moved or the safety of the location improved. Follow instructions in NWSM 50-1115.

6. Relocating River Gauges. A river gauge should be moved only after all other options have been exhausted. A different river gauge location is likely to change such forecast components as the relationship of the gauge reading to the discharge rate, flood wave travel time and attenuation, and flood stage. Moving the gauge may add or exclude a significant tributary from the drainage area. All users of the stage data will be informed of the change.

A new or moved river gauge location will mean establishing a new gauge datum if an arbitrary datum is used. If mean sea level is the datum, a bench mark or a new reference mark with known mean sea level will have to be located. It will then be necessary to run levels from the known elevation to the new gauge site.

A wire weight gauge will require a new check bar elevation determination, while a staff gauge will require the individual gauge sections be set to given elevations above the datum. If moving the gauge is necessary, observers should contact their NWSREP.

7. When To Report. Observations of river stage and precipitation should be taken at 7 a.m. each day unless otherwise specified by or agreed upon with the NWS. Special observations are taken at 1 p.m., 7 p.m., and 1 a.m. "only" when a report is required or when the cooperative observer believes an emergency situation has occurred.

There are two types of reporting stations, daily and criteria. Criteria stations are sometimes called occasional stations. In many areas of the country, criteria (occasional) stations are being converted to daily stations.

At a “daily” reporting station, reports are to be sent immediately after the 7 a.m. observation. Extra reports are sent at 1 p.m., 7 p.m., and 1 a.m. when the river stage reaches a level designated by the NWSREP (the criteria level).

The reporting station should send its first report when the river stage reaches the criteria level specified by the NWS. Reports should continue daily until the stages fall below this level. If the river stage goes above a second criteria level, extra reports are to be made at 1 p.m., 7 p.m., and 1 a.m., until the stage falls below this level.

Observations of both precipitation and river stage should be recorded on WS Form B-91 at 7 a.m. every day at criteria reporting stations, even if stages are below criteria and are not sent. Always report river stage and precipitation together.

If no precipitation has occurred, the daily record from both types of stations should indicate 0 or 0.00.

When the rain gauge measurement reaches a criteria value (usually 0.50 inch), an initial report should be communicated to the WFO and any additional 0.50 inch amounts. The criteria are determined locally.

8. What To Report. The report should contain the following information:
 - a. Location (station name or number), date, and time of observation.
 - b. The amount of precipitation having fallen since the previous 7 a.m. observation (inches and hundredths).
 - c. Character of the precipitation (intermittent, continuous, showers).
 - d. The weather at the observation time (clear, cloudy, rain, snow, etc.).
 - e. The depth of snow and ice on the ground (nearest whole inch).
 - f. The water equivalent of snow and ice (nearest tenth inch), if agreement with the NWS.
 - g. The river stage at the observation time (feet and tenths).
 - h. The tendency of the river stage (rising, falling or stationary).
 - i. The river stage at the previous 7 a.m. observation, if not previously reported.

- j. In the remarks section, enter special comments such as snow melting slowly or rapidly, unusually heavy rainfall in a short period of time (e.g., 1.54" in 30 minutes), ice breaking up or an ice jam forming on the river, etc.

Obtain a stage measurement at the river crest, recording the approximate time of occurrence. It is also very helpful to take observations, both as the river begins a significant rise and as it recedes from a crest. These reports, even when not transmitted, will be valuable input to computer models that relate precipitation to river stage, and to determine the relationships of river stages at different points on the river.

Do not risk injury to collect data

When the water surface is disturbed due to turbulence or waves, record the stage as the average of the peaks and troughs.

9. Report Forms. All necessary forms will be furnished by the NWS. Each pad of forms contains detailed instructions. A sample of WS Form B-91 is shown in Figure A-38.

APPENDIX D - Evaporation Station Observations

<u>Table Of Contents:</u>	<u>Page</u>
1. Introduction.....	D-2
2. Setting up the Observation Site	D-2
2.1 Exposure of Equipment.....	D-2
2.2 Plot Layout.....	D-3
2.3 Enclosure	D-3
3. Evaporation Equipment	D-3
3.1 Evaporation Pan.....	D-4
3.1.1 Installation	D-4
3.1.2 Maintenance.....	D-5
3.1.3 Control of Algae	D-6
3.2 Fixed Point Gauge	D-6
3.3 Measuring the Amount of Evaporation	D-7
3.4 Micrometer Hook Gauge	D-8
3.5 Water Storage Tank	D-9
3.6 Anemometer.....	D-9
3.6.1 Installation	D-9
3.6.2 Maintenance.....	D-10
3.6.3 Wind Movement Readings	D-10
3.6.4 Data From 5-Digit-Counter Type Anemometers.....	D-10
3.6.5 Data From 6-Digit-Counter Type Anemometers.....	D-10
3.7 Dry and Wet Bulb Temperatures	D-10
3.7.1 Types of Psychrometers.....	D-11
3.7.2 Maintenance.....	D-12
3.7.3 Moistening the Wet Bulb.....	D-12
3.7.4 Taking Psychrometer Observations.....	D-12
3.8 Water Temperatures.....	D-13
3.8.1 Installation	D-13
3.8.1.2 Submerged-Mounted Thermometer.....	D-13
3.8.1.3 Recording Thermometers.....	D-14
3.8.2 Maintenance.....	D-14
3.8.3 Accuracy Checks	D-14
3.8.4 Rejoining Separated Mercury Columns.....	D-14
3.8.5 Reading and Resetting the Sixes Thermometer.....	D-14
4. Reading Observations from Evaporation Stations.....	D-15

Figures	Page
D-1 Evaporation Station Plot Layout Example.....	D-3
D-2 Evaporation Pan.....	D-5
D-3 Stilling Well, Fixed Point Gauge and Measuring Tube.....	D-6
D-4 Transparent Measuring Tube and Stilling Well Inside the Pan.....	D-7
D-5 Evaporation Measurements.....	D-8
D-6 Hook Gauge.....	D-8
D-7 Anemometer.....	D-9
D-8 Totalizing Anemometer With 6-Digits.....	D-10
D-9 CRS With Fan.....	D-11
D-10 Sling Psychrometer.....	D-11
D-11 Sling Psychrometer (close up view).....	D-12
D-12 Sixes Thermometer.....	D-13
D-13 Submerged Mounted Thermometer.....	D-14
D-14 WS Form B-92, Record of Evaporation and Climatological Observations.....	D-15

1. Introduction. Observations are made of the amount of evaporation to the nearest hundredth of an inch from an open pan. Other elements recorded include wind movement, water and air temperatures, and precipitation. At some sites, additional parameters will be required, such as dry- and wet-bulb temperatures, humidity, and the temperature and moisture content of the soil. Appendix E contains instructions on soil temperature measurements.

2. Setting up the Observation Site.

2.1 Exposure of Equipment. The equipment site should be fairly level, sodded, and free from obstructions. It should be representative of the principal natural agricultural soils and conditions of the area.

Neither the pan nor instrument shelter should be placed over heat-absorbing surfaces such as asphalt, crushed rock, concrete slabs or pedestals. The equipment should be in full sunlight during as much of the daylight hours as possible, and be generally free of obstructions to wind flow. Obstructions that cannot be moved, such as trees, buildings, and nearby shrubs, should not be closer to the instruments than four times their heights. Shadows are permissible only near sunrise and sunset. Avoid areas subject to flooding or lawn sprinkling.

At reservoirs (flood control, water supply, and irrigation projects) the pan should be placed on the prevailing upwind side of the water. The pan site should be far enough from the water to avoid the chance of water or spray carried from a spillway, or picked up from the reservoir by a strong wind that will be deposited in the pan.

2.2 Plot Layout. The layout of the equipment on an example plot is shown in Figure D-1. The orientation of the layout is indicated by the position of the CRS and its door facing north.

Note the layout is designed to eliminate shadows from instruments at stations in the northern hemisphere. Shadows from small diameter fence posts will occur only briefly in the late afternoon. The minimum distances between instruments are illustrated.

The 16- by 20-foot plot shown allows ample room for more equipment. The size of the plot can be either smaller or larger depending on how much equipment is needed.

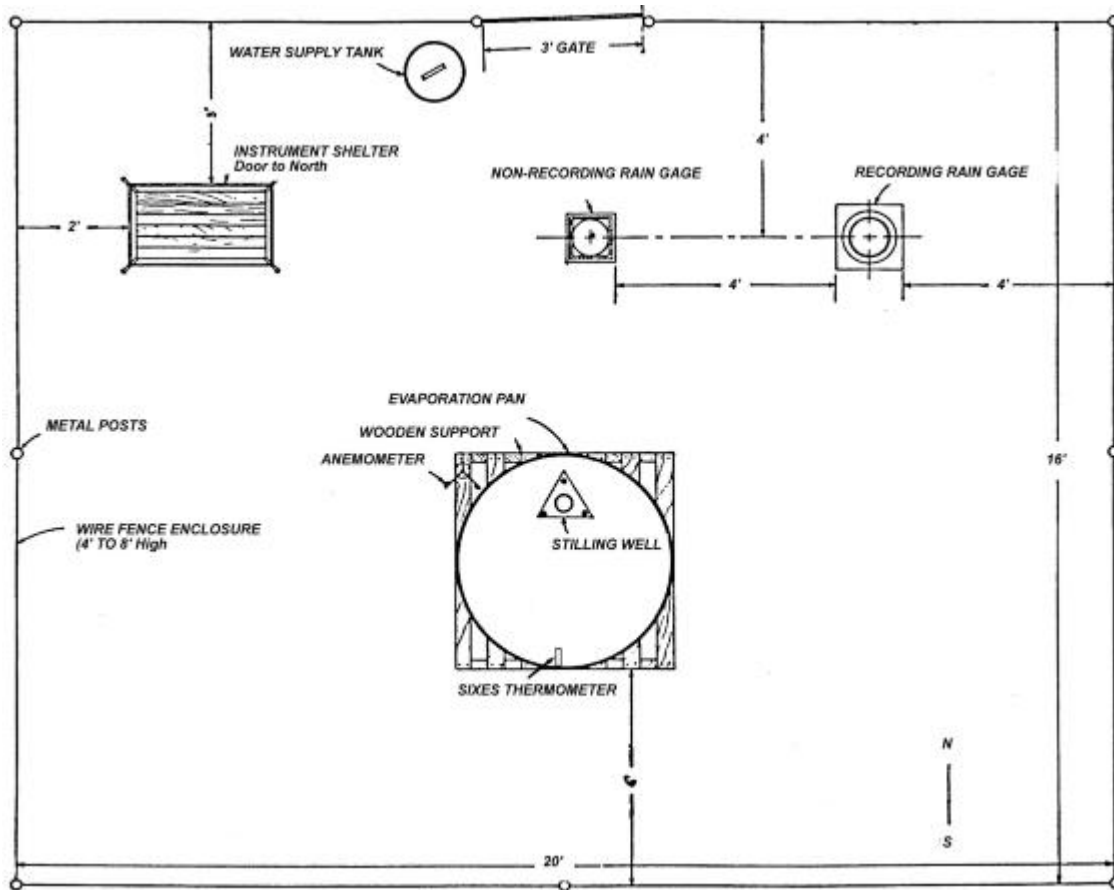

Figure D-1 Evaporation Station Plot Layout Example

2.3 Enclosure. The plot must be enclosed by a fence to keep out animals. A steel chain link fence (9 or 11 gauge), 4 or 5 feet high, with steel posts set in concrete is recommended. Fences of wood or other solid material will not be used. Burying a barrier underneath the fence may be necessary for protection from burrowing animals, or add 18 to 24 inches of one inch galvanized chicken mesh fence along the bottom of the chain link fence to keep out small animals.

3. Evaporation Equipment. This section describes the installation, maintenance, and method of taking observations from each instrument. Evaporation measurements are made with an evaporation pan and a fixed-point gauge with a measuring tube.

Evaporation stations have the following additional instruments:

- a. An anemometer to determine the daily wind movement over the pan and a display stand pintle (Section 3.6 page D-9).
- b. A non-recording precipitation gauge with appropriate measuring stick or in some cases, a weighing-type recording precipitation gauge.
- c. A water temperature thermometer to provide maximum, minimum, and current temperatures of the water in the evaporation pan (Section 3.8 page D-13).
- d. Maximum and minimum thermometers for measuring the air temperature. An MMTS system can also be used.
- e. An instrument shelter for housing the temperature (dry bulb and wet bulb) measuring instruments. From the dry bulb and wet bulb, dew point is calculated.
- f. A water storage tank (if necessary) to provide a reserve water supply for the pan (Section 3.5 page D-9).

3.1 Evaporation Pan. The pan is circular, 10 inches deep, and 47.5 inches in diameter (inside diameter). It is constructed of stainless steel (Figure D-2 page D-5). Also shown in Figure D-2 are the pan support, anemometer, stilling well, fixed point measuring tube, and sixes thermometer submerged.

3.1.1 Installation. The pan must be centered on a pressure treated wooden support resting on leveled ground in order to assure there is level water in the pan. Ensure that the pan is located in an area free from flooding even in heavy rains, or where runoff could wash away the support. If fill dirt is required to level the ground, it should be tamped firmly. The top of the wooden support should be a minimum ½ inch above the dirt. This will leave an air space between the bottom of the pan and the fill dirt to simplify inspecting the pan for leaks.



Figure D-2 Evaporation Pan

3.1.2 Maintenance. The pan should be routinely inspected for leaks. Leaks in an evaporation pan render measurements useless. The observer should notify the NWSREP if a leak is discovered in the pan. The observer should also record on the observing form, the date the leak was discovered and the date the pan was repaired or replaced.

Clean the pan as often as necessary to keep it free from any substance that will alter the evaporation rate, such as sediment, scum, oil films, and algae. Oil films greatly reduce evaporation.

The interior or exterior of the pan should never be painted. This would alter the evaporation characteristics. In order to compare measurements between sites, all pans must have identical characteristics.

Under no circumstances should the pan be lifted and emptied with a significant amount of water in it. This action can split or bend the pan. Most of the water should be siphoned or dipped out first. A length of plastic water hose can be used to siphon out the water.

During months when freezing conditions are likely, the pan must be emptied, cleaned, and stored, preferably indoors. If the pan is left in the fenced enclosure, it should be turned upside down and secured to the support with a strong rope.

3.1.3 Control of Algae. A small amount (follow label instructions) of copper sulphate may be added to the water to discourage algae growth. The NWSREP will supply the copper sulphate. If algae is already present, it must be removed by thoroughly cleaning the pan. Prior to emptying the pan, remove excess copper sulphate by placing 1-3 iron penny nails* in the pan overnight. The color of the water will change from blue, to orange, to clear with a muddy brown precipitate. Decant the water (siphon or dip out as described in 3.1.2) and rinse down the sink. Do not pour on the ground. Place precipitate in the trash.

Nails should not be coated or plated. The nails should be suspended on strings or placed on a plastic sheet on the bottom not directly touching the sides or the bottom of the pan. The nails can only be used once.

3.2 Fixed Point Gauge. The fixed point gauge consists of a pointed rod mounted in a tube called the stilling well. It is placed inside the evaporation pan, one foot from the north edge. The stilling well makes readings more precise by eliminating wind-caused surges and ripples in the water level.

The stilling well is 2.5 to 3.5 inches in diameter and 10 inches tall, and is attached to a base. All parts are made of non-corrosive metal (Figure D-3). The base is heavy enough to resist being moved by the wind. The stilling well has two small openings, 1/8 inch in diameter, located opposite each other near the base. Openings permit the flow of water in and out of the stilling well. The pointed rod is 1/4 inch in diameter. It is attached to the center of the base inside the well. The point is 7.5 inches above the bottom of the evaporation pan when in position.

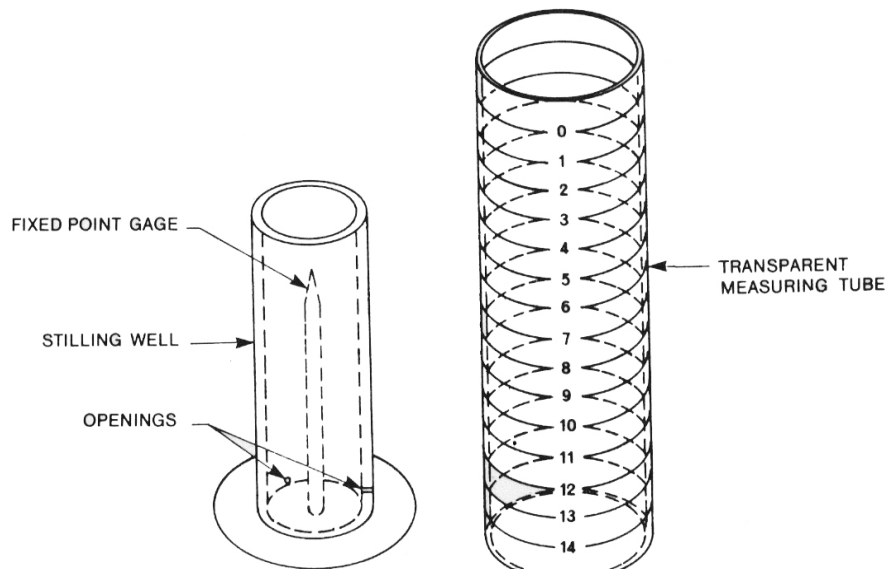

Figure D-3. Stilling Well, Fixed Point Gauge and Measuring Tube

Evaporated water must be replaced. This is accomplished by using the transparent measuring tube, shown beside the stilling well in Figure D- 4 page D-7. The tube is 15 inches deep with an inside diameter of 4-3/4 inches, which is one-hundredth of the surface area of the evaporation pan. The tube is graduated at one-inch intervals, with the zero mark at the top. One inch of water in the measuring tube is equivalent to .01 inch in the evaporation pan.



Figure D-4. Transparent Measuring Tube and Stilling Well Inside the Pan

3.3 Measuring the Amount of Evaporation. Evaporation is measured by determining the amount of water required to bring the water level in the stilling well exactly to the tip of the pointed rod. Use the transparent measuring tube (Figure D-4) to add or remove water from the evaporation pan. When water must be added, fill the measuring tube to the zero mark (the top mark on the tube), then pour (slowly) exactly enough water into the evaporation pan (not in the stilling well) to bring the water level to the tip of the fixed point. Read the level of water remaining in the measuring tube. If this reading is closest to the 12 mark, for example, 0.12 inches of water has evaporated (or else evaporation has exceeded precipitation by 0.12 inches). See Figure D-5 page D-8.

If precipitation has occurred since the previous observation, the water level may be above the tip of the fixed point. In this case, remove water by filling the measuring tube up to the zero level with water from the evaporation pan as many times as necessary to bring the water level to the fixed point. Be sure to keep track of the number of times the tube is filled. Each filling represents 0.15 inches of water. When enough water has been removed to bring the water level below the fixed point, fill the measuring tube with water from the storage tank (Section 3.5 page D-9) to the zero level, and pour enough water back into the pan to bring the level to the tip of the fixed point. Deduct this amount from the total removed.

An alternative to bringing the water level below the fixed point is to remove enough water from the pan into the measuring tube to bring the water exactly to the fixed point, measuring the amount in the tube, and subtracting this from 0.15 inch. For example, if the tube is filled to the “5” level (0.05 inch), subtract 0.05 from 0.15. The amount removed by dipping is thus 0.10 inch. This is added to the amount removed (if any) by filling the tube from the pan as described in the previous paragraph.

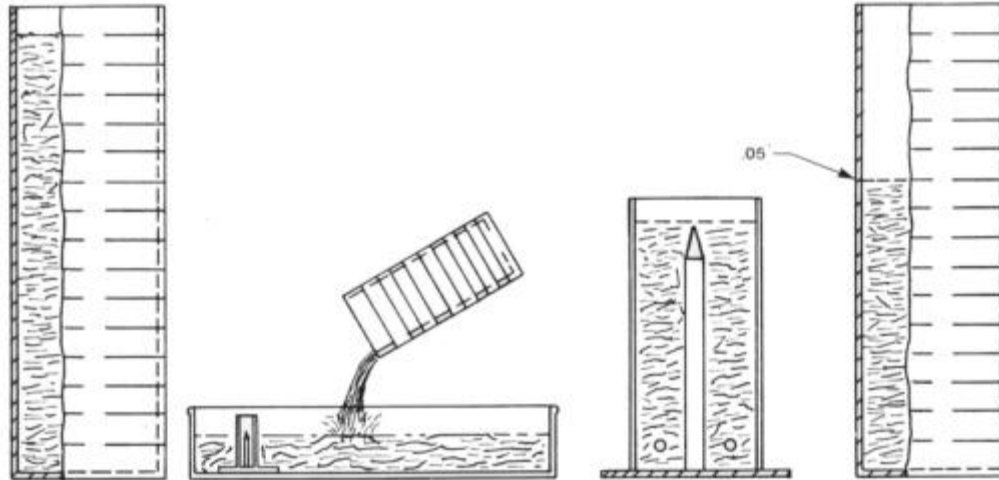

Figure D-5. Evaporation Measurements

For recording purposes, water added is positive and water removed is negative. For example, if 0.24 inches of water must be added, record this as +0.24. On the other hand, if rain has fallen and the measuring tube must be filled three times to bring the level below the fixed point, 0.45 inches is deducted. If 0.06 inch of water is then added to bring the level back to the fixed point, enter the sum of -0.45 and +0.06, or -0.39, on WS Form B-92.

3.4 Micrometer Hook Gauge. The Hook Gauge is no longer supported by NWS Logistics and measurement practices. The Hook Gauge allows the water level to drop over respective successive readings; this changes the exposure of the water surface to its surrounding environment. In contrast, the Fixed Point Gauge resets the water level to a constant exposure at each reading. In order to obtain more constant measurements and simplify operations, the NWS no longer supports use of the Hook Gauge. This section is included for historical and reference purposes.



Figure D-6. Hook Gauge

3.5 Water Storage Tank. If clean water is not available at the site, a storage tank should be installed. The tank should be placed where it will not shade or reduce wind flow over the pan. The tank should be thoroughly cleaned at the beginning of the evaporation measuring season. The water must be completely free of oil.

When the season ends, the tank must be emptied and secured to prevent freeze and wind damage.

3.6 Anemometer. A standard 3-cup, 5 digit counter anemometer (Figure D-7) is mounted on a wooden pan support.

3.6.1 Installation. The anemometer is mounted on a specially designed display stand pintle on the northwest projecting corner of the pan support. The center of the cups should be 6 to 8 inches above the rim of the pan. In this position, the shadow of the cup falls on the pan only during the late afternoon. The anemometer retaining screw (the knurled head set screw located in the adaptor at the bottom end of the anemometer) is used to attach the anemometer to its support base. This screw should be turned only hand-tight.



Figure D-7. Anemometer

3.6.2 Maintenance. The NWSREP will service and clean the anemometer on his/her routine inspection trips, normally twice a year. Bearings of an anemometer lacking oil will squeak and wear badly within a few hours. This problem should be reported to the NWSREP immediately. A squeaking anemometer should be removed and replaced with a new one and sent to NRC for service.

3.6.3 Wind Movement Readings. The anemometer counter is read daily at the scheduled time of observation to the nearest whole mile. For example, if the counter shows a total wind movement of 9291.3 miles, 9291 is recorded.

3.6.4 Data From 5-Digit-Counter Type Anemometers. The five digits appearing in the window of the meter indicate the total wind movement in tenths of a mile for any total from zero to 10,000 miles. The right hand digit indicates tenths of a mile.

Generally, the cooperative observer will not have to compute the number of miles of wind movement since the previous reading. When the observer is asked to compute the miles of wind travel, the procedure is to subtract the previous day's reading from the number currently on the counter. When 10,000 miles have accumulated, the reading starts over at zero. Thus, when the current day's reading is less than the preceding reading, compute the 24-hour wind movement by adding 10,000 to the current reading. Subtract the preceding reading from this total. For example, if today's reading is 10,109 and the previous reading 9,986, subtract 9,986 from 10,109. The movement will be 123 miles.

3.6.5 Data from 6-Digit-Counter Type Anemometers. The Totalizing Anemometer is equipped with a built-in counter to provide a simple, yet precise, method of determining miles of wind with total air passage. An internal gear train converts cup rotation to counter input. Miles of wind accumulate the same as a 5-digit anemometer. The 6-digit counter is **not** manually re-settable. The wind can typically accumulate for a year or longer (up to 99,999.9) before it automatically rolls over to zero. See Figure D-8.

3.7 Dry- And Wet-Bulb Temperatures. Dry- and wet-bulb temperatures are read in order to compute a measure of humidity. The NWSREP may request that the dry-bulb and wet-bulb temperature data be used to compute the dew point or relative humidity. The dry-bulb thermometer of the psychrometer gives the current air temperature. The wet-bulb temperature is the lowest temperature obtained from the moistened wick-covered thermometer of the psychrometer. The thermometer is cooled by evaporating water.



Figure D-8.
Totalizing
Anemometer with 6 -
Digits

3.7.1 Types of Psychrometers. The psychrometer in general use consists of two identical mercury or spirit-in-glass thermometers, shown hanging from a hook above the ventilating fan of a CRS in Figure D-9. The lower of the two thermometers (the wet-bulb thermometer) has a close fitting, loosely woven muslin wick covering the bulb. The fan is operated electrically providing forced ventilation of the thermometers. Some older instrument shelters are equipped with a hand cranked fan.

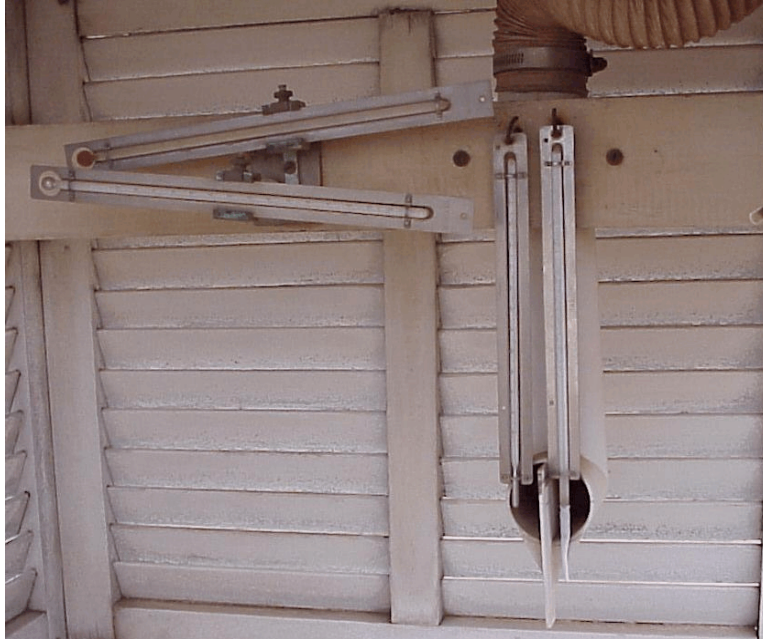

Figure D-9. CRS With Fan

Another type of psychrometer, called the sling psychrometer, is shown in Figure D-10. Evaporation of water from the wick covering the wet-bulb thermometer is enhanced by whirling the thermometers through the air around the sling handle.



Figure D-10. Sling Psychrometer

3.7.2 Maintenance. The only additional maintenance the wet-bulb thermometer requires over other dry-bulb thermometer is the muslin wick. The wick must be close-fitting and tubular, to hold tightly over the thermometer bulb. Slip about 3 inches of wicking over the bulb until it extends beyond the narrow part of the thermometer stem. A wick should be tied in place with a piece of thread. The wicking should be changed frequently to keep it clean. A dirty wick, or one filled with mineral salts (often invisible) from evaporated water, will not allow water to evaporate as readily as a clean wick. This will result in readings being too warm.

3.7.3 Moistening the Wet Bulb. The wet-bulb should be moistened just prior to ventilation, with the following two exceptions:

- a. High Temperature and Low Humidity. In hot, dry weather, moisten the wet-bulb thoroughly several minutes before reading, leaving a drop of water on the end. Natural ventilation will cause partial evaporative cooling before it is ventilated. The drop of water is necessary to prevent the wick from drying before the lowest wet-bulb reading can be obtained. Nevertheless, under very low humidity conditions the wet-bulb must be pre-cooled by one of the following methods to prevent premature drying:
 - (1) Store the moistening water in a porous jug in the shelter.
 - (2) Equip the wet-bulb with a longer wick and insert the end of the wick in a water container placed a few inches below the bulb. Move the container away before ventilating the wet-bulb.
- b. Dry-Bulb Temperature Below 37°F. Moisten the wick thoroughly 10-15 minutes before reading. This time interval will allow the latent heat released by possible freezing of the wet bulb wick to escape before ventilation is started. Use water at room temperature to melt any accumulation of ice. A thin coating of ice may form during the above 10 to 15 minute wait or during ventilation. The ice coating must be thin in order to get accurate readings at these wet-bulb temperatures. If water remains unfrozen at wet-bulb temperatures below 32°F in spite of ventilation, freezing may be induced by touching the wick with snow or ice.

3.7.4 Taking Psychrometer Observations. Moisten the wick and turn on the ventilating fan (Figure D-9 page D-11). Psychrometers with hand-cranked fans, turn the crank at least 3.5 revolutions per second to ventilate properly.



Figure D-11. Sling Psychrometer (close-up view)

For the sling Psychrometers (Figure D-11 page D-12), select a shady spot with plenty of room for whirling the psychrometer. Face into the wind. Whirl the psychrometer at least two revolutions per second, as far in front of the body as possible, for at least 10 to 15 seconds between each reading. Ventilate longer if the temperature is near or below freezing.

For both types of Psychrometers, read both thermometers to the nearest tenth of a degree, two or more times immediately following each period of ventilation. Repeat the ventilation operation until two successive readings of the wet-bulb are the same. Record the lowest wet- and dry-bulb readings. Follow the procedures given in Section 3.7.3 page D-12 if the air is very dry or the temperature is below 37°F.

3.8 Water Temperatures. Under standard conditions, the rate of evaporation increases rapidly with increasing water and air temperature, approximately doubling with each rise in temperature.

Maximum and minimum temperatures are determined from sensing elements placed beneath the surface of the water in the evaporation pan. Evaporation occurs at the immediate surface of the water. Since warmer water is lighter than colder (if above 39°F), it will rise to the top and tend to stratify there during the day, especially with the sun shining. Therefore, the thermometer should measure the water temperature preferably near the bottom of the pan.

Water temperatures can be measured with the maximum and minimum (Sixes) thermometer, as shown in Figure D-12.

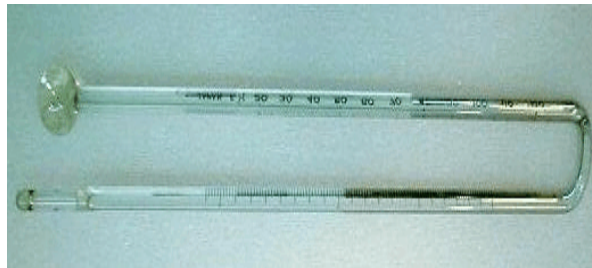

Figure D-12. Sixes Thermometer

3.8.1 Installation.

3.8.1.2 Submerged-Mounted Thermometer. The submerged-mount thermometer is mounted horizontally on a plastic holder which rests on the bottom of the pan (Figure D-13 page D-14). A non-magnetic metal handle is fastened to the bulb end of the holder and hooks over the edge of the pan. The holder should be located on the inside bottom (south side) of the pan, to be shaded as much as possible from direct sun rays. Submerge the thermometer gently to prevent the small indices inside the tube from jarring away from the mercury column.



Figure D-13 Submerged Mount Thermometer

3.8.1.3 Recording Thermometers. Any recording thermometer with an immersible sensing element may be used. The line connecting the thermometer to the recorder should be long enough to permit installation of the recorder where it will not cast a shadow on the pan, and more than four feet from any instrument. It should be in a low housing along a fence in the northern half of the enclosure.

3.8.2 Maintenance. Keep the Sixes thermometer assembly and plastic holder free from dust and sediment. Use a soft wet cloth for cleaning the unit. A very fine grade steel wool or SOS-type cleaning pad can be used to clean salt deposits from the thermometer bulb and tube.

3.8.3 Accuracy Checks. Check the accuracy of the water temperature readings once a month when the pan is cleaned by removing the Sixes thermometer from the pan and placing it in the instrument shelter. Allow enough time for the thermometer to dry and reach the air temperature. Read the current air temperature from the minimum thermometer without resetting. Then read the temperature from the Sixes thermometer. Enter the readings in the “Remarks” column of WS Form B-92. If readings differ by 2.0°F or more, the NWSREP should be notified.

3.8.4 Rejoining Separated Mercury Columns. The mercury columns in a Sixes thermometer are subject to separation, causing inaccurate readings. The column should be joined as soon as possible. Remove the thermometer and holder from the pan. Do not remove the thermometer from either its plastic holder or float frame. Hold the thermometer near its bulb end and swing rapidly in an arc until the mercury column is rejoined. Avoid striking objects and breaking the thermometer. Always perform maintenance on the sixes thermometer outdoors.

3.8.5 Reading and Resetting the Sixes Thermometer. Read temperatures to the nearest whole degree, as indicated by the end of the metal indices nearest the mercury columns. If possible, read while submerged. Then, remove the thermometer from the pan to reset the indices.

To reset the thermometer, place a horseshoe magnet (open end down and parallel to the thermometer tube) directly above one metal index. Move the magnet slowly toward the mercury

column until the index touches the mercury. Gently lift the magnet away from the tube so the index will not spring away from its contact with the mercury. Repeat this procedure for the other index.

The submerged-mount thermometer magnet comes with a small metal strip to bridge across the poles of the magnet and keep it from losing strength. Replace the strip after each use. If the strip is lost, a nail or small metal piece may be used.

4. Reading Observations from Evaporation Stations. Observations are recorded on WS Form B-92, "Record of Evaporation and Climatological Observations," unless instructed otherwise by an NWSREP. The cover of the form contains instructions for recording observations. If data is missing, **M** will be entered in the appropriate column(s) for the day(s). **If water freezes in the pan during the period the data will not be used.**

Station		County		State		Date (Month & yr.)		Time of Complete Observation (Local time)		Standard Time in Use		RECORD OF EVAPORATION AND CLIMATOLOGICAL OBSERVATIONS										
DATE	AIR TEMPERATURE °F					PRECIPITATION				WIND		EVAPORATION (Inches & hundredths)		WATER TEMP. °F		ADDITIONAL DATA/REMARKS						
	24 Hours Ending at Observation		At Observation		Supplemental Readings at _____			Time of beginning	Time of ending	Time of beginning	Time of ending	24 Hour Amounts		Gage Reading or Amount Added +	Reading When Tank Filled or Amount Removed -		Amount of Evaporation	24 Hours Ending at Observation				
	Max.	Min.	Dry-bulb	Wet-bulb	Dew Point	Dry-bulb	Wet-bulb	Dew Point					Rain, Melted Snow etc. (in. & hundredths)	Snow, Ice Pellets, Hail, Ice on ground (in.)	At Obsn. Snow, Ice Pellets Reading (Miles)		Anemometer Dial Reading (Miles)	24 Hour Movement			Max.	Min.
1																						
2																						
3																						
4																						
5																						
6																						
7																						
8																						
9																						
10																						
11																						
12																						
13																						
14																						
15																						
16																						
17																						
18																						
19																						
20																						
21																						
22																						
23																						
24																						
25																						
26																						
27																						
28																						
29																						
30																						
31																						
Sum																						
Avg.																						

WS FORM B-92 (5-89) U.S. DEPARTMENT OF COMMERCE NATIONAL WEATHER SERVICE OBSERVER GREATEST ADJUSTED TOTAL STATION NUMBER

Figure D-14. WS Form B-92, Record of Evaporation and Climatological Observations

APPENDIX E - Soil Temperature Stations

<u>Table of Contents:</u>	<u>Page</u>
1. Introduction.....	E-2
2. Exposure and Protection of Equipment	E-2
3. Size of Plot.....	E-2
4. Maintenance of Plots	E-2
4.1 Sod Covered Plots.....	E-2
4.2 Natural Cover.....	E-2
4.3 Bare Soil	E-3
4.4 Snow Cover.....	E-3
5. Types of Thermometers and Readings	E-3
6. Installation of Thermometers.....	E-3
7. Shelters.....	E-4
7.1 Thermometer Head Shelters	E-4
7.2 Location of Shelter.....	E-5
7.3 Replacing Soil In Trench	E-5
8. Depth of Soil Temperature Measurements	E-5
9. Observations	E-5
9.1 Type and Frequency.....	E-5
9.2 Time of Observation	E-6
10. Entry of Readings on Permanent Record Forms.....	E-6
11. Palmer Soil Thermometer	E-7
11.1 Resetting Maximum and Minimum Pointers.....	E-7
11.2 Maintenance.....	E-8
11.2.1 Loose Pointers.....	E-8
11.2.2 Frozen Pointers	E-8
11.2.3 Moisture in the Head.....	E-8
11.2.4 Broken Cover	E-8
11.3 On Site Accuracy Check by the NWSREP.....	E-8
11.3.1 In-Place Accuracy Checks by the NWSREP.....	E-8
11.3.2 Accuracy Check of Palmer Model 35B by NWSREP	E-9
11.3.3 The Calibration by the NWSREP	E-9

Figures	Page
E-1 Installation of Soil Thermometers	E-4
E-2 Palmer Soil Thermometer in Shelter.....	E-4
E-3 WS Form B-83a	E-6
E-4 Palmer Soil Thermometer	E-7

1. Introduction. Soil temperatures are essential to the agricultural industry. All species of plants have a specific range of temperatures in which they will grow. Most seeds require a certain amount of warmth in order to germinate. Some vegetation will suffer if the soil temperature is too warm.

Information collected from soil temperature stations is used for general weather purposes as well as for agriculture. Many stations measuring soil temperature transmit their readings over nationwide communications circuits, especially during the beginning and middle portions of the growing season. Nationwide weekly average soil temperatures are published during the growing season in the Weekly Weather and Crop Bulletin, and daily readings for one or more levels are published in “Climatological Data” by the NCDC.

Soil temperature stations may have the following additional instrumentation: precipitation gauge, air temperature thermometer with shelter, evaporation pan, and anemometer.

2. Exposure and Protection of Equipment. Soil thermometers should have an exposure typical of the principal natural agricultural soils and conditions of the area. The site should not be subject to irrigation, overflow, or unusual ground-water conditions. The site should be open to full sunshine, with the exception of certain designated sites or where partial shade is considered typical of the area. The observing plot should be fenced or have other protection from humans and animals.

3. Size of Plot. The plot should be 10 by 10 feet or larger, with the thermometers centrally located. Where both sod and bare plots are maintained, the bare plot should also be at least 10 by 10 feet. If the location is not typical of the surroundings, the plot should be larger, at least 30 by 30 feet.

4. Maintenance of Plots.

4.1 Sod-Covered Plots. Sod-covered plots should be under bluegrass, alta fescue, perennial rye, or other grasses used for lawns or pastures in the area. The area should be trimmed and maintained at a uniform 2 or 3 inch height. No irrigation should be applied, except to start cover before beginning observations. If during extreme drought, it is necessary to irrigate, the soil temperature should be noted as not being typical and should be excluded from published data.

4.2 Natural Cover. At some locations, normal climate and soil do not permit maintenance of a sod cover. The observer should maintain the cover like the natural cover common to the area.

4.3 Bare Soil. Bare soil plots should be kept free of weeds and other vegetation at all times. This can be done by scraping with a hoe or by chemical treatment. Shallow raking to avoid heavy crusting after precipitation is recommended. Avoid deep cultivation.

Local jurisdictions should be contacted in regard to herbicides that will be best suitable for particular type of soil and vegetation. The need for certification/license should also be verified. Notwithstanding, follow NWSM 50-5116 instructions.

4.4 Snow Cover. Snow cover should remain natural and undisturbed. The observation site should be located to allow snowfall to be natural and free of obstructions that may cause artificial drifting or wind scouring.

5. Types of Thermometers and Readings. Dial-type or digital thermometers may be used. Maximum/minimum and current temperatures are generally recorded at lesser depths. At greater depths where temperature changes are slower (generally, below the 8-inch level), the current temperature is usually recorded. At most observing sites, maximum and minimum air temperatures are read and recorded at the same time and location as the soil temperatures. See Section 11 page E-7 for a description of the Palmer soil and other types of thermometers in use.

6. Installation of Thermometers. Sensing elements should be located in and under undisturbed soil. The sensors should be in close contact with the ambient soil, with no insulating air spaces or pockets, and without artificial channels for the entry of water. They should be in or very near the center of the observation plot. Readouts should be mounted high enough above ground to make it easy and convenient to read and reset the thermometers.

Dig a small trench just to the north of the spot where the sensors will be imbedded in the earth. This should be as small as possible without hindering the necessary work. Remove the sod carefully and set it aside on boards or a tarpaulin for replacement later. The soil should be removed in layers, as it can be replaced as close to its original condition as possible.

The trench should be slightly deeper than the lowest depth for the sensor. This allows enough working space and permits a slight looping of the flexible cables to be installed. A hole should be made for the sensing elements with a rod 18 inches long and 5/16 inch in diameter for installing the 13-inch long mercury-in-steel sensors used with the Palmer soil thermometer (Section 11 page E-7). The rod should be pressed into the face of the south end of the pit at the proper depth and be driven into the soil nearly its full length. It should remain parallel to the surface above it so that it is the same depth throughout its full length. If smaller sensors (such as thermistors or thermocouples) are used, a rod with a diameter equal to or only slightly larger than the sensor should be used. See Figure E-1 page E-4, which shows the instrument trench (unshaded area) as it would appear before replacing the soil.

Press the sensing element into the hole with the least force possible. If too much resistance is met, withdraw the element and clear the hole with the rod.

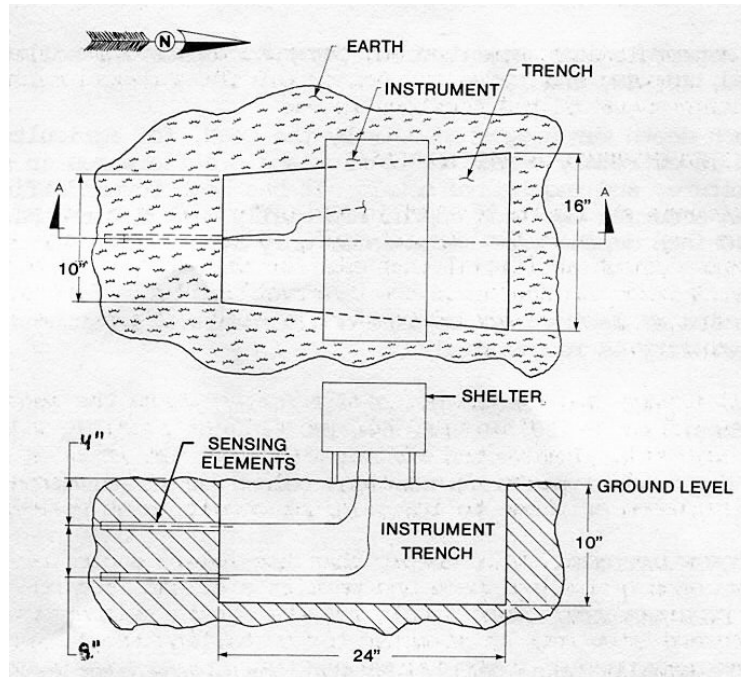

Figure E-1. Installation of Soil Thermometers

7. Shelters.

7.1 Thermometer Head Shelters. Soil temperature thermometer heads or recorders must be protected from the weather by a shelter, in which the access door opens from the side or top. The length of the shelter depends on the number of thermometers installed. Soil temperatures measured with an Electronic Thermometer will have the display mounted in or near a shelter housing of the air temperature sensor.



Figure E-2. Palmer Soil Thermometer in Shelter

7.2 Location of Shelter. The shelter should be located about one foot north of the south edge of the trench. Set the supports for the shelter in the trench before replacing the soil. The 5-foot cable will permit the shelter to be about three feet above ground. This will allow for a slight loop of the cable in the trench floor for sensors as deep as eight inches.

If electric wires connect the sensors to the recorders (as with the NIMBUS/MMTS), the shelter may be located outside and to the north of the trench, where no shadows will affect the soil above the sensors. The wires must be trenched into the earth a few inches. Do not run them across the ground surface.

7.3 Replacing Soil in Trench. The soil should be replaced as nearly as possible in its original condition. This will usually require firm packing as each layer is replaced. Soak the soil as it is returned to the trench, then replace the sod. Excess moisture will assist in renewing sod growth.

8. Depth of Soil Temperature Measurements. The following depths (in inches) have been recommended by the Commission for Climatology (CCI) and the Commission for Agricultural Meteorology (CAgM) of the World Meteorological Organization (WMO) for observing soil temperature: 2, 4, 8, 20, 40, 60, and 120.

The two-inch depth was suggested only by the CAgM, for agricultural purposes. This depth is extremely sensitive to micro scale differences in soil type and color, moisture, and vegetative cover. It has been found difficult to maintain an accurate two-inch depth, especially with a bare soil cover. The 60- and 120-inch depths were recommended only by the CC1, for climatological purposes.

Where a choice of depths must be made due to sensor limitations, the following order of priority is recommended:

Priority	1	2	3	4	5	6	7
Depth (inches)	4	8	20	40	2	60	120

Many soil temperature measuring stations record temperatures only at the 4-inch depth.

9. Observations.

9.1 Type and Frequency. Readings are taken daily. Daily ranges in the soil temperature can exceed air temperature ranges in the shallow layers. This amplitude diminishes rapidly to about 1°F at depths of 18 to 24 inches. Therefore, maximum and minimum temperatures are normally recorded at depths through 20 inches, while only the current temperature is recorded at greater depths.

11. Palmer Soil Thermometer. This section describes the operation, maintenance, and calibration procedures for the Palmer soil thermometer. This thermometer has been in general use for many years (Figure E-4).



Figure E-4 Palmer Soil
Thermometer

11.1 Resetting Maximum and Minimum Pointers. After the maximum and minimum temperatures have been recorded; carefully reset the red (maximum) and green (minimum) pointers. The red pointer is reset first by bringing it into contact with the black (current temperature) pointer. Next, the green pointer is gently rotated to the opposite side of the black pointer. Do not press down on the either pointer knob, as this will result in tension loss in the pressure washer and cause loose pointers.

During the resetting, check the “flex” of the black pointer. It should flex or move less than one degree in response to pressure from the red and green pointers. Movement in excess of this indicates either a loss of tension in the sensor system or too much drag tension in the maximum and/or minimum pointers. If lubrication does not correct the situation, the instrument must be replaced.

11.2 Maintenance. The most common maintenance needs of the Palmer soil thermometer are as follows: loose or frozen pointers, moisture in the head, broken cover, and calibration errors.

11.2.1 Loose Pointers. This usually results from improper resetting procedures. This is corrected by removing the bezel ring and glass cover (the red and green pointers are mounted in the glass cover). Remove the allen set-screw embedded in the green knob. The tightness of this knob controls the tension on both pointers. Hold the bottom of the connecting shaft (inside the glass cover) and carefully reset the green knob to the desired tension. Clockwise rotation increases the tension. Replace the allen set-screw in the green knob and reassemble. Replacing the tension washer under the green knob may be necessary.

11.2.2 Frozen Pointers. Frozen pointers can often be corrected by cleaning and lubricating. Use a good silicone lubricant, preferably in a pressure spray applicator. It may be necessary to remove the bezel ring and glass cover to perform adequate cleaning and lubrication.

11.2.3 Moisture in the Head. This indicates the need for a new gasket. Remove the bezel ring and glass cover. Replace the sealing gasket on a day with as low humidity as possible.

11.2.4 Broken Cover. A file or hacksaw may be required to remove the bezel ring. Make a cut across the outside edge of the ring and use a screwdriver to press downward and outward to snap it off. A new cover and ring should be replaced with a connecting screw to fasten it in place.

11.3 On-Site Accuracy Check by the NWSREP. Verify the accuracy of the thermometers at least twice a year. Without this, the thermometers are likely to drift upward or downward. The following describes the verification procedures.

11.3.1 In-Place Accuracy Checks by the NWSREP. Incorrect data resulting from long-term calibration drifts can be eliminated with careful periodic accuracy checks. The following three procedures may be used to accomplish this.

- a. A thermometer of known accuracy can be used for comparison. It is imperative that the sensor be pushed to the same depth as the Palmer soil thermometer sensor bulb and left there long enough to stabilize at the soil temperature (4 to 5 minutes).
- b. A less desirable technique for shallow depths is to remove soil to the level of the base of the Palmer 13-inch sensor bulb near the sensor but not directly at the sensor. The comparison thermometer sensor should then be inserted and the soil replaced above it. The thermometer must remain imbedded long enough for the removed and replaced soil to regain the temperature of adjacent undisturbed soil at the same depth.

- c. If the soil at the depth of a soil thermometer is in the process of freezing, the temperature will often remain at the 32°F ice-water equilibrium point for several days. Check the temperature during this period to determine the accuracy of the thermometer.

11.3.2 Accuracy Check of Palmer Model 35B by the NWSREP. An accuracy check of the Palmer model 35B should be performed at least twice a year.

Methods (a) and (b) in section 11.3.1 page E-8 should not be used on model 35B soil thermometers between about 9 a.m. and 6 p.m. on bright, sunny days, as sensitivity to heat penetration under these conditions can make it read higher.

Make the following two allowances for discrepancies between the Palmer model 35B and the check thermometer.

- a. The tolerance of the Palmer (about 2°F) and the check thermometer (generally 1% of the scale) may be additive.
- b. A seemingly slight difference in exposure between the two may contribute to a variation in readings. A spread of up to 4°F between the two readings should be considered satisfactory. For method “C” in Section 11.3.1 page E-9, a reading between 29°F and 35°F should be considered sufficiently accurate at the ice point.

Note: Never apply any allowable difference as a correction to future observations.

11.3.3 The Calibration by the NWSREP. If the checks in section 11.3.2 indicate a calibration offset, calibrate the thermometer as follows:

- a. Place both the probe and the reference thermometer in the shelter housing of the dial indicator and close the door.
- b. After a minimum of 10 minutes, open the door and record both readings.
- c. Immerse both the reference thermometer and the entire probe of the Palmer thermometer in a slushy ice bath.
- d. After a minimum of 10 minutes, record the temperatures. Leave the sensors in the ice bath, in case step (f) must be used.
- e. If the difference in the readings of the two thermometers is approximately the same in steps (b) and (d), an offset is indicated. See step (f) below. If the differences are not approximately the same, the Palmer must be considered inoperative and replaced.
- f. If an offset is indicated, turn the “reset” screw on the back of the dial head until the thermometer reads 32° F while the probe is still in the ice bath. On some older

instruments, an access screw in back of the dial head must be removed first. The adjustment on these models is limited to about two degrees. If a greater adjustment is needed, remove the bezel ring and glass cover. Place a screwdriver in the center screw of the black pointer hand and loosen it. Rotate the pointer hand gently to the desired setting. Re-tighten the center screw. If the instrument is equipped with a non-reusable bezel ring, the ring may be removed with a file.

APPENDIX F - Atmospheric Phenomena

<u>Table of Contents:</u>	<u>Page</u>
1. Introduction.....	F-2
2. Tornadoes, Waterspouts and Funnel Clouds	F-3
2.1 Tornado	F-3
2.2 Funnel Cloud.....	F-4
2.3 Waterspout.....	F-4
3. Thunderstorm.....	F-5
4. Damaging Winds, Squalls and Gusts.....	F-5
5. Hydrometeors.....	F-6
5.1 Forms of Precipitation	F-6
5.2 Hydrometeors Other Than Precipitation.....	F-9
6. Lithometeors	F-13
6.1 Haze	F-13
6.2 Smoke	F-13
6.3 Dust.....	F-13
6.4 Blowing Sand.....	F-15
7. Electrometeors	F-16
7.1 Aurora	F-16
7.2 Thunder	F-16
7.3 Lightning.....	F-16
8. Luminous Meteors	F-17
8.1 Halo Phenomena.....	F-17
8.2 Corona.....	F-18
8.3 Rainbow	F-18
8.4 Fog Bow.....	F-19
9. Reporting and Recording Atmospheric Phenomena.....	F-19
9.1 Real-Time Reporting	F-19
9.1.1 Reporting Tornadoes, Waterspouts, and Funnel Clouds	F-19
9.1.2 Reporting Other Phenomena.....	F-19
9.2 Recording Atmospheric Phenomena.....	F-20
9.2.1 Tornadoes, Waterspouts, and Funnel Clouds	F-20
9.2.2 Thunderstorms	F-20
9.2.3 Other Phenomena.....	F-20

Figures

F-1	Winds Associated with a Tornado	F-3
F-2	Tornado	F-3
F-3	Funnel Cloud.....	F-4
F-4	Waterspouts.....	F-4
F-5	Distant Thunderstorm	F-5
F-6	Microburst.....	F-5
F-7	Glaze	F-7
F-8	Hail.....	F-7
F-9	Snow Pellets.....	F-8
F-10	Snow Grains.....	F-8
F-11	Fog	F-9
F-12	Mist	F-9
F-13	Ice Fog	F-10
F-14	Dew	F-10
F-15	Frost Formed on Window	F-11
F-16	Rime.....	F-12
F-17	Blowing Snow.....	F-12
F-18	Haze	F-13
F-19	Smoke	F-13
F-20	Blowing Dust	F-14
F-21	Dust Storm	F-14
F-22	Dust Devil	F-15
F-23	Sandstorm	F-15
F-24	Northern Lights.....	F-16
F-25	Lightning.....	F-16
F-26	Halo with Sun Dogs.....	F-17
F-27	Corona.....	F-18
F-28	Double Rainbow	F-18
F-29	Fog Bow.....	F-19

1. Introduction. The following atmospheric phenomena should be observed and recorded on WS Form B-91 or other form designated by the NWSREP: Tornadoes, waterspouts, funnel clouds, thunderstorms, damaging winds (including squalls), fog, mist, haze, smoke, dust, frost, and any form of precipitation. Recording haze, smoke, dust and frost is optional, except when dangerous, i.e., to travelers or crops. Damaging and life-threatening phenomena, especially tornadoes, would be reported immediately to the NWS office or as directed by the NWSREP.

Observations of the phenomena are an important part of the record from climatological stations, and they are often the only written account of these occurrences from the observer's area that will be sent to NCDC. Except for precipitation, no instruments are required to record these phenomena.

2. Tornadoes, Waterspouts and Funnel Clouds.

Tornadoes and funnel clouds are nearly always associated with intense thunderstorms. While some waterspouts may develop in the absence of thunderstorms and often are much less destructive, others are tornadoes that have formed or moved over water, and are just as dangerous over water as land.

2.1 Tornado. Tornadoes are local storms usually of short duration, consisting of violently rotating column of air extending from a thunderstorm to the ground (Figure F-2). A tornado will usually appear hanging from the bottom of the storm cloud, generally close to, but outside the area in which rain is falling. Part or all of the funnel may be invisible if the air is dry, but the tornado can still often be identified by the rotating particulate matter, especially near the ground, and in intense tornadoes, by a loud roaring sound. Rotating debris not associated with clouds are whirlwinds (dust devils-see Figure F-22 page F-15) rather than tornadoes.

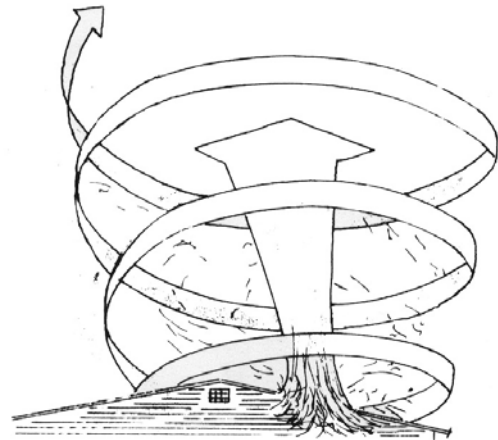

Figure F-1. Winds Associated with a Tornado

Tornadoes do their destructive work from strong rotary winds. As a tornado passes over a building, the winds twist and rip from the outside (Figure F-1). Walls collapse or topple outward, windows explode, and the debris of this destruction is driven through the air with dangerous force. Heavy, objects like machinery and railroad cars can be lifted and carried by the wind for considerable distances.



Figure F-2. Tornado

2.2 Funnel Cloud. A funnel cloud is a rotating column of air that is not in contact with the ground. Funnel clouds form at the base of dark, heavy cumulonimbus clouds and develop downward. Some never reach the ground. Others reach the ground (becoming tornadoes), then rise again or dissipate. See Figure F-3.



Figure F-3. Funnel Cloud

2.3 Waterspout. Over a large body of water, a tornado is called a waterspout. It rises from the water into the cloud in an upward spiral. Waterspouts are weaker than most tornadoes, but can still be dangerous. Waterspouts can overturn small boats, damage ships; do significant damage when hitting land, and cause fatalities. See Figure F-4.



Figure F-4. Waterspouts

3. Thunderstorm. For record purposes, a thunderstorm is considered in progress when thunder is heard, whether or not rain is falling or lightning is seen. The intensity may vary from occasional distant thunder to very frequent, sharp thunder with heavy rain, sometimes associated with strong winds and hail. See Figure F-5.



Figure F-5. Distant Thunderstorm

4. Damaging Winds, Squalls, and Gusts. Winds are considered “damaging” when vegetation, buildings, or other property has been injured, damaged, or destroyed. See Figure F-6.

A squall is a sudden, violent wind, often accompanied by rain or snow. Gusty winds are characterized by sudden, periodic increases in speed. There are noticeable differences in speed between the peaks and lulls. All of these often occur with thunderstorms, or they can occur alone.



Figure F-6. Microburst

5. Hydrometeors. A hydrometeor is any form of atmospheric water (liquid or frozen) or water vapor that (a) falls through the atmosphere, such as rain or snow; (b) is suspended in the atmosphere, such as fog; is blown from surfaces by the wind, such as blowing snow or blowing spray; or (d) is deposited on objects, such as freezing rain (glaze).

5.1 Forms of Precipitation. Hydrometeors include precipitation in all its forms. It may be continuous, intermittent, or showery. Dew is not considered precipitation. The intensity is classified as light, moderate, or heavy. Precipitation is observed in the following forms:

- a. Rain - Rain is drops of water in liquid form falling from the sky, the individual drops are larger than .02 inch in diameter.
- b. Drizzle - Drizzle is fairly uniform precipitation composed exclusively of fine droplets (less than .02 inch in diameter), uniformly dispersed, that may appear to float with the air currents.
- c. Ice Pellets - Ice Pellets are round or irregularly-shaped pellets of ice with a diameter of 1/5 inch or less, either transparent or translucent. Ice Pellets usually rebound when striking hard surfaces, making a sound on impact. The following two types of ice pellets are observed:
 - (1) Hard grains of ice consisting of frozen raindrops or melted and re-frozen snowflakes (often called sleet).
 - (2) Pellets of snow encased in a thin layer of ice. These rarely bounce on impact.

The first type (1) falls as continuous precipitation, the second type (2) is associated with showers.

- d. Glaze - Glaze is rain or drizzle that falls in liquid form, but freezes to objects and/or on the ground. It forms a smooth coating of transparent ice layers. Ice storms result from heavy coatings of glaze and may do great damage to trees, shrubs, and telephone and power lines, creating unsafe conditions. See Figure F-7.



Figure F-7. Glaze

- e. Hail - Hail is pieces of ice, often round or in irregularly shaped lumps, falling individually or several pieces frozen together. They range from 1/5 inch to two or more inches in diameter. Hail usually consists of alternate opaque and clear layers of ice (Figure F-8). Hail is normally associated with thunderstorms and temperatures above freezing. Hail can cause serious damage to anything it strikes. Crops may be destroyed and livestock injured.



Figure F-8. Hail

- f. Snow - Snow is white or translucent ice crystals, mostly in six-pointed star form, often mixed with simple crystals. Snow occurs under conditions similar to those of rain, but the air temperature aloft must be freezing or lower.
- g. Snow Pellets - Snow Pellets are white, opaque grains of ice, round or conical, 1/16 to 1/4 inch in diameter. The pellets are crisp and easily compressed and may bounce or burst when striking hard surfaces. See Figure F-9 page F-8.



Figure F-9. Snow Pellets

- h. Snow Grains (granular snow) - Snow Grains are minute opaque, branched, star like snowflakes or very fine simple crystals. They are smaller than snow pellets and usually fall in small quantities from low stratified clouds. They do not bounce or shatter on impact. See Figure F-10.



Figure F-10. Snow Grains

Both snow pellets and snow grains should be recorded.

5.2 Hydrometeors Other Than Precipitation.

- a. Fog - Fog is minute water droplets suspended in the atmosphere to form a cloud at the earth's surface. There is no visible downward motion. The horizontal visibility is $\frac{1}{2}$ mile or less. It is called ground fog if the depth is less than 20 feet. Fog differs from haze by its dampness, and gray color. See Figure F-11.



Figure F-11. Fog

- b. Mist - Mist is similar to fog except the horizontal visibility is greater than $\frac{1}{2}$ mile, but less than 7 miles. See Figure F-12.



Figure F-12. Mist

- c. Ice Fog - Ice Fog is minute suspended particles in the form of ice crystals and/or needles. It occurs at very low temperatures (-20°F or colder), usually in clear, calm weather at high latitudes. It does not produce rime or glaze on objects. See Figure F-13.



Figure F-13. Ice Fog

- d. Dew - Dew is liquid water that has condensed on objects on or near the surface of the earth with above freezing temperatures. Dew occurs on calm, clear nights. See Figure F-14.



Figure F-14.
Dew

- e. Frost - Frost is thin ice crystals shaped like scales, needles, feathers or fans that form on objects with a temperature of 32°F or lower. Frost can occur on the ground when the air temperature at the instrument shelter level is several degrees above freezing. It is the same as hoarfrost. See Figure F-15.



Figure F-15. Frost Formed on Window

- f. Freeze - Freeze is the condition of the lower atmosphere when the temperature of surface objects is 32°F or lower. A freeze may or may not be accompanied by a deposit of frost (Figure F-15). When vegetation is injured by a relatively low temperature (with or without a frost), the condition is termed a freeze.

During a freeze, the air at the instrument shelter level may be above 32°F, although the ground is 32°F or colder. This occurs most frequently during calm, clear nights, with the greatest temperature difference near sunrise.

Freezes are classified as follows:

- (1) Light Freeze - Little destructive effect on vegetation, except to tender plants and vines. Shelter level temperatures are often above freezing but drop below freezing for a short period at the surface.
- (2) Killing Freeze - Widely destructive to vegetation. It is often defined as a sufficiently severe freeze to cut short the growing season. Temperatures at thermometer level are generally below freezing. This is sometimes called a "killing frost."
- (3) Hard Freeze - Staple vegetation is destroyed. The ground surface is frozen solid under foot, and heavy ice forms on puddles and other exposed water surfaces. It is colder and more prolonged than a killing freeze.

- g. Rime - A white or milky and opaque granular deposit of ice formed by the rapid freezing of super cooled water droplets of fog, as they impinge on exposed objects. It is denser and harder than hoar frost, but lighter and softer than glaze. See Figure F-16.



Figure F-16. Rime

- h. Blowing Snow - Blowing snow is particles of snow raised from the surface by strong turbulent winds to eye level (six feet) or above (Figure F-17). It is blown about in sufficient quantities to restrict the horizontal visibility. It is called “drifting snow” if raised to a height below eye level. Blowing and drifting snow should be recorded when causing damage, such as blocking roads or exposing seeded fields.



Figure F-17. Blowing Snow

6. Lithometeors. Lithometeors are visible phenomena suspended in the air that are not associated with water vapor. Examples are haze and smoke.

6.1 Haze. Haze consists of fine dust or salt particles suspended in the air in sufficient quantity to reduce the visibility. It resembles a uniform veil that subdues all colors. Dark objects have a bluish tinge. Bright objects (the sun or distant lights) appear a dirty yellow or have a reddish hue. Haze may be caused by a variety of substances, including dust, salt, residue from distant fires, volcanoes, or pollen. See Figure F-18.



Figure F-18. Haze

6.2 Smoke. Smoke is suspended particulate matter resulting from combustion. Smoke will cause the disk of the sun at sunrise and sunset to appear very red or to have a reddish tinge at other times of day. Smoke coming from a great distance, such as from forest fires or volcanoes, usually has a light grayish or bluish color. As smoke continues traveling from its source, the larger particles drop out, leaving haze. See Figure F-19.



Figure F-19. Smoke

6.3 Dust. Dust is fine particles of dust or sand suspended in the air, often as the result of a dust storm or sand storm that may have occurred at or far away from the observing site. It imparts a tan or gray hue to distant objects. The sun's disk is pale, colorless, or tinged yellow. Dust manifests itself in the following additional forms.

- a. **Blowing Dust** - Blowing dust is dust picked up locally from the surface and blown about in clouds or sheets, reducing the horizontal visibility to 6 miles or less. See Figure F-20 page F-14.



Figure F-20. Blowing Dust

- b. Dust Storm - A dust storm is blowing dust reducing the visibility to 1/2 mile or less. A dust storm usually arrives suddenly in the form of an advancing dust wall (Figure F-21) which may be miles long and several thousand feet high. Ahead of the dust wall the air is very hot and the wind usually light.



Figure F-21. Dust Storm

- c. Dust Devil - The dust devil is a small vigorous whirlwind, usually of short duration, made visible by dust and debris picked up (Figure F-22) from the surface. Dust devils usually occur on hot, calm afternoons with clear skies. They are seldom intense enough to cause appreciable damage.



Figure F-22. Dust Devil

6.4 Blowing Sand. This is sand that is picked up from the surface of the earth by the wind and blown about in clouds or sheets, reducing the visibility to 6 miles or less. It is called a sandstorm when the wind is very strong and the visibility is reduced to 5/8 of a mile or less. See Figure F-23.



Figure F-23. Sandstorm

IMPORTANT: Road hazards created by dust storms and sand storms should be reported immediately to the Weather Forecast Office.

7. Electrometeors. An electrometeor is a visible or audible display of atmospheric electricity.

7.1 Aurora. The aurora, frequently known as the “northern lights” (Figure F-24) in the northern hemisphere, is a luminous phenomenon of arcs, bands, or curtains of light in the high (and occasionally middle) latitudes and at very high altitudes. Aurora is usually white, but they may have other colors. The lower edges of the arcs or curtains are usually well defined, while the upper edges are not. The aurora is caused by electrically charged particles ejected by the sun, acting on the rarified gases of the higher atmosphere. The particles are channeled by the earth's magnetic field, so the bases of the curtains are pointed toward the earth's magnetic poles.



Figure F-24. Northern Lights

7.2 Thunder. This is a sharp rumbling sound which accompanies and follows lightning discharges. It is caused by rapidly expanding gases along the channel of a lightning discharge.

7.3 Lightning. Lightning is the flash of light from a sudden visible electrical discharge (Figure F-25) produced by thunderstorms. It takes the following forms:

- a. Cloud-to-Ground - Bolts of lightning occurring between the cloud and ground.
- b. In-the-Cloud - Lightning within the cloud. The streaks are not visible from the ground.



Figure F-25. Lightning

- c. Cloud-to-Cloud - Streaks of lightning from one cloud to another, or from one part of a cloud through cloudless air to another. The streaks are visible from the ground.
- d. Cloud-to-Air - Lightning from a cloud into the air, but not striking the ground.

8. Luminous Meteors. A luminous meteor is an atmospheric phenomenon appearing as a luminous pattern in the sky. It is produced by the reflection, refraction, diffraction, or interference of light from the sun or moon. The following types are observed:

8.1 Halo Phenomena. This is a group of phenomena in the form of rings, arcs, pillars, or bright spots produced by the reflection or refraction of sunlight or moonlight by ice crystals suspended in the atmosphere. Cirrus and cirrostratus clouds often produce halos. The rings are about 22 degrees away from the sun or moon. See Figure F-26.



Figure F-26. Halo with Sun Dogs

8.2 Corona. A corona is one or more sequences of small colored rings centered on the sun or moon. A corona is usually smaller than a halo, and all colors may not be visible. Colors may be repeated irregularly, causing iridescence. Coronas are produced by sunlight or moonlight shining through thin clouds consisting of water vapor. See Figure F-27.



Figure F-27. Corona

8.3 Rainbow. A rainbow is a group of concentric arcs produced on a “screen” of falling precipitation by the light from the sun or moon. In some cases a double rainbow may be seen (Figure F-28), with the weaker bow being outside the stronger and having the sequence of colors reversed.



Figure F-28. Double Rainbow

8.4 Fog Bow. A fog bow is primarily a rainbow consisting of a white band which appears on a screen of fog. It is usually fringed with red on the outside and blue on the inside. See Figure F-29.



Figure F-29. Fog Bow

9. Reporting and Recording Atmospheric Phenomena. While all phenomena should be recorded on the forms used by the observer to record other parameters, only a few of the phenomena need to be reported in real-time.

9.1 Real-Time Reporting. Phenomena posing threats to lives and property should be reported to the NWS Forecast Office and, in many cases, to the police or other emergency preparedness offices, as soon as possible. This will greatly assist in the issuance of accurate warnings for areas in the path of the storm. The NWSREP will instruct the observer where to report.

9.1.1 Reporting Tornadoes, Waterspouts, and Funnel Clouds. Whenever a tornado, waterspout, or funnel cloud is observed, the observer should contact the designated NWS office immediately by telephone or other designated means, giving the following information:

- a. Distance and direction from the observing location.
- b. Direction toward which it is traveling.
- c. Time it was observed.

9.1.2 Reporting Other Phenomena. Record information in the “Remarks” of WS Form B-91 or other designated form. See Section 12 page A-40 of Appendix A for real-time reporting of other phenomena.

9.2 Recording Atmospheric Phenomena.

9.2.1 Tornadoes, Waterspouts, and Funnel Clouds. Record as many of the following as possible: time of occurrence, direction and length of path, width of the path, destruction from wind and hail, injuries, deaths, and any other relevant circumstances.

9.2.2 Thunderstorms. Record the time of occurrence, the direction and distance from the station and the direction toward which the storm moved.

9.2.3 Other Phenomena. Record other phenomena in the “Remarks” of WS Form B-91 or other designated form. Include information on damage, deaths, or injuries, if any.

APPENDIX G - Flash Flooding

<u>Table of Contents:</u>	<u>Page</u>
1. Introduction.....	G-1
2. Areas Most Subject to Flash Flooding.....	G-1
3. Flash Flood Warnings.....	G-1
4. Role of Cooperative Observers.....	G-2
5. Supplemental Precipitation Surveys	G-2
5.1 Purpose of Surveys	G-2
5.2 How the Cooperative Observer Can Help	G-2

1. Introduction. Flash floods are caused mostly by sudden heavy rains filling natural and man made drainage systems beyond their capacities. Water cannot be carried away fast enough, which results in the overflowing of the drainage systems with dangerous flood waters and its deadly cargo of uprooted trees, smashed structures, boulders, mud, and other debris. Flash floods may also result from dam breaks, the buildup of water behind ice jams, and by the breakup of ice jams.

2. Areas Most Subject to Flash Flooding. Flash flooding can occur quickly in urban areas, sweeping away vehicles and damaging residential and industrial property. It can occur in and near mountainous areas where steep slopes can accelerate runoff rates, quickly changing dry or trickling brooks into dangerous raging torrents. Flash flooding is especially likely near the headwaters of river basins, where there is relatively little time between the onset of heavy rain and flood conditions in smaller basins. Sudden flash flooding is possible in areas having no rain, due to thunderstorms many miles away, out of sight and hearing range.

Even moderate rain, falling on frozen, snow- or ice-covered ground, can produce flash flooding, especially if temperatures are high enough to add melted snow to the runoff. Flash flooding occurring on streams and rivers behind ice jams and following the breakup of ice jams can cause severe devastation from chunk ice scouring and literally destroying anything along the banks of rivers.

3. Flash Flood Warnings. The NWS assigns flash flood warning responsibilities to the WFO. These offices rely on satellite, radar, observations from weather stations operating 24 hours per day, and particularly on reports from private individuals, the police, and local preparedness agencies.

Because flash floods, and particularly the thunderstorms that may cause them, can occur suddenly and in limited areas, the density of weather observations from 24-hour stations is often

inadequate to detect conditions leading to flash flooding. Therefore, the NWS also relies on observer reports to issue warnings with enough lead time to protect lives and property adequately.

4. Role of Cooperative Observers. Cooperative observers can play a vital role in protecting lives and property by being alert to and making reports of excessive rains, rapidly rising or flooding streams to the WFO and to the police or other preparedness agencies in their communities. They should be encouraged to become involved in any preparedness plans developed by their community. Observers should be certain special telephone numbers they have been given for reporting these events are current.

5. Supplemental Precipitation Surveys. Frequently in the aftermath of flash floods or other exceptionally heavy rainfall events, the NWS or other authorities may decide to conduct supplemental precipitation surveys - popularly known as "bucket surveys". Within two or three days of the event, officials will go to the area of flooding or heavy rainfall to obtain data from citizens who do not routinely report rainfall. They will contact people who had trash cans, jars, other containers, or any type of personal rain gauge that can be used as unofficial gauges. They will also look for high water marks on buildings, trees, etc., to determine the maximum stream levels attained during flooding. Surveys must be completed before subsequent rains wash away the water marks and before memories dim and records are lost. The time rain began and ended (the duration of heavy rainfall) is also very important.

5.1 Purpose of Surveys. Data obtained from bucket surveys are used to correlate heavy rainfall amounts with flood and flash flood crests. This information is vital in developing models that relate heavy rainfall to peak water levels. These relationships are used to increase the accuracy of future flash flood forecasts. Bucket surveys are also needed to justify the building of dams, the widening of drainage channels, the control of upstream urbanization (which can greatly increase future flooding risks), and to decide legal questions.

5.2 How the Cooperative Observer Can Help. Many cooperative observers routinely compare rainfall amounts with other unofficial observers. The official observer can be of great help to the bucket survey team by providing the locations and rainfall amounts recorded by others, or by informing the team how best to contact other observers for further information. They can often assist the team to identify the area(s) having received the most precipitation.

The cooperative observer can take the initiative prior to the survey team arrival. He/she can call unofficial observers to get their rainfall amounts during or promptly after the storm before the information is forgotten. Once the cooperative observer collects this information, they should notify the weather office as soon as possible. This may be the only way the weather office learns of these extreme rainfall amounts or flood levels.