

Water Resources Data California Water Year 2002

Following is the PDF version to one of the four-volume set of Water Resources Data for the state of California.

For your convenience the Table of Contents and Index have been linked to the appropriate page within the volume, all Surface-Water and Water-Quality Stations have been book marked, those items that are colored blue are linked to the appropriate page and all web links have been activated.

All comments/suggestions on format should be forwarded to kengelki@usgs.gov.

U.S. Department of the Interior
U.S. Geological Survey

Water Resources Data California Water Year 2002

Volume 4. Northern Central Valley Basins and the Great Basin from Honey Lake Basin to Oregon State Line

By J.R. Smithson, M.F. Friebel, M.D. Webster, and G.L. Rockwell

Water-Data Report CA-02-4

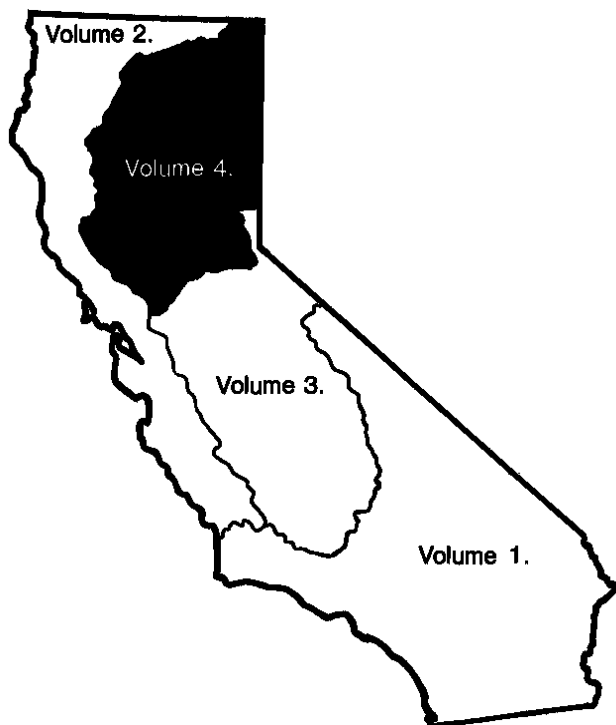

Prepared in cooperation with the
California Department of Water Resources and with other agencies



U.S. DEPARTMENT OF THE INTERIOR

GALE A. NORTON, Secretary

U.S. GEOLOGICAL SURVEY

Charles G. Groat, Director

For information on the water program in California write to:
District Chief, Water Resources Division
U.S. Geological Survey
Placer Hall, Suite 2015
6000 J Street
Sacramento, California 95819-6129

2003

PREFACE

This volume of the annual hydrologic data report of California is one of a series of annual reports that document hydrologic data gathered from the U.S. Geological Survey's surface- and ground-water data-collection networks in each State, Puerto Rico, and the Trust Territories. These records of streamflow, ground-water levels, and water quality provide the hydrologic information needed by Federal, State, and local agencies, and the private sector for developing and managing our Nation's land and water resources. Hydrologic data for California are contained in four volumes:

- Volume 1. Southern Great Basin from Mexican Border to Mono Lake Basin and Pacific Slope Basins from the Tijuana River to Santa Maria River
- Volume 2. Pacific Slope Basins from Arroyo Grande to Oregon State Line except Central Valley
- Volume 3. Southern Central Valley Basins and The Great Basin from Walker River to Truckee River
- Volume 4. Northern Central Valley Basins and The Great Basin from Honey Lake Basin to Oregon State Line

This report is the culmination of a concerted effort by dedicated personnel of the U.S. Geological Survey who collected, compiled, analyzed, verified, and organized the data. In addition to the authors, who had primary responsibility for assuring that the information contained herein is accurate, complete, and adheres to U.S. Geological Survey policy and established guidelines, the individuals contributing significantly to the collection, processing, and tabulation of the data are given on page V.

This report was prepared in cooperation with the California Department of Water Resources and with other agencies, under the general supervision of Michael V. Shulters, District Chief, California.

REPORT DOCUMENTATION PAGE*Form Approved*
OMB No. 0704-0188

Public reporting burden for this collection of information is estimated to average 1 hour per response, including the time for reviewing instructions, searching existing data sources, gathering and maintaining the data needed, and completing and reviewing the collection of information. Send comments regarding this burden estimate or any other aspect of this collection of information, including suggestions for reducing this burden, to Washington Headquarters Services, Directorate for Information Operations and Reports, 1215 Jefferson Davis Highway, Suite 1204, Arlington, VA 22202-4302, and to the Office of Management and Budget, Paperwork Reduction Project (0704-0188), Washington, DC 20503.

1. AGENCY USE ONLY (Leave blank)		2. REPORT DATE May 2002	3. REPORT TYPE AND DATES COVERED Annual—Oct. 1, 2001, to Sept. 30, 2002	
4. TITLE AND SUBTITLE Water Resources Data—California, Water Year 2002. Volume 4. Northern Central Valley Basins and The Great Basin from Honey Lake Basin to Oregon State Line			5. FUNDING NUMBERS	
6. AUTHOR(S) J.R. Smithson, M.F. Friebel, M.D. Webster, and G.L. Rockwell				
7. PERFORMING ORGANIZATION NAME(S) AND ADDRESS(ES) U.S. Geological Survey, Water Resources Division, California District Placer Hall, Suite 2015 6000 J Street Sacramento, CA 95819-6129			8. PERFORMING ORGANIZATION REPORT NUMBER USGS-WDR-CA-02-4	
9. SPONSORING / MONITORING AGENCY NAME(S) AND ADDRESS(ES) U.S. Geological Survey, Water Resources Division, California District Placer Hall, Suite 2015 6000 J Street Sacramento, CA 95819-6129			10. SPONSORING / MONITORING AGENCY REPORT NUMBER USGS-WDR-CA-02-4	
11. SUPPLEMENTARY NOTES Prepare in cooperation with the California Department of Water Resources and with other agencies.				
12a. DISTRIBUTION / AVAILABILITY STATEMENT No restriction on distribution. This report may be purchased from the National Technical Information Service, Springfield, VA 22161			12b. DISTRIBUTION CODE	
13. ABSTRACT (Maximum 200 words) Water-resources data for the 2002 water year for California consist of records of stage, discharge, and water quality of streams, stage and contents in lakes and reservoirs, and water levels and water quality in wells. Volume 4 contains discharge records for 191 gaging stations, stage and contents for 60 lakes and reservoirs, gage-height records for 2 stations, and water quality for 21 stations. Also included are 4 miscellaneous partial-record sites. These data represent that part of the National Water Data System operated by the U.S. Geological Survey and cooperating State and Federal agencies in California.				
14. SUBJECT TERMS *California, *Hydrologic data, *Surface water, *Water quality, Flow rate, Sampling sites, Gaging stations, Lakes, Reservoirs, Chemical analyses, Sediment, Water temperatures, Water analyses			15. NUMBER OF PAGES 494	
			16. PRICE CODE	
17. SECURITY CLASSIFICATION OF REPORT Unclassified	18. SECURITY CLASSIFICATION OF THIS PAGE Unclassified	19. SECURITY CLASSIFICATION OF ABSTRACT Unclassified	20. LIMITATION OF ABSTRACT	

WATER RESOURCES DIVISION

Robert R. Mason, Chief, Operations
James C. Bowers, Assistant Chief, Operations

Kevin Bazar, Hydrologic Technician
William L. Boults, Hydrologic Technician
William R. Brazelton, Hydrologic Technician
Susan Brockner, Hydrologic Technician
Lynda R. Christensen, Hydrologic Technician
Karl Davidek, Hydrologic Technician
Kimberly S. Engelking, Editor
Cory A. Escobedo, Hydrologic Clerk
Jon E. Ferguson, Hydrologic Technician
Laureen J. Fong-Frydendal, Hydrologic Technician
Michael Dean Galvez, Hydrologic Aid
James J. Gibbons, Lead Hydrologic Technician
Kim L. Hanson, Computer Specialist
William J. Hardy, Hydrologic Technician
Travis Hiatt, Hydrologic Technician
Paul D. Honeywell, Hydrologic Technician
Joe Grant, Hydrologic Technician
Rick T. Iwatsubo, Hydrologic Technician
Joel D. Johnson, Supervisory Hydrologist
Mark V. Johnson, Hydrologic Technician
Michael Judd, Hydrologic Technician
Michael P. Mann, Hydrologist
Ken Markham, (Retired U.S.G.S.)
Jon C. McNulty, Hydrologic Technician
Delia A. Millers, Hydrologic Clerk
Roger Mitchell, Hydrologic Technician
Allan C. Mlodnosky, Hydrologic Technician
James R. Mullen, (Retired U.S.G.S.)
Denis J. O'Halloran, Hydrologic Technician
Christine S. O'Neil, Hydrologic Technician
David Pratt, Hydrologist
Lee A. Price, Hydrologic Technician
M. Kathy Shay, Computer Specialist
Carol J. Simons, Hydrologic Technician
David M. Sparks, Hydrologic Technician
Gregory F. Susich, Hydrologic Technician
Steven P. Wells, Hydrologic Technician
M. Kay Witter, Editor
Mark H. Woloszyk, Hydrologic Technician
Kevin S. Wright, Hydrologic Technician
George S. Yamamoto, Scientific Illustrator
David K. Yancey, Computer Specialist
Brian T. Yost, Hydrologic Technician

Richard A. Hunrichs, Surface Water Hydrologist
Robert W. Meyer, Surface Water Hydrologist

CONTENTS

	Page
Preface.....	iii
Surface-Water and Water-Quality Stations in Downstream Order for Which Records are Published in this Volume.....	viii
Discontinued Gaging Stations.....	xiv
Discontinued Lakes and Reservoirs.....	xix
Discontinued Water-Quality Stations.....	xix
Introduction.....	1
Cooperation.....	1
Special Networks and Programs.....	2
Explanation of the Records.....	3
Station-Identification Numbers.....	3
Downstream-Order System.....	3
Latitude-Longitude System.....	3
Records of Stage and Water Discharge.....	3
Data Collection and Computation.....	4
Data Presentation.....	5
Identifying Estimated Daily Discharge.....	7
Accuracy of the Records.....	7
Other Records Available.....	7
Records of Surface-Water Quality.....	8
Changes in National Trends Network Procedures.....	8
Classification of Records.....	8
Arrangement of Records.....	8
Onsite Measurements and Sample Collection.....	8
Water Temperature.....	9
Sediment.....	9
Cross-Sectional Data.....	9
Laboratory Measurements.....	9
Quality-Control Data.....	10
Data Presentation.....	11
Access to USGS Water Data.....	11
Definition of Terms.....	12
Publications on Techniques of Water-Resources Investigations.....	24
Surface-Water-Discharge and Surface-Water-Quality Records.....	50
Remark Codes.....	50
Discharge at Partial-Record Stations and Miscellaneous Sites.....	460
Index.....	463

ILLUSTRATIONS

Figure 1. Diagram showing system for numbering miscellaneous site (latitude and longitude).....	3
2–23. Maps showing location of discharge and water-quality stations	
2. Alpine County.....	28
3. Amador County.....	29
4. Butte County.....	30
5. Colusa County.....	31
6. El Dorado County.....	32
7. Glenn County.....	33
8. Lake County.....	34
9. Lassen County.....	35
10. Modoc County.....	36
11. Napa County.....	37
12. Nevada County.....	38
13. Placer County.....	39
14. Plumas County.....	40
15. Sacramento County.....	41
16. Shasta County.....	42
17. Sierra County.....	43
18. Siskiyou County.....	44

CONTENTS

	Page
19–23. Maps showing location of discharge and water-quality stations—Continued:	
19. Solano County.....	45
20. Sutter County.....	46
21. Tehama County.....	47
22. Yolo County.....	48
23. Yuba County.....	49
24–36. Schematic diagrams showing diversions and storage:	
24. Pit and McCloud River Basins.....	55
25. Upper Sacramento River Basin.....	91
26. Battle Creek and Cow Creek Basins.....	100
27. Lower Sacramento River Basin.....	135
28. South Fork Feather River Basin.....	155
29. North Fork Feather River Basin.....	170
30. Feather River at Lake Oroville.....	200
31. North Yuba River Basin.....	213
32. South Yuba River Basin.....	249
33. Bear River Basin.....	255
34. Middle Fork American and Rubicon River Basins.....	334
35. South Fork American River Basin.....	370
36. Schematic diagram showing principal inflows and diversions, Sacramento–San Joaquin Delta.....	459

**SURFACE-WATER AND WATER-QUALITY STATIONS
IN DOWNSTREAM ORDER, FOR WHICH RECORDS ARE PUBLISHED IN THIS VOLUME**

[Letters after station name designate type of data collected: (d), discharge;
(l), elevation, gage heights, or contents; (c), chemical; (b), biological; (p), precipitation;
(g) gage height; (t), water temperature; and (s), sediment]

	Station No.	Page
<u>THE GREAT BASIN</u>		
HONEY LAKE BASIN		
Susan River above Willard Creek, near Susanville (cs)	10356380	51
Susan River near Litchfield (cs)	10359040	52
UPPER LAKE BASIN		
Bidwell Creek:		
Mill Creek at Upper Lake, near Lake City (cs)	10360401	53
Bidwell Creek below Mill Creek, near Fort Bidwell (cs)	10360900	54
<u>PACIFIC SLOPE BASINS IN CALIFORNIA</u>		
SACRAMENTO RIVER BASIN		
Sacramento River at Delta (d)	11342000	56
Shasta Lake:		
Pit River:		
North Fork Pit River (head of Pit River):		
South Fork Pit River near Likely (d)	11345500	58
Pit River near Canby (d)	11348500	59
Collett Reservoir near Little Valley (l)	11351600	61
Pit River below diversion to Muck Valley Powerplant, near Bieber (d)	11351950	62
Pit No. 1 Powerplant near Fall River Mills (d)	11354200	63
Pit River below Pit No. 1 Powerplant, near Fall River Mills (d)	11355010	64
Hat Creek:		
Lost Creek below diversion to Lost Creek Powerplant No. 1, near Old Station (d)	11358020	66
Hat Creek below Hat No. 1 Diversion Dam, near Burney (d)	11358700	67
Hat Creek Powerplant No. 1 near Burney (d)	11358800	68
Hat No. 2 Power Canal Diversion to Hat Creek, near Burney (d)	11359100	69
Lake Britton near Burney (l)	11361400	70
Iron Canyon Creek:		
Iron Canyon Reservoir near Big Bend (l)	11363920	70
McCloud River:		
Lake McCloud near McCloud (l)	11367740	70
Pit River below Pit No. 4 Dam (d)	11362500	72
Nelson Creek below diversion to Nelson Creek Powerplant, near Big Bend (d)	11362900	74
East Fork Nelson Creek below diversion to Nelson Creek, near Big Bend (d)	11362950	75
Pit River at Big Bend (d)	11363000	76
Iron Canyon Creek:		
James B. Black Powerplant near Big Bend (d)	11363910	78
Iron Canyon Creek below Iron Canyon Dam, near Big Bend (d)	11363930	79
Pit River near Montgomery Creek (d)	11365000	80
McCloud River near McCloud (d)	11367500	82
McCloud-Iron Canyon Diversion Tunnel near McCloud (d)	11367720	84
McCloud River below McCloud Dam, near McCloud (d)	11367760	85
McCloud River at Ah-Di-Na, near McCloud (d)	11367800	86
McCloud River above Shasta Lake (d)	11368000	88
Shasta Lake near Redding (l)	11370000	90
Sacramento River at Keswick (d)	11370500	92
Anderson-Cottonwood Irrigation District Canal at Sharon Street, at Redding (d)	11370700	94
Clear Creek:		
Whiskeytown Lake:		
Judge Francis Carr Powerplant near French Gulch (d)	11525430	95
Spring Creek Powerplant at Keswick (d)	11371600	96
Whiskeytown Lake near Igo (l)	11371700	97
Clear Creek near Igo (d)	11372000	98
South Cow Creek (head of Cow Creek):		
South Cow Creek Canal:		
South Cow Creek Canal Diversion to South Cow Creek, near Whitmore (d)	11372080	101

**SURFACE-WATER AND WATER-QUALITY STATIONS
IN DOWNSTREAM ORDER, FOR WHICH RECORDS ARE PUBLISHED IN THIS VOLUME—Continued**

	Station No.	Page
<u>PACIFIC SLOPE BASINS IN CALIFORNIA—Continued</u>		
SACRAMENTO RIVER BASIN—Continued		
Sacramento River—Continued:		
South Cow Creek (head of Cow Creek)—Continued:		
Old Cow Creek:		
Kilarc Canal:		
Kilarc Canal Diversion to Old Cow Creek, near Whitmore (d)	11372325	102
Old Cow Creek below diversion to Olsen Powerplant, near Whitmore (d)	11372350	103
Cow Creek near Millville (d)	11374000	104
Middle Fork Cottonwood Creek below diversion to Arbuckle Mountain Powerplant, near Platina (d)	11374305	106
Cottonwood Creek near Cottonwood (d)	11376000	107
North Fork Battle Creek (head of Battle Creek):		
North Fork Battle Creek below North Battle Creek Dam, near Manzanita Lake (d)	11376015	109
North Fork Battle Creek below McCumber Dam, near Manzanita Lake (d)	11376025	110
Volta No. 1 Powerplant near Manton (d)	11376043	111
Volta No. 2 Powerplant near Manton (d)	11376046	111
South Fork Battle Creek:		
South Powerplant near Manton (d)	11376410	111
Inskip Powerplant near Manton (d)	11376430	111
Coleman Powerplant near Cottonwood (d)	11376458	111
North Fork Battle Creek below diversion to Keswick Canal, near Manton (d)	11376050	112
Bailey Creek below diversion to Ponderosa–Bailey Creek Powerplant, near Manton (d)	11376120	113
North Fork Battle Creek below diversion to Cross Country Canal, near Manton (d)	11376140	114
North Fork Battle Creek below diversion to Eagle Canyon Canal, near Manton (d)	11376150	115
North Fork Battle Creek below diversion to Wildcat Canal, near Manton (d)	11376160	116
South Fork Battle Creek below diversion to South Battle Creek Canal, near Manton (d)	11376420	117
South Fork Battle Creek below diversion to Inskip Canal, near Manton (d)	11376440	118
South Fork Battle Creek below diversion to Coleman Canal, near Manton (d)	11376460	119
Battle Creek below Coleman Fish Hatchery, near Cottonwood (d)	11376550	120
Sacramento River above Bend Bridge, near Red Bluff (d)	11377100	122
Elder Creek near Paskenta (d)	11379500	124
Mill Creek near Los Molinos (dt)	11381500	126
Deer Creek near Vina (dt)	11383500	130
East Park Reservoir near Stonyford (l)	11385100	136
Stony Gorge Reservoir near Elk Creek (l)	11386100	136
Sacramento River at Colusa (d)	11389500	137
Butte Creek below diversion dam, near Stirling City (d)	11389720	139
Butte Creek below forks of Butte Diversion Dam, near De Sabla (d)	11389740	140
Butte Creek below Centerville Diversion Dam, near Paradise (d)	11389780	141
Toadtown Canal above Butte Canal, near Stirling City (d)	11389800	142
Butte Creek near Chico (dt)	11390000	143
Sacramento River below Wilkins Slough, near Grimes (dt)	11390500	148
Sacramento Slough near Knights Landing (cs)	11391100	151
Middle Fork Feather River (head of Feather River):		
Lake Oroville:		
South Fork Feather River:		
Little Grass Valley Reservoir near La Porte (l)	11395020	156
South Fork Feather River below Little Grass Valley Dam (d)	11395030	157
South Fork Tunnel near Strawberry Valley (d)	11395150	159
South Fork Feather River below diversion dam, near Strawberry Valley (d)	11395200	160
Lost Creek:		
Sly Creek Reservoir near Strawberry Valley (l)	11395400	161
Oroville–Wyandotte Canal near Clipper Mills (d)	11395500	162
Lost Creek near Clipper Mills (d)	11396000	163
South Fork Feather River below Forbestown Dam (d)	11396200	165
Miners Ranch Canal below Ponderosa Dam, near Forbestown (d)	11396310	167
Bangor Canal below Miners Ranch Reservoir, near Oroville (d)	11396330	168
Sucker Run at Kanaka Diversion, near Feather Falls (d)	11396395	169

**SURFACE-WATER AND WATER-QUALITY STATIONS
IN DOWNSTREAM ORDER, FOR WHICH RECORDS ARE PUBLISHED IN THIS VOLUME—Continued**

	Station No.	Page
<u>PACIFIC SLOPE BASINS IN CALIFORNIA—Continued</u>		
SACRAMENTO RIVER BASIN—Continued		
Sacramento River—Continued:		
Lake Oroville—Continued:		
North Fork Feather River:		
Lake Almanor at Prattville (l)	11399000	171
North Fork Feather River near Prattville (d)	11399500	172
Butt Creek below Almanor–Butt Creek Tunnel, near Prattville (d)	11400500	174
Butt Valley Reservoir near Caribou (l)	11401050	176
North Fork Feather River below Belden Dam (d)	11401112	177
Indian Creek (head of Each Branch North Fork Feather River):		
Ward Creek:		
South Branch Ward Creek below diversion dam, near Genesee (d)	11401165	179
Spanish Creek above Blackhawk Creek, at Keddie (d)	11402000	180
North Fork Feather River below Rock Creek Diversion Dam (d)	11403200	182
Milk Ranch Creek:		
Three Lakes Reservoir:		
Milk Ranch Conduit at outlet, near Bucks Lodge (d)	11403450	184
Bucks Creek:		
Bucks Lake near Bucks Lodge (l)	11403500	185
Lower Bucks Lake near Bucks Lodge (l)	11403520	186
Bucks Creek below diversion dam, near Bucks Lodge (d)	11403530	187
Grizzly Creek:		
Grizzly Forebay near Storrie (l)	11404250	189
Grizzly Creek below diversion dam, near Storrie (d)	11404300	190
North Fork Feather River below Grizzley Creek (d)	11404330	192
Camp Creek near Pulga (d)	11404380	194
North Fork Feather River below Poe Dam (d)	11404400	195
North Fork Feather River at Pulga (d)	11404500	196
West Branch Feather River:		
Philbrook Creek below Philbrook Dam, near Butte Meadows (d)	11405120	198
West Branch Feather River below Hendricks Diversion Dam, near Stirling (d)	11405200	199
Lake Oroville near Oroville (l)	11406800	201
Palermo Canal near Oroville (d)	11406810	203
Power Canal:		
Thermalito Afterbay near Oroville (l)	11406870	204
Western Canal at Intake, near Oroville (d)	11406880	206
Richvale Canal at Intake, near Oroville (d)	11406890	207
Pacific Gas and Electric Co. Lateral at Intake, near Oroville (d)	11406900	208
Sutter–Butte Canal at Intake, near Oroville (d)	11406910	209
Thermalito Afterbay Release to Feather River, near Oroville (d)	11406920	210
Feather River at Oroville (d)	11407000	211
Jackson Meadows Reservoir near Sierra City (l)	11407800	214
Middle Yuba River controlled release at Jackson Meadows Dam, near Sierra City (d)	11407815	215
Milton–Bowman Tunnel Outlet near Graniteville (d)	11408000	216
Middle Yuba River below Milton Dam, near Sierra City (d)	11408550	218
Lohman Ridge Tunnel at intake, near Camptonville (d)	11408870	220
Middle Yuba River below Our House Dam, near Camptonville (d)	11408880	221
Oregon Creek:		
Camptonville Tunnel at intake, near Camptonville (d)	11409350	222
Oregon Creek below Log Cabin Dam, near Camptonville (d)	11409400	223
Middle Yuba River near North San Juan (dts)	11410000	225
North Yuba River below Goodyears Bar (d)	11413000	231
Slate Creek:		
Slate Creek Tunnel near Strawberry Valley (d)	11413250	233
Slate Creek below diversion dam, near Strawberry Valley (d)	11413300	234
Deadwood Creek near Strawberry Valley (d)	11413320	235
Owl Gulch near Strawberry Valley (d)	11413323	236

**SURFACE-WATER AND WATER-QUALITY STATIONS
IN DOWNSTREAM ORDER, FOR WHICH RECORDS ARE PUBLISHED IN THIS VOLUME—Continued**

	Station No.	Page
<u>PACIFIC SLOPE BASINS IN CALIFORNIA—Continued</u>		
SACRAMENTO RIVER BASIN—Continued		
Sacramento River—Continued:		
Feather River—Continued:		
Middle Yuba River—Continued:		
New Bullards Bar Reservoir:		
New Colgate Powerplant near French Corral (d)	11413510	237
New Bullards Bar Reservoir near North San Juan (l)	11413515	238
North Yuba River below New Bullards Bar Dam, near North San Juan (d)	11413520	239
Yuba River below New Colgate Powerplant, near French Corral (dts)	11413700	241
South Yuba River:		
Kidd Lake near Soda Springs (l)	11413940	246
Upper Cascade Lake near Soda Springs (l)	11413943	247
Lower Cascade Lake near Soda Springs (l)	11413945	248
Lake Spaulding:		
White Rock Lake near Soda Springs (l)	11414050	250
Meadow Lake near Cisco (l)	11414070	251
Lake Sterling near Cisco (l)	11414080	252
Fordyce Lake near Cisco (l)	11414090	253
Fordyce Creek below Fordyce Dam, near Cisco (d)	11414100	254
Lake Spaulding near Emigrant Gap (l)	11414140	256
Drum Canal at tunnel outlet, near Emigrant Gap (d)	11414170	257
South Yuba Canal near Emigrant Gap (d)	11414200	259
South Yuba River controlled release at Lake Spaulding, near Emigrant Gap (d)	11414210	260
South Yuba River at Langs Crossing, near Emigrant Gap (d)	11414250	261
Blue Lake near Emigrant Gap (l)	11414260	262
Rucker Creek below Blue Lake, near Emigrant Gap (d)	11414265	263
Rucker Lake near Emigrant Gap (l)	11414275	264
Rucker Creek below Rucker Lake, near Emigrant Gap (d)	11414280	265
Canyon Creek:		
Feeley Lake near Graniteville (l)	11414345	266
Lake Creek below Feeley Lake, near Graniteville (d)	11414350	267
Carr Lake near Graniteville (l)	11414355	268
Lake Creek below Carr Lake, near Graniteville (d)	11414360	269
French Lake near Cisco (l)	11414400	270
Canyon Creek below French Lake, near Cisco (d)	11414410	271
Faucherie Lake near Cisco (l)	11414440	272
Canyon Creek below Faucherie Lake, near Cisco (d)	11414450	273
Sawmill Lake near Graniteville (l)	11414465	274
Canyon Creek below Sawmill Lake, near Graniteville (d)	11414470	275
Jackson Lake near Sierra City (l)	11414690	276
Jackson Creek below Jackson Lake, near Sierra City (d)	11414700	277
Bowman Lake near Graniteville (l)	11415500	278
Bowman–Spaulding Canal at Jordan Creek Siphon Venturi, near Emigrant Gap (d)	11416100	279
Canyon Creek below Bowman Lake (d)	11416500	281
Rock Lake near Graniteville (l)	11416580	283
Texas Creek below Rock Lake (d)	11416585	284
Lower Rock Lake near Graniteville (l)	11416590	285
Texas Creek below Lower Rock Lake, near Graniteville (d)	11416610	286
Culbertson Lake near Graniteville (l)	11416618	287
Texas Creek Tributary below Culbertson Lake, near Graniteville (d)	11416620	288
Middle Lindsey Lake near Graniteville (l)	11416660	289
Lindsey Creek below Middle Lindsey Lake (d)	11416670	290
Lower Lindsey Lake near Graniteville (l)	11416680	291
Lindsey Creek below Lower Lindsey Lake, near Graniteville (d)	11416700	292
South Yuba River at Jones Bar, near Grass Valley (dts)	11417500	293
Harry L. Englebright Lake near Smartville (l)	11417950	299
Yuba River below Engelbright Dam, near Smartville (dts)	11418000	300
Deer Creek near Smartville (d)	11418500	306

**SURFACE-WATER AND WATER-QUALITY STATIONS
IN DOWNSTREAM ORDER, FOR WHICH RECORDS ARE PUBLISHED IN THIS VOLUME—Continued**

	Station No.	Page
<u>PACIFIC SLOPE BASINS IN CALIFORNIA—Continued</u>		
SACRAMENTO RIVER BASIN—Continued		
Sacramento River—Continued:		
Feather River—Continued:		
Yuba River near Marysville (dt)	11421000	308
Bear River near Emigrant Gap (d)	11421710	312
Bear River below Drum Afterbay, near Blue Canyon (d)	11421770	313
Bear River below Dutch Flat Afterbay, near Dutch Flat (d)	11421790	314
Rollins Reservoir near Colfax (l)	11421800	316
Bear River Canal intake near Colfax (d)	11422000	317
Bear River below Rollins Dam, near Colfax (d)	11422500	319
Bear River fish release below New Camp Far West Reservoir, near Wheatland (d)	11423800	321
Bear River near Wheatland (d)	11424000	322
Mormon Ravine near Newcastle (d)	11425418	324
Sacramento River at Verona (d)	11425500	325
Sacramento Weir Spill to Yolo Bypass, near Sacramento (d)	11426000	327
North Fork American River (head of American River):		
North Fork of North Fork American River:		
Lake Valley Reservoir near Cisco (l)	11426170	328
Sixmile Valley:		
Kelly Lake near Cisco (l)	11426180	329
Canyon Creek near Blue Canyon (d)	11426195	330
Canyon Creek below Towle Diversion Dam, near Blue Canyon (d)	11426196	331
North Fork American River at North Fork Dam (d)	11427000	332
Middle Fork American River:		
French Meadows Reservoir near Foresthill (l)	11427400	335
Middle Fork American River at French Meadows (d)	11427500	336
Duncan Canyon Creek near French Meadows (d)	11427700	338
Duncan Creek below diversion dam, near French Meadows (d)	11427750	340
Middle Fork American River above Middle Fork Powerplant, near Foresthill (d)	11427760	341
Middle Fork American River below Interbay Dam, near Foresthill (d)	11427770	342
Rubicon River:		
Rubicon–Rockbound Tunnel near Meeks Bay (d)	11427940	344
Rubicon River below Rubicon Dam, near Meeks Bay (d)	11427960	345
Little Rubicon River:		
Buck Island Lake:		
Buck–Loon Tunnel near Meeks Bay (d)	11428300	346
Little Rubicon River below Buck Island Dam, near Meeks Bay (d)	11428400	347
Hell Hole Reservoir near Meeks Bay (l)	11428700	348
Rubicon River below Hell Hole Dam, near Meeks Bay (d)	11428800	349
South Fork Rubicon River:		
Gerle Creek:		
Loon Lake near Meeks Bay (l)	11429350	351
Gerle Creek below Loon Lake Dam, near Meeks Bay (d)	11429500	353
Gerle Reservoir near Meeks Bay (l)	11429600	355
South Fork Rubicon River below Gerle Creek, near Georgetown (d)	11430000	357
Pilot Creek above Stumpy Meadows Lake (d)	11431800	359
Pilot Creek below Mutton Canyon, near Georgetown (d)	11433040	361
South Fork Long Canyon Creek (head of Long Canyon Creek):		
South Fork Long Canyon Creek Diversion Tunnel near Volcanoville (d)	11433060	362
South Fork Long Canyon Creek below diversion dam, near Volcanoville (d)	11433065	363
North Fork Long Canyon Creek:		
North Fork Long Canyon Creek Diversion Tunnel near Volcanoville (d)	11433080	364
North Fork Long Canyon Creek below diversion dam, near Volcanoville (d)	11433085	365
Middle Fork American River near Foresthill (d)	11433300	366
North Fork American River at Auburn Dam Site, near Auburn (t)	11433790	368
South Fork American River:		
Lake Aloha near Phillips (l)	11434900	371

SURFACE-WATER AND WATER-QUALITY STATIONS
IN DOWNSTREAM ORDER, FOR WHICH RECORDS ARE PUBLISHED IN THIS VOLUME—Continued

	Station No.	Page
<u>PACIFIC SLOPE BASINS IN CALIFORNIA—Continued</u>		
SACRAMENTO RIVER BASIN—Continued		
Sacramento River—Continued:		
Folsom Lake:		
North Fork American River (head of American River):		
South Fork American River:		
Pyramid Creek at Twin Bridges (d)	11435100	372
Silver Lake (head of Silver Fork of South Fork American River):		
Silver Lake near Kirkwood (l)	11435900	373
Silver Lake Outlet near Kirkwood (d)	11436000	374
Caples Lake near Kirkwood (l)	11436950	376
Caples Creek Release below Caples Dam, near Kirkwood (d)	11436999	377
South Fork American River near Kyburz (d)	11439500	378
Silver Creek:		
Union Valley Reservoir near Riverton (l)	11441001	381
Junction Reservoir:		
South Fork Silver Creek:		
Ice House Reservoir near Kyburz (l)	11441100	383
South Fork Silver Creek near Ice House (d)	11441500	385
Junction Reservoir near Pollock Pines (l)	11441760	387
Silver Creek below Junction Dam, near Pollock Pines (d)	11441800	389
Camino Reservoir near Pollock Pines (l)	11441890	390
Silver Creek below Camino Diversion Dam (d)	11441900	392
Slab Creek Reservoir:		
Brush Creek Reservoir near Pollock Pines (l)	11442690	394
Brush Creek below Brush Creek Dam, near Pollock Pines (d)	11442700	396
Slab Creek Reservoir near Camino (l)	11443450	397
South Fork American River near Camino (d)	11443500	399
Rock Creek near Placerville (d)	11444201	401
South Fork American River near Placerville (d)	11444500	403
South Fork American River near Pilot Hill (t)	11446030	404
Folsom Lake near Folsom (l)	11446200	406
American River below Folsom Dam, near Folsom (t)	11446220	407
American River at Fair Oaks (dt)	11446500	409
American River at William B. Pond Park, at Carmichael (t)	11446700	413
American River below Watt Avenue Bridge, near Carmichael (t)	11446980	415
Natomas East Main Drainage Canal:		
Dry Creek at Vernon Street Bridge, at Roseville (d)	11447293	417
Arcade Creek near Del Paso Heights (dcts)	11447360	418
Sacramento River at Sacramento (g)	11447500	424
Sacramento River at Freeport (dcts)	11447650	426
Yolo Bypass:		
Clear Lake (head of Cache Creek):		
Kelsey Creek near Kelseyville (d)	11449500	437
Clear Lake at Lakeport (g)	11450000	439
Cache Creek near Lower Lake (d)	11451000	440
North Fork Cache Creek at Hough Springs, near Clearlake Oaks (d)	11451100	441
North Fork Cache Creek near Clearlake Oaks (d)	11451300	443
Harley Gulch near Wilbur Springs (d)	11451540	445
Davis Creek at dam, near Knoxville (d)	11451600	446
Sulphur Creek at Wilbur Springs (d)	11451690	447
Bear Creek above Holsten Chimney Canyon, near Rumsey (d)	11451715	449
Cache Creek at Yolo (d)	11452500	451
Yolo Bypass near Woodland (d)	11453000	452
Putah Creek near Guenoc (d)	11453500	453
Lake Berryessa near Winters (l)	11453900	455
Putah Creek near Winters (d)	11454000	456
Putah South Canal near Winters (d)	11454210	458

WATER RESOURCES DATA—CALIFORNIA, WATER YEAR 2002

DISCONTINUED GAGING STATIONS

The following continuous-record streamflow stations in California have been discontinued or converted to partial record stations. Daily records were collected and are stored in USGS Water Data for the period of record shown for each station.

Station No.	Station name	Drainage area (mi ²)	Period of record
10354000	Long Valley Creek near Scotts	125	1917, 1919, 1989–94
10354700	Mill Creek at Milford	2.26	1963–69
10355000	Baxter Creek near Janesville	19.6	1913–16, 1918–19
10355500	Schloss Creek at Janesville	1.05	1915, 1918–19
10356500	Susan River at Susanville	184	1900–05, 1913, 1917–21, 1951–94
10357000	Gold Run Creek near Susanville	15.1	1915–16
10358470	Willow Creek Tributary near Susanville	3.08	1966–71
10358500	Willow Creek near Susanville	90.4	1951–94
10359100	Shaffer Creek near Litchfield	5.63	1970–73
10359250	Pine Creek near Westwood	24.8	1951–61
10359300	Pine Creek near Susanville	226	1961–66, 1968, 1970–82
10359350	Eagle Lake Tributary near Susanville	.91	1963–65
10360230	Eagle Creek at Eagleville	6.36	1962–64, 1966–68, 1970
10360900	Bidwell Creek below Mill Creek, near Fort Bidwell	25.6	1961–82
10361000	Bidwell Creek at Fort Bidwell	—	1912, 1918–19
11341400	Sacramento River near Mount Shasta	135	1960–87
11341500	Sacramento River at Castella	256	1911–17, 1920–23
11342500	Sacramento River at Antler	460	1911, 1920–41
11343000	Parker Creek near Alturas	80.9	1931
11343500	North Fork Pit River near Alturas	203	1930–32, 1958–67
11344000	North Fork Pit River at Alturas	212	1929–31, 1972–85
11344500	South Fork Pit River at Jess Valley	100	1929–31
11346000	Crooks Canyon Creek near Likely	33.8	1929–31
11346500	Fitzhugh Creek near Alturas	36.7	1930–31
11347500	Pine Creek near Alturas	23.5	1919–31
11348000	Pit River at Alturas	857	1929–31
11348200	Pit River near Alturas	1,080	1966–71
11349000	Pit River near Lookout	1,585	1929–31, 1958–71, 1978–80
11349500	Ash Creek at Ash Valley	136	1929–31
11350500	Ash Creek at Adin	258	1904–06, 1929–33, 1958–70, 1972–82
11351000	Willow Creek near Adin	—	1930–31
11351500	Widow Valley Creek near Lookout	27.7	1930–31
11352000	Pit River near Bieber	2,475	1904–08, 1922–26, 1929–31, 1952–70, 1972–75
11352500	Horse Creek at Little Valley, near Pittville	237	1929–31, 1960–67
11352900	Beaver Creek near Hat Creek	23.2	1970–73
11353500	Bear Creek near Dana	84	1921–26
11353600	Dry Creek near Dana	6.46	1967–70
11353700	Fall River near Dana	123	1959–67
11354500	Fall River at Fall River Mills	—	1912–13, 1922
11355000	Pit River at Fall River Mills	3,651	1921–51, 1981
11355500	Hat Creek near Hat Creek	162	1926–29, 1930–94
11356500	Hat Creek at Hawkins Ranch, near Hat Creek	190	1912–13
11357000	Hat Creek at Wilcox Ranch, near Cassel	193	1922
11358000	Lost Creek near Bald Mountain	7.51	1930
11358500	Rising River near Cassel	22.2	1912–13, 1921–22
11359500	Hat Creek at Carbon	364	1922

WATER RESOURCES DATA—CALIFORNIA, WATER YEAR 2002

DISCONTINUED GAGING STATIONS—Continued

Station No.	Station name	Drainage area (mi ²)	Period of record
11360000	Burney Creek above Burney	60.1	1922
11360500	Burney Creek at Park Avenue, near Burney	94.6	1912–13, 1921–22, 1958–64, 1966–75, 1977–80
11363500	Kosk Creek near Henderson	54.8	1911–13, 1915–16
11364000	Pit River above Hatchet Creek	4,819	1926–37
11365500	Squaw Creek above Shasta Lake	64	1945–66
11366000	Squaw Creek at Ydalpom	99.5	1912–13
11366500	Pit River near Ydalpom	5,030	1911–43
11367000	Mud Creek near McCloud	—	1927–32
11367200	McCloud River below Big Springs, near McCloud	322	1956–59
11367300	Angel Creek near McCloud	17.1	1955–59
11367700	McCloud River above Panther Creek, near McCloud	401	1955–59
11368500	McCloud River near Gregory	633	1903–08
11369000	McCloud River at Baird	673	1911–43
11369500	Sacramento River at Kennett	6,355	1926–42
11371000	Clear Creek at French Gulch	115	1950–93
11371500	Clear Creek near Shasta	172	1912–13
11372050	Churn Creek near Redding	9.35	1961–66
11372060	Churn Creek below Newton Creek, near Redding	11.9	1966–72
11372200	South Cow Creek near Millville	77.3	1957–72
11372700	Clover Creek near Oak Run	19	1957–59
11373200	Oak Run Creek near Oak Run	11.0	1957–66
11373300	Little Cow Creek near Ingot	60.8	1958–65
11374060	Shingle Creek near Shingletown	3.25	1964–67
11374100	Bear Creek near Millville	75.7	1960–67
11374400	Middle Fork Cottonwood Creek near Ono	244	1957–75
11375500	North Fork Cottonwood Creek at Ono	58.8	1908–13
11375700	North Fork Cottonwood Creek near Igo	88.7	1957–80
11375810	Cottonwood Creek near Olinda	395	1971–86
11375815	Cottonwood Creek above South Fork, near Cottonwood	478	1982–85
11375820	South Fork Cottonwood Creek near Cottonwood	217	1963–78
11375870	South Fork Cottonwood Creek near Olinda	371	1977–86
11375900	South Fork Cottonwood Creek at Evergreen Road, near Cottonwood	397	1982–85
11376038	Manzanita Creek at park boundary, near Manzanita Lake	11.6	1979–81
11376450	Coleman Canal above Coleman Forebay, near Cottonwood	—	1979–85
11376490	Battle Creek above Coleman Powerhouse, near Cottonwood	355	1979
11376500	Battle Creek near Cottonwood	356	1941–61
11377200	Sacramento River at Bend Bridge	8,900	1968–70
11377500	Paynes Creek near Red Bluff	92.8	1950–66
11378500	Sacramento River at Red Bluff	9,077	1957–66
11378800	Red Bank Creek near Red Bluff	89.6	1960–82
11378860	Red Bank Creek at Rawson Road Bridge, near Red Bluff	109	1965–67
11379000	Antelope Creek near Red Bluff	123	1941–82
11380000	Elder Creek near Henleyville	130	1931–41
11380500	Elder Creek at Gerber	136	1941–69, 1977–79
11381000	Mill Creek near Mineral	21.2	1929–32
11381595	Mill Creek at Sherwood Bridge, near Los Molinos	13.3	1977–78
11381990	Thomes Creek tributary at Paskenta	.65	1968–70
11382000	Thomes Creek at Paskenta	203	1921–97
11382090	Thomes Creek at Rawson Road Bridge, near Richfield	28.4	1978–80
11382500	Deer Creek at Deer Creek Meadows	50.5	1929–32
11382550	Deer Creek below Slate Creek, near Deer Creek Meadows	69.4	1961–70
11383000	Deer Creek at Polk Springs	134	1929–31
11383600	Deer Creek at Red Bridge, near Vina	210	1977

WATER RESOURCES DATA—CALIFORNIA, WATER YEAR 2002

DISCONTINUED GAGING STATIONS—Continued

Station No.	Station name	Drainage area (mi ²)	Period of record
11383730	Sacramento River at Vina Bridge, near Corning	—	1945–78
11383800	Sacramento River near Hamilton City	10,833	1945–80
11384000	Big Chico Creek near Chico	72.4	1931–86
11384340	Mud Creek at Cohasset Road, near Chico	21.9	1968–69
11384350	Mud Creek near Chico	48.9	1966–74
11384500	Stony Creek near Stonyford	102	1914–15, 1919–34
11384600	Little Stony Creek above East Park Reservoir, near Lodoga	45.6	1967–82
11385000	Little Stony Creek near Lodoga	98.2	1909–34
11385500	Stony Creek above Stony Gorge Reservoir	281	1934–41
11386500	Grindstone Creek near Elk Creek	157	1936–37, 1940, 1966–72
11387000	Stony Creek near Fruto	597	1901–12, 1961–78
11387200	Stony Creek above Black Butte Lake, near Orland	623	1909, 1981–83
11387500	Stony Creek near Orland	635	1920–34
11387800	North Fork Stony Creek near Newville	63.4	1963–73
11387990	South Diverson Canal near Orland	—	1955–90
11388000	Stony Creek below Black Butte Dam, near Orland	738	1955–90
11388500	Stony Creek near Hamilton City	773	1941–73
11389000	Sacramento River at Butte City	12,080	1921–95
11389700	Butte Creek at Butte Meadows	44.4	1960–74
11389950	Little Butte Creek at Magalia	11.4	1969–85
11390200	Gold Run Creek Tributary near Nelson	1.31	1961
11390210	Cherokee Canal near Nelson	—	1970–74
11390655	South Fork Willow Creek near Fruto	38.9	1963–78
11390660	Walker Creek at Artois	60.4	1965–81
11390672	Stone Corral Creek near Sites	38.2	1958–64, 1966–85
11390890	Colusa Basin Drain at Road 99E, near Knights Landing	—	1996
11391000	Sacramento River at Knights Landing	14,535	1941–80
11391100	Sacramento Slough near Knights Landing	—	1996
11391400	Little Last Chance Creek below Frenchman Dam, near Chilcoot	81.1	1959–80
11391460	Berry Creek near Sattley	7.54	1973–81
11391500	Big Grizzly Creek at Grizzly Valley Dam, near Portola	44	1926–32, 1951–53, 1955–67, 1969–80
11392100	Middle Fork Feather River near Portola	586	1969–76, 1978–80
11392500	Middle Fork Feather River near Clio	686	1926–79
11393000	Middle Fork Feather River at Sloat	775	1911–27
11393500	Middle Fork Feather River below Sloat	819	1941–62
11394000	Middle Fork Feather River near Nelson Point	883	1924–32
11394500	Middle Fork Feather River near Merrimac	1,062	1952–86
11394620	Fall River near Feather Falls	9.89	1963–79
11394800	South Fork Feather River above Little Grass Valley Reservoir	8.09	1961–79
11395300	Lost Creek above Sly Creek Reservoir, near Strawberry Valley	14.1	1961–70
11396300	South Fork Feather River near Forbestown	105	1958–61
11396350	South Fork Feather River at Ponderosa Dam	108	1962–87, 1990
11396400	Sucker Run near Forbestown	18.7	1965–87
11396500	Palmero Canal at Enterprise	—	1912–65
11397000	South Fork Feather River at Enterprise	132	1912–66
11397500	Feather River at Bidwell Bar	1,341	1912–64
11400000	Butt Creek above Almanor–Butt Creek Tunnel, near Prattville	69.0	1937–64
11401000	Butt Creek at Butt Valley	81.3	1905–21
11401100	Butt Creek near Caribou	85.5	1970, 1976–81
11401125	Indian Creek near Boulder Creek Guard Station, near Taylorsville	68.6	1966–80
11401150	Red Clover Creek near Genesee	122	1959–65
11401180	Little Grizzly Creek near Genesee	29.6	1964–79

WATER RESOURCES DATA—CALIFORNIA, WATER YEAR 2002

DISCONTINUED GAGING STATIONS—Continued

Station No.	Station name	Drainage area (mi ²)	Period of record
11401200	Indian Creek near Taylorsville	526	1958–73, 1975–76, 1979–80
11401300	Lights Creek near Taylorsville	57.6	1958–62
11401500	Indian Creek near Crescent Mills	739	1906–09, 1911–18, 1930–93
11401900	Spanish Creek near Quincy	69.1	1959–63
11401940	Mill Creek near Quincy	6.72	1966–71
11402500	Spanish Creek at Keddie	194	1912–33
11403000	East Branch of North Fork Feather River near Rich Bar	1,025	1951–61, 1968–82
11403510	Bucks Creek Tunnel inlet near Storrie	—	1970, 1976
11404000	Grizzly Creek near Storrie	5.20	1930–44
11404100	Bucks Creek Tunnel Outlet near Storrie	—	1986–94
11405000	North Fork Feather River at Big Bend	1,965	1905–11
11405300	West Branch Feather River near Paradise	—	1958–86
11405500	Spring Valley Diversion near Yankee Hill	—	1926–52
11406000	Concow Creek near Yankee Hill	15.1	1928–30, 1932–52
11406500	West Branch Feather River near Yankee Hill	146	1931–63
11407150	Feather River near Gridley	3,676	1965–98
11407300	North Honcut Creek near Bangor	47.1	1961–81
11407500	South Honcut Creek near Bangor	30.6	1951–86
11407700	Feather River at Yuba City	3,974	1965–84
11407810	Middle Yuba River at Jackson Meadows Dam, near Sierra City	37.6	1989–94
11407900	Middle Yuba River below Jackson Meadows Dam, near Sierra City	38.3	1965–87
11408500	Middle Yuba River at Milton	39.8	1926–34, 1935–64
11408700	Middle Yuba River near Alleghany	96.6	1958–66
11408850	Middle Yuba River near Camptonville	136	1967–89
11409000	Middle Yuba River above Oregon Creek, near North San Juan	162	1941–69
11409300	Oregon Creek at Camptonville	23	1967–2000
11409500	Oregon Creek near North San Juan	34.4	1912–69
11410400	Haypress Creek near Sierra City	18.2	1961–66
11410500	North Yuba River near Sierra City	94.7	1924–44
11411000	Downie River at Downieville	72.7	1911–26
11411500	North Yuba River at Goodyears Bar	221	1911–31
11412000	Rock Creek at Goodyears Bar	8.98	1911–33
11412500	Goodyears Creek at Goodyears Bar	12.9	1911–33
11413100	North Yuba River above Slate Creek, near Strawberry Valley	351	1968–87
11413500	North Yuba River below Bullards Bar Dam	487	1941–66
11413600	Sweetland Creek near North San Juan	2.68	1969–73
11413700	Yuba River below New Colgate Powerplant, near French Corral	717	2001–02
11413900	Upper Castle Creek at Soda Springs	3.96	1958–63
11413950	South Yuba River Tributary near Soda Springs	.92	1972–73
11414000	South Yuba River near Cisco	51.8	1942–94
11414190	Drum Canal above Drum Forebay, near Blue Canyon	—	1964–91
11414500	Canyon Creek above Jackson Creek	16.6	1926–30
11415000	Jackson Creek at Mouth	5.45	1926–30
11417000	South Yuba River near Washington	198	1942–53, 1957–72
11417100	Poorman Creek near Washington	23.1	1961–71
11419000	Yuba River at Smartville	1,200	1904–41
11420000	Dry Creek near Brownsville	20.4	1949–60
11420500	Dry Creek at Virginia Ranch	71.3	1949–61
11420700	Dry Creek near Browns Valley	87.1	1964–80
11421500	Yuba River at Marysville	1,344	1944–57
11421700	Feather River below Shanghai Bend, near Olivehurst	5,334	1970–80
11421720	Boardman Canal near Emigrant Gap	—	1965–86
11421730	Bear River below Boardman Diversion Dam, near Emigrant Gap	4.01	1979–85

WATER RESOURCES DATA—CALIFORNIA, WATER YEAR 2002

DISCONTINUED GAGING STATIONS—Continued

Station No.	Station name	Drainage area (mi ²)	Period of record
11423000	Bear River near Auburn	140	1941–67
11423500	Bear River at Van Trent	265	1905–27
11424500	Dry Creek near Wheatland	99.9	1947–62
11424600	Wellman Creek near Smartville	.59	1968–73
11425000	Feather River at Nicolaus	5,921	1942, 1944–83, 1985
11425410	Rock Creek Lake near Auburn	—	1999–2000
11426110	Onion Creek Tributary No. 3 near Soda Springs	.65	1959–64, 1966–67
11426120	Onion Creek Tributary No. 5A near Soda Springs	.39	1959–64, 1966
11426130	Onion Creek Tributary No. 2 near Soda Springs	.48	1958–64, 1966–67
11426140	Onion Creek Tributary No. 1 near Soda Springs	.19	1958–64, 1966–67
11426150	Onion Creek near Soda Springs	3.58	1960–79
11426160	Onion Creek Tributary No. 7 near Soda Springs	.80	1959–64
11426200	North Fork Forbes Creek near Dutch Flat	1.68	1956–85
11426400	North Shirttail Creek near Dutch Flat	9.10	1957–85
11426500	North Fork American River near Colfax	308	1912–41
11428000	Rubicon River at Rubicon Springs, near Meeks Bay	31.4	1910–13, 1957–86
11429000	South Fork Rubicon River at sawmill, near Quintette	16.1	1910–14
11429800	Robbs Peak Tunnel near Riverton	—	1963–67
11430500	South Fork Rubicon River at Mouth, near Georgetown	56.9	1956–62
11431000	Rubicon River near Georgetown	195	1910–14, 1944–65
11431500	Georgetown Divide Ditch above Pilot Creek, near Georgetown	—	1951–62
11432000	Georgetown Divide Ditch near Georgetown	—	1947–60
11432500	Pilot Creek near Georgetown	15.1	1946–60
11433100	Long Canyon Creek near French Meadows	18.0	1960–92
11433200	Rubicon River near Foresthill	315	1959–84
11433260	North Fork of Middle Fork American River, near Foresthill	88.9	1965–85
11433400	Canyon Creek near Georgetown	12.7	1966–79
11433420	Maine Bar Canyon Creek near Greenwood	.75	1973–86
11433500	Middle Fork American River near Auburn	614	1912–86
11433800	North Fork American River below Auburn Damsite, near Auburn	973	1972–86
11434000	North Fork American River at Rattlesnake Bridge	996	1931–37, 1939–55
11435000	Pyramid Creek near Phillips	3.73	1961–64, 1966–70
11435500	South Fork American River at Kyburz	73.2	1924
11437000	Caples Lake Outlet near Kirkwood	13.5	1922–92
11438000	Silver Fork of South Fork American River, near Kyburz	107	1925–44
11439950	Alder Creek Pipeline Diversion near Whitehall	—	1976–82
11440000	Alder Creek near Whitehall	22.1	1923–81
11440500	Plum Creek near Riverton	7.32	1923–39
11440850	Picket Pen Creek near Kyburz	.49	1964–68
11441000	Silver Creek at Union Valley	83.0	1925–60
11442000	Silver Creek near Placerville	177	1922–61
11442500	South Fork American River below Silver Creek, near Pollock Pines	449	1923, 1970–93
11443000	American River Flume near Camino	—	1923–57
11445000	South Fork American River at Coloma	631	1930–41
11445500	South Fork American River near Lotus	673	1951–95
11446000	Weber Creek near Salmon Falls	97.6	1943–59
11447000	American River at Sacramento	1,936	1944–59
11447030	Strong Ranch Slough at Sacramento	5.02	1972–75
11447300	Dry Creek Tributary near Roseville	.39	1964–67
11447330	Magpie Creek near Del Paso Heights	2.03	1996–97
11448500	Adobe Creek near Kelseyville	6.36	1955–78
11448900	Highland Creek above Highland Creek Dam	11.9	1963–78
11449000	Highland Creek near Kelseyville	12.6	1955–62
11449010	Highland Creek below Highland Creek Dam, near Kelseyville	14.2	1966–77

WATER RESOURCES DATA—CALIFORNIA, WATER YEAR 2002

DISCONTINUED GAGING STATIONS—Continued

Station No.	Station name	Drainage area (mi ²)	Period of record
11449100	Scotts Creek near Lakeport	55.2	1961–80
11449350	Burns Valley Creek near Clearlake Highlands	4.37	1963–69
11449450	Copsey Creek near Lower Lake	13.2	1961–68
11449460	Seigler Creek at Lower Lake	12.5	1966–73
11450500	Cache Creek at Lower Lake	488	1901–15
11451500	North Fork Cache Creek near Lower Lake	197	1931–81
11451700	Bear Creek Tributary near Wilbur Springs	4.49	1962–63
11451720	Bear Creek near Rumsey	100	1959–80
11451760	Cache Creek above Rumsey	955	1961–62, 1965–73, 1976–82, 1984–86
11451950	Cache Creek near Brooks	1,041	1983–86
11452000	Cache Creek near Capay	1,044	1943–77
11453170	Dry Creek above Appletree Creek, near Middletown	.83	1978
11453200	Dry Creek near Middletown	8.35	1960–72, 1979–80
11453550	Hunting Creek near Knoxville	37.8	1969–76
11453570	Adams Creek near Knoxville	7.42	1970–76
11453580	Nevada Creek near Knoxville	7.06	1969–76
11453600	Pope Creek near Pope Valley	78.3	1961–80
11453700	Capell Creek Tributary near Wooden Valley	.87	1962–65
11454100	Pleasants Creek near Winters	15.9	1960–68
11454500	Putah Creek at Winters	635	1906–31
11455000	Putah Creek near Davis	638	1949–63

DISCONTINUED LAKES AND RESERVOIRS

The following continuous-record lake stations in California have been discontinued. Daily records were collected and are stored in NWIS for the period of record shown for each location.

Station No.	Station name	Drainage area (mi ²)	Period of record
11362650	Pit no. 5 Powerplant Forebay near Big Bend	—	1986–89
11387995	Black Butte Lake near Orland	738	1964–90
11403300	Three Lakes Reservoir near Bucks Lake	1.0	1984–87
11416650	Upper Lindsey Lake near Graniteville	.06	1999–2002
11423700	New Camp Far West Reservoir near Wheatland	283	1967–76, 1977–83
11425300	Halsey Forebay near Auburn	—	1980–86
11425320	Lake Arthur near Auburn	.86	1982–83
11425330	Halsey Afterbay near Auburn	—	1980–85

DISCONTINUED CONTINUOUS WATER-QUALITY STATIONS

The following continuous-record water-quality stations in California have been discontinued. Daily records were collected and are stored in USGS Water Data for the period of record shown for each location.

Station No.	Station name	Drainage area (mi ²)	Type of record	Period of record
10356500	Susan River at Susanville	184	WQ,B,S	1952–93
11341400	Sacramento River near Mt. Shasta	135	T	1966–71, 1973–87
11342000	Sacramento River at Delta	425	WQ,T	1951–81
11345500	South Fork Pit River near Likely	247	WQ,T,S	1951–79
11348500	Pit River near Canby	1,431	WQ,T,S	1951–79
11365000	Pit River near Montgomery Creek	4,952	WQ,T	1951, 1953–81

WATER RESOURCES DATA—CALIFORNIA, WATER YEAR 2002

DISCONTINUED CONTINUOUS WATER-QUALITY STATIONS—Continued

Station No.	Station name	Drainage area (mi ²)	Type of record	Period of record
11368000	McCloud River above Shasta Lake	604	T	1957–59
11370000	Shasta Lake near Redding	6,421	WQ	1978–80
11370500	Sacramento River at Keswick	6,468	B,WQ,C, T,S	1951–94
11371000	Clear Creek at French Gulch	115	S	1966–67
11372000	Clear Creek near Igo	228	WQ,T	1958–79
11372200	South Cow Creek near Millville	77.3	T	1966–71
11374000	Cow Creek near Millville	425	WQ,T,S	1959–71, 1973–76, 1978–79
11374400	Middle Fork Cottonwood Creek near Ono	244	T,S	1965, 1968–73 1977–79
11375700	North Fork Cottonwood Creek near Igo	88.7	T	1977–79
11375810	Cottonwood Creek near Olinda	395	T,S	1973–80
11375820	South Fork Cottonwood Creek near Cottonwood	217	T	1977–79
11375870	South Fork Cottonwood Creek near Olinda	371	T,S	1878, 1977–80
11376000	Cottonwood Creek near Cottonwood	927	WQ,T,S	1957–67, 1977–85
11376038	Manzanita Creek at park boundary, near Manzanita Lake	11.6	C,T	1980–81
11376550	Battle Creek below Coleman Fish Hatchery, near Cottonwood	357	WQ,T,S	1962–79
11377100	Sacramento River above Bend Bridge, near Red Bluff	8,900	WQ,C,T,S	1955–81, 1996–98
11377200	Sacramento River at Bend Bridge	—	T,S	1959–63, 1967, 1969–70
11378000	Sacramento River near Red Bluff	9,020	T,S	1961–68
11378500	Sacramento River at Red Bluff	9,077	T,S	1958–66
11379500	Elder Creek near Paskenta	92.4	WQ,T,S	1959–70
11380500	Elder Creek at Gerber	136	T,S	1972–79
11381595	Mill Creek at Sherwood Bridge, near Los Molinos	133	T,S	1977–79
11382000	Thomes Creek at Paskenta	203	WQ,T,S	1959–83
11382090	Thomes Creek at Rawson Road Bridge, near Richfield	284	T,S	1978–80
11383600	Deer Creek at Red Bridge, near Vina	210	T,S	1977
11383800	Sacramento River near Hamilton City	10,833	T,S	1977
11384600	Little Stony Creek above East Park Reservoir, near Lodoga	45.6	T	1967–79
11387000	Stony Creek near Fruto	597	T	1971–78
11387200	Stony Creek above Black Butte Lake, near Orland	623	T,S	1981–83
11387900	Masterson Hollow Creek near Newville	.96	T	1982
11388000	Stony Creek below Black Butte Dam, near Orland	738	WQ,S,T	1958–94
11389000	Sacramento River at Butte City	12,080	WQ,T,S	1955–67, 1969–80
11389470	Colusa Weir Spill, Butte Basin, near Colusa	—	T,S	1975
11389500	Sacramento River at Colusa	12,090	C,T	1975, 1977–80, 1995–98
11390000	Butte Creek near Chico	147	WQ	1953–79
11390210	Cherokee Canal near Nelson	—	T,S	1970–74
11390425	Sutter Bypass at Long Bridge, near Meridian	—	T,S	1979
11390480	Tisdale Weir near Grimes	—	S	1978–80
11390600	Sacramento River at Boyers Bend, near Dunnig	—	T	1960–63
11390890	Colusa Basin Drain at Road 99E, near Knights Landing	—	WQ,C,T,S	1996–98
11391000	Sacramento River at Knights Landing	14,535	T,S	1959–60, 1978–80
11391050	Sutter Bypass near Nicolaus	—	T,S	1980–81
11391100	Sacramento Slough near Knights Landing	—	WQ,C,T,S	1996–98
11391500	Big Grizzly Creek at Grizzly Valley Dam, near Portola	44	T	1963–67
11392500	Middle Fork Feather River near Clio	686	T	1964–82
11394500	Middle Fork Feather River near Merrimac	1,062	T	1963–82
11396350	South Fork Feather River at Ponderosa Dam	108	T	1963–67
11401180	Little Grizzly Creek near Genesee	29.6	T	1964–79
11401500	Indian Creek near Crescent Mills	739	WQ,T,S	1951–79
11404500	North Fork Feather River at Pulga	1,953	WQ,T	1963–83

WATER RESOURCES DATA—CALIFORNIA, WATER YEAR 2002

DISCONTINUED CONTINUOUS WATER-QUALITY STATIONS—Continued

Station No.	Station name	Drainage area (mi ²)	Type of record	Period of record
11405300	West Branch Feather River near Paradise	—	T	1963–80
11406870	Thermolito Afterbay at river outlet	—	T	1968
11406920	Thermolito Afterbay Release to Feather River near Oroville	—	T	1969–92
11407000	Feather River at Oroville	3,624	WQ,C,T,S	1906–07, 1951–92
11407150	Feather River near Gridley	3,676	WQ,T,S	1965–93
11407700	Feather River at Yuba City	3,974	T	1964–76
11409000	Middle Yuba River above Oregon Creek, near San Juan	162	T	1965–69
11409400	Oregon Creek below Log Cabin Dam, near Camptonville	29.1	T	1972–79
11409500	Oregon Creek near San Juan	34.4	T	1965–69
11410000	Middle Yuba River near North San Juan	198	T	1974–77
11413100	North Yuba River above Slate Creek, near Strawberry Valley	351	T	1968–69, 1974–77
11413520	North Yuba River below New Bullards Bar Dam, near North San Juan	490	T	1971–74
11413700	Yuba River below Colgate Powerplant, near French Corral	729	T,S	1975–78, 2001–02
11418500	Deer Creek near Smartville	84.6	T,S	1974–79
11420800	Yuba River at Daquerra Point Dam, near Browns Valley	1,330	T	1975–77
11421000	Yuba River near Marysville	1,339	WQ	1951–52, 1973–80,
11421500	Yuba River at Marysville	1,344	WQ,T,S	1961–66, 1973–76 1996–98
11425100	Feather River near Nicolaus	—	T	1969–72, 1974
11425500	Sacramento River at Verona	21,251	WQ,C,T,S	1952, 1969–70, 1980, 1996–98
11427000	North Fork American River at North Fork Dam	342	T,WQ,S	1959–83
11429350	Loon Lake near Meeks Bay	—	WQ	1996
11433300	Middle Fork American River, near Foresthill	524	WQ,B	1979
11433400	Canyon Creek near Georgetown	12.7	T	1966–71, 1973–79
11433800	North Fork American River below Auburn dam site, near Auburn	973	T	1983–86
11439500	South Fork American River near Kyburz	193	WQ,T,B,S	1966–79, 1980
11441001	Union Valley Reservoir near Riverton	—	WQ	1996
11441100	Ice House Reservoir near Kyburz	27.2	WQ	1996
11445500	South Fork American River near Lotus	673	B,S,WQ,T	1957–68, 1970–94
11446500	American River at Fair Oaks	1,888	WQ	1960–62
11447000	American River at Sacramento	1,936	WQ,S	1978, 1996–98
11447030	Strong Ranch Slough at Sacramento	5.02	C	1973–75
11447360	Arcade Creek near Del Paso Heights	31.5	WQ,T,C,S	1996–98
11447500	Sacramento River at Sacramento	23,502	S	1957–79
11447650	Sacramento River at Freeport	—	B,C	1974–81, 1989–98
11447810	Sacramento River at Greens Landing	—	C	1974–81
11449010	Highland Creek below Highland Creek Dam, near Kelseyville	14.2	T,S	1967–77
11451760	Cache Creek above Rumsey	955	T,S	1960–70, 1976, 1984–86
11451950	Cache Creek near Brooks	1,041	T,S	1984–86
11452500	Cache Creek at Yolo	1,139	T,S	1959–65, 1966–67, 1986
11453000	Yolo Bypass near Woodland	—	S	1957–61, 1980
11453170	Dry Creek above Appletree Creek, near Middletown	.83	C,T	1978
11453500	Putah Creek near Guenoc	113	T,S	1960–73
11453550	Hunting Creek near Knoxville	37.8	T,S	1973–74
11454000	Putah Creek near Winters	574	WQ,T	1951–81

Type of record: WQ (Water quality); B (Biological); C (Conductivity); T (Temperature); S (Sediment); P (Precipitation).

*THIS
PAGE
INTENTIONALLY
LEFT
BLANK*

WATER RESOURCES DATA—CALIFORNIA, WATER YEAR 2002
VOLUME 4—NORTHERN CENTRAL VALLEY BASINS AND THE GREAT BASIN
FROM HONEY LAKE BASIN TO OREGON STATE LINE

By J.R. Smithson, M.F. Friebel, M.D. Webster, G.L. Pope, *and* G.L. Rockwell

INTRODUCTION

The Water Resources Division of the U.S. Geological Survey, in cooperation with State and Federal agencies, obtains a large amount of data pertaining to the water resources of California each water year. These data, accumulated during many water years, constitute a valuable database for developing an improved understanding of the water resources of the State. To make these data readily available to interested parties outside the U.S. Geological Survey, the data are published annually in this report series entitled "Water Resources Data—California."

This volume of the report includes records on surface water in the State. Specifically, it contains: (1) discharge records for 191 streamflow-gaging stations and 4 partial-record station; (2) stage and content records for 60 lakes and reservoirs; (3) gage-height records for 2 stations; and (4) water-quality records for 20 streamflow-gaging stations. Records included for stream stages are only a small fraction of those obtained during the water year.

The series of annual reports for California began with the 1961 water year with a report that contained only data relating to the quantities of surface water. For the 1964 water year, a similar report was introduced that contained only data relating to water quality. Beginning with the 1975 water year, the report format changed to include data on quantities of surface water, quality of surface and ground water, and ground-water levels. From the 1985 through the 1993 water years, a separate volume for ground-water levels and quality was published for California.

Prior to introduction of this series and for several water years concurrent with it, water-resources data for California were published in U.S. Geological Survey Water-Supply Papers. Data on stream discharge and stage and on lake or reservoir contents and stage, through September 1960, were published annually under the title "Surface-Water Supply of the United States, Parts 10 and 11." For the 1961 through 1970 water years, the data were published in two 5-year reports. Data on chemical quality, temperature, and suspended sediment for the 1941 through 1970 water years were published annually under the title "Quality of Surface Waters of the United States," and water levels for the 1935 through 1974 water years were published under the title "Ground-Water Levels in the United States." These Water-Supply Papers may be consulted in public libraries of principal cities of the United States, or if not out of print, they may be purchased from U.S. Geological Survey, Information Services, Box 25286, Denver Federal Center, Denver, CO 80225-0046.

Publications similar to this report are published annually by the U.S. Geological Survey for all States. Each report has an identification number consisting of the two-letter State abbreviation, the last two digits of the water year, and the volume number. For example, this volume is identified as "U.S. Geological Survey Water-Data Report CA-00-4." For archiving and general distribution, the reports for 1971–74 water years also are identified as water-data reports. These water-data reports are for sale, in paper copy or on microfiche, by the National Technical Information Service, 5285 Port Royal Road, Springfield, VA 22161. For further ordering information, the Customer Inquiries telephone number is (703) 487-4650, between 8:30 a.m. and 5:30 p.m. Eastern Standard Time.

Additional information for ordering specific reports may be obtained from the District Office at the address given on the back of the title page or by telephone at (916) 278-3100.

COOPERATION

The U.S. Geological Survey and organizations of the State of California have had cooperative agreements for the systematic collection of records since 1903. Organizations that supplied data are acknowledged in station descriptions. Organizations that assisted in collecting data through cooperative agreement with the Survey are:

California Department of Water Resources, Thomas M. Hannigan, Director.

Georgetown Divide Public Utility District, Marie E. Davis, General Manager.

Hidden Valley Lake Community Services District, Mel Aust, General Manager.

Placer County, Edward McCarthy, Senior Civil Engineer.

Sacramento County Department of Water Resources, Keith DeVore, Director.

Shasta Valley Resource Conservation District, Pete Talley, General Manager.

Yolo County Flood Control and Water Conservation District, James F. Eagan, General Manager.

Yuba County Water Agency, Curt Aikens, Engineer-Administrator.

Assistance in the form of funds or services was given by the Bureau of Reclamation, U.S. Department of Interior.

WATER RESOURCES DATA—CALIFORNIA, WATER YEAR 2002

The following organizations aided in collecting records: Arbuckle Mountain Project; California Department of Water Resources; Energy Growth Partnership I; Five Bears Hydro, Inc.; Malacha Power Project, Inc.; Nelson Creek Power Co.; Nevada and Oroville–Wyandotte Irrigation Districts; Pacific Gas and Electric Co.; Placer and Yuba County Water Agencies; Sacramento Municipal Utility District; Shasta Hydroelectric; Sithe Energies, Inc.; Snow Mountain Hydroelectric; South Sutter Water District; STS Hydropower; and Synergics, Inc.

SPECIAL NETWORKS AND PROGRAMS

Hydrologic Benchmark Network is a network of 50 sites in small drainage basins around the country whose purpose is to provide consistent data on the streamflow representative of undeveloped watersheds nationwide, and to provide analyses on a continuing basis to compare and contrast conditions observed in basins more obviously affected by human activities. At 10 of these sites, water-quality information is being gathered on major ions and nutrients, primarily to assess the effects of acid deposition on stream chemistry. Additional information on the Hydrology Benchmark Program can be found at:

<http://water.usgs.gov/hbn/>

National Stream-Quality Accounting Network (NASQAN) monitors the water quality of large rivers within the Nation's largest river basins. From 1995 through 1999, a network of approximately 40 stations was operated in the Mississippi, Columbia, Colorado, and Rio Grande basins. For the period 2000 through 2004, sampling was reduced to a few index stations on the Colorado and Columbia so that a network of 5 stations could be implemented on the Yukon River. Samples are collected with sufficient frequency that the flux of a wide range of constituents can be estimated. The objective of NASQAN is to characterize the water quality of these large rivers by measuring concentration and mass transport of a wide range of dissolved and suspended constituents, including nutrients, major ions, dissolved and sediment-bound heavy metals, common pesticides, and inorganic and organic forms of carbon. This information will be used (1) to describe the long-term trends and changes in concentration and transport of these constituents; (2) to test findings of the National Water-Quality Assessment Program (NAWQA); (3) to characterize processes unique to large-river systems such as storage and re-mobilization of sediments and associated contaminants; and (4) to refine existing estimates of off-continent transport of water, sediment, and chemicals for assessing human effects on the world's oceans and for determining global cycles of carbon, nutrients, and other chemicals. Additional information about the NASQAN program can be found at:

<http://water.usgs.gov/nasqan>

The National Atmospheric Deposition Program/National Trends Network (NADP/NTN) provides continuous measurement and assessment of the chemical constituents in precipitation throughout the United States. As the lead federal agency, the USGS works together with over 100 organizations to provide a long-term, spatial and temporal record of atmospheric deposition generated from a network of 225 precipitation chemistry monitoring sites. This long-term nationally consistent monitoring program, coupled with ecosystem research, provides critical information toward a national scorecard to evaluate the effectiveness of ongoing and future regulations intended to reduce atmospheric emissions and subsequent impacts to the Nation's land and water resources. Reports and other information on the NADP/NTN Program, as well as all data from the individual sites, can be found at:

<http://bqs.usgs.gov/acidrain/>

The National Water-Quality Assessment (NAWQA) Program of the U.S. Geological Survey is a long-term program with goals to describe the status and trends of water-quality conditions for a large, representative part of the Nation's ground- and surface-water resources; provide an improved understanding of the primary natural and human factors affecting these observed conditions and trends; and provide information that supports development and evaluation of management, regulatory, and monitoring decisions by other agencies.

Assessment activities are being conducted in 59 study units (major watersheds and aquifer systems) that represent a wide range of environmental settings nationwide and that account for a large percentage of the Nation's water use. A wide array of chemical constituents will be measured in ground water, surface water, streambed sediments, and fish tissues. The coordinated application of comparative hydrologic studies at a wide range of spatial and temporal scales will provide information for decision making by water-resources managers and a foundation for aggregation and comparison of findings to address water-quality issues of regional and national interest.

Communication and coordination between USGS personnel and other local, State, and federal interests are critical components of the NAWQA Program. Each study unit has a local liaison committee consisting of representatives from key federal, State, and local water resources agencies, Indian nations, and universities in the study unit. Liaison committees typically meet semiannually to discuss their information needs, monitoring plans and progress, desired information products, and opportunities to collaborate efforts among the agencies. Additional information about the NAWQA Program can be found at:

<http://water.usgs.gov/nawqa/>

WATER RESOURCES DATA—CALIFORNIA, WATER YEAR 2002

EXPLANATION OF THE RECORDS

The surface-water records published in this report are for the 2002 water year that began October 1, 2001, and ended September 30, 2002. A calendar of the water year is provided on the inside of the front cover. The records contain streamflow data, stage and contents data for lakes and reservoirs, and water-quality data for surface water. The following sections of the introductory text are presented to provide users with a more detailed explanation of how the hydrologic data published in this report were collected, analyzed, computed, and arranged for presentation.

Station-Identification Numbers

Each streamsite data station in this report is assigned a unique identification number. This number is unique in that it applies specifically to a given station and to no other. The number usually is assigned when a station is first established and is retained for that station indefinitely. The systems used by the U.S. Geological Survey to assign identification numbers for surface-water stations and for ground-water well sites differ, but both are based on geographic location. The "downstream-order" system is used for regular surface-water stations and the "latitude-longitude" system is used for surface-water stations in California where only miscellaneous measurements are made.

Downstream-Order System

Since October 1, 1950, the order of listing hydrologic-station records in Survey reports has been in a downstream direction along the main stream. All stations on a tributary entering upstream from a mainstream station are listed before that station. A station on a tributary that enters between two mainstream stations is listed between them. A similar order is followed in listing stations on first rank, second rank, and other ranks of tributaries. The rank of any tributary with respect to the stream to which it is immediately tributary is indicated by an indentation in the "List of Stations" in the front of this report. Each indentation represents one rank. This downstream order and system of indentation show which stations are on tributaries between any two stations and the rank of the tributary on which each station is situated.

The station-identification number is assigned according to downstream order. In assigning station numbers, no distinction is made between partial-record stations and other stations; therefore, the station number for a partial-record station indicates downstream-order position in a list made up of both types of stations. Gaps are left in the series of numbers to allow for new stations that may be established; hence, the numbers are not consecutive. The complete eight-digit number for each station such as 11119750, which appears just to the left of the station name, includes the two-digit part number "11" plus the six-digit downstream-order number "119750." The part number designates the major river basin; for example, part "11" is the Pacific Slope Basins in California.

Latitude-Longitude System

The identification numbers for miscellaneous surface-water sites are assigned according to the grid system of latitude and longitude. The number consists of 15 digits. The first six digits denote the degrees, minutes, and seconds of latitude, the next seven digits denote degrees, minutes, and seconds of longitude, and the last two digits (assigned sequentially) identify the other sites within a 1-second grid. This site-identification number, once assigned, is a pure number and has no locational significance. In the rare instance where the initial determination of latitude and longitude are found to be in error, the station will retain its initial identification number; however, its true latitude and longitude will be listed in the LOCATION paragraph of the station description (fig. 1).

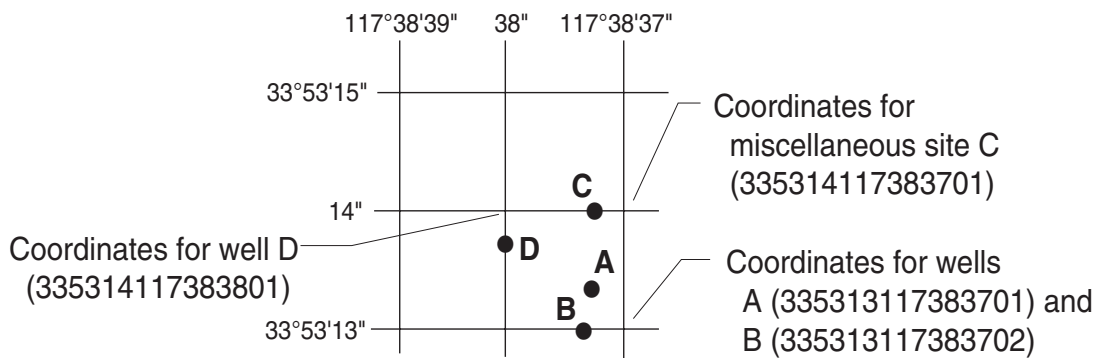

Figure 1. System for numbering miscellaneous sites (latitude and longitude).

Records of Stage and Water Discharge

Records of stage and water discharge may be complete or partial. Complete records of discharge are those obtained using a continuous stage-recording device through which either instantaneous or mean daily discharges may be computed for any time, or any period of time, during the period of record. Complete records of lake and reservoir contents, similarly, are those for which stage

WATER RESOURCES DATA—CALIFORNIA, WATER YEAR 2002

or contents may be computed or estimated with reasonable accuracy for any time, or period of time. They may be obtained using a continuous stage-recording device, but need not be. Because daily mean discharges and end-of-day contents commonly are published for such stations, they are referred to as "daily stations."

By contrast, partial records are obtained through discrete measurements without using a continuous stage-recording device and pertain only to a few flow characteristics, or perhaps only one. The nature of the partial record is indicated by table titles such as "Crest-stage partial records" or "Low-flow partial records." Records of miscellaneous discharge measurements or of measurements from special studies, such as low-flow seepage studies, may be considered as partial records, but they are presented separately in this report. Location of all complete-record stations for which data are given in this report are shown, by county, in figures 2 through 23.

Data Collection and Computation

The data obtained at a complete-record gaging station on a stream or canal consist of a continuous record of stage, individual measurements of discharge throughout a range of stages, and notations regarding factors that may affect the relation between stage and discharge. These data, together with supplemental information, such as weather records, are used to compute daily discharges. The data obtained at a complete-record gaging station on a lake or reservoir consist of a record of stage and of notations regarding factors that may affect the relation between stage and lake contents. These data are used with stage-area and stage-capacity curves or tables to compute water-surface areas and lake storage.

Continuous records of stage are obtained with digital recorders, data-collection platforms, or data loggers that sample stage values at selected time intervals. Measurements of discharge are made with current meters using methods adapted by the U.S. Geological Survey as a result of experience accumulated since 1880. These methods are described in standard textbooks, in U.S. Geological Survey Water-Supply Paper 2175, and in U.S. Geological Survey Techniques of Water-Resources Investigations (TWRI), Book 3, Chapters A1 through A19, and Book 8, Chapters A2 and B2. The methods are consistent with the American Society for Testing and Materials (ASTM) standards and generally follow the standards of the International Organization for Standards (ISO).

In computing discharge records, results of individual measurements are plotted against the corresponding stages, and stage-discharge relation curves are then constructed. From these curves, rating tables indicating the approximate discharge are prepared for any stage within the range of the measurements. If it is necessary to define extremes of discharge outside the range of current-meter measurements, the curves are extended using (1) logarithmic plotting; (2) velocity-area studies; (3) results of indirect measurements of peak discharge, such as slope-area or contracted-opening measurements, and computations of flow-over-dam or weirs; or (4) step-backwater techniques.

Daily mean discharges are computed by applying the daily mean stages (gage heights) to the stage-discharge curves or tables. If the stage-discharge relation is subject to change because of frequent or continual change in the physical features that form the control, the daily mean discharge is determined by the shifting-control method, in which correction factors based on individual discharge measurements and notes of the personnel making the measurements are applied to the gage heights before the discharges are determined from the curves or tables. This shifting-control method also is used if the stage-discharge relation is changed temporarily because of aquatic growth or debris on the control. For some stations, formation of ice in the winter may so obscure the stage-discharge relations that daily mean discharges must be estimated from other information such as temperature and precipitation records, notes or observations, and records for other stations in the same or nearby basins for comparable periods.

At some stream-gaging stations, the stage-discharge relation is affected by backwater from reservoirs, tributary streams, or other sources. This necessitates the use of the slope method in which the slope or fall in a reach of the stream is a factor in computing discharge. The slope or fall is obtained by means of an auxiliary gage set at some distance from the base gage. At some stations the stage-discharge relation is affected by changing stage; at these stations the rate of change in stage is used as a factor in computing discharge.

At some gaging stations, acoustic velocity meter (AVM) systems are used to compute discharge. The AVM system measures the stream's velocity at one or more paths in the cross section. Coefficients are developed to relate this path velocity to the mean velocity in the cross section. Because the AVM sensors are fixed in position, the adjustment coefficients generally vary with stage. Cross-sectional area curves are developed to relate stage, recorded as noted above, to cross-section area. Discharge is computed by multiplying path velocity by the appropriate stage-related coefficient and area.

In computing records of lake or reservoir contents, it is necessary to have available surveys, curves, or tables defining the relation of stage and contents. The application of stage to the stage-content curves or tables gives the contents from which daily, monthly, or yearly changes then are determined. If the stage-content relation changes because of deposition of sediment in a lake or reservoir, periodic resurveys may be necessary to redefine the relation. When this is done, the contents computed may become increasingly in error as time increases since the last survey. Discharges over lake or reservoir spillways are computed from stage-discharge relations in the same manner as other stream discharges are computed.

For some gaging stations, there are periods when no gage-height record is obtained, or the recorded gage height is so faulty that it cannot be used to compute daily discharge or contents. This happens when the recorder stops or otherwise fails to operate properly, intakes are plugged, the float is frozen in the well, or for various other reasons. For such periods, the daily discharges are estimated from the recorded range in stage, previous or following record, discharge measurements, weather records, and comparison with other station records from the same or nearby basins. Likewise, daily contents may be estimated from operator's logs, previous

WATER RESOURCES DATA—CALIFORNIA, WATER YEAR 2002

or following records, inflow-outflow studies, and other information. Information explaining how estimated daily-discharge values are identified in station records is included in the next two sections, "Data Presentation" (REMARKS paragraph) and "Identifying Estimated Daily Discharge."

Data Presentation

Streamflow data in this report are presented in a new format that is considerably different from the format in data reports prior to the 1991 water year. The major changes are that statistical characteristics of discharge now appear in tabular summaries following the water-year data table and less information is provided in the text or station manuscript above the table. These changes represent the results of a pilot program to reformat the annual water-data report to meet current user needs and data preferences.

The records published for each continuous-record surface-water discharge station (gaging station) now consist of four parts, the manuscript or station description; the data table of daily mean values of discharge for the current water year with summary data; a tabular statistical summary of monthly mean flow data for a designated period, by water year; and a summary statistics table that includes statistical data of annual, daily, and instantaneous flows as well as data pertaining to annual runoff, 7-day low-flow minimums, and flow duration.

Station manuscript

The manuscript provides, under various headings, descriptive information, such as station location; period of record; historical extremes outside the period of record; record accuracy; and other remarks pertinent to station operation and regulation. The following information, as appropriate, is provided with each continuous record of discharge or lake content. Comments follow to clarify information presented under the various headings of the station description.

LOCATION.—Information on locations is obtained from the most accurate maps available. The location of the gaging station is given with respect to the cultural and physical features in the vicinity and with respect to the reference place mentioned in the station name. River mileages, given for only a few stations, were determined by methods given in "River Mileage Measurement," Bulletin 14, Revision of October 1968, prepared by the Water Resources Council, or were provided by the U.S. Army Corps of Engineers.

DRAINAGE AREA.—Drainage areas are measured using the most accurate maps available. Because the type of maps available varies from one drainage basin to another, the accuracy of drainage areas likewise varies. Drainage areas are updated as better maps become available.

PERIOD OF RECORD.—This indicates the period for which there are published records for the station or for an equivalent station. An equivalent station is one that was in operation at a time when the present station was not, and whose location was such that records from it reasonably can be considered equivalent with records from the present station.

REVISED RECORDS.—Published records, because of new information, occasionally are incorrect, and revisions are printed in later reports. Listed under this heading are all the reports in which revisions have been published for the station and the water years to which the revisions apply. If a revision did not include daily, monthly, or annual figures of discharge, that fact is noted after the year dates as follows: "(M)" means that only the instantaneous maximum discharge was revised; "(m)" that only the instantaneous minimum was revised; and "(P)" that only peak discharges were revised. If the drainage area has been revised, the report is given in which the most recently revised figure was published.

GAGE.—The type of gage currently in use, the datum of the current gage referred to sea level (see glossary), and a condensed history of the types, locations, and datums of previous gages are given under this heading.

REMARKS.—All periods of estimated daily-discharge record will either be identified by date in this paragraph of the station description for water-discharge stations or flagged in the daily-discharge table. (See next section, "Identifying Estimated Daily Discharge.") If a REMARKS paragraph is used to identify estimated record, the paragraph will begin with this information presented as the first entry. The paragraph also is used to present information relative to the accuracy of the records, to special methods of computation, to conditions that affect natural flow at the station, and possibly to other pertinent items. For reservoir stations, information is given on the dam forming the reservoir, the capacity, outlet works and spillway, and purpose and use of the reservoir.

COOPERATION.—Records provided by a cooperating organization or obtained for the U.S. Geological Survey by a cooperating organization are identified.

EXTREMES FOR PERIOD OF RECORD.—Extremes may include maximum and minimum discharges or content. Unless otherwise qualified, the maximum discharge or content is the instantaneous maximum corresponding to the highest stage that occurred. The highest stage may have been obtained from a graphic or digital recorder, a crest-stage gage, or by direct observation of a nonrecording gage. If the maximum stage did not occur on the same day as the maximum discharge or content, it is given separately. Similarly, the minimum is the instantaneous minimum discharge, unless otherwise qualified, and was determined and is reported in the same manner as the maximum.

EXTREMES OUTSIDE PERIOD OF RECORD.—Included is information concerning major floods or unusually low flows that occurred outside the stated period of record. The information may or may not have been obtained by the U.S. Geological Survey.

EXTREMES FOR CURRENT YEAR.—Extremes given are similar to those for the period of record, except the peak discharge listing may include secondary peaks. For stations meeting certain criteria, all peak discharges and stages occurring during the water year that are greater than a selected base discharge are presented under this heading. The peaks greater than the base

WATER RESOURCES DATA—CALIFORNIA, WATER YEAR 2002

discharge, excluding the highest one, are referred to as secondary peaks. Peak discharges are not published for canals, ditches, drains, or streams for which the peaks are subject to substantial control by man. The time of occurrence for peaks is expressed in 24-hour local standard time. For example, 12:30 a.m. is 0030, and 1:30 p.m. is 1330.

REVISIONS.—If a critical error is discovered in published records, a revision is included in the first report published following discovery of the error.

Occasionally the records of a discontinued gaging station may need revision. Because for these stations there would be no current or, possible, future station manuscript published to document the revision in a "Revised Records" entry, users of data for these stations who obtained the record from previously published data reports may wish to contact the District Office to determine if the published records were revised after the station was discontinued. If the data were obtained by computer retrieval, the data would be current and there would be no need to check because any published revision of data is always accompanied by revision of the corresponding data in computer storage.

Manuscript information for lake or reservoir stations differs from that for stream-gaging stations in the nature of the "Remarks" and in the inclusion of a skeleton stage-capacity table when daily contents are given.

Data table of daily mean values

The daily table of discharge records for stream-gaging stations gives mean discharge for each day of the water year. In the monthly summary for the table, the line headed "TOTAL" gives the sum of the daily figures for each month; the line headed "MEAN" gives the average flow in cubic feet per second for the month; and the lines headed "MAX" and "MIN" give the maximum and minimum daily mean discharges, respectively, for each month. Discharge for the month also usually is expressed in cubic feet per second per square mile (line headed "CFSM"); or in inches (line headed "IN."); or in acre-feet (line headed "AC-FT"). Figures for cubic feet per second per square mile and runoff in inches or in acre-feet may be omitted if there is extensive regulation or diversion or if the drainage area includes large noncontributing areas. At some stations monthly and (or) yearly observed discharges are adjusted for reservoir storage or diversion, or diversion data or reservoir contents are given. These figures are identified by a symbol and corresponding footnote.

Statistics of monthly mean data

A tabular summary of the mean (line headed "MEAN"), maximum (line headed "MAX"), and minimum (line headed "MIN") of monthly mean flows for each month for a designated period is provided below the mean values table. The water years of the first occurrence of the maximum and minimum monthly flows are provided immediately below those figures. The designated period will be expressed as "FOR WATER YEARS ___—___, BY WATER YEAR (WY)," and will list the first and last water years of the range of years selected from the PERIOD OF RECORD paragraph in the station manuscript. It will consist of all of the station record within the specified water years, inclusive, including complete months of record for partial water years, if any, and may coincide with the period of record for the station. The water years for which the statistics are computed will be consecutive, unless a break in the station record is indicated in the manuscript.

Summary statistics

A table titled "SUMMARY STATISTICS" follows the statistics of monthly mean data tabulation for tables containing complex data for the current water year. This table consists of four columns, with the first column containing the line headings of the statistics being reported. The table provides a statistical summary of yearly, daily, and instantaneous flows, not only for the current water year but also for the previous calendar year and for a designated period, as appropriate. The designated period selected, "WATER YEARS ___—___," will consist of all of the station record within the specified water years, inclusive, including complete months of record for partial water years, if any, and may coincide with the period of record for the station. The water years for which the statistics are computed will be consecutive, unless a break in the station record is indicated in the manuscript. All of the calculations for the statistical characteristics designated ANNUAL (see line headings below), except for the "ANNUAL 7-DAY MINIMUM" statistic, are calculated for the designated period using complete water years. The other statistical characteristics may be calculated using partial water years.

The date or water year, as appropriate, of the first occurrence of each statistic reporting extreme values of discharge is provided adjacent to the statistic. Repeated occurrences may be noted in the REMARKS paragraph of the manuscript or in footnotes. Because the designated period may not be the same as the station period of record published in the manuscript, occasionally the dates of occurrence listed for the daily and instantaneous extremes in the designated-period column may not be within the selected water years listed in the heading. When this occurs, it will be noted in the REMARKS paragraph or in footnotes. Selected streamflow duration curve statistics and runoff data also are given. Runoff data may be omitted if there is extensive regulation or diversion of flow in the drainage basin.

The following summary statistics data, as appropriate, are provided with each continuous record of discharge. Comments follow to clarify information presented under the various line headings of the summary statistics table.

ANNUAL TOTAL.—The sum of the daily mean values of discharge for the year. At some stations the annual total discharge is adjusted for reservoir storage or diversion. The adjusted figures are identified by a symbol and corresponding footnotes.

ANNUAL MEAN.—The arithmetic mean of the individual daily mean discharges for the year noted or for the designated period. At some stations the yearly mean discharge is adjusted for reservoir storage or diversion. The adjusted figures are identified by a symbol and corresponding footnotes.

HIGHEST ANNUAL MEAN.—The maximum annual mean discharge occurring for the designated period.

WATER RESOURCES DATA—CALIFORNIA, WATER YEAR 2002

LOWEST ANNUAL MEAN.—The minimum annual mean discharge occurring for the designated period.

HIGHEST DAILY MEAN.—The maximum daily mean discharge for the year or for the designated period.

LOWEST DAILY MEAN.—The minimum daily mean discharge for the year or for the designated period.

MAXIMUM PEAK FLOW.—The maximum instantaneous peak discharge occurring for the water year or designated period.

Occasionally the maximum flow for a year may occur at midnight at the beginning or end of the year, on a recession from or rise toward a higher peak in the adjoining year. In this case, the maximum peak flow is given in the table and the maximum flow may be reported in a footnote or in the

MAXIMUM PEAK STAGE.—The maximum instantaneous peak stage occurring for the water year or designated period.

Occasionally the maximum stage for a year may occur at midnight at the beginning or end of the year, on a recession from or rise toward a higher peak in the adjoining year. In this case, the maximum peak stage is given in the table and the maximum stage may be reported in the REMARKS paragraph in the manuscript or in a footnote. If the dates of occurrence of the maximum peak stage and maximum peak flow are different, the REMARKS

INSTANTANEOUS LOW FLOW.—The minimum instantaneous discharge occurring for the water year or for the designated period.

ANNUAL RUNOFF.—Indicates the total quantity of water in runoff for a drainage area for the year. Data reports may use any of the following units of measurement in presenting annual runoff data:

Acre-foot (AC-FT) is the quantity of water required to cover 1 acre to a depth of 1 foot and is equivalent to 43,560 cubic feet, or about 326,000 gallons, or 1,233 cubic meters.

Cubic feet per second per square mile (CFSM) is the average number of cubic feet of water flowing per second from each square mile of area drained, assuming that the runoff is distributed uniformly in time and area.

Inches (IN.) indicates the depth to which the drainage area would be covered if all the runoff for a given period were distributed on it uniformly.

10 PERCENT EXCEEDS.—The discharge that is exceeded 10 percent of the time for the designated period.

50 PERCENT EXCEEDS.—The discharge that is exceeded 50 percent of the time for the designated period.

90 PERCENT EXCEEDS.—The discharge that is exceeded 90 percent of the time for the designated period.

Data collected at partial-record stations follow the information for continuous-record sites. Data for partial-record discharge stations are presented in two tables. The first is a table of annual maximum stage and discharge at crest-stage stations, and the second is a table of discharge measurements at low-flow partial-record stations. The tables of partial-record stations are followed by a listing of discharge measurements made at sites other than continuous-record or partial-record stations. These measurements generally are made in times of drought or flood to give better areal coverage to those events. Those measurements and others collected for some special reason are called measurements at miscellaneous sites.

Identifying Estimated Daily Discharge

Estimated daily-discharge values published in the water-discharge tables of annual State data reports are identified either by flagging individual daily values with the letter symbol "e" and printing the table footnote, "e Estimated," or by listing the dates of the estimated record in the REMARKS paragraph of the station description.

Accuracy of the Records

The accuracy of streamflow records depends primarily on (1) the stability of the stage-discharge relation or, if the control is unstable, the frequency of discharge measurements, and (2) the accuracy of measurements of stage and discharge, and interpretation of records.

The accuracy attributed to the records is indicated under "REMARKS." "Excellent" means that about 95 percent of the daily discharges are within 5 percent of the true; "good," within 10 percent; and "fair," within 15 percent. Records that do not meet the criteria mentioned, are rated "poor." Different accuracies may be attributed to different parts of a given record.

Daily mean discharges in this report are given to the nearest hundredth of a cubic foot per second (ft^3/s) for values less than $1 \text{ ft}^3/\text{s}$, to the nearest tenth between 1.0 and $10 \text{ ft}^3/\text{s}$, to whole numbers between 10 and $1,000 \text{ ft}^3/\text{s}$, and to three significant figures for more than $1,000 \text{ ft}^3/\text{s}$. The number of significant figures used is based solely on the magnitude of the discharge value. The same rounding rules apply to discharges listed for partial-record stations and miscellaneous sites.

Discharge at many stations, as indicated by the monthly mean, may not reflect natural runoff due to the effects of diversion, consumption, regulation by storage, increase or decrease in evaporation due to artificial causes, or to other factors. For such stations, figures of cubic feet per second per square mile and of runoff, in inches, are not published unless satisfactory adjustments can be made for diversions, for changes in contents of reservoirs, or for other changes incident to use and control. Evaporation from a reservoir is not included in the adjustments for changes in reservoir contents, unless it is so stated. Even at those stations where adjustments are made, large errors in computed runoff may occur if adjustments or losses are large in comparison with the measured discharge.

Other Records Available

The National Water Data Exchange (NAWDEx), U.S. Geological Survey, Reston, VA 20192, maintains an index of sites as well as an index of records of discharge collected by other agencies but not published by the U.S. Geological Survey. Information on records at specific sites can be obtained from that office upon request.

WATER RESOURCES DATA—CALIFORNIA, WATER YEAR 2002

Information used in the preparation of the records in this publication, such as discharge measurement notes, gage-height records, temperature measurements, and rating tables are on file in the District Office. Also, most of the daily mean discharges are in computer-readable form and have been analyzed statistically. Information on the availability of the unpublished information or on the results of statistical analyses of the published records may be obtained from the District Office.

Records of Surface-Water Quality

Records of surface-water quality ordinarily are obtained at or near stream-gaging stations because interpretation of records of surface-water quality nearly always requires corresponding discharge data. Records of surface-water quality in this report may involve various types of data and measurement frequencies.

Change in National Trends Network Procedures

Sample handling procedures at all National Trends Network stations were changed substantially on January 11, 1994, in order to reduce contamination from the sample shipping container. The data for samples before and after that date are different and not directly comparable. A tabular summary of the differences, based on a special intercomparison study, is available from the NADP Program Office, Illinois State Water Survey, 2204 Griffith Drive, Champaign, IL 61820-7495 (Telephone: 217-333-7873).

Classification of Records

Water-quality data for surface-water sites are grouped into one of three classifications. A continuing-record station is a site where data are collected on a regularly scheduled basis. Frequency may be one or more times daily, weekly, monthly, or quarterly. A partial-record station is a site where limited water-quality data are collected systematically over a period of years. Frequency of sampling is usually less than quarterly. A miscellaneous sampling site is a location other than a continuing or partial-record station, where random samples are collected to give better areal coverage to define water-quality conditions in the river basin.

A careful distinction needs to be made between "continuing records" as used in this report and "continuous recordings," which refers to a continuous graph or a series of discrete values punched at short intervals on a paper tape or stored electronically in a data logger. Some records of water quality, such as temperature and specific conductance, may be obtained through continuous recordings; however, because of costs, most data are obtained only monthly or less frequently. Locations of stations for which records on the quality of surface water appear in this report are shown in figures 2 through 23.

Arrangement of Records

Water-quality records collected at a surface-water daily record station are published immediately following that record, regardless of the frequency of sample collection. Station number and name are the same for both records. Where a surface-water daily record station is not available or where the water quality differs significantly from that at the nearby surface-water station, the continuing water-quality record is published with its own station number and name in the regular downstream order sequence. Water-quality data for partial-record stations and for miscellaneous sampling sites appear in separate tables following the table of discharge measurements at miscellaneous sites.

Onsite Measurements and Sample Collection

In obtaining water-quality data, a major concern is the assurance that the data obtained represent the in situ quality of the water. To assure this, certain measurements, such as water temperature, pH, and dissolved oxygen, are made onsite when samples are taken. To assure that measurements made in the laboratory also represent the in situ water, carefully prescribed procedures are followed in collecting the samples, in treating the samples to prevent changes in quality pending analysis, and in shipping the samples to the laboratory. Procedures for onsite measurements and for collecting, treating, and shipping samples are given in "Techniques of Water-Resources Investigations," Book 1, Chapter D2; Book 3, Chapter C2; and Book 5, Chapters A1, A3, and A4. All these references are listed in the section "Publications on Techniques of Water-Resources Investigations." Also, detailed information on collecting, treating, and shipping samples may be obtained from the District Office.

One sample can adequately define the water quality at a given time if the mixture of solutes throughout the stream cross section is homogeneous. However, the concentration of solutes at different locations in the cross section may vary widely with different rates of water discharge, depending on the source of material and the turbulence and mixing of the stream. Some streams must be sampled through several vertical sections to obtain a representative sample needed for an accurate mean concentration and for use in calculating load. All samples obtained for the National Stream-Quality Accounting Network (see definitions) are obtained from at least several verticals. Whether samples are obtained from the centroid of flow or from several verticals depends on flow conditions and other factors which must be evaluated by the collector.

Chemical-quality data published in this report are considered to be the most representative value available for the stations listed. The values reported represent water-quality conditions at the time of sampling as much as possible, consistent with available sampling techniques and methods of analysis. In the rare case where an apparent inconsistency exists between a reported pH value and the relative abundance of carbon dioxide species (carbonate and bicarbonate), the inconsistency is the result of a slight uptake of carbon dioxide from the air by the sample between measurement of pH in the field and determination of carbonate and bicarbonate in the laboratory.

WATER RESOURCES DATA—CALIFORNIA, WATER YEAR 2002

For chemical-quality stations equipped with digital monitors, the records consist of daily maximum and minimum values for each constituent measured and are based on hourly punches beginning at 0100 hours and ending at 2400 hours for the day of record. More detailed records (hourly values) may be obtained from the District Office.

Historical and current (2002) dissolved trace-element concentrations are reported herein for water that was collected, processed, and analyzed by using either ultraclean or other than ultraclean techniques. If ultraclean techniques were used, then those concentrations are reported in nanograms per liter (ng/L). If other than ultraclean techniques were used, then those concentrations are reported in micrograms per liter ($\mu\text{g/L}$) and could reflect contamination introduced during some phase of the procedure.

Water Temperature

Water temperatures are measured at the water-quality stations. In addition, water temperatures are taken at time of discharge measurements for water-discharge stations. For stations where water temperatures are taken manually once or twice daily, the water temperatures are taken at about the same time each day. Large streams have a small diurnal temperature change; shallow streams may have a daily range of several degrees and may follow closely the changes in air temperature. Some streams may be affected by waste-heat discharges.

At stations where recording instruments are used, either mean temperatures or maximum and minimum temperatures for each day are published. Water temperatures measured at the time of water-discharge measurements are on file in the District Office.

Sediment

Suspended-sediment concentrations are determined from samples collected by using depth-integrating samplers. Samples usually are obtained at several verticals in the cross section, or a single sample may be obtained at a fixed point and a coefficient applied to determine the mean concentration in the cross section.

During periods of rapidly changing flow or rapidly changing concentration, samples may have been collected more frequently (twice daily or, in some instances, hourly). The published sediment discharges for days of rapidly changing flow or concentration were computed by the subdivided-day method (time-discharge weighted average). Therefore, for those days when the published sediment discharge value differs from the value computed as the product of discharge times mean concentration times 0.0027, the reader can assume that the sediment discharge for that day was computed by the subdivided-day method. For periods when no samples were collected, daily discharges of suspended sediment were estimated on the basis of water discharge, sediment concentrations measured immediately before and after the periods, and suspended-sediment loads for other periods of similar discharge. Methods used in the computation of sediment records are described in the TWRI Book 3, Chapters C1 and C3. These methods are consistent with the ASTM standards and generally follow ISO standards.

At other stations, suspended-sediment samples were collected periodically at many verticals in the stream cross section. Although data collected periodically may represent conditions only at the time of observation, such data are useful in establishing seasonal relations between quality and streamflow and in predicting long-term sediment-discharge characteristics of the stream.

In addition to the records of suspended-sediment discharge, records of the periodic measurements of the particle-size distribution of suspended sediment, bed material, and bed load are included for some stations.

Estimates of bed-load and total-sediment discharge are included for some stations. Computations of monthly bed-load discharges are based on the relation between instantaneous water discharge and corresponding bed-load discharge for the station. Values of bed-load discharge used in defining this relation are based on samples obtained by use of the Helley-Smith or BL 84 bed-load samplers or by modified-Einstein or Meyer-Peter Muller computation procedures. Application of the bed-load-transport relation at a station was made on a daily basis or subdivided-day basis. The bed-load samplers are designed to collect time-weighted samples for the sediment moving within 0.25 ft of the streambed. Sediment moving in this portion of the flow cannot be sampled with standard suspended-sediment samplers. Calibration of the bed-load samplers has not been completed, and a trap efficiency of 1.0 has been assumed applicable to these devices. Error sources in the theoretical methods, based on analysis of bed-material characteristics, channel geometry, and associated hydraulic factors, are also undefined. In consequence, figures of bed-load discharge must be used with caution. They are estimates, at best, and are subject to revision.

Cross-Sectional Data

Cross-sectional surveys of water temperature, pH, specific conductance, dissolved oxygen, and suspended sediment are done at all NASQAN, NAWQA, and Hydrologic Benchmark Stations during various seasons and surface-water discharges. Documentation of cross-section variation of water quality is essential in order to determine how many samples in a cross section are necessary to ensure a representative composite sample.

Laboratory Measurements

Sediment samples, biochemical-oxygen-demand (BOD) samples, indicator-bacteria samples, and daily specific-conductance samples are analyzed locally. All other samples are analyzed in the U.S. Geological Survey's National Water-Quality Laboratory in Arvada, Colorado. Methods used to analyze sediment samples and to compute sediment records are described in the Techniques of Water-Resources Investigations, Book 5, Chapter C1. Methods used by the U.S. Geological Survey laboratories are given in TWRI Book 1, Chapter D2; Book 3, Chapter C2; and Book 5, Chapters A1, A3, A4, and A5. These methods are consistent with ASTM standards and generally follow ISO standards.

WATER RESOURCES DATA—CALIFORNIA, WATER YEAR 2002

Quality-Control Data

Data generated from quality-control (QC) samples are a requisite for evaluating the quality of the sampling and processing techniques as well as data from the actual samples themselves. Without QC data, environmental sample data cannot be adequately interpreted because the errors associated with the sample data are unknown. The various types of QC samples collected by this District are described in the following section. Procedures have been established for the storage of water quality-control data within the U.S. Geological Survey. These procedures allow for storage of all derived QC data and are identified so that they can be related to corresponding environmental samples.

Blank Samples

Blank samples are collected and analyzed to ensure that environmental samples have not been contaminated by the overall data-collection process. The blank solution used to develop specific types of blank samples is a solution that is free of the analytes of interest. Any measured value signal in blank samples for an analyte (a specific component measured in a chemical analysis) that was absent in the blank solution is believed to be due to contamination. There are many types of blank samples possible, each designed to segregate a different part of the overall data-collection process. The types of blank samples collected in this District are:

Source solution blank — a blank solution that is transferred to a sample bottle in an area of the office laboratory with an atmosphere that is relatively clean and protected with respect to target analytes.

Ambient blank — a blank solution that is put in the same type of bottle used for an environmental sample, kept with the set of sample bottles before sample collection, and opened at the site and exposed to the ambient conditions.

Field blank — a blank solution that is subjected to all aspects of sample collection, field processing preservation, transportation, and laboratory handling as an environmental sample.

Trip blank — a blank solution that is put in the same type of bottle used for an environmental sample and kept with the set of sample bottles before and after sample collection.

Equipment blank — a blank solution that is processed through all equipment used for collecting and processing an environmental sample (similar to a field blank but normally done in the more controlled conditions of the office).

Sampler blank — a blank solution that is poured or pumped through the same field sampler used for collecting an environmental sample.

Pump blank — a blank solution that is processed through the same pump-and-tubing system used for an environmental sample.

Standpipe blank — a blank solution that is poured from the containment vessel (stand-pipe) before the pump is inserted to obtain the pump blank.

Filter blank — a blank solution that is filtered in the same manner and through the same filter apparatus used for an environmental sample.

Splitter blank — a blank solution that is mixed and separated using a field splitter in the same manner and through the same apparatus used for an environmental sample.

Preservation blank — a blank solution that is treated with the sampler preservatives used for an environmental sample.

Canister blank — a blank solution that is taken directly from a stainless steel canister just before the VOC sampler is submerged to obtain a field blank sample.

Reference Samples

Reference material is a solution or material prepared by a laboratory whose composition is certified for one or more properties so that it can be used to assess a measurement method. Samples of reference material are submitted for analysis to ensure that an analytical method is accurate for the known properties of the reference material. Generally, the selected reference material properties are similar to the environmental sample properties.

Replicate Samples

Replicate samples are a set of environmental samples collected in a manner such that the samples are thought to be essentially identical in composition. Replicate is the general case for which a duplicate is the special case consisting of two samples. Replicate samples are collected and analyzed to establish the amount of variability in the data contributed by some part of the collection and analytical process. There are many types of replicate samples possible, each of which may yield slightly different results in a dynamic hydrologic setting, such as a flowing stream. The types of replicate samples collected in this District are:

Concurrent sample — a type of replicate sample in which the samples are collected simultaneously with two or more samplers or by using one sampler and alternating collection of samples into two or more compositing containers.

Sequential sample — a type of replicate sample in which the samples are collected one after the other, typically over a short time.

Split sample — a type of replicate sample in which a sample is split into subsamples contemporaneous in time and space.

Spike Samples

Spike samples are samples to which known quantities of a solution with one or more well-established analyte concentrations have been added. These samples are analyzed to determine the extent of matrix interference or degradation on the analyte concentration during sample processing and analysis.

WATER RESOURCES DATA—CALIFORNIA, WATER YEAR 2002

Concurrent sample — a type of spike sample that is collected at the same time with the same sampling and compositing devices then spiked with the same spike solution containing laboratory-certified concentrations of selected analytes.

Split sample — a type of spike sample in which a sample is split into subsamples contemporaneous in time and space then spiked with the same spike solution containing laboratory-certified concentrations of selected analytes.

Data Presentation

For continuing-record stations, information pertinent to the history of station operation is provided in descriptive headings preceding the tabular data. These descriptive headings give details regarding location, drainage area, period of record, type of data available, instrumentation, general remarks, cooperation, and extremes for parameters currently measured daily. Tables of chemical, physical, biological, radiochemical data, and other data obtained at a frequency less than daily are presented first. Tables of "daily values" of specific conductance, pH, water temperature, dissolved oxygen, and suspended sediment follow in sequence.

In the descriptive headings, if the location is identical to that of the discharge gaging station, neither the LOCATION nor the DRAINAGE AREA statements are repeated. The following information, as appropriate, is provided with each continuous-record station. Comments that follow clarify information presented under the various headings of the station description.

LOCATION.—See Data Presentation under "Records of Stage and Water Discharge"; same comments apply.

DRAINAGE AREA.—See Data Presentation under "Records of Stage and Water Discharge"; same comments apply.

PERIOD OF RECORD.—This indicates the periods for which there are published water-quality records for the station. The periods are shown separately for records of parameters measured daily or continuously and those measured less than daily. For those measured daily or continuously, periods of record are given for the individual parameters.

INSTRUMENTATION.—Information on instrumentation is given only if a water-quality monitor, temperature recorder, sediment-pumping sampler, or other sampling device is in operation at a station.

REMARKS.—Remarks provide added information pertinent to the collection, analysis, or computation of the records.

COOPERATION.—Records provided by a cooperating organization or obtained for the U.S. Geological Survey by a cooperating organization are identified here.

EXTREMES.—Maximums and minimums are given only for parameters measured daily or more frequently. None are given for parameters measured weekly or less frequently because the true maximums or minimums may not have been sampled. Extremes, when given, are provided for both the period of record and for the current water year.

REVISIONS.—If errors in water-quality records are discovered after publication, appropriate updates are made to the Water-Quality File in the U.S. Geological Survey's computerized data system, National Water Information System (NWIS), and subsequently by monthly transfer of update transactions to the U.S. Environmental Protection Agency's STORET system. Because the usual volume of updates makes it impractical to document individual changes in the State data-report series or elsewhere, potential users of U.S. Geological Survey water-quality data are encouraged to obtain all required data from the appropriate computer file to ensure the most recent updates.

The surface-water-quality records for partial-record stations and miscellaneous sampling sites are published in separate tables following the table of discharge measurements at miscellaneous sites. No descriptive statements are given for these records. Each station is published with its own station number and name in the regular downstream-order sequence.

ACCESS TO USGS WATER DATA

The U.S. Geological Survey provides near real-time stage and discharge data for many of the gaging stations equipped with the necessary telemetry and historic daily-mean and peak-flow discharge data for most current or discontinued gaging stations through the world wide web (WWW). These data may be accessed at

<http://water.usgs.gov>.

Some water-quality and ground-water data also are available through the WWW. In addition, data can be provided in various machine-readable formats on magnetic tape or 3-1/2 inch floppy disk. Information about the availability of specific types of additional data or products, and user charges, can be obtained locally from each of the Water Resources Division District Offices. (See address on the back of the title page.)

DEFINITION OF TERMS

Specialized technical terms related to streamflow, water-quality, and other hydrologic data, as used in this report, are defined below. Definitions of common terms such as algae, water level, and precipitation are given in standard dictionaries. Not all terms defined in this alphabetical list apply to every State. See also table for converting inch/pound units to International System (SI) Units on the inside of the back cover.

Acid neutralizing capacity (ANC) is the equivalent sum of all bases or base-producing materials, solutes plus particulates, in an aqueous system that can be titrated with acid to an equivalence point. This term designates titration of an "unfiltered" sample (formerly reported as alkalinity).

Acre-foot (AC-FT, acre-ft) is a unit of volume, commonly used to measure quantities of water used or stored, equivalent to the volume of water required to cover 1 acre to a depth of 1 foot and equivalent to 43,560 cubic feet, 325,851 gallons, or 1,233 cubic meters. (See also "[Annual runoff](#)")

Adenosine triphosphate (ATP) is an organic, phosphate-rich compound important in the transfer of energy in organisms. Its central role in living cells makes ATP an excellent indicator of the presence of living material in water. A measurement of ATP therefore provides a sensitive and rapid estimate of biomass. ATP is reported in micrograms per liter.

Algal growth potential (AGP) is the maximum algal dry weight biomass that can be produced in a natural water sample under standardized laboratory conditions. The growth potential is the algal biomass present at stationary phase and is expressed as milligrams dry weight of algae produced per liter of sample. (See also "[Biomass](#)" and "[Dry weight](#)")

Alkalinity is the capacity of solutes in an aqueous system to neutralize acid. This term designates titration of a "filtered" sample.

Annual runoff is the total quantity of water that is discharged ("runs off") from a drainage basin in a year. Data reports may present annual runoff data as volumes in acre-feet, as discharges per unit of drainage area in cubic feet per second per square mile, or as depths of water on the drainage basin in inches.

Annual 7-day minimum is the lowest mean value for any 7-consecutive-day period in a year. Annual 7-day minimum values are reported herein for the calendar year and the water year (October 1 through September 30). Most low-flow frequency analyses use a climatic year (April 1–March 31), which tends to prevent the low-flow period from being artificially split between adjacent years. The date shown in the summary statistics table is the initial date of the 7-day period. (This value should not be confused with the 7-day 10-year low-flow statistic.)

Aroclor is the registered trademark for a group of polychlorinated biphenyls that were manufactured by the Monsanto Company prior to 1976. Aroclors are assigned specific 4-digit reference numbers dependent upon molecular type and degree of substitution of the biphenyl ring hydrogen atoms by chlorine atoms. The first two digits of a numbered aroclor represent the molecular type, and the last two digits represent the percentage weight of the hydrogen-substituted chlorine.

Artificial substrate is a device that is purposely placed in a stream or lake for colonization of organisms. The artificial substrate simplifies the community structure by standardizing the substrate from which each sample is collected. Examples of artificial substrates are basket samplers (made of wire cages filled with clean streamside rocks) and multiplate samplers (made of hardboard) for benthic organism collection, and plexiglass strips for periphyton collection. (See also "[Substrate](#)")

Ash mass is the mass or amount of residue present after the residue from the dry mass determination has been ashed in a muffle furnace at a temperature of 500°C for 1 hour. Ash mass of zooplankton and phytoplankton is expressed in grams per cubic meter (g/m^3), and periphyton and benthic organisms in grams per square meter (g/m^2). (See also "[Biomass](#)" and "[Dry mass](#)")

Aspect is the direction toward which a slope faces with respect to the compass.

Bacteria are microscopic unicellular organisms, typically spherical, rodlike, or spiral and threadlike in shape, often clumped into colonies. Some bacteria cause disease, whereas others perform an essential role in nature in the recycling of materials; for example, by decomposing organic matter into a form available for reuse by plants.

Bankfull stage, as used in this report, is the stage at which a stream first overflows its natural banks formed by floods with 1- to 3-year recurrence intervals.

Base discharge (for peak discharge) is a discharge value, determined for selected stations, above which peak discharge data are published. The base discharge at each station is selected so that an average of about three peak flows per year will be published. (See also "[Peak flow](#)")

Base flow is sustained flow of a stream in the absence of direct runoff. It includes natural and human-induced streamflows. Natural base flow is sustained largely by ground-water discharge.

Bedload is material in transport that is supported primarily by the streambed. In this report, bedload is considered to consist of particles in transit from the bed to an elevation equal to the top of the bedload sampler nozzle (ranging from 0.25 to 0.5 foot) that are retained in the bedload sampler. A sample collected with a pressure-differential bedload sampler also may contain a component of the suspended load.

Bedload discharge (tons per day) is the rate of sediment moving as bedload, reported as dry weight, that passes through a cross section in a given time. NOTE: Bedload discharge values in this report may include a component of the suspended-sediment discharge. A correction may be necessary when computing the total sediment discharge by summing the bedload discharge and the suspended-sediment discharge. (See also "[Bedload](#)," "[Dry weight](#)," "[Sediment](#)," and "[Suspended-sediment discharge](#)")

WATER RESOURCES DATA—CALIFORNIA, WATER YEAR 2002

Bed material is the sediment mixture of which a streambed, lake, pond, reservoir, or estuary bottom is composed. (See also "Bedload" and "Sediment")

Benthic organisms are the group of organisms inhabiting the bottom of an aquatic environment. They include a number of types of organisms, such as bacteria, fungi, insect larvae and nymphs, snails, clams, and crayfish. They are useful as indicators of water quality.

Biochemical oxygen demand (BOD) is a measure of the quantity of dissolved oxygen, in milligrams per liter, necessary for the decomposition of organic matter by microorganisms, such as bacteria.

Biomass is the amount of living matter present at any given time, expressed as mass per unit area or volume of habitat.

Biomass pigment ratio is an indicator of the total proportion of periphyton that are autotrophic (plants). This is also called the Autotrophic Index.

Blue-green algae (*Cyanophyta*) are a group of phytoplankton organisms having a blue pigment, in addition to the green pigment called chlorophyll. Blue-green algae often cause nuisance conditions in water. Concentrations are expressed as a number of cells per milliliter (cells/mL) of sample. (See also "Phytoplankton")

Bottom material (See "Bed material")

Bulk electrical conductivity is the combined electrical conductivity of all material within a doughnut-shaped volume surrounding an induction probe. Bulk conductivity is affected by different physical and chemical properties of the material including the dissolved solids content of the pore water and lithology and porosity of the rock.

Cells/volume refers to the number of cells of any organism that is counted by using a microscope and grid or counting cell. Many planktonic organisms are multicelled and are counted according to the number of contained cells per sample volume, and are generally reported as cells or units per milliliter (mL) or liter (L).

Cells volume (biovolume) determination is one of several common methods used to estimate biomass of algae in aquatic systems. Cell members of algae are frequently used in aquatic surveys as an indicator of algal production. However, cell numbers alone cannot represent true biomass because of considerable cell-size variation among the algal species. Cell volume (μm^3) is determined by obtaining critical cell measurements or cell dimensions (for example, length, width, height, or radius) for 20 to 50 cells of each important species to obtain an average biovolume per cell. Cells are categorized according to the correspondence of their cellular shape to the nearest geometric solid or combinations of simple solids (for example, spheres, cones, or cylinders). Representative formulae used to compute biovolume are as follows:

$$\text{sphere } \frac{4}{3} \pi r^3 \quad \text{cone } \frac{1}{3} \pi r^2 h \quad \text{cylinder } \pi r^2 h.$$

pi (π) is the ratio of the circumference to the diameter of a circle; $\pi = 3.14159\dots$

From cell volume, total algal biomass expressed as biovolume ($\mu\text{m}^3/\text{mL}$) is thus determined by multiplying the number of cells of a given species by its average cell volume and then summing these volumes for all species.

Cfs-day (See "Cubic foot per second-day")

Channel bars, as used in this report, are the lowest prominent geomorphic features higher than the channel bed.

Chemical oxygen demand (COD) is a measure of the chemically oxidizable material in the water and furnishes an approximation of the amount of organic and reducing material present. The determined value may correlate with BOD or with carbonaceous organic pollution from sewage or industrial wastes. [See also "Biochemical oxygen demand (BOD)"]

***Clostridium perfringens* (*C. perfringens*)** is a spore-forming bacterium that is common in the feces of human and other warmblooded animals. Clostridial spores are being used experimentally as an indicator of past fecal contamination and presence of microorganisms that are resistant to disinfection and environmental stresses. (See also "Bacteria")

Coliphages are viruses that infect and replicate in coliform bacteria. They are indicative of sewage contamination of water and of the survival and transport of viruses in the environment.

Color unit is produced by 1 milligram per liter of platinum in the form of the chloroplatinate ion. Color is expressed in units of the platinum-cobalt scale.

Confined aquifer is a term used to describe an aquifer containing water between two relatively impermeable boundaries. The water level in a well tapping a confined aquifer stands above the top of the confined aquifer and can be higher or lower than the water table that may be present in the material above it. In some cases, the water level can rise above the ground surface, yielding a flowing well.

Contents is the volume of water in a reservoir or lake. Unless otherwise indicated, volume is computed on the basis of a level pool and does not include bank storage.

Continuous-record station is a site where data are collected with sufficient frequency to define daily mean values and variations within a day.

Control designates a feature in the channel that physically affects the water-surface elevation and thereby determines the stage-discharge relation at the gage. This feature may be a constriction of the channel, a bedrock outcrop, a gravel bar, an artificial structure, or a uniform cross section over a long reach of the channel.

Control structure, as used in this report, is a structure on a stream or canal that is used to regulate the flow or stage of the stream or to prevent the intrusion of saltwater.

Cubic foot per second (CFS, ft^3/s) is the rate of discharge representing a volume of 1 cubic foot passing a given point in 1 second. It is equivalent to approximately 7.48 gallons per second or approximately 449 gallons per minute, or 0.02832 cubic meters per second. The term "second-foot" sometimes is used synonymously with "cubic foot per second" but is now obsolete.

Cubic foot per second-day (CFS-DAY, Cfs-day, [(ft³/s)/d]) is the volume of water represented by a flow of 1 cubic foot per second for 24 hours. It is equivalent to 86,400 cubic feet, 1.98347 acre-feet, 646,317 gallons, or 2,446.6 cubic meters. The daily mean discharges reported in the daily value data tables are numerically equal to the daily volumes in cfs-days, and the totals also represent volumes in cfs-days.

Cubic foot per second per square mile [CFSM, (ft³/s)/mi²] is the average number of cubic feet of water flowing per second from each square mile of area drained, assuming the runoff is distributed uniformly in time and area. (See also "[Annual runoff](#)")

Daily mean suspended-sediment concentration is the time-weighted concentration of suspended sediment passing a stream cross section during a 24-hour day. (See also "[Sediment](#)" and "[Suspended-sediment concentration](#)")

Daily-record station is a site where data are collected with sufficient frequency to develop a record of one or more data values per day. The frequency of data collection can range from continuous recording to periodic sample or data collection on a daily or near-daily basis.

Data Collection Platform (DCP) is an electronic instrument that collects, processes, and stores data from various sensors, and transmits the data by satellite data relay, line-of-sight radio, and/or landline telemetry.

Data logger is a microprocessor-based data acquisition system designed specifically to acquire, process, and store data. Data are usually downloaded from onsite data loggers for entry into office data systems.

Datum is a surface or point relative to which measurements of height and/or horizontal position are reported. A vertical datum is a horizontal surface used as the zero point for measurements of gage height, stage, or elevation; a horizontal datum is a reference for positions given in terms of latitude-longitude, State Plane coordinates, or UTM coordinates. (See also "[Gage datum](#)", "[Land-surface datum](#)", "[National Geodetic Vertical Datum of 1929](#)", and "[North American Vertical Datum of 1988](#)")

Diatoms are the unicellular or colonial algae having a siliceous shell. Their concentrations are expressed as number of cells per milliliter (cells/mL) of sample. (See also "[Phytoplankton](#)")

Diel is of or pertaining to a 24-hour period of time; a regular daily cycle.

Discharge, or flow, is the rate that matter passes through a cross section of a stream channel or other water body per unit of time. The term commonly refers to the volume of water (including, unless otherwise stated, any sediment or other constituents suspended or dissolved in the water) that passes a cross section in a stream channel, canal, pipeline, etc., within a given period of time (cubic feet per second). Discharge also can apply to the rate at which constituents, such as suspended sediment, bedload, and dissolved or suspended chemicals, pass through a cross section, in which cases the quantity is expressed as the mass of constituent that passes the cross section in a given period of time (tons per day).

Dissolved refers to that material in a representative water sample that passes through a 0.45-micrometer membrane filter. This is a convenient operational definition used by Federal and State agencies that collect water-quality data. Determinations of "dissolved" constituent concentrations are made on sample water that has been filtered.

Dissolved oxygen (DO) is the molecular oxygen (oxygen gas) dissolved in water. The concentration in water is a function of atmospheric pressure, temperature, and dissolved-solids concentration of the water. The ability of water to retain oxygen decreases with increasing temperature or dissolved-solids concentration. Photosynthesis and respiration by plants commonly cause diurnal variations in dissolved-oxygen concentration in water from some streams.

Dissolved-solids concentration in water is the quantity of dissolved material in a sample of water. It is determined either analytically by the "residue-on-evaporation" method, or mathematically by totaling the concentrations of individual constituents reported in a comprehensive chemical analysis. During the analytical determination, the bicarbonate (generally a major dissolved component of water) is converted to carbonate. In the mathematical calculation, the bicarbonate value, in milligrams per liter, is multiplied by 0.4926 to convert it to carbonate. Alternatively, alkalinity concentration (as mg/L CaCO₃) can be converted to carbonate concentration by multiplying by 0.60.

Diversity index (H) (Shannon index) is a numerical expression of evenness of distribution of aquatic organisms. The formula for diversity index is:

$$\bar{d} = - \sum_{i \approx 1}^s \frac{n_i}{n} \log_2 \frac{n_i}{n},$$

where n_i is the number of individuals per taxon, n is the total number of individuals, and s is the total number of taxa in the sample of the community. Index values range from zero, when all the organisms in the sample are the same, to some positive number, when some or all of the organisms in the sample are different.

Drainage area of a stream at a specific location is that area upstream from the location, measured in a horizontal plane, that has a common outlet at the site for its surface runoff from precipitation that normally drains by gravity into a stream. Drainage areas given herein include all closed basins, or noncontributing areas, within the area unless otherwise specified.

Drainage basin is a part of the Earth's surface that contains a drainage system with a common outlet for its surface runoff. (See "[Drainage area](#)")

Dry mass refers to the mass of residue present after drying in an oven at 105°C, until the mass remains unchanged. This mass represents the total organic matter, ash and sediment, in the sample. Dry-mass values are expressed in the same units as ash mass. (See also "[Ash mass](#)", "[Biomass](#)", and "[Wet mass](#)")

Dry weight refers to the weight of animal tissue after it has been dried in an oven at 65°C until a constant weight is achieved. Dry weight represents total organic and inorganic matter in the tissue. (See also "[Wet weight](#)")

Embeddedness is the degree to which gravel-sized and larger particles are surrounded or enclosed by finer-sized particles. (See also "[Substrate embeddedness class](#)")

WATER RESOURCES DATA—CALIFORNIA, WATER YEAR 2002

Enterococcus bacteria are commonly found in the feces of humans and other warmblooded animals. Although some strains are ubiquitous and not related to fecal pollution, the presence of enterococci in water is an indication of fecal pollution and the possible presence of enteric pathogens. Enterococcus bacteria are those bacteria that produce pink to red colonies with black or reddish-brown precipitate after incubation at 41°C on mE agar (nutrient medium for bacterial growth) and subsequent transfer to EIA medium. Enterococci include *Streptococcus feacalis*, *Streptococcus feacium*, *Streptococcus avium*, and their variants. (See also "[Bacteria](#)")

EPT Index is the total number of distinct taxa within the insect orders Ephemeroptera, Plecoptera, and Trichoptera. This index summarizes the taxa richness within the aquatic insects that are generally considered pollution sensitive, the index usually decreases with pollution.

Escherichia coli (E. coli) are bacteria present in the intestine and feces of warmblooded animals. *E. coli* are a member species of the fecal coliform group of indicator bacteria. In the laboratory, they are defined as those bacteria that produce yellow or yellow-brown colonies on a filter pad saturated with urea substrate broth after primary culturing for 22 to 24 hours at 44.5°C on mTEC medium (nutrient medium for bacterial growth). Their concentrations are expressed as number of colonies per 100 mL of sample. (See also "[Bacteria](#)")

Estimated (E) concentration value is reported when an analyte is detected and all criteria for a positive result are met. If the concentration is less than the method detection limit (MDL), an 'E' code will be reported with the value. If the analyte is qualitatively identified as present, but the quantitative determination is substantially more uncertain, the National Water Quality Laboratory will identify the result with an 'E' code even though the measured value is greater than the MDL. A value reported with an 'E' code should be used with caution. When no analyte is detected in a sample, the default reporting value is the MDL preceded by a less than sign (<).

Euglenoids (Euglenophyta) are a group of algae that are usually free-swimming and rarely creeping. They have the ability to grow either photosynthetically in the light or heterotrophically in the dark. (See also "[Phytoplankton](#)")

Extractable organic halides (EOX) are organic compounds that contain halogen atoms such as chlorine. These organic compounds are semivolatile and extractable by ethyl acetate from air-dried streambed sediment. The ethyl acetate extract is combusted, and the concentration is determined by microcoulometric determination of the halides formed. The concentration is reported as micrograms of chlorine per gram of the dry weight of the streambed sediment.

Fecal coliform bacteria are present in the intestines or feces of warmblooded animals. They often are used as indicators of the sanitary quality of the water. In the laboratory, they are defined as all organisms that produce blue colonies within 24 hours when incubated at 44.5°C plus or minus 0.2°C on M-FC medium (nutrient medium for bacterial growth). Their concentrations are expressed as number of colonies per 100 mL of sample. (See also "[Bacteria](#)")

Fecal streptococcal bacteria are present in the intestines of warmblooded animals and are ubiquitous in the environment. They are characterized as gram-positive, cocci bacteria that are capable of growth in brain-heart infusion broth. In the laboratory, they are defined as all the organisms that produce red or pink colonies within 48 hours at 35°C plus or minus 1.0°C on KF-streptococcus medium (nutrient medium for bacterial growth). Their concentrations are expressed as number of colonies per 100 mL of sample. (See also "[Bacteria](#)")

Fire algae (Pyrrhophyta) are free-swimming unicells characterized by a red pigment spot. (See also "[Phytoplankton](#)")

Flow-duration percentiles are values on a scale of 100 that indicate the percentage of time for which a flow is not exceeded. For example, the 90th percentile of river flow is greater than or equal to 90 percent of all recorded flow rates.

Gage datum is a horizontal surface used as a zero point for measurement of stage or gage height. This surface usually is located slightly below the lowest point of the stream bottom such that the gage height is usually slightly greater than the maximum depth of water. Because the gage datum itself is not an actual physical object, the datum usually is defined by specifying the elevations of permanent reference marks such as bridge abutments and survey monuments, and the gage is set to agree with the reference marks. Gage datum is a local datum that is maintained independently of any national geodetic datum. However, if the elevation of the gage datum relative to the national datum (North American Vertical Datum of 1988 or National Geodetic Vertical Datum of 1929) has been determined, then the gage readings can be converted to elevations above the national datum by adding the elevation of the gage datum to the gage reading.

Gage height (G.H.) is the water-surface elevation, in feet above the gage datum. If the water surface is below the gage datum, the gage height is negative. Gage height often is used interchangeably with the more general term "stage," although gage height is more appropriate when used in reference to a reading on a gage.

Gage values are values that are recorded, transmitted, and/or computed from a gaging station. Gage values typically are collected at 5-, 15-, or 30-minute intervals.

Gaging station is a site on a stream, canal, lake, or reservoir where systematic observations of stage, discharge, or other hydrologic data are obtained.

Gas chromatography/flame ionization detector (GC/FID) is a laboratory analytical method used as a screening technique for semivolatile organic compounds that are extractable from water in methylene chloride.

Geomorphic channel units, as used in this report, are fluvial geomorphic descriptors of channel shape and stream velocity. Pools, riffles, and runs are types of geomorphic channel units considered for National Water-Quality Assessment (NAWQA) Program habitat sampling.

Green algae have chlorophyll pigments similar in color to those of higher green plants. Some forms produce algae mats or floating "moss" in lakes. Their concentrations are expressed as number of cells per milliliter (cells/mL) of sample. (See also "[Phytoplankton](#)")

Habitat, as used in this report, includes all nonliving (physical) aspects of the aquatic ecosystem, although living components like aquatic macrophytes and riparian vegetation also are usually included. Measurements of habitat are typically made over a wider geographic scale than are measurements of species distribution.

Habitat quality index is the qualitative description (level 1) of instream habitat and riparian conditions surrounding the reach sampled. Scores range from 0 to 100 percent with higher scores indicative of desirable habitat conditions for aquatic life. Index only applicable to wadable streams.

Hardness of water is a physical-chemical characteristic that commonly is recognized by the increased quantity of soap required to produce lather. It is computed as the sum of equivalents of polyvalent cations (primarily calcium and magnesium) and is expressed as the equivalent concentration of calcium carbonate (CaCO_3).

High tide is the maximum height reached by each rising tide. The high-high and low-high tides are the higher and lower of the two high tides, respectively, of each tidal day. See NOAA web site:

<http://www.co-ops.nos.noaa.gov/tideglos.html>

Hilsenhoff's Biotic Index (HBI) is an indicator of organic pollution that uses tolerance values to weight taxa abundances; usually increases with pollution. It is calculated as follows:

$$HBI = \frac{\sum(n)(a)}{N},$$

where n is the number of individuals of each taxon, a is the tolerance value of each taxon, and N is the total number of organisms in the sample.

Horizontal datum (See "Datum")

Hydrologic index stations referred to in this report are continuous-record gaging stations that have been selected as representative of streamflow patterns for their respective regions. Station locations are shown on index maps.

Hydrologic unit is a geographic area representing part or all of a surface drainage basin or distinct hydrologic feature as defined by the former Office of Water Data Coordination and delineated on the State Hydrologic Unit Maps by the USGS. Each hydrologic unit is identified by an 8-digit number.

Inch (IN., in.), as used in this report, refers to the depth to which the drainage area would be covered with water if all of the runoff for a given time period were uniformly distributed on it. (See also "Annual runoff")

Instantaneous discharge is the discharge at a particular instant of time. (See also "Discharge")

Island, as used in this report, is a mid-channel bar that has permanent woody vegetation, is flooded once a year on average, and remains stable except during large flood events.

Laboratory Reporting Level (LRL) is generally equal to twice the yearly determined long-term method detection level (LT-MDL). The LRL controls false negative error. The probability of falsely reporting a nondetection for a sample that contained an analyte at a concentration equal to or greater than the LRL is predicted to be less than or equal to 1 percent. The value of the LRL will be reported with a "less than" (<) remark code for samples in which the analyte was not detected. The National Water Quality Laboratory (NWQL) collects quality-control data from selected analytical methods on a continuing basis to determine LT-MDLs and to establish LRLs. These values are reevaluated annually on the basis of the most current quality-control data and, therefore, may change. [Note: In several previous NWQL documents (NWQL Technical Memorandum 98.07, 1998), the LRL was called the nondetection value or NDV—a term that is no longer used.]

Land-surface datum (lsd) is a datum plane that is approximately at land surface at each ground-water observation well.

Latent heat flux (often used interchangeably with latent heat-flux density) is the amount of heat energy that converts water from liquid to vapor (evaporation) or from vapor to liquid (condensation) across a specified cross-sectional area per unit time. Usually expressed in watts per square meter.

Light-attenuation coefficient, also known as the extinction coefficient, is a measure of water clarity. Light is attenuated according to the Lambert-Beer equation

$$I = I_o e^{-\lambda L},$$

where I_o is the source light intensity, I is the light intensity at length L (in meters) from the source, λ is the light-attenuation coefficient, and e is the base of the natural logarithm. The light-attenuation coefficient is defined as

$$\lambda = -\frac{1}{L} \log_e \frac{I}{I_o}$$

Lipid is any one of a family of compounds that are insoluble in water and that make up one of the principal components of living cells. Lipids include fats, oils, waxes, and steroids. Many environmental contaminants such as organochlorine pesticides are lipophilic.

WATER RESOURCES DATA—CALIFORNIA, WATER YEAR 2002

Long-Term Method Detection Level (LT-MDL) is a detection level derived by determining the standard deviation of a minimum of 24 method detection limit (MDL) spike sample measurements over an extended period of time. LT-MDL data are collected on a continuous basis to assess year-to-year variations in the LT-MDL. The LT-MDL controls false positive error. The chance of falsely reporting a concentration at or greater than the LT-MDL for a sample that did not contain the analyte is predicted to be less than or equal to 1 percent.

Low tide is the minimum height reached by each falling tide. The high-low and low-low tides are the higher and lower of the two low tides, respectively, of each tidal day. *See NOAA web site:*

<http://www.co-ops.nos.noaa.gov/tideglos.html>

Macrophytes are the macroscopic plants in the aquatic environment. The most common macrophytes are the rooted vascular plants that usually are arranged in zones in aquatic ecosystems and restricted in the area by the extent of illumination through the water and sediment deposition along the shoreline.

Mean concentration of suspended sediment (Daily mean suspended-sediment concentration) is the time-weighted concentration of suspended sediment passing a stream cross section during a given time period. (See also "[Daily mean suspended-sediment concentration](#)" and "[Suspended-sediment concentration](#)")

Mean discharge (MEAN) is the arithmetic mean of individual daily mean discharges during a specific period. (See also "[Discharge](#)")

Mean high or low tide is the average of all high or low tides, respectively, over a specific period.

Mean sea level is a local tidal datum. It is the arithmetic mean of hourly heights observed over the National Tidal Datum Epoch. Shorter series are specified in the name; for example, monthly mean sea level and yearly mean sea level. In order that they may be recovered when needed, such datums are referenced to fixed points known as benchmarks. (See also "[Datum](#)")

Measuring point (MP) is an arbitrary permanent reference point from which the distance to water surface in a well is measured to obtain water level.

Membrane filter is a thin microporous material of specific pore size used to filter bacteria, algae, and other very small particles from water.

Metamorphic stage refers to the stage of development that an organism exhibits during its transformation from an immature form to an adult form. This developmental process exists for most insects, and the degree of difference from the immature stage to the adult form varies from relatively slight to pronounced, with many intermediates. Examples of metamorphic stages of insects are egg-larva-adult or egg-nymph-adult.

Method Detection Limit (MDL) is the minimum concentration of a substance that can be measured and reported with 99-percent confidence that the analyte concentration is greater than zero. It is determined from the analysis of a sample in a given matrix containing the analyte. At the MDL concentration, the risk of a false positive is predicted to be less than or equal to 1 percent.

Methylene blue active substances (MBAS) are apparent detergents. The determination depends on the formation of a blue color when methylene blue dye reacts with synthetic anionic detergent compounds.

Micrograms per gram (UG/G, $\mu\text{g/g}$) is a unit expressing the concentration of a chemical constituent as the mass (micrograms) of the element per unit mass (gram) of material analyzed.

Micrograms per kilogram (UG/KG, $\mu\text{g/kg}$) is a unit expressing the concentration of a chemical constituent as the mass (micrograms) of the constituent per unit mass (kilogram) of the material analyzed. One microgram per kilogram is equivalent to 1 part per billion.

Micrograms per liter (UG/L, $\mu\text{g/L}$) is a unit expressing the concentration of chemical constituents in water as mass (micrograms) of constituent per unit volume (liter) of water. One thousand micrograms per liter is equivalent to 1 milligram per liter. One microgram per liter is equivalent to 1 part per billion.

Microsiemens per centimeter (US/CM, $\mu\text{S/cm}$) is a unit expressing the amount of electrical conductivity of a solution as measured between opposite faces of a centimeter cube of solution at a specified temperature. Siemens is the International System of Units nomenclature. It is synonymous with mhos and is the reciprocal of resistance in ohms.

Milligrams per liter (MG/L, mg/L) is a unit for expressing the concentration of chemical constituents in water as the mass (milligrams) of constituent per unit volume (liter) of water. Concentration of suspended sediment also is expressed in milligrams per liter and is based on the mass of dry sediment per liter of water-sediment mixture.

Minimum Reporting Level (MRL) is the smallest measured concentration of a constituent that may be reliably reported by using a given analytical method.

Miscellaneous site, miscellaneous station, or miscellaneous sampling site is a site where streamflow, sediment, and/or water-quality data or water-quality or sediment samples are collected once, or more often on a random or discontinuous basis to provide better areal coverage for defining hydrologic and water-quality conditions over a broad area in a river basin.

Most probable number (MPN) is an index of the number of coliform bacteria that, more probably than any other number, would give the results shown by the laboratory examination; it is not an actual enumeration. MPN is determined from the distribution of gas-positive cultures among multiple inoculated tubes.

Multiple-plate samplers are artificial substrates of known surface area used for obtaining benthic invertebrate samples. They consist of a series of spaced, hardboard plates on an eyebolt.

Nanograms per liter (NG/L, ng/L) is a unit expressing the concentration of chemical constituents in solution as mass (nanograms) of solute per unit volume (liter) of water. One million nanograms per liter is equivalent to 1 milligram per liter.

WATER RESOURCES DATA—CALIFORNIA, WATER YEAR 2002

National Geodetic Vertical Datum of 1929 (NGVD of 1929) is a fixed reference adopted as a standard geodetic datum for elevations determined by leveling. It was formerly called "Sea Level Datum of 1929" or "mean sea level". Although the datum was derived from the mean sea level at 26 tide stations, it does not necessarily represent local mean sea level at any particular place. (See "North American Vertical Datum of 1988") See also NOAA web site:

<http://www.ngs.noaa.gov/faq.shtml#WhatVD29VD88>

Natural substrate refers to any naturally occurring immersed or submersed solid surface, such as a rock or tree, upon which an organism lives. (See also "Substrate")

Nekton are the consumers in the aquatic environment and consist of large free-swimming organisms that are capable of sustained, directed mobility.

Nephelometric turbidity unit (NTU) is the measurement for reporting turbidity that is based on use of a standard suspension of formazin. Turbidity measured in NTU uses nephelometric methods that depend on passing specific light of a specific wavelength through the sample.

North American Vertical Datum of 1988 (NAVD 1988) is a fixed reference adopted as the official civilian vertical datum for elevations determined by Federal surveying and mapping activities in the United States. This datum was established in 1991 by minimum-constraint adjustment of the Canadian, Mexican, and United States first-order terrestrial leveling networks.

Open or screened interval is the length of unscreened opening or of well screen through which water enters a well, in feet below land surface.

Organic carbon (OC) is a measure of organic matter present in aqueous solution, suspension, or bottom sediment. May be reported as dissolved organic carbon (DOC), particulate organic carbon (POC), or total organic carbon (TOC).

Organic mass or volatile mass of a living substance is the difference between the dry mass and ash mass and represents the actual mass of the living matter. Organic mass is expressed in the same units as for ash mass and dry mass. (See also "Ash mass", "Biomass", and "Dry mass")

Organism count/area refers to the number of organisms collected and enumerated in a sample and adjusted to the number per area of habitat, usually square meter (m²), acre, or hectare. Periphyton, benthic organisms, and macrophytes are expressed in these terms.

Organism count/volume refers to the number of organisms collected and enumerated in a sample and adjusted to the number per sample volume, usually milliliter (mL) or liter (L). Numbers of planktonic organisms can be expressed in these terms.

Organochlorine compounds are any chemicals that contain carbon and chlorine. Organochlorine compounds that are important in investigations of water, sediment, and biological quality include certain pesticides and industrial compounds.

Parameter Code is a 5-digit number used in the USGS computerized data system, National Water Information System (NWIS), to uniquely identify a specific constituent or property.

Partial-record station is a site where discrete measurements of one or more hydrologic parameters are obtained over a period of time without continuous data being recorded or computed. A common example is a crest-stage gage partial-record station at which only peak stages and flows are recorded.

Particle size is the diameter, in millimeters (mm), of a particle determined by sieve or sedimentation methods. The sedimentation method utilizes the principle of Stokes Law to calculate sediment particle sizes. Sedimentation methods (pipet, bottom-withdrawal tube, visual-accumulation tube, sedigraph) determine fall diameter of particles in either distilled water (chemically dispersed) or in native water (the river water at the time and point of sampling).

Particle-size classification as used in this report agrees with the recommendation made by the American Geophysical Union Subcommittee on Sediment Terminology. The classification is as follows:

Classification	Size (mm)	Method of analysis
Clay	>0.00024–0.004	Sedimentation
Silt	>.004–.062	Sedimentation
Sand	>.062–2.0	Sedimentation/sieve
Gravel.	>2.0–64.0	Sieve
Cobble	>64–256	Manual measurement
Boulder	>256	Manual measurement

The particle-size distributions given in this report are not necessarily representative of all particles in transport in the stream. For the sedimentation method, most of the organic matter is removed, and the sample is subjected to mechanical and chemical dispersion before analysis in distilled water. Chemical dispersion is not used for native water analysis.

Peak flow (peak stage) is an instantaneous local maximum value in the continuous time series of streamflows or stages, preceded by a period of increasing values and followed by a period of decreasing values. Several peak values ordinarily occur in a year. The maximum peak value in a year is called the annual peak; peaks lower than the annual peak are called secondary peaks. Occasionally, the annual peak may not be the maximum value for the year; in such cases, the maximum value occurs at midnight at the beginning or end of the year, on the recession from or rise toward a higher peak in the adjoining year. If values are recorded at

WATER RESOURCES DATA—CALIFORNIA, WATER YEAR 2002

a discrete series of times, the peak recorded value may be taken as an approximation of the true peak, which may occur between the recording instants. If the values are recorded with finite precision, a sequence of equal recorded values may occur at the peak; in this case, the first value is taken as the peak.

Percent composition or percent of total is a unit for expressing the ratio of a particular part of a sample or population to the total sample or population, in terms of types, numbers, weight, mass, or volume.

Percent shading is a measure of the amount of sunlight potentially reaching the stream. A clinometer is used to measure left and right bank canopy angles. These values are added together, divided by 180, and multiplied by 100 to compute percentage of shade.

Periodic-record station is a site where stage, discharge, sediment, chemical, physical, or other hydrologic measurements are made one or more times during a year but at a frequency insufficient to develop a daily record.

Periphyton is the assemblage of microorganisms attached to and living upon submerged solid surfaces. Although primarily consisting of algae, they also include bacteria, fungi, protozoa, rotifers, and other small organisms. Periphyton are useful indicators of water quality.

Pesticides are chemical compounds used to control undesirable organisms. Major categories of pesticides include insecticides, miticides, fungicides, herbicides, and rodenticides.

pH of water is the negative logarithm of the hydrogen-ion activity. Solutions with pH less than 7.0 standard units are termed "acidic," and solutions with a pH greater than 7.0 are termed "basic." Solutions with a pH of 7.0 are neutral. The presence and concentration of many dissolved chemical constituents found in water are affected, in part, by the hydrogen-ion activity of water. Biological processes including growth, distribution of organisms, and toxicity of the water to organisms also are affected, in part, by the hydrogen-ion activity of water.

Phytoplankton is the plant part of the plankton. They are usually microscopic, and their movement is subject to the water currents. Phytoplankton growth is dependent upon solar radiation and nutrient substances. Because they are able to incorporate as well as release materials to the surrounding water, the phytoplankton have a profound effect upon the quality of the water. They are the primary food producers in the aquatic environment and commonly are known as algae. (See also "[Plankton](#)")

Picocurie (PC, pCi) is one trillionth (1×10^{-12}) of the amount of radioactive nuclide represented by a curie (Ci). A curie is the quantity of radioactive nuclide that yields 3.7×10^{10} radioactive disintegrations per second (dps). A picocurie yields 0.037 dps, or 2.22 dpm (disintegrations per minute).

Plankton is the community of suspended, floating, or weakly swimming organisms that live in the open water of lakes and rivers. Concentrations are expressed as a number of cells per milliliter (cells/mL) of sample.

Polychlorinated biphenyls (PCBs) are industrial chemicals that are mixtures of chlorinated biphenyl compounds having various percentages of chlorine. They are similar in structure to organochlorine insecticides.

Polychlorinated naphthalenes (PCNs) are industrial chemicals that are mixtures of chlorinated naphthalene compounds. They have properties and applications similar to polychlorinated biphenyls (PCBs) and have been identified in commercial PCB preparations.

Pool, as used in this report, is a small part of a stream reach with little velocity, commonly with water deeper than surrounding areas.

Primary productivity is a measure of the rate at which new organic matter is formed and accumulated through photosynthetic and chemosynthetic activity of producer organisms (chiefly, green plants). The rate of primary production is estimated by measuring the amount of oxygen released (oxygen method) or the amount of carbon assimilated (carbon method) by the plants.

Primary productivity (carbon method) is expressed as milligrams of carbon per area per unit time [$\text{mg C}/(\text{m}^2/\text{time})$] for periphyton and macrophytes or per volume [$\text{mg C}/(\text{m}^3/\text{time})$] for phytoplankton. The carbon method defines the amount of carbon dioxide consumed as measured by radioactive carbon (carbon-14). The carbon-14 method is of greater sensitivity than the oxygen light and dark bottle method and is preferred for use with unenriched water samples. Unit time may be either the hour or day, depending on the incubation period. (See also "[Primary productivity](#)")

Primary productivity (oxygen method) is expressed as milligrams of oxygen per area per unit time [$\text{mg O}/(\text{m}^2/\text{time})$] for periphyton and macrophytes or per volume [$\text{mg O}/(\text{m}^3/\text{time})$] for phytoplankton. The oxygen method defines production and respiration rates as estimated from changes in the measured dissolved-oxygen concentration. The oxygen light and dark bottle method is preferred if the rate of primary production is sufficient for accurate measurements to be made within 24 hours. Unit time may be either the hour or day, depending on the incubation period. (See also "[Primary productivity](#)")

Radioisotopes are isotopic forms of elements that exhibit radioactivity. Isotopes are varieties of a chemical element that differ in atomic weight but are very nearly alike in chemical properties. The difference arises because the atoms of the isotopic forms of an element differ in the number of neutrons in the nucleus; for example, ordinary chlorine is a mixture of isotopes having atomic weights of 35 and 37, and the natural mixture has an atomic weight of about 35.453. Many of the elements similarly exist as mixtures of isotopes, and a great many new isotopes have been produced in the operation of nuclear devices such as the cyclotron. There are 275 isotopes of the 81 stable elements, in addition to more than 800 radioactive isotopes.

Reach, as used in this report, is a length of stream that is chosen to represent a uniform set of physical, chemical, and biological conditions within a segment. It is the principal sampling unit for collecting physical, chemical, and biological data.

Recoverable from bed (bottom) material is the amount of a given constituent that is in solution after a representative sample of bottom material has been digested by a method (usually using an acid or mixture of acids) that results in dissolution of readily soluble substances. Complete dissolution of all bottom material is not achieved by the digestion treatment and thus the determination

represents less than the total amount (that is, less than 95 percent) of the constituent in the sample. To achieve comparability of analytical data, equivalent digestion procedures would be required of all laboratories performing such analyses because different digestion procedures are likely to produce different analytical results. (See also "[Bed material](#)")

Recurrence interval, also referred to as return period, is the average time, usually expressed in years, between occurrences of hydrologic events of a specified type (such as exceedances of a specified high flow or nonexceedance of a specified low flow). The terms "return period" and "recurrence interval" do not imply regular cyclic occurrence. The actual times between occurrences vary randomly, with most of the times being less than the average and a few being substantially greater than the average. For example, the 100-year flood is the flow rate that is exceeded by the annual maximum peak flow at intervals whose average length is 100 years (that is, once in 100 years, on average); almost two-thirds of all exceedances of the 100-year flood occur less than 100 years after the previous exceedance, half occur less than 70 years after the previous exceedance, and about one-eighth occur more than 200 years after the previous exceedance. Similarly, the 7-day 10-year low flow ($7Q_{10}$) is the flow rate below which the annual minimum 7-day-mean flow dips at intervals whose average length is 10 years (that is, once in 10 years, on average); almost two-thirds of the nonexceedances of the $7Q_{10}$ occur less than 10 years after the previous nonexceedance, half occur less than 7 years after, and about one-eighth occur more than 20 years after the previous nonexceedance. The recurrence interval for annual events is the reciprocal of the annual probability of occurrence. Thus, the 100-year flood has a 1-percent chance of being exceeded by the maximum peak flow in any year, and there is a 10-percent chance in any year that the annual minimum 7-day-mean flow will be less than the $7Q_{10}$.

Replicate samples are a group of samples collected in a manner such that the samples are thought to be essentially identical in composition.

Return period (See "[Recurrence interval](#)")

Riffle, as used in this report, is a shallow part of the stream where water flows swiftly over completely or partially submerged obstructions to produce surface agitation.

River mileage is the curvilinear distance, in miles, measured upstream from the mouth along the meandering path of a stream channel in accordance with Bulletin No. 14 (October 1968) of the Water Resources Council, and typically is used to denote location along a river.

Run, as used in this report, is a relatively shallow part of a stream with moderate velocity and little or no surface turbulence.

Runoff is the quantity of water that is discharged ("runs off") from a drainage basin during a given time period. Runoff data may be presented as volumes in acre-feet, as mean discharges per unit of drainage area in cubic feet per second per square mile, or as depths of water on the drainage basin in inches. (See also "[Annual runoff](#)")

Sea level, as used in this report, refers to one of the two commonly used national vertical datums, ([NGVD 1929](#) or [NAVD 1988](#)). See separate entries for definitions of these datums. See [conversion factors and vertical datum page](#) (inside back cover) for identification of the datum used in this report.

Sediment is solid material that originates mostly from disintegrated rocks; when transported by, suspended in, or deposited from water, it is referred to as "fluvial sediment." Sediment includes chemical and biochemical precipitates and decomposed organic material, such as humus. The quantity, characteristics, and cause of the occurrence of sediment in streams are affected by environmental and land-use factors. Some major factors are topography, soil characteristics, land cover, and depth and intensity of precipitation.

Sensible heat flux (often used interchangeably with latent sensible heat-flux density) is the amount of heat energy that moves by turbulent transport through the air across a specified cross-sectional area per unit time and goes to heating (cooling) the air. Usually expressed in watts per square meter.

Seven-day 10-year low flow ($7Q_{10}$) is the discharge below which the annual 7-day minimum flow falls in 1 year out of 10 on the long-term average. The recurrence interval of the $7Q_{10}$ is 10 years; the chance that the annual 7-day minimum flow will be less than the $7Q_{10}$ is 10 percent in any given year. (See also "[Annual 7-day minimum](#)" and "[Recurrence interval](#)").

Shelves, as used in this report, are streambank features extending nearly horizontally from the flood plain to the lower limit of persistent woody vegetation.

Sodium adsorption ratio (SAR) is the expression of relative activity of sodium ions in exchange reactions within soil and is an index of sodium or alkali hazard to the soil. Sodium hazard in water is an index that can be used to evaluate the suitability of water for irrigating crops.

Soil heat flux (often used interchangeably with soil heat-flux density) is the amount of heat energy that moves by conduction across a specified cross-sectional area of soil per unit time and goes to heating (or cooling) the soil. Usually expressed in watts per square meter.

Soil-water content is the water lost from the soil upon drying to constant mass at 105°C; expressed either as mass of water per unit mass of dry soil or as the volume of water per unit bulk volume of soil.

Specific electrical conductance (conductivity) is a measure of the capacity of water (or other media) to conduct an electrical current. It is expressed in microsiemens per centimeter at 25°C. Specific electrical conductance is a function of the types and quantity of dissolved substances in water and can be used for approximating the dissolved-solids content of the water. Commonly, the concentration of dissolved solids (in milligrams per liter) is from 55 to 75 percent of the specific conductance (in microsiemens). This relation is not constant from stream to stream, and it may vary in the same source with changes in the composition of the water.

Stable isotope ratio (per MIL) is a unit expressing the ratio of the abundance of two radioactive isotopes. Isotope ratios are used in hydrologic studies to determine the age or source of specific water, to evaluate mixing of different water, as an aid in determining reaction rates, and other chemical or hydrologic processes.

Stage (See "[Gage height](#)")

WATER RESOURCES DATA—CALIFORNIA, WATER YEAR 2002

Stage-discharge relation is the relation between the water-surface elevation, termed stage (gage height), and the volume of water flowing in a channel per unit time.

Streamflow is the discharge that occurs in a natural channel. Although the term "discharge" can be applied to the flow of a canal, the word "streamflow" uniquely describes the discharge in a surface stream course. The term "streamflow" is more general than "runoff" as streamflow may be applied to discharge whether or not it is affected by diversion or regulation.

Substrate is the physical surface upon which an organism lives.

Substrate Embeddedness Class is a visual estimate of riffle streambed substrate larger than gravel that is surrounded or covered by fine sediment (<2mm, sand or finer). Below are the class categories expressed as the percentage covered by fine sediment:

0	no gravel or larger substrate
1	> 75 percent
2	51–75 percent
3	26–50 percent
4	5–25 percent
5	< 5 percent

Surface area of a lake is that area (acres) encompassed by the boundary of the lake as shown on USGS topographic maps, or other available maps or photographs. Because surface area changes with lake stage, surface areas listed in this report represent those determined for the stage at the time the maps or photographs were obtained.

Surficial bed material is the upper surface (0.1 to 0.2 foot) of the bed material that is sampled using U.S. Series Bed-Material Samplers.

Suspended (as used in tables of chemical analyses) refers to the amount (concentration) of undissolved material in a water-sediment mixture. It is defined operationally as the material retained on a 0.45-micrometer filter.

Suspended, recoverable is the amount of a given constituent that is in solution after the part of a representative suspended water-sediment sample that is retained on a 0.45-micrometer membrane filter has been digested by a method (usually using a dilute acid solution) that results in dissolution of only readily soluble substances. Complete dissolution of all the particulate matter is not achieved by the digestion treatment and thus the determination represents something less than the "total" amount (that is, less than 95 percent) of the constituent present in the sample. To achieve comparability of analytical data, equivalent digestion procedures are required of all laboratories performing such analyses because different digestion procedures are likely to produce different analytical results. Determinations of "suspended, recoverable" constituents are made either by directly analyzing the suspended material collected on the filter or, more commonly, by difference, on the basis of determinations of (1) dissolved and (2) total recoverable concentrations of the constituent. (See also "[Suspended](#)")

Suspended sediment is the sediment maintained in suspension by the upward components of turbulent currents or that exists in suspension as a colloid. (See also "[Sediment](#)")

Suspended-sediment concentration is the velocity-weighted concentration of suspended sediment in the sampled zone (from the water surface to a point approximately 0.3 foot above the bed) expressed as milligrams of dry sediment per liter of water-sediment mixture (mg/L). The analytical technique uses the mass of all of the sediment and the net weight of the water-sediment mixture in a sample to compute the suspended-sediment concentration. (See also "[Sediment](#)" and "[Suspended sediment](#)")

Suspended-sediment discharge (tons/day) is the rate of sediment transport, as measured by dry mass or volume, that passes a cross section in a given time. It is calculated in units of tons per day as follows:

$$\text{concentration (mg/L)} \times \text{discharge (ft}^3/\text{s)} \times 0.0027.$$

(See also "[Sediment](#)", "[Suspended sediment](#)", and "[Suspended-sediment concentration](#)")

Suspended-sediment load is a general term that refers to a given characteristic of the material in suspension that passes a point during a specified period of time. The term needs to be qualified, such as "annual suspended-sediment load" or "sand-size suspended-sediment load," and so on. It is not synonymous with either suspended-sediment discharge or concentration. (See also "[Sediment](#)")

Suspended, total is the total amount of a given constituent in the part of a water-sediment sample that is retained on a 0.45-micrometer membrane filter. This term is used only when the analytical procedure assures measurement of at least 95 percent of the constituent determined. Knowledge of the expected form of the constituent in the sample, as well as the analytical methodology used, is required to determine when the results should be reported as "suspended, total." Determinations of "suspended, total" constituents are made either by directly analyzing portions of the suspended material collected on the filter or, more commonly, by difference, on the basis of determinations of (1) dissolved and (2) total concentrations of the constituent. (See also "[Suspended](#)")

Suspended solids, total residue at 105°C concentration is the concentration of inorganic and organic material retained on a filter, expressed as milligrams of dry material per liter of water (mg/L). An aliquot of the sample is used for this analysis.

WATER RESOURCES DATA—CALIFORNIA, WATER YEAR 2002

Synoptic studies are short-term investigations of specific water-quality conditions during selected seasonal or hydrologic periods to provide improved spatial resolution for critical water-quality conditions. For the period and conditions sampled, they assess the spatial distribution of selected water-quality conditions in relation to causative factors, such as land use and contaminant sources.

Taxa (Species) richness is the number of species (taxa) present in a defined area or sampling unit.

Taxonomy is the division of biology concerned with the classification and naming of organisms. The classification of organisms is based upon a hierarchical scheme beginning with Kingdom and ending with Species at the base. The higher the classification level, the fewer features the organisms have in common. For example, the taxonomy of a particular mayfly, *Hexagenia limbata* is the following:

Kingdom Animal
 Phylum Arthropoda
 Class Insecta
 Order Ephemeroptera
 Family Ephemeridae
 Genus *Hexagenia*
 Species *Hexagenia limbata*

Thalweg is the line formed by connecting points of minimum streambed elevation (deepest part of the channel).

Thermograph is an instrument that continuously records variations of temperature on a chart. The more general term "temperature recorder" is used in the table descriptions and refers to any instrument that records temperature whether on a chart, a tape, or any other medium.

Time-weighted average is computed by multiplying the number of days in the sampling period by the concentrations of individual constituents for the corresponding period and dividing the sum of the products by the total number of days. A time-weighted average represents the composition of water resulting from the mixing of flow proportionally to the duration of the concentration.

Tons per acre-foot (T/acre-ft) is the dry mass (tons) of a constituent per unit volume (acre-foot) of water. It is computed by multiplying the concentration of the constituent, in milligrams per liter, by 0.00136.

Tons per day (T/DAY, tons/d) is a common chemical or sediment discharge unit. It is the quantity of a substance in solution, in suspension, or as bedload that passes a stream section during a 24-hour period. It is equivalent to 2,000 pounds per day, or 0.9072 metric tons per day.

Total is the amount of a given constituent in a representative whole-water (unfiltered) sample, regardless of the constituent's physical or chemical form. This term is used only when the analytical procedure assures measurement of at least 95 percent of the constituent present in both the dissolved and suspended phases of the sample. A knowledge of the expected form of the constituent in the sample, as well as the analytical methodology used, is required to judge when the results should be reported as "total." (Note that the word "total" does double duty here, indicating both that the sample consists of a water-suspended sediment mixture and that the analytical method determined at least 95 percent of the constituent in the sample.)

Total coliform bacteria are a particular group of bacteria that are used as indicators of possible sewage pollution. This group includes coliforms that inhabit the intestine of warmblooded animals and those that inhabit soils. They are characterized as aerobic or facultative anaerobic, gram-negative, nonspore-forming, rod-shaped bacteria that ferment lactose with gas formation within 48 hours at 35°C. In the laboratory, these bacteria are defined as all the organisms that produce colonies with a golden-green metallic sheen within 24 hours when incubated at 35°C plus or minus 1.0°C on M-Endo medium (nutrient medium for bacterial growth). Their concentrations are expressed as number of colonies per 100 milliliters of sample. (See also "[Bacteria](#)")

Total discharge is the quantity of a given constituent, measured as dry mass or volume, that passes a stream cross section per unit of time. When referring to constituents other than water, this term needs to be qualified, such as "total sediment discharge," "total chloride discharge," and so on.

Total in bottom material is the amount of a given constituent in a representative sample of bottom material. This term is used only when the analytical procedure assures measurement of at least 95 percent of the constituent determined. A knowledge of the expected form of the constituent in the sample, as well as the analytical methodology used, is required to judge when the results should be reported as "total in bottom material."

Total length (fish) is the straight-line distance from the anterior point of a fish specimen's snout, with the mouth closed, to the posterior end of the caudal (tail) fin, with the lobes of the caudal fin squeezed together.

Total load refers to all of a constituent in transport. When referring to sediment, it includes suspended load plus bed load.

Total organism count is the number of organisms collected and enumerated in any particular sample. (See also "[Organism count/volume](#)")

Total recoverable is the amount of a given constituent in a whole-water sample after a sample has been digested by a method (usually using a dilute acid solution) that results in dissolution of only readily soluble substances. Complete dissolution of all particulate matter is not achieved by the digestion treatment, and thus the determination represents something less than the "total" amount (that is, less than 95 percent) of the constituent present in the dissolved and suspended phases of the sample. To achieve comparability of analytical data for whole-water samples, equivalent digestion procedures are required of all laboratories performing such analyses because different digestion procedures may produce different analytical results.

WATER RESOURCES DATA—CALIFORNIA, WATER YEAR 2002

Total sediment discharge is the mass of suspended-sediment plus bed-load transport, measured as dry weight, that passes a cross section in a given time. It is a rate and is reported as tons per day. (See also "[Bedload](#)", "[Bedload discharge](#)", "[Sediment](#)", "[Suspended sediment](#)", and "[Suspended-Sediment Concentration](#)")

Total sediment load or total load is the sediment in transport as bedload and suspended-sediment load. The term may be qualified, such as "annual suspended-sediment load" or "sand-size suspended-sediment load," and so on. It differs from total sediment discharge in that load refers to the material, whereas discharge refers to the quantity of material, expressed in units of mass per unit time. (See also "[Sediment](#)", "[Suspended-Sediment Load](#)", and "[Total load](#)")

Transect, as used in this report, is a line across a stream perpendicular to the flow and along which measurements are taken, so that morphological and flow characteristics along the line are described from bank to bank. Unlike a cross section, no attempt is made to determine known elevation points along the line.

Turbidity is the reduction in the transparency of a solution due to the presence of suspended and some dissolved substances. The measurement technique records the collective optical properties of the solution that cause light to be scattered and attenuated rather than transmitted in straight lines; the higher the intensity of scattered or attenuated light, the higher the value of the turbidity. Turbidity is expressed in nephelometric turbidity units (NTU). Depending on the method used, the turbidity units as NTU can be defined as the intensity of light of a specified wavelength scattered or attenuated by suspended particles or absorbed at a method specified angle, usually 90 degrees, from the path of the incident light. Currently approved methods for the measurement of turbidity in the USGS include those that conform to U.S. EPA Method 180.1, ASTM D1889-00, and ISO 7027. Measurements of turbidity by these different methods and different instruments are unlikely to yield equivalent values.

Ultraviolet (UV) absorbance (absorption) at 254 or 280 nanometers is a measure of the aggregate concentration of the mixture of UV absorbing organic materials dissolved in the analyzed water, such as lignin, tannin, humic substances, and various aromatic compounds. UV absorbance (absorption) at 254 or 280 nanometers is measured in UV absorption units per centimeter of pathlength of UV light through a sample.

Unconfined aquifer is an aquifer whose upper surface is a water table free to fluctuate under atmospheric pressure. (See "[Water-table aquifer](#)")

Vertical datum (See "[Datum](#)")

Volatile organic compounds (VOCs) are organic compounds that can be isolated from the water phase of a sample by purging the water sample with inert gas, such as helium, and subsequently analyzed by gas chromatography. Many VOCs are human-made chemicals that are used and produced in the manufacture of paints, adhesives, petroleum products, pharmaceuticals, and refrigerants. They are often components of fuels, solvents, hydraulic fluids, paint thinners, and dry cleaning agents commonly used in urban settings. VOC contamination of drinking-water supplies is a human health concern because many are toxic and are known or suspected human carcinogens.

Water table is that surface in a ground-water body at which the water pressure is equal to the atmospheric pressure.

Water-table aquifer is an unconfined aquifer within which the water table is found.

Water year in USGS reports dealing with surface-water supply is the 12-month period October 1 through September 30. The water year is designated by the calendar year in which it ends and which includes 9 of the 12 months. Thus, the year ending September 30, 2002, is called the "2002 water year."

WDR is used as an abbreviation for "Water-Data Report" in the REVISED RECORDS paragraph to refer to State annual hydrologic-data reports. (WRD was used as an abbreviation for "Water-Resources Data" in reports published prior to 1976.)

Weighted average is used in this report to indicate discharge-weighted average. It is computed by multiplying the discharge for a sampling period by the concentrations of individual constituents for the corresponding period and dividing the sum of the products by the sum of the discharges. A discharge-weighted average approximates the composition of water that would be found in a reservoir containing all the water passing a given location during the water year after thorough mixing in the reservoir.

Wet mass is the mass of living matter plus contained water. (See also "[Biomass](#)" and "[Dry mass](#)")

Wet weight refers to the weight of animal tissue or other substance including its contained water. (See also "[Dry weight](#)")

WSP is used as an acronym for "Water-Supply Paper" in reference to previously published reports.

Zooplankton is the animal part of the plankton. Zooplankton are capable of extensive movements within the water column and often are large enough to be seen with the unaided eye. Zooplankton are secondary consumers feeding upon bacteria, phytoplankton, and detritus. Because they are the grazers in the aquatic environment, the zooplankton are a vital part of the aquatic food web. The zooplankton community is dominated by small crustaceans and rotifers. (See also "[Plankton](#)")

TECHNIQUES OF WATER-RESOURCES INVESTIGATIONS OF THE U.S. GEOLOGICAL SURVEY

The U.S. Geological Survey publishes a series of manuals describing procedures for planning and conducting specialized work in water-resources investigations. The material is grouped under major subject headings called books and is further divided into sections and chapters. For example, Section A of Book 3 (Applications of Hydraulics) pertains to surface water. The chapter, the unit of publication, is limited to a narrow field of subject matter. This format permits flexibility in revision and publication as the need arises.

The reports listed below are for sale by the U.S. Geological Survey, Information Services, Box 25286, Federal Center, Denver, Colorado 80225 (authorized agent of the Superintendent of Documents, Government Printing Office). Prepayment is required. Remittance should be made in the form of a check or money order payable to the "U.S. Geological Survey." Prices are not included because they are subject to change. Current prices can be obtained by writing to the above address. When ordering or inquiring about prices for any of these publications, please give the title, book number, chapter number, and mention the "U.S. Geological Survey Techniques of Water-Resources Investigations."

Book 1. Collection of Water Data by Direct Measurement

Section D. Water Quality

- 1-D1. *Water temperature—influential factors, field measurement, and data presentation*, by H.H. Stevens, Jr., J.F. Ficke, and G.F. Smoot: USGS–TWRI Book 1, Chapter D1. 1975. 65 p.
- 1-D2. *Guidelines for collection and field analysis of ground-water samples for selected unstable constituents*, by W.W. Wood: USGS–TWRI Book 1, Chapter D2. 1976. 24 p.

Book 2. Collection of Environmental Data

Section D. Surface Geophysical Methods

- 2-D1. *Application of surface geophysics to ground-water investigations*, by A.A.R. Zohdy, G.P. Eaton, and D.R. Mabey: USGS–TWRI Book 2, Chapter D1. 1974. 116 p.
- 2-D2. *Application of seismic-refraction techniques to hydrologic studies*, by F.P. Haeni: USGS–TWRI Book 2, Chapter D2. 1988. 86 p.

Section E. Subsurface Geophysical Methods

- 2-E1. *Application of borehole geophysics to water-resources investigations*, by W.S. Keys and L.M. MacCary: USGS–TWRI Book 2, Chapter E1. 1971. 126 p.
- 2-E2. *Borehole geophysics applied to ground-water investigations*, by W.S. Keys: USGS–TWRI Book 2, Chapter E2. 1990. 150 p.

Section F. Drilling and Sampling Methods

- 2-F1. *Application of drilling, coring, and sampling techniques to test holes and wells*, by Eugene Shuter and W.E. Teasdale: USGS–TWRI Book 2, Chapter F1. 1989. 97 p.

Book 3. Applications of Hydraulics

Section A. Surface-Water Techniques

- 3-A1. *General field and office procedures for indirect discharge measurements*, by M.A. Benson and Tate Dalrymple: USGS–TWRI Book 3, Chapter A1. 1967. 30 p.
- 3-A2. *Measurement of peak discharge by the slope-area method*, by Tate Dalrymple and M.A. Benson: USGS–TWRI Book 3, Chapter A2. 1967. 12 p.
- 3-A3. *Measurement of peak discharge at culverts by indirect methods*, by G.L. Bodhaine: USGS–TWRI Book 3, Chapter A3. 1968. 60 p.
- 3-A4. *Measurement of peak discharge at width contractions by indirect methods*, by H.F. Matthai: USGS–TWRI Book 3, Chapter A4. 1967. 44 p.
- 3-A5. *Measurement of peak discharge at dams by indirect methods*, by Harry Hulsing: USGS–TWRI Book 3. Chapter A5. 1967. 29 p.
- 3-A6. *General procedure for gaging streams*, by R.W. Carter and Jacob Davidian: USGS–TWRI Book 3, Chapter A6. 1968. 13 p.

WATER RESOURCES DATA—CALIFORNIA, WATER YEAR 2002

- 3-A7. *Stage measurement at gaging stations*, by T.J. Buchanan and W.P. Somers: USGS–TWRI Book 3, Chapter A7. 1968. 28 p.
- 3-A8. *Discharge measurements at gaging stations*, by T.J. Buchanan and W.P. Somers: USGS–TWRI Book 3, Chapter A8. 1969. 65 p.
- 3-A9. *Measurement of time of travel in streams by dye tracing*, by F.A. Kilpatrick and J.F. Wilson, Jr.: USGS–TWRI Book 3, Chapter A9. 1989. 27 p.
- 3-A10. *Discharge ratings at gaging stations*, by E.J. Kennedy: USGS–TWRI Book 3, Chapter A10. 1984. 59 p.
- 3-A11. *Measurement of discharge by the moving-boat method*, by G.F. Smoot and C.E. Novak: USGS–TWRI Book 3, Chapter A11. 1969. 22 p.
- 3-A12. *Fluorometric procedures for dye tracing*, Revised, by J.F. Wilson, Jr., E.D. Cobb, and F.A. Kilpatrick: USGS–TWRI Book 3, Chapter A12. 1986. 34 p.
- 3-A13. *Computation of continuous records of streamflow*, by E.J. Kennedy: USGS–TWRI Book 3, Chapter A13. 1983. 53 p.
- 3-A14. *Use of flumes in measuring discharge*, by F.A. Kilpatrick and V.R. Schneider: USGS–TWRI Book 3, Chapter A14. 1983. 46 p.
- 3-A15. *Computation of water-surface profiles in open channels*, by Jacob Davidian: USGS–TWRI Book 3, Chapter A15. 1984. 48 p.
- 3-A16. *Measurement of discharge using tracers*, by F.A. Kilpatrick and E.D. Cobb: USGS–TWRI Book 3, Chapter A16. 1985. 52 p.
- 3-A17. *Acoustic velocity meter systems*, by Antonius Laenen: USGS–TWRI Book 3, Chapter A17. 1985. 38 p.
- 3-A18. *Determination of stream reaeration coefficients by use of tracers*, by F.A. Kilpatrick, R.E. Rathbun, Nobuhiro Yotsukura, G.W. Parker, and L.L. DeLong: USGS–TWRI Book 3, Chapter A18. 1989. 52 p.
- 3-A19. *Levels at streamflow gaging stations*, by E.J. Kennedy: USGS–TWRI Book 3, Chapter A19. 1990. 31 p.
- 3-A20. *Simulation of soluble waste transport and buildup in surface waters using tracers*, by F.A. Kilpatrick: USGS–TWRI Book 3, Chapter A20. 1993. 38 p.
- 3-A21. *Stream-gaging cableways*, by C. Russell Wagner: USGS–TWRI Book 3, Chapter A21. 1995. 56 p.

Section B. Ground-Water Techniques

- 3-B1. *Aquifer-test design, observation, and data analysis*, by R.W. Stallman: USGS–TWRI Book 3, Chapter B1. 1971. 26 p.
- 3-B2. *Introduction to ground-water hydraulics, a programmed text for self-instruction*, by G.D. Bennett: USGS–TWRI Book 3, Chapter B2. 1976. 172 p.
- 3-B3. *Type curves for selected problems of flow to wells in confined aquifers*, by J.E. Reed: USGS–TWRI Book 3, Chapter B3. 1980. 106 p.
- 3-B4. *Regression modeling of ground-water flow*, by R.L. Cooley and R.L. Naff: USGS–TWRI Book 3, Chapter B4. 1990. 232 p.
- 3-B4. *Supplement 1. Regression modeling of ground-water flow—Modifications to the computer code for nonlinear regression solution of steady-state ground-water flow problems*, by R.L. Cooley: USGS–TWRI Book 3, Chapter B4. 1993. 8 p.
- 3-B5. *Definition of boundary and initial conditions in the analysis of saturated ground-water flow systems—An introduction*, by O.L. Franke, T.E. Reilly, and G.D. Bennett: USGS–TWRI Book 3, Chapter B5. 1987. 15 p.
- 3-B6. *The principle of superposition and its application in ground-water hydraulics*, by T.E. Reilly, O.L. Franke, and G.D. Bennett: USGS–TWRI Book 3, Chapter B6. 1987. 28 p.
- 3-B7. *Analytical solutions for one-, two-, and three-dimensional solute transport in ground-water systems with uniform flow*, by E.J. Wexler: USGS–TWRI Book 3, Chapter B7. 1992. 190 p.
- 3-B8. *System and boundary conceptualization in ground-water flow simulation*, by T.E. Reilly: USGS–TWRI Book 3, Chapter B8. 2001. 29 p.

Section C. Sedimentation and Erosion Techniques

- 3-C1. *Fluvial sediment concepts*, by H.P. Guy: USGS–TWRI Book 3, Chapter C1. 1970. 55 p.
- 3-C2. *Field methods for measurement of fluvial sediment*, by T.K. Edwards and G.D. Glysson: USGS–TWRI Book 3, Chapter C2. 1999. 89 p.
- 3-C3. *Computation of fluvial-sediment discharge*, by George Porterfield: USGS–TWRI Book 3, Chapter C3. 1972. 66 p.

Book 4. Hydrologic Analysis and Interpretation

Section A. Statistical Analysis

- 4-A1. *Some statistical tools in hydrology*, by H.C. Riggs: USGS–TWRI Book 4, Chapter A1. 1968. 39 p.
- 4-A2. *Frequency curves*, by H.C. Riggs: USGS–TWRI Book 4, Chapter A2. 1968. 15 p.

WATER RESOURCES DATA—CALIFORNIA, WATER YEAR 2002

- 4-A3. Statistical methods in water resources, by D.R. Helsel and R.M. Hirsch: USGS–TWRI Book 4, Chapter A3. 1991. Available only online at <http://water.usgs.gov/pubs/twri/twri4a3/>. (Accessed August 30, 2002.)

Section B. Surface Water

- 4-B1. *Low-flow investigations*, by H.C. Riggs: USGS–TWRI Book 4, Chapter B1. 1972. 18 p.
 4-B2. *Storage analyses for water supply*, by H.C. Riggs and C.H. Hardison: USGS–TWRI Book 4, Chapter B2. 1973. 20 p.
 4-B3. *Regional analyses of streamflow characteristics*, by H.C. Riggs: USGS–TWRI Book 4, Chapter B3. 1973. 15 p.

Section D. Interrelated Phases of the Hydrologic Cycle

- 4-D1. *Computation of rate and volume of stream depletion by wells*, by C.T. Jenkins: USGS–TWRI Book 4, Chapter D1. 1970. 17 p.

Book 5. Laboratory Analysis

Section A. Water Analysis

- 5-A1. *Methods for determination of inorganic substances in water and fluvial sediments*, by M.J. Fishman and L.C. Friedman, editors: USGS–TWRI Book 5, Chapter A1. 1989. 545 p.
 5-A2. *Determination of minor elements in water by emission spectroscopy*, by P.R. Barnett and E.C. Mallory, Jr.: USGS–TWRI Book 5, Chapter A2. 1971. 31 p.
 5-A3. *Methods for the determination of organic substances in water and fluvial sediments*, edited by R.L. Wershaw, M.J. Fishman, R.R. Grabbe, and L.E. Lowe: USGS–TWRI Book 5, Chapter A3. 1987. 80 p.
 5-A4. *Methods for collection and analysis of aquatic biological and microbiological samples*, by L.J. Britton and P.E. Greeson, editors: USGS–TWRI Book 5, Chapter A4. 1989. 363 p.
 5-A5. *Methods for determination of radioactive substances in water and fluvial sediments*, by L.L. Thatcher, V.J. Janzer, and K.W. Edwards: USGS–TWRI Book 5, Chapter A5. 1977. 95 p.
 5-A6. *Quality assurance practices for the chemical and biological analyses of water and fluvial sediments*, by L.C. Friedman and D.E. Erdmann: USGS–TWRI Book 5, Chapter A6. 1982. 181 p.

Section C. Sediment Analysis

- 5-C1. *Laboratory theory and methods for sediment analysis*, by H.P. Guy: USGS–TWRI Book 5, Chapter C1. 1969. 58 p.

Book 6. Modeling Techniques

Section A. Ground Water

- 6-A1. *A modular three-dimensional finite-difference ground-water flow model*, by M.G. McDonald and A.W. Harbaugh: USGS–TWRI Book 6, Chapter A1. 1988. 586 p.
 6-A2. *Documentation of a computer program to simulate aquifer-system compaction using the modular finite-difference ground-water flow model*, by S.A. Leake and D.E. Prudic: USGS–TWRI Book 6, Chapter A2. 1991. 68 p.
 6-A3. *A modular finite-element model (MODFE) for areal and axisymmetric ground-water-flow problems, Part 1: Model Description and User's Manual*, by L.J. Torak: USGS–TWRI Book 6, Chapter A3. 1993. 136 p.
 6-A4. *A modular finite-element model (MODFE) for areal and axisymmetric ground-water-flow problems, Part 2: Derivation of finite-element equations and comparisons with analytical solutions*, by R.L. Cooley: USGS–TWRI Book 6, Chapter A4. 1992. 108 p.
 6-A5. *A modular finite-element model (MODFE) for areal and axisymmetric ground-water-flow problems, Part 3: Design philosophy and programming details*, by L.J. Torak: USGS–TWRI Book 6, Chapter A5. 1993. 243 p.
 6-A6. *A coupled surface-water and ground-water flow model (MODBRANCH) for simulation of stream-aquifer interaction*, by Eric D. Swain and Eliezer J. Wexler: USGS–TWRI Book 6, Chapter A6. 1996. 125 p.
 6-A7. *User's guide to SEAWAT: A computer program for simulation of three-dimensional variable-density ground-water flow*, by Weixing Guo and Christian D. Langevin: USGS–TWRI Book 6, Chapter A7. 2002. 77 p.

Book 7. Automated Data Processing and Computations

Section C. Computer Programs

- 7-C1. *Finite difference model for aquifer simulation in two dimensions with results of numerical experiments*, by P.C. Trescott, G.F. Pinder, and S.P. Larson: USGS–TWRI Book 7, Chapter C1. 1976. 116 p.
 7-C2. *Computer model of two-dimensional solute transport and dispersion in ground water*, by L.F. Konikow and J.D. Bredehoeft: USGS–TWRI Book 7, Chapter C2. 1978. 90 p.
 7-C3. *A model for simulation of flow in singular and interconnected channels*, by R.W. Schaffranek, R.A. Baltzer, and D.E. Goldberg: USGS–TWRI Book 7, Chapter C3. 1981. 110 p.

WATER RESOURCES DATA—CALIFORNIA, WATER YEAR 2002

Book 8. Instrumentation**Section A. Instruments for Measurement of Water Level**

- 8-A1. *Methods of measuring water levels in deep wells*, by M.S. Garber and F.C. Koopman: USGS–TWRI Book 8, Chapter A1. 1968. 23 p.
- 8-A2. *Installation and service manual for U.S. Geological Survey manometers*, by J.D. Craig: USGS–TWRI Book 8, Chapter A2. 1983. 57 p.

Section B. Instruments for Measurement of Discharge

- 8-B2. *Calibration and maintenance of vertical-axis type current meters*, by G.F. Smoot and C.E. Novak: USGS–TWRI Book 8, Chapter B2. 1968. 15 p.

Book 9. Handbooks for Water-Resources Investigations**Section A. National Field Manual for the Collection of Water-Quality Data**

- 9-A1. *National field manual for the collection of water-quality data: Preparations for water sampling*, by F.D. Wilde, D.B. Radtke, Jacob Gibs, and R.T. Iwatsubo: USGS–TWRI Book 9, Chapter A1. 1998. 47 p.
- 9-A2. *National field manual for the collection of water-quality data: Selection of equipment for water sampling*, edited by F.D. Wilde, D.B. Radtke, Jacob Gibs, and R.T. Iwatsubo: USGS–TWRI Book 9, Chapter A2. 1998. 94 p.
- 9-A3. *National field manual for the collection of water-quality data: Cleaning of equipment for water sampling*, edited by F.D. Wilde, D.B. Radtke, Jacob Gibs, and R.T. Iwatsubo: USGS–TWRI Book 9, Chapter A3. 1998. 75 p.
- 9-A4. *National field manual for the collection of water-quality data: Collection of water samples*, edited by F.D. Wilde, D.B. Radtke, Jacob Gibs, and R.T. Iwatsubo: USGS–TWRI Book 9, Chapter A4. 1999. 156 p.
- 9-A5. *National field manual for the collection of water-quality data: Processing of water samples*, edited by F.D. Wilde, D.B. Radtke, Jacob Gibs, and R.T. Iwatsubo: USGS–TWRI Book 9, Chapter A5. 1999. 149 p.
- 9-A6. *National field manual for the collection of water-quality data: Field measurements*, edited by F.D. Wilde and D.B. Radtke: USGS–TWRI Book 9, Chapter A6. 1998. Variously paginated.
- 9-A7. *National field manual for the collection of water-quality data: Biological indicators*, edited by D.N. Myers and F.D. Wilde: USGS–TWRI Book 9, Chapter A7. 1997 and 1999. Variously paginated.
- 9-A8. *National field manual for the collection of water-quality data: Bottom-material samples*, by D.B. Radtke: USGS–TWRI Book 9, Chapter A8. 1998. 48 p.
- 9-A9. *National field manual for the collection of water-quality data: Safety in field activities*, by S.L. Lane and R.G. Fay: USGS–TWRI Book 9, Chapter A9. 1998. 60 p.

WATER RESOURCES DATA—CALIFORNIA, WATER YEAR 2002

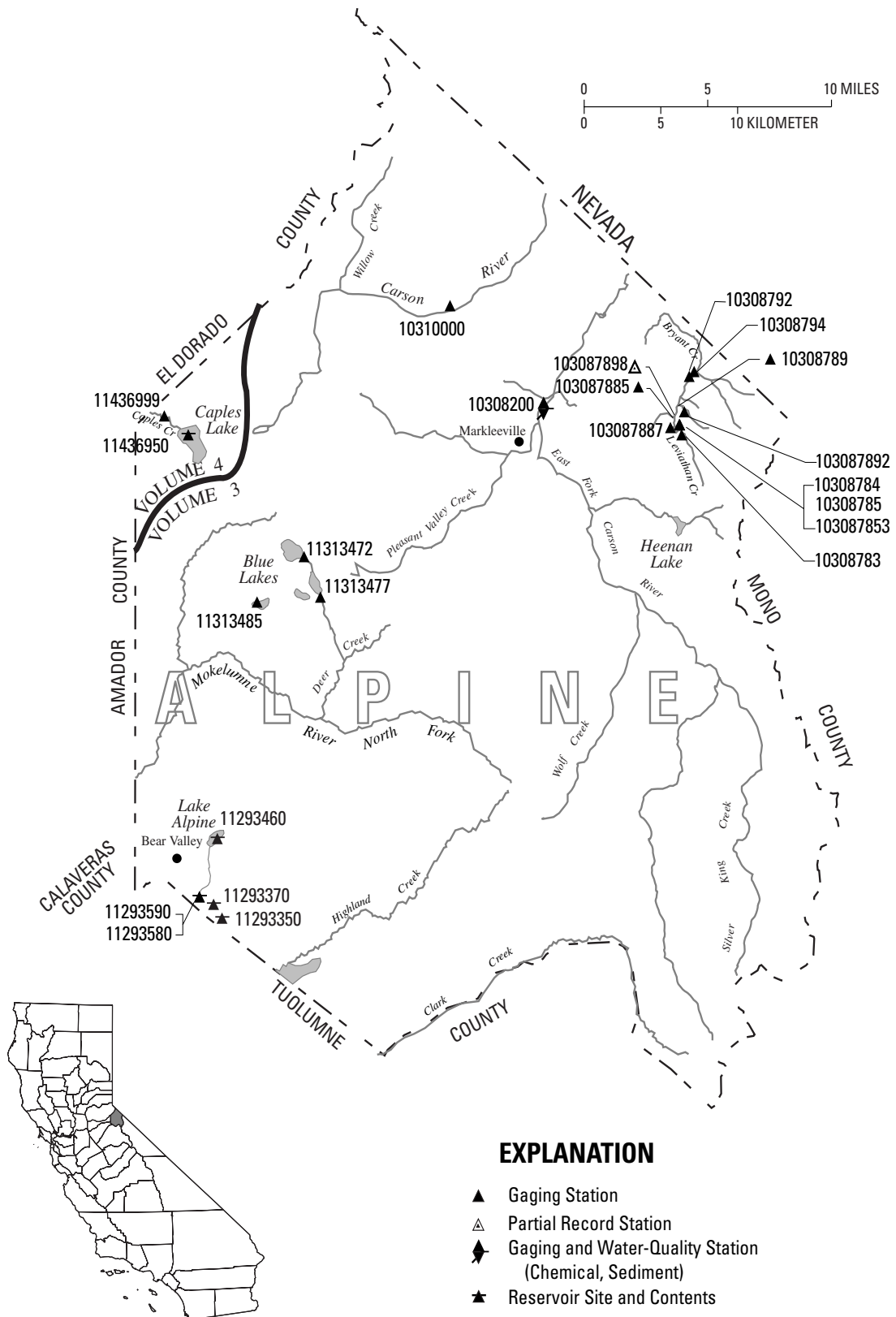

Figure 2. Location of discharge stations in Alpine County.

(NOTE: Records for stations 10308200 through 10310000 and 11293350 through 11313485 published in volume 3.)

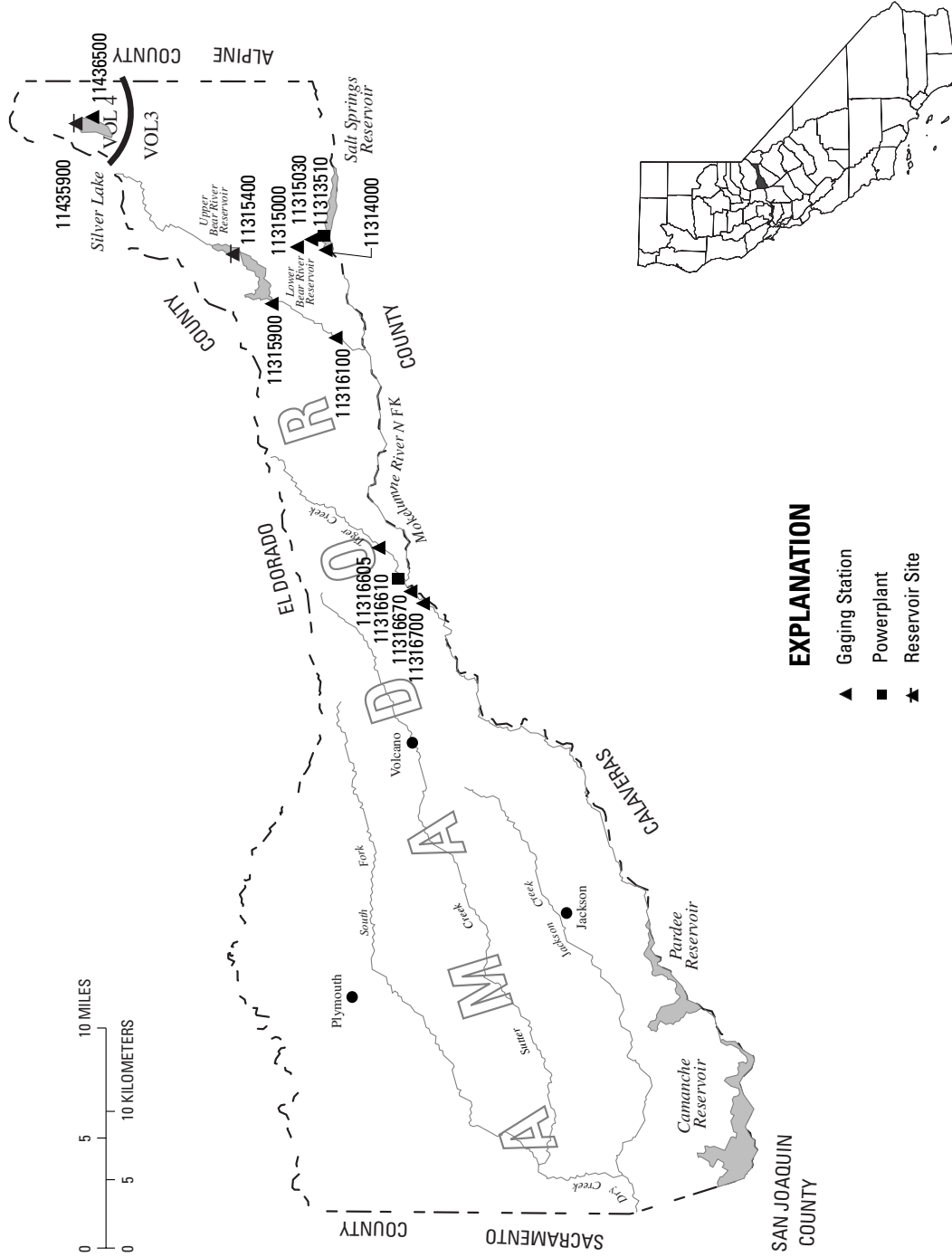

Figure 3. Location of discharge stations in Amador County.
 (NOTE: Records for stations 11313510 through 11316700 published in volume 3.)

WATER RESOURCES DATA—CALIFORNIA, WATER YEAR 2002

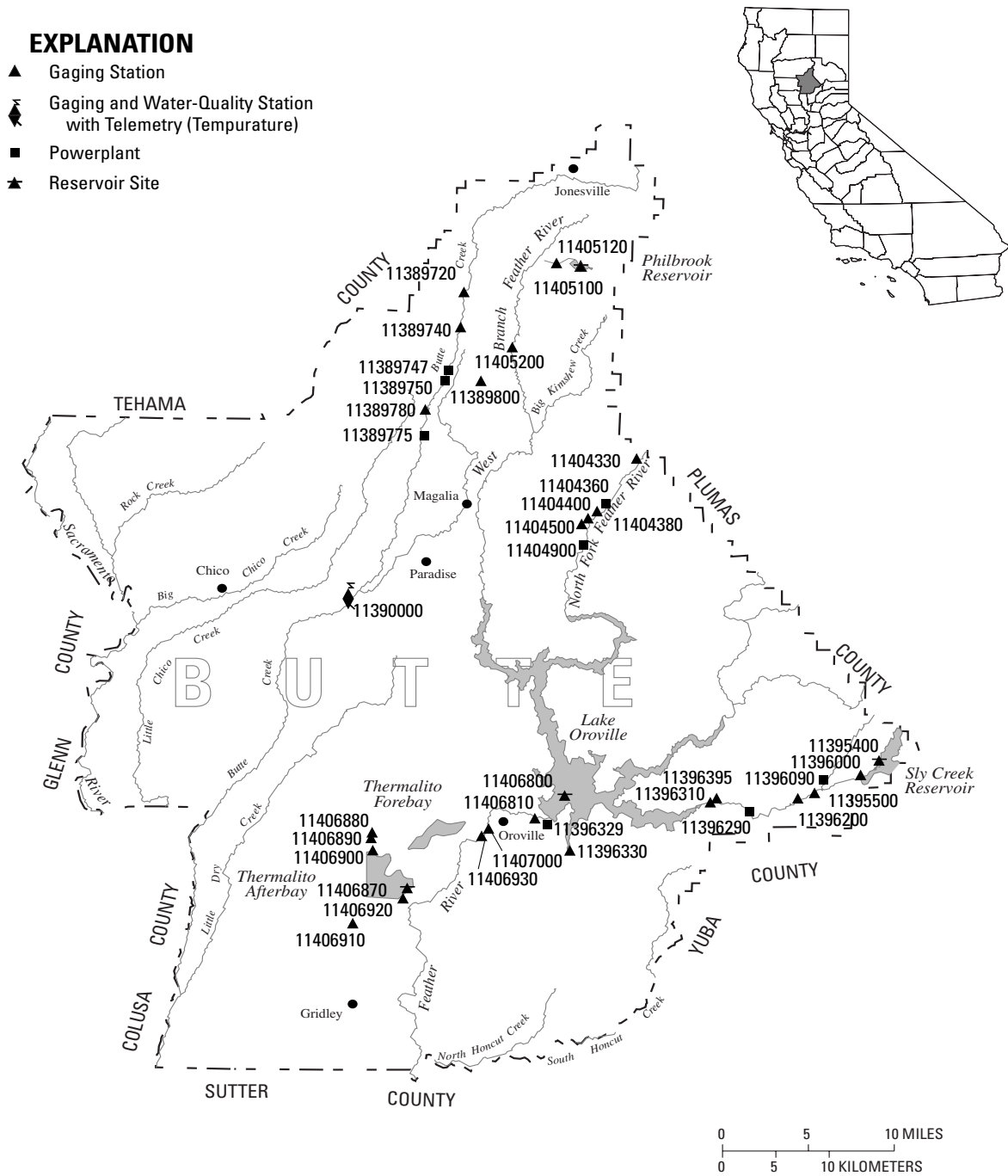

Figure 4. Location of discharge and water-quality stations in Butte County.

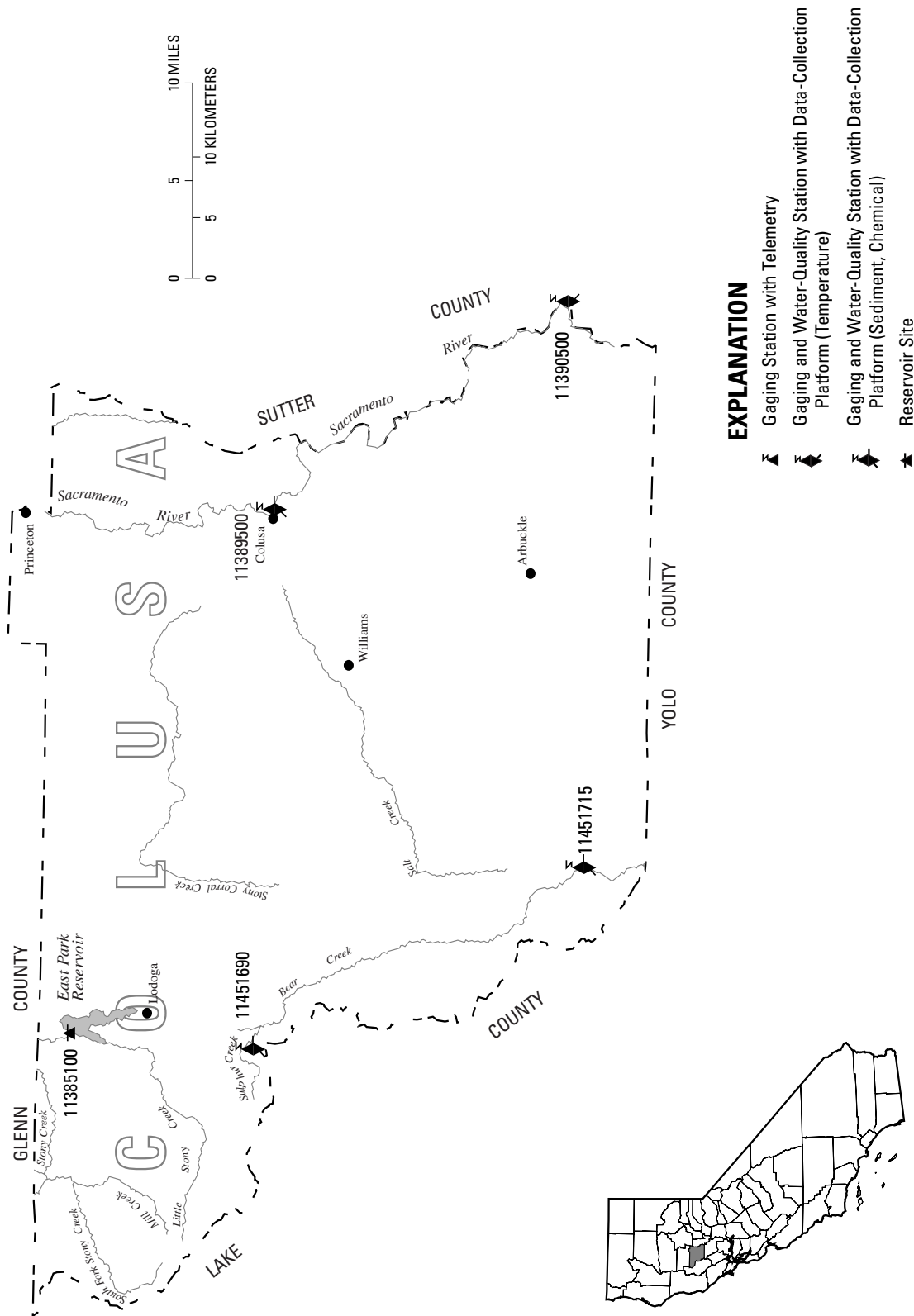

Figure 5. Location of discharge and water-quality stations in Colusa County.

WATER RESOURCES DATA—CALIFORNIA, WATER YEAR 2002

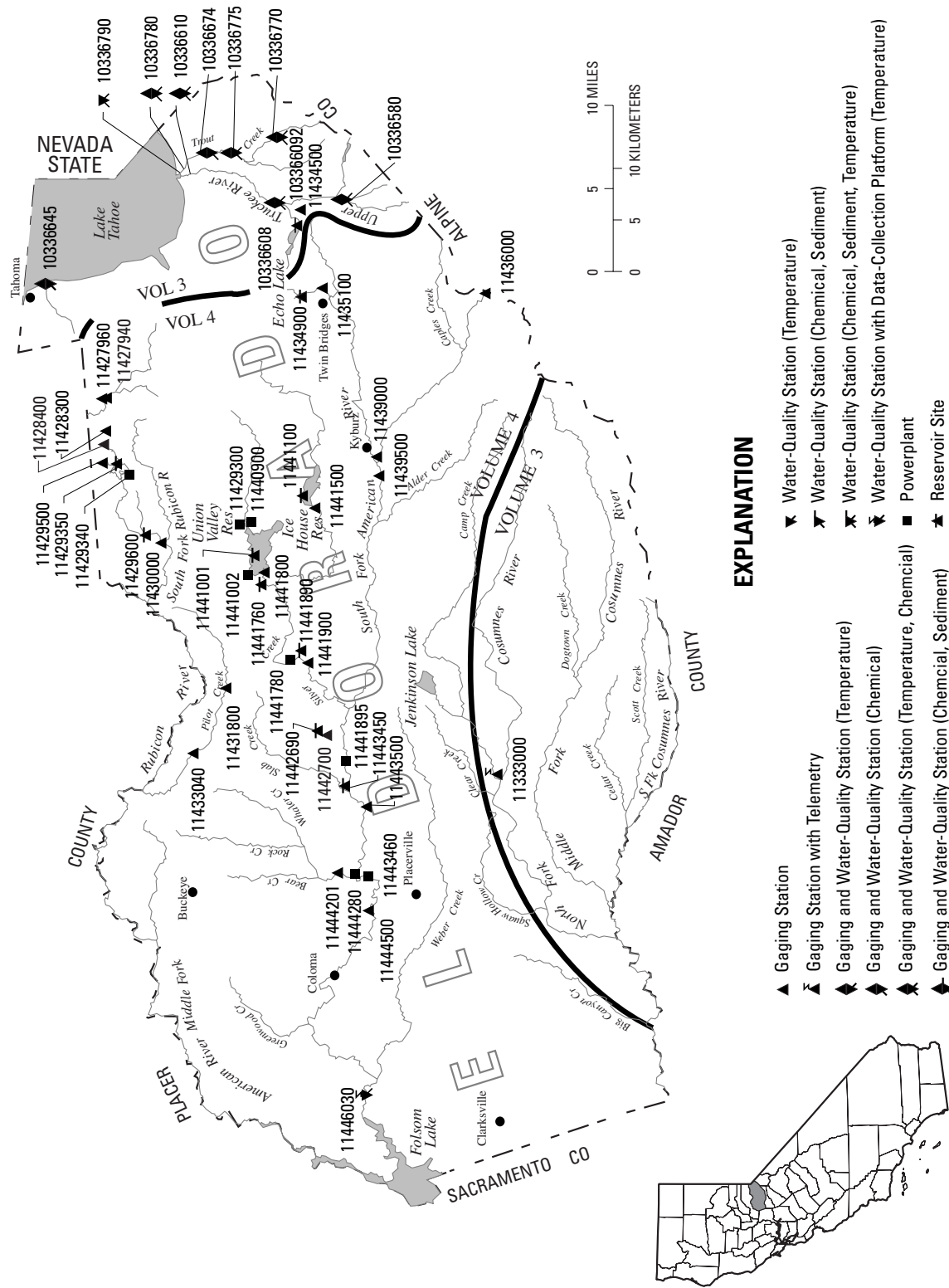

Figure 7. Location of discharge and water-quality stations in El Dorado County. (NOTE: Records for stations 10336580 and 11333000 published in volume 3.)

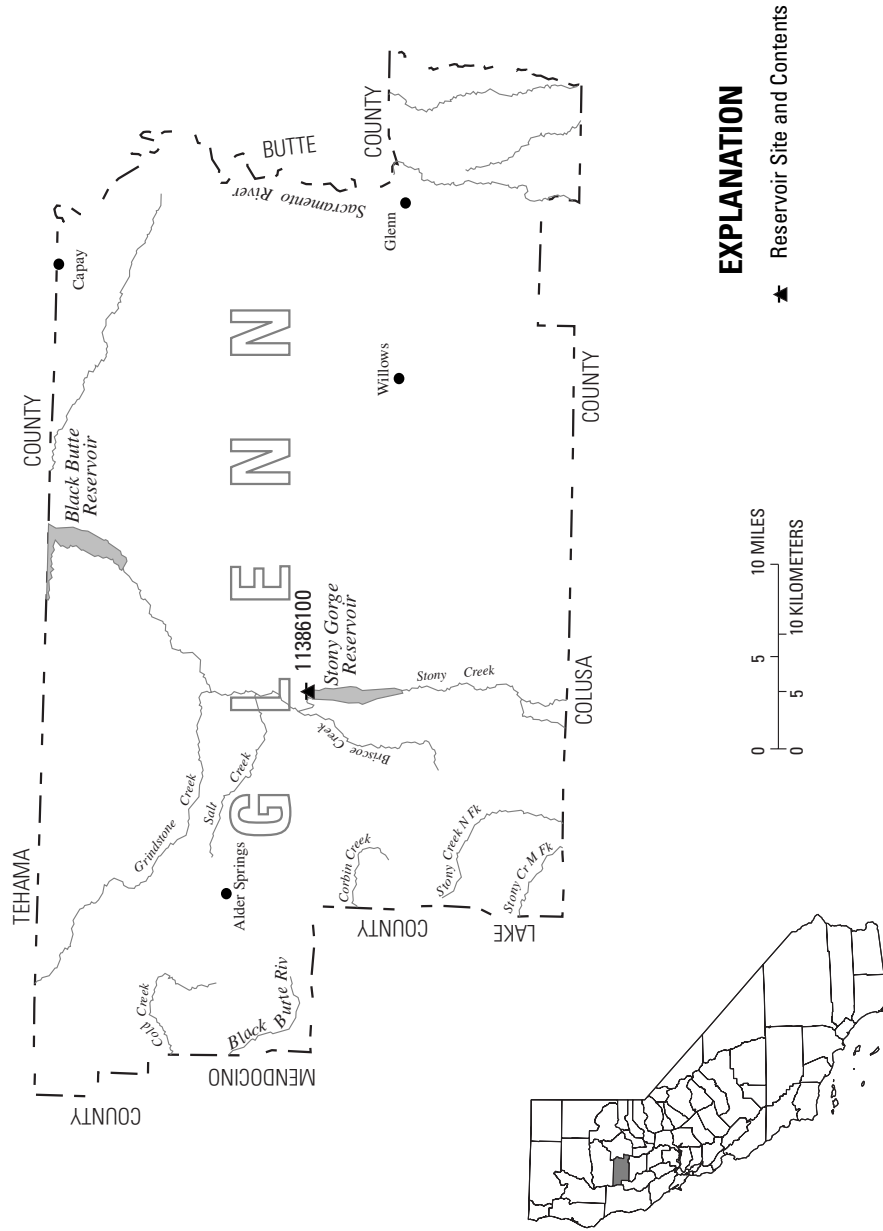

Figure 7. Location of discharge station in Glenn County.

WATER RESOURCES DATA—CALIFORNIA, WATER YEAR 2002

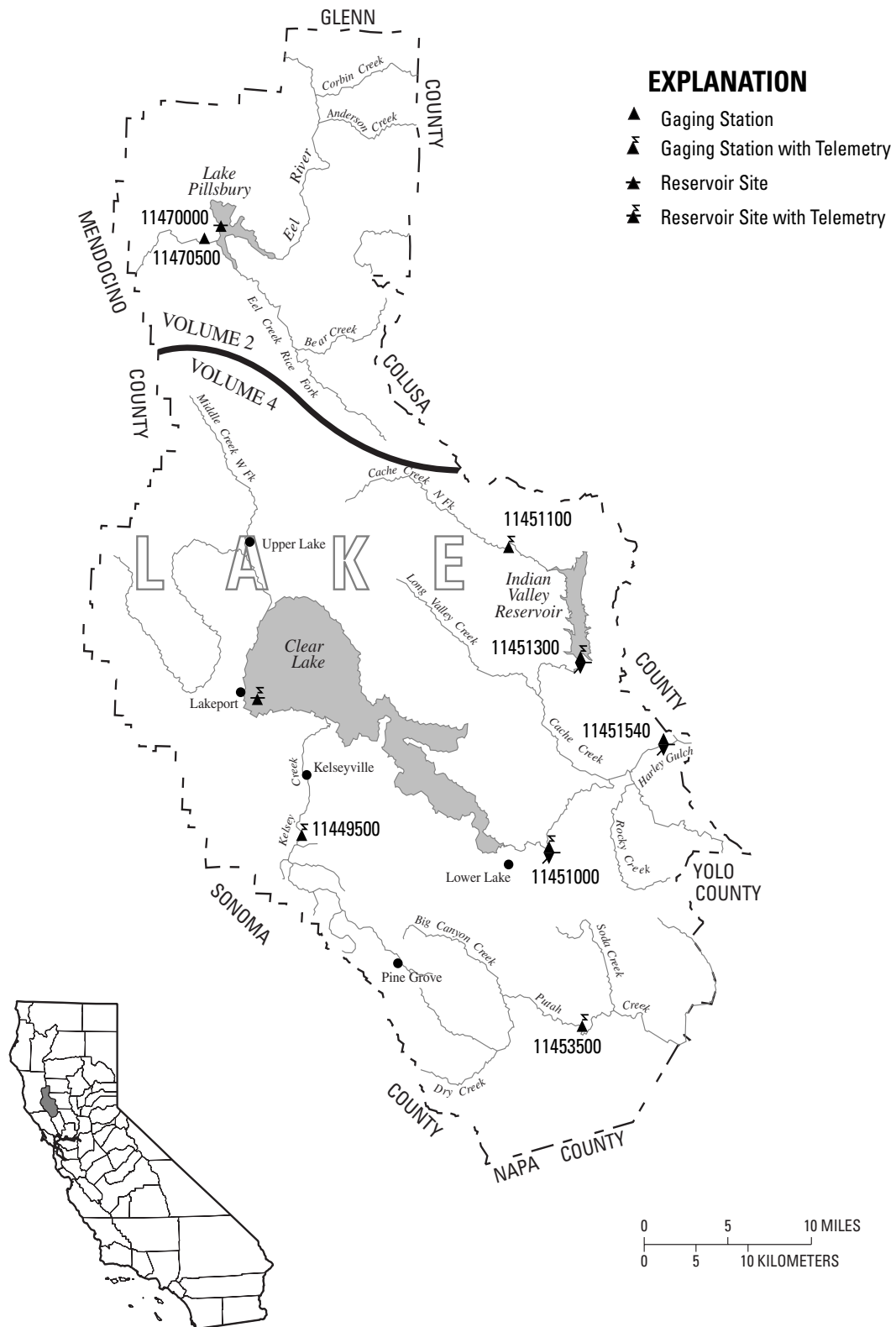

Figure 8. Location of discharge stations in Lake County.
 (NOTE: Records for stations 11470000 and 11470500 published in volume 2.)

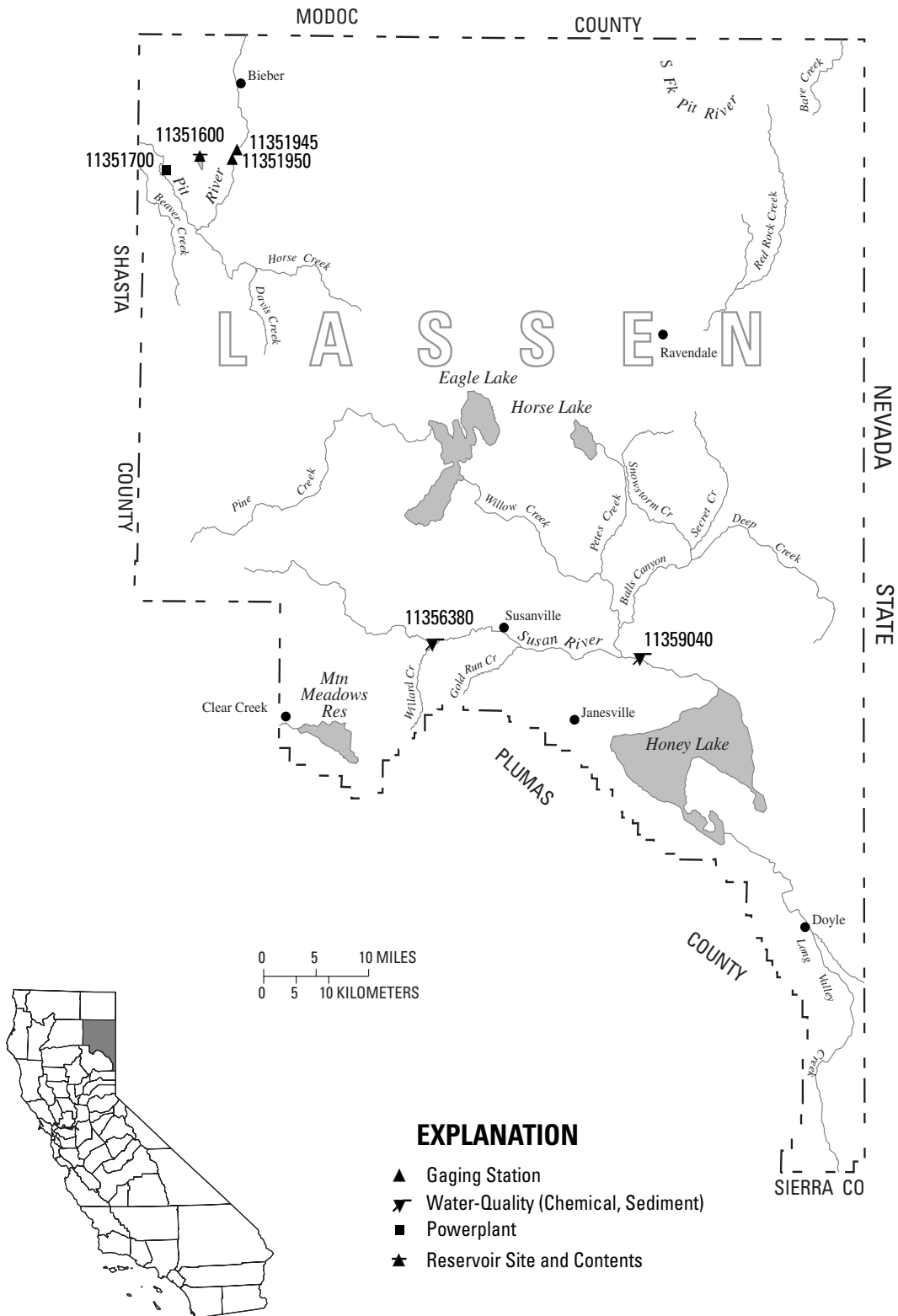
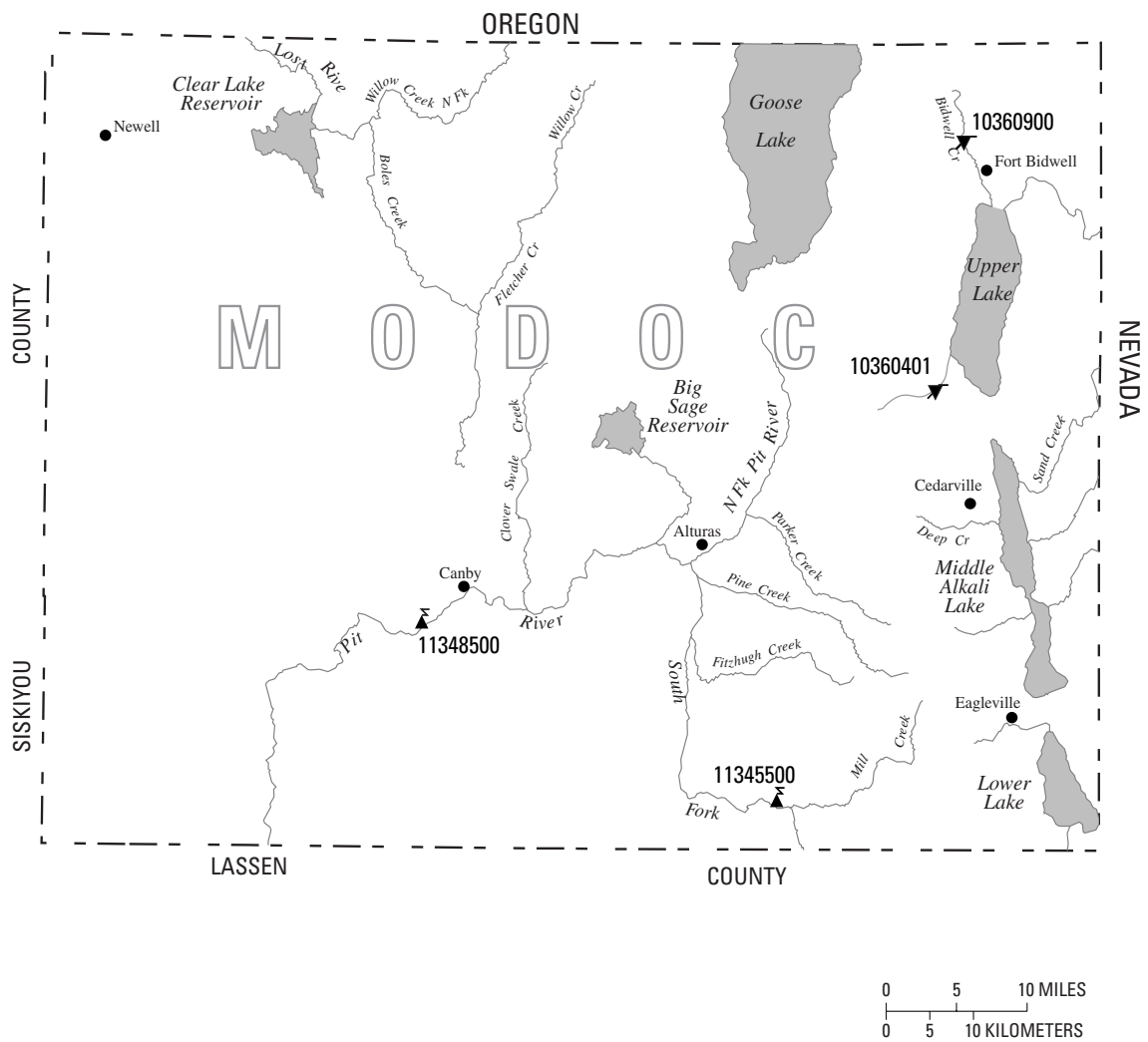

Figure 9. Location of discharge stations in Lassen County.

WATER RESOURCES DATA—CALIFORNIA, WATER YEAR 2002



EXPLANATION

- ▲ Gaging Station
- ▲ Gaging Station with Telemetry
- ▼ Water-Quality (Chemical)
- ▼ Water-Quality (Chemical, Sediment)



Figure 10. Location of discharge stations in Modoc County.

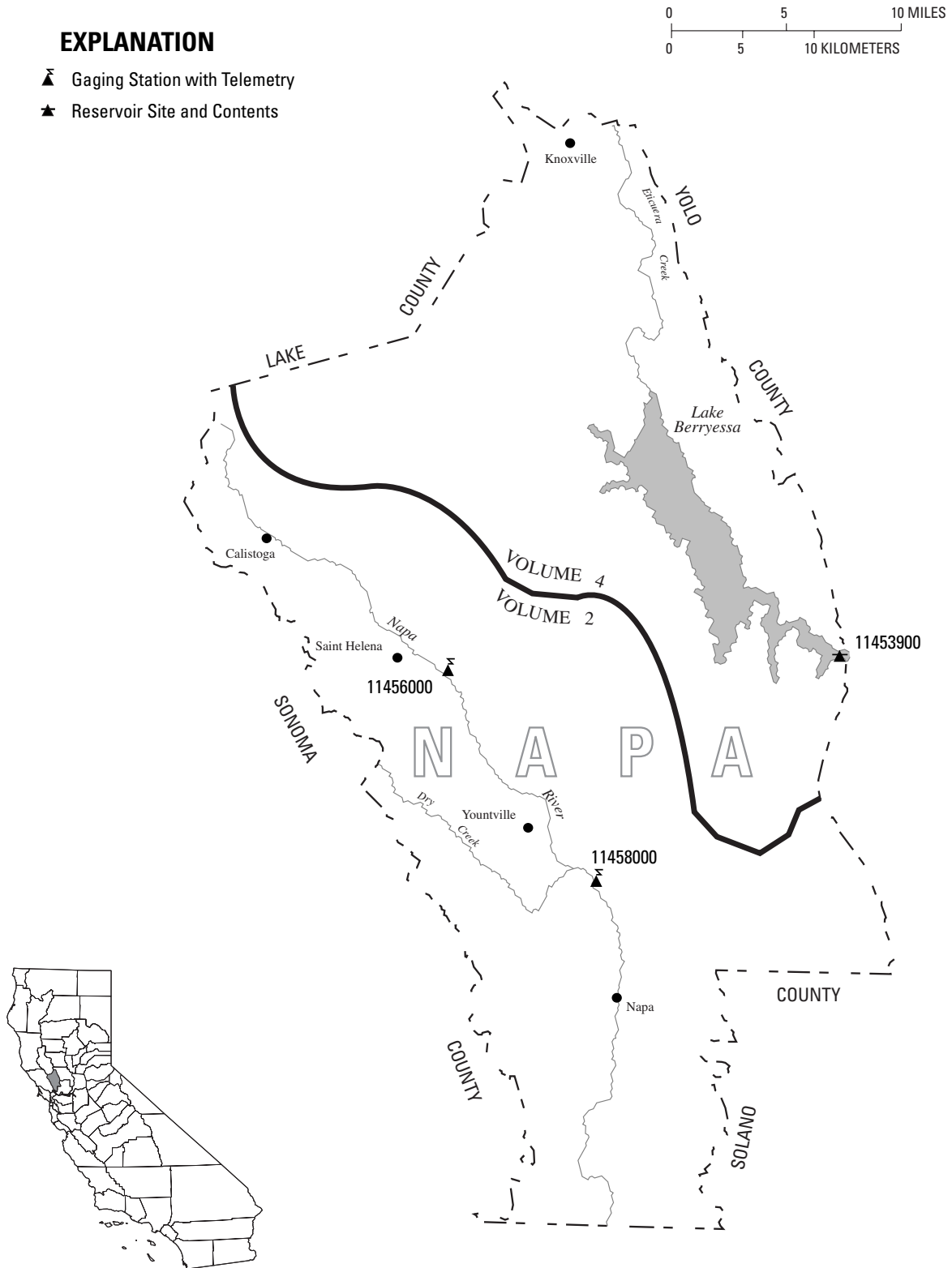

Figure 11. Location of discharge stations in Napa County.
 (NOTE: Records for stations 11456000 and 11458000 published in volume 2.)

WATER RESOURCES DATA—CALIFORNIA, WATER YEAR 2002

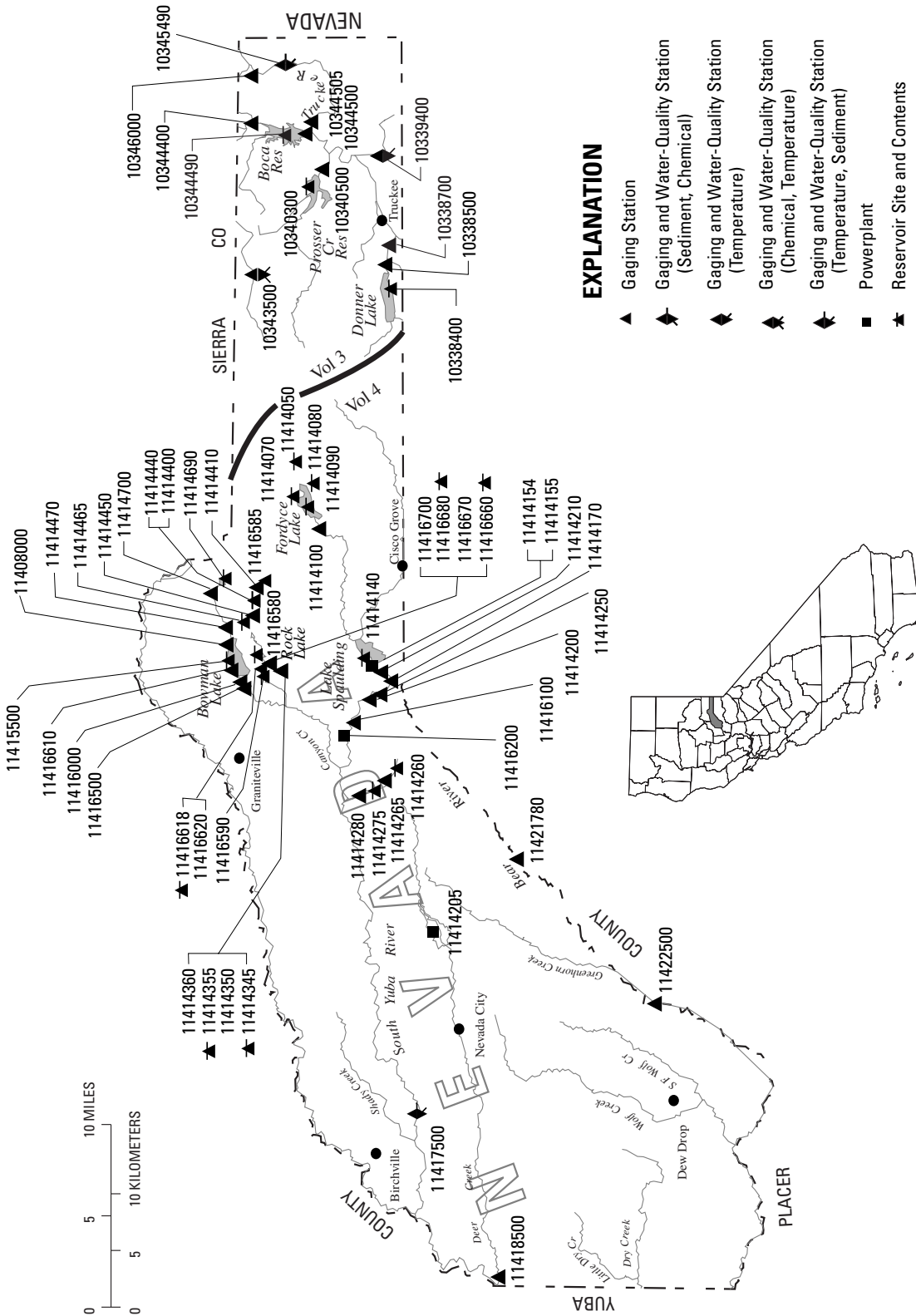

Figure 12. Location of discharge and water-quality stations in Nevada County. (NOTE: Records for stations 10338400 through 10346000 published in volume 3.)

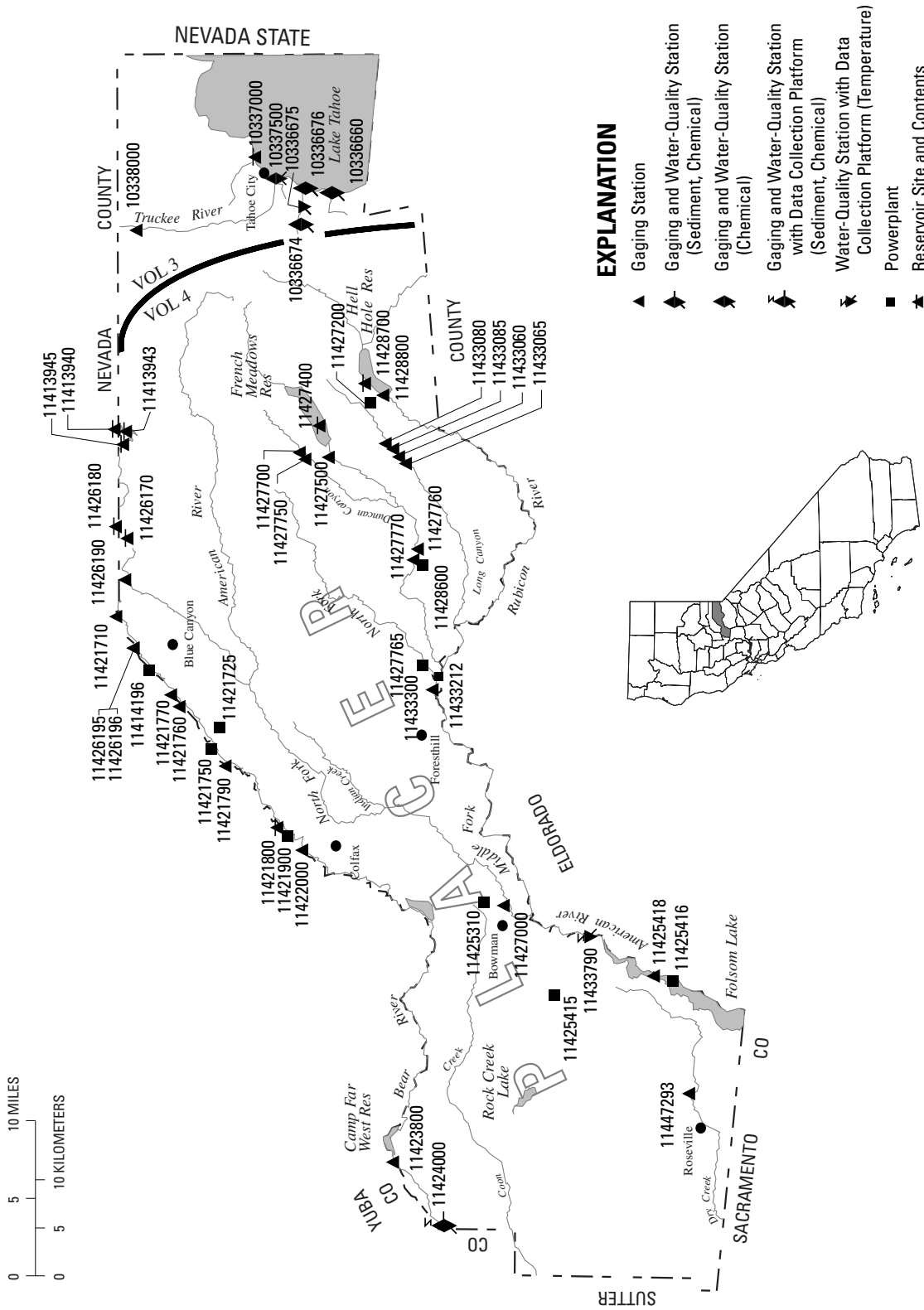

Figure 13. Location of discharge and water-quality stations in Placer County. (NOTE: Records for stations 10336660 through 10338000 published in volume 3.)

WATER RESOURCES DATA—CALIFORNIA, WATER YEAR 2002

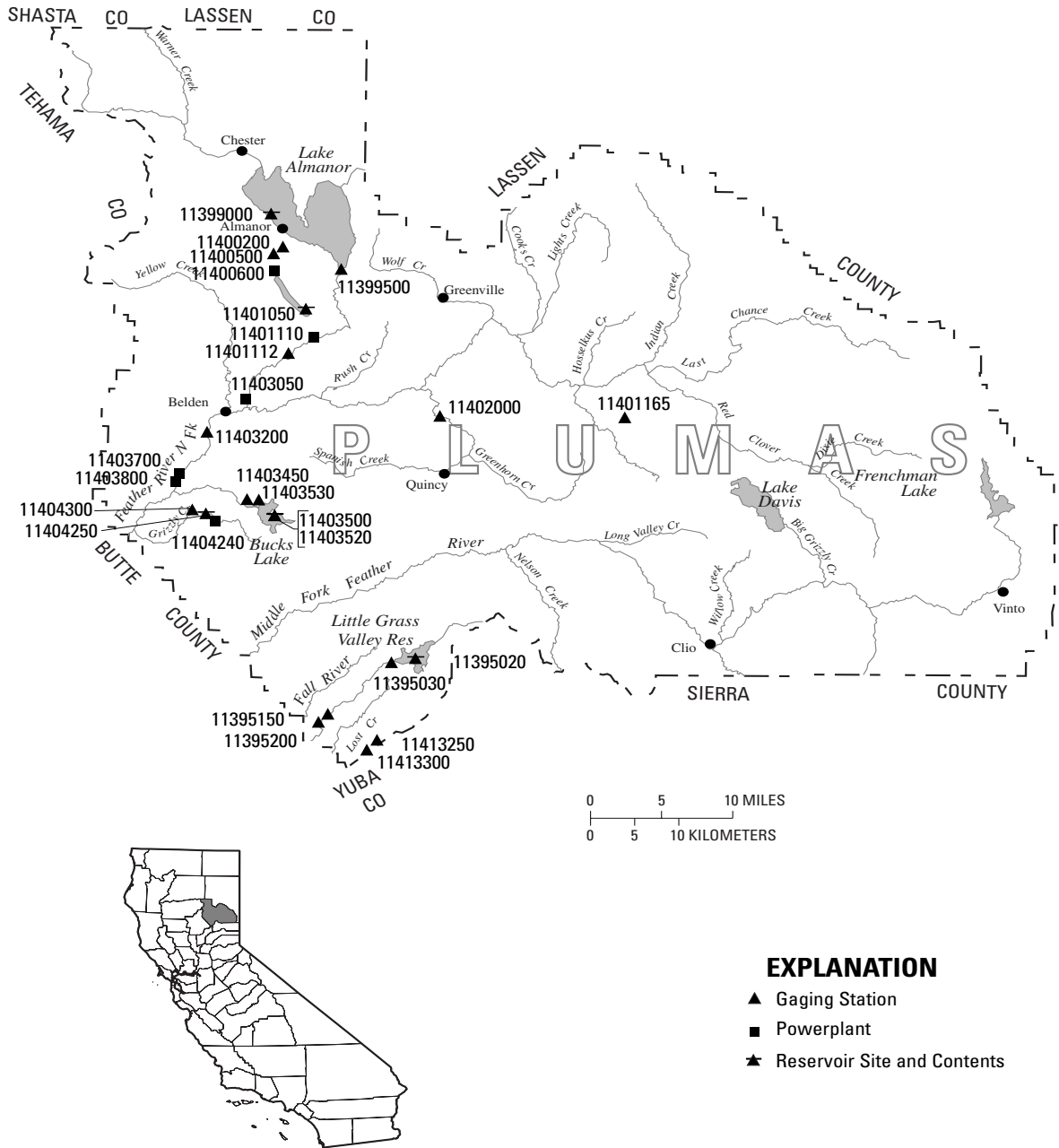

Figure 14. Location of discharge stations in Plumas County.

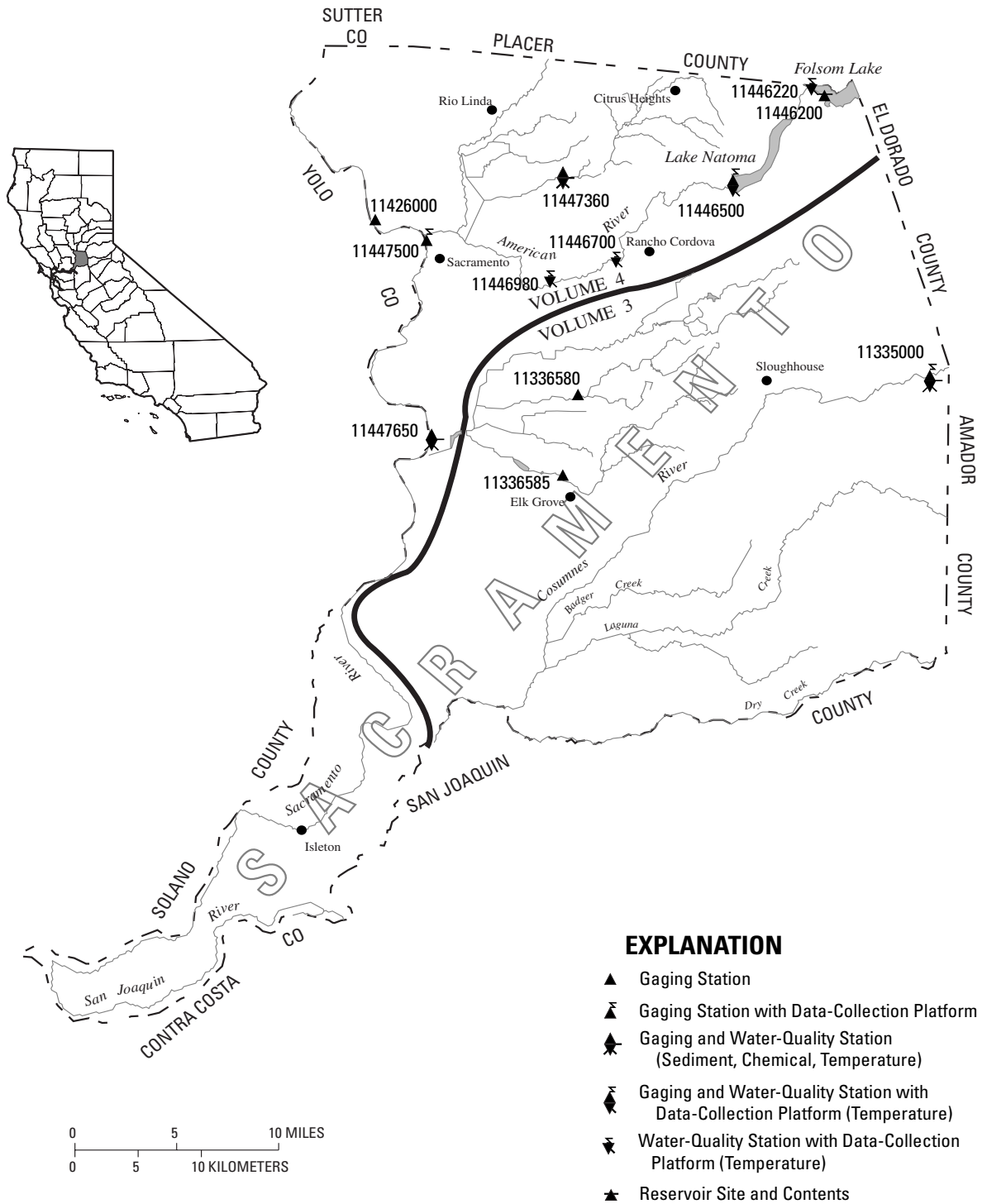

Figure 15. Location of discharge, stage, and water-quality stations in Sacramento County.
 (NOTE: Records for stations 11335000 through 11336585 published in volume 3.)

WATER RESOURCES DATA—CALIFORNIA, WATER YEAR 2002

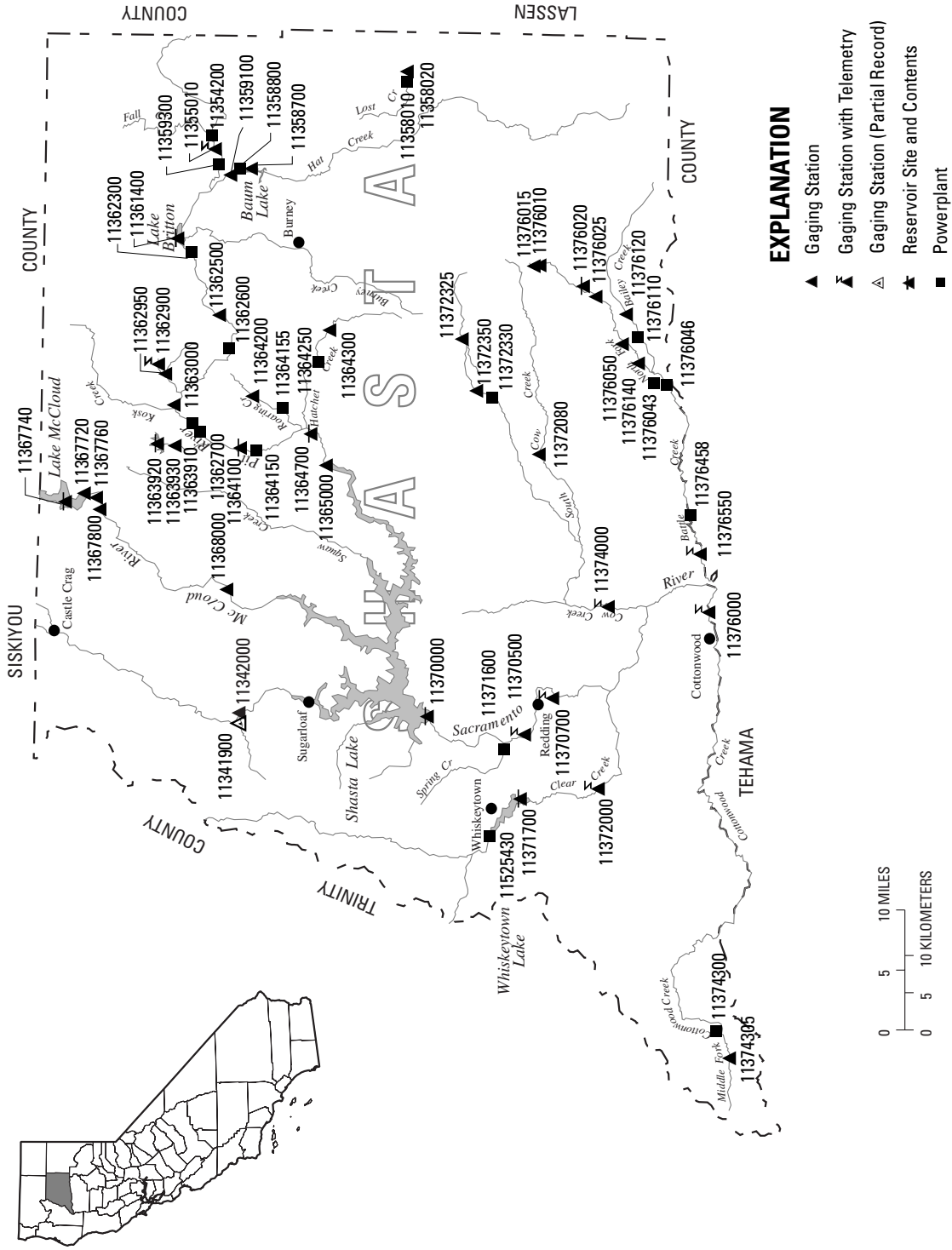

Figure 16. Location of discharge stations in Shasta County.

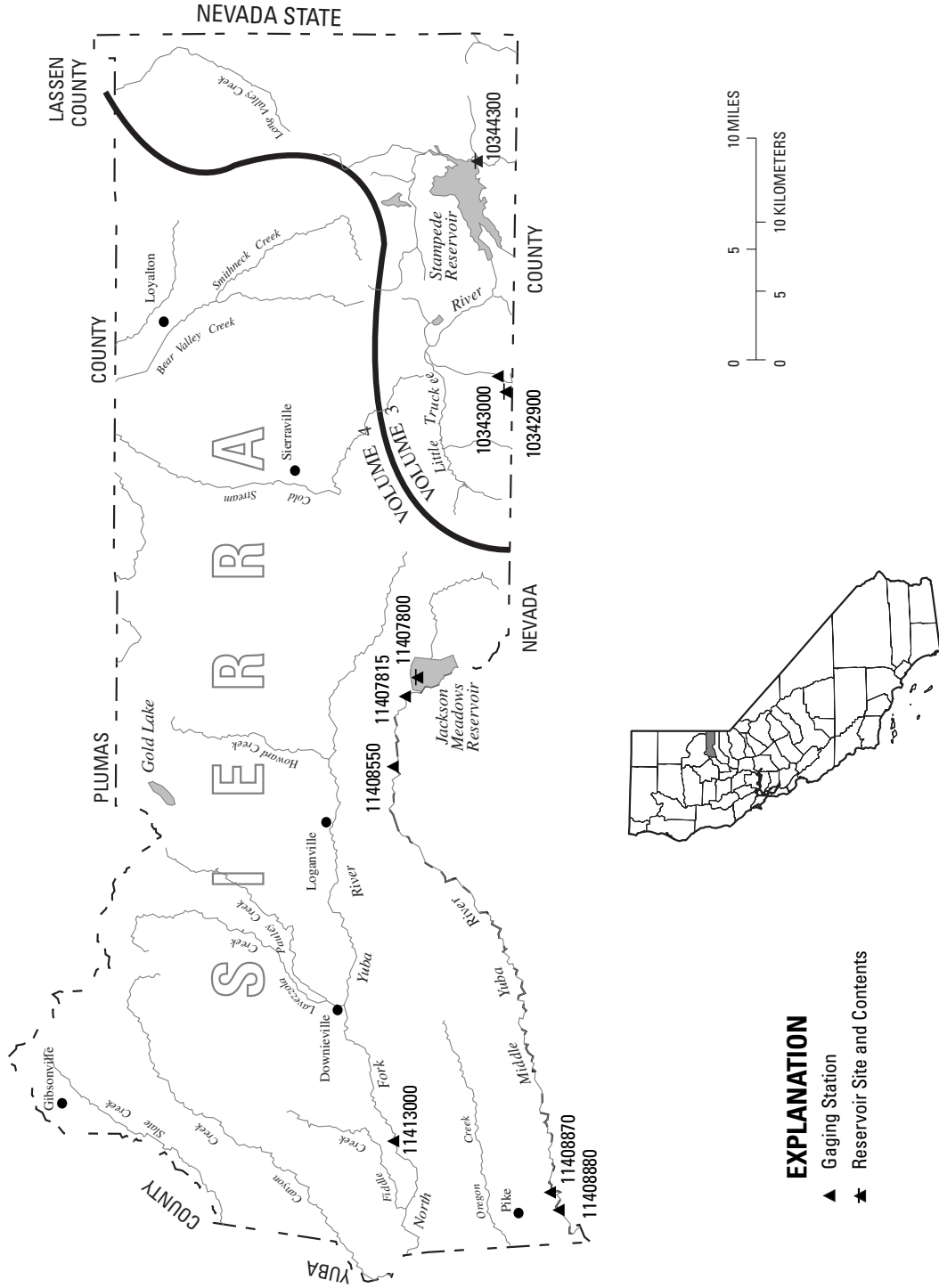
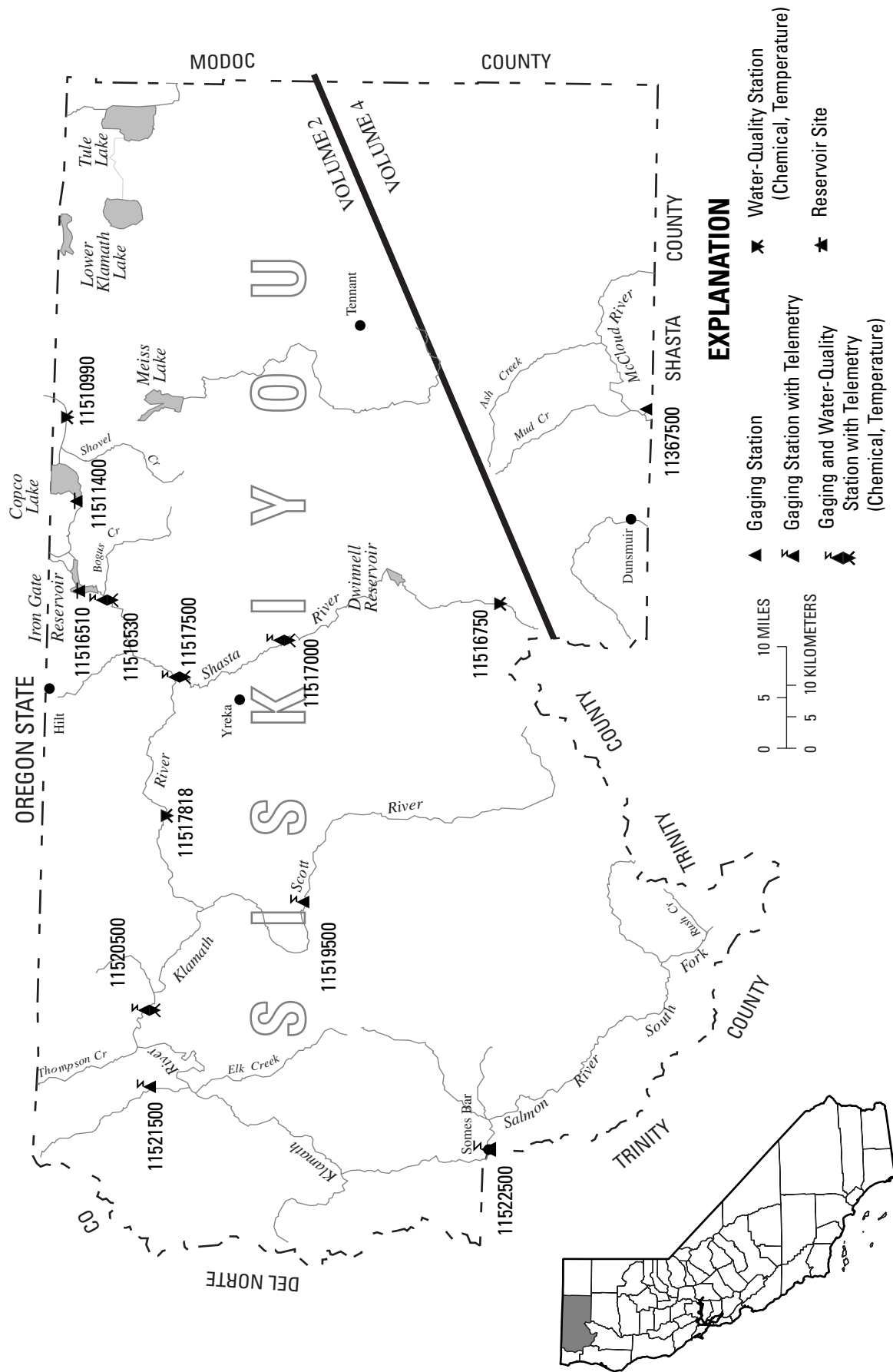

Figure 17. Location of discharge stations in Sierra County.
 (NOTE: Records for stations 10342900 through 10344300 published in volume 3.)



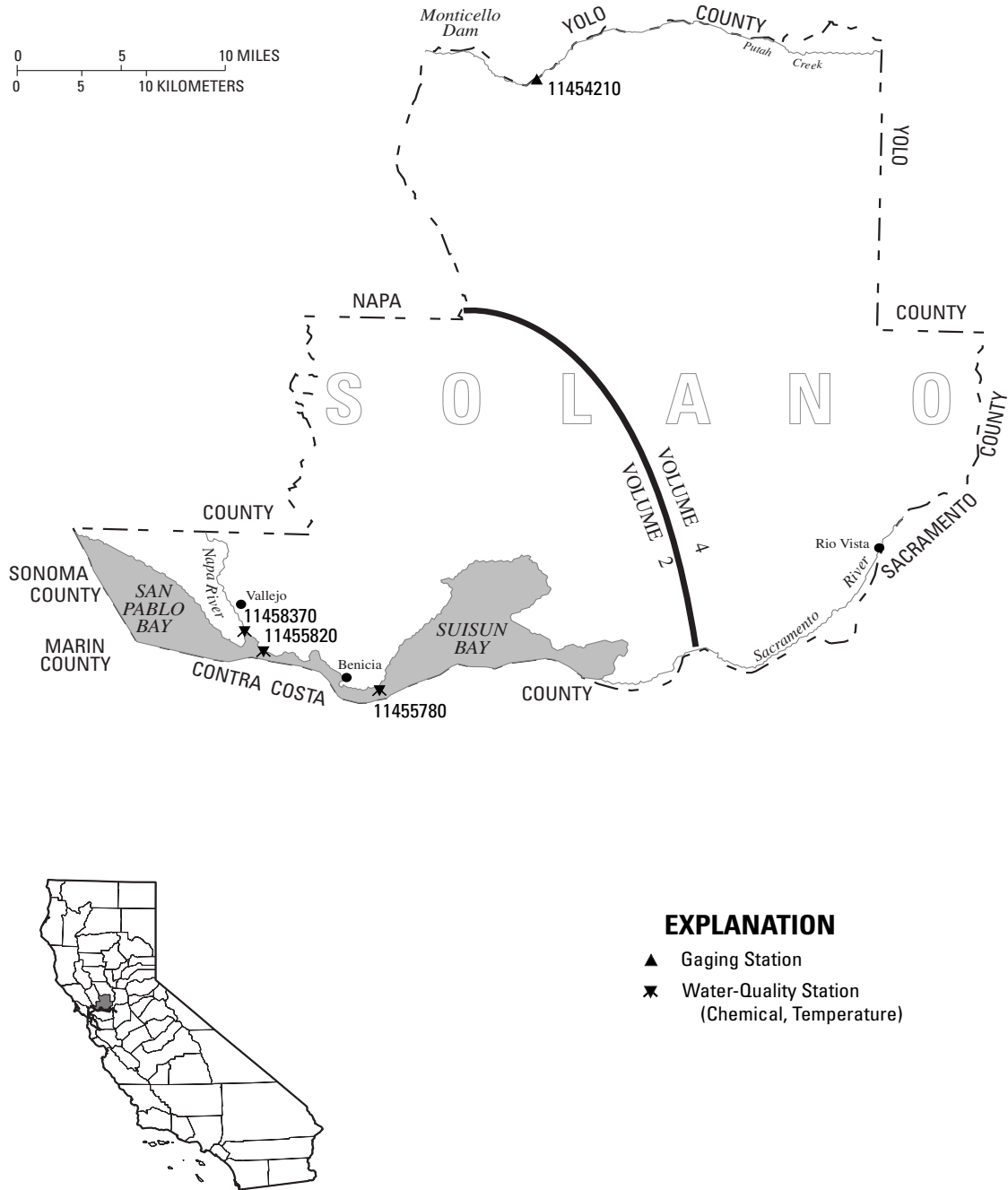

Figure 19. Location of discharge and water-quality stations in Solano County.
 (NOTE: Records for station 11455780 through 11458370 published in volume 2.)

WATER RESOURCES DATA—CALIFORNIA, WATER YEAR 2002

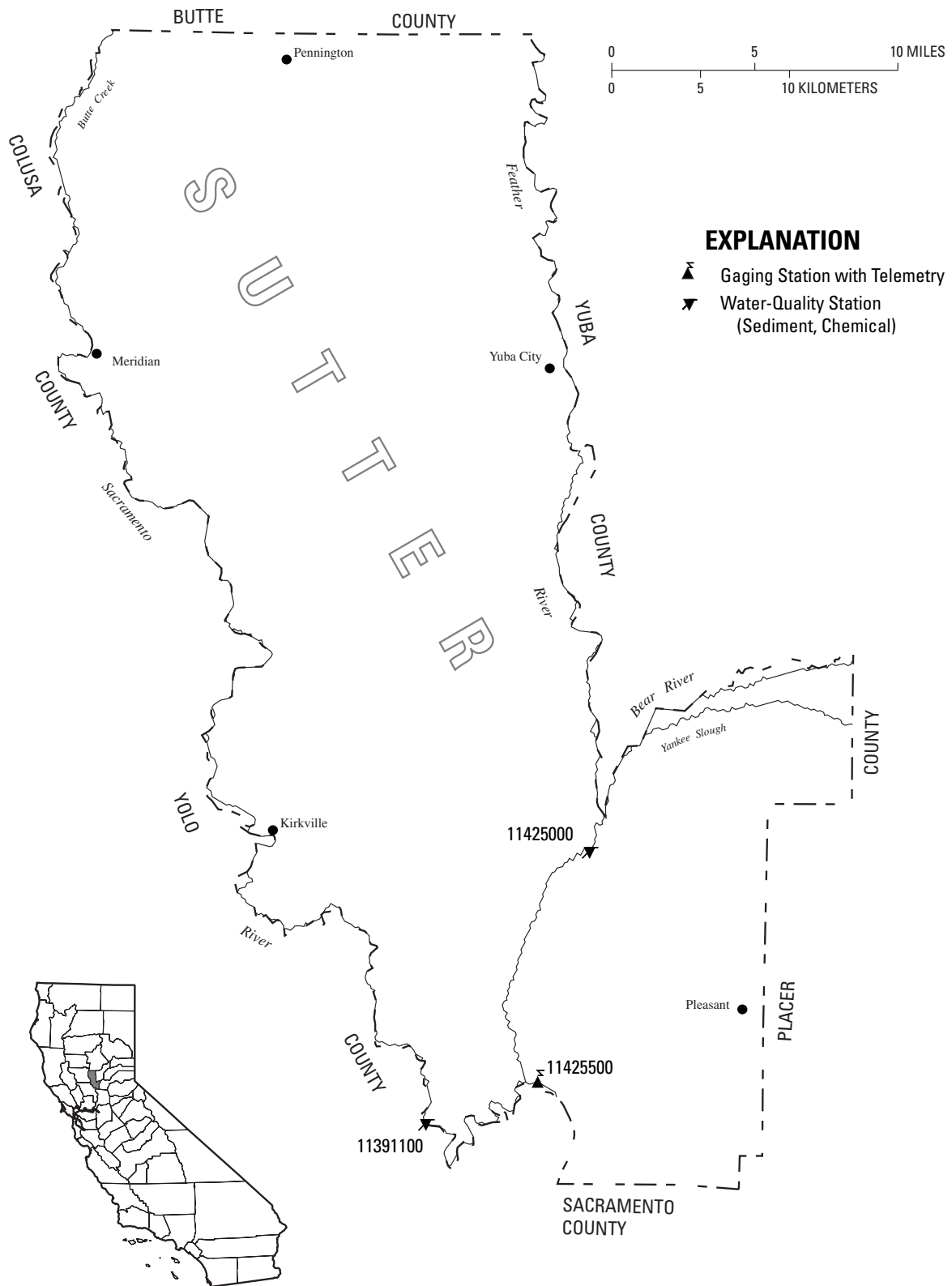

Figure 20. Location of discharge and water-quality stations in Sutter County.

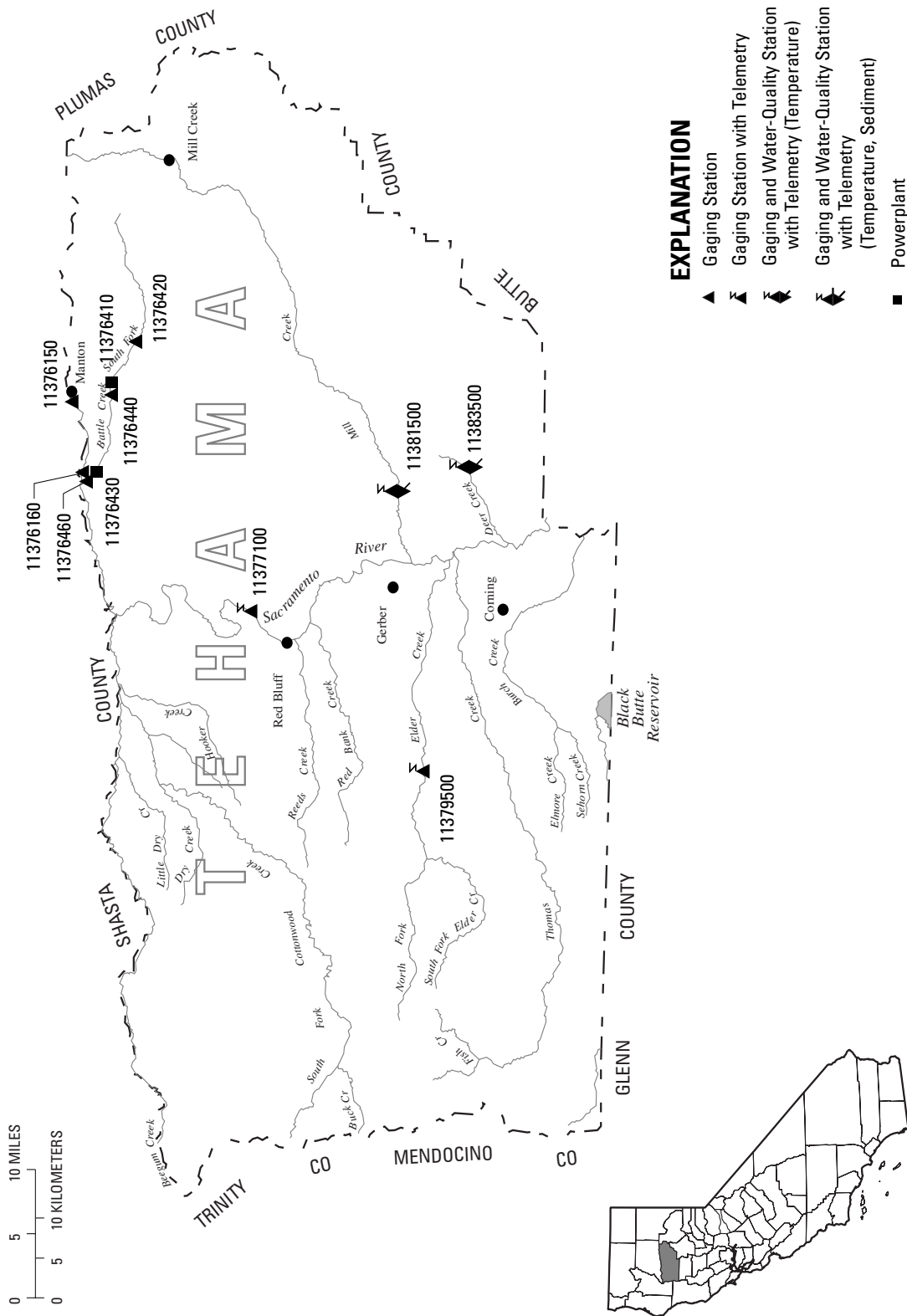

Figure 21. Location of discharge and water-quality stations in Tehama County.

WATER RESOURCES DATA—CALIFORNIA, WATER YEAR 2002

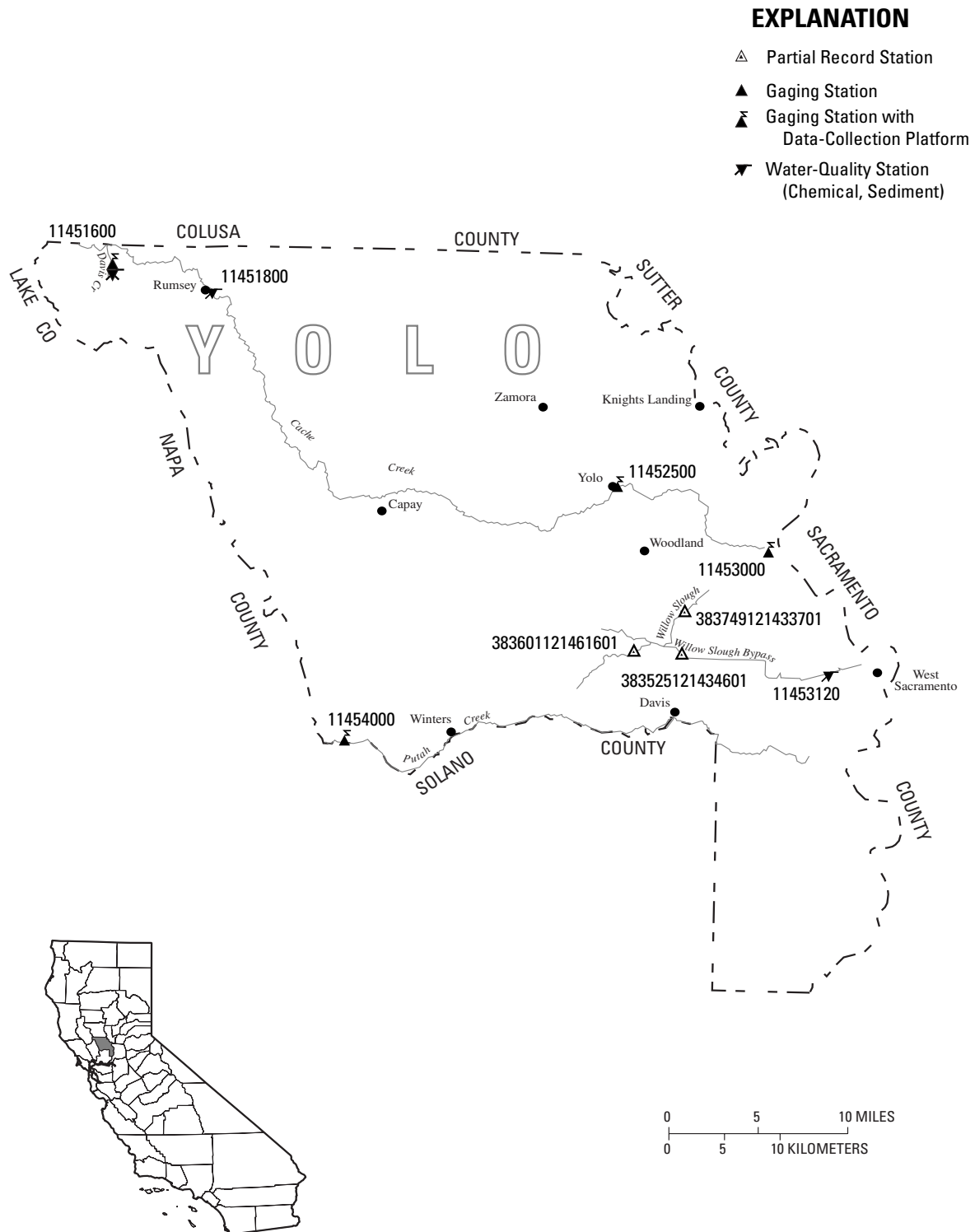

Figure 22. Location of discharge and water-quality stations in Yolo County.

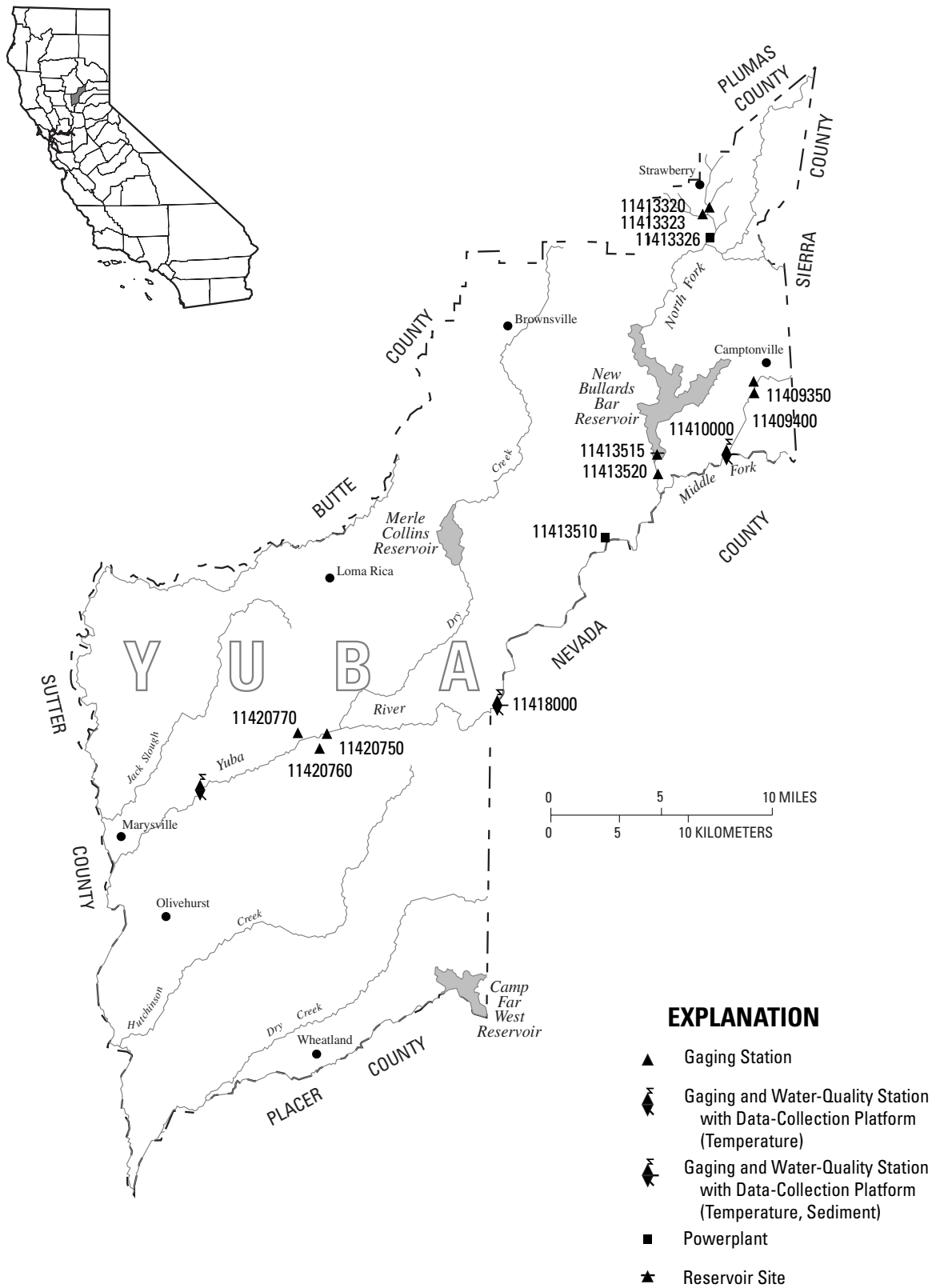

Figure 23. Location of discharge and water-quality stations in Yuba County.

WATER RESOURCES DATA—CALIFORNIA, WATER YEAR 2001

SURFACE-WATER-DISCHARGE AND SURFACE-WATER-QUALITY RECORDS

Remark Codes

The following remark codes may appear with the water-quality data in this section:

<u>PRINTED OUTPUT</u>	<u>REMARK</u>
e	Value is estimated.
>	Actual value is known to be greater than the value shown.
<	Actual value is known to be less than the value shown.
M	Presence of material verified, but not quantified.
N	Presumptive evidence of presence of material.
U	Material specifically analyzed for, but not detected.
A	Value is an average.
V	Analyte was detected in both the environmental sample and the associated blanks.
S	Most probable value.
K	Results based on colony count outside the acceptance range (non-ideal colony count).
L	Biological organism count less than 0.5 percent (organism may be observed rather than counted).
D	Biological organism count equal to or greater than 15 percent (dominant).
ND	Not detected.
SS	Suspended-sediment data determined from a sample collected and processed according to National Water-Quality Assessment (NAWQA) protocol.
&	Biological organism estimated as dominant.
*	Instantaneous discharge at the time of cross-sectional measurements.
**	Partial sampled width.
1	Laboratory value.
2	Laboratory fixed-end point titration.
†	Sample collected using an automatic sampler.

Dissolved Trace-Element Concentrations

NOTE: Traditionally, dissolved trace-element concentrations have been reported at the microgram per liter ($\mu\text{g/L}$) level. Recent evidence, mostly from large rivers, indicates that actual dissolved-phase concentrations for a number of trace elements are within the range of 10's to 100's of nanograms per liter (ng/L). Data above the $\mu\text{g/L}$ level should be viewed with caution. Such data may actually represent elevated environmental concentrations from natural or human causes; however, these data could reflect contamination introduced during sampling, processing, or analysis. To confidently produce dissolved trace-element data with insignificant contamination, the U.S. Geological Survey began using new trace-element protocols at some stations in water year 1994.

Data Precision

NOTE: Precision varies for different analytical methods used to determine the same constituent. The presence of trailing zeroes after the decimal in values printed in this report does not necessarily indicate that the method used for the determination is as precise as the level implied by the rightmost zero.

10356380 SUSAN RIVER ABOVE WILLARD CREEK, NEAR SUSANVILLE, CA

LOCATION.—Lat 40°23'45", long 120°46'51", in NE 1/4 NE 1/4 sec.7, T.29 N., R.11 E., Lassen County, Hydrologic Unit 18080003, 6.2 mi southwest of Susanville, and 7.1 mi southeast of Hogflat Reservoir at State Highway 36.

DRAINAGE AREA.—128 mi².

PERIOD OF RECORD.—June 2001 to current year.

CHEMICAL DATA: June 2001 to current year.

SEDIMENT DATA: July to September 2002.

WATER-QUALITY DATA, WATER YEAR OCTOBER 2001 TO SEPTEMBER 2002

Date	Time	DIS-CHARGE, INST. CUBIC FEET PER SECOND (00061)	TURBIDITY LAB HACH 2100AN (NTU) (99872)	BARO-METRIC PRES-SURE (MM OF HG) (00025)	OXYGEN, DIS-SOLVED (MG/L) (00300)	OXYGEN, (PER-CENT SATURATION) (00301)	PH WATER WHOLE FIELD (STANDARD UNITS) (00400)	SPE-CIFIC CON-DUCTANCE (US/CM) (00095)
DEC 27...	1100	10	.7	644	--	--	8.3	165
MAR 27...	1030	40	3.5	644	10.8	100	8.3	97
JUL 01...	1130	87	4.2	646	7.2	93	8.2	56

Date	TEMPERATURE WATER (DEG C) (00010)	CHLORIDE, DIS-SOLVED (MG/L AS CL) (00940)	SOLIDS, RESIDUE AT 180 DEG. C SOLVED (MG/L) (70300)	NITRO-GEN, AM-MONIA + ORGANIC TOTAL (MG/L AS N) (00625)	NITRO-GEN, NO2+NO3 DIS-SOLVED (MG/L AS N) (00631)	PHOS-PHORUS TOTAL (MG/L AS P) (00665)	SEDI-MENT, SUS-PENDED (MG/L) (80154)	SEDI-MENT, DIS-CHARGE, SUS-PENDED (T/DAY) (80155)
DEC 27...	3.5	1.01	126	.13	.23	e.06	--	--
MAR 27...	5.0	.89	80	.19	e.04	e.05	--	--
JUL 01...	19.5	<.30	46	.38	e.03	.033	11	2.6

e Estimated.

< Actual value is known to be less than the value shown.

10359040 SUSAN RIVER NEAR LITCHFIELD, CA

LOCATION.—Lat 40°22'40", long 120°23'38", in NW 1/4 NW 1/4 sec.15, T.29 N., R.14 E., Lassen County, Hydrologic Unit 18080003, 0.5 mi south of Litchfield and 13.3 mi east of Susanville.

DRAINAGE AREA.—Not determined.

PERIOD OF RECORD.—June 2001 to current year.

CHEMICAL DATA: June 2001 to current year.

SEDIMENT DATA: July to September 2002.

WATER-QUALITY DATA, WATER YEAR OCTOBER 2001 TO SEPTEMBER 2002

Date	Time	DIS-CHARGE, INST. CUBIC FEET PER SECOND (00061)	TURBIDITY LAB HACH 2100AN (NTU) (99872)	BARO-METRIC PRES-SURE (MM OF HG) (00025)	OXYGEN, DIS-SOLVED (MG/L) (00300)	OXYGEN, (PER-CENT SATURATION) (00301)	PH WATER WHOLE FIELD (STANDARD UNITS) (00400)	SPE-CIFIC CON-DUCTANCE (US/CM) (00095)
DEC 27...	1320	15	.6	656	15.2	135	8.1	379
MAR 27...	1315	25	8.8	659	10.9	124	8.5	341
JUL 01...	1330	3.5	8.9	660	14.5	210	9.7	358

Date	TEMPERATURE WATER (DEG C) (00010)	CHLORIDE, DIS-SOLVED (MG/L AS CL) (00940)	SOLIDS, RESIDUE AT 180 DEG. C DIS-SOLVED (MG/L) (70300)	NITRO-GEN, AM-MONIA + ORGANIC TOTAL (MG/L AS N) (00625)	NITRO-GEN, NO2+NO3 DIS-SOLVED (MG/L AS N) (00631)	PHOS-PHORUS TOTAL (MG/L AS P) (00665)	SEDI-MENT, SUS-PENDED (MG/L) (80154)	SEDI-MENT, DIS-CHARGE, SUS-PENDED (T/DAY) (80155)
DEC 27...	4.0	7.91	254	.60	<.05	e.05	--	--
MAR 27...	14.5	6.47	224	.41	<.05	.10	--	--
JUL 01...	26.5	7.28	245	.56	<.013	.190	9.0	.09

< Actual value is known to be less than the value shown.
e Estimated.

10360401 MILL CREEK AT UPPER LAKE, NEAR LAKE CITY, CA

LOCATION.—Lat 41°38'44", long 120°12'45", in SE 1/4 NW 1/4 sec.36, T.44 N., R.15 E., Modoc County, Hydrologic Unit 18080001, 9.1 mi north of Cedarville, and 0.1 mi north of Lake City, on the Surprise Valley Road.

DRAINAGE AREA.—8.83 mi².

PERIOD OF RECORD.—June 2001 to current year.

CHEMICAL DATA: June 2001 to current year.

SEDIMENT DATA: September 2001 to current year.

WATER-QUALITY DATA, WATER YEAR OCTOBER 2001 TO SEPTEMBER 2002

Date	Time	DIS- CHARGE, INST. CUBIC FEET PER SECOND (00061)	TURBID- ITY LAB HACH 2100AN (NTU) (99872)	BARO- METRIC PRES- SURE (MM OF HG) (00025)	OXYGEN, DIS- SOLVED OXYGEN, DIS- SOLVED (MG/L) (00300)	OXYGEN, DIS- SOLVED SATUR- ATION (00301)	PH WATER WHOLE FIELD (STAND- ARD UNITS) (00400)	SPE- CIFIC CON- DUCT- ANCE (US/CM) (00095)
DEC 28...	1040	.59	.6	644	11.3	97	7.4	119
MAR 28...	1115	3.7	5.0	648	10.2	96	8.3	114
JUL 02...	1045	3.1	4.5	644	9.1	102	8.0	86

Date	TEMPER- ATURE WATER (DEG C) (00010)	CHLO- RIDE, DIS- SOLVED (MG/L) AS CL) (00940)	SOLIDS, RESIDUE AT 180 DEG. C DIS- SOLVED (MG/L) (70300)	NITRO- GEN, AM- MONIA + ORGANIC TOTAL (MG/L) AS N) (00625)	NITRO- GEN, NO2+NO3 DIS- SOLVED (MG/L) AS N) (00631)	PHOS- PHORUS TOTAL (MG/L) AS P) (00665)	SEDI- MENT, DIS- SUS- PENDEDED (MG/L) (80154)	CHARGE, DIS- SUS- PENDEDED (T/DAY) (80155)
DEC 28...	2.0	.58	94	--	--	--	4.0	.01
MAR 28...	6.0	.42	93	--	--	--	12	.12
JUL 02...	13.0	e.21	69	.09	<.05	.053	10	.08

e Estimated.

< Actual value is known to be less than the value shown.

10360900 BIDWELL CREEK BELOW MILL CREEK, NEAR FORT BIDWELL, CA

LOCATION.—Lat 41°52'57", long 120°10'26", in NE 1/4 SE 1/4 sec.6, T.46 N., R.16 E., Modoc County, Hydrologic Unit 18080001, 23.1 mi north of Cedarville and 2.5 mi northwest of Fort Bidwell.

DRAINAGE AREA.—25.6 mi².

PERIOD OF RECORD.—Water years 1960–1982, June 2001 to current year.

WATER DISCHARGE.—Water years 1960–1982.

CHEMICAL DATA: June 2001 to current year.

SEDIMENT DATA: July to September 2002.

WATER-QUALITY DATA, WATER YEAR OCTOBER 2001 TO SEPTEMBER 2002

Date	Time	DIS- CHARGE, INST. CUBIC FEET PER SECOND (00061)	TURBID- ITY LAB HACH 2100AN (NTU) (99872)	BARO- METRIC PRES- SURE (MM OF HG) (00025)	OXYGEN, OXYGEN, DIS- SOLVED (MG/L) (00300)	OXYGEN, DIS- SOLVED CENT SATUR- ATION) (00301)	PH WATER WHOLE FIELD (STAND- ARD UNITS) (00400)	SPE- CIFIC CON- DUCT- ANCE (US/CM) (00095)
DEC								
28...	0920	4.8	.8	637	11.0	94	7.2	87
MAR								
28...	0945	22	7.5	641	11.1	98	8.2	89
JUL								
02...	0920	19	2.5	639	9.1	96	8.0	60

Date	TEMPER- ATURE WATER (DEG C) (00010)	CHLO- RIDE, DIS- SOLVED (MG/L) AS CL) (00940)	SOLIDS, RESIDUE AT 180 DEG. C DIS- SOLVED (MG/L) (70300)	NITRO- GEN,AM- MONIA + ORGANIC TOTAL (MG/L) AS N) (00625)	NITRO- GEN, NO2+NO3 DIS- SOLVED (MG/L) AS N) (00631)	PHOS- PHORUS TOTAL (MG/L) AS P) (00665)	SEDI- MENT, SUS- PENDE (MG/L) (80154)	SEDI- MENT, DIS- CHARGE, SUS- PENDE (T/DAY) (80155)
DEC								
28...	1.5	.59	84	e.09	e.04	<.06	--	--
MAR								
28...	3.0	.60	88	--	<.05	e.06	--	--
JUL								
02...	10.0	e.23	53	.08	<.013	.026	3.0	.16

e Estimated.

< Actual value is known to be less than the value shown.

SACRAMENTO RIVER BASIN

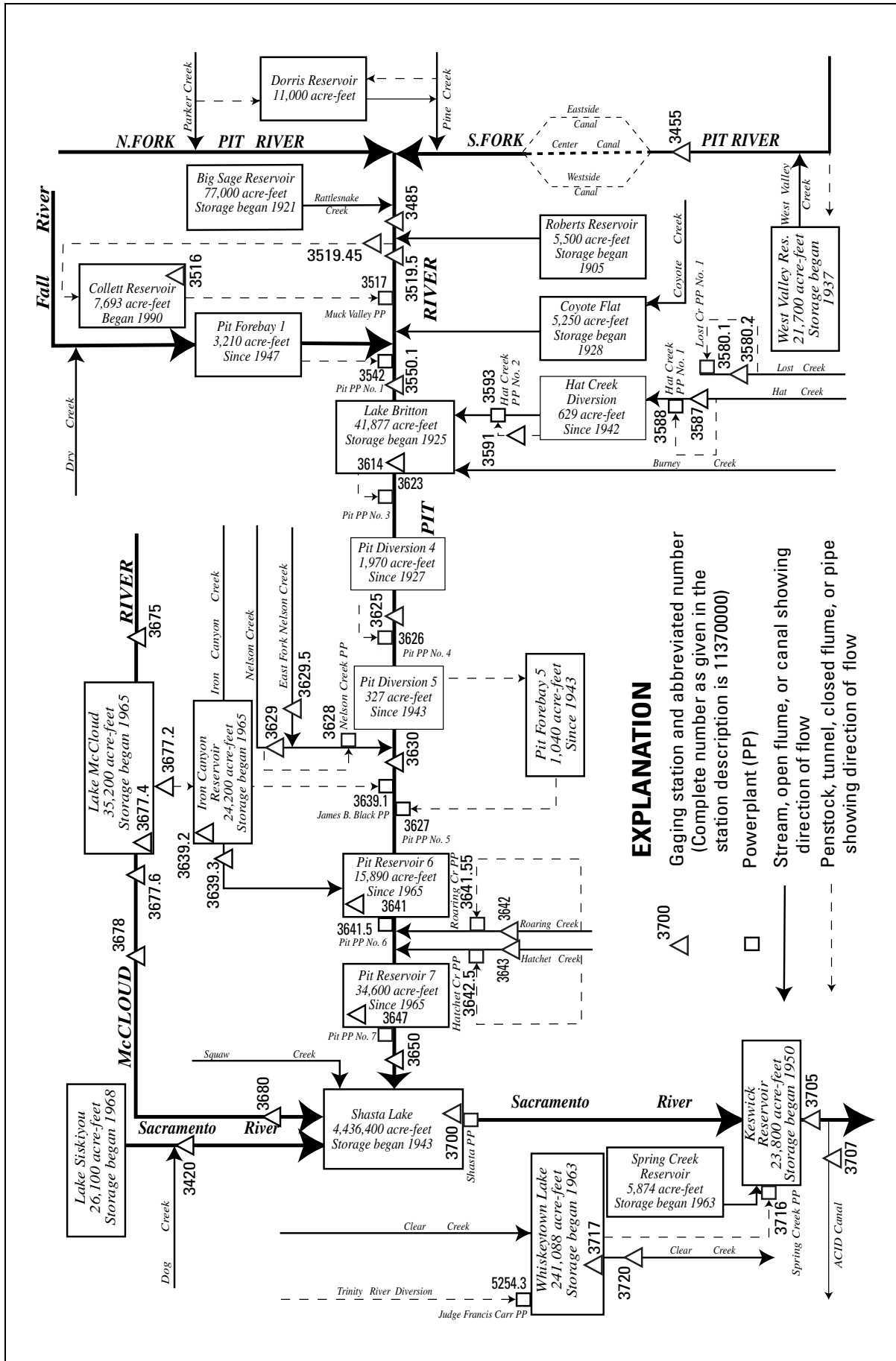

Figure 24. Diversions and storage in Pit and McCloud River Basins.

11342000 SACRAMENTO RIVER AT DELTA, CA

LOCATION.—Lat 40°56'23", long 122°24'58", in SW 1/4 NW 1/4 sec.35, T.36 N., R.5 W., [Shasta County](#), Hydrologic Unit 18020005, U.S. Bureau of Reclamation property, on left bank, 0.2 mi downstream from Dog Creek, 0.6 mi southeast of Delta, 2.8 mi south of Lamoine, and 29 mi downstream from Lake Siskiyou.

DRAINAGE AREA.—425 mi².

PERIOD OF RECORD.—October 1944 to current year. Monthly discharge only for some periods, published in WSP 1315-A.

CHEMICAL DATA: Water years 1951–81.

WATER TEMPERATURE: Water years 1951, 1954–57, 1963–79.

REVISED RECORDS.—WSP 1395: 1951(M). WDR-CA-94-4: 1993(P).

GAGE.—Water-stage recorder. Datum of gage is 1,075.00 ft above sea level (levels by U.S. Bureau of Reclamation).

REMARKS.—Records good. Some regulation by Lake Siskiyou, capacity, 26,100 acre-ft, since December 1968. Some minor diversions for irrigation upstream from station. See schematic diagram of [Pit and McCloud River Basins](#).

EXTREMES FOR PERIOD OF RECORD.—Maximum discharge, 69,800 ft³/s, Jan. 16, 1974, gage height, 27.20 ft in gage well, 28.7 ft from floodmarks, from rating curve extended above 19,000 ft³/s, on basis of slope-area measurements at gage height 19.50 ft, and of peak flow; minimum daily, 117 ft³/s, Aug. 5, 6, 12–15, 1977.

EXTREMES FOR CURRENT YEAR.—Peak discharges greater than base discharge of 8,000 ft³/s, or maximum:

Date	Time	Discharge (ft ³ /s)	Gage height (ft)
Jan. 2	1315	23,400	14.31

DISCHARGE, CUBIC FEET PER SECOND, WATER YEAR OCTOBER 2001 TO SEPTEMBER 2002
DAILY MEAN VALUES

DAY	OCT	NOV	DEC	JAN	FEB	MAR	APR	MAY	JUN	JUL	AUG	SEP
1	206	235	2780	4410	706	1490	1710	1140	1120	299	229	207
2	204	219	3800	16000	734	1370	1920	1110	1020	291	228	207
3	203	213	3030	8890	675	1270	2100	1140	810	291	228	206
4	202	208	1670	4810	707	1210	2300	1140	729	285	228	207
5	202	207	1430	3520	662	1140	2470	1160	688	282	236	207
6	203	207	1700	4460	655	1170	2260	1190	654	279	230	209
7	204	205	1480	4930	2070	1250	2080	1180	610	276	227	221
8	205	207	1160	4450	2940	1340	1970	1030	571	273	224	219
9	201	207	1090	3890	1840	1160	2260	1000	544	270	222	214
10	201	207	947	3170	1400	1210	2430	958	520	264	221	211
11	202	263	799	2710	1280	1230	2160	905	493	260	219	208
12	195	1860	788	2460	1160	1240	2030	901	472	263	218	207
13	193	820	732	2290	1140	1290	2070	943	450	269	216	207
14	193	753	815	2140	1140	1150	2580	958	437	253	216	205
15	192	541	745	1970	1090	1060	2520	939	427	251	216	205
16	193	648	722	1810	1080	1070	1970	900	416	248	217	206
17	192	783	903	1450	1140	1050	1660	901	402	246	218	209
18	192	503	1320	1220	1120	979	1440	946	400	246	216	186
19	192	419	2330	1250	1720	952	1200	1040	387	246	217	176
20	192	526	2880	1100	2450	923	1140	1510	376	243	217	175
21	192	1570	2130	1160	2370	941	1120	1210	364	241	217	174
22	192	2110	2260	1080	2290	1070	1130	1070	364	240	219	174
23	192	1050	2140	961	2530	1750	1230	987	358	240	218	174
24	190	971	1570	942	2260	1580	1250	1000	349	238	220	173
25	190	860	1300	872	1980	1420	1290	1050	338	237	217	189
26	190	704	1130	968	1710	1310	1360	1040	328	234	216	203
27	191	614	1290	966	1680	1270	1270	1010	320	231	211	204
28	193	666	2390	843	1610	1280	1170	1010	317	228	211	205
29	202	756	2820	782	---	1430	1080	959	314	228	209	208
30	485	651	2890	766	---	1500	1240	984	307	228	209	209
31	298	---	4600	749	---	1580	---	916	---	229	210	---
TOTAL	6482	19183	55641	87019	42139	38685	52410	32227	14885	7909	6800	6005
MEAN	209.1	639.4	1795	2807	1505	1248	1747	1040	496.2	255.1	219.4	200.2
MAX	485	2110	4600	16000	2940	1750	2580	1510	1120	299	236	221
MIN	190	205	722	749	655	923	1080	900	307	228	209	173
AC-FT	12860	38050	110400	172600	83580	76730	104000	63920	29520	15690	13490	11910

11342000 SACRAMENTO RIVER AT DELTA, CA—Continued

STATISTICS OF MONTHLY MEAN DATA FOR WATER YEARS 1945 - 2002, BY WATER YEAR (WY)

	OCT	NOV	DEC	JAN	FEB	MAR	APR	MAY	JUN	JUL	AUG	SEP
MEAN	349.6	775.1	1331	1887	2331	2253	2014	1680	814.6	342.5	236.0	232.7
MAX	1837	6075	5770	7162	9557	7957	4264	4216	3741	1198	462	514
(WY)	1951	1974	1997	1995	1958	1983	1963	1983	1998	1998	1983	1957
MIN	150	187	197	214	226	243	264	410	229	145	122	154
(WY)	1945	1992	1977	1991	1977	1977	1977	1977	1977	1977	1977	1991

SUMMARY STATISTICS	FOR 2001 CALENDAR YEAR		FOR 2002 WATER YEAR		WATER YEARS 1945 - 2002	
ANNUAL TOTAL	332587		369385			
ANNUAL MEAN	911.2		1012		1181	
HIGHEST ANNUAL MEAN					2715	
LOWEST ANNUAL MEAN					228	
HIGHEST DAILY MEAN	7230	Feb 21	16000	Jan 2	53900	Jan 16 1974
LOWEST DAILY MEAN	190	Oct 24	173	Sep 24	117	Aug 5 1977
ANNUAL SEVEN-DAY MINIMUM	191	Oct 21	176	Sep 18	117	Aug 11 1977
MAXIMUM PEAK FLOW			23400		69800	
MAXIMUM PEAK STAGE			14.31		27.20	
ANNUAL RUNOFF (AC-FT)	659700		732700		855600	
10 PERCENT EXCEEDS	2250		2200		2650	
50 PERCENT EXCEEDS	450		766		528	
90 PERCENT EXCEEDS	200		204		200	

11345500 SOUTH FORK PIT RIVER NEAR LIKELY, CA

LOCATION.—Lat 41°13'51", long 120°26'10", in NE 1/4 SE 1/4 sec.11, T.39 N., R.13 E., [Modoc County](#), Hydrologic Unit 18020002, on left bank, 250 ft downstream from highway bridge, 1.4 mi downstream from West Valley Creek, and 3.5 mi east of Likely.

DRAINAGE AREA.—247 mi².

PERIOD OF RECORD.—October 1928 to current year. Monthly discharge only for some periods, published in WSP 1315-A.

CHEMICAL DATA: Water years 1951–79.

WATER TEMPERATURE: Water years 1965–79.

SEDIMENT DATA: Water years 1957–61, 1967–70.

REVISED RECORDS.—WSP 1931: Drainage area, 1932(M), 1938(M), 1952(M). WDR CA-88-4: 1983(M).

GAGE.—Water-stage recorder. Datum of gage is 4,507.74 ft above sea level. Prior to Oct. 1, 1931, at site 1,000 ft downstream at different datum.

REMARKS.—Records fair. Considerable regulation by West Valley Reservoir on West Valley Creek beginning in May 1937, usable capacity, 21,700 acre-ft. Diversions for irrigation of about 3,800 acres upstream from station. See schematic diagram of [Pit and McCloud River Basins](#).

EXTREMES FOR PERIOD OF RECORD.—Maximum discharge, 1,620 ft³/s, June 2, 1971, gage height, 6.05 ft; minimum, 0.2 ft³/s, Feb. 3, 1941.

DISCHARGE, CUBIC FEET PER SECOND, WATER YEAR OCTOBER 2001 TO SEPTEMBER 2002

DAILY MEAN VALUES

DAY	OCT	NOV	DEC	JAN	FEB	MAR	APR	MAY	JUN	JUL	AUG	SEP
1	18	21	19	28	e10	e5.8	25	116	122	102	109	75
2	19	20	20	30	e11	e5.6	30	107	118	104	108	74
3	19	17	19	29	e11	e5.4	29	111	119	101	108	85
4	19	17	25	18	e12	e5.2	33	111	118	99	108	95
5	19	16	21	16	e14	5.2	38	113	113	98	108	81
6	22	16	19	16	e13	6.1	42	113	113	97	106	61
7	25	16	21	16	e12	9.3	42	113	111	97	103	61
8	25	16	19	15	e10	15	42	110	107	102	103	63
9	25	17	19	18	e11	15	46	104	107	105	97	61
10	26	17	35	14	e10	11	52	105	106	103	93	60
11	28	18	34	13	e10	14	51	103	109	103	92	72
12	29	17	18	13	e10	22	68	99	109	103	91	84
13	29	20	9.0	12	e10	18	86	99	105	109	91	82
14	29	19	9.0	e12	e10	16	110	101	103	110	89	80
15	29	18	13	e11	e11	13	132	101	102	108	89	74
16	29	18	12	e11	12	13	104	95	102	104	81	64
17	29	16	11	e10	14	11	95	94	103	115	75	50
18	29	14	12	e10	14	15	86	95	113	119	74	46
19	28	15	11	e10	14	15	75	98	116	113	73	40
20	28	15	12	e9.7	25	17	67	100	113	113	72	36
21	28	17	11	e9.4	48	15	62	102	114	115	72	30
22	28	20	12	e9.2	44	14	61	98	116	114	85	29
23	28	17	9.5	e9.1	30	15	64	88	114	113	95	28
24	28	18	17	e8.8	18	17	62	87	114	109	95	27
25	29	17	22	e8.7	10	14	63	95	116	108	93	23
26	29	18	13	e8.8	7.1	12	72	94	119	105	93	15
27	29	23	9.7	e8.9	6.4	12	77	96	115	117	91	12
28	29	23	10	e9.2	e6.0	13	82	98	103	128	85	11
29	29	20	14	e9.5	---	16	94	97	99	125	79	11
30	30	23	17	e9.7	---	18	121	108	96	110	78	16
31	28	---	29	e10	---	21	---	120	---	110	77	---
TOTAL	819	539	522.2	413.0	413.5	404.6	2011	3171	3315	3359	2813	1546
MEAN	26.42	17.97	16.85	13.32	14.77	13.05	67.03	102.3	110.5	108.4	90.74	51.53
MAX	30	23	35	30	48	22	132	120	122	128	109	95
MIN	18	14	9.0	8.7	6.0	5.2	25	87	96	97	72	11
AC-FT	1620	1070	1040	819	820	803	3990	6290	6580	6660	5580	3070

STATISTICS OF MONTHLY MEAN DATA FOR WATER YEARS 1929 - 2002, BY WATER YEAR (WY)

MEAN	32.06	27.91	28.29	30.62	34.48	47.36	107.2	230.1	178.0	92.97	115.5	57.45
MAX (WY)	63.4	57.8	107	98.5	101	219	385	570	643	238	236	159
MIN (WY)	1997	1985	1965	1997	1965	1972	1952	1984	1998	1995	1995	1975
MIN (WY)	1932	1980	1980	1941	1978	1977	1991	1931	1931	1931	1934	1931

SUMMARY STATISTICS FOR 2001 CALENDAR YEAR FOR 2002 WATER YEAR WATER YEARS 1929 - 2002

ANNUAL TOTAL	13835.5	19326.3	
ANNUAL MEAN	37.91	52.95	82.07
HIGHEST ANNUAL MEAN			183
LOWEST ANNUAL MEAN			27.3
HIGHEST DAILY MEAN	130	Jun 2	132
LOWEST DAILY MEAN	4.8	Feb 28	5.2
ANNUAL SEVEN-DAY MINIMUM	5.5	Feb 24	5.6
MAXIMUM PEAK FLOW			143
MAXIMUM PEAK STAGE			2.92
ANNUAL RUNOFF (AC-FT)	27440	38330	59450
10 PERCENT EXCEEDS	91	110	187
50 PERCENT EXCEEDS	25	29	42
90 PERCENT EXCEEDS	10	10	12

e Estimated.

11348500 PIT RIVER NEAR CANBY, CA

LOCATION.—Lat 41°24'22", long 120°55'36", in NW 1/4 SW 1/4 sec.10, T.41 N., R.9 E., Modoc County, Hydrologic Unit 18020002, on right bank, at lower end of Warm Spring Valley, and 3.9 mi southwest of Canby.

DRAINAGE AREA.—1,431 mi², excluding Goose Lake Basin.

PERIOD OF RECORD.—January 1904 to December 1905, May 1929 to current year (1929–31 incomplete). Monthly discharge only for February and March 1904 published in WSP 1315-A.

CHEMICAL DATA: Water years 1951–79.

WATER TEMPERATURE: Water years 1965–79.

SEDIMENT DATA: Water years 1957–61, 1967–70.

REVISED RECORDS.—WSP 1445: 1904, 1935(M), 1936, 1937(M). WSP 1931: Drainage area. WSP 1315-A, 1950: Monthly total.

GAGE.—Water-stage recorder. Datum of gage is 4,266.0 ft above sea level. January 1904 to December 1905, nonrecording gage and May 6, 1929, to Sept. 30, 1931, water-stage recorder, at site 100 ft upstream at different datum.

REVISION.—Revision of monthly total for October 1929 published in error in 1950 compilation (WSP 1315-A), correct value is 12.1.

REMARKS.—Records fair. Low flow regulated by many small reservoirs, total capacity about 144,000 acre-ft. Diversions for irrigation of about 39,000 acres upstream from station. See schematic diagram of Pit and McCloud River Basins.

EXTREMES FOR PERIOD OF RECORD.—Maximum discharge observed, 13,000 ft³/s, Mar. 8, 1904, gage height, 15.0 ft, site and datum then in use; no flow July 18, 19, 2000, and July 14, 15, 2002.

EXTREMES FOR CURRENT YEAR.—Peak discharges greater than base discharge of 800 ft³/s, or maximum:

Date	Time	Discharge (ft ³ /s)	Gage height (ft)	Date	Time	Discharge (ft ³ /s)	Gage height (ft)
Jan. 2	2015	915	4.74	Feb. 22	2100	883	4.68

DISCHARGE, CUBIC FEET PER SECOND, WATER YEAR OCTOBER 2001 TO SEPTEMBER 2002

DAILY MEAN VALUES

DAY	OCT	NOV	DEC	JAN	FEB	MAR	APR	MAY	JUN	JUL	AUG	SEP
1	25	22	89	831	e62	146	164	174	2.7	2.6	2.1	5.5
2	23	21	94	760	e64	127	160	299	6.5	2.8	2.6	5.3
3	21	21	115	802	e65	116	151	365	12	2.6	2.4	3.9
4	10	26	95	609	e66	109	157	327	10	2.4	2.4	2.4
5	2.8	34	107	340	e67	104	149	192	2.7	15	2.4	2.8
6	3.7	22	142	245	e67	107	151	99	2.9	16	2.4	2.9
7	4.4	21	161	219	e67	124	161	42	2.4	10	2.4	3.2
8	3.1	21	156	205	e68	144	144	59	2.6	20	2.4	3.1
9	4.5	20	149	204	e69	145	116	63	2.7	13	2.5	3.0
10	6.7	19	118	199	e69	181	118	75	2.6	6.5	2.5	2.9
11	6.8	19	85	170	e71	259	124	107	2.8	3.3	2.5	2.5
12	6.5	20	97	149	e73	344	96	79	9.4	0.10	2.3	1.1
13	6.3	20	97	131	e74	337	44	52	13	0.57	3.4	3.4
14	9.2	20	115	115	e76	267	21	45	4.7	0.00	10	40
15	12	19	90	94	e79	207	35	80	4.8	0.00	7.5	29
16	13	24	100	79	82	177	104	79	3.3	2.3	5.7	8.6
17	13	22	106	83	91	156	160	47	2.4	2.5	4.7	9.2
18	11	21	122	79	120	142	190	24	2.3	5.4	4.5	8.3
19	10	21	145	e75	144	132	211	41	2.3	4.8	4.3	6.1
20	10	24	148	e72	207	132	207	40	2.3	4.6	3.0	5.5
21	10	29	158	e64	616	129	189	27	2.4	2.6	2.6	5.1
22	11	35	148	e59	767	132	161	25	2.5	2.3	2.4	4.5
23	10	35	125	e58	807	133	99	29	2.6	1.8	2.7	4.5
24	9.8	57	109	e58	736	128	32	22	2.4	2.3	4.2	5.8
25	10	139	90	e58	502	137	33	16	3.5	2.2	11	16
26	11	176	86	e57	307	146	23	16	15	2.1	11	39
27	92	136	86	e58	219	142	18	13	90	2.2	9.0	22
28	34	140	88	e59	178	136	13	11	26	2.3	8.9	9.8
29	21	91	125	e61	---	133	5.2	6.2	2.2	2.5	7.5	3.3
30	22	88	286	e64	---	142	58	3.6	2.4	2.5	4.9	3.7
31	26	---	566	e63	---	154	---	3.0	---	2.6	5.6	---
TOTAL	458.8	1363	4198	6120	5813	4968	3294.2	2460.8	243.4	139.87	141.8	262.4
MEAN	14.80	45.43	135.4	197.4	207.6	160.3	109.8	79.38	8.113	4.512	4.574	8.747
MAX	92	176	566	831	807	344	211	365	90	20	11	40
MIN	2.8	19	85	57	62	104	5.2	3.0	2.2	0.00	2.1	1.1
AC-FT	910	2700	8330	12140	11530	9850	6530	4880	483	277	281	520

e Estimated.

SACRAMENTO RIVER BASIN

11348500 PIT RIVER NEAR CANBY, CA—Continued

STATISTICS OF MONTHLY MEAN DATA FOR WATER YEARS 1904 - 2002, BY WATER YEAR (WY)

	OCT	NOV	DEC	JAN	FEB	MAR	APR	MAY	JUN	JUL	AUG	SEP
MEAN	78.86	104.8	191.0	308.5	426.7	542.5	462.6	462.4	273.0	65.09	43.37	64.45
MAX	1068	418	1225	1684	2249	1749	2774	2176	1746	312	125	201
(WY)	1963	1982	1938	1970	1986	1972	1952	1995	1971	1971	1983	1998
MIN	0.26	12.7	31.0	14.7	19.2	5.83	1.29	2.32	3.53	4.51	0.22	0.28
(WY)	1935	1935	1937	1937	1937	1934	1934	1992	1992	2002	1934	1934

SUMMARY STATISTICS	FOR 2001 CALENDAR YEAR		FOR 2002 WATER YEAR		WATER YEARS 1904 - 2002	
ANNUAL TOTAL	16125.9		29463.27			
ANNUAL MEAN	44.18		80.72		250.7	
HIGHEST ANNUAL MEAN					676 1971	
LOWEST ANNUAL MEAN					22.4 1934	
HIGHEST DAILY MEAN	566	Dec 31	831	Jan 1	8580	Feb 19 1986
LOWEST DAILY MEAN	1.2	Jul 13	0.00	Jul 14	0.00	Jul 18 2000
ANNUAL SEVEN-DAY MINIMUM	1.9	Jul 10	1.3	Jul 11	0.13	Apr 17 1934
MAXIMUM PEAK FLOW			915	Jan 2	13000	Mar 8 1904
MAXIMUM PEAK STAGE			4.74	Jan 2	15.00	Mar 8 1904
ANNUAL RUNOFF (AC-FT)	31990		58440		181600	
10 PERCENT EXCEEDS	97		176		637	
50 PERCENT EXCEEDS	23		29		96	
90 PERCENT EXCEEDS	2.5		2.5		16	

11351600 COLLETT RESERVOIR NEAR LITTLE VALLEY, CA

LOCATION.—Lat 40°58'00", long 121°13'00", unsurveyed, Lassen County, Hydrologic Unit 18020003, on right bank, 1.9 mi east of Muck Valley Powerplant, 5.5 mi northwest of Little Valley, and 9.1 mi southwest of Nubieber.

PERIOD OF RECORD.—October 1991 to September 1992, October 1993 to current year.

GAGE.—Water-stage recorder. Datum of gage is sea level.

REMARKS.—Lake is formed by earth and rockfill dam. Storage began Dec. 31, 1990. Water is diverted from the Pit River through a tunnel to the reservoir. Operating pool from elevation 4,030 ft, capacity 155 acre-ft, to 4,065 ft, capacity 7,693 acre-ft. Crest of spillway is at elevation 4,065 ft. Reservoir is used for power generation. Figures given represent total contents. Data not published below the minimum operating level at elevation 4,030 ft, capacity 155 acre-ft. See schematic diagram of [Pit and McCloud River Basins](#).

COOPERATION.—Records were provided by Malacha Hydro Limited Partnership, under general supervision of the U.S. Geological Survey, in connection with Federal Energy Regulatory Commission project no. 8296.

Capacity table (elevation, in feet, and contents, in acre-feet)
(Based on table provided by Malacha Hydro Limited Partnership, dated November 1991)

4,030	155	4,035	931	4,050	4,052	4,065	7,693
4,032	395	4,040	1,899				

RESERVOIR STORAGE (ACRE-FEET), WATER YEAR OCTOBER 2001 TO SEPTEMBER 2002

DAILY OBSERVATION AT 2400 HOURS

DAY	OCT	NOV	DEC	JAN	FEB	MAR	APR	MAY	JUN	JUL	AUG	SEP
1	---	---	1380	4590	2289	2708	4618	7076	3065	---	---	---
2	---	---	1606	4965	2394	3304	4872	6774	3055	---	---	---
3	---	---	1627	5287	2489	3745	5301	6735	2763	---	---	---
4	---	---	1612	5602	2572	3460	5760	7351	2473	---	---	---
5	---	---	1636	6333	2660	3135	5800	7324	2201	---	---	---
6	---	---	1651	6295	2770	2819	5889	7523	1927	---	---	---
7	---	---	1624	6112	2923	2589	6030	7472	1678	---	---	---
8	---	---	2148	5956	2517	2489	5535	7235	1669	---	---	---
9	---	---	2614	5800	2822	3160	5712	6930	1666	---	---	---
10	---	---	2448	5627	3146	3928	5896	6625	1463	---	---	---
11	---	---	2192	5462	2829	4181	6130	6728	1263	---	---	---
12	---	---	2110	5462	2505	4077	6442	6712	1050	---	---	---
13	---	---	2008	5451	2189	3976	6774	6454	835	---	---	---
14	---	---	1871	5051	2460	3872	7092	6153	640	---	---	---
15	---	---	2079	4593	2715	3769	6682	5834	637	---	---	---
16	---	---	2353	4161	2966	3769	6119	5572	631	---	---	---
17	---	---	2017	3783	3241	3769	5738	5521	464	---	---	---
18	---	---	1964	3392	3541	3443	6041	5513	390	---	---	---
19	---	---	1902	3602	3265	3112	6458	5510	348	---	---	---
20	---	---	1930	3820	3171	2786	6934	5171	316	---	---	---
21	---	---	1865	3399	3082	2663	7398	4836	284	---	---	---
22	---	---	2340	2967	3049	2492	7188	4498	284	---	---	---
23	---	---	2819	2527	3191	3032	7402	4265	284	---	---	---
24	---	217	2614	2148	3429	3575	7394	4227	272	---	---	---
25	---	293	2979	1927	3433	3412	7382	4220	268	---	---	---
26	---	415	2689	2148	3345	3231	7375	4209	245	---	---	---
27	---	695	2378	2292	3245	3055	7366	4202	222	---	---	---
28	---	911	2091	2425	3002	2852	7355	3931	199	---	---	---
29	---	1047	2524	2579	---	3325	7355	3680	177	---	---	---
30	---	1156	3135	2689	---	3779	7363	3372	---	---	---	---
31	---	---	3490	2777	---	4223	---	3069	---	---	---	---
MAX	---	---	3490	6333	3541	4223	7402	7523	---	---	---	---
MIN	---	---	1380	1927	2189	2489	4618	3069	---	---	---	---
a	0.00	1370	9160	18400	13760	19420	3150	8640	2620	0.00	0.00	0.00
b	0.00	2310	11720	18220	14360	21270	6730	4690	0.00	0.00	0.00	0.00

a Discharge, in acre-feet, for Muck Valley Powerplant (station 11351700), provided by Malacha Hydro Limited Partnership.

b Discharge, in acre-feet, for Pit River Tunnel Flow (station 11351945), provided by Malacha Hydro Limited Partnership.

11351950 PIT RIVER BELOW DIVERSION TO MUCK VALLEY POWERPLANT, NEAR BIEBER, CA

LOCATION.—Lat 41°00'55", long 121°09'13", in NE 1/4 SW 1/4 sec.27, T.37 N., R.7 E., Lassen County, Hydrologic Unit 18020003, on right bank, 1.7 mi upstream from North Gulch, 2.2 mi upstream from Spring Gulch, and 7.4 mi south of Bieber.

DRAINAGE AREA.—2,475 mi², excluding Goose Lake Basin.

PERIOD OF RECORD.—October 1994 to current year.

GAGE.—Acoustic-velocity meter measures minimum bypass flow; water-stage recorder and Ogee weir for spillway. Elevation of gage is 4,120 ft above sea level, from topographic map.

REMARKS.—Flow at this station has two components which are combined for publication: low-flow release (station 11351946) and flow over Ogee weir (station 11351948). Water is diverted upstream of weir through a tunnel to Collett Reservoir (station 11351600), for power generation. During powerplant operation, the minimum release is 50 ft³/s. See schematic diagram of [Pit and McCloud River Basins](#).

COOPERATION.—Records were provided by Malacha Hydro Limited Partnership, under general supervision of the U.S. Geological Survey, in connection with Federal Energy Regulatory commission project no. 8296.

EXTREMES FOR PERIOD OF RECORD.—Maximum daily discharge, 16,800 ft³/s, Jan. 3, 1997; no flow many days during most years.

DISCHARGE, CUBIC FEET PER SECOND, WATER YEAR OCTOBER 2001 TO SEPTEMBER 2002
DAILY MEAN VALUES

DAY	OCT	NOV	DEC	JAN	FEB	MAR	APR	MAY	JUN	JUL	AUG	SEP
1	0.00	0.00	27	198	53	54	53	24	11	0.00	0.00	0.00
2	0.00	0.00	27	786	53	54	54	26	8.0	0.00	0.00	0.00
3	0.00	0.00	27	1310	53	54	53	55	8.0	0.00	0.00	0.00
4	0.00	0.00	27	1330	53	54	53	55	7.0	0.00	0.00	0.00
5	0.00	0.00	27	952	53	54	53	55	0.00	0.00	0.00	0.00
6	0.00	0.00	27	299	54	54	53	54	2.0	0.00	0.00	0.00
7	0.00	0.00	27	147	54	54	53	55	0.00	0.00	0.00	0.00
8	0.00	0.00	27	84	54	54	53	37	1.0	0.00	0.00	0.00
9	0.00	0.00	28	132	54	53	53	11	0.00	0.00	0.00	0.00
10	0.00	0.00	27	53	54	53	53	20	0.00	0.00	0.00	0.00
11	0.00	0.00	27	54	54	54	53	38	0.00	0.00	0.00	0.00
12	0.00	0.00	27	54	54	55	53	13	0.00	0.00	0.00	0.00
13	0.00	0.00	27	54	54	233	53	34	0.00	0.00	0.00	0.00
14	0.00	0.00	27	54	54	166	53	47	0.00	0.00	0.00	0.00
15	0.00	0.00	28	54	54	55	53	37	0.00	0.00	0.00	0.00
16	0.00	0.00	28	54	54	54	53	44	0.00	0.00	0.00	0.00
17	0.00	1.0	28	54	54	54	53	29	0.00	0.00	0.00	0.00
18	0.00	2.0	28	54	54	54	53	11	0.00	0.00	0.00	0.00
19	0.00	17	28	54	54	54	53	10	0.00	0.00	0.00	0.00
20	0.00	7.0	28	54	54	54	53	13	0.00	0.00	0.00	0.00
21	0.00	6.0	28	54	54	54	52	12	0.00	0.00	0.00	0.00
22	0.00	8.0	28	53	438	54	52	12	0.00	0.00	0.00	0.00
23	0.00	16	28	54	651	54	52	32	0.00	0.00	0.00	0.00
24	0.00	23	28	54	727	54	46	26	0.00	0.00	0.00	0.00
25	0.00	26	28	54	651	54	13	13	0.00	0.00	0.00	0.00
26	0.00	26	28	54	353	54	18	9.0	0.00	0.00	0.00	0.00
27	0.00	27	28	54	55	54	20	9.0	0.00	0.00	0.00	0.00
28	0.00	27	28	54	54	54	20	21	0.00	0.00	0.00	0.00
29	0.00	27	28	54	---	54	19	43	0.00	0.00	0.00	0.00
30	0.00	27	28	54	---	54	20	17	0.00	7.0	0.00	0.00
31	0.00	---	28	53	---	54	---	13	---	16	0.00	---
TOTAL	0.00	240.00	855	6423	4058	1965	1373	875.0	37.00	23.00	0.00	0.00
MEAN	0.000	8.000	27.58	207.2	144.9	63.39	45.77	28.23	1.233	0.742	0.000	0.000
MAX	0.00	27	28	1330	727	233	54	55	11	16	0.00	0.00
MIN	0.00	0.00	27	53	53	53	13	9.0	0.00	0.00	0.00	0.00
AC-FT	0.00	476	1700	12740	8050	3900	2720	1740	73	46	0.00	0.00

STATISTICS OF MONTHLY MEAN DATA FOR WATER YEARS 1995 - 2002, BY WATER YEAR (WY)

	1995	1996	1997	1998	1999	2000	2001	2002
MEAN	34.25	77.44	157.1	878.6	1008	1148	591.6	928.6
MAX	53.0	325	475	3344	3089	3316	1677	3679
(WY)	1999	1999	1999	1997	1996	1995	1995	1998
MIN	0.000	8.00	24.9	18.4	20.2	18.4	12.9	1.52
(WY)	2002	2002	2001	2001	2001	2001	2001	2001

SUMMARY STATISTICS

	FOR 2001 CALENDAR YEAR	FOR 2002 WATER YEAR	WATER YEARS 1995 - 2002
ANNUAL TOTAL	3249.00	15849.00	
ANNUAL MEAN	8.901	43.42	430.0
HIGHEST ANNUAL MEAN			997
LOWEST ANNUAL MEAN			12.8
HIGHEST DAILY MEAN	46	Apr 22	1330
LOWEST DAILY MEAN	0.00	May 23	0.00
ANNUAL SEVEN-DAY MINIMUM	0.00	May 23	0.00
ANNUAL RUNOFF (AC-FT)	6440	31440	311500
10 PERCENT EXCEEDS	27	54	1330
50 PERCENT EXCEEDS	1.0	13	53
90 PERCENT EXCEEDS	0.00	0.00	0.00

11354200 PIT NO. 1 POWERPLANT NEAR FALL RIVER MILLS, CA

LOCATION.—Lat 40°59'28", long 121°29'49", in SE 1/4 NE 1/4 sec.10, T.37 N., R.4 E., [Shasta County](#), Hydrologic Unit 18020003, on right bank of Pit River, 2.3 mi downstream from Pit River Falls, and 3.2 mi southwest of Fall River Mills.

PERIOD OF RECORD.—October 1986 to current year. Unpublished records for water years 1973–86 available in files of the U.S. Geological Survey. Fragmentary record for water years 1922–72 available in files of the Pacific Gas & Electric Co.

GAGE.—Discharge computed from powerplant output.

REMARKS.—Water is diverted from Fall River at Pit No. 1 Forebay at NW 1/4 SW 1/4 sec.25, T.37 N., R.4 E., through a tunnel to powerplant and then into Pit River. See schematic diagram of [Pit and McCloud River Basins](#).

COOPERATION.—Records were collected by Pacific Gas & Electric Co., under general supervision of the U.S. Geological Survey, in connection with Federal Energy Regulatory Commission project no. 2687.

EXTREMES FOR PERIOD OF RECORD.—Maximum daily discharge, 2,490 ft³/s, Mar. 13, 1995; no flow several days most years.

DISCHARGE, CUBIC FEET PER SECOND, WATER YEAR OCTOBER 2001 TO SEPTEMBER 2002

DAILY MEAN VALUES

DAY	OCT	NOV	DEC	JAN	FEB	MAR	APR	MAY	JUN	JUL	AUG	SEP
1	1090	1130	1220	1420	946	1280	1380	1320	1110	1000	983	1040
2	944	1210	1310	1410	895	1260	1280	1290	1010	1010	978	1040
3	815	1190	1340	1750	1160	1320	1340	1300	1080	996	880	992
4	1120	1170	1540	1460	1180	1260	1340	1280	1080	1030	956	1020
5	1140	1100	1220	1460	1220	1220	1370	1250	1090	980	962	1050
6	1190	1170	1260	1480	1240	1300	1480	1200	1060	1010	932	1030
7	1080	1160	1280	1480	1210	1430	1320	1310	1040	1010	1020	1050
8	1200	1150	1300	1460	1290	1460	1380	1110	1070	996	1070	1050
9	1150	1200	1300	1440	1380	1380	1450	1210	1080	1000	1070	1050
10	1130	1180	1270	1440	1260	1410	1450	1310	1030	1020	1030	1050
11	731	1230	1220	1380	1210	1400	1620	1230	1040	1000	1020	1030
12	1170	1220	1210	1370	1190	1320	1660	1190	996	997	1020	1210
13	1160	1180	1270	1360	1240	1360	1680	1130	1030	1040	1060	808
14	1140	1170	1300	1370	1240	1370	1640	1280	1030	998	1090	804
15	1160	702	1230	1380	1230	1360	1450	1290	1060	1000	1030	844
16	1160	1210	1250	1320	1220	1310	1470	1380	1040	1000	1020	796
17	1170	1210	1250	1280	1320	1290	1500	1300	1040	999	1050	1040
18	1160	1200	1250	1340	1290	1430	1430	1140	1030	999	996	1030
19	1300	1180	1280	1280	1300	1300	1470	1150	1030	1010	1090	1040
20	1170	1170	1320	1260	1310	1310	1350	1260	1030	1010	1000	1070
21	1140	1260	1420	1260	1300	1310	1350	1070	1040	969	1040	1090
22	1100	1250	1340	1320	1300	1310	1320	1270	1040	1020	1030	1050
23	1110	1290	1340	1270	1190	1350	1320	1200	1030	1000	1000	1060
24	1100	1450	1250	1290	1400	1330	1280	1210	1010	993	1070	1050
25	1050	1300	1260	1240	1340	1340	1260	1140	1020	1000	1040	1080
26	1180	1340	1130	1270	1320	1330	1200	1090	1010	995	1060	1050
27	1160	1240	1270	1290	1320	1330	1280	1190	997	998	1030	1070
28	1220	1230	1250	1260	1320	1360	1270	1130	1020	1000	1040	1060
29	1160	1280	1220	1250	---	1340	1280	1080	1010	993	982	1070
30	1300	1230	1230	1240	---	1270	1300	1140	1010	972	1020	917
31	1230	---	1350	941	---	1310	---	1070	---	965	999	---
TOTAL	34930	36002	39680	41771	34821	41350	41920	37520	31163	31010	31568	30541
MEAN	1127	1200	1280	1347	1244	1334	1397	1210	1039	1000	1018	1018
MAX	1300	1450	1540	1750	1400	1460	1680	1380	1110	1040	1090	1210
MIN	731	702	1130	941	895	1220	1200	1070	996	965	880	796
AC-FT	69280	71410	78710	82850	69070	82020	83150	74420	61810	61510	62620	60580

STATISTICS OF MONTHLY MEAN DATA FOR WATER YEARS 1987 - 2002, BY WATER YEAR (WY)

MEAN	1158	1140	1186	1273	1316	1459	1453	1349	1187	1099	1082	1102
MAX	1394	1527	1533	1720	1871	1972	1927	1939	1698	1412	1379	1278
(WY)	1999	1999	1999	1998	1998	1995	1995	1998	1998	1998	1998	2000
MIN	941	562	987	996	749	1053	1014	947	914	844	835	900
(WY)	1995	2001	1995	1992	1994	1992	1994	1992	1994	1992	1992	1994

SUMMARY STATISTICS

	FOR 2001 CALENDAR YEAR		FOR 2002 WATER YEAR		WATER YEARS 1987 - 2002	
ANNUAL TOTAL	439299		432276			
ANNUAL MEAN	1204		1184		1233	
HIGHEST ANNUAL MEAN					1572	
LOWEST ANNUAL MEAN					955	
HIGHEST DAILY MEAN	1540	Dec 4	1750	Jan 3	2490	Mar 13 1995
LOWEST DAILY MEAN	702	Nov 15	702	Nov 15	0.00	Aug 21 1992
ANNUAL SEVEN-DAY MINIMUM	1050	Oct 1	909	Sep 13	0.00	Nov 6 2000
ANNUAL RUNOFF (AC-FT)	871300		857400		893400	
10 PERCENT EXCEEDS	1340		1380		1640	
50 PERCENT EXCEEDS	1190		1200		1190	
90 PERCENT EXCEEDS	1080		999		959	

11355010 PIT RIVER BELOW PIT NO. 1 POWERPLANT, NEAR FALL RIVER MILLS, CA

LOCATION.—Lat 40°59'00", long 121°30'39", in NE 1/4 NW 1/4 sec.15, T.36 N., R.4 E., [Shasta County](#), Hydrologic Unit 18020003, on left bank, 0.9 mi downstream from Pit No. 1 Powerplant, and 4 mi southwest of Fall River Mills.

DRAINAGE AREA.—3,761 mi², excluding Goose Lake Basin.

PERIOD OF RECORD.—August 1975 to current year.

GAGE.—Water-stage recorder and crest-stage gage. Elevation of gage is 2,798.21 ft above sea level (levels by Pacific Gas and Electric Co.).

REMARKS.—Records excellent. Low flow regulated by many small reservoirs (total usable reservoir capacity, 210,000 acre-ft) and Pit No. 1 Powerplant. Many diversions upstream from station for irrigation. See schematic diagram of [Pit and McCloud River Basins](#).

EXTREMES FOR PERIOD OF RECORD.—Maximum discharge, 30,000 ft³/s, Feb. 20, 1986, gage height, 17.03 ft; minimum daily, 535 ft³/s, Sept. 11, 1994.

EXTREMES OUTSIDE PERIOD OF RECORD.—Flood of January 1974 reached a stage of 14.8 ft, from floodmarks on right bank, discharge, 22,600 ft³/s.

EXTREMES FOR CURRENT YEAR.—Peak discharges greater than base discharge of 4,000 ft³/s, or maximum:

Date	Time	Discharge (ft ³ /s)	Gage height (ft)
Jan. 4	0030	4,390	8.42

DISCHARGE, CUBIC FEET PER SECOND, WATER YEAR OCTOBER 2001 TO SEPTEMBER 2002

DAILY MEAN VALUES

DAY	OCT	NOV	DEC	JAN	FEB	MAR	APR	MAY	JUN	JUL	AUG	SEP
1	1280	1350	1530	2140	1290	2040	1590	1580	1410	1160	1160	1180
2	1170	1400	1610	2800	1440	1730	1490	1670	1180	1160	1180	1180
3	1310	1390	1670	3720	1420	1550	1540	1780	1230	1150	1060	1140
4	1290	1370	1930	3540	1450	1610	1550	1890	1340	1190	1110	1150
5	1320	1370	1610	3050	1480	1800	1570	1740	1380	1140	1110	1180
6	1350	1360	1640	2870	1500	1880	1680	1770	1350	1170	1140	1160
7	1260	1330	1700	2600	1490	2010	1550	1700	1350	1170	1200	1180
8	1370	1340	1710	2530	1670	2040	1700	1490	1350	1150	1220	1180
9	1330	1380	1550	2530	1850	1840	1870	1550	1260	1160	1210	1180
10	1310	1370	1600	2470	1550	1650	1820	1620	1200	1170	1180	1190
11	1350	1420	1770	2330	1570	1790	1840	1520	1270	1160	1160	1170
12	1340	1410	1700	2170	1750	2200	1860	1370	1270	1150	1160	1340
13	1330	1430	1690	2030	1800	2350	1870	1310	1310	1160	1230	1010
14	1320	1390	1740	2060	1690	2430	1830	1580	1290	1150	1240	1130
15	1330	1380	1620	2120	1500	2330	1710	1620	1310	1150	1180	1200
16	1330	1390	1500	2030	1480	2110	1980	1690	1230	1160	1180	1140
17	1350	1390	1600	1910	1570	1980	2040	1630	1210	1150	1200	1290
18	1330	1400	1760	1950	1550	2120	1780	1460	1230	1150	1110	1190
19	1300	1370	1750	1760	1680	2060	1690	1330	1230	1170	1250	1190
20	1330	1390	1850	1530	1970	2030	1570	1440	1220	1160	1150	1210
21	1310	1460	1960	1650	2200	1890	1560	1360	1220	1130	1190	1230
22	1300	1470	1840	1890	2350	1880	1660	1600	1210	1180	1180	1180
23	1350	1500	1640	1820	2550	1790	1720	1520	1200	1160	1160	1190
24	1280	1670	1630	1840	2780	1560	1480	1520	1200	1160	1210	1200
25	1310	1530	1730	1740	2820	1680	1450	1450	1190	1170	1150	1210
26	1360	1610	1590	1680	2690	1890	1400	1270	1170	1160	1200	1190
27	1340	1630	1830	1560	2390	1900	1470	1360	1160	1160	1170	1200
28	1400	1570	1810	1550	2170	1930	1470	1300	1200	1180	1170	1200
29	1340	1630	1710	1510	---	1800	1480	1370	1170	1160	1120	1200
30	1490	1560	1540	1550	---	1500	1510	1480	1140	1150	1160	1170
31	1420	---	1890	1380	---	1520	---	1380	---	1160	1140	---
TOTAL	41200	43260	52700	66310	51650	58890	49730	47350	37480	35950	36280	35560
MEAN	1329	1442	1700	2139	1845	1900	1658	1527	1249	1160	1170	1185
MAX	1490	1670	1960	3720	2820	2430	2040	1890	1410	1190	1250	1340
MIN	1170	1330	1500	1380	1290	1500	1400	1270	1140	1130	1060	1010
AC-FT	81720	85810	104500	131500	102400	116800	98640	93920	74340	71310	71960	70530

11355010 PIT RIVER BELOW PIT NO. 1 POWERPLANT, NEAR FALL RIVER MILLS, CA—Continued

STATISTICS OF MONTHLY MEAN DATA FOR WATER YEARS 1975 - 2002, BY WATER YEAR (WY)

	OCT	NOV	DEC	JAN	FEB	MAR	APR	MAY	JUN	JUL	AUG	SEP
MEAN	1407	1633	1820	2306	2848	3185	2532	2280	1669	1318	1279	1316
MAX	1776	3181	3834	6060	8539	6539	5614	6883	4582	1809	1618	1628
(WY)	1999	1982	1984	1997	1986	1993	1982	1995	1998	1998	1998	1998
MIN	939	1133	1214	1222	1268	1294	1173	1050	1012	954	828	784
(WY)	1995	1993	1993	1991	1994	1992	1992	1992	1992	1994	1994	1994

SUMMARY STATISTICS	FOR 2001 CALENDAR YEAR		FOR 2002 WATER YEAR		WATER YEARS 1975 - 2002	
ANNUAL TOTAL	527130		556360			
ANNUAL MEAN	1444		1524		1960	
HIGHEST ANNUAL MEAN					2914	
LOWEST ANNUAL MEAN					1149	
HIGHEST DAILY MEAN	1960	Dec 21	3720	Jan 3	28800	Feb 20 1986
LOWEST DAILY MEAN	1100	Aug 28	1010	Sep 13	535	Sep 11 1994
ANNUAL SEVEN-DAY MINIMUM	1230	Aug 15	1130	Jul 31	663	Sep 7 1994
MAXIMUM PEAK FLOW			4390	Jan 4	30000	Feb 20 1986
MAXIMUM PEAK STAGE			8.42	Jan 4	17.03	Feb 20 1986
ANNUAL RUNOFF (AC-FT)	1046000		1104000		1420000	
10 PERCENT EXCEEDS	1700		1990		3260	
50 PERCENT EXCEEDS	1400		1420		1510	
90 PERCENT EXCEEDS	1240		1160		1170	

11358020 LOST CREEK BELOW DIVERSION TO LOST CREEK POWERPLANT NO. 1, NEAR OLD STATION, CA

LOCATION.—Lat 40°45'35", long 121°24'46", in NW 1/4 SW 1/4 sec.34, T.34 N., R.5 E., [Shasta County](#), Hydrologic Unit 18020003, on right bank, 0.4 mi downstream from Lost Creek Diversion Dam, 2.5 mi downstream from Porcupine Reservoir, 6.0 mi north of Old Station, and 13.2 mi southeast of Cassel.

DRAINAGE AREA.—7.53 mi².

PERIOD OF RECORD.—October 1989 to September 1997, October 1998 to current year (operated as low-flow station only).

GAGE.—Water-stage recorder and sharp-crested weir. Elevation of gage is 3,900 ft above sea level, from topographic map.

REMARKS.—During times of powerplant operation, the minimum release requirement is 15 ft³/s; flow is computed to 80 ft³/s. See schematic diagram of [Pit and McCloud River Basins](#).

COOPERATION.—Records were collected by Snow Mountain Hydro, under general supervision of the U.S. Geological Survey, in connection with Federal Energy Regulatory Commission project no. 3863.

DISCHARGE, CUBIC FEET PER SECOND, WATER YEAR OCTOBER 2001 TO SEPTEMBER 2002
DAILY MEAN VALUES

DAY	OCT	NOV	DEC	JAN	FEB	MAR	APR	MAY	JUN	JUL	AUG	SEP
1	16	16	21	16	16	16	16	16	16	16	16	16
2	21	16	35	16	16	16	16	16	18	16	20	16
3	16	16	16	16	16	16	16	16	16	16	17	16
4	16	16	16	16	16	16	16	16	16	16	16	16
5	16	16	18	16	16	16	16	16	16	16	16	16
6	16	16	16	16	18	16	16	16	16	16	16	16
7	16	16	16	16	23	16	16	16	16	16	16	16
8	16	16	16	16	16	16	16	16	16	16	16	16
9	16	16	16	16	16	16	16	16	16	16	16	16
10	16	16	16	16	16	34	16	16	16	16	16	16
11	16	16	16	16	16	16	16	16	16	16	16	18
12	16	16	16	16	16	28	16	16	16	16	16	16
13	16	16	16	16	16	24	16	16	16	16	16	16
14	16	16	16	16	16	16	16	16	16	16	16	20
15	16	16	16	16	16	16	16	16	16	16	16	20
16	16	16	16	16	16	18	16	16	16	16	16	16
17	16	16	16	16	16	16	17	16	16	16	16	16
18	16	16	16	16	16	16	37	16	16	17	16	16
19	16	16	16	16	16	16	16	16	16	16	16	16
20	16	18	16	16	16	16	16	16	16	16	16	16
21	16	16	16	16	16	16	16	16	16	16	16	16
22	16	16	16	16	16	16	18	16	16	16	16	16
23	16	16	16	16	16	16	16	16	16	16	16	16
24	16	46	16	16	16	16	16	16	16	16	16	16
25	16	47	16	16	16	16	16	16	16	16	16	19
26	16	16	16	16	16	16	34	16	16	16	16	18
27	16	16	16	16	16	16	19	16	16	16	16	16
28	16	16	16	16	16	16	16	16	16	16	19	16
29	16	39	16	16	---	16	21	16	16	17	16	16
30	16	35	16	16	---	16	16	16	16	17	16	16
31	16	---	16	16	---	16	---	16	---	16	16	---
TOTAL	501	585	522	496	457	536	530	496	482	499	504	495
MEAN	16.16	19.50	16.84	16.00	16.32	17.29	17.67	16.00	16.07	16.10	16.26	16.50
MAX	21	47	35	16	23	34	37	16	18	17	20	20
MIN	16	16	16	16	16	16	16	16	16	16	16	16
AC-FT	994	1160	1040	984	906	1060	1050	984	956	990	1000	982
a	2800	2510	2800	2870	2500	2670	2490	2600	2380	2390	2390	2300

a Discharge, in acre-feet, for Lost Creek Powerplant No. 1 (station 11358010), provided by Snow Mountain Hydro.

11358700 HAT CREEK BELOW HAT NO. 1 DIVERSION DAM, NEAR BURNEY, CA

LOCATION.—Lat 40°55'08", long 121°33'02", in NW 1/4 SW 1/4 sec.5, T.36 N., R.4 E., [Shasta County](#), Hydrologic Unit 18020003, on right bank, at Hat No. 1 Diversion Dam on Hat Creek, and 6.5 mi northeast of Burney.

DRAINAGE AREA.—347 mi².

PERIOD OF RECORD.—Oct. 1 to Dec. 8, 1987 (fragmentary); Dec. 9, 1987, to current year (operated as a low-flow station only). Unpublished fragmentary records for water years 1980–87 available in files of the U.S. Geological Survey.

GAGE.—Water-stage recorder and Cipolletti weir. Elevation of gage is 3,180 ft above sea level, from topographic map.

REMARKS.—This station records fishwater release only. The minimum release requirement is 2.0 ft³/s at all times. Flow is computed to 9.0 ft³/s. See schematic diagram of [Pit and McCloud River Basins](#).

COOPERATION.—Records were collected by Pacific Gas & Electric Co., under general supervision of the U.S. Geological Survey, in connection with Federal Energy Regulatory Commission project no. 2661.

DISCHARGE, CUBIC FEET PER SECOND, WATER YEAR OCTOBER 2001 TO SEPTEMBER 2002
DAILY MEAN VALUES

DAY	OCT	NOV	DEC	JAN	FEB	MAR	APR	MAY	JUN	JUL	AUG	SEP
1	3.3	3.1	3.2	3.2	3.2	3.1	3.0	3.2	2.9	3.1	3.1	3.3
2	3.5	3.0	3.2	3.2	3.2	3.1	2.9	3.1	2.9	3.2	3.1	3.3
3	3.5	3.0	3.2	3.0	3.2	3.1	2.9	3.1	2.9	3.1	3.2	3.3
4	3.4	3.0	3.2	3.0	3.2	3.0	2.9	3.1	3.3	3.1	3.1	3.3
5	3.4	3.0	3.2	3.0	3.2	3.0	3.0	3.1	3.3	3.2	3.1	3.4
6	3.4	3.0	3.2	3.0	3.2	3.0	3.0	3.0	3.2	3.3	3.1	3.4
7	3.4	3.0	3.2	3.0	3.3	3.0	2.9	3.1	3.3	3.3	3.0	3.4
8	3.4	3.0	3.2	2.9	3.3	3.1	3.0	3.0	3.3	3.2	3.5	3.3
9	3.4	3.0	3.3	2.9	3.2	3.3	3.0	3.0	3.3	3.2	3.7	3.2
10	3.4	3.0	3.2	2.9	3.3	3.3	3.5	3.0	3.3	3.0	3.4	3.2
11	3.4	3.0	3.2	2.9	3.3	3.3	3.3	3.0	3.3	3.0	3.3	3.2
12	3.3	3.0	3.2	3.0	3.3	3.3	3.2	3.0	3.3	3.7	3.3	3.2
13	3.2	3.0	3.2	3.3	3.2	3.2	3.1	3.0	3.2	3.6	3.2	3.2
14	3.0	3.0	3.2	3.3	3.3	3.2	3.1	3.1	3.2	3.5	3.1	3.5
15	3.0	3.0	3.3	3.3	3.1	3.2	3.1	3.0	3.2	3.5	3.0	3.6
16	3.0	3.1	3.3	3.3	3.0	3.2	3.1	3.0	3.2	3.5	3.1	3.4
17	3.1	3.2	3.3	3.3	3.0	3.2	3.1	3.0	3.2	3.5	3.1	3.4
18	3.1	3.1	3.3	3.3	3.0	3.2	3.1	3.0	3.3	3.4	3.2	3.4
19	3.1	3.1	3.3	3.3	3.0	3.2	3.1	3.0	3.1	3.4	3.3	3.4
20	3.1	3.1	3.3	3.3	3.0	3.1	3.1	3.1	3.1	3.4	3.4	3.3
21	3.1	3.1	3.3	3.3	3.0	3.1	3.1	3.0	3.1	3.5	3.4	3.3
22	3.1	3.2	3.3	3.3	3.0	3.1	3.1	3.0	3.0	3.4	3.4	3.4
23	3.1	3.2	3.3	3.3	3.0	3.1	3.1	3.0	3.0	3.3	3.4	3.4
24	3.2	3.2	3.3	3.3	3.0	3.1	3.1	3.0	3.0	3.2	3.4	3.4
25	3.2	3.4	3.3	3.2	3.0	3.1	3.1	3.0	3.0	3.3	3.4	3.4
26	3.2	3.3	3.3	3.3	3.0	3.1	3.1	3.0	3.1	3.4	3.3	3.3
27	3.2	3.3	3.2	3.3	3.0	3.1	3.1	3.0	3.2	3.4	3.1	3.3
28	3.2	3.3	3.2	3.3	3.4	3.1	3.1	2.9	3.2	3.4	3.2	3.2
29	3.2	3.3	3.2	3.3	---	3.0	3.2	3.0	3.2	3.4	3.2	3.2
30	3.1	3.2	3.1	3.3	---	3.0	3.3	3.0	3.1	3.1	3.2	3.2
31	3.2	---	3.2	3.3	---	3.0	---	2.9	---	3.1	3.2	---
TOTAL	100.2	93.2	100.4	98.6	87.9	96.9	92.7	93.7	94.7	102.7	100.5	99.8
MEAN	3.232	3.107	3.239	3.181	3.139	3.126	3.090	3.023	3.157	3.313	3.242	3.327
MAX	3.5	3.4	3.3	3.3	3.4	3.3	3.5	3.2	3.3	3.7	3.7	3.6
MIN	3.0	3.0	3.1	2.9	3.0	3.0	2.9	2.9	2.9	3.0	3.0	3.2
AC-FT	199	185	199	196	174	192	184	186	188	204	199	198

11358800 HAT CREEK NO. 1 POWERPLANT NEAR BURNEY, CA

LOCATION.—Lat 40°55'45", long 121°32'37", in SW 1/4 SW 1/4 sec.32, T.36 N., R.4 E., [Shasta County](#), Hydrologic Unit 18020003, on right bank of Hat Creek, at the upper end of Baum Lake, and 7.4 mi northeast of Burney.

PERIOD OF RECORD.—October 1986 to current year. Unpublished records for water years 1981–86 available in files of the U.S. Geological Survey. Fragmentary records for water years 1921–80 available in the files of the Pacific Gas & Electric Co.

GAGE.—Discharge computed from powerplant output.

REMARKS.—Water is diverted from left bank of Hat Creek at NW 1/4 SW 1/4 sec.5, T.36 N., R.8 W., through a canal to powerplant and then into Hat Creek. See schematic diagram of [Pit and McCloud River Basins](#).

COOPERATION.—Records were collected by Pacific Gas & Electric Co., under general supervision of the U.S. Geological Survey, in connection with Federal Energy Regulatory Commission project no. 2661.

EXTREMES FOR PERIOD OF RECORD.—Maximum daily discharge, 518 ft³/s, Nov. 2, 1998; no flow several days most years.

DISCHARGE, CUBIC FEET PER SECOND, WATER YEAR OCTOBER 2001 TO SEPTEMBER 2002
DAILY MEAN VALUES

DAY	OCT	NOV	DEC	JAN	FEB	MAR	APR	MAY	JUN	JUL	AUG	SEP
1	291	346	385	372	356	351	315	291	281	277	272	272
2	280	346	392	381	356	350	312	292	284	278	271	271
3	301	348	386	388	356	352	312	288	285	274	267	269
4	304	349	379	383	355	352	325	287	287	269	267	265
5	308	327	379	370	355	352	323	286	293	270	270	267
6	310	352	380	369	356	356	322	286	289	268	270	268
7	312	358	377	380	360	360	312	289	288	273	271	269
8	314	340	372	383	362	355	310	293	290	279	269	270
9	309	359	377	382	358	352	304	301	294	285	269	268
10	306	358	372	380	356	357	246	294	298	281	269	269
11	305	362	368	373	356	354	286	283	292	281	271	267
12	308	373	366	364	356	353	275	272	291	277	270	267
13	307	377	365	362	356	352	282	279	289	273	268	267
14	306	372	376	366	355	308	288	288	287	272	268	262
15	303	372	369	369	354	341	288	291	286	272	268	275
16	302	356	367	367	352	352	286	290	285	274	268	268
17	309	370	358	363	359	350	288	280	284	275	270	274
18	309	369	370	362	356	349	284	287	264	276	270	274
19	308	368	374	361	359	348	282	296	286	275	274	275
20	306	370	377	361	364	348	281	318	285	276	271	275
21	304	372	374	363	362	346	284	324	281	277	266	274
22	300	383	373	362	360	332	298	306	280	276	269	274
23	294	384	372	358	359	331	296	305	290	275	269	272
24	310	389	368	358	357	329	276	301	288	275	270	268
25	312	382	366	357	355	326	273	296	292	274	274	267
26	327	378	366	363	354	324	268	293	280	276	279	268
27	328	374	366	362	354	325	280	296	274	275	278	272
28	333	374	366	359	308	324	282	297	274	275	275	274
29	340	379	369	357	---	325	284	299	276	264	273	273
30	343	375	368	356	---	324	285	302	276	284	272	268
31	348	---	371	355	---	321	---	285	---	272	273	---
TOTAL	9637	10962	11548	11386	9946	10599	8747	9095	8549	8528	8391	8102
MEAN	310.9	365.4	372.5	367.3	355.2	341.9	291.6	293.4	285.0	275.1	270.7	270.1
MAX	348	389	392	388	364	360	325	324	298	285	279	275
MIN	280	327	358	355	308	308	246	272	264	264	266	262
AC-FT	19110	21740	22910	22580	19730	21020	17350	18040	16960	16920	16640	16070
a	25890	28330	29900	29850	25860	28170	24210	24910	23530	23550	23050	22150

STATISTICS OF MONTHLY MEAN DATA FOR WATER YEARS 1987 - 2002, BY WATER YEAR (WY)

MEAN	302.1	322.6	343.8	348.4	330.6	343.9	314.7	288.2	296.0	284.4	266.9	270.6
MAX	432	437	433	422	431	408	393	384	430	410	344	349
(WY)	1987	1999	1999	1997	1999	2000	1999	1998	1998	1998	1998	1998
MIN	187	72.5	248	266	69.5	258	203	150	200	195	170	192
(WY)	1993	1990	1995	1993	1996	1992	1992	1991	1994	1994	1992	1994

SUMMARY STATISTICS

	FOR 2001 CALENDAR YEAR	FOR 2002 WATER YEAR	WATER YEARS 1987 - 2002
ANNUAL TOTAL	121731	115490	
ANNUAL MEAN	333.5	316.4	309.3
HIGHEST ANNUAL MEAN			383 1999
LOWEST ANNUAL MEAN			225 1992
HIGHEST DAILY MEAN	396 Jan 8	392 Dec 2	518 Nov 2 1998
LOWEST DAILY MEAN	277 Aug 21	246 Apr 10	0.00 Mar 17 1987
ANNUAL SEVEN-DAY MINIMUM	282 Aug 17	267 Sep 8	0.00 Nov 7 1989
ANNUAL RUNOFF (AC-FT)	241500	229100	224100
10 PERCENT EXCEEDS	388	372	407
50 PERCENT EXCEEDS	314	306	303
90 PERCENT EXCEEDS	288	270	221

a Discharge, in acre-feet, for Hat Creek No. 2 Powerplant (station 11359300), provided by Pacific Gas & Electric Co.

11359100 HAT NO. 2 POWER CANAL DIVERSION TO HAT CREEK, NEAR BURNEY, CA

LOCATION.—Lat 40°57'01", long 121°32'39", in SE 1/4 NW 1/4 sec.29, T.36 N., R.4 E., [Shasta County](#), Hydrologic Unit 18020003, on right bank of Hat No. 2 Power Canal, 75 ft downstream from Hat No. 2 Diversion Dam on Hat Creek, and 7.9 mi northeast of Burney.

PERIOD OF RECORD.—Oct. 1 to Dec. 9, 1987 (fragmentary); Dec. 10, 1987, to current year (operated as a low-flow station only). Unpublished fragmentary records for water years 1979–87 available in files of the U.S. Geological Survey.

GAGE.—Water-stage recorder and Parshall flume. Elevation of gage is 2,980 ft above sea level, from topographic map.

REMARKS.—This station records fishwater release only. The minimum release requirement is 8.0 ft³/s at all times. Flow is computed to 15 ft³/s. See schematic diagram of [Pit and McCloud River Basins](#).

COOPERATION.—Records were collected by Pacific Gas & Electric Co., under general supervision of the U.S. Geological Survey, in connection with Federal Energy Regulatory Commission project no. 2661.

DISCHARGE, CUBIC FEET PER SECOND, WATER YEAR OCTOBER 2001 TO SEPTEMBER 2002

DAILY MEAN VALUES

DAY	OCT	NOV	DEC	JAN	FEB	MAR	APR	MAY	JUN	JUL	AUG	SEP
1	9.3	9.8	9.3	9.3	9.4	9.4	9.2	9.3	9.4	9.5	9.3	9.3
2	9.3	9.7	9.4	9.4	9.4	9.4	9.1	9.4	9.4	9.6	9.2	9.3
3	9.4	9.6	9.4	9.4	9.4	9.4	9.1	9.3	9.4	9.6	9.1	9.3
4	9.4	9.7	9.3	9.4	9.3	9.4	9.2	9.2	9.4	9.6	9.1	9.3
5	9.4	9.7	9.3	9.3	9.3	9.4	9.3	9.2	9.5	9.5	9.3	9.3
6	9.4	9.7	9.3	9.3	9.3	9.4	9.3	9.2	9.5	9.5	9.3	9.3
7	9.4	9.7	9.3	9.3	9.4	9.5	9.3	9.3	9.5	9.6	9.3	9.3
8	9.4	9.7	9.2	9.3	9.4	9.5	9.3	9.3	9.5	9.6	9.3	9.3
9	9.4	9.7	9.3	9.3	9.4	9.5	9.1	9.4	9.6	9.8	9.3	9.3
10	9.4	9.7	9.2	9.3	9.4	9.5	9.1	9.4	9.7	9.8	9.2	9.3
11	9.4	9.7	9.1	9.2	9.3	9.5	9.1	9.3	9.6	9.7	9.2	9.3
12	9.4	9.8	9.1	9.2	9.4	9.5	9.0	9.1	9.6	9.6	9.2	9.3
13	9.4	9.9	9.1	9.2	9.4	9.5	9.2	9.1	9.6	9.5	9.1	9.3
14	9.4	9.8	9.2	9.4	9.4	9.5	9.3	9.2	9.5	9.4	9.0	9.3
15	9.4	9.7	9.2	9.5	9.4	9.5	9.3	9.3	9.5	9.3	9.0	9.3
16	9.4	9.4	9.1	9.5	9.4	9.5	9.3	9.3	9.5	9.3	9.1	9.3
17	9.4	9.2	9.2	9.5	9.4	9.5	9.3	9.2	9.5	9.4	9.1	9.3
18	9.4	9.1	9.2	9.5	9.4	9.5	9.3	9.2	9.5	9.5	9.1	9.3
19	9.4	9.1	9.2	9.4	9.4	9.4	9.3	9.3	9.6	9.5	9.2	9.3
20	9.4	9.2	9.3	9.4	9.5	9.4	9.3	9.5	9.6	9.5	9.2	9.3
21	9.4	9.2	9.3	9.4	9.5	9.5	9.3	9.7	9.7	9.5	9.1	9.4
22	9.4	9.3	9.3	9.4	9.4	9.4	9.4	9.6	9.6	9.5	9.0	9.3
23	9.4	9.4	9.3	9.4	9.4	9.4	9.4	9.4	9.7	9.5	9.1	9.3
24	9.4	9.5	9.2	9.4	9.4	9.3	9.2	9.4	9.7	9.5	9.0	9.3
25	9.5	9.4	9.2	9.4	9.4	9.3	9.1	9.4	9.7	9.5	9.0	9.2
26	9.6	9.3	9.1	9.4	9.6	9.3	9.1	9.4	9.7	9.5	9.2	9.3
27	9.6	9.3	9.2	9.4	9.5	9.3	9.1	9.4	9.7	9.5	9.4	9.3
28	9.7	9.2	9.1	9.4	9.4	9.3	9.2	9.4	9.7	9.5	9.3	9.3
29	9.7	9.3	9.2	9.4	---	9.3	9.3	9.4	9.7	9.5	9.3	9.3
30	9.7	9.3	9.2	9.4	---	9.3	9.3	9.5	9.6	9.4	9.3	9.3
31	9.8	---	9.3	9.4	---	9.3	---	9.4	---	9.4	9.3	---
TOTAL	293.0	285.1	286.1	290.5	263.3	291.9	276.8	289.5	287.2	295.1	284.6	279.0
MEAN	9.452	9.503	9.229	9.371	9.404	9.416	9.227	9.339	9.573	9.519	9.181	9.300
MAX	9.8	9.9	9.4	9.5	9.6	9.5	9.4	9.7	9.7	9.8	9.4	9.4
MIN	9.3	9.1	9.1	9.2	9.3	9.3	9.0	9.1	9.4	9.3	9.0	9.2
AC-FT	581	565	567	576	522	579	549	574	570	585	565	553

RESERVOIRS IN PIT AND McCLOUD RIVER BASINS, CA

- 11361400 LAKE BRITTON NEAR BURNEY.**—Lat 41°01'20", long 121°40'32", in SW 1/4 SW 1/4 sec.19, T.37 N., R.3 E., [Shasta County](#), Hydrologic Unit 18020003, Shasta National Forest, at control house on right bank 200 ft upstream from dam on Pit River, 1.1 mi downstream from Clark Creek, 1.3 mi northwest of Burney Falls, and 9 mi north of Burney.
- DRAINAGE AREA.**—4,607 mi², excluding Goose Lake Basin.
- PERIOD OF RECORD.**—October 1965 to current year (monthend contents only). Fragmentary records for water years 1925–65 in files of the Pacific Gas & Electric Co.
- GAGE.**—Remote telemark read once daily. Datum of gage is 19.53 ft above sea level (levels by Pacific Gas & Electric Co.). Monthend contents based on capacity table dated Dec. 1, 1976, provided by Pacific Gas & Electric Co.
- REMARKS.**—Reservoir is formed by gravity-type concrete dam. Storage began July 15, 1925. Usable capacity, 41,877 acre-ft, between elevations 2,665.0 ft, invert of sluice gate, and 2,758.0 ft, top of flash boards. Dead storage, 30 acre-ft. Normal operating pool is from elevation 2,744.0 ft, capacity, 26,183 acre-ft, to 2,757.0 ft, capacity, 40,626 acre-ft. Figures given represent total contents. Lake is used for power generation and recreation. See schematic diagram of [Pit and McCloud River Basins](#). Records prior to water year 1977 reported usable contents only.
- COOPERATION.**—Record of contents collected by Pacific Gas & Electric Co., under general supervision of the U.S. Geological Survey, in connection with a Federal Energy Regulatory Commission project. Contents not rounded to U.S. Geological Survey standards.
- EXTREMES (AT 2400) FOR PERIOD OF RECORD.**—Maximum total contents, 47,922 acre-ft, Feb. 20, 1986, elevation, 2,762.50 ft; minimum total contents, 26,755 acre-ft, Oct. 9, 1976, elevation, 2,744.60 ft.
- EXTREMES (AT 2400) FOR CURRENT YEAR.**—Maximum contents, 40,123 acre-ft, Jan. 5, elevation, 2,756.60 ft; minimum, 28,854 acre-ft, Dec. 30, elevation, 2,746.72 ft.
- 11363920 IRON CANYON RESERVOIR NEAR BIG BEND.**—Lat 41°02'41", long 121°58'52", in SW 1/4 SE 1/4 sec.21, T.37 N., R.1 W., [Shasta County](#), Hydrologic Unit 18020003, Shasta National Forest, in control house on left bank 500 ft upstream from Iron Canyon Dam on Iron Canyon Creek, 3.7 mi northwest of Big Bend.
- DRAINAGE AREA.**—11.1 mi².
- PERIOD OF RECORD.**—December 1965 to current year (monthend contents only).
- GAGE.**—Water-stage recorder. Datum of gage is sea level (levels by Pacific Gas & Electric Co.). Monthend contents based on capacity table dated May 17, 1965, provided by Pacific Gas & Electric Co.
- REMARKS.**—Reservoir is formed by a rockfill dam completed in 1965. Usable capacity is 24,197 acre-ft, between elevations 2,525.00 ft, invert of sluice pipe, and 2,665.00 ft, crest of spillway. Dead storage, 44 acre-ft. Normal operating pool is from elevation 2,565.0 ft, capacity, 990 acre-ft, to 2,664.0 ft, capacity, 23,738 acre-ft. Water is diverted from Lake McCloud (station 11367740) through a tunnel to Iron Canyon Reservoir and then into the Pit River via James B. Black Powerplant (station 11363910). Figures given represent total contents. Water is used for power generation and recreation. See schematic diagram of [Pit and McCloud River Basins](#).
- COOPERATION.**—Record of contents collected by Pacific Gas & Electric Co., under general supervision of the U.S. Geological Survey, in connection with a Federal Energy Regulatory Commission project. Contents not rounded to U.S. Geological Survey standards.
- EXTREMES (AT 2400) FOR PERIOD OF RECORD.**—Maximum contents, 23,539 acre-ft, May 16, 22, 1977, elevation, 2,663.60 ft; normal minimum since reservoir first filled, 2,860 acre-ft, May 23, 24, 29, June 2, 7, 9, 14, 23, 24, 1966, elevation, 2,590.00 ft. Contents reduced to 195 acre-ft, elevation, 2,540.00 ft, Feb. 10, 1971, when reservoir was drained for inspection.
- EXTREMES (AT 2400) FOR CURRENT YEAR.**—Maximum contents, 21,839 acre-ft, June 27, elevation, 2,660.10 ft; minimum, 3,765 acre-ft, Jan. 16, elevation, 2,597.50 ft.
- 11367740 LAKE McCLOUD NEAR McCLOUD.**—Lat 41°08'06", long 122°04'26", in SE 1/4 SW 1/4 sec.22, T.38 N., R.2 W., [Shasta County](#), Hydrologic Unit 18020004, Shasta National Forest, on McCloud Dam near spillway on McCloud River, 200 ft downstream from Panther Creek, and 8.8 mi southeast of McCloud.
- DRAINAGE AREA.**—403 mi².
- PERIOD OF RECORD.**—October 1965 to current year (monthend contents only).
- GAGE.**—Water-stage recorder. Datum of gage is sea level (levels by Pacific Gas & Electric Co.). Monthend contents based on capacity table dated June 29, 1965, provided by Pacific Gas & Electric Co.
- REMARKS.**—Reservoir is formed by a rockfill dam completed in 1965. Usable capacity, 35,231 acre-ft, between elevations 2,471.30 ft, invert of sluice pipe, and 2,680.00 ft, maximum operational water surface. Dead storage, 3 acre-ft. Normal operating pool is from elevation 2,635.00 ft, capacity, 16,425 acre-ft, to 2,680.00 ft, capacity, 35,234 acre-ft. Water is diverted from Lake McCloud through a diversion tunnel to Iron Canyon Reservoir (station 11363920) and then into the Pit River via James B. Black Powerplant (station 11363910). Figures given represent total contents. Water is used for power generation and recreation. See schematic diagram of [Pit and McCloud River Basins](#).
- COOPERATION.**—Record of contents collected by Pacific Gas & Electric Co., under general supervision of the U.S. Geological Survey, in connection with a Federal Energy Regulatory Commission project. Contents not rounded to U.S. Geological Survey standards.
- EXTREMES (AT 2400) FOR PERIOD OF RECORD.**—Maximum contents, 35,967 acre-ft, Jan. 15, 1974, elevation, 2,681.40 ft; minimum since reservoir first filled, 13,017 acre-ft, Oct. 14–22, 1981, elevation, 2,632.50 ft.
- EXTREMES (AT 2400) FOR CURRENT YEAR.**—Maximum contents, 32,173 acre-ft, July 2-5, elevation, 2,673.90 ft; minimum, 18,921 acre-ft, Jan. 26, 27, elevation, 2,642.40 ft.

RESERVOIRS IN PIT AND McCLOUD RIVER BASINS, CA—Continued

MONTHEND ELEVATION AND CONTENTS AT 2400 HOURS, WATER YEAR OCTOBER 2001 TO SEPTEMBER 2002

Date	11361400 LAKE BRITTON			11363920 IRON CANYON RESERVOIR			11367740 LAKE McCLOUD		
	Elevation (ft)	Contents (acre- ft)	Change in contents (acre- ft)	Elevation (ft)	Contents (acre- ft)	Change in contents (acre- ft)	Elevation (ft)	Contents acre- ft)	Change in contents (acre- ft)
Sept. 30	2,754.53	37,559	--	2,648.60	16,864	--	2,660.50	26,012	--
Oct. 31	2,754.74	37,822	+263	2,647.70	16,507	-357	2,661.20	26,304	+292
Nov. 30	2,750.65	33,048	-4,774	2,622.70	8,609	-7,898	2,654.10	23,329	-2,975
Dec. 31	2,747.71	29,876	-3,172	2,622.80	8,635	+26	2,646.50	20,386	-2,943
CAL YR 2001			-5,880			-1,897			+158
Jan. 31	2,749.29	31,552	+1,676	2,628.20	10,076	+1,441	2,643.90	19,457	-929
Feb. 28	2,752.01	34,588	+3,036	2,612.10	6,187	-3,889	2,653.00	22,911	+3,454
Mar. 31	2,749.34	31,606	-2,982	2,614.00	6,593	+406	2,647.10	20,615	-2,296
Apr. 30	2,751.17	33,631	+2,025	2,627.20	9,813	+3,220	2,657.30	24,650	+4,035
May 31	2,752.75	35,445	+1,814	2,639.30	13,473	+3,660	2,665.90	28,390	+3,740
June 30	2,754.58	37,624	+2,179	2,659.70	21,679	+8,206	2,673.70	32,045	+3,655
July 31	2,755.17	38,342	+718	2,654.10	19,136	-2,543	2,670.20	30,367	-1,678
Aug. 31	2,754.20	37,165	-1,177	2,643.60	14,980	-4,156	2,660.10	25,820	-4,547
Sept. 30	2,750.45	32,824	-4,341	2,643.40	14,901	-79	2,655.40	23,849	-1,971
WTR YR 2002			-4,735			-1,963			-2,163

11362500 PIT RIVER BELOW PIT NO. 4 DAM, CA

LOCATION.—Lat 40°58'25", long 121°46'42", unsurveyed, T.36 N., R.2 E., [Shasta County](#), Hydrologic Unit 18020003, Shasta National Forest, on right bank, 0.6 mi downstream from Ruling Creek, 1.3 mi downstream from Pit No. 4 Dam, and 2.7 mi downstream from Pit No. 3 Powerplant.

DRAINAGE AREA.—4,648 mi², excluding Goose Lake Basin.

PERIOD OF RECORD.—May 1922 to current year. Monthly discharge only for some periods, published in WSP 1315-A. Published as "near Pecks Bridge" April to October 1922, and as "at Lindsay Flat" November 1922 to June 1927.

REVISED RECORDS.—WSP 843: 1935(M). WSP 1315-A: 1928(M). WDR CA-75-4: Drainage area.

GAGE.—Water-stage recorder. Elevation of gage is 2,358 ft above sea level, from river-profile map. Prior to November 1922, water-stage recorder at site at Pecks Bridge 7.4 mi upstream at different datum. November 1922 to June 20, 1927, at site at Lindsay Flat 1.8 mi upstream at different datum. June 20, 1927, to Sept. 5, 1990, at site 200 ft downstream at datum 0.15 ft lower.

REMARKS.—Low flow completely regulated by small reservoirs and powerplants, total usable reservoir capacity, 253,000 acre-ft. Many diversions upstream from station; diversion to Pit No. 4 Powerplant began June 9, 1955. See schematic diagram of [Pit and McCloud River Basins](#).

COOPERATION.—Records were collected by Pacific Gas & Electric Co., under general supervision of the U.S. Geological Survey, in connection with Federal Energy Regulatory Commission project no. 233.

EXTREMES FOR PERIOD OF RECORD.—Maximum discharge, 33,700 ft³/s, Feb. 20, 1986, gage height, 18.70 ft; minimum daily, prior to diversion to Pit No. 4 Powerplant in 1955, 234 ft³/s, Sept. 13, 1953; minimum daily, since diversion to Pit No. 4 Powerplant, 22 ft³/s, Dec. 2–4, 1969.

DISCHARGE, CUBIC FEET PER SECOND, WATER YEAR OCTOBER 2001 TO SEPTEMBER 2002

DAILY MEAN VALUES

DAY	OCT	NOV	DEC	JAN	FEB	MAR	APR	MAY	JUN	JUL	AUG	SEP
1	188	189	193	185	187	188	180	184	174	166	168	196
2	189	184	196	188	185	187	181	184	171	163	168	199
3	192	187	192	187	185	195	189	186	173	162	206	207
4	191	189	180	189	186	196	194	185	176	163	289	195
5	190	189	182	184	186	194	201	205	176	164	320	186
6	195	185	182	188	188	187	196	293	175	163	440	191
7	190	186	184	185	195	188	197	486	172	163	476	188
8	190	184	186	185	196	189	191	663	175	165	623	188
9	190	184	182	182	191	185	188	871	176	454	662	192
10	243	186	180	183	192	189	196	1050	174	165	896	191
11	191	188	181	184	191	191	199	241	176	161	1450	191
12	190	187	186	186	187	189	191	172	175	752	1790	191
13	188	188	187	186	186	188	190	176	176	178	419	186
14	187	192	183	186	187	187	190	177	176	160	174	184
15	187	189	183	179	189	183	183	174	176	167	173	199
16	186	189	185	195	182	182	200	176	176	173	172	186
17	186	186	189	191	185	183	185	175	178	172	171	186
18	186	187	184	185	181	189	184	175	177	169	171	191
19	187	188	186	189	185	181	576	176	176	169	171	196
20	188	188	183	198	181	181	200	176	176	170	172	190
21	189	192	178	196	182	181	181	176	176	171	174	186
22	189	193	181	188	182	181	188	172	176	171	174	185
23	189	183	184	186	183	181	188	178	176	174	173	185
24	192	188	183	187	183	181	186	176	174	175	171	184
25	192	186	183	186	184	181	186	176	129	171	171	199
26	189	184	183	191	183	181	184	176	136	171	173	185
27	190	188	184	189	180	181	183	176	161	170	174	189
28	190	182	186	188	182	180	185	176	162	168	574	190
29	187	179	186	189	---	185	185	174	163	168	178	193
30	188	182	186	184	---	185	186	177	165	168	183	192
31	188	---	187	184	---	182	---	177	---	168	188	---
TOTAL	5917	5602	5725	5803	5204	5751	6063	8059	5122	6074	11444	5721
MEAN	190.9	186.7	184.7	187.2	185.9	185.5	202.1	260.0	170.7	195.9	369.2	190.7
MAX	243	193	196	198	196	196	576	1050	178	752	1790	207
MIN	186	179	178	179	180	180	180	172	129	160	168	184
AC-FT	11740	11110	11360	11510	10320	11410	12030	15990	10160	12050	22700	11350
a	100700	112900	130800	149100	116400	142500	119900	109400	87920	84350	83930	93140
b	111100	125200	147800	173000	135700	163800	138800	124900	100900	95470	93460	100500

a Discharge, in acre-feet, for Pit No. 3 Powerplant (station 11362300), provided by Pacific Gas & Electric Co.
 b Diversion, in acre-feet, to Pit No. 4 Powerplant (station 11362600), provided by Pacific Gas & Electric Co.

11362500 PIT RIVER BELOW PIT NO. 4 DAM, CA—Continued

STATISTICS OF MONTHLY MEAN DATA FOR WATER YEARS 1927 - 1954, BY WATER YEAR (WY)

	OCT	NOV	DEC	JAN	FEB	MAR	APR	MAY	JUN	JUL	AUG	SEP
MEAN	1945	2102	2458	2700	3338	3799	3766	2877	2307	1925	1833	1865
MAX	2385	2544	5968	5523	6872	8510	11400	5507	4096	2652	2146	2318
(WY)	1954	1954	1938	1953	1942	1938	1952	1938	1953	1952	1954	1953
MIN	1571	1666	1745	1698	1742	1895	1730	1635	1612	1569	1509	1541
(WY)	1935	1934	1935	1937	1933	1934	1934	1934	1934	1934	1934	1934

SUMMARY STATISTICS

WATER YEARS 1927 - 1954

ANNUAL MEAN	2572
HIGHEST ANNUAL MEAN	4066 1952
LOWEST ANNUAL MEAN	1703 1934
HIGHEST DAILY MEAN	26200 Dec 12 1937
LOWEST DAILY MEAN	234 Sep 13 1953
ANNUAL SEVEN-DAY MINIMUM	1450 Aug 2 1936
MAXIMUM PEAK FLOW	a30200 Dec 12 1937
MAXIMUM PEAK STAGE	17.90 Dec 12 1937
ANNUAL RUNOFF (AC-FT)	1863000
10 PERCENT EXCEEDS	3810
50 PERCENT EXCEEDS	2170
90 PERCENT EXCEEDS	1630

STATISTICS OF MONTHLY MEAN DATA FOR WATER YEARS 1955 - 2002, BY WATER YEAR (WY)

	1955	1956	1957	1958	1959	1960	1961	1962	1963	1964	1965	1966
MEAN	229.9	231.5	433.4	970.5	1066	1187	802.6	538.0	270.2	167.9	169.2	161.8
MAX	2189	2436	3791	7250	7657	5545	3416	4770	2788	490	458	268
(WY)	1955	1955	1965	1970	1986	1995	1982	1995	1998	1955	1992	1973
MIN	96.8	66.4	49.8	50.0	49.0	49.7	88.3	128	128	137	120	79.8
(WY)	1962	1957	1979	1981	1981	1981	1961	1961	1961	1964	1955	1955

SUMMARY STATISTICS

FOR 2001 CALENDAR YEAR

FOR 2002 WATER YEAR

WATER YEARS 1955 - 2002

ANNUAL TOTAL	77607	76485	
ANNUAL MEAN	212.6	209.5	516.5
HIGHEST ANNUAL MEAN			1868 1955
LOWEST ANNUAL MEAN			98.4 1961
HIGHEST DAILY MEAN	1190 Mar 19	1790 Aug 12	31100 Feb 20 1986
LOWEST DAILY MEAN	161 Mar 3	129 Jun 25	22 Dec 2 1969
ANNUAL SEVEN-DAY MINIMUM	164 Feb 27	155 Jun 25	27 Dec 1 1969
MAXIMUM PEAK FLOW		1850 Aug 11	33700 Feb 20 1986
MAXIMUM PEAK STAGE		6.57 Aug 11	18.70 Feb 20 1986
ANNUAL RUNOFF (AC-FT)	153900	151700	374200
10 PERCENT EXCEEDS	195	196	1230
50 PERCENT EXCEEDS	189	185	159
90 PERCENT EXCEEDS	181	171	60

a From rating curve extended above 12,000 ft³/s on basis of velocity-area studies.

11362900 NELSON CREEK BELOW DIVERSION TO NELSON CREEK POWERPLANT, NEAR BIG BEND, CA

LOCATION.—Lat 41°02'32", long 121°52'34", in NE 1/4 NE 1/4 sec.29, T.37 N., R.1 E., [Shasta County](#), Hydrologic Unit 18020003, on right bank, 400 ft upstream from Snowslide Creek, 0.3 mi downstream from Bull Creek, and 2.3 mi northeast of Big Bend.

DRAINAGE AREA.—13.2 mi².

PERIOD OF RECORD.—October 1993 to September 1996, October 1996 to current year (operated as a low-flow station only).

GAGE.—Water-stage recorder and broad-crested weir; water-stage recorder and sharp-crested weir. Elevation of gages is 2,320 ft above sea level, from topographic map.

REMARKS.—Records good. Flow at this station has two components which are combined for publication: flow over a broad-crested weir (station 11362880) and flow over a sharp-crested weir (station 11362890). Water is diverted upstream of weirs through a tunnel to Nelson Creek Powerplant (station 11362800), returning to Nelson Creek at its confluence with the Pit River. Flow is computed to 100 ft³/s. See schematic diagram of [Pit and McCloud River Basins](#).

EXTREMES FOR PERIOD OF RECORD.—Maximum discharge, 623 ft³/s, Feb. 19, 1996; minimum daily, 7.4 ft³/s, Sept. 8, 21, 22, 1994.

DISCHARGE, CUBIC FEET PER SECOND, WATER YEAR OCTOBER 2001 TO SEPTEMBER 2002

DAILY MEAN VALUES

DAY	OCT	NOV	DEC	JAN	FEB	MAR	APR	MAY	JUN	JUL	AUG	SEP
1	9.4	12	41	73	17	36	40	32	16	17	13	11
2	9.3	11	81	---	17	33	56	28	17	17	13	11
3	9.3	10	67	---	17	22	47	25	17	17	13	11
4	9.3	10	34	73	17	17	48	23	17	17	13	11
5	9.2	9.8	17	47	17	18	50	22	17	16	13	11
6	9.3	9.8	16	50	17	58	49	21	17	16	13	11
7	9.3	9.6	16	48	21	---	43	20	17	16	13	11
8	9.3	9.6	16	46	17	61	40	19	17	16	12	11
9	9.2	9.6	17	45	17	51	43	19	17	16	12	11
10	9.2	9.6	16	32	17	48	59	17	17	16	12	11
11	9.2	12	16	27	17	48	52	17	17	15	12	11
12	9.2	35	16	20	17	51	48	17	17	15	12	11
13	9.2	18	16	18	17	48	46	17	17	15	12	11
14	9.2	17	27	18	17	43	49	17	17	15	12	11
15	9.2	16	19	17	17	41	45	17	17	15	12	11
16	9.2	18	18	17	17	38	35	17	17	15	12	11
17	9.2	18	19	17	17	35	31	17	17	14	12	11
18	9.2	15	23	17	17	34	28	17	17	14	12	11
19	9.2	14	16	17	18	29	28	18	17	14	11	11
20	9.2	21	16	17	55	31	27	17	17	14	12	11
21	9.2	---	16	17	54	32	25	17	17	14	11	11
22	9.2	---	16	17	47	36	23	17	17	14	11	11
23	9.2	19	17	17	64	41	21	17	17	14	11	11
24	9.2	37	17	17	58	44	20	17	18	14	11	10
25	9.2	31	17	17	51	41	20	17	18	14	11	10
26	9.2	20	17	17	44	36	21	17	18	14	11	10
27	9.2	18	17	17	41	32	36	17	18	13	11	10
28	9.2	18	16	17	37	31	25	17	18	13	11	10
29	9.3	18	17	17	---	33	20	17	18	13	11	10
30	14	16	17	17	---	35	31	16	17	13	11	10
31	20	---	---	17	---	37	---	17	---	13	11	---
TOTAL	301.7	---	---	---	779	---	1106	583	515	459	367	323
MEAN	9.732	---	---	---	27.82	---	36.87	18.81	17.17	14.81	11.84	10.77
MAX	20	---	---	---	64	---	59	32	18	17	13	11
MIN	9.2	---	---	---	17	---	20	16	16	13	11	10
AC-FT	598	---	---	---	1550	---	2190	1160	1020	910	728	641

11362950 EAST FORK NELSON CREEK BELOW DIVERSION TO NELSON CREEK, NEAR BIG BEND, CA

LOCATION.—Lat 41°02'25", long 121°52'28", in NE 1/4 NE 1/4 sec.29, T.37 N., R.1 E., [Shasta County](#), Hydrologic Unit 18020003, on right bank, 700 ft upstream from Nelson Creek, and 2.3 mi northeast of Big Bend.

DRAINAGE AREA.—8.18 mi².

PERIOD OF RECORD.—October 1993 to September 1996, October 1996 to current year (operated as a low-flow station only).

GAGE.—Water-stage recorder and broad-crested weir; water-stage recorder and sharp-crested weir. Elevation of gages is 2,360 ft above sea level, from topographic map.

REMARKS.—Records good. Flow at this station has two components which are combined for publication: flow over a broad-crested weir (station 11362940) and flow over a sharp-crested weir (station 11362945). Water is diverted upstream of weirs through a pipe to Nelson Creek (station 11362900). Flows computed to 50 ft³/s. See schematic diagram of [Pit and McCloud River Basins](#).

EXTREMES FOR PERIOD OF RECORD.—Maximum discharge, 267 ft³/s, Mar. 15, 1995; minimum daily, 0.07 ft³/s, Aug. 12 to Sept. 23, 1994, and Oct. 11, 1994.

DISCHARGE, CUBIC FEET PER SECOND, WATER YEAR OCTOBER 2001 TO SEPTEMBER 2002
DAILY MEAN VALUES

DAY	OCT	NOV	DEC	JAN	FEB	MAR	APR	MAY	JUN	JUL	AUG	SEP
1	0.62	0.62	5.1	15	6.7	23	---	---	8.8	3.5	e2.1	e1.8
2	0.62	0.58	7.8	---	6.6	23	---	23	8.3	3.5	e2.2	e1.5
3	0.62	0.56	5.8	---	6.5	20	---	23	7.9	3.4	e2.2	e1.5
4	0.62	0.56	3.9	23	6.3	19	---	22	7.6	3.4	e2.2	e1.5
5	0.62	0.56	4.5	19	6.1	19	---	21	7.5	3.4	e1.8	e1.5
6	0.62	0.56	7.3	18	6.0	---	---	20	7.3	3.2	e1.9	e1.5
7	0.62	0.50	5.8	16	8.1	---	---	20	7.1	3.0	e2.0	e1.5
8	0.62	0.50	4.5	16	8.4	---	---	19	7.0	3.0	e2.0	e1.5
9	0.62	0.50	4.0	15	7.4	---	---	18	7.0	2.8	e1.9	e1.5
10	0.62	0.50	3.4	14	7.1	---	---	18	6.9	2.8	e1.9	e1.5
11	0.62	0.90	3.0	13	7.0	---	---	17	6.8	2.7	e1.9	1.6
12	0.59	2.0	2.7	13	7.0	---	---	16	6.6	e2.4	e1.8	1.6
13	0.56	2.4	2.8	12	7.2	---	---	16	6.5	e2.4	e1.8	1.6
14	0.56	1.7	2.8	12	7.2	---	---	15	6.4	e2.4	e1.8	1.6
15	0.56	1.2	2.4	11	7.2	---	---	15	6.2	e2.4	e1.8	1.5
16	0.56	1.2	2.4	11	7.5	---	---	14	6.1	e2.4	e1.8	1.5
17	0.56	1.4	2.7	10	8.2	24	---	12	6.0	e2.4	e1.8	1.5
18	0.50	1.0	4.3	9.5	8.6	23	---	12	6.0	e2.3	e1.8	1.4
19	0.50	0.83	5.2	9.1	12	23	---	12	5.9	e2.2	e1.7	1.3
20	0.50	2.0	4.8	8.6	21	23	24	12	5.6	e2.2	e1.7	1.3
21	0.54	8.9	4.2	8.4	---	23	24	13	5.6	e2.2	e1.6	1.3
22	0.53	8.4	4.7	8.0	---	23	24	12	5.6	e2.2	e1.7	1.2
23	0.50	3.3	4.6	7.8	---	24	24	12	5.4	e2.1	e1.8	1.1
24	0.50	3.1	3.8	7.6	---	24	23	11	5.2	e2.0	e1.7	1.1
25	0.50	2.4	3.4	7.5	---	23	23	11	5.0	e2.1	e1.6	1.1
26	0.50	2.1	3.3	7.5	---	23	23	10	4.5	e2.2	e1.7	1.1
27	0.50	1.8	3.5	7.2	---	23	24	10	3.9	e2.1	e1.8	1.1
28	0.50	2.0	4.6	7.1	24	24	23	9.9	3.8	e1.9	e1.9	1.2
29	0.51	2.0	5.4	7.0	---	24	22	9.6	3.7	e2.2	e2.0	1.1
30	1.2	1.8	6.8	7.0	---	---	---	9.3	3.5	e2.1	e1.9	1.2
31	1.6	---	15	6.9	---	---	---	8.9	---	e2.0	e1.9	---
TOTAL	19.09	55.87	144.5	---	---	---	---	---	183.7	78.9	57.7	41.7
MEAN	0.616	1.862	4.661	---	---	---	---	---	6.123	2.545	1.861	1.390
MAX	1.6	8.9	15	---	---	---	---	---	8.8	3.5	2.2	1.8
MIN	0.50	0.50	2.4	---	---	---	---	---	3.5	1.9	1.6	1.1
AC-FT	38	111	287	---	---	---	---	---	364	156	114	83

e Estimated.

11363000 PIT RIVER AT BIG BEND, CA

LOCATION.—Lat 41°01'10", long 121°54'36", in NW 1/4 SW 1/4 sec.31, T.37 N., R.1 E., [Shasta County](#), Hydrologic Unit 18020003, on left bank at Big Bend, 0.4 mi downstream from Nelson Creek, 1.5 mi upstream from Kosk Creek, and 3.1 mi downstream from Pit No. 5 Dam.

DRAINAGE AREA.—4,711 mi², excluding Goose Lake Basin.

PERIOD OF RECORD.—October 1910 to current year. Monthly discharge only for some periods, published in WSP 1315-A. Published as "at Henderson" 1910–23.

REVISED RECORDS.—WSP 1345: 1911, 1914(M), 1916(M), 1917, 1928, 1935–36(M). WDR CA-75-4: Drainage area.

GAGE.—Water-stage recorder. Datum of gage is 1,674.47 ft above sea level. Prior to Dec. 28, 1912, nonrecording gage; Dec. 28, 1912, to June 21, 1924, water-stage recorder at same site, at datum 7.69 ft higher. June 22, 1924, to Sept. 30, 1988, at site 200 ft downstream at same datum.

REMARKS.—Low flow completely regulated by many reservoirs and powerplants, total usable reservoir capacity, about 253,000 acre-ft. Many diversions upstream from station; diversion to Pit No. 5 Powerplant (station 11362700) began May 1, 1944. See schematic diagram of [Pit and McCloud River Basins](#).

COOPERATION.—Records were collected by Pacific Gas & Electric Co., under general supervision of the U.S. Geological Survey, in connection with Federal Energy Regulatory Commission project no. 233.

EXTREMES FOR PERIOD OF RECORD.—Maximum discharge, 49,000 ft³/s, Jan. 25, 1970, gage height, 18.17 ft, in gage well, 19.0 ft, from floodmarks, site then in use, from rating curve extended above 17,000 ft³/s; maximum gage height, 18.70 ft, Feb. 20, 1986, site then in use; minimum daily, 692 ft³/s, July 9, 1925; since diversion to Pit No. 5 Powerplant, minimum daily, 34 ft³/s, Mar. 29, 1955.

EXTREMES FOR CURRENT YEAR.—Peak discharges greater than base discharge of 6,000 ft³/s, or maximum:

Date	Time	Discharge (ft ³ /s)	Gage height (ft)
Aug. 25	0030	1,920	8.42

DISCHARGE, CUBIC FEET PER SECOND, WATER YEAR OCTOBER 2001 TO SEPTEMBER 2002

DAILY MEAN VALUES

DAY	OCT	NOV	DEC	JAN	FEB	MAR	APR	MAY	JUN	JUL	AUG	SEP
1	153	165	274	351	203	270	287	259	167	170	184	166
2	162	186	308	622	203	285	298	242	168	172	183	164
3	173	188	253	528	191	275	303	241	183	176	170	158
4	170	182	218	413	193	268	303	241	177	164	169	171
5	168	191	233	367	190	267	307	259	168	160	150	169
6	167	197	256	411	178	287	295	382	166	159	179	170
7	161	179	225	514	206	439	299	568	178	156	181	159
8	171	171	216	343	235	379	289	740	168	162	162	155
9	185	184	210	329	216	225	305	996	172	167	157	153
10	175	180	198	309	210	209	338	1230	176	163	158	159
11	173	184	188	295	209	356	311	249	164	164	165	171
12	169	212	179	294	215	291	303	226	160	154	157	170
13	162	185	179	276	208	197	297	214	167	156	165	160
14	163	161	195	264	213	149	306	213	166	157	163	155
15	168	164	172	257	216	143	284	212	167	154	153	157
16	177	169	170	250	219	198	272	207	159	160	174	162
17	177	174	176	243	225	173	259	202	169	180	250	163
18	165	184	204	243	220	276	249	201	168	183	281	176
19	163	180	233	225	245	268	241	209	173	185	454	157
20	170	191	237	216	339	262	258	212	180	168	491	160
21	175	327	223	227	287	262	252	212	177	159	684	157
22	180	265	246	217	153	270	244	207	162	162	707	163
23	171	187	253	213	382	303	249	198	158	156	939	163
24	167	181	231	212	381	294	248	194	167	174	1440	166
25	161	172	215	210	209	275	250	184	150	172	1860	158
26	163	177	209	215	148	265	248	179	161	175	447	156
27	158	185	211	209	148	259	253	181	158	159	184	151
28	159	198	227	205	137	251	248	192	163	161	203	157
29	176	190	240	196	---	254	235	185	166	156	172	161
30	174	186	267	201	---	276	261	181	168	174	176	159
31	188	---	398	201	---	280	---	178	---	166	161	---
TOTAL	5244	5695	7044	9056	6179	8206	8292	9394	5026	5124	11119	4846
MEAN	169.2	189.8	227.2	292.1	220.7	264.7	276.4	303.0	167.5	165.3	358.7	161.5
MAX	188	327	398	622	382	439	338	1230	183	185	1860	176
MIN	153	161	170	196	137	143	235	178	150	154	150	151
AC-FT	10400	11300	13970	17960	12260	16280	16450	18630	9970	10160	22050	9610

11363000 PIT RIVER AT BIG BEND, CA—Continued

STATISTICS OF MONTHLY MEAN DATA FOR WATER YEARS 1911 - 1943, BY WATER YEAR (WY)

	OCT	NOV	DEC	JAN	FEB	MAR	APR	MAY	JUN	JUL	AUG	SEP
MEAN	2206	2373	2676	3000	3927	4449	4446	3229	2520	2214	2100	2107
MAX	3021	3186	6792	7675	7989	9953	11410	6216	3763	3218	2987	2975
(WY)	1912	1912	1938	1914	1942	1938	1917	1938	1911	1911	1911	1911
MIN	1607	1740	1764	1750	1746	2051	1860	1734	1672	1584	1526	1565
(WY)	1935	1934	1935	1937	1933	1931	1934	1934	1934	1934	1934	1934

SUMMARY STATISTICS

WATER YEARS 1911 - 1943

ANNUAL MEAN	2931
HIGHEST ANNUAL MEAN	4597 1938
LOWEST ANNUAL MEAN	1787 1934
HIGHEST DAILY MEAN	30300 Dec 12 1937
LOWEST DAILY MEAN	692 Jul 9 1925
ANNUAL SEVEN-DAY MINIMUM	915 Jul 4 1925
MAXIMUM PEAK FLOW	a34200 Dec 12 1937
MAXIMUM PEAK STAGE	16.26 Dec 12 1937
ANNUAL RUNOFF (AC-FT)	2123000
10 PERCENT EXCEEDS	4520
50 PERCENT EXCEEDS	2440
90 PERCENT EXCEEDS	1750

STATISTICS OF MONTHLY MEAN DATA FOR WATER YEARS 1944 - 2002, BY WATER YEAR (WY)

	1944	1949	1979	1949	1977	1977	1977	1977	1944	1944	1944	1945
MEAN	203.4	217.1	483.3	1042	1220	1397	1087	655.8	282.4	135.6	136.5	127.3
MAX	2322	2469	3889	8804	9457	6658	8441	5420	3052	203	448	284
(WY)	1944	1944	1965	1970	1986	1995	1952	1995	1998	1998	1992	1986
MIN	58.8	56.0	45.0	51.4	57.1	52.6	49.9	114	78.5	63.5	60.9	60.1
(WY)	1949	1979	1979	1949	1977	1977	1977	1977	1944	1944	1944	1945

SUMMARY STATISTICS

FOR 2001 CALENDAR YEAR

FOR 2002 WATER YEAR

WATER YEARS 1944 - 2002

ANNUAL TOTAL	65784	85225	
ANNUAL MEAN	180.2	233.5	579.2
HIGHEST ANNUAL MEAN			1638 1995
LOWEST ANNUAL MEAN			86.5 1977
HIGHEST DAILY MEAN	398 Dec 31	1860 Aug 25	36500 Feb 21 1986
LOWEST DAILY MEAN	147 Jun 30	137 Feb 28	34 Mar 29 1955
ANNUAL SEVEN-DAY MINIMUM	150 Jun 29	158 Jul 10	40 Dec 7 1978
MAXIMUM PEAK FLOW		1920 Aug 25	49000 Jan 25 1970
MAXIMUM PEAK STAGE		8.42 Aug 25	18.70 Feb 20 1986
ANNUAL RUNOFF (AC-FT)	130500	169000	419600
10 PERCENT EXCEEDS	207	305	1540
50 PERCENT EXCEEDS	177	188	142
90 PERCENT EXCEEDS	155	159	76

a From rating extended above 11,000 ft³/s on basis of velocity-area studies.

11363910 JAMES B. BLACK POWERPLANT NEAR BIG BEND, CA

LOCATION.—Lat 40°59'12", long 121°58'35", in SW 1/4 SE 1/4 sec.9, T.36 N., R.1 W., [Shasta County](#), Hydrologic Unit 18020003, at powerplant, on right bank of Pit River, and 5.8 mi downstream from Big Bend.

PERIOD OF RECORD.—December 1965 to current year.

GAGE.—Discharge computed from powerplant output.

REMARKS.—Water is diverted from Lake McCloud (station 11367740) at SE 1/4 SW 1/4 sec.22, T.38 N., R.2 W., through McCloud–Iron Canyon Diversion Tunnel (station 11367720) to Iron Canyon Reservoir (station 11363920), then through the penstock for powerplant and into the Pit River. Records are combined flow of diversion from McCloud River at McCloud Dam plus Iron Canyon Creek. See schematic diagram of [Pit and McCloud River Basins](#).

COOPERATION.—Records were collected by Pacific Gas & Electric Co., under general supervision of the U.S. Geological Survey, in connection with Federal Energy Regulatory Commission project no. 2106.

EXTREMES FOR PERIOD OF RECORD.—Maximum daily discharge, 2,420 ft³/s, July 15, 1966; no flow several days most years.

DISCHARGE, CUBIC FEET PER SECOND, WATER YEAR OCTOBER 2001 TO SEPTEMBER 2002
DAILY MEAN VALUES

DAY	OCT	NOV	DEC	JAN	FEB	MAR	APR	MAY	JUN	JUL	AUG	SEP
1	616	863	1160	684	571	871	895	922	730	898	788	1080
2	772	787	1060	914	585	1090	943	836	773	852	736	757
3	773	769	1240	649	820	1360	1010	899	736	880	678	622
4	805	661	1100	903	990	1080	1240	760	736	631	705	464
5	869	662	1110	936	975	1120	1400	707	746	792	612	366
6	670	818	1050	947	943	1390	1260	344	584	639	625	512
7	601	1090	973	1150	838	1350	1270	575	564	655	963	569
8	735	933	976	1790	427	1110	1170	561	653	898	965	471
9	651	1100	896	1810	466	1190	919	838	610	1060	1120	402
10	778	866	958	1900	724	1100	926	719	650	902	1030	576
11	693	769	857	1770	806	1130	1200	758	650	667	1030	596
12	587	822	948	1550	670	1010	1450	800	422	867	1120	930
13	563	1120	836	1470	783	927	1330	852	412	523	859	691
14	470	867	630	1340	764	1170	1200	763	399	478	664	681
15	666	888	632	1400	957	1250	1050	816	430	752	764	605
16	782	914	666	1410	949	839	1110	976	347	785	771	592
17	732	800	628	1150	813	900	1250	1020	406	855	725	526
18	655	845	769	1310	922	798	1430	986	461	786	664	539
19	591	831	631	1270	997	817	1220	959	588	830	461	939
20	498	814	770	1160	1060	760	713	998	449	702	641	921
21	130	674	812	1140	1210	898	676	977	526	568	659	572
22	606	756	805	938	1240	991	866	907	617	869	663	587
23	607	885	903	981	1300	974	750	894	566	777	607	663
24	749	834	891	782	1510	916	948	967	566	887	1200	557
25	727	836	950	256	1670	1030	1010	614	628	778	722	848
26	704	915	800	587	1180	1120	936	589	558	473	931	778
27	473	1200	735	312	1130	1160	712	746	579	703	924	861
28	175	1310	784	555	990	1110	1030	901	701	716	1030	588
29	761	950	852	506	---	1130	943	1130	751	847	701	536
30	724	1310	835	634	---	1030	893	1020	603	796	597	560
31	768	---	905	675	---	947	---	1040	---	751	901	---
TOTAL	19931	26889	27162	32879	26290	32568	31750	25874	17441	23617	24856	19389
MEAN	642.9	896.3	876.2	1061	938.9	1051	1058	834.6	581.4	761.8	801.8	646.3
MAX	869	1310	1240	1900	1670	1390	1450	1130	773	1060	1200	1080
MIN	130	661	628	256	427	760	676	344	347	473	461	366
AC-FT	39530	53330	53880	65220	52150	64600	62980	51320	34590	46840	49300	38460
a	123400	139500	169300	194200	154200	185200	159900	143000	117800	112400	108600	112800

STATISTICS OF MONTHLY MEAN DATA FOR WATER YEARS 1966 - 2002, BY WATER YEAR (WY)

	1966	1967	1968	1969	1970	1971	1972	1973	1974	1975	1976	1977	1978	1979	1980	1981	1982	1983	1984	1985	1986	1987	1988	1989	1990	1991	1992	1993	1994	1995	1996	1997	1998	1999	2000	2001	2002					
MEAN	752.8	759.8	890.1	977.0	1047	1178	1145	1009	889.3	838.2	811.5	784.6																														
MAX	1122	1401	1538	1651	1625	1565	1670	1797	1735	1260	1101	1225																														
(WY)	1976	1974	1974	1970	1998	1995	1966	1967	1967	1966	1983	1983																														
MIN	505	428	433	500	373	581	421	368	523	533	465	515																														
(WY)	1993	1992	1992	1992	1978	1991	1990	1977	1987	1994	1992	1992																														

SUMMARY STATISTICS

	FOR 2001 CALENDAR YEAR		FOR 2002 WATER YEAR		WATER YEARS 1966 - 2002	
ANNUAL TOTAL	295634.00		308646			
ANNUAL MEAN	810.0		845.6		920.1	
HIGHEST ANNUAL MEAN					1313	
LOWEST ANNUAL MEAN					547	
HIGHEST DAILY MEAN	1640	Jun 14	1900	Jan 10	2420	Jul 15 1966
LOWEST DAILY MEAN	0.00	Jan 7	130	Oct 21	0.00	Jun 2 1966
ANNUAL SEVEN-DAY MINIMUM	407	May 28	411	Jun 12	0.00	Feb 3 1971
ANNUAL RUNOFF (AC-FT)	586400		612200		666600	
10 PERCENT EXCEEDS	1160		1190		1480	
50 PERCENT EXCEEDS	846		817		887	
90 PERCENT EXCEEDS	371		561		403	

a Discharge, in acre-feet, for Pit No. 5 Powerplant (station 11362700), provided by Pacific Gas & Electric Co.

11363930 IRON CANYON CREEK BELOW IRON CANYON DAM, NEAR BIG BEND, CA

LOCATION.—Lat 41°02'22", long 121°59'03", in NW 1/4 NW 1/4 sec.28, T.37 N., R.1 W., [Shasta County](#), Hydrologic Unit 18020003, on left bank, 0.2 mi downstream from Iron Canyon Dam, and 4.2 mi west of Big Bend.

DRAINAGE AREA.—11.2 mi².

PERIOD OF RECORD.—August 1966 to current year (beginning October 1994, operated as a low-flow station only).

REVISED RECORDS.—WDR CA-95-4: Drainage area.

GAGE.—Water-stage recorder, 60° sharp-crested V-notch weir, and concrete control with flashboards in 2- by 10-ft opening. Datum of gage is 2,461.52 ft above sea level (levels by Pacific Gas & Electric Co.).

REMARKS.—Flow is completely regulated by Iron Canyon Reservoir (station 11363920). There is an interbasin diversion from Lake McCloud (station 11367740) to Iron Canyon Reservoir and then through a tunnel to James B. Black Powerplant on the Pit River (station 11363910). This station records fishwater release only. The minimum release requirement is 3.0 ft³/s at all times. Flow is computed to 12.0 ft³/s. See schematic diagram of [Pit and McCloud River Basins](#).

COOPERATION.—Records were collected by Pacific Gas & Electric Co., under general supervision of the U.S. Geological Survey, in connection with Federal Energy Regulatory Commission project no. 2106.

EXTREMES FOR PERIOD OF RECORD.—Maximum discharge, 650 ft³/s, Feb. 5, 1986, gage height unknown (flashboards removed from weir), from equation for a 4- by 4-ft slide gate. Flow was the result of full travel test of slide gate at Iron Canyon Dam; maximum gage height, 3.24 ft, Feb. 25, 1978 (flashboards in weir), was the result of failure of the James B. Black Penstock; no flow, July 15–18, 1967.

DISCHARGE, CUBIC FEET PER SECOND, WATER YEAR OCTOBER 2001 TO SEPTEMBER 2002

DAILY MEAN VALUES

DAY	OCT	NOV	DEC	JAN	FEB	MAR	APR	MAY	JUN	JUL	AUG	SEP
1	6.8	7.6	7.5	6.9	6.0	5.6	5.5	6.4	6.4	7.0	6.4	7.2
2	6.8	7.6	8.0	8.6	6.0	5.7	5.5	6.2	6.4	6.8	6.4	7.2
3	6.6	7.6	7.2	8.2	6.0	5.6	5.5	6.3	6.4	6.8	6.4	7.0
4	6.4	7.6	6.2	7.6	6.0	4.7	5.5	6.2	6.4	6.8	6.4	6.8
5	6.4	7.6	6.2	7.6	6.0	5.6	5.6	6.4	6.4	6.8	6.4	6.8
6	6.4	7.6	6.3	7.6	6.0	5.6	5.3	6.4	6.4	6.8	6.9	7.0
7	6.4	7.3	6.0	7.5	6.4	5.8	5.1	6.4	6.4	6.8	7.6	7.2
8	6.4	7.2	6.0	7.2	6.4	5.4	4.9	5.4	6.6	6.8	7.4	7.2
9	6.7	7.1	5.8	6.9	6.4	5.3	5.2	6.4	6.8	6.0	7.2	7.2
10	6.8	6.8	5.6	6.4	6.4	5.4	5.4	6.4	6.8	6.4	7.2	7.2
11	6.8	6.8	5.6	5.9	6.4	5.5	5.6	6.4	6.8	6.4	7.2	7.0
12	7.1	7.6	5.6	5.6	6.4	5.3	5.2	6.4	6.8	6.4	7.2	6.8
13	7.2	7.4	5.6	5.3	6.4	5.3	5.0	6.4	6.8	6.4	7.2	6.8
14	7.2	6.9	5.6	5.1	6.4	5.3	4.9	6.4	6.8	6.4	7.2	6.8
15	7.2	6.3	5.6	5.0	6.4	5.1	5.1	6.4	6.8	6.4	7.2	6.8
16	7.2	6.8	5.6	4.9	6.4	5.3	5.6	6.4	6.8	6.4	7.2	6.8
17	7.2	6.8	5.6	4.9	6.4	5.3	5.5	6.4	7.2	6.4	7.2	6.9
18	7.2	6.8	6.0	4.9	6.4	5.4	5.2	6.4	7.2	6.4	7.2	7.4
19	7.2	6.8	6.4	4.9	6.4	5.4	5.0	6.4	7.2	6.4	7.2	7.8
20	7.2	7.5	6.4	4.9	6.7	5.5	5.0	6.7	7.2	6.4	6.3	7.6
21	7.2	8.0	6.4	4.9	6.4	5.6	5.2	6.8	7.2	6.4	6.8	7.6
22	7.2	7.3	6.4	4.9	6.3	5.6	5.5	6.6	7.2	6.4	6.8	7.6
23	7.2	6.8	6.4	5.0	6.3	5.9	5.5	6.4	7.2	6.6	6.8	7.6
24	7.2	6.8	6.4	5.0	6.0	6.0	5.6	6.4	7.2	6.6	6.8	7.6
25	7.2	6.8	6.4	5.3	5.7	5.8	5.6	6.4	7.2	6.4	6.8	7.6
26	7.2	6.8	6.0	5.6	5.2	5.6	5.7	6.4	7.2	6.4	6.8	7.6
27	7.2	6.5	6.0	5.6	5.2	5.5	6.0	6.4	7.2	6.4	7.0	7.6
28	7.2	6.4	6.4	6.0	5.3	5.4	6.3	6.4	7.2	6.4	7.2	7.6
29	7.2	6.2	6.4	6.0	---	5.4	6.4	6.4	7.2	6.4	7.2	7.6
30	7.8	6.0	6.5	6.0	---	5.5	6.4	6.4	7.2	6.4	7.2	7.6
31	8.0	---	7.2	6.0	---	5.5	---	6.4	---	6.4	7.2	---
TOTAL	217.8	211.3	193.3	186.2	172.3	169.9	163.8	197.8	206.6	201.8	216.0	217.5
MEAN	7.026	7.043	6.235	6.006	6.154	5.481	5.460	6.381	6.887	6.510	6.968	7.250
MAX	8.0	8.0	8.0	8.6	6.7	6.0	6.4	6.8	7.2	7.0	7.6	7.8
MIN	6.4	6.0	5.6	4.9	5.2	4.7	4.9	5.4	6.4	6.0	6.3	6.8
AC-FT	432	419	383	369	342	337	325	392	410	400	428	431

11365000 PIT RIVER NEAR MONTGOMERY CREEK, CA

LOCATION.—Lat 40°50'38", long 122°00'05", in NE 1/4 SW 1/4 sec.32, T.35 N., R.1 W., [Shasta County](#), Hydrologic Unit 18020003, Shasta National Forest, on left bank, 0.7 mi downstream from Pit No. 7 Dam and Powerplant, 1.4 mi upstream from Potem Creek, and 4.1 mi west of town of Montgomery Creek.

DRAINAGE AREA.—4,952 mi², excluding Goose Lake Basin.

PERIOD OF RECORD.—October 1944 to current year (monthly discharge only December 1964 to May 1965). Monthly discharge only for some periods, published in WSP 1315-A.

CHEMICAL DATA: Water years 1951, 1953, 1955–81.

WATER TEMPERATURE: Water years 1951, 1954–57, 1959.

REVISED RECORDS.—WSP 1931: Drainage area. WDR CA-86-4: 1983 (M).

GAGE.—Water-stage recorder and crest-stage gage. Datum of gage is 1,000.00 ft above sea level (levels by Pacific Gas & Electric Co.).

October 1944 to Feb. 17, 1963, at site 0.7 mi upstream at different datum. Feb. 17, 1963, to May 21, 1965, at site 1.5 mi upstream at different datum. May 21, 1965, to June 20, 1981, at site 0.9 mi downstream at datum 1,036.00 ft above sea level.

REMARKS.—Low flow completely regulated by many reservoirs and powerplants, total usable reservoir capacity, 337,000 acre-ft. Many diversions upstream from station for irrigation. Diversion from McCloud River to Iron Canyon Reservoir (station 11363920) began December 1965. See schematic diagram of [Pit and McCloud River Basins](#).

COOPERATION.—Records were collected by Pacific Gas & Electric Co., under general supervision of the U.S. Geological Survey, in connection with Federal Energy Regulatory Commission project no. 2106.

EXTREMES FOR PERIOD OF RECORD.—Maximum discharge, 73,000 ft³/s, Jan. 24, 1970, gage height, 32.36 ft, site and datum then in use; maximum gage height, 74.65 ft, Feb. 19, 1986; minimum daily, 30 ft³/s, July 12, 27, 1975, result of construction work below Pit No. 7 Powerplant.

DISCHARGE, CUBIC FEET PER SECOND, WATER YEAR OCTOBER 2001 TO SEPTEMBER 2002

DAILY MEAN VALUES

DAY	OCT	NOV	DEC	JAN	FEB	MAR	APR	MAY	JUN	JUL	AUG	SEP
1	2960	3380	5940	4980	4180	e3830	e3080	e4630	e2820	3100	3170	2330
2	3240	3370	7770	8780	4070	e3820	e3860	e4230	e2740	3210	2890	2950
3	3240	3180	6780	9660	3960	e3800	e4060	e4300	e3710	3140	2130	2920
4	3130	3070	4900	8370	3320	e3700	e5010	e3780	e3790	2540	3080	2890
5	3210	3410	5260	8420	3490	e4230	e6010	e4340	e3530	2780	2750	2950
6	2520	3880	5410	8220	3210	e5010	e5730	e4010	e2890	2150	2720	2230
7	2300	3530	4780	8080	2390	e3970	e6370	e3550	e2180	2240	3100	2140
8	2590	3010	4710	8320	4130	e3960	e4440	e3630	e2360	3250	2980	2370
9	2700	2790	4550	8300	3690	e3950	e4420	e4050	e2030	3960	3290	3090
10	3460	2320	4960	7600	4500	e3950	e4950	e4000	e3220	3660	2910	2820
11	2680	2460	4840	7040	4410	e3940	e5010	e4740	e3190	2820	2730	2310
12	3190	3590	4630	6180	3650	e3880	e6740	e4710	e3060	2180	2810	2850
13	3130	4270	4140	6620	3910	e3820	e5670	e4420	e3820	2770	2550	3040
14	2460	3500	4440	6850	4310	e3790	e6490	e3890	e2050	2050	2550	1600
15	3210	3350	3950	7150	4680	e5320	e4290	e3790	e2660	2970	3300	1760
16	3160	3770	3790	6150	5070	e6850	e4530	e3550	e2400	2960	3010	3290
17	2930	2970	3710	5860	4530	e5530	e4710	e3470	e2970	3080	2860	2530
18	3100	3330	4400	5890	4350	e4800	e5180	e4160	e2800	3010	2770	3020
19	2590	3310	5080	5750	4770	e4680	e5380	e4750	e3150	3030	2330	3280
20	2600	2860	5620	5010	6240	e4240	e4360	e4590	e3120	2320	2330	3760
21	2210	3590	5240	5230	6710	e3800	e6350	e4660	e2330	1990	2520	1920
22	3050	6240	4550	6210	7980	e5220	e4380	e3970	e2330	2510	2570	1770
23	3020	5210	5380	4690	8270	e6400	e4750	e3790	e2880	3000	2650	2680
24	2920	5110	5330	3820	e7820	e5720	e4820	e3730	3610	3420	2880	2930
25	3000	4420	5150	3400	e4620	e5140	e4770	e2860	3440	3290	2850	3410
26	2960	4090	4590	3690	e3810	e5380	e4360	e1890	2620	3040	3000	3270
27	2130	4120	6140	5460	e3390	e5000	e3220	e2590	2720	2200	3270	3860
28	2100	4110	7120	3460	e3820	e5410	e4370	e4190	2880	2020	3790	2690
29	3590	4090	6800	3880	---	e6090	e4290	e4570	2990	2580	2990	2490
30	2820	5440	7650	3590	---	e7000	e4690	e4270	1750	3060	2630	2590
31	3270	---	5910	3420	---	e5080	---	e4140	---	3090	1540	---
TOTAL	89470	111770	163520	190080	129280	147310	146290	123250	86040	87420	86950	81740
MEAN	2886	3726	5275	6132	4617	4752	4876	3976	2868	2820	2805	2725
MAX	3590	6240	7770	9660	8270	7000	6740	4750	3820	3960	3790	3860
MIN	2100	2320	3710	3400	2390	3700	3080	1890	1750	1990	1540	1600
AC-FT	177500	221700	324300	377000	256400	292200	290200	244500	170700	173400	172500	162100
a	14379	14130	11446	12104	15576	8149	14613	14430	14753	13933	14828	14669
b	187600	223400	288000	325700	248500	313600	264400	233100	171700	182000	184200	173400
c	32079	33255	29553	31401	32543	32115	32165	32080	32507	32634	32552	33071

e Estimated.

a Contents, in acre-feet, at end of month for Pit No. 6 Reservoir (station 11364100), provided by Pacific Gas & Electric Co.

b Discharge, in acre-feet, for Pit No. 6 Powerplant (station 11364150), provided by Pacific Gas & Electric Co.

c Contents, in acre-feet, at end of month for Pit No. 7 Reservoir (station 11364700), provided by Pacific Gas & Electric Co.

11365000 PIT RIVER NEAR MONTGOMERY CREEK, CA—Continued

STATISTICS OF MONTHLY MEAN DATA FOR WATER YEARS 1945 - 1965, BY WATER YEAR (WY)

	OCT	NOV	DEC	JAN	FEB	MAR	APR	MAY	JUN	JUL	AUG	SEP
MEAN	2643	2828	3821	4320	5592	5331	5711	4297	3127	2376	2231	2284
MAX	5999	3710	9541	11240	12970	8212	13350	7380	5044	3037	2651	2744
(WY)	1963	1951	1956	1956	1958	1956	1952	1952	1953	1958	1958	1959
MIN	2112	2232	2219	2137	2500	3225	3404	2299	2353	1935	1971	1899
(WY)	1950	1950	1950	1949	1948	1964	1947	1947	1950	1949	1947	1949

SUMMARY STATISTICS

WATER YEARS 1945 - 1965

ANNUAL TOTAL	
ANNUAL MEAN	3704
HIGHEST ANNUAL MEAN	5529 1956
LOWEST ANNUAL MEAN	2658 1947
HIGHEST DAILY MEAN	32100 Dec 23 1955
LOWEST DAILY MEAN	150 Jul 19 1965
ANNUAL SEVEN-DAY MINIMUM	1610 Jul 19 1965
MAXIMUM PEAK FLOW	37100 Dec 23 1955
MAXIMUM PEAK STAGE	14.12 Dec 23 1955
ANNUAL RUNOFF (AC-FT)	2684000
10 PERCENT EXCEEDS	6080
50 PERCENT EXCEEDS	3010
90 PERCENT EXCEEDS	1740

STATISTICS OF MONTHLY MEAN DATA FOR WATER YEARS 1966 - 2002, BY WATER YEAR (WY)

MEAN	3413	4104	4757	6555	7164	7975	6531	5423	4014	3283	3104	3112
MAX	5865	8683	9814	20890	18670	16030	12920	11900	8911	4633	4187	4257
(WY)	1997	1997	1982	1970	1986	1983	1982	1995	1998	1998	1983	1998
MIN	2286	2533	2408	2632	2784	3241	2626	2404	2268	2291	2049	1428
(WY)	1993	1993	1991	1991	1991	1977	1977	1992	1992	1994	1992	1966

SUMMARY STATISTICS

FOR 2001 CALENDAR YEAR

FOR 2002 WATER YEAR

WATER YEARS 1966 - 2002

ANNUAL TOTAL	1307315	1443120	
ANNUAL MEAN	3582	3954	4942
HIGHEST ANNUAL MEAN			7693 1974
LOWEST ANNUAL MEAN			2808 1992
HIGHEST DAILY MEAN	7770 Dec 2	9660 Jan 3	53900 Jan 23 1970
LOWEST DAILY MEAN	189 Aug 5	1540 Aug 31	30 Jul 12 1975
ANNUAL SEVEN-DAY MINIMUM	2510 Sep 17	2480 Sep 11	939 Sep 5 1966
MAXIMUM PEAK FLOW		19600 Jan 2	73000 Jan 24 1970
MAXIMUM PEAK STAGE		67.14 Jan 2	74.65 Feb 19 1986
ANNUAL RUNOFF (AC-FT)	2593000	2862000	3580000
10 PERCENT EXCEEDS	5090	6040	8460
50 PERCENT EXCEEDS	3510	3660	4020
90 PERCENT EXCEEDS	2120	2440	2130

11367500 McCLOUD RIVER NEAR McCLOUD, CA

LOCATION.—Lat 41°11'18", long 122°03'52", in NW 1/4 NE 1/4 sec.34, T.39 N., R.2 W., [Siskiyou County](#), Hydrologic Unit 18020004, on right bank, 0.4 mi downstream from Angel Creek, and 6 mi southeast of McCloud.

DRAINAGE AREA.—358 mi².

PERIOD OF RECORD.—April 1931 to current year.

REVISED RECORDS.—WSP 843: 1936(M). WSP 1445: 1940(M). WSP 1931: Drainage area.

GAGE.—Water-stage recorder. Datum of gage is 2,711.2 ft above sea level, from river-profile map.

REMARKS.—Two small diversions upstream from station for irrigation and one 22-in. pipeline for town of McCloud. See schematic diagram of [Pit and McCloud River Basins](#).

COOPERATION.—Records were collected by Pacific Gas & Electric Co., under general supervision of the U.S. Geological Survey, in connection with Federal Energy Regulatory Commission project no. 2106

EXTREMES FOR PERIOD OF RECORD.—Maximum discharge, 15,400 ft³/s, Jan. 1, 1997, gage height, 11.22 ft, from rating curve extended above 8,800 ft³/s on basis of slope-area measurement of peak flow; minimum daily, 524 ft³/s, Nov. 23, 24, 1932.

EXTREMES FOR CURRENT YEAR.—Peak discharges greater than base discharge of 1,500 ft³/s, or maximum:

Date	Time	Discharge (ft ³ /s)	Gage height (ft)
Jan. 2	1815	1,520	2.61

DISCHARGE, CUBIC FEET PER SECOND, WATER YEAR OCTOBER 2001 TO SEPTEMBER 2002
DAILY MEAN VALUES

DAY	OCT	NOV	DEC	JAN	FEB	MAR	APR	MAY	JUN	JUL	AUG	SEP
1	697	691	733	874	755	857	952	954	863	769	748	729
2	696	688	752	1290	753	846	979	938	856	769	747	728
3	695	686	738	1270	753	838	1010	939	846	768	747	728
4	695	684	723	1070	748	832	1040	952	838	767	747	727
5	694	683	721	972	748	832	1100	950	834	765	746	727
6	694	683	718	950	748	863	1110	950	830	764	745	727
7	694	683	724	958	772	981	1100	948	825	763	743	727
8	694	683	718	949	813	933	1080	934	821	761	743	727
9	694	683	716	955	795	899	1100	925	817	759	741	727
10	694	683	709	918	780	888	1180	920	814	759	742	727
11	694	688	705	888	775	874	1150	907	811	759	741	727
12	694	728	702	866	771	885	1140	903	806	759	739	727
13	694	721	707	852	770	904	1120	909	802	759	738	726
14	694	712	703	841	769	881	1170	915	800	758	737	726
15	694	704	694	829	770	870	1200	909	797	758	737	726
16	694	695	699	819	775	859	1120	905	793	757	737	725
17	693	695	699	812	783	851	1070	902	791	755	737	725
18	692	691	703	805	785	840	1030	908	790	755	737	723
19	693	690	705	798	794	833	996	921	788	754	737	722
20	692	722	705	794	817	831	977	934	786	753	737	722
21	691	926	700	794	880	837	962	910	784	753	737	721
22	691	859	706	788	886	850	956	899	783	753	737	721
23	690	782	698	781	922	890	961	883	780	751	736	720
24	689	772	694	775	939	897	963	877	780	749	735	719
25	689	741	694	775	917	888	966	872	778	748	734	719
26	689	727	694	779	893	882	981	874	776	748	733	718
27	689	717	701	771	881	885	977	879	774	748	732	718
28	688	726	725	765	871	890	968	876	772	748	732	718
29	690	721	745	760	---	908	953	871	771	748	732	717
30	703	716	765	754	---	922	962	870	769	748	731	717
31	697	---	844	759	---	935	---	868	---	748	731	---
TOTAL	21487	21580	22240	27011	22663	27181	31273	28202	24075	23453	22896	21711
MEAN	693.1	719.3	717.4	871.3	809.4	876.8	1042	909.7	802.5	756.5	738.6	723.7
MAX	703	926	844	1290	939	981	1200	954	863	769	748	729
MIN	688	683	694	754	748	831	952	868	769	748	731	717
AC-FT	42620	42800	44110	53580	44950	53910	62030	55940	47750	46520	45410	43060

11367500 McCLOUD RIVER NEAR McCLOUD, CA—Continued

STATISTICS OF MONTHLY MEAN DATA FOR WATER YEARS 1931 - 2002, BY WATER YEAR (WY)

	OCT	NOV	DEC	JAN	FEB	MAR	APR	MAY	JUN	JUL	AUG	SEP
MEAN	766.3	791.1	863.3	909.0	976.3	1049	1127	1122	950.1	835.8	796.8	775.1
MAX	1030	1569	1879	2348	2155	2220	1896	2182	1574	1219	1101	1059
(WY)	1984	1974	1956	1970	1958	1983	1974	1938	1998	1983	1983	1983
MIN	536	537	534	539	549	568	674	606	574	561	556	544
(WY)	1933	1933	1933	1933	1933	1935	1994	1992	1992	1934	1992	1932

SUMMARY STATISTICS	FOR 2001 CALENDAR YEAR		FOR 2002 WATER YEAR		WATER YEARS 1931 - 2002	
ANNUAL TOTAL	278678		293772			
ANNUAL MEAN	763.5		804.9		915.4	
HIGHEST ANNUAL MEAN					1406	
LOWEST ANNUAL MEAN					589	
HIGHEST DAILY MEAN	1030	Mar 25	1290	Jan 2	11900	Jan 1 1997
LOWEST DAILY MEAN	683	Nov 5	683	Nov 5	524	Nov 23 1932
ANNUAL SEVEN-DAY MINIMUM	683	Nov 4	683	Nov 4	528	Nov 20 1932
MAXIMUM PEAK FLOW			1520	Jan 2	15400	Jan 1 1997
MAXIMUM PEAK STAGE			2.61	Jan 2	11.22	Jan 1 1997
ANNUAL RUNOFF (AC-FT)	552800		582700		663100	
10 PERCENT EXCEEDS	886		953		1260	
50 PERCENT EXCEEDS	740		765		840	
90 PERCENT EXCEEDS	694		694		617	

11367720 McCLOUD-IRON CANYON DIVERSION TUNNEL NEAR McCLOUD, CA

LOCATION.—Lat 41°08'06", long 122°04'26", in SE 1/4 SW 1/4 sec.22, T.38 N., R.2 W., [Shasta County](#), Hydrologic Unit 18020004, Shasta National Forest, on left bank of Lake McCloud, and 8.8 mi southeast of McCloud.

PERIOD OF RECORD.—December 1965 to current year.

REVISED RECORDS.—WDR CA-75-4: 1973.

GAGE.—None. Water-stage recorders on Iron Canyon Reservoir and Lake McCloud (stations 11363920 and 11367740) used to compute record.

REMARKS.—Water is diverted from Lake McCloud (station 11367740) via tunnel to Iron Canyon Reservoir (station 11363920) and then via penstock into James B. Black Powerplant (station 11363910) on the Pit River. Diversion began Dec. 1, 1965. See schematic diagram of [Pit and McCloud River Basins](#).

COOPERATION.—Records were collected by Pacific Gas & Electric Co., under general supervision of the U.S. Geological Survey, in connection with Federal Energy Regulatory Commission project no. 2106.

EXTREMES FOR PERIOD OF RECORD.—Maximum daily discharge, 1,890 ft³/s, several days during May and June 1967; no flow several days in 1965–68, 1971, 1978, June 8, 10, 2001.

DISCHARGE, CUBIC FEET PER SECOND, WATER YEAR OCTOBER 2001 TO SEPTEMBER 2002
DAILY MEAN VALUES

DAY	OCT	NOV	DEC	JAN	FEB	MAR	APR	MAY	JUN	JUL	AUG	SEP
1	539	592	870	777	596	947	878	841	773	597	623	650
2	562	604	865	852	589	943	877	829	762	612	623	638
3	577	610	890	853	616	973	883	826	747	627	615	605
4	596	602	893	866	657	959	925	812	732	620	603	581
5	616	598	894	873	685	952	982	796	720	625	596	549
6	612	612	886	877	699	986	1010	746	697	618	604	531
7	600	645	872	901	704	1020	1040	731	679	613	626	525
8	607	661	860	976	666	1010	1040	716	666	630	639	506
9	601	687	840	1050	637	1010	1010	726	651	655	664	506
10	607	687	830	1130	646	994	991	724	641	665	677	503
11	607	679	810	1180	660	984	1010	724	634	652	688	504
12	612	699	804	1210	655	964	1060	728	632	661	705	542
13	596	718	779	1210	664	924	1080	735	584	639	698	536
14	573	718	739	1190	668	935	1090	734	567	620	675	546
15	576	717	704	1190	692	954	1070	740	551	619	664	540
16	592	721	680	1190	713	912	1060	754	520	621	653	538
17	600	712	658	1140	716	884	1070	771	520	627	640	525
18	594	706	655	1130	729	849	1090	782	519	627	623	522
19	585	703	660	1110	748	823	1090	791	528	630	592	554
20	566	694	667	1090	747	794	1010	802	524	624	582	579
21	511	696	661	1060	823	787	949	806	524	607	574	562
22	520	716	666	1000	860	805	922	803	534	618	568	550
23	528	738	684	964	903	813	888	798	537	627	566	548
24	548	738	694	903	964	815	881	800	540	637	614	536
25	561	735	710	779	1040	828	882	770	547	637	606	558
26	570	740	707	734	1030	851	876	744	549	610	623	564
27	549	772	689	655	1020	873	847	734	550	608	634	580
28	504	813	690	635	986	887	855	741	559	604	652	559
29	530	831	706	607	---	898	852	766	575	616	636	539
30	547	862	716	607	---	898	844	779	575	616	611	532
31	566	---	750	608	---	885	---	793	---	617	624	---
TOTAL	17752	21006	23529	29347	21113	28157	29062	23842	18137	19379	19498	16508
MEAN	572.6	700.2	759.0	946.7	754.0	908.3	968.7	769.1	604.6	625.1	629.0	550.3
MAX	616	862	894	1210	1040	1020	1090	841	773	665	705	650
MIN	504	592	655	607	589	787	844	716	519	597	566	503
AC-FT	35210	41670	46670	58210	41880	55850	57640	47290	35970	38440	38670	32740

STATISTICS OF MONTHLY MEAN DATA FOR WATER YEARS 1966 - 2002, BY WATER YEAR (WY)

	1966	1967	1968	1969	1970	1971	1972	1973	1974	1975	1976	1977	1978	1979	1980	1981	1982	1983	1984	1985	1986	1987	1988	1989	1990	1991	1992	1993	1994	1995	1996	1997	1998	1999	2000	2001	2002				
MEAN	663.6	680.3	812.4	882.7	967.2	1102	1129	1016	890.4	784.3	748.3	710.7																													
MAX	1028	1205	1362	1451	1583	1592	1624	1729	1854	1305	1150	1123																													
(WY)	1984	1984	1974	1970	1970	1970	1966	1967	1967	1967	1971	1983																													
MIN	0.000	0.000	333	383	439	562	445	388	416	409	343	383																													
(WY)	1966	1966	1992	1992	1991	1991	1990	1977	1992	1992	1992	1992																													

SUMMARY STATISTICS

	FOR 2001 CALENDAR YEAR		FOR 2002 WATER YEAR		WATER YEARS 1966 - 2002	
ANNUAL TOTAL	265647.00		267330			
ANNUAL MEAN	727.8		732.4		865.0	
HIGHEST ANNUAL MEAN					1260	
LOWEST ANNUAL MEAN					453	
HIGHEST DAILY MEAN	1100	Apr 6	1210	Jan 12	1890	May 20 1967
LOWEST DAILY MEAN	0.00	Jun 8	503	Sep 10	0.00	Oct 1 1965
ANNUAL SEVEN-DAY MINIMUM	476	Jun 4	517	Sep 6	0.00	Oct 1 1965
ANNUAL RUNOFF (AC-FT)	526900		530200		626600	
10 PERCENT EXCEEDS	891		988		1390	
50 PERCENT EXCEEDS	705		690		803	
90 PERCENT EXCEEDS	596		549		490	

11367760 McCLOUD RIVER BELOW McCLOUD DAM, NEAR McCLOUD, CA

LOCATION.—Lat 41°07'44", long 122°04'08", in SW 1/4 NE 1/4 sec.27, T.38 N., R.2 W., [Shasta County](#), Hydrologic Unit 18020004, Shasta National Forest, on left bank, 0.1 mi downstream from Lizard Creek, 0.6 mi downstream from McCloud Dam, and 9 mi southeast of McCloud.

DRAINAGE AREA.—404 mi².

PERIOD OF RECORD.—April 1966 to current year (operated as a low-flow station only).

GAGE.—Water-stage recorder. Datum of gage is 2,398.76 ft above sea level (levels by Pacific Gas & Electric Co.). Prior to Apr. 7, 1972, at datum 3.00 ft higher.

REMARKS.—Low flow regulated by Lake McCloud (station 11367740) since November 1965. Most of McCloud River runoff is diverted from reservoir through tunnel to Iron Canyon Reservoir (station 11363920) in Pit River Basin. This station records fishwater release. The minimum release requirement is 40 ft³/s at all times. Prior to water year 1974, flow was computed up to 400 ft³/s. During water years 1975–81, because of channel changes, flow was computed up to 200 ft³/s. Currently, because of maximum required release, flow is computed to 220 ft³/s. See schematic diagram of [Pit and McCloud River Basins](#).

COOPERATION.—Records were collected by Pacific Gas & Electric Co., under general supervision of the U.S. Geological Survey, in connection with Federal Energy Regulatory Commission project no. 2106.

DISCHARGE, CUBIC FEET PER SECOND, WATER YEAR OCTOBER 2001 TO SEPTEMBER 2002

DAILY MEAN VALUES

DAY	OCT	NOV	DEC	JAN	FEB	MAR	APR	MAY	JUN	JUL	AUG	SEP
1	158	161	136	64	116	55	71	102	147	159	164	182
2	158	161	107	88	116	54	71	102	148	159	163	181
3	158	161	79	76	116	55	71	102	148	159	163	181
4	158	161	84	67	116	63	71	102	148	159	163	181
5	158	161	97	64	118	63	71	102	149	159	163	181
6	158	161	108	64	120	63	71	102	149	159	163	181
7	158	161	108	66	109	64	71	102	151	159	164	181
8	158	161	108	66	85	63	71	104	154	159	169	181
9	158	160	108	61	84	63	71	108	154	161	169	181
10	158	160	118	57	83	63	71	108	154	161	169	181
11	158	160	120	56	83	63	71	108	154	161	168	181
12	158	162	123	55	83	63	72	111	154	165	168	181
13	158	146	131	59	83	105	71	113	154	165	168	183
14	158	145	131	69	83	65	72	113	154	164	168	184
15	158	147	139	73	83	65	72	121	155	164	168	184
16	160	151	130	69	83	65	72	142	155	164	167	184
17	161	152	129	68	83	65	76	143	155	164	167	183
18	160	151	129	77	83	71	77	143	156	164	167	183
19	160	151	117	85	84	75	81	143	156	164	167	184
20	160	152	107	88	79	82	86	143	156	164	167	184
21	160	142	107	90	71	85	91	143	157	164	167	183
22	160	71	107	94	72	86	95	143	157	164	167	183
23	161	100	108	99	58	86	95	143	157	164	167	183
24	160	115	115	104	57	86	95	143	157	164	167	183
25	161	131	126	104	56	86	95	143	158	163	167	183
26	161	135	131	105	55	79	97	144	158	164	167	182
27	161	135	134	112	55	70	102	146	158	164	166	182
28	160	137	122	116	55	70	102	146	158	163	166	182
29	161	136	97	116	---	70	102	146	158	163	167	182
30	161	136	80	116	---	70	102	146	159	163	172	182
31	161	---	64	116	---	70	---	146	---	163	174	---
TOTAL	4938	4363	3500	2544	2369	2183	2436	3903	4628	5032	5172	5467
MEAN	159.3	145.4	112.9	82.06	84.61	70.42	81.20	125.9	154.3	162.3	166.8	182.2
MAX	161	162	139	116	120	105	102	146	159	165	174	184
MIN	158	71	64	55	55	54	71	102	147	159	163	181
AC-FT	9790	8650	6940	5050	4700	4330	4830	7740	9180	9980	10260	10840

11367800 McCLOUD RIVER AT AH-DI-NA, NEAR McCLOUD, CA

LOCATION.—Lat 41°06'39", long 122°05'42", in NE 1/4 SW 1/4 sec.33, T.38 N., R.2 W., [Shasta County](#), Hydrologic Unit 18020004, Shasta National Forest, on right bank at Ah-Di-Na, 1.8 mi downstream from Squirrel Creek, 3.9 mi downstream from McCloud Dam, and 9.6 mi south of McCloud.

DRAINAGE AREA.—427 mi².

PERIOD OF RECORD.—October 1964 to current year.

REVISED RECORDS.—WDR CA-98-4: 1997 (m).

GAGE.—Water-stage recorder. Elevation of gage is 2,160 ft above sea level, from topographic map.

REMARKS.—Low flow completely regulated by Lake McCloud (station 11367740) 3.9 mi upstream since November 1965. Diversion to Iron Canyon Reservoir (station 11363920) through McCloud-Iron Canyon diversion tunnel (station 11367720) started Dec. 1, 1965. This station records fishwater release. The minimum release requirements range from 160 to 210 ft³/s per schedule outlined in Federal Energy Regulatory Commission License 2106. See schematic diagram of [Pit and McCloud River Basins](#).

COOPERATION.—Records were collected by Pacific Gas & Electric Co., under general supervision of the U.S. Geological Survey, in connection with Federal Energy Regulatory Commission project no. 2106.

EXTREMES FOR PERIOD OF RECORD.—Prior to completion of McCloud Dam in 1965, maximum discharge, 9,660 ft³/s, Dec. 22, 1964, gage height, 9.43 ft, from rating curve extended above 2,500 ft³/s; minimum daily, 86 ft³/s, Oct. 1–26, 1964. Since completion of McCloud Dam, maximum discharge, 31,700 ft³/s, Jan. 1, 1997, gage height, 14.77 ft, from rating curve extended above 8,000 ft³/s on basis of slope-area measurement of peak flow; minimum daily, 41 ft³/s, Dec. 18–20, 1971 (caused by valve malfunction at McCloud Dam).

EXTREMES OUTSIDE PERIOD OF RECORD.—Flood of Dec. 21, 1955, reached a stage of 12.5 ft, discharge, 17,800 ft³/s, from rating curve extended above 2,500 ft³/s.

EXTREMES FOR CURRENT YEAR.—Peak discharges greater than base discharge of 3,000 ft³/s, or maximum:

Date	Time	Discharge (ft ³ /s)	Gage height (ft)
Mar. 13	1300	2,170	4.60

DISCHARGE, CUBIC FEET PER SECOND, WATER YEAR OCTOBER 2001 TO SEPTEMBER 2002

DAILY MEAN VALUES

DAY	OCT	NOV	DEC	JAN	FEB	MAR	APR	MAY	JUN	JUL	AUG	SEP
1	204	209	264	355	206	224	233	204	215	215	211	230
2	204	207	301	1070	204	213	244	202	216	214	211	230
3	204	206	254	748	204	203	254	201	216	214	211	230
4	204	206	210	436	201	205	260	200	215	214	211	230
5	204	206	203	334	202	201	264	198	216	213	211	230
6	204	206	217	321	204	231	250	198	215	213	211	230
7	204	206	219	335	247	275	238	198	215	212	212	230
8	204	206	210	332	267	259	229	186	219	212	218	230
9	203	206	204	327	234	239	231	180	217	214	216	230
10	202	205	209	295	216	232	230	179	217	214	214	230
11	201	213	206	267	205	232	222	178	216	213	214	230
12	201	266	205	248	200	237	214	179	214	218	214	231
13	201	244	211	240	199	401	210	180	211	218	213	233
14	201	220	209	238	198	220	213	179	211	217	212	233
15	201	210	213	229	199	211	208	185	211	217	212	233
16	204	212	202	215	206	202	200	214	211	217	212	233
17	206	213	201	203	211	195	196	219	211	217	212	233
18	206	209	214	204	211	193	188	219	211	217	211	233
19	206	207	224	206	237	191	187	227	213	215	211	233
20	205	227	222	205	288	194	188	228	215	214	211	233
21	204	345	215	205	301	197	190	225	216	214	211	233
22	204	248	215	204	298	204	193	221	216	214	211	232
23	206	207	211	206	321	243	191	219	216	213	211	232
24	206	207	213	207	314	243	190	218	215	213	211	231
25	206	210	219	206	283	236	189	216	215	213	211	231
26	206	208	220	209	260	225	190	215	215	212	211	231
27	205	209	224	210	245	211	198	219	215	212	211	230
28	206	217	245	213	235	210	195	218	215	212	211	230
29	206	214	254	211	---	215	192	216	215	211	212	230
30	228	211	263	209	---	222	202	215	215	211	219	230
31	214	---	369	206	---	226	---	214	---	211	221	---
TOTAL	6360	6560	7046	9094	6596	6990	6389	6350	6438	6634	6588	6935
MEAN	205.2	218.7	227.3	293.4	235.6	225.5	213.0	204.8	214.6	214.0	212.5	231.2
MAX	228	345	369	1070	321	401	264	228	219	218	221	233
MIN	201	205	201	203	198	191	187	178	211	211	211	230
AC-FT	12620	13010	13980	18040	13080	13860	12670	12600	12770	13160	13070	13760

11367800 McCLOUD RIVER AT AH-DI-NA, NEAR McCLOUD, CA—Continued

STATISTICS OF MONTHLY MEAN DATA FOR WATER YEARS 1965 - 2002, BY WATER YEAR (WY)

	OCT	NOV	DEC	JAN	FEB	MAR	APR	MAY	JUN	JUL	AUG	SEP
MEAN	249.2	280.6	308.1	449.3	412.2	469.4	355.0	345.4	260.7	225.1	222.5	233.4
MAX	919	1140	1863	2211	1770	2107	2102	1498	1173	1035	992	954
(WY)	1966	1974	1965	1970	1986	1983	1965	1965	1965	1965	1965	1965
MIN	180	182	93.2	93.4	119	167	166	162	160	159	155	182
(WY)	1978	1978	1972	1972	1972	1977	1968	1977	1977	1977	1977	1977

SUMMARY STATISTICS	FOR 2001 CALENDAR YEAR		FOR 2002 WATER YEAR		WATER YEARS 1965 - 2002	
ANNUAL TOTAL	72794		81980			
ANNUAL MEAN	199.4		224.6		317.2	
HIGHEST ANNUAL MEAN					1326	
LOWEST ANNUAL MEAN					168	
HIGHEST DAILY MEAN	369	Dec 31	1070	Jan 2	25200	Jan 1 1997
LOWEST DAILY MEAN	177	May 10	178	May 11	41	Dec 18 1971
ANNUAL SEVEN-DAY MINIMUM	178	May 20	180	May 9	42	Dec 15 1971
MAXIMUM PEAK FLOW			2170		31700	
MAXIMUM PEAK STAGE			4.60		14.77	
ANNUAL RUNOFF (AC-FT)	144400		162600		229800	
10 PERCENT EXCEEDS	219		247		472	
50 PERCENT EXCEEDS	196		213		208	
90 PERCENT EXCEEDS	181		201		169	

11368000 McCLOUD RIVER ABOVE SHASTA LAKE, CA

LOCATION.—Lat 40°57'30", long 122°13'07", unsurveyed, T.36 N., R.3 W., [Shasta County](#), Hydrologic Unit 18020004, on right bank, just upstream from Shasta Lake, 0.2 mi downstream from Big Bollibokka Creek, and 11.3 mi east of Lamoine.

DRAINAGE AREA.—604 mi².

PERIOD OF RECORD.—October 1945 to current year. Prior to 1950, published as "above Shasta Reservoir."

TEMPERATURE: Water years 1956–59.

REVISED RECORDS.—WSP 1445: 1953(M). WSP 1931: Drainage area. WDR CA-94-4: 1993(P).

GAGE.—Water-stage recorder. Datum of gage is 1,100.00 ft above sea level (levels by U.S. Bureau of Reclamation).

REMARKS.—Low flow completely regulated by Lake McCloud (station 11367740) 16.5 mi upstream since Nov. 3, 1965. Diversions to Iron Canyon Reservoir (station 11363920) began Dec. 1, 1965. See schematic diagram of [Pit and McCloud River Basins](#).

COOPERATION.—Records were collected by Pacific Gas & Electric Co., under general supervision of the U.S. Geological Survey, in connection with Federal Energy Regulatory Commission project no. 2106.

EXTREMES FOR PERIOD OF RECORD.—Maximum discharge, 51,300 ft³/s, Jan. 1, 1997, gage height, 29.00 ft, from rating curve extended above 15,000 ft³/s on basis of slope-area measurement of peak flow; minimum daily, 109 ft³/s, Dec. 16–20, 1971. Minimum prior to regulation by Lake McCloud, 825 ft³/s, Jan. 3, 1950.

EXTREMES FOR CURRENT YEAR.—Peak discharges greater than base discharge of 4,500 ft³/s, or maximum:

Date	Time	Discharge (ft ³ /s)	Gage height (ft)
Jan. 2	1615	10,000	17.88

DISCHARGE, CUBIC FEET PER SECOND, WATER YEAR OCTOBER 2001 TO SEPTEMBER 2002
DAILY MEAN VALUES

DAY	OCT	NOV	DEC	JAN	FEB	MAR	APR	MAY	JUN	JUL	AUG	SEP
1	262	287	1890	2480	521	816	706	505	380	305	275	285
2	261	275	3540	7490	508	766	713	472	378	302	274	287
3	258	270	2850	5600	496	721	728	454	367	300	273	287
4	260	267	1580	2980	484	691	731	438	362	299	275	287
5	259	266	1290	2040	476	676	733	429	359	298	277	287
6	260	266	1470	2120	474	761	700	419	355	297	273	288
7	261	266	1350	2330	890	902	665	408	348	297	273	292
8	261	266	1110	2130	1430	865	637	399	350	296	278	292
9	258	266	955	1920	1070	806	652	399	352	295	279	289
10	257	266	845	1640	889	860	651	393	346	294	277	288
11	257	300	772	1420	793	945	618	386	340	292	275	285
12	255	695	701	1270	737	958	596	379	335	294	275	284
13	256	688	683	1150	709	1090	578	376	332	295	273	288
14	255	550	720	1080	681	869	582	370	331	293	272	287
15	254	446	666	976	664	816	569	367	330	290	271	288
16	255	435	638	896	661	770	557	394	330	288	272	288
17	258	459	687	821	678	727	546	393	330	287	271	289
18	258	409	884	775	678	686	510	388	330	287	270	289
19	258	387	1490	744	925	654	485	437	328	287	271	286
20	258	511	1640	710	1490	635	475	484	324	286	271	285
21	258	1460	1450	714	1500	624	464	458	324	285	272	285
22	258	1420	1540	666	1350	638	461	429	329	283	272	284
23	257	749	1650	632	1380	930	452	411	325	283	272	283
24	257	695	1320	614	1270	950	443	399	321	282	271	281
25	258	636	1100	602	1120	892	438	392	317	280	271	281
26	258	585	953	635	1010	832	437	385	314	278	269	281
27	259	535	906	602	930	774	453	386	312	277	267	281
28	262	570	1130	586	871	740	449	387	312	275	266	282
29	267	628	1370	565	---	723	446	379	309	275	266	285
30	412	589	1530	546	---	714	516	373	307	275	273	285
31	325	---	2650	532	---	708	---	368	---	275	276	---
TOTAL	8232	15442	41360	47266	24685	24539	16991	12657	10077	8950	8450	8579
MEAN	265.5	514.7	1334	1525	881.6	791.6	566.4	408.3	335.9	288.7	272.6	286.0
MAX	412	1460	3540	7490	1500	1090	733	505	380	305	279	292
MIN	254	266	638	532	474	624	437	367	307	275	266	281
AC-FT	16330	30630	82040	93750	48960	48670	33700	25110	19990	17750	16760	17020

11368000 McCLOUD RIVER ABOVE SHASTA LAKE, CA—Continued

STATISTICS OF MONTHLY MEAN DATA FOR WATER YEARS 1946 - 1965, BY WATER YEAR (WY)

	OCT	NOV	DEC	JAN	FEB	MAR	APR	MAY	JUN	JUL	AUG	SEP
MEAN	1121	1252	2080	2077	2617	2177	2467	1965	1460	1159	1059	1020
MAX	1899	2162	6513	4525	7493	3966	4599	2978	2248	1715	1489	1395
(WY)	1951	1951	1956	1953	1958	1958	1963	1958	1958	1958	1958	1958
MIN	856	870	856	903	1040	1265	1320	1085	1069	901	852	839
(WY)	1950	1950	1950	1949	1948	1964	1964	1947	1949	1950	1950	1950

SUMMARY STATISTICS

WATER YEARS 1946 - 1965

ANNUAL MEAN	1699
HIGHEST ANNUAL MEAN	2703
LOWEST ANNUAL MEAN	1213
HIGHEST DAILY MEAN	36100
LOWEST DAILY MEAN	825
ANNUAL SEVEN-DAY MINIMUM	826
MAXIMUM PEAK FLOW	a45200
MAXIMUM PEAK STAGE	28.20
ANNUAL RUNOFF (AC-FT)	1231000
10 PERCENT EXCEEDS	2670
50 PERCENT EXCEEDS	1270
90 PERCENT EXCEEDS	928

STATISTICS OF MONTHLY MEAN DATA FOR WATER YEARS 1967 - 2002, BY WATER YEAR (WY)

MEAN	308.0	574.1	850.9	1457	1518	1609	944.4	674.4	433.1	323.1	284.6	290.4
MAX	468	4068	3681	6043	5118	5825	2794	1930	1379	540	409	366
(WY)	1990	1974	1997	1970	1986	1983	1982	1983	1998	1998	1998	1998
MIN	206	227	235	222	232	248	226	232	215	200	192	200
(WY)	1992	1992	1977	1991	1977	1977	1977	1977	1977	1977	1991	1991

SUMMARY STATISTICS

FOR 2001 CALENDAR YEAR

FOR 2002 WATER YEAR

WATER YEARS 1967 - 2002

ANNUAL TOTAL	193075	227228	
ANNUAL MEAN	529.0	622.5	768.9
HIGHEST ANNUAL MEAN			1720
LOWEST ANNUAL MEAN			230
HIGHEST DAILY MEAN	3950	Feb 21	7490
LOWEST DAILY MEAN	217	Sep 6	254
ANNUAL SEVEN-DAY MINIMUM	219	Aug 31	256
MAXIMUM PEAK FLOW			10000
MAXIMUM PEAK STAGE			17.88
ANNUAL RUNOFF (AC-FT)	383000	450700	557100
10 PERCENT EXCEEDS	1090	1200	1510
50 PERCENT EXCEEDS	328	399	365
90 PERCENT EXCEEDS	235	267	251

a From rating curve extended above 6,400 ft³/s on basis of slope-area measurement of peak flow.

11370000 SHASTA LAKE NEAR REDDING, CA

LOCATION.—Lat 40°43'08", long 122°25'12", in SE 1/4 NW 1/4 sec.15, T.33 N., R.5 W., [Shasta County](#), Hydrologic Unit 18020005, in Shasta Dam on Sacramento River, near right bank, 2 mi downstream from Squaw Creek, and 9.5 mi north of Redding.

DRAINAGE AREA.—6,421 mi², excluding Goose Lake Basin.

PERIOD OF RECORD.—November 1942 to current year. Prior to 1950, published as "Shasta Reservoir near Redding."

CHEMICAL DATA: Water years 1978–80.

GAGE.—Water-stage recorder. Datum of gage is sea level (levels by U.S. Bureau of Reclamation). Prior to July 10, 1944, nonrecording gage at various sites near dam at same datum. Contents based on capacity table dated May 8, 1967, provided by U.S. Bureau of Reclamation.

REMARKS.—Lake is formed by concrete gravity-type dam completed in 1949; regulation began Dec. 30, 1943. Usable capacity, 4,436,400 acre-ft, between elevations 737.75 ft, invert of lowest set of river outlets, and 1,067.0 ft, top of flashboard gates on drum-type spillway gates. Operating pool from elevation, 840.0 ft, capacity, 587,127 acre-ft to 1,067.0 ft, capacity, 4,552,090 acre-ft. Dead storage, 115,800 acre-ft. Installation of flashboard gates on top of drum gates completed Nov. 12, 1964. All water passes down the Sacramento River, most of which is through powerplant at dam. Figures given represent total contents at 2400 hours. Lake is used for flood control, power generation, irrigation, and recreation. See schematic diagram of [Pit and McCloud River Basins](#).

COOPERATION.—Records were provided by U.S. Bureau of Reclamation, not rounded to U.S. Geological Survey standards.

EXTREMES (AT 2400 HOURS) FOR PERIOD OF RECORD.—Maximum contents, 4,550,300 acre-ft, May 19, 1967, elevation, 1,066.94 ft; minimum since first filling, 562,600 acre-ft, Sept. 13, 1977, elevation, 836.68 ft.

EXTREMES (AT 2400 HOURS) FOR CURRENT YEAR.—Maximum contents, 4,308,823 acre-ft, Apr. 24, elevation, 1,058.69 ft; minimum, 2,138,026 acre-ft, Nov. 11, elevation, 965.16 ft.

Capacity table (elevation, in feet, and contents, in acre-feet)
(Based on table provided by U.S. Bureau of Reclamation, dated May 8, 1967)

830	515,543	890	1,051,713	950	1,876,996	1,010	3,051,750
840	587,127	900	1,167,888	960	2,046,829	1,020	3,286,929
850	665,511	910	1,291,854	970	2,226,093	1,030	3,533,478
860	751,027	920	1,424,780	980	2,416,019	1,050	4,063,108
870	843,589	930	1,566,238	990	2,616,622	1,067	4,552,090
880	943,929	940	1,717,255	1,000	2,828,544		

RESERVOIR STORAGE (ACRE-FEET), WATER YEAR OCTOBER 2001 TO SEPTEMBER 2002

DAILY OBSERVATION AT 2400 HOURS

DAY	OCT	NOV	DEC	JAN	FEB	MAR	APR	MAY	JUN	JUL	AUG	SEP
1	2195436	2163977	2329224	3023439	3522384	3845930	4141476	4297582	4113472	3661702	3087425	2754999
2	2190497	2160179	2384331	3130364	3527679	3853414	4148773	4293258	4102313	3645417	3071047	2751367
3	2186307	2156563	2421691	3185506	3531713	3861432	4156658	4291240	4093664	3629166	3053588	2747949
4	2180850	2154393	2439120	3213201	3534492	3865441	4168203	4286925	4084765	3609619	3037580	2745813
5	2179759	2152767	2464943	3240596	3538039	3869450	4180054	4283195	4075880	3591705	3021393	2739845
6	2177576	2151869	2490548	3267916	3540066	3878836	4191654	4279177	4065329	3572824	3004805	2731346
7	2176121	2150251	2507527	3293435	3551216	3891459	4209538	4274012	4053988	3555270	2990106	2723483
8	2175393	2147374	2522169	3318536	3565184	3902486	4211783	4267125	4039895	3539306	2975898	2716074
9	2175212	2143060	2532627	3336712	3577662	3910851	4222017	4264255	4026122	3523140	2963299	2710368
10	2174666	2138566	2543375	3351318	3585563	3923803	4231683	4261099	4015120	3507009	2950308	2703817
11	2173938	2138026	2552522	3365222	3594008	3935993	4241392	4259667	4004137	3486937	2936668	2696650
12	2174302	2148813	2559821	3375988	3599638	3946026	4253385	4257668	3991544	3467197	2922643	2689714
13	2175757	2156924	2570952	3387013	3606036	3955527	4263395	4250815	3978687	3448771	2909104	2683618
14	2175212	2160179	2583174	3398326	3612962	3966153	4275160	4241963	3961521	3428181	2894934	2674186
15	2176121	2161988	2591969	3410632	3620421	3975962	4280325	4235395	3944399	3409396	2882156	2665406
16	2176667	2165243	2601200	3422496	3629166	3985522	4287212	4226281	3926232	3389964	2870491	2660180
17	2177030	2167232	2611276	3431147	3636630	3996198	4292105	4216900	3910042	3370850	2859318	2653307
18	2177212	2168317	2625306	3439332	3644125	4002494	4296717	4209793	3893071	3351805	2846848	2647278
19	2176303	2169040	2651436	3447529	3664818	4006600	4299888	4209224	3875613	3332344	2834863	2642704
20	2175393	2170125	2684039	3454484	3697595	4010169	4302194	4204391	3859561	3312238	2823550	2638962
21	2173938	2187580	2711425	3462454	3723746	4013745	4307959	4202688	3841407	3290303	2813997	2627581
22	2173756	2210084	2748163	3470442	3749759	4022821	4308247	4196181	3822252	3271526	2805968	2617656
23	2173938	2219837	2785237	3475684	3773782	4041553	4308535	4189673	3804237	3251849	2801001	2610042
24	2172847	2232756	2810957	3480677	3795766	4055647	4308823	4180903	3787292	3233202	2796898	2601405
25	2172119	2241639	2831813	3485180	3808737	4066995	4307094	4172708	3769014	3214386	2792795	2594014
26	2171756	2247392	2849463	3492958	3820390	4078102	4306517	4159755	3751077	3195192	2788692	2587674
27	2171029	2251487	2868739	3500737	3831563	4087542	4303923	4149618	3732925	3174423	2781585	2581129
28	2169040	2260794	2892728	3504249	3839544	4099523	4301041	4143158	3713517	3154685	2775356	2572774
29	2167774	2272949	2918414	3509020	---	4111798	4297870	4135590	3697856	3136431	2769127	2566702
30	2168859	2284384	2949189	3513307	---	4125780	4296717	4129704	3678844	3118709	2764616	2558201
31	2167051	---	2986262	3516585	---	4136151	---	4121856	---	3102924	2758417	---
a	966.77	973.13	1007.12	1029.33	1041.77	1052.62	1058.27	1052.11	1035.67	1012.22	966.75	987.14
b	-32592	+117333	+701878	+530323	+322959	+296607	+160566	-174861	-443012	-575920	-344507	-200216
MAX	2195436	2284384	2986262	3516585	3839544	4136151	4308823	4297582	4113472	3661702	3087425	2754999
MIN	2167051	2138026	2329224	3023439	3522384	3845930	4141476	4121856	3678844	3102924	2758417	2558201

a Elevation, in feet, at end of month.
b Change in contents, in acre-feet.

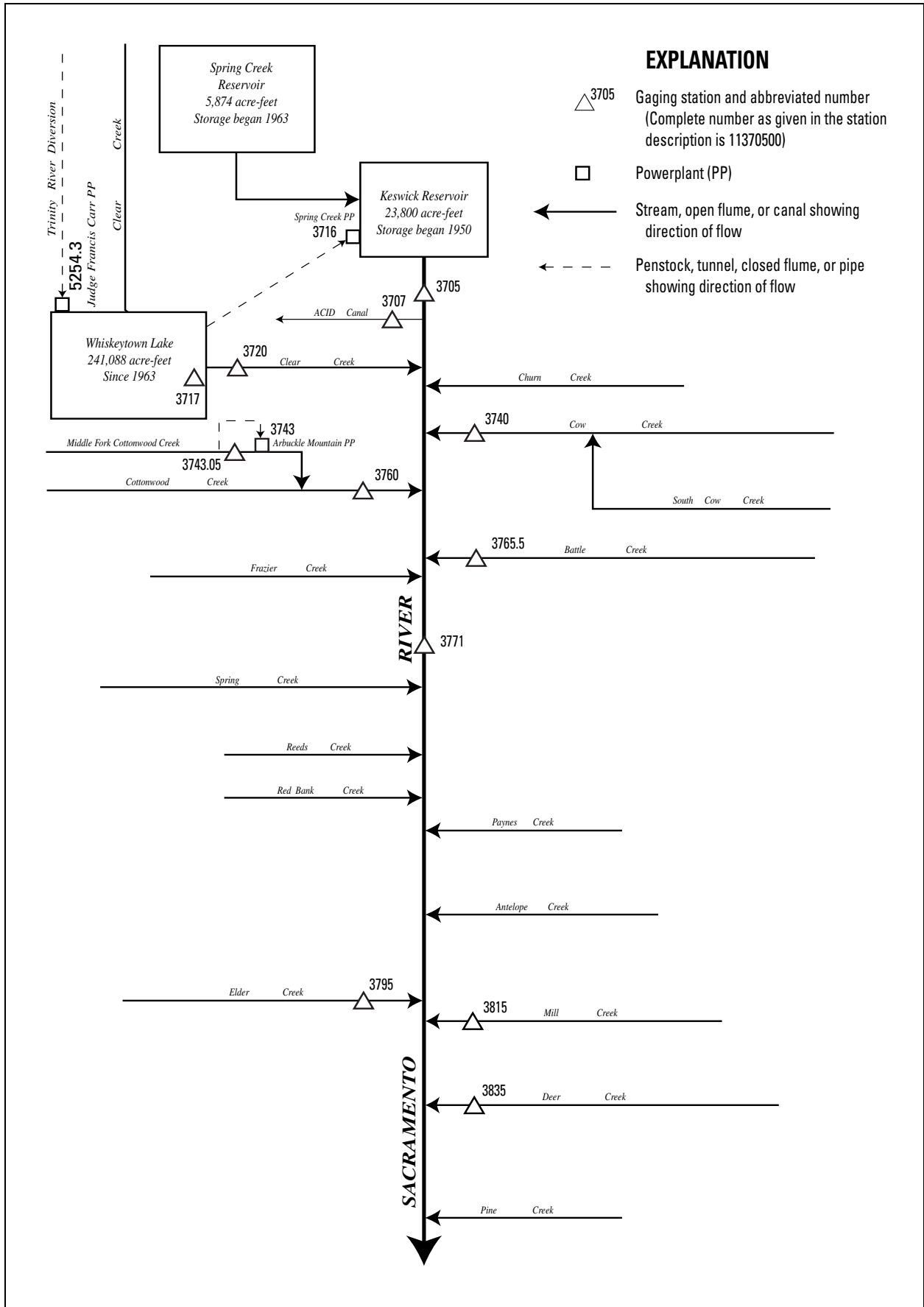

Figure 25. Diversions and storage in upper Sacramento River Basin.

11370500 SACRAMENTO RIVER AT KESWICK, CA

LOCATION.—Lat 40°36'04", long 122°26'36", in SW 1/4 NW 1/4 sec.28, T.32 N., R.5 W., *Shasta County*, Hydrologic Unit 18020101, on right bank, 0.4 mi upstream from Middle Creek, 0.8 mi downstream from Keswick Dam, 1.6 mi downstream from Keswick, and 10 mi downstream from Shasta Dam.

DRAINAGE AREA.—6,468 mi², excluding Goose Lake Basin.

PERIOD OF RECORD.—October 1938 to current year. Monthly discharge only for some periods, published in WSP 1315-A.

CHEMICAL DATA: Water years 1951–94. Published as "near Keswick" in 1951 and 1953, and as "at Keswick Dam, near Keswick" in 1968–69.

BIOLOGICAL DATA: Water years 1979–81.

SPECIFIC CONDUCTANCE: Water years 1978–94.

WATER TEMPERATURE: Water years 1978–94.

SEDIMENT DATA: Water years 1978–94.

REVISED RECORDS.—WSP 1931: Drainage area.

GAGE.—Water-stage recorder. Datum of gage is 479.81 ft above sea level. Prior to Oct. 1, 1939, at site 1.5 mi upstream at datum 20.2 ft higher and Oct. 1, 1939, to Apr. 30, 1942, at site 1.5 mi upstream at datum 15.2 ft higher. Aug. 20, 1960, to July 3, 1973, auxiliary water-stage recorder at city of Redding pumping plant 2.1 mi downstream.

REMARKS.—Records excellent. Flow completely regulated by Shasta Lake (station 11370000) beginning Dec. 30, 1943. Minor regulation by Keswick Reservoir since 1950, total capacity, 23,800 acre-ft, operational capacity, 4,170 acre-ft, between normal operating elevations of 579.0 ft and 586.0 ft. No diversion between Shasta Dam and station at Keswick. Since December 1963, water is released from Whiskeytown Lake (station 11371700), through a tunnel to Spring Creek Powerplant (station 11371600), and then into Keswick Reservoir. See schematic diagrams of [upper Sacramento River Basin](#) and [Pit and McCloud River Basins](#).

EXTREMES FOR PERIOD OF RECORD.—Maximum discharge, 186,000 ft³/s, Feb. 23, 1940, gage height, 47.2 ft, site and datum then in use, from rating curve extended above 75,000 ft³/s, on basis of peak discharge at Kennet, plus 4,000 ft³/s estimated inflow; minimum observed, 2,730 ft³/s, Aug. 22, 1939. Since regulation by Shasta Dam in 1943, maximum discharge, 81,400 ft³/s, Apr. 1, 1974, gage height, 31.92 ft; maximum gage height, 32.71 ft, Jan. 4, 1997; minimum discharge, 154 ft³/s, May 15, 1948.

DISCHARGE, CUBIC FEET PER SECOND, WATER YEAR OCTOBER 2001 TO SEPTEMBER 2002

DAILY MEAN VALUES

DAY	OCT	NOV	DEC	JAN	FEB	MAR	APR	MAY	JUN	JUL	AUG	SEP
1	7790	5520	4420	3850	4030	6520	4120	8050	10700	14300	13600	7680
2	7750	5590	4250	8570	4020	6590	4140	7790	10700	14000	13500	7680
3	7680	5370	4030	14700	4030	6600	4150	7680	10700	13900	13500	7670
4	7690	5350	3890	13000	4030	6610	4130	8320	10900	14200	13600	7460
5	6880	5350	3920	11400	4020	6610	4130	8320	10700	14200	13600	7460
6	6260	5220	3850	11100	4030	6620	4140	8300	10700	14200	13600	8110
7	6210	5060	3820	11100	4090	6630	4130	8330	11200	14100	13100	8190
8	6200	5070	3830	11000	4060	6740	4150	8370	11200	14300	12700	8150
9	6180	5070	3800	9710	4050	6520	4160	8050	11300	14400	12200	8170
10	6000	5030	3790	9600	4040	6460	4180	8050	11300	14400	12200	8170
11	5770	5030	3920	8680	4050	6200	4160	8590	11800	14400	12200	8170
12	5560	4940	3890	8150	4050	6150	4170	8670	12000	14900	12200	8050
13	5560	4800	3890	7660	4050	6110	4410	8610	12700	15000	12200	8040
14	5560	4490	3970	7110	3990	6090	4820	10200	13600	15000	12200	8070
15	5600	4450	3940	6580	4060	5950	5290	11100	13700	15100	11700	8060
16	5520	4340	3900	6050	4060	5530	5280	10400	13700	15000	11700	8100
17	5450	4280	3900	5710	4040	5530	5280	10500	13700	15000	11200	8110
18	5440	4220	3890	5440	4030	5610	5280	10500	14200	15000	11300	8100
19	5470	4280	3960	5460	4100	5630	5690	10500	14000	15000	11200	7740
20	5620	4220	4130	5260	4140	5450	5690	10500	14200	15100	10300	7750
21	5790	4090	4100	5020	4180	5210	5690	9730	14300	15000	9840	7720
22	5770	4030	4100	4940	4070	4860	6290	9660	14900	15000	9180	7790
23	5720	4040	4180	4620	4050	4780	7020	9670	14700	15100	8360	7820
24	5710	4020	3780	4380	3920	4580	7030	9660	14600	15000	7970	7790
25	5770	4040	3610	4210	3830	4360	7500	10000	14700	15100	7970	7710
26	5800	3990	3610	4030	3860	4050	7550	10700	14700	14600	8170	7730
27	5760	3980	3600	4030	6650	4100	8020	10700	14700	14600	9300	7730
28	5740	3950	3590	4030	6670	4140	7900	10700	14600	14600	9490	7300
29	5750	3990	3680	4040	---	4140	8050	10700	14100	14700	8490	7330
30	5740	3850	3720	4060	---	4130	8090	10700	14500	14000	7690	7260
31	5740	---	3850	4040	---	4130	---	10700	---	13500	7700	---
TOTAL	187480	137660	120810	217530	118200	172630	164640	293750	388800	452700	341960	235110
MEAN	6048	4589	3897	7017	4221	5569	5488	9476	12960	14600	11030	7837
MAX	7790	5590	4420	14700	6670	6740	8090	11100	14900	15100	13600	8190
MIN	5440	3850	3590	3850	3830	4050	4120	7680	10700	13500	7690	7260
AC-FT	371900	273000	239600	431500	234400	342400	326600	582700	771200	897900	678300	466300

11370500 SACRAMENTO RIVER AT KESWICK, CA—Continued

STATISTICS OF MONTHLY MEAN DATA FOR WATER YEARS 1946 - 1962, BY WATER YEAR (WY)

	OCT	NOV	DEC	JAN	FEB	MAR	APR	MAY	JUN	JUL	AUG	SEP
MEAN	5992	5603	6611	10610	11700	6564	6714	8212	8564	9951	10030	7331
MAX	8572	8970	16680	32870	44170	14490	21180	13400	10300	11810	11870	10030
(WY)	1959	1958	1951	1953	1958	1957	1958	1948	1948	1951	1958	1958
MIN	4785	4064	3726	3234	3060	2546	2830	5247	6437	7480	7057	5239
(WY)	1948	1952	1960	1962	1950	1950	1950	1951	1947	1947	1947	1947

SUMMARY STATISTICS

WATER YEARS 1946 - 1962

ANNUAL MEAN	8141
HIGHEST ANNUAL MEAN	13910 1958
LOWEST ANNUAL MEAN	5364 1950
HIGHEST DAILY MEAN	75800 Feb 21 1958
LOWEST DAILY MEAN	2360 Mar 15 1950
ANNUAL SEVEN-DAY MINIMUM	2440 Mar 9 1950
MAXIMUM PEAK FLOW	78800 Feb 21 1958
MAXIMUM PEAK STAGE	31.55 Feb 21 1958
ANNUAL RUNOFF (AC-FT)	5898000
10 PERCENT EXCEEDS	11600
50 PERCENT EXCEEDS	7000
90 PERCENT EXCEEDS	3720

STATISTICS OF MONTHLY MEAN DATA FOR WATER YEARS 1964 - 2002, BY WATER YEAR (WY)

MEAN	6187	7155	9653	11320	13570	11520	8820	10550	11590	12800	11610	8263
MAX	10290	23430	27340	41600	40420	47170	26840	17410	15590	15070	14700	11800
(WY)	1984	1974	1974	1997	1998	1983	1974	1995	1998	2000	1998	1971
MIN	3431	3182	2847	3258	3268	2869	3096	6953	7342	7754	8070	4564
(WY)	1978	1993	1978	1993	1990	1991	1991	1992	1992	1992	1992	1977

SUMMARY STATISTICS

FOR 2001 CALENDAR YEAR

FOR 2002 WATER YEAR

WATER YEARS 1964 - 2002

ANNUAL TOTAL	2793420	2831270	
ANNUAL MEAN	7653	7757	10240
HIGHEST ANNUAL MEAN			18230 1974
LOWEST ANNUAL MEAN			5390 1992
HIGHEST DAILY MEAN	15600 Jul 26	15100 Jul 15	79700 Mar 31 1974
LOWEST DAILY MEAN	3190 Feb 8	3590 Dec 28	2360 Mar 17 1989
ANNUAL SEVEN-DAY MINIMUM	3420 Feb 13	3660 Dec 24	2460 Mar 12 1989
MAXIMUM PEAK FLOW		15400 Jan 2	81400 Apr 1 1974
MAXIMUM PEAK STAGE		16.49 Jan 2	32.71 Jan 4 1997
INSTANTANEOUS LOW FLOW			154 May 15 1948
ANNUAL RUNOFF (AC-FT)	5541000	5616000	7420000
10 PERCENT EXCEEDS	14300	14200	15000
50 PERCENT EXCEEDS	6200	6630	8510
90 PERCENT EXCEEDS	3680	4020	4040

11370700 ANDERSON-COTTONWOOD IRRIGATION DISTRICT CANAL AT SHARON STREET, AT REDDING, CA

LOCATION.—Lat 40°34'08", long 122°22'49", unsurveyed, [Shasta County](#), Hydrologic Unit 18020101, on right bank of canal, 10 ft upstream from Sharon Street, 900 ft downstream from Parkview Avenue, and 0.75 mi southwest of Mercy Hospital.

PERIOD OF RECORD.—April to September 1989, April 1991 to current year (beginning October 1994, irrigation season only).

GAGE.—Water-stage recorder. Elevation of gage is 480 ft above sea level, from topographic map.

REMARKS.—Records fair. Canal diverts from Sacramento River 0.3 mi downstream from Southern Pacific Railroad bridge and 0.1 mi upstream from Highway 273; water is used for irrigation. See schematic diagrams for [upper Sacramento River Basin](#) and [Pit and McCloud River Basins](#).

EXTREMES FOR PERIOD OF RECORD.—Maximum daily discharge, 370 ft³/s, June 9, 1989; no flow at times each year.

DISCHARGE, CUBIC FEET PER SECOND, WATER YEAR OCTOBER 2001 TO SEPTEMBER 2002

DAILY MEAN VALUES

DAY	OCT	NOV	DEC	JAN	FEB	MAR	APR	MAY	JUN	JUL	AUG	SEP
1	256	---	---	---	---	---	---	291	279	308	292	259
2	254	---	---	---	---	---	---	291	283	309	299	258
3	245	---	---	---	---	---	---	286	290	293	295	262
4	241	---	---	---	---	---	---	291	288	296	299	262
5	233	---	---	---	---	---	12	292	283	290	300	262
6	231	---	---	---	---	---	58	296	284	293	291	263
7	238	---	---	---	---	---	58	291	299	295	290	265
8	240	---	---	---	---	---	74	287	304	297	286	263
9	244	---	---	---	---	---	101	283	310	299	288	269
10	243	---	---	---	---	---	118	264	310	295	288	267
11	236	---	---	---	---	---	140	151	314	293	290	265
12	229	---	---	---	---	---	147	238	318	290	300	261
13	228	---	---	---	---	---	177	241	322	286	296	260
14	226	---	---	---	---	---	236	254	322	302	292	264
15	230	---	---	---	---	---	270	275	314	311	286	266
16	229	---	---	---	---	---	273	266	311	307	283	268
17	228	---	---	---	---	---	272	262	316	302	282	270
18	230	---	---	---	---	---	273	258	316	300	274	271
19	233	---	---	---	---	---	272	264	312	300	272	268
20	236	---	---	---	---	---	264	268	315	299	269	263
21	240	---	---	---	---	---	264	262	313	300	272	260
22	242	---	---	---	---	---	270	253	317	297	269	262
23	240	---	---	---	---	---	281	250	316	296	258	271
24	224	---	---	---	---	---	275	253	310	296	251	264
25	152	---	---	---	---	---	274	259	236	299	254	257
26	76	---	---	---	---	---	273	271	73	297	262	255
27	52	---	---	---	---	---	286	280	153	288	275	251
28	51	---	---	---	---	---	287	281	242	293	284	245
29	33	---	---	---	---	---	288	282	298	307	272	246
30	7.7	---	---	---	---	---	292	283	303	302	269	249
31	1.3	---	---	---	---	---	---	281	---	288	263	---
TOTAL	6049.0	---	---	---	---	---	---	8304	8651	9228	8701	7846
MEAN	195.1	---	---	---	---	---	---	267.9	288.4	297.7	280.7	261.5
MAX	256	---	---	---	---	---	---	296	322	311	300	271
MIN	1.3	---	---	---	---	---	---	151	73	286	251	245
AC-FT	12000	---	---	---	---	---	---	16470	17160	18300	17260	15560

11525430 JUDGE FRANCIS CARR POWERPLANT NEAR FRENCH GULCH, CA

LOCATION.—Lat 40°38'49", long 122°37'34", Shasta County, Hydrologic Unit 18010212, at powerplant, 1.6 mi downstream from Mill Creek, and 3.8 mi south of French Gulch.

PERIOD OF RECORD.—April 1963 to current year.

GAGE.—Recorded powerplant output.

REMARKS.—Water is diverted from Trinity River at NW 1/4 SE 1/4 sec.8, T.33 N., R.8 W., through a tunnel to powerplant and then into Whiskeytown Lake (station 11371700). See schematic diagram of upper Sacramento River Basin and Pit and McCloud River Basins.

COOPERATION.—Records were provided by U.S. Bureau of Reclamation, not rounded to U.S. Geological Survey standards.

EXTREMES FOR PERIOD OF RECORD.—Maximum daily discharge, 4,000 ft³/s, Oct. 18, 1987; no flow for many days most years.

DISCHARGE, CUBIC FEET PER SECOND, WATER YEAR OCTOBER 2001 TO SEPTEMBER 2002

DAILY MEAN VALUES

DAY	OCT	NOV	DEC	JAN	FEB	MAR	APR	MAY	JUN	JUL	AUG	SEP
1	1353	0	0	0	0	14	14	14	1146	2309	2285	2277
2	1252	0	0	0	578	14	14	14	1074	2310	2082	2173
3	2039	394	0	0	56	14	14	14	1231	2131	2308	2196
4	1928	0	0	0	0	14	14	14	1380	2136	2247	2263
5	1951	305	0	0	0	14	14	14	1420	1989	2170	1229
6	2565	14	0	0	0	14	14	14	1353	2435	2149	1357
7	2712	0	0	0	0	14	14	14	1050	2339	2138	1362
8	2700	0	0	0	0	14	14	14	1354	2158	2174	1315
9	2487	0	0	0	0	14	14	14	1179	2108	2261	1395
10	2661	0	0	0	0	14	14	40	1500	2171	2209	1272
11	2558	0	0	0	0	14	14	67	1612	2186	2143	1321
12	2141	0	0	13	0	14	14	564	1932	2235	2201	1308
13	2166	0	0	0	0	14	501	750	1740	2309	2146	1540
14	2149	0	0	7	14	21	891	654	1651	2136	2148	1337
15	1275	0	0	2	14	375	1229	1536	1667	2069	2142	1350
16	941	0	0	0	14	14	1019	879	1656	2242	2130	1440
17	671	0	0	0	14	172	1008	1635	1869	2082	2132	1526
18	625	0	0	0	14	438	514	1583	1938	1769	1971	1450
19	1719	0	0	0	14	14	688	1497	1929	2771	2137	1449
20	1693	0	0	0	14	14	802	372	2094	2369	2166	1522
21	2160	0	0	0	14	14	892	556	2071	2097	2156	283
22	2119	0	0	0	14	483	614	588	2128	2273	2328	14
23	2200	0	0	0	14	23	335	474	2116	2083	2149	600
24	2176	0	0	0	14	14	1459	983	2289	2198	2147	14
25	2375	0	0	0	14	14	1468	158	2279	2163	2223	14
26	2283	0	0	0	14	14	1444	774	2324	2249	2233	199
27	2174	0	0	0	14	14	1414	1345	2283	2288	2070	868
28	2018	0	0	0	14	14	1423	995	2194	2104	2247	14
29	0	0	0	0	---	14	1365	924	2296	2145	2176	14
30	0	0	0	317	---	14	493	1241	2265	2104	2124	14
31	0	---	0	32	---	14	---	947	---	2149	2966	---
TOTAL	55091	713	0	371	844	1862	17727	18688	53020	68107	68158	33116
MEAN	1777	23.77	0.000	11.97	30.14	60.06	590.9	602.8	1767	2197	2199	1104
MAX	2712	394	0	317	578	483	1468	1635	2324	2771	2966	2277
MIN	0	0	0	0	0	14	14	14	1050	1769	1971	14
AC-FT	109300	1410	0.00	736	1670	3690	35160	37070	105200	135100	135200	65690

STATISTICS OF MONTHLY MEAN DATA FOR WATER YEARS 1963 - 2002, BY WATER YEAR (WY)

MEAN	1255	794.5	650.7	588.6	717.9	796.6	1127	1302	1792	2316	2183	1958
MAX	3363	2158	2891	2755	3223	3111	3220	3513	3662	3589	3236	3504
(WY)	1988	1967	1979	1982	1974	1974	1970	1974	1969	1968	1977	1988
MIN	0.000	0.000	0.000	0.000	0.000	0.000	0.000	0.000	0.000	0.000	0.000	0.000
(WY)	1996	1996	1996	1986	1996	1988	1978	1996	1996	1996	1996	1996

SUMMARY STATISTICS

FOR 2001 CALENDAR YEAR

FOR 2002 WATER YEAR

WATER YEARS 1963 - 2002

ANNUAL TOTAL	362064	317697	
ANNUAL MEAN	992.0	870.4	1303
HIGHEST ANNUAL MEAN			2485
LOWEST ANNUAL MEAN			0.000
HIGHEST DAILY MEAN	3398	Jul 21	2966
LOWEST DAILY MEAN	0	Jan 1	0
ANNUAL SEVEN-DAY MINIMUM	0.00	Feb 18	0.00
ANNUAL RUNOFF (AC-FT)	718200	630200	944000
10 PERCENT EXCEEDS	2550	2230	3100
50 PERCENT EXCEEDS	691	372	1010
90 PERCENT EXCEEDS	0.00	0.00	0.00

11371600 SPRING CREEK POWERPLANT AT KESWICK, CA

LOCATION.—Lat 40°37'41", long 122°27'59", in NE 1/4 SE 1/4 sec.18, T.32 N., R.5 W., [Shasta County](#), Hydrologic Unit 18020112, at powerplant on Spring Creek, 0.4 mi northwest of Keswick, and 4.9 mi northwest of Redding.

PERIOD OF RECORD.—December 1963 to current year.

GAGE.—Discharge computed from powerplant output.

REMARKS.—Water is released from Whiskeytown Lake (station 11371700) through a tunnel to powerplant and then into Keswick Reservoir.

Spring Creek Reservoir releases into Keswick Reservoir at Spring Creek Powerplant. See schematic diagrams of [upper Sacramento River Basin](#) and [Pit and McCloud River Basins](#).

COOPERATION.—Records were provided by U.S. Bureau of Reclamation, not rounded to U.S. Geological Survey standards.

EXTREMES FOR PERIOD OF RECORD.—Maximum daily discharge, 4,800 ft³/s, May 2, 1983; no flow for many days most years.

DISCHARGE, CUBIC FEET PER SECOND, WATER YEAR OCTOBER 2001 TO SEPTEMBER 2002

DAILY MEAN VALUES

DAY	OCT	NOV	DEC	JAN	FEB	MAR	APR	MAY	JUN	JUL	AUG	SEP
1	1987	0	0	2316	252	384	253	0	1347	2032	2246	2212
2	2497	0	0	1561	250	264	243	0	1199	2209	2059	2117
3	2537	0	0	3807	303	612	257	0	1146	2085	2041	2428
4	2507	0	0	3950	267	261	273	0	1250	1964	2086	2346
5	2426	0	0	3961	90	271	248	0	1390	1869	2312	1206
6	2490	0	0	3981	134	366	255	0	1398	2230	2326	1236
7	2502	0	0	2696	260	462	284	0	1173	2304	2016	1282
8	2502	0	0	2358	421	530	250	0	1270	2432	2031	1272
9	2890	0	0	905	664	261	250	324	1262	2059	1734	1272
10	2480	0	0	789	275	253	260	736	1306	2099	2411	1250
11	2503	0	0	1140	258	272	219	1049	1476	2013	2165	1255
12	2082	0	0	932	259	264	245	860	2014	1954	2122	1227
13	2080	0	0	808	259	261	249	0	1518	2158	2120	1233
14	2090	0	0	597	270	184	275	0	1761	2295	2099	1218
15	1879	0	15	527	253	243	89	1518	1646	2298	2128	1230
16	1921	0	0	573	278	330	0	865	1648	2099	2146	1230
17	1920	0	174	869	287	1326	0	1671	1747	2055	2327	1221
18	1888	0	372	462	290	332	0	1326	1844	2130	1737	1258
19	1900	0	967	311	583	261	0	2070	1807	2108	2028	1235
20	2022	0	1441	245	1643	240	0	406	2028	2488	1924	1253
21	1994	0	2764	258	1157	236	0	1387	2037	2183	2112	14
22	2073	0	2500	276	1139	280	0	845	1943	2127	2102	14
23	2008	0	2247	281	839	302	0	759	2250	2104	2401	14
24	2016	0	2271	273	899	278	0	20	2278	2123	2129	14
25	2089	0	2296	265	252	251	0	266	2152	2097	2224	14
26	2100	0	2264	459	597	256	0	760	2521	2149	2110	14
27	1970	0	2193	250	644	274	0	1340	2100	2361	2287	14
28	1959	0	2235	225	1093	587	0	1231	1867	2004	2071	14
29	0	0	2417	250	---	517	0	979	2779	2109	2081	14
30	0	0	1365	226	---	774	0	1408	2160	2009	2026	14
31	0	---	1643	270	---	548	---	895	---	2021	2452	---
TOTAL	61312	0	27164	35821	13916	11680	3650	20715	52317	66168	66053	29121
MEAN	1978	0.000	876.3	1156	497.0	376.8	121.7	668.2	1744	2134	2131	970.7
MAX	2890	0	2764	3981	1643	1326	284	2070	2779	2488	2452	2428
MIN	0	0	0	225	90	184	0	0	1146	1869	1734	14
AC-FT	121600	0.00	53880	71050	27600	23170	7240	41090	103800	131200	131000	57760
a	115	22	1840	5070	1540	2480	1120	26	1660	266	0	0

STATISTICS OF MONTHLY MEAN DATA FOR WATER YEARS 1964 - 2002, BY WATER YEAR (WY)

MEAN	1511	1184	1045	1258	1535	1509	1307	1483	1862	2298	2196	2033
MAX	3691	3174	4032	4532	4498	4364	4405	4265	3866	3886	3654	3526
(WY)	1989	1967	1974	1974	1974	1983	1983	1983	1969	1968	1977	1988
MIN	18.3	0.000	1.55	2.10	0.000	64.3	5.23	5.45	113	195	201	81.4
(WY)	1996	2002	1992	1991	1995	1996	1987	1991	1996	1996	1996	1996

SUMMARY STATISTICS

	FOR 2001 CALENDAR YEAR		FOR 2002 WATER YEAR		WATER YEARS 1964 - 2002	
ANNUAL TOTAL	464256		387917			
ANNUAL MEAN	1272		1063		1599	
HIGHEST ANNUAL MEAN					3389	
LOWEST ANNUAL MEAN					80.8	
HIGHEST DAILY MEAN	3776		3981		4800	
LOWEST DAILY MEAN	0		0		0	
ANNUAL SEVEN-DAY MINIMUM	0.00		0.00		0.00	
ANNUAL RUNOFF (AC-FT)	920900		769400		1159000	
10 PERCENT EXCEEDS	2500		2300		3440	
50 PERCENT EXCEEDS	1290		865		1460	
90 PERCENT EXCEEDS	0.00		0.00		0.00	

a Discharge, in acre-feet, from Spring Creek Reservoir, provided by U.S. Bureau of Reclamation.

11371700 WHISKEYTOWN LAKE NEAR IGO, CA

LOCATION.—Lat 40°37'03", long 122°31'31", unsurveyed, [Shasta County](#), Hydrologic Unit 18010112, Whiskeytown–Shasta–Trinity National Recreation Area, at outlet works to Spring Creek Powerplant, on Clear Creek, 1.8 mi downstream from Whiskey Creek, and 7.8 mi northeast of Igo.

DRAINAGE AREA.—200 mi².

PERIOD OF RECORD.—May 1963 to current year. Prior to October 1964 published as "Whiskeytown Reservoir near Igo".

GAGE.—Water-stage recorder. Datum of gage is sea level (levels by U.S. Bureau of Reclamation). Contents based on capacity table dated April 1962 provided by U.S. Bureau of Reclamation.

REMARKS.—Lake is formed by earth and rockfill dam. Storage began in May 1963. Usable capacity, 241,088 acre-ft, between elevations 972.0 ft, invert of sluice pipe, and 1,210.00 ft, crest of glory hole spillway. Dead storage, 8 acre-ft. Normal operating pool is from elevation 1,197.0 ft, capacity, 201,288 acre-ft, to 1,210.0 ft, capacity, 241,096 acre-ft. Transbasin water enters the reservoir through Judge Francis Carr Powerplant (station 11525430) and is released through Spring Creek Tunnel to Spring Creek Powerplant (station 11371600) and Keswick Reservoir. Figures given represent total contents at 2400 hours. Lake is used for power generation and recreation. See schematic diagrams of [upper Sacramento River Basin](#) and [Pit and McCloud River Basins](#).

COOPERATION.—Records were provided by U.S. Bureau of Reclamation, not rounded to U.S. Geological Survey standards.

EXTREMES (AT 2400 HOURS) FOR PERIOD OF RECORD.—Maximum contents, 258,600 acre-ft, Mar. 2, 1983, elevation, 1,215.34 ft; minimum since first filling, 145,562 acre-ft, Dec. 27, 1992, elevation, 1,176.05 ft.

EXTREMES (AT 2400 HOURS) FOR CURRENT YEAR.—Maximum contents, 240,168 acre-ft, May 4, elevation, 1,209.71 ft; minimum, 203,041 acre-ft, Apr. 12, elevation, 1,197.60 ft.

Capacity table (elevation, in feet, and contents, in acre-feet)
(Based on survey by U.S. Bureau of Reclamation in 1962)

1,015	714	1,040	3,055	1,080	15,076	1,140	73,960
1,020	994	1,050	4,898	1,100	27,542	1,180	155,276
1,030	1,797	1,060	7,418	1,120	46,701	1,220	274,389

RESERVOIR STORAGE (ACRE-FEET), WATER YEAR OCTOBER 2001 TO SEPTEMBER 2002

DAILY OBSERVATION AT 2400 HOURS

DAY	OCT	NOV	DEC	JAN	FEB	MAR	APR	MAY	JUN	JUL	AUG	SEP
1	222331	205358	216501	207037	204857	205034	203946	239976	238151	237641	238247	239111
2	219757	205152	220063	218962	208800	205299	203946	240040	237831	237863	238151	239047
3	218719	205623	222115	219114	205564	204857	203975	240104	237927	237927	238503	238503
4	217473	205358	223102	215744	205270	205034	203975	240168	238183	238087	238695	238215
5	216440	205653	224243	211442	205299	205211	204005	240136	238215	238343	238279	238087
6	216410	205446	225572	207452	205270	205358	203917	240072	238279	238695	237768	238151
7	216683	205270	226535	205829	205947	205181	203712	240008	237831	238727	237895	238151
8	216865	205063	227374	204563	206389	204769	203537	240008	237895	238087	238087	238087
9	216349	204887	227965	205623	205918	205034	203508	239271	237673	238151	238983	238247
10	216440	204739	228400	206360	206036	205358	203362	237959	237831	238215	238471	238151
11	216440	204916	228713	206065	206094	205476	203274	236084	238087	238439	238343	238183
12	216349	206271	228963	205947	206094	205535	203041	235607	237927	238887	238407	238247
13	216288	206654	229652	205829	206124	205653	203946	236878	238279	239015	238343	238599
14	216015	206772	230122	206006	206094	205829	205505	238023	238087	238503	238311	238375
15	214567	206713	230466	206124	206065	206536	207987	238215	238119	237927	238183	238215
16	212400	206831	230842	206036	206006	206360	210365	238279	238055	238119	238023	238183
17	209709	206801	231030	205270	205977	204592	212640	238247	238183	238055	237514	238311
18	206919	206713	230967	205122	206065	205122	213903	238887	238407	237196	237831	238247
19	206330	206654	230654	205211	206389	204887	215472	238471	238535	238407	237863	238247
20	205387	206713	231468	205387	205918	204710	217200	239015	238503	238087	238215	238279
21	205417	207541	228775	205505	205977	204504	219145	237959	238439	237800	238151	238311
22	205240	208313	227530	205564	205711	205594	220492	237704	238663	238055	238503	237800
23	205299	208432	225478	205535	205888	206094	221350	237355	238279	237959	238151	238439
24	205299	209293	222639	205476	205653	206389	224336	239207	238215	238055	238055	237927
25	205476	209531	219298	205446	206419	206595	227343	239047	238279	238119	237991	237418
26	205623	209620	215804	205122	206360	206713	230247	238887	237736	238279	238151	237291
27	205711	209620	212460	205034	206124	206743	233013	238631	237927	237991	237577	238503
28	205446	210574	209501	204975	204916	206094	235861	238471	238439	238055	237863	238087
29	205328	211412	207008	204828	---	205594	238599	238471	237291	238023	237991	237673
30	205741	212011	206919	205270	---	204533	239816	238375	237323	238087	238151	237259
31	205623	---	207155	205063	---	203946	---	238503	---	238279	239047	---
a	1198.48	1200.63	1199.00	1198.29	1198.24	1197.91	1209.60	1209.19	1208.82	1209.12	1209.36	1208.80
b	-18034	+6388	-4856	-2092	-147	-970	+35900	-1313	-1180	+956	+768	-1788
MAX	222331	212011	231468	219114	208800	206743	239816	240168	238663	239015	239047	239111
MIN	205240	204739	206919	204563	204857	203946	203041	235607	237291	237196	237514	237259

a Elevation, in feet, at end of month.

b Change in contents, in acre-feet.

11372000 CLEAR CREEK NEAR IGO, CA

LOCATION.—Lat 40°30'48", long 122°31'23", unsurveyed, [Shasta County](#), Hydrologic Unit 18020112, on left bank, at old highway bridge on Redding-Igo Road, 1.0 mi northeast of Igo, 7.0 mi downstream from Whiskeytown Dam, 8.3 mi southwest of Redding, and 10.4 mi upstream from mouth.

DRAINAGE AREA.—228 mi².

PERIOD OF RECORD.—October 1940 to current year.

CHEMICAL DATA: Water years 1958–79.

WATER TEMPERATURE: Water years 1965–79.

REVISED RECORDS.—WSP 1345: Drainage area. WSP 1395: 1941(M).

GAGE.—Water-stage recorder. Datum of gage is 672.99 ft above sea level.

REMARKS.—Records good. Low flow completely regulated by Whiskeytown Lake (station 11371700) since May 1963. Transbasin diversion from Trinity River through Judge Francis Carr Powerplant (station 11525430) to Whiskeytown Lake began in April 1963. Diversions from Whiskeytown Lake to Spring Creek Powerplant (station 11371600) began in December 1963. See schematic diagrams of [upper Sacramento River Basin](#) and [Pit and McCloud River Basins](#).

EXTREMES FOR PERIOD OF RECORD.—Maximum discharge, 24,500 ft³/s, Dec. 21, 1955, gage height, 13.75 ft; minimum daily, 9.0 ft³/s, Sept. 4–7, 1950. Since completion of Whiskeytown Dam in 1963, maximum discharge, 19,200 ft³/s, Mar. 3, 1983, gage height, 12.73 ft, from rating curve extended above 12,000 ft³/s, on basis of slope-area measurement of peak flow; minimum daily, 30 ft³/s, Oct. 10, 11, 1977.

DISCHARGE, CUBIC FEET PER SECOND, WATER YEAR OCTOBER 2001 TO SEPTEMBER 2002

DAILY MEAN VALUES

DAY	OCT	NOV	DEC	JAN	FEB	MAR	APR	MAY	JUN	JUL	AUG	SEP
1	129	198	943	659	252	223	210	181	167	125	85	76
2	129	198	829	1840	252	213	210	177	162	87	85	76
3	132	198	531	796	250	210	208	175	162	70	85	76
4	136	198	376	553	249	207	207	175	161	70	85	76
5	141	198	463	512	247	207	206	175	161	69	86	77
6	149	198	472	592	246	227	204	185	160	69	86	76
7	160	198	365	528	281	219	201	186	161	69	85	76
8	166	198	323	475	287	210	200	174	159	71	85	76
9	174	198	307	423	268	211	209	175	159	75	85	76
10	180	198	288	383	262	347	216	173	159	81	85	76
11	179	201	275	359	258	279	202	169	158	82	85	76
12	177	252	267	341	255	257	199	168	158	86	85	76
13	180	286	305	328	255	242	195	167	158	91	85	130
14	181	279	478	317	252	231	193	161	158	88	85	250
15	182	222	337	306	252	225	191	153	158	89	85	252
16	184	230	307	297	252	219	195	153	158	86	85	252
17	181	231	326	291	251	215	197	153	157	74	85	252
18	185	215	311	285	251	210	192	153	158	73	85	252
19	193	210	426	280	488	206	189	158	158	73	85	252
20	194	209	828	275	589	202	189	175	157	73	85	252
21	193	429	609	276	402	200	184	178	156	77	85	252
22	194	346	939	271	327	227	184	167	156	77	85	252
23	195	240	721	267	296	350	182	161	156	78	75	252
24	195	389	477	264	273	313	179	158	156	77	69	252
25	195	277	389	262	256	277	175	157	156	77	68	252
26	195	239	346	273	246	256	178	155	155	78	68	252
27	195	226	326	263	238	242	178	156	155	83	68	247
28	195	349	325	261	232	231	178	155	155	84	72	206
29	197	582	462	257	---	223	178	156	155	85	78	206
30	213	311	506	255	---	217	187	162	154	85	76	205
31	203	---	596	252	---	212	---	162	---	85	76	---
TOTAL	5502	7703	14453	12741	7967	7308	5816	5153	4743	2487	2522	5181
MEAN	177.5	256.8	466.2	411.0	284.5	235.7	193.9	166.2	158.1	80.23	81.35	172.7
MAX	213	582	943	1840	589	350	216	186	167	125	86	252
MIN	129	198	267	252	232	200	175	153	154	69	68	76
AC-FT	10910	15280	28670	25270	15800	14500	11540	10220	9410	4930	5000	10280

11372000 CLEAR CREEK NEAR IGO, CA—Continued

STATISTICS OF MONTHLY MEAN DATA FOR WATER YEARS 1941 - 1962, BY WATER YEAR (WY)

	OCT	NOV	DEC	JAN	FEB	MAR	APR	MAY	JUN	JUL	AUG	SEP
MEAN	76.7	150	597	807	1226	834	676	347	161	63.4	35.1	32.8
MAX	373	427	2336	2513	5753	2595	2431	773	289	126	64.6	89.7
(WY)	1951	1951	1956	1941	1958	1941	1941	1957	1953	1941	1941	1957
MIN	25.8	39.0	47.0	65.5	142	168	172	87.6	66.5	24.3	14.3	13.4
(WY)	1950	1960	1950	1947	1948	1955	1944	1947	1950	1950	1950	1944

SUMMARY STATISTICS WATER YEARS 1941 - 1962

ANNUAL MEAN	413
HIGHEST ANNUAL MEAN	1092 1941
LOWEST ANNUAL MEAN	128 1944
HIGHEST DAILY MEAN	15100 Mar 1 1941
LOWEST DAILY MEAN	9.0 Sep 4 1950
ANNUAL SEVEN-DAY MINIMUM	9.5 Sep 1 1950
MAXIMUM PEAK FLOW	24500 Dec 21 1955
MAXIMUM PEAK STAGE	13.75 Dec 21 1955
ANNUAL RUNOFF (AC-FT)	299000
10 PERCENT EXCEEDS	929
50 PERCENT EXCEEDS	133
90 PERCENT EXCEEDS	27

STATISTICS OF MONTHLY MEAN DATA FOR WATER YEARS 1965 - 2002, BY WATER YEAR (WY)

	MEAN	80.84	149.1	209.2	302.7	313.3	335.8	167.3	107.9	77.01	60.77	58.32	61.49
MAX	317	299	625	1358	1612	3437	668	419	249	150	151	225	
(WY)	1993	1974	1965	1970	1998	1983	1974	1982	1993	1999	1999	1999	
MIN	38.8	70.7	94.2	54.3	49.8	51.3	50.7	48.6	42.9	39.2	37.9	37.9	
(WY)	1978	1969	1977	1977	1977	1977	1977	1966	1966	1966	1966	1977	

SUMMARY STATISTICS FOR 2001 CALENDAR YEAR FOR 2002 WATER YEAR WATER YEARS 1965 - 2002

ANNUAL TOTAL	71503	81576	
ANNUAL MEAN	195.9	223.5	161.0
HIGHEST ANNUAL MEAN			570 1983
LOWEST ANNUAL MEAN			57.9 1977
HIGHEST DAILY MEAN	943 Dec 1	1840 Jan 2	15000 Mar 3 1983
LOWEST DAILY MEAN	71 Aug 21	68 Aug 25	30 Oct 10 1977
ANNUAL SEVEN-DAY MINIMUM	72 Aug 17	70 Jul 3	31 Oct 5 1977
MAXIMUM PEAK FLOW		2470 Jan 2	19200 Mar 3 1983
MAXIMUM PEAK STAGE		6.76 Jan 2	12.73 Mar 3 1983
ANNUAL RUNOFF (AC-FT)	141800	161800	116700
10 PERCENT EXCEEDS	347	349	268
50 PERCENT EXCEEDS	160	197	78
90 PERCENT EXCEEDS	75	78	50

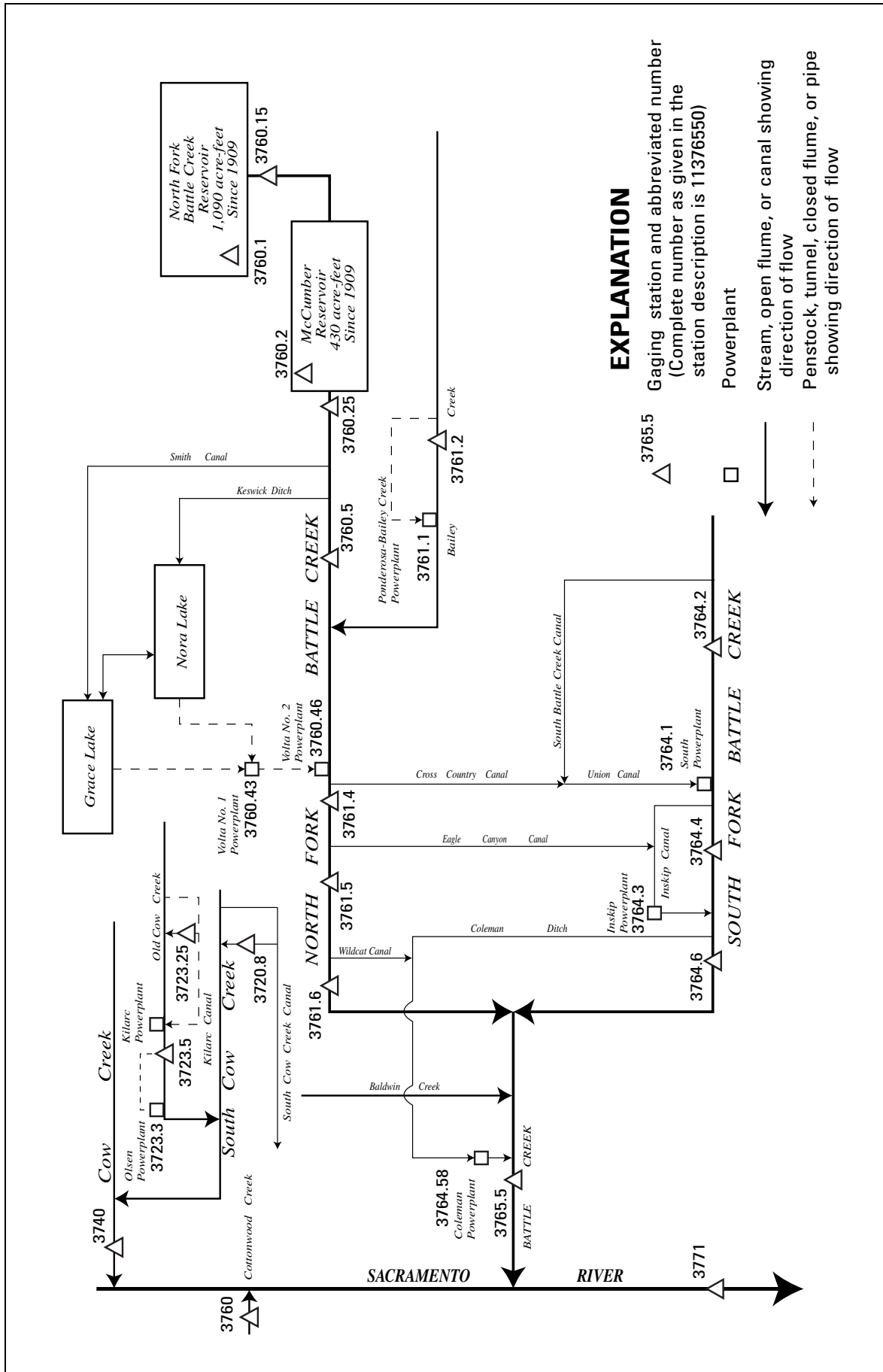

EXPLANATION

- △ Gaging station and abbreviated number (Complete number as given in the station description is 11376550)
- Powerplant
- Stream, open flume, or canal showing direction of flow
- ← Penstock, tunnel, closed flume, or pipe showing direction of flow

Figure 26. Diversions and storage in Battle Creek and Cow Creek Basins.

11372080 SOUTH COW CREEK CANAL DIVERSION TO SOUTH COW CREEK, NEAR WHITMORE, CA

LOCATION.—Lat 40°35'35", long 121°58'53", in NE 1/4 NW 1/4 sec.33, T.32 N., R.1 W., [Shasta County](#), Hydrologic Unit 18020118, on left bank, 2.5 mi northeast of Cow Creek Powerplant, and 4.3 mi southwest of Whitmore.

PERIOD OF RECORD.—October 1986 to current year (operated as a low-flow station only). Unpublished records for water years 1984–86 available in files of the U.S. Geological Survey.

GAGE.—Water-stage recorder. Elevation of gage is 1,560 ft above sea level, from topographic map.

REMARKS.—This station records fishwater release only. The minimum release requirements are 2.0 ft³/s during dry years and 4.0 ft³/s during normal years. Flow is computed to 7.8 ft³/s. See schematic diagram of [Battle Creek and Cow Creek Basins](#).

COOPERATION.—Records were collected by Pacific Gas & Electric Co., under general supervision of the U.S. Geological Survey, in connection with Federal Energy Regulatory Commission project no. 606.

DISCHARGE, CUBIC FEET PER SECOND, WATER YEAR OCTOBER 2001 TO SEPTEMBER 2002

DAILY MEAN VALUES

DAY	OCT	NOV	DEC	JAN	FEB	MAR	APR	MAY	JUN	JUL	AUG	SEP
1	4.0	3.9	4.2	4.0	3.9	4.9	4.7	4.8	4.7	4.9	4.9	4.8
2	4.0	3.9	4.2	---	3.9	4.8	4.7	4.8	4.7	4.9	4.9	4.8
3	4.0	3.9	4.2	---	3.9	4.8	4.8	4.7	4.7	4.9	4.9	4.8
4	4.0	3.9	4.2	5.7	3.9	4.7	4.9	4.7	4.7	4.9	4.9	4.8
5	4.0	3.9	4.2	5.5	3.9	4.7	4.9	4.7	4.7	4.9	4.9	4.8
6	4.0	3.9	4.2	5.9	3.9	5.0	4.9	4.7	4.7	4.9	4.9	4.8
7	4.0	3.9	4.2	5.6	4.2	5.5	4.8	4.7	4.7	4.9	4.9	4.8
8	4.0	3.9	4.2	5.4	4.7	5.3	4.8	4.7	4.7	4.9	4.9	4.8
9	4.1	3.9	4.1	5.3	4.5	5.2	4.9	4.6	4.7	4.9	4.9	4.8
10	4.0	3.9	4.1	5.1	4.2	---	5.0	4.6	4.7	4.9	4.9	4.8
11	3.9	3.9	4.1	5.0	4.1	4.5	5.0	4.5	4.7	4.9	4.9	4.8
12	4.0	3.9	4.1	4.9	4.0	4.7	4.9	4.5	4.7	4.9	4.9	4.8
13	4.0	3.9	4.1	4.8	3.9	4.9	4.9	4.5	4.7	4.9	4.9	4.8
14	3.9	3.9	4.1	4.8	3.9	4.8	5.0	4.4	4.7	4.9	4.8	4.8
15	4.0	3.9	4.1	4.7	3.9	4.7	5.1	5.3	4.7	4.9	4.8	4.8
16	4.0	3.9	4.1	4.6	3.9	4.7	5.0	5.9	4.7	4.9	4.8	4.8
17	3.9	3.9	---	4.5	4.2	4.7	4.9	5.9	4.7	4.9	4.8	4.8
18	3.9	3.9	---	4.4	3.9	4.6	4.8	5.9	4.8	4.9	4.8	4.8
19	3.9	4.0	---	4.0	5.4	4.5	4.7	6.0	4.9	4.9	4.8	4.8
20	3.9	3.9	---	3.9	---	4.5	4.7	6.2	4.8	4.9	4.8	4.8
21	3.9	4.0	5.7	4.1	5.4	4.5	4.6	5.8	4.9	4.9	4.8	4.8
22	3.9	4.0	5.9	3.9	5.3	4.5	4.6	5.6	4.8	4.9	4.8	4.8
23	3.9	4.0	5.6	3.9	5.1	4.7	4.6	5.4	4.9	4.9	4.8	4.8
24	4.0	4.1	5.3	3.9	4.9	4.8	4.6	5.2	4.9	4.9	4.8	4.8
25	4.0	4.1	5.1	3.9	4.8	4.7	4.6	5.1	4.9	4.9	4.8	4.8
26	4.0	4.1	4.9	4.5	4.8	4.6	4.7	5.1	4.9	4.9	4.8	4.8
27	4.0	4.1	4.8	4.2	5.1	4.6	4.9	4.9	4.9	4.9	4.8	4.8
28	4.0	4.1	5.0	3.9	5.0	4.6	4.7	4.8	4.9	4.9	4.8	4.8
29	3.9	4.1	5.7	3.9	---	4.6	4.7	4.8	4.9	4.9	4.8	4.8
30	3.9	4.1	---	3.9	---	4.6	4.8	4.7	4.9	4.9	4.8	4.8
31	3.9	---	---	3.9	---	4.6	---	4.7	---	4.9	4.8	---
TOTAL	122.9	118.8	---	---	---	---	144.2	156.2	143.3	151.9	150.1	144.0
MEAN	3.965	3.960	---	---	---	---	4.807	5.039	4.777	4.900	4.842	4.800
MAX	4.1	4.1	---	---	---	---	5.1	6.2	4.9	4.9	4.9	4.8
MIN	3.9	3.9	---	---	---	---	4.6	4.4	4.7	4.9	4.8	4.8
AC-FT	244	236	---	---	---	---	286	310	284	301	298	286

11372325 KILARC CANAL DIVERSION TO OLD COW CREEK, NEAR WHITMORE, CA

LOCATION.—Lat 40°41'13", long 121°48'27", in SW 1/4 NE 1/4 sec.25, T.32 N., R.1 E., [Shasta County](#), Hydrologic Unit 18020118, on right bank of Kilarc Canal, 3.6 mi upstream of Kilarc Powerplant, and 6.9 mi northeast of Whitmore.

PERIOD OF RECORD.—October 1986 to current year (operated as a low-flow station only). Unpublished records for water years 1983–86 available in files of the U.S. Geological Survey.

GAGE.—Water-stage recorder and Cipolletti weir. Elevation of gage is 3,840 ft above sea level, from topographic map.

REMARKS.—This station records fishwater release only. The minimum release requirement is 2.0 ft³/s during dry or normal years. Flow is computed to 5.0 ft³/s. See schematic diagram of [Battle Creek and Cow Creek Basins](#).

COOPERATION.—Records were collected by Pacific Gas & Electric Co., under general supervision of the U.S. Geological Survey, in connection with a Federal Energy Regulatory Commission project no. 606.

DISCHARGE, CUBIC FEET PER SECOND, WATER YEAR OCTOBER 2001 TO SEPTEMBER 2002

DAILY MEAN VALUES

DAY	OCT	NOV	DEC	JAN	FEB	MAR	APR	MAY	JUN	JUL	AUG	SEP
1	2.6	2.6	3.1	3.8	2.8	3.2	3.7	3.5	3.0	2.8	2.8	2.8
2	2.6	2.6	3.7	3.5	2.8	3.1	3.8	3.5	2.9	2.8	2.8	2.8
3	2.6	2.6	3.5	2.9	2.8	3.0	3.8	3.5	2.8	2.8	2.8	2.8
4	2.6	2.6	3.1	3.0	2.8	2.9	3.8	3.5	2.8	2.8	2.8	2.8
5	2.6	2.6	3.4	2.9	2.8	3.0	3.8	3.5	2.9	2.8	2.8	2.8
6	2.6	2.6	4.0	3.1	2.8	3.8	3.7	3.5	3.0	2.8	2.8	2.8
7	2.6	2.6	3.6	3.2	2.9	3.9	3.8	3.5	3.0	2.8	2.8	2.8
8	2.6	2.6	3.3	3.2	2.8	3.8	3.6	3.5	3.0	2.8	2.8	2.8
9	2.6	2.6	3.2	3.1	2.8	3.7	3.6	3.5	3.0	2.8	2.8	2.8
10	2.6	2.6	3.0	3.0	2.8	3.7	3.7	3.5	3.0	2.8	2.8	2.8
11	2.6	2.6	2.9	2.9	2.8	3.7	3.6	3.4	2.9	2.8	2.8	2.8
12	2.6	2.7	2.8	2.9	2.8	3.8	3.5	3.4	2.9	2.8	2.8	2.8
13	2.6	2.7	2.9	2.9	2.8	3.6	3.5	3.4	2.9	2.8	2.8	2.8
14	2.6	2.6	2.9	2.9	2.8	3.4	3.5	3.4	2.9	2.8	2.8	2.8
15	2.6	2.6	2.8	2.9	2.8	3.2	3.5	3.4	2.9	2.8	2.8	2.8
16	2.6	2.6	2.7	2.9	2.9	3.1	3.5	3.4	2.9	2.8	2.8	2.8
17	2.6	2.6	3.2	2.9	2.9	3.1	3.6	3.4	2.9	2.8	2.8	2.8
18	2.6	2.6	3.1	2.9	2.8	3.0	3.5	3.4	2.9	2.8	2.8	2.8
19	2.6	2.6	3.2	2.9	3.1	3.0	2.9	3.4	2.9	2.8	2.8	2.8
20	2.6	2.6	3.2	2.8	3.2	3.0	3.0	3.4	2.9	2.8	2.8	2.8
21	2.6	2.9	3.0	2.8	3.5	2.9	3.2	3.4	2.9	2.9	2.8	2.8
22	---	2.8	3.0	2.9	3.7	3.1	3.2	3.4	2.9	2.9	2.8	2.8
23	---	2.7	2.9	2.9	3.7	3.5	3.2	3.2	2.9	2.9	2.8	2.8
24	---	2.7	2.8	2.8	3.6	3.4	3.2	3.1	2.9	2.9	2.8	2.8
25	2.2	2.6	2.7	2.8	3.5	3.2	3.2	3.1	2.9	2.9	2.8	2.8
26	2.6	2.6	2.8	2.8	3.4	3.1	3.2	3.2	2.8	2.8	2.8	2.8
27	2.6	2.6	2.8	2.8	3.4	3.3	3.2	3.1	2.8	2.8	2.8	2.8
28	2.6	3.6	3.0	2.8	3.5	3.5	2.8	3.1	2.8	2.8	2.8	2.8
29	2.6	3.9	3.3	2.8	---	3.8	3.2	3.1	2.8	2.8	2.8	2.8
30	2.6	3.0	3.5	2.9	---	3.8	3.5	3.1	2.8	2.9	2.8	2.8
31	2.6	---	4.0	2.8	---	3.7	---	3.0	---	2.8	2.8	---
TOTAL	---	81.6	97.4	91.7	85.3	104.3	103.3	103.8	86.9	87.4	86.8	84.0
MEAN	---	2.720	3.142	2.958	3.046	3.365	3.443	3.348	2.897	2.819	2.800	2.800
MAX	---	3.9	4.0	3.8	3.7	3.9	3.8	3.5	3.0	2.9	2.8	2.8
MIN	---	2.6	2.7	2.8	2.8	2.9	2.8	3.0	2.8	2.8	2.8	2.8
AC-FT	---	162	193	182	169	207	205	206	172	173	172	167

NOTE: Canal out of service Oct. 22–24 and all flow remained in the natural channel.

11372350 OLD COW CREEK BELOW DIVERSION TO OLSEN POWERPLANT, NEAR WHITMORE, CA

LOCATION.—Lat 40°40'10", long 121°53'27", in NW 1/4 SW 1/4 sec.32, T.33 N., R.1 E., [Shasta County](#), Hydrologic Unit 18020118, on right bank, 1.2 mi downstream from Kilarc Powerhouse, 2.2 mi upstream from Glendenning Creek, and 3.0 mi north of Whitmore.

DRAINAGE AREA.—32.6 mi².

PERIOD OF RECORD.—January 1990 to September 1992 (operated as low-flow station only); October 1996 to September 1997; October 1998 to current year.

GAGE.—Water-stage recorder. Elevation of gage is 2,340 ft above sea level, from topographic map.

REMARKS.—This station records regulated bypass flow or natural flow only. During times of powerplant operation the minimum release requirement is 30 ft³/s. See schematic diagram of [Battle Creek and Cow Creek Basins](#).

COOPERATION.—Records were collected by Synergics Incorporated, under general supervision of the U.S. Geological Survey, in connection with Federal Energy Regulatory Commission project no. 8361.

EXTREMES FOR PERIOD OF RECORD.—Maximum discharge, 2,280 ft³/s, Jan. 1, 1997, gage height, 7.29 ft; minimum daily, 6.9 ft³/s, Aug. 7, 9, 1997.

DISCHARGE, CUBIC FEET PER SECOND, WATER YEAR OCTOBER 2001 TO SEPTEMBER 2002
DAILY MEAN VALUES

DAY	OCT	NOV	DEC	JAN	FEB	MAR	APR	MAY	JUN	JUL	AUG	SEP
1	26	27	57	34	36	34	34	31	31	30	27	24
2	26	26	65	60	35	34	34	30	31	30	27	25
3	26	26	52	42	34	34	35	31	30	30	27	25
4	26	26	39	36	34	34	35	68	30	29	27	25
5	26	26	63	36	34	34	35	31	30	29	27	25
6	26	26	86	62	34	34	34	31	30	29	27	25
7	26	25	53	65	34	35	34	32	31	29	27	25
8	26	33	47	34	34	34	34	32	31	28	26	25
9	26	33	47	34	36	34	35	31	31	29	26	25
10	26	34	41	34	37	34	39	31	31	31	21	25
11	25	34	39	34	36	34	35	30	31	31	24	26
12	25	36	40	34	36	34	37	30	31	31	22	26
13	25	40	38	34	36	34	36	30	31	31	25	25
14	25	32	41	34	36	34	56	30	31	31	26	25
15	25	29	42	34	37	34	39	30	31	30	26	25
16	25	29	35	34	38	34	31	30	31	30	25	25
17	25	31	40	34	38	34	34	30	32	31	25	25
18	27	28	36	33	38	34	30	30	31	30	25	25
19	24	28	36	33	36	33	30	32	33	30	25	25
20	24	30	36	34	71	33	30	31	34	29	23	25
21	24	45	36	34	39	34	31	31	33	29	23	25
22	21	60	36	34	35	34	31	30	36	29	23	25
23	24	36	36	34	35	34	31	30	34	29	24	26
24	24	61	35	34	34	34	30	30	33	29	24	26
25	25	39	36	36	34	34	31	30	32	28	23	32
26	25	36	38	34	33	34	31	30	33	28	23	28
27	25	34	36	34	34	34	33	30	32	28	23	27
28	25	33	35	36	34	33	30	30	32	28	22	27
29	25	39	34	37	---	34	31	30	31	28	24	27
30	31	37	36	34	---	34	31	31	31	27	23	26
31	30	---	35	35	---	34	---	31	---	27	24	---
TOTAL	789	1019	1326	1157	1028	1052	1017	984	949	908	764	770
MEAN	25.45	33.97	42.77	37.32	36.71	33.94	33.90	31.74	31.63	29.29	24.65	25.67
MAX	31	61	86	65	71	35	56	68	36	31	27	32
MIN	21	25	34	33	33	33	30	30	30	27	21	24
AC-FT	1560	2020	2630	2290	2040	2090	2020	1950	1880	1800	1520	1530
a	0.00	0.00	605	1640	1160	2340	4910	3080	436	0.00	0.00	0.00

STATISTICS OF MONTHLY MEAN DATA FOR WATER YEARS 1997 - 2002, BY WATER YEAR (WY)

	1997	1998	1999	2000	2001	2002
MEAN	32.00	35.09	49.52	64.75	41.20	35.32
MAX (WY)	36.8	45.1	97.5	184	52.7	54.9
MIN (WY)	25.5	27.6	29.1	27.1	20.4	17.4
MEAN	2002	2001	2001	2001	2001	2001

SUMMARY STATISTICS

	FOR 2001 CALENDAR YEAR	FOR 2002 WATER YEAR	WATER YEARS 1997 - 2002
ANNUAL TOTAL	8703	11763	
ANNUAL MEAN	23.84	32.23	36.64
HIGHEST ANNUAL MEAN			47.2
LOWEST ANNUAL MEAN			22.5
HIGHEST DAILY MEAN	86	Dec 6	1510
LOWEST DAILY MEAN	16	Mar 12	6.9
ANNUAL SEVEN-DAY MINIMUM	16	May 6	7.1
MAXIMUM PEAK FLOW			2280
MAXIMUM PEAK STAGE			7.29
ANNUAL RUNOFF (AC-FT)	17260	23330	26540
10 PERCENT EXCEEDS	35	37	44
50 PERCENT EXCEEDS	21	31	33
90 PERCENT EXCEEDS	17	25	18

a Discharge, in acre-feet, for Olsen Powerplant (station 11372330), provided by Synergics Incorporated.

11374000 COW CREEK NEAR MILLVILLE, CA

LOCATION.—Lat 40°30'19", long 122°13'56", in NE 1/4 NW 1/4 sec.32, T.31 N., R.3 W., [Shasta County](#), Hydrologic Unit 18020101, on right bank, 2.9 mi upstream from mouth, 4.2 mi southwest of Millville, and 4.3 mi downstream from Little Cow Creek.

DRAINAGE AREA.—425 mi².

PERIOD OF RECORD.—October 1949 to current year.

CHEMICAL DATA: Water years 1959–66.

WATER TEMPERATURE: Water years 1966–71, 1973–76, 1978–79.

SEDIMENT DATA: Water year 1978.

REVISED RECORDS.—WSP 1931: Drainage area.

GAGE.—Water-stage recorder and crest-stage gage. Datum of gage is 385.7 ft above sea level. Prior to June 11, 1987, at datum 3.00 ft higher.

REMARKS.—Records good. Numerous small diversions upstream from station for irrigation. See schematic diagrams of [upper Sacramento River](#) and [Battle Creek and Cow Creek Basins](#).

EXTREMES FOR PERIOD OF RECORD.—Maximum discharge, 48,700 ft³/s, Nov. 16, 1981, gage height, 24.22 ft, present datum; maximum gage height, 24.55 ft, Dec. 27, 1951, present datum; minimum daily, 0.02 ft³/s, July 29, 1977.

EXTREMES OUTSIDE PERIOD OF RECORD.—Flood of 1937 or 1940 reached a stage of 26.8 ft from floodmarks, present datum; probable backwater effect from high flows on the Sacramento River.

EXTREMES FOR CURRENT YEAR.—Peak discharges greater than base discharge of 13,900 ft³/s, or maximum:

Date	Time	Discharge (ft ³ /s)	Gage height (ft)	Date	Time	Discharge (ft ³ /s)	Gage height (ft)
Jan. 2	0330	14,300	13.84	Feb. 20	0700	20,000	16.16

DISCHARGE, CUBIC FEET PER SECOND, WATER YEAR OCTOBER 2001 TO SEPTEMBER 2002

DAILY MEAN VALUES

DAY	OCT	NOV	DEC	JAN	FEB	MAR	APR	MAY	JUN	JUL	AUG	SEP
1	27	102	4220	2890	336	528	445	624	176	43	15	13
2	24	75	5360	10500	330	489	449	492	172	41	14	14
3	22	66	1980	5630	321	455	475	439	165	34	15	13
4	22	62	1100	2410	311	428	489	408	153	36	16	11
5	22	60	3460	1810	302	411	516	395	141	36	18	13
6	24	63	6980	3690	296	631	511	377	135	33	20	13
7	24	62	1830	2280	377	1770	489	355	125	31	19	20
8	26	64	975	1670	922	1110	468	330	115	33	20	21
9	24	62	1630	1340	525	758	485	311	116	32	20	16
10	22	63	840	1050	434	1880	682	300	115	29	17	17
11	21	77	626	880	405	1390	604	287	108	26	15	16
12	23	185	516	773	366	1030	553	266	110	26	11	15
13	22	341	516	685	349	845	508	258	93	28	12	15
14	24	199	5330	622	340	729	506	256	80	24	13	15
15	26	144	1320	561	322	644	555	251	80	19	9.7	16
16	26	122	809	513	320	591	517	243	78	19	12	16
17	24	194	4770	477	328	546	758	237	78	20	15	19
18	25	148	2150	443	321	517	566	234	70	19	15	19
19	26	116	3840	420	2700	468	471	253	75	19	12	17
20	28	155	4720	401	11100	438	424	358	70	19	13	18
21	26	1010	2380	404	2970	419	394	355	63	19	16	19
22	29	2240	3220	425	1700	423	366	320	66	19	13	17
23	29	401	3840	366	1280	823	348	273	66	18	16	16
24	26	3300	1760	345	1040	1280	331	249	65	19	17	17
25	27	935	1110	339	856	779	330	232	59	17	18	18
26	28	386	843	496	730	630	337	225	55	19	17	15
27	28	264	712	598	648	554	427	216	50	19	17	14
28	30	284	677	448	590	499	507	213	52	18	15	18
29	35	3110	2220	405	---	480	409	205	53	14	15	19
30	84	1110	2970	361	---	467	568	193	45	15	15	22
31	153	---	5720	331	---	456	---	185	---	15	15	---
TOTAL	977	15400	78424	43563	30519	22468	14488	9340	2829	759	475.7	492
MEAN	31.52	513.3	2530	1405	1090	724.8	482.9	301.3	94.30	24.48	15.35	16.40
MAX	153	3300	6980	10500	11100	1880	758	624	176	43	20	22
MIN	21	60	516	331	296	411	330	185	45	14	9.7	11
AC-FT	1940	30550	155600	86410	60530	44570	28740	18530	5610	1510	944	976

11374000 COW CREEK NEAR MILLVILLE, CA—Continued

STATISTICS OF MONTHLY MEAN DATA FOR WATER YEARS 1950 - 2002, BY WATER YEAR (WY)

	OCT	NOV	DEC	JAN	FEB	MAR	APR	MAY	JUN	JUL	AUG	SEP
MEAN	124.7	480.3	1132	1732	1683	1366	843.6	542.7	229.4	63.73	37.82	47.68
MAX	1057	2539	3929	5593	5636	5275	3012	2375	1386	324	148	130
(WY)	1963	1982	1984	1970	1998	1983	1963	1998	1998	1998	1998	1983
MIN	19.4	58.3	76.1	80.7	103	118	63.0	54.1	13.5	0.63	0.74	3.19
(WY)	1992	1992	1991	1991	1977	1977	1977	1992	1992	1977	1977	1992

SUMMARY STATISTICS	FOR 2001 CALENDAR YEAR		FOR 2002 WATER YEAR		WATER YEARS 1950 - 2002	
ANNUAL TOTAL	183505		219734.7			
ANNUAL MEAN	502.8		602.0		686.0	
HIGHEST ANNUAL MEAN					1634 1998	
LOWEST ANNUAL MEAN					66.8 1977	
HIGHEST DAILY MEAN	6980	Dec 6	11100	Feb 20	32500	Dec 27 1951
LOWEST DAILY MEAN	10	Aug 15	9.7	Aug 15	0.02	Jul 29 1977
ANNUAL SEVEN-DAY MINIMUM	11	Aug 15	13	Aug 11	0.09	Jul 23 1977
MAXIMUM PEAK FLOW			20000	Feb 20	48700	Nov 16 1981
MAXIMUM PEAK STAGE			16.16	Feb 20	24.55	Dec 27 1951
ANNUAL RUNOFF (AC-FT)	364000		435800		497000	
10 PERCENT EXCEEDS	1570		1490		1640	
50 PERCENT EXCEEDS	148		249		190	
90 PERCENT EXCEEDS	13		16		24	

11374305 MIDDLE FORK COTTONWOOD CREEK BELOW DIVERSION TO ARBUCKLE MOUNTAIN POWERPLANT, NEAR PLATINA, CA

LOCATION.—Lat 40°24'35", long 122°52'52", in NW 1/4 SE 1/4 sec.4, T.29 N., R.9 W., [Shasta County](#), Hydrologic Unit 18020113, on left bank, 1.2 mi downstream from Cow Gulch, 1.0 mi upstream from Knob Gulch, and 2.4 mi northeast of the town of Platina.

DRAINAGE AREA.—46.0 mi².

PERIOD OF RECORD.—October 1997 to current year (low-flow records only, collected only seasonally during period of upstream diversion for power generation).

GAGE.—Water-stage recorder and V-notched weir. Elevation of gage is 2,050 ft above sea level, from topographic map.

REMARKS.—No records computed above 90 ft³/s. Record is only collected during the part of the year when flow is generally high enough to allow for upstream diversion of water to Arbutle Mountain Powerplant (station 11374300). This year, record was collected Jan. 11 to Apr. 30, 2002. Flow was above 90 ft³/s, Feb. 20, 21, 2002. During times of powerplant operation, the minimum release requirement is 5.0 ft³/s. See schematic diagram of [upper Sacramento River Basin](#).

COOPERATION.—Records were collected by Arbutle Mountain Hydro, LLC, under general supervision of the U.S. Geological Survey, in connection with Federal Energy Regulatory Commission Project no. 7178.

DISCHARGE, CUBIC FEET PER SECOND, WATER YEAR OCTOBER 2001 TO SEPTEMBER 2002
DAILY MEAN VALUES

DAY	OCT	NOV	DEC	JAN	FEB	MAR	APR	MAY	JUN	JUL	AUG	SEP
1	---	---	---	---	10	6.5	6.3	---	---	---	---	---
2	---	---	---	---	11	5.9	6.3	---	---	---	---	---
3	---	---	---	---	8.8	6.1	6.3	---	---	---	---	---
4	---	---	---	---	7.7	6.3	7.5	---	---	---	---	---
5	---	---	---	---	7.7	6.5	6.5	---	---	---	---	---
6	---	---	---	---	10	6.3	6.3	---	---	---	---	---
7	---	---	---	---	17	6.3	6.3	---	---	---	---	---
8	---	---	---	---	13	6.1	6.3	---	---	---	---	---
9	---	---	---	---	7.5	6.5	6.3	---	---	---	---	---
10	---	---	---	---	7.7	6.9	6.3	---	---	---	---	---
11	---	---	---	83	7.7	6.3	6.3	---	---	---	---	---
12	---	---	---	16	19	6.5	6.3	---	---	---	---	---
13	---	---	---	31	41	6.3	6.3	---	---	---	---	---
14	---	---	---	40	11	6.3	6.3	---	---	---	---	---
15	---	---	---	29	9.0	6.3	6.3	---	---	---	---	---
16	---	---	---	31	7.3	6.3	6.5	---	---	---	---	---
17	---	---	---	34	7.3	6.3	6.3	---	---	---	---	---
18	---	---	---	27	7.3	6.3	6.3	---	---	---	---	---
19	---	---	---	16	41	7.9	5.9	---	---	---	---	---
20	---	---	---	11	---	6.3	5.8	---	---	---	---	---
21	---	---	---	12	---	6.3	5.8	---	---	---	---	---
22	---	---	---	11	82	6.7	5.9	---	---	---	---	---
23	---	---	---	11	86	6.1	5.8	---	---	---	---	---
24	---	---	---	11	53	6.3	5.8	---	---	---	---	---
25	---	---	---	13	28	6.3	5.8	---	---	---	---	---
26	---	---	---	10	11	6.3	5.8	---	---	---	---	---
27	---	---	---	10	9.7	6.3	5.8	---	---	---	---	---
28	---	---	---	10	6.9	6.3	5.8	---	---	---	---	---
29	---	---	---	10	---	6.3	5.9	---	---	---	---	---
30	---	---	---	10	---	6.3	6.1	---	---	---	---	---
31	---	---	---	10	---	6.3	---	---	---	---	---	---
TOTAL	---	---	---	---	---	197.7	185.2	---	---	---	---	---
MEAN	---	---	---	---	---	6.377	6.173	---	---	---	---	---
MAX	---	---	---	---	---	7.9	7.5	---	---	---	---	---
MIN	---	---	---	---	---	5.9	5.8	---	---	---	---	---
AC-FT	---	---	---	---	---	392	367	---	---	---	---	---
a	---	---	---	2480	3250	3000	1110	---	---	---	---	---

a Discharge, in acre-feet, for Arbutle Mountain Powerplant (station 11374300), provided by Arbutle Mountain Hydro, LLC.

11376000 COTTONWOOD CREEK NEAR COTTONWOOD, CA

LOCATION.—Lat 40°23'14", long 122°14'15", in NE 1/4 NE 1/4 sec.7, T.29 N., R.3 W., [Shasta County](#), Hydrologic Unit 18020102, on left bank, 2.2 mi east of Cottonwood, and 2.5 mi upstream from mouth.

DRAINAGE AREA.—927 mi².

PERIOD OF RECORD.—October 1940 to current year.

CHEMICAL DATA: Water years 1982–85.

WATER TEMPERATURE: Water years 1963–67, 1977–85.

SEDIMENT DATA: Water years 1957–67, 1977–85.

REVISED RECORDS.—WSP 1345: 1943, 1944(M), 1946–47, 1949(M), 1951–52. WSP 1931: Drainage area.

GAGE.—Water-stage recorder and crest-stage gage. Datum of gage is 363.80 ft above sea level (levels by U.S. Army Corps of Engineers). Prior to July 26, 1963, on right bank at datum 3.59 ft higher. July 26, 1963, to Sept. 13, 1972, at site 250 ft downstream on right bank at present datum. Sept. 21, 1967, to Jan. 14, 1968, supplementary gage at a site 1,450 ft downstream on right bank at datum 2.35 ft higher.

REMARKS.—Records fair. Small diversions for irrigation upstream from station. At times during irrigation season, Cottonwood Creek receives water from the Sacramento River by way of Anderson–Cottonwood Irrigation District Canal. See schematic diagrams of [upper Sacramento River](#) and [Battle Creek and Cow Creek Basins](#).

EXTREMES FOR PERIOD OF RECORD.—Maximum discharge, 86,000 ft³/s, Mar. 1, 1983, gage height, 21.59 ft, from rating curve extended above 34,000 ft³/s, on basis of runoff comparisons with upstream stations then in use; minimum, 15 ft³/s, several days during September 1945.

EXTREMES FOR CURRENT YEAR.—Peak discharges greater than base discharge of 11,000 ft³/s, or maximum:

Date	Time	Discharge (ft ³ /s)	Gage height (ft)	Date	Time	Discharge (ft ³ /s)	Gage height (ft)
Dec. 20	2130	19,100	12.54	Jan. 2	1545	24,300	13.62

DISCHARGE, CUBIC FEET PER SECOND, WATER YEAR OCTOBER 2001 TO SEPTEMBER 2002

DAILY MEAN VALUES

DAY	OCT	NOV	DEC	JAN	FEB	MAR	APR	MAY	JUN	JUL	AUG	SEP
1	85	78	3490	4700	792	1210	658	470	233	67	e60	78
2	92	70	4090	20900	775	1120	638	427	230	67	e63	72
3	92	63	3000	10400	750	1040	649	390	222	70	e67	70
4	70	57	1810	5200	729	982	677	369	247	72	e71	86
5	66	52	1740	3890	709	941	705	351	218	67	e72	73
6	52	50	2870	10900	694	988	710	348	196	61	e71	56
7	41	48	1870	7670	708	1040	669	355	177	61	e68	57
8	44	47	1360	4980	1030	979	645	350	167	60	e59	67
9	50	46	1210	4040	930	913	649	326	166	87	e53	77
10	68	45	976	3280	836	1060	700	331	180	93	e50	73
11	65	56	817	2790	788	1010	637	319	183	101	e49	70
12	62	85	691	2480	763	926	606	296	173	77	e47	58
13	63	146	627	2250	750	886	585	307	158	56	e46	52
14	70	173	4310	2040	742	847	577	348	165	57	e48	61
15	70	160	1850	1840	735	809	604	334	156	53	e56	56
16	75	127	1220	1650	729	787	591	310	153	55	e52	92
17	73	145	1310	1510	747	759	596	218	143	55	e53	78
18	55	156	1490	1400	740	732	562	230	140	57	e55	68
19	53	133	1900	1310	1910	703	513	233	121	47	e57	76
20	57	119	7170	1230	5390	679	484	296	112	72	e59	73
21	49	127	6680	1180	3410	661	470	410	103	79	e60	66
22	47	958	4770	1160	2610	663	451	379	110	81	e59	64
23	48	567	3360	1080	2300	927	438	327	115	74	58	56
24	50	1230	1840	1020	2030	900	424	310	117	70	61	66
25	56	986	1370	983	1750	785	419	292	101	74	66	60
26	62	518	1120	992	1550	728	400	277	94	68	52	57
27	51	371	965	957	1410	693	409	267	82	e67	58	69
28	43	333	1250	911	1310	667	415	277	101	e63	78	66
29	51	4390	3810	886	---	655	433	270	71	e61	65	66
30	68	1510	3750	841	---	657	452	266	67	e60	60	71
31	71	---	6570	812	---	656	---	255	---	e58	73	---
TOTAL	1899	12846	79286	105282	37617	26403	16766	9938	4501	2090	1846	2034
MEAN	61.26	428.2	2558	3396	1343	851.7	558.9	320.6	150.0	67.42	59.55	67.80
MAX	92	4390	7170	20900	5390	1210	710	470	247	101	78	92
MIN	41	45	627	812	694	655	400	218	67	47	46	52
AC-FT	3770	25480	157300	208800	74610	52370	33260	19710	8930	4150	3660	4030

e Estimated.

SACRAMENTO RIVER BASIN

11376000 COTTONWOOD CREEK NEAR COTTONWOOD, CA—Continued

STATISTICS OF MONTHLY MEAN DATA FOR WATER YEARS 1941 - 2002, BY WATER YEAR (WY)

	OCT	NOV	DEC	JAN	FEB	MAR	APR	MAY	JUN	JUL	AUG	SEP
MEAN	126.8	353.7	1206	2156	2468	1965	1175	643.9	321.0	119.2	70.80	77.00
MAX	805	1828	5428	9193	12430	10770	4270	2447	2082	495	178	164
(WY)	1958	1985	1984	1995	1998	1983	1941	1983	1998	1998	1998	1983
MIN	50.6	52.2	49.8	60.3	76.3	146	136	165	74.5	36.8	26.4	30.8
(WY)	1995	1991	1991	1991	1977	1977	1977	1977	1977	1994	1945	1945

SUMMARY STATISTICS	FOR 2001 CALENDAR YEAR		FOR 2002 WATER YEAR		WATER YEARS 1941 - 2002	
ANNUAL TOTAL	264183		300508			
ANNUAL MEAN	723.8		823.3		882.9	
HIGHEST ANNUAL MEAN					2714 1983	
LOWEST ANNUAL MEAN					94.4 1977	
HIGHEST DAILY MEAN	16900	Mar 5	20900	Jan 2	54300	Jan 16 1974
LOWEST DAILY MEAN	41	Oct 7	41	Oct 7	15	Sep 7 1945
ANNUAL SEVEN-DAY MINIMUM	49	Nov 5	49	Nov 5	16	Sep 4 1945
MAXIMUM PEAK FLOW			24300	Jan 2	86000	Mar 1 1983
MAXIMUM PEAK STAGE			13.62	Jan 2	21.59	Mar 1 1983
ANNUAL RUNOFF (AC-FT)	524000		596100		639600	
10 PERCENT EXCEEDS	1810		1840		2090	
50 PERCENT EXCEEDS	172		277		226	
90 PERCENT EXCEEDS	58		56		58	

11376015 NORTH FORK BATTLE CREEK BELOW NORTH BATTLE CREEK DAM, NEAR MANZANITA LAKE, CA

LOCATION.—Lat 40°36'10", long 121°39'17", in SE 1/4 SE 1/4 sec.20, T.32 N., R.3 E., [Shasta County](#), Hydrologic Unit 18020118, Lassen National Forest, on left bank, 300 ft downstream from North Battle Creek Dam, and 6.7 mi northwest of Manzanita Lake.

DRAINAGE AREA.—6.40 mi².

PERIOD OF RECORD.—October 1987 to current year (operated as a low-flow station only). Unpublished records for water years 1978–87 available in files of the U.S. Geological Survey. Fragmentary records for water years 1920–77 in files of the Pacific Gas & Electric Co.

GAGE.—Water-stage recorder and a compound weir consisting of a 5-ft rectangular and V-notch weir. Elevation of gage is 5,560 ft above sea level, from topographic map.

REMARKS.—This station records fishwater release only. The minimum release requirement is 0.30 ft³/s Oct. 1–31 and Apr. 1 to Sept. 30. No license requirement Nov. 1 to Mar. 31, records not computed. Each fall, North Fork Battle Creek Reservoir is drafted and flows may exceed the rated limits of the weirs; flow is computed to 60 ft³/s. See schematic diagram of [Battle Creek and Cow Creek Basins](#).

COOPERATION.—Records were collected by Pacific Gas & Electric Co., under general supervision of the U.S. Geological Survey, in connection with Federal Energy Regulatory Commission project no. 1121.

DISCHARGE, CUBIC FEET PER SECOND, WATER YEAR OCTOBER 2001 TO SEPTEMBER 2002
DAILY MEAN VALUES

DAY	OCT	NOV	DEC	JAN	FEB	MAR	APR	MAY	JUN	JUL	AUG	SEP
1	2.0	---	---	---	---	---	1.0	11	5.4	0.42	1.5	1.5
2	2.1	---	---	---	---	---	1.1	11	5.2	0.41	1.5	1.3
3	2.1	---	---	---	---	---	1.1	11	4.0	0.40	1.5	1.3
4	2.1	---	---	---	---	---	1.1	11	3.4	0.40	1.5	1.4
5	2.0	---	---	---	---	---	1.1	12	3.2	0.39	1.4	1.3
6	2.1	---	---	---	---	---	1.1	13	3.1	0.37	1.3	1.2
7	2.1	---	---	---	---	---	1.1	15	2.9	0.80	1.3	1.1
8	2.2	---	---	---	---	---	1.1	14	2.9	1.1	1.3	1.0
9	3.2	---	---	---	---	---	1.1	13	2.4	1.1	1.2	1.0
10	3.9	---	---	---	---	---	1.6	14	2.1	0.96	4.5	1.1
11	3.7	---	---	---	---	---	1.2	12	1.6	0.85	8.4	3.7
12	3.7	---	---	---	---	---	1.3	12	1.1	0.76	10	5.6
13	3.7	---	---	---	---	---	7.1	13	0.82	0.75	7.7	5.6
14	3.7	---	---	---	---	---	20	13	0.84	0.78	5.8	5.6
15	3.7	---	---	---	---	---	23	13	0.81	1.0	5.8	5.4
16	3.7	---	---	---	---	---	19	12	0.70	1.1	5.8	5.5
17	3.7	---	---	---	---	---	17	12	0.60	0.99	3.7	5.4
18	3.7	---	---	---	---	---	13	12	0.59	1.0	2.2	5.5
19	3.7	---	---	---	---	---	9.5	13	0.57	0.95	2.0	5.4
20	3.7	---	---	---	---	---	8.2	14	0.52	0.90	1.8	5.4
21	3.7	---	---	---	---	---	7.6	13	0.54	0.88	1.7	5.3
22	3.7	---	---	---	---	---	7.5	8.3	0.50	0.75	1.6	5.2
23	3.6	---	---	---	---	---	12	5.4	0.46	0.83	1.6	5.2
24	3.5	---	---	---	---	---	11	5.4	0.44	0.87	1.6	5.1
25	3.6	---	---	---	---	---	11	5.4	0.42	0.84	1.8	4.8
26	3.7	---	---	---	---	---	12	5.4	0.45	0.75	1.8	4.8
27	3.6	---	---	---	---	---	17	5.4	0.46	0.70	1.8	4.8
28	3.6	---	---	---	---	---	13	5.4	0.47	0.71	1.7	4.7
29	3.6	---	---	---	---	---	12	4.3	0.46	1.2	1.6	4.6
30	3.6	---	---	---	---	---	12	3.7	0.46	1.6	1.6	4.6
31	4.0	---	---	---	---	---	---	4.8	---	1.6	1.5	---
TOTAL	101.0	---	---	---	---	---	245.8	317.5	47.41	26.16	88.5	114.4
MEAN	3.258	---	---	---	---	---	8.193	10.24	1.580	0.844	2.855	3.813
MAX	4.0	---	---	---	---	---	23	15	5.4	1.6	10	5.6
MIN	2.0	---	---	---	---	---	1.0	3.7	0.42	0.37	1.2	1.0
AC-FT	200	---	---	---	---	---	488	630	94	52	176	227
a	166	207	303	477	597	748	1026	1080	1056	920	692	440

a Contents, in acre-feet, end of month for North Fork Battle Creek Reservoir (station 11376010), provided by Pacific Gas & Electric Co.

11376025 NORTH FORK BATTLE CREEK BELOW McCUMBER DAM, NEAR MANZANITA LAKE, CA

LOCATION.—Lat 40°32'15", long 121°43'53", in SW 1/4 SE 1/4 sec.15, T.31 N., R.2 E., [Shasta County](#), Hydrologic Unit 18020118, on right bank, 300 ft downstream from McCumber Dam, 3.0 mi northwest of Viola, and 9.0 mi west of Manzanita Lake.

DRAINAGE AREA.—27.6 mi².

PERIOD OF RECORD.—October 1987 to current year (operated as a low-flow station only). Unpublished records for water years 1978–87 available in files of the U.S. Geological Survey.

GAGE.—Water-stage recorder and V-notch weir. Elevation of gage is 4,080 ft above sea level, from topographic map.

REMARKS.—This station records fishwater release only. Prior to water year 1995 flow computed to 211 ft³/s. The minimum release requirement is 0.30 ft³/s at all times; flow is computed to 800 ft³/s. See schematic diagram of [Battle Creek and Cow Creek Basins](#).

COOPERATION.—Records were collected by Pacific Gas & Electric Co., under general supervision of the U.S. Geological Survey, in connection with Federal Energy Regulatory Commission project no. 1121.

DISCHARGE, CUBIC FEET PER SECOND, WATER YEAR OCTOBER 2001 TO SEPTEMBER 2002
DAILY MEAN VALUES

DAY	OCT	NOV	DEC	JAN	FEB	MAR	APR	MAY	JUN	JUL	AUG	SEP
1	7.7	4.1	7.7	14	5.4	30	20	31	9.3	2.0	2.2	2.2
2	7.4	4.1	8.2	20	5.4	30	24	29	8.8	2.0	2.2	2.1
3	7.2	4.1	10	21	5.4	30	27	29	7.9	2.0	2.2	2.0
4	7.2	5.5	11	21	5.4	29	27	29	6.5	2.0	2.2	2.0
5	7.2	6.3	11	21	5.4	22	27	29	5.5	1.8	2.2	2.0
6	7.2	6.3	11	21	5.4	17	23	29	4.9	1.6	2.1	2.0
7	7.2	6.3	11	21	5.4	17	22	30	5.0	1.6	1.8	2.0
8	5.0	6.3	11	23	5.4	17	20	28	5.8	1.6	1.6	2.0
9	2.9	6.3	11	30	5.4	17	22	27	4.1	1.6	1.5	2.0
10	1.4	6.3	11	32	5.4	17	29	26	3.9	1.6	1.6	2.0
11	0.36	6.3	11	32	5.3	17	27	24	2.6	1.6	1.6	3.8
12	0.43	6.3	11	31	4.9	17	24	23	2.3	1.5	1.8	6.4
13	1.5	6.1	11	33	4.9	17	23	23	2.3	1.4	2.0	8.7
14	2.2	5.9	11	34	4.9	14	38	24	2.3	1.4	2.0	9.0
15	2.2	5.9	11	33	4.9	13	48	23	2.2	1.4	2.0	9.4
16	2.2	5.9	7.7	29	4.9	13	42	22	2.2	1.5	2.0	9.4
17	2.2	5.9	7.2	20	4.9	9.8	40	21	2.2	1.6	2.0	9.4
18	2.2	5.9	8.8	13	6.6	7.9	33	20	2.2	1.6	2.0	9.4
19	2.2	5.9	8.8	13	8.2	7.8	27	24	2.2	1.8	2.0	9.3
20	2.2	5.9	8.8	12	8.5	6.6	23	28	2.2	2.0	2.0	8.8
21	5.0	5.9	8.8	12	15	4.7	21	24	2.2	2.0	2.0	8.1
22	5.3	5.9	8.8	11	21	4.5	21	20	2.2	2.0	2.0	7.3
23	4.5	5.9	8.8	7.3	21	4.5	24	14	2.2	2.0	2.0	7.2
24	4.3	5.9	8.8	5.6	27	4.5	26	13	2.2	2.0	2.1	7.2
25	4.1	5.9	8.8	5.4	31	4.7	26	12	2.2	2.0	2.2	7.2
26	4.1	7.0	8.8	5.4	31	6.3	28	12	2.1	2.1	2.2	6.9
27	4.1	8.2	8.8	5.4	31	14	39	11	2.0	2.2	2.2	6.7
28	4.1	8.2	6.4	5.4	30	14	32	11	2.0	2.2	2.2	6.7
29	4.1	8.2	4.2	5.4	---	16	32	10	2.0	2.2	2.2	6.7
30	4.1	7.9	4.2	5.4	---	19	33	8.9	2.0	2.2	2.2	6.7
31	4.1	---	6.9	5.4	---	20	---	9.1	---	2.2	2.2	---
TOTAL	125.89	184.6	282.5	547.7	319.0	461.3	848	664.0	105.5	56.7	62.5	174.6
MEAN	4.061	6.153	9.113	17.67	11.39	14.88	28.27	21.42	3.517	1.829	2.016	5.820
MAX	7.7	8.2	11	34	31	30	48	31	9.3	2.2	2.2	9.4
MIN	0.36	4.1	4.2	5.4	4.9	4.5	20	8.9	2.0	1.4	1.5	2.0
AC-FT	250	366	560	1090	633	915	1680	1320	209	112	124	346
a	253	235	191	139	327	436	436	428	403	299	299	156

a Contents, in acre-feet, at end of month for McCumber Reservoir (station 11376020), provided by Pacific Gas & Electric Co.

POWERPLANTS IN BATTLE CREEK AND COW CREEK BASINS

- 11376043 VOLTA NO. 1 POWERPLANT NEAR MANTON, CA, in NW 1/4 NE 1/4 sec.16, T.30 N., R.1 E., [Shasta County](#), Hydrologic Unit 18020118, 1.7 mi north of Manton. Powerplant consists of one unit with a total of 8,550 KW normal operating capacity. See schematic diagram of [Battle Creek and Cow Creek Basins](#).
- 11376046 VOLTA NO. 2 POWERPLANT NEAR MANTON, CA, in NE 1/4 SW 1/4 sec.16, T.30 N., R.1 E., [Shasta County](#), Hydrologic Unit 18020118, 1.2 mi northeast of Manton. Powerplant consists of one unit with a total of 956 KW normal operating capacity. See schematic diagram of [Battle Creek and Cow Creek Basins](#).
- 11376410 SOUTH POWERPLANT NEAR MANTON, CA, in NE 1/4 SE 1/4 sec.5, T.29 N., R.1 E., [Tehama County](#), Hydrologic Unit 18020118, 2.7 mi south of Manton. Powerplant consists of one unit with a total of 6,750 KW normal operating capacity. See schematic diagram of [Battle Creek and Cow Creek Basins](#).
- 11376430 INSKIP POWERPLANT NEAR MANTON, CA, in NE 1/4 NW 1/4 sec.3, T.29 N., R.1 W., [Tehama County](#), Hydrologic Unit 18020118, 5.5 mi southwest of Manton. Powerplant consists of one unit with a total of 7,650 KW normal operating capacity. See schematic diagram of [Battle Creek and Cow Creek Basins](#).
- 11376458 COLEMAN POWERPLANT NEAR COTTONWOOD, CA, in SW 1/4 SW 1/4 sec.32, T.30 N., R.2 W., [Shasta County](#), Hydrologic Unit 18020006, 8.5 mi east of Cottonwood. Powerplant consists of one unit with a total of 12,150 KW normal operating capacity. See schematic diagram of [Battle Creek and Cow Creek Basins](#).

MONTHLY DISCHARGE, IN ACRE-FEET, WATER YEAR OCTOBER 2001 TO SEPTEMBER 2002

Date	Volta No. 1	Volta No. 2	South	Inskip	Coleman
Oct.....	2,500	3,110	8,230	8,200	10,250
Nov.....	2,690	3,450	9,700	10,370	10,790
Dec.....	4,050	4,730	12,580	14,140	15,290
Jan.....	5,860	6,200	12,840	14,760	18,270
Feb.....	4,660	5,110	11,500	10,910	16,150
Mar.....	5,770	6,160	9,530	16,640	19,430
Apr.....	3,840	3,900	12,260	16,200	18,870
May.....	5,220	2,640	13,070	15,850	11,750
June.....	3,650	4,100	11,500	13,660	14,300
July.....	3,050	3,600	9,380	10,080	11,360
Aug.....	2,640	3,250	8,240	8,820	9,600
Sept.....	2,520	3,120	7,690	8,190	9,460

Note.—Records were provided by Pacific Gas & Electric Co., in connection with Federal Energy Regulatory Commission project no. 1121. Unpublished records for water years 1979–86 available in files of U.S.Geolgoical Survey. Fragmentary records prior to water year 1979 available in files of Pacific Gas & Electri Co.

11376050 NORTH FORK BATTLE CREEK BELOW DIVERSION TO KESWICK CANAL, NEAR MANTON, CA

LOCATION.—Lat 40°30'00", long 121°48'29", in NW 1/4 NE 1/4 sec.36, T.31 N., R.1 E., [Shasta County](#), Hydrologic Unit 18020118, on right bank, 4.2 mi east of Shingletown, and 5.5 mi northeast of Manton.

PERIOD OF RECORD.—October 1986 to current year (operated as a low-flow station only). Unpublished records for water years 1978–86 available in files of the U.S. Geological Survey.

GAGE.—Water-stage recorder and Parshall flume. Elevation of gage is 3,600 ft above sea level, from topographic map.

REMARKS.—This station records fishwater release only. The minimum release requirement is 3.0 ft³/s at all times; flow is computed to 5.6 ft³/s. See schematic diagram of [Battle Creek and Cow Creek Basins](#).

COOPERATION.—Records were collected by Pacific Gas & Electric Co., under general supervision of the U.S. Geological Survey, in connection with Federal Energy Regulatory Commission project no. 1121.

DISCHARGE, CUBIC FEET PER SECOND, WATER YEAR OCTOBER 2001 TO SEPTEMBER 2002
DAILY MEAN VALUES

DAY	OCT	NOV	DEC	JAN	FEB	MAR	APR	MAY	JUN	JUL	AUG	SEP
1	3.5	3.5	3.7	3.8	3.5	3.4	3.8	e3.7	3.6	3.6	3.6	3.5
2	3.5	3.5	3.7	3.8	3.5	3.5	3.6	e3.6	3.6	3.6	3.6	3.5
3	3.6	3.5	3.7	3.8	3.5	3.5	3.6	e3.7	3.6	3.6	3.6	3.4
4	3.6	3.5	3.7	3.7	3.6	3.5	3.6	e4.0	3.5	3.6	3.6	3.4
5	3.6	3.5	3.8	3.7	3.5	3.5	3.6	e4.7	3.5	3.6	3.5	3.4
6	3.6	3.5	3.9	3.7	3.5	3.5	3.6	e3.6	3.5	3.6	3.5	3.4
7	3.6	3.5	3.8	3.7	3.6	3.5	3.6	e3.6	3.5	3.6	3.6	3.4
8	3.6	3.5	3.8	3.7	3.6	3.4	3.6	e3.5	3.5	3.6	3.5	3.4
9	3.5	3.5	3.8	3.7	3.6	3.4	3.6	e3.5	3.5	3.6	3.5	3.4
10	3.5	3.5	3.8	3.7	3.6	3.4	3.7	e3.5	3.4	3.6	3.4	3.4
11	3.5	3.5	3.8	3.7	3.6	3.4	3.6	e3.4	3.4	3.6	3.5	3.4
12	3.5	3.8	3.7	3.7	3.6	3.4	3.6	e3.5	3.5	3.6	3.4	3.5
13	3.5	3.8	3.7	3.7	3.5	3.5	3.6	e3.5	3.6	3.6	3.5	3.5
14	3.5	3.7	3.8	3.7	3.5	3.4	3.7	e3.6	3.5	3.6	3.5	3.5
15	3.5	3.7	3.7	3.7	3.5	3.5	---	e3.5	3.5	3.6	3.5	3.5
16	3.5	3.7	3.7	3.6	3.6	3.6	---	e3.5	3.5	3.6	3.5	3.5
17	3.5	3.7	3.9	3.5	3.6	3.5	---	e3.6	3.5	3.6	3.5	3.5
18	3.5	3.6	3.6	3.5	3.6	3.4	---	e3.6	3.5	3.6	3.5	3.5
19	3.6	3.6	3.7	3.6	3.8	3.4	---	e3.7	3.5	3.6	3.5	3.5
20	3.6	3.6	3.6	3.5	4.1	3.4	---	e3.7	3.5	3.6	3.5	3.4
21	3.7	3.8	3.6	3.6	4.0	3.5	---	e3.6	3.5	3.5	3.5	3.4
22	3.7	3.9	3.6	3.5	4.1	3.7	---	e3.5	3.5	3.5	3.5	3.4
23	3.6	3.8	3.6	3.5	4.1	3.7	---	3.4	3.5	3.6	3.5	3.5
24	3.6	3.9	3.6	3.5	4.1	3.8	---	3.6	3.5	3.6	3.5	3.5
25	3.6	3.7	3.5	3.5	4.2	3.7	e3.6	3.7	3.5	3.6	3.5	3.5
26	3.6	3.6	3.5	3.6	4.2	3.7	e3.6	3.7	3.5	3.6	3.5	3.5
27	3.6	3.6	3.5	3.5	4.1	3.8	e3.6	3.7	3.5	3.5	3.5	3.6
28	3.6	3.6	3.6	3.5	3.9	3.8	e3.6	3.6	3.5	3.5	3.5	3.5
29	3.6	3.6	3.6	3.5	---	3.9	e3.6	3.6	3.6	3.6	3.5	3.5
30	3.6	3.6	3.6	3.5	---	3.9	e3.7	3.6	3.6	3.6	3.5	3.5
31	3.5	---	3.9	3.5	---	3.9	---	3.6	---	3.6	3.5	---
TOTAL	110.5	108.8	114.5	112.2	104.6	110.5	---	112.6	105.4	111.2	108.8	103.9
MEAN	3.565	3.627	3.694	3.619	3.736	3.565	---	3.632	3.513	3.587	3.510	3.463
MAX	3.7	3.9	3.9	3.8	4.2	3.9	---	4.7	3.6	3.6	3.6	3.6
MIN	3.5	3.5	3.5	3.5	3.5	3.4	---	3.4	3.4	3.5	3.4	3.4
AC-FT	219	216	227	223	207	219	---	223	209	221	216	206

e Estimated.

11376120 BAILEY CREEK BELOW DIVERSION TO PONDEROSA—BAILEY CREEK POWERPLANT, NEAR MANTON, CA

LOCATION.—Lat 40°27'59", long 121°59'20", in NE 1/4 SE 1/4 sec.11, T.30 N., R.1 E., [Shasta County](#), Hydrologic Unit 18020118, on right bank, 250 ft downstream from Spring Creek, 0.4 mi upstream from Ponderosa Way, 3.3 mi northeast of Manton, and 3.9 mi southeast of Shingletown.

DRAINAGE AREA.—29.6 mi².

PERIOD OF RECORD.—January 1990 to current year (operated as a low-flow station only).

GAGE.—Water-stage recorder and V-notch weir. Elevation of gage is 2,650 ft above sea level, from topographic map.

REMARKS.—During times of powerplant operation the minimum release requirement is 17 ft³/s; flow is computed to 109 ft³/s. See schematic diagram of [Battle Creek and Cow Creek Basins](#).

COOPERATION.—Records were collected by Snow Mountain Hydro, under general supervision of the U.S. Geological Survey, in connection with Federal Energy Regulatory Commission project no. 8357.

DISCHARGE, CUBIC FEET PER SECOND, WATER YEAR OCTOBER 2001 TO SEPTEMBER 2002

DAILY MEAN VALUES

DAY	OCT	NOV	DEC	JAN	FEB	MAR	APR	MAY	JUN	JUL	AUG	SEP
1	16	15	22	18	25	22	21	18	19	18	17	16
2	16	15	21	20	24	22	21	19	18	19	17	16
3	16	15	23	25	24	22	21	25	18	18	17	16
4	16	15	21	18	23	21	24	23	18	18	17	16
5	16	15	22	18	23	21	19	20	18	18	17	16
6	16	15	18	18	23	21	18	18	18	18	17	17
7	16	15	21	18	23	18	21	18	18	22	17	17
8	16	15	22	18	18	18	24	18	18	25	17	17
9	16	15	22	18	22	18	19	18	18	23	17	16
10	16	15	21	18	25	18	18	18	19	22	16	15
11	16	16	20	18	25	18	18	19	18	23	16	15
12	16	16	20	18	25	18	18	21	18	23	16	15
13	16	16	20	18	25	22	18	18	18	21	16	15
14	16	16	22	18	25	22	18	18	18	21	16	15
15	16	16	20	18	25	18	18	18	18	20	16	15
16	16	16	21	18	25	18	18	18	18	19	16	15
17	16	16	19	18	26	18	18	18	18	18	16	15
18	16	16	19	21	25	19	18	18	18	18	16	15
19	16	16	18	20	21	18	18	18	18	18	16	15
20	16	16	18	22	18	18	18	18	18	18	16	15
21	16	16	18	18	18	22	24	18	18	18	16	15
22	16	19	23	22	18	21	23	18	18	18	16	15
23	16	17	24	23	18	23	23	18	18	18	17	15
24	16	18	24	25	18	25	22	18	18	18	17	15
25	16	17	23	26	18	24	23	20	18	17	17	15
26	16	18	22	20	18	23	25	19	18	17	17	15
27	17	17	22	23	18	27	18	18	18	17	16	15
28	17	17	23	23	23	22	19	18	18	17	16	15
29	17	18	18	24	---	21	23	18	18	17	16	15
30	17	20	18	24	---	21	18	18	18	17	16	15
31	15	---	18	24	---	21	---	21	---	17	16	---
TOTAL	499	487	643	630	619	640	604	583	542	591	509	462
MEAN	16.10	16.23	20.74	20.32	22.11	20.65	20.13	18.81	18.07	19.06	16.42	15.40
MAX	17	20	24	26	26	27	25	25	19	25	17	17
MIN	15	15	18	18	18	18	18	18	18	17	16	15
AC-FT	990	966	1280	1250	1230	1270	1200	1160	1080	1170	1010	916
a	0	6.0	163	686	403	198	335	833	1920	139	0	0

a Discharge, in acre-feet, for Ponderosa-Bailey Creek Powerplant (station 11376110), provided by Snow Mountain Hydro.

11376150 NORTH FORK BATTLE CREEK BELOW DIVERSION TO EAGLE CANYON CANAL, NEAR MANTON, CA

LOCATION.—Lat 40°25'26", long 121°55'09", in NW 1/4 SE 1/4 sec.25, T.30 N., R.1 W., [Tehama County](#), Hydrologic Unit 18020118, on left bank, at diversion dam to Eagle Canyon Canal, and 2.8 mi southwest of Manton.

DRAINAGE AREA.—186 mi².

PERIOD OF RECORD.—October 1987 to current year (operated as a low-flow station only). Unpublished records for water years 1978–87 available in files of the U.S. Geological Survey. Fragmentary records for water year 1977 available in files of Pacific Gas & Electric Co.

GAGE.—Water-stage recorder and metal Alaskan fishladder. Elevation of gage is 1,400 ft above sea level, from topographic map.

REMARKS.—This station records fishwater release only. Prior to water year 1996 flow computed to 7.2 ft³/s. The minimum release requirement is 3.0 ft³/s at all times; flow is computed to 50 ft³/s. See schematic diagram of [Battle Creek and Cow Creek Basins](#).

COOPERATION.—Records were collected by Pacific Gas & Electric Co., under general supervision of the U.S. Geological Survey, in connection with Federal Energy Regulatory Commission project no. 1121.

DISCHARGE, CUBIC FEET PER SECOND, WATER YEAR OCTOBER 2001 TO SEPTEMBER 2002
DAILY MEAN VALUES

DAY	OCT	NOV	DEC	JAN	FEB	MAR	APR	MAY	JUN	JUL	AUG	SEP
1	e33	e33	e45	---	e38	---	e36	---	---	e25	e26	e26
2	e33	e33	e46	---	e37	---	e36	e39	---	e25	e26	e26
3	e33	e33	e40	---	e36	e49	e40	e35	e44	e25	e27	e26
4	e33	e33	e37	---	e36	e47	e44	e34	e38	e25	e27	e26
5	e33	e33	e38	---	e35	e46	e47	e32	e37	e25	e27	e26
6	e33	e33	---	---	e34	---	e46	e32	e43	e29	e27	e26
7	e33	e33	e39	---	e35	---	e42	e34	e40	e34	e26	e26
8	e33	e33	e36	---	e42	---	e39	e30	e34	e32	e26	e25
9	e33	e33	e43	---	e35	---	e43	e30	e27	e31	e26	e26
10	e33	e33	e36	---	e35	---	---	e32	e29	e31	e26	e26
11	e33	e34	e35	---	e34	---	e48	e31	e28	e29	e26	e26
12	e33	e38	e34	---	e35	---	e46	---	e31	e28	e26	e26
13	e33	e36	e34	---	e34	---	e44	---	e34	e28	e26	e26
14	e33	e33	e41	---	e34	e47	---	e44	e35	e28	e26	e26
15	e33	e33	e34	---	e34	e44	---	e41	e35	e28	e26	e26
16	e33	e33	e35	---	e34	e45	---	e41	e35	e28	e27	e26
17	e33	e33	---	e43	e35	e43	---	e43	e34	e28	e27	e26
18	e34	e33	e39	e36	e34	e38	---	---	e34	e27	e27	e26
19	e34	e33	---	e41	e49	e37	---	---	e33	e27	e27	e26
20	e34	e34	---	e40	---	e33	e48	---	e33	e26	e27	e26
21	e34	e37	e43	---	---	e29	e36	e47	e33	e26	e27	e26
22	e34	e39	e42	e40	---	e31	e33	e29	e33	e26	e27	e26
23	e34	e34	e38	e38	---	e36	e31	e27	e33	e26	e27	e26
24	e33	---	e34	e37	---	e49	e34	e29	e33	e26	e27	e26
25	e33	e36	e33	e37	---	e42	e41	e30	e33	e26	e27	e26
26	e33	e34	e32	e48	---	e35	e32	e31	e32	e26	e27	e26
27	e33	e34	e32	e42	---	e35	---	e33	e28	e26	e27	e26
28	e33	e36	e35	---	---	e35	e41	e34	e26	e26	e26	e25
29	e33	e41	e44	---	---	e34	e38	e37	e26	e27	e26	e25
30	e35	e36	---	---	---	e35	---	e50	e26	e26	e26	e26
31	e34	---	---	e50	---	e34	---	---	---	e27	e26	---
TOTAL	1032	---	---	---	---	---	---	---	---	847	822	777
MEAN	33.29	---	---	---	---	---	---	---	---	27.32	26.52	25.90
MAX	35	---	---	---	---	---	---	---	---	34	27	26
MIN	33	---	---	---	---	---	---	---	---	25	26	25
AC-FT	2050	---	---	---	---	---	---	---	---	1680	1630	1540

e Estimated.

11376160 NORTH FORK BATTLE CREEK BELOW DIVERSION TO WILDCAT CANAL, NEAR MANTON, CA

LOCATION.—Lat 40°25'14", long 121°57'36", in SE 1/4 SW 1/4 sec.27, T.30 N., R.1 W., Tehama County, Hydrologic Unit 18020118, on left bank, at diversion dam to Wildcat Canal, and 4.9 mi west of Manton.

DRAINAGE AREA.—189 mi².

PERIOD OF RECORD.—October 1987 to current year (operated as a low-flow station only). Unpublished records for water years 1978–87 available in files of the U.S. Geological Survey. Fragmentary records for water year 1977 available in files of Pacific Gas & Electric Co.

GAGE.—Water-stage recorder and metal Alaskan fishladder. Elevation of gage is 1,080 ft above sea level, from topographic map.

REMARKS.—This station records fishwater release only. The minimum release requirement is 3.0 ft³/s at all times; flow is computed to 60 ft³/s. See schematic diagram of [Battle Creek and Cow Creek Basins](#).

COOPERATION.—Records were collected by Pacific Gas & Electric Co., under general supervision of the U.S. Geological Survey, in connection with Federal Energy Regulatory Commission project no. 1121.

DISCHARGE, CUBIC FEET PER SECOND, WATER YEAR OCTOBER 2001 TO SEPTEMBER 2002

DAILY MEAN VALUES

DAY	OCT	NOV	DEC	JAN	FEB	MAR	APR	MAY	JUN	JUL	AUG	SEP
1	36	36	48	---	41	57	39	54	---	28	29	29
2	36	36	49	---	40	56	39	42	59	28	29	29
3	36	36	43	---	39	52	43	38	47	28	30	29
4	36	36	40	---	39	50	47	37	41	28	30	29
5	36	36	41	---	38	49	50	35	40	28	30	29
6	36	36	---	---	37	59	49	35	46	32	30	29
7	36	36	42	---	38	---	45	37	43	37	29	29
8	36	36	39	---	45	---	42	33	37	35	29	28
9	36	36	46	---	38	58	46	33	30	34	29	29
10	36	36	39	---	38	---	56	35	32	34	29	29
11	36	37	38	---	37	---	51	34	31	32	29	29
12	36	41	37	---	38	---	49	---	34	31	29	29
13	36	39	37	---	37	54	47	---	37	31	29	29
14	36	36	44	---	37	50	59	47	38	31	29	29
15	36	36	37	60	37	47	---	44	38	31	29	29
16	36	36	38	55	37	48	---	44	38	31	30	29
17	36	36	---	46	38	46	---	46	37	31	30	29
18	37	36	42	39	37	41	---	---	37	30	30	29
19	37	36	54	44	52	40	---	---	36	30	30	29
20	37	37	---	43	---	36	51	---	36	29	30	29
21	37	40	46	---	---	32	39	50	36	29	30	29
22	37	42	45	43	---	34	36	32	36	29	30	29
23	37	37	41	41	---	39	34	30	36	29	30	29
24	36	54	37	40	---	52	37	32	36	29	30	29
25	36	39	36	40	---	45	44	33	36	29	30	29
26	36	37	35	51	---	38	35	34	35	29	30	29
27	36	37	35	45	---	38	---	36	31	29	30	29
28	36	39	38	---	---	38	44	37	29	29	29	28
29	36	44	47	---	---	37	41	40	29	30	29	28
30	38	39	56	---	---	38	57	53	29	29	29	29
31	37	---	---	53	---	37	---	---	---	30	29	---
TOTAL	1125	1138	---	---	---	---	---	---	---	940	915	867
MEAN	36.29	37.93	---	---	---	---	---	---	---	30.32	29.52	28.90
MAX	38	54	---	---	---	---	---	---	---	37	30	29
MIN	36	36	---	---	---	---	---	---	---	28	29	28
AC-FT	2230	2260	---	---	---	---	---	---	---	1860	1810	1720

11376420 SOUTH FORK BATTLE CREEK BELOW DIVERSION TO SOUTH BATTLE CREEK CANAL, NEAR MANTON, CA

LOCATION.—Lat 40°22'08", long 121°47'48", in SW 1/4 NW 1/4 sec.18, T.29 N., R.2 E., Tehama County, Hydrologic Unit 18020118, on right bank, at diversion dam to South Battle Creek Canal, and 5.9 mi southeast of Manton.

DRAINAGE AREA.—66.7 mi².

PERIOD OF RECORD.—October 1987 to current year (operated as a low-flow station only). Unpublished records for water years 1978–87 available in files of the U.S. Geological Survey. Fragmentary records for water years 1976–77 in files of Pacific Gas & Electric Co.

GAGE.—Water-stage recorder and metal Alaskan fishladder. Elevation of gage is 2,040 ft above sea level, from topographic map.

REMARKS.—This station records fishwater release only. The minimum release requirement is 5.0 ft³/s at all times; flow is computed to 8.9 ft³/s. See schematic diagram of [Battle Creek and Cow Creek Basins](#).

COOPERATION.—Records were collected by Pacific Gas & Electric Co., under general supervision of the U.S. Geological Survey, in connection with Federal Energy Regulatory Commission project no. 1121.

DISCHARGE, CUBIC FEET PER SECOND, WATER YEAR OCTOBER 2001 TO SEPTEMBER 2002

DAILY MEAN VALUES

DAY	OCT	NOV	DEC	JAN	FEB	MAR	APR	MAY	JUN	JUL	AUG	SEP
1	5.7	5.6	---	---	5.6	---	---	---	---	6.2	6.3	6.3
2	5.7	5.6	---	---	5.6	---	---	---	---	6.2	6.3	6.3
3	5.7	5.6	---	---	5.6	---	---	---	---	6.2	6.3	6.3
4	5.7	5.6	5.6	---	5.6	---	---	---	---	6.2	6.3	6.3
5	5.7	5.7	5.6	---	5.6	---	---	---	---	6.2	6.3	6.3
6	5.7	5.7	---	---	5.6	---	---	---	---	6.2	6.3	6.2
7	5.6	5.6	---	---	5.7	---	---	---	7.3	6.3	6.3	6.2
8	5.7	5.7	5.5	---	---	---	---	---	5.9	6.3	6.3	6.3
9	5.7	5.7	5.5	---	---	---	---	---	5.7	6.3	6.3	6.3
10	5.7	5.7	5.6	---	5.6	---	---	---	5.7	6.3	6.3	6.3
11	5.7	5.7	5.6	---	5.6	---	---	---	5.8	6.3	6.3	6.3
12	5.7	---	5.6	---	5.6	---	---	---	5.8	6.3	6.3	6.3
13	5.7	---	5.6	---	5.6	---	---	---	5.8	6.3	6.3	6.3
14	5.7	5.5	5.6	---	5.6	---	---	---	5.8	6.3	6.3	6.3
15	5.7	5.5	5.6	---	5.6	---	---	---	5.9	6.3	6.3	6.3
16	5.7	5.4	5.6	---	5.5	---	---	---	5.9	6.3	6.3	6.3
17	5.7	5.5	---	---	5.8	---	---	---	5.9	6.3	6.3	6.3
18	5.7	5.5	---	---	5.5	---	---	---	5.8	6.3	6.3	6.2
19	5.7	5.5	---	---	---	---	---	---	5.9	6.3	6.3	6.3
20	5.7	5.5	---	5.8	---	---	---	---	5.9	6.3	6.3	6.2
21	5.7	---	---	5.6	---	---	---	---	5.9	6.3	6.3	6.3
22	5.7	---	6.0	5.8	---	---	---	---	5.9	6.3	6.3	6.3
23	5.7	---	5.5	5.8	---	---	---	---	5.8	6.3	6.3	6.3
24	5.7	---	5.6	5.6	---	---	---	---	5.9	6.3	6.2	6.3
25	5.6	---	5.6	5.6	---	---	---	---	6.0	6.3	6.3	6.3
26	5.7	5.5	5.6	---	---	---	---	---	6.0	6.3	6.3	6.3
27	5.7	5.5	5.7	5.5	---	---	---	---	6.1	6.3	6.3	6.3
28	5.7	5.6	5.8	5.6	---	---	---	---	6.1	6.3	6.3	6.2
29	5.7	5.6	---	5.6	---	---	---	---	6.1	6.3	6.3	6.2
30	---	5.6	---	5.6	---	---	---	---	6.2	6.3	6.3	6.2
31	5.6	---	---	5.6	---	---	---	---	---	6.3	6.3	---
TOTAL	---	---	---	---	---	---	---	---	---	194.7	195.2	188.3
MEAN	---	---	---	---	---	---	---	---	---	6.281	6.297	6.277
MAX	---	---	---	---	---	---	---	---	---	6.3	6.3	6.3
MIN	---	---	---	---	---	---	---	---	---	6.2	6.2	6.2
AC-FT	---	---	---	---	---	---	---	---	---	386	387	373

11376440 SOUTH FORK BATTLE CREEK BELOW DIVERSION TO INSKIP CANAL, NEAR MANTON, CA

LOCATION.—Lat 40°23'43", long 121°52'57", in NW 1/4 SE 1/4 sec.5, T.29 N., R.1 E., [Tehama County](#), Hydrologic Unit 18020118, on left bank, at diversion dam to Inskip Canal, and 2.8 mi south of Manton.

DRAINAGE AREA.—88.3 mi².

PERIOD OF RECORD.—October 1987 to current year (operated as a low-flow station only). Unpublished records for water years 1978–87 available in files of the U.S. Geological Survey. Fragmentary records for water year 1977 available in files of Pacific Gas & Electric Co.

GAGE.—Water-stage recorder and metal Alaskan fishladder. Elevation of gage is 1,440 ft above sea level, from topographic map.

REMARKS.—This station records fishwater release only. Prior to Feb. 6, 1998, flow computed to 12 ft³/s. The minimum release requirement is 5.0 ft³/s at all times; flow computed to 60 ft³/s. See schematic diagram of [Battle Creek and Cow Creek Basins](#).

COOPERATION.—Records were collected by Pacific Gas & Electric Co., under general supervision of the U.S. Geological Survey, in connection with Federal Energy Regulatory Commission project no. 1121.

DISCHARGE, CUBIC FEET PER SECOND, WATER YEAR OCTOBER 2001 TO SEPTEMBER 2002
DAILY MEAN VALUES

DAY	OCT	NOV	DEC	JAN	FEB	MAR	APR	MAY	JUN	JUL	AUG	SEP
1	9.1	9.1	55	---	---	40	---	---	51	9.6	6.5	6.4
2	9.2	9.3	---	---	---	30	---	---	40	9.5	6.5	6.4
3	9.0	9.2	38	---	---	25	---	---	30	9.4	6.5	6.4
4	8.9	9.2	14	---	---	28	---	---	23	9.4	6.4	6.4
5	8.9	9.2	14	---	---	25	---	---	21	9.5	6.4	6.4
6	9.0	9.3	24	---	---	---	---	---	19	9.3	6.4	6.5
7	9.1	9.1	25	---	---	---	---	---	19	9.0	6.4	6.4
8	9.2	9.1	14	---	27	---	---	---	19	7.5	6.3	6.4
9	9.3	9.1	21	---	20	49	---	---	19	6.3	6.3	6.4
10	9.2	9.1	11	---	17	---	---	---	19	6.1	6.4	6.9
11	9.2	9.3	9.1	---	18	35	---	---	19	6.1	6.5	6.5
12	9.2	30	8.6	---	19	31	---	---	19	6.5	6.5	6.6
13	9.1	18	9.0	50	17	50	---	---	18	6.5	6.6	7.6
14	9.2	9.1	48	39	17	43	---	---	18	6.6	6.5	7.5
15	9.1	9.1	11	29	18	34	---	---	18	6.6	6.5	7.5
16	8.9	9.0	9.9	25	18	30	---	---	18	6.7	6.5	7.0
17	8.7	9.1	---	24	18	25	---	---	18	6.7	6.5	6.8
18	9.0	9.1	44	20	18	22	---	---	18	6.7	6.5	6.8
19	8.9	9.1	---	22	22	21	---	---	18	6.6	6.5	6.9
20	9.0	9.2	---	18	---	22	---	---	18	6.6	6.6	6.9
21	9.1	17	---	19	---	32	51	---	18	7.0	6.5	6.9
22	9.1	---	---	17	---	44	47	---	18	6.4	6.6	6.9
23	9.2	17	---	18	---	---	55	57	18	6.4	6.4	7.0
24	8.9	---	---	17	---	---	---	50	18	6.4	6.4	7.0
25	9.0	39	---	16	---	58	---	50	14	6.4	6.5	7.0
26	9.1	11	60	31	57	48	---	53	9.4	6.4	6.4	7.0
27	8.9	8.7	11	21	55	51	---	53	9.3	6.4	6.4	7.1
28	8.8	9.0	15	---	50	---	---	46	9.1	6.4	6.4	7.1
29	8.9	9.2	50	---	---	---	---	46	9.9	6.4	6.4	7.1
30	9.5	8.9	---	---	---	---	---	57	9.8	6.5	6.5	7.1
31	8.8	---	---	---	---	---	---	57	---	6.4	6.4	---
TOTAL	280.5	---	---	---	---	---	---	---	575.5	222.3	200.2	204.9
MEAN	9.048	---	---	---	---	---	---	---	19.18	7.171	6.458	6.830
MAX	9.5	---	---	---	---	---	---	---	51	9.6	6.6	7.6
MIN	8.7	---	---	---	---	---	---	---	9.1	6.1	6.3	6.4
AC-FT	556	---	---	---	---	---	---	---	1140	441	397	406

11376460 SOUTH FORK BATTLE CREEK BELOW DIVERSION TO COLEMAN CANAL, NEAR MANTON, CA

LOCATION.—Lat 40°24'10", long 121°58'02", in NW 1/4 NW 1/4 sec.3, T.29 N., R.1 W., Tehama County, Hydrologic Unit 18020118, on right bank, 7.5 mi southwest of Shingletown, and 5.7 mi southwest of Manton.

DRAINAGE AREA.—102 mi².

PERIOD OF RECORD.—October 1987 to current year (operated as a low-flow station only). Unpublished records for water years 1978–86 available in files of the U.S. Geological Survey. Fragmentary records for water year 1977 available in files of Pacific Gas & Electric Co.

GAGE.—Water-stage recorder and metal Alaskan fishladder. Elevation of gage is 980 ft above sea level, from topographic map.

REMARKS.—This station records fishwater release only. Prior to water year 1996 flow computed to 10 ft³/s. The minimum release requirement is 5.0 ft³/s at all times; flow is computed to 45 ft³/s. See schematic diagram of Battle Creek and Cow Creek Basins.

COOPERATION.—Records were collected by the Pacific Gas & Electric Co., under general supervision of the U.S. Geological Survey, in connection with Federal Energy Regulatory Commission project no. 1121.

DISCHARGE, CUBIC FEET PER SECOND, WATER YEAR OCTOBER 2001 TO SEPTEMBER 2002

DAILY MEAN VALUES

DAY	OCT	NOV	DEC	JAN	FEB	MAR	APR	MAY	JUN	JUL	AUG	SEP
1	5.7	5.8	---	---	9.4	17	---	44	---	15	13	13
2	5.7	5.8	---	---	9.4	10	---	36	44	14	13	13
3	5.7	5.8	---	---	9.4	9.7	---	37	13	15	13	13
4	5.7	5.8	---	---	9.4	9.7	---	41	9.6	14	13	13
5	5.6	5.8	---	---	9.5	9.5	---	---	9.1	14	14	13
6	5.7	5.8	---	---	9.4	33	---	---	8.9	15	14	13
7	5.9	5.8	---	---	11	---	---	---	9.0	15	13	13
8	5.7	5.8	---	---	11	37	---	42	9.0	15	13	14
9	5.6	5.8	---	---	9.3	21	---	36	9.0	16	13	13
10	5.8	5.9	---	---	9.5	---	---	32	9.0	18	13	12
11	5.7	6.2	28	---	9.4	34	---	21	9.0	14	13	12
12	5.8	6.6	21	---	9.4	13	---	9.5	10	12	13	13
13	6.3	6.1	15	39	9.5	32	---	10	8.8	13	12	13
14	6.6	6.0	---	26	9.4	22	---	12	8.7	12	13	12
15	6.7	6.0	15	18	9.5	17	---	13	8.7	12	12	12
16	6.6	6.1	9.3	11	9.5	10	---	14	8.7	13	12	13
17	6.2	6.2	---	11	9.5	9.5	---	16	8.7	13	12	12
18	6.2	6.1	---	10	9.5	9.4	33	24	8.7	13	13	13
19	6.3	6.0	---	10	16	9.6	37	---	8.8	13	14	14
20	6.2	6.2	---	10	---	9.4	32	---	8.8	14	14	14
21	6.1	6.7	---	10	---	9.6	26	---	8.8	14	14	15
22	6.1	39	---	11	---	10	19	---	8.9	13	14	15
23	6.1	7.4	---	9.6	---	30	18	---	8.7	13	14	14
24	5.8	---	30	9.6	---	30	24	---	8.9	13	13	14
25	5.9	---	9.4	9.6	---	24	33	---	8.8	13	13	14
26	5.9	9.8	10	26	36	15	---	---	8.8	13	13	14
27	5.9	8.1	9.4	15	32	16	---	---	12	13	13	14
28	5.9	8.0	---	10	27	18	---	---	15	14	13	14
29	6.0	32	---	9.5	---	33	---	---	15	13	13	14
30	6.0	---	---	9.5	---	37	---	---	14	12	13	14
31	5.9	---	---	9.4	---	41	---	---	---	12	13	---
TOTAL	185.3	---	---	---	---	---	---	---	---	423	406	400
MEAN	5.977	---	---	---	---	---	---	---	---	13.65	13.10	13.33
MAX	6.7	---	---	---	---	---	---	---	---	18	14	15
MIN	5.6	---	---	---	---	---	---	---	---	12	12	12
AC-FT	368	---	---	---	---	---	---	---	---	839	805	793

11376550 BATTLE CREEK BELOW COLEMAN FISH HATCHERY, NEAR COTTONWOOD, CA

LOCATION.—Lat 40°23'54", long 122°08'43", in SW 1/4 NE 1/4 sec.1, T.29 N., R.3 W., [Shasta County](#), Hydrologic Unit 18020101, U.S. Fish and Wildlife Service land, on right bank, 3.7 mi downstream from Spring Branch, 5.7 mi upstream from mouth, and 7.0 mi east of Cottonwood.

DRAINAGE AREA.—357 mi².

PERIOD OF RECORD.—October 1940 to September 1996, October 1996 to September 1997 (operated as a low-flow station only), October 1997 to current year.

CHEMICAL DATA: Water years 1962–66.

WATER TEMPERATURE: Water years 1966–79.

SEDIMENT DATA: Water years 1962–70.

GAGE.—Water-stage recorder. Elevation of gage is 415 ft above sea level, from topographic map. Prior to Oct. 1, 1961, water-stage recorder at site 0.6 mi upstream at different datum published as station 11376500, "Battle Creek near Cottonwood"; low-flow records not equivalent owing to Coleman Fish Hatchery diversion, maximum flows considered equivalent.

REMARKS.—Records good. Some regulation at low flows by five small powerplants, several small reservoirs, and Coleman Fish Hatchery.

Coleman Fish Hatchery diverts from 50 to 90 ft³/s and pumps ground water for temperature control, which is returned above the station. At times, 10 ft³/s diverted upstream from station for irrigation. See schematic diagrams of [Battle Creek and Cow Creek Basins](#) and [upper Sacramento River Basin](#).

EXTREMES FOR PERIOD OF RECORD.—Maximum discharge, 24,300 ft³/s, Jan. 24, 1970, gage height, 14.75 ft, from rating curve extended above 4,200 ft³/s, on basis of slope-area measurement of peak flow; minimum, 52 ft³/s, Aug. 8, 1962.

EXTREMES OUTSIDE PERIOD OF RECORD.—Maximum stage known, 15.8 ft, Dec. 11, 1937, from floodmarks, site and datum then in use, discharge, 35,000 ft³/s, by slope-area measurement.

EXTREMES FOR CURRENT YEAR.—Peak discharges greater than base discharge of 3,100 ft³/s, or maximum:

Date	Time	Discharge (ft ³ /s)	Gage height (ft)
Jan. 2	2100	3,650	5.43

DISCHARGE, CUBIC FEET PER SECOND, WATER YEAR OCTOBER 2001 TO SEPTEMBER 2002

DAILY MEAN VALUES

DAY	OCT	NOV	DEC	JAN	FEB	MAR	APR	MAY	JUN	JUL	AUG	SEP
1	227	268	801	838	394	465	461	469	447	276	216	201
2	229	258	765	2390	391	456	459	443	437	274	215	202
3	231	256	535	1660	382	442	476	434	440	268	212	202
4	227	256	427	883	376	435	497	436	411	263	213	202
5	230	259	396	727	372	436	516	437	401	260	214	204
6	230	257	807	1240	368	468	501	442	401	254	209	205
7	238	262	457	951	384	617	486	449	396	249	209	201
8	231	259	383	751	457	531	479	446	392	249	209	204
9	223	260	793	700	417	482	485	433	376	245	206	201
10	223	265	415	624	394	529	536	428	357	238	206	202
11	225	272	357	572	384	533	509	419	340	238	207	201
12	223	338	339	539	381	499	494	402	335	235	207	201
13	227	369	326	518	378	479	490	414	338	236	207	202
14	229	275	668	505	374	468	515	417	334	236	205	201
15	224	257	423	487	375	450	578	423	331	235	209	211
16	218	253	367	471	381	441	527	425	329	230	207	208
17	216	263	928	457	390	432	525	430	319	228	206	210
18	220	257	590	434	383	419	489	440	315	227	205	209
19	221	251	766	426	564	417	457	451	314	225	205	208
20	230	254	1090	418	1770	408	445	527	306	226	206	209
21	229	357	659	429	847	401	422	460	308	223	207	208
22	236	501	708	437	665	410	413	413	305	226	206	208
23	233	335	581	404	620	449	406	395	301	227	207	209
24	233	1200	468	394	572	493	420	382	297	225	205	211
25	230	436	419	393	540	456	432	378	295	220	200	211
26	233	316	395	480	516	432	444	383	294	219	182	211
27	236	282	375	520	502	426	499	389	287	218	199	212
28	235	297	448	425	484	425	491	391	287	216	201	217
29	239	616	1030	427	---	441	450	400	284	218	204	216
30	282	389	1140	410	---	448	469	428	282	217	205	218
31	289	---	1460	398	---	450	---	413	---	215	202	---
TOTAL	7197	10118	19316	20308	14061	14238	14371	13197	10259	7316	6391	6205
MEAN	232.2	337.3	623.1	655.1	502.2	459.3	479.0	425.7	342.0	236.0	206.2	206.8
MAX	289	1200	1460	2390	1770	617	578	527	447	276	216	218
MIN	216	251	326	393	368	401	406	378	282	215	182	201
AC-FT	14280	20070	38310	40280	27890	28240	28500	26180	20350	14510	12680	12310

11376550 BATTLE CREEK BELOW COLEMAN FISH HATCHERY, NEAR COTTONWOOD, CA—Continued

STATISTICS OF MONTHLY MEAN DATA FOR WATER YEARS 1962 - 2002, BY WATER YEAR (WY)

	OCT	NOV	DEC	JAN	FEB	MAR	APR	MAY	JUN	JUL	AUG	SEP
MEAN	297.5	410.7	546.8	753.6	741.8	741.4	643.5	618.4	488.9	333.5	267.0	261.9
MAX	589	1058	1602	2434	1919	1802	1160	1578	1453	817	540	449
(WY)	1963	1982	1984	1970	1986	1983	1995	1998	1998	1998	1998	1998
MIN	139	205	224	234	260	266	231	266	207	168	160	154
(WY)	1993	1993	1992	1991	1977	1977	1977	1977	1992	1992	1992	1992

SUMMARY STATISTICS	FOR 2001 CALENDAR YEAR		FOR 2002 WATER YEAR		WATER YEARS 1962 - 2002	
ANNUAL TOTAL	124383		142977			
ANNUAL MEAN	340.8		391.7		508.2	
HIGHEST ANNUAL MEAN					926 1998	
LOWEST ANNUAL MEAN					238 1977	
HIGHEST DAILY MEAN	1460	Dec 31	2390	Jan 2	10900	Jan 16 1974
LOWEST DAILY MEAN	198	Aug 18	182	Aug 26	102	Oct 27 1992
ANNUAL SEVEN-DAY MINIMUM	201	Aug 16	199	Aug 25	110	Oct 22 1992
MAXIMUM PEAK FLOW			3650	Jan 2	24300	Jan 24 1970
MAXIMUM PEAK STAGE			5.43	Jan 2	14.75	Jan 24 1970
ANNUAL RUNOFF (AC-FT)	246700		283600		368100	
10 PERCENT EXCEEDS	468		550		892	
50 PERCENT EXCEEDS	296		381		370	
90 PERCENT EXCEEDS	211		208		223	

11377100 SACRAMENTO RIVER ABOVE BEND BRIDGE, NEAR RED BLUFF, CA

LOCATION.—Lat 40°17'19", long 122°11'08", in NW 1/4 NE 1/4 sec.15, T.28 N., R.3 W., [Tehama County](#), Hydrologic Unit 18020103, on left bank, 2.7 mi upstream from Bend Bridge, and 8.1 mi northeast of Red Bluff.

DRAINAGE AREA.—8,900 mi², excluding Goose Lake Basin.

PERIOD OF RECORD.—1879–88 annual observed maximums only, published in WSP 1315-A. January 1892 to current year. Monthly discharges only for some periods and yearly estimates for some incomplete years, published in WSP 1315-A. Published as "at Red Bluff" 1894–96, as "at Jellys Ferry" 1895–1902, and as "near Red Bluff" 1903–68 (station 11378000).

CHEMICAL DATA: Water years 1955–81, 1996–98.

SPECIFIC CONDUCTANCE: Water years 1955–63.

WATER TEMPERATURE: Water years 1955–80.

SEDIMENT DATA: Water years 1958–70, 1996–98 .

REVISED RECORDS.—WSP 861: 1904, 1907, 1909, 1914–15, 1927–28. WSP 1315-A: 1916(M), 1918(M), 1941(M). WSP 1931: Drainage area. WDR CA-69-2: 1965.

GAGE.—Water-stage recorder and crest-stage gage. Datum of gage is 285.77 ft above sea level. See WSP 2131 for history of changes prior to September 1968.

REMARKS.—Records excellent. Flow completely regulated by Shasta Lake (station 11370000), 52 mi upstream, since Dec. 30, 1943. Diversions, in addition to those on tributaries, for irrigation of about 22,000 acres between stations at Keswick and above Bend Bridge. Transbasin diversion from Trinity River to Whiskeytown Lake (station 11371700) via Judge Francis Carr Powerplant (station 11525430) started in April 1963. See schematic diagrams of [upper Sacramento River](#) and [Battle Creek and Cow Creek Basins](#).

EXTREMES FOR PERIOD OF RECORD.—Maximum discharge, 291,000 ft³/s, Feb. 28, 1940, gage height, 38.9 ft, site and datum then in use, from rating curve extended above 170,000 ft³/s, on basis of velocity-area studies; minimum (water years 1892–2000), 2,000 ft³/s, Mar. 29, 1944. Since regulation by Shasta Lake in 1943, maximum discharge, 170,000 ft³/s, Dec. 22, 1964, gage height, 28.15 ft, site and datum then in use; maximum gage height, 36.60 ft, Jan. 24, 1970.

DISCHARGE, CUBIC FEET PER SECOND, WATER YEAR OCTOBER 2001 TO SEPTEMBER 2002

DAILY MEAN VALUES

DAY	OCT	NOV	DEC	JAN	FEB	MAR	APR	MAY	JUN	JUL	AUG	SEP
1	8250	6810	16600	16600	6580	9330	6520	9840	11600	14800	13800	7980
2	8210	6560	21200	51000	6530	9140	6480	9600	11600	14500	13800	7930
3	8150	6580	13300	47300	6470	9050	6510	9210	11600	14200	13800	7950
4	8080	6340	9610	27900	6430	8950	6570	9510	11700	14500	13900	7820
5	7990	6350	10100	21200	6380	8880	6620	9690	11500	14600	13900	7740
6	7250	6490	20600	32900	6340	9120	6590	9660	11400	14600	13900	8070
7	6810	6380	10900	28000	6470	10700	6510	9620	11700	14400	13600	8360
8	6830	6200	8490	22200	7740	10300	6390	9570	11900	14700	13100	8410
9	6800	6200	9790	19300	7190	9420	6320	9310	11900	14700	12700	8410
10	6740	6170	7900	16900	6840	11600	6640	9200	11900	14800	12400	8400
11	6610	6220	7160	15300	6700	10800	6500	9590	12200	14800	12400	8410
12	6370	6450	6810	13800	6620	9740	6350	9660	12600	15000	12500	8330
13	6220	6980	6610	12900	6570	9280	6410	9680	12900	15300	12500	8280
14	6210	6550	19900	11900	6490	8980	6770	9920	13700	15300	12500	8430
15	6230	6050	10400	11100	6520	8740	7210	12700	14400	15400	12200	8490
16	6250	5880	8280	10200	6520	8270	7390	11600	14300	15400	12000	8520
17	6210	5960	13100	9640	6560	8020	7670	11400	14300	15300	11700	8510
18	6130	5750	10600	9060	6550	7950	7430	11400	14600	15300	11600	8550
19	6150	5700	12900	8830	9060	7890	7430	11500	14500	15400	11600	8260
20	6150	5680	20100	8560	32600	7730	7500	11800	14700	15400	11000	8140
21	6430	5950	21800	8240	15200	7490	7410	11500	14800	15500	10300	8130
22	6540	11600	17800	8170	11100	7190	7420	11000	15200	15400	9740	8150
23	6490	6980	18700	7750	9870	8010	8450	10900	15300	15400	9060	8230
24	6460	13700	11800	7380	9050	9210	8450	10700	15200	15400	8420	8220
25	6470	9480	9440	7110	8360	7810	8700	10700	15300	15400	8310	8180
26	6630	6910	8420	7200	7900	7110	8910	11600	15400	15200	8270	8120
27	6690	6250	7830	7480	8850	6800	9320	11600	15300	15000	9070	8180
28	6640	6140	8180	6990	9650	6710	9610	11600	15200	15000	9860	7920
29	6650	15800	15300	6870	---	6630	9480	11600	14600	15000	8950	7770
30	6870	9770	14400	6750	---	6580	9820	11600	15000	14600	8250	7760
31	6940	---	28200	6650	---	6540	---	11600	---	14000	7960	---
TOTAL	210450	217880	406220	475180	241140	263970	223380	328860	406300	464300	353090	245650
MEAN	6789	7263	13100	15330	8612	8515	7446	10610	13540	14980	11390	8188
MAX	8250	15800	28200	51000	32600	11600	9820	12700	15400	15500	13900	8550
MIN	6130	5680	6610	6650	6340	6540	6320	9200	11400	14000	7960	7740
AC-FT	417400	432200	805700	942500	478300	523600	443100	652300	805900	920900	700400	487200

11377100 SACRAMENTO RIVER ABOVE BEND BRIDGE, NEAR RED BLUFF, CA—Continued

STATISTICS OF MONTHLY MEAN DATA FOR WATER YEARS 1892 - 1943, BY WATER YEAR (WY)

	OCT	NOV	DEC	JAN	FEB	MAR	APR	MAY	JUN	JUL	AUG	SEP
MEAN	4853	7538	11940	18960	24760	22210	18280	12310	7635	5127	4381	4404
MAX	10910	21420	42780	72340	69240	73280	38810	27910	17640	10170	9050	8481
(WY)	1905	1904	1893	1909	1902	1904	1904	1896	1906	1893	1893	1893
MIN	2847	3300	3618	4142	4778	4434	4014	3253	2969	2622	2505	2551
(WY)	1933	1937	1937	1937	1920	1924	1924	1924	1924	1931	1931	1934

SUMMARY STATISTICS

WATER YEARS 1892 - 1943

ANNUAL MEAN	11800
HIGHEST ANNUAL MEAN	22180 1904
LOWEST ANNUAL MEAN	4096 1924
HIGHEST DAILY MEAN	261000 Feb 28 1940
LOWEST DAILY MEAN	2400 Aug 13 1931
ANNUAL SEVEN-DAY MINIMUM	2470 Aug 7 1931
MAXIMUM PEAK FLOW	291000 Feb 28 1940
MAXIMUM PEAK STAGE	38.9 Feb 28 1940
ANNUAL RUNOFF (AC-FT)	8545000
10 PERCENT EXCEEDS	24000
50 PERCENT EXCEEDS	6500
90 PERCENT EXCEEDS	3520

STATISTICS OF MONTHLY MEAN DATA FOR WATER YEARS 1946 - 1962, BY WATER YEAR (WY)

MEAN	6501	6932	11440	16840	19340	11950	10210	10260	9469	10030	10030	7510
MAX	10490	11180	29530	52620	76870	24840	32420	17830	12930	11630	11800	10230
(WY)	1958	1958	1956	1956	1958	1958	1958	1948	1948	1951	1958	1958
MIN	5468	4681	4336	5104	4579	4727	5335	6788	7253	7476	7080	5289
(WY)	1960	1960	1960	1957	1948	1955	1950	1947	1947	1947	1947	1947

SUMMARY STATISTICS

WATER YEARS 1946 - 1962

ANNUAL MEAN	10840
HIGHEST ANNUAL MEAN	20330 1958
LOWEST ANNUAL MEAN	6690 1947
HIGHEST DAILY MEAN	125000 Feb 19 1958
LOWEST DAILY MEAN	3640 Jan 31 1949
ANNUAL SEVEN-DAY MINIMUM	3830 Feb 27 1948
MAXIMUM PEAK FLOW	139000 Feb 19 1958
MAXIMUM PEAK STAGE	24.98 Feb 19 1958
ANNUAL RUNOFF (AC-FT)	7852000
10 PERCENT EXCEEDS	16900
50 PERCENT EXCEEDS	8430
90 PERCENT EXCEEDS	5190

STATISTICS OF MONTHLY MEAN DATA FOR WATER YEARS 1964 - 2002, BY WATER YEAR (WY)

MEAN	6833	9109	13800	18570	20550	17960	12090	12280	12400	13070	11700	8527
MAX	10600	29690	43350	61060	68400	75830	35110	22920	21150	16760	15790	11900
(WY)	1984	1974	1984	1970	1998	1983	1974	1995	1998	1998	1998	1998
MIN	3935	4068	4296	4573	4700	5476	4804	7322	7431	7811	7998	5323
(WY)	1978	1993	1977	1992	1990	1994	1991	1992	1992	1992	1992	1977

SUMMARY STATISTICS

FOR 2001 CALENDAR YEAR

FOR 2002 WATER YEAR

WATER YEARS 1964 - 2002

ANNUAL TOTAL	3677080	3836420	
ANNUAL MEAN	10070	10510	13050
HIGHEST ANNUAL MEAN			25450 1983
LOWEST ANNUAL MEAN			6494 1991
HIGHEST DAILY MEAN	37800	Mar 5 51000	Jan 2 127000 Jan 27 1970
LOWEST DAILY MEAN	4970	Feb 8 5680	Nov 20 3200 Oct 11 1977
ANNUAL SEVEN-DAY MINIMUM	5200	Feb 3 5850	Nov 15 3210 Oct 10 1977
MAXIMUM PEAK FLOW		65800	Jan 2 170000 Dec 22 1964
MAXIMUM PEAK STAGE		20.61	Jan 2 36.60 Jan 24 1970
ANNUAL RUNOFF (AC-FT)	7293000	7610000	9453000
10 PERCENT EXCEEDS	15300	15300	20400
50 PERCENT EXCEEDS	9060	9060	10000
90 PERCENT EXCEEDS	5980	6470	5630

11379500 ELDER CREEK NEAR PASKENTA, CA

LOCATION.—Lat 40°01'29", long 122°30'31", in SE 1/4 NW 1/4 sec.14, T.25 N., R.6 W., Tehama County, Hydrologic Unit 18020103, on left bank, 2.5 mi downstream from South Fork Elder Creek, 8.2 mi northwest of Flournoy, and 10 mi north of Paskenta.

DRAINAGE AREA.—92.4 mi².

PERIOD OF RECORD.—October 1948 to current year. Monthly discharge only for some periods, published in WSP 1315-A.

REVISED RECORDS.—WSP 1515: 1956. WDR CA-70-2: 1967(P). WDR CA-75-4: 1966–67(P), 1969–71(P), 1973(P). WDR CA-78-4: Drainage area. WDR CA-94-4: 1993(P).

GAGE.—Water-stage recorder. Datum of gage is 718.1 ft above sea level. Prior to Aug. 13, 1965, water-stage recorder at site 300 ft downstream at datum 5.13 ft lower.

REMARKS.—Records good. No regulation or large diversion upstream from station. See schematic diagram of upper Sacramento River Basin.

EXTREMES FOR PERIOD OF RECORD.—Maximum discharge, 17,700 ft³/s, Feb. 28, 1983, gage height, 12.10 ft, from rating curve extended above 5,200 ft³/s, on basis of slope-area measurements at gage height 11.34 ft and of peak flow; maximum gage height, 13.90 ft, Feb. 24, 1958, site and datum then in use; no flow at times some years.

EXTREMES FOR CURRENT YEAR.—Peak discharges greater than base discharge of 2,000 ft³/s, or maximum:

Date	Time	Discharge (ft ³ /s)	Gage height (ft)	Date	Time	Discharge (ft ³ /s)	Gage height (ft)
Dec. 1	1115	2,280	6.25	Jan. 2	0530	6,390	8.84
Dec. 20	1330	3,070	6.91				

DISCHARGE, CUBIC FEET PER SECOND, WATER YEAR OCTOBER 2001 TO SEPTEMBER 2002

DAILY MEAN VALUES

DAY	OCT	NOV	DEC	JAN	FEB	MAR	APR	MAY	JUN	JUL	AUG	SEP
1	1.7	5.2	712	909	67	109	91	44	19	7.4	e1.6	e0.42
2	1.3	4.6	527	3820	65	103	98	40	19	e7.0	e1.6	e0.37
3	1.2	4.2	239	1050	61	97	112	37	18	e6.9	e1.5	e0.36
4	1.1	4.0	135	564	59	92	120	36	16	e6.2	e1.5	e0.35
5	1.1	3.9	112	508	57	89	123	35	15	e6.0	e1.4	e0.34
6	1.4	3.9	135	1260	55	93	113	34	15	e5.5	e1.3	0.32
7	1.6	3.9	109	832	66	100	104	32	14	e5.3	e1.3	0.45
8	1.7	3.9	89	573	107	91	96	31	13	e5.2	e1.3	0.48
9	1.6	3.9	88	461	78	86	96	31	13	e5.0	e1.3	0.44
10	1.5	3.9	71	345	71	113	97	30	13	e4.7	e1.3	0.54
11	1.5	8.6	60	282	68	92	91	29	13	e4.6	e1.4	0.52
12	1.4	66	53	250	66	87	89	28	12	e4.6	e1.4	0.50
13	1.4	30	89	224	66	85	84	28	12	e4.5	e1.4	0.48
14	1.4	20	520	202	67	82	87	27	12	e4.0	e1.3	0.42
15	1.3	14	154	178	68	78	87	26	11	e3.7	e1.2	0.44
16	1.4	12	112	158	68	76	78	26	11	e3.4	e1.2	0.53
17	1.5	11	231	147	75	72	71	25	11	e3.2	e1.1	0.55
18	1.5	9.6	161	135	69	69	62	25	11	e3.0	e1.0	0.53
19	1.5	8.6	194	126	135	65	55	25	10	e2.8	e0.84	0.46
20	1.5	8.3	1230	117	252	62	51	60	9.8	e2.7	e0.74	0.44
21	1.6	50	581	113	201	62	48	112	9.7	e2.5	e0.68	0.49
22	1.7	130	651	106	185	64	46	42	9.7	e2.4	e0.62	0.47
23	1.8	37	318	99	177	113	44	32	9.3	e2.3	e0.57	0.45
24	1.8	314	221	93	155	90	42	28	9.2	e2.2	e0.54	0.41
25	1.9	88	177	89	137	74	42	26	9.0	e2.1	e0.52	0.38
26	1.9	38	157	90	126	68	42	25	8.6	e2.1	e0.51	0.37
27	2.0	25	159	84	120	66	43	24	8.4	e2.0	e0.51	0.44
28	2.1	207	248	81	116	65	44	23	8.1	e1.9	e0.51	0.53
29	2.4	313	468	78	---	71	42	22	7.9	e1.8	e0.50	0.60
30	7.2	81	456	72	---	77	42	22	7.6	e1.7	e0.49	0.72
31	7.2	---	699	68	---	83	---	20	---	e1.7	e0.47	---
TOTAL	60.2	1512.5	9156	13114	2837	2574	2240	1025	355.3	118.4	31.60	13.80
MEAN	1.942	50.42	295.4	423.0	101.3	83.03	74.67	33.06	11.84	3.819	1.019	0.460
MAX	7.2	314	1230	3820	252	113	123	112	19	7.4	1.6	0.72
MIN	1.1	3.9	53	68	55	62	42	20	7.6	1.7	0.47	0.32
AC-FT	119	3000	18160	26010	5630	5110	4440	2030	705	235	63	27

e Estimated.

11379500 ELDER CREEK NEAR PASKENTA, CA—Continued

STATISTICS OF MONTHLY MEAN DATA FOR WATER YEARS 1949 - 2002, BY WATER YEAR (WY)

	OCT	NOV	DEC	JAN	FEB	MAR	APR	MAY	JUN	JUL	AUG	SEP
MEAN	9.029	47.10	132.2	251.5	292.9	239.4	150.3	82.27	31.24	8.869	3.414	3.085
MAX	102	310	649	1208	1636	1176	497	463	262	49.6	17.5	11.3
(WY)	1958	1974	1984	1995	1958	1983	1958	1998	1998	1998	1998	1978
MIN	0.66	2.89	4.06	5.38	7.00	22.6	13.8	13.4	2.52	0.32	0.002	0.15
(WY)	1992	1991	1991	1991	1977	1964	1977	1977	1977	1977	1994	1991

SUMMARY STATISTICS	FOR 2001 CALENDAR YEAR	FOR 2002 WATER YEAR	WATER YEARS 1949 - 2002
ANNUAL TOTAL	34209.62	33037.80	
ANNUAL MEAN	93.72	90.51	103.4
HIGHEST ANNUAL MEAN			303 1983
LOWEST ANNUAL MEAN			6.69 1977
HIGHEST DAILY MEAN	3860 Mar 4	3820 Jan 2	7650 Dec 22 1964
LOWEST DAILY MEAN	0.54 Sep 8	0.32 Sep 6	0.00 Aug 6 1950
ANNUAL SEVEN-DAY MINIMUM	0.55 Sep 6	0.37 Sep 1	0.00 Aug 14 1950
MAXIMUM PEAK FLOW		6390 Jan 2	17700 Feb 28 1983
MAXIMUM PEAK STAGE		8.84 Jan 2	13.90 Feb 24 1958
ANNUAL RUNOFF (AC-FT)	67850	65530	74890
10 PERCENT EXCEEDS	227	177	240
50 PERCENT EXCEEDS	17	26	19
90 PERCENT EXCEEDS	0.77	0.56	1.5

11381500 MILL CREEK NEAR LOS MOLINOS, CA

LOCATION.—Lat 40°03'17", long 122°01'23", in NE 1/4 NW 1/4 sec.6, T.25 N., R.1 W., Tehama County, Hydrologic Unit 18020103, on right bank, 4.5 mi northeast of Los Molinos, and 5.5 mi upstream from mouth.

DRAINAGE AREA.—131 mi².

WATER-DISCHARGE RECORDS

PERIOD OF RECORD.—September 1909 to August 1913 (fragmentary), October 1928 to current year.

REVISED RECORDS.—WSP 1315-A: 1929(M). WSP 1931: Drainage area. WSP 2131: 1938(M).

GAGE.—Water-stage recorder. Elevation of gage is 385 ft above sea level, from topographic map. Prior to September 1913, nonrecording gage at site 0.3 mi downstream at different datum.

REMARKS.—Records good. No storage or large diversion upstream from station. See schematic diagram of [upper Sacramento River Basin](#).

EXTREMES FOR PERIOD OF RECORD (water years 1929–2001).—Maximum discharge, 36,400 ft³/s, Dec. 11, 1937, gage height, 23.4 ft, from floodmarks, from rating curve extended above 14,000 ft³/s, on basis of step-backwater computation and slope-area measurement of peak flow; minimum, 49 ft³/s, Dec. 13, 1932.

EXTREMES FOR CURRENT YEAR.—Peak discharges greater than base discharge of 2,400 ft³/s, or maximum:

Date	Time	Discharge (ft ³ /s)	Gage height (ft)
Jan. 1	1330	2,470	6.37

DISCHARGE, CUBIC FEET PER SECOND, WATER YEAR OCTOBER 2001 TO SEPTEMBER 2002

DAILY MEAN VALUES

DAY	OCT	NOV	DEC	JAN	FEB	MAR	APR	MAY	JUN	JUL	AUG	SEP
1	100	108	710	1610	173	278	380	280	411	164	114	92
2	99	104	942	1630	171	263	415	273	369	160	112	92
3	97	100	478	851	167	247	468	279	341	157	113	91
4	97	97	313	570	164	232	504	295	320	155	113	90
5	97	95	271	637	162	228	541	319	322	152	113	90
6	97	93	316	899	160	340	484	326	327	149	112	90
7	97	92	278	614	163	621	466	345	315	145	110	91
8	97	90	223	523	221	499	446	319	296	138	109	92
9	97	88	318	446	187	404	451	309	265	131	107	92
10	97	88	241	384	173	879	476	314	249	130	107	90
11	96	102	196	343	170	504	460	284	242	127	105	90
12	95	289	177	314	169	423	442	286	237	125	104	90
13	95	232	167	291	169	395	445	315	239	124	103	90
14	95	146	374	275	169	352	519	308	235	122	102	90
15	95	121	246	268	169	320	569	319	233	120	102	90
16	95	113	196	244	174	302	440	334	224	119	100	90
17	95	120	621	228	189	284	402	346	215	119	100	91
18	95	115	441	215	183	270	353	370	217	119	98	91
19	95	110	557	206	206	252	324	376	215	120	97	90
20	95	111	513	198	549	243	305	363	207	119	97	90
21	95	231	445	201	553	244	288	308	204	117	97	89
22	95	548	502	205	446	255	279	279	208	121	97	87
23	95	224	336	186	420	308	288	270	196	119	97	87
24	95	739	273	180	381	327	304	262	190	117	97	86
25	95	327	235	177	341	303	323	269	184	116	97	85
26	95	195	214	204	313	287	342	284	182	116	97	85
27	95	162	209	214	298	285	371	307	181	115	95	85
28	95	152	490	191	288	287	330	308	177	115	95	87
29	95	330	480	186	---	312	299	337	173	114	93	88
30	124	243	1280	179	---	335	288	394	170	114	93	89
31	149	---	733	176	---	354	---	420	---	114	93	---
TOTAL	3054	5565	12775	12845	6928	10633	12002	9798	7344	3973	3169	2680
MEAN	98.52	185.5	412.1	414.4	247.4	343.0	400.1	316.1	244.8	128.2	102.2	89.33
MAX	149	739	1280	1630	553	879	569	420	411	164	114	92
MIN	95	88	167	176	160	228	279	262	170	114	93	85
AC-FT	6060	11040	25340	25480	13740	21090	23810	19430	14570	7880	6290	5320

11381500 MILL CREEK NEAR LOS MOLINOS, CA—Continued

STATISTICS OF MONTHLY MEAN DATA FOR WATER YEARS 1929 - 2002, BY WATER YEAR (WY)

	OCT	NOV	DEC	JAN	FEB	MAR	APR	MAY	JUN	JUL	AUG	SEP
MEAN	124.7	199.4	347.0	449.1	481.3	450.9	430.0	440.2	328.7	179.3	118.1	106.8
MAX	684	1039	1365	1837	1744	1278	862	923	790	510	230	168
(WY)	1963	1974	1965	1970	1986	1983	1982	1938	1998	1998	1983	1983
MIN	76.0	75.1	87.4	96.8	98.6	107	112	122	94.9	67.8	61.4	65.4
(WY)	1930	1930	1977	1977	1977	1977	1977	1977	1931	1931	1931	1931

SUMMARY STATISTICS	FOR 2001 CALENDAR YEAR		FOR 2002 WATER YEAR		WATER YEARS 1929 - 2002	
ANNUAL TOTAL	77376		90766			
ANNUAL MEAN	212.0		248.7		303.7	
HIGHEST ANNUAL MEAN					576	
LOWEST ANNUAL MEAN					93.6	
HIGHEST DAILY MEAN	1280	Dec 30	1630	Jan 2	14400	Jan 1 1997
LOWEST DAILY MEAN	88	Nov 9	85	Sep 25	52	Dec 12 1932
ANNUAL SEVEN-DAY MINIMUM	92	Aug 10	86	Sep 22	60	Jul 28 1931
MAXIMUM PEAK FLOW			2470	Jan 1	36400	Dec 11 1937
MAXIMUM PEAK STAGE			6.37	Jan 1	23.40	Dec 11 1937
ANNUAL RUNOFF (AC-FT)	153500		180000		220000	
10 PERCENT EXCEEDS	369		455		580	
50 PERCENT EXCEEDS	152		204		180	
90 PERCENT EXCEEDS	95		93		92	

11381500 MILL CREEK NEAR LOS MOLINOS, CA—Continued

WATER-QUALITY RECORDS

PERIOD OF RECORD.—Water year 1999 to current year.

WATER TEMPERATURE: Water year 1999 to current year.

PERIOD OF DAILY RECORD.—

WATER TEMPERATURE: October 1998 to current year.

INSTRUMENTATION.—Temperature recorder since Oct. 5, 1998.

REMARKS.—Records rated excellent.

EXTREMES FOR PERIOD OF DAILY RECORD.—

WATER TEMPERATURE: Maximum recorded, 27.0°C, July 14, 2002; minimum recorded, 0.5°C, Dec. 23, 1998.

EXTREME FOR CURRENT YEAR.—

WATER TEMPERATURE: Maximum recorded, 27.0°C, July 14; minimum recorded, 2.5°C, Jan. 29–31.

CROSS-SECTIONAL DATA, WATER YEAR OCTOBER 2001 TO SEPTEMBER 2002

Date	Time	DEPTH BOTTOM AT SAMPLE LOC- ATION, (FEET) (81903)	TEMPER- ATURE WATER (DEG C) (00010)	SAMPLE LOC- ATION, CROSS SECTION (FT FM L BANK) (00009)
APR				
04...*	1505	3.90	12.0	10.0
04...*	1510	4.10	12.0	20.0
04...*	1515	3.70	12.0	30.0
04...*	1520	3.70	12.0	40.0
04...*	1525	3.30	12.0	54.0

* Instantaneous discharge at the time of the cross-sectional measurement: Apr. 4, 494 ft³/s.

11381500 MILL CREEK NEAR LOS MOLINOS, CA—Continued

WATER TEMPERATURE, DEGREES C, WATER YEAR OCTOBER 2001 TO SEPTEMBER 2002

DAY	MAX	MIN	MAX	MIN	MAX	MIN	MAX	MIN	MAX	MIN	MAX	MIN
	OCTOBER		NOVEMBER		DECEMBER		JANUARY		FEBRUARY		MARCH	
1	20.0	17.0	13.0	12.0	8.5	8.0	10.5	9.5	5.5	3.5	8.5	6.5
2	20.0	17.5	12.5	11.0	9.5	8.5	11.0	10.0	6.0	5.0	8.0	6.0
3	20.0	18.0	12.5	11.0	8.5	7.5	10.0	8.5	6.0	5.0	8.5	6.5
4	19.5	17.5	12.5	11.0	7.5	6.0	8.5	7.5	6.0	5.0	8.5	7.5
5	19.0	17.0	12.5	11.0	8.0	7.0	9.0	8.0	6.5	5.5	8.5	8.0
6	17.5	15.5	12.0	11.0	9.0	8.0	9.5	9.0	6.5	5.5	10.0	8.5
7	17.0	15.5	11.5	10.5	9.0	7.5	9.0	7.5	8.0	6.0	9.0	7.0
8	17.5	15.5	11.0	10.0	8.0	7.5	9.0	8.5	7.5	6.0	7.0	5.0
9	17.0	15.0	11.5	10.0	8.5	7.5	9.0	8.0	7.0	5.5	7.5	5.5
10	15.5	13.5	12.0	10.5	7.5	6.0	8.5	7.5	7.0	6.0	9.0	7.0
11	15.5	14.0	13.0	11.0	6.0	5.5	8.5	7.5	7.5	6.5	10.0	8.0
12	15.5	13.5	13.0	12.5	6.0	5.0	8.5	8.0	9.0	7.0	10.5	9.5
13	16.0	13.5	12.5	11.5	7.5	6.0	8.0	6.5	9.5	8.5	9.5	7.5
14	15.5	14.0	12.5	11.5	7.5	6.5	7.0	5.5	9.5	8.0	8.0	6.0
15	15.5	14.0	13.0	12.0	6.5	5.5	5.5	4.5	9.0	8.5	8.0	6.0
16	16.0	14.0	12.5	12.0	7.0	5.5	5.0	4.5	9.0	8.5	8.0	6.5
17	16.0	14.5	12.5	11.5	8.5	7.0	5.5	4.5	9.0	8.0	7.5	6.5
18	15.5	14.0	11.5	10.5	8.5	8.0	5.0	4.5	8.5	8.0	7.0	5.0
19	15.0	13.5	11.5	10.5	8.5	8.5	4.5	4.5	8.5	8.5	8.5	6.5
20	14.5	13.0	12.5	11.5	8.5	8.0	5.0	4.5	9.5	8.5	10.0	8.5
21	14.0	13.0	12.5	12.0	8.0	7.5	6.0	5.0	9.5	8.5	11.0	10.0
22	14.5	12.5	12.5	10.5	8.0	8.0	5.5	3.5	10.0	8.5	11.0	10.0
23	14.0	13.0	10.5	9.0	8.5	7.5	4.0	3.0	10.0	9.0	10.0	9.0
24	13.5	12.0	10.5	9.0	7.5	6.5	4.5	3.5	9.0	8.0	10.5	9.0
25	13.0	11.0	9.5	8.0	8.0	6.5	5.5	4.5	9.0	7.5	10.5	8.5
26	13.0	11.0	8.0	7.0	9.0	8.0	7.0	5.5	9.5	8.0	11.0	9.0
27	13.0	11.5	7.0	6.5	9.0	9.0	6.5	4.5	10.0	8.5	11.5	9.5
28	13.5	12.5	7.0	6.5	9.5	9.0	4.5	3.5	10.0	8.5	12.5	10.0
29	13.5	13.0	7.5	6.5	10.0	9.0	3.5	2.5	---	---	13.0	11.0
30	14.0	13.5	8.0	7.0	11.0	9.5	3.5	2.5	---	---	13.0	11.0
31	13.5	12.5	---	---	11.0	10.0	3.5	2.5	---	---	13.0	10.5
MONTH	20.0	11.0	13.0	6.5	11.0	5.0	11.0	2.5	10.0	3.5	13.0	5.0
	APRIL		MAY		JUNE		JULY		AUGUST		SEPTEMBER	
1	13.5	10.5	12.5	9.5	19.5	17.0	24.0	21.5	26.0	22.5	23.0	20.0
2	13.5	11.0	14.5	11.5	18.5	16.0	24.0	22.0	25.5	22.5	23.0	20.5
3	13.5	11.5	15.5	13.0	18.5	15.5	24.0	21.5	25.0	22.0	22.5	20.0
4	13.0	12.0	16.0	13.5	19.0	15.5	24.0	21.5	23.0	21.0	21.5	19.5
5	12.5	10.5	16.0	13.5	21.0	17.0	24.0	21.5	22.0	19.5	20.0	18.0
6	12.0	9.5	15.5	12.5	21.0	17.5	25.0	21.5	22.0	18.5	19.0	17.0
7	12.5	10.5	15.0	12.5	19.5	16.5	24.5	22.0	21.5	18.5	19.0	16.0
8	13.0	11.0	14.0	11.0	18.5	15.0	24.0	21.0	22.0	18.5	18.5	15.5
9	12.5	10.5	14.5	11.5	16.0	13.5	25.0	21.0	23.0	19.0	19.0	15.5
10	13.0	10.0	14.5	12.0	17.5	14.5	26.5	22.0	24.0	20.0	20.0	16.5
11	13.0	11.5	14.0	11.0	19.0	16.0	26.5	23.0	24.5	21.0	20.5	17.0
12	13.0	11.0	16.0	13.0	19.5	17.0	26.5	24.0	25.0	21.5	20.5	17.5
13	14.5	11.5	17.0	13.5	20.5	17.5	26.5	23.0	25.5	22.0	20.5	18.0
14	14.5	12.5	16.0	13.0	20.5	18.0	27.0	23.5	25.5	22.5	20.0	18.0
15	12.5	10.5	16.5	13.5	20.5	18.5	25.5	23.0	25.5	22.5	19.5	18.0
16	10.5	8.5	16.5	13.5	20.5	18.5	24.5	21.5	25.0	22.5	19.5	17.0
17	8.5	7.0	17.5	14.0	20.0	18.0	24.5	21.0	25.0	22.5	19.5	17.0
18	9.5	7.0	17.0	14.5	21.5	19.0	24.5	21.0	24.0	21.5	19.5	17.0
19	11.0	8.0	15.0	11.0	21.0	19.0	25.5	21.5	23.5	21.5	20.0	17.0
20	12.5	9.5	11.0	10.0	21.0	19.0	26.0	22.5	22.5	20.0	20.0	17.5
21	13.0	10.5	12.5	9.5	21.0	19.5	25.5	23.0	22.0	19.5	20.5	18.0
22	14.0	11.5	14.0	10.0	21.0	19.5	25.5	22.5	22.0	19.0	20.5	18.0
23	15.0	12.5	15.5	12.0	22.0	19.5	25.0	22.5	21.5	19.0	20.5	18.0
24	15.0	12.5	17.0	14.0	22.0	20.0	25.0	21.5	21.5	18.5	20.0	17.5
25	16.0	13.0	18.0	15.0	22.5	20.5	24.5	21.0	22.0	18.5	20.0	17.5
26	15.5	13.0	18.5	15.5	23.0	21.5	24.5	20.5	22.0	19.0	19.0	17.0
27	13.0	10.0	18.0	15.5	23.0	21.0	25.5	21.5	22.0	19.5	18.5	17.0
28	10.5	8.5	18.0	14.0	23.5	21.5	26.0	22.5	23.5	20.0	18.0	16.0
29	10.5	9.5	20.0	16.0	24.0	22.0	25.5	22.5	23.0	20.5	17.5	16.0
30	10.5	9.5	20.5	17.5	24.0	22.0	25.5	22.5	23.0	20.5	17.0	16.0
31	---	---	20.0	18.0	---	---	25.5	23.0	23.0	20.0	---	---
MONTH	16.0	7.0	20.5	9.5	24.0	13.5	27.0	20.5	26.0	18.5	23.0	15.5

11383500 DEER CREEK NEAR VINA, CA

LOCATION.—Lat 40°00'51", long 121°56'50", in NW 1/4 NE 1/4 sec.23, T.25 N., R.1 W., Tehama County, Hydrologic Unit 18020103, on left bank, 0.5 mi upstream from irrigation diversion dam, and 7.9 mi northeast of Vina.

DRAINAGE AREA.—208 mi².

WATER-DISCHARGE RECORDS

PERIOD OF RECORD.—October 1911 to September 1915, March 1920 to current year. December 1937 to January 1939 first published in WDR CA-94-4. Monthly discharge only for some periods, published in WSP 1315-A.

REVISED RECORDS.—WSP 1315-A: 1940–42(M). WSP 1931: Drainage area.

GAGE.—Water-stage recorder. Datum of gage is 479.2 ft above sea level, from river-profile survey. Prior to Oct. 9, 1928, nonrecording gage at site 0.8 mi downstream at different datum. Oct. 9, 1928, to Jan. 19, 1939, water-stage recorder at present site at datum 2.64 ft higher.

REMARKS.—Records good. No storage or large diversions upstream from station. See schematic diagram of upper Sacramento River Basin.

EXTREMES FOR PERIOD OF RECORD.—Maximum discharge, 24,000 ft³/s, Jan. 1, 1997, gage height, 15.56 ft, from rating curve extended above 9,200 ft³/s; maximum gage height, 19.20 ft, Dec. 10, 1937; minimum, 43 ft³/s, Dec. 13, 1932.

EXTREMES FOR CURRENT YEAR.—Peak discharges greater than base discharge of 2,500 ft³/s, or maximum:

Date	Time	Discharge (ft ³ /s)	Gage height (ft)	Date	Time	Discharge (ft ³ /s)	Gage height (ft)
Dec. 2	0915	3,120	6.89	Jan. 2	0900	3,180	6.94

DISCHARGE, CUBIC FEET PER SECOND, WATER YEAR OCTOBER 2001 TO SEPTEMBER 2002

DAILY MEAN VALUES

DAY	OCT	NOV	DEC	JAN	FEB	MAR	APR	MAY	JUN	JUL	AUG	SEP
1	81	96	1040	697	171	310	404	252	136	93	76	79
2	81	87	1500	2620	168	290	427	236	134	91	76	80
3	81	85	612	1570	162	269	461	228	131	90	76	78
4	81	84	365	882	158	259	484	225	128	89	77	78
5	81	83	307	640	155	255	508	220	126	89	78	78
6	81	82	335	890	153	314	479	215	123	88	78	79
7	83	82	322	901	156	573	459	213	121	87	78	80
8	83	81	269	674	238	491	439	203	119	85	77	81
9	82	81	267	566	214	430	433	197	118	85	75	81
10	81	82	230	485	193	817	482	193	118	83	75	80
11	81	113	207	422	185	552	451	195	118	81	75	80
12	81	253	190	375	181	489	435	184	116	80	76	79
13	81	250	179	338	181	458	418	178	114	80	75	79
14	80	152	391	310	180	414	426	175	113	81	75	78
15	80	121	272	285	179	378	449	173	112	80	75	77
16	80	109	230	259	184	358	395	169	110	79	75	79
17	80	108	486	242	203	337	390	165	109	79	76	80
18	80	103	440	226	199	309	357	162	109	80	76	78
19	79	97	466	214	218	293	326	168	108	80	76	76
20	78	97	671	202	529	288	301	218	106	80	76	75
21	78	142	537	199	622	286	284	211	105	78	77	75
22	80	475	597	201	510	298	272	183	110	87	78	75
23	80	238	528	183	485	352	265	171	109	84	79	75
24	79	652	399	177	445	406	263	162	106	79	79	75
25	78	341	327	173	398	371	260	156	104	77	79	75
26	78	214	286	201	369	348	265	152	103	76	79	75
27	78	175	265	225	347	344	298	148	101	78	78	75
28	79	162	285	195	331	343	298	146	99	78	79	77
29	81	320	490	188	---	366	263	144	97	77	79	79
30	116	235	594	176	---	381	256	141	96	77	79	80
31	133	---	1030	173	---	390	---	138	---	76	79	---
TOTAL	2575	5200	14117	14889	7514	11769	11248	5721	3399	2547	2386	2336
MEAN	83.06	173.3	455.4	480.3	268.4	379.6	374.9	184.5	113.3	82.16	76.97	77.87
MAX	133	652	1500	2620	622	817	508	252	136	93	79	81
MIN	78	81	179	173	153	255	256	138	96	76	75	75
AC-FT	5110	10310	28000	29530	14900	23340	22310	11350	6740	5050	4730	4630

SACRAMENTO RIVER BASIN

131

11383500 DEER CREEK NEAR VINA, CA—Continued

STATISTICS OF MONTHLY MEAN DATA FOR WATER YEARS 1912 - 2002, BY WATER YEAR (WY)

	OCT	NOV	DEC	JAN	FEB	MAR	APR	MAY	JUN	JUL	AUG	SEP
MEAN	113.3	195.2	375.4	545.0	640.3	583.8	528.7	388.6	201.6	118.1	98.23	95.26
MAX	775	984	1825	2458	2600	2105	1494	1193	674	267	194	174
(WY)	1963	1974	1956	1970	1986	1983	1982	1995	1998	1983	1983	1983
MIN	63.4	65.2	82.5	87.4	95.3	109	99.5	77.2	66.1	55.8	53.3	55.2
(WY)	1935	1930	1931	1991	1977	1977	1977	1924	1924	1931	1931	1931

SUMMARY STATISTICS	FOR 2001 CALENDAR YEAR		FOR 2002 WATER YEAR		WATER YEARS 1912 - 2002	
ANNUAL TOTAL	73678		83701			
ANNUAL MEAN	201.9		229.3		322.4	
HIGHEST ANNUAL MEAN					700 1983	
LOWEST ANNUAL MEAN					86.2 1977	
HIGHEST DAILY MEAN	1620	Mar 5	2620	Jan 2	20100	Jan 1 1997
LOWEST DAILY MEAN	73	Aug 17	75	Aug 9	52	Aug 25 1931
ANNUAL SEVEN-DAY MINIMUM	74	Aug 12	75	Sep 20	53	Aug 21 1931
MAXIMUM PEAK FLOW			3180	Jan 2	24000	Jan 1 1997
MAXIMUM PEAK STAGE			6.94	Jan 2	19.20	Dec 10 1937
ANNUAL RUNOFF (AC-FT)	146100		166000		233600	
10 PERCENT EXCEEDS	401		470		686	
50 PERCENT EXCEEDS	120		158		146	
90 PERCENT EXCEEDS	77		78		79	

11383500 DEER CREEK NEAR VINA, CA—Continued

WATER-QUALITY RECORDS

PERIOD OF RECORD.—Water years 1999 to current year.

WATER TEMPERATURE: Water years 1999 to current year.

TURBIDITY: Water years 2001 to current year.

SEDIMENT DATA: Water years 2001–02 .

PERIOD OF DAILY RECORD.—

WATER TEMPERATURE: October 1998 to current year.

TURBIDITY: January 2001 to current year.

INSTRUMENTATION.—Temperature recorder since Oct. 5, 1998, and Turbidity recorder since October 2000.

REMARKS.—Temperature record rated excellent. Turbidity record rated fair. Interruption in record due to malfunction of the recording equipment.

Unpublished sediment data available in files of the U.S. Geological Survey for December 2000 to October 2002.

EXTREMES FOR PERIOD OF DAILY RECORD.—

WATER TEMPERATURE: Maximum recorded, 28.0°C, July 14, 2002; minimum recorded, 0.5°C, Dec. 23, 24, 1998.

TURBIDITY: Maximum recorded, 100 NTU, Nov. 22, 2002; minimum recorded, <0.5 NTU, many days during most years.

EXTREME FOR CURRENT YEAR.—

WATER TEMPERATURE: Maximum recorded, 28.0°C, July 14; minimum recorded, 2.0°C, Jan. 30, 31.

TURBIDITY: Maximum recorded, 100 NTU, Nov. 22; minimum recorded, <0.5 NTU, many days during the year.

CROSS-SECTIONAL DATA, WATER YEAR OCTOBER 2001 TO SEPTEMBER 2002

Date	Time	DEPTH BOTTOM AT SAMPLE LOC- ATION, (FEET) (81903)	TUR- BID- ITY FIELD WATER UNFLTRD (NTU) (61028)	TEMPER- ATURE WATER (DEG C) (00010)	SAMPLE LOC- ATION, CROSS SECTION (FT FM L BANK) (00009)
APR					
04...*	1100	2.40	5.9	12.0	66.0
04...*	1105	2.00	6.2	12.0	53.0
04...*	1110	2.20	6.4	12.0	42.0
04...*	1115	1.70	6.3	12.0	28.0
04...*	1120	1.60	6.0	12.0	16.0
JUL					
24...*	1100	1.92	<.5	23.5	62.0
24...*	1105	1.90	<.5	23.5	54.0
24...*	1110	2.30	<.5	23.5	48.0
24...*	1115	2.28	<.5	23.5	42.0
24...*	1120	1.30	<.5	23.5	24.0

* Instantaneous discharge at the time of the cross-sectional measurements: Apr. 4, 512 ft³/s; July 24, 80 ft³/s.
 < Actual value is known to be less than the value shown.

11383500 DEER CREEK NEAR VINA, CA—Continued

TEMPERATURE, WATER (DEGREE C), WATER YEAR OCTOBER 2001 TO SEPTEMBER 2002

DAY	MAX		MIN		MAX		MIN		MAX		MIN	
	OCTOBER	NOVEMBER	DECEMBER	JANUARY	FEBRUARY	MARCH	APRIL	MAY	JUNE	JULY	AUGUST	SEPTEMBER
1	20.0	17.5	13.0	12.0	8.5	7.5	10.0	9.5	4.5	3.0	8.0	6.5
2	20.5	18.0	12.5	11.5	9.0	8.0	10.5	10.0	5.0	3.5	7.0	6.0
3	20.0	18.0	12.5	11.0	8.5	7.5	10.0	8.0	5.0	4.0	7.5	6.0
4	19.5	17.5	12.5	10.5	7.5	6.5	8.0	7.5	5.5	4.0	8.0	6.5
5	18.0	16.5	12.5	10.5	8.0	7.0	8.5	7.5	5.5	4.5	8.0	7.0
6	17.5	15.5	12.0	10.5	9.0	8.0	9.0	8.0	6.0	4.5	9.0	8.0
7	17.5	15.5	11.5	10.0	9.0	7.5	8.5	7.5	7.5	6.0	9.0	5.5
8	18.0	16.0	11.0	9.5	7.5	7.0	8.5	8.0	7.5	6.0	6.0	4.5
9	16.5	15.0	11.5	10.0	8.0	7.0	8.5	8.0	6.5	5.0	7.0	5.0
10	16.0	14.0	11.5	10.0	7.0	6.0	8.0	7.5	6.5	5.5	8.5	6.5
11	16.0	14.5	12.5	11.0	6.0	5.0	8.0	7.0	7.0	5.5	9.5	7.5
12	16.0	14.0	13.0	12.5	6.0	4.5	8.0	7.5	8.0	6.5	10.0	9.0
13	16.0	14.0	12.5	12.0	7.0	5.5	7.5	6.0	8.5	7.5	9.5	7.5
14	16.0	14.5	12.5	11.5	7.0	6.5	6.5	5.0	9.0	7.5	7.5	6.0
15	15.5	14.0	12.5	12.0	6.5	5.5	5.0	4.5	8.5	7.5	7.0	6.0
16	16.0	14.5	12.0	12.0	6.5	5.5	4.5	4.0	8.5	8.0	7.5	6.0
17	16.0	14.5	12.5	12.0	8.0	6.5	5.0	4.0	8.5	7.5	7.0	6.0
18	16.0	14.0	12.0	11.0	8.0	8.0	4.5	4.0	8.5	7.5	6.5	5.0
19	15.0	13.5	11.5	11.0	8.5	8.0	4.5	3.5	8.5	8.0	8.0	6.0
20	14.5	13.0	12.5	11.5	8.5	7.5	5.0	4.0	9.0	8.5	9.5	7.5
21	14.5	13.0	12.5	12.0	7.5	7.5	6.0	4.5	9.0	8.0	10.5	8.5
22	14.5	12.5	12.5	10.5	8.0	7.5	5.5	4.0	9.5	8.0	10.5	9.5
23	14.5	13.0	10.5	9.5	8.0	7.5	4.0	3.0	9.0	8.5	10.0	9.0
24	13.0	11.5	10.0	9.0	7.5	6.5	4.0	3.0	8.5	7.5	10.0	8.5
25	13.0	11.0	9.5	8.0	7.5	6.5	5.0	3.5	8.5	7.0	9.5	8.0
26	13.0	11.5	8.0	7.0	8.5	7.5	6.0	5.0	9.0	7.5	10.5	8.5
27	13.0	11.5	7.0	6.0	9.0	8.5	6.0	4.5	9.5	8.0	11.0	9.0
28	13.0	12.5	7.0	6.5	9.0	8.5	4.5	3.5	9.5	8.0	12.0	9.5
29	13.5	13.0	7.5	6.5	9.5	9.0	3.5	2.5	---	---	13.0	10.5
30	14.0	13.5	7.5	7.0	10.5	9.5	3.0	2.0	---	---	12.5	11.0
31	14.0	13.0	---	---	10.5	9.5	3.0	2.0	---	---	13.0	10.5
MONTH	20.5	11.0	13.0	6.0	10.5	4.5	10.5	2.0	9.5	3.0	13.0	4.5
1	13.5	10.5	12.5	10.0	24.0	22.0	26.0	23.5	26.5	24.0	23.5	21.5
2	14.0	11.0	14.5	11.0	23.0	20.5	26.0	23.5	26.5	24.0	24.0	21.5
3	14.0	11.0	15.5	13.0	22.5	20.0	25.5	23.0	26.0	23.5	23.0	21.0
4	14.0	11.5	17.0	14.0	22.5	19.5	25.5	23.0	24.0	22.0	22.0	20.0
5	13.0	11.5	17.0	14.5	24.0	20.5	25.5	23.0	23.5	20.5	21.5	19.0
6	13.0	10.0	17.0	14.5	24.5	21.5	26.0	23.0	23.0	20.5	20.0	18.0
7	13.5	10.5	16.5	14.5	23.5	21.0	25.5	23.5	22.5	20.0	19.5	17.0
8	13.5	10.5	16.0	13.0	21.5	19.0	25.0	22.5	23.0	20.0	19.0	16.5
9	13.0	11.0	16.0	13.0	20.0	17.0	26.0	23.0	23.5	20.5	19.5	17.0
10	13.0	10.5	15.5	13.5	21.0	17.5	27.0	24.0	24.5	21.5	20.0	17.0
11	13.5	11.5	16.0	12.5	22.0	18.5	27.5	25.0	25.0	22.0	20.5	18.0
12	14.0	11.5	17.0	13.5	23.0	19.5	27.5	25.5	25.5	22.5	21.0	18.5
13	15.5	12.0	18.0	15.0	23.5	20.0	27.5	25.0	26.0	23.5	21.0	19.0
14	16.0	13.5	18.0	15.0	23.5	20.5	28.0	25.5	26.5	24.0	20.5	18.5
15	15.0	12.0	18.0	15.5	23.5	21.0	26.5	24.5	26.0	24.0	20.0	18.5
16	12.5	9.5	18.5	15.5	23.5	21.0	25.5	23.0	26.0	24.0	20.0	17.5
17	9.5	7.5	19.5	16.5	23.0	20.5	25.5	22.5	25.5	23.5	20.0	18.0
18	9.5	7.0	19.5	17.0	24.0	21.5	25.5	23.0	25.0	23.0	20.0	17.5
19	11.0	7.5	18.0	14.0	24.0	21.5	26.5	23.5	24.5	22.5	20.0	18.0
20	12.0	9.5	14.0	12.5	24.0	21.5	27.0	24.0	23.5	21.5	20.5	18.0
21	13.0	10.5	13.5	11.5	24.0	21.5	26.5	24.5	23.0	21.0	21.0	18.5
22	14.0	11.5	15.0	11.5	24.0	21.0	26.5	24.0	22.5	20.5	21.0	18.5
23	15.0	12.5	16.5	13.0	24.5	21.5	26.0	23.5	22.5	20.0	20.5	18.5
24	15.5	13.0	18.0	14.5	25.0	22.0	25.5	23.0	22.0	19.5	20.5	18.0
25	16.5	14.0	19.0	16.0	25.5	22.5	25.5	22.5	22.5	19.5	20.0	18.0
26	16.0	14.5	20.0	17.5	25.5	23.0	25.0	22.5	22.5	20.5	19.5	17.5
27	14.5	11.5	20.0	18.0	25.5	23.0	26.0	23.0	23.0	20.5	19.5	17.5
28	11.5	9.5	20.0	17.5	25.5	23.0	26.5	24.0	24.0	21.0	18.5	16.5
29	10.5	10.0	22.5	19.0	26.0	23.5	26.5	23.5	24.0	21.5	18.5	16.5
30	11.0	10.0	24.0	21.0	26.5	23.5	26.5	24.0	24.0	21.5	18.0	16.0
31	---	---	25.0	22.0	---	---	26.5	24.0	23.5	21.0	---	---
MONTH	16.5	7.0	25.0	10.0	26.5	17.0	28.0	22.5	26.5	19.5	24.0	16.0

SACRAMENTO RIVER BASIN

11383500 DEER CREEK NEAR VINA, CA—Continued

TURBIDITY (NTU), WATER YEAR OCTOBER 2001 TO SEPTEMBER 2002

DAY	MAX	MIN	MAX	MIN	MAX	MIN	MAX	MIN	MAX	MIN	MAX	MIN
	OCTOBER		NOVEMBER		DECEMBER		JANUARY		FEBRUARY		MARCH	
1	2.8	<0.5	7.3	1.1	76	<0.5	7.0	1.2	0.6	<0.5	0.7	<0.5
2	3.6	<0.5	2.7	1.1	92	3.1	48	4.6	<0.5	<0.5	1.3	<0.5
3	6.7	<0.5	2.5	1.0	89	10	25	5.3	<0.5	<0.5	1.6	<0.5
4	6.4	<0.5	3.9	1.0	38	17	8.8	1.9	2.1	<0.5	<0.5	<0.5
5	2.8	<0.5	4.1	1.0	36	16	9.1	1.1	<0.5	<0.5	0.9	<0.5
6	2.0	<0.5	3.2	1.1	92	4.1	9.3	1.3	0.9	<0.5	2.9	<0.5
7	10	<0.5	4.3	1.0	18	0.9	14	3.2	0.7	<0.5	7.4	2.9
8	7.0	<0.5	4.0	<0.5	9.0	1.0	6.8	<0.5	1.3	<0.5	4.4	0.9
9	2.3	<0.5	6.0	<0.5	9.0	<0.5	2.3	0.9	4.7	<0.5	3.6	<0.5
10	1.4	<0.5	4.0	<0.5	7.0	<0.5	4.9	0.6	1.6	<0.5	36	1.5
11	---	---	9.0	<0.5	7.0	<0.5	1.4	<0.5	<0.5	<0.5	1.5	0.6
12	---	---	67	1.9	8.0	<0.5	1.9	<0.5	6.1	<0.5	0.9	<0.5
13	---	---	32	5.1	7.0	<0.5	3.2	<0.5	0.8	<0.5	1.0	<0.5
14	---	---	9.5	1.8	9.0	<0.5	0.6	<0.5	<0.5	<0.5	0.8	<0.5
15	---	---	9.0	1.0	8.0	<0.5	0.6	<0.5	<0.5	<0.5	0.8	<0.5
16	---	---	9.0	1.0	3.0	<0.5	0.7	<0.5	2.9	<0.5	2.3	<0.5
17	---	---	9.0	1.0	9.2	<0.5	<0.5	<0.5	1.7	<0.5	1.7	<0.5
18	---	---	8.0	<0.5	9.7	1.0	1.2	<0.5	0.6	<0.5	3.2	<0.5
19	---	---	9.0	<0.5	10	1.0	1.0	<0.5	1.4	<0.5	1.1	<0.5
20	---	---	9.0	<0.5	9.9	<0.5	1.0	<0.5	12	<0.5	0.7	<0.5
21	1.5	<0.5	9.9	<0.5	9.0	1.0	4.3	<0.5	8.0	2.0	1.5	<0.5
22	1.7	<0.5	100	6.7	8.0	1.0	1.5	<0.5	2.7	1.0	2.7	<0.5
23	1.0	<0.5	21	3.9	9.0	1.0	4.1	<0.5	4.6	<0.5	2.8	<0.5
24	2.3	<0.5	59	3.3	9.0	<0.5	2.5	<0.5	16	<0.5	5.9	<0.5
25	1.4	<0.5	10	1.0	7.0	<0.5	<0.5	<0.5	1.4	<0.5	1.5	<0.5
26	1.5	<0.5	9.0	1.0	9.0	<0.5	0.7	<0.5	7.8	<0.5	3.2	<0.5
27	2.0	0.6	9.0	<0.5	6.0	<0.5	0.9	<0.5	1.2	<0.5	1.1	<0.5
28	2.7	<0.5	7.0	<0.5	8.8	<0.5	<0.5	<0.5	4.1	<0.5	0.7	<0.5
29	2.8	0.6	9.1	1.0	9.0	1.0	<0.5	<0.5	---	---	2.1	<0.5
30	5.0	0.8	9.0	<0.5	20	1.2	<0.5	<0.5	---	---	2.3	0.8
31	9.1	2.6	---	---	31	3.2	<0.5	<0.5	---	---	2.6	1.0
MONTH	---	---	100	<0.5	92	<0.5	48	<0.5	16	<0.5	36	<0.5
	APRIL		MAY		JUNE		JULY		AUGUST		SEPTEMBER	
1	2.6	1.0	4.0	<0.5	1.2	<0.5	7.9	<0.5	<0.5	<0.5	1.6	<0.5
2	4.3	1.6	1.9	<0.5	1.5	<0.5	4.1	<0.5	1.2	<0.5	2.0	<0.5
3	8.3	2.9	1.2	<0.5	<0.5	<0.5	3.3	<0.5	1.0	<0.5	1.4	<0.5
4	5.2	3.0	14	0.6	0.9	<0.5	2.0	<0.5	<0.5	<0.5	3.8	<0.5
5	5.4	3.4	3.5	0.6	0.6	<0.5	11	0.8	2.8	<0.5	<0.5	<0.5
6	5.7	2.6	3.5	0.8	0.6	<0.5	8.2	<0.5	5.8	<0.5	<0.5	<0.5
7	3.8	1.8	2.9	1.1	0.8	<0.5	2.6	<0.5	7.0	<0.5	<0.5	<0.5
8	5.1	1.8	2.8	0.8	0.8	<0.5	8.2	0.6	0.9	<0.5	<0.5	<0.5
9	4.6	1.7	2.3	<0.5	<0.5	<0.5	10	<0.5	1.1	<0.5	<0.5	<0.5
10	3.2	2.0	1.0	<0.5	1.4	<0.5	18	<0.5	<0.5	<0.5	<0.5	<0.5
11	3.1	1.6	1.2	<0.5	<0.5	<0.5	1.7	<0.5	1.6	<0.5	<0.5	<0.5
12	2.9	1.2	1.6	<0.5	<0.5	<0.5	8.4	<0.5	1.6	<0.5	<0.5	<0.5
13	4.0	1.2	1.2	<0.5	<0.5	<0.5	2.0	<0.5	3.6	<0.5	<0.5	<0.5
14	3.3	1.7	1.6	<0.5	0.7	<0.5	8.7	0.6	<0.5	<0.5	<0.5	<0.5
15	4.4	1.9	1.3	<0.5	2.1	<0.5	8.8	<0.5	1.0	<0.5	<0.5	<0.5
16	5.3	0.9	4.3	<0.5	0.9	<0.5	1.7	<0.5	1.5	<0.5	1.8	<0.5
17	2.0	0.7	1.0	<0.5	0.9	<0.5	2.8	<0.5	2.5	<0.5	<0.5	<0.5
18	1.8	0.7	2.5	<0.5	0.8	<0.5	5.1	<0.5	2.4	<0.5	<0.5	<0.5
19	2.9	0.7	1.1	<0.5	5.3	<0.5	1.9	<0.5	0.6	<0.5	<0.5	<0.5
20	2.9	<0.5	2.3	0.7	1.2	<0.5	1.5	<0.5	1.2	<0.5	0.7	<0.5
21	1.9	0.7	2.1	<0.5	0.9	<0.5	1.3	<0.5	1.5	<0.5	<0.5	<0.5
22	1.6	0.6	1.2	<0.5	1.6	<0.5	1.6	<0.5	3.5	<0.5	4.0	<0.5
23	3.6	<0.5	1.6	<0.5	3.8	<0.5	1.4	<0.5	0.6	<0.5	4.8	<0.5
24	3.5	<0.5	1.1	<0.5	1.1	<0.5	1.0	<0.5	2.2	<0.5	4.8	<0.5
25	2.0	<0.5	1.2	<0.5	1.1	<0.5	<0.5	<0.5	0.6	<0.5	<0.5	<0.5
26	1.8	<0.5	1.9	<0.5	9.7	<0.5	1.6	<0.5	0.9	<0.5	1.3	<0.5
27	3.0	<0.5	3.1	<0.5	1.0	<0.5	<0.5	<0.5	1.9	<0.5	<0.5	<0.5
28	5.6	<0.5	2.6	<0.5	7.7	<0.5	1.3	<0.5	0.6	<0.5	1.5	<0.5
29	1.7	<0.5	1.1	<0.5	2.7	0.6	<0.5	<0.5	4.8	<0.5	1.8	<0.5
30	8.8	<0.5	3.1	<0.5	6.9	1.4	0.8	<0.5	1.4	<0.5	1.8	<0.5
31	---	---	0.9	<0.5	---	---	1.6	<0.5	3.7	<0.5	---	---
MONTH	8.8	<0.5	14	<0.5	9.7	<0.5	18	<0.5	7.0	<0.5	4.8	<0.5

< Actual value is known to be less than the value shown.

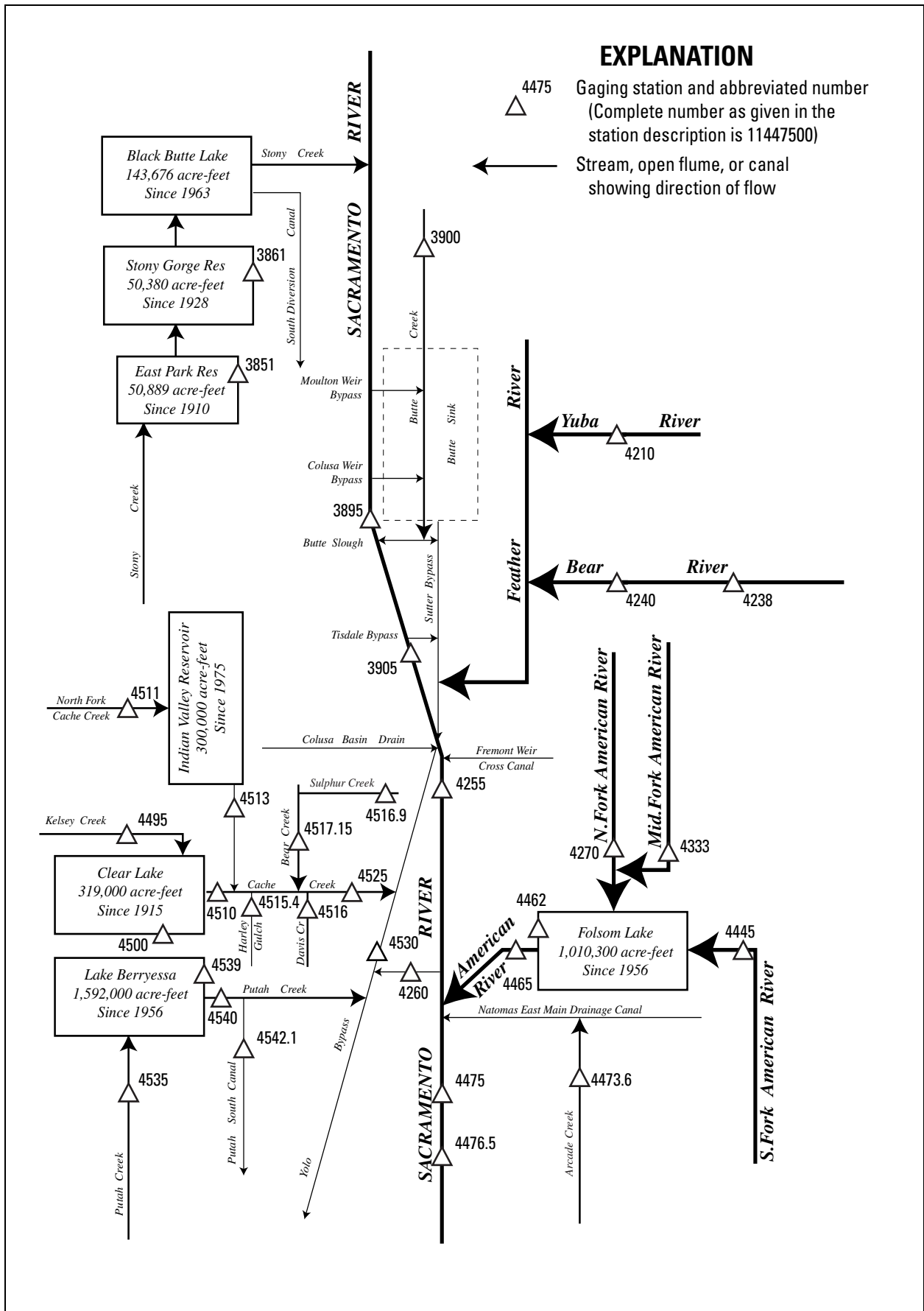

EXPLANATION

- △ 4475 Gaging station and abbreviated number
(Complete number as given in the station description is 11447500)
- ← Stream, open flume, or canal showing direction of flow

Figure 27. Diversions and storage in lower Sacramento River Basin.

RESERVOIRS IN STONY CREEK BASIN, CA

11385100 EAST PARK RESERVOIR NEAR STONYFORD

LOCATION.—Lat 39°21'24", long 122°30'53", in SW 1/4 NE 1/4 sec.3, T.17 N., R.6 W., [Colusa County](#), Hydrologic Unit 18020115, near south side of spillway section on East Park Dam on Little Stony Creek, 1.9 mi southeast of Stonyford.

DRAINAGE AREA.—98.2 mi².

PERIOD OF RECORD.—October 1969 to current year.

GAGE.—Nonrecording gage read once daily. Datum of gage is sea level (levels by U.S. Bureau of Reclamation).

REMARKS.—Reservoir is formed by a concrete arch-type dam. Storage began in 1910. Capacity, 48,210 acre-ft, between elevations 1,131.68 ft, invert of sluice pipe, and 1,198.18 ft, crest of spillway. Capacity increased to 50,889 acre-ft with the addition of flashboards to an elevation of 1,199.68 ft. Dead storage, 279 acre-ft. Records of contents provided by U.S. Bureau of Reclamation. See schematic diagram of [lower Sacramento River Basin](#).

EXTREMES FOR PERIOD OF RECORD.—Maximum contents, 53,500 acre-ft, Mar. 30, 1974, elevation, 1,201.10 ft; minimum, 280 acre-ft, Aug. 8 to Oct. 31, 1972, Apr. 30 to Nov. 1, 1977, elevation, 1,131.68 ft.

EXTREMES FOR CURRENT YEAR.—Maximum contents, 51,001 acre-ft, Jan. 2, elevation, 1,199.74 ft; minimum, 7,472 acre-ft, Sept. 30, elevation, 1,161.13 ft.

11386100 STONY GORGE RESERVOIR NEAR ELK CREEK

LOCATION.—Lat 39°35'09", long 122°31'54", in NE 1/4 SE 1/4 sec.16, T.20 N., R.6 W., [Glenn County](#), Hydrologic Unit 18020115, on south end of Stony Gorge Dam on Stony Creek, 1.3 mi southeast of Elk Creek.

DRAINAGE AREA.—301 mi².

PERIOD OF RECORD.—October 1969 to current year.

GAGE.—Nonrecording gage read once daily. Datum of gage is sea level (levels by U.S. Bureau of Reclamation).

REMARKS.—Reservoir is formed by slab and buttress-type dam. Storage began in 1928. Capacity, 50,380 acre-ft, between elevations 728.0 ft, top of low intake, and 841.0 ft, crest of spillway. No dead storage. Records of contents provided by U.S. Bureau of Reclamation. See schematic diagram of [lower Sacramento River Basin](#).

EXTREMES FOR PERIOD OF RECORD.—Maximum contents, 54,630 acre-ft, Mar. 26, 1971, elevation, 844.20 ft; minimum, 3,810 acre-ft, Nov. 6, 1971, elevation, 779.20 ft.

EXTREMES FOR CURRENT YEAR.—Maximum contents, 50,087 acre-ft, Apr. 7, elevation, 840.77 ft; minimum, 15,854 acre-ft, Oct. 29, 30, elevation, 805.66 ft.

MONTHEND ELEVATION AND CONTENTS AT 0800 HOURS, WATER YEAR OCTOBER 2001 TO SEPTEMBER 2002

Date	Elevation (ft)	Contents (acre-ft)	Change in contents (acre-ft)	11385100 EAST PARK RESERVOIR			11386100 STONY GORGE RESERVOIR		
				Elevation (ft)	Contents (acre-ft)	Change in contents (acre-ft)	Elevation (ft)	Contents (acre-ft)	Change in contents (acre-ft)
Sept. 30	1,186.76	30,559	-1,462	821.56	28,587	-406	821.56	28,587	-406
Oct. 31	1,186.16	29,764	-795	805.78	15,933	-12,654	805.78	15,933	-12,654
Nov. 30	1,188.41	32,813	3,049	819.70	26,862	10,929	819.70	26,862	10,929
Dec. 31	1,199.07	49,791	16,978	832.40	39,894	13,032	832.40	39,894	13,032
CAL YR 2001	-	-	8,051	-	-	964	-	-	964
Jan. 31	1,198.38	48,568	-1,223	828.65	35,740	-4,154	828.65	35,740	-4,154
Feb. 28	1,198.35	48,515	-53	832.27	39,745	4,005	832.27	39,745	4,005
Mar. 31	1,198.30	48,426	-89	838.88	47,673	7,928	838.88	47,673	7,928
Apr. 30	1,196.79	45,807	-2,619	832.65	40,180	-7,493	832.65	40,180	-7,493
May 31	1,186.12	29,711	-16,096	833.87	41,591	1,411	833.87	41,591	1,411
June 30	1,177.31	19,563	-10,148	829.16	36,289	-5,302	829.16	36,289	-5,302
July 31	1,167.62	11,434	-8,129	820.28	27,393	-8,896	820.28	27,393	-8,896
Aug. 31	1,162.48	8,210	-3,224	821.98	28,983	1,590	821.98	28,983	1,590
Sept. 30	1,161.13	7,472	-738	821.32	28,361	-622	821.32	28,361	-622
WTR YR 2002	-	-	-23,087	-	-	-226	-	-	-226

11389500 SACRAMENTO RIVER AT COLUSA, CA

LOCATION.—Lat 39°12'51", long 121°59'57", at north end of Jimeno Grant, Colusa County, Hydrologic Unit 18020104, on right bank, 60 ft downstream from highway bridge at Colusa, and at mile 89.4 upstream from Sacramento.

DRAINAGE AREA.—12,090 mi².

PERIOD OF RECORD.—April 1921 to current year (prior to October 1940, low-water periods only).

CHEMICAL DATA: Water years 1959–66, 1996–99, 2001.

SPECIFIC CONDUCTANCE: Water years 1995–98.

WATER TEMPERATURE: Water years 1975, 1977–80, 1995–98.

SEDIMENT: Water years 1973–80, 1996–1999.

REVISED RECORDS.—WSP 1345: 1952. WDR CA-77-4: Drainage area.

GAGE.—Water-stage recorder and crest-stage gage. Datum of gage is 2.95 ft below sea level. Prior to December 1930, water-stage recorder in center fender pier 50 ft upstream from bridge at same datum.

REMARKS.—Records good. Natural flow of stream affected by storage reservoirs, including Shasta Lake (station 11370000) since 1943, power development, bypassing for flood control, diversions for irrigation, and return flow from irrigated areas. When discharge exceeds about 30,000 ft³/s, flow begins over Colusa Weir, 2.5 mi upstream on left bank, into Butte Sink and Sutter Bypass. See schematic diagram of lower Sacramento River Basin.

EXTREMES FOR PERIOD OF RECORD.—Maximum discharge (since water year 1941), 51,800 ft³/s, Mar. 4, 1983, gage height, 68.50 ft, maximum gage height, 69.20 ft, Feb. 18, 1942; minimum recorded, 820 ft³/s, July 25, 26, 1931, gage height, 34.79 ft.

DISCHARGE, CUBIC FEET PER SECOND, WATER YEAR OCTOBER 2001 TO SEPTEMBER 2002
DAILY MEAN VALUES

DAY	OCT	NOV	DEC	JAN	FEB	MAR	APR	MAY	JUN	JUL	AUG	SEP
1	e7000	4880	13800	34300	e9400	11200	7820	6380	8310	9860	e10000	5830
2	e6900	4820	19000	33200	9280	11000	7660	6560	8130	10000	e9600	5730
3	e6600	4640	29700	40600	9070	10700	7460	6660	8060	9710	9590	5910
4	e6400	4630	22800	42600	8890	10600	7460	6250	7980	9320	9460	5750
5	e6180	4450	15100	38000	8750	10400	7530	6150	7930	9260	9660	5800
6	e6000	4410	12100	34100	8600	10300	7650	6450	7820	9420	9860	5720
7	e5500	4560	17800	36200	8500	10500	7530	6530	7470	9420	9710	5900
8	e5110	4500	15300	35600	8460	11900	7300	6540	7320	9320	9540	6360
9	e4800	4360	11900	33400	9200	12500	7010	6530	7390	9560	9280	6560
10	e4600	4390	11800	31700	9400	11900	6770	6330	7490	9720	8780	6680
11	e4410	4570	11100	28100	8940	14100	6760	6080	7530	9710	8510	6670
12	4310	4820	9910	24800	8700	14200	6530	6220	7250	9650	e8400	6600
13	4050	5610	9220	21900	8500	12700	6130	6520	7380	9760	8650	6560
14	3930	6520	9100	19300	8400	12000	5920	6620	7450	10000	8530	6470
15	4020	5890	18600	17300	8310	11400	6000	6750	7990	10200	8580	6700
16	4010	5440	16100	16000	8290	10900	6240	7280	8640	10300	8550	7370
17	3950	5210	12200	14900	8330	10400	6180	8000	8780	10600	8500	7560
18	3820	5070	14400	14100	8340	9950	5980	7880	8940	10300	8380	7340
19	3740	4920	15300	13400	8360	9630	5590	7840	9130	10200	8320	7120
20	3670	4720	15500	12800	8970	9320	5210	8380	9320	10300	8450	7090
21	3630	4730	23800	e12300	22400	8950	5120	9140	9240	10500	8290	6900
22	3790	4980	29100	e11900	21900	8740	4890	9710	9350	10500	7630	6790
23	3950	9650	26500	11700	16100	8590	4670	9430	9620	10700	7190	6780
24	3920	8590	28500	11400	13600	9090	4940	9180	10100	10700	6760	6820
25	3870	14800	22700	10900	12400	10700	5170	8900	10100	10700	6140	6790
26	3860	14300	18100	10600	11500	9920	5290	8630	10200	10800	5940	6620
27	3940	9200	15500	e10300	10700	8980	5540	8910	10300	10700	5960	6510
28	4050	7410	13500	e10600	10600	8390	5800	9120	10300	10400	6200	6500
29	4080	6890	13700	e10400	---	8130	6320	8770	10100	10500	6880	6450
30	4330	14000	22300	e10000	---	7940	6180	8580	9810	10600	6870	6270
31	4700	---	25700	e9650	---	7860	---	8520	---	10400	6300	---
TOTAL	143120	192960	540130	662050	293890	322890	188650	234840	259430	313110	254510	196150
MEAN	4617	6432	17420	21360	10500	10420	6288	7575	8648	10100	8210	6538
MAX	7000	14800	29700	42600	22400	14200	7820	9710	10300	10800	10000	7560
MIN	3630	4360	9100	9650	8290	7860	4670	6080	7250	9260	5940	5720
AC-FT	283900	382700	1071000	1313000	582900	640500	374200	465800	514600	621100	504800	389100

e Estimated.

SACRAMENTO RIVER BASIN

11389500 SACRAMENTO RIVER AT COLUSA, CA—Continued

STATISTICS OF MONTHLY MEAN DATA FOR WATER YEARS 1946 - 2002, BY WATER YEAR (WY)

	OCT	NOV	DEC	JAN	FEB	MAR	APR	MAY	JUN	JUL	AUG	SEP
MEAN	6471	8686	13630	17660	19840	17360	12500	10560	9065	8755	8292	7225
MAX	12040	27000	38000	39720	45500	44450	31490	26680	24590	13890	12320	10850
(WY)	1958	1974	1984	1997	1998	1983	1982	1983	1998	1998	1998	1998
MIN	3219	3860	4141	5193	5147	5852	4966	5015	4852	5073	5081	4322
(WY)	1978	1993	1977	1991	1991	1977	1994	1947	1992	1992	1947	1977

SUMMARY STATISTICS	FOR 2001 CALENDAR YEAR		FOR 2002 WATER YEAR		WATER YEARS 1946 - 2002	
ANNUAL TOTAL	3486870		3601730			
ANNUAL MEAN	9553		9868		11630	
HIGHEST ANNUAL MEAN					21790	
LOWEST ANNUAL MEAN					5671	
HIGHEST DAILY MEAN	38800	Mar 6	42600	Jan 4	51300	Mar 4 1983
LOWEST DAILY MEAN	3630	Oct 21	3630	Oct 21	2620	Oct 16 1977
ANNUAL SEVEN-DAY MINIMUM	3790	Oct 18	3790	Oct 18	2690	Oct 12 1977
MAXIMUM PEAK FLOW			43300	Jan 4	51800	Mar 4 1983
MAXIMUM PEAK STAGE			65.67	Jan 4	68.83	Jan 3 1997
ANNUAL RUNOFF (AC-FT)	6916000		7144000		8428000	
10 PERCENT EXCEEDS	15100		15300		24400	
50 PERCENT EXCEEDS	7940		8550		8350	
90 PERCENT EXCEEDS	4860		4820		5340	

11389720 BUTTE CREEK BELOW DIVERSION DAM, NEAR STIRLING CITY, CA

LOCATION.—Lat 39°58'53", long 121°35'15", unsurveyed, T.25 N., R.3 E., Butte County, Hydrologic Unit 18020120, on left bank, 400 ft downstream from diversion dam, 0.1 mi upstream from Haw Creek, and 6.2 mi northwest of Stirling City.

DRAINAGE AREA.—61.3 mi².

PERIOD OF RECORD.—January to February 1986, June 1986 to current year (low-flow records only).

GAGE.—Water-stage recorder. Elevation of gage is 2,840 ft above sea level, from topographic map.

REMARKS.—Flow regulated by diversion dam 400 ft upstream. Flows computed to 100 ft³/s. Most of the water is diverted at diversion dam to Butte Creek Canal and then to De Sabla Powerplant (station 11389750).

COOPERATION.—Records were collected by Pacific Gas & Electric Co., under general supervision of the U.S. Geological Survey, in connection with Federal Energy Regulatory Commission project no. 803.

DISCHARGE, CUBIC FEET PER SECOND, WATER YEAR OCTOBER 2001 TO SEPTEMBER 2002

DAILY MEAN VALUES

DAY	OCT	NOV	DEC	JAN	FEB	MAR	APR	MAY	JUN	JUL	AUG	SEP
1	8.7	9.6	---	---	53	---	---	---	23	20	21	21
2	8.7	9.5	---	---	51	---	---	---	21	21	21	21
3	8.7	9.4	---	---	49	---	---	---	19	21	21	21
4	8.7	9.4	---	---	48	---	---	---	19	21	21	22
5	8.8	9.4	---	---	48	---	---	---	19	21	21	22
6	8.8	9.5	---	---	42	---	---	---	19	21	21	22
7	8.8	9.5	---	---	---	---	---	---	19	21	21	22
8	8.8	9.5	---	---	---	---	---	---	19	21	21	22
9	8.8	9.6	59	---	---	---	---	---	18	21	21	22
10	8.8	9.6	47	---	---	---	---	---	19	21	21	21
11	8.8	29	37	---	---	---	---	---	19	21	21	21
12	8.8	---	31	---	---	---	---	---	19	21	21	21
13	8.8	52	36	---	---	---	---	---	19	21	21	21
14	8.8	19	48	---	---	---	---	---	19	21	21	21
15	8.8	9.9	39	---	---	---	---	---	19	21	21	21
16	8.8	9.8	40	---	---	---	---	---	19	21	21	21
17	8.7	10	---	---	---	---	---	54	20	21	21	21
18	8.7	9.8	---	---	---	---	---	53	20	21	22	21
19	8.6	9.8	---	58	---	---	---	---	20	21	22	22
20	8.6	9.8	---	54	---	---	---	---	20	21	22	22
21	8.6	41	---	58	---	---	---	---	19	21	22	22
22	8.6	---	---	50	---	---	---	---	20	21	22	22
23	8.6	39	---	50	---	---	---	51	20	21	22	22
24	8.6	---	---	52	---	---	---	42	20	21	22	22
25	9.0	---	55	---	---	---	---	37	20	21	22	22
26	9.2	58	53	---	---	---	---	34	20	21	22	22
27	9.2	27	60	---	---	---	---	32	20	21	21	22
28	9.3	31	---	---	---	---	---	31	20	21	21	22
29	9.4	38	---	---	---	---	---	29	20	21	22	22
30	35	32	---	---	---	---	---	28	20	21	21	22
31	11	---	---	55	---	---	---	26	---	21	22	---
TOTAL	301.5	---	---	---	---	---	---	---	588	650	662	648
MEAN	9.726	---	---	---	---	---	---	---	19.60	20.97	21.35	21.60
MAX	35	---	---	---	---	---	---	---	23	21	22	22
MIN	8.6	---	---	---	---	---	---	---	18	20	21	21
AC-FT	598	---	---	---	---	---	---	---	1170	1290	1310	1290

11389740 BUTTE CREEK BELOW FORKS OF BUTTE DIVERSION DAM, NEAR DE SABLE, CA

LOCATION.—Lat 39°54'05", long 121°37'24", in NW 1/4 NE 1/4 sec.34, T.24 N., R.3 E., Butte County, Hydrologic Unit 18020120, on left bank, 30 ft downstream from diversion dam, 0.2 mi upstream from American Ravine, and 2.0 mi north of De Sable.

DRAINAGE AREA.—96.4 mi².

PERIOD OF RECORD.—April 1992 to current year (low-flow records only).

GAGE.—Water-stage recorder and concrete control. Elevation of gage is 1,900 ft above sea level, from topographic map.

REMARKS.—No records computed above 60 ft³/s. Flow regulated by Forks of Butte Diversion Dam 30 ft upstream. Water is diverted out of creek to Butte Canal 7.4 mi upstream by Pacific Gas and Electric Co. Water is diverted 30 ft upstream to Forks of Butte Powerplant (station 11389747).

COOPERATION.—Records were collected by Energy Growth Partnership I, under general supervision of the U.S. Geological Survey, in connection with Federal Energy Regulatory Commission project no. 6896.

DISCHARGE, CUBIC FEET PER SECOND, WATER YEAR OCTOBER 2001 TO SEPTEMBER 2002

DAILY MEAN VALUES

DAY	OCT	NOV	DEC	JAN	FEB	MAR	APR	MAY	JUN	JUL	AUG	SEP
1	22	25	---	---	48	48	48	48	54	41	36	33
2	22	24	---	---	47	48	48	48	59	41	36	33
3	21	23	---	---	48	48	48	48	55	40	36	33
4	21	23	---	---	48	48	48	48	53	40	36	33
5	22	23	---	---	48	48	48	48	51	39	36	33
6	22	23	---	---	48	---	48	48	50	37	36	33
7	22	23	50	---	55	---	48	48	50	38	36	34
8	22	23	48	---	---	---	48	48	49	43	35	34
9	22	23	48	---	48	---	48	48	47	39	35	34
10	22	23	48	---	48	---	48	48	46	36	35	33
11	22	44	48	49	48	---	48	48	46	37	35	33
12	22	50	48	48	48	---	48	48	46	38	35	33
13	22	48	48	48	49	59	48	48	46	38	35	33
14	22	48	48	48	48	48	48	48	45	38	35	33
15	22	31	48	48	48	48	50	48	45	38	35	33
16	22	28	48	48	48	48	48	48	44	37	35	33
17	22	29	---	48	48	48	48	48	44	37	34	34
18	22	26	48	48	48	48	48	48	44	37	34	34
19	22	26	48	48	48	48	48	48	44	38	34	33
20	22	27	---	48	---	48	48	48	44	37	34	33
21	22	---	48	48	---	---	48	48	43	37	34	34
22	22	---	48	48	---	48	47	47	43	37	34	33
23	22	48	48	48	48	48	48	48	43	37	34	33
24	22	---	48	48	48	---	48	48	43	37	34	33
25	22	48	48	48	48	51	48	48	42	37	34	33
26	23	48	48	60	48	48	48	48	42	36	34	33
27	23	53	48	47	48	48	48	48	42	36	34	34
28	23	53	48	48	48	48	48	48	42	36	33	34
29	23	48	---	48	---	48	48	48	42	36	33	34
30	44	48	---	48	---	48	48	48	42	36	34	35
31	37	---	---	48	---	48	---	48	---	36	33	---
TOTAL	721	---	---	---	---	---	1441	1487	1386	1170	1074	1001
MEAN	23.26	---	---	---	---	---	48.03	47.97	46.20	37.74	34.65	33.37
MAX	44	---	---	---	---	---	50	48	59	43	36	35
MIN	21	---	---	---	---	---	47	47	42	36	33	33
AC-FT	1430	---	---	---	---	---	2860	2950	2750	2320	2130	1990
a	58	1810	8840	10350	7020	11520	10810	6210	14	0	0	0

a Diversion, in acre-feet, to Forks of Butte Powerplant (station 11389747), provided by Energy Growth Partnership I.

11389780 BUTTE CREEK BELOW CENTERVILLE DIVERSION DAM, NEAR PARADISE, CA

LOCATION.—Lat 39°52'01", long 121°37'58", in SW 1/4 NW 1/4 sec.10, T.23 N., R.3 E., Butte County, Hydrologic Unit 18020120, on left bank, 400 ft downstream from Centerville Diversion Dam, 0.2 mi downstream from De Sabla Powerplant, and 6.8 mi north of Paradise.

DRAINAGE AREA.—101 mi².

PERIOD OF RECORD.—November 1985 to February 1986, June 1986 to current year (low-flow records only).

GAGE.—Water-stage recorder. Elevation of gage is 1,130 ft above sea level, from topographic map.

REMARKS.—Flow regulated by several reservoirs and diversions upstream. Flows computed to 60 ft³/s. Most of the water is diverted at Centerville Diversion Dam to the Centerville Powerplant (station 11389775).

COOPERATION.—Records were collected by Pacific Gas & Electric Co., under general supervision of the U.S. Geological Survey, in connection with Federal Energy Regulatory Commission project no. 803.

DISCHARGE, CUBIC FEET PER SECOND, WATER YEAR OCTOBER 2001 TO SEPTEMBER 2002

DAILY MEAN VALUES

DAY	OCT	NOV	DEC	JAN	FEB	MAR	APR	MAY	JUN	JUL	AUG	SEP
1	49	46	---	---	---	---	---	---	---	46	47	47
2	49	46	---	---	---	---	---	---	---	46	47	47
3	50	46	---	---	---	---	---	---	---	46	47	47
4	47	46	---	---	---	---	---	---	---	46	47	47
5	45	45	---	---	---	---	---	---	---	46	47	47
6	46	47	---	---	---	---	---	---	---	45	47	47
7	46	50	---	---	---	---	---	---	52	45	47	47
8	46	49	---	---	---	---	---	47	51	46	47	47
9	46	51	---	---	---	---	---	46	49	48	47	47
10	45	52	---	---	---	---	---	46	55	48	47	47
11	46	---	---	---	---	---	---	45	49	47	47	47
12	47	---	---	---	---	---	---	47	46	47	47	47
13	51	---	---	---	---	---	---	45	50	47	47	47
14	49	---	---	---	---	---	---	46	58	47	47	47
15	48	---	---	---	---	---	---	---	54	47	47	47
16	46	46	---	---	---	---	---	---	54	46	47	47
17	46	47	---	---	---	---	---	---	51	48	47	46
18	46	46	---	---	---	---	---	---	46	48	47	46
19	48	46	---	---	---	---	---	---	46	48	47	46
20	50	46	---	---	---	---	---	---	---	48	47	46
21	46	---	---	---	---	---	---	---	45	48	47	46
22	46	---	---	---	---	---	---	---	45	48	47	46
23	46	---	---	---	---	---	---	---	45	48	47	46
24	46	---	---	---	---	---	---	---	45	47	47	46
25	45	---	---	---	---	---	---	---	46	47	47	46
26	46	---	---	---	---	---	---	---	47	47	47	46
27	45	---	---	---	---	---	---	---	47	47	47	46
28	46	---	---	---	---	---	---	---	47	47	47	46
29	46	---	---	---	---	---	---	---	46	47	47	46
30	---	---	---	---	---	---	---	---	46	47	47	46
31	---	---	---	---	---	---	---	---	---	47	47	---
TOTAL	---	---	---	---	---	---	---	---	---	1455	1457	1396
MEAN	---	---	---	---	---	---	---	---	---	46.94	47.00	46.53
MAX	---	---	---	---	---	---	---	---	---	48	47	47
MIN	---	---	---	---	---	---	---	---	---	45	47	46
AC-FT	---	---	---	---	---	---	---	---	---	2890	2890	2770
a	3200	4030	5330	5550	6120	7130	8580	8410	6690	5890	5360	4290

a Discharge, in acre-feet, from Centerville Powerplant (station 11389775), provided by Pacific Gas & Electric Co.

11389800 TOADTOWN CANAL ABOVE BUTTE CANAL, NEAR STIRLING CITY, CA

LOCATION.—Lat 39°53'09", long 121°36'35", in NE 1/4 NW 1/4 sec.2, T.23 N., R.3 E., **Butte County**, Hydrologic Unit 18020120, on right bank, 600 ft upstream from Butte Canal, and 4.6 mi west of Stirling City.

PERIOD OF RECORD.—October 1986 to current year. Monthly discharges for water years 1931–86 are published as a line item to Butte Creek near Chico (station 11390000).

GAGE.—Water-stage recorder and Parshall flume. Elevation of gage is 2,790 ft above sea level, from topographic map.

REMARKS.—Canal diverts from right bank of West Branch Feather River, in sec.16, T.24 N., R.4 E. at Hendricks Diversion Dam to Hendricks Canal, flows through tunnel down Long Ravine to Toadtown Canal, and discharges into Butte Canal. Butte Canal flows to De Sabla Powerplant (station 11389750) on Butte Creek.

COOPERATION.—Records were collected by Pacific Gas & Electric Co., under general supervision of the U.S. Geological Survey, in connection with Federal Energy Regulatory Commission project no. 803.

EXTREMES FOR PERIOD OF RECORD.—Maximum daily discharge, 127 ft³/s, Feb. 12, May 20, 1995, no flow at times in most years.

DISCHARGE, CUBIC FEET PER SECOND, WATER YEAR OCTOBER 2001 TO SEPTEMBER 2002
DAILY MEAN VALUES

DAY	OCT	NOV	DEC	JAN	FEB	MAR	APR	MAY	JUN	JUL	AUG	SEP
1	25	31	60	51	88	95	113	1.5	114	49	49	50
2	25	28	55	70	86	97	113	3.2	114	48	49	50
3	25	28	39	90	83	101	113	7.3	113	47	48	49
4	25	27	84	92	81	101	113	7.1	113	46	48	49
5	25	27	91	92	79	101	113	5.8	107	45	48	49
6	26	27	96	101	78	95	113	4.7	95	44	48	49
7	25	27	96	98	85	89	113	3.7	91	44	48	49
8	25	26	94	97	87	87	113	3.2	88	44	47	49
9	25	26	86	101	87	87	101	3.0	87	49	47	48
10	25	26	77	105	87	88	101	3.6	85	48	46	50
11	25	44	71	105	94	87	110	3.8	83	48	45	51
12	25	55	66	105	103	87	110	5.4	79	48	46	51
13	25	53	64	105	105	92	110	8.5	76	47	50	51
14	25	50	70	105	103	96	110	3.8	74	46	50	50
15	25	43	60	105	104	96	51	0.00	72	44	50	50
16	25	38	59	98	101	96	2.5	50	69	41	49	50
17	25	41	79	98	97	96	5.6	111	67	49	49	34
18	25	37	81	107	97	95	54	114	66	49	48	22
19	25	34	67	105	96	100	111	113	64	49	48	21
20	25	37	73	103	98	110	111	108	62	48	48	21
21	25	57	87	102	103	111	111	100	61	47	48	21
22	25	89	89	98	108	100	110	104	60	48	51	20
23	26	78	88	103	108	91	111	112	59	47	51	20
24	25	68	77	107	108	92	111	113	57	46	50	20
25	25	61	71	84	110	97	110	114	56	46	50	19
26	24	75	71	65	114	111	110	114	55	46	50	19
27	25	65	76	66	114	112	102	114	53	45	50	19
28	25	58	67	65	103	113	95	114	53	45	50	18
29	25	54	51	70	---	113	30	114	52	45	50	19
30	59	53	52	75	---	112	2.0	114	51	49	51	19
31	48	---	55	82	---	113	---	114	---	49	50	---
TOTAL	833	1363	2252	2850	2707	3061	2773.1	1787.60	2276	1446	1512	1087
MEAN	26.87	45.43	72.65	91.94	96.68	98.74	92.44	57.66	75.87	46.65	48.77	36.23
MAX	59	89	96	107	114	113	113	114	114	49	51	51
MIN	24	26	39	51	78	87	2.0	0.00	51	41	45	18
AC-FT	1650	2700	4470	5650	5370	6070	5500	3550	4510	2870	3000	2160
a	3930	5470	7580	8870	8450	9380	8830	5200	7510	4800	4590	3590

a Discharge, in acre-feet, from De Sabla Powerplant (station 11389750), provided by Pacific Gas & Electric Co.

11390000 BUTTE CREEK NEAR CHICO, CA

LOCATION.—Lat 39°43'34", long 121°42'28", in NW 1/4 NW 1/4 sec.36, T.22 N., R.2 E., Butte County, Hydrologic Unit 18020105, on right bank, 0.7 mi downstream from Little Butte Creek, and 7.5 mi east of Chico.

DRAINAGE AREA.—147 mi².

WATER-DISCHARGE RECORDS

PERIOD OF RECORD.—October 1930 to current year. Monthly discharge only for some periods, published in WSP 1315-A.

REVISED RECORDS.—WSP 1445: 1953(M). WSP 1931: Drainage area.

GAGE.—Water-stage recorder and crest-stage gage. Elevation of gage is 320 ft above sea level, from topographic map. Prior to Aug. 13, 1944, water-stage recorder at site 0.4 mi upstream at different datum. Aug. 13, 1944, to June 5, 1986, at datum 3.00 ft higher.

REMARKS.—Records good. Flow slightly regulated by storage in Magalia Reservoir, usable capacity, 2,640 acre-ft, and since 1957 by Paradise Reservoir, usable capacity, 11,500 acre-ft. Diversions upstream from station for irrigation and domestic use of about 7,000 acre-ft annually. Butte Creek receives water above station from West Branch Feather River by way of Toadtown Canal (station 11389800).

EXTREMES FOR PERIOD OF RECORD.—Maximum discharge, 35,600 ft³/s, Jan. 1, 1997, gage height, 15.06 ft, in gage well, 15.7 ft from floodmarks, on basis of slope-area measurement of peak flow; maximum gage height, 17.52 ft, Feb. 17, 1986, present datum; minimum discharge, 10 ft³/s, Nov. 29, 1952.

EXTREMES FOR CURRENT YEAR.—Peak discharges greater than base discharge of 2,700 ft³/s, or maximum:

Date	Time	Discharge (ft ³ /s)	Gage height (ft)
Jan. 2	1645	3,750	4.61

DISCHARGE, CUBIC FEET PER SECOND YEAR OCTOBER 2001 TO SEPTEMBER 2002
DAILY MEAN VALUES

DAY	OCT	NOV	DEC	JAN	FEB	MAR	APR	MAY	JUN	JUL	AUG	SEP
1	84	114	889	954	307	429	482	268	273	142	121	117
2	83	103	1550	2810	299	413	488	256	268	139	120	115
3	82	100	747	2150	287	399	497	250	264	135	120	115
4	82	98	503	1260	276	387	504	243	259	134	122	115
5	83	96	484	929	272	390	515	244	252	133	122	116
6	85	97	746	1170	265	514	494	241	229	130	121	117
7	86	97	565	1090	307	759	499	241	217	127	119	118
8	87	96	440	841	512	713	489	231	214	126	117	119
9	87	95	384	743	414	600	486	223	211	131	116	117
10	86	96	334	639	367	778	482	221	211	129	115	116
11	86	182	292	573	342	693	478	214	207	126	113	119
12	86	372	262	525	347	640	473	208	200	124	112	118
13	83	322	251	493	348	610	466	204	194	123	117	118
14	85	203	511	466	351	560	478	201	192	121	117	117
15	84	155	344	438	347	522	474	199	187	119	117	117
16	85	131	288	412	350	490	364	206	186	112	115	118
17	86	138	706	387	369	477	368	307	184	122	115	109
18	85	128	581	382	351	462	365	313	180	123	115	85
19	86	119	546	367	422	439	436	337	178	125	115	82
20	87	126	694	353	872	441	425	395	173	126	116	81
21	89	199	642	359	830	440	405	349	170	125	116	75
22	90	703	659	346	677	448	396	319	169	126	120	77
23	92	312	652	329	618	530	391	315	166	123	120	77
24	91	809	513	325	558	631	391	305	162	122	120	74
25	91	458	432	306	505	593	387	296	158	121	120	76
26	90	302	383	409	479	553	404	294	154	120	120	78
27	91	237	367	421	470	517	459	292	154	119	119	80
28	93	211	418	364	453	491	433	290	152	118	118	80
29	95	397	645	338	---	480	373	285	150	117	118	78
30	216	288	726	317	---	481	279	279	148	121	119	84
31	201	---	1560	307	---	478	---	276	---	122	118	---
TOTAL	2937	6784	18114	20803	11995	16358	13181	8302	5862	3881	3653	3008
MEAN	94.74	226.1	584.3	671.1	428.4	527.7	439.4	267.8	195.4	125.2	117.8	100.3
MAX	216	809	1560	2810	872	778	515	395	273	142	122	119
MIN	82	95	251	306	265	387	279	199	148	112	112	74
AC-FT	5830	13460	35930	41260	23790	32450	26140	16470	11630	7700	7250	5970

SACRAMENTO RIVER BASIN

11390000 BUTTE CREEK NEAR CHICO, CA—Continued

STATISTICS OF MONTHLY MEAN DATA FOR WATER YEARS 1931 - 2002, BY WATER YEAR (WY)

	OCT	NOV	DEC	JAN	FEB	MAR	APR	MAY	JUN	JUL	AUG	SEP
MEAN	137.8	225.2	454.5	687.2	815.4	765.0	673.2	497.7	284.9	165.3	132.7	119.0
MAX	775	1269	2061	2847	2925	2601	1848	1314	773	356	223	183
(WY)	1963	1974	1956	1997	1986	1995	1982	1995	1998	1998	1975	1998
MIN	65.8	77.8	89.5	91.0	114	123	114	134	79.4	54.4	46.1	51.9
(WY)	1992	1992	1991	1991	1977	1977	1977	1977	1977	1977	1931	1992

SUMMARY STATISTICS	FOR 2001 CALENDAR YEAR		FOR 2002 WATER YEAR		WATER YEARS 1931 - 2002	
ANNUAL TOTAL	99610		114878			
ANNUAL MEAN	272.9		314.7		411.1	
HIGHEST ANNUAL MEAN					834	
LOWEST ANNUAL MEAN					94.0	
HIGHEST DAILY MEAN	1560	Dec 31	2810	Jan 2	26600	Jan 1 1997
LOWEST DAILY MEAN	82	Oct 3	74	Sep 24	44	Aug 23 1931
ANNUAL SEVEN-DAY MINIMUM	84	Oct 1	77	Sep 21	44	Aug 23 1931
MAXIMUM PEAK FLOW			3750	Jan 2	35600	Jan 1 1997
MAXIMUM PEAK STAGE			4.61	Jan 2	17.52	Feb 17 1986
ANNUAL RUNOFF (AC-FT)	197600		227900		297800	
10 PERCENT EXCEEDS	536		596		852	
50 PERCENT EXCEEDS	183		250		209	
90 PERCENT EXCEEDS	95		91		102	

11390000 BUTTE CREEK NEAR CHICO, CA—Continued

WATER-QUALITY RECORDS

PERIOD OF RECORD.—Water years 1953–79, 1999 to current year.

CHEMICAL DATA: Water years 1953–79.

WATER TEMPERATURE: Water years 1962–79, 1999 to current year.

TURBIDITY: Water years 2001 to current year.

SEDIMENT DATA: Water years 2001–02.

PERIOD OF DAILY RECORD.—

WATER TEMPERATURE: November 1961 to January 1979, October 1998 to current year.

TURBIDITY: January 2001 to current year.

INSTRUMENTATION.—Temperature recorder since October 1998 and Turbidity recorder since October 2000.

REMARKS.—Temperature record rated excellent. Turbidity record rated fair. Interruption in record due to malfunction of the recording equipment.

Unpublished sediment data available in the files of the U.S. Geological Survey for December 2000 to October 2002.

EXTREMES FOR PERIOD OF DAILY RECORD.—

WATER TEMPERATURE: Maximum recorded, 27.5°C, July 13, 14, 2002; minimum recorded, 0.5°C, Dec. 8, 31, 1978, Jan. 1, 1979.

TURBIDITY: Maximum recorded, 140 NTU, Dec. 1, 2, 2001; minimum recorded, <0.5 NTU, many days during most years.

EXTREME FOR CURRENT YEAR.—

WATER TEMPERATURE: Maximum recorded, 27.5°C, July 13, 14; minimum recorded, 2.5°C, Jan. 23, 30, 31.

TURBIDITY: Maximum record, 140 NTU, Dec. 1, 2; minimum recorded, <0.5 NTU, many days during the year.

CROSS-SECTIONAL DATA, WATER YEAR OCTOBER 2001 TO SEPTEMBER 2002

Date	Time	DEPTH BOTTOM AT SAMPLE LOC- ATION, (FEET) (81903)	TUR- BID- ITY FIELD WATER UNFLTRD (NTU) (61028)	TEMPER- ATURE WATER (DEG C) (00010)	SAMPLE LOC- ATION, CROSS SECTION (FT FM L BANK) (00009)
APR					
03...*	1435	.66	2.1	14.0	35.0
03...*	1440	1.30	2.2	14.0	70.0
03...*	1445	1.80	2.4	14.0	89.0
03...*	1450	1.90	2.7	14.0	106
03...*	1455	1.78	1.7	14.0	123
JUL					
25...*	1140	.86	.6	21.5	32.0
25...*	1145	1.36	.6	21.0	48.0
25...*	1150	1.98	.7	21.0	56.0
25...*	1155	2.28	1.2	21.0	61.0
25...*	1200	2.18	.7	21.0	66.0

* Instantaneous discharge at the time of the cross-sectional measurements: Apr. 3, 499 ft³/s; July 25, 118 ft³/s.

SACRAMENTO RIVER BASIN

11390000 BUTTE CREEK NEAR CHICO, CA—Continued

TEMPERATURE, WATER (DEG. C), WATER YEAR OCTOBER 2001 TO SEPTEMBER 2002

DAY	MAX		MIN		MAX		MIN		MAX		MIN		MAX		MIN	
	OCTOBER		NOVEMBER		DECEMBER		JANUARY		FEBRUARY		MARCH					
1	20.0	15.5	13.0	10.5	9.0	6.5	10.0	9.5	5.5	3.0	9.0	6.0	9.0	6.0		
2	20.5	16.0	13.0	10.0	9.5	8.5	10.5	10.0	6.0	3.5	9.0	5.5	9.0	5.5		
3	20.0	16.0	13.0	10.0	9.0	7.5	10.0	8.5	6.5	3.5	9.0	5.5	9.0	5.5		
4	19.5	16.0	13.0	10.0	7.5	6.5	8.5	8.0	6.5	3.5	9.5	6.0	9.5	6.0		
5	19.0	15.5	13.0	10.0	7.5	7.0	9.0	8.0	6.5	4.0	8.0	6.5	8.0	6.5		
6	18.0	14.5	12.5	10.0	8.5	7.0	9.5	9.0	6.5	4.0	9.0	7.5	9.0	7.5		
7	17.5	14.0	11.5	9.0	8.5	7.0	9.5	8.5	7.0	5.5	9.0	6.0	9.0	6.0		
8	18.0	15.0	11.5	8.5	8.0	7.0	9.0	8.5	7.5	5.5	7.5	5.0	7.5	5.0		
9	17.0	13.5	11.5	9.0	8.5	6.5	9.5	8.0	7.5	4.5	7.0	5.5	7.0	5.5		
10	16.5	12.5	11.5	9.5	7.5	5.5	8.5	7.5	7.5	5.0	8.5	7.0	8.5	7.0		
11	16.5	14.0	12.5	11.0	6.5	5.0	8.5	7.0	7.5	5.0	9.5	7.0	9.5	7.0		
12	16.0	12.5	12.0	11.5	6.5	4.5	8.5	7.5	8.5	5.5	10.0	8.5	10.0	8.5		
13	16.5	12.5	11.5	11.0	7.0	5.5	7.5	6.0	8.5	6.5	9.5	6.5	9.5	6.5		
14	15.5	13.0	12.5	11.0	8.0	6.0	7.0	5.5	9.5	6.5	9.0	5.5	9.0	5.5		
15	16.0	12.5	12.5	10.5	6.5	5.0	6.0	4.5	8.0	6.5	8.0	5.5	8.0	5.5		
16	16.0	13.0	11.5	10.5	6.5	5.5	6.0	4.0	8.5	7.0	8.0	5.5	8.0	5.5		
17	16.0	13.5	12.0	10.5	7.5	6.5	6.0	4.5	8.5	6.5	8.0	5.5	8.0	5.5		
18	16.0	12.5	11.0	9.5	8.0	7.5	6.0	4.0	8.5	6.0	8.0	4.5	8.0	4.5		
19	15.0	12.0	11.5	9.5	8.5	8.0	5.5	3.5	7.5	7.0	9.0	5.0	9.0	5.0		
20	15.0	12.0	11.5	10.5	8.0	7.5	5.5	4.0	9.0	7.5	10.5	6.5	10.5	6.5		
21	15.0	11.5	11.5	11.0	8.0	7.0	6.0	4.5	10.0	8.0	11.5	7.5	11.5	7.5		
22	14.5	11.5	12.0	10.0	8.5	7.5	5.5	3.5	10.0	8.0	9.5	8.5	9.5	8.5		
23	14.5	12.0	10.0	9.0	8.5	7.0	5.0	2.5	10.0	8.0	9.5	8.0	9.5	8.0		
24	13.5	10.0	11.0	9.0	7.5	6.0	5.0	3.0	10.0	7.0	10.0	7.5	10.0	7.5		
25	13.5	10.5	9.5	8.0	7.5	6.5	5.0	3.5	10.0	7.0	10.0	7.0	10.0	7.0		
26	13.5	10.5	8.5	6.5	8.5	7.5	6.0	5.0	10.0	7.0	11.5	7.5	11.5	7.5		
27	13.5	11.0	7.5	5.5	8.5	8.0	6.5	4.5	10.5	7.5	11.5	7.5	11.5	7.5		
28	13.0	12.0	7.0	6.5	9.0	8.0	4.5	4.0	10.0	7.0	12.5	8.5	12.5	8.5		
29	13.0	12.0	7.5	6.5	9.5	9.0	5.0	3.0	---	---	13.0	9.0	13.0	9.0		
30	13.0	12.0	7.0	6.5	10.5	9.0	4.5	2.5	---	---	13.0	9.5	13.0	9.5		
31	13.5	11.5	---	---	10.5	10.0	4.5	2.5	---	---	13.5	9.0	13.5	9.0		
MONTH	20.5	10.0	13.0	5.5	10.5	4.5	10.5	2.5	10.5	3.0	13.5	4.5	13.5	4.5		
	APRIL		MAY		JUNE		JULY		AUGUST		SEPTEMBER					
1	13.5	9.5	13.0	9.0	21.5	17.0	25.5	19.5	26.0	20.5	23.5	18.0	23.5	18.0		
2	14.0	10.0	15.0	9.0	21.0	16.0	25.5	20.0	26.0	20.5	23.5	18.5	23.5	18.5		
3	14.0	10.5	15.5	11.0	21.0	16.0	25.0	19.5	25.5	20.5	23.0	18.0	23.0	18.0		
4	12.5	11.0	16.5	11.5	21.5	15.0	25.0	19.5	23.0	19.5	22.0	17.5	22.0	17.5		
5	12.0	10.0	17.0	12.0	22.5	16.0	25.5	19.0	23.5	18.5	21.0	16.5	21.0	16.5		
6	13.0	9.0	17.0	12.0	23.0	16.5	25.5	19.5	23.0	17.5	20.5	16.0	20.5	16.0		
7	13.5	9.5	16.5	12.0	22.0	17.0	25.0	20.0	22.5	17.0	19.5	15.0	19.5	15.0		
8	13.5	10.0	16.0	11.0	20.5	16.5	25.5	19.5	23.0	16.5	19.5	14.5	19.5	14.5		
9	11.5	10.0	16.0	11.0	19.5	15.0	26.0	19.5	23.5	17.0	19.5	14.0	19.5	14.0		
10	13.5	9.5	15.0	11.5	20.0	14.0	27.0	20.0	24.0	18.5	20.0	14.5	20.0	14.5		
11	13.0	10.0	16.5	10.5	21.0	15.0	27.0	21.0	24.5	19.0	20.5	15.0	20.5	15.0		
12	14.0	10.5	17.0	11.5	21.5	15.5	26.5	22.0	25.0	19.0	20.5	15.5	20.5	15.5		
13	14.5	10.5	17.5	13.0	22.0	16.0	27.5	21.5	25.5	20.0	21.0	16.0	21.0	16.0		
14	15.0	11.5	18.0	12.5	22.5	16.5	27.5	22.0	25.5	20.5	20.0	16.0	20.0	16.0		
15	13.0	10.0	18.0	13.0	22.5	16.5	26.5	21.0	25.5	20.5	19.0	16.5	19.0	16.5		
16	10.0	8.5	18.5	13.0	22.5	17.0	25.5	20.0	25.5	20.5	20.0	15.5	20.0	15.5		
17	10.0	7.5	19.0	14.0	22.5	16.5	25.5	19.5	25.0	20.5	19.5	15.5	19.5	15.5		
18	9.0	6.5	18.0	13.5	23.0	17.0	25.0	20.0	25.0	20.0	20.5	15.5	20.5	15.5		
19	11.0	6.5	14.5	12.5	23.0	17.5	26.0	20.0	23.5	19.5	20.5	16.0	20.5	16.0		
20	12.0	7.5	12.5	10.5	23.5	17.5	26.5	20.5	23.0	18.5	21.0	16.0	21.0	16.0		
21	13.0	8.0	12.5	9.5	22.5	18.0	25.5	21.0	22.5	18.0	21.0	16.5	21.0	16.5		
22	13.5	9.0	14.5	9.0	23.0	17.5	26.0	21.0	22.5	17.5	21.5	16.5	21.5	16.5		
23	14.5	10.0	15.5	9.5	23.5	18.0	25.5	20.0	22.0	17.0	21.0	16.5	21.0	16.5		
24	14.5	10.5	17.0	11.0	24.0	18.0	25.5	20.0	22.0	16.5	21.0	16.5	21.0	16.5		
25	15.5	11.0	18.0	12.0	24.5	18.5	25.0	19.5	22.0	17.0	---	---	---	---		
26	13.0	11.5	18.5	13.0	24.5	19.0	25.0	19.0	22.5	17.5	---	---	---	---		
27	11.5	9.5	17.0	14.0	24.5	19.0	26.0	20.0	22.5	17.0	---	---	---	---		
28	11.0	8.5	19.0	13.5	25.0	19.5	26.0	20.5	23.5	18.0	---	---	---	---		
29	9.5	9.0	21.0	14.5	25.5	19.5	26.0	20.5	23.0	18.5	---	---	---	---		
30	11.5	8.0	22.0	16.0	25.5	20.0	26.0	21.0	23.0	18.5	---	---	---	---		
31	---	---	22.5	17.0	---	---	26.0	21.0	23.0	18.0	---	---	---	---		
MONTH	15.5	6.5	22.5	9.0	25.5	14.0	27.5	19.0	26.0	16.5	---	---	---	---		

11390000 BUTTE CREEK NEAR CHICO, CA—Continued

TURBIDITY (NTU), WATER YEAR OCTOBER 2001 TO SEPTEMBER 2002

DAY	MAX	MIN	MAX	MIN	MAX	MIN	MAX	MIN	MAX	MIN	MAX	MIN
	OCTOBER		NOVEMBER		DECEMBER		JANUARY		FEBRUARY		MARCH	
1	2.2	<0.5	9.1	5.1	140	1.0	9.4	2.9	1.1	0.6	2.1	<0.5
2	3.0	<0.5	6.9	4.5	140	10	130	7.1	1.8	0.7	2.3	0.6
3	<0.5	<0.5	7.7	4.1	14	4.4	65	13	2.7	0.7	3.5	0.6
4	4.5	<0.5	7.5	3.8	11	3.4	18	5.7	1.2	0.6	1.3	<0.5
5	2.3	<0.5	5.5	3.8	14	2.4	30	3.3	1.0	0.6	1.4	<0.5
6	4.3	<0.5	5.4	3.0	10	2.9	40	4.9	3.8	<0.5	6.9	0.6
7	<0.5	<0.5	---	---	7.2	1.4	14	4.1	4.4	0.6	20	3.2
8	0.8	<0.5	---	---	8.0	1.0	11	3.0	14	2.7	9.7	2.1
9	0.9	<0.5	---	---	9.0	1.0	8.7	2.3	6.3	1.0	3.6	1.4
10	5.2	<0.5	---	---	9.0	1.0	7.2	1.9	1.7	0.8	15	3.6
11	---	---	---	---	9.0	1.0	8.3	1.4	2.9	0.8	3.7	1.4
12	---	---	---	---	9.0	1.0	6.1	1.5	16	0.9	6.7	0.9
13	---	---	---	---	9.0	1.0	7.4	1.0	1.4	0.9	2.2	0.8
14	---	---	7.9	1.4	27	2.5	8.5	0.8	2.8	0.6	2.2	0.8
15	---	---	8.5	<0.5	9.0	1.0	6.1	0.8	3.2	<0.5	2.4	0.7
16	---	---	8.3	<0.5	9.0	1.0	9.8	0.8	1.3	0.7	1.6	<0.5
17	---	---	8.2	<0.5	16	1.3	5.4	0.8	4.9	1.1	1.7	<0.5
18	---	---	8.0	<0.5	7.1	1.6	4.9	0.7	3.7	0.7	2.8	<0.5
19	3.2	<0.5	6.7	<0.5	4.1	1.5	6.3	0.7	12	0.6	1.6	<0.5
20	1.7	<0.5	7.5	<0.5	8.9	1.6	5.1	0.6	15	5.4	2.3	<0.5
21	3.9	0.6	41	<0.5	5.0	1.5	5.9	0.7	7.2	2.6	8.6	0.7
22	3.2	0.7	80	4.8	9.5	1.3	3.4	0.8	4.9	1.4	2.3	0.8
23	4.1	0.9	12	<0.5	9.9	1.1	5.1	<0.5	2.9	1.4	3.7	1.8
24	3.7	1.1	130	<0.5	9.0	1.0	4.9	<0.5	2.0	1.1	12	2.6
25	3.4	1.3	12	<0.5	9.0	1.0	3.5	<0.5	2.2	0.7	5.5	1.7
26	2.9	1.2	11	<0.5	9.0	1.0	14	0.6	4.2	0.8	5.3	1.3
27	3.0	1.2	8.9	<0.5	9.0	1.0	9.6	1.6	1.5	0.9	3.6	1.0
28	2.9	1.4	9.0	1.0	9.0	1.0	1.6	0.9	2.2	0.9	4.3	0.9
29	3.7	1.5	12	2.3	7.9	2.3	1.6	<0.5	---	---	1.9	0.7
30	98	1.9	7.3	1.0	48	1.2	1.6	<0.5	---	---	2.2	1.1
31	29	7.1	---	---	56	6.2	1.3	0.7	---	---	3.5	0.7
MONTH	---	---	---	---	140	1.0	130	<0.5	16	0.5	20	<0.5
	APRIL		MAY		JUNE		JULY		AUGUST		SEPTEMBER	
1	2.5	0.7	5.8	1.0	---	---	6.3	<0.5	3.1	<0.5	9.7	1.6
2	4.2	1.0	2.1	1.0	---	---	6.9	<0.5	3.4	<0.5	9.7	1.5
3	3.5	1.1	3.3	1.3	---	---	7.7	<0.5	2.4	<0.5	9.7	<0.5
4	8.5	1.1	4.0	1.6	---	---	10	<0.5	2.6	<0.5	4.3	<0.5
5	2.6	1.0	3.9	1.6	1.5	<0.5	15	0.6	4.5	<0.5	4.1	<0.5
6	4.0	1.1	6.5	0.7	3.4	<0.5	7.1	0.8	7.0	<0.5	4.5	0.9
7	5.2	1.4	2.7	0.7	7.2	<0.5	5.0	0.6	2.9	0.9	6.6	1.4
8	3.9	1.3	4.0	0.8	7.1	1.5	9.7	0.6	5.0	0.9	---	---
9	3.2	1.6	2.4	<0.5	8.0	0.7	8.9	0.6	2.3	1.0	---	---
10	6.5	1.9	2.0	<0.5	3.1	<0.5	8.9	1.3	2.1	1.0	---	---
11	5.8	2.9	3.7	<0.5	2.7	<0.5	8.8	1.0	4.2	0.8	---	---
12	7.9	4.2	6.4	<0.5	1.3	<0.5	16	1.1	3.9	1.3	---	---
13	13	5.8	2.0	<0.5	3.0	<0.5	9.9	0.9	5.2	2.5	---	---
14	20	3.7	3.3	<0.5	4.4	<0.5	6.4	<0.5	10	1.2	---	---
15	6.3	3.8	1.3	<0.5	4.6	<0.5	5.3	<0.5	3.0	0.7	---	---
16	7.9	4.5	3.0	<0.5	5.5	<0.5	9.2	<0.5	3.2	0.9	---	---
17	7.3	5.6	4.6	1.8	1.8	<0.5	2.6	<0.5	2.6	0.9	---	---
18	8.9	6.2	3.2	1.0	2.2	<0.5	2.5	0.6	6.7	1.0	---	---
19	12	8.6	3.8	0.9	4.8	<0.5	4.2	0.9	4.4	1.3	---	---
20	23	12	5.4	1.2	3.2	0.6	3.1	1.3	5.9	1.2	---	---
21	20	1.5	3.3	<0.5	3.6	0.6	2.4	<0.5	9.6	0.7	---	---
22	5.7	1.1	5.6	<0.5	9.5	0.6	1.5	<0.5	9.6	1.6	---	---
23	2.6	1.1	0.9	<0.5	3.9	<0.5	6.0	<0.5	2.0	1.3	---	---
24	4.6	1.1	0.7	<0.5	8.6	<0.5	2.6	<0.5	2.1	1.0	---	---
25	5.2	1.4	3.0	<0.5	3.0	<0.5	1.5	<0.5	2.1	0.9	---	---
26	4.3	1.7	3.0	<0.5	3.2	<0.5	3.9	<0.5	2.7	1.1	---	---
27	7.8	1.9	0.9	<0.5	8.9	<0.5	2.3	<0.5	2.6	1.0	---	---
28	9.9	1.0	5.8	0.4	6.6	<0.5	3.9	<0.5	5.8	1.4	---	---
29	9.3	1.0	---	---	5.6	<0.5	6.5	<0.5	6.8	1.6	---	---
30	4.7	0.9	---	---	9.1	<0.5	3.3	<0.5	5.2	3.5	---	---
31	---	---	---	---	---	---	1.6	<0.5	4.9	3.2	---	---
MONTH	23	0.7	---	---	---	---	16	<0.5	10	<0.5	---	---

< Actual value is known to be less than the value shown.

11390500 SACRAMENTO RIVER BELOW WILKINS SLOUGH, NEAR GRIMES, CA

LOCATION.—Lat 39°00'36", long 121°49'25", in NW 1/4 NE 1/4 sec.2, T.13 N., R.1 E., Colusa County, Hydrologic Unit 18020104, on right bank, 1,200 ft downstream from Wilkins Slough, 5.8 mi southeast of Grimes, and at mile 62.9 upstream from Sacramento.

DRAINAGE AREA.—12,926 mi².

WATER-DISCHARGE RECORDS

PERIOD OF RECORD.—August 1931 to current year (prior to October 1938, low-water periods only). Monthly discharge only for some periods, published in WSP 1315-A. Prior to October 1965, published as "below Wilkins Slough".

GAGE.—Water-stage recorder and crest-stage gage. Datum of gage is 3.00 ft below sea level.

REMARKS.—Records good. Natural flow of stream affected by storage reservoirs, power development, bypassing for flood control, diversions for irrigation, and return flow from irrigated areas. When discharge exceeds about 23,000 ft³/s, flow begins over Tisdale Weir, 1.0 mi upstream on left bank, into Sutter Bypass. Records tabulated below do not include flow over Tisdale Weir. See schematic diagram of [lower Sacramento River Basin](#).

EXTREMES FOR PERIOD OF RECORD.—Maximum discharge (water years 1939–2002), 32,700 ft³/s, Feb. 20, 1986, gage height, 52.50 ft, maximum gage height, 52.75 ft, Mar. 1, 1940; minimum daily, 645 ft³/s, Aug. 9, 1939.

DISCHARGE, CUBIC FEET PER SECOND, WATER YEAR OCTOBER 2001 TO SEPTEMBER 2002

DAILY MEAN VALUES

DAY	OCT	NOV	DEC	JAN	FEB	MAR	APR	MAY	JUN	JUL	AUG	SEP
1	7150	4880	15200	26000	9990	11200	8090	5240	7180	8310	8800	6120
2	7030	5070	15800	25900	9750	11300	7990	5260	6960	8630	8440	5880
3	6830	4930	24300	28000	9490	11000	7780	5310	6890	8520	8410	5920
4	6640	4850	23100	29200	9250	10700	7670	5060	6780	8090	8390	5840
5	6490	4750	18000	28300	9140	10500	7600	4830	6660	7800	8560	5900
6	6360	4640	13900	27000	8940	10400	7690	5040	6560	7900	8790	5910
7	5960	4690	16200	27200	8770	10500	7680	5190	6230	7890	8880	6020
8	5420	4670	17300	27300	8690	11500	7500	5180	6000	7910	8740	6510
9	5050	4560	13900	26600	8980	12800	7130	4990	6140	7900	8510	6720
10	4840	4520	12300	26000	9660	12400	6830	4950	6120	8120	8080	6820
11	4670	4710	12400	24900	9300	13500	6640	4750	6200	8230	7700	6910
12	4470	5040	11000	23800	8970	15000	6630	4750	5950	8180	7660	6840
13	4290	5710	10100	22400	8710	13800	6340	5110	5840	8230	7740	6820
14	4100	7110	9550	20400	8530	12800	6060	5250	5860	8530	7710	6720
15	4070	7030	15000	18600	8420	12100	5920	5330	6250	8730	7720	6780
16	4100	6510	18000	17200	8370	11500	5930	5470	6900	8850	7800	7180
17	4060	6200	14100	16100	8460	11000	5970	6490	7310	9090	7760	7640
18	3920	5960	13500	15200	8490	10500	5730	6580	7470	9130	7830	7540
19	3840	5730	16000	14400	8530	10000	5440	6680	7650	8910	7700	7390
20	3810	5520	15400	13700	8600	9620	4920	7330	7880	8940	7790	7330
21	3760	5440	19800	13100	17000	9180	4670	8370	7820	9140	7920	7190
22	3840	5590	24700	12600	22300	8970	4450	9300	7820	9180	7550	7070
23	4040	8010	23800	12300	18200	8870	4150	9430	7910	9420	7080	7020
24	4070	10100	24600	11900	14900	9020	4010	9200	8340	9430	6700	7040
25	4020	12300	22900	11400	13400	10500	4220	8800	8510	9450	6190	7060
26	3980	16100	19600	11000	12300	10600	4120	8390	8580	9460	5800	6920
27	3950	11700	17200	10700	11400	9710	4220	8070	8740	9470	5900	6810
28	4100	9020	15100	11000	10700	8940	4480	8210	8770	9220	6030	6750
29	4080	8080	14100	10900	---	8490	5130	7890	8700	9140	6620	6710
30	4160	11300	19400	10500	---	8240	5290	7550	8560	9290	6990	6600
31	4550	---	23100	10200	---	8140	---	7380	---	9210	6610	---
TOTAL	147650	204720	529350	583800	299240	332780	180280	201380	216580	270300	236400	201960
MEAN	4763	6824	17080	18830	10690	10730	6009	6496	7219	8719	7626	6732
MAX	7150	16100	24700	29200	22300	15000	8090	9430	8770	9470	8880	7640
MIN	3760	4520	9550	10200	8370	8140	4010	4750	5840	7800	5800	5840
AC-FT	292900	406100	1050000	1158000	593500	660100	357600	399400	429600	536100	468900	400600

STATISTICS OF MONTHLY MEAN DATA FOR WATER YEARS 1946 - 2002, BY WATER YEAR (WY)

MEAN	6494	8439	12360	15010	16830	15480	11390	9341	7889	7500	7313	7233
MAX	11800	20510	27430	27310	29090	29490	24920	23110	20670	12500	10940	10620
(WY)	1958	1974	1984	1997	1998	1983	1982	1983	1998	1998	1998	1967
MIN	3330	3839	4103	5281	5012	5152	4201	3397	3451	3784	4086	4065
(WY)	1978	1993	1977	1991	1991	1977	1994	1992	1992	1992	1947	1977

SUMMARY STATISTICS	FOR 2001 CALENDAR YEAR	FOR 2002 WATER YEAR	WATER YEARS 1946 - 2002
ANNUAL TOTAL	3355320	3404440	
ANNUAL MEAN	9193	9327	10410
HIGHEST ANNUAL MEAN			17980
LOWEST ANNUAL MEAN			5109
HIGHEST DAILY MEAN	27400	Mar 6	32600
LOWEST DAILY MEAN	3760	Oct 21	2720
ANNUAL SEVEN-DAY MINIMUM	3900	Oct 17	2880
MAXIMUM PEAK FLOW		29400	32700
MAXIMUM PEAK STAGE		49.85	52.68
ANNUAL RUNOFF (AC-FT)	6655000	6753000	7542000
10 PERCENT EXCEEDS	15700	16000	22100
50 PERCENT EXCEEDS	7810	7920	8010
90 PERCENT EXCEEDS	4950	4750	5050

11390500 SACRAMENTO RIVER BELOW WILKINS SLOUGH, NEAR GRIMES, CA—Continued

WATER-QUALITY RECORDS

PERIOD OF RECORD.—October 1966 to current year.

WATER TEMPERATURE: October 1966 to current year.

PERIOD OF DAILY RECORD.—

WATER TEMPERATURE: October 1966 to current year.

INSTRUMENTATION.—Water-temperature recorder since October 1966.

REMARKS.—Water-temperature records rated excellent except for Oct. 30 to Jan. 1, Feb. 8 to Mar. 24, Apr. 14–30, May 13–18, May 28 to Sept. 3, which are good; and Oct. 1–29, May 1–12, Sept. 4–30, which are fair. Temperature recorder located at gaging station on right bank. Water temperature is affected by regulation from dams upstream.

EXTREMES FOR PERIOD OF DAILY RECORD.—

WATER TEMPERATURE: Maximum recorded, 25.5°C, Sept. 6–8, 1977, June 3–5, 1992; minimum recorded, 3.5°C, Dec. 23–25, 1990.

EXTREMES FOR CURRENT YEAR.—

WATER TEMPERATURE: Maximum recorded, 22.5°C, Sept. 2; minimum recorded, 7.0°C, Jan. 30 to Feb. 1.

CROSS-SECTIONAL DATA, WATER YEAR OCTOBER 2001 TO SEPTEMBER 2002

DATE	TIME	DEPTH BOTTOM AT SAMPLE LOC- TION, (FEET) (81903)	TEMPER- ATURE WATER (DEG C) (00010)	SAMPLE LOC- TION, CROSS SECTION (FT FM L BANK) (00009)
MAY				
09...*	1100	1.50	17.5	10.0
09...*	1102	8.60	16.5	31.0
09...*	1104	10.7	16.5	52.0
09...*	1106	11.2	16.5	73.0
09...*	1109	12.1	16.5	94.0
09...*	1112	12.2	16.5	115
09...*	1114	12.4	16.5	136
09...*	1117	13.0	16.5	157
09...*	1120	14.1	16.5	178
09...*	1123	14.3	17.0	199
JUL				
08...*	1650	8.80	20.5	218
08...*	1655	17.0	20.5	196
08...*	1700	16.0	20.5	172
08...*	1708	15.0	20.5	150
08...*	1710	15.0	20.5	126
08...*	1712	14.3	20.5	104
08...*	1715	13.9	20.5	80.0
08...*	1717	12.7	21.0	58.0
08...*	1719	4.80	21.0	34.0
08...*	1722	3.50	21.0	12.0

* Instantaneous discharge at time of cross-section measurement: 5,000 ft³/s, May 9, 2002; 7,880 ft³/s, July 8, 2002.

11390500 SACRAMENTO RIVER BELOW WILKINS SLOUGH, NEAR GRIMES, CA—Continued

WATER TEMPERATURE, DEGREES C, WATER YEAR OCTOBER 2001 TO SEPTEMBER 2002

DAY	MAX	MIN	MAX	MIN	MAX	MIN	MAX	MIN	MAX	MIN	MAX	MIN
	OCTOBER		NOVEMBER		DECEMBER		JANUARY		FEBRUARY		MARCH	
1	19.0	18.0	15.5	15.0	9.0	8.5	11.0	10.5	8.0	7.0	12.5	11.5
2	19.5	18.5	15.5	15.0	9.5	9.0	11.0	11.0	8.0	7.5	11.5	10.5
3	19.5	19.0	16.0	15.0	9.5	9.5	11.5	11.0	8.5	8.0	11.5	10.5
4	19.5	19.0	16.0	15.0	9.5	9.5	11.5	10.5	9.0	8.5	11.5	10.5
5	19.0	18.5	15.5	15.0	9.5	9.0	10.5	10.0	9.5	9.0	12.0	11.0
6	18.5	18.0	15.5	15.0	9.5	9.0	10.0	9.5	9.5	9.0	12.0	11.0
7	18.5	17.0	15.0	14.5	10.0	9.5	10.0	10.0	9.5	9.0	12.0	11.5
8	18.5	17.5	15.0	14.0	10.0	9.5	10.0	9.5	10.0	9.5	12.0	11.0
9	18.0	17.0	14.5	14.0	10.5	9.5	11.0	10.0	10.0	9.0	11.0	10.0
10	17.5	16.5	14.0	14.0	10.0	9.5	10.5	10.0	10.0	9.5	11.0	10.0
11	17.5	16.5	14.5	14.0	9.5	9.0	10.5	9.5	10.0	9.5	10.5	10.0
12	17.0	16.0	14.5	14.5	9.0	8.5	10.0	10.0	10.5	10.0	11.0	10.0
13	17.0	16.0	14.5	14.0	9.0	9.0	10.0	10.0	10.5	10.5	12.0	11.0
14	17.5	16.5	14.5	14.0	9.0	9.0	10.0	9.5	11.5	10.5	12.5	11.5
15	17.5	17.0	14.5	14.0	9.0	8.5	10.0	9.0	11.5	11.0	12.0	11.0
16	17.5	17.0	15.0	14.5	8.5	8.0	9.0	8.5	11.5	11.0	11.5	11.0
17	17.5	17.0	15.0	14.5	8.0	8.0	8.5	8.0	11.5	11.0	11.5	11.0
18	17.5	16.5	15.0	14.5	9.0	8.0	9.0	8.0	11.5	11.0	11.5	10.5
19	17.5	17.0	14.5	14.0	9.0	9.0	8.5	8.0	11.5	11.0	11.5	10.5
20	17.5	17.0	14.5	14.0	9.5	9.0	8.5	8.0	11.5	11.0	12.0	11.0
21	17.0	16.5	14.0	14.0	9.5	9.0	8.5	8.0	11.5	10.5	13.0	12.0
22	17.0	16.5	14.0	14.0	9.0	8.5	8.5	8.0	11.0	10.5	13.0	12.5
23	16.5	15.5	14.0	13.0	9.5	8.5	8.5	8.0	12.0	11.0	13.0	12.5
24	16.0	15.0	13.0	12.5	9.5	9.0	8.0	8.0	12.5	11.5	14.0	12.5
25	16.0	15.5	12.5	11.0	9.0	8.5	8.0	8.0	12.5	11.5	13.5	11.5
26	15.5	15.0	11.0	10.0	9.0	8.5	8.5	8.0	12.5	11.5	14.0	12.5
27	15.5	15.5	10.0	9.5	9.0	8.5	8.5	8.5	13.0	12.0	14.5	13.5
28	15.5	15.5	9.5	9.5	9.0	9.0	8.5	8.0	13.0	12.5	15.5	14.5
29	15.5	15.0	9.5	9.5	9.5	9.0	8.0	7.5	---	---	16.0	15.0
30	15.5	15.0	9.5	9.0	10.0	9.5	7.5	7.0	---	---	16.5	15.5
31	15.5	15.0	---	---	10.5	10.0	7.5	7.0	---	---	17.5	16.0
MONTH	19.5	15.0	16.0	9.0	10.5	8.0	11.5	7.0	13.0	7.0	17.5	10.0
	APRIL		MAY		JUNE		JULY		AUGUST		SEPTEMBER	
1	18.0	17.0	15.5	14.5	21.5	20.5	21.5	20.0	21.5	20.0	22.0	21.0
2	18.5	17.5	16.0	15.0	21.0	20.5	21.0	20.0	21.5	20.0	22.5	21.5
3	19.0	18.0	16.5	15.5	20.5	20.0	21.0	20.0	21.5	20.0	22.0	21.0
4	18.5	18.0	17.0	16.0	20.5	20.0	21.0	20.0	21.0	19.5	22.0	21.0
5	18.0	17.5	18.0	17.0	21.0	20.5	21.0	20.0	20.5	19.0	21.0	20.0
6	18.0	17.0	18.5	18.0	21.5	20.5	21.0	20.0	20.0	18.5	20.5	19.5
7	18.0	17.0	18.5	18.0	21.5	20.5	21.0	20.0	19.5	18.5	20.0	19.0
8	18.0	17.0	18.0	17.5	21.0	19.5	21.0	20.0	20.0	18.5	20.0	19.0
9	17.5	17.0	17.5	17.0	19.5	18.0	21.0	20.0	20.5	19.0	19.5	19.0
10	17.5	16.5	17.0	17.0	18.0	17.0	21.0	20.0	21.0	19.5	19.5	19.0
11	17.5	17.0	17.5	17.0	19.0	17.5	21.5	20.0	21.5	20.0	19.5	19.0
12	18.0	17.0	18.0	17.0	20.0	18.5	21.5	20.5	22.0	20.5	20.0	19.5
13	18.5	17.5	18.0	17.5	20.5	19.5	21.5	20.5	21.5	20.5	20.0	19.5
14	19.5	17.0	18.5	18.0	20.5	19.5	21.5	20.0	22.0	20.5	20.0	19.5
15	19.5	18.5	19.0	18.5	20.5	20.0	21.0	20.0	21.5	20.5	20.0	19.5
16	19.0	17.0	19.5	19.0	20.5	20.0	21.0	20.0	21.5	20.5	19.5	19.0
17	17.0	15.5	19.5	19.0	20.5	19.5	21.0	19.5	21.5	20.0	19.0	18.5
18	16.0	15.0	19.0	18.0	21.0	20.0	20.5	19.5	21.0	20.0	19.0	18.5
19	15.5	14.5	19.0	18.0	21.0	20.0	21.0	19.5	21.0	20.0	19.0	18.0
20	15.5	14.5	18.0	16.0	20.5	20.0	21.0	19.5	20.5	19.5	19.5	18.5
21	16.5	15.0	16.0	15.0	20.5	19.5	21.0	20.0	20.5	19.5	19.5	19.0
22	17.5	16.0	16.5	15.5	20.0	19.0	21.0	19.5	20.0	19.5	20.0	19.0
23	18.5	17.0	17.5	16.5	20.5	19.0	21.0	19.5	20.0	19.0	20.0	19.0
24	18.5	18.0	18.5	17.0	20.5	19.5	21.0	19.5	20.5	19.5	19.5	19.0
25	19.0	18.0	19.5	18.5	20.5	19.5	21.0	19.5	21.0	20.0	19.5	19.0
26	18.5	17.5	20.0	19.5	20.5	19.5	21.0	19.5	21.5	20.5	19.0	18.5
27	17.5	16.5	20.0	19.5	20.5	19.5	21.0	19.5	22.0	20.5	18.5	18.0
28	16.5	16.0	20.0	19.0	20.5	20.0	21.0	19.5	22.0	21.0	18.5	18.0
29	16.5	15.0	20.0	19.0	20.5	19.5	21.0	20.0	22.0	21.0	18.0	17.5
30	15.0	14.5	20.5	18.0	21.0	20.0	21.0	20.0	21.5	21.0	18.0	17.0
31	---	---	21.5	20.5	---	---	21.0	20.0	22.0	21.0	---	---
MONTH	19.5	14.5	21.5	14.5	21.5	17.0	21.5	19.5	22.0	18.5	22.5	17.0

11391100 SACRAMENTO SLOUGH NEAR KNIGHTS LANDING, CA

LOCATION.—Lat 38°46'45", long 121°38'15", in SE 1/4 NE 1/4, sec.20, T.11 S, R.3 E, Sutter County, Hydrologic Unit 18020104, on right bank, 1 mi east of Karnak Pumping Plant, and 4.5 mi east of Knights Landing.

DRAINAGE AREA.—Not determined.

PERIOD OF RECORD.—Water years 1996 to 1998, January 2001 to current year.

CHEMICAL DATA: February 1996 to September 1998, January 2001 to current year.

SPECIFIC CONDUCTANCE: October 1995 to September 1996.

WATER TEMPERATURE: October 1995 to September 1996.

SEDIMENT DATA: February 1996 to September 1998, January 2001 to current year.

PERIOD OF DAILY RECORD.—

SPECIFIC CONDUCTANCE: October 1995 to September 1996.

WATER TEMPERATURE: October 1995 to September 1996.

REMARKS.—Discharge values were provided by Department of Water Resources and reviewed by U.S. Geological Survey.

WATER-QUALITY DATA, WATER YEAR OCTOBER 2001 TO SEPTEMBER 2002

Date	Time	DIS- CHARGE, INST. CUBIC FEET PER SECOND (00061)	BARO- METRIC PRES- SURE (MM OF HG) (00025)	OXYGEN, DIS- SOLVED (PER- CENT SATUR- ATION) (MG/L) (00300)	OXYGEN, DIS- SOLVED (PER- CENT SATUR- ATION) (MG/L) (00301)	PH WATER WHOLE FIELD (STAND- ARD UNITS) (00400)	SPE- CIFIC CON- DUCT- ANCE (US/CM) (00095)	TEMPER- ATURE WATER (DEG C) (00010)	ALKA- LILITY WAT.DIS GRAN T. FIELD CACO3 (MG/L) (29802)	
NOV										
13...	0950	e13	758	4.8	48	7.6	293	15.0	120	
JAN										
24...	0800	e18	775	10.2	83	7.8	138	7.0	120	
FEB										
21...	1200	e18	770	9.8	93	8.0	794	13.5	230	
MAR										
21...	1010	e16	765	10.1	--	8.0	324	--	150	
APR										
25...	0900	e11	762	7.9	85	7.6	319	19.0	120	
MAY										
22...	1010	e17	768	7.9	81	7.6	309	17.0	130	
JUN										
19...	0950	e15	757	7.4	92	7.6	521	26.0	180	
JUL										
17...	1020	e17	767	6.3	77	7.7	370	25.5	140	
SEP										
18...	0930	e14	758	8.7	99	7.9	484	21.5	170	
Date		CHLO- RIDE, DIS- SOLVED (MG/L AS CL) (00940)	SULFATE DIS- SOLVED (MG/L AS SO4) (00945)	NITRO- GEN, AMMONIA DIS- SOLVED (MG/L AS N) (00608)	NITRO- GEN,AM- MONIA + ORGANIC TOTAL (MG/L AS N) (00625)	NITRO- GEN, NO2+NO3 DIS- SOLVED (MG/L AS N) (00631)	NITRO- GEN, NITRITE DIS- SOLVED (MG/L AS N) (00613)	ORTHO- PHOS- PHATE, DIS- SOLVED (MG/L AS P) (00671)	PHOS- PHORUS TOTAL (MG/L AS P) (00665)	2,6- ETHYL ANILINE WAT FLT 0.7 U GF, REC (UG/L) (82660)
NOV										
13...	10.0	6.0	<.04	.63	<.05	<.008	.05	.20	--	
JAN										
24...	11.7	8.1	e.02	.46	.27	<.006	.06	.136	<.002	
FEB										
21...	--	--	<.04	.55	.39	.013	.09	.185	<.006	
MAR										
21...	11.2	9.1	<.04	.40	.14	<.008	.05	.128	<.006	
APR										
25...	27.0	9.2	e.03	.50	.09	.010	.09	.196	<.006	
MAY										
22...	20.4	11.7	<.04	.51	.29	.010	.10	.184	<.006	
JUN										
19...	55.5	16.3	<.04	.60	.26	.023	.11	.21	<.006	
JUL										
17...	15.9	9.4	<.04	.54	.06	e.005	.13	.21	<.006	
SEP										
18...	39.7	10.2	<.04	.41	.05	e.005	.11	.187	<.006	

e Estimated.

< Actual value is known to be less than the value shown.

SACRAMENTO RIVER BASIN

11391100 SACRAMENTO SLOUGH NEAR KNIGHTS LANDING, CA—Continued

WATER-QUALITY DATA, WATER YEAR OCTOBER 2001 TO SEPTEMBER 2002

Date	ACETO- CHLOR, WATER, FLTRD REC (UG/L) (49260)	ALA- CHLOR, WATER, DISS, REC, (UG/L) (46342)	ALPHA BHC DIS- SOLVED (UG/L) (34253)	ATRA- ZINE, WATER, DISS, REC (UG/L) (39632)	BEN- FLUR- ALIN WAT FLD 0.7 U GF, REC (UG/L) (82673)	BUTYL- ATE, WATER, DISS, REC (UG/L) (04028)	CAR- BARYL WATER FLTRD 0.7 U GF, REC (UG/L) (82680)	CARBO- FURAN WATER FLTRD 0.7 U GF, REC (UG/L) (82674)	CHLOR- PYRIFOS DIS- SOLVED (UG/L) (38933)
NOV 13...	--	--	--	--	--	--	--	--	--
JAN 24...	<.004	<.002	<.005	<.007	<.010	<.002	<.041	<.020	.011
FEB 21...	<.006	<.004	<.005	<.007	<.010	<.002	<.041	<.020	<.005
MAR 21...	<.006	<.004	<.005	<.007	<.010	<.002	<.041	<.020	<.005
APR 25...	<.006	<.004	<.005	<.007	<.010	<.002	<.041	<.020	<.005
MAY 22...	<.006	<.004	<.005	<.007	<.010	<.002	<.041	<.021	<.005
JUN 19...	<.006	<.004	<.005	<.007	<.010	<.002	e.080	<.020	<.005
JUL 17...	<.006	<.004	<.005	<.007	<.010	<.002	e.010	<.020	<.005
SEP 18...	<.006	<.004	<.005	<.007	<.010	<.002	<.041	<.020	<.005
Date	CYANA- ZINE, WATER, DISS, REC (UG/L) (04041)	DCPA WATER FLTRD 0.7 U GF, REC (UG/L) (82682)	DEETHYL ATRA- ZINE, WATER, DISS, REC (UG/L) (04040)	DI- AZINON, DIS- SOLVED (UG/L) (39572)	DI- ELDRIN DIS- SOLVED (UG/L) (39381)	DISUL- FOTON WATER FLTRD 0.7 U GF, REC (UG/L) (82677)	EPTC WATER FLTRD 0.7 U GF, REC (UG/L) (82668)	ETHAL- ALIN WAT FLT 0.7 U GF, REC (UG/L) (82663)	ETHO- PROP WATER FLTRD 0.7 U GF, RE (UG/L) (82672)
NOV 13...	--	--	--	--	--	--	--	--	--
JAN 24...	<.018	<.003	<.006	.041	<.005	<.02	<.002	<.009	<.005
FEB 21...	<.018	<.003	<.006	.008	<.005	<.02	<.002	<.009	<.005
MAR 21...	<.018	<.003	<.006	.012	<.005	<.02	<.002	<.009	<.005
APR 25...	<.018	<.003	<.006	.037	<.005	<.02	<.002	<.009	<.005
MAY 22...	<.018	<.003	<.006	.013	<.005	<.02	<.021	<.009	<.005
JUN 19...	<.018	<.003	<.006	.014	<.005	<.02	.002	<.009	<.005
JUL 17...	<.018	<.003	<.006	<.005	<.005	<.02	<.002	<.009	<.005
SEP 18...	<.018	<.003	<.006	<.005	<.005	<.02	<.002	<.009	<.005
Date	FONOFOS WATER DISS REC (UG/L) (04095)	LINDANE DIS- SOLVED (UG/L) (39341)	LIN- URON WATER FLTRD 0.7 U GF, REC (UG/L) (82666)	MALA- THION, DIS- SOLVED (UG/L) (39532)	METHYL AZIN- PHOS WAT FLT 0.7 U GF, REC (UG/L) (82686)	METHYL PARA- THION WAT FLT 0.7 U GF, REC (UG/L) (82667)	METO- LACHLOR WATER DISSOLV (UG/L) (39415)	METRI- BUZIN WATER DISSOLV (UG/L) (82630)	MOL- INATE WATER FLTRD 0.7 U GF, REC (UG/L) (82671)
NOV 13...	--	--	--	--	--	--	--	--	--
JAN 24...	<.003	<.004	<.035	<.027	<.050	<.006	<.013	<.006	.045
FEB 21...	<.003	<.004	<.035	<.027	<.050	<.006	e.004	<.006	.067
MAR 21...	<.003	<.004	<.035	<.027	<.050	<.006	e.002	<.006	.018
APR 25...	<.003	<.004	<.035	<.027	<.050	<.006	<.013	<.006	.027
MAY 22...	<.003	<.004	<.035	<.027	<.050	<.006	.025	<.006	9.16
JUN 19...	<.003	<.004	<.035	<.027	<.050	<.006	.113	<.006	3.05
JUL 17...	<.003	<.004	<.035	<.027	<.050	<.006	.021	<.006	.522
SEP 18...	<.003	<.004	<.035	e.008	<.050	<.006	e.005	<.006	.148

< Actual value is known to be less than the value shown.
e Estimated.

11391100 SACRAMENTO SLOUGH NEAR KNIGHTS LANDING, CA—Continued

WATER-QUALITY DATA, WATER YEAR OCTOBER 2001 TO SEPTEMBER 2002

Date	NAPROP-AMIDE WATER FLTRD 0.7 U GF, REC (82684)	P,P' DDE DISSOLV (UG/L) (34653)	PARATHION, DIS- SOLVED (UG/L) (39542)	PEBULATE WATER FILTRD 0.7 U GF, REC (82669)	PENDIMETHALIN WAT FLT 0.7 U GF, REC (82683)	PERMETHRIN CIS WAT FLT 0.7 U GF, REC (82687)	PHORATE WATER FLTRD 0.7 U GF, REC (82664)	PRO-METON, WATER, DISS, REC (UG/L) (04037)	PRON-AMIDE WATER FLTRD 0.7 U GF, RE (UG/L) (82676)
	NOV 13...	--	--	--	--	--	--	--	--
JAN 24...	<.007	<.003	<.007	<.002	<.010	<.006	<.011	<.01	<.004
FEB 21...	<.007	<.003	<.010	<.004	<.022	<.006	<.011	<.01	<.004
MAR 21...	<.007	<.003	<.010	<.004	<.022	<.006	<.011	<.01	<.004
APR 25...	<.007	<.003	<.010	<.004	<.022	<.006	<.011	<.01	<.004
MAY 22...	<.007	<.003	<.010	<.004	<.022	<.006	<.011	<.01	<.004
JUN 19...	<.007	<.003	<.010	<.004	<.022	<.006	<.011	<.01	<.004
JUL 17...	<.007	<.003	<.010	<.004	.025	<.006	<.011	<.01	<.004
SEP 18...	<.007	<.003	<.010	<.004	<.022	<.006	<.011	<.01	<.004

Date	PROPA-CHLOR, WATER, DISS, REC (UG/L) (04024)	PRO-PANIL WATER FLTRD 0.7 U GF, REC (UG/L) (82679)	PRO-PARGITE FLTRD 0.7 U GF, REC (UG/L) (82685)	SI-MAZINE, WATER, DISS, REC (UG/L) (04035)	TEBUTHIURON WATER FLTRD 0.7 U GF, REC (UG/L) (82670)	TER-BACIL WATER FLTRD 0.7 U GF, REC (UG/L) (82665)	TER-BUFOS WATER FLTRD 0.7 U GF, REC (UG/L) (82675)	TER-BUTHYL-AZINE, WATER, DISS, REC (UG/L) (04022)	THIO-BENCARB WATER FLTRD 0.7 U GF, REC (UG/L) (82681)
	NOV 13...	--	--	--	--	--	--	--	--
JAN 24...	<.010	<.011	<.02	e.008	<.02	<.034	<.02	--	.010
FEB 21...	<.010	<.011	<.02	e.004	<.02	<.034	<.02	U	.009
MAR 21...	<.010	<.011	<.02	.063	<.02	<.034	<.02	U	.005
APR 25...	<.010	<.011	<.02	<.007	<.02	<.034	<.02	--	.005
MAY 22...	<.010	<.011	<.02	<.005	<.02	<.034	<.02	--	1.19
JUN 19...	<.010	1.22	.04	<.005	<.02	<.034	<.02	--	.234
JUL 17...	<.010	.068	<.02	<.005	<.02	<.034	<.02	--	.061
SEP 18...	<.010	<.011	<.02	<.005	<.02	<.034	<.02	--	.022

Date	TRIAL-LATE WATER FLTRD 0.7 U GF, REC (UG/L) (82678)	TRI-FLUR-ALIN WAT FLT 0.7 U GF, REC (UG/L) (82661)
	NOV 13...	--
JAN 24...	<.002	<.009
FEB 21...	<.002	<.009
MAR 21...	<.002	e.003
APR 25...	<.002	<.009
MAY 22...	<.002	e.008
JUN 19...	<.002	e.005
JUL 17...	<.002	<.009
SEP 18...	<.002	<.009

< Actual value is known to be less than the value shown.
e Estimated.
U Material specifically analyzed for, but not detected.

SACRAMENTO RIVER BASIN

11391100 SACRAMENTO SLOUGH NEAR KNIGHTS LANDING, CA—Continued

PARTICLE-SIZE DISTRIBUTION OF SUSPENDED SEDIMENT, WATER YEAR OCTOBER 2001 TO SEPTEMBER 2002

Date	Time	DIS- CHARGE, INST. CUBIC FEET PER SECOND (00061)	TEMPER- ATURE WATER (DEG C) (00010)	SEDI- MENT, SUS- PENDED (MG/L) (80154)	SEDI- MENT, DIS- CHARGE, SUS- PENDED (T/DAY) (80155)	SED. SUSP. SIEVE DIAM. % FINER THAN .062 MM (70331)
NOV						
13...SS	0950	e13	15.0	31	e1.1	69
JAN						
24...SS	0800	e18	7.0	27	e1.3	99
FEB						
21...SS	1200	e18	13.5	48	e2.3	79
MAR						
21...SS	1010	e16	--	48	e2.1	94
APR						
25...SS	0900	e11	19.0	77	e2.3	97
MAY						
22...SS	1010	e17	17.0	81	e3.7	98
JUN						
19...SS	0950	e15	26.0	48	e1.9	99
JUL						
17...SS	1020	e17	25.5	60	e2.8	--
SEP						
18...SS	0930	e14	21.5	39	e1.5	93

SS Suspended-sediment data determined from a sample collected and processed according to National Water Quality Assessment (NAWQA) protocol.

e Estimated.

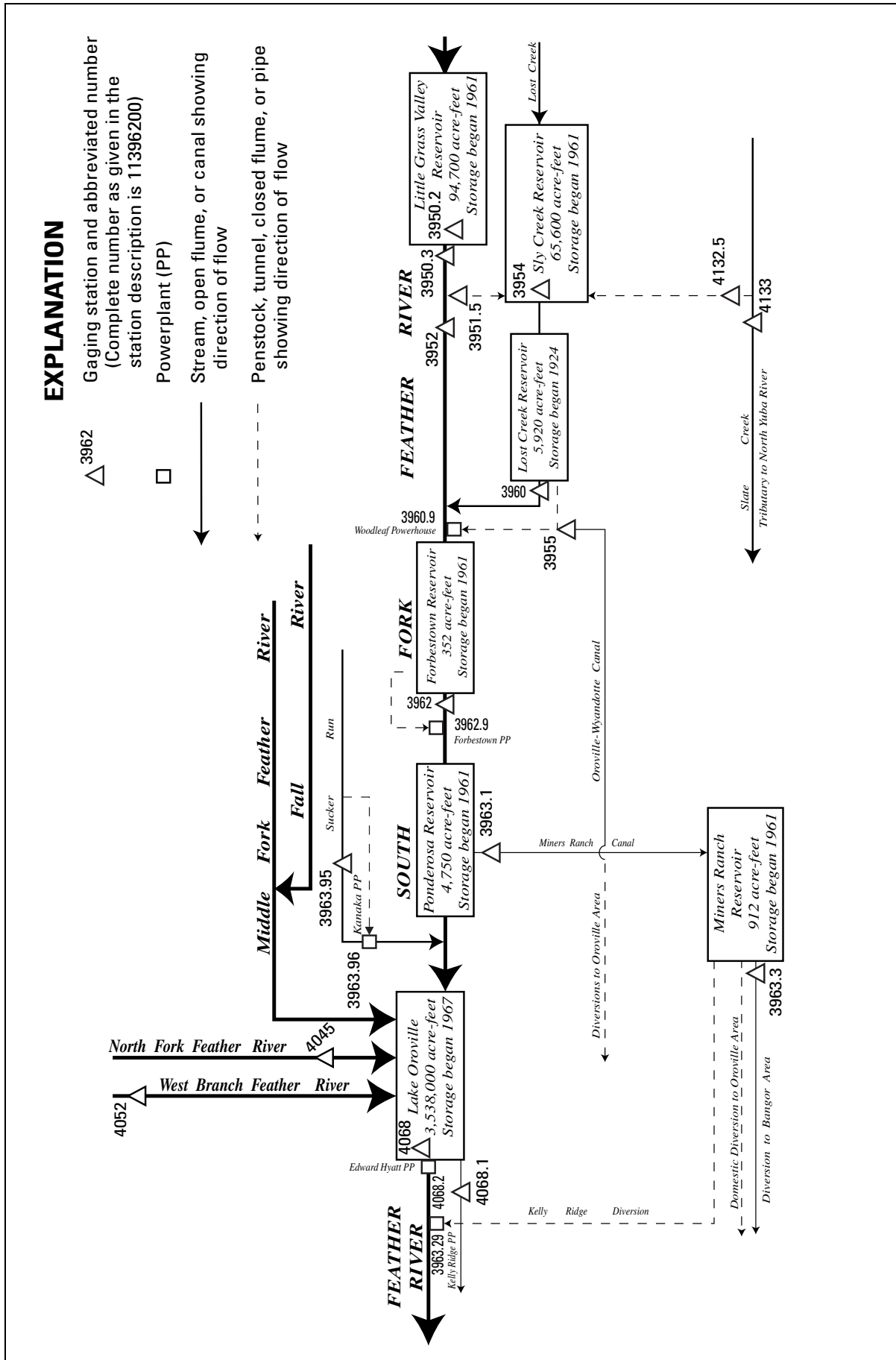

Figure 28. Diversions and storage in South Fork Feather River Basin.

11395020 LITTLE GRASS VALLEY RESERVOIR NEAR LA PORTE, CA

LOCATION.—Lat 39°43'25", long 121°01'10", in SE 1/4 NW 1/4 sec.31, T.22 N., R.9 E., [Plumas County](#), Hydrologic Unit 18020123, Plumas National Forest, on right bank, 300 ft upstream from dam on South Fork Feather River, and 3.3 mi northwest of La Porte.

DRAINAGE AREA.—25.8 mi².

PERIOD OF RECORD.—October 1961 to current year. Monthend elevation and contents only, October 1961 to October 1962.

GAGE.—Water-stage recorder. Datum of gage is sea level (levels by Oroville–Wyandotte Irrigation District). Prior to Nov. 1, 1962, in valve chamber in dam at same datum.

REMARKS.—Reservoir is formed by rockfill dam. Storage began in October 1961. Total capacity, 94,700 acre-ft, between elevations 4,876 ft, invert of release valve, and 5,047 ft, top of spillway gates, all of which is available for release. Water is released down South Fork Feather River for power development and irrigation. Records represent total contents at 2400 hours. See schematic diagram of [South Fork Feather River Basin](#).

COOPERATION.—Records provided by Oroville–Wyandotte Irrigation District, under general supervision of the U.S. Geological Survey, in connection with Federal Energy Regulatory Commission project no. 2088.

EXTREMES FOR PERIOD OF RECORD.—Maximum contents, 98,000 acre-ft, May 1, 1995, May 17, 1996, elevation, 5,049.0 ft; minimum since reservoir first filled, 30,300 acre-ft, many days during 1977, elevation, 4,994.8 ft.

EXTREMES FOR CURRENT YEAR.—Maximum contents, 91,900 acre-ft, June 16, elevation, 5,045.3 ft; minimum, 47,000 acre-ft, Oct. 29, elevation, 5,012.2 ft.

Capacity table (elevation, in feet, and contents, in acre-feet)
(Based on survey by Pacific Gas & Electric Co. in 1963)

4,990	26,300	5,010	44,400	5,030	68,900	5,048	96,300
5,000	34,600	5,020	55,900	5,040	83,500	5,049	98,000

RESERVOIR STORAGE (ACRE-FEET) WATER YEAR OCTOBER 2001 TO SEPTEMBER 2002

DAILY OBSERVATION AT 2400 HOURS

DAY	OCT	NOV	DEC	JAN	FEB	MAR	APR	MAY	JUN	JUL	AUG	SEP
1	58000	47200	49600	53900	62400	67100	74300	e88700	91400	87900	76800	65500
2	57600	47200	50200	54800	62500	67300	74900	88900	91400	87600	76500	65100
3	56800	47200	50300	55500	62500	67500	75500	89000	91500	87100	76000	64900
4	56100	47200	50400	56000	62600	67700	76000	89200	91700	86800	75500	64500
5	55400	47200	50500	56500	62600	67800	76800	89300	91700	86500	75000	64100
6	54800	47200	50600	57400	62600	68600	77500	89500	91700	86000	74700	63800
7	54200	47200	50700	58100	63000	69200	78100	89600	91700	85700	74400	63400
8	53500	47200	50800	58600	63200	69500	78700	89800	91700	85200	74100	63200
9	52900	47200	50800	59000	63200	69900	79400	90000	91700	84900	73700	62800
10	52200	47200	51000	59300	63300	70200	80100	90100	91700	84600	73400	62400
11	51500	47200	51000	59500	63300	70600	80900	90300	91900	84300	73100	62100
12	50800	47400	51000	59800	63400	70800	81600	90400	91900	83800	72700	61700
13	50200	47400	51200	60000	63400	70900	82200	90400	91900	83500	72200	61300
14	49500	47500	51300	60300	63600	71200	82900	90600	91900	83000	72000	61000
15	48800	47500	51300	60400	63700	71500	83600	90700	91900	82600	71500	60600
16	48100	47500	51400	60600	63800	71700	84100	90700	91900	82500	71200	60300
17	47600	47500	51600	60700	63800	71800	84900	90900	91900	82000	70800	59900
18	47400	47500	51600	60800	63900	72100	85400	90900	91700	81700	70300	59500
19	47300	47500	51800	61000	64300	72200	85700	91100	91500	81400	70100	59300
20	47300	47500	51900	61100	64700	72400	86000	91100	91200	81000	69600	59000
21	47200	48000	52000	61200	65000	72500	86300	91200	91100	80700	69300	58900
22	47200	48200	52100	61300	65200	72700	86600	91200	90700	80300	68900	58700
23	47200	48200	52200	61500	65600	72700	87000	91200	90600	80000	68500	58600
24	47200	48800	52200	61600	65900	72700	87300	91400	90300	79700	68200	58500
25	47100	48900	52200	61600	66200	72700	e87600	91400	90100	79200	67800	58500
26	47100	49000	52300	62000	66400	72800	e87700	91400	89800	79000	67500	58500
27	47100	49000	52400	62000	66700	73000	e87900	91400	89300	78500	67200	58500
28	47100	49100	52600	62100	66900	73100	e88200	91200	89000	78200	66800	58400
29	47000	49200	52700	62300	---	73400	e88400	91200	88700	77900	66500	58400
30	47200	49200	53100	62300	---	73600	e88500	91200	88200	77500	66200	58400
31	47200	---	53600	62400	---	74000	---	91200	---	77200	65900	---
MAX	58000	49200	53600	62400	66900	74000	88500	91400	91900	87900	76800	65500
MIN	47000	47200	49600	53900	62400	67100	74300	88700	88200	77200	65900	58400
a	5012.4	5014.2	5018.0	5025.0	5028.5	5033.5	5043.2	5044.9	5043.0	5035.7	5027.7	5021.9
b	-11200	+2000	+4400	+8800	+4500	+7100	+14500	+2700	-3000	-11000	-11300	-7500

CAL YR 2001 b +12900
WTR YR 2002 b 0

e Estimated.

a Elevation, in feet, at end of month.

b Change in contents, in acre-feet.

11395030 SOUTH FORK FEATHER RIVER BELOW LITTLE GRASS VALLEY DAM, CA

LOCATION.—Lat 39°43'26", long 121°01'16", in SW 1/4 NW 1/4 sec.31, T.22 N., R.9 E., [Plumas County](#), Hydrologic Unit 18020123, Plumas National Forest, on left bank, 0.1 mi downstream from Little Grass Valley Dam, and 3.5 mi northwest of La Porte.

DRAINAGE AREA.—25.9 mi².

PERIOD OF RECORD.—October 1927 to September 1933 (published as "near La Porte"), October 1960 to current year.

REVISED RECORDS.—WSP 1931: Drainage area.

GAGE.—Water-stage recorder. Datum of gage is 4,809.0 ft above sea level. Prior to Oct. 1, 1960, at site 0.4 mi upstream at different datum. Oct. 1, 1960, to Oct. 30, 1962, at present site and datum. Nov. 1, 1962, to May 31, 1966, at site on outlet works at base of Little Grass Valley Dam 0.1 mi upstream at datum 4,850.00 ft above sea level.

REMARKS.—Flow regulated by Little Grass Valley Reservoir (station 11395020) beginning in October 1961. No diversion upstream from station. See schematic diagram of [South Fork Feather River Basin](#).

COOPERATION.—Records provided by Oroville–Wyandotte Irrigation District, under general supervision of the U.S. Geological Survey, in connection with Federal Energy Regulatory Commission project no. 2088.

EXTREMES FOR PERIOD OF RECORD.—Maximum discharge, 7,370 ft³/s, Jan. 1, 1997, gage height, 14.80 ft; minimum daily, 0.2 ft³/s, Oct. 28–31, Nov. 2, 1961, during initial operation of Little Grass Valley Reservoir; since operation stabilized in 1964, 1.4 ft³/s, Jan. 27, 1964.

DISCHARGE, CUBIC FEET PER SECOND, WATER YEAR OCTOBER 2001 TO SEPTEMBER 2002

DAILY MEAN VALUES

DAY	OCT	NOV	DEC	JAN	FEB	MAR	APR	MAY	JUN	JUL	AUG	SEP
1	147	7.0	7.9	10	7.7	8.6	10	109	11	179	177	174
2	245	6.9	10	15	7.7	8.4	11	109	11	179	177	173
3	330	6.9	8.8	13	7.7	8.4	12	110	11	179	177	173
4	342	6.9	8.4	10	7.7	8.4	12	110	11	179	177	173
5	342	6.9	8.2	9.7	7.7	8.4	12	111	11	179	177	173
6	341	6.9	8.5	14	7.7	11	11	111	11	178	177	173
7	340	6.9	8.6	11	8.0	10	11	110	11	178	177	173
8	340	6.9	8.4	9.9	8.5	9.3	11	110	11	178	177	173
9	339	6.9	8.2	9.6	8.0	9.1	12	110	11	178	177	173
10	339	6.9	8.2	9.2	7.9	9.0	12	110	11	178	177	173
11	339	7.1	8.0	9.0	7.9	8.9	12	110	11	178	176	172
12	337	7.4	7.9	8.8	8.0	8.9	12	110	11	178	176	172
13	336	7.4	7.9	8.6	7.9	8.8	13	110	11	178	176	172
14	335	7.1	7.9	8.5	7.9	8.6	13	110	11	178	177	172
15	334	7.1	7.9	8.4	7.9	8.6	12	110	11	177	176	172
16	334	7.1	7.9	8.2	8.0	8.6	11	110	11	178	176	172
17	251	7.1	7.9	8.2	8.1	8.4	10	110	71	178	176	172
18	128	7.1	7.9	8.2	7.9	8.4	9.6	110	120	177	176	172
19	34	10	7.9	8.2	8.3	8.3	9.4	110	119	178	176	172
20	7.0	10	7.9	8.2	11	8.4	9.4	110	119	178	176	119
21	7.1	9.3	7.9	8.2	9.5	26	9.3	110	119	177	176	72
22	7.1	11	7.9	8.0	9.4	68	9.5	110	119	177	176	72
23	7.1	8.4	7.9	7.9	9.5	105	9.9	110	119	177	175	38
24	6.7	11	7.7	7.9	9.1	105	11	110	153	177	175	12
25	6.9	9.1	7.7	7.9	8.9	105	69	110	177	177	175	12
26	6.9	8.4	7.8	7.9	8.9	48	110	110	179	177	174	12
27	6.9	8.2	7.9	7.9	8.7	8.4	110	110	179	177	174	12
28	6.9	8.2	8.1	7.9	8.6	8.6	109	110	179	177	174	12
29	6.9	8.1	8.8	7.9	---	9.0	109	110	179	177	174	12
30	7.0	7.9	9.9	7.8	---	9.2	109	110	179	177	174	12
31	7.1	---	13	7.7	---	9.5	---	54	---	177	174	---
TOTAL	5616.6	236.1	258.9	282.7	234.1	678.2	881.1	3354	2187	5510	5452	3664
MEAN	181.2	7.870	8.352	9.119	8.361	21.88	29.37	108.2	72.90	177.7	175.9	122.1
MAX	342	11	13	15	11	105	110	111	179	179	177	174
MIN	6.7	6.9	7.7	7.7	7.7	8.3	9.3	54	11	177	174	12
AC-FT	11140	468	514	561	464	1350	1750	6650	4340	10930	10810	7270

SACRAMENTO RIVER BASIN

11395030 SOUTH FORK FEATHER RIVER BELOW LITTLE GRASS VALLEY DAM, CA—Continued

STATISTICS OF MONTHLY MEAN DATA FOR WATER YEARS 1928 - 1933, BY WATER YEAR (WY)

	OCT	NOV	DEC	JAN	FEB	MAR	APR	MAY	JUN	JUL	AUG	SEP
MEAN	2.56	19.5	47.6	26.3	45.2	134	181	201	78.8	7.70	1.74	1.35
MAX	6.62	94.5	206	51.3	94.7	386	301	384	169	13.7	2.54	1.72
(WY)	1932	1928	1930	1928	1930	1928	1930	1932	1933	1932	1932	1930
MIN	1.43	1.67	2.65	3.60	3.55	14.5	106	48.9	13.8	2.38	1.06	1.04
(WY)	1929	1930	1933	1933	1933	1933	1933	1931	1931	1931	1931	1931

SUMMARY STATISTICS

WATER YEARS 1928 - 1933

ANNUAL MEAN	62.3
HIGHEST ANNUAL MEAN	85.6 1932
LOWEST ANNUAL MEAN	28.0 1931
HIGHEST DAILY MEAN	1800 Mar 25 1928
LOWEST DAILY MEAN	.90 Aug 25 1931
ANNUAL SEVEN-DAY MINIMUM	.90 Sep 1 1931
MAXIMUM PEAK FLOW	2600 Mar 26 1928
MAXIMUM PEAK STAGE	7.00 Mar 26 1928
ANNUAL RUNOFF (AC-FT)	45140
10 PERCENT EXCEEDS	202
50 PERCENT EXCEEDS	10
90 PERCENT EXCEEDS	1.4

STATISTICS OF MONTHLY MEAN DATA FOR WATER YEARS 1964 - 2002, BY WATER YEAR (WY)

	1964	1965	1966	1967	1968	1969	1970	1971	1972	1973	1974	1975	1976	1977	1978	1979	1980	1981	1982	1983	1984	1985	1986	1987	1988	1989	1990	1991	1992	1993	1994	1995	1996	1997	1998	1999	2000	2001	2002												
MEAN	106.4	74.17	68.29	97.52	94.76	104.5	81.67	132.4	103.2	115.3	142.3	158.8																																							
MAX	305	404	420	725	694	586	317	489	403	350	344	389																																							
(WY)	1970	1982	1982	1997	1986	1995	1989	1995	1998	1983	1968	1984																																							
MIN	13.0	2.94	4.01	2.36	2.25	3.70	4.31	4.38	3.99	3.71	5.42	10.0																																							
(WY)	1986	1976	1979	1964	1976	1964	1964	1977	1977	1977	2001	1981																																							

SUMMARY STATISTICS

FOR 2001 CALENDAR YEAR

FOR 2002 WATER YEAR

WATER YEARS 1964 - 2002

ANNUAL TOTAL	12865.8	28354.7	
ANNUAL MEAN	35.25	77.68	106.7
HIGHEST ANNUAL MEAN			250 1982
LOWEST ANNUAL MEAN			29.5 1981
HIGHEST DAILY MEAN	342 Oct 4	342 Oct 4	5420 Jan 1 1997
LOWEST DAILY MEAN	5.2 Aug 9	6.7 Oct 24	1.4 Jan 27 1964
ANNUAL SEVEN-DAY MINIMUM	5.2 Aug 9	6.9 Oct 24	1.4 Jan 27 1964
MAXIMUM PEAK FLOW		377 Oct 3	7370 Jan 1 1997
MAXIMUM PEAK STAGE		9.37 Oct 3	14.80 Jan 1 1997
ANNUAL RUNOFF (AC-FT)	25520	56240	77320
10 PERCENT EXCEEDS	112	178	248
50 PERCENT EXCEEDS	20	11	49
90 PERCENT EXCEEDS	5.5	7.7	5.5

11395150 SOUTH FORK TUNNEL NEAR STRAWBERRY VALLEY, CA

LOCATION.—Lat 39°38'55", long 120°07'00", in NW 1/4 SW 1/4 sec.29, T.21 N., R.8 E., [Plumas County](#), Hydrologic Unit 18020123, Plumas National Forest, 3.2 mi upstream from Rock Creek, and 5.8 mi north of Strawberry Valley.

PERIOD OF RECORD.—October 1973 to current year. Records of daily discharge for November 1961 to September 1973 are in files of the U.S. Geological Survey. Monthly diversion used to adjust South Fork Feather River below diversion dam near Strawberry Valley (station 11395200) since October 1961.

GAGE.—Water-stage recorder. Datum of gage is sea level.

REMARKS.—Tunnel diverts water from South Fork Feather River to Sly Creek Reservoir (station 11395400) for power development. See schematic diagram of [South Fork Feather River Basin](#).

COOPERATION.—Records provided by Oroville–Wyandotte Irrigation District, under general supervision of the U.S. Geological Survey, in connection with Federal Energy Regulatory Commission project no. 2088.

EXTREMES FOR PERIOD OF RECORD.—Maximum daily discharge, 570 ft³/s, Mar. 13, May 25–29, June 3, 1983; no flow at times in many years.

DISCHARGE, CUBIC FEET PER SECOND, WATER YEAR OCTOBER 2001 TO SEPTEMBER 2002
DAILY MEAN VALUES

DAY	OCT	NOV	DEC	JAN	FEB	MAR	APR	MAY	JUN	JUL	AUG	SEP
1	136	18	22	187	26	94	137	153	18	182	180	178
2	237	0.00	120	328	25	85	154	150	16	181	180	177
3	324	0.00	66	336	24	78	167	150	16	180	179	177
4	344	0.00	41	207	23	73	173	149	15	180	180	176
5	343	18	37	154	23	72	164	148	14	182	180	176
6	341	0.00	44	306	23	187	144	146	13	182	180	176
7	341	0.00	47	242	38	227	133	144	13	183	180	176
8	339	25	39	192	72	175	127	140	12	184	179	175
9	339	3.0	36	159	49	138	129	136	11	184	179	175
10	336	2.9	32	131	44	121	132	135	11	183	179	175
11	335	6.4	29	113	42	104	122	134	11	184	178	175
12	333	21	26	100	42	101	116	132	10	183	178	175
13	333	19	25	90	45	95	115	131	10	183	178	174
14	333	8.4	28	82	46	86	118	129	9.9	183	178	173
15	332	5.7	21	76	49	80	112	128	9.7	182	178	172
16	332	4.9	21	70	51	76	93	125	9.4	182	178	172
17	274	5.4	36	64	61	71	83	121	35	182	177	172
18	151	4.8	33	59	57	66	74	119	119	182	177	172
19	47	4.4	31	54	76	62	69	122	121	182	178	173
20	0.00	11	33	50	201	61	67	138	122	181	179	146
21	0.00	42	27	48	179	69	65	132	121	181	179	67
22	15	101	28	43	159	116	65	130	122	181	179	68
23	0.00	29	26	40	167	176	64	129	122	181	178	53
24	16	91	23	37	142	175	65	126	146	180	178	3.2
25	0.00	53	22	35	120	174	101	125	182	180	178	2.6
26	8.0	30	25	41	108	139	168	126	184	180	178	2.5
27	0.00	22	29	34	103	73	173	126	184	181	178	2.5
28	0.00	19	45	32	100	76	164	125	183	181	178	2.5
29	0.00	20	86	29	---	92	161	124	183	181	178	2.6
30	26	16	120	27	---	109	140	122	183	182	178	2.6
31	0.00	---	289	27	---	121	---	97	---	180	177	---
TOTAL	5615.00	580.90	1487	3393	2095	3372	3595	4092	2206.0	5633	5534	3671.5
MEAN	181.1	19.36	47.97	109.5	74.82	108.8	119.8	132.0	73.53	181.7	178.5	122.4
MAX	344	101	289	336	201	227	173	153	184	184	180	178
MIN	0.00	0.00	21	27	23	61	64	97	9.4	180	177	2.5
AC-FT	11140	1150	2950	6730	4160	6690	7130	8120	4380	11170	10980	7280

STATISTICS OF MONTHLY MEAN DATA FOR WATER YEARS 1974 - 2002, BY WATER YEAR (WY)

	1974	1975	1976	1977	1978	1979	1980	1981	1982	1983	1984	1985	1986	1987	1988	1989	1990	1991	1992	1993	1994	1995	1996	1997	1998	1999	2000	2001	2002	
MEAN	96.44	97.48	102.9	123.7	146.2	175.9	152.3	166.8	111.8	115.5	126.9	143.9																		
MAX	202	377	462	381	406	454	429	520	421	363	327	390																		
(WY)	1999	1982	1982	1974	1996	1983	1989	1993	1983	1983	1983	1978																		
MIN	6.21	4.14	3.36	5.99	8.49	9.71	8.68	16.4	7.22	3.33	1.50	0.000																		
(WY)	1986	1977	1977	1977	1977	1977	1977	1977	1977	2001	2001	1981																		

SUMMARY STATISTICS

	FOR 2001 CALENDAR YEAR		FOR 2002 WATER YEAR		WATER YEARS 1974 - 2002	
ANNUAL TOTAL	22072.91		41274.40			
ANNUAL MEAN	60.47		113.1		129.9	
HIGHEST ANNUAL MEAN					294	
LOWEST ANNUAL MEAN					35.0	
HIGHEST DAILY MEAN	344	Oct 4	344	Oct 4	570	Mar 13 1983
LOWEST DAILY MEAN	0.00	Aug 25	0.00	Oct 20	0.00	Jan 16 1980
ANNUAL SEVEN-DAY MINIMUM	0.21	Aug 23	2.6	Sep 24	0.00	Jan 16 1980
ANNUAL RUNOFF (AC-FT)	43780		81870		94110	
10 PERCENT EXCEEDS	150		183		314	
50 PERCENT EXCEEDS	29		121		92	
90 PERCENT EXCEEDS	1.9		11		8.5	

11395200 SOUTH FORK FEATHER RIVER BELOW DIVERSION DAM, NEAR STRAWBERRY VALLEY, CA

LOCATION.—Lat 39°38'51", long 121°07'04", in NE 1/4 SE 1/4 sec.30, T.21 N., R.8 E., [Plumas County](#), Hydrologic Unit 18020123, Plumas National Forest, on left bank, 0.1 mi downstream from diversion dam, 3.1 mi upstream from Rock Creek, and 5.8 mi north of Strawberry Valley.

DRAINAGE AREA.—37.7 mi².

PERIOD OF RECORD.—October 1960 to current year.

REVISED RECORDS.—WDR CA-80-4: 1976(M).

GAGE.—Water-stage recorder and since May 8, 1987, sharp-crested rectangular weir. Datum of gage is 3,535.02 ft above sea level (levels by Oroville–Wyandotte Irrigation District).

REMARKS.—Flow regulated by Little Grass Valley Reservoir (station 11395020) since October 1961. South Fork Diversion Tunnel, maximum capacity, about 600 ft³/s, 500 ft upstream, diverts to Sly Creek Reservoir (station 11395400); diversion began in November 1961. See schematic diagram of [South Fork Feather River Basin](#).

COOPERATION.—Records provided by Oroville–Wyandotte Irrigation District, under general supervision of the U.S. Geological Survey, in connection with Federal Energy Regulatory Commission project no. 2088.

EXTREMES FOR PERIOD OF RECORD.—Maximum discharge, 11,300 ft³/s, Jan. 1, 1997, gage height unknown, from computation of peak flow over diversion dam; minimum daily, 0.30 ft³/s, Dec. 25, 1962, to Jan. 2, 1963, Mar. 1–3, 1963, during initial operation of Little Grass Valley Reservoir; since operation stabilized in 1964, 0.70 ft³/s, Jan. 18, 1968.

DISCHARGE, CUBIC FEET PER SECOND, WATER YEAR OCTOBER 2001 TO SEPTEMBER 2002
DAILY MEAN VALUES

DAY	OCT	NOV	DEC	JAN	FEB	MAR	APR	MAY	JUN	JUL	AUG	SEP
1	5.6	6.1	6.2	6.7	6.0	6.4	5.6	11	10	12	11	11
2	5.6	6.0	6.7	7.0	6.0	6.4	5.6	11	10	12	11	11
3	5.8	6.2	6.6	7.1	6.0	6.4	5.6	11	10	12	11	11
4	5.8	6.2	6.3	6.8	6.0	6.4	5.6	11	11	12	11	11
5	5.8	6.0	6.2	6.7	6.0	6.4	5.6	11	11	12	11	11
6	5.8	6.0	6.2	7.0	6.0	6.7	5.6	11	11	12	11	11
7	5.8	6.2	6.2	7.0	6.2	6.9	5.6	11	11	12	11	11
8	5.8	6.0	6.2	6.7	6.4	6.8	5.6	11	11	11	11	11
9	5.8	5.8	6.2	6.7	6.4	6.7	5.6	11	11	11	11	11
10	5.8	5.8	6.2	6.6	6.4	6.5	5.6	11	11	11	11	11
11	5.8	5.9	6.2	6.4	6.2	6.4	5.6	11	11	11	11	11
12	5.8	6.2	6.2	6.4	6.2	5.8	5.6	11	11	11	11	11
13	5.8	6.2	6.2	6.2	6.2	5.5	5.6	11	11	11	11	11
14	5.8	6.2	6.2	6.2	6.2	5.6	5.5	11	11	11	11	11
15	5.8	5.9	6.2	6.2	6.2	5.6	5.5	11	11	11	11	11
16	5.8	5.8	6.2	6.2	6.3	5.6	5.5	11	11	11	11	11
17	5.8	5.9	6.3	6.2	6.4	5.6	5.5	11	11	11	11	11
18	5.7	5.8	6.2	6.2	6.4	5.6	5.5	11	12	11	11	11
19	5.6	5.8	6.2	6.0	6.4	5.5	5.4	11	12	11	11	11
20	5.9	5.8	6.2	6.0	6.6	5.5	5.3	11	12	11	11	11
21	6.2	6.3	6.2	6.0	6.7	5.5	5.3	11	12	11	11	10
22	6.8	6.4	6.2	6.0	6.7	5.5	5.3	11	12	11	11	10
23	6.1	6.2	6.2	6.0	6.7	5.6	5.3	11	12	11	11	11
24	6.5	6.4	6.2	6.0	6.6	5.6	5.3	11	12	11	11	11
25	6.6	6.2	6.2	6.0	6.4	5.6	5.3	11	12	11	11	11
26	6.1	6.2	6.2	6.2	6.4	5.6	5.5	11	12	11	11	11
27	5.9	6.2	6.2	6.2	6.4	5.6	5.6	11	12	11	11	11
28	6.2	6.2	6.2	6.2	6.4	5.6	5.6	11	12	11	11	11
29	6.2	6.2	6.2	6.2	---	5.5	5.6	11	12	11	11	12
30	6.2	6.2	6.5	6.0	---	5.5	22	11	12	11	11	12
31	6.2	---	7.0	6.0	---	5.5	---	11	---	11	11	---
TOTAL	184.4	182.3	194.4	197.1	176.8	183.4	181.8	341	340	348	341	330
MEAN	5.948	6.077	6.271	6.358	6.314	5.916	6.060	11.00	11.33	11.23	11.00	11.00
MAX	6.8	6.4	7.0	7.1	6.7	6.9	22	11	12	12	11	12
MIN	5.6	5.8	6.2	6.0	6.0	5.5	5.3	11	10	11	11	10
AC-FT	366	362	386	391	351	364	361	676	674	690	676	655

STATISTICS OF MONTHLY MEAN DATA FOR WATER YEARS 1964 - 2002, BY WATER YEAR (WY)

MEAN	10.48	12.84	40.55	78.31	52.25	46.44	23.80	43.27	20.73	9.589	10.14	10.42
MAX	21.8	226	808	885	1113	741	317	417	230	13.3	18.5	18.8
(WY)	2001	1982	1965	1970	1986	1995	1982	1995	1998	1968	1973	1973
MIN	2.92	2.62	2.41	3.94	2.73	3.79	3.68	3.61	2.20	2.57	3.32	3.45
(WY)	1978	1978	1980	1976	1978	1980	1970	1977	1977	1977	1977	1977

SUMMARY STATISTICS

	FOR 2001 CALENDAR YEAR		FOR 2002 WATER YEAR		WATER YEARS 1964 - 2002	
ANNUAL TOTAL	2100.8		3000.2			
ANNUAL MEAN	5.756		8.220		29.88	
HIGHEST ANNUAL MEAN					120	
LOWEST ANNUAL MEAN					3.72	
HIGHEST DAILY MEAN	11	Aug 14	22	Apr 30	9020	Jan 1 1997
LOWEST DAILY MEAN	5.1	Sep 1	5.3	Apr 20	0.70	Jan 18 1968
ANNUAL SEVEN-DAY MINIMUM	5.3	Jul 3	5.3	Apr 19	1.1	Jan 18 1968
MAXIMUM PEAK FLOW			164		11300	
MAXIMUM PEAK STAGE			6.81		unknown	
ANNUAL RUNOFF (AC-FT)	4170		5950		21640	
10 PERCENT EXCEEDS	6.2		11		12	
50 PERCENT EXCEEDS	5.6		6.4		7.8	
90 PERCENT EXCEEDS	5.3		5.6		4.6	

11395400 SLY CREEK RESERVOIR NEAR STRAWBERRY VALLEY, CA

LOCATION.—Lat 39°35'01", long 121°06'59", in NE 1/4 NE 1/4 sec.19, T.20 N., R.8 E., [Butte County](#), Hydrologic Unit 18020123, Plumas National Forest, on right bank, 100 ft upstream from dam on Lost Creek, and 1.4 mi northwest of Strawberry Valley.

DRAINAGE AREA.—24.0 mi².

PERIOD OF RECORD.—November 1961 to current year (fragmentary prior to Mar. 14, 1962).

GAGE.—Water-stage recorder. Datum of gage is sea level (levels by Oroville–Wyandotte Irrigation District). Prior to Sept. 30, 1966, water-stage recorder in valve chamber inside dam at same datum. Oct. 1, 1966, to December 1974, nonrecording gage read once daily.

REMARKS.—Reservoir is formed by earthfill dam. Storage began in November 1961. Total capacity, 65,600 acre-ft, between elevations 3,285 ft, invert of outlet, and 3,531 ft, top of spillway gate, all of which is available for release. Water is diverted into reservoir from South Fork Feather River through South Fork Diversion Tunnel and from North Yuba River Basin through Slate Creek Tunnel (station 11413250). Records represent total contents at 2400 hours. See schematic diagram of [South Fork Feather River Basin](#).

COOPERATION.—Records provided by Oroville–Wyandotte Irrigation District, under general supervision of the U.S. Geological Survey, in connection with Federal Energy Regulatory Commission project no. 2088.

EXTREMES FOR PERIOD OF RECORD.—Maximum contents, 65,600 acre-ft, June 22, 1978, elevation, 3,530.9 ft; minimum observed under normal operating conditions since reservoir first filled, 860 acre-ft, Feb. 11, 1976, elevation, 3,320.0 ft. Reservoir completely drained for powerplant construction, Sept. 12 to Oct. 17, 1981.

EXTREMES FOR CURRENT YEAR.—Maximum contents, 54,600 acre-ft, May 30, elevation, 3,512.0 ft; minimum, 12,700 acre-ft, Dec. 29, elevation, 3,405.0.

Capacity table (elevation, in feet, and contents, in acre-feet)
(Based on survey by Pacific Gas & Electric Co. in 1946)

3,310	450	3,340	2,150	3,400	11,500	3,480	38,500
3,315	655	3,360	4,300	3,420	16,600	3,510	53,400
3,320	860	3,380	7,360	3,450	26,300	3,531	65,600

RESERVOIR STORAGE, (ACRE-FEET), WATER YEAR OCTOBER 2001 TO SEPTEMBER 2002

DAILY OBSERVATION AT 2400 HOURS

DAY	OCT	NOV	DEC	JAN	FEB	MAR	APR	MAY	JUN	JUL	AUG	SEP
1	17100	16000	18200	15900	22400	22400	29600	46800	54300	47100	38200	33100
2	17000	15500	19400	17700	21600	22900	29900	46900	54200	46700	37800	33400
3	17200	15300	19800	19300	20700	23300	30400	46900	53900	46600	37800	33500
4	17500	15200	20000	20300	19800	23500	31300	47400	54200	46500	37600	33800
5	18100	15200	20100	21000	19100	23600	32300	48000	53800	46100	37200	34100
6	18800	15300	20400	23000	18200	25100	33800	48300	53200	46000	36800	34400
7	19400	15300	20600	25100	17500	27000	35100	48800	52900	46000	36400	34800
8	20000	15300	20700	26700	17300	28300	35900	49200	52500	45600	36100	34800
9	20600	15400	20800	28000	17200	29200	36500	49500	52300	45100	35600	35100
10	21300	15400	20400	29100	16900	30000	37400	49800	52000	44800	35500	35500
11	21600	15500	20200	30100	16200	30200	38300	50200	51600	44500	35400	35800
12	21600	15600	19800	31000	15800	30500	38800	50500	51200	44200	35000	36100
13	21900	15700	19300	31800	15300	30600	39800	50600	50900	44000	34600	36100
14	22300	15300	18900	32500	15000	30900	41000	51100	50600	43900	34200	36400
15	22300	15100	18800	33200	14700	30800	41900	51300	50300	43900	33800	36800
16	22400	15000	18700	33700	14600	30700	42400	51400	50000	43200	33400	37100
17	22300	14800	18400	33700	14700	30800	43000	51700	49600	42800	33300	37400
18	22000	14600	17900	33200	14600	30200	43100	51900	49500	42400	33200	37400
19	21500	14200	17400	32600	14600	29800	43200	52100	49400	42100	32800	37700
20	21200	13900	16800	32000	16400	29500	43600	52400	49200	42000	32300	38000
21	20900	14100	16100	31300	17500	29200	44000	52700	49000	42000	31800	38100
22	20300	15300	16100	30600	18400	28900	44100	53100	48700	41600	31400	38200
23	19700	15500	15700	29900	19500	28800	44700	53200	48600	41200	31000	38300
24	19200	16400	15300	29100	20300	28600	44700	53400	48400	40700	30800	38100
25	18600	16900	14900	28300	20700	28600	44800	53600	48300	40400	31200	37400
26	18000	17200	14200	27600	21200	28700	45200	54000	48200	39900	31500	36400
27	17700	17400	13500	26700	21700	28500	45900	54200	47900	39800	31800	35500
28	17400	17600	12800	26000	22100	28800	46400	54200	47700	39700	32100	35100
29	16900	17700	12800	25100	---	28800	46600	54300	47600	39200	32100	35100
30	16500	17900	13200	24200	---	29000	46700	54200	47400	38800	32500	35100
31	16500	---	15200	23300	---	29300	---	54300	---	38400	32800	---
MAX	22400	17900	20800	33700	22400	30900	46700	54300	54300	47100	38200	38300
MIN	16500	13900	12800	15900	14600	22400	29600	46800	47400	38400	30800	33100
a	3419.6	3424.4	3414.9	3441.6	3437.9	3458.0	3497.0	3511.6	3488.5	3479.7	3466.7	3472.2
b	-900	+1400	-2700	+8100	-1200	+7200	+17400	+7600	-6900	-9000	-5600	+2300

CAL YR 2001 b +5960

WTR YR 2002 b +17700

a Elevation, in feet, at end of month.

b Change in contents, in acre-feet.

11395500 OROVILLE–WYANDOTTE CANAL NEAR CLIPPER MILLS, CA

LOCATION.—Lat 39°33'15", long 121°11'31", in NW 1/4 NE 1/4 sec.33, T.20 N., R.7 E., [Butte County](#), Hydrologic Unit 18020123, in concrete valve house at head of canal, and 2.5 mi north of Clipper Mills.

PERIOD OF RECORD.—October 1927 to September 1941 (published as "Forbestown Ditch"), October 1953 to current year. Monthly discharge only for October 1953 to September 1961, published with records for Lost Creek near Clipper Mills.

GAGE.—Water-stage recorder and Parshall flume. Datum of gage is 3,166.0 ft above sea level (levels by Oroville–Wyandotte Irrigation District). Prior to Sept. 30, 1941, nonrecording gages and Oct. 1, 1941, to Nov. 16, 1962, water-stage recorder at sites at different datums 4 mi upstream in abandoned part of canal, 0.3 mi downstream from Lost Creek Dam.

REMARKS.—Water is discharged to canal through valve in Woodleaf Penstock. Prior to Nov. 16, 1962, canal diverted from Lost Creek Dam. Water is used for irrigation and domestic supply. Demand for water reduced when a large lumber mill closed at Woodleaf in 1962. See schematic diagram of [South Fork Feather River Basin](#).

COOPERATION.—Records provided by Oroville–Wyandotte Irrigation District, under general supervision of the U.S. Geological Survey, in connection with Federal Energy Regulatory Commission project no. 2088.

EXTREMES FOR PERIOD OF RECORD.—Maximum daily discharge, 43 ft³/s, Aug. 9 to Sept. 9, 1937, Aug. 13–15, 1977; no flow at times in many years.

DISCHARGE, CUBIC FEET PER SECOND, WATER YEAR OCTOBER 2001 TO SEPTEMBER 2002

DAILY MEAN VALUES

DAY	OCT	NOV	DEC	JAN	FEB	MAR	APR	MAY	JUN	JUL	AUG	SEP
1	23	0.00	0.00	0.00	0.00	0.00	0.00	0.42	14	22	24	24
2	23	0.00	0.00	0.00	0.00	0.00	0.00	0.00	14	22	24	24
3	23	0.00	0.00	0.00	0.00	0.00	0.00	0.00	14	23	24	24
4	23	0.00	7.9	0.00	6.7	0.00	0.00	0.00	13	23	24	24
5	23	0.00	12	0.00	10	0.00	0.00	0.00	12	23	24	24
6	23	0.00	4.4	0.00	5.6	0.00	0.00	2.7	12	23	24	24
7	23	6.2	0.00	0.00	0.00	0.00	0.00	8.9	13	23	24	24
8	17	0.00	0.00	0.00	0.00	0.00	0.00	15	13	23	24	24
9	12	0.00	0.00	0.00	0.00	0.00	0.00	9.1	13	23	20	24
10	12	0.00	0.00	0.00	0.00	0.00	0.00	6.1	13	23	24	24
11	12	0.00	0.00	0.00	0.00	0.00	0.00	6.2	13	23	24	24
12	12	0.86	0.00	0.00	0.00	0.00	0.00	6.1	14	23	12	24
13	12	4.3	0.00	0.00	0.00	0.00	0.00	6.1	15	23	16	24
14	5.3	0.00	0.00	0.00	0.00	0.00	0.00	11	15	23	24	24
15	0.00	0.00	0.00	6.3	0.00	0.00	0.00	13	15	23	24	24
16	0.00	0.00	0.00	4.8	0.00	0.00	0.00	13	15	23	24	24
17	0.00	0.00	0.00	0.00	0.00	0.00	0.00	14	15	23	24	24
18	0.00	0.00	0.00	0.00	0.00	0.00	0.00	15	16	23	24	24
19	0.00	0.00	0.00	0.00	0.00	0.00	0.00	15	17	23	24	24
20	0.00	0.00	0.00	0.00	0.00	0.00	0.00	15	17	23	24	24
21	0.00	0.00	0.00	0.00	6.8	0.00	0.00	15	17	23	24	24
22	6.8	0.00	0.00	0.00	10	0.00	0.00	14	17	23	24	24
23	10	0.00	0.00	0.00	3.3	0.00	0.00	12	17	24	24	24
24	10	0.00	0.00	0.00	0.00	0.00	0.00	12	19	24	24	24
25	3.8	0.00	0.00	0.00	0.00	0.00	0.00	12	20	24	24	24
26	0.00	0.00	0.00	0.00	0.00	0.00	0.00	12	20	24	24	24
27	0.00	0.00	0.00	0.00	0.00	0.00	0.00	12	20	24	8.1	24
28	0.00	0.00	0.00	0.00	0.00	0.00	0.00	12	20	24	16	24
29	0.00	0.00	0.00	0.00	---	0.00	0.52	12	20	24	24	24
30	0.00	0.00	0.00	0.00	---	0.00	1.0	12	20	24	24	24
31	0.00	---	0.00	0.00	---	0.00	---	13	---	24	24	---
TOTAL	273.90	11.36	24.30	11.10	42.40	0.00	1.52	294.62	473	720	696.1	720
MEAN	8.835	0.379	0.784	0.358	1.514	0.000	0.051	9.504	15.77	23.23	22.45	24.00
MAX	23	6.2	12	6.3	10	0.00	1.0	15	20	24	24	24
MIN	0.00	0.00	0.00	0.00	0.00	0.00	0.00	0.00	12	22	8.1	24
AC-FT	543	23	48	22	84	0.00	3.0	584	938	1430	1380	1430

STATISTICS OF MONTHLY MEAN DATA FOR WATER YEARS 1963 - 2002, BY WATER YEAR (WY)

MEAN	12.31	5.249	2.198	1.261	0.768	0.929	1.689	5.926	12.35	17.62	20.75	19.98
MAX	20.2	16.5	8.64	6.89	5.34	6.70	11.4	20.2	29.3	26.4	37.4	30.9
(WY)	1967	1968	1977	1968	1977	1964	1977	1977	1963	1976	1977	1977
MIN	3.75	0.38	0.000	0.000	0.000	0.000	0.000	0.000	0.88	7.60	9.47	9.29
(WY)	1990	2002	1982	1980	1963	1963	1963	1975	1998	1998	1965	1965

SUMMARY STATISTICS

	FOR 2001 CALENDAR YEAR		FOR 2002 WATER YEAR		WATER YEARS 1963 - 2002	
ANNUAL TOTAL	3715.76		3268.30			
ANNUAL MEAN	10.18		8.954		8.461	
HIGHEST ANNUAL MEAN					16.7 1977	
LOWEST ANNUAL MEAN					4.33 1998	
HIGHEST DAILY MEAN	24	May 28	24	Jul 23	43	Aug 13 1977
LOWEST DAILY MEAN	0.00	Jan 1	0.00	Oct 15	0.00	Dec 12 1962
ANNUAL SEVEN-DAY MINIMUM	0.00	Jan 1	0.00	Oct 15	0.00	Dec 15 1962
ANNUAL RUNOFF (AC-FT)	7370		6480		6130	
10 PERCENT EXCEEDS	24		24		23	
50 PERCENT EXCEEDS	5.5		0.42		5.4	
90 PERCENT EXCEEDS	0.00		0.00		0.00	

11396000 LOST CREEK NEAR CLIPPER MILLS, CA

LOCATION.—Lat 39°34'25", long 121°08'26", in SE 1/4 SW 1/4 sec.24, T.20 N., R.7 E., [Butte County](#), Hydrologic Unit 18020123, Plumas National Forest, on left bank, 0.3 mi downstream from Lost Creek Reservoir, and 2.8 mi north of Clipper Mills.

DRAINAGE AREA.—30.0 mi².

PERIOD OF RECORD.—October 1927 to September 1941, October 1948 to current year. Records for Woodleaf Powerplant from February 1963 to September 1966 in files of the U.S. Geological Survey.

REVISED RECORDS.—WSP 1395: 1954. WSP 1931: Drainage area.

GAGE.—Water-stage recorder. Sharp-crested weir for low-water control since June 20, 1987. Elevation of gage is 3,170 ft above sea level, from topographic map. Prior to June 20, 1987, at site 100 ft downstream at same datum.

REMARKS.—Flow regulated by Sly Creek Reservoir (station 11395400) 1.5 mi upstream and Lost Creek Reservoir 0.3 mi upstream, usable capacity, 5,920 acre-ft with flashboards. Water is diverted into Sly Creek Reservoir through South Fork Diversion Tunnel from South Fork Feather River and through Slate Creek Tunnel (station 11413250) from North Yuba River Basin. Woodleaf Tunnel diverts from Lost Creek Reservoir to Woodleaf Powerhouse. Oroville–Wyandotte Canal (station 11395500) diverts from Woodleaf Penstock for irrigation and domestic use. Records represent seepage, release, and spill from Lost Creek Reservoir to Lost Creek. See schematic diagram of [South Fork Feather River Basin](#).

COOPERATION.—Records provided by Oroville–Wyandotte Irrigation District, under general supervision of the U.S. Geological Survey, in connection with Federal Energy Regulatory Commission project no. 2088.

EXTREMES FOR PERIOD OF RECORD.—Maximum discharge, 5,760 ft³/s, Jan. 1, 1997, gage height, 13.50 ft; no flow at times in some years.

DISCHARGE, CUBIC FEET PER SECOND, WATER YEAR OCTOBER 2001 TO SEPTEMBER 2002
DAILY MEAN VALUES

DAY	OCT	NOV	DEC	JAN	FEB	MAR	APR	MAY	JUN	JUL	AUG	SEP
1	8.2	6.9	7.1	7.2	6.1	5.9	8.8	9.6	10	9.3	9.3	10
2	8.1	5.5	8.6	8.6	6.1	5.9	9.0	9.6	10	9.2	9.0	9.7
3	8.2	5.5	6.7	8.1	6.1	5.9	15	9.7	10	9.1	8.7	9.9
4	8.2	5.5	6.3	7.2	6.1	5.9	15	9.5	9.3	9.1	8.6	10
5	8.2	5.5	6.4	6.8	6.0	5.9	15	9.8	8.6	9.1	8.7	9.9
6	8.2	5.5	6.7	7.1	6.1	6.8	15	10	8.6	9.1	8.8	9.6
7	8.2	5.5	6.2	6.7	6.4	7.8	15	12	8.9	9.1	8.6	9.4
8	8.1	5.5	5.9	6.3	6.4	7.1	15	14	9.7	9.1	8.6	9.8
9	8.1	5.5	5.9	6.3	6.3	6.7	15	13	10	9.2	8.6	10
10	8.4	5.5	5.9	6.3	6.1	6.9	15	12	9.6	9.5	8.6	9.9
11	8.4	5.5	5.9	6.1	6.1	6.7	14	12	9.3	9.5	8.6	9.6
12	8.4	5.8	5.9	6.1	6.1	6.4	13	12	9.3	9.3	8.7	9.3
13	8.4	5.6	5.9	6.1	6.1	5.8	12	11	9.5	9.2	9.1	9.7
14	8.4	5.5	5.9	6.0	6.1	5.7	11	11	9.5	9.1	8.9	10
15	8.4	5.5	5.9	5.9	6.1	5.5	11	11	9.4	9.1	8.9	9.9
16	8.4	5.6	5.9	5.9	6.1	5.5	11	11	9.4	9.1	9.0	9.6
17	8.4	5.8	7.0	5.9	6.1	5.5	11	11	9.3	9.1	8.7	9.4
18	8.4	5.7	6.4	5.9	6.1	5.5	11	11	9.3	9.3	8.6	9.7
19	8.4	5.7	6.3	5.9	6.5	5.5	10	11	9.5	9.3	8.6	10
20	8.4	5.7	6.4	5.9	6.8	5.4	10	11	9.5	9.2	8.8	9.7
21	8.4	6.4	6.3	6.1	6.5	5.3	10	11	9.5	9.1	9.2	9.4
22	8.4	6.5	6.7	6.1	6.3	5.5	10	11	9.9	9.1	9.7	9.2
23	8.4	5.9	6.8	5.9	6.3	5.9	9.6	11	10	9.1	9.5	9.0
24	8.4	6.8	6.4	5.9	6.2	5.9	9.8	10	10	9.1	9.6	9.5
25	8.6	5.9	6.3	5.9	6.1	5.9	10	10	9.8	9.1	9.7	10
26	9.0	5.9	6.3	6.4	5.9	5.8	10	11	9.8	9.1	9.4	10
27	9.1	5.7	6.3	6.3	5.9	5.5	9.6	11	9.5	9.1	9.1	11
28	9.0	5.7	6.5	6.3	5.9	5.5	9.5	11	9.3	9.1	9.1	10
29	8.9	5.9	6.8	6.2	---	7.3	9.5	11	9.3	9.1	10	10
30	9.3	5.9	7.3	6.0	---	9.1	9.5	11	9.3	9.1	11	9.9
31	8.8	---	8.1	6.1	---	8.8	---	11	---	9.4	11	---
TOTAL	262.2	173.4	201.0	197.5	172.9	192.8	349.3	340.2	285.1	284.4	282.7	293.1
MEAN	8.458	5.780	6.484	6.371	6.175	6.219	11.64	10.97	9.503	9.174	9.119	9.770
MAX	9.3	6.9	8.6	8.6	6.8	9.1	15	14	10	9.5	11	11
MIN	8.1	5.5	5.9	5.9	5.9	5.3	8.8	9.5	8.6	9.1	8.6	9.0
AC-FT	520	344	399	392	343	382	693	675	565	564	561	581
a	11000	4800	18220	21920	24500	26680	20440	14010	141880	18860	15330	2930

a Diversion, acre-feet, through Woodleaf Powerhouse (station 11396090), provided by Oroville–Wyandotte Irrigation District.

SACRAMENTO RIVER BASIN

11396000 LOST CREEK NEAR CLIPPER MILLS, CA—Continued

STATISTICS OF MONTHLY MEAN DATA FOR WATER YEARS 1928 - 1961, BY WATER YEAR (WY)

	OCT	NOV	DEC	JAN	FEB	MAR	APR	MAY	JUN	JUL	AUG	SEP
MEAN	3.78	8.61	66.0	93.4	170	175	191	129	29.9	6.42	4.23	5.13
MAX	13.4	121	544	485	562	467	423	441	153	34.7	10.2	15.3
(WY)	1928	1951	1956	1956	1958	1938	1938	1952	1952	1952	1961	1960
MIN	.20	.000	.000	.15	.50	25.7	4.68	1.21	1.33	.20	.10	.10
(WY)	1935	1960	1960	1960	1937	1933	1931	1931	1934	1939	1934	1934

SUMMARY STATISTICS

WATER YEARS 1928 - 1961

ANNUAL MEAN	73.0
HIGHEST ANNUAL MEAN	167 1938
LOWEST ANNUAL MEAN	6.78 1931
HIGHEST DAILY MEAN	3840 Dec 22 1955
LOWEST DAILY MEAN	.00 Jul 30 1940
ANNUAL SEVEN-DAY MINIMUM	.00 Nov 1 1959
MAXIMUM PEAK FLOW	5000 Dec 22 1955
MAXIMUM PEAK STAGE	a6.90 Dec 22 1955
ANNUAL RUNOFF (AC-FT)	52890
10 PERCENT EXCEEDS	212
50 PERCENT EXCEEDS	8.4
90 PERCENT EXCEEDS	.30

STATISTICS OF MONTHLY MEAN DATA FOR WATER YEARS 1962 - 2002, BY WATER YEAR (WY)

	1962	1963	1964	1965	1966	1967	1968	1969	1970	1971	1972	1973
MEAN	12.78	6.807	41.11	53.49	74.09	80.44	53.15	45.29	39.06	4.362	3.897	4.196
MAX	392	179	417	674	512	573	410	454	750	16.0	22.2	34.4
(WY)	1963	1963	1998	1997	1986	1983	1993	1995	1995	1962	1966	1997
MIN	0.006	0.029	0.094	0.10	0.35	0.33	0.22	0.13	0.097	0.10	0.000	0.000
(WY)	1965	1975	1975	1962	1964	1964	1968	1968	1966	1963	1964	1963

SUMMARY STATISTICS

FOR 2001 CALENDAR YEAR

FOR 2002 WATER YEAR

WATER YEARS 1962 - 2002

ANNUAL TOTAL	2811.6	3034.6	
ANNUAL MEAN	7.703	8.314	34.69
HIGHEST ANNUAL MEAN			200 1995
LOWEST ANNUAL MEAN			0.49 1964
HIGHEST DAILY MEAN	26 Apr 25	15 Apr 3	4490 Jan 1 1997
LOWEST DAILY MEAN	5.5 Nov 2	5.3 Mar 21	0.00 Oct 21 1961
ANNUAL SEVEN-DAY MINIMUM	5.5 Nov 2	5.5 Mar 15	0.00 Oct 21 1961
MAXIMUM PEAK FLOW		21 Apr 3	5760 Jan 1 1997
MAXIMUM PEAK STAGE		b5.32 Apr 7	13.50 Jan 1 1997
ANNUAL RUNOFF (AC-FT)	5580	6020	25130
TOTAL DIVERSION (AC-FT) c	122400	192900	
10 PERCENT EXCEEDS	8.8	11	14
50 PERCENT EXCEEDS	8.4	8.6	2.1
90 PERCENT EXCEEDS	5.9	5.9	0.18

a Site then in use.

b Rocks in weir.

c Diversion, in acre-feet, through Woodleaf Powerhouse (station 11396090), provided by Oroville-Wyandotte Irrigation District.

11396200 SOUTH FORK FEATHER RIVER BELOW FORBESTOWN DAM, CA

LOCATION.—Lat 39°33'05", long 121°12'30", in SE 1/4 NE 1/4 sec.32, T.20 N., R.7 E., [Butte County](#), Hydrologic Unit 18020123, Plumas National Forest, on right bank, 500 ft downstream from Forbestown Dam, 0.4 mi upstream from Oroleve Creek, and 4.0 mi northeast of Forbestown.

DRAINAGE AREA.—87.5 mi².

PERIOD OF RECORD.—July 1962 to current year. Records for Forbestown Powerplant from February 1963 to September 1966 in files of the U.S. Geological Survey.

GAGE.—Water-stage recorder. Elevation of gage is 1,690 ft above sea level, from topographic map.

REMARKS.—Flow regulated by Little Grass Valley Reservoir (station 11395020), Sly Creek Reservoir (station 11395400), and smaller reservoirs. Water from North Yuba River Basin is imported through Slate Creek Tunnel (station 11413250) to Sly Creek Reservoir. Oroville–Wyandotte Canal (station 11395500) diverts upstream from station. Tunnel 600 ft upstream from station diverts most flow through Forbestown Powerplant (station 11396290) except fishwater releases and uncontrolled spill over Forbestown Dam. See schematic diagram of [South Fork Feather River Basin](#).

COOPERATION.—Records provided by Oroville–Wyandotte Irrigation District, under general supervision of the U.S. Geological Survey, in connection with Federal Energy Regulatory Commission project no. 2088.

EXTREMES FOR PERIOD OF RECORD.—Maximum discharge, 21,800 ft³/s, Jan. 1, 1997, gage height, 17.64 ft, from rating curve extended above 5,400 ft³/s, on basis of flow-over-dam measurement of peak flow; minimum daily, 0.60 ft³/s, Apr. 4, 1963, during initial operation of Little Grass Valley Reservoir; since operation stabilized in 1964, 1.3 ft³/s, Mar. 15, 1980.

DISCHARGE, CUBI FEET PER SECOND, WATER YEAR OCTOBER 2001 TO SEPTEMBER 2002
DAILY MEAN VALUES

DAY	OCT	NOV	DEC	JAN	FEB	MAR	APR	MAY	JUN	JUL	AUG	SEP
1	5.5	5.5	8.0	5.9	5.9	5.9	5.9	10	10	10	10	29
2	5.5	5.5	6.0	6.1	5.9	5.9	5.9	13	10	10	10	29
3	5.5	5.5	5.8	6.0	5.9	5.9	5.9	10	10	10	10	29
4	5.5	5.5	5.8	5.9	5.8	5.9	5.9	10	10	10	10	29
5	5.5	5.5	5.8	5.9	5.8	5.9	5.9	10	10	10	10	29
6	5.5	5.5	5.7	25	5.8	6.1	5.9	10	10	11	10	29
7	5.5	5.5	5.7	72	5.9	6.1	5.9	10	10	11	10	29
8	5.5	5.5	5.7	135	5.9	6.0	5.9	10	10	10	10	29
9	5.5	5.5	5.7	116	5.9	5.9	5.8	10	10	10	10	29
10	5.5	5.5	5.7	101	5.9	6.1	5.7	10	10	10	10	29
11	5.5	5.5	5.7	90	5.8	6.0	5.7	10	10	10	10	29
12	5.5	5.7	5.7	82	5.9	5.9	5.7	10	10	10	10	29
13	5.5	7.4	5.7	77	5.8	5.9	5.8	10	10	10	10	29
14	5.5	5.5	5.8	73	5.8	6.0	5.8	10	10	10	10	29
15	5.5	5.5	5.7	69	5.8	5.9	5.8	10	10	10	10	29
16	5.5	5.5	5.7	64	5.9	5.9	5.7	10	10	10	10	29
17	5.5	5.5	5.9	39	5.9	5.9	5.7	10	10	10	10	29
18	5.5	5.5	5.7	5.9	5.9	5.9	5.7	10	10	10	10	29
19	5.5	5.5	5.8	5.9	6.0	5.9	5.7	10	10	10	10	20
20	5.5	5.5	5.9	5.9	5.9	5.9	5.7	11	10	10	11	14
21	5.5	5.9	5.8	5.9	5.9	5.9	5.7	10	10	10	11	12
22	5.5	5.7	5.9	5.9	5.8	6.0	5.7	10	10	10	11	12
23	5.5	5.5	5.8	5.9	5.9	6.0	5.7	10	10	10	14	11
24	5.5	5.8	5.8	5.9	5.9	5.9	5.8	10	10	10	16	10
25	5.5	5.5	5.8	5.9	5.8	5.9	5.7	10	10	10	16	11
26	5.5	12	5.7	6.1	5.8	5.9	5.7	10	10	10	23	11
27	5.5	33	5.7	5.9	5.9	5.9	5.7	10	10	10	29	11
28	5.5	32	5.8	5.9	5.8	6.0	5.7	10	10	10	29	11
29	5.5	43	5.9	5.9	---	5.9	5.7	11	10	10	29	11
30	5.6	26	5.8	5.9	---	5.9	5.7	10	10	10	29	11
31	5.6	---	6.0	5.9	---	5.9	---	10	---	10	29	---
TOTAL	170.7	286.5	181.5	1055.6	164.2	184.1	173.1	315	300	312	437	667
MEAN	5.506	9.550	5.855	34.05	5.864	5.939	5.770	10.16	10.00	10.06	14.10	22.23
MAX	5.6	43	8.0	135	6.0	6.1	5.9	13	10	11	29	29
MIN	5.5	5.5	5.7	5.9	5.8	5.9	5.7	10	10	10	10	10
AC-FT	339	568	360	2090	326	365	343	625	595	619	867	1320
a	9860	4220	20970	25450	27010	30610	22650	13860	13610	18230	14740	2840

a Diversion, in acre-feet, to Forbestown Powerplant (station 11396290), provided by Oroville–Wyandotte Irrigation District.

SACRAMENTO RIVER BASIN

11396200 SOUTH FORK FEATHER RIVER BELOW FORBESTOWN DAM, CA—Continued

STATISTICS OF MONTHLY MEAN DATA FOR WATER YEARS 1964 - 2002, BY WATER YEAR (WY)

	OCT	NOV	DEC	JAN	FEB	MAR	APR	MAY	JUN	JUL	AUG	SEP
MEAN	14.94	17.78	88.62	165.2	168.7	163.9	88.38	95.61	43.52	11.69	10.79	14.01
MAX	76.1	240	1262	2059	2000	1472	718	990	617	30.6	27.3	120
(WY)	1966	1982	1997	1997	1986	1995	1982	1996	1998	1986	1986	1996
MIN	4.21	3.68	3.37	4.06	4.46	4.47	4.06	4.02	2.90	4.04	3.37	3.84
(WY)	1978	1976	1976	1976	1972	1972	1964	1977	1977	1977	1977	1977

SUMMARY STATISTICS	FOR 2001 CALENDAR YEAR	FOR 2002 WATER YEAR	WATER YEARS 1964 - 2002
ANNUAL TOTAL	2182.7	4246.7	
ANNUAL MEAN	5.980	11.63	73.24
HIGHEST ANNUAL MEAN			325 1997
LOWEST ANNUAL MEAN			4.36 1977
HIGHEST DAILY MEAN	43 Nov 29	135 Jan 8	17300 Jan 1 1997
LOWEST DAILY MEAN	5.2 Apr 11	5.5 Oct 1	1.3 Mar 15 1980
ANNUAL SEVEN-DAY MINIMUM	5.2 Apr 25	5.5 Oct 1	1.7 Mar 25 1980
MAXIMUM PEAK FLOW		293 Jan 17	21800 Jan 1 1997
MAXIMUM PEAK STAGE		6.51 Jan 17	17.64 Jan 1 1997
ANNUAL RUNOFF (AC-FT)	4330	8420	53060
TOTAL DIVERSION (AC-FT) a	124900	204100	
10 PERCENT EXCEEDS	6.1	29	110
50 PERCENT EXCEEDS	5.7	6.0	10
90 PERCENT EXCEEDS	5.3	5.5	5.0

a Diversion, in acre-feet, to Forbestown Powerplant (station 11396290), provided by Oroville-Wyandotte Irrigation District.

11396310 MINERS RANCH CANAL BELOW PONDEROSA DAM, NEAR FORBESTOWN, CA

LOCATION.—Lat 39°33'00", long 121°18'20", in SE 1/4 NW 1/4 sec.33, T.20 N., R.6 E., [Butte County](#), Hydrologic Unit 18020123, on right bank, 800 ft downstream from Ponderosa Dam, and 3 mi northwest of Forbestown.

PERIOD OF RECORD.—October 1962 to current year.

REVISED RECORDS.—WDR CA-88-4: diversion only.

GAGE.—Water-stage recorder and concrete control. Elevation of gage is 975 ft above sea level, from topographic map.

REMARKS.—Canal diverts from South Fork Feather River at Ponderosa Dam. Water is used for power development and irrigation. See schematic diagram of [South Fork Feather River Basin](#).

COOPERATION.—Records provided by Oroville–Wyandotte Irrigation District, under general supervision of the U.S. Geological Survey, in connection with Federal Energy Regulatory Commission project no. 2088.

EXTREMES FOR PERIOD OF RECORD.—Maximum daily discharge, 314 ft³/s, May 13, 1984; no flow at times in most years.

DISCHARGE, CUBIC FEET PER SECOND, WATER YEAR OCTOBER 2001 TO SEPTEMBER 2002

DAILY MEAN VALUES

DAY	OCT	NOV	DEC	JAN	FEB	MAR	APR	MAY	JUN	JUL	AUG	SEP
1	187	0.00	125	266	267	267	274	193	285	284	279	29
2	0.11	84	132	266	267	267	277	278	284	284	279	29
3	0.00	0.00	125	266	269	269	278	279	213	250	278	32
4	0.00	0.00	127	267	271	270	276	280	285	284	278	35
5	0.00	0.00	133	270	271	270	276	280	285	284	278	35
6	63	0.00	135	273	271	271	275	281	285	284	279	36
7	94	81	192	255	270	271	275	279	285	284	279	36
8	0.00	0.00	263	266	269	270	276	276	285	284	278	35
9	84	0.00	269	265	269	271	276	273	269	284	278	35
10	0.00	0.00	273	220	268	270	240	271	251	284	278	35
11	0.00	0.00	60	174	269	270	237	272	285	284	278	35
12	92	14	0.00	172	268	268	267	275	285	284	278	35
13	0.00	67	185	148	265	266	277	278	283	284	278	35
14	0.00	0.00	275	18	263	266	275	191	281	284	279	32
15	88	0.00	275	51	263	266	273	284	281	284	279	31
16	0.00	66	275	92	262	266	271	272	281	284	278	31
17	0.00	0.00	276	35	263	266	269	282	281	285	278	31
18	0.00	0.00	273	99	267	266	268	278	282	284	278	31
19	102	0.00	271	264	269	266	269	278	284	283	278	31
20	0.00	0.00	268	251	269	269	269	278	284	281	200	31
21	0.00	80	265	249	267	270	270	277	284	280	234	31
22	0.00	0.00	263	256	266	270	271	275	284	279	279	31
23	107	0.00	263	261	266	270	158	280	284	277	279	30
24	0.00	0.00	263	269	266	270	273	278	284	276	248	214
25	0.00	0.00	263	272	265	271	274	270	284	276	20	277
26	51	0.00	263	273	266	271	275	278	285	239	35	280
27	0.00	0.00	265	273	267	270	274	272	284	277	36	280
28	0.00	69	268	273	267	270	267	279	284	279	76	274
29	0.00	100	269	273	---	271	276	284	284	279	37	280
30	76	129	269	269	---	272	277	284	284	279	29	60
31	0.00	---	267	267	---	272	---	285	---	279	29	---
TOTAL	944.11	690.00	6850.00	6853	7480	8342	8013	8440	8395	8663	6790	2417
MEAN	30.46	23.00	221.0	221.1	267.1	269.1	267.1	272.3	279.8	279.5	219.0	80.57
MAX	187	129	276	273	271	272	278	285	285	285	279	280
MIN	0.00	0.00	0.00	18	262	266	158	191	213	239	20	29
AC-FT	1870	1370	13590	13590	14840	16550	15890	16740	16650	17180	13470	4790
a	0.00	254	12670	12930	14260	15770	14790	15450	14910	15290	11840	2820

STATISTICS OF MONTHLY MEAN DATA FOR WATER YEARS 1963 - 2002, BY WATER YEAR (WY)

MEAN	169.3	182.8	192.7	196.4	213.5	217.6	212.0	220.1	237.5	247.6	246.3	183.2
MAX	263	269	264	264	267	269	276	280	285	284	289	270
(WY)	1980	1992	1999	1999	2002	1998	1987	1999	2000	2001	1986	1980
MIN	26.6	20.9	18.1	16.6	10.5	16.8	14.5	22.2	51.9	49.3	43.0	25.0
(WY)	1987	1978	1977	1977	1977	1977	1977	1977	1977	1977	1977	1992

SUMMARY STATISTICS

	FOR 2001 CALENDAR YEAR	FOR 2002 WATER YEAR	WATER YEARS 1963 - 2002
ANNUAL TOTAL	67085.41	73877.11	
ANNUAL MEAN	183.8	202.4	210.4
HIGHEST ANNUAL MEAN			257
LOWEST ANNUAL MEAN			52.2
HIGHEST DAILY MEAN	290	Jul 16	285
LOWEST DAILY MEAN	0.00	Jan 1	0.00
ANNUAL SEVEN-DAY MINIMUM	2.6	Sep 23	9.4
ANNUAL RUNOFF (AC-FT)	133100	146500	152400
TOTAL DIVERSION (AC-FT) a	116800	131000	
10 PERCENT EXCEEDS	286	284	279
50 PERCENT EXCEEDS	251	269	248
90 PERCENT EXCEEDS	0.00	0.00	44

a Discharge, in acre-feet, through Kelly Ridge Powerplant (station 11396329), provided by Oroville–Wyandotte Irrigation District.

11396330 BANGOR CANAL BELOW MINERS RANCH RESERVOIR, NEAR OROVILLE, CA

LOCATION.—Lat 39°30'15", long 121°27'16", in NE 1/4 SW 1/4 sec.18, T.19 N., R.5 E., [Butte County](#), Hydrologic Unit 18020124, on left bank, 400 ft downstream from outlet at Miners Ranch Dam, and 5 mi east of Oroville.

PERIOD OF RECORD.—January 1963 to current year.

GAGE.—Water-stage recorder and Parshall flume. Elevation of gage is 815 ft above sea level, from topographic map.

REMARKS.—Flow regulated by Miners Ranch Reservoir, capacity, 912 acre-ft. Canal completed in November 1962. Water is used for irrigation. See schematic diagram of [South Fork Feather River Basin](#).

COOPERATION.—Records provided by Oroville–Wyandotte Irrigation District, under general supervision of the U.S. Geological Survey, in connection with Federal Energy Regulatory Commission project no. 2088.

EXTREMES FOR PERIOD OF RECORD.—Maximum daily discharge, 65 ft³/s, Aug. 17–20, 1963; no flow for several days in 1965, 1969.

DISCHARGE, CUBIC FEET PER SECOND, WATER YEAR OCTOBER 2001 TO SEPTEMBER 2002
DAILY MEAN VALUES

DAY	OCT	NOV	DEC	JAN	FEB	MAR	APR	MAY	JUN	JUL	AUG	SEP
1	15	9.9	8.6	8.0	7.5	5.4	6.8	8.7	17	17	18	18
2	14	8.9	8.5	8.0	7.5	9.7	7.6	9.1	17	18	17	18
3	14	9.1	8.2	8.0	7.5	9.7	8.5	10	17	18	17	18
4	14	9.1	8.1	8.2	7.5	9.7	8.8	11	17	18	17	18
5	14	8.8	8.0	8.2	7.5	9.7	9.1	11	17	18	17	19
6	14	8.7	8.2	8.2	7.5	9.7	9.2	11	18	18	18	18
7	14	8.7	8.3	8.5	7.5	8.5	9.1	11	18	18	17	18
8	14	8.7	8.2	8.5	7.5	8.8	8.8	11	18	18	18	18
9	13	8.5	8.2	8.3	7.5	8.8	8.8	11	17	18	18	18
10	12	8.3	8.2	7.6	7.5	8.8	8.6	11	17	17	18	18
11	12	8.2	8.3	6.9	7.5	9.1	8.7	11	18	17	18	18
12	12	8.1	7.8	7.0	7.5	9.4	8.7	11	17	17	19	18
13	12	8.3	7.3	6.9	7.5	8.1	9.0	11	17	17	18	18
14	12	8.5	7.5	6.9	7.5	8.7	9.1	15	17	17	18	18
15	12	8.5	7.8	6.9	7.5	7.2	9.2	16	17	17	18	18
16	12	8.6	8.0	6.8	7.5	7.2	9.2	17	17	17	19	18
17	12	8.8	8.0	6.9	7.5	7.2	8.8	17	17	17	18	17
18	12	8.5	8.2	6.6	7.5	7.2	8.8	17	17	17	18	17
19	11	8.5	8.2	6.7	7.5	7.0	8.8	17	17	17	18	18
20	9.9	8.3	8.2	6.9	7.5	6.8	8.8	17	17	17	17	17
21	10	8.5	8.2	6.7	7.5	7.1	8.8	17	17	17	17	17
22	9.9	8.8	8.2	6.6	7.5	7.3	8.8	17	17	17	17	17
23	10	8.8	8.2	7.4	7.5	7.2	8.6	17	17	17	17	17
24	11	8.9	8.2	8.6	7.5	7.3	8.5	17	17	17	17	17
25	10	8.9	8.2	8.5	7.5	7.2	8.5	17	17	17	17	17
26	10	8.8	8.0	8.5	7.5	7.2	8.5	17	17	17	17	17
27	11	8.8	8.0	8.7	7.3	7.2	8.5	17	17	17	17	17
28	10	8.9	8.0	8.1	3.1	7.2	8.5	17	17	17	17	18
29	10	8.5	8.0	7.2	---	7.2	8.5	17	17	17	17	18
30	10	8.5	8.0	7.2	---	6.9	8.5	17	17	18	17	17
31	11	---	8.0	7.5	---	6.6	---	17	---	18	18	---
TOTAL	367.8	260.4	250.8	235.0	205.4	245.1	260.1	440.8	514	537	544	530
MEAN	11.86	8.680	8.090	7.581	7.336	7.906	8.670	14.22	17.13	17.32	17.55	17.67
MAX	15	9.9	8.6	8.7	7.5	9.7	9.2	17	18	18	19	19
MIN	9.9	8.1	7.3	6.6	3.1	5.4	6.8	8.7	17	17	17	17
AC-FT	730	517	497	466	407	486	516	874	1020	1070	1080	1050

STATISTICS OF MONTHLY MEAN DATA FOR WATER YEARS 1963 - 2002, BY WATER YEAR (WY)

MEAN	16.57	7.952	5.730	4.769	4.371	4.776	8.711	15.94	21.32	23.71	23.86	21.72
MAX	29.7	14.3	11.2	12.0	7.68	8.27	20.3	27.8	42.0	56.4	53.4	36.2
(WY)	1965	1972	1975	1963	1980	1988	1970	1970	1963	1963	1963	1963
MIN	5.42	1.47	0.035	0.30	0.25	0.20	2.65	6.41	11.0	16.0	16.0	14.4
(WY)	1985	1969	1966	1966	1966	1966	1983	1995	1998	1982	2001	1993

SUMMARY STATISTICS	FOR 2001 CALENDAR YEAR		FOR 2002 WATER YEAR		WATER YEARS 1963 - 2002	
ANNUAL TOTAL	4073.2		4390.4			
ANNUAL MEAN	11.16		12.03		13.12	
HIGHEST ANNUAL MEAN					18.0	1977
LOWEST ANNUAL MEAN					8.95	1993
HIGHEST DAILY MEAN	16 May 14		19 Aug 12		65	Aug 17 1963
LOWEST DAILY MEAN	6.1 Feb 4		3.1 Feb 28		0.00	Jan 7 1965
ANNUAL SEVEN-DAY MINIMUM	6.1 Feb 12		6.5 Feb 23		0.00	Jan 7 1965
ANNUAL RUNOFF (AC-FT)	8080		8710		9510	
10 PERCENT EXCEEDS	16		18		27	
50 PERCENT EXCEEDS	9.9		9.9		11	
90 PERCENT EXCEEDS	6.2		7.4		3.0	

11396395 SUCKER RUN AT KANAKA DIVERSION, NEAR FEATHER FALLS, CA

LOCATION.—Lat 39°33'44", long 121°16'46", in SE 1/4 NE 1/4 sec.27, T.20 N., R.6 E., [Butte County](#), Hydrologic Unit 18020123, on left bank, at Kanaka Diversion Measuring Weir, 2.5 mi upstream from confluence with South Fork Feather River, and 2.5 mi southwest of Feather Falls.

DRAINAGE AREA.—15.5 mi².

PERIOD OF RECORD.—March 1989 to September 1998, October 1999 to current year.

GAGE.—Water-stage recorder and 120° V-notch weir. Elevation of gage is 1,660 ft above sea level, from topographic map.

REMARKS.—Water from creek is diverted upstream from gage to Kanaka Powerplant (station 11396396). See schematic diagram of [South Fork Feather River Basin](#).

COOPERATION.—Records provided by STS Hydro Power Ltd., under general supervision of the U.S. Geological Survey, in connection with Federal Energy Regulatory Commission project nos. 7120 and 7242.

EXTREMES FOR PERIOD OF RECORD.—Maximum discharge, 1,500 ft³/s, Jan. 1, 1997, gage height, 4.40 ft; minimum daily, 1.2 ft³/s, Aug. 21, 22, 27, 1992, Aug. 13, 1994.

DISCHARGE, CUBIC FEET PER SECOND, WATER YEAR OCTOBER 2001 TO SEPTEMBER 2002
DAILY MEAN VALUES

DAY	OCT	NOV	DEC	JAN	FEB	MAR	APR	MAY	JUN	JUL	AUG	SEP
1	e2.4	3.6	7.7	6.2	12	14	16	12	7.5	4.4	2.8	2.2
2	e2.4	3.4	52	51	12	14	15	11	7.4	4.2	2.7	2.2
3	e2.3	3.3	5.9	29	12	13	15	11	7.3	4.1	2.7	2.2
4	e2.3	3.3	5.6	5.6	12	13	14	10	7.0	4.0	2.7	2.1
5	e2.2	3.3	7.1	5.4	12	13	14	10	6.6	4.0	2.7	2.1
6	e2.2	3.2	8.9	37	12	17	14	9.8	6.5	3.9	2.6	2.1
7	e2.2	3.2	5.4	7.1	13	28	14	9.7	6.3	3.8	2.6	2.1
8	e2.2	3.2	5.4	5.3	14	14	13	9.5	6.1	3.8	2.5	2.1
9	e2.2	3.2	5.3	9.8	15	14	14	9.4	6.0	3.7	2.4	2.0
10	e2.1	3.2	5.2	5.4	14	14	14	9.4	6.0	3.6	2.3	2.0
11	e2.1	4.8	5.1	5.6	13	14	13	9.4	6.1	3.5	2.3	2.0
12	e2.1	6.0	7.3	5.4	13	14	13	9.2	6.0	3.4	2.3	2.0
13	e2.1	5.7	8.2	5.4	13	14	12	9.1	5.9	3.4	2.3	2.0
14	e2.0	5.8	13	5.4	12	14	12	8.9	5.8	3.3	2.3	2.0
15	e2.0	4.8	9.8	5.3	12	14	13	8.8	5.8	3.3	2.2	2.0
16	2.0	4.4	5.3	5.3	12	14	13	8.6	5.7	3.2	2.2	2.0
17	2.0	4.3	50	5.3	14	14	14	8.4	5.6	3.2	2.2	2.1
18	2.0	4.1	11	5.3	14	14	14	8.3	5.5	3.2	2.1	2.1
19	2.0	4.0	5.4	5.3	14	13	13	8.8	5.5	3.3	2.2	2.1
20	2.0	3.9	5.9	5.3	14	13	12	9.5	5.3	3.2	2.2	2.1
21	2.0	9.3	5.4	5.3	14	14	12	9.5	5.2	3.1	2.3	2.1
22	2.2	7.9	6.2	5.3	14	15	12	10	5.2	3.1	2.3	2.1
23	2.3	6.4	7.4	5.3	14	14	11	9.5	5.2	3.2	2.4	2.1
24	2.3	11	5.3	5.3	13	14	11	8.9	5.1	3.1	2.4	2.1
25	2.3	5.6	5.3	5.3	14	13	11	8.6	5.0	3.0	2.4	2.1
26	2.3	6.8	5.3	5.7	16	14	11	8.4	4.9	2.9	2.4	2.1
27	2.3	6.3	5.3	7.3	15	14	11	8.3	4.7	2.8	2.3	2.1
28	2.3	6.0	5.3	5.3	15	14	11	8.3	4.7	2.7	2.3	2.3
29	2.4	5.6	5.4	5.3	---	14	11	8.1	4.6	2.8	2.3	2.5
30	4.9	5.3	12	5.3	---	14	11	8.0	4.6	2.8	2.3	2.6
31	4.9	---	37	5.3	---	16	---	7.8	---	2.7	2.3	---
TOTAL	73.0	150.9	329.4	276.1	374	448	384	286.2	173.1	104.7	74.0	63.6
MEAN	2.355	5.030	10.63	8.906	13.36	14.45	12.80	9.232	5.770	3.377	2.387	2.120
MAX	4.9	11	52	51	16	28	16	12	7.5	4.4	2.8	2.6
MIN	2.0	3.2	5.1	5.3	12	13	11	7.8	4.6	2.7	2.1	2.0
AC-FT	145	299	653	548	742	889	762	568	343	208	147	126

STATISTICS OF MONTHLY MEAN DATA FOR WATER YEARS 1989 - 2002, BY WATER YEAR (WY)

	4.392	5.491	10.94	30.14	28.26	24.80	16.33	12.69	7.583	6.203	4.246	3.848
MEAN	4.392	5.491	10.94	30.14	28.26	24.80	16.33	12.69	7.583	6.203	4.246	3.848
MAX	7.19	7.32	51.7	128	91.7	92.0	37.5	45.5	10.4	13.7	8.09	7.58
(WY)	1990	1990	1997	1997	1998	1995	1995	1995	1998	1995	1995	1998
MIN	2.35	3.44	4.34	4.44	5.11	12.1	9.83	6.40	4.24	2.85	1.55	1.33
(WY)	2002	1993	1991	1991	1991	1994	1994	1992	1992	1994	1994	1992

SUMMARY STATISTICS	FOR 2001 CALENDAR YEAR		FOR 2002 WATER YEAR		WATER YEARS 1989 - 2002	
ANNUAL TOTAL	2638.6		2737.0			
ANNUAL MEAN	7.229		7.499		12.90	
HIGHEST ANNUAL MEAN					28.2	
LOWEST ANNUAL MEAN					6.29	
HIGHEST DAILY MEAN	63	Feb 21	52	Dec 2	1100	Jan 1 1997
LOWEST DAILY MEAN	1.8	Sep 23	2.0	Oct 14	1.2	Aug 21 1992
ANNUAL SEVEN-DAY MINIMUM	1.9	Sep 18	2.0	Oct 14	1.3	Aug 21 1992
MAXIMUM PEAK FLOW			154		1500	
MAXIMUM PEAK STAGE			2.67		4.40	
ANNUAL RUNOFF (AC-FT)	5230		5430		9350	
10 PERCENT EXCEEDS	14		14		17	
50 PERCENT EXCEEDS	5.4		5.4		6.8	
90 PERCENT EXCEEDS	2.1		2.1		2.5	

e Estimated.

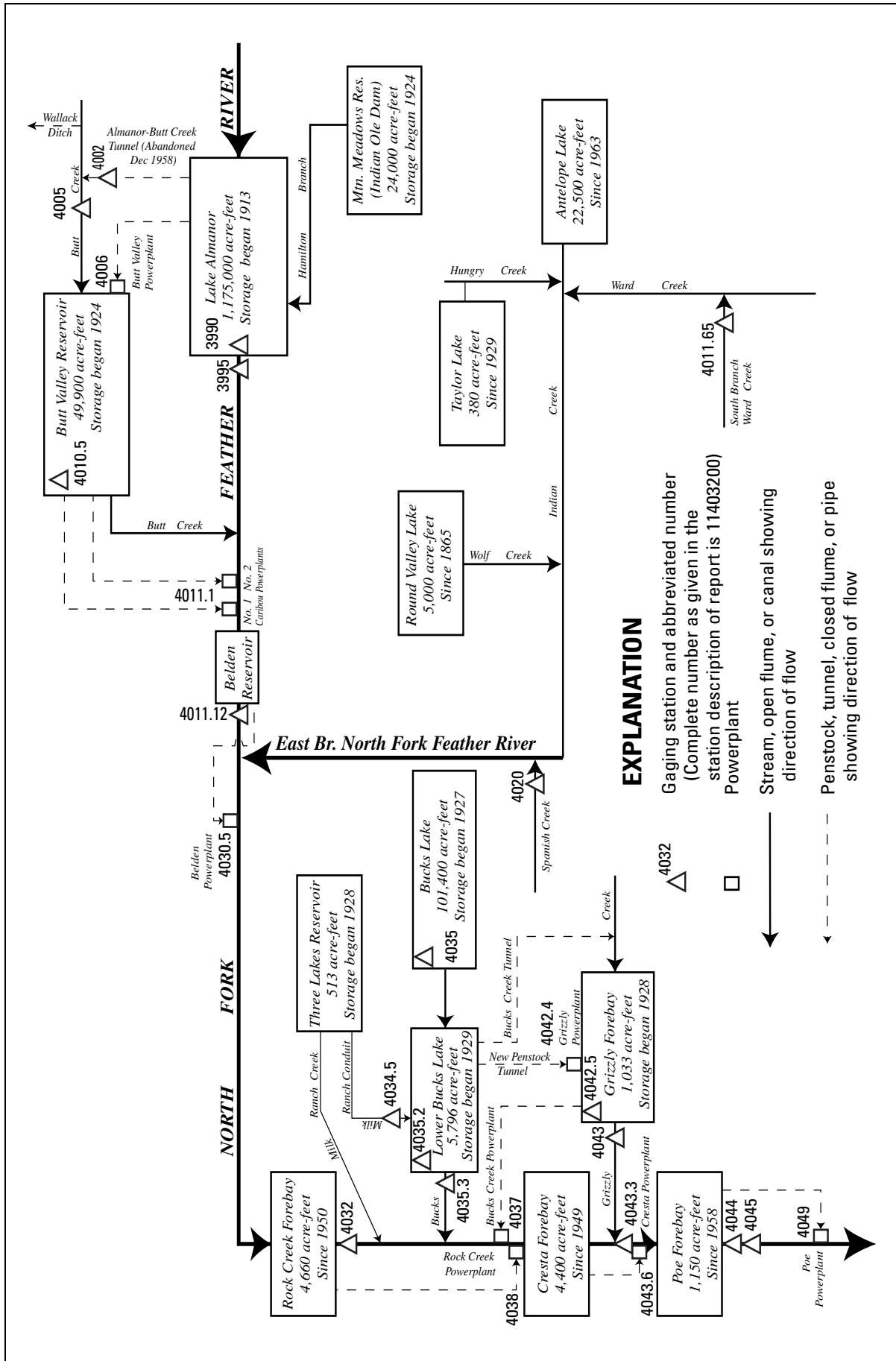

Figure 29. Diversions and storage in North Fork Feather River Basin.

11399000 LAKE ALMANOR AT PRATTVILLE, CA

LOCATION.—Lat 40°12'46", long 121°09'43", in SW 1/4 NE 1/4 sec.11, T.27 N., R.7 E., [Plumas County](#), Hydrologic Unit 18020121, Lassen National Forest, at intake tower to Butt Valley Tunnel at Prattville, 4.7 mi northwest of Lake Almanor Dam, and 5.6 mi northwest of Canyon Dam.

DRAINAGE AREA.—491 mi².

PERIOD OF RECORD.—July 1913 to current year. Monthly contents only for some periods, published in WSP 1315-A. Published as "near Prattville" 1937–60. Prior to October 1964, records published as usable contents.

REVISED RECORDS.—WSP 1931: Drainage area.

GAGE.—Nonrecording gage read once daily. Datum of gage is 10.23 ft below sea level (levels by Pacific Gas & Electric Co.). Prior to June 1, 1965, nonrecording gage at site 4.7 mi southeast at same datum.

REMARKS.—Lake is formed by earthfill dam; storage began in July 1913; dam raised to gage height 4,455 ft in 1917 and 4,515 ft in 1927. Usable capacity, 1,175,000 acre-ft, between gage heights 4,422 ft, invert of outlet, and 4,495.5 ft, maximum storage limit. Dead storage, 8,948 acre-ft. Water is diverted by tunnel and penstock to Butt Valley Powerplant (station 11400600) and then is used for power development in the North Fork Feather River. Figures given, including extremes, represent total contents at 2400 hours. See schematic diagram of [North Fork Feather River Basin](#).

COOPERATION.—Records were collected by Pacific Gas & Electric Co., under general supervision of the U.S. Geological Survey, in connection with Federal Energy Regulatory Commission project no. 2105. Contents not rounded to U.S. Geological Survey standards.

EXTREMES FOR PERIOD OF RECORD.—Maximum contents, 1,142,960 acre-ft, June 8, 1982, gage height, 4,494.00 ft; minimum, 5,230 acre-ft, Feb. 5, 1918, gage height, 4,416.1 ft.

EXTREMES FOR CURRENT YEAR.—Maximum contents, 909,943 acre-ft, June 30, gage height, 4,485.06 ft; minimum, 604,959 acre-ft, Nov. 9, 10, gage height, 4,471.89 ft.

Capacity table (gage height, in feet, and contents, in acre-feet)
(Based on surveys by Pacific Gas & Electric Co. in 1924 and 1926)

4,422	8,948	4,432	34,173	4,445	156,414	4,470	565,519
4,424	10,067	4,434	49,510	4,450	220,848	4,480	787,304
4,426	11,260	4,437	74,189	4,455	294,531	4,490	1,036,269
4,428	13,480	4,440	101,869	4,460	376,686	4,495.5	1,183,835
4,430	21,200						

RESERVOIR STORAGE, ACRE-FEET, WATER YEAR OCTOBER 2001 TO SEPTEMBER 2002

DAILY OBSERVATION AT 2400 HOURS

DAY	OCT	NOV	DEC	JAN	FEB	MAR	APR	MAY	JUN	JUL	AUG	SEP
1	659522	610473	622452	647693	693454	729792	773635	839330	893318	908947	878539	832584
2	657544	609411	626333	651622	694349	730715	775284	840779	895051	908947	877308	830182
3	655126	609198	626765	653592	695244	732100	777172	842472	895794	908449	876816	827305
4	652716	609198	627629	655565	696141	733255	780218	843683	895051	908698	875832	823939
5	650311	608561	628928	658201	697038	735338	782324	845864	895299	909196	873867	821527
6	647693	607076	629794	661064	697711	736716	784434	847806	894804	908449	872394	819360
7	645952	606017	630227	663493	700183	739466	786782	849508	895051	907454	870433	817196
8	643535	605171	630444	665484	700859	741072	788663	851445	895299	905963	869209	816716
9	642218	604959	630661	667478	701759	742451	791490	853139	895794	904969	867741	814556
10	640903	604959	630661	669699	702435	744752	794322	854835	896290	902984	866518	811921
11	639372	605806	630227	670588	703112	746596	796688	856776	897282	901002	865297	810964
12	637842	608349	630661	672146	704014	748443	799294	858233	897530	899019	865541	808574
13	636751	609198	632397	673483	704917	750292	801905	859692	898522	898522	865297	806666
14	635007	610048	634137	674599	705821	751218	805236	861639	899019	897778	863589	804283
15	633267	610899	633049	675939	706952	752144	807858	863101	900011	896786	862126	801905
16	631529	611750	632397	676833	707857	753535	810486	865053	900754	895547	859692	799294
17	629794	612602	632832	677728	709443	754463	812400	867007	901497	894061	858233	797161
18	628062	613455	633484	678624	710351	755391	813837	868719	901993	893071	856776	794795
19	626333	614308	634137	679520	713304	756321	815756	871413	902984	891341	855078	792669
20	625038	614522	636751	680866	715353	757483	817677	873867	903480	890600	853623	790547
21	623313	615590	637187	682214	717177	758647	819120	875341	904225	889612	851929	788192
22	621592	615590	638061	683113	717405	760278	820805	876324	905218	888378	850236	785842
23	619659	615590	638497	684013	721062	761911	822492	878293	905714	887146	848535	783730
24	619016	617944	638716	684914	722895	763312	824422	879771	906460	886161	846835	781621
25	619230	617730	639372	685815	724730	764481	826587	880752	907205	884930	845137	779282
26	617515	617515	638934	688297	725649	765651	829223	882225	907952	883208	843199	777172
27	615804	616873	639153	689202	727259	767056	832103	883700	908449	882962	841989	774813
28	614522	618372	640903	690326	727949	767994	834027	885914	908947	882717	841021	772693
29	614308	619445	641999	691219	---	769402	835953	887885	909445	881489	838847	770341
30	613455	619874	644193	691889	---	770811	837882	889859	909943	880998	836435	767994
31	611963	---	645732	692783	---	772222	---	891835	---	879771	834749	---
MAX	659522	619874	645732	692783	727949	772222	837882	891835	909943	909196	878539	832584
MIN	611963	604959	622452	647693	693454	729792	773635	839330	893318	879771	834749	767994
a	4472.22	4472.59	4473.78	4475.90	4477.45	4479.36	4482.12	4484.33	4485.06	4483.84	4481.99	4479.19
b	-50655	+7611	+25858	+47051	+35166	+44273	+65660	+53953	+18108	-30172	-45022	-66755

CAL YR 2001 MAX 796688 MIN 604959 b -78769
WTR YR 2002 MAX 909943 MIN 604959 b +105376

a Gage height, in feet, at end of month.
b Change in contents, in acre-feet.

11399500 NORTH FORK FEATHER RIVER NEAR PRATTVILLE, CA

LOCATION.—Lat 40°10'06", long 121°05'31", in NE 1/4 SW 1/4 sec.28, T.27 N., R.8 E., [Plumas County](#), Hydrologic Unit 18020121, Plumas National Forest, on left bank, 0.4 mi downstream from Almanor Dam, 4.5 mi southeast of Prattville, and 9 mi upstream from Butt Creek.

DRAINAGE AREA.—493 mi².

PERIOD OF RECORD.—June 1905 to current year. Published as "below Prattville" prior to 1911. No record for January, February, or March 1911. Estimated mean discharge for water year 1911 published in WSP 1315-A.

REVISED RECORDS.—WSP 1245: 1951 (yearly summaries). WSP 1285: 1952 (yearly summaries). WDR CA-88-4: 1987 (monthly and yearly totals for Butt Valley Powerplant).

GAGE.—Water-stage recorder and broad-crested weir. Datum of gage is 4,390.09 ft above sea level. Prior to Oct. 1, 1936, nonrecording gages or water-stage recorders at several sites within 0.5 mi of present site at various datums.

REMARKS.—Flow regulated since 1913 by Lake Almanor (station 11399000) 0.5 mi upstream and since 1924 by Mountain Meadows Reservoir, capacity, 24,000 acre-ft, 12 mi upstream on Hamilton Branch. Water diverted from Lake Almanor to Butt Valley Reservoir (station 11401050) through old Almanor–Butt Creek Tunnel from May 1921 to December 1958, for use at Caribou Powerplant. Old tunnel closed Dec. 30, 1958, and diversion began Dec. 31, 1958, to Butt Valley Powerplant (station 11400600) at upstream end of Butt Valley Reservoir. See schematic diagram of [North Fork Feather River Basin](#).

COOPERATION.—Records were collected by Pacific Gas & Electric Co., under general supervision of the U.S. Geological Survey, in connection with Federal Energy Regulatory Commission project no. 2105.

EXTREMES FOR PERIOD OF RECORD.—Maximum discharge, 10,000 ft³/s, Mar. 19, 1907, before construction of dam, gage height, 16.2 ft, at former site, from rating curve extended above 3,700 ft³/s; no flow at times during 1914, 1919, 1923.

DISCHARGE, CUBIC FEET PER SECOND, WATER YEAR OCTOBER 2001 TO SEPTEMBER 2002

DAILY MEAN VALUES

DAY	OCT	NOV	DEC	JAN	FEB	MAR	APR	MAY	JUN	JUL	AUG	SEP
1	36	37	37	37	38	35	36	36	37	37	36	35
2	36	37	38	38	38	35	36	36	37	37	36	35
3	36	37	37	38	38	35	36	36	37	37	36	35
4	36	37	37	38	37	35	36	36	37	37	36	35
5	36	37	37	38	36	35	36	36	37	37	36	35
6	36	37	37	38	36	36	36	36	37	37	36	35
7	36	37	37	38	36	36	35	36	37	37	36	35
8	36	37	37	38	36	36	35	36	37	37	36	35
9	36	37	37	38	36	36	35	36	37	37	36	35
10	36	37	37	38	36	36	35	36	37	37	36	35
11	36	37	37	38	36	36	35	36	37	37	36	35
12	36	37	37	38	36	36	35	36	37	37	36	35
13	36	37	37	38	36	36	35	36	37	37	36	35
14	36	37	37	38	36	36	35	37	37	37	36	35
15	36	37	37	38	36	36	36	37	37	37	36	35
16	37	37	37	38	36	36	36	37	37	37	36	35
17	39	37	37	38	36	36	36	37	37	37	36	35
18	124	37	37	38	36	36	36	37	37	37	36	35
19	38	37	37	38	36	36	36	37	37	37	36	35
20	38	37	37	38	36	36	36	37	37	37	36	35
21	38	37	37	38	36	36	35	37	37	37	36	35
22	38	37	37	38	36	36	35	37	37	37	36	35
23	38	37	37	38	36	36	35	37	37	37	36	35
24	37	37	37	38	36	36	35	37	37	37	36	35
25	37	37	37	38	36	36	36	37	37	37	36	35
26	37	37	37	38	36	36	36	37	37	37	36	35
27	37	37	37	38	36	36	36	37	37	37	36	35
28	37	37	37	38	36	36	36	37	37	37	36	35
29	37	37	37	38	---	36	36	37	37	37	36	35
30	38	37	37	38	---	36	36	37	37	37	36	35
31	38	---	38	38	---	36	---	37	---	36	35	---
TOTAL	1228	1110	1149	1177	1015	1111	1068	1134	1110	1143	1113	1050
MEAN	39.61	37.00	37.06	37.97	36.25	35.84	35.60	36.58	37.00	36.87	35.90	35.00
MAX	124	37	38	38	38	36	36	37	37	37	36	35
MIN	36	37	37	37	36	35	35	36	37	36	35	35
AC-FT	2440	2200	2280	2330	2010	2200	2120	2250	2200	2270	2210	2080
a	73220	29210	19000	411	1420	97	600	421	8180	51590	69350	95090

a Diversion, in acre-feet, to Butt Valley Powerplant (station 11400600), provided by Pacific Gas & Electric Co.

11399500 NORTH FORK FEATHER RIVER NEAR PRATTVILLE, CA—Continued

STATISTICS OF MONTHLY MEAN DATA FOR WATER YEARS 1925 - 1958, BY WATER YEAR (WY)

	OCT	NOV	DEC	JAN	FEB	MAR	APR	MAY	JUN	JUL	AUG	SEP
MEAN	498	393	371	282	349	272	318	327	349	479	602	569
MAX	1607	1414	1418	1489	2124	1609	1852	2206	1065	1280	1755	1762
(WY)	1931	1931	1938	1946	1938	1929	1938	1938	1935	1929	1929	1929
MIN	3.80	3.32	3.41	3.20	3.20	3.61	2.63	2.02	2.11	8.02	3.72	3.16
(WY)	1942	1940	1937	1944	1944	1944	1939	1939	1939	1943	1937	1937

SUMMARY STATISTICS

WATER YEARS 1925 - 1958

ANNUAL TOTAL	
ANNUAL MEAN	401
HIGHEST ANNUAL MEAN	1061 1929
LOWEST ANNUAL MEAN	27.1 1937
HIGHEST DAILY MEAN	2670 May 17 1942
LOWEST DAILY MEAN	.50 Apr 28 1949
ANNUAL SEVEN-DAY MINIMUM	.87 Apr 25 1949
MAXIMUM PEAK FLOW	2710 May 22 1941
MAXIMUM PEAK STAGE	6.95 May 22 1941
ANNUAL RUNOFF (AC-FT)	290600
10 PERCENT EXCEEDS	1060
50 PERCENT EXCEEDS	60
90 PERCENT EXCEEDS	4.4

STATISTICS OF MONTHLY MEAN DATA FOR WATER YEARS 1960 - 2002, BY WATER YEAR (WY)

	1960	1961	1962	1963	1964	1965	1966	1967	1968	1969	1970	1971	1972	1973	1974	1975	1976	1977	1978	1979	1980	1981	1982	1983	1984	1985	1986	1987	1988	1989	1990	1991	1992	1993	1994	1995	1996	1997	1998	1999	2000	2001	2002							
MEAN	47.18	44.38	33.34	77.19	75.74	37.34	41.64	49.67	66.03	61.46	58.04	44.16																																						
MAX	510	546	59.6	1901	1800	163	293	352	660	688	596	415																																						
(WY)	1997	1997	1997	1997	1997	1997	1983	1996	1996	1996	1996	1996																																						
MIN	17.3	8.65	7.47	8.67	10.0	9.90	10.1	15.7	16.0	15.4	14.9	15.0																																						
(WY)	1978	1960	1960	1960	1962	1964	1964	1977	1977	1977	1977	1977																																						

SUMMARY STATISTICS

FOR 2001 CALENDAR YEAR

FOR 2002 WATER YEAR

WATER YEARS 1960 - 2002

ANNUAL TOTAL	14378	13408	
ANNUAL MEAN	39.39	36.73	52.89
HIGHEST ANNUAL MEAN			459 1997
LOWEST ANNUAL MEAN			22.3 1962
HIGHEST DAILY MEAN	498 May 12	124 Oct 18	2140 Jan 5 1997
LOWEST DAILY MEAN	35 Jan 4	35 Mar 1	2.9 Jan 9 1960
ANNUAL SEVEN-DAY MINIMUM	35 Jan 2	35 Apr 7	4.7 Oct 26 1966
MAXIMUM PEAK FLOW		197 Oct 18	10000 Mar 19 1907
MAXIMUM PEAK STAGE		3.46 Oct 18	16.20 Mar 19 1907
ANNUAL RUNOFF (AC-FT)	28520	26590	38310
ANNUAL DIVERSION (AC-FT) ^a	459800	348600	
10 PERCENT EXCEEDS	39	38	40
50 PERCENT EXCEEDS	37	37	36
90 PERCENT EXCEEDS	36	35	33

^a A Diversion, in acre-feet, to Butt Valley Powerplant (station 11400600), provided by Pacific Gas & Electric Co.

11400500 BUTT CREEK BELOW ALMANOR–BUTT CREEK TUNNEL, NEAR PRATTVILLE, CA

LOCATION.—Lat 40°11'14", long 121°11'13", in NE 1/4 NW 1/4 sec.22, T.27 N., R.7 E., [Plumas County](#), Hydrologic Unit 18020121, on right bank, 500 ft downstream from outlet of old Almanor–Butt Creek Tunnel, and 2.2 mi southwest of Prattville.

DRAINAGE AREA.—69.3 mi².

PERIOD OF RECORD.—October 1936 to September 1959, October 1964 to current year. Published as "below tunnel No. 1" 1938–40. Records for water years 1937–38 published in WSP 1515. Records prior to 1964 not equivalent owing to inflow from Almanor–Butt Creek Tunnel.

GAGE.—Water-stage recorder and concrete control. Elevation of gage is 4,300 ft above sea level, from topographic map. Prior to Oct. 5, 1937, at site 200 ft downstream at datum 4 ft lower.

REMARKS.—No regulation upstream from station. Howell–Bunger valve in conduit from Lake Almanor (station 11399000) to Butt Valley Powerplant (station 11400600) is opened for short periods several times a year, causing sharp peaks. Wallack Ditch upstream from station diverts about 3 ft³/s during each irrigation season into Yellow Creek Basin. Some inflow 500 ft upstream that is the leakage from the abandoned Almanor–Butt Creek Tunnel at Outlet (station 11400200) is included in the table below. See schematic diagram of [North Fork Feather River Basin](#).

COOPERATION.—Records were collected by Pacific Gas & Electric Co., under general supervision of the U.S. Geological Survey, in connection with Federal Energy Regulatory Commission project no. 2105.

EXTREMES FOR PERIOD OF RECORD.—Maximum discharge, 4,080 ft³/s, Jan. 1, 1997, gage height, 6.22 ft, from rating curve extended above 1,400 ft³/s; minimum daily, 26 ft³/s, several days during May and June 1976.

DISCHARGE, CUBIC FEET PER SECOND, WATER YEAR OCTOBER 2001 TO SEPTEMBER 2002

DAILY MEAN VALUES

DAY	OCT	NOV	DEC	JAN	FEB	MAR	APR	MAY	JUN	JUL	AUG	SEP
1	36	40	47	83	65	100	182	109	72	48	43	42
2	36	39	57	170	65	93	198	105	70	47	43	42
3	36	39	56	165	65	89	213	108	67	47	44	42
4	36	39	51	106	65	90	225	110	64	47	44	42
5	36	39	51	92	65	93	226	110	63	47	44	42
6	36	39	59	233	65	140	208	110	62	47	44	42
7	36	39	59	177	63	149	199	109	61	47	44	42
8	36	39	54	132	69	118	194	103	60	46	44	42
9	36	39	52	114	70	105	205	100	59	46	43	42
10	36	39	49	101	68	103	207	101	59	45	43	42
11	36	48	48	91	63	99	198	95	57	45	43	42
12	36	69	47	84	58	108	195	92	57	45	43	42
13	36	55	47	80	58	106	195	92	56	45	43	42
14	36	46	47	79	58	96	219	90	55	45	43	42
15	36	43	45	78	59	91	215	90	55	45	43	42
16	36	41	49	81	61	88	184	89	54	45	43	42
17	36	43	55	79	64	86	171	88	53	45	43	42
18	36	41	52	77	62	83	152	89	53	45	43	42
19	36	41	52	75	65	82	136	92	53	46	43	41
20	37	41	52	76	143	89	129	111	52	46	43	41
21	37	66	50	73	129	99	122	95	54	47	43	41
22	37	154	50	70	114	110	119	89	53	47	43	41
23	37	58	48	71	129	118	121	84	51	45	43	41
24	37	60	46	71	116	113	122	81	51	45	43	41
25	37	58	48	71	109	109	125	78	50	45	42	41
26	37	51	48	67	106	112	131	77	49	45	42	41
27	37	47	49	63	105	121	140	77	49	45	42	41
28	37	47	54	63	105	132	123	76	49	44	42	41
29	37	48	59	65	---	149	118	75	48	44	42	41
30	49	46	62	65	---	159	114	75	48	44	42	41
31	45	---	90	65	---	169	---	74	---	44	42	---
TOTAL	1148	1494	1633	2917	2264	3399	5086	2874	1684	1414	1332	1248
MEAN	37.03	49.80	52.68	94.10	80.86	109.6	169.5	92.71	56.13	45.61	42.97	41.60
MAX	49	154	90	233	143	169	226	111	72	48	44	42
MIN	36	39	45	63	58	82	114	74	48	44	42	41
AC-FT	2280	2960	3240	5790	4490	6740	10090	5700	3340	2800	2640	2480
a	430	408	450	451	403	446	422	437	422	437	431	416

a Inflow, in acre-feet, from Almanor–Butt Creek Tunnel at Outlet (station 11400200), provided by Pacific Gas & Electric Co.

11400500 BUTT CREEK BELOW ALMANOR-BUTT CREEK TUNNEL, NEAR PRATTVILLE, CA—Continued

STATISTICS OF MONTHLY MEAN DATA FOR WATER YEARS 1937 - 2002, BY WATER YEAR (WY)

	OCT	NOV	DEC	JAN	FEB	MAR	APR	MAY	JUN	JUL	AUG	SEP
MEAN	356.5	330.8	342.1	291.7	289.4	323.2	332.5	365.0	355.9	373.3	365.6	361.6
MAX	995	1073	1419	1098	1025	1050	1178	1176	1092	1038	1019	990
(WY)	1943	1938	1959	1953	1941	1953	1952	1956	1958	1953	1953	1953
MIN	32.3	39.2	39.3	39.4	38.0	47.8	47.5	42.7	32.9	28.7	27.8	29.4
(WY)	1989	1992	1991	1992	1937	1977	1977	1976	1976	1977	1977	1992

SUMMARY STATISTICS	FOR 2001 CALENDAR YEAR		FOR 2002 WATER YEAR		WATER YEARS 1937 - 2002	
ANNUAL TOTAL	20762		26493			
ANNUAL MEAN	56.88		72.58		341.0	
HIGHEST ANNUAL MEAN					974 1953	
LOWEST ANNUAL MEAN					40.1 1977	
HIGHEST DAILY MEAN	228	Mar 25	233	Jan 6	2830	Feb 17 1986
LOWEST DAILY MEAN	35	Sep 20	36	Oct 1	26	May 26 1976
ANNUAL SEVEN-DAY MINIMUM	35	Sep 18	36	Oct 1	26	May 30 1976
MAXIMUM PEAK FLOW			317	Jan 6	4080	Jan 1 1997
MAXIMUM PEAK STAGE			1.66	Jan 6	6.22	Jan 1 1997
ANNUAL RUNOFF (AC-FT)	41180		52550		247000	
ANNUAL INFLOW (AC-FT) a	5320		5150			
10 PERCENT EXCEEDS	100		129		987	
50 PERCENT EXCEEDS	48		54		95	
90 PERCENT EXCEEDS	36		39		42	

a Inflow, in acre-feet, from Almanor-Butt Creek Tunnel at Outlet (station 11400200), provided by Pacific Gas & Electric Co.

11401050 BUTT VALLEY RESERVOIR NEAR CARIBOU, CA

LOCATION.—Lat 40°06'59", long 121°08'42", in SE 1/4 SW 1/4 sec.12, T.26 N., R.7 E., [Plumas County](#), Hydrologic Unit 18020121, on center intake tower in Butt Valley Reservoir, 2.5 mi north of Caribou, and 5.4 mi southwest of Canyon Dam.

DRAINAGE AREA.—83.5 mi².

PERIOD OF RECORD.—October 1985 to current year. Unpublished records for water years 1983–85 available in files of the U.S. Geological Survey.

GAGE.—Water-stage recorder. Datum of gage is 10.23 ft below sea level (levels by Great Western Power Co.).

REMARKS.—Lake is formed by earthfill dam. Storage began in 1924. Usable capacity, 49,900 acre-ft, between elevations 4,075.9 ft, invert of outlet tunnel, and 4,132.1 ft, crest of spillway. Water is diverted by tunnel and penstock to Caribou Powerplants (station 11401110). Figures given, including extremes, represent total contents at 2400 hours. See schematic diagram of [North Fork Feather River Basin](#).

REVISED RECORDS.—WDR CA-00-4 (discharge through Caribou Powerplants).

COOPERATION.—Records were collected by Pacific Gas & Electric Co., under general supervision of the U.S. Geological Survey, in connection with Federal Energy Regulatory Commission project no. 2105. Contents not rounded to U.S. Geological Survey standards.

EXTREMES FOR PERIOD OF RECORD.—Maximum contents, 52,667 acre-ft, Feb. 18, 19, 1986, elevation, 4,133.80 ft; minimum, 4,284 acre-ft, Mar. 3, 1997, elevation, 4,094.95 ft.

EXTREMES FOR CURRENT YEAR.—Maximum contents, 47,114 acre-ft, Aug. 26, elevation, 4,130.33 ft; minimum, 26,867 acre-ft, Nov. 20, elevation, 4,116.59 ft.

Capacity table (elevation, in feet, and contents, in acre-feet)
(Based on surveys by Great Western Power Co. in 1923 and 1924)

4,090	1,754	4,110	18,395	4,130	46,591	4,137	57,891
4,100	8,024	4,120	31,592				

RESERVOIR STORAGE (ACRE-FEET), WATER YEAR OCTOBER 2001 TO SEPTEMBER 2002

DAILY OBSERVATION AT 2400 HOURS

DAY	OCT	NOV	DEC	JAN	FEB	MAR	APR	MAY	JUN	JUL	AUG	SEP
1	46703	30328	31038	32621	33282	35716	36146	43995	37852	36680	45885	45006
2	46466	29618	31718	33311	33035	35863	35774	44150	36576	37036	45995	45336
3	46340	29907	31944	33747	32762	36012	35528	44290	36502	37689	46073	45728
4	46120	30186	31916	34066	32509	35938	36027	44430	37763	37541	46230	45634
5	46371	30641	31831	34385	32283	35997	36517	44539	37467	37437	46136	45791
6	46655	31095	31463	34964	32057	36398	36962	44632	37600	37467	46214	45508
7	46640	31746	31421	35398	32029	36873	37407	44756	37823	37600	46261	46293
8	46340	32001	31605	35731	31902	37140	37823	44725	37615	38045	46026	45838
9	45822	31817	31845	36056	31675	37393	38282	44741	37304	38178	45948	45618
10	45320	31817	32114	36279	31534	37748	38741	44772	37244	38060	45885	45822
11	44539	31803	32142	36606	31322	37437	39196	44694	37111	38652	45618	44663
12	43311	31520	31010	36754	31137	37022	39621	44647	37823	39242	45320	44461
13	42557	30257	30797	36264	31222	37200	40030	44616	37689	38237	44943	44647
14	41711	29797	29673	36502	31322	37200	40500	44632	37570	38697	45006	44787
15	40621	28971	30385	36725	31421	37378	40954	42649	37496	38923	45445	44943
16	39257	28114	31279	36576	31605	37496	41393	42557	37378	39848	45995	45069
17	37808	27739	32283	36636	31760	37600	41772	42480	37333	40757	46466	46057
18	36636	27781	32382	36457	31859	37659	41957	42372	37155	41711	46893	45822
19	35152	26893	32692	36235	32128	36947	42126	42388	37036	42680	46877	45900
20	33790	26867	32269	36042	32495	36368	42249	42449	36888	43157	46640	45806
21	32495	28238	32396	35848	32762	35863	42372	42418	36814	43793	46766	45555
22	32198	29026	32396	35514	33006	35543	42634	42434	36710	44772	46798	45524
23	31746	29357	32085	35268	33384	35804	42726	42403	36651	45210	46750	45587
24	31944	30158	31873	35008	33703	35442	42880	42341	36457	45289	46766	45493
25	33166	30868	31562	34776	34022	35528	43049	42326	36383	45367	46924	45398
26	33703	31435	31704	34718	34979	35658	43219	42280	36309	45477	47114	45649
27	33122	31548	31888	34486	35311	35658	43420	42249	36205	45445	46450	45618
28	32551	31619	31675	34486	35485	35789	43575	42172	36116	45414	45430	45602
29	30471	31038	31859	34110	---	36042	43715	41575	35982	45697	45351	45759
30	29866	30499	32099	33732	---	36294	43855	40303	35863	45932	45383	45602
31	29522	---	32368	33544	---	36532	---	39196	---	45932	45398	---
MAX	46703	32001	32692	36754	35485	37748	43855	44772	37852	45932	47114	46293
MIN	29522	26867	29673	32621	31137	35442	35528	39196	35863	36680	44943	44461
a	4118.52	4119.22	4120.54	4121.36	4122.70	4123.41	4128.25	4125.20	4122.96	4129.58	4129.24	4129.37
b	-17209	+977	+1869	+1176	+1941	+1047	+7323	-4659	-3333	+10069	-534	+204
c	87010	30980	22800	7780	6170	7240	3990	12150	15790	37930	61540	84200

CAL YR 2001 MAX 49414 MIN 26867 b +905 c 461200
WTR YR 2002 MAX 47114 MIN 26867 b -1129 c 377600

a Elevation, in feet, at end of month.

b Change in contents, in acre-feet.

c Discharge, in acre-feet, through Caribou Powerplants (station 11401110), provided by Pacific Gas & Electric Co.

11401112 NORTH FORK FEATHER RIVER BELOW BELDEN DAM, CA

LOCATION.—Lat 40°04'17", long 121°09'49", in NE 1/4 NW 1/4 sec.35, T.26 N., R.7 E., [Plumas County](#), Hydrologic Unit 18020121, Plumas National Forest, on left bank, 0.4 mi downstream from Belden Dam, 0.5 mi upstream from Deadwood Canyon, and 6.4 mi northeast of Belden.

DRAINAGE AREA.—612 mi².

PERIOD OF RECORD.—October 1969 to current year. Records for July 1959 to September 1969 available in files of Pacific Gas & Electric Co.

REVISED RECORDS.—WDR CA-78-4: 1977 (monthly and yearly summaries).

GAGE.—Water-stage recorder. Datum of gage is 2,800.77 ft above sea level (levels by Pacific Gas & Electric Co.).

REMARKS.—Flow regulated by Butt Valley Reservoir (station 11401050), Lake Almanor (station 11399000), Belden Reservoir, and Mountain Meadows Reservoir, combined capacity, 1,267,000 acre-ft. Diversion to Belden Powerplant (station 11403050) began on Aug. 27, 1969. See schematic diagram of [North Fork Feather River Basin](#).

COOPERATION.—Records were collected by Pacific Gas & Electric Co., under general supervision of the U.S. Geological Survey, in connection with Federal Energy Regulatory Commission project no. 2105.

EXTREMES FOR PERIOD OF RECORD.—Maximum discharge, 3,460 ft³/s, Jan. 1, 1997, gage height, 9.17 ft; minimum daily, 2.3 ft³/s, Oct. 25, 1981.

DISCHARGE, CUBIC FEET PER SECOND, WATER YEAR OCTOBER 2001 TO SEPTEMBER 2002
DAILY MEAN VALUES

DAY	OCT	NOV	DEC	JAN	FEB	MAR	APR	MAY	JUN	JUL	AUG	SEP
1	68	67	66	67	67	66	63	147	144	144	144	143
2	67	68	64	68	66	66	64	145	144	144	144	122
3	67	68	67	68	66	66	65	145	144	143	143	63
4	68	68	67	68	67	67	65	145	144	144	144	63
5	68	68	67	68	67	67	65	145	144	144	144	64
6	67	67	67	68	66	66	65	145	144	143	143	63
7	67	68	67	68	67	68	64	145	144	144	144	64
8	67	67	68	67	67	66	64	145	144	144	144	64
9	67	68	67	67	67	67	105	145	144	144	143	64
10	67	67	67	67	67	67	111	145	144	144	143	64
11	67	65	67	67	66	66	94	145	144	144	143	63
12	67	65	67	66	66	67	94	146	144	144	143	63
13	67	65	67	67	66	65	94	145	144	144	143	64
14	67	65	66	67	66	64	94	145	144	144	143	64
15	68	66	66	67	67	63	94	145	144	144	143	64
16	68	66	67	66	67	63	94	145	144	144	144	64
17	68	65	68	67	67	63	112	145	144	144	144	76
18	68	66	67	67	67	64	148	145	143	143	143	73
19	67	65	67	67	67	64	148	145	145	143	143	62
20	69	66	67	67	67	63	148	145	144	143	143	62
21	69	66	67	67	67	63	149	145	144	143	143	68
22	69	67	67	67	67	63	149	145	144	142	143	63
23	69	66	67	67	67	63	148	145	144	142	143	63
24	69	66	67	67	67	64	148	145	144	143	143	63
25	68	65	68	67	67	64	155	145	144	142	143	63
26	67	65	68	66	67	64	149	145	143	142	143	64
27	66	65	67	67	66	64	149	145	144	143	143	64
28	67	65	67	67	66	64	149	144	144	143	143	64
29	67	67	67	66	---	63	149	144	144	143	143	64
30	68	68	67	67	---	63	149	144	144	143	143	64
31	67	---	67	67	---	63	---	144	---	144	142	---
TOTAL	2095	1990	2075	2079	1867	2006	3345	4494	4319	4445	4440	2069
MEAN	67.58	66.33	66.94	67.06	66.68	64.71	111.5	145.0	144.0	143.4	143.2	68.97
MAX	69	68	68	68	67	68	155	147	145	144	144	143
MIN	66	65	64	66	66	63	63	144	143	142	142	62
AC-FT	4160	3950	4120	4120	3700	3980	6630	8910	8570	8820	8810	4100
a	85210	28930	21130	6210	4270	6280	2210	5170	7190	31910	70290	83160

a Diversion, in acre-feet, to Belden Powerplant (station 11403050), provided by Pacific Gas & Electric Co.

SACRAMENTO RIVER BASIN

11401112 NORTH FORK FEATHER RIVER BELOW BELDEN DAM, CA—Continued

STATISTICS OF MONTHLY MEAN DATA FOR WATER YEARS 1970 - 2002, BY WATER YEAR (WY)

	OCT	NOV	DEC	JAN	FEB	MAR	APR	MAY	JUN	JUL	AUG	SEP
MEAN	128.6	136.1	117.2	131.4	108.6	105.8	172.1	168.0	146.5	139.8	136.4	119.8
MAX	1414	2487	1664	1200	616	591	743	549	374	199	173	1134
(WY)	1975	1975	1975	1997	1997	1975	1983	1995	1995	1970	1970	1987
MIN	57.8	38.4	45.2	51.6	51.2	50.0	63.1	62.2	56.5	64.2	89.0	61.9
(WY)	1985	1981	1976	1976	1976	1976	1972	1971	1971	1971	1972	1976

SUMMARY STATISTICS	FOR 2001 CALENDAR YEAR		FOR 2002 WATER YEAR		WATER YEARS 1970 - 2002	
ANNUAL TOTAL	34822		35224			
ANNUAL MEAN	95.40		96.50		134.3	
HIGHEST ANNUAL MEAN					745 1975	
LOWEST ANNUAL MEAN					76.3 1977	
HIGHEST DAILY MEAN	521	May 12	155	Apr 25	2800	Nov 20 1974
LOWEST DAILY MEAN	63	Mar 28	62	Sep 19	2.3	Oct 25 1981
ANNUAL SEVEN-DAY MINIMUM	64	Apr 1	63	Mar 15	3.5	Oct 25 1981
MAXIMUM PEAK FLOW			225	Apr 25	3460	Jan 1 1997
MAXIMUM PEAK STAGE			3.96	Apr 25	9.17	Jan 1 1997
ANNUAL RUNOFF (AC-FT)	69070		69870		97290	
ANNUAL DIVERSION (AC-FT) a	434200		351900			
10 PERCENT EXCEEDS	148		145		149	
50 PERCENT EXCEEDS	67		67		68	
90 PERCENT EXCEEDS	65		64		60	

a Diversion, in acre-feet, to Belden Powerplant (station 11403050), provided by Pacific Gas & Electric Co.

11401165 SOUTH BRANCH WARD CREEK BELOW DIVERSION DAM, NEAR GENESEE, CA

LOCATION.—Lat 40°00'07", long 120°42'07", in SE 1/4 NE 1/4 sec.26, T.25 N., R.11 E., [Plumas County](#), Hydrologic Unit 18020122, on left bank, 20 ft downstream from diversion dam, 30 ft downstream from Nye Creek, 3.5 mi upstream from Indian Creek, and 3.8 mi southeast of Genesee.

DRAINAGE AREA.—6.74 mi².

PERIOD OF RECORD.—October 1990 to current year (low-flow records only).

GAGE.—Water-stage recorder and V-notch sharp-crested weir in concrete control. Elevation of gage is 5,300 ft above sea level, from topographic map.

REMARKS.—No records computed above 12 ft³/s. Flow regulated at diversion dam 20 ft upstream. Some water is diverted to Five Bears Powerplant and bypasses this gage. See schematic diagram of [North Fork Feather River Basin](#).

COOPERATION.—Records were collected by Five Bears Hydro, Inc., under general supervision of the U.S. Geological Survey, in connection with Federal Energy Regulatory Commission project no. 6281.

DISCHARGE, CUBIC FEET PER SECOND, WATER YEAR OCTOBER 2001 TO SEPTEMBER 2002

DAILY MEAN VALUES

DAY	OCT	NOV	DEC	JAN	FEB	MAR	APR	MAY	JUN	JUL	AUG	SEP
1	3.0	2.6	4.8	3.5	3.5	7.0	10	11	4.4	3.1	2.8	2.8
2	3.0	2.6	4.8	3.5	3.5	6.8	10	11	4.3	3.1	2.8	2.7
3	3.0	2.6	3.5	3.5	3.5	6.6	12	10	4.3	3.1	2.8	2.5
4	3.0	2.6	3.5	3.7	3.4	6.6	11	10	4.1	3.1	2.8	2.5
5	3.0	2.5	3.5	3.7	3.4	6.8	11	10	4.2	3.1	2.8	2.5
6	3.0	2.5	3.5	3.5	3.4	10	11	10	4.1	3.0	2.8	2.5
7	3.0	2.5	3.4	3.5	3.5	---	12	11	4.1	3.0	2.8	2.5
8	3.0	2.4	3.5	3.5	3.5	12	12	11	4.2	3.0	2.8	2.5
9	3.0	2.6	3.4	3.5	3.6	10	10	11	4.2	3.0	2.8	2.5
10	3.0	3.0	3.4	3.5	3.6	11	10	10	4.1	2.9	2.8	2.5
11	3.0	3.0	3.5	3.5	3.6	10	10	10	4.2	2.9	2.8	2.5
12	3.0	3.4	3.4	3.5	3.6	10	10	9.1	4.0	2.9	2.8	2.5
13	3.0	3.4	3.5	3.6	3.5	10	10	8.7	4.0	2.9	2.8	2.5
14	3.0	3.4	3.4	3.5	3.6	10	10	7.8	4.0	2.9	2.8	2.5
15	2.9	3.5	3.4	3.6	3.6	10	10	7.1	3.6	2.9	2.8	2.5
16	2.8	3.5	3.5	3.5	3.4	10	10	6.6	3.4	2.9	2.8	2.5
17	2.8	3.4	3.4	3.3	3.5	11	10	5.9	3.5	2.9	2.8	2.5
18	2.8	3.7	3.4	3.5	3.5	10	10	5.6	3.5	3.0	2.8	2.5
19	2.8	4.1	3.5	3.5	3.6	11	10	5.6	3.6	2.9	2.8	2.5
20	2.8	3.9	3.5	3.5	3.6	10	10	5.7	3.5	2.9	2.8	2.5
21	2.9	4.2	3.3	3.5	3.5	10	10	5.4	3.7	2.9	2.8	2.5
22	2.8	3.4	3.4	3.4	3.4	10	10	5.3	3.9	2.9	2.8	2.5
23	2.9	3.5	3.4	3.4	3.5	10	10	5.2	3.6	2.9	2.8	2.5
24	2.7	3.4	3.4	3.4	3.5	10	10	5.1	3.4	2.9	2.8	2.0
25	2.7	3.5	3.4	3.5	3.7	10	10	5.0	3.3	2.9	2.8	2.6
26	2.7	3.7	3.4	3.5	3.6	10	10	4.9	3.2	2.9	2.8	2.5
27	2.8	4.1	3.5	3.5	3.5	10	10	4.8	3.2	2.9	2.8	2.5
28	2.8	4.0	3.5	3.4	4.8	10	10	4.8	3.2	2.8	2.8	2.5
29	2.8	3.9	3.5	3.5	---	11	10	4.7	3.2	2.8	2.8	2.5
30	3.1	3.8	3.4	3.5	---	10	10	4.6	3.2	2.8	2.8	2.5
31	2.8	---	3.5	3.4	---	10	---	4.5	---	2.8	2.8	---
TOTAL	89.9	98.7	109.5	108.4	99.9	---	309	231.4	113.2	91.0	86.8	75.1
MEAN	2.900	3.290	3.532	3.497	3.568	---	10.30	7.465	3.773	2.935	2.800	2.503
MAX	3.1	4.2	4.8	3.7	4.8	---	12	11	4.4	3.1	2.8	2.8
MIN	2.7	2.4	3.3	3.3	3.4	---	10	4.5	3.2	2.8	2.8	2.0
AC-FT	178	196	217	215	198	---	613	459	225	180	172	149

11402000 SPANISH CREEK ABOVE BLACKHAWK CREEK, AT KEDDIE, CA

LOCATION.—Lat 40°00' 11", long 120°57' 12", in SE 1/4 NE 1/4 sec.27, T.25 N., R.9 E., [Plumas County](#), Hydrologic Unit 18020122, on right bank, 200 ft upstream from Blackhawk Creek, and 0.9 mi southeast of Keddie.

DRAINAGE AREA.—184 mi².

PERIOD OF RECORD.—October 1933 to current year.

REVISED RECORDS.—WSP 1041: 1938(M).

GAGE.—Water-stage recorder. Datum of gage is 3,129.86 ft above sea level.

REMARKS.—Records good. Low flow regulated by five small reservoirs having a combined capacity of 800 acre-ft. Approximately 4,600 acres irrigated upstream from station (from information provided by U.S. Forest Service). City of Quincy diverts about 450 acre-ft annually for municipal supply. See schematic diagram of [North Fork Feather River Basin](#).

EXTREMES FOR PERIOD OF RECORD.—Maximum discharge, 22,100 ft³/s, Jan. 2, 1997, gage height, 15.68 ft, from rating curve extended above 5,200 ft³/s, on basis of slope-area measurement of peak flow; minimum daily, 3.0 ft³/s, Sept. 4, 5, 1988.

EXTREMES FOR CURRENT YEAR.—Peak discharges greater than base discharge of 1,700 ft³/s, or maximum:

Date	Time	Discharge (ft ³ /s)	Gage height (ft)
Jan. 2	2330	1410	4.71

DISCHARGE, CUBIC FEET PER SECOND, WATER YEAR OCTOBER 2001 TO SEPTEMBER 2002

DAILY MEAN VALUES

DAY	OCT	NOV	DEC	JAN	FEB	MAR	APR	MAY	JUN	JUL	AUG	SEP
1	25	44	113	459	121	214	349	177	97	39	12	18
2	23	38	553	975	115	196	379	168	94	34	12	17
3	18	37	340	973	111	182	421	169	89	36	12	15
4	19	37	194	501	108	176	453	169	76	36	19	17
5	20	37	159	357	106	172	484	174	83	30	14	12
6	19	38	158	735	105	285	414	171	70	29	21	18
7	26	36	161	632	132	584	383	174	74	28	20	18
8	26	30	141	468	334	472	366	171	63	26	26	20
9	23	38	132	390	213	347	374	164	65	20	22	19
10	22	37	120	328	182	390	361	170	60	23	16	11
11	19	38	109	275	169	368	352	168	54	28	19	12
12	20	55	100	239	162	344	349	157	51	31	14	16
13	13	89	94	216	161	344	346	151	52	28	12	14
14	15	58	146	199	158	298	382	144	50	27	15	12
15	18	49	119	183	159	265	407	141	56	25	16	12
16	24	46	104	169	162	244	316	143	53	24	12	15
17	23	46	255	160	194	228	288	143	48	26	20	16
18	29	45	238	150	190	207	253	147	41	23	20	16
19	31	45	189	143	191	192	226	142	34	24	17	16
20	28	43	211	136	318	187	212	171	33	23	16	17
21	24	51	191	138	371	188	198	158	35	25	9.7	17
22	29	227	177	138	330	210	192	148	40	16	8.6	17
23	31	118	182	123	387	289	192	142	36	22	10	17
24	29	227	159	116	342	308	200	133	40	13	9.8	18
25	24	213	e147	116	287	297	209	125	37	19	17	17
26	29	121	e142	161	254	273	245	120	42	12	19	9.9
27	30	92	e136	172	237	262	234	119	32	15	10	16
28	31	80	e155	142	229	262	212	117	34	14	12	15
29	30	86	e183	132	---	289	195	107	40	14	10	16
30	43	80	289	112	---	319	186	104	41	13	15	18
31	62	---	719	115	---	331	---	98	---	14	14	---
TOTAL	803	2181	6116	9153	5828	8723	9178	4585	1620	737	470.1	471.9
MEAN	25.90	72.70	197.3	295.3	208.1	281.4	305.9	147.9	54.00	23.77	15.16	15.73
MAX	62	227	719	975	387	584	484	177	97	39	26	20
MIN	13	30	94	112	105	172	186	98	32	12	8.6	9.9
AC-FT	1590	4330	12130	18150	11560	17300	18200	9090	3210	1460	932	936

e Estimated.

11402000 SPANISH CREEK ABOVE BLACKHAWK CREEK, AT KEDDIE, CA—Continued

STATISTICS OF MONTHLY MEAN DATA FOR WATER YEARS 1934 - 2002, BY WATER YEAR (WY)

	OCT	NOV	DEC	JAN	FEB	MAR	APR	MAY	JUN	JUL	AUG	SEP
MEAN	57.90	128.7	280.5	438.7	522.9	560.7	556.2	421.8	170.8	52.16	28.82	30.54
MAX	702	1015	1498	2657	2843	2043	1715	1301	755	187	74.6	63.8
(WY)	1963	1982	1956	1997	1986	1995	1952	1938	1983	1983	1983	1983
MIN	18.4	34.9	35.3	37.5	50.5	56.1	44.3	50.6	18.6	10.8	5.10	7.57
(WY)	1989	1991	1977	1937	1991	1977	1977	1977	1977	1934	1934	1934

SUMMARY STATISTICS	FOR 2001 CALENDAR YEAR	FOR 2002 WATER YEAR	WATER YEARS 1934 - 2002
ANNUAL TOTAL	36484.6	49866.0	
ANNUAL MEAN	99.96	136.6	269.5
HIGHEST ANNUAL MEAN			641 1995
LOWEST ANNUAL MEAN			34.1 1977
HIGHEST DAILY MEAN	847 Mar 25	975 Jan 2	18000 Jan 2 1997
LOWEST DAILY MEAN	8.8 Aug 17	8.6 Aug 22	3.0 Sep 4 1988
ANNUAL SEVEN-DAY MINIMUM	11 Aug 15	12 Aug 21	4.4 Aug 18 1934
MAXIMUM PEAK FLOW		1410 Jan 2	22100 Jan 2 1997
MAXIMUM PEAK STAGE		4.71 Jan 2	15.68 Jan 2 1997
ANNUAL RUNOFF (AC-FT)	72370	98910	195200
10 PERCENT EXCEEDS	230	341	644
50 PERCENT EXCEEDS	56	104	89
90 PERCENT EXCEEDS	15	16	24

11403200 NORTH FORK FEATHER RIVER BELOW ROCK CREEK DIVERSION DAM, CA

LOCATION.—Lat 39°58'49", long 121°16'33", in SW 1/4 NW 1/4 sec.35, T.25 N., R.6 E., [Plumas County](#), Hydrologic Unit 18020121, Plumas National Forest, on left bank, 0.7 mi downstream from Rock Creek Diversion Dam, and 5.0 mi northeast of Storrie.

DRAINAGE AREA.—1,773 mi².

PERIOD OF RECORD.—October 1985 to February 1986, October 1986 to current year. Unpublished records for water years 1982–85 available in files of the U.S. Geological Survey.

GAGE.—Water-stage recorder. Elevation of gage is 2,120 ft above sea level, from topographic map.

REMARKS.—Low and medium flow regulated by Rock Creek Forebay 0.7 mi upstream. Most of the flow is diverted to Rock Creek Powerplant (station 11403800). Diversion to Rock Creek Powerplant began Feb. 28, 1950. See schematic diagram of [North Fork Feather River Basin](#).

COOPERATION.—Records were collected by Pacific Gas & Electric Co., under general supervision of the U.S. Geological Survey, in connection with Federal Energy Regulatory Commission project no. 1962.

EXTREMES FOR PERIOD OF RECORD.—Maximum discharge, 91,600 ft³/s, Jan. 2, 1997, gage height, 31.85 ft; minimum daily, 50 ft³/s, Feb. 7, 1989.

DISCHARGE, CUBIC FEET PER SECOND, WATER YEAR OCTOBER 2001 TO SEPTEMBER 2002

DAILY MEAN VALUES

DAY	OCT	NOV	DEC	JAN	FEB	MAR	APR	MAY	JUN	JUL	AUG	SEP
1	113	86	72	431	117	118	283	287	257	221	194	198
2	111	60	271	2040	117	119	278	282	1130	212	193	196
3	111	60	330	2240	117	119	303	279	257	209	193	197
4	111	60	71	849	116	120	294	278	238	211	553	219
5	111	60	74	267	116	121	291	273	241	211	205	217
6	111	60	76	1340	116	125	784	264	243	150	196	218
7	111	59	72	1350	119	225	1220	270	240	774	196	219
8	111	60	70	785	118	272	292	272	244	218	195	650
9	110	60	70	444	117	266	289	268	241	196	195	217
10	110	60	68	227	117	256	292	272	239	197	191	215
11	110	61	65	128	117	957	288	271	234	199	191	214
12	110	63	57	123	117	1310	291	274	239	198	194	214
13	110	62	58	122	116	282	291	274	241	197	194	213
14	110	61	60	121	117	263	290	272	243	195	193	213
15	110	60	58	120	116	259	290	1440	242	196	195	213
16	110	60	58	119	117	262	284	502	240	195	201	215
17	110	60	64	119	116	259	288	272	237	196	202	215
18	110	60	61	119	116	263	288	270	239	195	202	215
19	110	60	62	119	119	265	285	270	240	195	201	215
20	110	60	99	118	127	260	481	265	234	196	201	216
21	110	70	123	119	129	301	760	268	236	196	201	216
22	109	423	125	118	177	333	286	267	239	198	200	214
23	110	87	125	118	123	315	285	267	230	198	201	214
24	110	73	123	117	121	1160	290	265	236	198	199	214
25	110	68	122	117	120	893	289	267	238	195	199	215
26	110	66	121	122	120	305	287	270	241	193	200	216
27	110	66	121	119	121	307	294	270	170	195	199	214
28	110	66	121	118	120	294	294	271	236	194	199	216
29	111	67	121	118	---	291	290	266	230	194	198	217
30	113	65	123	118	---	293	284	263	231	195	202	215
31	111	---	607	117	---	290	---	261	---	195	201	---
TOTAL	3424	2283	3648	12482	3379	10903	10761	9790	8006	6712	6484	6840
MEAN	110.5	76.10	117.7	402.6	120.7	351.7	358.7	315.8	266.9	216.5	209.2	228.0
MAX	113	423	607	2240	177	1310	1220	1440	1130	774	553	650
MIN	109	59	57	117	116	118	278	261	170	150	191	196
AC-FT	6790	4530	7240	24760	6700	21630	21340	19420	15880	13310	12860	13570
a	102100	63860	85350	85660	71050	81160	84010	54230	28520	46470	67320	87240

a Diversion, in acre-feet, to Rock Creek Powerplant (station 11403800), provided by Pacific Gas & Electric Co.

11403200 NORTH FORK FEATHER RIVER BELOW ROCK CREEK DIVERSION DAM, CA—Continued

STATISTICS OF MONTHLY MEAN DATA FOR WATER YEARS 1987 - 2002, BY WATER YEAR (WY)

	OCT	NOV	DEC	JAN	FEB	MAR	APR	MAY	JUN	JUL	AUG	SEP
MEAN	122.2	89.05	293.5	1106	771.6	1296	775.4	803.0	418.9	127.3	123.0	138.9
MAX	211	226	3012	12700	3378	8612	5384	7371	2684	217	209	313
(WY)	2000	1999	1997	1997	1996	1995	1995	1995	1995	2002	2002	1997
MIN	52.7	53.2	52.4	52.0	52.9	52.9	54.2	55.3	55.7	55.3	53.0	53.0
(WY)	1988	1988	1995	1992	1994	1994	1990	1987	1987	1987	1987	1987

SUMMARY STATISTICS	FOR 2001 CALENDAR YEAR		FOR 2002 WATER YEAR		WATER YEARS 1987 - 2002	
ANNUAL TOTAL	37895		84712			
ANNUAL MEAN	103.8		232.1		505.0	
HIGHEST ANNUAL MEAN					2333	
LOWEST ANNUAL MEAN					77.7	
HIGHEST DAILY MEAN	1010	Feb 11	2240	Jan 3	74400	Jan 2 1997
LOWEST DAILY MEAN	52	Feb 2	57	Dec 12	50	Feb 7 1989
ANNUAL SEVEN-DAY MINIMUM	53	Jan 28	59	Dec 12	51	Dec 22 1993
MAXIMUM PEAK FLOW			3380	Jan 2	91600	Jan 2 1997
MAXIMUM PEAK STAGE			9.81	Jan 2	31.85	Jan 2 1997
ANNUAL RUNOFF (AC-FT)	75160		168000		365900	
ANNUAL DIVERSION (AC-FT) a	891000		857000			
10 PERCENT EXCEEDS	115		292		640	
50 PERCENT EXCEEDS	110		198		108	
90 PERCENT EXCEEDS	56		70		53	

a Diversion, in acre-feet, to Rock Creek Powerplant (station 11403800), provided by Pacific Gas & Electric Co.

11403450 MILK RANCH CONDUIT AT OUTLET, NEAR BUCKS LODGE, CA

LOCATION.—Lat 39°54'09", long 121°13'36", in SW 1/4 SW 1/4 sec.29, T.24 N., R.7 E., [Plumas County](#), Hydrologic Unit 18020121, Plumas National Forest, on left bank, 150 ft upstream from right abutment of Lower Bucks Lake Dam, 200 ft upstream from outlet, and 3.4 mi northwest of Bucks Lodge.

PERIOD OF RECORD.—October 1986 to current year. Unpublished records for water years 1981–84 available in files of the U.S. Geological Survey.

GAGE.—Water-stage recorder in 3-ft steel pipe. Elevation of gage is 5,050 ft above sea level.

REMARKS.—Conduit diverts from channel below Three Lakes Reservoir, capacity, 513 acre-ft, and from 12 additional diversions along the conduit. Water is used for power at Bucks Creek Powerplant (station 11403700) and Grizzly Powerplant (station 11404240). See schematic diagram of [North Fork Feather River Basin](#).

COOPERATION.—Records were collected by Pacific Gas & Electric Co., under general supervision of the U.S. Geological Survey, in connection with Federal Energy Regulatory Commission project no. 619.

EXTREMES FOR PERIOD OF RECORD.—Maximum daily discharge, 71 ft³/s, Apr. 29, 1995, May 17, 1996; no flow for many days in water years 1997–2000, and several days in May 2001.

DISCHARGE, CUBIC FEET PER SECOND, WATER YEAR OCTOBER 2001 TO SEPTEMBER 2002

DAILY MEAN VALUES

DAY	OCT	NOV	DEC	JAN	FEB	MAR	APR	MAY	JUN	JUL	AUG	SEP
1	0.27	0.54	3.7	11	7.2	12	22	24	29	2.7	0.62	0.36
2	0.27	0.46	7.4	29	7.1	11	26	28	24	2.4	0.61	0.35
3	0.27	0.41	4.9	18	6.8	11	36	37	22	2.2	0.61	0.35
4	0.25	0.41	4.1	13	6.8	11	40	43	20	2.2	0.61	0.38
5	0.23	0.41	3.8	14	6.7	11	36	46	18	2.1	0.60	0.40
6	0.23	0.39	6.9	35	6.6	18	34	49	17	2.0	0.60	0.41
7	0.23	0.36	5.7	20	9.1	16	36	48	15	1.9	0.56	0.41
8	0.26	0.36	4.6	16	11	12	39	42	13	1.8	0.52	0.41
9	0.27	0.36	4.3	15	8.1	12	40	40	12	1.7	0.50	0.40
10	0.27	0.36	4.1	13	7.0	12	45	36	11	1.5	0.49	0.33
11	0.27	1.5	3.9	12	6.8	11	48	32	11	1.4	0.49	0.34
12	0.27	4.5	3.7	12	7.1	12	50	36	10	1.3	0.47	0.34
13	0.26	2.9	3.5	12	7.0	11	52	41	7.9	1.2	0.46	0.34
14	0.23	2.2	3.6	11	7.1	11	55	43	6.3	1.1	0.50	0.34
15	0.23	1.4	3.4	11	7.2	9.8	46	43	5.8	1.1	0.50	0.34
16	0.23	1.0	3.4	12	7.2	10	34	44	5.6	1.0	0.49	0.36
17	0.23	1.5	3.8	12	7.7	9.7	30	45	5.8	0.99	0.49	5.4
18	0.23	1.0	3.5	12	6.9	9.0	28	44	6.0	1.0	0.48	10
19	0.23	0.90	3.5	11	8.7	8.9	27	37	5.8	0.99	0.48	10
20	0.23	0.92	3.5	11	20	9.5	26	34	5.3	0.91	0.49	9.8
21	0.23	9.8	3.3	11	14	11	25	28	5.1	0.87	0.49	9.8
22	0.23	16	3.2	11	14	12	28	28	5.0	0.87	0.50	9.8
23	0.23	4.7	3.1	9.8	15	12	33	28	4.7	0.84	0.49	9.6
24	0.23	12	3.1	8.9	12	11	38	28	4.3	0.79	0.48	9.6
25	0.23	6.2	3.1	8.8	12	10	45	30	4.1	0.77	0.46	9.5
26	0.23	4.8	3.7	11	12	10	44	33	3.8	0.72	0.42	9.3
27	0.23	4.3	4.3	9.8	12	11	39	33	3.6	0.70	0.39	9.1
28	0.23	4.0	5.0	8.6	12	13	32	34	3.4	0.66	0.39	9.1
29	0.23	4.2	5.9	8.2	---	17	29	37	3.2	0.64	0.39	9.0
30	2.2	3.6	9.6	7.7	---	19	26	40	3.0	0.66	0.39	8.9
31	0.92	---	18	7.2	---	20	---	37	---	0.64	0.38	---
TOTAL	10.15	91.48	147.6	402.0	265.1	373.9	1089	1148	290.7	39.65	15.35	134.76
MEAN	0.327	3.049	4.761	12.97	9.468	12.06	36.30	37.03	9.690	1.279	0.495	4.492
MAX	2.2	16	18	35	20	20	55	49	29	2.7	0.62	10
MIN	0.23	0.36	3.1	7.2	6.6	8.9	22	24	3.0	0.64	0.38	0.33
AC-FT	20	181	293	797	526	742	2160	2280	577	79	30	267

STATISTICS OF MONTHLY MEAN DATA FOR WATER YEARS 1987 - 2002, BY WATER YEAR (WY)

	1987	1988	1989	1990	1991	1992	1993	1994	1995	1996	1997	1998	1999	2000	2001	2002
MEAN	3.270	3.850	5.651	6.075	8.529	15.56	26.20	25.98	12.57	5.364	2.917	3.261				
MAX	9.22	8.15	27.5	19.2	38.7	42.7	59.6	66.6	57.3	30.5	7.35	8.22				
(WY)	2000	1990	1997	1995	1996	1989	1989	1993	1993	1995	1992	2000				
MIN	0.000	0.000	0.000	0.000	0.000	0.000	0.000	0.000	0.000	0.000	0.000	0.000				
(WY)	1998	1998	1998	1998	1997	1997	1997	1997	1997	1997	1997	1997				

SUMMARY STATISTICS

	FOR 2001 CALENDAR YEAR		FOR 2002 WATER YEAR		WATER YEARS 1987 - 2002	
ANNUAL TOTAL	1585.95		4007.69			
ANNUAL MEAN	4.345		10.98		9.929	
HIGHEST ANNUAL MEAN					21.6	
LOWEST ANNUAL MEAN					0.000	
HIGHEST DAILY MEAN	47	Mar 25	55	Apr 14	71	Apr 29 1995
LOWEST DAILY MEAN	0.00	May 17	0.23	Oct 5	0.00	Jan 2 1997
ANNUAL SEVEN-DAY MINIMUM	0.00	May 16	0.23	Oct 14	0.00	Jan 2 1997
ANNUAL RUNOFF (AC-FT)	3150		7950		7190	
10 PERCENT EXCEEDS	9.6		34		30	
50 PERCENT EXCEEDS	2.7		6.7		4.3	
90 PERCENT EXCEEDS	0.23		0.35		0.00	

11403500 BUCKS LAKE NEAR BUCKS LODGE, CA

LOCATION.—Lat 39°53'45", long 121°12'08", in SE 1/4 NW 1/4 sec.33, T.24 N., R.7 E., **Plumas County**, Hydrologic Unit 18020121, Plumas National Forest, in outlet structure, 100 ft upstream from dam on Bucks Creek, 2.0 mi northwest of Bucks Lodge, and 15 mi west of Quincy.

DRAINAGE AREA.—28.6 mi².

PERIOD OF RECORD.—Water years 1927–28 (year-end contents only, published in WSP 1315-A), October 1928 to current year. Prior to October 1954, published as "Bucks Creek Reservoir near Bucks Ranch".

GAGE.—Water-stage recorder. Datum of gage is 3.50 ft below sea level (levels by Feather River Power Co.).

REMARKS.—Reservoir is formed by concrete-faced, rockfill dam, completed in 1927; storage began in May 1927. Capacity, 101,400 acre-ft, between elevations 5,064.75 ft, sill of outlet gate, and 5,154.85 ft, spillway crest. Storage of 274 acre-ft is not available for release. Released water flows down Bucks Creek to Lower Bucks Lake (station 11403520), where most of the water is diverted to Bucks Creek Tunnel or Grizzly Powerplant (station 11404240), which discharges into Grizzly Creek. Figures given, including extremes, represent total contents at 2400 hours. See schematic diagram of [North Fork Feather River Basin](#).

COOPERATION.—Records were collected by Pacific Gas & Electric Co., under general supervision of the U.S. Geological Survey, in connection with Federal Energy Regulatory Commission project no. 619. Contents not rounded to U.S. Geological Survey standards.

EXTREMES FOR PERIOD OF RECORD.—Maximum contents, 107,278 acre-ft, May 17, 1996, elevation, 5,157.9 ft; minimum, 12,330 acre-ft, Feb. 27, 1929, elevation, 5,090.7 ft.

EXTREMES FOR CURRENT YEAR.—Maximum contents, 96,935 acre-ft, July 9, elevation, 5,152.24 ft; minimum, 55,898 acre-ft, Nov. 20, elevation, 5,126.96 ft.

Capacity table (elevation, in feet, and contents, in acre-feet)
(Based on survey by Feather River Power Co. in 1927)

5,090	11,742	5,110	32,519	5,130	59,997	5,150	92,950
5,095	16,183	5,120	45,472	5,140	75,894	5,160	111,220
5,100	21,180						

RESERVOIR STORAGE, ACRE-FEET, WATER YEAR OCTOBER 2001 TO SEPTEMBER 2002

DAILY OBSERVATION AT 2400 HOURS

DAY	OCT	NOV	DEC	JAN	FEB	MAR	APR	MAY	JUN	JUL	AUG	SEP
1	69290	59486	58336	57945	60150	64073	70038	82782	94737	96772	93027	84849
2	68923	59294	58520	58634	59858	64194	70385	83084	94862	96808	92295	84626
3	68413	59271	58520	59010	59678	64359	70743	83597	94999	96826	92204	84078
4	67805	59158	58520	59192	59723	64464	71152	84009	95186	96844	92112	83769
5	67324	58840	58520	59452	59768	64630	71578	84506	95311	96844	91952	83278
6	66899	58657	58520	59971	59813	65184	72054	84935	95410	96880	91222	83030
7	66498	58290	58463	60266	60150	65558	72463	85380	95535	96880	90903	82499
8	66006	58153	58474	60575	60324	65753	72938	85791	95622	96899	90197	82393
9	65797	57762	58405	60962	60440	65962	73447	86288	95684	96935	89946	81843
10	65603	57515	58313	61155	60537	66260	74084	86698	95746	96736	89326	81347
11	65154	57629	58061	60885	60575	66409	74551	87047	95858	96316	89181	80779
12	64735	57800	58061	60962	60711	66557	75138	87316	95932	95994	88916	80317
13	64555	57876	58014	60633	60807	66721	75880	87584	95982	95671	88904	79812
14	64389	57439	58084	60575	60943	66840	76208	87875	96044	95609	88783	79364
15	64164	57287	57968	60769	61117	66944	76742	88239	96106	95547	88421	78945
16	63569	56812	58084	60885	61310	67115	77218	88505	96143	95398	88069	78480
17	62971	56717	58176	60846	61484	67260	77594	88844	96205	95336	87948	78075
18	62855	56622	58014	60421	61600	67372	77925	89133	96254	95161	87608	77564
19	62546	56070	58084	60363	61947	67468	78210	89446	96292	95074	87340	77127
20	62005	55898	58245	60105	62276	67580	78465	90128	96354	94912	87328	76897
21	61445	56431	58313	60517	62507	67693	78735	90584	96415	94775	87328	76398
22	61059	56888	58451	60459	62778	67965	79065	91039	96453	94700	87328	75880
23	60459	57040	58531	60537	62990	68205	79439	91496	96490	94675	87328	75501
24	60285	57899	58405	60169	63203	68460	79753	91861	96520	94475	87145	75104
25	60324	57991	58405	60189	63415	68636	80282	92318	96556	94400	86903	74534
26	60324	58084	58428	60653	63588	68860	80743	92775	96628	94250	86852	74084
27	60227	58130	58176	60769	63762	68971	81329	93187	96646	94237	86852	73532
28	59858	58268	57991	60923	64013	69147	81630	93645	96664	94075	86715	73040
29	59543	58313	57724	61078	---	69370	82038	94037	96682	94012	86202	72598
30	59813	58313	57534	61001	---	69545	82428	94325	96736	93622	85860	72037
31	59554	---	57648	60575	---	69800	---	94513	---	93393	85380	---
MAX	69290	59486	58531	61155	64013	69800	82428	94513	96736	96935	93027	84849
MIN	59543	55898	57534	57945	59678	64073	70038	82782	94737	93393	85380	72037
a	5129.47	5128.38	5127.88	5130.22	5132.00	5135.75	5143.34	5150.40	5152.13	5149.73	5145.04	5137.10
b	-10230	-1241	-665	+2927	+3438	+5787	+12628	+12085	+2223	-3343	-8013	-13343
CAL YR 2001	MAX 71391	MIN 44668	b +2253									
WTR YR 2002	MAX 96935	MIN 55898	b +11752									

a Elevation, in feet, at end of month.

b Change in contents, in acre-feet.

11403520 LOWER BUCKS LAKE NEAR BUCKS LODGE, CA

LOCATION.—Lat 39°53'59", long 121°13'32", in NE 1/4 NW 1/4 sec.32, T.24 N., R.7 E., [Plumas County](#), Hydrologic Unit 18020121, Plumas National Forest, in outlet tower for Bucks Creek Tunnel, 900 ft upstream from Buck Diversion Dam, 1.3 mi downstream from Bucks Lake Dam, and 3.2 mi northwest of Bucks Lodge.

DRAINAGE AREA.—31.3 mi².

PERIOD OF RECORD.—October 1985 to current year. Unpublished records for water years 1981–85 available in files of the U.S. Geological Survey.

GAGE.—Water-stage recorder. Datum of gage is 3.50 ft below sea level (levels by Pacific Gas & Electric Co.).

REMARKS.—Lake is formed by concrete dam. Storage began in October 1929. Usable capacity, 5,796 acre-ft, between elevations 4,952 ft, point of lowest drawdown, and 5,021.95 ft, crest of spillway. Water is received from Bucks Lake (station 11403500) and from Milk Ranch Conduit (station 11403450). Most of the water is diverted through Bucks Creek Tunnel or Grizzly Powerplant (station 11404240) and discharges into Grizzly Creek for power development downstream. Figures given, including extremes, represent total contents at 2400 hours. See schematic diagram of [North Fork Feather River Basin](#).

COOPERATION.—Records were collected by Pacific Gas & Electric Co., under general supervision of the U.S. Geological Survey, in connection with Federal Energy Regulatory Commission project no. 619. Contents not rounded to U.S. Geological Survey standards.

EXTREMES FOR PERIOD OF RECORD.—Maximum contents, 6,203 acre-ft, May 18, 1996, elevation, 5,024.6 ft; minimum, 99 acre-ft, Sept. 9, 1993, elevation, 4,956.1 ft.

EXTREMES FOR CURRENT YEAR.—Maximum contents, 5,883 acre-ft, July 1, elevation, 5,021.38 ft; minimum, 3,607 acre-ft, May 12, elevation, 5,003.92 ft.

Capacity table (elevation, in feet, and contents, in acre-feet)
(Based on survey by Feather River Power Co. in 1928)

4,950	24	4,980	1,314	5,000	3,175	5,020	5,573
4,960	194	4,990	2,171	5,010	4,307	5,030	6,981
4,970	624						

RESERVOIR STORAGE, ACRE-FEET, WATER YEAR OCTOBER 2001 TO SEPTEMBER 2002

DAILY OBSERVATION AT 2400 HOURS

DAY	OCT	NOV	DEC	JAN	FEB	MAR	APR	MAY	JUN	JUL	AUG	SEP
1	4158	5336	4709	4523	4436	5479	4983	5143	5238	5883	5195	5391
2	4248	5489	4749	4564	4438	5508	5037	5199	5291	5750	5409	5230
3	4373	5272	4743	4603	4713	5534	5112	5269	5340	5717	5429	5317
4	4500	5266	4735	4622	4722	5562	5192	5347	5383	5682	5404	5240
5	4616	5377	4542	4583	4740	5592	5263	5429	5424	5649	5180	5376
6	4825	5295	4509	4688	4753	5587	5326	5210	5459	5616	5297	5233
7	5028	5389	4541	4721	4798	5642	5391	5124	5489	5582	5192	5419
8	5366	5296	4487	4765	4836	5481	5463	4826	5515	5354	5287	5248
9	5391	5384	4555	4794	4862	5495	5537	4523	5534	5070	5206	5264
10	5243	5346	4484	4454	4878	5522	5658	4152	5554	4946	5361	5251
11	5354	5266	4689	4600	4896	5534	5823	3675	5575	5093	5180	5252
12	5456	5515	4434	4442	4902	5549	5487	3607	5616	5234	5447	5274
13	5303	5361	4620	4608	4927	5559	5594	3663	5639	5431	5386	5279
14	5306	5556	4470	4695	4933	5568	5804	3776	5663	5429	5188	5274
15	5222	5365	4681	4713	4974	5320	5557	3900	5682	5253	5251	5351
16	5324	5452	4514	4483	5004	5333	5439	4008	5701	5437	5369	5277
17	5423	5410	4396	4353	5032	5341	5181	4106	5719	5222	5205	5259
18	5201	5341	4690	4596	5055	5346	4826	4193	5743	5396	5199	5303
19	5129	5420	4513	4434	5094	5351	4873	4269	5762	5252	5450	5338
20	5242	5436	4523	4614	5154	5359	4915	4348	5781	5201	5446	5155
21	5345	5370	4514	4471	5193	5369	4964	4426	5795	5389	5442	5140
22	5288	5565	4519	4588	5238	5393	5022	4502	5809	5431	5426	5199
23	5395	5550	4470	4416	5282	5414	5089	4575	5825	5193	5404	5132
24	5475	5627	4683	4726	5318	5429	5166	4643	5836	5447	5192	5045
25	5450	5447	4538	4756	5348	5439	5193	4712	5847	5251	5441	5043
26	5423	5203	4422	4719	5383	5354	5279	4780	5854	5437	5416	5033
27	5279	4869	4573	4725	5416	5139	5361	4848	5861	5203	5395	5000
28	5374	4557	4464	4730	5452	5127	5081	4914	5869	5381	5217	4950
29	5502	4351	4267	4552	---	4886	5059	5000	5874	5206	5320	4923
30	5272	4695	4337	4459	---	4910	5097	5092	5880	5259	5229	4890
31	5494	---	4696	4446	---	4941	---	5172	---	5205	5303	---
MAX	5502	5627	4749	4794	5452	5642	5823	5429	5880	5883	5450	5419
MIN	4158	4351	4267	4353	4436	4886	4826	3607	5238	4946	5180	4890
a	5019.35	5012.99	5013.00	5011.01	5019.01	5015.13	5016.26	5016.82	5021.36	5017.07	5017.82	5014.78
b	+1558	-799	+1	-250	+1006	-511	+156	+75	+708	-675	+98	-413
CAL YR 2001	MAX 5627	MIN 3572	b -513									
WTR YR 2002	MAX 5883	MIN 3607	b +954									

a Elevation, in feet, at end of month.
b Change in contents, in acre-feet.

11403530 BUCKS CREEK BELOW DIVERSION DAM, NEAR BUCKS LODGE, CA

LOCATION.—Lat 39°54'16", long 121°13'47", in NW 1/4 SW 1/4 sec.29, T.24 N., R.7 E., [Plumas County](#), Hydrologic Unit 18020121, Plumas National Forest, on left bank, 20 ft upstream from unnamed tributary, 0.2 mi downstream from diversion dam, and 3.6 mi northwest of Bucks Lodge.

DRAINAGE AREA.—31.5 mi².

PERIOD OF RECORD.—October 1990 to current year. Unpublished records for water years 1981–90 available in files of the U.S. Geological Survey.

GAGE.—Water-stage recorder and concrete control with V-notch sharp-crested weir Sept. 19, 1990, to Sept. 24, 1998. Ultrasonic-velocity meter since Sept. 24, 1998. Elevation of gage is 4,850 ft above sea level, from topographic map.

REMARKS.—Flow regulated by diversion dam at Lower Bucks Lake 0.2 mi upstream, where most of the flow is diverted to Grizzly Creek via Bucks Creek Tunnel outlet or Grizzly Powerplant (station 11404240). Low flows regulated by fixed-plate orifice at outlet of diversion dam. See schematic diagram of [North Fork Feather River Basin](#).

COOPERATION.—Records were collected by Pacific Gas & Electric Co., under general supervision of the U.S. Geological Survey, in connection with Federal Energy Regulatory Commission project no. 619.

EXTREMES FOR PERIOD OF RECORD.—Maximum discharge recorded, 5,870 ft³/s, Feb. 17, 1986, gage height, 9.54 ft; no flow on several days in February 1986.

DISCHARGE, CUBIC FEET PER SECOND, WATER YEAR OCTOBER 2001 TO SEPTEMBER 2002

DAILY MEAN VALUES

DAY	OCT	NOV	DEC	JAN	FEB	MAR	APR	MAY	JUN	JUL	AUG	SEP
1	3.7	4.0	3.9	1.5	1.5	1.6	3.9	4.0	4.0	4.1	4.0	3.7
2	3.8	4.0	3.9	1.5	1.5	1.6	3.9	4.0	4.0	4.1	4.1	3.7
3	3.8	4.0	3.9	1.5	1.5	1.6	4.0	4.0	4.0	4.1	4.1	3.7
4	3.8	4.0	2.6	1.5	1.5	1.6	4.0	4.0	4.0	4.1	4.1	3.7
5	3.8	4.0	1.5	1.5	1.5	1.6	4.0	4.0	4.0	4.1	4.0	3.7
6	3.9	4.0	1.5	1.5	1.5	1.6	4.0	4.0	4.0	4.1	4.0	3.7
7	3.9	4.0	1.5	1.5	1.5	1.6	4.0	4.0	4.1	4.1	4.0	3.7
8	4.0	4.0	1.5	1.5	1.5	1.6	4.0	3.9	4.1	4.1	4.0	3.6
9	4.0	4.0	1.5	1.5	1.5	1.6	4.1	3.9	4.1	4.0	4.0	3.6
10	4.0	4.0	1.5	1.5	1.5	1.6	4.1	3.8	4.1	4.0	4.0	3.6
11	4.0	4.0	1.5	1.5	1.5	1.6	4.1	3.7	4.1	4.0	4.0	3.6
12	4.0	4.0	1.5	1.5	1.5	1.6	4.1	3.6	4.1	4.0	4.1	3.6
13	4.0	4.0	1.5	1.5	1.5	1.6	4.1	3.6	4.1	4.1	4.1	3.6
14	4.0	4.0	1.5	1.5	1.5	1.6	4.1	3.6	4.1	4.1	4.0	3.6
15	4.0	4.0	1.5	1.5	1.5	1.6	4.1	3.7	4.1	4.0	4.0	4.1
16	4.0	4.0	1.5	1.5	1.6	1.6	4.1	3.7	4.1	4.1	3.8	4.1
17	4.0	4.0	1.5	1.5	1.6	1.6	4.0	3.7	4.1	4.0	3.7	4.0
18	4.0	4.0	1.5	1.5	1.6	1.6	3.9	3.7	4.1	4.1	3.7	4.0
19	3.9	4.0	1.5	1.5	1.6	1.6	3.9	3.8	4.1	4.0	3.7	4.1
20	4.0	4.0	1.5	1.5	1.6	1.6	3.9	3.8	4.1	4.1	3.7	4.0
21	4.0	4.0	1.5	1.5	1.6	1.6	3.9	3.8	4.1	4.0	3.7	4.0
22	4.0	4.0	1.5	1.5	1.6	1.6	3.9	3.8	4.1	4.1	3.7	4.0
23	4.0	4.0	1.5	1.5	1.6	1.6	4.0	3.8	4.1	4.1	3.7	4.0
24	4.0	4.1	1.5	1.5	1.6	1.6	4.0	3.9	4.1	4.1	3.7	4.0
25	4.0	4.0	1.5	1.5	1.6	1.6	4.0	3.9	4.1	4.1	3.7	4.0
26	4.0	4.0	1.5	1.5	1.6	1.6	4.0	3.9	4.1	4.1	3.7	4.0
27	4.0	3.9	1.5	1.5	1.6	1.6	4.0	3.9	4.1	4.0	3.7	4.0
28	4.0	3.9	1.5	1.5	1.6	2.5	4.0	3.9	4.1	4.0	3.7	4.0
29	4.0	3.8	1.5	1.5	---	3.9	4.0	3.9	4.1	4.1	3.7	4.0
30	4.0	3.8	1.5	1.5	---	3.9	4.0	4.0	4.1	4.0	3.7	4.0
31	4.0	---	1.5	1.5	---	3.9	---	4.0	---	4.0	3.7	---
TOTAL	122.6	119.5	54.8	46.5	43.3	57.4	120.1	119.3	122.4	125.9	119.8	115.4
MEAN	3.955	3.983	1.768	1.500	1.546	1.852	4.003	3.848	4.080	4.061	3.865	3.847
MAX	4.0	4.1	3.9	1.5	1.6	3.9	4.1	4.0	4.1	4.1	4.1	4.1
MIN	3.7	3.8	1.5	1.5	1.5	1.6	3.9	3.6	4.0	4.0	3.7	3.6
AC-FT	243	237	109	92	86	114	238	237	243	250	238	229
a	7910	6320	4720	5240	879	1180	2050	2460	0	4550	7040	12960

a Diversion, in acre-feet, to Grizzly Powerplant (station 11404240), provided by Pacific Gas & Electric Co.

SACRAMENTO RIVER BASIN

11403530 BUCKS CREEK BELOW DIVERSION DAM, NEAR BUCKS LODGE, CA—Continued

STATISTICS OF MONTHLY MEAN DATA FOR WATER YEARS 1986 - 2002, BY WATER YEAR (WY)

	OCT	NOV	DEC	JAN	FEB	MAR	APR	MAY	JUN	JUL	AUG	SEP
MEAN	3.299	2.997	1.695	1.500	12.71	1.681	3.633	23.76	26.75	3.585	3.928	4.155
MAX	4.30	3.98	1.82	1.50	57.9	1.85	4.00	187	167	4.70	9.06	11.6
(WY)	1994	2002	2001	1999	1986	2002	2002	1995	1995	1991	1993	1993
MIN	1.54	1.64	1.54	1.50	1.50	1.52	2.70	1.78	1.47	1.45	1.45	1.51
(WY)	1995	1996	1999	1999	1999	1999	1999	1994	1994	1994	1994	1994

SUMMARY STATISTICS	FOR 2001 CALENDAR YEAR		FOR 2002 WATER YEAR		WATER YEARS 1986 - 2002	
ANNUAL TOTAL	1138.9		1167.0			
ANNUAL MEAN	3.120		3.197		3.072	
HIGHEST ANNUAL MEAN					3.20 2002	
LOWEST ANNUAL MEAN					2.87 1999	
HIGHEST DAILY MEAN	4.1	Nov 24	4.1	Nov 24	1340	May 18 1996
LOWEST DAILY MEAN	1.5	Jan 1	1.5	Dec 5	0.00	Feb 1 1986
ANNUAL SEVEN-DAY MINIMUM	1.5	Jan 1	1.5	Dec 5	0.00	Feb 1 1986
MAXIMUM PEAK FLOW			4.4 Oct 7		5870	Feb 17 1986
MAXIMUM PEAK STAGE					9.54	Feb 17 1986
ANNUAL RUNOFF (AC-FT)	2260		2310		2230	
ANNUAL DIVERSION (AC-FT) a	24540		55310			
10 PERCENT EXCEEDS	4.0		4.1		4.0	
50 PERCENT EXCEEDS	3.8		3.9		3.7	
90 PERCENT EXCEEDS	1.5		1.5		1.5	

a Diversion, in acre-feet, to Grizzly Powerplant (station 11404240), provided by Pacific Gas & Electric Co.

11404250 GRIZZLY FOREBAY NEAR STORRIE, CA

LOCATION.—Lat 39°53'32", long 121°17'25", in SW 1/4 NE 1/4 sec.34, T.24 N., R.6 E., [Plumas County](#), Hydrologic Unit 18020121, Plumas National Forest, in outlet tower for Bucks Creek Powerplant, 100 ft upstream from Grizzly Diversion Dam, 2.4 mi southeast of Storrie, and 6.2 mi west of Bucks Lodge.

DRAINAGE AREA.—14.4 mi².

PERIOD OF RECORD.—October 1986 to current year. Unpublished records for water years 1981–86 available in files of the U.S. Geological Survey.

GAGE.—Water-stage recorder. Datum of gage is 3.50 ft below sea level (levels by Pacific Gas & Electric Co.).

REMARKS.—Lake is formed by concrete dam. Storage began in July 1928. Usable capacity, 1,033 acre-ft, between elevations 4,271 ft, bottom of diversion tunnel, and 4,316.0 ft, crest of spillway. Water is received from Bucks Creek via Bucks Creek Tunnel and Grizzly Powerplant (station 11404240) which enter Grizzly Creek upstream. Most of the water is diverted through tunnel to Bucks Creek Powerplant (station 11403700) for power development downstream on North Fork Feather River. Figures given, including extremes, represent total contents at 2400 hours. See schematic diagram of [North Fork Feather River Basin](#).

COOPERATION.—Records were collected by Pacific Gas & Electric Co., under general supervision of the U.S. Geological Survey, in connection with Federal Energy Regulatory Commission project no. 619. Contents not rounded to U.S. Geological Survey standards.

EXTREMES FOR PERIOD OF RECORD.—Maximum contents, 1,329 acre-ft, Dec. 30, 1996, elevation, 4,321.5 ft; minimum, 216 acre-ft, Sept. 20, 1991, elevation, 4,282.8 ft.

EXTREMES FOR CURRENT YEAR.—Maximum contents, 1,129 acre-ft, Jan. 2, elevation, 4,316.44 ft; minimum, 742 acre-ft, Nov. 23, elevation, 4,305.19 ft.

Capacity table (elevation, in feet, and contents, in acre-feet)
(Based on survey by Feather River Power Co. in 1928)

4,290	350	4,300	592	4,310	898	4,320	1,268
4,295	464	4,305	736				

RESERVOIR STORAGE, ACRE-FEET, WATER YEAR OCTOBER 2001 TO SEPTEMBER 2002

DAILY OBSERVATION AT 2400 HOURS

DAY	OCT	NOV	DEC	JAN	FEB	MAR	APR	MAY	JUN	JUL	AUG	SEP
1	1033	895	903	860	976	952	1053	880	828	821	799	979
2	1053	877	1028	1129	994	936	1032	897	829	892	800	978
3	1046	925	830	978	946	925	977	969	830	923	817	1031
4	1027	941	794	812	944	943	975	1046	835	948	833	1059
5	1021	957	868	847	929	903	818	961	846	940	874	1031
6	1029	988	945	966	959	1005	790	1049	805	943	923	1030
7	1057	1007	976	930	1004	883	799	932	826	953	973	919
8	939	992	997	964	922	910	924	885	855	928	1035	818
9	860	972	978	973	849	811	1017	825	885	978	1015	812
10	872	981	966	1024	781	771	1071	799	907	955	1027	817
11	889	971	985	1010	798	816	960	873	926	925	1078	852
12	918	835	1048	953	863	821	1024	824	924	897	906	851
13	948	892	993	931	863	854	995	800	918	943	893	870
14	984	825	976	926	878	919	1001	781	922	956	891	888
15	1018	804	852	879	885	887	1039	882	914	1001	873	837
16	1052	860	890	914	894	867	884	958	906	964	802	918
17	1074	890	1005	1075	936	868	794	987	899	1060	843	967
18	1040	924	874	1053	935	830	862	988	900	971	874	1001
19	1023	956	959	1050	927	805	820	998	911	962	911	1002
20	1014	876	934	984	900	843	864	967	915	966	910	1006
21	1011	1031	934	968	900	883	834	911	912	983	905	1071
22	1012	829	955	959	864	895	864	855	906	892	913	1038
23	1007	742	1013	962	894	870	901	838	888	889	927	1077
24	955	931	1006	857	886	885	957	816	880	899	915	1055
25	966	823	977	768	832	888	858	834	876	888	933	1055
26	982	826	1022	781	860	798	895	844	879	815	948	1040
27	933	808	787	800	893	857	789	859	874	804	960	1019
28	931	837	773	794	925	874	868	844	869	802	978	1013
29	871	948	887	899	---	944	781	875	856	795	986	1021
30	920	981	821	957	---	958	816	890	830	790	1005	1022
31	936	---	884	965	---	961	---	820	---	795	1021	---
MAX	1074	1031	1048	1129	1004	1005	1071	1049	926	1060	1078	1077
MIN	860	742	773	768	781	771	781	781	805	790	799	812
a	4311.11	4312.40	4309.63	4311.95	4310.79	4311.82	4307.52	4307.63	4307.97	4306.87	4313.52	4313.55
b	-73	+45	-97	+81	-40	+36	-145	+4	+10	-35	+226	+1

CAL YR 2001 MAX 1090 MIN 742 b -12

WTR YR 2002 MAX 1129 MIN 742 b +13

a Elevation, in feet, at end of month.

b Change in contents, in acre-feet.

11404300 GRIZZLY CREEK BELOW DIVERSION DAM, NEAR STORRIE, CA

LOCATION.—Lat 39°53'29", long 121°17'35", in SW 1/4 NE 1/4 sec.34, T.24 N., R.6 E., [Plumas County](#), Hydrologic Unit 18020121, Plumas National Forest, on right bank, 0.2 mi downstream from diversion dam, and 2.4 mi southeast of Storrie.

DRAINAGE AREA.—14.4 mi².

PERIOD OF RECORD.—October 1985 to current year. Unpublished records for water years 1976–85 available in files of the U.S. Geological Survey.

GAGE.—Water-stage recorder and concrete control with V-notch sharp-crested weir, since Oct. 8, 1987. Elevation of gage is 4,320 ft above sea level, from topographic map. Prior to Oct. 8, 1987, at datum 1.79 ft higher.

REMARKS.—Flow regulated by diversion dam 0.2 mi upstream. There is considerable inflow upstream from the diversion dam from Bucks Creek Tunnel outlet and Grizzly Powerplant (station 11404240). Most of the flow is diverted to Bucks Creek Powerplant (station 11403700) on North Fork Feather River. See schematic diagram of [North Fork Feather River Basin](#).

COOPERATION.—Records were collected by Pacific Gas & Electric Co., under general supervision of the U.S. Geological Survey, in connection with Federal Energy Regulatory Commission project no. 619.

EXTREMES FOR PERIOD OF RECORD.—Maximum discharge, 6,300 ft³/s, Jan. 1, 1997, gage height, 7.33 ft, from rating curve extended above 260 ft³/s, on basis of computation of peak flow over dam; maximum gage height, 9.54 ft, Feb. 17, 1986, datum then in use; minimum daily, 1.9 ft³/s, June 14, 1988.

DISCHARGE, CUBIC FEET PER SECOND, WATER YEAR OCTOBER 2001 TO SEPTEMBER 2002
DAILY MEAN VALUES

DAY	OCT	NOV	DEC	JAN	FEB	MAR	APR	MAY	JUN	JUL	AUG	SEP
1	4.8	4.7	4.8	2.6	2.4	2.5	4.9	4.7	4.6	4.5	4.4	4.6
2	4.8	4.7	5.8	7.3	2.4	2.5	5.0	4.7	4.6	4.5	4.4	4.6
3	4.8	4.7	5.2	18	2.4	2.5	4.9	4.7	4.5	4.5	4.4	4.6
4	4.8	4.7	3.5	2.9	2.3	2.4	4.9	4.8	4.6	4.6	4.5	4.6
5	4.8	4.7	2.4	2.8	2.3	2.4	4.9	4.8	4.6	4.6	4.5	4.6
6	4.8	4.7	2.4	3.1	2.3	2.6	4.7	4.8	4.6	4.6	4.5	4.6
7	4.8	4.8	2.4	3.0	2.5	2.7	4.6	4.8	4.5	4.6	4.6	4.6
8	4.8	4.8	2.4	2.8	2.5	2.6	4.7	4.7	4.5	4.6	4.6	4.5
9	4.7	4.7	2.4	2.8	2.4	2.6	4.9	4.6	4.6	4.6	4.6	4.4
10	4.6	4.7	2.4	2.8	2.3	2.6	4.9	4.6	4.6	4.6	4.7	4.4
11	4.7	4.9	2.4	2.7	2.3	2.5	4.9	4.6	4.6	4.6	4.7	4.4
12	4.7	4.9	2.4	2.7	2.3	2.5	4.8	4.6	4.6	4.6	4.6	4.4
13	4.7	4.7	2.4	2.6	2.3	2.5	4.9	4.6	4.6	4.6	4.5	4.4
14	4.7	4.7	2.4	2.6	2.4	2.5	4.9	4.6	4.6	4.6	4.5	4.4
15	4.7	4.6	2.3	2.6	2.4	2.5	4.9	4.6	4.6	4.6	4.5	4.4
16	4.8	4.6	2.3	2.6	2.4	2.5	4.8	4.7	4.6	4.6	4.5	4.4
17	4.8	4.6	2.4	2.5	2.5	2.5	4.7	4.8	4.6	4.6	4.4	4.5
18	4.8	4.6	2.4	2.6	2.5	2.4	4.7	4.8	4.6	4.7	4.4	4.5
19	4.8	4.7	2.4	2.6	2.5	2.4	4.7	4.8	4.6	4.6	4.5	4.6
20	4.8	4.7	2.4	2.5	2.5	2.4	4.7	4.9	4.6	4.6	4.5	4.6
21	4.8	4.8	2.4	2.5	2.5	2.4	4.7	4.8	4.6	4.6	4.5	4.6
22	4.8	5.2	2.4	2.5	2.5	2.5	4.7	4.7	4.6	4.6	4.5	4.6
23	4.8	4.7	2.4	2.5	2.5	2.5	4.7	4.6	4.6	4.6	4.5	4.6
24	4.8	5.3	2.4	2.4	2.5	2.5	4.8	4.6	4.5	4.6	4.5	4.6
25	4.7	4.8	2.4	2.3	2.5	2.5	4.7	4.6	4.5	4.6	4.5	4.6
26	4.7	4.7	2.4	2.4	2.5	2.5	4.8	4.6	4.5	4.5	4.5	4.6
27	4.7	4.7	2.3	2.3	2.4	2.4	4.8	4.6	4.5	4.4	4.5	4.6
28	4.7	4.7	2.3	2.3	2.5	3.5	4.6	4.6	4.5	4.4	4.6	4.6
29	4.7	4.7	2.3	2.3	---	4.9	4.7	4.6	4.5	4.4	4.6	4.6
30	4.9	4.7	2.5	2.3	---	4.9	4.6	4.6	4.5	4.4	4.6	4.6
31	4.7	---	2.7	2.3	---	4.9	---	4.6	---	4.4	4.6	---
TOTAL	147.5	142.5	84.0	100.2	67.8	85.6	143.5	145.1	137.0	141.3	140.2	136.1
MEAN	4.758	4.750	2.710	3.232	2.421	2.761	4.783	4.681	4.567	4.558	4.523	4.537
MAX	4.9	5.3	5.8	18	2.5	4.9	5.0	4.9	4.6	4.7	4.7	4.6
MIN	4.6	4.6	2.3	2.3	2.3	2.4	4.6	4.6	4.5	4.4	4.4	4.4
AC-FT	293	283	167	199	134	170	285	288	272	280	278	270
a	8160	8140	7600	10720	3660	5840	10210	7790	1160	5110	6930	13030

a Diversion, in acre-feet, to Bucks Creek Powerplant (station 11403700), provided by Pacific Gas & Electric Co.

11404300 GRIZZLY CREEK BELOW DIVERSION DAM, NEAR STORRIE, CA—Continued

STATISTICS OF MONTHLY MEAN DATA FOR WATER YEARS 1986 - 2002, BY WATER YEAR (WY)

	OCT	NOV	DEC	JAN	FEB	MAR	APR	MAY	JUN	JUL	AUG	SEP
MEAN	4.626	4.975	21.16	48.58	57.29	41.25	18.56	30.97	31.07	8.846	3.954	3.893
MAX	11.8	19.7	284	650	396	174	215	277	286	61.0	5.49	5.57
(WY)	1996	1999	1997	1997	1997	1995	1995	1995	1998	1998	1991	1999
MIN	2.01	2.01	2.09	2.11	2.17	2.20	2.10	2.03	2.01	2.08	2.03	2.00
(WY)	1995	1988	1994	1994	1994	1988	1987	1987	1992	1992	1992	1992

SUMMARY STATISTICS	FOR 2001 CALENDAR YEAR		FOR 2002 WATER YEAR		WATER YEARS 1986 - 2002	
ANNUAL TOTAL	1433.6		1470.8			
ANNUAL MEAN	3.928		4.030		22.76	
HIGHEST ANNUAL MEAN					125 1997	
LOWEST ANNUAL MEAN					2.58 1994	
HIGHEST DAILY MEAN	5.8	Dec 2	18	Jan 3	4810	Jan 1 1997
LOWEST DAILY MEAN	2.3	Jan 1	2.3	Dec 15	1.9	Jun 14 1988
ANNUAL SEVEN-DAY MINIMUM	2.3	Jan 1	2.3	Jan 25	2.0	May 2 1987
MAXIMUM PEAK FLOW			90 Jan 3		6300 Jan 1 1997	
MAXIMUM PEAK STAGE			1.85 Jan 3		9.54 Feb 17 1986	
ANNUAL RUNOFF (AC-FT)	2840		2920		16490	
ANNUAL DIVERSION (AC-FT) a	48800		88340			
10 PERCENT EXCEEDS	4.8		4.8		5.0	
50 PERCENT EXCEEDS	4.5		4.6		3.0	
90 PERCENT EXCEEDS	2.4		2.4		2.1	

a Diversion, in acre-feet, to Bucks Creek Powerplant (station 11403700), provided by Pacific Gas & Electric Co.

11404330 NORTH FORK FEATHER RIVER BELOW GRIZZLY CREEK, CA

LOCATION.—Lat 39°51'09", long 121°23'29", in NE 1/4 NW 1/4 sec.14, T.23 N., R.5 E., [Butte County](#), Hydrologic Unit 18020121, Lassen National Forest, on left bank, 0.7 mi upstream from Bear Ranch Creek, 1.6 mi downstream from Grizzly Creek, and 2.1 mi downstream from Cresta Dam.

DRAINAGE AREA.—1,914 mi².

PERIOD OF RECORD.—October 1985 to February 1986, October 1986 to current year. Unpublished records for water years 1982–85 available in files of the U.S. Geological Survey.

GAGE.—Water-stage recorder. Elevation of gage is 1,480 ft above sea level, from topographic map.

REMARKS.—Flow regulated by numerous reservoirs upstream, combined capacity, 1,386,000 acre-ft. Most of the flow bypasses this station through Cresta Powerplant (station 11404360). Diversion through Cresta Powerplant began in 1949. See schematic diagram of [North Fork Feather River Basin](#).

COOPERATION.—Records were collected by Pacific Gas & Electric Co., under general supervision of the U.S. Geological Survey, in connection with Federal Energy Regulatory Commission project no. 1962.

EXTREMES FOR PERIOD OF RECORD.—Maximum discharge, 115,000 ft³/s, Jan. 1, 1997, gage height, 29.97 ft; minimum daily, 37 ft³/s, July 25, 1994.

DISCHARGE, CUBIC FEET PER SECOND, WATER YEAR OCTOBER 2001 TO SEPTEMBER 2002

DAILY MEAN VALUES

DAY	OCT	NOV	DEC	JAN	FEB	MAR	APR	MAY	JUN	JUL	AUG	SEP
1	57	61	203	326	176	198	341	294	1110	281	237	250
2	56	59	565	2430	174	195	351	300	297	243	238	246
3	56	58	240	2220	172	193	354	317	292	243	568	238
4	56	57	162	516	170	191	350	320	277	247	240	e270
5	57	58	161	352	167	191	348	306	287	249	264	e241
6	57	59	173	1490	166	288	745	282	295	805	259	e250
7	57	58	149	806	228	422	1160	306	295	258	252	e667
8	57	58	133	351	232	426	350	304	304	257	254	e249
9	58	57	130	320	192	394	343	301	301	243	259	e255
10	57	57	117	298	186	408	346	308	292	248	255	e247
11	57	80	110	285	183	982	345	298	284	256	253	244
12	56	136	105	271	181	1770	349	307	280	260	253	240
13	57	107	105	257	181	418	353	292	287	254	247	247
14	57	78	125	248	180	742	367	308	286	251	253	247
15	57	68	104	236	180	381	343	1280	280	247	261	248
16	57	65	102	227	183	377	325	467	278	242	265	246
17	57	66	197	223	193	347	338	305	279	246	268	245
18	57	64	147	215	183	340	314	304	271	247	248	244
19	58	62	146	212	202	359	303	302	273	247	249	249
20	57	62	206	207	251	354	467	304	285	249	247	241
21	57	194	213	212	224	359	836	320	295	245	255	250
22	58	560	232	202	216	359	302	324	308	242	250	253
23	59	111	229	195	228	355	299	315	307	245	241	247
24	58	338	201	185	218	1080	311	315	304	239	243	247
25	58	156	186	184	210	884	306	317	309	239	244	249
26	58	113	185	215	205	337	296	316	311	235	253	250
27	57	98	191	195	204	329	336	304	303	237	246	253
28	57	95	223	186	203	315	297	316	303	246	236	253
29	57	108	266	182	---	324	315	303	312	243	245	249
30	97	97	299	178	---	328	303	302	318	239	246	242
31	70	---	463	177	---	318	---	300	---	239	247	---
TOTAL	1824	3240	6068	13601	5488	13964	11793	10637	9623	8222	8076	7857
MEAN	58.84	108.0	195.7	438.7	196.0	450.5	393.1	343.1	320.8	265.2	260.5	261.9
MAX	97	560	565	2430	251	1770	1160	1280	1110	805	568	667
MIN	56	57	102	177	166	191	296	282	271	235	236	238
AC-FT	3620	6430	12040	26980	10890	27700	23390	21100	19090	16310	16020	15580
a	113600	82150	106600	125400	87360	110500	128900	86610	35740	50430	69770	98690

e Estimated.

a Diversion, in acre-feet, to Cresta Powerplant (station 11404360), provided by Pacific Gas & Electric Co.

11404330 NORTH FORK FEATHER RIVER BELOW GRIZZLY CREEK, CA—Continued

STATISTICS OF MONTHLY MEAN DATA FOR WATER YEARS 1986 - 2002, BY WATER YEAR (WY)

	OCT	NOV	DEC	JAN	FEB	MAR	APR	MAY	JUN	JUL	AUG	SEP
MEAN	94.69	131.2	469.4	1550	1300	1951	1085	1122	554.9	105.8	88.35	88.18
MAX	302	588	5071	16310	6576	10220	6777	9322	3842	265	261	262
(WY)	2000	1999	1997	1997	1997	1995	1995	1995	1995	2002	2002	2002
MIN	57.4	57.8	59.0	55.7	61.5	86.0	78.0	67.7	55.6	54.3	54.6	56.0
(WY)	1992	1993	1990	1991	1991	1988	1988	1992	1988	2001	2001	1991

SUMMARY STATISTICS	FOR 2001 CALENDAR YEAR		FOR 2002 WATER YEAR		WATER YEARS 1986 - 2002	
ANNUAL TOTAL	36928		100393			
ANNUAL MEAN	101.2		275.0		715.9	
HIGHEST ANNUAL MEAN					3115	
LOWEST ANNUAL MEAN					75.2	
HIGHEST DAILY MEAN	565	Dec 2	2430	Jan 2	96900	Jan 1 1997
LOWEST DAILY MEAN	51	Aug 9	56	Oct 2	37	Jul 25 1994
ANNUAL SEVEN-DAY MINIMUM	52	Aug 4	57	Oct 1	52	Dec 10 1989
MAXIMUM PEAK FLOW			5040	Jan 2	115000	Jan 1 1997
MAXIMUM PEAK STAGE			10.27	Jan 2	29.97	Jan 1 1997
ANNUAL RUNOFF (AC-FT)	73250		199100		518600	
ANNUAL DIVERSION (AC-FT) a	1074000		1096000			
10 PERCENT EXCEEDS	186		354		1290	
50 PERCENT EXCEEDS	68		247		86	
90 PERCENT EXCEEDS	55		59		56	

a Diversion, in acre-feet, to Cresta Powerplant (station 11404360), provided by Pacific Gas & Electric Co.

11404400 NORTH FORK FEATHER RIVER BELOW POE DAM, CA

LOCATION.—Lat 39°48'32", long 121°26'04", in SW 1/4 NE 1/4 sec.32, T.23 N., R.5 E., [Butte County](#), Hydrologic Unit 18020121, Plumas National Forest, on right bank, 900 ft downstream from Poe Dam, 0.4 mi upstream from Mill Creek, and 0.8 mi northeast of Pulga.

DRAINAGE AREA.—1,942 mi².

PERIOD OF RECORD.—October 1999 to current year (low-flow records only). Records for water years 1976–99 available in the files of the U.S. Geological Survey.

GAGE.—Non-recording gage read daily. Elevation of gage is 1,350 ft above sea level, from topographic map.

REMARKS.—Records not computed above 137 ft³/s. See schematic diagram of [North Fork Feather River Basin](#).

COOPERATION.—Records were collected by Pacific Gas & Electric Co., under general supervision of the U.S. Geological Survey, in connection with Federal Energy Regulatory Commission project no. 2107.

DISCHARGE, CUBIC FEET PER SECOND, WATER YEAR OCTOBER 2001 TO SEPTEMBER 2002

INSTANTANEOUS VALUES

DAY	OCT	NOV	DEC	JAN	FEB	MAR	APR	MAY	JUN	JUL	AUG	SEP
1	120	124	133	---	128	120	124	128	116	116	109	113
2	124	124	---	---	124	124	137	124	120	128	113	116
3	128	124	---	---	120	120	128	128	116	128	116	113
4	113	124	---	---	120	120	113	120	124	113	113	120
5	128	116	128	---	124	120	120	124	124	113	120	128
6	133	116	124	---	133	133	120	120	124	120	113	116
7	124	113	124	---	133	124	120	128	128	124	113	124
8	116	116	124	---	113	120	124	133	124	116	113	113
9	120	113	128	128	116	116	120	124	128	124	113	113
10	128	113	128	120	116	124	124	124	120	120	109	113
11	116	113	128	116	124	128	128	124	120	109	109	116
12	113	124	120	116	128	120	128	120	120	116	105	113
13	124	120	128	120	124	120	124	116	113	116	120	113
14	116	113	120	116	124	120	133	120	116	120	113	116
15	113	113	124	120	133	120	124	128	116	109	113	116
16	116	113	124	120	124	128	124	128	116	116	113	120
17	120	116	120	124	116	128	128	124	116	116	109	---
18	116	116	120	137	124	128	120	128	113	116	113	---
19	116	116	120	128	124	128	120	124	113	109	128	---
20	128	116	124	133	120	---	120	120	120	113	120	---
21	128	120	128	133	120	128	124	124	120	113	120	128
22	120	---	128	128	128	128	120	120	120	109	116	120
23	116	128	124	120	128	120	120	116	113	113	124	113
24	120	120	124	120	124	120	120	128	116	113	120	128
25	120	120	124	120	120	120	128	---	113	109	113	116
26	116	120	124	133	128	128	137	128	120	109	116	120
27	113	120	120	120	124	128	124	124	120	120	113	120
28	116	120	128	120	120	128	116	120	116	109	116	116
29	128	120	128	133	---	120	124	124	120	109	120	113
30	128	120	124	128	---	128	124	113	116	109	116	120
31	120	---	---	128	---	128	---	116	---	109	120	---
TOTAL	3737	---	---	---	3460	---	3716	---	3561	3564	3569	---
MEAN	120.5	---	---	---	123.6	---	123.9	---	118.7	115.0	115.1	---
MAX	133	---	---	---	133	---	137	---	128	128	128	---
MIN	113	---	---	---	113	---	113	---	113	109	105	---
AC-FT	7410	---	---	---	6860	---	7370	---	7060	7070	7080	---

11404500 NORTH FORK FEATHER RIVER AT PULGA, CA

LOCATION.—Lat 39°47'40", long 121°27'02", in SE 1/4 NE 1/4 sec.6, T.22 N., R.5 E., [Butte County](#), Hydrologic Unit 18020121, Plumas National Forest, on left bank, between railroad and highway bridges, 0.6 mi downstream from Flea Valley Creek and Pulga, and 1.6 mi downstream from Poe Dam.

DRAINAGE AREA.—1,953 mi².

PERIOD OF RECORD.—October 1910 to current year. Monthly discharge only for some periods and yearly estimates for water years 1911 and 1938, published in WSP 1315-A. Prior to October 1960, published as "at Big Bar."

CHEMICAL DATA: Water years 1963–66, 1972, 1977.

WATER TEMPERATURE: Water years 1963–83.

REVISED RECORDS.—WSP 931: 1938(M), 1940. WSP 1515: 1935. WDR CA-77-4: 1976 (yearly summaries).

GAGE.—Water-stage recorder. Datum of gage is 1,305.62 ft above sea level. Prior to Oct. 1, 1937, at site 1.1 mi upstream at different datum. Oct. 1, 1937, to Sept. 30, 1958, at present site at datum 5.00 ft higher.

REMARKS.—Flow regulated by Lake Almanor, Bucks Lake, Butt Valley Reservoir (stations 11399000, 11403500, 11401050), Mountain Meadows Reservoir, and five forebays, combined capacity, 1,386,000 acre-ft. Diversion through Poe Powerplant (station 11404900) began on May 29, 1958. See schematic diagram of [North Fork Feather River Basin](#).

COOPERATION.—Records were collected by Pacific Gas & Electric Co., under general supervision of the U.S. Geological Survey, in connection with Federal Energy Regulatory Commission project no. 2107.

EXTREMES FOR PERIOD OF RECORD.—Maximum discharge, 105,400 ft³/s, Jan. 1, 1997, gage height, 41.65 ft, from rating curve extended above 32,000 ft³/s, on basis of slope area measurement of peak discharge; minimum daily, 5.4 ft³/s, Sept. 18, 1977.

DISCHARGE, CUBIC FEET PER SECOND, WATER YEAR OCTOBER 2001 TO SEPTEMBER 2002

DAILY MEAN VALUES

DAY	OCT	NOV	DEC	JAN	FEB	MAR	APR	MAY	JUN	JUL	AUG	SEP
1	115	117	184	1750	149	152	156	148	130	122	116	116
2	116	121	1380	4640	145	149	163	148	131	120	117	122
3	117	117	1250	4560	143	148	157	147	131	121	122	119
4	117	121	224	2490	141	146	159	145	132	118	119	116
5	121	116	172	1190	142	148	163	141	129	117	118	121
6	119	115	181	1610	146	184	159	138	129	117	117	117
7	117	113	160	979	163	201	154	143	133	122	118	120
8	113	113	154	323	158	185	154	142	132	125	115	118
9	114	113	146	186	147	175	156	143	132	123	117	116
10	117	111	143	172	146	190	155	146	128	121	120	124
11	116	120	138	167	148	182	151	140	125	121	118	119
12	115	136	135	162	148	185	152	138	127	121	123	118
13	109	130	136	164	145	172	152	137	126	123	121	121
14	111	118	151	155	145	168	153	139	126	123	117	119
15	111	115	143	156	146	168	149	141	125	118	118	119
16	117	113	142	152	146	172	152	142	121	117	119	137
17	117	116	193	155	146	169	156	137	122	117	116	158
18	113	113	168	158	144	167	154	137	124	118	117	210
19	113	113	159	154	153	164	156	142	120	116	122	259
20	117	114	182	154	183	164	154	142	121	116	123	287
21	116	185	180	156	169	161	152	141	125	119	123	127
22	118	599	187	152	169	165	155	138	126	117	122	123
23	117	131	182	150	164	173	148	135	125	120	125	117
24	115	184	167	149	162	168	147	139	123	119	125	116
25	114	134	158	151	154	166	143	137	120	120	118	119
26	112	127	152	176	156	166	148	134	122	116	118	119
27	113	124	148	159	159	165	158	134	124	119	116	123
28	118	126	158	157	153	161	154	133	123	114	119	120
29	126	132	173	153	---	157	150	133	125	116	121	120
30	133	129	191	149	---	159	149	129	123	117	119	121
31	122	---	2280	152	---	154	---	129	---	116	118	---
TOTAL	3609	4216	9517	21181	4270	5184	4609	4318	3780	3689	3697	4041
MEAN	116.4	140.5	307.0	683.3	152.5	167.2	153.6	139.3	126.0	119.0	119.3	134.7
MAX	133	599	2280	4640	183	201	163	148	133	125	125	287
MIN	109	111	135	149	141	146	143	129	120	114	115	116
AC-FT	7160	8360	18880	42010	8470	10280	9140	8560	7500	7320	7330	8020
a	95230	73060	106900	119000	86710	122300	131900	93880	48780	59880	74680	96700

a Diversion, in acre-feet, to Poe Powerplant (station 11404900), provided by Pacific Gas & Electric Co.

11404500 NORTH FORK FEATHER RIVER AT PULGA, CA—Continued

STATISTICS OF MONTHLY MEAN DATA FOR WATER YEARS 1911 - 2002, BY WATER YEAR (WY)

	OCT	NOV	DEC	JAN	FEB	MAR	APR	MAY	JUN	JUL	AUG	SEP
MEAN	923.2	1116	1654	2201	2718	2827	3405	2951	1569	933.2	876.1	834.9
MAX	2943	4594	10690	14120	14320	11960	13580	12460	7689	2771	2441	2430
(WY)	1963	1951	1956	1997	1986	1995	1952	1922	1911	1952	1952	1952
MIN	16.4	26.4	50.7	52.6	56.0	58.2	54.9	41.7	34.0	32.6	13.3	14.2
(WY)	1978	1978	1977	1977	1990	1977	1990	1977	1977	1977	1977	1977

SUMMARY STATISTICS	FOR 2001 CALENDAR YEAR		FOR 2002 WATER YEAR		WATER YEARS 1911 - 2002	
ANNUAL TOTAL	52350		72111			
ANNUAL MEAN	143.4		197.6		1805	
HIGHEST ANNUAL MEAN					5320	
LOWEST ANNUAL MEAN					42.7	
HIGHEST DAILY MEAN	2280	Dec 31	4640	Jan 2	101000	Jan 1 1997
LOWEST DAILY MEAN	101	Aug 1	109	Oct 13	5.4	Sep 18 1977
ANNUAL SEVEN-DAY MINIMUM	105	Aug 1	113	Oct 13	12	Aug 10 1977
MAXIMUM PEAK FLOW			7690	Jan 2	105400	Jan 1 1997
MAXIMUM PEAK STAGE			12.92	Jan 2	41.65	Jan 1 1997
ANNUAL RUNOFF (AC-FT)	103800		143000		1308000	
ANNUAL DIVERSION (AC-FT) a	971600		1109000			
10 PERCENT EXCEEDS	164		174		4470	
50 PERCENT EXCEEDS	121		136		1250	
90 PERCENT EXCEEDS	110		116		55	

a Diversion, in acre-feet, to Poe Powerplant (station 11404900), provided by Pacific Gas & Electric Co.

11405120 PHILBROOK CREEK BELOW PHILBROOK DAM, NEAR BUTTE MEADOWS, CA

LOCATION.—Lat 40°01'48", long 121°28'36", unsurveyed, T.25 N., R.4 E., Butte County, Hydrologic Unit 18020121, Lassen National Forest, on right bank, 500 ft downstream from outlet structure on Philbrook Dam, and 5.4 mi southeast of Butte Meadows.

DRAINAGE AREA.—5.05 mi².

PERIOD OF RECORD.—July 1989 to current year (no winter records). Unpublished records for water years 1986–89 available in files of the U.S. Geological Survey.

GAGE.—Water-stage recorder, Parshall flume, and V-notch sharp-crested weir. Elevation of gage is 5,490 ft above sea level, from topographic map. October 1985 to July 1989, nonrecording gage at same site and datum. In June 1989, V-notch sharp-crested weir installed in flume to be used at low flows.

REMARKS.—Records not computed for winter months. Flow completely regulated by Philbrook Reservoir, usable capacity, 5,370 acre-ft, 500 ft upstream. Spillwater from Philbrook Reservoir bypasses this station.

COOPERATION.—Records were collected by Pacific Gas & Electric Co., under general supervision of the U.S. Geological Survey, in connection with Federal Energy Regulatory Commission project no. 803.

DISCHARGE, CUBIC FEET PER SECOND, WATER YEAR OCTOBER 2001 TO SEPTEMBER 2002
DAILY MEAN VALUES

DAY	OCT	NOV	DEC	JAN	FEB	MAR	APR	MAY	JUN	JUL	AUG	SEP
1	2.3	2.4	2.7	---	---	---	---	3.1	3.2	3.4	27	34
2	2.3	2.4	2.7	---	---	---	---	3.1	3.2	3.4	27	33
3	2.3	2.4	2.7	---	---	---	---	3.1	3.2	3.4	27	33
4	2.3	2.4	2.7	---	---	---	---	3.1	3.2	3.4	27	33
5	2.3	2.4	2.7	---	---	---	---	3.1	3.2	3.4	27	32
6	2.3	2.4	2.7	---	---	---	---	3.1	3.2	3.4	27	32
7	2.3	2.4	2.8	---	---	---	---	3.1	3.2	3.4	27	32
8	2.3	2.4	2.8	---	---	---	---	3.1	3.2	7.4	27	32
9	2.3	2.3	2.8	---	---	---	---	3.1	3.2	11	27	31
10	2.3	2.3	2.8	---	---	---	---	3.1	3.2	11	27	31
11	2.3	2.4	---	---	---	---	---	3.1	3.2	11	27	31
12	2.3	2.5	---	---	---	---	---	3.1	3.2	11	30	30
13	2.3	2.4	---	---	---	---	---	3.1	3.2	11	32	30
14	2.3	2.4	---	---	---	---	---	3.1	3.3	11	32	30
15	2.3	2.4	---	---	---	---	---	3.1	3.3	11	32	29
16	2.3	2.4	---	---	---	---	---	3.2	3.3	18	32	28
17	2.3	2.4	---	---	---	---	---	3.2	3.3	23	32	3.7
18	2.4	2.4	---	---	---	---	---	3.2	3.3	23	32	3.8
19	2.4	2.4	---	---	---	---	---	3.2	3.3	23	31	3.8
20	2.4	2.4	---	---	---	---	---	3.2	3.3	23	31	3.7
21	2.4	2.6	---	---	---	---	---	3.2	3.3	23	34	3.6
22	2.4	2.8	---	---	---	---	---	3.2	3.3	23	36	3.6
23	2.4	2.6	---	---	---	---	---	3.2	3.3	23	35	3.6
24	2.4	2.8	---	---	---	---	---	3.2	3.3	23	35	3.0
25	2.4	2.7	---	---	---	---	---	3.2	3.4	23	35	2.4
26	2.4	2.7	---	---	---	---	3.1	3.2	3.4	23	35	2.4
27	2.4	2.7	---	---	---	---	3.2	3.2	3.4	23	35	2.4
28	2.4	2.7	---	---	---	---	3.1	3.2	3.4	22	34	2.4
29	2.4	2.7	---	---	---	---	3.1	3.2	3.4	25	34	2.4
30	2.4	2.7	---	---	---	---	3.1	3.2	3.4	27	34	2.4
31	2.4	---	---	---	---	---	---	3.2	---	27	34	---
TOTAL	72.7	74.9	---	---	---	---	---	97.7	98.3	480.2	962	544.2
MEAN	2.345	2.497	---	---	---	---	---	3.152	3.277	15.49	31.03	18.14
MAX	2.4	2.8	---	---	---	---	---	3.2	3.4	27	36	34
MIN	2.3	2.3	---	---	---	---	---	3.1	3.2	3.4	27	2.4
AC-FT	144	149	---	---	---	---	---	194	195	952	1910	1080
a	750	1490	2200	3670	3730	3860	4390	4530	5040	3690	1900	665

a Contents, in acre-feet, from Philbrook Reservoir (station 11405100), provided by Pacific Gas & Electric Co.

11405200 WEST BRANCH FEATHER RIVER BELOW HENDRICKS DIVERSION DAM, NEAR STIRLING CITY, CA

LOCATION.—Lat 39°56'03", long 121°31'43", in NW 1/4 SE 1/4 sec.16, T.24 N., R.4 E., Butte County, Hydrologic Unit 18020121, on right bank, 200 ft upstream from road bridge, 1,800 ft downstream from Hendricks Diversion Dam, and 1.9 mi north of Stirling City.

DRAINAGE AREA.—46.1 mi².

PERIOD OF RECORD.—August 1986 to current year (low-flow records only).

GAGE.—Water-stage recorder. Elevation of gage is 3,210 ft above sea level, from topographic map.

REMARKS.—Flows computed to 100 ft³/s. Most of the water is diverted at Hendricks Diversion Dam to the Hendricks Canal and Toadtown Canal (station 11389800) and then to De Sabla Powerplant (station 11389750) on Butte Creek.

COOPERATION.—Records were collected by Pacific Gas & Electric Co., under general supervision of the U.S. Geological Survey, in connection with Federal Energy Regulatory Commission project no. 803.

DISCHARGE, CUBIC FEET PER SECOND, WATER YEAR OCTOBER 2001 TO SEPTEMBER 2002

DAILY MEAN VALUES

DAY	OCT	NOV	DEC	JAN	FEB	MAR	APR	MAY	JUN	JUL	AUG	SEP
1	e8.6	9.5	9.4	12	17	20	20	---	22	17	17	15
2	e8.6	9.5	9.2	12	17	20	20	---	22	17	17	15
3	e8.6	9.4	9.4	13	19	20	20	---	22	17	17	15
4	e8.6	9.4	9.8	13	19	20	20	---	20	17	17	15
5	e8.6	9.5	9.9	13	19	20	20	---	19	17	17	15
6	e8.6	9.4	10	13	18	20	20	---	18	17	17	15
7	e8.6	9.4	11	13	19	20	20	---	18	17	17	15
8	e8.6	9.4	10	13	21	20	20	---	18	17	17	15
9	e8.6	9.4	10	13	20	20	20	---	18	17	17	15
10	e8.6	9.4	9.9	13	20	20	20	---	18	17	17	13
11	e8.6	10	9.8	13	20	20	20	---	18	17	17	11
12	e8.6	11	9.8	13	19	20	20	---	18	17	17	11
13	e8.6	10	9.8	13	19	20	20	---	18	17	17	11
14	e8.6	9.2	9.8	12	19	20	20	---	17	17	17	11
15	e8.6	9.0	9.6	12	19	20	---	---	17	17	17	11
16	e8.8	8.9	9.7	17	20	20	---	---	17	17	17	11
17	e8.9	9.0	11	19	20	20	---	25	17	17	17	13
18	e8.9	8.9	11	17	20	20	---	24	17	17	17	15
19	e8.9	8.8	11	17	20	20	20	23	17	17	17	15
20	e9.0	8.9	11	16	21	20	20	23	17	17	17	15
21	e9.0	9.6	10	16	21	20	20	23	17	17	17	15
22	e9.0	11	10	16	21	20	20	23	17	17	17	15
23	e9.0	9.6	10	17	21	20	21	23	17	17	17	15
24	e9.0	9.7	10	18	20	20	19	23	17	17	17	15
25	9.0	9.9	9.9	19	20	20	21	22	17	17	17	15
26	9.0	9.2	9.9	20	20	20	21	22	17	17	17	15
27	9.0	8.8	10	20	20	20	21	21	17	17	17	16
28	9.1	8.7	11	20	20	20	21	21	17	17	17	17
29	9.1	8.7	11	20	---	20	---	22	17	18	16	17
30	9.6	9.0	11	19	---	20	---	22	17	17	15	17
31	9.3	---	12	19	---	20	---	22	---	17	15	---
TOTAL	273.6	282.2	315.9	481	549	620	---	---	538	528	522	429
MEAN	8.826	9.407	10.19	15.52	19.61	20.00	---	---	17.93	17.03	16.84	14.30
MAX	9.6	11	12	20	21	20	---	---	22	18	17	17
MIN	8.6	8.7	9.2	12	17	20	---	---	17	17	15	11
AC-FT	543	560	627	954	1090	1230	---	---	1070	1050	1040	851

e Estimated.

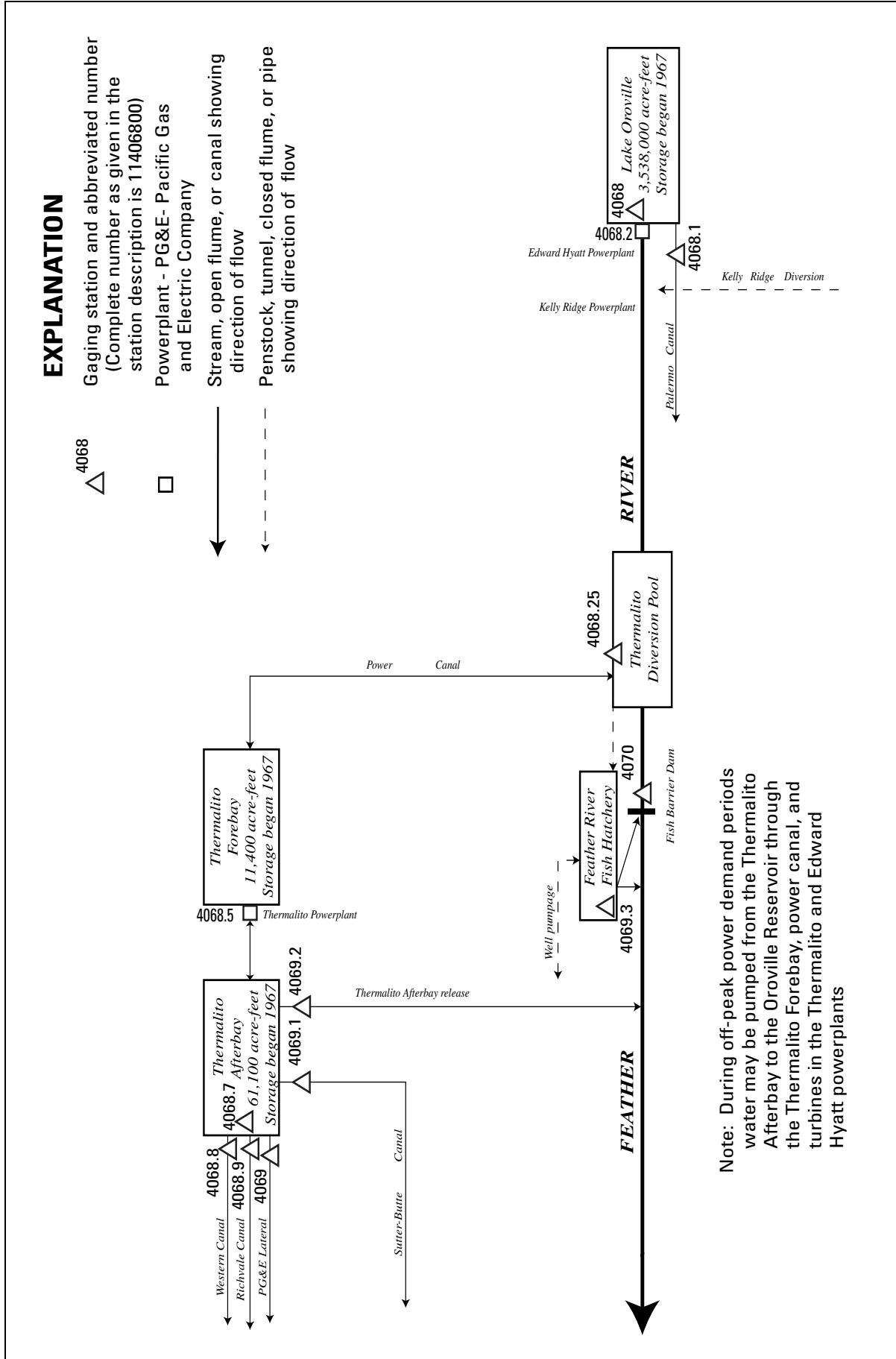

Figure 30. Diversions and storage from Feather River at Lake Oroville.

11406800 LAKE OROVILLE NEAR OROVILLE, CA

LOCATION.—Lat 39°32'06", long 121°28'25", in NE 1/4 SW 1/4 sec.1, T.19 N., R.4 E., [Butte County](#), Hydrologic Unit 18020123, near intake structure, at left end of Oroville Dam on Feather River, 1.0 mi downstream from North Fork Feather River, and 4.2 mi east of Oroville.

DRAINAGE AREA.—3,607 mi².

PERIOD OF RECORD.—November 1967 to current year.

GAGE.—Water-stage recorder. Datum of gage is 0.47 ft above sea level (levels by California Department of Water Resources). Contents based on capacity table in use since Sept. 21, 1967.

REMARKS.—Reservoir is formed by an earthfill dam with concrete chute-type sidehill spillway completed May 13, 1968; storage began Nov. 14, 1967. Usable capacity, 2,685,385 acre-ft, between elevations 640.0 ft, minimum power pool, and 900.0 ft, normal maximum pool. Dead storage, 852,192 acre-ft. Total capacity at normal maximum pool, 3,537,577 acre-ft; temporary detention storage occurred at times during construction; maximum was 155,200 acre-ft, Dec. 23, 1964. Water is released to Edward Hyatt Powerplant (station 11406820) through penstock in left abutment of dam and to Palermo Canal (station 11406810) through concrete tunnel also in left abutment of dam. Three of the total of six turbines in the Edward Hyatt Powerplant are reversible and during periods of low power demand water is pumped at times from the river back into Lake Oroville. Records, including extremes, represent total contents at 2400 hours. Maximum inflow of 266,000 ft³/s during a 2-hour period Feb. 17, 1986. See schematic diagram showing diversions and storage from [Feather River at Lake Oroville](#).

COOPERATION.—Records were collected by California Department of Water Resources, under general supervision of the U.S. Geological Survey, in connection with Federal Energy Regulatory Commission project no. 2100. Contents not rounded to U.S. Geological Survey standards.

EXTREMES FOR PERIOD OF RECORD.—Maximum contents, 3,536,000 acre-ft, June 4, 1973, gage height, 899.88 ft; minimum since initial storage began, 882,395 acre-ft, Sept. 7, 1977, gage height, 645.11 ft.

EXTREMES FOR CURRENT YEAR.—Maximum contents, 2,659,224 acre-ft, Apr. 28, gage height, 838.67 ft; minimum, 1,362,994 acre-ft, Nov. 20, gage height, 713.80 ft.

Capacity table (gage height, in feet, and contents, in acre-feet)
(Based on table provided by California Department of Water Resources, dated Sept. 21, 1967)

640	852,192	710	1,332,547	780	1,974,240	850	2,808,349
650	911,975	720	1,413,685	790	2,080,969	860	2,944,741
660	974,560	730	1,498,175	800	2,191,742	870	3,085,747
670	1,040,003	740	1,586,086	810	2,306,597	880	3,231,454
680	1,108,406	750	1,677,554	820	2,425,571	890	3,382,038
690	1,179,915	760	1,772,690	830	2,548,850	900	3,537,577
700	1,254,634	770	1,871,511	840	2,676,446		

11406800 LAKE OROVILLE NEAR OROVILLE, CA—Continued

RESERVOIR STORAGE, (ACRE-FEET), WATER YEAR OCTOBER 2001 TO SEPTEMBER 2002

DAILY OBSERVATION AT 2400 HOURS

DAY	OCT	NOV	DEC	JAN	FEB	MAR	APR	MAY	JUN	JUL	AUG	SEP
1	1481004	1429730	1422400	1622240	1919505	2127110	2424120	2653544	2642595	2339020	1868087	1534237
2	1478611	1427979	1441025	1654809	1924127	2134962	2435035	2650062	2648902	2321711	1853837	1525319
3	1476051	1421736	1452214	1682877	1929477	2142390	2446594	2644653	2646326	2306128	1841856	1517568
4	1474941	1416423	1454830	1698730	1931745	2149170	2459170	2648903	2638738	2290502	1833403	1510362
5	1475368	1411951	1458127	1718291	1934426	2154738	2472405	2655092	2627447	2273329	1821320	1504217
6	1477843	1407654	1456774	1754424	1937627	2167694	2486182	2650449	2619639	2256130	1809688	1500071
7	1481945	1402954	1460327	1776471	1941970	2185431	2507570	2648902	2608023	2238794	1795565	1494643
8	1482287	1398593	1464820	1792829	1951091	2199535	2519494	2645296	2601656	2222576	1783371	1493610
9	1480320	1394242	1471449	1803990	1957432	2214044	2529585	2641951	2599494	2205648	1769008	1486740
10	1478782	1389164	1469322	1812542	1972461	2228049	2541582	2640023	2588954	2189374	1758183	1480918
11	1475538	1384343	1467792	1819740	1976651	2238794	2552489	2642594	2578571	2173408	1749038	1473663
12	1473408	1384506	1468217	1829832	1980951	2248656	2562169	2655867	2565570	2154961	1734285	1465498
13	1471193	1382956	1464735	1842554	1983682	2260277	2573138	2649676	2551611	2145056	1721425	1460496
14	1469747	1379209	1469662	1846043	1987257	2268125	2586419	2641823	2537329	2135073	1711942	1459057
15	1466518	1374330	1475624	1848938	1990416	2275528	2600256	2638480	2526593	2118066	1699953	1458211
16	1467027	1369464	1480149	1851937	1995447	2284574	2609298	2633858	2522108	2100500	1688212	1450359
17	1464734	1367036	1487598	1854538	2000335	2293528	2617339	2628472	2510548	2080209	1681194	1442033
18	1463971	1366954	1493869	1858946	2004779	2298889	2623093	2631677	2494080	2063623	1676155	1438510
19	1461513	1364286	1496968	1863563	2011351	2306128	2627575	2638995	2481010	2048099	1664066	1431985
20	1460581	1362994	1503266	1868288	2027210	2312447	2631549	2636939	2468356	2036189	1653608	1426979
21	1458465	1367440	1505859	1870906	2040261	2316079	2637710	2635784	2460271	2026676	1639156	1425479
22	1456943	1384751	1511663	1875446	2051864	2323591	2639252	2633858	2454525	2012837	1626070	1425812
23	1452214	1392767	1524709	1879384	2066543	2335834	2640794	2632703	2447935	1996954	1612241	1419077
24	1447159	1406333	1529161	1882620	2085650	2349898	2643623	2631677	2435765	1981371	1605719	1413605
25	1441361	1415594	1540993	1885555	2098311	2357723	2647743	2632446	2423032	1966712	1602014	1408727
26	1437086	1417086	1542223	1894484	2106965	2364377	2650449	2643366	2409028	1948912	1592462	1402130
27	1435663	1412778	1543806	1901405	2113445	2370687	2655350	2645683	2393400	1935252	1582145	1400896
28	1433907	1415262	1546007	1906301	2120159	2377843	2659224	2643752	2374978	1925978	1570806	1402130
29	1432319	1417500	1558283	1909366	---	2383460	2658966	2641651	2362237	1912639	1559967	1404519
30	1432486	1416920	1575174	1911922	---	2394480	2659095	2640409	2353690	1897434	1548210	1399662
31	1433405	---	1595882	1915916	---	2414816	---	2639509	---	1883126	1539412	---
MAX	1482287	1429730	1595882	1915916	2120159	2414816	2659224	2655867	2648902	2339020	1868087	1534237
MIN	1432319	1362994	1422400	1622240	1919505	2127110	2424120	2628472	2353690	1883126	1539412	1399662
a	722.37	720.39	741.09	774.37	793.58	819.11	838.66	837.14	814.00	771.15	734.74	718.30
b	-54279	-16485	+178962	+320034	+204243	+294657	+244279	-19586	-285819	-470564	-343714	-139750
c	4202	1297	574	947	1337	2819	4015	6282	8804	8638	7003	6335
d	187500	129800	129200	85280	39090	56810	117500	250500	370900	544600	433500	258900

CAL YR 2001 b -129060

WTR YR 2002 b -88022

ANNUAL DIVERSION (AC-FT) CAL YR 2001 d 2068000

ANNUAL DIVERSION (AC-FT) WTR YR 2002 d 2604000

a Gage height, in feet, at end of month.

b Change in contents, in acre-feet.

c Total evaporation, in acre-feet, provided by California Department of Water Resources; not reviewed by the U.S. Geological Survey.

d Diversion, in acre-feet, to Edward Hyatt Powerplant (station 11406820), provided by California Department of Water Resources.

11406810 PALERMO CANAL NEAR OROVILLE, CA

LOCATION.—Lat 39°31'59", long 121°28'54", in SW 1/4 SW 1/4 sec.1, T.19 N., R.4 E., [Butte County](#), Hydrologic Unit 18020106, on right bank, 50 ft downstream from Oroville Dam, and 4.4 mi east of Oroville.

PERIOD OF RECORD.—April 1965 to current year. Daily discharge records of diversion from Kelly Ridge Penstock for period April 1965 to October 1968, when Kelly Ridge Penstock supplied the entire flow of Palermo Canal, are in files of the U.S. Geological Survey.

GAGE.—Water-stage recorder and Parshall flume. Datum of gage is 547.67 ft above sea level (levels by California Department of Water Resources). April 1965 to October 1968, water-stage recorder and Parshall flume at site of diversion from Kelly Ridge Penstock, 0.4 mi downstream at different datum.

REMARKS.—Canal diverts from left end of Oroville Dam. Water is used for irrigation near Oroville. During period of construction of Oroville Dam, water was released from Kelly Ridge Penstock to meet irrigation requirements. See schematic diagram showing diversions and storage from [Feather River at Lake Oroville](#).

COOPERATION.—Records were provided by California Department of Water Resources, under general supervision of the U.S. Geological Survey, in connection with Federal Energy Regulatory Commission project no. 2100.

EXTREMES FOR PERIOD OF RECORD.—Maximum daily discharge, 28 ft³/s, several days during July to September 1967; no flow at times in some years.

DISCHARGE, CUBIC FEET PER SECOND, WATER YEAR OCTOBER 2001 TO SEPTEMBER 2002
DAILY MEAN VALUES

DAY	OCT	NOV	DEC	JAN	FEB	MAR	APR	MAY	JUN	JUL	AUG	SEP
1	17	6.3	1.1	1.1	0.00	0.00	0.00	8.4	14	15	16	16
2	16	6.3	1.2	1.3	0.00	0.00	0.00	9.6	14	16	16	16
3	15	6.2	1.2	1.0	0.00	0.00	0.00	9.6	14	16	16	16
4	14	6.2	1.2	1.0	0.00	0.00	5.1	9.7	14	16	16	16
5	13	6.2	1.0	1.0	0.00	0.00	5.6	9.7	14	16	16	16
6	13	6.2	1.0	1.1	0.00	0.00	3.0	13	14	16	16	16
7	13	6.2	1.0	0.30	0.00	0.00	3.0	14	14	16	16	16
8	13	6.2	1.0	0.00	0.00	0.00	3.0	14	14	16	16	16
9	13	4.3	1.0	0.00	0.00	0.00	3.1	14	14	16	16	16
10	13	3.2	1.0	0.00	0.00	0.00	3.1	14	14	16	16	17
11	13	3.3	1.0	0.00	0.00	0.00	3.1	14	14	16	16	17
12	13	3.2	1.0	0.00	0.00	0.00	3.1	14	14	16	16	17
13	13	3.0	1.0	0.00	0.00	0.00	3.1	14	14	16	16	17
14	13	3.1	1.0	0.00	0.00	0.00	3.1	14	14	16	16	17
15	13	2.8	1.0	0.00	0.00	0.00	3.2	14	14	16	16	17
16	13	2.7	1.0	0.00	0.00	0.00	3.2	14	14	16	16	17
17	13	2.6	1.0	0.00	0.00	0.00	3.1	14	14	16	16	17
18	13	2.9	1.0	0.00	0.00	0.00	3.2	14	14	16	16	17
19	13	2.9	1.0	0.00	0.00	0.00	3.2	14	14	16	16	17
20	13	3.0	1.0	0.00	0.00	0.00	3.2	14	14	16	16	17
21	13	3.0	1.0	0.00	0.00	0.00	3.2	14	14	16	16	17
22	13	3.0	1.0	0.00	0.00	0.00	3.2	14	14	16	16	17
23	11	3.0	1.0	0.00	0.00	0.00	4.9	14	14	16	16	17
24	9.9	3.0	1.0	0.00	0.00	0.00	5.7	14	14	16	16	17
25	10	3.0	1.0	0.00	0.00	0.00	5.7	14	14	16	16	17
26	10	2.7	1.0	0.00	0.00	0.00	5.7	14	14	16	16	17
27	10	1.6	1.0	0.00	0.00	0.00	5.7	14	14	16	16	17
28	10	1.1	1.0	0.00	0.00	0.00	5.7	14	14	16	16	17
29	7.2	1.1	1.0	0.00	---	0.00	5.7	14	14	16	16	17
30	6.1	1.1	1.0	0.00	---	0.00	5.7	14	14	16	16	17
31	6.3	---	1.1	0.00	---	0.00	---	14	---	16	16	---
TOTAL	376.5	109.4	31.8	6.80	0.00	0.00	108.60	410.0	420	495	496	501
MEAN	12.15	3.647	1.026	0.219	0.000	0.000	3.620	13.23	14.00	15.97	16.00	16.70
MAX	17	6.3	1.2	1.3	0.00	0.00	5.7	14	14	16	16	17
MIN	6.1	1.1	1.0	0.00	0.00	0.00	0.00	8.4	14	15	16	16
AC-FT	747	217	63	13	0.00	0.00	215	813	833	982	984	994

STATISTICS OF MONTHLY MEAN DATA FOR WATER YEARS 1969 - 2002, BY WATER YEAR (WY)

MEAN	12.37	5.069	3.193	2.582	2.126	2.568	5.943	14.25	18.48	19.26	19.58	18.71
MAX	18.0	8.56	5.94	5.12	5.33	6.22	19.1	22.3	24.5	24.5	24.5	22.8
(WY)	1979	1994	1975	1971	1974	1988	1970	1976	1976	1975	1978	1975
MIN	6.85	2.04	0.000	0.21	0.000	0.000	0.000	3.21	11.3	16.0	16.0	13.8
(WY)	1973	1983	1982	1995	1975	1979	1991	1995	1998	1991	2002	1985

SUMMARY STATISTICS

	FOR 2001 CALENDAR YEAR	FOR 2002 WATER YEAR	WATER YEARS 1969 - 2002
ANNUAL TOTAL	3337.74	2955.10	
ANNUAL MEAN	9.144	8.096	10.39
HIGHEST ANNUAL MEAN			13.3
LOWEST ANNUAL MEAN			7.54
HIGHEST DAILY MEAN	18	May 4	26
LOWEST DAILY MEAN	0.00	Jan 18	0.00
ANNUAL SEVEN-DAY MINIMUM	0.00	Jan 18	0.00
ANNUAL RUNOFF (AC-FT)	6620	5860	7520
10 PERCENT EXCEEDS	17	16	20
50 PERCENT EXCEEDS	10	6.3	8.2
90 PERCENT EXCEEDS	0.00	0.00	1.2

11406870 THERMALITO AFTERBAY NEAR OROVILLE, CA

LOCATION.—Lat 39°27'30", long 121°38'17", in NE 1/4 SE 1/4 sec.33, T.19 N., R.3 E., [Butte County](#), Hydrologic Unit 18020106, at dam, 195 ft northeast of centerline of outlet structure, and 5.7 mi southwest of Oroville.

PERIOD OF RECORD.—October 1967 to current year.

GAGE.—Water-stage recorder. Datum of gage is 100.47 ft above sea level (levels by California Department of Water Resources). Auxiliary water-stage recorder 90 ft southwest of centerline of Western Canal outlet and 7.2 mi west of Oroville.

REMARKS.—Reservoir is formed by an earthfill dam completed in 1967. Diversion from the reservoir began Oct. 12, 1967. Usable capacity, 61,144 acre-ft, between gage heights 120.0 and 139.0 ft, extreme operating levels. Normal operating range is from 123 to 136.5 ft. Water is released to four canals (stations 11406880, 11406890, 11406900, and 11406910) and to the Feather River (station 11406920) from the reservoir. Total maximum release to the four canals is approximately 4,000 ft³/s. Water is pumped, at times, from Thermalito Afterbay back into Thermalito Forebay (station 11406840) during off-peak periods to be re-released through Thermalito Powerplant (station 11406850) for power generation during peak-demand periods. Records, including extremes, represent total contents at 2400 hours. See schematic diagram showing diversions and storage from [Feather River at Lake Oroville](#).

COOPERATION.—Records were collected by California Department of Water Resources, under general supervision of the U.S. Geological Survey, in connection with Federal Energy Regulatory Commission project no. 2100. Contents not rounded to U.S. Geological Survey standards.

EXTREMES FOR PERIOD OF RECORD.—Maximum contents, 57,300 acre-ft, May 24, 1969, gage height, 136.56 ft; minimum since initial operation began, 5,590 acre-ft, Mar. 1, 1968, gage height, 119.09 ft.

EXTREMES FOR CURRENT YEAR.—Maximum contents, 53,727 acre-ft, May 17, gage height, 135.72 ft; minimum, 16,351 acre-ft, Nov. 2, gage height, 124.50 ft.

Capacity table (gage height, in feet, and contents, in acre-feet)
(Based on table provided by California Department of Water Resources, dated Oct. 10, 1968)

119	5,465	124	15,157	128	25,832	134	46,719
120	7,054	126	20,171	130	32,150	139	68,198
122	10,792						

11406870 THERMALITO AFTERBAY NEAR OROVILLE, CA—Continued

RESERVOIR STORAGE, (ACRE-FEET), WATER YEAR OCTOBER 2001 TO SEPTEMBER 2002
DAILY OBSERVATION AT 2400 HOURS

DAY	OCT	NOV	DEC	JAN	FEB	MAR	APR	MAY	JUN	JUL	AUG	SEP
1	27104	16732	20924	30802	43529	27689	31919	32518	28625	25771	35451	41521
2	28688	16351	20681	35069	42918	26646	33460	35173	20520	28062	35800	43797
3	30380	17782	20600	38865	42766	25621	35139	40183	18804	27875	34312	45697
4	30575	18264	21799	41409	44646	24616	36080	38106	20332	28437	27196	44568
5	29737	18856	23803	36256	45151	23803	36927	33358	26222	28783	26920	43951
6	22012	19299	32185	28093	45541	25028	33731	37389	28941	29290	27165	42690
7	23373	19932	34517	27720	46365	25294	26737	39595	32318	30413	28155	41334
8	20600	20735	32719	26981	45776	26101	24092	42425	28846	31523	29833	33629
9	18778	22383	29769	28124	44607	25146	25116	44723	23516	33156	32887	33731
10	18572	23861	33596	30607	36256	25146	24587	46958	25443	33630	31655	35730
11	19116	24939	36714	32285	36080	25472	25502	44607	26585	34483	29290	34793
12	20627	26161	37890	29865	37175	26646	26889	30380	29961	37353	32418	36820
13	19535	27782	42956	23373	38720	27073	27319	36150	31490	30737	31031	36608
14	20306	30705	43070	26282	39898	29385	27012	42652	34655	25353	31326	34414
15	20573	33562	39999	27782	40109	31490	26011	46208	33799	27442	31787	30478
16	18882	36538	37711	29290	39558	30933	26312	50494	26161	30575	32618	33936
17	19351	36820	39375	30478	39595	30187	26767	53727	28531	34277	29865	34896
18	19747	33325	40664	31721	39705	32118	27813	48711	31523	35835	25831	35905
19	19641	33765	42311	32052	42236	32752	29417	37926	33970	36750	26524	36785
20	19906	34038	44684	31096	42463	33697	28783	38358	34827	34312	26342	37568
21	19509	32385	48631	34140	42010	37104	27319	38720	32385	28751	29513	35277
22	18752	28594	48470	35416	41110	36998	29099	39120	26828	27627	31688	31622
23	19351	25057	42842	36080	39631	35835	30219	39631	21414	30025	36080	34209
24	20520	22411	44298	37675	30835	31260	29385	41073	23487	31787	33156	34175
25	20897	19012	35069	39558	26981	33629	29099	39266	25383	34346	28500	35451
26	20600	16787	37282	39083	27349	35870	29737	31260	27534	36750	28846	36714
27	19641	19932	39229	38358	28343	37639	27042	28062	31424	36291	30154	35730
28	18469	19509	44336	39448	28093	38539	24734	29417	33122	31096	33596	30966
29	17959	19325	41897	40961	---	40850	26859	32052	30640	30705	36927	26255
30	18239	20279	36538	42880	---	39999	27504	34724	24470	32251	41185	26312
31	16984	---	39302	43529	---	31064	---	35277	---	33663	43223	---
MAX	30575	36820	48631	43529	46365	40850	36927	53727	34827	37353	43223	45697
MIN	16984	16351	20600	23373	26981	23803	24092	28062	18804	25353	25831	26255
a	124.76	126.04	132.05	133.18	128.74	129.67	128.55	130.92	127.54	130.45	133.10	128.16
b	-4815	+3295	+19023	+4227	-15436	+2971	-3560	+7773	-10807	+9193	+9560	-16911
c	2844	464	291	301	426	789	827	1853	2142	2282	2103	1733
d	151200	130700	110900	66360	18310	38960	93560	231200	352800	526000	402300	223000

CAL YR 2001 b +14861

WTR YR 2002 b +4513

ANNUAL DIVERSION (AC-FT) CAL YR 2001 d 1807000

ANNUAL DIVERSION (AC-FT) WTR YR 2002 d 2345000

a Gage height, in feet, at end of month.

b Change in contents, in acre-feet.

c Total evaporation, in acre-feet, provided by California Department of Water Resources; not reviewed by the U.S. Geological Survey.

d Diversion, in acre-feet, to Thermalito Powerplant (station 11406850), provided by California Department of Water Resources.

11406880 WESTERN CANAL AT INTAKE, NEAR OROVILLE, CA

LOCATION.—Lat 39°30'19", long 121°41'06", in SW 1/4 NW 1/4 sec.18, T.19 N., R.3 E., [Butte County](#), Hydrologic Unit 18020105, on left bank, 500 ft downstream from Thermalito Afterbay Dam, and 7.3 mi west of Oroville.

PERIOD OF RECORD.—October 1967 to current year.

GAGE.—Water-stage recorder. Datum of gage is 100.47 ft above sea level (levels by California Department of Water Resources).

REMARKS.—Water is diverted from Thermalito Afterbay (station 11406870) and is used for irrigation. See schematic diagram showing diversions and storage from [Feather River at Lake Oroville](#).

COOPERATION.—Records collected by California Department of Water Resources, under general supervision of the U.S. Geological Survey, in connection with Federal Energy Regulatory Commission project no. 2100.

EXTREMES FOR PERIOD OF RECORD.—Maximum daily discharge, 1,230 ft³/s, May 11, 12, 2001; no flow at times each year.

DISCHARGE, CUBIC FEET PER SECOND, WATER YEAR OCTOBER 2001 TO SEPTEMBER 2002
DAILY MEAN VALUES

DAY	OCT	NOV	DEC	JAN	FEB	MAR	APR	MAY	JUN	JUL	AUG	SEP
1	352	777	159	70	0.00	0.00	0.00	862	647	1020	831	247
2	414	669	83	55	0.00	0.00	0.00	932	647	1000	822	247
3	427	617	50	22	0.00	0.00	0.00	976	663	981	813	234
4	427	598	51	0.00	0.00	0.00	0.00	1100	687	972	802	207
5	447	588	50	0.00	0.00	0.00	0.00	1180	708	972	789	178
6	457	587	63	0.00	0.00	0.00	0.00	1200	773	972	777	168
7	472	548	87	0.00	0.00	0.00	0.00	1200	824	988	764	157
8	515	506	98	0.00	0.00	0.00	31	1200	872	1010	757	160
9	595	478	99	0.00	0.00	0.00	48	1200	872	1040	757	167
10	665	458	111	0.00	0.00	0.00	76	1200	901	1050	757	154
11	702	457	134	0.00	0.00	0.00	97	1170	954	1050	757	148
12	694	364	180	0.00	0.00	0.00	98	1160	1040	1060	757	148
13	667	294	215	0.00	0.00	0.00	95	1140	1110	1070	745	148
14	667	251	222	0.00	0.00	0.00	96	1100	1110	1070	718	147
15	730	213	207	0.00	0.00	0.00	142	1070	1100	1050	689	136
16	799	198	197	0.00	0.00	0.00	183	988	1070	1040	667	43
17	817	198	199	0.00	0.00	0.00	198	947	1030	1050	631	0.00
18	844	197	199	0.00	0.00	0.00	198	906	993	1050	612	0.00
19	858	206	198	0.00	0.00	0.00	227	811	972	1040	580	0.00
20	857	208	183	0.00	0.00	0.00	283	712	960	1020	536	0.00
21	857	196	142	0.00	0.00	0.00	359	583	962	1010	481	0.00
22	802	196	123	0.00	0.00	0.00	457	427	972	1010	446	0.00
23	757	197	123	0.00	0.00	0.00	532	358	989	999	424	0.00
24	792	197	123	0.00	0.00	0.00	547	348	1010	976	403	26
25	831	196	122	0.00	0.00	0.00	614	396	1050	967	397	43
26	878	190	124	0.00	0.00	0.00	703	474	1040	951	397	40
27	897	179	123	0.00	0.00	0.00	747	497	1040	931	377	47
28	897	177	100	0.00	0.00	0.00	772	562	1020	915	342	57
29	958	178	69	0.00	---	0.00	797	653	997	907	328	55
30	935	167	70	0.00	---	0.00	798	697	996	888	302	57
31	865	---	70	0.00	---	0.00	---	662	---	856	263	---
TOTAL	21875	10285	3974	147.00	0.00	0.00	8098.00	26711	28009	30915	18721	3014.00
MEAN	705.6	342.8	128.2	4.742	0.000	0.000	269.9	861.6	933.6	997.3	603.9	100.5
MAX	958	777	222	70	0.00	0.00	798	1200	1110	1070	831	247
MIN	352	167	50	0.00	0.00	0.00	0.00	348	647	856	263	0.00
AC-FT	43390	20400	7880	292	0.00	0.00	16060	52980	55560	61320	37130	5980

STATISTICS OF MONTHLY MEAN DATA FOR WATER YEARS 1968 - 2002, BY WATER YEAR (WY)

	MEAN	290.3	256.4	126.4	30.98	0.000	0.382	145.7	703.0	705.2	799.0	657.9	167.5
MAX	706	607	403	155	0.000	12.4	566	947	959	1032	890	305	
(WY)	2002	1975	2000	1977	1968	1972	1977	1999	1981	1981	1981	1995	
MIN	95.2	38.9	0.000	0.000	0.000	0.000	1.00	271	477	504	456	49.9	
(WY)	1990	1974	1971	1969	1968	1968	1982	1995	1983	1970	1970	1977	

SUMMARY STATISTICS

	FOR 2001 CALENDAR YEAR		FOR 2002 WATER YEAR		WATER YEARS 1968 - 2002	
ANNUAL TOTAL	147214.0		151749.00			
ANNUAL MEAN	403.3		415.8		325.8	
HIGHEST ANNUAL MEAN					443	
LOWEST ANNUAL MEAN					217	
HIGHEST DAILY MEAN	1230	May 11	1200	May 6	1230	May 11 2001
LOWEST DAILY MEAN	0.00	Jan 13	0.00	Jan 4	0.00	Dec 4 1967
ANNUAL SEVEN-DAY MINIMUM	0.00	Jan 13	0.00	Jan 4	0.00	Jan 5 1968
ANNUAL RUNOFF (AC-FT)	292000		301000		236100	
10 PERCENT EXCEEDS	860		1010		850	
50 PERCENT EXCEEDS	288		227		214	
90 PERCENT EXCEEDS	0.00		0.00		0.00	

11406890 RICHVALE CANAL AT INTAKE, NEAR OROVILLE, CA

LOCATION.—Lat 39°30'19", long 121°41'06", in SW 1/4 NW 1/4 sec.18, T.19 N., R.3 E., **Butte County**, Hydrologic Unit 18020105, on right bank, 500 ft downstream from axis of Thermalito Afterbay Dam, and 7.3 mi west of Oroville.

PERIOD OF RECORD.—April 1968 to current year.

REVISED RECORDS.—WDR CA-91-4: 1990.

GAGE.—Water-stage recorder. Datum of gage is 100.47 ft above sea level (levels by California Department of Water Resources).

REMARKS.—Canal diverts from Thermalito Afterbay (station 11406870); water is used for irrigation. See schematic diagram showing diversions and storage from **Feather River at Lake Oroville**.

COOPERATION.—Records collected by California Department of Water Resources, under general supervision of the U.S. Geological Survey, in connection with Federal Energy Regulatory Commission project no. 2100.

EXTREMES FOR PERIOD OF RECORD.—Maximum daily discharge, 511 ft³/s, May 16, 1974; no flow for many days each year.

DISCHARGE, CUBIC FEET PER SECOND, WATER YEAR OCTOBER 2001 TO SEPTEMBER 2002
DAILY MEAN VALUES

DAY	OCT	NOV	DEC	JAN	FEB	MAR	APR	MAY	JUN	JUL	AUG	SEP
1	41	322	254	168	0.00	0.00	0.00	433	257	444	384	117
2	73	329	253	164	0.00	0.00	0.00	450	258	444	373	113
3	106	330	252	160	0.00	0.00	0.00	444	259	444	369	115
4	117	330	253	166	0.00	0.00	0.00	429	309	444	368	115
5	116	330	255	168	0.00	0.00	0.00	428	329	444	369	114
6	114	330	254	168	0.00	0.00	0.00	414	340	444	369	97
7	113	329	255	182	0.00	0.00	0.00	416	355	444	358	88
8	176	316	254	202	0.00	0.00	0.00	419	380	443	354	73
9	231	282	253	209	0.00	0.00	0.00	434	388	444	354	69
10	261	265	254	215	0.00	0.00	0.00	450	389	444	353	70
11	279	265	254	219	0.00	0.00	0.00	431	396	444	354	50
12	284	265	254	218	0.00	0.00	0.00	392	399	444	354	42
13	283	265	255	218	0.00	0.00	22	364	428	428	315	43
14	285	259	255	220	0.00	0.00	56	354	461	423	288	43
15	285	255	253	220	0.00	0.00	90	321	469	418	262	42
16	324	254	253	220	0.00	0.00	133	309	468	421	254	e36
17	354	253	253	220	0.00	0.00	152	308	469	424	253	e30
18	359	253	254	220	0.00	0.00	154	309	401	424	253	e55
19	320	255	256	218	0.00	0.00	154	244	374	424	254	71
20	299	252	247	219	0.00	0.00	196	190	374	423	254	72
21	297	252	245	63	0.00	0.00	233	174	373	413	243	72
22	299	253	244	0.00	0.00	0.00	277	160	373	409	229	70
23	301	253	243	0.00	0.00	0.00	289	153	395	409	218	69
24	300	252	245	0.00	0.00	0.00	300	153	404	402	196	143
25	310	251	243	0.00	0.00	0.00	340	153	411	399	178	196
26	315	253	245	0.00	0.00	0.00	369	159	435	399	174	203
27	314	256	243	0.00	0.00	0.00	385	194	459	399	174	204
28	312	253	244	0.00	0.00	0.00	370	235	463	399	160	203
29	308	255	244	0.00	---	0.00	401	255	457	399	155	203
30	305	254	243	0.00	---	0.00	414	259	447	399	155	204
31	303	---	199	0.00	---	0.00	---	259	---	388	133	---
TOTAL	7784	8271	7709	4057.00	0.00	0.00	4335.00	9693	11720	13127	8507	3022
MEAN	251.1	275.7	248.7	130.9	0.000	0.000	144.5	312.7	390.7	423.5	274.4	100.7
MAX	359	330	256	220	0.00	0.00	414	450	469	444	384	204
MIN	41	251	199	0.00	0.00	0.00	0.00	153	257	388	133	30
AC-FT	15440	16410	15290	8050	0.00	0.00	8600	19230	23250	26040	16870	5990

STATISTICS OF MONTHLY MEAN DATA FOR WATER YEARS 1968 - 2002, BY WATER YEAR (WY)

	1968	1969	1970	1971	1972	1973	1974	1975	1976	1977	1978	1979	1980	1981	1982	1983	1984	1985	1986	1987	1988	1989	1990	1991	1992	1993	1994	1995	1996	1997	1998	1999	2000	2001	2002		
MEAN	47.40	79.70	70.67	27.13	0.000	0.224	71.20	286.7	296.4	326.1	278.3	75.39																									
MAX	251	328	297	185	0.000	6.32	201	436	400	444	397	154																									
(WY)	2002	2000	2001	2000	1969	1972	1972	1974	1979	1999	1999	1995																									
MIN	0.000	0.000	0.000	0.000	0.000	0.000	0.000	104	129	140	130	8.43																									
(WY)	1972	1969	1969	1969	1969	1969	1983	1991	1991	1991	1991	1977																									

SUMMARY STATISTICS

	FOR 2001 CALENDAR YEAR				FOR 2002 WATER YEAR				WATER YEARS 1968 - 2002			
ANNUAL TOTAL	77000.00				78225.00							
ANNUAL MEAN	211.0				214.3				131.8			
HIGHEST ANNUAL MEAN									216			
LOWEST ANNUAL MEAN									66.4			
HIGHEST DAILY MEAN	459				May 7				469			
LOWEST DAILY MEAN	0.00				Jan 20				0.00			
ANNUAL SEVEN-DAY MINIMUM	0.00				Jan 20				0.00			
ANNUAL RUNOFF (AC-FT)	152700				155200				95460			
10 PERCENT EXCEEDS	410				422				364			
50 PERCENT EXCEEDS	253				247				62			
90 PERCENT EXCEEDS	0.00				0.00				0.00			

e Estimated.

11406900 PACIFIC GAS & ELECTRIC CO. LATERAL AT INTAKE, NEAR OROVILLE, CA

LOCATION.—Lat 39°29'22", long 121°41'12", in SE 1/4 NW 1/4 sec.19, T.19 N., R.3 E., Butte County, Hydrologic Unit 18020106, on right bank, 82 ft downstream from axis of Thermalito Afterbay Dam, and 7.2 mi west of Oroville.

PERIOD OF RECORD.—April 1968 to current year.

GAGE.—Water-stage recorder. Datum of gage is 113.47 ft above sea level (levels by California Department of Water Resources).

REMARKS.—Flow regulated at outlet works from Thermalito Afterbay (station 11406870); water is used for irrigation. See schematic diagram showing diversions and storage from Feather River at Lake Oroville.

COOPERATION.—Records collected by California Department of Water Resources, under general supervision of the U.S. Geological Survey, in connection with Federal Energy Regulatory Commission project no. 2100.

EXTREMES FOR PERIOD OF RECORD.—Maximum daily discharge, 46 ft³/s, Apr. 24, 1977, May 16, 1978; no flow for many days each year.

DISCHARGE, CUBIC FEET PER SECOND, WATER YEAR OCTOBER 2001 TO SEPTEMBER 2002

DAILY MEAN VALUES

DAY	OCT	NOV	DEC	JAN	FEB	MAR	APR	MAY	JUN	JUL	AUG	SEP
1	0.00	14	1.9	1.8	0.00	0.00	0.00	30	3.0	15	19	1.8
2	3.5	7.6	1.9	0.80	0.00	0.00	0.00	28	2.8	15	19	1.8
3	5.2	3.9	1.8	0.00	0.00	0.00	0.00	25	3.3	16	19	1.8
4	5.1	4.0	1.8	0.00	0.00	0.00	0.00	21	2.9	16	19	0.61
5	3.9	8.0	1.8	0.00	0.00	0.00	0.00	20	3.6	16	19	0.00
6	3.1	11	1.8	0.00	0.00	0.00	0.00	14	4.0	16	19	0.00
7	3.0	11	2.0	0.00	0.00	0.00	0.00	9.8	3.8	16	19	0.00
8	4.2	11	2.0	0.00	0.00	0.00	0.00	16	4.4	16	16	0.00
9	4.7	11	2.0	0.00	0.00	0.00	0.00	21	13	16	13	0.00
10	11	11	2.1	0.00	0.00	0.00	0.00	21	17	16	13	0.00
11	13	11	2.3	0.00	0.00	0.00	0.00	18	17	16	14	0.00
12	11	11	2.4	0.00	0.00	0.00	0.00	17	23	17	15	0.00
13	11	8.2	2.2	0.00	0.00	0.00	0.00	16	29	18	15	0.00
14	11	4.1	4.1	0.00	0.00	0.00	0.00	13	30	18	15	0.00
15	11	4.2	6.8	0.00	0.00	0.00	0.00	4.6	30	18	14	0.00
16	6.1	4.3	6.8	0.00	0.00	0.00	0.00	2.1	27	17	14	0.00
17	2.4	4.3	4.2	0.00	0.00	0.00	0.00	2.0	25	16	14	0.00
18	2.8	4.2	1.9	0.00	0.00	0.00	0.00	1.9	24	16	14	0.00
19	2.8	2.7	1.9	0.00	0.00	0.00	0.00	1.7	24	16	14	0.00
20	2.8	1.9	1.9	0.00	0.00	0.00	0.00	1.6	21	16	14	0.00
21	2.8	1.9	1.9	0.00	0.00	0.00	0.00	1.6	16	16	14	0.00
22	2.5	1.9	2.0	0.00	0.00	0.00	0.00	1.1	13	16	13	0.00
23	2.8	1.8	1.9	0.00	0.00	0.00	0.00	1.0	13	16	13	0.00
24	3.4	1.7	1.9	0.00	0.00	0.00	4.3	1.1	14	16	7.8	0.00
25	3.3	1.8	1.9	0.00	0.00	0.00	6.8	1.6	14	17	4.0	0.00
26	11	1.9	1.8	0.00	0.00	0.00	13	1.9	14	18	3.9	0.00
27	17	1.9	1.8	0.00	0.00	0.00	14	1.8	14	19	3.5	0.00
28	16	1.9	1.8	0.00	0.00	0.00	14	1.9	15	20	2.5	0.00
29	15	1.9	1.9	0.00	---	0.00	30	3.2	15	20	1.8	0.00
30	15	1.9	1.9	0.00	---	0.00	35	4.4	15	20	2.2	0.00
31	15	---	1.8	0.00	---	0.00	---	3.7	---	19	2.0	---
TOTAL	221.40	167.0	74.2	2.60	0.00	0.00	117.10	307.0	450.8	523	385.7	6.01
MEAN	7.142	5.567	2.394	0.084	0.000	0.000	3.903	9.903	15.03	16.87	12.44	0.200
MAX	17	14	6.8	1.8	0.00	0.00	35	30	30	20	19	1.8
MIN	0.00	1.7	1.8	0.00	0.00	0.00	0.00	1.0	2.8	15	1.8	0.00
AC-FT	439	331	147	5.2	0.00	0.00	232	609	894	1040	765	12

STATISTICS OF MONTHLY MEAN DATA FOR WATER YEARS 1968 - 2002, BY WATER YEAR (WY)

MEAN	0.638	2.033	0.922	0.120	0.000	0.000	3.534	12.52	12.65	13.68	10.99	1.197
MAX	7.14	6.58	5.74	1.00	0.000	0.000	14.8	23.2	18.3	17.1	15.1	2.62
(WY)	2002	1996	2000	2000	1969	1969	1977	1975	1981	1981	1999	1972
MIN	0.000	0.000	0.000	0.000	0.000	0.000	0.000	6.55	8.40	9.37	7.12	0.000
(WY)	1969	1969	1969	1969	1969	1969	1974	1994	1998	1970	1988	1994

SUMMARY STATISTICS

FOR 2001 CALENDAR YEAR

FOR 2002 WATER YEAR

WATER YEARS 1968 - 2002

ANNUAL TOTAL	2333.28	2254.81		
ANNUAL MEAN	6.393	6.178	4.925	
HIGHEST ANNUAL MEAN			6.18	2002
LOWEST ANNUAL MEAN			3.67	1983
HIGHEST DAILY MEAN	26	May 5	35	Apr 30
LOWEST DAILY MEAN	0.00	Jan 11	0.00	Oct 1
ANNUAL SEVEN-DAY MINIMUM	0.00	Jan 11	0.00	Jan 3
ANNUAL RUNOFF (AC-FT)	4630	4470	3570	
10 PERCENT EXCEEDS	16	17	15	
50 PERCENT EXCEEDS	2.4	1.9	0.00	
90 PERCENT EXCEEDS	0.00	0.00	0.00	

11406910 SUTTER-BUTTE CANAL AT INTAKE, NEAR OROVILLE, CA

LOCATION.—Lat 39°27'01", long 121°39'27", in NW corner of Boga Fernandez Grant, T.18 N., R.3 E., [Butte County](#), Hydrologic Unit 18020105, on left bank, 675 ft downstream from Thermalito Afterbay Dam, and 6.8 mi southwest of Oroville.

PERIOD OF RECORD.—November 1967 to current year.

GAGE.—Water-stage recorder. Datum of gage is 109.97 ft above sea level (levels by California Department of Water Resources). Prior to May 1, 1970, at datum 109.50 ft lower.

REMARKS.—Water is diverted from Thermalito Afterbay and is used for irrigation. See schematic diagram showing diversions and storage from [Feather River at Lake Oroville](#).

COOPERATION.—Records collected by California Department of Water Resources, under general supervision of the U.S. Geological Survey, in connection with Federal Energy Regulatory Commission project no. 2100.

EXTREMES FOR PERIOD OF RECORD.—Maximum daily discharge, 2,110 ft³/s, Apr. 22–24, 1968; no flow for many days each year.

DISCHARGE, CUBIC FEET PER SECOND, WATER YEAR OCTOBER 2001 TO SEPTEMBER 2002
DAILY MEAN VALUES

DAY	OCT	NOV	DEC	JAN	FEB	MAR	APR	MAY	JUN	JUL	AUG	SEP
1	568	741	615	491	0.00	0.00	0.00	1710	1460	1650	1600	1030
2	554	827	618	498	0.00	0.00	0.00	1710	1470	1650	1600	1020
3	559	823	618	496	0.00	0.00	0.00	1710	1470	1650	1600	992
4	588	823	576	489	0.00	0.00	0.00	1740	1520	1680	1600	958
5	606	825	536	483	0.00	0.00	0.00	1750	1540	1680	1580	931
6	621	850	535	483	0.00	0.00	0.00	1770	1560	1680	1560	887
7	624	840	540	481	0.00	0.00	0.00	1770	1600	1660	1550	862
8	662	834	536	485	0.00	0.00	0.00	1770	1610	1650	1540	847
9	641	826	538	482	0.00	0.00	0.00	1770	1610	1660	1540	824
10	625	825	540	487	0.00	0.00	155	1780	1610	1680	1520	829
11	640	820	543	477	0.00	0.00	200	1760	1640	1680	1500	801
12	639	822	551	473	0.00	0.00	236	1650	1710	1670	1500	743
13	665	836	551	476	0.00	0.00	250	1580	1750	1680	1510	718
14	682	793	551	478	0.00	0.00	249	1530	1730	1660	1510	707
15	678	769	548	477	0.00	0.00	293	1470	1710	1650	1480	689
16	713	769	555	481	0.00	0.00	364	1490	1700	1650	1470	683
17	724	765	551	448	0.00	0.00	444	1550	1680	1640	1480	674
18	752	763	545	292	0.00	0.00	546	1590	1680	1630	1440	644
19	746	770	537	220	0.00	0.00	628	1530	1690	1630	1420	635
20	764	755	526	221	0.00	0.00	726	1390	1680	1620	1420	627
21	779	736	516	65	0.00	0.00	773	1290	1640	1620	1400	637
22	776	732	506	0.00	0.00	0.00	929	1140	1630	1640	1350	632
23	765	734	507	0.00	0.00	0.00	1100	1080	1610	1640	1310	625
24	755	733	504	0.00	0.00	0.00	1300	991	1610	1640	1290	636
25	770	735	508	0.00	0.00	0.00	1470	939	1620	1640	1270	619
26	788	733	511	0.00	0.00	0.00	1580	931	1630	1670	1250	614
27	796	689	506	0.00	0.00	0.00	1710	974	1640	1670	1220	648
28	797	644	497	0.00	0.00	0.00	1730	1010	1650	1640	1140	669
29	796	629	494	0.00	---	0.00	1710	1140	1670	1610	1100	667
30	788	619	492	0.00	---	0.00	1690	1240	1670	1610	1090	688
31	782	---	495	0.00	---	0.00	---	1350	---	1600	1050	---
TOTAL	21643	23060	16646	8983.00	0.00	0.00	18083.00	45105	48790	51130	43890	22536
MEAN	698.2	768.7	537.0	289.8	0.000	0.000	602.8	1455	1626	1649	1416	751.2
MAX	797	850	618	498	0.00	0.00	1730	1780	1750	1680	1600	1030
MIN	554	619	492	0.00	0.00	0.00	0.00	931	1460	1600	1050	614
AC-FT	42930	45740	33020	17820	0.00	0.00	35870	89470	96770	101400	87060	44700

STATISTICS OF MONTHLY MEAN DATA FOR WATER YEARS 1968 - 2002, BY WATER YEAR (WY)

	1968	1969	1970	1971	1972	1973	1974	1975	1976	1977	1978	1979	1980	1981	1982	1983	1984	1985	1986	1987	1988	1989	1990	1991	1992	1993	1994	1995	1996	1997	1998	1999	2000	2001	2002			
MEAN	403.6	192.5	147.5	56.49	21.52	86.80	530.2	1405	1393	1484	1361	731.4																										
MAX	698	769	612	384	374	571	1294	1815	1643	1709	1608	893																										
(WY)	2002	2002	2001	2001	1977	1976	1968	1975	1975	1981	1982	1995																										
MIN	77.2	0.000	0.000	0.000	0.000	0.000	0.000	519	826	834	776	283																										
(WY)	1978	1975	1971	1969	1969	1978	1983	1977	1992	1991	1991	1977																										

SUMMARY STATISTICS	FOR 2001 CALENDAR YEAR		FOR 2002 WATER YEAR		WATER YEARS 1968 - 2002	
ANNUAL TOTAL	288573.00		299866.00			
ANNUAL MEAN	790.6		821.6		653.0	
HIGHEST ANNUAL MEAN					822	
LOWEST ANNUAL MEAN					401	
HIGHEST DAILY MEAN	1730	May 11	1780	May 10	2110	Apr 22 1968
LOWEST DAILY MEAN	0.00	Jan 30	0.00	Jan 22	0.00	Jan 8 1968
ANNUAL SEVEN-DAY MINIMUM	0.00	Jan 30	0.00	Jan 22	0.00	Jan 8 1968
ANNUAL RUNOFF (AC-FT)	572400		594800		473000	
10 PERCENT EXCEEDS	1490		1660		1560	
50 PERCENT EXCEEDS	733		733		458	
90 PERCENT EXCEEDS	0.00		0.00		0.00	

11406920 THERMALITO AFTERBAY RELEASE TO FEATHER RIVER, NEAR OROVILLE, CA

LOCATION.—Lat 39°27'23", long 121°38'10", in NW 1/4 SE 1/4 sec.33, T.19 N., R.3 E., [Butte County](#), Hydrologic Unit 18020106, on left bank of outlet channel, 955 ft downstream from centerline of Thermalito Afterbay Dam, and 5.7 mi southwest of Oroville.

PERIOD OF RECORD.—November 1967 to current year.

WATER TEMPERATURE: Water years 1969–92.

GAGE.—Water-stage recorder. Datum of gage is 113.47 ft above sea level (levels by California Department of Water Resources). Prior to May 1, 1970, at datum 13.00 ft lower.

REMARKS.—Flow regulated by gates of Thermalito Afterbay outlet 955 ft upstream. See schematic diagram showing diversions and storage from [Feather River at Lake Oroville](#).

COOPERATION.—Records collected by California Department of Water Resources, under general supervision of the U.S. Geological Survey, in connection with Federal Energy Regulatory Commission project no. 2100.

EXTREMES FOR PERIOD OF RECORD.—Maximum discharge, 21,600 ft³/s, Jan. 28, 1970, gage height, 23.30 ft, datum then in use, 21,600 ft³/s, Jan. 2, 1997, gage height, 11.45 ft; no flow for many days during 1968.

DISCHARGE, CUBIC FEET PER SECOND, WATER YEAR OCTOBER 2001 TO SEPTEMBER 2002
DAILY MEAN VALUES

DAY	OCT	NOV	DEC	JAN	FEB	MAR	APR	MAY	JUN	JUL	AUG	SEP
1	583	883	583	582	582	582	582	583	1390	4870	4830	3320
2	583	880	586	581	582	580	586	589	1490	4830	4830	3320
3	582	886	585	585	579	583	579	584	1710	4830	4830	3320
4	579	884	587	581	583	581	586	585	2390	4850	4830	3370
5	574	886	581	584	581	586	584	580	2390	5600	4830	3400
6	580	881	584	583	584	587	576	582	2390	5840	4810	3390
7	579	886	581	583	585	580	581	579	2390	5840	4320	3400
8	582	883	584	586	585	592	582	579	2390	5840	4330	3400
9	582	883	586	584	593	587	584	581	2390	5840	4330	3410
10	586	886	585	585	580	582	585	582	2400	5790	4330	3410
11	784	884	587	585	574	583	581	581	2530	5740	4330	3400
12	884	886	581	586	576	585	582	580	3040	5740	4330	3400
13	884	844	584	579	584	588	575	581	3400	5820	4300	3390
14	886	640	582	585	588	590	584	582	3400	5330	3710	2900
15	886	588	583	586	585	588	584	593	3400	5330	3720	2900
16	886	582	582	585	588	580	586	1010	3400	5330	3830	2900
17	886	589	583	580	588	580	586	1720	3400	5320	3830	2900
18	883	587	581	585	591	583	588	1890	3400	4830	3840	2910
19	885	591	588	583	587	579	581	1890	3350	4830	4330	2900
20	883	584	583	578	581	581	581	1890	3290	4830	4330	2900
21	885	580	588	581	584	586	585	1690	3320	4830	4330	2890
22	884	588	591	586	580	589	582	1480	3320	4830	4320	2890
23	886	588	585	585	579	576	580	1290	3330	4830	3840	2900
24	887	584	590	584	583	578	584	1080	3240	4830	3810	2900
25	885	584	582	588	577	585	584	881	2760	4830	3260	2900
26	888	582	584	586	577	585	588	682	3390	4830	2270	2900
27	885	586	580	584	579	579	586	684	3680	4830	2320	2900
28	880	580	583	584	582	583	584	686	4680	4830	3030	2880
29	885	583	579	583	---	585	582	680	4910	4720	3310	2390
30	882	585	583	585	---	583	582	689	4910	4780	3320	2140
31	885	---	585	581	---	581	---	997	---	4830	3320	---
TOTAL	24289	21453	18106	18093	16317	18087	17490	27980	91480	160200	123950	91930
MEAN	783.5	715.1	584.1	583.6	582.8	583.5	583.0	902.6	3049	5168	3998	3064
MAX	888	886	591	588	593	592	588	1890	4910	5840	4830	3410
MIN	574	580	579	578	574	576	575	579	1390	4720	2270	2140
AC-FT	48180	42550	35910	35890	32360	35880	34690	55500	181500	317800	245900	182300

STATISTICS OF MONTHLY MEAN DATA FOR WATER YEARS 1968 - 2002, BY WATER YEAR (WY)

	1968	1969	1970	1971	1972	1973	1974	1975	1976	1977	1978	1979	1980	1981	1982	1983	1984	1985	1986	1987	1988	1989	1990	1991	1992	1993	1994	1995	1996	1997	1998	1999	2000	2001	2002			
MEAN	1927	2268	4013	4419	5262	5590	4400	3438	3153	3914	3488	2854																										
MAX	5867	11020	15120	14700	14600	16890	15410	12340	9717	8232	7043	7085																										
(WY)	1975	1974	1984	1997	1983	1983	1983	1983	1983	1999	1974	1974																										
MIN	145	336	56.7	391	345	239	207	549	337	0.13	116	398																										
(WY)	1978	1978	1968	1993	1968	1992	1992	1977	1990	1968	1968	1968																										

SUMMARY STATISTICS

	FOR 2001 CALENDAR YEAR			FOR 2002 WATER YEAR			WATER YEARS 1968 - 2002		
ANNUAL TOTAL	363810			629375					
ANNUAL MEAN	996.7			1724			3808		
HIGHEST ANNUAL MEAN							9352		
LOWEST ANNUAL MEAN							970		
HIGHEST DAILY MEAN	2910	Jun 3		5840	Jul 6		21200	Jan 28	1970
LOWEST DAILY MEAN	428	Apr 9		574	Oct 5		0.00	Nov 16	1967
ANNUAL SEVEN-DAY MINIMUM	431	Apr 9		580	Feb 22		0.00	Nov 16	1967
MAXIMUM PEAK FLOW				5900			21600		
MAXIMUM PEAK STAGE				5.13			23.30		
ANNUAL RUNOFF (AC-FT)	721600			1248000			2759000		
10 PERCENT EXCEEDS	1390			4820			9440		
50 PERCENT EXCEEDS	1010			589			2290		
90 PERCENT EXCEEDS	580			581			585		

11407000 FEATHER RIVER AT OROVILLE, CA

LOCATION.—Lat 39°31'18", long 121°32'48", in Boga Fernandez Grant, T.19 N., R.4 E., [Butte County](#), Hydrologic Unit 18020106, on right bank, 300 ft upstream from fish barrier dam on Feather River, 0.4 mi downstream from Thermalito Diversion Dam, 0.8 mi northeast of Oroville Post Office, and 4.8 mi downstream from Oroville Dam.

DRAINAGE AREA.—3,624 mi².

PERIOD OF RECORD.—October 1901 to current year. Monthly discharge only for some periods, published in WSP 1315-A. October 1934 to September 1961 published as "near Oroville."

CHEMICAL DATA: Water years 1906–07, 1951–77.

SPECIFIC CONDUCTANCE: Water years 1972–78.

WATER TEMPERATURE: Water years 1954–92.

SEDIMENT DATA: Water years 1957–79.

REVISED RECORDS.—WSP 843: 1907(M), 1909(M), 1914–15(M), 1919(M), 1927–28(M). WSP 881: 1913–28 (yearly summaries). WSP 1515: 1906–8. WSP 1931: Drainage area. WDR CA-74-2: 1968–70, adjusted monthly discharge.

GAGE.—Water-stage recorder. Datum of gage is 148.97 ft above sea level (levels by California Department of Water Resources). See WSP 1931 for history of changes prior to Oct. 1, 1964.

REMARKS.—Flow completely regulated by Lake Oroville (station 11406800), beginning November 1967, and Thermalito Diversion Pool (station 11406825), capacity 13,500 acre-ft. Diversions upstream from station for power and irrigation. Feather River Fish Hatchery (station 11406930) diverts up to 120 ft³/s at Thermalito Diversion Dam 0.4 mi upstream from gage. Daily figures shown are combined figures of river flow and diversion to fish hatchery. See schematic diagram showing diversions and storage from [Feather River at Lake Oroville](#).

COOPERATION.—Records were collected by California Department of Water Resources, under general supervision of the U.S. Geological Survey, in connection with Federal Energy Regulatory Commission project no. 2100.

EXTREMES FOR PERIOD OF RECORD.—Prior to completion of Oroville Dam: Maximum discharge observed, 230,000 ft³/s, Mar. 19, 1907, elevation, 167.5 ft above sea level, site and datum then in use, maximum discharge (since completion of Oroville Dam), 161,000 ft³/s, Jan. 2, 1997, gage height, 25.45 ft; minimum, 300 ft³/s, estimated, Nov. 9, 1931.

Combined flow (since completion of Oroville Dam): Maximum daily discharge, 132,000 ft³/s, Feb. 18, 1986; minimum daily, 222 ft³/s, Sept. 19, 1972.

EXTREMES FOR CURRENT YEAR.—River only: Maximum discharge, 1,760 ft³/s, Aug. 26, gage height, 1.69 ft; minimum daily, 508 ft³/s, Dec. 3.

Combined flow: Maximum daily discharge, 1,750 ft³/s, Aug. 26; minimum daily, 612 ft³/s, June 18.

DISCHARGE, CUBIC FEET PER SECOND, WATER YEAR OCTOBER 2001 TO SEPTEMBER 2002

DAILY MEAN VALUES

DAY	OCT	NOV	DEC	JAN	FEB	MAR	APR	MAY	JUN	JUL	AUG	SEP
1	636	626	621	620	619	628	633	625	625	655	708	695
2	631	677	622	636	618	625	634	623	625	706	710	702
3	631	622	614	618	618	625	643	623	624	706	709	703
4	633	624	619	619	619	621	639	625	626	705	710	658
5	643	623	617	618	619	625	636	624	627	704	713	633
6	633	651	618	633	618	629	634	623	627	701	714	629
7	633	634	616	623	619	628	632	625	628	708	713	628
8	633	629	617	622	620	628	630	621	628	712	715	628
9	634	630	619	627	619	624	632	618	621	709	710	633
10	633	631	619	628	618	629	630	618	620	766	706	633
11	632	632	621	629	618	626	631	616	620	799	709	632
12	633	636	623	631	619	624	626	620	621	796	714	633
13	633	631	629	631	619	627	626	622	621	708	719	629
14	633	627	634	632	620	626	625	622	623	709	863	625
15	626	623	631	635	619	628	624	623	622	709	837	625
16	636	621	632	636	619	627	624	623	623	705	720	628
17	653	625	642	638	619	626	623	621	624	705	720	626
18	634	625	630	637	620	626	620	622	612	706	719	626
19	622	628	624	639	622	626	622	622	668	706	719	623
20	622	626	629	639	619	628	620	624	695	705	718	627
21	622	628	623	638	619	633	618	624	700	705	716	624
22	622	627	621	635	620	637	618	622	701	707	722	627
23	619	624	619	631	621	641	621	622	698	704	720	625
24	618	630	619	629	619	641	619	620	698	705	718	627
25	620	625	618	629	619	639	619	619	661	705	788	626
26	617	623	620	629	620	638	621	620	616	704	1750	630
27	621	624	620	624	619	638	621	622	616	706	1670	633
28	621	629	625	624	616	635	621	621	622	711	1030	633
29	620	630	626	621	---	634	626	621	619	794	714	634
30	621	636	631	620	---	634	626	620	620	751	696	633
31	616	---	622	618	---	634	---	626	---	710	695	---
TOTAL	19481	18897	19321	19489	17334	19530	18794	19277	19131	22222	24765	19108
MEAN	628.4	629.9	623.3	628.7	619.1	630.0	626.5	621.8	637.7	716.8	798.9	636.9
MAX	653	677	642	639	622	641	643	626	701	799	1750	703
MIN	616	621	614	618	616	621	618	616	612	655	695	623
AC-FT	38640	37480	38320	38660	34380	38740	37280	38240	37950	44080	49120	37900
MEAN ^a	2282	2561	5372	6925	4675	6107	6378	4144	1909	1683	1875	2212
AC-FT ^a	140300	152400	330300	425800	259600	375500	379500	254800	113600	103500	115300	131600

^a Adjusted for unreviewed evaporation, change in contents, and diversions in and out of Lake Oroville, Thermalito Diversion Pool, Thermalito Forebay, and Thermalito Afterbay (station 11406870).

SACRAMENTO RIVER BASIN

11407000 FEATHER RIVER AT OROVILLE, CA—Continued

STATISTICS OF MONTHLY MEAN DATA FOR WATER YEARS 1902 - 1967, BY WATER YEAR (WY)

	OCT	NOV	DEC	JAN	FEB	MAR	APR	MAY	JUN	JUL	AUG	SEP
MEAN	2085	3069	5296	6790	9463	10080	12120	9930	5176	2505	1980	1792
MAX	12370	19710	28410	39860	28030	39760	30100	25150	15650	5999	3265	2883
(WY)	1963	1904	1956	1909	1904	1904	1911	1938	1911	1907	1967	1967
MIN	745	853	1102	1350	1714	1564	2146	1246	924	852	956	992
(WY)	1933	1933	1950	1947	1933	1924	1924	1924	1924	1924	1924	1924

SUMMARY STATISTICS

WATER YEARS 1902 - 1967

ANNUAL MEAN	5834
HIGHEST ANNUAL MEAN	12860 1907
LOWEST ANNUAL MEAN	1623 1924
HIGHEST DAILY MEAN	187000 Mar 19 1907
LOWEST DAILY MEAN	577 Oct 3 1932
ANNUAL SEVEN-DAY MINIMUM	652 Sep 30 1932
MAXIMUM PEAK FLOW	230000 Mar 19 1907
MAXIMUM PEAK STAGE	167.5 Mar 19 1907
ANNUAL RUNOFF (AC-FT)	4226000
10 PERCENT EXCEEDS	13300
50 PERCENT EXCEEDS	2870
90 PERCENT EXCEEDS	1470

STATISTICS OF MONTHLY MEAN DATA FOR WATER YEARS 1969 - 2002, BY WATER YEAR (WY)

MEAN	565.6	743.2	1165	2939	2213	1997	977.3	757.5	520.6	522.1	511.6	507.8
MAX	1580	3313	7728	26750	25180	18870	7064	7916	998	775	799	659
(WY)	1996	1982	1997	1997	1986	1995	1982	1995	1989	1992	2002	1999
MIN	399	397	392	401	399	404	401	387	405	404	393	389
(WY)	1969	1979	1979	1976	1978	1978	1977	1969	1974	1981	1979	1972

SUMMARY STATISTICS

FOR 2001 CALENDAR YEAR

FOR 2002 WATER YEAR

WATER YEARS 1969 - 2002

ANNUAL TOTAL	233323	237349	
ANNUAL MEAN	639.2	650.3	1115
ANNUAL MEAN a	3013	3843	b6115
HIGHEST ANNUAL MEAN			3936 1997
LOWEST ANNUAL MEAN			404 1976
HIGHEST DAILY MEAN	746 Jul 30	1750 Aug 26	132000 Feb 18 1986
LOWEST DAILY MEAN	614 May 19	612 Jun 18	222 Sep 19 1972
ANNUAL SEVEN-DAY MINIMUM	616 May 17	617 Dec 3	337 Sep 13 1972
MAXIMUM PEAK FLOW			161000 Jan 2 1997
MAXIMUM PEAK STAGE			25.45 Jan 2 1997
ANNUAL RUNOFF (AC-FT)	462800	470800	807500
ANNUAL RUNOFF (AC-FT) a	2181000	2782000	b 4430000
10 PERCENT EXCEEDS	690	709	653
50 PERCENT EXCEEDS	631	627	438
90 PERCENT EXCEEDS	620	619	402

a Adjusted for unreviewed evaporation, change in contents, and diversions in and out of Lake Oroville, Thermalito Diversion Pool, Thermalito Forebay, and Thermalito Afterbay (station 11406870).

b Includes water year 1968.

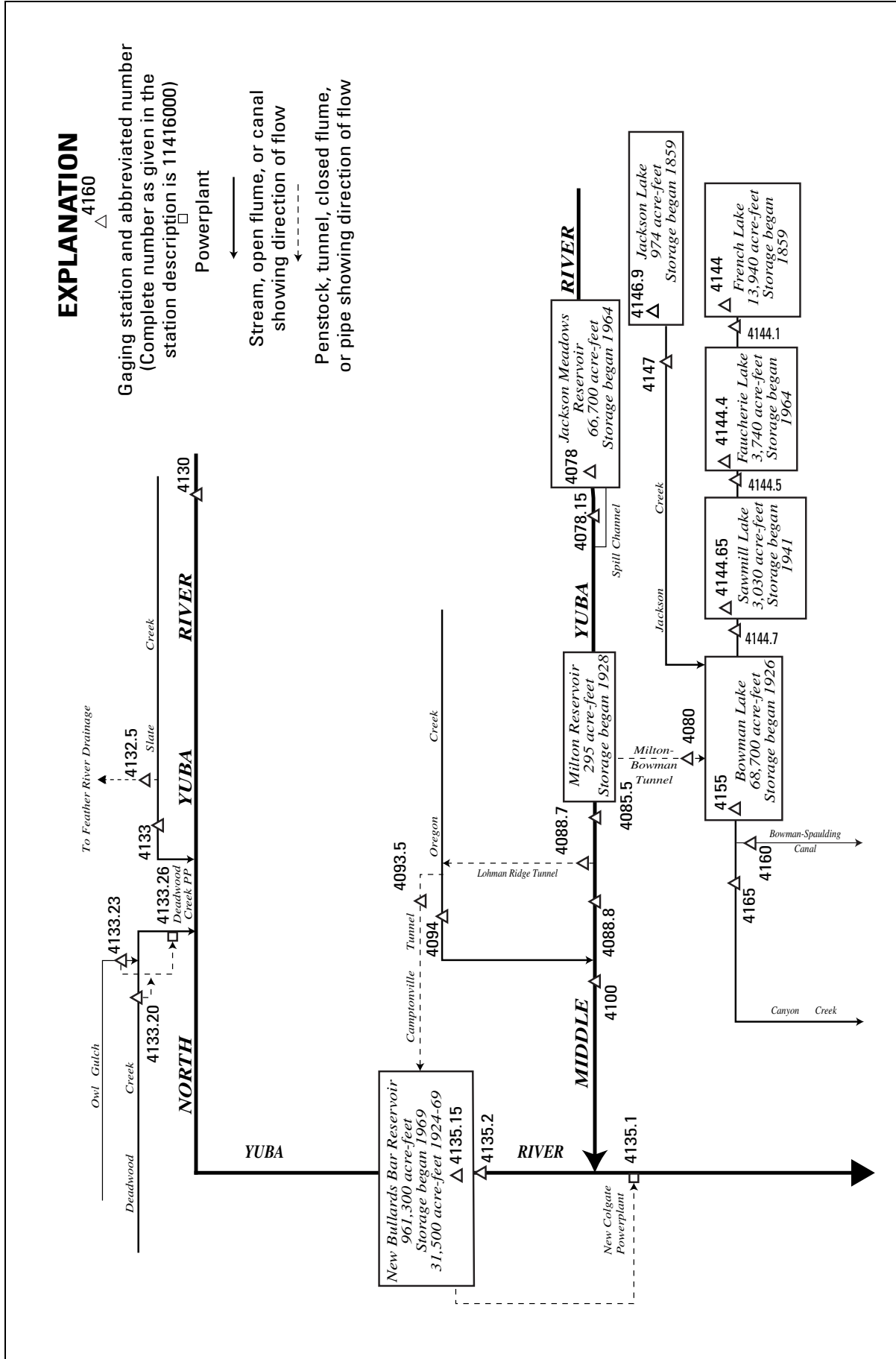

Figure 31. Diversions and storage in North and Middle Yuba River Basins.

11407800 JACKSON MEADOWS RESERVOIR NEAR SIERRA CITY, CA

LOCATION.—Lat 39°30'33", long 120°33'08", in NW 1/4 SE 1/4 sec.18, T.19 N., R.13 E., [Sierra County](#), Hydrologic Unit 18020125, Tahoe National Forest, on right bank, at Jackson Meadows Dam on Middle Yuba River, 0.7 mi downstream from Pass Creek, and 5.7 mi southeast of Sierra City.

DRAINAGE AREA.—37.6 mi².

PERIOD OF RECORD.—November 1964 to current year.

GAGE.—Water-stage recorder. Datum of gage is sea level (levels by Nevada Irrigation District).

REMARKS.—Reservoir is formed by an earthfill dam. Storage began Nov. 9, 1964. Usable capacity, 66,700 acre-ft, between elevations 5,933.0 ft, bottom of intake tower, and 6,036.0 ft, top of radial spillway gates. Dead contents, 2,500 acre-ft. Records, including extremes, represent total contents. See schematic diagram of [North and Middle Yuba River Basin](#).

COOPERATION.—Records were collected by Nevada Irrigation District, under general supervision of the U.S. Geological Survey, in connection with Federal Energy Regulatory Commission project no. 2266.

EXTREMES FOR PERIOD OF RECORD.—Maximum contents, 71,100 acre-ft, May 31 and June 1, 1993, elevation, 6,037.78 ft; minimum since reservoir first filled, 2,500 acre-ft, Sept. 27–29, 1976, elevation, 5,933.1 ft.

EXTREMES FOR CURRENT YEAR.—Maximum contents, 66,400 acre-ft, June 14–20, maximum elevation, 6,033.35 ft, June 16–18; minimum, 26,600 acre-ft, Nov. 18–20, minimum elevation, 5988.60 ft, Nov. 19.

Capacity table (elevation, in feet, and contents, in acre-feet)
(Based on table provided by Nevada Irrigation District, dated February 1965)

5,930	2,000	5,960	10,600	5,990	27,600	6,020	53,200
5,940	3,920	5,970	15,400	6,000	35,300	6,030	63,000
5,950	6,760	5,980	21,000	6,010	43,900	6,040	73,500

RESERVOIR STORAGE (ACRE-FEET), WATER YEAR OCTOBER 2001 TO SEPTEMBER 2002

DAILY OBSERVATION AT 2400 HOURS

DAY	OCT	NOV	DEC	JAN	FEB	MAR	APR	MAY	JUN	JUL	AUG	SEP
1	32600	28700	27600	28900	31400	30800	31100	46100	63800	66200	58600	50200
2	32500	28600	27900	29100	31400	30700	31400	46400	64200	66100	58400	50000
3	32400	28400	27900	29200	31400	30600	31900	46800	64500	66000	58100	49700
4	32300	28300	27900	29200	31400	30500	32500	47400	64800	65900	57800	49400
5	32200	28200	28000	29300	31500	30500	33100	48000	65100	65800	57500	49100
6	32100	28000	28000	29600	31500	30700	33700	48800	65400	65500	57200	48900
7	32000	27900	28100	29800	31600	30800	34200	49600	65700	65200	56900	48600
8	31900	27800	28100	30000	31600	30800	34800	50300	65900	65000	56600	48400
9	31900	27600	28100	30100	31700	30700	35400	50900	66000	64700	56300	48100
10	31700	27500	28100	30200	31700	30700	36100	51500	66100	64500	56100	47800
11	31600	27400	28100	30300	31700	30700	36700	52000	66200	64200	55800	47600
12	31400	27300	28100	30400	31700	30600	37500	52500	66300	64000	55600	47300
13	31300	27200	28200	30400	31800	30600	38200	53200	66300	63700	55300	47100
14	31100	27100	28200	30500	31800	30500	39400	53900	66400	63400	55000	46800
15	31000	27000	28200	30500	31700	30500	40300	54700	66400	63200	54800	46600
16	30900	26900	28300	30600	31600	30400	40900	55400	66400	62900	54500	46300
17	30700	26700	28400	30600	31400	30400	41300	56200	66400	62600	54200	46100
18	30600	26600	28400	30700	31300	30300	41600	56900	66400	62400	54000	45800
19	30400	26600	28400	30700	31300	30200	41900	57700	66400	62100	53700	45600
20	30300	26600	28400	30800	31300	30100	42100	58300	66400	61900	53400	45300
21	30200	26800	28500	30900	31300	30100	42300	58700	66300	61600	53100	45100
22	30000	27000	28500	30900	31200	30100	42500	59000	66300	61300	52900	44800
23	29900	27000	28500	30900	31200	30300	42800	59300	66200	61000	52600	44500
24	29700	27300	28500	31000	31100	30300	43300	59700	66200	60800	52300	44300
25	29600	27400	28500	31000	31100	30300	43900	60100	66200	60500	52100	44000
26	29400	27400	28600	31200	31000	30300	44400	60500	66200	60200	51800	43700
27	29300	27400	28600	31200	30900	30300	44900	61000	66200	60000	51500	43400
28	29100	27500	28600	31300	30900	30400	45200	61600	66200	59700	51200	43200
29	29000	27500	28700	31300	---	30500	45600	62100	66200	59400	51000	42900
30	29000	27500	28700	31300	---	30600	45900	62700	66200	59200	50700	42600
31	28900	---	28800	31400	---	30800	---	63300	---	58900	50500	---
MAX	32600	28700	28800	31400	31800	30800	45900	63300	66400	66200	58600	50200
MIN	28900	26600	27600	28900	30900	30100	31100	46100	63800	58900	50500	42600
a	5991.70	5989.87	5991.67	5995.02	5994.37	5994.31	6012.29	6030.32	6033.14	6025.93	6017.26	6008.59
b	-3800	-1400	+1300	+2600	-500	-100	+15100	+17400	+2900	-7300	-8400	-7900
CAL YR 2001	MAX 46800	MIN 26600	b -6000									
WTR YR 2002	MAX 66400	MIN 26600	b +9900									

a Elevation, in feet, at end of month.

b Change in contents, in acre-feet.

11407815 MIDDLE YUBA RIVER CONTROLLED RELEASE AT JACKSON MEADOWS DAM, NEAR SIERRA CITY, CA

LOCATION.—Lat 39°30'36", long 120°33'15", in NW 1/4 SE 1/4 sec.18, T.19 N., R.13 E., [Sierra County](#), Hydrologic Unit 18020125, Tahoe National Forest, in outlet structure, near right bank, below Jackson Meadows Dam on Middle Yuba River, 0.7 mi downstream from Pass Creek, and 5.7 mi southeast of Sierra City.

DRAINAGE AREA.—37.6 mi².

PERIOD OF RECORD.—July 1994 to current year.

GAGE.—Ultrasonic meter measures flow in two outlet pipes. Elevation of gage is 5,910 ft above sea level, from topographic map.

REMARKS.—Flow regulated by Jackson Meadows Reservoir (station 11407800). Flow over the spillway bypasses this station. See schematic diagram of [North and Middle Yuba River Basin](#).

COOPERATION.—Records were collected by Nevada Irrigation District, under general supervision of the U.S. Geological Survey, in connection with Federal Energy Regulatory Commission project no. 2266.

EXTREMES FOR PERIOD OF RECORD.—Maximum daily discharge, 415 ft³/s, May 23, 28, 1996; minimum daily, 7.9 ft³/s, several days November 1994.

DISCHARGE, CUBIC FEET PER SECOND, WATER YEAR OCTOBER 2001 TO SEPTEMBER 2002

DAILY MEAN VALUES

DAY	OCT	NOV	DEC	JAN	FEB	MAR	APR	MAY	JUN	JUL	AUG	SEP
1	44	70	e9.5	e9.3	9.4	99	60	66	71	14	132	124
2	44	70	e9.5	e9.3	9.4	99	60	66	71	38	131	124
3	44	70	e9.5	e9.3	9.4	99	61	66	71	61	129	124
4	44	70	e9.5	e9.3	9.4	99	61	67	71	61	129	123
5	44	70	e9.5	e9.3	9.4	99	61	67	71	93	129	123
6	44	40	e9.5	e9.3	9.4	99	61	67	66	135	129	123
7	44	70	e9.5	e9.3	9.5	99	62	67	60	135	129	123
8	44	70	e9.4	e9.3	9.5	99	62	67	60	135	128	123
9	44	70	e9.4	e9.3	9.4	99	62	68	60	135	128	123
10	62	69	e9.4	e9.3	9.4	99	62	68	60	135	128	122
11	72	69	e9.4	9.3	9.4	99	62	68	60	135	128	122
12	72	69	e9.4	9.2	9.4	99	63	68	61	134	128	122
13	72	69	e9.4	9.3	9.4	99	63	68	60	134	128	122
14	71	69	e9.4	9.4	17	99	63	68	60	134	128	122
15	71	69	e9.3	9.4	66	99	65	69	61	134	127	122
16	71	69	e9.3	9.4	100	99	65	69	61	134	127	122
17	71	69	e9.3	9.4	100	99	65	69	61	134	127	121
18	71	39	e9.3	9.4	100	99	65	69	61	134	127	121
19	71	9.5	e9.3	9.4	99	99	65	69	61	133	127	121
20	71	9.5	e9.3	9.4	99	76	65	70	60	133	127	121
21	71	9.5	e9.3	9.4	99	60	65	70	61	133	126	121
22	71	9.5	e9.3	9.4	99	60	65	70	60	133	125	120
23	71	9.5	e9.3	9.4	99	60	65	70	61	133	125	126
24	70	e9.5	e9.3	9.4	99	60	65	70	60	133	125	134
25	70	e9.5	e9.3	9.4	99	60	66	70	38	133	125	134
26	70	e9.5	e9.3	9.4	99	60	66	70	14	133	125	134
27	70	e9.5	e9.3	9.4	99	60	66	70	14	132	125	134
28	70	e9.5	e9.3	9.4	99	60	66	70	14	132	124	134
29	70	e9.5	e9.3	9.4	---	60	66	70	14	132	124	134
30	70	e9.5	e9.3	9.4	---	60	66	71	14	132	124	133
31	70	---	e9.3	9.4	---	60	---	71	---	132	124	---
TOTAL	1944	1305.0	290.4	290.0	1495.4	2617	1909	2128	1617	3739	3938	3752
MEAN	62.71	43.50	9.368	9.355	53.41	84.42	63.63	68.65	53.90	120.6	127.0	125.1
MAX	72	70	9.5	9.4	100	99	66	71	71	135	132	134
MIN	44	9.5	9.3	9.2	9.4	60	60	66	14	14	124	120
AC-FT	3860	2590	576	575	2970	5190	3790	4220	3210	7420	7810	7440

e Estimated.

11408000 MILTON-BOWMAN TUNNEL OUTLET NEAR GRANITEVILLE, CA

LOCATION.—Lat 39°27'37", long 120°36'37", in NW 1/4 NE 1/4 sec.3, T.18 N., R.12 E., Nevada County, Hydrologic Unit 18020125, on right bank, 100 ft downstream from tunnel outlet, near upper end of Bowman Lake, and 6.9 mi east of Graniteville.

PERIOD OF RECORD.—May 1928 to September 1930, February 1931 to current year. Monthly discharge only for some periods, published in WSP 1315-A. Prior to October 1962, published as "Milton-Bowman tunnel at outlet."

GAGE.—Water-stage recorder and Parshall flume. Datum of gage is 5,592.51 ft above sea level. Prior to Sept. 22, 1964, at datum 0.56 ft higher.

REMARKS.—Tunnel diverts from Middle Yuba River at Milton Reservoir, in sec.12, T.19 N., R.12 E., and discharges into Bowman Lake. Nearly the entire flow of Middle Yuba River is diverted during low and medium flows. Middle Yuba River is regulated by Jackson Meadows Reservoir (station 11407800) since November 1964. See schematic diagram of [North and Middle Yuba River Basin](#).

COOPERATION.—Records were collected by Nevada Irrigation District, under general supervision of the U.S. Geological Survey, in connection with Federal Energy Regulatory Commission project no. 2266.

EXTREMES FOR PERIOD OF RECORD.—Maximum daily discharge, 492 ft³/s, Feb. 11, 1941; minimum daily, 0.4 ft³/s, Oct. 7, 1944.

DISCHARGE, CUBIC FEET PER SECOND, WATER YEAR OCTOBER 2001 TO SEPTEMBER 2002

DAILY MEAN VALUES

DAY	OCT	NOV	DEC	JAN	FEB	MAR	APR	MAY	JUN	JUL	AUG	SEP
1	38	67	10	17	12	110	88	92	92	14	128	123
2	38	67	19	25	12	109	93	92	91	22	128	123
3	38	67	15	30	12	108	99	96	90	58	128	122
4	38	67	11	22	11	108	106	99	89	59	127	122
5	38	67	12	22	11	108	108	102	88	75	127	122
6	38	66	12	57	11	131	104	103	84	130	127	123
7	38	66	12	40	12	126	103	103	74	131	127	122
8	38	66	11	30	15	117	104	101	73	131	126	122
9	38	66	11	26	13	114	106	99	72	131	126	122
10	49	66	10	23	12	114	113	98	72	130	126	122
11	68	69	10	21	12	112	109	95	71	130	126	121
12	68	68	9.8	20	13	112	110	96	71	130	126	121
13	68	68	9.8	19	13	112	111	98	70	130	126	121
14	67	67	12	18	14	110	118	99	70	132	125	121
15	68	66	9.6	17	48	110	116	99	69	130	130	121
16	67	65	9.4	17	100	110	102	99	69	130	126	121
17	67	65	12	16	102	109	97	99	69	129	125	120
18	67	52	10	16	101	108	92	99	69	130	125	120
19	67	9.9	9.8	15	105	108	89	97	68	129	125	120
20	67	7.1	11	15	121	93	88	99	68	129	125	120
21	67	13	10	15	115	71	87	96	67	129	125	119
22	67	28	11	14	113	72	88	95	67	129	125	119
23	67	12	10	13	114	75	91	93	67	129	124	122
24	67	25	9.6	13	112	73	95	93	67	128	124	133
25	67	16	9.5	13	111	72	101	93	57	128	124	132
26	67	11	9.7	15	111	72	104	93	20	128	124	132
27	67	9.4	9.8	13	111	73	101	93	18	128	124	132
28	67	9.2	11	13	111	74	96	93	17	128	123	132
29	67	10	12	12	---	78	97	93	16	128	123	132
30	73	8.4	13	12	---	82	94	93	15	128	123	132
31	68	---	21	12	---	85	---	93	---	128	123	---
TOTAL	1809	1344.0	353.0	611	1648	3056	3010	2993	1930	3591	3891	3714
MEAN	58.35	44.80	11.39	19.71	58.86	98.58	100.3	96.55	64.33	115.8	125.5	123.8
MAX	73	69	21	57	121	131	118	103	92	132	130	133
MIN	38	7.1	9.4	12	11	71	87	92	15	14	123	119
AC-FT	3590	2670	700	1210	3270	6060	5970	5940	3830	7120	7720	7370

11408000 MILTON-BOWMAN TUNNEL OUTLET NEAR GRANITEVILLE, CA—Continued

STATISTICS OF MONTHLY MEAN DATA FOR WATER YEARS 1928 - 1964, BY WATER YEAR (WY)

	OCT	NOV	DEC	JAN	FEB	MAR	APR	MAY	JUN	JUL	AUG	SEP
MEAN	8.00	14.6	31.4	35.3	51.6	72.9	176	242	142	28.6	6.77	3.88
MAX	101	65.4	118	124	143	213	294	414	272	90.9	26.8	10.1
(WY)	1963	1951	1956	1942	1963	1940	1936	1937	1933	1938	1952	1952
MIN	.50	.50	.70	1.00	4.28	9.19	19.7	45.6	24.8	4.21	2.06	1.00
(WY)	1931	1931	1931	1931	1931	1933	1938	1936	1934	1939	1964	1931

SUMMARY STATISTICS

WATER YEARS 1928 - 1964

ANNUAL MEAN	67.9
HIGHEST ANNUAL MEAN	97.2 1930
LOWEST ANNUAL MEAN	33.5 1949
HIGHEST DAILY MEAN	492 Feb 11 1941
LOWEST DAILY MEAN	.40 Oct 7 1944
ANNUAL SEVEN-DAY MINIMUM	.50 Oct 1 1930
ANNUAL RUNOFF (AC-FT)	49180
10 PERCENT EXCEEDS	220
50 PERCENT EXCEEDS	20
90 PERCENT EXCEEDS	3.0

STATISTICS OF MONTHLY MEAN DATA FOR WATER YEARS 1966 - 2002, BY WATER YEAR (WY)

	1966	1967	1968	1969	1970	1971	1972	1973	1974	1975	1976	1977	1978	1979	1980	1981	1982	1983	1984	1985	1986	1987	1988	1989	1990	1991	1992	1993	1994	1995	1996	1997	1998	1999	2000	2001	2002
MEAN	148.4	121.3	54.96	35.74	39.45	62.09	60.71	97.59	80.98	68.09	89.81	150.2																									
MAX	310	368	357	211	197	265	225	333	280	174	253	300																									
(WY)	1981	1973	1973	1985	1985	1986	1999	1969	1998	1976	1968	1974																									
MIN	1.52	1.34	1.25	1.17	1.20	1.68	5.38	7.69	5.23	3.95	2.20	1.72																									
(WY)	1977	1977	1977	1977	1977	1977	1977	1986	1976	1977	1993	1981																									

SUMMARY STATISTICS

FOR 2001 CALENDAR YEAR

FOR 2002 WATER YEAR

WATER YEARS 1966 - 2002

ANNUAL TOTAL	18133.3	27950.0	
ANNUAL MEAN	49.68	76.58	84.23
HIGHEST ANNUAL MEAN			133 1998
LOWEST ANNUAL MEAN			14.5 1977
HIGHEST DAILY MEAN	168 Mar 25	133 Sep 24	438 Nov 4 1972
LOWEST DAILY MEAN	6.5 Jan 17	7.1 Nov 20	1.1 Dec 11 1976
ANNUAL SEVEN-DAY MINIMUM	6.6 Jan 15	9.9 Dec 21	1.1 Dec 26 1976
ANNUAL RUNOFF (AC-FT)	35970	55440	61020
10 PERCENT EXCEEDS	106	128	253
50 PERCENT EXCEEDS	38	88	28
90 PERCENT EXCEEDS	7.0	12	5.6

11408550 MIDDLE YUBA RIVER BELOW MILTON DAM, NEAR SIERRA CITY, CA

LOCATION.—Lat 39°31'19", long 120°34'57", in SW 1/4 SW 1/4 sec.12, T.19 N., R.12 E., [Sierra County](#), Hydrologic Unit 18020125, Tahoe National Forest, on right bank, 350 ft downstream from Milton Dam, and 4.1 mi southeast of Sierra City.

DRAINAGE AREA.—39.9 mi².

PERIOD OF RECORD.—October 1987 to current year. Unpublished records for water years 1965–87 available in files of the U.S. Geological Survey.

REVISED RECORDS.—WDR CA-88-4: Drainage area.

GAGE.—Water-stage recorder, sharp-crested weir, and crest-stage gage. Elevation of gage is 5,690 ft above sea level, from topographic map. Prior to October 1987, nonrecording gage 450 ft downstream at different datum.

REMARKS.—Middle Yuba River is regulated by Jackson Meadows Reservoir (station 11407800) since November 1964 and Milton Reservoir. Tunnel diverts from Middle Yuba River at Milton Dam, in sec.12, T.19 N., R.12 E., and discharges into Bowman Lake via Milton–Bowman Tunnel (station 11408000). Practically the entire flow of Middle Yuba River is diverted during low and medium flows. See schematic diagram of [North and Middle Yuba River Basins](#).

COOPERATION.—Records were collected by Nevada Irrigation District, under general supervision of the U.S. Geological Survey, in connection with Federal Energy Regulatory Commission project no. 2266.

EXTREMES FOR PERIOD OF RECORD.—Maximum discharge, 8,610 ft³/s, Jan. 2, 1997, gage height, 17.1 ft, from floodmarks; minimum daily, 0.77 ft³/s, Nov. 3, 1990.

DISCHARGE, CUBIC FEET PER SECOND, WATER YEAR OCTOBER 2001 TO SEPTEMBER 2002

DAILY MEAN VALUES

DAY	OCT	NOV	DEC	JAN	FEB	MAR	APR	MAY	JUN	JUL	AUG	SEP
1	3.7	e3.7	3.4	3.4	3.5	3.7	3.6	3.5	3.4	3.5	3.7	3.8
2	3.7	3.7	3.6	3.6	3.5	3.7	3.6	3.5	3.4	3.5	3.7	3.8
3	3.7	3.7	3.4	3.5	3.5	3.7	3.6	3.5	3.4	3.7	3.7	3.8
4	3.7	3.6	3.4	3.5	3.5	3.7	3.6	3.5	3.4	3.7	3.7	3.8
5	3.7	3.7	3.4	3.5	3.5	3.7	3.6	3.5	3.4	3.7	3.7	3.8
6	3.7	3.7	3.4	3.7	3.5	3.9	3.6	3.5	3.4	3.8	3.7	3.8
7	3.7	3.7	3.4	3.6	3.5	3.8	3.6	3.5	3.3	3.8	3.7	3.8
8	3.7	3.6	3.4	3.5	3.5	3.7	3.6	3.5	3.3	3.8	3.7	3.8
9	3.7	3.6	3.4	3.5	3.5	3.7	3.6	3.4	3.3	3.8	3.7	3.8
10	3.8	3.6	3.4	3.5	3.5	3.7	3.6	3.4	3.3	3.8	3.7	3.8
11	3.8	3.7	3.3	3.5	3.5	3.7	3.6	3.4	3.3	3.8	3.7	3.8
12	3.8	3.7	3.4	3.5	3.5	3.7	3.6	3.4	3.3	3.8	3.7	3.8
13	3.8	3.7	3.4	3.5	3.5	3.7	3.6	3.4	3.3	3.2	3.7	3.8
14	3.8	3.7	3.4	3.5	3.5	3.7	3.6	3.4	3.3	2.2	3.7	3.8
15	3.8	3.7	3.4	3.5	3.6	3.7	3.6	3.4	3.3	3.8	3.7	3.8
16	3.8	3.6	3.4	3.5	3.7	3.7	3.6	3.4	3.3	3.8	3.7	3.8
17	3.8	3.6	3.4	3.5	3.7	3.7	3.6	3.4	3.3	3.8	3.7	3.7
18	3.7	3.5	3.4	3.5	3.7	3.7	3.5	3.4	3.3	3.8	3.7	3.7
19	3.7	3.4	3.4	3.5	3.8	3.7	3.5	3.4	4.0	3.8	3.7	3.8
20	3.8	3.4	3.4	3.5	3.8	3.6	3.5	3.5	3.7	3.8	3.7	3.8
21	3.7	3.6	3.4	3.5	3.8	3.6	3.5	3.5	3.7	3.8	3.7	3.8
22	3.7	3.6	3.4	3.5	3.8	3.6	3.5	3.4	3.7	3.8	3.7	3.8
23	3.7	3.4	3.4	3.5	3.8	3.6	3.5	3.4	3.7	3.8	3.7	3.8
24	3.7	3.6	3.4	3.5	3.8	3.6	3.5	3.4	3.7	3.8	3.7	3.8
25	3.7	3.4	3.4	3.5	3.7	3.6	3.5	3.4	3.6	3.8	3.7	3.8
26	3.7	3.4	3.4	3.5	3.7	3.6	3.6	3.4	3.6	3.8	3.7	3.8
27	3.7	3.4	3.4	3.5	3.7	3.6	3.5	3.4	3.5	3.8	3.7	3.8
28	e3.7	3.4	3.4	3.5	3.7	3.6	3.5	3.4	3.5	3.8	3.8	3.8
29	e3.7	3.4	3.4	3.5	---	3.6	3.5	3.4	3.5	3.8	3.8	3.8
30	e3.7	3.3	3.5	3.5	---	3.6	3.5	3.4	3.5	3.8	3.8	3.8
31	e3.7	---	3.5	3.5	---	3.6	---	3.4	---	3.7	3.8	---
TOTAL	115.6	107.1	105.7	108.8	101.3	113.8	106.8	106.4	103.7	114.6	115.1	113.8
MEAN	3.729	3.570	3.410	3.510	3.618	3.671	3.560	3.432	3.457	3.697	3.713	3.793
MAX	3.8	3.7	3.6	3.7	3.8	3.9	3.6	3.5	4.0	3.8	3.8	3.8
MIN	3.7	3.3	3.3	3.4	3.5	3.6	3.5	3.4	3.3	2.2	3.7	3.7
AC-FT	229	212	210	216	201	226	212	211	206	227	228	226

e Estimated.

11408550 MIDDLE YUBA RIVER BELOW MILTON DAM, NEAR SIERRA CITY, CA—Continued

STATISTICS OF MONTHLY MEAN DATA FOR WATER YEARS 1988 - 2002, BY WATER YEAR (WY)

	OCT	NOV	DEC	JAN	FEB	MAR	APR	MAY	JUN	JUL	AUG	SEP
MEAN	4.022	3.758	3.592	44.96	22.21	9.321	34.38	102.7	86.06	17.97	3.887	3.869
MAX	7.02	4.94	4.24	620	195	61.3	213	723	631	119	5.36	4.68
(WY)	1994	1994	2001	1997	1993	1995	1996	1995	1995	1995	1993	1993
MIN	3.39	3.21	3.26	3.24	3.19	3.45	3.09	3.16	3.38	3.37	3.39	3.42
(WY)	2001	1996	1989	1996	1989	1990	1994	2000	1990	1988	1995	1990

SUMMARY STATISTICS	FOR 2001 CALENDAR YEAR	FOR 2002 WATER YEAR	WATER YEARS 1988 - 2002
ANNUAL TOTAL	1508.2	1312.7	
ANNUAL MEAN	4.132	3.596	28.06
HIGHEST ANNUAL MEAN			146 1995
LOWEST ANNUAL MEAN			3.53 1990
HIGHEST DAILY MEAN	5.1 Mar 25	4.0 Jun 19	6860 Jan 2 1997
LOWEST DAILY MEAN	3.3 Nov 30	2.2 Jul 14	0.77 Nov 3 1990
ANNUAL SEVEN-DAY MINIMUM	3.4 Nov 25	3.3 Jun 7	1.8 Apr 9 1994
MAXIMUM PEAK FLOW		49 Jun 19	8610 Jan 2 1997
MAXIMUM PEAK STAGE		5.81 Jun 19	17.10 Jan 2 1997
ANNUAL RUNOFF (AC-FT)	2990	2600	20330
10 PERCENT EXCEEDS	4.8	3.8	5.1
50 PERCENT EXCEEDS	4.0	3.6	3.8
90 PERCENT EXCEEDS	3.4	3.4	3.3

11408870 LOHMAN RIDGE TUNNEL AT INTAKE, NEAR CAMPTONVILLE, CA

LOCATION.—Lat 39°24'25", long 120°59'43", in SW 1/4 NE 1/4 sec.20, T.18 N., R.8 E., [Sierra County](#), Hydrologic Unit 18020125, Tahoe National Forest, at tunnel intake at Our House Dam, and 4.0 mi southeast of Camptonville.

PERIOD OF RECORD.—October 1988 to current year. Records of monthly diversion published with "Middle Yuba River below Our House Dam, near Camptonville" (station 11408880), for water years 1969–88.

GAGE.—Water-stage recorder. Datum of gage is 2,014.77 ft above sea level.

REMARKS.—Records good. Tunnel diverts water from Middle Yuba River to New Bullards Bar Reservoir (station 11413515) for power development. See schematic diagram of [North and Middle Yuba River Basins](#).

EXTREMES FOR PERIOD OF RECORD.—Maximum daily discharge, 839 ft³/s, Mar. 25, 1989; no flow for many days in most years.

DISCHARGE, CUBIC FEET PER SECOND, WATER YEAR OCTOBER 2001 TO SEPTEMBER 2002

DAILY MEAN VALUES

DAY	OCT	NOV	DEC	JAN	FEB	MAR	APR	MAY	JUN	JUL	AUG	SEP
1	0.00	4.1	132	593	118	302	473	263	199	23	2.2	0.16
2	0.00	0.33	528	642	113	272	503	240	177	22	e3.0	0.15
3	0.00	0.02	379	763	109	240	552	243	155	20	e2.6	0.16
4	0.00	0.00	192	542	105	220	594	266	141	20	e2.8	0.11
5	0.00	0.00	181	417	104	210	609	293	130	19	e2.6	0.02
6	0.00	0.00	256	729	103	539	545	315	123	15	e2.4	0.05
7	0.00	0.00	240	746	116	780	521	331	117	15	e2.1	0.21
8	0.00	0.00	181	589	266	705	504	321	104	14	e0.63	0.24
9	0.00	0.00	164	483	188	540	510	301	91	14	e0.38	0.20
10	0.00	0.00	136	411	168	536	552	288	79	12	e0.88	0.13
11	0.00	0.39	114	358	160	484	535	249	71	11	e0.70	0.09
12	0.00	22	99	319	159	453	517	237	65	11	e0.52	0.07
13	0.00	61	90	285	164	423	502	247	59	10	e0.52	0.06
14	0.00	22	154	256	165	380	529	258	56	10	e0.31	0.05
15	0.00	3.9	122	222	167	350	582	271	50	8.8	e0.22	0.04
16	0.00	0.47	101	202	167	330	460	272	53	6.3	e0.14	0.04
17	0.00	0.13	331	191	197	315	410	269	57	7.2	e0.12	0.09
18	0.00	0.0	278	180	183	290	365	273	53	7.0	e0.09	0.10
19	0.00	0.00	185	171	285	270	315	268	51	7.2	e0.08	0.06
20	0.00	0.00	192	160	803	265	294	307	48	6.1	e0.05	0.01
21	0.00	41	185	159	763	261	269	251	45	5.1	e0.09	0.00
22	0.00	377	197	153	603	292	274	224	42	4.4	e0.12	0.00
23	0.00	119	225	136	548	441	280	211	40	3.3	0.12	0.00
24	0.00	239	179	128	465	530	290	205	37	2.6	0.13	0.00
25	0.00	236	150	123	400	467	308	195	34	1.7	0.18	0.00
26	0.00	108	131	210	361	411	351	196	32	1.2	0.19	0.00
27	0.00	72	140	205	342	390	359	199	29	1.1	0.19	0.00
28	0.00	59	192	167	326	388	314	204	28	0.88	0.15	0.00
29	0.00	98	342	145	---	427	298	207	26	0.65	0.13	0.06
30	9.2	86	380	131	---	454	288	212	25	0.42	0.13	0.39
31	23	---	778	124	---	454	---	210	---	1.1	0.14	---
TOTAL	32.20	1549.34	6954	9940	7648	12419	12903	7826	2217	281.05	23.91	2.49
MEAN	1.039	51.64	224.3	320.6	273.1	400.6	430.1	252.5	73.90	9.066	0.771	0.083
MAX	23	377	778	763	803	780	609	331	199	23	3.0	0.39
MIN	0.00	0.00	90	123	103	210	269	195	25	0.42	0.05	0.00
AC-FT	64	3070	13790	19720	15170	24630	25590	15520	4400	557	47	4.9

STATISTICS OF MONTHLY MEAN DATA FOR WATER YEARS 1989 - 2002, BY WATER YEAR (WY)

MEAN	10.23	38.62	122.0	213.1	311.9	392.5	430.9	314.7	170.0	55.86	9.952	4.899
MAX	51.4	112	486	509	649	644	688	701	503	269	41.4	23.6
(WY)	1990	1997	1997	1995	1998	1993	1995	1996	1993	1995	1998	1998
MIN	0.000	1.42	1.36	0.66	16.6	206	182	38.0	8.47	0.22	0.000	0.000
(WY)	1989	1991	1991	1997	1991	1997	1994	1995	2001	2001	1992	1992

SUMMARY STATISTICS	FOR 2001 CALENDAR YEAR		FOR 2002 WATER YEAR		WATER YEARS 1989 - 2002	
ANNUAL TOTAL	33102.86		61795.99			
ANNUAL MEAN	90.69		169.3		171.9	
HIGHEST ANNUAL MEAN					305	
LOWEST ANNUAL MEAN					71.7	
HIGHEST DAILY MEAN	778	Dec 31	803	Feb 20	839	Mar 25 1989
LOWEST DAILY MEAN	0.00	Jul 11	0.00	Oct 1	0.00	Oct 1 1988
ANNUAL SEVEN-DAY MINIMUM	0.00	Jul 11	0.00	Oct 1	0.00	Oct 1 1988
ANNUAL RUNOFF (AC-FT)	65660		122600		124600	
10 PERCENT EXCEEDS	280		469		546	
50 PERCENT EXCEEDS	23		117		50	
90 PERCENT EXCEEDS	0.00		0.00		0.00	

e Estimated.

11408880 MIDDLE YUBA RIVER BELOW OUR HOUSE DAM, NEAR CAMPTONVILLE, CA

LOCATION.—Lat 39°24'42", long 120°59'49", in SW 1/4 NW 1/4 sec.20, T.18 N., R.9 E., Sierra County, Hydrologic Unit 18020125, Tahoe National Forest, on right bank, 300 ft downstream from Our House Dam, and 4.0 mi southeast of Camptonville.

DRAINAGE AREA.—145 mi².

PERIOD OF RECORD.—October 1968 to current year.

GAGE.—Water-stage recorder, sharp-crested weir since Oct. 16, 1990, and crest-stage gage. Datum of gage is 1,957.51 ft above sea level. Prior to Nov. 4, 1970, water-stage recorder at datum 10 ft higher. Prior to Oct. 1, 1987, at site 75 ft downstream.

REMARKS.—Records good. Natural flow of stream affected by Jackson Meadows Reservoir (station 11407800), Milton–Bowman Tunnel (station 11408000), which diverts upstream from station to Bowman Lake (station 11415500), and Lohman Ridge Tunnel (station 11408870), which diverts 300 ft upstream to Oregon Creek and then to New Bullards Bar Reservoir (station 11413515) via Camptonville Tunnel (station 11409350). Other small diversions upstream from station. See schematic diagram of [North and Middle Yuba River Basins](#).

EXTREMES FOR PERIOD OF RECORD.—Maximum discharge, 27,500 ft³/s, Jan. 2, 1997, gage height, 30.7 ft, from floodmark, present datum, from rating curve extended above 8,600 ft³/s, on basis of theoretical rating of Our House Dam spillway; minimum daily, 2.1 ft³/s, Jan. 10, 1982.

DISCHARGE, CUBIC FEET PER SECOND, WATER YEAR OCTOBER 2001 TO SEPTEMBER 2002
DAILY MEAN VALUES

DAY	OCT	NOV	DEC	JAN	FEB	MAR	APR	MAY	JUN	JUL	AUG	SEP
1	24	31	38	45	40	42	36	54	55	38	35	30
2	24	30	98	85	39	42	36	54	54	38	34	30
3	24	30	42	135	39	41	36	54	54	38	34	30
4	24	28	39	44	39	41	36	54	54	36	33	29
5	24	28	39	42	39	41	36	55	e54	37	33	29
6	24	28	40	224	39	138	36	55	e54	40	33	29
7	25	28	40	82	40	226	35	55	54	39	33	30
8	25	28	39	44	42	69	35	55	e53	38	35	30
9	25	27	39	43	41	45	34	55	e53	38	34	30
10	25	27	38	41	40	45	36	54	e53	38	33	30
11	24	29	37	41	40	45	35	53	e53	38	33	30
12	24	34	36	41	40	44	35	53	53	38	33	29
13	24	39	36	40	40	44	44	54	53	38	33	29
14	24	37	37	40	41	43	52	54	53	38	33	29
15	24	38	36	40	41	43	53	54	53	38	33	29
16	24	36	36	39	41	42	52	54	46	38	32	29
17	24	35	40	39	41	38	52	54	40	38	32	29
18	24	33	38	38	41	34	51	54	40	38	31	30
19	24	32	37	36	42	33	51	55	40	38	32	29
20	24	31	41	40	420	33	52	54	40	38	31	28
21	24	35	40	40	107	34	52	53	39	38	31	28
22	24	42	40	40	46	34	52	53	39	38	32	28
23	25	38	40	40	45	36	52	53	39	38	32	28
24	25	41	37	40	44	36	52	55	39	38	32	28
25	25	41	35	40	43	36	54	55	39	38	32	28
26	24	38	39	41	43	35	56	55	39	38	32	28
27	24	36	39	41	43	35	55	56	39	38	31	28
28	25	33	40	40	43	35	55	56	39	38	31	28
29	25	34	41	40	---	35	54	56	38	38	30	29
30	29	38	42	40	---	36	55	56	38	39	31	30
31	31	---	243	40	---	36	---	55	---	37	30	---
TOTAL	765	1005	1462	1621	1599	1517	1370	1687	1397	1178	1004	871
MEAN	24.68	33.50	47.16	52.29	57.11	48.94	45.67	54.42	46.57	38.00	32.39	29.03
MAX	31	42	243	224	420	226	56	56	55	40	35	30
MIN	24	27	35	36	39	33	34	53	38	36	30	28
AC-FT	1520	1990	2900	3220	3170	3010	2720	3350	2770	2340	1990	1730

STATISTICS OF MONTHLY MEAN DATA FOR WATER YEARS 1969 - 2002, BY WATER YEAR (WY)

	31.05	73.29	155.2	354.4	232.5	227.4	151.0	208.9	114.3	33.79	30.22	29.91
MEAN	31.05	73.29	155.2	354.4	232.5	227.4	151.0	208.9	114.3	33.79	30.22	29.91
MAX	52.7	462	1040	2973	1521	1228	1368	1697	994	49.6	42.1	39.6
(WY)	1983	1982	1982	1997	1986	1995	1982	1995	1995	1983	1984	1986
MIN	16.6	20.4	20.7	7.10	28.0	31.3	33.9	32.5	28.8	17.5	13.0	14.3
(WY)	1978	1978	1987	1987	1977	1976	1970	1970	1977	1977	1977	1977

SUMMARY STATISTICS	FOR 2001 CALENDAR YEAR		FOR 2002 WATER YEAR		WATER YEARS 1969 - 2002	
ANNUAL TOTAL	13795		15476			
ANNUAL MEAN	37.79		42.40		136.6	
HIGHEST ANNUAL MEAN					481	
LOWEST ANNUAL MEAN					26.3	
HIGHEST DAILY MEAN	243		420		21000	
LOWEST DAILY MEAN	23		24		2.1	
ANNUAL SEVEN-DAY MINIMUM	24		24		3.2	
MAXIMUM PEAK FLOW			626		27500	
MAXIMUM PEAK STAGE			19.97		30.70	
ANNUAL RUNOFF (AC-FT)	27360		30700		98950	
10 PERCENT EXCEEDS	54		54		139	
50 PERCENT EXCEEDS	37		38		35	
90 PERCENT EXCEEDS	24		28		26	

e Estimated.

11409350 CAMPTONVILLE TUNNEL AT INTAKE, NEAR CAMPTONVILLE, CA

LOCATION.—Lat 39°26'25", long 121°03'30", in NW 1/4 SW 1/4 sec.11, T.18 N., R.8 E., [Yuba County](#), Hydrologic Unit 18020125, Tahoe National Forest, at tunnel intake, at Log Cabin Dam, 1.0 mi southwest of town of Camptonville.

PERIOD OF RECORD.—October 1988 to current year. Records of monthly diversion published with "Oregon Creek below Log Cabin Dam, near Camptonville" (station 11409400) for water years 1969–88.

GAGE.—Water-stage recorder. Datum of gage is 1,952.00 ft above sea level (from contractor's drawings).

REMARKS.—Records good. Water is diverted to Oregon Creek from the Middle Yuba River through Lohman Ridge Tunnel (station 11408870) 1,000 ft upstream. Camptonville Tunnel diverts water from Oregon Creek to New Bullards Bar Reservoir (station 11413515) for power development. See schematic diagram of [North and Middle Yuba River Basins](#).

EXTREMES FOR PERIOD OF RECORD.—Maximum daily discharge, 1,090 ft³/s, Mar. 25, 1989, Feb. 3, 1998; no flow for many days each year.

DISCHARGE, CUBIC FEET PER SECOND, WATER YEAR OCTOBER 2001 TO SEPTEMBER 2002

DAILY MEAN VALUES

DAY	OCT	NOV	DEC	JAN	FEB	MAR	APR	MAY	JUN	JUL	AUG	SEP
1	0.00	2.4	128	784	e140	413	605	325	205	21	0.00	0.00
2	0.00	0.00	644	846	e136	373	630	298	175	19	0.00	0.00
3	0.00	0.00	513	999	e132	335	668	297	147	17	0.00	0.00
4	0.00	0.00	238	745	e130	313	701	316	131	16	0.00	0.00
5	0.00	0.00	207	607	e129	299	713	343	122	16	0.00	0.00
6	0.00	0.00	379	914	e127	672	658	366	116	12	0.00	0.00
7	0.00	0.00	337	883	e190	1010	633	384	107	11	0.00	0.00
8	0.00	0.00	216	761	365	897	613	372	95	11	0.00	0.00
9	0.00	0.00	177	658	245	727	615	348	83	9.8	0.00	0.00
10	0.00	0.00	145	574	205	720	652	332	73	8.1	0.00	0.00
11	0.00	0.00	118	499	e190	673	639	293	65	6.6	0.00	0.00
12	0.00	17	99	449	189	633	619	275	59	6.1	0.00	0.00
13	0.00	64	86	408	193	594	600	284	53	5.0	0.00	0.00
14	0.00	20	160	368	196	536	618	293	49	3.5	0.00	0.00
15	0.00	2.3	122	330	200	492	668	304	45	2.6	0.00	0.00
16	0.00	0.00	96	289	202	463	555	305	47	1.0	0.00	0.00
17	0.00	0.00	485	256	267	439	505	300	51	1.6	0.00	0.00
18	0.00	0.00	424	227	239	404	448	304	49	1.4	0.00	0.00
19	0.00	0.00	268	207	390	375	389	295	47	1.8	0.00	0.00
20	0.00	0.00	278	187	1050	364	366	350	44	1.0	0.00	0.00
21	0.00	33	260	185	935	357	339	302	41	0.17	0.00	0.00
22	0.00	529	276	176	778	383	340	266	38	0.00	0.00	0.00
23	0.00	125	341	152	715	583	343	240	36	0.00	0.00	0.00
24	0.00	270	243	140	631	699	350	226	33	0.00	0.00	0.00
25	0.00	303	181	133	552	637	368	209	31	0.00	0.00	0.00
26	0.00	105	152	269	499	569	414	208	29	0.00	0.00	0.00
27	0.00	64	162	286	469	537	429	212	27	0.00	0.00	0.00
28	0.00	48	246	200	445	527	381	217	25	0.00	0.00	0.00
29	0.00	87	511	168	---	563	358	222	24	0.00	0.00	0.00
30	4.8	78	545	e152	---	590	348	226	23	0.00	0.00	0.00
31	24	---	1010	e144	---	587	---	222	---	0.00	0.00	---
TOTAL	28.80	1747.70	9047	12996	9939	16764	15565	8934	2070	171.67	0.00	0.00
MEAN	0.929	58.26	291.8	419.2	355.0	540.8	518.8	288.2	69.00	5.538	0.000	0.000
MAX	24	529	1010	999	1050	1010	713	384	205	21	0.00	0.00
MIN	0.00	0.00	86	133	127	299	339	208	23	0.00	0.00	0.00
AC-FT	57	3470	17940	25780	19710	33250	30870	17720	4110	341	0.00	0.00

STATISTICS OF MONTHLY MEAN DATA FOR WATER YEARS 1989 - 2002, BY WATER YEAR (WY)

	MEAN	NOV	DEC	JAN	FEB	MAR	APR	MAY	JUN	JUL	AUG	SEP
MEAN	9.730	44.80	147.3	293.3	418.4	545.0	521.0	366.7	183.0	62.55	7.676	3.068
MAX	54.9	127	628	695	865	793	867	820	542	347	37.8	19.8
(WY)	1990	1999	1997	1995	1998	1993	1995	1996	1993	1995	1998	1998
MIN	0.000	1.28	0.83	1.16	16.7	308	173	53.2	3.95	0.000	0.000	0.000
(WY)	1989	1991	1991	1991	1991	1994	1994	1992	2001	2001	1992	1991

SUMMARY STATISTICS

	FOR 2001 CALENDAR YEAR		FOR 2002 WATER YEAR		WATER YEARS 1989 - 2002	
ANNUAL TOTAL	41330.96		77263.17			
ANNUAL MEAN	113.2		211.7		215.7	
HIGHEST ANNUAL MEAN					364	
LOWEST ANNUAL MEAN					75.7	
HIGHEST DAILY MEAN	1010	Dec 31	1050	Feb 20	1090	Mar 25 1989
LOWEST DAILY MEAN	0.00	Jun 10	0.00	Oct 1	0.00	Oct 1 1988
ANNUAL SEVEN-DAY MINIMUM	0.00	Jul 1	0.00	Oct 1	0.00	Oct 1 1988
ANNUAL RUNOFF (AC-FT)	81980		153300		156200	
10 PERCENT EXCEEDS	375		614		711	
50 PERCENT EXCEEDS	24		128		59	
90 PERCENT EXCEEDS	0.00		0.00		0.00	

e Estimated.

11409400 OREGON CREEK BELOW LOG CABIN DAM, NEAR CAMPTONVILLE, CA

LOCATION.—Lat 39°26'22", long 121°03'29", in SW 1/4 SW 1/4 sec.11, T.18 N., R.8 E., [Yuba County](#), Hydrologic Unit 18020125, Tahoe National Forest, on left bank, 500 ft downstream from Log Cabin Dam, 670 ft upstream from High Point Ravine, and 1.1 mi southwest of Camptonville.

DRAINAGE AREA.—29.1 mi².

PERIOD OF RECORD.—August 1968 to current year.

WATER TEMPERATURE: Water years 1972–79.

REVISED RECORDS.—WDR CA-81-4: 1980(M).

GAGE.—Water-stage recorder, sharp-crested weir since Nov. 13, 1990, and crest-stage gage. Datum of gage is 1,912.73 ft above sea level (levels by Yuba County Water Agency). Prior to July 24, 1973, at site 470 ft downstream at datum 8.40 ft lower. July 24, 1973, to Sept. 30, 1986, at site on right bank. Oct. 1, 1986, to Nov. 13, 1990, a sharp-crested weir was put in at same location and gage house located on left bank. The weir was deemed too shallow so a new sharp-crested weir was put in 70 ft downstream at a datum 7.24 ft lower.

REMARKS.—Records good. Lohman Ridge Tunnel (station 11408870) diverts water into the basin from the Middle Yuba River. Camptonville Tunnel (station 11409350), maximum capacity, about 1,000 ft³/s, 520 ft upstream, diverts water out of the basin to New Bullards Bar Reservoir (station 11413515); diversion began October 1968. See schematic diagram of [North and Middle Yuba River Basins](#).

EXTREMES FOR PERIOD OF RECORD.—Maximum discharge, 6,400 ft³/s, Feb. 17, 1986, gage height, 11.24 ft, datum then in use, from rating curve extended above 50 ft³/s, based on flow-over-dam computation, maximum gage height, 15.70 ft (from floodmark), Jan. 1, 1997; minimum daily, 0.34 ft³/s, Sept. 18, 1972.

DISCHARGE, CUBIC FEET PER SECOND, WATER YEAR OCTOBER 2001 TO SEPTEMBER 2002
DAILY MEAN VALUES

DAY	OCT	NOV	DEC	JAN	FEB	MAR	APR	MAY	JUN	JUL	AUG	SEP
1	2.1	11	11	15	11	13	11	13	13	9.7	5.3	2.2
2	2.0	5.8	16	20	11	12	11	13	13	9.7	6.3	2.1
3	2.0	3.4	14	36	11	12	11	14	13	9.7	6.3	2.1
4	1.9	3.1	12	15	11	12	10	14	13	9.7	6.2	2.0
5	1.9	3.1	12	14	11	12	10	14	13	9.7	6.2	1.9
6	1.9	3.0	13	17	11	15	10	14	13	9.7	6.0	2.1
7	2.1	3.0	13	16	11	29	9.9	14	13	9.7	5.8	2.2
8	2.2	3.0	12	15	12	16	9.9	14	13	9.7	5.4	2.3
9	2.2	3.0	12	14	12	15	10	14	13	9.7	3.5	2.6
10	2.3	3.0	11	14	12	15	10	14	13	9.5	4.0	2.3
11	2.2	3.5	10	13	11	14	10	14	13	9.5	3.6	2.1
12	2.2	10	10	13	11	14	9.9	13	13	9.5	3.1	2.0
13	2.2	14	10	13	12	13	12	14	13	9.5	3.1	2.0
14	2.1	11	11	12	12	13	14	14	13	9.4	2.8	1.9
15	2.1	9.2	11	12	12	12	15	14	13	9.4	2.6	1.9
16	2.1	6.8	10	e12	12	12	14	14	12	9.3	2.4	1.9
17	2.1	4.9	13	e12	12	12	14	14	12	9.3	2.3	2.0
18	2.1	4.4	13	e12	12	11	14	14	11	9.3	2.3	2.0
19	2.2	4.3	12	e12	13	10	14	14	10	9.4	2.3	2.0
20	2.2	4.1	12	e12	128	11	14	14	10	9.3	2.2	1.9
21	2.2	6.6	12	e12	17	10	14	14	10	9.1	2.3	1.8
22	2.2	16	12	12	15	11	14	14	10	8.8	2.4	1.9
23	2.3	13	12	12	15	12	14	13	10	8.1	2.5	1.8
24	2.4	14	12	11	14	12	14	13	10	6.9	2.5	1.8
25	2.4	15	11	11	14	12	14	13	9.9	6.4	2.5	1.8
26	2.4	12	11	12	13	12	14	13	9.9	5.6	2.5	1.8
27	2.4	11	11	12	13	12	14	14	9.9	5.0	2.4	1.8
28	2.4	10	12	12	13	12	14	14	9.8	4.9	2.3	1.9
29	2.5	11	13	11	---	12	14	14	9.8	4.4	2.2	1.7
30	6.2	11	13	11	---	11	13	14	9.8	4.1	2.1	1.8
31	13	---	74	11	---	11	---	14	---	3.8	2.1	---
TOTAL	82.5	233.2	431	426	462	400	372.7	427	349.1	257.8	107.5	59.6
MEAN	2.661	7.773	13.90	13.74	16.50	12.90	12.42	13.77	11.64	8.316	3.468	1.987
MAX	13	16	74	36	128	29	15	14	13	9.7	6.3	2.6
MIN	1.9	3.0	10	11	11	10	9.9	13	9.8	3.8	2.1	1.7
AC-FT	164	463	855	845	916	793	739	847	692	511	213	118

e Estimated.

SACRAMENTO RIVER BASIN

11409400 OREGON CREEK BELOW LOG CABIN DAM, NEAR CAMPTONVILLE, CA—Continued

STATISTICS OF MONTHLY MEAN DATA FOR WATER YEARS 1968 - 2002, BY WATER YEAR (WY)

	OCT	NOV	DEC	JAN	FEB	MAR	APR	MAY	JUN	JUL	AUG	SEP
MEAN	6.491	15.73	46.55	95.08	62.19	43.75	27.94	18.98	22.73	8.327	6.411	5.697
MAX	12.8	72.5	273	604	617	189	268	111	394	15.2	13.1	14.3
(WY)	1972	1982	1982	1969	1986	1969	1969	1969	1998	1983	1983	1984
MIN	1.95	2.27	1.97	4.57	3.39	7.14	8.11	8.00	4.89	1.82	1.32	1.37
(WY)	1989	1977	1977	1977	1977	1977	1986	1986	1987	1977	1977	1988

SUMMARY STATISTICS	FOR 2001 CALENDAR YEAR		FOR 2002 WATER YEAR		WATER YEARS 1968 - 2002	
ANNUAL TOTAL	3197.2		3608.4			
ANNUAL MEAN	8.759		9.886		29.88	
HIGHEST ANNUAL MEAN					128	1969
LOWEST ANNUAL MEAN					4.20	1977
HIGHEST DAILY MEAN	74	Dec 31	128	Feb 20	5340	Feb 17 1986
LOWEST DAILY MEAN	1.6	Aug 9	1.7	Sep 29	0.34	Sep 18 1972
ANNUAL SEVEN-DAY MINIMUM	1.7	Aug 7	1.8	Sep 23	0.74	Sep 18 1972
MAXIMUM PEAK FLOW			237	Feb 20	6400	Feb 17 1986
MAXIMUM PEAK STAGE			8.70	Feb 20	15.70	Jan 1 1997
ANNUAL RUNOFF (AC-FT)	6340		7160		21650	
10 PERCENT EXCEEDS	15		14		18	
50 PERCENT EXCEEDS	10		11		10	
90 PERCENT EXCEEDS	1.9		2.1		3.3	

11410000 MIDDLE YUBA RIVER NEAR NORTH SAN JUAN, CA

LOCATION.—Lat 39°23'39", long 121°05'02", in NW 1/4 SE 1/4 sec.28, T.18 N., R.8 E., Yuba County, Hydrologic Unit 18020125, Tahoe National Forest, on right bank, 100 ft downstream of State Highway 49 bridge, 400 ft downstream from Oregon Creek, and 2 mi northeast of North San Juan.

DRAINAGE AREA.—198 mi².

WATER-DISCHARGE RECORDS

PERIOD OF RECORD.—July to September 1900 (monthly discharge only, September 1900), August 1911 to March 1941, October 2000 to current year.

GAGE.—Water-stage recorder and crest-stage gage. Elevation of gage is 1,450 ft above sea level, from topographic map. July 1 to Sept. 30, 1900, and Aug. 1, 1911, to Oct. 7, 1930, nonrecording gage at site 0.5 mi downstream at different datum. Oct. 8, 1930, to Mar. 31, 1941, water-stage recorder 0.9 mi downstream at datum 1,400.62 ft above sea level.

REMARKS.—Records good. Natural flow of stream affected by storage in Milton Reservoir beginning 1928 and Jackson Meadows Reservoir (station 11407800) beginning November 1964. Milton–Bowman Tunnel (station 11408000) diverts water from Milton Reservoir to Bowman Lake (station 11415500) beginning May 1928, and Lohman Ridge Tunnel (station 11408870) diverts water to Oregon Creek and then to New Bullards Bar Reservoir (station 11413515) via Camptonville Tunnel (station 11409350) beginning October 1968. Other small diversions upstream from station. See schematic diagram of [North and Middle Yuba River Basins](#).

EXTREMES FOR PERIOD OF RECORD.—Maximum discharge 26,000 ft³/s, Mar. 25, 1928, gage height, 15.3 ft, site and datum then in use, from floodmarks, from rating curve extended above 1,200 ft³/s; minimum daily, 14 ft³/s, Aug. 27, 28, 1931.

DISCHARGE, CUBIC FEET PER SECOND, WATER YEAR OCTOBER 2001 TO SEPTEMBER 2002

DAILY MEAN VALUES

DAY	OCT	NOV	DEC	JAN	FEB	MAR	APR	MAY	JUN	JUL	AUG	SEP
1	30	44	62	134	66	76	71	82	77	48	43	34
2	29	41	248	174	65	74	70	81	77	48	42	33
3	29	38	108	412	65	72	68	80	75	46	43	33
4	29	37	64	110	64	70	67	80	73	46	42	33
5	28	36	120	100	63	71	66	81	73	44	41	33
6	29	36	140	459	63	236	65	81	73	48	41	33
7	30	36	77	249	68	568	63	81	73	48	40	33
8	30	36	62	106	77	230	62	81	74	48	41	34
9	30	35	58	94	68	109	63	80	76	46	41	34
10	30	36	54	87	66	138	62	80	75	46	38	34
11	30	38	52	82	65	111	61	79	73	46	38	33
12	30	59	49	79	65	100	61	78	72	46	37	33
13	30	64	50	75	65	94	65	78	72	46	36	32
14	30	52	91	73	65	89	82	78	72	46	36	32
15	30	51	62	70	65	85	85	79	72	45	36	32
16	30	48	54	68	65	84	83	78	67	46	36	32
17	30	44	212	66	77	81	87	78	53	46	35	32
18	30	43	107	65	68	70	86	78	52	47	35	32
19	30	41	70	61	128	68	82	79	52	47	35	32
20	30	40	112	65	906	66	82	91	52	47	34	32
21	30	76	109	67	326	65	82	85	52	48	34	31
22	30	105	97	66	111	71	81	81	50	48	e35	31
23	31	57	101	64	98	160	81	79	50	47	e35	31
24	31	80	77	63	90	203	80	78	50	47	35	31
25	31	69	63	62	85	124	81	78	50	46	36	31
26	31	55	62	108	82	100	84	79	50	46	36	30
27	31	49	60	93	81	89	84	79	49	46	35	30
28	31	48	68	79	79	84	82	79	48	45	34	30
29	32	59	87	73	---	81	82	80	48	45	34	31
30	42	58	102	69	---	77	82	79	48	45	34	31
31	47	---	628	67	---	73	---	79	---	44	34	---
TOTAL	961	1511	3306	3440	3186	3619	2250	2479	1878	1437	1152	963
MEAN	31.00	50.37	106.6	111.0	113.8	116.7	75.00	79.97	62.60	46.35	37.16	32.10
MAX	47	105	628	459	906	568	87	91	77	48	43	34
MIN	28	35	49	61	63	65	61	78	48	44	34	30
AC-FT	1910	3000	6560	6820	6320	7180	4460	4920	3730	2850	2280	1910

e Estimated.

SACRAMENTO RIVER BASIN

11410000 MIDDLE YUBA RIVER NEAR NORTH SAN JUAN, CA—Continued

STATISTICS OF MONTHLY MEAN DATA FOR WATER YEARS 1912 - 1927, BY WATER YEAR (WY)

	OCT	NOV	DEC	JAN	FEB	MAR	APR	MAY	JUN	JUL	AUG	SEP
MEAN	65.9	180	276	458	898	690	1132	1247	610	129	51.7	47.2
MAX	101	779	758	2286	2942	1643	1647	2673	1850	239	70.0	73.7
(WY)	1919	1927	1923	1914	1927	1916	1927	1915	1922	1922	1916	1918
MIN	42.1	54.5	78.4	77.4	104	116	315	180	45.3	25.7	23.5	24.9
(WY)	1914	1924	1924	1918	1920	1924	1924	1924	1924	1924	1924	1924

SUMMARY STATISTICS

WATER YEARS 1912 - 1927

ANNUAL MEAN	479
HIGHEST ANNUAL MEAN	830 1927
LOWEST ANNUAL MEAN	111 1924
HIGHEST DAILY MEAN	15300 Feb 21 1927
LOWEST DAILY MEAN	21 Aug 12 1924
ANNUAL SEVEN-DAY MINIMUM	22 Aug 8 1924
MAXIMUM PEAK FLOW	21900 Feb 21 1927
MAXIMUM PEAK STAGE	14.00 Feb 21 1927
ANNUAL RUNOFF (AC-FT)	346900
10 PERCENT EXCEEDS	1270
50 PERCENT EXCEEDS	156
90 PERCENT EXCEEDS	44

STATISTICS OF MONTHLY MEAN DATA FOR WATER YEARS 1929 - 1940, BY WATER YEAR (WY)

MEAN	41.7	70.9	246	334	609	744	828	763	316	60.9	33.2	29.0
MAX	63.2	174	1152	941	1629	1937	1832	2215	1053	135	61.6	48.3
(WY)	1939	1938	1938	1936	1940	1940	1935	1938	1938	1938	1938	1938
MIN	31.9	26.0	39.3	56.3	111	269	164	107	52.8	20.7	15.5	16.2
(WY)	1935	1930	1931	1937	1933	1931	1931	1931	1931	1931	1931	1931

SUMMARY STATISTICS

WATER YEARS 1929 - 1940

ANNUAL MEAN	338
HIGHEST ANNUAL MEAN	818 1938
LOWEST ANNUAL MEAN	90.5 1931
HIGHEST DAILY MEAN	16100 Dec 11 1937
LOWEST DAILY MEAN	14 Aug 27 1931
ANNUAL SEVEN-DAY MINIMUM	15 Aug 22 1931
MAXIMUM PEAK FLOW	26000 Mar 25 1928
MAXIMUM PEAK STAGE	15.30 Mar 25 1928
ANNUAL RUNOFF (AC-FT)	244800
10 PERCENT EXCEEDS	905
50 PERCENT EXCEEDS	90
90 PERCENT EXCEEDS	27

STATISTICS OF MONTHLY MEAN DATA FOR WATER YEARS 2001 - 2002, BY WATER YEAR (WY)

MEAN	38.00	50.08	81.00	84.02	94.30	95.58	73.72	75.50	61.22	41.98	33.58	30.75
MAX	45.0	50.4	107	111	114	117	75.0	80.0	62.6	46.4	37.2	32.1
(WY)	2001	2002	2002	2002	2002	2002	2002	2002	2002	2002	2002	2002
MIN	31.0	49.8	55.4	57.1	74.8	74.4	72.4	71.0	59.8	37.6	30.0	29.4
(WY)	2002	2001	2001	2001	2001	2001	2001	2001	2001	2001	2001	2001

SUMMARY STATISTICS

FOR 2001 CALENDAR YEAR

FOR 2002 WATER YEAR

WATER YEARS 2001 - 2002

ANNUAL TOTAL	21097	26182	
ANNUAL MEAN	57.80	71.73	63.16
HIGHEST ANNUAL MEAN			71.7 2002
LOWEST ANNUAL MEAN			54.6 2001
HIGHEST DAILY MEAN	628 Dec 31	906 Feb 20	906 Feb 20 2002
LOWEST DAILY MEAN	27 Aug 29	28 Oct 5	27 Aug 29 2001
ANNUAL SEVEN-DAY MINIMUM	28 Sep 4	29 Oct 1	28 Sep 4 2001
MAXIMUM PEAK FLOW		1260 Feb 20	1260 Feb 20 2002
MAXIMUM PEAK STAGE		10.14 Feb 20	10.14 Feb 20 2002
ANNUAL RUNOFF (AC-FT)	41850	51930	45760
10 PERCENT EXCEEDS	82	99	84
50 PERCENT EXCEEDS	54	63	54
90 PERCENT EXCEEDS	29	31	31

11410000 MIDDLE YUBA RIVER NEAR NORTH SAN JUAN, CA—Continued

WATER-QUALITY RECORDS

PERIOD OF RECORD.—Water years 1975–77, October 2000 to current year.

WATER TEMPERATURE: Water years 1975–77, October 2000 to current year.

SEDIMENT DATA: November 2000 to September 2001 (daily), October 2001 to current year (storm season only).

PERIOD OF DAILY RECORD.—October 1974 to September 1977, October 2000 to current year.

WATER TEMPERATURE: October 1974 to September 1977, October 2000 to current year.

SUSPENDED-SEDIMENT DISCHARGE: November 2000 to September 2001 (daily). October 2001 to current year (storm season only).

INSTRUMENTATION.—Water-temperature recorder September 1974–77 and since October 2000.

REMARKS.—Water-temperature records rated excellent except for Oct. 13 to Nov. 17, Mar. 5 to Apr. 9, June 5 to July 25, which are rated good; and Oct. 1–12, which are rated fair. Interruptions in record were due to malfunction of the recording instrument.

EXTREMES FOR PERIOD OF DAILY RECORD.—

WATER TEMPERATURE: Maximum recorded, 30.5°C, June 25, 29, 1977; minimum recorded, 0.0°C, Dec. 24, 1974, Jan. 2, 3, 1975, Jan. 17, 1977.

SEDIMENT CONCENTRATION: Maximum daily mean, 60 mg/L, Feb. 20, 2002; minimum daily mean, 0 mg/L, several days during each water year.

SEDIMENT LOAD: Maximum daily, 164 tons, Feb. 20, 2002; minimum daily, 0 ton, several days each water year.

EXTREMES FOR CURRENT YEAR.—

WATER TEMPERATURE: Maximum recorded, 28.5°C, July 14; minimum recorded, 1.0°C Jan. 30, 31.

SEDIMENT CONCENTRATION: Maximum daily mean, 60 mg/L, Feb. 20; minimum daily mean, 0 mg/L, many days during the year.

SEDIMENT LOAD: Maximum daily, 164 tons, Feb. 20; minimum daily, 0 ton, several days during the year.

CROSS-SECTIONAL DATA, WATER YEAR OCTOBER 2001 TO SEPTEMBER 2002

DATE	TIME	DEPTH BOTTOM AT SAMPLE LOC- ATION, (FEET) (81903)	TEMPER- ATURE WATER (DEG C) (00010)	SAMPLE LOC- ATION, CROSS SECTION (FT FM L BANK) (00009)
APR				
16...	1428	3.00	8.5	76.0
16...	1430	6.00	8.5	68.0
16...	1432	8.00	8.5	60.0
16...	1434	8.00	8.5	52.0
16...	1436	5.00	8.5	44.0
16...	1438	5.00	9.0	36.0
16...	1440	4.00	9.0	28.0
16...	1442	3.00	9.0	20.0
16...	1443	2.00	9.0	12.0
16...	1444	1.00	9.0	4.00
AUG				
05...	1458	3.00	23.0	47.0
05...	1459	3.00	23.0	44.0
05...	1500	7.00	23.0	40.0
05...	1501	7.00	23.0	36.0
05...	1502	7.00	23.0	32.0
05...	1503	4.00	23.0	28.0
05...	1504	4.50	23.0	24.0
05...	1505	4.00	23.0	20.0
05...	1506	2.50	23.0	12.0
05...	1507	2.00	23.0	7.00
05...	1508	1.50	23.0	2.00

SUSPENDED-SEDIMENT DISCHARGE, WATER YEAR OCTOBER 2001 TO SEPTEMBER 2002

DATE	TIME	DIS- CHARGE, INST. CUBIC FEET PER SECOND (00061)	TEMPER- ATURE WATER (DEG C) (00010)	SEDI- MENT, DIS- CHARGE, SUS- PENDED (MG/L) (80154)	SEDI- MENT, DIS- CHARGE, SUS- PENDED (T/DAY) (80155)
OCT					
01...	1600	30	18.5	1.0	.08
31...	1345	47	12.5	46	5.8
DEC					
17...	1545	264	6.0	30	21.4
31...	1245	853	8.0	49	113
FEB					
22...	1215	110	8.0	4.0	1.2
APR					
02...	1430	70	12.0	2.0	.38
MAY					
10...	1100	80	12.0	2.0	.43
JUN					
13...	1230	74	20.0	2.0	.40

* Instantaneous discharge at time of cross-sectional measurement: 82 ft³/s, Apr. 16, 2002; 42 ft³/s, Aug. 5, 2002.

11410000 MIDDLE YUBA RIVER NEAR NORTH SAN JUAN, CA—Continued

WATER TEMPERATURE (DEGREES C), WATER YEAR OCTOBER 2001 TO SEPTEMBER 2002

DAY	MAX		MIN		MAX		MIN		MAX		MIN		MAX		MIN	
	OCTOBER		NOVEMBER		DECEMBER		JANUARY		FEBRUARY		MARCH					
1	19.5	16.5	12.5	10.5	7.5	6.5	9.5	8.0	3.5	2.0	8.0	5.5				
2	19.5	17.0	11.5	10.0	8.5	7.0	9.5	8.5	3.5	1.5	7.5	4.5				
3	19.5	17.0	11.5	10.0	8.0	6.5	9.0	7.5	3.5	2.0	7.5	5.0				
4	19.0	16.5	11.0	9.5	7.0	5.0	7.5	6.0	3.5	1.5	8.0	5.5				
5	18.0	16.0	11.0	9.5	7.0	5.5	8.0	6.0	4.0	2.0	8.5	6.0				
6	17.5	15.5	11.0	9.5	8.0	6.5	8.5	7.5	4.5	2.5	9.0	7.5				
7	17.0	15.0	10.5	9.0	8.0	6.5	9.0	7.5	6.0	4.0	8.0	6.5				
8	17.5	15.0	10.0	8.5	7.0	5.5	9.0	7.5	6.0	5.0	7.5	5.5				
9	16.5	14.5	10.0	8.5	7.0	6.0	8.5	7.5	5.5	3.5	8.0	5.5				
10	15.5	13.0	10.5	8.5	6.0	5.0	8.0	6.0	5.5	3.5	8.5	7.0				
11	16.0	13.5	11.5	10.0	5.0	3.5	7.0	5.5	6.0	4.0	9.5	6.5				
12	15.5	13.0	12.0	11.0	5.0	3.5	7.0	5.5	6.5	4.5	10.0	8.0				
13	15.0	13.0	12.0	11.0	6.0	4.5	6.5	5.0	7.0	5.5	9.0	7.5				
14	15.0	12.5	12.0	11.0	6.0	5.0	5.5	4.0	8.5	6.5	8.0	6.0				
15	15.0	13.0	11.5	10.5	5.0	3.5	4.5	3.0	8.0	6.0	7.0	5.0				
16	15.5	13.0	11.5	10.0	5.5	3.5	4.0	2.5	8.5	7.0	7.0	5.0				
17	16.0	14.0	11.5	10.5	7.0	5.0	4.0	3.0	8.5	7.0	6.5	5.0				
18	15.0	13.0	11.0	10.0	7.5	6.0	3.5	2.0	8.0	6.0	6.5	3.5				
19	14.5	12.5	10.5	9.5	7.5	6.5	3.5	2.0	8.0	7.0	8.0	4.5				
20	14.5	12.5	11.5	10.0	7.5	5.5	3.5	2.0	8.5	7.0	9.5	6.0				
21	14.0	12.0	11.0	10.5	7.0	5.5	4.0	2.5	9.0	7.0	10.5	7.5				
22	13.5	11.5	11.5	10.5	7.0	6.5	4.0	3.0	9.5	7.0	10.5	8.5				
23	13.5	11.5	11.0	9.5	7.0	5.5	3.5	2.0	9.5	8.0	9.0	7.5				
24	12.5	10.5	10.0	9.0	6.0	4.5	3.0	1.5	8.5	6.0	9.0	7.0				
25	12.0	10.0	9.0	8.0	6.5	4.5	4.0	2.0	8.5	6.0	10.0	7.0				
26	12.0	10.0	8.5	6.0	7.5	6.0	5.5	3.5	9.0	6.0	10.5	7.5				
27	12.5	10.5	6.5	4.5	8.5	7.0	5.5	4.5	9.0	6.5	11.0	7.5				
28	13.0	11.0	6.5	5.5	8.5	7.5	4.5	3.5	9.0	6.5	12.5	8.5				
29	13.5	12.0	7.0	6.0	9.0	7.5	3.5	2.0	---	---	13.0	9.5				
30	13.5	12.5	7.0	6.0	9.0	8.0	2.5	1.0	---	---	13.5	9.5				
31	13.0	12.0	---	---	9.5	8.0	2.5	1.0	---	---	13.5	10.0				
MONTH	19.5	10.0	12.5	4.5	9.5	3.5	9.5	1.0	9.5	1.5	13.5	3.5				
DAY	APRIL		MAY		JUNE		JULY		AUGUST		SEPTEMBER					
1	14.0	10.5	12.5	9.0	21.5	18.0	26.5	21.5	27.0	23.0	23.5	19.5				
2	14.5	11.0	14.5	9.5	21.0	16.0	26.0	21.5	26.5	22.0	23.5	19.5				
3	15.5	12.0	15.5	11.0	21.0	16.0	25.5	21.0	26.0	22.0	23.0	19.5				
4	15.0	12.0	16.0	11.5	22.0	16.5	25.0	20.5	25.0	21.0	22.5	19.0				
5	14.5	11.5	16.5	12.0	23.5	18.0	25.5	21.0	23.5	---	21.0	18.0				
6	14.0	10.5	16.5	12.0	24.0	18.5	26.0	21.0	23.0	---	20.5	17.5				
7	14.0	10.5	16.0	12.0	23.0	18.5	26.0	21.5	23.0	---	19.5	16.0				
8	14.5	11.0	15.5	11.0	22.0	18.0	26.0	21.0	23.5	18.5	19.0	15.0				
9	14.0	11.5	15.5	11.0	20.5	16.0	26.5	21.5	24.5	19.5	19.5	15.5				
10	14.5	11.0	14.0	11.0	20.5	15.5	27.5	22.5	25.0	20.5	20.0	16.0				
11	14.5	11.5	14.5	9.5	22.0	16.0	27.5	23.0	25.0	20.5	20.5	16.5				
12	15.0	11.5	16.0	11.0	22.5	17.5	28.0	24.0	25.5	21.0	20.5	17.0				
13	16.0	12.0	16.5	12.5	23.0	18.0	28.0	24.0	26.0	22.0	20.5	17.0				
14	16.0	12.5	17.0	12.0	23.5	18.5	28.5	24.0	26.5	22.5	20.5	17.0				
15	15.0	10.5	17.5	13.0	23.0	18.0	26.5	23.0	26.5	22.5	20.0	17.5				
16	10.5	8.0	18.0	13.0	23.0	18.0	26.0	21.5	26.5	22.5	19.5	16.5				
17	9.0	7.0	18.5	13.5	23.0	18.5	26.0	21.5	25.5	21.5	19.5	16.5				
18	9.5	6.5	18.0	14.0	24.0	19.5	25.5	22.5	25.0	21.0	19.5	16.5				
19	10.5	6.0	17.0	13.0	24.5	19.5	26.5	22.0	24.0	20.5	19.5	16.0				
20	11.5	7.0	13.5	10.5	24.5	20.0	27.0	22.0	23.0	19.5	19.5	16.5				
21	12.5	8.0	12.0	9.5	24.0	20.0	26.5	23.0	22.5	18.5	19.5	16.5				
22	13.5	9.0	14.0	9.0	24.0	19.5	26.5	22.5	---	19.0	20.0	16.5				
23	14.5	10.0	16.0	10.0	24.5	19.5	26.0	22.0	22.5	---	19.5	16.5				
24	14.5	11.0	17.5	12.0	25.0	20.0	26.0	21.5	22.0	18.0	19.5	16.0				
25	15.5	11.5	18.5	13.0	25.0	20.5	25.5	21.5	22.0	18.0	19.0	16.0				
26	14.5	12.0	18.5	14.0	25.0	21.0	25.5	---	22.5	18.5	18.5	15.5				
27	12.5	10.5	18.5	15.0	25.5	20.5	26.0	22.0	22.5	18.5	18.0	16.0				
28	12.0	9.0	19.5	15.0	25.5	21.0	27.0	22.5	23.0	19.0	17.5	15.0				
29	11.0	9.0	21.0	15.5	26.0	21.5	27.0	23.0	23.0	19.5	17.5	16.0				
30	11.5	8.0	22.5	17.5	26.5	21.5	27.0	23.0	23.0	19.5	17.0	14.5				
31	---	---	23.0	18.0	---	---	27.5	23.5	23.0	19.0	---	---				
MONTH	16.0	6.0	23.0	9.0	26.5	15.5	28.5	---	---	---	23.5	14.5				

11410000 MIDDLE YUBA RIVER NEAR NORTH SAN JUAN, CA—Continued

SEDIMENT DISCHARGE, SUSPENDED (TONS/DAY), WATER YEAR OCTOBER 2001 TO SEPTEMBER 2002

DAY	MEAN DISCHARGE (CFS)	MEAN CONCENTRATION (MG/L)	SEDIMENT DISCHARGE (TONS/DAY)	MEAN DISCHARGE (CFS)	MEAN CONCENTRATION (MG/L)	SEDIMENT DISCHARGE (TONS/DAY)	MEAN DISCHARGE (CFS)	MEAN CONCENTRATION (MG/L)	SEDIMENT DISCHARGE (TONS/DAY)
	OCTOBER			NOVEMBER			DECEMBER		
1	30	1.0	0.08	44	3.0	0.39	62	5.0	0.76
2	29	1.0	0.11	41	1.0	0.13	248	13	14.0
3	29	2.0	0.15	38	1.0	0.08	108	18	5.6
4	29	2.0	0.14	37	1.0	0.06	64	7.0	1.2
5	28	2.0	0.13	36	0.0	0.04	120	6.0	2.3
6	29	2.0	0.12	36	0.0	0.02	140	6.0	2.5
7	30	1.0	0.12	36	0.0	0.00	77	3.0	0.65
8	30	1.0	0.10	36	0.0	0.02	62	3.0	0.46
9	30	1.0	0.09	35	0.0	0.04	58	2.0	0.39
10	30	1.0	0.08	36	1.0	0.06	54	2.0	0.33
11	30	1.0	0.09	38	1.0	0.09	52	2.0	0.26
12	30	1.0	0.11	59	4.0	0.81	49	1.0	0.17
13	30	1.0	0.12	64	5.0	0.88	50	3.0	0.36
14	30	2.0	0.13	52	2.0	0.32	91	14	3.4
15	30	2.0	0.14	51	2.0	0.27	62	5.0	0.89
16	30	2.0	0.15	48	2.0	0.26	54	5.0	0.79
17	30	2.0	0.16	44	2.0	0.24	212	23	16.0
18	30	2.0	0.16	43	2.0	0.23	107	5.0	1.6
19	30	2.0	0.16	41	2.0	0.22	70	3.0	0.58
20	30	2.0	0.16	40	2.0	0.22	112	5.0	1.6
21	30	2.0	0.17	76	3.0	0.93	109	6.0	1.9
22	30	2.0	0.16	105	3.0	1.1	97	4.0	1.2
23	31	2.0	0.17	57	2.0	0.31	101	5.0	1.3
24	31	2.0	0.17	80	3.0	0.59	77	4.0	0.80
25	31	2.0	0.18	69	2.0	0.41	63	3.0	0.57
26	31	2.0	0.20	55	2.0	0.28	62	3.0	0.48
27	31	3.0	0.21	49	1.0	0.15	60	2.0	0.31
28	31	3.0	0.23	48	1.0	0.13	68	3.0	0.63
29	32	3.0	0.25	59	1.0	0.24	87	4.0	0.84
30	42	29	3.8	58	4.0	0.58	102	6.0	1.9
31	47	46	5.7	---	---	---	628	35	70.0
TOTAL	961	---	13.74	1511	---	9.10	3306	---	133.77
DAY	JANUARY			FEBRUARY			MARCH		
	MEAN DISCHARGE (CFS)	MEAN CONCENTRATION (MG/L)	SEDIMENT DISCHARGE (TONS/DAY)	MEAN DISCHARGE (CFS)	MEAN CONCENTRATION (MG/L)	SEDIMENT DISCHARGE (TONS/DAY)	MEAN DISCHARGE (CFS)	MEAN CONCENTRATION (MG/L)	SEDIMENT DISCHARGE (TONS/DAY)
1	134	7.0	2.9	66	1.0	0.18	76	2.0	0.44
2	174	19	9.5	65	1.0	0.18	74	2.0	0.33
3	412	15	24.0	65	1.0	0.17	72	1.0	0.25
4	110	6.0	1.8	64	1.0	0.18	70	1.0	0.23
5	100	7.0	2.0	63	1.0	0.20	71	2.0	0.42
6	459	26	41.0	63	1.0	0.22	236	9.0	7.5
7	249	12	11.0	68	1.0	0.26	568	12	18.0
8	106	0.0	0.12	77	2.0	0.33	230	8.0	5.6
9	94	0.0	0.04	68	2.0	0.32	109	5.0	1.6
10	87	1.0	0.18	66	2.0	0.33	138	5.0	1.7
11	82	0.0	0.02	65	2.0	0.35	111	4.0	1.2
12	79	0.0	0.00	65	2.0	0.35	100	3.0	0.84
13	75	0.0	0.00	65	2.0	0.32	94	3.0	0.72
14	73	0.0	0.00	65	1.0	0.19	89	2.0	0.54
15	70	0.0	0.00	65	1.0	0.17	85	3.0	0.66
16	68	0.0	0.00	65	1.0	0.18	84	3.0	0.60
17	66	0.0	0.00	77	2.0	0.41	81	2.0	0.50
18	65	0.0	0.00	68	2.0	0.37	70	2.0	0.35
19	61	0.0	0.00	128	5.0	2.6	68	1.0	0.23
20	65	0.0	0.00	906	60	164	66	2.0	0.34
21	67	0.0	0.00	326	14	17.0	65	2.0	0.32
22	66	0.0	0.05	111	5.0	1.5	71	2.0	0.43
23	64	1.0	0.26	98	4.0	1.1	160	13	6.3
24	63	0.0	0.06	90	3.0	0.72	203	21	12.0
25	62	1.0	0.15	85	2.0	0.48	124	6.0	2.1
26	108	1.0	0.39	82	2.0	0.41	100	4.0	1.1
27	93	1.0	0.26	81	2.0	0.34	89	3.0	0.78
28	79	1.0	0.21	79	3.0	0.72	84	4.0	0.81
29	73	1.0	0.22	---	---	---	81	2.0	0.49
30	69	2.0	0.33	---	---	---	77	2.0	0.47
31	67	1.0	0.20	---	---	---	73	3.0	0.50
TOTAL	3440	---	94.69	3186	---	193.58	3619	---	67.35

11410000 MIDDLE YUBA RIVER NEAR NORTH SAN JUAN, CA—Continued

SEDIMENT DISCHARGE, SUSPENDED (TONS/DAY), WATER YEAR OCTOBER 2001 TO SEPTEMBER 2002

DAY	MEAN DISCHARGE (CFS)	MEAN CONCENTRATION (MG/L)	SEDIMENT DISCHARGE (TONS/DAY)	MEAN DISCHARGE (CFS)	MEAN CONCENTRATION (MG/L)	SEDIMENT DISCHARGE (TONS/DAY)	MEAN DISCHARGE (CFS)	MEAN CONCENTRATION (MG/L)	SEDIMENT DISCHARGE (TONS/DAY)
	APRIL			MAY			JUNE		
1	71	3.0	0.53	82	1.0	0.28	77	1.0	0.21
2	70	2.0	0.41	81	2.0	0.42	77	1.0	0.21
3	68	2.0	0.32	80	2.0	0.43	75	1.0	0.20
4	67	1.0	0.23	80	2.0	0.43	73	1.0	0.22
5	66	2.0	0.34	81	2.0	0.43	73	2.0	0.46
6	65	2.0	0.35	81	2.0	0.44	73	4.0	0.72
7	63	2.0	0.34	81	2.0	0.44	73	4.0	0.69
8	62	2.0	0.36	81	2.0	0.40	74	3.0	0.59
9	63	3.0	0.46	80	1.0	0.24	76	2.0	0.50
10	62	2.0	0.38	80	2.0	0.33	75	2.0	0.45
11	61	3.0	0.48	79	2.0	0.35	73	3.0	0.57
12	61	3.0	0.49	78	1.0	0.28	72	3.0	0.52
13	65	3.0	0.53	78	1.0	0.28	72	2.0	0.34
14	82	3.0	0.66	78	3.0	0.56	72	2.0	0.39
15	85	3.0	0.65	79	2.0	0.48	72	2.0	0.39
16	83	2.0	0.48	78	3.0	0.58	67	2.0	0.36
17	87	3.0	0.66	78	2.0	0.45	53	2.0	0.27
18	86	2.0	0.45	78	2.0	0.51	52	1.0	0.18
19	82	1.0	0.25	79	3.0	0.61	52	2.0	0.24
20	82	1.0	0.30	91	3.0	0.86	52	1.0	0.20
21	82	2.0	0.37	85	3.0	0.68	52	3.0	0.40
22	81	2.0	0.43	81	2.0	0.46	50	3.0	0.41
23	81	2.0	0.47	79	2.0	0.46	50	3.0	0.41
24	80	3.0	0.59	78	3.0	0.61	50	3.0	0.41
25	81	2.0	0.46	78	3.0	0.63	50	3.0	0.39
26	84	2.0	0.45	79	3.0	0.64	50	2.0	0.33
27	84	2.0	0.45	79	3.0	0.64	49	2.0	0.27
28	82	2.0	0.44	79	3.0	0.57	48	2.0	0.26
29	82	2.0	0.44	80	1.0	0.25	48	2.0	0.26
30	82	2.0	0.41	79	1.0	0.21	48	2.0	0.26
31	---	---	---	79	1.0	0.21	---	---	---
TOTAL	2250	---	13.18	2479	---	14.16	1878	---	11.11
	JULY			AUGUST			SEPTEMBER		
1	48	---	---	43	---	---	34	---	---
2	48	---	---	42	---	---	33	---	---
3	46	---	---	43	---	---	33	---	---
4	46	---	---	42	---	---	33	---	---
5	44	---	---	41	---	---	33	---	---
6	48	---	---	41	---	---	33	---	---
7	48	---	---	40	---	---	33	---	---
8	48	---	---	41	---	---	34	---	---
9	46	---	---	41	---	---	34	---	---
10	46	---	---	38	---	---	34	---	---
11	46	---	---	38	---	---	33	---	---
12	46	---	---	37	---	---	33	---	---
13	46	---	---	36	---	---	32	---	---
14	46	---	---	36	---	---	32	---	---
15	45	---	---	36	---	---	32	---	---
16	46	---	---	36	---	---	32	---	---
17	46	---	---	35	---	---	32	---	---
18	47	---	---	35	---	---	32	---	---
19	47	---	---	35	---	---	32	---	---
20	47	---	---	34	---	---	32	---	---
21	48	---	---	34	---	---	31	---	---
22	48	---	---	e35	---	---	31	---	---
23	47	---	---	e35	---	---	31	---	---
24	47	---	---	35	---	---	31	---	---
25	46	---	---	36	---	---	31	---	---
26	46	---	---	36	---	---	30	---	---
27	46	---	---	35	---	---	30	---	---
28	45	---	---	34	---	---	30	---	---
29	45	---	---	34	---	---	31	---	---
30	45	---	---	34	---	---	31	---	---
31	44	---	---	34	---	---	---	---	---
TOTAL	1437	---	---	1152	---	---	963	---	---

e Estimated.

11413000 NORTH YUBA RIVER BELOW GOODYEARS BAR, CA

LOCATION.—Lat 39°31'30", long 120°56'13", in NE 1/4 SW 1/4 sec.11, T.19 N., R.9 E., [Sierra County](#), Hydrologic Unit 18020125, Tahoe National Forest, on right bank, 200 ft downstream from St. Catherine Creek, 3.1 mi southwest of Goodyears Bar, and 6.4 mi southwest of Downieville.

DRAINAGE AREA.—250 mi².

PERIOD OF RECORD.—October 1930 to current year. Prior to October 1949, published as "North Fork Yuba River below Goodyears Bar." Monthly and yearly discharge only for some periods, published in WSP 1315-A.

REVISED RECORDS.—WSP 1041: 1944. WSP 1931: Drainage area.

GAGE.—Water-stage recorder. Datum of gage is 2,453 ft above sea level (river-profile survey).

REMARKS.—Records good. Several small diversions upstream from station for irrigation and mining. See schematic diagram of [North and Middle Yuba River Basins](#).

EXTREMES FOR PERIOD OF RECORD.—Maximum discharge, 45,500 ft³/s, Jan. 2, 1997, gage height, 25.65 ft, from rating curve extended above 11,900 ft³/s, on basis of one float measurement at 17,900 ft³/s and slope-area measurements at gage heights 19.15 and 23.8 ft; minimum daily, 60 ft³/s, Sept. 7–14, 1977.

EXTREMES FOR CURRENT YEAR.—Peak discharges greater than base discharge of 3,200 ft³/s, or maximum:

Date	Time	Discharge (ft ³ /s)	Gage height (ft)
Apr. 14	2200	2,740	7.36

DISCHARGE, CUBIC FEET PER SECOND, WATER YEAR OCTOBER 2001 TO SEPTEMBER 2002

DAILY MEAN VALUES

DAY	OCT	NOV	DEC	JAN	FEB	MAR	APR	MAY	JUN	JUL	AUG	SEP
1	98	119	352	1070	318	681	1160	921	1250	261	153	125
2	98	111	1170	1490	310	630	1300	911	1100	252	151	124
3	98	106	710	1720	303	593	1530	1030	999	244	150	123
4	97	105	420	1100	297	576	1740	1190	942	238	150	123
5	97	104	370	884	295	571	1810	1310	911	234	148	122
6	98	104	441	1780	291	1260	1580	1420	880	230	148	125
7	98	103	455	1540	343	1500	1510	1490	830	225	147	128
8	99	103	363	1240	551	1170	1490	1380	764	218	145	128
9	99	103	334	1040	418	964	1590	1330	677	213	143	125
10	99	103	297	910	383	971	1740	1280	619	206	141	124
11	99	114	271	814	374	897	1690	1110	581	203	139	122
12	98	182	251	753	374	885	1710	1180	547	201	138	121
13	98	207	243	702	387	849	1740	1290	526	196	137	120
14	98	145	323	654	392	786	2050	1340	505	192	135	119
15	98	135	269	601	403	738	2160	1420	479	190	134	120
16	97	124	249	552	406	705	1530	1430	450	189	134	119
17	97	121	503	519	461	675	1320	1470	422	186	133	120
18	98	118	471	483	419	623	1160	1530	412	185	132	121
19	98	115	379	462	538	595	1030	1430	399	187	132	118
20	98	113	399	437	1360	596	961	1350	379	182	133	116
21	98	221	362	441	1170	605	927	1110	367	179	134	116
22	98	1060	387	413	1010	668	961	1020	353	176	134	116
23	99	307	418	382	1020	821	1010	1010	342	173	135	115
24	98	748	355	369	878	834	1090	998	328	170	135	115
25	98	523	311	359	789	803	1200	1020	314	166	133	115
26	98	289	297	444	744	764	1310	1070	306	165	132	115
27	98	230	313	417	736	758	1220	1120	295	163	130	114
28	99	210	402	378	718	786	1070	1200	283	160	128	115
29	100	251	615	354	---	899	1030	1250	276	157	127	117
30	159	223	734	335	---	998	970	1320	269	155	128	120
31	170	---	1660	326	---	1060	---	1320	---	155	126	---
TOTAL	3175	6497	14124	22969	15688	25261	41589	38250	16805	6051	4265	3601
MEAN	102.4	216.6	455.6	740.9	560.3	814.9	1386	1234	560.2	195.2	137.6	120.0
MAX	170	1060	1660	1780	1360	1500	2160	1530	1250	261	153	128
MIN	97	103	243	326	291	571	927	911	269	155	126	114
AC-FT	6300	12890	28010	45560	31120	50110	82490	75870	33330	12000	8460	7140

SACRAMENTO RIVER BASIN

11413000 NORTH YUBA RIVER BELOW GOODYEARS BAR, CA—Continued

STATISTICS OF MONTHLY MEAN DATA FOR WATER YEARS 1931 - 2002, BY WATER YEAR (WY)

	OCT	NOV	DEC	JAN	FEB	MAR	APR	MAY	JUN	JUL	AUG	SEP
MEAN	185.3	350.5	639.9	878.4	957.9	1070	1376	1784	1109	367.5	186.1	151.1
MAX	1407	2380	3830	4526	4367	3074	2822	3894	3627	1384	417	256
(WY)	1963	1951	1965	1997	1986	1995	1982	1952	1983	1983	1983	1983
MIN	71.8	107	97.3	117	138	151	241	335	170	82.7	66.8	71.0
(WY)	1978	1978	1977	1991	1977	1977	1977	1977	1992	1977	1977	1977

SUMMARY STATISTICS	FOR 2001 CALENDAR YEAR		FOR 2002 WATER YEAR		WATER YEARS 1931 - 2002	
ANNUAL TOTAL	122117		198275			
ANNUAL MEAN	334.6		543.2		753.1	
HIGHEST ANNUAL MEAN					1566	
LOWEST ANNUAL MEAN					141	
HIGHEST DAILY MEAN	1740	Mar 25	2160	Apr 15	29600	Jan 2 1997
LOWEST DAILY MEAN	97	Oct 4	97	Oct 4	60	Sep 7 1977
ANNUAL SEVEN-DAY MINIMUM	98	Oct 1	98	Oct 1	60	Sep 7 1977
MAXIMUM PEAK FLOW			2740	Apr 14	45500	Jan 2 1997
MAXIMUM PEAK STAGE			7.36	Apr 14	25.65	Jan 2 1997
ANNUAL RUNOFF (AC-FT)	242200		393300		545600	
10 PERCENT EXCEEDS	874		1310		1850	
50 PERCENT EXCEEDS	184		359		329	
90 PERCENT EXCEEDS	100		106		127	

11413250 SLATE CREEK TUNNEL NEAR STRAWBERRY VALLEY, CA

LOCATION.—Lat 39°36'57", long 121°03'03", in SE 1/4 SW 1/4 sec.2, T.20 N., R.8 E., [Plumas County](#), Hydrologic Unit 18020125, Plumas National Forest, on right bank, 30 ft upstream from diversion dam on Slate Creek, 0.3 mi upstream from Feny Ravine, and 4.5 mi northeast of town of Strawberry Valley.

PERIOD OF RECORD.—February 1962 to current year. Monthly discharge only published as adjustment to Slate Creek below diversion dam near Strawberry Valley (station 11413300) February 1962 to September 1966; records of daily discharge are in files of the U.S. Geological Survey.

GAGE.—Water-stage recorder. Datum of gage is sea level.

REMARKS.—Tunnel diverts water from Slate Creek to Sly Creek Reservoir (station 11395400) for power development. See schematic diagrams of [South Fork Feather River Basin](#) and [North and Middle Yuba River Basins](#).

COOPERATION.—Records provided by Oroville–Wyandotte Irrigation District, under general supervision of the U.S. Geological Survey, in connection with Federal Energy Regulatory Commission project no. 2088.

EXTREMES FOR PERIOD OF RECORD.—Maximum daily discharge, 863 ft³/s, Apr. 6, 1963; no flow for many days in each year.

DISCHARGE, CUBIC FEET PER SECOND, WATER YEAR OCTOBER 2001 TO SEPTEMBER 2002
DAILY MEAN VALUES

DAY	OCT	NOV	DEC	JAN	FEB	MAR	APR	MAY	JUN	JUL	AUG	SEP
1	0.00	0.00	30	475	63	253	456	211	100	11	0.00	0.00
2	0.00	0.00	370	e529	59	224	542	202	88	9.9	0.00	0.00
3	0.00	0.00	202	e529	57	204	643	216	78	9.0	0.00	0.00
4	0.00	0.00	102	e464	56	193	703	230	72	8.5	0.00	0.00
5	0.00	0.00	80	351	57	190	700	241	68	8.1	0.00	0.00
6	0.00	0.00	87	763	55	567	595	245	66	7.7	0.00	0.00
7	0.00	0.00	104	688	85	801	555	243	64	7.4	0.00	0.00
8	0.00	0.00	81	485	200	560	539	220	55	6.9	0.00	0.00
9	0.00	0.00	72	382	127	401	540	203	49	6.3	0.00	0.00
10	0.00	0.00	62	318	110	344	581	196	45	5.5	0.00	0.00
11	0.00	0.00	54	271	104	288	546	172	42	4.9	0.00	0.00
12	0.00	0.00	46	242	103	284	521	167	39	1.5	0.00	0.00
13	0.00	0.00	46	221	110	268	520	174	37	0.00	0.00	0.00
14	0.00	0.00	54	202	111	240	592	171	35	0.00	0.00	0.00
15	0.00	0.00	44	179	121	221	586	170	33	0.00	0.00	0.00
16	0.00	0.00	42	159	125	202	415	163	30	0.00	0.00	0.00
17	0.00	0.00	78	144	151	186	347	160	28	0.00	0.00	0.00
18	0.00	0.00	79	130	140	166	294	155	28	0.00	0.00	0.00
19	0.00	0.00	73	120	202	156	259	147	26	0.00	0.00	0.00
20	0.00	0.00	74	110	730	158	240	176	24	0.00	0.00	0.00
21	0.00	81	62	108	577	166	228	150	23	0.00	0.00	0.00
22	0.00	365	62	97	464	195	233	146	21	0.00	0.00	0.00
23	0.00	62	59	88	491	219	245	142	20	0.00	0.00	0.00
24	0.00	265	51	84	403	211	269	136	18	0.00	0.00	0.00
25	0.00	140	48	80	338	209	292	130	17	0.00	0.00	0.00
26	0.00	64	52	88	301	207	302	124	15	0.00	0.00	0.00
27	0.00	41	59	81	289	212	301	120	14	0.00	0.00	0.00
28	0.00	32	92	71	278	234	255	118	13	0.00	0.00	0.00
29	0.00	31	214	68	---	307	238	115	12	0.00	0.00	0.00
30	0.00	27	305	63	---	363	224	116	12	0.00	0.00	0.00
31	0.00	---	764	63	---	399	---	109	---	0.00	0.00	---
TOTAL	0.00	1108.00	3548	7653	5907	8628	12761	5268	1172	86.70	0.00	0.00
MEAN	0.000	36.93	114.5	246.9	211.0	278.3	425.4	169.9	39.07	2.797	0.000	0.000
MAX	0.00	365	764	763	730	801	703	245	100	11	0.00	0.00
MIN	0.00	0.00	30	63	55	156	224	109	12	0.00	0.00	0.00
AC-FT	0.00	2200	7040	15180	11720	17110	25310	10450	2320	172	0.00	0.00

STATISTICS OF MONTHLY MEAN DATA FOR WATER YEARS 1963 - 2002, BY WATER YEAR (WY)

	7.779	61.38	90.71	132.3	150.6	216.7	229.0	208.7	107.0	22.42	2.969	1.413
MEAN	7.779	61.38	90.71	132.3	150.6	216.7	229.0	208.7	107.0	22.42	2.969	1.413
MAX	43.5	321	302	408	595	588	690	638	470	144	24.2	21.1
(WY)	1983	1984	1967	1995	1996	1993	1993	1973	1998	1983	1983	1986
MIN	0.000	0.000	0.000	0.000	0.000	0.000	0.000	0.000	0.028	0.000	0.000	0.000
(WY)	1963	1963	1974	1965	1965	1969	1969	1977	1977	1966	1963	1963

SUMMARY STATISTICS

FOR 2001 CALENDAR YEAR

FOR 2002 WATER YEAR

WATER YEARS 1963 - 2002

ANNUAL TOTAL	28640.24	46131.70	
ANNUAL MEAN	78.47	126.4	102.2
HIGHEST ANNUAL MEAN			209
LOWEST ANNUAL MEAN			0.002
HIGHEST DAILY MEAN	786	Mar 25	801
LOWEST DAILY MEAN	0.00	Jul 7	0.00
ANNUAL SEVEN-DAY MINIMUM	0.00	Jul 7	0.00
ANNUAL RUNOFF (AC-FT)	56810	91500	74070
10 PERCENT EXCEEDS	281	367	338
50 PERCENT EXCEEDS	15	57	16
90 PERCENT EXCEEDS	0.00	0.00	0.00

e Estimated.

11413300 SLATE CREEK BELOW DIVERSION DAM, NEAR STRAWBERRY VALLEY, CA

LOCATION.—Lat 39°36'52", long 121°03'04", in SE 1/4 SW 1/4 sec.2, T.20 N., R.8 E., [Plumas County](#), Hydrologic Unit 18020125, Plumas National Forest, on right bank, 300 ft downstream from diversion dam, 0.2 mi upstream from Feney Ravine, and 4.5 mi northeast of town of Strawberry Valley.

DRAINAGE AREA.—49.4 mi².

PERIOD OF RECORD.—October 1960 to current year.

GAGE.—Water-stage recorder and 130° V-notch weir since October 1982. Elevation of gage is 3,570 ft above sea level, from topographic map.

REMARKS.—Slate Creek Tunnel (station 11413250) diverts up to 900 ft³/s from Slate Creek Reservoir, capacity, 223 acre-ft, at diversion dam 300 ft upstream, to Sly Creek Reservoir (station 11395400). Diversion began in February 1962. See schematic diagrams of [South Fork Feather River Basin](#) and [North and Middle Yuba River Basins](#).

COOPERATION.—Records provided by Oroville–Wyandotte Irrigation District, under general supervision of the U.S. Geological Survey, in connection with Federal Energy Regulatory Commission project no. 2088.

EXTREMES FOR PERIOD OF RECORD.—Creek only: Maximum discharge, 17,300 ft³/s, Jan. 1, 1997, gage height, 17.20 ft, from rating curve extended above 5,500 ft³/s, on basis of computed flow over dam at gage heights 12.75, 15.90, 16.89 and 17.20 ft; minimum, 0.3 ft³/s, Mar. 4, 5, 1962.

DISCHARGE, CUBIC FEET PER SECOND, WATER YEAR OCTOBER 2001 TO SEPTEMBER 2002

DAILY MEAN VALUES

DAY	OCT	NOV	DEC	JAN	FEB	MAR	APR	MAY	JUN	JUL	AUG	SEP
1	6.9	15	15	11	11	12	11	10	11	10	12	7.9
2	6.7	11	77	341	11	12	11	10	11	10	12	7.7
3	6.6	9.9	16	339	11	12	11	10	11	10	12	7.5
4	6.6	9.2	16	41	11	12	11	10	11	10	12	7.5
5	6.6	8.9	16	11	11	12	11	10	11	10	11	7.5
6	6.6	8.6	16	167	11	117	11	10	11	10	11	7.5
7	6.7	8.5	16	17	12	65	11	10	11	10	11	7.7
8	6.7	8.5	16	11	12	13	11	10	11	10	11	8.0
9	6.7	8.4	15	11	12	12	11	10	11	10	11	8.2
10	6.7	8.3	15	11	12	12	11	10	11	10	10	7.9
11	6.6	13	15	11	12	11	11	10	11	10	9.8	7.8
12	6.5	48	16	11	12	11	11	10	11	15	9.6	7.7
13	6.4	72	13	11	12	11	11	10	11	17	9.5	7.5
14	6.9	38	11	11	12	11	11	10	11	17	9.2	7.5
15	6.4	23	11	11	12	11	11	10	11	16	9.1	7.5
16	6.4	18	11	11	12	11	10	10	11	16	9.0	7.5
17	6.4	16	11	11	12	11	10	10	11	16	8.7	7.6
18	6.4	15	11	11	12	11	10	10	11	16	8.5	7.7
19	6.4	14	11	11	12	11	10	10	11	16	8.5	7.5
20	6.4	13	11	11	19	11	10	10	11	15	8.5	7.0
21	6.4	13	11	11	13	11	10	10	11	15	8.6	6.9
22	6.4	10	11	11	12	11	10	10	11	14	8.8	6.9
23	6.4	12	11	11	12	11	10	10	11	14	8.7	6.8
24	6.4	89	11	11	12	11	10	10	11	14	8.6	6.7
25	6.4	16	11	11	12	11	10	10	11	13	8.5	6.7
26	6.4	15	11	11	12	11	10	10	11	13	8.5	6.7
27	6.4	15	11	11	12	11	10	10	10	13	8.3	6.7
28	6.5	15	11	11	12	11	10	10	10	13	8.1	6.8
29	6.6	15	11	11	---	11	10	10	10	12	7.9	7.3
30	35	15	11	11	---	11	10	10	10	12	7.9	7.7
31	34	---	188	11	---	11	---	10	---	12	7.9	---
TOTAL	258.5	581.3	637	1191	338	510	315	310	326	399	295.2	221.9
MEAN	8.339	19.38	20.55	38.42	12.07	16.45	10.50	10.00	10.87	12.87	9.523	7.397
MAX	35	89	188	341	19	117	11	10	11	17	12	8.2
MIN	6.4	8.3	11	11	11	11	10	10	10	10	7.9	6.7
AC-FT	513	1150	1260	2360	670	1010	625	615	647	791	586	440

STATISTICS OF MONTHLY MEAN DATA FOR WATER YEARS 1963 - 2002, BY WATER YEAR (WY)

MEAN	23.97	52.88	141.9	240.8	195.7	206.9	182.8	181.2	46.69	12.13	11.04	10.30
MAX	437	545	1303	1334	1415	901	753	795	481	21.3	19.3	17.7
(WY)	1963	1974	1965	1970	1986	1983	1982	1983	1983	1998	1965	1998
MIN	5.85	7.51	5.80	9.04	8.49	6.61	6.12	6.15	6.95	5.17	3.82	6.13
(WY)	1971	1977	1977	1975	1973	1968	1968	1968	1973	1977	1977	1987

SUMMARY STATISTICS

FOR 2001 CALENDAR YEAR

FOR 2002 WATER YEAR

WATER YEARS 1963 - 2002

ANNUAL TOTAL	4649.0	5382.9		
ANNUAL MEAN	12.74	14.75	108.6	
HIGHEST ANNUAL MEAN			352	1982
LOWEST ANNUAL MEAN			10.4	1976
HIGHEST DAILY MEAN	283	Mar 25	341	Jan 2
LOWEST DAILY MEAN	6.3	Sep 22	6.4	Oct 13
ANNUAL SEVEN-DAY MINIMUM	6.4	Sep 18	6.4	Oct 15
MAXIMUM PEAK FLOW			905	Jan 3
MAXIMUM PEAK STAGE			7.70	Jan 3
ANNUAL RUNOFF (AC-FT)	9220	10680	78670	17.20
10 PERCENT EXCEEDS	15	15	294	Jan 1 1997
50 PERCENT EXCEEDS	11	11	11	Feb 18 1975
90 PERCENT EXCEEDS	6.6	6.9	8.3	Feb 21 1975

11413320 DEADWOOD CREEK NEAR STRAWBERRY VALLEY, CA

LOCATION.—Lat 39°33'00", long 121°05'36", in SW 1/4 SW 1/4 sec.33, T.20 N., R.8 E., [Yuba County](#), Hydrologic Unit 18020125, Plumas National Forest, on right bank, 250 ft upstream of confluence with Owl Gulch, and 1.3 mi southeast of Strawberry Valley.

DRAINAGE AREA.—3.16 mi².

PERIOD OF RECORD.—October 1994 to current year.

GAGE.—Water-stage recorder and 120° V-notch weir. Elevation of gage is 3,275 ft above sea level, from topographic map.

REMARKS.—Water from creek is diverted at gage to Deadwood Creek Powerplant (station 11413326). See schematic diagram of [North and Middle Yuba River Basins](#).

COOPERATION.—Records provided by Yuba County Water Agency, under general supervision of the U.S. Geological Survey, in connection with Federal Energy Regulatory Commission project no. 6780.

EXTREMES FOR PERIOD OF RECORD.—Maximum daily discharge, 400 ft³/s, Jan. 1, 1997; minimum daily, 1.7 ft³/s, several days in February and March 1997.

DISCHARGE, CUBIC FEET PER SECOND, WATER YEAR OCTOBER 2001 TO SEPTEMBER 2002
DAILY MEAN VALUES

DAY	OCT	NOV	DEC	JAN	FEB	MAR	APR	MAY	JUN	JUL	AUG	SEP
1	2.0	2.3	3.2	3.0	2.8	2.8	2.9	2.6	2.6	3.6	2.9	2.3
2	1.9	2.2	8.8	10	2.8	2.8	2.9	2.6	2.6	3.6	3.0	2.2
3	1.9	2.1	2.8	5.4	2.8	2.8	2.9	2.6	2.6	3.6	3.0	2.2
4	1.9	2.0	2.8	16	2.8	2.8	2.9	2.6	2.7	3.6	3.0	2.2
5	1.9	2.0	2.8	9.6	2.7	2.8	2.9	2.6	2.6	3.6	3.0	2.3
6	2.0	2.0	2.8	4.3	3.0	3.3	2.9	2.6	2.6	3.5	2.8	2.3
7	2.0	2.0	2.8	2.9	2.8	4.7	2.9	2.6	2.6	3.6	2.6	2.3
8	1.9	2.0	2.8	2.9	2.8	3.0	2.9	2.6	2.6	3.5	2.5	2.3
9	1.9	2.0	2.8	2.9	2.8	2.9	2.9	2.6	2.6	3.5	2.6	2.2
10	1.9	2.0	2.7	2.8	2.8	2.9	2.9	2.6	2.6	3.4	2.2	2.2
11	1.9	3.1	2.7	2.8	2.8	2.9	2.9	2.6	3.4	3.4	2.3	2.2
12	1.8	7.2	2.9	2.8	2.8	2.9	2.9	2.6	4.3	3.3	2.3	2.2
13	1.8	5.8	2.9	2.8	2.8	2.9	2.9	2.6	4.2	3.2	2.5	2.1
14	1.8	3.1	2.9	2.8	2.8	2.9	2.9	2.6	4.2	3.2	2.5	2.2
15	1.8	2.6	2.8	2.8	2.8	2.9	2.9	2.6	4.2	3.2	2.5	2.1
16	1.8	2.4	2.8	2.8	2.8	2.9	2.9	2.6	4.1	3.2	2.5	2.2
17	1.8	2.6	3.1	2.8	2.8	2.9	2.9	2.6	4.1	3.1	2.4	2.2
18	1.8	2.6	2.9	2.8	2.8	2.9	2.9	2.6	4.1	3.1	2.4	2.2
19	2.4	2.6	2.9	2.8	2.8	2.9	2.9	2.6	4.1	3.1	2.4	2.1
20	2.4	2.6	2.9	2.8	3.0	2.9	2.9	2.6	4.0	3.1	2.4	2.0
21	2.4	6.2	2.9	2.8	2.9	2.9	2.9	2.6	4.0	3.1	2.4	2.0
22	2.4	6.2	2.9	2.8	2.9	2.9	3.1	2.6	4.0	3.1	2.4	2.0
23	2.5	2.5	2.9	2.8	2.9	2.9	2.8	2.6	4.0	3.0	2.4	2.0
24	2.5	13	2.9	2.8	2.8	2.9	2.8	2.6	3.5	3.0	2.4	2.0
25	2.5	4.0	2.9	2.8	2.8	2.9	2.8	2.6	3.8	3.0	2.4	2.0
26	2.4	2.8	2.9	2.8	2.8	2.9	2.7	2.6	3.7	2.9	2.4	2.0
27	2.5	3.9	2.8	2.8	2.8	2.9	2.6	2.6	3.7	3.0	2.3	2.0
28	2.5	3.7	3.0	2.8	2.8	2.9	2.6	2.6	3.7	3.1	2.3	2.0
29	2.7	4.2	3.5	2.8	---	2.9	2.6	2.6	3.7	3.1	2.3	2.1
30	5.6	4.1	3.5	2.8	---	2.9	2.6	2.6	3.6	3.0	2.3	2.2
31	2.8	---	6.2	2.8	---	2.9	---	2.6	---	2.9	2.3	---
TOTAL	69.4	105.8	99.5	118.6	79.0	91.7	85.5	80.6	104.5	100.6	77.7	64.3
MEAN	2.239	3.527	3.210	3.826	2.821	2.958	2.850	2.600	3.483	3.245	2.506	2.143
MAX	5.6	13	8.8	16	3.0	4.7	3.1	2.6	4.3	3.6	3.0	2.3
MIN	1.8	2.0	2.7	2.8	2.7	2.8	2.6	2.6	2.6	2.9	2.2	2.0
AC-FT	138	210	197	235	157	182	170	160	207	200	154	128
a	0.00	18	753	1060	736	1290	631	317	48	0.00	0.00	0.00

STATISTICS OF MONTHLY MEAN DATA FOR WATER YEARS 1995 - 2002, BY WATER YEAR (WY)

	1995	1996	1997	1998	1999	2000	2001	2002	1995	1996	1997	1998	1999	2000	2001	2002
MEAN	3.696	3.817	5.424	11.23	9.950	6.504	3.972	3.960	3.077	3.137	3.159	3.266	3.266	3.266	3.266	3.266
MAX (WY)	4.75	4.73	17.7	42.4	20.3	22.8	10.7	10.7	3.61	4.16	4.13	4.35	4.35	4.35	4.35	4.35
MIN (WY)	1.999	1997	1997	1997	1998	1995	1995	1995	2001	1997	1997	1996	1996	1996	1996	1996
MIN (WY)	2.04	3.09	2.75	3.34	2.82	2.78	2.69	2.60	2.54	2.57	2.17	1.96	1.96	1.96	1.96	1.96

SUMMARY STATISTICS

	FOR 2001 CALENDAR YEAR		FOR 2002 WATER YEAR		WATER YEARS 1995 - 2002	
ANNUAL TOTAL	1120.1		1077.2			
ANNUAL MEAN	3.069		2.951		5.080	
HIGHEST ANNUAL MEAN					8.23	1997
LOWEST ANNUAL MEAN					2.95	2002
HIGHEST DAILY MEAN	16	Feb 22	16	Jan 4	400	Jan 1 1997
LOWEST DAILY MEAN	1.8	Oct 12	1.8	Oct 12	1.7	Feb 24 1997
ANNUAL SEVEN-DAY MINIMUM	1.8	Oct 12	1.8	Oct 12	1.7	Feb 23 1997
ANNUAL RUNOFF (AC-FT)	2220		2140		3680	
TOTAL DIVERSION (AC-FT) a	2410		4860		8260	
10 PERCENT EXCEEDS	4.1		3.6		5.8	
50 PERCENT EXCEEDS	2.8		2.8		2.9	
90 PERCENT EXCEEDS	2.0		2.1		2.6	

a Diversion, in acre-feet, to Deadwood Creek Powerplant (station 11413326), provided by Yuba County Water Agency.

11413323 OWL GULCH NEAR STRAWBERRY VALLEY, CA

LOCATION.—Lat 39°32'44", long 121°05'39", in SW 1/4 SW 1/4 sec.33, T.20 N., R.8 E., [Yuba County](#), Hydrologic Unit 18020125, Plumas National Forest, on left bank, 250 ft upstream from Deadwood Creek, and 1.3 mi southeast of Strawberry Valley.

DRAINAGE AREA.—2.07 mi².

PERIOD OF RECORD.—October 1994 to current year.

GAGE.—Water-stage recorder and 120° V-notch weir. Elevation of gage is 3,050 ft above sea level, from topographic map.

REMARKS.—Water from creek is diverted at gage to Deadwood Creek Powerplant (station 11413326). See schematic diagram of [North and Middle Yuba River Basins](#).

COOPERATION.—Records provided by Yuba County Water Agency, under general supervision of the U.S. Geological Survey, in connection with Federal Energy Regulatory Commission project no. 6780.

EXTREMES FOR PERIOD OF RECORD.—Maximum daily discharge, 346 ft³/s, Jan. 1, 1997; minimum daily, 0.58 ft³/s, Sept. 17–22, 1997.

DISCHARGE, CUBIC FEET PER SECOND, WATER YEAR OCTOBER 2001 TO SEPTEMBER 2002
DAILY MEAN VALUES

DAY	OCT	NOV	DEC	JAN	FEB	MAR	APR	MAY	JUN	JUL	AUG	SEP
1	0.77	0.97	2.4	7.0	1.7	1.8	1.7	1.8	1.8	1.9	1.4	1.1
2	0.80	0.93	4.3	5.5	1.7	1.7	1.7	1.8	1.8	1.9	1.4	1.0
3	0.77	0.93	4.0	4.3	1.7	1.7	1.7	1.8	1.8	1.8	1.4	1.0
4	0.77	0.89	3.6	4.3	1.7	1.7	1.7	1.8	1.8	1.8	1.4	0.97
5	0.77	0.89	3.2	4.3	1.7	1.7	1.8	1.8	1.8	1.8	1.4	0.97
6	0.77	0.89	2.9	4.3	1.7	2.6	1.8	1.8	1.8	1.8	1.4	1.1
7	0.77	0.89	2.6	2.9	1.7	5.6	1.8	1.8	1.8	1.8	1.3	1.1
8	0.80	0.89	2.3	2.4	1.7	2.3	1.8	1.8	1.8	1.8	1.3	1.1
9	0.80	0.89	2.0	2.5	1.7	2.0	1.8	1.8	1.8	1.8	1.3	1.1
10	0.77	0.89	1.7	2.1	1.7	2.1	1.8	1.8	1.8	1.7	1.3	1.1
11	0.77	1.1	1.7	2.0	1.7	2.0	1.8	1.8	2.3	1.7	1.2	1.1
12	0.77	2.0	1.6	1.8	1.7	2.0	1.8	1.8	2.4	1.7	1.2	1.1
13	0.73	1.9	1.6	1.8	1.7	2.0	1.8	1.8	2.4	1.7	1.2	1.1
14	0.77	1.6	1.6	1.7	1.7	1.9	1.8	1.8	2.4	1.7	1.2	1.1
15	0.77	1.3	1.6	1.7	1.7	1.8	1.8	1.8	2.3	1.7	1.2	1.0
16	0.77	1.1	1.6	1.7	1.7	1.8	1.8	1.8	2.3	1.7	1.2	1.1
17	0.77	1.0	1.8	1.7	1.7	1.8	1.8	1.8	2.3	1.7	1.1	1.1
18	0.77	1.0	1.8	1.7	1.8	1.8	1.8	1.8	2.3	1.7	1.1	1.0
19	0.77	0.97	1.8	1.7	2.0	1.8	1.8	1.8	2.3	1.7	1.1	0.97
20	0.73	0.93	1.8	1.7	2.6	1.7	1.8	1.8	2.3	1.6	1.1	0.97
21	0.77	2.8	1.8	1.7	1.9	1.7	1.8	1.8	2.3	1.6	1.1	0.97
22	0.77	3.7	1.8	1.7	1.8	1.9	2.1	1.8	2.3	1.6	1.1	1.0
23	0.77	1.7	1.8	1.7	1.8	2.1	1.8	1.8	2.3	1.5	1.1	0.73
24	0.77	5.5	1.8	1.7	1.8	2.0	1.8	1.8	2.2	1.5	1.1	1.1
25	0.77	2.2	1.8	1.7	1.8	1.9	1.8	1.8	2.1	1.7	1.1	0.80
26	0.77	1.5	1.8	1.7	1.8	1.9	1.8	1.8	2.1	1.5	1.1	0.80
27	0.77	2.4	1.8	1.7	1.8	1.9	1.8	1.8	2.1	1.5	1.1	0.80
28	0.77	2.3	1.8	1.7	1.8	1.8	1.8	1.8	2.0	1.5	1.1	0.84
29	0.80	1.8	1.8	1.7	---	1.8	1.8	1.8	2.0	1.5	1.1	0.84
30	1.7	1.8	2.1	1.7	---	1.7	1.9	1.8	2.0	1.5	1.1	0.89
31	1.2	---	3.2	1.7	---	1.7	---	1.8	---	1.4	1.1	---
TOTAL	25.27	47.66	67.4	75.8	49.8	62.2	54.0	55.8	62.7	51.8	37.3	29.85
MEAN	0.815	1.589	2.174	2.445	1.779	2.006	1.800	1.800	2.090	1.671	1.203	0.995
MAX	1.7	5.5	4.3	7.0	2.6	5.6	2.1	1.8	2.4	1.9	1.4	1.1
MIN	0.73	0.89	1.6	1.7	1.7	1.7	1.7	1.8	1.8	1.4	1.1	0.73
AC-FT	50	95	134	150	99	123	107	111	124	103	74	59

STATISTICS OF MONTHLY MEAN DATA FOR WATER YEARS 1995 - 2002, BY WATER YEAR (WY)

	1995	1996	1997	1998	1999	2000	2001	2002	2001	2002	2001	2002
MEAN	1.579	1.764	3.464	9.245	8.651	5.883	3.238	3.327	2.066	1.783	1.446	1.362
MAX	2.85	2.17	14.2	35.3	23.7	16.3	8.74	10.6	2.87	2.06	1.90	2.09
(WY)	1999	1999	1997	1997	1998	1995	1995	1998	1998	1997	1998	1998
MIN	0.82	1.47	1.70	1.77	1.78	1.90	1.80	1.80	1.75	1.29	0.77	0.78
(WY)	2002	2001	2000	2001	2002	2001	2002	2002	2001	2001	1997	2001

SUMMARY STATISTICS	FOR 2001 CALENDAR YEAR		FOR 2002 WATER YEAR		WATER YEARS 1995 - 2002	
ANNUAL TOTAL	581.32		619.58			
ANNUAL MEAN	1.593		1.697		3.630	
HIGHEST ANNUAL MEAN					6.02	
LOWEST ANNUAL MEAN					1.61	
HIGHEST DAILY MEAN	5.5	Nov 24	7.0	Jan 1	346	Jan 1 1997
LOWEST DAILY MEAN	0.73	Sep 20	0.73	Oct 13	0.58	Sep 17 1997
ANNUAL SEVEN-DAY MINIMUM	0.74	Sep 18	0.76	Oct 10	0.58	Sep 16 1997
ANNUAL RUNOFF (AC-FT)	1150		1230		2630	
10 PERCENT EXCEEDS	2.2		2.3		6.5	
50 PERCENT EXCEEDS	1.7		1.7		1.8	
90 PERCENT EXCEEDS	0.77		0.89		1.2	

11413510 NEW COLGATE POWERPLANT NEAR FRENCH CORRAL, CA

LOCATION.—Lat 39°19'51", long 121°11'23", in NE 1/4 SE 1/4 sec.16, T.17 N., R.7 E., Yuba County, Hydrologic Unit 18020125, at powerplant, on right bank of Yuba River, 0.3 mi upstream from Dobbins Creek, and 2.3 mi northwest of French Corral.

PERIOD OF RECORD.—October 1966 to current year. Prior to October 1969, published as "Colgate Powerplant."

GAGE.—Recorded output from powerplant turbines.

REMARKS.—Water is diverted from North Yuba River at New Bullards Bar Reservoir (station 11413515). Colgate Powerplant was rebuilt during the 1970 water year with an increased capacity. Prior to Oct. 31, 1973, Browns Valley Ditch diverted up to 10 ft³/s at times from the head of the penstock for use in irrigation. See schematic diagram of [North and Middle Yuba River Basins](#).

COOPERATION.—Records provided by Yuba County Water Agency, under general supervision of the U.S. Geological Survey, in connection with Federal Energy Regulatory Commission project no. 2246.

DISCHARGE, CUBIC FEET PER SECOND, WATER YEAR OCTOBER 2001 TO SEPTEMBER 2002
DAILY MEAN VALUES

DAY	OCT	NOV	DEC	JAN	FEB	MAR	APR	MAY	JUN	JUL	AUG	SEP
1	677	870	0.00	0.00	1070	634	1460	2280	485	2590	2520	533
2	823	821	0.00	0.00	1040	633	1660	2300	696	2630	2440	595
3	728	3.0	702	332	1040	632	1900	2440	2040	2460	1190	629
4	734	12	188	319	1490	1400	1930	1340	2140	1190	1350	602
5	770	794	277	312	2110	1550	1840	1230	2190	2300	2440	509
6	0.00	854	312	325	1530	838	1190	2310	1610	1060	2330	581
7	0.00	916	318	697	1140	270	1270	2320	1700	1040	2510	550
8	724	1030	0.00	756	1360	635	1970	2410	593	2410	2170	615
9	679	1020	0.00	742	1040	2230	1620	2440	437	2410	2200	553
10	740	260	277	797	1060	1600	1380	2620	1850	2370	1070	570
11	728	108	230	735	1500	2750	1650	2010	2220	2420	1070	533
12	799	923	265	772	1330	1680	2210	2310	2160	2340	2210	532
13	0.00	913	385	1270	1180	1610	1350	2470	2250	1610	2430	525
14	0.00	464	394	1620	1220	1230	1280	2490	2080	838	2440	555
15	847	467	0.00	1580	1230	1420	1960	2420	1020	2190	2550	531
16	811	0.00	0.00	2060	522	414	2140	2080	780	2240	2590	688
17	800	0.00	374	2060	483	748	2220	1890	2290	2300	1220	485
18	813	0.00	226	2550	616	1880	2160	515	2170	2370	1180	0.00
19	711	1070	0.00	1630	1440	2000	1850	622	2540	2420	2330	1020
20	0.00	1200	37	1620	628	2020	1060	1930	2380	907	1470	942
21	0.00	1020	0.00	1050	0.00	1980	1240	1900	2400	959	1490	4.0
22	1070	112	0.00	875	0.00	2120	2000	1840	1300	2210	1470	630
23	1220	145	0.00	925	0.00	482	1890	2080	1240	2260	1490	630
24	1310	119	0.00	963	0.00	631	2010	2000	2210	2430	1030	520
25	1380	102	0.00	876	1520	2140	2300	576	2230	2330	1020	547
26	1220	605	315	467	1250	1440	2100	535	2300	2350	1050	497
27	0.00	542	0.00	462	1160	1370	1040	580	2660	882	1050	528
28	0.00	704	0.00	824	485	1330	1240	1840	2570	827	911	534
29	1220	0.00	0.00	1280	---	1700	2180	2140	1290	2500	689	516
30	990	219	0.00	1330	---	542	2230	2100	1250	2510	599	537
31	841	---	0.00	1130	---	436	---	1900	---	2400	631	---
TOTAL	20635.00	15293.00	4300.00	30359.00	27444.00	40345	52330	57918	53081	61753	51140	16491.00
MEAN	665.6	509.8	138.7	979.3	980.1	1301	1744	1868	1769	1992	1650	549.7
MAX	1380	1200	702	2550	2110	2750	2300	2620	2660	2630	2590	1020
MIN	0.00	0.00	0.00	0.00	0.00	270	1040	515	437	827	599	0.00
AC-FT	40930	30330	8530	60220	54440	80020	103800	114900	105300	122500	101400	32710

STATISTICS OF MONTHLY MEAN DATA FOR WATER YEARS 1971 - 2002, BY WATER YEAR (WY)

	1971	1972	1973	1974	1975	1976	1977	1978	1979	1980	1981	1982	1983	1984	1985	1986	1987	1988	1989	1990	1991	1992	1993	1994	1995	1996	1997	1998	1999	2000	2001	2002			
MEAN	1183	1110	1338	1500	1670	1700	1713	1516	1652	1781	1926	1325																							
MAX	2497	2433	3262	3496	3525	3519	3508	3565	3629	3057	3130	2995																							
(WY)	1976	1976	1975	1984	1998	1980	1993	1982	1983	1983	1984	1980																							
MIN	0.000	302	96.6	152	54.6	39.3	103	206	404	386	319	0.000																							
(WY)	1975	1978	1978	1977	1977	1977	1979	1977	1977	1977	1977	1974																							

SUMMARY STATISTICS

	FOR 2001 CALENDAR YEAR		FOR 2002 WATER YEAR		WATER YEARS 1971 - 2002	
ANNUAL TOTAL	273318.00		431089.00			
ANNUAL MEAN	748.8		1181		1534	
HIGHEST ANNUAL MEAN					2686	
LOWEST ANNUAL MEAN					316	
HIGHEST DAILY MEAN	2930	Jul 10	2750	Mar 11	4200	Jun 2 1971
LOWEST DAILY MEAN	0.00	Jan 6	0.00	Oct 6	0.00	Mar 14 1971
ANNUAL SEVEN-DAY MINIMUM	5.3	Dec 19	0.00	Dec 27	0.00	Feb 29 1972
ANNUAL RUNOFF (AC-FT)	542100		855100		1112000	
10 PERCENT EXCEEDS	1870		2340		3370	
50 PERCENT EXCEEDS	702		1050		1270	
90 PERCENT EXCEEDS	0.00		1.8		146	

11413515 NEW BULLARDS BAR RESERVOIR NEAR NORTH SAN JUAN, CA

LOCATION.—Lat 39°23'34", long 121°08'25", in SE 1/4 NW 1/4 sec.25, T.18 N., R.7 E., [Yuba County](#), Hydrologic Unit 18020125, Plumas National Forest, in center of dam on North Yuba River, 2.2 mi upstream from Middle Yuba River, and 2.4 mi northwest of North San Juan.

DRAINAGE AREA.—489 mi².

PERIOD OF RECORD.—January 1969 to current year.

GAGE.—Water-stage recorder. Datum of gage is sea level (levels by Yuba County Water Agency).

REMARKS.—Reservoir is formed by concrete-arch dam with a concrete-sidehill spillway. Spill controlled by three 30-ft by 53-ft radial gates. Storage began in January 1969. Usable capacity, 727,380 acre-ft, between elevations 1,732.0 ft, minimum power pool and 1,955.0 ft, normal gross pool. Dead storage, 233,920 acre-ft. Total capacity at normal gross pool, 961,300 acre-ft, elevation, 1,955.0 ft. Water is released to New Colgate Powerplant (station 11413510) through a tunnel at the dam. Water is diverted into the reservoir from Middle Yuba River via Lohman Ridge Tunnel to Oregon Creek then via Camptonville Tunnel (stations 11408870 and 11409350). Records, including extremes, represent total contents at 2400 hours. See schematic diagram of [North and Middle Yuba River Basins](#).

COOPERATION.—Records provided by Yuba County Water Agency, under general supervision of the U.S. Geological Survey, in connection with Federal Energy Regulatory Commission project no. 2246. Contents not rounded to U.S. Geological Survey standards.

EXTREMES FOR PERIOD OF RECORD.—Maximum contents, 972,224 acre-ft, June 27, 1995, elevation, 1,957.27 ft; minimum since reservoir first filled, 178,230 acre-ft, Dec. 29, 1980, elevation, 1,700.00 ft.

EXTREMES FOR CURRENT YEAR.—Maximum contents, 818,569 acre-ft, June 1, elevation, 1,923.58 ft; minimum, 490,517 acre-ft, Nov. 19, 20, elevation, 1,834.64 ft.

Capacity table (elevation, in feet, and contents, in acre-feet)
(Based on survey by Yuba County Water Agency in 1969)

1,600	64,900	1,690	162,983	1,800	389,977	1,900	721,130
1,630	90,570	1,720	211,768	1,850	539,748	1,960	985,471
1,660	122,993	1,750	270,110				

RESERVOIR STORAGE, (ACRE-FEET), WATER YEAR OCTOBER 2001 TO SEPTEMBER 2002

DAILY OBSERVATION AT 2400 HOURS

DAY	OCT	NOV	DEC	JAN	FEB	MAR	APR	MAY	JUN	JUL	AUG	SEP
1	535893	502739	516558	608458	658261	707532	761359	809355	818569	747561	642752	558881
2	534612	502928	520550	619663	657626	710631	764360	807947	817408	743470	640875	557768
3	533366	503212	522521	625947	656170	710749	767741	809099	815733	741773	638635	556666
4	532055	501886	525211	630741	653450	710513	771463	810850	813932	737944	634242	555814
5	532252	500374	528007	640287	651702	721130	775570	810765	813161	736456	629977	554773
6	532448	498769	530127	647587	651591	722717	778982	810850	812091	734970	625476	553765
7	531270	496981	532252	652929	652111	723313	781025	810465	812690	730924	621609	552692
8	530225	495195	534186	657140	652297	723035	784034	809868	813289	726813	617721	551687
9	528920	494820	535203	660321	652259	726335	787890	808757	811449	722757	615962	550750
10	527747	495008	536090	663134	651256	726653	790916	808373	808672	718516	614134	549646
11	526380	494445	536814	665304	650588	728408	792811	807392	805986	714567	610168	548578
12	526575	494039	537572	666295	650254	730045	796314	806412	802924	711967	605791	547545
13	526770	493695	538659	666333	649809	731924	800632	805519	800251	710710	601363	546479
14	525341	493226	540046	666182	649476	733086	804455	804795	799572	707023	596711	545381
15	523946	493601	541335	664827	650588	735894	806114	804795	799191	703153	591976	544252
16	522586	493976	544916	663322	651925	738025	806924	805306	795765	699103	589879	543522
17	521228	494351	547845	660546	652817	737703	807179	808416	792769	695029	587787	543721
18	520002	492571	550315	659534	654008	736777	807435	811620	788940	690815	583583	541931
19	520163	490517	553094	658336	662121	735934	808971	812561	785333	689466	580951	540277
20	520454	490517	555377	658336	669693	735131	809996	812476	781693	687964	578224	540475
21	518584	495665	558274	658598	675837	734649	809697	812219	780190	684162	575643	539616
22	516397	496886	561518	658411	681596	738911	809611	811235	778690	680105	572931	538594
23	513993	500940	563789	658187	686580	742864	809227	810423	775278	675875	571184	537769
24	511531	503559	565692	658000	688927	743389	808928	812005	771835	671661	569441	536913
25	509364	503718	566815	659983	692012	744887	809355	813889	768236	667577	567632	536189
26	509523	503591	568587	661332	694835	746304	811663	815862	763867	666220	565794	535367
27	509778	503212	571047	661670	699958	747724	813075	815647	759595	664977	564230	534547
28	507679	504635	574921	661070	704012	748861	812561	815089	757874	660508	563009	533792
29	506441	505204	579949	660058	---	752523	811663	814575	756238	656020	561958	533071
30	505553	507774	591167	659422	---	756442	810636	814575	751871	651665	560909	532088
31	504067	---	597978	658785	---	758898	---	816850	---	647106	559962	---
MAX	535893	507774	597978	666333	704012	758898	813075	816850	818569	747561	642752	558881
MIN	504067	490517	516558	608458	649476	707532	761359	804795	751871	647106	559962	532088
a	1838.97	1840.13	1867.07	1883.82	1895.65	1909.37	1921.73	1923.18	1907.65	1880.68	1856.05	1847.67
b	-34296	+3707	+90204	+60807	+45227	+54886	+51738	+6214	-64979	-104765	-87144	-27874

CAL YR 2001 b -3385

WTR YR 2002 b -6275

a Elevation, in feet, at end of month.

b Change in contents, in acre-feet.

11413520 NORTH YUBA RIVER BELOW NEW BULLARDS BAR DAM, NEAR NORTH SAN JUAN, CA

LOCATION.—Lat 39°23'26", long 121°08'36", in SE 1/4 NW 1/4 sec.25, T.18 N., R.7 E., [Yuba County](#), Hydrologic Unit 18020125, Plumas National Forest, on right bank, at old Colgate Dam, 0.2 mi downstream from New Bullards Bar Dam, and 2.5 mi northwest of North San Juan.

DRAINAGE AREA.—490 mi².

PERIOD OF RECORD.—August 1966 to current year.

GAGE.—Water-stage recorder, and sharp-crested low-water control since Oct. 1, 1986. Elevation of gage is 1,350 ft above sea level, from topographic map. Auxiliary water-stage recorder for high flow 0.9 mi downstream at different datum.

REMARKS.—Records good. Flow regulated by New Bullards Bar Reservoir (station 11413515) since 1969. Prior to 1969, flow regulated by Bullards Bar Reservoir (usable capacity, 31,500 acre-ft). New Colgate Powerplant (station 11413510) diverts at New Bullards Bar Dam 0.2 mi upstream. Water is diverted to Feather River Basin through Slate Creek Tunnel (station 11413250). Camptonville Tunnel (station 11409350) diverts water from Middle Yuba River to New Bullards Bar Reservoir. Records include flow over New Bullards Bar Reservoir spillway. See schematic diagram of [North and Middle Yuba River Basins](#).

EXTREMES FOR PERIOD OF RECORD.—Maximum discharge, 56,200 ft³/s, Jan. 22, 1970, gage height, 35.29 ft, at auxiliary gage, from rating curve extended above 40,000 ft³/s, on basis of computation of flow over old Colgate Dam; minimum daily, 0.42 ft³/s, Nov. 5, 1966.

EXTREMES OUTSIDE PERIOD OF RECORD.—Flood of Dec. 22, 1964, reached a stage of 49.8 ft, from floodmarks, discharge, 91,600 ft³/s, at auxiliary gage, from computation of flow over old Colgate Dam.

DISCHARGE, CUBIC FEET PER SECOND, WATER YEAR OCTOBER 2001 TO SEPTEMBER 2002

DAILY MEAN VALUES

DAY	OCT	NOV	DEC	JAN	FEB	MAR	APR	MAY	JUN	JUL	AUG	SEP
1	6.8	6.6	6.8	6.3	6.0	6.5	6.4	6.4	6.4	5.8	7.0	6.4
2	6.7	6.6	7.7	7.4	6.0	6.0	6.2	6.4	6.3	5.8	7.0	6.4
3	6.6	6.4	6.9	6.8	6.0	6.0	6.2	6.4	6.2	5.8	7.0	6.4
4	6.6	6.2	6.6	6.3	6.0	6.0	6.2	6.4	6.2	5.8	7.0	6.4
5	6.6	6.2	8.2	6.3	6.0	6.1	6.2	6.4	6.2	5.8	7.0	6.4
6	6.6	6.2	7.9	7.0	6.0	7.3	6.2	6.4	6.2	5.8	7.0	6.4
7	6.5	6.2	6.8	6.4	6.5	7.1	6.3	6.4	6.2	5.8	7.0	6.4
8	6.5	6.2	6.6	6.2	6.3	6.5	6.4	6.4	6.2	5.8	7.0	6.4
9	6.4	6.2	6.6	6.1	6.1	6.3	6.4	6.4	6.2	5.8	7.0	6.4
10	6.4	6.2	6.5	5.8	6.0	6.8	6.4	6.4	6.2	5.8	7.0	6.4
11	6.4	6.3	6.5	5.8	6.0	6.4	6.4	6.4	6.1	5.8	7.0	6.4
12	6.4	6.8	6.4	5.8	6.0	6.2	6.4	6.4	6.0	5.8	7.0	6.4
13	6.4	6.7	6.2	5.8	6.0	6.2	6.4	6.4	6.0	5.7	7.0	6.4
14	6.4	5.8	6.9	5.8	6.0	6.0	6.4	6.4	6.0	5.6	7.0	6.4
15	6.4	5.8	6.3	5.8	6.0	6.0	6.6	7.4	6.0	5.6	6.9	6.4
16	6.4	6.2	6.2	5.8	6.1	6.0	6.7	6.4	6.0	5.6	6.9	6.4
17	6.5	5.8	7.7	6.0	6.2	6.0	6.8	6.4	6.0	5.6	6.8	6.4
18	6.4	5.3	6.5	6.0	6.0	6.0	6.6	6.4	6.0	5.6	6.8	6.4
19	6.4	6.3	6.3	6.0	7.2	6.0	6.6	6.6	6.0	5.6	6.8	6.4
20	6.4	6.7	7.0	6.0	8.0	6.0	6.6	6.8	6.0	5.6	7.7	6.4
21	6.4	8.1	7.0	6.1	6.5	6.0	6.6	6.5	6.0	5.6	7.3	6.4
22	6.4	7.4	6.6	6.0	6.3	6.3	6.5	6.4	6.0	5.6	6.6	6.4
23	6.4	6.4	6.5	6.0	6.2	7.2	6.4	6.4	6.0	5.6	7.2	6.4
24	6.4	7.0	6.3	6.0	6.2	7.1	6.4	6.4	6.0	5.6	7.1	6.4
25	6.4	6.5	6.2	6.0	6.2	6.5	6.4	6.4	5.9	5.5	6.4	6.4
26	6.4	6.4	6.1	7.0	6.2	6.4	6.4	6.4	5.8	6.2	6.4	6.4
27	6.4	6.4	5.8	6.3	6.2	6.3	6.4	6.4	5.8	6.8	6.4	6.4
28	6.4	6.5	6.1	6.2	6.2	6.2	6.5	6.4	5.8	6.8	6.4	6.4
29	6.4	6.8	6.3	6.1	---	6.2	6.6	6.4	5.8	6.8	6.4	6.4
30	6.9	6.5	6.7	6.0	---	6.2	6.6	6.4	5.8	7.0	6.4	6.4
31	6.7	---	7.4	6.0	---	6.4	---	6.4	---	7.0	6.4	---
TOTAL	201.0	192.7	207.6	191.1	174.4	196.2	193.2	200.1	181.3	183.0	212.9	192.0
MEAN	6.484	6.423	6.697	6.165	6.229	6.329	6.440	6.455	6.043	5.903	6.868	6.400
MAX	6.9	8.1	8.2	7.4	8.0	7.3	6.8	7.4	6.4	7.0	7.7	6.4
MIN	6.4	5.3	5.8	5.8	6.0	6.0	6.2	6.4	5.8	5.5	6.4	6.4
AC-FT	399	382	412	379	346	389	383	397	360	363	422	381

SACRAMENTO RIVER BASIN

11413520 NORTH YUBA RIVER BELOW NEW BULLARDS BAR DAM, NEAR NORTH SAN JUAN, CA—Continued

STATISTICS OF MONTHLY MEAN DATA FOR WATER YEARS 1966 - 2002, BY WATER YEAR (WY)

	OCT	NOV	DEC	JAN	FEB	MAR	APR	MAY	JUN	JUL	AUG	SEP
MEAN	17.48	33.86	267.7	755.3	826.5	651.4	362.1	475.6	246.5	35.10	7.537	7.963
MAX	381	404	3570	8990	7457	4648	4144	4289	3759	759	25.4	45.9
(WY)	1975	1967	1984	1970	1986	1995	1982	1967	1967	1967	1967	1969
MIN	2.60	3.41	4.97	4.65	2.10	5.32	3.09	4.12	1.92	3.48	3.21	2.89
(WY)	1971	1971	1978	1981	1971	1976	1970	1970	1970	1977	1977	1966

SUMMARY STATISTICS	FOR 2001 CALENDAR YEAR	FOR 2002 WATER YEAR	WATER YEARS 1966 - 2002
ANNUAL TOTAL	2401.0	2325.5	
ANNUAL MEAN	6.578	6.371	304.9
HIGHEST ANNUAL MEAN			1560
LOWEST ANNUAL MEAN			4.62
HIGHEST DAILY MEAN	8.5 Jul 18	8.2 Dec 5	48200
LOWEST DAILY MEAN	5.3 Nov 18	5.3 Nov 18	0.42
ANNUAL SEVEN-DAY MINIMUM	6.0 Nov 13	5.6 Jul 19	0.68
MAXIMUM PEAK FLOW		20 May 15	56200
MAXIMUM PEAK STAGE		a4.53 Nov 21	35.29
ANNUAL RUNOFF (AC-FT)	4760	4610	220900
10 PERCENT EXCEEDS	7.0	7.0	33
50 PERCENT EXCEEDS	6.5	6.4	6.7
90 PERCENT EXCEEDS	6.4	5.8	5.0

a Auxiliary gage.

11413700 YUBA RIVER BELOW NEW COLGATE POWERPLANT, NEAR FRENCH CORRAL, CA

LOCATION.—Lat 39°19'50", long 121°11'34", in NW 1/4 SE 1/4 sec.16, T.17 N., R.7 E., [Yuba County](#), Hydrologic Unit 18020125, on right bank, 0.1 mi upstream of Dobbins Creek, 0.2 mi downstream of New Colgate Powerplant, and 2.3 mi northwest of French Corral.

DRAINAGE AREA.—717 mi².

WATER-DISCHARGE RECORDS

PERIOD OF RECORD.—October 2000 to September 2002 (discontinued).

GAGE.—Water-stage recorder, and crest-stage gage. Elevation of gage is 550 ft above sea level, from topographic map.

REMARKS.—Records fair. Flow regulated by New Bullards Bar Reservoir (station 11413515) since January 1969, and several other reservoirs. Flow through New Colgate Powerplant (station 11413510) is diverted from New Bullards Bar Reservoir. See schematic diagram of [North and Middle Yuba River Basins](#).

EXTREMES FOR PERIOD OF RECORD.—Maximum discharge, 4,180 ft³/s, Feb. 20, 2002, gage height, 11.82 ft; minimum daily, 41 ft³/s, Sept. 9, 22, 23, 2001.

DISCHARGE, CUBIC FEET PER SECOND, WATER YEAR OCTOBER 2001 TO SEPTEMBER 2002

DAILY MEAN VALUES

DAY	OCT	NOV	DEC	JAN	FEB	MAR	APR	MAY	JUN	JUL	AUG	SEP
1	796	1040	135	340	1150	808	1540	2400	694	2710	2640	708
2	940	1010	398	489	1110	782	1750	2440	758	2760	2560	750
3	855	69	684	885	1130	783	1890	2580	2140	2580	1240	764
4	842	67	371	601	1550	1440	1960	1390	2240	1230	1360	758
5	888	980	634	540	2170	1610	1900	1290	2300	2440	2570	692
6	43	1040	831	883	1600	1220	1250	2410	1710	1110	2470	708
7	43	1090	561	1120	1210	1080	1290	2450	1770	1100	2660	714
8	833	1210	161	968	1460	1130	2040	2530	767	2560	2280	757
9	767	1220	140	933	1110	2490	1690	2590	653	2550	2300	727
10	853	425	425	951	1130	1900	1450	2760	1930	2510	1130	720
11	847	219	372	877	1570	3050	1740	2080	2320	2570	1130	756
12	902	1110	393	906	1390	1850	2290	2410	2270	2500	2340	755
13	44	1130	536	1380	1240	1720	1390	e2620	2360	1700	2560	746
14	43	673	668	1710	1260	1330	1340	e2630	2180	933	2600	759
15	961	666	170	1680	1270	1480	2030	e2680	1070	2290	2700	758
16	926	118	134	2160	690	650	2230	2150	895	2360	2730	761
17	907	114	928	2160	713	882	2330	1960	2410	2440	1270	572
18	932	111	456	2680	781	1940	2270	714	2270	2500	1240	50
19	818	1250	196	1680	1740	2080	1950	711	2630	2550	2430	1160
20	44	1380	389	1680	1930	2070	1140	2030	2470	976	1600	1070
21	44	1240	337	1110	578	2050	1280	2010	2500	1040	1610	48
22	1170	468	252	972	282	2190	2090	1910	1310	2340	1600	712
23	1330	322	270	1030	229	974	2020	2150	1270	2370	1620	710
24	1410	343	202	1040	199	1210	2290	2120	2300	2570	1100	602
25	1490	308	164	982	1560	2420	2410	752	2320	2470	1090	629
26	1330	815	456	784	1360	1610	2220	726	2420	2470	1120	583
27	45	748	137	746	1270	1490	1110	754	2790	948	1120	614
28	51	873	149	971	708	1450	1290	1930	2680	909	999	619
29	1380	126	247	1350	---	1810	2280	2230	1330	2650	849	597
30	1190	374	254	1380	---	743	2340	2220	1290	2620	749	618
31	1050	---	871	1190	---	687	---	2000	---	2570	771	---
TOTAL	23774	20539	11921	36178	32390	46929	54800	61627	56047	65326	54438	20417
MEAN	766.9	684.6	384.5	1167	1157	1514	1827	1988	1868	2107	1756	680.6
MAX	1490	1380	928	2680	2170	3050	2410	2760	2790	2760	2730	1160
MIN	43	67	134	340	199	650	1110	711	653	909	749	48
AC-FT	47160	40740	23650	71760	64250	93080	108700	122200	111200	129600	108000	40500

STATISTICS OF MONTHLY MEAN DATA FOR WATER YEARS 2001 - 2002, BY WATER YEAR (WY)

	2001	2002	2001	2002	2001	2002	2001	2002	2001	2002	2001	2002
MEAN	880.0	878.7	610.6	997.9	790.3	938.9	1232	1423	1426	2082	1801	648.2
MAX	993	1073	837	1167	1157	1514	1827	1988	1868	2107	1845	681
(WY)	2001	2001	2001	2002	2002	2002	2002	2002	2002	2002	2001	2002
MIN	767	685	385	829	424	364	638	858	983	2057	1756	616
(WY)	2002	2002	2002	2001	2001	2001	2001	2001	2001	2001	2002	2001

SUMMARY STATISTICS

	FOR 2001 CALENDAR YEAR		FOR 2002 WATER YEAR		WATER YEARS 2001 - 2002	
ANNUAL TOTAL	319735		484386			
ANNUAL MEAN	876.0		1327		1146	
HIGHEST ANNUAL MEAN					1327	
LOWEST ANNUAL MEAN					965	
HIGHEST DAILY MEAN	3080		3050		3080	
LOWEST DAILY MEAN	41		43		41	
ANNUAL SEVEN-DAY MINIMUM	166		230		166	
MAXIMUM PEAK FLOW			4180		4180	
MAXIMUM PEAK STAGE			11.82		11.82	
ANNUAL RUNOFF (AC-FT)	634200		960800		830400	
10 PERCENT EXCEEDS	1980		2480		2420	
50 PERCENT EXCEEDS	814		1160		1040	
90 PERCENT EXCEEDS	98		331		126	

e Estimated.

11413700 YUBA RIVER BELOW NEW COLGATE POWERPLANT, NEAR FRENCH CORRAL, CA—Continued

WATER-QUALITY RECORDS

PERIOD OF RECORD.—Water years 1975–78, January 2001 to September 2002 (discontinued).

WATER TEMPERATURE: Water years 1975–78, January 2001 to September 2002 (discontinued).

SEDIMENT DATA: January 2001 to June 2002 (discontinued).

PERIOD OF DAILY RECORD.—

WATER TEMPERATURE: Water years 1975–78, January 2001 to September 2002 (discontinued).

SUSPENDED-SEDIMENT DISCHARGE: January 2001 to June 2002 (discontinued).

INSTRUMENTATION.—Water-temperature recorder October 1974 to September 1978, and January 19, 2001 to September 2002.

REMARKS.—Water-temperature records rated excellent except for Dec. 30 to Jan. 11, which are rated good. Water temperature is affected by regulation from New Colgate Powerplant.

EXTREMES FOR PERIOD OF DAILY RECORD.—

WATER TEMPERATURE: Maximum recorded, 27.0°C, July 25, 1976; minimum recorded, 1.0°C, Jan. 9, 1977.

SEDIMENT CONCENTRATION: Maximum daily mean, 85 mg/L, Dec. 31, 2001; minimum daily mean, 1 mg/L, many days during each year.

SEDIMENT LOAD: Maximum daily, 207 tons, Dec. 31, 2001; minimum daily, 0.26 ton, June 23, 2001.

EXTREMES FOR CURRENT YEAR.—

WATER TEMPERATURE: Maximum recorded, 21.0°C, Sept. 18, 21; minimum recorded, 5.0°C, Dec. 16.

SEDIMENT CONCENTRATION: Maximum daily mean, 85 mg/L, Dec. 31; minimum daily mean, 1 mg/L, many days during water year.

SEDIMENT LOAD: Maximum daily, 207 tons, Dec. 31; minimum daily, 0.30 ton, Oct. 27.

CROSS-SECTIONAL DATA, WATER YEAR OCTOBER 2001 TO SEPTEMBER 2002

DATE	TIME	DEPTH BOTTOM AT SAMPLE LOC- ATION, (FEET) (81903)	TEMPER- ATURE WATER (DEG C) (00010)	SAMPLE LOC- ATION, CROSS SECTION (FT FM L BANK) (00009)
APR				
16...	1229	4.60	7.5	162
16...	1231	5.30	7.5	145
16...	1232	5.00	7.5	128
16...	1234	9.30	7.5	111
16...	1235	9.60	7.5	94.0
16...	1237	8.50	7.5	77.0
16...	1239	8.20	8.0	60.0
16...	1241	5.80	8.0	43.0
16...	1242	4.40	8.0	26.0
16...	1244	6.20	8.0	9.00
AUG				
05...	1247	5.00	9.0	8.00
05...	1250	5.00	9.0	25.0
05...	1252	5.00	9.0	42.0
05...	1254	8.00	9.0	59.0
05...	1257	8.50	8.5	76.0
05...	1259	9.50	8.5	93.0
05...	1301	10.0	8.5	110
05...	1304	8.50	8.5	127
05...	1306	6.50	8.5	144
05...	1310	5.50	8.5	161

SUSPENDED-SEDIMENT DISCHARGE, WATER YEAR OCTOBER 2001 TO SEPTEMBER 2002

DATE	TIME	DIS- CHARGE, INST. CUBIC FEET PER SECOND (00061)	TEMPER- ATURE WATER (DEG C) (00010)	SEDI- MENT, DIS- CHARGE, SUS- PENDED (MG/L) (80154)	SEDI- MENT, DIS- CHARGE, SUS- PENDED (T/DAY) (80155)
OCT					
02...	1345	1750	9.0	2.0	9.5
JAN					
03...	1500	563	10.0	9.0	13.7
MAR					
06...	1415	1080	8.0	4.0	11.7
APR					
08...	1745	1790	7.5	2.0	9.7
MAY					
30...	1445	3660	8.0	<.5	<.01

* Instantaneous discharge at time of cross-sectional measurement: 3,060 ft³/s, Apr. 16, 3,640 ft³/s, Aug. 5.
< Actual value is known to be less than the value shown.

11413700 YUBA RIVER BELOW NEW COLGATE POWERPLANT, NEAR FRENCH CORRAL, CA—Continued

WATER TEMPERATURE (DEGREES C), WATER YEAR OCTOBER 2001 TO SEPTEMBER 2002

DAY	MAX	MIN	MAX	MIN	MAX	MIN	MAX	MIN	MAX	MIN	MAX	MIN
	OCTOBER		NOVEMBER		DECEMBER		JANUARY		FEBRUARY		MARCH	
1	18.0	8.5	9.0	9.0	8.5	7.5	9.5	9.5	8.0	7.0	8.5	7.5
2	17.0	8.5	9.5	9.0	9.0	8.0	10.0	9.5	8.0	7.5	8.0	7.5
3	17.0	8.5	13.0	9.0	9.0	8.0	10.0	8.5	8.0	7.0	8.0	7.5
4	17.0	8.5	13.0	11.0	9.0	7.0	8.5	8.0	8.0	7.5	8.0	7.5
5	16.5	8.5	11.0	9.0	9.0	7.0	8.5	8.0	8.0	7.5	8.0	7.5
6	18.5	15.0	9.0	8.5	9.0	7.5	9.5	8.5	8.0	7.5	8.5	7.5
7	18.5	16.0	9.0	9.0	9.0	8.0	9.0	8.5	7.5	7.5	9.0	8.0
8	17.0	8.5	9.0	8.5	8.5	7.5	9.5	8.5	8.0	7.5	8.0	7.0
9	16.0	8.5	9.0	9.0	8.0	7.0	9.5	8.0	8.0	7.5	8.0	7.5
10	14.5	8.5	10.5	8.5	9.0	6.5	8.5	8.0	8.0	7.5	8.0	7.5
11	14.5	8.5	12.5	9.0	9.0	6.0	8.5	7.5	8.0	7.5	8.0	7.5
12	14.0	8.5	12.0	9.0	9.0	5.5	8.5	7.5	8.0	7.5	8.0	7.5
13	16.5	13.0	11.5	9.0	9.0	5.5	8.5	8.0	8.0	7.5	8.0	7.5
14	16.0	14.0	11.5	9.0	9.0	6.0	8.5	8.0	8.0	7.5	8.0	7.5
15	15.0	8.5	12.0	9.0	7.0	5.5	8.5	8.0	8.0	7.5	8.0	7.5
16	14.0	8.5	12.5	11.0	6.0	5.0	8.5	8.0	8.0	7.5	8.0	7.5
17	14.0	8.5	13.0	12.0	9.0	5.5	8.0	8.0	8.0	7.5	8.0	7.5
18	13.5	8.5	13.0	11.5	9.0	7.5	8.5	8.0	8.5	7.5	8.0	7.5
19	13.5	8.5	11.5	9.0	8.5	8.0	8.0	8.0	8.0	7.5	8.0	7.5
20	15.5	12.0	11.0	9.0	9.0	7.5	8.0	8.0	9.0	7.5	8.0	7.5
21	15.0	13.0	11.5	9.0	7.5	7.0	8.0	7.5	9.5	8.5	8.0	7.5
22	14.0	8.5	12.0	9.0	7.5	7.0	8.0	7.5	10.5	9.5	8.0	7.5
23	12.5	8.5	11.5	9.0	8.0	7.5	8.0	7.5	11.0	10.0	8.5	7.5
24	12.0	8.5	11.0	9.0	7.5	6.5	8.0	7.5	10.5	9.0	8.5	7.5
25	11.5	8.5	10.5	9.0	6.5	6.0	8.0	7.5	9.5	7.5	8.0	7.5
26	11.0	8.5	9.5	9.0	9.0	6.5	8.0	7.0	8.0	7.5	8.0	7.5
27	13.0	10.5	9.0	7.5	8.0	7.5	8.0	7.5	8.0	7.5	8.0	7.5
28	13.5	12.0	9.0	7.5	8.5	8.0	8.0	7.5	8.5	7.5	8.5	7.5
29	12.5	8.5	8.5	7.0	9.0	8.5	8.0	7.5	---	---	8.0	7.5
30	9.5	9.0	9.0	7.0	10.0	9.0	8.0	7.5	---	---	9.5	8.0
31	9.5	8.5	---	---	10.0	9.5	8.0	7.5	---	---	9.5	8.0
MONTH	18.5	8.5	13.0	7.0	10.0	5.0	10.0	7.0	11.0	7.0	9.5	7.0
	APRIL		MAY		JUNE		JULY		AUGUST		SEPTEMBER	
1	8.5	7.5	8.0	7.5	11.5	8.5	9.0	8.0	9.0	8.5	10.5	9.0
2	8.5	7.5	8.0	7.5	11.5	8.5	9.0	8.0	9.0	8.5	10.5	9.0
3	8.5	7.5	8.0	7.5	9.5	8.0	8.5	8.0	9.0	8.5	10.5	9.0
4	8.0	7.5	8.5	7.5	9.0	8.0	9.5	8.5	9.0	8.5	10.5	9.0
5	8.0	7.5	8.5	7.5	9.0	8.0	9.5	8.0	9.0	8.5	10.0	9.0
6	8.5	7.5	8.5	7.5	9.5	8.0	9.5	8.5	9.0	8.5	18.0	9.0
7	8.5	7.5	8.0	7.5	9.5	8.0	10.0	8.5	9.0	8.5	10.5	9.0
8	8.0	7.5	8.0	7.5	10.5	8.0	9.0	8.0	9.0	8.5	10.0	9.0
9	8.0	7.5	8.0	7.5	10.0	8.5	9.0	8.5	9.5	8.5	10.0	9.0
10	8.5	7.5	8.0	7.5	9.5	8.0	9.5	8.5	10.0	8.5	10.0	9.0
11	8.5	7.5	8.0	7.5	8.5	8.0	9.0	8.5	10.0	8.5	10.0	9.0
12	8.5	7.5	8.5	7.5	9.0	8.0	9.5	8.5	10.0	8.5	10.0	9.0
13	8.0	7.5	8.0	7.5	9.0	8.0	11.0	8.5	9.5	8.5	10.5	9.0
14	8.5	7.5	8.0	7.5	9.0	8.0	11.0	8.5	9.5	8.5	10.0	9.0
15	8.5	7.5	8.0	7.5	9.5	8.5	9.0	8.5	9.5	8.5	10.0	9.0
16	8.0	7.5	8.5	7.5	11.5	8.5	9.0	8.0	9.5	8.5	10.0	9.0
17	8.0	7.5	8.0	8.0	9.5	8.0	9.5	8.5	10.0	9.0	17.0	9.0
18	8.0	7.5	10.0	8.0	9.5	8.0	9.5	8.5	10.0	9.0	21.0	17.0
19	8.0	7.5	10.0	8.0	8.5	8.0	9.0	8.5	10.0	9.0	19.5	9.0
20	8.5	7.5	8.5	7.5	8.5	8.0	10.0	8.5	10.0	9.0	19.5	9.0
21	8.0	7.5	8.5	7.5	8.5	8.0	11.5	8.5	10.0	9.0	21.0	16.5
22	8.0	7.5	8.0	7.5	8.5	8.0	9.5	8.5	10.0	9.0	19.0	9.0
23	8.5	7.5	8.0	7.5	10.0	8.0	9.0	8.5	10.0	9.0	10.0	9.0
24	8.5	7.5	8.5	7.5	9.0	8.0	9.0	8.5	10.0	9.0	10.5	9.0
25	8.0	7.5	10.5	8.0	9.0	8.0	9.0	8.5	10.0	9.0	10.5	9.0
26	8.0	7.5	10.5	8.0	9.0	8.0	9.0	8.5	10.0	9.0	10.5	9.5
27	8.5	7.5	10.5	8.0	8.5	8.0	9.5	8.5	10.5	9.0	10.5	9.0
28	8.0	7.5	9.0	8.0	8.5	8.0	10.5	8.5	10.0	9.0	10.5	9.0
29	8.0	7.5	8.5	8.0	10.0	8.5	9.5	8.5	10.5	9.0	10.0	9.0
30	8.0	7.5	9.0	8.0	10.5	8.5	9.0	8.5	10.5	9.0	10.5	9.5
31	---	---	9.5	8.0	---	---	9.0	8.5	10.5	9.0	---	---
MONTH	8.5	7.5	10.5	7.5	11.5	8.0	11.5	8.0	10.5	8.5	21.0	9.0

SACRAMENTO RIVER BASIN

11413700 YUBA RIVER BELOW NEW COLGATE POWERPLANT, NEAR FRENCH CORRAL, CA—Continued

SEDIMENT DISCHARGE, SUSPENDED (TONS/DAY), WATER YEAR OCTOBER 2001 TO SEPTEMBER 2002

DAY	MEAN DISCHARGE (CFS)	MEAN CONCEN- TRATION (MG/L)	SEDIMENT DISCHARGE (TONS/DAY)	MEAN DISCHARGE (CFS)	MEAN CONCEN- TRATION (MG/L)	SEDIMENT DISCHARGE (TONS/DAY)	MEAN DISCHARGE (CFS)	MEAN CONCEN- TRATION (MG/L)	SEDIMENT DISCHARGE (TONS/DAY)
	OCTOBER			NOVEMBER			DECEMBER		
1	796	2.0	4.3	1040	4.0	11.0	135	3.0	1.1
2	940	2.0	5.4	1010	3.0	9.4	398	14	20.0
3	855	4.0	8.9	69	3.0	0.59	684	23	40.0
4	842	4.0	8.4	67	3.0	0.51	371	13	12.0
5	888	3.0	8.2	980	3.0	6.9	634	13	35.0
6	43	3.0	0.36	1040	2.0	6.4	831	18	39.0
7	43	3.0	0.33	1090	2.0	6.0	561	7.0	9.9
8	833	3.0	5.7	1210	2.0	7.1	161	6.0	2.6
9	767	2.0	4.7	1220	2.0	7.7	140	6.0	2.3
10	853	2.0	4.7	425	3.0	2.9	425	6.0	6.9
11	847	2.0	5.3	219	3.0	1.6	372	5.0	4.5
12	902	3.0	6.3	1110	3.0	8.6	393	2.0	1.3
13	44	3.0	0.34	1130	3.0	9.2	536	1.0	2.0
14	43	3.0	0.37	673	3.0	5.5	668	11	23.0
15	961	3.0	9.0	666	3.0	5.4	170	6.0	2.9
16	926	4.0	9.4	118	3.0	0.96	134	6.0	2.2
17	907	4.0	9.7	114	3.0	0.95	928	7.0	18.0
18	932	4.0	9.7	111	3.0	0.96	456	7.0	9.3
19	818	4.0	8.2	1250	3.0	11.0	196	4.0	2.2
20	44	4.0	0.42	1380	3.0	13.0	389	5.0	5.9
21	44	3.0	0.40	1240	3.0	12.0	337	7.0	6.3
22	1170	3.0	10.0	468	4.0	4.5	252	7.0	4.7
23	1330	3.0	11.0	322	4.0	3.2	270	7.0	5.1
24	1410	3.0	11.0	343	4.0	3.5	202	7.0	3.8
25	1490	3.0	11.0	308	4.0	3.2	164	7.0	3.1
26	1330	3.0	9.6	815	4.0	8.2	456	7.0	8.6
27	45	3.0	0.30	748	2.0	4.2	137	7.0	2.6
28	51	2.0	0.32	873	2.0	4.8	149	8.0	3.3
29	1380	2.0	8.1	126	2.0	0.80	247	17	11.0
30	1190	2.0	7.0	374	3.0	2.8	254	24	23.0
31	1050	4.0	10.0	---	---	---	871	85	207
TOTAL	23774	---	188.44	20539	---	162.87	11921	---	518.6
	JANUARY			FEBRUARY			MARCH		
1	340	15	15.0	1150	2.0	5.0	808	5.0	12.0
2	489	7.0	8.7	1110	1.0	4.2	782	5.0	10.0
3	885	9.0	20.0	1130	1.0	3.7	783	4.0	8.4
4	601	4.0	6.1	1550	1.0	4.5	1440	3.0	12.0
5	540	3.0	3.7	2170	1.0	7.5	1610	2.0	10.0
6	883	3.0	8.1	1600	2.0	6.8	1220	4.0	13.0
7	1120	3.0	9.0	1210	2.0	6.1	1080	4.0	13.0
8	968	2.0	6.2	1460	2.0	8.5	1130	4.0	11.0
9	933	2.0	5.7	1110	2.0	7.3	2490	3.0	22.0
10	951	2.0	5.4	1130	3.0	8.3	1900	3.0	13.0
11	877	2.0	4.8	1570	3.0	13.0	3050	2.0	18.0
12	906	2.0	4.9	1390	4.0	15.0	1850	3.0	15.0
13	1380	2.0	7.5	1240	5.0	16.0	1720	4.0	16.0
14	1710	2.0	9.0	1260	4.0	12.0	1330	4.0	14.0
15	1680	2.0	6.8	1270	2.0	7.5	1480	3.0	13.0
16	2160	1.0	6.9	690	2.0	3.7	650	3.0	5.3
17	2160	2.0	11.0	713	2.0	3.9	882	3.0	7.1
18	2680	2.0	17.0	781	2.0	4.2	1940	3.0	16.0
19	1680	3.0	13.0	1740	2.0	9.4	2080	3.0	17.0
20	1680	3.0	15.0	1930	2.0	10.0	2070	3.0	17.0
21	1110	4.0	11.0	578	2.0	3.4	2050	3.0	17.0
22	972	4.0	9.9	282	4.0	2.8	2190	3.0	20.0
23	1030	3.0	6.9	229	4.0	2.5	974	6.0	16.0
24	1040	1.0	3.5	199	4.0	2.3	1210	8.0	26.0
25	982	2.0	4.7	1560	5.0	23.0	2420	4.0	23.0
26	784	2.0	5.3	1360	5.0	18.0	1610	2.0	9.5
27	746	3.0	6.5	1270	4.0	14.0	1490	2.0	10.0
28	971	4.0	10.0	708	3.0	6.7	1450	3.0	12.0
29	1350	3.0	11.0	---	---	---	1810	3.0	15.0
30	1380	2.0	7.8	---	---	---	743	3.0	5.6
31	1190	2.0	5.8	---	---	---	687	3.0	4.8
TOTAL	36178	---	266.2	32390	---	229.3	46929	---	421.7

11413700 YUBA RIVER BELOW NEW COLGATE POWERPLANT, NEAR FRENCH CORRAL, CA—Continued

SEDIMENT DISCHARGE, SUSPENDED (TONS/DAY), WATER YEAR OCTOBER 2001 TO SEPTEMBER 2002

DAY	MEAN DISCHARGE (CFS)	MEAN CONCENTRATION (MG/L)	SEDIMENT DISCHARGE (TONS/DAY)	MEAN DISCHARGE (CFS)	MEAN CONCENTRATION (MG/L)	SEDIMENT DISCHARGE (TONS/DAY)	MEAN DISCHARGE (CFS)	MEAN CONCENTRATION (MG/L)	SEDIMENT DISCHARGE (TONS/DAY)	
	APRIL			MAY			JUNE			
1	1540	2.0	10.0	2400	2.0	16.0	694	1.0	2.3	
2	1750	2.0	10.0	2440	3.0	19.0	758	1.0	3.1	
3	1890	2.0	10.0	2580	3.0	21.0	2140	2.0	10.0	
4	1960	2.0	11.0	1390	3.0	11.0	2240	2.0	12.0	
5	1900	2.0	10.0	1290	3.0	10.0	2300	2.0	9.5	
6	1250	2.0	7.9	2410	3.0	20.0	1710	1.0	5.0	
7	1290	3.0	9.4	2450	3.0	20.0	1770	1.0	4.8	
8	2040	3.0	15.0	2530	3.0	20.0	767	1.0	2.1	
9	1690	1.0	5.6	2590	3.0	20.0	653	1.0	1.8	
10	1450	1.0	3.9	2760	2.0	16.0	1930	1.0	6.6	
11	1740	1.0	4.7	2080	2.0	13.0	2320	3.0	17.0	
12	2290	1.0	6.2	2410	3.0	17.0	2270	3.0	15.0	
13	1390	1.0	3.7	e2620	3.0	e20.0	2360	2.0	13.0	
14	1340	1.0	3.6	e2630	2.0	e15.0	2180	2.0	12.0	
15	2030	1.0	5.5	e2680	2.0	e14.0	1070	2.0	5.8	
16	2230	1.0	7.0	2150	2.0	12.0	895	2.0	4.8	
17	2330	3.0	16.0	1960	2.0	11.0	2410	2.0	13.0	
18	2270	4.0	22.0	714	2.0	4.5	2270	2.0	10.0	
19	1950	2.0	12.0	711	3.0	5.1	2630	1.0	9.4	
20	1140	2.0	7.2	2030	3.0	16.0	2470	1.0	7.9	
21	1280	3.0	9.3	2010	3.0	16.0	2500	2.0	13.0	
22	2090	3.0	15.0	1910	3.0	13.0	1310	2.0	8.3	
23	2020	1.0	6.9	2150	2.0	12.0	1270	3.0	9.2	
24	2290	2.0	13.0	2120	2.0	11.0	2300	3.0	18.0	
25	2410	3.0	17.0	752	2.0	4.1	2320	3.0	15.0	
26	2220	1.0	7.2	726	2.0	3.9	2420	2.0	13.0	
27	1110	1.0	3.7	754	2.0	4.1	2790	2.0	11.0	
28	1290	1.0	5.2	1930	2.0	10.0	2680	1.0	7.5	
29	2280	2.0	11.0	2230	2.0	12.0	1330	1.0	3.6	
30	2340	2.0	13.0	2220	1.0	5.7	1290	1.0	3.5	
31	---	---	---	2000	1.0	5.0	---	---	---	
TOTAL	54800	---	282.0	61627	---	397.4	56047	---	267.2	
		JULY			AUGUST			SEPTEMBER		
1	2710	---	---	2640	---	---	708	---	---	
2	2760	---	---	2560	---	---	750	---	---	
3	2580	---	---	1240	---	---	764	---	---	
4	1230	---	---	1360	---	---	758	---	---	
5	2440	---	---	2570	---	---	692	---	---	
6	1110	---	---	2470	---	---	708	---	---	
7	1100	---	---	2660	---	---	714	---	---	
8	2560	---	---	2280	---	---	757	---	---	
9	2550	---	---	2300	---	---	727	---	---	
10	2510	---	---	1130	---	---	720	---	---	
11	2570	---	---	1130	---	---	756	---	---	
12	2500	---	---	2340	---	---	755	---	---	
13	1700	---	---	2560	---	---	746	---	---	
14	933	---	---	2600	---	---	759	---	---	
15	2290	---	---	2700	---	---	758	---	---	
16	2360	---	---	2730	---	---	761	---	---	
17	2440	---	---	1270	---	---	572	---	---	
18	2500	---	---	1240	---	---	50	---	---	
19	2550	---	---	2430	---	---	1160	---	---	
20	976	---	---	1600	---	---	1070	---	---	
21	1040	---	---	1610	---	---	48	---	---	
22	2340	---	---	1600	---	---	712	---	---	
23	2370	---	---	1620	---	---	710	---	---	
24	2570	---	---	1100	---	---	602	---	---	
25	2470	---	---	1090	---	---	629	---	---	
26	2470	---	---	1120	---	---	583	---	---	
27	948	---	---	1120	---	---	614	---	---	
28	909	---	---	999	---	---	619	---	---	
29	2650	---	---	849	---	---	597	---	---	
30	2620	---	---	749	---	---	618	---	---	
31	2570	---	---	771	---	---	---	---	---	
TOTAL	65326	---	---	54438	---	---	20417	---	---	

e Estimated.

11413940 KIDD LAKE NEAR SODA SPRINGS, CA

LOCATION.—Lat 39°18'41", long 120°25'54", in SW 1/4 NW 1/4 sec.29, T.17 N., R.14 E., Placer County, Hydrologic Unit 18020125, on outlet structure, on Kidd Lake Dam, and 3.0 mi west of Soda Springs.

DRAINAGE AREA.—1.00 mi².

PERIOD OF RECORD.—July 1991 to September 2000, October 2001 to September 2002. Unpublished records for water years 1966–91 available in files of the U.S. Geological Survey.

GAGE.—Water-stage recorder. Datum of gage is 6,600.3 ft above sea level (levels by Pacific Gas & Electric Co.). Prior to July 1991, nonrecording gage at same site and datum.

REMARKS.—Records not collected during winter months. Reservoir is formed on natural lake by rock-fill dam completed in 1855. Usable capacity, 1,505 acre-ft, between gage heights 0.0 ft, invert of outlet, and 27.3 ft, crest of spillway. Water is used for power development downstream. Records represent usable contents at 2400 hours.

COOPERATION.—Records were collected by Pacific Gas & Electric Co., under general supervision of the U.S. Geological Survey, in connection with Federal Energy Regulatory Commission project no. 2310.

Capacity table (gage height, in feet, and contents, in acre-feet)
(Based on survey by Pacific Gas & Electric Co., dated April 1965)

0	0	8	259	20	918	28	1,568
4	117	16	654				

RESERVOIR STORAGE, ACRE-FEET, WATER YEAR OCTOBER 2001 TO SEPTEMBER 2002

DAILY OBSERVATION AT 2400 HOURS

DAY	OCT	NOV	DEC	JAN	FEB	MAR	APR	MAY	JUN	JUL	AUG	SEP
1	87	81	---	---	---	---	---	1020	1310	1250	990	594
2	86	81	---	---	---	---	---	1030	1310	1250	978	582
3	85	80	---	---	---	---	---	1040	1310	1250	965	571
4	83	79	---	---	---	---	---	1050	1310	1240	953	559
5	82	78	---	---	---	---	---	1060	1310	1240	941	547
6	81	77	---	---	---	---	---	1080	1310	1240	928	535
7	80	76	---	---	---	---	---	1090	1310	1240	916	523
8	79	75	---	---	---	---	---	1110	1310	1230	904	512
9	78	75	---	---	---	---	---	1120	1300	1230	893	500
10	78	74	---	---	---	---	---	1130	1300	1230	880	492
11	77	80	---	---	---	---	---	1140	1300	1220	865	485
12	76	87	---	---	---	---	---	1150	1300	1220	851	482
13	75	89	---	---	---	---	---	1160	1300	1210	837	478
14	75	89	---	---	---	---	---	1180	1300	1210	823	475
15	74	89	---	---	---	---	---	1190	1290	1200	809	472
16	73	89	---	---	---	---	---	1210	1290	1190	795	469
17	73	88	---	---	---	---	---	1220	1290	1170	782	467
18	72	88	---	---	---	---	---	1230	1290	1160	768	463
19	71	88	---	---	---	---	---	1240	1280	1150	755	461
20	71	88	---	---	---	---	---	1260	1280	1130	742	459
21	71	96	---	---	---	---	---	1260	1280	1120	729	457
22	70	103	---	---	---	---	953	1270	1280	1110	716	454
23	70	104	---	---	---	---	959	1270	1270	1090	704	453
24	70	115	---	---	---	---	967	1280	1270	1080	689	450
25	70	118	---	---	---	---	980	1280	1270	1070	676	447
26	71	119	---	---	---	---	992	1290	1270	1050	663	445
27	71	120	---	---	---	---	1000	1300	1260	1040	655	442
28	71	123	---	---	---	---	1010	1300	1260	1030	645	439
29	71	127	---	---	---	---	1020	1310	1260	1020	632	436
30	80	---	---	---	---	---	1020	1310	1260	1010	619	433
31	82	---	---	---	---	---	---	1310	---	1000	606	---
MAX	87	---	---	---	---	---	---	1310	1310	1250	990	594
MIN	70	---	---	---	---	---	---	1020	1260	1000	606	433
a	2.86						21.40	25.05	24.37	21.14	15.21	12.05
b								+290	-50	-260	-394	-173

a Gage height, in feet, at end of month.

b Change in contents, in acre-feet.

11413945 LOWER CASCADE LAKE NEAR SODA SPRINGS, CA

LOCATION.—Lat 39°18'12", long 120°26'19", in SE 1/4 SE 1/4 sec.30, T.17 N., R.14 E., Placer County, Hydrologic Unit 18020125, Tahoe National Forest, on outlet structure, on Lower Cascade Lake Dam, and 3.6 mi southwest of Soda Springs.

DRAINAGE AREA.—1.02 mi².

PERIOD OF RECORD.—July 1991 to current year. Unpublished records for water years 1966–90 available in files of the U.S. Geological Survey.

GAGE.—Water-stage recorder. Datum of gage is 6,560.4 ft above sea level (levels by Pacific Gas & Electric Co.). Prior to July 1991, nonrecording gage at same site and datum.

REMARKS.—No records computed during the winter months. Reservoir is formed on natural lake by rock-fill dam completed in 1860. Usable capacity, 484 acre-ft, between gage heights 0.0 ft, invert of outlet, and 21.5 ft, crest of spillway. Water is used for power development downstream.

COOPERATION.—Records were collected by Pacific Gas & Electric Co., under general supervision of the U.S. Geological Survey, in connection with Federal Energy Regulatory Commission project no. 2310.

Capacity table (gage height, in feet, and contents, in acre-feet)
(Based on survey by Pacific Gas & Electric Co., dated April 1965)

0	0	8	133	16	318	22	500
4	62	12	218	20	435	23	530

RESERVOIR STORAGE, ACRE-FEET, WATER YEAR OCTOBER 2001 TO SEPTEMBER 2002

DAILY OBSERVATION AT 2400 HOURS

DAY	OCT	NOV	DEC	JAN	FEB	MAR	APR	MAY	JUN	JUL	AUG	SEP
1	346	82	---	---	---	---	---	483	491	481	451	426
2	343	75	---	---	---	---	---	484	491	480	451	424
3	338	64	---	---	---	---	---	486	491	479	450	422
4	332	50	---	---	---	---	---	487	490	478	449	420
5	325	30	---	---	---	---	---	487	488	478	448	418
6	317	30	---	---	---	---	---	486	489	477	447	415
7	309	29	---	---	---	---	---	484	487	476	446	413
8	299	25	---	---	---	---	---	485	486	476	445	411
9	289	22	---	---	---	---	---	484	487	475	445	409
10	279	22	---	---	---	---	---	484	488	474	444	407
11	264	28	---	---	---	---	---	483	488	474	443	409
12	241	51	---	---	---	---	---	485	487	473	443	412
13	217	61	---	---	---	---	---	486	487	473	442	414
14	193	63	---	---	---	---	---	485	487	472	441	416
15	173	61	---	---	---	---	---	488	487	471	441	417
16	159	56	---	---	---	---	---	486	486	471	440	417
17	145	46	---	---	---	---	---	487	486	470	439	417
18	132	30	---	---	---	---	---	491	486	469	439	416
19	120	25	---	---	---	---	---	490	486	469	438	415
20	108	22	---	---	---	---	---	493	485	468	437	414
21	98	---	---	---	---	---	---	490	485	467	436	412
22	86	---	---	---	---	---	---	473	488	485	467	436
23	4	---	---	---	---	---	---	477	488	484	466	435
24	0	---	---	---	---	---	---	480	489	484	465	435
25	0	---	---	---	---	---	---	486	489	483	464	434
26	0	---	---	---	---	---	---	485	489	483	462	434
27	0	---	---	---	---	---	---	486	489	483	460	433
28	0	---	---	---	---	---	---	483	489	482	458	432
29	6	---	---	---	---	---	---	483	493	482	456	430
30	65	---	---	---	---	---	---	482	493	481	455	429
31	81	---	---	---	---	---	---	493	---	453	427	---
MAX	346	---	---	---	---	---	---	493	491	481	451	426
MIN	0	---	---	---	---	---	---	483	481	453	427	363
a	5.11						21.45	21.79	21.41	20.54	19.75	17.61
b	-266							+11	-12	-28	-26	-64

WTR YR 2002 b +16

a Gage height, in feet, at end of month.
b Change in contents, in acre-feet.

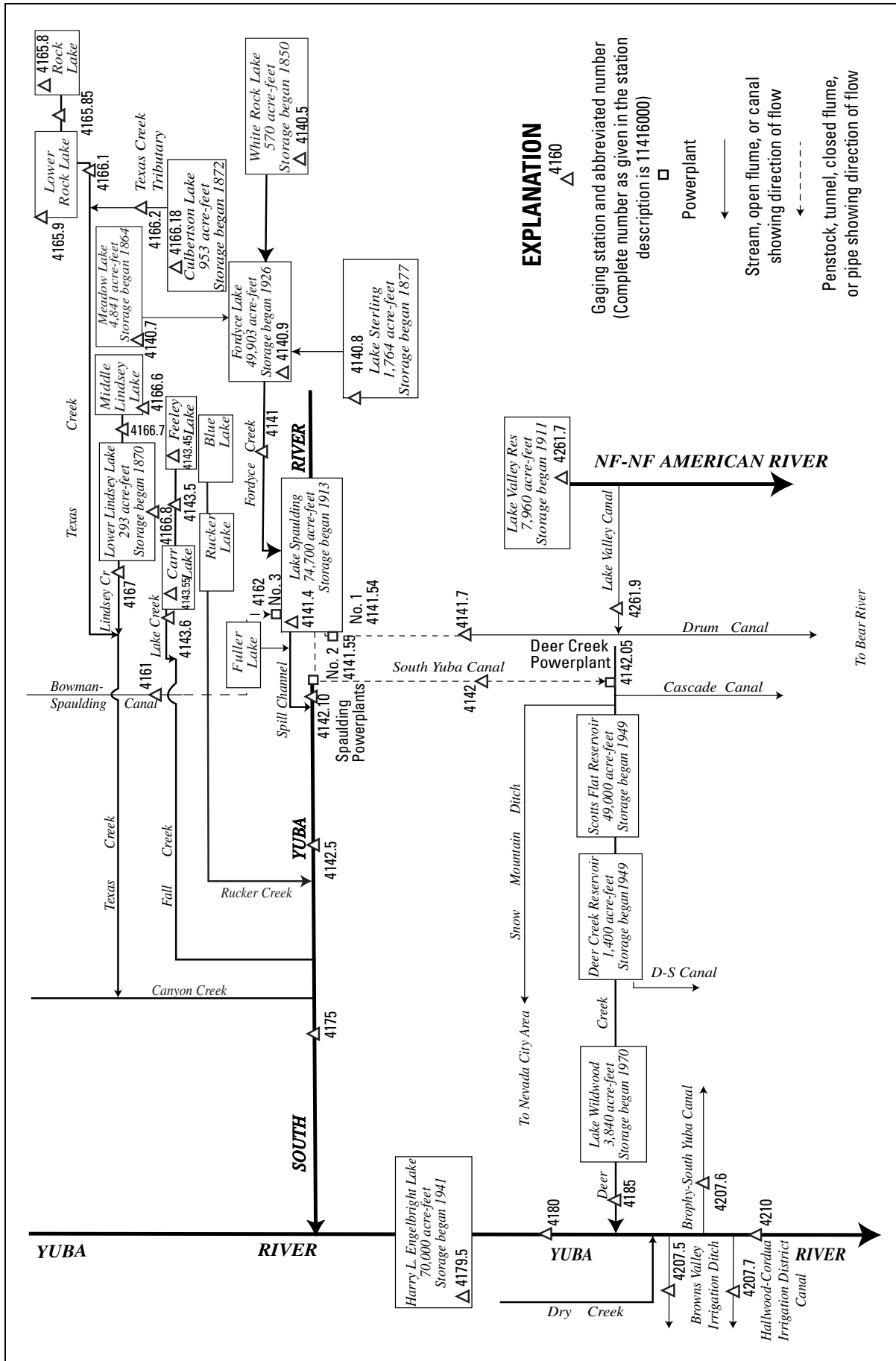

Figure 32. Diversions and storage in South Yuba River Basin.

11414090 FORDYCE LAKE NEAR CISCO, CA

LOCATION.—Lat 39°22'44", long 120°29'40", in NE 1/4 SE 1/4 sec.34, T.18 N., R.12 E., Nevada County, Hydrologic Unit 18020125, near left abutment of Fordyce Dam, on Fordyce Creek, and 5.3 mi northeast of Cisco.

DRAINAGE AREA.—31.7 mi².

PERIOD OF RECORD.—October 1977 to current year. Periodic gage heights only for October 1965 to September 1976 and daily contents for water year 1977 are in the files of the U.S. Geological Survey.

GAGE.—Water-stage recorder. Datum of gage is 6,290.5 ft above sea level (levels by Pacific Gas & Electric Co.). Prior to Nov. 29, 1976, nonrecording gage on upstream side of dam at same datum.

REMARKS.—Lake is formed by a rockfill dam; storage began in 1926. In 1980 the capacity of Fordyce Lake was increased by the addition of 3 ft of flashboards. Capacity, 49,903 acre-ft, between gage heights 0.85 ft, bottom of outlet valve, and 114.6 ft, top of flashboards in spillway. Released water flows down Fordyce Creek (station 11414100) to Lake Spaulding (station 11414140) for use in a power and irrigation system. See schematic diagram of [South Yuba River Basin](#).

COOPERATION.—Records were collected by Pacific Gas & Electric Co., under general supervision of the U.S. Geological Survey, in connection with Federal Energy Regulatory Commission project no. 2310.

EXTREMES FOR PERIOD OF RECORD.—Maximum contents, 50,100 acre-ft, June 4, 2000, June 7, 2002, maximum gage height, 114.88 ft, June 4, 2000; minimum, 250 acre-ft, Oct. 31 to Nov. 7, 1979.

EXTREMES FOR CURRENT YEAR.—Maximum contents, 50,100 acre-ft, June 7, gage height, 114.82 ft; minimum, 10,100 acre-ft, Dec. 12, 25–28, minimum gage height, 45.64 ft, Dec. 27.

Capacity table (gage height, in feet, and contents, in acre-feet)
(Based on table provided by Pacific Gas & Electric Co., dated October 1992)

4	219	20	2,608	40	8,185	80	26,770
5	278	25	3,827	50	11,797	90	32,820
10	774	30	5,170	60	16,174	100	39,342
15	1,572	35	6,628	70	21,196	114.6	49,903

RESERVOIR STORAGE, ACRE-FEET, WATER YEAR OCTOBER 2001 TO SEPTEMBER 2002

DAILY OBSERVATION AT 2400 HOURS

DAY	OCT	NOV	DEC	JAN	FEB	MAR	APR	MAY	JUN	JUL	AUG	SEP
1	16600	13100	10900	10400	11900	12600	14500	22700	47700	45100	32200	21800
2	16500	13000	11000	10600	11900	12600	14600	23000	48000	44700	31800	21400
3	16300	12900	10900	10600	11900	12700	14600	23500	48400	44200	31400	21000
4	16100	12800	10800	10600	11900	12700	14800	24200	48800	43800	31000	20600
5	16000	12700	10700	10700	11900	12800	14900	25100	49300	43400	30800	20200
6	15800	12600	10600	11000	11900	12800	15000	26100	49800	43000	30700	19800
7	15700	12500	10500	11200	11900	13000	15100	27100	50100	42600	30700	19400
8	15500	12400	10400	11300	11800	13100	15100	27900	49900	42100	30600	19100
9	15400	12300	10300	11400	11800	13200	15200	28700	49700	41700	30600	18800
10	15300	12200	10200	11500	11800	13300	15300	29400	49700	41300	30500	18400
11	15200	12200	10200	11500	11800	13400	15600	29900	49600	40800	30500	18000
12	15100	12100	10100	11600	11800	13400	16200	30600	49700	40400	30200	17700
13	15000	12000	10200	11600	11800	13500	16800	31600	49700	40000	29700	17400
14	14900	11900	10200	11700	11700	13600	17800	32600	49700	39600	29300	17000
15	14800	11800	10200	11700	11700	13600	18600	33700	49600	39100	28800	16700
16	14700	11700	10200	11700	11700	13600	18800	34800	49500	38700	28400	16400
17	14600	11600	10200	11700	11700	13700	18900	36100	49300	38300	28000	16100
18	14500	11500	10200	11800	11600	13800	18900	37400	49200	e37900	27600	15700
19	14400	11400	10200	11800	11700	13900	18800	38400	49000	e37500	27100	15400
20	14300	11300	10200	11800	11800	13900	18700	39000	48800	e37100	26700	15100
21	14200	11400	10200	11800	12000	14000	18700	39400	48500	e36700	26300	14800
22	14100	11500	10200	11800	12100	14000	18800	39700	48200	e36300	25900	14500
23	14000	11400	10200	11800	12300	14100	19200	40000	48000	35900	25400	14200
24	13900	11500	10200	11800	12400	14100	19800	40600	47600	35400	25000	13900
25	13800	11500	10100	11800	12400	14200	20500	41400	47300	35000	24600	13600
26	13700	11400	10100	11900	12500	14200	21200	42300	47000	34600	24200	13300
27	13600	11300	10100	11900	12500	14300	21700	43300	46600	34200	23800	13000
28	13400	11200	10100	12000	12600	14300	22000	44300	46200	33800	23400	12700
29	13300	11100	10200	12000	---	14300	22300	45200	45900	33400	23000	12400
30	13300	11000	10200	11900	---	14400	22500	46200	45500	33000	22600	12100
31	13200	---	10400	11900	---	14400	---	47000	---	32600	22200	---
MAX	16600	13100	11000	12000	12600	14400	22500	47000	50100	45100	32200	21800
MIN	13200	11000	10100	10400	11600	12600	14500	22700	45500	32600	22200	12100
a	53.43	47.96	46.31	50.36	51.90	56.19	72.49	110.75	108.71	89.63	71.83	50.76
b	-3600	-2200	-600	+1500	+700	+1800	+8100	+24500	-1500	-12900	-10400	-10100

CAL YR 2001 MAX 39600 MIN 5910 b +4450

WTR YR 2002 MAX 50100 MIN 10100 b -4700

e Estimated.

a Gage height, in feet, at end of month.

b Change in contents, in acre-feet.

11414100 FORDYCE CREEK BELOW FORDYCE DAM, NEAR CISCO, CA

LOCATION.—Lat 39°22'48", long 120°29'54", in NW 1/4 SE 1/4 sec.34, T.18 N., R.13 E., Nevada County, Hydrologic Unit 18020125, Tahoe National Forest, on right bank, 850 ft downstream from Fordyce Dam, and 5.3 mi northeast of Cisco.

DRAINAGE AREA.—31.7 mi².

PERIOD OF RECORD.—June 1966 to current year.

GAGE.—Water-stage recorder. Elevation of gage is 6,250 ft above sea level, from topographic map.

REMARKS.—Flow regulated by Fordyce Lake (station 11414090). See schematic diagram of South Yuba River Basin.

COOPERATION.—Records were collected by Pacific Gas & Electric Co., under general supervision of the U.S. Geological Survey, in connection with Federal Energy Regulatory Commission project no. 2310.

EXTREMES FOR PERIOD OF RECORD.—Maximum discharge, 4,660 ft³/s, July 9, 1974, gage height, 7.90 ft, in gage well, 6.82 ft, from high-water marks, from rating curve extended above 1,000 ft³/s, on basis of slope-area measurement of peak flow; minimum daily, 3.5 ft³/s, Jan. 2–9, 1979.

DISCHARGE, CUBIC FEET PER SECOND, WATER YEAR OCTOBER 2001 TO SEPTEMBER 2002
DAILY MEAN VALUES

DAY	OCT	NOV	DEC	JAN	FEB	MAR	APR	MAY	JUN	JUL	AUG	SEP
1	104	71	68	22	22	73	74	29	358	239	220	236
2	104	71	68	22	22	73	75	30	343	238	221	235
3	104	70	68	22	22	73	76	30	341	237	218	232
4	103	70	68	22	49	73	77	31	338	236	221	232
5	103	70	67	22	74	73	78	32	337	235	101	232
6	103	70	67	22	74	74	79	33	338	235	25	228
7	103	70	68	22	74	73	79	33	354	233	24	228
8	102	69	67	22	74	73	81	34	478	233	24	228
9	85	69	66	22	73	73	81	34	333	232	25	226
10	74	69	66	22	73	73	112	35	245	231	24	222
11	74	69	45	22	73	73	144	35	253	230	24	215
12	74	69	22	22	73	73	144	35	253	230	76	214
13	74	69	22	22	73	72	145	36	253	229	255	214
14	73	69	22	22	73	72	148	37	252	228	253	213
15	73	69	22	22	72	71	149	37	253	227	250	211
16	73	69	22	21	72	71	149	38	250	227	253	211
17	73	68	22	21	72	71	149	39	251	225	248	210
18	73	68	22	21	72	71	149	40	251	226	248	210
19	73	68	22	21	72	71	149	41	250	226	247	208
20	73	68	22	21	75	71	149	42	249	229	247	208
21	72	68	22	21	73	72	149	43	248	229	245	207
22	72	68	22	21	73	71	86	43	248	226	246	206
23	72	68	22	21	73	71	27	43	246	223	246	204
24	72	68	22	22	73	71	27	44	245	222	246	203
25	72	68	22	21	73	71	28	44	245	225	243	202
26	71	68	22	21	73	71	28	45	244	225	243	201
27	71	68	22	21	73	71	29	47	243	221	245	199
28	71	68	22	21	73	72	28	150	242	222	241	198
29	71	68	22	21	---	72	29	256	241	220	239	197
30	71	68	22	21	---	73	29	291	241	221	240	196
31	71	---	22	22	---	73	---	366	---	221	238	---
TOTAL	2504	2065	1158	668	1868	2235	2747	2073	8423	7081	5876	6426
MEAN	80.77	68.83	37.35	21.55	66.71	72.10	91.57	66.87	280.8	228.4	189.5	214.2
MAX	104	71	68	22	75	74	149	366	478	239	255	236
MIN	71	68	22	21	22	71	27	29	241	220	24	196
AC-FT	4970	4100	2300	1320	3710	4430	5450	4110	16710	14050	11660	12750

STATISTICS OF MONTHLY MEAN DATA FOR WATER YEARS 1966 - 2002, BY WATER YEAR (WY)

MEAN	86.96	47.09	28.62	35.48	55.01	70.25	67.32	182.6	353.9	281.8	209.4	143.0
MAX	428	236	173	278	328	353	315	727	957	542	403	497
(WY)	1976	1977	1982	1997	1984	1984	1986	1996	1995	1995	1983	1980
MIN	4.35	3.90	3.75	4.76	4.78	5.07	9.21	17.0	36.4	21.7	11.4	4.84
(WY)	1978	1979	1979	1981	1977	1977	1977	1977	1976	1981	1987	1977

SUMMARY STATISTICS

FOR 2001 CALENDAR YEAR

FOR 2002 WATER YEAR

WATER YEARS 1966 - 2002

ANNUAL TOTAL	19578.1	43124										
ANNUAL MEAN	53.64	118.1							130.7			
HIGHEST ANNUAL MEAN									288			1982
LOWEST ANNUAL MEAN									49.3			1981
HIGHEST DAILY MEAN				123	Aug 14		478	Jun 8	3750	May 17		1996
LOWEST DAILY MEAN				8.3	Jan 11		21	Jan 16	3.5	Jan 2		1979
ANNUAL SEVEN-DAY MINIMUM				8.5	Feb 15		21	Jan 16	3.5	Jan 2		1979
MAXIMUM PEAK FLOW							566	Jun 8	4660	Jul 9		1974
MAXIMUM PEAK STAGE							3.95	Jun 8	7.90	Jul 9		1974
ANNUAL RUNOFF (AC-FT)	38830	85540							94700			
10 PERCENT EXCEEDS		116					245		401			
50 PERCENT EXCEEDS		28					73		34			
90 PERCENT EXCEEDS		8.6					22		7.0			

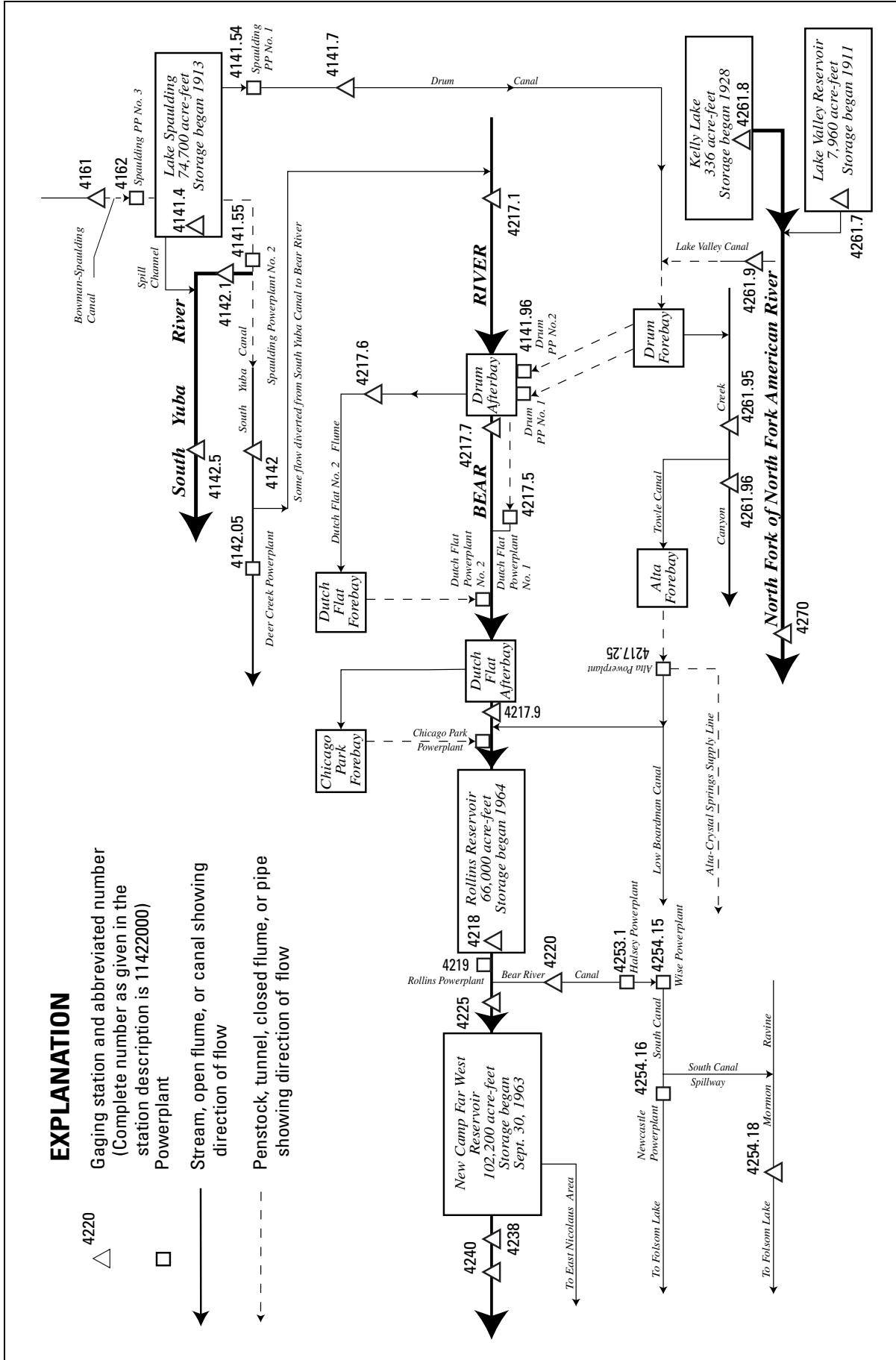

Figure 33. Diversions and storage in Bear River Basin.

11414140 LAKE SPAULDING NEAR EMIGRANT GAP, CA

LOCATION.—Lat 39°19'35", long 120°38'32", in SE 1/4 NE 1/4 sec.20, T.17 N., R.12 E., Nevada County, Hydrologic Unit 18020125, near center of Spaulding Dam, on South Yuba River, and 2.5 mi northeast of Emigrant Gap.

DRAINAGE AREA.—118 mi².

PERIOD OF RECORD.—October 1964 to current year.

GAGE.—Water-stage recorder. Datum of gage is 4,809.6 ft above sea level (levels by Pacific Gas & Electric Co.). Prior to July 1968, nonrecording gage at same site and datum.

REMARKS.—Lake is formed by three concrete-arch dams with spillway on the middle arch. Storage began in 1913. Capacity, 74,700 acre-ft, between gage heights 0.6 ft, bottom of outlet, and 205.0 ft, top of radial gates. Released water flows through Spaulding Powerplants Nos. 1 and 2 (stations 11414154 and 11414155). Flow through Powerplant No. 1 is transported out of Yuba River Basin by Drum Canal to Bear River Basin. See schematic diagrams of [South Yuba River](#) and [Bear River Basins](#).

COOPERATION.—Records were collected by Pacific Gas & Electric Co., under general supervision of the U.S. Geological Survey, in connection with Federal Energy Regulatory Commission project no. 2310. Contents not rounded to U.S. Geological Survey standards.

EXTREMES FOR PERIOD OF RECORD.—Maximum contents, 75,100 acre-ft, July 13, 1967, gage height, 205.5 ft; minimum, 914 acre-ft, Feb. 28, 1976, gage height, 25.5 ft.

EXTREMES FOR CURRENT YEAR.—Maximum contents, 74,500 acre-ft, May 31, gage height, 204.68 ft; minimum, 11,100 acre-ft, Feb. 7, 8, minimum gage height, 74.77 ft, Feb. 7.

Capacity table (gage height, in feet, and contents, in acre-feet)
(Based on survey by Pacific Gas & Electric Co., dated Apr. 23, 1965)

20	566	40	2,741	100	19,541	200	71,328
25	874	50	4,578	150	41,545	206	75,473
30	1,352	70	9,631				

RESERVOIR STORAGE, ACRE-FEET, WATER YEAR OCTOBER 2001 TO SEPTEMBER 2002

DAILY OBSERVATION AT 2400 HOURS

DAY	OCT	NOV	DEC	JAN	FEB	MAR	APR	MAY	JUN	JUL	AUG	SEP
1	20100	19000	22000	25800	12400	21000	25000	54200	74400	69200	47400	34000
2	20100	18900	23000	26400	12400	21000	26300	54100	74200	68200	46800	33700
3	20100	18800	23300	26900	12400	20800	28100	54600	73800	67200	46400	33400
4	20100	18800	23600	26800	11900	20700	30200	55600	73500	66300	45900	33200
5	20100	18700	23600	26800	11600	20800	31800	56900	73200	65300	45400	32800
6	20100	18700	23900	28000	11300	22800	32800	58400	72800	65100	44600	32500
7	20100	18600	24300	28700	11100	23800	33800	59900	72600	64800	43900	32300
8	20100	18600	24600	28900	11100	24200	35000	61000	72600	64500	43100	31900
9	20100	18500	24800	28600	11300	24300	36200	61900	72300	63900	42300	31600
10	20100	18400	25000	28000	11500	24400	37500	62600	71700	63000	42100	31300
11	20000	18400	25100	27400	11800	24500	39400	62800	71400	62000	41900	31000
12	20000	18500	25200	26800	12000	24800	41000	63500	71300	61100	41200	30700
13	19900	18500	25300	26100	12300	24900	42700	64700	71500	60300	40800	30500
14	19900	18500	25300	25300	12600	24700	45500	66000	71500	59400	40400	30200
15	19800	18500	25400	24500	13000	24400	47800	67400	71500	58600	40000	30600
16	19800	18400	25500	23600	13500	24100	48600	68700	71400	58000	39600	31300
17	19700	18400	25400	22800	13900	23700	49000	70200	71300	57100	39300	32000
18	19600	18400	25600	21900	14300	23400	49100	71800	71100	56200	38900	32700
19	19600	18400	25700	21000	15000	23000	49100	73000	71000	55600	38900	33300
20	19500	18300	25600	20100	17100	22700	49100	73500	70800	54900	38500	34000
21	19400	18700	25700	19400	18300	22500	49200	73400	70600	54300	37900	34600
22	19400	20100	25700	18700	19100	22600	49400	72600	71100	53500	37600	35300
23	19300	20300	25800	18500	20000	22700	49900	71800	71500	52800	37200	35900
24	19300	21700	25900	17500	20500	22700	50700	71300	71400	52200	36800	36500
25	19300	21800	26100	16500	20700	22300	52000	71200	71100	51500	36400	37100
26	19200	22000	26100	16000	20800	21800	53300	71200	70700	50900	36000	37800
27	19200	22100	25600	15500	20800	21500	54000	71300	70300	50200	35400	38100
28	19100	22200	25000	14900	20900	21500	54200	72000	69900	49600	35100	38700
29	19100	22000	24700	14000	---	21900	54300	73300	70200	48900	34400	39400
30	19100	22100	24700	13100	---	22600	54300	74200	70300	48300	33800	39900
31	19100	---	25800	12700	---	23400	---	74500	---	47800	33900	---
MAX	20100	22200	26100	28900	20900	24900	54300	74500	74400	69200	47400	39900
MIN	19100	18300	22000	12700	11100	20700	25000	54100	69900	47800	33800	30200
a	98.66	106.82	116.09	79.97	103.78	110.20	173.14	204.68	198.43	161.68	134.58	146.76
b	-1000	+3000	+3700	-13100	+8200	+2500	+30900	+20200	-4200	-22500	-13900	+6000
c	6890	7770	12880	21710	11930	22830	33060	36760	36900	35670	30710	13190
d	5910	3510	2780	2460	2550	2820	3060	5260	5790	4490	5030	4450

CAL YR 2001 MAX 73200 MIN 16400 b +3600 c 191000 d 46250

WTR YR 2002 MAX 74500 MIN 11100 b +19800 c 270300 d 48120

a Gage height, in feet, at end of month.

b Change in contents, in acre-feet.

c Diversion, in acre-feet, to Spaulding No. 1 Powerplant (station 11414154), provided by Pacific Gas & Electric Co.

d Diversion, in acre-feet, to Spaulding No. 2 Powerplant (station 11414154), provided by Pacific Gas & Electric Co.

11414170 DRUM CANAL AT TUNNEL OUTLET, NEAR EMIGRANT GAP, CA

LOCATION.—Lat 39°19'03", long 120°39'08", in SE 1/4 SW 1/4 sec.20, T.17 N., R.12 E., Nevada County, Hydrologic Unit 18020125, Tahoe National Forest, 100 ft downstream from tunnel outlet, 1.0 mi downstream from Spaulding No. 1 Powerplant, and 1.7 mi northeast of Emigrant Gap.

PERIOD OF RECORD.—October 1964 to current year. Prior to October 1972, published as "Drum Canal at intake."

GAGE.—Water-stage recorder. Elevation of gage is 4,880 ft above sea level, from topographic map. Prior to Oct. 1, 1968, in powerplant 0.7 mi upstream at different datum.

REMARKS.—Canal diverts from Spaulding No. 1 Powerplant (station 11414154) at Lake Spaulding Dam. Most of the water from Drum Canal enters the Bear River via Drum No. 1 and 2 Powerplants (station 11414196) at Drum Afterbay. Some of the water is diverted out of Drum Forebay to Alta Powerplant (station 11421725). See schematic diagrams of [South Yuba River Basin](#) and [Bear River Basin](#).

COOPERATION.—Records were collected by Pacific Gas & Electric Co., under general supervision of the U.S. Geological Survey, in connection with a Federal Energy Regulatory Commission project no. 2310.

EXTREMES FOR PERIOD OF RECORD.—Maximum daily discharge, 864 ft³/s, May 1, 1998; no flow for several days in most years.

DISCHARGE, CUBIC FEET PER SECOND, WATER YEAR OCTOBER 2001 TO SEPTEMBER 2002
DAILY MEAN VALUES

DAY	OCT	NOV	DEC	JAN	FEB	MAR	APR	MAY	JUN	JUL	AUG	SEP
1	65	123	250	579	460	417	466	778	855	746	578	323
2	109	121	152	576	261	417	785	784	855	744	581	519
3	109	115	157	592	268	440	782	782	854	740	580	505
4	109	114	110	588	514	440	758	782	850	649	578	482
5	109	113	224	471	508	441	766	786	850	688	576	520
6	109	112	139	579	486	403	774	779	848	318	574	522
7	109	112	103	583	474	406	783	779	849	323	575	510
8	109	111	103	592	453	437	791	781	850	323	581	530
9	109	111	134	704	272	443	789	782	848	445	582	530
10	109	111	102	773	273	441	755	781	816	665	283	527
11	109	111	102	781	261	416	735	780	688	675	309	518
12	109	111	102	782	260	421	778	782	659	617	586	516
13	110	113	111	794	257	445	777	780	513	622	581	515
14	112	113	172	799	260	568	778	784	715	623	579	513
15	113	113	101	797	248	585	779	781	711	587	577	182
16	114	113	107	788	241	587	780	779	715	414	568	0.00
17	115	112	204	779	243	594	780	785	716	636	567	0.00
18	116	107	110	771	246	596	781	789	724	628	542	0.00
19	116	105	110	773	251	595	781	790	724	612	360	0.00
20	117	102	234	776	263	593	777	715	723	615	576	0.00
21	118	102	148	687	398	589	783	673	690	624	570	0.00
22	119	105	193	673	398	587	781	769	322	629	568	0.00
23	120	105	142	402	366	573	780	763	335	624	567	0.00
24	121	170	114	789	361	598	783	764	596	620	563	0.00
25	121	245	114	795	398	696	786	778	732	624	559	0.00
26	121	109	184	604	433	776	785	777	730	643	561	0.00
27	122	104	460	593	465	779	782	778	728	635	671	176
28	122	127	597	596	440	776	782	780	729	639	528	7.9
29	122	244	594	736	---	777	781	784	331	636	728	7.9
30	123	115	590	769	---	781	778	829	333	635	705	72
31	123	---	574	490	---	710	---	853	---	630	328	---
TOTAL	3509	3669	6537	21011	9758	17327	23016	24127	20889	18609	17081	7475.80
MEAN	113.2	122.3	210.9	677.8	348.5	558.9	767.2	778.3	696.3	600.3	551.0	249.2
MAX	123	245	597	799	514	781	791	853	855	746	728	530
MIN	65	102	101	402	241	403	466	673	322	318	283	0.00
AC-FT	6960	7280	12970	41680	19350	34370	45650	47860	41430	36910	33880	14830
a	5610	6700	13000	42000	19730	35760	46150	46250	38600	34320	31750	13360
b	1220	1150	765	482	696	897	339	267	1170	1470	1300	879

a Discharge, in acre-feet, to Drum No. 1 and 2 Powerplants (station 11414196), provided by Pacific Gas & Electric Co.

b Discharge, in acre-feet, to Alta Powerplant (station 11421725), provided by Pacific Gas & Electric Co.

SACRAMENTO RIVER BASIN

11414170 DRUM CANAL AT TUNNEL OUTLET, NEAR EMIGRANT GAP, CA—Continued

STATISTICS OF MONTHLY MEAN DATA FOR WATER YEARS 1965 - 2002, BY WATER YEAR (WY)

	OCT	NOV	DEC	JAN	FEB	MAR	APR	MAY	JUN	JUL	AUG	SEP
MEAN	396.9	413.8	451.0	444.3	464.5	524.9	609.4	654.6	641.0	615.1	578.8	362.4
MAX	817	824	835	837	833	838	839	855	851	820	820	661
(WY)	1983	1984	1984	1984	1984	1984	1996	1998	1999	1983	1998	1986
MIN	0.000	29.5	31.1	30.2	0.000	22.6	22.9	5.77	166	178	0.000	0.000
(WY)	1966	1987	1977	1997	1991	1988	1988	1976	1977	1977	1965	1965

SUMMARY STATISTICS	FOR 2001 CALENDAR YEAR		FOR 2002 WATER YEAR		WATER YEARS 1965 - 2002	
ANNUAL TOTAL	110096.00		173008.80			
ANNUAL MEAN	301.6		474.0		513.5	
HIGHEST ANNUAL MEAN					796	
LOWEST ANNUAL MEAN					101	
HIGHEST DAILY MEAN	829	May 16	855	Jun 1	864	May 1 1998
LOWEST DAILY MEAN	0.00	Sep 17	0.00	Sep 16	0.00	Jul 31 1965
ANNUAL SEVEN-DAY MINIMUM	0.00	Sep 17	0.00	Sep 16	0.00	Jul 31 1965
ANNUAL RUNOFF (AC-FT)	218400		343200		372000	
ANNUAL DISCHARGE (AC-FT) a	206700		333200			
ANNUAL DISCHARGE (AC-FT) b	9590		10630			
10 PERCENT EXCEEDS	576		782		827	
50 PERCENT EXCEEDS	241		567		567	
90 PERCENT EXCEEDS	105		109		43	

a Discharge, in acre-feet, to Drum No. 1 and 2 Powerplants (station 11414196), provided by Pacific Gas & Electric Co.

b Discharge, in acre-feet, to Alta Powerplant (station 11421725), provided by Pacific Gas & Electric Co.

11414200 SOUTH YUBA CANAL NEAR EMIGRANT GAP, CA

LOCATION.—Lat 39°18'49", long 120°39'43", in SE 1/4 NE 1/4 sec.30, T.17 N., R.12 E., Nevada County, Hydrologic Unit 18020125, on left bank of concrete flume, 400 ft downstream from Bowman Lake Road, and 2.5 mi northeast of Emigrant Gap.

PERIOD OF RECORD.—October 1964 to current year.

GAGE.—Water-stage recorder and concrete control. Elevation of gage is 4,590 ft above sea level, from topographic map.

REMARKS.—Canal diverts from Spaulding No. 2 Powerplant (station 11414155) at Lake Spaulding Dam. Downstream from the gage, some flow is diverted to Bear River. The remainder of the water enters Deer Creek at Deer Creek Powerplant (station 11414205). See schematic diagrams of South Yuba River Basin and Bear River Basin.

COOPERATION.—Records were collected by Pacific Gas & Electric Co., under general supervision of the U.S. Geological Survey, in connection with Federal Energy Regulatory Commission project no. 2310.

EXTREMES FOR PERIOD OF RECORD.—Maximum daily discharge, 165 ft³/s, Aug. 3, 1965; no flow at times in some years.

DISCHARGE, CUBIC FEET PER SECOND, WATER YEAR OCTOBER 2001 TO SEPTEMBER 2002
DAILY MEAN VALUES

DAY	OCT	NOV	DEC	JAN	FEB	MAR	APR	MAY	JUN	JUL	AUG	SEP
1	90	51	47	37	36	50	35	43	135	70	70	83
2	91	51	41	36	37	50	35	42	135	70	70	83
3	91	51	44	37	37	50	36	42	136	71	71	85
4	90	51	44	38	36	50	84	43	136	74	70	80
5	89	51	44	38	35	51	126	43	136	74	69	73
6	89	50	43	36	38	44	127	47	136	73	69	73
7	89	49	42	37	41	34	127	28	137	76	70	72
8	89	49	42	35	40	33	128	58	136	76	70	72
9	88	50	41	34	40	33	130	68	136	76	73	72
10	77	52	41	33	40	33	131	68	109	76	74	72
11	87	54	41	31	40	40	132	65	70	75	79	72
12	90	53	41	31	40	43	133	65	69	73	78	72
13	90	50	41	30	39	45	133	66	69	71	77	71
14	90	50	41	37	39	46	50	66	70	69	79	71
15	90	50	41	40	39	49	0.00	66	71	71	82	72
16	90	51	41	39	39	50	0.00	66	70	70	82	74
17	90	51	40	39	39	50	0.00	67	70	70	82	76
18	91	50	40	39	38	50	0.00	67	70	70	82	76
19	91	50	40	39	40	50	0.00	66	70	71	83	76
20	91	50	40	40	40	59	0.00	53	70	71	82	59
21	92	51	39	40	49	62	0.00	41	70	70	80	78
22	83	48	39	39	52	62	0.00	55	69	70	79	75
23	78	49	38	53	50	58	0.00	55	70	70	80	82
24	77	47	39	63	50	64	0.00	92	70	70	80	105
25	77	46	39	69	50	62	0.00	132	69	70	81	98
26	77	49	40	46	50	47	0.00	133	70	70	82	73
27	77	45	40	35	49	36	0.00	133	71	70	82	72
28	77	45	36	35	50	36	26	134	69	70	83	43
29	77	48	40	35	---	35	43	135	69	70	83	27
30	62	46	42	35	---	35	45	135	68	70	83	73
31	51	---	36	36	---	36	---	135	---	70	83	---
TOTAL	2611	1488	1263	1212	1173	1443	1521.00	2309	2726	2217	2408	2210
MEAN	84.23	49.60	40.74	39.10	41.89	46.55	50.70	74.48	90.87	71.52	77.68	73.67
MAX	92	54	47	69	52	64	133	135	137	76	83	105
MIN	51	45	36	30	35	33	0.00	28	68	69	69	27
AC-FT	5180	2950	2510	2400	2330	2860	3020	4580	5410	4400	4780	4380
a	4530	2430	2390	2330	2320	2940	1130	3140	3540	3830	4160	3650

STATISTICS OF MONTHLY MEAN DATA FOR WATER YEARS 1965 - 2002, BY WATER YEAR (WY)

MEAN	77.84	66.14	69.57	71.72	75.54	82.74	76.07	106.9	107.3	95.86	90.88	87.47
MAX	158	157	157	155	151	147	146	156	163	160	155	152
(WY)	1966	1966	1966	1984	1984	1980	1967	1980	1965	1965	1965	1965
MIN	35.9	14.7	33.4	18.2	11.4	15.6	11.3	27.2	7.92	46.1	41.7	38.0
(WY)	1978	1995	1978	1997	1997	1997	1979	1977	2001	1977	1977	1977

SUMMARY STATISTICS

	FOR 2001 CALENDAR YEAR		FOR 2002 WATER YEAR		WATER YEARS 1965 - 2002	
ANNUAL TOTAL	21759.69		22581.00			
ANNUAL MEAN	59.62		61.87		84.07	
HIGHEST ANNUAL MEAN					124	1967
LOWEST ANNUAL MEAN					47.2	1977
HIGHEST DAILY MEAN	94	Sep 14	137	Jun 7	165	Aug 3 1965
LOWEST DAILY MEAN	0.00	Jun 9	0.00	Apr 15	0.00	Apr 20 1966
ANNUAL SEVEN-DAY MINIMUM	0.00	Jun 9	0.00	Apr 15	0.00	Apr 5 1986
ANNUAL RUNOFF (AC-FT)	43160		44790		60900	
ANNUAL DISCHARGE (AC-FT) a	37860		36390			
10 PERCENT EXCEEDS	90		90		141	
50 PERCENT EXCEEDS	61		62		76	
90 PERCENT EXCEEDS	39		36		39	

a Discharge, in acre-feet, to Deer Creek Powerplant (station 11414205), provided by Pacific Gas & Electric Co.

11414210 SOUTH YUBA RIVER CONTROLLED RELEASE AT LAKE SPAULDING, NEAR EMIGRANT GAP, CA

LOCATION.—Lat 39°19'28", long 120°38'42", in NE 1/4 SE 1/4 sec.20, T.17 N., R.12 E., Nevada County, Hydrologic Unit 18020125, on left bank, 200 ft downstream from Spaulding No. 2 Powerplant, 0.2 mi downstream from Spaulding Dam, and 2.3 mi northeast of Emigrant Gap.

DRAINAGE AREA.—118 mi².

PERIOD OF RECORD.—October 1985 to current year. Unpublished records for water years 1965–85 in files of the U.S. Geological Survey. Prior to October 2000, published as "South Yuba River below Spaulding No. 2 Powerplant, near Emigrant Gap".

GAGE.—Water-stage recorder, V-notch sharp-crested weir, and steel-lipped rectangular weir. Elevation of gage is 4,670 ft above sea level, from topographic map. Prior to June 1988, at same site and different datum.

REMARKS.—Flow regulated by Lake Spaulding (station 11414140) 0.2 mi upstream. Water is released at the intake to South Yuba Canal (station 11414200) 100 ft upstream. Flow over Lake Spaulding spillway bypasses this station. See schematic diagrams of [South Yuba River and Bear River Basins](#).

COOPERATION.—Records were collected by Pacific Gas & Electric Co., under general supervision of the U.S. Geological Survey, in connection with Federal Energy Regulatory Commission project no. 2310.

EXTREMES FOR PERIOD OF RECORD.—Maximum discharge, 194 ft³/s, Apr. 14, June 8, 1986, gage height, 3.37 ft, from rating curve extended above 45 ft³/s, on basis of weir formula; minimum daily, 0.09 ft³/s, Nov. 5–7, 1985.

DISCHARGE, CUBIC FEET PER SECOND, WATER YEAR OCTOBER 2001 TO SEPTEMBER 2002

DAILY MEAN VALUES

DAY	OCT	NOV	DEC	JAN	FEB	MAR	APR	MAY	JUN	JUL	AUG	SEP
1	6.5	5.3	2.3	3.1	1.4	1.3	2.1	2.3	35	4.5	6.8	6.5
2	5.9	5.3	4.5	4.3	1.3	1.3	2.3	2.2	35	4.5	6.4	6.5
3	5.7	5.3	1.9	2.7	1.3	1.4	2.3	2.2	35	4.5	5.9	6.5
4	5.5	5.3	1.6	2.1	1.4	1.5	2.2	2.1	35	4.5	6.2	6.5
5	5.3	5.3	1.9	2.0	1.5	1.5	2.0	2.1	35	4.5	6.5	6.5
6	5.2	5.8	2.2	3.0	1.4	3.8	1.9	2.1	35	4.6	6.5	6.5
7	5.0	6.5	1.7	2.3	2.1	2.0	1.7	6.2	17	5.1	6.5	6.5
8	5.7	6.5	1.6	2.0	1.8	1.7	1.6	2.1	4.2	5.3	6.8	6.5
9	6.4	6.1	1.7	1.9	1.4	1.6	1.6	2.0	3.9	6.4	6.8	6.5
10	6.3	5.6	1.5	1.8	1.4	1.7	1.6	2.0	3.2	7.6	6.8	6.5
11	6.4	3.8	1.5	1.7	1.4	1.9	1.5	2.0	2.4	7.6	6.7	6.5
12	5.9	4.0	1.4	1.7	1.4	2.2	1.5	2.0	2.4	6.5	6.5	6.5
13	5.9	4.8	1.5	1.7	1.4	1.7	2.2	2.3	2.4	6.0	6.5	6.5
14	5.9	4.7	2.0	1.7	1.5	1.6	2.7	2.7	2.6	7.6	6.5	6.5
15	5.9	4.5	1.7	1.5	1.5	1.6	2.7	2.7	2.8	6.8	6.5	6.5
16	5.9	4.5	1.7	1.5	1.5	1.6	2.7	2.7	2.9	6.1	6.5	6.5
17	5.9	4.5	2.3	1.5	1.8	1.6	2.8	2.7	3.0	6.2	6.5	6.5
18	5.9	4.5	1.8	1.5	1.5	1.6	2.8	2.7	3.0	6.2	6.5	6.4
19	5.7	4.5	1.7	1.5	2.8	1.7	2.7	2.7	3.0	6.2	6.5	6.2
20	5.5	4.5	2.2	1.5	2.8	1.8	2.6	52	3.0	6.3	6.5	5.0
21	5.3	5.3	1.9	1.5	1.7	1.8	2.6	112	3.0	6.8	6.5	6.2
22	5.6	5.7	2.0	1.4	1.7	2.0	2.2	99	3.0	6.8	6.5	6.2
23	6.0	4.5	1.7	1.3	1.7	2.1	1.9	98	3.0	6.8	6.5	6.0
24	5.9	5.2	1.5	1.6	1.5	2.2	1.7	67	3.0	6.8	6.5	6.1
25	5.9	1.7	1.5	1.6	1.5	2.2	1.6	35	3.0	6.6	6.5	6.3
26	5.9	1.1	2.1	1.5	1.5	2.2	2.9	35	3.2	6.5	6.5	5.9
27	5.9	1.5	3.1	1.5	1.4	2.1	9.5	35	3.6	6.8	6.5	5.8
28	5.9	2.1	3.8	1.5	1.4	2.2	6.9	35	4.0	6.8	6.5	5.6
29	5.9	2.4	3.8	1.5	---	2.3	2.4	35	4.5	6.8	6.5	5.6
30	5.6	2.1	4.4	1.5	---	2.1	2.4	35	4.5	6.8	6.5	5.6
31	5.3	---	4.2	1.4	---	2.0	---	35	---	6.8	6.5	---
TOTAL	179.6	132.9	68.7	57.3	45.0	58.3	77.6	720.8	300.6	191.3	201.9	187.4
MEAN	5.794	4.430	2.216	1.848	1.607	1.881	2.587	23.25	10.02	6.171	6.513	6.247
MAX	6.5	6.5	4.5	4.3	2.8	3.8	9.5	112	35	7.6	6.8	6.5
MIN	5.0	1.1	1.4	1.3	1.3	1.3	1.5	2.0	2.4	4.5	5.9	5.0
AC-FT	356	264	136	114	89	116	154	1430	596	379	400	372

STATISTICS OF MONTHLY MEAN DATA FOR WATER YEARS 1986 - 2002, BY WATER YEAR (WY)

	1986	1987	1988	1989	2000	2001	2002	2003	2004	2005	2006	2007
MEAN	4.656	4.424	4.298	4.024	8.948	14.45	20.52	23.93	22.81	6.624	4.936	4.997
MAX	7.45	6.63	21.2	17.7	61.4	111	118	85.8	111	29.1	8.84	8.22
(WY)	2000	1999	1997	1995	1986	1986	1986	1986	1986	1998	1997	1997
MIN	1.50	1.52	1.72	1.70	1.57	1.88	1.32	1.75	1.71	1.71	1.55	1.58
(WY)	1986	1986	1987	1989	2001	2002	2001	1987	1987	1986	1986	1987

SUMMARY STATISTICS

	FOR 2001 CALENDAR YEAR	FOR 2002 WATER YEAR	WATER YEARS 1986 - 2002
ANNUAL TOTAL	1264.03	2221.4	
ANNUAL MEAN	3.463	6.086	10.36
HIGHEST ANNUAL MEAN			41.3
LOWEST ANNUAL MEAN			2.05
HIGHEST DAILY MEAN	7.5 Sep 30	112 May 21	166 Jun 14 1986
LOWEST DAILY MEAN	0.90 Apr 12	1.1 Nov 26	0.09 Nov 5 1985
ANNUAL SEVEN-DAY MINIMUM	0.96 Apr 11	1.4 Jan 31	0.64 Nov 4 1985
MAXIMUM PEAK FLOW		127 May 20	194 Apr 14 1986
MAXIMUM PEAK STAGE		2.63 May 20	3.37 Apr 14 1986
ANNUAL RUNOFF (AC-FT)	2510	4410	7510
10 PERCENT EXCEEDS	6.2	6.8	32
50 PERCENT EXCEEDS	3.1	3.2	4.5
90 PERCENT EXCEEDS	1.2	1.5	1.7

11414250 SOUTH YUBA RIVER AT LANGS CROSSING, NEAR EMIGRANT GAP, CA

LOCATION.—Lat 39°19'07", long 120°39'24", in SW 1/4 SW 1/4 sec.20, T.17 N., R.12 E., Nevada County, Hydrologic Unit 18020125, on right bank, 50 ft downstream from road bridge, 0.8 mi downstream from Spaulding Nos. 1 and 2 Powerplants, and 1.6 mi northeast of Emigrant Gap.

DRAINAGE AREA.—120 mi².

PERIOD OF RECORD.—December 1965 to current year.

GAGE.—Water-stage recorder. Datum of gage is 4,432.44 ft above sea level (levels by Pacific Gas & Electric Co.).

REMARKS.—Flow regulated by Lake Spaulding (station 11414140) 0.8 mi upstream. Lake Spaulding receives water from Canyon Creek via the Bowman-Spaulding Canal (station 11416100). Most of the water is diverted out of the Yuba River just downstream from Spaulding Dam via Drum Canal (station 11414170) and South Yuba Canal (station 11414200). See schematic diagrams of South Yuba River and Bear River Basins.

COOPERATION.—Records were collected by Pacific Gas & Electric Co., under general supervision of the U.S. Geological Survey, in connection with Federal Energy Regulatory Commission project no. 2310.

EXTREMES FOR PERIOD OF RECORD.—Maximum discharge, about 34,200 ft³/s, Jan. 1, 1997, gage height, 23.60 ft, from rating curve extended above 8,800 ft³/s, on basis of spillway rating at Spaulding Dam; minimum daily, 2.1 ft³/s, on several days during July and September 1977.

DISCHARGE, CUBIC FEET PER SECOND, WATER YEAR OCTOBER 2001 TO SEPTEMBER 2002
DAILY MEAN VALUES

DAY	OCT	NOV	DEC	JAN	FEB	MAR	APR	MAY	JUN	JUL	AUG	SEP
1	7.9	6.6	14	36	6.5	10	13	9.0	568	8.0	7.8	7.1
2	6.3	6.7	68	48	6.3	9.7	13	8.3	351	8.2	7.0	7.3
3	5.6	6.7	21	42	6.3	9.3	13	7.8	291	7.6	5.7	7.4
4	6.8	6.8	14	20	6.6	9.1	12	7.5	284	7.4	6.5	7.4
5	6.6	6.9	13	15	6.8	8.9	12	7.5	279	7.2	7.4	7.5
6	5.9	6.9	15	27	6.8	38	11	7.7	274	7.1	7.4	7.5
7	5.8	7.0	14	22	13	30	10	12	135	7.7	7.4	7.6
8	6.8	7.1	13	17	17	19	9.6	7.1	12	7.6	7.5	7.6
9	8.9	7.2	12	15	12	15	9.5	6.8	10	8.7	7.5	7.6
10	8.1	7.2	11	15	11	16	9.5	6.6	9.7	11	7.4	7.8
11	8.5	7.3	10	14	10	16	9.3	6.1	8.2	10	7.4	7.6
12	6.9	7.4	9.6	13	10	20	8.3	5.8	7.8	9.1	7.3	7.2
13	6.9	7.5	9.4	12	11	17	8.2	5.7	7.6	7.8	7.3	7.2
14	6.8	7.5	10	12	11	13	8.6	6.5	7.4	10	7.4	7.2
15	6.8	7.4	9.6	11	11	12	8.8	6.9	7.7	9.1	7.2	7.4
16	6.8	7.0	9.6	10	11	11	9.0	7.4	7.8	7.3	7.2	7.6
17	6.8	6.6	14	9.7	13	11	9.5	8.1	8.0	7.5	7.1	7.5
18	6.6	6.3	13	9.4	12	11	9.7	9.5	7.7	7.5	7.0	7.4
19	6.4	6.1	12	8.9	29	11	10	13	7.4	7.5	7.0	7.3
20	5.9	6.6	12	8.4	48	11	10	68	7.4	7.6	6.9	5.9
21	5.6	7.4	12	8.1	25	12	10	118	7.4	7.8	7.0	8.3
22	6.1	8.2	11	8.2	19	13	9.6	320	7.3	7.7	7.7	8.4
23	7.3	9.1	10	7.7	17	19	8.8	436	7.2	7.7	7.7	8.1
24	7.0	9.8	9.9	7.2	14	19	8.2	320	7.2	7.7	7.7	8.5
25	7.2	10	9.7	7.3	13	18	8.4	245	6.7	7.4	7.8	8.4
26	7.0	11	10	7.2	12	16	11	246	6.4	7.3	7.7	7.6
27	7.0	12	11	7.8	11	15	17	246	7.0	8.1	7.4	7.4
28	7.0	13	11	7.2	11	15	15	162	7.2	8.1	7.2	6.9
29	7.0	13	18	7.1	---	16	9.3	48	7.8	8.1	7.2	6.9
30	10	14	32	6.9	---	14	9.5	157	7.7	8.1	7.2	6.8
31	6.7	---	55	6.7	---	14	---	412	---	7.9	7.1	---
TOTAL	215.0	246.3	493.8	446.8	380.3	469.0	310.8	2927.3	2362.6	249.8	225.1	224.4
MEAN	6.935	8.210	15.93	14.41	13.58	15.13	10.36	94.43	78.75	8.058	7.261	7.480
MAX	10	14	68	48	48	38	17	436	568	11	7.8	8.5
MIN	5.6	6.1	9.4	6.7	6.3	8.9	8.2	5.7	6.4	7.1	5.7	5.9
AC-FT	426	489	979	886	754	930	616	5810	4690	495	446	445

STATISTICS OF MONTHLY MEAN DATA FOR WATER YEARS 1966 - 2002, BY WATER YEAR (WY)

	7.166	39.52	46.46	114.0	88.98	85.09	81.15	317.3	409.5	66.28	6.216	6.499
MEAN	7.166	39.52	46.46	114.0	88.98	85.09	81.15	317.3	409.5	66.28	6.216	6.499
MAX	18.8	683	685	2465	1626	1304	620	1734	2613	822	9.44	10.3
(WY)	1972	1984	1982	1997	1986	1986	1982	1996	1983	1983	1971	1986
MIN	2.68	4.51	5.44	4.51	5.58	5.10	3.41	5.29	3.05	2.34	2.43	2.73
(WY)	1978	1978	1977	1976	1977	1977	1977	1977	1977	1977	1977	1977

SUMMARY STATISTICS

FOR 2001 CALENDAR YEAR

FOR 2002 WATER YEAR

WATER YEARS 1966 - 2002

ANNUAL TOTAL	3694.2	8551.2	
ANNUAL MEAN	10.12	23.43	108.1
HIGHEST ANNUAL MEAN			448
LOWEST ANNUAL MEAN			4.35
HIGHEST DAILY MEAN	68	Dec 2	25400
LOWEST DAILY MEAN	4.5	Aug 13	2.1
ANNUAL SEVEN-DAY MINIMUM	5.6	Jan 3	2.1
MAXIMUM PEAK FLOW			1340
MAXIMUM PEAK STAGE			7.64
ANNUAL RUNOFF (AC-FT)	7330	16960	78310
10 PERCENT EXCEEDS	17	19	90
50 PERCENT EXCEEDS	7.8	8.2	7.7
90 PERCENT EXCEEDS	6.1	6.8	5.4

11414260 BLUE LAKE NEAR EMIGRANT GAP, CA

LOCATION.—Lat 39°21'31", long 120°38'07", in NE 1/4 NW 1/4 sec.9, T.17 N., R.12 E., Nevada County, Hydrologic Unit 18020125, Tahoe National Forest, on outlet structure on Blue Lake Dam, 0.7 mi upstream from Rucker Lake, and 4.6 mi northeast of Emigrant Gap.

DRAINAGE AREA.—0.27 mi².

PERIOD OF RECORD.—October 1999 to current year. Unpublished records for water years 1966–99 available in the files of the U.S. Geological Survey.

GAGE.—Nonrecording gage observed intermittently during the summer months. Datum of gage is 5,932 ft above sea level (levels by Pacific Gas & Electric Co.).

REMARKS.—Reservoir is formed by an earthfill dam completed in 1870, reconstructed in 2000. Usable capacity, 1,163 acre-ft, between gage heights 0.0 ft, invert of outlet valve, and 20.8 ft, crest of spillway. Figures given represent usable contents. Released water is used for hydroelectric power and irrigation downstream. Water was below the outlet structure the entire year.

COOPERATION.—Records were collected by Pacific Gas & Electric Co., under general supervision of the U.S. Geological Survey, in connection with Federal Energy Regulatory Commission project no. 2310.

Capacity table (elevation, in feet, and contents, in acre-feet)
(Based on survey by Pacific Gas & Electric Co. in 1965)

0	0	8	410	16	865	20	1112
4	199	12	631				

NOTE: There was no storage for the entire year.

11414265 RUCKER CREEK BELOW BLUE LAKE, NEAR EMIGRANT GAP, CA

LOCATION.—Lat 39°21'32", long 120°38'09", in NE 1/4 NW 1/4 sec.9, T.17 N., R.12 E., Nevada County, Hydrologic Unit 18020125, Tahoe National Forest, on left bank, 300 ft downstream from outlet structure on Blue Lake Dam, and 4.6 mi northeast of Emigrant Gap.

DRAINAGE AREA.—0.27 mi².

PERIOD OF RECORD.—October 1999 to current year. Unpublished records for water years 1965–99 available in the files of the U.S. Geological Survey.

GAGE.—Nonrecording gage observed intermittently during the summer months. Datum of gage is 5,910 ft above sea level (from topographic map).

REMARKS.—Flow regulated by Blue Lake (station 11414260) 300 ft upstream. There are no diversions upstream of station.

COOPERATION.—Records were collected by Pacific Gas & Electric Co., under general supervision of the U.S. Geological Survey, in connection with Federal Energy Regulatory Commission project no. 2310.

DISCHARGE, CUBIC FEET PER SECOND, WATER YEAR OCTOBER 2001 TO SEPTEMBER 2002
DAILY INSTANTANEOUS VALUES

DAY	OCT	NOV	DEC	JAN	FEB	MAR	APR	MAY	JUN	JUL	AUG	SEP
1	---	---	---	---	---	---	---	---	---	---	---	e0.20
2	---	---	---	---	---	---	---	---	---	---	---	---
3	e0.20	---	---	---	---	---	---	---	---	e0.20	e0.20	---
4	---	---	---	---	---	---	---	---	---	---	---	e0.20
5	---	---	---	---	---	---	---	---	e0.20	---	---	---
6	---	---	---	---	---	---	---	---	---	---	e0.20	---
7	---	---	---	---	---	---	---	---	---	e0.20	---	---
8	---	---	---	---	---	---	---	---	---	---	---	e0.20
9	e0.20	---	---	---	---	---	---	---	---	---	e0.20	---
10	---	---	---	---	---	---	---	---	---	e0.20	---	---
11	---	---	---	---	---	---	---	---	---	---	---	e0.20
12	---	---	---	---	---	---	---	---	---	---	---	---
13	---	---	---	---	---	---	---	---	e0.20	---	---	---
14	---	---	---	---	---	---	---	---	---	e0.20	e0.20	e0.20
15	---	---	---	---	---	---	---	---	---	---	---	---
16	0.00	---	---	---	---	---	---	e0.20	---	---	---	---
17	e0.20	---	---	---	---	---	---	---	---	---	---	0.30
18	---	---	---	---	---	---	---	---	---	e0.20	e0.20	e0.20
19	---	---	---	---	---	---	---	---	---	---	---	---
20	---	---	---	---	---	---	---	e0.20	---	---	---	---
21	---	---	---	---	---	---	---	---	---	e0.20	e0.20	e0.20
22	e0.20	---	---	---	---	---	---	---	---	---	0.29	---
23	---	---	---	---	---	---	---	---	---	---	---	---
24	---	---	---	---	---	---	---	---	---	e0.20	e0.20	---
25	---	---	---	---	---	---	---	e0.20	---	---	---	---
26	---	---	---	---	---	---	---	e0.20	0.31	e0.20	---	---
27	---	---	---	---	---	---	---	---	---	e0.20	e0.20	---
28	---	---	---	---	---	---	---	---	---	---	---	---
29	e0.20	---	---	---	---	---	---	e0.20	---	---	---	---
30	---	---	---	---	---	---	---	---	---	---	---	---
31	---	---	---	---	---	---	---	---	---	---	---	---
TOTAL	---	---	---	---	---	---	---	---	---	---	---	---
MEAN	---	---	---	---	---	---	---	---	---	---	---	---
MAX	---	---	---	---	---	---	---	---	---	---	---	---
MIN	---	---	---	---	---	---	---	---	---	---	---	---
AC-FT	---	---	---	---	---	---	---	---	---	---	---	---

e Estimated.

11414360 LAKE CREEK BELOW CARR LAKE, NEAR GRANITEVILLE, CA

LOCATION.—Lat 39°23'57", long 120°38'31", in SE 1/4 NE 1/4 sec.29, T.18 N., R.12 E., Nevada County, Hydrologic Unit 18020125, Tahoe National Forest, on right bank, 65 ft downstream from Carr Lake, 2.0 mi upstream from Fall Creek, and 5.8 mi southeast of Graniteville.

DRAINAGE AREA.—0.48 mi².

PERIOD OF RECORD.—October 1995 to current year. Unpublished records for water years 1965–95 available in files of the U.S. Geological Survey.

GAGE.—Water-stage recorder and compound rectangular weir. Elevation of gage is 6,650 ft above sea level (levels by Pacific Gas & Electric Co.). August 1965 to November 1975, nonrecording gage at site 65 ft upstream at different datum. November 1975 to July 1984, nonrecording gage at same site but different datum. July 1984 to September 1995, nonrecording gage at same site and datum.

REMARKS.—Records not computed for winter months. Flow regulated by Carr Lake. See schematic diagram of South Yuba River Basin.

COOPERATION.—Records were collected by Pacific Gas & Electric Co., under general supervision of the U.S. Geological Survey, in connection with Federal Energy Regulatory Commission project no. 2310.

DISCHARGE, CUBIC FEET PER SECOND, WATER YEAR OCTOBER 2001 TO SEPTEMBER 2002
DAILY MEAN VALUES

DAY	OCT	NOV	DEC	JAN	FEB	MAR	APR	MAY	JUN	JUL	AUG	SEP
1	1.3	2.0	---	---	---	---	---	---	---	0.94	0.61	0.51
2	1.3	2.0	---	---	---	---	---	---	---	0.94	0.51	0.49
3	1.4	2.0	---	---	---	---	---	---	---	0.98	0.58	0.41
4	1.4	2.0	---	---	---	---	---	---	---	1.1	0.60	0.57
5	1.3	2.1	---	---	---	---	---	---	---	1.1	0.60	0.72
6	1.3	2.2	---	---	---	---	---	---	---	1.0	0.66	0.73
7	1.3	2.2	---	---	---	---	---	---	---	0.94	0.78	0.73
8	1.3	2.2	---	---	---	---	---	---	---	0.94	0.79	0.66
9	1.3	2.2	---	---	---	---	---	---	---	0.94	0.84	0.68
10	1.3	2.2	---	---	---	---	---	---	---	1.2	0.74	0.73
11	1.3	2.2	---	---	---	---	---	---	---	1.6	0.82	1.8
12	1.0	2.2	---	---	---	---	---	---	---	1.0	0.85	3.1
13	0.92	2.2	---	---	---	---	---	---	---	0.82	0.88	3.1
14	0.83	5.6	---	---	---	---	---	---	---	0.83	0.65	3.1
15	0.83	---	---	---	---	---	---	---	---	0.77	0.64	3.1
16	0.83	---	---	---	---	---	---	---	---	0.73	0.64	3.1
17	1.1	---	---	---	---	---	---	---	---	0.73	0.65	3.3
18	1.5	---	---	---	---	---	---	---	0.98	0.71	0.75	3.1
19	1.5	---	---	---	---	---	---	---	1.4	0.54	0.83	2.8
20	1.6	---	---	---	---	---	---	---	1.2	0.45	0.83	2.9
21	1.7	---	---	---	---	---	---	---	1.0	0.63	0.78	3.5
22	1.8	---	---	---	---	---	---	---	0.92	0.73	0.73	3.6
23	1.8	---	---	---	---	---	---	---	0.83	0.57	0.72	3.5
24	1.7	---	---	---	---	---	---	---	0.83	0.59	0.68	3.3
25	1.5	---	---	---	---	---	---	---	0.92	0.66	0.73	3.1
26	1.5	---	---	---	---	---	---	---	0.95	0.63	0.72	2.9
27	1.5	---	---	---	---	---	---	---	0.94	0.53	0.65	2.8
28	1.5	---	---	---	---	---	---	---	0.85	0.48	0.63	2.6
29	1.5	---	---	---	---	---	---	---	0.83	0.59	0.56	2.7
30	1.5	---	---	---	---	---	---	---	0.80	0.64	0.56	2.8
31	1.6	---	---	---	---	---	---	---	---	0.64	0.56	---
TOTAL	42.21	---	---	---	---	---	---	---	---	24.95	21.57	66.43
MEAN	1.362	---	---	---	---	---	---	---	---	0.805	0.696	2.214
MAX	1.8	---	---	---	---	---	---	---	---	1.6	0.88	3.6
MIN	0.83	---	---	---	---	---	---	---	---	0.45	0.51	0.41
AC-FT	84	---	---	---	---	---	---	---	---	49	43	132

11414400 FRENCH LAKE NEAR CISCO, CA

LOCATION.—Lat 39°25'16", long 120°32'28", in SE 1/4 SW 1/4 sec.17, T.18 N., R.13 E., Nevada County, Hydrologic Unit 18020125, Tahoe National Forest, on right bank, near French Lake Dam on Canyon Creek, 0.5 mi upstream from Weil Lake, and 8.2 mi north of Cisco.

DRAINAGE AREA.—4.60 mi².

PERIOD OF RECORD.—October 1986 to current year. Unpublished records for water years 1966–86 available in the files of the U.S. Geological Survey.

GAGE.—Water-stage recorder. Datum of gage is sea level (levels by Nevada Irrigation District).

REMARKS.—Reservoir is formed on natural lake by rock-filled dam completed in 1859. Usable capacity, 13,940 acre-ft, between elevations 6,594.90 ft, invert of outlet gate, and 6,660.28 ft, crest of spillway. Figures given represent usable contents. Released water is used for hydroelectric power and irrigation downstream. See schematic diagram of [North and Middle Yuba River Basins](#).

COOPERATION.—Records were collected by Nevada Irrigation District, under general supervision of the U.S. Geological Survey, in connection with Federal Energy Regulatory Commission project no. 2266.

EXTREMES FOR PERIOD OF RECORD.—Maximum contents, 14,300 acre-ft, June 19, 1998, May 8, 23, 24, 2000, May 30, 2001, maximum elevation, 6661.34 ft, May 8, 2000; minimum, 5,640 acre-ft, Nov. 19, 20, 2001, minimum elevation, 6629.80 ft, Nov. 20, 2001.

EXTREMES FOR CURRENT YEAR.—Maximum contents, 14,300 acre-ft, May 30, elevation, 6661.18 ft; minimum, 5,640 acre-ft, Nov. 19, 20, minimum elevation, 6629.80 ft, Nov. 20.

Capacity table (elevation, in feet, and contents, in acre-feet)
(Based on survey by Nevada Irrigation District in 1964)

6,610	1,805	6,630	5,677	6,650	10,701	6,662	14,542
6,620	3,636	6,640	8,006				

RESERVOIR STORAGE (ACRE-FEET), WATER YEAR OCTOBER 2001 TO SEPTEMBER 2002

DAILY OBSERVATION AT 2400 HOURS

DAY	OCT	NOV	DEC	JAN	FEB	MAR	APR	MAY	JUN	JUL	AUG	SEP
1	10600	6690	6350	6820	7430	7740	8500	11300	14200	13900	13300	11900
2	10600	6540	6420	6880	7430	7740	8600	11400	14200	13900	13300	11800
3	10600	6380	6430	6910	7420	7750	8720	11500	14200	13900	13300	11700
4	10500	6230	6430	6920	7420	7760	8860	11600	14200	13900	13300	11500
5	10500	6070	6470	6950	7420	7770	8980	11800	14200	13800	13300	11400
6	10500	5920	6470	7160	7410	7880	9080	11900	14200	13800	13200	11200
7	10500	5760	6480	7240	7450	7930	9180	12100	14200	13800	13200	11000
8	10500	5670	6480	7270	7440	7930	9290	12200	14100	13800	13200	10800
9	10500	5660	6490	7300	7440	7940	9420	12300	14100	13800	13200	10600
10	10500	5650	6480	7310	7440	7970	9580	12400	14100	13800	13200	10500
11	10400	5660	6480	7320	7430	7970	9710	12500	14100	13700	13100	10300
12	10200	5690	6480	7330	7430	7990	9860	12600	14100	13700	13100	10100
13	9980	5690	6500	7340	7430	8000	10000	12800	14100	13700	13100	9950
14	9790	5690	6530	7340	7430	8000	10200	13000	14100	13700	13100	9770
15	9600	5680	6530	7350	7430	8010	10400	13100	14000	13700	13100	9600
16	9400	5670	6530	7350	7440	8020	10500	13300	14000	13600	13000	9420
17	9220	5660	6570	7360	7440	8030	10500	13500	14000	13600	13000	9250
18	9040	5650	6570	7360	7440	8030	10500	13700	14000	13600	13000	9070
19	8860	5640	6560	7360	7480	8030	10600	13800	14000	13600	13000	8930
20	8680	5640	6590	7360	7560	8030	10600	13900	14000	13600	12900	8770
21	8500	5890	6590	7380	7610	8050	10600	14000	14000	13600	12900	8600
22	8320	6070	6620	7380	7630	8090	10700	14000	14000	13500	12800	8440
23	8140	6080	6620	7380	7670	8140	10700	14000	14000	13500	12800	8280
24	7960	6240	6620	7380	7680	8160	10800	14100	14000	13500	12700	8120
25	7790	6260	6620	7380	7690	8170	11000	14100	14000	13500	12600	7970
26	7630	6270	6620	7440	7710	8180	11100	14200	14000	13500	12600	7880
27	7460	6270	6630	7440	7720	8200	11200	14200	14000	13400	12500	7860
28	7290	6290	6640	7440	7740	8230	11200	14200	13900	13400	12400	7850
29	7130	6310	6660	7440	---	8280	11300	14200	13900	13400	12300	7850
30	7010	6310	6730	7440	---	8340	11300	14300	13900	13400	12100	7840
31	6850	---	6790	7430	---	8400	---	14200	---	13400	12000	---
MAX	10600	6690	6790	7440	7740	8400	11300	14300	14200	13900	13300	11900
MIN	6850	5640	6350	6820	7410	7740	8500	11300	13900	13400	12000	7840
a	6635.15	6632.78	6634.93	6637.61	6638.86	6641.56	6651.96	6661.15	6660.23	6658.53	6654.40	6639.29
b	-3750	-540	+480	+640	+310	+660	+2900	+2900	-300	-500	-1400	-4160
CAL YR 2001	MAX 13200	MIN 5640	b -170									
WTR YR 2002	MAX 14300	MIN 5640	b -2760									

a Elevation, in feet, at end of month.

b Change in contents, in acre-feet.

11414440 FAUCHERIE LAKE NEAR CISCO, CA

LOCATION.—Lat 39°25'45", long 120°34'04", in SE 1/4 NE 1/4 sec.13, T.18 N., R.12 E., Nevada County, Hydrologic Unit 18020125, Tahoe National Forest, near right bank end of Faucherie Dam, on Canyon Creek, and 8.5 mi north of Cisco.

DRAINAGE AREA.—8.97 mi².

PERIOD OF RECORD.—October 1986 to current year. Unpublished records for water years 1965–86 available in files of the U.S. Geological Survey.

GAGE.—Water-stage recorder installed Dec. 8, 1999. Records prior to Dec. 8, 1999, are instantaneous values. Datum of gage is sea level (levels by Nevada Irrigation District).

REMARKS.—Reservoir is formed on natural lake by earth-filled dam initially constructed prior to 1880 and enlarged in 1964. Usable capacity, 3,740 acre-ft, between elevations 6,090.00 ft, invert of outlet gate, and 6,123.00 ft, crest of spillway. Dead storage, below elevation 6,090 ft, 240 acre-ft. Figures given represent total contents. Released water is used for hydroelectric power and irrigation downstream. See schematic diagram of [North Yuba and Middle River Basins](#).

COOPERATION.—Records were collected by Nevada Irrigation District, under general supervision of the U.S. Geological Survey, in connection with Federal Energy Regulatory Commission project no. 2266.

EXTREMES FOR PERIOD OF RECORD.—Maximum contents recorded, 4,110 acre-ft, May 8, 2000, elevation, 6,123.85 ft; minimum recorded, 1,850 acre-ft, Nov. 20, 2001, elevation, 6106.96 ft.

EXTREMES FOR CURRENT YEAR.—Maximum contents, 4,070 acre-ft, May 30, 31, elevation, 6,123.60 ft; minimum, 1,850 acre-ft, Nov. 20, elevation, 6,106.96 ft.

Capacity table (elevation, in feet, and contents, in acre-feet)
(Based on survey by Nevada Irrigation District in 1964)

6,090	240	6,100	1,095	6,110	2,216	6,120	3,540
6,095	628	6,105	1,629	6,115	2,854	6,125	4,280

RESERVOIR STORAGE (ACRE-FEET), WATER YEAR OCTOBER 2001 TO SEPTEMBER 2002

DAILY OBSERVATION AT 2400 HOURS

DAY	OCT	NOV	DEC	JAN	FEB	MAR	APR	MAY	JUN	JUL	AUG	SEP
1	3950	4030	3220	4000	3990	3990	4020	4000	4060	3990	3980	4020
2	3950	4030	3320	4020	3990	3990	4020	4020	4040	3990	3980	4020
3	3950	4030	3370	4000	3990	3990	4030	4030	4050	3980	3980	4020
4	3950	4030	3390	3990	3990	3990	4030	4030	4050	3980	3980	4020
5	3950	4030	3440	4010	3990	3990	4020	4030	4050	3980	3970	4030
6	3950	3990	3470	4040	3980	4020	4020	4040	4050	3980	3960	4030
7	3960	3950	3500	4010	4000	4000	4020	4030	4040	3980	3970	4030
8	3960	3850	3520	4000	3990	3990	4020	4020	4030	3980	3970	4030
9	3960	3640	3540	4000	3990	3990	4030	4020	4020	3980	3980	4030
10	3960	3440	3560	3990	3990	3990	4030	4010	4020	3980	3980	4030
11	4020	3280	3580	3990	3990	3990	4030	4020	4020	3980	3980	4030
12	4030	3120	3600	3990	3990	3990	4020	4030	4020	3980	3980	4030
13	4030	2950	3630	3990	3990	3990	4030	4030	4030	3980	3980	4030
14	4030	2790	3670	3990	3990	3990	4060	4030	4020	3980	3980	4030
15	4030	2620	3690	3990	3990	3990	4010	4030	4010	3980	3980	4030
16	4030	2440	3710	3990	3990	3990	4010	4030	4010	3980	3980	4030
17	4030	2270	3750	3990	3990	3990	4000	4040	4010	3980	3980	4030
18	4030	2100	3770	3990	3990	3990	3990	4040	4010	3980	3980	4030
19	4030	1930	3780	3990	4000	3990	3990	4010	4010	3980	3980	4030
20	4030	1850	3820	3990	4020	3990	3990	4010	4000	3980	3990	4030
21	4030	2240	3840	3990	4010	3990	4000	4010	4000	3980	4000	4030
22	4030	2610	3880	3990	4000	4000	4010	4010	4000	3980	4000	4030
23	4030	2650	3900	3980	4000	3990	4010	4020	4000	3980	4000	4030
24	4030	2980	3910	3990	3990	3990	4020	4030	3990	3980	4000	4030
25	4030	3050	3930	3990	3990	3990	4030	4040	3990	3980	4000	4030
26	4030	3090	3950	4000	3990	3990	4020	4050	3990	3980	4000	4000
27	4030	3100	3970	3990	3990	3990	4010	4060	3990	3980	4000	3990
28	4030	3120	4000	3990	3990	4000	4000	4060	3990	3980	4020	3980
29	4030	3160	4000	3990	---	4010	4000	4060	3990	3980	4020	3980
30	4030	3170	4020	3990	---	4010	4000	4070	3990	3980	4020	3980
31	4030	---	4010	3990	---	4010	---	4070	---	3980	4020	---
MAX	4030	4030	4020	4040	4020	4020	4060	4070	4060	3990	4020	4030
MIN	3950	1850	3220	3980	3980	3990	3990	4000	3990	3980	3960	3980
a	6123.31	6117.40	6123.20	6123.05	6123.09	6123.21	6123.13	6123.60	6123.05	6122.99	6123.27	6122.99
b	+80	-860	+840	-20	0	+20	-10	+70	-80	-10	+40	-40
CAL YR 2001	MAX 4050	MIN 1850	b +20									
WTR YR 2002	MAX 4070	MIN 1850	b +30									

a Elevation, in feet, at end of month.

b Change in contents, in acre-feet.

11414465 SAWMILL LAKE NEAR GRANITEVILLE, CA

LOCATION.—Lat 39°26'44", long 120°36'02", in NW 1/4 NW 1/4 sec.11, T.18 N., R.12 E., Nevada County, Hydrologic Unit 18020125, Tahoe National Forest, near right bank end of Sawmill Lake Dam, on Canyon Creek, 0.8 mi upstream from Bowman Lake, and 7.2 mi east of Graniteville.

DRAINAGE AREA.—16.4 mi².

PERIOD OF RECORD.—October 1986 to current year. Unpublished records for water years 1966–86 available in files of the U.S. Geological Survey.

GAGE.—Water-stage recorder, installed Nov. 22, 1999. Records prior to Nov. 22, 1999, are instantaneous values. Datum of gage is sea level (levels by Nevada Irrigation District).

REMARKS.—Reservoir is formed by a rock-filled dam initially constructed prior to 1880 and enlarged in 1941. Usable capacity, 3,030 acre-ft, between elevations 5,805 ft, base of dam, and 5,860 ft, crest of spillway. Figures given represent usable contents. Released water is used for hydroelectric power and irrigation downstream. See schematic diagram of [North and Middle Yuba River Basins](#).

COOPERATION.—Records were collected by Nevada Irrigation District, under general supervision of the U.S. Geological Survey, in connection with Federal Energy Regulatory Commission project no. 2266.

EXTREMES FOR PERIOD OF RECORD.—Maximum storage recorded, 3,180 acre-ft, May 8, 2000, elevation, 5,861.31 ft; minimum recorded, 1,400 acre-ft, Nov. 22, 1999, elevation, 5,843.15 ft.

EXTREMES FOR CURRENT YEAR.—Maximum contents, 3,160 acre-ft, Apr. 14, elevation, 5,861.13 ft; minimum, 2,950 acre-ft, Nov. 23, elevation, 5,859.18 ft.

Capacity table (elevation, in feet, and contents, in acre-feet)
(Based on survey by Nevada Irrigation District in 1964)

5,805	0	5,830	430	5,850	2,000	5,863	3,375
5,820	110	5,840	1,130	5,860	3,030		

RESERVOIR STORAGE (ACRE-FEET), WATER YEAR OCTOBER 2001 TO SEPTEMBER 2002

DAILY OBSERVATION AT 2400 HOURS

DAY	OCT	NOV	DEC	JAN	FEB	MAR	APR	MAY	JUN	JUL	AUG	SEP
1	3000	3090	3070	3090	3070	3070	3100	3080	3130	3060	3050	3080
2	2990	3090	3080	3120	3070	3070	3110	3100	3110	3060	3050	3080
3	2990	3090	3070	3090	3070	3070	3130	3110	3110	3060	3050	3080
4	2990	3090	3070	3080	3070	3070	3130	3120	3110	3060	3050	3080
5	2980	3090	3070	3090	3070	3080	3110	3120	3120	3060	3050	3090
6	2980	3100	3070	3140	3070	3120	3110	3130	3110	3060	3050	3100
7	2980	3090	3070	3100	3070	3090	3110	3120	3110	3060	3050	3100
8	2970	3090	3070	3090	3070	3080	3120	3110	3100	3060	3040	3100
9	2970	3090	3070	3080	3070	3070	3120	3110	3090	3060	3040	3100
10	2960	3090	3070	3080	3070	3080	3130	3100	3080	3060	3040	3100
11	2980	3070	3070	3080	3070	3070	3120	3100	3090	3060	3040	3100
12	3090	3070	3060	3080	3070	3080	3120	3120	3090	3060	3050	3100
13	3090	3070	3070	3070	3070	3070	3130	3120	3090	3050	3050	3100
14	3090	3070	3070	3070	3070	3070	3160	3120	3090	3050	3050	3090
15	3090	3060	3070	3070	3070	3070	3100	3120	3080	3050	3050	3090
16	3090	3060	3070	3070	3070	3070	3090	3120	3080	3050	3050	3090
17	3090	3060	3070	3070	3070	3070	3080	3130	3080	3050	3050	3090
18	3090	3060	3070	3070	3070	3070	3080	3130	3080	3050	3050	3090
19	3090	3060	3060	3070	3080	3070	3080	3100	3080	3050	3050	3090
20	3090	2980	3070	3070	3110	3070	3080	3100	3070	3050	3050	3090
21	3090	2970	3070	3070	3090	3070	3080	3090	3070	3050	3070	3090
22	3090	3050	3070	3070	3090	3080	3090	3090	3070	3050	3070	3090
23	3090	2950	3060	3070	3080	3080	3100	3100	3070	3050	3070	3090
24	3090	3080	3060	3070	3080	3070	3110	3100	3070	3050	3070	3090
25	3090	3000	3060	3070	3080	3070	3120	3120	3070	3050	3070	3090
26	3090	2960	3070	3080	3080	3070	3100	3120	3060	3050	3070	3080
27	3090	2980	3070	3070	3080	3080	3090	3130	3060	3050	3070	3060
28	3090	3010	3070	3070	3080	3080	3090	3140	3060	3050	3080	3060
29	3090	3040	3080	3070	---	3100	3090	3140	3060	3050	3080	3060
30	3100	3060	3110	3070	---	3100	3080	3140	3060	3050	3080	3060
31	3090	---	3100	3070	---	3100	---	3140	---	3050	3080	---
MAX	3100	3100	3110	3140	3110	3120	3160	3140	3130	3060	3080	3100
MIN	2960	2950	3060	3070	3070	3070	3080	3080	3060	3050	3040	3060
a	5860.52	5860.26	5860.65	5860.32	5860.42	5860.59	5860.47	5860.97	5860.27	5860.18	5860.47	5860.26
b	+90	-30	+40	-30	+10	+20	-20	+60	-80	-10	+30	-20

CAL YR 2001 MAX 3140 MIN 2790 b +40
WTR YR 2002 MAX 3160 MIN 2950 b +60

a Elevation, in feet, at end of month.
b Change in contents, in acre-feet.

11414470 CANYON CREEK BELOW SAWMILL LAKE, NEAR GRANITEVILLE, CA

LOCATION.—Lat 39°26'44", long 120°36'05", in NW 1/4 NW 1/4 sec.11, T.18 N., R.12 E., [Nevada County](#), Hydrologic Unit 18020125, Tahoe National Forest, on right bank, 130 ft downstream from outlet at Sawmill Lake Dam, on Canyon Creek, 0.8 mi upstream from Bowman Lake, and 7.2 mi east of Graniteville.

DRAINAGE AREA.—16.4 mi².

PERIOD OF RECORD.—October 1989 to current year. Unpublished records for water years 1965–89 available in files of the U.S. Geological Survey.

GAGE.—Water-stage recorder and V-notch sharp-crested weir in concrete control. Elevation of gage is 5,790 ft above sea level, from topographic map. September 1964 to July 6, 1988, nonrecording gage at two sites 470 ft downstream at different datum. July 7, 1988, to January 1989, nonrecording gage at same site and datum.

REMARKS.—No records computed above 2.6 ft³/s. Flow completely regulated by Sawmill Lake (station 11414465). Flow over the spillway bypasses this station. See schematic diagram of [North and Middle Yuba River Basins](#).

COOPERATION.—Records were collected by Nevada Irrigation District, under general supervision of the U.S. Geological Survey, in connection with Federal Energy Regulatory Commission project no. 2266.

EXTREMES FOR CURRENT YEAR.—No flow below 2.6 ft³/s this water year.

11414690 JACKSON LAKE NEAR SIERRA CITY, CA

LOCATION.—Lat 39°27'52", long 120°33'44", in SW 1/4 SW 1/4 sec.31, T.19 N., R.13 E., Nevada County, Hydrologic Unit 18020125, Tahoe National Forest, on outlet structure on Jackson Lake Dam, on Jackson Creek, 3.0 mi upstream from Bowman Lake, and 8.0 mi southeast of Sierra City.

DRAINAGE AREA.—0.65 mi².

PERIOD OF RECORD.—October 1986 to current year. Unpublished records for water years 1965–86 available in files of U.S. Geological Survey.

GAGE.—Water-stage recorder. Datum of gage is 6,570 ft above sea level (levels by Nevada Irrigation District).

REMARKS.—Reservoir is formed on natural lake by earth-filled dam completed in 1859. Usable capacity, 974 acre-ft, between gage height 0.0 ft, invert of outlet, and 22.67 ft, crest of spillway. Dead storage below gage height 0.0 ft, 360 acre-ft. Figures given represent total contents.

Released water is used for hydroelectric power and irrigation downstream. See schematic diagram of [North and Middle Yuba River Basins](#).

COOPERATION.—Records were collected by Nevada Irrigation District, under general supervision of the U.S. Geological Survey, in connection with Federal Energy Regulatory Commission project no. 2266.

EXTREMES FOR PERIOD OF RECORD.—Maximum contents recorded, 1,370 acre-ft, May 21–25, 2000, maximum elevation, 6,593.33 ft, May 24, 2000; minimum recorded, 428 acre-ft, Nov. 21, 22, 1998, elevation, 6571.80 ft.

EXTREMES FOR CURRENT YEAR.—Maximum contents, 1,350 acre-ft, many days in April–June, maximum elevation, 6,593.05 ft, May 17, 30; minimum, 910 acre-ft, Nov. 20, elevation, 6583.34 ft.

Capacity table (gage height, in feet, and contents, in acre-feet)
(Based on survey by Nevada Irrigation District in 1964)

0	360	10	730	20	1,185	24	1,407
5	545	15	958				

RESERVOIR STORAGE (ACRE-FEET), WATER YEAR OCTOBER 2001 TO SEPTEMBER 2002

DAILY OBSERVATION AT 2400 HOURS

DAY	OCT	NOV	DEC	JAN	FEB	MAR	APR	MAY	JUN	JUL	AUG	SEP
1	992	930	978	1020	1050	1060	1110	1340	1350	1320	1210	1110
2	990	928	994	1030	1020	1060	1120	1340	1350	1320	1210	1110
3	987	926	993	1030	1050	1060	1130	1350	1350	1310	1200	1100
4	985	925	993	1030	1050	1060	1140	1350	1350	1310	1200	1100
5	982	923	997	1030	1020	1060	1150	1350	1350	1310	1200	1090
6	979	921	997	1050	1050	1070	1160	1350	1350	1300	1190	1090
7	977	919	996	e1050	1050	1080	1170	1350	1350	1300	1190	1090
8	974	917	e995	e1050	1050	1080	1180	1350	1340	1300	1180	1090
9	972	916	995	1060	1050	1080	1200	1350	1340	1300	1180	1080
10	968	914	995	1060	1050	1080	1210	1350	1340	1290	1180	1080
11	967	916	e994	1060	1050	1080	1230	1350	1340	1290	1170	1080
12	964	920	993	1060	1050	1080	1240	1350	1340	1290	1170	1070
13	960	921	e997	1060	1050	1080	1260	1350	1340	1280	1170	1070
14	958	920	e1000	1060	1040	1080	1290	1350	1340	1280	1160	1070
15	956	919	e1000	1050	1040	1090	1300	1350	1340	1280	1160	1060
16	954	918	999	1050	1040	1090	1320	1350	1340	1270	1160	1060
17	952	917	1000	1050	1040	1090	1320	1350	1340	1270	1150	1060
18	950	915	1000	1050	1040	1090	1330	1350	1340	1270	1150	1050
19	948	913	1000	1050	1050	1090	1330	1350	1340	1260	1150	1050
20	946	910	1010	1050	1050	1090	1330	1350	1340	1260	1150	1050
21	943	934	1010	1060	1060	1090	1330	1350	1340	1260	1140	1050
22	942	949	1010	1050	1060	1090	1330	1340	1340	1250	1140	1040
23	939	948	1010	1050	1060	1090	1340	1340	1330	1250	1140	1040
24	937	969	1010	1050	1060	1100	1340	1350	1330	1240	1130	1040
25	936	971	1010	1050	1060	1100	1350	1350	1330	1240	1130	1030
26	933	971	1010	1060	1060	1090	1350	1350	1330	1240	1130	1030
27	931	970	1010	1060	1060	1090	1350	1350	1330	1230	1120	1030
28	929	970	1010	1060	1060	1100	1340	1350	1330	1230	1120	1030
29	926	974	1010	1060	---	1100	1340	1350	1320	1220	1120	1020
30	934	972	1020	1060	---	1100	1340	1350	1320	1220	1110	1020
31	932	---	e1020	1060	---	1100	---	1350	---	1220	1110	---
MAX	992	974	1020	1060	1060	1100	1350	1350	1350	1320	1210	1110
MIN	926	910	978	1020	1020	1060	1110	1340	1320	1220	1110	1020
a	6584.43	6585.32		6587.14	6587.23	6588.21	6592.85	6593.04	6592.44	6590.56	6588.37	6586.37
b	-63	+40	+48	+40	0	+40	+240	+10	-30	-100	-110	-90
CAL YR 2001	MAX 1350	MIN 805	b +154									
WTR YR 2002	MAX 1350	MIN 910	b +25									

e Estimated.

a Elevation, in feet, at end of month.

b Change in contents, in acre-feet.

11414700 JACKSON CREEK BELOW JACKSON LAKE, NEAR SIERRA CITY, CA

LOCATION.—Lat 39°27'53", long 120°33'46", in SW 1/4 SW 1/4 sec.31, T.19 N., R.13 E., Nevada County, Hydrologic Unit 18020125, Tahoe National Forest, on left bank, 75 ft downstream from Jackson Lake Dam, on Jackson Creek, 3.0 mi upstream from Bowman Lake, and 8.0 mi southeast of Sierra City.

DRAINAGE AREA.—0.65 mi².

PERIOD OF RECORD.—January 1989 to September 1992, April 1993 to current year (low-flow records only). Unpublished records for water years 1965–88 available in files of the U.S. Geological Survey.

GAGE.—Water-stage recorder and V-notch sharp-crested weir. Elevation of gage is 6,570 ft above sea level, from topographic map. October 1964 to October 1986, nonrecording gage at site 25 ft downstream at different datum. October 1986 to January 1989, nonrecording gage at same site and datum.

REMARKS.—No records computed above 2.9 ft³/s. Flow regulated by Jackson Lake (station 11414690). Flow over the spillway bypasses this station. See schematic diagram of [North and Middle Yuba River Basins](#).

COOPERATION.—Records were collected by Nevada Irrigation District, under general supervision of the U.S. Geological Survey, in connection with Federal Energy Regulatory Commission project no. 2266.

DISCHARGE, CUBIC FEET PER SECOND, WATER YEAR OCTOBER 2001 TO SEPTEMBER 2002

DAILY MEAN VALUES

DAY	OCT	NOV	DEC	JAN	FEB	MAR	APR	MAY	JUN	JUL	AUG	SEP
1	1.2	0.88	0.89	0.90	0.96	0.94	0.90	1.3	1.3	0.99	1.3	1.2
2	1.2	0.87	0.87	0.90	0.96	0.95	0.88	1.3	1.2	---	1.3	1.2
3	1.2	0.87	0.89	0.90	0.96	0.94	0.93	1.3	1.2	0.94	1.3	1.2
4	1.2	0.87	0.89	0.89	0.96	0.94	1.1	1.3	1.2	0.91	1.3	1.2
5	1.2	0.87	0.89	0.89	0.96	0.94	1.1	1.3	1.2	0.92	1.3	1.2
6	1.1	0.87	0.89	0.92	0.95	0.96	1.1	1.3	1.2	0.73	1.3	1.2
7	1.1	0.86	0.89	0.92	0.95	0.96	1.2	1.3	1.2	0.87	---	1.3
8	1.2	0.86	0.89	0.92	0.96	0.96	1.2	1.3	1.2	0.98	1.5	1.3
9	1.2	0.86	0.89	0.92	0.95	0.96	1.2	1.3	1.2	0.96	1.4	1.3
10	1.2	0.86	0.89	0.92	0.95	0.96	1.2	1.3	1.2	0.91	1.4	1.3
11	---	0.86	0.89	0.92	0.94	0.96	1.2	1.3	1.2	0.97	1.4	1.3
12	0.91	0.86	0.89	0.92	0.95	0.96	1.2	1.3	1.2	1.2	1.4	1.3
13	0.90	0.86	0.89	0.92	0.95	0.96	1.2	1.3	1.2	1.2	1.3	1.3
14	0.90	0.86	0.89	0.92	0.95	0.95	1.3	1.3	1.2	1.2	1.2	1.3
15	0.89	0.86	0.89	0.92	0.95	0.96	1.3	1.3	1.2	1.2	1.2	1.3
16	0.89	0.86	0.89	0.93	0.95	0.95	1.3	1.3	1.2	1.2	1.2	1.3
17	0.89	0.86	0.89	0.97	0.94	0.95	1.3	1.3	1.1	1.3	1.2	1.3
18	0.89	0.85	0.89	0.99	0.93	0.93	1.3	1.3	1.1	1.3	1.2	1.3
19	0.89	0.85	0.89	0.99	0.93	0.92	1.3	1.3	1.1	1.3	1.2	1.3
20	0.89	0.85	0.89	1.0	0.95	0.89	1.3	1.3	1.0	1.3	1.2	1.3
21	0.89	0.85	0.89	1.0	0.95	0.85	1.3	1.3	1.0	1.3	1.2	1.3
22	0.89	0.87	0.89	1.0	0.94	0.85	1.3	1.3	1.0	1.3	1.2	1.2
23	0.88	0.86	0.89	1.0	0.94	0.85	1.3	1.3	1.0	1.3	1.2	1.2
24	0.88	0.85	0.88	---	0.94	0.88	1.3	1.3	1.0	1.3	1.2	1.2
25	0.88	0.82	0.87	0.99	0.95	0.87	1.3	1.3	1.0	1.3	1.2	1.2
26	0.88	0.83	0.88	0.99	0.95	0.86	1.3	1.3	1.0	1.3	1.2	1.2
27	0.88	---	0.88	1.0	0.95	0.86	1.3	1.3	1.0	1.3	1.2	1.2
28	0.88	0.92	0.88	0.99	0.95	0.87	1.3	1.3	1.0	1.3	1.2	1.2
29	0.88	0.90	0.89	0.99	---	0.87	1.3	1.3	1.0	1.3	1.2	1.2
30	0.89	0.90	0.89	0.99	---	0.91	1.3	1.3	1.0	1.3	1.2	1.3
31	0.88	---	0.90	0.97	---	0.91	---	1.3	---	1.3	1.2	---
TOTAL	---	---	27.52	---	26.57	28.52	36.51	40.3	33.6	---	---	37.6
MEAN	---	---	0.888	---	0.949	0.920	1.217	1.300	1.120	---	---	1.253
MAX	---	---	0.90	---	0.96	0.96	1.3	1.3	1.3	---	---	1.3
MIN	---	---	0.87	---	0.93	0.85	0.88	1.3	1.0	---	---	1.2
AC-FT	---	---	55	---	53	57	72	80	67	---	---	75

11415500 BOWMAN LAKE NEAR GRANITEVILLE, CA

LOCATION.—Lat 39°27'01", long 120°39'09", in SE 1/4 SW 1/4 sec.5, T.18 N., R.12 E., Nevada County, Hydrologic Unit 18020125, on right bank, near rockfill portion of Bowman Dam on Canyon Creek, 4.6 mi east of Graniteville, and 8 mi south of Sierra City.

DRAINAGE AREA.—27.1 mi².

PERIOD OF RECORD.—December 1926 to current year.

REVISED RECORDS.—WSP 1931: Drainage area.

GAGE.—Water-stage recorder. Datum of gage is sea level (levels by Nevada Irrigation District). Prior to Oct. 8, 1964, nonrecording gage at same site and datum.

REMARKS.—Lake is formed by one rockfill and one concrete-arch dam; storage began in November 1926. Total capacity, 68,700 acre-ft, between elevations 5,400 ft, bottom of outlet tunnel, and 5,563.6 ft, top of radial spillway gates and crest of concrete-arch dam. Flashboards are occasionally added, increasing elevation to 5,565.8 ft and capacity to 70,400 acre-ft, all of which is available for release. Lake receives water from "Middle Yuba River via Milton-Bowman Tunnel" (station 11408000), and releases it through "Bowman-Spaulding Canal" (station 11416000) which conveys it to reservoirs of Pacific Gas & Electric Co. Water is eventually used for irrigation by Nevada Irrigation District. Records, including extremes, represent total contents. See schematic diagram of [North and Middle Yuba River Basins](#).

COOPERATION.—Records were collected by Nevada Irrigation District, under general supervision of the U.S. Geological Survey, in connection with Federal Energy Regulatory Commission project no. 2266.

EXTREMES FOR PERIOD OF RECORD.—Maximum contents, 71,000 acre-ft, May 30, 1965, elevation, 5,566.5 ft; lake completely drained for inspection and repair Nov. 25 to Dec. 9, 1949, Oct. 1–20, 1966, Oct. 4–29, 1972, and Sept. 21–30, 1981.

EXTREMES FOR CURRENT YEAR.—Maximum contents, 59,000 acre-ft, June 12, elevation, 5,551.87 ft; minimum, 18,800 acre-ft, Oct. 11, 12, minimum elevation, 5,490.28 ft, Oct. 12.

Capacity table (elevation, in feet, and contents, in acre-feet)
(Based on table dated Nov. 24, 1926)

5,419.6	0	5,450	4,100	5,480	14,200	5,540	49,800
5,430	900	5,460	6,900	5,510	30,000	5,570	73,800
5,440	2,100	5,470	10,200				

RESERVOIR STORAGE (ACRE-FEET), WATER YEAR OCTOBER 2001 TO SEPTEMBER 2002

DAILY OBSERVATION AT 2400 HOURS

DAY	OCT	NOV	DEC	JAN	FEB	MAR	APR	MAY	JUN	JUL	AUG	SEP
1	19700	22400	28000	28600	26200	26800	32000	44200	55200	53100	56500	52200
2	19700	22700	28400	28900	26000	27100	32400	44300	55600	53200	56300	52100
3	19500	22900	28500	29100	25700	27300	33000	44500	56000	53300	56200	52100
4	19400	23100	28400	29100	25500	27600	33700	44800	56500	53400	56000	52000
5	19300	23300	28500	29000	25200	27800	34500	45100	56900	53600	55900	51900
6	19200	23500	28500	29800	25000	28600	35100	45500	57400	53900	55700	51900
7	19100	23800	28500	30200	24800	29300	35600	46000	57800	54100	55500	51900
8	19000	24000	28400	30400	24600	29600	36200	46300	58200	54400	55400	51900
9	18900	24200	28500	30400	24400	29800	36900	46600	58500	54600	55200	51900
10	18900	24500	28400	30400	24100	30100	37600	46800	58700	54900	55000	51900
11	18800	24800	28400	30300	23900	30200	38200	46900	58800	55100	54900	51900
12	18800	25100	28300	30300	23700	30400	38900	47100	59000	55400	54700	51900
13	19000	25400	28300	30200	23500	30600	39600	47400	58900	55600	54600	51900
14	19100	25600	28400	30100	23300	30700	40500	47700	58700	55900	54400	51900
15	19300	25800	28300	30000	23200	30800	41300	48000	58500	56100	54200	51900
16	19500	26000	28300	29800	23200	30900	41700	48300	58200	56400	54100	51900
17	19600	26200	28400	29600	23300	30900	41900	48700	57900	56600	53900	51900
18	19800	26400	28300	29500	23300	31000	42100	49000	57600	56800	53800	51900
19	20000	26500	28300	29300	23400	31000	42200	49400	57300	56900	53600	51900
20	20100	26600	28300	29100	23900	31000	42300	49800	56900	57000	53400	51900
21	20300	26900	28200	29000	24300	31000	42300	50100	56600	57000	53300	51900
22	20400	27300	28100	28800	24600	31100	42400	50300	56300	57100	53100	51900
23	20600	27400	28000	28500	24900	31200	42500	50600	55900	57100	53000	51900
24	20700	27900	27900	28200	25200	31300	42700	50900	55500	57100	52900	52000
25	20900	28100	27800	27900	25400	31300	43000	51300	55100	57100	52800	52000
26	21000	28200	27700	27800	25700	31200	43500	51700	54600	57000	52700	52000
27	21200	28100	27600	27600	26100	31200	43800	52200	54200	57000	52600	51900
28	21300	28100	27600	27400	26400	31200	43900	52800	53700	57000	52400	51700
29	21500	28100	27700	27100	---	31300	44100	53300	53200	56900	52300	51600
30	21900	28000	27900	26800	---	31500	44200	54000	53100	56700	52300	51500
31	22200	---	28400	26500	---	31700	---	54600	---	56600	52200	---
MAX	22200	28200	28500	30400	26400	31700	44200	54600	59000	57100	56500	52200
MIN	18800	22400	27600	26500	23200	26800	32000	44200	53100	53100	52200	51500
a	5496.55	5507.01	5507.70	5504.29	5504.17	5512.89	5531.99	5546.11	5544.12	5548.79	5542.99	5541.97
b	+2500	+5800	+400	-1900	-100	+5300	+12500	+10400	-1500	+3500	-4400	-700
CAL YR 2001	MAX 50900	MIN 18800	b -300									
WTR YR 2002	MAX 59000	MIN 18800	b +31800									

a Elevation, in feet, at end of month.
b Change in contents, in acre-feet.

11416100 BOWMAN-SPAULDING CANAL AT JORDAN CREEK SIPHON VENTURI, NEAR EMIGRANT GAP, CA

LOCATION.—Lat 39°20'32", long 120°38'26", in SW 1/4 NW 1/4 sec.16, T.17 N., R.12 E., [Nevada County](#), Hydrologic Unit 18020125, at outlet of Jordan Creek Siphon, 0.6 mi downstream from Fuller Lake, and 3.5 mi northeast of Emigrant Gap.

PERIOD OF RECORD.—October 1964 to current year.

GAGE.—Water-stage recorder and Venturi section. Elevation of gage is 5,340 ft above sea level, from topographic map.

REMARKS.—Records show water diverted from Bowman Lake (station 11415500) plus numerous small tributaries before it enters Lake Spaulding (station 11414140). Most of the water at this gage flows downstream through Spaulding No. 3 Powerplant (station 11416200). See schematic diagrams of [South Yuba River Basin](#) and [Bear River Basin](#).

COOPERATION.—Records were collected by Pacific Gas & Electric Co., under general supervision of the U.S. Geological Survey, in connection with Federal Energy Regulatory Commission project no. 2310.

EXTREMES FOR PERIOD OF RECORD.—Maximum daily discharge, 335 ft³/s, Dec. 25, 1983; no flow at times in most years.

DISCHARGE, CUBIC FEET PER SECOND, WATER YEAR OCTOBER 2001 TO SEPTEMBER 2002

DAILY MEAN VALUES

DAY	OCT	NOV	DEC	JAN	FEB	MAR	APR	MAY	JUN	JUL	AUG	SEP
1	84	68	73	117	207	102	290	287	184	0.00	196	212
2	90	48	93	186	194	99	285	297	179	0.00	194	207
3	93	54	97	274	189	99	303	306	138	0.00	197	205
4	94	69	89	240	184	102	308	313	104	0.00	195	205
5	94	68	89	209	183	146	307	320	106	0.00	196	208
6	94	69	91	242	183	221	276	319	107	0.00	202	208
7	94	72	85	254	185	243	271	317	105	0.00	203	206
8	94	72	83	232	201	180	274	315	103	0.00	203	204
9	94	72	82	214	197	176	288	311	100	0.00	202	205
10	95	72	80	197	193	177	313	305	95	0.00	209	205
11	95	72	74	188	190	172	317	296	94	0.00	207	205
12	95	72	75	187	186	182	306	290	94	0.00	204	206
13	96	73	75	182	185	181	298	298	157	0.00	202	213
14	96	74	76	179	186	176	308	302	267	0.00	202	212
15	96	75	72	176	189	175	318	306	290	0.00	202	210
16	96	76	68	177	190	196	294	306	299	0.00	202	208
17	97	75	70	178	189	205	281	306	292	0.00	202	211
18	97	75	92	184	184	199	261	306	296	0.00	200	209
19	98	73	99	185	188	189	250	288	303	95	200	201
20	98	70	98	185	275	187	243	226	303	156	200	198
21	98	69	103	185	284	187	237	205	303	129	199	199
22	99	84	105	187	249	192	258	195	299	125	202	199
23	99	91	106	199	216	205	299	194	296	124	204	199
24	99	90	106	216	191	206	314	193	297	129	201	200
25	97	91	106	215	143	193	320	190	298	154	200	199
26	98	86	106	210	107	189	324	187	295	159	189	199
27	97	74	107	204	109	214	318	185	294	158	198	200
28	98	68	108	204	110	227	301	184	291	158	205	198
29	97	67	105	204	---	249	290	184	288	159	210	202
30	81	68	102	202	---	284	293	185	162	190	212	200
31	72	---	112	208	---	291	---	185	---	198	212	---
TOTAL	2925	2187	2827	6220	5287	5844	8745	8101	6439	1934.00	6250	6133
MEAN	94.35	72.90	91.19	200.6	188.8	188.5	291.5	261.3	214.6	62.39	201.6	204.4
MAX	99	91	112	274	284	291	324	320	303	198	212	213
MIN	72	48	68	117	107	99	237	184	94	0.00	189	198
AC-FT	5800	4340	5610	12340	10490	11590	17350	16070	12770	3840	12400	12160
a	5720	3970	5530	12660	10680	11730	17060	15530	12580	0	0	0

a Discharge, in acre-feet, through Spaulding No. 3 Powerplant (station 11416200), provided by Pacific Gas & Electric Co.

11416100 BOWMAN-SPAULDING CANAL AT JORDAN CREEK SIPHON VENTURI, NEAR EMIGRANT GAP, CA—Continued

STATISTICS OF MONTHLY MEAN DATA FOR WATER YEARS 1965 - 2002, BY WATER YEAR (WY)

	OCT	NOV	DEC	JAN	FEB	MAR	APR	MAY	JUN	JUL	AUG	SEP
MEAN	194.8	197.0	198.9	195.0	186.9	210.4	225.4	235.9	235.3	200.7	251.8	255.4
MAX	306	308	312	313	311	311	311	319	315	305	316	311
(WY)	1983	1984	1984	1984	1995	1983	1980	1983	1983	1983	1993	1983
MIN	29.5	0.000	41.9	37.8	21.4	26.3	19.3	33.9	0.000	45.6	40.2	143
(WY)	1973	1965	1978	1977	1991	1977	1977	1965	1965	1991	1988	1977

SUMMARY STATISTICS	FOR 2001 CALENDAR YEAR		FOR 2002 WATER YEAR		WATER YEARS 1965 - 2002	
ANNUAL TOTAL	48623.80		62892.00			
ANNUAL MEAN	133.2		172.3		215.7	
HIGHEST ANNUAL MEAN					304 1983	
LOWEST ANNUAL MEAN					77.9 1977	
HIGHEST DAILY MEAN	299	Jul 3	324	Apr 26	335	Dec 25 1983
LOWEST DAILY MEAN	0.00	Jul 11	0.00	Jul 1	0.00	Oct 29 1964
ANNUAL SEVEN-DAY MINIMUM	0.00	Jul 11	0.00	Jul 1	0.00	Oct 29 1964
ANNUAL RUNOFF (AC-FT)	96450		124700		156300	
ANNUAL DISCHARGE (AC-FT) a	78600		95470			
10 PERCENT EXCEEDS	284		297		306	
50 PERCENT EXCEEDS	104		188		249	
90 PERCENT EXCEEDS	68		72		68	

a Discharge, in acre-feet, through Spaulding No. 3 Powerplant (station 11416200), provided by Pacific Gas & Electric Co.

11416500 CANYON CREEK BELOW BOWMAN LAKE, CA

LOCATION.—Lat 39°26'23", long 120°39'37", in NE 1/4 SE 1/4 sec.7, T.18 N., R.12 E., Nevada County, Hydrologic Unit 18020125, on left bank, 1 mi downstream from Bowman Dam, 3.5 mi upstream from Texas Creek, and 8.8 mi south of Sierra City.

DRAINAGE AREA.—28.3 mi².

PERIOD OF RECORD.—January 1927 to current year.

REVISED RECORDS.—WSP 1315-A: 1930(M). WSP 1931: Drainage area.

GAGE.—Water-stage recorder. Elevation of gage is 5,300 ft above sea level, from topographic map.

REMARKS.—Flow regulated by Bowman Lake (station 11415500), several smaller reservoirs, and diversion into Bowman–Spaulding Canal (station 11416000). See schematic diagram of [North and Middle Yuba River Basins](#).

COOPERATION.—Records were collected by Nevada Irrigation District, under general supervision of the U.S. Geological Survey, in connection with Federal Energy Regulatory Commission project no. 2266.

EXTREMES FOR PERIOD OF RECORD.—Maximum discharge, about 5,500 ft³/s, Jan. 2, 1997, gage height, 13.01 ft, from floodmarks (backwater from debris), from rating curve extended above 1,500 ft³/s, on basis of computation of flow over Bowman Dam; no flow at times in some years.

DISCHARGE, CUBIC FEET PER SECOND, WATER YEAR OCTOBER 2001 TO SEPTEMBER 2002

DAILY MEAN VALUES

DAY	OCT	NOV	DEC	JAN	FEB	MAR	APR	MAY	JUN	JUL	AUG	SEP
1	5.3	5.0	4.3	6.5	3.9	3.9	7.3	4.3	4.7	6.2	4.0	4.0
2	5.1	4.9	5.0	14	3.8	4.2	7.4	4.2	4.9	6.2	4.0	4.2
3	4.4	4.6	5.5	9.6	3.8	4.2	7.7	4.1	5.6	6.2	3.9	4.2
4	4.4	4.4	5.0	5.7	3.7	4.2	7.4	3.9	6.2	6.1	4.0	4.2
5	4.4	4.1	5.0	5.5	3.8	4.6	6.3	3.9	6.3	6.1	4.0	4.1
6	4.3	3.9	5.8	15	3.8	18	5.8	3.7	6.4	5.9	4.1	4.2
7	4.1	3.7	5.4	7.3	5.0	7.7	5.8	3.6	6.3	5.9	4.0	4.3
8	4.1	3.6	4.8	6.0	6.5	5.5	5.8	3.6	6.3	6.2	3.7	4.2
9	4.2	3.6	4.6	5.4	4.8	4.9	6.3	3.5	6.4	6.1	3.7	4.1
10	4.5	3.6	4.4	5.1	4.4	4.8	6.7	3.5	6.4	6.9	3.6	4.1
11	4.5	3.9	4.2	4.7	4.3	4.7	5.7	3.4	6.4	6.3	3.3	4.0
12	4.7	4.8	4.1	4.6	4.4	5.1	5.4	3.3	6.6	6.2	3.4	3.8
13	4.8	5.0	4.2	4.4	4.5	4.9	5.1	3.3	6.7	6.2	3.4	3.8
14	4.9	4.1	4.3	4.4	4.6	4.5	5.2	3.3	6.5	6.2	3.4	3.8
15	4.9	3.6	4.0	4.3	4.8	4.3	5.0	3.3	6.5	6.3	3.4	3.9
16	4.9	3.4	4.0	4.3	4.8	4.2	4.4	3.2	6.5	6.9	3.4	4.0
17	4.9	3.3	4.6	4.3	5.1	4.1	4.4	3.2	6.5	7.1	3.5	4.0
18	4.9	3.3	4.1	4.3	4.7	4.0	4.4	3.2	6.5	10	3.6	3.9
19	4.9	3.3	4.0	4.2	8.6	4.1	4.6	3.2	6.5	6.3	3.9	3.8
20	4.9	3.3	4.1	4.1	17	4.4	4.8	3.6	6.4	6.5	3.9	3.7
21	4.9	11	3.9	4.3	7.4	5.0	4.9	4.1	6.4	6.5	4.0	3.7
22	4.9	16	3.8	4.2	6.5	5.5	4.9	4.2	6.5	6.1	4.0	3.7
23	5.0	4.9	3.7	4.1	6.6	5.5	4.7	3.8	6.5	4.5	4.0	3.7
24	5.1	11	3.6	4.1	5.2	5.3	4.5	3.5	6.5	4.2	3.9	3.6
25	5.1	5.7	3.6	4.1	4.9	5.1	4.3	3.4	6.5	4.2	4.0	3.6
26	5.2	4.5	3.9	4.2	4.8	5.2	4.3	3.3	6.4	4.3	3.7	3.6
27	5.0	4.1	4.2	4.3	4.9	5.4	4.7	3.3	6.5	4.0	3.8	3.7
28	5.1	4.0	5.0	4.2	4.7	6.8	4.5	3.9	6.4	3.9	3.9	3.7
29	5.1	4.0	6.8	4.1	---	9.3	4.5	4.7	6.5	4.0	4.1	4.0
30	5.8	4.0	9.1	4.2	---	7.4	4.5	4.7	6.3	3.9	4.1	4.1
31	5.1	---	10	3.9	---	7.0	---	4.7	---	3.9	4.1	---
TOTAL	149.4	148.6	149.0	169.4	151.3	173.8	161.3	114.9	189.1	179.3	117.8	117.7
MEAN	4.819	4.953	4.806	5.465	5.404	5.606	5.377	3.706	6.303	5.784	3.800	3.923
MAX	5.8	16	10	15	17	18	7.7	4.7	6.7	10	4.1	4.3
MIN	4.1	3.3	3.6	3.9	3.7	3.9	4.3	3.2	4.7	3.9	3.3	3.6
AC-FT	296	295	296	336	300	345	320	228	375	356	234	233
a	5340	2910	4180	9820	7890	7610	8670	10240	10780	3550	12690	12140

a Diversion, in acre-feet, to Bowman–Spaulding Canal (station 11416000), provided by Nevada Irrigation District.

SACRAMENTO RIVER BASIN

11416500 CANYON CREEK BELOW BOWMAN LAKE, CA—Continued

STATISTICS OF MONTHLY MEAN DATA FOR WATER YEARS 1927 - 2002, BY WATER YEAR (WY)

	OCT	NOV	DEC	JAN	FEB	MAR	APR	MAY	JUN	JUL	AUG	SEP
MEAN	3.117	6.202	16.78	22.62	17.70	27.34	42.49	122.3	140.5	13.78	2.731	2.621
MAX	24.1	195	360	453	198	629	325	773	542	314	37.3	17.0
(WY)	1973	1984	1965	1997	1965	1986	1940	1963	1952	1952	1952	1952
MIN	0.13	0.19	0.20	0.20	0.50	0.58	0.46	0.43	0.30	0.029	0.000	0.000
(WY)	1935	1940	1937	1937	1933	1935	1934	1947	1977	1935	1934	1963

SUMMARY STATISTICS	FOR 2001 CALENDAR YEAR	FOR 2002 WATER YEAR	WATER YEARS 1927 - 2002
ANNUAL TOTAL	1803.2	1821.6	
ANNUAL MEAN	4.940	4.991	34.44
HIGHEST ANNUAL MEAN			165
LOWEST ANNUAL MEAN			0.81
HIGHEST DAILY MEAN	20	Mar 25	5520
LOWEST DAILY MEAN	3.3	Nov 17	0.00
ANNUAL SEVEN-DAY MINIMUM	3.5	Nov 14	0.00
MAXIMUM PEAK FLOW		60	5500
MAXIMUM PEAK STAGE		4.28	13.01
ANNUAL RUNOFF (AC-FT)	3580	3610	24950
ANNUAL DIVERSION (AC-FT) a	80140	95830	
10 PERCENT EXCEEDS	6.0	6.5	51
50 PERCENT EXCEEDS	4.6	4.4	3.3
90 PERCENT EXCEEDS	3.9	3.6	0.30

a Diversion, in acre-feet, to Bowman-Spaulding Canal (station 11416000), provided by Nevada Irrigation District.

11416610 TEXAS CREEK BELOW LOWER ROCK LAKE, NEAR GRANITEVILLE, CA

LOCATION.—Lat 39°25'42", long 120°37'19", in SW 1/4 NW 1/4 sec.15, T.18 N., R.12 E., Nevada County, Hydrologic Unit 18020125, Tahoe National Forest, on right bank, 200 ft downstream from outlet structure on Lower Rock Lake Dam, and 6.4 mi east of Graniteville.

DRAINAGE AREA.—0.36 mi².

PERIOD OF RECORD.—October 1995 to current year (low-flow records only). Unpublished records for water years 1974 and 1979–95 available in files of the U.S. Geological Survey.

GAGE.—Water-stage recorder and Parshall flume. Elevation of gage is 6,615 ft above sea level, from topographic map. August 1965 to August 1995, nonrecording gage at same site and datum.

REMARKS.—Records not computed for winter months or above 1.2 ft³/s. Flow regulated by Lower Rock Lake. See schematic diagram of South Yuba River Basin.

COOPERATION.—Records were collected by Pacific Gas & Electric Co., under general supervision of the U.S. Geological Survey, in connection with Federal Energy Regulatory Commission project no. 2310.

DISCHARGE, CUBIC FEET PER SECOND, WATER YEAR OCTOBER 2001 TO SEPTEMBER 2002
DAILY MEAN VALUES

DAY	OCT	NOV	DEC	JAN	FEB	MAR	APR	MAY	JUN	JUL	AUG	SEP
1	1.1	0.29	---	---	---	---	---	---	---	0.18	0.29	0.29
2	1.0	0.26	---	---	---	---	---	---	---	0.16	0.29	0.42
3	1.2	0.18	---	---	---	---	---	---	---	0.14	0.28	0.41
4	---	0.17	---	---	---	---	---	---	---	0.12	0.28	0.43
5	---	0.22	---	---	---	---	---	---	---	0.11	0.26	0.50
6	1.2	0.17	---	---	---	---	---	---	---	0.11	0.26	0.50
7	1.2	0.21	---	---	---	---	---	---	---	0.27	0.32	0.50
8	1.2	0.20	---	---	---	---	---	---	---	0.38	0.39	0.50
9	1.1	0.17	---	---	---	---	---	---	---	0.33	0.39	0.50
10	1.1	0.15	---	---	---	---	---	---	---	0.31	0.39	0.48
11	1.1	0.15	---	---	---	---	---	---	---	0.27	0.38	---
12	1.0	0.15	---	---	---	---	---	---	---	0.25	0.35	---
13	1.0	0.15	---	---	---	---	---	---	---	0.18	0.35	---
14	0.98	---	---	---	---	---	---	---	---	0.30	0.35	---
15	0.95	---	---	---	---	---	---	---	---	0.44	0.35	---
16	0.93	---	---	---	---	---	---	---	---	0.43	0.35	---
17	0.90	---	---	---	---	---	---	---	---	0.41	0.34	---
18	0.89	---	---	---	---	---	---	---	0.34	0.40	0.34	---
19	0.87	---	---	---	---	---	---	---	0.32	0.39	0.34	---
20	0.87	---	---	---	---	---	---	---	0.37	0.38	0.34	---
21	0.85	---	---	---	---	---	---	---	0.39	0.38	0.34	---
22	0.84	---	---	---	---	---	---	---	0.38	0.39	0.28	---
23	0.81	---	---	---	---	---	---	---	0.36	0.38	0.28	---
24	0.80	---	---	---	---	---	---	---	0.34	0.37	0.28	---
25	0.80	---	---	---	---	---	---	---	0.34	0.37	0.27	---
26	0.76	---	---	---	---	---	---	---	0.33	0.37	0.26	---
27	0.62	---	---	---	---	---	---	---	0.32	0.36	0.26	---
28	0.38	---	---	---	---	---	---	---	0.30	0.35	0.21	---
29	0.21	---	---	---	---	---	---	---	0.29	0.35	0.20	---
30	0.21	---	---	---	---	---	---	---	0.24	0.35	0.19	---
31	0.28	---	---	---	---	---	---	---	---	0.30	0.18	---
TOTAL	---	---	---	---	---	---	---	---	---	9.53	9.39	---
MEAN	---	---	---	---	---	---	---	---	---	0.307	0.303	---
MAX	---	---	---	---	---	---	---	---	---	0.44	0.39	---
MIN	---	---	---	---	---	---	---	---	---	0.11	0.18	---
AC-FT	---	---	---	---	---	---	---	---	---	19	19	---

11416620 TEXAS CREEK TRIBUTARY BELOW CULBERTSON LAKE, NEAR GRANITEVILLE, CA

LOCATION.—Lat 39°25'17", long 120°37'21", in SW 1/4 SW 1/4 sec.15, T.18 N., R.12 E., Nevada County, Hydrologic Unit 18020125, Tahoe National Forest, on right bank, 150 ft downstream from outlet structure, on Culbertson Lake Dam, 0.15 mi upstream from Texas Creek, and 6.4 mi east of Graniteville.

DRAINAGE AREA.—0.44 mi².

PERIOD OF RECORD.—October 1988 to current year (low-flow records only). Unpublished records for water years 1965–88 available in files of the U.S. Geological Survey.

GAGE.—Water-stage recorder and V-notch sharp-crested weir. Elevation of gage is 6,420 ft above sea level. October 1965 to August 1988, nonrecording gage at site 10 ft downstream at different datum. August to September 1988, nonrecording gage at same site and datum.

REMARKS.—Records not computed for winter months or above 1.2 ft³/s. Low and medium flow regulated by Culbertson Lake (capacity, 953 acre-ft). See schematic diagram of [South Yuba River Basin](#).

COOPERATION.—Records were collected by Pacific Gas & Electric Co., under general supervision of the U.S. Geological Survey, in connection with Federal Energy Regulatory Commission project no. 2310.

DISCHARGE, CUBIC FEET PER SECOND, WATER YEAR OCTOBER 2001 TO SEPTEMBER 2002
DAILY MEAN VALUES

DAY	OCT	NOV	DEC	JAN	FEB	MAR	APR	MAY	JUN	JUL	AUG	SEP
1	---	---	---	---	---	---	---	---	---	0.91	0.68	0.91
2	---	---	---	---	---	---	---	---	---	1.0	0.70	1.0
3	---	---	---	---	---	---	---	---	---	0.96	0.69	1.0
4	---	---	---	---	---	---	---	---	---	0.95	0.68	1.0
5	---	---	---	---	---	---	---	---	---	0.90	0.67	0.99
6	---	---	---	---	---	---	---	---	---	0.87	0.67	0.99
7	---	---	---	---	---	---	---	---	---	0.83	0.76	0.99
8	---	---	---	---	---	---	---	---	---	0.81	0.88	0.99
9	---	---	---	---	---	---	---	---	---	0.78	0.85	0.99
10	---	---	---	---	---	---	---	---	---	0.75	0.82	0.96
11	---	---	---	---	---	---	---	---	---	0.72	0.83	---
12	---	---	---	---	---	---	---	---	---	0.70	0.73	---
13	---	---	---	---	---	---	---	---	---	0.66	0.66	---
14	---	---	---	---	---	---	---	---	0.56	0.73	0.76	---
15	1.2	---	---	---	---	---	---	---	0.50	0.77	0.93	---
16	1.2	---	---	---	---	---	---	---	0.50	0.74	0.92	---
17	---	---	---	---	---	---	---	---	0.49	0.71	0.91	---
18	---	---	---	---	---	---	---	---	0.49	0.68	0.91	---
19	---	---	---	---	---	---	---	---	0.65	0.67	0.89	---
20	---	---	---	---	---	---	---	---	0.79	0.66	0.89	---
21	---	---	---	---	---	---	---	---	0.76	0.76	0.89	---
22	---	---	---	---	---	---	---	---	0.74	0.84	0.88	---
23	---	---	---	---	---	---	---	---	0.70	0.81	0.85	---
24	---	---	---	---	---	---	---	---	0.68	0.79	0.85	---
25	---	---	---	---	---	---	---	---	0.65	0.78	0.85	---
26	---	---	---	---	---	---	---	---	0.78	0.75	0.85	---
27	---	---	---	---	---	---	---	---	0.88	0.73	0.83	---
28	---	---	---	---	---	---	---	---	0.85	0.73	0.82	---
29	---	---	---	---	---	---	---	---	0.83	0.70	0.80	---
30	---	---	---	---	---	---	---	---	0.82	0.69	0.79	---
31	---	---	---	---	---	---	---	---	---	0.67	0.79	---
TOTAL	---	---	---	---	---	---	---	---	---	24.05	25.03	---
MEAN	---	---	---	---	---	---	---	---	---	0.776	0.807	---
MAX	---	---	---	---	---	---	---	---	---	1.0	0.93	---
MIN	---	---	---	---	---	---	---	---	---	0.66	0.66	---
AC-FT	---	---	---	---	---	---	---	---	---	48	50	---

11416700 LINDSEY CREEK BELOW LOWER LINDSEY LAKE, NEAR GRANITEVILLE, CA

LOCATION.—Lat 39°24'43", long 120°38'35", in NE 1/4 SE 1/4 sec.20, T.18 N., R.12 E., Nevada County, Hydrologic Unit 18020125, Tahoe National Forest, on left bank, 10 ft downstream from outlet structure on Lower Lindsey Lake Dam, and 5.5 mi east of Graniteville.

DRAINAGE AREA.—0.91 mi².

PERIOD OF RECORD.—October 1988 to current year (low-flow records only). Unpublished records for water years 1965–88 available in files of the U.S. Geological Survey.

GAGE.—Water-stage recorder and V-notch sharp-crested weir. Elevation of gage is 6,225 ft above sea level, from topographic map. October 1965 to July 1984, nonrecording gage at same site and different datum. July 1984 to August 1988, nonrecording gage at same site and different datum.

REMARKS.—Records not computed for winter months or above 1.2 ft³/s. Low and medium flow regulated by Lower Lindsey Lake, capacity, 293 acre-ft. Spillway flows bypass this station. See schematic diagram of South Yuba River Basin.

COOPERATION.—Records were collected by Pacific Gas & Electric Co., under general supervision of the U.S. Geological Survey, in connection with Federal Energy Regulatory Commission project no. 2310.

DISCHARGE, CUBIC FEET PER SECOND, WATER YEAR OCTOBER 2001 TO SEPTEMBER 2002
DAILY MEAN VALUES

DAY	OCT	NOV	DEC	JAN	FEB	MAR	APR	MAY	JUN	JUL	AUG	SEP
1	0.79	0.72	---	---	---	---	---	---	---	0.54	0.96	---
2	0.80	0.72	---	---	---	---	---	---	---	0.55	0.91	1.0
3	0.78	0.73	---	---	---	---	---	---	---	0.70	0.91	1.0
4	0.78	0.75	---	---	---	---	---	---	---	0.74	0.88	0.94
5	0.75	0.75	---	---	---	---	---	---	---	0.78	0.88	0.85
6	0.75	0.75	---	---	---	---	---	---	---	0.79	0.88	0.77
7	0.75	0.95	---	---	---	---	---	---	---	0.96	0.93	0.62
8	0.75	1.1	---	---	---	---	---	---	---	1.0	0.94	0.60
9	0.74	1.1	---	---	---	---	---	---	---	1.0	0.94	0.60
10	0.68	1.1	---	---	---	---	---	---	---	1.0	0.92	0.60
11	0.66	1.1	---	---	---	---	---	---	---	1.0	0.91	0.53
12	0.41	1.1	---	---	---	---	---	---	---	1.0	0.91	0.63
13	0.29	1.1	---	---	---	---	---	---	---	1.0	0.91	0.63
14	0.26	---	---	---	---	---	---	---	e1.1	1.2	0.90	0.62
15	0.24	---	---	---	---	---	---	---	---	1.2	0.90	0.65
16	0.24	---	---	---	---	---	---	---	---	1.2	0.75	0.66
17	0.65	---	---	---	---	---	---	---	---	1.2	0.73	0.72
18	0.91	---	---	---	---	---	---	---	---	---	0.79	0.57
19	0.89	---	---	---	---	---	---	---	0.89	---	0.93	0.30
20	0.88	---	---	---	---	---	---	---	0.94	---	1.0	0.28
21	0.86	---	---	---	---	---	---	---	0.94	---	1.0	0.50
22	0.83	---	---	---	---	---	---	---	0.81	---	1.0	0.60
23	0.81	---	---	---	---	---	---	---	0.78	0.91	1.0	0.59
24	0.78	---	---	---	---	---	---	---	0.78	0.91	1.0	0.43
25	0.71	---	---	---	---	---	---	---	0.77	0.88	1.0	0.71
26	0.67	---	---	---	---	---	---	---	0.65	0.86	0.97	0.91
27	0.69	---	---	---	---	---	---	---	0.62	0.78	---	0.84
28	0.69	---	---	---	---	---	---	---	0.68	0.89	---	0.81
29	0.66	---	---	---	---	---	---	---	0.71	0.99	---	0.81
30	0.66	---	---	---	---	---	---	---	0.55	0.97	---	0.90
31	0.71	---	---	---	---	---	---	---	---	0.97	---	---
TOTAL	21.07	---	---	---	---	---	---	---	---	---	---	---
MEAN	0.680	---	---	---	---	---	---	---	---	---	---	---
MAX	0.91	---	---	---	---	---	---	---	---	---	---	---
MIN	0.24	---	---	---	---	---	---	---	---	---	---	---
AC-FT	42	---	---	---	---	---	---	---	---	---	---	---

e Estimated.

11417500 SOUTH YUBA RIVER AT JONES BAR, NEAR GRASS VALLEY, CA

LOCATION.—Lat 39°17'32", long 121°06'13", in NW 1/4 SE 1/4 sec.32, T.17 N., R.8 E., Nevada County, Hydrologic Unit 18020125, on left bank at Jones Bar, 100 ft upstream from Rush Creek, 0.9 mi downstream from bridge on State Highway 49, and 5 mi northwest of Grass Valley.

DRAINAGE AREA.—308 mi².

WATER-DISCHARGE RECORDS

PERIOD OF RECORD.—October 1940 to September 1948, April 1959 to current year. Published as "South Fork Yuba River at Jones Bar" 1940–48, and as "South Yuba River at Jones Bar" 1959–63. Yearly discharge for the 1947 water year published in WSP 1315-A.

REVISED RECORDS.—WSP 1315-A: 1942–43(M), drainage area at former site. WSP 1931: Drainage area.

GAGE.—Water-stage recorder and crest-stage gage. Elevation of gage is 1,060 ft above sea level, from river-profile map. Oct. 1, 1940, to Sept. 30, 1948, at site 150 ft upstream at datum 2.00 ft higher.

REMARKS.—Records good. Flow regulated by Lake Spaulding, Fordyce Lake, and Bowman Lake (stations 11414140, 11414090, and 11415500) and many smaller reservoirs. Diversions into and out of basin for several powerplants and for irrigation. See schematic diagram of [South Yuba River Basin](#).

EXTREMES FOR PERIOD OF RECORD.—Maximum discharge, 53,600 ft³/s, Dec. 22, 1964, gage height, 25.0 ft, from floodmarks, from rating curve extended above 23,000 ft³/s, on basis of slope-area measurement of peak flow; minimum daily, 1.0 ft³/s, Sept. 10–13, 1944.

EXTREMES OUTSIDE PERIOD OF RECORD.—Flood of Dec. 23, 1955, reached a stage of 30.7 ft, from floodmarks, present datum, at site 100 ft upstream.

DISCHARGE, CUBIC FEET PER SECOND, WATER YEAR OCTOBER 2001 TO SEPTEMBER 2002

DAILY MEAN VALUES

DAY	OCT	NOV	DEC	JAN	FEB	MAR	APR	MAY	JUN	JUL	AUG	SEP
1	35	55	215	827	194	335	505	229	834	65	44	39
2	35	42	1460	992	184	310	503	229	533	71	43	38
3	33	39	865	1330	173	289	515	224	457	72	43	38
4	32	37	386	770	168	275	526	221	445	70	42	38
5	31	36	321	577	165	266	514	222	432	69	41	38
6	30	36	417	970	162	736	462	220	395	68	42	39
7	31	36	378	844	173	1500	441	223	377	67	43	41
8	31	35	275	654	452	1040	422	223	164	66	43	43
9	31	36	234	545	308	706	407	208	103	65	42	44
10	31	36	202	464	255	844	434	202	98	64	41	44
11	32	39	171	400	233	734	413	196	96	66	41	44
12	32	71	148	358	226	640	389	190	92	66	40	42
13	32	143	135	329	226	588	372	195	86	64	39	40
14	32	84	348	305	233	516	372	191	79	60	38	42
15	32	59	244	285	231	460	410	188	77	60	37	42
16	32	49	181	261	229	439	349	184	75	61	37	46
17	32	45	623	244	318	415	357	179	75	60	37	e48
18	31	43	583	227	293	392	340	176	79	61	37	45
19	31	42	343	215	460	367	307	174	79	62	36	44
20	31	41	475	204	1710	360	295	258	77	69	36	43
21	31	62	447	201	1030	356	282	393	74	53	37	43
22	31	516	432	217	725	385	281	410	73	51	38	42
23	31	241	527	188	627	913	279	715	73	50	38	43
24	31	361	367	185	536	1120	275	673	72	49	37	44
25	32	407	292	181	455	797	272	461	70	47	37	43
26	32	162	258	348	407	639	277	450	69	45	37	43
27	32	108	261	372	382	566	286	438	67	45	37	43
28	33	88	314	265	360	527	286	433	67	45	37	42
29	34	150	637	230	---	531	263	252	66	45	37	43
30	50	151	648	208	---	540	252	195	66	44	38	43
31	85	---	1410	201	---	511	---	483	---	44	38	---
TOTAL	1059	3250	13597	13397	10915	18097	11086	9035	5350	1824	1213	1267
MEAN	34.16	108.3	438.6	432.2	389.8	583.8	369.5	291.5	178.3	58.84	39.13	42.23
MAX	85	516	1460	1330	1710	1500	526	715	834	72	44	48
MIN	30	35	135	181	162	266	252	174	66	44	36	38
AC-FT	2100	6450	26970	26570	21650	35900	21990	17920	10610	3620	2410	2510

e Estimated.

SACRAMENTO RIVER BASIN

11417500 SOUTH YUBA RIVER AT JONES BAR, NEAR GRASS VALLEY, CA—Continued

STATISTICS OF MONTHLY MEAN DATA FOR WATER YEARS 1941 - 2002, BY WATER YEAR (WY)

	OCT	NOV	DEC	JAN	FEB	MAR	APR	MAY	JUN	JUL	AUG	SEP
MEAN	79.20	197.2	468.7	767.2	793.5	763.3	676.1	876.0	661.1	122.0	39.48	39.46
MAX	1197	1350	3756	4865	4078	3029	2804	3323	3618	996	84.9	132
(WY)	1963	1984	1965	1997	1986	1986	1982	1963	1967	1983	1983	1965
MIN	11.7	24.2	37.4	45.0	64.0	67.2	51.1	68.3	31.8	11.6	3.05	1.42
(WY)	1945	1960	1960	1991	1977	1977	1977	1992	1977	1947	1947	1947

SUMMARY STATISTICS	FOR 2001 CALENDAR YEAR		FOR 2002 WATER YEAR		WATER YEARS 1941 - 2002	
ANNUAL TOTAL	54881		90090			
ANNUAL MEAN	150.4		246.8		460.9	
HIGHEST ANNUAL MEAN					1135 1995	
LOWEST ANNUAL MEAN					42.6 1977	
HIGHEST DAILY MEAN	1460	Dec 2	1710	Feb 20	30300	Jan 1 1997
LOWEST DAILY MEAN	29	Aug 16	30	Oct 6	1.0	Sep 10 1944
ANNUAL SEVEN-DAY MINIMUM	31	Aug 10	31	Oct 4	1.0	Sep 9 1944
MAXIMUM PEAK FLOW			2910	Dec 2	53600	Dec 22 1964
MAXIMUM PEAK STAGE			9.29	Dec 2	25.00	Dec 22 1964
ANNUAL RUNOFF (AC-FT)	108900		178700		333900	
10 PERCENT EXCEEDS	344		542		1150	
50 PERCENT EXCEEDS	71		179		126	
90 PERCENT EXCEEDS	31		36		32	

11417500 SOUTH YUBA RIVER AT JONES BAR, NEAR GRASS VALLEY, CA—Continued

WATER-QUALITY RECORDS

PERIOD OF RECORD.—Water years 1965–79, November 2000 to current year.

WATER TEMPERATURE: Water years 1965–79, November 2000 to current year.

SEDIMENT DATA: Water years 1967–74, November 2000 to September 2001 (daily). October 2001 to current year (storm season only).

PERIOD OF DAILY RECORD.—

WATER TEMPERATURE: Water years 1965–79, November 2000 to current year.

SUSPENDED-SEDIMENT DISCHARGE: November 2000 to September 2001 (daily). October 2001 to current year (storm season only).

INSTRUMENTATION.—Water-temperature recorder from February 1965 to April 1979, and since November 2000.

REMARKS.—Water-temperature records rated excellent except for May 9–18, which are rated good. Water-quality and suspended-sediment samples taken at site 100 yards downstream of continuous water-quality monitor.

EXTREMES FOR PERIOD OF DAILY RECORD.—

WATER TEMPERATURE: Maximum recorded, 28.5°C, Aug. 7, 8, 1978; minimum recorded, 0.0°C, several days in most years.

SEDIMENT CONCENTRATION: Maximum daily mean, 182 mg/L, Feb. 20, 2002; minimum daily mean, 0 mg/L, many days during each water year.

SEDIMENT LOAD: Maximum daily, 861 tons, Feb. 20, 2002; minimum daily, 0 ton, many days during each water year.

EXTREMES FOR CURRENT YEAR.—

WATER TEMPERATURE: Maximum recorded, 27.5°C, July 12–14; minimum recorded, 1.0°C, Jan. 30, 31.

SEDIMENT CONCENTRATION: Maximum daily mean, 182 mg/L, Feb. 20; minimum daily mean, 0 mg/L, Mar. 4, May 14–16.

SEDIMENT LOAD: Maximum daily, 861 tons, Feb. 20; minimum daily, 0 ton, May 15.

CROSS-SECTIONAL DATA, WATER YEAR OCTOBER 2001 TO SEPTEMBER 2002

DATE	TIME	DEPTH BOTTOM AT SAMPLE LOC- ATION, (FEET) (81903)	TEMPER- ATURE WATER (DEG C) (00010)	SAMPLE LOC- ATION, CROSS SECTION (FT FM L BANK) (00009)
APR				
16...	1630	4.00	9.0	5.00
16...	1632	4.00	9.0	15.0
16...	1634	5.50	9.0	25.0
16...	1636	5.50	9.0	35.0
16...	1637	6.50	9.0	45.0
16...	1638	6.50	9.0	55.0
16...	1640	4.00	9.0	65.0
16...	1641	2.50	9.0	75.0
16...	1642	1.50	9.0	85.0
16...	1643	1.50	9.0	95.0
AUG				
05...	1701	6.00	24.0	48.0
05...	1702	7.00	24.0	43.0
05...	1703	7.00	24.0	38.0
05...	1704	7.00	24.0	33.0
05...	1705	7.00	24.0	28.0
05...	1706	7.00	24.0	23.0
05...	1707	7.00	24.0	18.0
05...	1708	7.00	24.0	13.0
05...	1709	7.00	24.0	8.00
05...	1710	2.50	24.0	3.00

SUSPENDED-SEDIMENT DISCHARGE, WATER YEAR OCTOBER 2001 TO SEPTEMBER 2002

Date	Time	DIS- CHARGE, INST. CUBIC FEET PER SECOND (00061)	TEMPER- ATURE WATER (DEG C) (00010)	SEDI- MENT, DIS- CHARGE, SUS- PENDED (MG/L) (80154)	SEDI- MENT, DIS- CHARGE, SUS- PENDED (T/DAY) (80155)
OCT					
05...	1515	31	17.5	2.0	.17
DEC					
14...	1545	371	6.0	10	10.0
JAN					
02...	1430	956	9.0	92	237
MAR					
07...	1215	1250	7.5	30	101
APR					
09...	1445	408	12.0	2.0	2.2
MAY					
09...	1500	212	16.0	1.0	.57
JUN					
12...	1415	92	20.5	2.0	.50

* Instantaneous discharge at time of cross-sectional measurement: 337 ft³/s, Apr. 16, 2002; 42 ft³/s, Aug. 5, 2002.

11417500 SOUTH YUBA RIVER AT JONES BAR, NEAR GRASS VALLEY, CA—Continued

WATER TEMPERATURE, DEGREES C, WATER YEAR OCTOBER 2001 TO SEPTEMBER 2002

DAY	MAX	MIN	MAX	MIN	MAX	MIN	MAX	MIN	MAX	MIN	MAX	MIN
	OCTOBER		NOVEMBER		DECEMBER		JANUARY		FEBRUARY		MARCH	
1	19.0	17.0	12.5	11.5	7.5	7.0	8.5	8.0	3.0	1.5	7.5	5.5
2	19.5	17.0	12.0	11.0	8.0	7.0	9.5	8.5	3.0	2.0	7.0	5.0
3	19.5	17.0	12.0	11.0	7.5	6.5	8.5	7.0	3.0	2.0	7.5	5.0
4	19.0	17.0	11.5	10.5	6.5	5.5	7.0	6.5	3.0	2.0	8.0	5.5
5	18.5	16.5	11.5	10.5	7.0	6.0	7.5	6.5	3.5	2.0	8.0	6.0
6	17.5	16.0	11.5	10.5	7.5	6.5	9.0	7.5	4.0	2.5	8.5	7.5
7	17.5	15.5	10.5	10.0	7.5	6.5	8.5	8.0	6.0	3.5	8.0	6.0
8	17.5	15.5	10.0	9.0	6.5	5.5	8.5	8.0	6.0	5.0	7.0	5.0
9	17.0	15.0	10.0	9.0	6.5	6.0	8.5	7.5	5.0	4.0	7.0	5.5
10	15.5	14.0	10.0	9.0	6.0	5.0	7.5	6.5	5.0	3.5	8.0	7.0
11	15.5	14.0	11.5	10.0	5.0	4.0	7.0	6.0	5.5	4.0	8.5	6.5
12	15.5	13.5	11.5	11.0	5.0	4.0	7.0	6.0	6.5	5.0	9.0	8.5
13	15.0	13.5	11.5	11.0	5.5	4.5	6.0	5.0	7.0	5.5	8.5	7.5
14	15.0	13.5	12.0	11.0	6.0	5.0	5.0	4.0	8.0	6.5	8.0	6.0
15	15.0	13.5	11.5	11.0	5.0	4.0	4.0	3.5	7.5	6.5	6.5	5.5
16	15.0	13.5	11.0	10.5	5.0	3.5	3.5	2.5	8.0	7.0	6.5	5.0
17	15.5	14.0	12.0	11.0	6.5	5.0	4.0	3.0	8.0	7.0	6.5	4.0
18	15.0	13.5	11.5	10.5	6.5	6.0	3.5	2.5	7.5	6.5	6.0	3.0
19	14.5	13.5	11.0	10.0	7.5	6.5	3.0	2.0	8.0	7.0	7.5	4.0
20	14.5	13.0	11.0	10.5	7.0	5.5	3.0	2.0	8.0	7.5	8.5	6.0
21	14.0	12.5	11.0	11.0	6.5	5.5	4.0	3.0	8.5	7.0	10.5	7.5
22	14.0	12.5	11.0	10.5	7.0	6.5	4.0	3.0	9.0	7.5	9.5	8.5
23	13.5	12.0	10.5	9.5	6.5	5.5	3.0	2.0	9.0	7.5	8.5	7.5
24	13.0	11.0	10.0	9.0	5.5	5.0	2.5	2.0	8.0	6.5	8.5	7.0
25	12.0	10.5	9.0	8.0	6.0	5.0	3.5	2.0	8.0	6.5	9.0	7.0
26	12.5	11.0	8.0	6.5	7.5	6.0	5.5	3.5	8.5	6.5	10.0	7.5
27	12.5	11.0	6.5	5.0	8.0	7.0	5.0	4.0	9.0	7.0	10.5	8.0
28	13.0	12.0	6.0	5.5	8.0	7.5	4.0	3.0	8.5	6.5	11.5	9.0
29	13.0	12.5	6.5	6.0	8.0	8.0	3.0	2.0	---	---	12.5	9.5
30	13.5	12.5	7.0	6.0	9.0	8.0	2.0	1.0	---	---	12.5	10.0
31	13.0	12.5	---	---	9.0	8.5	2.0	1.0	---	---	13.0	10.0
MONTH	19.5	10.5	12.5	5.0	9.0	3.5	9.5	1.0	9.0	1.5	13.0	3.0
	APRIL		MAY		JUNE		JULY		AUGUST		SEPTEMBER	
1	13.5	10.5	12.5	9.5	20.0	17.5	26.0	23.0	26.5	23.5	23.0	20.0
2	13.5	11.0	14.5	10.5	19.5	16.5	26.0	23.0	26.0	23.0	23.0	20.5
3	14.0	11.5	15.5	12.0	19.5	16.0	25.5	22.5	26.0	23.0	22.5	20.0
4	14.0	12.0	16.0	12.5	20.5	17.0	25.0	22.0	25.0	22.5	22.5	20.0
5	13.0	11.0	16.5	13.5	21.5	18.0	25.5	22.0	24.0	21.5	21.0	19.0
6	13.0	10.0	17.0	13.5	22.0	18.5	25.5	22.5	23.0	20.0	20.5	18.0
7	13.5	11.0	16.5	14.0	21.5	18.5	25.5	23.0	23.0	19.5	19.5	17.0
8	14.0	11.5	16.5	13.0	20.5	18.5	25.5	22.5	23.0	20.0	19.5	16.5
9	13.0	11.5	16.0	13.0	20.0	17.0	26.0	22.5	23.5	20.5	19.5	16.5
10	13.5	11.0	15.0	13.0	21.0	17.5	27.0	23.5	24.5	21.0	20.0	17.0
11	14.0	11.5	15.5	11.5	22.0	18.5	27.0	24.0	24.5	21.5	20.5	17.5
12	14.5	11.5	16.5	13.0	22.5	19.5	27.5	25.0	25.0	21.5	20.5	17.5
13	15.0	12.0	17.0	14.5	23.0	20.0	27.5	24.5	25.5	22.5	21.0	18.0
14	16.0	13.5	18.0	14.5	23.5	20.5	27.5	25.0	26.0	23.0	20.5	18.0
15	14.5	10.5	18.0	15.0	23.5	20.5	26.0	24.0	26.0	23.0	20.0	18.0
16	10.5	8.5	18.5	15.5	23.5	20.5	25.5	22.5	26.0	23.0	20.0	17.5
17	8.5	7.5	19.5	16.0	23.5	20.0	25.5	22.5	25.5	22.5	19.5	17.0
18	8.5	6.5	19.0	16.5	24.0	20.5	25.5	23.0	25.0	22.0	20.0	17.0
19	10.0	6.5	18.0	15.0	24.5	21.0	26.0	23.0	24.0	21.5	19.5	17.0
20	11.5	8.0	15.0	12.0	24.5	21.5	26.5	23.5	23.0	20.5	20.0	17.0
21	12.5	9.0	12.0	11.0	24.0	21.0	26.0	24.0	22.5	20.0	20.0	17.5
22	13.5	10.0	14.0	10.5	24.0	21.0	26.5	23.5	22.5	19.5	20.0	17.5
23	14.5	11.0	14.0	11.5	24.5	21.0	25.5	23.0	22.5	19.5	20.0	17.5
24	14.5	12.0	15.5	12.5	24.5	21.5	26.0	23.0	22.5	19.0	19.5	17.5
25	15.0	12.5	17.0	13.5	25.0	21.5	25.5	22.5	22.0	19.0	19.5	17.0
26	14.5	12.5	17.5	14.5	25.0	22.5	25.0	22.0	22.5	19.0	19.0	16.5
27	12.5	11.0	18.0	15.0	25.0	22.0	25.5	22.5	22.5	19.5	18.5	16.5
28	11.0	9.5	18.5	15.5	25.0	22.5	26.0	23.0	23.0	20.0	18.0	16.0
29	10.5	10.0	20.5	16.5	25.5	22.5	26.5	23.5	23.0	20.5	17.5	16.5
30	11.0	9.0	22.5	18.5	26.0	22.5	26.5	24.0	23.5	20.5	17.0	15.5
31	---	---	22.5	20.0	---	---	26.5	24.0	23.0	20.0	---	---
MONTH	16.0	6.5	22.5	9.5	26.0	16.0	27.5	22.0	26.5	19.0	23.0	15.5

11417500 SOUTH YUBA RIVER AT JONES BAR, NEAR GRASS VALLEY, CA—Continued

SEDIMENT DISCHARGE, SUSPENDED (TONS/DAY), WATER YEAR OCTOBER 2001 TO SEPTEMBER 2002

DAY	MEAN DISCHARGE (CFS)	MEAN CONCENTRATION (MG/L)	SEDIMENT DISCHARGE (TONS/DAY)	MEAN DISCHARGE (CFS)	MEAN CONCENTRATION (MG/L)	SEDIMENT DISCHARGE (TONS/DAY)	MEAN DISCHARGE (CFS)	MEAN CONCENTRATION (MG/L)	SEDIMENT DISCHARGE (TONS/DAY)
	OCTOBER			NOVEMBER			DECEMBER		
1	35	1.0	0.09	55	3.0	0.46	215	9.0	5.3
2	35	1.0	0.09	42	2.0	0.23	1460	26	129
3	33	1.0	0.10	39	2.0	0.19	865	27	67.0
4	32	1.0	0.13	37	2.0	0.16	386	12	13.0
5	31	2.0	0.13	36	1.0	0.14	321	6.0	5.4
6	30	1.0	0.08	36	1.0	0.12	417	11	12.0
7	31	1.0	0.08	36	1.0	0.11	378	6.0	6.2
8	31	1.0	0.08	35	2.0	0.17	275	4.0	3.2
9	31	1.0	0.08	36	2.0	0.24	234	4.0	2.2
10	31	1.0	0.08	36	3.0	0.31	202	3.0	1.5
11	32	1.0	0.09	39	4.0	0.41	171	2.0	0.97
12	32	1.0	0.09	71	12	3.0	148	2.0	0.73
13	32	1.0	0.09	143	31	12.0	135	2.0	0.56
14	32	1.0	0.09	84	9.0	2.2	348	14	13.0
15	32	1.0	0.09	59	7.0	1.1	244	10	6.4
16	32	1.0	0.09	49	7.0	0.92	181	8.0	4.0
17	32	1.0	0.09	45	7.0	0.87	623	19	39.0
18	31	1.0	0.08	43	7.0	0.83	583	14	24.0
19	31	1.0	0.09	42	7.0	0.80	343	5.0	4.8
20	31	1.0	0.08	41	7.0	0.78	475	13	19.0
21	31	1.0	0.08	62	7.0	1.2	447	19	23.0
22	31	1.0	0.08	516	8.0	11.0	432	16	18.0
23	31	1.0	0.08	241	7.0	4.8	527	13	18.0
24	31	1.0	0.09	361	8.0	7.9	367	10	9.8
25	32	1.0	0.10	407	8.0	9.3	292	7.0	5.3
26	32	1.0	0.12	162	7.0	3.2	258	4.0	2.6
27	32	2.0	0.13	108	3.0	0.85	261	1.0	1.0
28	33	2.0	0.15	88	3.0	0.69	314	7.0	6.6
29	34	2.0	0.17	150	4.0	1.7	637	27	47.0
30	50	2.0	0.33	151	8.0	3.1	648	31	57.0
31	85	4.0	0.84	---	---	---	1410	60	242
TOTAL	1059	---	3.99	3250	---	68.78	13597	---	787.56
	JANUARY			FEBRUARY			MARCH		
1	827	14	33.0	194	2.0	0.90	335	2.0	1.6
2	992	75	206	184	1.0	0.74	310	1.0	1.1
3	1330	25	101	173	1.0	0.57	289	1.0	0.46
4	770	9.0	18.0	168	1.0	0.46	275	0.0	0.04
5	577	10	15.0	165	1.0	0.45	266	1.0	0.89
6	970	22	59.0	162	1.0	0.45	736	29	85.0
7	844	7.0	17.0	173	1.0	0.51	1500	42	172
8	654	5.0	8.8	452	2.0	2.8	1040	35	98.0
9	545	4.0	5.5	308	2.0	1.9	706	27	52.0
10	464	2.0	2.8	255	2.0	1.5	844	24	54.0
11	400	2.0	2.2	233	2.0	1.3	734	10	20.0
12	358	2.0	1.9	226	2.0	1.2	640	5.0	8.5
13	329	2.0	1.8	226	2.0	1.2	588	3.0	5.3
14	305	2.0	1.5	233	2.0	1.3	516	4.0	5.5
15	285	1.0	0.97	231	2.0	1.4	460	4.0	4.8
16	261	2.0	1.4	229	3.0	1.9	439	3.0	3.9
17	244	2.0	1.2	318	4.0	3.5	415	3.0	2.9
18	227	1.0	0.69	293	5.0	4.0	392	8.0	8.4
19	215	1.0	0.58	460	35	72.0	367	26	26.0
20	204	1.0	0.55	1710	182	861	360	7.0	7.3
21	201	1.0	0.54	1030	28	88.0	356	3.0	3.1
22	217	1.0	0.68	725	6.0	13.0	385	6.0	6.7
23	188	2.0	0.88	627	5.0	8.3	913	27	72.0
24	185	1.0	0.63	536	4.0	5.6	1120	48	147
25	181	2.0	0.95	455	3.0	3.6	797	17	37.0
26	348	3.0	3.5	407	2.0	2.1	639	6.0	11.0
27	372	5.0	4.7	382	1.0	1.1	566	5.0	6.9
28	265	4.0	2.8	360	1.0	1.1	527	5.0	7.5
29	230	3.0	1.8	---	---	---	531	3.0	4.6
30	208	2.0	1.2	---	---	---	540	3.0	4.4
31	201	2.0	1.1	---	---	---	511	3.0	4.1
TOTAL	13397	---	497.67	10915	---	1081.88	18097	---	861.99

11417950 HARRY L. ENGLEBRIGHT LAKE NEAR SMARTVILLE, CA

LOCATION.—Lat 39°14'23", long 121°16'07", in SE 1/4 SW 1/4 sec.14, T.16 N., R.6E., [Yuba County](#), Hydrologic Unit 18020125, in intake tower on right bank of reservoir, 0.9 mi upstream from Deer Creek and 2.7 mi northeast of Smartville.

DRAINAGE AREA.—1,108 mi².

PERIOD OF RECORD.—October 2001 to September 2002. Records of daily storage, 1973–2001, available in files of the U.S. Geological Survey.

GAGE.—Water-stage recorder. Datum of gage is mean sea level (Army Corp of Engineers).

REMARKS.—Reservoir is formed by a concrete arch dam 1,142 ft long and 260 ft tall. Completed in 1941 by the Army Corp of Engineers, water storage began the same year. Gross pool is 70,000 acre-ft with a usable storage of 45,000 acre-ft between elevation of spill lip, 527 ft and elevation of intake to Narrows Powerplant No. 1 (station 1141970), 450 ft. Reservoir receives inflow from North, Middle and South Forks of Yuba River which are regulated releases except during spill conditions. Dam has no low-level outlet except water that is released through Narrows Powerplant Nos. 1 and 2 (station 11417980). Site is used by Pacific Gas & Electric Co. to compute mid-night storage contents for Reservoir. Records, including extremes for current year, represent contents at 2400 hours. See schematic diagram of the [South Yuba River Basin](#).

COOPERATION.—Records collected by Pacific Gas & Electric Co., under general supervision of the U.S. Geological Survey, in connection with Federal Energy Regulatory Commission project no. 1403.

EXTREMES FOR PERIOD OF RECORD.—Maximum contents, 44,900 acre-ft, Feb. 20, 2002, elevation, 524.79 ft; minimum contents, 35,500 acre-ft, Mar. 17, 2002, elevation, 515.72 ft.

EXTREMES FOR CURRENT YEAR.—Maximum contents, 44,900 acre-ft, Feb. 20, elevation, 524.79 ft; minimum, 35,500 acre-ft, Mar. 17, elevation, 515.72 ft.

Capacity table (elevation, in feet, and contents, in acre-feet)
(Based on table provided by Pacific Gas & Electric Co., dated 1942)

450.00	0	479.00	13,000	507.00	29,900	536.00	52,400
464.00	5,800	493.00	20,800	522.00	41,000	544.00	59,700

RESERVOIR STORAGE, (ACRE-FEET), WATER YEAR OCTOBER 2001 TO SEPTEMBER 2002

DAILY OBSERVATION AT 2400 HOURS

DAY	OCT	NOV	DEC	JAN	FEB	MAR	APR	MAY	JUN	JUL	AUG	SEP
1	41800	42400	40200	39000	37400	38200	38900	40000	40000	39900	41000	42300
2	42400	42700	42700	39400	37600	37400	39000	40600	38400	41100	42000	42200
3	42900	41300	41700	40900	37900	36600	39600	41300	39400	42000	40400	42200
4	43300	40000	40500	40900	38100	37200	40200	39800	40600	40500	39200	42200
5	43800	40200	40400	40900	38400	38100	40600	38000	41800	41200	40100	42100
6	42600	40600	41700	42200	38600	39600	39800	38300	41800	39400	40800	42200
7	41500	41000	42200	42500	38900	42800	39100	38500	42000	37700	41900	42300
8	41800	41700	41800	41900	39100	41900	39700	38800	39800	38500	42400	42500
9	41900	42400	41100	41000	39400	40400	39600	39300	37200	39300	42700	42700
10	42200	41600	41100	40100	39600	38200	39000	40100	37200	40100	40600	42900
11	42400	40500	40900	38800	39900	38900	38900	39700	38000	40900	38600	43100
12	42600	41200	40700	37500	40100	39800	39800	40200	38500	41500	38800	43300
13	41400	42000	40800	37000	40400	40100	39400	41100	39300	40700	39400	43500
14	40400	41800	41600	37200	40600	39700	38700	42000	39700	38500	40000	43700
15	41000	41600	41200	37200	40700	39400	38200	43100	37900	38800	40800	44000
16	41500	40400	40600	38200	39700	37300	38700	43600	35600	39200	41800	44200
17	42000	39200	43000	39000	38900	35500	38800	43800	36500	39800	40400	44100
18	42300	38000	44000	41000	38200	36000	41300	41400	37100	40500	39400	43000
19	42300	39000	43400	41000	40200	36600	41400	39100	38400	41300	40700	44000
20	40600	40100	43500	41700	44900	37200	40000	39800	39400	39200	40700	44800
21	39100	41100	43200	41000	43100	37800	38800	40400	40300	37300	41100	43800
22	39500	41500	42500	40000	39900	38700	39200	41000	39100	37900	41600	44000
23	40300	41100	42100	39300	38600	38800	39300	42500	37700	38500	42100	44100
24	41300	41000	41100	38700	37200	40000	40000	43800	38400	39500	41700	44100
25	42400	41000	40200	38100	38400	42300	40800	42000	38900	40300	41600	44100
26	43300	41400	40100	37500	39100	42700	41300	40200	39400	41100	41900	44000
27	41600	41600	39300	36900	39600	42600	39800	38500	40500	39000	42200	44000
28	40100	42000	38200	36400	38800	42400	38600	39100	41500	36800	42400	44000
29	40900	41200	38000	36700	---	42700	39100	39900	40000	38000	42500	43900
30	41600	40800	38000	36900	---	41000	39500	40600	38600	39100	42400	43900
31	42000	---	40500	37100	---	39000	---	41200	---	40000	42400	---
MAX	43800	42700	44000	42500	44900	42800	41400	43800	42000	42000	42700	44800
MIN	39100	38000	38000	36400	37200	35500	38200	38000	35600	36800	38600	42100
a	522.87	521.82	520.27	516.67	519.55	520.60	519.66	521.63	519.60	519.46	523.69	525.55
b	+500	-1200	-300	-3400	+1700	+200	+500	+1700	-2600	+1400	+2400	+1500

CAL YR 2001 b -800

WTR YR 2002 b +2400

a Elevation, in feet, at end of month.

b Change in contents, in acre-feet.

11418000 YUBA RIVER BELOW ENGLEBRIGHT DAM, NEAR SMARTVILLE, CA

LOCATION.—Lat 39°14'07", long 121°16'23", in NW 1/4 NW 1/4 sec.23, T.16 N., R.6 E., [Yuba County](#), Hydrologic Unit 18020125, on right bank, 2,000 ft downstream from Englebright Dam, 0.5 mi upstream from Deer Creek, and 2.3 mi northeast of Smartville.

DRAINAGE AREA.—1,108 mi².

WATER-DISCHARGE RECORDS

PERIOD OF RECORD.—October 1941 to current year. Prior to October 1953, published as "at Narrows Dam". October 1953 to September 1969, published as "at Englebright Dam". If records for Deer Creek near Smartville (station 11418500) since 1941 are added to records at this station, records equivalent to those published from 1903 to 1941 as "Yuba River at Smartville" (station 11419000) can be obtained.

REVISED RECORDS.—WSP 1931: Drainage area. WDR CA-97-4: 1999(M).

GAGE.—Water-stage recorder. Datum of gage is 278.68 ft above sea level (levels by International Engineering Co.). Prior to Sept. 19, 1958, at site 2,000 ft upstream at datum 248.31 ft higher, and Sept. 19, 1958, to Sept. 30, 1969, at datum 278.68 ft lower. Supplementary gage 2,000 ft upstream since Oct. 1, 1969, at Englebright Dam at datum 248.31 ft higher.

REMARKS.—Diversions up to 1,800 ft³/s (see stations [11413250](#), [11414190](#), and [11414200](#)) out of basin for power and irrigation upstream from station. Flow regulation by Lake Spaulding (station 11414140), Jackson Meadows and New Bullards Bar Reservoirs (stations 11407800 and 11413515), Englebright Reservoir beginning in 1941, capacity, 70,000 acre-ft, Bowman and Fordyce Lakes (stations 11415500 and 11414090), and many smaller reservoirs. See schematic diagram of [South Yuba River Basin](#).

EXTREMES FOR PERIOD OF RECORD.—Maximum discharge, 171,000 ft³/s, Dec. 22, 1964, gage height, 546.14 ft, site and datum then in use, from rating curve extended above 25,000 ft³/s, on basis of computation of peak flow over spillway of dam at gage heights 544.72 and 546.14 ft; no flow at times in 1942, 1949, 1956, 1958–61, 1968–69.

DISCHARGE, CUBIC FEET PER SECOND, WATER YEAR OCTOBER 2001 TO SEPTEMBER 2002

DAILY MEAN VALUES

DAY	OCT	NOV	DEC	JAN	FEB	MAR	APR	MAY	JUN	JUL	AUG	SEP
1	650	e823	654	2060	1590	1570	2140	2270	2000	2070	1990	e747
2	595	e799	672	1630	1590	1560	2140	2270	2000	2070	1980	e748
3	573	e798	2030	1640	1590	1560	2140	2280	2000	2080	1980	e742
4	601	e792	1280	1480	1600	1570	2140	2300	2000	2080	1970	e731
5	616	e753	1010	1260	1600	1570	2140	2310	2010	2060	1980	e717
6	643	e800	735	1440	1610	1580	2140	2340	2010	2050	1980	e640
7	661	810	661	1960	1600	1520	2140	2400	2010	2050	1960	e620
8	658	811	661	1960	1600	e2970	2140	2390	2010	2070	1960	e620
9	664	814	661	1960	1600	e4140	2140	2380	1990	2100	2030	e613
10	671	813	643	1960	1600	e4170	2140	2360	1990	2100	2100	e620
11	681	811	628	1960	1600	e3450	2140	2300	1990	2110	2090	e620
12	766	804	624	1970	1600	e2280	2140	2220	2000	2130	2090	e620
13	681	799	624	1960	1580	e2290	2150	2180	2000	2110	2100	e621
14	611	800	624	1960	1570	2150	2140	2160	2010	2110	2100	e620
15	598	790	625	1960	1570	2150	2130	2070	2010	2120	2100	e614
16	624	768	624	1980	1560	2140	2140	1980	2020	2140	2090	e617
17	661	747	626	1980	1560	2140	2140	1990	2020	2120	1910	e621
18	713	736	628	1850	1560	2130	2150	1980	2010	2120	1760	e621
19	821	736	864	1740	1560	2130	2150	1980	2010	2100	1730	e613
20	871	757	1130	1740	1940	2140	2140	1970	2010	2100	e1510	e617
21	883	763	1130	1740	2690	2140	2140	1980	2010	2060	e1310	e625
22	891	713	1130	1740	2640	2140	2140	2000	2010	e1970	e1270	e619
23	893	741	1120	1660	1620	e2280	2140	2000	2010	e1960	e1270	e618
24	895	e676	1120	1610	1570	e2290	2140	2020	2010	e1960	e1270	e621
25	883	e702	973	1610	1560	e2310	2140	2010	2070	1990	e1140	619
26	878	e729	827	1600	1570	e2320	2140	1980	2170	2000	e963	619
27	884	e728	826	1600	1570	2160	2140	1980	2170	2000	e951	621
28	878	702	1020	1600	1570	2160	2130	1980	2150	1990	e879	625
29	878	675	1170	1600	---	2160	2200	1990	2110	2000	e772	625
30	e858	654	1050	1600	---	2160	2280	2000	2090	2020	e747	654
31	e839	---	1510	1600	---	2140	---	2010	---	2010	e748	---
TOTAL	23019	22844	27880	54410	46870	69470	64410	66080	60900	63850	50730	19228
MEAN	742.5	761.5	899.4	1755	1674	2241	2147	2132	2030	2060	1636	640.9
MAX	895	823	2030	2060	2690	4170	2280	2400	2170	2140	2100	748
MIN	573	654	624	1260	1560	1520	2130	1970	1990	1960	747	613
AC-FT	45660	45310	55300	107900	92970	137800	127800	131100	120800	126600	100600	38140
a	24400	20080	13020	5670	254	858	11690	38360	45490	38880	30530	12280

e Estimated.

a Combined flow, in acre-feet, from Browns Valley Irrigation Ditch (station 11420750), Brophy-South Canal (station 11420760), and Hallwood-Cordua Irrigation District Canal (station 11420770), provided by Pacific Gas & Electric Co.

11418000 YUBA RIVER BELOW ENGLEBRIGHT DAM, NEAR SMARTVILLE, CA—Continued

STATISTICS OF MONTHLY MEAN DATA FOR WATER YEARS 1942 - 2002, BY WATER YEAR (WY)

	OCT	NOV	DEC	JAN	FEB	MAR	APR	MAY	JUN	JUL	AUG	SEP
MEAN	966.4	1221	2623	3504	3892	3574	3675	3910	2656	1399	1308	997.6
MAX	5206	8964	18100	22350	17330	13060	11950	13330	9017	4034	3140	3144
(WY)	1963	1951	1965	1997	1986	1995	1982	1952	1983	1983	1980	1980
MIN	207	41.3	175	283	211	199	437	367	501	430	326	202
(WY)	1960	1942	1960	1977	1977	1977	1976	1977	1977	1977	1944	1977

SUMMARY STATISTICS	FOR 2001 CALENDAR YEAR		FOR 2002 WATER YEAR		WATER YEARS 1942 - 2002	
ANNUAL TOTAL	368999		569691			
ANNUAL MEAN	1011		1561		2470	
HIGHEST ANNUAL MEAN					5251 1982	
LOWEST ANNUAL MEAN					414 1977	
HIGHEST DAILY MEAN	2280	Jul 6	4170	Mar 10	134000	Jan 2 1997
LOWEST DAILY MEAN	573	Oct 3	573	Oct 3	0.00	Nov 8 1941
ANNUAL SEVEN-DAY MINIMUM	606	Sep 10	618	Sep 14	0.00	Nov 8 1941
MAXIMUM PEAK FLOW			unknown		171000 Dec 22 1964	
MAXIMUM PEAK STAGE			unknown		546.14 Dec 22 1964	
ANNUAL RUNOFF (AC-FT)	731900		1130000		1790000	
ANNUAL DISCHARGE (AC-FT) a	247400		241500			
10 PERCENT EXCEEDS	1950		2150		5140	
50 PERCENT EXCEEDS	878		1740		1300	
90 PERCENT EXCEEDS	645		627		450	

a Combined flow, in acre-feet, from Browns Valley Irrigation Ditch (station 11420750), Brophy-South Canal (station 11420760), and Hallwood-Cordua Irrigation District Canal (station 11420770), provided by Pacific Gas & Electric Co.

11418000 YUBA RIVER BELOW ENGLEBRIGHT DAM, NEAR SMARTVILLE, CA—Continued

WATER-QUALITY RECORDS

PERIOD OF RECORD.—Water years 1973–78, January 2001 to current year.

WATER TEMPERATURE: Water years 1973–78, March 2001 to current year.

SEDIMENT DATA: January 2001 to September 2001 (daily). October 2001 to current year (storm season only).

PERIOD OF DAILY RECORD.—

WATER TEMPERATURE: Water years 1973–78, March to 2001 to current year.

SUSPENDED-SEDIMENT DISCHARGE: January 2001 to September 2001 (daily). October 2001 to current year (storm season only).

INSTRUMENTATION.—Water-temperature recorder October 1972–78 and since March 23, 2001.

REMARKS.—Water-temperature records rated excellent except for Oct. 28, 29, Nov. 6–14, which are rated good. Interruptions in record due to malfunction of the recording instrument. Water temperatures can be affected by releases from Englebright Reservoir.

EXTREMES FOR PERIOD OF DAILY RECORD.—

WATER TEMPERATURE: Maximum recorded, 20.0°C, Oct. 1, 3, 5, 7, 11, 1974; minimum recorded, 3.0°C, Dec. 19, 20, 1973.

SEDIMENT CONCENTRATION: Maximum daily mean, 8 mg/L, Jan. 1–4, 2002; minimum daily mean, 1 mg/L, many days during each water year.

SEDIMENT LOAD: Maximum daily, e58 tons, estimated, Mar. 10, 2002; minimum daily, 1.6 tons, Oct. 2, 2001.

EXTREMES FOR CURRENT YEAR.—

WATER TEMPERATURE: Maximum recorded, 13.5°C, Oct. 12, June 10, 26, but may have been higher during periods of missing record; minimum recorded, 7.0°C, on several days in January and February, but may have been lower during period of missing record.

SEDIMENT CONCENTRATION: Maximum daily mean, 8 mg/L, Jan. 1–4; minimum daily mean, 1 mg/L, many days during water year.

SEDIMENT LOAD: Maximum daily, e58 tons, estimated, Mar. 10; minimum daily, 1.6 tons, Oct. 2.

CROSS-SECTIONAL DATA, WATER YEAR OCTOBER 2001 TO SEPTEMBER 2002

DATE	TIME	DEPTH BOTTOM AT SAMPLE LOC- ATION, (FEET) (81903)	TEMPER- ATURE WATER (DEG C) (00010)	SAMPLE LOC- ATION, CROSS SECTION (FT FM L BANK) (00009)
APR				
16...*	0907	6.20	11.0	142
16...*	0911	9.50	11.0	127
16...*	0913	10.0	11.0	112
16...*	0915	7.70	11.0	97.0
16...*	0917	8.40	11.0	82.0
16...*	0918	8.00	11.0	67.0
16...*	0920	7.80	11.0	52.0
16...*	0922	7.70	11.0	37.0
16...*	0924	7.10	11.0	22.0
16...*	0926	5.10	11.0	7.00
AUG				
05...*	0952	6.50	11.5	7.00
05...*	0950	7.50	11.5	21.0
05...*	0948	7.50	11.5	35.0
05...*	0946	8.00	11.5	49.0
05...*	0943	7.50	11.5	63.0
05...*	0940	8.00	11.5	77.0
05...*	0938	9.00	11.5	91.0
05...*	0935	10.0	11.5	105
05...*	0932	9.50	11.5	119
05...*	0928	5.00	11.5	135

SUSPENDED-SEDIMENT DISCHARGE, WATER YEAR OCTOBER 2001 TO SEPTEMBER 2002

DATE	TIME	DIS- CHARGE, INST. CUBIC FEET PER SECOND (00061)	TEMPER- ATURE WATER (DEG C) (00010)	SEDI- MENT, SUS- PENDED (MG/L) (80154)	SEDI- MENT, DIS- CHARGE, SUS- PENDED (T/DAY) (80155)
OCT					
03...	1415	554	12.5	2.0	3.0
JAN					
18...	1500	1740	8.5	3.0	14.1
MAR					
08...	1430	3440	9.0	4.0	37.2
APR					
10...	1430	2140	10.5	2.0	11.6
MAY					
31...	1415	2010	12.5	1.0	5.4

* Instantaneous discharge at time of cross-sectional measurement: 2,130 ft³/s, Apr. 16, 2002; 1,960 ft³/s, Aug. 5, 2002.

e Estimated.

11418000 YUBA RIVER BELOW ENGLEBRIGHT DAM, NEAR SMARTVILLE, CA—Continued

WATER TEMPERATURE, DEGREES C, WATER YEAR OCTOBER 2001 TO SEPTEMBER 2002

DAY	MAX	MIN	MAX	MIN	MAX	MIN	MAX	MIN	MAX	MIN	MAX	MIN
	OCTOBER		NOVEMBER		DECEMBER		JANUARY		FEBRUARY		MARCH	
1	13.0	12.0	---	---	10.5	10.0	9.5	8.5	7.5	7.0	9.5	9.0
2	13.0	12.0	---	---	10.0	10.0	9.5	9.0	7.5	7.0	9.5	9.0
3	13.0	12.0	---	---	10.5	10.0	9.5	9.0	7.5	7.0	9.5	8.5
4	13.0	12.0	---	---	10.5	10.0	9.5	9.0	7.5	7.0	9.5	8.5
5	13.0	12.0	---	---	10.0	10.0	9.5	9.0	7.5	7.0	9.0	8.5
6	13.0	12.0	11.5	---	10.0	9.5	9.5	9.0	7.5	7.0	9.0	8.5
7	13.0	12.0	11.5	10.5	10.0	9.5	9.5	9.0	7.5	7.0	---	---
8	13.0	12.0	11.0	10.5	10.0	9.5	9.5	9.0	7.5	7.0	---	---
9	13.0	12.0	11.0	10.5	9.5	9.0	9.5	9.0	8.0	7.5	---	---
10	13.0	12.0	11.0	10.5	9.5	9.0	9.5	9.0	8.0	7.5	---	---
11	13.0	12.0	11.0	10.5	9.5	9.0	9.5	9.0	8.0	7.5	---	---
12	13.5	12.5	11.0	10.5	9.5	9.0	9.5	9.0	8.0	7.5	---	---
13	13.0	12.5	10.5	10.5	9.5	9.0	9.0	9.0	8.0	7.5	---	---
14	13.0	12.5	11.5	10.5	9.5	9.0	9.0	8.5	8.0	7.5	9.0	8.5
15	13.0	12.5	11.0	10.5	9.5	9.0	9.0	8.5	8.0	7.5	9.0	8.5
16	13.0	12.5	11.0	10.5	9.0	9.0	8.5	8.5	8.0	8.0	8.5	8.5
17	13.0	12.5	11.0	10.5	9.0	9.0	8.5	8.5	8.0	8.0	8.5	8.0
18	13.0	12.0	11.5	10.5	9.0	8.5	8.5	8.5	8.5	8.0	9.0	8.0
19	12.5	12.0	11.5	10.5	9.0	8.5	8.5	8.0	8.5	8.0	8.5	8.5
20	12.5	12.0	11.5	11.0	9.0	9.0	8.0	8.0	8.5	8.0	9.0	8.5
21	12.5	12.0	11.0	11.0	9.0	9.0	8.0	8.0	9.0	8.5	9.0	8.5
22	12.5	12.0	11.0	10.5	9.0	8.5	8.0	8.0	9.0	8.5	8.5	8.5
23	12.5	12.0	11.0	10.5	9.0	8.5	8.0	8.0	8.5	8.5	---	---
24	12.5	11.5	---	---	9.0	8.5	8.0	8.0	9.0	8.5	---	---
25	12.0	11.5	---	---	9.0	8.5	8.0	8.0	9.5	8.5	---	---
26	12.0	11.5	---	---	8.5	8.5	8.0	8.0	9.5	8.5	9.0	---
27	11.5	11.0	---	---	8.5	8.5	8.0	7.5	9.0	8.5	9.5	8.5
28	11.5	11.0	11.0	10.5	9.0	8.5	7.5	7.5	9.5	8.5	9.5	9.0
29	11.5	11.0	10.5	10.5	9.0	8.5	8.0	7.5	---	---	9.5	9.0
30	---	---	10.5	10.5	9.0	8.5	7.5	7.0	---	---	10.0	9.0
31	---	---	---	---	9.0	8.5	7.5	7.0	---	---	10.5	9.0
MONTH	---	---	---	---	10.5	8.5	9.5	7.0	9.5	7.0	---	---
	APRIL		MAY		JUNE		JULY		AUGUST		SEPTEMBER	
1	10.5	9.5	10.5	9.5	12.0	11.5	12.0	11.5	12.0	11.5	13.0	11.5
2	10.5	9.5	10.0	9.5	12.5	12.0	12.0	11.5	12.0	11.5	12.5	12.0
3	10.5	9.5	10.0	9.5	13.0	12.5	11.5	11.5	11.5	11.5	12.5	12.0
4	10.5	10.0	10.0	9.5	13.0	12.5	12.0	11.0	12.0	11.5	13.0	12.0
5	10.0	10.0	11.0	9.5	12.5	12.5	11.5	11.5	12.5	11.5	12.5	11.5
6	10.5	10.0	11.0	10.0	12.5	12.5	12.0	11.5	12.0	11.5	12.0	11.0
7	10.5	10.0	10.5	10.0	12.5	12.5	11.5	11.5	12.0	11.5	12.0	11.0
8	11.0	10.0	10.5	10.0	13.0	12.5	12.0	11.5	11.5	11.0	12.5	11.5
9	10.5	10.0	10.5	10.0	13.0	12.5	12.0	12.0	11.5	11.5	12.0	11.5
10	10.5	10.0	10.5	10.0	13.5	12.5	12.0	11.5	12.0	11.5	13.0	11.5
11	10.5	10.0	10.5	10.0	13.0	12.5	12.0	11.5	12.0	11.5	12.5	11.5
12	10.5	10.0	10.5	10.0	12.5	12.5	11.5	11.5	12.0	11.5	12.5	11.5
13	10.5	10.0	11.0	10.0	12.5	12.0	11.5	11.5	12.0	11.5	12.5	11.5
14	10.5	10.0	10.5	10.0	12.5	12.0	12.0	11.5	12.0	11.5	13.0	12.0
15	11.0	10.0	10.5	10.0	12.0	12.0	12.0	11.5	12.0	11.5	12.5	12.0
16	11.0	10.0	10.5	10.0	12.5	12.0	12.5	11.5	---	11.5	13.0	11.5
17	10.5	10.0	10.5	10.0	12.5	12.5	12.0	11.5	12.0	11.5	13.0	12.0
18	10.5	9.5	10.5	10.0	12.5	12.0	---	11.5	12.0	11.5	12.5	12.0
19	10.5	9.5	11.0	10.0	12.0	12.0	12.0	11.5	12.0	11.5	---	---
20	10.0	9.5	11.0	10.5	12.5	11.5	11.5	11.5	12.0	11.5	---	---
21	10.5	9.5	11.0	10.5	12.0	11.5	12.0	11.5	12.0	11.5	---	---
22	10.5	9.5	11.0	10.5	11.5	11.5	---	---	12.0	11.5	---	---
23	10.5	9.5	11.0	10.5	11.5	11.5	---	---	13.0	11.5	---	---
24	10.5	9.5	11.0	10.5	12.0	11.5	12.5	---	12.0	11.5	---	---
25	10.5	9.5	11.0	10.5	12.0	11.5	12.0	11.5	12.0	11.5	13.0	12.0
26	10.0	9.5	11.0	10.5	13.5	11.5	12.0	11.5	12.0	11.5	13.0	12.0
27	10.0	9.5	11.5	11.0	12.5	11.5	12.0	11.5	12.0	11.5	13.0	12.0
28	10.5	9.5	12.0	11.5	12.5	11.5	12.0	11.5	12.5	11.5	13.0	12.0
29	10.5	10.0	12.0	11.5	11.5	11.5	12.0	11.5	12.5	11.5	13.0	12.5
30	10.5	9.5	12.0	11.5	11.5	11.5	12.0	12.0	12.5	11.5	13.0	12.0
31	---	---	12.0	11.5	---	---	12.0	11.5	12.5	11.5	---	---
MONTH	11.0	9.5	12.0	9.5	13.5	11.5	---	---	---	11.0	---	---

11418000 YUBA RIVER BELOW ENGLEBRIGHT DAM, NEAR SMARTVILLE, CA—Continued

SEDIMENT DISCHARGE, SUSPENDED (TONS/DAY), WATER YEAR OCTOBER 2001 TO SEPTEMBER 2002

DAY	MEAN DISCHARGE (CFS)	MEAN CONCENTRATION (MG/L)	SEDIMENT DISCHARGE (TONS/DAY)	MEAN DISCHARGE (CFS)	MEAN CONCENTRATION (MG/L)	SEDIMENT DISCHARGE (TONS/DAY)	MEAN DISCHARGE (CFS)	MEAN CONCENTRATION (MG/L)	SEDIMENT DISCHARGE (TONS/DAY)
	OCTOBER			NOVEMBER			DECEMBER		
1	650	1.0	1.8	e823	3.0	e5.8	654	1.0	2.0
2	595	1.0	1.6	e799	3.0	e5.8	672	1.0	2.3
3	573	1.0	2.2	e798	3.0	e5.9	2030	4.0	22.0
4	601	2.0	3.2	e792	3.0	e6.1	1280	4.0	14.0
5	616	2.0	3.3	e753	3.0	e5.9	1010	4.0	11.0
6	643	2.0	3.5	e800	3.0	e6.4	735	4.0	7.9
7	661	2.0	3.6	810	3.0	6.3	661	4.0	7.1
8	658	2.0	3.6	811	3.0	6.1	661	4.0	7.1
9	664	2.0	3.6	814	3.0	6.0	661	4.0	7.1
10	671	2.0	3.7	813	3.0	5.7	643	4.0	6.9
11	681	2.0	4.4	811	3.0	5.5	628	4.0	6.8
12	766	3.0	5.9	804	2.0	5.3	624	4.0	6.7
13	681	3.0	6.0	799	2.0	5.0	624	4.0	6.7
14	611	4.0	6.1	800	2.0	4.8	624	4.0	6.7
15	598	4.0	6.6	790	2.0	4.6	625	4.0	6.7
16	624	5.0	7.6	768	2.0	4.3	624	4.0	6.7
17	661	5.0	8.7	747	2.0	3.9	626	4.0	6.8
18	713	5.0	8.9	736	2.0	3.7	628	4.0	6.8
19	821	4.0	9.4	736	2.0	3.5	864	4.0	9.3
20	871	4.0	9.1	757	2.0	3.4	1130	4.0	12.0
21	883	4.0	8.3	763	2.0	3.3	1130	4.0	12.0
22	891	3.0	7.5	713	1.0	2.9	1130	4.0	12.0
23	893	3.0	6.6	741	1.0	2.8	1120	4.0	12.0
24	895	2.0	5.7	e676	1.0	e2.4	1120	4.0	12.0
25	883	2.0	4.9	e702	1.0	e2.3	973	4.0	11.0
26	878	2.0	4.9	e729	1.0	e2.2	827	4.0	8.9
27	884	2.0	5.2	e728	1.0	e2.0	826	4.0	8.9
28	878	2.0	5.3	702	1.0	2.0	1020	4.0	11.0
29	878	2.0	5.5	675	1.0	2.0	1170	4.0	13.0
30	e858	2.0	e5.6	654	1.0	2.0	1050	4.0	11.0
31	e839	3.0	e5.7	---	---	---	1510	6.0	28.0
TOTAL	23019	---	168.0	22844	---	127.9	27880	---	302.4
	JANUARY			FEBRUARY			MARCH		
1	2060	8.0	44.0	1590	3.0	11.0	1570	6.0	26.0
2	1630	8.0	35.0	1590	3.0	11.0	1560	6.0	24.0
3	1640	8.0	36.0	1590	2.0	10.0	1560	5.0	22.0
4	1480	8.0	32.0	1600	2.0	9.8	1570	5.0	20.0
5	1260	7.0	25.0	1600	2.0	9.2	1570	4.0	19.0
6	1440	7.0	27.0	1610	2.0	8.7	1580	4.0	17.0
7	1960	6.0	34.0	1600	2.0	8.1	1520	3.0	15.0
8	1960	6.0	32.0	1600	2.0	7.6	e2970	4.0	e29.0
9	1960	5.0	29.0	1600	2.0	7.1	e4140	5.0	e51.0
10	1960	5.0	26.0	1600	2.0	6.5	e4170	5.0	e58.0
11	1960	5.0	24.0	1600	1.0	6.0	e3450	6.0	e53.0
12	1970	4.0	22.0	1600	1.0	5.4	e2280	6.0	e39.0
13	1960	4.0	20.0	1580	1.0	4.8	e2290	7.0	e43.0
14	1960	3.0	18.0	1570	1.0	4.4	2150	7.0	39.0
15	1960	3.0	16.0	1570	1.0	4.9	2150	6.0	37.0
16	1980	3.0	16.0	1560	1.0	5.6	2140	6.0	36.0
17	1980	3.0	16.0	1560	1.0	6.3	2140	6.0	34.0
18	1850	3.0	14.0	1560	2.0	7.0	2130	6.0	32.0
19	1740	3.0	13.0	1560	2.0	7.7	2130	5.0	30.0
20	1740	3.0	12.0	1940	3.0	19.0	2140	5.0	29.0
21	1740	2.0	11.0	2690	7.0	51.0	2140	5.0	30.0
22	1740	2.0	10.0	2640	7.0	50.0	2140	5.0	31.0
23	1660	2.0	9.4	1620	7.0	31.0	e2280	5.0	e33.0
24	1610	2.0	11.0	1570	7.0	30.0	e2290	6.0	e34.0
25	1610	3.0	13.0	1560	7.0	30.0	e2310	6.0	e36.0
26	1600	3.0	13.0	1570	7.0	30.0	e2320	6.0	e37.0
27	1600	3.0	13.0	1570	7.0	30.0	2160	6.0	35.0
28	1600	3.0	13.0	1570	7.0	28.0	2160	6.0	34.0
29	1600	3.0	13.0	---	---	---	2160	6.0	32.0
30	1600	3.0	12.0	---	---	---	2160	5.0	31.0
31	1600	3.0	12.0	---	---	---	2140	5.0	30.0
TOTAL	54410	---	621.4	46870	---	440.1	69470	---	1016.0

e Estimated.

11418000 YUBA RIVER BELOW ENGLEBRIGHT DAM, NEAR SMARTVILLE, CA—Continued

SEDIMENT DISCHARGE, SUSPENDED (TONS/DAY), WATER YEAR OCTOBER 2001 TO SEPTEMBER 2002

DAY	MEAN DISCHARGE (CFS)	MEAN CONCENTRATION (MG/L)	SEDIMENT DISCHARGE (TONS/DAY)	MEAN DISCHARGE (CFS)	MEAN CONCENTRATION (MG/L)	SEDIMENT DISCHARGE (TONS/DAY)	MEAN DISCHARGE (CFS)	MEAN CONCENTRATION (MG/L)	SEDIMENT DISCHARGE (TONS/DAY)
	APRIL			MAY			JUNE		
1	2140	5.0	28.0	2270	2.0	12.0	2000	1.0	5.4
2	2140	5.0	27.0	2270	2.0	13.0	2000	1.0	5.4
3	2140	5.0	26.0	2280	2.0	14.0	2000	1.0	5.4
4	2140	4.0	25.0	2300	2.0	15.0	2000	1.0	5.4
5	2140	4.0	24.0	2310	3.0	16.0	2010	1.0	5.4
6	2140	4.0	22.0	2340	3.0	17.0	2010	1.0	5.4
7	2140	4.0	21.0	2400	3.0	18.0	2010	1.0	5.4
8	2140	3.0	20.0	2390	3.0	19.0	2010	1.0	5.4
9	2140	3.0	19.0	2380	3.0	17.0	1990	1.0	5.4
10	2140	3.0	17.0	2360	2.0	16.0	1990	1.0	5.4
11	2140	3.0	16.0	2300	2.0	13.0	1990	1.0	5.4
12	2140	2.0	14.0	2220	2.0	11.0	2000	1.0	5.4
13	2150	2.0	13.0	2180	2.0	9.3	2000	1.0	5.4
14	2140	2.0	11.0	2160	1.0	7.5	2010	1.0	5.4
15	2130	2.0	9.1	2070	1.0	5.9	2010	1.0	5.4
16	2140	1.0	7.5	1980	1.0	6.1	2020	1.0	5.5
17	2140	1.0	6.0	1990	1.0	6.9	2020	1.0	5.5
18	2150	1.0	5.8	1980	1.0	7.6	2010	1.0	5.4
19	2150	1.0	5.8	1980	2.0	8.4	2010	1.0	5.4
20	2140	1.0	5.8	1970	2.0	9.1	2010	1.0	5.4
21	2140	1.0	5.8	1980	2.0	9.9	2010	1.0	5.4
22	2140	1.0	5.8	2000	2.0	11.0	2010	1.0	5.4
23	2140	1.0	5.8	2000	2.0	11.0	2010	1.0	5.4
24	2140	1.0	5.9	2020	2.0	11.0	2010	1.0	5.4
25	2140	1.0	6.6	2010	2.0	11.0	2070	1.0	5.6
26	2140	1.0	7.4	1980	2.0	11.0	2170	1.0	5.9
27	2140	1.0	8.2	1980	2.0	11.0	2170	1.0	5.9
28	2130	2.0	9.0	1980	2.0	11.0	2150	1.0	5.8
29	2200	2.0	10.0	1990	2.0	11.0	2110	1.0	5.7
30	2280	2.0	11.0	2000	2.0	11.0	2090	1.0	5.6
31	---	---	---	2010	2.0	8.6	---	---	---
TOTAL	64410	---	398.5	66080	---	359.3	60900	---	164.3
	JULY			AUGUST			SEPTEMBER		
1	2070	---	---	1990	---	---	e747	---	---
2	2070	---	---	1980	---	---	e748	---	---
3	2080	---	---	1980	---	---	e742	---	---
4	2080	---	---	1970	---	---	e731	---	---
5	2060	---	---	1980	---	---	e717	---	---
6	2050	---	---	1980	---	---	e640	---	---
7	2050	---	---	1960	---	---	e620	---	---
8	2070	---	---	1960	---	---	e620	---	---
9	2100	---	---	2030	---	---	e613	---	---
10	2100	---	---	2100	---	---	e620	---	---
11	2110	---	---	2090	---	---	e620	---	---
12	2130	---	---	2090	---	---	e620	---	---
13	2110	---	---	2100	---	---	e621	---	---
14	2110	---	---	2100	---	---	e620	---	---
15	2120	---	---	2100	---	---	e614	---	---
16	2140	---	---	2090	---	---	e617	---	---
17	2120	---	---	1910	---	---	e621	---	---
18	2120	---	---	1760	---	---	e621	---	---
19	2100	---	---	1730	---	---	e613	---	---
20	2100	---	---	e1510	---	---	e617	---	---
21	2060	---	---	e1310	---	---	e625	---	---
22	e1970	---	---	e1270	---	---	e619	---	---
23	e1960	---	---	e1270	---	---	e618	---	---
24	e1960	---	---	e1270	---	---	e621	---	---
25	1990	---	---	e1140	---	---	619	---	---
26	2000	---	---	e963	---	---	619	---	---
27	2000	---	---	e951	---	---	621	---	---
28	1990	---	---	e879	---	---	625	---	---
29	2000	---	---	e772	---	---	625	---	---
30	2020	---	---	e747	---	---	654	---	---
31	2010	---	---	e748	---	---	---	---	---
TOTAL	63850	---	---	50730	---	---	19228	---	---

e Estimated.

11418500 DEER CREEK NEAR SMARTVILLE, CA

LOCATION.—Lat 39°13'28", long 121°16'03", in SW 1/4 SE 1/4 sec.23, T.16 N., R.6 E., Nevada County, Hydrologic Unit 18020125, on left bank, 400 ft upstream from county road bridge, 0.9 mi upstream from mouth, and 2 mi northeast of Smartville.

DRAINAGE AREA.—84.6 mi².

PERIOD OF RECORD.—June 1935 to current year.

WATER TEMPERATURE: Water years 1974–79.

SEDIMENT DATA: Water years 1974–79.

REVISED RECORDS.—WSP 1395: Drainage area.

GAGE.—Water-stage recorder. Elevation of gage is 630 ft above sea level, from river-profile map. June 21, 1935, to Nov. 30, 1938, nonrecording gage at same site and datum.

REMARKS.—Records good. Natural flow of stream is affected by Scotts Flat Reservoir beginning in 1949, usable capacity, 26,300 acre-ft, increased to 49,000 acre-ft in July 1964; Deer Creek Reservoir, capacity, 1,400 acre-ft beginning 1949; Lake Wildwood, capacity, 3,840 acre-ft beginning in 1970, power developments, and diversion for irrigation. At times water from South Yuba River is diverted to Deer Creek and water from Deer Creek is diverted to Bear River. See schematic diagram of [South Yuba River Basin](#).

EXTREMES FOR PERIOD OF RECORD.—Maximum discharge, 12,100 ft³/s, Feb. 17, 1986, gage height, 14.05 ft, from rating curve extended above 5,200 ft³/s; minimum daily, 0.06 ft³/s, Aug. 5, 1977.

EXTREMES OUTSIDE PERIOD OF RECORD.—Flood of March 1928 reached a stage of 14.5 ft from floodmarks, discharge, 14,000 ft³/s.

DISCHARGE, CUBIC FEET PER SECOND, WATER YEAR OCTOBER 2001 TO SEPTEMBER 2002

DAILY MEAN VALUES

DAY	OCT	NOV	DEC	JAN	FEB	MAR	APR	MAY	JUN	JUL	AUG	SEP
1	4.6	26	36	223	52	51	140	20	10	5.3	5.5	6.0
2	3.5	19	313	672	49	47	136	20	9.3	4.9	5.4	4.6
3	3.1	14	102	436	47	45	128	20	7.3	4.8	6.1	3.0
4	2.7	6.5	36	184	44	44	122	20	8.2	5.7	5.4	2.3
5	2.5	5.0	169	143	42	45	121	18	7.7	5.7	5.0	2.1
6	2.6	3.2	402	296	41	595	120	16	7.4	5.4	4.6	2.2
7	3.0	3.2	119	175	48	711	118	16	6.6	4.5	4.3	2.4
8	2.7	3.2	62	117	147	336	106	15	7.0	3.6	4.5	3.0
9	2.7	3.3	50	95	74	163	112	14	10	4.0	4.5	3.0
10	2.4	3.3	41	79	55	352	109	14	4.6	4.8	5.6	2.8
11	2.2	3.5	34	69	48	212	91	14	3.6	5.3	5.6	3.2
12	13	17	31	61	46	137	62	14	3.7	4.3	4.3	3.1
13	120	21	30	57	46	127	48	13	3.6	4.8	3.9	3.2
14	203	9.7	481	52	43	134	37	14	4.3	4.5	3.8	4.2
15	243	6.9	140	50	41	127	36	13	6.4	3.7	3.3	3.9
16	244	5.5	63	47	41	128	37	13	7.3	3.1	3.7	3.2
17	221	5.2	563	43	138	118	41	12	5.9	2.6	4.6	3.5
18	154	5.3	275	41	78	111	43	12	6.1	3.0	4.8	5.1
19	56	5.2	107	39	325	133	40	11	6.3	3.3	3.6	4.0
20	28	5.0	562	38	1050	139	33	53	6.5	4.0	2.9	3.7
21	17	13	427	41	254	136	28	82	6.1	4.4	3.2	5.0
22	12	68	233	45	143	155	23	33	6.9	4.0	3.6	5.4
23	9.9	15	273	38	105	725	20	21	6.8	4.0	4.3	3.8
24	8.0	66	129	35	87	547	18	17	5.3	4.1	5.4	3.3
25	6.6	29	87	35	74	291	17	17	5.6	4.3	5.3	3.6
26	3.3	13	70	402	67	209	17	14	6.4	5.7	3.9	3.5
27	3.0	9.6	61	278	62	174	20	12	5.4	6.6	3.7	3.9
28	3.0	8.0	83	110	58	171	18	9.1	5.6	5.5	3.0	4.2
29	3.1	14	381	79	---	159	20	11	6.7	4.6	3.1	4.8
30	13	18	313	65	---	151	20	12	6.2	4.5	3.7	4.8
31	27	---	818	55	---	144	---	12	---	5.0	6.0	---
TOTAL	1419.9	424.6	6491	4100	3305	6617	1881	582.1	192.8	140.0	136.6	110.8
MEAN	45.80	14.15	209.4	132.3	118.0	213.5	62.70	18.78	6.427	4.516	4.406	3.693
MAX	244	68	818	672	1050	725	140	82	10	6.6	6.1	6.0
MIN	2.2	3.2	30	35	41	44	17	9.1	3.6	2.6	2.9	2.1
AC-FT	2820	842	12870	8130	6560	13120	3730	1150	382	278	271	220

11418500 DEER CREEK NEAR SMARTVILLE, CA—Continued

STATISTICS OF MONTHLY MEAN DATA FOR WATER YEARS 1936 - 2002, BY WATER YEAR (WY)

	OCT	NOV	DEC	JAN	FEB	MAR	APR	MAY	JUN	JUL	AUG	SEP
MEAN	28.52	59.59	163.4	299.8	375.6	321.5	180.1	70.04	20.58	6.545	5.020	5.923
MAX	373	388	960	1418	1399	1162	888	301	129	23.2	14.2	19.1
(WY)	1963	1951	1956	1997	1986	1938	1982	1995	1998	1974	1969	1980
MIN	1.07	2.25	2.89	5.25	14.5	10.5	3.91	3.58	0.48	0.36	0.33	0.27
(WY)	1989	1940	1977	1991	1991	1977	1977	1981	1977	1940	1940	1937

SUMMARY STATISTICS	FOR 2001 CALENDAR YEAR		FOR 2002 WATER YEAR		WATER YEARS 1936 - 2002	
ANNUAL TOTAL	17379.6		25400.8			
ANNUAL MEAN	47.62		69.59		126.9	
HIGHEST ANNUAL MEAN					327 1983	
LOWEST ANNUAL MEAN					5.48 1977	
HIGHEST DAILY MEAN	818	Dec 31	1050	Feb 20	10200	Feb 17 1986
LOWEST DAILY MEAN	1.9	Sep 5	2.1	Sep 5	0.06	Aug 5 1977
ANNUAL SEVEN-DAY MINIMUM	2.5	Sep 4	2.5	Sep 4	0.16	Aug 3 1940
MAXIMUM PEAK FLOW			1800	Feb 20	12100	Feb 17 1986
MAXIMUM PEAK STAGE			7.01	Feb 20	14.05	Feb 17 1986
ANNUAL RUNOFF (AC-FT)	34470		50380		91910	
10 PERCENT EXCEEDS	121		174		312	
50 PERCENT EXCEEDS	10		15		17	
90 PERCENT EXCEEDS	3.3		3.3		2.8	

11421000 YUBA RIVER NEAR MARYSVILLE, CA

LOCATION.—Lat 39°10'33", long 121°31'26", in New Helvetia Grant, [Yuba County](#), Hydrologic Unit 18020107, on left bank, 4.2 mi northeast of Marysville, and 5 mi downstream from Dry Creek.

DRAINAGE AREA.—1,339 mi².

WATER-DISCHARGE RECORDS

PERIOD OF RECORD.—October 1940 to current year (prior to October 1943, low-water periods only). Published as "at Marysville" October 1940 to September 1957. Separate records published for two sites August 1954 to September 1955. Yearly discharge for the water year 1945 published in WSP 1315-A.

REVISED RECORDS.—WSP 1715: 1956(M). WSP 1931: Drainage area. WDR CA-99-4: 1997(M).

GAGE.—Water-stage recorder and crest-stage gage. Datum of gage is 2.95 ft below sea level. Prior to August 1954, and Oct. 1, 1956, to Sept. 30, 1957, at Simpson Lane Bridge in Marysville, 4.2 mi downstream, at same datum. Sept. 3, 1963, to Sept. 23, 1968, auxiliary water-stage recorder at Simpson Lane Bridge at same datum.

REMARKS.—Records good. Flow regulated by New Bullards Bar Reservoir since January 1969, and several other reservoirs. Many diversions upstream from station for power and for irrigation. See schematic diagrams of [South Yuba River Basin](#) and [lower Sacramento River Basin](#).

EXTREMES FOR PERIOD OF RECORD.—Maximum discharge (water years 1944, 1947–2002), 180,000 ft³/s, Dec. 22, 1964, gage height, 90.15 ft, from floodmarks, from rating curve extended above 91,000 ft³/s, on basis of U.S. Army Corps of Engineers flood-routing study, maximum gage height, 91.64 ft, from floodmarks, Jan. 2, 1997; minimum recorded, 10 ft³/s, July 2, 1959.

DISCHARGE, CUBIC FEET PER SECOND, WATER YEAR OCTOBER 2001 TO SEPTEMBER 2002

DAILY MEAN VALUES

DAY	OCT	NOV	DEC	JAN	FEB	MAR	APR	MAY	JUN	JUL	AUG	SEP
1	487	472	457	2580	1620	1610	2520	1630	1490	1450	1470	506
2	444	435	774	2970	1620	1590	2510	1600	1440	1440	1460	507
3	409	430	1790	2590	1600	1560	2500	1590	1370	1440	1440	504
4	408	428	1350	1960	1610	1550	2490	1600	1320	1450	1440	496
5	402	416	983	1530	1610	1580	2490	1590	1290	1430	1430	519
6	395	406	1040	2000	1610	2080	2430	1590	1290	1430	1440	478
7	402	394	697	2270	1610	2710	2400	1630	1280	1420	1430	441
8	402	397	597	2230	1680	3640	2390	1640	1270	1410	1440	438
9	396	399	562	2150	1650	4640	2480	1620	1250	1430	1480	442
10	404	401	535	2100	1630	5040	2480	1640	1230	1440	1600	440
11	408	409	499	2060	1620	4660	2440	1650	1210	1430	1600	451
12	424	453	484	2040	1620	2890	2340	1660	1180	1450	1590	474
13	443	512	480	2030	1610	2670	2310	1630	1170	1440	1610	488
14	449	468	988	2010	1570	2620	2290	1640	1180	1420	1620	486
15	447	456	745	1990	1560	2580	2260	1600	1200	1410	1630	483
16	451	434	588	1990	1550	2540	2240	1490	1200	1440	1630	468
17	434	415	1040	1990	1620	2520	2240	1510	1210	1430	1510	480
18	437	404	1050	1980	1610	2490	2240	1530	1200	1460	1340	484
19	431	399	769	1840	1660	2490	2220	1550	1170	1440	1270	443
20	441	409	1500	1830	3070	2490	2140	1720	1220	1450	1170	441
21	427	444	1870	1830	3070	2490	2070	1900	1290	1440	988	460
22	431	531	1350	1830	2920	2540	1940	1860	1290	1420	942	476
23	438	443	1430	1760	2090	3450	1890	1840	1270	1430	931	474
24	441	530	1250	1630	1750	4100	1840	1840	1260	1430	922	470
25	440	514	1090	1620	1700	3270	1780	1800	1280	1420	854	448
26	432	474	824	1860	1680	2880	1760	1690	1410	1430	678	443
27	437	473	786	2030	1670	2710	1730	1600	1440	1430	624	430
28	427	463	891	1730	1640	2660	1620	1560	1460	1420	600	419
29	419	458	1690	e1690	---	2600	1540	1560	1470	1410	504	423
30	472	446	1410	e1670	---	2580	1630	1530	1450	1420	471	425
31	487	---	2690	e1640	---	2550	---	1490	---	1440	487	---
TOTAL	13365	13313	32209	61430	50250	85780	65210	50780	38790	44400	37601	13937
MEAN	431.1	443.8	1039	1982	1795	2767	2174	1638	1293	1432	1213	464.6
MAX	487	531	2690	2970	3070	5040	2520	1900	1490	1460	1630	519
MIN	395	394	457	1530	1550	1550	1540	1490	1170	1410	471	419
AC-FT	26510	26410	63890	121800	99670	170100	129300	100700	76940	88070	74580	27640

e Estimated.

11421000 YUBA RIVER NEAR MARYSVILLE, CA—Continued

STATISTICS OF MONTHLY MEAN DATA FOR WATER YEARS 1944 - 1968, BY WATER YEAR (WY)

	OCT	NOV	DEC	JAN	FEB	MAR	APR	MAY	JUN	JUL	AUG	SEP
MEAN	507	846	3323	3574	4555	3928	4965	5064	2610	514	218	240
MAX	6222	8586	18650	13160	12470	7321	10400	13750	8712	2669	551	458
(WY)	1963	1951	1965	1956	1958	1958	1952	1952	1952	1952	1967	1952
MIN	50.5	116	157	573	965	1360	2139	1264	265	30.5	35.3	47.9
(WY)	1962	1960	1960	1960	1948	1964	1961	1947	1959	1959	1959	1961

SUMMARY STATISTICS

WATER YEARS 1944 - 1968

ANNUAL MEAN	2518
HIGHEST ANNUAL MEAN	5393 1952
LOWEST ANNUAL MEAN	882 1961
HIGHEST DAILY MEAN	136000 Dec 23 1955
LOWEST DAILY MEAN	15 Nov 7 1959
ANNUAL SEVEN-DAY MINIMUM	15 Nov 5 1959
MAXIMUM PEAK FLOW	180000 Dec 22 1964
MAXIMUM PEAK STAGE	90.15 Dec 22 1964
ANNUAL RUNOFF (AC-FT)	1824000
10 PERCENT EXCEEDS	6450
50 PERCENT EXCEEDS	822
90 PERCENT EXCEEDS	108

STATISTICS OF MONTHLY MEAN DATA FOR WATER YEARS 1970 - 2002, BY WATER YEAR (WY)

	1970	1970	1977	1977	1977	1977	1977	1977	1977	1977	1977	1977
MEAN	1102	1373	2377	4234	4492	4402	2898	2263	1899	1281	1450	1284
MAX	2731	4475	11430	26180	20970	15100	14280	9721	8633	3735	2829	2900
(WY)	1976	1984	1984	1997	1986	1983	1982	1995	1983	1983	1984	1980
MIN	132	182	371	230	211	188	173	166	155	88.4	71.7	85.8
(WY)	1970	1970	1977	1977	1977	1977	1977	1977	1977	1977	1977	1977

SUMMARY STATISTICS

FOR 2001 CALENDAR YEAR

FOR 2002 WATER YEAR

WATER YEARS 1970 - 2002

ANNUAL TOTAL	278865	507065	
ANNUAL MEAN	764.0	1389	2412
HIGHEST ANNUAL MEAN			5818 1982
LOWEST ANNUAL MEAN			229 1977
HIGHEST DAILY MEAN	2690 Dec 31	5040 Mar 10	140000 Jan 2 1997
LOWEST DAILY MEAN	234 Jun 30	394 Nov 7	62 Jul 19 1977
ANNUAL SEVEN-DAY MINIMUM	247 Jun 18	401 Oct 4	65 Jul 31 1977
MAXIMUM PEAK FLOW		5490 Mar 10	161000 Jan 2 1997
MAXIMUM PEAK STAGE		65.49 Mar 10	91.64 Jan 2 1997
ANNUAL RUNOFF (AC-FT)	553100	1006000	1747000
10 PERCENT EXCEEDS	1520	2490	5040
50 PERCENT EXCEEDS	648	1440	1310
90 PERCENT EXCEEDS	294	436	328

11421000 YUBA RIVER NEAR MARYSVILLE, CA—Continued

WATER-QUALITY RECORDS

PERIOD OF RECORD.—Water years 1951–52, 1973–80, 1990 to current year. Published as "Yuba River at Marysville" (station 11421500) during water years 1966, 1973–76.

CHEMICAL DATA: Water years 1951–52, 1973–80. Published as "Yuba River at Marysville" (station 11421500) water years 1966, 1973–76.
WATER TEMPERATURE: Water years 1973–78, 1990 to current year.

PERIOD OF DAILY RECORD.—

WATER TEMPERATURE: November 1972 to September 1978, October 1989 to current year.

INSTRUMENTATION.—Water-temperature recorder November 1972 to September 1978, October 1989 to current year.

REMARKS.—Water-temperature records are rated excellent except Oct. 1 to Nov. 8, Nov. 17–19, Jan. 26, 29, Feb. 1–6, Mar. 18 to Apr. 1, May 13–29, July 17–23, which are rated good; and Apr. 2–24, 26, which are rated fair. Water temperatures can be affected by releases from Englebright Reservoir located approximately 13 mi upstream from station. Interruptions in record were due to malfunction of the recording instrument.

EXTREMES FOR PERIOD OF DAILY RECORD.—

WATER TEMPERATURE: Maximum recorded, 28.5°C, July 16, 30, 1977, Aug. 11, 1992; minimum recorded, 4.5°C, Dec. 22, 23, 29–31, 1990.

EXTREMES FOR CURRENT YEAR.—

WATER TEMPERATURE: Maximum recorded, 21.0°C, Sept. 2; minimum recorded, 6.5°C, Jan. 23, 24, 29, Feb. 2, 3.

CROSS-SECTIONAL DATA, WATER YEAR OCTOBER 2001 TO SEPTEMBER 2002

DATE	TIME	DEPTH BOTTOM AT SAMPLE LOC- ATION, (FEET) (81903)	TEMPER- ATURE WATER (DEG C) (00010)	SAMPLE LOC- ATION, CROSS SECTION (FT FM L BANK) (00009)
APR				
26...*	0937	5.50	11.0	8.00
26...*	0940	4.00	11.0	23.0
26...*	0942	4.20	11.0	38.0
26...*	0944	5.20	11.0	53.0
26...*	0948	6.50	11.0	68.0
26...*	0951	6.50	11.0	83.0
26...*	0953	5.80	11.0	98.0
26...*	0956	4.50	11.0	113
26...*	0959	2.50	11.0	128
26...*	1002	.50	11.0	143
JUL				
17...*	1417	1.20	17.5	142
17...*	1423	3.20	17.0	127
17...*	1426	4.20	17.0	112
17...*	1430	5.70	17.0	97.0
17...*	1433	6.00	17.0	82.0
17...*	1435	5.30	17.0	67.0
17...*	1437	4.50	17.0	52.0
17...*	1440	3.30	17.0	37.0
17...*	1442	4.00	17.0	22.0
17...*	1444	3.90	17.0	7.00

* Instantaneous discharge at time of cross-sectional measurements: Apr. 26, 1,760 ft³/s; July 17, 1,420 ft³/s.

11421000 YUBA RIVER NEAR MARYSVILLE, CA—Continued

WATER TEMPERATURE (DEGREE C), WATER YEAR OCTOBER 2001 TO SEPTEMBER 2002

DAY	OCTOBER		NOVEMBER		DECEMBER		JANUARY		FEBRUARY		MARCH	
	MAX	MIN	MAX	MIN	MAX	MIN	MAX	MIN	MAX	MIN	MAX	MIN
1	20.0	16.0	16.0	13.0	11.0	10.0	10.5	9.0	9.0	7.0	---	---
2	20.5	16.5	16.0	13.0	11.5	10.0	11.5	10.0	9.5	6.5	---	---
3	20.5	16.5	16.0	13.0	11.0	9.5	11.5	9.5	9.5	6.5	---	---
4	20.0	16.5	16.5	13.0	11.5	9.0	11.0	8.5	9.5	7.0	---	---
5	19.5	16.0	16.0	13.0	10.5	9.5	10.0	9.5	9.5	7.0	---	---
6	19.5	15.5	15.5	13.0	11.5	10.0	11.0	9.5	---	7.0	---	---
7	19.0	15.5	15.5	12.5	12.0	10.0	10.5	9.5	---	---	---	---
8	19.0	15.5	16.0	12.5	11.5	9.5	10.5	9.0	---	---	---	---
9	18.5	15.0	15.5	10.5	12.0	9.5	10.5	9.0	---	---	---	---
10	18.5	14.5	15.0	11.0	11.5	9.0	11.5	9.0	---	---	---	---
11	18.5	15.5	15.0	11.5	11.5	8.5	11.0	9.0	---	---	---	---
12	18.0	14.0	14.0	11.0	11.5	9.0	10.0	9.0	---	---	---	---
13	18.5	14.5	14.0	11.0	11.0	9.0	10.0	8.5	---	---	---	---
14	19.0	15.0	15.0	11.0	10.5	8.5	10.0	7.5	---	---	---	---
15	19.0	15.5	15.0	11.0	10.5	8.0	9.5	8.0	---	---	---	---
16	18.0	15.5	14.5	10.0	10.5	8.5	10.0	7.5	---	---	---	---
17	19.0	15.5	15.5	11.0	10.0	8.5	9.5	7.5	---	---	---	---
18	19.0	15.0	14.5	10.5	10.5	9.0	10.0	7.5	---	---	11.5	---
19	18.0	15.0	14.5	10.0	11.0	9.5	9.5	7.5	---	---	12.0	8.5
20	18.0	14.5	14.5	11.0	10.0	8.5	9.5	7.0	---	---	11.5	9.0
21	17.5	14.0	14.0	10.5	10.5	8.5	9.0	7.0	---	---	12.0	9.0
22	17.5	14.0	15.0	11.0	10.0	8.5	9.0	7.0	---	---	10.5	9.0
23	17.0	14.0	13.5	10.0	11.0	9.0	9.5	6.5	---	---	11.0	9.5
24	16.5	13.0	13.0	9.5	10.0	8.5	9.5	6.5	---	---	12.0	10.0
25	16.5	13.5	12.5	10.0	10.0	8.5	9.5	7.0	---	---	12.0	9.5
26	17.0	13.5	12.5	10.5	10.5	9.0	9.0	7.5	---	---	12.5	9.5
27	16.0	13.5	12.5	9.5	10.0	9.0	9.0	7.0	---	---	13.0	9.5
28	15.5	14.0	11.5	10.0	11.0	9.0	8.0	7.0	---	---	14.0	9.5
29	15.5	14.0	11.5	10.0	10.5	9.0	---	6.5	---	---	14.0	10.0
30	14.5	14.0	12.0	10.5	10.5	9.5	---	---	---	---	14.0	10.0
31	16.5	13.5	---	---	12.0	9.5	---	---	---	---	14.0	10.0
MONTH	20.5	13.0	16.5	9.5	12.0	8.0	---	---	---	---	---	---
DAY	APRIL		MAY		JUNE		JULY		AUGUST		SEPTEMBER	
	MAX	MIN	MAX	MIN	MAX	MIN	MAX	MIN	MAX	MIN	MAX	MIN
1	15.0	10.5	14.5	10.5	17.5	13.5	19.0	13.0	18.5	13.0	20.5	15.0
2	15.0	11.0	15.0	10.0	18.0	12.5	18.5	13.5	18.5	13.0	21.0	15.5
3	15.0	11.0	14.5	10.5	18.5	13.0	---	13.0	18.0	13.0	20.5	15.5
4	13.0	11.0	15.0	10.0	19.0	13.5	18.5	13.0	17.5	13.0	20.0	15.0
5	13.0	11.0	15.5	10.5	19.0	14.0	18.5	13.0	18.0	13.0	19.0	14.0
6	14.5	11.0	16.0	10.5	19.0	14.0	19.0	13.0	17.5	12.5	19.5	14.5
7	14.5	11.0	15.5	11.0	19.0	13.5	18.5	13.0	18.0	12.5	19.5	14.0
8	14.5	11.0	15.5	10.5	18.0	13.0	19.0	13.0	17.5	12.5	20.0	14.5
9	12.5	11.5	15.5	10.5	18.0	12.5	19.0	13.5	17.5	12.5	19.5	14.5
10	15.0	11.0	15.0	10.5	19.0	13.0	19.0	13.5	17.5	13.0	20.0	15.0
11	14.5	11.5	15.5	10.5	19.5	14.0	18.0	13.5	18.0	12.5	20.5	15.0
12	15.5	11.5	15.5	10.5	19.0	14.0	18.0	13.5	17.5	12.5	20.5	15.5
13	15.5	11.5	15.5	11.0	19.0	13.5	18.5	13.0	17.5	13.0	20.0	15.5
14	16.0	11.5	16.0	10.5	18.5	13.0	18.5	13.0	17.5	13.0	20.0	15.5
15	14.5	11.0	16.5	11.0	19.0	13.5	18.0	13.0	17.5	13.0	19.0	15.5
16	12.5	11.0	16.5	11.0	19.0	13.0	18.0	12.5	17.5	13.0	20.0	15.0
17	14.0	10.5	16.5	11.0	19.0	13.0	18.0	12.5	17.5	13.0	20.0	15.5
18	15.0	10.5	16.0	11.0	19.0	13.5	17.5	13.0	18.0	12.5	20.0	15.0
19	15.0	10.0	13.0	11.0	19.0	13.5	18.5	13.0	18.0	13.0	20.0	15.0
20	15.0	10.5	13.0	11.5	19.0	13.5	18.0	13.0	18.0	13.0	20.5	15.5
21	15.0	10.0	15.0	11.5	18.0	13.0	17.5	13.0	18.5	13.0	20.5	15.5
22	15.5	10.5	16.0	11.0	18.0	13.0	18.5	13.0	18.5	13.0	20.5	15.5
23	16.0	11.0	16.0	11.0	18.5	13.0	18.5	13.0	18.5	13.0	20.0	15.5
24	15.0	11.0	16.5	11.0	19.0	13.0	18.5	13.0	19.0	13.0	20.0	15.5
25	15.0	10.5	17.0	11.5	19.0	13.5	18.0	13.0	19.0	13.0	20.0	15.5
26	12.0	10.5	16.5	12.0	18.5	13.5	18.0	12.5	19.5	13.5	20.0	15.5
27	13.5	10.0	16.5	12.0	18.5	13.0	18.5	13.0	20.0	14.0	19.0	15.0
28	14.0	9.5	17.5	12.5	18.0	13.5	18.0	13.0	20.0	14.5	19.5	15.0
29	12.0	10.5	18.5	13.0	18.5	13.0	18.5	13.0	20.0	15.0	19.5	15.5
30	14.0	10.0	19.0	13.0	19.0	13.0	17.5	13.5	20.5	15.0	19.0	15.0
31	---	---	18.5	13.5	---	---	18.0	13.0	20.5	15.0	---	---
MONTH	16.0	9.5	19.0	10.0	19.5	12.5	---	12.5	20.5	12.5	21.0	14.0

11421710 BEAR RIVER NEAR EMIGRANT GAP, CA

LOCATION.—Lat 39°18'23", long 120°40'41", in NW 1/4 SW 1/4 sec.30, T.17 N., R.12 E., [Placer County](#), Hydrologic Unit 18020126, on left bank, 20 ft upstream from Highway 20 Bridge, and 0.7 mi northwest of Emigrant Gap.

DRAINAGE AREA.—0.76 mi².

PERIOD OF RECORD.—October 1987 to current year (low-flow records only). Unpublished records for water years 1981–87 available in files of the U.S. Geological Survey.

GAGE.—Water-stage recorder and concrete culvert. Elevation of gage is 4,550 ft above sea level, from topographic map. Prior to October 1987, nonrecording gage at same site and datum.

REMARKS.—No records computed above 160 ft³/s. Some water is diverted into stream from South Yuba Canal (station 11414200). See schematic diagram of [Bear River Basin](#).

COOPERATION.—Records were collected by Pacific Gas & Electric Co., under general supervision of the U.S. Geological Survey, in connection with Federal Energy Regulatory Commission project no. 2310.

DISCHARGE, CUBIC FEET PER SECOND, WATER YEAR OCTOBER 2001 TO SEPTEMBER 2002

DAILY MEAN VALUES

DAY	OCT	NOV	DEC	JAN	FEB	MAR	APR	MAY	JUN	JUL	AUG	SEP
1	8.5	8.1	8.1	19	7.3	11	15	9.2	---	6.6	6.1	6.9
2	7.4	8.4	26	38	6.9	9.5	16	8.4	---	6.6	6.1	7.5
3	7.1	8.2	13	32	6.6	9.2	17	8.0	---	6.5	6.1	7.7
4	6.7	8.5	10	17	7.0	9.2	64	7.6	---	5.8	6.1	7.5
5	7.5	8.5	9.2	15	7.3	9.6	115	7.4	---	6.0	6.1	7.3
6	9.1	8.3	11	26	7.3	48	115	7.1	---	5.7	6.1	6.7
7	8.0	8.1	9.9	19	11	26	115	7.0	---	7.1	5.9	6.1
8	7.3	8.1	8.8	16	15	18	115	6.7	---	6.8	5.7	6.1
9	7.1	8.1	8.5	15	10	13	117	7.0	---	6.8	5.7	6.1
10	13	8.1	8.0	14	8.6	14	118	7.9	---	7.3	6.0	6.1
11	8.0	8.5	7.7	13	8.2	13	118	7.3	8.3	7.2	6.1	6.1
12	6.7	10	7.3	13	8.6	14	118	7.4	7.1	7.0	6.1	6.1
13	6.9	8.9	7.3	12	9.2	14	117	7.5	8.8	6.5	6.1	6.1
14	6.7	8.2	8.2	12	10	12	54	7.6	9.6	6.0	6.1	5.9
15	6.5	8.1	7.4	11	10	11	11	8.3	8.0	6.0	6.1	6.8
16	6.7	8.1	7.3	10	10	10	11	7.9	7.9	5.5	6.1	8.8
17	6.9	8.1	11	10	12	9.8	11	7.5	7.9	5.7	6.1	9.9
18	7.1	8.1	10	9.6	9.5	9.2	11	7.1	7.9	5.7	6.1	10
19	7.0	8.1	9.0	9.4	22	9.4	11	8.0	7.8	5.7	5.7	10
20	7.4	8.1	8.7	9.1	39	10	12	11	7.8	5.7	5.7	9.1
21	7.7	11	8.2	9.1	20	11	12	9.2	7.7	5.7	6.0	8.6
22	7.4	15	7.9	8.7	17	13	12	9.4	6.8	5.5	6.7	8.0
23	7.3	9.0	7.9	7.6	17	16	10	8.0	6.5	5.4	6.9	22
24	7.1	14	7.4	8.2	14	14	9.4	45	6.9	5.4	6.9	46
25	6.9	5.6	7.0	8.5	13	13	8.8	93	7.3	5.2	7.1	37
26	6.9	7.4	7.0	8.5	13	14	8.7	93	7.1	5.2	7.1	7.9
27	6.9	7.3	7.8	8.0	13	14	11	92	7.1	5.1	7.1	9.0
28	6.9	7.7	13	7.7	12	15	11	92	7.0	5.5	7.1	6.9
29	7.3	7.9	19	7.7	---	17	10	92	6.1	5.8	7.4	6.5
30	8.5	7.5	23	7.7	---	16	10	---	5.7	5.7	7.7	6.2
31	7.5	---	41	7.3	---	16	---	---	---	5.7	7.2	---
TOTAL	232.0	259.0	345.6	409.1	344.5	438.9	1383.9	---	---	186.4	197.3	304.9
MEAN	7.484	8.633	11.15	13.20	12.30	14.16	46.13	---	---	6.013	6.365	10.16
MAX	13	15	41	38	39	48	118	---	---	7.3	7.7	46
MIN	6.5	5.6	7.0	7.3	6.6	9.2	8.7	---	---	5.1	5.7	5.9
AC-FT	460	514	685	811	683	871	2740	---	---	370	391	605

11421770 BEAR RIVER BELOW DRUM AFTERBAY, NEAR BLUE CANYON, CA

LOCATION.—Lat 39°15'16", long 120°46'26", in SW 1/4 NW 1/4 sec.17, T.16 N., R.11 E., [Placer County](#), Hydrologic Unit 18020126, on left bank, 60 ft downstream from Drum Afterbay Dam, and 3.5 mi west of Blue Canyon.

DRAINAGE AREA.—12.3 mi².

PERIOD OF RECORD.—April 1966 to current year, low flows only April to September 1966 and since October 1998.

GAGE.—Water-stage recorder and 4-ft steel Cipolletti weir set in a concrete broad-crested weir. Elevation of gage is 3,300 ft above sea level, from topographic map. April 1966 to May 25, 1967, water-stage recorder at present site at different datum. May 26, 1967, to Feb. 11, 1968, water-stage recorder at site 1,000 ft downstream at different datum.

REMARKS.—Records not computed above 13.5 ft³/s. Water for Dutch Flat No. 1 Powerplant (station 11421750) and Dutch Flat No. 2 Flume (station 11421760) is diverted from Drum Afterbay just upstream from station. See schematic diagram of [Bear River Basin](#).

COOPERATION.—Records were collected by Pacific Gas & Electric Co., under general supervision of the U.S. Geological Survey, in connection with Federal Energy Regulatory Commission project no. 2310.

DISCHARGE, CUBIC FEET PER SECOND, WATER YEAR OCTOBER 2001 TO SEPTEMBER 2002

DAILY MEAN VALUES

DAY	OCT	NOV	DEC	JAN	FEB	MAR	APR	MAY	JUN	JUL	AUG	SEP
1	6.4	6.4	6.1	6.1	6.1	11	---	---	11	11	11	11
2	6.3	6.4	6.1	6.1	6.1	11	---	---	11	11	11	11
3	6.3	6.4	6.1	6.1	6.1	11	---	---	11	11	11	11
4	6.3	6.4	6.1	6.0	6.1	11	---	---	11	11	11	11
5	6.3	6.4	6.1	6.1	6.1	11	---	---	11	11	11	11
6	6.3	6.4	6.0	6.1	6.1	---	---	---	11	11	11	11
7	6.3	6.3	6.1	6.0	6.1	---	---	---	11	11	11	11
8	6.3	6.3	6.1	6.1	6.1	---	---	---	11	11	11	11
9	6.3	6.3	6.1	6.0	6.1	11	---	---	11	---	11	11
10	6.3	6.3	6.1	6.1	6.1	---	---	---	11	11	11	11
11	6.3	6.3	6.1	6.2	6.1	---	---	---	11	---	11	11
12	6.3	6.3	6.1	6.2	6.1	---	---	---	11	11	11	11
13	6.2	6.3	6.1	6.3	6.1	---	---	---	11	11	11	11
14	6.3	6.2	6.1	6.2	6.0	---	---	---	11	11	11	11
15	6.2	6.1	6.1	6.3	6.0	---	---	---	11	11	11	11
16	6.3	6.1	6.1	6.2	6.0	---	---	---	11	11	11	11
17	6.4	6.0	6.1	6.3	6.1	---	---	---	11	11	11	11
18	6.3	6.1	6.1	6.2	6.1	---	---	---	11	11	11	11
19	6.4	6.1	6.1	6.2	6.1	---	---	---	11	---	11	11
20	6.4	6.1	6.1	6.2	6.0	---	---	---	11	11	11	11
21	6.4	6.1	6.1	6.2	6.0	---	---	---	11	11	11	11
22	6.4	6.1	6.1	6.3	6.0	---	---	---	11	11	11	11
23	6.5	6.1	6.1	---	6.1	---	---	---	11	11	11	11
24	6.4	6.1	6.1	---	6.1	---	---	---	11	11	---	11
25	6.4	6.1	6.1	6.1	6.1	---	---	11	11	11	11	11
26	6.4	6.1	6.1	6.1	6.1	---	---	11	11	---	11	11
27	6.4	6.1	6.1	6.1	6.1	---	---	11	11	11	---	11
28	6.4	6.1	6.1	6.2	9.4	---	---	11	11	11	11	11
29	6.4	6.1	6.1	6.1	---	---	---	11	11	---	11	11
30	6.4	6.0	6.1	6.2	---	---	---	11	11	---	11	11
31	6.4	---	6.1	6.2	---	---	---	11	---	11	11	---
TOTAL	196.7	186.1	189.0	---	173.5	---	---	---	330	---	---	330
MEAN	6.345	6.203	6.097	---	6.196	---	---	---	11.00	---	---	11.00
MAX	6.5	6.4	6.1	---	9.4	---	---	---	11	---	---	11
MIN	6.2	6.0	6.0	---	6.0	---	---	---	11	---	---	11
AC-FT	390	369	375	---	344	---	---	---	655	---	---	655
a	100	325	5110	24800	20620	31480	34740	37080	27840	30490	29760	13640
b	3870	5360	10200	20380	1170	0	0	4420	15710	3900	1780	117

CAL YR 2001 a 99560 b 256000

WTR YR 2002 a 108900 b 66900

a Diversion, in acre-feet, to Dutch Flat No. 2 Flume (station 11421750), provided by Nevada Irrigation District.

b Diversion, in acre-feet, to Dutch Flat No. 1 Powerplant (station 11421760), provided by Pacific Gas & Electric Co.

11421790 BEAR RIVER BELOW DUTCH FLAT AFTERBAY, NEAR DUTCH FLAT, CA

LOCATION.—Lat 39°12'49", long 120°50'39", in NE 1/4 NW 1/4 sec.34, T.16 N., R.10 E., Placer County, Hydrologic Unit 18020126, at left bank downstream end of spillway, on Dutch Flat Afterbay Dam, and 0.6 mi north of Dutch Flat.

DRAINAGE AREA.—21.5 mi².

PERIOD OF RECORD.—December 1965 to current year.

REVISED RECORDS.—WDR CA-82-4: 1978, 1979(M), 1980.

GAGE.—Water-stage recorder and concrete control. Elevation of gage is 2,600 ft above sea level, from topographic map.

REMARKS.—Water is imported from South Yuba River Basin via Drum Canal above forebay. Chicago Park Flume (station 11421780) diverts upstream from station to Chicago Park Powerplant. Records include spill over Dutch Flat Afterbay Dam. See schematic diagram of Bear River Basin.

COOPERATION.—Records were collected by Nevada Irrigation District, under general supervision of the U.S. Geological Survey, in connection with Federal Energy Regulatory Commission project no. 2266.

EXTREMES FOR PERIOD OF RECORD.—Maximum discharge, 4,240 ft³/s, Feb. 17, 1986; minimum daily, 0.08 ft³/s, Mar. 8–19, 1968.

DISCHARGE, CUBIC FEET PER SECOND, WATER YEAR OCTOBER 2001 TO SEPTEMBER 2002

DAILY MEAN VALUES

DAY	OCT	NOV	DEC	JAN	FEB	MAR	APR	MAY	JUN	JUL	AUG	SEP
1	12	8.1	8.0	8.2	7.8	7.9	8.0	12	12	12	12	12
2	12	8.2	8.0	7.8	7.8	7.9	8.0	12	12	12	12	12
3	12	8.2	8.0	7.8	7.8	7.9	8.2	12	12	12	12	12
4	12	8.2	8.0	144	7.8	8.0	8.2	12	12	12	12	12
5	12	8.2	8.0	7.9	7.8	7.9	8.2	12	12	12	12	12
6	11	8.2	8.0	7.8	7.8	8.1	8.2	12	12	12	12	12
7	7.6	8.2	8.0	7.9	7.8	8.1	8.1	12	12	12	12	12
8	7.8	8.2	8.0	7.8	7.9	8.1	8.1	12	12	12	12	12
9	7.8	8.1	8.0	7.8	7.8	8.0	8.1	12	12	12	12	12
10	7.8	8.1	8.0	7.9	7.8	28	8.1	12	12	12	13	12
11	7.8	8.2	8.0	7.8	8.0	8.1	8.1	12	12	12	13	12
12	7.7	8.2	8.0	7.8	7.8	8.1	8.1	12	12	12	12	12
13	7.6	8.2	8.0	7.8	7.9	8.1	8.1	12	12	12	13	12
14	7.5	8.1	8.0	7.8	7.9	8.0	8.1	12	12	12	12	12
15	7.6	8.2	8.0	7.8	8.0	8.0	8.1	12	12	12	12	22
16	7.6	8.2	8.0	7.8	8.0	8.0	8.1	12	12	12	12	45
17	7.8	8.2	8.0	7.8	7.9	8.1	8.1	12	12	12	12	54
18	7.8	8.0	8.0	7.8	8.0	8.0	8.1	12	12	12	13	53
19	7.8	8.0	8.0	7.8	8.0	8.0	8.1	12	12	12	13	53
20	8.0	8.0	8.0	7.8	8.0	8.0	8.1	12	12	12	12	31
21	8.0	8.0	8.0	7.8	7.9	8.0	8.0	12	12	12	12	20
22	8.0	8.0	8.0	7.8	7.9	8.0	8.0	12	12	12	12	20
23	8.0	8.0	8.0	7.8	7.9	8.1	8.0	12	12	12	12	20
24	8.0	8.0	7.9	7.8	7.9	8.1	8.1	12	12	12	12	20
25	8.0	8.0	7.9	7.8	7.9	8.0	8.0	12	12	12	12	20
26	8.0	8.0	7.8	7.8	7.9	8.0	8.0	12	12	12	12	17
27	8.0	8.0	7.9	7.9	7.9	8.0	8.1	12	12	12	12	13
28	8.0	8.0	7.8	7.9	7.9	8.0	8.2	12	12	12	13	13
29	8.0	8.0	7.9	7.8	---	8.0	8.1	12	12	13	12	13
30	8.0	8.0	7.9	7.9	---	8.0	10	12	12	12	12	13
31	8.0	---	26	7.8	---	8.0	---	12	---	12	13	---
TOTAL	267.2	243.0	265.1	379.0	220.8	268.5	244.7	372	360	373	379	595
MEAN	8.619	8.100	8.552	12.23	7.886	8.661	8.157	12.00	12.00	12.03	12.23	19.83
MAX	12	8.2	26	144	8.0	28	10	12	12	13	13	54
MIN	7.5	8.0	7.8	7.8	7.8	7.9	8.0	12	12	12	12	12
AC-FT	530	482	526	752	438	533	485	738	714	740	752	1180
a	4400	7570	19650	51610	26920	45290	51540	50370	43070	34810	31780	14000

a Diversion, in acre-feet, to Chicago Park Flume (station 11421780).

11421790 BEAR RIVER BELOW DUTCH FLAT AFTERBAY, NEAR DUTCH FLAT, CA—Continued

STATISTICS OF MONTHLY MEAN DATA FOR WATER YEARS 1966 - 2002, BY WATER YEAR (WY)

	OCT	NOV	DEC	JAN	FEB	MAR	APR	MAY	JUN	JUL	AUG	SEP
MEAN	18.35	11.56	40.97	49.76	55.39	61.46	58.05	24.70	13.87	10.96	10.67	14.76
MAX	266	71.1	350	531	380	395	602	142	63.5	22.0	13.1	21.5
(WY)	1968	1984	1997	1997	1986	1966	1969	1998	1998	1970	1969	2001
MIN	4.81	2.65	2.42	4.94	4.10	4.26	3.94	5.30	5.13	5.00	5.00	5.00
(WY)	1978	1968	1968	1975	1974	1973	1973	1977	1977	1977	1977	1977

SUMMARY STATISTICS	FOR 2001 CALENDAR YEAR		FOR 2002 WATER YEAR		WATER YEARS 1966 - 2002	
ANNUAL TOTAL	3903.8		3967.3			
ANNUAL MEAN	10.70		10.87		27.85	
HIGHEST ANNUAL MEAN					80.1 1982	
LOWEST ANNUAL MEAN					5.53 1977	
HIGHEST DAILY MEAN	108	Jan 21	144	Jan 4	3400	Feb 17 1986
LOWEST DAILY MEAN	7.1	Jan 18	7.5	Oct 14	0.08	Mar 8 1968
ANNUAL SEVEN-DAY MINIMUM	7.3	Feb 14	7.7	Oct 10	0.08	Mar 8 1968
MAXIMUM PEAK FLOW			703	Jan 4	4240	Feb 17 1986
ANNUAL RUNOFF (AC-FT)	7740		7870		20170	
ANNUAL DIVERSION (AC-FT) a	228700		381000			
10 PERCENT EXCEEDS	11		12		24	
50 PERCENT EXCEEDS	8.0		8.1		9.6	
90 PERCENT EXCEEDS	7.3		7.8		5.0	

a Diversion, in acre-feet, to Chicago Park Flume (station 11421780).

11421800 ROLLINS RESERVOIR NEAR COLFAX, CA

LOCATION.—Lat 39°08'08", long 120°56'57", in NE 1/4 SE 1/4 sec.22, T.15 N., R.9 E., [Placer County](#), Hydrologic Unit 18020126, on left bank, 300 ft upstream from Rollins Dam on Bear River, and 2.3 mi north of Colfax.

DRAINAGE AREA.—104 mi².

PERIOD OF RECORD.—December 1964 to current year.

REVISED RECORDS.—WDR CA-01-4: Oct. 10, 1977, contents; 1978–2000, minimum contents for period of record.

GAGE.—Water-stage recorder. Datum of gage is sea level (levels by Nevada Irrigation District).

REMARKS.—Reservoir is formed by an earthfill dam. Storage began Dec. 15, 1964. Usable capacity, 66,000 acre-ft, between elevations 1,970.0 ft, invert of outlet tunnel, and 2,171.0 ft, spillway crest. Dead storage, 270 acre-ft. Several diversions into and out of basin upstream for power development and irrigation. Water is normally released through Rollins Powerplant (station 11421900). Part of the water then is diverted to Bear River Canal (station 11422000) for power development. Water is later used for irrigation. See schematic diagram of [Bear River Basin](#).

COOPERATION.—Records were collected by Nevada Irrigation District, under general supervision of the U.S. Geological Survey, in connection with Federal Energy Regulatory Commission project no. 2266.

EXTREMES FOR PERIOD OF RECORD.—Maximum contents, 71,700 acre-ft, Feb. 17, 1986, elevation, 2,177.7 ft; minimum since reservoir first filled, 4,550 acre-ft, Oct. 13, 1977, elevation, 2,204.7 ft.

EXTREMES FOR CURRENT YEAR.—Maximum contents, 66,900 acre-ft, Mar. 23, 24, maximum elevation, 2,172.04 ft, Mar. 24; minimum, 34,000 acre-ft, Oct. 28, 29, minimum elevation, 2,122.50 ft, Oct. 28.

Capacity table (elevation, in feet, and contents, in acre-feet)
(Based on table provided by Nevada Irrigation District in 1964)

2,020	3,920	2,050	8,940	2,100	23,900	2,160	57,300
2,030	5,320	2,060	11,200	2,120	32,700	2,178	72,000
2,040	6,990	2,080	16,800	2,140	43,800		

RESERVOIR STORAGE (ACRE-FEET), WATER YEAR OCTOBER 2001 TO SEPTEMBER 2002

DAILY OBSERVATION AT 2400 HOURS

DAY	OCT	NOV	DEC	JAN	FEB	MAR	APR	MAY	JUN	JUL	AUG	SEP
1	43400	34500	41500	54100	64700	64100	66300	66500	66700	64700	65300	62200
2	42700	34800	44000	55800	63900	63800	66500	66500	66700	65000	65300	62000
3	42000	34900	45100	57600	63000	63500	66600	66500	66700	65300	65300	61900
4	41300	35100	45400	58400	62500	63200	66600	66500	66600	65600	65300	61700
5	e41000	35300	46500	59000	62100	62900	66700	66400	66600	65800	65200	61600
6	e40200	35500	47600	59700	61800	64100	66700	66500	66500	65300	65200	61500
7	e39400	35600	48100	60200	61500	66500	66700	66400	66600	64800	65100	61400
8	e38700	35700	48300	60700	61600	66800	66700	66400	66600	64300	65000	61200
9	e38000	35900	48600	61100	60900	66500	66700	66400	66500	64000	65000	61100
10	e37500	36000	48700	61500	60500	66700	66700	66400	66400	63900	64500	61100
11	e37100	36200	48800	62000	60300	66600	66600	66400	66100	64300	63900	61000
12	e36600	36500	48800	62500	60000	66500	66600	66400	65900	64500	63700	60900
13	e36200	36900	49000	62900	59800	66500	66600	66400	65300	64600	63600	60900
14	e36000	37100	49600	63100	59700	66500	66600	66400	64900	64700	63700	60900
15	e35900	37200	49700	63500	59700	66500	66500	66300	64600	64800	63600	60400
16	e35800	36900	49800	63800	59900	66500	66500	66300	64500	64500	63600	59400
17	e35800	36900	51300	64000	60000	66500	66600	66300	64300	64500	63500	58500
18	e35800	36800	52200	64300	60100	66500	66600	66200	64100	64600	63500	57500
19	e35700	36800	52600	64500	61000	66500	66600	66300	64300	64600	63100	56600
20	e35700	36800	53300	64600	63600	66500	66600	66500	64500	64700	63000	55600
21	e35500	37000	52600	64600	64400	66400	66600	66300	64900	64800	62900	54700
22	35200	37700	52400	64700	64700	66500	66600	66300	64500	64900	62800	53700
23	35000	38000	52100	64100	64900	66900	66600	66400	63900	64900	62700	52700
24	34800	38800	51500	64200	64900	66900	66500	66400	64000	65000	62800	51600
25	34700	39800	50700	64300	64900	66700	66600	66500	64300	65100	62700	50600
26	34500	39900	49700	64700	64800	66700	66500	66500	64600	65100	62600	49600
27	34200	40000	49500	65000	64700	66700	66500	66500	64900	65200	62900	48600
28	34000	40000	49500	65000	64300	66700	66500	66500	65300	65200	62800	47500
29	34000	40500	50100	65100	---	66700	66500	66500	64800	65200	63000	46500
30	34200	40900	50800	65300	---	66600	66500	66500	64500	65300	63200	45500
31	34300	---	52900	65100	---	66700	---	66700	---	65400	62700	---
MAX	43400	40900	53300	65300	64900	66900	66700	66700	66700	65800	65300	62200
MIN	34000	34500	41500	54100	59700	62900	66300	66200	63900	63900	62600	45500
a	2123.17	2135.10	2153.97	2169.97	2168.95	2171.80	2171.66	2171.78	2169.14	2170.24	2166.94	2142.76
b	-9800	+6600	+12000	+12200	-800	+2400	-200	+200	-2200	+900	-2700	-17200
c	12010	2140	25100	57930	44060	60780	57680	59780	49990	36140	37130	32760
CAL YR 2001	MAX 66100	MIN 34000	b -600	c 289100								
WTR YR 2002	MAX 66900	MIN 34000	b +1400	c 475500								

e Estimated.

a Elevation, in feet, at end of month.

b Change in contents, in acre-feet.

c Discharge, in acre-feet, through Rollins Powerplant (station 11421900), provided by Pacific Gas & Electric Co.

11422000 BEAR RIVER CANAL INTAKE NEAR COLFAX, CA

LOCATION.—Lat 39°07'58", long 120°57'12", in SW 1/4 SE 1/4 sec.22, T.15 N., R.9 E., [Placer County](#), Hydrologic Unit 18020126, on right bank, 400 ft downstream from canal inlet, 0.2 mi downstream from Rollins Dam, and 2.2 mi north of Colfax.

PERIOD OF RECORD.—January 1912 to September 1953, October 1964 to current year. Monthly discharge only for some periods published in WSP 1315-A. Prior to October 1912, published as "Pacific Gas & Electric Co.'s Canal near Colfax"; October 1912 to September 1953, published as "Bear River Canal near Colfax".

GAGE.—Water-stage recorder. Elevation of gage is 1,950 ft above sea level, from topographic map. Prior to Mar. 25, 1946, water-stage recorder at site 1.5 mi downstream at different datum.

REMARKS.—Canal diverts from left bank of Bear River. Water is used to develop power at Halsey and Wise Powerplants (stations 11425310 and 11425415). Part of the water is distributed for irrigation, and the remainder is eventually spilled into North Fork American River. Capacity of canal is believed to have been increased in 1917 and 1931. See schematic diagram of [Bear River Basin](#).

COOPERATION.—Records were collected by Pacific Gas & Electric Co., under general supervision of the U.S. Geological Survey, in connection with Federal Energy Regulatory Commission project no. 2310.

EXTREMES FOR PERIOD OF RECORD.—Maximum daily discharge, 531 ft³/s, Oct. 5, 6, 1980; no flow at times in most years.

DISCHARGE, CUBIC FEET PER SECOND, WATER YEAR OCTOBER 2001 TO SEPTEMBER 2002

DAILY MEAN VALUES

DAY	OCT	NOV	DEC	JAN	FEB	MAR	APR	MAY	JUN	JUL	AUG	SEP
1	279	0.00	107	379	436	451	452	443	453	447	452	452
2	279	0.00	109	379	435	451	449	446	453	447	452	452
3	279	0.00	110	379	436	451	445	446	453	447	452	452
4	278	0.00	110	379	436	451	445	446	452	448	452	452
5	287	0.00	111	379	436	416	445	446	452	447	452	452
6	292	0.00	154	379	436	344	444	446	452	448	453	452
7	290	0.00	177	379	430	344	444	446	451	448	452	451
8	289	0.00	177	413	438	344	443	446	451	448	452	451
9	287	0.00	178	435	453	344	443	446	450	449	452	450
10	286	0.00	175	435	452	344	443	446	450	449	453	450
11	279	0.00	177	435	452	420	442	446	450	447	453	450
12	251	0.00	180	435	452	455	442	446	450	447	453	450
13	240	0.00	178	435	438	455	442	446	450	447	453	448
14	64	0.00	176	451	428	455	442	445	449	447	454	446
15	64	83	176	459	426	455	441	451	449	448	453	446
16	64	243	176	459	414	401	441	457	449	449	453	446
17	64	159	177	459	413	399	441	456	448	449	453	445
18	64	137	178	459	432	425	441	456	449	449	453	445
19	64	118	179	459	432	451	441	454	447	449	453	445
20	100	116	220	459	401	450	441	411	447	449	453	445
21	124	114	300	385	428	450	441	456	447	449	453	444
22	133	113	299	421	428	429	441	455	447	450	453	443
23	145	111	300	461	428	359	440	455	447	451	453	441
24	126	108	299	461	447	341	441	454	446	451	453	441
25	122	109	299	429	450	358	441	454	446	451	453	446
26	141	109	299	410	450	430	441	454	446	451	452	446
27	171	109	299	410	451	453	441	454	446	451	452	445
28	130	109	300	379	451	453	441	454	446	451	452	443
29	13	109	299	416	---	453	400	454	447	451	452	444
30	0.00	107	300	435	---	453	412	454	447	452	452	444
31	0.00	---	376	435	---	452	---	454	---	452	452	---
TOTAL	5205.00	1954.00	6595	13088	12209	12937	13206	13923	13470	13919	14030	13417
MEAN	167.9	65.13	212.7	422.2	436.0	417.3	440.2	449.1	449.0	449.0	452.6	447.2
MAX	292	243	376	461	453	455	452	457	453	452	454	452
MIN	0.00	0.00	107	379	401	341	400	411	446	447	452	441
AC-FT	10320	3880	13080	25960	24220	25660	26190	27620	26720	27610	27830	26610
a	6670	2850	12180	23310	21740	23270	23520	24410	22510	24390	24410	23440
b	5380	3800	14390	20430	19080	20660	20450	20810	21630	22730	23160	21590

a Discharge, in acre-feet, to Halsey Powerplant (station 11425310), provided by Pacific Gas & Electric Co.

b Discharge, in acre-feet, to Wise Powerplant (station 11425415), provided by Pacific Gas & Electric Co.

SACRAMENTO RIVER BASIN

11422000 BEAR RIVER CANAL INTAKE NEAR COLFAX, CA—Continued

STATISTICS OF MONTHLY MEAN DATA FOR WATER YEARS 1918 - 1931, BY WATER YEAR (WY)

	OCT	NOV	DEC	JAN	FEB	MAR	APR	MAY	JUN	JUL	AUG	SEP
MEAN	184	158	156	124	139	154	200	253	253	250	251	235
MAX	300	285	281	257	265	257	286	278	300	317	300	300
(WY)	1929	1929	1925	1925	1925	1922	1925	1925	1927	1931	1926	1927
MIN	.000	.000	.000	.000	.000	.000	53.2	158	190	162	167	93.7
(WY)	1930	1930	1930	1930	1930	1930	1931	1931	1931	1918	1918	1924

SUMMARY STATISTICS

WATER YEARS 1918 - 1931

ANNUAL MEAN	197
HIGHEST ANNUAL MEAN	245 1929
LOWEST ANNUAL MEAN	121 1931
HIGHEST DAILY MEAN	345 Aug 2 1931
LOWEST DAILY MEAN	.00 Nov 12 1917
ANNUAL SEVEN-DAY MINIMUM	.00 Mar 17 1918
ANNUAL RUNOFF (AC-FT)	142400
10 PERCENT EXCEEDS	300
50 PERCENT EXCEEDS	232
90 PERCENT EXCEEDS	.00

STATISTICS OF MONTHLY MEAN DATA FOR WATER YEARS 1932 - 2002, BY WATER YEAR (WY)

	1932	1933	1934	1935	1936	1937	1938	1939	1940	1941	1942	1943	1944	1945	1946	1947	1948	1949	1950	1951	1952	1953	1954	1955	1956	1957	1958	1959	1960	1961	1962	1963	1964	1965	1966	1967	1968	1969	1970	1971	1972	1973	1974	1975	1976	1977	1978	1979	1980	1981	1982	1983	1984	1985	1986	1987	1988	1989	1990	1991	1992	1993	1994	1995	1996	1997	1998	1999	2000	2001	2002
MEAN	328.3	305.1	368.2	352.9	345.9	323.9	317.1	390.6	403.2	411.0	410.7	396.5																																																											
MAX	492	495	488	479	478	485	490	498	499	493	497	496																																																											
(WY)	1968	1968	1976	1979	1980	1980	1978	1978	1978	1967	1967	1967																																																											
MIN	69.8	27.9	52.7	8.65	27.8	18.5	18.4	106	139	143	136	114																																																											
(WY)	1978	1978	1977	1946	1946	1977	1940	1977	1977	1977	1977	1977																																																											

SUMMARY STATISTICS

FOR 2001 CALENDAR YEAR

FOR 2002 WATER YEAR

WATER YEARS 1932 - 2002

ANNUAL TOTAL	110700.00	133953.00	
ANNUAL MEAN	303.3	367.0	363.0
HIGHEST ANNUAL MEAN			462 1980
LOWEST ANNUAL MEAN			118 1977
HIGHEST DAILY MEAN	453 Mar 15	461 Jan 23	531 Oct 5 1980
LOWEST DAILY MEAN	0.00 Oct 30	0.00 Oct 30	0.00 Mar 12 1932
ANNUAL SEVEN-DAY MINIMUM	0.00 Oct 30	0.00 Oct 30	0.00 Mar 12 1932
ANNUAL RUNOFF (AC-FT)	219600	265700	263000
ANNUAL DISCHARGE (AC-FT) a	187400	232700	
ANNUAL DISCHARGE (AC-FT) b	175200	214100	
10 PERCENT EXCEEDS	440	453	474
50 PERCENT EXCEEDS	331	445	424
90 PERCENT EXCEEDS	111	111	139

a Discharge, in acre-feet, to Halsey Powerplant (station 11425310), provided by Pacific Gas & Electric Co.

b Discharge, in acre-feet, to Wise Powerplant (station 11425415), provided by Pacific Gas & Electric Co.

11422500 BEAR RIVER BELOW ROLLINS DAM, NEAR COLFAX, CA

LOCATION.—Lat 39°07'53", long 120°57'29", in SE 1/4 SW 1/4 sec.22, T.15 N., R.9 E., Nevada County, Hydrologic Unit 18020126, on right bank, 20 ft upstream from new highway bridge, 0.5 mi downstream from Rollins Dam, and 2.2 mi north of Colfax.

DRAINAGE AREA.—105 mi².

PERIOD OF RECORD.—January 1912 to September 1913, October 1913 to July 1915 (gage heights and discharge measurements only), August 1915 to June 1917, November 1949 to September 1953, August 1964 to current year. Monthly discharge only for some periods, published in WSP 1315-A. Prior to August 1964, published as Bear River near Colfax. Records for November and December 1911 include diversion to Bear River Canal and are not equivalent.

GAGE.—Water-stage recorder and concrete control. Datum of gage is 1,927.41 ft above sea level. Prior to Aug. 8, 1915, nonrecording gages at several sites above diversion dam 0.3 mi upstream at different datums. Aug. 8, 1915, to June 30, 1917, nonrecording gage 0.7 mi downstream at different datum. Nov. 1, 1949, to Sept. 30, 1953, at site 0.2 mi downstream at different datum. Aug. 17, 1964, to Feb. 4, 1986, at present site and datum. Feb. 5, 1986, to Mar. 19, 1987, at site 160 ft downstream at datum 8.00 ft lower.

REMARKS.—Flow regulated by Rollins Reservoir (station 11421800) beginning Dec. 15, 1964. Bear River Canal (station 11422000) diverts upstream from station. See schematic diagram of [Bear River Basin](#).

COOPERATION.—Records were collected by Nevada Irrigation District, under general supervision of the U.S. Geological Survey, in connection with Federal Energy Regulatory Commission project no. 2266.

EXTREMES FOR PERIOD OF RECORD.—Maximum discharge (prior to construction of Rollins Dam in 1964), 9,620 ft³/s, Nov. 20, 1950, gage height, 21.40 ft, site and datum then in use, from rating curve extended above 3,600 ft³/s, on basis of slope-area measurement of peak flow; no flow at times in 1912, 1952. Maximum discharge since construction of Rollins Dam, 34,300 ft³/s, Jan. 2, 1997, gage height, 18.01 ft, maximum gage height, 20.62 ft, Feb. 17, 1986, site and datum then in use, from rating curve extended above 11,600 ft³/s; minimum daily, 0.5 ft³/s, Nov. 17, 1964.

DISCHARGE, CUBIC FEET PER SECOND, WATER YEAR OCTOBER 2001 TO SEPTEMBER 2002

DAILY MEAN VALUES

DAY	OCT	NOV	DEC	JAN	FEB	MAR	APR	MAY	JUN	JUL	AUG	SEP
1	85	42	23	439	417	403	589	519	561	123	147	135
2	85	23	28	450	416	403	511	500	593	123	148	134
3	86	26	24	454	414	403	610	510	616	130	151	131
4	87	26	23	454	411	402	683	485	590	135	150	132
5	87	26	25	456	410	437	745	469	527	135	153	129
6	87	e26	26	457	409	534	770	470	484	135	155	129
7	87	e28	24	458	413	567	760	467	498	134	153	129
8	87	e27	24	423	408	1030	738	469	531	133	153	128
9	87	e22	23	399	387	886	773	464	573	146	154	113
10	86	e22	23	402	175	773	736	459	529	153	153	104
11	87	e22	23	404	168	782	703	452	436	132	151	103
12	86	e22	23	405	168	660	673	451	407	101	149	103
13	85	e22	23	407	73	571	654	453	407	101	149	105
14	83	e22	27	391	24	519	640	453	409	100	149	107
15	83	e22	24	385	25	546	626	436	410	116	148	110
16	83	e22	23	386	25	597	582	417	409	129	148	106
17	83	e22	27	386	26	601	597	411	409	129	148	93
18	83	e22	24	387	25	578	609	415	408	132	148	85
19	83	e22	24	388	32	514	566	419	182	133	149	81
20	83	e22	73	388	178	497	561	497	161	131	150	80
21	83	20	503	469	419	473	569	469	161	131	149	79
22	83	18	523	432	430	496	559	434	162	143	147	78
23	84	20	523	386	432	812	546	446	160	155	145	78
24	84	22	520	386	410	1190	535	460	144	156	143	82
25	81	21	515	420	405	1160	536	493	123	156	143	82
26	84	21	513	448	405	891	533	504	124	147	143	81
27	86	22	509	446	405	852	515	498	124	143	144	80
28	88	22	509	481	404	817	508	504	124	145	145	79
29	85	23	512	440	---	852	578	501	124	146	142	80
30	78	23	516	418	---	746	560	494	123	147	140	79
31	79	---	446	418	---	791	---	552	---	147	138	---
TOTAL	2618	700	6123	13063	7914	20783	18565	14571	10509	4167	4585	3035
MEAN	84.45	23.33	197.5	421.4	282.6	670.4	618.8	470.0	350.3	134.4	147.9	101.2
MAX	88	42	523	481	432	1190	773	552	616	156	155	135
MIN	78	18	23	385	24	402	508	411	123	100	138	78
AC-FT	5190	1390	12140	25910	15700	41220	36820	28900	20840	8270	9090	6020

e Estimated.

11423800 BEAR RIVER FISH RELEASE BELOW NEW CAMP FAR WEST RESERVOIR, NEAR WHEATLAND, CA

LOCATION.—Lat 39°02'30", long 121°19'52", in NE 1/4 NW 1/4 sec.29, T.14 N., R.6 E., [Placer County](#), Hydrologic Unit 18020108, on left bank, 5.4 mi northeast of Wheatland, and 1.2 mi downstream from New Camp Far West Reservoir.

DRAINAGE AREA.—Not determined.

PERIOD OF RECORD.—October 1989 to current year.

GAGE.—Water-stage recorder. Elevation of gage is 120 ft above sea level, from topographic map.

REMARKS.—The gage measures required fish-release flow and is entirely regulated by New Camp Far West Reservoir. See schematic diagrams of [lower Sacramento River Basin](#) and [Bear River Basin](#).

COOPERATION.—Records provided by South Sutter Water District, under general supervision of the U.S. Geological Survey, in connection with Federal Energy Regulatory Commission project no. 2997.

EXTREMES FOR PERIOD OF RECORD.—Maximum daily discharge, 43 ft³/s, Dec. 4, 1994; minimum daily, 7.3 ft³/s, Mar. 11, 12, 2002.

DISCHARGE, CUBIC FEET PER SECOND, WATER YEAR OCTOBER 2001 TO SEPTEMBER 2002
DAILY MEAN VALUES

DAY	OCT	NOV	DEC	JAN	FEB	MAR	APR	MAY	JUN	JUL	AUG	SEP
1	11	12	12	19	12	11	11	27	29	17	12	10
2	11	12	12	22	12	11	18	27	29	11	12	10
3	11	12	12	15	12	11	27	27	28	12	12	10
4	11	12	12	12	12	11	26	27	28	12	12	10
5	11	12	20	12	11	11	26	26	29	12	12	10
6	11	12	24	13	11	12	26	27	29	12	12	10
7	11	12	e13	14	11	14	26	27	29	12	12	10
8	11	12	e13	12	11	11	26	27	29	12	10	10
9	11	12	e13	11	11	7.8	26	27	29	12	10	10
10	11	12	e13	12	11	7.5	26	27	28	12	10	10
11	11	12	e13	12	11	7.3	26	27	28	12	10	10
12	11	12	e13	12	11	7.3	27	27	27	12	10	10
13	11	12	e13	11	12	9.8	27	27	27	12	10	10
14	11	12	e13	11	12	13	27	27	27	12	10	10
15	11	12	e13	11	12	13	27	27	27	12	10	10
16	12	12	e13	12	11	13	27	27	27	12	10	10
17	13	12	e13	12	11	13	27	27	27	12	10	10
18	13	12	e13	12	11	12	27	26	27	12	10	10
19	12	12	e13	12	11	12	27	26	27	12	10	10
20	12	12	e13	12	12	12	27	26	27	12	10	10
21	12	12	e13	12	12	12	27	27	27	12	10	10
22	12	12	e13	12	12	12	26	28	27	12	10	10
23	12	12	e13	12	12	12	28	27	27	12	10	10
24	12	12	e13	12	12	13	27	27	27	12	10	10
25	12	12	e13	12	12	13	27	28	27	12	10	10
26	12	12	e13	12	11	13	27	28	27	12	10	10
27	12	12	11	12	11	12	27	29	27	12	10	10
28	12	12	13	12	11	12	26	29	27	12	10	10
29	12	12	18	12	---	12	27	29	27	12	10	11
30	12	12	18	12	---	12	27	29	28	12	10	11
31	12	---	21	12	---	11	---	29	---	12	10	---
TOTAL	359	360	433	391	321	353.7	776	846	829	376	324	302
MEAN	11.58	12.00	13.97	12.61	11.46	11.41	25.87	27.29	27.63	12.13	10.45	10.07
MAX	13	12	24	22	12	14	28	29	29	17	12	11
MIN	11	12	11	11	11	7.3	11	26	27	11	10	10
AC-FT	712	714	859	776	637	702	1540	1680	1640	746	643	599

STATISTICS OF MONTHLY MEAN DATA FOR WATER YEARS 1990 - 2002, BY WATER YEAR (WY)

MEAN	12.53	12.86	13.12	13.39	13.37	13.84	27.31	27.77	27.56	11.31	11.18	11.28
MAX	14.5	18.0	16.4	21.7	18.7	21.7	32.0	30.5	30.1	12.9	13.0	13.0
(WY)	1998	1996	1996	1995	1995	1995	1995	1995	1995	1995	1995	1995
MIN	11.0	11.0	11.0	10.9	11.0	11.2	23.7	25.9	25.8	10.2	10.1	10.1
(WY)	1991	1991	1991	1991	1991	1991	1999	1990	1990	2001	2001	2002

SUMMARY STATISTICS

FOR 2001 CALENDAR YEAR

FOR 2002 WATER YEAR

WATER YEARS 1990 - 2002

ANNUAL TOTAL	5630	5670.7	
ANNUAL MEAN	15.42	15.54	16.28
HIGHEST ANNUAL MEAN			19.5
LOWEST ANNUAL MEAN			15.0
HIGHEST DAILY MEAN	28	Apr 16	29
LOWEST DAILY MEAN	10	Jul 2	7.3
ANNUAL SEVEN-DAY MINIMUM	10	Jul 2	9.1
ANNUAL RUNOFF (AC-FT)	11170	11250	11790
10 PERCENT EXCEEDS	26	27	28
50 PERCENT EXCEEDS	12	12	13
90 PERCENT EXCEEDS	10	10	11

e Estimated.

11424000 BEAR RIVER NEAR WHEATLAND, CA

LOCATION.—Lat 39°00'00", long 121°24'20", in SE 1/4 SW 1/4 sec.3, T.13 N., R.5 E., [Placer County](#), Hydrologic Unit 18020108, on right bank, 200 ft downstream from bridge on State Highway 65, 1 mi southeast of Wheatland, and 6.5 mi downstream from New Camp Far West Reservoir.

DRAINAGE AREA.—292 mi².

PERIOD OF RECORD.—October 1928 to current year.

CHEMICAL DATA: Water years 1953 to July 1980, June 1999 to September 1999.

SEDIMENT DATA: June 1999 to September 1999.

REVISED RECORDS.—WSP 1931: Drainage area.

GAGE.—Water-stage recorder. Datum of gage is 71.92 ft above sea level. See WSP 2131 for history of changes prior to May 28, 1970.

REMARKS.—Records good. Natural flow of stream affected by inflow from Yuba and American River Basins. Flow regulated by Lake Combie, usable capacity, 7,840 acre-ft, since 1928; Rollins Reservoir (station 11421800), since December 1964; and New Camp Far West Reservoir, usable capacity, 102,200 acre-ft, since October 1963. Many diversions for irrigation and power. See schematic diagrams of [Bear River Basin](#) and [lower Sacramento River Basin](#).

EXTREMES FOR PERIOD OF RECORD.—Maximum discharge, 48,000 ft³/s, Feb. 17, 1986, gage height, 21.60 ft, maximum gage height, 23.72 ft, Jan. 2, 1997; no flow at times.

DISCHARGE, CUBIC FEET PER SECOND, WATER YEAR OCTOBER 2001 TO SEPTEMBER 2002

DAILY MEAN VALUES

DAY	OCT	NOV	DEC	JAN	FEB	MAR	APR	MAY	JUN	JUL	AUG	SEP
1	9.7	22	17	31	783	731	913	133	68	28	16	50
2	9.0	17	21	96	784	728	823	84	56	15	15	50
3	8.7	16	18	56	781	726	761	24	50	15	16	52
4	9.0	16	16	23	781	727	756	28	47	15	19	50
5	9.9	15	22	21	781	732	754	24	108	16	19	51
6	9.9	15	33	31	373	746	755	21	281	16	18	50
7	10	15	32	23	20	2090	756	24	221	15	16	52
8	10	14	28	20	18	2190	759	23	141	17	23	54
9	10	15	22	16	17	1810	762	22	79	16	53	52
10	10	17	20	15	17	1660	479	23	60	16	58	52
11	10	17	20	18	17	1630	610	24	39	16	54	53
12	10	22	16	20	18	1390	942	23	30	15	53	53
13	12	19	14	20	18	926	797	23	30	15	55	50
14	12	16	20	19	18	1090	746	23	30	15	55	49
15	12	15	16	20	17	905	735	23	31	18	55	50
16	12	15	15	19	18	847	540	25	35	19	56	51
17	15	15	17	167	36	844	451	27	35	20	57	51
18	15	15	16	818	436	841	516	24	35	20	55	49
19	15	15	15	815	759	806	544	25	37	20	53	49
20	15	15	21	815	1800	758	532	31	37	17	54	47
21	15	19	26	814	1990	726	515	38	36	16	58	40
22	14	19	20	792	1340	725	461	40	32	17	53	39
23	14	16	20	794	1030	1190	268	32	29	17	53	38
24	16	21	18	794	869	2460	277	27	32	16	53	39
25	15	17	17	796	780	2200	222	25	34	17	51	46
26	15	17	16	e793	736	1880	197	67	34	17	54	48
27	15	16	13	e790	726	1430	180	164	33	16	58	48
28	15	15	20	e787	727	1210	157	144	33	18	56	48
29	15	16	65	e784	---	1080	128	133	32	19	58	41
30	18	15	39	780	---	1020	100	130	32	16	51	28
31	21	---	68	745	---	948	---	87	---	11	50	---
TOTAL	397.2	497	721	11732	15690	37046	16436	1541	1777	524	1395	1430
MEAN	12.81	16.57	23.26	378.5	560.4	1195	547.9	49.71	59.23	16.90	45.00	47.67
MAX	21	22	68	818	1990	2460	942	164	281	28	58	54
MIN	8.7	14	13	15	17	725	100	21	29	11	15	28
AC-FT	788	986	1430	23270	31120	73480	32600	3060	3520	1040	2770	2840

e Estimated.

11425418 MORMON RAVINE NEAR NEWCASTLE, CA

LOCATION.—Lat 38°50'12", long 121°05'36", in SE 1/4 NW 1/4 sec.4, T.11 N., R.8 E., [Placer County](#), Hydrologic Unit 18020128, on right bank, 200 ft upstream from Folsom Lake, 700 ft north of Newcastle Powerplant, and 3.3 mi southeast of Newcastle.

DRAINAGE AREA.—3.84 mi².

PERIOD OF RECORD.—October 1989 to current year (low-flow records only).

GAGE.—Water-stage recorder and V-notch sharp-crested weir. Elevation of gage is 500 ft above sea level, from topographic map.

REMARKS.—Records not computed above 8.5 ft³/s. Low flow augmented by release from end of South Canal. Most of the water in South Canal is diverted to Newcastle Powerplant (station 11425416). See schematic diagram of [Bear River Basin](#).

COOPERATION.—Records were collected by Pacific Gas & Electric Co., under general supervision of the U.S. Geological Survey, in connection with Federal Energy Regulatory Commission project no. 2310.

DISCHARGE, CUBIC FEET PER SECOND, WATER YEAR OCTOBER 2001 TO SEPTEMBER 2002

DAILY MEAN VALUES

DAY	OCT	NOV	DEC	JAN	FEB	MAR	APR	MAY	JUN	JUL	AUG	SEP
1	---	1.2	---	---	---	---	---	---	---	---	---	7.4
2	---	0.80	---	---	---	---	---	---	---	---	---	7.2
3	---	2.9	---	---	---	---	---	---	---	---	---	7.2
4	---	---	---	---	---	---	---	---	---	---	---	---
5	---	0.94	---	---	---	---	---	---	---	---	---	---
6	---	1.1	---	---	---	---	---	---	---	---	---	---
7	---	0.96	---	---	---	---	---	---	7.3	---	---	---
8	---	---	---	---	---	---	---	---	---	---	---	---
9	---	2.0	---	---	---	---	---	---	8.1	---	---	8.1
10	---	1.5	---	---	---	---	---	---	7.8	---	---	---
11	---	0.95	---	---	---	---	---	---	7.4	---	---	7.7
12	---	---	---	---	---	---	---	---	---	---	---	7.8
13	---	---	---	---	---	---	---	---	---	---	6.8	7.7
14	---	---	---	---	---	---	---	---	---	---	7.0	---
15	---	---	---	---	---	---	---	7.7	---	---	6.8	7.7
16	1.3	---	---	---	---	---	---	---	---	---	7.1	---
17	---	---	---	---	---	---	---	---	---	---	7.2	---
18	---	---	---	---	---	---	---	---	---	---	7.6	---
19	2.0	---	---	---	---	---	---	---	---	---	---	8.1
20	1.2	---	---	---	---	---	---	---	---	---	---	7.4
21	0.92	---	---	---	---	---	---	---	---	---	7.5	7.7
22	1.1	---	---	---	---	---	---	---	---	---	7.2	7.4
23	1.5	---	---	---	---	---	---	---	---	---	7.4	7.3
24	---	---	---	---	---	---	---	---	---	---	7.9	6.9
25	1.1	---	---	---	---	---	---	---	---	---	---	7.2
26	0.71	---	---	---	---	---	---	---	---	---	---	7.5
27	0.73	---	---	---	---	---	---	---	---	---	---	---
28	---	---	---	---	---	---	---	---	---	---	7.6	---
29	---	---	---	---	---	---	---	---	---	---	7.7	---
30	---	---	---	---	---	---	---	---	---	---	8.2	---
31	---	---	---	---	---	---	---	---	---	---	---	---
TOTAL	---	---	---	---	---	---	---	---	---	---	---	---
MEAN	---	---	---	---	---	---	---	---	---	---	---	---
MAX	---	---	---	---	---	---	---	---	---	---	---	---
MIN	---	---	---	---	---	---	---	---	---	---	---	---
AC-FT	---	---	---	---	---	---	---	---	---	---	---	---
a	0	0	10040	17580	15770	15860	13790	8950	2280	0	5070	8950

CAL YR 2001 a 68410

WTR YR 2002 b 98290

a Diversion, in acre-feet, to Newcastle Powerplant (station 11425416), provided by Pacific Gas & Electric Co.

11425500 SACRAMENTO RIVER AT VERONA, CA

LOCATION.—Lat 38°46'28", long 121°35'50", in SW 1/4 NW 1/4 sec.25, T.11 N., R.3 E., [Sutter County](#), Hydrologic Unit 18020109, on left bank, 1.3 mi southeast of Verona, 1.5 mi downstream from Feather River, 6.2 mi east of Knights Landing, and at mile 19.1 upstream from Sacramento.

DRAINAGE AREA.—21,251 mi².

PERIOD OF RECORD.—May 1926 to September 1929 (low-water periods only), October 1929 to current year.

CHEMICAL DATA: Water years 1952, 1969–70, 1996–98.

SPECIFIC CONDUCTANCE: Water years 1995–98.

WATER TEMPERATURE: Water years 1980, 1995–98.

SEDIMENT: Water years 1980, 1996–98.

REVISED RECORDS.—WDR CA-77-4: Drainage area.

GAGE.—Water-stage recorder and crest-stage gage. Datum of gage is 3.00 ft below sea level. May 1926 to Sept. 30, 1987, at site 0.5 mi upstream at same datum.

REMARKS.—Records good. Natural flow of stream affected by storage reservoirs, power developments, diversions for irrigation, return flow from irrigated areas, and bypassing for flood control. When discharge exceeds about 55,000 ft³/s, flow begins over Fremont Weir, 3.5 mi upstream on right bank, into Yolo Bypass (station 11453000). See schematic diagram of [lower Sacramento River Basin](#).

EXTREMES FOR PERIOD OF RECORD.—Maximum discharge, 94,000 ft³/s, Jan. 2, 1997, gage height, 42.09 ft; maximum gage height, 42.11 ft, Feb. 20, 1986, site then in use; minimum daily, 304 ft³/s, July 23, 24, 1931.

DISCHARGE, CUBIC FEET PER SECOND, WATER YEAR OCTOBER 2001 TO SEPTEMBER 2002
DAILY MEAN VALUES

DAY	OCT	NOV	DEC	JAN	FEB	MAR	APR	MAY	JUN	JUL	AUG	SEP
1	9840	8860	19000	36900	16100	15600	13800	9110	11000	15400	17400	13400
2	9560	8970	20700	39500	15900	15800	13700	8960	11100	15300	16900	12900
3	9190	8800	27500	46700	15500	15700	13600	8700	11000	15500	16700	12500
4	8960	8800	31100	53900	15100	15300	13400	8320	11100	15400	16800	12700
5	8800	8720	28700	58600	14600	15100	12800	8050	11400	15000	16800	12800
6	8580	8550	25600	58800	14400	15200	12700	7860	11400	15300	17000	12800
7	8320	8420	24300	57800	13900	17400	12800	8120	11100	15800	17100	12600
8	7850	8280	25500	56700	13700	20500	12700	8180	10600	15800	16800	12600
9	7360	8130	23700	55700	13600	22400	12500	8190	10300	15800	16500	12800
10	7030	7960	20800	53800	13900	22700	12500	7850	10300	15900	16300	12900
11	6900	8170	19300	50300	13800	23900	12100	7790	10200	16100	15900	13100
12	6840	8860	17600	45200	13400	24400	12300	7980	10000	16300	15700	13400
13	6770	10500	15800	39700	13100	22800	12000	8090	10000	16300	15700	13100
14	6740	12000	15100	34700	12900	20800	11700	8400	10400	16400	15900	12800
15	6700	12500	17400	31500	12700	19500	11600	8750	10500	16500	15800	12400
16	6700	12000	22900	29400	12500	18400	11400	8930	11000	16600	16000	12200
17	7140	11300	21800	27600	12600	17600	11200	9470	11800	16800	16000	12600
18	6740	10700	20600	26100	12800	16800	11100	10600	12300	17000	15800	12800
19	6610	10200	22100	24800	13300	15800	10800	11400	12500	16700	15900	12800
20	6640	9830	22000	23100	14200	15300	10100	12700	12800	16600	16300	12600
21	6690	9640	24700	21700	19900	14800	9750	15700	13300	16800	16600	12400
22	6690	10000	30400	20700	27900	14500	9350	17300	13200	17000	16500	12200
23	6830	10900	31800	19800	27500	14900	8820	17400	13200	17300	16000	12100
24	6820	14100	32800	19100	23700	18100	8200	16800	13600	17500	15200	11900
25	6740	16300	32600	18300	20500	20700	8100	15600	13900	17500	14500	11800
26	6570	20600	30500	17700	18600	20000	8210	14300	13800	17400	13600	11600
27	6550	19600	27700	18000	17200	18200	8180	13100	13900	17500	13100	11600
28	6920	16400	25300	18100	16100	16500	8180	12600	14300	17500	13300	11400
29	6960	14600	24800	17600	---	15100	8490	12200	15100	17200	13700	11300
30	7040	14400	28100	17100	---	14300	9000	11700	15400	17100	13800	11100
31	8060	---	32700	16700	---	14000	---	11300	---	17300	13700	---
TOTAL	229140	338090	762900	1055600	449400	552100	331080	335450	360500	510600	487300	373200
MEAN	7392	11270	24610	34050	16050	17810	11040	10820	12020	16470	15720	12440
MAX	9840	20600	32800	58800	27900	24400	13800	17400	15400	17500	17400	13400
MIN	6550	7960	15100	16700	12500	14000	8100	7790	10000	15000	13100	11100
AC-FT	454500	670600	1513000	2094000	891400	1095000	656700	665400	715100	1013000	966600	740200

11426000 SACRAMENTO WEIR SPILL TO YOLO BYPASS, NEAR SACRAMENTO, CA

LOCATION.—Lat 38°36'25", long 121°33'15", unsurveyed, [Sacramento County](#), Hydrologic Unit 18020109, on right bank, 100 ft upstream from weir, 3.2 mi upstream from American River, 4 mi northwest of Sacramento, and 4.2 mi upstream from Sacramento.

PERIOD OF RECORD.—October 1939 to current year. Monthly discharge only for water years 1940–51, published in WSP 1735. Published as "Sacramento Weir near Sacramento" 1939–61. Gage-height records collected at same site February 1926 to September 1934 and major flood flows only October 1934 to September 1939 are contained in reports of California Department of Water Resources.

GAGE.—Water-stage recorder and concrete weir crest. Datum of gage is 3.00 ft below sea level. October 1939 to September 1942, October 1959 to September 1963, water-stage recorder or nonrecording gage at downstream end of weir. October 1942 to September 1959, water-stage recorder on left bank of Sacramento River opposite center of weir. February 1963 to September 1985, water-stage recorder on right bank of Sacramento River 100 ft downstream from end of weir.

REMARKS.—Crest of weir is at gage height 20.2 ft and top of movable gates are at 28.0 ft. Weir consists of 48 gates each 38.1 ft long. Flow over weir enters Yolo Bypass by way of Sacramento Bypass. Flow regulated by weir gates. February 1963 to September 1985, stage was obtained by averaging the stage obtained at sites on the Sacramento River above and below the weir. See schematic diagram of [lower Sacramento River Basin](#).

COOPERATION.—Records provided by California Department of Water Resources; not reviewed by the U.S. Geological Survey.

EXTREMES FOR PERIOD OF RECORD.—Maximum discharge, 128,000 ft³/s, Feb. 20, 1986, gage height, 30.84 ft, maximum gage height, 33.01 ft, Dec. 23, 1955; no flow all or most of each year.

EXTREMES FOR CURRENT YEAR.—No flow for 2002 water year.

STATISTICS OF MONTHLY MEAN DATA FOR WATER YEARS 1943 - 2002, BY WATER YEAR (WY)

	OCT	NOV	DEC	JAN	FEB	MAR	APR	MAY	JUN	JUL	AUG	SEP
MEAN	1.231	122.7	523.8	775.2	755.6	518.1	84.91	2.126	0.212	0.000	0.000	0.000
MAX	72.6	7014	12470	19700	23920	17830	2042	79.1	12.7	0.000	0.000	0.000
(WY)	1963	1951	1965	1997	1986	1983	1982	1983	1998	1943	1943	1943
MIN	0.000	0.000	0.000	0.000	0.000	0.000	0.000	0.000	0.000	0.000	0.000	0.000
(WY)	1944	1944	1944	1944	1944	1944	1944	1943	1943	1943	1943	1943

SUMMARY STATISTICS	FOR 2001 CALENDAR YEAR	FOR 2002 WATER YEAR	WATER YEARS 1943 - 2002
ANNUAL TOTAL	0.0	0.0	
ANNUAL MEAN	0.000	0.000	227.1
HIGHEST ANNUAL MEAN			2075 1986
LOWEST ANNUAL MEAN			0.000 1944
HIGHEST DAILY MEAN	0.00 Jan 1	0.00 Oct 1	123000 Feb 20 1986
LOWEST DAILY MEAN	0.00 Jan 1	0.00 Oct 1	0.00 Jan 1 1943
ANNUAL SEVEN-DAY MINIMUM	0.00 Jan 1	0.00 Oct 1	0.00 Jan 1 1943
MAXIMUM PEAK FLOW			128000 Feb 20 1986
MAXIMUM PEAK STAGE			33.01 Dec 23 1955
ANNUAL RUNOFF (AC-FT)	0.00	0.00	164500
10 PERCENT EXCEEDS	0.00	0.00	0.00
50 PERCENT EXCEEDS	0.00	0.00	0.00
90 PERCENT EXCEEDS	0.00	0.00	0.00

11426170 LAKE VALLEY RESERVOIR NEAR CISCO, CA

LOCATION.—Lat 39°18'01", long 120°35'46", in NE 1/4 NW 1/4 sec.35, T.17 N., R.12 E., [Placer County](#), Hydrologic Unit 18020128, on dam near left abutment, on North Fork of North Fork American River, and 1.3 mi west of Cisco.

DRAINAGE AREA.—4.54 mi².

PERIOD OF RECORD.—July 1987 to current year. Unpublished records for water years 1980–86 available in files of the U.S. Geological Survey.

GAGE.—Water-stage recorder. Datum of gage is 5,727.4 ft above sea level (levels by Pacific Gas & Electric Co.). Prior to July 1987, nonrecording gage at same site and datum.

REMARKS.—Lake is formed by an earthfill dam; storage began in 1911. Usable capacity, 7,960 acre-ft, between gage heights 6.2 ft, natural rim of lake, and 57.5 ft, top of flashboards. Released water is diverted downstream to Lake Valley Canal (station 11426190) and then to several powerplants. Records, including extremes, represent usable contents at 2400 hours. See schematic diagrams of [Bear River Basin](#) and [South Yuba River Basin](#).

COOPERATION.—Records were collected by Pacific Gas & Electric Co., under general supervision of the U.S. Geological Survey, in connection with Federal Energy Regulatory Commission project no. 2310.

EXTREMES FOR PERIOD OF RECORD.—Maximum contents, 8,225 acre-ft, Jan. 1, 1997, gage height, 58.35 ft; minimum, 1,153 acre-ft, Feb. 28, 1990, gage height, 25.01 ft.

EXTREMES FOR CURRENT YEAR.—Maximum contents, 7,950 acre-ft, May 26, 27, maximum gage height, 57.46 ft, May 26; minimum, 3,090 acre-ft, Nov. 20, gage height, 38.27 ft.

Capacity table (gage height, in feet, and contents, in acre-feet)
(Based on survey by Pacific Gas & Electric Co., dated June 18, 1965)

8	41	14	304	25	1,152	50	5,810
10	102	17	476	30	1,830	59	8,411
12	189	20	693	40	3,455		

RESERVOIR STORAGE, ACRE-FEET, WATER YEAR OCTOBER 2001 TO SEPTEMBER 2002

DAILY OBSERVATION AT 2400 HOURS

DAY	OCT	NOV	DEC	JAN	FEB	MAR	APR	MAY	JUN	JUL	AUG	SEP
1	3650	3300	3230	e3590	3790	4330	4630	6420	7910	7690	7230	6360
2	3640	3280	e3250	e3610	3760	4360	4670	6450	7910	7680	7210	6320
3	3630	3260	e3260	e3630	3730	4380	4730	6500	7910	7670	7190	6280
4	3630	3250	e3270	e3660	3710	4400	4810	6530	7910	7650	7170	6240
5	3620	3230	e3290	e3690	3680	4420	4870	6600	7920	7640	7150	6200
6	3610	3220	e3290	e3710	3650	4650	4920	6680	7920	7620	7140	6170
7	3610	3200	e3300	e3740	3650	4750	4970	6740	7900	7610	7130	6130
8	3610	3190	e3320	e3770	3640	4790	5020	6810	7880	7590	7110	6090
9	3600	3180	e3330	e3800	3640	4810	5080	6850	7850	7580	7080	6060
10	3590	3160	e3340	e3820	3630	4860	5160	6930	7840	7560	7080	6020
11	3590	3170	e3350	e3850	3620	4890	5250	7000	7830	7560	7070	5980
12	3570	3180	e3370	e3880	3620	4910	5350	7100	7820	7540	7060	5940
13	3570	3180	e3370	e3900	3610	4940	5450	7140	7820	7520	7040	5910
14	3560	3160	e3390	e3930	3620	4960	5600	7230	7820	7500	7010	5880
15	3540	3150	e3400	e3950	3640	4950	5700	7270	7820	7480	6980	5870
16	3530	3140	e3410	e3970	3650	4920	5780	7350	7820	7460	6940	5860
17	3510	3130	e3420	e4010	3680	4900	5850	7430	7820	7450	6910	5850
18	3490	3120	e3430	e4000	3700	4860	5890	7440	7820	7440	6870	5840
19	3480	3100	e3440	4040	3780	4830	5910	7480	7810	7420	6840	5830
20	3460	3090	e3450	4020	3940	4790	5920	7560	7810	7410	6790	5820
21	3440	3150	e3470	4010	4010	4760	5930	7630	7800	7390	6770	5820
22	3420	3200	e3470	3990	4070	4750	5950	7740	7790	7370	6720	5810
23	3410	3200	e3490	3960	4130	4750	5990	7820	7780	7360	6680	5800
24	3390	3270	e3500	3940	4170	4730	6040	7890	7770	7350	6640	5800
25	3370	3270	e3510	3910	4210	4690	6110	7940	7760	7330	6600	5790
26	3350	3260	e3520	3940	4240	4660	6190	7950	7750	7320	6570	5780
27	3340	3250	e3530	3920	4270	4630	6260	7950	7740	7300	6540	5750
28	3320	3240	e3540	3900	4310	4610	6290	7930	7730	7290	6490	5730
29	3300	3240	e3550	3870	---	4600	6350	7910	7710	7270	6450	5710
30	3320	3220	e3570	3840	---	4600	6380	7910	7710	7260	6420	5680
31	3310	---	e3570	3820	---	4610	---	7910	---	7240	6380	---
MAX	3650	3300	3570	4040	4310	4960	6380	7950	7920	7690	7230	6360
MIN	3300	3090	3230	3590	3610	4330	4630	6420	7710	7240	6380	5680
a	39.38	38.97		41.59	43.72	45.03	52.08	57.31	56.64	55.09	52.08	49.55
b	-350	-90	+350	+250	+490	+300	+1770	+1530	-200	-470	-860	-700
c	240	605	1110	1450	1330	1960	2110	2020	490	110	470	363

CAL YR 2001 MAX 5060 MIN 1160 b +190 c 7530
WTR YR 2002 MAX 7950 MIN 3090 b +2020 c 12260

e Estimated.

a Gage height, in feet, at end of month.

b Change in contents, in acre-feet.

c Diversion, in acre-feet, to Lake Valley Canal (station 11426190), provided by Pacific Gas & Electric Co.

11426180 KELLY LAKE NEAR CISCO, CA

LOCATION.—Lat 39°18'40", long 120°34'49", in SE 1/4 NW 1/4 sec.25, T.17 N., R.12 E., Placer County, Hydrologic Unit 18020128, Tahoe National Forest, on outlet structure on Kelly Lake Dam, on unnamed tributary to North Fork of North Fork American River, and 2.2 mi west of Cisco.

DRAINAGE AREA.—0.58 mi².

PERIOD OF RECORD.—October 1991 to current year. Unpublished records for water years 1965–91 available in files of the U.S. Geological Survey.

GAGE.—Water-stage recorder. Datum of gage is 5,888.9 ft above sea level (levels by Pacific Gas & Electric Co.). Prior to October 1991, nonrecording gage at same site and datum.

REMARKS.—No records computed during the winter months. Reservoir is formed on natural lake by rock-fill dam completed in 1928. Usable capacity, 336 acre-ft, between gage heights 0.0 ft, invert of outlet, and 17.1 ft, top of flashboards. Water is used for power development downstream. Records, including extremes, represent usable contents at 2400 hours. See schematic diagram of Bear River Basin.

COOPERATION.—Records were collected by Pacific Gas & Electric Co., under general supervision of the U.S. Geological Survey, in connection with Federal Energy Regulatory Commission project no. 2310.

Capacity table (gage height, in feet, and contents, in acre-feet)
(Based on survey by Pacific Gas & Electric Co., dated December 1933)

0	0	8	130	16	308	19	387
4	61	12	213				

RESERVOIR STORAGE, ACRE-FEET, WATER YEAR OCTOBER 2001 TO SEPTEMBER 2002
DAILY OBSERVATION AT 2400 HOURS

DAY	OCT	NOV	DEC	JAN	FEB	MAR	APR	MAY	JUN	JUL	AUG	SEP
1	249	144	---	---	---	---	---	---	338	318	294	273
2	250	138	---	---	---	---	---	---	337	317	293	272
3	249	132	---	---	---	---	---	---	337	317	291	271
4	249	126	---	---	---	---	---	---	337	317	290	270
5	248	120	---	---	---	---	---	e344	336	315	289	270
6	248	116	---	---	---	---	---	e343	336	315	288	268
7	248	110	---	---	---	---	---	e343	335	313	287	268
8	248	107	---	---	---	---	---	e342	334	312	286	267
9	247	104	---	---	---	---	---	e342	333	312	286	264
10	247	101	---	---	---	---	---	e342	332	311	285	263
11	247	98	---	---	---	---	---	e342	332	310	285	261
12	246	95	---	---	---	---	---	e341	331	309	284	261
13	245	93	---	---	---	---	---	e344	331	308	284	260
14	245	91	---	---	---	---	---	e347	331	307	283	259
15	241	86	---	---	---	---	---	e347	330	306	283	259
16	235	78	---	---	---	---	---	e347	330	305	282	258
17	228	69	---	---	---	---	---	e347	329	304	282	258
18	221	61	---	---	---	---	---	e346	329	303	281	258
19	216	55	---	---	---	---	---	e345	329	303	281	256
20	209	51	---	---	---	---	---	e344	328	302	280	256
21	202	44	---	---	---	---	---	e341	327	301	280	256
22	196	40	---	---	---	---	---	e339	326	300	279	255
23	190	36	---	---	---	---	---	e336	326	300	279	255
24	184	32	---	---	---	---	---	e336	325	299	278	254
25	178	29	---	---	---	---	---	e336	325	298	278	254
26	172	29	---	---	---	---	---	e336	324	298	276	253
27	166	---	---	---	---	---	---	e337	323	297	276	253
28	160	---	---	---	---	---	---	e337	323	297	275	252
29	154	---	---	---	---	---	---	e337	322	296	274	252
30	153	---	---	---	---	---	---	e337	320	296	274	245
31	149	---	---	---	---	---	---	e337	---	295	273	---
MAX	250	---	---	---	---	---	---	---	338	318	294	273
MIN	149	---	---	---	---	---	---	---	320	295	273	245
a	8.96								16.47	15.49	14.61	13.46
b	-101								-17	-25	-22	-28

WTR YR 2002 b -5

e Estimated.

a Gage height, in feet, at end of month.

b Change in contents, in acre-feet.

11426195 CANYON CREEK NEAR BLUE CANYON, CA

LOCATION.—Lat 39°15'27", long 120°43'57", in NW 1/4 NW 1/4 sec.15, T.16 N., R.11 E., [Placer County](#), Hydrologic Unit 18020128, on left bank, 200 ft upstream from culvert, and 1.2 mi west of Blue Canyon.

DRAINAGE AREA.—0.51 mi².

PERIOD OF RECORD.—October 1999 to current year (low-flow records only). Unpublished records for water years 1981–99 available in files of the U.S. Geological Survey.

GAGE.—Nonrecording gage read most days. Datum of gage is 4,660 ft above sea level (from topographic map).

REMARKS.—No records computed above 1.2 ft³/s. No regulation or diversion upstream from station. See schematic diagram of [Bear River Basin](#).

COOPERATION.—Records were collected by Pacific Gas & Electric Co., under general supervision of the U.S. Geological Survey, in connection with Federal Energy Regulatory Commission project no. 2310.

DISCHARGE, CUBIC FEET PER SECOND, WATER YEAR OCTOBER 2001 TO SEPTEMBER 2002
DAILY INSTANTANEOUS VALUES

DAY	OCT	NOV	DEC	JAN	FEB	MAR	APR	MAY	JUN	JUL	AUG	SEP
1	---	0.01	0.14	---	---	---	---	1.1	0.49	0.16	0.06	0.03
2	0.02	0.02	---	---	0.54	---	0.61	1.1	0.40	0.14	0.06	---
3	0.02	0.01	---	---	0.56	---	---	1.1	0.34	0.14	0.06	0.02
4	0.01	0.02	---	---	---	---	---	0.85	0.36	0.16	0.06	0.02
5	0.02	0.02	0.70	---	0.42	---	---	0.92	0.34	0.14	0.06	0.02
6	0.02	0.01	1.2	---	0.46	---	---	0.92	0.30	0.14	---	0.03
7	0.02	0.01	1.1	---	0.44	---	---	0.82	0.30	0.14	0.06	0.03
8	0.01	0.01	0.46	---	---	---	---	0.76	0.30	0.14	0.06	0.02
9	0.01	0.01	0.44	---	---	---	---	---	0.32	0.14	0.05	0.03
10	0.01	0.01	0.32	---	0.85	---	---	0.76	0.30	0.13	0.06	0.03
11	---	0.09	0.25	---	0.82	---	---	0.76	0.27	0.11	0.05	0.03
12	0.01	0.22	---	---	0.79	---	---	0.76	---	0.12	0.05	0.02
13	0.01	0.17	0.24	---	0.85	---	---	0.64	0.29	0.10	0.05	0.02
14	0.01	0.01	---	---	0.96	---	---	0.64	0.27	0.12	0.05	0.02
15	0.02	0.01	0.24	---	0.99	---	---	0.54	0.27	0.10	0.05	0.02
16	0.02	0.02	0.22	1.1	0.99	---	---	0.49	0.22	0.10	0.04	0.02
17	0.02	0.01	0.64	1.1	---	---	---	0.51	0.27	0.10	0.04	0.02
18	0.02	0.02	0.64	0.96	---	---	---	0.54	0.25	0.08	0.04	0.02
19	0.01	0.01	0.46	0.92	1.0	---	---	0.51	0.25	0.09	0.04	---
20	0.02	0.01	0.46	0.85	---	---	---	---	0.21	0.08	0.04	0.02
21	0.02	0.85	0.49	0.76	---	---	---	---	0.21	0.08	0.04	0.02
22	0.02	0.29	---	0.79	---	---	---	0.99	0.22	0.09	0.04	0.02
23	0.02	0.09	0.36	0.76	---	---	---	0.73	0.21	0.06	0.03	0.01
24	0.02	0.85	0.34	0.70	---	---	---	1.0	0.21	0.06	0.02	0.02
25	0.02	0.14	0.25	---	---	---	---	0.99	0.19	0.07	0.03	0.02
26	0.02	0.12	0.25	0.56	---	---	1.1	0.85	0.21	0.07	0.04	0.02
27	0.01	0.11	0.44	0.61	---	---	---	0.64	0.16	0.07	0.03	---
28	0.01	0.10	0.49	0.61	---	---	---	---	0.21	0.08	0.03	0.02
29	0.02	0.10	---	0.61	---	---	---	0.54	0.16	0.06	0.03	0.02
30	0.25	0.11	---	0.54	---	---	---	0.54	0.16	0.08	0.03	0.02
31	0.01	---	---	---	---	---	---	---	---	0.05	0.03	---
TOTAL	---	3.46	---	---	---	---	---	---	---	3.20	---	---
MEAN	---	0.115	---	---	---	---	---	---	---	0.103	---	---
MAX	---	0.85	---	---	---	---	---	---	---	0.16	---	---
MIN	---	0.01	---	---	---	---	---	---	---	0.05	---	---
AC-FT	---	6.9	---	---	---	---	---	---	---	6.3	---	---

11426196 CANYON CREEK BELOW TOWLE DIVERSION DAM, NEAR BLUE CANYON, CA

LOCATION.—Lat 39°14'31", long 120°45'03", in SE 1/4 NW 1/4 sec.21, T.16 N., R.11 E., [Placer County](#), Hydrologic Unit 18020128, on left bank, 4 ft downstream from Towle Diversion Dam, and 2.4 mi southwest of Blue Canyon.

DRAINAGE AREA.—1.35 mi².

PERIOD OF RECORD.—October 1999 to current year (low-flow records only). Unpublished records for water years 1981–99 available in files of the U.S. Geological Survey.

GAGE.—Nonrecording gage read most days. Datum of gage is 4,320 ft above sea level (from topographic map).

REMARKS.—No records computed above 1.2 ft³/s. Flow regulated by Towle Diversion Dam. Water from the Drum Canal is diverted out of Drum Forebay to Canyon Creek upstream. Most of this water is diverted at the Towle Diversion Dam. See schematic diagram of [Bear River Basin](#).

COOPERATION.—Records were collected by Pacific Gas & Electric Co., under general supervision of the U.S. Geological Survey, in connection with Federal Energy Regulatory Commission project no. 2310.

DISCHARGE, CUBIC FEET PER SECOND, WATER YEAR OCTOBER 2001 TO SEPTEMBER 2002
DAILY INSTANTANEOUS VALUES

DAY	OCT	NOV	DEC	JAN	FEB	MAR	APR	MAY	JUN	JUL	AUG	SEP
1	---	0.09	0.56	---	---	1.1	---	1.1	1.0	0.42	0.25	0.05
2	0.44	0.44	---	---	1.0	1.1	1.1	1.1	1.0	0.40	0.22	0.05
3	0.79	0.30	---	---	1.1	1.1	1.1	1.1	1.0	0.38	0.22	---
4	0.25	0.21	---	---	---	1.1	1.1	1.1	1.1	0.38	0.24	---
5	0.11	0.12	0.79	---	1.1	1.2	1.1	1.1	1.1	0.36	0.22	---
6	0.06	---	1.1	---	1.1	---	1.1	1.0	1.1	0.29	---	---
7	0.08	---	1.1	---	1.1	---	1.0	1.1	0.79	0.30	0.18	---
8	0.05	---	0.85	1.1	---	1.1	1.0	1.0	0.59	0.29	0.18	---
9	0.02	---	1.0	1.1	---	1.0	1.0	---	0.56	0.36	0.18	---
10	0.02	---	1.0	1.1	1.0	1.1	1.0	1.1	0.85	0.25	0.17	---
11	---	---	1.2	1.0	1.1	1.0	1.1	1.0	0.76	0.25	0.17	---
12	0.05	---	---	1.2	1.0	1.0	1.0	1.1	---	0.22	0.22	---
13	0.14	---	1.1	1.0	1.0	1.1	1.0	1.0	0.56	0.09	0.25	0.56
14	0.14	0.17	---	1.0	0.99	1.1	1.0	1.0	0.56	0.40	0.25	0.14
15	0.14	0.17	1.1	1.0	1.1	1.1	1.0	1.0	0.54	0.22	0.25	0.14
16	0.16	0.10	---	1.0	1.1	1.1	1.0	1.1	0.44	0.12	0.22	0.29
17	0.08	0.05	---	1.0	---	1.1	1.0	1.0	0.40	0.12	0.18	0.56
18	0.03	0.17	1.1	1.1	---	1.1	1.0	1.0	0.34	0.08	0.17	0.64
19	0.21	0.08	1.1	1.0	1.1	1.0	1.1	1.0	0.25	0.12	0.17	---
20	0.14	0.05	1.1	1.0	---	1.0	1.1	---	0.25	0.29	0.13	0.51
21	0.04	0.89	1.0	1.0	1.1	1.0	1.1	---	0.30	0.30	0.13	0.51
22	0.07	0.34	1.0	1.0	1.0	1.0	---	---	0.25	0.22	0.13	0.51
23	0.07	0.18	1.0	1.0	1.1	1.0	---	---	0.59	0.10	0.10	0.67
24	0.16	1.0	1.0	1.0	1.0	1.0	1.1	---	0.44	0.08	0.10	0.44
25	0.16	0.17	1.2	---	1.0	1.0	---	---	0.34	0.09	0.06	0.44
26	0.09	0.17	1.0	1.1	1.0	1.1	1.0	---	0.34	0.06	0.06	0.54
27	0.12	0.44	---	1.1	1.0	1.1	1.1	---	0.30	0.32	0.08	---
28	0.10	0.54	---	1.0	1.0	1.1	1.1	---	0.44	0.32	0.06	0.51
29	0.14	0.44	---	0.92	---	1.1	1.1	---	0.44	0.29	0.07	0.44
30	0.30	0.54	---	1.0	---	1.1	1.1	---	0.44	0.22	0.08	0.44
31	0.10	---	---	---	---	1.1	---	---	---	0.24	0.07	---
TOTAL	---	---	---	---	---	---	---	---	---	7.58	---	---
MEAN	---	---	---	---	---	---	---	---	---	0.245	---	---
MAX	---	---	---	---	---	---	---	---	---	0.42	---	---
MIN	---	---	---	---	---	---	---	---	---	0.06	---	---
AC-FT	---	---	---	---	---	---	---	---	---	15	---	---

11427000 NORTH FORK AMERICAN RIVER AT NORTH FORK DAM, CA

LOCATION.—Lat 38°56'10", long 121°01'22", in SW 1/4 NW 1/4 sec.31, T.13 N., R.9 E., [Placer County](#), Hydrologic Unit 18020128, on left bank, 50 ft upstream from crest of North Fork Dam, 2 mi upstream from Middle Fork, and 4 mi northeast of Auburn.

DRAINAGE AREA.—342 mi².

PERIOD OF RECORD.—October 1941 to current year.

CHEMICAL DATA: Water years 1977–80.

WATER TEMPERATURE: Water years 1959–83.

SEDIMENT DATA: Water year 1980 (periodic record).

REVISED RECORDS.—WSP 1931: Drainage area.

GAGE.—Water-stage recorder and ogee section of concrete debris dam. Datum of gage is 715.0 ft above sea level (levels by U.S. Army Corps of Engineers).

REMARKS.—Records fair. Minor regulation by Lake Clementine, usable capacity, 12,800 acre-ft, formed by North Fork Dam. Storage in Big Reservoir and Lake Valley Reservoir (station 11426170), combined capacity, 10,300 acre-ft, upstream from station. Lake Valley Canal (station 11426190) diverts from North Fork of North Fork American River into Bear River Basin for power development in powerplants of Pacific Gas & Electric Co. Combined storage and diversion have small effect on natural flow. See schematic diagrams of [Bear River Basin](#) and [lower Sacramento River Basin](#).

EXTREMES FOR PERIOD OF RECORD.—Maximum discharge, 65,400 ft³/s, Dec. 23, 1964, gage height, 11.87 ft, from rating curve extended above 24,000 ft³/s, on basis of computed flow over crest of dam at gage height 10.22 ft; no flow, Aug. 27–30, Sept. 2–11, 1944; Oct. 5, 6, 1963; Nov. 7–10, 1965, caused by operation of valve in North Fork Dam.

EXTREMES FOR CURRENT YEAR.—Peak discharges greater than base discharge of 4,300 ft³/s, or maximum:

Date	Time	Discharge (ft ³ /s)	Gage height (ft)	Date	Time	Discharge (ft ³ /s)	Gage height (ft)
Feb. 20	1115	4,650	3.66	Mar. 7	0045	5,070	3.78

DISCHARGE, CUBIC FEET PER SECOND, WATER YEAR OCTOBER 2001 TO SEPTEMBER 2002

DAILY MEAN VALUES

DAY	OCT	NOV	DEC	JAN	FEB	MAR	APR	MAY	JUN	JUL	AUG	SEP
1	34	69	255	1910	366	919	1650	912	1180	173	69	41
2	33	50	1300	1700	358	825	1780	846	1050	164	66	40
3	33	44	1500	3010	342	741	1990	911	854	156	65	39
4	32	40	676	1780	331	702	2280	1110	778	153	65	40
5	32	39	520	1290	326	692	2310	1310	761	140	65	47
6	31	39	731	1520	322	1890	1840	1410	765	131	63	39
7	32	39	674	1780	327	3840	1820	1480	722	133	61	38
8	34	35	531	1400	686	2660	1790	1400	649	120	61	39
9	33	38	452	1140	590	1840	1850	1300	566	112	59	40
10	33	38	397	971	e495	1710	1820	1230	484	105	58	39
11	33	43	343	846	e489	1590	1870	1030	428	100	57	37
12	32	83	304	775	e482	1470	1840	1040	403	96	56	36
13	33	192	276	721	e476	1430	1830	1200	397	94	55	36
14	31	126	484	666	480	1250	1980	1300	396	91	54	36
15	30	86	464	612	511	1100	2450	1370	385	87	54	35
16	30	72	357	561	512	1050	1540	1370	350	89	52	36
17	30	65	635	514	642	981	1290	1370	318	90	53	37
18	30	62	846	474	628	898	1130	1460	294	89	52	37
19	31	61	574	443	752	834	968	1410	299	88	48	37
20	30	64	671	418	3910	818	906	1240	293	85	48	37
21	30	81	825	404	2760	827	849	1130	270	83	46	36
22	30	886	677	407	1910	924	e926	916	261	82	46	36
23	31	509	966	371	1700	1480	1010	880	247	80	47	36
24	31	566	735	348	1420	2050	1100	882	232	79	47	33
25	31	988	558	338	1180	1640	1270	911	e213	77	46	31
26	32	360	e481	498	1060	1380	1420	1000	208	75	46	32
27	33	228	e447	744	1020	1260	1330	1030	207	74	45	32
28	34	181	513	552	978	1230	1120	1070	198	74	45	33
29	34	226	941	466	---	1360	982	1130	188	72	43	35
30	46	275	1130	413	---	1540	1010	1180	178	71	43	36
31	78	---	2740	387	---	1560	---	1230	---	69	42	---
TOTAL	1047	5585	22003	27459	25053	42491	45951	36058	13574	3132	1657	1106
MEAN	33.77	186.2	709.8	885.8	894.8	1371	1532	1163	452.5	101.0	53.45	36.87
MAX	78	988	2740	3010	3910	3840	2450	1480	1180	173	69	47
MIN	30	35	255	338	322	692	849	846	178	69	42	31
AC-FT	2080	11080	43640	54460	49690	84280	91140	71520	26920	6210	3290	2190

e Estimated.

11427000 NORTH FORK AMERICAN RIVER AT NORTH FORK DAM, CA—Continued

STATISTICS OF MONTHLY MEAN DATA FOR WATER YEARS 1942 - 2002, BY WATER YEAR (WY)

	OCT	NOV	DEC	JAN	FEB	MAR	APR	MAY	JUN	JUL	AUG	SEP
MEAN	102.4	361.8	883.9	1354	1452	1495	1564	1607	782.7	192.5	66.42	50.13
MAX	1749	3307	5781	7303	8403	5187	4490	3688	2855	928	214	121
(WY)	1963	1951	1965	1997	1986	1995	1982	1952	1983	1983	1983	1982
MIN	18.3	35.6	33.9	44.6	70.5	114	207	273	71.7	25.8	13.4	14.9
(WY)	1978	1960	1977	1991	1991	1977	1977	1992	1992	1977	1977	1977

SUMMARY STATISTICS	FOR 2001 CALENDAR YEAR		FOR 2002 WATER YEAR		WATER YEARS 1942 - 2002	
ANNUAL TOTAL	134016		225116			
ANNUAL MEAN	367.2		616.8		822.8	
HIGHEST ANNUAL MEAN					1843	
LOWEST ANNUAL MEAN					88.5	
HIGHEST DAILY MEAN	2740	Dec 31	3910	Feb 20	50100	Jan 2 1997
LOWEST DAILY MEAN	28	Sep 8	30	Oct 15	0.00	Aug 27 1944
ANNUAL SEVEN-DAY MINIMUM	29	Sep 6	30	Oct 15	0.00	Sep 2 1944
MAXIMUM PEAK FLOW			5070	Mar 7	65400	Dec 23 1964
MAXIMUM PEAK STAGE			3.78	Mar 7	11.87	Dec 23 1964
ANNUAL RUNOFF (AC-FT)	265800		446500		596100	
10 PERCENT EXCEEDS	1110		1530		2040	
50 PERCENT EXCEEDS	142		397		272	
90 PERCENT EXCEEDS	32		35		42	

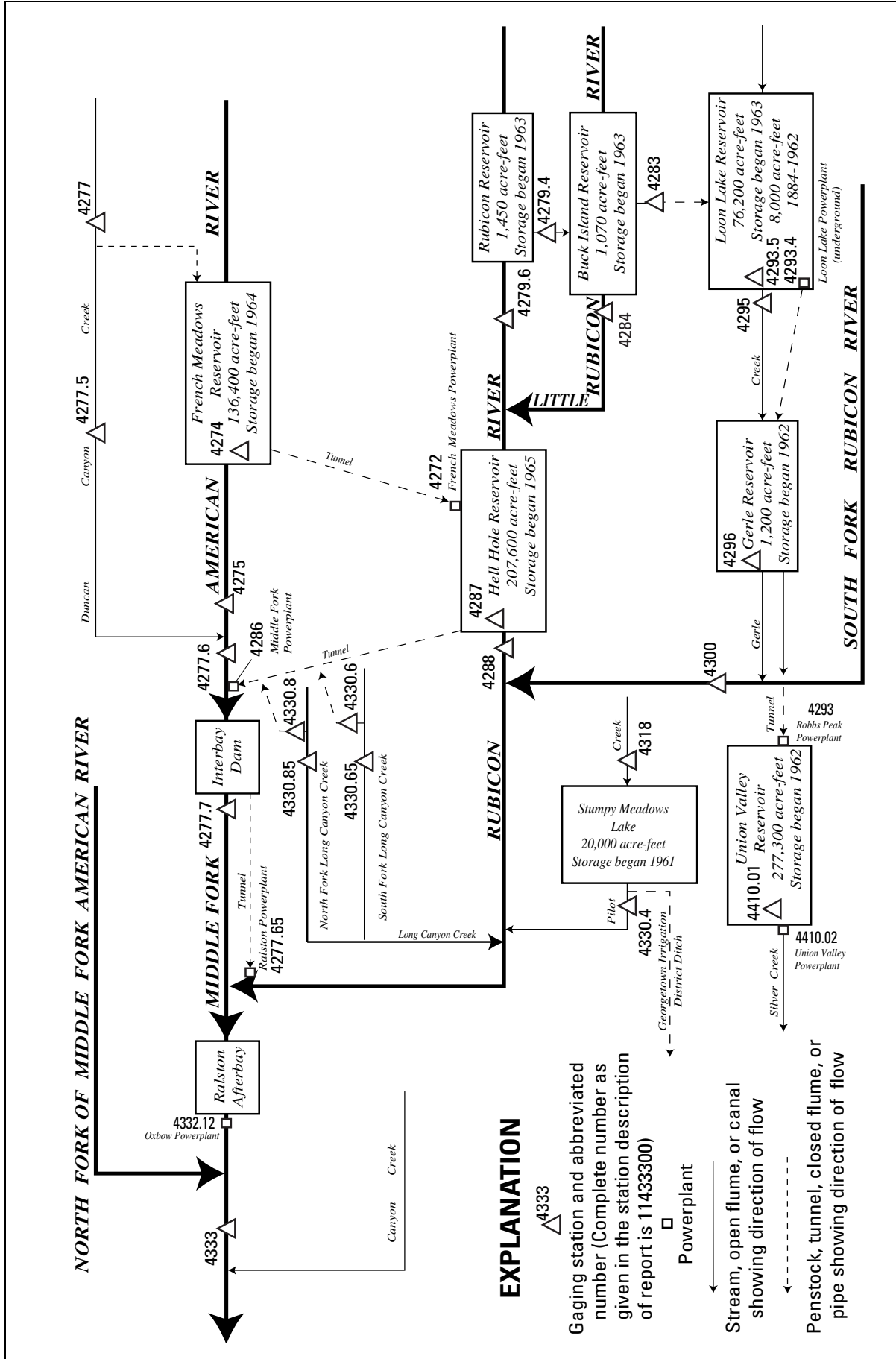

Figure 34. Diversions and storage in Middle Fork American and Rubicon River Basins.

11427400 FRENCH MEADOWS RESERVOIR NEAR FORESTHILL, CA

LOCATION.—Lat 39°06'32", long 120°25'49", in SW 1/4 NE 1/4 sec.32, T.15 N., R.14 E., Placer County, Hydrologic Unit 18020128, Tahoe National Forest, on left bank, 2.2 mi upstream from dam, on Middle Fork American River, 6.9 mi upstream from Chipmunk Creek, and 21 mi northeast of Foresthill.

DRAINAGE AREA.—47.0 mi².

PERIOD OF RECORD.—December 1964 to current year.

GAGE.—Water-stage recorder. Datum of gage is sea level (levels by Placer County Water Agency).

REMARKS.—Reservoir is formed by rockfill dam with earth core. Storage began Dec. 21, 1964. Usable capacity, 125,601 acre-ft, between elevations 5,125 ft, minimum operating level, and 5,263 ft, top of radial gates. Dead storage, 10,804 acre-ft. Reservoir is used to store water for hydroelectric power. Up to 400 ft³/s diverted from Duncan Creek through a tunnel to reservoir. Water is released through a tunnel to French Meadows Powerplant (station 11427200) at Hell Hole Reservoir (station 11428700) on the Rubicon River; releases began Dec. 13, 1965. See schematic diagram of [Middle Fork American and Rubicon River Basins](#).

COOPERATION.—Records provided by Placer County Water Agency, under general supervision of the U.S. Geological Survey, in connection with Federal Energy Regulatory Commission project no. 2079.

EXTREMES FOR PERIOD OF RECORD.—Maximum contents, 137,700 acre-ft, May 19, 1966, elevation, 5,263.9 ft; minimum since reservoir first filled, 28,500 acre-ft, Oct. 21–24, 1991, elevation, 5,157.6 ft.

EXTREMES FOR CURRENT YEAR.—Maximum contents, 122,400 acre-ft, June 16, 17, elevation, 5,252.8 ft; minimum, 38,400 acre-ft, Feb. 6–8, elevation, 5,171.8 ft.

Capacity table (elevation, in feet, and contents, in acre-feet)
(Based on a survey by Placer County Water Agency in 1965)

5,125	10,800	5,150	23,700	5,200	62,400	5,270	146,500
5,130	13,100	5,170	37,100	5,230	94,100		

RESERVOIR STORAGE, (ACRE-FEET), WATER YEAR OCTOBER 2001 TO SEPTEMBER 2002

DAILY OBSERVATION AT 2400 HOURS

DAY	OCT	NOV	DEC	JAN	FEB	MAR	APR	MAY	JUN	JUL	AUG	SEP
1	44400	e42700	42400	41700	39000	44400	55900	87800	118700	120700	110100	98900
2	44400	e42700	42800	42300	38900	44800	56100	88400	119500	120400	109600	98600
3	44400	e42700	43000	42800	38700	45100	58400	88900	120000	120000	109600	98200
4	44300	e42700	43100	43100	38700	45400	60200	90100	120400	119700	109600	97700
5	44300	42700	43200	43500	38500	45600	61600	91200	120700	119500	109100	97300
6	44200	42700	43300	44300	38400	46900	63000	92600	120900	119500	108700	96900
7	44100	42600	43300	44500	38400	47600	64400	94000	121200	119500	108200	96500
8	44000	42600	43400	44600	38400	48000	65600	95200	121700	119100	107800	96200
9	43900	42600	43500	44600	38600	48500	66900	96400	122100	118700	107500	95700
10	43900	42500	43500	44600	38700	49000	68200	97500	122100	118300	107100	95400
11	43800	42600	43400	44500	38700	49200	69600	98300	122000	117900	106900	95000
12	43700	42600	43100	44600	38700	49500	71000	99400	122000	117500	106500	94500
13	43600	42600	43100	44600	38700	49600	72700	100400	121800	117200	106100	94200
14	43500	42600	43000	44500	38700	49800	74800	101700	121800	117000	105600	93700
15	43500	42600	42900	44200	38700	50000	76400	103100	122100	116500	105300	93400
16	43400	42600	42700	43800	38900	50300	77400	104400	122400	116100	104800	92900
17	43300	42600	42600	43500	39100	50600	78100	105800	122100	115700	104500	92600
18	43200	42600	42300	43100	39300	50700	78800	107200	122000	115300	104300	92100
19	43100	42000	42000	43100	39600	50700	79200	108300	121800	114900	103800	91700
20	e43000	41500	41600	43100	40600	50800	79700	109200	121700	114500	103400	91200
21	e43000	41300	41300	42700	41200	50900	80300	109700	121800	114300	103100	90600
22	e43000	42000	41200	42400	41600	51200	80700	110200	122000	113900	102600	90100
23	e42900	42000	41100	42000	42300	51600	81300	110700	122100	113500	102200	89500
24	e42900	42700	40900	41600	42800	52000	82000	111400	121700	113000	101900	88900
25	e42800	42900	40800	41200	43100	52100	83100	112200	121400	112600	101600	88600
26	e42800	43000	40500	41200	43400	52300	84200	113100	121200	112200	101100	88000
27	e42700	42600	40200	41200	43800	52500	85300	114100	120900	112000	100800	87500
28	e42700	42500	39900	40700	44100	52800	86000	115000	120900	111600	100300	86900
29	e42700	42400	40200	40300	---	53300	86800	115900	121000	111200	100000	86400
30	e42800	42300	40600	39900	---	54100	87400	116900	121000	110800	99500	86000
31	e42800	---	41300	39400	---	55000	---	117800	---	110500	99100	---
MAX	44400	43000	43500	44600	44100	55000	87400	117800	122400	120700	110100	98900
MIN	42700	41300	39900	39400	38400	44400	55900	87800	118700	110500	99100	86000
a	5177.5	5176.9	5175.6	5173.1	5179.1	5191.9	5224.1	5249.3	5251.8	5243.6	5234.3	5222.9
b	-1700	-500	-1000	-1900	+4700	+10900	+32400	+30400	+3200	-10500	-11400	-13100

CAL YR 2001 b -9600

WTR YR 2002 b +41500

e Estimated.

a Elevation, in feet, at end of month.

b Change in contents, in acre-feet.

11427500 MIDDLE FORK AMERICAN RIVER AT FRENCH MEADOWS, CA

LOCATION.—Lat 39°06'35", long 120°28'49", in SW 1/4 NW 1/4 sec.36, T.15 N., R.13 E., Placer County, Hydrologic Unit 18020128, Tahoe National Forest, on left bank, 0.6 mi downstream from French Meadows Dam, 4.1 mi upstream from Chipmunk Creek, and 14 mi south of Cisco.

DRAINAGE AREA.—47.9 mi².

PERIOD OF RECORD.—October 1951 to current year.

REVISED RECORDS.—WSP 1445: 1953–54. WSP 1931: Drainage area.

GAGE.—Water-stage recorder. Elevation of gage is 4,920 ft above sea level, from topographic map. Prior to Oct. 1, 1962, at site 0.8 mi upstream at different datum.

REMARKS.—Considerable regulation by French Meadows Reservoir (station 11427400) 0.6 mi upstream beginning December 1964. Water diverted into basin from Duncan Creek to French Meadows Reservoir since December 1964. Water diverted out of basin from French Meadows Reservoir through French Meadows Powerplant (station 11427200) to Hell Hole Reservoir (station 11428700) since December 1965. See schematic diagram of [Middle Fork American and Rubicon River Basins](#).

COOPERATION.—Records provided by Placer County Water Agency, under general supervision of the U.S. Geological Survey, in connection with Federal Energy Regulatory Commission project no. 2079.

EXTREMES FOR PERIOD OF RECORD.—Maximum discharge, 21,500 ft³/s, Jan. 31, 1963, gage height, 14.20 ft, from rating curve extended above 1,100 ft³/s, on basis of peak flow at former site; minimum, 0.3 ft³/s, Oct. 4, 5, 21–25, 1960, Oct. 5, 6, 1961. Maximum discharge since construction of French Meadows Dam in 1964, 6,050 ft³/s, May 16, 1996, gage height, 11.61 ft, from flow over spillway of French Meadows Reservoir; minimum daily, 0.8 ft³/s, Oct. 22–25, 1964.

DISCHARGE, CUBIC FEET PER SECOND, WATER YEAR OCTOBER 2001 TO SEPTEMBER 2002

DAILY MEAN VALUES

DAY	OCT	NOV	DEC	JAN	FEB	MAR	APR	MAY	JUN	JUL	AUG	SEP
1	9.1	16	9.9	15	9.7	14	17	11	10	9.3	9.7	9.9
2	9.1	16	15	20	9.7	13	18	11	10	9.2	9.6	9.9
3	10	16	11	19	9.7	13	18	11	10	9.1	9.5	9.9
4	29	16	11	14	9.6	13	18	10	9.9	9.1	9.5	9.9
5	58	16	11	14	9.5	13	17	10	9.7	9.1	9.5	9.9
6	61	16	11	18	9.4	29	16	10	9.5	9.1	9.5	9.9
7	50	16	11	15	10	18	16	10	9.5	9.2	9.5	9.9
8	40	17	11	14	11	15	16	10	9.5	9.3	9.5	9.9
9	43	19	11	14	10	14	14	9.9	9.5	9.3	9.5	9.9
10	39	19	11	13	10	14	13	10	9.5	9.3	9.5	9.9
11	36	19	11	13	10	13	12	9.9	9.5	9.3	9.5	9.9
12	36	33	10	13	10	14	12	9.9	9.5	9.3	9.5	9.9
13	36	30	10	12	11	13	12	10	9.4	9.5	9.5	9.9
14	35	15	10	12	11	13	12	11	9.3	9.7	9.5	9.9
15	35	9.3	10	12	11	12	11	11	9.3	9.7	9.5	9.9
16	35	9.3	10	11	11	12	11	11	9.3	9.9	9.5	9.9
17	35	9.3	11	11	12	12	11	11	9.3	9.9	9.5	9.9
18	35	9.3	10	11	11	12	11	11	9.3	9.7	9.5	9.9
19	35	9.3	10	11	16	12	11	10	9.3	9.7	9.5	9.7
20	27	9.3	10	11	25	12	11	11	9.3	9.7	9.5	9.7
21	16	12	10	11	17	13	12	12	9.3	9.7	9.5	9.7
22	16	12	10	10	16	14	12	12	9.3	9.7	9.5	9.7
23	16	9.8	10	10	16	14	12	11	9.3	9.7	9.5	9.7
24	16	14	10	10	15	14	11	11	9.3	9.7	9.6	9.7
25	16	11	10	10	14	14	11	11	9.3	9.7	9.9	9.7
26	16	10	10	10	14	14	11	11	9.3	9.7	9.9	9.7
27	16	9.8	10	10	14	14	13	11	9.3	9.7	9.9	9.7
28	16	9.8	11	10	14	15	11	11	9.3	9.7	9.9	9.7
29	16	9.9	13	9.9	---	17	12	11	9.3	9.7	9.9	9.7
30	16	9.7	15	9.9	---	16	12	10	9.3	9.7	9.9	9.6
31	16	---	22	9.8	---	17	---	10	---	9.7	9.9	---
TOTAL	869.2	427.8	345.9	383.6	346.6	443	394	329.7	283.6	295.1	297.7	294.5
MEAN	28.04	14.26	11.16	12.37	12.38	14.29	13.13	10.64	9.453	9.519	9.603	9.817
MAX	61	33	22	20	25	29	18	12	10	9.9	9.9	9.9
MIN	9.1	9.3	9.9	9.8	9.4	12	11	9.9	9.3	9.1	9.5	9.6
AC-FT	1720	849	686	761	687	879	781	654	563	585	590	584
a	0.00	2150	4220	8990	3380	3060	3810	2140	7090	10670	10470	12380

a Diversion, in acre-feet, from French Meadows Reservoir to Hell Hole Reservoir through French Meadows Powerplant (station 11427200), provided by Placer County Water Agency.

11427500 MIDDLE FORK AMERICAN RIVER AT FRENCH MEADOWS, CA—Continued

STATISTICS OF MONTHLY MEAN DATA FOR WATER YEARS 1952 - 1964, BY WATER YEAR (WY)

	OCT	NOV	DEC	JAN	FEB	MAR	APR	MAY	JUN	JUL	AUG	SEP
MEAN	19.8	20.3	101	92.5	143	151	356	550	297	52.4	6.04	2.10
MAX	222	106	882	377	561	367	537	1110	775	232	25.3	5.06
(WY)	1963	1964	1956	1956	1963	1960	1962	1958	1952	1952	1952	1952
MIN	.40	1.60	1.76	5.57	40.1	55.2	187	210	69.7	6.22	1.57	.64
(WY)	1961	1960	1960	1960	1955	1962	1955	1959	1959	1959	1959	1961

SUMMARY STATISTICS

WATER YEARS 1952 - 1964

ANNUAL MEAN	149
HIGHEST ANNUAL MEAN	265 1956
LOWEST ANNUAL MEAN	68.7 1961
HIGHEST DAILY MEAN	11300 Dec 23 1955
LOWEST DAILY MEAN	.30 Oct 22 1960
ANNUAL SEVEN-DAY MINIMUM	.34 Oct 19 1960
MAXIMUM PEAK FLOW	21500 Jan 31 1963
MAXIMUM PEAK STAGE	14.20 Jan 31 1963
ANNUAL RUNOFF (AC-FT)	108000
10 PERCENT EXCEEDS	446
50 PERCENT EXCEEDS	38
90 PERCENT EXCEEDS	1.5

STATISTICS OF MONTHLY MEAN DATA FOR WATER YEARS 1965 - 2002, BY WATER YEAR (WY)

	1965	1966	1967	1968	1969	1970	1971	1972	1973	1974	1975	1976	1977
MEAN	15.30	10.36	12.71	19.40	17.96	22.15	23.02	57.72	41.26	15.98	8.616	11.65	
MAX	266	42.7	83.3	249	200	375	248	518	272	136	15.0	136	
(WY)	1966	1966	1965	1997	1982	1986	1965	1965	1995	1983	1965	1965	
MIN	1.67	3.16	3.91	4.37	4.53	4.40	4.47	3.95	3.68	2.98	2.76	2.70	
(WY)	1965	1978	1977	1977	1977	1977	1977	1976	1977	1977	1977	1977	

SUMMARY STATISTICS

FOR 2001 CALENDAR YEAR

FOR 2002 WATER YEAR

WATER YEARS 1965 - 2002

ANNUAL TOTAL	4447.1	4710.7	
ANNUAL MEAN	12.18	12.91	21.37
HIGHEST ANNUAL MEAN			97.3 1965
LOWEST ANNUAL MEAN			3.90 1977
HIGHEST DAILY MEAN	61 Oct 6	61 Oct 6	3430 May 16 1996
LOWEST DAILY MEAN	9.1 Sep 27	9.1 Oct 1	0.80 Oct 22 1964
ANNUAL SEVEN-DAY MINIMUM	9.1 Sep 26	9.2 Jul 1	0.84 Oct 21 1964
MAXIMUM PEAK FLOW		66 Oct 6	6050 May 16 1996
MAXIMUM PEAK STAGE		6.44 Oct 6	11.61 May 16 1996
ANNUAL RUNOFF (AC-FT)	8820	9340	15480
TOTAL DIVERSION (AC-FT) a	58230	68370	
10 PERCENT EXCEEDS	16	17	15
50 PERCENT EXCEEDS	10	10	9.7
90 PERCENT EXCEEDS	9.5	9.3	5.9

a Diversion, in acre-feet, from French Meadows Reservoir to Hell Hole Reservoir through French Meadows Powerplant (station 11427200), provided by Placer County Water Agency.

11427700 DUNCAN CANYON CREEK NEAR FRENCH MEADOWS, CA

LOCATION.—Lat 39°08'09", long 120°28'39", in NE 1/4 NW 1/4 sec.24, T.15 N., R.13 E., Placer County, Hydrologic Unit 18020128, Tahoe National Forest, on left bank, 0.2 mi upstream from diversion dam, 0.5 mi downstream from Little Duncan Creek, 2 mi northwest of French Meadows, and 20 mi northeast of Foresthill.

DRAINAGE AREA.—9.94 mi².

PERIOD OF RECORD.—August 1960 to current year. Published as "Duncan Creek near French Meadows" 1961–2000.

GAGE.—Water-stage recorder. Elevation of gage is 5,270 ft above sea level, from topographic map. Prior to Sept. 3, 1965, at site 150 ft upstream at datum 9.56 ft higher.

REMARKS.—No regulation or diversion upstream from station. See schematic diagram of Middle Fork American and Rubicon River Basins.

COOPERATION.—Records provided by Placer County Water Agency, under general supervision of the U.S. Geological Survey, in connection with Federal Energy Regulatory Commission project no. 2079.

EXTREMES FOR PERIOD OF RECORD.—Maximum discharge, 3,650 ft³/s, Dec. 22, 1964, gage height, 10.6 ft, from floodmarks, from rating curve extended above 400 ft³/s, on basis of computation of flow over diversion dam; maximum gage height, 10.95, Jan. 1, 1997 (backwater from debris dam); minimum daily, 0.10 ft³/s, several days during July and August 1977.

EXTREMES FOR CURRENT YEAR.—Peak discharges greater than base discharge of 250 ft³/s, or maximum:

Date	Time	Discharge (ft ³ /s)	Gage height (ft)	Date	Time	Discharge (ft ³ /s)	Gage height (ft)
Nov. 24	1100	304	7.32	Apr. 4	1700	269	7.25
Mar. 6	1300	251	7.21	Apr. 14	1700	325	7.36

DISCHARGE, CUBIC FEET PER SECOND, WATER YEAR OCTOBER 2001 TO SEPTEMBER 2002
DAILY MEAN VALUES

DAY	OCT	NOV	DEC	JAN	FEB	MAR	APR	MAY	JUN	JUL	AUG	SEP
1	0.53	1.3	e7.1	50	12	49	114	68	101	5.5	1.6	0.93
2	0.53	0.97	86	72	12	43	143	70	79	5.2	1.5	0.90
3	0.53	0.90	30	62	11	41	189	87	67	4.9	1.5	0.86
4	0.50	0.85	11	42	11	41	224	110	61	4.6	1.5	0.86
5	0.47	0.85	10	36	12	39	201	136	56	4.4	1.5	0.88
6	0.47	0.80	13	93	12	153	173	155	50	4.3	1.5	0.97
7	0.47	0.76	13	67	14	100	170	161	43	4.1	1.5	1.0
8	0.47	0.76	11	54	17	68	174	154	36	3.9	1.4	1.0
9	0.47	0.76	11	43	14	54	172	147	30	3.6	1.4	0.98
10	0.47	0.76	10	38	14	47	190	127	26	3.4	1.3	0.92
11	0.47	3.3	9.9	35	15	42	185	116	23	3.2	1.3	0.88
12	0.47	5.0	9.3	34	16	42	192	127	21	3.1	1.2	0.85
13	0.47	5.0	e9.0	32	17	38	209	147	20	2.9	1.2	0.85
14	0.47	3.3	e8.6	30	17	34	252	159	19	2.8	1.2	0.83
15	0.47	2.6	e8.6	27	19	31	216	166	17	2.7	1.1	0.80
16	0.48	1.8	e8.4	24	20	29	141	166	15	2.6	1.1	0.83
17	0.51	1.5	e8.4	23	20	28	106	175	13	2.5	1.1	0.85
18	0.53	1.4	e8.4	21	18	25	82	173	12	2.5	1.0	0.86
19	0.53	1.2	8.4	20	35	25	68	143	11	2.5	1.0	0.83
20	0.53	1.2	e8.4	19	139	26	60	120	11	2.3	1.0	0.79
21	0.53	39	e8.3	19	83	30	58	93	11	2.3	1.0	0.77
22	0.53	68	e8.1	18	73	34	64	86	10	2.2	1.1	0.76
23	0.53	10	e7.9	16	73	34	74	86	9.4	2.1	1.1	0.74
24	0.53	83	7.9	15	56	30	95	87	8.7	2.0	1.0	0.72
25	0.53	20	7.9	15	52	28	125	98	8.1	1.9	1.0	0.72
26	0.53	11	8.7	e14	51	30	133	107	7.6	1.9	1.0	0.72
27	0.53	9.1	9.8	e14	52	33	119	112	7.1	1.8	0.98	0.74
28	0.56	7.6	13	13	52	41	98	114	6.7	1.8	0.97	0.80
29	0.60	7.6	23	14	---	57	90	118	6.3	1.7	0.96	0.89
30	4.9	7.2	45	14	---	70	77	122	5.9	1.7	0.96	0.95
31	3.1	---	117	12	---	87	---	116	---	1.6	0.96	---
TOTAL	22.71	297.51	546.1	986	937	1429	4194	3846	791.8	92.0	36.93	25.48
MEAN	0.733	9.917	17.62	31.81	33.46	46.10	139.8	124.1	26.39	2.968	1.191	0.849
MAX	4.9	83	117	93	139	153	252	175	101	5.5	1.6	1.0
MIN	0.47	0.76	7.1	12	11	25	58	68	5.9	1.6	0.96	0.72
AC-FT	45	590	1080	1960	1860	2830	8320	7630	1570	182	73	51

e Estimated.

11427700 DUNCAN CANYON CREEK NEAR FRENCH MEADOWS, CA—Continued

STATISTICS OF MONTHLY MEAN DATA FOR WATER YEARS 1960 - 2002, BY WATER YEAR (WY)

	OCT	NOV	DEC	JAN	FEB	MAR	APR	MAY	JUN	JUL	AUG	SEP
MEAN	3.875	17.01	32.95	43.26	40.85	51.12	78.28	120.1	58.98	8.941	1.554	1.107
MAX	51.1	172	256	213	291	161	162	245	316	100	10.4	4.51
(WY)	1963	1984	1965	1997	1986	1986	1989	1993	1983	1983	1983	1982
MIN	0.22	1.09	0.76	1.76	3.24	5.75	12.7	12.9	2.71	0.51	0.19	0.34
(WY)	1978	1977	1977	1991	1977	1977	1977	1992	1992	1977	1977	1960

SUMMARY STATISTICS	FOR 2001 CALENDAR YEAR		FOR 2002 WATER YEAR		WATER YEARS 1960 - 2002	
ANNUAL TOTAL	6761.70		13204.53			
ANNUAL MEAN	18.53		36.18		38.14	
HIGHEST ANNUAL MEAN					86.8	
LOWEST ANNUAL MEAN					4.27	
HIGHEST DAILY MEAN	151	May 8	252	Apr 14	2800	Jan 1 1997
LOWEST DAILY MEAN	0.34	Aug 19	0.47	Oct 5	0.10	Jul 31 1977
ANNUAL SEVEN-DAY MINIMUM	0.37	Aug 15	0.47	Oct 5	0.11	Aug 8 1977
MAXIMUM PEAK FLOW			325	Apr 14	3650	Dec 22 1964
MAXIMUM PEAK STAGE			7.36	Apr 14	a 10.95	Jan 1 1997
ANNUAL RUNOFF (AC-FT)	13410		26190		27630	
10 PERCENT EXCEEDS	72		118		107	
50 PERCENT EXCEEDS	4.9		11		9.1	
90 PERCENT EXCEEDS	0.41		0.76		0.76	

a Backwater from debris dam.

11427750 DUNCAN CANYON CREEK BELOW DIVERSION DAM, NEAR FRENCH MEADOWS, CA

LOCATION.—Lat 39°07'59", long 120°28'58", in NE 1/4 SE 1/4 sec.23, T.15 N., R.13 E., Placer County, Hydrologic Unit 18020128, Tahoe National Forest, on right bank, 800 ft downstream from unnamed right bank tributary, 1,000 ft downstream from Duncan Canyon Creek Diversion Dam, and 20 mi northeast of Foresthill.

DRAINAGE AREA.—10.5 mi².

PERIOD OF RECORD.—October 1964 to current year. Published as "Duncan Creek below Diversion Dam, near French Meadows" 1965–2000.

GAGE.—Water-stage recorder. Elevation of gage is 5,210 ft above sea level, from topographic map.

REMARKS.—Natural flow affected by transmountain diversion through Duncan Canyon Creek Diversion Tunnel to French Meadows Reservoir (station 11427400). Maximum design flow of tunnel is 400 ft³/s. See schematic diagram of Middle Fork American and Rubicon River Basins.

COOPERATION.—Records provided by Placer County Water Agency, under general supervision of the U.S. Geological Survey, in connection with Federal Energy Regulatory Commission project no. 2079.

EXTREMES FOR PERIOD OF RECORD.—Maximum discharge, 3,640 ft³/s, Dec. 22, 1964, gage height, 8.74 ft, in gage well, 10.0 ft, from floodmarks, from rating curve extended above 400 ft³/s, on basis of computation of peak flow over diversion dam; no flow at times in 1965–66.

DISCHARGE, CUBIC FEET PER SECOND, WATER YEAR OCTOBER 2001 TO SEPTEMBER 2002

DAILY MEAN VALUES

DAY	OCT	NOV	DEC	JAN	FEB	MAR	APR	MAY	JUN	JUL	AUG	SEP
1	0.59	1.4	8.6	20	13	20	23	11	11	6.2	1.8	1.0
2	0.59	1.0	16	22	13	19	23	11	11	5.8	1.8	1.0
3	0.59	0.89	13	21	13	18	24	11	11	5.5	1.8	0.97
4	0.59	0.88	12	18	13	18	24	11	11	5.2	1.8	0.95
5	0.55	0.88	e11	17	13	18	22	11	10	5.0	1.7	0.95
6	0.54	0.85	12	21	13	38	20	11	10	4.8	1.7	1.0
7	0.54	0.81	13	20	13	24	20	11	10	4.6	1.6	1.1
8	0.54	0.81	12	20	14	20	19	11	10	4.3	1.6	1.1
9	0.54	0.81	12	18	14	18	19	10	10	4.1	1.6	1.0
10	0.54	0.81	11	17	14	17	19	10	9.7	3.8	1.5	0.97
11	0.54	3.4	10	18	15	16	18	10	10	3.7	1.4	0.93
12	0.54	5.1	9.8	18	15	16	18	9.9	12	3.5	1.4	0.87
13	0.54	5.6	e9.7	17	16	16	17	11	12	3.4	1.3	0.88
14	0.54	3.5	e9.3	17	16	15	18	11	12	3.2	1.3	0.90
15	0.54	2.8	e9.3	16	17	15	17	11	12	3.1	1.3	0.89
16	0.54	1.9	e9.1	16	16	14	16	11	12	3.0	1.2	0.83
17	0.54	1.6	e9.0	15	16	14	15	11	12	2.9	1.2	0.85
18	0.53	1.5	e9.0	14	16	14	15	11	12	2.9	1.2	0.94
19	0.53	1.4	9.0	14	18	14	15	11	12	2.9	1.2	0.84
20	0.54	1.3	e9.0	14	29	14	15	11	12	2.7	1.1	0.81
21	0.54	7.3	e9.0	14	24	15	16	11	11	2.6	1.2	0.81
22	0.53	15	8.9	14	23	17	16	11	10	2.5	1.2	0.82
23	0.54	11	8.9	13	23	17	16	12	9.6	2.4	1.2	0.78
24	0.54	22	8.5	13	20	16	16	12	9.0	2.3	1.2	0.74
25	0.56	13	8.5	13	20	15	13	11	8.4	2.2	1.2	0.74
26	0.57	12	9.2	e13	20	16	12	11	8.0	2.2	1.1	0.74
27	0.58	9.3	10	13	21	16	12	11	7.6	2.1	1.1	0.74
28	0.59	8.0	12	13	21	18	12	11	7.3	2.0	1.1	0.83
29	0.61	7.9	15	e12	---	21	12	11	6.9	2.0	1.0	0.92
30	4.3	7.6	19	e12	---	22	12	11	6.5	1.9	1.1	0.96
31	3.8	---	29	13	---	22	---	11	---	1.9	1.1	---
TOTAL	24.15	150.34	351.8	496	479	553	514	338.9	306.0	104.7	42.0	26.86
MEAN	0.779	5.011	11.35	16.00	17.11	17.84	17.13	10.93	10.20	3.377	1.355	0.895
MAX	4.3	22	29	22	29	38	24	12	12	6.2	1.8	1.1
MIN	0.53	0.81	8.5	12	13	14	12	9.9	6.5	1.9	1.0	0.74
AC-FT	48	298	698	984	950	1100	1020	672	607	208	83	53

STATISTICS OF MONTHLY MEAN DATA FOR WATER YEARS 1965 - 2002, BY WATER YEAR (WY)

MEAN	2.086	8.304	21.02	29.51	21.48	19.14	15.76	27.81	13.36	3.901	1.396	1.076
MAX	17.3	76.1	244	225	237	80.3	91.7	149	107	21.9	5.87	3.61
(WY)	1983	1982	1965	1997	1986	1986	1982	1967	1998	1983	1983	1983
MIN	0.061	1.15	0.76	1.69	2.02	2.63	4.80	3.88	2.15	0.44	0.28	0.090
(WY)	1966	1991	1977	1991	1974	1965	1974	1976	1965	1965	1977	1965

SUMMARY STATISTICS

FOR 2001 CALENDAR YEAR

FOR 2002 WATER YEAR

WATER YEARS 1965 - 2002

ANNUAL TOTAL	2344.42	3386.75	
ANNUAL MEAN	6.423	9.279	13.72
HIGHEST ANNUAL MEAN			43.1
LOWEST ANNUAL MEAN			2.16
HIGHEST DAILY MEAN	29	Dec 31	2560
LOWEST DAILY MEAN	0.10	Sep 6	0.00
ANNUAL SEVEN-DAY MINIMUM	0.22	Sep 1	0.00
MAXIMUM PEAK FLOW			3640
MAXIMUM PEAK STAGE			8.74
ANNUAL RUNOFF (AC-FT)	4650	6720	9940
10 PERCENT EXCEEDS	15	18	16
50 PERCENT EXCEEDS	5.0	10	5.5
90 PERCENT EXCEEDS	0.44	0.81	0.73

e Estimated.

11427760 MIDDLE FORK AMERICAN RIVER ABOVE MIDDLE FORK POWERPLANT, NEAR FORESTHILL, CA

LOCATION.—Lat 39°01'31", long 120°35'40", in NW 1/4 NW 1/4 sec.36, T.14 N., R.12 E., [Placer County](#), Hydrologic Unit 18020128, Tahoe National Forest, on right bank, 300 ft upstream from Middle Fork Powerplant, 3.7 mi upstream from Big Mosquito Creek, and 11 mi east of Foresthill.

DRAINAGE AREA.—87.8 mi².

PERIOD OF RECORD.—August 1965 to current year.

GAGE.—Water-stage recorder. Elevation of gage is 2,540 ft above sea level, from topographic map. Prior to May 15, 1980, at datum 5.00 ft higher. May 15, 1980, to Oct. 11, 1984, at datum 4.00 ft higher.

REMARKS.—Considerable regulation by French Meadows Reservoir (station 11427400) 11 mi upstream. Transbasin diversions from French Meadows Reservoir to Hell Hole Reservoir (station 11428700) through French Meadows Powerplant (station 11427200). See schematic diagram of [Middle Fork American and Rubicon River Basins](#).

COOPERATION.—Records provided by Placer County Water Agency, under general supervision of the U.S. Geological Survey, in connection with Federal Energy Regulatory Commission project no. 2079.

EXTREMES FOR PERIOD OF RECORD.—Maximum discharge, 13,900 ft³/s, Jan. 2, 1997, gage height, 14.6 ft, from floodmark, from rating curve extended above 4,200 ft³/s; minimum daily, 5.3 ft³/s, Sept. 11, 1977.

DISCHARGE, CUBIC FEET PER SECOND, WATER YEAR OCTOBER 2001 TO SEPTEMBER 2002

DAILY MEAN VALUES

DAY	OCT	NOV	DEC	JAN	FEB	MAR	APR	MAY	JUN	JUL	AUG	SEP
1	10	21	45	202	64	185	260	126	65	35	22	19
2	10	20	202	235	63	170	270	121	63	34	22	19
3	10	19	118	303	62	160	286	116	62	33	22	18
4	13	19	72	204	61	155	291	112	60	32	22	18
5	45	19	67	169	61	153	268	110	58	32	22	18
6	53	18	82	211	61	347	243	108	57	32	22	19
7	50	18	80	197	68	339	236	105	56	31	22	19
8	39	18	68	182	114	258	227	101	55	31	21	19
9	41	22	65	167	88	223	219	98	54	30	21	19
10	41	22	57	155	85	220	210	96	53	29	21	18
11	37	28	51	146	87	202	203	92	51	29	21	19
12	36	46	47	143	91	202	197	88	54	29	21	19
13	36	59	45	136	98	195	191	86	53	28	20	19
14	36	30	61	131	99	181	190	86	52	28	20	18
15	36	18	47	122	106	171	183	84	51	27	20	18
16	36	15	45	114	110	163	162	81	50	27	20	19
17	36	14	69	106	135	158	159	79	49	27	20	19
18	36	13	62	100	117	145	146	76	48	26	19	18
19	36	13	54	95	187	140	136	75	48	26	19	18
20	36	13	59	90	459	141	135	94	47	26	19	18
21	19	41	56	91	320	146	136	93	46	25	19	18
22	17	154	59	86	278	161	142	87	44	25	19	18
23	18	43	62	79	266	196	138	87	43	25	19	18
24	17	150	54	76	229	187	136	84	43	24	19	18
25	17	74	50	75	210	178	135	79	41	24	20	18
26	17	46	49	88	202	176	134	76	40	23	20	18
27	17	37	54	82	200	180	147	74	38	23	19	18
28	18	34	73	73	195	191	133	72	38	23	19	18
29	18	47	136	68	---	213	135	70	37	23	19	19
30	24	39	147	67	---	229	136	69	36	23	19	19
31	30	---	332	65	---	243	---	66	---	23	19	---
TOTAL	885	1110	2468	4058	4116	6008	5584	2791	1492	853	627	553
MEAN	28.55	37.00	79.61	130.9	147.0	193.8	186.1	90.03	49.73	27.52	20.23	18.43
MAX	53	154	332	303	459	347	291	126	65	35	22	19
MIN	10	13	45	65	61	140	133	66	36	23	19	18
AC-FT	1760	2200	4900	8050	8160	11920	11080	5540	2960	1690	1240	1100

STATISTICS OF MONTHLY MEAN DATA FOR WATER YEARS 1966 - 2002, BY WATER YEAR (WY)

MEAN	27.23	45.67	87.60	172.9	172.4	208.6	178.2	177.7	95.23	35.95	19.32	17.26
MAX	270	262	446	781	969	696	601	600	451	184	33.2	29.5
(WY)	1966	1984	1997	1997	1986	1986	1982	1982	1995	1983	1983	1982
MIN	7.43	13.0	12.2	15.7	18.4	21.7	19.3	21.5	15.4	8.64	6.35	6.59
(WY)	1978	1978	1977	1977	1977	1977	1977	1977	1977	1977	1977	1977

SUMMARY STATISTICS

FOR 2001 CALENDAR YEAR

FOR 2002 WATER YEAR

WATER YEARS 1966 - 2002

ANNUAL TOTAL	17054	30545		
ANNUAL MEAN	46.72	83.68	102.9	
HIGHEST ANNUAL MEAN			271	1982
LOWEST ANNUAL MEAN			14.3	1977
HIGHEST DAILY MEAN	332	Dec 31	459	Feb 20
LOWEST DAILY MEAN	10	Aug 27	10	Oct 1
ANNUAL SEVEN-DAY MINIMUM	10	Sep 27	17	Nov 14
MAXIMUM PEAK FLOW			525	Mar 6
MAXIMUM PEAK STAGE			6.65	Mar 6
ANNUAL RUNOFF (AC-FT)	33830	60590	74520	
10 PERCENT EXCEEDS	110	198	245	
50 PERCENT EXCEEDS	32	55	39	
90 PERCENT EXCEEDS	11	18	15	

11427770 MIDDLE FORK AMERICAN RIVER BELOW INTERBAY DAM, NEAR FORESTHILL, CA

LOCATION.—Lat 39°01'35", long 120°36'09", in SW 1/4 SE 1/4 sec.26, T.14 N., R.12 E., Placer County, Hydrologic Unit 18020128, Tahoe National Forest, on left bank, at Interbay Dam, 3.3 mi upstream from Big Mosquito Creek, and 10.6 mi east of Foresthill.

DRAINAGE AREA.—89.1 mi².

PERIOD OF RECORD.—October 1965 to current year (since October 1985, operated as low-flow station only).

GAGE.—Acoustic-velocity meter system. Elevation of gage is 2,470 ft above sea level, from topographic map. Prior to February 1986, water-stage recorder at same site. March 1986 to September 1987, nonrecording gage and V-notch sharp-crested weir at same site and datum as previous gage.

REMARKS.—Flow regulated by French Meadows Reservoir (station 11427400) and after Aug. 22, 1966, by Interbay Reservoir (usable capacity, 130 acre-ft, between normal operating limits) 500 ft upstream. Water is diverted out of the basin from French Meadows Reservoir to Hell Hole Reservoir (station 11428700) and from Interbay Reservoir to Ralston Powerplant (station 11427765). Water is diverted into the basin from Hell Hole Reservoir to Middle Fork Powerplant (station 11428600) and through South Fork and North Fork Long Canyon Creek Diversion Tunnels (stations 11433060 and 11433080). See schematic diagram of [Middle Fork American and Rubicon River Basins](#). Beginning October 1985, only flows less than 35 ft³/s are computed.

COOPERATION.—Records provided by Placer County Water Agency, under general supervision of the U.S. Geological Survey, in connection with Federal Energy Regulatory Commission project no. 2079.

EXTREMES FOR PERIOD OF RECORD.—Maximum discharge (water years 1966–85), 9,900 ft³/s, Jan. 13, 1980, gage height, 7.95 ft; minimum daily, 1.0 ft³/s, Oct. 25–30, 1966, Jan. 19, 1967.

DISCHARGE, CUBIC FEET PER SECOND, WATER YEAR OCTOBER 2001 TO SEPTEMBER 2002
DAILY MEAN VALUES

DAY	OCT	NOV	DEC	JAN	FEB	MAR	APR	MAY	JUN	JUL	AUG	SEP
1	15	23	24	24	23	23	24	24	23	24	e23	23
2	16	23	24	24	23	24	24	24	24	24	23	23
3	15	22	23	24	24	24	24	24	24	24	23	23
4	16	22	24	24	24	24	24	24	24	24	23	23
5	---	23	23	24	24	24	24	24	24	24	23	23
6	---	22	23	23	24	24	24	24	24	24	23	23
7	---	22	23	23	24	23	24	24	24	24	23	23
8	---	21	24	23	24	24	24	23	23	24	23	23
9	---	23	24	23	24	24	24	24	24	24	23	23
10	---	23	24	23	24	24	24	24	24	24	23	23
11	---	23	24	24	24	24	23	24	24	24	23	20
12	---	23	24	24	24	24	23	23	24	24	23	18
13	---	23	23	23	24	24	23	24	24	24	23	20
14	---	23	23	23	24	24	23	24	24	23	23	20
15	---	21	24	23	24	23	24	23	24	24	23	20
16	---	18	24	23	24	23	23	23	24	24	23	20
17	---	17	24	23	24	23	23	24	24	23	23	20
18	---	17	24	23	24	23	23	24	24	23	23	20
19	---	16	24	24	23	24	24	23	24	23	23	20
20	---	16	24	23	24	24	24	23	24	24	23	20
21	21	20	23	24	24	24	24	23	24	24	23	20
22	20	23	24	24	24	24	23	23	24	23	23	20
23	20	24	24	24	23	24	23	24	24	24	23	21
24	20	24	24	24	24	24	23	23	24	24	23	21
25	20	24	24	23	24	24	23	23	23	23	23	21
26	20	23	24	23	23	24	23	24	24	23	23	20
27	20	24	24	23	24	23	23	24	24	24	23	20
28	20	24	24	24	24	24	23	23	24	23	23	20
29	20	24	24	24	---	24	24	24	24	24	23	20
30	22	24	24	24	---	24	24	23	23	23	23	20
31	23	---	24	23	---	24	---	23	---	22	23	---
TOTAL	---	655	737	728	667	737	706	731	716	732	715	631
MEAN	---	21.83	23.77	23.48	23.82	23.77	23.53	23.58	23.87	23.61	23.06	21.03
MAX	---	24	24	24	24	24	24	24	24	24	25	23
MIN	---	16	23	23	23	23	23	23	23	22	23	18
AC-FT	---	1300	1460	1440	1320	1460	1400	1450	1420	1450	1420	1250
a	0.00	1050	14460	23740	22830	16750	18500	19610	23690	23980	24010	8670

e Estimated.

a Diversion, in acre-feet, through Ralston Powerplant (station 11427765), provided by Placer County Water Agency.

11427770 MIDDLE FORK AMERICAN RIVER BELOW INTERBAY DAM, NEAR FORESTHILL, CA—Continued

STATISTICS OF MONTHLY MEAN DATA FOR WATER YEARS 1966 - 1985, BY WATER YEAR (WY)

	OCT	NOV	DEC	JAN	FEB	MAR	APR	MAY	JUN	JUL	AUG	SEP
MEAN	30.5	27.4	73.8	93.7	86.6	101	117	118	78.2	29.4	18.8	18.3
MAX	270	140	548	398	928	508	868	857	313	152	23.7	24.7
(WY)	1966	1984	1984	1980	1982	1983	1982	1982	1967	1983	1983	1983
MIN	5.84	6.38	6.22	6.15	9.32	7.61	11.6	11.1	11.3	7.52	5.86	5.68
(WY)	1978	1968	1968	1968	1968	1968	1977	1977	1977	1977	1977	1977

SUMMARY STATISTICS	WATER YEARS 1966 - 1985	FOR 2001 CALENDAR YEAR	FOR 2002 WATER YEAR
ANNUAL MEAN	66.0		
HIGHEST ANNUAL MEAN	347	1982	
LOWEST ANNUAL MEAN	10.0	1968	
HIGHEST DAILY MEAN	8090	Feb 16 1982	
LOWEST DAILY MEAN	1.0	Oct 25 1966	
ANNUAL SEVEN-DAY MINIMUM	1.3	Oct 25 1966	
INSTANTANEOUS PEAK FLOW	9900	Jan 13 1980	
INSTANTANEOUS PEAK STAGE	7.95	Jan 13 1980	
ANNUAL RUNOFF (AC-FT)	47810		
TOTAL DIVERSION (AC-FT) a		210400	197300
10 PERCENT EXCEEDS	141		
50 PERCENT EXCEEDS	22		
90 PERCENT EXCEEDS	11		

a Diversion, in acre-feet, through Ralston Powerplant (station 11427765), provided by Placer County Water Agency.

11427960 RUBICON RIVER BELOW RUBICON DAM, NEAR MEEKS BAY, CA

LOCATION.—Lat 38°59'20", long 120°13'20", in NW 1/4 SW 1/4 sec.9, T.13 N., R.16 E., [El Dorado County](#), Hydrologic Unit 18020128, Eldorado National Forest, at outlet structure, on diversion dam on Rubicon River, 3.3 mi upstream from Rubicon Springs, and 6.2 mi southwest of Meeks Bay.

DRAINAGE AREA.—26.8 mi².

PERIOD OF RECORD.—October 1991 to current year (low-flow records only). Unpublished records for water years 1964–91 available in files of the U.S. Geological Survey.

GAGE.—Differential-pressure gage and orifice control in outlet pipes. Auxiliary nonrecording gage 1,300 ft downstream at different datum. Datum of gage is 6,520 ft above sea level, from topographic map. Prior to Sept. 4, 1991, nonrecording gage at site 1,300 ft downstream at different datum.

REMARKS.—Records not computed above 10 ft³/s. Flow regulated by Rubicon Reservoir. Flow over the spillway bypasses this station. Most of the water is diverted through Rubicon–Rockbound Tunnel (station 11427940) to Rockbound Lake, which flows into Buck Island Lake. Water is then diverted via Buck–Loon Tunnel (station 11428300) to Loon Lake (station 11429350) for power development. See schematic diagram of [Middle Fork American and Rubicon River Basins](#).

COOPERATION.—Records were collected by Sacramento Municipal Utility District, under general supervision of the U.S. Geological Survey, in connection with Federal Energy Regulatory Commission project no. 2101.

DISCHARGE, CUBIC FEET PER SECOND, WATER YEAR OCTOBER 2001 TO SEPTEMBER 2002

DAILY MEAN VALUES

DAY	OCT	NOV	DEC	JAN	FEB	MAR	APR	MAY	JUN	JUL	AUG	SEP
1	0.24	1.2	6.4	6.5	6.1	6.0	7.2	6.7	8.1	6.2	6.4	1.5
2	0.22	1.2	6.4	6.4	6.1	6.0	7.4	6.7	7.7	6.6	6.4	1.5
3	0.21	1.2	6.4	6.5	6.0	6.0	7.5	7.0	7.4	7.0	6.3	1.5
4	0.51	1.2	6.4	6.3	6.0	6.0	7.7	7.3	7.4	7.0	6.3	1.5
5	1.0	1.2	6.4	6.3	6.0	6.0	7.7	7.6	7.5	7.0	4.9	1.5
6	1.0	1.2	6.4	6.9	6.0	6.2	7.5	7.7	7.4	7.0	3.5	1.4
7	1.0	1.2	6.4	7.1	6.0	6.2	7.5	7.9	7.1	7.0	3.4	1.4
8	1.0	1.2	6.4	6.7	6.0	6.0	7.5	7.7	7.0	7.0	3.4	1.4
9	1.0	1.2	6.4	6.5	6.0	6.0	7.7	7.7	6.8	6.9	3.4	1.4
10	1.1	1.2	6.4	6.3	6.0	6.0	7.6	7.5	6.5	e6.9	3.4	1.4
11	1.1	1.2	6.4	6.3	6.0	6.3	7.7	7.2	6.5	e6.8	3.3	1.4
12	1.1	1.3	6.4	6.3	6.0	6.8	7.8	7.4	6.7	e6.7	3.3	1.4
13	1.1	1.3	6.2	6.3	6.0	6.8	7.7	7.6	6.7	e6.7	3.3	1.3
14	1.1	1.4	6.3	6.3	6.0	6.7	7.8	7.9	6.8	e6.7	2.5	1.3
15	1.1	1.4	6.3	6.1	6.0	6.7	7.9	7.9	6.7	e6.7	2.0	1.3
16	1.1	1.4	6.2	6.1	6.0	6.7	7.5	7.9	6.6	6.7	2.0	1.3
17	1.1	1.4	6.3	6.1	6.0	6.6	7.1	8.0	6.6	6.7	1.9	1.3
18	1.1	1.4	6.3	6.1	6.0	6.7	6.9	8.3	6.6	6.7	1.9	1.3
19	1.1	4.6	6.2	6.1	6.0	6.7	6.8	8.1	6.6	6.7	1.9	1.3
20	1.1	6.5	6.2	6.1	6.4	6.7	6.7	7.6	6.6	6.6	1.9	1.3
21	1.1	6.5	6.2	6.1	6.4	6.8	6.7	7.2	6.6	6.6	1.9	1.3
22	1.1	7.9	6.2	6.1	6.3	6.8	6.8	7.0	6.4	6.6	1.8	1.3
23	1.1	7.0	6.2	6.1	6.3	6.8	7.0	6.8	6.4	6.6	1.7	1.3
24	1.1	7.2	6.2	6.1	6.2	6.8	7.2	6.9	6.4	6.6	1.6	1.2
25	1.1	7.0	6.2	6.1	6.1	6.7	7.5	7.1	6.3	6.6	1.6	1.2
26	1.1	6.6	6.2	6.1	6.1	6.6	7.7	7.4	6.3	6.5	1.6	1.2
27	1.0	6.4	6.3	6.1	6.1	6.7	7.3	7.6	6.3	6.5	1.6	1.2
28	1.1	6.4	6.3	6.1	6.0	6.8	7.0	7.7	6.3	6.5	1.6	1.2
29	1.1	6.4	6.3	6.1	---	7.0	6.9	7.9	6.2	6.5	1.6	1.2
30	1.1	6.4	6.4	6.1	---	7.0	6.8	8.0	6.2	6.4	1.6	1.2
31	1.2	---	6.5	6.1	---	7.2	---	8.2	---	6.4	1.5	---
TOTAL	30.38	101.7	195.8	194.4	170.1	202.3	220.1	233.5	202.7	207.4	89.5	40.0
MEAN	0.980	3.390	6.316	6.271	6.075	6.526	7.337	7.532	6.757	6.690	2.887	1.333
MAX	1.2	7.9	6.5	7.1	6.4	7.2	7.9	8.3	8.1	7.0	6.4	1.5
MIN	0.21	1.2	6.2	6.1	6.0	6.0	6.7	6.7	6.2	6.2	1.5	1.2
AC-FT	60	202	388	386	337	401	437	463	402	411	178	79

e Estimated.

11428400 LITTLE RUBICON RIVER BELOW BUCK ISLAND DAM, NEAR MEEKS BAY, CA

LOCATION.—Lat 39°00' 18", long 120°15' 19", in SW 1/4 NW 1/4 sec.6, T.13 N., R.16 E., [El Dorado County](#), Hydrologic Unit 18020128, Eldorado National Forest, at outlet structure on Buck Island Diversion Dam, and 7.4 mi southwest of Meeks Bay.

DRAINAGE AREA.—6.00 mi².

PERIOD OF RECORD.—October 1990 to current year (low-flow records only). Unpublished records for water years 1964–90 available in files of the U.S. Geological Survey.

GAGE.—Water-stage recorder and V-notch sharp-crested weir. Elevation of gage is 6,420 ft above sea level, from topographic map. Aug. 14, 1964, to Oct. 4, 1973, nonrecording gage at site 60 ft downstream at different datum. Nonrecording gage at present site Oct. 4, 1973, to Aug. 26, 1986, at different datum and Aug. 27, 1986, to Sept. 30, 1990, at same datum.

REMARKS.—No records computed above 2 ft³/s. Flow regulated by Buck Island Reservoir. Flow over the spillway bypasses this station. Most of the water is diverted at Buck Island Reservoir via Buck–Loon Tunnel (station 11428300) to Loon Lake (station 11429350). Buck Island Lake receives water from Rubicon River via Rubicon–Rockbound Tunnel (station 11427940). See schematic diagram of [Middle Fork American and Rubicon River Basins](#).

COOPERATION.—Records were collected by Sacramento Municipal Utility District, under general supervision of the U.S. Geological Survey, in connection with Federal Energy Regulatory Commission project no. 2101.

DISCHARGE, CUBIC FEET PER SECOND, WATER YEAR OCTOBER 2001 TO SEPTEMBER 2002

DAILY MEAN VALUES

DAY	OCT	NOV	DEC	JAN	FEB	MAR	APR	MAY	JUN	JUL	AUG	SEP
1	1.3	1.3	1.4	1.5	1.3	1.3	1.4	1.2	1.3	1.2	1.3	1.2
2	1.3	1.3	1.4	1.5	1.3	1.3	1.4	1.2	1.3	1.4	1.3	1.2
3	1.3	1.3	1.4	1.4	1.3	1.3	1.4	1.2	1.2	1.4	1.2	1.2
4	1.3	1.3	1.4	1.4	1.3	1.2	1.5	1.3	1.2	1.3	1.2	1.2
5	1.3	1.3	1.4	e1.3	1.3	1.2	1.5	1.4	1.2	1.2	1.2	1.2
6	1.3	1.3	1.4	e1.4	1.3	1.3	1.5	1.4	1.2	1.2	1.2	1.2
7	1.3	1.3	1.4	e1.6	1.2	1.3	1.5	1.4	1.2	1.2	1.2	1.2
8	1.3	1.2	1.4	1.5	1.3	1.3	1.5	1.4	1.2	1.2	1.2	1.2
9	1.3	1.2	1.4	1.3	1.2	1.3	1.5	1.4	1.1	1.2	1.2	1.2
10	1.3	1.2	1.4	1.2	1.2	1.3	1.5	1.4	1.1	1.3	1.2	1.2
11	1.3	1.2	1.4	1.2	1.2	1.2	1.5	1.3	1.2	1.4	1.2	1.2
12	1.2	1.2	1.4	1.2	1.2	1.3	1.5	1.3	1.3	1.4	1.2	1.2
13	1.2	1.3	1.4	1.2	1.3	1.2	1.5	1.3	1.3	1.4	1.2	1.2
14	1.2	1.2	1.4	1.2	1.3	1.2	1.5	1.2	1.4	1.4	1.2	1.2
15	1.2	1.2	1.4	1.2	1.3	1.3	1.6	1.3	1.3	1.4	1.2	1.2
16	1.2	1.2	1.4	1.2	1.2	1.3	1.4	1.3	1.3	1.4	1.2	1.2
17	1.2	1.2	1.4	1.3	1.3	1.3	1.3	1.3	1.3	1.4	1.2	1.2
18	1.2	1.2	1.4	1.3	1.3	1.3	1.2	1.3	1.3	1.4	1.2	1.3
19	1.2	1.2	1.4	1.3	1.2	1.2	1.2	1.3	1.3	1.4	1.2	1.3
20	1.2	1.3	1.3	1.3	1.3	1.2	1.2	1.2	1.3	1.3	1.2	1.3
21	1.2	1.4	1.3	1.3	1.4	1.2	1.2	1.2	1.3	1.3	1.2	1.3
22	1.2	1.8	1.3	1.3	1.4	1.3	1.2	1.1	1.3	1.3	1.2	1.3
23	1.2	1.6	1.3	1.3	1.3	1.3	1.2	1.0	1.3	1.3	1.2	1.3
24	1.3	1.6	1.3	1.3	1.3	1.3	1.3	1.0	1.3	1.3	1.2	1.3
25	1.3	1.6	1.3	1.3	1.3	1.3	1.3	1.1	1.3	1.3	1.2	1.3
26	1.3	1.5	1.3	1.3	1.3	1.2	1.4	1.1	1.3	1.3	1.2	1.3
27	1.3	1.4	1.3	1.3	1.3	1.2	1.4	1.2	1.3	1.3	1.2	1.3
28	1.3	1.4	1.3	1.3	1.3	1.2	1.3	1.2	1.2	1.3	1.2	1.3
29	1.3	1.4	1.3	1.3	---	1.3	1.3	1.2	1.2	1.3	1.2	1.3
30	1.3	1.4	1.3	1.2	---	1.3	1.2	1.3	1.2	1.3	1.2	1.3
31	1.3	---	1.4	1.2	---	1.3	---	1.3	---	1.3	1.2	---
TOTAL	39.1	40.0	42.3	40.6	35.9	39.2	41.4	38.8	37.7	40.8	37.4	37.3
MEAN	1.261	1.333	1.365	1.310	1.282	1.265	1.380	1.252	1.257	1.316	1.206	1.243
MAX	1.3	1.8	1.4	1.6	1.4	1.3	1.6	1.4	1.4	1.4	1.3	1.3
MIN	1.2	1.2	1.3	1.2	1.2	1.2	1.2	1.0	1.1	1.2	1.2	1.2
AC-FT	78	79	84	81	71	78	82	77	75	81	74	74

e Estimated.

11428700 HELL HOLE RESERVOIR NEAR MEEKS BAY, CA

LOCATION.—Lat 39°03'54", long 120°24'50", in SE 1/4 NW 1/4 sec.16, T.14 N., R.14 E., Placer County, Hydrologic Unit 18020128, Eldorado National Forest, on right bank, 0.3 mi upstream from Hell Hole Dam, on Rubicon River, and 15.6 mi west of Meeks Bay.

DRAINAGE AREA.—114 mi².

PERIOD OF RECORD.—December 1965 to current year.

GAGE.—Water-stage recorder. Datum of gage is sea level (levels by Placer County Water Agency).

REMARKS.—Reservoir is formed by rockfill dam with earth core. Storage began Dec. 6, 1965. Usable capacity, 207,342 acre-ft, between elevations 4,287.65 ft, invert of river outlet, and 4,630.0 ft, crest of ogee spillway. Dead storage, 248 acre-ft. Reservoir is used to store water for hydroelectric power. Water is diverted into reservoir from French Meadows Reservoir (station 11427400) on the Middle Fork American River through French Meadows Powerplant (station 11427200). Water is diverted out of reservoir to the Middle Fork American River through Middle Fork Powerplant. See schematic diagram of [Middle Fork American and Rubicon River Basins](#).

COOPERATION.—Records provided by Placer County Water Agency, under general supervision of the U.S. Geological Survey, in connection with Federal Energy Regulatory Commission project no. 2079.

EXTREMES FOR PERIOD OF RECORD.—Maximum contents, 217,400 acre-ft, Jan. 2, 1997, elevation, 4,637.7 ft; minimum since reservoir first filled, 37,499 acre-ft, Mar. 23, 1973, elevation, 4,428.28 ft.

EXTREMES FOR CURRENT YEAR.—Maximum contents, 158,200 acre-ft, June 15, elevation, 4,587.5 ft; minimum, 34,000 acre-ft, Nov. 11–13, elevation, 4,421.4 ft.

Capacity table (elevation, in feet, and contents, in acre-feet)
(Based on survey by Placer County Water Agency in 1966)

4,340	5,220	4,400	24,200	4,500	83,000	4,600	171,900
4,360	9,840	4,450	49,600	4,550	122,700	4,650	233,400
4,380	16,200						

RESERVOIR STORAGE, (ACRE-FEET), WATER YEAR OCTOBER 2001 TO SEPTEMBER 2002

DAILY OBSERVATION AT 2400 HOURS

DAY	OCT	NOV	DEC	JAN	FEB	MAR	APR	MAY	JUN	JUL	AUG	SEP
1	37500	35000	41300	45500	53000	56600	76400	118800	152700	152100	139300	124700
2	37500	34900	41900	46500	53200	57100	78100	119300	153500	151500	138900	124000
3	37400	34800	41800	47600	53200	57600	80100	120200	154100	151000	138200	123400
4	37400	34700	41600	48000	53200	58000	82400	121300	154700	150800	137700	122900
5	37300	34600	41400	48400	53000	58400	84400	122600	155500	150600	137100	122200
6	37200	34500	41200	50000	52600	60100	86000	124100	156200	149800	136600	121600
7	37100	34400	41100	50900	52200	61000	87500	125600	157000	149000	136200	120900
8	37100	34200	41100	51600	52000	61700	89100	126700	157200	148500	135600	120600
9	37000	34200	41200	52100	51900	62400	90900	127700	157200	148100	135200	120400
10	36900	34100	41000	52400	51900	63000	92600	128500	157500	147700	134700	120200
11	36900	34000	40900	52700	51500	63500	94400	129400	157500	147200	134200	119900
12	36800	34000	40500	53200	51100	64400	96300	130600	157600	146900	133800	120300
13	36700	34000	40500	53700	50700	64900	98100	131500	157700	146300	133400	120500
14	36700	34100	40500	53900	50400	65400	100600	132700	158000	146100	132900	120800
15	36600	34100	40500	54000	50100	65800	102800	133900	157800	145900	132400	121000
16	36500	34100	40600	54000	50200	66300	104000	135200	157700	145500	132000	121300
17	36400	34100	40900	53800	50400	66700	104700	136600	157600	145100	131400	121600
18	36400	34100	40900	53700	50400	66800	105600	138400	157600	144600	131100	121900
19	36300	e34100	41000	53800	50700	67000	106500	139800	157200	144200	130700	122100
20	36200	34800	41300	54000	52700	67200	107300	141000	157000	144500	130600	122500
21	36100	36000	41200	53900	53700	67600	108100	142000	156500	144100	130100	123000
22	36000	37500	41300	53800	54000	68100	108900	142700	156100	143700	129600	123300
23	35800	37700	41500	53700	54800	68900	109900	143300	155700	143300	129100	123800
24	35700	39400	41600	53600	55300	69600	111300	143700	155400	142800	128700	124300
25	35600	39700	41700	53500	55300	70100	113100	144800	155000	142300	128300	124400
26	35500	39900	41800	53700	55400	70700	114900	146000	154500	141800	127800	124900
27	35400	40400	42000	53700	55800	71200	116200	147200	154000	141600	127300	125300
28	35300	40600	42300	53700	56300	71600	116900	148100	153300	141200	126800	125700
29	35200	41000	42800	53500	---	72600	117600	149400	153400	140700	126200	126200
30	35200	41200	43400	53300	---	73800	118400	150500	152600	140300	125600	126300
31	35100	---	45000	53200	---	75000	---	151700	---	139800	125100	---
MAX	37500	41200	45000	54000	56300	75000	118400	151700	158000	152100	139300	126300
MIN	35100	34000	40500	45500	50100	56600	76400	118800	152600	139800	125100	119900
a	4423.5	4435.3	4442.0	4456.0	4460.9	4488.9	4544.9	4581.2	4582.1	4569.1	4552.8	4554.2
b	-2500	+6100	+3800	+8200	+3100	+18700	+43400	+33300	+900	-12800	-14700	+1200

CAL YR 2001 b -38400

WTR YR 2002 b +88700

e Estimated

a Elevation, in feet, at end of month.

b Change in contents, in acre-feet.

11428800 RUBICON RIVER BELOW HELL HOLE DAM, NEAR MEEKS BAY, CA

LOCATION.—Lat 39°03'24", long 120°24'25", in NE 1/4 NE 1/4 sec.21, T.14 N., R.14 E., Placer County, Hydrologic Unit 18020128, Eldorado National Forest, on right bank, 600 ft downstream from outlet of dam, and 15.3 mi west of Meeks Bay.

DRAINAGE AREA.—114 mi².

PERIOD OF RECORD.—November 1965 to current year.

GAGE.—Water-stage recorder and V-notch sharp-crested weir. Datum of gage is 4,231.52 ft above sea level (levels by Placer County Water Agency).

REMARKS.—Flow completely regulated by Hell Hole Reservoir (station 11428700) 600 ft upstream from station. During years when Hell Hole Dam spills, records include flow which bypasses the station. Transbasin diversions upstream from station through Buck-Loon Tunnel (station 11428300) to Loon Lake Reservoir (station 11429350); from Middle Fork American River Basin through tunnel from French Meadows Reservoir (station 11427400) to Hell Hole Reservoir; from Hell Hole Reservoir through tunnel to Middle Fork Powerplant (station 11428600). Diversion began Sept. 8, 1966. See schematic diagram of [Middle Fork American and Rubicon River Basins](#).

COOPERATION.—Records provided by Placer County Water Agency, under general supervision of the U.S. Geological Survey, in connection with Federal Energy Regulatory Commission project no. 2079.

EXTREMES FOR PERIOD OF RECORD.—Maximum discharge, 28,800 ft³/s, Jan. 2, 1997, including flow over spillway; no flow Aug. 25 to Sept. 11, 1966.

DISCHARGE, CUBIC FEET PER SECOND, WATER YEAR OCTOBER 2001 TO SEPTEMBER 2002

DAILY MEAN VALUES

DAY	OCT	NOV	DEC	JAN	FEB	MAR	APR	MAY	JUN	JUL	AUG	SEP
1	21	55	22	13	11	13	12	12	21	21	22	22
2	28	55	28	16	11	12	13	11	20	21	22	23
3	34	55	24	15	11	12	14	11	24	21	22	22
4	34	54	22	12	11	12	14	11	25	21	21	22
5	34	54	22	12	11	12	14	14	22	21	21	22
6	34	54	23	15	11	17	13	13	21	21	21	22
7	34	54	23	14	12	16	13	13	21	21	21	22
8	34	53	23	13	13	14	13	13	21	21	21	22
9	34	53	22	13	12	13	13	12	21	21	21	22
10	34	53	22	12	12	14	13	12	21	21	21	39
11	35	53	22	12	12	14	13	12	21	21	21	46
12	35	39	22	11	11	14	13	12	20	21	21	46
13	35	32	22	11	11	14	12	12	20	21	21	43
14	35	27	21	11	11	13	13	16	20	21	21	42
15	38	21	22	12	11	13	13	22	20	21	21	43
16	40	21	17	12	11	13	11	22	20	21	21	43
17	35	21	14	12	12	13	11	22	20	21	21	43
18	35	21	16	11	12	13	11	22	21	22	21	43
19	42	21	16	11	16	13	11	21	21	22	21	42
20	54	21	13	11	20	13	11	21	20	22	21	43
21	55	23	13	11	15	13	11	21	20	22	21	43
22	55	25	13	11	14	13	12	21	20	22	21	44
23	55	23	13	11	13	14	11	21	20	22	21	45
24	55	25	13	11	13	14	11	21	20	22	21	46
25	55	23	12	11	13	14	11	21	20	22	21	38
26	55	22	12	11	13	13	12	20	20	22	21	45
27	55	22	13	11	13	13	12	20	20	22	21	44
28	55	22	13	11	13	13	12	20	20	22	21	44
29	55	22	14	11	---	13	11	20	20	22	21	44
30	55	22	14	11	---	12	12	20	20	22	22	44
31	55	---	18	11	---	12	---	21	---	22	22	---
TOTAL	1310	1046	564	370	349	412	366	530	620	665	656	1109
MEAN	42.26	34.87	18.19	11.94	12.46	13.29	12.20	17.10	20.67	21.45	21.16	36.97
MAX	55	55	28	16	20	17	14	22	25	22	22	46
MIN	21	21	12	11	11	12	11	11	20	21	21	22
AC-FT	2600	2070	1120	734	692	817	726	1050	1230	1320	1300	2200
a	0.00	155	10050	16390	15040	5480	8470	16140	22410	23630	23920	8540

a Diversion, in acre-feet, from Hell Hole Reservoir through Middle Fork Powerplant (station 11428600), provided by Placer County Water Agency.

SACRAMENTO RIVER BASIN

11428800 RUBICON RIVER BELOW HELL HOLE DAM, NEAR MEEKS BAY, CA—Continued

STATISTICS OF MONTHLY MEAN DATA FOR WATER YEARS 1966 - 2002, BY WATER YEAR (WY)

	OCT	NOV	DEC	JAN	FEB	MAR	APR	MAY	JUN	JUL	AUG	SEP
MEAN	19.21	18.14	24.41	59.13	21.33	29.88	21.35	64.42	104.3	44.23	15.89	17.74
MAX	42.3	34.9	318	1615	172	478	129	1053	1007	303	23.6	37.0
(WY)	2002	2002	1982	1997	1982	1986	1982	1996	1995	1983	1995	2002
MIN	7.14	7.51	7.57	6.24	6.34	6.33	7.78	7.92	7.74	6.93	6.50	6.43
(WY)	1974	1977	1989	1977	1977	1977	1977	1977	1977	1977	1977	1977

SUMMARY STATISTICS	FOR 2001 CALENDAR YEAR		FOR 2002 WATER YEAR		WATER YEARS 1966 - 2002	
ANNUAL TOTAL	7593		7997			
ANNUAL MEAN	20.80		21.91		37.27	
HIGHEST ANNUAL MEAN					158	
LOWEST ANNUAL MEAN					7.11	
HIGHEST DAILY MEAN	55	Oct 21	55	Oct 21	17100	Jan 2 1997
LOWEST DAILY MEAN	11	Jan 27	11	Jan 12	0.00	Aug 25 1966
ANNUAL SEVEN-DAY MINIMUM	12	Jan 21	11	Jan 18	0.00	Aug 25 1966
MAXIMUM PEAK FLOW			55		28800	
ANNUAL RUNOFF (AC-FT)	15060		15860		27000	
TOTAL DIVERSION (AC-FT) a	182800		150200			
10 PERCENT EXCEEDS	34		43		27	
50 PERCENT EXCEEDS	21		21		18	
90 PERCENT EXCEEDS	12		11		9.2	

a Diversion, in acre-feet, from Hell Hole Reservoir through Middle Fork Powerplant (station 11428600), provided by Placer County Water Agency.

11429350 LOON LAKE NEAR MEEKS BAY, CA

LOCATION.—Lat 38°58'59", long 120°19'22", in SE 1/4 SW 1/4 sec.8, T.13 N., R.15 E., El Dorado County, Hydrologic Unit 18020128, Eldorado National Forest, in powerplant intake structure, 1.6 mi southwest of right bank end of Loon Lake Dam on Gerle Creek, and 10 mi southwest of Meeks Bay.

DRAINAGE AREA.—7.96 mi².

PERIOD OF RECORD.—December 1963 to current year.

CHEMICAL ANALYSES: June to September 1996.

REVISED RECORDS.—WDR CA-76-4: Drainage area.

GAGE.—Water-stage recorder. Datum of gage is sea level (levels by Sacramento Municipal Utility District). Prior to Sept. 23, 1975, at site 1.6 mi northeast on right bank end of Loon Lake Dam at same datum.

REMARKS.—Reservoir is formed by an earthfill dam completed Dec. 27, 1963; storage began Dec. 5, 1963. Prior to September 1962, reservoir was formed by granite-block dam built in 1884, capacity, 8,000 acre-ft. Usable capacity, 73,868 acre-ft, between elevations 6,325 ft, invert of fishwater release valve, and 6,410 ft, crest of spillway. Dead storage, 2,300 acre-ft. Lake receives water from Rubicon River via Rubicon–Rockbound Tunnel to Buck Island Lake and from Buck Island Lake to Loon Lake via Buck–Loon Tunnel (stations 11427940 and 11428300, respectively). Records, including extremes, represent total contents. See schematic diagram of [Middle Fork American and Rubicon River Basins](#).

COOPERATION.—Records were collected by Sacramento Municipal Utility District, under general supervision of the U.S. Geological Survey, in connection with Federal Energy Regulatory Commission project no. 2101. Contents not rounded to U.S. Geological Survey standards.

EXTREMES FOR PERIOD OF RECORD.—Maximum contents, 77,700 acre-ft, June 6, 1969, elevation, 6,411.1 ft; minimum since reservoir first filled, 3,262 acre-ft, Nov. 8, 9, 1988, elevation, 6,328.70 ft.

EXTREMES FOR CURRENT YEAR.—Maximum contents, 68,208 acre-ft, June 23, elevation, 6,409.22 ft; minimum, 17,271 acre-ft, Feb. 13, elevation, 6361.35 ft.

Capacity table (elevation, in feet, and contents, in acre-feet)
(Table provided by Sacramento Municipal Utility District based on June, 2000, survey)

6,330	2,359	6,350	9,835	6,370	24,156	6,412	72,109
6,340	4,809	6,360	16,291	6,390	44,030		

RESERVOIR STORAGE, ACRE-FEET, WATER YEAR OCTOBER 2000 TO SEPTEMBER 2001

DAILY OBSERVATION AT 2400 HOURS

(NOT PREVIOUSLY PUBLISHED)

DAY	OCT	NOV	DEC	JAN	FEB	MAR	APR	MAY	JUN	JUL	AUG	SEP
1	23577	18633	18633	11815	11983	12963	21804	34733	56619	56530	54916	50905
2	23450	18481	18655	11809	11977	12996	22438	35854	56835	56504	54866	50857
3	22678	18481	18663	11809	11977	13009	22837	36556	57026	56390	54829	50809
4	22521	18488	18663	11796	11990	13067	23079	36992	57102	56352	54791	50760
5	22487	18503	18171	11796	12002	13119	23247	37588	57064	56340	54741	50712
6	22388	18534	17205	11790	12071	13139	23467	38369	57026	55985	54704	50664
7	22116	18511	16723	11784	12121	13165	23729	39286	57013	55960	54804	50615
8	21641	18549	16112	11784	12140	13217	23882	40386	56975	55935	54754	50555
9	21519	18564	15414	11790	12222	13308	24002	41687	56949	55897	54716	50507
10	21406	18617	14811	11840	12323	e13358	24061	e42851	56924	55872	54679	50327
11	21010	18640	14273	11852	12431	13427	24216	43951	56924	55834	54641	50098
12	20602	18633	14165	11846	12482	13466	24293	45120	56924	55796	54579	50074
13	20404	18633	13585	11846	12482	13512	24370	46189	56924	55758	54541	50038
14	20206	18640	13139	11859	12495	13591	24456	47153	56924	55720	54491	49859
15	20072	18640	e12665	11865	12507	13671	24577	48149	56937	55670	54441	49393
16	19774	18640	12450	11865	12514	e13748	24802	e49528	56962	55645	53981	49179
17	e19430	18625	12260	11846	12520	13844	25193	50628	56962	55607	53696	48977
18	19184	18617	11965	11840	12552	13991	25728	e53202	56962	55557	53362	48929
19	18999	18610	11790	11840	12622	14212	26331	e53206	56975	55506	53337	48905
20	18785	18602	11796	11840	12674	14551	26751	e53210	56975	55456	53275	48858
21	18602	18587	11809	11840	12738	14997	27011	53213	56975	55418	53226	48799
22	18481	18587	11821	11834	12789	15498	27219	e53857	e56733	55380	53164	48775
23	18239	18579	11834	11846	12808	15970	27509	54354	e56721	55343	53139	48728
24	18148	18572	11859	11896	12886	16492	28030	54791	e56688	55292	53090	48692
25	18118	18564	11859	11940	12938	17286	28804	55292	e56655	55255	53041	48739
26	18088	18557	11834	11983	12944	17931	29843	55670	56606	55205	52721	48704
27	18239	18541	11834	11983	12970	18412	30957	55998	56606	55154	52121	48656
28	18428	18534	11827	11971	12957	19022	31982	e56282	56593	55104	51499	e48633
29	18572	18595	11821	11996	---	19758	32765	56530	56581	55042	51135	48585
30	18617	18602	11821	11990	---	20436	33598	e56524	56555	55004	50990	48349
31	18640	---	11821	11983	---	21107	---	56390	---	54966	50941	---
MAX	23577	18640	18663	11996	12970	21107	33598	56530	57102	56530	54916	50905
MIN	18088	18481	11790	11784	11977	12963	21804	34733	56555	54966	50941	48349
a	6363.18	6363.13	6353.32	6353.58	6355.11	6366.33	6380.19	6400.31	6400.44	6399.18	6395.91	6393.74
b	-9076	-38	-6781	+162	+974	+8150	+12491	+22792	+165	-1589	-4025	-2592

CAL YR 2000 MAX 68479 MIN 11790 b -16502
WTR YR 2001 MAX 57102 MIN 11784 b +20633

e Estimated.

a Elevation, in feet, at end of month.

b Change in contents, in acre-feet.

SACRAMENTO RIVER BASIN

11429350 LOON LAKE NEAR MEEKS BAY, CA—Continued

RESERVOIR STORAGE, ACRE-FEET, WATER YEAR OCTOBER 2001 TO SEPTEMBER 2002

DAILY OBSERVATION AT 2400 HOURS

DAY	OCT	NOV	DEC	JAN	FEB	MAR	APR	MAY	JUN	JUL	AUG	SEP
1	47433	40429	44165	43074	25403	19362	21633	35988	58603	66078	62149	58551
2	47094	40212	44642	43489	24603	19478	22273	36111	59835	65655	62056	58127
3	46873	39963	44847	43804	24620	19587	22795	36060	60737	65221	61963	58011
4	46733	39780	44926	43736	23968	19696	23340	36691	61369	65153	61831	57959
5	46548	39575	44653	43872	22820	19813	23968	37567	61818	65085	61672	57857
6	46501	39339	44528	44403	21944	20261	24499	38549	62401	65139	61567	57716
7	46258	39125	44392	44938	21276	20618	24880	39694	63174	65098	61474	57626
8	46039	38922	44279	45395	20610	20810	25132	40766	64382	65139	61369	57524
9	45843	38613	44211	44744	20174	20930	25455	41709	64382	65085	61263	57396
10	45498	38401	43928	44347	19899	21099	26384	42606	64140	64409	60961	57306
11	45189	38443	43939	43568	18892	21187	27310	43298	64072	64396	60567	57217
12	45063	38539	43669	42784	17991	21309	28011	44030	64180	64180	60488	57128
13	44835	38539	43489	42084	17271	21430	29046	44574	64234	63965	60397	57051
14	44619	38528	43736	41127	17308	21544	30317	45212	64652	63509	60292	56988
15	44437	38496	43489	40310	17381	21633	31593	46490	65193	63468	60200	56898
16	44097	38475	43534	39253	17470	21731	32206	47726	65628	63442	60109	56809
17	43951	38443	42762	38411	17588	21845	32736	49024	66023	63415	60031	56758
18	43804	38422	42617	37736	17648	21894	33052	e50845	66474	63361	59939	56682
19	43691	38390	42461	36659	17470	21960	32953	e51998	66885	63308	59822	56543
20	43658	38496	42217	35916	17841	21536	33161	53250	67229	63254	59731	56327
21	43613	38890	42084	35179	18096	20954	33369	54018	67656	63174	59627	56251
22	43298	40310	42062	34198	18261	20874	33151	54018	67932	63121	59523	56175
23	42996	41083	41940	33071	18534	20874	33121	53584	68208	63040	59432	56023
24	42795	42217	41918	31904	18655	20698	33250	53250	68070	62960	59354	55935
25	42528	42974	41974	31178	18823	20555	34018	52942	67918	62880	59263	55771
26	42195	43332	41885	30669	18984	20499	35047	53041	68056	62800	59159	55645
27	42029	43466	41841	30184	19145	20420	35936	53028	68098	62720	59017	55557
28	41764	43646	41974	29392	19308	20420	36473	54043	67932	62627	58900	55468
29	41127	43838	42128	28554	---	20650	36070	54891	67518	62534	58810	55280
30	40886	43917	42372	27382	---	20994	36297	55846	66967	62375	58706	55280
31	40657	---	42773	26393	---	21438	---	57166	---	62268	58629	---
MAX	47433	43917	44926	45395	25403	21960	36473	57166	68208	66078	62149	58551
MIN	40657	38390	41841	26393	17271	19362	21633	35988	58603	62268	58629	55280
a	6386.96	6389.90	6388.88	6372.56	6364.05	6366.74	6382.85	6400.92	6408.32	6404.84	6402.06	6399.43
b	-7692	+3260	-1144	-16380	-7085	+2130	+14859	+20869	+9801	-4699	-3639	-3349

CAL YR 2001 MAX 57102 MIN 11784 b +30952
WTR YR 2002 MAX 68208 MIN 17271 b +6931

e Estimated.

a Elevation, in feet, at end of month.

b Change in contents, in acre-feet.

11429500 GERLE CREEK BELOW LOON LAKE DAM, NEAR MEEKS BAY, CA

LOCATION.—Lat 39°00'20", long 120°18'52", in NE 1/4 NE 1/4 sec.5, T.13 N., R.15 E., [El Dorado County](#), Hydrologic Unit 18020128, Eldorado National Forest, on right bank, 0.3 mi downstream from Loon Lake Dam, and 11 mi southwest of Meeks Bay.

DRAINAGE AREA.—8.01 mi².

PERIOD OF RECORD.—July 1910 to April 1914 (fragmentary), August 1962 to current year. Prior to August 1962, published as "near Rubicon Springs."

GAGE.—Water-stage recorder and V-notch sharp-crested weir. Elevation of gage is 6,250 ft above sea level, from topographic map. Prior to August 1962, nonrecording gage at site 1,400 ft upstream at different datum.

REMARKS.—Beginning in 1884, flow regulated by Loon Lake (station 11429350). Original dam was dismantled during September and October 1962 to permit construction of a new earthfill dam, which was completed Dec. 27, 1963. Loon Lake receives water from Rubicon River via Buck-Loon Tunnel (station 11428300). Since August 1971, most of the water is diverted past the station via Loon Lake Powerplant (station 11429340) and returns to Gerle Creek at Gerle Creek Dam. See schematic diagram of [Middle Fork American and Rubicon River Basins](#).

COOPERATION.—Records were collected by Sacramento Municipal Utility District, under general supervision of the U.S. Geological Survey, in connection with Federal Energy Regulatory Commission project no. 2101.

EXTREMES FOR PERIOD OF RECORD.—Maximum discharge, 3,240 ft³/s, unregulated, Feb. 1, 1963, gage height, 12.65 ft, from rating curve extended above 970 ft³/s, on basis of slope-area measurement of peak flow; no flow Oct. 15, 1913.

Maximum discharge since construction of Loon Lake Dam in 1963, 1,050 ft³/s, June 5, 1969, gage height, 9.03 ft; minimum daily, 3.6 ft³/s, Sept. 27, 28, Nov. 3, 1977.

DISCHARGE, CUBIC FEET PER SECOND, WATER YEAR OCTOBER 2001 TO SEPTEMBER 2002

DAILY MEAN VALUES

DAY	OCT	NOV	DEC	JAN	FEB	MAR	APR	MAY	JUN	JUL	AUG	SEP
1	10	10	10	11	9.2	11	11	11	9.8	10	10	9.5
2	10	10	11	11	9.5	11	12	11	9.8	10	10	9.5
3	10	10	11	10	9.5	11	12	12	9.8	10	10	9.5
4	10	10	10	10	9.5	11	12	12	9.8	10	10	9.5
5	10	10	10	10	9.5	11	12	12	9.8	10	10	9.5
6	10	10	11	10	9.5	13	12	11	9.9	10	9.8	9.5
7	10	10	10	10	9.5	11	12	10	10	10	9.8	9.5
8	10	10	10	10	9.5	11	12	9.9	10	10	9.8	9.5
9	10	10	10	10	9.5	11	12	9.8	10	10	9.8	9.5
10	10	10	10	10	9.6	11	12	9.5	10	10	9.8	9.5
11	10	10	10	10	9.5	11	13	9.7	10	10	9.8	9.5
12	10	11	10	10	9.4	11	12	9.7	10	10	9.8	9.5
13	10	11	10	10	10	11	12	9.9	10	10	9.8	9.5
14	10	10	10	9.8	10	11	13	9.9	10	10	9.8	9.5
15	10	10	10	9.8	10	11	12	9.9	10	10	9.8	9.5
16	10	10	10	9.8	10	11	11	9.7	10	10	9.8	9.5
17	10	10	10	9.8	10	11	10	9.8	10	10	9.8	9.5
18	10	10	10	9.5	10	11	10	9.8	10	10	9.8	9.5
19	10	10	10	9.5	12	9.9	10	9.7	10	10	9.8	9.5
20	10	10	10	9.5	13	10	10	11	10	10	9.8	9.5
21	10	15	11	9.5	12	10	11	11	10	10	9.8	9.5
22	10	13	10	9.5	11	10	11	10	10	10	9.8	9.5
23	10	10	10	9.3	12	10	11	9.9	10	10	9.5	9.5
24	10	15	10	9.2	12	9.9	12	9.8	10	10	9.5	9.5
25	10	11	10	9.2	12	9.9	12	9.8	10	10	9.5	9.5
26	10	11	9.8	9.2	11	10	12	9.8	10	10	9.5	9.5
27	10	10	9.8	9.2	11	10	11	9.8	10	10	9.5	9.5
28	10	10	10	9.2	11	11	11	9.8	10	10	9.5	9.5
29	10	10	11	9.2	---	11	11	9.8	10	10	9.5	9.5
30	12	10	11	9.0	---	11	10	9.8	10	10	9.5	9.5
31	10	---	11	8.9	---	11	---	9.8	---	10	9.5	---
TOTAL	312	317	316.6	301.1	290.7	333.7	344	316.6	298.9	310	302.1	285.0
MEAN	10.06	10.57	10.21	9.713	10.38	10.76	11.47	10.21	9.963	10.00	9.745	9.500
MAX	12	15	11	11	13	13	13	12	10	10	10	9.5
MIN	10	10	9.8	8.9	9.2	9.9	10	9.5	9.8	10	9.5	9.5
AC-FT	619	629	628	597	577	662	682	628	593	615	599	565
a	6890	2010	5630	23110	11290	3360	7580	8440	8330	5010	2200	2120

a Diversion, in acre-feet, to Loon Lake Powerplant (station 11429340), provided by Sacramento Municipal Utility District.

SACRAMENTO RIVER BASIN

11429500 GERLE CREEK BELOW LOON LAKE DAM, NEAR MEEKS BAY, CA—Continued

STATISTICS OF MONTHLY MEAN DATA FOR WATER YEARS 1965 - 1970, BY WATER YEAR (WY)

	OCT	NOV	DEC	JAN	FEB	MAR	APR	MAY	JUN	JUL	AUG	SEP
MEAN	112	132	165	74.7	103	192	133	63.0	390	341	232	115
MAX	190	356	343	134	261	347	244	209	721	493	351	338
(WY)	1970	1966	1966	1968	1970	1970	1967	1969	1969	1967	1969	1967
MIN	7.53	7.93	8.95	8.41	9.13	9.57	8.75	10.5	185	196	50.8	8.20
(WY)	1965	1968	1969	1965	1968	1968	1965	1968	1966	1965	1965	1970

SUMMARY STATISTICS

WATER YEARS 1965 - 1970

ANNUAL MEAN	171
HIGHEST ANNUAL MEAN	217 1970
LOWEST ANNUAL MEAN	127 1965
HIGHEST DAILY MEAN	1030 Jun 5 1969
LOWEST DAILY MEAN	6.0 Dec 2 1969
ANNUAL SEVEN-DAY MINIMUM	6.4 Dec 10 1969
MAXIMUM PEAK FLOW	1050 Jun 5 1969
MAXIMUM PEAK STAGE	9.03 Jun 5 1969
ANNUAL RUNOFF (AC-FT)	124100
10 PERCENT EXCEEDS	394
50 PERCENT EXCEEDS	28
90 PERCENT EXCEEDS	8.1

STATISTICS OF MONTHLY MEAN DATA FOR WATER YEARS 1972 - 2002, BY WATER YEAR (WY)

MEAN	9.093	8.969	9.535	9.357	9.252	9.373	9.415	10.99	9.247	9.200	8.825	8.853
MAX	13.3	11.8	23.9	13.0	12.8	11.6	13.6	48.7	13.6	15.7	12.0	12.0
(WY)	1993	2000	1984	1997	1996	1996	2000	1996	1999	1995	1999	1998
MIN	3.93	4.00	4.45	4.61	5.12	4.67	4.27	4.64	4.13	4.30	4.09	3.99
(WY)	1978	1978	1978	1978	1978	1977	1977	1977	1977	1977	1977	1977

SUMMARY STATISTICS

FOR 2001 CALENDAR YEAR

FOR 2002 WATER YEAR

WATER YEARS 1972 - 2002

ANNUAL TOTAL	3707.3	3727.7	
ANNUAL MEAN	10.16	10.21	9.346
HIGHEST ANNUAL MEAN			13.5 1996
LOWEST ANNUAL MEAN			6.06 1977
HIGHEST DAILY MEAN	16 Mar 25	15 Nov 21	403 May 17 1996
LOWEST DAILY MEAN	8.6 May 2	8.9 Jan 31	3.6 Sep 27 1977
ANNUAL SEVEN-DAY MINIMUM	8.6 Jun 19	9.1 Jan 25	3.7 Sep 23 1977
MAXIMUM PEAK FLOW		26 Nov 24	510 May 18 1996
MAXIMUM PEAK STAGE		2.38 Nov 24	6.65 May 18 1996
ANNUAL RUNOFF (AC-FT)	7350	7390	6770
ANNUAL DIVERSION (AC-FT) a	20360	85970	
10 PERCENT EXCEEDS	12	11	11
50 PERCENT EXCEEDS	10	10	8.9
90 PERCENT EXCEEDS	8.9	9.5	8.0

a Diversion, in acre-feet, to Loon Lake Powerplant (station 11429340), provided by Sacramento Municipal Utility District.

11429600 GERLE RESERVOIR NEAR MEEKS BAY, CA

LOCATION.—Lat 38°57'59", long 120°23'33", in SE 1/4 SW 1/4 sec.15, T.13 N., R.14 E., El Dorado County, Hydrologic Unit 18020128, Eldorado National Forest, on left-bank side of upstream face of dam on Gerle Creek, 0.2 mi downstream from Angel Creek, and 15.2 mi southwest of Meeks Bay.

DRAINAGE AREA.—28.7 mi².

PERIOD OF RECORD.—October 1993 to current year. Unpublished records for water years 1980–93 available in files of the U.S. Geological Survey.

GAGE.—Water-stage recorder. Datum of gage is sea level (levels by Sacramento Municipal Utility District). Prior to June 9, 1988, nonrecording gage at same site and datum.

REMARKS.—Reservoir is formed by concrete dam completed in 1962. Storage began in 1962. Usable capacity, 1,200 acre-ft, below elevation, 5,230.9 ft, crest of spillway. Most of the water is diverted at this reservoir to Robbs Peak Powerplant (station 11429300). Records, including extremes, represent total contents at 2400 hours. See schematic diagram of Middle Fork American and Rubicon River Basins.

COOPERATION.—Records were collected by Sacramento Municipal Utility District, under general supervision of the U.S. Geological Survey, in connection with Federal Energy Regulatory Commission project no. 2101.

EXTREMES FOR PERIOD OF RECORD.—Maximum contents, 1,469 acre-ft, Jan. 1, 1997, elevation, 5,235.39 ft; minimum, 809 acre-ft, Nov. 12, 2001, elevation, 5,221.23 ft.

EXTREMES FOR CURRENT YEAR.—Maximum contents, 1,170 acre-ft, May 23, 24, maximum elevation, 5,229.58 ft, May 24; minimum, 809 acre-ft, Nov. 12, elevation, 5,221.23 ft.

Capacity table (elevation, in feet, and contents, in acre-feet)
(Based on table provided by Sacramento Municipal Utility District, recomputed October 1991)

5,200	203	5,210	431	5,220	761	5,230	1,193
5,205	304	5,215	583	5,225	964	5,235	1,448

RESERVOIR STORAGE, ACRE-FEET, WATER YEAR OCTOBER 2000 TO SEPTEMBER 2001

DAILY OBSERVATION AT 2400 HOURS

(NOT PREVIOUSLY PUBLISHED)

DAY	OCT	NOV	DEC	JAN	FEB	MAR	APR	MAY	JUN	JUL	AUG	SEP
1	911	902	940	869	931	957	943	983	1100	1140	1170	1090
2	955	1030	963	897	931	903	905	939	1130	1150	1170	1100
3	1100	1010	896	921	919	915	889	929	1160	1080	1170	1100
4	958	945	905	945	892	871	911	931	1090	1090	1170	1100
5	956	875	943	967	933	906	926	934	1120	1100	1170	1100
6	969	907	1040	988	894	950	866	939	1140	1110	1170	1100
7	941	928	971	993	950	912	906	933	1160	1110	1160	1100
8	983	945	1030	1020	943	936	873	970	1160	1120	1150	1110
9	918	872	1050	913	871	887	880	e929	1110	1120	1150	1110
10	899	890	1030	931	894	e901	891	948	1130	1130	1150	1100
11	972	908	1020	921	938	926	909	980	1150	1130	1150	1110
12	980	925	928	897	945	967	904	914	1160	1130	1090	1110
13	916	902	986	926	958	956	913	924	1080	1140	1090	1110
14	939	871	976	951	920	899	933	e915	1070	1140	1100	1080
15	934	889	945	974	953	906	934	947	1080	1140	1100	1070
16	958	905	929	928	894	e949	938	e912	1100	1150	1050	1090
17	e946	922	951	928	885	924	928	915	1110	1150	1120	1090
18	922	937	977	937	931	912	945	e945	1120	1150	1070	1090
19	925	952	894	866	981	941	937	e921	1130	1150	1060	1100
20	919	967	925	857	889	939	909	e899	1140	1150	1070	1100
21	907	954	956	867	932	954	910	862	1150	1160	1070	1100
22	891	897	974	940	944	974	948	918	e1080	1160	1080	1100
23	923	914	926	974	910	948	990	945	e1090	1160	1080	1110
24	973	930	956	889	943	988	992	1080	e1100	1160	1080	1110
25	928	946	939	890	938	1020	1010	1150	1110	1160	1090	1120
26	969	962	880	882	964	943	1000	1110	1110	1160	1160	1120
27	864	979	907	922	925	947	967	1140	1120	1160	1140	1130
28	917	963	930	927	963	973	939	e1080	1130	1160	1170	e1130
29	935	967	954	930	---	950	945	1080	1140	1160	1140	1130
30	958	964	977	931	---	956	984	e1040	1140	1170	1090	1140
31	962	---	863	931	---	987	---	1070	---	1170	1090	---
MAX	1100	1030	1050	1020	981	1020	1010	1150	1160	1170	1170	1140
MIN	864	871	863	857	871	871	866	862	1070	1080	1050	1070
a	5224.94	5224.99	5222.58	5224.21	5224.96	5225.51	5225.45	5227.40	5228.89	5229.45	5228.04	5228.90
b	+50	+2	-101	+68	+32	+24	-3	+86	-30	+30	+20	+50
CAL YR 2000	MAX 1261	MIN 863	b -88									
WTR YR 2001	MAX 1170	MIN 857	b +228									

e Estimated.

a Elevation, in feet, at end of month.

b Change in contents, in acre-feet

SACRAMENTO RIVER BASIN

11429600 GERLE RESERVOIR NEAR MEEKS BAY, CA—Continued

RESERVOIR STORAGE, ACRE-FEET, WATER YEAR OCTOBER 2001 TO SEPTEMBER 2002

DAILY OBSERVATION AT 2400 HOURS

DAY	OCT	NOV	DEC	JAN	FEB	MAR	APR	MAY	JUN	JUL	AUG	SEP
1	1160	948	906	944	1080	901	1070	1040	1130	1110	1120	1000
2	1130	983	913	991	1010	879	1010	945	1090	1120	1090	1010
3	1140	983	935	964	834	908	1120	980	1090	1090	1130	1040
4	1060	986	959	1030	1070	932	1160	997	1120	1090	1090	1030
5	1150	953	1030	984	1110	916	998	962	1040	1130	1080	1060
6	924	972	971	989	1070	1030	1020	954	1060	1110	1130	1070
7	1090	940	993	1040	1040	929	1020	990	e1040	1110	1110	1100
8	1090	927	990	993	1050	892	1030	983	1080	1140	1140	1140
9	1060	940	988	1110	1000	879	1000	942	1030	1050	1040	1080
10	1030	934	996	1080	1070	884	993	937	1100	1090	1080	1040
11	1030	838	920	1020	1150	884	1010	927	1060	1010	1100	1010
12	985	809	932	1090	1060	902	997	937	965	1120	1130	1050
13	1120	810	923	1090	1040	890	971	996	1080	1070	1050	1080
14	1050	828	954	1090	913	865	1030	1020	983	1090	1090	1110
15	1090	842	956	1000	932	858	1030	911	1020	1140	1050	1140
16	1090	854	911	1000	968	853	1090	925	1030	1100	1080	1090
17	988	864	1060	985	937	855	956	e915	1100	1130	1100	1070
18	974	874	989	1010	900	854	951	e910	1010	1060	1130	1010
19	888	880	939	1080	1030	855	970	894	1100	1060	1100	1050
20	898	889	1070	1080	1030	1050	891	906	1080	1090	1090	1050
21	906	925	932	1020	995	1120	920	907	1130	1120	1020	1060
22	1010	945	922	1120	976	1080	1080	1130	1110	1140	1050	997
23	984	945	959	1120	930	1020	1070	1170	1050	1040	1080	1040
24	964	965	936	1130	954	1010	1060	1170	1060	1070	1110	1070
25	974	905	895	997	902	940	952	1120	1020	1110	1080	966
26	991	972	936	990	903	958	942	1140	1060	1140	1070	925
27	915	969	933	1020	911	912	931	1070	1120	1050	1130	955
28	1010	952	850	992	928	961	915	1020	1110	1080	1160	967
29	999	940	904	1140	---	985	1120	1140	1100	1110	1050	1120
30	948	969	930	1120	---	999	1000	1090	1100	1120	1090	1120
31	980	---	956	1100	---	969	---	1090	---	1110	966	---
MAX	1160	986	1070	1140	1150	1120	1160	1170	1130	1140	1160	1140
MIN	888	809	850	944	834	853	891	894	965	1010	966	925
a	5225.37	5225.10	5224.80	5228.09	5224.16	5225.10	5225.84	5227.75	5227.92	5228.18	5225.03	5228.43
b	-160	-11	-13	+144	-172	+41	+31	+90	+10	+10	-144	+154
CAL YR 2001	MAX 1170	MIN 809	b +93									
WTR YR 2002	MAX 1170	MIN 809	b -20									

e Estimated.

a Elevation, in feet, at end of month.

b Change in contents, in acre-feet

11430000 SOUTH FORK RUBICON RIVER BELOW GERLE CREEK, NEAR GEORGETOWN, CA

LOCATION.—Lat 38°57'17", long 120°24'02", in SW 1/4 SW 1/4 sec.22, T.13 N., R.14 E., El Dorado County, Hydrologic Unit 18020128, Eldorado National Forest, on left bank, 600 ft downstream from Gerle Creek, 1.2 mi downstream from South Fork Rubicon River Diversion Dam, and 18 mi east of Georgetown.

DRAINAGE AREA.—47.6 mi².

PERIOD OF RECORD.—February 1910 to June 1914 (published as "Little South Fork Rubicon River below Gerle Creek, near Quintette"), August 1961 to current year.

REVISED RECORDS.—WSP 1931: Drainage area.

GAGE.—Water-stage recorder. Elevation of gage is 4,970 ft above sea level, from topographic map. Feb. 1, 1910, to June 21, 1914, nonrecording gage at site about 700 ft downstream at different datum.

REMARKS.—Beginning in 1884, flow regulated by Loon Lake (station 11429350). Original dam was dismantled during September and October 1962 to permit construction of a new earthfill dam completed Dec. 27, 1963. Loon Lake receives water from Rubicon River via Rubicon-Rockbound Tunnel (station 11427940) to Buck Island Lake and from Buck Island Lake to Loon Lake via Buck-Loon Tunnel (station 11428300). Prior to Dec. 3, 1961, water was diverted out of the basin in Georgetown Divide Ditch. Water is diverted 1.2 mi upstream at South Fork Rubicon River Diversion Dam to Robbs Peak Powerplant (station 11429300). Diversion of up to 1,440 ft³/s to Silver Creek Basin began in October 1962. See schematic diagram of [Middle Fork American and Rubicon River Basins](#).

COOPERATION.—Records were collected by Sacramento Municipal Utility District, under general supervision of the U.S. Geological Survey, in connection with Federal Energy Regulatory Commission project no. 2101.

EXTREMES FOR PERIOD OF RECORD.—Maximum discharge, 12,600 ft³/s, Jan. 1, 1997, gage height, 12.65 ft, from rating curve extended above 2,500 ft³/s, on basis of slope-area measurement of peak flow; minimum, 0.8 ft³/s, Sept. 21, 1962.

DISCHARGE, CUBIC FEET PER SECOND, WATER YEAR OCTOBER 2001 TO SEPTEMBER 2002
DAILY MEAN VALUES

DAY	OCT	NOV	DEC	JAN	FEB	MAR	APR	MAY	JUN	JUL	AUG	SEP
1	8.1	6.1	8.8	12	8.6	10	11	12	14	12	13	11
2	7.3	6.2	19	17	8.5	9.7	11	12	14	12	12	11
3	7.6	6.6	12	17	8.4	9.6	12	12	13	12	12	11
4	7.9	6.5	10	13	8.2	9.6	14	12	13	12	12	12
5	7.4	6.4	10	12	e8.1	9.6	13	11	12	12	12	12
6	7.3	6.2	12	e13	e7.9	21	11	11	11	12	12	12
7	5.9	6.3	10	e12	e8.9	17	11	11	11	12	12	12
8	7.2	6.0	9.8	e12	11	13	11	12	11	13	12	12
9	7.2	5.9	9.6	e12	9.2	11	11	12	11	13	12	12
10	6.5	5.8	9.5	12	8.4	11	9.4	12	11	12	12	12
11	6.4	7.0	9.6	11	8.8	11	8.2	12	11	12	12	11
12	6.1	7.7	9.3	11	9.5	11	7.8	12	11	11	12	11
13	7.2	8.1	9.3	11	9.0	11	7.4	12	11	12	12	12
14	8.1	7.6	9.8	11	8.9	10	7.1	12	11	12	12	12
15	7.9	7.4	9.4	11	8.7	9.3	7.0	12	11	12	12	12
16	8.5	7.4	9.5	11	9.3	8.9	6.1	11	12	12	11	12
17	9.8	7.4	10	11	9.9	8.8	6.6	11	12	12	12	12
18	10	7.4	10	9.7	8.8	7.9	6.2	11	12	12	12	11
19	6.3	7.4	10	9.6	12	7.1	6.5	11	12	12	12	11
20	5.9	7.4	10	9.4	16	8.1	6.8	12	12	12	12	12
21	5.8	10	e10	9.6	13	9.0	6.5	12	12	12	12	11
22	5.8	12	e9.4	9.0	12	9.9	6.9	12	12	12	12	11
23	6.3	9.2	8.6	11	12	10	7.1	14	12	12	12	11
24	6.2	15	8.6	9.7	11	9.7	6.8	14	12	12	12	12
25	6.1	11	8.5	9.2	11	9.3	6.4	14	11	12	12	13
26	6.0	9.3	8.6	9.0	10	8.8	6.2	13	11	12	12	12
27	6.0	9.1	8.6	8.0	10	9.1	6.5	14	12	12	12	12
28	5.6	8.5	9.7	8.3	10	9.0	6.0	13	12	12	12	14
29	6.7	8.7	11	e32	---	10	7.4	13	12	12	12	14
30	7.8	8.2	12	e8.7	---	10	9.6	13	12	12	12	13
31	6.0	---	16	e8.7	---	11	---	13	---	12	12	---
TOTAL	216.9	237.8	318.6	360.9	277.1	320.4	253.5	378	354	373	372	356
MEAN	6.997	7.927	10.28	11.64	9.896	10.34	8.450	12.19	11.80	12.03	12.00	11.87
MAX	10	15	19	32	16	21	14	14	14	13	13	14
MIN	5.6	5.8	8.5	8.0	7.9	7.1	6.0	11	11	11	11	11
AC-FT	430	472	632	716	550	636	503	750	702	740	738	706
a	7300	2540	9120	29130	18190	15270	29720	22560	11600	5180	2260	1830

e Estimated.

a Diversion, in acre-feet, to Robbs Peak Powerplant (station 11429300), provided by Sacramento Municipal Utility District.

SACRAMENTO RIVER BASIN

11430000 SOUTH FORK RUBICON RIVER BELOW GERLE CREEK, NEAR GEORGETOWN, CA—Continued

STATISTICS OF MONTHLY MEAN DATA FOR WATER YEARS 1963 - 2002, BY WATER YEAR (WY)

	OCT	NOV	DEC	JAN	FEB	MAR	APR	MAY	JUN	JUL	AUG	SEP
MEAN	10.73	18.49	34.76	56.54	34.80	19.86	13.02	25.74	19.84	12.82	9.286	9.460
MAX	52.2	268	396	530	524	130	141	276	249	92.5	12.5	22.3
(WY)	1963	1984	1965	1997	1986	1986	1982	1996	1983	1967	1983	1982
MIN	2.40	2.75	4.79	4.86	5.03	3.11	2.35	2.42	2.29	2.36	2.03	1.99
(WY)	1978	1978	1968	1968	1966	1977	1977	1977	1977	1977	1977	1977

SUMMARY STATISTICS	FOR 2001 CALENDAR YEAR		FOR 2002 WATER YEAR		WATER YEARS 1963 - 2002	
ANNUAL TOTAL	2943.5		3818.2			
ANNUAL MEAN	8.064		10.46		22.09	
HIGHEST ANNUAL MEAN					67.1 1997	
LOWEST ANNUAL MEAN					3.59 1977	
HIGHEST DAILY MEAN	19	Dec 2	32	Jan 29	8050	Jan 1 1997
LOWEST DAILY MEAN	5.1	Jun 15	5.6	Oct 28	1.3	Sep 29 1963
ANNUAL SEVEN-DAY MINIMUM	5.6	Aug 19	6.0	Oct 22	1.5	Sep 28 1963
MAXIMUM PEAK FLOW			346	Jan 29	12600	Jan 1 1997
MAXIMUM PEAK STAGE			4.42	Jan 29	12.65	Jan 1 1997
ANNUAL RUNOFF (AC-FT)	5840		7570		16000	
ANNUAL DIVERSION (AC-FT) a	60950		154700			
10 PERCENT EXCEEDS	11		12		13	
50 PERCENT EXCEEDS	7.5		11		8.6	
90 PERCENT EXCEEDS	6.0		6.8		5.3	

a Diversion, in acre-feet, to Robbs Peak Powerplant (station 11429300), provided by Sacramento Municipal Utility District.

11431800 PILOT CREEK ABOVE STUMPY MEADOWS LAKE, CA

LOCATION.—Lat 38°53'41", long 120°34'02", in NE 1/4 NW 1/4 sec.18, T.12 N., R.13 E., El Dorado County, Hydrologic Unit 18020128, on right bank, 2.1 mi upstream from Stumpy Meadows Dam, and 12.5 mi east of Georgetown.

DRAINAGE AREA.—11.7 mi².

PERIOD OF RECORD.—October 1960 to current year. Prior to October 1971, published as "above Stumpy Meadows Reservoir."

GAGE.—Water-stage recorder. Elevation of gage is 4,280 ft above sea level, from topographic map.

REMARKS.—Records good. No regulation or diversion upstream from station. See schematic diagram of [Middle Fork American and Rubicon River Basins](#).

EXTREMES FOR PERIOD OF RECORD.—Maximum discharge, 3,510 ft³/s, Feb. 17, 1986, gage height, 7.15 ft, from rating curve extended above 540 ft³/s, on basis of slope-area measurement at gage height 6.31 ft, maximum gage height, 8.05 ft, Jan. 31, 1963; minimum daily, 0.14 ft³/s, Aug. 16, 1977.

EXTREMES FOR CURRENT YEAR.—Peak discharges greater than base discharge of 140 ft³/s, or maximum:

Date	Time	Discharge (ft ³ /s)	Gage height (ft)	Date	Time	Discharge (ft ³ /s)	Gage height (ft)
Dec. 2	1215	143	2.10	Mar. 6	1945	143	2.10

DISCHARGE, CUBIC FEET PER SECOND, WATER YEAR OCTOBER 2001 TO SEPTEMBER 2002

DAILY MEAN VALUES

DAY	OCT	NOV	DEC	JAN	FEB	MAR	APR	MAY	JUN	JUL	AUG	SEP
1	2.1	3.5	7.0	33	e11	31	53	21	11	7.2	4.6	3.5
2	2.2	3.3	66	52	10	29	57	22	11	7.0	4.5	3.2
3	2.1	3.2	24	73	9.6	27	61	22	11	6.8	4.5	3.1
4	2.1	3.1	13	40	11	26	65	21	11	6.9	4.8	3.1
5	2.1	3.1	12	29	9.5	25	61	19	11	6.8	4.7	3.2
6	2.3	3.1	12	29	9.3	88	53	19	10	6.6	4.6	3.6
7	2.5	3.1	12	28	12	103	50	18	9.9	6.6	4.3	3.8
8	2.6	3.0	10	25	23	72	47	17	9.8	6.4	4.3	3.7
9	2.5	3.1	9.5	23	14	58	45	16	9.7	6.2	4.1	3.5
10	2.4	3.1	8.5	20	13	55	43	16	9.6	6.0	3.9	3.3
11	2.3	5.8	7.8	18	13	48	41	16	9.5	5.9	4.0	3.2
12	2.3	7.4	7.7	17	13	45	39	15	9.2	5.9	3.8	3.2
13	2.2	6.9	7.6	16	14	43	37	15	9.1	5.7	3.7	3.2
14	2.2	4.7	9.1	15	14	39	37	14	9.1	5.6	3.7	3.2
15	2.1	4.3	11	15	15	36	36	14	8.9	5.5	3.6	3.1
16	2.1	4.2	7.9	14	16	34	32	13	8.7	5.5	3.7	3.3
17	2.1	4.1	14	13	20	32	31	13	8.5	5.4	3.7	3.4
18	2.2	4.1	13	13	17	29	28	13	8.5	5.5	3.6	3.3
19	2.2	3.9	10	12	23	28	27	13	8.4	5.6	3.6	3.1
20	2.2	3.9	10	12	48	27	26	18	8.2	5.3	3.7	3.0
21	2.3	8.1	9.5	12	44	27	26	19	8.1	5.2	3.8	3.1
22	2.3	16	8.9	11	42	30	26	18	8.1	5.2	3.9	3.1
23	2.3	7.0	8.7	13	44	40	26	17	8.0	5.1	3.9	2.8
24	2.4	23	7.9	11	40	38	24	16	7.7	5.0	3.9	2.8
25	2.3	11	7.7	11	37	36	23	15	7.5	4.9	3.8	2.8
26	2.3	6.9	7.8	12	35	35	23	14	7.4	4.9	3.8	2.7
27	2.3	5.7	8.0	12	34	35	25	13	7.4	4.9	3.6	2.7
28	2.5	5.3	11	12	33	37	23	13	7.2	4.9	3.5	3.1
29	2.7	6.5	23	e12	---	43	24	12	7.2	4.8	3.5	3.6
30	5.2	5.7	22	e12	---	47	23	12	7.2	4.7	3.6	3.7
31	4.6	---	56	e12	---	50	---	11	---	4.7	3.6	---
TOTAL	76.0	176.1	442.6	627	624.4	1293	1112	495	267.9	176.7	122.3	96.4
MEAN	2.452	5.870	14.28	20.23	22.30	41.71	37.07	15.97	8.930	5.700	3.945	3.213
MAX	5.2	23	66	73	48	103	65	22	11	7.2	4.8	3.8
MIN	2.1	3.0	7.0	11	9.3	25	23	11	7.2	4.7	3.5	2.7
AC-FT	151	349	878	1240	1240	2560	2210	982	531	350	243	191

e Estimated.

SACRAMENTO RIVER BASIN

11431800 PILOT CREEK ABOVE STUMPY MEADOWS LAKE, CA—Continued

STATISTICS OF MONTHLY MEAN DATA FOR WATER YEARS 1961 - 2002, BY WATER YEAR (WY)

	OCT	NOV	DEC	JAN	FEB	MAR	APR	MAY	JUN	JUL	AUG	SEP
MEAN	6.458	12.40	25.14	46.63	49.39	53.39	46.87	35.31	15.21	8.323	5.333	4.791
MAX	24.8	74.1	159	268	373	195	139	118	50.4	17.8	16.2	16.3
(WY)	1963	1984	1965	1997	1986	1983	1982	1967	1967	1998	1961	1961
MIN	0.87	2.79	3.35	4.55	4.64	4.82	3.38	4.06	1.93	0.64	0.18	0.50
(WY)	1978	1977	1977	1991	1977	1977	1977	1977	1977	1977	1977	1977

SUMMARY STATISTICS	FOR 2001 CALENDAR YEAR		FOR 2002 WATER YEAR		WATER YEARS 1961 - 2002	
ANNUAL TOTAL	3391.6		5509.4			
ANNUAL MEAN	9.292		15.09		25.66	
HIGHEST ANNUAL MEAN					64.8 1983	
LOWEST ANNUAL MEAN					2.96 1977	
HIGHEST DAILY MEAN	66	Dec 2	103	Mar 7	2840	Feb 17 1986
LOWEST DAILY MEAN	1.4	Aug 28	2.1	Oct 1	0.14	Aug 16 1977
ANNUAL SEVEN-DAY MINIMUM	1.6	Aug 16	2.2	Oct 13	0.15	Aug 12 1977
MAXIMUM PEAK FLOW			143		3510 Feb 17 1986	
MAXIMUM PEAK STAGE			2.10		8.05 Jan 31 1963	
ANNUAL RUNOFF (AC-FT)	6730		10930		18590	
10 PERCENT EXCEEDS	21		37		58	
50 PERCENT EXCEEDS	7.1		9.3		10	
90 PERCENT EXCEEDS	1.9		3.1		3.4	

11433040 PILOT CREEK BELOW MUTTON CANYON, NEAR GEORGETOWN, CA

LOCATION.—Lat 38°55'25", long 120°38'27", in NE 1/4 NW 1/4 sec.4, T.12 N., R.12 E., [El Dorado County](#), Hydrologic Unit 18020128, Eldorado National Forest, on left bank, 450 ft downstream from Mutton Canyon, 500 ft downstream from Georgetown Divide Diversion Dam, 2.5 mi downstream from Stumpy Meadows Dam, and 10 mi east of Georgetown.

DRAINAGE AREA.—21.1 mi².

PERIOD OF RECORD.—June 1961 to current year.

GAGE.—Water-stage recorder. Elevation of gage is 3,760 ft above sea level, from topographic map.

REMARKS.—Records fair. Flow regulated by Stumpy Meadows Lake 2.5 mi upstream, usable capacity, 20,000 acre-ft, completed in November 1961. Georgetown Irrigation District Ditch, capacity, about 60 ft³/s, diverts water out of Pilot Creek, 500 ft upstream from station. See schematic diagram of [Middle Fork American and Rubicon River Basins](#).

EXTREMES FOR PERIOD OF RECORD.—Maximum discharge, 7,830 ft³/s, Jan. 2, 1997, gage height, 10.95 ft, from rating curve extended above 970 ft³/s, on basis of slope-area measurement at gage height 10.06 ft; minimum daily, 0.20 ft³/s, Sept. 24, Nov. 1–5, 1966.

DISCHARGE, CUBIC FEET PER SECOND, WATER YEAR OCTOBER 2001 TO SEPTEMBER 2002

DAILY MEAN VALUES

DAY	OCT	NOV	DEC	JAN	FEB	MAR	APR	MAY	JUN	JUL	AUG	SEP
1	2.7	2.6	4.3	7.6	4.1	9.5	69	19	4.9	4.3	4.9	4.9
2	2.7	2.5	19	16	4.0	8.3	70	14	4.9	4.3	4.8	4.9
3	2.7	2.5	7.0	16	4.0	7.5	73	12	5.0	4.4	4.9	4.9
4	2.6	2.5	4.4	8.6	4.0	6.9	75	9.7	5.3	4.9	4.8	4.8
5	2.6	3.9	3.8	6.8	4.0	6.9	76	8.0	5.3	5.0	4.8	4.7
6	2.6	5.6	5.8	7.8	4.0	37	70	6.3	5.1	5.1	4.7	4.7
7	2.6	4.5	4.4	6.5	5.5	40	64	5.5	5.1	5.1	4.7	4.7
8	2.6	4.3	3.8	6.1	8.4	26	59	5.4	5.1	5.0	4.7	4.7
9	2.6	3.5	3.7	5.9	5.3	21	58	5.5	5.0	4.7	4.8	4.6
10	2.5	2.2	3.5	5.6	4.8	22	55	5.9	5.0	4.6	5.1	4.5
11	2.6	2.7	3.3	5.4	4.6	20	51	5.9	5.3	4.6	5.1	4.5
12	2.6	4.1	3.2	5.2	4.6	18	48	5.5	5.1	4.6	5.1	4.5
13	2.6	3.1	3.1	5.1	4.7	17	44	5.5	4.7	4.5	5.1	4.5
14	2.6	2.6	3.3	4.9	4.7	15	42	5.3	4.6	4.5	5.0	4.5
15	2.5	2.5	3.1	4.7	4.7	14	41	5.3	4.5	4.5	4.9	4.5
16	2.5	2.5	3.0	4.6	4.8	13	38	5.3	4.5	4.5	4.9	4.5
17	2.9	2.5	7.8	4.5	6.3	13	47	5.3	4.5	4.5	5.0	4.5
18	3.3	2.5	5.6	4.4	5.7	11	46	5.1	4.5	4.5	5.0	4.4
19	3.0	2.5	4.3	4.3	14	14	39	5.2	4.4	4.5	5.0	4.3
20	3.0	2.4	4.0	4.2	28	31	35	7.1	4.5	4.4	5.0	4.3
21	3.0	4.0	3.8	4.6	18	38	32	8.0	4.5	4.4	5.1	4.3
22	3.0	6.1	4.1	4.8	17	45	32	7.1	4.5	4.4	5.1	4.3
23	3.0	3.2	4.7	4.2	17	97	31	6.7	4.5	4.3	5.1	4.4
24	2.9	5.4	4.1	4.0	15	90	29	6.2	4.5	4.4	5.1	4.5
25	2.7	3.9	3.8	4.0	13	68	22	5.7	4.5	4.5	5.1	4.5
26	2.7	3.1	3.7	4.4	12	58	14	5.4	4.4	4.7	5.1	4.5
27	2.7	2.9	3.7	4.4	11	56	18	5.3	4.4	4.7	5.1	4.5
28	2.7	2.8	5.1	4.3	11	55	16	5.2	4.3	4.7	5.0	4.6
29	2.7	3.4	7.3	4.2	---	58	19	5.1	4.3	4.7	4.9	4.7
30	3.2	3.4	6.8	4.2	---	61	20	5.1	4.3	4.7	5.0	4.7
31	2.9	---	14	4.2	---	66	---	5.1	---	4.9	4.9	---
TOTAL	85.3	99.7	161.5	181.5	244.2	1043.1	1333	211.7	141.5	142.9	153.8	136.9
MEAN	2.752	3.323	5.210	5.855	8.721	33.65	44.43	6.829	4.717	4.610	4.961	4.563
MAX	3.3	6.1	19	16	28	97	76	19	5.3	5.1	5.1	4.9
MIN	2.5	2.2	3.0	4.0	4.0	6.9	14	5.1	4.3	4.3	4.7	4.3
AC-FT	169	198	320	360	484	2070	2640	420	281	283	305	272

STATISTICS OF MONTHLY MEAN DATA FOR WATER YEARS 1961 - 2002, BY WATER YEAR (WY)

MEAN	2.975	5.682	28.65	60.73	79.04	75.45	66.43	37.04	9.448	4.271	3.369	2.954
MAX	7.19	28.6	340	621	585	370	289	171	54.4	15.6	13.4	8.54
(WY)	1963	1984	1965	1997	1986	1983	1982	1995	1967	1983	1983	1983
MIN	0.46	0.46	0.54	0.53	0.89	1.21	0.98	1.12	0.66	0.45	0.38	0.37
(WY)	1962	1962	1962	1962	1991	1977	1977	1977	1977	1977	1977	1977

SUMMARY STATISTICS

FOR 2001 CALENDAR YEAR

FOR 2002 WATER YEAR

WATER YEARS 1961 - 2002

ANNUAL TOTAL	1841.0	3935.1	
ANNUAL MEAN	5.044	10.78	31.11
HIGHEST ANNUAL MEAN			109
LOWEST ANNUAL MEAN			0.84
HIGHEST DAILY MEAN	36	Apr 26	97
LOWEST DAILY MEAN	2.2	Nov 10	2.2
ANNUAL SEVEN-DAY MINIMUM	2.4	Jun 19	2.5
MAXIMUM PEAK FLOW			105
MAXIMUM PEAK STAGE		4.89	Mar 23
ANNUAL RUNOFF (AC-FT)	3650	7810	22540
10 PERCENT EXCEEDS	8.5	31	84
50 PERCENT EXCEEDS	3.1	4.8	4.3
90 PERCENT EXCEEDS	2.5	2.9	1.3

11433060 SOUTH FORK LONG CANYON CREEK DIVERSION TUNNEL NEAR VOLCANOVILLE, CA

LOCATION.—Lat 39°03'04", long 120°28'14", in SW 1/4 NE 1/4 sec.24, T.14 N., R.13 E., [Placer County](#), Hydrologic Unit 18020128, Eldorado National Forest, on right bank at diversion dam, 3.3 mi upstream from confluence with North and South Forks Long Canyon Creek, and 17.2 mi east of Volcanoville.

PERIOD OF RECORD.—October 1965 to current year.

GAGE.—Water-stage recorder and sharp-crested weir. Elevation of gage is 4,630 ft above sea level, from topographic map.

REMARKS.—Tunnel completed in September 1965; diversion began in February 1966. Flow is diverted from South Fork Long Canyon Creek to a tunnel from Hell Hole Reservoir to Middle Fork Powerplant on the Middle Fork American River. See schematic diagram of [Middle Fork American and Rubicon River Basins](#).

COOPERATION.—Records provided by Placer County Water Agency, under general supervision of the U.S. Geological Survey, in connection with Federal Energy Regulatory Commission project no. 2079.

EXTREMES FOR PERIOD OF RECORD.—Maximum daily discharge, 251 ft³/s, Nov. 12, 1973; no flow for part of each year.

DISCHARGE, CUBIC FEET PER SECOND, WATER YEAR OCTOBER 2001 TO SEPTEMBER 2002
DAILY MEAN VALUES

DAY	OCT	NOV	DEC	JAN	FEB	MAR	APR	MAY	JUN	JUL	AUG	SEP
1	0.00	0.00	0.00	0.00	3.5	28	52	28	12	0.00	0.00	0.00
2	0.00	0.00	0.00	20	3.5	24	57	27	9.8	0.00	0.00	0.00
3	0.00	0.00	0.00	40	3.5	22	65	27	8.3	0.00	0.00	0.00
4	0.00	0.00	0.00	24	3.5	22	68	29	7.2	0.00	0.00	0.00
5	0.00	0.00	0.00	19	3.5	22	64	29	6.5	0.00	0.00	0.00
6	0.00	0.00	0.00	36	3.5	83	61	30	5.6	0.00	0.00	0.00
7	0.00	0.00	0.00	31	4.8	60	60	31	4.8	0.00	0.00	0.00
8	0.00	0.00	0.00	25	10	39	60	29	4.0	0.00	0.00	0.00
9	0.00	0.00	0.00	22	7.9	34	58	28	3.5	0.00	0.00	0.00
10	0.00	0.00	0.00	19	6.9	32	59	27	2.8	0.00	0.00	0.00
11	0.00	0.00	0.00	18	7.2	31	57	25	2.1	0.00	0.00	0.00
12	0.00	0.00	0.00	18	7.9	34	57	25	0.42	0.00	0.00	0.00
13	0.00	0.00	0.00	16	9.0	32	56	26	0.00	0.00	0.00	0.00
14	0.00	0.00	0.00	15	9.0	28	60	26	0.00	0.00	0.00	0.00
15	0.00	0.00	0.00	13	11	26	57	26	0.00	0.00	0.00	0.00
16	0.00	0.00	0.00	11	12	24	46	24	0.00	0.00	0.00	0.00
17	0.00	0.00	0.00	9.4	13	23	41	24	0.00	0.00	0.00	0.00
18	0.00	0.00	0.00	8.7	11	21	36	24	0.00	0.00	0.00	0.00
19	0.00	0.00	0.00	7.6	24	21	34	23	0.00	0.00	0.00	0.00
20	0.00	0.00	0.00	6.9	102	21	32	24	0.00	0.00	0.00	0.00
21	0.00	0.00	0.00	7.2	60	24	33	22	0.00	0.00	0.00	0.00
22	0.00	0.00	0.00	5.9	45	29	33	22	0.00	0.00	0.00	0.00
23	0.00	0.00	0.00	5.3	44	31	33	21	0.00	0.00	0.00	0.00
24	0.00	0.00	0.00	4.8	36	28	33	18	0.00	0.00	0.00	0.00
25	0.00	0.00	0.00	4.8	32	27	35	13	0.00	0.00	0.00	0.00
26	0.00	0.00	0.00	5.0	31	27	36	16	0.00	0.00	0.00	0.00
27	0.00	0.00	0.00	4.8	32	30	36	16	0.00	0.00	0.00	0.00
28	0.00	0.00	0.00	4.2	31	34	31	15	0.00	0.00	0.00	0.00
29	0.00	0.00	0.00	3.5	---	42	32	13	0.00	0.00	0.00	0.00
30	0.00	0.00	0.00	3.5	---	45	31	13	0.00	0.00	0.00	0.00
31	0.00	---	0.00	3.5	---	47	---	12	---	0.00	0.00	---
TOTAL	0.00	0.00	0.00	412.10	567.7	991	1413	713	67.02	0.00	0.00	0.00
MEAN	0.000	0.000	0.000	13.29	20.27	31.97	47.10	23.00	2.234	0.000	0.000	0.000
MAX	0.00	0.00	0.00	40	102	83	68	31	12	0.00	0.00	0.00
MIN	0.00	0.00	0.00	0.00	3.5	21	31	12	0.00	0.00	0.00	0.00
AC-FT	0.00	0.00	0.00	817	1130	1970	2800	1410	133	0.00	0.00	0.00

STATISTICS OF MONTHLY MEAN DATA FOR WATER YEARS 1966 - 2002, BY WATER YEAR (WY)

	1966	1966	1966	1966	1991	1974	1974	1974	1966	1966	1966	1966
MEAN	0.002	3.061	5.028	10.40	13.80	22.32	28.38	25.08	8.233	0.299	0.002	0.000
MAX	0.034	37.2	38.6	42.1	77.3	77.7	67.8	80.6	54.0	4.54	0.067	0.001
(WY)	1980	1974	1984	1974	1996	1989	1980	1975	1998	1983	1983	1972
MIN	0.000	0.000	0.000	0.000	0.000	0.000	0.000	0.000	0.000	0.000	0.000	0.000
(WY)	1966	1966	1966	1966	1991	1974	1974	1974	1966	1966	1966	1966

SUMMARY STATISTICS FOR 2001 CALENDAR YEAR FOR 2002 WATER YEAR WATER YEARS 1966 - 2002

ANNUAL TOTAL	1502.68	4163.82	
ANNUAL MEAN	4.117	11.41	9.684
HIGHEST ANNUAL MEAN			24.1
LOWEST ANNUAL MEAN			0.43
HIGHEST DAILY MEAN	53	Mar 25	102
LOWEST DAILY MEAN	0.00	Jan 1	0.00
ANNUAL SEVEN-DAY MINIMUM	0.00	Jan 1	0.00
ANNUAL RUNOFF (AC-FT)	2980	8260	7020
10 PERCENT EXCEEDS	19	34	33
50 PERCENT EXCEEDS	0.00	0.00	0.00
90 PERCENT EXCEEDS	0.00	0.00	0.00

11433065 SOUTH FORK LONG CANYON CREEK BELOW DIVERSION DAM, NEAR VOLCANOVILLE, CA

LOCATION.—Lat 39°03'04", long 120°28'14", in SW 1/4 NE 1/4 sec.24, T.14 N., R.13 E., Placer County, Hydrologic Unit 18020128, Eldorado National Forest, on right bank, 21 ft below diversion dam, 3.3 mi upstream from confluence of North and South Forks Long Canyon Creek, and 17.2 mi east of Volcanoville.

PERIOD OF RECORD.—October 1988 to current year.

GAGE.—Water-stage recorder. Elevation of gage is 4,630 ft above sea level, from topographic map.

REMARKS.—Discharge is computed only during periods of operation of South Fork Long Canyon Creek Diversion Tunnel (station 11433060). See schematic diagram of [Middle Fork American and Rubicon River Basins](#).

COOPERATION.—Records provided by Placer County Water Agency, under general supervision of the U.S. Geological Survey, in connection with Federal Energy Regulatory Commission project no. 2079.

DISCHARGE, CUBIC FEET PER SECOND, WATER YEAR OCTOBER 2001 TO SEPTEMBER 2002

DAILY MEAN VALUES

DAY	OCT	NOV	DEC	JAN	FEB	MAR	APR	MAY	JUN	JUL	AUG	SEP
1	---	---	---	---	5.9	6.2	6.4	6.3	5.9	---	---	---
2	---	---	---	6.2	5.9	6.2	6.4	6.3	5.9	---	---	---
3	---	---	---	6.3	5.9	6.2	6.5	6.3	5.9	---	---	---
4	---	---	---	6.2	5.9	6.0	6.5	6.3	5.9	---	---	---
5	---	---	---	6.0	5.9	6.0	6.5	6.4	5.9	---	---	---
6	---	---	---	6.2	5.9	6.5	6.6	6.4	5.9	---	---	---
7	---	---	---	6.2	5.9	6.3	6.6	6.4	5.9	---	---	---
8	---	---	---	6.0	6.0	6.4	6.6	6.4	5.9	---	---	---
9	---	---	---	6.0	6.0	6.3	6.6	6.4	5.8	---	---	---
10	---	---	---	6.0	6.0	6.2	6.6	6.4	5.8	---	---	---
11	---	---	---	6.0	6.0	6.3	6.5	6.4	5.8	---	---	---
12	---	---	---	6.0	6.0	6.3	6.5	6.4	6.3	---	---	---
13	---	---	---	6.0	6.0	6.3	6.5	6.4	---	---	---	---
14	---	---	---	6.0	6.0	6.3	6.5	6.4	---	---	---	---
15	---	---	---	6.0	6.0	6.2	6.5	6.4	---	---	---	---
16	---	---	---	6.0	6.0	6.2	6.4	6.3	---	---	---	---
17	---	---	---	6.0	6.2	6.2	6.3	6.3	---	---	---	---
18	---	---	---	5.9	6.0	6.2	6.3	6.3	---	---	---	---
19	---	---	---	5.9	6.3	6.0	6.3	6.2	---	---	---	---
20	---	---	---	5.9	7.0	6.0	6.2	6.2	---	---	---	---
21	---	---	---	5.9	6.8	6.0	6.2	6.0	---	---	---	---
22	---	---	---	5.9	6.5	6.0	6.3	6.0	---	---	---	---
23	---	---	---	5.9	6.4	6.0	6.3	6.0	---	---	---	---
24	---	---	---	5.9	6.3	6.0	6.3	5.8	---	---	---	---
25	---	---	---	5.9	6.2	6.0	6.3	4.9	---	---	---	---
26	---	---	---	5.9	6.3	6.0	6.3	4.9	---	---	---	---
27	---	---	---	5.9	6.2	6.0	6.4	5.0	---	---	---	---
28	---	---	---	5.9	6.2	6.0	6.3	5.5	---	---	---	---
29	---	---	---	5.9	---	6.2	6.2	6.2	---	---	---	---
30	---	---	---	5.9	---	6.3	6.2	5.9	---	---	---	---
31	---	---	---	5.9	---	6.3	---	5.9	---	---	---	---
TOTAL	---	---	---	---	171.7	191.1	192.1	189.0	---	---	---	---
MEAN	---	---	---	---	6.132	6.165	6.403	6.097	---	---	---	---
MAX	---	---	---	---	7.0	6.5	6.6	6.4	---	---	---	---
MIN	---	---	---	---	5.9	6.0	6.2	4.9	---	---	---	---
AC-FT	---	---	---	---	341	379	381	375	---	---	---	---

11433080 NORTH FORK LONG CANYON CREEK DIVERSION TUNNEL NEAR VOLCANOVILLE, CA

LOCATION.—Lat 39°02'57", long 120°28'56", in SW 1/4 NW 1/4 sec.24, T.14 N., R.13 E., Placer County, Hydrologic Unit 18020128, Eldorado National Forest, on left bank at diversion dam, 3.2 mi upstream from confluence of North and South Forks Long Canyon Creek, and 16.9 mi east of Volcanoville.

PERIOD OF RECORD.—October 1965 to current year.

GAGE.—Water-stage recorder and Parshall flume. Elevation of gage is 4,700 ft above sea level, from topographic map.

REMARKS.—Tunnel completed in September 1965 and diversions began in February 1966. Flow is diverted from North Fork Long Canyon Creek to a tunnel from Hell Hole Reservoir to Middle Fork Powerplant (stations 11428700 and 11428600) on the Middle Fork American River. See schematic diagram of [Middle Fork American and Rubicon River Basins](#).

COOPERATION.—Records provided by Placer County Water Agency, under general supervision of the U.S. Geological Survey, in connection with Federal Energy Regulatory Commission project no. 2079.

EXTREMES FOR PERIOD OF RECORD.—Maximum daily discharge, 100 ft³/s, Jan. 15, 1998; no flow for part of each year.

DISCHARGE, CUBIC FEET PER SECOND, WATER YEAR OCTOBER 2001 TO SEPTEMBER 2002

DAILY MEAN VALUES

DAY	OCT	NOV	DEC	JAN	FEB	MAR	APR	MAY	JUN	JUL	AUG	SEP
1	0.00	0.00	0.00	0.00	0.99	18	34	13	0.00	0.00	0.00	0.00
2	0.00	0.00	0.00	20	0.92	16	38	12	0.00	0.00	0.00	0.00
3	0.00	0.00	0.00	31	0.92	16	44	12	0.00	0.00	0.00	0.00
4	0.00	0.00	0.00	15	1.1	16	45	13	0.00	0.00	0.00	0.00
5	0.00	0.00	0.00	12	1.3	16	37	13	0.00	0.00	0.00	0.00
6	0.00	0.00	0.00	34	1.4	52	35	12	0.00	0.00	0.00	0.00
7	0.00	0.00	0.00	23	3.0	33	35	11	0.00	0.00	0.00	0.00
8	0.00	0.00	0.00	18	8.5	23	34	10	0.00	0.00	0.00	0.00
9	0.00	0.00	0.00	15	4.6	20	32	9.3	0.00	0.00	0.00	0.00
10	0.00	0.00	0.00	14	4.5	17	34	8.6	0.00	0.00	0.00	0.00
11	0.00	0.00	0.00	13	5.4	17	32	7.5	0.00	0.00	0.00	0.00
12	0.00	0.00	0.00	13	6.9	20	31	6.9	0.00	0.00	0.00	0.00
13	0.00	0.00	0.00	12	6.3	18	32	6.5	0.00	0.00	0.00	0.00
14	0.00	0.00	0.00	9.8	8.4	15	35	5.7	0.00	0.00	0.00	0.00
15	0.00	0.00	0.00	8.2	9.1	13	27	5.2	0.00	0.00	0.00	0.00
16	0.00	0.00	0.00	6.5	9.5	12	20	4.6	0.00	0.00	0.00	0.00
17	0.00	0.00	0.00	5.4	10	10	17	4.1	0.00	0.00	0.00	0.00
18	0.00	0.00	0.00	4.3	7.3	8.4	15	3.6	0.00	0.00	0.00	0.00
19	0.00	0.00	0.00	4.0	24	8.6	15	3.2	0.00	0.00	0.00	0.00
20	0.00	0.00	0.00	3.5	46	11	16	4.6	0.00	0.00	0.00	0.00
21	0.00	0.00	0.00	3.2	41	16	17	5.0	0.00	0.00	0.00	0.00
22	0.00	0.00	0.00	2.5	34	18	16	8.0	0.00	0.00	0.00	0.00
23	0.00	0.00	0.00	2.4	31	17	15	7.7	0.00	0.00	0.00	0.00
24	0.00	0.00	0.00	1.9	25	14	16	5.9	0.00	0.00	0.00	0.00
25	0.00	0.00	0.00	1.9	23	13	17	1.6	0.00	0.00	0.00	0.00
26	0.00	0.00	0.00	1.7	23	16	16	0.00	0.00	0.00	0.00	0.00
27	0.00	0.00	0.00	1.7	23	19	18	0.00	0.00	0.00	0.00	0.00
28	0.00	0.00	0.00	1.2	22	24	14	0.00	0.00	0.00	0.00	0.00
29	0.00	0.00	0.00	1.1	---	29	16	0.00	0.00	0.00	0.00	0.00
30	0.00	0.00	0.00	1.1	---	29	15	0.00	0.00	0.00	0.00	0.00
31	0.00	---	0.00	1.2	---	30	---	0.00	---	0.00	0.00	---
TOTAL	0.00	0.00	0.00	281.60	382.13	585.0	768	194.00	0.00	0.00	0.00	0.00
MEAN	0.000	0.000	0.000	9.084	13.65	18.87	25.60	6.258	0.000	0.000	0.000	0.000
MAX	0.00	0.00	0.00	34	46	52	45	13	0.00	0.00	0.00	0.00
MIN	0.00	0.00	0.00	0.00	0.92	8.4	14	0.00	0.00	0.00	0.00	0.00
AC-FT	0.00	0.00	0.00	559	758	1160	1520	385	0.00	0.00	0.00	0.00

STATISTICS OF MONTHLY MEAN DATA FOR WATER YEARS 1966 - 2002, BY WATER YEAR (WY)

	1966	1967	1968	1969	1970	1971	1972	1973	1974	1975	1976	1977	1978	1979	1980	1981	1982	1983	1984	1985	1986	1987	1988	1989	1990	1991	1992	1993	1994	1995	1996	1997	1998	1999	2000	2001	2002			
MEAN	0.042	0.739	1.729	4.031	6.580	11.25	13.67	10.70	2.452	0.016	0.003	0.004																												
MAX	0.74	13.2	12.7	18.5	35.6	35.5	33.0	39.9	22.5	0.20	0.093	0.077																												
(WY)	1980	1982	1997	1998	1996	1993	1993	1998	1998	1973	1973	1973																												
MIN	0.000	0.000	0.000	0.000	0.000	0.000	0.000	0.000	0.000	0.000	0.000	0.000																												
(WY)	1966	1966	1966	1966	1974	1974	1974	1974	1966	1966	1966	1966																												

SUMMARY STATISTICS

FOR 2001 CALENDAR YEAR

FOR 2002 WATER YEAR

WATER YEARS 1966 - 2002

ANNUAL TOTAL	863.73	2210.73		
ANNUAL MEAN	2.366	6.057	4.250	
HIGHEST ANNUAL MEAN			12.7	1998
LOWEST ANNUAL MEAN			0.007	1977
HIGHEST DAILY MEAN	46	Mar 25	52	Mar 6
LOWEST DAILY MEAN	0.00	Jan 1	0.00	Oct 1
ANNUAL SEVEN-DAY MINIMUM	0.00	Jan 1	0.00	Oct 1
ANNUAL RUNOFF (AC-FT)	1710		4380	3080
10 PERCENT EXCEEDS	9.6		20	16
50 PERCENT EXCEEDS	0.00		0.00	0.00
90 PERCENT EXCEEDS	0.00		0.00	0.00

11433085 NORTH FORK LONG CANYON CREEK BELOW DIVERSION DAM, NEAR VOLCANOVILLE, CA

LOCATION.—Lat 39°02'57", long 120°28'56", in SW 1/4 NW 1/4 sec.24, T.14 N., R.13 E., Placer County, Hydrologic Unit 18020128, Eldorado National Forest, on right bank, 26 ft below diversion dam, 3.2 mi upstream from confluence of North and South Forks Long Canyon Creek, and 16.9 mi east of Volcanoville.

PERIOD OF RECORD.—October 1988 to current year.

GAGE.—Water-stage recorder. Elevation of gage is 4,700 ft above sea level, from topographic map.

REMARKS.—Discharge is computed only during periods of operation of North Fork Long Canyon Creek Diversion Tunnel (station 11433080). See schematic diagram of [Middle Fork American and Rubicon River Basins](#).

COOPERATION.—Records provided by Placer County Water Agency, under general supervision of the U.S. Geological Survey, in connection with Federal Energy Regulatory Commission project no. 2079.

DISCHARGE, CUBIC FEET PER SECOND, WATER YEAR OCTOBER 2001 TO SEPTEMBER 2002

DAILY MEAN VALUES

DAY	OCT	NOV	DEC	JAN	FEB	MAR	APR	MAY	JUN	JUL	AUG	SEP
1	---	---	---	---	3.2	3.8	5.9	4.5	---	---	---	---
2	---	---	---	4.2	3.2	3.6	5.6	4.5	---	---	---	---
3	---	---	---	3.4	3.2	3.6	6.2	4.5	---	---	---	---
4	---	---	---	3.0	3.3	3.6	6.2	4.5	---	---	---	---
5	---	---	---	3.2	3.3	3.6	5.7	4.6	---	---	---	---
6	---	---	---	4.0	3.3	4.8	5.5	4.6	---	---	---	---
7	---	---	---	3.9	3.3	4.7	5.5	4.5	---	---	---	---
8	---	---	---	3.7	3.3	4.2	5.5	4.4	---	---	---	---
9	---	---	---	3.7	3.4	3.9	5.5	4.2	---	---	---	---
10	---	---	---	3.6	3.4	3.9	5.5	4.2	---	---	---	---
11	---	---	---	3.6	3.4	3.9	5.2	4.1	---	---	---	---
12	---	---	---	3.6	3.4	4.0	5.2	4.1	---	---	---	---
13	---	---	---	3.6	3.4	4.0	5.2	4.0	---	---	---	---
14	---	---	---	3.6	3.4	3.9	5.3	3.9	---	---	---	---
15	---	---	---	3.5	3.3	3.8	5.2	3.9	---	---	---	---
16	---	---	---	3.4	3.3	3.7	4.8	3.8	---	---	---	---
17	---	---	---	3.4	3.4	3.7	4.7	3.7	---	---	---	---
18	---	---	---	3.4	3.3	4.0	4.6	3.6	---	---	---	---
19	---	---	---	3.4	4.4	4.2	4.6	3.5	---	---	---	---
20	---	---	---	3.3	e6.4	4.5	4.7	3.7	---	---	---	---
21	---	---	---	3.3	5.0	4.6	4.8	3.6	---	---	---	---
22	---	---	---	3.2	4.5	4.8	4.7	3.6	---	---	---	---
23	---	---	---	3.2	4.2	4.7	4.7	3.7	---	---	---	---
24	---	---	---	3.1	4.1	4.5	4.7	3.6	---	---	---	---
25	---	---	---	3.1	4.1	4.5	4.6	4.9	---	---	---	---
26	---	---	---	3.1	4.1	4.6	4.6	---	---	---	---	---
27	---	---	---	3.1	4.0	4.7	4.7	---	---	---	---	---
28	---	---	---	3.1	3.8	4.8	4.5	---	---	---	---	---
29	---	---	---	3.0	---	5.2	4.6	---	---	---	---	---
30	---	---	---	3.1	---	5.3	4.6	---	---	---	---	---
31	---	---	---	3.2	---	5.6	---	---	---	---	---	---
TOTAL	---	---	---	---	104.4	132.7	153.1	---	---	---	---	---
MEAN	---	---	---	---	3.729	4.281	5.103	---	---	---	---	---
MAX	---	---	---	---	6.4	5.6	6.2	---	---	---	---	---
MIN	---	---	---	---	3.2	3.6	4.5	---	---	---	---	---
AC-FT	---	---	---	---	207	263	304	---	---	---	---	---

e Estimated.

11433300 MIDDLE FORK AMERICAN RIVER NEAR FORESTHILL, CA

LOCATION.—Lat 39°00'22", long 120°45'35", in NW 1/4 NW 1/4 sec.4, T.13 N., R.11 E., Placer County, Hydrologic Unit 18020128, Tahoe National Forest, on right bank, 1.6 mi downstream from Oxbow Powerplant, and 3.3 mi east of Foresthill.

DRAINAGE AREA.—524 mi².

PERIOD OF RECORD.—October 1958 to current year.

CHEMICAL DATA: Water year 1979.

BIOLOGICAL DATA: Water year 1979.

GAGE.—Water-stage recorder. Elevation of gage is 1,070 ft above sea level, from topographic map. Prior to Oct. 22, 1965, at site 3.2 mi downstream at different datum. Oct. 22, 1965, to Aug. 28, 1985, at site 400 ft downstream at different datum.

REMARKS.—Flow regulated by French Meadows Reservoir, Hell Hole Reservoir, Loon Lake (stations 11427400, 11428700, and 11429350, respectively), Stumpy Meadows Lake, usable capacity, 17,500 acre-ft, several smaller reservoirs, and Oxbow Powerplant (station 11433212). Robbs Peak Powerplant (station 11429300) and Georgetown Divide Ditch, capacity about 60 ft³/s, divert water out of basin upstream from station. See schematic diagrams of lower Sacramento River Basin and Middle Fork American and Rubicon River Basins.

COOPERATION.—Records provided by Placer County Water Agency, under general supervision of the U.S. Geological Survey, in connection with Federal Energy Regulatory Commission project no. 2079.

EXTREMES FOR PERIOD OF RECORD.—Maximum discharge, 310,000 ft³/s, Dec. 23, 1964, gage height, 69.0 ft, from floodmarks, site and datum then in use, caused by overtopping of the partly constructed Hell Hole Dam on the Rubicon River, from rating curve extended above 28,000 ft³/s, on basis of slope-area measurement at gage height 38.0 ft and slope-conveyance study at gage height 69.0 ft, at site and datum then in use; next highest peak, 123,000 ft³/s, Jan. 2, 1997, gage height, 29.56 ft, from rating curve extended above 37,000 ft³/s; minimum, 35 ft³/s, Oct. 10–20, 1961.

DISCHARGE, CUBIC FEET PER SECOND, WATER YEAR OCTOBER 2001 TO SEPTEMBER 2002
DAILY MEAN VALUES

DAY	OCT	NOV	DEC	JAN	FEB	MAR	APR	MAY	JUN	JUL	AUG	SEP
1	211	121	304	1730	863	1090	1380	968	591	725	498	427
2	151	112	1600	1440	497	857	1550	962	596	642	606	519
3	94	112	1540	2310	513	775	1560	786	632	499	450	507
4	77	111	729	1570	445	875	1720	802	723	474	386	558
5	79	110	592	1140	611	842	1680	738	757	362	594	610
6	103	106	752	1180	689	1760	1370	697	652	526	543	588
7	108	95	708	1370	751	2980	1470	721	443	568	509	504
8	100	88	593	1340	1090	2150	1430	860	516	558	507	418
9	90	90	491	1230	680	1640	1390	857	564	548	520	344
10	92	91	588	996	644	1500	1380	739	561	667	483	358
11	92	95	381	996	847	1380	1320	746	677	512	359	455
12	92	116	577	860	864	1290	1290	620	693	530	470	271
13	92	138	473	659	858	1350	1140	769	617	371	506	191
14	92	95	533	841	926	1140	1180	769	471	416	499	118
15	92	86	451	1010	895	1230	1200	760	513	393	501	104
16	92	85	322	965	616	1090	1080	705	457	500	495	102
17	92	85	662	908	824	950	1180	689	571	513	427	102
18	92	84	775	952	795	1030	1090	608	578	537	410	101
19	94	83	721	542	1140	1040	739	506	738	456	404	100
20	99	84	692	515	3240	941	711	808	703	272	336	100
21	107	94	783	845	2310	937	711	896	571	334	487	100
22	121	555	532	902	2020	1030	860	780	491	497	502	99
23	93	274	682	690	1590	1320	995	832	481	523	479	99
24	87	686	586	898	1520	1530	605	739	641	536	424	99
25	90	548	473	732	1420	1480	714	485	699	512	408	99
26	92	281	572	533	1540	1200	670	494	614	494	477	106
27	93	178	640	764	1120	1330	732	560	508	488	497	99
28	94	269	639	874	1120	1480	896	737	594	296	555	109
29	94	262	882	782	---	1270	1020	711	290	459	577	117
30	100	240	1080	717	---	1450	947	736	579	480	527	116
31	129	---	2450	746	---	1330	---	726	---	539	420	---
TOTAL	3134	5374	22803	31037	30428	40267	34010	22806	17521	15227	14856	7520
MEAN	101.1	179.1	735.6	1001	1087	1299	1134	735.7	584.0	491.2	479.2	250.7
MAX	211	686	2450	2310	3240	2980	1720	968	757	725	606	610
MIN	77	83	304	515	445	775	605	485	290	272	336	99
AC-FT	6220	10660	45230	61560	60350	79870	67460	45240	34750	30200	29470	14920
a	0.00	2520	27120	39310	36550	46560	40110	29140	27630	25570	23790	8630

a Diversion, in acre-feet, through Oxbow Powerplant (station 11433212), provided by Placer County Water Agency.

11433300 MIDDLE FORK AMERICAN RIVER NEAR FORESTHILL, CA—Continued

STATISTICS OF MONTHLY MEAN DATA FOR WATER YEARS 1959 - 2002, BY WATER YEAR (WY)

	OCT	NOV	DEC	JAN	FEB	MAR	APR	MAY	JUN	JUL	AUG	SEP
MEAN	438.6	645.9	1136	1628	1853	1835	1733	1528	1012	664.5	624.8	516.9
MAX	1634	2952	7172	8778	8815	5076	5572	4642	3300	1836	1142	1084
(WY)	1963	1984	1965	1997	1986	1983	1982	1963	1983	1983	1983	1983
MIN	54.3	47.1	64.8	85.2	111	240	110	120	124	99.2	47.2	42.8
(WY)	1961	1960	1960	1991	1991	1977	1977	1977	1977	1966	1959	1962

SUMMARY STATISTICS	FOR 2001 CALENDAR YEAR		FOR 2002 WATER YEAR		WATER YEARS 1959 - 2002	
ANNUAL TOTAL	198961		244983			
ANNUAL MEAN	545.1		671.2		1131	
HIGHEST ANNUAL MEAN					2723	
LOWEST ANNUAL MEAN					179	
HIGHEST DAILY MEAN	2450	Dec 31	3240	Feb 20	65000	Dec 23 1964
LOWEST DAILY MEAN	77	Oct 4	77	Oct 4	35	Oct 19 1961
ANNUAL SEVEN-DAY MINIMUM	86	Nov 15	86	Nov 15	38	Oct 14 1961
MAXIMUM PEAK FLOW			3990	Feb 20	310000	Dec 23 1964
MAXIMUM PEAK STAGE			15.69	Feb 20	69.00	Dec 23 1964
ANNUAL RUNOFF (AC-FT)	394600		485900		819200	
TOTAL DIVERSION (AC-FT) a	274000		306900			
10 PERCENT EXCEEDS	832		1340		2360	
50 PERCENT EXCEEDS	577		588		749	
90 PERCENT EXCEEDS	100		99		100	

a Diversion, in acre-feet, through Oxbow Powerplant (station 11433212), provided by Placer County Water Agency.

11433790 NORTH FORK AMERICAN RIVER AT AUBURN DAM SITE, NEAR AUBURN, CA

LOCATION.—Lat 39°51'06", long 121°03'26", in SW 1/4 NW 1/4 sec.23, T.12 N., R.8 E., Placer County, Hydrologic Unit 18020128, on the right bank upstream side of the Auburn Dam Site diversion tunnel, 0.7 mi upstream from Knickerbocker Creek, and 1.3 mi southeast of Auburn.

DRAINAGE AREA.— 972 mi².

PERIOD OF RECORD.—Water year 1999 to current year.

WATER TEMPERATURE: Water year 1999 to current year.

PERIOD OF DAILY RECORD.—

WATER TEMPERATURE: June 1999 to current year.

INSTRUMENTATION.—Water-temperature recorder since June 4, 1999.

REMARKS.—Water-temperature records rated excellent except for Oct.19 to Dec. 5, July 4–11, and Aug. 4–14, which are rated good. Water temperature can be affected by upstream releases.

EXTREMES FOR PERIOD OF DAILY RECORD.—

WATER TEMPERATURE: Maximum recorded, 25.0°C, July 2, 2001; minimum recorded, 3.0°C, Jan. 31, 2002.

EXTREMES FOR CURRENT YEAR.—

WATER TEMPERATURE: Maximum recorded, 24.5°C, June 30, July 14; minimum recorded, 3.0°C, Jan. 31.

CROSS-SECTIONAL DATA, WATER YEAR OCTOBER 2001 TO SEPTEMBER 2002

DATE	TIME	DEPTH BOTTOM AT SAMPLE LOC- TION, (FEET) (81903)	TEMPER- ATURE WATER (DEG C) (00010)	SAMPLE LOC- ATION, CROSS SECTION (FT FM L BANK) (00009)
JUL				
16...	1157	.35	21.0	55.5
16...	1158	1.37	20.5	50.5
16...	1159	1.35	20.5	46.0
16...	1200	2.60	20.5	41.0
16...	1201	1.93	20.5	36.0
16...	1202	1.55	20.5	31.5
16...	1203	2.30	20.5	26.5
16...	1204	2.20	20.5	22.0
16...	1205	2.25	20.5	17.0
16...	1206	2.00	20.5	12.0
16...	1207	1.25	20.5	7.50
SEP				
23...	0923	.55	20.0	51.0
23...	0924	1.20	20.0	46.0
23...	0925	2.10	20.0	40.5
23...	0926	2.00	20.0	35.0
23...	0927	1.30	19.5	30.0
23...	0928	2.00	19.5	24.0
23...	0929	1.90	19.5	19.0
23...	0930	2.10	19.5	13.5
23...	0931	1.40	19.5	8.00
23...	0932	1.00	19.5	3.00

* Instantaneous discharge at time of cross-sectional measurement: Unknown.

11433790 NORTH FORK AMERICAN RIVER AT AUBURN DAM SITE, NEAR AUBURN, CA—Continued

WATER TEMPERATURE (DEGREES C), WATER YEAR OCTOBER 2001 TO SEPTEMBER 2002

DAY	MAX	MIN	MAX	MIN	MAX	MIN	MAX	MIN	MAX	MIN	MAX	MIN
	OCTOBER		NOVEMBER		DECEMBER		JANUARY		FEBRUARY		MARCH	
1	21.0	19.0	16.0	14.5	9.5	9.0	9.0	8.0	5.0	3.5	9.5	8.0
2	21.5	19.5	16.0	14.0	9.5	8.5	9.0	8.5	5.0	3.5	9.0	7.0
3	21.5	19.5	16.0	13.5	9.0	8.0	9.0	8.5	5.0	3.5	9.0	7.0
4	21.5	19.0	15.5	13.5	8.5	7.5	8.5	7.5	5.5	3.5	9.5	7.5
5	21.0	19.0	15.5	13.5	8.5	7.5	8.0	7.5	5.5	3.5	9.0	7.5
6	20.5	18.0	15.0	13.5	9.0	8.0	8.0	7.5	5.5	3.5	9.0	8.0
7	20.5	18.0	15.0	13.0	8.5	7.5	8.5	8.0	5.5	4.5	8.5	7.5
8	20.5	18.5	14.5	12.5	8.5	7.5	8.5	8.0	6.5	5.0	8.0	7.0
9	20.0	17.5	14.5	12.5	8.5	7.5	8.0	7.5	6.0	4.5	8.0	6.5
10	19.5	16.5	14.0	12.5	8.0	7.0	8.0	7.0	7.0	5.0	8.5	7.0
11	18.5	17.0	14.5	13.0	7.5	6.5	7.5	7.0	7.5	5.0	9.0	7.5
12	18.5	16.0	14.5	14.0	7.5	6.0	7.5	6.5	7.5	5.5	9.5	8.0
13	19.0	16.0	15.0	13.5	7.5	6.5	7.0	6.5	7.0	6.0	10.0	8.5
14	19.0	16.0	15.5	14.0	8.0	7.0	7.0	6.0	8.0	6.0	10.0	8.0
15	18.5	16.5	15.5	14.0	7.0	6.0	6.5	5.0	7.5	6.5	8.5	7.0
16	18.5	16.5	15.0	14.0	7.0	5.5	6.0	4.5	8.5	7.0	8.0	7.0
17	19.0	16.5	14.5	13.5	7.5	7.0	6.0	4.5	8.0	7.0	7.5	6.5
18	19.0	16.0	14.5	13.0	7.5	7.0	5.5	4.5	8.5	7.0	8.0	6.0
19	18.0	16.0	14.0	13.0	7.5	7.0	5.5	4.5	8.0	7.5	8.0	6.0
20	18.5	16.0	14.0	13.0	8.0	7.0	5.5	4.0	8.5	7.0	9.0	6.5
21	18.0	15.5	13.5	13.0	8.0	7.0	5.0	4.0	9.0	8.0	10.0	7.5
22	17.5	15.5	15.0	13.0	8.0	7.0	5.5	4.5	9.0	7.5	9.5	9.0
23	17.0	15.5	13.5	13.0	8.0	7.0	5.0	4.0	9.5	8.0	10.0	9.0
24	16.5	14.5	13.0	11.5	7.5	6.5	5.0	3.5	10.0	8.0	9.5	8.5
25	16.0	14.0	12.0	11.0	7.5	6.0	5.5	4.0	9.5	7.5	9.5	8.5
26	16.0	14.0	11.0	10.0	8.0	7.0	5.5	4.5	9.0	7.5	10.5	8.5
27	16.0	14.0	10.0	8.5	8.0	7.0	6.0	4.5	9.5	7.5	11.0	9.0
28	16.0	14.5	9.5	8.5	8.0	7.5	5.0	4.5	9.5	8.0	11.5	9.5
29	16.0	14.5	9.5	8.0	8.5	8.0	5.0	4.0	---	---	12.0	10.0
30	15.5	15.0	9.5	8.5	9.0	8.5	5.0	3.5	---	---	12.5	10.5
31	16.5	15.0	---	---	9.0	8.5	5.0	3.0	---	---	13.0	11.0
MONTH	21.5	14.0	16.0	8.0	9.5	5.5	9.0	3.0	10.0	3.5	13.0	6.0
	APRIL		MAY		JUNE		JULY		AUGUST		SEPTEMBER	
1	13.0	11.0	12.0	9.5	19.0	16.5	24.0	19.5	22.0	18.5	20.5	16.0
2	13.0	11.0	12.5	10.0	19.5	16.0	22.5	18.5	22.0	18.5	20.5	17.0
3	13.0	11.5	13.5	11.0	19.5	16.5	22.0	18.0	21.0	18.0	19.5	17.0
4	12.5	11.5	14.5	12.0	20.0	16.5	23.0	18.5	21.5	18.0	19.0	16.5
5	12.0	11.0	15.0	12.5	20.5	17.0	23.0	19.0	21.5	18.0	18.0	15.0
6	11.5	10.5	15.0	13.0	21.0	17.0	24.0	19.0	20.0	17.0	17.5	15.0
7	12.0	10.5	15.0	13.0	21.0	18.0	23.0	19.5	20.5	16.5	17.0	14.0
8	12.5	11.0	14.5	12.5	21.0	18.5	22.5	19.0	20.5	17.0	17.0	14.0
9	11.5	11.0	14.5	12.5	20.5	17.5	23.0	19.0	20.5	17.0	18.0	14.0
10	12.0	10.5	14.0	12.0	20.5	16.5	23.5	19.0	21.0	17.0	18.5	15.0
11	12.0	11.0	14.5	12.0	21.5	17.0	22.0	18.5	21.5	17.0	19.0	15.5
12	12.5	11.0	15.0	11.5	21.5	17.0	23.5	19.0	22.0	18.0	19.0	15.5
13	13.0	11.5	15.0	12.5	21.0	17.0	23.5	19.5	22.0	18.5	19.0	16.5
14	13.5	12.0	15.5	13.0	21.5	17.5	24.5	20.0	21.5	18.0	20.0	17.5
15	13.0	11.0	15.5	13.0	22.5	18.5	23.0	20.0	21.5	18.0	20.5	18.5
16	11.0	9.0	16.0	13.5	22.5	18.5	23.0	19.0	21.5	18.0	20.5	18.0
17	10.0	8.5	16.0	14.0	22.5	18.5	22.5	19.0	20.5	17.5	21.0	19.0
18	9.5	8.0	16.0	14.0	23.0	18.5	22.0	19.0	21.0	17.0	21.5	19.0
19	10.0	7.5	15.0	13.0	23.0	19.0	22.5	18.0	20.5	17.5	21.5	19.0
20	11.0	8.5	13.5	12.0	22.0	18.0	23.5	19.0	20.5	17.0	22.0	19.5
21	12.0	9.0	12.5	11.5	21.5	17.0	23.0	19.5	21.0	17.0	22.0	19.5
22	12.5	10.0	13.5	10.5	22.0	17.5	23.5	20.0	20.0	17.0	22.5	19.5
23	13.5	11.0	14.5	11.0	23.0	18.5	23.0	19.5	19.5	17.0	22.0	19.5
24	14.0	11.5	15.5	12.0	23.0	19.0	22.5	19.0	19.5	16.0	22.5	20.0
25	14.0	12.0	16.5	13.5	23.0	18.5	22.0	18.5	20.0	16.0	22.0	19.5
26	13.0	11.5	17.0	14.0	22.0	18.0	22.0	18.0	20.0	16.5	21.5	19.5
27	12.0	11.0	17.5	15.0	22.5	18.0	22.5	18.0	20.0	16.5	20.5	19.0
28	12.5	10.5	18.0	15.5	23.0	19.0	22.5	19.0	20.0	16.5	20.0	18.0
29	11.0	10.5	18.5	15.5	23.0	18.5	23.5	19.0	19.0	16.5	20.0	18.5
30	11.5	9.5	19.0	16.5	24.5	19.5	23.5	20.0	19.0	16.5	20.0	18.0
31	---	---	19.5	17.0	---	---	22.5	19.5	19.0	16.0	---	---
MONTH	14.0	7.5	19.5	9.5	24.5	16.0	24.5	18.0	22.0	16.0	22.5	14.0

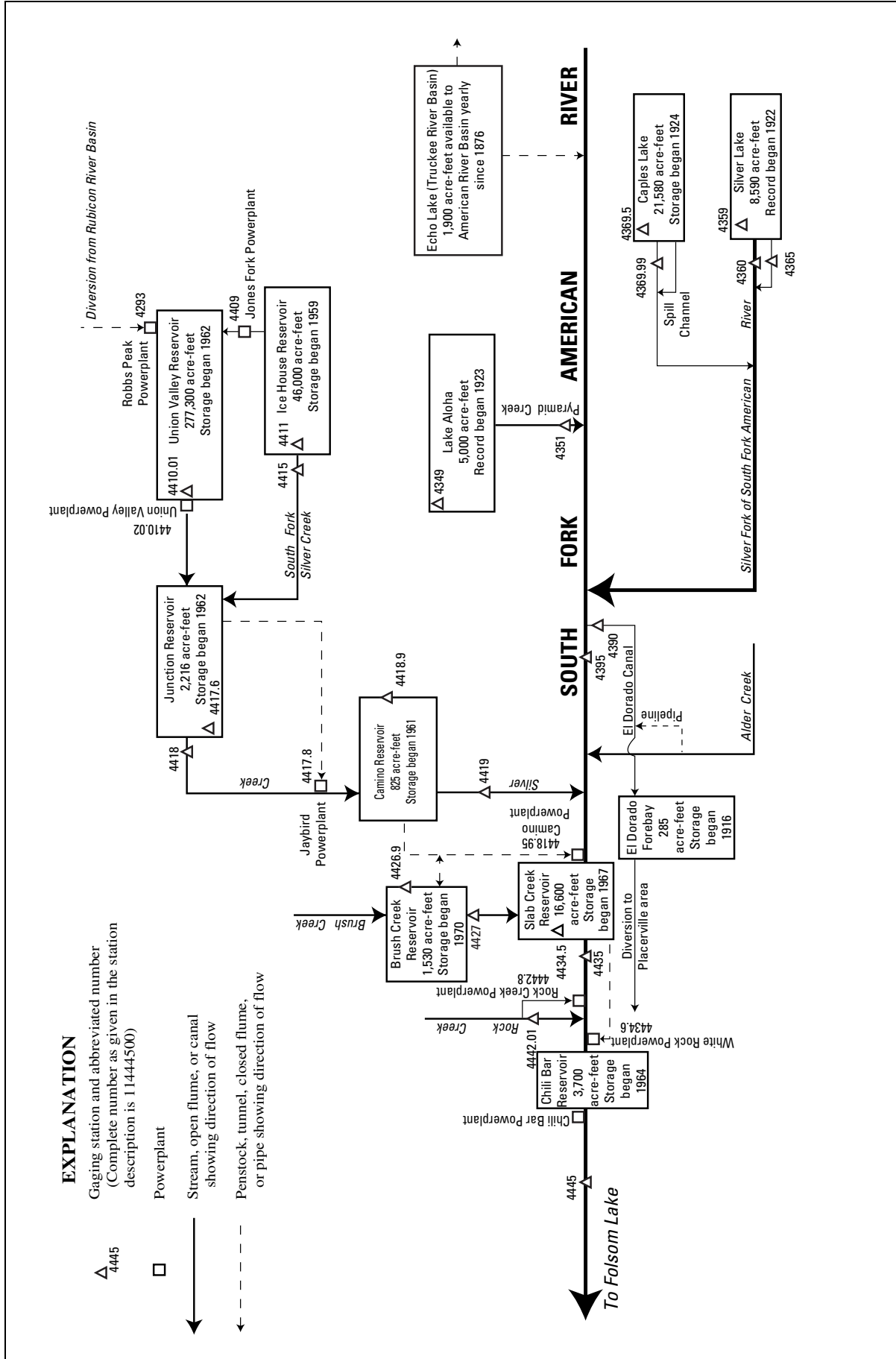

EXPLANATION

△ 4445
Gaging station and abbreviated number
(Complete number as given in the station
description is 11444500)

□
Powerplant

→
Stream, open flume, or canal
showing direction of flow

- - -
Penstock, tunnel, closed flume,
or pipe showing direction of flow

Figure 35. Diversions and storage in South Fork American River Basin.

11435100 PYRAMID CREEK AT TWIN BRIDGES, CA

LOCATION.—Lat 38°48'57", long 120°06'58", in NW 1/4 SW 1/4 sec.9, T.11 N., R.17 E., El Dorado County, Hydrologic Unit 18020129, Eldorado National Forest, on right bank, 0.5 mi northeast of Twin Bridges, 2.2 mi west of Phillips, and 3.6 mi downstream from Lake Aloha.

DRAINAGE AREA.—8.76 mi².

PERIOD OF RECORD.—October 1970 to current year.

GAGE.—Water-stage recorder. Elevation of gage is 6,320 ft above sea level, from topographic map. Prior to October 1987, at datum 1.00 ft higher.

REMARKS.—Flow regulated by Lake Aloha, capacity, 5,000 acre-ft. Lake of the Woods, Ropi Lake, and Toem Lake (unknown capacities) also regulate at times. See schematic diagram of [South Fork American River Basin](#).

COOPERATION.—Records were collected by the El Dorado Irrigation District, under general supervision of the U.S. Geological Survey, in connection with Federal Energy Regulatory Commission project no. 184.

EXTREMES FOR PERIOD OF RECORD.—Maximum discharge, 2,920 ft³/s, Jan. 2, 1997, gage height, 7.22 ft, from rating curve extended above 300 ft³/s; minimum daily, 0.03 ft³/s, Oct. 26–28, 1992.

DISCHARGE, CUBIC FEET PER SECOND, WATER YEAR OCTOBER 2001 TO SEPTEMBER 2002
DAILY MEAN VALUES

DAY	OCT	NOV	DEC	JAN	FEB	MAR	APR	MAY	JUN	JUL	AUG	SEP
1	3.0	8.3	e15	22	e11	20	45	32	165	53	14	47
2	2.9	6.1	e16	22	e11	18	50	35	132	55	14	47
3	2.9	6.5	e18	22	e11	17	58	45	128	52	14	46
4	2.8	6.5	e17	19	e10	17	68	59	140	47	13	46
5	2.8	6.5	e17	18	e10	17	62	74	139	42	15	44
6	2.8	6.4	e16	55	e10	21	54	85	139	40	41	35
7	3.2	6.3	e16	41	e10	21	54	88	137	37	44	34
8	3.3	6.3	16	28	e10	20	59	80	134	36	43	33
9	3.1	6.3	16	23	e10	18	61	76	126	32	43	32
10	3.0	6.3	15	21	e10	17	60	64	115	31	43	15
11	3.0	6.1	15	20	e10	17	64	60	113	32	42	7.1
12	2.9	8.2	14	20	e10	18	75	77	113	34	44	5.6
13	2.8	e7.5	14	19	e10	17	74	94	112	38	57	5.0
14	2.9	e7.3	17	18	e10	16	105	102	87	35	57	4.7
15	2.9	e7.1	18	16	e10	15	94	102	66	32	57	4.5
16	2.8	e7.0	15	15	e10	16	48	102	59	29	56	4.4
17	2.7	e7.0	16	15	e10	16	40	116	56	26	55	4.4
18	2.7	e7.0	16	14	14	16	34	129	53	24	55	4.3
19	2.7	e7.0	15	14	18	15	30	120	54	22	54	4.1
20	2.6	e7.0	15	14	34	17	28	93	58	21	53	4.1
21	2.6	e7.5	15	13	33	19	29	68	59	20	53	4.0
22	2.6	e20	15	14	34	21	35	57	61	20	53	3.9
23	2.5	e16	17	16	31	20	44	56	64	18	52	3.9
24	2.3	e21	15	15	23	19	52	56	64	17	52	3.8
25	2.3	e17	14	13	22	17	66	65	64	16	51	3.7
26	2.2	e16	16	12	22	18	69	85	72	16	51	3.6
27	2.1	e16	16	e12	22	20	49	99	71	16	50	3.5
28	1.9	e16	17	e11	22	24	37	105	64	15	50	3.6
29	1.7	e15	24	e12	---	31	39	121	58	15	49	3.6
30	6.0	e15	29	e11	---	37	34	153	55	15	48	3.6
31	9.8	---	30	e11	---	41	---	165	---	15	48	---
TOTAL	93.8	296.2	525	576	448	616	1617	2663	2758	901	1371	464.4
MEAN	3.026	9.873	16.94	18.58	16.00	19.87	53.90	85.90	91.93	29.06	44.23	15.48
MAX	9.8	21	30	55	34	41	105	165	165	55	57	47
MIN	1.7	6.1	14	11	10	15	28	32	53	15	13	3.5
AC-FT	186	588	1040	1140	889	1220	3210	5280	5470	1790	2720	921

STATISTICS OF MONTHLY MEAN DATA FOR WATER YEARS 1971 - 2002, BY WATER YEAR (WY)

	1971	1972	1973	1974	1975	1976	1977	1978	1979	1980	1981	1982
MEAN	11.81	17.32	16.06	19.79	17.64	24.48	41.26	96.23	100.3	67.31	44.07	18.15
MAX	35.8	57.1	53.2	133	55.6	63.2	70.2	160	249	198	90.2	77.4
(WY)	1996	1997	1997	1997	1982	1982	1997	1974	1998	1995	1974	1983
MIN	0.18	0.74	1.93	2.25	3.54	7.13	14.7	29.5	14.7	18.9	2.52	0.28
(WY)	1991	1991	1991	1991	1991	1977	1975	1977	2001	2001	1981	1981

SUMMARY STATISTICS	FOR 2001 CALENDAR YEAR	FOR 2002 WATER YEAR	WATER YEARS 1971 - 2002
ANNUAL TOTAL	7770.2	12329.4	
ANNUAL MEAN	21.29	33.78	39.65
HIGHEST ANNUAL MEAN			65.1
LOWEST ANNUAL MEAN			15.3
HIGHEST DAILY MEAN	125	May 16	1570
LOWEST DAILY MEAN	1.7	Oct 29	0.03
ANNUAL SEVEN-DAY MINIMUM	2.1	Oct 23	0.04
MAXIMUM PEAK FLOW		190	May 30
MAXIMUM PEAK STAGE		3.61	May 30
ANNUAL RUNOFF (AC-FT)	15410	24460	28730
10 PERCENT EXCEEDS	51	74	98
50 PERCENT EXCEEDS	15	20	20
90 PERCENT EXCEEDS	3.5	3.9	3.5

e Estimated.

11435900 SILVER LAKE NEAR KIRKWOOD, CA

LOCATION.—Lat 38°40'07", long 120°07'14", in NW 1/4 SE 1/4 sec.32, T.10 N., R.17 E., [Amador County](#), Hydrologic Unit 18020129, Eldorado National Forest, on outlet structure, 3.5 mi southwest of Kirkwood.

DRAINAGE AREA.—15.2 mi².

PERIOD OF RECORD.—October 1985 to current year. Unpublished records for water years 1981–85 available in files of U.S. Geological Survey.

GAGE.—Water-stage recorder. Datum of gage is 7,184.3 ft above sea level (levels by Pacific Gas & Electric Co.). October 1985 to Mar. 5, 1991, nonrecording gage at same site and datum.

REMARKS.—Lake is formed by earthfill and rock masonry dam initially constructed in 1876 and enlarged in 1929. Capacity, 8,590 acre-ft, between gage heights 0.0 ft, invert of outlet, and 22.7 ft, top of radial gates and flashboards. Released water is used for power development on South Fork American River. See schematic diagram of [South Fork American River Basin](#).

COOPERATION.—Records were collected by El Dorado Irrigation District, under general supervision of the U.S. Geological Survey, in connection with Federal Energy Regulatory Commission project no. 184. Contents not rounded to U.S. Geological Survey standards.

EXTREMES FOR PERIOD OF RECORD.—Maximum contents, 8,791 acre-ft, June 3, 1996, gage height, 23.10 ft; minimum, 0 acre-ft, Feb. 13, 15, 20, 22, 27, 1991, gage height, 0 ft.

EXTREMES FOR CURRENT YEAR.—Maximum contents, 8,680 acre-ft, June 22–24, gage height, 22.78 ft; minimum, 1,525 acre-ft, Nov. 20, gage height, 5.52 ft.

Capacity table (gage height, in feet, and contents, in acre-feet)
(Based on table provided by El Dorado Irrigation District, dated Sept. 30, 1999)

0.0	0	6.0	1,671	15.0	5,003	21.0	7,799
2.0	519	9.0	2,646	18.0	6,364	24.0	8,792
4.0	1,076	12.0	3,756				

RESERVOIR STORAGE (ACRE-FEET), WATER YEAR OCTOBER 2001 TO SEPTEMBER 2002

DAILY OBSERVATION AT 2400 HOURS

DAY	OCT	NOV	DEC	JAN	FEB	MAR	APR	MAY	JUN	JUL	AUG	SEP
1	3612	1842	1983	2489	3073	3574	e3995	e4023	e8223	8500	e7236	e6117
2	3550	1795	2089	2540	3073	3597	e3987	e3963	e8119	8461	e7169	e6094
3	3489	1758	2112	2564	3077	3620	e4035	e3931	e8069	8421	7121	e6057
4	3431	1721	2118	2581	3077	3647	e4091	e3955	8084	8376	7063	e6025
5	3374	1680	2125	2608	3077	3674	e4205	e4055	8123	8342	7039	e6001
6	3318	1638	2131	2681	3081	3776	e4193	e4193	8143	8297	6987	e5965
7	3262	1607	2135	2758	3099	3827	e4144	e4362	8163	8252	6953	e5891
8	3199	1589	2141	2797	3121	3843	e4136	e4483	8143	8208	6915	e5827
9	3143	1571	2154	2833	3118	3855	e4164	e4542	8040	8163	6882	e5772
10	3088	1568	2157	2854	3110	3887	e4144	e4580	8010	8123	6868	e5703
11	3029	1571	2164	2882	3118	3895	e4140	e4521	8084	8079	6816	e5653
12	2975	1586	2167	2904	3121	3919	e4209	e4471	8193	8040	6768	e5581
13	2922	1586	2180	2925	3129	3923	e4222	e4475	8307	7995	6730	e5490
14	2868	1583	2209	2943	3154	3923	e4280	e4670	8391	7946	6697	e5418
15	2780	1580	2216	2968	3162	3911	e4458	e4986	8451	7897	6659	e5316
16	2730	1571	2219	2971	3173	3895	e4329	e5228	8500	7853	6636	e5219
17	2657	1568	2245	2986	3206	3895	e4193	e5581	8540	7813	6594	e5139
18	2588	1553	2248	2989	3214	3859	e4075	e5882	8590	7774	6570	e5056
19	2520	1544	2255	2993	3240	3835	e3983	e6257	8630	7735	6523	e4951
20	2452	1525	2281	3004	3258	3815	e3903	e6504	8660	7696	6476	e4886
21	2384	1647	2284	3015	3299	3819	e3851	e6645	8675	7657	6467	e4812
22	2324	1721	2314	3015	3344	e3815	e3808	e6655	8680	7608	6467	e4734
23	2261	1727	2324	2993	3385	e3827	e3808	e6650	8680	7565	6429	e4674
24	2199	1851	2327	3011	3416	e3831	e3883	e6697	8680	7521	e6401	e4592
25	2135	1870	2331	3015	3443	e3808	e3991	e6773	8660	7482	e6359	e4491
26	2086	1886	2337	3051	3477	e3784	e4099	e6930	8645	e7439	e6322	e4391
27	2012	1883	2347	3055	3508	e3760	e4177	e7125	8620	e7424	e6280	e4313
28	1955	1911	2368	3062	3543	e3764	e4168	e7381	8595	e7381	e6243	e4242
29	1917	1939	2388	3070	---	e3796	e4116	e7628	8570	e7337	e6210	e4172
30	1908	1942	2432	3073	---	e3851	e4095	e7872	8535	e7299	e6182	e4099
31	1864	---	2466	3073	---	e3919	---	e8153	---	e7265	e6145	---
MAX	3612	1942	2466	3073	3543	3923	4458	8153	8680	8500	7236	6117
MIN	1864	1525	1983	2489	3073	3574	3808	3931	8010	7265	6145	4099
a	6.62	6.87	8.47	10.20	11.45				22.49			
b	-1841	+78	+524	+607	+470	+376	+176	+4058	+382	-1270	-1120	-2046

CAL YR 2001 MAX 8615 MIN 1099 b +877
WTR YR 2002 MAX 8680 MIN 1525 b +394

e Estimated.

a Gage height, in feet, at end of month.

b Change in contents, in acre-feet.

11436000 SILVER LAKE OUTLET NEAR KIRKWOOD, CA

LOCATION.—Lat 38°40'18", long 120°07'19", in NE 1/4 SW 1/4 sec.32, T.10 N., R.17 E., El Dorado County, Hydrologic Unit 18020129, Eldorado National Forest, on right bank, 1,000 ft downstream from Silver Lake Dam, and 3.5 mi southwest of Kirkwood.

DRAINAGE AREA.—15.2 mi².

PERIOD OF RECORD.—September 1922 to current year. Records for water year 1923 incomplete, yearly estimate published in WSP 1315-A.

REVISED RECORDS.—WDR CA-75-4: 1927(M), 1929(M), 1932(M), 1937–38(M), 1940–45(M), 1950–53(M), 1955–58(M), 1963(M), 1965(M), 1967(M), 1969–70(M), 1973(M).

GAGE.—Water-stage recorder. Concrete control since Sept. 8, 1986. Datum of gage is 7,198.0 ft above sea level (levels by Pacific Gas & Electric Co.).

REMARKS.—Low and medium flow regulated by Silver Lake (station 11435900) 1,000 ft upstream. Some water, in addition to that released through dam and over spillway, escapes from Silver Lake through porous rock formation and is measured at staff gage (station 11436500) 0.25 mi east of station. For leakage from Silver Lake, refer to monthly figures below. See schematic diagram of [South Fork American River Basin](#).

COOPERATION.—Records were collected by El Dorado Irrigation District, under general supervision of the U.S. Geological Survey, in connection with Federal Energy Regulatory Commission project no. 184.

EXTREMES FOR PERIOD OF RECORD.—Maximum discharge, 2,170 ft³/s, Jan. 2, 1997, gage height, 7.79 ft, from rating curve extended above 430 ft³/s; no flow many days in February and March 1948, Jan. 13, 14, 1954, and Nov. 3, 1959, to Feb. 5, 1960.

DISCHARGE, CUBIC FEET PER SECOND, WATER YEAR OCTOBER 2001 TO SEPTEMBER 2002

DAILY MEAN VALUES

DAY	OCT	NOV	DEC	JAN	FEB	MAR	APR	MAY	JUN	JUL	AUG	SEP
1	26	20	4.3	4.9	5.2	6.2	72	71	221	2.7	3.8	3.7
2	25	20	4.4	4.9	5.2	6.2	88	67	170	3.7	3.7	3.7
3	25	19	4.8	5.0	5.2	6.2	103	67	121	3.6	3.4	3.7
4	25	19	4.8	5.0	5.2	6.2	128	71	121	3.3	3.4	3.6
5	25	19	4.7	5.0	5.2	6.2	153	88	120	3.2	3.3	12
6	25	19	4.4	5.1	5.2	6.2	142	111	106	3.1	3.2	20
7	25	14	4.4	5.2	5.2	6.2	129	142	90	3.3	3.1	20
8	24	9.5	4.4	5.2	5.2	6.3	131	165	89	3.7	2.9	20
9	24	7.4	4.4	5.2	5.3	6.4	137	170	88	3.6	3.2	20
10	24	4.9	4.4	5.2	5.6	6.3	129	165	59	3.6	3.5	20
11	24	4.9	4.4	5.2	5.6	6.3	133	149	9.4	3.7	3.6	26
12	23	4.9	4.4	5.2	5.6	6.4	152	145	2.8	3.7	3.6	35
13	23	4.9	4.5	5.2	5.6	7.7	162	101	2.7	3.7	4.0	35
14	23	4.9	4.5	5.2	5.6	13	198	66	2.7	3.8	4.1	35
15	31	4.9	4.6	5.2	5.7	18	246	68	2.7	3.7	3.7	34
16	32	4.9	4.5	5.2	5.7	19	179	68	2.5	3.7	3.5	34
17	32	4.8	4.5	5.2	5.8	19	129	69	3.5	3.5	3.3	34
18	32	4.7	4.4	5.2	5.8	22	95	71	4.1	3.5	3.4	34
19	31	4.7	4.4	5.2	5.9	22	75	71	3.3	3.5	3.7	34
20	31	4.7	4.5	5.2	6.0	20	66	72	3.2	3.5	4.1	33
21	30	5.1	4.6	5.2	6.0	19	61	72	3.2	3.7	4.0	33
22	30	5.1	4.6	5.2	6.0	19	60	72	3.2	3.5	4.0	33
23	30	4.8	4.6	5.2	6.0	20	62	56	3.0	3.5	3.9	34
24	29	5.1	4.6	5.2	6.0	22	71	40	2.8	3.4	3.6	35
25	29	4.5	4.6	5.2	6.1	25	93	40	2.8	3.2	3.7	35
26	28	4.1	4.6	5.2	6.1	27	100	41	3.6	3.5	3.4	34
27	28	4.1	4.6	5.2	6.2	24	90	41	3.9	3.9	3.3	34
28	28	4.2	4.6	5.2	6.2	24	85	56	3.3	3.9	3.3	34
29	27	4.3	4.7	5.2	---	25	81	76	2.8	4.0	3.4	34
30	27	4.3	4.7	5.2	---	31	76	78	2.7	3.9	3.7	33
31	23	---	4.8	5.2	---	43	---	159	---	3.9	3.7	---
TOTAL	839	245.7	140.7	159.9	158.4	494.8	3426	2728	1253.2	110.5	110.5	799.7
MEAN	27.06	8.190	4.539	5.158	5.657	15.96	114.2	88.00	41.77	3.565	3.565	26.66
MAX	32	20	4.8	5.2	6.2	43	246	170	221	4.0	4.1	35
MIN	23	4.1	4.3	4.9	5.2	6.2	60	40	2.5	2.7	2.9	3.6
AC-FT	1660	487	279	317	314	981	6800	5410	2490	219	219	1590
a	0	0	0	0	0	0	0	196	827	681	324	69

a Leakage (station 11436500), in acre-feet, from Silver Lake, provided by El Dorado Irrigation District.

11436000 SILVER LAKE OUTLET NEAR KIRKWOOD, CA—Continued

STATISTICS OF MONTHLY MEAN DATA FOR WATER YEARS 1923 - 2002, BY WATER YEAR (WY)

	OCT	NOV	DEC	JAN	FEB	MAR	APR	MAY	JUN	JUL	AUG	SEP
MEAN	25.37	18.33	15.80	14.85	13.46	15.57	44.90	126.1	86.85	19.39	8.257	36.78
MAX	54.3	110	116	188	93.2	98.2	133	306	353	186	50.5	74.6
(WY)	1953	1951	1951	1997	1963	1986	1943	1969	1983	1983	1987	1983
MIN	0.11	0.15	0.000	0.000	0.093	0.013	0.20	1.37	1.43	0.91	0.44	0.16
(WY)	1930	1929	1960	1960	1948	1948	1924	1977	1977	1959	1925	1923

SUMMARY STATISTICS	FOR 2001 CALENDAR YEAR		FOR 2002 WATER YEAR		WATER YEARS 1923 - 2002	
ANNUAL TOTAL	5931.8		10466.4			
ANNUAL MEAN	16.25		28.68		35.51	
HIGHEST ANNUAL MEAN					85.4 1983	
LOWEST ANNUAL MEAN					8.76 1976	
HIGHEST DAILY MEAN	136	Apr 30	246	Apr 15	1940	Jan 2 1997
LOWEST DAILY MEAN	2.5	Jun 24	2.5	Jun 16	0.00	Feb 24 1948
ANNUAL SEVEN-DAY MINIMUM	2.7	Jun 21	3.0	Jun 12	0.00	Feb 28 1948
MAXIMUM PEAK FLOW			263	Apr 15	2170	Jan 2 1997
MAXIMUM PEAK STAGE			4.69	Apr 15	7.79	Jan 2 1997
ANNUAL RUNOFF (AC-FT)	11770		20760		25730	
ANNUAL LEAKAGE (AC-FT) a	1930		2100			
10 PERCENT EXCEEDS	32		88		95	
50 PERCENT EXCEEDS	6.5		5.7		11	
90 PERCENT EXCEEDS	2.9		3.5		0.80	

a Leakage (station 11436500), in acre-feet, from Silver Lake, provided by El Dorado Irrigation District.

11436950 CAPLES LAKE NEAR KIRKWOOD, CA

LOCATION.—Lat 38°42'27", long 120°02'55", in SW 1/4 SW 1/4 sec.18, T.10 N., R.18 E., [Alpine County](#), Hydrologic Unit 18020129, Eldorado National Forest, on Caples Lake Dam, near the center of the earthfill portion, and 1.3 mi east of Kirkwood.

DRAINAGE AREA.—13.5 mi².

PERIOD OF RECORD.—October 1985 to current year. Unpublished records for water years 1981–85 available in files of the U.S. Geological Survey.

GAGE.—Water-stage recorder since Oct. 1, 1991. Datum of gage is 7,894.0 ft above sea level (levels by Pacific Gas & Electric Co.). Prior to Oct. 1, 1991, nonrecording gage read periodically except for Oct. 16, 1986, to Sept. 30, 1987, Dec. 18, 1990, to May 26, 1991, and July 30 to Sept. 16, 1991, when there was a water-stage recorder at same site and datum.

REMARKS.—Lake is formed by one earthfill and one concrete dam at spillway; dam was completed and storage began in 1924. Capacity, 21,580 acre-ft, between gage heights 6.0 and 62.0 ft, top of 3 ft of flashboards; capacity, 19,751 acre-ft, at spillway level. Released water is measured at Caples Creek Release (station 11436999). When gage height is above spillway crest of 59.0 ft, there is leakage or spill which is not measured. Released water is used for power development on South Fork American River. See schematic diagram of [South Fork American River Basin](#).

COOPERATION.—Records were collected by El Dorado Irrigation District, under general supervision of the U.S. Geological Survey, in connection with Federal Energy Regulatory Commission project no. 184. Contents not rounded to U.S. Geological Survey standards.

EXTREMES FOR PERIOD OF RECORD.—Maximum contents, 22,493 acre-ft, June 20, 2002, gage height, 62.25 ft; minimum, 2,427 acre-ft, Mar. 30, 31, 1987, gage height, 20.7 ft.

EXTREMES FOR CURRENT YEAR.—Maximum contents, 22,493 acre-ft, June 20, gage height, 62.25 ft; minimum, 15,315 acre-ft, Nov. 19, 20, gage height, 49.97 ft.

Capacity table (gage height, in feet, and contents, in acre-feet)
(Based on survey by El Dorado Irrigation District, dated Sept. 30, 1999)

15.0	1,347	30.0	6,086	45.0	12,743	60.0	21,103
20.0	2,665	35.0	8,129	50.0	15,331	63.0	22,338
25.0	4,254	40.0	10,349	55.0	18,122		

RESERVOIR STORAGE (ACRE-FEET), WATER YEAR OCTOBER 2001 TO SEPTEMBER 2002
DAILY OBSERVATION AT 2400 HOURS

DAY	OCT	NOV	DEC	JAN	FEB	MAR	APR	MAY	JUN	JUL	AUG	SEP
1	17856	15866	15562	15773	15752	15692	16074	18746	21946	22301	e21495	e20203
2	17787	15800	15708	15800	15730	15670	16146	18705	21804	22326	e21539	e20161
3	17724	15735	15762	15800	15730	15670	16251	18716	21600	22332	e21459	e20113
4	17661	15676	15757	15800	15730	15670	16428	18746	21428	22307	e21354	e20017
5	17620	15611	15757	15800	15703	15670	16545	18840	21403	22313	e21281	e19974
6	17557	15546	15757	15855	15703	15768	16668	18975	21366	22319	e21195	19968
7	17501	15482	15757	15855	15714	15822	16768	19146	21385	22319	e21042	19896
8	17427	15455	15757	15860	15703	15833	16897	19324	21354	22294	e21023	19878
9	17364	15455	15746	15860	15703	15833	17054	19472	21231	22276	e20981	19831
10	17302	15422	15746	15860	15670	15828	17172	19627	21164	22288	e20932	19777
11	17234	15433	15746	15860	15665	15849	17331	19711	21140	22301	e20907	19735
12	17201	15428	15725	15833	15660	15849	17489	19837	21268	22313	e20858	19723
13	17139	15428	15725	15833	15660	15838	17695	20059	21477	22344	e20834	19669
14	17077	15428	15762	15833	15660	15838	18012	20209	21686	22344	e20785	19651
15	16981	15412	15757	15833	15660	15838	18261	20276	21878	22363	e20737	19568
16	16925	15412	15741	15811	15622	15838	18407	20360	22021	22344	e20700	19550
17	16852	15385	15757	15811	15643	15838	18535	20481	22176	22350	e20676	19508
18	16762	15347	15757	15811	15643	15855	18605	20663	22375	22332	e20639	19466
19	16695	15315	15735	15811	15692	15844	18611	20749	22481	22319	e20609	19425
20	16628	15315	15757	15773	15692	15855	18558	20767	22493	22269	e20566	19371
21	16534	15406	15757	15773	15703	15855	18535	20670	22468	22244	e20542	19347
22	16495	15433	15757	15773	15703	15855	18482	20548	22474	22207	e20500	19300
23	16400	15433	15773	15773	15703	15909	18500	20493	22450	22145	e20518	19253
24	16339	15509	15757	15773	15703	15909	18512	20530	22400	22089	e20506	19229
25	16279	15509	15757	15746	15703	15909	18593	20682	22412	22027	e20493	19205
26	16185	15487	15757	15768	15703	15915	17150	20871	22394	21946	e20481	19140
27	16118	15487	15757	15768	15703	15915	18711	21103	22369	21866	e20463	19111
28	16019	15509	15757	15768	15676	15942	18740	21360	22357	21816	e20445	19063
29	15981	15509	15757	15768	---	15948	18757	21680	22350	21730	e20384	19010
30	15964	15509	15773	15752	---	15959	18740	21835	22313	21680	e20312	18993
31	15898	---	15773	15752	---	16019	---	21946	---	21588	e20258	---
MAX	17856	15866	15773	15860	15752	16019	18757	21946	22493	22363	21539	20203
MIN	15898	15315	15562	15746	15622	15670	16074	18705	21140	21588	20258	18993
a	51.05	50.33	50.82	50.78	50.64	51.27	56.06	61.37	61.96	60.79		56.49
b	-2027	-389	+264	-21	-76	+343	+2721	+3206	+367	-725	-1330	-1265

CAL YR 2001 MAX 21841 MIN 9778 b +3292
WTR YR 2002 MAX 22493 MIN 15315 b +1068

e Estimated.

a Gage height, in feet, at end of month.

b Change in contents, in acre-feet.

11436999 CAPLES CREEK RELEASE BELOW CAPLES DAM, NEAR KIRKWOOD, CA

LOCATION.—Lat 38°42'31", long 120°03'02", in NW 1/4 SW 1/4 sec.18, T.10 N., R.18 E., [Alpine County](#), Hydrologic Unit 18020129, Eldorado National Forest, on right bank, 500 ft downstream from main dam and outlet gate of Caples Lake, and 1.3 mi east of Kirkwood.

DRAINAGE AREA.—13.5 mi².

PERIOD OF RECORD.—October 1992 to current year. Unpublished records for water years 1971 and 1978–92 available in files of the U.S. Geological Survey. Records of release flows plus spillway flows for September 1922 to September 1992 were published as "Caples Lake Outlet near Kirkwood" (station 11437000).

REVISED RECORDS.—WSP 1931: Drainage area.

GAGE.—Water-stage recorder and concrete control. Elevation of gage is 7,730 ft above sea level, from topographic map.

REMARKS.—Flow regulated by Caples Lake (station 11436950) 500 ft upstream. Flow over Caples Lake Spillway bypasses this gage. No diversion upstream from station. See schematic diagram of [South Fork American River Basin](#).

COOPERATION.—Records were collected by El Dorado Irrigation District, under general supervision of the U.S. Geological Survey, in connection with Federal Energy Regulatory Commission project no. 184.

EXTREMES FOR PERIOD OF RECORD.—Maximum discharge, 292 ft³/s, May 28, 1999, gage height, 3.21 ft; minimum daily, 5.5 ft³/s, Sept. 10, 1996.

DISCHARGE, CUBIC FEET PER SECOND, WATER YEAR OCTOBER 2001 TO SEPTEMBER 2002

DAILY MEAN VALUES

DAY	OCT	NOV	DEC	JAN	FEB	MAR	APR	MAY	JUN	JUL	AUG	SEP
1	24	27	8.8	8.6	8.7	9.0	9.3	52	242	49	39	20
2	24	28	8.9	8.6	8.8	9.2	9.3	52	262	36	39	20
3	24	28	9.0	8.6	8.8	9.2	9.5	53	260	26	39	15
4	24	28	8.9	8.6	8.8	9.2	9.5	53	241	26	39	12
5	24	28	8.9	8.6	8.6	9.2	9.4	53	211	24	39	15
6	24	28	8.9	8.7	8.6	9.2	9.3	53	193	23	31	15
7	24	17	8.8	8.7	8.8	9.2	9.3	46	166	25	18	15
8	24	9.8	8.8	8.6	8.8	9.2	9.4	39	157	22	14	15
9	24	9.4	8.8	8.6	8.8	9.2	9.4	40	156	14	14	15
10	24	8.9	8.9	8.6	8.8	9.2	9.5	40	126	10	16	15
11	24	9.0	8.8	8.6	8.8	9.2	9.5	40	69	9.5	19	15
12	24	8.9	8.8	8.8	8.8	9.2	9.5	40	24	8.8	19	15
13	24	9.0	8.8	8.8	8.8	9.2	9.6	40	7.5	8.8	13	15
14	24	9.0	8.8	8.8	8.8	9.2	9.7	92	7.5	8.8	8.2	15
15	31	9.0	8.8	8.8	8.8	9.0	9.4	145	7.5	8.8	8.1	15
16	32	8.9	8.8	8.8	8.8	9.0	9.4	146	7.5	8.8	8.1	15
17	32	8.8	8.8	8.8	8.8	9.0	9.4	146	7.9	11	8.1	15
18	32	8.8	8.8	8.8	8.8	9.0	20	146	8.3	16	8.1	15
19	32	8.8	8.8	8.8	8.8	9.0	43	147	21	19	8.1	15
20	32	8.8	8.8	8.8	9.0	9.0	52	147	35	19	8.1	15
21	31	9.1	8.8	8.8	8.8	9.0	52	147	35	19	8.1	15
22	31	9.0	8.8	8.8	8.8	9.0	52	130	35	21	8.2	15
23	31	8.8	8.8	8.7	8.8	9.2	52	96	50	23	8.2	15
24	31	8.9	8.8	8.6	8.8	9.2	52	50	62	27	8.3	15
25	31	8.8	8.8	8.6	8.9	9.2	53	34	57	29	8.3	15
26	31	8.8	8.8	8.7	9.0	9.4	53	34	53	31	8.3	15
27	31	8.8	8.8	8.6	9.0	9.4	53	34	53	34	8.3	15
28	31	8.8	8.8	8.8	9.0	9.4	52	40	53	34	12	15
29	31	8.9	8.6	8.7	---	9.4	52	70	53	33	17	15
30	31	8.8	8.6	8.7	---	9.2	52	163	53	34	20	15
31	29	---	8.6	8.8	---	9.2	---	218	---	37	20	---
TOTAL	866	389.8	272.9	269.8	246.8	284.2	798.4	2586	2713.2	695.5	522.5	457
MEAN	27.94	12.99	8.803	8.703	8.814	9.168	26.61	83.42	90.44	22.44	16.85	15.23
MAX	32	28	9.0	8.8	9.0	9.4	53	218	262	49	39	20
MIN	24	8.8	8.6	8.6	8.6	9.0	9.3	34	7.5	8.8	8.1	12
AC-FT	1720	773	541	535	490	564	1580	5130	5380	1380	1040	906

STATISTICS OF MONTHLY MEAN DATA FOR WATER YEARS 1993 - 2002, BY WATER YEAR (WY)

MEAN	26.98	22.28	18.58	31.24	26.53	19.87	28.48	60.91	101.8	54.39	25.73	29.36
MAX	54.5	57.3	35.1	116	92.4	40.0	83.5	134	203	183	64.5	55.3
(WY)	1996	2001	2001	1997	1997	1997	1995	1999	1995	1995	1995	1995
MIN	6.72	6.75	6.60	8.70	8.81	8.63	7.52	8.18	5.90	5.99	10.1	15.2
(WY)	1998	1998	1998	2002	2002	2001	2001	2001	2001	2001	1999	2002

SUMMARY STATISTICS	FOR 2001 CALENDAR YEAR	FOR 2002 WATER YEAR	WATER YEARS 1993 - 2002
ANNUAL TOTAL	5571.1	10102.1	
ANNUAL MEAN	15.26	27.68	37.17
HIGHEST ANNUAL MEAN			63.1
LOWEST ANNUAL MEAN			19.8
HIGHEST DAILY MEAN	69	Aug 17	290
LOWEST DAILY MEAN	5.8	Mar 26	5.5
ANNUAL SEVEN-DAY MINIMUM	5.9	Jun 1	5.9
MAXIMUM PEAK FLOW		286	292
MAXIMUM PEAK STAGE		3.19	3.21
ANNUAL RUNOFF (AC-FT)	11050	20040	26930
10 PERCENT EXCEEDS	30	53	82
50 PERCENT EXCEEDS	8.8	9.5	20
90 PERCENT EXCEEDS	5.9	8.6	8.1

11439500 SOUTH FORK AMERICAN RIVER NEAR KYBURZ, CA

LOCATION.—Lat 38°45'49", long 120°19'39", in SW 1/4 SW 1/4 sec.29, T.11 N., R.15 E., El Dorado County, Hydrologic Unit 18020129, Eldorado National Forest, on right bank, 0.8 mi downstream from Silver Fork American River, and 1.9 mi southwest of Kyburz.

DRAINAGE AREA.—193 mi².

PERIOD OF RECORD.—August to December 1907, October 1922 to current year. Prior to October 1956, records for river and El Dorado Canal published separately; combined flow only, October 1956 to September 1960.

CHEMICAL DATA: Water years 1979, 1980.

BIOLOGICAL DATA: Water years 1979, 1980.

SUSPENDED SEDIMENT: Water year 1980.

WATER TEMPERATURE: Water years 1966–79.

REVISED RECORDS.—WSP 1445: 1923(M), 1925(M), 1927(M), 1928 (river only), 1935–37(M). WSP 1515: 1928 (combined). WSP 1931: Drainage area.

GAGE.—Water-stage recorder on river; water-stage recorder for canal diversion (station 11439000). Elevation of gage is 3,840 ft above sea level, from topographic map. Prior to Oct. 1, 1962, at datum 1.00 ft higher.

REMARKS.—Low and medium flows regulated by Echo Lake, Silver Lake, Caples Lake (stations 10336608, 11435900, and 11436950), and Lake Aloha, total capacity, 37,100 acre-ft. Some water is diverted out of river 0.6 mi upstream at diversion dam to El Dorado Canal (station 11439000). Part of this water is used for irrigation and domestic use and the remainder is returned to river at El Dorado Powerplant. See schematic diagram of [South Fork American River Basin](#).

COOPERATION.—Records were collected by El Dorado Irrigation District, under general supervision of the U.S. Geological Survey, in connection with Federal Energy Regulatory Commission project no. 184.

EXTREMES FOR PERIOD OF RECORD.—River only: Maximum discharge, 25,000 ft³/s, Jan. 2, 1997, gage height, 14.26 ft (from floodmarks), from rating curve extended above 6,300 ft³/s, on basis of contracted-opening measurement at gage height 10.40 ft; minimum daily, 0.13 ft³/s, Nov. 26, 1977.

Combined flow: Maximum discharge, 25,000 ft³/s, Jan. 2, 1997; minimum daily, 10 ft³/s, Oct. 17, 19, 1929.

DISCHARGE, CUBIC FEET PER SECOND, WATER YEAR OCTOBER 2001 TO SEPTEMBER 2002

DAILY MEAN VALUES

DAY	OCT	NOV	DEC	JAN	FEB	MAR	APR	MAY	JUN	JUL	AUG	SEP
1	20	31	74	221	114	282	719	598	1520	185	64	63
2	19	22	126	213	104	249	850	614	1320	173	65	62
3	18	21	93	303	100	233	1010	691	1150	154	64	62
4	19	21	88	198	99	233	1200	830	1150	140	63	63
5	21	22	87	171	100	231	1170	978	1150	130	63	64
6	21	22	87	366	99	354	1030	1100	1080	120	73	74
7	20	51	92	400	105	382	1010	1190	984	114	76	73
8	19	48	86	290	124	295	1050	1150	887	112	67	71
9	18	39	86	232	111	263	1090	1110	774	98	63	70
10	19	36	82	200	109	253	1040	1050	674	86	62	62
11	19	36	79	185	115	239	1110	917	537	81	63	50
12	20	50	76	182	123	262	1200	1000	476	80	65	55
13	19	65	76	176	129	266	1210	1080	448	102	73	51
14	20	59	82	169	130	249	1510	1160	400	85	72	49
15	24	58	75	151	138	239	1520	1280	345	77	66	48
16	32	56	81	139	150	233	968	1270	317	72	65	48
17	20	50	82	146	165	227	800	1370	291	67	64	48
18	38	46	80	123	150	218	670	1470	294	67	63	47
19	28	42	77	136	166	220	615	1310	311	76	62	46
20	24	40	81	127	353	236	591	1130	332	68	62	46
21	24	68	80	127	354	258	569	943	325	65	62	46
22	24	482	79	117	333	302	618	856	306	64	62	45
23	24	142	81	103	371	328	702	819	291	63	61	45
24	23	275	78	122	303	297	813	758	287	61	61	46
25	22	179	81	112	277	282	964	798	263	63	61	46
26	22	97	83	113	276	282	1040	866	255	62	61	45
27	21	78	93	113	288	301	855	921	251	64	61	45
28	21	75	101	96	288	346	717	972	229	64	60	45
29	21	76	173	99	---	440	730	1120	210	63	59	46
30	33	74	209	105	---	547	661	1320	196	62	61	49
31	47	---	304	120	---	610	---	1480	---	61	63	---
TOTAL	720	2361	3052	5355	5174	9157	28032	32151	17053	2779	1987	1610
MEAN	23.23	78.70	98.45	172.7	184.8	295.4	934.4	1037	568.4	89.65	64.10	53.67
MAX	47	482	304	400	371	610	1520	1480	1520	185	76	74
MIN	18	21	74	96	99	218	569	598	196	61	59	45
AC-FT	1430	4680	6050	10620	10260	18160	55600	63770	33820	5510	3940	3190

11439500 SOUTH FORK AMERICAN RIVER NEAR KYBURZ, CA—Continued

STATISTICS OF MONTHLY MEAN DATA FOR WATER YEARS 1923 - 2002, BY WATER YEAR (WY)

	OCT	NOV	DEC	JAN	FEB	MAR	APR	MAY	JUN	JUL	AUG	SEP
MEAN	36.98	78.55	129.0	155.6	176.3	277.6	640.7	1200	838.4	183.0	27.48	26.04
MAX	223	1283	1587	1964	1333	1252	1497	2765	3551	1628	343	417
(WY)	1984	1951	1951	1997	1986	1986	1982	1969	1983	1995	1983	1983
MIN	0.77	0.49	0.69	0.57	0.76	2.42	38.9	56.8	0.76	0.62	0.58	0.54
(WY)	1929	1929	1931	1929	1931	1933	1977	1977	1924	1924	1926	1924

SUMMARY STATISTICS	FOR 2001 CALENDAR YEAR	FOR 2002 WATER YEAR	WATER YEARS 1923 - 2002
ANNUAL TOTAL	55164	109431	
ANNUAL MEAN	151.1	299.8	314.3
HIGHEST ANNUAL MEAN			907 1983
LOWEST ANNUAL MEAN			19.4 1977
HIGHEST DAILY MEAN	1050 May 1	1520 Apr 15	18000 Jan 2 1997
LOWEST DAILY MEAN	14 Sep 6	18 Oct 3	0.13 Nov 26 1977
ANNUAL SEVEN-DAY MINIMUM	15 Sep 18	19 Oct 7	0.36 Nov 5 1928
MAXIMUM PEAK FLOW		2100 Apr 14	25000 Jan 2 1997
MAXIMUM PEAK STAGE		5.34 Apr 14	14.26 Jan 2 1997
ANNUAL RUNOFF (AC-FT)	109400	217100	227700
10 PERCENT EXCEEDS	465	1000	1030
50 PERCENT EXCEEDS	73	113	53
90 PERCENT EXCEEDS	20	36	3.0

11439501 SOUTH FORK AMERICAN RIVER NEAR KYBURZ, CA—Continued

SOUTH FORK AMERICAN RIVER AND EL DORADO CANAL NEAR KYBURZ, CA

DISCHARGE, CUBIC FEET PER SECOND, WATER YEAR OCTOBER 2001 TO SEPTEMBER 2002

DAILY MEAN VALUES

DAY	OCT	NOV	DEC	JAN	FEB	MAR	APR	MAY	JUN	JUL	AUG	SEP
1	78	84	74	221	114	282	719	618	1540	209	88	87
2	77	75	126	213	104	249	850	629	1340	197	89	86
3	76	70	93	303	100	233	1010	702	1170	178	88	86
4	77	67	88	198	99	233	1200	841	1170	163	87	87
5	78	66	87	171	100	231	1170	989	1170	153	87	88
6	77	65	87	366	99	354	1030	1110	1100	143	97	99
7	76	63	92	400	105	382	1010	1200	1010	137	100	98
8	75	48	86	290	124	295	1050	1160	910	135	91	96
9	73	39	86	232	111	263	1090	1120	797	122	87	95
10	74	36	82	200	109	253	1040	1060	697	110	86	87
11	71	36	79	185	115	239	1110	928	560	105	87	75
12	72	50	76	182	123	262	1200	1010	499	104	89	80
13	70	65	76	176	129	266	1210	1090	472	126	97	76
14	71	59	82	169	130	249	1510	1170	424	109	96	74
15	71	58	75	151	138	239	1520	1290	369	101	90	73
16	86	56	81	139	150	233	968	1290	340	96	89	73
17	86	50	82	146	165	227	800	1390	314	91	88	73
18	88	46	80	123	150	218	670	1490	317	91	87	72
19	85	42	77	136	166	220	615	1330	334	100	86	71
20	84	40	81	127	353	236	591	1150	355	92	86	71
21	84	68	80	127	354	258	569	966	348	89	86	71
22	83	482	79	117	333	302	618	879	329	88	86	70
23	83	142	81	103	371	328	702	842	314	87	85	70
24	81	275	78	122	303	297	813	780	310	85	85	71
25	80	179	81	112	277	282	964	821	286	87	85	71
26	79	97	83	113	276	282	1040	889	278	86	85	70
27	78	78	93	113	288	301	855	944	275	88	85	70
28	77	75	101	96	288	346	717	995	253	88	84	70
29	77	76	173	99	---	440	730	1140	234	87	83	71
30	96	74	209	105	---	547	681	1340	220	86	85	70
31	117	---	304	120	---	610	---	1500	---	85	87	---
TOTAL	2480	2661	3052	5355	5174	9157	28052	32663	17735	3518	2731	2351
MEAN	80.00	88.70	98.45	172.7	184.8	295.4	935.1	1054	591.2	113.5	88.10	78.37
MAX	117	482	304	400	371	610	1520	1500	1540	209	100	99
MIN	70	36	74	96	99	218	569	618	220	85	83	70
AC-FT	4920	5280	6050	10620	10260	18160	55640	64790	35180	6980	5420	4660
a	3940	595	0	0	0	0	40	1080	1390	1470	1480	1470

STATISTICS OF MONTHLY MEAN DATA FOR WATER YEARS 1923 - 2002, BY WATER YEAR (WY)

	1923	1924	1925	1926	1927	1928	1929	1930	1931	1932	1933	1934
MEAN	109.4	158.8	215.6	239.3	269.3	378.9	741.9	1318	965.4	305.1	146.1	131.9
MAX	365	1301	1698	1964	1412	1344	1533	2905	3561	1637	357	424
(WY)	1983	1951	1951	1997	1986	1986	1982	1969	1983	1995	1983	1983
MIN	20.8	25.1	44.2	35.9	38.4	53.7	178	207	99.7	55.4	65.6	46.4
(WY)	1978	1930	1960	1929	1977	1977	1977	1977	1924	2001	2001	1987

SUMMARY STATISTICS

FOR 2001 CALENDAR YEAR

FOR 2002 WATER YEAR

WATER YEARS 1923 - 2002

ANNUAL TOTAL	63225	114929		
ANNUAL MEAN	173.2	314.9		415.1
HIGHEST ANNUAL MEAN				980
LOWEST ANNUAL MEAN				104
HIGHEST DAILY MEAN	1060	May 1	1540	Jun 1
LOWEST DAILY MEAN	36	Nov 10	36	Nov 10
ANNUAL SEVEN-DAY MINIMUM	47	Jul 28	48	Nov 8
MAXIMUM PEAK FLOW			2100	Apr 14
ANNUAL RUNOFF (AC-FT)	125400		228000	
ANNUAL DIVERSION (AC-FT) a	16000		11000	
10 PERCENT EXCEEDS	478		1010	1130
50 PERCENT EXCEEDS	82		117	166
90 PERCENT EXCEEDS	53		72	74

a Diversion, in acre-feet, to El Dorado Canal (station 11439000), provided by El Dorado Irrigation District.

11441001 UNION VALLEY RESERVOIR NEAR RIVERTON, CA

LOCATION (REVISED).—Lat 38°51'53", long 120°26'13", in NW 1/4 NW 1/4 sec.29, T.12 N., R.14 E., El Dorado County, Hydrologic Unit 18020129, Eldorado National Forest, in valve control house, near left bank at Union Valley Dam, on Silver Creek, 0.7 mi upstream from Little Silver Creek, and 6.6 mi north of Riverton.

DRAINAGE AREA.—83.7 mi².

PERIOD OF RECORD.—October 1962 to current year.

CHEMICAL ANALYSES.—June to September 1996.

GAGE.—Water-stage recorder. Datum of gage is sea level (levels by Sacramento Municipal Utility District).

REMARKS.—Reservoir is formed by earthfill dam completed in December 1962; storage began May 1962. Usable capacity, 270,300 acre-ft, between elevations 4,645.0 ft, minimum operating level, and 4,870.0 ft, top of radial spillway gates. Dead storage, 7,000 acre-ft. Reservoir receives water from the South Fork Rubicon River via Robbs Peak Powerplant (station 11429300) and from South Fork Silver Creek, since April 1985, via Jones Fork Powerplant (station 11440900). Water is used for power development in the South Fork American River Basin. Discharge to Union Valley Powerplant (station 11441002) is shown as a line item below this table. Records, including extremes, represent total contents. See schematic diagrams of [Middle Fork American and Rubicon River Basins](#) and [South Fork American River Basin](#).

COOPERATION.—Records were collected by Sacramento Municipal Utility District, under general supervision of the U.S. Geological Survey, in connection with Federal Energy Regulatory Commission project no. 2101. Contents not rounded to U.S. Geological Survey standards.

EXTREMES FOR PERIOD OF RECORD.—Maximum contents, 279,100 acre-ft, July 9, 1974, elevation, 4,870.6 ft; minimum since reservoir first filled, 18,300 acre-ft, Jan. 13, 1977, elevation, 4,683.3 ft.

EXTREMES FOR CURRENT YEAR.—Maximum contents, 260,864 acre-ft, June 29, elevation, 4,867.95 ft; minimum, 85,385 acre-ft, Oct. 1, elevation, 4,781.86 ft.

Capacity table (elevation, in feet, and contents, in acre-feet)
(Table provided by Sacramento Municipal Utility District, based on May, 2000, survey)

4,680	11,975	4,740	42,705	4,800	111,259	4,840	188,042
4,700	19,134	4,760	60,412	4,820	145,982	4,870	266,912
4,720	29,169	4,780	83,008				

RESERVOIR STORAGE (ACRE-FEET), WATER YEAR OCTOBER 2000 TO SEPTEMBER 2001

DAILY OBSERVATION AT 2400 HOURS

(NOT PREVIOUSLY PUBLISHED)

DAY	OCT	NOV	DEC	JAN	FEB	MAR	APR	MAY	JUN	JUL	AUG	SEP
1	123663	126773	83261	41767	31793	35513	60382	91871	112946	105993	96278	86110
2	122633	125690	81339	40680	31893	35771	61714	93737	113041	105013	95281	85721
3	122532	125194	80334	40307	32131	35907	62378	94736	113136	103548	95267	85152
4	122078	124392	78984	39900	32319	36201	62975	95814	113326	103399	95253	84715
5	122028	122784	77627	39023	32541	36050	63493	97183	113374	102969	94264	84715
6	121860	122028	76812	39132	32878	36174	64139	98526	113438	103073	93751	84395
7	122162	120891	75023	39001	32598	36538	64695	100096	112645	103073	92198	84484
8	122751	119680	73150	38338	32649	36940	65223	101555	112250	102600	91517	84472
9	123307	118445	71857	38010	32954	37444	64927	102025	112392	102600	90799	84459
10	123781	116229	71120	37967	33211	e37804	65340	e102814	112439	102319	90799	83973
11	124392	114618	69730	38003	33385	38181	65861	103995	112471	102319	90610	84177
12	125006	112740	68251	38060	33638	38510	66311	105434	112502	101848	89992	84165
13	125484	111306	67292	37656	33794	38943	66784	106614	112645	101379	89992	84331
14	125827	109096	66439	37402	33996	39482	67281	107620	112297	101364	89536	83858
15	126239	106979	e64960	36996	34121	39966	67912	108818	112124	101364	88856	83973
16	126790	104773	64181	36794	33755	e40434	68778	e110067	111604	101350	88697	84126
17	e127222	103162	63202	35852	33879	40935	69841	110946	111353	101335	87640	84292
18	127620	101672	60935	35183	33990	41668	71188	e112340	110805	100926	87390	84292
19	127897	99879	59180	34942	34193	42489	72771	e112373	110493	100926	87023	84280
20	128210	97995	57559	34775	34470	43588	73868	e112406	109933	100911	87023	84280
21	128523	95968	55764	34457	34636	44813	74730	112439	109127	100474	87010	84254
22	128663	94375	53917	34193	34305	46120	75636	112803	e108997	100024	86578	84126
23	128890	93337	52730	33885	34523	47347	76764	112613	e109003	99546	86214	84114
24	128907	92787	51082	33957	34742	48665	78546	112487	e108600	99258	86149	84101
25	129152	91585	49352	33185	34915	50888	80730	112724	108464	98826	85876	84177
26	129204	90610	48214	32980	35069	52486	82957	113088	108464	98725	85721	84177
27	129379	88870	47632	33089	35264	53687	85049	113279	108495	98081	85630	84177
28	129397	87890	45817	33198	35365	55180	86840	e113597	107712	97098	85902	e84165
29	129642	85902	44062	32839	---	56886	88246	113374	107452	97226	86344	84152
30	128820	85385	43951	32471	---	57453	89938	e113358	106205	97212	86526	84344
31	127759	---	43173	31999	---	58904	---	113120	---	96744	86123	---
MAX	129642	126773	83261	41767	35365	58904	89938	113597	113438	105993	96278	86110
MIN	121860	85385	43173	31999	31793	35513	60382	91871	106205	96744	85630	83858
a	4810.00	4781.86	4740.60	4724.68	4729.86	4758.48	4785.32	4801.18	4796.72	4790.26	4782.43	4781.05
b	-4850	-42374	-42212	-11174	+3366	+23539	+31034	+23182	-6915	-9461	-10621	-1779
c	7360	47600	58590	16250	1930	1610	924	7210	9960	11880	14570	3720
CAL YR 2000	MAX 271981	MIN 43173	b -66731	c 445000								
WTR YR 2001	MAX 129642	MIN 31793	b -48265	c 181600								

e Estimated.

a Elevation, in feet, at end of month.

b Change in contents, in acre-feet.

c Diversion, in acre-feet, to Union Valley Powerplant, provided by Sacramento Municipal Utility District.

SACRAMENTO RIVER BASIN

11441001 UNION VALLEY RESERVOIR NEAR RIVERTON, CA—Continued

RESERVOIR STORAGE, ACRE-FEET, WATER YEAR OCTOBER 2001 TO SEPTEMBER 2002
DAILY OBSERVATION AT 2400 HOURS

DAY	OCT	NOV	DEC	JAN	FEB	MAR	APR	MAY	JUN	JUL	AUG	SEP
1	85385	92198	98568	113295	124154	141857	170837	226242	254401	260455	233979	201113
2	85747	92376	99431	114506	123798	142607	173101	225399	255119	260397	232470	199354
3	85928	92581	99315	115824	124137	143229	175780	225741	256041	260221	231879	198036
4	86136	92787	99561	116553	122700	142871	178556	227350	256532	260251	231343	196938
5	86136	93007	100358	117333	122481	142795	181477	229420	256966	259259	229767	194875
6	86474	93213	100984	118757	122936	144933	183752	231611	257545	258706	228463	193179
7	86461	93502	101467	120160	123341	146787	186436	233736	256677	258357	227350	191681
8	86631	93737	101936	120658	124409	147518	188919	235713	e257284	257690	225636	190633
9	86827	94083	102437	121459	125365	148367	191751	237619	257777	257024	223853	188688
10	87167	94277	102999	121375	126016	149220	194049	239318	257980	256417	224088	187881
11	87442	94542	103355	121726	125519	149921	196486	240556	258096	256013	223827	186345
12	87548	94806	102733	121994	126583	150742	198754	242048	258416	254918	222314	184114
13	87534	95057	102142	123071	125981	151546	201137	243518	258852	254257	221430	183142
14	87784	95253	102526	123764	125758	152294	204054	244968	259609	253712	220601	181253
15	87890	95505	103221	123849	126067	152215	207150	246648	259842	253340	219568	179979
16	88207	95673	103251	123290	126618	152867	208735	247689	260134	252510	218436	178579
17	88432	95729	104413	123730	127256	152373	210480	249241	259725	251398	218333	177076
18	88564	95757	104848	123392	127811	152235	211607	e252539	259288	250290	217513	176197
19	88763	e95772	105268	123832	129082	152827	212587	e255868	259172	248958	217231	175539
20	88737	e95786	105479	123646	131510	153223	213596	254544	259405	247548	216363	174121
21	88737	96278	106099	123561	133290	154614	214482	253597	259463	247210	215268	172841
22	88830	97653	106690	123985	134727	156035	215650	252910	259346	246312	214456	171913
23	89163	97938	107116	124087	136139	157668	216720	252253	259638	245080	214127	170773
24	89349	99258	107452	124426	137195	158885	218308	252367	259667	243435	213293	169767
25	89590	99807	107682	124188	138148	160027	219749	252539	259813	242408	212034	168702
26	89884	99431	108111	124631	139032	160888	221846	252111	260046	241163	210430	168447
27	90126	98281	108541	124801	139956	161999	223617	251854	259754	239895	208859	168383
28	90314	98654	109235	124443	140886	163179	224822	252439	260163	238961	207570	167071
29	90961	98324	109902	123409	---	164803	225636	253025	260864	238632	206336	167007
30	91653	98195	110790	123663	---	166628	225899	252767	260397	236665	204372	165850
31	91898	---	112329	123578	---	168532	---	253397	---	235577	203078	---
MAX	91898	99807	112329	124801	140886	168532	225899	255868	260864	260455	233979	201113
MIN	85385	92198	98568	113295	122481	141857	170837	225399	254401	235577	203078	165850
a	4786.77	4791.28	4800.68	4807.56	4817.30	4831.18	4855.36	4865.37	4867.79	4858.98	4846.35	4829.91
b	+7554	+6297	+14134	+11249	+17308	+27646	+57367	+27498	+7000	-24820	-32499	-37228
c	31	2820	4590	35460	15860	5960	7140	33490	17960	30440	34140	41940

CAL YR 2001 MAX 113597 MIN 31793 b +69156 c 75480
WTR YR 2002 MAX 260864 MIN 85385 b +81506 c 229900

e Estimated.

a Elevation, in feet, at end of month.

b Change in contents, in acre-feet.

c Diversion, in acre-feet, to Union Valley Powerplant, provided by Sacramento Municipal Utility District.

11441100 ICE HOUSE RESERVOIR NEAR KYBURZ, CA

LOCATION.—Lat 38°49'51", long 120°21'35", in SE 1/4 NW 1/4 sec.1, T.11 N., R.14 E., El Dorado County, Hydrologic Unit 18020129, Eldorado National Forest, in powerplant intake structure, near right bank, 0.5 mi north of Ice House Dam on South Fork Silver Creek, and 5.2 mi northwest of Kyburz.

DRAINAGE AREA.—27.2 mi².

PERIOD OF RECORD.—October 1959 to current year.

CHEMICAL ANALYSES: June to September 1996.

REVISED RECORDS.—WSP 1931: 1960.

GAGE.—Water-stage recorder. Datum of gage is sea level (levels by Sacramento Municipal Utility District). Prior to July 15, 1985, at site 0.5 mi downstream at Ice House Dam at same datum.

REMARKS.—Reservoir is formed by an earthfill dam; storage began Dec. 15, 1959. Usable capacity, 45,839 acre-ft, between elevations 5,327.5 ft, centerline of fishwater outlet, and 5,450.0 ft, top of spillway gates. Dead storage, 160 acre-ft. Reservoir is used to store water for power development. Reservoir is also forebay for Jones Fork Powerplant (station 11440900), which diverts up to 350 ft³/s to powerplant completed in April 1985, then to Union Valley Reservoir (station 11441001). Records, including extremes, represent total contents. See schematic diagram of [South Fork American River Basin](#).

COOPERATION.—Records were collected by Sacramento Municipal Utility District, under general supervision of the U.S. Geological Survey, in connection with Federal Energy Regulatory Commission project no. 2101. Contents not rounded to U.S. Geological Survey standards.

EXTREMES FOR PERIOD OF RECORD.—Maximum contents, 46,400 acre-ft, June 27, 1971, elevation, 5,450.6 ft; minimum since reservoir first filled, 1,450 acre-ft, Dec. 8, 1983, elevation, 5,347.9 ft.

EXTREMES FOR CURRENT YEAR.—Maximum contents, 42,368 acre-ft, June 29, elevation, 5,448.39 ft; minimum, 16,826 acre-ft, Feb. 14, elevation, 5,401.99 ft.

Capacity table (elevation, in feet, and contents in acre-feet)
(Table provided by Sacramento Municipal Utility District, based on June, 2000, survey)

5,345	849	5,360	3,145	5,400	15,956	5,440	37,061
5,350	1,451	5,380	8,400	5,420	25,587	5,451	44,074

RESERVOIR STORAGE, ACRE-FEET, WATER YEAR OCTOBER 2000 TO SEPTEMBER 2001

DAILY OBSERVATION AT 2400 HOURS

(NOT PREVIOUSLY PUBLISHED)

DAY	OCT	NOV	DEC	JAN	FEB	MAR	APR	MAY	JUN	JUL	AUG	SEP
1	23926	19781	18680	15545	14806	14898	17751	23700	32563	31563	29602	28115
2	23860	19786	18592	15545	14806	14927	17973	24133	32627	31252	29585	28093
3	23608	19478	18518	15549	14794	14940	18092	24412	32680	30948	29568	27895
4	23277	19492	18509	15536	14785	14994	18211	24688	32721	30804	29545	27829
5	23246	19497	18431	15506	14785	15015	18330	25081	32750	30656	29529	27813
6	23215	19300	18256	15489	14789	14844	18440	25502	32780	30576	29428	27791
7	23129	19281	18010	15468	14802	14856	18564	26023	32803	30570	29310	27671
8	22922	19253	17937	15459	14814	14869	18648	26618	32832	30428	29170	27654
9	22775	19234	17715	15455	14839	14898	18722	27158	32862	e30416	29215	27632
10	22549	19220	17454	15434	14835	e14896	18768	e27656	32879	30405	29198	27621
11	22269	19182	17359	15408	14869	14894	18861	28154	32903	30394	29175	27599
12	22015	19150	17181	15374	14810	14894	18930	28624	32915	30382	29159	27583
13	21791	19136	16936	15366	14773	14898	19014	29047	32932	30263	29136	27403
14	21569	19089	16795	15349	14756	14919	19080	29394	32938	30246	29114	27381
15	21309	19038	e16643	15357	14748	14952	19154	29782	32944	30229	29092	27365
16	20963	19005	16491	15209	14760	e14973	19257	e30176	32944	30206	29069	27327
17	e20842	18982	16391	15180	14773	14994	19408	30570	32944	30189	29047	27310
18	e20720	18958	16378	15125	14789	15024	19629	e30720	32897	30172	29025	27294
19	20594	18935	16312	15057	14802	15074	19890	e31020	32727	30150	29002	27272
20	20503	18916	16134	15007	14827	15175	20066	e31320	32645	30138	28980	27251
21	20334	18903	15922	14948	14852	15323	20186	31471	32534	30031	28952	27229
22	20234	18884	15913	14885	14865	15481	20296	31679	e32489	29827	28930	27207
23	20095	18875	15836	14827	14865	15343	20479	31864	e32399	29816	28907	27185
24	20071	18851	15767	14806	14869	15827	20715	32027	e32309	29799	28796	27153
25	20081	18810	15771	14823	14881	16099	21075	32154	32265	29782	28768	27164
26	20066	18796	15737	14814	14877	16303	21545	32271	32259	29765	28596	27153
27	20047	18772	15720	14785	14894	16478	22015	32382	32259	29737	28402	27126
28	20009	18754	15703	14773	14890	16698	22408	e32466	32253	29714	28259	e27107
29	19809	18768	15681	14794	---	16967	22760	32551	32044	29692	28170	27088
30	19814	18740	15651	14794	---	17212	23170	e32516	31737	29675	28148	26990
31	19814	---	15587	14802	---	17476	---	32481	---	29630	28132	---
MAX	23926	19786	18680	15549	14894	17476	23170	32551	32944	31563	29602	28115
MIN	19809	18740	15587	14773	14748	14844	17751	23700	31737	29630	28132	26990
a	5408.51	5406.22	5399.14	5397.28	5397.49	5403.45	5415.34	5432.37	5431.09	5427.40	5424.71	5422.62
b	-6155	-1074	-3153	-785	+88	+2586	+5694	+9311	-744	-2107	-1498	-1142

CAL YR 2000 MAX 45057 MIN 15587 b -6446
WTR YR 2001 MAX 32944 MIN 14748 b +1021

e Estimated.

a Elevation, in feet, at end of month.

b Change in contents, in acre-feet.

SACRAMENTO RIVER BASIN

11441100 ICE HOUSE RESERVOIR NEAR KYBURZ, CA—Continued

RESERVOIR STORAGE, ACRE-FEET, WATER YEAR OCTOBER 2001 TO SEPTEMBER 2002

DAILY OBSERVATION AT 2400 HOURS

DAY	OCT	NOV	DEC	JAN	FEB	MAR	APR	MAY	JUN	JUL	AUG	SEP
1	26801	25890	25794	24574	19145	18243	20551	30377	40643	41953	40394	38570
2	26768	25847	25916	24678	19028	18334	20894	30525	41040	41786	40350	38295
3	26731	25842	25991	24725	18889	18412	21324	30787	41040	41798	40305	38245
4	26709	25794	26017	24746	18754	18486	21836	31102	41027	41805	40261	38170
5	26693	25783	25969	24756	18399	18574	22308	31494	41084	41766	40216	38120
6	26677	25757	25985	24834	18010	18782	22690	31980	41168	41766	40013	38077
7	26655	25677	26007	24751	17783	18916	22947	32487	41232	41766	39962	38033
8	26639	25598	26033	24735	17472	18996	23185	32962	41315	41760	39924	37990
9	26618	25502	26065	24547	17409	19024	23629	33404	41315	41747	39880	37946
10	26585	25465	26028	24340	17346	19122	24029	33706	41097	41502	39835	37890
11	26569	25497	26001	24071	16994	19168	24511	34056	40988	41489	39721	37847
12	26548	25555	25932	23839	16923	19229	25012	34480	40950	41425	39677	37754
13	26526	25370	25937	23700	16830	19314	25545	34798	40988	41348	39633	37524
14	26510	25238	25916	23419	16826	19356	26204	35183	41168	41104	39582	37487
15	26488	25033	25677	23455	16848	19295	26822	35795	41309	41084	39538	37438
16	26451	24897	25661	22922	16910	19347	27185	36325	41431	41065	39494	37252
17	26429	24876	25439	22942	16972	19389	27436	36846	41547	41033	39450	37043
18	26419	24866	25302	22659	16945	19365	27676	e37285	41689	41014	39399	36613
19	26397	24855	25039	22383	17038	19365	27862	e38163	41837	40982	39349	36209
20	26370	24840	24887	21496	17203	19267	28033	38601	41953	40950	39304	35801
21	26349	24986	24803	21226	17368	19281	28225	38620	42063	40911	39248	35401
22	26327	25323	24782	21496	17512	19337	28225	38557	42147	40879	39204	34997
23	26317	25391	24725	21226	17661	19483	28347	38526	42225	40841	39153	34672
24	26295	25598	24699	20851	17769	19554	28724	38520	42212	40803	39109	34438
25	26279	25693	24704	20556	17851	19568	29215	38564	42212	40758	39059	34289
26	26247	25666	24558	20411	17951	19653	29692	38952	42284	40720	38971	34253
27	26188	25682	24537	20354	18051	19733	30053	39380	42342	40630	38921	34205
28	26113	25624	24371	20085	18147	19800	30308	39525	42322	40592	38877	34170
29	26044	25704	24371	19771	---	19947	30286	39677	42368	40554	38827	34128
30	26023	25719	24423	19502	---	20085	30502	39867	42160	40509	38776	34033
31	25959	---	24506	19253	---	20325	---	40159	---	40464	38632	---
MAX	26801	25890	26065	24834	19145	20325	30502	40159	42368	41953	40394	38570
MIN	25959	24840	24371	19253	16826	18243	20551	30377	40643	40464	38632	34033
a	5420.70	5420.25	5417.94	5407.32	5404.93	5409.58	5428.94	5444.95	5448.07	5445.43	5442.53	5435.00
b	-1031	-240	-1213	-5253	-1106	+2178	+10177	+9657	+2001	-1696	-1832	-4599

CAL YR 2001 MAX 32944 MIN 14748 b +8919
WTR YR 2002 MAX 42368 MIN 16826 b +7043

e Estimated.

a Elevation, in feet, at end of month.

b Change in contents, in acre-feet.

11441500 SOUTH FORK SILVER CREEK NEAR ICE HOUSE, CA

LOCATION.—Lat 38°49'08", long 120°21'51", in NW 1/4 NW 1/4 sec.12, T.11 N., R.14 E., El Dorado County, Hydrologic Unit 18020129, Eldorado National Forest, on right bank, 300 ft upstream from Peavine Creek, 0.4 mi downstream from Ice House Dam, and 4.8 mi northwest of Kyburz.

DRAINAGE AREA.—27.5 mi².

PERIOD OF RECORD.—October 1924 to current year.

REVISED RECORDS.—WSP 1395: 1928, 1938. WSP 1635: Drainage area at former site.

GAGE.—Water-stage recorder and concrete control. Elevation of gage is 5,290 ft above sea level, from topographic map. Prior to Oct. 1, 1959, at site 0.3 mi upstream at different datum.

REMARKS.—Flow regulated by Ice House Reservoir (station 11441100) beginning in December 1959. Diversion to Jones Fork Powerplant (station 11440900) starting April 1985 bypasses station and returns to Silver Creek at Union Valley Reservoir (station 11441001). See schematic diagram of [South Fork American River Basin](#).

COOPERATION.—Records were collected by Sacramento Municipal Utility District, under general supervision of the U.S. Geological Survey, in connection with Federal Energy Regulatory Commission project no. 2101.

EXTREMES FOR PERIOD OF RECORD.—Maximum discharge prior to construction of Ice House Dam in 1959, 3,940 ft³/s, Dec. 23, 1955, gage height, 6.71 ft, site and datum then in use, from rating curve extended above 540 ft³/s, on basis of slope-area measurement at gage height 6.69 ft; no flow Oct. 31 to Nov. 9, 1958.

Maximum discharge since construction of the dam, 7,530 ft³/s, May 16, 1996, gage height, 7.64 ft, from rating curve extended above 730 ft³/s, on basis of computation of flow over dam at gage height 5.66 ft; minimum daily, 1.2 ft³/s, Mar. 17–19, 1960.

DISCHARGE, CUBIC FEET PER SECOND, WATER YEAR OCTOBER 2001 TO SEPTEMBER 2002

DAILY MEAN VALUES

DAY	OCT	NOV	DEC	JAN	FEB	MAR	APR	MAY	JUN	JUL	AUG	SEP
1	7.3	6.8	7.1	7.7	6.8	7.2	6.3	11	11	18	18	19
2	7.1	6.9	7.9	8.2	6.8	7.1	6.6	10	11	18	18	19
3	7.1	7.1	7.4	8.0	6.8	7.1	6.4	11	11	18	18	20
4	7.1	7.1	7.2	7.5	6.8	7.1	6.2	10	11	18	18	20
5	7.1	7.1	7.3	7.4	6.7	7.2	6.2	11	11	18	18	20
6	7.1	7.1	7.4	7.4	6.5	8.3	6.2	11	11	18	18	20
7	7.4	7.1	7.4	7.4	6.7	7.8	6.3	11	11	18	18	20
8	7.4	7.1	7.4	7.4	7.2	7.3	6.4	10	11	18	18	20
9	7.4	7.1	7.4	7.6	7.0	7.1	5.6	10	11	18	18	20
10	7.3	7.1	7.2	7.7	6.9	7.1	4.0	11	11	18	18	20
11	7.2	7.1	7.1	7.5	7.0	7.2	3.8	11	11	18	18	20
12	7.2	7.4	7.1	7.4	6.9	7.4	3.7	11	11	18	18	20
13	7.1	7.5	7.3	7.4	6.8	7.4	3.7	10	11	18	18	20
14	7.1	7.1	7.3	7.4	6.8	7.2	3.7	11	11	19	18	20
15	7.1	7.1	7.1	7.3	6.8	6.7	3.9	11	12	19	18	20
16	7.1	7.1	7.1	7.2	6.8	6.5	4.0	11	11	19	18	20
17	7.1	7.1	7.1	7.1	6.8	6.5	4.0	11	11	18	18	20
18	7.1	7.1	7.1	7.1	6.8	6.5	4.0	11	11	18	18	20
19	7.1	7.0	7.1	7.1	7.9	6.1	4.2	11	11	18	18	20
20	7.1	6.8	7.1	7.1	8.6	6.0	4.2	12	11	18	18	20
21	7.1	7.9	7.1	7.1	7.4	6.1	4.0	12	11	18	19	20
22	7.1	8.1	7.1	7.1	7.4	6.4	3.9	11	11	18	18	19
23	7.1	7.2	7.1	6.9	7.7	6.6	3.7	11	11	18	18	19
24	6.9	7.6	7.1	6.9	7.7	6.3	3.7	11	11	18	18	19
25	6.8	7.2	7.1	7.1	7.7	6.4	4.0	11	11	18	18	19
26	6.8	7.1	7.1	7.2	7.3	6.2	4.0	11	11	18	18	19
27	6.8	7.1	7.1	7.4	7.2	6.0	4.1	11	11	18	19	19
28	6.8	7.1	7.3	7.4	7.4	6.2	4.4	11	11	18	19	19
29	6.8	7.1	7.7	7.2	---	6.1	4.4	11	11	18	19	19
30	6.9	7.1	7.7	6.7	---	6.1	6.8	12	13	18	19	20
31	6.8	---	7.7	6.8	---	6.2	---	11	---	18	19	---
TOTAL	219.4	215.3	225.2	226.7	199.2	209.4	142.4	339	333	561	564	590
MEAN	7.077	7.177	7.265	7.313	7.114	6.755	4.747	10.94	11.10	18.10	18.19	19.67
MAX	7.4	8.1	7.9	8.2	8.6	8.3	6.8	12	13	19	19	20
MIN	6.8	6.8	7.1	6.7	6.5	6.0	3.7	10	11	18	18	19
AC-FT	435	427	447	450	395	415	282	672	661	1110	1120	1170
a	529	1190	2670	7450	3100	1120	1940	4240	3280	1130	428	3450

a Diversion, in acre-feet, to Jones Fork Powerplant (station 11440900), provided by Sacramento Municipal Utility District.

SACRAMENTO RIVER BASIN

11441500 SOUTH FORK SILVER CREEK NEAR ICE HOUSE, CA—Continued

STATISTICS OF MONTHLY MEAN DATA FOR WATER YEARS 1925 - 1959, BY WATER YEAR (WY)

	OCT	NOV	DEC	JAN	FEB	MAR	APR	MAY	JUN	JUL	AUG	SEP
MEAN	4.98	24.1	36.6	31.3	35.8	61.6	155	296	197	42.7	5.82	2.03
MAX	28.0	326	305	163	91.7	191	280	531	418	132	22.8	7.62
(WY)	1948	1951	1951	1956	1925	1928	1943	1952	1952	1952	1952	1952
MIN	.65	.64	2.34	3.00	3.00	6.92	54.9	66.2	35.0	2.92	.22	.18
(WY)	1933	1930	1933	1933	1933	1933	1944	1934	1931	1934	1931	1931

SUMMARY STATISTICS

WATER YEARS 1925 - 1959

ANNUAL MEAN	74.5
HIGHEST ANNUAL MEAN	123 1956
LOWEST ANNUAL MEAN	25.3 1931
HIGHEST DAILY MEAN	2780 Dec 23 1955
LOWEST DAILY MEAN	.00 Oct 31 1958
ANNUAL SEVEN-DAY MINIMUM	.00 Oct 31 1958
MAXIMUM PEAK FLOW	3940 Dec 23 1955
MAXIMUM PEAK STAGE	6.71 Dec 23 1955
ANNUAL RUNOFF (AC-FT)	53970
10 PERCENT EXCEEDS	237
50 PERCENT EXCEEDS	20
90 PERCENT EXCEEDS	1.4

STATISTICS OF MONTHLY MEAN DATA FOR WATER YEARS 1961 - 1984, BY WATER YEAR (WY)

MEAN	112	87.6	49.4	57.1	71.2	43.6	56.0	125	157	78.1	80.9	90.1
MAX	330	332	171	216	316	199	348	449	382	363	378	360
(WY)	1970	1966	1980	1982	1971	1969	1983	1982	1983	1983	1983	1983
MIN	5.64	5.05	5.21	4.76	5.48	3.67	2.94	4.17	3.80	4.02	3.79	3.97
(WY)	1965	1963	1963	1967	1973	1984	1977	1977	1977	1977	1977	1977

SUMMARY STATISTICS

WATER YEARS 1961 - 1984

ANNUAL MEAN	84.0
HIGHEST ANNUAL MEAN	226 1983
LOWEST ANNUAL MEAN	24.8 1977
HIGHEST DAILY MEAN	1560 Jan 22 1970
LOWEST DAILY MEAN	1.3 Jan 26 1984
ANNUAL SEVEN-DAY MINIMUM	1.4 Jan 24 1984
MAXIMUM PEAK FLOW	1930 May 26 1982
MAXIMUM PEAK STAGE	5.74 May 26 1982
ANNUAL RUNOFF (AC-FT)	60830
10 PERCENT EXCEEDS	256
50 PERCENT EXCEEDS	12
90 PERCENT EXCEEDS	5.3

STATISTICS OF MONTHLY MEAN DATA FOR WATER YEARS 1986 - 2002, BY WATER YEAR (WY)

MEAN	10.24	7.638	5.564	15.74	5.585	8.690	5.258	12.99	22.39	15.36	12.20	12.29
MAX	14.3	11.2	7.26	184	7.11	55.0	6.13	87.9	168	61.9	18.2	19.7
(WY)	1998	1997	2002	1997	2002	1986	1990	1996	1995	1995	1997	2002
MIN	5.32	5.65	4.78	3.65	3.97	4.13	4.01	5.49	5.54	5.46	5.21	5.29
(WY)	1989	1993	1990	1987	1987	1987	1986	1988	1988	1987	1992	1992

SUMMARY STATISTICS

FOR 2001 CALENDAR YEAR

FOR 2002 WATER YEAR

WATER YEARS 1986 - 2002

ANNUAL TOTAL	2160.7	3824.6	
ANNUAL MEAN	5.920	10.48	11.20
HIGHEST ANNUAL MEAN			26.2 1995
LOWEST ANNUAL MEAN			5.68 1988
HIGHEST DAILY MEAN	10 Aug 14	20 Sep 3	2840 Jan 2 1997
LOWEST DAILY MEAN	3.9 Jan 7	3.7 Apr 12	2.8 Jan 3 1986
ANNUAL SEVEN-DAY MINIMUM	3.9 Jan 4	3.8 Apr 10	3.0 Apr 11 1989
MAXIMUM PEAK FLOW		256 Aug 21	7530 May 16 1996
MAXIMUM PEAK STAGE		3.98 Aug 21	7.64 May 16 1996
ANNUAL RUNOFF (AC-FT)	4290	7590	8110
ANNUAL DIVERSION (AC-FT) a	11640	30530	
10 PERCENT EXCEEDS	7.1	19	16
50 PERCENT EXCEEDS	6.0	7.4	6.2
90 PERCENT EXCEEDS	4.4	6.4	4.6

a Diversion, in acre-feet, to Jones Fork Powerplant (station 11440900), provided by Sacramento Municipal Utility District.

11441760 JUNCTION RESERVOIR NEAR POLLOCK PINES, CA

LOCATION.—Lat 38°51'07", long 120°27'22", in SW 1/4 SW 1/4 sec.30, T.12 N., R.14 E., El Dorado County, Hydrologic Unit 18020129, in outlet structure to Jaybird Powerplant, 100 ft upstream from left abutment of Junction Diversion Dam, 0.3 mi downstream from South Fork Silver Creek, and 9.0 mi northeast of Pollock Pines.

DRAINAGE AREA.—147 mi².

PERIOD OF RECORD.—October 1991 to current year. Unpublished records for water years 1980–91 available in files of the U.S. Geological Survey.

GAGE.—Water-stage recorder. Datum of gage is sea level (levels by Sacramento Municipal Utility District). Prior to Apr. 13, 1987, nonrecording gage at same site and datum.

REMARKS.—Reservoir is formed by concrete arch dam completed in 1962. Storage began in 1962. Usable capacity, 2,216 acre-ft, between elevations, 4,397 ft, maximum drawdown level, and 4,450 ft, crest of spillway. Dead storage, 392 acre-ft. Most of the flow is diverted at this reservoir to Jaybird Powerplant (station 11441780). Several days missing due to equipment malfunction. Records, including extremes, represent total contents at 2400 hours. See schematic diagram of [South Fork American River Basin](#).

COOPERATION.—Records were collected by Sacramento Municipal Utility District, under general supervision of the U.S. Geological Survey, in connection with Federal Energy Regulatory Commission project no. 2101.

EXTREMES FOR PERIOD OF RECORD.—Maximum contents, 3,737 acre-ft, Jan. 2, 1997, elevation, 4,459.10 ft; minimum, 462 acre-ft, May 3–7, 2001, minimum elevation, 4,394.70 ft, May 3, 2001.

EXTREMES FOR CURRENT YEAR.—Maximum contents, 2,520 acre-ft, Aug. 9, elevation, 4,448.55 ft; minimum, 1,020 acre-ft, Feb. 18, elevation, 4,416.71 ft.

Capacity table (elevation, in feet, and contents, in acre-feet)
(Based on table provided by Sacramento Municipal Utility District, surveyed May 2000)

4,390	380	4,410	816	4,440	2,020	4,460	3,305
4,400	568	4,420	1,134				

RESERVOIR STORAGE, ACRE-FEET, WATER YEAR OCTOBER 2000 TO SEPTEMBER 2001

DAILY OBSERVATION AT 2400 HOURS

(NOT PREVIOUSLY PUBLISHED)

DAY	OCT	NOV	DEC	JAN	FEB	MAR	APR	MAY	JUN	JUL	AUG	SEP
1	1560	2180	1970	2190	1920	1840	2320	1210	2430	2260	2160	1920
2	1370	2420	e1860	2230	1900	1870	2250	695	2470	2140	2350	1840
3	1210	2380	2200	2080	1930	1910	1950	462	2510	2370	1920	1880
4	1680	1920	2170	1840	1960	1730	1870	462	2370	2400	1720	2110
5	1000	2380	2090	2210	1970	2130	1830	462	2300	2290	2230	1810
6	625	2140	1790	2200	1930	2310	1820	e462	2150	2240	1970	2000
7	589	1910	1970	1910	2170	2290	1920	462	2330	2120	2240	1930
8	627	2030	2030	2140	2110	2220	1920	676	2400	2200	2120	1830
9	674	1880	2320	2100	2150	2360	2510	1850	2390	1970	2160	1810
10	737	2100	1700	1910	2180	2360	2410	1990	2260	2080	2010	2380
11	785	1910	2160	1900	2210	2250	2210	2070	2140	2060	2030	2380
12	831	1880	2130	1720	2110	2220	2220	2140	2070	2200	2170	2270
13	874	1950	1600	1960	2150	2340	2260	2220	2020	2200	2020	2040
14	916	1770	1710	2090	2070	2110	2350	e2290	2000	2130	2270	2330
15	958	2210	2000	2040	1830	2160	2410	2360	1970	2030	2160	2230
16	1000	2000	1730	2210	2260	e2150	2400	e2350	2160	1990	2250	2230
17	e1040	1720	1940	2220	2190	2140	2310	---	2260	2000	2350	2240
18	1080	1740	2190	2130	2220	2280	2280	---	2190	2060	2310	2070
19	1120	2020	2190	2300	1980	2300	2380	---	2230	1820	2230	1880
20	1160	1950	1640	2170	1970	1840	2180	---	1970	1730	2060	1830
21	1210	2200	1750	2020	1930	2010	2380	---	2310	1960	1940	1820
22	1240	2100	2020	2060	2470	2220	2250	2120	---	2190	2220	1830
23	1300	1890	1950	2090	2120	2390	2300	2180	---	2080	2580	1750
24	1340	1840	1840	1820	1960	2320	2240	2210	---	2120	2450	1720
25	1390	2210	1990	1960	1990	2290	2370	2060	2170	2250	2470	1590
26	1440	1830	1970	2080	1960	2210	2270	1980	2200	2120	2470	1540
27	1450	2380	1790	1910	1900	2040	2210	2030	1880	1950	2150	1550
28	1740	1990	2050	1900	1880	1750	2330	e2280	2140	2090	2280	1550
29	1620	2150	2200	2100	---	1840	2400	2530	2090	1930	2260	1490
30	1990	1530	1930	2140	---	2510	1920	e2490	2470	1890	2260	1480
31	2260	---	2160	1850	---	2320	---	2450	---	2130	2500	---
MAX	2260	2420	2320	2300	2470	2510	2510	---	---	2400	2580	2380
MIN	589	1530	1600	1720	1830	1730	1820	---	---	1730	1720	1480
a	4444.31	4429.85	4442.52	4436.63	4437.38	4445.28	4438.11	4447.43	4447.73	4442.03	4448.26	4428.73
b	-81	-730	+630	-310	+30	+440	-400	+530	+20	-340	+370	-1020

CAL YR 2000 MAX 3201 MIN 589 b -547
WTR YR 2001 b -861

e Estimated.

a Elevation, in feet, at end of month.

b Change in contents, in acre-feet.

11441800 SILVER CREEK BELOW JUNCTION DAM, NEAR POLLOCK PINES, CA

LOCATION.—Lat 38°51'08", long 120°27'22", in SW 1/4 SW 1/4 sec.30, T.12 N., R.14 E., El Dorado County, Hydrologic Unit 18020129, Eldorado National Forest, at outlet structure, on Junction Dam, and 9 mi northeast of Pollock Pines.

DRAINAGE AREA.—147 mi².

PERIOD OF RECORD.—October 1987 to current year (low-flow records only). Unpublished records for water years 1965–87 available in files of the U.S. Geological Survey.

GAGE.—Differential-pressure gage and orifice control in outlet pipe. Auxiliary nonrecording gage 550 ft downstream at different datum. Elevation of gage is 4,280 ft above sea level, from topographic map. August 1964 to December 1986, nonrecording gage at site 500 ft downstream at different datum. December 1986 to September 1987, nonrecording gage at site 550 ft downstream.

REMARKS.—Records not computed above 30 ft³/s. Flow completely regulated by Junction Dam. Flow over the spillway bypasses this station. Diversion through Jaybird Powerplant (station 11441780) since 1962 bypasses this station. See schematic diagram of [South Fork American River Basin](#).

COOPERATION.—Records were collected by Sacramento Municipal Utility District, under general supervision of the U.S. Geological Survey, in connection with Federal Energy Regulatory Commission project no. 2101.

DISCHARGE, CUBIC FEET PER SECOND, WATER YEAR OCTOBER 2001 TO SEPTEMBER 2002

DAILY MEAN VALUES

DAY	OCT	NOV	DEC	JAN	FEB	MAR	APR	MAY	JUN	JUL	AUG	SEP
1	11	10	6.5	6.7	7.7	7.7	7.6	21	21	21	23	23
2	11	6.9	6.5	6.6	7.6	7.7	7.4	21	21	21	23	23
3	11	6.9	6.5	6.6	7.7	7.8	7.3	21	21	21	23	28
4	11	6.9	6.6	6.5	7.5	7.7	7.2	21	21	21	24	28
5	11	6.8	6.5	6.6	7.7	7.6	7.2	21	21	21	23	25
6	11	6.7	6.5	6.6	7.6	7.6	7.2	21	21	21	23	24
7	11	6.7	6.5	6.6	7.7	7.6	7.2	21	21	21	23	23
8	11	6.7	6.5	6.5	7.7	7.6	7.3	21	e21	21	23	23
9	11	6.7	6.6	6.5	7.7	7.6	9.0	21	e21	21	23	24
10	11	6.7	6.6	6.4	7.7	7.5	11	21	21	21	23	23
11	11	6.9	6.6	6.6	7.6	7.6	11	21	21	21	23	23
12	11	6.7	6.6	6.7	7.5	7.5	11	21	21	21	23	23
13	11	6.5	6.6	6.7	7.3	7.2	11	21	21	21	27	23
14	11	6.6	6.5	6.6	7.5	6.7	11	21	21	21	30	23
15	11	6.4	6.4	6.7	7.4	7.3	11	21	21	21	21	23
16	11	6.4	6.4	6.6	7.1	7.9	11	21	21	21	21	23
17	11	6.4	6.6	6.7	6.9	7.4	11	21	21	21	21	28
18	11	6.4	6.6	6.6	6.8	7.5	11	e21	21	21	20	28
19	11	6.5	6.7	6.6	6.9	7.3	11	e21	21	21	22	24
20	11	6.5	6.7	6.6	7.2	7.3	11	e21	21	21	28	23
21	11	6.4	6.6	6.7	7.5	7.4	11	21	21	21	28	23
22	11	6.4	6.6	6.7	7.7	7.4	11	21	21	21	25	23
23	11	6.5	6.7	6.7	7.8	7.4	11	21	21	21	23	23
24	11	6.6	6.7	6.7	7.7	7.4	11	21	21	21	23	23
25	11	6.6	6.7	6.7	7.6	7.3	11	21	21	21	23	23
26	11	6.6	6.7	6.6	7.6	7.3	11	21	21	21	23	23
27	11	6.7	6.6	6.6	7.7	7.4	11	21	21	21	23	23
28	11	6.7	6.5	6.6	7.7	7.4	11	21	21	21	23	23
29	11	6.5	6.5	e6.6	---	7.4	11	21	21	21	23	23
30	11	6.5	6.6	e7.1	---	7.5	15	21	21	21	23	23
31	11	---	6.7	e7.7	---	7.6	---	21	---	21	23	---
TOTAL	341	201.8	203.9	206.7	210.1	231.6	302.4	651	630	651	727	715
MEAN	11.00	6.727	6.577	6.668	7.504	7.471	10.08	21.00	21.00	21.00	23.45	23.83
MAX	11	10	6.7	7.7	7.8	7.9	15	21	21	21	30	28
MIN	11	6.4	6.4	6.4	6.8	6.7	7.2	21	21	21	20	23
AC-FT	676	400	404	410	417	459	600	1290	1250	1290	1440	1420
a	42	3610	8000	39640	21250	14090	14060	36190	19230	31250	34840	42400

CAL YR 2001 a 95830

WTR YR 2002 a 264600

e Estimated.

a Diversion, in acre-feet, to Jaybird Powerplant (station 11441780), provided by Sacramento Municipal Utility District.

11441890 CAMINO RESERVOIR NEAR POLLOCK PINES, CA

LOCATION.—Lat 38°49'44", long 120°32'09", in NW 1/4 NW 1/4 sec.4, T.11 N., R.13 E., El Dorado County, Hydrologic Unit 18020129, Eldorado National Forest, in outlet tower to Camino Powerplant, 100 ft upstream from right abutment of Camino Diversion Dam, 0.3 mi upstream from Round Tent Canyon, and 5.3 mi northwest of Pollock Pines.

DRAINAGE AREA.—160 mi².

PERIOD OF RECORD.—October 1991 to current year. Unpublished records for water years 1980–91 available in files of the U.S. Geological Survey.

GAGE.—Water-stage recorder. Datum of gage is sea level (levels by Sacramento Municipal Utility District). Prior to Apr. 8, 1987, nonrecording gage at same site and datum.

REMARKS.—Reservoir is formed by concrete-arch dam completed in 1961. Storage began in 1961. Usable capacity, 775 acre-ft, between elevations, 2,840 ft, centerline of outlet valve, and 2,915 ft, maximum water surface level. Dead storage, 50 acre-ft. Most of the water is diverted at this reservoir to Camino Powerplant (station 11441895). Missing days due to equipment malfunction. Records, including extremes, represent total contents at 2400 hours. See schematic diagram of [South Fork American River Basin](#).

COOPERATION.—Records were collected by Sacramento Municipal Utility District, under general supervision of the U.S. Geological Survey, in connection with Federal Energy Regulatory Commission project no. 2101.

EXTREMES FOR PERIOD OF RECORD.—Maximum contents, 819 acre-ft, Jan. 21, 1993, elevation, 2,915.29 ft; no storage on many days in 1999.

EXTREMES FOR CURRENT YEAR.—Maximum contents, 769 acre-ft, June 30, elevation, 2,912.54 ft; minimum, 300 acre-ft, Oct. 21, elevation, 2,878.47 ft.

Capacity table (elevation, in feet, and contents, in acre-feet)
(Based on table provided by Sacramento Municipal Utility District, recomputed October 1991)

2,860	149	2,880	315	2,900	564	2,920	910
2,870	223	2,890	428	2,910	724		

RESERVOIR STORAGE, ACRE-FEET, WATER YEAR OCTOBER 2000 TO SEPTEMBER 2001

DAILY OBSERVATION AT 2400 HOURS

(NOT PREVIOUSLY PUBLISHED)

DAY	OCT	NOV	DEC	JAN	FEB	MAR	APR	MAY	JUN	JUL	AUG	SEP
1	452	561	670	557	614	699	684	676	570	689	662	659
2	642	626	606	652	699	570	626	747	592	626	538	619
3	688	296	542	469	744	648	681	646	621	627	695	654
4	700	613	533	521	684	502	705	522	569	645	660	645
5	381	474	507	611	723	625	577	556	614	710	660	646
6	602	596	554	677	672	665	685	e548	648	674	737	713
7	424	565	532	622	665	614	563	540	665	621	716	598
8	186	625	632	532	606	579	677	464	627	612	620	639
9	111	683	616	557	657	577	642	508	579	677	688	680
10	111	676	628	623	711	---	630	e562	653	530	626	695
11	85	691	623	610	574	593	594	616	499	731	482	709
12	85	663	601	586	635	568	618	672	583	559	581	560
13	85	650	704	574	671	644	723	686	600	611	669	704
14	85	693	541	526	615	562	592	e594	607	699	558	652
15	64	601	e586	561	559	689	562	502	522	644	523	664
16	---	609	631	556	519	e638	611	e553	661	724	612	676
17	---	624	617	580	632	588	542	604	554	641	591	669
18	---	642	678	601	691	549	602	---	632	586	600	570
19	---	486	642	475	626	681	654	---	611	596	563	633
20	---	610	644	564	594	573	535	---	638	633	620	625
21	---	640	596	653	665	600	573	---	622	566	654	660
22	---	571	633	592	747	579	607	635	---	679	707	588
23	---	653	655	627	556	586	649	524	---	530	640	615
24	---	639	652	693	706	580	653	596	---	563	622	455
25	---	658	614	641	570	589	643	532	620	507	625	674
26	241	621	615	621	603	615	642	716	643	676	677	606
27	349	635	647	675	625	666	687	659	576	621	703	593
28	340	599	642	634	517	595	680	e689	596	624	703	e516
29	579	550	665	508	---	610	655	719	628	552	717	439
30	473	470	566	542	---	651	642	e638	660	545	721	434
31	525	---	504	619	---	697	---	556	---	646	641	---
MAX	---	693	704	693	747	---	723	---	---	731	737	713
MIN	---	296	504	469	517	---	535	---	---	507	482	434
a	2897.29	2893.26	2895.78	2903.60	2896.69	2908.43	2905.05	2899.48	2906.22	2905.34	2905.00	2890.43
b	-63	-55	+34	+115	-102	+180	-55	-86	+104	-14	-5	-207

CAL YR 2000 b -156
WTR YR 2001 b -154

e Estimated.

a Elevation, in feet, at end of month.

b Change in contents, in acre-feet.

11441900 SILVER CREEK BELOW CAMINO DIVERSION DAM, CA

LOCATION.—Lat 38°49'26", long 120°32'18", on line between secs.4 and 5, T.11 N., R.13 E., [El Dorado County](#), Hydrologic Unit 18020129, Eldorado National Forest, on right bank, 300 ft downstream from Round Tent Canyon, 0.4 mi downstream from diversion dam, and 5 mi northeast of Pollock Pines.

DRAINAGE AREA.—171 mi².

PERIOD OF RECORD.—October 1960 to current year.

GAGE.—Water-stage recorder. Datum of gage is 2,754.06 ft above sea level (Sacramento Municipal Utility District benchmark).

REMARKS.—Flow is regulated by Ice House Reservoir (station 11441100) since 1959, Union Valley Reservoir (station 11441001) since 1962, and Junction and Camino Reservoirs (stations 11441760 and 11441890). Diversion to Camino Powerplant (station 11441895) since 1961 bypasses this station. See schematic diagram of [South Fork American River Basin](#).

COOPERATION.—Records were collected by Sacramento Municipal Utility District, under general supervision of the U.S. Geological Survey, in connection with Federal Energy Regulatory Commission project no. 2101.

EXTREMES FOR PERIOD OF RECORD.—Maximum discharge, about 47,700 ft³/s, Jan. 2, 1997, gage height, 15.72 ft, backwater from log jam, from rating curve extended above 4,700 ft³/s, on basis of slope-area measurement at gage height 11.28 ft; minimum daily, 1.0 ft³/s, Nov. 1, 1980.

DISCHARGE, CUBIC FEET PER SECOND, WATER YEAR OCTOBER 2001 TO SEPTEMBER 2002

DAILY MEAN VALUES

DAY	OCT	NOV	DEC	JAN	FEB	MAR	APR	MAY	JUN	JUL	AUG	SEP
1	13	13	7.7	34	8.0	17	20	27	22	21	21	23
2	13	10	30	38	7.7	15	18	26	22	21	22	23
3	13	7.3	15	47	7.9	14	17	27	22	21	21	23
4	13	7.3	11	34	7.6	13	16	26	22	21	21	22
5	13	7.3	9.9	27	7.9	12	15	26	21	21	21	22
6	13	7.3	12	27	8.1	34	14	26	21	21	20	23
7	13	7.4	11	26	9.4	60	13	26	21	22	23	23
8	13	7.4	10	25	16	75	12	26	e21	21	30	22
9	13	7.4	10	22	13	65	11	26	e21	22	29	24
10	14	7.3	9.4	20	13	49	11	26	21	21	31	23
11	14	7.2	8.8	17	12	31	10	26	21	21	30	23
12	14	7.3	8.1	16	12	29	10	27	21	22	29	23
13	14	7.1	8.0	15	12	28	10	27	21	21	27	23
14	14	7.2	9.0	14	13	25	10	27	21	21	29	22
15	14	7.3	7.9	13	13	23	10	26	21	21	27	23
16	14	7.2	7.9	12	14	21	11	27	21	21	33	23
17	14	7.3	14	11	16	19	11	26	21	21	29	23
18	13	7.4	14	11	15	17	11	e26	21	21	25	23
19	13	7.4	12	10	30	16	11	e26	21	21	31	23
20	13	7.5	12	10	71	15	11	e26	21	21	27	23
21	16	7.9	11	10	54	15	11	26	21	21	29	24
22	13	7.2	12	9.7	42	15	11	26	21	21	32	25
23	13	7.3	12	9.3	36	24	11	24	22	21	26	24
24	13	8.7	11	9.0	30	27	11	21	21	21	25	24
25	13	7.1	10	8.8	26	26	11	21	21	21	25	23
26	13	7.2	10	9.6	22	25	11	21	21	21	26	23
27	13	7.3	10	9.1	20	24	12	22	21	21	25	24
28	13	7.3	14	8.8	19	24	11	22	22	22	25	24
29	13	7.3	24	8.4	---	23	11	22	21	21	24	24
30	13	7.2	27	8.3	---	22	17	21	21	21	23	24
31	12	---	45	8.1	---	21	---	21	---	21	23	---
TOTAL	413	229.1	413.7	528.1	555.6	824	369	773	636	655	809	696
MEAN	13.32	7.637	13.35	17.04	19.84	26.58	12.30	24.94	21.20	21.13	26.10	23.20
MAX	16	13	45	47	71	75	20	27	22	22	33	25
MIN	12	7.1	7.7	8.1	7.6	12	10	21	21	21	20	22
AC-FT	819	454	821	1050	1100	1630	732	1530	1260	1300	1600	1380
a	456	5040	12030	44450	26520	22000	18700	39360	20780	32900	35980	43240

e Estimated.

a Diversion, in acre-feet, to Camino Powerplant (station 11441895), provided by Sacramento Municipal Utility District.

11441900 SILVER CREEK BELOW CAMINO DIVERSION DAM, CA—Continued

STATISTICS OF MONTHLY MEAN DATA FOR WATER YEARS 1961 - 2002, BY WATER YEAR (WY)

	OCT	NOV	DEC	JAN	FEB	MAR	APR	MAY	JUN	JUL	AUG	SEP
MEAN	27.33	42.66	68.82	192.0	122.2	110.7	111.0	178.4	138.9	63.32	31.79	25.96
MAX	138	1088	856	4122	1168	1207	956	1505	1019	503	364	188
(WY)	1995	1984	1965	1997	1986	1986	1962	1995	1995	1995	1962	1962
MIN	3.12	3.44	5.39	5.21	5.45	3.56	3.14	3.30	3.29	2.98	3.11	3.18
(WY)	1978	1978	1977	1977	1977	1977	1977	1977	1977	1977	1977	1977

SUMMARY STATISTICS	FOR 2001 CALENDAR YEAR		FOR 2002 WATER YEAR		WATER YEARS 1961 - 2002	
ANNUAL TOTAL	5060.8		6901.5			
ANNUAL MEAN	13.87		18.91		92.67	
HIGHEST ANNUAL MEAN					461	
LOWEST ANNUAL MEAN					4.16	
HIGHEST DAILY MEAN	57	Apr 20	75	Mar 8	32900	Jan 2 1997
LOWEST DAILY MEAN	7.1	Nov 13	7.1	Nov 13	1.0	Nov 1 1980
ANNUAL SEVEN-DAY MINIMUM	7.2	Nov 10	7.2	Nov 10	2.7	Mar 2 1977
MAXIMUM PEAK FLOW			102		47700	
MAXIMUM PEAK STAGE			3.40		15.72	
ANNUAL RUNOFF (AC-FT)	10040		13690		67140	
ANNUAL DIVERSION (AC-FT) a	121900		301500			
10 PERCENT EXCEEDS	14		27		119	
50 PERCENT EXCEEDS	14		21		19	
90 PERCENT EXCEEDS	9.7		8.1		7.2	

a Diversion, in acre-feet, to Camino Powerplant (station 11441895), provided by Sacramento Municipal Utility District.

11442690 BRUSH CREEK RESERVOIR NEAR POLLOCK PINES, CA

LOCATION.—Lat 38°48'42", long 120°37'14", in NW 1/4 SE 1/4 sec.10, T.11 N., R.12 E., El Dorado County, Hydrologic Unit 18020129, Eldorado National Forest, in outlet tower to Camino Powerplant, 200 ft upstream from left abutment of Brush Creek Diversion Dam, and 4.0 mi northwest of Pollock Pines.

DRAINAGE AREA.—7.99 mi².

PERIOD OF RECORD.—October 1991 to current year. Unpublished records for water years 1980–91 available in files of the U.S. Geological Survey.

GAGE.—Water-stage recorder. Datum of gage is sea level (levels by Sacramento Municipal Utility District). Prior to Apr. 7, 1987, nonrecording gage at same site and datum.

REMARKS.—Reservoir is formed by concrete-arch dam completed in 1970. Storage began in 1970. Usable capacity, 1,275 acre-ft, between elevations 2,825 ft, invert of tunnel, and 2,915 ft, crest of spillway. Dead storage, 255 acre-ft. Most of the water is diverted at this reservoir to Camino Powerplant (station 11441895). Records, including extremes, represent total contents at 2400 hours. See schematic diagram of [South Fork American River Basin](#).

COOPERATION.—Records were collected by Sacramento Municipal Utility District, under general supervision of the U.S. Geological Survey, in connection with Federal Energy Regulatory Commission project no. 2101.

EXTREMES FOR PERIOD OF RECORD.—Maximum contents, 1,546 acre-ft, Jan. 25, 1997, elevation, 2,915.72 ft; minimum, 541 acre-ft, June 29, 1995, elevation, 2,853.64 ft.

EXTREMES FOR CURRENT YEAR.—Maximum contents, 1,480 acre-ft, Feb. 23, elevation, 2,912.28 ft; minimum, 934 acre-ft, Feb. 18, elevation, 2,882.20 ft.

Capacity table (elevation, in feet, and contents, in acre-feet)
(Based on table provided by Sacramento Municipal Utility District, November, 1999)

2,820	220	2,850	499	2,880	900	2,900	1,239
2,830	300	2,860	619	2,890	1,062	2,915	1,532
2,840	393	2,870	753				

RESERVOIR STORAGE, ACRE-FEET, WATER YEAR OCTOBER 2000 TO SEPTEMBER 2001

DAILY OBSERVATION AT 2400 HOURS

(NOT PREVIOUSLY PUBLISHED)

DAY	OCT	NOV	DEC	JAN	FEB	MAR	APR	MAY	JUN	JUL	AUG	SEP
1	1180	1180	1350	1350	1280	1270	1450	1450	1140	1330	1310	1420
2	1040	1340	e1340	1350	1280	1280	1450	1450	1140	1320	1300	1410
3	1040	1340	1340	1340	1280	1280	1360	1450	1140	1320	1340	1410
4	1190	1160	1040	1330	1380	1290	1400	1450	1150	1320	1340	1410
5	883	1090	1220	1330	1430	1320	1400	1450	1150	1330	1390	1400
6	884	e1140	1160	1320	1450	1340	1400	1360	1340	1330	1180	1410
7	885	1260	1160	1320	1450	1360	1400	1390	1340	1330	1220	1440
8	883	1290	1150	1310	1440	1370	1320	1390	1340	1330	1220	1440
9	885	1280	1150	1310	1440	1390	1330	1160	1340	1370	1330	1430
10	890	1280	1140	1300	1440	e1400	1330	1250	1340	1370	1350	1430
11	892	1280	1250	1310	1440	1400	1340	1350	1390	1370	1360	1430
12	892	1270	1200	1300	1440	1350	1350	1350	1390	1370	1270	1420
13	892	1130	1070	1300	1430	1360	1420	1380	1390	1360	1360	1420
14	892	1030	1080	1300	1320	1360	1430	1410	1390	1360	1390	1410
15	892	988	1090	1290	1210	1390	1440	1410	1390	1360	1380	1410
16	892	1020	1280	1330	1210	e1380	1440	1410	1390	1360	1390	1410
17	e892	1140	1340	1330	1210	1390	1450	1410	1390	1360	1380	1400
18	892	1210	1330	1330	1210	1390	1390	1410	1390	1350	1380	1400
19	891	1120	1330	1320	1220	1390	1400	e1410	1380	1350	1380	1390
20	891	1130	1300	1320	1250	1400	1430	e1400	1230	1350	1370	1390
21	e891	1270	1230	1310	1270	1410	1450	e1400	1230	1340	1370	1390
22	889	1110	1220	1310	1320	1410	1410	1400	e1220	1340	1410	1380
23	888	1320	1220	1300	1330	1420	1430	1400	e1270	1340	1410	1380
24	887	1430	1360	1300	1340	1420	1360	1400	e1330	1330	1400	1370
25	750	1420	1390	1300	1250	1430	1370	1390	1330	1330	1400	1370
26	755	1420	1380	1300	1280	1430	1380	1390	1330	1330	1350	1400
27	758	1260	1380	1300	1310	1440	1390	1390	1330	1320	1320	1270
28	766	1290	1370	1300	1270	1440	1400	1390	1330	1320	1400	1230
29	957	1360	1370	1300	---	1440	1440	1390	1330	1320	1420	1230
30	965	1350	1360	1290	---	1440	1450	1310	1330	1310	1420	1230
31	1100	---	1360	1290	---	1440	---	1070	---	1310	1420	---
MAX	1190	1430	1390	1350	1450	1440	1450	1450	1390	1370	1420	1440
MIN	750	988	1040	1290	1210	1270	1320	1070	1140	1310	1180	1230
a	2891.93	2906.08	2906.26	2902.53	2901.45	2910.69	2910.79	2890.32	2904.65	2903.78	2909.62	2899.37
b	-278	+250	+10	-70	-20	+170	+10	-380	+260	-20	+110	-190
CAL YR 2000	MAX 1464	MIN 746	b +81									
WTR YR 2001	MAX 1450	MIN 750	b -148									

e Estimated.

a Elevation, in feet, at end of month.

b Change in contents, in acre-feet.

11442690 BRUSH CREEK RESERVOIR NEAR POLLOCK PINES, CA—Continued

RESERVOIR STORAGE, ACRE-FEET, WATER YEAR OCTOBER 2001 TO SEPTEMBER 2002
DAILY OBSERVATION AT 2400 HOURS

DAY	OCT	NOV	DEC	JAN	FEB	MAR	APR	MAY	JUN	JUL	AUG	SEP
1	1220	1190	1150	1320	1270	1440	1370	1330	1350	e1400	1320	1280
2	1220	1190	1200	1210	1270	1450	1370	1330	1390	1400	1310	1300
3	1220	1190	1220	1320	1270	1310	1240	1370	1390	1390	1310	1290
4	1210	1180	1220	1340	1120	1310	1250	1390	1380	1400	1300	1290
5	1210	1170	1230	1250	1040	1310	1250	1410	1370	1390	1300	1280
6	1210	1170	1240	1240	1090	1320	1370	1410	1370	1390	1200	1270
7	1210	1160	1250	1210	1240	1380	1240	1400	e1370	1430	1200	1270
8	1210	1160	1260	1210	1320	1410	1320	1400	1370	1430	1200	1260
9	1200	1160	1260	1210	1370	1240	1320	1400	1370	1430	1120	1320
10	1200	1150	1260	1220	1380	1260	1320	1230	1370	1420	1330	1340
11	1200	1260	1260	1220	1250	1280	1320	1260	1370	1420	1360	1330
12	1200	1310	1260	1220	1340	1290	1320	1260	1360	1410	1380	1280
13	1200	1340	1260	1310	1350	1300	1320	1260	1360	1410	1380	1270
14	1200	1350	1260	1310	1350	1310	1320	1290	1360	1400	1370	1270
15	1190	1360	1290	1310	1350	1320	1320	1360	1360	1400	1180	1270
16	1190	1260	1360	1150	1240	1330	1320	1350	1360	1390	1270	1340
17	1190	1280	1360	1150	1020	1330	1320	e1340	1360	1390	1370	1330
18	1250	1230	1370	1150	934	1330	1320	e1340	1360	1380	1380	1330
19	1250	1310	1350	1060	981	1340	1320	1330	1360	1380	1370	1320
20	1240	1400	1330	1190	1310	1360	1320	1340	1370	1370	1370	1310
21	1240	1430	1330	1290	1360	1390	1330	1340	1370	1370	1360	1300
22	1230	1440	1340	1360	1460	1390	1330	1340	1370	1370	1350	1350
23	1220	1240	1350	1290	1480	1420	1330	1340	1360	1360	1350	1300
24	1220	1250	1360	1290	1410	1450	1320	1330	1360	1360	1340	1390
25	1210	1250	1360	1310	1420	1380	1320	1330	1360	1350	1330	1390
26	1210	1250	1390	1310	1430	1340	1320	1320	1360	1350	1170	1380
27	1200	1240	1260	1310	1430	1250	1320	1320	1350	1340	1240	1370
28	1200	1220	1250	1280	1440	1260	1320	1310	1350	1340	1380	1370
29	1200	1150	1270	1280	---	1340	1320	1310	1350	1330	1430	1360
30	1200	1150	1270	1280	---	1350	1330	1300	1300	1330	1300	1350
31	1190	---	1290	1270	---	1360	---	1290	---	1320	1380	---
MAX	1250	1440	1390	1360	1480	1450	1370	1410	1390	1430	1430	1390
MIN	1190	1150	1150	1060	934	1240	1240	1230	1300	1320	1120	1260
a	2897.51	2894.93	2902.99	2901.89	2910.45	2906.39	2904.70	2902.85	2903.03	2904.43	2907.61	2906.13
b	-40	-40	+140	-20	+170	-80	-30	-40	+10	+20	+60	-30
CAL YR 2001	MAX 1450	MIN 1070	b -70									
WTR YR 2002	MAX 1480	MIN 934	b +120									

e Estimated.

a Elevation, in feet, at end of month.

b Change in contents, in acre-feet.

11442700 BRUSH CREEK BELOW BRUSH CREEK DAM, NEAR POLLOCK PINES, CA

LOCATION.—Lat 38°48'41", long 120°37'20", in NW 1/4 SE 1/4 sec.10, T.11 N., R.12 E., [El Dorado County](#), Hydrologic Unit 18020129, Eldorado National Forest, at outlet structure on Brush Creek Dam, and 4.0 mi northwest of Pollock Pines.

DRAINAGE AREA.—7.99 mi².

PERIOD OF RECORD.—October 1987 to current year. Unpublished records for water years 1971–87 available in files of the U.S. Geological Survey.

GAGE.—Differential-pressure gage and orifice control in outlet pipe. Auxiliary water-stage recorder 200 ft downstream at different datum. Elevation of gage is 2,700 ft above sea level, from topographic map. Prior to October 1987, nonrecording gage 400 ft downstream at different datum.

REMARKS.—Flow completely regulated by Brush Creek Reservoir (station 11442690). See schematic diagram of [South Fork American River Basin](#).

COOPERATION.—Records were collected by Sacramento Municipal Utility District, under general supervision of the U.S. Geological Survey, in connection with Federal Energy Regulatory Commission project no. 2101.

EXTREMES FOR PERIOD OF RECORD.—Maximum daily discharge, 620 ft³/s, Jan. 2, 1997; minimum daily, 2.1 ft³/s, many days in 1988.

DISCHARGE, CUBIC FEET PER SECOND, WATER YEAR OCTOBER 2001 TO SEPTEMBER 2002

DAILY MEAN VALUES

DAY	OCT	NOV	DEC	JAN	FEB	MAR	APR	MAY	JUN	JUL	AUG	SEP
1	2.7	4.6	4.6	4.6	4.6	4.6	7.0	6.9	7.7	4.3	3.9	4.0
2	2.7	4.6	4.8	4.6	4.6	4.6	7.0	6.9	7.7	4.1	3.9	4.0
3	2.7	4.6	4.7	4.6	4.6	4.6	6.9	7.0	7.7	4.1	3.9	3.9
4	2.6	4.6	4.6	4.6	4.5	4.6	7.0	7.0	7.7	4.1	3.9	4.2
5	2.6	4.6	4.6	4.6	4.5	4.6	7.0	7.0	6.6	4.1	3.9	4.0
6	2.6	4.5	4.7	4.6	4.7	4.7	6.9	7.0	3.6	4.1	3.9	4.0
7	2.6	4.5	4.6	4.6	4.7	5.7	6.9	7.0	3.8	4.0	3.9	4.0
8	2.6	4.5	4.6	4.6	4.7	7.2	6.9	7.0	3.8	4.2	3.9	4.0
9	2.6	4.5	4.6	4.6	4.7	7.3	7.0	7.0	3.8	4.4	3.9	4.0
10	2.6	4.5	4.6	4.6	4.6	7.3	7.0	7.0	3.8	4.5	3.9	4.0
11	2.6	4.6	4.6	4.6	4.6	7.1	6.9	6.9	3.8	4.0	3.9	4.0
12	2.6	4.6	4.6	4.6	4.6	7.0	6.9	7.0	4.0	4.4	3.9	4.0
13	2.6	4.6	4.6	4.6	4.6	7.0	6.9	7.0	3.8	4.2	4.0	4.0
14	2.6	4.6	4.7	4.5	4.6	7.0	6.9	7.0	3.7	4.2	4.0	4.0
15	2.6	4.6	4.6	4.5	4.6	7.0	6.9	6.9	3.7	4.0	4.0	4.0
16	2.6	4.6	4.6	4.5	4.6	7.1	6.9	7.4	3.7	3.9	4.0	4.0
17	2.6	4.5	4.6	4.5	4.7	7.1	7.0	8.0	3.8	3.9	4.0	4.0
18	2.6	4.5	4.6	4.6	4.6	7.0	7.0	8.2	3.9	3.9	4.0	4.0
19	2.7	4.6	4.6	4.5	4.7	7.0	6.9	8.2	3.9	3.9	3.8	4.0
20	2.7	4.5	4.6	4.5	4.8	7.0	6.9	8.2	3.9	3.9	3.9	4.0
21	2.7	4.6	4.6	4.6	4.7	6.9	6.9	8.2	4.0	3.9	4.0	4.0
22	2.7	4.6	4.6	4.7	4.7	6.9	6.9	7.8	3.9	4.0	4.0	4.0
23	2.6	4.6	4.6	4.6	4.6	7.0	6.9	7.5	3.9	3.9	4.0	4.0
24	2.6	4.5	4.6	4.6	4.6	7.0	6.9	7.8	4.0	3.9	3.9	4.0
25	2.6	4.5	4.6	4.6	4.6	7.0	6.9	7.7	4.0	3.9	3.9	4.0
26	2.6	4.5	4.6	4.6	4.6	6.9	6.9	7.7	3.9	3.9	4.0	4.0
27	2.6	4.5	4.6	4.6	4.6	7.0	6.9	7.7	3.9	3.9	4.0	4.0
28	2.6	4.5	4.5	4.6	4.6	7.0	6.9	7.7	3.9	3.9	4.0	4.0
29	2.6	4.6	4.5	4.6	---	7.0	6.9	7.7	4.0	3.9	4.0	4.0
30	2.6	4.6	4.5	4.6	---	7.0	6.9	7.7	4.1	3.9	3.9	4.0
31	3.9	---	4.6	4.6	---	7.0	---	7.7	---	3.9	4.0	---
TOTAL	82.6	136.7	142.8	142.1	129.6	202.2	207.8	229.8	134.0	125.2	122.2	120.1
MEAN	2.665	4.557	4.606	4.584	4.629	6.523	6.927	7.413	4.467	4.039	3.942	4.003
MAX	3.9	4.6	4.8	4.7	4.8	7.3	7.0	8.2	7.7	4.5	4.0	4.2
MIN	2.6	4.5	4.5	4.5	4.5	4.6	6.9	6.9	3.6	3.9	3.8	3.9
AC-FT	164	271	283	282	257	401	412	456	266	248	242	238

STATISTICS OF MONTHLY MEAN DATA FOR WATER YEARS 1988 - 2002, BY WATER YEAR (WY)

	3.093	5.780	5.760	9.143	5.821	6.007	6.107	5.967	3.267	3.156	3.123	3.130
MEAN	3.093	5.780	5.760	9.143	5.821	6.007	6.107	5.967	3.267	3.156	3.123	3.130
MAX	3.86	8.06	7.81	58.0	7.76	8.95	10.4	9.09	4.47	4.26	3.94	4.00
(WY)	1994	1990	1990	1997	1997	1997	1997	1997	2002	1995	2002	2002
MIN	2.44	4.16	4.09	4.10	4.12	4.39	4.23	4.28	2.24	2.18	2.14	2.14
(WY)	1993	1991	1988	1988	1988	1992	1988	1988	1988	1988	1988	1988

SUMMARY STATISTICS

FOR 2001 CALENDAR YEAR

FOR 2002 WATER YEAR

WATER YEARS 1988 - 2002

ANNUAL TOTAL	1534.4	1775.1	
ANNUAL MEAN	4.204	4.863	5.029
HIGHEST ANNUAL MEAN			10.5
LOWEST ANNUAL MEAN			3.39
HIGHEST DAILY MEAN	6.9	Feb 17	8.2
LOWEST DAILY MEAN	2.4	Jun 13	2.6
ANNUAL SEVEN-DAY MINIMUM	2.5	Jun 8	2.6
ANNUAL RUNOFF (AC-FT)	3040	3520	3640
10 PERCENT EXCEEDS	6.8	7.0	7.0
50 PERCENT EXCEEDS	4.5	4.6	4.4
90 PERCENT EXCEEDS	2.6	3.8	2.5

11443450 SLAB CREEK RESERVOIR NEAR CAMINO, CA

LOCATION.—Lat 38°46'21", long 120°41'58", in SW 1/4 NE 1/4 sec.25, T.11 N., R.11 E., El Dorado County, Hydrologic Unit 18020129, Eldorado National Forest, on left bank, 100 ft upstream from dam on South Fork American River, 1,600 ft upstream from Iowa Canyon, and 2.7 mi northwest of Camino.

DRAINAGE AREA.—493 mi².

PERIOD OF RECORD.—May 1987 to current year. Unpublished records for water years 1969–86 available in files of the U.S. Geological Survey.

GAGE.—Water-stage recorder. Datum of gage is sea level (levels by Sacramento Municipal Utility District). Prior to May 26, 1987, nonrecording gage at same site and datum. September 1980 to October 1993, supplementary water-stage recorder at left abutment of dam operated by U.S. Geological Survey during periods of spill.

REMARKS.—Reservoir is formed by concrete-arch dam completed in 1967. Storage began in October 1967. Usable capacity, 16,567 acre-ft, between elevations 1,670 ft, invert of tunnel, and 1,850 ft, crest of spillway. Dead storage, 600 acre-ft. Reservoir receives water from South Fork American River and Silver Creek via El Dorado and Camino Powerplants (station 11441895) 10 mi upstream. Nearly the entire flow is diverted at this reservoir to White Rock Powerplant (station 11443460). See [South Fork American River near Camino \(station 11443500\)](#) for additional information on diversions and releases from Slab Creek Reservoir. Missing days are due to equipment malfunction. Records, including extremes, represent usable contents. See schematic diagram of [South Fork American River Basin](#).

COOPERATION.—Records were collected by Sacramento Municipal Utility District, under general supervision of the U.S. Geological Survey, in connection with Federal Energy Regulatory Commission project no. 2101.

EXTREMES FOR PERIOD OF RECORD.—Maximum contents, 18,637 acre-ft, Jan. 1, 1997, elevation, 1,859.70 ft; minimum, 3,917 acre-ft, Oct. 27, 1991, elevation unknown.

EXTREMES FOR CURRENT YEAR.—Maximum contents, 13,700 acre-ft, Feb. 22–24, maximum elevation, 1,851.88 ft, Feb. 23, minimum, 7,790 acre-ft, Apr. 25, elevation, 1,819.76 ft.

Capacity table (elevation, in feet, and contents, in acre-feet)
(Based on survey by Sacramento Municipal Utility District, May 2000)

1,730	928	1,760	2,281	1,820	7,825	1,850	13,302
1,740	1,309	1,780	3,596	1,840	11,183	1,855	14,493
1,750	1,758	1,800	5,381				

RESERVOIR STORAGE, ACRE-FEET, WATER YEAR OCTOBER 2000 TO SEPTEMBER 2001

DAILY OBSERVATION AT 2400 HOURS

(NOT PREVIOUSLY PUBLISHED)

DAY	OCT	NOV	DEC	JAN	FEB	MAR	APR	MAY	JUN	JUL	AUG	SEP
1	13200	9400	10400	12900	12800	11800	12600	12200	10600	11400	10900	12300
2	12100	8390	10400	12500	12900	11500	11900	11600	10200	11400	11600	12300
3	13100	8420	9850	12000	12700	11000	12100	11100	10000	11300	11200	12900
4	13000	9800	9470	11900	12500	10300	11900	11200	10200	11700	10900	13000
5	11900	10700	9680	11600	12700	10700	11700	11500	10500	11500	11200	13200
6	10800	10700	9310	10900	12200	11600	11000	e11700	9920	10900	11800	12600
7	11000	10900	9520	11000	12600	12300	11300	11900	10500	10400	12400	12900
8	11300	10600	10600	11100	12300	12500	10700	11200	11100	11100	12100	13000
9	11400	10900	12400	11200	12100	12700	10800	10500	10900	10500	12000	12800
10	11400	10600	13100	10600	12000	e12400	11100	e11200	10900	10500	11700	12700
11	11300	10600	12000	10400	12300	12100	12200	12200	11300	10500	11400	12700
12	11400	11200	10700	10400	11500	12300	12300	12400	11200	10900	11500	12600
13	11200	10600	10100	10900	10900	12000	12000	11900	11300	10500	11500	12800
14	11300	9790	10800	10800	11200	12100	12300	12200	11900	10500	11700	12700
15	11200	10300	12100	11500	11100	11500	12600	12600	11200	10500	12300	13000
16	11300	10400	12900	11900	11200	e12000	12600	e12300	11500	10600	12800	12800
17	11300	10000	12600	11900	11400	12500	12500	12100	11700	10200	12400	12400
18	11100	8610	12200	11900	11200	12500	12700	---	11200	10100	12500	12200
19	11200	8580	11100	11900	11500	12200	12500	---	10800	10300	12700	12500
20	11400	8930	11600	12000	11700	12500	12200	---	11300	9650	13000	12200
21	11400	8970	11800	12100	12300	11600	12200	---	11100	9360	12900	11900
22	11600	9190	12200	11900	12200	12400	12600	12500	---	9580	13000	12200
23	11700	9500	12500	11900	12200	12600	12200	12700	---	9980	13000	12400
24	11300	9600	12700	12200	11300	12600	11700	11900	---	9950	12900	12700
25	10900	10400	12700	12300	11600	12500	12400	12000	10900	10000	12700	12800
26	10500	10900	13000	12100	11300	12400	11700	12400	10600	9860	13000	13000
27	10100	10800	12500	12100	11600	12400	11200	12400	10700	10200	13000	12900
28	9930	9790	11500	11900	12200	12100	11400	e12000	10900	10300	13200	e13000
29	10000	10100	11600	12500	---	12300	12400	11700	11000	10300	13200	13100
30	9480	10600	12500	12600	---	12500	11700	e11100	11400	10600	12900	13200
31	9940	---	12500	12500	---	12400	---	10500	---	10500	12300	---
MAX	13200	11200	13100	12900	12900	12700	12700	---	---	11700	13200	13200
MIN	9480	8390	9310	10400	10900	10300	10700	---	---	9360	10900	11900
a	1833.32	1837.10	1846.39	1846.17	1845.14	1846.13	1842.79	1836.21	1840.90	1836.40	1845.69	1849.34
b	-6174	+660	+1900	0	-300	+200	-700	-1200	+900	-900	+1800	+900

CAL YR 2000 MAX 16811 MIN 8390 b -2630
WTR YR 2001 b -2914

e Estimated.

a Elevation, in feet, at end of month.

b Change in contents, in acre-feet.

11443500 SOUTH FORK AMERICAN RIVER NEAR CAMINO, CA

LOCATION.—Lat 38°46'23", long 120°42'02", in SW 1/4 NE 1/4 sec.25, T.11 N., R.11 E., El Dorado County, Hydrologic Unit 18020129, on right bank, 500 ft upstream from Iowa Canyon Creek, and 2.8 mi northwest of Camino.

DRAINAGE AREA.—493 mi².

PERIOD OF RECORD.—October 1922 to current year. Monthly discharge only for October 1922, WSP 1315-A. Records for river and American River Flume, published separately October 1922 to September 1956 and October 1962 to December 1964, when flume was destroyed. Records of river and flume combined October 1956 to September 1962.

REVISED RECORDS.—WSP 931: 1928, 1938, 1940(M). WSP 1931: Drainage area at former site.

GAGE.—Acoustic-velocity meter. Elevation of gage is 1,625 ft above sea level, from topographic map. Prior to May 26, 1987, water-stage recorder at different datum at site 1,000 ft downstream. Auxiliary water-stage recorder on Slab Creek Dam records spill discharges which are combined with release discharges. See WSP 2131 for history of changes prior to Oct. 12, 1966.

REMARKS.—Flow regulated by several reservoirs. Since 1967 diversion from Slab Creek Dam to White Rock Powerplant (station 11443460) bypasses this station. Echo Lake Conduit (station 11434500) imports up to 1,900 acre-ft each year from Truckee River Basin. Variable amounts of El Dorado Canal water, up to 40 ft³/s May to October, and about 7 ft³/s remainder of the year, diverted for irrigation and domestic use between Pollock Pines and Placerville. Water from Jenkinson Lake in North Fork Cosumnes River Basin diverted to Camino and substituted for flow from El Dorado Canal in some years. Since October 1962, water is imported from the Upper Rubicon River Basin by way of Robbs Peak Powerplant (station 11429300). See schematic diagram of [South Fork American River Basin](#).

COOPERATION.—Records were collected by Sacramento Municipal Utility District, under general supervision of the U.S. Geological Survey, in connection with Federal Energy Regulatory Commission project no. 2101.

EXTREMES FOR PERIOD OF RECORD.—Maximum discharge, 62,300 ft³/s, Jan. 2, 1997, from rating curve extended above 24,000 ft³/s, on basis of computation of peak flow over dam; minimum daily, 1.3 ft³/s, Aug. 24, 1931.

DISCHARGE, CUBIC FEET PER SECOND, WATER YEAR OCTOBER 2001 TO SEPTEMBER 2002

DAILY MEAN VALUES

DAY	OCT	NOV	DEC	JAN	FEB	MAR	APR	MAY	JUN	JUL	AUG	SEP
1	38	37	10	10	11	13	38	e37	37	37	38	38
2	38	37	10	10	11	13	38	e37	37	37	38	38
3	38	37	11	10	11	13	38	37	37	37	38	38
4	38	37	10	10	11	13	37	37	37	37	38	39
5	38	37	11	10	11	13	37	37	37	37	38	38
6	38	37	11	11	11	11	37	38	38	38	37	38
7	38	37	11	11	11	11	38	37	38	37	38	38
8	38	37	11	11	11	22	39	38	e38	38	38	38
9	38	37	11	11	11	38	38	37	e38	38	38	38
10	38	37	11	11	11	38	38	37	39	37	38	39
11	38	37	11	11	11	38	38	37	39	37	38	38
12	38	37	11	11	11	38	39	38	38	37	38	38
13	38	37	11	11	11	39	39	38	38	37	38	38
14	38	36	11	11	11	39	39	38	38	38	38	38
15	38	36	11	11	11	38	38	38	37	38	38	38
16	38	23	11	11	11	38	37	38	37	38	38	38
17	38	10	11	11	11	38	37	38	37	38	38	38
18	38	10	11	11	11	39	37	e37	37	37	38	38
19	38	11	10	11	11	39	37	e37	37	38	38	39
20	38	10	10	11	e11	39	37	e37	37	37	38	38
21	38	11	10	11	e11	39	37	37	37	37	38	38
22	37	11	10	11	e266	38	37	37	37	38	38	38
23	38	10	10	11	e871	38	37	37	37	38	38	38
24	38	10	11	11	e975	39	37	37	37	38	38	38
25	38	10	11	11	e635	39	37	37	37	37	38	38
26	37	10	10	11	e86	39	37	37	37	37	38	39
27	37	10	10	11	e14	39	37	37	37	37	38	38
28	37	10	10	11	13	38	37	37	37	37	38	38
29	37	10	10	11	---	37	37	37	37	38	37	38
30	37	11	10	11	---	37	37	36	37	38	38	38
31	37	---	10	11	---	38	---	37	---	38	38	---
TOTAL	1171	720	327	336	3091	991	1126	1154	1121	1161	1176	1144
MEAN	37.77	24.00	10.55	10.84	110.4	31.97	37.53	37.23	37.37	37.45	37.94	38.13
MAX	38	37	11	11	975	39	39	38	39	38	38	39
MIN	37	10	10	10	11	11	37	36	37	37	37	38
AC-FT	2320	1430	649	666	6130	1970	2230	2290	2220	2300	2330	2270
a	5480	13300	27150	63940	39270	59720	85880	107900	58150	37580	41240	46260

e Estimated.

a Diversion, in acre-feet, to White Rock Powerplant (station 11443460), provided by Sacramento Municipal Utility District.

SACRAMENTO RIVER BASIN

11443500 SOUTH FORK AMERICAN RIVER NEAR CAMINO, CA—Continued

STATISTICS OF MONTHLY MEAN DATA FOR WATER YEARS 1923 - 1957, BY WATER YEAR (WY)

	OCT	NOV	DEC	JAN	FEB	MAR	APR	MAY	JUN	JUL	AUG	SEP
MEAN	54.8	254	569	601	855	1171	2069	2681	1557	285	39.7	31.1
MAX	221	3951	4780	3422	2125	3367	4015	6382	4031	1310	168	150
(WY)	1952	1951	1951	1956	1927	1943	1952	1952	1952	1952	1951	1951
MIN	4.43	5.46	12.9	43.0	116	146	620	418	13.8	1.97	2.01	6.97
(WY)	1930	1930	1950	1929	1929	1924	1924	1934	1924	1931	1931	1955

SUMMARY STATISTICS

WATER YEARS 1923 - 1957

ANNUAL MEAN	846
HIGHEST ANNUAL MEAN	1760 1951
LOWEST ANNUAL MEAN	161 1924
HIGHEST DAILY MEAN	40000 Dec 23 1955
LOWEST DAILY MEAN	1.3 Aug 24 1931
ANNUAL SEVEN-DAY MINIMUM	1.5 Jul 29 1931
MAXIMUM PEAK FLOW	49800 Dec 23 1955
MAXIMUM PEAK STAGE	32.6 Dec 23 1955
ANNUAL RUNOFF (AC-FT)	612700
10 PERCENT EXCEEDS	2520
50 PERCENT EXCEEDS	230
90 PERCENT EXCEEDS	13

STATISTICS OF MONTHLY MEAN DATA FOR WATER YEARS 1923 - 1957, COMBINED RIVER PLUS FLUME, BY WATER YEAR (WY)

	1923	1930	1930	1924	1929	1933	1924	1924	1934	1924	1931	1931	1924
MEAN	167	364	684	713	959	1259	2176	2815	1695	413	154	142	142
MAX	288	4051	4780	3422	2229	3490	4181	6552	4201	1474	324	227	227
(WY)	1948	1951	1951	1956	1927	1943	1952	1952	1952	1952	1952	1952	1952
MIN	44.1	49.8	134	141	212	252	727	533	97.3	50.2	35.5	53.4	53.4
(WY)	1930	1930	1924	1929	1933	1924	1924	1934	1924	1931	1931	1924	1924

SUMMARY STATISTICS

WATER YEARS 1923 - 1957

ANNUAL MEAN	960
HIGHEST ANNUAL MEAN	1860 1952
LOWEST ANNUAL MEAN	249 1924
HIGHEST DAILY MEAN	40000 Dec 23 1955
LOWEST DAILY MEAN	20 Aug 24 1931
ANNUAL SEVEN-DAY MINIMUM	30 Aug 19 1931
ANNUAL RUNOFF (AC-FT)	695700
10 PERCENT EXCEEDS	2660
50 PERCENT EXCEEDS	350
90 PERCENT EXCEEDS	120

STATISTICS OF MONTHLY MEAN DATA FOR WATER YEARS 1968 - 2002, BY WATER YEAR (WY)

	1968	1968	1984	1997	1986	1986	1971	1995	1995	1995	1995	1980	1980
MEAN	46.95	83.12	126.1	320.7	218.4	121.1	120.5	316.2	282.0	79.61	35.07	35.00	35.00
MAX	453	1093	1112	4836	2709	1090	1402	2434	2619	936	45.1	48.2	48.2
(WY)	1968	1968	1984	1997	1986	1986	1971	1995	1995	1995	1980	1980	1980
MIN	9.97	10.2	10.0	10.0	5.63	10.9	10.0	9.73	9.98	9.93	10.4	10.1	10.1
(WY)	1978	1978	1988	1988	1970	1992	1988	1977	1977	1977	1977	1977	1977

SUMMARY STATISTICS

FOR 2001 CALENDAR YEAR

FOR 2002 WATER YEAR

WATER YEARS 1968 - 2002

ANNUAL TOTAL	10576	13518	
ANNUAL MEAN	28.98	37.04	148.4
HIGHEST ANNUAL MEAN			608 1995
LOWEST ANNUAL MEAN			13.3 1977
HIGHEST DAILY MEAN	40 Jan 1	975 Feb 24	48900 Jan 2 1997
LOWEST DAILY MEAN	10 May 18	10 Nov 17	2.4 Feb 12 1970
ANNUAL SEVEN-DAY MINIMUM	10 May 18	10 Nov 23	2.6 Feb 9 1970
MAXIMUM PEAK FLOW		1410 Feb 23	62300 Jan 2 1997
ANNUAL RUNOFF (AC-FT)	20980	26810	107500
ANNUAL DIVERSION (AC-FT) a	284900	585800	
10 PERCENT EXCEEDS	39	38	71
50 PERCENT EXCEEDS	37	37	36
90 PERCENT EXCEEDS	11	11	11

a Diversion, in acre-feet, to White Rock Powerplant (station 11443460), provided by Sacramento Municipal Utility District.

11444201 ROCK CREEK NEAR PLACERVILLE, CA

LOCATION.—Lat 38°47'39", long 120°46'28", in NE 1/4 NW 1/4 sec.20, T.11 N., R.11 E., El Dorado County, Hydrologic Unit 18020129, on left bank, 500 ft downstream from Rock Creek Road, and 4.0 mi north of Placerville.

DRAINAGE AREA.—73.0 mi².

PERIOD OF RECORD.—October 1986 to current year.

GAGE.—Water-stage recorder and broad-crested weir; water-stage recorder and sharp-crested weir. Elevation of gages is 1,305 ft above sea level, from topographic map.

REMARKS.—Flow at this station has two components which are combined for publication: flow over a broad-crested weir (station 11444200) and flow over a sharp-crested weir (station 11444260). Water is diverted upstream from weirs through a tunnel to Rock Creek Powerplant (station 11444280), returning to Rock Creek at its confluence with the South Fork American River. Extremes also represent combined flows. See schematic diagram of [South Fork American River Basin](#).

COOPERATION.—Records provided by Sithe Energies, Inc., under general supervision of the U.S. Geological Survey, in connection with Federal Energy Regulatory Commission project no. 3189.

EXTREMES FOR PERIOD OF RECORD.—Maximum discharge, 6,690 ft³/s, Jan. 2, 1997; no flow Sept. 29 to Oct. 3, 1987.

DISCHARGE, CUBIC FEET PER SECOND, WATER YEAR OCTOBER 2001 TO SEPTEMBER 2002
DAILY MEAN VALUES

DAY	OCT	NOV	DEC	JAN	FEB	MAR	APR	MAY	JUN	JUL	AUG	SEP
1	8.9	14	30	91	22	21	21	33	28	16	13	10
2	8.5	13	143	123	22	21	25	39	27	16	13	9.7
3	8.2	12	133	245	22	21	23	38	25	16	13	9.6
4	8.2	12	23	80	22	22	22	36	25	16	13	9.5
5	8.4	11	25	41	22	22	22	35	23	16	13	9.7
6	8.8	11	53	29	36	103	22	35	22	16	13	9.9
7	9.1	11	22	21	36	336	22	35	22	16	13	9.9
8	9.4	12	26	21	38	143	22	35	22	14	13	9.9
9	9.3	11	41	21	28	45	24	34	21	14	12	9.7
10	8.9	11	36	21	23	27	26	34	21	14	12	9.4
11	8.8	14	29	22	21	22	23	34	21	13	12	9.4
12	8.8	30	27	21	22	22	23	33	20	13	11	9.5
13	8.5	32	25	22	21	22	28	32	23	12	11	9.2
14	8.7	16	45	22	21	26	22	31	25	12	10	9.1
15	8.6	15	22	22	21	31	25	32	23	12	10	8.9
16	8.4	15	22	22	23	71	38	31	23	12	10	9.3
17	8.4	16	82	35	68	29	23	31	22	12	10	9.7
18	8.6	16	49	37	23	21	23	29	22	12	10	9.7
19	8.8	16	22	36	133	22	23	30	20	12	10	9.2
20	8.8	18	58	36	585	30	24	54	21	12	10	8.9
21	8.7	24	62	36	123	21	24	31	20	12	10	8.9
22	8.9	70	33	22	40	22	25	23	20	12	10	8.8
23	9.1	30	100	37	21	187	24	24	20	12	10	8.8
24	9.1	27	36	35	21	412	25	37	20	12	11	8.8
25	9.1	21	22	34	23	187	29	35	18	13	11	8.8
26	9.1	32	21	96	37	82	39	33	18	13	10	8.8
27	9.1	23	21	60	21	75	29	31	18	13	10	9.0
28	9.1	20	22	22	21	71	24	30	18	13	9.9	10
29	9.6	26	47	22	---	40	24	30	18	13	9.9	11
30	14	25	31	22	---	31	24	29	18	13	10	12
31	19	---	225	22	---	25	---	29	---	13	10	---
TOTAL	288.9	604	1533	1376	1516	2210	748	1023	644	415	343.8	285.1
MEAN	9.319	20.13	49.45	44.39	54.14	71.29	24.93	33.00	21.47	13.39	11.09	9.503
MAX	19	70	225	245	585	412	39	54	28	16	13	12
MIN	8.2	11	21	21	21	21	21	23	18	12	9.9	8.8
AC-FT	573	1200	3040	2730	3010	4380	1480	2030	1280	823	682	565
a	0.00	167	2280	2130	2550	4020	2040	299	0.00	0.00	0.00	0.00

a Discharge, in acre-feet, through Rock Creek Powerplant (station 11444280) near Placerville, provided by Sithe Energies U.S.A., Inc.

SACRAMENTO RIVER BASIN

11444201 ROCK CREEK NEAR PLACERVILLE, CA—Continued

STATISTICS OF MONTHLY MEAN DATA FOR WATER YEARS 1987 - 2002, BY WATER YEAR (WY)

	OCT	NOV	DEC	JAN	FEB	MAR	APR	MAY	JUN	JUL	AUG	SEP
MEAN	13.66	21.14	55.02	135.6	112.5	90.99	38.45	32.28	19.34	14.38	12.12	10.53
MAX	25.0	36.6	403	737	326	454	99.6	127	31.5	35.2	39.2	25.7
(WY)	2001	1999	1997	1997	1998	1995	1995	1995	1995	1999	1999	1998
MIN	4.60	6.15	9.97	11.4	12.5	16.4	16.6	11.3	6.35	3.18	1.97	1.86
(WY)	1993	1993	1990	1991	1991	1988	1994	1992	1992	1988	1994	1992

SUMMARY STATISTICS	FOR 2001 CALENDAR YEAR		FOR 2002 WATER YEAR		WATER YEARS 1987 - 2002	
ANNUAL TOTAL	8550.3		10986.8			
ANNUAL MEAN	23.43		30.10		46.10	
ANNUAL MEAN a	35.7		48.7		61.4	
HIGHEST ANNUAL MEAN					118	1997
LOWEST ANNUAL MEAN					14.3	1988
HIGHEST DAILY MEAN	225	Dec 31	585	Feb 20	4660	Jan 2 1997
LOWEST DAILY MEAN	5.5	Sep 8	8.2	Oct 3	0.00	Sep 29 1987
ANNUAL SEVEN-DAY MINIMUM	5.6	Sep 5	8.6	Oct 12	0.35	Sep 28 1987
MAXIMUM PEAK FLOW					6690	Jan 2 1997
ANNUAL RUNOFF (AC-FT)	16960		21790		33400	
TOTAL DIVERSION (AC-FT) b	8850		13490		11100	
ANNUAL RUNOFF (AC-FT) a	25810		35280			
10 PERCENT EXCEEDS	36		40		66	
50 PERCENT EXCEEDS	21		22		21	
90 PERCENT EXCEEDS	7.3		9.2		5.2	

a Adjusted for Rock Creek Powerplant near Placerville.

b Discharge, in acre-feet, through Rock Creek Powerplant (station 11444280) near Placerville, provided by Sithe Energies U.S.A., Inc.

11444500 SOUTH FORK AMERICAN RIVER NEAR PLACERVILLE, CA

LOCATION.—Lat 38°46'16", long 120°48'55", in NE 1/4 SW 1/4 sec.25, T.11 N., R.10 E., El Dorado County, Hydrologic Unit 18020129, on right bank, 700 ft downstream from Chili Bar Dam, 0.5 mi upstream from Big Canyon, and 2.5 mi north of Placerville.

DRAINAGE AREA.—598 mi².

PERIOD OF RECORD.—August 1911 to July 1920 (monthly discharge only for some periods, published in WSP 1315-A), July 1964 to current year.

REVISED RECORDS.—WSP 1931: Drainage area.

GAGE.—Water-stage recorder. Elevation of gage is 925 ft above sea level, from topographic map. Aug. 11, 1911, to July 31, 1920, nonrecording gage 0.6 mi downstream at different datum.

REMARKS.—Flow regulated by Chili Bar Reservoir, capacity, 3,700 acre-ft, Chili Bar Powerplant, and other storage and powerplants (see station 11443500). See schematic diagrams of [South Fork American River](#) and [lower Sacramento River Basins](#).

COOPERATION.—Records provided by Pacific Gas & Electric Co., under general supervision of the U.S. Geological Survey, in connection with Federal Energy Regulatory Commission project no. 2155.

EXTREMES FOR PERIOD OF RECORD.—Maximum discharge, 71,000 ft³/s, Jan. 2, 1997, gage height unknown, on basis of computations of flow over dam, maximum gage height, 17.4 ft, from floodmarks, datum then in use, Dec. 23, 1964; minimum daily, 0.2 ft³/s, Nov. 12, 1964.

DISCHARGE, CUBIC FEET PER SECOND, WATER YEAR OCTOBER 2001 TO SEPTEMBER 2002

DAILY MEAN VALUES

DAY	OCT	NOV	DEC	JAN	FEB	MAR	APR	MAY	JUN	JUL	AUG	SEP
1	126	134	472	976	2190	2380	1880	2470	1470	1200	1230	767
2	128	129	456	1450	1090	633	1910	1810	1970	554	1020	1530
3	126	129	1030	1100	1340	273	2490	584	1610	540	947	877
4	125	129	643	953	879	617	2050	1110	1880	530	533	621
5	123	129	350	1290	1010	1240	2680	1630	2530	537	745	1190
6	123	129	184	1320	464	1730	649	1840	2060	591	559	1910
7	127	129	184	1660	580	2660	862	2300	2170	525	473	610
8	127	126	184	1190	1270	2800	2410	1810	829	427	581	504
9	126	127	184	1700	1110	1100	2330	1920	1080	1120	953	391
10	125	127	479	1510	1130	1180	1840	1910	1110	735	518	674
11	124	129	257	1310	1440	1370	1640	573	1900	491	1100	1520
12	125	320	1040	1090	1380	730	1430	553	1530	499	1210	890
13	126	139	1090	826	1210	756	1300	1690	1820	465	765	1420
14	125	374	844	1350	724	1810	1520	1950	1490	671	527	1390
15	124	344	739	1440	1400	1830	2800	1700	721	503	817	591
16	122	358	634	1660	675	884	2420	1830	523	495	633	952
17	122	134	351	1260	1240	438	1300	2450	210	766	588	913
18	123	134	720	1540	1160	931	1430	1310	527	949	669	852
19	122	152	839	628	424	1440	1270	1420	522	860	197	1370
20	121	172	798	578	1080	1070	718	2640	530	1090	518	1020
21	126	129	906	448	658	1340	611	2840	551	527	589	516
22	130	138	553	1650	644	1700	1130	2560	553	444	520	802
23	129	417	179	1280	1160	595	2270	2500	539	682	501	1650
24	127	390	184	1100	1440	728	2130	2730	226	1410	518	1050
25	126	764	191	1150	1040	1820	1700	2570	1050	762	527	935
26	125	801	440	1940	1270	711	1290	1920	602	784	411	429
27	128	505	869	832	1640	2060	1440	1860	530	581	1150	205
28	128	445	1810	1750	674	2130	909	2300	531	452	1180	209
29	127	649	634	1400	---	1190	471	2290	836	325	848	202
30	146	525	610	887	---	835	1710	2620	978	859	1670	207
31	133	---	1360	736	---	228	---	1550	---	952	885	---
TOTAL	3915	8307	19214	38004	30322	39209	48590	59240	32878	21326	23382	26197
MEAN	126.3	276.9	619.8	1226	1083	1265	1620	1911	1096	687.9	754.3	873.2
MAX	146	801	1810	1940	2190	2800	2800	2840	2530	1410	1670	1910
MIN	121	126	179	448	424	228	471	553	210	325	197	202
AC-FT	7770	16480	38110	75380	60140	77770	96380	117500	65210	42300	46380	51960

STATISTICS OF MONTHLY MEAN DATA FOR WATER YEARS 1965 - 2002, BY WATER YEAR (WY)

MEAN	507.9	756.1	1264	1802	1792	1927	2035	2496	1967	1168	957.6	835.4
MAX	935	3806	5386	9673	6613	5561	5382	6159	6496	3648	1719	1401
(WY)	1984	1984	1965	1997	1986	1983	1982	1995	1983	1983	1998	1995
MIN	126	106	320	188	125	124	255	295	228	88.2	142	206
(WY)	2002	1978	1977	1977	1977	1977	1977	1977	1977	1977	1977	2001

SUMMARY STATISTICS

	FOR 2001 CALENDAR YEAR	FOR 2002 WATER YEAR	WATER YEARS 1965 - 2002
ANNUAL TOTAL	182420	350584	
ANNUAL MEAN	499.8	960.5	1457
HIGHEST ANNUAL MEAN			3275
LOWEST ANNUAL MEAN			224
HIGHEST DAILY MEAN	1940	May 9	2840
LOWEST DAILY MEAN	121	Oct 20	121
ANNUAL SEVEN-DAY MINIMUM	123	Oct 14	123
MAXIMUM PEAK FLOW			4290
MAXIMUM PEAK STAGE		6.74	Mar 7
ANNUAL RUNOFF (AC-FT)	361800	695400	1056000
10 PERCENT EXCEEDS	1030		1910
50 PERCENT EXCEEDS	380		826
90 PERCENT EXCEEDS	129		129

11446030 SOUTH FORK AMERICAN RIVER NEAR PILOT HILL, CA

LOCATION.—Lat 38°45'47", long 121°00'26", in SE 1/4 NE 1/4 sec.31, T.11 N., R.9 E., [El Dorado County](#), Hydrologic Unit 18020128, on left bank, 0.1 mi downstream from Weber Creek, and 5.0 mi south of Pilot Hill.

DRAINAGE AREA.—801 mi².

PERIOD OF RECORD.—Water year 1999 to current year.

WATER TEMPERATURE: Water year 1999 to current year.

PERIOD OF DAILY RECORD.—

WATER TEMPERATURE: August 1999 to current year.

INSTRUMENTATION.—Water-temperature recorder since Aug. 4, 1999.

REMARKS.—Water-temperature records rated excellent except for Dec. 6 to Jan. 30, and Mar. 3–10, which are rated good. Period of missing record due to vandalism at site. Water temperature can be affected by upstream powerplant releases.

EXTREMES FOR PERIOD OF DAILY RECORD.—

WATER TEMPERATURE: Maximum recorded, 25.5°C, Aug. 17, 2001, but may have been higher during periods of missing record; minimum recorded, 3.0°C, Jan. 23, 24, 30, 31, Feb. 2–5, 2002.

EXTREMES FOR CURRENT YEAR.—

WATER TEMPERATURE: Maximum recorded, 24.0°C, June 25, July 8, 14; minimum recorded, 3.0°C, Jan. 23, 24, 30, 31, Feb. 2–5.

CROSS-SECTIONAL DATA, WATER YEAR OCTOBER 2001 TO SEPTEMBER 2002

DATE	TIME	DEPTH BOTTOM AT SAMPLE LOC- ATION, (FEET) (81903)	TEMPER- ATURE WATER (DEG C) (00010)	SAMPLE LOC- ATION, CROSS SECTION (FT FM L BANK) (00009)
AUG				
23...*	1305	1.50	17.5	4.00
23...*	1306	2.30	17.5	11.0
23...*	1307	3.00	17.5	18.0
23...*	1308	2.50	17.5	25.0
23...*	1309	1.80	17.5	32.0
23...*	1310	2.00	17.5	39.0
23...*	1311	1.80	17.5	46.0
23...*	1312	1.30	17.5	53.0
23...*	1313	1.50	17.5	60.0
23...*	1314	1.00	17.5	67.0

* Estimated discharge at time of cross-sectional measurement: 194 ft³/s.

11446030 SOUTH FORK AMERICAN RIVER NEAR PILOT HILL, CA—Continued

WATER TEMPERATURE, (DEGREES C), WATER YEAR OCTOBER 2001 TO SEPTEMBER 2002

DAY	MAX	MIN	MAX	MIN	MAX	MIN	MAX	MIN	MAX	MIN	MAX	MIN
	OCTOBER		NOVEMBER		DECEMBER		JANUARY		FEBRUARY		MARCH	
1	21.5	19.5	16.0	15.0	10.0	9.5	9.5	8.0	5.0	3.5	8.5	6.5
2	22.0	20.0	15.5	14.5	10.0	9.5	10.5	8.0	5.0	3.0	8.5	5.5
3	22.0	20.0	15.5	14.0	10.0	9.0	10.5	9.0	5.0	3.0	9.0	7.0
4	22.0	20.0	15.5	14.0	9.0	8.0	9.5	8.0	5.5	3.0	10.0	7.5
5	21.5	20.0	15.5	14.0	9.0	8.5	9.0	7.5	5.0	3.0	10.0	7.0
6	20.0	19.0	15.0	14.0	10.5	8.5	9.0	7.5	5.5	4.0	9.5	7.0
7	20.0	18.5	14.5	13.5	10.5	9.5	8.5	7.0	6.0	5.0	9.5	8.0
8	20.0	18.5	14.0	13.0	10.0	8.5	8.0	6.5	7.5	5.0	9.0	6.5
9	19.5	18.0	14.0	13.0	9.0	8.0	7.5	6.5	6.0	4.0	8.5	6.5
10	18.5	17.0	14.0	13.0	8.5	7.5	7.5	6.0	6.5	4.0	9.5	7.5
11	18.5	17.0	15.0	13.5	7.5	6.5	7.0	6.0	6.0	4.0	---	---
12	18.0	16.5	15.0	13.5	8.0	6.0	7.0	6.0	6.0	4.5	---	---
13	18.0	16.5	14.5	13.5	7.5	6.5	7.0	6.0	5.5	4.5	---	---
14	18.0	16.5	15.0	13.5	8.0	7.0	6.0	5.5	7.5	5.0	---	---
15	18.0	17.0	15.0	14.5	7.0	5.5	6.0	4.5	7.0	5.0	---	---
16	18.0	17.0	14.5	13.5	7.0	5.5	5.5	4.0	7.5	5.5	---	---
17	18.5	17.0	14.5	13.5	8.5	6.5	6.0	4.5	8.0	6.0	---	---
18	18.0	16.5	14.5	13.5	8.5	7.5	5.5	4.0	7.5	5.5	---	---
19	17.5	16.5	14.0	13.5	8.0	6.5	5.0	3.5	9.0	6.0	---	---
20	17.5	16.0	14.0	13.5	7.5	7.0	5.0	4.0	10.0	9.0	9.5	---
21	17.5	16.0	13.5	13.0	8.0	6.5	5.0	4.5	11.0	8.5	10.0	6.5
22	17.0	15.5	14.0	13.0	8.0	7.0	5.5	4.0	11.0	9.0	9.0	7.0
23	17.0	15.5	13.5	12.5	8.5	7.0	5.0	3.0	11.0	10.0	10.5	8.0
24	16.5	15.0	13.0	12.0	8.0	6.5	5.0	3.0	10.5	7.5	11.5	9.0
25	16.0	14.5	12.0	11.5	7.5	6.0	5.0	3.5	9.5	6.5	11.0	8.5
26	16.0	14.5	12.0	10.5	8.5	7.5	5.5	4.5	9.5	7.0	12.0	8.0
27	16.0	15.0	10.5	9.5	8.5	7.5	6.0	4.5	9.5	7.0	12.0	8.0
28	16.0	15.0	10.0	9.5	8.0	6.5	5.5	4.0	9.5	6.5	11.5	8.0
29	16.0	15.0	10.0	9.0	9.0	7.0	5.0	3.5	---	---	12.5	8.5
30	16.5	15.5	10.5	9.5	9.5	8.5	4.5	3.0	---	---	12.5	9.0
31	16.5	15.0	---	---	10.5	8.5	4.5	3.0	---	---	14.5	11.0
MONTH	22.0	14.5	16.0	9.0	10.5	5.5	10.5	3.0	11.0	3.0	---	---
	APRIL		MAY		JUNE		JULY		AUGUST		SEPTEMBER	
1	15.5	11.0	11.5	9.0	16.0	12.5	22.5	18.5	19.5	16.0	17.5	14.5
2	13.5	10.0	12.0	8.5	16.5	12.0	22.0	18.5	18.5	15.5	17.5	15.0
3	13.0	10.0	13.0	9.0	17.0	12.5	23.0	20.0	19.0	15.5	16.5	13.0
4	11.5	10.5	16.0	12.0	18.0	13.0	23.0	20.0	18.5	15.5	16.5	14.0
5	11.5	10.5	14.5	10.0	17.5	13.5	23.5	20.5	20.0	16.5	16.0	14.5
6	13.5	10.0	12.5	9.5	17.5	13.5	23.5	20.5	18.5	15.0	15.0	13.0
7	14.5	12.0	13.0	9.5	18.0	14.0	23.0	20.0	20.0	16.0	15.0	11.5
8	14.0	11.0	14.0	9.5	17.5	14.0	24.0	20.0	20.5	17.0	16.5	13.5
9	11.0	10.0	13.5	10.0	18.0	15.0	23.0	21.0	19.5	17.5	17.5	14.0
10	13.5	10.0	14.5	10.5	18.0	14.0	22.5	18.0	18.5	15.5	17.5	15.0
11	13.5	10.5	15.0	10.5	18.5	15.0	23.0	20.5	20.0	17.0	16.0	14.0
12	14.0	10.5	16.0	13.5	18.0	14.0	23.5	20.5	19.0	14.5	15.5	12.0
13	14.5	10.5	17.0	12.5	18.0	14.0	23.5	20.5	18.0	14.0	15.5	13.5
14	15.5	11.0	15.5	11.0	17.5	13.5	24.0	20.5	18.5	16.0	15.0	11.5
15	12.5	10.5	15.0	11.0	18.0	14.0	22.0	20.0	20.0	17.0	14.5	11.5
16	11.0	9.5	15.5	11.5	19.5	16.5	22.5	19.0	18.5	16.0	16.0	13.5
17	11.0	9.5	15.0	11.5	21.0	17.0	22.5	19.5	19.0	17.0	15.0	12.0
18	11.5	9.0	15.0	11.5	22.5	19.5	20.5	18.5	19.5	16.5	15.0	12.0
19	11.0	8.0	14.5	11.5	22.0	19.0	21.0	17.5	19.0	17.0	15.0	12.5
20	12.0	8.0	13.0	12.0	22.5	19.5	21.0	18.0	20.0	17.5	15.5	11.5
21	12.5	10.5	13.0	11.5	21.5	19.0	20.5	16.5	19.5	16.5	15.0	11.5
22	15.0	11.0	13.0	10.0	21.5	18.5	22.0	18.0	19.5	17.0	17.0	14.0
23	12.0	9.0	12.5	9.5	22.0	19.0	21.5	18.5	19.5	16.5	15.0	12.5
24	12.0	9.0	13.0	9.5	23.0	19.0	19.5	18.0	19.5	16.5	15.0	11.5
25	14.0	9.5	13.0	9.5	24.0	21.0	19.5	15.0	19.5	16.5	15.5	11.5
26	11.5	10.5	14.0	10.0	21.0	18.0	19.0	17.0	20.0	16.5	15.0	11.5
27	11.5	10.5	14.5	10.5	22.5	19.5	20.0	17.5	20.0	17.5	15.5	13.5
28	13.0	10.0	13.5	10.5	23.0	20.5	21.5	18.5	18.0	14.5	15.5	14.0
29	12.5	10.5	15.0	11.0	23.0	20.0	22.5	18.5	17.5	14.0	16.0	14.5
30	13.0	10.0	15.0	11.5	22.5	20.0	22.5	19.5	17.0	15.0	16.0	14.5
31	---	---	16.5	11.5	---	---	19.5	17.0	17.0	13.5	---	---
MONTH	15.5	8.0	17.0	8.5	24.0	12.0	24.0	15.0	20.5	13.5	17.5	11.5

11446200 FOLSOM LAKE NEAR FOLSOM, CA

LOCATION.—Lat 38°42'29", long 121°09'22", in NW 1/4 NE 1/4 sec.24, T.10 N., R.7 E., [Sacramento County](#), Hydrologic Unit 18020128, near center of dam on American River, 0.7 mi downstream from South Fork American River, and 2.3 mi northeast of Folsom.

DRAINAGE AREA.—1,861 mi².

PERIOD OF RECORD.—February 1955 to current year. Prior to October 1959, published as "Folsom Reservoir near Folsom".

REVISED RECORDS.—WSP 1931: Drainage area.

GAGE.—Water-stage recorder. Datum of gage is sea level (levels by U.S. Bureau of Reclamation).

REMARKS.—Reservoir is formed by concrete gravity-type dam with rolled-earth-wing dams, auxiliary dams, and dikes, completed May 14, 1956; storage began Feb. 25, 1955. Total capacity, 1,010,300 acre-ft, between elevations 205.5 ft, invert of lower tier of river outlets, and 466.0 ft gross pool elevation, all of which are available for release. Spillway design flood pool elevation, 475.4 ft, capacity, 1,120,200 acre-ft. Records, including extremes, represent usable contents at 2400 hours. See schematic diagram of [lower Sacramento River Basin](#).

COOPERATION.—Records provided by U.S. Bureau of Reclamation.

EXTREMES FOR PERIOD OF RECORD.—Maximum contents, 1,024,400 acre-ft, June 15, 1963, elevation, 467.23 ft; minimum since storage pool first filled, 140,600 acre-ft, Nov. 20, 21, 1977, elevation, 347.57 ft.

EXTREMES FOR CURRENT YEAR.—Maximum contents, 834,700 acre-ft, June 7, elevation, 452.82 ft; minimum, 255,500 acre-ft, Nov. 21, elevation, 378.91 ft.

Capacity table (elevation, in feet, and contents, in acre-feet)
(Based on survey by U.S. Bureau of Reclamation in 1992)

345	123,600	370	210,500	400	376,900	460	908,400
350	137,900	380	258,600	420	525,500	479	1,125,000
360	170,600	390	314,100	440	703,800		

RESERVOIR STORAGE, (ACRE-FEET), WATER YEAR OCTOBER 2001 TO SEPTEMBER 2002

DAILY OBSERVATION AT 2400 HOURS

DAY	OCT	NOV	DEC	JAN	FEB	MAR	APR	MAY	JUN	JUL	AUG	SEP
1	365100	285800	261800	347500	484900	607600	723800	760800	823700	764300	608000	545600
2	362300	283800	266000	358700	486600	611000	727800	762200	825400	762100	605500	545700
3	359000	282100	274400	374700	488400	611400	734100	761900	826400	758900	603000	545200
4	355900	280500	277200	384200	489500	611200	739700	761100	828000	755400	599700	544000
5	352700	278700	278000	389700	491000	612800	747000	761800	830900	751200	596000	543400
6	350100	276800	279500	396300	491300	621300	749600	764500	832600	746300	593200	544200
7	347400	274900	280200	404500	492800	643200	751200	767600	834700	741600	590400	543800
8	345100	273000	280400	410900	496500	655600	753900	770200	834300	736700	587600	542600
9	342700	270900	280000	416400	499200	660000	757700	772000	832500	732600	585600	540200
10	340200	269300	280300	421500	501100	663400	759700	774200	832600	728500	583400	538900
11	337200	267500	279600	425600	504700	666700	762300	773800	831900	722900	581300	538500
12	334600	266800	279300	428800	507300	667900	763000	772300	832100	717300	579500	538500
13	332700	266100	280600	431400	510300	668100	764200	771700	830700	711500	577800	537100
14	329900	265400	283100	434400	512000	669900	765200	773200	829200	705000	575700	536500
15	327200	264300	284600	438500	514300	672400	769500	775500	826100	699200	573300	535400
16	324500	263100	285000	442000	517200	673500	772300	777300	822300	693100	571100	533700
17	321700	261600	286000	445700	520500	674000	772200	779700	817700	687400	568500	532400
18	319100	259900	288300	449100	523900	674000	771500	781100	813500	682100	565900	530800
19	316400	258600	290800	450800	528200	674500	770200	781900	809700	677200	562600	529800
20	313800	256900	294600	451200	547900	675100	767600	785700	806000	672300	559800	529000
21	311200	255500	298100	451700	560500	676000	764100	791200	802200	667200	557600	527300
22	308800	255800	301100	454500	568900	678500	761100	794300	797900	661100	555400	525100
23	306400	256700	305400	456900	576200	684500	762000	797400	793500	654100	553600	524500
24	303800	256900	307700	458800	583200	691200	762800	800700	789300	648400	551800	523700
25	301400	260800	307700	460900	588500	697100	763000	804800	785600	642500	550500	522100
26	298900	261600	308500	464600	593500	701100	762600	807300	782500	636600	548500	520600
27	296100	261000	309700	469800	598800	705500	762600	808500	778300	630700	547500	517700
28	293800	260400	314600	473600	602400	711700	761500	811800	773700	625100	547700	515000
29	291700	260800	318900	477600	---	715900	759400	814600	769400	618200	547600	512500
30	289500	261900	324700	479500	---	719300	759100	819300	766500	613200	547500	509800
31	287400	---	337300	481000	---	720600	---	822200	---	610400	546700	---
MAX	365100	285800	337300	481000	602400	720600	772300	822200	834700	764300	608000	545700
MIN	287400	255500	261800	347500	484900	607600	723800	760800	766500	610400	546700	509800
a	384.90	380.16	393.42	414.11	428.73	441.47	445.40	451.62	446.14	429.63	422.26	417.75
b	-80200	-25500	+75400	+143700	+121400	+118200	+38500	+63100	-55700	-156100	-63700	-36900
c	1726	228	54	0	0	1051	3662	5736	9031	7379	6637	7260

CAL YR 2001 b -195600

WTR YR 2002 b +142200

a Elevation, in feet, at end of month.

b Change in contents, in acre-feet.

c Total evaporation, in acre-feet, provided by U.S. Bureau of Reclamation; not reviewed by U.S. Geological Survey.

11446220 AMERICAN RIVER BELOW FOLSOM DAM, NEAR FOLSOM, CA

LOCATION.—Lat 38°42'14", long 121°09'48", in NE 1/4 SE 1/4 sec.24, T.10 N., R.7 E., [Sacramento County](#), Hydrologic Unit 18020111, on left bank, 0.3 mi downstream from Folsom Dam, and 1.5 mi north of Folsom.

DRAINAGE AREA.— 1,863 mi².

PERIOD OF RECORD.—October 1998 to current year.

WATER TEMPERATURE.—October 1998 to current year.

PERIOD OF DAILY RECORD.—

WATER TEMPERATURE.—October 1998 to current year.

INSTRUMENTATION.—Water-temperature recorder since Oct. 23, 1998.

REMARKS.—Water-temperature records rated excellent . Interruption in record due to malfunction of the recording instrument. Water temperature is affected by upstream releases from Folsom Dam.

EXTREMES FOR PERIOD OF DAILY RECORD.—

WATER TEMPERATURE: Maximum recorded, 21.0°C, several days in October 2001, but may have been higher during period of missing record; minimum recorded, 6.5°C, Feb. 9, 2002.

EXTREMES FOR CURRENT YEAR.—

WATER TEMPERATURE: Maximum recorded, 21.0°C, several days in October, but may have been higher during period of missing record; minimum recorded, 6.5°C, Feb. 9.

WATER TEMPERATURE, (DEGREES C), WATER YEAR OCTOBER 2001 TO SEPTEMBER 2002

DAY	MAX	MIN	MAX	MIN	MAX	MIN	MAX	MIN	MAX	MIN	MAX	MIN
	OCTOBER		NOVEMBER		DECEMBER		JANUARY		FEBRUARY		MARCH	
1	20.5	19.5	19.0	17.5	14.0	13.5	10.0	9.5	8.0	7.0	9.0	7.0
2	20.5	19.5	19.0	17.5	14.0	13.0	10.0	9.5	8.0	7.0	8.5	7.5
3	20.5	19.5	18.5	17.5	14.0	13.0	10.0	9.5	8.0	7.0	8.5	7.5
4	20.5	19.5	18.5	17.5	13.5	13.0	10.0	9.0	8.0	7.0	9.5	7.5
5	20.5	20.0	18.5	17.0	13.5	13.0	10.0	9.5	8.0	7.5	9.5	8.0
6	21.0	20.0	18.5	17.0	13.5	12.5	10.0	9.5	8.5	7.0	9.5	8.0
7	21.0	20.0	18.5	16.5	13.0	12.0	10.0	9.0	8.0	7.0	9.0	8.0
8	21.0	20.0	18.0	16.5	12.5	12.0	9.5	9.0	8.0	7.0	9.5	8.0
9	---	---	18.0	16.5	12.5	11.5	9.5	9.0	8.0	6.5	9.5	8.5
10	---	---	17.5	10.0	12.0	11.0	9.5	9.0	8.5	7.0	9.0	8.5
11	21.0	20.0	15.5	10.0	12.0	11.0	9.5	9.0	8.0	7.0	9.5	8.5
12	21.0	20.0	15.5	10.0	12.0	11.0	9.5	9.0	8.5	7.0	9.5	8.5
13	21.0	20.0	15.5	10.0	11.5	11.0	9.5	9.0	8.0	7.5	9.0	8.5
14	20.5	20.0	15.0	10.0	11.5	11.0	9.5	9.0	8.0	7.0	9.5	9.0
15	21.0	20.0	15.0	10.0	11.5	10.5	9.5	8.5	8.0	7.5	9.5	8.5
16	20.5	20.0	15.0	10.0	11.5	10.5	9.5	8.5	8.5	7.0	9.0	8.5
17	20.5	19.5	15.0	10.5	11.0	10.5	9.0	8.5	8.0	7.0	9.0	8.5
18	21.0	19.5	15.0	10.5	11.0	10.5	9.0	8.5	8.0	7.0	9.5	9.0
19	20.5	19.5	15.0	10.5	11.0	10.0	9.0	8.5	8.0	7.0	9.5	9.0
20	20.5	19.5	15.0	11.0	11.0	10.5	9.0	8.0	8.0	7.5	9.5	9.0
21	20.5	19.5	15.0	11.0	11.0	10.5	9.0	8.0	8.5	7.5	9.5	9.0
22	20.5	19.0	15.5	11.5	10.5	10.0	8.5	8.0	8.5	7.5	9.5	8.5
23	20.0	19.0	15.5	12.5	10.5	10.0	8.5	8.0	8.0	7.0	9.5	8.5
24	20.0	19.0	16.0	12.5	10.5	9.5	8.5	7.5	9.5	7.5	9.5	8.5
25	20.0	19.0	15.5	14.5	10.5	9.5	8.5	8.0	8.5	7.5	9.5	9.0
26	19.5	19.0	15.5	14.0	10.5	9.5	8.5	8.0	8.5	7.5	10.0	9.0
27	19.5	19.0	15.5	14.0	10.0	9.5	8.5	7.5	8.0	7.5	10.0	9.0
28	19.5	18.5	15.5	14.5	10.0	9.5	8.5	7.5	8.5	7.5	10.0	9.5
29	19.5	18.5	14.5	14.0	10.0	9.5	8.0	7.0	---	---	10.0	9.0
30	19.0	18.5	14.5	14.0	10.0	9.5	8.0	7.0	---	---	10.5	9.0
31	19.0	18.0	---	---	10.5	9.5	8.0	7.5	---	---	10.5	9.5
MONTH	---	---	19.0	10.0	14.0	9.5	10.0	7.0	9.5	6.5	10.5	7.0

SACRAMENTO RIVER BASIN

11446220 AMERICAN RIVER BELOW FOLSOM DAM, NEAR FOLSOM, CA—Continued

WATER TEMPERATURE, (DEGREES C), WATER YEAR OCTOBER 2001 TO SEPTEMBER 2002

DAY	MAX	MIN	MAX	MIN	MAX	MIN	MAX	MIN	MAX	MIN	MAX	MIN
	APRIL		MAY		JUNE		JULY		AUGUST		SEPTEMBER	
1	10.5	9.5	12.5	10.0	13.5	12.0	16.5	11.5	17.0	13.0	15.5	12.5
2	10.5	9.5	12.0	10.5	14.0	11.5	14.5	11.5	17.0	13.0	17.5	13.0
3	10.0	9.0	12.0	11.0	13.5	11.5	17.0	11.5	17.0	13.5	17.5	13.0
4	10.5	9.5	12.0	10.0	13.5	11.5	16.5	11.5	17.0	12.5	17.5	14.0
5	10.5	9.5	12.5	10.0	14.0	11.5	14.5	12.0	17.5	12.5	18.0	13.5
6	10.5	9.5	12.0	11.0	14.0	12.0	17.0	12.0	18.0	12.5	17.5	13.5
7	10.5	9.0	12.5	10.5	14.0	11.0	17.0	12.0	18.0	13.0	18.0	13.0
8	10.5	10.0	12.5	11.5	13.5	11.5	17.0	12.0	18.0	13.0	18.0	12.5
9	11.0	9.5	12.0	10.5	14.5	10.5	15.0	12.0	16.0	12.0	18.0	13.0
10	11.5	10.0	13.5	9.5	14.5	12.0	13.5	12.0	15.5	11.5	18.0	13.0
11	11.0	9.5	13.0	9.5	15.0	12.5	13.5	11.5	16.0	12.0	18.5	13.0
12	11.0	10.0	13.0	10.0	14.5	12.0	13.5	12.0	16.0	13.0	18.0	14.5
13	11.5	10.0	12.5	10.5	14.5	11.0	14.0	12.5	16.5	12.5	18.5	13.5
14	11.0	9.5	13.0	11.0	15.0	13.0	14.0	12.5	17.5	12.5	18.5	14.0
15	11.5	9.5	13.0	12.0	15.0	12.5	14.0	12.0	17.0	12.5	18.0	14.0
16	11.5	10.0	13.0	10.5	15.0	13.0	14.0	12.5	16.5	12.5	18.5	14.0
17	11.5	10.0	13.0	11.0	15.0	13.0	14.0	12.5	16.5	13.5	18.5	14.0
18	12.0	11.0	12.5	11.0	15.0	12.5	14.5	12.5	16.5	12.0	18.5	13.5
19	12.5	11.0	13.5	10.5	15.0	12.5	15.0	12.5	17.0	12.5	18.5	14.0
20	12.0	11.0	13.5	11.0	15.0	13.0	14.5	12.0	17.0	12.5	18.5	14.0
21	11.5	10.5	13.5	11.5	15.5	13.0	15.0	12.5	16.5	12.5	18.5	14.0
22	12.0	11.0	13.0	11.5	15.5	13.0	15.0	12.5	16.5	13.0	18.5	15.5
23	12.0	10.5	13.5	10.0	15.5	13.0	15.0	14.5	16.5	14.0	18.5	14.5
24	11.5	10.5	13.5	11.0	16.0	13.0	15.5	14.5	16.5	12.5	18.5	14.5
25	12.0	10.5	13.5	10.5	16.0	13.0	15.5	15.0	16.5	13.0	18.5	14.5
26	11.5	11.0	13.0	10.5	16.0	12.5	16.0	15.0	17.0	13.5	18.5	14.5
27	11.5	10.5	13.0	12.0	14.0	12.0	16.0	14.0	17.0	13.5	19.0	14.5
28	12.0	11.0	15.0	11.5	14.0	12.0	16.5	15.5	17.0	14.0	19.0	15.5
29	12.0	11.5	13.5	11.5	14.5	11.5	16.5	15.0	17.5	14.0	19.0	16.0
30	12.0	10.5	13.5	12.0	16.5	12.0	16.5	14.5	17.5	12.0	19.0	15.0
31	---	---	13.5	12.5	---	---	17.0	13.0	17.5	12.0	---	---
MONTH	12.5	9.0	15.0	9.5	16.5	10.5	17.0	11.5	18.0	11.5	19.0	12.5

11446500 AMERICAN RIVER AT FAIR OAKS, CA

LOCATION.—Lat 38°38'08", long 121°13'36", in SE 1/4 NE 1/4 sec.17, T.9 N., R.7 E., [Sacramento County](#), Hydrologic Unit 18020111, on right bank, 2,100 ft downstream from Nimbus Dam, 2.4 mi east of Fair Oaks, 8.1 mi downstream from South Fork, and at mile 22.2.

DRAINAGE AREA.—1,888 mi².

WATER-DISCHARGE RECORDS

PERIOD OF RECORD.—November 1904 to current year. Monthly discharge only for some periods, published in WSP 1315-A.

REVISED RECORDS.—WSP 1181: 1928(M). WSP 1515: 1907(M), 1910, 1931(M), 1943(M). WSP 1931: Drainage area.

GAGE.—Water-stage recorder. Datum of gage is 71.53 ft above sea level. See WSP 2131 for history of changes prior to July 15, 1970.

REMARKS.—Records good. Flow regulated by Folsom Lake (station 11446200) beginning Feb. 25, 1955. Some minor regulation of high flows by temporary pondage during period of construction January 1953 to February 1955. Diurnal fluctuations from Folsom Powerplant re-regulated by Nimbus Reservoir, capacity, 2,800 acre-ft, between normal operating elevations 118.5 and 125.0 ft, and by Nimbus Powerplant. Many diversions upstream from station for irrigation, municipal, and domestic water supply. Diversions for San Juan Suburban Water District, city of Folsom, city of Roseville, and State of California are made at Folsom Dam. Diversion to Folsom South Canal from Nimbus Reservoir started in June 1973. Some inflow from Bear and Yuba River Basins. See schematic diagram of [lower Sacramento River Basin](#).

EXTREMES FOR PERIOD OF RECORD.—Maximum discharge, 180,000 ft³/s, Nov. 21, 1950, gage height, 31.85 ft, site and datum then in use; minimum, 3.6 ft³/s, Aug. 16, 1924. Maximum discharge since regulation by Folsom Lake in 1955, 134,000 ft³/s, Feb. 19, 1986, gage height, 27.96 ft; minimum daily, 160 ft³/s, Apr. 17, 1955.

DISCHARGE, CUBIC FEET PER SECOND, WATER YEAR OCTOBER 2001 TO SEPTEMBER 2002

DAILY MEAN VALUES

DAY	OCT	NOV	DEC	JAN	FEB	MAR	APR	MAY	JUN	JUL	AUG	SEP
1	1520	988	944	1420	1480	1480	3080	3190	2280	2490	2510	1500
2	1560	966	1200	1420	1530	1490	3000	3070	2290	2480	2480	1500
3	1510	949	1200	1480	1480	2060	3000	3070	2290	2510	2480	1500
4	1520	951	1270	1470	1500	2090	3320	2810	2300	2570	2480	1500
5	1520	950	1450	1500	1500	2030	3360	2780	2300	2960	2480	1490
6	1280	957	1460	1510	1500	2000	3380	2780	2290	3080	2460	1480
7	1240	965	1470	1480	1520	2020	3370	2770	2290	3070	2140	1470
8	1250	975	1470	1460	1540	e3940	3360	2780	2290	3080	2010	1470
9	1250	978	1500	1470	1520	3950	3910	2790	2280	3080	2010	1470
10	1240	974	1490	1460	1490	3960	4000	2790	2280	e3440	2010	1460
11	1250	945	1490	1480	1480	3940	4010	2800	2270	e3550	2010	1460
12	1260	947	1470	1460	1500	3940	3990	2800	2280	e3550	2010	1470
13	1260	969	1470	1470	1540	3970	3990	2780	2850	3530	2000	1470
14	1270	970	1510	1440	1520	3630	4000	2790	3070	3530	2030	1470
15	1260	972	1480	e1440	1530	3600	4000	2770	3080	3530	2050	1460
16	1260	969	1480	e1430	1520	3150	4000	2770	3080	3520	2050	e1400
17	1230	972	1500	e1430	1520	3020	4010	2770	3080	3530	2050	e1470
18	1250	979	1500	1480	1530	3020	4010	2790	3080	3530	2040	e1460
19	1240	987	1480	1470	1520	3090	4020	2780	3090	3540	2050	e1470
20	1240	954	1490	1450	1510	3110	4000	2790	3070	3540	e1780	e1480
21	1240	964	1480	1480	1460	3070	4010	2790	3030	3540	e1760	e1460
22	1230	971	1470	1490	1450	3070	4020	2790	2980	3540	e1760	e1470
23	1230	971	1480	1490	1520	3050	3670	2790	2990	3890	e1750	e1470
24	1230	978	1470	1480	1530	3020	3560	2350	3030	3970	e1540	e1470
25	1240	984	1470	1470	1520	3050	3590	2280	3080	3990	e1520	e1470
26	1240	960	1500	1490	1510	2630	3570	2260	3080	3990	e1520	e1470
27	1260	953	1480	1470	1490	2440	3560	2270	3070	3670	1510	e1470
28	1240	955	1470	1470	1490	2440	3560	2280	3080	3540	1500	e1470
29	1240	951	1490	1480	---	2470	3570	2280	3070	e3560	1490	e1460
30	1180	952	1470	1480	---	2950	3560	2290	2660	e3150	1490	e1460
31	1090	---	1470	1540	---	3040	---	2300	---	e2640	1500	---
TOTAL	39830	28956	44574	45560	42200	90720	110480	83350	81910	103590	60470	44120
MEAN	1285	965.2	1438	1470	1507	2926	3683	2689	2730	3342	1951	1471
MAX	1560	988	1510	1540	1540	3970	4020	3190	3090	3990	2510	1500
MIN	1090	945	944	1420	1450	1480	3000	2260	2270	2480	1490	1400
AC-FT	79000	57430	88410	90370	83700	179900	219100	165300	162500	205500	119900	87510

e Estimated.

11446500 AMERICAN RIVER AT FAIR OAKS, CA—Continued

WATER-QUALITY RECORDS

PERIOD OF RECORD.—Water years 1960–65, October 1998 to current year.

WATER TEMPERATURE: Water years 1961–65, October 1998 to current year.

CHEMICAL DATA: Water years 1960–62.

PERIOD OF DAILY RECORD.—

WATER TEMPERATURE: Water years 1961–65, October 1998 to current year.

INSTRUMENTATION.—Water-temperature recorder since Oct. 29, 1998. Water-temperature probe was relocated 300 ft upstream on May 10, 2001, to obtain more representative stream temperatures.

REMARKS.—Water-temperature records rated excellent except for May 25 to July 11 and Aug. 31 to Sept. 26, which are rated good; and Sept. 27–30, which are rated fair. Water temperature is affected by upstream releases from Nimbus Dam. Interruption in record was due to malfunction of the recording instrument.

EXTREMES FOR PERIOD OF DAILY RECORD.—

WATER TEMPERATURE: Maximum recorded, 21.5°C, Oct. 1–4, 2001; minimum recorded, 7.5°C, Jan. 10, 1999, Jan. 30 to Feb. 1, 2002.

EXTREMES FOR CURRENT YEAR.—

WATER TEMPERATURE: Maximum recorded, 21.5°C, Oct. 1–4; minimum recorded, 7.5°C, Jan. 30 to Feb. 1.

CROSS-SECTIONAL DATA, WATER YEAR OCTOBER 2001 TO SEPTEMBER 2002

DATE	TIME	DEPTH BOTTOM AT SAMPLE LOC- ATION, (FEET) (81903)	TEMPER- ATURE WATER (DEG C) (00010)	SAMPLE LOC- ATION, CROSS SECTION (FT FM L BANK) (00009)
APR				
09...	0907	10.0	11.5	247
09...	0912	14.0	11.5	221
09...	0916	15.8	11.5	195
09...	0924	15.4	11.5	169
09...	0929	13.0	11.5	143
09...	0934	15.4	11.5	117
09...	0937	16.3	11.5	91.0
09...	0941	17.5	11.5	65.0
09...	0944	17.7	11.5	39.0
09...	0947	8.60	11.5	13.0
AUG				
08...	0952	9.00	17.0	238
08...	0956	12.3	17.0	213
08...	0959	11.8	17.0	188
08...	1002	12.1	17.0	163
08...	1012	11.3	17.0	138
08...	1016	14.5	17.0	113
08...	1021	14.7	17.0	88.0
08...	1024	17.3	17.0	63.0
08...	1027	16.8	17.0	38.0
08...	1030	10.6	17.5	13.0

* Instantaneous discharge at time of cross-sectional measurement: 4,020 ft³/s, Apr. 9, 2002; 2,020 ft³/s, Aug. 8, 2002.

SACRAMENTO RIVER BASIN

11446500 AMERICAN RIVER AT FAIR OAKS, CA—Continued

WATER TEMPERATURE (DEGREES C), WATER YEAR OCTOBER 2001 TO SEPTEMBER 2002

DAY	MAX	MIN	MAX	MIN	MAX	MIN	MAX	MIN	MAX	MIN	MAX	MIN
	OCTOBER		NOVEMBER		DECEMBER		JANUARY		FEBRUARY		MARCH	
1	21.5	20.0	20.0	18.0	13.5	13.0	11.5	11.0	8.0	7.5	9.5	9.0
2	21.5	20.0	20.0	18.0	13.5	13.0	11.5	11.0	8.0	8.0	9.5	9.0
3	21.5	20.5	20.0	17.5	14.0	13.0	11.5	11.0	8.0	8.0	9.5	9.0
4	21.5	20.0	20.0	17.5	14.0	13.0	11.5	11.0	8.0	8.0	9.5	9.0
5	21.0	19.5	20.0	17.5	13.5	13.0	11.0	11.0	8.0	8.0	9.5	9.0
6	21.0	19.5	19.5	17.5	14.0	13.0	11.0	10.5	8.0	8.0	10.0	9.5
7	21.0	19.5	19.5	17.0	14.0	13.0	11.0	10.5	8.5	8.0	10.0	9.5
8	21.0	19.5	19.0	17.0	14.0	13.0	11.0	10.5	8.5	8.0	10.0	9.0
9	21.0	19.5	19.0	17.0	13.5	13.0	11.0	10.5	8.5	8.0	9.5	9.0
10	21.0	19.5	19.0	17.0	13.5	12.5	11.0	10.0	8.5	8.0	9.5	9.5
11	21.0	19.5	18.5	17.5	13.0	12.5	11.0	10.0	8.5	8.0	9.5	9.0
12	21.0	19.5	17.5	16.5	13.0	12.0	10.5	10.0	8.5	8.0	9.5	9.5
13	21.0	19.5	17.5	16.0	12.5	11.5	10.5	10.0	8.5	8.5	9.5	9.0
14	21.0	19.5	17.5	16.0	12.5	12.0	10.5	9.5	8.5	8.0	9.5	9.0
15	21.0	19.5	16.5	15.5	12.5	11.5	10.5	9.0	8.5	8.0	9.5	9.5
16	21.0	20.0	16.0	15.0	12.0	11.5	9.0	9.0	8.5	8.0	10.0	9.0
17	21.0	19.5	16.0	14.5	12.0	11.5	9.0	9.0	8.5	8.0	9.5	9.0
18	21.0	19.5	16.0	14.5	12.0	11.0	9.0	9.0	8.5	8.0	9.5	9.0
19	21.0	19.5	15.5	14.5	12.0	11.0	9.0	9.0	8.5	8.0	10.0	9.0
20	21.0	19.5	15.5	14.5	11.5	11.0	9.0	8.5	8.5	8.5	10.0	10.0
21	21.0	19.0	15.0	14.5	11.5	11.0	9.0	8.5	9.0	8.5	10.0	10.0
22	20.5	19.0	15.5	14.0	11.5	11.0	8.5	8.5	9.0	8.5	10.5	10.0
23	21.0	19.0	15.0	14.0	11.5	11.0	8.5	8.5	9.5	8.5	10.0	9.5
24	20.5	19.0	15.0	13.5	11.5	10.5	8.5	8.0	9.5	9.0	10.0	9.5
25	20.5	19.0	14.5	13.0	11.5	11.0	8.5	8.0	9.5	9.0	10.0	9.5
26	20.5	19.0	14.5	13.0	11.5	11.0	8.5	8.5	9.5	9.0	10.5	10.0
27	20.0	19.0	14.5	13.0	11.0	10.5	8.5	8.5	9.5	9.0	11.0	10.5
28	20.0	19.0	14.0	13.0	11.0	10.5	8.5	8.0	9.5	9.0	11.0	10.5
29	19.5	19.0	13.5	12.5	11.0	10.5	8.0	8.0	---	---	11.5	11.0
30	19.5	18.5	14.5	13.0	11.5	10.5	8.0	7.5	---	---	11.5	11.0
31	20.0	18.5	---	---	11.5	11.0	8.0	7.5	---	---	11.5	11.0
MONTH	21.5	18.5	20.0	12.5	14.0	10.5	11.5	7.5	9.5	7.5	11.5	9.0
	APRIL		MAY		JUNE		JULY		AUGUST		SEPTEMBER	
1	11.5	11.0	13.0	12.0	15.0	14.0	16.5	15.5	17.5	16.5	19.0	17.0
2	11.5	11.0	13.0	12.5	15.5	15.0	16.0	15.0	17.0	16.5	17.5	16.5
3	11.5	11.0	13.0	12.5	15.0	15.0	16.5	15.5	17.0	16.5	17.5	16.5
4	11.5	10.5	13.0	12.5	16.0	15.0	16.0	15.5	17.0	16.5	18.0	16.5
5	11.0	10.5	13.5	13.0	16.0	15.0	16.0	15.5	17.0	16.0	17.5	17.0
6	11.5	10.5	13.5	13.0	16.0	14.5	16.5	15.5	17.5	16.5	17.5	16.5
7	11.5	11.0	14.0	13.0	15.0	14.5	16.5	15.5	18.0	17.0	17.5	17.0
8	11.5	11.0	13.5	13.0	16.5	15.0	17.0	16.0	18.0	17.0	18.0	17.0
9	11.5	10.5	14.0	13.0	16.0	15.0	16.5	16.0	18.0	17.0	18.0	17.0
10	11.5	10.5	14.0	13.0	16.0	15.0	16.5	15.0	17.5	16.5	18.0	17.0
11	11.5	11.0	14.0	13.0	15.5	15.0	15.0	14.0	17.5	17.0	18.0	17.5
12	12.0	11.5	14.0	14.0	16.0	15.5	15.0	14.0	17.5	16.5	18.0	17.0
13	12.0	11.5	14.5	13.5	16.5	15.5	15.0	14.5	17.5	17.0	18.0	17.5
14	12.5	11.5	14.5	13.5	16.0	15.0	15.0	14.5	17.5	17.0	18.0	17.5
15	12.0	11.0	14.5	13.5	16.0	15.5	15.5	14.5	18.0	17.0	18.5	17.0
16	11.5	11.0	14.5	14.0	16.0	15.5	15.0	14.5	18.0	17.5	18.0	18.0
17	11.5	11.0	14.5	13.5	16.5	15.5	15.5	15.0	17.5	17.5	18.0	17.5
18	12.0	11.0	14.5	13.5	16.5	16.0	15.5	15.0	18.0	17.5	19.0	18.0
19	12.5	11.5	14.5	13.5	16.5	16.0	16.0	15.0	18.0	17.5	18.5	18.0
20	12.5	12.0	14.0	13.5	16.5	15.5	16.0	15.0	18.0	17.5	18.5	18.0
21	12.5	12.0	13.5	13.5	17.0	16.0	16.0	15.5	18.0	17.5	18.5	18.0
22	13.0	12.0	14.0	13.5	16.5	16.0	16.0	15.5	17.5	17.0	19.0	17.5
23	13.0	12.5	14.5	14.0	16.5	16.0	16.0	15.5	18.0	17.5	19.0	18.0
24	13.0	12.0	14.5	14.0	17.0	16.5	16.0	15.5	18.0	17.5	18.5	17.5
25	13.0	12.0	15.0	14.0	17.0	16.5	16.5	16.0	---	---	19.0	18.0
26	13.0	12.0	14.5	14.0	17.5	16.5	16.5	16.0	---	---	18.5	18.0
27	12.0	11.5	15.0	14.0	17.5	15.5	16.5	16.0	19.0	17.5	18.5	18.0
28	12.0	11.5	15.0	14.5	16.0	15.5	17.0	16.5	19.0	17.0	18.5	18.0
29	12.5	12.0	16.0	14.5	16.0	15.0	17.5	16.5	18.5	17.5	18.5	17.5
30	12.0	12.0	15.5	14.5	16.5	15.5	17.5	17.0	18.5	18.0	18.5	18.0
31	---	---	15.0	14.0	---	---	17.5	17.0	19.0	18.0	---	---
MONTH	13.0	10.5	16.0	12.0	17.5	14.0	17.5	14.0	---	---	19.0	16.5

11446700 AMERICAN RIVER AT WILLIAM B. POND PARK, AT CARMICHAEL, CA

LOCATION.—Lat 38°35'29", long 121°19'54", in T.9 N., R.6.E., Rio De Los Americanos Grant, Sacramento County, Hydrologic Unit 18020111, on right bank, 20 ft downstream of the pedestrian bridge at William B. Pond Park on the American River Parkway, and 15.8 mi downstream of Folsom Dam.

DRAINAGE AREA.— 1,932 mi².

PERIOD OF RECORD.—October 2000 to current year.

WATER TEMPERATURE: October 2000 to current year.

PERIOD OF DAILY RECORD.—

WATER TEMPERATURE: October 2000 to current year.

INSTRUMENTATION.—Water-temperature recorder since October 10, 2000.

REMARKS.—Water-temperature records rated excellent.

EXREMES FOR PERIOD OF DAILY RECORD.—

WATER TEMPERATURE: Maximum recorded, 23.5°C, Aug. 24, 2001; minimum recorded, 7.0°C, several days January and February 2002.

EXREMES FOR CURRENT YEAR.—

WATER TEMPERATURE: Maximum recorded, 23.0°C, Oct. 1–3; minimum recorded, 7.0°C, several days January and February.

CROSS-SECTIONAL DATA, WATER YEAR OCTOBER 2001 TO SEPTEMBER 2002

DATE	TIME	DEPTH BOTTOM AT SAMPLE LOC- ATION, (FEET) (81903)	TEMPER- ATURE WATER (DEG C) (00010)	SAMPLE LOC- ATION, CROSS SECTION (FT FM L BANK) (00009)
APR				
09...	1455	2.30	12.5	18.0
09...	1503	2.30	12.0	55.0
09...	1510	2.80	12.0	92.0
09...	1520	2.60	12.0	129
09...	1527	3.10	12.0	166
09...	1531	3.00	12.0	203
09...	1540	3.30	12.0	240
09...	1547	3.60	12.0	277
09...	1554	4.20	12.0	314
09...	1612	7.70	12.0	351
AUG				
08...	1644	1.10	22.5	23.0
08...	1649	2.00	21.0	69.0
08...	1654	2.50	20.5	115
08...	1706	2.00	20.5	161
08...	1714	2.50	20.5	207
08...	1718	3.00	20.5	253
08...	1722	2.70	20.5	299
08...	1726	5.90	20.5	345
08...	1745	18.7	20.5	391
08...	1753	17.9	20.5	437

* Estimated discharge at time of cross-sectional measurement: 4,030 ft³/s, Apr. 9; 2,010 ft³/s, Aug. 8.

SACRAMENTO RIVER BASIN

11446700 AMERICAN RIVER AT WILLIAM B. POND PARK, AT CARMICHAEL, CA—Continued

WATER TEMPERATURE (DEGREES C), WATER YEAR OCTOBER 2001 TO SEPTEMBER 2002

DAY	MAX	MIN	MAX	MIN	MAX	MIN	MAX	MIN	MAX	MIN	MAX	MIN
	OCTOBER		NOVEMBER		DECEMBER		JANUARY		FEBRUARY		MARCH	
1	23.0	20.0	19.5	17.5	13.5	12.5	11.0	10.5	9.0	7.0	10.5	8.0
2	23.0	20.0	19.0	17.5	13.0	12.5	11.5	11.0	9.0	7.0	11.0	8.5
3	23.0	20.0	19.5	17.5	13.5	12.5	11.5	10.5	9.0	7.0	11.0	8.5
4	22.0	19.5	19.0	17.0	13.0	12.0	11.0	10.0	9.5	7.0	11.5	8.5
5	21.5	19.0	19.0	17.5	12.5	12.0	11.0	10.5	9.0	7.0	10.5	8.5
6	21.5	19.0	18.5	17.0	13.5	12.0	11.0	10.0	9.5	7.0	11.0	9.5
7	21.5	19.0	18.5	16.5	13.5	12.0	11.0	10.0	9.0	7.5	11.0	9.5
8	21.5	19.0	18.5	16.5	13.0	12.0	11.0	10.0	9.5	7.5	11.0	9.0
9	21.0	19.0	18.5	16.5	13.0	12.0	11.0	10.0	9.5	7.5	10.0	8.5
10	21.5	19.0	18.0	16.5	12.5	11.0	11.0	9.5	10.0	7.5	10.5	9.0
11	21.0	19.0	18.0	17.0	12.0	11.0	10.5	9.0	10.0	7.5	11.0	9.0
12	21.0	19.0	18.0	16.0	12.0	11.0	10.0	9.5	10.0	7.5	10.5	9.5
13	21.5	19.0	17.0	16.0	12.0	10.5	10.0	9.5	9.0	8.0	11.0	9.0
14	21.5	19.0	17.0	16.0	12.0	10.5	10.0	9.0	9.5	8.0	11.0	9.0
15	21.5	19.0	16.5	15.0	11.5	10.0	10.0	8.5	9.0	7.5	11.0	9.0
16	21.0	19.5	16.0	14.5	11.0	10.0	9.5	8.5	9.5	8.0	11.0	9.0
17	21.0	19.0	16.0	14.5	11.0	10.5	9.5	8.5	9.5	8.0	10.5	9.0
18	21.5	19.0	15.5	13.5	11.5	10.5	9.5	8.0	10.0	8.0	11.0	8.5
19	21.0	19.0	15.5	14.0	11.0	10.5	9.5	8.0	9.0	8.0	11.0	8.5
20	21.0	19.0	15.0	14.0	10.5	10.0	9.5	8.0	10.0	8.5	11.5	9.5
21	21.0	19.0	15.0	14.5	11.0	10.0	9.0	8.0	11.0	8.5	12.0	9.5
22	21.0	18.5	15.0	14.0	10.5	10.0	9.5	8.0	11.0	8.0	11.0	9.5
23	21.0	19.0	14.0	13.0	11.0	10.0	9.0	7.5	11.0	8.5	11.0	10.0
24	20.5	18.0	14.5	13.5	11.0	10.0	9.0	7.5	11.5	8.5	11.5	9.5
25	20.5	18.0	13.5	13.0	10.5	10.0	9.0	7.5	11.5	8.5	11.5	9.5
26	20.5	18.0	13.5	12.5	10.5	10.0	8.5	8.0	11.0	8.5	12.5	9.5
27	20.0	18.5	13.5	12.0	10.5	10.0	9.0	8.0	11.5	8.5	13.0	10.0
28	20.0	18.5	13.0	12.5	10.5	10.0	9.0	7.5	11.5	8.5	13.5	10.5
29	19.5	18.5	13.0	12.0	11.0	10.5	9.0	7.5	---	---	14.0	11.0
30	19.0	18.5	13.5	12.5	11.0	10.5	8.5	7.0	---	---	13.5	11.0
31	20.0	18.0	---	---	11.5	10.5	9.0	7.0	---	---	14.0	11.0
MONTH	23.0	18.0	19.5	12.0	13.5	10.0	11.5	7.0	11.5	7.0	14.0	8.0
DAY	MAX	MIN	MAX	MIN	MAX	MIN	MAX	MIN	MAX	MIN	MAX	MIN
	APRIL		MAY		JUNE		JULY		AUGUST		SEPTEMBER	
1	14.0	11.0	14.5	12.0	17.5	14.0	19.5	16.0	20.5	17.0	21.5	18.0
2	14.0	11.0	15.0	12.0	18.5	14.5	18.5	15.5	20.0	17.0	20.5	17.0
3	14.0	11.0	15.5	12.5	18.5	14.5	19.0	15.5	19.5	16.5	20.0	16.5
4	12.0	11.0	15.5	12.5	18.5	15.0	19.0	15.5	20.0	16.0	20.0	17.0
5	12.5	11.0	16.0	12.5	19.0	15.5	19.0	15.5	20.0	17.0	19.5	16.0
6	13.0	10.5	16.0	13.0	19.0	15.5	19.0	15.5	20.0	16.0	19.5	16.5
7	13.5	11.0	16.0	12.5	18.5	14.5	19.0	15.5	20.5	16.5	20.0	16.0
8	13.5	11.0	16.0	13.0	18.0	14.5	19.0	16.0	20.5	17.0	20.0	16.5
9	12.0	11.0	16.0	13.0	18.5	15.0	19.0	16.0	20.5	17.0	20.5	16.5
10	13.0	10.5	16.0	13.0	18.5	15.0	18.5	15.5	20.5	17.5	20.5	16.5
11	13.5	11.0	16.0	13.0	19.0	15.5	17.5	15.0	20.5	16.5	20.5	16.5
12	14.0	11.5	16.5	13.5	19.0	15.0	17.5	14.5	20.5	17.0	20.5	17.0
13	14.0	11.5	16.5	13.5	18.5	15.0	17.5	14.5	20.5	17.0	20.5	16.5
14	14.5	11.5	17.0	13.0	18.5	15.0	17.5	14.5	20.5	17.0	20.5	17.0
15	13.5	11.5	16.5	13.5	18.5	15.0	17.0	15.0	20.0	17.0	20.0	17.0
16	12.0	11.0	17.0	13.5	18.5	15.0	17.5	14.5	20.5	17.0	20.5	16.5
17	13.0	11.0	17.0	13.5	18.5	15.5	17.5	14.5	20.0	17.0	20.0	17.0
18	13.0	10.5	16.5	13.0	19.0	15.5	18.0	15.0	20.5	17.0	20.5	17.0
19	14.0	11.5	15.0	13.5	19.0	16.0	18.0	15.0	20.0	17.0	20.5	17.5
20	14.5	12.0	14.0	13.5	19.0	16.0	18.5	15.5	20.5	17.0	21.0	17.5
21	14.5	12.0	15.0	13.0	19.0	15.0	18.0	15.0	20.5	17.0	20.5	17.0
22	14.5	12.0	16.5	13.0	19.0	15.5	18.0	15.5	20.0	17.0	20.5	17.0
23	15.0	12.5	17.0	13.5	19.0	16.0	18.0	15.5	20.5	16.5	21.0	17.5
24	15.0	12.5	17.5	14.0	19.5	16.0	18.5	15.5	20.5	17.0	20.5	17.0
25	15.0	12.0	18.0	14.0	19.5	16.5	18.5	15.5	20.5	17.0	20.5	17.0
26	13.5	12.0	17.5	13.5	19.5	16.5	18.5	16.0	20.5	17.0	20.0	17.5
27	13.0	12.0	18.0	14.0	19.5	16.5	19.0	16.5	21.0	17.5	19.0	16.5
28	13.5	11.5	18.0	14.0	18.5	15.5	19.5	16.0	21.0	17.5	19.0	17.0
29	13.0	11.5	18.5	14.5	19.0	15.5	19.5	16.5	21.0	17.0	19.5	17.0
30	13.5	11.5	18.5	15.5	19.5	15.0	20.0	16.5	21.5	17.5	19.5	16.5
31	---	---	18.0	14.5	---	---	20.0	16.5	21.5	18.0	---	---
MONTH	15.0	10.5	18.5	12.0	19.5	14.0	20.0	14.5	21.5	16.0	21.5	16.0

11446980 AMERICAN RIVER BELOW WATT AVENUE BRIDGE, NEAR CARMICHAEL, CA

LOCATION.—Lat 38°34'32", long 121°23'14", in SE 1/4 NW 1/4 sec.12, T.8 N., R.5 E., Sacramento County, Hydrologic Unit 18020111, on right bank, 19.8 mi downstream from Folsom Dam, and 5 mi southwest of Carmichael.

DRAINAGE AREA.—1,938 mi².

PERIOD OF RECORD.—November 1998 to current year.

WATER TEMPERATURE.—November 1998 to current year.

PERIOD OF DAILY RECORD.—

WATER TEMPERATURE.—November 1998 to current year.

INSTRUMENTATION.—Water-temperature recorder since Nov. 13, 1998.

REMARKS.—Water-temperature records rated excellent except for Dec. 23 to Jan. 3, May 10–14, and Aug. 9–24, which are rated good.

Interruptions in record were due to malfunction of the recording instrument. Water temperature can be affected by releases from Folsom and Nimbus Dams.

EXTREMES FOR PERIOD OF DAILY RECORD.—

WATER TEMPERATURE: Maximum recorded, 24.0°C, Aug. 24, 2001; minimum recorded, 6.5°C, Jan. 30, 31, 2002.

EXTREMES FOR CURRENT YEAR.—

WATER TEMPERATURE: Maximum recorded, 23.0°C, Oct. 1–3; minimum recorded, 6.5°C, Jan. 30, 31.

CROSS-SECTIONAL DATA, WATER YEAR OCTOBER 2001 TO SEPTEMBER 2002

DATE	TIME	DEPTH BOTTOM AT SAMPLE LOC- ATION, (FEET) (81903)	TEMPER- ATURE WATER (DEG C) (00010)	SAMPLE LOC- ATION, CROSS SECTION (FT FM L BANK) (00009)
MAY				
10...	0857	5.20	12.5	8.00
10...	0852	4.00	12.5	26.0
10...	0846	5.50	12.5	42.0
10...	0845	3.50	12.5	60.0
10...	0840	4.60	12.5	76.0
10...	0832	5.80	12.5	94.0
10...	0830	6.80	12.5	110
10...	0827	8.40	12.5	128
10...	0825	7.10	12.5	144
10...	0823	2.30	12.5	162
AUG				
08...	1305	1.80	19.0	162
08...	1307	6.00	19.0	145
08...	1309	9.30	19.0	128
08...	1318	6.90	19.0	111
08...	1320	6.10	19.0	94.0
08...	1324	4.70	19.0	77.0
08...	1328	3.80	19.0	60.0
08...	1329	3.90	19.0	43.0
08...	1330	3.40	19.0	26.0
08...	1332	4.00	19.0	9.00

* Estimated discharge at time of cross-sectional measurement: 2,810 ft³/s, May 10; 2,020 ft³/s, Aug. 8.

11446980 AMERICAN RIVER BELOW WATT AVENUE BRIDGE, NEAR CARMICHAEL, CA—Continued

WATER TEMPERATURE (DEGREES C), WATER YEAR OCTOBER 2001 TO SEPTEMBER 2002

DAY	MAX	MIN	MAX	MIN	MAX	MIN	MAX	MIN	MAX	MIN	MAX	MIN
	OCTOBER		NOVEMBER		DECEMBER		JANUARY		FEBRUARY		MARCH	
1	23.0	20.5	19.0	18.0	13.5	12.5	11.5	10.5	8.5	7.0	11.5	8.5
2	23.0	20.5	19.0	17.5	12.5	12.0	12.0	11.0	9.0	7.0	11.5	9.0
3	23.0	20.0	19.5	17.5	13.5	12.0	11.5	10.5	9.0	7.0	11.5	9.0
4	22.5	20.0	19.0	17.5	13.0	12.0	11.0	---	9.5	7.0	11.5	9.0
5	21.0	19.0	19.0	17.5	13.0	12.0	11.0	10.5	9.0	7.5	11.0	9.0
6	21.0	19.0	18.5	17.5	13.5	12.5	11.0	10.5	9.5	7.5	11.5	10.0
7	21.0	19.5	18.0	17.0	13.5	12.5	11.0	10.0	9.5	8.0	11.5	10.0
8	21.5	19.5	18.0	16.5	13.0	12.0	11.0	10.0	9.5	8.0	11.5	9.0
9	21.0	19.5	18.0	17.0	13.0	---	11.0	10.5	9.5	7.5	10.5	9.0
10	21.0	19.0	18.0	17.0	12.5	11.0	11.0	9.5	10.0	8.0	11.0	9.5
11	21.0	19.5	18.5	17.5	12.0	10.5	10.5	9.5	10.0	8.0	11.5	9.5
12	20.5	19.0	18.0	16.5	12.0	10.5	10.5	9.5	10.0	8.0	11.0	9.5
13	21.5	19.0	17.0	16.0	12.0	11.0	10.5	9.5	10.0	8.5	11.5	9.0
14	21.5	19.5	17.5	16.5	11.5	10.5	10.0	9.0	10.0	8.5	11.5	9.0
15	21.0	19.5	17.0	16.0	11.0	9.5	9.5	8.5	9.5	8.5	11.5	9.0
16	21.0	19.5	16.0	15.0	11.0	10.0	9.5	8.0	10.0	8.0	11.5	9.5
17	21.0	19.5	16.5	15.5	11.0	10.5	9.5	8.0	9.5	8.5	10.5	9.0
18	21.0	19.0	15.5	14.5	11.5	10.5	9.0	8.0	10.0	8.0	11.5	8.5
19	21.0	19.0	15.5	14.5	11.0	10.0	9.0	8.0	10.0	8.5	12.0	9.0
20	21.0	19.5	15.5	15.0	11.0	10.0	9.0	7.5	10.5	9.0	12.5	9.5
21	20.5	19.0	15.0	14.5	11.0	10.0	9.0	8.0	11.0	9.0	12.5	10.0
22	20.5	18.5	15.5	14.5	11.0	10.0	9.0	7.5	11.0	9.0	11.5	10.0
23	20.5	19.0	15.0	13.5	11.0	10.0	8.5	7.0	11.0	9.5	11.5	10.0
24	20.0	18.5	14.0	13.5	11.0	10.0	9.0	7.0	12.0	8.5	12.0	10.0
25	20.0	18.5	13.5	13.0	10.5	10.0	9.0	7.5	12.0	9.5	12.5	9.5
26	20.0	18.5	13.5	12.5	11.0	10.0	9.0	8.0	11.5	9.5	13.5	10.0
27	20.0	18.5	13.0	12.0	10.5	10.0	9.0	7.5	12.0	9.5	14.0	10.0
28	19.5	18.5	13.0	12.0	10.5	10.0	8.5	7.5	12.0	9.5	14.5	11.0
29	19.5	18.5	13.0	11.5	11.0	10.5	8.5	7.0	---	---	15.0	11.5
30	19.5	18.5	13.5	12.5	11.5	10.5	8.5	6.5	---	---	15.0	11.5
31	20.0	18.0	---	---	11.5	11.0	8.5	6.5	---	---	15.0	11.5
MONTH	23.0	18.0	19.5	11.5	13.5	---	12.0	---	12.0	7.0	15.0	8.5
	APRIL		MAY		JUNE		JULY		AUGUST		SEPTEMBER	
1	15.0	11.0	15.5	12.0	18.0	14.5	20.5	16.5	21.5	17.5	22.0	18.5
2	15.0	11.5	16.0	12.0	19.5	14.5	19.5	16.5	21.0	17.5	21.5	18.5
3	15.0	11.5	16.0	12.5	19.0	15.5	20.0	15.5	20.5	17.0	20.5	17.5
4	13.0	11.0	16.5	12.5	19.5	15.5	20.0	16.0	20.5	16.5	20.0	17.5
5	13.0	11.0	17.0	13.0	20.0	16.0	20.0	16.0	20.5	17.0	19.5	16.5
6	14.0	11.0	17.0	13.5	20.5	16.0	20.0	16.0	20.5	16.5	19.5	16.5
7	14.5	11.5	17.0	12.5	19.5	15.5	20.0	16.0	21.0	16.5	19.5	16.5
8	14.5	11.5	16.5	13.0	19.0	15.0	20.5	16.0	21.0	17.0	20.0	17.0
9	13.0	11.5	17.0	12.5	19.0	15.5	20.5	16.5	21.5	17.0	20.5	17.0
10	14.0	11.0	16.5	12.5	19.5	15.5	20.0	16.0	21.5	17.5	20.5	17.5
11	14.5	11.5	17.0	13.0	20.0	16.0	19.0	15.0	21.0	17.0	20.5	17.5
12	15.0	11.5	17.0	13.0	20.0	16.0	18.5	15.0	21.0	17.0	20.5	17.5
13	15.5	12.0	17.0	13.5	19.5	15.5	18.5	14.5	21.0	17.5	20.5	17.5
14	16.0	12.0	17.5	13.0	20.0	15.0	18.5	14.5	21.0	17.0	20.5	17.5
15	14.5	11.5	17.5	13.5	19.5	15.5	18.0	14.5	21.0	17.5	20.0	17.5
16	12.5	10.5	18.0	13.5	20.0	15.5	18.5	14.5	21.0	17.5	20.5	17.0
17	13.5	11.0	18.0	13.5	20.0	15.5	18.5	14.5	20.0	17.5	20.5	18.0
18	14.0	10.5	17.0	13.5	20.0	16.0	19.0	15.0	21.0	17.0	20.5	18.0
19	14.5	11.5	15.5	13.5	20.5	16.5	19.5	15.0	20.0	17.0	21.0	18.0
20	15.0	12.0	14.5	13.5	20.0	16.5	19.5	15.5	20.5	17.0	21.0	18.5
21	15.5	12.0	15.0	13.0	19.5	15.5	19.0	15.5	21.0	17.5	21.0	18.0
22	15.5	12.0	17.0	13.0	20.0	16.0	19.5	15.5	20.0	17.0	21.0	18.0
23	16.0	12.5	17.5	13.5	20.0	16.0	19.5	15.5	20.5	17.0	21.5	18.0
24	16.0	12.5	18.5	14.0	20.5	16.5	19.5	15.5	20.5	17.5	21.0	18.0
25	15.5	12.5	18.5	14.5	21.0	16.5	19.5	15.5	21.0	17.5	20.5	18.0
26	14.0	12.5	18.0	14.0	20.5	16.5	20.0	16.0	21.0	18.0	20.5	18.0
27	14.0	12.0	18.5	14.5	21.0	16.5	20.0	16.5	21.5	18.0	19.5	17.0
28	14.5	11.5	19.0	14.5	19.5	15.5	20.5	16.5	22.0	18.5	19.5	17.5
29	13.5	11.5	19.5	15.0	20.0	15.5	20.5	16.5	21.0	18.0	20.0	17.5
30	14.5	12.0	20.0	16.0	20.5	15.5	20.5	17.0	21.5	18.0	19.5	17.0
31	---	---	19.5	15.5	---	---	21.0	17.0	21.5	18.5	---	---
MONTH	16.0	10.5	20.0	12.0	21.0	14.5	21.0	14.5	22.0	16.5	22.0	16.5

11447293 DRY CREEK AT VERNON STREET BRIDGE, AT ROSEVILLE, CA

LOCATION.—Lat 38°44'00", long 121°18'03", in SE 1/4 SE 1/4 sec.10, T.10 N, R.6 E, Placer County, Hydrologic Unit 18020111, on left bank downstream side of bridge, and 0.5 mi below confluence of Cirby Creek at Roseville.

DRAINAGE AREA.—80.1 mi².

PERIOD OF RECORD.—October 1996 to September 1999 (no low-flow records), October 1999 to current year.

GAGE.—Water-stage recorder and crest-stage gage. Datum of gage is 99.86 ft above sea level (levels by City of Roseville). Prior to Nov. 10, 1999, at site 30 ft upstream at same datum.

REMARKS.—Records good. Low summer flow sustained by ground-water seepage and residential and industrial wastewater.

EXTREMES FOR PERIOD OF RECORD.—Maximum discharge, 7,950 ft³/s, Jan. 22, 1997, gage height, 24.39 ft; minimum daily, excluding no-flow records, 4.4 ft³/s, Oct. 27, 2001.

EXTREMES FOR CURRENT YEAR.—Peak discharges greater than a base discharge of 1,500 ft³/s, or maximum:

Date	Time	Discharge (ft ³ /s)	Gage height (ft)
Jan. 2	2200	1,120	13.67

DISCHARGE, CUBIC FEET PER SECOND, WATER YEAR OCTOBER 2001 TO SEPTEMBER 2002

DAILY MEAN VALUES

DAY	OCT	NOV	DEC	JAN	FEB	MAR	APR	MAY	JUN	JUL	AUG	SEP
1	20	17	126	188	65	57	58	111	26	19	13	19
2	19	15	542	817	69	54	55	61	30	14	17	15
3	17	12	169	564	61	54	53	52	31	14	22	13
4	14	10	77	217	57	53	52	48	27	14	23	11
5	17	9.0	112	193	58	58	55	44	26	20	20	11
6	25	11	136	208	62	436	53	38	20	17	21	12
7	24	11	77	149	84	378	53	35	16	12	19	16
8	25	9.9	57	129	120	173	50	34	17	14	19	22
9	26	10	76	115	73	114	46	33	15	12	15	24
10	24	8.1	57	103	66	346	54	32	17	10	13	17
11	22	12	44	98	63	180	52	34	18	9.5	10	14
12	22	290	40	91	58	129	51	30	17	9.4	10	15
13	23	188	46	88	59	112	47	28	19	9.1	10	15
14	21	54	320	84	59	99	46	26	19	11	9.5	16
15	16	31	91	79	53	91	53	26	18	13	9.6	15
16	14	26	54	73	63	87	56	24	17	14	11	16
17	10	25	109	69	132	82	95	22	16	17	13	17
18	7.6	20	100	65	93	85	101	23	16	17	15	20
19	7.6	18	67	63	128	69	66	60	16	14	15	20
20	8.2	17	338	65	175	65	51	334	15	18	17	17
21	7.3	62	219	64	110	66	47	360	13	14	22	19
22	10	84	129	64	94	119	41	114	17	14	21	16
23	7.4	35	250	57	83	245	39	80	20	15	18	17
24	6.5	230	122	53	75	215	37	65	20	17	24	15
25	5.2	89	90	53	72	117	38	50	17	12	21	14
26	5.2	44	80	214	66	98	37	42	13	12	19	24
27	4.4	31	75	162	65	88	43	41	13	14	14	23
28	5.1	32	211	110	63	80	46	37	16	12	12	27
29	6.4	71	566	92	---	73	45	36	19	12	12	30
30	73	40	334	75	---	66	52	31	20	14	17	32
31	37	---	416	67	---	64	---	28	---	14	20	---
TOTAL	529.9	1512.0	5130	4469	2226	3953	1572	1979	564	428.0	502.1	542
MEAN	17.09	50.40	165.5	144.2	79.50	127.5	52.40	63.84	18.80	13.81	16.20	18.07
MAX	73	290	566	817	175	436	101	360	31	20	24	32
MIN	4.4	8.1	40	53	53	53	37	22	13	9.1	9.5	11
AC-FT	1050	3000	10180	8860	4420	7840	3120	3930	1120	849	996	1080

STATISTICS OF MONTHLY MEAN DATA FOR WATER YEARS 2000 - 2002, BY WATER YEAR (WY)

MEAN	31.30	36.98	73.22	168.1	282.1	136.4	83.03	51.32	20.90	14.38	14.91	23.70
MAX	54.2	50.4	165	272	591	173	112	63.8	24.3	17.1	16.2	29.8
(WY)	2001	2002	2002	2000	2000	2000	2001	2002	2000	2000	2002	2000
MIN	17.1	27.7	26.7	88.2	79.5	108	52.4	33.2	18.8	12.2	12.6	18.1
(WY)	2002	2001	2000	2001	2002	2001	2002	2001	2002	2001	2001	2002

SUMMARY STATISTICS

FOR 2001 CALENDAR YEAR

FOR 2002 WATER YEAR

WATER YEARS 2000 - 2002

ANNUAL TOTAL	24301.4	23407.0		
ANNUAL MEAN	66.58	64.13	76.94	
HIGHEST ANNUAL MEAN			110	2000
LOWEST ANNUAL MEAN			56.1	2001
HIGHEST DAILY MEAN	636	Feb 11	817	Jan 2
LOWEST DAILY MEAN	4.4	Oct 27	4.4	Oct 27
ANNUAL SEVEN-DAY MINIMUM	5.7	Oct 23	5.7	Oct 23
MAXIMUM PEAK FLOW			1120	Jan 2
MAXIMUM PEAK STAGE			13.67	Jan 2
ANNUAL RUNOFF (AC-FT)	48200	46430	55740	
10 PERCENT EXCEEDS	161	129	164	
50 PERCENT EXCEEDS	29	34	28	
90 PERCENT EXCEEDS	10	12	13	

11447360 ARCADE CREEK NEAR DEL PASO HEIGHTS, CA

LOCATION.—Lat 38°38'01", long 121°22'54", in Del Paso Grant, [Sacramento County](#), Hydrologic Unit 18020111, on right bank, 500 ft upstream from bridge on Watt Avenue, at intersection with Longview Drive, and 1.3 mi east of Del Paso Heights.

DRAINAGE AREA.—31.4 mi².

WATER-DISCHARGE RECORDS

PERIOD OF RECORD.—July 1963 to June 1978, December 1995 to current year.

GAGE.—Water-stage recorder. Elevation of gage is 50 ft above sea level, from topographic map. Prior to December 1995, at site 0.3 mi upstream at different datum.

REMARKS.—Records fair except for estimated daily discharges and discharges below 1 ft³/s, which are poor. Low summer flow sustained by residential and industrial wastewater. See schematic diagram of [lower Sacramento River Basin](#).

EXTREMES FOR PERIOD OF RECORD.—Maximum discharge, 3,320 ft³/s, Feb. 3, 1998, gage height, 15.63; no flow for many days in most years.

EXTREMES FOR CURRENT YEAR.—Peak discharges greater than a base discharge of 500 ft³/s, or maximum:

Date	Time	Discharge (ft ³ /s)	Gage height (ft)	Date	Time	Discharge (ft ³ /s)	Gage height (ft)
Nov. 24	1200	611	10.12	Dec. 28	2215	625	10.21
Dec. 2	1245	1,030	11.83	Jan. 2	0915	859	11.29
Dec. 14	0730	672	10.50	Mar. 6	1400	579	9.91
Dec. 20	1745	631	10.25	May 20	1915	698	10.64

DISCHARGE, CUBIC FEET PER SECOND, WATER YEAR OCTOBER 2001 TO SEPTEMBER 2002
DAILY MEAN VALUES

DAY	OCT	NOV	DEC	JAN	FEB	MAR	APR	MAY	JUN	JUL	AUG	SEP
1	0.80	e1.0	110	20	1.3	1.4	1.7	0.72	2.3	1.5	2.6	1.7
2	0.72	e1.0	429	543	1.1	0.83	1.7	0.84	1.8	1.5	2.8	1.7
3	0.76	e1.0	35	126	0.99	0.85	2.0	0.98	2.0	1.5	1.9	1.4
4	0.68	e1.0	6.6	15	0.91	0.92	1.9	1.1	3.3	1.3	1.8	1.2
5	0.63	e0.84	63	40	0.98	1.4	1.6	1.4	2.3	1.4	2.0	0.85
6	0.67	e0.90	31	37	1.1	275	1.9	1.4	2.2	1.4	1.8	1.5
7	0.74	e0.90	4.6	8.2	17	127	2.4	0.76	1.9	1.6	1.7	1.2
8	0.86	e1.2	2.7	4.6	28	23	3.0	0.82	1.4	1.6	1.6	1.4
9	0.85	e0.95	39	3.8	2.0	7.9	2.8	0.70	0.92	1.6	2.1	1.5
10	0.64	e1.0	3.9	2.8	1.0	133	1.7	0.96	0.62	2.0	2.4	1.5
11	0.84	e50	2.0	2.2	0.89	18	0.83	0.85	0.82	2.1	1.9	0.96
12	0.61	e161	1.6	2.2	0.77	6.8	1.0	1.1	1.2	1.9	1.8	0.91
13	0.52	e34	2.8	1.9	0.67	4.3	1.1	1.3	1.4	1.8	1.7	0.89
14	0.78	e5.5	266	1.7	3.4	3.8	1.2	1.4	1.3	1.9	1.7	1.1
15	1.0	e6.4	8.0	1.8	1.0	2.8	22	1.6	1.2	2.0	1.8	1.2
16	0.88	2.1	3.2	1.7	4.8	5.1	2.2	2.2	1.3	1.9	1.6	1.4
17	0.80	1.9	29	1.6	66	3.4	24	1.6	1.2	1.9	1.7	1.6
18	0.88	1.5	6.4	1.8	7.1	4.5	29	1.8	1.4	1.9	1.8	1.8
19	e2.6	1.1	2.4	1.2	34	1.8	1.2	32	1.5	1.9	2.0	0.98
20	e1.0	0.87	244	1.1	20	1.6	0.63	318	1.3	2.0	1.7	0.90
21	e0.69	15	31	2.4	3.5	1.3	0.66	214	1.1	2.0	1.7	1.3
22	e0.62	20	26	3.7	2.1	41	0.93	15	1.1	1.9	1.6	1.3
23	e0.86	3.0	80	1.5	1.9	68	0.77	5.4	1.2	2.0	1.6	1.2
24	e0.65	199	6.4	0.95	1.4	22	0.84	4.4	1.3	2.1	1.8	0.89
25	e0.86	12	3.3	0.89	1.2	4.1	0.87	3.2	1.4	1.8	1.7	0.97
26	e1.6	3.0	2.9	102	1.2	2.5	0.64	2.8	1.4	1.7	1.7	0.64
27	e0.65	2.0	2.5	16	0.95	1.5	0.83	2.4	1.4	1.9	1.5	0.73
28	e0.45	2.1	192	13	0.96	1.5	0.75	2.4	1.6	1.8	1.5	0.72
29	e0.40	41	281	5.2	---	1.3	0.49	2.4	1.4	1.7	1.7	0.80
30	e82	4.1	97	2.0	---	1.4	0.75	2.5	1.5	1.9	1.4	0.96
31	e0.84	---	126	1.6	---	1.8	---	2.2	---	1.8	1.6	---
TOTAL	106.88	575.36	2138.3	966.84	206.22	769.80	111.39	628.23	44.76	55.3	56.2	35.20
MEAN	3.448	19.18	68.98	31.19	7.365	24.83	3.713	20.27	1.492	1.784	1.813	1.173
MAX	82	199	429	543	66	275	29	318	3.3	2.1	2.8	1.8
MIN	0.40	0.84	1.6	0.89	0.67	0.83	0.49	0.70	0.62	1.3	1.4	0.64
AC-FT	212	1140	4240	1920	409	1530	221	1250	89	110	111	70

e Estimated.

11447360 ARCADE CREEK NEAR DEL PASO HEIGHTS, CA—Continued

STATISTICS OF MONTHLY MEAN DATA FOR WATER YEARS 1963 - 2002, BY WATER YEAR (WY)

	OCT	NOV	DEC	JAN	FEB	MAR	APR	MAY	JUN	JUL	AUG	SEP
MEAN	5.209	21.81	32.90	67.15	53.08	18.94	11.64	6.289	3.096	3.280	2.932	3.306
MAX	16.9	76.0	92.4	227	232	64.0	34.7	27.6	5.90	10.0	5.53	14.0
(WY)	2001	1974	1997	1969	1998	1975	1996	1998	1975	1974	1975	1965
MIN	0.65	1.67	0.40	3.15	0.93	0.85	0.12	0.64	0.000	0.000	0.001	1.02
(WY)	1966	2001	2000	1976	1971	1966	1977	1965	1977	1977	1977	1996

SUMMARY STATISTICS	FOR 2001 CALENDAR YEAR		FOR 2002 WATER YEAR		WATER YEARS 1963 - 2002	
ANNUAL TOTAL	6673.64		5694.48			
ANNUAL MEAN	18.28		15.60		18.11	
HIGHEST ANNUAL MEAN					38.2 1998	
LOWEST ANNUAL MEAN					2.64 1977	
HIGHEST DAILY MEAN	429	Dec 2	543	Jan 2	1910	Feb 3 1998
LOWEST DAILY MEAN	0.00	Jan 1	0.40	Oct 29	0.00	Oct 27 1963
ANNUAL SEVEN-DAY MINIMUM	0.00	Jan 1	0.71	Oct 1	0.00	Dec 31 1963
MAXIMUM PEAK FLOW			1030	Dec 2	3320	Feb 3 1998
MAXIMUM PEAK STAGE			11.83	Dec 2	15.63	Feb 3 1998
ANNUAL RUNOFF (AC-FT)	13240		11300		13120	
10 PERCENT EXCEEDS	43		29		23	
50 PERCENT EXCEEDS	1.9		1.7		2.3	
90 PERCENT EXCEEDS	0.89		0.82		0.44	

11447360 ARCADE CREEK NEAR DEL PASO HEIGHTS, CA—Continued

WATER-QUALITY RECORDS

PERIOD OF RECORD.—Water years 1996 to April 1999, January 2001 to current year.

CHEMICAL DATA: Water years 1996 to April 1999, January 2001 to current year.

SPECIFIC CONDUCTANCE: Water years 1996 to April 1999, January 2001 to current year.

WATER TEMPERATURE: Water years 1996 to April 1999, January 2001 to current year.

SEDIMENT DATA: Water years 1996 to April 1999, January 2001 to current year.

PERIOD OF DAILY RECORD.—

SPECIFIC CONDUCTANCE: July 1997 to September 1999.

WATER TEMPERATURE: July 1997 to September 1999.

INSTRUMENTATION.—Water-quality monitor July 1997 to September 1999.

REMARKS.—National Water-Quality Assessment (NAWQA) Program urban runoff study. Variability of chemical concentration result from fluctuations in discharge and storm-drain runoff.

WATER-QUALITY DATA, WATER YEAR OCTOBER 2001 TO SEPTEMBER 2002

Date	Time	DIS-CHARGE, INST. CUBIC FEET PER SECOND (00061)	BARO-METRIC PRES-SURE (MM OF HG) (00025)	OXYGEN, DIS-SOLVED (MG/L) (00300)	OXYGEN, (PER-CENT SATURATION) (00301)	PH WATER FIELD (STANDARD UNITS) (00400)	SPE-CIFIC CON-DUCTANCE (US/CM) (00095)	TEMPER-ATURE WATER (DEG C) (00010)	ALKA-LINITY WAT. DIS GRAN T. FIELD CACO3 (MG/L) (29802)
NOV 28...	1010	1.6	761	8.0	69	7.4	170	9.0	45
JAN 25...	1150	1.0	765	12.7	99	7.1	208	5.0	66
FEB 08...	1100	16	768	9.1	80	7.4	101	10.0	40
MAR 22...	1250	1.3	760	9.5	91	7.3	283	13.5	80
APR 10...	0840	1.8	765	5.7	56	7.0	284	14.5	84
MAY 10...	1020	.87	765	6.7	67	7.4	305	15.5	85
JUN 21...	0950	.83	759	8.0	88	7.3	277	20.0	74
JUL 19...	0950	1.9	761	8.0	92	7.5	298	22.0	90
SEP 20...	1130	1.1	759	7.3	81	7.4	293	20.0	72

Date	CHLO-RIDE, DIS-SOLVED (MG/L AS CL) (00940)	SULFATE DIS-SOLVED (MG/L AS SO4) (00945)	NITRO-GEN, AMMONIA DIS-SOLVED (MG/L AS N) (00608)	NITRO-GEN, AM-MONIA + ORGANIC TOTAL (MG/L AS N) (00625)	NITRO-GEN, NO2+NO3 DIS-SOLVED (MG/L AS N) (00631)	NITRO-GEN, NITRITE DIS-SOLVED (MG/L AS N) (00613)	ORTHO-PHOS-PHATE, DIS-SOLVED (MG/L AS P) (00671)	PHOS-PHORUS TOTAL (MG/L AS P) (00665)	2,6-DI-ETHYL ANILINE WAT FLT 0.7 U GF, REC (UG/L) (82660)
NOV 28...	14.7	8.6	.05	.99	.71	.008	.06	.152	<.002
JAN 25...	26.8	17.0	e.02	.62	.80	.010	.04	.102	<.002
FEB 08...	7.17	5.6	<.04	.17	1.61	.011	<.02	.021	<.006
MAR 22...	25.8	12.8	<.04	.78	.29	e.004	.04	.102	<.006
APR 10...	25.8	12.8	.08	1.3	.49	.044	.13	.26	<.006
MAY 10...	29.4	12.0	e.03	.82	.53	.045	.16	.25	<.006
JUN 21...	29.6	10.2	.05	.82	.58	.022	.23	.25	<.006
JUL 19...	28.6	9.7	<.04	.64	.32	.012	.24	.29	<.006
SEP 20...	29.3	10.4	<.04	.67	.56	.012	.15	.21	<.006

< Actual value is known to be less than the value shown.

e Estimated.

11447360 ARCADE CREEK NEAR DEL PASO HEIGHTS, CA—Continued

WATER-QUALITY DATA, WATER YEAR OCTOBER 2001 TO SEPTEMBER 2002

Date	ACETO- CHLOR, WATER, FLTRD REC (UG/L) (49260)	ALA- CHLOR, WATER, DISS, REC, (UG/L) (46342)	ALPHA BHC DIS- SOLVED (UG/L) (34253)	ATRA- ZINE, WATER, DISS, REC (UG/L) (39632)	BEN- FLUR- ALIN WAT FLD 0.7 U GF, REC (UG/L) (82673)	BUTYL- ATE, WATER, DISS, REC (UG/L) (04028)	CAR- BARYL WATER FLTRD 0.7 U GF, REC (UG/L) (82680)	CARBO- FURAN WATER FLTRD 0.7 U GF, REC (UG/L) (82674)	CHLOR- PYRIFOS DIS- SOLVED (UG/L) (38933)
NOV 28...	<.004	<.002	<.005	<.007	<.010	<.002	e.071	<.020	e.004
JAN 25...	<.004	<.002	<.005	<.007	<.010	<.002	e.021	<.020	<.005
FEB 08...	<.006	<.004	<.005	<.007	<.010	<.002	e.133	<.020	<.020
MAR 22...	<.006	<.004	<.005	<.007	<.010	<.002	e.027	e.057	.009
APR 10...	<.006	<.004	<.005	e.004	<.010	<.002	e.146	<.020	.016
MAY 10...	<.006	<.004	<.005	e.007	<.010	<.002	e.060	<.020	e.004
JUN 21...	<.006	<.004	<.005	<.009	<.010	<.002	e.038	<.020	<.005
JUL 19...	<.006	<.004	<.005	<.007	<.010	<.002	<.041	<.020	<.005
SEP 20...	<.006	<.004	<.005	<.007	<.010	<.002	e.024	<.020	<.005
Date	CYANA- ZINE, WATER, DISS, REC (UG/L) (04041)	DCPA WATER FLTRD 0.7 U GF, REC (UG/L) (82682)	DEETHYL ATRA- ZINE, WATER, DISS, REC (UG/L) (04040)	DI- AZINON, DIS- SOLVED (UG/L) (39572)	DI- ELDRIN DIS- SOLVED (UG/L) (39381)	DISUL- FOTON WATER FLTRD 0.7 U GF, REC (UG/L) (82677)	EPTC WATER FLTRD 0.7 U GF, REC (UG/L) (82668)	ETHAL- FLUR- ALIN WAT FLT 0.7 U GF, REC (UG/L) (82663)	ETHO- PROP WATER FLTRD 0.7 U GF, RE (UG/L) (82672)
NOV 28...	<.018	e.002	<.006	.249	<.005	<.02	<.002	<.009	<.005
JAN 25...	<.018	<.003	<.006	.150	<.005	<.02	<.002	<.009	<.005
FEB 08...	<.018	e.001	<.006	.396	<.005	<.02	<.002	<.009	<.005
MAR 22...	<.018	e.003	<.006	.149	<.005	<.02	<.002	<.009	<.005
APR 10...	<.018	.003	<.006	.430	<.005	<.02	<.015	<.009	<.005
MAY 10...	<.018	e.002	<.006	.147	<.005	<.02	e.002	<.009	<.005
JUN 21...	<.018	<.003	<.006	.153	<.005	<.02	<.002	<.009	<.005
JUL 19...	<.018	<.003	<.006	.247	<.005	<.02	<.002	<.009	<.005
SEP 20...	<.018	<.003	<.006	.101	<.005	<.02	<.002	<.009	<.005
Date	FONOFOS WATER DISS REC (UG/L) (04095)	LINDANE DIS- SOLVED (UG/L) (39341)	LIN- URON WATER FLTRD 0.7 U GF, REC (UG/L) (82666)	MALA- THION, DIS- SOLVED (UG/L) (39532)	METHYL AZIN- PHOS WAT FLT 0.7 U GF, REC (UG/L) (82686)	METHYL PARA- THION WAT FLT 0.7 U GF, REC (UG/L) (82667)	METO- LACHLOR WATER DISSOLV (UG/L) (39415)	METRI- BUZIN WATER DISSOLV (UG/L) (82630)	MOL- INATE WATER FLTRD 0.7 U GF, RE (UG/L) (82671)
NOV 28...	<.003	<.004	<.035	.088	<.050	<.006	e.006	<.006	<.002
JAN 25...	<.003	<.004	<.035	.028	<.050	<.006	e.009	<.006	<.002
FEB 08...	<.003	<.004	<.035	.218	<.050	<.006	.045	<.006	<.002
MAR 22...	<.003	<.004	<.035	e.025	<.050	<.006	e.009	<.006	<.002
APR 10...	<.003	<.004	<.035	.075	<.050	<.006	e.009	<.006	<.002
MAY 10...	<.003	<.004	<.035	<.027	<.050	<.006	.022	<.006	.015
JUN 21...	<.003	<.004	<.035	<.027	<.050	<.100	e.010	<.006	<.007
JUL 19...	<.003	<.004	<.035	<.027	<.050	<.006	e.011	<.006	<.002
SEP 20...	<.003	<.004	<.035	e.011	<.050	<.030	e.005	<.006	<.002

< Actual value is known to be less than the value shown.
e Estimated.

SACRAMENTO RIVER BASIN

11447360 ARCADE CREEK NEAR DEL PASO HEIGHTS, CA—Continued

WATER-QUALITY DATA, WATER YEAR OCTOBER 2001 TO SEPTEMBER 2002

Date	NAPROP-AMIDE WATER FLTRD 0.7 U GF, REC (UG/L) (82684)	P, P' DDE DISSOLV (UG/L) (34653)	PARA-THION, DIS- SOLVED (UG/L) (39542)	PEB-ULATE WATER FILTRD 0.7 U GF, REC (UG/L) (82669)	PENDI-METH- ALIN WAT FLT 0.7 U GF, REC (UG/L) (82683)	PER-METHRIN CIS WAT FLT 0.7 U GF, REC (UG/L) (82687)	PHORATE WATER FLTRD 0.7 U GF, REC (UG/L) (82664)	PRO-METON, WATER, DISS, REC (UG/L) (04037)	PRON-AMIDE WATER FLTRD 0.7 U GF, RE (UG/L) (82676)
NOV 28...	<.007	<.003	<.007	<.002	<.010	<.006	<.011	.07	<.004
JAN 25...	<.007	<.003	<.007	<.002	<.010	<.006	<.011	.03	<.004
FEB 08...	e.007	<.003	<.010	<.004	.046	<.006	<.011	.24	<.004
MAR 22...	<.007	<.003	<.010	<.004	.036	<.006	<.011	.24	<.004
APR 10...	<.007	<.003	<.010	<.004	e.016	<.006	<.011	.22	<.004
MAY 10...	<.007	<.003	<.010	<.004	<.022	<.006	<.011	.05	<.004
JUN 21...	<.007	<.003	<.010	<.004	<.022	<.006	<.011	.13	<.004
JUL 19...	<.007	<.003	<.010	<.004	<.022	<.006	<.011	.06	<.004
SEP 20...	<.007	<.003	<.010	<.004	<.022	<.006	<.011	.04	<.004

Date	PROPA-CHLOR, WATER, DISS, REC (UG/L) (04024)	PRO-PANIL WATER FLTRD 0.7 U GF, REC (UG/L) (82679)	PRO-PARGITE WATER FLTRD 0.7 U GF, REC (UG/L) (82685)	SI-MAZINE, WATER, DISS, REC (UG/L) (04035)	TEBU-THIURON WATER FLTRD 0.7 U GF, REC (UG/L) (82670)	TER-BACIL WATER FLTRD 0.7 U GF, REC (UG/L) (82665)	TER-BUFOS WATER FLTRD 0.7 U GF, REC (UG/L) (82675)	TER-BUTHYL- AZINE, WATER, DISS, REC (UG/L) (04022)	THIO-BENCARB FLTRD 0.7 U GF, REC (UG/L) (82681)
NOV 28...	<.010	<.011	<.02	.014	<.02	<.034	<.02	U	<.005
JAN 25...	<.010	<.011	<.02	.027	.02	<.034	<.02	--	<.005
FEB 08...	<.010	<.011	<.02	.052	<.02	<.100	<.02	U	<.005
MAR 22...	<.010	<.011	<.02	.016	.06	<.034	<.02	U	<.005
APR 10...	<.010	<.011	<.02	.008	<.05	<.034	<.02	--	<.005
MAY 10...	<.010	<.011	<.02	.006	e.02	<.034	<.02	--	e.003
JUN 21...	<.010	<.011	<.02	.016	<.02	<.034	<.02	--	<.005
JUL 19...	<.010	<.011	<.02	<.005	<.02	<.034	<.02	--	<.005
SEP 20...	<.010	<.011	<.02	e.004	.17	<.034	<.02	--	<.005

< Actual value is known to be less than the value shown.

e Estimated.

U Material specifically analyzed for, but not detected.

11447360 ARCADE CREEK NEAR DEL PASO HEIGHTS, CA—Continued

WATER-QUALITY DATA, WATER YEAR OCTOBER 2001 TO SEPTEMBER 2002

Date	TRIAL- LATE WATER FLTRD 0.7 U GF, REC (UG/L) (82678)	TRI- FLUR- ALIN WAT FLT 0.7 U GF, REC (UG/L) (82661)
NOV 28...	<.002	e.003
JAN 25...	<.002	<.009
FEB 08...	<.002	e.001
MAR 22...	<.002	e.004
APR 10...	<.002	<.009
MAY 10...	<.002	<.009
JUN 21...	<.002	<.009
JUL 19...	<.002	<.009
SEP 20...	<.002	<.009

PARTICLE-SIZE DISTRIBUTION OF SUSPENDED SEDIMENT, WATER YEAR OCTOBER 2001 TO SEPTEMBER 2002

Date	Time	DIS- CHARGE, INST. CUBIC FEET PER SECOND (00061)	TEMPER- ATURE WATER (DEG C) (00010)	SEDI- MENT, SUS- PENDE (MG/L) (80154)	SEDI- MENT, DIS- CHARGE, SUS- PENDE (T/DAY) (80155)	SED. SUSP. SIEVE DIAM. % FINER THAN .062 MM (70331)
NOV 28...SS	1010	1.6	9.0	14	.06	93
JAN 25...SS	1150	1.0	5.0	22	.06	94
FEB 08...SS	1100	16	10.0	27	1.2	92
MAR 22...SS	1250	1.3	13.5	5.0	.02	80
APR 10...SS	0840	1.8	14.5	13	.06	81
MAY 10...SS	1020	.87	15.5	13	.03	89
JUN 21...SS	0950	.83	20.0	10	.02	75
JUL 19...SS	0950	1.9	22.0	8.0	.04	62
SEP 20...SS	1130	1.1	20.0	9.0	.03	84

< Actual value is known to be less than the value shown.

e Estimated.

SS Suspended-sediment data determined from a sample collected and processed according to National Water Quality Assessment (NAWQA) protocol.

11447500 SACRAMENTO RIVER AT SACRAMENTO, CA

LOCATION.—Lat 38°35'12", long 121°30'16", in T.9 N., R.4 E., [Sacramento County](#), Hydrologic Unit 18020109, on left bank, 1,000 ft upstream from I Street Bridge, in city of Sacramento, 0.5 mi downstream from American River.

DRAINAGE AREA.—23,502 mi².

PERIOD OF RECORD.—January 1904 to July 1905 (gauge heights only), June to November 1921, October 1948 to September 1979 (water discharge), October 1985 to September 1989 (peak elevation of year only, see [station 11447650](#)), October 1989 to September 1996, October 2001 to September 2002 (elevation only). Gauge heights collected in this vicinity November 1879 to May 1888, December 1890 to September 1963, are contained in reports of National Weather Service. Elevation for October 1979 to September 1989 in files of the U.S. Geological Survey.

REVISED RECORDS.—WDR CA-76-4; Drainage area.

GAGE.—Water-stage recorder. Datum of gage is sea level. Prior to Oct. 15, 1912, nonrecording gage in vicinity of I Street Bridge. Oct. 15, 1912 to Nov. 16, 1956, water-stage recorder at various sites in vicinity of I Street Bridge. Prior to November 1956, datum of gage at low-water mark of Oct. 23, 1856, 0.12 ft above sea level.

REMARKS.—Natural flow of stream affected by storage reservoirs, power development, diversions for irrigation, and return flow from irrigated areas. Floodflows bypass station through Sacramento Weir Spill to Yolo Bypass (stations 11426000 and 11453000). See schematic diagram of [lower Sacramento River Basin](#).

EXTREMES FOR PERIOD OF RECORD (since 1949).—Maximum elevation, 30.58 ft, Feb. 19, 1986; minimum elevation prior to October 1989 is unknown. Minimum elevation since October 1989, 0.67 ft, Nov. 15, 1991.

EXTREMES FOR CURRENT YEAR.—Maximum elevation, 18.91 ft, Jan. 6; minimum, 1.23 ft, Oct. 24.

GAGE HEIGHT, FEET, WATER YEAR OCTOBER 2001 TO SEPTEMBER 2002

DAY	OCTOBER		NOVEMBER		DECEMBER		JANUARY		FEBRUARY		MARCH	
	MAX	MIN	MAX	MIN	MAX	MIN	MAX	MIN	MAX	MIN	MAX	MIN
1	4.01	2.69	3.80	2.18	7.07	4.40	11.95	11.08	5.77	5.08	5.67	4.83
2	4.03	2.78	3.97	2.22	8.06	6.21	13.48	11.95	5.50	4.93	5.73	4.98
3	3.99	2.73	4.07	2.21	9.11	7.35	15.55	13.48	5.40	4.78	5.80	4.97
4	4.48	2.85	4.24	2.15	9.64	8.91	17.57	15.55	5.34	4.58	5.74	4.96
5	4.29	2.94	4.26	2.27	9.59	8.80	18.81	17.57	5.27	4.42	5.88	4.97
6	4.10	2.58	4.26	2.18	8.87	7.69	18.91	18.81	5.38	4.40	6.24	5.04
7	4.16	2.40	3.98	2.08	7.76	7.06	18.83	18.49	5.46	4.40	6.81	5.60
8	4.10	2.24	3.64	1.71	7.77	7.28	18.49	18.17	5.16	4.44	7.50	6.43
9	4.07	1.92	3.43	1.70	7.70	6.92	18.17	17.79	5.05	4.13	8.05	7.18
10	4.04	1.82	3.45	1.78	6.93	6.18	17.79	17.12	5.09	4.03	8.29	7.75
11	3.88	1.77	3.89	2.15	6.49	5.86	17.12	15.95	5.07	4.14	8.51	7.86
12	3.80	1.57	4.44	2.52	6.13	5.46	15.95	14.38	5.09	4.09	8.68	8.28
13	3.65	1.63	4.40	3.05	5.74	4.98	14.38	12.62	4.98	4.09	8.50	7.95
14	3.75	1.84	4.63	3.07	6.02	4.91	12.62	11.21	4.85	4.00	7.95	7.19
15	3.67	1.90	4.81	3.27	6.30	4.95	11.21	10.16	4.70	3.99	7.20	6.77
16	3.93	2.02	4.78	3.29	7.57	6.11	10.16	9.37	4.61	3.87	6.94	6.32
17	3.99	2.27	4.58	3.09	7.42	6.89	9.37	8.75	4.87	3.99	6.51	5.98
18	3.95	2.09	4.34	2.78	7.06	6.30	8.76	8.21	4.86	4.02	6.14	5.51
19	3.99	1.93	4.14	2.53	7.24	6.42	8.24	7.65	4.99	3.97	5.76	5.16
20	4.24	1.88	3.89	2.36	7.69	6.74	7.65	7.05	5.10	4.15	5.66	5.01
21	4.24	2.06	4.01	2.17	8.18	7.20	7.09	6.71	6.53	4.47	5.78	4.96
22	4.03	1.89	3.99	2.63	9.66	8.18	6.88	6.36	9.05	6.53	5.84	4.99
23	3.80	1.69	3.66	2.35	9.85	9.62	6.56	6.03	9.22	8.53	6.15	5.08
24	3.09	1.23	5.78	3.24	10.07	9.75	6.44	5.88	8.53	7.23	6.71	5.43
25	3.01	1.24	5.24	4.39	10.08	9.83	6.44	5.66	7.23	6.52	7.36	6.47
26	3.00	1.38	6.13	4.66	9.83	9.10	6.81	5.59	6.56	5.98	7.07	6.64
27	3.37	1.75	5.95	5.25	9.10	8.37	6.76	5.88	6.23	5.53	6.64	6.10
28	3.21	1.72	5.50	4.72	8.67	8.01	6.74	5.95	5.94	5.28	6.10	5.57
29	3.19	1.73	5.55	4.67	8.87	8.09	6.44	5.77	---	---	5.92	5.22
30	3.85	1.75	5.26	4.13	9.80	8.41	6.24	5.51	---	---	5.83	5.06
31	3.68	2.18	---	---	11.08	9.75	5.98	5.30	---	---	5.81	4.92
MONTH	4.48	1.23	6.13	1.70	11.08	4.40	18.91	5.30	9.22	3.87	8.68	4.83

11447650 SACRAMENTO RIVER AT FREEPORT, CA

LOCATION.—Lat 38°27'15", long 121°29'54", in SW 1/4 SW 1/4 sec.13, T.7 N., R.4 E., [Sacramento County](#), Hydrologic Unit 18020109, on left bank, 630 ft downstream from drawbridge at Freeport, and 11 mi south of Sacramento.

DRAINAGE AREA.—Indeterminate.

WATER-DISCHARGE RECORDS

PERIOD OF RECORD.—January 1904 to July 1905 (gage heights only), June to November 1921, October 1948 to current year. Prior to October 1979, published as "Sacramento River at Sacramento" (station 11447500).

REVISED RECORD.—WDR CA-96-4: 1994–1995 (P).

GAGE.—Water-stage recorder and acoustic-velocity system. Datum of gage is 100 ft below sea level. Prior to Oct. 1, 2001, datum was sea level. Prior to Nov. 16, 1956, nonrecording gage and water-stage recorder at various sites in vicinity of I Street Bridge in Sacramento, 13 mi upstream at datum of low-water mark of Oct. 23, 1856, 0.12 ft above sea level. Nov. 17, 1956, to Sept. 20, 1979, at site 1,000 ft upstream from I Street Bridge.

REMARKS.—Records good. Natural flow of stream affected by storage reservoirs, power development, diversions for irrigation, return flow from irrigated areas, and tide. Floodflows bypass station through Sacramento Weir Spill to Yolo Bypass (stations 11426000 and 11453000). See schematic diagram of [lower Sacramento River Basin](#).

EXTREMES FOR PERIOD OF RECORD (since 1949).—Maximum discharge, 117,000 ft³/s, Feb. 19, 1986, elevation, 125.00 ft, at present datum; minimum daily, 3,970 ft³/s, Oct. 15, 1977.

EXTREMES OUTSIDE PERIOD OF RECORD.—Maximum discharge known prior to Nov. 21, 1950, 103,000 ft³/s, Jan. 17, 1909, elevation, 129.6 ft, site then in use at present datum, from reports of California Department of Water Resources.

DISCHARGE, CUBIC FEET PER SECONG, WATER YEAR OCTOBER 2001 TO SEPTEMBER 2002

DAILY MEAN VALUES

DAY	OCT	NOV	DEC	JAN	FEB	MAR	APR	MAY	JUN	JUL	AUG	SEP
1	e11400	9380	18700	40000	18700	18000	17000	12000	12700	17300	19100	14800
2	10500	9340	22700	44000	18400	17900	16500	11300	13100	16700	18500	14100
3	10300	9010	28900	50600	18200	18500	16700	11500	12800	17300	18000	13400
4	9280	9080	33900	57700	17700	18300	17100	10900	12800	17400	18800	13400
5	9710	e9670	32800	63900	17000	17900	16700	10300	12900	17200	18400	13600
6	9670	e9510	30000	65600	16600	18000	16100	9640	12800	17400	18700	13600
7	9120	9400	27300	64500	15900	19700	16200	10100	12500	17700	18700	13700
8	8780	9340	28000	63200	15900	23800	15700	9950	12200	18200	18200	13500
9	8270	9300	27000	62000	15600	26100	16200	9990	12000	17900	17800	13900
10	8430	8930	24300	60300	15600	27400	16400	9830	11500	18000	17600	13800
11	7950	8880	22200	57400	15700	27900	16100	9620	11300	18300	17200	14000
12	8170	9450	20800	52600	15200	28800	16100	9850	11000	18800	16900	14400
13	7730	11900	18900	46800	15000	27800	16000	9660	11600	18800	16900	14600
14	7190	12700	17700	40900	14700	25800	14900	10100	12700	19000	17300	14400
15	e7960	13400	18900	36600	14600	23900	15600	10400	12900	19200	17200	13800
16	e7950	13100	24100	33600	14300	22700	15200	10600	13300	19400	17300	14000
17	7180	12400	24900	31300	14600	21500	14900	11000	14200	19500	17400	13600
18	e7170	11800	23400	29400	14900	20900	15400	12000	14500	19700	17100	14000
19	7140	11300	24100	27600	15100	19900	14800	13600	14600	19600	16600	13900
20	6970	10800	24700	26100	15700	19100	14000	15000	14700	19000	17600	13700
21	7020	10400	26800	24400	19600	18300	13700	19000	15200	18900	17800	13500
22	e7930	11500	31900	23400	28600	18100	13100	20200	15400	19700	17500	13300
23	8520	11900	35200	22400	31100	18300	12300	20300	15100	20000	17500	13300
24	e8060	13700	36200	21700	27400	20500	10800	19800	15600	20400	16600	13100
25	8230	18200	36200	20700	23500	23800	11000	18000	16000	20600	15800	12800
26	e7810	20900	34500	19900	21200	23600	10900	16500	15700	20500	15100	12000
27	e7820	22200	31300	20400	19500	21600	10800	15400	16100	20200	14100	12700
28	8070	18900	28900	20500	18600	19700	11300	14500	16500	20000	13500	12800
29	7790	16700	28600	20000	---	18200	11100	14300	17400	20200	14500	12400
30	e8220	16000	30500	19600	---	17600	11700	13600	17700	19700	14900	12800
31	e9140	---	35300	19300	---	17400	---	13100	---	19300	14900	---
TOTAL	259480	369090	848700	1186400	508900	661000	434300	402040	416800	585900	527500	406900
MEAN	8370	12300	27380	38270	18180	21320	14480	12970	13890	18900	17020	13560
MAX	11400	22200	36200	65600	31100	28800	17100	20300	17700	20600	19100	14800
MIN	6970	8880	17700	19300	14300	17400	10800	9620	11000	16700	13500	12000
AC-FT	514700	732100	1683000	2353000	1009000	1311000	861400	797400	826700	1162000	1046000	807100

e Estimated.

11447650 SACRAMENTO RIVER AT FREEPORT, CA—Continued

STATISTICS OF MONTHLY MEAN DATA FOR WATER YEARS 1949 - 2002, BY WATER YEAR (WY)

	OCT	NOV	DEC	JAN	FEB	MAR	APR	MAY	JUN	JUL	AUG	SEP
MEAN	12390	16270	26400	34900	41040	37980	29480	24400	18200	15150	14590	14850
MAX	28690	48820	74510	87110	81370	78290	76580	69820	55690	31000	25180	25320
(WY)	1963	1984	1984	1997	1998	1983	1982	1952	1998	1983	1998	1998
MIN	4494	6380	7208	8984	8003	6573	5961	6414	6865	6345	7061	6838
(WY)	1978	1993	1960	1991	1977	1977	1977	1992	1977	1949	1949	1977

SUMMARY STATISTICS	FOR 2001 CALENDAR YEAR	FOR 2002 WATER YEAR	WATER YEARS 1949 - 2002
ANNUAL TOTAL	5625210	6607010	
ANNUAL MEAN	15410	18100	23720
HIGHEST ANNUAL MEAN			46900 1983
LOWEST ANNUAL MEAN			7608 1977
HIGHEST DAILY MEAN	46200	Mar 9 65600	Jan 6 115000 Feb 19 1986
LOWEST DAILY MEAN	6790	May 7 6970	Oct 20 3970 Oct 15 1977
ANNUAL SEVEN-DAY MINIMUM	7130	May 6 7340	Oct 16 4060 Oct 13 1977
MAXIMUM PEAK FLOW		66000	Jan 6 117000 Feb 19 1986
MAXIMUM PEAK STAGE		114.33	Jan 6 125.00 Feb 19 1986
ANNUAL RUNOFF (AC-FT)	11160000	13110000	17180000
10 PERCENT EXCEEDS	26900	27900	55800
50 PERCENT EXCEEDS	13100	16200	16000
90 PERCENT EXCEEDS	8710	9490	9030

11447650 SACRAMENTO RIVER AT FREEPORT, CA—Continued

WATER-QUALITY RECORDS

PERIOD OF RECORD.—Water years 1957 to current year.

CHEMICAL DATA: Water years 1959 to current year.

BIOLOGICAL DATA: Water years 1974–81.

SPECIFIC CONDUCTANCE: Water years 1974–75, 1989–98.

WATER TEMPERATURE: Water year 1960 to current year.

SEDIMENT DATA: Water year 1957 to current year (prior to water year 1980, published as 11447500 "Sacramento River at Sacramento").

PERIOD OF DAILY RECORD.—October 1956 to current year.

CHEMICAL DATA: June 1960 to June 1963.

SPECIFIC CONDUCTANCE: Water years 1974–75, 1989–94, 1996–98.

WATER TEMPERATURE: June 1960 to current year.

SUSPENDED SEDIMENT DISCHARGE: October 1956 to current year.

INSTRUMENTATION.—Water-temperature recorder June 1960 to November 1988. Water-quality monitor since November 1988.

REMARKS.—Water-temperature records rated excellent except for Nov. 7–16, Dec. 17 to Feb. 9, Mar. 2–13, May 14–18, June 12–14, July 14–20, Aug. 28 to Sept. 8, which are rated good; Feb. 10–15, Feb. 22 to Mar. 1, Mar. 14 to Apr. 10, Apr. 18 to May 13, June 15–18, July 21 to Aug. 4, which are rated fair; and June 19 to July 9, Aug. 5–27, which are rated poor. Records of sediment discharge from 1957 to 1979 were obtained at "Sacramento River at Sacramento" (station 11447500) and are considered equivalent. Additional specific-conductance, monthly chemical, and trace-element data are available in files of the U.S. Geological Survey. Chemical Data for water year 2000 available in the files of the U.S. Geological Survey. Interruptions in record were due to malfunction of the recording instrument.

EXTREMES FOR PERIOD OF DAILY RECORD.—

SPECIFIC CONDUCTANCE: Maximum recorded, 318 microsiemens, Nov. 22, 1974; minimum recorded, 32 microsiemens, Apr. 6, 1974.

WATER TEMPERATURE: Maximum recorded, 27.0°C, Sept. 8, 1977; minimum recorded, 3.0°C, Dec. 25–27, 1990.

SEDIMENT CONCENTRATION: Maximum daily mean, 1,960 mg/L, Dec. 24, 1964; minimum daily, 2 mg/L, Jan. 27, 31, Nov. 21, 1991.

SEDIMENT LOAD: Maximum daily, 525,000 tons, Dec. 24, 1964; minimum daily, 35 tons, Jan. 31, 1991.

EXTREMES FOR CURRENT YEAR.—

WATER TEMPERATURE: Maximum recorded, 23.5°C, Sept. 2, 3, but may have been higher during periods of missing record; minimum recorded, 7.0°C, Jan. 30 to Feb. 2.

SEDIMENT CONCENTRATION: Maximum daily mean, 297 mg/L, Dec. 4; minimum daily mean, 6 mg/L, Nov. 10.

SEDIMENT LOAD: Maximum daily, 42,100 tons, Jan. 6; minimum daily, 145 tons, Nov. 10.

WATER-QUALITY DATA, WATER YEAR OCTOBER 2001 TO SEPTEMBER 2002

Date	Time	DIS- CHARGE, INST. CUBIC FEET PER SECOND (00061)	BARO- METRIC PRES- SURE (MM OF HG) (00025)	OXYGEN, DIS- SOLVED (PER- CENT SATUR- ATION) (00300)	OXYGEN, DIS- SOLVED (PER- CENT SATUR- ATION) (00301)	PH WATER WHOLE FIELD (STAND- ARD UNITS) (00400)	SPE- CIFIC CON- DUCT- ANCE (US/CM) (00095)	TEMPER- ATURE WATER (DEG C) (00010)	ALKA- LILITY WAT.DIS GRAN T. FIELD CACO3 (MG/L) (29802)
NOV									
13...	1200	14500	758	8.0	80	7.8	187	15.0	63
JAN									
24...	1300	18200	775	10.2	85	7.9	91	8.0	75
FEB									
25...	1300	22500	770	12.0	110	7.2	145	12.0	57
MAR									
21...	1230	18200	763	10.7	99	7.7	164	12.0	64
APR									
25...	1030	14800	767	10.3	106	7.7	126	17.0	52
MAY									
22...	1300	20700	765	9.3	94	7.5	168	16.0	66
JUN									
19...	1220	13500	760	8.9	102	7.5	124	22.0	58
JUL									
17...	1210	17900	770	--	--	7.6	123	21.0	41
SEP									
18...	1120	18600	758	10.3	114	7.9	152	20.0	68

11447650 SACRAMENTO RIVER AT FREEPORT, CA—Continued

WATER-QUALITY DATA, WATER YEAR OCTOBER 2001 TO SEPTEMBER 2002

Date	CHLO- RIDE, DIS- SOLVED (MG/L AS CL) (00940)	SULFATE DIS- SOLVED (MG/L AS SO4) (00945)	NITRO- GEN, AMMONIA DIS- SOLVED (MG/L AS N) (00608)	NITRO- GEN, AM- MONIA + ORGANIC TOTAL (MG/L AS N) (00625)	NITRO- GEN, NO2+NO3 DIS- SOLVED (MG/L AS N) (00631)	NITRO- GEN, NITRITE DIS- SOLVED (MG/L AS N) (00613)	NITRO- GEN, PAR TICULATE WAT FLT SUSP (MG/L AS N) (49570)	ORTHO- PHOS- PHATE, DIS- SOLVED (MG/L AS P) (00671)	PHOS- PHORUS TOTAL (MG/L AS P) (00665)
NOV									
13...	7.55	7.9	<.04	.33	.11	.009	--	.03	.103
JAN									
24...	6.49	11.4	.014	.20	.33	<.006	.08	.03	.071
FEB									
25...	5.22	7.3	<.04	.55	.20	<.008	.15	e.01	.117
MAR									
21...	7.29	7.3	<.04	.11	.14	<.008	.06	e.01	.034
APR									
25...	5.25	6.2	<.04	.21	.07	e.006	.09	e.02	.044
MAY									
22...	6.67	11.7	<.04	.27	.15	e.006	<.02	.04	.087
JUN									
19...	4.60	5.7	<.04	.18	<.05	<.008	.04	<.02	.046
JUL									
17...	3.01	4.4	<.04	.14	e.04	<.008	<.02	e.01	.041
SEP									
18...	5.01	5.1	<.04	.12	<.05	e.005	.09	e.01	.042
Date	CARBON, INORG + ORGANIC PARTIC. TOTAL (MG/L AS C) (00694)	CARBON, INOR- GANIC, PARTIC. TOTAL (MG/L AS C) (00688)	CARBON, ORGANIC DIS- SOLVED (MG/L AS C) (00681)	CARBON, ORGANIC PARTIC- ULATE TOTAL (MG/L AS C) (00689)	2,6-DI- ETHYL ANILINE WAT FLT 0.7 U GF, REC (UG/L) (82660)	ACETO- CHLOR, WATER FLTRD REC (UG/L) (49260)	ALA- CHLOR, WATER, DISS, REC, (UG/L) (46342)	ALPHA BHC DIS- SOLVED (UG/L) (34253)	ATRA- ZINE, WATER, DISS, REC (UG/L) (39632)
NOV									
13...	--	--	3.1	.5	--	--	--	--	--
JAN									
24...	.9	<.1	2.3	.9	<.002	<.004	<.002	<.005	<.007
FEB									
25...	1.4	<.1	2.5	1.4	<.002	<.004	<.002	<.005	<.007
MAR									
21...	.6	<.1	1.5	.6	<.006	<.006	<.004	<.005	e.004
APR									
25...	.6	<.1	1.8	.6	<.006	<.006	<.004	<.005	<.007
MAY									
22...	.7	<.1	2.1	.7	<.006	<.006	<.004	<.005	.008
JUN									
19...	.5	<.1	1.9	.5	<.006	<.006	<.004	<.005	<.007
JUL									
17...	.4	<.1	1.5	.3	<.006	<.006	<.004	<.005	<.007
SEP									
18...	.5	<.1	1.5	.5	<.006	<.006	<.004	<.005	<.007

< Actual value is known to be less than the value shown.

e Estimated.

SACRAMENTO RIVER BASIN

11447650 SACRAMENTO RIVER AT FREEPORT, CA—Continued

WATER-QUALITY DATA, WATER YEAR OCTOBER 2001 TO SEPTEMBER 2002

Date	BEN- FLUR- ALIN WAT FLD 0.7 U GF, REC (UG/L) (82673)	BUTYL- ATE, WATER, DISS, REC (UG/L) (04028)	CAR- BARYL WATER FLTRD 0.7 U GF, REC (UG/L) (82680)	CARBO- FURAN WATER FLTRD 0.7 U GF, REC (UG/L) (82674)	CHLOR- PYRIFOS DIS- SOLVED (UG/L) (38933)	CYANA- ZINE, WATER, DISS, REC (UG/L) (04041)	DCPA WATER FLTRD 0.7 U GF, REC (UG/L) (82682)	DEETHYL ATRA- ZINE, WATER, DISS, REC (UG/L) (04040)	DI- AZINON, DIS- SOLVED (UG/L) (39572)
NOV 13...	--	--	--	--	--	--	--	--	--
JAN 24...	<.010	<.002	<.041	<.020	<.005	<.018	<.003	<.006	.011
FEB 25...	<.010	<.002	<.041	<.020	<.005	<.018	<.003	<.006	.008
MAR 21...	<.010	<.002	<.041	<.020	<.005	<.018	<.003	<.006	<.005
APR 25...	<.010	<.002	<.041	<.020	<.005	<.018	<.003	<.006	e.004
MAY 22...	<.010	<.002	e.006	<.020	e.004	<.018	<.003	<.006	.012
JUN 19...	<.010	<.002	<.041	<.020	<.005	<.018	<.003	<.006	e.004
JUL 17...	<.010	<.002	<.041	<.020	<.005	<.018	<.003	<.006	<.005
SEP 18...	<.010	<.002	<.041	<.020	<.005	<.018	<.003	<.006	<.005
Date	DI- ELDRIN DIS- SOLVED (UG/L) (39381)	DISUL- FOTON WATER FLTRD 0.7 U GF, REC (UG/L) (82677)	EPTC WATER FLTRD 0.7 U GF, REC (UG/L) (82668)	ETHAL- FLUR- ALIN WAT FLT 0.7 U GF, REC (UG/L) (82663)	ETHO- PROP WATER FLTRD 0.7 U GF, REC (UG/L) (82672)	FONOFOS WATER DISS REC (UG/L) (04095)	LINDANE DIS- SOLVED (UG/L) (39341)	LIN- URON WATER FLTRD 0.7 U GF, REC (UG/L) (82666)	MALA- THION, DIS- SOLVED (UG/L) (39532)
NOV 13...	--	--	--	--	--	--	--	--	--
JAN 24...	<.005	<.02	<.002	<.009	<.005	<.003	<.004	<.035	<.027
FEB 25...	<.005	<.02	<.002	<.009	<.005	<.003	<.004	<.035	<.027
MAR 21...	<.005	<.02	<.002	<.009	<.005	<.003	<.004	<.035	<.027
APR 25...	<.005	<.02	<.002	<.009	<.005	<.003	<.004	<.035	<.027
MAY 22...	<.005	<.02	e.001	<.009	<.005	<.003	<.004	<.035	<.027
JUN 19...	<.005	<.02	<.002	<.009	<.005	<.003	<.004	<.035	<.027
JUL 17...	<.005	<.02	<.002	<.009	<.005	<.003	<.004	<.035	<.027
SEP 18...	<.005	<.02	<.002	<.009	<.005	<.003	<.004	<.035	<.027

< Actual value is known to be less than the value shown.

e Estimated.

11447650 SACRAMENTO RIVER AT FREEPORT, CA—Continued

WATER-QUALITY DATA, WATER YEAR OCTOBER 2001 TO SEPTEMBER 2002

Date	METHYL AZIN- PHOS WAT FLT 0.7 U GF, REC (UG/L) (82686)	METHYL PARA- THION WAT FLT 0.7 U GF, REC (UG/L) (82667)	METO- LACHLOR WATER (UG/L) (39415)	METRI- BUZIN SENCOR WATER (UG/L) (82630)	MOL- INATE WATER 0.7 U GF, REC (UG/L) (82671)	NAPROP- AMIDE WATER FLTRD 0.7 U GF, REC (UG/L) (82684)	P, P' DDE DISSOLV (UG/L) (34653)	PARA- THION, DIS- SOLVED (UG/L) (39542)	PEB- ULATE WATER FILTRD 0.7 U GF, REC (UG/L) (82669)
NOV 13...	--	--	--	--	--	--	--	--	--
JAN 24...	<.050	<.006	<.013	<.006	.012	<.007	<.003	<.007	<.002
FEB 25...	<.050	<.006	<.013	<.006	.006	<.007	<.003	<.007	<.002
MAR 21...	<.050	<.006	<.013	<.006	.003	<.007	<.003	<.010	<.004
APR 25...	<.050	<.006	<.013	<.006	e.004	<.007	<.003	<.010	<.004
MAY 22...	<.050	<.006	.028	<.006	2.08	<.007	<.003	<.010	<.004
JUN 19...	<.050	<.060	.018	<.006	.128	<.007	<.003	<.010	<.004
JUL 17...	<.050	<.006	.013	<.006	.024	<.007	<.003	<.010	<.004
SEP 18...	<.050	<.006	e.006	<.006	.014	<.007	<.003	<.010	<.004
Date	PENDI- METH- ALIN WAT FLT 0.7 U GF, REC (UG/L) (82683)	PER- METHRIN CIS WAT FLT 0.7 U GF, REC (UG/L) (82687)	PHORATE WATER FLTRD 0.7 U GF, REC (UG/L) (82664)	PRO- METON, WATER, DISS, REC (UG/L) (04037)	PRON- AMIDE WATER FLTRD 0.7 U GF, REC (UG/L) (82676)	PROPA- CHLOR, WATER, DISS, REC (UG/L) (04024)	PRO- PANIL WATER FLTRD 0.7 U GF, REC (UG/L) (82679)	PRO- PARGITE WATER FLTRD 0.7 U GF, REC (UG/L) (82685)	SI- MAZINE, WATER, DISS, REC (UG/L) (04035)
NOV 13...	--	--	--	--	--	--	--	--	--
JAN 24...	<.010	<.006	<.011	<.01	<.004	<.010	<.011	<.02	<.011
FEB 25...	<.010	<.006	<.011	<.01	<.004	<.010	<.011	<.02	e.007
MAR 21...	<.022	<.006	<.011	<.01	<.004	<.010	<.011	<.02	.009
APR 25...	<.022	<.006	<.011	<.01	<.004	<.010	<.011	<.02	.006
MAY 22...	<.022	<.006	<.011	<.01	<.004	<.010	<.011	<.02	<.010
JUN 19...	<.022	<.006	<.011	.02	<.004	<.010	.141	<.02	<.005
JUL 17...	<.022	<.006	<.011	<.01	<.004	<.010	<.011	<.02	<.005
SEP 18...	<.022	<.006	<.011	<.01	<.004	<.010	<.011	<.02	<.005

< Actual value is known to be less than the value shown.

e Estimated.

SACRAMENTO RIVER BASIN

11447650 SACRAMENTO RIVER AT FREEPORT, CA—Continued

WATER-QUALITY DATA, WATER YEAR OCTOBER 2001 TO SEPTEMBER 2002

Date	TEBU- THIURON WATER FLTRD 0.7 U GF, REC (82670)	TER- BACIL WATER FLTRD 0.7 U GF, REC (82665)	TER- BUFOS WATER FLTRD 0.7 U GF, REC (82675)	TER- BUTHYL- AZINE, WATER, DISS, REC (04022)	THIO- BENCARB WATER FLTRD 0.7 U GF, REC (82681)	TRIAL- LATE WATER FLTRD 0.7 U GF, REC (82678)	TRI- FLUR- ALIN WAT FLT 0.7 U GF, REC (82661)
NOV 13...	--	--	--	--	--	--	--
JAN 24...	<.02	<.034	<.02	--	e.004	<.002	<.009
FEB 25...	<.02	<.034	<.02	--	e.004	<.002	<.009
MAR 21...	<.02	<.034	<.02	U	<.005	<.002	<.009
APR 25...	<.02	<.034	<.02	--	<.005	<.002	<.009
MAY 22...	<.02	<.034	<.02	--	.650	<.002	<.009
JUN 19...	<.02	<.034	<.02	--	.035	<.002	<.009
JUL 17...	<.02	<.034	<.02	--	.010	<.002	<.009
SEP 18...	<.02	<.034	<.02	--	.007	<.002	<.009

CROSS-SECTIONAL DATA, WATER YEAR OCTOBER 2001 TO SEPTEMBER 2002

DATE	TIME	DEPTH BOTTOM AT SAMPLE LOC- ATION, (FEET) (81903)	TEMPER- ATURE WATER (DEG C) (00010)	SAMPLE LOC- ATION, CROSS SECTION (FT FM L BANK) (00009)
APR				
11...*	1115	21.3	15.5	172
11...*	1120	21.0	15.5	274
11...*	1122	23.4	15.5	377
11...*	1125	26.0	15.5	462
11...*	1127	28.2	15.5	547
JUL				
09...*	0951	29.0	21.0	547
09...*	0955	27.5	21.0	462
09...*	0958	24.3	21.0	377
09...*	1003	23.5	21.0	274
09...*	1007	20.5	21.0	172

< Actual value is known to be less than the value shown.

e Estimated.

U Material specifically analyzed for, but not detected.

* Instantaneous discharge at time of cross-sectional measurement: 18,300 ft³/s, Apr. 11; 21,300 ft³/s, July 9.

11447650 SACRAMENTO RIVER AT FREEPORT, CA—Continued

PARTICLE-SIZE DISTRIBUTION OF SUSPENDED SEDIMENT, WATER YEAR OCTOBER 2001 TO SEPTEMBER 2002

DATE	TIME	DIS- CHARGE, INST. CUBIC FEET PER SECOND (00061)	TEMPER- ATURE WATER (DEG C) (00010)	SED. SUSP. SIEVE DIAM. % FINER THAN .062 MM (70331)	SEDI- MENT, SUS- PENDE (MG/L) (80154)	SEDI- MENT, DIS- CHARGE, SUS- PENDE (T/DAY) (80155)
NOV						
13...SS	1200	14500	15.0	81	20	783
19...	1212	10600	15.0	89	19	544
JAN						
08...	1114	60200	10.5	64	148	24100
24...SS	1300	18200	8.0	92	40	1970
FEB						
25...SS	1300	22500	12.0	93	76	4620
MAR						
05...	1042	12600	11.5	85	21	714
21...SS	1230	18200	12.0	90	12	590
APR						
11...	1023	18100	15.5	74	26	1270
25...SS	1030	14800	17.0	90	13	519
MAY						
22...SS	1300	20700	16.0	92	56	3130
24...	1116	22500	17.5	92	68	4130
JUN						
19...SS	1220	13500	22.0	82	21	765
JUL						
09...	0830	22200	21.0	91	22	1320
17...SS	1210	17900	21.0	66	21	1010
AUG						
27...	1050	12900	21.5	89	22	766
SEP						
18...SS	1120	18600	20.0	73	16	804

PARTICLE-SIZE DISTRIBUTION OF SURFACE BED MATERIAL, WATER YEAR OCTOBER 2001 TO SEPTEMBER 2002

DATE	TIME	DIS- CHARGE, INST. CUBIC FEET PER SECOND (00061)	TEMPER- ATURE WATER (DEG C) (00010)	BED MAT. SIEVE DIAM. % FINER THAN (80164)	BED MAT. SIEVE DIAM. % FINER THAN (80165)	BED MAT. SIEVE DIAM. % FINER THAN (80166)	BED MAT. SIEVE DIAM. % FINER THAN (80167)	BED MAT. SIEVE DIAM. % FINER THAN (80168)	BED MAT. SIEVE DIAM. % FINER THAN (80169)	BED MAT. SIEVE DIAM. % FINER THAN (80170)	BED MAT. SIEVE DIAM. % FINER THAN (80171)	BED MAT. SIEVE DIAM. % FINER THAN (80172)	NUMBER OF SAM- PLING POINTS (COUNT) (00063)
JAN													
09...	1500	61500	10.0	--	1	6	37	88	94	98	100	--	1
09...	1513	61500	10.0	--	--	6	51	91	97	98	100	--	1
09...	1520	61500	10.0	--	1	13	71	94	98	99	100	--	1
09...	1524	61500	10.0	1	2	14	60	82	85	87	88	100	1
09...	1531	61500	10.0	--	2	27	95	99	100	--	--	--	1
JUL													
09...	0855	22200	21.0	6	18	25	53	89	97	100	--	--	1
09...	0900	22200	21.0	4	15	21	69	91	96	99	100	--	1
09...	0905	22200	21.0	1	5	18	86	99	100	--	--	--	1
09...	0910	22200	21.0	5	17	36	84	97	99	100	--	--	1
09...	0915	22200	21.0	4	15	38	97	100	--	--	--	--	1

SS Suspended-sediment data determined from a sample collected and processed according to National Water-Quality Assessment (NAWQA) protocol.

SACRAMENTO RIVER BASIN

11447650 SACRAMENTO RIVER AT FREEPORT, CA—Continued

WATER TEMPERATURE, DEGREES C, WATER YEAR OCTOBER 2001 TO SEPTEMBER 2002

DAY	MAX	MIN	MAX	MIN	MAX	MIN	MAX	MIN	MAX	MIN	MAX	MIN
	OCTOBER		NOVEMBER		DECEMBER		JANUARY		FEBRUARY		MARCH	
1	21.0	20.0	16.0	16.0	10.0	10.0	11.0	11.0	7.0	7.0	12.5	12.0
2	21.0	20.0	16.0	15.5	10.0	9.5	12.0	11.0	7.5	7.0	12.0	11.5
3	21.5	20.5	16.0	15.5	10.0	9.5	12.0	11.5	8.0	7.5	11.5	11.5
4	23.0	21.0	16.5	15.5	10.0	9.5	12.0	11.5	8.0	8.0	12.0	11.5
5	21.0	20.5	16.5	15.5	10.0	9.5	11.5	11.5	8.5	8.0	12.0	11.5
6	20.5	20.0	16.0	15.5	10.0	9.5	11.5	11.0	9.0	8.5	12.0	11.5
7	20.0	19.5	16.0	15.5	10.0	9.5	11.0	10.5	9.5	9.0	12.0	12.0
8	20.0	19.0	15.5	15.0	10.0	10.0	11.0	10.5	9.5	9.0	12.0	11.5
9	19.5	19.0	15.5	15.0	10.0	10.0	11.0	10.5	9.5	9.5	11.5	11.0
10	19.5	18.5	15.5	15.0	10.0	10.0	11.0	10.5	10.0	9.5	11.0	11.0
11	19.0	18.5	15.5	15.0	10.0	9.5	10.5	10.5	10.0	9.5	11.0	10.5
12	19.0	18.0	15.0	15.0	9.5	9.0	10.5	10.0	10.0	10.0	11.5	11.0
13	18.5	18.0	15.0	15.0	9.0	9.0	10.5	10.0	10.5	10.0	11.0	10.5
14	18.5	17.5	15.0	14.5	9.0	9.0	10.0	10.0	10.5	10.0	11.0	10.5
15	19.0	18.0	15.0	15.0	9.0	8.5	10.0	9.5	11.0	10.5	11.5	11.0
16	19.0	18.0	15.0	15.0	9.0	8.5	9.5	9.0	---	---	12.0	11.0
17	19.0	18.0	15.0	15.0	8.5	8.5	9.0	8.5	---	---	11.5	11.0
18	19.0	18.0	15.5	15.0	8.5	8.5	8.5	8.0	---	---	11.0	10.5
19	19.0	18.0	15.5	15.0	9.0	8.5	8.0	8.0	---	---	11.5	10.5
20	19.0	18.0	15.0	15.0	9.0	9.0	8.0	8.0	---	---	11.5	11.0
21	18.5	18.0	15.0	14.5	9.5	9.0	8.0	8.0	---	---	12.0	11.5
22	18.5	17.5	15.0	14.5	9.5	9.5	8.0	8.0	12.0	11.5	12.5	12.0
23	18.0	17.5	14.5	14.0	9.5	9.0	8.0	7.5	11.5	11.0	12.5	12.0
24	18.0	17.0	14.0	13.5	9.0	9.0	8.0	7.5	12.0	11.0	13.0	12.0
25	17.5	16.5	13.5	12.5	9.5	9.0	8.0	7.5	12.0	11.5	13.0	12.0
26	17.5	16.5	12.5	12.0	9.5	9.0	8.0	8.0	12.5	12.0	13.0	12.5
27	17.0	16.0	12.0	10.5	9.5	9.0	8.0	8.0	12.5	12.0	13.5	12.5
28	17.0	16.0	10.5	10.0	9.5	9.0	8.0	7.5	13.0	12.5	14.5	13.0
29	16.5	16.0	10.0	10.0	10.0	9.5	8.0	7.5	---	---	15.0	14.0
30	16.5	16.0	10.0	9.5	10.5	10.0	7.5	7.0	---	---	15.5	15.0
31	16.5	16.0	---	---	11.0	10.5	7.0	7.0	---	---	16.0	15.0
MONTH	23.0	16.0	16.5	9.5	11.0	8.5	12.0	7.0	---	---	16.0	10.5
	APRIL		MAY		JUNE		JULY		AUGUST		SEPTEMBER	
1	16.5	15.5	15.5	14.5	---	---	22.5	21.5	22.5	21.5	23.0	22.5
2	17.0	16.0	16.5	15.0	---	---	23.0	22.0	22.5	21.5	23.5	22.5
3	17.0	16.5	16.5	15.5	---	---	22.5	21.5	22.5	21.5	23.5	22.5
4	17.0	16.5	17.5	16.0	---	---	22.0	21.0	22.0	21.0	23.0	22.0
5	16.5	15.5	18.0	17.0	---	---	22.0	21.0	21.5	20.5	22.0	21.0
6	16.0	15.5	19.0	17.5	---	---	22.0	21.0	21.0	20.0	21.0	20.5
7	16.0	15.5	19.0	18.0	---	---	22.0	21.0	21.0	20.0	20.5	20.0
8	16.5	16.0	19.0	18.0	---	---	21.5	21.0	21.0	20.0	20.5	20.0
9	16.0	15.5	19.0	18.0	---	---	22.0	21.0	21.5	20.5	20.5	20.0
10	15.5	15.0	18.5	18.0	---	---	22.5	21.0	22.0	21.0	20.5	20.0
11	---	---	18.5	17.5	---	---	22.5	21.5	22.0	21.5	21.0	20.5
12	---	---	18.5	17.5	21.0	20.0	22.5	21.5	22.5	21.5	21.0	20.5
13	---	---	19.0	18.0	21.0	20.5	22.5	21.0	22.5	21.5	21.0	20.5
14	---	---	19.5	18.5	21.0	20.5	22.5	21.5	22.5	22.0	21.0	20.5
15	---	---	20.0	19.0	21.0	20.5	22.0	21.0	22.5	22.0	20.5	20.0
16	---	---	20.5	19.5	21.5	20.5	21.5	20.5	22.5	22.0	20.5	20.0
17	---	---	21.0	20.0	21.5	20.5	21.5	20.5	22.5	22.0	20.5	20.0
18	15.0	14.0	21.5	20.0	22.0	21.0	21.5	20.5	22.0	21.5	20.0	20.0
19	15.0	14.0	---	---	22.5	21.5	21.5	20.5	22.0	21.0	20.0	20.0
20	15.5	14.5	---	---	22.5	22.0	22.0	20.5	21.5	21.0	20.0	20.0
21	15.5	15.0	---	---	22.0	21.0	22.0	21.0	21.5	21.0	20.5	20.0
22	16.5	15.0	---	---	21.0	20.5	21.5	20.5	21.5	21.0	20.5	20.0
23	17.5	15.5	---	---	21.0	20.5	21.5	20.5	21.0	20.5	21.0	20.5
24	18.0	16.0	---	---	21.5	20.5	21.5	20.5	20.5	20.0	21.0	20.5
25	18.0	17.0	---	---	22.5	21.0	22.0	21.0	21.0	20.5	21.0	20.5
26	17.5	17.0	---	---	22.0	21.5	22.0	21.0	21.5	21.0	20.5	20.0
27	17.0	16.0	---	---	22.0	21.0	22.0	21.0	22.0	21.5	20.0	19.5
28	16.5	15.5	---	---	22.0	21.0	22.0	21.0	22.5	22.0	19.5	19.0
29	15.5	15.0	---	---	22.0	21.0	22.0	21.0	22.5	22.0	19.0	18.5
30	15.5	14.5	---	---	22.0	21.0	22.0	21.0	22.5	22.0	18.5	18.5
31	---	---	---	---	---	---	22.5	21.5	22.5	22.0	---	---
MONTH	---	---	---	---	---	---	23.0	20.5	22.5	20.0	23.5	18.5

11447650 SACRAMENTO RIVER AT FREEPORT, CA—Continued

SEDIMENT DISCHARGE, SUSPENDED (TONS/DAY), WATER YEAR OCTOBER 2001 TO SEPTEMBER 2002

DAY	MEAN	MEAN	SEDIMENT	MEAN	MEAN	SEDIMENT	MEAN	MEAN	SEDIMENT
	DISCHARGE (CFS)	CONCEN- TRATION (MG/L)	DISCHARGE (TONS/DAY)	DISCHARGE (CFS)	CONCEN- TRATION (MG/L)	DISCHARGE (TONS/DAY)	DISCHARGE (CFS)	CONCEN- TRATION (MG/L)	DISCHARGE (TONS/DAY)
	OCTOBER			NOVEMBER			DECEMBER		
1	e11400	9.0	e277	9380	9.0	228	18700	19	961
2	10500	9.0	255	9340	9.0	227	22700	135	8270
3	10300	9.0	249	9010	10	243	28900	283	22100
4	9280	10	251	9080	11	270	33900	297	27200
5	9710	10	262	e9670	12	e313	32800	280	24800
6	9670	10	261	e9510	13	e334	30000	243	19700
7	9120	10	246	9400	12	305	27300	198	14600
8	8780	10	237	9340	10	252	28000	153	11600
9	8270	10	223	9300	8.0	201	27000	110	8020
10	8430	10	228	8930	6.0	145	24300	98	6430
11	7950	10	215	8880	7.0	168	22200	97	5810
12	8170	10	221	9450	8.0	204	20800	95	5330
13	7730	10	209	11900	10	322	18900	93	4740
14	7190	10	194	12700	12	411	17700	91	4340
15	e7960	10	e215	13400	14	507	18900	89	4540
16	e7950	10	e215	13100	16	565	24100	86	5590
17	7180	10	194	12400	18	604	24900	72	4840
18	e7170	9.0	e174	11800	20	638	23400	57	3600
19	7140	9.0	174	11300	21	639	24100	41	2670
20	6970	9.0	169	10800	23	672	24700	26	1730
21	7020	9.0	171	10400	25	703	26800	32	2320
22	e7930	9.0	e193	11500	26	804	31900	215	18500
23	8520	9.0	207	11900	28	896	35200	266	25300
24	e8060	9.0	e196	13700	37	1370	36200	252	24600
25	8230	9.0	200	18200	72	3530	36200	232	22700
26	e7810	9.0	e190	20900	109	6140	34500	170	15900
27	e7820	9.0	e190	22200	102	6100	31300	107	9050
28	8070	9.0	196	18900	79	4030	28900	95	7410
29	7790	9.0	189	16700	57	2570	28600	94	7270
30	e8220	9.0	e200	16000	34	1470	30500	94	7740
31	e9140	9.0	e222	---	---	---	35300	116	11100
TOTAL	259480	---	6623	369090	---	34861	848700	---	338761
	JANUARY			FEBRUARY			MARCH		
1	40000	147	15900	18700	22	1110	18000	38	1840
2	44000	177	21000	18400	21	1040	17900	34	1650
3	50600	208	28400	18200	21	1030	18500	31	1550
4	57700	237	36900	17700	21	1000	18300	27	1330
5	63900	241	41600	17000	21	965	17900	24	1160
6	65600	238	42100	16600	20	895	18000	31	1500
7	64500	229	39900	15900	20	860	19700	30	1590
8	63200	166	28300	15900	20	859	23800	29	1860
9	62000	192	32100	15600	19	798	26100	49	3450
10	60300	185	30100	15600	19	802	27400	48	3550
11	57400	165	25600	15700	19	804	27900	42	3170
12	52600	144	20500	15200	18	741	28800	36	2800
13	46800	108	13600	15000	18	731	27800	36	2710
14	40900	66	7280	14700	17	677	25800	36	2510
15	36600	29	2860	14600	15	591	23900	37	2390
16	33600	26	2360	14300	14	541	22700	38	2330
17	31300	34	2870	14600	17	668	21500	39	2260
18	29400	47	3730	14900	21	845	20900	37	2080
19	27600	62	4630	15100	26	1060	19900	35	1880
20	26100	76	5360	15700	30	1280	19100	32	1650
21	24400	70	4620	19600	35	1850	18300	30	1480
22	23400	58	3670	28600	39	3010	18100	30	1470
23	22400	50	3020	31100	43	3610	18300	30	1480
24	21700	44	2580	27400	43	3180	20500	30	1660
25	20700	38	2130	23500	43	2730	23800	31	1990
26	19900	32	1720	21200	42	2400	23600	31	1980
27	20400	27	1490	19500	42	2210	21600	31	1810
28	20500	24	1330	18600	41	2060	19700	31	1650
29	20000	23	1240	---	---	---	18200	32	1570
30	19600	22	1170	---	---	---	17600	33	1570
31	19300	22	1150	---	---	---	17400	34	1600
TOTAL	1186400	---	429210	508900	---	38347	661000	---	61520

e Estimated.

SACRAMENTO RIVER BASIN

11447650 SACRAMENTO RIVER AT FREEPORT, CA—Continued

SEDIMENT DISCHARGE, SUSPENDED (TONS/DAY), WATER YEAR OCTOBER 2001 TO SEPTEMBER 2002

DAY	MEAN	MEAN	SEDIMENT	MEAN	MEAN	SEDIMENT	MEAN	MEAN	SEDIMENT
	DISCHARGE (CFS)	CONCEN- TRATION (MG/L)	DISCHARGE (TONS/DAY)	DISCHARGE (CFS)	CONCEN- TRATION (MG/L)	DISCHARGE (TONS/DAY)	DISCHARGE (CFS)	CONCEN- TRATION (MG/L)	DISCHARGE (TONS/DAY)
	APRIL			MAY			JUNE		
1	17000	36	1650	12000	27	876	12700	30	1030
2	16500	37	1650	11300	25	765	13100	28	993
3	16700	34	1530	11500	23	712	12800	26	896
4	17100	30	1390	10900	21	618	12800	23	798
5	16700	26	1170	10300	19	529	12900	21	730
6	16100	22	955	9640	17	442	12800	20	689
7	16200	21	918	10100	15	408	12500	22	741
8	15700	22	935	9950	14	376	12200	25	823
9	16200	22	962	9990	15	405	12000	27	878
10	16400	23	1020	9830	18	478	11500	27	841
11	16100	26	1130	9620	20	519	11300	26	794
12	16100	27	1180	9850	22	585	11000	25	745
13	16000	27	1170	9660	25	652	11600	24	751
14	14900	27	1080	10100	25	680	12700	24	826
15	15600	28	1180	10400	26	727	12900	23	801
16	15200	28	1150	10600	27	775	13300	22	789
17	14900	28	1120	11000	37	1100	14200	21	805
18	15400	28	1170	12000	49	1590	14500	21	821
19	14800	25	1000	13600	61	2240	14600	23	909
20	14000	21	792	15000	73	2970	14700	26	1030
21	13700	17	627	19000	80	4100	15200	29	1190
22	13100	13	461	20200	76	4140	15400	28	1160
23	12300	9.0	299	20300	72	3940	15100	28	1140
24	10800	11	320	19800	70	3740	15600	27	1140
25	11000	14	415	18000	79	3840	16000	26	1120
26	10900	17	499	16500	68	3030	15700	22	930
27	10800	20	583	15400	54	2240	16100	16	694
28	11300	23	702	14500	41	1600	16500	13	578
29	11100	26	782	14300	36	1390	17400	14	657
30	11700	26	823	13600	34	1250	17700	17	812
31	---	---	---	13100	32	1130	---	---	---
TOTAL	434300	---	28663	402040	---	47847	416800	---	26111
	JULY			AUGUST			SEPTEMBER		
1	17300	19	885	19100	30	1550	14800	20	798
2	16700	21	949	18500	30	1500	14100	16	610
3	17300	22	1030	18000	32	1550	13400	13	469
4	17400	23	1080	18800	35	1770	13400	13	469
5	17200	24	1120	18400	37	1840	13600	15	550
6	17400	25	1180	18700	40	2020	13600	15	549
7	17700	26	1240	18700	40	2020	13700	16	590
8	18200	28	1380	18200	40	1970	13500	16	585
9	17900	33	1600	17800	36	1730	13900	17	637
10	18000	41	1990	17600	31	1470	13800	17	635
11	18300	40	1980	17200	26	1210	14000	17	643
12	18800	38	1930	16900	21	961	14400	16	624
13	18800	36	1820	16900	19	869	14600	15	591
14	19000	34	1740	17300	18	839	14400	14	545
15	19200	32	1660	17200	20	930	13800	13	484
16	19400	32	1680	17300	24	1120	14000	11	415
17	19500	32	1690	17400	27	1270	13600	10	368
18	19700	32	1710	17100	30	1390	14000	10	378
19	19600	32	1690	16600	33	1480	13900	11	414
20	19000	35	1790	17600	36	1710	13700	11	408
21	18900	38	1940	17800	40	1920	13500	11	402
22	19700	41	2180	17500	42	1980	13300	11	396
23	20000	44	2370	17500	39	1840	13300	11	396
24	20400	43	2370	16600	34	1520	13100	11	388
25	20600	42	2340	15800	30	1280	12800	11	381
26	20500	40	2210	15100	25	1020	12000	12	388
27	20200	37	2020	14100	26	989	12700	12	410
28	20000	35	1890	13500	30	1090	12800	12	414
29	20200	32	1750	14500	30	1170	12400	13	434
30	19700	29	1540	14900	27	1090	12800	12	415
31	19300	29	1510	14900	23	927	---	---	---
TOTAL	585900	---	52264	527500	---	44025	406900	---	14786
YEAR	6607010		1123018						

11449500 KELSEY CREEK NEAR KELSEYVILLE, CA

LOCATION.—Lat 38°55'39", long 122°50'33", in SE 1/4 SE 1/4 sec.34, T.13 N., R.9 W., [Lake County](#), Hydrologic Unit 18020116, on left bank, 1.6 mi downstream from Widow Creek, and 3.5 mi south of Kelseyville.

DRAINAGE AREA.—36.6 mi².

PERIOD OF RECORD.—October 1946 to current year.

REVISED RECORDS.—WSP 1285: 1947–48(M), 1950–52(P). WSP 1931: Drainage area. WDR CA-96-4: 1956–93(P).

GAGE.—Water-stage recorder. Datum of gage is 1,475.44 ft above sea level. Prior to July 16, 1955, at site 600 ft upstream at different datum.

REMARKS.—Records good except for estimated daily discharges, which are poor. Some minor diversions upstream from station. See schematic diagram of [lower Sacramento River Basin](#).

EXTREMES FOR PERIOD OF RECORD.—Maximum discharge, 8,600 ft³/s, Mar. 9, 1995, gage height, 13.80 ft; minimum daily, 0.13 ft³/s, Sept. 6–11, 1992.

EXTREMES FOR CURRENT YEAR.—Peak discharges greater than base discharge of 2,400 ft³/s, or maximum:

Date	Time	Discharge (ft ³ /s)	Gage height (ft)
Dec. 1	1230	2,490	9.18

DISCHARGE, CUBIC FEET PER SECOND, WATER YEAR OCTOBER 2001 TO SEPTEMBER 2002

DAILY MEAN VALUES

DAY	OCT	NOV	DEC	JAN	FEB	MAR	APR	MAY	JUN	JUL	AUG	SEP
1	1.9	6.7	733	287	38	32	37	18	8.5	2.9	1.5	1.4
2	1.4	6.0	e880	1340	38	30	35	17	8.4	2.6	1.5	1.3
3	e0.96	5.7	e430	416	36	29	33	15	7.7	2.5	1.6	1.3
4	e0.93	5.3	e205	239	35	28	32	16	7.5	2.5	1.6	1.3
5	e0.99	5.2	e215	328	33	28	30	15	7.1	2.3	1.7	1.3
6	e1.1	5.3	e320	459	33	33	30	14	6.6	2.2	1.7	1.4
7	e1.7	5.5	e176	264	43	50	28	13	6.4	2.2	1.7	1.5
8	2.5	5.5	e122	196	72	42	27	14	6.3	2.2	1.7	1.6
9	2.5	5.7	e90	157	48	37	26	12	6.3	2.2	1.6	1.6
10	2.3	6.1	e74	128	43	68	26	13	5.9	1.9	1.6	1.6
11	2.3	14	e59	110	40	51	25	12	5.6	e2.0	1.5	1.6
12	2.2	151	e48	95	39	45	24	13	5.3	e2.0	1.4	1.5
13	2.2	50	49	e85	37	42	23	12	5.1	e1.9	1.3	1.5
14	2.0	26	260	e77	36	40	22	11	4.9	e2.0	1.3	1.4
15	2.0	20	94	e69	34	38	22	12	4.9	e1.9	1.3	1.4
16	1.6	17	75	e64	34	36	21	11	4.8	e1.8	1.3	1.5
17	1.8	18	206	e59	44	35	24	11	4.7	1.9	1.3	1.6
18	2.5	15	119	e56	37	33	21	10	4.7	1.9	1.3	1.7
19	2.6	14	97	e53	40	32	20	11	4.8	1.9	1.3	1.7
20	2.6	15	339	e51	58	30	20	19	4.4	1.6	1.3	1.6
21	2.8	49	292	e50	51	29	19	23	4.1	1.6	1.3	1.6
22	2.8	123	313	e48	46	36	18	15	4.0	1.6	1.3	1.6
23	3.1	41	211	e46	44	150	18	14	3.9	1.6	1.4	1.6
24	3.1	206	147	43	42	93	17	13	3.8	1.7	1.5	1.6
25	3.1	88	118	42	39	68	17	12	3.6	1.7	1.5	1.6
26	3.2	45	105	55	37	58	17	11	3.5	1.6	1.5	1.6
27	3.3	34	92	49	35	52	17	11	3.4	1.6	1.5	1.7
28	3.6	76	184	45	33	48	16	11	3.1	1.6	1.5	1.7
29	3.9	272	229	43	---	44	19	10	3.0	1.6	1.4	1.8
30	9.9	76	249	40	---	41	17	9.8	3.1	1.6	1.4	1.7
31	12	---	296	39	---	39	---	8.9	---	1.6	1.4	---
TOTAL	88.88	1407.0	6827	5033	1145	1417	701	407.7	155.4	60.2	45.2	46.3
MEAN	2.867	46.90	220.2	162.4	40.89	45.71	23.37	13.15	5.180	1.942	1.458	1.543
MAX	12	272	880	1340	72	150	37	23	8.5	2.9	1.7	1.8
MIN	0.93	5.2	48	39	33	28	16	8.9	3.0	1.6	1.3	1.3
AC-FT	176	2790	13540	9980	2270	2810	1390	809	308	119	90	92

e Estimated.

SACRAMENTO RIVER BASIN

11449500 KELSEY CREEK NEAR KELSEYVILLE, CA—Continued

STATISTICS OF MONTHLY MEAN DATA FOR WATER YEARS 1947 - 2002, BY WATER YEAR (WY)

	OCT	NOV	DEC	JAN	FEB	MAR	APR	MAY	JUN	JUL	AUG	SEP
MEAN	11.01	45.40	124.3	203.8	212.8	149.2	76.19	31.15	13.00	5.663	3.531	3.709
MAX	154	334	688	929	919	640	429	163	64.1	19.2	9.40	16.3
(WY)	1963	1974	1956	1995	1986	1983	1982	1983	1998	1998	1998	1957
MIN	1.22	3.55	4.19	4.83	8.97	11.4	5.67	6.12	1.98	0.46	0.20	0.16
(WY)	1992	1991	1991	1991	1977	1977	1977	1977	1977	1977	1977	1992

SUMMARY STATISTICS	FOR 2001 CALENDAR YEAR	FOR 2002 WATER YEAR	WATER YEARS 1947 - 2002
ANNUAL TOTAL	20453.15	17333.68	
ANNUAL MEAN	56.04	47.49	72.69
HIGHEST ANNUAL MEAN			206 1983
LOWEST ANNUAL MEAN			4.78 1977
HIGHEST DAILY MEAN	931 Mar 4	1340 Jan 2	6020 Feb 17 1986
LOWEST DAILY MEAN	0.82 Aug 19	0.93 Oct 4	0.13 Sep 6 1992
ANNUAL SEVEN-DAY MINIMUM	0.84 Aug 14	1.3 Oct 1	0.13 Sep 5 1992
MAXIMUM PEAK FLOW		2490 Dec 1	8600 Mar 9 1995
MAXIMUM PEAK STAGE		9.18 Dec 1	13.80 Mar 9 1995
ANNUAL RUNOFF (AC-FT)	40570	34380	52660
10 PERCENT EXCEEDS	166	113	153
50 PERCENT EXCEEDS	10	13	13
90 PERCENT EXCEEDS	0.96	1.5	2.5

11450000 CLEAR LAKE AT LAKEPORT, CA

LOCATION.—Lat 39°02'21", long 122°54'44", in NE 1/4 NE 1/4 sec.25, T.14 N., R.10 W., [Lake County](#), Hydrologic Unit 18020116, on pier behind 410 Esplanade Street in Lakeport.

DRAINAGE AREA.—528 mi².

PERIOD OF RECORD.—1874–1900 (incomplete), January 1913 to April 1982, October 1984 to current year.

GAGE.—Water-stage recorder. Datum of gage is 1,318.26 ft above sea level (California State Land Commission Benchmark). Prior to July 8, 1947, nonrecording gage, and July 8, 1947, to Mar. 17, 1949, at municipal wharf at foot of Third Street in Lakeport at datum 0.33 ft higher. Mar. 18, 1949, to Sept. 30, 1967, at private pier at foot of Fourth Street at datum 0.33 ft higher. Gage relocated at same datum, Apr. 20, 1982, and published as "at Clearlake" for 1982–84.

REMARKS.—This natural lake is regulated by gates on a dam at outlet, completed in 1915. Capacity between gage heights 0.00 and 7.56 ft, limits stipulated by court decree of 1920, about 319,000 acre-ft. Water is released down natural channel of Cache Creek (station 11451000), from which it is diverted for irrigation. See schematic diagram of [lower Sacramento River Basin](#).

EXTREMES FOR PERIOD OF RECORD.—Maximum gage height, 11.44 ft, Feb. 24, 1998, minimum observed, –3.50 ft, Sept. 24–27, 1920.

EXTREMES OUTSIDE PERIOD OF RECORD.—Flood of Mar. 4, 1983, reached a stage of 11.24 ft, present datum, from floodmarks.

GAGE HEIGHT, FEET, WATER YEAR OCTOBER 2001 TO SEPTEMBER 2002
DAILY MEAN VALUES

DAY	OCT	NOV	DEC	JAN	FEB	MAR	APR	MAY	JUN	JUL	AUG	SEP
1	1.18	0.91	1.67	4.58	6.02	6.52	6.88	6.73	5.82	4.67	3.28	2.10
2	1.17	0.91	1.89	5.02	6.03	6.51	6.88	6.71	5.78	4.61	3.24	2.06
3	1.16	0.91	2.07	5.38	6.04	6.51	6.88	6.68	5.72	4.51	3.20	2.01
4	1.14	0.93	2.15	5.58	6.05	6.51	6.88	6.65	5.68	4.53	3.15	1.95
5	1.12	0.93	2.23	5.69	6.06	6.52	6.88	6.61	5.63	4.50	3.07	1.88
6	1.11	0.92	2.35	5.82	6.06	6.54	6.88	6.57	5.58	4.44	3.04	1.83
7	1.09	0.91	2.44	5.89	6.07	6.53	6.89	6.55	5.52	4.36	3.01	1.80
8	1.07	0.92	2.48	5.91	6.11	6.57	6.88	6.51	5.45	4.32	2.97	1.76
9	1.07	0.94	2.50	5.91	6.13	6.59	6.89	6.46	5.41	4.29	2.94	1.73
10	1.05	0.93	2.51	5.89	6.14	6.61	6.89	6.41	5.36	4.24	2.91	1.71
11	1.01	0.94	2.54	5.87	6.15	6.63	6.89	6.39	5.32	4.24	2.88	1.69
12	1.02	0.93	2.57	5.83	6.16	6.61	6.89	6.36	5.28	4.17	2.84	1.66
13	1.00	0.95	2.58	5.80	6.17	6.62	6.89	6.29	5.23	4.01	2.81	1.64
14	1.00	0.96	2.67	5.77	6.17	6.64	6.84	6.27	5.19	3.93	2.78	1.62
15	0.99	0.96	2.77	5.80	6.18	6.64	6.81	6.23	5.15	3.90	2.75	1.56
16	0.98	0.96	2.83	5.82	6.20	6.63	6.83	6.21	5.09	3.91	2.71	1.54
17	0.98	0.96	2.91	5.83	6.21	6.64	6.83	6.17	5.04	3.87	2.67	1.51
18	0.97	0.98	2.96	5.85	6.22	6.66	6.83	6.16	5.00	3.84	2.64	1.51
19	0.96	1.04	3.04	5.85	6.26	6.67	6.83	6.13	4.98	3.82	2.59	1.49
20	0.95	1.08	3.18	5.86	6.31	6.68	6.83	6.12	4.93	3.78	2.53	1.47
21	0.93	1.13	3.28	5.85	6.36	6.68	6.82	6.11	4.90	3.74	2.50	1.45
22	0.90	1.19	3.42	5.88	6.38	6.74	6.82	6.08	4.87	3.69	2.46	1.44
23	0.89	1.22	3.56	5.90	6.40	6.77	6.82	6.06	4.83	3.66	2.42	1.42
24	0.90	1.26	3.66	5.91	6.43	6.80	6.79	6.04	4.81	3.61	2.38	1.41
25	0.90	1.33	3.72	5.92	6.46	6.82	6.79	6.03	4.79	3.57	2.33	1.39
26	0.91	1.35	3.78	5.94	6.47	6.83	6.76	6.00	4.78	3.53	2.30	1.35
27	0.90	1.36	3.84	5.97	6.49	6.84	6.73	5.98	4.77	3.48	2.27	1.33
28	0.90	1.40	3.92	5.99	6.50	6.85	6.75	5.96	4.74	3.44	2.23	1.30
29	0.90	1.47	4.07	6.00	---	6.86	6.75	5.93	4.71	3.39	2.20	1.24
30	0.90	1.52	4.17	6.01	---	6.87	6.74	5.91	4.69	3.35	2.16	1.22
31	0.91	---	4.38	6.02	---	6.87	---	5.89	---	3.32	2.13	---
MEAN	1.00	1.07	2.97	5.79	6.22	6.67	6.84	6.26	5.17	3.96	2.69	1.60
MAX	1.18	1.52	4.38	6.02	6.50	6.87	6.89	6.73	5.82	4.67	3.28	2.10
MIN	0.89	0.91	1.67	4.58	6.02	6.51	6.73	5.89	4.69	3.32	2.13	1.22

11451000 CACHE CREEK NEAR LOWER LAKE, CA

LOCATION.—Lat 38°55'27", long 122°33'53", in sec.6, T.12 N., R.6 W., Lake County, Hydrologic Unit 18020116, on left bank, 500 ft downstream from Cache Creek Dam, 1.9 mi downstream from Copsy Creek, and 2.5 mi northeast of Lower Lake.

DRAINAGE AREA.—528 mi².

PERIOD OF RECORD.—May 1944 to current year.

GAGE.—Water-stage recorder and rain gage (station 385525122335501). Datum of gage is 1,279.34 ft above sea level. Prior to Oct. 2, 1987, at datum 1.00 ft higher.

REMARKS.—Records fair. Flow regulated by Clear Lake (station 11450000) from Cache Creek Dam, 500 ft upstream. See schematic diagram of lower Sacramento River Basin.

EXTREMES FOR PERIOD OF RECORD.—Maximum discharge, 10,200 ft³/s, Feb. 17, 1998, gage height, 11.01 ft, present datum; no flow Nov. 8–20, 1977, Apr. 5, 6, 1987.

DISCHARGE, CUBIC FEET PER SECOND, WATER YEAR OCTOBER 2001 TO SEPTEMBER 2002
DAILY MEAN VALUES

DAY	OCT	NOV	DEC	JAN	FEB	MAR	APR	MAY	JUN	JUL	AUG	SEP
1	5.4	3.9	3.3	4.3	11	9.0	11	194	686	338	355	436
2	5.4	3.6	2.9	320	11	10	11	429	675	396	374	433
3	5.4	3.6	2.1	6.8	11	9.0	10	496	717	424	331	425
4	5.4	3.6	2.0	827	11	8.9	9.8	466	736	429	295	424
5	5.3	3.5	2.0	1770	11	9.0	9.8	445	694	429	295	430
6	5.3	3.2	2.1	1920	11	9.0	9.8	468	716	429	295	414
7	5.3	3.1	2.2	1870	11	9.1	10	497	702	429	329	362
8	5.3	3.1	2.2	1870	12	9.2	12	515	652	448	360	309
9	5.3	3.0	2.3	1870	12	9.4	18	511	588	468	360	270
10	5.3	2.9	2.4	1830	13	9.9	16	516	505	483	356	254
11	5.3	2.9	2.4	1790	17	9.3	13	540	498	510	355	248
12	5.3	2.8	2.4	1670	16	9.2	13	542	563	522	355	236
13	5.2	1.9	2.5	1300	15	9.4	13	538	560	524	353	195
14	5.1	1.8	2.7	341	12	9.7	14	548	499	486	352	183
15	5.1	1.9	2.6	14	12	9.8	14	584	472	428	352	183
16	5.1	2.1	2.6	13	11	9.9	14	633	440	384	352	185
17	5.1	2.1	2.7	13	11	9.9	15	663	450	377	351	164
18	5.0	2.0	2.7	13	11	10	16	602	454	406	351	117
19	4.7	1.9	2.7	13	11	10	16	510	437	415	350	93
20	4.6	1.9	2.8	13	11	10	16	438	405	368	350	93
21	4.6	2.0	3.3	13	12	11	17	323	360	338	386	93
22	4.7	2.1	3.8	12	13	11	17	235	318	379	407	93
23	4.7	2.0	3.2	12	15	12	21	170	303	417	405	72
24	4.7	2.2	2.8	12	12	14	18	178	256	405	404	146
25	4.7	2.1	2.8	12	9.8	12	16	231	216	379	402	267
26	4.2	2.9	2.8	12	9.8	12	16	281	186	413	372	266
27	4.1	3.4	3.3	13	9.8	12	17	362	212	454	361	263
28	4.0	3.5	3.9	12	9.8	13	16	464	262	455	374	258
29	3.9	2.9	3.8	11	---	15	17	577	262	475	404	256
30	4.1	2.2	3.9	11	---	13	18	650	286	454	429	167
31	4.0	---	4.0	11	---	11	---	679	---	373	428	---
TOTAL	151.6	80.1	87.2	17599.1	332.2	325.7	434.4	14285	14110	13235	11243	7335
MEAN	4.890	2.670	2.813	567.7	11.86	10.51	14.48	460.8	470.3	426.9	362.7	244.5
MAX	5.4	3.9	4.0	1920	17	15	21	679	736	524	429	436
MIN	3.9	1.8	2.0	4.3	9.8	8.9	9.8	170	186	338	295	72
AC-FT	301	159	173	34910	659	646	862	28330	27990	26250	22300	14550
a	1.31	8.00	9.29	4.47	0.88	1.06	0.36	0.92	0.00	0.00	0.00	0.00

STATISTICS OF MONTHLY MEAN DATA FOR WATER YEARS 1945 - 2002, BY WATER YEAR (WY)

	MEAN	MAX	MIN	(WY)	(WY)	(WY)	(WY)	(WY)	(WY)	(WY)	(WY)	(WY)	(WY)
MEAN	32.96	15.54	107.3	612.1	825.1	811.4	525.7	331.4	380.1	399.0	320.6	167.7	
MAX	191	683	2584	3047	4988	4919	3538	951	702	651	514	325	
(WY)	1996	1984	1984	1997	1998	1983	1958	1983	2000	1998	1999	1995	
MIN	0.40	0.17	0.14	0.18	0.17	0.32	0.42	0.40	0.29	0.41	0.71	0.55	
(WY)	1978	1978	1991	1991	1991	1955	1990	1990	1991	1977	1977	1977	

SUMMARY STATISTICS	FOR 2001 CALENDAR YEAR	FOR 2002 WATER YEAR	WATER YEARS 1945 - 2002
ANNUAL TOTAL	25228.8	79218.3	
ANNUAL MEAN	69.12	217.0	375.2
HIGHEST ANNUAL MEAN			1342
LOWEST ANNUAL MEAN			0.67
HIGHEST DAILY MEAN	507	Aug 16	7200
LOWEST DAILY MEAN	1.8	Nov 14	0.00
ANNUAL SEVEN-DAY MINIMUM	2.0	Nov 13	0.00
MAXIMUM PEAK FLOW			2180
MAXIMUM PEAK STAGE			6.96
ANNUAL RUNOFF (AC-FT)	50040	157100	271800
10 PERCENT EXCEEDS	202	513	629
50 PERCENT EXCEEDS	6.1	15	57
90 PERCENT EXCEEDS	2.9	2.9	1.2

a Precipitation, in inches.

11451100 NORTH FORK CACHE CREEK AT HOUGH SPRINGS, NEAR CLEARLAKE OAKS, CA

LOCATION.—Lat 39°09'56", long 122°37'08", in SE 1/4 NW 1/4 sec.10, T.15 N., R.7 W., [Lake County](#), Hydrologic Unit 18020116, on right bank, 0.5 mi upstream from Spanish Creek, 0.9 mi upstream from Hough Springs, and 10 mi northeast of Clearlake Oaks.

DRAINAGE AREA.—60.2 mi².

PERIOD OF RECORD.—October 1971 to current year.

GAGE.—Water-stage recorder and crest-stage gage. Elevation of gage is 1,534.13 ft above sea level. Prior to Jan. 13, 1980, at datum 2.0 ft higher. Recording rain gage (station 391056122420801) 4.7 mi northwest of gage. Elevation of rain gage is 2,050 ft above sea level, from topographic map.

REMARKS.—Records good except for daily discharges in August and September, which are poor. No regulation or diversion upstream from station. See schematic diagram of [lower Sacramento River Basin](#).

EXTREMES FOR PERIOD OF RECORD.—Maximum discharge, 13,200 ft³/s, Jan. 1, 1997, gage height, 14.14 ft, from rating curve extended above 3,900 ft³/s, on basis of slope-area measurement at gage height 11.23 ft; no flow at times in 1972, 1976–77, 1987–88, 1990–92, 1994.

EXTREMES FOR CURRENT YEAR.—Peak discharges greater than base discharge of 1,500 ft³/s, or maximum:

Date	Time	Discharge (ft ³ /s)	Gage height (ft)	Date	Time	Discharge (ft ³ /s)	Gage height (ft)
Dec. 1	1230	2,990	8.67	Jan. 2	0315	3,860	9.39

DISCHARGE, CUBIC FEET PER SECOND, WATER YEAR OCTOBER 2001 TO SEPTEMBER 2002

DAILY MEAN VALUES

DAY	OCT	NOV	DEC	JAN	FEB	MAR	APR	MAY	JUN	JUL	AUG	SEP
1	0.98	3.6	1170	848	83	78	57	27	10	2.9	0.45	0.16
2	0.92	3.2	672	2870	81	73	53	25	9.9	2.7	0.41	0.16
3	0.84	3.1	457	1230	77	70	52	24	9.5	2.5	0.42	0.15
4	0.86	3.0	258	614	73	67	50	23	9.0	2.4	0.43	0.13
5	0.99	2.9	385	510	71	67	49	21	8.5	2.3	0.51	0.11
6	1.2	3.1	555	724	69	77	48	20	8.0	2.2	0.48	0.16
7	1.4	3.1	300	536	82	111	46	20	7.6	1.9	0.45	0.22
8	1.5	3.3	205	418	109	104	45	20	7.5	1.8	0.42	0.29
9	1.5	3.3	157	337	86	93	43	19	7.2	1.8	0.36	0.30
10	1.5	3.8	122	276	81	124	41	19	7.1	1.7	0.36	0.28
11	1.5	11	100	232	77	110	40	18	6.9	1.4	0.36	0.25
12	1.6	74	83	201	75	100	39	17	6.6	1.3	0.31	0.23
13	1.8	34	93	181	73	94	38	17	6.3	1.4	0.24	0.21
14	2.0	23	451	162	71	87	38	17	6.2	1.3	0.21	0.20
15	2.1	17	216	145	68	84	37	16	6.0	1.1	0.17	0.21
16	2.2	14	173	132	68	79	38	15	5.7	1.0	0.14	0.25
17	2.2	16	396	121	73	75	41	14	5.5	0.99	0.11	0.27
18	2.2	13	274	112	67	71	37	14	5.5	0.98	0.12	0.28
19	2.3	12	231	105	95	67	35	15	5.4	0.88	0.15	0.26
20	2.3	12	349	99	187	65	34	22	5.0	0.83	0.15	0.23
21	2.3	121	347	98	147	63	33	28	4.7	0.73	0.15	0.24
22	2.3	203	408	94	125	70	31	20	4.8	0.71	0.25	0.24
23	2.5	48	389	87	115	106	30	17	4.6	0.65	0.30	0.24
24	2.7	365	301	84	105	96	29	16	4.5	0.62	0.31	0.25
25	2.8	149	246	82	96	85	29	15	4.3	0.59	0.26	0.26
26	2.8	65	217	117	90	79	28	14	4.0	0.59	0.24	0.26
27	2.8	43	208	106	86	74	27	14	3.6	0.56	0.22	0.28
28	2.9	66	382	98	83	69	26	14	3.5	0.50	0.18	0.34
29	3.5	322	745	93	---	66	29	13	3.3	0.49	0.15	0.40
30	11	130	651	87	---	62	29	12	3.1	0.51	0.15	0.51
31	6.2	---	854	84	---	59	---	11	---	0.48	0.15	---
TOTAL	73.69	1770.4	11395	10883	2513	2525	1152	557	183.8	39.81	8.61	7.37
MEAN	2.377	59.01	367.6	351.1	89.75	81.45	38.40	17.97	6.127	1.284	0.278	0.246
MAX	11	365	1170	2870	187	124	57	28	10	2.9	0.51	0.51
MIN	0.84	2.9	83	82	67	59	26	11	3.1	0.48	0.11	0.11
AC-FT	146	3510	22600	21590	4980	5010	2280	1100	365	79	17	15
a	1.31	8.00	9.30	4.48	0.91	1.04	0.34	0.92	0.00	0.00	0.00	0.00

a Precipitation, in inches.

SACRAMENTO RIVER BASIN

11451100 NORTH FORK CACHE CREEK AT HOUGH SPRINGS, NEAR CLEARLAKE OAKS, CA—Continued

STATISTICS OF MONTHLY MEAN DATA FOR WATER YEARS 1972 - 2002, BY WATER YEAR (WY)

	OCT	NOV	DEC	JAN	FEB	MAR	APR	MAY	JUN	JUL	AUG	SEP
MEAN	3.172	54.41	142.5	307.1	343.9	277.4	113.6	45.90	15.79	4.649	1.627	1.252
MAX	12.4	405	738	1750	1382	1258	631	242	90.9	26.7	10.8	6.75
(WY)	1980	1982	1997	1995	1998	1995	1982	1995	1998	1998	1998	1998
MIN	0.19	1.11	1.17	4.74	9.59	9.88	5.13	3.93	1.69	0.19	0.000	0.000
(WY)	1992	1977	1977	1991	1991	1977	1977	1977	1977	1977	1977	1994

SUMMARY STATISTICS	FOR 2001 CALENDAR YEAR	FOR 2002 WATER YEAR	WATER YEARS 1972 - 2002
ANNUAL TOTAL	30776.16	31108.68	
ANNUAL MEAN	84.32	85.23	108.2
HIGHEST ANNUAL MEAN			335 1995
LOWEST ANNUAL MEAN			3.67 1977
HIGHEST DAILY MEAN	1590 Mar 4	2870 Jan 2	8340 Feb 17 1986
LOWEST DAILY MEAN	0.33 Sep 8	0.11 Aug 17	0.00 Aug 27 1972
ANNUAL SEVEN-DAY MINIMUM	0.41 Sep 4	0.14 Aug 15	0.00 Aug 27 1972
MAXIMUM PEAK FLOW		3860 Jan 2	13200 Jan 1 1997
MAXIMUM PEAK STAGE		9.39 Jan 2	14.14 Jan 1 1997
ANNUAL RUNOFF (AC-FT)	61040	61700	78390
10 PERCENT EXCEEDS	264	211	262
50 PERCENT EXCEEDS	13	17	12
90 PERCENT EXCEEDS	0.85	0.26	0.52

11451300 NORTH FORK CACHE CREEK NEAR CLEARLAKE OAKS, CA

LOCATION (REVISED).—Lat 39°04'32", long 122°31'59", in SE 1/4 NW 1/4 sec.9, T.14 N., R.6 W., [Lake County](#), Hydrologic Unit 18020116, on right bank, 1,900 ft downstream from Indian Valley Dam, and 8 mi northeast of Clearlake Oaks.

DRAINAGE AREA.—121 mi².

PERIOD OF RECORD.—October 1983 to September 1985 (operated as a low-flow station only), October 1985 to current year.

GAGE.—Water-stage recorder and crest-stage gage. Elevation of gage is 1,320 ft above sea level, from topographic map. Recording rain gage (station 390500122321601) located on top of Indian Valley Dam.

REMARKS.—Records good. Flow completely regulated by Indian Valley Reservoir, capacity 300,000 acre-ft. See schematic diagram of [lower Sacramento River Basin](#).

EXTREMES FOR PERIOD OF RECORD.—Maximum discharge, 7,950 ft³/s, Feb. 11, 1998, gage height, 10.61, maximum gage height, 10.62 ft, Jan. 2, 1997; minimum daily, 0.37 ft³/s, Oct. 15, 1994.

EXTREMES OUTSIDE PERIOD OF RECORD.—Flood of Jan. 26, 1983, reached a stage of 12.74 ft, present datum, discharge about 9,500 ft³/s.

DISCHARGE, CUBIC FEET PER SECOND, WATER YEAR OCTOBER 2001 TO SEPTEMBER 2002
DAILY MEAN VALUES

DAY	OCT	NOV	DEC	JAN	FEB	MAR	APR	MAY	JUN	JUL	AUG	SEP
1	e30	17	18	18	11	14	132	576	133	455	412	6.5
2	e22	17	20	20	11	14	185	291	133	454	312	6.5
3	e18	17	19	18	16	14	314	186	133	429	229	6.5
4	e18	17	19	18	18	14	377	186	134	385	230	6.6
5	e17	17	19	18	18	14	397	186	133	368	229	47
6	e17	17	19	18	18	14	387	173	132	368	229	130
7	e18	17	19	18	18	14	376	144	232	353	236	172
8	e17	17	19	18	18	14	376	130	285	339	251	150
9	e18	17	18	18	18	14	381	130	285	337	237	151
10	e18	17	18	18	18	14	385	129	285	336	213	152
11	e18	16	18	19	18	14	386	129	285	335	186	151
12	17	17	18	20	18	14	410	129	284	293	207	150
13	17	16	18	20	18	13	428	130	295	348	239	137
14	17	16	19	20	18	11	444	131	412	370	217	128
15	17	16	18	20	18	11	504	133	493	370	222	145
16	17	16	18	20	18	11	580	132	470	368	249	153
17	17	16	18	20	18	11	596	132	468	369	225	182
18	17	16	18	20	18	11	564	172	469	368	190	218
19	17	16	18	20	18	12	531	155	468	369	161	226
20	17	16	19	20	16	12	491	118	508	371	143	243
21	17	16	19	20	14	12	483	133	553	370	135	258
22	17	16	19	20	14	12	553	133	563	369	122	258
23	17	16	19	20	14	12	595	132	560	367	85	306
24	17	18	18	20	14	12	606	133	609	365	51	226
25	17	17	18	20	14	12	646	133	641	366	24	115
26	17	17	18	20	14	12	691	133	640	334	6.5	90
27	17	17	17	16	14	12	729	133	610	293	6.4	85
28	17	17	18	11	14	12	756	133	560	269	6.5	85
29	17	17	18	11	---	96	762	133	504	243	6.5	51
30	17	17	18	11	---	132	760	133	455	277	6.5	8.3
31	17	---	18	11	---	132	---	133	---	376	6.5	---
TOTAL	551	499	570	561	454	716	14825	4954	11732	11014	5072.9	4043.4
MEAN	17.77	16.63	18.39	18.10	16.21	23.10	494.2	159.8	391.1	355.3	163.6	134.8
MAX	30	18	20	20	18	132	762	576	641	455	412	306
MIN	17	16	17	11	11	11	132	118	132	243	6.4	6.5
AC-FT	1090	990	1130	1110	901	1420	29410	9830	23270	21850	10060	8020
a	1.15	5.97	7.72	3.63	0.96	0.92	0.32	0.49	0.00	0.00	0.00	0.00

e Estimated.

a Precipitation, in inches.

SACRAMENTO RIVER BASIN

11451300 NORTH FORK CACHE CREEK NEAR CLEARLAKE OAKS, CA—Continued

STATISTICS OF MONTHLY MEAN DATA FOR WATER YEARS 1986 - 2002, BY WATER YEAR (WY)

	OCT	NOV	DEC	JAN	FEB	MAR	APR	MAY	JUN	JUL	AUG	SEP
MEAN	35.09	14.15	22.36	138.9	317.3	194.2	218.1	204.0	251.6	231.1	136.8	94.98
MAX	172	35.5	187	1675	1964	849	557	717	659	559	342	348
(WY)	1998	1997	1999	1997	1998	1986	1987	1987	2001	2001	1996	1996
MIN	6.65	6.96	7.21	7.02	4.63	1.90	8.26	6.98	8.10	8.16	8.17	9.10
(WY)	1994	1995	1994	1994	1994	1994	1993	1993	1993	1993	1990	1990

SUMMARY STATISTICS	FOR 2001 CALENDAR YEAR		FOR 2002 WATER YEAR		WATER YEARS 1986 - 2002	
ANNUAL TOTAL	86814.3		54992.3			
ANNUAL MEAN	237.8		150.7		153.8	
HIGHEST ANNUAL MEAN					326	
LOWEST ANNUAL MEAN					8.54	
HIGHEST DAILY MEAN	770	May 4	762	Apr 29	6690	Feb 11 1998
LOWEST DAILY MEAN	8.7	Feb 5	6.4	Aug 27	0.37	Oct 15 1994
ANNUAL SEVEN-DAY MINIMUM	8.8	Feb 1	6.5	Aug 26	1.8	Mar 9 1994
MAXIMUM PEAK FLOW			780	Apr 28	7950	Feb 11 1998
MAXIMUM PEAK STAGE			4.70	Apr 28	10.62	Jan 2 1997
ANNUAL RUNOFF (AC-FT)	172200		109100		111400	
10 PERCENT EXCEEDS	655		435		401	
50 PERCENT EXCEEDS	19		20		13	
90 PERCENT EXCEEDS	9.5		14		7.7	

11451540 HARLEY GULCH NEAR WILBUR SPRINGS, CA

LOCATION.—Lat 39°00'33", long 122°26'04", in sec.5, T.13 N., R.5 W., [Lake County](#), Hydrologic Unit 18020116, on right bank, 500 ft downstream of Highway 20, and 2.2 mi southwest of Wilbur Hot Springs Resort.

DRAINAGE AREA.—2.90 mi².

PERIOD OF RECORD.—December 1999 to current year.

GAGE.—Water-stage recorder. Elevation of gage is 1,530 ft above sea level, from topographic map.

REMARKS.—Records good. No regulation or diversion upstream from station. See schematic diagram of [lower Sacramento River Basin](#).

EXTREMES FOR PERIOD OF RECORD.—Maximum discharge, 167 ft³/s, Jan. 2, 2002, gage height, 3.24 ft; no flow at times each year.

EXTREMES FOR CURRENT YEAR.—Peak discharges greater than base discharge of 60 ft³/s, or maximum:

Date	Time	Discharge (ft ³ /s)	Gage height (ft)	Date	Time	Discharge (ft ³ /s)	Gage height (ft)
Dec. 2	0530	115	2.99	Jan. 2	0015	167	3.24
Dec. 30	2000	77	2.74				

DISCHARGE, CUBIC FEET PER SECOND, WATER YEAR OCTOBER 2001 TO SEPTEMBER 2002

DAILY MEAN VALUES

DAY	OCT	NOV	DEC	JAN	FEB	MAR	APR	MAY	JUN	JUL	AUG	SEP
1	0.00	0.00	7.5	12	0.38	0.21	0.21	0.16	0.04	0.01	0.00	0.00
2	0.00	0.00	15	33	0.35	0.20	0.19	0.13	0.04	0.01	0.00	0.00
3	0.00	0.00	2.0	2.7	0.34	0.20	0.17	0.10	0.03	0.00	0.00	0.00
4	0.00	0.00	0.34	1.3	0.34	0.21	0.17	0.09	0.03	0.00	0.00	0.00
5	0.00	0.00	0.46	4.5	0.33	0.23	0.19	0.07	0.02	0.00	0.00	0.00
6	0.00	0.00	0.33	3.5	0.32	0.32	0.19	0.06	0.02	0.00	0.00	0.00
7	0.00	0.00	0.18	1.5	0.44	0.37	0.17	0.06	0.02	0.00	0.00	0.00
8	0.00	0.00	0.13	1.2	0.40	0.24	0.17	0.06	0.02	0.00	0.00	0.00
9	0.00	0.00	0.63	0.98	0.32	0.24	0.18	0.06	0.02	0.00	0.00	0.00
10	0.00	0.00	0.22	0.84	0.29	0.32	0.17	0.05	0.01	0.00	0.00	0.00
11	0.00	0.06	0.14	0.75	0.29	0.24	0.17	0.04	0.01	0.00	0.00	0.00
12	0.00	0.72	0.10	0.69	0.29	0.24	0.16	0.04	0.01	0.00	0.00	0.00
13	0.00	0.09	0.36	0.64	0.28	0.22	0.16	0.04	0.01	0.00	0.00	0.00
14	0.00	0.07	4.3	0.61	0.27	0.21	0.16	0.04	0.01	0.00	0.00	0.00
15	0.00	0.06	0.44	0.55	0.26	0.23	0.14	0.04	0.02	0.00	0.00	0.00
16	0.00	0.06	0.22	0.51	0.33	0.22	0.19	0.04	0.02	0.00	0.00	0.00
17	0.00	0.06	0.49	0.50	0.36	0.23	0.22	0.04	0.01	0.00	0.00	0.01
18	0.00	0.06	0.23	0.47	0.27	0.20	0.17	0.04	0.02	0.00	0.00	0.00
19	0.00	0.05	0.19	0.47	0.63	0.19	0.15	0.04	0.02	0.00	0.00	0.00
20	0.00	0.05	11	0.45	0.70	0.21	0.15	0.23	0.02	0.00	0.00	0.00
21	0.00	0.34	3.3	0.47	0.44	0.20	0.14	0.17	0.01	0.00	0.00	0.01
22	0.00	0.17	6.1	0.43	0.38	0.27	0.13	0.09	0.01	0.00	0.00	0.01
23	0.00	0.08	1.5	0.39	0.34	0.37	0.13	0.07	0.01	0.00	0.00	0.01
24	0.00	4.0	0.74	0.40	0.30	0.25	0.11	0.06	0.01	0.00	0.00	0.01
25	0.00	0.17	0.52	0.41	0.28	0.22	0.11	0.06	0.01	0.00	0.00	0.01
26	0.00	0.09	0.41	0.60	0.27	0.22	0.11	0.06	0.01	0.00	0.00	0.01
27	0.00	0.07	0.39	0.43	0.25	0.22	0.11	0.06	0.01	0.00	0.00	0.01
28	0.00	0.31	13	0.45	0.24	0.20	0.10	0.05	0.01	0.00	0.00	0.01
29	0.00	1.4	9.1	0.40	---	0.18	0.23	0.05	0.01	0.00	0.00	0.01
30	0.00	0.14	11	0.36	---	0.18	0.18	0.05	0.01	0.00	0.00	0.01
31	0.00	---	4.0	0.36	---	0.18	---	0.04	---	0.00	0.00	---
TOTAL	0.00	8.05	94.32	71.86	9.69	7.22	4.83	2.19	0.50	0.02	0.00	0.11
MEAN	0.000	0.268	3.043	2.318	0.346	0.233	0.161	0.071	0.017	0.001	0.000	0.004
MAX	0.00	4.0	15	33	0.70	0.37	0.23	0.23	0.04	0.01	0.00	0.01
MIN	0.00	0.00	0.10	0.36	0.24	0.18	0.10	0.04	0.01	0.00	0.00	0.00
AC-FT	0.00	16	187	143	19	14	9.6	4.3	1.0	0.04	0.00	0.2

STATISTICS OF MONTHLY MEAN DATA FOR WATER YEARS 2000 - 2002, BY WATER YEAR (WY)

	2000	2001	2002	2000	2001	2002	2000	2001	2002	2000	2001	2002
MEAN	0.035	0.214	1.082	1.315	1.994	1.052	0.229	0.103	0.027	0.007	0.007	0.009
MAX	0.070	0.27	3.04	2.32	3.19	1.95	0.33	0.15	0.046	0.017	0.021	0.022
(WY)	2001	2002	2002	2002	2000	2001	2000	2000	2000	2000	2000	2000
MIN	0.000	0.16	0.065	0.63	0.35	0.23	0.16	0.071	0.017	0.001	0.000	0.000
(WY)	2002	2001	2000	2000	2002	2002	2002	2002	2002	2002	2001	2001

SUMMARY STATISTICS

FOR 2001 CALENDAR YEAR

FOR 2002 WATER YEAR

WATER YEARS 2000 - 2002

ANNUAL TOTAL	270.46	198.79	
ANNUAL MEAN	0.741	0.545	0.518
HIGHEST ANNUAL MEAN			0.54
LOWEST ANNUAL MEAN			0.49
HIGHEST DAILY MEAN	27	Mar 4	33
LOWEST DAILY MEAN	0.00	Jul 12	0.00
ANNUAL SEVEN-DAY MINIMUM	0.00	Jul 12	0.00
MAXIMUM PEAK FLOW			167
MAXIMUM PEAK STAGE			3.24
ANNUAL RUNOFF (AC-FT)	536	394	375
10 PERCENT EXCEEDS	1.5	0.51	0.63
50 PERCENT EXCEEDS	0.08	0.06	0.10
90 PERCENT EXCEEDS	0.00	0.00	0.00

11451600 DAVIS CREEK AT DAM, NEAR KNOXVILLE, CA

LOCATION.—Lat 38°51'51", long 122°21'11", in sec.30, T.12 N., R.6 W., [Yolo County](#), Hydrologic Unit 18020116, on left bank of Davis Creek Dam spillway, and 2.5 mi northwest of Knoxville.

DRAINAGE AREA.—10.2 mi².

PERIOD OF RECORD.—December 1999 to current year.

GAGE.—Water-stage recorder. Datum of gage is 1,480 ft above sea level, from topographic map.

REMARKS.—Records poor. Flow is completely regulated by Davis Creek Reservoir. See schematic diagram of [lower Sacramento River Basin](#).

EXTREMES FOR PERIOD OF RECORD.—Maximum discharge, 739 ft³/s, Jan. 2, 2002, gage height, 28.44 ft; no flow for many days in each year.

EXTREMES FOR CURRENT YEAR.—Maximum discharge, 739 ft³/s, Jan. 2, gage height, 28.44 ft; no flow for many days.

DISCHARGE, CUBIC FEET PER SECOND, WATER YEAR OCTOBER 2001 TO SEPTEMBER 2002

DAILY MEAN VALUES

DAY	OCT	NOV	DEC	JAN	FEB	MAR	APR	MAY	JUN	JUL	AUG	SEP
1	0.00	0.00	0.00	57	5.6	2.0	0.54	0.00	0.00	e0.00	0.00	0.00
2	0.00	0.00	0.00	504	5.6	1.6	0.54	0.00	0.00	e0.00	0.00	0.00
3	0.00	0.00	0.00	138	5.3	1.8	0.54	0.00	0.00	e0.00	0.00	0.00
4	0.00	0.00	0.00	56	5.0	2.1	0.44	0.00	0.00	e0.00	0.00	0.00
5	0.00	0.00	0.00	50	4.8	2.3	0.54	0.00	e0.00	e0.00	0.00	0.00
6	0.00	0.00	0.00	66	4.8	2.4	0.53	0.00	e0.00	e0.00	0.00	0.00
7	0.00	0.00	0.00	42	5.6	2.9	0.42	0.00	e0.00	e0.00	0.00	0.00
8	0.00	0.00	0.00	31	7.9	2.5	e0.36	0.00	e0.00	e0.00	0.00	0.00
9	0.00	0.00	0.00	25	5.7	2.4	e0.22	0.00	e0.00	e0.00	0.00	0.00
10	0.00	0.00	0.00	e20	4.7	5.4	e0.10	0.00	e0.00	e0.00	0.00	0.00
11	0.00	0.00	0.00	e16	4.4	4.6	e0.06	0.00	e0.00	e0.00	0.00	0.00
12	0.00	0.00	0.00	e14	4.1	3.0	e0.02	0.00	e0.00	e0.00	0.00	0.00
13	0.00	0.00	0.00	14	4.1	2.2	e0.00	0.00	e0.00	e0.00	0.00	0.00
14	0.00	0.00	0.00	12	3.7	1.8	e0.00	0.00	e0.00	e0.00	0.00	0.00
15	0.00	0.00	0.00	11	3.7	1.8	e0.00	0.00	e0.00	e0.00	0.00	0.00
16	0.00	0.00	0.00	9.5	4.0	1.8	e0.00	0.00	e0.00	e0.00	0.00	0.00
17	0.00	0.00	0.00	9.0	4.7	1.8	e0.00	0.00	e0.00	e0.00	0.00	0.00
18	0.00	0.00	0.00	8.5	4.2	1.6	0.00	0.00	e0.00	e0.00	0.00	0.00
19	0.00	0.00	0.00	8.2	5.3	1.5	0.00	0.00	e0.00	e0.00	0.00	0.00
20	0.00	0.00	0.22	7.8	7.1	1.6	0.00	0.00	e0.00	e0.00	0.00	0.00
21	0.00	0.00	20	7.7	6.1	1.7	0.00	0.00	e0.00	e0.00	0.00	0.00
22	0.00	0.00	40	7.0	5.5	1.9	0.00	0.00	e0.00	e0.00	0.00	0.00
23	0.00	0.00	37	6.5	4.6	2.9	0.00	0.00	e0.00	e0.00	0.00	0.00
24	0.00	0.00	21	6.3	4.0	2.3	0.00	0.00	e0.00	0.00	0.00	0.00
25	0.00	0.00	15	6.3	3.4	1.9	0.00	0.00	e0.00	0.00	0.00	0.00
26	0.00	0.00	11	8.1	3.0	1.8	0.00	0.00	e0.00	0.00	0.00	0.00
27	0.00	0.00	9.2	7.6	2.9	1.8	0.00	0.00	e0.00	0.00	0.00	0.00
28	0.00	0.00	32	7.9	2.6	1.3	0.00	0.00	e0.00	0.00	0.00	0.00
29	0.00	0.00	78	7.1	---	0.61	0.00	0.00	e0.00	0.00	0.00	0.00
30	0.00	0.00	60	5.9	---	0.56	0.00	0.00	e0.00	0.00	0.00	0.00
31	0.00	---	100	5.6	---	0.54	---	0.00	---	0.00	0.00	---
TOTAL	0.00	0.00	423.42	1175.0	132.4	64.41	4.31	0.00	0.00	0.00	0.00	0.00
MEAN	0.000	0.000	13.66	37.90	4.729	2.078	0.144	0.000	0.000	0.000	0.000	0.000
MAX	0.00	0.00	100	504	7.9	5.4	0.54	0.00	0.00	0.00	0.00	0.00
MIN	0.00	0.00	0.00	5.6	2.6	0.54	0.00	0.00	0.00	0.00	0.00	0.00
AC-FT	0.00	0.00	840	2330	263	128	8.5	0.00	0.00	0.00	0.00	0.00

STATISTICS OF MONTHLY MEAN DATA FOR WATER YEARS 2000 - 2002, BY WATER YEAR (WY)

MEAN	0.000	0.000	6.829	12.63	11.71	8.750	1.803	0.228	0.000	0.000	0.000	0.000
MAX	0.000	0.000	13.7	37.9	29.6	18.9	3.43	0.69	0.000	0.000	0.000	0.000
(WY)	2001	2001	2002	2002	2000	2000	2000	2000	2000	2000	2000	2000
MIN	0.000	0.000	0.000	0.000	0.17	2.08	0.14	0.000	0.000	0.000	0.000	0.000
(WY)	2001	2001	2001	2000	2001	2002	2002	2001	2000	2000	2000	2000

SUMMARY STATISTICS

FOR 2001 CALENDAR YEAR

FOR 2002 WATER YEAR

WATER YEARS 2000 - 2002

ANNUAL TOTAL	646.56	1799.54		
ANNUAL MEAN	1.771	4.930	2.771	
HIGHEST ANNUAL MEAN			4.93	2002
LOWEST ANNUAL MEAN			0.61	2001
HIGHEST DAILY MEAN	100	Dec 31	504	Jan 2
LOWEST DAILY MEAN	0.00	Jan 1	0.00	Oct 1
ANNUAL SEVEN-DAY MINIMUM	0.00	Jan 1	0.00	Oct 1
MAXIMUM PEAK FLOW			739	Jan 2
MAXIMUM PEAK STAGE			28.44	Jan 2
ANNUAL RUNOFF (AC-FT)	1280		3570	2010
10 PERCENT EXCEEDS	3.2		7.3	4.8
50 PERCENT EXCEEDS	0.00		0.00	0.00
90 PERCENT EXCEEDS	0.00		0.00	0.00

e Estimated.

11451690 SULPHUR CREEK AT WILBUR SPRINGS, CA

LOCATION.—Lat 39°02'19", long 122°25'08", in sec.28, T.14 N., R.5 W., Colusa County, Hydrologic Unit 18020116, on right bank, 0.85 mi upstream from mouth at Bear Creek, and at Wilbur Springs.

DRAINAGE AREA.—9.87 mi².

PERIOD OF RECORD.—October 1999 to current year.

GAGE.—Water-stage recorder. Datum of gage is 1,315 ft above sea level, from topographic map.

REMARKS.—Records good except for estimated daily discharges, which are fair. No regulation or diversion upstream from station. See schematic diagram of lower Sacramento River Basin.

EXTREMES FOR PERIOD OF RECORD.—Maximum discharge, 353 ft³/s, Jan. 2, 2002, gage height, 5.22 ft; minimum daily, 0.05 ft³/s, Aug. 14, 15, 2001.

EXTREMES FOR CURRENT YEAR.—Peak discharges greater than base discharge of 180 ft³/s, or maximum.

Date	Time	Discharge (ft ³ /s)	Gage height (ft)	Date	Time	Discharge (ft ³ /s)	Gage height (ft)
Jan. 2	0645	329	5.10	Jan. 2	0145	353	5.22

DISCHARGE, CUBIC FEET PER SECOND, WATER YEAR OCTOBER 2001 TO SEPTEMBER 2002

DAILY MEAN VALUES

DAY	OCT	NOV	DEC	JAN	FEB	MAR	APR	MAY	JUN	JUL	AUG	SEP
1	0.27	0.33	29	51	3.0	1.7	1.3	1.1	0.25	0.21	0.17	0.22
2	0.27	0.33	77	156	3.0	1.7	1.3	0.96	0.23	0.20	0.17	0.22
3	0.27	e0.31	23	43	2.8	1.7	1.3	0.86	0.22	0.20	0.17	0.21
4	0.27	e0.33	7.1	25	2.7	1.7	1.3	0.83	0.19	0.20	0.18	0.22
5	e0.28	e0.34	6.1	37	2.7	1.7	1.3	0.76	0.17	0.17	0.18	0.23
6	e0.29	e0.35	7.3	38	2.6	1.9	1.3	0.72	0.15	0.17	0.19	0.24
7	e0.28	e0.34	3.9	24	3.0	2.3	1.3	0.70	0.14	0.19	0.19	0.26
8	e0.28	e0.34	2.7	18	3.1	1.8	1.2	0.66	0.14	0.21	0.19	0.25
9	e0.28	e0.33	3.8	13	2.5	1.7	1.2	0.64	0.15	0.21	0.19	0.26
10	e0.29	e0.39	2.4	10	2.4	2.2	1.3	0.66	0.16	0.20	0.18	0.27
11	0.29	0.50	1.6	8.7	2.4	1.8	1.2	0.68	0.16	0.21	0.19	0.27
12	e0.28	5.1	1.2	7.7	2.4	1.7	1.2	0.61	0.16	0.26	0.18	0.26
13	e0.28	1.7	1.6	7.0	2.3	1.8	1.1	0.57	0.16	0.28	0.17	0.26
14	e0.28	0.86	32	6.3	2.2	1.8	1.1	0.58	0.18	0.28	0.17	0.26
15	e0.28	0.64	7.3	6.3	2.1	1.8	1.1	0.57	0.22	0.25	0.18	0.27
16	e0.29	0.60	4.3	5.8	2.3	1.8	1.1	0.51	0.22	0.25	0.18	0.27
17	e0.29	e0.60	7.2	5.4	2.7	1.8	1.3	0.46	0.23	0.25	0.19	0.27
18	e0.29	e0.51	4.8	5.2	2.3	1.7	1.1	0.43	0.23	0.27	0.19	0.27
19	e0.30	0.49	3.9	5.3	3.6	1.6	1.1	0.66	0.24	0.26	0.19	0.27
20	e0.29	0.48	43	4.8	6.3	1.7	1.1	1.7	0.24	0.25	0.19	0.27
21	e0.30	1.8	29	4.6	3.6	1.6	1.0	1.4	0.26	0.24	0.19	0.27
22	0.29	e6.7	37	4.2	2.9	1.8	1.0	0.79	0.23	0.28	0.19	0.27
23	e0.31	e1.6	23	3.9	2.7	2.1	0.96	0.63	0.26	0.28	0.20	0.27
24	e0.30	e28	12	3.8	2.4	1.7	0.92	0.52	0.24	0.27	0.21	0.28
25	e0.30	e6.7	7.8	3.6	2.1	1.7	0.93	0.44	0.24	0.19	0.21	0.27
26	e0.31	e2.6	5.9	4.7	1.9	1.6	0.95	0.40	0.24	0.17	0.20	0.28
27	0.31	e1.9	5.0	3.8	1.9	1.6	0.97	0.36	0.24	0.17	0.20	0.30
28	0.34	1.9	46	3.6	1.8	1.4	0.92	0.38	0.30	0.17	0.21	0.31
29	0.34	e7.4	72	3.5	---	1.3	1.2	0.35	0.21	0.18	0.21	0.30
30	0.49	e3.3	68	3.1	---	1.3	1.1	0.31	0.20	0.18	0.22	0.31
31	0.32	---	50	3.0	---	1.3	---	0.30	---	0.17	0.22	---
TOTAL	9.26	76.77	624.9	519.3	75.7	53.3	34.15	20.54	6.26	6.82	5.90	7.91
MEAN	0.299	2.559	20.16	16.75	2.704	1.719	1.138	0.663	0.209	0.220	0.190	0.264
MAX	0.49	28	77	156	6.3	2.3	1.3	1.7	0.30	0.28	0.22	0.31
MIN	0.27	0.31	1.2	3.0	1.8	1.3	0.92	0.30	0.14	0.17	0.17	0.21
AC-FT	18	152	1240	1030	150	106	68	41	12	14	12	16

e Estimated.

SACRAMENTO RIVER BASIN

11451690 SULPHUR CREEK AT WILBUR SPRINGS, CA—Continued

STATISTICS OF MONTHLY MEAN DATA FOR WATER YEARS 2000 - 2002, BY WATER YEAR (WY)

	OCT	NOV	DEC	JAN	FEB	MAR	APR	MAY	JUN	JUL	AUG	SEP
MEAN	0.310	1.254	7.153	7.956	10.22	6.203	1.712	0.904	0.327	0.202	0.169	0.218
MAX	0.32	2.56	20.2	16.8	19.1	9.10	2.60	1.36	0.44	0.22	0.19	0.26
(WY)	2001	2002	2002	2002	2000	2000	2000	2000	2000	2001	2002	2002
MIN	0.30	0.59	0.63	3.39	2.70	1.72	1.14	0.66	0.21	0.16	0.14	0.15
(WY)	2002	2000	2000	2001	2002	2002	2002	2002	2002	2000	2001	2000

SUMMARY STATISTICS	FOR 2001 CALENDAR YEAR	FOR 2002 WATER YEAR	WATER YEARS 2000 - 2002
ANNUAL TOTAL	1388.71	1440.81	
ANNUAL MEAN	3.805	3.947	2.969
HIGHEST ANNUAL MEAN			3.95 2002
LOWEST ANNUAL MEAN			1.99 2001
HIGHEST DAILY MEAN	93 Mar 4	156 Jan 2	156 Jan 2 2002
LOWEST DAILY MEAN	0.05 Aug 14	0.14 Jun 7	0.05 Aug 14 2001
ANNUAL SEVEN-DAY MINIMUM	0.07 Aug 10	0.15 Jun 6	0.07 Aug 10 2001
MAXIMUM PEAK FLOW		353 Jan 2	353 Jan 2 2002
MAXIMUM PEAK STAGE		5.22 Jan 2	5.22 Jan 2 2002
ANNUAL RUNOFF (AC-FT)	2750	2860	2150
10 PERCENT EXCEEDS	7.2	6.3	4.8
50 PERCENT EXCEEDS	0.57	0.60	0.59
90 PERCENT EXCEEDS	0.20	0.19	0.19

11451715 BEAR CREEK ABOVE HOLSTEN CHIMNEY CANYON, NEAR RUMSEY, CA

LOCATION.—Lat 38°57'28", long 122°20'30", in NW 1/4 SE 1/4 sec.19, T.13 N., R.4 W., Colusa County, Hydrologic Unit 18020116, on the left bank downstream side of Highway 16 bridge, 2.9 mi upstream from confluence with Cache Creek, and 7.4 mi northwest of Rumsey.

DRAINAGE AREA.—94.9 mi².

PERIOD OF RECORD.—November 1997 to current year.

GAGE.—Water-stage recorder and crest-stage gage. Elevation of gage is 920 ft above sea level, from topographic map.

REMARKS.—Records good except for estimated daily discharges, which are fair. Some minor diversions upstream from station. See schematic diagram of lower Sacramento River Basin.

EXTREMES FOR PERIOD OF RECORD.—Maximum discharge, 8,510 ft³/s, Feb. 2, 1998, gage height, 13.57 ft, from rating curve extended above 3,000 ft³/s; minimum daily, 0.56 ft³/s, Aug. 15, 2002.

EXTREMES OUTSIDE PERIOD OF RECORD.—Maximum discharge, 9,200 ft³/s, Jan. 5, 1965.

EXTREMES FOR CURRENT YEAR.—Peak discharges greater than base discharge of 2,000 ft³/s, or maximum:

Date	Time	Discharge (ft ³ /s)	Gage height (ft)	Date	Time	Discharge (ft ³ /s)	Gage height (ft)
Dec. 1	1615	2,100	9.71	Jan. 2	0345	3,470	10.89

DISCHARGE, CUBIC FEET PER SECOND, WATER YEAR OCTOBER 2001 TO SEPTEMBER 2002

DAILY MEAN VALUES

DAY	OCT	NOV	DEC	JAN	FEB	MAR	APR	MAY	JUN	JUL	AUG	SEP
1	1.8	2.9	451	486	44	24	14	9.1	4.0	1.5	0.71	0.93
2	1.8	2.3	757	1630	e42	23	13	8.6	3.9	1.4	0.66	0.90
3	1.7	2.2	294	423	e40	e22	12	8.1	4.0	1.4	0.65	0.83
4	1.7	2.2	e87	e258	e39	22	12	8.0	3.8	1.4	0.67	0.80
5	1.7	2.2	62	373	e38	23	12	7.6	3.6	1.3	0.84	0.78
6	1.8	2.2	60	479	e37	24	12	7.3	3.3	1.3	0.88	0.78
7	1.9	2.2	49	263	39	27	12	7.1	3.2	1.2	0.83	0.85
8	1.9	2.1	37	203	e47	e25	11	6.8	3.0	1.1	0.82	1.0
9	1.8	2.1	57	175	e37	e22	11	6.5	2.8	1.1	0.75	1.1
10	1.7	2.2	e38	147	e34	27	11	6.4	2.7	1.1	0.68	1.0
11	1.7	4.4	e31	e128	34	25	10	6.5	2.7	1.1	0.66	1.0
12	1.7	12	e27	117	34	22	10	6.3	2.8	1.0	0.65	0.99
13	1.6	16	e25	e105	33	21	9.8	6.0	2.8	1.1	0.60	1.0
14	1.6	6.1	e374	e97	32	e21	9.5	5.8	2.8	1.1	0.58	0.96
15	1.7	4.1	e83	e89	31	21	9.1	5.9	2.8	0.89	0.56	0.96
16	1.8	3.6	51	e81	31	21	9.1	5.8	2.6	0.92	0.56	1.0
17	1.8	3.5	66	e76	40	20	9.9	5.6	2.4	0.99	0.61	1.2
18	1.9	3.1	61	e72	33	e20	9.1	5.4	2.3	1.0	0.66	1.2
19	1.8	2.9	47	e70	35	e19	8.9	5.9	2.4	0.98	0.70	1.1
20	1.9	2.8	314	e66	47	19	8.7	9.1	2.2	0.98	0.77	0.98
21	1.9	3.7	343	e64	36	19	9.0	10	2.1	0.90	0.82	0.99
22	2.0	13	349	e60	33	19	8.8	7.2	2.1	0.83	0.88	1.1
23	1.9	8.2	211	e57	32	24	8.7	6.0	2.1	0.81	0.90	1.1
24	1.9	228	e115	e54	29	21	8.6	5.4	2.0	0.83	0.91	1.1
25	1.8	86	90	e54	28	19	8.5	5.2	2.0	0.82	0.91	1.1
26	1.9	e23	80	61	26	19	8.6	5.0	1.9	0.77	0.91	1.1
27	1.9	e12	73	e54	26	18	8.9	4.8	1.8	0.72	0.87	1.1
28	2.0	10	467	e53	25	17	8.3	4.9	1.7	0.71	0.80	1.2
29	2.1	260	817	e53	---	15	9.3	4.8	1.7	0.62	0.79	1.3
30	4.0	59	483	e46	---	15	9.6	4.5	1.6	0.61	0.83	1.3
31	4.4	---	606	e44	---	14	---	4.3	---	0.70	0.88	---
TOTAL	61.1	784.0	6605	5938	982	648	302.4	199.9	79.1	31.18	23.34	30.75
MEAN	1.971	26.13	213.1	191.5	35.07	20.90	10.08	6.448	2.637	1.006	0.753	1.025
MAX	4.4	260	817	1630	47	27	14	10	4.0	1.5	0.91	1.3
MIN	1.6	2.1	25	44	25	14	8.3	4.3	1.6	0.61	0.56	0.78
AC-FT	121	1560	13100	11780	1950	1290	600	397	157	62	46	61

e Estimated.

SACRAMENTO RIVER BASIN

11451715 BEAR CREEK ABOVE HOLSTEN CHIMNEY CANYON, NEAR RUMSEY, CA—Continued

STATISTICS OF MONTHLY MEAN DATA FOR WATER YEARS 1998 - 2002, BY WATER YEAR (WY)

	OCT	NOV	DEC	JAN	FEB	MAR	APR	MAY	JUN	JUL	AUG	SEP
MEAN	3.154	11.81	54.52	101.6	310.5	101.9	48.49	33.88	15.06	4.617	2.545	2.361
MAX	5.48	26.1	213	252	1029	180	126	124	56.6	14.2	5.97	5.34
(WY)	1999	2002	2002	1998	1998	1998	1998	1998	1998	1998	1998	1998
MIN	1.97	3.06	3.33	13.6	35.1	20.9	10.1	4.93	2.64	1.01	0.75	1.03
(WY)	2002	2001	2001	1999	2002	2002	2002	2001	2002	2002	2002	2002

SUMMARY STATISTICS	FOR 2001 CALENDAR YEAR		FOR 2002 WATER YEAR		WATER YEARS 1998 - 2002	
ANNUAL TOTAL	14148.9		15684.77			
ANNUAL MEAN	38.76		42.97		33.15	
HIGHEST ANNUAL MEAN					43.0	
LOWEST ANNUAL MEAN					19.1	
HIGHEST DAILY MEAN	944	Mar 4	1630	Jan 2	2660	Feb 3 1998
LOWEST DAILY MEAN	1.1	Aug 10	0.56	Aug 15	0.56	Aug 15 2002
ANNUAL SEVEN-DAY MINIMUM	1.2	Aug 7	0.60	Aug 11	0.60	Aug 11 2002
MAXIMUM PEAK FLOW			3470	Jan 2	8510	Feb 2 1998
MAXIMUM PEAK STAGE			10.89	Jan 2	13.57	Feb 2 1998
ANNUAL RUNOFF (AC-FT)	28060		31110		24020	
10 PERCENT EXCEEDS	80		78		65	
50 PERCENT EXCEEDS	3.9		5.8		5.2	
90 PERCENT EXCEEDS	1.4		0.84		1.4	

11452500 CACHE CREEK AT YOLO, CA

LOCATION.—Lat 38°43'38", long 121°48'22", in Rio Jesus Maria Grant, [Yolo County](#), Hydrologic Unit 18020110, on left bank, 35 ft upstream from Interstate Highway 5 bridge, 0.5 mi south of Yolo, and 7.3 mi downstream from Moore Dam.

DRAINAGE AREA.—1,139 mi².

PERIOD OF RECORD.—January 1903 to current year. Records for water year 1903 incomplete; yearly estimate published in WSP 1315-A.

WATER TEMPERATURE: Water years 1959–65, November 1966 to February 1967.

SEDIMENT DATA: Water years 1959–65, November 1966 to February 1967 (daily record), 1986 (periodic record).

REVISED RECORDS.—WSP 1315-A: 1914(M). WSP 1345: 1906. WSP 1445: 1955. WSP 1931: Drainage area.

GAGE.—Water-stage recorder. Datum of gage is sea level. See WSP 2131 for history of changes prior to Apr. 25, 1969. Apr. 25, 1969, to July 1976, at site 765 ft upstream at same datum.

REMARKS.—Records fair. Some regulation by Clear Lake (station 11450000) beginning in 1915 and Indian Valley Reservoir beginning in 1974, capacity, 300,000 acre-ft. Diversions for irrigation of about 30,000 acres between Capay and Yolo, from data furnished by Clear Lake Water Co. See schematic diagram of [lower Sacramento River Basin](#).

EXTREMES FOR PERIOD OF RECORD.—Maximum discharge, 41,400 ft³/s, Feb. 25, 1958, gage height, 85.35 ft, present datum, maximum stage observed, 86.4 ft, present datum, Mar. 10, 1904; no flow at times in most years.

DISCHARGE, CUBIC FEET PER SECOND, WATER YEAR OCTOBER 2001 TO SEPTEMBER 2002

DAILY MEAN VALUES

DAY	OCT	NOV	DEC	JAN	FEB	MAR	APR	MAY	JUN	JUL	AUG	SEP
1	0.00	0.00	236	1840	219	135	36	44	4.4	3.9	0.22	0.00
2	6.7	0.00	3070	7380	213	129	20	39	12	0.00	1.7	0.00
3	2.6	0.00	2360	5790	207	124	12	19	11	0.00	45	0.00
4	3.3	0.00	833	2270	198	120	17	2.2	7.7	4.7	13	0.00
5	10	0.00	443	2740	195	116	33	3.7	16	22	0.78	0.00
6	5.8	0.00	455	4510	192	120	56	4.6	9.8	13	0.34	0.00
7	2.2	0.00	742	3880	189	125	57	5.9	1.1	0.24	0.00	0.00
8	1.8	0.00	441	3300	194	130	50	11	4.8	0.00	0.00	9.9
9	0.00	0.00	316	3010	218	135	28	5.4	18	0.00	0.00	31
10	0.00	0.00	270	2810	198	132	21	0.00	26	3.3	0.06	21
11	0.00	0.00	209	2630	183	135	23	0.00	3.4	3.3	12	10
12	0.00	11	171	2530	175	140	15	4.2	0.00	0.00	13	5.0
13	0.00	39	146	2290	175	127	12	7.3	0.00	0.00	0.00	2.0
14	0.00	75	466	1870	171	119	12	6.5	0.00	2.5	0.00	0.06
15	0.00	47	709	1020	165	115	15	2.2	0.00	7.9	6.1	0.00
16	0.00	12	345	639	161	112	6.2	4.1	0.00	0.37	1.3	0.00
17	0.00	11	253	539	167	111	14	4.9	0.00	0.00	6.2	0.00
18	0.00	4.9	345	480	174	109	54	1.1	0.00	0.00	7.2	0.00
19	0.00	3.2	318	436	164	103	27	1.8	2.3	0.00	13	0.00
20	0.00	2.4	266	406	157	98	12	30	2.7	0.00	8.5	0.00
21	0.00	2.2	1510	380	203	95	23	67	3.7	0.00	5.8	0.00
22	0.00	1.5	894	356	209	95	14	85	9.2	0.00	3.9	0.00
23	0.00	3.4	1450	334	190	101	11	76	16	0.00	7.7	0.00
24	0.00	82	800	312	180	109	19	42	14	0.00	8.6	0.00
25	0.00	395	557	296	169	112	16	18	0.00	0.00	7.8	0.00
26	0.00	242	437	293	156	104	12	3.1	0.00	0.29	7.1	0.00
27	0.00	123	373	301	146	97	11	5.3	0.00	0.00	3.4	0.00
28	0.00	86	477	291	140	92	14	2.2	0.00	1.9	0.00	0.00
29	0.00	129	3630	269	---	86	20	0.00	0.00	5.5	0.00	6.2
30	0.00	480	2170	250	---	83	16	0.00	6.5	9.6	0.00	28
31	0.00	---	3620	229	---	36	---	2.5	---	11	0.00	---
TOTAL	32.40	1749.60	28312	53681	5108	3445	676.2	498.00	168.60	89.50	172.70	113.16
MEAN	1.045	58.32	913.3	1732	182.4	111.1	22.54	16.06	5.620	2.887	5.571	3.772
MAX	10	480	3630	7380	219	140	57	85	26	22	45	31
MIN	0.00	0.00	146	229	140	36	6.2	0.00	0.00	0.00	0.00	0.00
AC-FT	64	3470	56160	106500	10130	6830	1340	988	334	178	343	224

STATISTICS OF MONTHLY MEAN DATA FOR WATER YEARS 1903 - 2002, BY WATER YEAR (WY)

MEAN	13.53	60.76	427.9	1384	1992	1516	856.2	195.1	62.54	26.77	12.85	7.908
MAX	335	1593	5644	7446	12750	10930	6353	1655	784	421	189	105
(WY)	1963	1984	1984	1914	1998	1983	1958	1904	1906	1907	1907	1998
MIN	0.000	0.000	0.000	0.000	0.000	0.000	0.000	0.000	0.000	0.000	0.000	0.000
(WY)	1904	1906	1906	1920	1920	1920	1924	1919	1913	1912	1910	1903

SUMMARY STATISTICS

	FOR 2001 CALENDAR YEAR	FOR 2002 WATER YEAR	WATER YEARS 1903 - 2002
ANNUAL TOTAL	63735.10	94046.16	
ANNUAL MEAN	174.6	257.7	537.7
HIGHEST ANNUAL MEAN			2449
LOWEST ANNUAL MEAN			0.000
HIGHEST DAILY MEAN	5920	Mar 5	7380
LOWEST DAILY MEAN	0.00	May 24	0.00
ANNUAL SEVEN-DAY MINIMUM	0.00	Jul 4	0.00
MAXIMUM PEAK FLOW			12400
MAXIMUM PEAK STAGE			67.43
ANNUAL RUNOFF (AC-FT)	126400	186500	389600
10 PERCENT EXCEEDS	439	442	1400
50 PERCENT EXCEEDS	17	12	3.2
90 PERCENT EXCEEDS	0.00	0.00	0.00

11453000 YOLO BYPASS NEAR WOODLAND, CA

LOCATION.—Lat 38°40'40", long 121°38'35", unsurveyed, [Yolo County](#), Hydrologic Unit 1802109, on left bank, 300 ft upstream from Sacramento and Woodland Railroad Bridge, 6 mi upstream from Sacramento Bypass, 6 mi downstream from Fremont Weir, and 7 mi east of Woodland.

PERIOD OF RECORD.—October 1939 to current year (since October 1977, high-flow records only). Monthly discharge only for some periods, published in WSP 1315-A.

SEDIMENT DATA: Water years 1957–61, 1980.

REVISED RECORDS.—WDR CA-96-4: 1995(M).

GAGE.—Water-stage recorder. Datum of gage is 3.41 ft below sea level. Prior to Dec. 17, 1941, nonrecording gage, and Dec. 18–31, 1941, water-stage recorder, at datum 0.73 ft higher. Prior to Sept. 30, 1977, a supplementary water-stage recorder 6 mi downstream at different datum recorded low flow.

REMARKS.—Flow is from Cache Creek and Knights Landing Ridge Cut plus floodwater passing over Fremont Weir. Beginning October 1977, only flows above 1,000 ft³/s are computed. See schematic diagram of [lower Sacramento River Basin](#).

EXTREMES FOR PERIOD OF RECORD.—Maximum discharge, 374,000 ft³/s, Feb. 20, 1986, gage height, 34.87 ft; no flow at times in several years.

EXTREMES FOR CURRENT YEAR.—Maximum discharge, 36,400 ft³/s, Jan. 6, gage height, 26.18 ft.

DISCHARGE, CUBIC FEET PER SECOND, WATER YEAR OCTOBER 2001 TO SEPTEMBER 2002

DAILY MEAN VALUES

DAY	OCT	NOV	DEC	JAN	FEB	MAR	APR	MAY	JUN	JUL	AUG	SEP
1	---	---	---	5450	---	---	---	---	---	---	---	---
2	---	---	1040	5970	---	---	---	---	---	---	---	---
3	---	---	2070	9720	---	---	---	---	---	---	---	---
4	---	---	3130	8130	---	---	---	---	---	---	---	---
5	---	---	3510	16600	---	---	---	---	---	---	---	---
6	---	---	3190	34500	---	---	---	---	---	---	---	---
7	---	---	2720	23300	---	---	---	---	---	---	---	---
8	---	---	2870	15400	---	---	---	---	---	---	---	---
9	---	---	2740	12000	---	---	---	---	---	---	---	---
10	---	---	1930	9200	---	---	---	---	---	---	---	---
11	---	---	---	7850	---	---	---	---	---	---	---	---
12	---	---	---	7400	---	---	---	---	---	---	---	---
13	---	---	---	7070	---	---	---	---	---	---	---	---
14	---	---	---	6650	---	---	---	---	---	---	---	---
15	---	---	---	5920	---	---	---	---	---	---	---	---
16	---	---	---	5090	---	---	---	---	---	---	---	---
17	---	---	---	4600	---	---	---	---	---	---	---	---
18	---	---	---	4140	---	---	---	---	---	---	---	---
19	---	---	---	3590	---	---	---	---	---	---	---	---
20	---	---	---	2930	---	---	---	---	---	---	---	---
21	---	---	---	2180	---	---	---	---	---	---	---	---
22	---	---	2080	1620	---	---	---	---	---	---	---	---
23	---	---	2880	1230	---	---	---	---	---	---	---	---
24	---	---	3240	---	---	---	---	---	---	---	---	---
25	---	---	3390	---	---	---	---	---	---	---	---	---
26	---	---	3440	---	---	---	---	---	---	---	---	---
27	---	---	3250	---	---	---	---	---	---	---	---	---
28	---	---	2730	---	---	---	---	---	---	---	---	---
29	---	---	2750	---	---	---	---	---	---	---	---	---
30	---	---	4190	---	---	---	---	---	---	---	---	---
31	---	---	4740	---	---	---	---	---	---	---	---	---
TOTAL	---	---	---	---	---	---	---	---	---	---	---	---
MEAN	---	---	---	---	---	---	---	---	---	---	---	---
MAX	---	---	---	---	---	---	---	---	---	---	---	---
MIN	---	---	---	---	---	---	---	---	---	---	---	---
AC-FT	---	---	---	---	---	---	---	---	---	---	---	---

STATISTICS OF MONTHLY MEAN DATA FOR WATER YEARS 1946 - 1977, BY WATER YEAR (WY)

	441.3	738.1	5638	13230	11240	3398	3849	430.0	144.2	20.67	26.09	51.05
MEAN	441.3	738.1	5638	13230	11240	3398	3849	430.0	144.2	20.67	26.09	51.05
MAX	13420	10890	48790	86470	92890	27910	37310	4546	1420	107	84.9	155
(WY)	1963	1951	1956	1970	1958	1958	1958	1952	1967	1958	1958	1954
MIN	1.01	2.19	0.92	2.43	0.88	3.55	0.083	0.55	0.53	0.000	0.000	0.63
(WY)	1977	1960	1977	1977	1977	1977	1976	1977	1977	1966	1966	1977

SUMMARY STATISTICS

WATER YEARS 1946 - 1977

ANNUAL MEAN	3230
HIGHEST ANNUAL MEAN	13020
LOWEST ANNUAL MEAN	1.53
HIGHEST DAILY MEAN	259000
LOWEST DAILY MEAN	0.00
ANNUAL SEVEN-DAY MINIMUM	0.00
MAXIMUM PEAK FLOW	265000
MAXIMUM PEAK STAGE	32.48
ANNUAL RUNOFF (AC-FT)	2340000
10 PERCENT EXCEEDS	3080
50 PERCENT EXCEEDS	35
90 PERCENT EXCEEDS	1.9

11453500 PUTAH CREEK NEAR GUENOC, CA

LOCATION.—Lat 38°46'44", long 122°30'59", in Guenoc Grant, [Lake County](#), Hydrologic Unit 18020117, on right bank just upstream from Coyote Valley damsite, 2.8 mi upstream from Soda Creek, and 3.2 mi downstream from highway bridge at Guenoc.

DRAINAGE AREA.—113 mi².

PERIOD OF RECORD.—February 1904 to September 1906, July 1930 to September 1976, and April 1998 to current year. Monthly discharge only for some periods, published in WSP 1315-A.

REVISED RECORDS.—WSP 1285: 1937(M), 1938, 1940, 1943(M), 1951(M).

GAGE.—Water-stage recorder. Datum of gage is 911.18 ft above sea level. February 1904 to September 1906, nonrecording gage 0.2 mi upstream at different datum, July 1930 to September 1976, at datum 3.00 ft higher.

REMARKS.—Records good. Some regulation by Hartmann Dam on Coyote Creek since 1969, capacity, 3,000 acre-ft; diversions and ground-water withdrawals for domestic use and irrigation of about 1,600 acres above station. See schematic diagram of [lower Sacramento River Basin](#).

EXTREMES FOR PERIOD OF RECORD.—Maximum discharge, 32,000 ft³/s, Dec. 11, 1937, gage height, 22.7 ft, from rating curve extended above 13,000 ft³/s; no flow many days in 1964, 1970, 1974–76.

EXTREMES FOR CURRENT YEAR.—Peak discharges greater than base discharge of 5,000 ft³/s, or maximum:

Date	Time	Discharge (ft ³ /s)	Gage height (ft)	Date	Time	Discharge (ft ³ /s)	Gage height (ft)
Dec. 1	1415	6,960	14.27	Jan. 2	0400	8,490	15.33

DISCHARGE, CUBIC FEET PER SECOND, WATER YEAR OCTOBER 2001 TO SEPTEMBER 2002

DAILY MEAN VALUES

DAY	OCT	NOV	DEC	JAN	FEB	MAR	APR	MAY	JUN	JUL	AUG	SEP
1	1.5	0.16	2190	1500	113	92	78	35	17	0.71	0.25	0.00
2	1.4	0.14	2670	5600	109	87	74	36	17	0.54	0.27	0.00
3	1.3	0.15	1290	1860	105	83	70	35	17	0.48	0.25	0.00
4	1.3	0.16	561	1080	101	80	68	34	15	0.44	0.20	0.00
5	1.2	0.18	595	1420	98	79	65	33	15	0.37	0.14	0.00
6	0.69	0.18	964	1990	95	98	64	33	14	0.40	0.20	0.00
7	0.49	0.20	475	1150	106	226	61	31	12	0.12	0.17	0.00
8	0.41	0.21	318	847	314	178	58	30	12	0.00	0.09	0.00
9	0.39	0.23	247	668	162	130	56	29	11	0.00	0.05	0.00
10	0.48	0.27	198	538	135	392	56	28	11	0.00	0.03	0.00
11	0.34	0.37	168	448	123	265	52	28	9.6	0.54	0.02	0.00
12	0.25	213	147	384	117	194	50	27	9.8	0.72	0.02	0.00
13	0.19	107	133	338	111	160	48	27	9.5	0.83	0.02	0.00
14	0.14	50	820	302	105	140	46	25	9.3	0.88	0.02	0.00
15	0.07	36	342	271	100	127	45	24	9.3	0.90	0.02	0.00
16	0.05	24	250	237	98	117	43	23	8.9	0.89	0.02	0.00
17	0.03	26	759	213	112	108	47	22	8.2	0.87	0.03	0.00
18	0.02	25	479	193	100	100	44	22	6.5	0.88	0.03	0.00
19	0.02	18	339	178	114	92	41	25	5.8	0.87	0.03	0.00
20	0.04	17	817	164	354	87	39	32	4.6	0.82	0.02	0.00
21	0.04	86	1100	157	213	84	38	52	3.2	0.79	0.01	0.00
22	0.02	531	1060	149	156	91	37	39	2.9	0.79	0.01	0.00
23	0.02	115	869	137	137	272	36	32	3.0	0.78	0.00	0.00
24	0.01	832	566	129	127	210	34	28	2.3	0.77	0.00	0.00
25	0.00	316	428	124	117	150	34	26	2.1	0.77	0.00	0.00
26	0.0	136	383	178	108	128	35	24	1.7	0.77	0.00	0.00
27	0.01	94	331	172	102	115	34	23	1.3	0.78	0.00	0.00
28	0.02	86	1300	145	97	104	33	22	1.1	0.73	0.00	0.00
29	0.02	885	1830	134	---	95	36	22	0.88	0.74	0.00	0.00
30	0.17	241	1570	124	---	89	37	20	0.77	0.27	0.00	0.00
31	0.19	---	1860	117	---	82	---	19	---	0.02	0.00	---
TOTAL	10.81	3840.25	25059	20947	3729	4255	1459	886	241.75	18.47	1.90	0.00
MEAN	0.349	128.0	808.4	675.7	133.2	137.3	48.63	28.58	8.058	0.596	0.061	0.000
MAX	1.5	885	2670	5600	354	392	78	52	17	0.90	0.27	0.00
MIN	0.00	0.14	133	117	95	79	33	19	0.77	0.00	0.00	0.00
AC-FT	21	7620	49700	41550	7400	8440	2890	1760	480	37	3.8	0.00

SACRAMENTO RIVER BASIN

11453500 PUTAH CREEK NEAR GUENOC, CA—Continued

STATISTICS OF MONTHLY MEAN DATA FOR WATER YEARS 1905 - 2002, BY WATER YEAR (WY)

	OCT	NOV	DEC	JAN	FEB	MAR	APR	MAY	JUN	JUL	AUG	SEP
MEAN	15.54	89.61	382.0	621.6	662.6	399.5	216.8	68.08	26.76	7.735	3.673	2.628
MAX	329	1005	1684	2288	2107	1326	906	264	165	36.8	12.0	10.0
(WY)	1963	1974	1956	1970	1958	1938	1958	1998	1906	1998	1906	1905
MIN	0.27	1.35	2.34	15.2	36.7	55.9	26.6	9.48	1.57	0.47	0.000	0.000
(WY)	1965	1932	1937	1976	1976	1976	1931	1976	1976	1976	1976	1976

SUMMARY STATISTICS	FOR 2001 CALENDAR YEAR	FOR 2002 WATER YEAR	WATER YEARS 1905 - 2002
ANNUAL TOTAL	59588.20	60448.18	
ANNUAL MEAN	163.3	165.6	205.4
HIGHEST ANNUAL MEAN			467 1938
LOWEST ANNUAL MEAN			21.8 1976
HIGHEST DAILY MEAN	2670 Dec 2	5600 Jan 2	16500 Dec 10 1937
LOWEST DAILY MEAN	0.00 Jul 1	0.00 Oct 25	0.00 Aug 20 1964
ANNUAL SEVEN-DAY MINIMUM	0.00 Aug 23	0.00 Aug 23	0.00 Jul 26 1976
MAXIMUM PEAK FLOW		8490 Jan 2	32000 Dec 11 1937
MAXIMUM PEAK STAGE		15.33 Jan 2	22.70 Dec 11 1937
ANNUAL RUNOFF (AC-FT)	118200	119900	148800
10 PERCENT EXCEEDS	493	383	448
50 PERCENT EXCEEDS	16	27	24
90 PERCENT EXCEEDS	0.02	0.00	1.4

11453900 LAKE BERRYESSA NEAR WINTERS, CA

LOCATION.—Lat 38°30'48", long 122°06'13", in SE 1/4 NW 1/4 sec.29, T.8 N., R.2 W., Napa County, Hydrologic Unit 18020117, near center of Monticello Dam on Putah Creek, and 7.4 mi west of Winters.

DRAINAGE AREA.—566 mi².

PERIOD OF RECORD.—January 1957 to current year.

REVISED RECORDS.—WSP 1735: 1958–60. WSP 1931: Drainage area.

GAGE.—Water-stage recorder. Datum of gage is sea level (levels by U.S. Bureau of Reclamation).

REMARKS.—Reservoir is formed by concrete arch-gravity dam completed November 1956. Usable capacity, 1,592,000 acre-ft, between elevations 253.25 ft, invert of outlet valves, and 440 ft, crest of glory-hole spillway. Dead storage, 10,340 acre-ft. Water is released down Putah Creek and is diverted into Putah South Canal (station 11454210) for irrigation of about 46,000 acres in the lower Sacramento Valley. Total diverted during current year was 198,900 acre-ft. Releases for irrigation began in May 1959. Records, including extremes, show total contents at 2400 hours. See schematic diagram of lower Sacramento River Basin.

COOPERATION.—Records provided by U.S. Bureau of Reclamation.

EXTREMES FOR PERIOD OF RECORD.—Maximum contents, 1,733,500 acre-ft, Mar. 2, 1983, elevation, 446.67 ft; minimum since irrigation pool first filled, 422,130 acre-ft, Dec. 1, 1992, elevation, 361.73 ft.

EXTREMES FOR CURRENT YEAR.—Maximum contents, 1,508,000 acre-ft, Mar. 28, elevation, 435.05 ft; minimum, 1,243,400 acre-ft, Nov. 9, elevation, 420.43 ft.

Capacity table (elevation, in feet, and contents, in acre-feet)
(Based on survey by U.S. Bureau of Reclamation in 1956)

360	404,550	390	765,730	410	1,068,100	430	1,414,200
370	511,760	400	911,200	420	1,236,000	450	1,799,900
380	632,360						

RESERVOIR STORAGE (ACRE-FEET), WATER YEAR OCTOBER 2001 TO SEPTEMBER 2002

DAILY OBSERVATION AT 2400 HOURS

DAY	OCT	NOV	DEC	JAN	FEB	MAR	APR	MAY	JUN	JUL	AUG	SEP
1	1263600	1245900	1268900	1382100	1480800	1494600	1506600	1487500	1455700	1409200	1359300	1317600
2	1262900	1245700	1284700	1418800	1481300	1494600	1506600	1486600	1454400	1407600	1357500	1316300
3	1262200	1245300	1290500	1427400	1481500	1494600	1506500	1485400	1453400	1405900	1355900	1315100
4	1261500	1245000	1292800	1431800	1481900	1494600	1506500	1484000	1453800	1404300	1354600	1313800
5	1261000	1244600	1294900	1434400	1482100	1494800	1505900	1483000	1450600	1402500	1353500	1312400
6	1260000	1244500	1297400	1449700	1482500	1496100	1505700	1481900	1449200	1401200	1351700	1311000
7	1259600	1244100	1298100	1455100	1483400	1497400	1505500	1480200	1447300	1399500	1349900	1309800
8	1259600	1243800	1299300	1458400	1484500	1497600	1505300	1479500	1445500	1398300	1348500	1308500
9	1257500	1243400	1299800	1461400	1484700	1498000	1505300	1477600	1443100	1396300	1347600	1307600
10	1257000	1243600	1300200	1463600	1485400	1498900	1505000	1476300	1441600	1395000	1346000	1306700
11	1256300	1243600	1300000	1465300	1485800	1501000	1504400	1475200	1440500	1392800	1344500	1305100
12	1254500	1246000	1300400	1465900	1486200	1502100	1504200	1473700	1439000	1391500	1343100	1304100
13	1254400	1246600	1300700	1467200	1486200	1502100	1504000	1472600	1437500	1389900	1341800	1302800
14	1253800	1246600	1305000	1469600	1487100	1502300	1503800	1471400	1435900	1388400	1340200	1301600
15	1253500	1246600	1305800	1470700	1487500	1502500	1503100	1470500	1434400	1386800	1339200	1300500
16	1253000	1246400	1306600	1471300	1488100	1502900	1501800	1468800	1433100	1385000	1337700	1299100
17	1252600	1246200	1308700	1472200	1488600	1503400	1501000	1468300	1431600	1383500	1336300	1298800
18	1251900	1246000	1310300	1472800	1488800	1503400	1499900	1466800	1430000	1381900	1334700	1297400
19	1251600	1245900	1311000	1473500	1489600	1503100	1498900	1466100	1428300	1380300	1333600	1296700
20	1251100	1245700	1316200	1474100	1491100	1503400	1498400	1466100	1426700	1378600	1331800	1296700
21	1250400	1246700	1321300	1474800	1491600	1503800	1497600	1465500	1425000	1377000	1330900	1295200
22	1249500	1247600	1326800	1475700	1492800	1503800	1496900	1465100	1423000	1375200	1329700	1294000
23	1248800	1247400	1330200	1475700	1492900	1504800	1496500	1464200	1421700	1373700	1328300	1293300
24	1248300	1247400	1331300	1476100	1493100	1505700	1495400	1463600	1419900	1371900	1327000	1292400
25	1247800	1247400	1333100	1476700	1493900	1505900	1494300	1462900	1418200	1370300	1325900	1291400
26	1247100	1247900	1335200	1477000	1494300	1506500	1493100	1462000	1416900	1368500	1324900	1290800
27	1246400	1248100	1336100	1478200	1494600	1507000	1492600	1461000	1415100	1367100	1323800	1289400
28	1246000	1253300	1344900	1479100	1494800	1508000	1491300	1460300	1413800	1365200	1322900	1288200
29	1246000	1256100	1355500	1479500	---	1506800	1490700	1459400	1412300	1363600	1321100	1287300
30	1246200	1256600	1364500	1480200	---	1506800	1489400	1458300	1410700	1362200	1319700	1286800
31	1246000	---	1370300	1480400	---	1506800	---	1457100	---	1360700	1318600	---
MAX	1263600	1256600	1370300	1480400	1494800	1508000	1506600	1487500	1455700	1409200	1359300	1317600
MIN	1246000	1243400	1268900	1382100	1480800	1494600	1489400	1457100	1410700	1360700	1318600	1286800
a	420.58	421.19	427.59	433.58	434.35	434.99	434.06	432.33	429.81	427.06	424.71	422.91
b	-18300	+10600	+113700	+110100	+14400	+12000	-17400	-32300	-46400	-50000	-42100	-31800
c	5058	1381	972	1210	1809	3808	5443	7930	10298	10427	8668	7660

CAL YR 2001 b +22500

WTR YR 2002 b +6500

a Elevation, in feet, at end of month.

b Change in contents, in acre-feet.

c Total evaporation, in acre-feet, provided by U.S. Bureau of Reclamation, not reviewed by U.S. Geological Survey.

11454000 PUTAH CREEK NEAR WINTERS, CA

LOCATION.—Lat 38°30'55", long 122°04'51", in NE 1/4 NE 1/4 sec.28, T.8 N., R.2 W., Yolo County, Hydrologic Unit 18020109, on left bank, 1 mi downstream from Cold Canyon, 1.3 mi downstream from Monticello Dam, and 6 mi west of Winters.

DRAINAGE AREA.—574 mi².

PERIOD OF RECORD.—July 1930 to current year.

CHEMICAL DATA: Water years 1951–66, 1973–81.

WATER TEMPERATURE: Water years 1966–81.

REVISED RECORDS.—WSP 901: 1937–38(M). WSP 1285: 1932(M), 1935–36(M), 1940(M), 1942–43(M), 1951, 1952(M). WSP 1565: 1957. WSP 1931: Drainage area.

GAGE.—Water-stage recorder. Datum of gage is 160.75 ft above sea level (river-profile survey). June 28, 1930, to Feb. 29, 1940, at datum about 1 ft higher.

REMARKS.—Records good. Flow completely regulated by Lake Berryessa (station 11453900) beginning January 1957. See schematic diagram of lower Sacramento River Basin.

EXTREMES FOR PERIOD OF RECORD.—Maximum discharge, 81,000 ft³/s, Feb. 27, 1940, gage height, 30.5 ft, present datum, from rating curve extended above 30,000 ft³/s; no flow Sept. 6–15, 1950, July 26 to Sept. 1, Sept. 6–9, 1955.

Since completion of Monticello Dam in 1957: Maximum discharge, 18,700 ft³/s, Mar. 2, 1983, gage height, 19.55 ft; minimum daily, 6.1 ft³/s, Dec. 19, 1967.

EXTREMES OUTSIDE PERIOD OF RECORD.—Maximum stage known since at least 1905, Feb. 27, 1940, on basis of records for station at Winters.

DISCHARGE, CUBIC FEET PER SECOND, WATER YEAR OCTOBER 2001 TO SEPTEMBER 2002

DAILY MEAN VALUES

DAY	OCT	NOV	DEC	JAN	FEB	MAR	APR	MAY	JUN	JUL	AUG	SEP
1	246	83	56	89	65	66	128	564	540	651	628	480
2	246	83	87	172	65	75	128	574	553	677	617	467
3	246	83	46	106	70	97	143	615	563	681	581	486
4	249	83	60	89	76	104	154	629	584	682	553	506
5	249	79	79	81	76	76	174	615	595	668	538	519
6	231	69	88	77	75	66	189	596	663	655	574	512
7	216	73	93	73	69	51	189	584	674	628	608	481
8	212	83	90	71	64	57	188	589	657	628	611	456
9	216	79	83	69	59	73	187	599	662	651	629	447
10	215	70	83	68	54	67	191	599	648	684	638	462
11	233	62	83	67	54	61	221	601	626	691	624	497
12	242	48	83	66	54	61	239	564	634	696	609	507
13	218	54	83	65	54	65	277	519	625	685	596	501
14	141	65	82	65	56	68	296	487	648	654	591	466
15	120	68	75	64	63	70	319	465	652	626	581	401
16	160	68	75	63	66	73	354	511	626	625	579	375
17	143	68	77	66	71	74	381	529	641	642	594	391
18	152	68	81	69	71	77	356	506	695	635	592	392
19	141	63	82	69	71	82	370	488	703	635	548	392
20	217	56	83	69	71	82	380	356	729	629	489	382
21	198	56	83	69	72	77	385	277	749	625	489	352
22	159	56	79	69	71	68	399	292	725	632	507	336
23	182	71	80	69	71	61	417	299	692	658	522	343
24	174	86	78	69	71	61	462	287	675	678	510	345
25	198	85	77	69	71	65	489	311	692	740	469	398
26	179	85	77	69	71	70	513	333	651	738	465	412
27	157	97	77	68	71	72	534	352	637	703	493	400
28	140	91	109	73	71	83	557	393	662	672	497	354
29	105	69	149	78	---	159	574	458	644	662	483	308
30	79	60	107	77	---	165	560	478	632	631	512	306
31	72	---	115	73	---	129	---	509	---	615	500	---
TOTAL	5736	2161	2600	2341	1873	2455	9754	14979	19477	20477	17227	12674
MEAN	185.0	72.03	83.87	75.52	66.89	79.19	325.1	483.2	649.2	660.5	555.7	422.5
MAX	249	97	149	172	76	165	574	629	749	740	638	519
MIN	72	48	46	63	54	51	128	277	540	615	465	306
AC-FT	11380	4290	5160	4640	3720	4870	19350	29710	38630	40620	34170	25140

11454000 PUTAH CREEK NEAR WINTERS, CA—Continued

STATISTICS OF MONTHLY MEAN DATA FOR WATER YEARS 1931 - 1956, BY WATER YEAR (WY)

	OCT	NOV	DEC	JAN	FEB	MAR	APR	MAY	JUN	JUL	AUG	SEP
MEAN	8.62	96.0	993	1284	1716	976	514	137	42.1	12.5	6.94	5.84
MAX	45.4	807	5110	3957	6468	3506	2729	452	156	63.7	31.7	20.8
(WY)	1951	1951	1956	1952	1938	1938	1941	1941	1942	1941	1941	1941
MIN	.89	3.17	7.16	44.6	66.7	118	40.8	12.3	6.72	2.39	.000	1.47
(WY)	1956	1956	1931	1947	1948	1932	1931	1931	1931	1955	1955	1931

SUMMARY STATISTICS

WATER YEARS 1931 - 1956

ANNUAL MEAN	477
HIGHEST ANNUAL MEAN	1387 1941
LOWEST ANNUAL MEAN	48.1 1931
HIGHEST DAILY MEAN	54500 Feb 27 1940
LOWEST DAILY MEAN	.00 Sep 6 1950
ANNUAL SEVEN-DAY MINIMUM	.00 Sep 6 1950
MAXIMUM PEAK FLOW	81000 Feb 27 1940
MAXIMUM PEAK STAGE	30.5 Feb 27 1940
ANNUAL RUNOFF (AC-FT)	345500
10 PERCENT EXCEEDS	924
50 PERCENT EXCEEDS	38
90 PERCENT EXCEEDS	3.0

STATISTICS OF MONTHLY MEAN DATA FOR WATER YEARS 1960 - 2002, BY WATER YEAR (WY)

	1960	1963	1961	1960	1960	1962	1960	1960	1960	1960	1960	1960
MEAN	223.2	88.71	107.4	475.9	667.9	741.3	632.8	545.0	600.1	627.8	546.8	400.2
MAX	476	263	1625	4406	6271	7791	5023	1018	773	802	681	610
(WY)	1972	1987	1984	1970	1998	1983	1982	1983	1981	1984	1975	1968
MIN	13.3	14.9	11.6	11.6	21.6	40.9	110	155	328	338	298	175
(WY)	1960	1963	1961	1960	1960	1962	1960	1960	1960	1960	1960	1960

SUMMARY STATISTICS

FOR 2001 CALENDAR YEAR

FOR 2002 WATER YEAR

WATER YEARS 1960 - 2002

ANNUAL TOTAL	113854	111754	
ANNUAL MEAN	311.9	306.2	470.4
HIGHEST ANNUAL MEAN			1580 1983
LOWEST ANNUAL MEAN			132 1960
HIGHEST DAILY MEAN	711 Jun 23	749 Jun 21	17700 Mar 2 1983
LOWEST DAILY MEAN	46 Dec 3	46 Dec 3	6.1 Dec 19 1967
ANNUAL SEVEN-DAY MINIMUM	59 Feb 13	56 Feb 9	8.3 Nov 7 1963
MAXIMUM PEAK FLOW		764 Jul 26	18700 Mar 2 1983
MAXIMUM PEAK STAGE		8.63 Jul 26	19.55 Mar 2 1983
ANNUAL RUNOFF (AC-FT)	225800	221700	340800
10 PERCENT EXCEEDS	620	646	715
50 PERCENT EXCEEDS	246	217	352
90 PERCENT EXCEEDS	68	66	53

11454210 PUTAH SOUTH CANAL NEAR WINTERS, CA

LOCATION.—Lat 38°29'34", long 122°00'07", in Rio De Los Putos Grant, T.8 N., R.1 W., [Solano County](#), Hydrologic Unit 18020109, on left bank, 500 ft downstream from diversion headgate structure on Lake Solano, and 2.7 mi southwest of Winters.

PERIOD OF RECORD.—October 1994 to September 1997, October 1998 to current year. Monthly and yearly totals were published during water years 1972–93.

GAGE.—Water-stage recorder. Elevation of gage is 160 ft above sea level, from topographic map.

REMARKS.—Water from canal is diverted for irrigation, municipal, and industrial use. See schematic diagram of [lower Sacramento River Basin](#).

COOPERATION.—Records provided by U.S. Bureau of Reclamation.

EXTREMES FOR PERIOD OF RECORD.—Maximum daily discharge, 784 ft³/s, June 21, 2000; no flow on some days during most years.

DISCHARGE, CUBIC FEET PER SECOND, WATER YEAR OCTOBER 2001 TO SEPTEMBER 2002

DAILY MEAN VALUES

DAY	OCT	NOV	DEC	JAN	FEB	MAR	APR	MAY	JUN	JUL	AUG	SEP
1	239	70	12	49	56	67	98	524	507	596	576	439
2	237	63	9.3	49	59	75	100	537	510	617	562	436
3	245	59	18	49	59	79	118	580	523	631	532	459
4	246	e59	e33	49	56	76	131	577	542	632	501	459
5	231	e59	e48	52	53	62	157	576	561	616	488	475
6	218	59	90	54	49	48	157	546	600	605	524	492
7	210	59	79	54	44	44	154	541	619	575	545	468
8	205	60	62	54	44	57	159	549	621	570	551	429
9	200	46	59	54	41	64	163	556	618	589	581	410
10	196	44	59	55	39	64	165	564	604	618	589	429
11	217	42	59	54	39	55	200	562	581	631	578	461
12	225	e35	56	53	39	36	226	529	599	654	560	471
13	224	e47	54	53	52	59	253	479	582	645	544	463
14	131	38	58	54	59	52	277	452	597	608	545	435
15	119	42	59	54	59	58	300	455	609	571	524	368
16	137	43	59	49	61	58	303	480	586	578	530	338
17	115	43	59	48	64	58	337	469	589	576	547	345
18	125	37	62	55	58	58	350	471	643	579	546	353
19	123	28	61	55	55	64	349	467	656	577	511	352
20	198	31	59	54	64	e63	354	369	681	572	445	339
21	184	34	59	54	34	45	356	293	711	566	438	320
22	148	33	59	54	64	48	368	276	688	571	464	296
23	157	33	59	54	61	48	386	270	640	602	471	305
24	174	30	59	54	59	48	424	264	621	618	463	313
25	181	28	59	54	57	48	450	292	643	680	419	350
26	160	29	59	54	54	49	478	300	608	688	420	366
27	142	29	61	54	e33	49	486	332	590	651	443	359
28	129	29	64	53	59	48	517	377	607	629	452	313
29	85	28	64	54	---	66	523	413	599	598	447	267
30	78	22	59	54	---	82	517	445	577	570	457	267
31	40	---	51	55	---	84	---	478	---	561	451	---
TOTAL	5319	1259	1708.3	1642	1471	1812	8856	14023	18112	18774	15704	11577
MEAN	171.6	41.97	55.11	52.97	52.54	58.45	295.2	452.4	603.7	605.6	506.6	385.9
MAX	246	70	90	55	64	84	523	580	711	688	589	492
MIN	40	22	9.3	48	33	36	98	264	507	561	419	267
AC-FT	10550	2500	3390	3260	2920	3590	17570	27810	35930	37240	31150	22960

STATISTICS OF MONTHLY MEAN DATA FOR WATER YEARS 1995 - 2002, BY WATER YEAR (WY)

MEAN	188.6	56.07	46.32	45.05	47.72	81.06	264.3	457.7	584.9	598.0	527.9	373.5
MAX	219	79.0	55.5	54.5	55.1	182	450	573	666	640	575	410
(WY)	1996	1996	1999	2001	1997	1997	1997	1999	2000	1999	1995	1995
MIN	134	42.0	33.6	34.5	42.2	37.8	168	281	518	532	492	325
(WY)	2001	2002	2000	1995	1999	1996	1995	1995	1995	2001	2001	2000

SUMMARY STATISTICS	FOR 2001 CALENDAR YEAR		FOR 2002 WATER YEAR		WATER YEARS 1995 - 2002	
ANNUAL TOTAL	100527.3		100257.3			
ANNUAL MEAN	275.4		274.7		273.7	
HIGHEST ANNUAL MEAN					299	
LOWEST ANNUAL MEAN					246	
HIGHEST DAILY MEAN	665		711		784	
LOWEST DAILY MEAN	9.3		9.3		0.00	
ANNUAL SEVEN-DAY MINIMUM	21		21		12	
ANNUAL RUNOFF (AC-FT)	199400		198900		198300	
10 PERCENT EXCEEDS	570		596		597	
50 PERCENT EXCEEDS	228		205		210	
90 PERCENT EXCEEDS	44		46		40	

e Estimated.

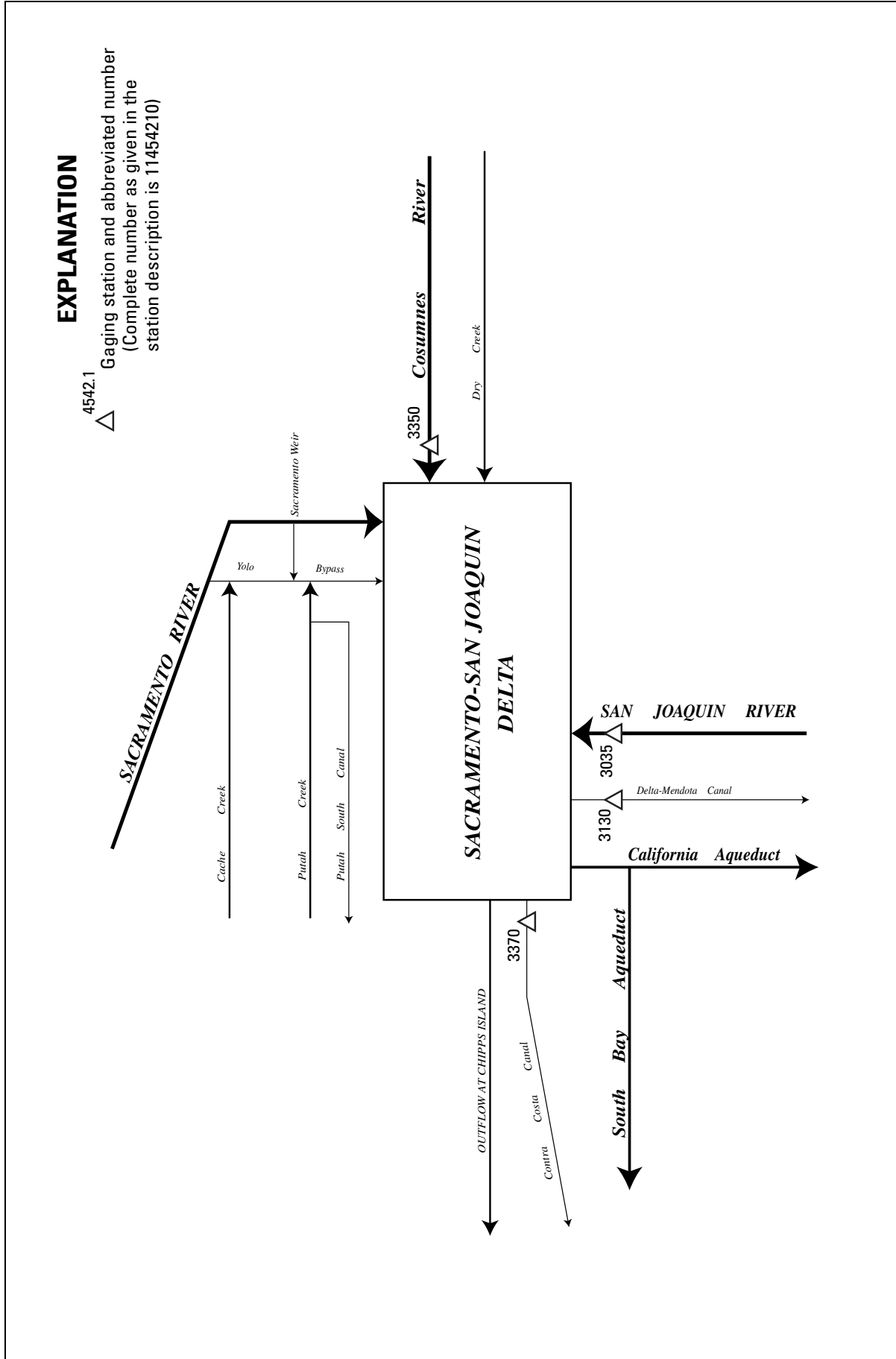

Figure 36. Principal inflows and diversions, Sacramento-San Joaquin Delta.

As the number of streams on which streamflow information is likely to be desired far exceeds the number of stream-gaging stations feasible to operate at one time, the U.S. Geological Survey collects limited streamflow data at sites other than stream-gaging stations. When limited streamflow data are collected on a systematic basis over a period of years for use in hydrologic analyses, the site at which the data are collected is called a partial-record station. Data collected at these partial-record stations are usable in low- or flood-flow analyses, depending on the type of data collected.

Special study and miscellaneous sites

Discharge measurements in the following table were made at special study and miscellaneous sites throughout the area covered by this volume.

Discharge measurements made at special study and miscellaneous sites during water year 2002

Stream	Tributary to	Location	Drainage area (mi ²)	Measured previously (water year)	Measurements	
					Date	Discharge (ft ³ /s)
SACRAMENTO RIVER BASIN						
11341900	Dog Creek at Delta, Lat 40°56'17", long 122°25'13", in SE 1/4 CA	NE 1/4 sec.34, T.36 N., R.5 W., Shasta County , Hydrologic Unit 18020005, 0.1 mi upstream from mouth, 0.5 mi southwest of Delta, and 25 mi north of Redding.	17.3	a1975, 1976–84, 1986–2002	01-04-02 09-24-02	332 b2.61

Station No.	Station name	Location	Drainage area (mi ²)	Measured previously (water year)	Measurements		
					Date	Gage Height	Discharge (ft ³ /s)
SACRAMENTO RIVER BASIN							
38352512143 4601	Willow Slough Bypass near Davis, CA	Lat 38°35'25", long 121°43'46", in SE 1/4 SE 1/4 sec.27, T.9 N., R.2 E., Yolo County , Hydrologic Unit 18020109, at County Road 102, and 3.5 mi northeast of Davis.	—	1999–2002	10-05-01 10-12-01 10-18-01 04-24-02 05-03-02 05-08-02 05-16-02 05-21-02 05-31-02 06-05-02 06-12-02 06-19-02 06-25-02 07-03-02 07-08-02 07-19-02 07-22-02 07-30-02 08-06-02 08-15-02 08-23-02 08-30-02 09-06-02 09-13-02 09-20-02 09-27-02	4.97 4.46 4.63 5.10 5.71 4.96 4.60 7.36 4.63 5.26 4.60 5.37 5.37 4.94 5.00 5.46 5.35 4.80 4.20 4.10 5.14 3.90 4.14 4.33 4.13 3.93	7.2 .18 .00 10 46 9.4 .26 73 .18 18 7.2 26 26 7.8 7.8 33 26 7.6 5.9 7.7 15 9.1 15 13 14 14

a Published as a miscellaneous measurement.

b Base flow.

Station No.	Station name	Location	Drainage area (mi ²)	Measured previously (water year)	Measurements							
					Date	Gage Height	Discharge (ft ³ /s)					
SACRAMENTO RIVER BASIN												
38360112146 1601	Dry Slough near Davis, CA	Lat 38°36'01", long 121°46'16", in SE 1/4 NE 1/4 sec.29, T.9 N., R.2 E., Yolo County , Hydrologic Unit 18020109, 0.3 mi upstream of confluence of Willow and Dry Sloughs, and 3.4 mi north of Davis	—	2002	07-19-02	—	15					
					07-22-02	—	12					
					07-30-02	—	3.0					
					08-06-02	—	4.2					
					08-15-02	—	6.8					
					08-23-02	—	11					
					08-30-02	—	15					
					09-06-02	—	15					
					09-13-02	—	18					
					09-20-02	—	23					
					09-27-02	—	28					
					38374912143 3701	Willow Slough near Woodland, CA	Lat 38°37'49", long 121°43'37", in NW 1/4 NW 1/4 sec.14, T.9 N., R.2 E., Yolo County , Hydrologic Unit 18020109, 1,000 ft downstream of County Road 102, and 3.8 miles southeast of Woodland.	—	1999–2002	10-04-01	6.20	9.6
										10-12-01	5.35	.30
10-18-01	5.50	.00										
04-25-02	6.44	2.8										
05-03-02	6.43	7.0										
05-08-02	—	37										
05-13-02	6.65	26										
05-21-02	—	45										
05-31-02	6.00	4.7										
06-05-02	6.38	23										
06-12-02	6.29	16										
06-19-02	6.26	14										
06-25-02	6.25	8.9										
07-03-02	5.80	5.4										
07-09-02	6.10	12										
07-19-02	6.00	54										
07-22-02	—	42										
07-30-02	5.73	26										
08-06-02	5.00	18										
08-15-02	4.49	9.9										
08-23-02	5.17	27										
08-30-02	6.08	29										
09-06-02	5.32	24										
09-13-02	5.38	26										
09-20-02	5.66	30										
09-27-02	6.22	32										

*THIS
PAGE
INTENTIONALLY
LEFT
BLANK*

	Page		Page
A			
ACCESS TO USGS WATER DATA	11	Bear River Basin, diversions and storage in	255
Accuracy of the Records	7	BEAR RIVER BELOW DRUM AFTERBAY, NEAR BLUE CANYON	313
Acid neutralizing capacity, definition of	12	BEAR RIVER BELOW DUTCH FLAT AFTERBAY,	
Acre-foot, definition of	12	NEAR DUTCH FLAT	314
Adenosine triphosphate, definition of	12	BEAR RIVER BELOW ROLLINS DAM, NEAR COLFAX	319
Algae		BEAR RIVER CANAL INTAKE NEAR COLFAX	317
Blue-green, definition of	13	BEAR RIVER FISH RELEASE BELOW NEW CAMP FAR WEST	
Euglenoids, definition of	15	RESERVOIR, NEAR WHEATLAND	321
Fire, definition of	15	BEAR RIVER NEAR EMIGRANT GAP	312
Green, definition of	15	BEAR RIVER NEAR WHEATLAND	322
Algal growth potential, definition of	12	Bed material, definition of	13
Alkalinity, definition of	12	Bedload discharge, definition of	12
Almanor–Butt Creek Tunnel at Outlet	174	Bedload, definition of	12
Alpine County, location of discharge stations in	28	Belden Powerplant	177
Alta Powerplant	257	Benthic organisms, definition of	13
Amador County, location of discharge stations in	29	BIDWELL CREEK BELOW MILL CREEK, NEAR FORT BIDWELL	54
Ambient blank	10	Biochemical oxygen demand (BOD), definition of	13
AMERICAN RIVER AT FAIR OAKS	409	Biomass, Pigment ratio, definition of	13
AMERICAN RIVER AT WILLIAM B. POND PARK,		Biomass, definition of	13
AT CARMICHAEL	413	Biovolume, definition of	13
American River Basin, Middle Fork, diversions and storage in	334	Blank Samples	10
American River Basin, South Fork, diversions and storage in	370	BLUE LAKE NEAR EMIGRANT GAP	262
AMERICAN RIVER BELOW FOLSOM DAM, NEAR FOLSOM	407	Blue-green algae, definition of	13
AMERICAN RIVER BELOW WATT AVENUE BRIDGE,		BOD (See "Biochemical oxygen demand")	13
NEAR CARMICHAEL	415	Bottom material (See "Bed material")	13
ANDERSON–COTTONWOOD IRRIGATION DISTRICT CANAL		Boulder, definition of	18
AT SHARON STREET, AT REDDING	94	BOWMAN LAKE NEAR GRANITEVILLE	278
Annual 7-day minimum, definition of	12	Bowman–Spaulding Canal	281
Annual mean, explanation of	6	BOWMAN–SPAULDING CANAL AT JORDAN CREEK SIPHON	
Annual runoff, definition of	12	VENTURI, NEAR EMIGRANT GAP	279
Annual runoff, explanation of	7	Brophy South Canal	300
Annual total, explanation of	6	Browns Valley Irrigation Ditch	300
Aquifer, Unconfined, definition of	23	BRUSH CREEK BELOW BRUSH CREEK DAM,	
Aquifer, water table, definition of	23	NEAR POLLOCK PINES	396
Arbuckle Mountain Powerplant	106	BRUSH CREEK RESERVOIR NEAR POLLOCK PINES	394
ARCADE CREEK NEAR DEL PASO HEIGHTS	418	BUCK–LOON TUNNEL NEAR MEEKS BAY	346
Aroclor, definition of	12	BUCKS CREEK BELOW DIVERSION DAM,	
Arrangement of Records	8	NEAR BUCKS LODGE	187
Artificial substrate, definition of	12	Bucks Creek Powerplant	190
Ash mass, definition of	12	BUCKS LAKE NEAR BUCKS LODGE	185
Aspect, definition of	12	Bulk electrical conductivity, definition of	13
B			
Bacteria		BUTT CREEK BELOW ALMANOR–BUTT CREEK TUNNEL,	
Enterococcus, definition of	15	NEAR PRATTVILLE	174
Escherichia coli (E. Coli), definition of	15	Butt Valley Powerplant	172
Fecal coliform, definition of	15	BUTT VALLEY RESERVOIR NEAR CARIBOU	176
Fecal streptococcal, definition of	15	Butte County, location of discharge and water-quality stations	30
Total coliform, definition of	22	BUTTE CREEK BELOW CENTERVILLE DIVERSION DAM,	
Bacteria, definition of	12	NEAR PARADISE	141
BAILEY CREEK BELOW DIVERSION TO PONDEROSA–BAILEY		BUTTE CREEK BELOW DIVERSION DAM,	
CREEK POWERPLANT, NEAR MANTON	113	NEAR STIRLING CITY	139
BANGOR CANAL BELOW MINERS RANCH RESERVOIR,		BUTTE CREEK BELOW FORKS OF BUTTE DIVERSION DAM,	
NEAR OROVILLE	168	NEAR DE SABL A	140
Bankfull stage, definition of	12	BUTTE CREEK NEAR CHICO	143
Base discharge (for peak discharge), definition of	12	Butte Powerplant	140
Base flow, definition of	12	C	
Battle Creek and Cow Creek Basins, diversions and storage in	100	C. perfringens, definitions of	13
BATTLE CREEK BELOW COLEMAN FISH HATCHERY,		CACHE CREEK AT YOLO	451
NEAR COTTONWOOD	120	CACHE CREEK NEAR LOWER LAKE	440
BEAR CREEK ABOVE HOLSTEN CHIMNEY CANYON,		Camino Powerplant	392
NEAR RUMSEY	449	CAMINO RESERVOIR NEAR POLLOCK PINES	390
		CAMP CREEK NEAR PULGA	194
		CAMPTONVILLE TUNNEL AT INTAKE, NEAR CAMPTONVILLE	222
		Canister blank	10

Page

CANYON CREEK BELOW BOWMAN LAKE 281

CANYON CREEK BELOW FAUCHERIE LAKE, NEAR CISCO 273

CANYON CREEK BELOW FRENCH LAKE, NEAR CISCO 271

CANYON CREEK BELOW SAWMILL LAKE,
NEAR GRANITEVILLE 275

CANYON CREEK BELOW TOWLE DIVERSION DAM,
NEAR BLUE CANYON 331

CANYON CREEK NEAR BLUE CANYON 330

CAPLES CREEK RELEASE BELOW CAPLES DAM,
NEAR KIRKWOOD 377

CAPLES LAKE NEAR KIRKWOOD 376

Caribou Powerplants 176

CARR LAKE NEAR GRANITEVILLE 268

Cells volume (biovolume), definition of 13

Cells/volume, definition of 13

Centerville Powerplant 141

Cfs-day (See "Cubic foot per second-day") 13

Channel bars, definition of 13

Chemical oxygen demand (COD), definition of 13

Chicago Park Flume 314

Classification of Records 8

Clay, definition of 18

CLEAR CREEK NEAR IGO 98

CLEAR LAKE AT LAKEPORT 439

Clostridium perfringens, definition of 13

Cobble, definition of 18

COD (See "Chemical oxygen demand") 13

COLEMAN POWERPLANT NEAR COTTONWOOD 111

Coliphages, definition of 13

COLLETT RESERVOIR NEAR LITTLE VALLEY 61

Color unit, definition of 13

Colusa County, location of discharge and water-quality stations 31

Conductivity, Bulk electrical, definition of 13

Conductivity, definition of 20

Confined aquifer, definition of 13

Contents, definition of 13

Continuing-record station 8

Continuous-record station, definition of 13

Control structure, definition of 13

Control, definition of 13

COOPERATION 1

Cooperation paragraph 5

COTTONWOOD CREEK NEAR COTTONWOOD 107

Cow Creek and Battle Creek Basins, diversions and storge in 100

COW CREEK NEAR MILLVILLE 104

Cresta Powerplant 192

Cross-Sectional Data 9

Cubic foot per second per day, definition of 14

Cubic foot per second per square mile, definition of 14

Cubic foot per second, definition of 13

CULBERTSON LAKE NEAR GRANITEVILLE 287

D

Daily mean suspended-sediment concentration, definition of 14

Daily mean values, data table of 6

Daily-record station, definition of 14

Data Collection and Computation 4

Data Collection Platform, definition of 14

Data logger, definition of 14

Data Precision 50

Data Presentation 5, 11

Datum

 Gage, definition of 15

 Land-surface, definition of 16

Page

Datum—Continued:

 NAVD of 1988, definition of 18

 NGVD of 1929, definition of 18

Datum, definition of 14

DAVIS CREEK AT DAM, NEAR KNOXVILLE 446

De Sabla Powerplant 142

DEADWOOD CREEK NEAR STRAWBERRY VALLEY 235

Deadwood Creek Powerplant 235

DEER CREEK NEAR SMARTVILLE 306

DEER CREEK NEAR VINA 130

Deer Creek Powerplant 259

DEFINITION OF TERMS 12

Diatoms, definition of 14

Diel, definition of 14

Discharge

 Base, definition of 12

 Bedload, definition of 12

 Instantaneous, definition of 16

 Mean, definition of 17

 Peak, definition of 12

 Total sediment, definition of 23

 Total, definition of 22

Discharge at partial-record stations and miscellaneous sites 460

Discharge measurements made at special study and miscellaneous sites
 during water year 2002 460

Discharge, definition of 14

DISCONTINUED CONTINUOUS WATER-QUALITY STATIONS xix

DISCONTINUED LAKES AND RESERVOIRS xix

Dissolved oxygen, definition of 14

Dissolved Trace-Element Concentrations 50

Dissolved, definition of 14

Dissolved-solids concentration, definition of 14

Diversions and storage

 American River Basin, Middle Fork 334

 American River Basin, South Fork 370

 Battle Creek and Cow Creek Basins 100

 Bear River Basin 255

 Cow Creek and Battle Creek Basins 100

 Feather River at Lake Oroville 200

 Feather River Basin, North Fork 170

 Feather River Basin, South Fork 155

 Lower Sacramento River Basin 135

 Middle and North Yuba River Basins 213

 Middle Fork American and Rubicon River Basins 334

 North and Middle Yuba River Basins 213

 North Fork Feather River Basin 170

 Pit and McCloud River Basins 55

 Rubicon River Basin 334

 Sacramento River Basin, lower 135

 Sacramento River Basin, upper 91

 South Fork American River Basin 370

 South Fork Feather River Basin 155

 South Yuba River Basin 249

 Upper Sacramento River Basin 91

 Yuba River Basin, south 249

 Yuba River Basins, north and middle 213

Diversity index, definition of 14

Dog Creek at Delta 460

Downstream Order System 3

Drainage area paragraph 5

Drainage area, definition of 14

Drainage basin, definition of 14

DRUM CANAL AT TUNNEL OUTLET, NEAR EMIGRANT GAP 257

Drum No. 1 and 2 Powerplants 257

DRY CREEK AT VERNON STREET BRIDGE, AT ROSEVILLE 417

Page

Dry mass, definition of 14

Dry Slough near Davis 460

Dry weight, definition of 14

DUNCAN CANYON CREEK BELOW DIVERSION DAM,
NEAR FRENCH MEADOWS 340

DUNCAN CANYON CREEK NEAR FRENCH MEADOWS 338

Dutch Flat No. 1 Powerplant 313

Dutch Flat No. 2 Flume 313

E

EAST FORK NELSON CREEK BELOW DIVERSION
TO NELSON CREEK, NEAR BIG BEND 75

EAST PARK RESERVOIR NEAR STONYFORD 136

Edward Hyatt Powerplant 201

EL DORADO CANAL AND SOUTH FORK AMERICAN RIVER
NEAR KYBURZ (combined) 380

ELDER CREEK NEAR PASKENTA 124

Embeddedness, definition of 14

Enterococcus bacteria, definition of 15

EPT Index, definition of 15

Equipment blank 10

Escherichia coli (E. coli), definition of 15

Estimated (E) concentration value, definition of 15

Euglenoids, definition of 15

EXPLANATION OF THE RECORDS 3

Extractable organic halides, definition of 15

Extremes for current year paragraph 5

Extremes for period of record paragraph 5

Extremes outside period of record paragraph 5

F

FAUCHERIE LAKE NEAR CISCO 272

Feather River at Lake Oroville, diversions and storage from 200

FEATHER RIVER AT OROVILLE 211

Feather River Basin, North Fork, diversions and storage in 170

Feather River Basin, South Fork, diversions and storage in 155

Feather River Fish Hatchery 211

Fecal coliform bacteria, definition of 15

Fecal streptococcal bacteria, definition of 15

FEELEY LAKE NEAR GRANITEVILLE 266

Field blank 10

Filter blank 10

Fire algae, definition of 15

Flow

 Annual 7-day minimum, definition of 12

 Base, definition of 12

 Peak, definition of 18

 Seven-day 10-year low flow, definition of 20

 Streamflow, definition of 21

Flow-duration percentiles, definition of 15

FOLSOM LAKE NEAR FOLSOM 406

Forbestown Powerplant 165

FORDYCE CREEK BELOW FORDYCE DAM, NEAR CISCO 254

FORDYCE LAKE NEAR CISCO 253

FRENCH LAKE NEAR CISCO 270

French Meadows Powerplant 336

FRENCH MEADOWS RESERVOIR NEAR FORESTHILL 335

G

Gage datum, definition of 15

Gage height, definition of 15

Gage paragraph 5

Page

Gage values, definition of 15

Gaging station, definition of 15

GAGING STATIONS, DISCONTINUEDxiv

Gas chromatography/flame ionization detector, definition of 15

Geomorphic channel units, definition of 15

GERLE CREEK BELOW LOON LAKE DAM, NEAR MEEKS BAY ..353

GERLE RESERVOIR NEAR MEEKS BAY 355

Glenn County, location of discharge stations in 33

Gravel, definition of 18

Green algae, definition of 15

GRIZZLY CREEK BELOW DIVERSION DAM, NEAR STORRIE 190

GRIZZLY FOREBAY NEAR STORRIE 189

Grizzly Powerplant 187

H

Habitat quality index, definition of 16

Habitat, definition of 16

Hallwood-Cordua Irrigation Ditch 300

Halsey Powerplant 317

Hardness, definition of 16

HARLEY GULCH NEAR WILBUR SPRINGS 445

HARRY L. ENGLEBRIGHT LAKE NEAR SMARTVILLE 299

HAT CREEK BELOW HAT NO. 1 DIVERSION DAM,
NEAR BURNEY 67

HAT CREEK NO. 1 POWERPLANT NEAR BURNEY 68

Hat Creek No. 2 Powerplant 68

HAT NO. 2 POWER CANAL DIVERSION TO HAT CREEK,
NEAR BURNEY 69

HELL HOLE RESERVOIR NEAR MEEKS BAY 348

High tide, definition of 16

Highest annual mean, explanation of 6

Highest daily mean, explanation of 6

Hilsenhoff's Biotic Index, definition of 16

Horizontal datum (See "Datum") 16

Hydrologic Benchmark Network 2

Hydrologic index stations, definition of 16

Hydrologic unit, definition of 16

I

ICE HOUSE RESERVOIR NEAR KYBURZ 383

Identifying Estimated Daily Discharge 7

Inch, definition of 16

INSKIP POWERPLANT NEAR MANTON 111

Instantaneous discharge, definition of 16

Instantaneous low flow, explanation of 7

INTRODUCTION 1

IRON CANYON CREEK BELOW IRON CANYON DAM,
NEAR BIG BEND 79

IRON CANYON RESERVOIR NEAR BIG BEND 70

Island, definition of 16

J

JACKSON CREEK BELOW JACKSON LAKE, NEAR SIERRA CITY 277

JACKSON LAKE NEAR SIERRA CITY 276

JACKSON MEADOWS RESERVOIR NEAR SIERRA CITY 214

JAMES B. BLACK POWERPLANT NEAR BIG BEND 78

Jaybird Powerplant 389

Jones Fork Powerplant 385

JUDGE FRANCIS CARR POWERPLANT NEAR FRENCH GULCH ...95

JUNCTION RESERVOIR NEAR POLLOCK PINES 387

	Page
K	
KELLY LAKE NEAR CISCO	329
Kelly Ridge Powerplant	167
KELSEY CREEK NEAR KELSEYVILLE	437
KIDD LAKE NEAR SODA SPRINGS	246
KILARC CANAL DIVERSION TO OLD COW CREEK, NEAR WHITMORE	102
L	
Laboratory Measurements	9
Laboratory Reporting Level, definition of	16
LAKE ALMANOR AT PRATTVILLE	171
LAKE ALOHA NEAR PHILLIPS	371
LAKE BERRYESSA NEAR WINTERS	455
LAKE BRITTON NEAR BURNEY	70
Lake County, location of discharge stations	34
LAKE CREEK BELOW CARR LAKE, NEAR GRANITEVILLE	269
LAKE CREEK BELOW FEELEY LAKE, NEAR GRANITEVILLE	267
LAKE McCLOUD NEAR McCLOUD	70
LAKE OROVILLE NEAR OROVILLE	201
LAKE SPAULDING NEAR EMIGRANT GAP	256
LAKE STERLING NEAR CISCO	252
Lake Valley Canal	328
LAKE VALLEY RESERVOIR NEAR CISCO	328
Lakes and reservoirs	
BLUE LAKE NEAR EMIGRANT GAP	262
BOWMAN LAKE NEAR GRANITEVILLE	278
BRUSH CREEK RESERVOIR NEAR POLLOCK PINES	394
BUCKS LAKE NEAR BUCKS LODGE	185
BUTT VALLEY RESERVOIR NEAR CARIBOU	176
CAMINO RESERVOIR NEAR POLLOCK PINES	390
CAPLES LAKE NEAR KIRKWOOD	376
CARR LAKE NEAR GRANITEVILLE	268
CLEAR LAKE AT LAKEPORT	439
COLLETT RESERVOIR NEAR LITTLE VALLEY	61
CULBERTSON LAKE NEAR GRANITEVILLE	287
EAST PARK RESERVOIR NEAR STONYFORD	136
FAUCHERIE LAKE NEAR CISCO	272
FEELEY LAKE NEAR GRANITEVILLE	266
FOLSOM LAKE NEAR FOLSOM	406
FORDYCE LAKE NEAR CISCO	253
FRENCH LAKE NEAR CISCO	270
FRENCH MEADOWS RESERVOIR NEAR FORESTHILL	335
GERLE RESERVOIR NEAR MEEKS BAY	355
GRIZZLY FOREBAY NEAR STORRIE	189
Harry L. Englebright Lake	299
HELL HOLE RESERVOIR NEAR MEEKS BAY	348
ICE HOUSE RESERVOIR NEAR KYBURZ	383
JACKSON LAKE NEAR SIERRA CITY	276
JACKSON MEADOWS RESERVOIR NEAR SIERRA CITY	214
JUNCTION RESERVOIR NEAR POLLOCK PINES	387
KELLY LAKE NEAR CISCO	329
KIDD LAKE NEAR SODA SPRINGS	246
LAKE ALMANOR AT PRATTVILLE	171
LAKE ALOHA NEAR PHILLIPS	371
LAKE BERRYESSA NEAR WINTERS	455
LAKE OROVILLE NEAR OROVILLE	201
LAKE SPAULDING NEAR EMIGRANT GAP	256
LAKE STERLING NEAR CISCO	252
LAKE VALLEY RESERVOIR NEAR CISCO	328
LITTLE GRASS VALLEY RESERVOIR NEAR LA PORTE	156
LOON LAKE NEAR MEEKS BAY	351
LOWER BUCKS LAKE NEAR BUCKS LODGE	186
LOWER CASCADE LAKE NEAR SODA SPRINGS	248
LOWER LINDSEY LAKE NEAR GRANITEVILLE	291
LOWER ROCK LAKE NEAR GRANITEVILLE	285
Lower Sacramento River Basin, diversions and storage in	135
Lowest annual mean, explanation of	6
Lowest daily mean, explanation of	6

Lakes and reservoirs—Continued:	
LOWER LINDSEY LAKE NEAR GRANITEVILLE	291
LOWER ROCK LAKE NEAR GRANITEVILLE	285
MEADOW LAKE NEAR CISCO	251
MIDDLE LINDSEY LAKE NEAR GRANITEVILLE	289
NEW BULLARDS BAR RESERVOIR NEAR NORTH SAN JUAN	238
ROCK LAKE NEAR GRANITEVILLE	283
ROLLINS RESERVOIR NEAR COLFAX	316
RUCKER LAKE NEAR EMIGRANT GAP	264
SAWMILL LAKE NEAR GRANITEVILLE	274
SHASTA LAKE NEAR REDDING	90
SILVER LAKE NEAR KIRKWOOD	373
SLAB CREEK RESERVOIR NEAR CAMINO	397
SLY CREEK RESERVOIR NEAR STRAWBERRY VALLEY	161
STONY GORGE RESERVOIR NEAR ELK CREEK	136
THERMALITO AFTERBAY NEAR OROVILLE	204
UNION VALLEY RESERVOIR NEAR RIVERTON	381
UPPER CASCADE LAKE NEAR SODA SPRINGS	247
WHISKEYTOWN LAKE NEAR IGO	97
WHITE ROCK LAKE NEAR SODA SPRINGS	250
Land-surface datum, definition of	16
Lassen County, location of discharge and water-quality stations	35
Latent heat flux, definition of	16
Latitude-Longitude System	3
Light-attenuation coefficient, definition of	16
LINDSEY CREEK BELOW LOWER LINDSEY LAKE, NEAR GRANITEVILLE	292
LINDSEY CREEK BELOW MIDDLE LINDSEY LAKE	290
Lipid, definition of	16
LITTLE GRASS VALLEY RESERVOIR NEAR LA PORTE	156
LITTLE RUBICON RIVER BELOW BUCK ISLAND DAM, NEAR MEEKS BAY	347
Location paragraph	5
LOHMAN RIDGE TUNNEL AT INTAKE, NEAR CAMPTONVILLE	220
Long-Term Method Detection Level, definition of	17
LOON LAKE NEAR MEEKS BAY	351
Loon Lake Powerplant	353
LOST CREEK BELOW DIVERSION TO LOST CREEK POWERPLANT NO. 1, NEAR OLD STATION	66
LOST CREEK NEAR CLIPPER MILLS	163
Lost Creek Powerplant No. 1	66
Low flow, 7-day 10-year, definition of	20
Low tide, definition of	17
LOWER BUCKS LAKE NEAR BUCKS LODGE	186
LOWER CASCADE LAKE NEAR SODA SPRINGS	248
LOWER LINDSEY LAKE NEAR GRANITEVILLE	291
LOWER ROCK LAKE NEAR GRANITEVILLE	285
Lower Sacramento River Basin, diversions and storage in	135
Lowest annual mean, explanation of	6
Lowest daily mean, explanation of	6

M

Macrophytes, definition of	17
Mass	
Ash, definition of	12
Biomass, definition of	13
Dry, definition of	14
Organic, definition of	18
Wet, definition of	23
Maximum Peak Flow, explanation of	6
Maximum Peak Stage, explanation of	7
McCLOUD RIVER ABOVE SHASTA LAKE	88
McCloud River and Pit Basins, diversions and storage in	55

Page	Page		
McCLOUD RIVER AT AH-DI-NA, NEAR McCLOUD	86	National Stream-Quality Accounting Network	2
McCLOUD RIVER BELOW McCLOUD DAM, NEAR McCLOUD	85	National Trends Network	2
McCLOUD RIVER NEAR McCLOUD	82	National Trends Network, change in procedures	8
McCLOUD-IRON CANYON DIVERSION TUNNEL		National Water Data Exchange	7
NEAR McCLOUD	84	National Water Information System (NWIS)	11
McCumber Dam	110	National Water-Quality Assessment Program	2
MEADOW LAKE NEAR CISCO	251	Natural substrate, definition of	18
Mean concentration of suspended sediment, definition of	17	NAVD of 1988 (See "National American Vertical Datum of 1988)	18
Mean discharge, definition of	17	Nekton, definition of	18
Mean high tide, definition of	17	NELSON CREEK BELOW DIVERSION	
Mean low tide, definition of	17	TO NELSON CREEK POWERPLANT, NEAR BIG BEND	74
Mean sea level, definition of	17	Nelson Creek Powerplant	74
Measuring point, definition of	17	Nephelometric turbidity unit, definition of	18
Membrane filter, definition of	17	Nevada County, location of discharge and water-quality stations	38
Metamorphic stage, definition of	17	NEW BULLARDS BAR RESERVOIR NEAR NORTH SAN JUAN	238
Method Detection Limit, definition of	17	NEW COLGATE POWERPLANT NEAR FRENCH CORRAL	237
Methylene blue active substance, definition of	17	Newcastle Powerplant	324
Micrograms per gram, definition of	17	NGVD of 1929 (See "National Geodetic Vertical Datum of 1929)	18
Micrograms per kilogram, definition of	17	North American Vertical Datum of 1988, definition of	18
Micrograms per liter, definition of	17	North and Middle Yuba River Basins, diversions and storage in	213
Microsiemens per centimeter, definition of	17	NORTH FORK AMERICAN RIVER AT AUBURN DAM SITE,	
Middle and North Yuba River Basins, diversions and storage in	213	NEAR AUBURN	368
Middle Fork American and Rubicon River Basins,		NORTH FORK AMERICAN RIVER AT NORTH FORK DAM	332
diversions and storage in	334	NORTH FORK BATTLE CREEK BELOW DIVERSION	
MIDDLE FORK AMERICAN RIVER ABOVE MIDDLE FORK		TO CROSS COUNTRY CANAL, NEAR MANTON	114
POWERPLANT, NEAR FORESTHILL	341	NORTH FORK BATTLE CREEK BELOW DIVERSION	
MIDDLE FORK AMERICAN RIVER AT FRENCH MEADOWS	336	TO EAGLE CANYON CANAL, NEAR MANTON	115
MIDDLE FORK AMERICAN RIVER BELOW INTERBAY DAM,		NORTH FORK BATTLE CREEK BELOW DIVERSION	
NEAR FORESTHILL	342	TO KESWICK CANAL, NEAR MANTON	112
MIDDLE FORK AMERICAN RIVER NEAR FORESTHILL	366	NORTH FORK BATTLE CREEK BELOW DIVERSION	
MIDDLE FORK COTTONWOOD CREEK BELOW DIVERSION TO		TO WILDCAT CANAL, NEAR MANTON	116
ARBUCKLE MOUNTAIN POWERPLANT, NEAR PLATINA	106	NORTH FORK BATTLE CREEK BELOW McCUMBER DAM,	
Middle Fork Powerplant	349	NEAR MANZANITA LAKE	110
MIDDLE LINDSEY LAKE NEAR GRANITEVILLE	289	NORTH FORK BATTLE CREEK BELOW NORTH BATTLE CREEK	
MIDDLE YUBA RIVER BELOW MILTON DAM,		DAM, NEAR MANZANITA LAKE	109
NEAR SIERRA CITY	218	North Fork Battle Creek Reservoir	109
MIDDLE YUBA RIVER BELOW OUR HOUSE DAM,		NORTH FORK CACHE CREEK AT HOUGH SPRINGS,	
NEAR CAMPTONVILLE	221	NEAR CLEARLAKE OAKS	441
MIDDLE YUBA RIVER CONTROLLED RELEASE		NORTH FORK CACHE CREEK NEAR CLEARLAKE OAKS	443
AT JACKSON MEADOWS DAM, NEAR SIERRA CITY	215	NORTH FORK FEATHER RIVER AT PULGA	196
MIDDLE YUBA RIVER NEAR NORTH SAN JUAN	225	North Fork Feather River Basin, diversions and storage in	170
MILL CREEK AT UPPER LAKE, NEAR LAKE CITY	53	NORTH FORK FEATHER RIVER BELOW BELDEN DAM	177
MILL CREEK NEAR LOS MOLINOS	126	NORTH FORK FEATHER RIVER BELOW GRIZZLY CREEK	192
Milligrams per liter, definition of	17	NORTH FORK FEATHER RIVER BELOW POE DAM	195
MILTON-BOWMAN TUNNEL OUTLET NEAR GRANITEVILLE	216	NORTH FORK FEATHER RIVER	
MINERS RANCH CANAL BELOW PONDEROSA DAM,		BELOW ROCK CREEK DIVERSION DAM	182
NEAR FORBESTOWN	167	NORTH FORK FEATHER RIVER NEAR PRATTVILLE	172
Minimum Reporting Level, definition of	17	NORTH FORK LONG CANYON CREEK BELOW DIVERSION DAM,	
Miscellaneous and special study sites	460	NEAR VOLCANOVILLE	365
Miscellaneous sampling site	8	NORTH FORK LONG CANYON CREEK DIVERSION TUNNEL	
Miscellaneous site, definition of	17	NEAR VOLCANOVILLE	364
Miscellaneous sites and partial-record stations, discharge at	460	NORTH YUBA RIVER BELOW GOODYEARS BAR	231
Modoc County, location of discharge stations	36	NORTH YUBA RIVER BELOW NEW BULLARDS BAR DAM,	
Monthly mean data, statistics of	6	NEAR NORTH SAN JUAN	239
MORMON RAVINE NEAR NEWCASTLE	324		
Most probable number (MPN), definition of	17	O	
Muck Valley Powerplant	61	OLD COW CREEK BELOW DIVERSION TO OLSEN POWERPLANT,	
Multiple-plate samplers, definition of	17	NEAR WHITMORE	103
		Olsen Powerplant	103
N		Onsite Measurements and Sample Collection	8
Nanograms per liter, definition of	17	Open or screened interval, definition of	18
Napa County, location of discharge and water-quality stations	37	OREGON CREEK BELOW LOG CABIN DAM,	
National Atmospheric Deposition Program	2	NEAR CAMPTONVILLE	223
National Geodetic Vertical Datum of 1929, definition of	18	Organic carbon, definition of	18

Page	Page		
Organic mass, definition of	18	Plankton, definition of	19
Organism count/area, definition of	18	Plumas County, location of discharge stations	40
Organism count/volume, definition of	18	Poe Powerplant	196
Organisms, Benthic, definition of	13	Polychlorinated biphenyls (PCBs), definition of	19
Organochlorine compounds, definition of	18	Polychlorinated naphthalenes (PCNs), definition of	19
OROVILLE–WYANDOTTE CANAL NEAR CLIPPER MILLS	162	PONDEROSA–BAILEY CREEK POWERPLANT	113
Other Records Available	7	Pool, definition of	19
OWL GULCH NEAR STRAWBERRY VALLEY	236	POWERPLANTS IN BATTLE CREEK AND COW CREEK BASINS ..	111
Oxbow Powerplant	366	Preservation blank	10
P		Primary productivity	
PACIFIC GAS & ELECTRIC CO. LATERAL AT INTAKE,		Carbon method, definition of	19
NEAR OROVILLE	208	Oxygen method, definition of	19
PALERMO CANAL NEAR OROVILLE	203	Primary productivity, definition of	19
Parameter Code, definition of	18	Principal inflows and diversions, Sacramento–San Joaquin Delta	459
Partial-record station	8	Pump blank	10
Partial-record station, definition of	18	PUTAH CREEK NEAR GUENOC	453
Partial-record stations and miscellaneous sites, discharge at	460	PUTAH CREEK NEAR WINTERS	456
Particle size, definition of	18	PUTAH SOUTH CANAL NEAR WINTERS	458
Particle-size classification		PYRAMID CREEK AT TWIN BRIDGES	372
Clay, definition of	18	Q	
Gravel, definition of	18	Quality-Control Data	10
Sand, definition of	18	R	
Silt, definition of	18	Radioisotopes, definition of	19
Particle-size classification, definition of	18	Ralston Powerplant	342
PCBs (See Polychlorinated biphenyls)	19	Reach, definition of	19
PCNs (See "Polychlorinated naphthalenes")	19	Records of Stage and Water Discharge	3
Peak flow (peak stage), definition of	18	Records of Surface-Water Quality	8
Peak stage, definition of	18	Recoverable from bed (bottom) material, definition of	19
Percent composition (percent of total), definition of	19	Recurrence interval, definition of	20
Percent shading, definition of	19	Reference Samples	10
Period of record paragraph	5	Remarks Codes	50
Periodic-record station, definition of	19	Remarks paragraph	5
Periphyton, definition of	19	Replicate Samples	10
Pesticides, definition of	19	Concurrent sample	10
pH, definition of	19	Sequential samples	10
PHILBROOK CREEK BELOW PHILBROOK DAM,		Split sample	10
NEAR BUTTE MEADOWS	198	Replicate samples, definition of	20
Phytoplankton, definition of	19	RESERVOIRS IN PIT AND McCLOUD RIVER BASINS	70
Picocurie, definition of	19	RESERVOIRS IN STONY CREEK BASIN	136
PILOT CREEK ABOVE STUMPY MEADOWS LAKE	359	Return period (See "Recurrence interval")	20
PILOT CREEK BELOW MUTTON CANYON,		Revised record paragraph	5
NEAR GEORGETOWN	361	Revisions paragraph	5
Pit and McCloud River Basins, diversions and storage in	55	RICHVALE CANAL AT INTAKE, NEAR OROVILLE	207
PIT NO. 1 POWERPLANT NEAR FALL RIVER MILLS	63	Riffle, definition of	20
Pit No. 3 Powerplant	72	River mileage, definition of	20
Pit No. 4 Powerplant	72	Robbs Peak Powerplant	357
Pit No. 5 Powerplant	78	ROCK CREEK NEAR PLACERVILLE	401
Pit No. 6 Powerplant	80	Rock Creek Powerplant	182, 401
Pit No. 6 Reservoir	80	ROCK LAKE NEAR GRANITEVILLE	283
Pit No. 7 Reservoir	80	Rollins Powerplant	316
PIT RIVER AT BIG BEND	76	ROLLINS RESERVOIR NEAR COLFAX	316
PIT RIVER BELOW DIVERSION		Rubicon River Basin, diversions and storage in	334
TO MUCK VALLEY POWERPLANT, NEAR BIEBER	62	RUBICON RIVER BELOW HELL HOLE DAM, NEAR MEEKS BAY ..	349
PIT RIVER BELOW PIT NO. 1 POWERPLANT,		RUBICON RIVER BELOW RUBICON DAM, NEAR MEEKS BAY ..	345
NEAR FALL RIVER MILLS	64	RUBICON–ROCKBOUND TUNNEL NEAR MEEKS BAY	344
PIT RIVER BELOW PIT NO. 4 DAM	72	RUCKER CREEK BELOW BLUE LAKE, NEAR EMIGRANT GAP ..	263
PIT RIVER NEAR CANBY	59	RUCKER CREEK BELOW RUCKER LAKE,	
PIT RIVER NEAR MONTGOMERY CREEK	80	NEAR EMIGRANT GAP	265
Pit River Tunnel Flow	61	RUCKER LAKE NEAR EMIGRANT GAP	264
Placer County, location of discharge and water-quality stations	39	Run, definition of	20
Plankton		Runoff, Annual, definition of	12
Phytoplankton, definition of	19		
Zooplankton, definition of	23		

Page	Page
Runoff, definition of	20
S	
Sacramento County, location of discharge and water-quality stations	41
SACRAMENTO RIVER ABOVE BEND BRIDGE, NEAR RED BLUFF	122
SACRAMENTO RIVER AT COLUSA	137
SACRAMENTO RIVER AT DELTA	56
SACRAMENTO RIVER AT FREEPORT	426
SACRAMENTO RIVER AT KESWICK	92
SACRAMENTO RIVER AT SACRAMENTO	424
SACRAMENTO RIVER AT VERONA	325
Sacramento River Basin, lower, diversions and storage in	135
Sacramento River Basin, upper, diversions and storage in	91
SACRAMENTO RIVER BELOW WILKINS SLOUGH, NEAR GRIMES	148
SACRAMENTO SLOUGH NEAR KNIGHTS LANDING	151
SACRAMENTO WEIR SPILL TO YOLO BYPASS, NEAR SACRAMENTO	327
Sacramento–San Joaquin Delta, principal inflows and diversions	459
Sampler blank	10
Sand, definition of	18
SAWMILL LAKE NEAR GRANITEVILLE	274
Sea level, definition of	20
Sediment	9
Sediment, definition of	20
Sensible heat flux, definition of	20
Seven-day 10-year low flow, definition of	20
Shasta County, location of discharge and water-quality stations	42
SHASTA LAKE NEAR REDDING	90
Shelves, definition of	20
Sierra County, location of discharge stations	43
Silt, definition of	18
SILVER CREEK BELOW CAMINO DIVERSION DAM	392
SILVER CREEK BELOW JUNCTION DAM, NEAR POLLOCK PINES	389
Silver Lake Leakage	374
SILVER LAKE NEAR KIRKWOOD	373
SILVER LAKE OUTLET NEAR KIRKWOOD	374
Siskiyou County, location of discharge and water-quality stations	44
SLAB CREEK RESERVOIR NEAR CAMINO	397
SLATE CREEK BELOW DIVERSION DAM, NEAR STRAWBERRY VALLEY	234
SLATE CREEK TUNNEL NEAR STRAWBERRY VALLEY	233
SLY CREEK RESERVOIR NEAR STRAWBERRY VALLEY	161
Sodium adsorption ratio, definition of	20
Soil heat flux, definition of	20
Soil-water content, definition of	20
Solano County, location of discharge and water-quality stations in	45
Source solution blank	10
SOUTH BRANCH WARD CREEK BELOW DIVERSION DAM, NEAR GENESEE	179
SOUTH COW CREEK CANAL DIVERSION TO SOUTH COW CREEK, NEAR WHITMORE	101
SOUTH FORK AMERICAN RIVER AND EL DORADO CANAL NEAR KYBURZ (combined)	380
South Fork American River Basin, diversions and storage in	370
SOUTH FORK AMERICAN RIVER NEAR CAMINO	399
SOUTH FORK AMERICAN RIVER NEAR KYBURZ	378
SOUTH FORK AMERICAN RIVER NEAR PILOT HILL	404
SOUTH FORK AMERICAN RIVER NEAR PLACERVILLE	403
SOUTH FORK BATTLE CREEK BELOW DIVERSION TO COLEMAN CANAL, NEAR MANTON	119
SOUTH FORK BATTLE CREEK BELOW DIVERSION TO INSKIP CANAL, NEAR MANTON	118
SOUTH FORK BATTLE CREEK BELOW DIVERSION TO SOUTH BATTLE CREEK CANAL, NEAR MANTON	117
South Fork Feather River Basin, diversions and storage in	155
SOUTH FORK FEATHER RIVER BELOW DIVERSION DAM, NEAR STRAWBERRY VALLEY	160
SOUTH FORK FEATHER RIVER BELOW FORBESTOWN DAM	165
SOUTH FORK FEATHER RIVER BELOW LITTLE GRASS VALLEY DAM	157
SOUTH FORK LONG CANYON CREEK BELOW DIVERSION DAM, NEAR VOLCANOVILLE	363
SOUTH FORK LONG CANYON CREEK DIVERSION TUNNEL NEAR VOLCANOVILLE	362
SOUTH FORK PIT RIVER NEAR LIKELY	58
SOUTH FORK RUBICON RIVER BELOW GERLE CREEK, NEAR GEORGETOWN	357
SOUTH FORK SILVER CREEK NEAR ICE HOUSE	385
SOUTH FORK TUNNEL NEAR STRAWBERRY VALLEY	159
SOUTH POWERPLANT NEAR MANTON	111
SOUTH YUBA CANAL NEAR EMIGRANT GAP	259
SOUTH YUBA RIVER AT JONES BAR, NEAR GRASS VALLEY	293
SOUTH YUBA RIVER AT LANGS CROSSING, NEAR EMIGRANT GAP	261
South Yuba River Basin, diversions and storage in	249
SOUTH YUBA RIVER CONTROLLED RELEASE AT LAKE SPAULDING, NEAR EMIGRANT GAP	260
SPANISH CREEK ABOVE BLACKHAWK CREEK, AT KEDDIE	180
Spaulding No. 3 Powerplant	279
Spaulding Powerplants Nos. 1 and 2	256
SPECIAL NETWORKS AND PROGRAMS	2
Special study and miscellaneous sites	460
Specific electrical conductance (conductivity), definition of	20
Spike Samples	10
Concurrent sample	11
Split sample	11
Splitter blank	10
SPRING CREEK POWERPLANT AT KESWICK	96
Stable isotope ratio, definition of	20
Stage	
Bankfull, definition of	12
Peak, definition of	18
Stage (See “Gage height”)	20
Stage-discharge relation, definition of	21
Standpipe blank	10
Station manuscript, explanation of	5
Station-Identification Numbers	3
Stations	
Continuous-record, definition of	13
Daily record, definition of	14
Gaging, definition of	15
Hydrologic index, definition of	16
Miscellaneous site, definition of	17
Partial-record, definition of	18
Periodic-record, definition of	19
STONY GORGE RESERVOIR NEAR ELK CREEK	136
Streamflow, definition of	21
Substrate	
Artificial, definition of	12
Embeddedness Class, definition of	21
Natural, definition of	18
Substrate, definition of	21
SUCKER RUN AT KANAKA DIVERSION, NEAR FEATHER FALLS	169
SULPHUR CREEK AT WILBUR SPRINGS	447
Summary statistics, explanation of	6

Page

Surface area of a lake, definition of 21

Surficial bed material, definition of 21

SUSAN RIVER ABOVE WILLARD CREEK, NEAR SUSANVILLE ... 51

SUSAN RIVER NEAR LITCHFIELD 52

Suspended

 Recoverable, definition of 21

 Total, definition of 21

Suspended sediment

 Concentration, definition of 21

 Discharge, definition of 21

 Load, definition of 21

Suspended sediment, definition of 21

Suspended solids, total residue, definition of 21

Suspended, definition of 21

Sutter County, location of discharge and water -quality stations 46

SUTTER–BUTTE CANAL AT INTAKE, NEAR OROVILLE 209

Synoptic studies, definition of 22

System for numbering miscellaneous sites (latitude and longitude) 3

T

Taxa (Species) richness, definition of 22

Taxonomy, definition of 22

TECHNIQUES OF WATER-RESOURCES INVESTIGATIONS
OF THE U.S. GEOLOGICAL SURVEY 24

Tehama County, location of discharge and water-quality stations 47

TEXAS CREEK BELOW LOWER ROCK LAKE,
NEAR GRANITEVILLE 286

TEXAS CREEK BELOW ROCK LAKE 284

TEXAS CREEK TRIBUTARY BELOW CULBERTSON LAKE,
NEAR GRANITEVILLE 288

Thalweg, definition of 22

THERMALITO AFTERBAY NEAR OROVILLE 204

THERMALITO AFTERBAY RELEASE TO FEATHER RIVER,
NEAR OROVILLE 210

Thermalito Powerplant 204

Thermograph, definition of 22

Time-weighted average, definition of 22

TOADTOWN CANAL ABOVE BUTTE CANAL,
NEAR STIRLING CITY 142

Tons per acre-foot, definition of 22

Tons per day, definition of 22

Total coliform bacteria, definition of 22

Total discharge, definition of 22

Total in bottom material, definition of 22

Total length, definition of 22

Total load, definition of 22

Total organism count, definition of 22

Total recoverable, definition of 22

Total sediment discharge, definition of 23

Total sediment load, definition of 23

Total, definition of 22

Transect, definition of 23

Trip blank 10

Turbidity, definition of 23

U

Ultraviolet (UV) absorption, definition of 23

Unconfined aquifer, definition of 23

Union Valley Powerplant 381

UNION VALLEY RESERVOIR NEAR RIVERTON 381

UPPER CASCADE LAKE NEAR SODA SPRINGS 247

Upper Sacramento River Basin, diversions and storage in 91

Page

V

Vertical datum (See "Datum") 23

VOCs (See "Volatile organic compounds") 23

Volatile organic compounds (VOCs), definition of 23

VOLTA NO. 1 POWERPLANT NEAR MANTON 111

VOLTA NO. 2 POWERPLANT NEAR MANTON 111

W

Water table, definition of 23

Water Temperature 9

Water year, definition of 23

Water-Data Report (See "WDR") 23

Water-Supply Paper (See "WSP") 23

Water-table aquifer, definition of 23

WDR, definition of 23

Weighted average, definition of 23

WEST BRANCH FEATHER RIVER BELOW
HENDRICKS DIVERSION DAM, NEAR STIRLING CITY 199

WESTERN CANAL AT INTAKE, NEAR OROVILLE 206

Wet mass, definition of 23

Wet weight, definition of 23

WHISKEYTOWN LAKE NEAR IGO 97

WHITE ROCK LAKE NEAR SODA SPRINGS 250

White Rock Powerplant 399

Willow Slough Bypass near Davis 460

Willow Slough near Woodland 461

Wise Powerplant 317

Woodleaf Powerhouse 163

WSP, definition of 23

Y

YOLO BYPASS NEAR WOODLAND 452

Yolo County, location of discharge and water-quality stations 48

Yuba County, location of discharge stations 49

Yuba River Basin, South, diversions and storage in 249

Yuba River Basins, North and Middle, diversions and storage in 213

YUBA RIVER BELOW ENGLEBRIGHT DAM,
NEAR SMARTVILLE 300

YUBA RIVER BELOW NEW COLGATE POWERPLANT,
NEAR FRENCH CORRAL 241

YUBA RIVER NEAR MARYSVILLE 308

Z

Zooplankton, definition of 23

CALENDAR FOR WATER YEAR 2002

2001

OCTOBER							NOVEMBER							DECEMBER						
S	M	T	W	T	F	S	S	M	T	W	T	F	S	S	M	T	W	T	F	S
	1	2	3	4	5	6					1	2	3							1
7	8	9	10	11	12	13	4	5	6	7	8	9	10	2	3	4	5	6	7	8
14	15	16	17	18	19	20	11	12	13	14	15	16	17	9	10	11	12	13	14	15
21	22	23	24	25	26	27	18	19	20	21	22	23	24	16	17	18	19	20	21	22
28	29	30	31				25	26	27	28	29	30		23	24	25	26	27	28	29
														30	31					

2002

JANUARY							FEBRUARY							MARCH						
S	M	T	W	T	F	S	S	M	T	W	T	F	S	S	M	T	W	T	F	S
		1	2	3	4	5						1	2						1	2
6	7	8	9	10	11	12	3	4	5	6	7	8	9	3	4	5	6	7	8	9
13	14	15	16	17	18	19	10	11	12	13	14	15	16	10	11	12	13	14	15	16
20	21	22	23	24	25	26	17	18	19	20	21	22	23	17	18	19	20	21	22	23
27	28	29	30	31			24	25	26	27	28			24	25	26	27	28	29	30
														31						

APRIL							MAY							JUNE						
S	M	T	W	T	F	S	S	M	T	W	T	F	S	S	M	T	W	T	F	S
	1	2	3	4	5	6			1	2	3	4								1
7	8	9	10	11	12	13	5	6	7	8	9	10	11	2	3	4	5	6	7	8
14	15	16	17	18	19	20	12	13	14	15	16	17	18	9	10	11	12	13	14	15
21	22	23	24	25	26	27	19	20	21	22	23	24	25	16	17	18	19	20	21	22
28	29	30					26	27	28	29	30	31		23	24	25	26	27	28	29
														30						

JULY							AUGUST							SEPTEMBER						
S	M	T	W	T	F	S	S	M	T	W	T	F	S	S	M	T	W	T	F	S
	1	2	3	4	5	6					1	2	3	1	2	3	4	5	6	7
7	8	9	10	11	12	13	4	5	6	7	8	9	10	8	9	10	11	12	13	14
14	15	16	17	18	19	20	11	12	13	14	15	16	17	15	16	17	18	19	20	21
21	22	23	24	25	26	27	18	19	20	21	22	23	24	22	23	24	25	26	27	28
28	29	30	31				25	26	27	28	29	30	31	29	30					

CONVERSION FACTORS AND VERTICAL DATUM

Multiply	By	To obtain
Length		
inch (in.)	2.54×10^1	millimeter
	2.54×10^{-2}	meter
foot (ft)	3.048×10^{-1}	meter
mile (mi)	1.609×10^0	kilometer
Area		
acre	4.047×10^3	square meter
	4.047×10^{-1}	square hectometer
	4.047×10^{-3}	square kilometer
square mile (mi ²)	2.590×10^0	square kilometer
Volume		
gallon (gal)	3.785×10^0	liter
	3.785×10^0	cubic decimeter
	3.785×10^{-3}	cubic meter
million gallons (Mgal)	3.785×10^3	cubic meter
	3.785×10^{-3}	cubic hectometer
cubic foot (ft ³)	2.832×10^1	cubic decimeter
	2.832×10^{-2}	cubic meter
cubic-foot-per-second day [(ft ³ /s) d]	2.447×10^3	cubic meter
	2.447×10^{-3}	cubic hectometer
acre-foot (acre-ft)	1.233×10^3	cubic meter
	1.233×10^{-3}	cubic hectometer
	1.233×10^{-6}	cubic kilometer
Flow		
cubic foot per second (ft ³ /s)	2.832×10^1	liter per second
	2.832×10^1	cubic decimeter per second
	2.832×10^{-2}	cubic meter per second
gallon per minute (gal/min)	6.309×10^{-2}	liter per second
	6.309×10^{-2}	cubic decimeter per second
	6.309×10^{-5}	cubic meter per second
million gallons per day (Mgal/d)	4.381×10^1	cubic decimeter per second
	4.381×10^{-2}	cubic meter per second
Mass		
ton (short)	9.072×10^{-1}	megagram or metric ton