

Office of Prevention, Education, and Control

Honoring the Gift of Heart Health

A Heart Health
Educator's
Manual

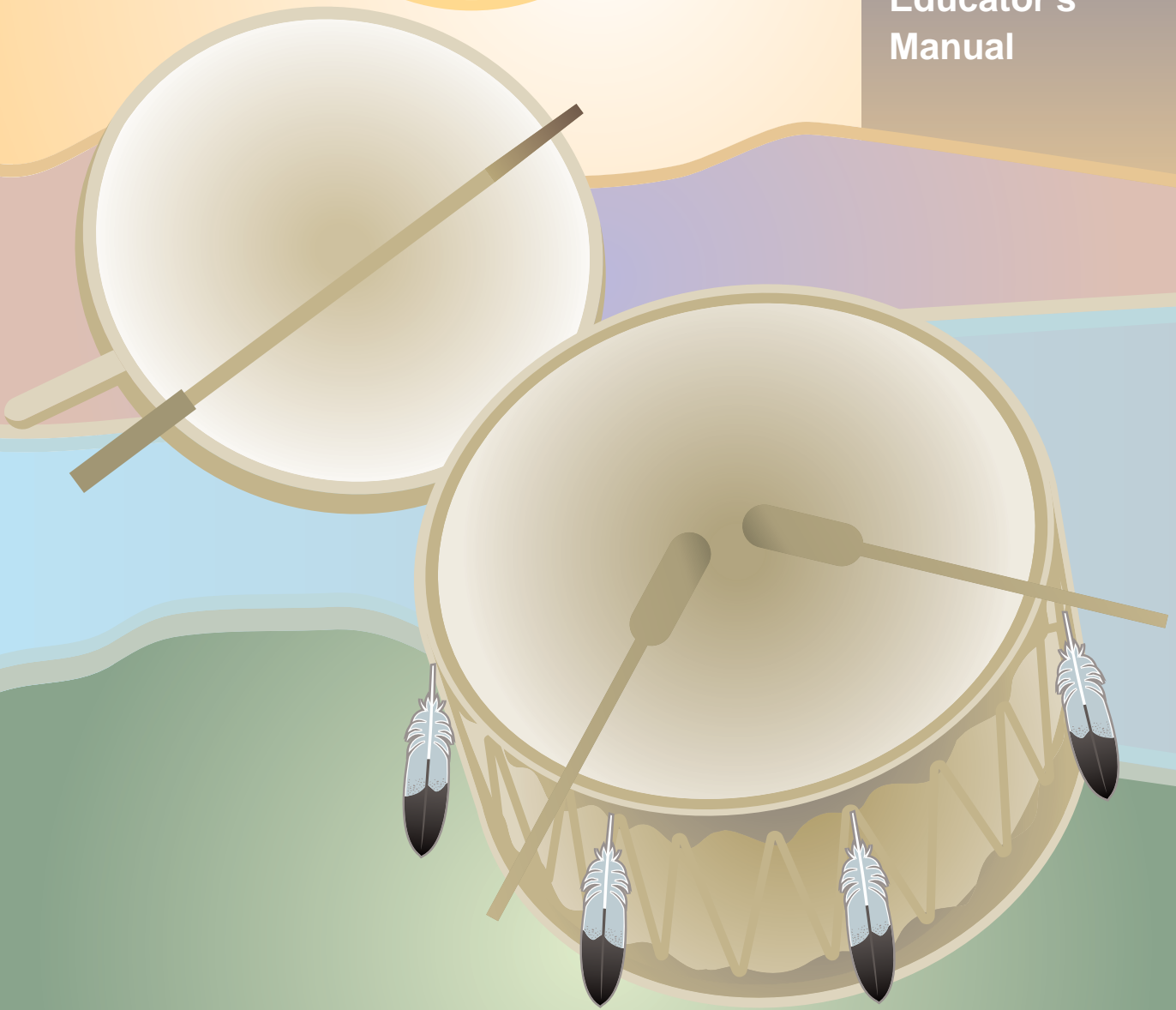

U.S. DEPARTMENT OF HEALTH AND HUMAN SERVICES
National Institutes of Health • Indian Health Service



Honoring the Gift of Heart Health

A Heart Health Educator's Manual

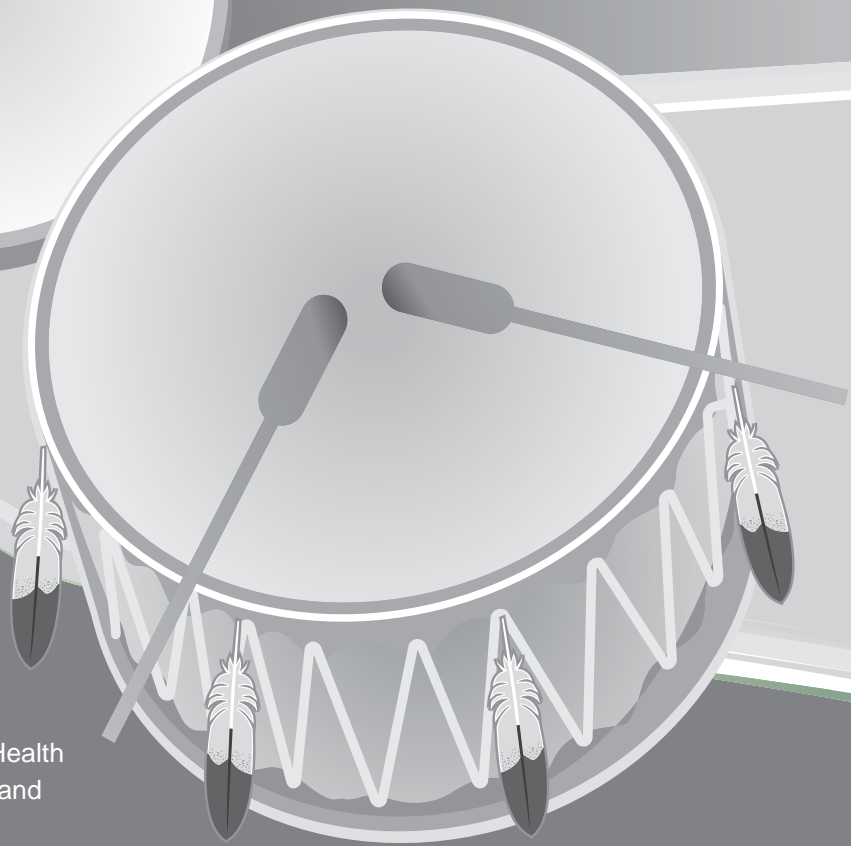

U.S. DEPARTMENT
OF HEALTH AND
HUMAN SERVICES



National Institutes of Health
National Heart, Lung, and
Blood Institute
and
Indian Health Service



NIH Publication No. 03-5218
November 2003

Native Poem

Hear my voice, the wind,

The buffalo, the

Drumbeat,

The voice of your ancestor,

Giving of spirit, giving

Of love, giving of life,

Our ancestors, show us

The way,

Strong heart, strong body,

Strong mind.

A Native Youth

Table of Contents

How To Use This Manual.....	1
session one	
Are You at Risk for Heart Disease?	9
session two	
Act in Time to Heart Attack Signs	25
session three	
Be More Physically Active.....	41
session four	
What You Need To Know About High Blood Pressure, Salt, and Sodium	57
session five	
What You Need To Know About High Blood Cholesterol	75
session six	
Maintain a Healthy Weight.....	101
session seven	
Make Heart Healthy Eating a Family Affair	119
session eight	
Eat in a Heart Healthy Way—Even When Time or Money Is Tight	135
session nine	
Enjoy Living Smoke Free.....	151
session ten	
Review and Graduation	169
Appendix	
Activities For Training Heart Health Educators.....	175

Dear Heart Health Educator:

Cardiovascular disease (CVD) is the #1 killer of all Americans, including American Indians and Alaska Natives (AI/AN). The factors that increase a person's risk of CVD (such as high blood pressure, high blood cholesterol, obesity, smoking, physical inactivity, and diabetes) can be reduced by making lifestyle changes. The good news is that with a little information, a few skills, and a bit of motivation, these changes can be made.

Honoring the Gift of Heart Health is a user-friendly program for heart health educators, developed especially for AI/AN communities. The manual provides the "how-to" for leading group education sessions. It offers "hands-on" activities that help people build the skills they need to make simple, practical, and lasting changes to help them fight heart disease. You can use this program to teach community groups ways to promote heart health for themselves and their families. This manual also can be used to train heart health educators or as the basis for other community activities.

Honoring the Gift of Heart Health is dedicated to you and other community educators throughout tribal communities and Alaska Villages. You devote your time and energy to help others improve their health and live longer. Please use this program to lead others to a healthier life. You can make a difference.

Much success,



Barbara Alving, M.D.

Acting Director

National Heart, Lung, and Blood Institute

Acknowledgements

The development of the *Honoring the Gift of Heart Health: A Heart Health Educator's Manual* involved the dedication of many individuals, groups, and organizations that are committed to helping AI/AN communities live healthier. The National Heart, Lung, and Blood Institute (NHLBI) appreciatively acknowledge the following:

The Indian Health Service (IHS) nutritionists, nurses, and health educators for their insight and contributions throughout the development of this manual.

Special appreciation to Pueblo of Laguna, Ponca of Oklahoma, and Bristol Bay Area Health Corporation, who shared a wealth of knowledge and provided direction to produce this manual.

Reviewers

Jill Breyen, R.D.
Tribal Nutritionist
Red Lake Tribal Health Program
Red Lake, NM

Randy Burden, Pharm.D., M.Div., C.D.E,
Former Director
Native American Cardiovascular Risk Reduction
Program
Santa Fe, NM

Cecilia Butler, R.D.
Clinical Dietitian
Santa Fe Indian Hospital
Santa Fe, NM

Jean Charles-Azure, R.D., M.P.H.
IHS Principal Nutrition Consultant
Indian Health Service Headquarters
Rockville, MD

Theresa Clay, M.S.
Health Education Manager
University of New Mexico
Albuquerque, NM

Sandra Dodge, C.N.P.
Public Health Nurse
Crownpoint Hospital
Crownpoint, NM

Jan Frederick, M.S., R.D.
Acting Area Nutrition Consultant
Phoenix Area Indian Health Service
Phoenix, AZ

James Galloway, M.D., F.A.C.P., F.A.C.C.
Director, Native American Cardiology
Senior Cardiologist, IHS
Flagstaff, AZ

Brenda Gabbard, R.N.
Nurse Consultant
Navajo Area Indian Health Service
Window Rock, AZ

Michael Jones, R.N., B.S.N.
Supervisor Public Health Nurse
Sells Indian Hospital
Sells, AZ

Jean Ann Mattias, R.D.
Area Nutrition Consultant
Tucson Area Indian Health Service
Sells, AZ

Diane L. Phillips, R.D., L.D.
Dietitian, Native American Cardiovascular
Risk Reduction Program
Santa Fe, NM

Dennis Randles, R.N., M.S.N., M.B.A.-HCM
Nursing Executive
Winslow Indian Health Center
Winslow, AZ

Glen Revene, M.S., R.D., C.D.E.
Public Health Nutritionist
Wind River Service Unit
Ft. Washakie, WY

Lorene Reano, M.P.H
Tobacco Control Coordinator
CDC National Epidemiology Program
Albuquerque, NM

Cathy Sassin, R.D.
Nutrition Director
Sonoma County Indian Health
Santa Rosa, CA

Verna Schad, R.N., M.S.N., C.N.P.
Nurse Consultant
Aberdeen Area Office
Aberdeen, SD

Melanie Sipe, R.D., C.D.E.
Acting Area Nutrition Consultant
IHS Oklahoma Area
Claremore, OK

Sara Thomas, M.S., R.D.
Public Health Nutritionist
Warm Springs Health and Wellness Center
Warm Springs, OR

Mary Wachacha
Health Education Consultant
IHS/NHLBI CVH Tribal Project Liaison
Indian Health Service Headquarters
Rockville, MD

Lorraine Whitehair, R.D.
Public Health Nutritionist
Acoma-Canoncita-Laguna Hospital
San Fidel, NM

Miranda Yang-Oshida, M.S., R.D.
Supervisory Dietician
Northern Navajo Medical Center
Shiprock, NM

Ellie Zephier, M.P.H., R.D.
Nutrition Consultant
Aberdeen Indian Health Service
Aberdeen, SD

Bristol Bay Team

Shelley Wallace, Project Coordinator
Patty Ferman
Cathy Flavin
Helen Gregorio
Elizabeth Lind
Alice Trefon

Ponca of Oklahoma Team

Elizabeth Primeaux, Project Coordinator
Deloyce Decorah
Sue Feathers
Joyce Greenwood
Mary Helen Deer
Chris LittleCook
Steve Pensoneau
Betty Stalling
Alexis Warrior

Pueblo of Laguna Team

Natalie Thomas, Project Coordinator
Tina Aguilar
Lora Carr
Michelle Curtis
Ramona Dillard
Isabel Gaco
Bernard Kayate
Sue Lorenzo
Lucia Ruben
Merle Scott
Virginia Siow
Tim Smith
Nadine Tafoya
Tina Tah
Marshal Thomas
Melissa Wyaco

Tribal Leaders

Robert Clark
Chief Executive Officer
Bristol Bay Area Health Corporation
Bristol Bay, AK

Bennett Arketa
Chairman
Ponca Tribe
Ponca City, OK

Harry Early
Governor
Pueblo of Laguna
Laguna, NM

NHLBI Staff

Office of Prevention, Education, and Control

Matilde Alvarado, R.N., M.S.N.
Coordinator
Minority Health Education and Outreach
Activities

Celmarie Alviles-Rios
Intern

Robinson Fulwood, Ph.D., M.S.P.H.
Senior Manager for Public Health Program
Development

Frank GrayShield, M.P.H.
Community Health Specialist

Janet Kelly, M.S., R.D.
Nutrition Education Specialist

Katharine Liu
Intern

Laina Pack Ransom
Publication Production Manager

Lenee Simon, M.P.H.
Community Health Specialist

Juliana Tu, M.S., C.H.E.S.
Community Health Specialist

About *Honoring the Gift of Heart Health*

This manual is one part of a collection of educational materials to strengthen the heart-beat of AI/AN communities. The materials were developed through a partnership between the NHLBI and IHS. The materials include:

■ *Honoring the Gift of Heart Health* manual and visuals

Honoring the Gift of Heart Health gives AI/AN the knowledge, skills, and motivation to help them take action against heart disease. It also provides the tools and strategies to promote heart health to American Indian individuals, family, and communities.

- **Easy To Read Brochures.** The NHLBI, the Center on Minority Health and Health Disparities (formerly the Office of Research on Minority Health), and the IHS, in partnership with Laguna Pueblo in New Mexico; Bristol Bay Area Health Corporation in Alaska; and the Ponca Tribe in Oklahoma, have developed a series of practical and easy-to-use educational materials for keeping a healthy heart.

There are three sets of brochures, one for each of the tribal groups listed above. Each set has four brochures on practical tips for heart healthy living:

- *Your Choice for Change!*
- *Be Heart Healthy! Learn Ways To Lower Your Cholesterol*
- *Lower Your Blood Pressure! Get Your Blood Pressure Checked Today!*
- *Watch Your Weight for a Healthy Heart!*

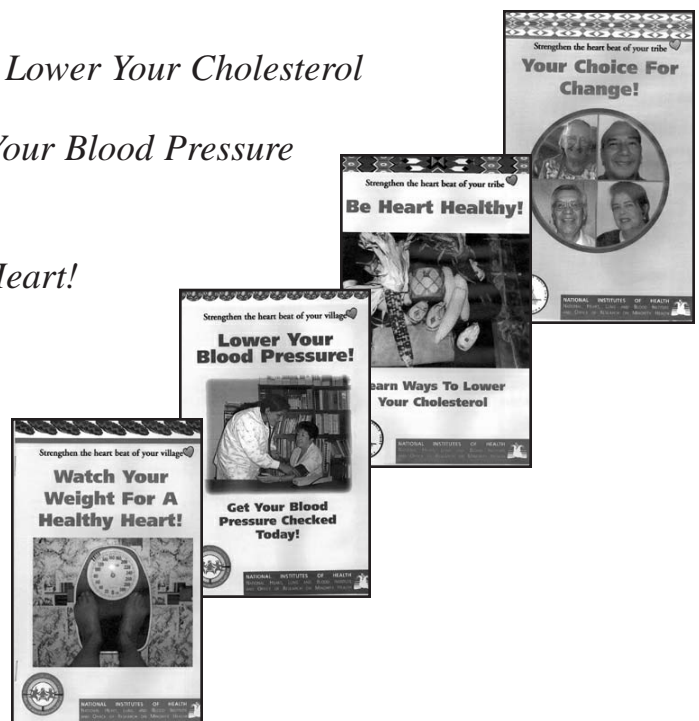

- ***Your Heart, Your Drum: A Video for American Indian and Alaska Native People.*** This 10-minute motivational video, filmed among the Laguna Pueblo, New Mexico; Ponca Tribe, Oklahoma; and Bristol Bay, Alaska communities, focuses on the problem of CVD among AI/AN people and how they can deal with major risk factors for heart disease: high blood cholesterol, high blood pressure, overweight and obesity, and physical inactivity.



- ***Building Healthy Hearts for American Indians and Alaska Natives: A Background Report*** contains information on:

- The impact on CVD on native peoples.
- Native culture and perception of health.
- Examples of innovative community-based health promotion and disease prevention program for American Indians and Alaska Natives.

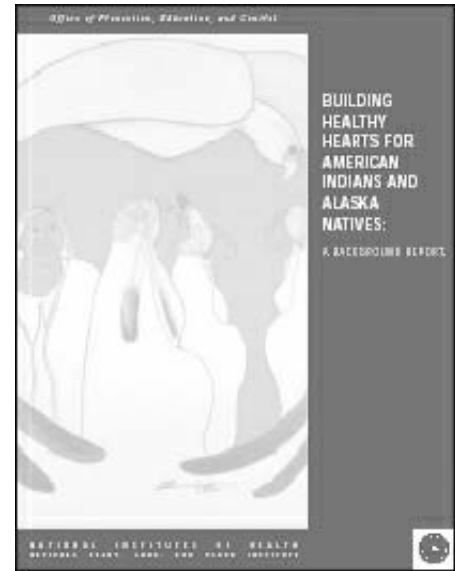

The Role of the Heart Health Educators

Honoring the Gift of Heart Health community educators play a key role in building healthy communities. They help people learn about heart health issues and show them ways to live healthier lives. Without them, many AI/AN might not receive such vital information. The great power embodied in heart health educators is that they are committed to work with people and teaching others to make healthful choices. An elder encourages...*"Let us peacefully cooperate together, so a future goodness is insured... If we could learn from one another, it could be a saving grace."*

Heart health educators have special qualities. They know their communities well and most importantly they respect the tribes' and villages' culture and beliefs. They enjoy teaching others and feel proud of being part of the community. They are also good listeners, caring, patient, fair, nonjudgmental, confident, pleasant, approachable, and willing to try ways to improve their own health.

This curriculum provides individuals the journey to a rebalanced life and help them keep a strong mind and body.

We thank you for your interest and willingness to help AI/AN learn about heart health. We also welcome your feedback on how you are implementing this program. Please send your comments to:

National Institutes of Health
National Heart, Lung, and Blood Institute
Office of Prevention, Education, and Control
31 Center Drive, MSC 2480
Building 31, Rm. 4A10
Bethesda, MD 20892-2480
Attn: American Indian/Alaska Native Program

How To Use This Manual

Heart Health Educators

This manual is for you! *The Honoring the Gift of Heart Health* manual includes the information you need to teach 10 fun and educational sessions and have fun while doing it. These sessions help group members learn about what they can do to prevent heart disease. The manual provides worksheets and handouts for group members to take home to read again and share with family and friends. It also includes teaching tips and how to start a program in your community.

Heart Health Trainers

This manual is also for you! The *Honoring the Gift of Heart Health* manual can be used to train heart health educators. Conduct your training as if you were teaching the program to community group members. Also, review the structure of the manual and include the special training activities in Sessions 1, 3, 7, and 9 and food displays that can be used along with the manual. These activities are described in the Appendix beginning on page 175.

About the Sessions

Each session covers a different topic on heart health (see box).

- The manual includes extra information in the session to help you answer questions.
- A CD of visuals with teaching notes helps you present the information for each session.

You may want to take your group on a grocery store tour between Sessions 9 and 10. Call your local clinic, medical center, or the American Heart Association.

Your Heart, Your Life Sessions

1. Are You at Risk for Heart Disease?
(covers ways to prevent heart disease)
2. Act in Time to Heart Attack Signs
3. Be More Physically Active
4. What You Need To Know About High Blood Pressure, Salt, and Sodium
5. What You Need To Know About High Blood Cholesterol
6. Maintain a Healthy Weight
7. Make Heart Healthy Eating a Family Affair
8. Eat in a Heart Healthy Way—Even When Time or Money Is Tight
9. Enjoy Living Smoke Free
10. Review and Graduation

Ask if they have a registered dietitian or nutritionist who conducts tours on shopping for a healthy diet. Check with the manager at a local grocery or call their offices to see if they have dietitians on staff who offer store tours.

Symbols

These symbols are used throughout the manual. They let you know quickly what comes next.



Do an activity.



Use a visual. The visuals are included on a CD.



Give out a handout. The handouts are on pages 191–303.



Help group members create a pledge for heart health.



Give out a recipe.



Do a training activity.



Note: The visuals can be presented as overheads or paper copies, if you do not have a computer at your training/education site. Photocopy the handouts for the participants ahead of time.

Session Length

Most sessions last about 2 hours. The first session (Are You at Risk for Heart Disease?) may not last that long. Session 5 (What You Need To Know About High Blood Cholesterol) could last a little longer.

Session Outline

Sessions 2 through 9 follow the same structure. Each session of the manual begins with a summary page that explains:

- What you want group members to do or learn
- Materials and supplies that you will need
- Worksheets and materials that you will hand out
- The session outline

Each session includes five major parts:

PART 1 — Introducing the Session

- Welcome the group.
- Spend a few minutes reviewing the information from the last session (Sessions 2 through 10).
 - Ask the group to talk about their pledges. (See Weekly Pledge—Part 3.)
 - Praise group members who did well with their pledges.
 - Encourage members who have a hard time with their pledges.
 - Ask members to share what worked and what did not work in meeting their pledges.
 - Try to make sure all members have a chance to share. Sharing helps the members keep their pledges.
- Explain what you will talk about in today’s session.

PART 2 — Conducting the Session

- Present new information.
- Lead the group in fun and educational activities.
- Ask the group members questions.
- Let the group members ask questions about what they have heard.

PART 3 — Review of the Key Points

- Ask questions to help the group members review what they just learned.
- Repeat the important points.

PART 4 — Weekly Pledge

- Help group members come up with a pledge that is specific and focuses on one action.
 - "I will eat less fat" is too general. A specific pledge that a member can easily do is "I will take the skin off my chicken and not eat it."
- Give at least one example before you ask members to make their pledges. Here are some examples:
 - I will remove my salt shaker from the table.
 - I will take a 20-minute walk after dinner 3 nights a week.

PART 5 — Closing

- Tell the group that you enjoyed holding the session and wish them luck in meeting their pledges.
- Thank the group for their helpful comments and ask them what they thought of the session.
- Tell the group if there is anything they should do before the next session.

A Few More Things

Breaks

You should take a short break at the middle of each session. You may want to use the time to do some easy stretches (see page 219).

Refreshments

You may want to have a small, heart healthy snack and beverage at the break. Some ideas are salsa with baked unsalted tortilla chips, fruit or vegetables with lowfat dip, juices, and water. Or, you can make one of the recipes from this manual and have group members taste it.

Getting Started

At Least 6 Weeks in Advance:

1. **Find a place** to teach *Honoring the Gift of Heart Health* in your area that people can get to easily. Call local clinics, schools, churches, and community centers. Reserve a room at a time when community members can attend.
2. **Let community leaders and others know** that you are offering the program. **Ask** clinic personnel, clergy, and caseworkers to recommend the program.
Say:
 - The program can help participants and their families lead healthier lives.
 - Participants will learn about healthy, low-cost cooking, how to become more physically active, how to quit smoking, and ways to prevent heart disease.
3. **Post flyers** at health fairs and in community sites, like clinics, grocery stores, churches, and other places in your community. (See sample flyer on page 192.)



Note: A small group (about 10 to 12 people) is best. Try to get about 15 people to sign up. Several people will not show up or will drop out.

Before You Start Session 1:

1. **Read through the entire manual at least once.** As you go along, find the symbols that let you know quickly what comes next.
2. **Begin to call clinics** or hospitals to make a list of where people can get their blood pressure, blood sugar (test for diabetes), or cholesterol checked.

At Least 1 Week Before Each Session:

1. **Read through the session** two or three times along with the visuals and handouts.
2. **Carefully read the information that you will present to the group members.** Practice what you will say in front of a mirror or to a friend or family member. Be sure to use the visuals. Also practice making a few changes in your own life.

3. **Review the instructions for each activity.** Make a list of things you need to do before the session, like displaying items on a table or getting a VCR and TV monitor.
4. **Pay attention to the "More Information" boxes.** This extra information helps you answer questions from the group.
5. **Ask** a health educator, dietitian, nurse, or doctor to explain any information you do not understand. Contact them at your local hospital or neighborhood clinic.
6. **Review** the list of handouts, materials, and supplies you will need for each session. These are described at the beginning of each session.
 - Make enough copies of the handouts for all group members.
 - Gather all the materials and supplies needed to conduct the session.

The Day of the Session:

1. **Review** the list of materials, supplies, and handouts. Make sure that you have everything.
2. **Arrive at the site ahead of time** so that you can set up the room. Test the VCR, TV monitor, and computer. Allow 30 minutes to an hour to set up.

Working With Your Group

Leading the Group

- **Get to know the members of your group.** They may have different backgrounds, interests, and needs.
- Use words and terms that are familiar to the people in your group.
- **Encourage** the group to ask questions to:
 - Help them see how the information applies to their lives.
 - Help them remember what they learn.
- Keep the sessions flowing smoothly so everyone is interested and involved.

- Be ready to deal with people who talk too much. Thank the person for sharing his or her opinion. Then, quickly ask if anyone else has something to share.
- If members (who do not read or write well) need help, do it in a way that will not bring attention to them.
 - Offer help. Do not force anyone to accept help.
 - Change the activity to a group discussion.
- Watch for clues from members who do not understand, such as:
 - Puzzled looks
 - Wrinkled foreheads
 - Looking away from you
 - Being quiet
- Try to give the information in a different way if you see these signs.

Motivating Group Members

- **Praise or reward** members' efforts to keep them motivated.
 - Give praise when it is deserved. This gives it more meaning.
 - Praise people in front of others. This can help them stay committed.
- **Encourage** the group members to share their opinions.
 - Show interest in the members and what they have to say.
 - Be patient. Some people may not speak because they have never been asked to share their opinions in a group setting.
 - Try to involve everyone in the discussion and activities, but do not force anyone to speak. People will speak up when they become used to the group.

Taking Small Steps Toward Change

People are more likely to develop new habits if you promote small changes, slowly. This brings more success.

Getting People To Come

- Remind the group members that it is important to come to all the sessions. Tell them that they will:
 - Learn something new at each session.
 - Help family members.
 - Socialize and meet people.
- Ask people to team up and call one another as a reminder to attend the session. This encourages people to come.

Answering Hard Questions

Remember that it's okay not to know all the answers! Say that you will have the correct answer by the next session. Call a local health educator, nutritionist, or nurse to find an answer.

Keeping People on Track

Give the group the correct information when a group member gives incorrect or incomplete information. Give the person credit for any part of his or her answer that is correct. Say that people often hear incorrect information and believe it to be fact. Tell the group that this is one important reason why they are in the program—to get correct information.

And Finally . . .

Have a good time. You are doing an important service for your community.

Thank you!



Are You at Risk for Heart Disease?

Objectives

By the end of this session, group members will:

- Know about the *Honoring the Gift of Heart Health* program.
 - Know that heart disease can be prevented.
 - Be able to name six risk factors for heart disease that can be prevented.
 - Know other group members.
-

Materials and Supplies

To conduct this session you will need:

- *Honoring the Gift of Heart Health* manual and CD of visuals
- Name tags
- Hearts cut from red felt (try to get the kind that has a sticky backing) or red construction paper (Use the shape on page 193 to cut the heart.)
- Safety pins if not using felt with sticky backing
- Blackboard and chalk or several large pieces of paper, a marker, and tape
- Clear container with 4 cups of water

Handouts

Give group members these handouts during the session:

- Introducing the American Indian (or Alaska Native) Family (page 191)
 - Are You at Risk for Heart Disease? (page 194)
 - Take Care of Your Heart: Diabetes and Heart Disease (page 195)
 - Be Smart About Your Heart: Control the ABCs of Diabetes (page 196)
-

Session Outline

Introducing the Session

1. Welcome
2. Program Overview
3. Program Rules

Conducting the Session

1. Getting To Know Each Other
2. Getting To Know the Secrets of the Heart
 - a. The Heart and Its Structure
 - b. How the Heart Works
3. Facts About Heart Disease
4. Risk Factor Activity

Review of Key Points

Closing



Note: Read the chart on pages 17-18 to be ready to answer questions from the group members.

Introducing the Session

1. Welcome

- **Introduce yourself** as people walk in.
- **Ask each person** his or her name. Write it on a name tag. Give each person a name tag and a felt or paper heart.
- **Ask group members** to wear the name tags on their shirt. Ask them to place the heart where their own heart is found.
- **Welcome** the group members to the session. Tell them that you are very happy to see them.

2. Program Overview

- **Say:**
Heart disease is the #1 reason why people die in this country. The National Heart, Lung, and Blood Institute and the Indian Health Service created the program Strengthening the Heartbeat of American Indian and Alaska Native Communities to help prevent development of heart disease.
- **Say:**
Together we will learn about the risk factors for heart disease. We will also learn things you and your family can do to have a healthy heart.
- **Say:**
This program from Strengthening the Heartbeat of American Indian and Alaska Native Communities is called *Honoring the Gift of Heart Health*. It has 10 sessions and an optional grocery store tour. The sessions cover these topics. (Show the names of the sessions on the blackboard or a large piece of paper.)
 1. Are You at Risk for Heart Disease? (covers basic information on heart disease prevention)
 2. Act in Time to Heart Attack Signs
 3. Be More Physically Active

4. What You Need To Know About High Blood Pressure, Salt, and Sodium
5. What You Need To Know About High Blood Cholesterol
6. Maintain a Healthy Weight
7. Make Heart Healthy Eating a Family Affair
8. Eat in a Heart Healthy Way—Even When Time or Money Is Tight
9. Enjoy Living Smoke Free
10. Review and Graduation

■ **Say:**

Please come to all of the sessions. I will lead the sessions, but I need each of you to participate. This will help you learn the information and enjoy the sessions more. Please feel free to ask questions. Your questions also help others to learn.

- **Give each group member** “Introducing the American Indian (or Alaska Native) Family” (page 191) and ask for a volunteer to read.



3. Program Rules



Note: This section will help members feel like a team. It will also make it easier for you to teach.

■ **Say:**

Everyone will feel more at ease if they know what to expect from this program. Before we begin, let’s talk about the best way to run the sessions. Let’s agree as a group on a few basic rules.

■ **Say:**

This program takes effort and time from each group member. It is important for you to attend each session and to arrive on time. The sessions are about 2 hours long.

- *Optional (If you are able to make changes)*

Ask:

- How often do you want to meet? (Once a week, twice, etc.)

- Is this a good time to meet? (If not, set a meeting time that is best for everyone.)
- Is this a good place to meet? (If not, decide on a location that is best for everyone.)



Note: Give group members 2 to 3 minutes to answer each question. Help them choose one answer that most people like. Go on to the next question.

■ **Say:**

Here are some things that you can do to help you learn the most from the sessions.

- Feel free to ask questions.
- Please tell about your personal experiences. This will make the program mean more to all of us.
- Try to stay on the subject. We have a lot of information to talk about in a short time.

■ *Optional—*

- Call me at (give your telephone number) if you have questions or concerns about this program. I am here to help you in any way that I can.

■ **Say:**

Because you will share your experiences and opinions, we need to agree on a few things.

■ **Ask:**

- Do you agree to keep other members' comments to yourself?
- Do you agree not to judge others?

■ **Ask:**

- Do you have other rules that you would like to talk about?
- Do you agree to try to come to all of the sessions?

Conducting the Session

1. Getting To Know Each Other

■ Say:

We'll begin today's session by introducing ourselves and getting to know each other a little better.

■ Ask the group members

- To give their name and tell one or two things about themselves.
- To tell why they came to this program and what they hope to learn.



Note: Start this activity by going first. Tell the group why you are interested in heart health. Be honest and talk about yourself. Give each group member a chance to answer.

■ Say:

You can help your family and friends by giving them information and encouraging them to live healthier lives. Thank you for making this effort.

2. Getting To Know the Secrets of the Heart

■ Say:

Now we know a little bit about each other. Let's get to know a few facts about the heart.

A. The Heart and Its Structure

■ Say:

The heart is an amazing part of the body. It can pump approximately 5 liters of blood every minute. It beats about 100,000 times a day.



Note: Hold up a clear container that has 1 liter (about 4 cups) of water in it. Remind the group that the heart pumps five times this amount of blood each minute.

■ **Say:**

The heart sends blood to the lungs to pick up oxygen. Then it delivers oxygen to all the cells in the body.

■ **Say:**

You can feel the beat of your heart by taking your pulse. To find your pulse, gently place the index and middle finger of one hand on the inside wrist of your other hand. Slide your two fingers toward the thumb side of your wrist until you feel a slight beating. (Show the group how to do this.)

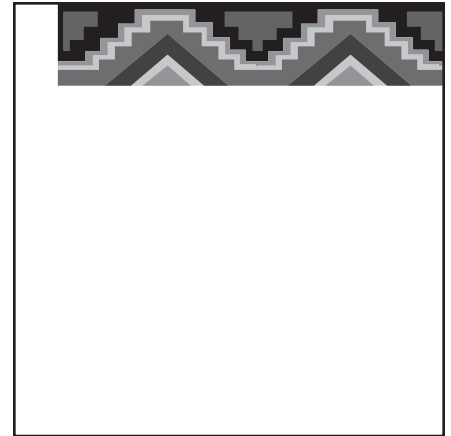

B. How the Heart Works

■ **Show visual 1-1. Say:**

The heart is a hollow, muscular, cone-shaped organ, about the size of a fist. (Hold up your fist for the group members to see.)



■ **Point out each part of the heart. Say:**

- The heart has two upper chambers and two lower chambers.
- The upper chambers (right atrium and left atrium) receive blood.
- The lower chambers (right ventricle and left ventricle) pump blood.

■ **Show visual 1-2. Say:**

- The heart is located in the middle of the chest. (Did you place your felt or paper heart in the correct spot?)
- The heart is part of the circulatory system.
- The circulatory system is made of all the vessels that carry the blood throughout the body.
- Vessels are long, hollow tubes of tissue, much like drinking straws.
- Vessels carry blood to and from the heart.



■ **Show visual 1-3. Say:**



- Blood (with little oxygen) enters the right top chamber of the heart.
- Blood then flows down to the right lower chamber so it can be pumped out to the lungs.
- In the lungs, waste is taken from the blood (carbon dioxide). The blood then gathers more oxygen.
- The blood, rich with oxygen, returns to the heart and enters the upper left chamber.
- The blood then flows down to the lower left chamber and is pumped to all of the body organs and tissues.

■ **Say:**

Since the heart is such an important pump, you want to keep it free from heart disease such as a heart attack, a stroke (brain attack), or angina (chest pain). When the heart stops, life stops. So when you take care of your heart, you take care of your life.

3. Facts About Heart Disease



Note: Before the session, read the chart on page 17-18. This chart lists the risk factors for heart disease that you can do something about. It gives you steps you can take to prevent those risk factors.

■ **Say:**

Now that we know how important the heart is, let's talk about heart disease and what we can do to protect our hearts.

■ **Ask:**

Do you know someone who has heart disease? Give members about 5 minutes to answer.

More Information

Heart Disease Risk Factors You Can Do Something About

RISK FACTORS	FACTS YOU NEED TO KNOW	TAKE THESE STEPS TO PREVENT HEART DISEASE																
<p>High blood pressure High blood pressure is called the silent killer because it has no signs or symptoms, yet it can cause very serious illness.</p>	<p>When your blood pressure is high, your heart works harder than it should to move blood to all parts of the body. If not treated, high blood pressure can lead to stroke (brain attack), heart attack, eye and kidney problems, and death.</p> <p>Check your numbers (mmHg*):</p> <table border="1" style="width: 100%; border-collapse: collapse; margin-bottom: 10px;"> <thead> <tr> <th style="width: 33%;">Category</th> <th style="width: 33%;">Systolic</th> <th style="width: 33%;">Diastolic</th> </tr> </thead> <tbody> <tr> <td>Normal</td> <td><120</td> <td><80</td> </tr> <tr> <td>Prehypertension</td> <td>120–139</td> <td>80–89</td> </tr> <tr> <td>Hypertension</td> <td>≥140</td> <td>≥90</td> </tr> </tbody> </table> <p>*Millimeters of mercury</p>	Category	Systolic	Diastolic	Normal	<120	<80	Prehypertension	120–139	80–89	Hypertension	≥140	≥90	<ul style="list-style-type: none"> • Check your blood pressure at least every 2 years, or more often if you have high or high-normal blood pressure. • Aim for a healthy weight. • Be physically active on most days. • Choose and prepare foods with less salt and sodium. • Eat more fruits, vegetables, and lowfat dairy products. • If you drink alcohol, do so in moderation. • If your doctor prescribes blood pressure medicine, take it as prescribed. 				
Category	Systolic	Diastolic																
Normal	<120	<80																
Prehypertension	120–139	80–89																
Hypertension	≥140	≥90																
<p>High blood cholesterol Cholesterol in your arteries is like rust in a pipe. When there is too much cholesterol in the blood, the arteries become clogged, which leads to heart disease.</p>	<p>Check your total cholesterol numbers (mg/dL):</p> <table border="1" style="width: 100%; border-collapse: collapse; margin-bottom: 10px;"> <tbody> <tr> <td style="width: 33%;">Desirable</td> <td style="width: 66%;"><200</td> </tr> <tr> <td>Borderline High</td> <td>200–239</td> </tr> <tr> <td>High</td> <td>≥240</td> </tr> </tbody> </table> <p>Check your LDL cholesterol numbers (mg/dL):</p> <table border="1" style="width: 100%; border-collapse: collapse; margin-bottom: 10px;"> <tbody> <tr> <td style="width: 33%;">Optimal</td> <td style="width: 66%;"><100</td> </tr> <tr> <td>Near Optimal/ Above Optimal</td> <td>100–129</td> </tr> <tr> <td>Borderline High</td> <td>130–159</td> </tr> <tr> <td>High</td> <td>160–189</td> </tr> <tr> <td>Very High</td> <td>≥ 190</td> </tr> </tbody> </table> <p>HDL levels of 60 mg/dL or more help lower your risk for heart disease, while a level less than 40 mg/dL is a major risk factor for heart disease.</p> <p>Triglycerides A normal triglyceride level is less than 150 mg/dL.</p>	Desirable	<200	Borderline High	200–239	High	≥240	Optimal	<100	Near Optimal/ Above Optimal	100–129	Borderline High	130–159	High	160–189	Very High	≥ 190	<ul style="list-style-type: none"> • A "lipoprotein profile," which measures all of your cholesterol levels (total, LDL, and HDL) and triglycerides, can be done at a doctor's office. • Get your blood cholesterol levels checked at least once every 5 years if you are age 20 or older. • Learn what your numbers means. If they are high, ask your doctor how you can lower them. • Choose foods that are lower in saturated fat, trans fat, and cholesterol. • Aim for a healthy weight. • Be physically active. <p>In addition to the above, this can help control triglycerides:</p> <ul style="list-style-type: none"> • Eat a heart healthy diet that is not too high in carbohydrates. High carbohydrate diets have been shown to play a role in raising triglycerides. • Avoid smoking and alcohol. Smoking raises triglycerides and lowers HDL cholesterol. Excess alcohol also raises triglycerides.
Desirable	<200																	
Borderline High	200–239																	
High	≥240																	
Optimal	<100																	
Near Optimal/ Above Optimal	100–129																	
Borderline High	130–159																	
High	160–189																	
Very High	≥ 190																	
		<p><i>(continued on next page)</i></p>																

More Information

Heart Disease Risk Factors You Can Do Something About *(continued)*

RISK FACTORS	FACTS YOU NEED TO KNOW	TAKE THESE STEPS TO PREVENT HEART DISEASE								
<p>Overweight Being overweight occurs when extra fat is stored in your body. It increases your risk of developing high blood pressure, high blood cholesterol, heart disease, stroke, and diabetes.</p>	<p>Check your Body Mass Index (BMI) and Waist Circumference:</p> <table border="1" style="width: 100%; border-collapse: collapse;"> <thead> <tr> <th style="text-align: left;">Category</th> <th style="text-align: left;">BMI</th> </tr> </thead> <tbody> <tr> <td>Normal</td> <td>18.5– 24.9</td> </tr> <tr> <td>Overweight</td> <td>25–29.9</td> </tr> <tr> <td>Obese</td> <td>≥ 30</td> </tr> </tbody> </table> <ul style="list-style-type: none"> • A waist measurement of more than 35 inches for a woman and more than 40 for a man increases the risk of heart disease. 	Category	BMI	Normal	18.5– 24.9	Overweight	25–29.9	Obese	≥ 30	<ul style="list-style-type: none"> • Get your BMI and waist measured every 2 years, or more often if your doctor recommends it. • Aim for a healthy weight. Try not to gain extra weight. • If you are overweight, try to lose weight slowly. Lose 1 to 2 pounds a week. • Eat sensible portions and be physically active.
Category	BMI									
Normal	18.5– 24.9									
Overweight	25–29.9									
Obese	≥ 30									
<p>Diabetes When the sugar in the blood is high, your body cannot use the food you eat for energy.</p>	<ul style="list-style-type: none"> • Diabetes is serious. You may not know you have it. It can lead to heart attacks, blindness, amputations, and kidney disease. • Nearly one out of every eight adult American Indian and Alaska Natives has diabetes. • Being overweight is a major risk factor for Diabetes. 	<ul style="list-style-type: none"> • Find out if you have diabetes. • Get your blood sugar level checked at least every 3 years beginning at the age of 45. You should be tested at a younger age and more often if you are at risk for diabetes. 								
<p>Physical inactivity Being inactive can double your chances of heart disease and take away years from your life.</p>	<ul style="list-style-type: none"> • Physical inactivity increases your risk of high blood pressure, high blood cholesterol, diabetes, and overweight or obesity. • Adults should do 30 minutes of moderate physical activity on most days, preferably daily. • Children should aim for 60 minutes of moderate physical activity on most days, preferably daily. 	<ul style="list-style-type: none"> • Stay active. You can build up to 30 minutes each day by being active for 10 minutes three times a day. • Try walking, dancing, and playing soccer. 								
<p>Smoking You put your health and your family's health at risk when you smoke.</p>	<ul style="list-style-type: none"> • Cigarette smoking is addictive. It harms your heart and lungs. It can raise your blood pressure and blood cholesterol and those of others around the smoker. 	<ul style="list-style-type: none"> • Stop smoking now or cut back gradually. • If you can't quit the first time, keep trying. • If you don't smoke, don't start. 								

■ **Show visual 1-4. Say:**



- Heart disease is a serious health problem for AI/AN.
 - It is the #1 cause of death for AI/AN. One out of four dies each year of heart disease.
 - Many AI/AN believe that a heart attack or stroke happens suddenly because of a scary experience, getting bad news, or having strong feelings, like anger.
 - A heart attack or stroke may seem sudden, but the truth is that heart disease happens over many years. Often it starts when you are very young.
 - Taking steps to prevent heart disease at any age is important.
 - This program will show you ways you and your family can have a healthier heart.

- In every session, you will hear about something called "risk factors." This is a term for the traits or habits that make a person more likely to get heart disease. Some of these, like age, family history, and being a man or woman, are things you cannot change. But the good news is that there are some risk factors that you can do something about. They are:
 - High blood pressure
 - High blood cholesterol
 - Overweight or obesity
 - Cigarette smoking
 - Diabetes
 - Physical inactivity

4. Risk Factor Activity



- **Give each group member** a copy of the handout on page 194.
Read aloud each risk factor. As you read each one, ask members, "Are You at Risk for Heart Disease?"

- **Say:**

The more risk factors you have checked, the greater your risk for heart disease and stroke. Talk to your doctor about your risk.

- **Say:**

This program will explain how these risk factors affect the health of the heart. It will also teach you ways that you and your family can prevent or control them, like:

- Being physically active.
- Eating in a heart healthy way.
- Maintaining a healthy weight.
- Quitting smoking.
- Taking prescribed medications.

- **Give each group member** a copy of the handout "Take Care of Your Heart: Diabetes and Heart Disease" on page 195.



- **Say:**

Diabetes is a serious problem for AI/AN and is a **major** risk factor for heart disease and stroke.

- **Say:**

- Diabetes is a disease in which the body does not produce enough insulin or does not use insulin properly. Insulin is a hormone that is needed to change sugar, starches, and other foods into energy needed for daily life. With diabetes, the blood glucose (sugar) levels are high.
- Diabetes is serious and can lead to heart attack, blindness, amputation, and kidney problems.

- Diabetes is more and more common today for AI/AN. About one out of eight AI/AN adults has diabetes.

■ **Say:**

Type 2 Diabetes is most common in adults but is now starting to appear in children.

■ **Ask:**

What are some risk factors that increase your chances of getting diabetes?



Note: Give the group about 5 minutes to answer. Write their answers on the blackboard or large piece of paper taped to the wall.

■ **Show visual 1-5 and add any of the reasons if they are not said.**



■ **Say:**

Your chances of getting diabetes increases if:

- You are overweight, especially if you have extra weight around the waist.
- You are physically inactive.
- You have a family member with diabetes.
- You had diabetes during pregnancy (gestational diabetes), or you gave birth to at least one baby weighing more than 9 pounds.
- Your blood pressure is 140/90 mmHg or higher, or you have been told that you have high blood pressure.
- Your cholesterol levels are not normal. Your HDL cholesterol ("good" cholesterol) is less than 40 mg/dL, or your triglyceride level is 150 mg/dL or higher. You will learn more about triglycerides in Session 5.

■ **Say:**

There are some important things you should know about the signs and symptoms of diabetes.

- Many people have no signs and symptoms for Type 2 Diabetes.
- It develops gradually and sometimes has no symptoms.
- Even if you have no symptoms of diabetes, if you have any of the risk factors above, ask your health care provider about getting tested for it.

■ **Read** what to look for on the handout.

■ **Give each group member** the handout "Be Smart About Your Heart: Control the ABCs of Diabetes," page 196.



■ **Say:**

You can reduce your risk for heart disease by controlling your blood sugar and heart disease risk factors.

■ **Say:**

Some people have "pre-diabetes," which is when blood glucose levels are higher than normal but not in the diabetes range. People with this condition can reduce the risks of developing the diabetes by losing a small amount of weight and increasing their physical activity.

■ **Say:**

If you have diabetes, controlling your blood glucose levels will help prevent complications.

■ **Say:**

Be Smart About Your Heart: Learn the ABCs of Diabetes Control. If you have diabetes, three key steps can help you lower your risk of heart attack and stroke. Follow these "ABCs."

■ **Read and discuss** the ABCs.

■ **Say:**

Be sure to ask your health care provider:

- What are my ABC numbers?
- What should my ABC target numbers be?

- What actions should I take to reach my ABC target numbers?
- Read the steps to lowering your risk for heart attack and stroke from the handout.

■ **Say:**

It can be hard to change old unhealthy habits and learn new healthy ones. This program will teach you what you need to know and how to make these changes slowly. Seeing you make healthy changes may make others want to make these changes, too.

Review

■ **Ask:**

What are the risk factors that we can present or control?

- Answers are: high blood pressure, high blood cholesterol, smoking, diabetes, overweight, and being inactive.

Closing

■ **Ask:**

Do you have any questions about the program?

■ *(Optional)* **Ask:**

How many of you want to go on a grocery store tour? During week eight or nine we can be led through the store by a registered dietitian who will help us learn how to shop for our hearts. (If enough group members are interested, call the grocery store or clinic in your area.)

■ **Thank the group members** for coming.

Tell them that you are looking forward to seeing them at the next session.

■ **Say:**

In the next session we are going to discuss *Act in Time for Heart Attack Signs*.



Note: Think about today's session. What worked and what didn't? Have you made any changes in your own life that were covered in today's session?

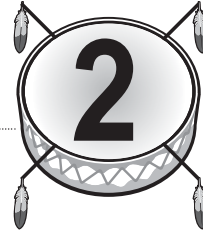

Act in Time to Heart Attack Signs

Objectives

By the end of this session, group members will learn:

- How the heart functions
- What a heart attack is
- Why it is important to seek treatment quickly if a heart attack happens
- The heart attack warning signs
- Why people delay in seeking help for a heart attack
- The benefits of calling emergency medical services
- The six "Steps to Survival" in response to heart attack warning signs

Materials and Supplies

To conduct this session, you will need:

- Blackboard and chalk or several large pieces of paper, marker pens, and tape.
- VHS videocassette player and television monitor.

Handouts

- “Act in Time to Heart Attack Signs,” pages 197–198.
(You will need one copy for each person in the group.)
- Role-plays: At Home, At Work, and At Night, pages 199–201.
(You will need two copies of each of the three scripts.)
- “Steps to Survival,” pages 202–213.
(You will need one copy of each sheet.)
- Heart Attack Survival Plan, page 214.
(You will need one copy for each person in the group.)

Session Outline

Introducing the Session

1. Welcome
2. Review of last week’s session
3. About This Session

Conducting the Session

1. Extent of the Problem
2. What Is a Heart Attack?
3. Importance of Rapid Treatment for a Heart Attack
4. What Are the Heart Attack Warning Signs?
5. Delay Can Be Deadly
6. The Role of Emergency Medical Services
7. Steps to Survival

Review of Today's Key Points

Weekly Pledge

Closing

Introducing the Session

1. Welcome

- Welcome the group members to the session.

2. Review of Last Week's Session

- **Ask:**

At the last session we talked about the risk factors for heart disease. Who remembers the risk factors that we can prevent or control?



Note: Allow about 3 minutes for their responses. Answers are:

- high blood pressure
- high blood cholesterol
- smoking
- diabetes
- overweight and obesity
- being physically active

- **Ask:**

Would any of you like to share what you are doing to improve your heart health?



Note: Allow about 2 minutes for their responses.

3. About This Session

■ **Say:**

Healthy choices can control the risk factors for heart disease and protect our hearts.

■ **Say:**

However, heart disease develops over many years. Sometimes, despite our best efforts, heart disease can result in a heart attack. That is why it is important to know the warning signs of a heart attack and what to do if you experience them. In today's session we will discuss these warning signs and the importance of taking quick action if you experience warning signs. By the end of this session, you will know:

- How the heart functions
- What a heart attack is
- The importance of fast treatment for a heart attack
- The heart attack warning signs
- Why people delay in seeking help for a heart attack
- The benefits of calling 9-1-1
- Six steps you can take now to help you survive a heart attack

Conducting the Session

1. Extent of the Problem

■ **Say:**

- Each year about 1.1 million people in the United States will have a heart attack, and about half will die.
- About half of the people who die of a heart attack will die before they reach the hospital.

■ **Say:**

Do you know anyone who had a heart attack?



Note: Give the group about 5 minutes to talk about their experience with a heart attack.

2. What Is a Heart Attack?

■ **Say:**

Now let's talk about what a heart attack is and how one happens.

■ **Show** drawing of a heart and coronary arteries (visual 2-1).

■ **Say:**

- The heart is an organ that pumps blood throughout the body.
- Blood carries oxygen and nutrients through the arteries to every part of the body.
- Coronary arteries carry the oxygen-rich blood to the heart muscle.
- Normally, the coronary arteries supply all of the blood that our heart needs to do its work, even when we are very active, and the demands on our heart are great.



■ **Show** visual 2-2.



■ **Say:**

- A heart attack occurs when the blood supply going to a portion of the heart through one of the coronary arteries is blocked. Here's how this happens.
- Heart disease, which can lead to a heart attack, develops over time as fatty deposits build up on the inside of the coronary arteries, narrowing them so that not enough blood gets through to meet the needs of the heart.
- When the coronary artery becomes nearly or completely blocked, usually by a clot, blood flow is closed off and a heart attack begins.
- If the blockage continues, part of the heart muscle will start to die.

■ **Say:**

- When a heart attack occurs, quick action and medical treatment can restore the blood flow to the heart and keep heart muscle from dying. But this can happen only if the person receives medical help right away.
- In general, there will be less heart damage if the blocked coronary artery can be opened quickly, and blood flow restored. Treatments work best if given as soon as possible, ideally within 1 hour after symptoms begin.
- Once a part of the heart muscle has died, nothing can be done to restore it.

■ **Ask:**

Does anyone have any questions or comments about what happens during a heart attack?



Note: Give the group about 5 minutes to respond.

3. Importance of Rapid Treatment for a Heart Attack

■ **Say:**

- Treatments for a heart attack have improved over the years.
- Twenty years ago, not much could be done to stop a heart attack.
- Today there are medications and procedures that can open up the heart's artery while a heart attack is happening, and restore blood flow.
- There are "clot-busting" medicines and other artery-opening procedures that can break up the clots narrowing an artery and quickly restore blood flow to the heart.

■ **Show visual 2-3.**



■ **Say:**

- There is also a procedure called angioplasty, in which a balloon is inserted into the coronary artery and inflated to open the artery and restore the blood flow.
- Sometimes with angioplasty, doctors will insert a stent. A stent is a wire mesh tube that is used to prop open the artery that has been cleared using angioplasty.
- The stent stays in the artery permanently and holds it open to improve blood flow to the heart muscle.
- The sooner these and other treatments are given, the more heart muscle can be saved.

■ **Say:**

- These treatments should be given as soon as possible, ideally within 1 hour after symptoms start.
- The more heart muscle that is saved, the better chance a heart attack patient has of surviving and resuming a normal life.

4. What Are the Heart Attack Warning Signs?

■ Say:

It is important to know how to recognize a heart attack for yourself and others around you. This activity should help you recognize the warning signs of a heart attack.

■ Ask:

What warning signs would make you think someone is having a heart attack?



Note: Write group members' responses on a blackboard or a large piece of paper taped to the wall.

- ### ■ Give each group member “Act in Time to Heart Attack Signs” pages 197–198.



■ Say:

These are the warning signs most commonly reported by heart attack patients, both women and men:

- **Your chest hurts or feels squeezed.** Most heart attacks involve some type of discomfort in the center of the chest that lasts more than a few minutes. It can feel like uncomfortable pressure, squeezing, fullness, or pain. The discomfort can range from mild to severe.
- **Discomfort in one or both arms, back, neck, jaw, or stomach.**
- **Shortness of breath.** You may feel like you can't breathe or catch your breath.
- **Breaking out in a cold sweat.** People having a heart attack can also break out in a cold sweat.
- **Nausea.** Some heart attack patients feel or get sick to their stomach.
- **Light-headedness.** People having a heart attack may also feel light-headed.

■ **Say:**

As with men, women's most common heart attack symptom is chest pain or discomfort.



- Whether you are a man or a woman, you do not need to have all of the symptoms at once to be having a heart attack.
- The symptoms mentioned are the most common ones, and most people experience more than one of them. Some signs tend to occur with certain others. For example, chest discomfort often occurs along with shortness of breath. Also, arm pain, sweating, and nausea may occur together.



Note: Chest pain can be a symptom of other serious conditions besides a heart attack. Regardless of the cause, group members should be encouraged to seek prompt medical care if they or their family members experience chest discomfort or pain.

■ **Say:**

People are often not sure that they are having a heart attack. A major reason is that they believe in a myth about how heart attacks happen.

- Many people think that all heart attacks happen the way you see in soap operas or the movies—a person has crushing chest pain and falls to the floor.
- But this is a myth. The reality is that not all heart attacks happen this way. Many heart attacks start slowly with symptoms gradually getting stronger.
- Sometimes the pain or discomfort is relatively mild, and the symptoms may come and go.

So a heart attack often is not a sudden, deadly event. A variety of symptoms may signal that someone is in danger.

■ **Say:**

Besides the myth of the "soap opera heart attack," there are other reasons why people often are not sure that they are having a heart attack. It is normal to be uncertain. What do you think are some of the reasons why people do not recognize when they are having a heart attack?



Note: Give the group about 5 minutes to call out answers. Write the answers on the chalkboard or a large piece of paper taped to the wall.

If any of the following reasons are not mentioned by the group,

■ **Say:**

- People may not realize they are having a heart attack because they may confuse the symptoms with those of other medical conditions or diseases, such as heart failure, arthritis, asthma, or cancer.
- People may also confuse heart attack warning signs with other conditions like a pulled muscle, indigestion, or the flu.
- Also, some people do not believe they are at risk for having a heart attack. When they have symptoms, they tend to ignore them or wait to see if the symptoms get worse before they call for help.
- A heart attack is often not a sudden, deadly event, and a variety of symptoms may signal that someone is in danger.

5. Delay Can Be Deadly

■ **Say:**

People often wait too long before they seek medical care for the symptoms of a heart attack.

- Some people wait 2 to 4 hours, or even a day or more, before getting help.
- If you think a heart attack is happening, the most important thing to remember is this—*call 9-1-1 in 5 minutes or less.*

■ **Ask:**

Think about yourself and your family—what might prevent you from seeking care quickly for heart attack warning signs?



Note: Give the group about 5 minutes to answer. Write their answers on the blackboard or a large piece of paper taped to the wall.

■ **Say:**

These are some of the reasons heart attack survivors have given for why they delayed in seeking care when they thought they were having a heart attack.

- They did not know the symptoms and thought that what they were feeling was due to something else.
- They were afraid or did not want to admit that their symptoms might be serious.
- They were embarrassed about going to the hospital and finding out it was a false alarm.
- They did not understand the importance of getting to the hospital right away.

■ **Say:**

When people having heart attacks decide to seek help, they often do not call 9-1-1. Only half of all heart attack patients arrive at the hospital by ambulance.

Here are some reasons heart attack patients give for not calling 9-1-1 when they have symptoms:

- They did not think their symptoms were severe enough.
- They were unaware that calling 9-1-1 has many life-saving advantages. It is like bringing the emergency department to your door.
- They thought transporting themselves to the hospital would be faster.
- They were concerned about being embarrassed when an emergency vehicle—ambulance or fire engine—showed up at their door.
- They were afraid of being embarrassed if the symptoms were a false alarm.

If you are having a heart attack and for some reason you cannot call 9-1-1, or someone cannot make the call for you, have someone drive you to the hospital at once. Never drive yourself unless there is absolutely no other choice. You might pass out along the way, putting yourself and others in danger.

■ **Say:**

It is easy to talk about what to do when a heart attack happens, but it may not be so easy to take the right action if you or someone you know is actually experiencing symptoms. Let's take time to act out different scenarios to prepare you for a real situation.

Ask for volunteers in the group to form three teams of two people each. **Give each team** a copy of one of the three different "role-plays": at home, at work, and at night (pages 199–201).



Ask the teams to take a few minutes to read the sheets, decide who will play the roles, and think about what they will say. **Then ask each team** in turn to present their "drama" to the group.

■ **Ask:**

Now that you have seen the three scenarios, what do you think is the **main action** you must take when someone is experiencing the symptoms of a heart attack?



Note: Give the group a moment to call out the answer. If no one gives the correct answer, say:

The answer is to call 9-1-1 in 5 minutes or less.

6. The Role of Emergency Medical Services

■ **Say:**

Our actors did a great job of showing us why it is important to call 9-1-1 right away if you suspect a heart attack, and how emergency medical personnel can help. Let's talk more about the advantages of calling emergency medical services.

- Emergency medical personnel arrive fast and can start treatment right away. They may carry oxygen, heart medicine, pain relief medicine, or other medications, such as aspirin, that can help in case of a heart attack.
- In many locations, emergency medical personnel are linked to the hospital, so they can send information about a patient's condition to the emergency department even before the patient arrives.

- Heart attack patients who are brought by ambulance tend to receive faster treatment when they arrive at the hospital.
- Your heart may stop beating during a heart attack. Emergency medical personnel carry equipment to restart the heart if that happens.



Note: Most communities have the 9-1-1 system. However, if yours does not, **say:** Let's discuss the emergency medical number in our community. The best way to get the care you need is to call the local emergency number. In our community, that number is: _____.

■ **Ask:**

It is a good idea to plan ahead for who will take care of your family in an emergency. Emergency medical personnel will usually contact a relative or friend or to make emergency arrangements if necessary. What would you do if you suddenly had to go to the hospital in an ambulance?



Note: Give the group about 5 minutes to discuss their answers.

7. Steps to Survival

■ **Say:**

We have learned a lot today about heart attacks and what to do if one happens. Here's the good news: Knowing what to do and planning ahead can help a person survive a heart attack. There are six steps you can take now to prepare for a possible heart attack.

- **Ask** for a volunteer from the group to come to the front of the room. Give the volunteer Step One of the "Steps to Survival" sheets (pages 202–203).



- Ask the volunteer to show the picture on the front of the sheet to the group and read the facts written on the back of the sheet. If there is also a question written on the back of the sheet, the volunteer should ask the group the question. Allow about 2 minutes for the group to answer. Then ask that volunteer to sit down. Select another volunteer to present Step Two of the "Steps to Survival," pages 204–205, and so on until all six steps on pages 206–213 have been presented.

Review of Today's Key Points

■ Say:

Let's review the main points that we learned today.

Q: What is a heart attack?

- A:**
- A heart attack occurs when a coronary artery becomes blocked and blood flow is closed off.
 - If blockage continues, parts of the heart muscle start to die.

Q: What stops a heart attack?

- A:**
- Quick action and medical treatment restore blood flow and save heart muscle.
 - Dead heart muscle cannot be restored.

Q: Why is it important to get treatment quickly?

- A:**
- "Clot-busting" and other medicines open up the artery and restore blood flow.
 - Angioplasty opens the artery and restores blood flow.
 - It is best to receive treatment within 1 hour after symptoms start. This will improve chances of survival and will help save heart muscle.

Q: What are the warning signs of a heart attack?

- A:**
- Your chest hurts or feels squeezed.
 - One or both of your arms, your back, or stomach may hurt.
 - You may feel pain in the neck or jaw.
 - You feel like you cannot breathe.
 - You may feel light-headed or break out in a cold sweat.
 - You may feel sick to your stomach.

Q: What should you do if you experience these symptoms?

- A:
- Call 9-1-1 in 5 minutes or less even if you are not sure you are having a heart attack.
 - Calling 9-1-1 gets you treated more quickly.
 - Do not drive yourself to the hospital.

Weekly Pledge



■ Say:

Pledge to do one thing this week to be prepared if a heart attack happens. Here are some examples:

- Learn the heart attack warning signs.
- Think about what you would do if a heart attack happens in different situations—at home, at work, in the middle of the night.
- Talk with family and friends about the warning signs and the need to call 9-1-1 right away.
- Talk to your doctor about your heart attack risk.



Note: Give each group member a copy of the “Heart Attack Survival Plan” (page 214).

■ Say:

It is also a good idea to fill out this heart attack survival plan and keep it in a handy place. Also, you might give a copy to family and friends you would likely call if you experience warning signs.

Closing

■ Say:

Thank you for coming today and for completing this important section of the program. The next session is about physical activity. Please wear comfortable walking shoes and clothing.



Be More Physically Active

Objectives

By the end of this session, group members will learn that:

- Physical activity is good for the heart and overall health.
 - Adults should be physically active for a total of 30 minutes on most days, preferably daily.
 - Children should be physically active for a total of 60 minutes on most days, preferably daily.
 - Brisk walking is a simple activity almost everyone can do.
 - There are ways to fit more activity into a busy schedule.
-

Materials and Supplies

To conduct this session you will need:

- *Honoring the Gift of Heart Health* manual and CD of visuals
- Blackboard and chalk or several large pieces of paper, a marker, and tape
- Cool drinking water and cups
- (Optional) Wolf and the Hen Game in the Appendix, page 178.
- (Optional) Music for walking activity and tape or CD player

Handouts

Give group members these handouts during this session:

- "The Great Race" role-play, pages 215–216.
- Take Heart. Say Yes to Physical Activity, pages 217–218.
- Stretching Exercises, page 219.
- How To Exercise, page 220.
- Make Physical Activity a Habit—My Personal Record, page 221.
- Sample Walking Program, page 222.

Session Outline

Introducing the Session

1. Welcome
2. Review of Last Week's Session
3. About This Session

Conducting the Session

1. Facts About Physical Activity
2. *(Optional)* "The Great Race" Role-Play
3. Benefits of Physical Activity
4. Types of Physical Activity
5. Getting Started: Important Things To Know
6. Finding Time To Be Physically Active

7. Walking: An Activity For Almost Everyone

A. Discussion/Stretching

B. Wolf and the Hen Icebreaker Game (*optional*)

C. Walking Activity

Review of Today's Key Points

Weekly Pledge

Closing



Note: If you have time, include a 30-minute activity (like the walking activity in this session) at the beginning or at the end of the other sessions.

Introducing the Session

1. Welcome

- Welcome the group members to the session.

2. Review of Last Week's Session

■ Say:

At the last session we talked about the heart attack signs. Who remembers the warning signs of a heart attack?



Note: Give the group about 3 minutes to answer. Write their answers on the blackboard or a large piece of paper taped to the wall.

Add these signs if they are not said:

- Your chest hurts or feels squeezed.
- You feel like you can't breathe.
- You may feel pain in the neck or jaw.
- One or both of your arms, your back, or stomach may hurt.
- You may feel sick to your stomach.
- You may feel light-headed or break out in a cold sweat.

■ Say:

Who remembers what you should do if you experience these symptoms?

The answers are

- Call 9-1-1 in 5 minutes or less even if you are not sure you are having a heart attack.
- Calling 9-1-1 gets you treated more quickly.
- Do not drive yourself to the hospital.

■ **Say:**

At the end of the session we pledged to do one thing to be prepared if a heart attack happens. Share with the group what you did.

3. About This Session

■ **Say:**

Today's session discusses physical activity and how important it is to your heart health. When the session ends, you will know:

- How physical activity can help you and your family.
- What kind of activities are good for you and for your heart.
- How much activity you should do.
- How you can find time to be active.

Conducting the Session

1. Facts About Physical Activity

■ **Say:**

Not getting enough physical activity is a major health risk for people today.

- Being physically inactive puts you at risk for heart disease. The good news is that you can do something about this risk factor.
- Unfortunately, physical inactivity is rising among AI/AN, including men, women, and children.
- As a person gets older, having little or no physical activity can lead to health problems.

2. "The Great Race" Role-Play *(optional)*

- If you choose, ask for three volunteers to be the actors for the role-play "The Great Race" on pages 215–216.
- Allow 5 to 10 minutes for open discussion by asking the following questions:
 1. What are some of the lessons we learned from this story?
 2. How can physical activity become a part of your lives and our community?

3. Benefits of Physical Activity

- **Ask:**
How do you think physical activity can help you?

 **Note:** Give the group about 5 minutes to answer. Write their answers on the blackboard or a large piece of paper taped to the wall.

- **Show visuals 3-1 and 3-2.** Add any of these reasons if they are not said. **Say:** Physical activity can:

- Strengthen your heart and lungs and increase physical fitness.
- Give you more energy.
- Build and maintain healthy bones, muscles, and joints.
- Help you feel better about yourself.
- Help you control your weight.
- Help lower your blood pressure.
- Help you lower your stress and reduce feelings of depression and anxiety.
- Help lower your blood cholesterol.
- Help you sleep better.
- Help lower your chance for heart disease, diabetes, and cancer.



■ **Show visual 3-3. Say:**

People feel better when they are active. Physical activity may help you lose excess weight and control your appetite.



4. Types of Physical Activity

■ **Ask:**

What do you do to be physically active?



Note: Give the group about 5 minutes to answer. Write their answers on the blackboard or a large piece of paper taped to the wall.

■ **Say:**

There are different types of physical activity. Physical activity includes some of the things that you probably do each day, like walking, climbing stairs, or doing household chores.

■ **Show visual 3-4. Say:**

You may want to start with activities like these:

- Walking
- Climbing stairs
- Dancing
- Raking leaves
- Picking berries
- Vacuuming
- Gardening
- Bowling
- Playing traditional games
- Fishing



■ **Show visual 3-5. Say:**

After a while, you will be able to do even more. Activities that you might enjoy include:

- Playing soccer, basketball, or baseball
- Running or jogging
- Doing aerobics or floor exercises (calisthenics)
- Herding cattle
- Hiking
- Sledding
- Skiing
- Bicycling
- Jumping rope
- Rollerblading
- Chopping wood
- Swimming
- Hunting
- Skating



■ **Say:**

All types of physical activity are good for you. Aerobic activities such as brisk walking that speed your heart rate and breathing help your heart. Other activities can help improve strength and flexibility.

■ **Say:**

Start slowly. Then move on to higher level activities. For example, when you are comfortable walking, gradually begin to jog. You'll feel great!

■ **Say:**

You don't have to be an athlete to become fit. Just get moving! Find something you like to do and that you have time for.

■ **Ask:**

How much physical activity do you think you need each day to improve your health?

Answer: Adults should accumulate a total of **30 minutes** of moderate physical activity on most days, preferably daily. Children should accumulate at least **60 minutes** of moderate physical activity on most days, preferably daily.

■ **Show visual 3-6. Say:**

If you can't set aside 30 minutes at one time to be active, you can break your activity into shorter periods of 10 minutes or more. Just make sure it adds up to at least 30 minutes on most days.



■ **Say:** Here's an example:

- Use your stationary bike for 10 minutes before you go to work10
- Take a 10-minute walk with your kids after work10
- Do aerobic exercises for 10 more minutes later in the day+10

30

More Information

Just Move It

- Physical activity is important in weight management.
- Try to set a goal to be physically active for at least 30 minutes a day.

Here are some examples of how many calories you can burn from various activities for 30 minutes.

Activity	Calories burned per 30 minutes*
Walking (leisurely), 2 miles per hour	85
Walking (brisk), 4 miles per hour	170
Garden work.....	135
Raking leaves	145
Traditional dancing	190
Bicycling (leisurely) 10 miles per hour	205
Chopping wood.....	205
Ice skating, skiing, or sledding	240
Swimming laps, medium level	240
Jogging, 5 miles per hour	275

**For a healthy 150-pound person. A lighter person burns fewer calories; a heavier person burns more.*

5. Getting Started: Important Things To Know



Note: This session gives information for people who are just starting to be active. It also helps people add more activity to what they already do.

■ Say:

There are a few things that you should know before starting to be physically active:

1. Most people do not need to see a doctor before they start a slow, sensible program of physical activity. You should talk with your doctor if you:
 - Have heart trouble or have had a heart attack.
 - Take medicine for high blood pressure or a heart condition.
 - Are over 40 years old if you are a man, or over 50 if you are a woman, and you want to do a harder activity, like jogging.
 - Have one or more risk factor, like high blood pressure, high blood cholesterol, diabetes, overweight, or smoking and want to do a harder activity.
 - Have a family history of heart disease at an early age (before the age of 55 for men and 65 for women).
2. Start slowly. Build up the time and effort that you put into any activity. You should not be tired the next day.
3. Drink plenty of fluids before and after exercising, even if you are not thirsty. Drink water. Special sports drinks are not needed.
4. Wear comfortable clothing. Wear shoes and socks that give your feet support. You do not need to buy fancy outfits.
5. Never wrap your body in plastic or wear clothing that is too heavy. This will not help you lose fat, but it can:
 - Make you sweat too much.
 - Make your body temperature rise.
 - Make your heart beat too fast.

- Make you sick to your stomach.
- Cause you to pass out.
- Cause damage to your organs.

■ **Ask:**

Does anyone have any questions? Give the group 2 to 3 minutes to ask questions.

6. Finding Time To Be Physically Active

■ **Say:**

I know that all of you have busy lives. You may be wondering how you will ever find time to be active. Let's look at some ways.

- **Give each member** a copy of the "Take Heart—Say Yes to Physical Activity" handout on pages 217–218. Let's see how to add movement to what you do every day. **(Read the suggestions aloud.)**



- Take a walk/snowshoe.
- Take the stairs.
- Get off the bus one or two stops early and walk.
- Dance to your favorite music.

■ **Ask:**

What are some other ways to become more active even when you don't have time?



Note: Give the group about 5 minutes to answer. Write their answers on the blackboard or a large piece of paper taped to the wall. Add these ways if group members do not say them.

- Take a 15- to 20-minute walk during your lunch break at work or after dinner with your family.
- Jump rope a few minutes each day. Work up to jumping for 10 minutes.

7. Walking: An Activity for Almost Everyone



Tips for Preparing for the Walking Activity

Before the start of this session:

- **Review** the "Stretching Exercises" handout (page 219). Practice until you know each part well enough to teach them to the group members.
- *(Optional)* **Review** the Wolf and the Hen Game in Appendix page 178. This game can also be used as an icebreaker in other sessions.
- **Practice** a brisk walk. Take long strides and swing your arms.



When leading this activity, remember:

- Music can get people in the mood for being active. Use a lively song for the warm up exercises, a faster beat for the walking, and a relaxing song for the cool down period.
- Be enthusiastic. Group members will pick up on your enthusiasm and feel good about exercising.
- Lead the walk in a circle if you have to do the walking indoors or if space is limited.

A. Discussion/Stretching

- **Say:**
Brisk walking is an excellent form of physical activity. It's easy to do, and you do not need special equipment. All you need are shoes for support and socks for cushioning.
- **Say:**
Walking can be done outdoors or indoors. If you do not feel safe walking in your neighborhood, a school or churchyard may be a safer place to walk. Many

shopping malls let people walk inside the mall before the stores open. Some malls even have walking clubs that meet every day.

■ **Say:**

It's important to spend time warming up and cooling down each time you exercise. Although the risk of injury from walking is low, the warmup gets your leg muscles ready for the activity. The cool-down lets your heartbeat slowly return to normal. This keeps your leg muscles from getting stiff.

- **Ask the group members** to stand up and spread out, leaving at least 3 feet between them and the next group member.

- Turn on the music.

■ **Say:**

It is important to warm up your muscles and stretch before you begin physical activity. First we will warm up our muscles and then we will stretch. Let's walk in place slowly for 3 minutes.

■ **Say:**

Now, I am going to show you some stretching exercises. Watch me and then try doing them yourselves. Some are easier to do than others. With time and practice, you will be able to do them all. If you have a bit of trouble at first, just do your best. You will get a handout that tells you how to do these stretching exercises. Use the handout to help you do them at home.

B. (Optional) Wolf and the Hen Game

- **Lead the group** in the Wolf and the Hen Game on page 178.

C. Walking Activity

- After the stretching exercises and Wolf and the Hen Game (*optional*), **lead the group members** on a 15- to 20-minute walk. Walk slowly for the first 5 minutes. Then show them how to do a brisk walk for 5 to 10 minutes.
- During the last 5 minutes, slow your pace.

■ **Say:**

We are slowing down now so that our bodies can gradually relax. This is called the cool-down period. It is an important part. It's usually recommended that you gradually slow your pace during the last 5 minutes of an activity. Doing a few stretching exercises to loosen the muscles should also be a part of your cool-down.

■ **Say:**

For instance, runners or joggers may cool down by walking for a few minutes and then stretching their leg muscles before they stop entirely.

■ **Ask:**

How do you feel? Do you think you could continue to walk like this? Why or why not?



Note: Give the group about 3 to 5 minutes to answer.

■ **Say:**

If you already walk three or more times a week, add other activities to become more fit. Try running, jumping rope, or doing aerobic dance.

■ **Tell the group:**

One of the hardest parts of being more active is staying motivated. Many people find that having a partner helps them stay active because:

- You motivate each other. You can set goals together and help each other meet them.
- It makes the time go by faster. You will focus on talking rather than on the activity.
- A partner can be a family member, neighbor, or friend.

■ **Ask:**

What are other ways to help you stay motivated to continue being physically active? Where are some safe places in your neighborhood to be active?



Note: Give the group about 3 minutes to answer. Write their answers on the blackboard or on a large piece of paper taped to the wall.

- **Give each group member** a copy of the handouts "Stretching Exercises," "How to Exercise," "Make Physical Activity a Habit—My Personal Record," and "Sample Walking Program," pages 219–222.



- **Say:**

Use the "Make Physical Activity a Habit—My Personal Record" handout to track your daily progress.

Review of Today's Key Points

- **Say:**

Let's review what we have learned today.

- **Ask:**

Q: What are some of the benefits of regular physical activity?

A: • Strengthen your heart and lungs.

- Build and maintain healthy bones, muscles, and joints.
- Help you lose excess weight, prevent weight gain, and control your appetite.
- Lower blood cholesterol and blood pressure.
- Help you sleep better, reduce stress, increase energy, and reduce feelings of depression.
- Lower your chance for heart disease, diabetes, and cancer.

Q: What is an activity that just about everyone can do?

A: Brisk walking.

Q: What are simple ways to become more active throughout the day?

- A:** • Get off the bus early and walk.
- Park farther away and walk.
 - Use the stairs.
 - Dance to your favorite music.

Q: What is the minimum amount of activity recommended for you to do every day?

A: A total of 30 minutes for adults and 60 minutes for children on most days of the week, preferably daily.



Weekly Pledge

■ **Say:**

Pledge one thing you will do to be more active during the coming week. Start by sharing your own pledge. You can write your pledges on the "Take Heart: Say Yes to Physical Activity" handout.



Note: Make sure each member gives details about what he or she plans to do. For example, instead of saying "I am going to walk," have them say "I am going to walk three times a week for 30 minutes."

Closing

■ **Say:**

Thank you for coming today. What did you think of today's session? I am looking forward to seeing you at the next session. The next session will be about how to cut back on salt and sodium to prevent high blood pressure.



Note: Think about today's class. What worked and didn't work? Have you made any changes in your own life that were covered in today's session?



What You Need To Know About High Blood Pressure, Salt, and Sodium

Objectives

By the end of this session, the group members will learn:

- It is best to have a blood pressure of less than 120/80 mmHg.
 - Blood pressure between 120/80 and 139/89 mmHg is *prehypertension*.
 - A blood pressure of 140/90 mmHg or more is high.
 - Eating less salt and sodium can lower the risk of developing high blood pressure.
 - There are steps you can take to lower the amount of salt and sodium in your diet.
-

Materials and Supplies

To conduct this session you will need:

- *Honoring the Gift of Heart Health* manual and CD of visuals
- Blackboard and chalk or several large pieces of paper, a marker, and tape
- Measuring spoons (1 teaspoon, 1/4 teaspoon)
- Small amount of salt
- Mary's seasoning mixture (page 235). Prepare enough to give a small sample to each group member

- Story or discussion about the traditional use of sodium



Note: (*Optional*) Arrange for a health professional to come to the session to take blood pressure readings.

Handouts

Give these handouts to each group member during this session:

- “Will’s Journey to Heart Health” Role-Play (pages 223–225)
- *Honoring the Gift of Heart Health* wallet card (page 226)
- Take Steps—Healthy Habits to Lower High Blood Pressure! (page 227)
- Medicine for High Blood Pressure (page 228)
- Tips for Taking Medicine for High Blood Pressure (page 229)
- Read the Food Label for Sodium! (page 230)
- Will’s Food Choices (pages 231–233)
- Sodium in Foods (page 234)
- Keep Your Heart in Mind. Eat Less Salt and Sodium. (pages 235–236)
- Tips To Eat Less Salt and Sodium (page 237)
- Use Herbs and Spices Instead of Salt (page 238)
- Pinto Beans (or Alaska Salmon Salad) Recipe (page 239)
- List of places where members can get their blood pressure checked.*
* Prepare this list before the session. You may find information at your local health department, a hospital, or clinic.

Session Outline

Introducing the Session

1. Welcome
2. Review of Last Week's Session
3. About This Session

Conducting the Session

1. The Facts Don't Lie
2. "Will's Journey to Heart Health" Role-Play
3. Facts About Blood Pressure
4. Lowering High Blood Pressure
5. Salt and Sodium—How Much Do We Need?
6. About the Food Label
7. Shake the Salt and Sodium Habit
8. Pinto Beans (or Alaska Salmon Salad) Recipe

Review of Today's Key Points

(Optional) **Blood Pressure Check**

Weekly Pledge

Closing

Introducing the Session

1. Welcome

- Welcome the group members to the session.

2. Review of Last Week's Session

- **Say:**

Last week we talked about why you should be physically active. What do you remember about the benefits of being physically active?



Note: Give the group about 3 minutes to answer. Write their responses on the blackboard or a large piece of paper taped to the wall.

- Add these benefits if they are not said. **Say, physical activity:**

- Strengthens your heart and lungs
- Increases physical fitness
- Builds and maintains healthy bones, muscles, and joints.
- Helps you feel better about yourself
- Helps you lose weight and control your appetite
- Helps you lower your blood pressure
- Helps you lower your blood cholesterol
- Helps you sleep better
- Helps you reduce stress and feelings of depression and anxiety
- Helps you have more energy
- Helps lower your chances of developing diabetes (high blood sugar)

■ **Say:**

At the end of the session, everyone made a pledge to be more active. Share with the group what you did? What problems did you face (like not having time or not getting family support)? How did you solve them? Give the group 5 minutes to answer.

3. About the Session

■ **Say:**

Today’s session is about blood pressure and the steps we can take to lower your blood pressure or keep it from rising.

Conducting the Session

1. The Facts Don’t Lie

■ **Say:**

Nearly 50 million people in the United States have high blood pressure, and anyone can get it.

- AI/AN are less likely to be treated for their high blood pressure.
- High blood pressure—also called hypertension—can lead to stroke, heart attack, kidney failure, and blindness.

2. (Optional) “Will’s Journey to Heart Health” Role-Play

If you choose, ask for four volunteers to be the actors (three actors, one narrator) for the role-play, “Will’s Journey to Heart Health” (pages 223– 225).



Allow 5 to 10 minutes for open discussion by asking the following questions:

1. What are some of the lessons we learned from this role-play?
2. Is there any part of the play that you can use in your own life?

3. Facts About Blood Pressure

■ **Show visual 4-1. Say:**

Blood pressure is the force of the blood against the walls of your arteries. Blood pressure is needed to move the blood through your body.



■ **Say:**

Measuring blood pressure is easy and does not hurt.

■ **Say:**

Your blood pressure reading has two numbers—for example, 120 over 80. Both numbers are important.

■ **Show visual 4-2. Say:**

The first number (120) is the pressure of the blood when the heart beats, and the second number (80) is the pressure when the heart rests. It is written like this (120/80).



■ **Say:**

It is important to know and remember your blood pressure numbers—just like you know your shoe size.

■ **Ask:**

Do you know your blood pressure number? Give the group about 2 minutes for their comments.

■ **Say:**

It is best to have a blood pressure less than 120/80 mmHg. Blood pressure between 120/80 and 139/89 mmHg is *prehypertension*. This means that you don't have high blood pressure yet but are likely to develop it in the future unless you adopt healthy lifestyle changes. Blood pressure is considered high when it is 140/90 mmHg or higher.

■ **Show visual 4-3. Say:**

If you have high blood pressure, it means that your heart has to pump harder than it should to get blood to all parts of your body. High blood pressure raises your chances for a stroke and heart attack, kidney problems, and blindness.



■ **Say:**

High blood pressure is also known as the ‘silent killer’ because it may cause no symptoms. Most people have it without feeling sick, until they have a stroke or heart attack or some other problem caused by high blood pressure.

■ **Show visual 4-4. Say:**

The best way to find out if you have high blood pressure is to have it checked. If you have high blood pressure your doctor or nurse will check it at most visits.



■ **Give group members:**

- a list of clinics and hospitals where they can get their blood pressure checked.
- a copy of the *Honoring the Gift of Heart Health* wallet card (page 226).

■ **Say:**

Ask for your blood pressure numbers each time you have it checked. Keep a record of each reading on this card.

More Information

What your blood pressure numbers mean (adults ages 18 and older)*

First Number (mmHg)	Second Number (mmHg)	Results
less than 120	less than 80	Good for you!
120–139	80–89	It is time to make changes in what you eat and drink, your activity, weight, and smoking habits. Talk to the doctor especially if you have diabetes.
140 or more	90 or more	You have high blood pressure. Ask your doctor or nurse how to control it.

* These readings are for adults (18 and older) who do not take blood pressure medicine and do not have short-term illness.

4. Lowering High Blood Pressure

- **Ask the group members** to raise their hand if someone in their family has high blood pressure.

- **Say:**

If a member of your family has high blood pressure, you are at greater risk of getting it, too. Even if you do not have high blood pressure now, because a family member has it, you are still at a greater risk.

- **Say:**

The good news is that you can take steps to lower your blood pressure or keep it from rising. Let's find out how.

- **Give each member** a copy of the handouts “Take Steps—Healthy Habits to Lower High Blood Pressure!” (page 227), “Medicine for High Blood Pressure” (page 228), and “Tips for Taking Medicine for High Blood Pressure” (page 229).



- **Read aloud** the steps to lower blood pressure or keep it from rising.

- **Say:**

Which steps could you and your family take to prevent or lower high blood pressure?

Give participants a few minutes to answer.

- **Read aloud** “Medicine for High Blood Pressure” facts and “Tips for Taking Medicines for High Blood Pressure.”

5. Salt and Sodium—How Much Do We Need?



Note: For this discussion, you will need a $\frac{1}{4}$ teaspoon measuring spoon, a teaspoon-measuring spoon, and some salt. *Optional:* a piece of dark colored paper to display the different amounts of salt.

- **Say:**

Eating less salt and sodium can help you prevent or lower high blood pressure. You probably know what salt is, but you may wonder what sodium is. Sodium is a part of salt. Also, it is part of mixtures used to flavor and preserve foods.

■ **Say:**

Now let's look at how much sodium we really need. The body only needs about 500 milligrams of sodium each day. That's about a quarter of a teaspoon of salt. *(Use a measuring spoon to show 1/4 teaspoon of salt.)* Most people are eating much more than 500 milligrams of sodium every day.

■ **Say:**

You should cut back the amount of sodium you get from all foods and beverages to less than 2,400 milligrams of sodium per day or about 1 teaspoon of salt. *(Now show 1 teaspoon of salt.)* This is the same amount as listed on the bottom of the Nutrition Facts label.

■ **Say:**

Most people in the United States eat about 4,000 to 6,000 milligrams of sodium each day. *(Now show 2 1/2 teaspoons of salt.)* This is about 8 to 12 times more sodium than what the body needs. Eating this much salt and sodium may lead to high blood pressure.

■ **Show visual 4-5. Say:**

Let's talk about where sodium is found in foods.

- Most of the sodium that we eat comes from packaged foods. Examples are regular canned soups and vegetables, frozen dinners, salty chips, and cured meats like hot dogs.
- Sodium also comes from salt added during cooking or at the table.
- The rest is found naturally in many foods.



6. About the Food Label

■ **Show visual 4-6. Say:**

The food label found on packaged foods is one of the best tools we have for choosing foods for a healthy diet. In this session, we will talk about what you can find on the food label. We will also learn how to use the food label to choose foods that are lower in sodium.



- **Give each group member** a copy of “Read the Food Label for Sodium,” page 230.



■ **Say:**

The food label gives serving size and number of servings in the container. It also gives the amount of calories, saturated fat, cholesterol, total fat, and sodium in one serving of the food. We will talk about saturated fat, cholesterol, total fat, and calories in the next two sessions.

Sodium Food Label Activity

- **Point out** where the Percent Daily Value (DV) is located on the food label.

■ **Say:**

The Percent DV will help you compare products. It quickly tells you if a food is high or low in the nutrient. Remember—it is easy to take in more than 2,400 milligrams of sodium. Choose foods with a lower Percent DV for sodium. A 5 Percent DV or less is low and 20 Percent DV or more is high. Once you get into the habit of looking at food labels, it will be easy.

■ **Say:**

Let's take a close look at the nutrition facts on an actual label to see where the amount of sodium is found. Let's go back to the "Read the Food Label for Sodium" handout.

- **Point to visual 4-6. Say:**

The Percent DV for sodium for frozen carrots is circled on the food label.



■ **Say:**

The sodium content of the same food can vary depending on how it is packaged or what brand it is. Compare food labels to choose foods that are lower in sodium.

■ **Say:**

Look at the bottom of the handout. Look at the Percent DV for frozen carrots and canned carrots. Which carrots are lower in sodium? Alaska educators, see below.

Answer: Frozen carrots are lower in sodium. One serving of frozen carrots has only 2 Percent DV for sodium. One serving of canned carrots has 16 Percent DV for sodium (three times more than frozen carrots). Rinsing the canned carrots with cold water can help reduce the sodium content.

For Alaska: Ask participants to compare the percent DV for canned soup and homemade soup. Then explain that the canned soup has almost four times the sodium of homemade soup.

■ **Say:**

You can also think of Percent Daily Value like a budget. This means 28 Percent DV of sodium is like a daily budget of \$100 and one serving cost you \$28. That is not bad if it is for a whole meal, but if it is for one food you could go over budget (in sodium) for the day.

■ **Say:**

Choosing foods that are lower in salt and sodium may help prevent and lower high blood pressure. Eating more fruits, vegetables, whole wheat breads, cereals, and lowfat dairy foods may also help lower blood pressure.

More Information

The latest research shows that potassium, calcium, and magnesium are also important in protecting against high blood pressure. Eat foods that are rich in these nutrients:

- **Potassium:** bananas, broccoli, cantaloupe, dried beans, honeydew, mushrooms, oranges, mushrooms, potatoes, and squash.
- **Calcium:** fat free or lowfat milk, cheese, yogurt, calcium fortified oranges, juniper ashes, leafy greens, and salmon.
- **Magnesium:** whole wheat breads and cereals, rhubarb, nuts, and seeds.

■ **Say:**

Let's try an activity that will help us choose foods that are low in salt and sodium. First, I am going to describe a situation that may apply to you or to a member of your family. Then, using food labels, we are going to learn how to choose lower sodium foods.

- **Give each group member** copies of the “Will’s Food Choices,” (pages 231–233). Read or ask a volunteer to read the story below.



Will’s blood pressure was slightly higher the last time he visited his doctor. The doctor told him to cut back on the amount of sodium he eats. Use the food labels to help Will’s wife, Sally, choose foods that will help Will follow his doctor’s advice.

■ **Say:**

Let's go over some questions. Use the food labels to choose the right answers. Alaska Native educators should substitute salmon and marinade for the chicken and carrots.

(See below for the Alaska substitutions.)

■ **Ask these questions.**

After group members guess, give them the correct answer.

Questions

Correct Answers

When buying juice, should Sally choose tomato juice or orange juice?

Orange juice

Should she buy frozen carrots or canned carrots?

Frozen carrots

Should she serve rice made from a packaged mix or plain rice with herb seasoning?

Plain rice with herb seasoning

Is there less sodium in canned chicken or roasted chicken?

Roasted chicken

If you are trying to cut back on sodium, is it better to eat canned soup or homemade soup?

Homemade soup

■ **Alaska Food Label Substitutions:**

Questions

Correct Answers

Should she prepare fresh salmon or canned salmon that is preserved in salt?

Fresh salmon

Should she serve commercial fish marinade/sauce or homemade fish marinade?

Homemade fish marinade/sauce

7. Shake the Salt and Sodium Habit

- **Give each group member** a copy of the “Sodium in Foods” handout, page 234.



- **Ask:**

Does anyone see a food on the right side of the page that you eat often? Ask the person to name a lower sodium food on the left side that he or she could eat instead.

- **Say:**

Let's now review some practical tips that will help you cut back on salt and sodium.

- **Give each group member** a copy of the “Keep Your Heart in Mind. Eat Less Salt and Sodium” (pages 235–236) and “Tips To Eat Less Salt and Sodium” (page 237) handouts. **Go over** the tips shown on both handouts on how to cut back on salt and sodium when you shop, when you cook, and when you are at the table.



- **Say:**

Here is a sample of Mary's secret recipe from the bottom of the page of the “Keep Heart in Mind” handout. You can use this or a salt-free seasoning mixture available in grocery stores. Fill an empty saltshaker with it and put it on your table. Tell your family to try this instead of salt. **Give each group member** a sample of Mary's seasoning mixture.



- **Ask:**

Why is it hard for you to cut back on salt and sodium?



Note: Write their responses on a blackboard or large piece of paper taped to the wall. Then write down some possible solutions.

Examples

Problems You May Encounter

Solutions

No flavor in food.

Use spices or herbs to add flavor to foods. (See “Use Herbs and Spices Instead of Salt” on page 238.)

Family member(s) will get upset.

Cut back on salt slowly, using less salt each time you cook so family members can get used to the taste.

Adding salt is a habit that is hard to break.

Give yourself time to get used to using less salt. Cut back on salt slowly. Choose brands that are lower in salt. Reduce the amount of salt added at the table.

8. Pinto Beans (or Alaska Salmon Salad) Recipe



■ Give the group members a copy of the recipe (page 239). Ask them to prepare it during the coming week. Tell them that using this recipe will give them a chance to practice some of the ideas from the session.

■ Give the group members the handout “Use Herbs and Spices Instead of Salt” (page 238). Ask them to use some of the herbs and spices in place of salt when they cook this week.



Review of Today's Key Points

■ Say:

Let's review what we learned today.

■ Ask these questions:

Q: What is blood pressure?

A: Blood pressure is the force of the blood against the walls of your arteries. Blood pressure is needed for the blood to move through your body.

Q: What is the best blood pressure reading to have?

A: It is best to have a blood pressure reading less than 120/80 mmHg.

Q: What is *prehypertension*?

A: Blood pressure between 120/80 and 139/89 mmHg is *prehypertension*. This means that a person does not have high blood pressure yet but is likely to develop it in the future unless they adopt healthy lifestyle changes.

Q: What is high blood pressure?

A: High blood pressure is 140/90 mmHg or greater. Have your blood pressure checked.

Q: Why is high blood pressure dangerous?

A: High blood pressure can lead to heart attacks, stroke, kidney problems, eye problems, and death.

Q: What can you do to help make your blood pressure medicine work better?

A: Eat more fruits and vegetables, cut back on salt and sodium, lose weight, and be more physically active. Take your medicine regularly and talk to your doctor about side effects.

Q: Why should you cut back on salt and sodium in your food?

A: You should cut back on salt and sodium to help prevent or lower high blood pressure.

Q: What are some ways to cut back on salt and sodium?

A: Use herbs and spices to season foods. Be careful! Some seasonings such as garlic salt and onion salt are high in sodium. Check the food label to choose foods lower in sodium. Eat more fruits and vegetables for snacks instead of salty snacks like nuts, pretzels, or chips.

Blood Pressure Check

(Optional—if you could get a health professional to come to your session.)

- **Tell the group members** that a health professional will now check their blood pressure.
- **Ask the group members** to write their blood pressure on the wallet card.

Weekly Pledge

- **Say:**
Pledge one thing that you will do to eat less salt and sodium this week. Write down your pledge on the “Keep Your Heart in Mind. Eat Less Salt and Sodium” handout (pages 235–236).



Note: Make your own pledge first. Encourage each member to give details about what he or she plans to do. Think about these:

- I will use food labels to help me choose canned soups that are lower in sodium or prepare homemade soup without adding salt.
- I will choose fresh meat more often than of canned meat.
- I will reduce the amount of salt I add at the table.

- **Say:**
We will talk about how you did with your pledge at the next session. Remember to keep working on your pledge to be more active.

Closing

■ **Say:**

Thank you for coming today. What did you think of today's session? I am looking forward to seeing you at the next session. The next session will be about blood cholesterol and fat, saturated fat, and cholesterol in our food.



Note: Think about today's session. What worked and didn't work? Have you decided to make any changes in your own life, based on what was covered in today's session?



What You Need To Know About High Blood Cholesterol

Objectives

By the end of this session, group members will:

- Know what cholesterol is and how it affects the body.
 - Know what cholesterol levels are best.
 - Learn the steps they can take to lower their blood cholesterol levels.
-

Materials and Supplies

To conduct this session you will need:

- *Honoring the Gift of Heart Health* manual and CD of visuals
- Blackboard and chalk or several large pieces of paper, markers, and tape
- "An Artery Model" (instructions for making this teaching tool are found on page 86)
- *(Optional)* Storytelling: The Legend of the Rock
- Seven paper plates
- A set of measuring spoons
- Can of shortening or lard

- Bottle of vegetable oil*
- Boiled beans (canned)*
- Beef hot dog*
- Berries*
- Snack cakes (packed cupcakes)*
- Cheddar cheese*
- Sour cream*

**You can use a picture of these foods.*

Handouts

Give each group member these handouts during this session:

- Storytelling: The Legend of the Rock (page 240)
- List of places where members can get their cholesterol levels checked
Prepare this list before the session. You may find information at your local health department, a hospital, or clinic.
- Be Good to Your Heart. Know Your Cholesterol Number and Take Action!
(pages 241–242)
- Fats and Oils To Choose (page 243)
- Read the Food Label for Saturated Fat, Trans Fat, and Cholesterol (page 244)
- Sally’s Breakfast Choices (pages 245–247)
- Guess the Fat Activity Sheet (page 248)
- Cooking With Less Saturated Fat (pages 249–250)
- Chicken Chile Stew (or Moose Stew) Recipe (page 251)

Session Outline

Introducing the Session

1. Welcome
2. Review of Last Week's Session
3. About This Session

Conducting the Session

1. Facts About Blood Cholesterol
2. *(Optional)* Storytelling: The Legend of the Rock
3. Cholesterol and Heart Disease
4. What Are Your Numbers?
5. Healthy Arteries Activity
6. Facts About Saturated Fat, Trans Fat, and Cholesterol
7. Food Label Activity
8. Guess the Amount of Fat Activity
9. Cooking With Less Saturated Fat Activity
10. Reduced Fat Chicken Chile (or Moose Stew) Recipe

Review of Today's Key Points

Weekly Pledge

Closing

Introducing the Session

1. Welcome

- Welcome group members to the session.

2. Review of Last Week's Session

- **Say:**

Last week we talked about salt and sodium.

- **Ask:** (Give the correct answer if group members do not.)

Q: Who remembers why you should try to limit the amount of salt and sodium in your diet?

A: You should cut back on salt and sodium to help prevent or lower high blood pressure.

Q: Does anyone remember some ways to reduce the amount of salt that you eat?

A: To cut back on salt and sodium you can:

- Check the food label to choose foods lower in sodium.
- Use herbs and spices instead of salt to season foods.
- Eat more fruits, vegetables, and lowfat dairy products for snacks. Choose low sodium or unsalted nuts, pretzels, and popcorn.

- **Say:**

At the end of last session, you made a pledge to choose foods lower in salt and sodium. Share with the group what you did. What problems did you have? How did you solve them? Give the group 5 minutes to answer.

3. About This Session

■ **Say:**

Today we are going to talk about high blood cholesterol as a risk factor for heart disease. We will learn what we can do to keep our blood cholesterol low. We will also do some group activities that show how much saturated fat is in some foods and how to cook with less saturated fat.

Conducting the Session

1. Facts About Blood Cholesterol

■ **Say:**

If a person's blood cholesterol level is too high, he or she is more likely to get heart disease. Here are some facts about blood cholesterol:

- About 65 million adults in the United States have high blood cholesterol. This increases their risk of heart disease.
- About half of AI/AN adults have had their blood cholesterol checked.
- About one in three of AI/AN who have had their blood cholesterol checked have levels that are too high.

Insert Local Facts: _____

2. (Optional) Storytelling: Legend of the Rock



- **Ask for a volunteer** to read the story "The Legend of the Rock" (page 240)

- **Allow 5 to 10 minutes** for open discussion by asking the following questions:

- What are some of the lessons we learn from this legend about changing your lifestyle?
- What are some changes you can make to eat a diet low in saturated fat, trans fat, and cholesterol? How can your community help you?

3. Cholesterol and Heart Disease



Note: This section explains what cholesterol is, why the body needs cholesterol, how much cholesterol the body needs, and where cholesterol comes from.

■ **Say:**

Cholesterol is a soft waxy substance. It comes from two sources—your body and the foods you eat. Your liver makes all the cholesterol you need. The cholesterol that comes from foods that you eat is called dietary cholesterol. Your body needs cholesterol to produce hormones, and some vitamins. The body can make all of the cholesterol it needs without any from the diet.

Other types of fats in food that raise blood cholesterol are saturated fat and trans fat. Today we will learn how to lower our intake of these fats.

■ **Say:**

If your blood cholesterol level is too high, you are at increased risk for heart disease, stroke, and several other health problems.

■ **Ask:**

Do any of you know someone who has high blood cholesterol? Give the group about 3 minutes to answer.

■ **Say:**

A person's blood cholesterol level is affected by several things. Some of these you cannot change, such as your age, whether you are a man or a woman, or the genes you got from your parents (having family members with high blood cholesterol). You can change the types of food you eat, the amount of physical activity you do, and your weight.

■ **Say:**

You can help prevent or lower high blood cholesterol by:

- Eating a heart healthy diet low in saturated fat, trans fat, and cholesterol
- Being active every day
- Maintaining a healthy weight

■ **Explain the types of cholesterol. Show visual 5-1. Say:**



- Cholesterol travels through the bloodstream in different types of packages called "lipoproteins" (fat plus protein).
- Low-density lipoproteins (LDL) clog your blood vessels with plaque, like rust in a pipe. This is why LDL cholesterol is often called "bad" cholesterol.
- Cholesterol also travels in the blood in high-density lipoproteins, or HDL. HDLs help to remove cholesterol from your body. This is why HDL cholesterol is often called the "good" cholesterol. Let's try to picture it this way.
 - The LDL car (bad cholesterol) throws fat and cholesterol into the street (like the blood in your vessels).
 - The HDL person (good cholesterol) cleans up fat and cholesterol deposited by the LDL and gets rid of it. (Your liver gets rid of it from your body.)
- Just remember, "**L**" is for **L**ousy, and the **L**ower the better. "**H**" is for **H**ealthy, and the **H**igher the better.

4. What Are Your Numbers?



■ **Show visual 5-2. Ask:**

How do you find out if you have high blood cholesterol or high levels of other fats in the blood (triglycerides)?

Answer: Your cholesterol levels are measured with a blood test that can be done best at a doctor's office but also at a cholesterol screening site (health fair).

- A "lipoprotein profile," which measures all of your cholesterol levels (total, LDL, and HDL) and triglycerides, can be done at a doctor's office. This test is recommended for adults over 20. You have to fast 12 hours before this test. We will talk more about triglycerides (another fat in the blood) later.
- Most screening sites offer basic (total and possibly HDL) cholesterol results. It is important for adults over 20 to followup with your doctor for a complete lipoprotein profile.
- **Ask:**
Have you ever had your blood cholesterol checked? If you have, do you remember your levels?

- **Give and review** the cholesterol levels that are found on the "Be Good to Your Heart—Know Your Cholesterol Numbers and Take Action!" handout (pages 241–242).



- **Show visual 5-3.**



- **Say:**

Here are what the **total cholesterol numbers** (mg/dL) mean:

Less than 200	Desirable
200-239	Borderline high Depending on your other risk factors, you may be at a higher risk for heart disease. Talk to your doctor about your overall risk for heart disease.
240 or more	High You are at a higher risk for clogged arteries and a heart attack. See your doctor to determine your risk for heart disease.

- **Say:**

Here is what your **HDL and LDL cholesterol numbers** (mg/dL) mean:

LDL (bad) cholesterol: Keep it low!

- **Less than 100** Optimal (ideal)
- **100–129** Near optimal/above ideal
- **130–159** Borderline high
- **160–189** High
- **190 and above** Very high

HDL (good) cholesterol: The higher the better!

- **Keep it above 40**

More Information

Heart Disease Risk and Your LDL Level

The goal for a person's LDL (bad cholesterol) level is different for everyone. It depends on what other risk factors you have. The number of risk factors such as high blood pressure, low HDL, family history of heart disease, age/gender, and smoking impact your LDL goal. The higher your LDL level and the more risk factors one has, the greater chances you have of developing heart disease or having a heart attack. Your doctor can help you set a goal for your LDL level.

What About Triglycerides?

■ **Say:**

Have any of you heard of triglycerides? Give the group 3 minutes to answer.

■ **Say:**

Triglycerides are another type of fat in the blood. They come from fat that you eat and are made in the body. When you take in too many calories or eat a diet too high in carbohydrates, more triglycerides are made. When your triglycerides are high, it puts you at increased risk for heart disease.

■ **Say:**

People with high triglycerides often have low HDL cholesterol (good cholesterol). People with diabetes often have high triglycerides and low HDL cholesterol.

■ **Say:**

So what should you do to have a healthy triglyceride level? You can:

- Maintain a healthy weight or lose weight, if you are overweight.
- Be physically active on all or most days of the week.
- Eat a heart healthy diet that is low in saturated fat, trans fat, and cholesterol.
- Eat a variety of whole grains, fruits, and vegetables instead of sugary snacks and beverages.
- Avoid smoking and alcohol. Smoking raises triglycerides and lowers HDL cholesterol. Excess alcohol also raises triglycerides.

■ **Say:**

So what is a healthy triglyceride level? It is best to have a triglyceride level less than 150.

More Information

Here is what your Triglyceride numbers (mg/dL) mean:

Less than 150 Normal

150-199 Borderline-high
You may be at an increased risk for heart disease. To lower your level, aim for a healthy weight and be more physically active.

200-499 High
Weight control and physical activity are very important to lower your level. Watch out for other heart disease risk factors such as overweight and obesity, diabetes, low HDL, and high blood pressure.

Over 500 Very High
Alert! See your doctor immediately. This level requires attention to prevent severe problems with your pancreas.

■ **Encourage the group members** to make an appointment to have their cholesterol and triglycerides checked. Be sure to ask for the results and have them write their results on their wallet cards. Give group members a list of clinics and hospitals where they can get low-cost or free blood cholesterol testing.

5. Healthy Arteries Activity



Note: This section uses the visuals and an artery model to show how cholesterol can collect on the walls of the arteries and slow down and block the flow of blood. Blocked arteries can cause a heart attack or stroke.

■ **Show visual 5-4. Say:**

Blood flows freely to all cells of the body when arteries are healthy.



■ **Say:**

When your LDL cholesterol is too high, cholesterol may become trapped in the walls of the arteries, causing them to harden. The opening of the arteries can become clogged and narrowed.

■ **Show the artery model.**

(See the next two pages to help you explain the artery model.) Pass the artery model around so that group members can look at it closely.

■ **Say:**

Have you ever seen someone fry food with lard and dump the hot lard down the sink? (Give them a moment to answer. Then ask them why not.)

■ **Say:**

It is because it will clog the pipes. These same foods and others (you will learn about them next) will clog your pipes (arteries). So we want to treat our body just as well as we treat our pipes.

How to make an artery model

What you will need:

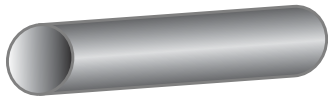

one empty paper towel roll

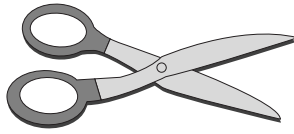

scissors

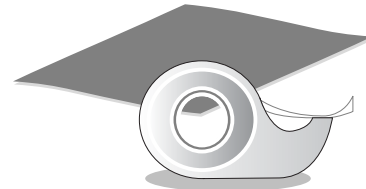

red construction paper and tape
or red felt with a sticky backing

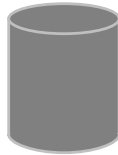

red modeling clay



yellow modeling clay

What you need to do:

1. Cut construction paper or felt to fit around the outside of the roll.

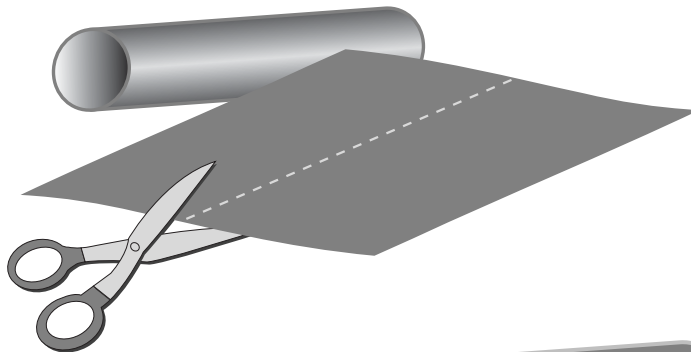

2. Tape construction paper or stick felt around the outside of the roll.

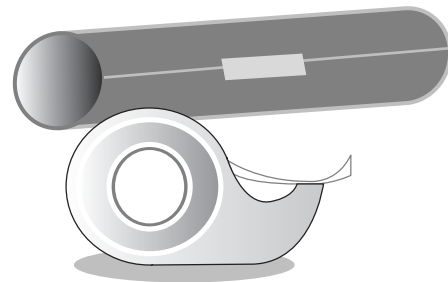

3. Roll out a thin piece of yellow and red clay into doughnut-shaped figures.

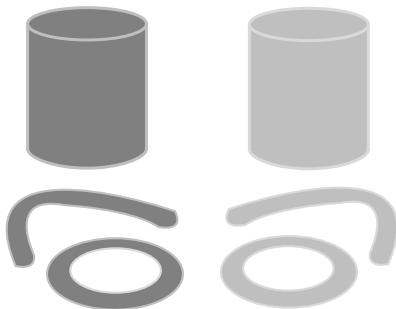

4. Make one small round ball of the red clay.

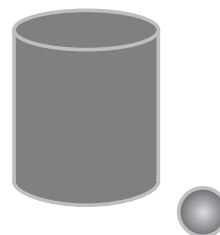

How To Explain the Artery Model

1. Place the red pieces of clay on the outside edge of both ends of the roll.

Say: This is a healthy artery. The blood can flow through the opening easily.

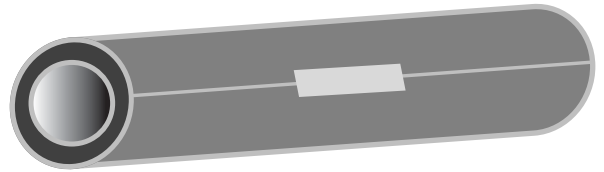

2. Add pieces of the yellow clay to the inside edge of the red clay on one end of the roll.

Say: This is the beginning of a clogged artery. Cholesterol is starting to build up.

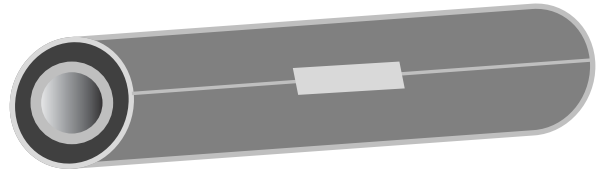

3. Continue to add pieces of yellow clay to this end of the roll almost to fill in the opening completely.

Say: The opening of the clogged artery is getting smaller. Blood cannot flow through easily.

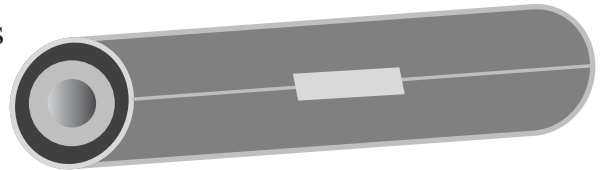

4. Put a red ball in the small opening what is left at the end of the roll.

Say: When the inside of an artery becomes narrowed, a blood clot may block an artery going to the heart. This may cause a heart attack. If the blood clot blocks an artery going to the brain, it may cause a stroke, or “brain attack.” Other problems caused by narrowed arteries are angina (chest pain) and poor blood circulation.

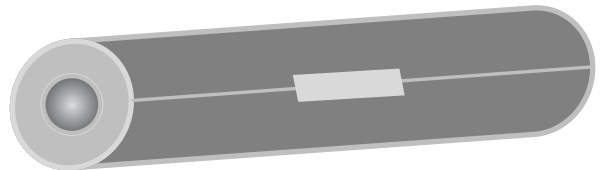

6. Facts About Saturated Fat, Trans Fat, and Cholesterol

■ Say:

Today we will talk about the different types of fat and how they affect heart health.

- There are two main types of fat—saturated fat and unsaturated fat. Most foods contain some of both types. The total fat found in food is its saturated fat plus its unsaturated fat.
- Eating too much saturated and trans fat will raise your blood cholesterol level more than anything else you eat. This will raise your chances of developing heart disease.
- A type of unsaturated fat called "trans fat" also raises cholesterol. Trans fat is found in a variety of baked goods (cookies, pies, and crackers), fried foods, and stick margarine. Choose tub (soft) margarine instead of stick (hard) margarine and look for "trans fat free" spreads.

■ Explain to the group members: It is important to limit the saturated and trans fat you eat, but you need some dietary fat to be healthy. Fats are necessary because they are used by the body to:

- Store and provide energy
- Help carry vitamins A, D, E, and K throughout the body

■ Ask:

What types of fat do you use to cook your food?



Note: Allow about 3 minutes for their responses. Write responses on a blackboard or large piece of paper taped to the wall.

■ Show the group members a stick of butter (or a can of lard). Say:

- Butter (or lard) is an example of a food high in saturated fat.
- Saturated fat is usually solid at room temperature.
- Saturated fat is usually found in foods from animals.

■ **Show visual 5-5. Say:**

Here are foods that are **higher in saturated fat:**

- Fatty cuts of meat, such as chuck, regular ground beef, ribs, bacon, and sausage
- Canned meats such as pork and mini sausages
- Whole milk and products made from whole milk (regular cheeses)
- The skin of chicken and other birds
- Butter
- Shortening
- Lard
- Oils such as coconut, palm and palm kernel oil
- Tortilla, fry bread, and other bread made with lard, butter, or shortening
- Doughnuts and pastries
- Ice cream sundae with whipped cream and toppings



■ **Show visual 5-6. Say:**

Here are foods that are **lower in saturated fat:**

- Lean meat such loin, round, and extra lean ground beef
- Fish
- Poultry without the skin
- Beans
- Rice
- Tub margarine
- Fat free and lowfat milk, cheese, and yogurt
- Vegetable oil
- Corn tortillas and bread (made without fat)
- Fruits and vegetables



■ **Say:**

You want to limit the amount of saturated fat in your diet.

■ **Show the group members** a bottle of vegetable oil.

■ **Say:**

Unsaturated fats are usually liquid at room temperature. As mentioned before, a few oils (coconut, palm, and palm kernel) are high in saturated fat.

■ *(Optional):*

Types of unsaturated fats are polyunsaturated and monounsaturated.

More Information

Polyunsaturated fat is found in:

- Vegetable oils
 - safflower oil
 - corn oil
 - sunflower oil
 - soybean oil
- Some types of fish

Monounsaturated fat is found in:

- Vegetable oils
 - canola oil
 - olive oil
 - peanut oil
- Avocados
- Nuts

- **Give the group members** the "Fats and Oils To Choose" handout (page 243).



■ **Say:**

The graph will quickly show you which products have the least amount of saturated fat.

■ **Ask:**

What three oils have the least amount of saturated fat? Answer: canola oil, safflower oil, sunflower oil.

■ **Say:**

Although polyunsaturated and monounsaturated fats are better for our health than saturated fat, we need to eat less of all types of fat. Fats are high in calories and all fats have the same number of calories. Cutting back on calories helps us lose weight. We will talk about this at the next session.

■ **Show visual 5-7. Say:**

Foods high in cholesterol can also raise your blood cholesterol and increase your risk of heart disease. Dietary cholesterol is found only in food that comes from animals. Foods that are highest in cholesterol are:



- Egg yolks
- Organ meats such as liver, kidneys, brains, tripe, heart, and tongue

■ **Show visual 5-8. Say:**

Foods that come from plants do not contain cholesterol. Foods that do not contain cholesterol include:

- Fruits
- Beans
- Grains
- Vegetables
- Rice
- Cereals



■ **Say:**

Plant foods that are prepared with an animal product (for example, flour tortillas made with lard) have cholesterol.

Fill up on fiber.

■ **Say:**

Plant foods are generally lower in saturated fat and cholesterol free. They also contain a type of dietary fiber (soluble) that is beneficial for lowering cholesterol.

■ **Show visual 5-9. Say:**

Soluble fiber is in foods such as oats, fruits, vegetables, and cooked dry beans and peas. So this gives you one more reason to eat a variety of fruits and vegetables. Fruits and vegetables that are a good source of soluble fiber are citrus fruits (oranges and grapefruit), pears, apples, peaches bananas, brussels sprouts, broccoli and carrots. For great sources of soluble fiber try to include a variety of cooked dry beans.



7. Food Label Activity

- **Give each group member** the "Read the Food Label for Saturated Fat, Trans Fat, and Cholesterol" and "Sally's Breakfast Choices" handouts (pages 244–247).



- **Point out** on the food label where to find saturated fat, trans fat, and cholesterol.

■ **Show visual 5-10. Say:**

For heart health, choose foods with a lower Percent DV for saturated fat and cholesterol. If you have high cholesterol, you may need to aim for a lower daily value for saturated fat and cholesterol. Try to keep trans fat as low as possible. A doctor or registered dietitian can help you with this.



■ **Show the group** where the Percent DV is found on the food label.

■ **Say:**

Look at the bottom of the handout. Look at the Percent DV for canned meat and lean sandwich meat. Which is lower in saturated fat?

■ **Answer:**

Lean sandwich meat is lower in saturated fat. Two ounces of lean sandwich meat has only 3 Percent of the DV of saturated fat. Two ounces of the canned lunch meat has 30 percent (over $\frac{1}{2}$) the DV of saturated fat.

■ **Say:**

Trans fat will soon be listed on the food label. It will be listed on a line below saturated fat as seen here. Compare labels to choose the food lowest in saturated fat, trans fat, and cholesterol.

■ **Say:**

Now look at "Sally's Breakfast Choices." We are going to practice choosing foods that are lower in saturated fat by using the food label. First, I am going to tell you about a problem for many busy people. Then we will use food labels to find some solutions.

Sally has little time in the morning to prepare breakfast. She often has a fry bread and a cup of coffee with $\frac{1}{4}$ cup of whole milk and 2 teaspoons of sugar. Look at the food labels. Help her select some breakfast foods that are lower in saturated fat and total fat than her choices.

Note: The correct answer is underlined.

- A fry bread or an oven bread?
- Coffee with whole milk or coffee with fat free milk?
- A doughnut or an English muffin?
- Fruit pastry or a bagel?
- Toast with butter or toast with light, soft margarine?
- Lowfat cheddar cheese or regular cheddar cheese?

■ Ask a volunteer to describe:

- What he or she usually eats for breakfast?
- Which foods are higher in fat?
- What lower fat foods can you choose to replace them?



Note: Write the answers on the blackboard or a large piece of paper taped to the wall. Help the volunteer select some substitutes, if needed.

8. Guess the Amount of Fat Activity



Before the session

1. Buy a can (or stick) of shortening. Also, buy three foods (or use pictures of them) from this list.
 - One beef hot dog
 - Two snack cakes (packaged cup cakes)
 - An ounce (about 15) fried tortilla chips
 - A cup of boiled beans (canned)
 - A cup of berries
 - Seven paper plates
2. Write the name of each food you bought on separate plates.
3. Label another plate "amount of fat per day."
4. Look at the chart on the next page. Find the amount of fat for each food you bought.



Note: You do not have to use all of the food in the chart on the next page. Choose the foods that are eaten most often in your community.

Foods	Teaspoons of Total Fat (Grams of Fat)
2 snack cakes (1 package)	About 4 ¹ / ₂ tsp (18g)
1 cup of berries	None
1 cup of boiled beans	About 1/2 teaspoon (1g)
1 beef hot dog (1.5 oz)	About 4 teaspoons (13g)
1 chocolate candy bar	About 3 ¹ / ₂ (14g)
2 tablespoon of mayonnaise	About 5 ¹ / ₂ teaspoons (22g)
Total amount of fat per day	No more than 5 ¹ / ₂ tablespoons (65g)

- Using the can of shortening, spoon the amount of fat listed in the chart onto the plate labeled for that food.
- Spoon out 5¹/₂ tablespoons of shortening. Place it on the plate labeled "amount of fat per day."
- Put all the plates away until you are ready to do the activity.
- Take the remaining plates and place each food item (or a picture of the foods) on the separate plates.

Group activity

■ **Say:**

We are going to play a guessing game that will help you learn about the total fat content of several foods. Learning about foods that are higher in fat and how to replace them with lower fat foods will help you make a healthier choice.

■ **Give each member** a "Guess the Fat Activity" sheet, page 248.

■ **Show the group members** the plates of foods (or pictures, food models) you prepared ahead of time.



■ **Say:**

Guess the number of teaspoons of fat that are found in one serving of each of these foods. Write your guess on the "Guess the Fat Activity Sheet" handout.

- **Ask the group members** to tell you the amount of fat they guessed for the first food item. After the members have shared the amount they guessed, **tell** them the actual number of teaspoons of fat each food contains. **Tell** them to write this amount on their activity sheet, too. **Bring out** the plate of fat you made ahead of time for that food to show them how much it is. Then do this for the other foods.

■ **Say:**

Children, teenage girls, active women, and men who do not get much physical activity should eat about 2,000 calories each day. No more than 30 percent (or about $\frac{1}{3}$) of your daily calories should come from fat. That is about $5\frac{1}{2}$ tablespoons of fat from all the food you eat during the day.

- **Show the group members** the plate labeled "amount of fat per day."

Say: The plates represent the most fat that people should eat each day. Compare the "amount of fat per day" with the amount of fat in these foods.

■ **Say:**

As you can see, it is easy to go over the limit for fat when we eat foods higher in fat like fried foods, some fast foods, hot dogs, chips, and ice cream. Eating foods lower in total fat, will also help you reduce your saturated fat, trans fat, and cholesterol intake. To make it easier to cut back on fat, eat more foods such as fruits, vegetables, whole grain cereals and breads, beans, and fat free or low-fat dairy products.

■ **Ask:**

How do you feel about the amount of fat in the foods you guessed and the true amounts?



Note: Give the group 3 to 5 minutes to talk about their reactions.

■ **Say:**

There are lower fat substitutes for some of the higher fat foods we often eat. Go over the list on the next page.

Foods	Lower Fat Substitutions
Chocolate bar	Granola or fruit and grain bar
Snack cake	Small bagel
Beef hot dog	Lowfat hot dog
Mayonnaise	Lowfat dressing or mustard

■ **Say:**

Also you can reduce the amount of fat that you eat by simply eating foods lower in fat less often or in smaller amounts.

9. Cooking With Less Saturated Fat Activity



Note: This section gives the group members information they need to cut back on the amount of saturated fat in their diets. This activity will help members understand that they can cut back on the fat in their diet without giving up their traditional foods.

■ **Ask:**

Before we do the next activity, can you tell me what you can do to cook with less fat?



Note: Give them about 3 minutes to answer. Write their answers on the blackboard or a large piece of paper taped to the wall.

■ **Say:**

The next activity shows how to prepare foods with less fat, saturated fat, trans fat, and cholesterol.

- **Give each group member** a copy of the "Cooking with Less Saturated Fat" on pages 249 and 250. Go over each of the dishes listed. Have volunteers read each recipe out loud.



- **Ask** why the recipes on the handout are lower in saturated fat. Alaska Native educators should substitute the Agutuk for beans.

(Correct Answers)

- The skin is taken off chicken and other birds, and fat is cut off beef and pork.
- Beans are naturally low in fat, and no fat (lard, shortening, or oil) is added.
- The potatoes are baked, not fried.
- The fat is drained from the cooked ground beef.
- The fat is sifted from the chilled soup and stew.
- The fruit shake is made with lowfat milk instead of whole milk.

Alaska substitution

- Agutuk is made with less shortening, sugar, and more berries.

10. Reduced Fat Chicken Chile (or Moose Stew) Recipe



- **Give the group members** a copy of the "Chicken Chile Stew" (or Moose Stew) recipe (page 251).



- **Ask:**

How has saturated fat been reduced in this recipe? Add any answers below that are not said.

- It is made with skinless chicken (or lean moose meat).
- No fat is added.
 - flavored with vegetables and seasonings instead of fat
 - cooked slowly in water (moist heat) instead of fat

- **Remind group members:**

Foods lower in fat still contain calories. Check the portion size. If you eat these foods in large quantities, you may gain weight.

- **Ask if there are any questions. Encourage** group members to try this recipe at home during this week.

Review of Today's Key Points

■ **Say to the group:** Let's review what we learned today.

Q: What may cause your arteries to become clogged?

A: Cholesterol buildup will clog the arteries.

Q: What is considered a desirable blood cholesterol level?

A: Less than 200 mg/dL.

Q: What steps can you take to keep your cholesterol level low?

- A:**
- Eat foods lower in saturated fat, trans fat, and cholesterol.
 - Maintain a healthy weight.
 - Stay physically active.
 - Eat a variety of whole grains, and fruits and vegetables.

Q: Can you name three foods that are high in saturated fat?

A: Lard, shortening, butter, fatty meat, poultry with skin, whole milk.

Q: What are some things that a person can do to make foods lower in fat?

- A:**
- Trim the fat from meat before cooking.
 - Take the skin off poultry.
 - Bake, boil, broil, or grill food instead of frying it.
 - Skim the fat off soups before serving.

Q: Can you name some foods that are high in soluble fiber?

- A:**
- Oats, fruits, vegetables, cooked dry beans, and peas.
 - Fruits and vegetables that are a good source of soluble fiber like citrus fruits (oranges and grapefruits), pears, apples, peaches, bananas, Brussels sprouts, broccoli, and carrots.

Weekly Pledge



■ Say:

Pledge to do one thing to lower your intake of saturated fat, trans fat, and cholesterol during this week.

You can write your pledge on the "Be Good to Your Heart. Know Your Cholesterol Numbers and Take Action!" handout.



Note: Tell the group members to give details about what they plan to do. If someone says they will use less oil in cooking, ask them to give you an example.

- I will take the skin off chicken and not eat it.
- I will eat fruit instead of chips for a snack.
- I will try fat free milk.

■ Say:

We will discuss results of your pledge during the next session. Remember to continue to work on your pledge to be physically active and to reduce sodium in your diet.

Closing

■ Say:

Thank you for coming today. What did you think of today's session? I am looking forward to seeing you at the next session. The next session will be about maintaining a healthy weight.



Note: Think about today's session. What worked and didn't work? Have you decided to make any changes in your own life, based on what was covered in today's session?

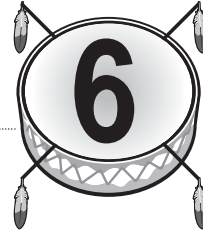

Maintain a Healthy Weight

Objectives

By the end of this session, group members will learn that:

- Being overweight is a risk factor for high blood cholesterol, high blood pressure, diabetes, and heart disease.
 - Healthy weights are given in ranges.
 - Losing weight or keeping a healthy weight means making lifelong changes.
 - Fad diets usually do not work and can be harmful.
-

Materials and Supplies

To conduct this session you will need:

- *Honoring the Gift of Heart Health* manual and CD of visuals
- Blackboard and chalk or several large pieces of paper, a marker, and tape
- Two bathroom scales
- A tape measure you can attach to the wall (to measure height)
- A cloth tape measure (to measure the waist)
- Food label (from a can or package)
- 10 serving dishes
- Four measuring cups

- Five spoons
 - One knife
 - Food:
 - A 16-ounce box of cereal
 - A 15-ounce can of fruit or vegetables
 - A block of cheddar cheese (about 1/2 pound)
 - Three cups cooked rice
 - A 15-ounce can of beans
-

Handouts

Give each group member these handouts during this session:

- "A Legacy of Good Health: A Story About Losing Weight" Role-Play (pages 252–253)
- "Protect Your Heart. Watch Your Weight." (pages 254–255)
- Sally's Habits and Her Weight (page 256)
- Tips To Help You Lose Weight (page 257)
- Serving Sizes (page 258)
- Read the Food Label for Calories (page 259)
- Sally's Snack Choices (pages 260–262)
- Zucchini Medley (or Green Bean Sauté) Recipe (page 263)

Session Outline

Introducing the Session

1. Welcome
2. Review of Last Week's Session
3. About This Session

Conducting the Session

1. Facts About Overweight and Obesity
2. *(Optional)* "A Legacy of Good Health: A Story About Losing Weight" Role-Play
3. Your Weight and Your Health
4. What Is a Healthy Weight?
5. The Healthy Way To Lose Weight
6. Beat Weight-Loss Barriers
7. How Much Is a Serving?
 - A. Serving Size Activity
 - B. Food Label for Calories Activity
8. Zucchini Medley (or Green Bean Sauté) Recipe

Review of Today's Key Points

Weekly Pledge

Closing

Introducing the Session

1. Welcome

- Welcome the group members to the session.

2. Review of Last Week's Session

■ Say:

Last week we talked about why it is important to cut back on saturated fat, trans fat, and cholesterol in our diet. Can you list three things you can do to make food lower in fat?



Note: Here are some possible answers:

- Trim the fat from meat before cooking.
- Take the skin off poultry before cooking.
- Bake, boil, broil, or barbecue food instead of frying it.

■ Ask:

At the end of the last session, you made a pledge to eat less saturated fat, trans fat, and cholesterol. What went well? Did you have any problems?

3. About This Session

■ Say:

Today we will discuss why keeping a healthy weight is important to heart health. You will learn how being overweight impacts health, how to assess your risk of being overweight, and healthy ways to maintain a healthy weight or lose weight if you are overweight.

When the session ends you will know that:

- Being overweight is a risk factor for high blood cholesterol, high blood pressure, diabetes, heart disease, and stroke.
- You can find out your risk for being overweight or obese the knowing your Body Mass Index (also known as BMI) and by measuring your waist circumference.
- To lose weight you can:
 - Cut down on the calories you eat.
 - Eat smaller portions.
 - Be physically active.
- Fad diets usually do not work and can be harmful to you.

Conducting the Session

1. Facts About Overweight and Obesity

- Overweight and obesity increase the risk of heart disease and stroke. Even losing 10 pounds can make a difference.
- Over one-half of all AI/AN women are overweight.
- About one of every three AI/AN men are overweight.
- About two of every five AI/AN children (ages 5 to 18) are overweight.

2. (Optional) "A Legacy of Good Health: A Story About Losing Weight" Role-Play



- If you choose, ask for three volunteers to be the actors for the role-play "A Legacy of Good Health: A Story About Losing Weight" on pages 252–253.
- Allow 5 to 10 minutes for open discussion by asking the following questions:
 - What are some of the lessons we learn from this role-play?
 - Is there any part of the play that you can use in your own life?

3. Your Weight and Your Health Activity



- **Say:**
Being overweight increases your risk of heart disease and stroke. It can also raise your chances of developing high blood cholesterol, high blood pressure, and diabetes. These also lead to heart disease.
- **Say:**
Besides heart disease, overweight can make other health problems worse, such as arthritis and sleep disorders. It also increases your risk of developing prostate, breast, and colon cancer.
- **Say:**
Even losing a small amount of weight can improve many health problems that come with being overweight. The reason we are talking about weight is that having a healthy weight is important to our communities, our families, and ourselves.

4. What Is A Healthy Weight?



 **Note:** Before this activity begins, place the scale where the group members can weigh themselves in private.

- **Give each group member** a copy of the "Protect Your Heart. Watch Your Weight." handouts (pages 254–255).



■ **Show visual 6-1. Say:**

Look at the handout about Will and Sally. Together, we are going to find if Will and Sally are at a healthy weight by using a number called the BMI.



■ **Say:**

The BMI is a measure of your weight relative to your height. This information (along with your waist measurement) can help you find your risk for developing conditions such as heart disease, stroke, and diabetes that are related to being overweight or obese.

More Information

BMI is related to a person's body fat.
The BMI number is not the same as a body fat percentage.

■ **Say:**

Will weighs 170 pounds, and he is 5 feet and 6 inches tall (1.68 meters). His wife, Sally, weighs 120 pounds, and she is 5 feet (1.52 meters) tall. Let's look at the BMI on your handout to find out if Will and Sally have a healthy weight. Use the color-coded legend to see if they are at a healthy weight, overweight, or obese category.

Answer: Will's BMI is 27, so he is overweight. Sally's BMI is 20; she has a healthy weight.

■ **Say:**

Now let's find out how much we weigh and look at the chart to find our BMI. If you do not know what you weigh, use the scales to get an approximate weight. Scales made for home use are usually not as accurate as the scales in the doctor's office. Clothing weighs about 2–3 pounds. If you do not know your height, use the wall measure.

■ **Help the group members** find their BMI using the chart. They do not need to share their results with others.

■ **Say:**

A healthy weight ranges from a BMI of 18.5–24.9. If you are in the healthy weight range, try not to gain any weight, even if the extra weight still keeps you in the healthy range.

- If you are in the overweight range, you need to consider whether you have a high waist circumference or other risk factors.

- **Show visual 6-2. Have group members** measure their waist using the cloth tape.



- **Say:**

A waist measurement of more than 35 inches for women and more than 40 inches for men is high. A high measurement increases your risk for heart disease. Think back to Session 1. How many risk factors for heart disease did you have?



Note: Use the Risk Factor Review box to remind group members of these risk factors.

Risk Factors Review

Heart disease risk factors you cannot change:

- Age (45 or older for men; 55 or older for women)
- Family history of heart disease

Risk factors you can do something about include:

- High blood pressure
- High blood cholesterol
- Cigarette smoking
- Diabetes
- Overweight
- Physical inactivity

- **Say:**

Look at the section "What Does Your BMI mean?" at the bottom of the "Protect Your Heart" handout. Let's review the information on the handout. Remember that this BMI chart is for adults.

WHAT DOES YOUR BMI MEAN?

Healthy Weight	Good for you! Try not to gain any weight.
Overweight	Try not to gain any weight. You need to lose weight if you have two or more risk factors and: <ul style="list-style-type: none">• are overweight, or• have a high waist measurement Ask your doctor or nutritionist for help.
Obese	You need to lose weight. Lose weight slowly—about 1 to 2 pounds a week. Ask your doctor or registered dietitian (RD) for help.

5. The Healthy Way To Lose Weight

■ **Say:**

We will talk about the healthy way to lose weight.

■ **Say:**

The measure of energy that the body gets from food is called calories. People gain weight when they eat more calories than their body uses for energy.

■ **Say:**

If you need to lose weight, you must choose foods with fewer calories or become more physically active. It's best to do both.

■ **Say:**

To lose 1 pound, you must burn 3,500 calories more than you eat. The number of calories that you burn depends on how active you are and your size.

■ **Say:**

Later in today's session, we will learn how to use food labels to cut back on calories. When cutting calories, it is important to eat a variety of foods from all of the food groups to be sure you get the vitamins and minerals you need. At the next session, we will talk about how to eat in a heart healthy way.

■ **Say:**

A pregnant woman should not try to lose weight unless her doctor tells her to do so.

- **Give the group members** the handout "Sally's Habits and Her Weight" on page 256. This handout is about how adding small amounts of daily activity can lead to weight loss over time.



- **Ask** volunteers to read each scene.

■ **Show visual 6-3. Say:**

Like Sally in scene three, if you eat smaller portions; eat a variety of lower fat, lower calorie foods; and increase your activity level, you can lose weight in a healthy way.



■ **Say:**

Most people, who lose weight and keep it off, lose the weight slowly. They learn to make lasting changes. You should try to lose 1 to 2 pounds each week until you reach a healthy weight.

- **Give each group member** a copy of the "Tips To Help You Lose Weight" on page 257. **Review** the tips for losing weight.



6. Beat Weight-Loss Barriers

■ **Ask:**

Have any of you ever tried to lose weight? Ask people to share their experience with the group. Ask them to tell what kept them motivated to lose weight.

■ **Ask:**

Why do you think it is difficult for some people to lose weight or keep off the weight they lose?



Note: Write their answers on the blackboard or on a large piece of paper taped to the wall.

Possible answers. Some people have a hard time losing weight because:

- They lack support from family members or friends.
- They do not know how to cook without fat or use a recipe.

- They believe that healthy foods are too expensive.
- People on commodities are unfamiliar with healthier ways to prepare these foods.
- Fruits and vegetables cost more than junk food at the local store.
- The neighborhood is dangerous for walkers due to unleashed dogs and no sidewalks.
- Working parents are often short on time and energy.
- Family and friends may make it hard for them to lose weight because they encourage them to go to places that focus on food.
- Their family may refuse to eat lower fat, lower calorie foods. It is hard for them to cook two separate meals.
- Change is difficult and takes time and effort.

■ **Ask:**

Have you found ways to solve these or other barriers?



Note: Give the members 3 to 5 minutes to answer. Write their answers on the blackboard or a piece of large paper taped to the wall.

Possible answers:

- Find another person who also wants to lose weight. You can talk to this person to stay motivated.
- Walk or plan other activities with another person. This makes it more fun and the time will pass quickly.
- Find activities that the whole family can enjoy to help others control their weight, too.
- Seek heart healthy recipes from the commodity food distributors.
- Look for free or low cost fitness facilities at local community centers or parks and recreation.

- Share cooking chores with a friend. (For example, if family members will not eat lower calorie dishes, make a dish and share it with a friend. Your friend can make a dish and share it with you.)
- Ask your doctor or an RD to help you develop a plan if you have a lot of weight to lose.

■ **Show visual 6-4. Say:**

Losing weight has become a moneymaking business. You hear about miracle diets that claim to help you lose weight fast and easily. These products make only one thing lighter—and that’s your pocketbook. Be careful about diets and exercise products that use personal testimonies in their ads.



■ **Say:**

Diets that promise quick weight loss rarely work over time. Many of these diets include only a few foods. People get bored with them quickly. These diets do not give you all the nutrients and energy your body needs. They are not healthy.

Before the session:

1. Buy or prepare the foods listed on page 102.
2. Prepare 3 cups of cooked rice.

When setting up for the session:

1. Check the “Serving Sizes” handout on page 258 for serving size of each food. Measure one serving of each food and put each in a separate dish or other container.
2. Place the dishes with these premeasured foods out of sight.
3. Place the box of dry cereal, a large bowl of cooked rice, a can of fruit or vegetables, a block of cheddar cheese, and a can of beans on a table with five dishes, four serving spoons, and a knife.

7. How Much Is a Serving?

■ Show visual 6-5. Say:

A key to choosing a healthy diet and losing weight is to know what to eat and how much. Let's look at how big a serving is according to the Food Guide Pyramid. In the next session, we will look at how much you should eat.



A. Serving Size Activity

■ Ask five volunteers to come to the table. Ask each volunteer to do one of the following:

1. Spoon out a serving of cereal and put it into a dish.
2. Spoon out a serving of cooked rice and put it into a dish.
3. Cut a serving of cheese and put it on a dish.
4. Spoon out a serving of the canned fruit or vegetable and put it into a dish.
5. Spoon out a serving of beans and put it into a dish.

■ Bring out the foods you measured before the session.

Compare the volunteers' serving sizes with the true amounts.

■ Give each group member a copy of the "Serving Sizes" handout found on page 258. Ask volunteers to read aloud the serving sizes for each. Tell them to keep this handout and use it at home.



B. Food Label for Calories Activity



Note: This activity will help group members choose foods that are lower in calories.

■ Say:

We have learned that to lose weight, a person must eat fewer calories than the body burns for energy. In the last session, you learned how to use the food label to choose foods that are lower in total fat, saturated fat, and cholesterol. Today, we are going to learn how to use the food label to choose foods that are lower in calories.

- **Give each member** a copy of the "Read the Food Label for Calories" handout (page 259).



- **Show visual 6-6. Say:**

Here's where you can look to find the number of calories in one serving on the food label. Look at the bottom of the handout. Look at the Percent DV for a can of regular soda and diet soda. Which soda has less calories?



Answer: Diet soda has no calories. Regular soda has 140 calories and 39 grams of sugar. Regular soda adds a lot of extra calories, mostly from sugar, to meals.

■ Say:

Let's try another group activity. I will tell you about a common problem for families today. Then we will learn how to use food labels to help solve the problem.

- **Give each group member** a copy of "Sally's Snack Choices" (pages 260–262). **Read** Sally's problem on page 115 and the questions at the end. Alaska Native Educators should substitute the powdered drink and candy bar for the milk and peaches. Alaska substitutions are below.



Note: The correct answers to the questions are underlined. The number of calories saved by making the right choice is given below the choices.

Sally's Problem

Sally and her family like to have snacks when they watch television. Recently she has noticed that her family has gained a little too much weight. Use the food labels to choose some tasty snacks that are lower in calories. What should Sally serve? Mark the number of your choice for each pair on the right. Then mark the number of calories saved by this choice. Correct answers are underlined, and calories saved are listed below.

Potato chips (1 oz/12 chips) or air-popped popcorn (1 cup)?

Choosing popcorn saves 130 calories.

Berries (1 cup) or chocolate chip cookies (3 cookies)?

Choosing strawberries saves 117 calories.

One cup of whole milk or fat free milk?

Choosing the fat free milk saves 60 calories.

Ice cream (1/2 cup) or a popsicle (1 popsicle)?

Choosing the popsicle saves 125 calories.

A 1/2 cup of peaches canned in fruit juice or peaches canned in syrup?

Choosing the peaches canned in fruit juice saves 50 calories.

A tablespoon of mayonnaise or fat free mayonnaise?

Choosing the fat free mayonnaise saves 90 calories.

Alaska Food Label Substitutions:

A cup of orange drink (made from a powdered mix) or a cup of a sugar free drink?

Choosing the sugar free drink saves 95 calories.

Chocolate candy bar or fruit and grain bar?

Choosing the fruit and grain bar saves 140 calories.

■ Ask:

1. What is one example of a snack that is higher in calories that your family eats?
2. What is one example of a snack that is lower in calories that your family would enjoy?

8. Zucchini Medley (or Green Bean Sauté) Recipe



- Give each group member a copy of the "Zucchini Medley (or Green Bean Sauté)" recipe on page 263.

- Say:

This dish is easy to make. It has only 52 calories and 1 gram of fat per serving. It is also low in sodium. Try this recipe at home during the upcoming week.



Review of Today's Key Points

- Say to the group:

Let's review what we learned today.

Q: Why is it important to maintain a healthy weight?

A: Being overweight may increase your risk of heart disease, high blood pressure, high blood cholesterol, and some forms of cancer and diabetes.

Q: What is the healthiest way to lose weight?

A: Eat smaller portions of a variety of lower fat, lower calorie foods, and increase your physical activity.

Q: How can the food label help you if you need to lose weight?

A: The food label tells you the serving size and the number of calories per serving. You can compare calories on different packages to choose the ones that are lower in calories.

Weekly Pledge



■ **Say:**

Pledge one thing you will do to help achieve or maintain a healthy weight. You can write this pledge on the "Protect Your Heart. Watch Your Weight." worksheet.



Note: Tell the group members to be very specific about what they plan to do. (For example, if they say they will eat fewer calories, ask them to name some ways they can do this.)

■ **Say:**

We will discuss the results of your pledges during the next session.

■ **Say:**

Don't forget to continue to work on your pledges to cut back on saturated fat, cholesterol, and sodium in your diet and do more physical activity.

Closing

■ **Say:**

Thank you for coming today. What did you think of today's session? I am looking forward to seeing you again at the next session. The next session will be about how to make heart healthy eating a family affair.



Note: Think about today's session. What worked and didn't work? Have you decided to make any changes in your own life, based on what was covered in today's session?



Make Heart Healthy Eating a Family Affair

Objectives

By the end of this session, the group members will learn:

- How to plan and prepare traditional American Indian (or Alaskan) meals in a heart healthy way.
- How to choose foods for a heart healthy diet using the American Indian (or Alaskan) Food Guide Pyramid.

Materials and Supplies

To conduct this session you will need:

- *Honoring the Gift of Heart Health* manual and CD of visuals
- Set of measuring cups (1 cup, 1/2 cup, 1/4 cup)
- Blackboard and chalk or several large pieces of paper, a marker, and tape

Handouts

Give each group member these handouts during this session:

- Choose a Variety of Heart Healthy Foods (page 264)
- The American Indian (or Alaska Native) Food Guide Pyramid (page 265)

- Using the Food Guide Pyramid: What Counts as a Serving? (page 266)
 - Indian Corn Casserole (or Ground Caribou Soup) Recipe (page 267)
-

Session Outline

Introducing the Session

1. Welcome
2. Review of Last Week's Session
3. About This Session

Conducting the Session

1. Eat a Variety of Heart Healthy Foods
2. The American Indian (or Alaskan) Diet
3. The American Indian (or Alaskan) Food Guide Pyramid
4. Let's Make a Meal: Eat In a Heart Healthy Way With the American Indian (or Alaskan) Food Guide Pyramid
5. Indian Corn Casserole (or Ground Caribou Soup) Recipe

Weekly Pledge

Review of Today's Key Points

Closing

Introducing the Session

1. Welcome

- Welcome the group members to the session.

2. Review of Last Week's Session

- **Say:**

At the last session we talked about aiming for a healthy weight.

- **Ask these questions:**

Q: Does anyone remember why a healthy weight is important to your heart health?

A: Being at a healthy weight reduces your risk of heart disease, stroke, high blood pressure, high blood cholesterol, diabetes, and some cancers.

Q: What is the healthiest way to lose weight?

A: The healthiest way to lose weight is to eat smaller portions of a variety of lower fat and lower calorie foods. Aim for at least 30 minutes of physical activity on all or most days of the week.

Q: How does the food label help people who are trying to lose weight?

A: The food label tells you the serving size and the number of calories in a serving.

- **Say:**

At the end of last session, you made a pledge to do something to help you keep or reach a healthy weight. What went well? How did you deal with any problem?

3. About This Session

■ **Say:**

What you choose to eat can make a difference in your heart health. During the session you will learn to:

- Choose a variety of foods for heart health.
- Identify the number of servings you should eat from each food group.
- Identify serving sizes and the number of recommended servings for each food group.

Conducting the Session

1. Eat a Variety of Heart Healthy Foods

■ **Ask:**

Why is it important to eat a variety of heart healthy foods?



Note: Give them about 5 minutes to answer. Write their answers on a blackboard or a large piece of paper taped to the wall. Add the answers below if the group members do not say them.

- Eat a variety of foods that are lower in saturated fat, trans fat, cholesterol, salt and sodium, and calories to help you have a healthy heart.
- No one food can give all the nutrients in the amounts your body needs.

More Information

Nutrients in the foods we eat include:

Carbohydrates

Protein

Fats

Vitamins

Minerals

- **Give each group member** a copy of "Choose a Variety of Heart Healthy Foods" (page 264) handout.



- **Ask:**
What are heart healthy foods in the breads, cereal, and grains group?

Possible answers: Whole wheat grains, lowfat crackers, corn tortillas, plain popcorn, (or pilot bread or baked potato for Alaska Natives), etc.

- **Ask:**
What are heart healthy foods in the meat group?

Possible answers: Salmon (and other fish), buffalo, clams, lean cuts of beef or pork and fish, chicken or turkey without the skin.

- **Briefly discuss** heart healthy choices from each food group on the "Choose a Variety of Heart Healthy Foods" handout.

2. The American Indian (or Alaskan) Diet

 **Note:** This session will get group members to think about the foods they eat. Some of their favorite native (or traditional Alaskan) foods are very nutritious. Other dishes can be modified to be prepared in more heart healthy ways.

- **Ask:**
What are some healthful foods that your grandparents or elders in your tribe enjoyed eating? (Or, What are some traditional Alaskan foods?)

 **Note:** Give the group members about 5 minutes to answer. Write their answers on a blackboard or a large piece of paper taped to the wall.

- **Say:**
Native (or Alaskan) foods are nutritious for you and your family. Here are a few ideas.

Native foods:

- Oven bread, tortillas
- Grains such as wild rice, oats, and cornmeal
- Vegetables such as sprouts, greens, rhubarb, camas root, white carrot, corn, seaweed, and celery
- Fruits such as juneberries, huckleberries, apples, and chokecherries
- Meat (deer or duck), fish (salmon), beans, and nuts (acorns)
- Calcium sources such as goat's milk and fish head soup

Alaskan foods:

- Pilot bread
- Fruit such as salmonberries, cranberries, crowberries, blueberries, apples, and cherries
- Vegetables such as wild greens, celery, beach asparagus, and fiddlehead fern
- Fish, game, and birds such as seal, herring, pike, salmon, whale, caribou, beaver, ptarmigan, ducks, and geese
- Calcium sources such as goat's milk and bone soup

■ Say:

Our ancestors lived in balance and harmony with the world around them. The food they ate reflected that balance. They hunted for elk, deer, bison (or moose and caribou in Alaska) and other game in the forests and dipped for salmon from the rivers. In the spring they harvested the first shoots and greens and dug nutritious roots. Summer brought sweet berries to eat and dry. In the fall, acorns, corn, and wild oats were gathered.

The people celebrated each food at the beginning of its season with a special feast. Food was shared, so no one had too little or too much. People ate many different kinds of foods. This variety provided all the nutrients to be healthy.

You can apply the same principles for a heart healthy diet today.

■ **Say:**

Some American Indians (or Alaskans) have adopted cooking and eating habits that can lead to health problems such as heart disease. What are some examples of these habits?



Note: Give the volunteers about 3 minutes to answer. Add these habits if they do not say them.

- Cooking foods with too much saturated fat like lard, shortening, and butter.
- In Alaska, cooking with beef and pork instead of lean game meat.
- Eating fried foods often, like french fries, chips, refried beans, fried chicken and fish, and fry bread.
- Eating higher saturated fat foods such as fatty meats (or chicken with the skin, hot dogs, and fatty canned meats in Alaska), high fat cheeses, sauces, milk, chips, and doughnuts.
- Eating high calorie foods such as regular soft drinks, candy, ice cream, and chocolate (or powdered juice mixes and punch-type drinks in Alaska).
- Eating fewer fruits, vegetables, corn tortillas, beans, and lean meats (or lean game meats in Alaska).

3. The American Indian (or Alaskan) Food Guide Pyramid

■ **Say:**

We can take steps to improve the way we eat and still enjoy our traditional foods. The first step is to learn which foods we should eat more often. The second step is to learn the amount of these foods that we should eat each day.

- **Show visual 7-1.** (Keep it in view throughout this activity.) **Say:** The American Indian (or Alaskan) Food Guide Pyramid is a helpful tool. It shows both the types and amounts of foods we can choose for better heart health.



- **Give each group member** a copy of the "American Indian Food Guide Pyramid" or "Alaskan Food Guide Pyramid" (page 265) and the "Using the Food Guide Pyramid: What Counts As a Serving" (page 266) handouts. Review the food groups, the number of servings, and the types of foods in each food group. **Point to** each food group on visual 7-1 (picture of food guide pyramid) as you talk about it.



- **Ask these questions:** (Hold up the right measuring cup for each answer.)

Q: What is one serving of a cooked vegetable?

A: $\frac{1}{2}$ cup

Q: How much milk or yogurt is considered one serving?

A: 1 cup

Q: Can you give an example of one serving from the largest group found on the American Indian (or Alaskan) Food Guide Pyramid?

A: The largest group is the grains group (breads, cereals, rice, and pasta). One slice of bread, 1 ounce (about 1 cup) of cereal, or $\frac{1}{2}$ cup of rice or pasta is a serving.

Explain: 6 to 11 servings are recommended each day. This may seem like a lot, but it adds up quickly if you count your servings.

Q: What makes up a fruit serving?

A: One medium apple, banana, or orange; or $\frac{1}{2}$ cup of raw or canned fruit; or $\frac{3}{4}$ cup of fruit juice.

- **Ask:**

How can fruits and vegetables become a part of your meals?

- **Show** a tray with two fruits and three vegetables (pictures or food models could be used). Display three plates labeled breakfast, lunch, and dinner. Label a small plate that is labeled snack.

■ **Ask:**

A volunteer to place the foods on the plates suggested by the group.

■ **After the volunteer is finished** placing the foods in meals,

say: Great Job! It is easier than you think to include fruits and vegetables into your meals.

■ **Show visual 7-1.** Point to each food group as you talk about it.

Say:



- Eat more servings of the foods toward the bottom of the pyramid. Use them as the base of your meals. Breads, cereal, rice, pasta, fruits, and vegetables are lower in saturated fat, trans fat, and cholesterol.
- Eat fewer servings of foods toward the top of the pyramid. Choose lowfat or fat free varieties such as fat free milk or lowfat (1 percent) milk; lowfat or fat free yogurt and cheeses; lean cuts of meat, fish, poultry without the skin, dry beans, eggs, and nuts.
- Egg yolks are high in cholesterol. Egg whites have no cholesterol. Eat no more than four egg yolks a week. Use egg whites or egg substitute for cooking or baking. For example, two egg whites equal one whole egg.
- Use fats only in small amounts. Eat fewer sweets. Foods in this group are higher in fat, saturated fat, and calories. Try lowfat and fat free salad dressings and mayonnaise.
- When our grandparents were young, sugar, fat, and salt were only available in small amounts or not available at all. Honey and natural maple syrup were a special treat. Food was eaten fresh or baked, roasted, boiled, or dried. This made them lower in fat.
- Today convenience foods that are high in calories, saturated fat, and sodium are easy to buy and prepare. Often, families on a tight schedule eat more of these foods than are healthy. Foods in the fats and sweets section of the pyramid (or tepee) are high in fat, sugar, or salt. Eat them only in very small amounts.

4. Let's Make a Meal: Eat in a Heart Healthy Way With the American Indian (or Alaskan) Food Guide Pyramid



■ Say:

We are going to play a game: Let's Make a Meal. The purpose of this activity is to learn how to use the American Indian (or Alaskan) Food Guide Pyramid to plan heart healthy meals.



Note: Write Sally's breakfast on the blackboard or on a large sheet of paper taped to the wall. Fill in the *breakfast* and *portion size*. Leave the *food group* and *better choices* column blank. (Optional) Repeat the game with lunch and dinner meals.

BREAKFAST			
Sally's Breakfast	Food Group	Portion Size	Better Choices
Fried egg	Meats and beans	1 egg	Boiled or poached egg, 1/2 cup egg substitute, or 2 egg whites. Scramble eggs with nonfat cooking spray instead of using fat.
Piece of canned pork meat (or bacon)	Meats and beans	3 ounces (or 3 strips)	Turkey ham (or turkey bacon) or a slice of lean turkey.
White toast	Grains	1 slice	Whole wheat toast
Butter	Fats, oils, and sweets	1 teaspoon	One teaspoon of lowfat, tub margarine, or jelly (or jam) with no added sugar.
Orange juice	Fruit	3/4 cup	This is an excellent choice! Make sure it is 100 percent fruit juice.
Coffee with whole milk (or 1 tbsp of evaporated milk)	Milk	1 cup (coffee) 1 Tbsp (milk)	Coffee with fat free milk (or 1 tbsp of evaporated fat free milk).

■ **Ask:**

To what food group does each food belong? What changes would make Sally's breakfast more heart healthy? Write the suggestions on the board or on the paper beside the foods they are replacing.

■ *(Optional Meals: Lunch and Dinner)*

LUNCH			
Sally's Lunch	Food Group	Portion Size	Better Choices
Large cheeseburger with mayonnaise	Meat and beans; grains; milk; vegetable; fats, oils and sweets.	1 large cheeseburger	Small hamburger with no cheese or mayonnaise, grilled chicken sandwich.
Super size French fries	Grain; fats, oils, and sweets.	1 larger serving of fries	Small order of fries or a side salad.
Large soda	Fats, oils, and sweets.	Fats, oils, and sweets	Water, diet soda, fat free milk, or small juice.

DINNER			
Sally's Dinner	Food Group	Portion Size	Better Choices
Fried chicken	Meats and beans; fats, oils, and sweets.	1 thigh piece	Baked chicken or chicken stir fry
Mashed potatoes (made with butter and cream) with gravy	Grains; fats, oils, and sweets.	1/2 cup	Prepare potatoes with fat free milk and low sodium chicken broth. Refrigerate the gravy ahead of time and skim off the fat.
Garlic bread with butter and cheese	Grains, fats, oils, and sweets; milk	1 slice	Prepare bread with lowfat tub margarine and lowfat cheese.
Whole milk	Milk group	1 cup	Fat free or lowfat milk.
Chocolate cake with icing	Fats, oils, and sweets group	1 piece	Fresh fruit cup or lowfat frozen yogurt.

■ **Ask:**

What are some ways to eat less saturated fat, cholesterol, sodium, and calories?
Add any of these reasons if they are not said:

- Choose a variety of whole grains, fruits, and vegetables, which are at the base of the food guide pyramid.
- Cut back on fats, oils, and sweets.
- Cook with lowfat methods such as baking, broiling, or boiling (without added fat), rather than frying.
- Choose lowfat or fat free dairy products, salad dressings, and mayonnaise.
- Choose lean cuts of meat. Trim away extra fat.
- Remove skin from poultry and do not eat it.
- Reduce the amount of high calorie foods without much added nutrition value such as soda pop, luncheon meats, pies, cakes, cookies, chips, and high fat crackers.
- Use food labels to choose foods lower in saturated fat, trans fat, cholesterol, sodium, and calories.
- Eat moderate portion sizes.

■ **Say:**

Put the pyramid on your refrigerator to help you eat in a heart healthy way.

■ **Say:**

Thanks for participating in Let's Make a Meal! You did great! Now you can make healthier choices for you and your family.

5. Indian Corn Casserole (or Ground Caribou Soup) Recipe



Note: This activity will give group members a chance to try a heart healthy recipe at home.

- **Give group members** a copy of the "Indian Corn Casserole" or "Ground Caribou Soup" recipe found on page 267.



- **Say:**

This dish contains beans and a variety of vegetables. It also is seasoned with lots of herbs and spices and just a little salt. Try to prepare it at home this week.

Review of Today's Key Points

- **Say to the group:**

Let's review what we learned today.

- **Ask:**

Q: What is heart healthy about native foods (or the traditional Alaskan diet)?

A: Many native foods provide a variety of foods that are lower in fat and sodium like oven bread, corn tortillas, beans, rice, root and leaf vegetables, berries, buffalo, venison, elk, and seafood. (Or, the traditional Alaskan diet provides a variety of foods that are lower in fat and sodium like lean game meats, fish, wild greens, and berries.)

Q: What are some foods everyone should eat less of?

- A:**
- Higher fat foods such as french fries and other fried foods, fatty meats, high fat cheeses, sauces, and milk (or canned meats and chips).
 - Salty foods like potato chips; canned meats, soups and vegetables; and sauces such as soy sauce, Worcestershire, and ketchup.
 - High fat and high sugar foods like pastries, donuts, cookies, and chocolate bars.

- High calorie and high sugar foods like candy, soda and sugary powdered drinks.

Q: How can the American Indian (or Alaskan) Food Guide Pyramid be used to plan heart healthy meals?

A: Use the American Indian (or Alaskan) Food Guide Pyramid to choose foods that are lower in fat, saturated fat, cholesterol, and sodium from each of the five major food groups. The Pyramid also gives the number of servings that you need from each group, each day.

Q: Why is it helpful to know the number of servings you should eat from each major food group?

A: It helps you know the amount of food you need to eat every day. It helps to control the amount of calories you eat.

Weekly Pledge

■ **Say:**

Pledge one thing that you will do to eat a greater variety of heart healthy foods this week. Tell group members your own pledge.



Note: Ask the group members to tell in detail what they plan to do. For example, if members say that they are going to eat more vegetables or fruit, ask them to tell you how they plan to do this. Think about these examples:

- I will take carrot and celery sticks as a snack to eat at work.
- I will add berries or bananas to my cereal.

■ **Say:**

We will talk about the results of your pledge at the next session. Don't forget to work on your pledges to do more physical activity; cut back on saturated fat, cholesterol, and sodium in your diet; and keep a healthy weight.

Closing

■ **Say:**

Thank you for coming today. What did you think of today's session? I am looking forward to seeing you again at the next session. The next session will be about eating in a heart healthy way—even when time or money is tight.



Note: Think about today's session. What worked and didn't work? Have you decided to make any changes in your own life, based on what was covered in today's session?

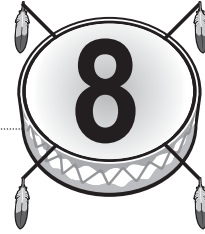

Eat in a Heart Healthy Way— Even When Time or Money Is Tight

Objectives

By the end of this session, the group members will learn:

- Quick and easy food preparation and mealtime tips.
 - How to eat out in a heart healthy way.
 - How to save money on their food bill.
-

Materials and Supplies

To conduct this session you will need:

- *Honoring the Gift of Heart Health* manual and CD of visuals
- (Optional) Examples of advertisements from magazines
- Blackboard and chalk or several large pieces of paper, markers, and tape
- Pencils

Handouts

Give each group member these handouts during this session:

- Tips for Busy Families (page 268)
- Ann’s Dilemma: A Real-Life Story (page 269)
- Tips for Eating Out the Heart Healthy Way (page 270)
 - For Alaska:
Be Heart Healthy and Save Money by Living Off the Land (page 270)
- Money-Saving Tips (page 271)
- Shopping List (page 272)
 - For Alaska: 5-a-Day the Alaskan Way (page 272)
- Quick Beef Casserole Recipe (page 273)

Session Outline

Introducing the Session

1. Welcome
2. Review of Last Week’s Session
3. About This Session

Conducting the Session

1. Eat in a Heart Healthy Way When There Is Little Time
 - A. Busy Times
 - B. Quick and Easy Meal Tips
 - C. Eating Out

2. Save Money on Your Food Bill
 - A. Money-Saving Tips
 - B. Food Advertising
 - C. Quick Beef Casserole Recipe

Review of Today's Key Points

Weekly Pledge

Closing

Introducing the Session

1. Welcome

- Welcome the group members to the session.

2. Review of Last Week's Session

- **Ask:**

How are you doing on the pledges to include a variety of heart healthy foods in your diet? What went well? What kind of problems did you have (like family not liking the change or lack of interest)? What did you do to solve these problems?



Note: Give the group members about 4 minutes for their comments.

3. About This Session

- **Say:**

Today you will learn how to eat in a heart healthy way—even when you have very little time and are on a tight budget. During this session you will learn:

- Quick and easy ways to fix heart healthy meals.
- How to eat right when eating out.
- How to make smart food-buying choices that meet your family's needs and budget.
- How advertising can change our buying habits to things that cost more or that we don't need.

Conducting the Session

1. Eat in a Heart Healthy Way When There Is Little Time

A. Busy Times



Note: Many people have little time to shop, prepare food, and clean up after meals. This session will help group members eat in a heart healthy way, even when they are in a rush.

■ Say:

Many people are very busy and think they don't have time to eat in a heart healthy way. These people may:

- Skip breakfast and lunch and eat one big meal in the evening.
- Eat out several times per week.
- Buy boxed or instant foods or foods that are already prepared.
- Buy food from vending machines.

■ Ask:

What foods do you eat when you don't have time to cook?



Note: Give the group about 5 minutes to answer. Write their answers on the blackboard or a large piece of paper taped to the wall.

■ Say:

Eating on the run often means that we are eating foods that are higher in fat, sodium, and calories. For example, we eat snacks and candies from a vending machine or high fat meals at a restaurant.

■ **Say:**

People often eat these foods because they are easy to buy or quick to fix. When people are in a hurry, they don't often think about what food is heart healthy. These foods can be higher in fat, sodium, and calories.

■ **Say:**

They may also eat bigger portions of foods that are higher in fat and calories when there is no time to prepare side dishes like salad, vegetables, or rice.

B. Quick and Easy Meal Tips



Note: This part of the session will help members to think about ways to fix meals in less time.

■ **Say:**

People often find that they are too tired to fix the kinds of meals they would like their families to eat. We need to learn some shortcuts.

- **Give each group member** a copy of the "Tips for Busy Families" handout on page 268.



Note: Show **visual 8-1** while you review the "Plan Your Meals" and "Use a Shopping List" sections. Show **visual 8-2** when you review the "Cook in Advance." Ask volunteers to read the tips out loud, one at a time. Let members comment as the tips are read.



■ **Ask:**

Would you find any of these tips difficult to do?



Note: Give the group members 3 to 5 minutes to answer.

Group Activity



Note: This group activity will help group members think about creative ways a family can enjoy heart healthy meals when time is limited.

- **Divide the group members** into smaller groups with about three to four people in each group. **Distribute** the "Ann's Dilemma: A Real-Life Story" handout on page 269.



- **Say:**

I am going to read a real-life situation. Follow the story on the handout. Think about ways Ann can solve her problem.

- **Ask each small group** to discuss ways that Ann can make sure that her family eats in a heart healthy way.



Note: Give the group about five minutes to come up with their suggestions.

Ann's Dilemma

Ann is married and has two sons, ages 7 and 10. Her husband, Paul, works for the tribal council Monday through Friday. He leaves for work at 8:00 a.m. and gets home at 5:30 p.m. Ann also works Monday through Friday at the school. She leaves home at 10:00 a.m. and gets home around 6:00 p.m.

She prepares the family's dinner after she comes home from work every night. Many times, she is too tired to cook, so she often picks up a pepperoni pizza, burgers and fries, or fried chicken on her way home.

Ann sees that the whole family is gaining weight. Paul wants her to make traditional American Indian dinners. Ann tries to get her husband to help her with dinner, but he is also very tired. Besides, he thinks that cooking is the woman's job.

Ann's Dilemma (Alaska version)

Ann is married and has two sons, ages 7 and 10. Her husband Paul works for a fishery Monday through Friday. He leaves for work at 8:00 a.m. and gets home at 5:30 p.m. Ann also works Monday through Friday at the school. She leaves home at 10:00 a.m. and gets home around 6:00 p.m.

She prepares the family's dinner after she comes home from work every night. Many times, she is too tired to cook, so they often eat packaged foods that are high in saturated fat and sodium.

Ann sees that the whole family is gaining weight. Paul wants her to make traditional Alaska Native dinners. Ann tries to get her husband to help her with dinner, but he is also very tired. Besides, he thinks that cooking is the woman's job.

■ Ask one person from each group

to present their group's suggestions to the others.

Add these ideas if they are not said:

- Ann could cook two or three meals over the weekend and store them in the freezer.
- She could make crock-pot meals, which don't require as much time. They slowly cook during the day and are ready when the family gets home.
- Her family could help her by putting casseroles, from the freezer or prepared the night before, into the oven.
- Several families could get together and share meals.
- Her family could help her by setting the table and doing the dishes.
- Ann can buy roasted chicken instead of fried chicken or burgers and fries, or she could buy a vegetarian pizza and a salad instead of a meat pizza more often.

C. Eating Out



Note: This activity will teach the group members how to make heart healthy choices at fast food restaurants.

■ **Ask:**

Where do you eat when you eat out?



Note: Give the members about 3 minutes to answer. Write their answers on the blackboard or on a large piece of paper taped to the wall.

■ **Say:**

Many people eat at fast food restaurants because:

- The food is served quickly.
- The food tastes good.
- The food is less expensive than food at sit down restaurants.
- Special food and toys appeal to children.
- There may be a playground for children.

■ **Say:**

Fast foods can be higher in fat, sodium, and calories, but you can choose lower fat, lower sodium, and lower calorie foods from the menu. **Show visual 8-3** and keep it on display while you review the handout.



■ **Give each group member** a copy of the "Tips for Eating Out the Heart Healthy Way" handout on page 270.



■ **Ask volunteers** to read the suggestions on the handout out loud.

■ **Say:**

Do you have other ideas for making heart healthy choices at restaurants?



Note: Give the members 2 to 3 minutes to answer. Write their answers on the blackboard or a large piece of paper.

2. Save Money on Your Food Bill

A. Money-Saving Tips

■ **Ask:**

What do you do to save money on food?



Note: Give the group members about 5 minutes to answer. Write their answers on the blackboard or on a large piece of paper taped to the wall.

- **Give each group member** a copy of the "Money-Saving Tips" handout on page 271. **Ask** volunteers to read the tips out loud.



- **Give each group member** a copy of the "Shopping List" handout on page 272.



■ **Say:**

You can use this shopping list when you go to the store. Just check off or write on the blank lines what you want to buy.

B. Food Advertising



Note: This section will help make the group members more aware of how advertising plays into their food-buying decisions.

■ **Say:**

Food advertising is big business.

- Advertisements try to get adults and children to buy a certain product.
- Advertising costs money. Billions of dollars are spent on food advertising. The people buying the food, the consumers, pay for this.
- Nationally advertised items usually cost more than store brands and brands that are not nationally advertised.
- Most people are more likely to buy fancy and eye-catching packaging.
- People are very brand loyal and will often buy a product even if it costs more.

- **Ask the group members** to describe advertisements that have prompted them to buy a certain product.



Note: Give them about 5 minutes to answer.

- **Go over** different advertising themes that are used to get people to buy food products. (Show or describe an example of the following advertising themes.)

- *(Optional)* **Show** examples of advertising themes from magazines.

Popular advertising themes include:

- **Family**
Advertisers try to get you to use their product based on your love for your family. This works well with AI/AN because the family plays an important role in our lives. Family theme ads often target AI/AN women because of their role as family caregiver.
- **Health**
This theme focuses on the positive health effects of using certain products. This works because people care about their health.
- **Sex appeal**
Sex appeal sells a product. Many people want to believe that they too will be beautiful and sexy if they use the product.
- **Humor**
A funny situation often helps people remember the product.
- **Appearance**
Food advertisers show food that may look better than the real thing. This makes people want to try the product.
- **Famous People**
Famous people are used to sell a product. They also can have a celebrity use a product in a television show or movie.

■ **Say:**

Advertising can be helpful because it tells people about different products they can buy. But ads also can get people to buy products that they do not need, cannot afford, or think are better than they really are.

■ **Ask:**

What can you ask yourself when you are trying to decide what brand to buy?
Allow 4 to 5 minutes for responses.

Add these questions if they are not said.

1. Is there a less expensive product that serves the same purpose?
2. Have I compared the products' nutrition label with an item that costs less?
3. Am I buying it because it comes in a nice package?
4. Am I buying it because the product says it will make me look better or help me lose weight?
5. Am I buying it because I have a coupon or because it's on sale?
6. Do I really need it?
7. Can I afford it, even with a coupon?
8. Can I wait until it goes on sale?
9. Is this product available in the commodity program?

■ **Say:**

Even if you want to buy name brands, you can still save money by buying the products when they are on sale.

C. Quick Beef Casserole Recipe



- Give group members a copy of the "Quick Beef Casserole" recipe on page 273. Ask them to try this dish sometime this week.

- Ask:

How can this dish help us eat in a heart healthy way when we have little time?



Add these if they are not said.

- Made ahead of time and frozen to save time
- Includes a lot of vegetables
- Is lower in fat because the meat is drained after cooking and no fat is added while cooking

Review of Today's Key Points

- Say to the group:

Let's review what we learned today.

Q: What can you do to save time in meal preparation?

- A:**
- Get help from your family.
 - Cook several dishes at one time and freeze part of them.
 - Make larger quantities and use the leftovers.
 - Pack lunches the night before.
 - Learn simple, fast recipes.
 - Use a crock pot.

Q: What can you do to eat healthier when eating out?

- A:**
- Order sandwiches without (or with lowfat) mayonnaise or sauces.
 - Order small, plain hamburgers or lean roast beef or turkey sandwiches instead of super-size or deluxe sandwiches.
 - Ask for lowfat salad dressing or bring your own.
 - Choose water, fruit juice, or lowfat (1 percent) or fat free (skim) milk instead of soda or a milk shake.
 - Order smaller sizes.
 - Choose baked or grilled foods instead of fried foods.
 - Remove the skin from chicken, and do not eat it.
 - Choose vegetarian pizza and ask for less cheese.

Q: What can you do to save money when shopping?

- A:**
- Plan weekly meals and shop with a list.
 - Use a list and don't go to the store too often.
 - Check the food sale ads.
 - Choose pre-prepared foods less often.
 - Buy only the amount of food the family needs.
 - Shop alone and make sure you're not hungry.
 - Check your receipt for errors.
 - Try not to shop at convenience stores.
 - Try store brands and use them as often as possible.

Weekly Pledge



■ Say:

Pledge one thing that you will do to choose foods for a heart healthy diet when you are eating out or when eating on the run during the next week. List one thing you will do to save money on your food bill.



Note: Ask them to give details about what they plan to do. For example, if they tell you they will choose certain foods less often when they eat out, ask what they will substitute. If they say they will save money when they buy groceries, ask them to tell you exactly how they plan to do so. Consider these examples:

- I will use low fat mayonnaise instead of regular mayonnaise on my sandwiches.
- I will try a store-brand product to see if my family likes it.

■ Say:

Remember to continue using the skills you learned in other sessions and keep working on your pledges to:

- Do more physical activity.
- Cut back on saturated fat, trans fat, cholesterol, and salt and sodium in your diet.
- Keep a healthy weight.

■ Ask:

Do you need help keeping any of your pledges?

Closing

■ Say:

Thank you for coming today. What did you think of today's session? I am looking forward to seeing you at the next session. The next session will be on enjoying living smoke-free.



Note: Think about today's session. What worked and didn't work? Have you made any changes in your own life based on what was covered in today's session?

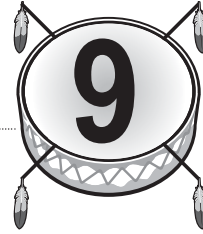

Enjoy Living Smoke Free

Objectives

By the end of this session, the group members will learn:

- How cigarette smoking harms the smoker.
 - How secondhand smoke harms people who are near people who smoke.
 - Tips that can help a smoker who wants to quit.
 - Ways to ask people not to smoke when they are nearby.
-

Materials and Supplies

To conduct this session you will need:

- *Honoring the Gift of Heart Health* manual and CD of visuals
- Blackboard and chalk or several large sheets of paper, a marker, and tape
- (Optional) VCR and TV monitor
- (Optional) Video or storytelling

Handouts

Give each group member these handouts during this session:

- Storytelling: The Origin of Tobacco (page 274)
 - For Alaska: Take the Path to Heart Healthy Living (page 274)
- How Smoking Can Harm You (page 275)
- How Smoking Harms Infants and Children (page 276)
- Lift the Lid on Spit Tobacco: Get the Truth (page 277)
- The Cost of Smoking (page 278)
- Smoke-Free Family Sign (page 279)
- Tips To Quit Smoking (page 280)
- Help Your Heart—Stop Smoking (page 281)
- Break Free From the Smoking Habit (page 282)
- List of Local Smoking Cessation Programs* (page 283)
 - *Prepare this list ahead of time. Information may be available from:
 - Your local health department and hospital
 - A local chapter of the American Lung Association:
Call 1-800-4-CANCER (1-800-422-6237), or visit <http://cancer.gov/>
 - The American Indian Tobacco Education Network: (916) 929-9761.



Note: Posters can be ordered from the Indian Health Service, American Indian Tobacco Education Network, American Lung Association, American Heart Association, American Cancer Society, and the National Cancer Institute.

Session Outline

Introducing the Session

1. Welcome
2. Review of Last Week's Session
3. About This Session

Conducting the Session

1. *(Optional)* Video, Storytelling, or Poster
2. Facts About Smoking
3. How Smoking Harms Infants and Children
4. Youth and Smoking
5. Smoking and Your Pocketbook
6. Secondhand Smoke
 - A. How Secondhand Smoke Can Harm You or Those Around You
 - B. Secondhand Smoke Role-Play Activity
7. Quitting Smoking

Review of Today's Key Points

Weekly Pledge

Closing

Introducing the Session

1. Welcome

- Welcome the group members to the session.

2. Review of Last Week's Session

■ Say:

At the last session, we talked about ways to save money on our food bills. Who can name some of them? (List ideas on board or paper as members name them.)

Add these ideas if they are not said:

- Plan weekly meals and shop with a list.
- Check the food sale ads.
- Use fewer pre-prepared foods.
- Buy only the amount of food the family needs.
- Shop alone. Make sure you're not hungry.
- Watch for errors at the register.
- Clip coupons for products you use.
- Shop at convenience stores less often.

■ Ask:

How are you doing with your pledge to eat in a heart healthy way even when time or money is tight? What went well? Did you have problems? If so, what did you do to solve them?



Note: Give the members 5 to 8 minutes to answer.

3. About This Session

■ **Say:**

This session is about not starting to smoke and stopping smoking. During this session you will learn:

- How cigarette smoking harms the smoker.
- How secondhand smoke hurts can harm you or those around you.
- Ways to ask people not to smoke when they are nearby.
- Helpful ways to stop smoking for you and others.

■ **Ask:**

- How many of you smoke?
- How many live with a smoker?

■ **Say:**

Tobacco is used in a variety of ways—cigarettes, cigars, pipes, and chewing tobacco. This session focuses on cigarette smoking because it is the most common way people use tobacco.



Note: Other names for cigarettes: smokes, cigs, and butts. Smokeless tobacco: dip, spit tobacco, and snuff.

Conducting the Session

1. (Optional) Video, Storytelling, or Poster

- **Show** a video on tobacco. The Tobacco Clearinghouse of California (www.adp.ca.gov/RC/RC_sub.shtml) distributes many videos.
- If you choose, ask for a volunteer to read the legend "The Origin of Tobacco" on page 274.
- Allow 5 to 10 minutes for open discussion by asking the following questions:
 1. How is tobacco ceremonially used in your tribe?
 2. Where do people purchase tobacco in your community?
 3. What would your tribe be willing to do about the smoke shop and what about the purchase of tobacco through the Internet?



For Alaska:

- If you choose, ask for a volunteer to read the poster "Take the Path to Heart Healthy Living" on page 274.
- Allow 5 to 10 minutes for open discussion by asking the following questions:
 1. Have you had any experiences in quitting smoking? Please describe.
 2. Have you helped someone quit smoking? How?

2. Facts About Smoking

■ Say:

There are many reasons why you should not start smoking, or why you should stop smoking. Let's go over these reasons.

- In the United States, more than 400,000 (four hundred thousand) people die each year from diseases related to smoking. More than 2,000 persons die each day. Smoking causes about one in every five deaths.
- Health care costs due to smoking are about \$80 billion each year. The annual amount is \$3,391 per person. On the average, smoking will take 4 to 8 years of your life. More importantly, it will reduce the quality of your life, leaving you with less money, energy, and more illness.
- An estimated 57 million people smoke in the United States and 7.6 million use smokeless tobacco. More than half (70 percent) of the 57 million smokers have made at least one attempt to quit. About half (46 percent) try to quit each year. Most smokers make several attempts to quit before they are successful.
- More than one out of every three AI/AN men and women smoke (about 34.1 percent). About one out of every two AI/AN women (44.3 percent) of reproductive age (18 to 44) smoke.
- Most smokers use tobacco regularly because they are "addicted" to the powerful drug called nicotine. Nicotine is found in all tobacco products. Most cigarettes contain 10 milligrams (mg) or more of nicotine. Through inhaling smoke, the average smoker takes 1 to 2 mg of nicotine per cigarette.
- Smoking can harm those around you! Cigarette smoking puts the health of your family, children, elders, and friends at risk.

■ Show visual 9-1. Say:

Today we are going to talk about what can happen when you smoke. We are also going to talk about ways to stop smoking or support a friend or family member who wants to quit.



- **Give each group member** a copy of the handout "How Smoking Can Harm You" on page 275 and review the information.



Note: Ask volunteers to read each tip out loud. Keep the visual on display while you review this handout.

3. How Smoking Harms Infants and Children

- **Show visual 9-2. Ask:**
Do you think pregnant women should smoke?



A: Pregnant women should not smoke because it will affect their baby's health and well-being. They also should stay away from others who smoke because of the harm that secondhand smoke causes.

- **Say:**
Many people have heard that it is not good for pregnant women to smoke or be around others who smoke. Do you know why? Let's go over some problems that can happen.

- **Give** participants the handout "How Smoking Can Harm Infants and Children" on page 276.



Note: Ask volunteers to read it out loud, or you can cut out each fact on the dotted lines and put them in a box. Let the members draw a slip of paper and read the facts aloud. Keep the visual on display while you review the handout.

4. Youth and Smoking

- **Show visual 9-3. Ask:**
Why do you think many people begin smoking as teenagers?
Review visual 9-3 to show the reasons for teenage smoking. Also, add these reasons if they are not said.



- AI/AN youth start smoking at much younger ages than other youth, and the source of tobacco is from family and friends.
- Teens want to be like their friends.
- Young people smoke to try to look older.
- They want to be like celebrities who smoke in movies or on television.
- Some teens are influenced by advertisements that make smoking look "cool" or sophisticated.
- Some teens may want to be like parents or other family members who smoke.
- Some teens will smoke just to do something their parents don't want them to do.
- Young people downplay the harm smoking can do or think they will not be harmed.
- Teens may like the jackets, hats, and other prizes tobacco companies offer.

■ **Say:**

Let's look at some of the facts about young people and smoking.

- Each day more than 3,000 people under age 18 become regular smokers. That's more than 1 million teens per year. Roughly, one-third of them will eventually die from a tobacco-related disease.
- It can be hard for young people who use tobacco to play sports. Smoking causes shortness of breath and dizziness. Chewing tobacco causes dehydration.
- Use of spit tobacco can cause cracked lips, white spots, sores, and bleeding in the mouth.
- People who start smoking at a young age are likely to smoke all their lives.
- The longer a person smokes, the more likely he or she will develop problems caused by smoking.
- Young people who smoke cigarettes are also more likely to try other drugs, especially marijuana.
- It is illegal in all states to sell cigarettes, smokeless tobacco, and tobacco products to persons under age 18.

■ **Say:**

If you smoke, set an example by quitting. Be honest. Admit that you're having trouble kicking the habit. Let young people know they may have the same problem if they start smoking and try to quit later. Try not to smoke in front of your children. Never ask your children to bring you cigarettes or light a cigarette. Asking them to do those things can send the message that smoking is okay for them to do.

- **Give** participants the handout "Lift the Lid on Spit Tobacco: Get the Truth" on page 277.



Note: Ask volunteers to read it out loud. Keep the visual on display while you review the handout.

5. Smoking and Your Pocketbook

■ **Say:**

Smoking costs a lot in other ways. Let's look at some things a smoker could buy with the money that he or she uses for cigarettes.

- **Give out** and review the "The Cost of Smoking" handout on page 278.



6. Secondhand Smoke

A. How Secondhand Smoke Can Harm You or Those Around You

■ **Ask:**

What have you heard about secondhand smoke?



Note: Give the group members 3 to 5 minutes to answer.

■ **Say:**

Secondhand smoke is the smoke that you breathe in from someone else's cigarette. Even nonsmokers can be harmed if they are near secondhand smoke.

■ **Say:**

Let's take a look at some facts about secondhand smoke.

- Secondhand smoke contains poisons such as arsenic, cyanide, ammonia, and formaldehyde.
- Breathing secondhand smoke causes eye irritation, nose and throat discomfort, headaches, and coughing.
- Up to 5,000 (five thousand) nonsmokers die from lung cancer caused by secondhand smoke each year.
- Infants and children who live with someone who smokes are twice as likely to have respiratory illness, bronchitis, and pneumonia as are children who do not live with someone who smokes.
- Secondhand smoke can bring on an asthma attack.

B. Secondhand Smoke Role-Play Activity

■ Say:

Let's try role playing. Some people have a hard time telling smokers not to smoke around them or around their children. This activity will let you practice what you say when someone smokes around you or your family.

- **Divide the members into groups of three.** Give each group a scene from the role play activity on the next page to act out. Ask them to act out a solution to the problem, too.



Note: Read the scenes one at a time or hand out copies to each group. Give one group about 5 minutes to role play a solution.

- **Ask the group members** if they have any comments or questions about the legend or role play.

■ Say:

One thing we all can do in our homes to prevent these situations is to post a sign that says "Thank You for Not Smoking" or "We're a Smoke-Free Family." This lets guests know your house is smoke free.

- **Give participants** a copy of the "Smoke-Free Family Sign" on page 279.



■ Say:

This can be used on a tabletop or taped to the wall or refrigerator.



Scenes For Role-Play Activity: What Can You Do?

■ Scene 1:

Your in-laws are at your house visiting your family. Your spouse is at the store buying a few things. The rest of the family is sitting in the living room and talking. Your father-in-law asks you for an ashtray as he lights a cigarette. You know smoking around the children is harmful. What can you do?

Solutions:

- Tell him that cigarette smoke is a threat to the health of your children.
- Ask him if he would please go outside to smoke.
- Tell him your family has become a smoke-free family.
- Notify family members ahead of time that you do not allow smoking inside your house.
- Post a "no smoking sign" for visitors.

■ Scene 2:

You and your family go to a friend's house to celebrate her son's birthday. There are many adults and children inside the house. A few of the guests are smoking, which is making the house very smoky. The smoke is hurting your throat. It is also hurting your daughter's eyes. You promised your friend you would help her, so you don't want to leave. What can you do?

Solution: Tell your friend that you are very sorry, but you cannot help her. You must leave because the smoke is affecting you and your child's health.

■ Scene 3:

You go out to eat with a friend to celebrate a special occasion. You ask to sit in the nonsmoking section of the restaurant. The nonsmoking area is in a corner of the restaurant. There are no walls separating the smoking section from the non-smoking section. As you order your meal, four people sit down about three tables away from you in the smoking section. They begin to smoke one cigarette after another. After a minute or two, you begin to smell their smoke at your table. You tell the waiter the smoke is a threat to your health. He says he can't ask them to stop because they are in the smoking section. What do you do?

Solutions:

- Ask to be moved to another table further from the smokers.
- Ask the waiter to wrap up your food and leave. Tell the manager that you have heart disease.

7. Quitting Smoking

■ Say:

The nicotine found in cigarettes and other tobacco products causes addiction. When smokers try to cut back or quit, the absence of nicotine leads to withdrawal symptoms. Two things are going on: the smoker's body is reacting to the absence of the drug nicotine, and the person is faced with giving up a habit. Both must be dealt with to succeed at quitting.

■ Ask if anyone in the group used to smoke and quit or knows anyone who has quit smoking. If so, what are the reasons you think people want to quit?



Note: Give the group 3 to 5 minutes to answer the questions. Write the answers on the blackboard or a large piece of paper taped to the wall. Add these reasons if the group does not say them.

- You will live longer and live better.
- Quitting will lower your chance of having a heart attack, stroke, cancer, and respiratory problems.
- If you are pregnant, quitting smoking will improve your chances of having a healthy baby.
- The people you live with, especially your children and elders, will be healthier.
- You will have extra money to spend on things other than cigarettes.

■ Say:

To quit smoking you need to know your personal feelings or situations that bring on the urge to smoke.

■ Ask:

What do you think are some of these feelings or situations that bring on the urge to light up?



Note: Give the group 3 to 5 minutes to answer the questions. Write the answers on the blackboard or a large piece of paper taped to the wall. Add these reasons if the group does not say them.

- Drinking coffee
- Having an alcoholic drink
- Talking on the phone
- Watching someone else smoking
- Experiencing stress

■ **Say:**

We will review key steps people can take to overcome the urges to smoke.



Note: Write the words in bold on the blackboard or a large piece of paper taped to the wall.

1. **Find new habits.** Replace those situations with new activities. If stress causes you to light up. Try deep breathing to calm you. (Take a slow, deep breath, count to five, and release it.) Let's try it now.
2. **Keep busy.** Get involved in activities that require the use of your hands such as beading, weaving, and a fixing-up project around the house.
3. **Keep moving.** Try going for a nature walk, work in the garden, do stretch exercises, or practice your favorite dance steps.
4. **Know what to expect.** During the first week after quitting, a person may experience temporary withdrawal symptoms. These include headaches, irritability, tiredness, and trouble concentrating. While these feelings are not pleasant, it is important to know that they are signs that your body is recovering from smoking.



Note: Give each member a copy of the list of local smoking cessation programs in your area, page 283.



- **Give each member a copy** of the handout "Tips To Quit Smoking" on page 280. Ask volunteers to read the tips aloud.



- **Say:**

These tips have helped other people. If you are a smoker, they can help you quit. If you are not a smoker, share the tips with a family member who would like to quit. Studies have shown that these steps will help you quit and quit for good. You have the best chance of quitting if you use them together.

- **Say:**

Nagging people about their smoking can make them become angry or defensive. Try these positive ways to help people you know who want to quit:

- Say things like, "It's hard, but I know you can do it."
- Help them stay away from smokers in the beginning when it is the hardest.
- Suggest other activities that will help them get through the urges. For example, ask them to go to a movie with you.

- **Ask:**

Do you have any questions about the information we covered today?



Note: The details provided in the box on the next page may help you answer these questions.

More Information

- Tobacco companies spend billions of dollars advertising their products to get people to smoke. They do this through advertising in magazines, and on billboards and posters at local stores.
- Tobacco ads usually show happy, attractive people enjoying life while they smoke cigarettes. Many want to be like these people and start smoking.
- Tobacco companies also advertise their products by supporting special events such as powwows and rodeos. They go to community events, dances, and festivals to promote their products by giving away free merchandise and cigarettes.
- Tobacco companies pay movie companies to have stars smoke on screen. This allows them to get around the law that bans cigarette advertising on television or in the movies.
- Tobacco companies recruit new smokers to make up for the thousands of people who die each day of diseases related to cigarette smoking. They target young people because young smokers are likely to be lifelong smokers. Teenage smokers are important for the tobacco companies because teens will continue to buy cigarettes for many years.
- The advertising programs from tobacco companies influence young people. The number of youths who began smoking increased when tobacco companies introduced cartoon-like characters to sell cigarettes. Tobacco companies also give away gifts that appeal to youth to get them to smoke a certain brand.

Review of Today's Key Points

■ Say:

Let's review what we learned today.

■ Ask these questions:

Q: When people smoke, they are likely to develop which diseases?

A: Smoking contributes to heart disease, cancer, stroke, and respiratory diseases (emphysema, asthma, etc).

Q: Should a pregnant woman smoke? Why or why not?

A: Pregnant women should not smoke. Smoking reduces the oxygen the baby receives, causes the baby to be born too early, contributes to lower birth weight, and increases the chance of a baby to be born dead.

Q: What is secondhand smoke?

A: Secondhand smoke is smoke that you breathe in from someone else's cigarette. It is filled with harmful chemicals.

Q: What can you do if someone is smoking around you, and you don't like it?

A: Ask the person not to smoke inside or leave the area yourself. Post a sign that says "Thank You for Not Smoking" or "We're a Smoke-Free Family."

Weekly Pledge

■ Say:

Pledge one thing that you will do to prevent or stop smoking or on how you will cut back on your exposure to secondhand smoke.



Note: Ask each member to give details about what he or she plans to do. Here are some examples:

- I will smoke half the cigarettes I usually smoke each day.
- I will ask my children to make a sign to let people know our home is smoke free.

- **Give each group member** the handouts “Help Your Heart—Stop Smoking” and “Break Free From the Smoking Habit” on pages 281–282.



- **Say:**
Write your pledges on this handout.

- **Say:**
We will talk about your nonsmoking pledge at the next session. Keep working on the pledges you made during earlier sessions, including last week’s pledge to eat in a heart healthy way, even when you’re rushed or trying to stick to a budget.

Closing

- **Say:**
Thank you for coming today. What did you think of today’s session? I am looking forward to seeing you next week. The next session will be a review and graduation celebration.
- **Ask members** if they want a potluck dinner at the final session. Ask for volunteers to bring heart healthy dishes. Don’t forget nonfood items such as paper plates, plastic forks, and spoons.



Note: Think about today’s session. What worked and didn’t work? Have you decided to make any changes in your own life based on what was covered in today’s session?

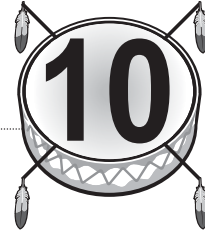

Review and Graduation

Objectives

This session is designed to:

- Review information learned in Sessions 1 through 9 using games and activities.
 - Recognize the group's efforts and accomplishments.
-

Materials and Supplies

To conduct this session you will need:

- Bingo Facts
- "Heart Health Bingo" cards
- Bingo card markers (You can use pennies, dried corn, or other items.)
- Pens
- Stamped envelopes
- *(Optional)* Food (if having a potluck)
- *(Optional)* Small gift or certificate for each group member

Handouts

Give each group member these handouts during this session:

- Heart Health Bingo Cards (pages 284–300)
- *(Optional)* A Letter to Myself sample (page 301)
- A Letter to Myself (page 302)
- Certificate (page 303)

Session Outline

Introducing the Session

- 1 Welcome
2. Review of Last Week's Session
3. About This Session

Conducting the Session

1. Heart Health Bingo
2. Letter to Yourself Activity

Recognition for Completing *Honoring the Gift of Heart Health*

(Optional) Potluck Meal

Closing

Introducing the Session

1. Welcome

- Welcome the group members to the session.

2. Review of Last Week's Session



Note: If the group went on a grocery store tour, ask them to share what they learned from the tour. If not, go to the following review of Session 9.

- **Say:**

During Session 9, we talked about how cigarette smoking or chewing tobacco can harm you. Who can name some of the ways?



Note: Give the group 3 to 5 minutes to answer. Write their answers on the blackboard on a large piece of paper taped to the wall. Add these reasons if the group members do not say them.

- Cigarette smoking can cause health problems, like:
 - Heart disease
 - Stroke
 - Asthma
 - Cancer
 - Emphysema
- Cigarette smoking irritates the eyes and can trigger asthma attacks.
- Less serious but very unpleasant effects of smoking are:
 - Yellow stains on teeth and fingers
 - Bad breath
 - Poorer sense of smell and taste
 - Early wrinkling of the face
 - Many colds and sore throats

■ **Ask:**

How did you do with your pledge to do one thing to quit smoking or to protect your family from secondhand smoke? Did anything work very well? Did anything cause a problem?



Note: Give the group 5 to 8 minutes for their comments.

3. About This Session

■ **Say:**

During this session, we will go over information we learned in Sessions 1 through 9. Thank you all for taking part in the sessions, and congratulations for making the effort to learn how to lessen the chance of heart disease and stroke for you and your families.

Conducting the Session

1. Heart Health Bingo



Note: Copy the bingo game facts (pages 284–285) on stiff paper and cut on the dotted lines. Place the pieces in a box and mix well. Also copy the bingo cards (pages 286–300) on stiff paper and cut them out.



■ **Give one card to each person.** Give them eight pennies, eight pieces of dried corn, or other items that can be used to mark the card.



■ **Say:**

We are going to play a bingo game to review facts about preventing heart disease. Here's how to play:

1. To start, place a marker on the free space in the center of the card.
2. Then listen as the bingo caller reads facts about heart health. These facts will be drawn from a box.
3. If the fact that is read matches a fact on your card, place a marker on it.

4. If you get three markers in a row, call out "Bingo." The row can be up and down, across, or diagonal. (Hold up your card and show the group.)



Note: Play two or three games as time permits. At the end of each game, have the group members turn in their card for new ones. If you are able, you may want to award a small prize to the winners.

2. Letter to Yourself Activity



Note: Bring a stamped envelope and pen for each member. If you have members who do not write well, let them tell you the information and you can write it down for them.

- **Give each group member a pen**, the "A Letter to Myself" handout (page 302) and a stamped envelope. You may want to show or read to the group members the sample "A Letter to Myself" (page 301) to give them ideas.



- **Ask the group members** to use the handout to list healthy changes they will continue to work on until they become a habit.
- **Tell them to address the envelope** to themselves and place the letter inside. Collect the sealed, self-addressed envelopes.
- **Say:**
I will mail your letter to you in about 3 months. Getting this letter will help remind you to keep using what you learned in these sessions to protect your heart health.

Recognition for Completing *Honoring the Gift of Heart Health*

- **Show visual 10-1. Say:**
Everyone gave time and effort to attend the sessions. I hope you will use the information to help improve your heart health and your family's heart health.
- *(Optional)* If you choose to, provide certificates or small gifts.



■ **Say:**

Now, I would like to give each of you a certificate to honor your efforts and your achievements.

- **Call each group member's name** and hand the person the certificate or the small gift of recognition. (See page 303 for a sample certificate that you can copy and complete. You can also find certificates in business supply stores.)



■ **Say:**

Now you have a chance to talk about what you have found helpful. Would anyone like to share a short story about your family's reactions to your pledged activities?

(Optional) **Potluck Meal**

■ **Say:**

Now is the time for the potluck meal. Place the dishes you brought on the table. We will begin the celebration.

Closing

■ **Say:**

Thank you for coming and for completing the program. I wish everyone well and hope you continue to *Honor the Gift of Heart Health*.

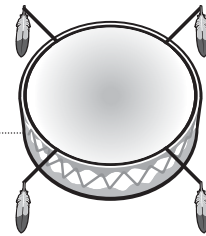

Activities for Training Heart Health Educators



The *Honoring the Gift of Heart Health* manual also can be used to train heart health educators. Conduct your training as if you were teaching community members. Include special activities for heart health educators in Sessions 1, 3, 7, and 9. Instructions and handouts for these activities are included in this appendix.

Food displays (posters) are a great way to teach about nutrition. Examples of food displays that you can create and use along with the nutrition sessions are in the back of the appendix on pages 182–188.

Publicize your training of heart health educators using the flyer on page 189. Post the flyer in local clinics and organizations. Ask community leaders for help in finding people for your training.

Session 1

During Session 1, you will describe a presentation activity that will be included as part of Session 9 after the Risk Factor Activity on pages 20 and 21. Review the "Teaching Tips" handout on page 176, and the "Seven Golden Rules for Teaching Groups" handout on page 177. Give each heart health educator a copy of the manual to use during the training.

Preparing for a Presentation

- **Say:** When you complete the *Honoring the Gift of Heart Health* training program, you will be able to conduct your own program for groups in your community. As a heart health educator, you will not be giving medical advice. You will give information and support others to encourage them to live healthier lives and use health services that are available in their community.

- **Say:** After we have gone through all of the sessions, each of you will make a brief presentation on a topic discussed during the program. We will make the presentation as part of our graduation at Session 10. You can choose the topic you will present. You can make the presentation alone or with a partner. You will choose a topic at the end of Session 7. You will have 2 weeks to prepare. After each presentation, the group will have a chance to give positive suggestions to the presenter.
- **Say:** Now we will review some steps that will help you prepare a more effective and interesting presentation.
- **Say:** Let's review these teaching tips and the "Seven Golden Rules for Teaching Groups" on page 177. Refer to them when you prepare your presentation and teach *Honoring the Gift of Heart Health*.

TEACHING TIPS

Before the Session

- Review the manual carefully several times.
- Get information about your audience (level of education, how open they are to new health information, etc.).
- Practice teaching in front of family or friends using all your materials.
- Gather materials and equipment you will need (posters, music, videotapes, handouts, extension cords, monitor, VCR, flipchart, markers, measuring tape, masking tape, and food items).

The Day of the Session

- Arrive at least 30 minutes before the start of the session.
- Set up chairs and tables in a circle so you can get the group involved.
- Find electrical outlets and light switches.
- Set up audiovisual equipment.
- Get videotapes to the place on the tape where you need to start.
- Place posters where the audience can see them. Make sure not to damage the walls.
- Put handouts in the order that you will give them out. Make sure you have enough for everyone.
- Setup any activities or snacks that you have planned.

After the Session

- Make sure to leave the room clean and arranged the way you found it.

Seven Golden Rules for Teaching Groups

1. Maintain eye contact with everyone.
2. Speak so that everyone can hear: talk with a clear, strong, and kind voice.
3. Show your enthusiasm: move around and use your hands to gesture.
4. Keep track of time: wear a watch or have a clock in the room. Plan your presentation so that you do not have to rush. Do not let the class run too long.
5. Show interest in your audience:
 - Greet them when they come in.
 - Tell them you value their time and attendance.
 - Listen to what people say.
 - Talk simply and to the point.
 - Help them to set goals.
 - Stay calm and use humor. Focus on the positive.
 - End with a review of the most important points. Thank them for coming.
6. Aim to have everyone participate: people tend to learn more when they are involved. Try not to lecture.
 - Ask questions. Praise correct answers. Correct wrong information politely.
 - Answer questions. Be honest. Find answers to questions you can not answer.
7. Pay attention to content: Your presentation must provide correct information.

Session 3

The Wolf and the Hen is an optional physical activity game that can be used in Session 3 or any other session. This activity is fun, interactive icebreaker for all ages. It is a great way to enable groups to be active during trainings.

Instructions

- Divide the class into groups of 4 to 6 (depending on how many participants you have).
- Each group chooses one player to be the "wolf" and another to be the "mother hen." The other four members line up behind mother hen as "chicks."
- The mother hen approaches the wolf with outstretched arms. The chicks follow behind her, each holding the chick in front at the waist.
- Wolf peeks around the mother hen and describes the clothes of one of the chicks in line.
- Repeat the game a few times. Between each game have the participants skip around for a few minutes before they form in new groups.

Teaching Cues

- As the wolf approaches the mother hen, mother hen says, "How do you do, Mr. Wolf? What are you looking for?"
- The wolf slyly replies, "How do you do? I am looking for a chick!"
- Mother hen replies, "Well, what does your chick look like?"
- Wolf then describes one of the chicks in line: color of clothing, hair color, etc.
- Mother hen replies, "Well, try and get your chick!"
- Wolf tries to get the chick with a two finger tag, but mother hen protects her flock with outstretched arms. Chicks move together to stay behind the mother hen.

Adapted from PATHWAYS, Modified American Indian Physical Activity Games. 6/1/99.

Session 7

After the Review of Today's Key Points on page 132 and 133, you will ask the heart health educators to choose a topic from a list of presentation topics or suggest their own. They can also choose a partner, if they'd like.

Selection of Group Presentation Topics

■ **Say:** As part of our graduation celebration (Session 10), each of you will make a short presentation on your own or with another group member. Each presentation will be 3 to 5 minutes and will highlight a topic we have covered. Here is a list of some topics you might want to choose. I will give you a few minutes to select your topic and choose a partner. Then we'll make a list of the topics and presenters. Don't be nervous. We are all friends here.



Note: Here is a list of topics to include. List all or some of these topics on a large sheet of paper or blackboard. You or group members may add other topics.

- How the Heart Works
- Heart Disease Risk Factors You Can Prevent
- Ways To Prevent High Blood Pressure
- Ways To Prevent High Blood Cholesterol
- How To Prepare Meals Lower in Saturated Fat and Cholesterol
- How To Use the Food Label
- How To Use the American Indian or Alaska Native Food Guide Pyramid To Eat in a Heart Healthy Way
- How Smoking Can Harm You
- How To Keep a Healthy Weight
- How To Prepare Meals Lower in Calories
- How To Increase Your Physical Activity
- Benefits of Regular Physical Activity
- Ways To Limit Salt and Sodium
- Steps You Can Take To Quit Smoking
- How To Save Money on Your Food Bill
- Ways To Plan a Heart Healthy Meal With Little Time and Money
- Eat Right When Eating Out

- **Ask:** What topics do you want to present? Write the member's name (and the partner's name) beside the topic.



Note: If too many people choose the same topics, you should ask them to pick another.

- **Say:** Remember to use the Teaching Tips on page 176 and Seven Golden Rules on page 177.
- **Help the group members** find materials in the manual that cover the topic they have picked.

Session 10

After the "A Letter to Myself Activity" on page 173, the heart health educators will present a 3- to 5-minute presentation on the topic they chose during Session 7. Group members will also be invited to give each other positive comments.

1. Group Presentations

- **Say:** Now we will make our short presentations. Don't be nervous. This exercise will give you a chance to practice your teaching skills and get comments. Each time you present, you will become more comfortable and learn new ways to get people involved. So relax and let's have fun.

2. Partner Presentations

- **Say:** First we will hear presentations from group members who are presenting as pairs. Who would like to go first?



Note: After each presentation, allow a couple of minutes for questions or comments from other group members. Thank both members and give positive comments. Politely correct any wrong information. Then ask another pair to present until all partner presentations are completed.

3. Individual Presentations

■ **Say:** Now we will hear from individual presenters.

After the last individual presenter . . .

■ **Ask:** Does anyone have any questions or final comments?

Allow a few minutes for group members to speak. Then. . .

■ **Say:** You have made great progress in the goal to help others learn about heart health. I hope you will use every opportunity to spread the word—AI/AN do not have to die of heart disease. Heart health educators, like you, are important to helping our families and communities live longer, healthier lives.

You May Want To Practice More

Here are some ideas to help your confidence and to give you more practice:

- Observe an experienced trainer or educator, while he or she teaches a session or the entire program.
- Schedule an opportunity for each educator to present a full session to other educators in the group.
- With another trainer or educator, team teach a session or the entire program to a community group. Ask the trainer to be available for support.

Food Displays

Purpose:

Visually encourage participants to learn about healthy food choices.

Use of display:

- Reinforce a class or presentation. The food displays can be used with this manual. There are three types of food displays. The recommended use of the food displays with the manual are:
 1. Teaspoons of Fat in Food—
Session 5: What You Need To Know About High Blood Cholesterol.
 2. How Much Calories and Sugar Are in Your Favorite Beverages?—
Session 6: Maintain a Healthy Weight
 3. Making the Best Choice: How To Choose a Healthier Fast Food Meal—
Use after Session 7: Make Heart Healthy Eating a Family Affair.
- Teach participants about food choices in a variety of settings such as health fairs, waiting room area, schools, worksite cafeteria, community health centers, WIC etc.

What you need?

- Poster board 20 x 30 inches
- Food pictures or food models
- Plastic spoons preferably colored
- White clay, velcro, glue, markers
- For the sugar displays, use sugar cubes displayed on a manila file folder folded in half (see picture on page 184)

1. Teaspoons of Fat in Food

This display has teaspoons that represent the number of teaspoons of actual fat in foods. An example is fried chicken compared to baked or grilled skinless chicken. The number of teaspoons can be found by dividing the number of fat grams by four. For example: a food with 20 fat grams has 5 teaspoons of fat.

Some foods that can be compared are:

3 ounces of sausage..... 8¹/₂ teaspoons of fat (34 grams)

3 ounces of lean pork..... 1¹/₂ teaspoons of fat (5 grams)

3.5 ounces of skinless chicken breast
(broiled)..... 1¹/₂ teaspoons of fat (5 grams)

3.5 ounces of chicken break with the
skin (fried in 1 tablespoon of oil) 1¹/₂ teaspoons of fat (5 grams)

Fat Matters—but Calories Count!

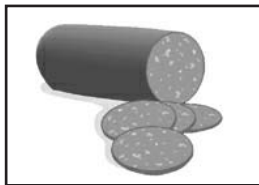

Pork Sausage (3 ounces)

Calories: 300

Total fat: 25g

Saturated fat: 9g

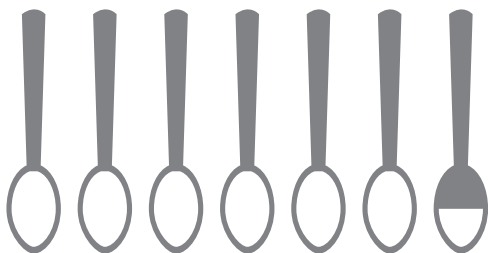

**25g of Total fat =
6¹/₂ teaspoons of fat**

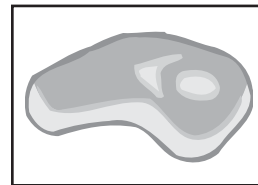

Pork Tenderloin (3 ounces)

Calories: 140

Total fat: 4g

Saturated fat: 1g



**4g of Total fat =
1 teaspoon of fat**

2. How Much Calories and Sugar Are in Your Favorite Beverages?

This display is used to demonstrate how much calories and sugar are in beverages.

- Cut a manila file folder in half and fold in half. See picture below.
- Write the name of the beverage on one side. On the other side write the number of calories, grams of sugar, and teaspoons of sugar in the beverage. Glue the number of teaspoons (sugar cubes) that are in each beverage.
- Use the handout on page 185 for the calories and grams and teaspoons of sugar in common beverages.

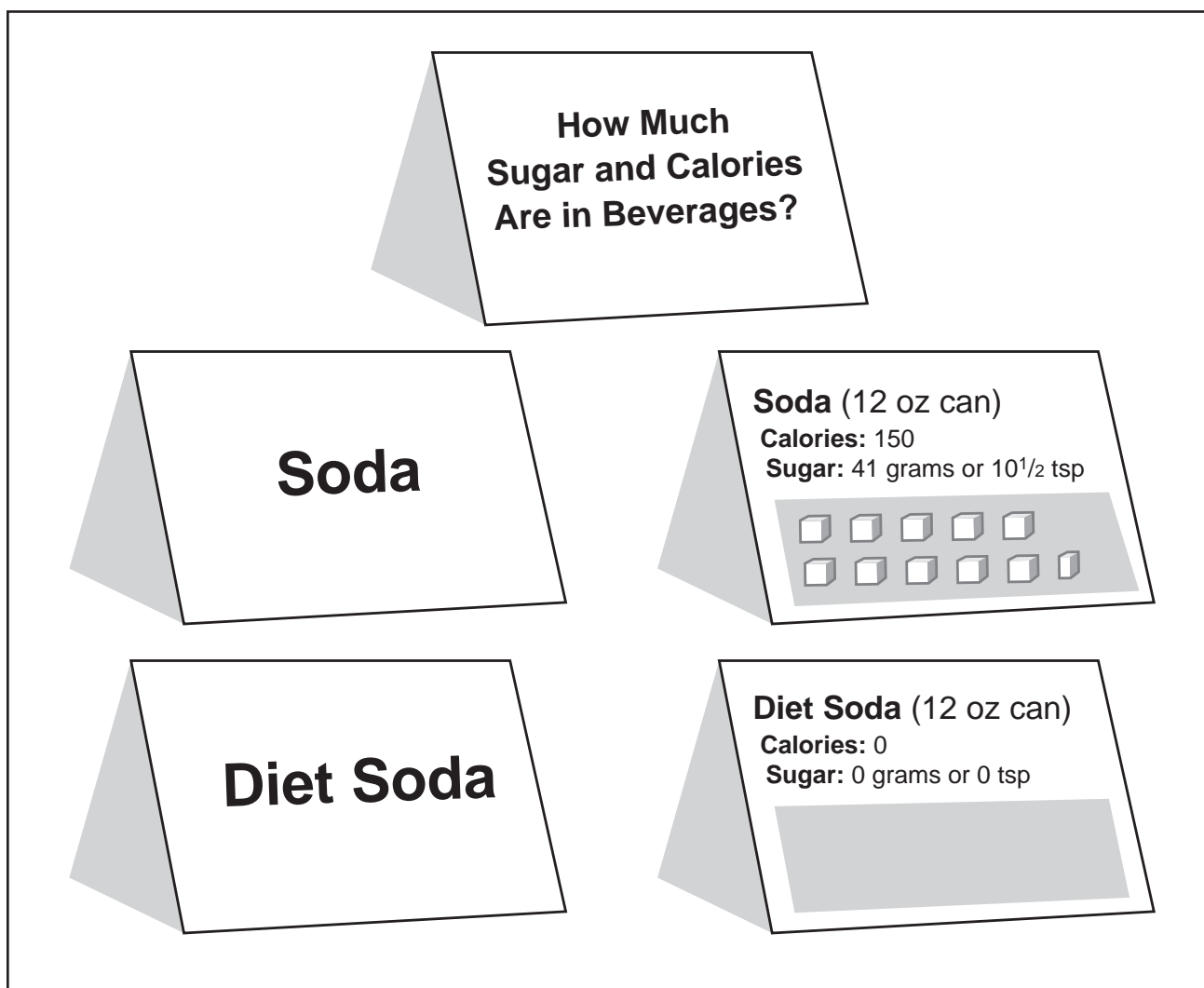

How Much SUGAR and CALORIES Are in Your Favorite Beverage?

Beverage (12-oz serving)	Grams (g) of Sugar	Approximate Number of Teaspoons of Sugar	Calories
Bottled Water	0g	0 tsp	0
Coke	39g	9 ¹ / ₂ tsp	150
Diet Coke	0g	0 tsp	0
Pepsi	41g	10 ¹ / ₂ tsp	150
Diet Pepsi	0g	0 tsp	0
Mountain Dew	46g	11 ¹ / ₂ tsp	170
Diet Mountain Dew	0g	0 tsp	0
7-Up	39g	9 ¹ / ₂ tsp	160
Diet 7-Up	0g	0 tsp	0
Root Beer	46g	11 ¹ / ₂ tsp	170
Sunkist	52g	13 tsp	210
Dr. Pepper	40g	10 tsp	160
Diet Dr. Pepper	0g	0 tsp	0
Kool-Aid	36g	9 tsp	145
Sugar-Free Kool-Aid	0g	0 tsp	0
County Time Lemonade	25g	6 ¹ / ₂ tsp	105
Sugar-Free Lemonade	0g	0 tsp	0
Hi-C Fruit Punch	46g	11 ¹ / ₂ tsp	195
Nestea	33g	8 ¹ / ₂ tsp	120
Hawaiian Punch	43g	10 ¹ / ₂ tsp	180
Gatorade	8.5g	2 tsp	75

3. Making the Best Choice in Fast Food Places

This displays how to make healthy choices at fast food places. Nutrition information of fast food can be found on most company web sites and most places have nutrition facts brochures available.

Here are two sample meals:

HIGH Calorie Menu Choice:

Food Items	Calories	Total Fat (g)	Saturated Fat (g)
Double Meat Cheeseburger	1,120	76	30
Medium Fries	360	18	5
Medium Chocolate Shake	500	8	5
Total	1,980	102	40

102 g of total fat = 25¹/₂ teaspoons of fat

LOWER Calorie Menu Choice:

Food Items	Calories	Total Fat (g)	Saturated Fat (g)
Grilled Chicken Sandwich, No Mayonnaise	330	7	1
Garden Salad	25	0	0
Light Dressing	50	5	1
Lowfat Milk (1percent)	110	2	2
Total	515	14	4

14g of total fat = 3¹/₂ teaspoons of fat

The sign on page 188 can be made into a table tent sign by gluing the sign to a manila folder.

Making the Best Choice:

How to Choose a Healthier Fast Food Meal

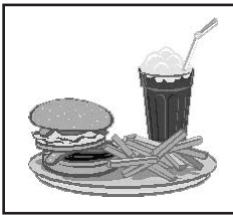

High Calorie Menu Choice:

102g of total fat = 25¹/₂ teaspoons of fat

Food Items	Calories	Total Fat	Saturated Fat
Double Meat Cheeseburger	1,120	76g	30g
Medium Fries	360	18g	5g
Medium Chocolate Shake	500	8g	5g
Total	1,980	102g	40g

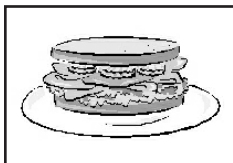

Lower Calorie Menu Choice:

14g of total fat = 3¹/₂ teaspoons of fat

Food Items	Calories	Total Fat	Saturated Fat
Grill Chicken Sandwich, no mayo	330	7g	1g
Salad, lowfat dressing	75	5g	1g
Lowfat Milk (1 percent)	110	2g	2g
Total	515	14g	4g



Making the Best Choice

How To Choose a Healthier Fast Food Meal

- Choose your sandwich without mayonnaise or special sauce.
- Leave the cheese off.
- Choose **NOT** to super-size.
- Have a water, unsweetened iced tea, or diet soda instead of a regular soda or a shake.
- Choose lowfat or nonfat dressing.
- Plan ahead—have a healthy, lowfat breakfast and lunch if you eat out for dinner.

**One out of four American Indians and Alaska Natives dies of heart disease.
Learn to help others live a healthier life, feel better, and have fun!**

Be a Heart Health Educator!

Honoring the Gift of Heart Health is a FREE, hands-on program that can help you reduce your own, your family's, and your community's risk of heart disease.

Learn how to:

- ♥ Teach small groups in your community about the risks that increase their chances of heart disease.
- ♥ Organize fun activities to show how to change habits and lead healthier lives.
- ♥ Keep group members motivated.



The training program includes:

- ♥ Tips on how to be a successful heart health educator
- ♥ A manual and CD of visuals with everything you need to teach *Honoring the Gift of Heart Health* to your community
- ♥ Facts to help you increase physical activity, eating in a heart healthy way, aim for a healthy weight, and live smoke-free
- ♥ Games, role-playing, and other fun activities

Sign up today! A FREE training will be held:

Date: _____ Time: _____

Location: _____

For more information, contact: _____

Upon completion of training, each participant will receive a certificate.

U.S. DEPARTMENT OF HEALTH AND HUMAN SERVICES

National Institutes of Health

National Heart, Lung, and Blood Institute

and

Indian Health Service



For More Information

The NHLBI Health Information Center is a service of the National Heart, Lung, and Blood Institute (NHLBI) of the National Institutes of Health. The NHLBI Health Information Center provides information to health professionals, patients, and the public about the treatment, diagnosis, and prevention of heart, lung, and blood diseases. Please contact the Information Center for prices and availability of publications.

NHLBI Health Information Center
P.O. Box 30105
Bethesda, MD 20824-0105
Telephone: (301) 592-8573
TTY: (240) 629-3255
Fax: (301) 592-8563
E-mail: nhlbiinfo@rover.nhlbi.nih.gov

The NHLBI also maintains a World Wide Web site at <http://www.nhlbi.nih.gov>. Selected publications are also available on the NHLBI Web site.

DISCRIMINATION PROHIBITED: Under provisions of applicable public laws enacted by Congress since 1964, no person in the United States shall, on the grounds of race, color, national origin, handicap, or age be excluded from participation in, be denied the benefits of, or be subjected to discrimination under any program or activity (or, on the basis of sex, with respect to any education program and activity) receiving Federal financial assistance. In addition, Executive Order 11141 prohibits discrimination on the basis of age by contractors and subcontractors in the performance of Federal contracts, and Executive Order 11246 States that no federally funded contractor may discriminate against any employee or applicant for employment because of race, color, religion, sex, or national origin. Therefore, the National Heart, Lung, and Blood Institute must be operated in compliance with these laws and Executive Orders.



U.S. DEPARTMENT OF HEALTH AND HUMAN SERVICES
National Institutes of Health
National Heart, Lung, and Blood Institute
and
Indian Health Service
NIH Publication No. 03-5218
November 2003

INTRODUCING THE AMERICAN INDIAN FAMILY OF
Honoring the Gift of Heart Health



Sara

Michael

Will

Sally

Mary

Ann

Maggie

An American Indian Family's Journey

This manual tells a story of an American Indian family's journey to heart health.

This path has turns and bumps, but this family's positive outlook gave them the strength to make changes in their lives.

They have learned that heart health is a gift to pass on to future generations.

The grandmother's (Mary) wisdom and the family's strong support enabled them to make heart healthy changes together.

The family will show you how to choose the same journey to heart health. They will share practical tips and traditional ways for you and those around you to protect your heart. Learn from their example and be encouraged that you can do it too!

Honor the gift of heart health
by choosing a healthy lifestyle for you and your family!

Join the *Honoring the Gift of Heart Health* Program

Did You Know...

*Nearly one out of four American Indians and Alaska Natives dies of heart disease.
But you can do something about it!*

In the program, you will:

- ✓ Learn how to keep your and your family's hearts healthy.
- ✓ Find ways to increase physical activity, eat in a heart-healthy way, keep a healthy weight, and not smoke.
- ✓ Enjoy videos, games, role-playing, and other activities that make learning fun.
- ✓ Get take-home materials you can share with others.

THE PROGRAM IS FREE.



**Everyone who completes the program
will receive a certificate.**

Honoring the Gift of Heart Health classes meet once a week for 10 weeks.

Sponsored by: _____

Location: _____

Day/time: _____

Classes begin on: _____

For more information or to register, contact: _____

Strengthen the Heartbeat of Your Community and Future Generations!



U.S. DEPARTMENT OF HEALTH AND HUMAN SERVICES
National Institutes of Health
National Heart, Lung, and Blood Institute
and
Indian Health Service

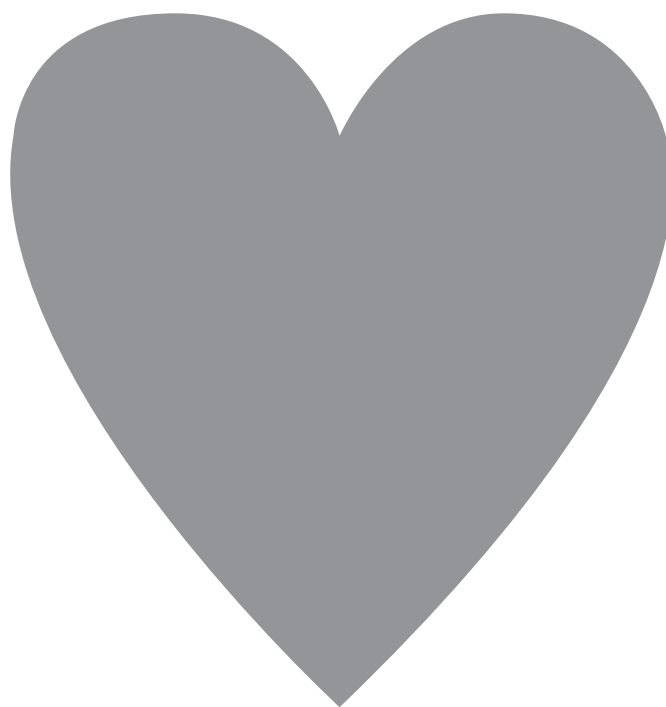

Use this shape to cut out the heart (see page 11).

Are You at Risk for Heart Disease?

Name: _____

Risk factors are traits or habits that make a person more likely to develop heart disease. Read this list of risk factors for heart disease. Check the ones you have. Think about the risk factors for your family members too.

Heart disease risk factors you can do something about:

Check the ones you have.

- Cigarette smoking
- High blood pressure Not sure
- High blood cholesterol Not sure
- Diabetes Not sure
- Being overweight or obese Not sure
- Not being physically active

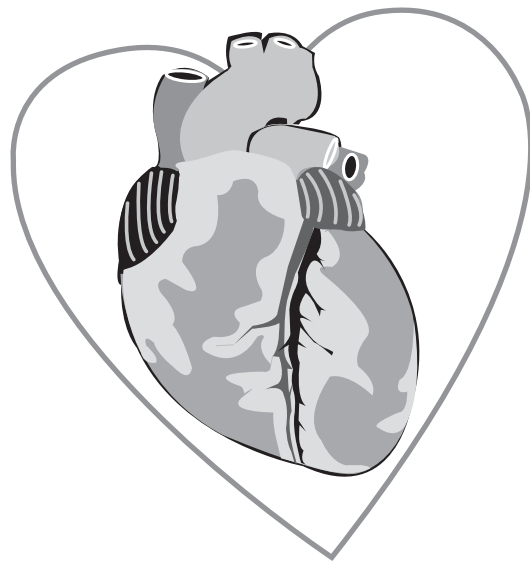

Heart disease risk factors you cannot control:

- Age (45 years or older for men and 55 years or older for women)
- People in your family having early heart disease (before age 55 in men or before age 65 in women).

The more risk factors you have checked, the greater your risk for heart disease. Talk to your doctor about your risk.

Take Care of Your Heart: Diabetes and Heart Disease

Having diabetes can lead to heart attack or stroke,
but it doesn't have to.

What is diabetes?

- Diabetes is a disease in which the body does not produce enough insulin or does not use insulin properly. Insulin is a hormone that is needed to change sugar, starches, and other foods into energy needed for daily life. With diabetes, the blood glucose (sugar) levels are high.
- Diabetes is serious and can lead to heart attack, blindness, amputation, and kidney problems.
- Diabetes is more and more common today for AI/AN. About one out of eight AI/AN adults has diabetes.

Type 2 Diabetes is most common in adults, but it is now starting to appear in children.

What are the signs and symptoms of Type 2 Diabetes?

- Many people have no signs or symptoms. Type 2 Diabetes develops gradually and sometimes has no symptoms. Even if you have no symptoms of diabetes, if you have any of the risk factors above, ask your health care provider about getting tested for it.

Your chances of getting diabetes are greater if:

- You are overweight, especially if you have extra weight around the waist.
- You are physically inactive.
- You have a family member with diabetes.
- You had diabetes during pregnancy (gestational diabetes), or gave birth to at least one baby weighing more than 9 pounds.
- Your blood pressure is 140/90 mmHg or higher, or you have been told that you have high blood pressure.
- Your cholesterol levels are not normal. Your HDL cholesterol ("good" cholesterol) is 40 mg/dL or lower, or your triglyceride level is 150 mg/dL or higher.

Here are signs to look for:

- Increased thirst
- Increased hunger
- Fatigue
- Increased urination, especially at night
- Weight loss
- Blurred vision
- Sores that do not heal

Be Smart About Your Heart: Control the ABCs of Diabetes

Some people have “**pre-diabetes,**” which is when blood glucose levels are higher than normal but not in the diabetes range. People with this condition can reduce the risks of developing the diabetes by losing a small amount of weight and increasing their physical activity.

If you have diabetes, controlling your blood glucose levels will help prevent complications.

The ABCs of Diabetes

If you have diabetes, three key steps can help you lower your risk of heart attack and stroke. Follow these "ABCs":

- **A is for A1C test,** which is short for hemoglobin A1C. This test measures your average blood glucose (blood sugar) over the last 3 months. It lets you know if your blood glucose level is under control. Get this test at least twice a year.

Number to aim for: below 7.

- **B is for blood pressure.** The higher your blood pressure, the harder your heart has to work. Get your blood pressure measured at every doctor's visit.

Numbers to aim for: below 120/80 mmHg.

- **C is for cholesterol.** "Bad" cholesterol, or LDL, builds up and clogs your arteries. Get your LDL cholesterol tested at least once a year.

Number to aim for: below 100 mg/dL.

Be sure to ask your health care provider:

- What are my ABC numbers?
- What should my ABC target numbers be?
- What actions should I take to reach my ABC target numbers?

To lower your risk of heart attack and stroke, also take these steps:

- Get physical activity every day.
- Eat less salt, cholesterol, and fat, especially saturated fat.
- Eat more fiber. Choose whole grains, fruits, vegetables, and beans.
- Stay at a healthy weight.
- If you smoke, stop.
- Take medicines as prescribed.
- Ask your doctor about taking aspirin.
- Ask others to help you manage your diabetes.

ACT IN TIME TO HEART ATTACK SIGNS
Heart Attack Warning Signs

LEARN WHAT A HEART ATTACK FEELS LIKE.

Act fast. Call 9-1-1.

It could save your life.

Treatments can stop a heart attack as it is happening.

They work best if given within 1 hour of when heart attack signs begin.

If you think you are having a heart attack, call 9-1-1 right away.

KNOW THE HEART ATTACK WARNING SIGNS:

Your chest hurts
or feels squeezed

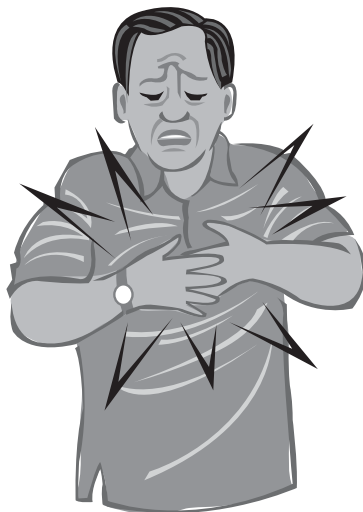

One or both arms, your back,
or stomach may hurt.



You may feel pain in the
neck or jaw.



You feel like
you can't breathe.



You may feel light-headed or
break out in a cold sweat.



You may feel sick
to your stomach.

ACT IN TIME TO HEART ATTACK SIGNS

Heart Attack Warning Signs

YOU MAY NOT BE SURE IT IS A HEART ATTACK.

A heart attack may not be sudden or very painful. You may not be sure what is wrong.
But it is important to check it out right away.



**ACT FAST.
CALL 9-1-1.**



**Call 9-1-1 in 5 minutes or less.
Do not drive yourself to the hospital.**



When you call 9-1-1, an emergency vehicle arrives right away. Treatment can begin at once.

TO HELP SURVIVE A HEART ATTACK, TAKE THESE STEPS:

1

Learn the heart attack warning signs, and act fast if you feel them.

2

Talk with family and friends about the warning signs and the need to call 9-1-1 right away.

3

Ask your doctor about your heart attack risk and how to lower it.

ACT IN TIME TO HEART ATTACK SIGNS

Role-Play 1: at Home

Actor 1

You are at home having breakfast with your spouse. You tell him/her that you woke up not feeling well. You have a variety of symptoms, including:

- some pressure and discomfort in your chest
- your arm hurts
- you feel short of breath
- you feel a little light-headed

Actor 2

You look worried—you are not sure what is wrong with your spouse, but he/she looks sick. You tell your spouse you have recently heard about the signs of a heart attack and you worry that this may be the problem. You say that maybe it is best if you call 9-1-1.

Actor 1

You insist it is nothing, probably just indigestion. It will pass; you will be fine.

Actor 2

You reply by telling your spouse why it is important to call 9-1-1 right away:

- Even if you are not sure it is a heart attack, it is best to check it out.
- If it is a heart attack, fast treatment can prevent damage to the heart.
- Getting to the hospital quickly means that treatment can start right away and maybe save your life.

You call 9-1-1.

ACT IN TIME TO HEART ATTACK SIGNS

Role Play-2: at Work

Actor 1

You are at work one afternoon and you see that your coworker does not look well. You ask if anything is wrong.

Actor 2

You reply that you came to work this morning not feeling quite right. You describe the symptoms:

- a heavy feeling in the center of the chest
- difficulty catching your breath
- sick to your stomach
- light-headed
- some pain going down the left arm

Actor 1

You say you have heard that these signs may mean a heart attack. If so, it is best to get it checked out right away at the hospital. You offer to call 9-1-1.

Actor 2

You give your coworker many reasons why this is impossible.

- You ate a big lunch, and it's just indigestion, nothing serious.
- You don't want to cause a scene at work and get everybody worried.
- Why not wait and see if the pain will go away in a little while?
- If you went to the hospital, no one would be there to pick up your grandson from daycare.

Actor 1

You overcome your friend's excuses and tell him/her why it is important to call 9-1-1 right away. You make the call.

ACT IN TIME TO HEART ATTACK SIGNS

Role-Play 3: at Night

Actor 1

You are at home one night reading a magazine when you suddenly start to feel very sick. You call your neighbor on the phone to say you are not feeling well. You describe your symptoms.

- You suddenly feel a very bad pain in the center of your chest.
- You are out of breath and you are breaking out in a cold sweat.

You feel it is something bad, and you think you should drive yourself to the hospital. Will your neighbor go with you?

Actor 2

You tell your neighbor you are worried about him/her. These symptoms sound like the warning signs of a heart attack. You say in this case it is best to call 9-1-1, not to drive yourself, so you will get to the hospital safely and be treated right away when you arrive.

Actor 1

You protest that you don't want to wake up the neighborhood and cause a big scene with the siren and all the lights; it's easier to drive.

Actor 2

You tell your neighbor why it is better to call the emergency service:

- Emergency personnel can start medical care right away.
- If your heart stops beating, emergency personnel can revive you.
- Heart attack patients who arrive by ambulance tend to receive faster treatment when they get to the hospital.

Actor 1

You agree that this makes sense. You ask your neighbor to call 9-1-1 for you right away and then come over to be with you.

ACT IN TIME TO HEART ATTACK SIGNS

Steps to Survival—Step 1

Learn the heart attack
warning signs.



Steps to Survival

STEP 1

■ **Say:**

It is important to know the heart attack warning signs so you can be ready to act fast if they happen. Does anyone remember the warning signs?

If the group does not cover all the signs, say:

Let's review them one more time. The warning signs are:

- **Chest discomfort.** Most heart attack victims have some type of discomfort in the center of the chest that lasts for more than a few minutes or goes away and comes back. It can feel like uncomfortable pressure, squeezing, fullness, or pain.
- **Discomfort in other areas of the upper body.** This can include pain or discomfort in one or both arms, the back, neck, jaw, or stomach.
- **Shortness of breath.** This often comes along with chest discomfort. But it can also come before the chest discomfort.
- **Other signs** are breaking out in a cold sweat, nausea, or feeling light-headed.

ACT IN TIME TO HEART ATTACK SIGNS

Steps to Survival—Step 2

Think about what you would do
if you have a heart attack.





Steps to Survival

STEP 2

■ **Say:**

Think about what you should do if you or someone you know has heart attack warning signs. Think about what you would do in different situations such as at home, at work, and in the middle of the night.

Ask the group to call out suggestions about what they would do.

ACT IN TIME TO HEART ATTACK SIGNS

Steps to Survival—Step 3

Talk with your family and friends about the heart attack warning signs and the importance of calling 9-1-1.



Steps to Survival

STEP 3

■ Say:

It is important that the people around you know what to do if you have the warning signs of a heart attack. Ask them to learn the signs. Tell them about the importance of calling 9-1-1 right away—within 5 minutes. Explain why it is better to call 9-1-1 than to have someone drive you to the hospital.

Ask the group to call out the reasons why it is good to call 9-1-1.

If the group does not give all the reasons, say:

Let's recall the reasons:

- Emergency personnel can begin treatment right away—even before you get to the hospital.
- If your heart stops beating during the heart attack, emergency personnel have the equipment to start it beating again.
- Heart attack patients who are brought by ambulance tend to get faster treatment when they arrive at the hospital.

ACT IN TIME TO HEART ATTACK SIGNS

Steps to Survival—Step 4

Talk to your doctor
about your risk of a heart attack.



Steps to Survival

STEP 4

■ **Say:**

Ask your doctor about your risk of having a heart attack. Find out if you have conditions that raise your risk, and ask your doctor what you can do to lower your risk.

Ask the group to call out the things that can increase a person's risk of a heart attack.

If the group does not give all the risks, say:

Let's recall the factors that can increase your chance of having a heart attack:

- Age (45 or older for men; 55 or older for women)
- A previous heart attack
- Family history of early heart disease
- Diabetes
- High blood cholesterol
- High blood pressure
- Smoking
- Overweight
- Physical inactivity

ACT IN TIME TO HEART ATTACK SIGNS

Steps to Survival—Step 5

Talk to your doctor about what you should do if you experience any of the heart attack warning signs.





Steps to Survival

STEP 5

■ **Say:**

Be sure to talk to your doctor about what you should do if you experience any of the heart attack warning signs. Your doctor may have special instructions for you depending on your medical condition.

ACT IN TIME TO HEART ATTACK SIGNS

Steps to Survival—Step 6

Gather important information
to take along with you to the hospital.



Steps to Survival

STEP 6

■ **Say:**

When you go home, be sure to fill out the information on the handout. It gives health care providers the information they need to know about you in case of an emergency—

- a person to contact,
- the name and phone number of your doctor or clinic,
- the medications you are taking,
- and any allergies you may have to certain medications.

ACT IN TIME TO HEART ATTACK SIGNS

Heart Attack Survival Plan

Information To Share With Emergency Personnel/Hospital Staff

Medicines you are taking:

Medicines you are allergic to:

If symptoms stop completely in less than 5 minutes, you should still call your health care provider.

Health care provider's phone number during office hours: _____

Health care provider's phone number after office hours: _____

Person You Would Like Contacted If You Go to the Hospital

Name: _____

Home phone number: _____

Work phone number: _____

The Great Race

Narrator: Sara and Michael are Sally's and Will's daughter and son. They are talking with Maggie, their cousin, on a sunny April afternoon. Every afternoon they gather by the General Store thinking of things to do and eat Big Hunk candy bars.

Sara: Did you hear? John BrokeShoulder is going to run in the New Mexico Marathon on Monday. Maggie said it was in the newspaper this morning.

Michael: I did! He's going to be the next Thomas Longboat, the "Bronze Mercury" who won the Boston Marathon in 1907, or Ellison Brown, who won the Marathon in 1936 and 1939.

Maggie: Remember the story that grandma Mary tells us about how our ancestors used to walk and run everywhere before there were horses? She says that running was the only way to carry critical information between villages. Running was their way of life. They were always in such good shape and had so much energy and strength. She tells us that now everyone has so many demands and feels that they have to drive even to the nearest store. This lifestyle has caused our people to increase our chances of getting heart disease.

Sara: You're right! We need to get active too. Running will keep us healthy, and it's an activity that we can do anytime, together or on our own.

Maggie: How about we start running together? Instead of sitting down all afternoon, we can be up and moving around.

Michael: We can start out by brisk walking for 30 minutes a day. Then, we can start jogging short distances and as we get better, we can increase our speed and distance. We'll also have to get comfortable running shoes and make sure that we have plenty of water. Let's try it!

Narrator: One month later...

Sara: Ready for our daily run?



Michael: I sure am! Boy, running was a little hard at first, but now I look forward to running. It's given me more energy; I am less bored; and I don't fall asleep during class anymore.

Maggie: Running has been great! Now, I can walk the five blocks to the General Store without getting out-of-breath. Plus, I lost 7 lbs.!

Narrator: Sara, Michael, and Maggie continued to run. Soon, they got their friends and the whole community involved. They joined a local running program and are now encouraging younger kids to run. Sara is now training for the New Mexico Marathon.

Take Heart—Say Yes to Physical Activity.

Regular physical activity can help your heart and lungs work better, lower your blood pressure and blood cholesterol, and help you control your appetite and weight. What's more, it can help you reduce feelings of depression, and sleep better, as well as feel more energetic and good about yourself. Even better, physical activity can reduce your risk for diabetes and some types of cancer.



Make staying active a lifelong habit

Mary has learned that the more physical activity you do, the easier it gets.

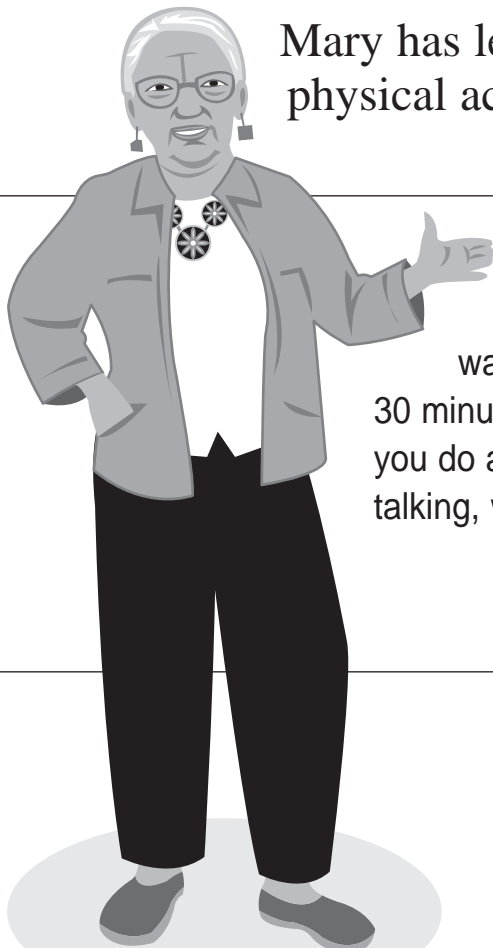

“I do not wait until the end of the day. I am active throughout the day. I take the stairs and walk everywhere I can. Now I am up to walking 30 minutes a day with my neighbor. It helps to like what you do and to do it with someone else. We are so busy talking, we walk even longer.”

Keep moving. Start slowly and work your way up!

Strive to do 30 minutes of activity every day. If you're short on time, try three 10-minute periods.

Start with Light Activities

- Slow walking
- Watering the lawn or garden
- Light house cleaning
- Cooking

Moderate Activity

The next level is moderate activities such as:

- Brisk walking
- Climbing stairs
- Dancing
- Raking leaves
- Vacuuming
- Weeding and hoeing a garden
- Bowling
- Playing traditional games

High Activity

Those who want to increase their level of physical activity should try:

- Running
- Doing aerobics
- Swimming
- Bicycling
- Working out at the gym
- Chopping wood
- Playing basketball, tennis, or soccer

Other things to do to help you and your family get started:

- Leave a pair of walking shoes in your car.
- Set a date and time with a coworker to begin walking.

Mary, Sally, and Will have all increased their physical activity. They now dance and use their exercise machine almost every day; Ann also lifts weights at the gym.

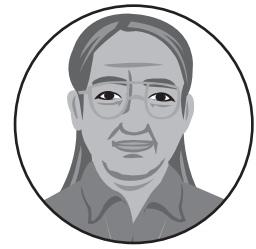
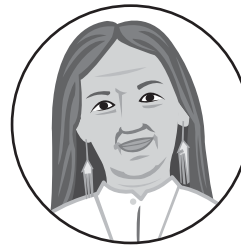
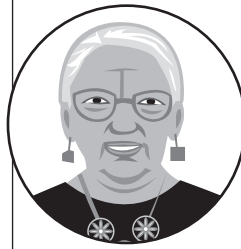

Make your personal pledge to be physically active like this AI family does!

Look at these examples:

Morning

Park the car a few blocks away and walk for 10 minutes.

Noon

During lunch, walk with a friend for 10 minutes.

Evening

After dinner, take a walk with your family.

Write the changes you will try to make this week:

Your health and your family's health are priceless. Make an investment in it!

Stretching Exercises

Do these stretches gently and slowly. Do not bounce.



1. Deep breathing

Arms up, breathe in, arms down, breathe out. Two times each.

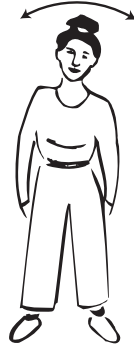

2. Neck Stretching

Side to side. Two times.



3. Shoulder Stretches

Up and down five times on each side.



4. Side Stretches

Up and down five times in each direction.



5. Waist Stretches

Side to side three times in each direction.



6. Twists

Side to side three times in each direction.



7. Back and Leg Stretches

Down and up five times.

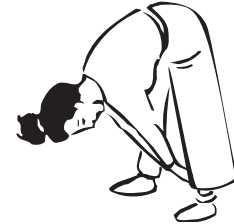

8. Back Stretch

Arms through legs six times.

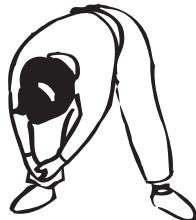

9. Leg Stretch (1)

Hold on to ankle, four times on each side.



10. Leg Stretch (2)

Down and up five times.

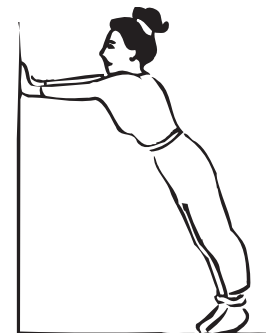

11. Leg Stretch (3)

Move heels up and down six times.

How To Exercise



1. Do stretching exercises. (See handout on stretching exercises.) Then walk slowly for 5 minutes.



2. Walk briskly for 20 minutes.



3. Walk slowly for 5 minutes.



4. Relax!

Developed by the California Diabetes Control Program, Department of Health Services, State of California.

Make Physical Activity a Habit

My Personal Record



Name _____

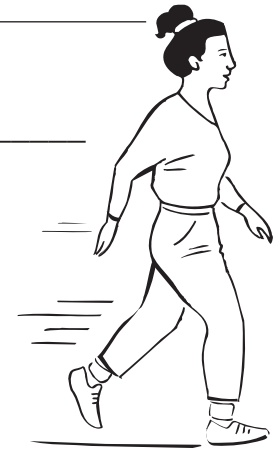



**Track your progress every day.
Start out slowly.**

Aim to reach 30 minutes or more a day!

Write in the log the number of minutes you are active each day:

	Sunday	Monday	Tuesday	Wednesday	Thursday	Friday	Saturday
Example Week 1	5 min	5	10	10	15	15	15
Week 1							
Week 2							
Week 3							
Week 4							
Week 5							
Week 6							
Week 7							
Week 8							

Sample Walking Program

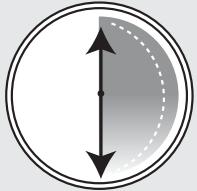
	 Warm Up	 Walk	 Cool Down	 Total Time
Week 1*	Walk slowly 5 minutes	Walk briskly 5 minutes	Walk slowly 5 minutes	15 minutes
Week 2*	Walk slowly 5 minutes	Walk briskly 7 minutes	Walk slowly 5 minutes	17 minutes
Week 3*	Walk slowly 5 minutes	Walk briskly 9 minutes	Walk slowly 5 minutes	19 minutes
Week 4*	Walk slowly 5 minutes	Walk briskly 11 minutes	Walk slowly 5 minutes	21 minutes
Week 5*	Walk slowly 5 minutes	Walk briskly 13 minutes	Walk slowly 5 minutes	23 minutes
Week 6*	Walk slowly 5 minutes	Walk briskly 15 minutes	Walk slowly 5 minutes	25 minutes
Week 7*	Walk slowly 5 minutes	Walk briskly 18 minutes	Walk slowly 5 minutes	28 minutes
Week 8*	Walk slowly 5 minutes	Walk briskly 20 minutes	Walk slowly 5 minutes	30 minutes

*Do every day of the week

Will's Journey to Heart Health

Description of Actors (Read by Narrator):

Sally (Wife of Will):

- Sally is a traditional woman and who carries out her role as wife and mother according to the old ways. She was 15 when she married Will.

Ann (Sally's younger sister) and **Mary** (Sally and Ann's mother):

- Ann and Mary (who lives with Sally) are comforting Sally on the couch. Her husband of 25 years had a heart attack this morning.

Will

- He had been overweight and was recently diagnosed as having diabetes and high blood pressure. Sitting on the table is the shoebox filled with all his different medications he was supposed to start taking.

Dialogue

Narrator: The women demonstrate grief and comforting actions and alternate in verbalizing their thoughts about Will's heart attack:

Sally: "Will is mostly a good man. Sometimes he spends days away at the rodeos, but when he returns, he always brings plenty of groceries, cases of "real" soda for the kids and bluebird flour for the frybread he loves. He always eats two or three at one sitting and likes to dip it into the stew."

Mary: "He likes his eggs, bacon, and potatoes in the morning which he eats with frybread dipped in honey, and coffee—always 4 teaspoons of sugar—always shaking the salt shaker. He has to have coffee with his morning cigarettes!"

Ann: "He said he started smoking in the military because that was what fighting men did. He never stopped."

Sally: "He always goes out on the porch to drink his coffee and smokes as he waits for the sun to rise. He said his father always said that greeting the morning sun is one of man's sacred moments."

Mary: "He rides out each day to check the cattle, fences, and the hay fields. He was always busy repairing, mending things, and taking care of the cattle."

Will's Journey to Heart Health *(continued)*

- Ann:** "He always helps me and the children and supports his relatives when they needed help."
- Sally:** "He was pretty healthy until the past year. He put off going to see the doctors at the hospital all these years and never got a checkup! I guess it was the symptoms of diabetes such as the rapid weight-loss and tremendous thirst, and it really scared him when he started losing his eyesight. That got him to go see the doctor."
- Mary:** "Will went to the medicine man first, but the medicine man told him that Indians didn't use to have these symptoms. Since they stopped living and eating in the traditional way, they have been coming down with this new illness. He recommended that Will go see the white man's doctor and get some medicine and come back for a healing ceremony and songs for his spirit."
- Sally:** "I was with him when the doctor listened to his chest, took his blood pressure, and checked his blood cholesterol. I could see the doctor's eyes, and I didn't have a good feeling when the doctor asked Will if he'd ever been told he had high blood pressure or diabetes and if these diseases ran in his family."
- Sally:** "The doctor prescribed medicine for high blood pressure and diabetes. He said Will had to lose weight, start walking for at least 30 minutes daily, add more vegetables and fruit to his meals, and cut down on his food portions, the frybread, fatty foods, salt, and sugar he was eating and drinking. The doctor also referred us to a nutritionist to help us learn about a heart healthy meal plan and something about reading the food labels on packaged foods."
- Mary:** "He is a good man, but he has his ideas. I guess that he was trying to recapture his high school days because he put up a basketball hoop and started shooting hoops, and started walking. I guess after all these years only his horse had gotten regular exercise. Anyhow, after eating his regular breakfast and watching the sunrise, he went for a walk. When he got back, he collapsed on the porch saying his chest hurt."

Will's Journey to Heart Health *(continued)*

Ann: "The doctor said Will could decrease the risk of another heart attack if he controls his blood pressure and diabetes. I guess he lived life like his father did because his father never had any checkups before he went into the hospital, where he died from a stroke because of high blood pressure."

Sally: "Mother, sister, would you help me find a way to help others learn about having regular checkups for heart disease, high blood pressure, high blood cholesterol, and about quitting smoking and chewing tobacco? Maybe we could get the grandmothers and mothers together to see what we can do about those smoke shops. They sell cigarettes to anybody."

End—All take a bow.

Epilogue

- **Sally** runs for council and gets new tribal enterprise going to replace revenue lost from the closing of the tribal smoke shops.
- **Ann** vows to make sure her family has regular check-ups and learns new ways to prepare healthy foods.
- **Mary** organizes mothers into a voting block to promote cardiovascular health education and physical activity on and off reservations and in schools, including nutritious lunches, and promotes popular support for closing of reservation smoke shops.
- **Will** recovers from his heart attack and starts working with a doctor and a nutritionist on how to live heart healthy. He now walks every day after dinner and has learned to eat more heart healthy. He has lost 20 pounds and travels throughout the surrounding villages speaking about heart health and his experience having a heart attack.

Honoring the Gift of Heart Health Wallet Card

Cut along dotted lines, paste back to back, and fold in half to make your own personal wallet card.

Try these tips for a healthy heart!

- More** + fruits, vegetables, and lowfat dairy products
 + physical activity
- Lower** – saturated and trans fat, cholesterol, and sodium
 – BMI, waist circumference
- None** 0 cigarettes

= Heart Health



U.S. DEPARTMENT OF HEALTH AND HUMAN SERVICES
 National Institutes of Health
 National Heart, Lung, and Blood Institute

Front

Health for Your Heart

Prevent heart disease.

Get your blood pressure
 and blood cholesterol
 checked.

Name _____

(fold)

Know Your Number! It may save your life.

Blood Pressure	Blood Cholesterol
It is best to have a reading less than 120/80. A reading of 140/90 or more is high blood pressure.	It is best to have a level less than 200. A level of 240 or higher may lead to a heart attack.
If your blood pressure and blood cholesterol levels are at a desirable level, check your blood pressure once a year and your blood cholesterol once every 5 years.	

Back

Your Personal Record

FOR BLOOD PRESSURE AND CHOLESTEROL

DATE	BLOOD PRESSURE	CHOLESTEROL
	/	
	/	
	/	
	/	
	/	
	/	
	/	
	/	
	/	
	/	

Take Steps— Healthy Habits to Lower High Blood Pressure!

To PREVENT high blood pressure:

1. Aim for a healthy weight.

Try not to gain extra weight. Lose weight if you are overweight. Try losing weight slowly, about half a pound to 1 pound each week until you reach a healthy weight.



2. Be active every day.

You can walk, dance, use the stairs, play sports, or do any activity you enjoy.

3. Use less salt and sodium in cooking.

Buy foods marked “sodium free,” “low sodium,” or “reduced sodium.” Take the salt shaker off the table.

4. Eat more fruits and vegetables, whole grain breads and cereals, and lowfat dairy products.



5. Cut back on alcohol.

Men who drink should have no more than one or two drinks each day. Women who drink should have no more than one drink a day. Pregnant women should not drink any alcohol.

To LOWER high blood pressure:

1. Practice these steps:

- Maintain a healthy weight.
- Be active every day.
- Eat fewer foods high in salt and sodium.
- Eat more fruits and vegetables, whole grain breads and cereals, and lowfat dairy products.
- If you drink alcoholic beverages, do so in moderation.

2. Take your medicine the way your doctor tells you.

3. Have your blood pressure checked often.



Medicine for High Blood Pressure

FACTS:

- Many people with high blood pressure may take more than one medicine to keep their blood pressure low.
- Some medicines can cause side effects or reactions, which can be corrected. If this happens, talk to your doctor.
- Eating more fruits and vegetables, cutting back on salt and sodium, losing weight, and being physically active can help your medicines work better.

Type	How it works	What you need to know
Diuretics or "water pills"	Help your kidneys clear excess fluid and sodium from your body, which allow the blood vessels to widen to reduce your blood pressure.	<ul style="list-style-type: none">• The doctor may give you potassium pills to offset the loss of potassium. Take the medicine as the doctor tells you.• The doctor may give you a diuretic alone or in combination with another blood pressure lowering medicine.
Beta blockers	Makes the heart beat slower and with less force, which helps the blood pressure go down.	<ul style="list-style-type: none">• Avoid beta blockers if you have asthma or a problem with your lungs.• Do not stop the beta blocker medicine all at once. It can lead to a very large rise in blood pressure and increase your chance of a heart attack.
ACE* inhibitors and ARBs**	Blocks a substance in the blood that causes your blood vessel to tighten, thus relaxing the blood vessel, which lowers blood pressure.	<ul style="list-style-type: none">• Your doctor will check your kidneys and watch your blood pressure closely.• Not to be taken if pregnant.
Calcium channel blockers	Prevent calcium from entering the muscle cells of the heart and blood vessels. This action causes the blood vessels to relax, open wider, and lower the blood pressure.	<ul style="list-style-type: none">• Talk to your doctor before taking any allergy medicine.

Other types of medicines: There are many other medicines available to control your high blood pressure. Talk to your doctor to learn more about your high blood pressure treatment plan.

*ACE (angiotensin-converter enzyme)

**ARBs (angiotensin-receptor blockers)

Tips for Taking Medicine for High Blood Pressure

Here are some tips:

- Make sure you take medicine every day, not only on the days when you do not feel well.
- Tell the doctor the names of all other medicines, herbs, or supplements you take. Bring everything with you when you have a doctor's appointment.
- Tell the doctor or health aide right away if the medicine makes you feel strange or sick. Ask the doctor about changing the dosage or switching to another type of medicine.
- Refill your medicine before you run out.
- Have your blood pressure checked often to see if the medicine is working for you.
- Don't stop taking your medicine if your blood pressure is okay. That means the medicine is working.

Questions to ask the doctor:

When the doctor gives you medicine for high blood pressure, ask:

Name of medicine(s): _____

Amount of medicine to take: _____

When to take it? _____

What to eat or drink with it? _____

What other medicine is OK to take at the same time? _____

Other: _____

If problems occur, call this number immediately: _____

Read the Food Label for Sodium!

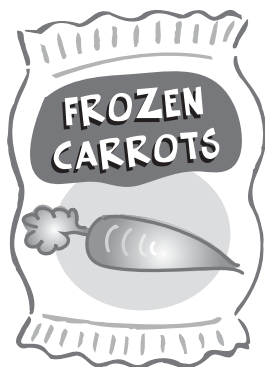

Food labels tell you what you need to know about choosing foods that are lower in sodium. Here's a food label for frozen carrots. The label tells you:

Amount Per Serving

The nutrient amounts are for one serving. So, if you eat more or less than a serving, you need to add or subtract nutrient amounts. For example, if you eat 1 cup of carrots, you are eating two servings.

Nutrients: Sodium

Listed are the amounts of sodium in one serving. These amounts are given in milligrams.

Frozen Carrots

Nutrition Facts	
Serving Size 1/2 cup (64g)	
Servings Per Container 5	
Amount Per Serving	
Calories 30	Calories from Fat 0
% Daily Value*	
Total Fat 0g	0%
Saturated Fat 0g	0%
Trans Fat 0g	
Cholesterol 0mg	0%
Sodium 35mg	2%
Total Carbohydrate 6g	2%
Dietary Fiber 2g	8%
Sugars 3g	
Protein 1g	
Vitamin A 100% • Vitamin C 2%	
Calcium 2% • Iron 0%	
<small>*Percent Daily Values are based on a 2,000 calorie diet. Your Daily Values may be higher or lower depending on your calorie needs.</small>	

Number of Servings

The serving size is 1/2 cup. There are about five servings in the package. Remember, the numbers on the label are for ONE serving, NOT the whole container.

Percent Daily Value

The Percent DV helps you compare products and quickly tells you if the food is high or low in sodium. Choose products with the lowest Percent DV for sodium. 5 percent or less is low and 20 percent or more is high.

The Choice Is Yours—Compare!

Which one would you choose?

Frozen carrots are lower in sodium.

Read the food labels and choose foods that are lower in sodium to help keep your heart strong.

Calories 30	Calories from Fat 0
% Daily Value*	
Total Fat 0g	0%
Saturated Fat 0g	0%
Trans Fat 0g	
Cholesterol 0mg	0%
Sodium 35mg	2%

Frozen Carrots

One serving (1/2 cup) of frozen carrots has only 35 mg of sodium and 2 percent of the Daily Value for sodium, which is low (5 Percent DV is low).

Calories 30	Calories from Fat 0
% Daily Value*	
Total Fat 0g	0%
Saturated Fat 0g	0%
Trans Fat 0g	
Cholesterol 0mg	0%
Sodium 380mg	16%

Canned Carrots

One serving (1/2 cup) of canned carrots has 380 mg of sodium and 16 Percent DV for sodium. That is more than ten times the sodium found in a serving of frozen carrots.

Will's Food Choices



Will's blood pressure was slightly higher the last time he visited his doctor.

The doctor told him to cut back on the amount of sodium he eats.

Use the food labels to help Will's wife, Sally, choose foods that will help Will follow his doctor's advice.

Mark the number of your choice for each pair between the labels.

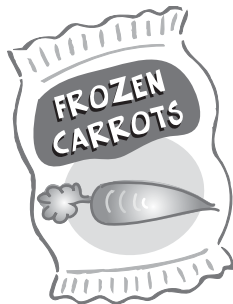

1 - Tomato Juice

Nutrition Facts	
Serving Size 3/4 cup (17ml)	
Servings Per Container 1	
Amount Per Serving	
Calories 30	Calories from Fat 0
% Daily Value*	
Total Fat 0g	0%
Saturated Fat 0g	0%
Trans Fat 0g	
Cholesterol 0mg	0%
Sodium 657mg	27%
Total Carbohydrate 7g	2%
Dietary Fiber 0g	0%
Sugars 6g	
Protein 1g	
Vitamin A 6%	Vitamin C 0%
Calcium 0%	Iron 5%

2 - Orange Juice

Nutrition Facts	
Serving Size 3/4 cup (177ml)	
Servings Per Container 1	
Amount Per Serving	
Calories 90	Calories from Fat 0
% Daily Value*	
Total Fat 0g	0%
Saturated Fat 0g	0%
Trans Fat 0g	
Cholesterol 0mg	0%
Sodium 3mg	0%
Total Carbohydrate 21g	7%
Dietary Fiber 0g	0%
Sugars 20g	
Protein 1g	
Vitamin A 0%	Vitamin C 100%
Calcium 0%	Iron 0%

Lower
Sodium
Choice

3 - Frozen Carrots

Nutrition Facts	
Serving Size 1/2 cup (64g)	
Servings Per Container 5	
Amount Per Serving	
Calories 30	Calories from Fat 0
% Daily Value*	
Total Fat 0g	0%
Saturated Fat 0g	0%
Trans Fat 0g	
Cholesterol 0mg	0%
Sodium 35mg	2%
Total Carbohydrate 6g	2%
Dietary Fiber 2g	8%
Sugars 3g	
Protein 1g	
Vitamin A 100%	Vitamin C 2%
Calcium 2%	Iron 0%

4 - Canned Carrots

Nutrition Facts	
Serving Size 1/2 cup (73g)	
Servings Per Container 3.5	
Amount Per Serving	
Calories 30	Calories from Fat 0
% Daily Value*	
Total Fat 0g	0%
Saturated Fat 0g	0%
Trans Fat 0g	
Cholesterol 0mg	0%
Sodium 380mg	16%
Total Carbohydrate 5g	2%
Dietary Fiber 2g	8%
Sugars 4g	
Protein 0g	
Vitamin A 100%	Vitamin C 0%
Calcium 0%	Iron 0%

Lower
Sodium
Choice

* **Percent Daily Values** are based on a 2,000 calorie diet. Your Daily Values may be higher or lower depending on your calorie needs.

Will's Food Choices *(continued)*

5 – Packaged Rice Mix



Nutrition Facts	
Serving Size 1 cup (195g)	
Servings Per Container 3.5	
Amount Per Serving	
Calories 190	Calories from Fat 5
% Daily Value*	
Total Fat 1g	2%
Saturated Fat 0g	0%
<i>Trans</i> Fat 0g	
Cholesterol 0mg	0%
Sodium 820mg	34%
Total Carbohydrate 41g	14%
Dietary Fiber 2g	8%
Sugars 1g	
Protein 3g	
Vitamin A 0% • Vitamin C 4%	
Calcium 2% • Iron 10%	

Lower
Sodium
Choice

6 – Plain Rice with Herb Seasoning



Nutrition Facts	
Serving Size 1 cup (195g)	
Servings Per Container 3.5	
Amount Per Serving	
Calories 190	Calories from Fat 0
% Daily Value*	
Total Fat 0g	0%
Saturated Fat 0g	0%
<i>Trans</i> Fat 0g	
Cholesterol 0mg	0%
Sodium 5mg	0%
Total Carbohydrate 44g	15%
Dietary Fiber 1g	3%
Sugars 0g	
Protein 4g	
Vitamin A 0% • Vitamin C 0%	
Calcium 2% • Iron 8%	

7 – Canned Chicken



Nutrition Facts	
Serving Size 1 can (88 g)	
Servings per container 1	
Amount Per Serving	
Calories 90	Calories from Fat 15
% Daily Value*	
Total Fat 1.5g	2%
Saturated Fat 0g	0%
<i>Trans</i> Fat 0g	
Cholesterol 30mg	10%
Sodium 345mg	15%
Total Carbohydrate 0g	0%
Dietary Fiber 0g	
Sugars 0g	
Protein 20g	
Vitamin A 0% • Vitamin C 0%	
Calcium 0% • Iron 4%	

Lower
Sodium
Choice

8 – Roasted Chicken (Boneless, Skinless Breasts)



Nutrition Facts	
Serving Size 3 oz (88 g)	
Servings per container 4	
Amount Per Serving	
Calories 110	Calories from Fat 10
% Daily Value*	
Total Fat 1g	2%
Saturated Fat 0g	0%
<i>Trans</i> Fat 0g	
Cholesterol 75mg	0%
Sodium 30mg	1%
Total Carbohydrate 0g	0%
Dietary Fiber 0g	
Sugars 0g	
Protein 25g	
Vitamin A 0% • Vitamin C 0%	
Calcium 0% • Iron 4%	

* **Percent Daily Values** are based on a 2,000 calorie diet. Your Daily Values may be higher or lower depending on your calorie needs.

Will's Food Choices *(continued)*

9 – Canned or Packaged (Dry) Soup



Nutrition Facts	
Serving Size 1 cup (240 g)	
Servings per container 2	
Amount Per Serving	
Calories 90	Calories from Fat 15
% Daily Value*	
Total Fat 1.5g	2%
Saturated Fat 0g	0%
Trans Fat 0g	
Cholesterol 20mg	7%
Sodium 820mg	34%
Total Carbohydrate 11g	4%
Dietary Fiber 1g	4%
Sugars 2g	
Protein 7g	
Vitamin A 25%	• Vitamin C 0%
Calcium 0%	• Iron 4%

1 – Homemade Soup (or Canned, Low Sodium)



Nutrition Facts	
Serving Size 1 cup (240 g)	
Servings per container 2	
Amount Per Serving	
Calories 90	Calories from Fat 0
% Daily Value*	
Total Fat 0g	0%
Saturated Fat 0g	0%
Trans Fat 0g	
Cholesterol 0mg	0%
Sodium 210mg	9%
Total Carbohydrate 12g	4%
Dietary Fiber 8g	32%
Sugars 6g	
Protein 6g	
Vitamin A 200%	• Vitamin C 8%
Calcium 4%	• Iron 20%

Lower
Sodium
Choice

* **Percent Daily Values** are based on a 2,000 calorie diet. Your Daily Values may be higher or lower depending on your calorie needs.

Sodium in Foods

Choose **MORE** Often

(Foods **LOWER** in Sodium)

- Chicken and turkey (with skin removed)
- Fresh fish or rinsed canned fish such as salmon or tuna
- Canned foods packed in water
- Low sodium or reduced sodium cheeses
- Low salt or salt free chips, nuts, pretzels
- Plain rice, noodles, or pasta
- Homemade, low sodium, or reduced sodium chips
- Fresh, frozen, “no salt added,” or rinsed canned vegetables
- Spices, herbs, and flavorings such as cilantro, dill, basil, parsley, garlic powder, onion powder, vinegar, and chili

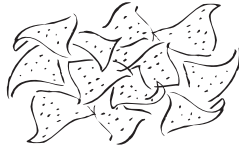

Choose **LESS** Often

(Foods **HIGHER** in Sodium)

- Smoked and cured meats such as bacon, ham, sausage, hot dogs, and bologna
- *Canned lunch meat, canned fish such as sardines (that are not rinsed), and salted/dried cod
- *Canned foods packed in broth or salt
- Most cheeses
- Salty chips, crackers, nuts, and pretzels
- Quick-cooking rice, boxes of mixed rice, potatoes, or noodles
- Regular canned soups or instant soups
- *Regular canned vegetables, pickles, olives, and pickled vegetables
- Condiments and seasonings such as soy sauce, ketchup, garlic salt, seasoning salt, bouillon cubes, meat tenderizer, and monosodium glutamate (MSG)

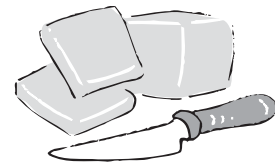

*Rinse canned foods to reduce the sodium.

Keep Your Heart in Mind. Eat Less Salt and Sodium.

Eating less salt and sodium can help prevent and lower your high blood pressure, and it sets a good example for your children.

Do you know your blood pressure reading?

It is best to have a blood pressure less than **120/80 mmHg**. If your blood pressure is between **120/80** and **139/89 mmHg** you have **prehypertension**. This means that you don't have high blood pressure yet but are likely to develop it if you don't make lifestyle changes. If your blood pressure is **140/90 mmHg** or higher, you have high blood pressure. High blood pressure does not go away by itself. Ask your doctor for help in lowering it. If you don't know your blood pressure reading, ask your doctor about it.

Write down your blood pressure reading here:



Spice it up!

Discover how much flavor you can add by using spices and herbs.

Mary has learned that it's not hard to get your family to eat less salt and sodium. After a while, her family got used to less salt and did not miss it!

To break your family's habit of using the salt shaker at the table, try Mary's secret recipe!

Also, look for other salt-free seasonings in the grocery store.

To make food taste good without salt, I use cilantro, cumin, fresh garlic, parsley, onion, green pepper, oregano, and even a dash of hot pepper when I cook. Everyone in my family got used to the taste of foods with less salt.



Fill the salt shaker with this combination of herbs and spices and use it, instead of salt, to flavor foods:

- 1/2 cup paprika
- 2 tablespoons oregano
- 2 teaspoons dried chili peppers
- 1 teaspoon garlic powder
- 1 teaspoon black pepper
- 1/2 teaspoon red pepper

Take the lead and try these simple changes

When Shopping

1. Buy fresh, plain, frozen, or no salt added canned vegetables. Choose food packed in water, instead of broth or salt.
2. Buy fresh garlic or garlic powder instead of garlic salt.
3. Choose foods labeled “low sodium,” “sodium free,” or “no salt added.”

When Cooking

1. Gradually reduce the amount of salt until you don't use any.
2. Add little or no salt to the water when cooking beans, rice, pasta, and vegetables.
3. Cut back on smoked, cured, and processed beef, pork, and poultry such as bologna, ham, and sausage.
4. Rinse all canned products to reduce the amount of sodium.

When Eating

1. Fill the salt shaker with a mixture of herbs and spices.
2. Gradually reduce the amount of salt added at the table until you add none.
3. Choose fruits and vegetables instead of salty snacks like chips, fries, and pork rinds.



Will has learned to control his high blood pressure. He takes his blood pressure pills with breakfast every morning to make sure that he doesn't forget to take them.

He has stopped smoking, walks daily, and found that food can still taste good with less salt and sodium.

Make your personal pledge to do what Will has done! Look at these examples:

Breakfast

Cook oatmeal with fat free or lowfat (1 percent) milk, raisins, cinnamon, and no salt.

Lunch

Use leftover roasted chicken to make a sandwich instead of using luncheon meats.

Dinner

Make your own stew with vegetables, and half the amount of salt.



Snack

Eat a bowl of berries instead of chips.

Write the changes you will try to make this week:

Your health and your family's health is priceless.
Make an investment in it!

Tips To Eat Less Salt and Sodium

1. Read the food label to choose foods lower in sodium.
2. Eat fewer canned and processed foods that are high in sodium (e.g., bologna, crisp pork rinds, sausage, pepperoni, salami, hot dogs, regular canned and instant soups, regular cheese, and chips).

3. Eat fresh fruits and vegetables instead of salty snacks.
4. Eat fewer salted crackers and nuts. Try unsalted nuts and unsalted or low sodium crackers.



5. Eat fewer olives and pickles.

6. Use half the amount of salt you normally use when cooking, if any. Gradually reduce the amount of salt you use, until you use none.



7. Season food with herbs and spices instead of salt.
8. Use reduced sodium bouillon, and soy sauce. If you use these condiments, do not add salt to your food.

9. Use garlic **powder** and onion **powder** instead of garlic salt or onion salt.

10. Use less salt at the table.

11. Eat vegetables and fruits without adding salt.



12. When eating out, ask that salt **not be** added to your portion, especially with french fries.

13. Taste your food before you add seasoning.

Use Herbs and Spices Instead of Salt

Basil: Use in soups, salads, vegetables, fish, and meats.



Cinnamon: Use in salads, vegetables, and breads.

Cilantro: Meats, sauces, stews, and rice.

Chili Powder/Chile Pequeño: Use in soups, salads, vegetables, and fish.

Cloves: Use in soups, salads, and vegetables.

Dill Weed and Dill Seed: Use in fish, soups, salads, and vegetables.

Garlic Powder: Used in pasta sauces, stews, soups, marinades, and meats.

Ginger: Use in soups, salads, vegetables, and meats.

Marjoram: Use in soups, salads, vegetables, beef, fish, and chicken.

Nutmeg: Use in vegetables and meats.

Oregano: Use in soups, salads, vegetables, meats, and chicken.



Onion Powder: Meats, poultry, soups, and salads.

Parsley: Use in salads, vegetables, fish, and meats.

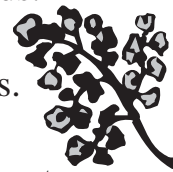

Rosemary: Use in salads, vegetables, fish, and meats.

Sage: Use in soups, salads, vegetables, meats, and chicken.

Thyme: Use in salads, vegetables, fish, and chicken.



Note: To start, use small amounts of these herbs and spices to see if you like them.

Pinto Beans

This is a delicious low cost recipe. Beans are naturally low in sodium.

Keep this recipe lower in fat by not adding lard or other fat.

Serve with rice that is cooked without salt.

3 cups	pinto beans, cooked
2 medium	tomatoes, chopped
1 large	green pepper, chopped
1/2 cup	celery, chopped
1/2 cup	onion, chopped
1 cup	water
2	garlic cloves, chopped
1/8 tsp	pepper

1. Cook dried beans as directed in package, until they are soft.
2. Cook celery, onion, and green pepper in vegetable oil spray in a large saucepan, until soft, about 5 minutes.
3. Add tomato, water, and seasonings to vegetable mixture. Bring to a boil. Add beans and return to a boil.
4. Cover and cook over low heat until flavors are blended and liquid is absorbed away, about 15 minutes. Stir once in a while to prevent from sticking.

Yield: 16 servings
Serving size: 1/2 cup
Each serving provides:
Calories: 133
Total fat: 0g
Saturated fat: 0g
Cholesterol: 0mg
Protein: 6g
Carbohydrates: 20g
Fiber: 6g
Sodium: 205mg

Quick Tips

This recipe is lower in salt and sodium than most bean dishes. It uses:

- Plain dry beans instead of regular canned beans
- Fresh instead of regular canned tomatoes
- Fresh peppers, garlic, and onions for flavoring, instead of onion or garlic salt
- Herbs and seasoning instead of salt

Remember these tips to make other dishes lower in salt and sodium.

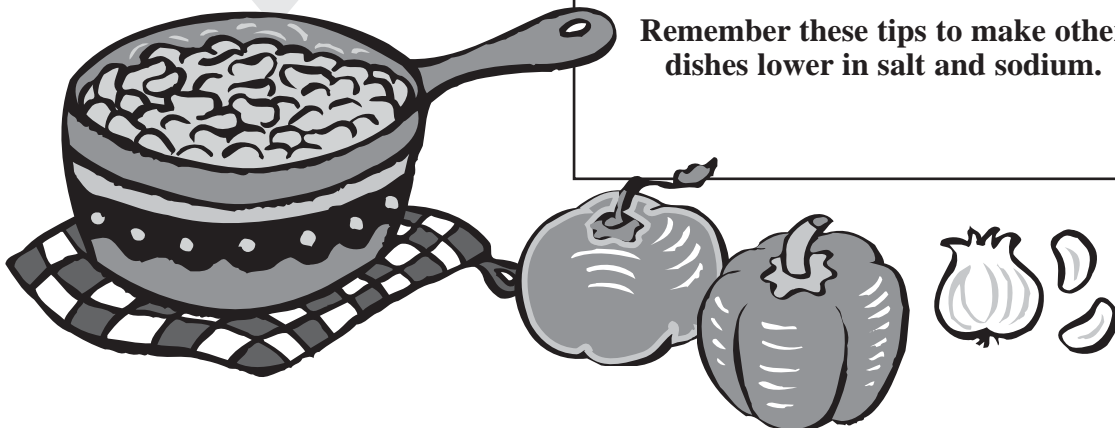

The Legend of the Rock

In the beginning, the Creator was lonely and decided to create the Mother Earth, and upon her the plants, fire, water, the four-leggeds, winged ones, those that swim, and then finally the two-leggeds—the people. The Creator said, “There is something different and special about the two-legged, because they will have strong, deep feelings, and thoughts, and also they will experience struggles, sorrow, and hurt.” In the Creator's wisdom, he knew there would be times enough to take and carry the hardships for the two-legged. The Creator gave them Rock. It is strong and durable. You can put Rock into the fire, and it remains the same. You can throw a Rock in the water and still it holds together strong. Rock will be strong enough to carry those messages back to the Creator when the hardships become too heavy for The People. Creator said, "This is my gift to The People. You don't have to carry your burdens alone. The Rock, as a source of strength, will remind you of the benefits of heart healthy living."



Be Good to Your Heart.

Know Your Cholesterol Numbers and Take Action!

Do you know your cholesterol and triglyceride numbers?

A lipid profile measures your cholesterol and triglyceride levels and can be tested at the doctor's office. Adults 20 and older should have a lipid profile.

Here is what your cholesterol numbers mean:

Total cholesterol (mg/dL):

Less than 200	Desirable
200–239	Borderline high: Depending on your other risk factors, you may be at a higher risk for heart disease.
240 or higher	High: You are at risk for clogged arteries and a heart attack.

LDL (lousy, bad) cholesterol (mg/dL): Keep it low!

Less than 100	Optimal (ideal)
100–129	Near optimal/above ideal
130–159	Borderline high
160–189	High
190 and above	Very high

Write Your Numbers Here

Total: _____

LDL: _____

HDL: _____

Triglycerides: _____

HDL (healthy, good) cholesterol (mg/dL):

The higher the better! Keep it above 40.

Triglycerides (mg/dL) Keep it below 150.

Make the switch to heart healthy eating today!



How I switched my family from whole to fat free milk:

To switch my family from drinking whole milk to fat free milk, I served them whole milk mixed with reduced fat milk for a month. During the next month, I served them reduced fat milk mixed with lowfat milk, then lowfat milk mixed with fat free milk, until they were drinking only fat free milk. Soon they couldn't even taste the difference.



Try some of these simple changes

When Shopping

1. Buy lowfat (1 percent) or fat free (skim) milk and lowfat or fat free cheese.
2. Buy nonstick cooking oil spray. Spray it on baking pans and skillets instead of using a lot of fat for greasing pans.
3. Use the food label to help you choose foods lower in saturated fat, trans fat, and cholesterol.



Sally has learned that eating foods high in saturated fat can raise her blood cholesterol level. So she's modified her favorite pie recipe by using soft margarine, fat free milk, and lowfat cream cheese. Now the pie is lower in fat, saturated fat, trans fat, and cholesterol, and it still tastes great.

Make your personal pledge to do what Sally has done! Look at these examples:

Breakfast

Use lowfat milk in coffee or cereal.



Lunch

Use leftover roasted turkey to make a sandwich. Eat it with some raw carrots and a banana for dessert.

Dinner

Bake chicken with herbs.

Take the skin off and throw it away before cooking.

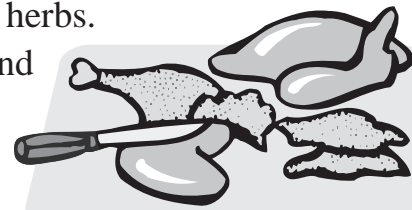

Snack

Eat an apple instead of fatty chips.

When Cooking

1. Trim the fat from meat and the skin and fat from chicken and turkey before cooking.
2. Cook ground meat, drain the fat, and rinse with hot tap water. This removes half the fat.
3. Cool soups and remove the layer of fat that rises to the top.

When Eating

1. Use fat free or lowfat salad dressing, mayonnaise, or sour cream.
2. Use lean meats instead of high fat canned meats.
3. Choose fruits and vegetables instead of high fat foods like chips or fries.

Write the changes you will try to make this week:

Your health and your family's health is priceless.
Make an investment in it!

Fats and Oils To Choose

When you do use fats and oils, choose those with less saturated fat.

Lower in Saturated Fat— Choose <u>More</u> Often	Higher in Saturated Fat— Choose <u>Less</u> Often
♥ Canola, olive, safflower, soybean, and sunflower oils	♥ Butter
♥ Margarine (especially light margarine)	♥ Solid shortening
	♥ Lard
	♥ Fatback
	♥ Stick margarine

Read the Food Label To Choose Foods
Lower in Saturated Fat, Trans Fat, and Cholesterol!

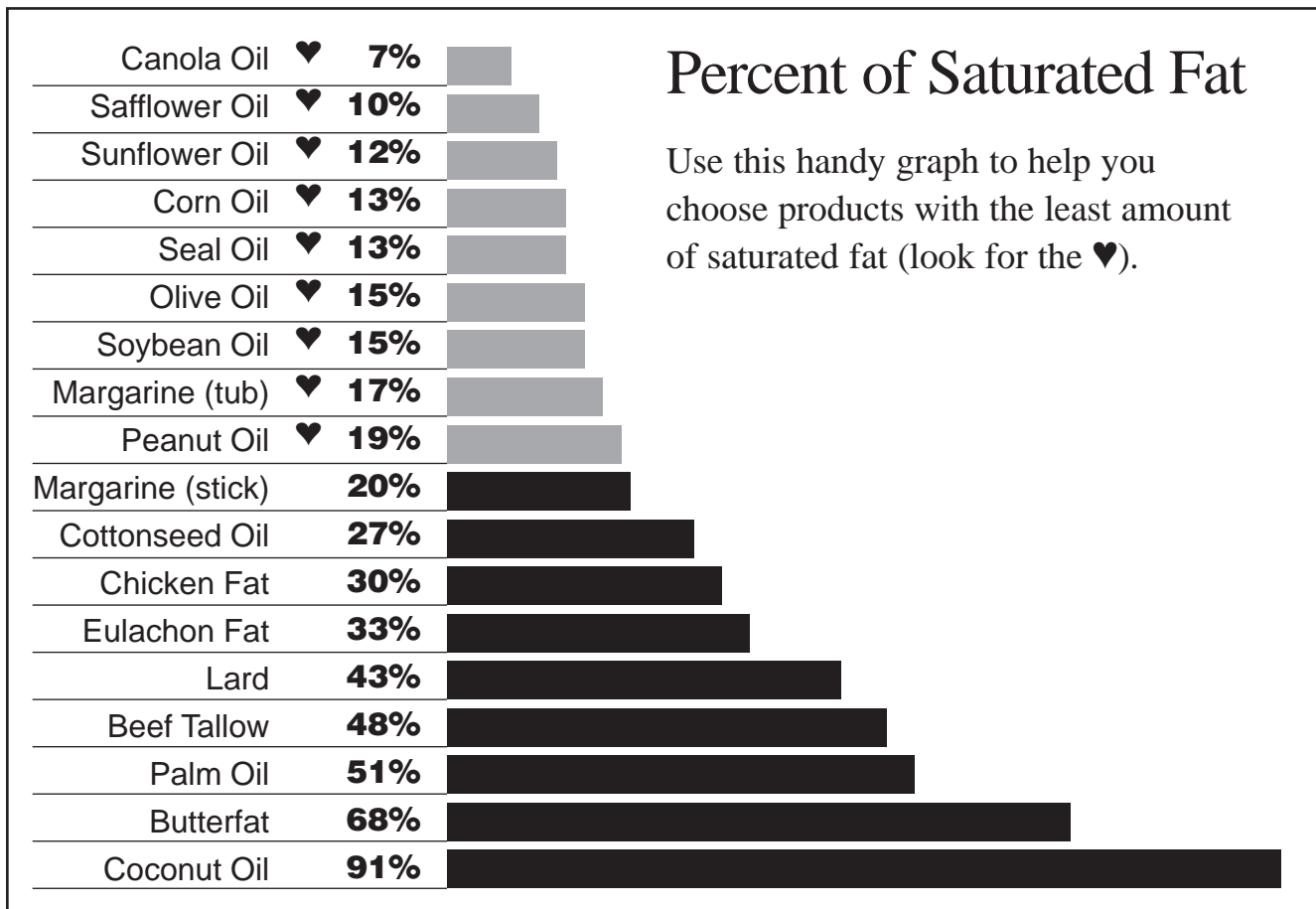

Adapted from Canola Council of Canada

Read the Food Label for Saturated Fat!



Food labels tell you what you need to know about choosing foods that are lower in saturated fat, trans fat, and cholesterol. Here's a food label for a can of pork luncheon meat. The label tells you:

Amount Per Serving

The nutrient amounts are for one serving. So, if you eat more or less than one serving, you need to add or subtract nutrient amounts. For example, if you eat 4 ounces of meat, you are eating two servings. So, you need to double the amount of total fat, saturated fat, and cholesterol.

Nutrients

Here are the amounts of saturated fat, trans fat, and cholesterol in one serving. These amounts are given in grams (g) or milligrams (mg).

Canned Lunch Meat

Nutrition Facts	
Serving Size 2 oz (56g)	
Servings Per Container 6	
Amount Per Serving	
Calories 190	Calories from Fat 155
% Daily Value*	
Total Fat 17g	26%
Saturated Fat 6g	30%
Trans Fat 0g	
Cholesterol 35mg	11%
Sodium 730mg	30%
Total Carbohydrate 1g	0%
Dietary Fiber 0g	0%
Sugars 0g	
Protein 7g	
Vitamin A 0%	Vitamin C 0%
Calcium 0%	Iron 2%

*Percent Daily Values are based on a 2,000 calorie diet. Your Daily Values may be higher or lower depending on your calorie needs.

Serving size and number of servings

The serving size is 2 ounces. There are six servings in the can.

Percent Daily Value

The Percent DV helps you compare products. Choose products with the lowest Percent DV for saturated fat, and cholesterol. If you have high blood cholesterol you need even less saturated fat, trans fat, and cholesterol. A doctor or registered dietitian can help you with this.

The Choice Is Yours—Compare!

Which one would you choose?

The lean meat is lower in saturated fat, cholesterol, and calories.

That makes the lean meat a better choice! Read food labels and choose products to keep your heart strong.

Calories 190	Calories from Fat 155
% Daily Value*	
Total Fat 17g	26%
Saturated Fat 6g	30%
Trans Fat 0g	
Cholesterol 35mg	11%
Sodium 730mg	30%

Canned Lunch Meat

Two ounces of canned meat have 30 percent (over 1/3) the DV of saturated fat you should limit yourself to in 1 day—that's a lot.

Calories 60	Calories from Fat 15
% Daily Value*	
Total Fat 1.5g	2%
Saturated Fat 0.5g	3%
Trans Fat 0g	
Cholesterol 25mg	8%
Sodium 470mg	20%

Lean Lunch Meat

Two ounces of lean lunch meat have only 3 Percent DV of saturated fat. You can learn a lot from a food label.

Sally's Breakfast Choices



Sally has little time in the morning to prepare breakfast. She often has fry bread and a cup of coffee with 1/2 cup of whole milk and 2 teaspoons of sugar.

Look at the food labels. Help her select some breakfast foods that are lower in saturated fat than her choices.

Which should she choose? Mark the number of your choice for each pair in the "Lower Fat Choice" space to the right.

1 - Fry Bread

Nutrition Facts	
Serving Size 1 piece (90g)	
Servings Per Recipe 12	
Amount Per Serving	
Calories 330	Calories from Fat 110
% Daily Value*	
Total Fat 12g	18%
Saturated Fat 4.5g	23%
<i>Trans</i> Fat 0g	
Cholesterol 7mg	2%
Sodium 161mg	7%
Total Carbohydrate 49g	16%
Dietary Fiber 2g	8%
Sugars 2g	
Protein 8g	
Vitamin A 0%	Vitamin C 0%
Calcium 0%	Iron 2%

2 - Oven Bread

Nutrition Facts	
Serving Size 1 slice (64g)	
Servings Per Recipe 12	
Amount Per Serving	
Calories 220	Calories from Fat 10
% Daily Value*	
Total Fat 1g	2%
Saturated Fat 0g	0%
<i>Trans</i> Fat 0g	
Cholesterol 0mg	0%
Sodium 100mg	4%
Total Carbohydrate 46g	15%
Dietary Fiber 2g	6%
Sugars 6g	
Protein 6g	
Vitamin A 0%	Vitamin C 0%
Calcium 1%	Iron 14%

Lower
Saturated
Fat
Choice

3 - Whole Milk

Nutrition Facts	
Serving Size 1 cup (236ml)	
Servings Per Container 16	
Amount Per Serving	
Calories 150	Calories from Fat 70
% Daily Value*	
Total Fat 8g	12%
Saturated Fat 5g	25%
<i>Trans</i> Fat 0g	
Cholesterol 35mg	12%
Sodium 125mg	5%
Total Carbohydrate 12g	4%
Dietary Fiber 0g	0%
Sugars 11g	
Protein 8g	
Vitamin A 6%	Vitamin C 4%
Calcium 30%	Iron 0% Vitamin D 25%

4 - Fat Free Milk

Nutrition Facts	
Serving Size 1 cup (236ml)	
Servings Per Container 16	
Amount Per Serving	
Calories 90	Calories from Fat 0
% Daily Value*	
Total Fat 0g	0%
Saturated Fat 0g	0%
<i>Trans</i> Fat 0g	
Cholesterol 5mg	2%
Sodium 125mg	5%
Total Carbohydrate 12g	4%
Dietary Fiber 0g	0%
Sugars 11g	
Protein 8g	
Vitamin A 10%	Vitamin C 4%
Calcium 30%	Iron 0% Vitamin D 25%

Lower
Saturated
Fat
Choice

* **Percent Daily Values** are based on a 2,000 calorie diet. Your Daily Values may be higher or lower depending on your calorie needs.

Sally's Breakfast Choices *(continued)*

5 - Doughnut

Nutrition Facts	
Serving Size 1 doughnut (54g)	
Servings Per Container 5	
Amount Per Serving	
Calories 290	Calories from Fat 170
% Daily Value*	
Total Fat 19g	30%
Saturated Fat 6g	32%
<i>Trans</i> Fat 2g	
Cholesterol 10mg	4%
Sodium 240mg	10%
Total Carbohydrate 27g	9%
Dietary Fiber 1g	0%
Sugars 15g	
Protein 3g	
Vitamin A 0% • Vitamin C 0%	
Calcium 2% • Iron 8%	

6 - English Muffin

Nutrition Facts	
Serving Size 1 muffin (57g)	
Servings Per Container 6	
Amount Per Serving	
Calories 130	Calories from Fat 10
% Daily Value*	
Total Fat 1g	2%
Saturated Fat 0g	0%
<i>Trans</i> Fat 0g	
Cholesterol 0mg	0%
Sodium 290mg	12%
Total Carbohydrate 25g	8%
Dietary Fiber 1g	4%
Sugars 4g	
Protein 4g	
Vitamin A 0% • Vitamin C 0%	
Calcium 15% • Iron 8%	

Lower
Saturated
Fat
Choice

7 - Bagel

Nutrition Facts	
Serving Size 1 bagel (75g)	
Servings Per Container 6	
Amount Per Serving	
Calories 210	Calories from Fat 10
% Daily Value*	
Total Fat 1g	0%
Saturated Fat 0g	0%
<i>Trans</i> Fat 0g	
Cholesterol 0mg	0%
Sodium 390mg	16%
Total Carbohydrate 43g	14%
Dietary Fiber 2g	8%
Sugars 2g	
Protein 8g	
Vitamin A 0% • Vitamin C 0%	
Calcium 6% • Iron 15%	

8 - Fruit Pastry

Nutrition Facts	
Serving Size 1 pastry (62g)	
Servings Per Container 5	
Amount Per Serving	
Calories 260	Calories from Fat 100
% Daily Value*	
Total Fat 11g	17%
Saturated Fat 3g	15%
<i>Trans</i> Fat 2g	
Cholesterol 0mg	0%
Sodium 190mg	8%
Total Carbohydrate 38g	13%
Dietary Fiber 1g	4%
Sugars 11g	
Protein 3g	
Vitamin A 0% • Vitamin C 0%	
Calcium 2% • Iron 6%	

Lower
Saturated
Fat
Choice

* **Percent Daily Values** are based on a 2,000 calorie diet. Your Daily Values may be higher or lower depending on your calorie needs.

Sally's Breakfast Choices *(continued)*

9 – Light Margarine, soft tub

Nutrition Facts	
Serving Size 1 Tbsp (14g)	
Servings Per Container 80	
Amount Per Serving	
Calories 50	Calories from Fat 50
% Daily Value*	
Total Fat 6g	9%
Saturated Fat 1.5g	8%
Trans Fat 0g	
Cholesterol 0mg	2%
Sodium 55mg	2%
Total Carbohydrate 0g	0%
Dietary Fiber 0g	0%
Sugars 0g	
Protein 0g	
Vitamin A 10% • Vitamin E 8% • Vitamin C 0%	
Calcium 0% • Iron 0%	

Lower
Saturated
Fat
Choice

10 – Butter

Nutrition Facts	
Serving Size 1Tbsp (14g)	
Servings Per Container 32	
Amount Per Serving	
Calories 100	Calories from Fat 100
% Daily Value*	
Total Fat 11g	17%
Saturated Fat 8g	38%
Trans Fat 0g	
Cholesterol 30mg	10%
Sodium 85mg	4%
Total Carbohydrate 0g	0%
Dietary Fiber 0g	0%
Sugars 0g	
Protein 0g	
Vitamin A 8% • Vitamin C 0%	
Calcium 0% • Iron 0%	

11 – Lowfat Cheddar Cheese

Nutrition Facts	
Serving Size 1 oz	
Servings Per Container 8	
Amount Per Serving	
Calories 50	Calories from Fat 15
% Daily Value*	
Total Fat 1.5g	2%
Saturated Fat 1g	5%
Trans Fat 0g	
Cholesterol 0mg	0%
Sodium 220mg	9%
Total Carbohydrate 1g	0%
Dietary Fiber 0g	0%
Sugars 0g	
Protein 8g	
Vitamin A 4% • Vitamin C 0%	
Calcium 10% • Iron 0%	

Lower
Saturated
Fat
Choice

8 – Cheddar Cheese





Nutrition Facts	
Serving Size 1 oz	
Servings Per Container 7	
Amount Per Serving	
Calories 120	Calories from Fat 90
% Daily Value*	
Total Fat 10g	15%
Saturated Fat 7g	35%
Trans Fat 0g	
Cholesterol 30mg	10%
Sodium 180mg	8%
Total Carbohydrate 0g	0%
Dietary Fiber 0g	0%
Sugars 0g	
Protein 6g	
Vitamin A 6% • Vitamin C 0%	
Calcium 20% • Iron 0%	

* **Percent Daily Values** are based on a 2,000 calorie diet. Your Daily Values may be higher or lower depending on your calorie needs.

Guess the Fat Activity Sheet

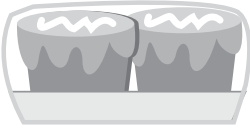
Try to guess the amount of fat (in teaspoons) that is found in each food.

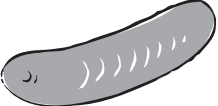
Write your answers on the “My Guess” line.

		Teaspoons of Fat	
Food		My Guess	True Amount
	2 snack cakes (1 package)	_____	_____
	1 cup of berries	_____	_____
	1 cup boiled beans	_____	_____
	1 beef hot dog (1.5 ounces)	_____	_____
	1 chocolate bar	_____	_____
	2 tablespoons of mayonnaise	_____	_____

Cooking With Less Saturated Fat

Poultry and Meat

1. Take the skin (skin has a high fat content) off chicken and turkey. Cut chunks of fat off of beef and pork.

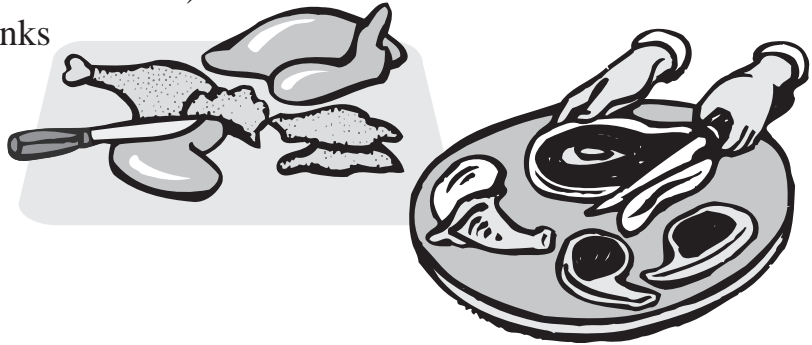

2. Cook meat by baking, broiling, boiling, grilling or microwaving.

Oven Fried Potatoes

1. Cut potatoes in the shape of thick french fries.
2. Leave peel on. Arrange on a baking sheet that has been lightly sprayed with nonstick cooking spray.
3. Bake at 350 °F for 1 hour.

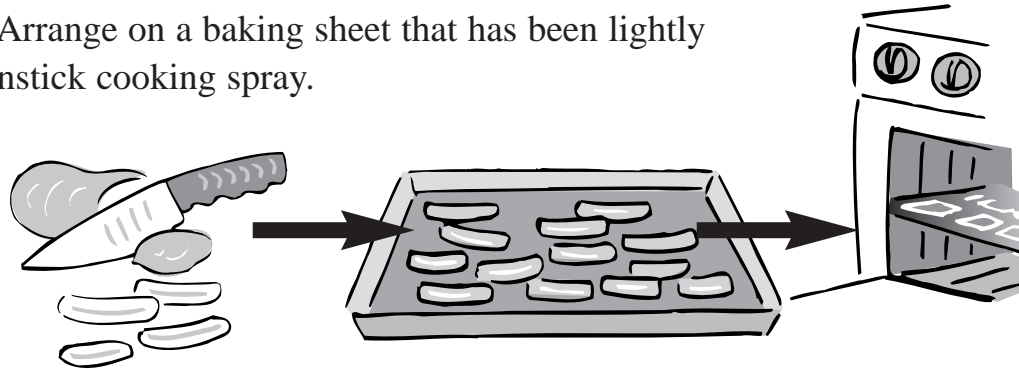

Beans

1. Cook beans in water until tender.
2. Season with onion, garlic, cumin, oregano, and if you wish, 1/2 teaspoon of salt.

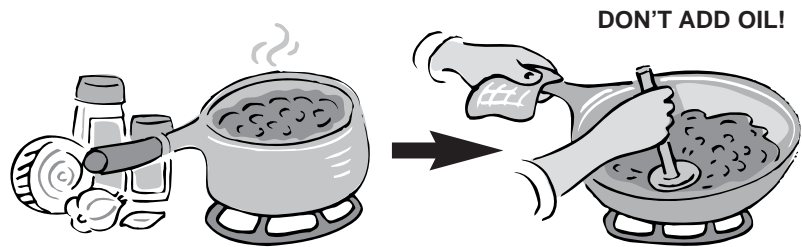

3. To thicken beans, mash and reify in skillet with a little water (without adding lard or vegetable shortening).

Cooking With Less Saturated Fat

Ground Meat

Drain and rinse ground meat.

1. Cook ground meat, like hamburger, until it is done.
2. Drain the fat from meat into a container and throw away.
3. Put the drained meat into a colander or strainer in a pot and rinse the meat with hot running water.
4. Use meat as usual.

***Tip:** Dice unpeeled potatoes and add to ground beef. Season with small amount of oregano, powdered cumin, and black pepper. Cook until potatoes are tender.

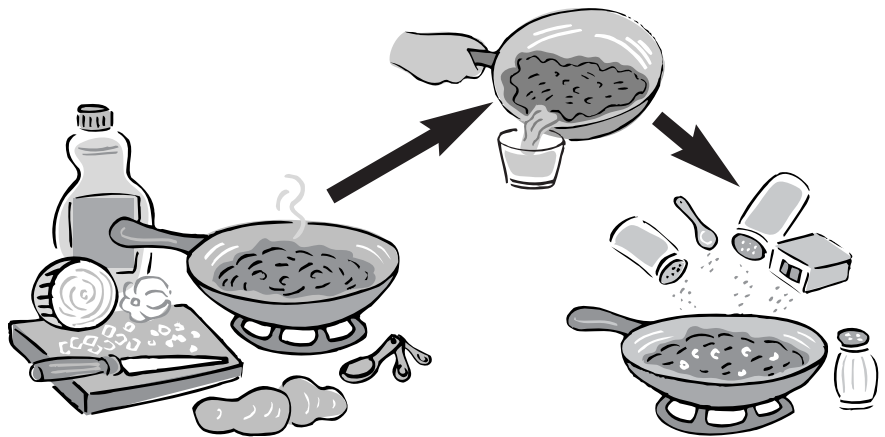

Soups and Stews

Chill soups and stews to harden the fat.

1. Put the soup or stew in the freezer or refrigerator. The fat layer will form a hard layer.
2. Take the fat layer off with a spoon.
3. Heat the soup or stew and serve as usual.



Fruit Shake

1. Cut your favorite fruit into chunks.
2. Place in a blender along with nonfat milk, vanilla, and ice.
3. Blend until it is smooth.



Chicken Chile Stew

3 lb	chicken (breast or leg), cubed
3 stalks	celery, chopped
1 medium	tomato, diced
7	green chilies, roasted, peeled, seeded, chopped
4 cloves	garlic cloves, peeled and crushed
as needed	nonstick cooking spray
pepper	to taste

1. Brown the chicken with nonfat cooking spray, in batches, in a heavy iron skillet.
2. Place the meat in a 3 or 4 quart covered casserole and add the remaining ingredients.
3. Deglaze (dissolve the hardened juices) in the skillet with the water and add to the casserole.
4. Barely cover the ingredients with water. Cover and simmer until the stew is thick and the meat is very tender, about 1¹/₂ hours.
5. Add pepper to taste before serving.

Yield: 10 servings
Serving size: 1/2 cup
Each serving provides:
Calories: 189
Total fat: 5g
Saturated fat: 1g
Cholesterol: 82 mg
Protein: 30g
Carbohydrates: 5g
Fiber: 1g
Sodium: 90mg

Quick Tips

This recipe is lower in saturated fat and cholesterol because:

- It is made with chicken without the skin and any extra fat is taken off.
- No fat is added.
- It is flavored with vegetables and seasonings.
- It is cooked slowly in water (moist heat).

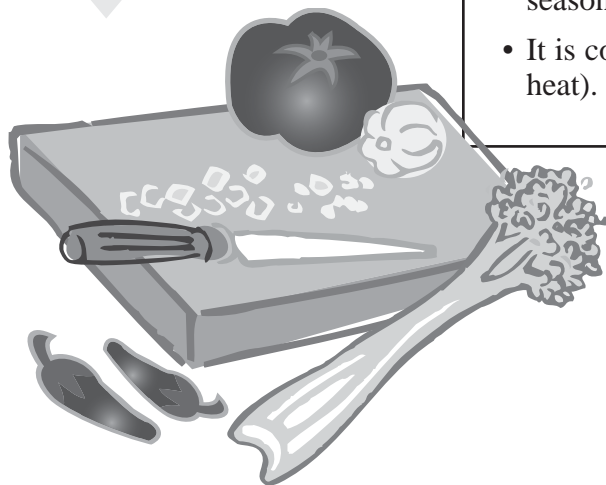

A Legacy of Good Health: A Story About Losing Weight

Two sisters are walking to the store with their mother. After a while, one of the sisters pauses to take a breath.

Ann: (huffing and puffing): How do you have so much energy, Sally? Have you lost weight? You look good!

Sally: Yes, Ann. The doctor told me to do it for my health. It seems that we are going to funerals all the time and that a lot of people have died of heart disease and diabetes. Did you know that being overweight causes diabetes and heart disease?

Ann: I know I should eat better and get more physical activity, but it's no use. Our mother, uncle, and grandmother were overweight. It's my fate.

Sally: It wasn't always like this. Grandmother Mary, tell us how our people lived in the olden days.

Mary: In the days of your great-great-grandfathers, food was a precious gift. People worked long and hard through hunting, gathering, and farming to feed their families. They ate the right amounts so there was always enough left for other people.

Sally: What sorts of activities did people participate in?

Mary:
The people led an active lifestyle in work and play. Races and ball games brought honor to men while keeping their bodies healthy and strong. Dancing was also a popular activity among men and women. Diseases due to overweight were unknown; your great-great grandparents were not overweight.

Sally: See, Ann? Our people come from a legacy of good health habits. Today we make choices and practice behaviors like eating too much and not being active that put our health and our spiritual well-being at risk. Besides, young people try to do the things that I do. They say they want to be like me.

A Legacy of Good Health: A Story About Losing Weight *(continued)*

Ann: Oh, but I don't have the time to pick up healthy habits. Besides, it's too late. My doctor says I already have high blood pressure and diabetes.

Sally: You're right; those conditions won't go away. But losing even a little weight decreases your risk of having a heart attack or a stroke. It lowers your chance of developing other problems. It even gives you more energy and makes you feel better. The pain in my back and feet went away. I haven't felt this young in years!

Ann: So what are you doing?

Sally: It is hard to lose weight and I have to go slowly but it is working. For example, I take only one spoonful of lowfat salad dressing with my salad. I am not having fried foods. I bake everything now. I drink water instead of soda. I don't pile the food on my plate. I cut down on the number of cakes and filler foods like chips; the money I save goes towards buying fruits and vegetables. When I am bored, lonely, or upset I take a nature walk instead of eating. The best part is that my family eats the same healthy goods that I eat.

Ann: How much have you lost?

Sally: I have lost 10 pounds. If you make up your mind you can do it too. Why don't you try it with me?

Ann: OK. Let's do it together.

Protect Your Heart. Watch Your Weight.

Check the chart to find your body mass index (BMI). Find your height on the left of the graph. Go straight across from that point until you come to your weight. The number at the top of that row is your BMI.

	HEALTHY WEIGHT						OVERWEIGHT					OBESE					
BMI	19	20	21	22	23	24	25	26	27	28	29	30	31	32	33	34	35
Height	Weight (in pounds)																
4'10"	91	96	100	105	110	115	119	124	129	134	138	143	148	153	158	162	167
4'11"	94	99	104	109	114	119	124	128	133	138	143	148	153	158	163	168	173
5'0"	97	102	107	112	118	123	128	133	138	143	148	153	158	163	168	174	179
5'1"	100	106	111	116	122	127	132	137	143	148	153	158	164	169	174	180	185
5'2"	104	109	115	120	126	131	136	142	147	153	158	164	169	175	180	186	191
5'3"	107	113	118	124	130	135	141	146	152	158	163	169	175	180	186	191	197
5'4"	110	116	122	128	134	140	145	151	157	163	169	174	180	186	192	197	204
5'5"	114	120	126	132	138	144	150	156	162	168	174	180	186	192	198	204	210
5'6"	118	124	130	136	142	148	155	161	167	173	179	186	192	198	204	210	216
5'7"	121	127	134	140	146	153	159	166	172	178	185	191	198	204	211	217	223
5'8"	125	131	138	144	151	158	164	171	177	184	190	197	203	210	216	223	230
5'9"	128	135	142	149	155	162	169	176	182	189	196	203	209	216	223	230	236
5'10"	132	139	146	153	160	167	174	181	188	195	202	209	216	222	229	236	243
5'11"	136	143	150	157	165	172	179	186	193	200	208	215	222	229	236	243	250
6'0"	140	147	154	162	169	177	184	191	199	206	213	221	228	235	242	250	258
6'1"	144	151	159	166	174	182	189	197	204	212	219	227	235	242	250	257	265
6'2"	148	155	163	171	179	186	194	202	210	218	225	233	241	249	256	264	272
6'3"	152	160	168	176	184	192	200	208	216	224	232	240	248	256	264	272	279
6'4"	156	164	172	180	189	197	205	213	221	230	238	246	254	263	271	279	287

the top of that row is your BMI.

What is BMI?

- BMI measures weight in relation to height.
- Heart disease risk increases at higher levels of overweight and obesity.

My weight _____

My BMI _____

Waist Circumference:

A waist measurement of more than 35 inches for women and more than 40 inches for men is high. A high waist measurement increases your risk for heart disease.

My waist measurement _____

What Does Your BMI Mean?

■ **Healthy Weight** (BMI from 18.5–24.9) Good for you! Make it a goal to keep your healthy weight.

■ **Overweight** (BMI from 25–29.9) Try not to gain any weight. You need to lose weight if you have two or more risk factors and:

- are overweight, or
- have a high waist measurement

Ask your doctor or registered dietitian for help.

■ **Obese** (BMI 30 or higher) You need to lose weight. Lose weight slowly about 1–2 pounds a week. Ask your doctor or registered dietitian for help.

Losing Weight Means Making Long-Term Changes.

Here's how Mary found success:



I have been diabetic for 25 years, and I used to weight 200 pounds. After I lost my first 25 pounds, my back and foot problems left me.

Try these tips to get started.

- ♥ Eat fewer foods high in fat—like fried chicken, pork rinds, sausage, and canned meats—that are fatty.
- ♥ Cut down on cakes, pastries, candy, and soft drinks.
- ♥ Eat more fruits, vegetables, and grains.
- ♥ Make stews with lean meat and vegetables.
- ♥ Serve small portions, and do not go for seconds. Don't skip meals.
- ♥ Aim for 30 minutes of physical activity each day.

Make your personal pledge to do what this AI family is doing!

Look at these examples:

When shopping

Read labels to choose foods lower in calories.

When cooking

- Bake fish instead of frying it.
- Use nonstick cooking oil spray instead of greasing the pan with oil.

When eating

Have green beans and rice with one piece of chicken instead of three pieces of chicken alone.

Get active

Walk for 10 minutes three times a day.

Write the changes you will try to make this week.

Sally's Habits and Her Weight



Eat moderate portions.



Be physically active most days.



Maintain weight.



Eat big portions.



Be physically inactive.



Gain weight.



Eat small portions.



Be physically active most days.



Lose weight.

Tips To Help You Lose Weight

1. Choose foods low in fat and low in calories. Try:

- ♥ Fat free (skim) milk or lowfat (1 percent) milk
- ♥ Cheeses marked “lowfat” or “fat free” on the package
- ♥ Fruits and vegetables without butter or sauce. Fruits and vegetables are low in calories and help you feel fuller.



- ♥ Rice, beans, cereals, corn tortillas, and pasta

- ♥ Lean cuts of meat, fish, and skinless turkey and chicken



- ♥ Drink water or low-calorie beverages instead of soda pop and sugar-filled fruit drinks.

2. Make foods the healthy way.

- ♥ Bake, broil, or boil foods instead of frying.
- ♥ Cook beans and rice without lard, bacon, or fatty meats.
- ♥ Use less high-fat cheeses, cream, and butter when cooking.
- ♥ Use cooking oil spray or a little bit of vegetable oil or margarine when cooking.

- ♥ Garnish salads with lowfat or fat free mayonnaise and salad dressings.



3. Limit your portion size.

- ♥ Serve smaller portions—do not go back for seconds.
- ♥ Eat smaller meals and snacks throughout the day instead of one big meal.
- ♥ If you drink fruit juice, make sure it is 100 percent fruit juice and keep an eye on the portion size. The calories in beverages add up quickly.

4. Get active! Don't make excuses!

- ♥ Do your favorite physical activity for at least 30 minutes each day. You can do 10 minutes of activity three times a day.

Try this: If you are pressed for time, walk for 10 minutes three times a day.

5. Aim for a healthy weight.

- ♥ Try not to gain extra weight. If you are overweight, try to lose weight slowly. Lose about 1 to 2 pounds a week. Even losing 10 pounds can help reduce your chances of developing heart disease.

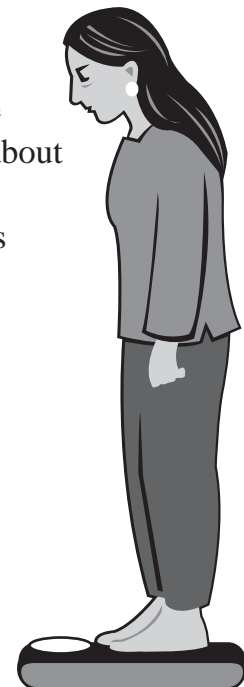

Serving Sizes*

Breads, Cereals, Rice, and Pasta

- ♥ 1 slice of bread
- ♥ 1 ounce of ready-to-eat cereal
- ♥ 1/2 cup of cooked cereal, rice, or pasta
- ♥ 1 tortilla

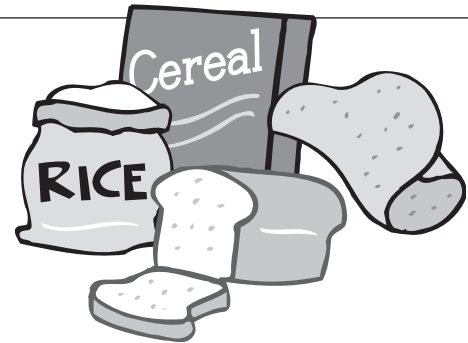

Fruit

- ♥ 1 medium apple, banana, or orange
- ♥ 1/2 cup of chopped, raw, cooked, or canned fruit
- ♥ 3/4 cup of 100 percent fruit juice
- ♥ 1/4 cup of dried fruit



Vegetables

- ♥ 1 cup of raw leafy vegetables
- ♥ 1/2 cup of other vegetables, cooked or chopped raw
- ♥ 3/4 cup of vegetable juice

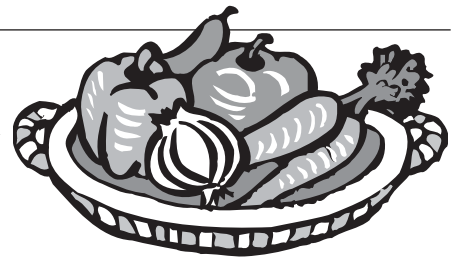

Milk, Yogurt, and Cheese

- ♥ 1 cup of fat free (skim) or lowfat milk (lactose free, if needed) or yogurt
- ♥ 1 1/2 ounces of lowfat natural cheese
- ♥ 2 ounces of lowfat processed cheese



Lean Meat, Poultry, Fish, Dry Beans, Eggs, and Nuts

- ♥ 2 to 3 ounces of cooked lean meat, poultry without the skin, or fish
- ♥ 1/2 cup of cooked dry beans or 1 egg equals 1 ounce of lean meat
- ♥ 2 tablespoons of peanut butter or 1/3 cup of nuts equals 1 ounce of meat

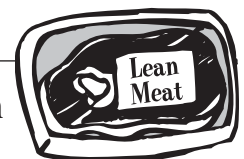

* These serving sizes may differ from those found on a food label.

Read the Food Label for Calories!



Food labels tell you what you need to know about choosing foods that are lower in calories. Here's a food label for a can of soda.

The label tells you:

■ **Amount Per Serving**

The nutrient amounts are for one serving. So, if you eat more or less than a serving, you need to add or subtract nutrient amounts. For example, if you drink two cans of soda in a day, you need to double the amount of calories on the label.

■ **Calories**

The amount of calories in one serving is given here.

Soda

Nutrition Facts	
Serving Size 1 can (340ml)	
Servings Per Container 1	
Amount Per Serving	
Calories 140	Calories from Fat 0
% Daily Value*	
Total Fat 0g	0%
Saturated Fat 0g	0%
<i>Trans</i> Fat 0g	
Cholesterol 0mg	0%
Sodium 50mg	2%
Total Carbohydrate 39g	13%
Dietary Fiber 0g	0%
Sugars 39g	
Protein 0g	
Vitamin A 0%	• Vitamin C 0%
Calcium 0%	• Iron 0%

*Percent Daily Values are based on a 2,000 calorie diet. Your Daily Values may be higher or lower depending on your calorie needs.

■ **Serving size and number of servings.**

Serving size and number of servings. The serving size is one can (12 ounces).

■ **Sugar**

The amount of sugar is shown here.

The Choice Is Yours—Compare!

Which one would you choose?

Drinking soda adds many calories which all come from sugar. Read the food label to find beverages that are sugar free and reduced in calories.

Calories 140	Calories from Fat 0
% Daily Value*	
Total Fat 0g	0%
Saturated Fat 0g	0%
<i>Trans</i> Fat 0g	
Cholesterol 0mg	0%
Sodium 50mg	2%

Soda

A can of soda has 140 calories and 39 grams of sugar.

Calories 0	Calories from Fat 0
% Daily Value*	
Total Fat 0g	0%
Saturated Fat 0g	0%
<i>Trans</i> Fat 0g	
Cholesterol 0mg	0%
Sodium 35mg	1%

Diet Soda

A can of diet soda has 0 calories and sugar. Drinking diet soda or water instead of regular soda saves a lot of calories, which is important when trying to lose weight or maintain a healthy weight.

Sally's Snack Choices



Sally and her family like to have snacks when they watch television.

Recently she has noticed that her family has gained a little too much weight.

Use the food labels to choose some tasty snacks that are lower in calories. What should Sally serve?

Mark the number of your choice for each pair on the right. Then mark the number of calories saved by this choice.



1 - Potato Chips

Nutrition Facts	
Serving Size 1oz (28g/ 12 chips)	
Servings Per Container 20	
Amount Per Serving	
Calories 160	Calories from Fat 90
% Daily Value*	
Total Fat 10g	16%
Saturated Fat 3g	15%
<i>Trans</i> Fat 1g	
Cholesterol 0mg	0%
Sodium 657mg	27%
Total Carbohydrate 7g	2%
Dietary Fiber 0g	0%
Sugars 6g	
Protein 1g	
Vitamin A 6%	• Vitamin C 0%
Calcium 0%	• Iron 5%

2 - Popcorn (air-popped)

Nutrition Facts	
Serving Size 1 cup (8g)	
Servings Per Container 4	
Amount Per Serving	
Calories 30	Calories from Fat 0
% Daily Value*	
Total Fat 0g	0%
Saturated Fat 0g	15%
<i>Trans</i> Fat 1g	
Cholesterol 0mg	0%
Sodium 0mg	0%
Total Carbohydrate 7g	2%
Dietary Fiber 1g	4%
Sugars 0g	
Protein 1g	
Vitamin A 0%	• Vitamin C 0%
Calcium 0%	• Iron 0%

Lower
Calorie
Choice

Number of
Calories
Saved

3 - Strawberries

Nutrition Facts	
Serving Size 1 cup (244g)	
Servings Per Container 2	
Amount Per Serving	
Calories 45	Calories from Fat 0
% Daily Value*	
Total Fat 0g	0%
Saturated Fat 0g	0%
<i>Trans</i> Fat 0g	
Cholesterol 0mg	0%
Sodium 1mg	0%
Total Carbohydrate 10g	3%
Dietary Fiber 3g	13%
Sugars 8g	
Protein 1g	
Vitamin A 1%	• Vitamin C 136%
Calcium 2%	• Iron 3%

4 - Chocolate Chip Cookies

Nutrition Facts	
Serving Size 3 cookies (30g)	
Servings Per Container 16	
Amount Per Serving	
Calories 160	Calories from Fat 70
% Daily Value*	
Total Fat 8g	0%
Saturated Fat 2.5g	0%
<i>Trans</i> Fat 1.5g	
Cholesterol 0mg	0%
Sodium 105mg	4%
Total Carbohydrate 21g	7%
Dietary Fiber 1g	4%
Sugars 10g	
Protein 2g	
Vitamin A 0%	• Vitamin C 0%
Calcium 0%	• Iron 4%

Lower
Calorie
Choice

Number of
Calories
Saved

* Percent Daily Values are based on a 2,000 calorie diet.

Sally's Snack Choices *(continued)*

5 - Whole Milk



Nutrition Facts	
Serving Size 1 cup (236ml)	
Servings Per Container 16	
Amount Per Serving	
Calories 150	Calories from Fat 70
% Daily Value*	
Total Fat 8g	12%
Saturated Fat 5g	25%
<i>Trans</i> Fat 0g	
Cholesterol 35mg	12%
Sodium 125mg	5%
Total Carbohydrate 12g	4%
Dietary Fiber 0g	0%
Sugars 11g	
Protein 8g	
Vitamin A 6% • Vitamin C 4%	
Calcium 30% Iron 0% Vitamin D 25%	

Lower
Calorie
Choice

Number of
Calories
Saved

6 - Fat Free Milk



Nutrition Facts	
Serving Size 1 cup (236ml)	
Servings Per Container 16	
Amount Per Serving	
Calories 90	Calories from Fat 0
% Daily Value*	
Total Fat 0g	0%
Saturated Fat 0g	0%
<i>Trans</i> Fat 0g	
Cholesterol 5mg	2%
Sodium 125mg	5%
Total Carbohydrate 12g	4%
Dietary Fiber 0g	0%
Sugars 11g	
Protein 8g	
Vitamin A 10% • Vitamin C 4%	
Calcium 30% Iron 0% Vitamin D 25%	

7 - Chocolate Ice Cream



Nutrition Facts	
Serving Size 1/2 cup (66g)	
Servings Per Container 16	
Amount Per Serving	
Calories 170	Calories from Fat 80
% Daily Value*	
Total Fat 9g	14%
Saturated Fat 6g	30%
<i>Trans</i> Fat 0g	
Cholesterol 20mg	7%
Sodium 40mg	2%
Total Carbohydrate 21g	7%
Dietary Fiber 1g	4%
Sugars 17g	
Protein 2g	
Vitamin A 4% • Vitamin C 0%	
Calcium 6% • Iron 4%	

Lower
Calorie
Choice

Number of
Calories
Saved

8 - Popsicle

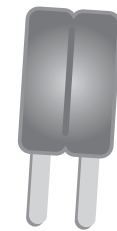

Nutrition Facts	
Serving Size 1 popsicle (88g)	
Servings Per Container 12	
Amount Per Serving	
Calories 45	Calories from Fat 80
% Daily Value*	
Total Fat 0g	0%
Saturated Fat 0g	0%
<i>Trans</i> Fat 0g	
Cholesterol 0mg	0%
Sodium 40mg	2%
Total Carbohydrate 11g	4%
Dietary Fiber 0g	0%
Sugars 11g	
Protein 0g	
Vitamin A 0% • Vitamin C 0%	
Calcium 0% • Iron 0%	

* Percent Daily Values are based on a 2,000 calorie diet.

Sally's Snack Choices *(continued)*

9 – Peaches (canned in fruit juice)



Nutrition Facts	
Serving Size 1/2 cup (110g)	
Servings Per Container 4	
Amount Per Serving	
Calories 50	Calories from Fat 0
% Daily Value*	
Total Fat 0g	0%
Saturated Fat 0g	0%
Trans Fat 0g	
Cholesterol 0mg	0%
Sodium 25mg	1%
Total Carbohydrate 13g	4%
Dietary Fiber 1g	4%
Sugars 9g	
Protein 0g	
Vitamin A 8%	Vitamin C 2%
Calcium 0%	Iron 0%

10 – Peaches (canned in syrup)



Nutrition Facts	
Serving Size 1/2 cup (110g)	
Servings Per Container 4	
Amount Per Serving	
Calories 100	Calories from Fat 0
% Daily Value*	
Total Fat 0g	0%
Saturated Fat 0g	0%
Trans Fat 0g	
Cholesterol 0mg	0%
Sodium 10mg	0%
Total Carbohydrate 24g	8%
Dietary Fiber 1g	4%
Sugars 23g	
Protein 0g	
Vitamin A 2%	Vitamin C 2%
Calcium 0%	Iron 0%

Lower
Calorie
Choice

Number of
Calories
Saved

11 – Mayonnaise



Nutrition Facts	
Serving Size 1Tbsp (14g)	
Servings Per Container 32	
Amount Per Serving	
Calories 100	Calories from Fat 100
% Daily Value*	
Total Fat 11g	17%
Saturated Fat 2g	10%
Trans Fat 0g	
Cholesterol 5mg	2%
Sodium 75mg	3%
Total Carbohydrate 0g	0%
Dietary Fiber 0g	0%
Sugars 0g	
Protein 0g	
Vitamin A 0%	Vitamin C 0%
Calcium 0%	Iron 0%

12 – Mayonnaise, Fat Free



Nutrition Facts	
Serving Size 14g (1Tbsp)	
Servings Per Container 32	
Amount Per Serving	
Calories 10	Calories from Fat 0
% Daily Value*	
Total Fat 0g	0%
Saturated Fat 0g	0%
Trans Fat 0g	
Cholesterol 0mg	0%
Sodium 135mg	6%
Total Carbohydrate 3g	1%
Dietary Fiber 0g	0%
Sugars 1g	
Protein 0g	
Vitamin A 0%	Vitamin C 0%
Calcium 0%	Iron 0%

Lower
Calorie
Choice

Number of
Calories
Saved

* Percent Daily Values are based on a 2,000 calorie diet.

Zucchini Medley

3	cups zucchini chunks
1 small	yellow onion, sliced
1 medium	tomato, diced
1/2 cup	mushroom, chopped
1/2 tsp	basil, ground
2 oz (1/2 cup)	low fat cheddar cheese

1. Place all ingredients except the cheese in a microwave-safe 2-quart casserole dish.
2. Microwave on high for 7 to 10 minutes or until vegetables are fork tender.
3. Add the cheese and microwave on high for 30 seconds.
4. Let stand for 2 to 3 minutes before serving.



Quick Tip

Your family will love this tasty vegetable side dish. The basil, onion, and small amount of cheese adds flavor but few calories.

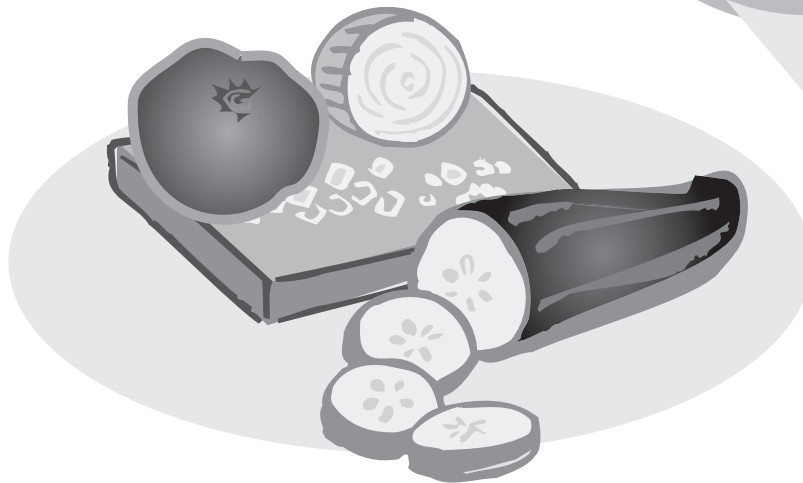
Yield: 4 servings
Serving size: 1 cup
Each serving provides:
Calories: 52
Total fat: 1g
Saturated fat: 0g
Cholesterol: 3mg
Protein: 3g
Carbohydrates: 6g
Fiber: 2g
Sodium: 93mg
Calcium: 79mg

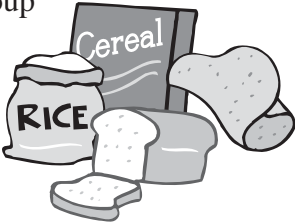

Choose a Variety of Heart Healthy Foods

<p>Grains Group: Breads, Cereal, Starchy Vegetable, Rice, and Pasta Group</p> 	<ul style="list-style-type: none"> ♥ Corn or lowfat whole wheat tortillas ♥ Sliced bread (like wheat, rye, or white), pita bread, English muffins, and bagels ♥ Starchy vegetables such as potatoes, corn, and cooked dry beans, peas, and lentils ♥ Unsalted lowfat crackers (like graham crackers), unsalted pretzels, and plain popcorn ♥ Cooked hot cereals (not instant) and whole grain cold cereals ♥ Pasta (like plain noodles, spaghetti, macaroni) and rice
<p>Fruit Group</p>	<ul style="list-style-type: none"> ♥ Fresh, frozen, or canned fruit juices ♥ Fresh, frozen, canned, or dried fruits (like oranges, papaya, grapefruit, bananas, apples, mangoes, pineapples, watermelons, peaches, and fruit cocktail)
<p>Vegetable Group (without added fat)</p>	<ul style="list-style-type: none"> ♥ Fresh, frozen, or no salt added canned vegetables (like, green beans, carrots, cabbage, tomatoes, yucca, squash, and broccoli)
<p>Milk Group: Milk, Yogurt, and Cheese (Choose lowfat more often)</p>	<ul style="list-style-type: none"> ♥ Fat free (skim) and lowfat (1percent) milk ♥ Lowfat or fat free yogurt ♥ Cheeses lower in fat and sodium 
<p>Meat and Beans Group: Lean Meat, Poultry, Fish, Eggs, and Nuts</p> 	<ul style="list-style-type: none"> ♥ Chicken or turkey without the skin ♥ Fish ♥ Lean cuts of meat ♥ Beef: round, sirloin, chuck, loin, extra lean ground beef ♥ Pork: leg, shoulder, tenderloin, lean ham ♥ Nuts ♥ Cooked, dry beans, peas, and lentils ♥ Eggs
<p>Fats (Use only in small amounts)</p>	<ul style="list-style-type: none"> ♥ Margarine (liquid, tub (soft), and reduced calorie) ♥ Oils (like canola, corn, safflower, olive, peanut, or sesame oil)
<p>Sweets (Some may be high in calorie. Choose in small amounts.)</p>	<ul style="list-style-type: none"> ♥ Frozen treats (frozen juice pops, frozen lowfat yogurt, sherbet) ♥ Lowfat cake and cookies (angel food cake, fig bar cookies, ginger-snaps, animal crackers, vanilla wafers)

The American Indian Food Guide Pyramid



KEY

These symbols show fats, oils, and added sugars in foods:

- **Fats** (naturally occurring and added)
- ▼ **Sugars** (added)

FOR MORE INFORMATION

Using the Food Guide Pyramid: What Counts as a Serving?

Here are examples of today's foods and traditional AI/AN Foods.

The number of servings depends on how many calories you need. This is based on your age, sex, size, and how active you are. Almost everyone should have at least the lowest number of servings.

<p>Grains Group: <i>Choose 6–11 servings per day</i></p> <ul style="list-style-type: none"> 1 slice bread, 1 tortilla 1 ounce (about 1 cup) ready-to-eat cereal 1/2 cup cooked cereal 1/2 English muffin or hamburger roll 1/2 cup spaghetti, noodles, macaroni, and rice 1/2 cup starchy vegetables* (peas, beans, corn) or 1 small potato 4-6 crackers 	<p>Traditional Grains:</p> <ul style="list-style-type: none"> Indian biscuits Popcorn Lukameen Mush Wild oats Wild oats Dried Corn
<p>Vegetable Group: <i>Choose 3–5 servings per day</i></p> <ul style="list-style-type: none"> 1 cup raw leafy greens 1/2 cup chopped raw or cooked vegetables 1/2 cup vegetable 	<p>Traditional Vegetables:</p> <ul style="list-style-type: none"> Sprouts or new shoots Peeled stems Spring greens Wild rhubarb Indian celery Wild mushrooms Seaweed Black tree moss Wild roots Squash
<p>Fruit Group: <i>Choose 2–4 servings per day</i></p> <ul style="list-style-type: none"> 3/4 cup 100 percent fruit juice 1 medium piece fresh fruit 1/2 cup canned or fresh chopped fruit 1/2 cup dried fruit 	<p>Traditional Fruits and Berries:</p> <ul style="list-style-type: none"> Wild berries such as huckleberries Choke cherries Wild crab apples Wild black cherries
<p>Milk Group: <i>Choose 2–3 servings per day</i></p> <ul style="list-style-type: none"> 1 cup milk or lactose reduced milk 1 cup yogurt 1 1/2 ounces cheese 	<p>Traditional Calcium Sources:</p> <ul style="list-style-type: none"> Bone soup or broth Oyster or clams Fish head soup Canned salmon with the bones Coush, camas, or wild carrots (in large amounts)
<p>Meats and Beans Group: <i>Choose 2-3 servings per day</i></p> <ul style="list-style-type: none"> 2-3 ounces cooked meat, poultry, or fish 1/2 cup of cooked, dry beans and lentils* 1 hot dog 1 egg 2 tablespoons peanut butter, nuts, or seeds 	<p>Traditional Meats, Fish, Birds, Eggs, and Nuts:</p> <ul style="list-style-type: none"> Deer, elk, mountain goat, rabbit, squirrel, or beaver Salmon or other fish Fowl Eggs of salmon or birds Acorns, hazelnuts, or pinenuts
<p>Extras—Fats and Sweets:</p> <p><i>Use only very small amounts!</i></p> <ul style="list-style-type: none"> Butter, margarine, mayonnaise, or salad dressing Lard, oil, or gravy Fried food, chips or fry bread Sugar, honey, syrup, candy, jam, or jelly Pie, cake, cookies, or desserts Soda pop, koolaid, sweetened punches, or tea. 	<p>Traditional Fats and Sweets:</p> <ul style="list-style-type: none"> Animal fat Fish oil Seal oil

The food groups are based on the American Dietetic Association (ADA) exchange list. The ADA exchange list groups starchy vegetables and beans in the grains group. Dried beans and peas can be grouped in the starchy grains group or meat and beans group.

Indian Corn Casserole

1 cup	dry black beans
2 cups	frozen corn kernels, divided
1/2 cup	fat free milk
3 cups	grated zucchini
1 cup	minced onion
1/2 cup	chopped green chili
1/2 cup	all-purpose flour
1 tsp.	ground cumin
1 tsp.	chili powder
1/2 tsp.	salt
1/2 tsp.	black pepper
About 15	dried cornhusks
As needed	nonfat cooking spray

1. Ahead of time, cook 1 cup of dried beans as directed on package, until they are soft. Set aside.
2. Soften dried cornhusks in simmering water for about 20 minutes.
3. Simmer 1/2 cup of corn in skim milk for 5 minutes. Remove from heat and let cool.
4. Blend corn and milk mixture in blender or food processor for about 2 minutes, or until creamy. Add to rest of corn and mix well. Set aside.
5. Combine zucchini, onion, and chile in large nonstick skillet. Cover and cook over medium-low heat for 10 minutes, stirring occasionally.
6. While zucchini mixture is cooking, remove corn husks from hot water and pat dry. Line a two-quart baking dish with husks, allowing excess to extend over sides of dish. Spray husks with vegetable spray to prevent mixture from sticking when baking.
7. To zucchini mixture add flour and next ingredients, stir well. Add corn and beans, stir well. Cook, uncovered, over medium heat four minutes, stirring frequently.
8. Spoon mixture into baking dish. Fold free ends of husks toward center of baking dish. Cover top of mixture with any extra husks, overlapping.

Yield: 6 servings
Serving size: 1 cup
Each serving provides*:
Calories: 219
Total fat: 1g
Saturated fat: 0g
Cholesterol: 0mg
Protein: 11g
Carbohydrates: 45g
Fiber: 8g
Sodium: 115mg
Calcium: 92mg

*Nutrition content does not include the cornhusks.

Source: ASU Diabetes Program, Raylene McCalman, M.S. and Ruth Bear, M.S.,R.D. Healthful Holiday Cooking Cookbook; Albuquerque Service Unit

Quick Tip

The variety of seasonings and tasty vegetables and beans in this meal will delight your entire family.

Tips for Busy Families



Plan Your Meals

- ♥ Plan weekly meals based on your family's schedule.

Use A Shopping List

- ♥ Save money and time by making only one trip to the store. Make and use a shopping list.



Share Meal Preparation Tasks

- ♥ Teach your family how to grocery shop.
- ♥ Include your family in preparing meals and cleaning up.
- ♥ Clean up as you cook—you will have less cleanup after you finish cooking.
- ♥ Share cooking duties with other family members or neighbors. For example, your family can cook enough to share with another family.

Cook in Advance

- ♥ Prepare some foods in advance (like spaghetti sauce). Use them for quick meals. You can add chicken or beef to the sauce and serve it over spaghetti or rice.
- ♥ Prepare parts of a meal the night before (such as: marinating chicken in the refrigerator overnight).
- ♥ Pack your lunch the night before.
- ♥ Cut and wash vegetables and make enough salad for two days. Do not add dressing until serving time.
- ♥ Cook two or three dishes on your day off and freeze part of them. Use the frozen dishes on the days when you don't have time to cook.
- ♥ Prep for recipes the night before by cutting and trimming meats
- ♥ Prepare meals in a crock pot.

Cook Simply

- ♥ Steam vegetables and serve them without sauces.
- ♥ Use frozen chopped vegetables when possible or use rinsed canned vegetables.
- ♥ Broil, grill, bake, or roast meats.
- ♥ Make one-pot meals, like stews and casseroles. Use a crock pot.
- ♥ Use frozen or canned (rinsed) chopped vegetables (such as green beans and carrots).
- ♥ Use the microwave for cooking or defrosting.
- ♥ Learn simple recipes that can be made in less than 30 minutes.

Use Herbs & Spices

- ♥ Chop fresh herbs and place in ice cube trays. Fill trays with water and freeze. Store the frozen cubes in a plastic bag. Use when you need fresh herbs.
- ♥ Grow cilantro, basil, or thyme on a sunny windowsill.
- ♥ Keep dried herbs on hand. One teaspoon of dried herbs is equal to 3 teaspoons of fresh herbs.

Keep Quick Snacks on Hand

- ♥ Try these healthy snacks:
 - Fresh fruits and vegetables
 - Whole grain, ready-to-eat, dry cereal
 - Fat free and lowfat yogurt
 - Fat free and lowfat cheese
 - Baked corn tortilla chips
 - Whole grain breads

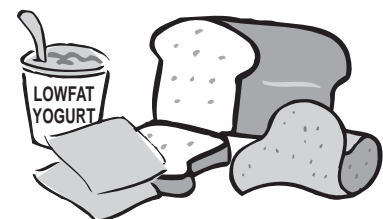

Tips for Eating Out the Heart-Healthy Way

You don't have to give up eating fast foods to eat right.

Here are some tips on how to make heart healthy choices at fast-food restaurants.

Sandwiches

- ♥ Order sandwiches without mayonnaise, tartar sauce, or special sauces. Try mustard or lowfat mayonnaise.
- ♥ Order small, plain hamburgers instead of super-size and deluxe sandwiches.
- ♥ Order sandwiches made with lean roast beef or turkey. Chicken salad and tuna salad made with regular mayonnaise are high in fat and calories.
- ♥ Choose grilled chicken sandwiches instead of breaded chicken sandwiches.

Main dishes

- ♥ Many entrees are big enough to serve two people (sometimes more). Share an entree with a friend or family member, or cut your meal in half (put it in a box right away) and take the rest home.
- ♥ Consider the appetizer selections. These items are generally smaller portions, and you may request that they be served as your entree item.
- ♥ Choose rotisserie-style chicken rather than fried chicken. Always remove the skin.
- ♥ Order pizza with vegetable toppings like peppers, mushrooms, or onions. Ask for half the usual amount of cheese.

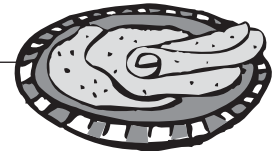

Side dishes

- ♥ Share a small order of French fries instead of eating a large order by yourself.
- ♥ Ask that no salt be added to your serving.
- ♥ Order a baked potato instead of fries.
 - Try salsa or vegetables as a potato topping.
 - Ask that high fat toppings be served on the side, and use less.
- ♥ Use low calorie/lowfat salad dressing when eating a salad. Bring your own if the restaurant does not offer a low fat version. You can buy packets at some stores. Ask that condiments such as dressing, cheese, and sour cream be served on the side, and use less.



Beverages

- ♥ Choose water, 100 percent fruit juice, or lowfat (1 percent) or fat free (skim) milk rather than a soda or a milk shake.
- ♥ If you want a soda, order a diet soda or small regular soda.
- ♥ If you drink 100 percent fruit juice, watch the serving size and keep in mind that it has a lot of naturally occurring sugar.



Desserts

- ♥ Try fresh fruit or a small nonfat frozen yogurt instead of cookies or pies.

Money-Saving Tips

You can save money on groceries. Follow these simple suggestions.

Before Going to the Store

- ♥ Plan weekly meals.
- ♥ Make a shopping list based on your meal plan.
- ♥ Check the food sale ads.
- ♥ Use coupons. Check the Sunday newspaper and clip coupons for foods you normally buy or need. Remember: coupons do not save you money if you buy products that you don't need. Always compare the price of the item with the coupon with other items on the shelf.
- ♥ Make fresh foods at home instead of using prepared items such as frozen entrees, bakery cakes, or salads.



Choosing a Store

- ♥ Shop at the store that has the lowest prices for the items you need. It may be a different store every week.
- ♥ Remember that convenience stores usually have higher prices and less variety than supermarkets.

At the Store

- ♥ Buy what is on your list. You are more likely to buy too much or buy items that you do not need when you do not use a list.
- ♥ Convenience can cost more. Some examples include:
 - canned beans
 - boneless chicken breasts
 - precut vegetables
- ♥ Buy fruits and vegetables that are in season.
- ♥ Buy only the amount of food the family can use even if a large size costs less.
- ♥ Shop alone when possible. Family members or friends may try to get you to buy items you do not need.
- ♥ Do not shop when you are hungry.
- ♥ Watch for errors at the cash register. Sometimes sale items do not ring up on sale.



♥ In Alaska:

- Buy "bulk" foods if they are cheaper. (In some places in Alaska, bulk foods may cost more due to increased shipping costs.)
- Buy fruits and vegetables that are in season. Apples are cheaper in the fall, oranges in the winter, and melons in the summer.
- Use cabbage instead of lettuce in salads, sandwiches, and tacos.
- Buy concentrated foods to cut down on cost. Frozen juice costs less than bottled or canned juice.
- Look for store brands and generic brands. They can be cheaper than the name brands on sale or with coupons.

Shopping List

Make a shopping list. Include the items you need for your menus and any basics you need to restock in your kitchen.

Produce

- ___ Fresh fruits (apples, peaches, oranges, berries, bananas, melon)
- ___ Fresh vegetables (cabbage, lettuce, onions, tomatoes, squash, sweet potatoes, peppers, cucumbers, green beans, celery)

Breads, Muffins, Rolls

- ___ Whole-grain bread, bagels, pita bread
- ___ English muffins
- ___ Corn tortillas or lowfat wheat tortillas
- ___
- ___
- ___



Whole-Grain Cereals, Rice, Crackers, Pasta, and Noodles

- ___ *Cereal, dry or cooked
- ___ Pasta (noodles, spaghetti)
- ___ Blue Corn Meal
- ___ *Saltines, soda crackers
- ___ Graham crackers
- ___ *Other crackers
- ___
- ___
- ___
- ___

Dairy Case

- ___ Fat free (skim) or lowfat (1 percent) milk
- ___ Fat free or lowfat yogurt
- ___ Fat free or lowfat cheeses
- ___ Fat free powdered milk
- ___ Light or diet margarine
- ___ Fat free sour cream
- ___ Fat free cream cheese
- ___ Eggs
- ___
- ___



Meats

- ___ Chicken
- ___ Turkey
- ___ Fish
- ___ Beef (round or sirloin)
- ___ Extra lean ground beef
- ___ Pork tenderloin, leg, shoulder
- ___
- ___



- ___ *Lower fat lunch meats like turkey and chicken
- ___ Dry beans and peas
- ___ Nuts and seeds
- ___
- ___

Baking Items

- ___ Flour
- ___ Sugar
- ___ Nonstick cooking spray
- ___ Fat free(skim) canned evaporated milk
- ___ Nonfat dry milk powder
- ___ Unsweetened cocoa powder
- ___ Baking powder
- ___ Reduced fat biscuit mix



Canned Fruits, Vegetables, Beans, and Soups

- ___ Canned fruits in unsweetened juice
- ___ Canned tomatoes (no salt added)
- ___ Low sodium tomato sauce or paste
- ___ Other canned vegetables (no salt added)
- ___
- ___
- ___ Canned broth (fat free, low sodium)*
- ___ Other canned soups*
- ___
- ___

- ___ Canned beans (no salt or seasoning added)
- ___
- ___

Fats and Oils

- ___ *Margarine (liquid, tub, or spray)
- ___ Vegetable oil (canola and olive oil are good choices.)

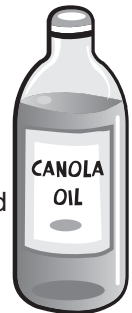

Frozen

- ___ Frozen fruits (without added sugar): berries (blueberries, strawberries, raspberries), peaches, and mixed fruit
- ___ Fat free or lowfat yogurt and desserts*
- ___ Frozen vegetables without sauces
- ___ Frozen fruit juices

*Use the nutrition label to choose foods lowest in fat, saturated fat, cholesterol, trans fat, sodium, and calories.

Quick Beef Casserole

1/2 pound	lean ground beef
1 cup	onion, chopped
1 cup	celery, chopped
1 cup	green pepper, cubed
3 1/2 cups	tomatoes, diced
1/2 tsp	salt
1/2 tsp	black pepper
1/2 tsp	paprika
1 cup	frozen peas
2 small	carrots, diced
1 cup	uncooked rice
1 1/2 cups	water

1. In a skillet, brown the ground beef and drain off the fat.
2. Add the rest of the ingredients. Mix well. Cook over medium heat and cover skillet until boiling. Reduce to low heat and simmer for 35 minutes.
3. Serve hot.

Yield: 8 servings

Serving size: 1 1/3 cup

Each serving provides:

Calories: 184

Total fat: 3g

Saturated fat: 1g

Cholesterol: 15mg

Protein: 10g

Carbohydrates: 31g

Fiber: 4g

Sodium: 125mg

Calcium: 33mg

Quick Tips

- Drain the meat after cooking to lower the amount of fat and calories.
- This one-dish meal can be made and frozen over the weekend. Reheat when you don't have the time to cook.

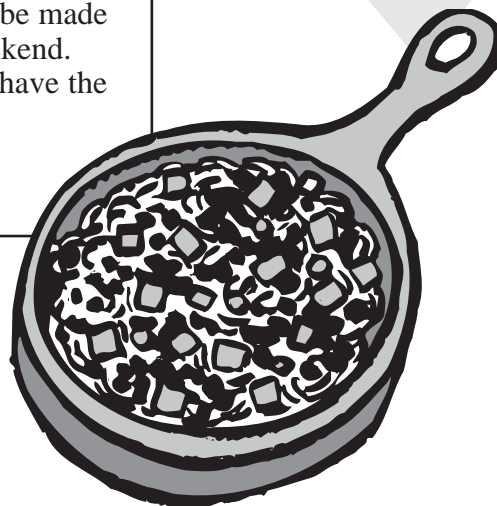

The Origin of Tobacco

Long ago there was a wise and peace-loving elder who traveled from tribe-to-tribe encouraging cooperation and friendship between the nations. He was a spokesman for the cause of good will and his mission was to promote unity among all beings.

At a very great age the elder called a council meeting of elders and representatives from the many clans, tribes, and nations, which he had visited and taught. He told them that his work was coming to an end, and he must soon join the spirit world. However, he promised to return in a new form as a reminder of the peaceful brotherhood he had sought to establish among the nations.

A short time after his death a new plant sprouted from his grave. This was the tobacco plant and has been used in ceremonies ever since as a symbol of unity, honesty, and peace. The rising smoke from the pipe is a reminder that the thoughts and prayers of people go upward to the Creator.



By: Little Turtle, Nipmuck Tribe from the Anthology of Traditional Stories Project of the National Cancer Institute, 1992.

How Smoking Can Harm You

Smoking can cause:

■ Heart Attack and Stroke

- About 80 to 90 percent of heart attacks and strokes are related to smoking.
- One year after a person stops smoking, the risk of having a heart attack or stroke will drop by more than half.

■ Cancer

- Smoking increases your risk of developing cancer of the bladder, stomach, uterus, and lung.
- About 80 to 90 percent of lung cancer is caused by smoking.
- The cancer death rate for men who smoke cigarettes is more than double that of nonsmokers.
- Men who smoke are 22 times more likely to develop lung cancer than men who do not smoke; women are 12 times more likely.

Smoking and secondhand smoke can cause:

- Serious respiratory diseases such as emphysema and chronic bronchitis
- More colds, sore throats, and respiratory infections
- Asthma attacks

Unpleasant effects include:

- Yellow stains on teeth and fingers
- Bad breath
- Gum disease
- Early wrinkling of the skin
- Decreased sense of smell and taste



How Smoking Harms Infants and Children



Each time a pregnant woman smokes, her baby's heart rate increases.

When a pregnant woman smokes, her baby gets less oxygen.

The birth weight for babies born to smokers is less than for babies born to nonsmokers.

Smoking increases the chance of a baby being born dead.

Babies whose mothers smoke have a greater risk of dying from SIDS (sudden infant death syndrome) or crib death.

Harmful chemicals pass through the placenta and directly into the baby's blood.

If the mother continues to smoke after the baby is born, the baby can get more chest colds, ear infections, bronchitis, pneumonia, and asthma.

Babies who are exposed to smoke cry, sneeze, and cough more than babies who are not.

Children who grow up in a home with smokers are more likely to become smokers.

Lift the Lid on Chew Tobacco: Get the Truth



What is chew tobacco? It's tobacco that is placed in the mouth and chewed rather than smoked. Smokeless tobacco is the term preferred by the tobacco industry. It makes the products sound safe; they aren't.

Getting hooked. People get hooked before they know the facts about dip and chew. They don't know that chew tobacco

- is highly addictive
- contains nicotine (addictive drug)
- hinders physical performance
- is not a safe alternative to cigarettes
- is costly
- can ruin your social life (stain teeth, bad breath, and smelly clothes)

Chew tobacco is not safe. There are no benefits of chewing or dipping tobacco. Here are some of the dangers:

- Sugar in chew tobacco may cause decay in exposed tooth roots.
- Dip and chew can cause your gums to pull away from the teeth in the place where the tobacco is held. The gums do not grow back.
- Leathery white patches, called leukoplakia (loo-ko-play-kia), and red sores are common in dippers and chewers. These sores can turn into cancer.

SOME ALTERNATIVES TO CHEW OR SNUFF TOBACCO		
<p>Sugarless Gum</p> <p>Can keep your mouth moist and active without the risk.</p> 	<p>Healthy Snacks</p> <p>Fruit and vegetable sticks can also be oral substitutes for chew tobacco. They are good too.</p> 	<p>Physical Activity</p> <p>Can reduce stress and renew energy. Try the activities you like, such as walking, swimming, jogging, or playing a sport.</p> 

Some ideas for quitting

1. **List your reasons** for quitting and post them in a place you can see them. Write down the things you will buy with the money you saved. Pick a quit date.
2. **Choose a method** for quitting. Talk to your health care provider, dentist, counselor, or coach about possible quitting methods.
3. **Seek support** from your friends. Avoid "hanging out" in places where chew tobacco is used. If your friends use chew tobacco, consider quitting as a group.

If you haven't started, why take the risk? If you have started, why not quit?

For more information: Check out "Spit Tobacco: A Guide for Quitting" at:
<http://www.nidcr.nih.gov/health/newsandhealth/spittobacco/>

The Cost of Smoking

1 pack a day* for . . .

1 Week = \$26 =  Buy fringe for a fancy shawl.

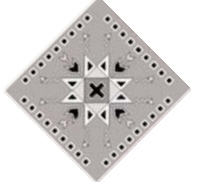
1 Month = \$112 =  Buy a fancy shawl.

6 Months = \$675 =  Do a powwow giveaway.

1 Year = \$1,368 =  Purchase dance regalia.

2 Years = \$2,737 =  Take road trips to 10 powwows.

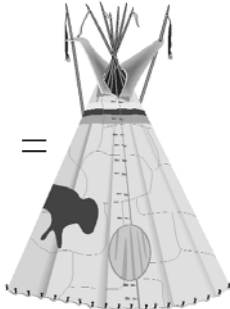
3 Years = \$4,106 =  Take the family to the “Gathering of the Nations Powwow.”[§]

4 Years = \$5,475 =  Buy a used car.

* Based on a pack of cigarettes that costs \$3.75

† Includes gourd, moccasins, broad cloth, eagle fan, and bandolier

§ Held in Albuquerque, New Mexico

Smoke-Free Family Sign

Thank You
for Not Smoking.



We're a
Smoke-Free Family.

We're a
Smoke-Free Family.



Thank You
for Not Smoking.

Tips To Quit Smoking

Quitting smoking is one of the most important things you will ever do.

Cigarette smoke contains more than 4,000 chemicals,
and 200 of these are poisonous.

Try these tips:

■ Get ready

- Set a quit date.
- Get rid of **ALL** cigarettes, lighters, matches, and ashtrays in your home, car, and place of work.
- Don't let people smoke in your home.
- Review your past attempts to quit. Think about what worked and what did not.
- Once you quit, don't smoke—**NOT EVEN A PUFF!**

■ Line up support

- Tell your family, friends, and coworkers that you are going to quit and want their support. Ask them not to smoke around you or leave cigarettes out.
- Get individual, group, or telephone counseling. The more counseling you have, the better your chances are of quitting.

■ Learn new activities

- Try to distract yourself from urges to smoke. Talk to someone, go for a walk, or get busy with a task.
- Change your routine. Use a different route to work. Drink tea instead of coffee.
- Do something to reduce your stress. Listen to music, talk to your friend, or walk.
- Plan something enjoyable to do every day.
- Drink a lot of water.

■ Use other aids

- Talk to your health care provider. Consider using nicotine patch, nicotine gum, or nicotine spray to help you stay off cigarettes.
- Check with your doctor about a medicine called Bupropion SR to help you reduce the cravings for smoking.

■ Be prepared if you slip

- **Alcohol.** Avoid drinking alcohol. Drinking lowers your chances of success.
- **Other smokers.** Being around smoking can make you want to smoke.
- **Weight gain.** Many smokers will gain weight when they quit, usually less than 10 pounds. Eat a healthy diet and stay active. Don't let weight gain distract you from your main goal—quitting smoking.
- **Bad mood or depression.** There are a lot of ways to improve your mood other than smoking.
- **Be kind to yourself.** Remind yourself of the reasons you want to quit. Try again.

Save tobacco for ceremonial use.

Help Your Heart—Stop Smoking

For many Indian people, tobacco is sacred. It is burned for peace or prayer. **Smoking cigarettes is different.** It becomes an addiction that leads to serious health problems. Quitting smoking will lower your risk of heart attack, stroke, and lung disease and help you breathe easier and have more energy.

What's more, your clothes, hair, and breath will smell fresher, and you will save money by not buying cigarettes. Most important, when you quit smoking, your children won't be exposed to your secondhand smoke. They will have your good example to follow.



Quit smoking and add years to your life!



Mike and Sara decided to quit smoking.

Mike made up his mind one morning, threw away his cigarettes, and said, "That's it, no more cigarettes."

Sara used the following three tips and quit too.

1.
Learn how to handle urges to smoke.

"Every time I felt under stress, I wanted to smoke. Instead of smoking, I said a prayer to ask for courage and strength, talked to a friend, or took a nature walk."

2.
Get support.

"I also attended a quit-smoking program in the clinic every Thursday night, and I got a lot of support from my family."

3.
Use the nicotine patch or gum.

"The doctor at the clinic suggested that I use the patch. The patch helped me slow down the urge to smoke."

Bingo Facts

(Photocopy and cut)

Protect your heart. When the heart stops, life stops.	Brisk walking is an activity almost everyone can do.
Physical activity makes your heart and lungs stronger.	Do 30 minutes of physical activity on most days.
Stay active. Walk with your family or a friend.	It is best to have a blood pressure reading less than 120/80 mmHg.
A blood pressure reading of 140/90 mmHg or greater is high.	Eat less salt and sodium to help prevent high blood pressure.
Hypertension is another term for high blood pressure.	Regular canned and instant soups contain a lot of sodium.
Use herbs and spices instead of salt.	You can have high blood pressure and not know it.
Being overweight increases your risk of heart disease.	Being overweight increases your risk of high blood pressure.
Being overweight increases your risk of high blood cholesterol.	Being overweight increases your risk of diabetes.
To lose weight, cut down on portion size and be more active.	The food label gives serving size and the number of calories in a serving.
A serving of cooked vegetables is $\frac{1}{2}$ cup.	Eat more fruit each day. Have berries with your cereal for breakfast.

Bingo Facts

(Photocopy and cut)

Eat more vegetables each day. Have a salad with lowfat dressing for lunch.	Order baked or grilled foods to cut down on fat and calories.
To save food dollars, plan weekly menus. Shop with a list!	Try fruit and fat free yogurt for snacks.
Smoking causes serious health problems such as heart disease and lung cancer.	Pregnant women should not smoke.
Children of smokers are more likely to become smokers.	A desirable blood cholesterol level is less than 200 mg/dL.
A high blood cholesterol level is 240 mg/dL or higher.	Cholesterol can clog your arteries and cause a heart attack or stroke.
To keep a desirable cholesterol level, eat in a heart healthy way, be active, and keep a healthy weight.	Trim visible fat from meat before cooking.
Use the food label to choose foods lower in saturated fat, trans fat, and cholesterol.	Saturated fat is solid at room temperature.
High blood pressure makes your heart work harder.	Cook more food than you need and freeze part to use when you don't have a lot of time to cook.
Whole grains, fruits, and other traditional AI/AN foods are naturally low in fat	Drain meat, and rinse with hot water after it is cooked, to get rid of some of the fat.
Too much cholesterol in your blood can clog your arteries.	Lard is high in saturated fat.

Sample Bingo Cards – 1

Heart Health Bingo



Stay active. Walk with your family or a friend.



Use herbs and spices instead of salt.



Children of smokers are more likely to become smokers.



Trim visible fat from meat before cooking.

♥
**FREE
SPACE**



To keep a desirable cholesterol level, eat in a heart-healthy way, be active, and keep a healthy weight.

Nutrition Facts	
Serving Size 2 oz (56g)	
Servings Per Container 6	
Amount Per Serving	
Calories 190	Calories from Fat 155
% Daily Value*	
Total Fat 17g	26%
Saturated Fat 6g	30%
Trans Fat 0g	
Cholesterol 35mg	11%
Sodium 730mg	30%
Total Carbohydrate 1g	0%
Dietary Fiber 0g	0%
Sugars 0g	
Protein 7g	
Vitamin A 0%	Vitamin C 0%
Calcium 0%	Iron 2%

*Percent Daily Values are based on a diet of other people's misdeeds.

Use the food label to choose foods lower in saturated fat, trans fat, and cholesterol.



Eat more vegetables each day. Have a salad with lowfat dressing for lunch.

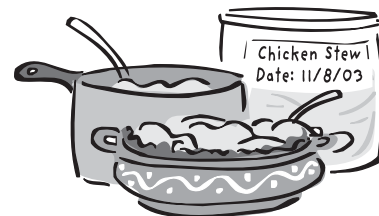

Cook more food than you need and freeze part to use when you don't have a lot of time to cook.

Sample Bingo Cards – 2

Heart Health Bingo



High blood pressure makes your heart work harder.



Whole grains, fruits, and other favorite AI/AN foods are naturally low in fat.

Nutrition Facts	
Serving Size 2 oz (56g)	
Servings Per Container 6	
Amount Per Serving	
Calories 190	Calories from Fat 155
% Daily Value*	
Total Fat 17g	26%
Saturated Fat 6g	30%
Trans Fat 0g	0%
Cholesterol 35mg	11%
Sodium 730mg	30%
Total Carbohydrate 1g	0%
Dietary Fiber 0g	0%
Sugars 0g	0%
Protein 7g	
Vitamin A 0%	Vitamin C 0%
Calcium 0%	Iron 2%

*Percent Daily Values are based on a diet of other people's misdeeds.

Use the food label to choose foods lower in saturated fat, trans fat, and cholesterol.

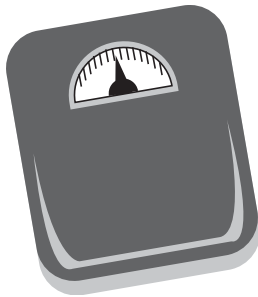

Being overweight increases your risk of diabetes.

♥
**FREE
SPACE**

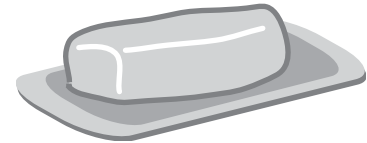

Saturated fat is solid at room temperature.



A blood pressure reading of 140/90 mmHg or greater is high.



Brisk walking is an activity almost everyone can do.



Pregnant women should not smoke.

Sample Bingo Cards – 3

Heart Health Bingo



Children of smokers are more likely to become smokers.

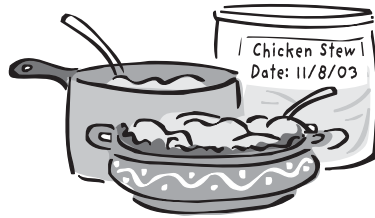

Cook more food than you need and freeze part to use when you don't have a lot of time to cook.



Lard is high in saturated fat.



Protect your heart. When the heart stops, life stops.

FREE SPACE



Eat less salt and sodium to help prevent high blood pressure.



To lose weight, cut down on portion size and be more active.



Eat more vegetables each day. Have a salad with lowfat dressing for lunch.



A high blood cholesterol level is 240 mg/dL or higher.

Sample Bingo Cards – 4

Heart Health Bingo



Cholesterol can clog your arteries and cause a heart attack or stroke.



Eat more fruit each day. Have berries with your cereal for breakfast.



Hypertension is another term for high blood pressure.



Smoking causes serious health problems such as heart disease and lung cancer.



Nutrition Facts	
Serving Size 2 oz (56g)	
Servings Per Container 6	
Amount Per Serving	
Calories 190	Calories from Fat 155
% Daily Value*	
Total Fat 17g	26%
Saturated Fat 6g	30%
Trans Fat 0g	
Cholesterol 35mg	11%
Sodium 730mg	30%
Total Carbohydrate 1g	0%
Dietary Fiber 0g	0%
Sugars 0g	
Protein 7g	
Vitamin A 0%	Vitamin C 0%
Calcium 0%	Iron 2%

*Percent Daily Values are based on a diet of other people's misdeeds.

The food label gives serving size and the number of calories in a serving.



Regular canned and instant soups contain a lot of sodium.



A desirable blood cholesterol level is less than 200 mg/dL.

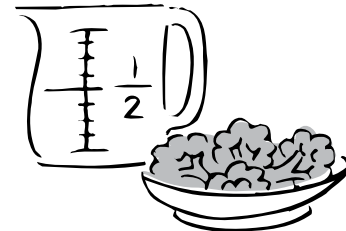

A serving of cooked vegetables is 1/2 cup.

Sample Bingo Cards – 5

Heart Health Bingo



Do 30 minutes of physical activity on most days.



Being overweight increases your risk of heart disease.



Try fruit and fat free yogurt for snacks.



Order baked or grilled foods to cut down on fat and calories.

♥
**FREE
SPACE**

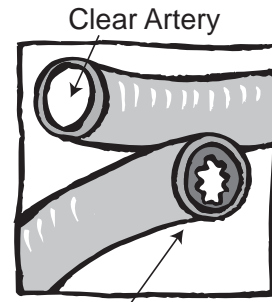

Too much cholesterol in your blood can clog your arteries.



Trim visible fat from meat before cooking.



You can have high blood pressure and not know it.



To save food dollars, plan weekly menus. Shop with a list!

Sample Bingo Cards – 6

Heart Health Bingo



To keep a desirable cholesterol level, eat in a heart-healthy way, be active, and keep a healthy weight.

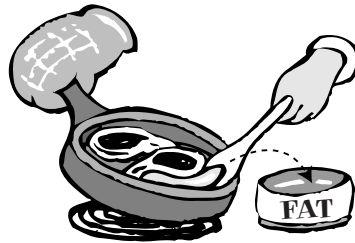

Drain meat, and rinse with hot water after it is cooked, to get rid of some of the fat.



It is best to have a blood pressure reading less than 120/80 mmHg .

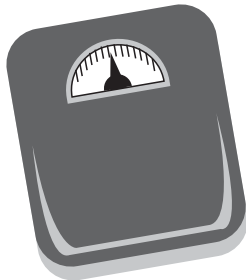

Being overweight increases your risk of high blood cholesterol.

♥
**FREE
SPACE**



Use herbs and spices instead of salt.



Stay active. Walk with your family or a friend.

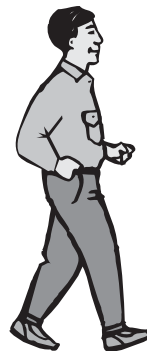

Brisk walking is an activity almost everyone can do.



Hypertension is another term for high blood pressure.

Sample Bingo Cards – 7

Heart Health Bingo



A desirable blood cholesterol level is less than 200 mg/dL.



Physical activity makes your heart and lungs stronger.



Hypertension is another term for high blood pressure.



Eat more vegetables each day. Have a salad for lunch.

♥
**FREE
SPACE**

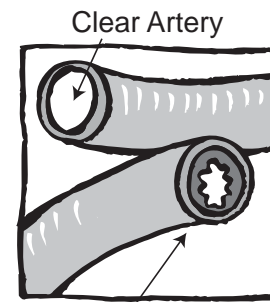

Too much cholesterol in your blood can clog your arteries.



Pregnant women should not smoke.



Use herbs and spices instead of salt.



A blood pressure reading of 140/90 mmHg or greater is high.

Sample Bingo Cards – 8

Heart Health Bingo



Whole grains, fruits, and other favorite AI/AN foods are naturally low in fat.

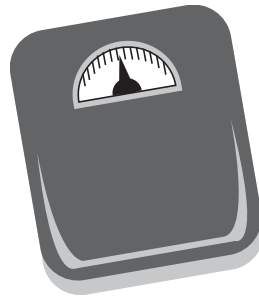

Being overweight increases your risk of high blood pressure.



Physical activity makes your heart and lungs stronger.



Smoking causes serious health problems such as heart disease and lung cancer.

♥
**FREE
SPACE**

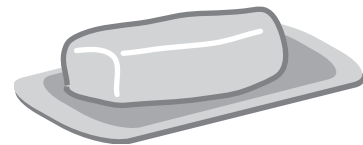

Saturated fat is solid at room temperature.



A blood pressure reading of 140/90 mmHg or greater is high.



To save food dollars, plan weekly menus. Shop with a list!



To lose weight, cut down on portion size and be more active.

Sample Bingo Cards – 9

Heart Health Bingo



Pregnant women should not smoke.



Eat more vegetables each day. Have a salad for lunch.

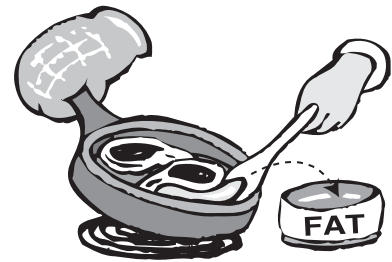

Drain meat, and rinse with hot water after it is cooked, to get rid of some of the fat.

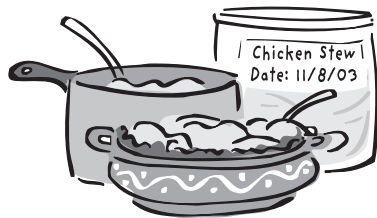

Cook more food than you need and freeze part to use when you don't have a lot of time to cook.

♥
**FREE
SPACE**



Stay active. Walk with your family or a friend.

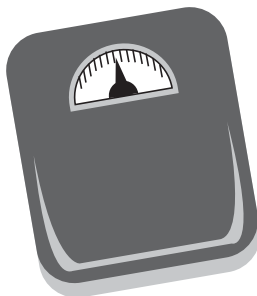

Being overweight increases your risk of diabetes.



Order baked or grilled foods to cut down on fat and calories.



Protect your heart. When the heart stops, life stops.

Sample Bingo Cards – 10

Heart Health Bingo



High blood pressure makes your heart work harder.

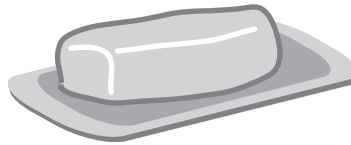

Saturated fat is solid at room temperature.



Eat less salt and sodium to help prevent high blood pressure.

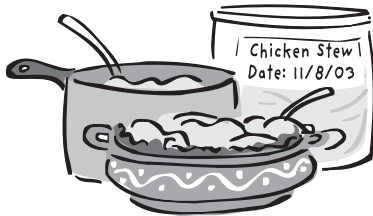

Cook more food than you need and freeze part to use when you don't have a lot of time to cook.

♥
**FREE
SPACE**



Regular canned and instant soups contain a lot of sodium.

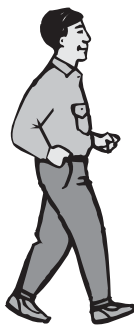

Brisk walking is an activity almost everyone can do.



Children of smokers are more likely to become smokers.

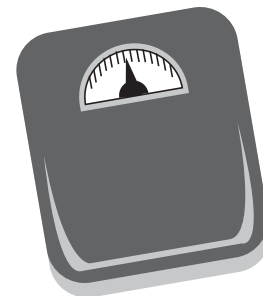

Being overweight increases your risk of diabetes.

Sample Bingo Cards – 11

Heart Health Bingo



It is best to have a blood pressure reading less than 120/80 mmHg.

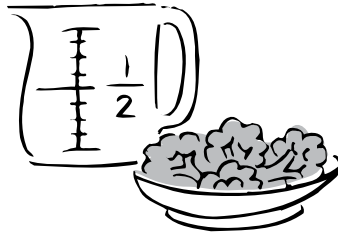

A serving of cooked vegetables is $\frac{1}{2}$ cup.



Smoking causes serious health problems such as heart disease and lung cancer.



To save food dollars, plan weekly menus. Shop with a list!



Eat more fruit each day. Have berries with your cereal for breakfast.



Lard is high in saturated fat.



Brisk walking is an activity almost everyone can do.



To lose weight, cut down on portion size and be more active.

Sample Bingo Cards – 12

Heart Health Bingo

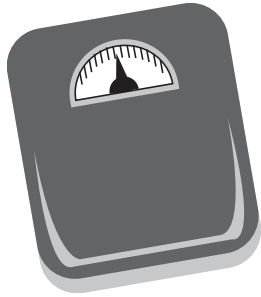

Being overweight increases your risk of heart disease.



Do 30 minutes of physical activity on most days.



Try fruit and fat free yogurt for snacks.



Cholesterol can clog your arteries and cause a heart attack or stroke.

♥
**FREE
SPACE**



To lose weight, cut down on portion size and be more active.



Hypertension is another term for high blood pressure.

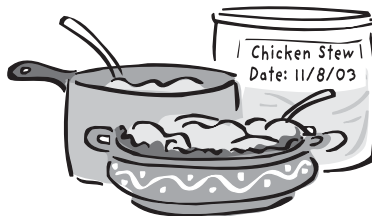

Cook more food than you need and freeze part to use when you don't have a lot of time to cook.



Regular canned and instant soups contain a lot of sodium.

Sample Bingo Cards – 13

Heart Health Bingo



High blood pressure makes your heart work harder.



Whole grains, fruits, and other favorite AI/AN foods are naturally low in fat.

Nutrition Facts	
Serving Size 2 oz (56g)	
Servings Per Container 6	
Amount Per Serving	
Calories 190	Calories from Fat 155
% Daily Value*	
Total Fat 17g	26%
Saturated Fat 6g	30%
Trans Fat 0g	
Cholesterol 35mg	11%
Sodium 730mg	30%
Total Carbohydrate 1g	0%
Dietary Fiber 0g	0%
Sugars 0g	
Protein 7g	
Vitamin A 0%	Vitamin C 0%
Calcium 0%	Iron 2%

*Percent Daily Values are based on a diet of other people's misdeeds.

Use the food label to choose foods lower in saturated fat, trans fat, and cholesterol.

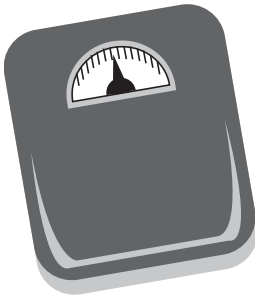

Being overweight increases your risk of diabetes.

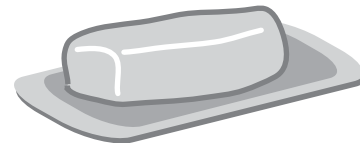
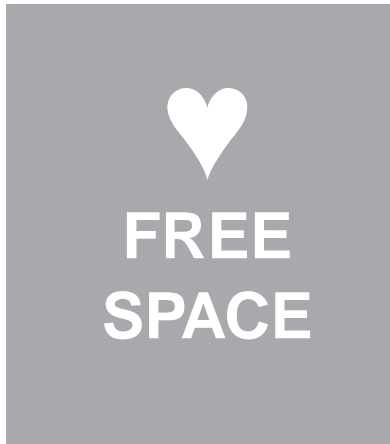

Saturated fat is solid at room temperature.



A blood pressure reading of 140/90 mmHg or greater is high.



Brisk walking is an activity almost everyone can do.



Pregnant women should not smoke.

Sample Bingo Cards – 14

Heart Health Bingo

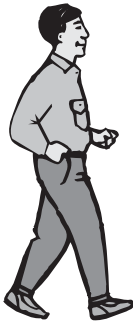

Brisk walking is an activity almost everyone can do.



You can have high blood pressure and not know it.



High blood pressure makes your heart work harder.

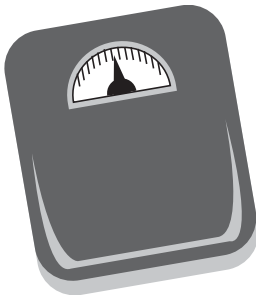

Being overweight increases your risk of high blood pressure.

FREE SPACE



Smoking causes serious health problems such as heart disease and lung cancer.

Nutrition Facts	
Serving Size 2 oz (56g)	
Servings Per Container 6	
Amount Per Serving	
Calories 190	Calories from Fat 155
% Daily Value*	
Total Fat 17g	26%
Saturated Fat 6g	30%
Trans Fat 0g	
Cholesterol 35mg	11%
Sodium 730mg	30%
Total Carbohydrate 1g	0%
Dietary Fiber 0g	0%
Sugars 0g	
Protein 7g	
Vitamin A 0%	Vitamin C 0%
Calcium 0%	Iron 2%

*Percent Daily Values are based on a diet of other people's misdeeds.
Percent Daily Values are based on a diet of other people's misdeeds.
Percent Daily Values are based on a diet of other people's misdeeds.

The food label gives serving size and the number of calories in a serving.



Children of smokers are more likely to become smokers.



A high blood cholesterol level is 240 mg/dL or higher.

Sample Bingo Cards – 15

Heart Health Bingo



Trim visible fat from meat before cooking.



Pregnant women should not smoke.

Nutrition Facts	
Serving Size 2 oz (56g)	
Servings Per Container 6	
Amount Per Serving	
Calories	190
Calories from Fat 155	
% Daily Value*	
Total Fat	17g
Saturated Fat	6g
Trans Fat	0g
Cholesterol	35mg
Sodium	730mg
Total Carbohydrate	1g
Dietary Fiber	0g
Sugars	0g
Protein	7g
Vitamin A	0%
Calcium	0%
Vitamin C	0%
Iron	2%

*Percent Daily Values are based on a diet of other people's misdeeds. © 2000. Values are for informational purposes only. Your Daily Values may be higher or lower depending on your calorie needs.

Use the food label to choose foods lower in saturated fat, trans fat, and cholesterol.



Stay active. Walk with your family or a friend.

FREE SPACE

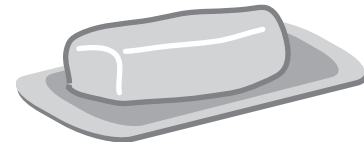

Saturated fat is solid at room temperature.

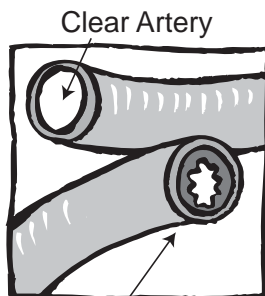

Too much cholesterol in your blood can clog your arteries.



Use herbs and spices instead of salt.



Drain meat, and rinse with hot water after it is cooked, to get rid of some of the fat.

Sample

A Letter to Myself

I have learned that there are many things that I can do to improve my health and lower my chances of developing heart disease. I can help family members make healthy choices, too. During the next 3 months, I will try to do these things to protect my heart:

1. I will take a walk with my family after dinner a few nights a week.
2. I will eat two to three servings of fruit every day.
3. When eating out, I will choose foods that are baked, broiled, or grilled.
4. I will switch to reduced fat (2 percent) milk for 1 month, then to lowfat (1 percent) milk for 1 month, and to fat free (skim) milk in 3 months.
5. I will have my blood pressure checked at the local clinic.

Signed John Smith

Date 10/03/2003



A Letter to Myself

I have learned that there are many things that I can do to improve my health and lower my chances of developing heart disease. I can help family members make healthy choices, too. During the next 3 months, I will try to do these things to protect my heart:

1. _____

2. _____

3. _____

4. _____

5. _____

Signed _____

Date _____

Certificate of Achievement

awarded to:

For Completing the
Honoring the Gift of Heart Health Program

Date

Heart Health Educator



