



**SFA Pacific, Inc.**  
**Engineering & Economic Consultants**

444 Castro Street, Suite 720  
Mountain View, California 94041  
Telephone: (650) 969-8876  
Fax: (650) 969-1317  
Email: [info@sfapacific.com](mailto:info@sfapacific.com)  
Website: [www.sfapacific.com](http://www.sfapacific.com)

**PROCESS SCREENING ANALYSIS OF ALTERNATIVE GAS  
TREATING AND SULFUR REMOVAL FOR GASIFICATION**

**Revised Final Report**

December 2002

Prepared by

Nick Korens  
Dale R. Simbeck  
Donald J. Wilhelm

SFA Pacific, Inc.  
Mountain View, California

Prepared for

U.S. Department of Energy  
National Energy Technology Laboratory  
Pittsburgh, Pennsylvania

NETL Project Manager  
James R. Longanbach

DOE Gasification Technologies Product Manager  
Gary J. Stiegel

Task Order No. 739656-00100  
Task 2

# **SFA Pacific, Inc.**

## Table of Contents

		<b>PAGE NO.</b>
<b>1. SUMMARY</b>	.....	1-1
Mercury Removal	.....	1-1
Acid Gas Removal	.....	1-2
Sulfur Recovery	.....	1-3
Tail Gas Treating	.....	1-3
Hot and Warm Gas Cleanup	.....	1-3
Acid Gas Injection	.....	1-5
CO <sub>2</sub> Removal for Sequestration	.....	1-5
<b>2. INTRODUCTION</b>	.....	2-1
Background	.....	2-1
Report Objective	.....	2-1
Approach to the Task	.....	2-2
<b>3. EMISSIONS REGULATIONS</b>	.....	3-1
Cleanup Process Implications	.....	3-2
Sulfur Removal	.....	3-2
Mercury Removal	.....	3-2
<b>4. IGCC GAS PROCESSING OPTIONS</b>	.....	4-1
Current IGCC Gas Processing	.....	4-1
Syngas Characteristics and Gas Cleaning	.....	4-1
AGR Processes Employed Commercially with Gasification	.....	4-3
Future IGCC Processes	.....	4-5
<b>5. MERCURY REMOVAL</b>	.....	5-1
Low Temperature Separation	.....	5-1
Activated Carbon	.....	5-2
Activated Carbon Bed Design Principles	.....	5-2
Metal Carbonyls	.....	5-4
Zeolites	.....	5-4
Other Methods	.....	5-7
<b>6. ACID GAS REMOVAL PROCESSES</b>	.....	6-1
Amine Processes	.....	6-2
Flowsheet and Process Design	.....	6-2
Performance and Cost Factors	.....	6-3
Generic Amine Processes	.....	6-5

**Table of Contents**  
(continued)

	<b>PAGE NO.</b>
<b>6. ACID GAS REMOVAL PROCESSES (continued)</b>	
MDEA .....	6-5
H <sub>2</sub> S/CO <sub>2</sub> Selectivity .....	6-5
COS Removal .....	6-6
CO <sub>2</sub> Removal .....	6-7
Degradation of MDEA and Its Corrosivity .....	6-8
Hindered Amines .....	6-9
Physical Solvents .....	6-10
Selexol .....	6-11
Rectisol .....	6-15
Mixed Amine/Physical Solvent Processes .....	6-18
Sulfinol .....	6-18
FLEXSORB PS and Hybrid FLEXSORB SE .....	6-19
General Perceptions of AGR Process Suitability for IGCC .....	6-19
AGR Process Selection .....	6-20
<b>7. SULFUR RECOVERY PROCESSES</b> .....	7-1
The Claus Process .....	7-1
Claus Plant Sulfur Recovery Efficiency .....	7-2
Oxygen-Blown Claus .....	7-4
The COPE Process .....	7-5
The OxyClaus Process .....	7-5
The SURE Process .....	7-8
Other Oxygen-Blown Claus Process Services .....	7-10
Extended Bed Claus Processes .....	7-10
The SuperClaus Process .....	7-10
Extended Cold-Bed Claus Process .....	7-11
Other Sulfur Recovery Processes .....	7-12
The Selectox Process .....	7-13
Wet Oxidation (Redox) Processes—LO-CAT and SulFerox .....	7-13
<b>8. TAIL GAS TREATING</b> .....	8-1
Reduction of Sulfur Compounds via Hydrogenation and Hydrolysis .....	8-1
Tail Gas Hydrogenation/Hydrolysis .....	8-2
Raw Synthesis Gas Hydrolysis .....	8-2
The SCOT Process .....	8-3

**Table of Contents**  
(continued)

	<b>PAGE NO.</b>
<b>9. HOT AND WARM GAS CLEANUP</b> .....	9-1
Drivers for HGCU.....	9-1
Waning Interest in HGCU .....	9-2
Further Temperature Considerations .....	9-3
Mercury Removal .....	9-3
“Hot Gas” or “Warm Gas” Cleanup?.....	9-3
GT Fuel Control Valves.....	9-3
Syngas Conversion to Synthetic Fuels.....	9-4
Particulates Removal Experience .....	9-4
Hot Desulfurization Demonstrations .....	9-5
HCl Removal .....	9-7
CO <sub>2</sub> Mitigation.....	9-7
Continuing DOE and EPRI Warm Gas Cleanup Programs .....	9-7
Outlook .....	9-8
<b>10. ACID GAS INJECTION</b> .....	10-1
<b>11. CO<sub>2</sub> REMOVAL FOR SEQUESTRATION</b> .....	11-1
<b>12. CONCLUSIONS AND RECOMMENDATIONS</b> .....	12-1
Conventional Cold Gas Cleanup.....	12-1
Hot and Warm Gas Cleanup .....	12-3
<b>13. REFERENCES</b> .....	13-1

## List of Tables

TABLE NO.	PAGE NO.
6-1 Solubilities of Gases in the Selexol Solvent.....	6-12

---

## List of Figures

FIGURE NO.	PAGE NO.
4-1 Simplified Flow Diagram of IGCC Meeting Current U.S. EPA Regulations .....	4-2
4-2 Simplified Flow Diagram of IGCC for Potential Future Emission Regulations .....	4-6
5-1 Low Temperature Mercury Separation Process.....	5-2
5-2 Pressure Drop through 4-10 Mesh Pittsburgh-Type HGR Carbon.....	5-3
5-3 HgSIV Mercury Removal and Recovery System.....	5-5
5-4 Integrated Carbon/Zeolite Hg-Removal System.....	5-6
6-1 Typical Amine Acid Gas Removal Process.....	6-3
6-2 COS vs. CO <sub>2</sub> Removal Using New aMDEA Formulation .....	6-7
6-3 The Selexol Process .....	6-13
6-4 Flow Diagram of Selexol Process for Acid Gas Removal from Coal-Derived Synthesis Gas .....	6-14
6-5 Absorption Coefficient $\alpha$ of Various Gases in Methanol .....	6-15
6-6 Rectisol Process Flow Diagram .....	6-16
6-7 Flow Diagram of Rectisol Process for Selective Hydrogen Sulfide Removal, Followed by Carbon Dioxide Removal .....	6-17
7-1 Typical Three-Stage Claus Sulfur Plant .....	7-2
7-2 Reaction Furnace Temperature .....	7-6
7-3 Claus Plant/H <sub>2</sub> S Removal in IGCC.....	7-8
7-4 Process Sketch of SURE Double Combustion Claus Process .....	7-9
7-5 Sketch of Multi Pass Waste Heat Boiler with Integral #2 Reaction Furnace.....	7-9
7-6 The Sulfreen Process .....	7-12
7-7 Simplified Flow Diagram of LO-CAT Autocirculation Process .....	7-15
8-1 The SCOT Process.....	8-4
11-1 CO <sub>2</sub> Separation Options for IGCC.....	11-3

## **Glossary and Abbreviations**

ACI	American Combustion, Inc.
AGE	acid gas enrichment
AGI	acid gas injection
AGR	acid gas removal
bar	SI unit of pressure (1 bar = 14.5 psi)
BFW	boiler feedwater
BSR	Beavon Stretford Reactor
Btu	British thermal units (1,055 joules)
°C	temperature, degrees Centigrade (Celsius)
CCT	Clean Coal Technology (DOE)
CFB	circulating fluidized-bed
CGCU	cold gas cleanup
CO	carbon monoxide
CO <sub>2</sub>	carbon dioxide
COPE	Claus Oxygen-based Process Expansion
COS	carbonyl sulfide
d	day
DEA	diethanolamine
DGA	diglycolamine
DIPA	diisopropanol amine
DOE	U.S. Department of Energy
DSRP	Direct Sulfur Recovery Process
EPA	U.S. Environmental Protection Agency
EPRI	Electric Power Research Institute
°F	temperature, degrees Fahrenheit ( $^{\circ}\text{F} = 1.8 \times ^{\circ}\text{C} + 32$ )
FEF	front end furnace
ft	feet
ft <sup>2</sup>	square feet
g	gram
GE	General Electric Company
GT	gas turbine
GTI	Gas Technology Institute
HAPS	Hazardous Air Pollutants
HCN	hydrogen cyanide

## **Glossary and Abbreviations**

## SFA Pacific, Inc.

(continued)

Hg	mercury
HGCU	hot gas cleanup
HP	high pressure (steam)
hr	hour
HRSG	heat recovery steam generator
HRU	heat recovery unit
HSS	heat stable salts
HTW	High-Temperature Winkler (gasification process)
IGCC	integrated gasification combined cycle
in <sup>2</sup>	square inch
KBR	Kellogg Brown & Root
lb(s)	pound(s) (454 grams)
LLB	Lurgi Lentjes Babcock
LNG	liquefied natural gas
LP	low pressure (steam)
lt	long ton (2,240 pounds, 1,016 kg) (Note: A long ton is not a metric ton.)
LTS	low temperature separation
M	thousand
MDEA	methyldiethanolamine
MEA	monoethanolamine
min	minute
MM	million (1 x 10 <sup>6</sup> )
MMEA	methyl monoethanolamine
mt	metric ton (2,204.6 pounds, 1,000 kg)
MW	megawatt
MWh	megawatts per hour
Ncm <sup>2</sup>	normal centimeters squared
Nm <sup>3</sup>	normal meters cubed
NSPS	New Source Performance Standards
OAQPS	Office of Air Quality Planning & Standards (U.S. EPA)
Oxyburner	oxygen burner
OxyClaus	oxygen-blown Claus



**Glossary and Abbreviations  
(continued)**

PCD	particulates control device
ppm	parts per million
ppmv	parts per million volume
ppmw	parts per million by weight
PSDF	Power Systems Development Facility
psi(a)	pounds per square inch (absolute)
R&D	research and development
Redox	reduction-oxidation
RTI	Research Triangle Institute
scf	standard cubic feet (1 atm, 60°F)
SCOT	Shell Claus Off-gas Treating
SCR	selective catalytic reduction
SGD	safeguard device
SHA	sterically hindered amines
SR	sulfur recovery
SRU	sulfur recovery unit
st	short ton (2,000 pounds, 907 kilograms)
SWPC	Siemens Westinghouse Power Corporation
SWS	sour water stripper
t	ton
TECO	Tampa Electric Company (Florida)
TGT	tail gas treating
UOP	Universal Oil Products
vol%	volume percent
WHB	waste heat boiler
wt%	weight percent
%	percent
@	at
µg	micrograms (10 <sup>-6</sup> grams)

**SFA Pacific, Inc.**

## **1. SUMMARY**

This report updates a 1987 SFA Pacific, Inc. report to the Electric Power Research Institute (EPRI) that dealt with acid gas treating and sulfur recovery for integrated gasification combined cycle (IGCC) power generation [1]. Not only are the emission regulations more stringent than those prevailing at the time of the first report, but there is now sufficient commercial experience in IGCC that points the way to the processes that will meet current and potential future regulations.

Using the SFA Pacific Gasification Database [2], together with a literature survey and limited contacts with licensors and plant operators, SFA Pacific identified the processes that are applicable to IGCC under the current and proposed U.S. emission standards and reviewed their performance characteristics. Mercury removal, acid gas cleanup, sulfur recovery, tail gas treating, and hot and warm gas cleanup processes were reviewed. In addition, CO<sub>2</sub> removal for potential sequestration and acid gas injection into saline aquifers and depleted gas/oil wells were addressed.

This report essentially concludes that the gas treating processes available in 1987 are still the commercial mainstays of the industry. However, in many cases their designs today and in the future would be different in some respects for different gasification processes and applications—and to meet the more stringent environmental regulations. The impact of the latter, of course, is usually increased capital and operating costs. Identifying the “best” process options for specific applications would require engineering and cost evaluations of the integrated system options, including process licensors’ evaluations. Such tasks are well beyond the scope of this review report.

Nevertheless, the gas treating processes—particularly the acid gas removal (AGR) process options—used with gasification processes since 1987 suggest industry preferences for certain processes. Those patterns, combined with general industry perceptions about the applicability of AGR processes in particular, provide some guidelines for the preliminary identification of options for various IGCC applications—and related performance, design, and optimization issues.

The summary of the other major findings and conclusions of this report follow.

### **Mercury Removal**

Recent experience with mercury removal from synthesis gas is limited to the Tennessee Eastman gasification facility, where carbon beds remove 90-95% of the mercury from coal derived synthesis gas. However, there is much commercial experience with mercury removal in the natural gas industry. There, mercury is being removed to below detectable limits. Similar performance of the carbon beds can be expected in synthesis gas applications. The major remaining problem is the disposal of mercury-laden spent carbon. Mercury sulfide on the spent

## **SFA Pacific, Inc.**

carbon is stable and currently the best option is to dispose of it at certified storage sites. Regeneration with mercury recovery is complex and expensive.

### **Acid Gas Removal (AGR)**

Currently, the processes of choice in commercial IGCC facilities for the removal of acid gases are both the chemical solvent AGR processes based on aqueous methyldiethanolamine (MDEA) and the physical solvent-based Selexol process—which uses mixtures of dimethyl ethers of polyethylene glycol. In most of the IGCC applications now, with both of these AGR processes, the AGR units are preceded by carbonyl sulfide (COS) hydrolysis units to convert most of the COS to H<sub>2</sub>S. This then enables the AGR units to accomplish deeper total sulfur removal and lower H<sub>2</sub>S levels. Total sulfur (COS+H<sub>2</sub>S) levels of <20 ppmv may be required if selective catalytic reduction (SCR) is to be used with IGCC—to prevent ammonium sulfate salt deposition and corrosion problems in the colder sections of the heat recovery steam generator (HRSG).

While physical solvent processes are capable of meeting the stringent sulfur cleanup required for SCR, the processes themselves are more expensive than the MDEA-based amine ones. With COS hydrolysis, MDEA-based solvents can also meet a 10-20 ppmv total sulfur level in the treated gas, albeit at the expense of increased solvent circulation rates and a decrease in H<sub>2</sub>S selectivity. The use of MDEA-based solvents will require acid gas enrichment (AGE) to give a suitable feed for the Claus plant. Commercial MDEA formulations (with proprietary additives) have been developed, which offer enhanced selectivity for H<sub>2</sub>S, and their use is widespread in the gas treating industry.

BASF Corporation has shown some success in tests of its newly formulated MDEA solvent that removes much of the COS while retaining a high degree of H<sub>2</sub>S selectivity. However, the performance to date is not adequate for the elimination of the COS hydrolysis step. In fact, SFA Pacific believes that if SCR is to be used, COS hydrolysis will be necessary for any acid gas removal system, except possibly the Rectisol process.

Although the Selexol process by itself is more expensive than an MDEA AGR process, the total AGR, sulfur recovery (SR) process, and tailgas treating (TGT) process package—based on Selexol could be more cost effective than the package based on MDEA—especially if the syngas pressure is high and deep sulfur removal is required (i.e., to 10-20 ppmv). Deeper desulfurization can be accomplished by chilling the Selexol process. However, CO<sub>2</sub> co-absorption then also increases.

For future IGCC with CO<sub>2</sub> removal for sequestration, a two-stage Selexol process presently appears to be the preferred AGR process—as indicated by ongoing engineering studies at EPRI and various engineering firms with IGCC interests. In CO<sub>2</sub> removal applications, the Selexol process is chilled—thus facilitating deep H<sub>2</sub>S removal as well as CO<sub>2</sub> removal.

The Rectisol physical solvent AGR process—based on low-temperature (refrigerated) methanol—is capable of deep total sulfur removal, but it is regarded as the most expensive AGR

process. Therefore, its use is generally reserved for chemical synthesis gas applications in which very pure syngas is required. Its use in IGCCs with CO<sub>2</sub> removal has also been proposed.

Further studies of the main IGCC processes with various feedstocks and all of the potentially competitive AGR options are required to quantify the relative performance and cost benefits of the various options and elucidate the ranges of conditions and cases in which they are competitive. Related studies are underway at EPRI and various engineering organizations.

## **Sulfur Recovery**

The Claus process remains the mainstay of sulfur recovery, and is likely to remain so in the future. The principal development over the past several years has been the use of oxygen-enriched Claus plants. While oxygen enrichment doesn't improve sulfur recovery to a significant extent, it does result in less tail gas and allows for more complete destruction of sour water stripper off-gases. The smaller tail gas flow allows for the more economical handling of the Claus tail gases, discussed further below.

Acid gas enrichment will be necessary to enable Claus plant sulfur recovery approaching 98%. For higher sulfur recovery a tail gas treating unit is necessary, as is the current practice in IGCC plants and elsewhere.

## **Tail Gas Treating**

The principal current tail gas treating approach is to hydrogenate/hydrolyze the sulfur species in the tail gas and then scrub out the resulting H<sub>2</sub>S in an acid gas removal absorber. This approach is capable of boosting total sulfur recovery to well over 99.9%.

In some IGCC plant designs Claus tail gas, after H<sub>2</sub>S scrubbing, is compressed and routed to the combustion turbine. This tail gas handling eliminates the need for a tail gas incinerator and provides additional fuel and mass flow to the combustion turbine. H<sub>2</sub>S can be scrubbed in a stand alone separate process, such as Shell Claus Off-gas Treating (SCOT), or could be routed to the acid gas removal unit upstream of the Claus plant.

Tail gas treating of this type will remain the dominant and a required step in order to meet the proposed regulations.

## **Hot and Warm Gas Cleanup**

Various systems for dry removal of the particulates and sulfur components of syngas over the 500-1,100°F temperature range have been tested at the pilot plant level and a small number have been installed in commercial-scale IGCC demonstration plants in the U.S. and Europe. However, both industry interest (which has always been limited) and government interest in hot gas cleanup (HGCU) have declined for several important reasons; namely:

## SFA Pacific, Inc.

- Process and equipment development challenges; e.g., attrition of the desulfurization sorbents; chloride stress corrosion issues; and the high cost and unproven status of gas turbine (GT) fuel control valves for syngas at temperatures above about 800°F.
- Hot gas desulfurization has not been demonstrated. The hot desulfurization processes in the Tampa Electric and Piñon Pine IGCC demonstrations were never operated.
- The trend toward increasingly stringent air emissions standards, including mercury removal from fossil power plant stack gas and the potential for mandated CO<sub>2</sub> mitigation. Specifically, HGCU at this stage of its development does not remove ammonia or HCN, COS, mercury (Hg), or CO<sub>2</sub> from syngas. Ammonia and HCN are converted to NO<sub>x</sub> and COS is converted to SO<sub>2</sub> in GTs. Very low levels of SO<sub>2</sub> are required to prevent ammonium bisulfate fouling of the low-temperature HRSG surfaces in IGCC, if SCR is required. Present indications are that efficient and economical Hg removal will require syngas at temperature levels of conventional cold gas cleanup (CGCU) and removal by activated carbon before the GT.
- The success of the demonstration and commercial O<sub>2</sub>-blown coal, petroleum coke, and petroleum residual oil gasification projects for IGCC and chemical synthesis gas production with conventional CGCU—in the U.S. and Europe. And the number of commercial IGCC projects with CGCU has been proliferating worldwide.

At the same time, hot particulates control devices (candle filters) have been successfully demonstrated at least three of the IGCC and gasification demonstration projects. These barrier filters represent the only currently commercially applicable HGCU technology. Particulates removal is the only hot gas cleaning technology perceived to have a future.

The U.S. DOE's recent extensive gasification industry interviews found that currently there is not much incentive for gas cleanup operations above 700°F. Prior engineering analyses have persuaded the industry that the efficiency improvements from operating above 800°F are not worth the additional capital costs due to materials and the increased equipment sizes resulting from the larger volumetric flows. DOE also found industry concerns about the effectiveness of dry sorbent-based technologies and the efficiency of regeneration at lower temperatures. Nevertheless, the interviews indicated some interest in the possibility of dry cleanup processes that operate at temperatures closer to downstream requirements of GT fuel systems and catalytic synthesis processes; e.g., in the 300-700°F range.

Recognizing many of the issues and limitations surrounding hot gas cleaning technologies and their applications, DOE's Gasification Technologies program has transitioned its gas cleaning component away from the development of high-temperature approaches to more moderate temperatures consistent with downstream applications.

The development of hot gas cleanup systems for deep cleaning of sulfur and nitrogen components from syngas appear to be long-term prospects, if at all achievable.

## **Acid Gas Injection**

A novel way to dispense with sulfur recovery and tail gas treating is to inject the acid gas into saline aquifers and depleted gas/oil reservoirs. Acid gas injection (AGI) has now been widely practiced by the oil and gas industry for the past decade. This eliminates the need to upgrade or build ever more expensive sulfur recovery facilities as the environmental regulations tighten. AGI may be a good alternative for IGCC plants, particularly if CO<sub>2</sub> removal for sequestration is required in the future.

## **CO<sub>2</sub> Removal for Sequestration**

Oxygen-blown IGCC plants with conventional cold gas cleanup are particularly suitable for nearly total CO<sub>2</sub> removal from synthesis gas, if CO<sub>2</sub> sequestration should be required. All that would be necessary is a CO shift reactor and an additional CO<sub>2</sub> scrubbing step. Thus, the H<sub>2</sub>S would be removed by one AGR process (absorber and stripper) and the CO<sub>2</sub> would be removed by the second-stage AGR process (absorber and stripper). CO shift and CO<sub>2</sub> removal can be integrated into the acid gas removal system as is widely done commercially in the petrochemical industry. CO shift can be done upstream of the main acid gas absorber, using sulfur tolerant catalyst, or after H<sub>2</sub>S removal. The first approach has the advantage that synthesis gas does not have to be cooled prior to shifting, and is particularly suitable to slurry fed gasifiers. The latter approach allows for simpler selective H<sub>2</sub>S removal.

**SFA Pacific, Inc.**



## 2. INTRODUCTION

### Background

In 1987, SFA Pacific, Inc. analyzed, for the Electric Power Research Institute (EPRI), alternative gas treating and sulfur recovery processes for use in Integrated Gasification Combined Cycle (IGCC) electric power plant applications. The resulting EPRI report [1] identified the suitable state-of-the-art processes for use in IGCC under the then-prevailing emission standards. Since that time, the emissions standards have become much more stringent, and the knowledge base of IGCC technologies has advanced significantly. Because of these changes, an update of the previous effort has become desirable; this report is the resulting update.

For the 1987 report, EPRI specified the raw syngas composition, temperature, and pressure—as well as the H<sub>2</sub>S and overall sulfur removal requirements, and other product gas characteristics. The focus of the 1987 analysis was on the New Source Performance Standards (NSPS) prevailing at that time, which essentially required 90% overall sulfur removal from bituminous coal-fired electric power plants. The analysis also limited fuel gas H<sub>2</sub>S content to 4 ppmv. Two more cases were also addressed then. The first specified a more stringent overall sulfur removal of 95% for power plants. The other case considered that the gasification synthesis gas was to be fed to a once-through methanol synthesis process, limiting the total synthesis gas sulfur content to less than 0.1 ppmv (H<sub>2</sub>S and COS combined). The 1987 report essentially centered on sulfur removal via acid gas scrubbing, sulfur recovery, and sulfur tail gas treating processes.

Current emissions standards have not only become more stringent in regard to the Criteria Pollutants (SO<sub>2</sub>, NO<sub>x</sub>, CO, and particulates), but now require virtually total removal of volatile and non-volatile trace elements and organic compounds that result from gasification of coal and hydrocarbons and the subsequent combustion of the resulting fuel gas. In addition, recent global pressures to limit CO<sub>2</sub> emissions have also focused attention on the abilities of the various gas treating processes to remove and isolate CO<sub>2</sub>. The selection of suitable gas treating, sulfur recovery, and tail gas processes becomes critical and complex if all of these emissions goals are to be achieved with a suitable degree of success.

### Report Objective

The objective of this report is to review the commercial gas treating and sulfur recovery processes that are suitable for IGCC applications and that can meet current and future more stringent emissions requirements. The performance characteristics, limitations, and other issues of the processes are addressed.

One of the ancillary goals was to identify suitable methods of removing mercury from gas streams to meet both emissions regulations and to prevent potential equipment failures both before and after gas combustion.

## **SFA Pacific, Inc.**

While this report was not intended to be a guide for choosing the best applicable process for a given situation, the patterns of commercial use of the various gas treating processes and general industry perceptions about the processes suggest some general guidelines for the preliminary selection of certain process for IGCC applications—particularly AGR processes. These guidelines are outlined in Section 6 – Acid Gas Removal Processes. However, it is emphasized that several process options may be applicable to any given project, the economics of which will depend on the type of gasification process, feedstock, emissions regulations, plant location, existing infrastructure and tie-ins to existing facilities, client preferences, etc. The choice between the processes for specific applications would require process licensors' evaluations—tasks that are well beyond the scope of this report. Therefore, the economics of gas cleanup are not addressed in this report, other than in qualitative terms; i.e., brief discussions of design and performance parameters that influence costs.

Anyone considering a specific project, gasification process, system configuration, and emissions standards is advised to contact the suppliers of the applicable processes covered in this report for the latest relevant technical and cost information and support.

### **Approach to the Task**

The principal approach used in this task was to review the developments that have taken place in gasification, gas treating and sulfur recovery and to identify those gas treating and sulfur recovery processes that have the best potential for meeting current and future emissions goals. The SFA Pacific Gasification Database [2] was used in the preliminary stages of the project to identify the newer large commercial gasification projects, the feedstocks and specific gasification technologies employed, and the specific applications (i.e., IGCC, cogeneration, H<sub>2</sub> production, chemicals, etc.). Recently published papers and reports on these projects were then reviewed—and selected industry contacts were made—to identify the specific gas treating processes used, as well as those most often chosen to meet specific syngas specifications and/or emissions goals. These processes were then screened for their performance in meeting their design emissions goals. Any known process limitations were identified.

The solvents discussed in this report represent those that are preferred in the current commercial gasification designs. These are solvents with which the most experience has been accumulated in gasification applications or comparable gas treating applications.

The process review was extended beyond gasification applications, since some processes that have long been used in the natural gas industry would also be applicable in gasification. This is particularly true for the removal of mercury, which the natural gas industry has been addressing for several decades. The natural gas industry also has vast experience in natural gas treating, using processes that are common with gasification applications. That common experience has also been reviewed. The experience of the refining industry in meeting the ever-tightening regulations in tail gas treating and sulfur recovery, especially in the use of oxygen-blown Claus units, has also been tapped.

### 3. EMISSIONS REGULATIONS

The original 1987 gas treating and sulfur removal process study addressed the then-applicable U.S. Environmental Protection Agency (EPA) New Source Performance Standards (NSPS) as published in the Federal Register in 1979 and the design emissions bases as specified by EPRI, outlined in the Introduction section of this report. Since that time, the NSPS standard has been tightened as well as new list of controllable pollutants has been added. Even stricter standards are being considered that would be applicable to IGCC systems. A brief outline of the current and possible future emissions standards is given below. These current and possible standards are the bases for the assessment of the performance of the gas treating and sulfur removal processes considered in this report.

The NSPS regulations have been revised several times since the promulgation of the U.S. Clean Air Act Amendments of 1970. Each revision resulted in the tightening of emissions specifications, especially for particulates and NO<sub>x</sub>. The current NSPS emissions limits for the criteria pollutants from fossil-fired utility and industrial boilers are as follows:

- Particulates (PM<sub>10</sub>)    0.03 lb/MMBtu
- NO<sub>x</sub>                        0.15 lb/MMBtu (or 1.6 lb/MWh)
- SO<sub>2</sub>                        1.2 lb/MMBtu

Now EPA is expected to stringently regulate the emissions of mercury by 2007—and to further tighten the emissions of all the criteria pollutants. At least one of the advanced pulverized coal-fired power plant suppliers has recently announced emissions goals that are lower than the current standards, yet undoubtedly achievable; e.g.:

- Particulates (PM<sub>10</sub>)    0.006 lb/MMBtu
- NO<sub>x</sub>                        0.016 lb/MMBtu (or up to 99.5% reduction)
- SO<sub>2</sub>                        0.040 lb/MMBtu (or up to 99% reduction)

The goal of the U.S. DOE's *Vision 21* Program is to effectively remove all environmental concerns associated with the use of fossil fuels for producing electricity, transportation fuels, and high-value chemicals. *Vision 21* is supporting R&D and technology demonstrations. The program's environmental targets are:

- Atmospheric release of—
  - < 0.01 lb/MMBtu of both SO<sub>2</sub> and NO<sub>x</sub>
  - < 0.005 lb/MMBtu PM
  - < one-half of emission rates for organic compounds listed in the “Utility Hazardous Air Pollutants (HAPS) Report”
  - < 1 lb/trillion Btu mercury
- 40-50% reduction of CO<sub>2</sub> emissions by efficiency improvement
  - 100% reduction with sequestration

## Cleanup Process Implications

### *Sulfur Removal*

The process implication of standards as low as the above emissions capabilities claims of vendors is that gas cleanup has to improve significantly over the performance currently achieved in the IGCC units. Currently, sulfur removal in IGCC units reaches about 97.5% for bituminous high-sulfur coals, well above the NSPS requirement of approximately 80% removal to achieve the maximum SO<sub>2</sub> specification of 1.2 lb/MMBtu of heat input. However, an SO<sub>2</sub> emissions standard of 0.04 lb/MMBtu would require better than a 99.5% sulfur removal level, which is achievable by some processes but at a high cost.

An additional complication for sulfur removal arises if the emissions standard proposed for NO<sub>x</sub> will be much lower than the current 0.15 lb/MMBtu emissions standard. Achieving a level of 0.016 lb/MMBtu (approximately 6 ppmv) in the IGCC exhaust gas could require the use of SCR. The SO<sub>3</sub> that is formed from SO<sub>2</sub> by combustion and by further oxidation of SO<sub>2</sub> over the SCR catalyst leads to the formation of sulfuric acid (H<sub>2</sub>SO<sub>4</sub>). The sulfuric acid, in turn, can react with ammonia slip from the SCR unit to form ammonium sulfate and ammonium bisulfate salts. These salts are known to deposit in the low temperature sections of the heat recovery steam generator (HRSG) units, which would lead to equipment corrosion and fouling, and will require frequent unit shutdowns for cleaning. To prevent such salts from forming would require extremely low levels of sulfur in the flue gas, probably less than 3 ppmv total sulfur (equivalent to about 20 ppmv in the clean synthesis gas). This would require better than 99.8% sulfur removal from the gas. Again, this is a possible but very costly target.

### *Mercury Removal*

Current experience at gasification plants shows that approximately 60% to 70% of the initial mercury in bituminous coal exits in the flue gas [3]. The level of mercury in the flue gases of these plants, based on the total heat input in the coal, is about 4 to 5 lb/trillion Btu. Since most of the mercury partitions into the gas phase, some type of a gas phase mercury removal process would have to be utilized. A conservative assumption would be that all mercury in coal partitions to the gas phase. Current experience at the Eastman Kingsport plant shows that approximately 90-95% of the mercury could be removed from gas by carbon beds.

The scope of this process review update is limited to sulfur and mercury removal from coal gases, and to the discussion of process performance as it relates to CO<sub>2</sub> in connection to the global warming issues. Control of NO<sub>x</sub>, particulates, and other trace gas constituents are only discussed in relation to sulfur and mercury control, when applicable.

## **4. IGCC GAS PROCESSING OPTIONS**

There are several possible gas scrubbing options for IGCC that can meet various emission specifications and processing goals. Typical current process layouts are based on minimal gas processing in order to meet current emission regulations. Future stricter regulations will require additional processing steps and improvements in the performance of the currently used processes. In addition, if CO<sub>2</sub> abatement will be required in the future, additional processing steps will be required. This section discusses the various gas processing options that are currently being utilized and that may be required in the future.

### **Current IGCC Gas Processing**

There is now a broad base of experience in gas scrubbing and sulfur recovery processes – made available from the numerous gasification projects that have been carried out in the past or that are operating currently. This experience covers a spectrum of gasification processes and feedstocks; namely, coals, all types of petroleum residues, natural gas, various waste streams, and biomass.

#### ***Syngas Characteristics and Gas Cleaning***

The raw syngases produced by the gasification of various feedstocks are similar in that the predominant gas components are hydrogen (H<sub>2</sub>) and carbon monoxide (CO) (the desired combustible or reactive components for chemical synthesis), carbon dioxide (CO<sub>2</sub>), water vapor (H<sub>2</sub>O), and various impurities. However, the concentrations of these various components depend on the feedstock composition and the specific gasification process employed.

The primary feedstock impurities of concern are the sulfur and ash constituents. In gasification, the sulfur is converted mainly to H<sub>2</sub>S and COS, a portion of the ash is entrained as particulates, and the mercury is vaporized. The entrained particulate matter also includes unburned carbon. Small amounts of HCN and NH<sub>3</sub>, and traces of metal carbonyl compounds, are also produced.

Gas scrubbing addresses mainly particulate scrubbing, sulfur removal, and the removal of various chemical trace components from the gas. The required extents of removal of each of the impurities depend on the application; i.e., IGCC or chemical synthesis. For example, to prevent deactivation of methanol and Fischer-Tropsch synthesis catalysts, reduction of the total syngas sulfur content to <0.1 ppmv is required. This is a much more stringent requirement than that for IGCC, which is project-specific, but currently probably not more stringent than the 10-20 ppmv (0.04-0.08 lb/MMBtu) specification for SCR operation (discussed later).

Figure 4-1 shows a simplified process flow diagram of a generic IGCC power plant that meets current U.S. EPA emission regulations. The flow scheme is based on a pressurized, oxygen-blown entrained-flow gasifier, currently the most widely used type. Other gasifiers, particularly fixed bed types, may require additional steps to remove pyrolysis byproducts. The hot raw gasifier synthesis can be immediately cooled in a waste heat boiler to generate high pressure

steam (the heat recovery mode of operation) or quenched with water, thereby adding steam directly to the syngas (the direct quench mode of operation). The cooled gas is then scrubbed to remove particulates, hydrogen chloride, hydrogen cyanide, and ammonia that may be present. Another option to water scrubbing for particulate removal is the use of ceramic candle filters or sintered metal filters. Both of these latter options have been used successfully in IGCC plants. The gas is then cooled to near ambient temperatures, and proceeds to an acid gas removal (AGR) unit, where the sulfur compounds and some carbon dioxide are removed. The scrubbed gas is then combusted in the gas turbine of the combined cycle power plant, while the removed acid gas from the AGR unit goes to a sulfur recovery (SR) unit, which recovers sulfur as a usable byproduct.

**Figure 4-1**  
**Simplified Flow Diagram of IGCC Meeting Current U.S. EPA Regulations**

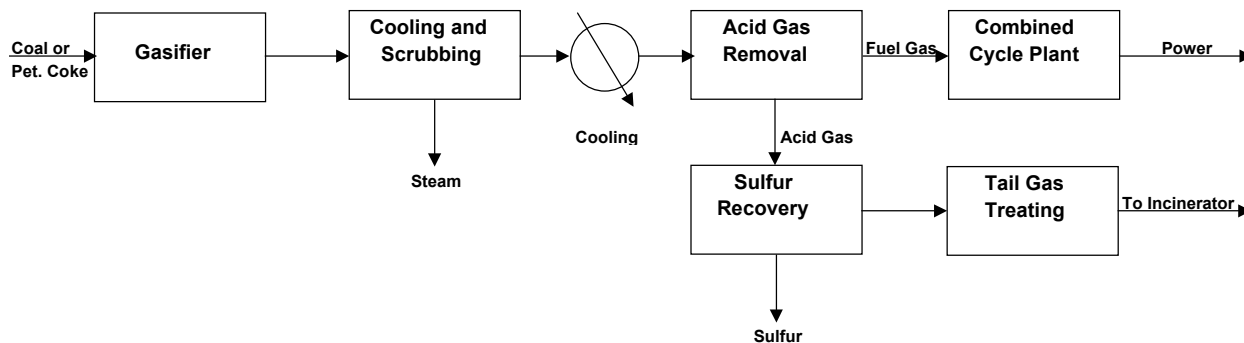

Source: SFA Pacific, Inc.

Conventional solvent based AGR units, both of amine and physical solvent types, and conventional Claus SR units – with their associated tail gas treating (TGT) units, are easily capable of meeting the fairly stringent current U.S. EPA emissions regulations. In a few circumstances, where local more stringent regulations apply, or in U.S. EPA designated non-attainment areas, further sulfur removal may be required. Carbonyl sulfide (COS), which is usually present at a several hundred ppmv level in syngas from coal and petroleum residues is difficult to remove quantitatively in AGR units. Therefore, further sulfur removal may be accomplished by the addition of a COS hydrolysis unit (before the AGR), which catalytically converts COS to H<sub>2</sub>S, which can then be easily scrubbed out in the AGR unit.

High sulfur coal IGCC plants that use COS hydrolysis, together with conventional AGR and SR units, have been able to achieve nearly 98% sulfur recovery, equivalent to sulfur emissions of about 0.10 lb/MMBtu of coal input [4]. By also using TGT units, even higher sulfur recoveries, up to 99.8%, can be achieved.

High levels of sulfur recovery have been reported in the Sarlux IGCC plant in Italy, which gasifies a high-sulfur petroleum residue. There, an oxygen-blown Claus (OxyClaus) unit,

## **SFA Pacific, Inc.**

licensed by Lurgi, is used. The tail gas from this sulfur recovery unit, after passing through a hydrolysis unit, is compressed and fed back to the main Selexol acid gas absorber. Thus, the only sulfur leaving the plant is that which leaves the AGR unit in the cleaned up syngas (fuel gas), which is combusted in the gas turbine. The overall sulfur recovery of the plant, designed for 95%, has reached as high as 99.8% in tests.

### ***AGR Processes Employed Commercially with Gasification***

As indicated in the Introduction of this report, the SFA Pacific Gasification Database [2] was used in the preliminary stages of this project to identify the newer, large commercial gasification projects, the specific gasification technologies employed, and the specific applications (i.e., IGCC, cogeneration, H<sub>2</sub> production, chemical synthesis, etc.). The Database was also used – along with recently published papers and reports on these projects, plus selected industry contacts – to identify the specific gas treating processes used, as well as those most often chosen to meet specific syngas specifications and/or emissions goals.

The results of this review are represented in Table 4-1, which provides a partial listing of gasification installations from the SFA Pacific Gasification Database showing the year of start up, feedstock, acid gas removal (AGR) process employed, and application. The major demonstration and commercial IGCC and/or cogeneration (cogen) projects are included (indicated as such in the table and highlighted by shading), as well as many projects producing or co-producing hydrogen, ammonia, Fischer-Tropsch liquids (hydrocarbons), and chemicals (C in the table). The Agip (2004 start up), PIEMSA (2006), and Total Fina (2006) projects are still in planning. Additional gasification projects that are known to be in planning are not included in Table 4-1 since data on the sulfur removal and sulfur recovery processes selected or proposed for those projects are not yet available. Of course not all projects in planning actually get built.

The Gasification Database and current publications show that both amine-based and physical solvent-based AGR processes are widely employed. Specifically, Table 4-1 shows the following patterns:

- MDEA (methyl diethanolamine) based AGR has been the predominant process for IGCC applications up to the late 1990s, and it continues to be selected for new projects. Ten of the projects in Table 4-1, including eight IGCC/cogeneration projects, employ MDEA.
- The Selexol process (based on mixed dimethyl ethers of polyethylene glycol as the physical solvent) has emerged as a competitor to MDEA. Selexol has now been used in or specified for five gasification projects. The first Selexol process applications since the SCE Cool Water IGCC demonstration in the 1980s have materialized just within the past several years. Keep in mind that the selection and design of the AGR and sulfur recovery (SR) process have to be completed by the time plant construction begins and that power plant construction then typically takes about three years.

# SFA Pacific, Inc.

**Table 4-1  
Partial Listing of Gasification Installations  
by Acid Gas Removal (AGR) Process and Year of Startup**

**Chemical (Amino) and Physical Solvents Employed in the AGR Processes Listed**

**Adip** - aqueous di-isopropanol amine or MDEA  
**MDEA** - aqueous methyldiethanolamine  
**Rectisol** - methanol  
**Selexol** - dimethyl ether of polyethylene glycol  
**Sulfinol** - mixture of aqueous amine (e.g., DIPA) and the physical solvent Sulfolane (tetra-hydrothiophene dioxide)  
**Sulfinol-M** - mixture of aqueous MDEA and Sulfolane

Plant Owner	Country	Start up	Feedstock	Gasification		Application <sup>a</sup>
				Process	AGR Process	
Sasol Chemical Ind. (Pty.) Ltd./Sasol Ltd.	South Africa	1955	subbit. coal	Lurgi Dry Ash	Rectisol	FT liquids
Mitsubishi Petrochemicals	Japan	1961	Bunker C oil	Shell	Adip	C
Lucky Goldstar Chemical Ltd.	South Korea	1969	Bunker C oil	Shell	Sulfinol	ammonia
Sasol Chemical Ind. (Pty.) Ltd./Sasol Ltd.	South Africa	1977	subbit. coal	Lurgi Dry Ash	Rectisol	FT liquids
Hydro Agri Brunsbüttel	Germany	1978	heavy vac. residue	Shell	Rectisol	ammonia
Sasol Chemical Ind (Pty.) Ltd./Sasol Ltd.	South Africa	1982	subbit. coal	Lurgi Dry Ash	Rectisol	FT liquids
Gujarat National Fertilizer Co.	India	1982	refinery residue	Texaco	Rectisol	ammonia
Eastman Chemical Co.	United States	1983	coal	Texaco	Rectisol	methanol, & other C
Dakota Gasification Co.	United States	1984	lignite & ref. residue	Lurgi Dry Ash	Rectisol	synthetic natural gas (methane)
SCE Cool Water	United States	1984	bituminous coal	Texaco	Selexol	IGCC
Quimigal Adubos	Portugal	1984	vacuum residue	Shell	Rectisol	ammonia
Mitteldeutsche Erdöl-Raffinerie GmbH	Germany	1985	visbreaker residue	Shell	Rectisol	methanol
Rheinbraun	Germany	1986	brown coal	HTW	Rectisol	methanol
SAR GmbH	Germany	1986	vacuum residue	Texaco	Sulfinol	H <sub>2</sub> & oxochemicals
LGTI	United States	1987	subbit. coal	E-GAS	MDEA	IGCC/Cogen
China Nat'l Tech. Import Co. (CNTIC)	China	1987	anthracite	Lurgi Dry Ash	Rectisol	ammonia
BP Chemicals, Ltd.	United Kingdom	1989	natural gas	Texaco	MDEA	acetyls
NUON (formerly Demkolec BV)	Netherlands	1994	coal	Shell	Sulfinol-M	IGCC
Global Energy, Inc.	United States	1995	coal, pet coke	E-GAS	MDEA <sup>b</sup>	IGCC
Dalian Chemical Industrial Corp.	China	1995	visbreaker residue	Texaco	Rectisol	ammonia
Frontier Oil & Refining Co. (Texaco Inc.)	United States	1996	pet coke	Texaco	MDEA	Cogen
Tampa Electric Co.	United States	1996	bit. coal	Texaco	MDEA <sup>b</sup>	IGCC
Schwarze Pump	Germany	1996	municipal waste	GSP/Noell	Rectisol	IGCC & methanol
Inner Mongolia Fertilizer Co.	China	1996	vacuum residue	Shell	Rectisol	ammonia
Jujiang Petrochemical Co.	China	1996	vacuum residue	Shell	Rectisol	ammonia
Sokolovska Uhelna, A.S.	Czech Republic	1996	coal	Lurgi Dry Ash	Rectisol	IGCC/Cogen
Elcogas SA	Spain	1997	coal & pet coke	PRENFLO	MDEA <sup>b</sup>	IGCC
Shell Nederland Raffinaderij BV	Netherlands	1997	visbreaker residue	Shell	Rectisol	IGCC/Cogen, H <sub>2</sub>
Unspecified owner	Germany	1997	visbreaker residue	Texaco	Sulfinol	methanol
Sierra Pacific Power Co.	United States	1998	coal	KRW	Limestone/ZnO <sup>c</sup>	IGCC
Lanzhou Chemical Industrial Co.	China	1998	vacuum residue	Shell	Rectisol	ammonia
ISAB Energy	Italy	2000	heavy oil	Texaco	MDEA <sup>b</sup>	IGCC, H <sub>2</sub>
Motiva Delaware Refinery	United States	2000	pet coke	Texaco	MDEA	IGCC/Cogen
Henan	China	2000	anthracite	Lurgi Dry Ash	Rectisol	ammonia
EPZ	Netherlands	2000	demolition wood	Lurgi CFB	Scrubber	fuel gas
Farmland Industries, Inc.	United States	2000	pet coke	Texaco	Selexol	ammonia
ExxonMobil Baytown Syngas Project	United States	2001	deasphalter bottom	Texaco	Rectisol	H <sub>2</sub> , CO
api Energia S.p.A.	Italy	2001	visbreaker residue	Texaco	Selexol <sup>b</sup>	IGCC, H <sub>2</sub>
SARLUX srl	Italy	2001	visbreaker residue	Texaco	Selexol <sup>b</sup>	IGCC/Cogen
ExxonMobil	Singapore	2001	residual oil	Texaco	FLEXSORB <sup>d</sup>	IGCC/Cogen
Shin Nihon Sekiyu (Nippon Pet. Ref. Co.)	Japan	2004	vacuum residue	Texaco	ADIP <sup>b</sup>	IGCC
AgipPetroli/EniPower	Italy	2004 <sup>e</sup>	visbreaker residue	Shell	Amine <sup>b</sup>	IGCC, H <sub>2</sub>
PIEMSA	Spain	2006 <sup>e</sup>	visbreaker tar	Texaco	MDEA <sup>b</sup>	IGCC, H <sub>2</sub>
Total Fina Elf/Texaco	France	2006 <sup>e</sup>	refinery residues	Texaco	Selexol	H <sub>2</sub>

<sup>a</sup> FT liquids = Fischer-Tropsch hydrocarbons, C = chemicals, IGCC = Integrated Gasification Combined Cycle, Cogen = Combustion Turbine Cogeneration

<sup>b</sup> COS hydrolysis precedes the acid gas removal process in this plant.

<sup>c</sup> Commissioning of this demonstration plant was unsuccessful and the project was terminated. Consequently, both the KRW gasification process and the limestone/ZnO hot gas cleanup process remain unproven.

<sup>d</sup> Version not disclosed—indicated only as "generic FLEXSORB."

<sup>e</sup> In planning/engineering/development.

Source: SFA Pacific Coal Gasification Database



## **SFA Pacific, Inc.**

- The Sulfinol Process, which is based on a mixture of chemical solvents (aqueous amines) and the physical solvent Sulfolane (tetra-hydrothiophene dioxide) has been used in five of the projects since 1969, including two IGCC plants (one which is just in start up now) and three chemical synthesis applications.
- The Rectisol process (based on refrigerated methanol as the physical solvent) continues to be the predominant process used when very pure syngas is required for chemical synthesis.
- Nearly all of the IGCC plants commissioned after 1994 employ COS hydrolysis before the AGR process, except where the Rectisol process is used. This step is necessary to facilitate low total sulfur removal in the MDEA and Selexol processes. The Rectisol process can remove both H<sub>2</sub>S and COS to very low levels.

The foregoing AGR processes also were the predominant processes reviewed in the 1987 Gas Treating Report. Thus it is clear that the predominant AGR processes employed commercially then are still the mainstays of the growing gasification market.

Note that the AGR processes compared in Tables 3-5 and 3-6 of the 1987 Gas Treating Report were based on syngas clean up without COS hydrolysis before the AGR units (as per EPRI's specifications). Thus, while relatively deep H<sub>2</sub>S removal (down to <4 ppmv) was achieved in the various licensor supplied designs, the COS content of the syngas remained very high. Those results would be unacceptable for most IGCC applications now. There was only one exception—the Rectisol process applied to low sulfur syngas, in which case the COS was reduced to 25 ppmv. Therefore, those tabular comparisons should not be used to assess the AGR process options for today's market and environmental standards.

Overall, in all types of AGR applications worldwide (natural gas, refinery gases, synthesis gas, etc.) hundreds of MDEA-based AGR units have been installed, more than 55 Selexol plants have been installed, over 200 Sulfinol units have been licensed, and more than 100 Rectisol units are in operation or under construction worldwide [66].

The increased experience with these processes in IGCC and other gasification projects over the past 10-15 years has enabled improved designs and performance, reduced risk, and greater confidence in their application.

These and other selected similar AGR processes and their characteristics are discussed further in Section 6. Considerations in the selection of AGR processes for IGCC applications are also discussed there.

### **Future IGCC Processes**

Future IGCC process schemes will have to take into account much stricter emission regulations for SO<sub>2</sub>, NO<sub>x</sub>, and particulates. They will also have to address the removal of various trace components, particularly mercury, which up to now has not been considered to any great extent. In addition, the potential for CO<sub>2</sub> recovery for sequestration may have to be addressed in the future. Figure 4-2 shows an example IGCC plant flow scheme that includes processing steps that consider all of these issues.

Figure 4-2  
Simplified Flow Diagram of IGCC for Potential Future Emission Regulations

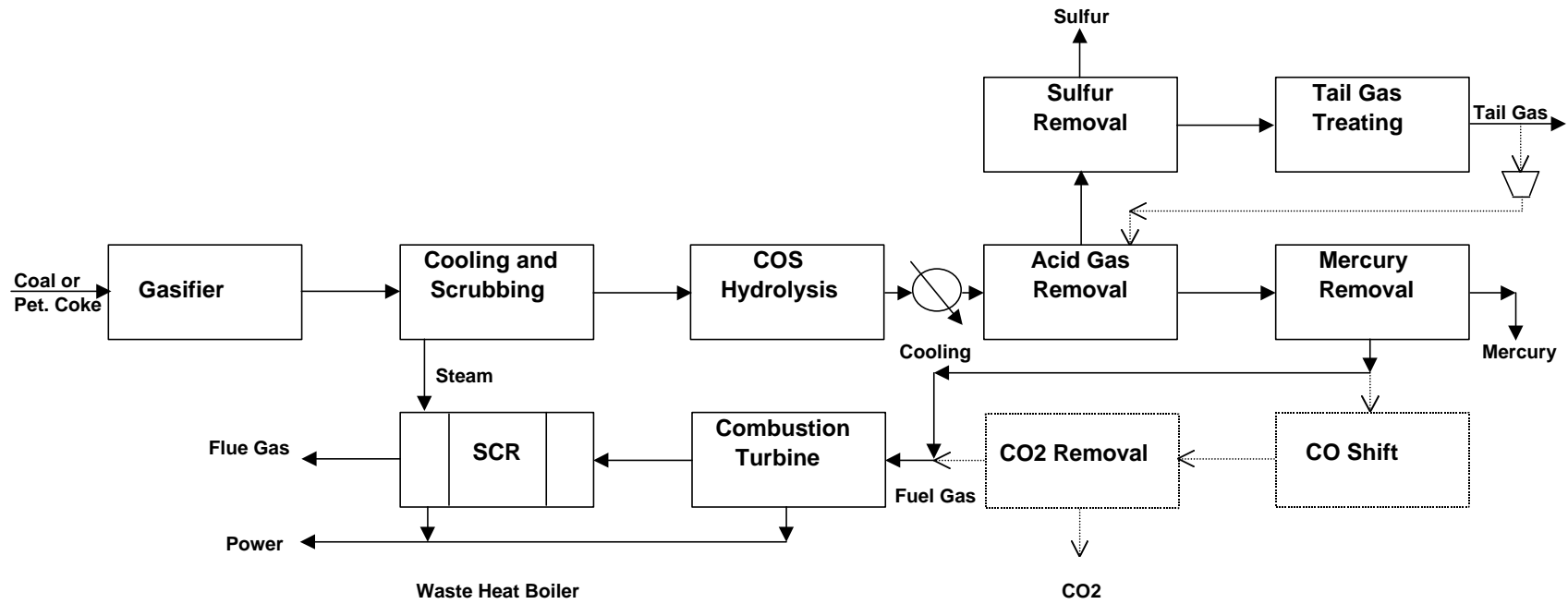

Source: SFA Pacific, Inc.

## SFA Pacific, Inc.

COS hydrolysis is no longer an option, but is a required step in order to meet the anticipated very strict sulfur emissions regulations. A mercury removal step is needed, either before or after the AGR unit, depending principally on the operating temperature of the AGR process.

Current NO<sub>x</sub> control methods for combustion turbines (CTs) may not be sufficient to meet the anticipated future single digit NO<sub>x</sub> limits; i.e., limits of 9 ppmv (@15% O<sub>2</sub>, dry). The lean premixed dry low-NO<sub>x</sub> combustors used with natural gas are not applicable to firing hydrogen-containing syngas, due to the high flame speeds of H<sub>2</sub>. With syngas, diffusion combustors must be used – and steam-injection and/or dilution with N<sub>2</sub> are used to reduce the flame temperature and control NO<sub>x</sub> formation. If the efforts of GE (and the other CT vendors) to develop a <9 ppmv NO<sub>x</sub> capability for their syngas-fired CTs are not successful, SCR would have to be used for post-combustion control of NO<sub>x</sub> to the desired low level. The SCR unit would be placed in the heat recovery steam generator (HRSG). However, the use of SCR will call for extremely low sulfur content – probably <20 ppmv and possibly as low as 10 ppmv – in the CT exhaust gas to prevent ammonium bisulfate fouling of the colder heat transfer (boiler feedwater heater and evaporator) tubes in the HRSG [64].

The performance of the SR and the TGT units will also be critical to meet the proposed standards. The H<sub>2</sub>S that is scrubbed out in a typical TGT unit is usually recycled back to the Claus plant, while the off-gas from the scrubber, which contains H<sub>2</sub>S and COS, is usually incinerated and vented to the atmosphere. The sulfur content of the TGT unit off-gas is typically about 250 ppmv. Although AGR processes, using COS hydrolysis up-stream, can lower TGT off-gas sulfur content to below 50 ppmv, future regulations may require even better performance. Another way of handling the problem would be to recycle all of the SR unit tail gas back to the main AGR unit absorber, as discussed in Section 7 under the OxyClaus process.

If CO<sub>2</sub> removal becomes mandatory, then the CO in the synthesis gas will have to be shifted with steam to CO<sub>2</sub> and H<sub>2</sub>, followed by partial or complete CO<sub>2</sub> removal. The placement of both the CO shift reactor and the bulk CO<sub>2</sub> removal units may be optional, depending on the gasification process, shift catalyst, and process economics. The shift reactor could immediately following gasification and water scrubbing of the raw syngas, if sufficient steam is available in the gas and a sulfur-tolerant shift catalyst is used. Bulk CO<sub>2</sub> removal could also be integrated into the overall AGR process by staging selective absorption for H<sub>2</sub>S first, followed by bulk CO<sub>2</sub> removal.

Given the depth of scrubbing that the synthesis gas undergoes in the IGCC flow scheme, it is unlikely that other trace components, other than mercury, will present any problems. It is expected that ammonia, HCN, HCl, and all of the particulates will be scrubbed out by water before reaching the COS hydrolysis or the AGR steps. Any remaining metal carbonyls will be scrubbed out by the carbon beds that are used for mercury removal.

As stated in the Section 2 – Introduction, the principal objective of this work is to assess the performance of currently available AGR, SR, and mercury removal processes that might meet the proposed stringent regulations.

**SFA Pacific, Inc.**

## 5. MERCURY REMOVAL

Future regulations propose to limit mercury air emissions from gasification off gases to levels that are barely detectable by current analytical methods. Prior concerns with mercury have been associated principally with metallurgical failures during gas processing. Mercury forms amalgams with aluminum and other metals and its control became paramount when heat exchanger failures in 1973 at an Algerian liquefied natural gas (LNG) plant were attributed to this phenomenon. Earlier, mercury amalgam formation was also blamed for equipment failures at the natural gas fields at Groningen, in The Netherlands. The natural gas industry spurred development of the mercury removal methods in the early 1970s. The gasification industry addressed this issue for the first time with the startup of the Eastman Chemical's coal-to-chemicals facility at Kingsport, Tennessee in 1983.

Little design data were available for mercury removal prior to the early 1970s. The caustic/chlorine industry had to remove mercury from the hydrogen gas prior to that time, and some data existed for mercury removal from air. Condensation of mercury by the low temperature separation process was used in these cases. This process is described briefly below. Two mercury adsorption systems have also been developed, one based on activated carbon and the other on zeolite adsorbents. The carbon system is non-regenerable, while the zeolite system is regenerable. These two systems are also discussed below.

### Low Temperature Separation

The first experience with mercury removal from natural gas, using the low temperature separation (LTS) process, was at the aforementioned Groningen fields in 1972 [5]. The process is shown schematically in Figure 5-1. Natural gas from the field is precooled and the water is condensed out. Dry glycol is then injected to further dry the gas to prevent water condensation in the pipeline. After heat exchange, for additional precooling, the gas is expanded through a Joule Thomson valve. The wet glycol, now containing the condensed mercury, is then separated from the natural gas. The gas leaves this separation process containing about 1-15  $\mu\text{g}/\text{Nm}^3$  of mercury, depending on the temperature of the process [6]. Although this level of mercury may be acceptable in the natural gas, it would be unacceptable in LNG or in IGCC fuel gas—an order of magnitude better removal would be required. For example, the two early Indonesian LNG plants, Arun and Badak, use activated carbon adsorption beds to remove mercury from natural gas before the liquefaction cycle. The Eastman coal-to-chemicals plant is also equipped with activated carbon adsorption beds.

Operating the LTS process at very low temperatures would improve mercury separation significantly. However, further treatment of the water/mercury condensed phase is required. The LTS process, in applications where virtually total removal of mercury is necessary, is not a very economic nor a practical method and has been superseded by adsorption.

**Figure 5-1**  
**Low Temperature Mercury Separation Process**

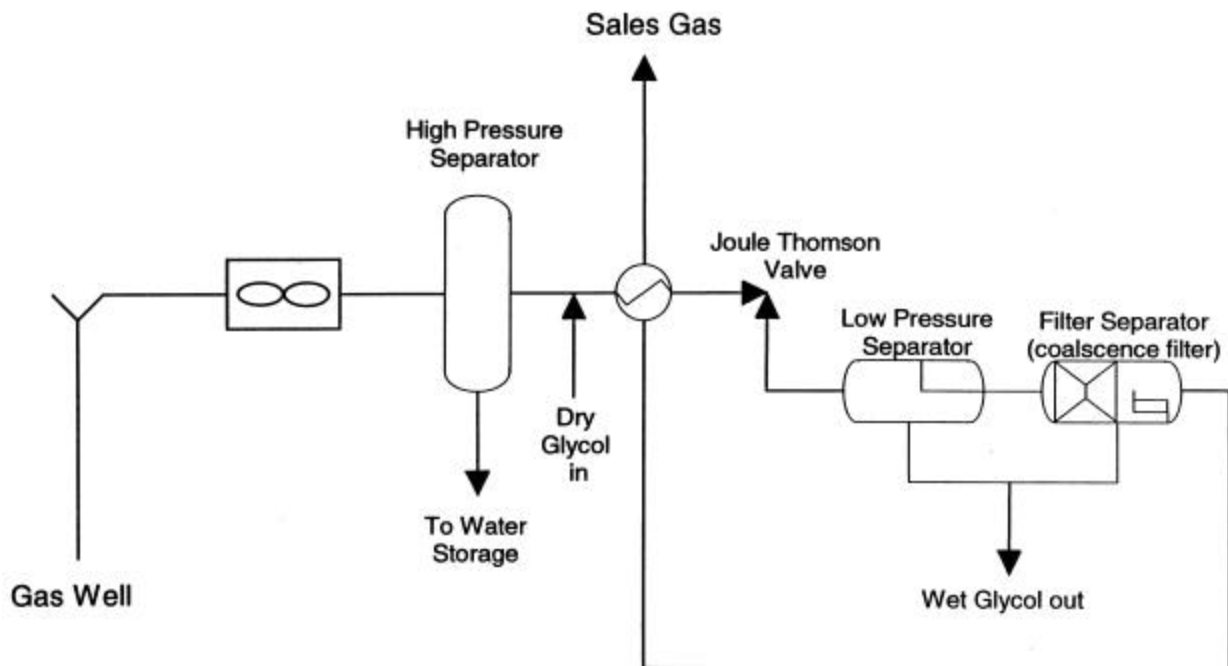

Source: Reference 6

### Activated Carbon

One of the principal suppliers and developers of activated carbon adsorbents for mercury removal, as well as for other gas components, is Calgon Carbon Corporation in Pittsburgh, Pennsylvania. The Calgon Type-HGR carbon has been used for low-pressure drop adsorption of mercury from natural gas since the early 1970s. Another activated carbon manufacturer is Norit, perhaps the biggest one in the world. There are many other activated carbon suppliers worldwide. The carbon is impregnated with sulfur at a concentration of about 10-15 wt%. The mercury reacts with sulfur as the gas goes through the sulfur bed to form HgS. After the sulfur on the carbon is exhausted, the spent adsorbent is shipped to a hazardous chemicals disposal site. HgS is a very stable compound and its long-term storage presents no problems. The spent carbon can also be incinerated and the mercury recovered from the incinerator gas via cooling and condensation.

### **Activated Carbon Bed Design Principles**

Simple design principles apply to calculating the quantity of carbon required for mercury removal [5]. The first is the consideration of pressure drop. Since the density of Type-HGR carbon is about 37 lbs/ft<sup>3</sup>, the allowable pressure drop in a vertical bed should not exceed 37 lbs/ft<sup>2</sup> (0.26 lbs/in<sup>2</sup>). Exceeding that pressure drop would cause the particles to lift in an upflow bed, or potentially crush and cause attrition of the solid particles. Referring to Figure 5-2, which

shows the reported pressure drops through Type-HGR carbon for various gases, at the assumed pressure drop of about 0.26 lbs/in<sup>2</sup> the allowable gas velocity is about 20 ft/min for high pressure natural gas. Assuming that the synthesis gas molecular weight is about 20, its allowable velocity, extrapolated from that of the natural gas, is about 16 ft/min. At this permitted gas velocity, for synthesis gas flow equivalent to a 250 MW IGCC plant, the carbon bed diameter would be about 15 feet and its length about 8 feet. This would require approximately 50,000 pounds of activated carbon.

**Figure 5-2**  
**Pressure Drop through 4-10 Mesh Pittsburgh-Type HGR Carbon**

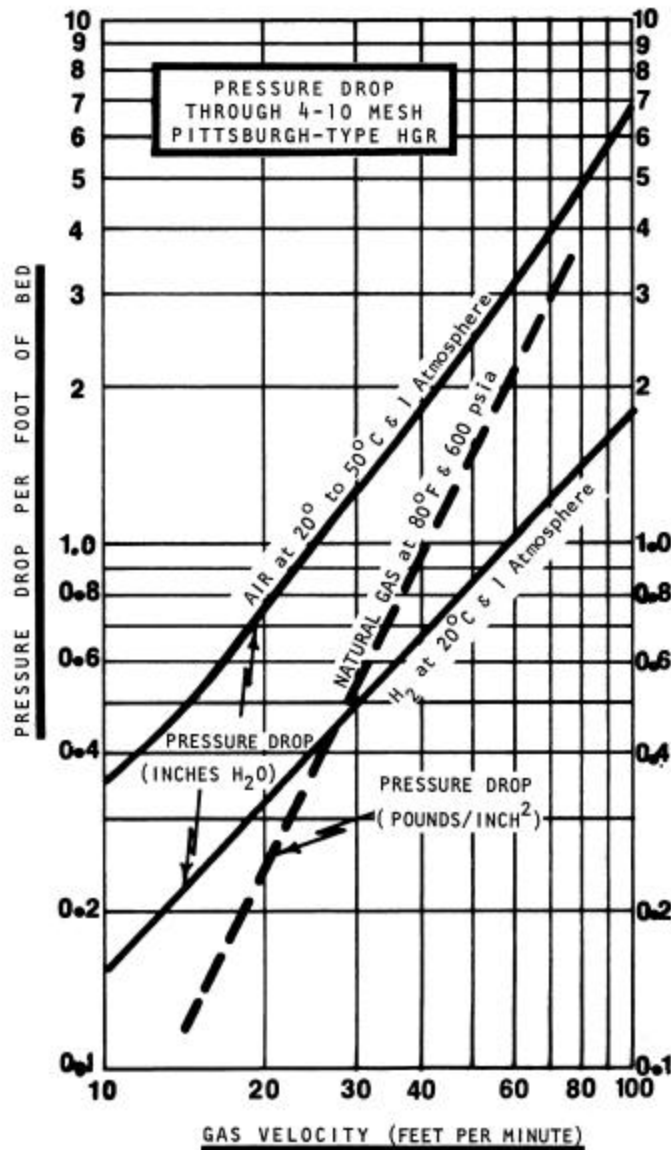

Source: Reference 5

## SFA Pacific, Inc.

For the carbon bed size calculated above, and assuming that only 5 percent of the sulfur will actively pick up the mercury, the carbon bed will load up with nearly 2,000 pounds of mercury. Assuming a synthesis gas mercury loading equivalent to that of the Polk County IGCC plant (approx. 0.01 lbs/hr), the carbon bed should last well over 20 years. To reach the proposed emission regulations (0.20 lbs Hg per Trillion Btu heat input or 99% removal, at operator's discretion) would require approximately 95% removal of mercury from the gas. The carbon beds in the Eastman Chemical plant achieve 90-95% mercury removal. The 99% level of mercury removal from synthesis gas has not been tested yet. However, there is commercial experience in nearly total mercury removal from natural gas. Calgon has supplied activated carbon to a Texas pipeline company that achieves well over 99.99% mercury removal from high-pressure natural gas [7]. In that case, the mercury in the inlet gas is about  $50\mu\text{g}/\text{Nm}^3$  and the mercury in the outlet gas is  $0.001\mu\text{g}/\text{Nm}^3$  (below detectable limits). The inlet mercury concentration of this natural gas case is similar to what one would expect in the synthesis gas from gasification of bituminous coal. There is little reason not to expect that carbon beds could remove mercury from synthesis gas to below detectable levels. However, if carbon beds are designed for mercury removal, attention has to be paid also to any other trace components that can be adsorbed by carbon. The mercury carrying capacity of activated carbon can be significantly compromised by the presence of other trace compounds.

The principle problem with activated carbon is that it is non-regenerable, and requires disposal at a hazardous chemicals site, unless one wishes to recover mercury by combustion. In this case, a complex and expensive cooling/condensation method would be used, followed by trim gas phase carbon beds for residual mercury removal, and flue gas scrubbing for the resulting  $\text{SO}_2$ .

**Metal Carbonyls.** Activated carbon can remove other trace components from synthesis gas. Iron and nickel carbonyls ( $\text{Fe}(\text{CO})_5$ ,  $\text{Ni}(\text{CO})_4$ ) are both undesirable trace components in synthesis gases. Metal carbonyls are often present in synthesis gas that is made from petroleum residues. Nickel carbonyls are damaging to combustion turbines but can be removed from synthesis gas by activated carbon. Nickel deposits are periodically found on the gas turbine combustors at the ISAB IGCC project in Italy. It is postulated that the nickel comes from nickel carbonyls in the synthesis gas produced from petroleum pitch [23]. Nickel carbonyl problems are being solved with a carbon bed at the AGIP refinery in Italy, where iron and nickel carbonyls are removed from synthesis gas produced from visbreaker tar [24].

Metal carbonyls can also be absorbed by low-temperature solvents such as used by the Rectisol process. These metal compounds, if not removed, wind up in the Claus plant feed, and are burned to  $\text{FeS}$  and  $\text{NiS}$  and are then deposited on the Claus catalyst. Both of these outcomes are undesirable.

## Zeolites

Zeolite adsorbents (Molecular Sieves) have been used by the natural gas industry primarily for drying. In the early 1970s, when the mercury problem surfaced, UOP began work on a zeolite adsorbent that would remove mercury from natural gas. The result was the development of a



Type 13X molecular sieve, loaded with about 0.5 wt% sulfur, that would remove mercury to very low levels. This work was followed by the development of a better molecular sieve product in the 1980s dubbed HgSIV [8]. HgSIV is a type X or Y zeolite with an outside coating of elemental silver. HgSIV both dries and removes mercury from the gas, it is also regenerable. The fact that HgSIV can be regenerated allows for small adsorbent bed sizes and its limited capacity for mercury is not a big detriment.

HgSIV is capable of removing mercury from natural gas to below detectable level ( $<0.01\mu\text{g}/\text{Nm}^3$ ). A number of commercial units (over 20), based on the HgSIV adsorbent, have been installed in natural gas service [9]. Several different process configurations can be used. One of these is shown in Figure 5-3. In this scheme, a portion of the cleaned gas is used to regenerate one of the spent beds. After cooling, the regeneration gas is compressed back into the feed gas. About 6% of the feed gas is used for regeneration. Typically, the regeneration offgas mercury content will be similar to that of the feed gas. Salable mercury can be recovered from the condensed liquid streams from the regeneration offgas.

**Figure 5-3**  
**HgSIV Mercury Removal and Recovery System**

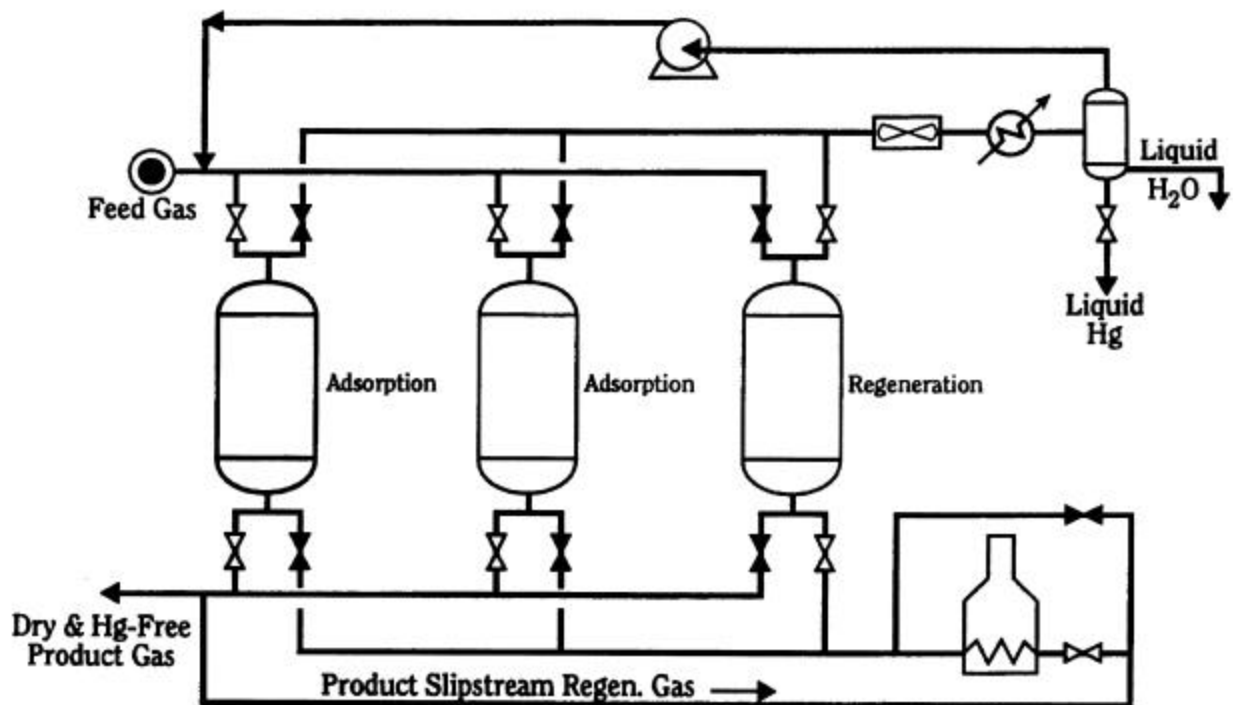

Source: Reference 8

Other process schemes are possible. A bulk non-regenerable mercury removal unit could be used upstream of the acid gas removal unit. In this case, a carbon bed could be used to remove

the bulk of the mercury, while a regenerable zeolite trim bed is downstream of the AGR unit to remove the balance of the mercury. The regeneration gas from the zeolite unit could then be recycled back to the bulk mercury removal unit. Such a scheme is depicted in Figure 5-4.

**Figure 5-4  
Integrated Carbon/Zeolite Hg-Removal System**

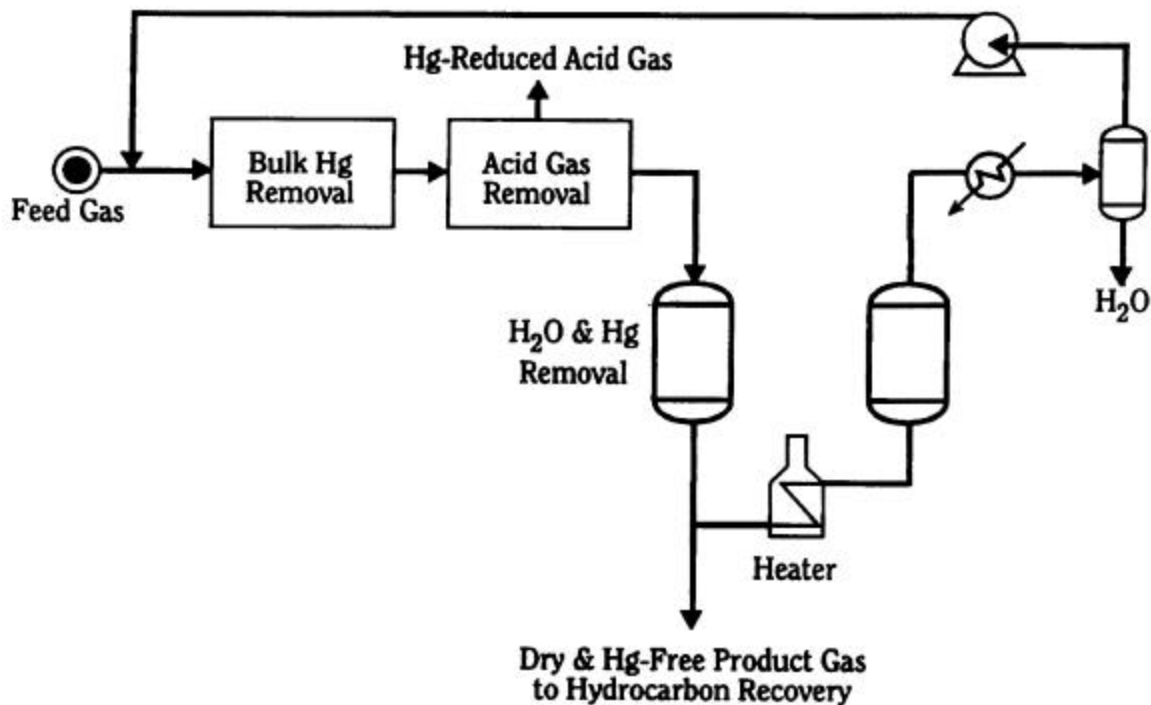

Source: Reference 8

In another scheme, the spent regeneration gas could be sent to a non-regenerable mercury unit. The cleaned regeneration gas could then be compressed and combined with the clean synthesis gas, or could it be used for fuel or other purposes. In this case, nitrogen could be used for regeneration, which can then be vented to the atmosphere after mercury removal. The advantage of such a scheme is that the regeneration gas flow is much lower than that of the synthesis gas. Thus, much smaller beds will be required for its cleanup, and the disposal of the spent bed will be less of a problem. An activated carbon bed, with higher loading capability than the zeolite, can be used for this purpose.

The principle disadvantage of the zeolite adsorbent is its low carrying capacity for mercury. These molecular sieves were developed for simultaneous dehydration and mercury removal from natural gas, and consequently only a small portion of the material is dedicated to mercury removal. Additional development work will be required to produce material with higher loadings. The other disadvantage of the material, if it is to be used for bulk removal and disposal

## **SFA Pacific, Inc.**

without regeneration, is its high cost. Zeolites are more expensive than activated carbon. Finally, there is no commercial experience with the use of zeolites to remove mercury from coal gasification gases.

### **Other Methods**

Several other methods to remove mercury have been investigated over the years. Among these was the use of selenium on activated carbon [6]. However, selenium's high toxicity causes potential disposal problems for the spent carbon. Sorption by chromic acid on silica gel has also been tried, but found to result in very low mercury loadings. Silver on activated carbon has also been tried [5]. This results in excellent loadings and high removal potential. However, silver's high cost precludes its use in non-regenerative mode. No commercial silver-loaded carbon has yet been developed that could be regenerated.

In the short term, activated carbon and zeolites are the only practical systems for mercury removal from gasification synthesis gases. Activated carbon has the current advantage because of its commercial track record.

**SFA Pacific, Inc.**

## **6. ACID GAS REMOVAL PROCESSES**

There are numerous commercial acid gas removal (AGR) processes available to treat a variety of gas streams. These range from throwaway regenerable adsorbent-type to regenerable solvent-type processes. The solvent-type processes are the primary ones of interest for acid gas removal from synthesis gases. The solvent-type processes can be subdivided into three generic types:

- Chemical solvent
- Physical solvent
- Mixed chemical/physical

There are many commercial installations of each type, treating a variety of natural and synthesis gases. For synthesis gas treating, the principal chemical-type solvents of primary interest are aqueous amines, MDEA (methyl diethanol amine) being the current favorite. Amine-based solvents have been preferred by the natural gas industry over the physical solvents. The physical solvents co-absorb hydrocarbons to a much greater extent than the amines, causing loss of valuable hydrocarbons. However, since synthesis gas does not contain appreciable quantities of hydrocarbons, physical solvents are also used for synthesis gas clean up.

The currently favored physical solvents are methanol and dimethyl ether of polyethylene glycol, as represented by the Rectisol and the Selexol processes, respectively. The mixed chemical/physical processes usually employ mixtures of an amine and a physical solvent in an effort to capture the best characteristics of each solvent. The best known example of the mixed/chemical solvent process is Sulfinol, a mixture of sulfolane (tetrahydrothiophene dioxide) and an aqueous solution of an amine, either DIPA (diisopropanol amine) or MDEA.

The principal challenge of the AGR processes is to remove the sulfur compounds from the synthesis gas to as low a level as possible, consistent with the prevailing emission regulations, and as economically as possible. As SO<sub>x</sub> emissions regulations become more stringent in the future, very high percentages of sulfur removal will be required. For example, to meet a SO<sub>x</sub> limit of 0.04 lb/MMBtu, better than 99.3% sulfur removal from the syngas will be required in the case of IGCC based on Illinois No. 6 coal containing 3.0% sulfur. To meet DOE's *Vision 21* Program SO<sub>2</sub> target of 0.01 lb/MMBtu, better than 99.83% sulfur removal would be required. The total sulfur content of the treated synthesis gas has to be less than about 80 ppmv in order to achieve the 0.04 lb/MMBtu limit. This would not be a problem if only H<sub>2</sub>S were present, since H<sub>2</sub>S is easily removed by most AGR processes down to very low levels. However, the presence of COS in synthesis gas complicates the task, since its solubility is much lower than that of H<sub>2</sub>S in both types of solvents—making it more difficult to remove.

For the sulfur recovery unit (SRU), usually based on the Claus process, to operate properly, it requires an H<sub>2</sub>S-rich acid gas feed, meaning that H<sub>2</sub>S has to be removed preferentially to CO<sub>2</sub> in the AGR. Thus, the AGR process has to show some level of selectivity for H<sub>2</sub>S over CO<sub>2</sub>. On the other hand, if CO<sub>2</sub> sequestration becomes desirable, then the AGR process should also have the capability for bulk removal of CO<sub>2</sub>. Although these two goals seem unreconcilable at first

glance, the task can usually be accomplished by staging acid gas absorption into separate tasks. For CO<sub>2</sub> capture, the capability of the process to achieve these two tasks in an efficient manner becomes very important.

The capabilities of the various solvent-based AGR processes to remove H<sub>2</sub>S, CO<sub>2</sub>, and COS are discussed below. Particular issues addressed are relative performance and cost factors, COS absorption, and the retention of H<sub>2</sub>S/CO<sub>2</sub> selectivity while also removing CO<sub>2</sub>.

## **Amine Processes**

Amine processes are based on the removal of an acid gas by virtue of a loose chemical bond between the acid gas component and the amine. Three main types of amines are used commercially,

- Primary amine, usually MEA (monoethanolamine)
- Secondary amine, usually DEA (diethanol amine)
- Tertiary amine, usually MDEA (methyl diethanol amine)

The primary amines form the most stable bond with the acid gas, followed by the secondary amines. The least stable bond is formed by the tertiary amine. Although MEA has been extensively used by the natural gas industry in the past, because of its corrosivity it has, in large part, been supplanted by the less corrosive DEA. Both of these solvents are also degraded by COS, with DEA showing less degradation than MEA. The latter forms a non-regenerable degradation compound with COS. Thus, unless COS is removed or hydrolyzed to H<sub>2</sub>S ahead of the amine scrubber, neither one of these two amines would be suitable for synthesis gas.

MDEA has become popular with the natural gas industry because it has a high H<sub>2</sub>S/CO<sub>2</sub> selectivity, is very stable against degradation and is the least corrosive of the amines. Overall, there are hundreds of MDEA units worldwide in various applications. It is being used for synthesis gas treating in IGCCs at several commercial and demonstration sites. Its capabilities are discussed after the process flowsheet and design discussion below.

ExxonMobil has developed a proprietary sterically hindered amine process (FLEXSORB SE) that is selective towards H<sub>2</sub>S. This process is discussed following MDEA. The FLEXSORB SE PLUS process (with an added physical solvent) is discussed in the section on mixed amine/physical solvent processes.

## **Flowsheet and Process Design**

A simplified process flow scheme, representing a typical amine chemical solvent AGR process, is shown in Figure 6-1. Gas to be treated is introduced into the bottom of a trayed or packed tower and is contacted countercurrently with lean, regenerated solvent. Treated gas, now free of the acid gases, exits at the top of the tower. The rich solvent, now loaded with the acid gases, is sent from the bottom of the absorption tower for regeneration in a stripping tower. A reboiler

supplies the heat to the regenerator to dissociate the chemically-bound acid gases from the solvent. Like the absorber, the stripping tower can be designed with either trays or packing. The stripped acid gases leave the top of the stripper and are vented to the atmosphere when only CO<sub>2</sub> is present, or are routed to a sulfur recovery plant when H<sub>2</sub>S or other sulfur compounds are present. The lean, regenerated solvent is then pumped backed to the absorption tower via a lean/rich solvent heat exchanger and a lean solvent cooler.

**Figure 6-1**  
**Typical Amine Acid Gas Removal Process**

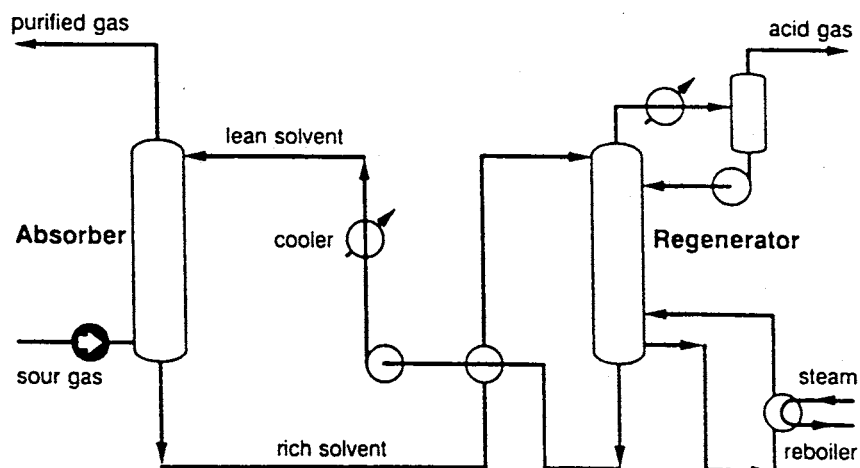

Source: Comprimo

Additional equipment (not shown in Figure 6-1) may also be needed. For example, filter elements and solvent reclaimers may be needed to remove solvent degradation products, corrosion byproducts, and feedgas contaminants—all of which may otherwise accumulate in the process.

There are many variations of the process flow scheme shown in Figure 6-1. These variations depend on the solvent used, the composition, pressure, and temperature of the feed gas, and the treating requirements. Flash vessels for the rich solvent may be needed between the absorber and the regenerator—for example, when CO<sub>2</sub> is to be preferentially flashed from the solvent if it contains high ratios of CO<sub>2</sub> to H<sub>2</sub>S. Flashing out CO<sub>2</sub> before the stripper enriches the H<sub>2</sub>S content in the acid gas leaving the regenerator, which is fed to the sulfur recovery (SR) plant. The performance of the SR plant is improved by increasing the H<sub>2</sub>S content of the H<sub>2</sub>S-rich feedgas.

**Performance and Cost Factors.** These factors are qualitatively illustrated by the following general comparison of amine-based AGR with physical solvent-based AGR processes for sulfur removal applications. Physical solvent-based processes are discussed further later, after the amine processes.

## SFA Pacific, Inc.

- H<sub>2</sub>S reaction rates with all aqueous amines are nearly “instantaneous”—enabling shorter gas-liquid contact times and smaller absorber column designs; i.e., a smaller number of trays or stages, and shorter and possibly smaller diameter columns. However, the rates of CO<sub>2</sub> reactions with various aqueous amines is much slower—and widely variable among the amines. The relative reaction rates of MEA, DIPA, and MDEA with CO<sub>2</sub> are as follows: 2,348 for MEA, 162 for DIPA, and 2 for MDEA [11]. The slowness of MDEA’s reaction with CO<sub>2</sub> accounts for its popularity for use in H<sub>2</sub>S selective service.
- The solvent loading (dissolution) rates in organic physical solvent systems are slower—such that approaching the high equilibrium solubilities enabled by physical solvents requires long contact times and the use of many trays or stages; i.e., taller and possibly larger diameter columns. However, as pressure increases, the physical solvent mass transfer rates and loadings improve—allowing a decrease in solvent circulation rates.
- The heat transfer coefficients of aqueous amine solutions are higher than those of organic physical solvents—so that less heat exchanger (coolers, reboilers) surface area is required with amine solutions.
- Amine-based AGR systems tend to have lower electric power requirements but higher stripping steam requirements than physical solvent-based AGR processes such as Selexol. The electric power requirements for pumping (solvent circulation), flash gas recompression, and refrigeration (if used—with physical solvents) and the heat requirements for solvent regeneration and are the major factors affecting the operating costs for AGR. The auxiliary electric power load of the AGR is subtracted from the IGCC plant’s power output.
  - The heats of reaction between amines and acid gases are appreciable, whereas there are no significant heats of reaction or solution with physical solvents. Hence the higher stripper steam requirements of the amine-based AGR systems. The lower heats of solution in physical solvent systems facilitate both absorption (less cooling) and solvent regeneration (less heat required). Nevertheless, generally some low-pressure steam is available in IGCC plants, which can be applied to the AGR stripping needs without significant thermal efficiency penalty to the overall IGCC process.
  - Refrigeration is not normally used with the current Selexol physical solvent AGR processes when only H<sub>2</sub>S removal is required, but is used in a 2-stage system when CO<sub>2</sub> removal is also required. The Rectisol physical solvent AGR process, based on methanol, is refrigerated for all applications to enhance solubilities and minimize solvent losses.
- COS hydrolysis upstream of the AGR is required for total sulfur removal to low levels—with both amine-based AGR processes and the Selexol Process. With refrigeration of the physical solvent processes, low total sulfur removal is achievable without prior COS hydrolysis.
- The primary material of construction for the MDEA, Selexol [67], and Rectisol processes is carbon steel. Some of the components in the Rectisol process require stainless steel,



which is much more expensive than carbon steel. Approximately 5% of the material in a Rectisol plant is stainless steel [70].

- With amine-based AGR, a second-stage acid gas enrichment (AGE) unit may be required to remove some of the CO<sub>2</sub> from the acid gas before it is fed to the SR unit. Physical solvent AGR processes produce a more concentrated H<sub>2</sub>S acid gas feed to the SR unit—enabling better SR performance and a smaller SR plant and tail gas treating (TGT) plant. Alternatively, the tail gas (after hydrogenation) may be recycled to the AGR—eliminating the separate TGT plant. Therefore, the selection of the optimal AGR process for an IGCC application should be based on the integrated performance and costs of the entire COS hydrolysis, AGR, SR, TGT package—and its impact on the overall IGCC system performance and costs.

**Generic Amine Processes.** There is a growing availability of generic gas treating process know how and design tools, such as commercial process simulation packages, especially for amine-based AGR systems—including MDEA. However, the quality, reliability, etc. of the physical and chemical property data will vary among the packages, so that a diligent evaluation by the potential user is recommended before committing to and depending on a package. The principal advantage of a generic design is the avoidance of a licensing fee and the flexibility and the economic advantage it gives the plant owner in being able to buy solvents, related process chemicals, and other services (e.g., process consulting). The main disadvantage is the potential lack of technical support if the plant does not perform as designed. Obviously, experienced process licensors will be able to offer the most know how based on actual operating data. Physical and chemical property data and process performance data (mass transfer, kinetics, etc.) for proprietary MDEA formulations must be purchased from the solvent or process developers or licensors.

## **MDEA**

**H<sub>2</sub>S/CO<sub>2</sub> Selectivity.** MDEA became popular with the natural gas industry because of its high selectivity for H<sub>2</sub>S over CO<sub>2</sub>. This high selectivity allows for a reduced solvent circulation rate, as well as a richer H<sub>2</sub>S feed to the sulfur recovery unit. MDEA's reaction with H<sub>2</sub>S is almost instantaneous. However, its CO<sub>2</sub> reaction kinetics is much slower. MDEA, like other tertiary amines, forms bicarbonates on reacting with CO<sub>2</sub>. Primary and secondary amines form carbamates with CO<sub>2</sub>. The bicarbonate reaction is much slower than the carbamate one, and is postulated to be limited by the slow CO<sub>2</sub> hydration reaction with the amine [10]. The reaction rate of MDEA with CO<sub>2</sub> is about 2,300 times slower than that of CO<sub>2</sub> with MEA [11].

The natural gas industry began reporting the first successful use of MDEA for selectively removing H<sub>2</sub>S in a test at a Marathon Oil Co. plant, utilizing generic MDEA. In that test, CO<sub>2</sub> removal was limited to about 30% while removing 99.0% of the H<sub>2</sub>S in the feed gas. The treated gas had approximately 220 ppmv of the H<sub>2</sub>S left in it, but was followed by a more complete removal with DEA to meet pipeline specifications. However, the solvent also was found to contain approximately 4% DEA—DEA enhances CO<sub>2</sub> pickup and led to the speculation that there would have been much better selectivity had the DEA not been there [12].

## SFA Pacific, Inc.

Some of the generic MDEA designs in IGCC plants that opted for a very high degree of CO<sub>2</sub> slip have been unable to achieve better than about 100 ppmv of H<sub>2</sub>S in the treated gas. The Polk IGCC facility, for example, leaves 100-200 ppmv of H<sub>2</sub>S in the treated gas while removing about 10-15% of the CO<sub>2</sub> from the feed gas to the MDEA absorber.

Commercial MDEA formulations (i.e., with proprietary additives) have been developed which are claimed to offer a much enhanced selectivity for H<sub>2</sub>S than is the case for generic MDEA. UCARSOL is the trade name for a series of formulated amine solvents originally developed by Union Carbide and offered by UOP as a licensed package. More than 500 units of the version, called the Amine Guard FS Process have been installed worldwide, mostly treating natural gas, ammonia syngas, and hydrogen streams [66].

A test in a commercial natural gas sweetening plant of a UCARSOL MDEA solvent carried out in the early 1980s, CO<sub>2</sub> coabsorption was limited to less than 30%, while leaving less than 4 ppmv of H<sub>2</sub>S in the treated gas. The feed gas in that test contained 0.55-0.78% H<sub>2</sub>S and approximately 12% CO<sub>2</sub> [13].

Other developers of formulated MDEA solvents include BASF (discussed below under COS Removal and CO<sub>2</sub> Removal), Dow Chemical, and Shell. Dow Chemical, which acquired Union Carbide in an early 2001 merger—and also owns UOP, independently developed a series of formulated amines covered by the trade name Gas/Spec. Following the merger with Union Carbide, Dow sold its North American Gas/Spec business and its Global Ethanolamines (EOA) business to the British chemical company INEOS plc in 2001. Shell now offers the ADIP-X process, based on aqueous MDEA with an additive.

The overall advantages claimed for the formulated selective MDEA solvents are that the solvent circulation is reduced significantly and that fewer trays can be used in the absorption tower. The MDEA solvent content can be higher than that of other amines because it is less corrosive, reducing the circulation rates further. This leads to a much smaller and a less expensive plant. In addition, the acid gas from the regenerator is enriched in H<sub>2</sub>S, and often allows the use of a conventional Claus SR process. The process layout is otherwise as simple as for any other amine, with the advantage that the solvent is usually more stable and a solvent reclaimer may not be needed.

**COS Removal.** MDEA does not combine with COS chemically. Only limited physical COS absorption takes place with MDEA. COS can be physically removed by MDEA only with very high solvent circulation rates, at which point the CO<sub>2</sub> is also removed quantitatively. For synthesis gases that contain appreciable quantities of COS, prior removal of the COS is usually required. A catalytic hydrolysis unit is usually employed ahead of the MDEA unit in these cases, as was done both at the Wabash River and Tampa Electric gasification plants.

A new formulated MDEA solvent was reported in 2000 that achieves a high degree of COS removal and retains appreciable selectivity for H<sub>2</sub>S over CO<sub>2</sub>. BASF Corporation ran a pilot plant and tested this new proprietary formulation in a commercial natural gas plant [14]. Figure 6-2 shows the result of the pilot plant runs. It shows the extent of COS removal as a function of CO<sub>2</sub> coabsorption. It shows that 80% of the COS can be removed while retaining a 40% CO<sub>2</sub>

slip through the absorber. In the commercial plant test, nearly 99% of the COS was removed while keeping a high acid gas solvent loading (about 0.58 moles acid gas per mole amine). Such a high solvent loading implies a very low solvent circulation rate even for the best of amine designs. Of course, a relatively high CO<sub>2</sub> removal was also obtained in this test, over 90%.

**Figure 6-2**  
**COS vs. CO<sub>2</sub> Removal Using New aMDEA Formulation**

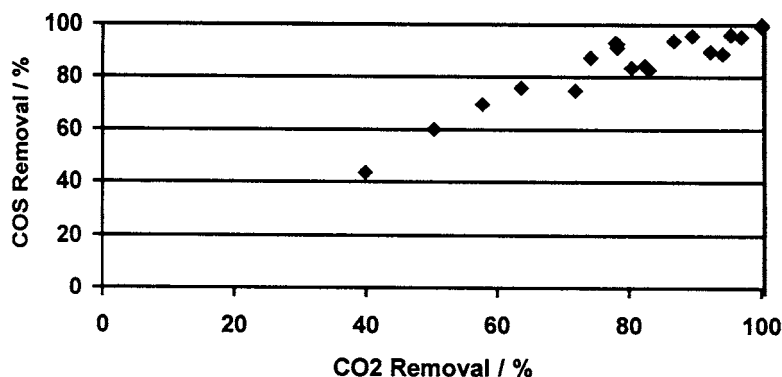

Source: Reference 14

The new BASF formulation shows promise for using MDEA with synthesis gases for COS removal while maintaining a relatively high H<sub>2</sub>S/CO<sub>2</sub> selectivity. H<sub>2</sub>S can be virtually completely removed while the COS removal level can be targeted to meet the overall sulfur removal regulations. This strategy would limit CO<sub>2</sub> coabsorption and may preclude the need for a COS hydrolysis unit upstream of the amine unit. Such a formulated MDEA process is yet to be demonstrated.

**CO<sub>2</sub> Removal.** MDEA can also be formulated for high levels of CO<sub>2</sub> removal. For this task, various additives (activators) are used. The kinetics of the CO<sub>2</sub> reaction with MDEA is highly improved with such additives allowing for reasonable absorber sizes and solvent circulation rates. Among some of the additives that have been used are MEA (monoethanolamine), DEA (diethanolamine) and DGA (diglycolamine) [15]. BASF has used piperazine in its activated MDEA formulations. Piperazine, even at low levels (about 5%) enhances the rate of CO<sub>2</sub> absorption an order of magnitude over non-activated MDEA [16]. While such formulations are of interest in applications where deep CO<sub>2</sub> removal is required, in synthesis gases, the retention of a high H<sub>2</sub>S/CO<sub>2</sub> selectivity is usually more important.

Activated amines are being used for the removal of CO<sub>2</sub> from synthesis gases in ammonia manufacture. The synthesis gas CO<sub>2</sub> partial pressure in ammonia plants is about 54 psi, a partial pressure high enough for consideration of a physical solvent. The treated synthesis gas CO<sub>2</sub> content in a typical ammonia plant is about 0.05 vol%. An activated MDEA solvent loading

## SFA Pacific, Inc.

approaching 0.75 moles of CO<sub>2</sub>/mole amine is typically achieved, resulting in a relatively low solvent circulation rate.

There are several activators that can be added to MDEA in various proportions to achieve a desired performance level. Formulations can be designed from high H<sub>2</sub>S/CO<sub>2</sub> selectivity to virtually total H<sub>2</sub>S and CO<sub>2</sub> removal. In many cases, the economics of an MDEA system can be competitive with a physical solvent even at high CO<sub>2</sub> partial pressures. At high CO<sub>2</sub> partial pressures and high solvent loadings, MDEA begins to act as a pseudo-physical solvent. The bulk of the CO<sub>2</sub> can be flashed off by pressure let-down, leading to low heat requirements in the solvent regenerator.

If both high H<sub>2</sub>S/CO<sub>2</sub> selectivity and deep CO<sub>2</sub> removal are desired, then two different MDEA solvent formulations might be used, one for selective removal, followed by another one for the removal of the remaining CO<sub>2</sub>. However, it is a nuisance to maintain two different solvent formulations, and some compromise may have to be reached between selectivity and CO<sub>2</sub> absorption.

For synthesis gas applications, where the CO<sub>2</sub>/H<sub>2</sub>S ratios are high (coal and petroleum residue gasification gases), current commercial MDEA solvents are not capable of producing an acid gas that is suitable for straight through Claus plants while providing deep sulfur removal. Under these conditions, the increased co-absorption of CO<sub>2</sub> makes the acid gas H<sub>2</sub>S content too dilute. This is true even when a COS hydrolysis unit is used upstream of the MDEA absorber. An acid gas enrichment step would be needed to accomplish this. Such an approach was followed at Agip's Sannazzaro refinery [17].

***Degradation of MDEA and Its Corrosivity.*** Early claims were that MDEA, unlike primary and secondary amines, do not degrade nor are corrosive, proved a little premature. MDEA does break down into various degradation products when subjected to high temperatures, which are typically found in the bottom of the solvent regenerator columns. Also, oxygen presence in the gas was found to be one cause of degradation of MDEA. The buildup of degradation products in the solvent changes the solvent characteristics and can lead to corrosion.

Corrosion problems have been experienced at a natural gas treating plant that uses a formulated MDEA solvent. This corrosion was attributed to the presence of 90-100 ppmv of oxygen in the natural gas being treated [18]. Such oxygen-caused degradation of MDEA and other amines has been known for some time [19]. The inlet gas stream at the plant contains 4% CO<sub>2</sub> and a small quantity of H<sub>2</sub>S. The degradation products noticed in the solvent included acetate, formate, and oxalate, all known to be caused by the degradation of MDEA by oxygen. Other signs of oxygen degradation include the thiosulfate, when H<sub>2</sub>S is present, as well as the presence of secondary amines, such as DEA and MMEA (methyl monoethanolamine), which also result from the degradation of MDEA.

Oxygen can also cause the formation of bicene [bis(2-hydroxyethyl)glycine] in MDEA-based solvents. Bicene is corrosive toward carbon steel. Other soluble metal species beside iron, such as chromium, are also found in amine solvents when treating gases with high concentrations of CO<sub>2</sub> [20]. Among several mechanisms proposed for bicene formation are the reactions of

cyanide with formaldehyde, and the direct degradation of DEA with oxygen to bicene. The latter mechanism is probably the more important one since cyanides and formaldehyde are not present in natural gas, and are usually scrubbed out with water from synthesis gas, preventing them from reaching the amine unit. However, DEA may be present in MDEA-based solvents as an activator additive, a degradation product, or as an unintended solvent impurity in the original MDEA charge.

Degradation products include carboxylic acids that tend to form heat stable salts (HSS). Because MDEA is more difficult to recover by conventional distillation methods used for other, lower boiling amines, ion exchange methods are often used to reclaim MDEA. The HSS degradation products are removed by ion exchange resins and the reclaimed MDEA is returned to the process. The use of ion exchange solvent reclaiming is claimed to be more economic than periodic purging of the degraded high-cost solvent [21].

Degradation of MDEA and the resultant corrosion can be limited by the following means:

- Controlling solution temperatures in the solvent stripping tower, particularly in the reboiler
- Maintaining lower acid gas loadings of the solvent—lower than the theoretical equilibrium capacity
- Using a lower amine concentration
- Operating the solvent stripper at the lowest feasible pressure, thus keeping the boiling point of the solvent as low as possible
- Monitoring of the solvent for degradation products and providing a means for solvent reclaiming, when needed

In spite of the solvent degradation and performance limitations mentioned above, with proper operating procedures and solvent monitoring, MDEA-based AGR processes have been preferred over physical solvents for conventional IGCC applications until about the mid-1990s, as already discussed in Section 4 of this report. Recently, the Selexol physical solvent process has become more competitive with MDEA-based AGR.

### ***Hindered Amines***

ExxonMobil developed the FLEXSORB SE process, which is based on a family of proprietary sterically hindered amines (SHAs) in aqueous solutions or other physical solvents. The FLEXSORB SHAs are secondary amines that have a large hydrocarbon group attached to the nitrogen group. The large molecular structure hinders the CO<sub>2</sub> approach to the amine. The larger the structure the more difficult it becomes for the CO<sub>2</sub> to get close to the amine. They also appear to be unstable to the carbamate form of product and revert easily to the carbonate form found in the tertiary amines. Like tertiary amines, they are capable of a high degree of solvent loading—1 mole/mole, instead of 0.5 mole/mole typical of primary and secondary amines.

One version of the solvent, FLEXSORB SE Plus, is very selective towards H<sub>2</sub>S and has been used in several plants for tail gas processing or lean acid gas enrichment (AGE). It is claimed

that FLEXSORB SE Plus use in such services results in lower circulation rates than for other amines. Recently, Qatargas chose this process over activated MDEA for AGE of its lean acid gas feed to an existing Claus plant [26].

The first FLEXSORB SE process application to IGCC is in the ExxonMobil Singapore project. The version of the process used there has not been disclosed.

## **Physical Solvents**

Two of the currently most-widely-used physical solvent processes for IGCC synthesis gases are Selexol and Rectisol. The Selexol process solvent is the dimethyl ether of polyethylene glycol, while the Rectisol solvent is methanol. Other physical solvent processes are also offered for license, but are less frequently used commercially. Since the operating principles of all physical solvent processes are similar, only the Selexol and Rectisol processes are individually discussed below.

The principal benefits of physical solvents are:

- High selectivity for H<sub>2</sub>S and COS over CO<sub>2</sub>
- High loadings at high acid gas partial pressures
- Solvent stability
- Low heat requirements because most of the solvent can be regenerated by a simple pressure letdown. (There is no significant heat of reaction or solution.)

The performance of a physical solvent can be easily predicted. The solubility of individual compounds follow Henry's law—the solubility of a compound in the solvent is directly proportional to its partial pressure in the gas phase—hence, the improvement in the performance of physical solvent AGR processes with increasing syngas pressure. The easily measured data for component solubility at several partial pressures and temperatures generally provides the necessary solubility curves.

Physical solvents are particularly applicable to synthesis gas applications. Unlike natural gases, where hydrocarbon coabsorption can be a problem for physical solvents, synthesis gases do not contain appreciable quantities of hydrocarbons. Physical solvent processes can be easily configured to take advantage of their high H<sub>2</sub>S/CO<sub>2</sub> selectivity together with high levels of CO<sub>2</sub> recovery. This is usually accomplished by staging absorption for high H<sub>2</sub>S removal, followed by CO<sub>2</sub> removal.

For physical solvents to be economically usable they must meet certain criteria. Among these criteria are the following:

- Very low vapor pressures—to prevent solvent losses
- High selectivity for acid gases vis-à-vis methane, hydrogen and carbon monoxide
- Low viscosity

## SFA Pacific, Inc.

- Heat stability
- Be non-corrosive to metals

Only a few solvents meet all these criteria. Among the ones that have been used commercially include N-methyl-2-pyrrolidone (Purisol process), tributylphosphate (Estasolvan process), propylene carbonate (Fluor Solvent process), methanol (Rectisol and IFPEXOL processes), polyethylene glycol dialkyl ethers (Selexol, Sepasolv MPE, and Genosorb processes). Methanol has a high vapor pressure and needs low temperatures (refrigeration) to prevent high solvent losses.

In recent IGCC projects, where physical solvents have been specified for acid gas removal, either the Selexol or the Rectisol processes have been chosen. At least twenty operating commercial gasification plants worldwide use either the Selexol or the Rectisol process for acid gas treating. These two processes are discussed below.

### **Selexol**

The Selexol process was patented by Allied Chemical Corp. and has been used since the late 1960s. The process was sold to Norton in 1982 and then bought by Union Carbide in 1990 [22]. The Dow Chemical Co. acquired the gas processing expertise, including the Selexol process, from Union Carbide in 2001. The process is offered for license by several engineering companies—the most experienced of which with the process is probably UOP. There are more than 55 Selexol plants worldwide, treating natural and synthesis gases [66].

The Selexol process solvent is a mixture of dimethyl ethers of polyethylene glycol, and has the formulation  $\text{CH}_3(\text{CH}_2\text{CH}_2\text{O})_n\text{CH}_3$ , where  $n$  is between 3 and 9. There are other process suppliers using the same solvent as the Selexol process. For example, Clariant GmbH, of Germany offers a family of dialkyl ethers of polyethylene glycol. The Clariant solvents, under the Genosorb name, include dimethyl ether- as well as dibutyl ether- of polyethylene glycols. The first-mentioned Clariant solvent is the same as that used in the Selexol process.

The Selexol solvent is chemically and thermally stable, and has a low vapor pressure that limits its losses to the treated gas. The solvent has a high solubility for  $\text{CO}_2$ ,  $\text{H}_2\text{S}$ , and  $\text{COS}$ . It also has an appreciable selectivity for  $\text{H}_2\text{S}$  over  $\text{CO}_2$ . Table 6-1 shows the comparative and actual solubilities of various gases relative to methane at  $25^\circ\text{C}$  in the Selexol solvent.

**Table 6-1**  
**Solubilities of Gases in the Selexol Solvent**

Component	Solubility Index <sup>a</sup>	Solubility, $\text{Ncm}^2/\text{g.bar}$ , @ $25^\circ\text{C}$
$\text{H}_2$	0.2	0.03
CO	0.8	0.08
$\text{CH}_4$	1.0	0.2
$\text{CO}_2$	15	3.1

## SFA Pacific, Inc.

COS	35	7.0
H <sub>2</sub> S	134	21
CH <sub>3</sub> SH	340	68
C <sub>6</sub> H <sub>6</sub>	3,800	759
H <sub>2</sub> O	11,000	2,200
HCN	38,000	6,600

<sup>a</sup> K' CH<sub>4</sub>/K' Component

Sources: DOW, Clariant GmbH

The solubility and K value data in Table 6-1 are based on single component solubilities. It would be expected that these values should be approximately the same for non-polar components even in acid gas loaded solvents. In loaded solvents, the CO<sub>2</sub>, H<sub>2</sub>S, and other polar component interactions become significant. Therefore, the data in Table 6-1 should not be relied on for loaded solvents. The tables are useful, nevertheless, in explaining the selectivity between the various components. It should be noted that several physical solvent AGR process vendors claim that physical solubility properties of their solvents in some commercial software process simulation packages are inaccurate and could give results that are misleading [74].

The Selexol process can be configured in various ways, depending on the requirements for the level of H<sub>2</sub>S/CO<sub>2</sub> selectivity, the depth of sulfur removal, the need for bulk CO<sub>2</sub> removal, and whether the gas needs to be dehydrated. Figure 6-3 shows a Selexol process layout for synthesis gas treating where a high level of both sulfur and CO<sub>2</sub> removal are required. The layout is similar to an amine unit, but with an extra low-pressure flash tank to reduce the load on the solvent regenerator. The offgas from the low-pressure flash is combined with the acid gas from the regenerator. This combined gas stream is then sent to a sulfur recovery unit. However, the H<sub>2</sub>S content could be too low for use in a conventional Claus plant. A hydraulic power recovery unit may be used between the absorber and the first flash vessel, as shown in Figure 6-3. Hydraulic power recovery turbines are sometimes also used in amine systems.

The Selexol process can, however, be configured to give both a rich acid gas feed to the Claus unit as well as to provide for bulk CO<sub>2</sub> removal, as is done at the Farmland's gasification facility in Kansas. There, petroleum coke is gasified to produce ammonia. The synthesis gas undergoes a CO shift reaction before seeing the Selexol unit. Thus, the H<sub>2</sub>S/CO<sub>2</sub> ratio is extremely low (0.6% H<sub>2</sub>S and 41% CO<sub>2</sub>). The first stage of the Selexol process layout at Farmland is selective absorption of H<sub>2</sub>S. The acid gas from first stage absorption undergoes CO<sub>2</sub> stripping in a second

**Figure 6-3**  
**The Selexol Process**



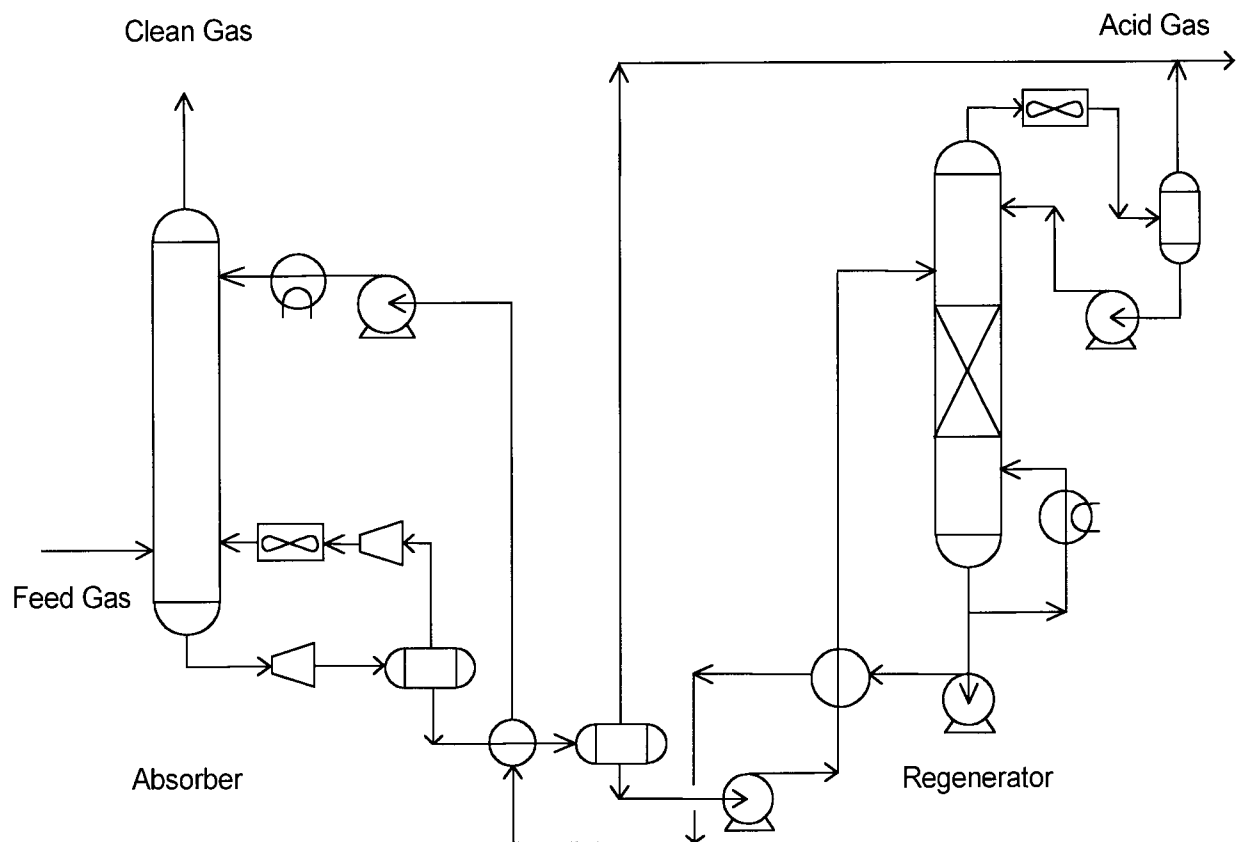

Source: SFA Pacific, Inc.

column using clean synthesis gas as the stripping medium. The resulting acid gas from the Selexol stripper has a 44% H<sub>2</sub>S content, suitable for a Claus unit.

Where selective H<sub>2</sub>S removal is required, together with deep CO<sub>2</sub> removal, two absorption and regeneration columns may be required—essentially a two-stage process. Such a process layout is illustrated in Figure 6-4 [23]. H<sub>2</sub>S is selectively removed in the first column by a lean solvent that has been deeply stripped with steam, while CO<sub>2</sub> is removed, from the now H<sub>2</sub>S-free gas, in the second absorber. The second-stage solvent can be regenerated with air or nitrogen if very deep CO<sub>2</sub> removal is required. If only bulk CO<sub>2</sub> removal is required, then the flashed gas, containing the bulk of the CO<sub>2</sub>, can be vented and the second regenerator duty can be substantially lowered or be totally eliminated.

For selective removal of H<sub>2</sub>S, without the need for bulk CO<sub>2</sub> removal, an absorber, a flash vessel and a steam stripper (regenerator) may be all that is required. The flashed gas is recompressed back into the absorption column, while the partially stripped solvent flows to the steam stripper.



**Rectisol**

The Rectisol process, developed by Lurgi GmbH, is the most widely used physical solvent gas treating process in the world. More than 100 Rectisol units are in operation or under construction worldwide. Its most prevalent application is for deep sulfur removal from synthesis gases that subsequently undergo catalytic conversion to such products as ammonia, hydrogen and Fischer Tropsch liquids.

The Rectisol process uses chilled methanol at a temperature of about -40°F to -80°F. Methanol's selectivity for H<sub>2</sub>S over CO<sub>2</sub> at these temperatures is about 6/1 [23], a little lower than that of Selexol at its usual operating temperature. However, the solubilities of H<sub>2</sub>S and COS in methanol, at typical process operating temperatures, are higher than in Selexol and allow for very deep sulfur removal (<0.1 ppmv H<sub>2</sub>S plus COS). Rectisol's high selectivity for H<sub>2</sub>S over CO<sub>2</sub>, combined with the ability to remove COS, is the primary advantage of the process. Figure 6-5 shows the solubilities of various gas components in methanol. Chilled methanol also absorbs HCN, NH<sub>3</sub>, and iron- and nickel-carbonyls. The solubilities of these trace components and other organic sulfur compounds are even higher than that of H<sub>2</sub>S. Rectisol's complex scheme and the need to refrigerate the solvent are its main disadvantages, resulting in high capital and operating costs.

**Figure 6-5**  
**Absorption Coefficient  $\alpha$  of Various Gases in Methanol**  
**(Partial Pressure: 1 bar)**

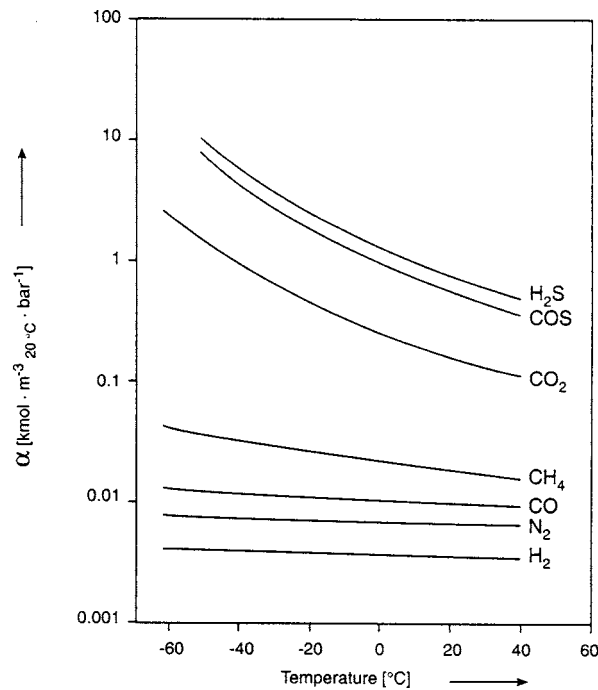

Source: Lurgi GmbH

As in the case of the solubility data presented in Table 6-1, the data in Figure 6-4 are based on single component solubilities and should not be applied to loaded solvents.

There are many possible process configurations for Rectisol, depending on process requirements. Different process layouts are used for selective H<sub>2</sub>S removal, deep CO<sub>2</sub> removal, and for deep non-selective CO<sub>2</sub> and H<sub>2</sub>S removal. An example flow scheme of a basic Rectisol process is shown in Figure 6-6. In this flow scheme, bulk removal of CO<sub>2</sub> and nearly all of the removal of H<sub>2</sub>S and COS take place in the bottom section of the absorber. The methanol solvent contacting the feed gas in the first stage of the absorber is stripped in two stages of flashing via pressure reduction. The regenerated solvent is virtually free of sulfur compounds but contains some CO<sub>2</sub>. The acid gas leaving the first stage solvent regenerator is suitable for a Claus plant. The second stage of absorption is designed for the removal of the remaining sulfur compounds and CO<sub>2</sub>. The solvent from the bottom of the second stage of the absorber is stripped deeply in a steam-heated regenerator and is returned to the top of the absorption column after cooling and refrigeration.

**Figure 6-6**  
**Rectisol Process Flow Diagram**

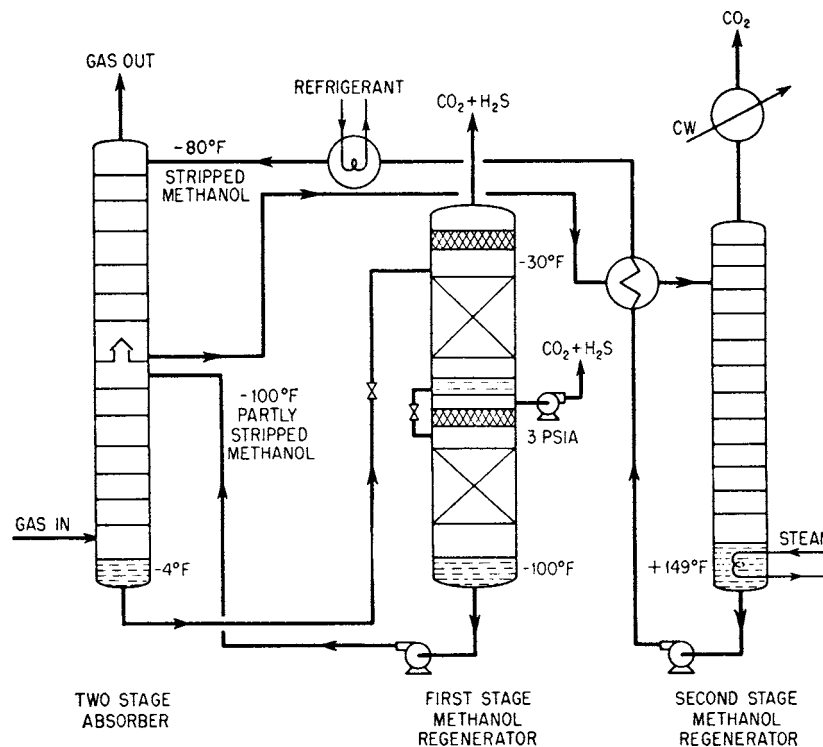

Source: Reference 23

If all carbon is to be removed from synthesis gas, such as for example for hydrogen manufacture or for CO<sub>2</sub> sequestration, then another Rectisol layout could be used. In such a scheme, separate absorption and solvent regeneration steps would be used, with a shift conversion step between the two steps. Selective removal of the sulfur compounds would take place in the first stage, followed by the shift conversion step. Bulk CO<sub>2</sub> removal would take place in the second stage. An example of such a flow scheme is shown in Figure 6-7. The actual layouts of the process can vary considerably from those shown in the figures and specific designs can only be obtained from process licensors.

**Figure 6-7**  
**Flow Diagram of Rectisol Process for Selective Hydrogen Sulfide Removal,**  
**Followed by Carbon Dioxide Removal**

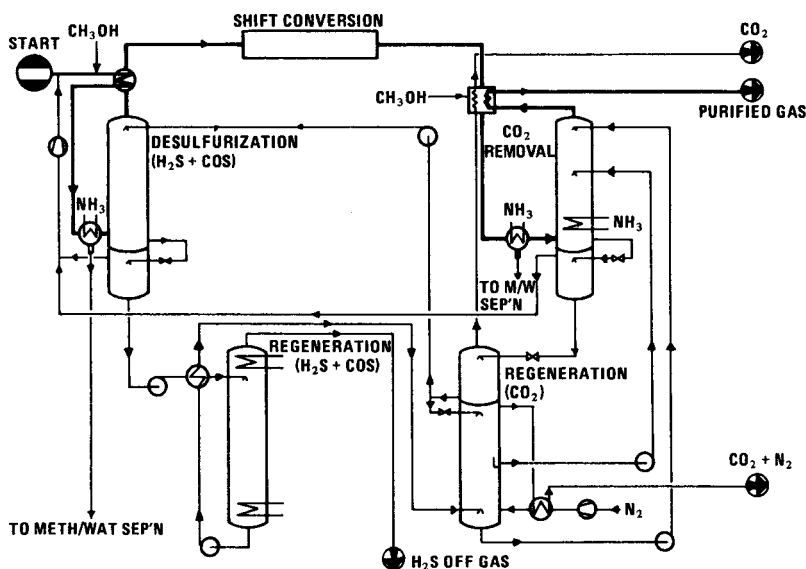

Source: Reference 23

The Rectisol process is very flexible and can be configured to address the separation of synthesis gas into various components, depending on the final products that are desired from the gas. It is very suitable to complex schemes where a combination of products are needed, such as for example hydrogen, carbon monoxide, ammonia and methanol synthesis gases and fuel gas side streams.

Chilled methanol will remove many metallic trace components from the gas, including mercury. If mercury is present in the gas, then a carbon bed may be required ahead of the Rectisol unit to prevent the mercury from forming metal amalgams in the low temperature sections of the process.

## **Mixed Amine/Physical Solvent Processes**

A number of processes use a mixture of amines and physical solvents to take advantage of the best characteristics of both types. A mixed solvent is generally a compromise between H<sub>2</sub>S selectivity and the degree of the physical solubilities of the other sulfur compounds. Among the most numerous applications of such processes used commercially are Sulfinol (Shell) and FLEXSORB (ExxonMobil). These two processes are described below.

### ***Sulfinol***

The Sulfinol process, developed by Shell in the early 1960s, is a combination process that uses a mixture of amines and a physical solvent. The solvent consists of an aqueous amine and sulfolane. Sulfinol-D uses diisopropanolamine (DIPA), while Sulfinol-M uses MDEA. The mixed solvents allow for better solvent loadings at high acid gas partial pressures and higher solubility of COS and organic sulfur compounds than straight aqueous amines.

There are some 200 Sulfinol plants in operation worldwide [66], most of which use the Sulfinol-D solvent formulations. Sulfinol-D is primarily used in cases where selective removal of H<sub>2</sub>S is not of primary concern, but where partial removal of organic sulfur compounds (mercaptans and CS<sub>2</sub>) is desired, typically in natural gas and refinery applications. Sulfinol-D is also able to remove some COS via physical solubility in sulfolane and partial hydrolysis to H<sub>2</sub>S induced by the secondary amine (DIPA). However, deep removal of COS by Sulfinol-D cannot be guaranteed. Unlike solvents that use other primary and secondary amines (MEA, DEA) Sulfinol-D is claimed not to be degraded by these sulfur compounds. Sulfinol-D has also been used for selective removal of H<sub>2</sub>S in at least one natural gas plant which was designed for a moderate amount of CO<sub>2</sub> slip.

Sulfinol-M is used when a higher degree of H<sub>2</sub>S selectivity is needed. H<sub>2</sub>S selectivity in Sulfinol-M is controlled by the kinetics of the reaction of H<sub>2</sub>S with MDEA as well as by the physical solubilities of H<sub>2</sub>S and CO<sub>2</sub> in the solvent. The CO<sub>2</sub> partial pressure over the solvent is several times greater than that of H<sub>2</sub>S at the same solvent loadings resulting in some degree of equilibrium selectivity [25]. The design for H<sub>2</sub>S selectivity becomes more complex for a solvent that claims a high degree of physical solubility, when both the interaction of the kinetic and physical solubility factors have to be considered simultaneously. A high degree of physical solubility is enhanced by equilibrium loading at long residence time and the use of many trays in the absorber, while fast reaction kinetics facilitates the use of a smaller number of trays and shorter contact time. While there are benefits to be gained by higher solubilities of the sulfur compounds in a solvent such as Sulfinol-M, these benefits are best obtained with a high absorber tray count, which in turn compromises H<sub>2</sub>S selectivity. Sulfinol-M is capable of virtually complete COS removal and a total treated gas sulfur specification of less than 40 ppmv.

For synthesis gas applications, where the ratio of CO<sub>2</sub> to H<sub>2</sub>S is high (higher than about 5/1), the Sulfinol-M process without an additional enrichment step is unlikely to give an acid gas suitable for a straight through Claus plant. It is also likely to require an upstream COS hydrolysis unit if a very high degree of sulfur removal is needed (about 10-20 ppmv total sulfur in treated gas). Sulfinol-M process could be a better choice than a straight MDEA process under certain

conditions. Specific performance parameters for the process, as for any other proprietary process, can only be obtained from the licensors.

### ***FLEXSORB PS and Hybrid FLEXSORB SE***

ExxonMobil offers two mixed hindered amine/physical solvent versions of the FLEXSORB Process, discussed earlier in this section under Amine Processes. It appears that they were developed as a competitive answer to the Sulfinol Process. The Hybrid FLEXSORB SE Process employs a solution of the FLEXSORB SE amine, water, and an unspecified physical solvent. Two plants are in operation. The FLEXSORB PS solvent consists of a different hindered amine, water, and a physical solvent. Five of these plants are believed to be operating [66]. In one Canadian natural gas plant, Sulfinol D solvent was replaced with FLEXSORB PS solvent to reduce the solvent circulation rate and reboiler duty. There are no known commercial applications of the FLEXSORB PS Process for the selective removal of H<sub>2</sub>S.

### **General Perceptions of AGR Process Suitability for IGCC**

The general industry perspective of AGR process for IGCC, reflected in the patterns indicated previously by Table 4-1 and also in ongoing EPRI-sponsored engineering and cost studies of IGCC [64,65,68,69], is summarized below.

- MDEA-based AGR is generally regarded as a low capital cost option for IGCC without CO<sub>2</sub> removal for sequestration—if the syngas pressure is low (e.g., less than 30 atm) and the SO<sub>2</sub> and NO<sub>x</sub> emissions limits are not stringent (i.e., if SCR is not required and required the total sulfur level is only about 30-50 ppmv). The stripping steam requirements of MDEA are higher than those of Selexol. If MDEA is pushed to deep sulfur removal, the CO<sub>2</sub> absorption will also increase—thereby diluting the acid gas feed to the SR plant and also reducing the fuel gas mass flow to the gas turbines (slightly reducing the power output).
- At high syngas pressures, physical solvent-based AGR processes become increasingly attractive. For example, with the ChevronTexaco Gasification Process at 900-1,000 psi and the Selexol AGR Process are being used in the API IGCC project in Italy and are also being evaluated in some current EPRI engineering studies. Without refrigeration, total sulfur levels of about 10-15 ppmv can be achieved. Lower levels are achievable with refrigeration, albeit with additional CO<sub>2</sub> co-absorption [67].
- AGR process options should be evaluated on the basis of the performance and costs of the total AGR, SR, TGT package. For example, the Selexol Process can produce a more concentrated acid gas feed to the SR unit, thereby improving its performance and reducing its cost, and the size and cost of the TGT unit. Alternatively, the tail gas (after hydrogenation) may be recycled to the absorber—eliminating the separate TGT unit.
- The syngas composition also impacts the selection of AGR. For example, the dry-fed Shell coal/coke gasification process produces less CO<sub>2</sub> than the slurry-fed ChevronTexaco and Global E-Gas gasification processes, thereby reducing the CO<sub>2</sub> co-absorption issue for MDEA-based AGR with the Shell Process.

## SFA Pacific, Inc.

- The Rectisol Process is regarded as the most expensive of these three AGR processes for IGCC without CO<sub>2</sub> recovery—because of its complexity and refrigeration requirements. Lurgi appears to concur with this perception, acknowledging that Selexol is one of “the solvents of choice in conventional IGCC gas purification” [71].
- COS hydrolysis before the AGR process is important for achieving low total sulfur levels in the cleaned up syngas with both chemical solvent-based AGR and the Selexol Process.
- If a future capability of removing CO<sub>2</sub> for sequestration is desired, the Selexol Process is more readily adapted to CO<sub>2</sub> removal by the addition of a second stage, and it is probably a better choice than MDEA.
- Two-stage physical solvent-based AGR processes are preferred for IGCC with CO<sub>2</sub> removal for sequestration [64]. For example, in ongoing EPRI/DOE-co-sponsored engineering and cost studies of CO<sub>2</sub> removal from power plants for sequestration, a two-stage Selexol Process is employed with the IGCC plant. H<sub>2</sub>S is removed in the first stage and CO<sub>2</sub> is removed in the second stage [68,69]. A similar configuration based on Selexol was employed in a recent Texaco/GE/Jacobs Engineering assessment of IGCC with CO<sub>2</sub> removal [72]. Fluor, an experienced gasification plant designer and constructor, also recently reported a study of IGCC with CO<sub>2</sub> removal based on the Selexol Process [73]. While Lurgi is promoting its Rectisol Process for IGCC with CO<sub>2</sub> removal, no economics have been published on this option [71].

No comparative engineering and economic evaluations specifically of AGR process options for gasification and IGCC applications are available. However, current EPRI site-specific studies of the ChevronTexaco, Global E-Gas, and Shell gasification-based IGCC processes with various fuels, and MDEA, Selexol, and/or Sulfinol AGR process options should add to the understanding of the suitability of the various AGR options for IGCC, and their overall impact on the IGCC system performance and costs. However, the form in which the results of these sponsor-private studies eventually may be published has not yet been determined [65].

### AGR Process Selection

Although the general perceptions of AGR discussed above provide some preliminary guidance in the selection of AGR options for an IGCC project, overall the final selection of an AGR process is a complex task. Several AGR options exist and a number of parameters affect the process design and the capital and operating costs of each option. The options may include various MDEA formulations (available from different licensors), the Selexol Process, the Purisol Process (which Lurgi is promoting as an alternative to Selexol for conventional IGCC [71]), the FLEXSORB hindered amine and mixed solvent processes, the Sulfinol mixed solvent process, and the Rectisol Process as an alternative to Selexol for low emissions IGCC with CO<sub>2</sub> removal.

The gasification process selected and feedstock options for an IGCC project will determine the untreated syngas flow rate, composition, and pressure. These parameters and the clean syngas composition specifications and plant emissions limits set the boundaries into which the gas treating package (AGR, SR, and TGT) must be fit.



## SFA Pacific, Inc.

Thus, the gasification process significantly selected impacts the AGR system options and their designs. The highest coal and petroleum coke gasification pressures (up to about 1,000 psi (69 bar) currently, and potentially about 20-30% higher) are achievable with the fuel/water slurry-fed ChevronTexaco Gasification Process. As noted previously, high pressure tends to favor physical solvent-based AGR systems. The slurry-fed Global E-Gas Gasification Process presently employs a T-shaped vessel configuration that limits its pressure to a lower level than that of the straight cylindrical design of ChevronTexaco. However, Global is considering a cylindrical design for a higher pressure gasifier. The dry pulverized fuel-fed Shell Gasification Process may be limited to a pressure of 600 psi (41 bar). The Shell Process also produces less CO<sub>2</sub> than the slurry-fed processes, which tends to encourage using MDEA for non-CO<sub>2</sub> removal situations, as noted previously [64].

The parameters that must be considered in AGR selection and gas treating system design optimization include the:

- Untreated syngas flow rate and composition, pressure, and temperature
- Acid gas components in the syngas, their concentrations, the depth of H<sub>2</sub>S and total sulfur removal required, and the selectivity desired. The overall plant SO<sub>2</sub> and NO<sub>x</sub> emissions must be considered here. A requirement for SCR on the combustion turbine exhaust gas, may be the factor that sets the total sulfur allowable in the clean syngas fuel. Future more stringent air emissions limits may necessitate significant changes in some AGR process designs (compared with current designs).
- Any parallel use of the syngas in co-production of hydrogen and/or chemicals—and the corresponding process requirements (e.g., CO shift for H<sub>2</sub> production) and synthesis gas specifications (e.g., <0.1 ppmv total sulfur for methanol and Fischer-Tropsch synthesis gas)
- Extent of CO<sub>2</sub> removal that is acceptable if it is not removed for sequestration—or that is required in the case of removal for sequestration, and the flexibility and cost of adding an optimal CO<sub>2</sub> removal capability at a later date
- AGR utilities requirements (stripper steam and auxiliary electric power). These will not be finalized until the design is optimized. The heat requirements for solvent regeneration and the electrical needs for pumping (solvent recirculation) and refrigeration (if used, with physical solvents) are the major factors affecting the operating costs for AGR, as discussed earlier.
- Solvent losses (make-up costs)
- Impact of the composition of the concentrated (H<sub>2</sub>S-rich) acid gas leaving the AGR process on the design and costs of the downstream SR and TGT processes. The integration with and impact of the AGR on the entire system must be evaluated. Some AGR designs may allow recycling the Claus plant tail gas (after it is hydrogenated), thereby eliminating the TGT process.
- Impact of potential tie-ins to existing facilities
- Process complexity and transient behavior (e.g., load-following capability)

## **SFA Pacific, Inc.**

- Process flexibility with regard to feedstock changes and potential future tightening of emissions limits
- Process train philosophy

Project planners and plant designers/constructors may conduct preliminary screenings of AGR process options using various techniques and tools, including commercial process simulators. In the case of generic amine processes, some planners/developers and engineering/construction firms may use related commercially available process simulators for the designs of their AGR plants. The trade-offs in going that route were discussed earlier in this section. For AGR based on proprietary MDEA formulations and physical solvents, the AGR process licensors should be relied on for definitive designs (including preferred configurations) and bids. As mentioned earlier in this report section, some physical solvent-based AGR process vendors claim that the solubility data in some commercial process simulation packages are not accurate and could produce misleading results. The system design and optimization tasks should involve the collaboration of the selected AGR vendor, or competing vendors. The AGR vendor's and plant constructor's respective track records supplying successful plants should also be major considerations. Customer preferences and biases, as well as the experience, preferences, biases, and affiliations (licensing, etc.) of plant designers/constructors may also influence the selection of the AGR process.

## 7. SULFUR RECOVERY PROCESSES

Currently, most of the world's sulfur is produced from the acid gases coming from gas treating. The Claus process remains the mainstay for sulfur recovery. Conventional three-stage Claus plants, with indirect reheat and feeds with a high H<sub>2</sub>S content, can approach 98% sulfur recovery efficiency. However, since environmental regulations have become more strict, SR plants are required to recover sulfur with over 99.8% efficiency. To meet these stricter regulations, the Claus process underwent various modifications and add-ons.

The add-on modifications to the Claus plant can be considered as a separate operation from the Claus process, in which case it is often called a tail gas treating (TGT) process. Or it can be called a Claus process extension. In this report, the add-on process is considered a TGT process only when the sulfur compounds in the Claus tail gas undergo conversion to H<sub>2</sub>S. TGT processes are covered in the next section of the report.

Other sulfur recovery processes can replace the Claus process where it is uneconomic or cannot meet the required specifications. Usually such processes are used in small-scale plants, or where the H<sub>2</sub>S content of the acid gas is too low for a Claus plant or one of its modified versions.

This section covers the conventional Claus process and its various modifications and extensions, as well as some other lesser-utilized sulfur recovery processes, such those based on wet oxidation (Redox).

### The Claus Process

The Claus process was invented in 1883. It originally was based on a direct catalytic reaction of H<sub>2</sub>S and oxygen. It was modified in 1936 to its current configuration, which includes a furnace in front of the catalytic stages. The next major modification to the process, in the mid-1960s, was the replacement of bauxite catalyst with synthetically produced aluminum oxide.

The Claus process converts H<sub>2</sub>S to elemental sulfur via the following reactions:

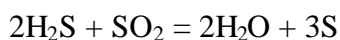
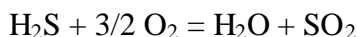

The second reaction, the Claus reaction, is equilibrium limited. The overall reaction is:

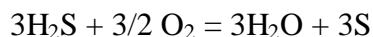

The sulfur in the vapor phase exists as S<sub>2</sub>, S<sub>6</sub>, and S<sub>8</sub> molecular species, with the S<sub>2</sub> predominating at higher temperatures, and S<sub>8</sub> predominating at lower temperatures.

A simplified process flow diagram of a typical three stage Claus plant is shown in Figure 7-1 [27]. One third of the H<sub>2</sub>S is burned in the furnace with oxygen from the air to give sufficient SO<sub>2</sub> to react with the remaining H<sub>2</sub>S. Since these reactions are highly exothermic, a waste heat boiler that recovers high pressure steam usually follows the furnace. Sulfur is condensed in a condenser that follows the high pressure steam recovery section. Low pressure steam is raised in the condenser. The tail gas from the first condenser then goes to several catalytic conversion stages, usually 2 to 3, where the remaining sulfur is recovered via the Claus reaction. Each catalytic stage consists of gas preheat, a catalytic reactor and a sulfur condenser. The liquid sulfur goes to the sulfur pit, while the tail gas proceeds to the incinerator or for further processing in a TGT unit.

**Figure 7-1**  
**Typical Three-Stage Claus Sulfur Plant**

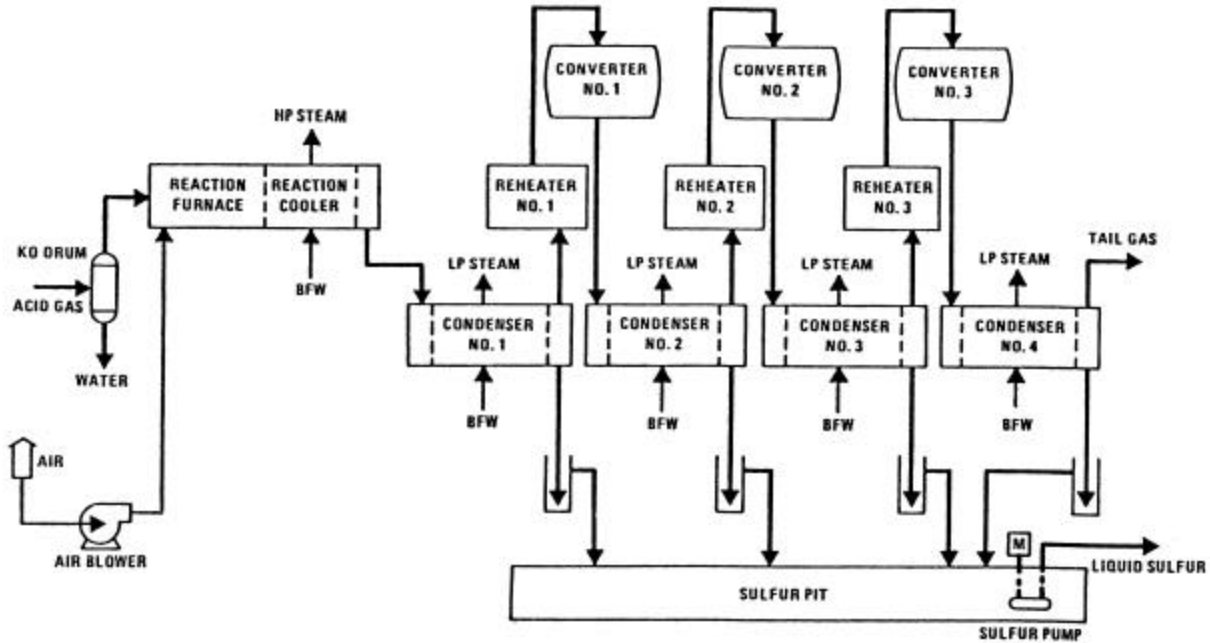

Source: Reference 27

### ***Claus Plant Sulfur Recovery Efficiency***

The Claus reaction is equilibrium limited and sulfur conversion is sensitive to the reaction temperature. The highest sulfur conversion in the thermal zone is limited to about 75% (typical furnace temperatures are in the range of 2,000-2,600°F (1,100-1,400°C)). As the temperature decreases, conversion increases dramatically. At 300°F (149°C), a temperature below the sulfur dew point, equilibrium conversion reaches well into the high 90% levels. Increased conversion

## SFA Pacific, Inc.

at sulfur sub-dew temperatures is the reason for Claus process modifications discussed later in this section of the report.

In the thermal stage, some of the  $H_2S$  is converted to COS and  $CS_2$ . COS and  $CS_2$  are partially converted to  $H_2S$  via hydrolysis in the catalytic stages as the temperature drops. The first catalytic stage usually operates at a higher temperature than subsequent stages to enhance this hydrolysis reaction and thus reduce the amounts of COS and  $CS_2$  in the tail gas. Incomplete hydrolysis of the COS and  $CS_2$  in the first stage results in reduced sulfur recovery efficiency.

The Claus plant furnace is often used for disposal of unwanted plant wastes such as sour water stripper off gases (with  $NH_3$ , HCN, and  $H_2S$ ), hydrocarbons and other waste-laden gases. Most of these wastes can be combusted in the furnace to destruction. However, their combustion results in decreased sulfur recovery efficiency and a tail gas that may contain some unconverted waste materials. Heavy hydrocarbons and HCN may also cause sulfur to turn dark.  $NH_3$  and HCN, if not completely destroyed, may form ammonium salts which plug the catalyst beds.  $NH_3$  is the most prevalent component and is usually the hardest to destroy completely.

In actual operating Claus plants the concentrations of some sulfur species (e.g. COS and  $CS_2$ ) appear to be higher than what one would calculate from equilibrium considerations. From these observations, it can be concluded that the Claus process is generally kinetically limited. Thus, most furnace designs have to address the three major parameters that affect reaction kinetics; temperature, residence time and mixing. To adequately destroy  $NH_3$ , a flame temperature above  $2,280^\circ F$  ( $1,250^\circ C$ ), and a residence time greater than 0.8 seconds are required in the furnace. Following these “rules of thumb,” and with good mixing in the furnace, the residual  $NH_3$  content should be well below 150 ppmv [28].

Claus plant sulfur recovery efficiency depends on many factors, among which the most important are:

- $H_2S$  concentration of the feed gas
- Number of catalytic stages
- Gas reheat method

Other lesser important factors that influence the recovery efficiency are:

- Water content of the feed gas
- Catalytic reactor and condenser temperatures
- Extent of COS and  $CS_2$  hydrolysis in the first stage
- Sulfur entrainment in the plant tail gas

As mentioned before, a three-stage plant, using indirect heat, and that has  $H_2S$ -rich feed (about 70-80%  $H_2S$ ) will approach a sulfur recovery efficiency of about 98%. Higher design efficiencies can be obtained with add-on units. However, the higher the upstream Claus plant efficiency the lower will be the load on the add-on unit, resulting in a lower investment. As the  $H_2S$  content of the feed gas is reduced sulfur recovery efficiency drops. The sulfur recovery

efficiency of a three-stage Claus plant with indirect reheat will drop to about 96% when the H<sub>2</sub>S content in the feed gas is about 50%.

In order to keep Claus plant recovery efficiencies approaching 94-96% for feed gases that contain about 20-50% H<sub>2</sub>S a split-flow design is often used. In this version of the Claus plant, part of the feed gas is bypassed around the furnace to the first catalytic stage, while the rest of the gas is oxidized in the furnace to mostly SO<sub>2</sub>. This results in a more stable temperature in the furnace.

Below about 15% H<sub>2</sub>S content in the feed gas other means have to be used to maintain a stable temperature in the furnace, such as feed air preheating or oxygen enrichment. Such a lean H<sub>2</sub>S feed gas results in low sulfur recovery efficiencies and high unit costs.

Large diluent streams in the feed to the Claus plant, such as N<sub>2</sub> from combustion, or a high CO<sub>2</sub> content in the feed gas, lead to higher cost Claus process and any add-on or tail gas units. One way to reduce diluent flows through the Claus plant and to obtain stable temperatures in the furnace for dilute H<sub>2</sub>S streams is oxygen blown Claus, discussed below.

## **Oxygen-Blown Claus**

Oxygen-blown Claus process was originally developed to increase capacity at existing conventional Claus plants and to increase flame temperatures of low H<sub>2</sub>S content gases. The process has also been used to provide the capacity and operating flexibility for sulfur plants where the feed gas is variable in flow and composition such as often found in refineries. The application of the process has now been extended to grass roots installations, even for rich H<sub>2</sub>S feed streams, to provide operating flexibility at lower costs than would be the case for conventional Claus units. At least four of the recently built gasification plants in Europe use oxygen enriched Claus units; Puertollano in Spain, and the three Italian plants, api Energia, ISAB, and SARLUX.

Oxygen enrichment results in higher temperatures in the front end furnace (FEF), potentially reaching temperatures as high as 2,900-3,000°F (1,600-1,650°C) as the enrichment moves beyond 40-70 vol% O<sub>2</sub> in the oxidant feed stream. A challenge for early process developers was finding a means to control high temperatures in the FEF. Although water vapor content of the gas stream has a tempering effect on the run-away temperatures, it is insufficient and high water content leads to other problems—excess water suppresses the Claus reaction. Two principal means have been used to achieve temperature control, recycle of cooled gas to the FEF (COPE process), and special burners that control the combustion process itself (OxyClaus process). Temperature control via staged combustion is also employed (SURE process).

It is safe to premix oxygen with air up to an oxygen level of about 28 vol%. Beyond that level, air and oxygen must be introduced separately. Proprietary burner designs have been developed by various companies for this purpose, mostly by oxygen suppliers.

Although oxygen enrichment has many benefits, its primary benefit for lean H<sub>2</sub>S feeds is a stable furnace temperature. Sulfur recovery is not significantly enhanced by oxygen enrichment. A recent assessment of an oxygen enrichment option at the Qatargas refinery, which has a 14-18% H<sub>2</sub>S feed, concluded that it would be more beneficial to install acid gas enrichment and add an air-blown extended Clausplant. Sulfur recovery, which at the Qatargas plant is about 95%, would have improved only marginally according to oxygen-blown Claus process licensors [26].

### ***The COPE Process***

The COPE (Claus Oxygen-based Process Expansion) process was developed by Air Products and Chemicals and Goar, Allison & Associates. In addition to these two companies, the process is also available from Technip USA. The basic feature of the process is the control of the FEF temperature by recycling cooled gas from the exit of the first sulfur condenser [29]. Gas recycle is only required when there is potential for the refractory to exceed a temperature of about 2,700°F. When gas recycle is not used, the process is known as COPE Phase I. The COPE Phase I process can increase the sulfur capacity of an air-blown Claus by about 50% for a rich acid gas feed [30]. The COPE Phase I process only needs a specially designed burner with separate feeding of air, oxygen, acid gas, recycle gas, and any fuel gas. The burner can handle up to 100 vol% oxygen.

The process has been used mainly to retrofit existing Claus plants at refineries to increase their capacity [31]. There are 19 Claus plants that use the COPE process. Six of these plants use the COPE Phase II version of the process (with gas recycle), the rest are equipped only with the proprietary COPE burner. All, except three plants, are retrofits of air-blown Claus facilities, mostly at refineries. Some of the revamped facilities doubled their sulfur handling capacities. One of the plants operates with 100% oxygen since 1985.

Only one IGCC facility, the Wabash River plant at Terre Haute, Indiana, uses the COPE process (Phase I). The tail gas from the COPE sulfur recovery unit is recycled back to the gasifier.

The licensors claim that the COPE process sulfur recovery can vary from 95-98% and that sulfur recovery can be improved by 0.5-1% over that of the conventional, air-blown Claus, depending on the H<sub>2</sub>S concentration in the feed gas.

### ***The OxyClaus Process***

The Lurgi Oel Gas Chemie GmbH OxyClaus process is based on a proprietary burner that is claimed to control FEF temperatures to below the refractory limit even when 100% oxygen is used with rich H<sub>2</sub>S streams. Beside the burner, no other cooling scheme is used in the OxyClaus FEF. The burner and the furnace are designed to reach thermal equilibrium instead of the kinetic equilibrium that is conventionally thought to prevail in a Claus furnace.

Figure 7-2 shows a plot of the theoretically calculated furnace temperatures reached using the kinetic models and the equilibrium models for the Claus reaction at various oxygen and H<sub>2</sub>S concentrations [32]. It shows that the equilibrium model reaction temperatures are far below those of the kinetic model. Lurgi's experience shows that actual furnace temperatures reached

Figure 7-2  
Reaction Furnace Temperature

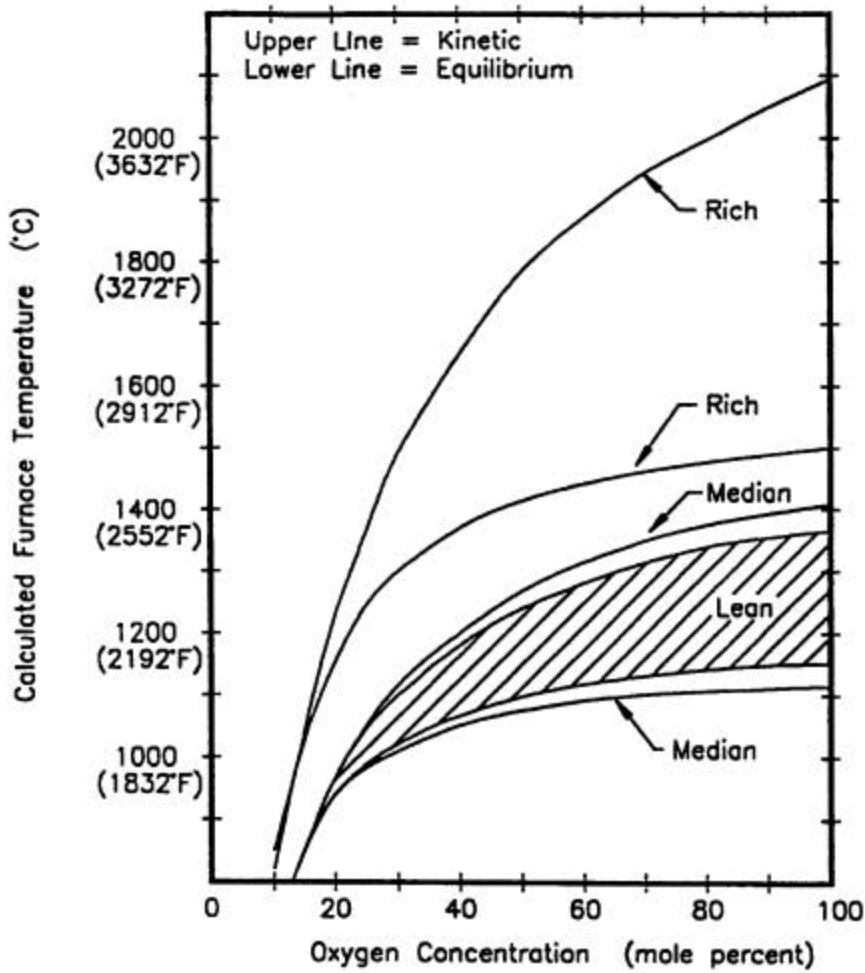

Feed Cases for Figure 7-2			
Composition	Rich Feed	Median Feed	Lean Feed
(mole %)			
H <sub>2</sub> S	90.00	50.00	20.00
CO <sub>2</sub>	9.00	49.00	79.00
CH <sub>4</sub>	0.75	0.75	0.75
C <sub>2</sub> H <sub>6</sub>	0.25	0.25	0.25
Total	100.00	100.00	100.00
Note: For the Lean Feed Case a 55% bypass was utilized.			

Source: Reference 32



## SFA Pacific, Inc.

with the OxyClaus commercial plants are closely duplicated by the equilibrium model calculations. It is postulated that the high temperatures reached with oxygen combustion causes some decomposition of H<sub>2</sub>S, CO<sub>2</sub> and H<sub>2</sub>O via the following reactions:

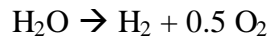
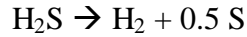

These reactions are highly endothermic and cause a moderating influence on the exothermic Claus reaction. Water dissociation supplies additional oxygen for the formation of SO<sub>2</sub>. It is also known that some of the H<sub>2</sub> and CO convert to H<sub>2</sub>S and COS, as the gas cools in the waste heat boiler, via the following reactions:

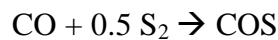
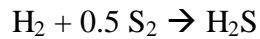

The COS and some of the unreacted H<sub>2</sub> and CO wind up in the Claus tail gas. The amount of H<sub>2</sub> in the tail gas is sufficient for the hydrogenation/hydrolysis step in the tail gas processing unit. This process step is discussed further in Section 8 – Tail Gas Treating.

The hydrogenated/hydrolyzed tail gas from the Claus plant, after compression, can be sent to the acid gas removal unit for H<sub>2</sub>S cleanup. The CO and any remaining hydrogen in the tail gas can then be consumed in a combustion turbine after undergoing H<sub>2</sub>S removal. A general scheme such as this is shown in Figure 7-3, where a tail gas from the OxyClaus unit is hydrogenated, and recompressed for treatment in a Lurgi Rectisol plant. Such a scheme is used at the SARLUX IGCC plant, using the Selexol process. There is little reason why other oxygen-blown Claus processes with an H<sub>2</sub>S-rich acid gas could not avail themselves of such schemes as well.

Lurgi built approximately 22 sulfur recovery trains based on the OxyClaus process. Most of these were refinery Claus unit revamps. Two new OxyClaus plants are used at the SARLUX and the ISAB IGCC plants, and an older Claus plant, previously revamped at the AGIP Sannazaro refinery with the OxyClaus process, will be used for the IGCC facility which is being engineered. None of the known OxyClaus plants operate on 100% oxygen. SARLUX operates with the highest oxygen concentration (70%) that Lurgi has used so far in a commercial plant.

**Figure 7-3**  
**Claus Plant/H<sub>2</sub>S Removal in IGCC**

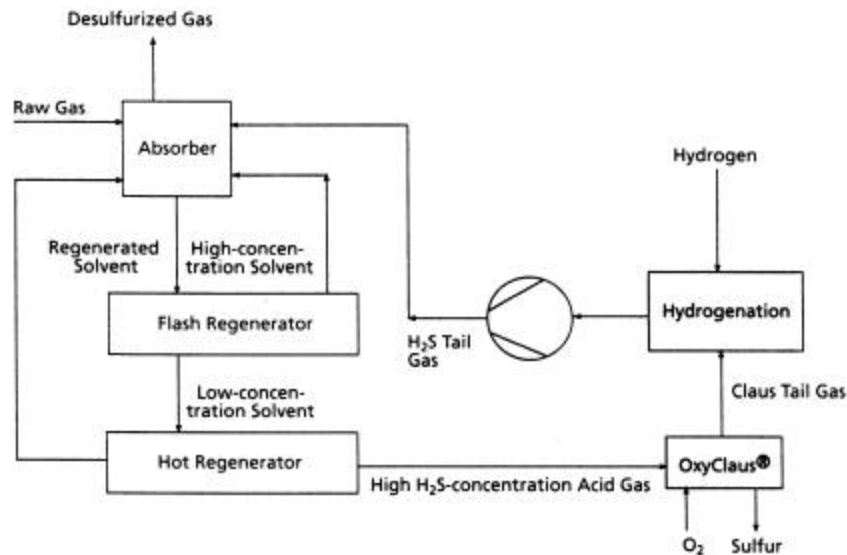

Source: Lurgi Oel Gas Chemie GmbH

### **The SURE Process**

The SURE oxygen-blown Claus process was developed by British Oxygen Corp. and Ralph M. Parsons Co. (now Parsons Corp.). The process is based on staged combustion. A portion of the oxygen and all of the air, together with all of the acid gas go to the first stage, while the rest of the oxygen is fed to the second combustion stage. The partially oxidized gases between the stages are cooled in a waste heat boiler. Only one burner is used (in the first stage)—the temperature of the gases going to the second stage is sufficiently high to autoignite with the rest of the oxygen. The process was initially developed to address Claus plant revamps. Figure 7-4 shows the version of the process used for a Claus plant revamp [33].

The two stage SURE process is only required for H<sub>2</sub>S-rich acid gas applications. A proprietary SURE burner in a single stage furnace is all that is required for a lean H<sub>2</sub>S feed, such as that at the Api Energia IGCC plant at the Falconara refinery, where 2 trains of a single stage SURE process are employed. The Api Energia IGCC SURE Claus plants operate with 100% oxygen. There were at least 8 such SURE burners operational in 1998 and 8 additional ones were in development projects, including the two needed for the Api Energia IGCC project.

For H<sub>2</sub>S-rich acid gases, a combination waste heat boiler (WHB) and second stage furnace have been developed by Siirtec Nigi and Parsons for the API Falconara refinery Claus plant revamp. These two functions were combined in one vessel and included the second stage oxygen lances. Figure 7-5 shows such a multi-pass WHB and second stage furnace.

Figure 7-4  
Process Sketch of SURE Double Combustion Claus Process

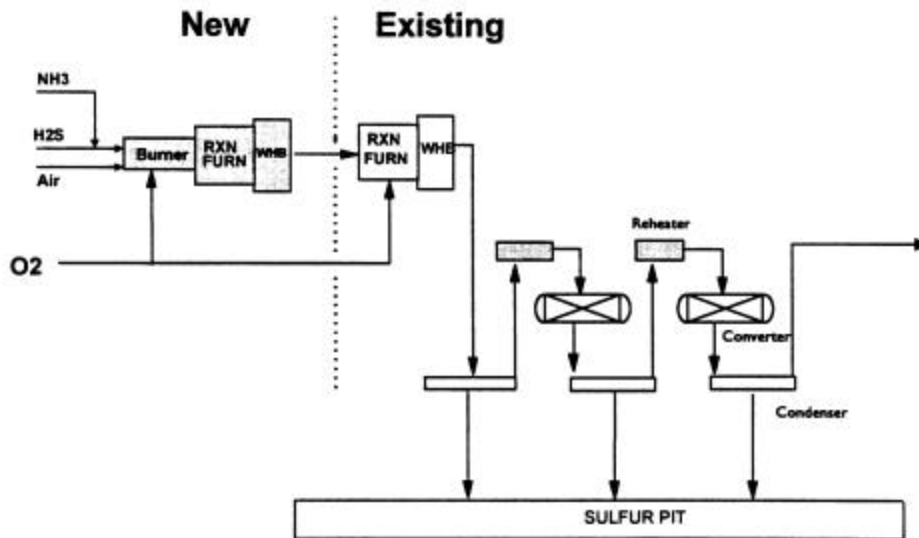

Source: Reference 33

Figure 7-5  
Sketch of Multi Pass Waste Heat Boiler with Integral #2 Reaction Furnace

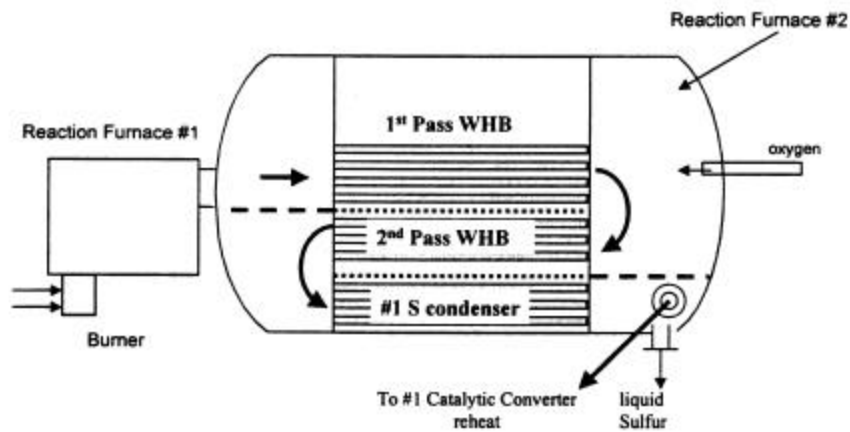

Source: Reference 33

### ***Other Oxygen-Blown Claus Process Services***

Besides the COPE, SURE, and the Lurgi OxyClaus processes, several other oxygen suppliers offer their own versions of the oxygen-blown Claus processes. Among these are Air Liquide and Praxair.

Air Liquide, in partnership with Big Three Industrial and American Combustion, Inc. (ACI), offered the ClausPlus process in the past. Air Liquide had since purchased ACI and is now offering a proprietary oxygen burner (Oxyburner). This burner is being offered primarily as a means to destroy ammonia at refinery Claus plants. It is capable of handling 100% oxygen [34].

Praxair offers oxygen enrichment services for Claus plants. These consist of oxygen supply and control, and the evaluation of conversion options.

### **Extended Bed Claus Processes**

There are two major extended bed Claus processes which improve Claus sulfur recovery by either adding, or replacing, the last Claus stage with a proprietary catalytic bed. Both of these processes can improve Claus sulfur recovery to over 99.5%. One process operates at above the sulfur dew point (SuperClaus), the other below the sulfur dew point (Sulfreen).

An extended bed process can be used without tail gas treating as long as the process tail gas sulfur regulations are within the sulfur recovery capabilities of the process. When sulfur recovery specifications reach 99.8+% then a tail gas treating process may be required, discussed in the next section of the report. In the extended bed processes, sulfur recoveries are limited by the presence of COS and/or CS<sub>2</sub> in the tail gas. Some of the extended bed processes offer modifications to their basic process to overcome this limitation. Usually, such modifications involve an additional hydrolysis step to convert all sulfur species to H<sub>2</sub>S, followed by some form of recycle. However, such modified processes have not been used in IGCC projects, and are not discussed in this report. Extended bed Claus processes could be used to reduce the load on a tail gas treating process.

#### ***The SuperClaus Process***

The SuperClaus process was developed by Comprimo, Gastec, and the University of Utrecht, in the Netherlands. The process is now owned by Stork Engineers & Contractors B.V. The process is based on the replacement or extension of the last stage of the Claus process by a catalytic bed that carries out a selective oxidation reaction. The first stages of the Claus reaction are carried out in the air deficient mode (high H<sub>2</sub>S content). The gas that enters the selective oxidation reactor has a high H<sub>2</sub>S content and very little SO<sub>2</sub>. Some oxidant is bypassed around the Claus reactors to the selective catalytic stage that contains a silica/alumina catalyst. The following reaction takes place in that bed:

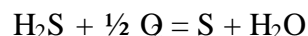

## SFA Pacific, Inc.

The reaction is not equilibrium limited as the Claus reaction, and most of the  $\text{H}_2\text{S}$  (over 85%) reacts to elemental sulfur. Because the reaction is not equilibrium limited, the catalyst is not sensitive to high  $\text{H}_2\text{O}$  content in the vapor and has little tendency to form undesirable compounds such as  $\text{SO}_2$ ,  $\text{COS}$ ,  $\text{CS}_2$ , and  $\text{CO}$ .

The process has been used successfully for about fifteen years in over two dozen commercial installations. Sulfur recoveries, for high  $\text{H}_2\text{S}$  content acid gas feeds (>50%  $\text{H}_2\text{S}$ ), can vary from 98.3 to 98.8% for three catalytic stages (2 Claus plus 1 selective oxidation), to 98.9-99.2% for four stages (3 Claus plus 1 selective oxidation) [35].

The SuperClaus process can also be configured to give higher sulfur recoveries by inserting a hydrogenation reactor between the last Claus reactor and the selective oxidation reactor. This step converts any remaining  $\text{SO}_2$  to  $\text{H}_2\text{S}$  and potentially raises sulfur recovery to about 99.5% for a rich  $\text{H}_2\text{S}$  acid gas feed. This version of the process is called "SuperClaus-99.5."

The principal problem with the selective oxidation processes is that an  $\text{H}_2\text{S}$ -rich acid gas stream is required together with an oxidant deficient furnace. Thus, as the acid gas stream gets leaner in  $\text{H}_2\text{S}$ , the sulfur recovery will drop appreciably and the lower combustion temperatures may lead to off-spec sulfur.

### ***Extended Cold-Bed Claus Process***

There are several processes that add a subdew reaction stage to a conventional Claus plant to increase its recovery. Among such processes are Sulfreen (offered by Lurgi and SNEA), CBA (offered by BP Amoco), and MCRC (offered by Delta Hudson). The Sulfreen process has the most installations and is the only one discussed here. The processes are similar, with the exception of how the regeneration gas stream is handled.

In the Sulfreen process, shown in Figure 7-6, the tail gas from the condenser of the last Claus reactor is sent directly, without reheat, to the subdew reactor. The last reactor operates below the sulfur dew point (270°F to 320°F) and adsorbs the sulfur on to the Claus catalyst. Sulfur recovery is enhanced by low temperature operation of the equilibrium limited Claus reaction. However, equilibrium is also limited by the presence of water. Typically, sulfur recoveries will vary from about 98.3% to 99.2%, depending on the number of adsorption stages and the  $\text{H}_2\text{S}$  content of the acid gas. There is a process variation that adds a hydrogenation reactor between the subdew adsorbers and the conventional last stage Claus reactor. This eliminates any excess  $\text{COS}$  and  $\text{CS}_2$  that may be present, and could potentially raise sulfur recovery up to 99.8%, again depending on the richness of the acid gas and the number of reaction stages.

The beds are cycled between adsorption and regeneration. To remove the sulfur from the loaded beds, hot gas (500°F to 550°F) is passed over the bed. The hot regeneration gas then goes to a condenser for sulfur recovery.

Figure 7-6  
The Sulfreon Process

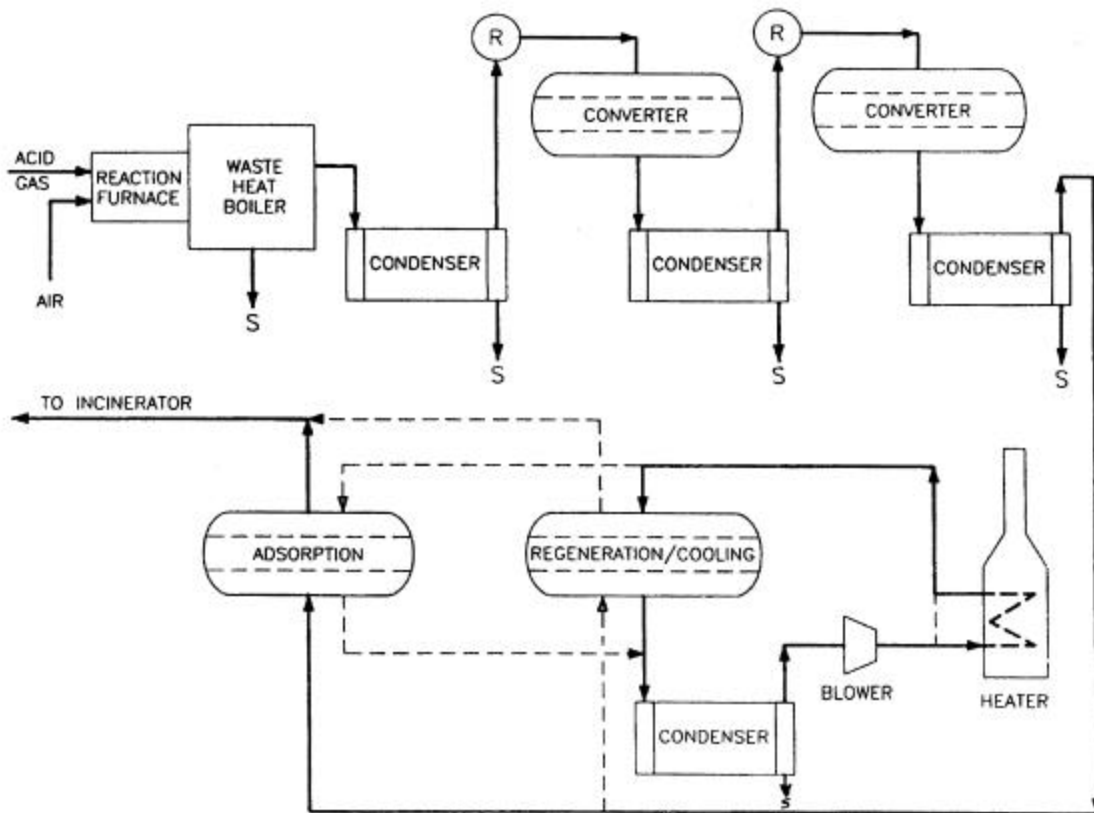

Source: Reference 35

The principal differences between the processes lie in the way regeneration gas is handled. In the Sulfreon process, regeneration gas is self contained within the subdew portion of the process (recycled back from the condenser, through a heater, and back to the bed being regenerated). In the other two processes (CBA and MCRC), regeneration is integrated with the conventional Claus plant—the regeneration gas comes from the last stage Claus condenser.

About 50 commercial Sulfreon plants have been built. However, the cyclical nature of the plant operation and their sulfur recovery limitations may discourage their application in the future.

### Other Sulfur Recovery Processes

Among the other important sulfur recovery processes are those based on catalytic oxidation and wet oxidation. Among the catalytic oxidation processes are the Selectox, BSR/Selectox, and the MODOP processes. The BSR/Selectox and the MODOP processes, are fed with the Claus tail gas and are usually considered tail gas processes. Wet oxidation processes include LO-CAT and

Sulferox. The three processes which will be briefly discussed below are Selectox, and the two wet oxidation processes (LO-CAT and Sulferox).

### ***The Selectox Process***

The Selectox process is based on replacing the Claus first stage thermal reactor (the furnace) with a catalytic oxidation step. A catalytic oxidation reactor can operate at much lower temperatures than the furnace and maintain a more stable flame temperature with lean H<sub>2</sub>S feeds. The proprietary catalyst was developed by Unocal and Ralph M. Parsons Co. UOP now owns the rights to the Unocal technology.

Two versions of the process are offered by UOP. The first is a once through option, treating acid gases with up to 5% H<sub>2</sub>S. In the once through mode, sulfur recoveries vary from 84 to 94% for H<sub>2</sub>S concentrations in the feed gas of 2 to 5%, respectively. In the recycle version, that handles H<sub>2</sub>S concentrations from 5 to 100%, gas is recycled from the Selectox reactor condenser to cool the reactor outlet temperature not to exceed 700°F. The temperature limit is set so that carbon steel can be used for the reactor vessel. A practical upper limit for H<sub>2</sub>S concentration in the acid gas feed is about 50% for plants larger than about 50 lt/day. Higher concentrations lead to extremely large flows in the recycle loop [36].

Approximately 80% of the H<sub>2</sub>S is converted to sulfur in the Selectox reactor. The reactions are of the typical Claus type—first H<sub>2</sub>S is oxidized to SO<sub>2</sub> as the predominant reaction, then H<sub>2</sub>S reacts with SO<sub>2</sub> to form elemental sulfur. The rest of the sulfur is recovered in conventional Claus stages. Up to 98% sulfur recovery efficiency can be achieved for a 50% H<sub>2</sub>S acid gas feed to the recycle version of the Selectox process. Higher sulfur recoveries can only be had with tail gas treating, for which UOP offers the BSR/Selectox process. In this tail gas process, the gases are first hydrogenated to H<sub>2</sub>S in the Beavon Stretford Reactor (BSR), then they proceed to another Selectox reactor stage. Sulfur recoveries up to 99.3% have been reported for BSR/Selectox.

About 16 Selectox plants have been built worldwide, ranging in size from about 0.5 to 30 lt/day of sulfur. It appears, from the installed plant inventory, that the process may not be economic for large sulfur plants, particularly for acid gases with a high H<sub>2</sub>S content.

The process appears to be particularly applicable for acid gases with very lean H<sub>2</sub>S feeds, but at relatively small scale. Reports have also surfaced that problems with catalyst deactivation, both Selectox and Claus, may be experienced when acid gases contain contaminants or gas flow upsets [37]. The absence of a Claus plant furnace allows some contaminants, such as various hydrocarbons, to react on the catalysts, causing hot spots. Thus, the process may not be as forgiving as conventional Claus.

### ***Wet Oxidation (Redox) Processes—LO-CAT and SulFerox***

The wet oxidation processes are based on reduction-oxidation (Redox) chemistry to oxidize the H<sub>2</sub>S to elemental sulfur in an alkaline solution containing an oxygen carrier. Vanadium and iron are the two oxygen carriers that are used. The best example of a process using the vanadium

## SFA Pacific, Inc.

carrier is Stretford. The most prominent examples of the processes using iron as a carrier are LO-CAT and SulFerox. LO-CAT was developed by ARI Technologies in the early 1970s and is now offered by U.S. Filter. The SulFerox process was developed by Shell Oil and Dow Chemical in the early 1980s. The Stretford process finds little use now because of the toxic nature of the vanadium solution. Thus, only the iron-based processes will be discussed below.

The optimum application for the wet oxidation processes is for low H<sub>2</sub>S content acid gases and small plants, 1-20 lt/day of sulfur. Costs are too high for larger plants because of equipment size limitations and plant complexity. Even for small plants, the cost of sulfur recovery exceeds by far the selling price for recovered sulfur.

Both the LO-CAT and the SulFerox processes are essentially the same in principle. The description that follows is that for the LO-CAT process.

A chelating agent is used to carry the trivalent iron that oxidizes H<sub>2</sub>S to elemental sulfur via the following simplified reaction:

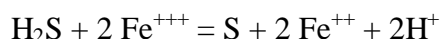

The divalent iron is then regenerated back with oxygen via:

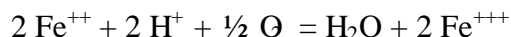

The overall reaction is:

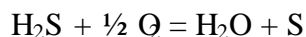

Figure 7-7 shows a simplified flow scheme for the LO-CAT process [38]. A single vessel is used for both H<sub>2</sub>S absorption and oxidation, as well as for the reoxidation of the solvent. The solution from the reactor tank, which now contains about 10 wt% sulfur slurry, is filtered and the sulfur cake recovered. Recovered sulfur may be of poor quality, although purities as high as 99.9% are reported, and has no obvious market value. The sulfur cake is sometimes sent to landfills.

The SulFerox process differs from the LO-CAT in that the oxidation and the regeneration steps are carried out in separate vessels and sulfur is recovered from the filters, melted, and sent to sulfur storage. Also, the SulFerox process uses a higher concentration of iron chelates (about 2-4 wt% vs. 250-3,000 ppmw for the LO-CAT process). This higher solution loading allows for lower circulation rates and smaller equipment sizes. The quality of the SulFerox sulfur may also be poor—it's purity is usually >99.5% but does not meet Claus sulfur specs for color, being dark yellow.

Both processes are capable of up to 99+% sulfur recovery. However, using the processes for Claus tail gas treating requires hydrolysis of all SO<sub>2</sub> in the tail gas to H<sub>2</sub>S because the SO<sub>2</sub> will react with the buffering base, KOH, and form K<sub>2</sub>SO<sub>4</sub>, which will consume the buffering solution and quickly saturate it [39].



## SFA Pacific, Inc.

There are about 100 LO-CAT and 20 SulFerox commercial operating plants worldwide. Recently, the two process suppliers merged their iron-chelate businesses in order to standardize the service and to jointly support reasearch and engineering in this type of process.

**Figure 7-7**  
**Simplified Flow Diagram of LO-CAT Autocirculation Process**

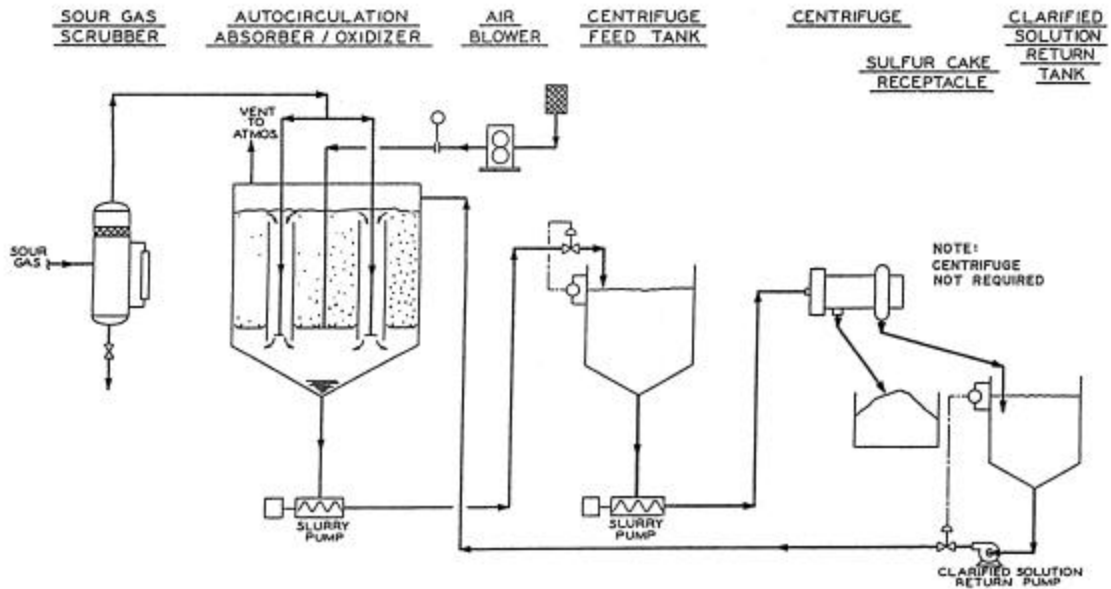

Source: Reference 38

**SFA Pacific, Inc.**

## 8. TAIL GAS TREATING

Tail gas treating involves the removal of the remaining sulfur compounds from gases remaining after sulfur recovery. Tail gas from a typical Claus process, whether a conventional Claus or one of the extended versions of the process, usually contains small but varying quantities of COS, CS<sub>2</sub>, H<sub>2</sub>S, SO<sub>2</sub>, and elemental sulfur vapors. In addition, there may be H<sub>2</sub>, CO, and CO<sub>2</sub> in the tail gas. In order to remove the rest of the sulfur compounds from the tail gas, all of the sulfur bearing species must first be converted to H<sub>2</sub>S. Then, the resulting H<sub>2</sub>S is absorbed into a solvent and the clean gas vented or recycled for further processing. This section discusses the currently most frequently used tail gas process—namely, catalytic hydrogenation/hydrolysis of the sulfur species to H<sub>2</sub>S combined with the subsequent absorption of H<sub>2</sub>S in a solvent.

Some of the extended Claus processes, already discussed in the Sulfur Recovery section of the report, are also offered as tail gas treating options. Usually such schemes involve placing a hydrolysis reactor between the last conventional Claus stage and the proprietary extended catalytic Claus stage of the given process. Such approaches have also been briefly mentioned in the Sulfur Recovery section. However, such processes have not been used up to now in commercial IGCC plants and are not discussed further.

Other sulfur recovery options, such as wet and catalytic oxidation, have also been used as tail gas treating options. These processes have already been discussed in the Sulfur Recovery section and will not be covered here because they would not be applicable to IGCC.

The clean gas resulting from the hydrolysis step can undergo further clean up in a dedicated absorption unit or be integrated with an upstream acid gas removal unit. The latter option is particularly suitable with physical absorption solvents, as has previously been discussed. The approach of treating the tail gas in a dedicated amine absorption unit and recycling the resulting acid gas to the Claus plant is the one used by the Shell Claus Off-gas Treating (SCOT) process, currently the most widely used tail gas treating option.

The hydrolysis process is also used separately from the tail gas treating process. This may be required when the acid gas removal process is incapable of removing sufficient quantity of the COS to meet the sulfur emissions regulations. In this case, the COS is hydrolyzed to H<sub>2</sub>S before the acid gas removal step, as is done in several of the commercial IGCC plants.

The hydrogenation and hydrolysis steps, and the SCOT processes are discussed below.

### **Reduction of Sulfur Compounds via Hydrogenation and Hydrolysis**

The reduction of COS, CS<sub>2</sub>, SO<sub>2</sub>, and sulfur vapor in Claus tail gas to H<sub>2</sub>S is necessary when sulfur recovery of 99.9+% is required by regulations. Usually the sulfur recovery level is set by the allowable emissions of sulfur from the tail gas incinerator. In addition, the reduction of COS is done on raw synthesis gas when the downstream acid gas removal process is unable to remove

## SFA Pacific, Inc.

COS to a sufficient extent to meet sulfur emissions regulations from combustion of the cleaned fuel gas. These sulfur compounds are reduced to H<sub>2</sub>S via hydrogenation or hydrolysis, at a raised temperature, over a catalytic bed.

### ***Tail Gas Hydrogenation/Hydrolysis***

The following description of the tail gas reduction/hydrolysis reactor is based on the one used in the SCOT process. Claus tail gas is reduced over a cobalt molybdate on alumina catalyst at a temperature of about 600°F (300°C). The reduction takes place mainly through the following reactions:

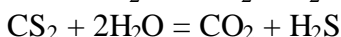
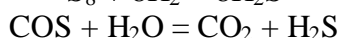
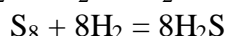
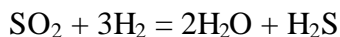

When CO is also present in the tail gas then the following reactions could also take place:

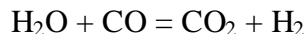
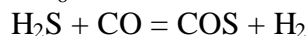
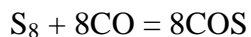
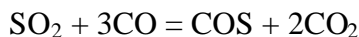

The last reaction (shift reaction) is very rapid, and the presence of CO does not seem to favor the first three reactions.

Elemental sulfur and SO<sub>2</sub> are reduced mainly via hydrogenation, while COS and CS<sub>2</sub> are mainly hydrolyzed to H<sub>2</sub>S. Sulfur and SO<sub>2</sub> are virtually completely converted to H<sub>2</sub>S when a stoichiometric excess of hydrogen is present (<10 ppmv SO<sub>2</sub>). CS<sub>2</sub> is virtually completely hydrolyzed (to about 1 ppmv). COS conversion can reach over 98%, with the resulting tail gas containing about 10 ppmv COS [40].

The hydrogen can be supplied from an outside source, can already be in the Claus tail gas, or obtained by partial oxidation of the fuel gas in a furnace. The tail gas is preheated to the reactor temperature by an in-line burner that combusts fuel gas directly into the tail gas. The same burner can also be used to supply the needed hydrogen by partial combustion of the fuel gas. When oxygen enrichment is used in the Claus plant, there is often sufficient hydrogen in the tail gas to carry out the reduction without an outside hydrogen source. There is usually sufficient water vapor in the Claus tail gas for the hydrolysis reactions.

### ***Raw Synthesis Gas Hydrolysis***

A hydrolysis reactor is often used to convert the COS in the raw syngas to H<sub>2</sub>S. The catalyst used in the reactor is of the activated alumina type. This catalyst does not activate the shift reaction, leaving the CO and other vapor constituents unconverted. The COS hydrolysis reaction over the catalyst is enhanced by low temperatures and high water concentrations. However, it is

limited by the vapor dew point and must be carried out at a temperature high enough that water does not condense on the catalyst. Conversion of COS is highest at low temperatures, but will require a higher volume of catalyst. The operating temperature can be 300°F-500°F (150°C-260°C). At its normal operating temperature of about 475°F (245°C), COS conversion reaches chemical equilibrium, which usually corresponds to about 1-10 ppmv COS remaining in the converted gas [41].

The COS hydrolysis reactor is best placed right after the synthesis gas particulate scrubber, where the synthesis gas temperature is near that of the reactor operating temperature.

There is now ample commercial experience with this operation with synthesis gas and it should pose no design problems for engineering contractors or catalyst suppliers.

## **The SCOT Process**

The SCOT (Shell Claus Off-gas Treating) process was developed by Shell in the early 1970s. Over 160 SCOT plants have been constructed worldwide since then. The process consists of a combination of a catalytic hydrogenation/hydrolysis step and an amine scrubbing unit. The hydrogenation/hydrolysis of the sulfur compounds in the tail gases from the Claus unit has already been covered above. This discussion will focus mainly on the options for amine scrubbing of the reduced gas from the hydrogenation/hydrolysis step.

The early SCOT units consisted of a hydrogenation/hydrolysis reactor and a conventional amine unit. Figure 8-1 shows a simplified schematic of a conventional early SCOT unit [42]. The Claus tail gas, after being reduced in the reactor, is cooled in a quench column and scrubbed by a Sulfinol solution. The clean tail gas goes to a Claus incinerator and the acid gas rich solution is regenerated in a stripping column. The treated tail gas can also be compressed and sent, with the clean fuel gas to the IGCC unit, avoiding the use of the incinerator as is done in the ISAB IGCC plant. The acid gas off the top of the stripper is recycled back to the Claus plant for further conversion of the H<sub>2</sub>S. The treated tail gas in the early plants typically contained 300 ppmv of H<sub>2</sub>S and about 10 ppmv of other sulfur compounds (COS + CS<sub>2</sub>) [40].

The absorber is operated at near atmospheric pressure and the amine solvent is not highly loaded with acid gases. Because the solution is not highly loaded, unlike high pressure operation, there is no need for an intermediate flash vessel and the loaded solution goes directly to a stripper.

Early SCOT units used DIPA in the Sulfinol (Sulfinol-D) solution. MDEA-based Sulfinol (Sulfinol-M) was used later to enhance H<sub>2</sub>S removal and to allow for selective rejection of CO<sub>2</sub> in the absorber. As environmental regulations tightened, the use of Sulfinol-M, together with a different plant configuration, allowed H<sub>2</sub>S levels to be reduced to below 10 ppmv in the treated tail gas. Also, the solution circulation rate with Sulfinol-M was reduced because of lower CO<sub>2</sub> absorption.

**Figure 8-1**  
**The SCOT Process**

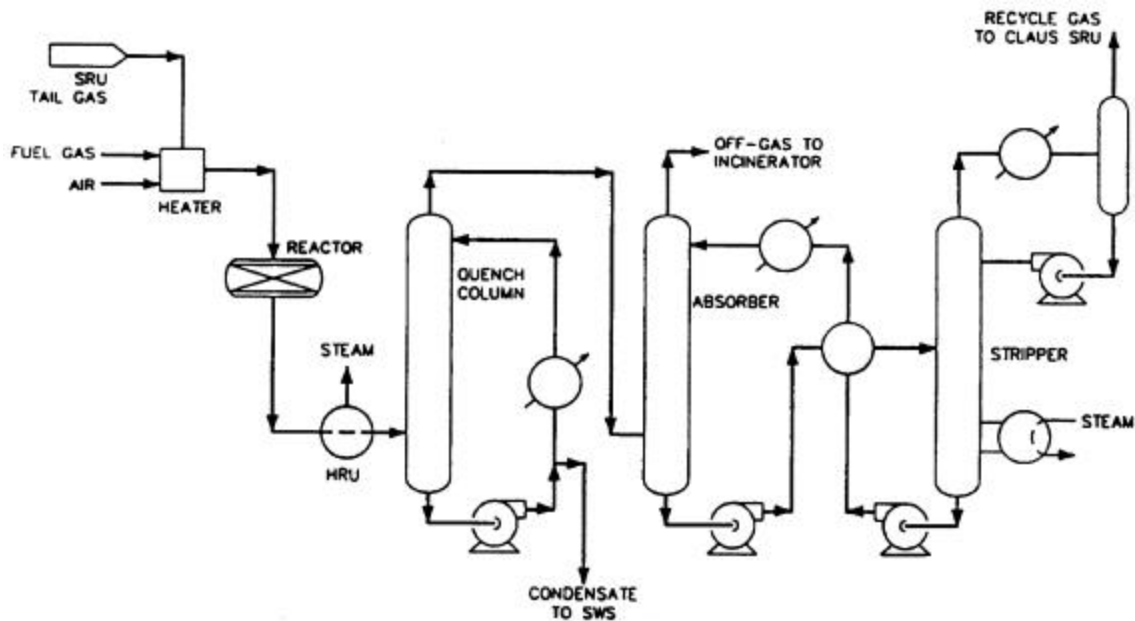

Source: Reference 42

To achieve the lowest  $H_2S$  content in the treated gas, the Super-SCOT configuration was introduced. In this version, the loaded Sulfinol-M solution is regenerated in two stages. The partially stripped solvent goes to the middle of the absorber, while the fully stripped solvent goes to the top of the absorber. The solvent going to the top of the absorber is cooled below that used in the conventional SCOT process. Cooling water is required for top of the absorber solvent cooling, since air cooling would be insufficient. Super-SCOT can meet a 10 ppmv  $H_2S$  specification, but only with high stripping heat and solvent circulation penalties.

A later version of the SCOT process was introduced to address the high circulation and stripping duties of the Super-SCOT version. An MDEA-based Ucarsol 103 solvent is used in the L-S SCOT process version. An additive to this solvent improves stripping through equilibrium changes in the bottom of the stripper. Thus better stripping is achieved with the same steam rate, or less steam can be used for the same stripping requirements. This version can also achieve a 10 ppmv  $H_2S$  specification in the treated tail gas. Any unconverted COS is not absorbed in any of the SCOT process versions that use selective solvents. COS is partially removed if aqueous DIPA or Sulfinol-D are used as a solvents. Other solvents, such as Flexsorb, have also been used in SCOT units.

The SCOT process can be configured in various other ways. For example, it can be integrated with the upstream acid gas removal unit if the same solvent is used in both units. In this mode, a common stripper can be utilized. Another configuration has been used to cascade the upstream gas cleanup with the SCOT unit. An  $H_2S$ -lean acid gas from the upstream gas treating unit is

## **SFA Pacific, Inc.**

sent to a SCOT process with two absorbers. In the first absorber, the H<sub>2</sub>S lean acid gas is enriched, while the second absorber treats the Claus tail gas. A common stripper is used for both SCOT absorbers. In this latter configuration, different solvents could be used in both the upstream and the SCOT units. There are many other possible configurations for laying out the SCOT process.

Other licensors offer similar processes to SCOT, using their proprietary solvents and catalytic reduction reactors. However, the SCOT process remains by far the most widely used commercially.

**SFA Pacific, Inc.**



## **9. HOT AND WARM GAS CLEANUP**

The development of hot gas cleanup (HGCU) systems for acid gas and particulates removal from syngas has been pursued in the U.S., Europe, and Japan since the 1970s. Until about the mid-1990s, this work was primarily focused on syngas from air-blown gasification of coal. Air-blown gasification systems produce over twice the volume of syngas (due to the nitrogen dilution) that O<sub>2</sub>-blown systems produce, and therefore incur more severe thermal, process efficiency, and capital cost penalties related to syngas cooling to comparable temperature levels. Conventional cold gas cleanup (CGCU) with air-blown systems is uneconomical. Hence, the success of air-blown gasification combined cycle power plants depends on the success of HGCU developments. However, HGCU is also applicable to syngas from O<sub>2</sub>-blown gasification, so that O<sub>2</sub> gasification also would benefit from the successful development of competitive HGCU systems [43].

### **Drivers for HGCU**

The drivers for HGCU in IGCC have been:

- The higher process efficiency achievable without syngas cooling and removal of water from the syngas.
- The elimination of sour water treating. (Sour water is produced when the syngas is cooled below the dew point of water.)
- The elimination of the “black mud” (troublesome ash-char-water mixture) produced in water-quenching or wet scrubbing of particulates from the syngas.
- Potential capital and operating cost savings related to the foregoing items.

Until the late 1990s, the focus of most HGCU programs was the removal of the sulfur, chloride, alkali, and particulates from syngas at temperatures close to the highest inlet temperature at which gas turbine (GT) fuel control and delivery systems could be designed. This level was set at about 1,000°F by the requirement for very low alkali (potassium and sodium) content of the fuel gas to prevent alkali corrosion of hot GT components and the desire to avoid expensive materials and unreliable refractory-lined piping [44,45]. Below 1,000°F the alkali vapor components are essentially completely condensed on particulates in the hot syngas, which are then filtered from the syngas by barrier filters [45]. However, this temperature requirement means that significant syngas cooling is still necessary, since commercial gasifiers produce raw syngas at 1,700-3,000°F, depending on the gasifier design and the feedstock [46].

The removal of particulates from the hot gas by dry filtration avoids wet (water) scrubbing and the production of black mud—the unburned carbon-ash-water mixture produced when the raw syngas is quenched or wet scrubbed to remove the entrained particulates. Particulates recovered dry can be easily recycled to gasification to improve fuel utilization and process efficiency. Black mud is difficult to process and is not amenable to recovery of unburned carbon. It is therefore also a waste disposal problem.

## **Waning Interest in HGCU**

Various HGCU systems have been tested at the pilot plant level and a small number have been installed in commercial-scale IGCC demonstration plants in the U.S. and Europe. However, both industry interest (which has always been limited) and government interest in HGCU have declined for several important reasons [45,47,48]; namely:

- Process and equipment development challenges in HGCU; e.g., excessive attrition of the solid desulfurization sorbents; chloride stress corrosion issues; and the high cost and unproven status of GT fuel control valves for syngas fuel at temperatures above about 800°F.
- Hot gas desulfurization has not been demonstrated. The hot desulfurization processes installed as parts of the Tampa Electric and Piñon Pine IGCC demonstrations were never operated. The Piñon Pine gasifier itself did not achieve operability.
- The trend toward increasingly stringent air emissions standards, including mercury removal from fossil power plant stack gas and the potential for mandated CO<sub>2</sub> mitigation. Specifically, HGCU at this stage of its development does not remove ammonia or HCN, COS, mercury, CO<sub>2</sub>, nor all of the H<sub>2</sub>S from syngas. Ammonia and HCN are converted to NO<sub>x</sub> and COS is converted to SO<sub>2</sub> in the GT. Very low levels of SO<sub>2</sub> are necessary to prevent ammonium bisulfate fouling of the low-temperature HRSG surfaces in IGCC cases in which SCR is required. Present indications are that efficient mercury removal will require syngas cooling to the temperature levels of CGCU.
- The success of the demonstration and commercial O<sub>2</sub>-blown coal, petroleum coke, and petroleum residual oil gasification projects for IGCC and chemical synthesis gas production with conventional CGCU—in the U.S. and Europe. The number of commercial IGCC projects with CGCU has been proliferating worldwide [49].

At the same time, hot particulates control devices (candle filters) have been successfully demonstrated at least three of the IGCC and gasification demonstration projects (Berrenrath, Buggenum, Puertollano, and the switch at Wabash to metallic candles). These barrier filters represent the only currently commercially applicable HGCU technology. One conclusion of the U.S. Department of Energy's (DOE's) recent extensive gasification industry interviews is that removal of particulates is the only hot gas cleaning technology that is viewed to have a future [48]. Nevertheless, further performance and cost improvements in the technology are desirable. Breakage (fragility) is the most serious issue with ceramic filters.

The DOE gasification industry interviews also found that currently there is not much incentive for gas cleanup operations above 700°F. Prior engineering analyses have persuaded the industry that the efficiency improvements from operating above 800°F are not worth the additional capital costs due to materials and the increased equipment sizes resulting from the larger volumetric flows. The industry interviews also found concerns about the effectiveness of dry sorbent-based technologies and the efficiency of regeneration at lower temperatures. Nevertheless, the interviews indicated some interest in the possibility of dry cleanup processes that could operate at temperatures closer to downstream requirements; e.g., in the 300-700°F range [48].

DOE has recognized many of the issues and limitations surrounding hot gas cleaning technologies and their applications. Consequently, DOE's Gasification Technologies program has transitioned its gas cleaning component away from the development of high-temperature approaches to more moderate temperatures consistent with downstream applications [48].

The commercial status of HGCU in IGCC is briefly reviewed here—focusing on the pertinent U.S. and European experience. Three long-running DOE R&D programs are also briefly mentioned. Overall, HGCU R&D in the U.S., Europe, and Asia appears to be continuing mainly at universities and both private and government research organizations, with government support.

## **Further Temperature Considerations**

### ***Mercury Removal***

The prospect of stringent mercury emissions standards for coal-conversion plants seriously dampens the outlook for hot or warm gas cleanup. It is believed that mercury removal becomes more difficult as the syngas temperature increases. If it is necessary to cool the syngas for mercury removal, then the rationale for hot or warm gas desulfurization is gone unless related economic benefits can be demonstrated [45,47,48].

### ***“Hot Gas” or “Warm Gas” Cleanup?***

The term “hot gas” cleanup is actually a misnomer, because of the required syngas cooling to 1,000°F for the removal of alkalis condensed on the particulate matter. Most of the cleanup systems that have been under development have maximum operating temperatures of about 900-1,100°F [43]. So substantial syngas cooling is still required before gas cleanup—and “hot gas” cleanup is really “warm gas” cleanup. Even with partial cooling the syngas cooler is a significant capital cost item in IGCC.

### ***GT Fuel Control Valves***

Even further cooling to temperatures below about 700-800°F is desirable, because of the expensive alloys and equipment sizes required for the GT combustor fuel control valves at higher syngas temperatures. GE prefers GT fuel temperatures under 300-400°F. Above 400°F, the teflon sealing system in the flow control valves may melt, and metal seals are required, which are leakage prone. Valve size also must increase as temperature is increased. Above about 600°F and up to 750°F other materials must be used. Above 750°F, higher-grade stainless steels and nickel-based super alloys must be used—culminating with Inconel at about 1,000°F. GE is not certain that valves are available which would be suitable for elevated temperature syngas fueling of the large GTs (>125 MW) considered for large IGCC power plants [50]. The only GT fuel control valve designed and installed for 1,000°F service is on the 70 MW GE Frame 7FA GT at the Piñon Pine IGCC. However, it appears that this fuel system will never be tested at the design conditions, since that IGCC demonstration has been terminated. Nevertheless, the GE Frame 6FA GT combined cycle portion of the plant is running well on natural gas [51].

## ***Syngas Conversion to Synthetic Fuels***

Catalytic synthesis gas conversion processes (e.g., methanol synthesis and Fischer-Tropsch synthesis) typically operate in the 400-650°F temperature range and require contaminant-free syngas (no sulfur, trace metallic, or nitrogen constituents, except N<sub>2</sub>). Some participants in DOE's gasification industry interviews indicated an interest in the potential for development of gas cleanup processes that operate at temperatures closer to the downstream requirements of synthesis processes than at the lower temperatures of conventional CGCU [47,48].

## **Particulates Removal Experience**

Candle filters have been the focus of most efforts for final fine particulates removal with large syngas flows. These devices are porous ceramic or metal tubes mounted in bundles in tube sheets contained in a filter vessel. The syngas flows from the outside through the porous tube walls and flows out of the vessel through the insides of the tubes. Back pulsing the filtered gas dislodges the particulates from the outside walls and they are discharged from the bottom of the vessel. The issues with candle filters are the large number of candles required, first costs, difficult and labor-intensive field installation, blinding of pores by fine particulates, ash bridging between candles, flyash sticking to the candles, the requirement for off-line cleaning in some cases, breakage (fragility) of the ceramic candles, and candle life. Candle breakage without downstream wet scrubbing or other safeguards could result in catastrophic GT damage from the particulates.

Ceramic candle filters are or have been employed successfully in the gasification demonstrations in Europe. Most of the European demonstration plants have cyclones upstream, which remove most of the particulates before the syngas enters the filter vessels, thus greatly reducing the dust loadings on the candles. If breakage occurs, downstream water scrubbers remove the particulates and protect the plants' CGCU systems. All of those gasifiers are O<sub>2</sub>-blown.

The 600 mt/d HTW lignite coal gasification demonstration plant (syngas to methanol) at Berrenrath, Germany concluded several years of successful operations late in 1997. The project reported 15,500 hours of apparently satisfactory operation with the filters up to the end of the demonstration program. The plant employed 450 candles supplied by Schumacher in an improved filter configuration jointly developed by Rheinbraun AG and Lurgi Lentjes Babcock (LLB) [52].

For the 250 MW coal-fired IGCC demonstration at Buggenum, The Netherlands (Shell Gasification Process), the last reported expected candle lifetime for the Buggenum plant's filters was 16,000 operating hours [53].

The 320 MW ELCOGAS coal- and coke-fired IGCC demonstration at Puertollano, Spain (Prenflo Gasification Process) employs similar filters (more than 2,000 candles), and appears to have resolved earlier candle failure problems. This plant does not have a cyclone ahead of the candle filters [54,55].

## **SFA Pacific, Inc.**

In the U.S., the 260 MW coal- and coke-fired IGCC demonstration at PSI Energy's Wabash River plant in Indiana (Global EGas Gasification Process) switched from ceramic to sintered metal candle filters in 1997, after two years of very costly experience with breakage of the fragile filters. During the first year of the plant's operation, 40% of its downtime was due to filter breakage, caused by bridging of the char between candles. The metallic high alloy filters also can be welded into the tube sheets, eliminating the difficulties of obtaining leakage-free seals at the tube sheets with the ceramic filters. The new filters have performed satisfactorily—running at 400 psi and 700-800°F—although the pores gradually get plugged by the very fine char. The candles have to be removed every six months for cleaning, since on-line cleaning is not possible. Eventually the candles become irreversibly plugged and must be replaced.

Global is still testing ceramic candles in a syngas slipstream—and they are still breaking. The Wabash River plant does not have a cyclone ahead of the filter, so its syngas solids loading at the filter is about 10 times that of the syngas into the ceramic candle filters at the Buggenum plant. Global is proposing to install a cyclone in the slipstream for the ongoing candles testing, which is sponsored by DOE. Global also indicated that its next commercial plant would include a cyclone ahead of the filters. The company also recently re-evaluated the metallic candle filters versus wet scrubbing and concluded that they are better off to stay with dry particulates removal to avoid the black mud and water issues of wet scrubbing [56]. The Wabash River IGCC is a U.S. DOE Clean Coal Technology (CCT) Program demonstration project.

The 100 MW coal-fired Piñon Pine IGCC plant at Sierra Pacific's Tracy Station near Reno, Nevada (Kellogg Brown & Root (KBR) air-blown gasification with HGCU) also experienced ceramic candle breakage over the course of its many aborted start-up attempts. The filter system, provided by Westinghouse, appears to be similar to that used at the Berrenrath demonstration plant.

With HGCU systems the hot gas filter system must follow the desulfurization system. Excessive sorbent attrition can place an excessive load on the filters, causing breakage or plugging of the solids withdrawal line.

### **Hot Desulfurization Demonstrations**

The only two large-scale “hot gas” desulfurization systems installed in the U.S.—both in DOE CCT IGCC demonstration projects—have never been demonstrated. Consequently, their ultimate commercial feasibility may never be known. Both systems were similarly based on the reaction of H<sub>2</sub>S with zinc oxide-nickel oxide solid sorbents in an adsorption column—followed by regeneration of the sorbent by contact with air in a separate column. The regenerator off-gas contains SO<sub>2</sub>, which must be converted to elemental sulfur or sulfuric acid in a final recovery operation. There are no large-scale hot or warm desulfurization demonstrations elsewhere.

As discussed earlier, the demise of the drivers for the development of these particular technologies probably now means that they are not worth pursuing as originally conceived for the demonstrations. The systems are briefly described further below.

## SFA Pacific, Inc.

The 260 MW coal-fired IGCC at Tampa Electric Company's (TECO's) Polk County Station in Florida (Texaco gasification process with a radiant syngas cooler, convective coolers, and water scrubbing) is equipped with both a 100% capacity CGCU system and a 10% capacity HGCU system—to be fed by a syngas slipstream. The plant is operating well with the CGCU system. The HGCU was based on a down-flow moving-bed H<sub>2</sub>S adsorption process developed by GE. The design placed the absorber column on top of the down-flow regenerator column—in one tall column. The regenerated sorbent is transported back to the top of the column. The SO<sub>2</sub> was to be converted to sulfuric acid for sale. Some observers have noted that the physical size of the 10% capacity HGCU appears to be much larger than that of the 100% capacity CGCU section of the plant.

The HGCU demonstration was cancelled for the following reasons: (1) The fouling factors in the waste heat boiler (radiant syngas cooler) were not as severe as predicted. Consequently, heat recovery was more efficient and the syngas was cooled to about 700°F—a much lower temperature than expected. A temperature of at least 900°F is needed for the HGCU. (2) Cold flow attrition tests on the sorbent showed that sorbent attrition would be very high—leading to extremely high annual sorbent costs. (3) There were also concerns about the potential for chloride stress corrosion cracking with the materials used in the HGCU [57].

The Piñon Pine IGCC system in Nevada is designed with a KBR air-blown, fluidized-bed gasifier (operating at 1,800°F) with limestone injection for partial in-situ H<sub>2</sub>S capture (as CaS)—followed by final H<sub>2</sub>S scrubbing from the syngas in an entrained-flow absorber. Unfortunately, numerous problems with solids transport (esp. flyash) in the gasifier system have prevented successful start up [51], and it appears that this DOE CCT Program demonstration project has been terminated.

The Piñon Pine flow scheme employs entrained-flow H<sub>2</sub>S adsorption and regeneration columns—called transport reactors by KBR. The coal ash-char-CaO-CaS solids from the gasifier, the SO<sub>2</sub> from the regenerator, and additional limestone, are fed to a “sulfator”—a bubbling fluidized bed combustor in which most of the sulfur is converted to CaSO<sub>4</sub>. Thus SO<sub>2</sub> emissions from this plant would come from both the GT exhaust gas and the sulfator. As in the TECO case, pre-startup testing indicated excessive sorbent attrition. As of the last start-up attempts (2000), a sulfur sorbent with satisfactory mechanical durability had not been identified [45].

It is instructive for future scale-up considerations to note that this 880 t/d gasifier design was a high-risk 40-fold scale-up from the successful 20-24 t/d pilot plant program in which the KBR gasifier was developed. Also, although the desulfurization transport reactor is patterned after proven catalytic reactors used in petroleum refining, the desulfurization system (including a qualified sorbent) itself was not previously demonstrated at an intermediate scale.

At the Berrenrath High-Temperature Winkler (HTW) gasification demonstration plant, Rheinbraun reportedly tested a technique called direct desulfurization or direct sulfur recovery. Apparently the addition (or presence) of a metal oxide catalyst into the gasifier or the syngas stream is required in this process, and an oxygen-containing gas is added to the syngas after the syngas cooler but before the candle filters at a temperature of about 400-520°F. Rheinbraun

## **SFA Pacific, Inc.**

claims that its tests at Berrenrath show that the H<sub>2</sub>S is completely converted into elemental sulphur, while the COS is partly converted. The sulfur (solid particulates) and the dust are separated from the syngas by the filter. Ammonia is not removed in this process. This process has been proposed for testing with a slipstream at the planned 400 MW HTW IGCC plant at Vresova in the Czech Republic. DOE and DOE-sponsored researchers have also been investigating variations on this process [52,54].

### **HCl Removal**

Nahcolite (naturally occurring sodium bicarbonate), Trona (naturally occurring sodium sesquicarbonate), synthetic sodium carbonate/bicarbonate mixtures, Ca(OH)<sub>2</sub>, and other sorbents are effective for dry removal of HCl and HF from syngas. Sorbent requirements and performance depends on the gas conditions and the contaminant concentrations. Injection before the filter is necessary.

### **CO<sub>2</sub> Mitigation**

There is no hot or warm gas cleanup process for CO<sub>2</sub> removal. However, it has been suggested that syngas shifted to H<sub>2</sub> and CO<sub>2</sub> could be separated with a hot gas membrane system into a pure H<sub>2</sub> stream and a CO<sub>2</sub> stream, which would contain all of the other gas contaminants, such as H<sub>2</sub>S, COS, NH<sub>3</sub>, etc. However, the H<sub>2</sub> would be produced at near-atmospheric pressure, requiring compression for use in IGCC or refinery processes [45,47,48]. The further processing of CO<sub>2</sub> that would be required would depend on the sequestering options available. Most likely, any hot gas membrane would require the prior removal of all particulate material and other trace components that may be corrosive or plug the membranes pores [45].

### **Continuing DOE and EPRI Warm Gas Cleanup Programs**

Three long-running DOE-supported R&D programs on warm gas cleanup continue—at Siemens Westinghouse Power Corporation (SWPC), Research Triangle Institute (RTI), and the Power Systems Development Facility (PSDF)—operated by Southern Company Services at Wilsonville, Alabama. EPRI is also providing support for the PSDF program, along with the Southern Company.

SWPC's activities include: the assessment of barrier filter materials and filter performance, the development of a candle filter failure safeguard device (SGD), and R&D on a conceptual 4-stage process that the investigators are calling the "Ultra-Clean Process." While this process is targeting removal of H<sub>2</sub>S, HCl, and particulates to sub-ppm levels, it does not remove NH<sub>3</sub>, HCN, or mercury [58]. A 10 t/d fluidized bed gasification pilot plant is being constructed at the Gas Technology Institute (GTI) for testing the "Ultra-Clean Process." The filter R&D programs have concluded this year, while the "Ultra-Clean Process" R&D contract will run at least until mid-2004.

## SFA Pacific, Inc.

RTI is investigating a conceptual multi-step process that includes H<sub>2</sub>S/CO<sub>2</sub>/H<sub>2</sub>O removal by a solubility-selective polymer membrane, recovery of elemental sulfur by RTI's Direct Sulfur Recovery Process (DSRP), and removal of ammonia by zeolite molecular sieves. While the work is targeting very low emissions levels, rapidly decreasing membrane selectivity as temperature increases above 25°C (77°F) is a challenge. The other participants in this program are DuPont, Air Liquide, North Carolina State University, Prototech Company, SRI International, and Nexant [55].

The PSDF facilities include a 1.6 t/hr KBR transport reactor, SWPC particulates control devices, (PCDs – with candle filters), and a low-NO<sub>x</sub> topping combustor with an Allison 501-KM gas turbine generator set (4 MW nominal). The transport reactor can be operated in the combustion mode or gasification mode. One of the PSDF's earlier anticipated uses was to have provided R&D support to the now defunct Piñon Pine IGCC demonstration. From DOE's perspective, the primary focus of the PSDF now is to demonstrate and evaluate the transport reactor and high-temperature, high-pressure PCDs for advanced power generation systems, such as GT combined cycles and fuel cells [55]. The transport reactor is also part of the research portfolio for DOE's *Vision 21* program, which includes evaluating the KBR reactor as a potential commercial gasifier and possibly using the facility for HGCU R&D [59]. Overall, the ambitious DOE/EPRI/Southern Company program for the PSDF through 2004 includes tests of both air- and O<sub>2</sub>-blown KBR reactor gasification, hot gas filtration, ash removal, hot gas desulfurization, sulfur recovery, and trace element and mercury removal from syngas [60].

As a circulating entrained-flow reactor, the transport reactor offers the fuel flexibility characteristic of circulating fluidized-bed (CFB) systems. In addition, since it operates at higher solids circulation rates than conventional CFB reactors, it offers potential performance improvements relative to CFB reactors [55]—but not necessarily relative to the already commercially proven O<sub>2</sub>-blown entrained-flow gasification processes.

### Outlook

Continued improvements in hot particle filtration, which is commercially available technology, can be expected. Upstream cyclones are important components of a hot particle removal system—to minimize the load on the hot filters. Overall, hot gas filtration offers definite advantages to IGCC over water scrubbing.

The development of hot gas cleanup systems for deep cleaning of sulfur and nitrogen components from syngas appear to be long-term prospects. Large-scale demonstrations probably would not be achievable or practical before about 2010. Justification for such demonstrations could become difficult if commercial IGCC projects with CGCU continue to proliferate and operate well over the next several years.

The prospects of developing hot or warm gas cleanup processes for mercury and CO<sub>2</sub> removal presently are very challenging. Either, or both, the requirement for mercury recovery and/or CO<sub>2</sub> recovery from coal-fired power plants could become the Achilles' heel of dry gas cleanup—dictating the use of O<sub>2</sub>-blown IGCC with CGCU.



## 10. ACID GAS INJECTION

Acid gas injection (AGI) is an alternative to sulfur recovery that is practiced widely in the natural gas and the petroleum industries. Essentially, it consists of compressing and injecting the acid gases from the gas processing units into depleted reservoirs or saline aquifers. It has previously been done on small acid gas streams that were too small for economic sulfur recovery. However, as the emission regulations have grown ever more stringent, it has become an economic alternative to the rising cost of sulfur recovery and tail gas treating. It is one way to eliminate all sulfur emissions, and in some cases, even to dispose of unwanted wastewater streams. Also, low sulfur prices make sulfur recovery less economic, and some operators have considered abandoning Claus sulfur recovery for AGI.

There were 22 AGI projects in Western Canada reported in 1999. Canada's first acid gas injection project was started in 1989. In terms of the amount of sulfur being injected, the Canadian projects vary from 1 to 465 t/d. There are also many operating projects in the United States. The biggest project under development in the United States is that of ExxonMobil at Labarge, Wyoming. In this project, about 63 MMscf/d of acid gas (65% H<sub>2</sub>S and 35% CO<sub>2</sub>) will be injected by 2003. The amount of sulfur that will be injected in this project is about 1,755 st/d.

These AGI projects, although intended primarily for sulfur disposal, are also CO<sub>2</sub> sequestration projects by default. The ExxonMobil project will also sequester about 1,300 st/d of CO<sub>2</sub>, equivalent to approximately 24% of the CO<sub>2</sub> emitted from a 250 MW coal-fired IGCC facility.

There are three basic steps to AGI; compression, pipeline, and the injection well. There is some controversy as to whether the acid gas has to be dehydrated also. Some feel that dehydration reduces the potential for corrosion, due to water phase dropout at elevated pressures, and many projects have dehydration as a component.

The acid gas from the solvent regenerator of a gas treating plant is compressed from essentially atmospheric pressure to the wellhead injection pressure (700-2,000 psi) in several stages, usually four. Water will condense out in interstage coolers of the first three stages. The final stage outlet should have no condensed water present. Some projects have incorporated a glycol dehydrator either after the second or the third compression stage to make certain that no water will drop out after the final compression stage. All of the equipment up to the first stage compressor cylinder can be carbon steel. Interstage coolers and associated piping and scrubbers have to be of stainless steel. If a dehydrator is used, then all equipment downstream of the dehydrator can also be of carbon steel [61]. One engineering company (Gas Liquids Engineering, Ltd.) does not use dehydrators in its AGI designs, and has had no problems with water condensation in any of its projects [62].

For economic reasons, the pipeline from the gas processing facility to the wellhead is kept as short as possible, particularly if no dehydration is used because stainless steel is often specified in this case. If a glycol dehydrator is used, then some H<sub>2</sub>S will be emitted from the glycol dehydrator vent. This H<sub>2</sub>S stream will need to be incinerated before venting.

## **SFA Pacific, Inc.**

Marathon Oil has patented a process to inject acid gases together with wastewaters into a disposal wells. The acid gas comes as a liquid from the last stage compressor cooler, and is then carried with added wastewater through the wellhead choke with minimum flashing. Such a system does not use dehydrators. This system was first used at the Marathon plant in New Mexico in 1996 [63]. Consideration has to be given to materials of construction where water is likely to condense. Part of the pipeline and the wellhead, which handle corrosive wastewater, will need to be of stainless steel.

AGI offers an attractive alternative to sulfur recovery if suitable injection strata are available. The costs of drilling the well and building the compression facility can in some cases be less than other sulfur abatement options.

## 11. CO<sub>2</sub> REMOVAL FOR SEQUESTRATION

IGCC is exceptionally suitable for near total removal of CO<sub>2</sub> for subsequent sequestration, should that become necessary. Synthesis gas is CO shifted and the resulting CO<sub>2</sub> is removed by one of the acid gas removal (AGR) processes from the shifted hydrogen-rich fuel gas. CO<sub>2</sub> is then flashed and stripped out of the loaded solvent and is available for compression for subsequent sequestration. There are several process configurations for IGCC that could be used to remove nearly all of the CO<sub>2</sub>. The process configurations depend on the placement of the CO shift step and the choice of the acid gas removal process. Figure 11-1 shows the processing options for handling acid gases in an IGCC plant. Essentially, the choice is whether the acid gases are removed from synthesis gas both before and after CO shift, or whether all are removed after the shift step.

If CO<sub>2</sub> is to be sequestered, and well injection of H<sub>2</sub>S together with CO<sub>2</sub> is allowed, as is commercially practiced (see the Acid Gas Injection section), then selective removal of H<sub>2</sub>S is not necessary, since there is no need for sulfur recovery. This configuration is shown as Option 1 in Figure 11-1. If H<sub>2</sub>S cannot be injected into the well with CO<sub>2</sub>, then selective removal of H<sub>2</sub>S will be necessary for the downstream sulfur plant. In either case, a physical solvent AGR process is the appropriate choice when sour gas CO shift is done.

Placement of the CO shift reactor ahead of the AGR has two advantages: (1) the gas isn't cooled after particulate removal and (2) the acid gas is removed in one step. This option may be particularly suitable for quench type gasifiers which have higher temperature, water-saturated raw synthesis gas after particulate removal. The shifted gas is then cooled and the acid gas scrubbed out. If sulfur recovery is necessary, then selective H<sub>2</sub>S removal is necessary. CO<sub>2</sub> is then removed sequentially. An acid gas enrichment step may be necessary to increase the H<sub>2</sub>S concentration to the sulfur recovery unit. Such configuration is shown as Option 2 in Figure 11-1. Because the CO<sub>2</sub> partial pressure is high, a physical solvent AGR process may be appropriate here. A physical solvent AGR process is even more appropriate for those gasifiers that produce more CO<sub>2</sub>. A sulfur tolerant CO shift catalyst has to be used in this case.

When selective removal of H<sub>2</sub>S is required and the synthesis gas is cooler and contains less CO<sub>2</sub>, then the CO shift reactor could be placed after H<sub>2</sub>S is removed in the AGR unit. Gasifiers that are dry fed usually contain less CO<sub>2</sub> and, if a waste heat boiler is used with the gasifier, then the synthesis gas temperature may be lower than that of the quench-only gasifier. In this case, CO is shifted after H<sub>2</sub>S removal, and the resulting CO<sub>2</sub> is removed in another absorber. Such a layout is shown as Option 3 in Figure 11-1, and is similar to that shown in Figure 6-6 (Acid Gas Removal section). Both amine and physical solvent processes could be considered in this case.

It is possible to use two separate AGR processes for H<sub>2</sub>S and CO<sub>2</sub> removal to take advantage of the best characteristic of each. However, one process is simpler and is the preferred option. H<sub>2</sub>S and CO<sub>2</sub> removal, although separate steps, are usually integrated in such a way that solvent absorption and regeneration are combined to use one column for each operation. Usually absorption takes place in two stages in the same column, with separate side feeds of partially and fully regenerated solvent. Solvent regeneration takes place via flashing and several stages of

## **SFA Pacific, Inc.**

stripping in the regenerator column. Such integration is shown in Figures 6-5 and 6-6, which show the Lurgi Rectisol process schemes, can also be used for the amine processes.

CO<sub>2</sub> recovery is enhanced slightly when the acid gas enrichment step is included. However, this is costly and is only justified for improved operation of the sulfur recovery plant. CO shifting and CO<sub>2</sub> removal add substantial costs to IGCC and decrease plant efficiency.

**Figure 11-1**  
**CO<sub>2</sub> Separation Options for IGCC**

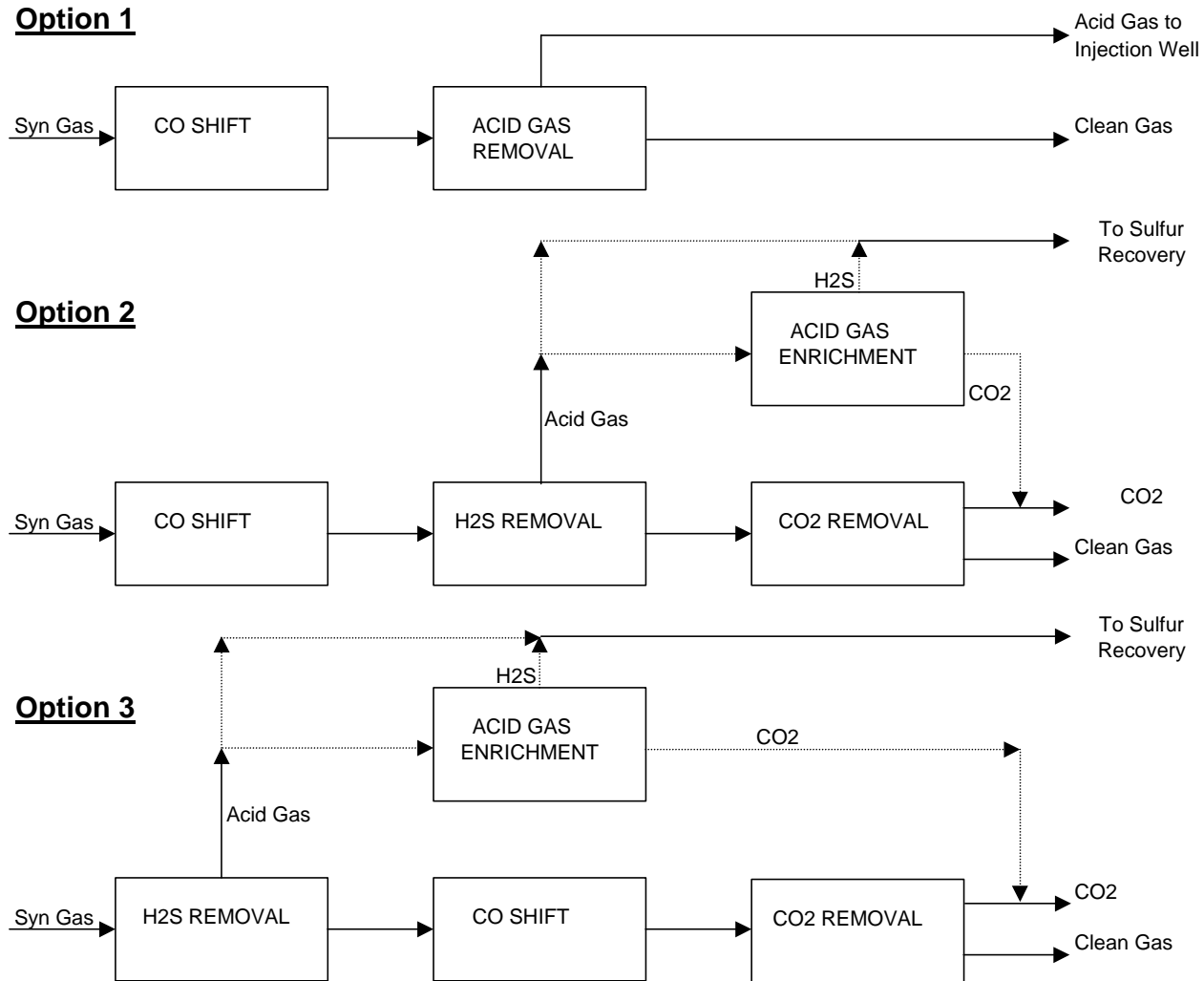

Source: SFA Pacific, Inc.

**SFA Pacific, Inc.**

## 12. CONCLUSIONS AND RECOMMENDATIONS

### Conventional Cold Gas Cleanup

The currently available technologies for acid gas removal, sulfur recovery, and mercury and metal carbonyl removal are capable of meeting anticipated future more stringent regulations, but at a substantial economic penalty. The following are some of the conclusions and recommendations reached in this study.

- The gas treating processes available in 1987 are still the mainstays of industry today.
- Carbon beds are necessary for the removal of mercury and metal carbonyls. The technology is commercial, and can remove the compounds to below detectable limits. However, the regeneration of spent carbon with mercury on it is currently uneconomical—it is usually disposed of at a suitable storage site. Mercury laden carbon regeneration should be investigated further.
- Currently the main processes of choice in commercial IGCC facilities for the removal of acid gases are both the chemical solvent acid gas removal (AGR) processes based on methyldiethanolamine (MDEA) and the physical solvent-based Selexol process—which employs mixtures of dimethyl ethers of polyethelene glycol.
- Commercial MDEA formulations (with proprietary additives) have been developed, which offer enhanced selectivity for H<sub>2</sub>S, and their use is widespread in the gas treating industry.
- BASF Corporation has shown some success in tests of its newly formulated MDEA solvent, which removes much of the COS while retaining a high degree of H<sub>2</sub>S selectivity. However, the performance to date is not adequate for the elimination of the COS hydrolysis step. In fact, SFA Pacific believes that, if SCR is required, COS hydrolysis will be necessary for any acid gas removal system, except possibly the Rectisol physical solvent process (based on refrigerated methanol).
- COS hydrolysis is required for amine-based AGR processes and recommended for physical solvent-based AGR processes, if stringent emissions regulations are to be met. With COS hydrolysis and sufficient solvent circulation, any of the AGR processes considered in this report can meet a 20 ppmv level of total sulfur in the clean synthesis gas. This level of sulfur should be adequate to prevent deposits of ammonium sulfate salts in the HRSG of the IGCC if SCR should be required for post-combustion NO<sub>x</sub> control with syngas-fired gas turbines.
- While physical solvent AGR processes are capable of meeting the stringent sulfur cleanup required for SCR, the processes themselves are more expensive than MDEA-based AGR processes. The H<sub>2</sub>S dissolution and reaction rates are faster in aqueous amine systems—enabling shorter contact times and smaller absorber column designs; i.e., a smaller number of trays or stages, and shorter and possibly smaller diameter columns. The heat transfer coefficients of aqueous amine solutions are higher than those of organic

physical solvents—so that less heat exchanger (coolers, reboilers) surface area is required with amine solutions. However, amine-based AGR systems tend to have higher stripper steam requirements than physical solvent AGR systems. The electric power requirements for pumping (solvent recirculation) and refrigeration (if used – with physical solvents) and the heat requirements for solvent regeneration and are the major factors affecting the operating costs for AGR.

- Although the Selexol Process by itself is more expensive than an MDEA AGR process, the total AGR, sulfur recovery (SR) process, and tail gas treating (TGT) process package—based on Selexol in some cases could be more cost effective than the package based on MDEA—especially if the syngas pressure is high and deep sulfur removal is required (e.g., down to 10-20 ppmv). Deeper desulfurization can be accomplished by chilling the Selexol process. However, CO<sub>2</sub> co-absorption then also increases.
- The Rectisol Process—based on low-temperature (refrigerated) methanol—is capable of deep total sulfur removal, but its complexity and refrigeration make it the most expensive AGR Process. Therefore, its use is generally reserved for chemical synthesis gas applications in which very pure syngas (as low as <0.1 ppmv total sulfur) is required. The Rectisol process is the predominant commercial AGR process in these applications.
- Acid gas enrichment is desirable for high sulfur recovery in Claus plants. This can be accomplished in physical solvent AGR units internally by arranging various solvent flashes sequentially in such a way that partially and fully stripped solvent streams can be used to stage acid gas absorption. In amine-type processes, H<sub>2</sub>S is enriched by separate low pressure, selective absorption of the acid gas from the primary solvent stripper. For mixed solvents, such as Sulfinol-M, a combination of the above methods can be used. The handling of flashed off gases could present some problems, since they will often contain sulfur compounds. They can ultimately be recycled for almost complete sulfur removal, but at additional complexity and cost.
- Some form of Claus tail gas treating (TGT) is required to reach 99.8+% sulfur recovery levels. This can be a combination of extended-bed Claus operation, followed by a hydrolysis step, or a conventional sequence of Claus and TGT. The simplest approach is acid gas enrichment for feed to the Claus plant, followed by TGT.
- TGT clean offgas, after additional absorption of the H<sub>2</sub>S in the AGR unit, can be incinerated or compressed for combustion in the turbine. An oxygen blown Claus is advantageous in the latter case because of the much smaller gas stream that is seen by the compressor. Oxygen blown Claus provides additional sulfur throughput flexibility and provides for easier disposal of sour water off gases.
- For future IGCC with CO<sub>2</sub> removal for sequestration, a two-stage Selexol process presently appears to be the preferred AGR process—as indicated by ongoing engineering studies at EPRI and various engineering firms with IGCC interests. In CO<sub>2</sub> removal applications, the Selexol Process is chilled—thus facilitating deep H<sub>2</sub>S removal as well as CO<sub>2</sub> removal. While the Rectisol process also has been proposed for use in IGCCs with CO<sub>2</sub> removal, this application does not appear to be the subject of any published cost studies.



## SFA Pacific, Inc.

- Further engineering and cost studies of the main IGCC processes with various feedstocks and all of the potentially competitive AGR options are required to quantify the relative performance and cost benefits of the various AGR options and elucidate the ranges of conditions and cases in which they are competitive. Related studies are underway at EPRI and various engineering organizations, which may be published later in some form. While information of this type exists within process licensor and engineering/construction organizations, it is generally proprietary. The FLEXSORB hindered amine processes, the Purisol physical solvent process, and the Sulfinol mixed amine/physical solvent process also should be evaluated.
- Acid gas injection (AGI) is now widely practiced by the oil and gas industry and should be investigated further for use with IGCC. It eliminates the need for sulfur recovery and TGT units by injecting acid gases from the AGR unit directly into a saline aquifer or a depleted gas or petroleum reservoir. It could prove more economical than trying to meet ever more stringent sulfur recovery regulations. It also provides a means for the sequestration of additional CO<sub>2</sub> should that be required in the future.
- Flexibility and operability of the AGR and SR systems are less compromised if they are not tightly integrated. In the AGR processes, for example, a separate enrichment train, rather than a tight integration of the enrichment section with the primary absorber and stripper, can improve the overall flexibility and operability of the system. The same could apply to the SR process when tail gas is recycled back to the primary absorber. It could be better to install a separate absorption stage. Although this approach may be more capital intensive, the overall economics of the IGCC system may be improved if the system availability is improved.
- This report provides information that IGCC project planners and developers can use to select AGR processes and gas treating process combinations and configurations for preliminary evaluations and screening studies. However, identifying the “best” process options for specific applications requires engineering and cost evaluations of the integrated system options—in which the inputs and evaluations of the specific process licensors are essential. The licensors should be contacted in the early stages of planning and project development to ensure that the most appropriate and best available information for the level of effort required is employed.

### Hot and Warm Gas Cleanup

- Continued improvements in hot dry particle filtration, which is commercially available technology, can be expected. Further improvements are still needed to increase filter element life and to reduce filter installation, operating, and maintenance costs. Upstream cyclones are important components of a hot particle removal system—to minimize the load on the hot filters. Overall, hot gas filtration offers definite advantages to IGCC over water scrubbing. They include: avoiding black mud, recovering dry char for recycle to the gasifier, and improved process efficiency.

## **SFA Pacific, Inc.**

- The development of both hot and warm gas cleanup systems for deep cleaning of sulfur and nitrogen components from syngas appear to be long-term prospects, if at all achievable. Large-scale demonstrations probably would not be achievable or practical before about 2010. Justification for such demonstrations could become difficult if commercial IGCC projects with CGCU continue to proliferate and operate well over the next several years. Related scale-up issues must be realistically addressed.
- The prospects of developing hot or warm gas cleanup processes for mercury and CO<sub>2</sub> removal presently are very dim. Either, or both, the requirement for mercury recovery and/or CO<sub>2</sub> recovery from coal-fired power plants could become the Achilles' heel of dry gas cleanup—dictating the use of O<sub>2</sub>-blown IGCC with CGCU.

### 13. REFERENCES

1. "Process Screening Study of Alternative Gas Treating and Sulfur Removal Systems for IGCC Power Plant Applications," a report prepared by SFA Pacific, Inc. for the Electric Power Research Institute, AP-5505, December 1987.
2. "SFA Pacific Worldwide Gasification Database – 2001 Update," a report prepared by SFA Pacific, Inc. for the U.S. Department of Energy, DE-AC01-94FE63260 Task 6, July 2001.
3. J. Ratafia-Brown and M. Ramezan, "Environmental Performance/Issues," Gasification-Based Power Systems Workshop, Gasification Technologies Program, NETL, Pittsburgh, PA, July 12, 2001.
4. "The Wabash River Coal Gasification Repowering Project," U.S. Department of Energy Topical Report Number 20, September 2000.
5. W. Bodle et al., "Considerations for Mercury in LNG Operations," proceedings of the Sixth International Conference on Liquefied Natural Gas (LNG 6), Kyoto, Japan, April 7-10, 1980.
6. S. Mussig, "Experience in Removing Mercury from Natural Gas and Subsequent Mercury Decontamination of Process Equipment," presented at the Laurance Reid Gas Conditioning Conference, Norman, OK, March 2-5, 1997.
7. M.J. Bourke and A.F. Mazzoni, "The Roles of Activated Carbon in Gas Conditioning," presented at the Laurance Reid Gas Conditioning Conference, Norman, OK, March 6-8, 1989.
8. J. Markovs and J. Corvini, "Mercury Removal from Natural Gas & Liquid Streams," presented at the Laurance Reid Gas Conditioning Conference, Norman, OK, March 3-6, 1996.
9. H.M. Malino, "Mercury Removal from Synthesis Gas," Gasification-Based Power Systems Workshop, Gasification Technologies Program, NETL, Pittsburgh, PA, July 12, 2001.
10. F. Douglas et al, "Amine-Based Gas Sweetening and Claus Sulfur Recovery Process Chemistry and Waste Stream Survey," Gas Research Institute Topical Report GRI-95/0187, December 1995.
11. R.A. Tomcej et al, "Tray Design for Selective Absorption," presented at the Laurance Reid Gas Conditioning Conference, Norman, OK, March 2-4, 1987.
12. J.L. Harbison and G.E. Handwerk, "Selective Removal of H<sub>2</sub>S Utilizing Generic MDEA," presented at the Laurance Reid Gas Conditioning Conference, Norman, OK, March 2-4, 1987.
13. J.C. Thomas, "Improved Selectivity Achieved with UCARSOL Innovator Solvent 111," presented at the Laurance Reid Gas Conditioning Conference, Norman, OK, March 7-8, 1988.

## SFA Pacific, Inc.

14. R.S. Hugo and R. Wagner, "Deep COS Removal with New Formulated MDEA Solvents," presented at the Laurance Reid Gas Conditioning Conference, Norman, OK, February 27-March 1, 2000.
15. R.H. Weiland and J.C. Dingman, "Effect of Solvent Blend Formulation on Selectivity in Gas Treating," presented at the Laurance Reid Gas Conditioning Conference, Norman, OK, February 26-March 1, 1995.
16. G.T. Rochelle et al., "Absorption of Carbon Dioxide by Piperazine Activated Methyl-diethanolamine," presented at the Laurance Reid Gas Conditioning Conference, Norman, OK, February 25-28, 2001.
17. J.D. de Graaf, "The Shell Gasification Process at the AGIP Refinery in Sannazzaro," Gasification Technologies 2001 Conference, San Francisco, CA, October 7-10, 2001.
18. M. Howard and A. Sargent, "Operating Experiences at Duke Energy Field Services Wilcox Plant with Oxygen Contamination and Amine Degradation," presented at the Laurance Reid Gas Conditioning Conference, Norman, OK, February 25-28, 2001.
19. P.C. Rooney et al., "The Role of Oxygen in the Degradation of MEA, DGA, DEA and MDEA," presented at the Laurance Reid Gas Conditioning Conference, Norman, OK, March 1-4, 1998.
20. P.E. Holub, "Amine Degradation Chemistry in CO<sub>2</sub> Service," presented at the Laurance Reid Gas Conditioning Conference, Norman, OK, March 1-4, 1998.
21. T.R. Bacon et al., "New Developments in Non-Thermal Reclaiming of Amines," presented at the Laurance Reid Gas Conditioning Conference, Norman, OK, March 7-9, 1988.
22. R. Epps, "Use of Selexol Solvent for Hydrocarbon Dewpoint Control and Dehydration of Natural Gas," presented at the Laurance Reid Gas Conditioning Conference, Norman, OK, February 27-March 2, 1994.
23. A.L. Kohl and F.C. Riesenfeld, "Gas Purification," Fourth Edition, Gulf Publishing Company, 1985.
24. G. Collodi, "Commercial Operation of ISAB Energy and SARLUX IGCC," Gasification Technologies 2001 Conference, San Francisco, CA, October 7-10, 2001.
25. M.A. Huffmaster, "Stripping Requirements for Selective Treating with Sulfinol and Amine Systems," presented at the Laurance Reid Gas Conditioning Conference, Norman, OK, March 2-5, 1997.
26. D. Clarke et al., "Qatargas Sulfur Recovery Improvement Project," presented at the Laurance Reid Gas Conditioning Conference, Norman, OK, February 25-28, 2001.
27. A.E. Chute, "Tailor Sulfur Plants to Unusual Conditions," *Hydrocarbon Processing*, April 1977, pp. 119-124.
28. B. Klint and P. Dale, "Ammonia Destruction in Claus Recovery Units," presented at the Laurance Reid Gas Conditioning Conference, Norman, OK, February 21-24, 1999.
29. B.G. Goar, "Consider the COPE Process for Improving Sulfur Plant Operations and Lowering Tail Gas Emissions," presented at the Laurance Reid Gas Conditioning Conference, Norman, OK, March 2-4, 1987.

## SFA Pacific, Inc.

30. "COPE," Gas Processes '96, *Hydrocarbon Processing*, April 1996, p. 112.
31. R. Best et al., "Boost Refinery Capacity and Flexibility with Hydrogen and Oxygen," presented at the SULFUR 99 Conference, October 17-20, 1999.
32. D.K. Stevens et al., "OxyClaus Technology for Sulfur Recovery," presented at the Laurance Reid Gas Conditioning Conference, Norman, OK, March 3-6, 1996.
33. L. Paszkowski et al., "Sulfur Plant Capacity Increase at the API Falconara Refinery," presented at the Laurance Reid Gas Conditioning Conference, Norman, OK, March 1-4, 1998.
34. J. Koenig et al., "New Air/Oxygen Claus Burner Technology," presented at the Laurance Reid Gas Conditioning Conference, Norman, OK, March 1-4, 1998.
35. B.G. Goar, "Sulfur Recovery Fundamentals," presented at the Laurance Reid Gas Conditioning Conference, Norman, OK, February 27-March 1, 2000.
36. H.W. Gowdy et al., "UOP's Selectox Process Improvements in the Technology," presented at the Laurance Reid Gas Conditioning Conference, Norman, OK, March 1-4, 1998.
37. S.G. Jones et al., "Lisbon Plant Selectox Unit 7 Years Operating Performance," presented at the Laurance Reid Gas Conditioning Conference, Norman, OK, February 25-28, 2001.
38. L.C. Hardison, "Recovery of Sulfur from Tail Gas Streams Using the LO-CAT Hydrogen Sulfide Oxidation Process," presented at American Institute of Chemical Engineers 1990 Summer National Meeting, San Diego, CA, August 19-22, 1990.
39. G. Peeles and R. Cantrall, "Case History: Pinnacle Gas Treating, Inc. Fast-Track LO-CAT II," presented at the Laurance Reid Gas Conditioning Conference, Norman, OK, February 21-24, 1999.
40. J.E. Naber et al., "The Shell Claus Off-Gas Process," presented at the 74th National Meeting of the American Institute of Chemical Engineers, New Orleans, LA, March 11-15, 1973.
41. N.R. Undengaard and V. Berzins, "Catalytic Conversion of COS for Gas Cleanup," *Energy Progress*, June 1984, pp. 115-117.
42. J. Harryman and P. Verhulst, "SCOT Technology Update," presented at the Laurance Reid Gas Conditioning Conference, Norman, OK, February 26-March 1, 1995.
43. D.R. Simbeck and A.D. Karp, "Air-Blown Versus Oxygen-Blown Gasification," Institution of Chemical Engineers' Conference, Gasification: An Alternative to Natural Gas, London, England, November 22-23, 1995.
44. D.M. Todd, "Clean Coal and Heavy Oil Technologies for Gas Turbines," Paper No. GER-3650D, 38th GE Turbine State-of-the-Art Technology Seminar, GEZ-7970, General Electric Company, Schenectady, NY, August 1994.
45. N. Holt, "Coal Gasification Research, Development and Demonstration – Needs and Opportunities," 2001 Gasification Technologies Conference, sponsored by the Gasification Technologies Council and EPRI, San Francisco, CA, October 7-10, 2001.
46. D.R. Simbeck et al., "Coal Gasification Guidebook: Status, Applications, and Technologies," EPRI Final Report TR-102034, December 1993.

## SFA Pacific, Inc.

47. G.J. Stiegel, S.J. Clayton, and J.G. Wimer, "DOE's Gasification Industry Interviews: Survey of Market Trends, Issues and R&D Needs," 2001 Gasification Technologies Conference, sponsored by the Gasification Technologies Council and EPRI, San Francisco, CA, October 7-10, 2001.
48. "Gasification Markets and Technologies – Present and Future: An Industry Perspective," U.S. DOE, in preparation for publication by the end of 2002.
49. Worldwide Gasification Database, SFA Pacific, Inc., Mountain View, CA, ongoing updates.
50. GE Power Systems, Schenectady, New York, private communications, March 2002.
51. Tour of the Piñon Pine IGCC plant conducted May 17, 2001 by Sierra Pacific for participants of the 16th International Fluidized Bed Combustion Conference, sponsored by the ASME and CIBO, Reno, NV, May 13-17, 2001.
52. Proceedings of the 1998 Gasification Technologies Conference, sponsored by the Gasification Technologies Council and EPRI, San Francisco, CA, October 1998.
53. Proceedings of the 1999 Gasification Technologies Conference, sponsored by the Gasification Technologies Council and EPRI, San Francisco, CA, October 1999.
54. Proceedings of the 2000 Gasification Technologies Conference, sponsored by the Gasification Technologies Council and EPRI, San Francisco, CA, October 2000.
55. Proceedings of the 2001 Gasification Technologies Conference, sponsored by the Gasification Technologies Council and EPRI, San Francisco, CA, October 7-10, 2001.
56. Global Energy, Inc., Houston, Texas, private communication, March 5, 2002.
57. TECO Energy, Tampa, Florida, private communication, March 7, 2002.
58. R.B. Slimane et al, "Experimental Studies in Support of the Ultra-Clean gas Cleanup Process Development," Eighteenth Annual International Pittsburgh Coal Conference, Newcastle, New South Wales, Australia, December 4-7, 2001.
59. "Vision 21 – Examples of Activities," [www.fossil.energy.gov/coal\\_power/vision21/vision21\\_examples.shtml](http://www.fossil.energy.gov/coal_power/vision21/vision21_examples.shtml).
60. EPRI Destinations, Target 66, Future Coal Generation Options, Project Descriptions, 66D: Power Systems Development Facility (PSDF), [www.epri.com](http://www.epri.com).
61. E. Wichert and T. Ryan, "Acid Gas Injection Eliminates Sulfur Recovery Expense," *Oil & Gas Journal*, April 28, 1997, pp. 67-72.
62. J.J. Carroll and J.R. Maddocks, "Design Considerations for Acid Gas Injection," presented at the Laurance Reid Gas Conditioning Conference, Norman, OK, February 21-24, 1999.
63. E. Hopkins, "Acid Gas Injection System Contributes to Gas Plant Emissions Reduction," *Compressor Tech*, November-December 2001.
64. "Phased Construction of Natural Gas Combined Cycle Plants with Coal Gasification and CO<sub>2</sub> Recovery," a report prepared by SFA Pacific for EPRI, EPRI Interim Report No. 1004233, October 2002.
65. EPRI, private communications, 2001-2002.

## SFA Pacific, Inc.

66. "Gas Processes 2002," *Hydrocarbon Processing*, May 2002.
67. UOP, Des Plaines, Illinois, private communications, October-November 2002.
68. "Evaluation of Innovative Fossil Fuel Power Plants with CO<sub>2</sub> Removal," EPRI, Palo Alto, CA, U.S. Department of Energy — Office of Fossil Energy, Germantown, MD and U.S. Department of Energy/NETL, Pittsburgh, PA, 2000. 1000316. Prepared by Parsons Energy and Chemicals Group Inc. and Wolk Integrated Technical Services.
69. R.L. Schoff et al, "Updated Performance and Cost Estimates for Innovative Fossil Fuel Cycles Incorporating CO<sub>2</sub> Removal," Proceedings of the Nineteenth Annual International Pittsburgh Coal Conference, Pittsburgh, PA, September 23-27, 2002.
70. Mg Engineering – Lurgi Oil & Gas, Houston, Texas, private communications, November 2002.
71. U. Koss and M. Meyer, " 'Zero Emission IGCC' with Rectisol Technology," Proceedings of the Gasification Technologies 2002 Conference, sponsored by the Gasification Technologies Council and EPRI, October 27-30, 2002.
72. L. O'Keefe et al, "A Single IGCC Design for Variable CO<sub>2</sub> Capture," Proceedings of the Gasification Technologies 2001 Conference, sponsored by the Gasification Technologies Council and EPRI, October 7-10, 2001.
73. R. Ravikumar and G. Sabbadini, "Impact of Carbon Tax on Hydrogen/CO<sub>2</sub>/Electricity Co-Production for Gasification Plants Compared to Natural Gas Based Combined Cycle and Hydrogen Plants," Proceedings of the Gasification Technologies 2002 Conference, sponsored by the Gasification Technologies Council and EPRI, October 27-30, 2002.
74. Private communications.

**SFA Pacific, Inc.**