

**Texas Fire Incident Reporting System
2004 Fire Statistics**

Fires in Texas



**State Fire Marshal's Office
Texas Department of Insurance
December 2005**

Published December 2005

Texas Department of Insurance

Jose Montemayor, Commissioner of Insurance

Paul Maldonado, State Fire Marshal

Texas Fire Incident Reporting System

P.O. Box 149221, Mail Code 112-FM

Austin, Texas 78714-9221

512-305-7900

www.tdi.state.tx.us/fire/fmtexfir.html

This publication may be reproduced in its entirety. Such reproduction must include credit to the original producer, specifically the Texas Department of Insurance.

Copies of this publication have been distributed in compliance with the State Depository Law and are available for public use through the Texas State Publication Depository Program at the Texas State Library and other state depository libraries.

The Texas Department of Insurance does not discriminate on the basis of race, color, national origin, sex, religion, age or disability in employment or in its activities. For fire prevention information presented in other media or for additional copies of this report, write to the address above.



Texas Department of Insurance

State Fire Marshal's Office, Mail Code 112-FM
333 Guadalupe • P. O. Box 149221, Austin, Texas 78714-9221
512-305-7900 • 512-305-7910 fax • www.tdi.state.tx.us

Dear Fire Professional:

For 23 years, the State Fire Marshal's Office has published annual fire data reports reflecting information provided by the Texas fire service. In 2004, 925 fire departments reported 1,117,263 fire and non-fire incidents to the Texas Fire Incident Reporting System. This reflects an increase of eleven percent in fire department participation and over a million incidents reported for the second year in a row. I deeply appreciate the commitment of the fire service for providing this information.

During 2004, fire departments reported 73,491 fires, resulting in 120 civilian deaths, 731 civilian injuries and \$333,745,277 in property loss. A fire occurred in Texas every seven minutes. The kitchen or cooking area was the most frequently identified area of origin in residential structure fires. 73 percent of the reported fire-related civilian deaths occurred in residential structure fires, 25 percent involved people aged 65 or over. Smoking was the most frequently identified cause in fatal residential structure fires.

The information in this 30th Edition of *Fires in Texas* is being provided to help citizens, state leadership, and the fire service better understand the fire problem and its long range impact on our state and its people. The injuries, loss of life and property damage resulting from all fires remains a source of great concern to us all.

I call upon all our citizens to join me in promoting fire safety and fire prevention throughout the year. With your help we can reduce fire loss in our state and make it a safer place for everyone.

Don't hesitate to call our office if I can assist you with your fire safety concerns.

Sincerely,

A handwritten signature in black ink that reads "Paul W. Maldonado". The signature is written in a cursive, flowing style.

Paul W. Maldonado
State Fire Marshal

Contents

Fires in Texas	1
Uses of Data	2
All Fires	3
Overview	4
Casualties and Dollar Loss by Type of Fire	5
Casualties and Dollar Loss by Month	6
Alarm Time by Type of Fire	7
Fires Caused by Fireworks	8
Structure Fires	9
Fire Cause	10
General	11
Residential	12
Fatal Residential	13
Public, Mercantile	14
Industrial	15
Area of Origin by Property Type	16
Residential	16
Assembly	17
Educational	17
Mercantile, Business	17
Detectors in Residential Structures	18

Incendiary/Suspicious Fires	19
Alarm Time	20
Residential Structures	21
Vehicles	21
Outside and Other	21
Heat Source	22
Vehicle Fires	23
Area of Origin	24
Heat Source	24
Outside and Other Fires	25
Fire Cause	26
Heat Source	27
Civilian Casualties	29
Type of Fire	29
Injuries	30
Fatalities	31
Injuries in Residential Structures	32
Fatalities in Residential Structures	33
Fire Service Casualties	34
Injures by Type of Fire	35
Injuries by Property Use	35
Fatalities	36
Fires by County	37
Fires by Region	43
Participating Fire Departments	47
Five Year Incident Comparison	53



Fires In Texas

According to the United States Fire Administration, the U.S. continues to experience a severe fire problem of great national concern. The USFA reports that fire kills more Americans than all natural disasters combined. In 2004, fire departments nationwide reported,

- 1,550,500 total fires
- 3,900 civilian fire deaths, approximately 82% occurred in the home
- 17,785 civilian fire injuries
- a residential structure fire occurred every 77 seconds.

In Texas for 2004, fire departments statewide reported,

- 73,491 total fires, a fire occurred every 7 minutes
- 120 civilian fire deaths, approximately 73% occurred in the home
- 731 civilian fire injuries
- smoke detectors present and operated in only 21% of residential structure fires
- 25% of civilian deaths in residential property involved the elderly (age 65 and over).
- \$333,745,277 in property loss due to fire
- 7,400 incendiary/suspicious fires.

This summary report is a statistical presentation of fire incident information collected and submitted by all participating fire departments. 925 fire departments participated in incident reporting in 2004, an increase of 11%. When reviewing the information in this report, it should be noted that two large metropolitan Texas fire departments had incomplete incident and/or casualty data submitted for 2004.

The information contained in this report is intended to assist policy makers, members of the fire service and the public to better understand Texas fire losses. Working together, we can do much to reduce the loss of life and property due to fire.

Uses of Data

Since 1982, Texas has participated in the collection of fire department incident information through TEXFIRS, the only statewide uniform system of fire and non-fire incident reporting.

Fire departments use this reporting system to uniformly code incident information. Accurate and complete information about fires and other incidents can provide a fire department with a valuable reference to:

- **help allocate limited resources;**
- **justify budget needs;**
- **review the need for personnel training; and**
- **focus the direction of fire education/prevention programs.**

State lawmakers, the press, the general public, insurance companies, and fire service administrators and leaders request TEXFIRS summary reports to help address fire safety concerns and new legislation issues.

Texas adopted the National Fire Incident Reporting System, NFIRS 5.0, as the TEXFIRS reporting system, without modification. This year's *FIRES IN TEXAS* is the fifth annual report incorporating this new system, Version 5.0.

Changes in the data collected and categories utilized should be considered when previous years' data are compared or trends are reviewed.

TEXFIRS/NFIRS data is forwarded to the National Fire Data Center (NFDC) at the U.S. Fire Administration each year. The NFDC can then compare and contrast statistics from states and large metropolitan departments to:

- **develop national public education campaigns;**
- **make recommendations for national codes and standards;**
- **guide allocation of federal funds;**
- **ascertain consumer product failures;**
- **identify the focus for research efforts; and**
- **support federal legislation.**

NFIRS data is used as the basis for the USFA's publication *Fire in the United States*, which is the single most comprehensive reference on the nature and scope of the fire problem in the United States.

NFIRS data is also used by the

Consumer Product Safety Commission (CPSC),
International Association of Fire Chiefs (IAFC),
International Association of Fire Fighters (IAFF),
National Association of State Fire Marshals (NASFM),
National Fire Protection Association (NFPA),
National Highway Traffic Safety Administration (NHTSA),
National Volunteer Fire Council (NVFC).



All Fires

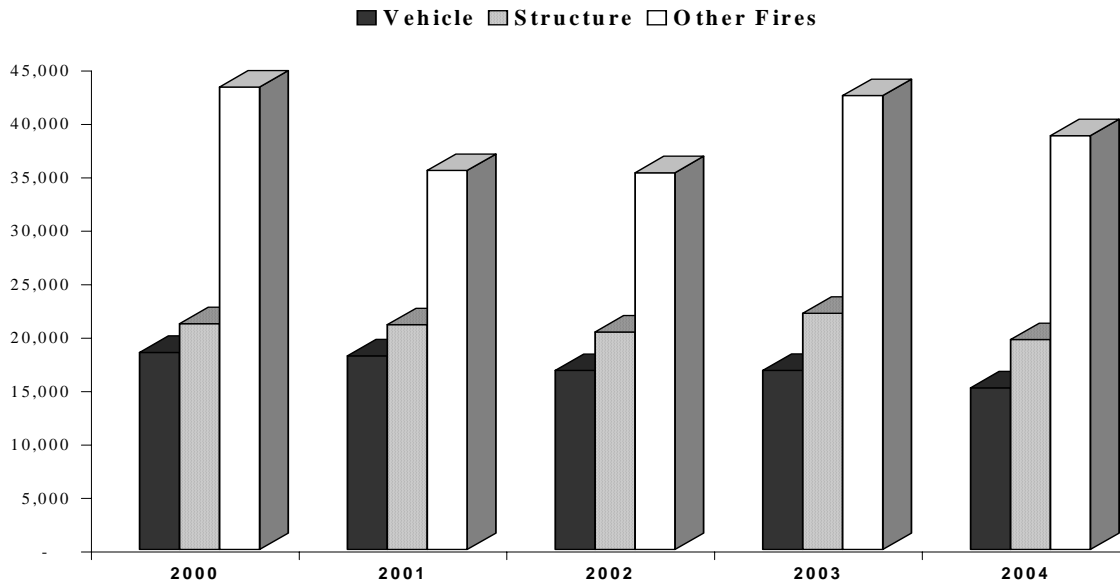

Fire departments reported a total of **73,491 fires** for this period, a decrease of **7,835 (10%)**.

Type of Fire	2000	2001	2002	2003	2004
Structure	21,134	21,033	20,352	22,100	19,638
Vehicle	18,440	18,118	16,747	16,760	15,130
Outside and Other	<u>43,269</u>	<u>35,463</u>	<u>35,248</u>	<u>42,466</u>	<u>38,723</u>
TOTAL FIRES	82,843	74,614	72,347	81,326	73,491

There were **38,723 outside or other types of fires**, a decrease of **3,743 (9%)**, **15,130 vehicle fires**, a decrease of **1,630 (10%)**, and **19,638 structure fires**, a decrease of **2,462 (11%)**.

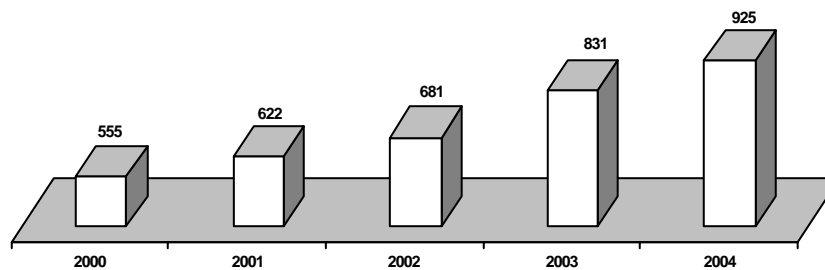

For the fourth year in a row we have seen an increase in fire department participation in the TEXFIRS program. The number of fire departments reporting should be considered when reviewing data comparisons between years.

Overview of Year 2004 Texas Fires

All Fires

In 2004, there were	73,491 fires,	124 deaths,	1,132 injuries, and	\$333,745,277	in property loss.
Each month, there were	6,124 fires,	10 deaths,	94 injuries, and	\$27,812,106	in property loss.
Each week, there were	1,413 fires,	2 deaths,	22 injuries, and	\$6,418,178	in property loss.
Each day, there were	201 fires,	0.3 deaths,	3 injuries, and	\$911,872	in property loss.
Each hour, there were	8 fires,	0 deaths,	0 injuries, and	\$37,995	in property loss.
Each minute, there were	0.14 fires,	0.00 deaths,	0.00 injuries, and	\$633	in property loss.
A fire occurred approximately every		7 minutes.			

Structure Fires

In 2004, there were	19,638 fires,	91 deaths,	961 injuries, and	\$267,765,996	in property loss.
Each month, there were	1,637 fires,	8 deaths,	80 injuries, and	\$22,313,833	in property loss.
Each week, there were	378 fires,	1.8 deaths,	18 injuries, and	\$5,149,346	in property loss.
Each day, there were	54 fires,	0 deaths,	3 injuries, and	\$731,601	in property loss.
Each hour, there were	2 fires,	0 deaths,	0 injuries, and	\$30,483	in property loss.
Each minute, there were	0.04 fires,	0.00 deaths,	0.00 injuries, and	\$508	in property loss.
A fire occurred approximately every		27 minutes.			

Residential Structure Fires

In 2004, there were	15,169 fires,	90 deaths,	837 injuries, and	\$196,800,851	in property loss.
Each month, there were	1,264 fires,	8 deaths,	70 injuries, and	\$16,400,071	in property loss.
Each week, there were	292 fires,	2 deaths,	16 injuries, and	\$3,784,632	in property loss.
Each day, there were	41 fires,	0 deaths,	2 injuries, and	\$537,707	in property loss.
Each hour, there were	2 fires,	0 deaths,	0 injuries, and	\$22,404	in property loss.
Each minute, there were	0.03 fires,	0.00 deaths,	0.00 injuries, and	\$373	in property loss.
A fire occurred approximately every		35 minutes.			

Incendiary/Suspicious Fires

In 2004, there were	7,400 fires,	8 deaths,	89 injuries, and	\$32,507,793	in property loss.
Each month, there were	617 fires,	1 deaths,	7 injuries, and	\$2,708,983	in property loss.
Each week, there were	142 fires,	0.2 death,	2 injuries, and	\$625,150	in property loss.
Each day, there were	20 fires,	0 deaths,	0 injuries, and	\$88,819	in property loss.
Each hour, there were	1 fire,	0 deaths,	0 injuries, and	\$3,701	in property loss.
Each minute, there were	0.01 fires,	0.00 deaths,	0.00 injuries, and	\$62	in property loss.
A fire occurred approximately every		71 minutes.			

Total Fires, Casualties and Dollar Loss by Fire Type

The following table shows the type of fires and the associated casualties and dollar loss.

Types of Fires	Total Fires	FS Injuries	FS Deaths	Civilian Injuries	Civilian Deaths	Total Casualties	Dollar Loss
Structure fires	19,638	344	3	617	88	1,052	\$267,765,996
Vehicle fires	15,130	21	1	69	24	115	\$53,297,313
Natural & cultivated vegetation fires	18,866	14	0	12	0	26	\$1,214,893
Outside rubbish fires	14,447	16	0	2	0	18	\$904,701
Fires, other	3,383	2	0	17	7	26	\$3,808,389
Special outside fires	2,027	4	0	14	1	19	\$6,753,985
Totals	73,491	401	4	731	120	1,256	\$333,745,277

Types of Fires by Percentage of Total

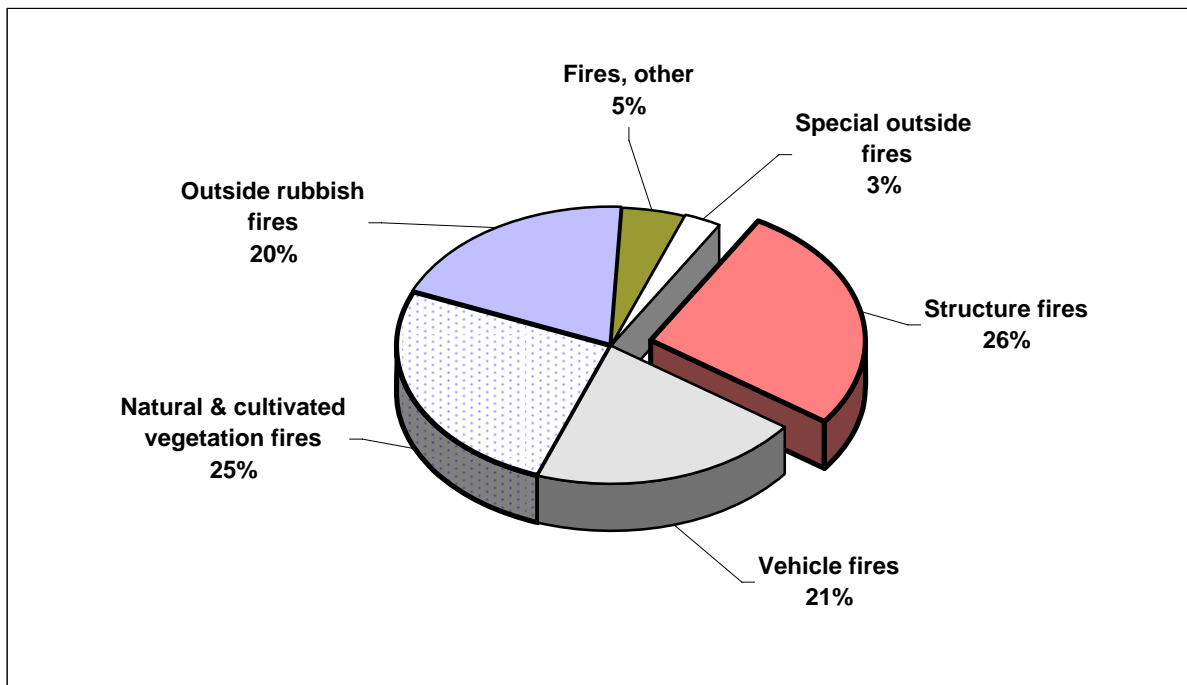

Total Fires, Casualties and Dollar Loss by Month

The following table shows all fires by month, with the associated casualties and dollar loss.

Month	Total Fires	FS Injuries	FS Deaths	Civilian Injuries	Civilian Deaths	Total Casualties	Dollar Loss
January	7,278	28	0	99	17	144	\$34,320,592
February	6,056	41	0	79	12	132	\$24,431,824
March	6,485	43	0	66	9	118	\$32,142,177
April	5,338	24	1	51	5	81	\$22,854,883
May	5,599	24	0	57	10	91	\$26,518,167
June	5,266	42	0	45	8	95	\$22,878,034
July	7,226	34	1	74	5	114	\$26,716,170
August	6,777	44	0	73	9	126	\$40,262,842
September	6,503	28	0	42	7	77	\$31,877,773
October	4,970	39	0	48	13	100	\$20,252,693
November	4,634	18	1	44	12	75	\$19,198,347
December	7,359	36	1	53	13	103	\$32,291,775
Totals	73,491	401	4	731	120	1,256	\$333,745,277

Total Fires by Month

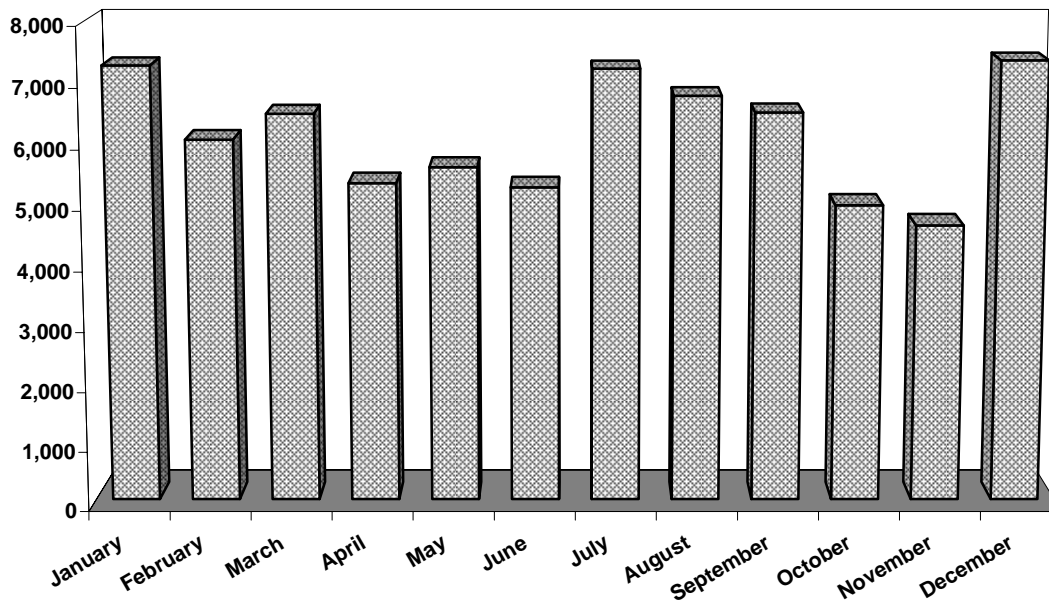

Time of Alarm by Type of Fire

The following table shows the time of alarm for the major categories of fires.

Alarm Time Interval	Total Fires	Structure Fires	Vehicle Fires	Natural & Cultivated Vegetation Fires	Outside Rubbish Fire	Fire, Other	Special Outside Fire
12:01 AM - 4:00 AM	6,663	2,277	1,875	726	1,336	255	194
4:01 AM - 8:00 AM	5,253	1,930	1,544	441	894	260	184
8:01 AM -12:00 PM	10,122	3,079	2,238	2,118	1,831	555	301
12:01 PM - 4:00 PM	19,257	4,028	3,256	7,731	3,034	777	431
4:01 PM - 8:00 PM	19,571	4,766	3,642	5,632	4,155	862	514
8:01 PM -12:00 AM	12,625	3,558	2,575	2,218	3,197	674	403
Totals	73,491	19,638	15,130	18,866	14,447	3,383	2,027

Time of Alarm for All Types of Fires

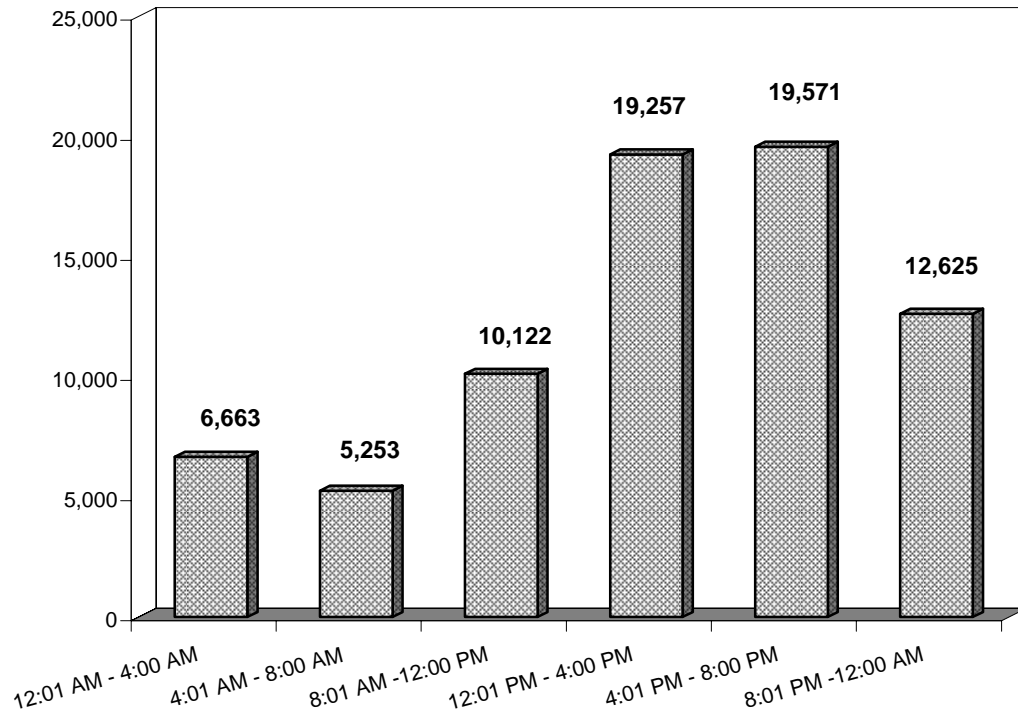

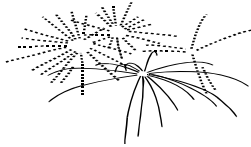

Fires Caused by Fireworks

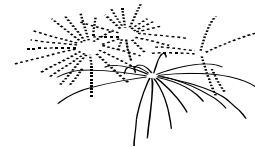

The following table shows the number of reported fires caused by fireworks each month along with the associated casualties and dollar loss.

Month	Total Fires	FS Injuries	FS Deaths	Civilian Injuries	Civilian Deaths	Loss
January	85	0	0	1	0	\$23,570
February	10	0	0	0	0	\$600
March	9	0	0	0	0	\$0
April	6	0	0	0	0	\$0
May	5	0	0	0	0	\$25
June	18	0	0	0	0	\$8,300
July	221	0	0	1	0	\$94,470
August	17	0	0	0	0	\$400
September	12	0	0	0	0	\$1,175
October	4	0	0	0	0	\$0
November	1	0	0	0	0	\$0
December	112	0	0	0	0	\$15,472
Totals	500	0	0	2	0	\$144,012

Fires Caused by Fireworks by Month

Most fires caused by fireworks, **44%**, occurred during the month of **July**.

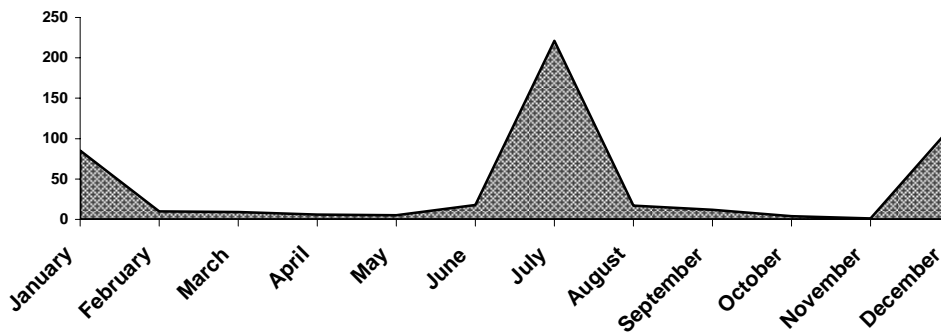

Fires Caused by Fireworks 2000-2004

There was a very slight decrease of **.02%** in the number of fireworks-related fires.

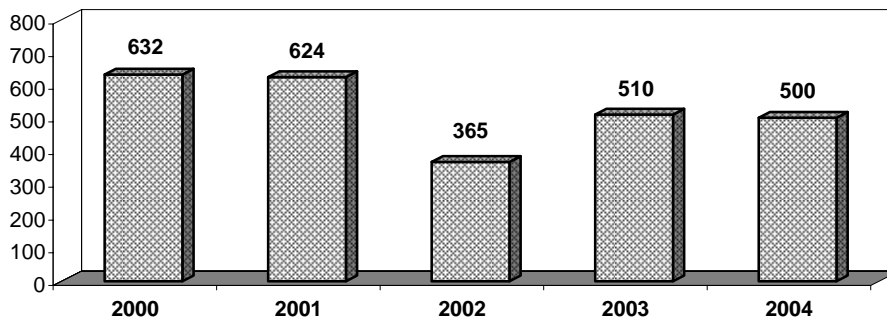



Structure Fires

In 2004, there were 19,638 structure fires reported throughout the state. These fires resulted in 617 civilian injuries, 88 civilian deaths, 344 fire service injuries, three fire service deaths and an estimated \$267,765,996 in property loss.

Total Fires, Casualties and Dollar Loss by Structure Type

Structure Type	Total Fires	FS Injuries	FS Deaths	Civilian Injuries	Civilian Deaths	Dollar Loss
Residential	15,169	284	2	553	88	\$196,800,851
Mercantile, business	982	13	0	8	0	\$24,708,409
Storage	919	20	0	9	0	\$8,670,262
Outside or special property	729	2	0	2	0	\$1,628,923
Assembly	637	12	1	9	0	\$10,588,239
Educational	352	1	0	9	0	\$1,706,119
Other	339	5	0	2	0	\$7,262,651
Manufacturing, processing	240	7	0	14	0	\$13,098,867
Health care, detention & correction	199	0	0	10	0	\$826,215
Industrial, utility, defense, agriculture, mining	72	0	0	1	0	\$2,475,460
Totals	19,638	344	3	617	88	\$267,765,996

77% of all structure fires occurred in residential properties.

Total Structure Fires 2000-2004

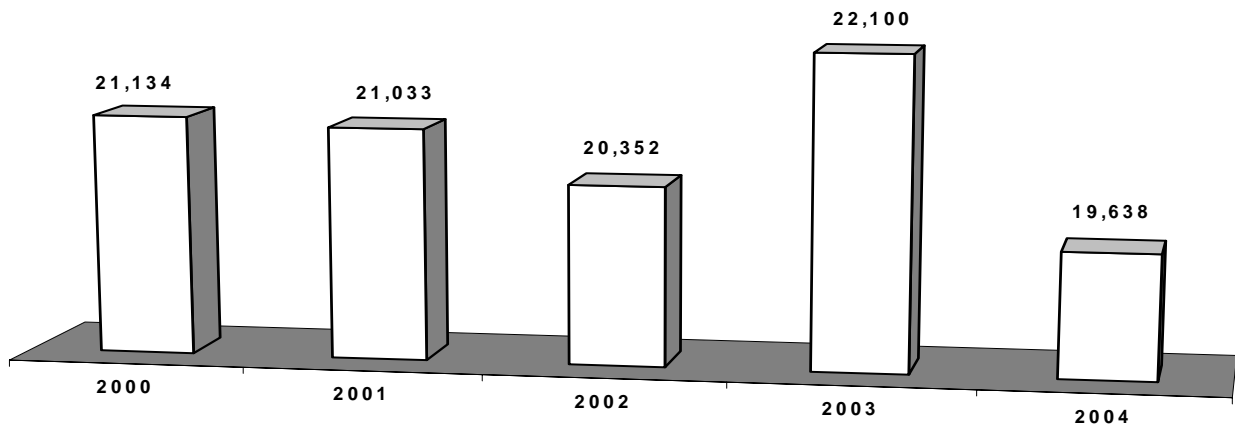

Total Structure Fires by Fire Cause

The table below shows the number of structure fires by cause identified.

Fire Cause	Total Fires	FS Injuries	FS Deaths	Civilian Injuries	Civilian Deaths	Dollar Loss
Appliances, air conditioning	654	13	0	19	0	\$6,871,058
Children playing	193	4	0	33	2	\$3,629,255
Cooking	3,560	14	0	87	5	\$8,285,486
Electrical distribution	661	9	0	22	1	\$15,635,997
Exposure	519	5	0	3	0	\$7,237,511
Heating	955	13	1	23	7	\$7,853,502
Incendiary/suspicious	1,855	44	1	34	6	\$23,549,484
Natural	505	22	0	5	1	\$13,289,285
Open flame, ember, torch	1,293	26	0	55	4	\$20,640,623
Other equipment	251	8	0	10	1	\$10,466,214
Other heat, flame, spark	813	9	0	25	5	\$9,411,865
Smoking	512	9	0	30	12	\$5,212,523
Unknown	7,867	168	1	271	44	\$135,683,193
Totals	19,638	344	3	617	88	\$267,765,996

Counties with the Greatest Number of Structure Fires

County	Total	County	Total
Dallas	3,219	Bell	411
Tarrant	1,292	Denton	385
Harris	1,200	Galveston	329
Bexar	1,136	Potter	323
Travis	625	Montgomery	300
Jefferson	490	McLennan	296
Nueces	462	Fort Bend	290
El Paso	442	Cameron	290
Collin	441	Gregg	255
Hidalgo	434	Smith	233

Fire Cause in Structure Fires by General Structure Type

The tables below show the fire cause identified in fires by general type of structure.

Fire Cause	Unclassified	Assembly	Educational	Health Care, Detention & Correction	Industrial, Utility, Defense, Agriculture, Mining
Appliances, air conditioning	5	21	13	23	0
Children playing	1	0	3	0	1
Cooking	29	149	25	46	2
Electrical distribution	5	34	11	8	2
Exposure	11	8	4	0	2
Heating	7	30	12	7	2
Incendiary/suspicious	46	61	148	17	8
Natural	4	12	4	1	6
Open flame, ember, torch	13	23	8	9	1
Other equipment	4	6	4	8	3
Other heat, flame, spark	12	34	8	11	4
Smoking	2	14	2	5	1
Unknown	200	245	110	64	40
Total	339	637	352	199	72

Fire Cause	Manufacturing, Processing	Mercantile, Business	Outside or Special Property	Residential	Storage
Appliances, air conditioning	8	64	10	499	11
Children playing	1	1	2	177	7
Cooking	8	93	24	3,182	2
Electrical distribution	3	66	3	506	23
Exposure	1	27	25	363	78
Heating	17	42	7	820	11
Incendiary/suspicious	5	106	97	1,259	108
Natural	16	22	13	378	49
Open flame, ember, torch	18	61	24	1,072	64
Other equipment	31	38	13	122	22
Other heat, flame, spark	25	30	14	631	44
Smoking	1	25	6	439	17
Unknown	106	407	491	5,721	483
Total	240	982	729	15,169	919

Cooking was identified as the leading known fire cause (**18%**) in all structure fires.

Incendiary/suspicious was the second most identified fire cause (**9%**) in all structure fires.

Fire Cause in Residential Structure Fires

The table below shows the number of fires in residential structures by fire cause and their associated casualties and dollar loss.

Fire Cause	Total Fires	Civilian Deaths	Civilian Injuries	Dollar Loss
Appliances, air conditioning	499	0	17	\$4,495,893
Children playing	177	2	33	\$3,569,195
Cooking	3,182	5	82	\$5,520,244
Electrical distribution	506	1	18	\$11,803,610
Exposure	363	0	3	\$5,439,142
Heating	820	7	22	\$6,900,090
Incendiary/suspicious	1,259	6	26	\$16,098,866
Natural	378	1	1	\$11,992,247
Open flame, ember, torch	1,072	4	47	\$15,647,745
Other equipment	122	1	6	\$1,866,479
Other heat, flame, spark	631	5	23	\$7,277,202
Smoking	439	12	29	\$4,565,148
Unknown	5,721	44	246	\$101,624,990
Totals	15,169	88	553	\$196,800,851

Most Frequently Identified Fire Cause in Residential Structure Fires

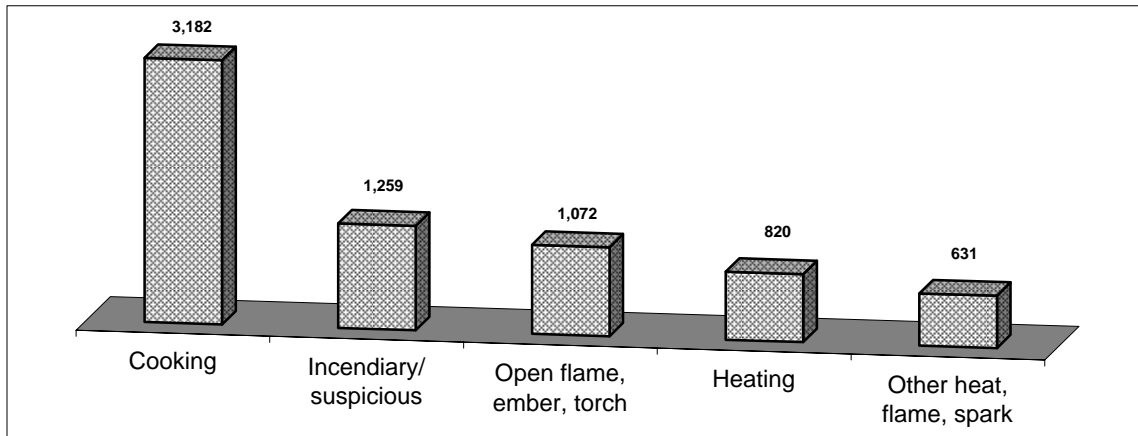

Cooking was the most frequently identified cause (**21%**) in residential structure fires and involved **15%** of all civilian injuries in residential structure fires.

Incendiary/suspicious was the second most identified cause (**8%**) in structure fires and involved **7%** of all civilian deaths occurring in residential structure fires.

Fire Cause in Fatal Residential Structure Fires

The table below shows the cause identified in residential structure fires where a civilian fatality was involved.

Fire Cause	Fatal Fires	Civilian Deaths
Appliances, air conditioning	0	0
Children playing	2	2
Cooking	2	5
Electrical distribution	1	1
Heating	1	7
Incendiary/suspicious	6	6
Natural	1	1
Open flame, ember, torch	4	4
Other equipment	1	1
Other heat, flame, spark	5	5
Smoking	9	12
Unknown	38	44
Totals	70	88

**Most Frequently Identified Fire Cause
in Residential Structure Fires Involving Civilian Fatalities**

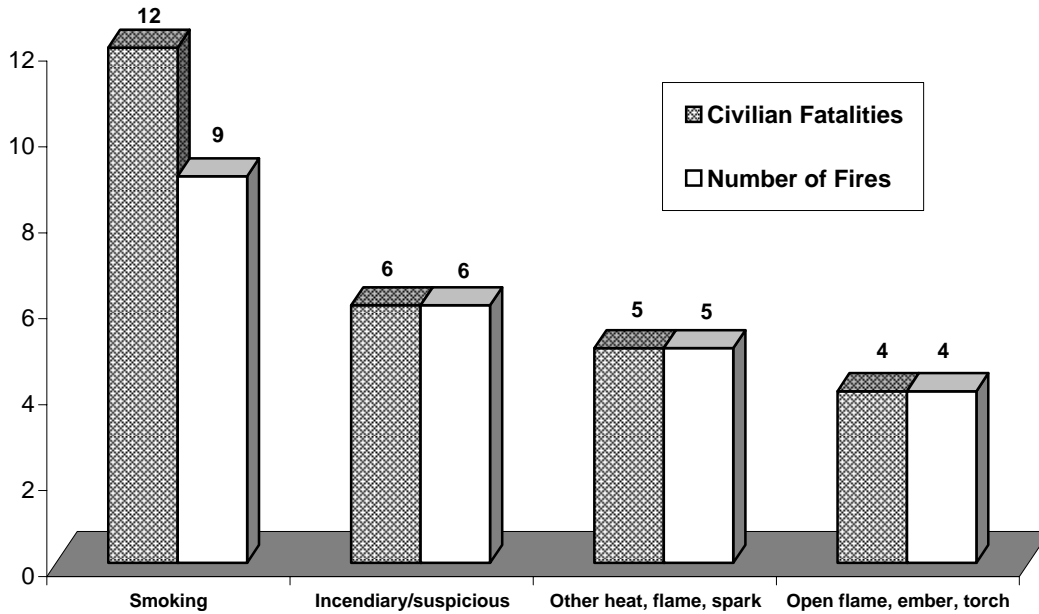

Smoking was the most frequently identified cause (**13%**) in fatal residential structure fires and involved 14% of all structure fire civilian fatalities.

Fire Cause in Public, Mercantile Structure Fires

The table below shows the number of fires in public, mercantile structures by identified cause and their associated casualties and dollar loss.

Fire Cause	Total Fires	Civilian Deaths	Civilian Injuries	Dollar Loss	Assembly	Educational	Health Care, Detention & Correction	Mercantile, Business
Appliances, air conditioning	121	0	2	\$1,462,910	21	13	23	64
Children playing	4	0	0	\$160	0	3	0	1
Cooking	313	0	3	\$2,429,392	149	25	46	93
Electrical distribution	119	0	4	\$2,264,787	34	11	8	66
Exposure	39	0	0	\$678,117	8	4	0	27
Heating	91	0	1	\$774,762	30	12	7	42
Incendiary/ suspicious	332	0	6	\$5,801,535	61	148	17	106
Natural	39	0	2	\$581,027	12	4	1	22
Open flame, ember, torch	101	0	7	\$1,076,382	23	8	9	61
Other equipment	56	0	3	\$2,274,200	6	4	8	38
Other heat, flame, spark	83	0	2	\$1,295,703	34	8	11	30
Smoking	46	0	0	\$566,775	14	2	5	25
Unknown	826	0	6	\$18,623,232	245	110	64	407
Totals	2,170	0	36	\$37,828,982	637	352	199	982

Most Frequently Identified Fire Cause in Public, Mercantile Structure Fires

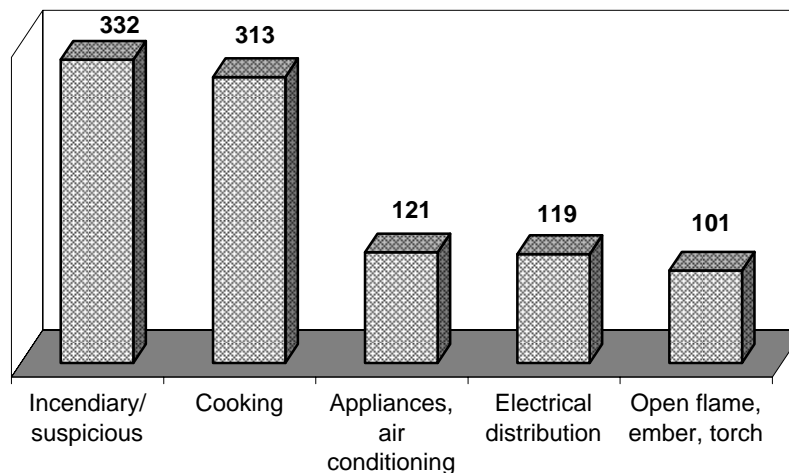

The most frequently identified cause was **incendiary/suspicious (15%)**.

Fire Cause in Industrial Structure Fires

The following table shows the number of fires in industrial structures by fire cause, with associated casualties and dollar loss.

Fire Cause	Total Fires	Civilian Deaths	Civilian Injuries	Dollar Loss	Industrial, Utility, Defense, Agriculture, Mining	Manufacturing, Processing	Outside or Special Property	Storage
Appliances, air conditioning	29	0	0	\$906,955	0	8	10	11
Children playing	11	0	0	\$53,900	1	1	2	7
Cooking	36	0	0	\$330,550	2	8	24	2
Electrical distribution	31	0	0	\$1,552,900	2	3	3	23
Exposure	106	0	0	\$1,101,252	2	1	25	78
Heating	37	0	0	\$147,650	2	17	7	11
Incendiary/suspicious	218	0	2	\$1,279,732	8	5	97	108
Natural	84	0	2	\$716,011	6	16	13	49
Open flame, ember, torch	107	0	1	\$3,913,496	1	18	24	64
Other equipment	69	0	1	\$6,317,535	3	31	13	22
Other heat, flame, spark	87	0	0	\$802,960	4	25	14	44
Smoking	25	0	1	\$80,600	1	1	6	17
Unknown	1120	0	19	\$8,669,971	40	106	491	483
Totals	1,960	0	26	\$25,873,512	72	240	729	919

Most Frequently Identified Fire Cause in Industrial Structure Fires

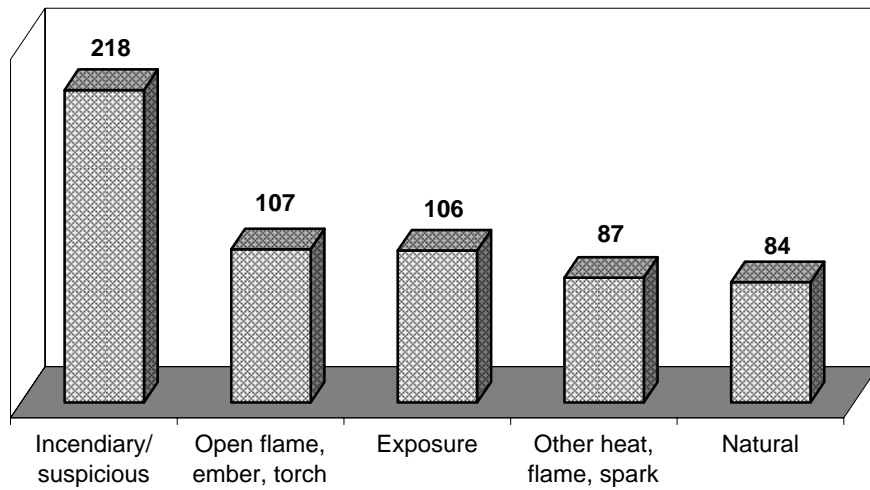

The most frequently identified cause was **incendiary/suspicious (11%)**.

Area of Origin in Residential Structure Fires

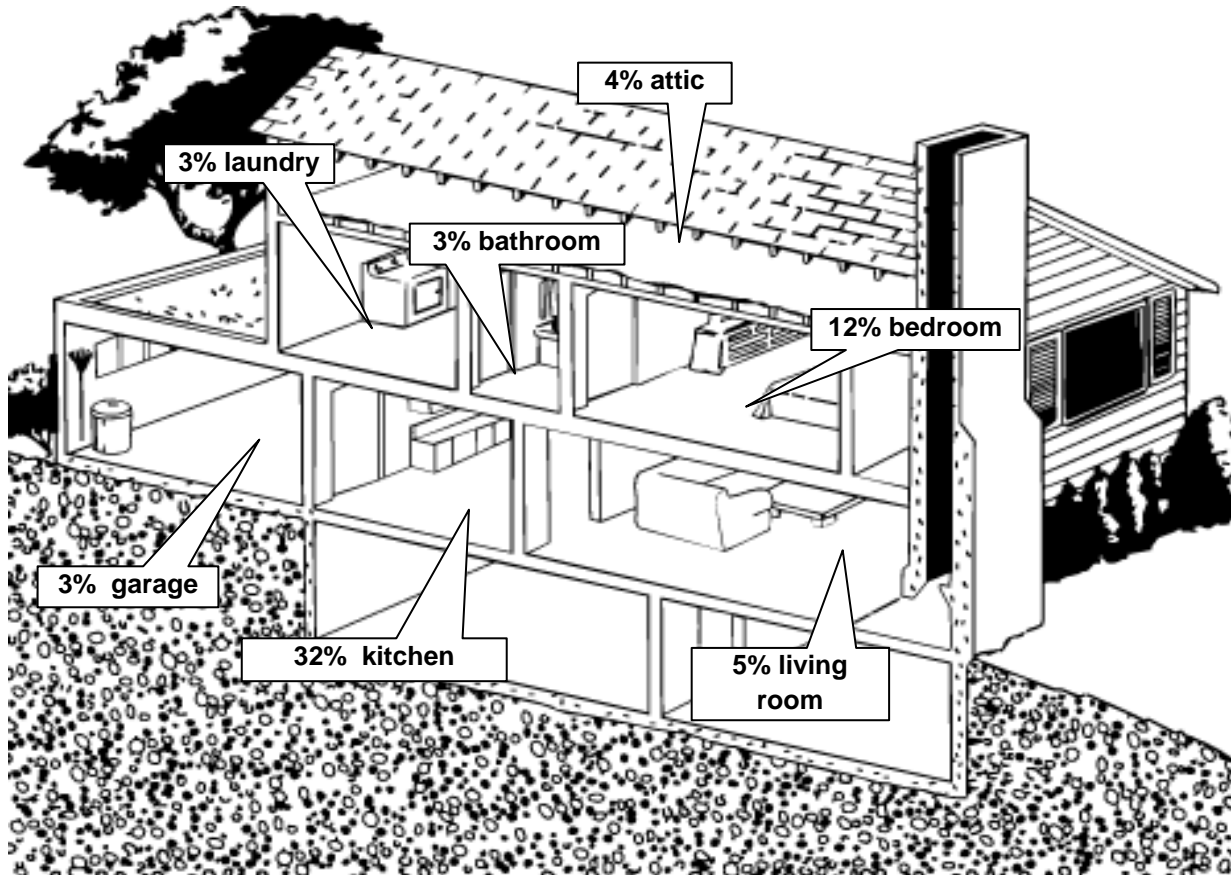

Most Frequently Identified Area of Origin in Residential Structure Fires

The following table shows the number of residential structure fires by most frequently identified area of origin and the corresponding percentage of all residential structure fires.

Area of Origin	# of Fires	% of Fires
Cooking area, kitchen	4,811	32%
Bedroom for less than 5 persons; included are jail or prison	1,757	12%
Undetermined	1,434	9%
Common room, den, family room, living room, lounge	799	5%
Attic: vacant, crawl space above top story, cupola	580	4%
Vehicle storage area; garage, carport	503	3%
Laundry area, wash house	475	3%
Bathroom, checkroom, lavatory, locker room	475	3%
All Other	4,335	29%
	15,169	100%

Most Frequently Identified Area of Origin in Assembly Structure Fires

The table below shows the number of assembly structure fires by most frequently identified area of origin and the corresponding percentage of all assembly structure fires.

Area of Origin	# of Fires	% of Fires
Cooking area, kitchen	226	35%
Undetermined	52	8%
Roof surface: exterior	33	5%
Bathroom, checkroom, lavatory, locker room	31	5%
Wall surface: exterior	29	5%
Attic: vacant, crawl space above top story, cupola	21	3%
Wall assembly	17	3%
All Other	228	36%
	637	100%

Most Frequently Identified Area of Origin in Educational Structure Fires

The table below shows the number of educational structure fires by most frequently identified area of origin and the corresponding percentage of all educational structure fires.

Area of Origin	# of Fires	% of Fires
Bathroom, checkroom, lavatory, locker room	79	22%
Undetermined	36	10%
Cooking area, kitchen	35	10%
Assembly area - less than 100 persons	27	8%
Corridor, mall	14	4%
Duct: HVAC, cable, exhaust, heating or AC	12	3%
Wall surface: exterior	11	3%
All Other	138	39%
	352	100%

Most Frequently Identified Area of Origin in Mercantile, Business Structure Fires

The table below shows the number of mercantile, business structure fires by most frequently identified area of origin and the corresponding percentage of all mercantile, business structure fires.

Area of Origin	# of Fires	% of Fires
Cooking area, kitchen	123	13%
Undetermined	93	9%
Office	70	7%
Sales area, showroom (exclude display window)	47	5%
Bathroom, checkroom, lavatory, locker room	42	4%
Roof surface: exterior	41	4%
Laundry area, wash house	33	3%
Equipment or service area, other	32	3%
All Other	501	51%
	982	100%

Detectors in Residential Structures

	Residential Structure Fires		Fatal Residential Structure Fires	
Present & Operated*	3,240	21%	8	11%
Present & Fire Too Small	443	3%	0	0%
Present & Operation Undetermined	711	5%	5	7%
Present & Failed to Operate	636	4%	5	7%
None Present**	4,641	31%	23	33%
Presence Undetermined	5,498	36%	29	42%
Total	15,169		70	

* Includes fire incidents where detectors are "Not in Room or Space of Origin" but **did** operate.

** Includes fire incidents where the detectors are present **outside** the "Area of Fire Origin" and **did not** operate.

Residential Structure Fires

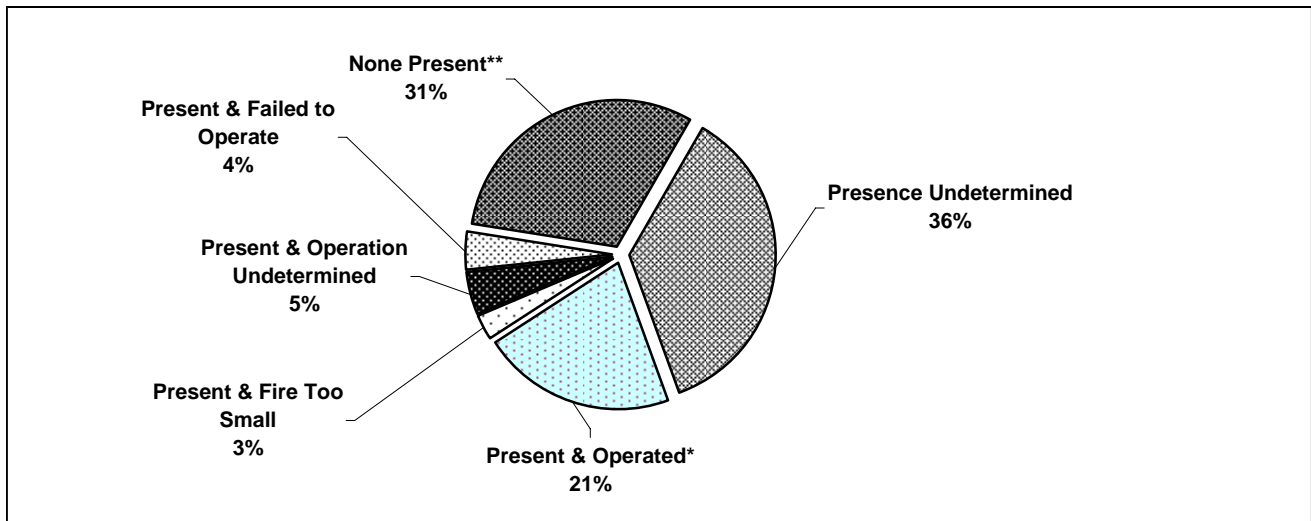

Fatal Residential Structure Fires

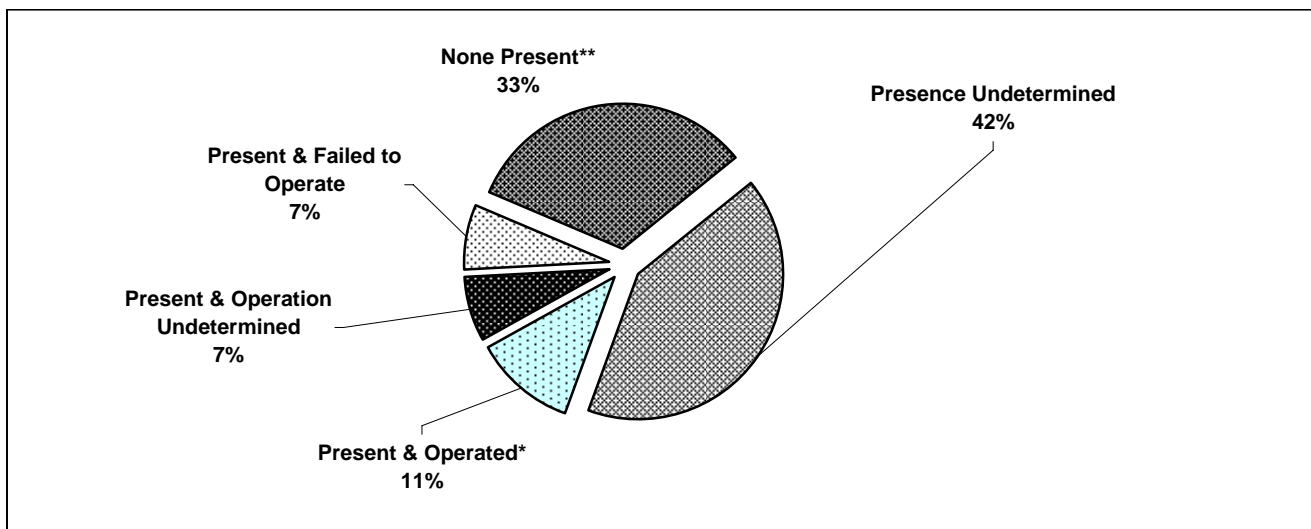



Incendiary/Suspicious Fires

During 2004, there were 7,400 fires determined to be incendiary/suspicious. These fires accounted for 10% of all reported fires, 8% of all fire-related injuries, 6% of all fire-related deaths and 10% of all fire-related dollar loss.

An incendiary fire is a fire that was determined to have been deliberately set to destroy property.

A suspicious fire is a fire that was suspected of having been deliberately or maliciously set to destroy property.

An unknown fire is a fire for which the cause was undetermined. In many cases, fires of unknown cause are later determined to have been incendiary or suspicious.

In this report, a fire set by a property owner to destroy or incinerate trash, grass, brush, or other property without value is not classified as incendiary or suspicious unless the fire was set with malicious intent.

Note: Primary fires sometimes spread to other properties, resulting in "exposure fires." Fire loss data for exposure fires are not included in this section of the report. Therefore, total fire losses that might be attributed to specific fire causes may be greater than indicated.

Incendiary/Suspicious Fires

Year	Total Fires	Dollar Loss	Civilian Injuries	FF Injuries	Civilian Deaths	FF Deaths
2000	12,958	\$72,055,918	69	100	32	0
2001	11,753	\$86,042,069	79	62	18	0
2002	10,083	\$76,825,633	92	76	26	0
2003	9,685	\$72,915,100	79	64	23	0
2004	7,400	\$32,507,793	38	51	7	1

Incendiary/Suspicious Fires 2000-2004

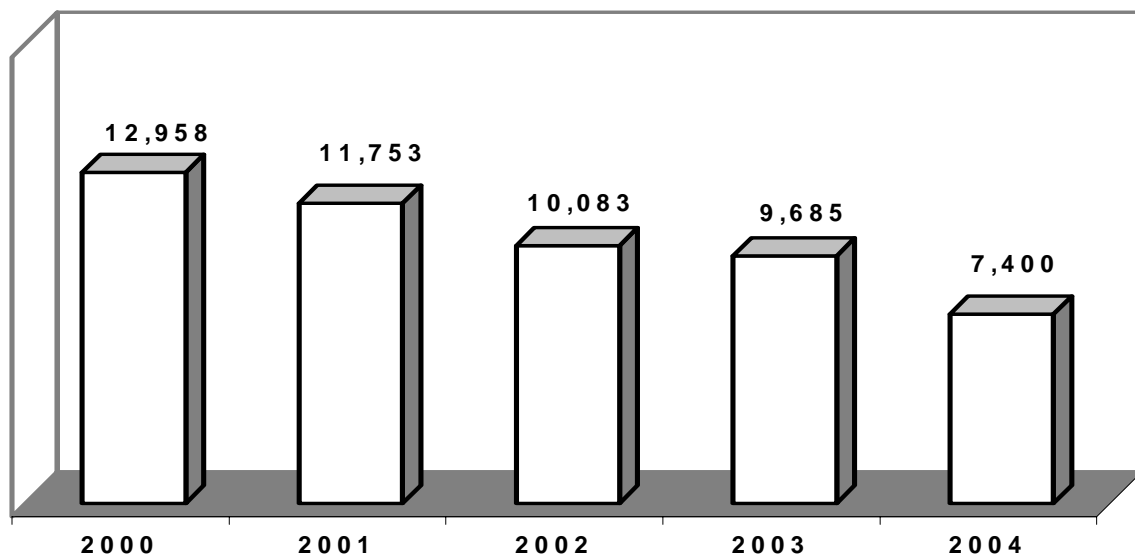

Incendiary/Suspicious Structure Fires

The following table shows the number of structure fires identified as incendiary/suspicious by time of alarm, with associated casualties and dollar loss.

Alarm Time Interval	Total Fires	Percentage	Dollar Loss	Percentage	Civilian Injuries	FF Injuries	Civilian Deaths	FF Deaths
12:01 AM - 4:00 AM	329	17.7%	\$6,890,337	29.3%	3	10	0	0
4:01 AM - 8:00 AM	226	12.2%	\$4,709,111	20.0%	2	4	1	0
8:01 AM - 12:00 PM	231	12.5%	\$1,675,314	7.1%	6	2	1	0
12:01 PM - 4:00 PM	345	18.6%	\$3,007,797	12.8%	4	8	3	1
4:01 PM - 8:00 PM	371	20.0%	\$3,632,323	15.4%	11	13	0	0
8:01 PM - 12:00 AM	353	19.0%	\$3,634,602	15.4%	8	7	1	0
Totals	1,855	100.0%	\$23,549,484	100.0%	34	44	6	1

Alarm Time Intervals for Incendiary/Suspicious Structure Fires

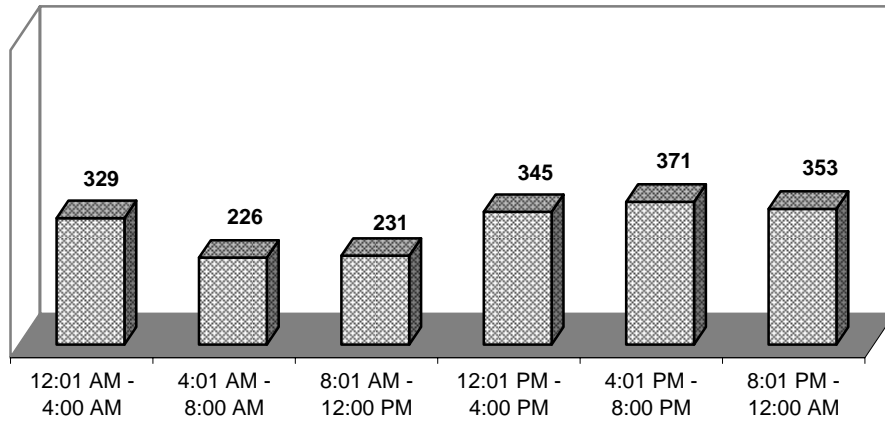

Most structure fires identified as incendiary/suspicious (**20%**) occurred between the hours of 4:01 PM and 8:00 PM.

Incendiary/Suspicious Structure Fires 2000-2004

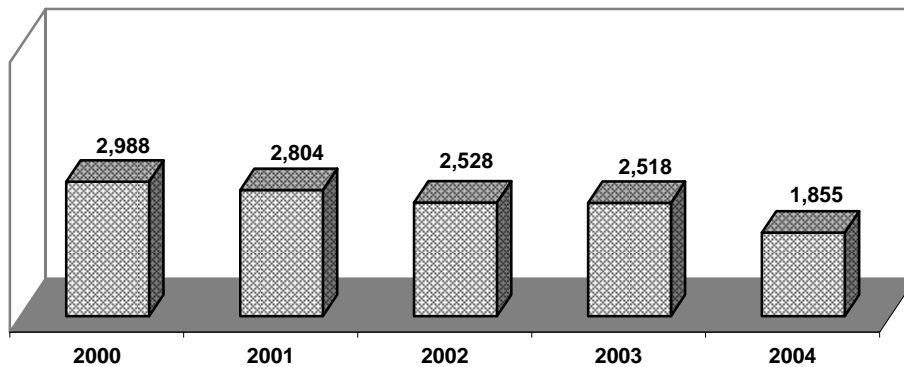

There was a **26%** decrease in the number of **incendiary/suspicious** structure fires reported for the year. **9%** of all structure fires in year 2004 were identified as **incendiary/suspicious**.

Incendiary/Suspicious Residential Structure Fires

Total Fires 1,259	Dollar Loss \$16,098,866	Civilian Injuries 26	FF Injuries 39	Civilian Deaths 6	FF Deaths 1
-----------------------------	------------------------------------	--------------------------------	--------------------------	-----------------------------	-----------------------

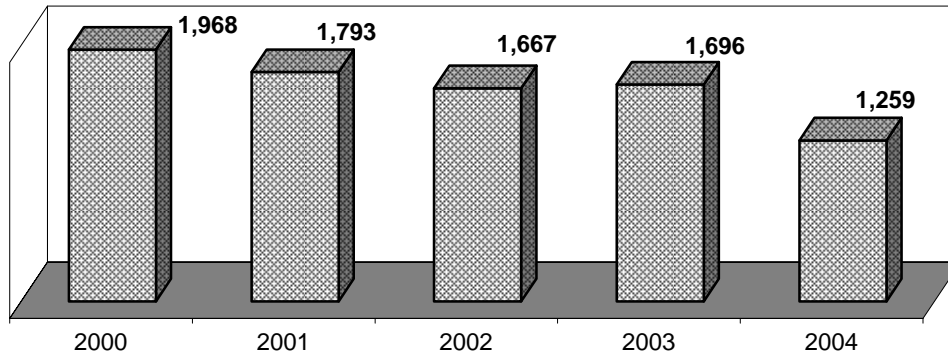

8% of all residential structure fires were identified as **incendiary/suspicious**.

Incendiary/Suspicious Vehicle Fires

Total Fires 1,442	Dollar Loss \$8,397,824	Civilian Injuries 2	FF Injuries 2	Civilian Deaths 0	FF Deaths 0
-----------------------------	-----------------------------------	-------------------------------	-------------------------	-----------------------------	-----------------------

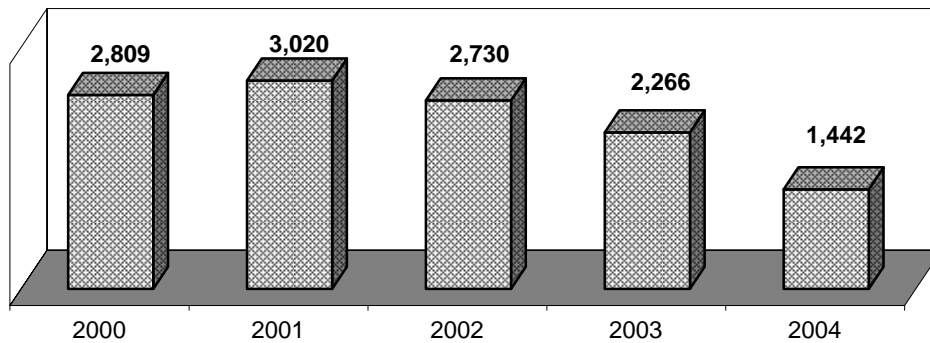

10% of all vehicle fires were identified as **incendiary/suspicious**.

Incendiary/Suspicious Outside and Other Fires

Total Fires 4,103	Dollar Loss \$560,485	Civilian Injuries 2	FF Injuries 5	Civilian Deaths 1	FF Deaths 0
-----------------------------	---------------------------------	-------------------------------	-------------------------	-----------------------------	-----------------------

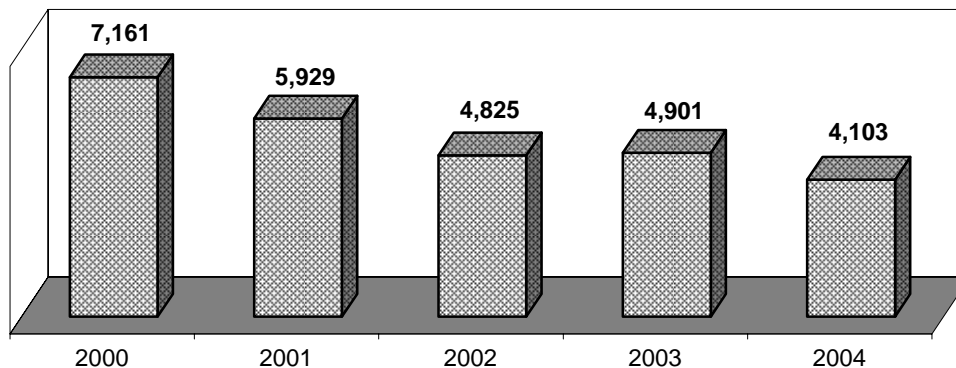

11% of all outside and other fires were identified as **incendiary/suspicious**.

Heat Source in Incendiary/Suspicious Outside and Other Fires

The table below shows the number of incendiary/suspicious outside and other fires by heat source.

Heat Source	Total Fires
Undetermined	1,464
Match	1,232
Heat from other open flame or smoking material	355
Heat source: other	248
Cigarette lighter	229
Hot ember or ash	77

Heat source was reported as **undetermined** in **36%** of all **incendiary/suspicious outside and other fires**.

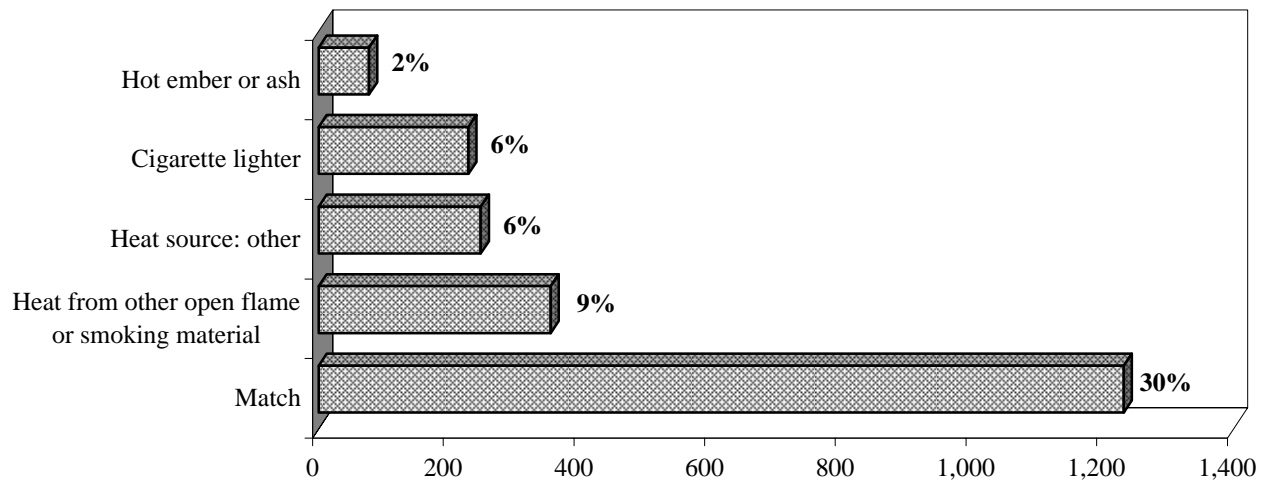

Matches continue to be the most frequently identified heat source in **incendiary/suspicious outside and other fires**.



Vehicle Fires

Fire departments reported 15,130 vehicle fires during this period. These fires caused an estimated \$53,297,313 in property damage, 24 fire-related civilian fatalities, 69 fire-related civilian injuries, 21 fire service injuries and one fire service death. Fire service injuries and deaths include all injuries resulting from duty-related activity.

There were more fires in passenger or road transport vehicles than in any other type of vehicle. The following table shows the percentage of fires in different types of vehicles.

Fires by Mobile Property Type

Mobile Property Type	% of Fires
Passenger or road transport vehicles	82.8%
Freight road vehicles	7.9%
Unknown	6.2%
Industrial, agricultural, construction vehicles	2.0%
Transport vehicles	0.4%
Water vessels	0.3%
Mobile property, miscellaneous	0.3%
Aircraft	0.1%

Total Vehicle Fires

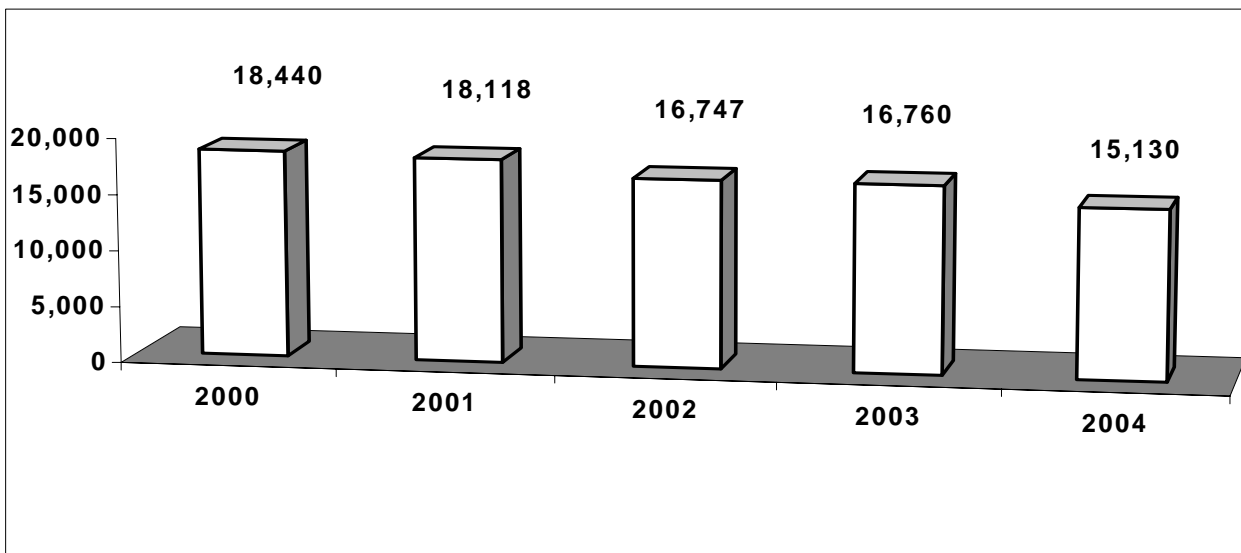

Area of Origin in Vehicle Fires

The table below shows the most frequently reported area of origin in vehicle fires.

Area of Origin	Total
Engine area, running gear, wheel area	7,620
Undetermined	3,202
Operator/passenger area of transportation equipment	1,495
Vehicle area, other	669
Cargo/trunk area - all vehicles	461
Exterior, exposed surface	428

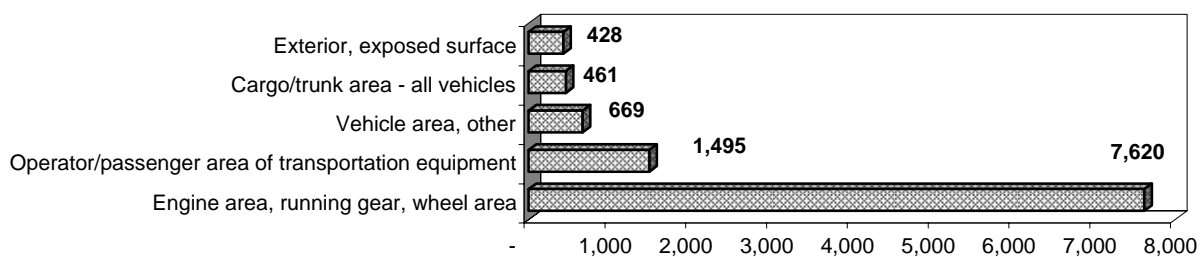

Heat Source in Vehicle Fires

The table below shows the most frequently reported heat source in vehicle fires.

Heat Source	Total
Undetermined	7,281
Heat from powered equipment, other	1,516
Arcing	1,299
Radiated, conducted heat from operating equipment	1,121
Spark, ember or flame from operating equipment	576
Match	560

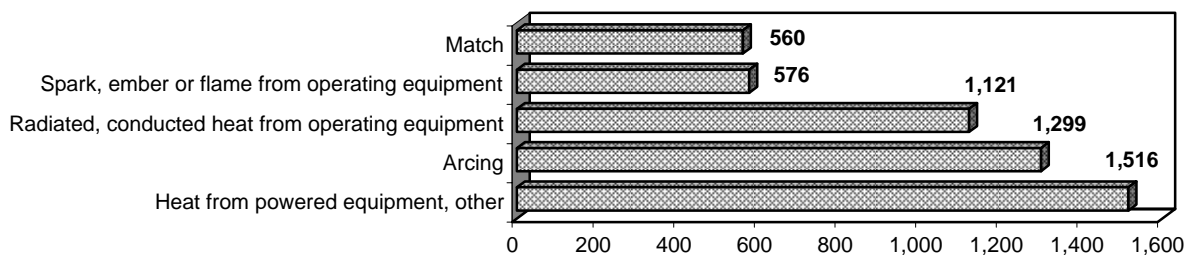



Outside and Other Fires

Fire departments reported 38,723 outside and other fires for this period, the most fires in any single fire category. This type of fire includes rubbish, trees, brush and grass fires, as well as any other type of fire not considered as a vehicle or a structure fire.

Eight civilian fatalities, 45 civilian injuries, 36 fire service injuries and property loss estimated at \$12,681,968 resulted from outside and other fires.

Total Outside and Other Fires 2000-2004

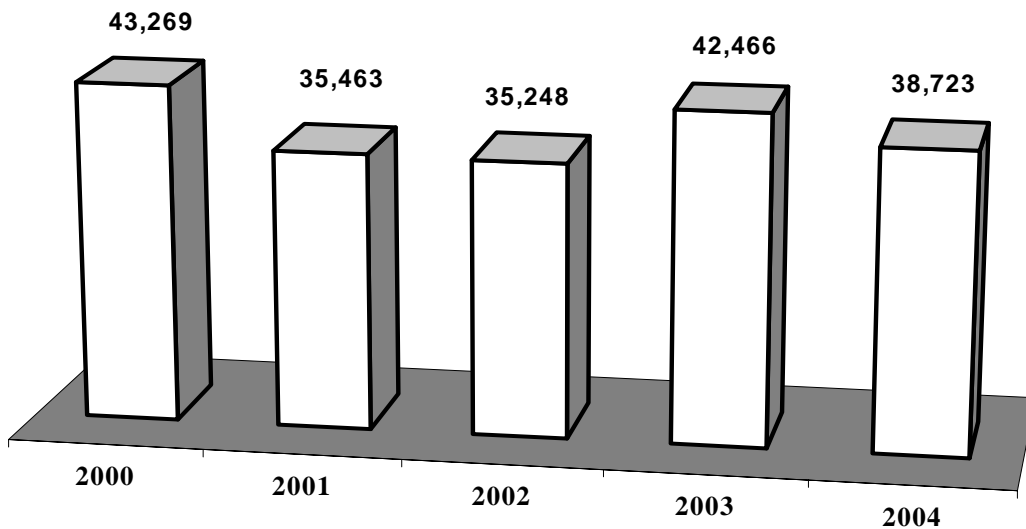

There was a decrease of 9% in the total number of outside and other fires.

Counties with the Greatest Number of Outside and Other Fires

County	Total	County	Total
Dallas	4,323	Collin	672
Harris	2,889	Montgomery	589
Bexar	2,377	Potter	554
Tarrant	2,187	Johnson	535
Hidalgo	1,569	Jefferson	474
El Paso	1,177	Galveston	442
Travis	1,117	Grayson	436
Cameron	972	McLennan	435
Denton	754	Webb	419
Nueces	714	Hunt	418

Fire Cause in Outside and Other Fires

The following table shows the number of outside and other fires by identified cause.

Fire Cause	Total Fires	FS Injuries	FS Deaths	Civilian Injuries	Civilian Deaths	Loss
Appliances, air conditioning	88	0	0	2	0	\$177,105
Children playing	148	0	0	0	0	\$16,454
Cooking	79	0	0	5	0	\$22,595
Electrical distribution	187	0	0	0	0	\$202,267
Exposure	437	0	0	0	0	\$342,302
Heating	36	0	0	1	0	\$41,270
Incendiary/suspicious	4,103	5	0	2	1	\$560,485
Natural	822	3	0	1	0	\$629,266
Open flame, ember, torch	2,770	2	0	6	0	\$469,215
Other equipment	138	0	0	2	5	\$5,858,390
Other heat, flame, spark	1,626	1	0	7	0	\$287,882
Smoking	676	0	0	0	0	\$30,041
Unknown	27,613	25	0	19	2	\$4,044,696
Totals	38,723	36	0	45	8	\$12,681,968

Most Frequently Identified Causes of Outside and Other Fires

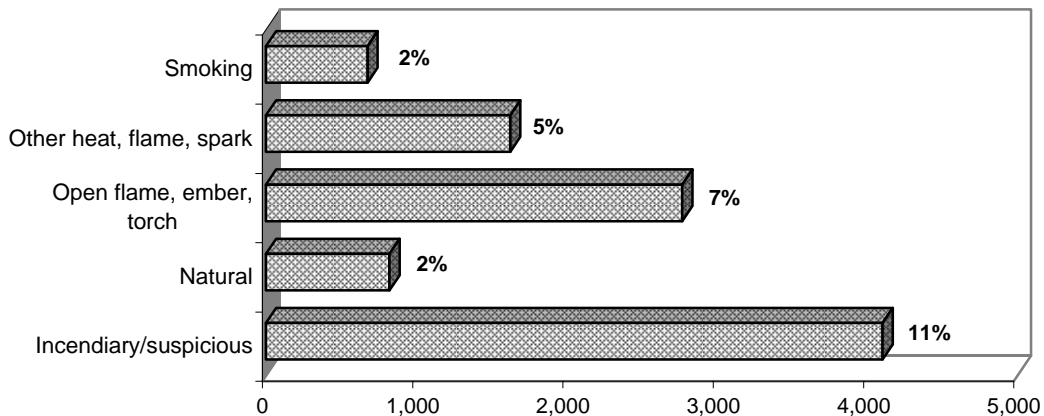

11% of outside and other fires was identified as **incendiary/suspicious** and included more than **4%** of the total dollar loss in all outside and other fires.

Heat Source in Outside and Other Fires

The table below shows the most frequently reported form of heat of ignition in outside and other fires.

Heat Source	Total Fires
Undetermined	28,921
Match	1,805
Heat from other open flame or smoking materials	1,103
Hot ember or ash	1,024
Heat source, other	953
Cigarette	573

Heat source was reported as undetermined in **75%** of all outside and other fires.

Heat Source Identified in Outside Fires

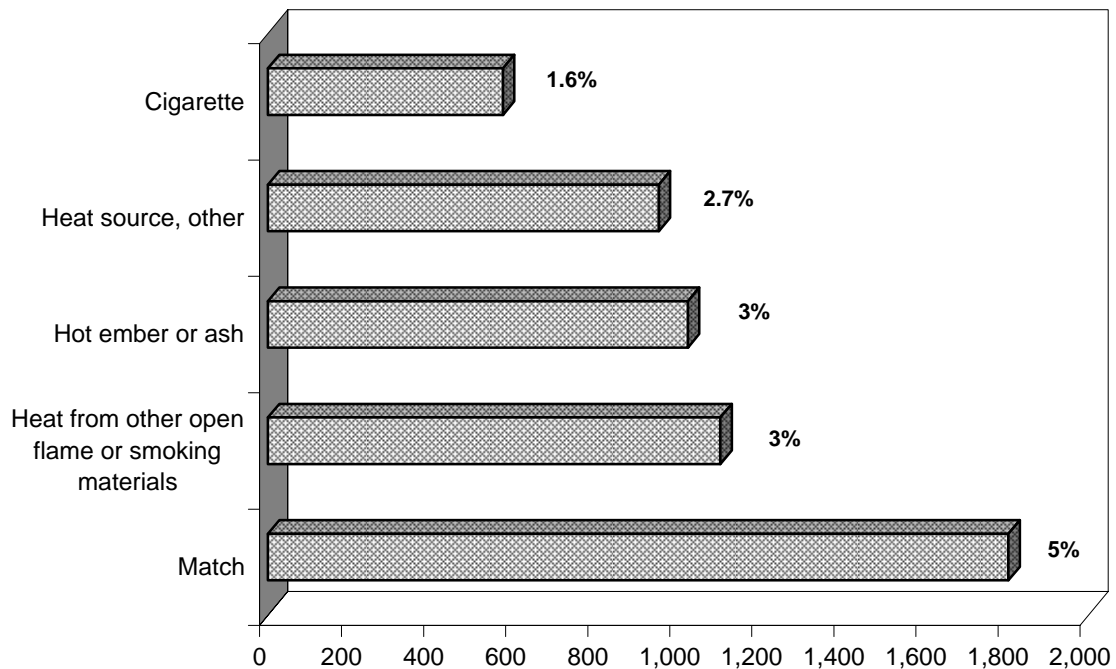

Matches were involved in the largest percentage (**5%**) of outside fires where a heat source was identified.



Casualties

During year 2004, fire departments reported 120 civilian deaths, 731 civilian injuries and 437 fire service injuries in fires. This chapter provides information on the deaths and injuries suffered by civilians and fire service personnel. The fire service also experienced 358 injuries in non fire-related incidents. All fire service counts in this section include mutual aid given incidents.

Civilian Casualties by Type of Fire

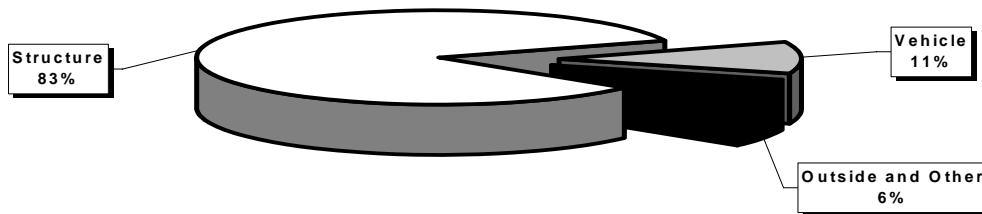

Of all civilian casualties, **705 (83%)** occurred in structure fires, **93 (11%)** occurred in vehicle fires, and **53 (6%)** occurred in outside and other fires. Of the **120** civilian fatalities, **88 (73%)** occurred in structure fires, **24 (20%)** occurred in vehicle fires and **8 (7%)** occurred in outside and other fires.

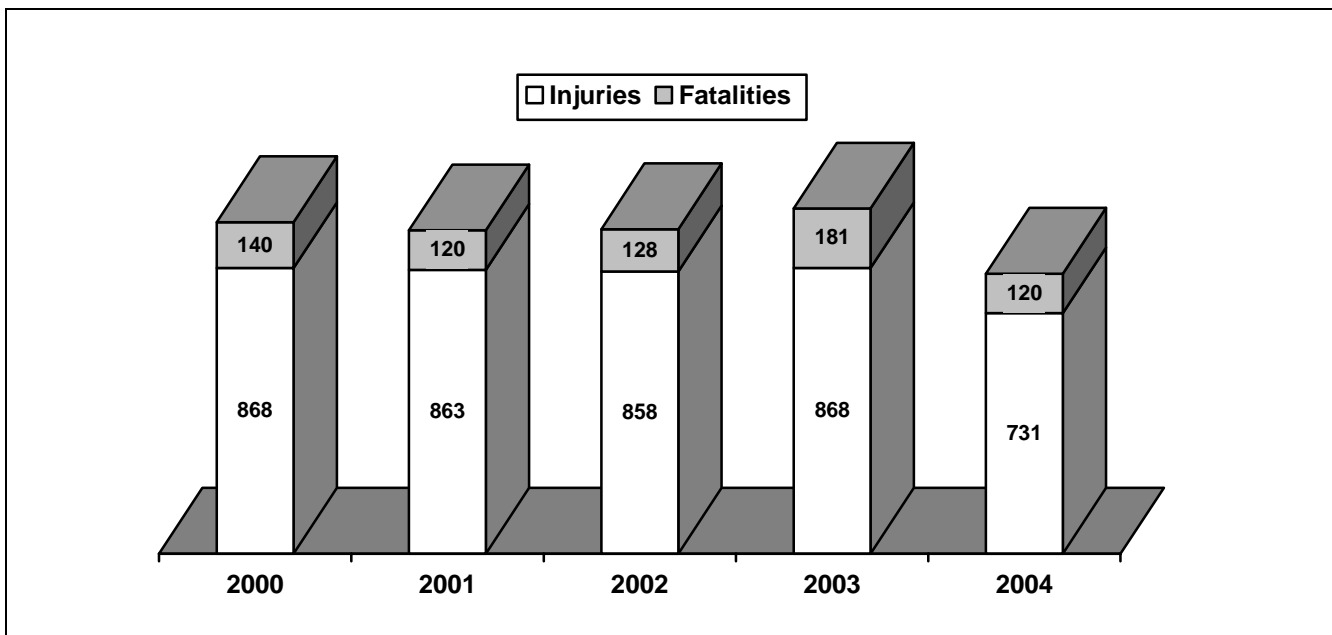

Civilian Injuries in All Fires

The following table shows the number of fire-related civilian injuries by age and gender.

Gender	4 and under	5-14	15-24	25-34	35-44	45-54	55-64	65 & over	Unknown	Totals
Male	22	17	70	88	85	55	28	42	11	418
Female	13	20	52	61	52	40	34	40	1	313
Totals	35	37	122	149	137	95	62	82	12	731

Most civilian injuries, **149 (20%)**, involved people between the ages of **25-34**.

Eighty-eight (12%) of civilian injuries involved males between the ages of **25-34**.

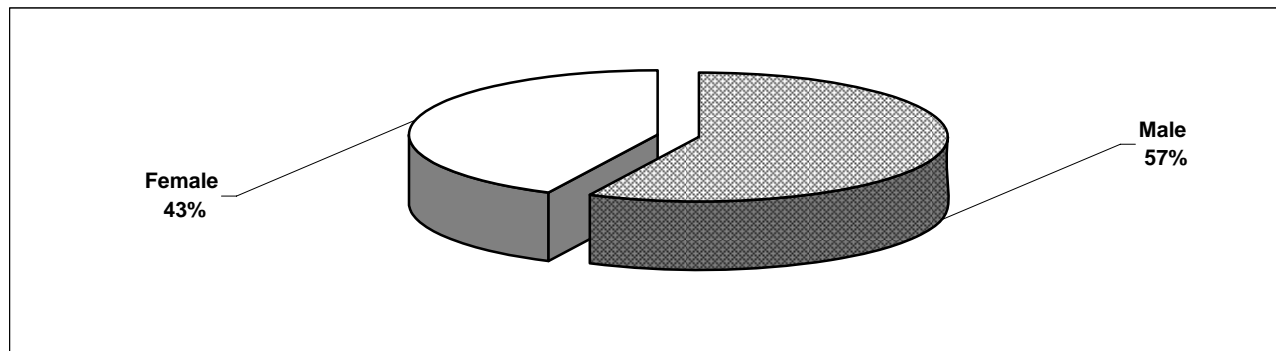
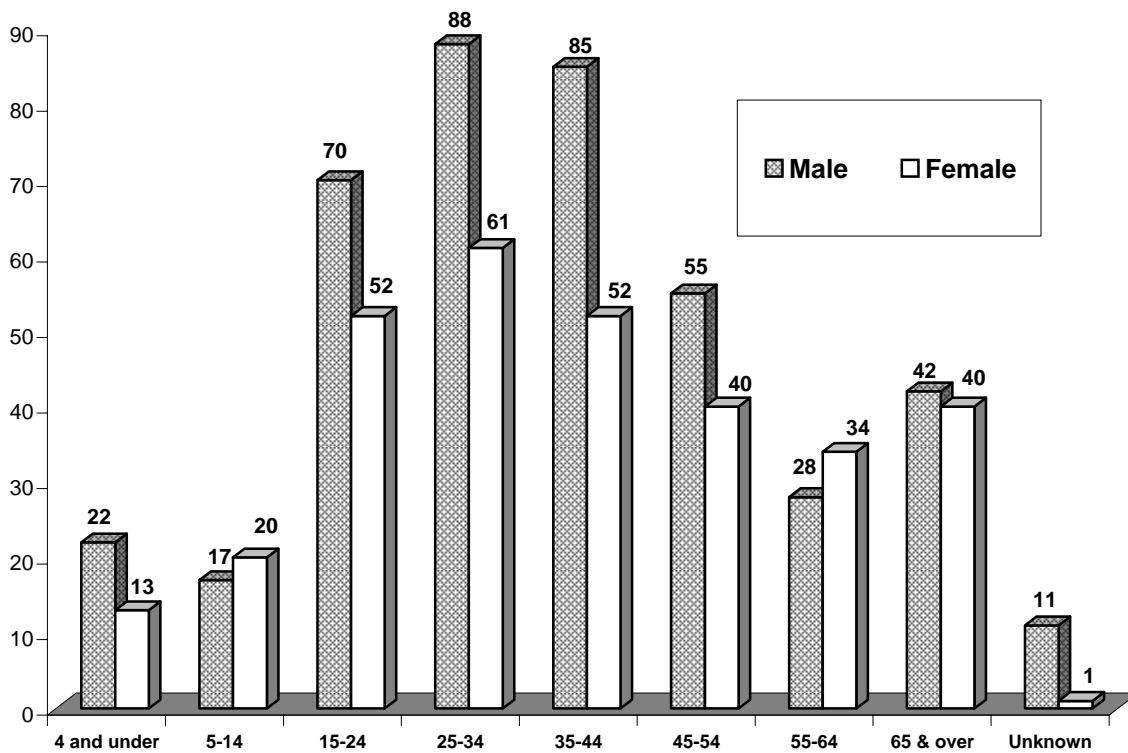

Civilian Fatalities in All Fires

The following table shows the number of fire-related civilian deaths by age and gender.

Gender	4 and under	5-14	15-24	25-34	35-44	45-54	55-64	65 & over	Unknown	Totals
Male	3	11	6	9	13	11	8	14	3	78
Female	6	3	4	5	3	8	5	8	0	42
Totals	9	14	10	14	16	19	13	22	3	120

Most civilian fire-related deaths (18%) involved people age **65 and older**.

Thirteen (11%) of all civilian fire-related deaths involved males between the ages of **35 - 44**.

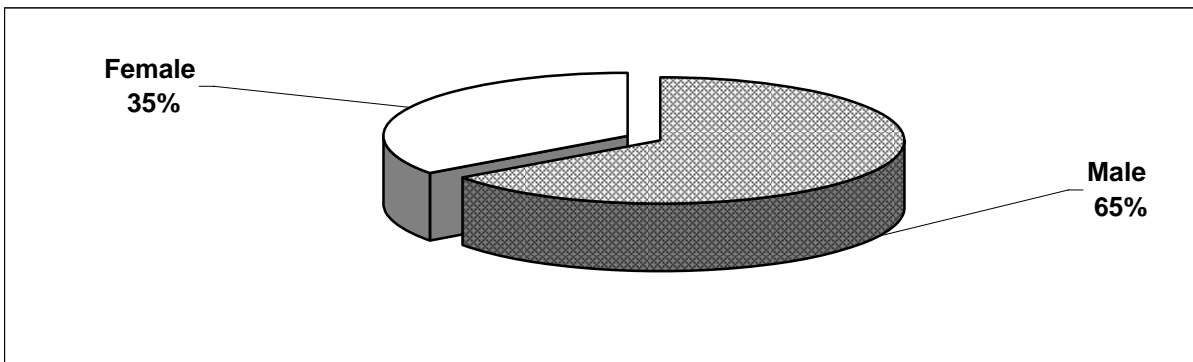
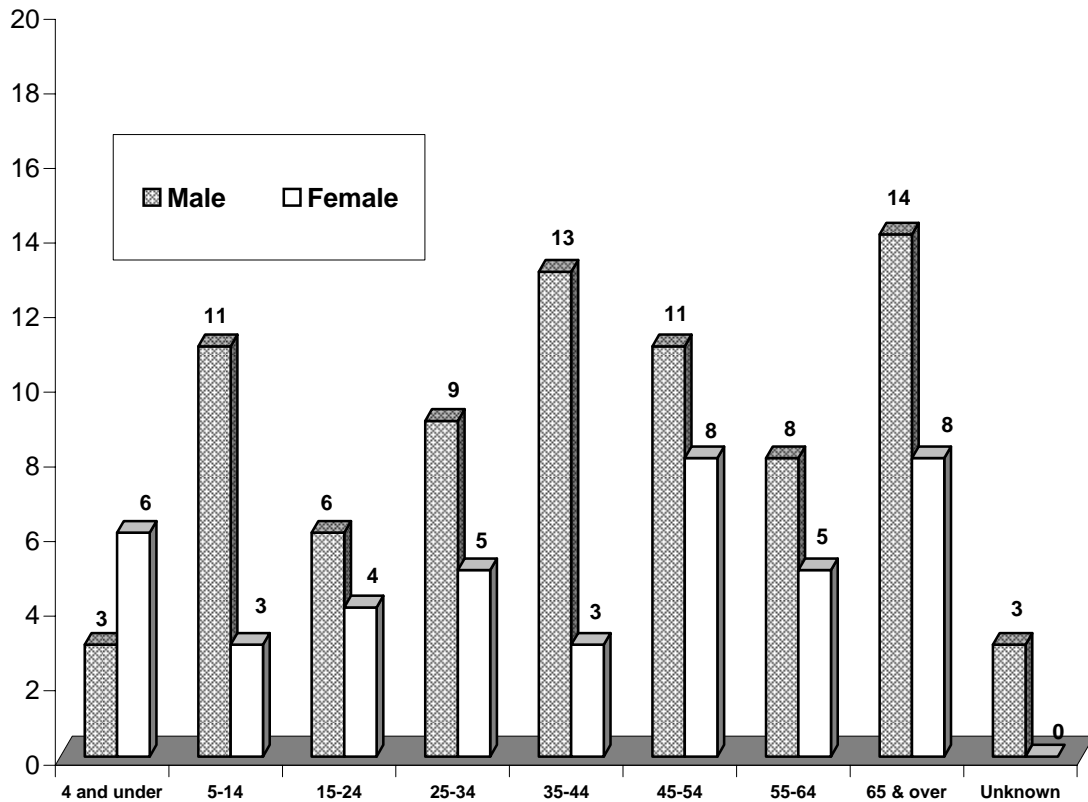

Civilian Injuries in Residential Structure Fires

The following table shows the number of fire-related civilian injuries in residential structure fires by age and gender.

Gender	4 and under	5-14	15-24	25-34	35-44	45-54	55-64	65 & over	Unknown	Totals
Male	18	15	41	59	54	34	23	33	6	283
Female	10	17	45	48	47	36	30	36	1	270
Totals	28	32	86	107	101	70	53	69	7	553

Most civilian injuries in residential structure fires (19%) involved people between the ages of 25-34. **Fifty-nine (11%)** of civilian residential structure fire injuries involved males between the ages of 25-34.

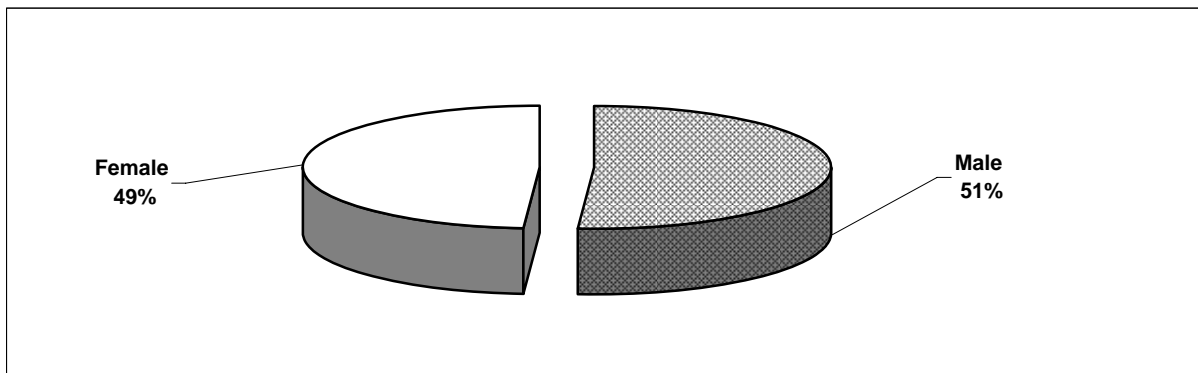
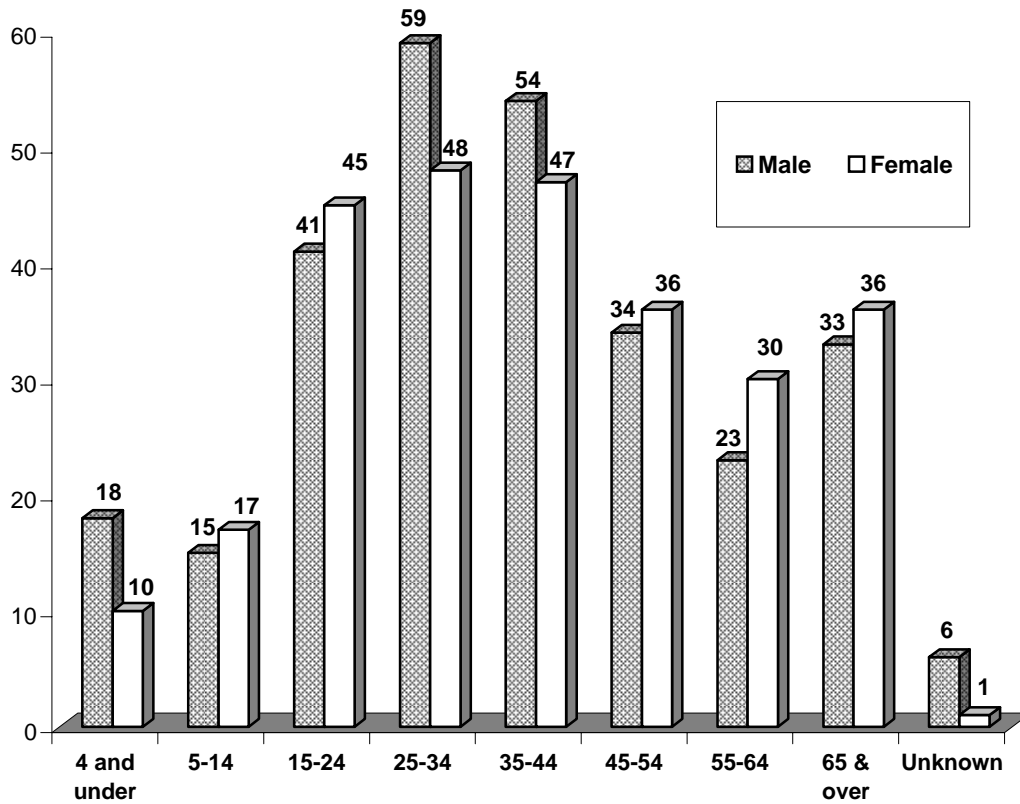

Civilian Fatalities in Residential Structure Fires

The following table shows the number of fire-related civilian deaths in residential structure fires by age and gender.

Gender	4 and under	5-14	15-24	25-34	35-44	45-54	55-64	65 & over	Unknown	Totals
Male	3	11	0	5	8	7	4	14	1	53
Female	5	3	1	4	2	8	4	8	0	35
Totals	8	14	1	9	10	15	8	22	1	88

Most civilian deaths in residential structure fires (25%) involved people age **65 and over**.

Fourteen (16%) of civilian residential structure fire deaths involved males age **65 and over**.

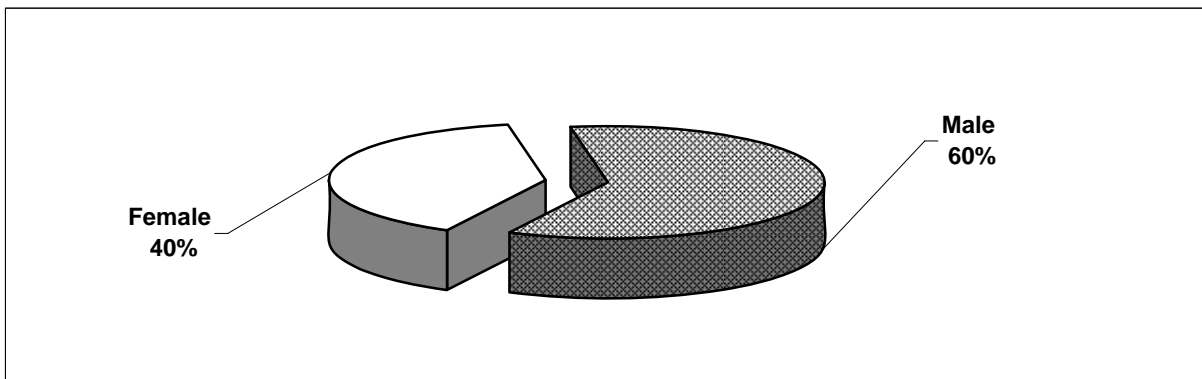
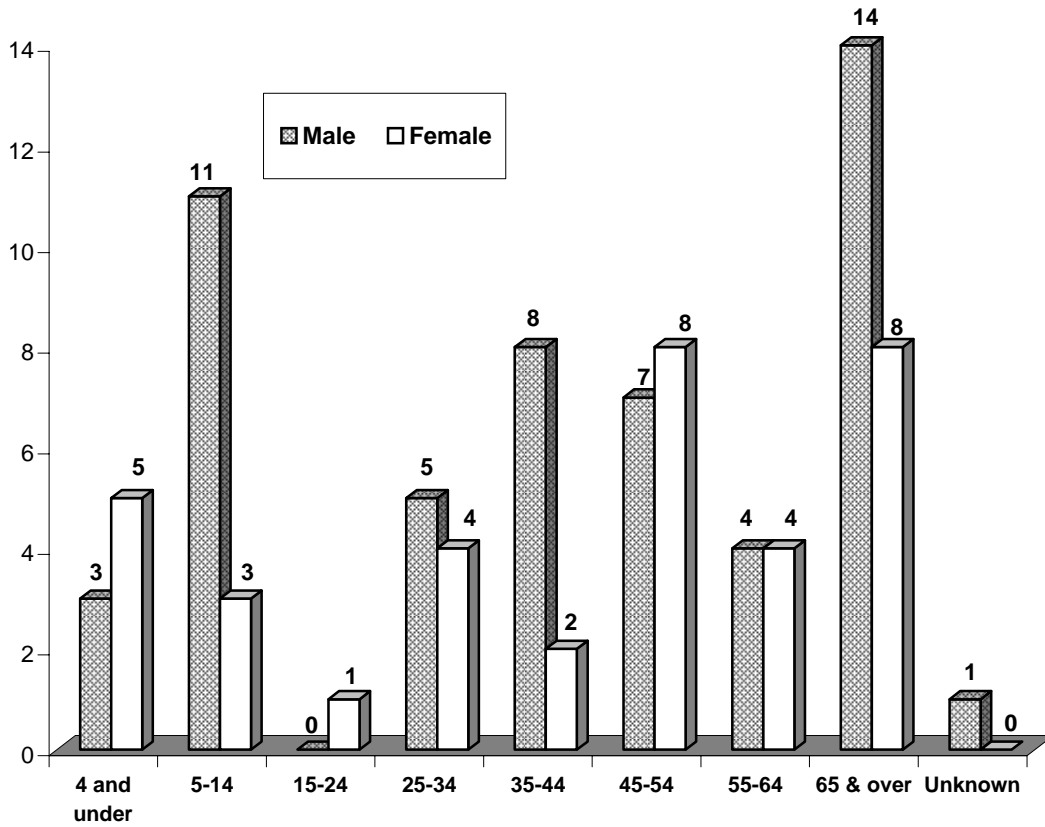

Fire Service Casualties in All Incident Types

The table below shows the number of fire service deaths and injuries in all incidents. Mutual aid calls are included.

Incident Type	Injuries	Deaths
Fire	437	4
Overpressure rupture, explosion, overheating - no fire	2	0
Rescue and emergency medical service incidents	305	0
Hazardous conditions - no fire	17	0
Service call	11	0
Good intent call	4	0
False alarm and false call	7	0
Severe weather and natural disaster	1	0
All other calls	11	0
Totals	795	4

Fire Service Injuries 1995-2004

The chart below shows the number of fire-related fire service personnel injuries during the years 1995-2004.

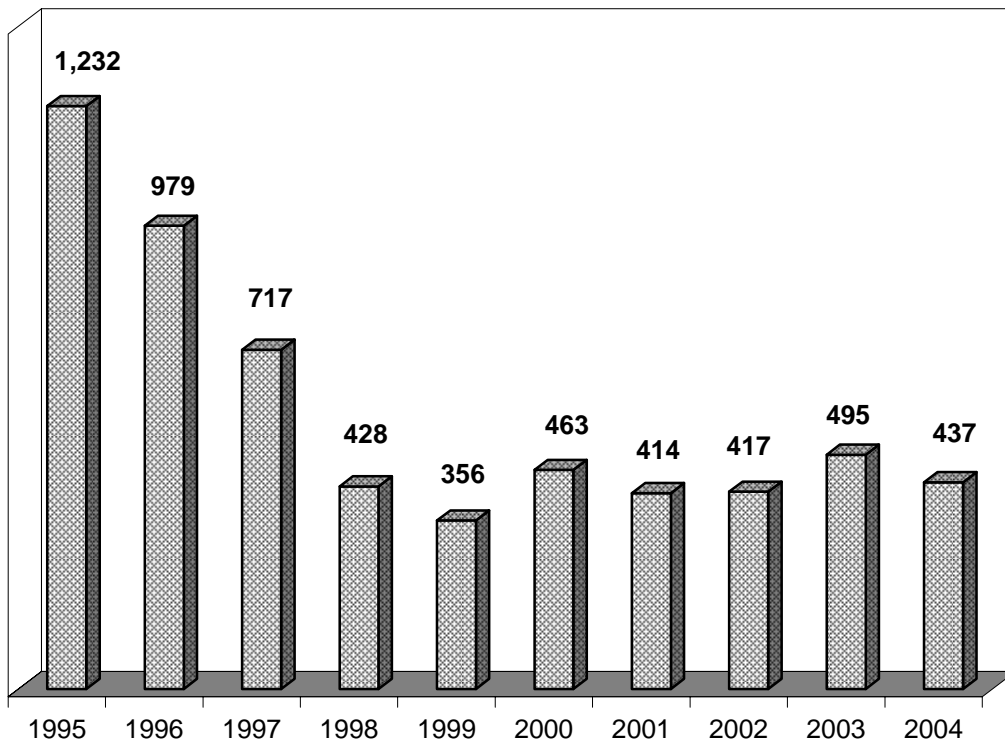

Fire Service Injuries by Type of Fire

The following table shows the number of fire service personnel injuries by type of fire incident.

Type of Fire	Injuries
Structure Fires	369
Vehicle Fires	21
Outside and Other Fires	47

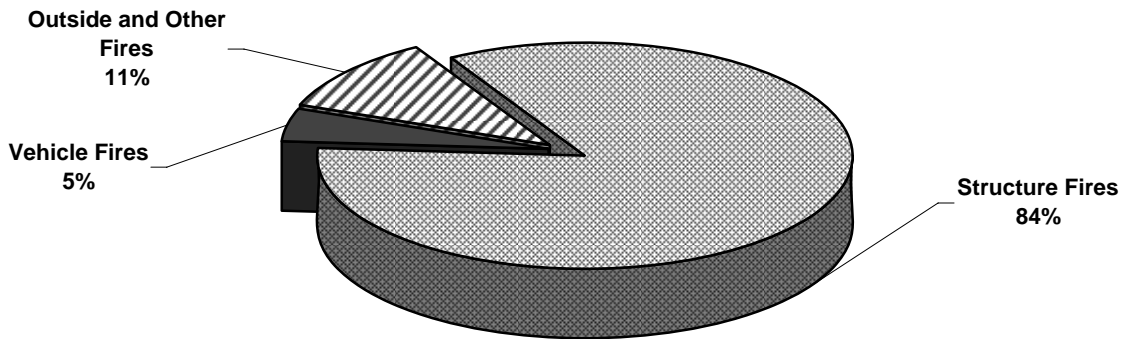

Most Frequent Fire Service Injuries by Property Use in Structures

The following table shows the number of fire service injuries in structures by known type of property.

Property Use	Injuries
Residential	289
Storage	20
Mercantile, business	13
Assembly	12
Manufacturing, processing	7

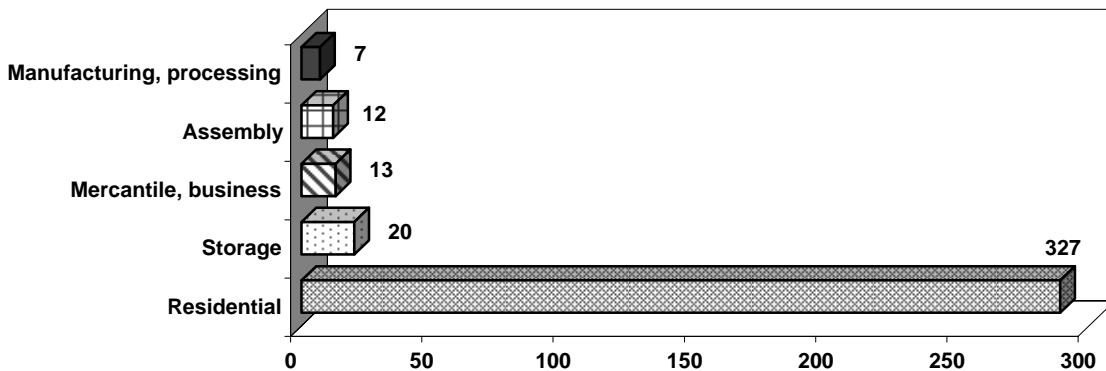

78% of all fire service injuries in structures occurred in residential property.

Fire Service Fatalities

The State Fire Marshal's Office investigates all line-of-duty deaths involving fire-service personnel in Texas. These investigations are conducted under statutory authority conferred upon the Texas Department of Insurance. For more information see our website at <http://www.tdi.state.tx.us/fire/fmlodinvesti.html>.

In 2004, TEXFIRS participating fire departments reported four fire service personnel fatalities.
Only incidents reported with complete data are reflected in this report.

Incident Type	Building Fire	Vehicle Fire	Chimney Fire	Building Fire
Property Type	Assembly	Open Land	Residential	Residential
Cause of Fire	Unknown	Unknown	Heating	Incendiary/ suspicious
Date	4/4/2004	7/9/2004	11/12/2004	12/20/2004
Age	34	60	56	24
Sex	Male	Male	Male	Male
Cause of Death	Caught/Trapped	Stress/Overexertion	Cardiac	Caught/Trapped
Nature of Death	Burns	Heart Attack		Asphyxiation

The following fire fighter fatality is not included elsewhere in this report due to incomplete or unreported information.

Incident Type	Scene Safety
Property Type	Street/Road
Cause of Fire	n/a
Date	10/20/2004
Age	58
Sex	Male
Cause of Death	Stress/Overexertion
Nature of Death	Heart Attack

Fire Service Fatalities 1995-2004

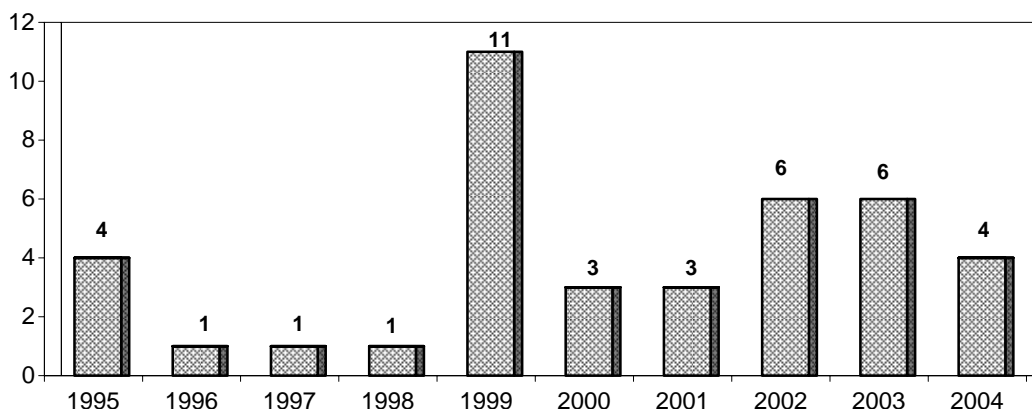

2004 Fires By County

County	Rept Depts	Pop Est	<u>FIRES</u>					Ttl Fires
			Civ Fat	Civ Inj	Structure	Vehicle	Outside/Other	
Anderson	8	56,117	0	2	59	29	150	238
Andrews	1	12,840	0	3	11	7	41	59
Angelina	5	81,492	2	5	110	53	94	257
Aransas	1	24,041	0	0	37	14	78	129
Archer	5	9,274	0	1	28	8	59	95
Armstrong	2	2,163	0	0	0	1	5	6
Atascosa	3	42,696	1	0	18	29	74	121
Austin	3	25,800	0	0	12	11	31	54
Bailey	1	6,662	0	0	14	2	52	68
Bandera	3	19,754	0	0	5	3	21	29
Bastrop	8	68,608	0	1	60	37	120	217
Baylor	0	3,933						
Bee	2	33,046	0	0	3	5	10	18
Bell	11	250,324	6	13	411	172	383	966
Bexar	23	1,493,965	12	42	1,136	1,171	2,377	4,684
Blanco	2	9,101	0	0	1	0	1	2
Borden	0	683						
Bosque	5	18,002	0	1	6	3	43	52
Bowie	7	90,248	0	3	157	75	212	444
Brazoria	13	271,130	2	1	143	76	235	454
Brazos	5	156,275	2	17	190	119	228	537
Brewster	0	9,226						
Briscoe	2	1,716	0	0	2	2	11	15
Brooks	0	7,753						
Brown	2	38,183	0	0	5	2	17	24
Burleson	4	17,057	0	0	18	15	42	75
Burnet	5	40,286	1	0	37	32	154	223
Caldwell	4	36,498	0	3	31	23	76	130
Calhoun	2	20,569	0	0	19	21	47	87
Callahan	3	13,314	0	0	14	15	64	93
Cameron	8	371,825	1	12	290	292	972	1,554
Camp	1	12,011	0	0	31	8	79	118
Carson	1	6,478	0	0	2	4	14	20
Cass	8	30,012	0	8	50	34	150	234
Castro	0	7,687						
Chambers	3	28,227	0	0	8	11	8	27
Cherokee	4	48,091	1	0	27	22	71	120
Childress	1	7,613	1	1	10	5	44	59
Clay	4	11,231	0	0	5	7	20	32
Cochran	0	3,340						
Coke	1	3,715	0	0	4	2	2	8
Coleman	1	8,738	0	0	6	7	53	66
Collin	18	627,938	2	14	441	203	672	1,316
Collingsworth	0	3,046						
Colorado	2	20,767	0	0	20	25	48	93
Comal	5	91,806	1	4	113	78	253	444
Comanche	1	13,616	0	0	1	1	9	11
Concho	0	3,744						

2004 Fires By County

County	Rept Depts	Pop Est	<u>FIRES</u>					Ttl Fires
			Civ Fat	Civ Inj	Structure	Vehicle	Outside/Other	
Cooke	3	38,626	0	1	52	27	87	166
Coryell	6	75,074	0	4	86	36	179	301
Cottle	1	1,748	0	0	1	6	29	36
Crane	0	3,849						
Crockett	0	3,950						
Crosby	0	6,645						
Culberson	0	2,727						
Dallam	0	6,175						
Dallas	23	2,294,706	6	44	3,219	2,538	4,323	10,080
Dawson	1	14,383	0	2	17	18	50	85
Deaf Smith	1	18,510	0	2	25	12	47	84
Delta	0	5,506						
Denton	18	530,597	1	31	385	201	754	1,340
Dewitt	1	20,354	0	0	10	11	43	64
Dickens	2	2,711	0	0	4	2	10	16
Dimmit	1	10,221	0	0	0	0	3	3
Donley	1	3,939	0	0	0	0	2	2
Duval	1	12,669	0	0	8	0	19	27
Eastland	6	18,379	0	1	40	20	99	159
Ector	3	124,488	4	5	202	71	214	487
Edwards	0	2,013						
El Paso	6	713,126	7	12	442	495	1,177	2,114
Ellis	18	128,710	0	11	177	144	381	702
Erath	4	33,704	0	0	19	23	85	127
Falls	2	17,765	0	0	13	8	31	52
Fannin	9	32,620	2	4	52	30	129	211
Fayette	8	22,513	0	0	29	28	72	129
Fisher	1	4,096	0	0	1	2	6	9
Floyd	2	7,330	0	0	7	2	28	37
Foard	0	1,551						
Fort Bend	14	442,620	0	11	290	185	351	826
Franklin	3	10,066	0	1	23	17	70	110
Freestone	5	18,597	0	0	25	19	78	122
Frio	2	16,386	0	3	14	29	88	131
Gaines	0	14,563						
Galveston	12	271,743	1	18	329	179	442	950
Garza	0	5,094						
Gillespie	3	22,502	0	1	12	8	104	124
Glasscock	0	1,334						
Goliad	0	7,104						
Gonzales	3	19,281	0	0	5	9	17	31
Gray	3	21,409	0	0	44	31	123	198
Grayson	14	115,933	2	13	192	106	436	734
Gregg	7	115,035	3	11	255	134	359	748
Grimes	3	25,241	1	0	25	17	67	109
Guadalupe	8	99,620	0	5	93	55	215	363
Hale	2	36,029	0	0	34	26	55	115
Hall	1	3,735	0	0	4	11	28	43

2004 Fires By County

County	Rept Depts	Pop Est	<u>FIRES</u>					Ttl Fires
			Civ Fat	Civ Inj	Structure	Vehicle	Outside/Other	
Hamilton	5	8,115	0	0	11	7	39	57
Hansford	2	5,207	0	0	5	3	29	37
Hardeman	1	4,374	0	0	0	1	2	3
Hardin	4	50,347	0	1	39	18	50	107
Harris	30	3,644,285	4	41	1,200	1,660	2,889	5,749
Harrison	4	62,727	0	6	87	46	152	285
Hartley	0	5,423						
Haskell	0	5,592						
Hays	5	119,359	1	3	69	79	177	325
Hemphill	0	3,336						
Henderson	12	79,184	0	3	125	55	208	388
Hidalgo	13	658,248	1	4	434	499	1,569	2,502
Hill	6	35,157	0	0	25	32	139	196
Hockley	1	22,781	0	0	31	17	77	125
Hood	4	46,492	0	0	37	25	120	182
Hopkins	6	33,201	0	1	58	33	184	275
Houston	5	23,303	0	0	36	23	72	131
Howard	1	32,879	1	2	32	26	47	105
Hudseth	0	3,300						
Hunt	10	81,781	0	1	165	104	418	687
Hutchinson	3	22,617	0	0	25	20	77	122
Irion	0	1,738						
Jack	0	8,981						
Jackson	2	14,400	0	0	6	9	19	34
Jasper	4	35,609	0	0	16	7	38	61
Jeff Davis	0	2,253						
Jefferson	8	248,223	3	24	490	243	474	1,207
Jim Hogg	0	5,062						
Jim Wells	1	40,807	0	0	9	8	26	43
Johnson	15	143,418	0	3	230	121	535	886
Jones	4	20,093	1	3	39	20	107	166
Karnes	1	15,458	0	0	4	9	28	41
Kaufman	10	85,377	0	1	100	73	334	507
Kendall	5	27,214	0	3	28	26	92	146
Kenedy	0	407						
Kent	0	744						
Kerr	5	45,675	2	6	34	46	81	161
Kimble	0	4,563						
King	0	323						
Kinney	0	3,337						
Kleberg	1	31,357	0	1	15	13	49	77
Knox	1	3,893	0	0	1	1	2	4
La Salle	0	5,945						
Lamar	12	49,710	0	0	127	53	206	386
Lamb	1	14,520	0	0	8	5	25	38
Lampasas	2	20,718	0	0	23	20	94	137
Lavaca	3	18,945	3	2	25	16	106	147
Lee	1	16,536	0	0	12	10	25	47

2004 Fires By County

County	Rept Depts	Pop Est	FIRES					Ttl Fires
			Civ Fat	Civ Inj	Structure	Vehicle	Outside/Other	
Leon	3	16,106	0	0	21	12	54	87
Liberty	4	74,821	0	2	10	8	77	95
Limestone	5	22,763	1	2	43	25	112	180
Lipscomb	1	3,074	0	0	1	3	14	18
Live Oak	0	11,694						
Llano	2	18,143	0	0	14	4	57	75
Loving	0	52						
Lubbock	4	251,018	0	2	45	19	102	166
Lynn	0	6,156						
Madison	1	13,203	0	0	3	0	17	20
Marion	0	11,115						
Martin	0	4,448						
Mason	0	3,844						
Matagorda	2	38,092	1	0	31	24	41	96
Maverick	1	50,436	0	2	24	22	62	108
McCulloch	4	8,108	0	1	12	14	61	87
McLennan	10	222,439	1	15	296	230	435	961
McMullen	0	853						
Medina	5	42,269	0	0	23	25	182	230
Menard	1	2,285	0	0	2	3	15	20
Midland	2	120,344	4	8	115	70	225	410
Milam	4	25,204	0	0	15	9	58	82
Mills	2	5,130	0	0	7	1	13	21
Mitchell	1	9,402	2	0	7	6	21	34
Montague	4	19,503	1	1	39	23	85	147
Montgomery	11	362,382	0	10	300	173	589	1,062
Moore	1	20,333	0	0	5	5	29	39
Morris	5	13,079	3	0	31	15	75	121
Motley	1	1,307	0	0	4	3	4	11
Nacogdoches	6	60,249	0	0	70	52	104	226
Navarro	9	48,243	0	3	56	37	133	226
Newton	2	14,345	1	0	6	7	36	49
Nolan	0	15,129						
Nueces	6	317,513	4	38	462	339	714	1,515
Ochiltree	1	9,143	0	0	0	0	1	1
Oldham	2	2,140	0	0	3	7	4	14
Orange	7	84,873	0	6	183	100	337	620
Palo Pinto	2	27,325	1	14	46	30	108	184
Panola	2	22,865	1	0	22	25	55	102
Parker	13	100,336	0	0	107	64	308	479
Parmer	0	9,933						
Pecos	1	15,949	0	0	5	2	5	12
Polk	3	46,397	0	0	6	9	7	22
Potter	2	118,410	2	31	323	145	554	1,022
Presidio	0	7,639						
Rains	2	11,066	0	0	8	14	60	82
Randall	4	109,062	0	1	40	21	84	145
Reagan	0	3,064						

2004 Fires By County

County	Rept Depts	Pop Est	FIRES					Ttl Fires
			Civ Fat	Civ Inj	Structure	Vehicle	Outside/Other	
Real	1	2,995	0	0	2	0	7	9
Red River	3	13,650	0	0	14	3	39	56
Reeves	0	11,842						
Refugio	2	7,640	1	1	4	9	16	29
Roberts	1	863	0	0	0	1	7	8
Robertson	4	16,136	0	0	16	16	52	84
Rockwall	1	58,260	1	1	47	15	36	98
Runnels	2	10,943	0	0	5	4	18	27
Rusk	7	47,973	0	0	45	16	143	204
Sabine	3	10,407	1	0	16	8	27	51
San Augustine	0	8,923						
San Jacinto	7	24,678	1	0	29	17	64	110
San Patricio	4	68,187	0	1	36	27	46	109
San Saba	2	6,086	0	1	14	4	38	56
Schleicher	1	2,779	0	0	1	0	22	23
Scurry	1	16,084	0	1	29	17	73	119
Shackelford	1	3,232	0	0	0	0	2	2
Shelby	4	26,156	0	1	40	25	77	142
Sherman	0	3,095						
Smith	8	186,414	2	8	233	169	361	763
Somervell	0	7,453						
Starr	4	59,832	0	0	44	37	309	390
Stephens	1	9,523	0	3	25	10	56	91
Sterling	0	1,305						
Stonewall	0	1,405						
Sutton	1	4,097	0	0	0	7	12	19
Swisher	0	7,854						
Tarrant	25	1,588,088	6	60	1,292	1,078	2,187	4,557
Taylor	4	125,108	1	15	194	111	368	673
Terrell	0	957						
Terry	1	12,576	0	0	19	7	37	63
Throckmorton	0	1,632						
Titus	3	29,224	1	3	69	49	146	264
Tom Green	8	103,772	1	4	149	80	188	417
Travis	9	869,868	1	47	625	589	1,117	2,331
Trinity	1	14,345	0	0	25	8	27	60
Tyler	7	20,806	2	0	46	11	57	114
Upshur	6	37,397	0	2	48	28	150	226
Upton	0	3,147						
Uvalde	2	26,616	0	0	1	2	9	12
Val Verde	1	47,410	0	0	14	9	67	90
Van Zandt	10	51,996	1	1	69	52	284	405
Victoria	12	85,777	0	9	113	72	170	355
Walker	5	62,217	0	2	74	47	126	247
Waller	5	34,757	1	0	46	50	108	204
Ward	1	10,358	0	0	12	10	28	50
Washington	5	31,248	0	0	25	19	54	98
Webb	1	219,464	0	0	126	246	419	791

2004 Fires By County

County	Rept Depts	Pop Est	<u>FIRES</u>					Ttl Fires
			Civ Fat	Civ Inj	Structure	Vehicle	Outside/Other	
Wharton	1	41,594	0	2	29	14	24	67
Wheeler	1	4,787	0	0	10	10	23	43
Wichita	2	127,321	0	0	24	20	77	121
Wilbarger	1	14,184	1	7	33	20	85	138
Willacy	3	20,231	0	0	4	4	19	27
Williamson	14	317,938	1	9	226	132	413	771
Wilson	4	36,726	0	0	23	11	95	129
Winkler	1	6,714	0	0	0	0	2	2
Wise	15	55,539	0	0	62	26	186	274
Wood	7	40,357	1	1	47	26	244	317
Yoakum	1	7,348	0	0	7	8	17	32
Young	1	17,938			26	8	42	76
Zapata	0	13,154						
Zavala	0	11,700						
	925	22,490,022	120	731	19,638	15,130	38,723	73,491

2004 Structure Fires by Region

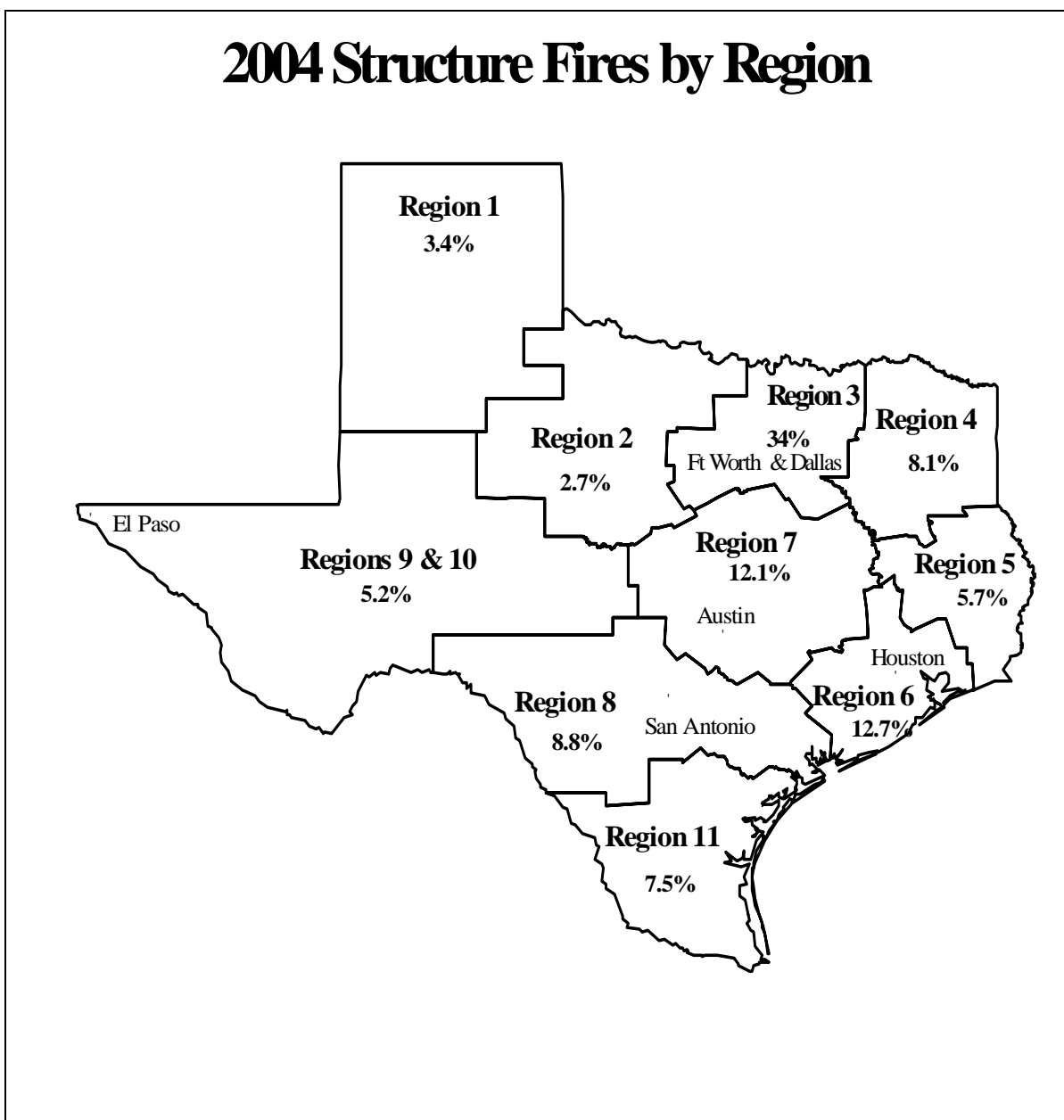

Texas fire departments reported a total of 19,638 structure fires.

Region 1	3.4%	672	
Region 2	2.7%	523	
Region 3	34.0%	6,679	Dallas Fire Department 1,820 (9.3% of the state total) Ft Worth Fire Department 749 (4% of the state total)
Region 4	8.1%	1,585	
Region 5	5.7%	1,112	
Region 6	12.7%	2,492	Houston Fire Department 255 (1.3% of the state total)
Region 7	12.1%	2,377	Austin Fire Department 543 (2.8% of the state total)
Region 8	8.8%	1,722	San Antonio Fire Department 969 (4.9% of the state total)
Region 9 & 10	5.2%	1,004	El Paso Fire Department 392 (2.0% of the state total)
Region 11	7.5%	1,472	

2004 Vehicle Fires by Region

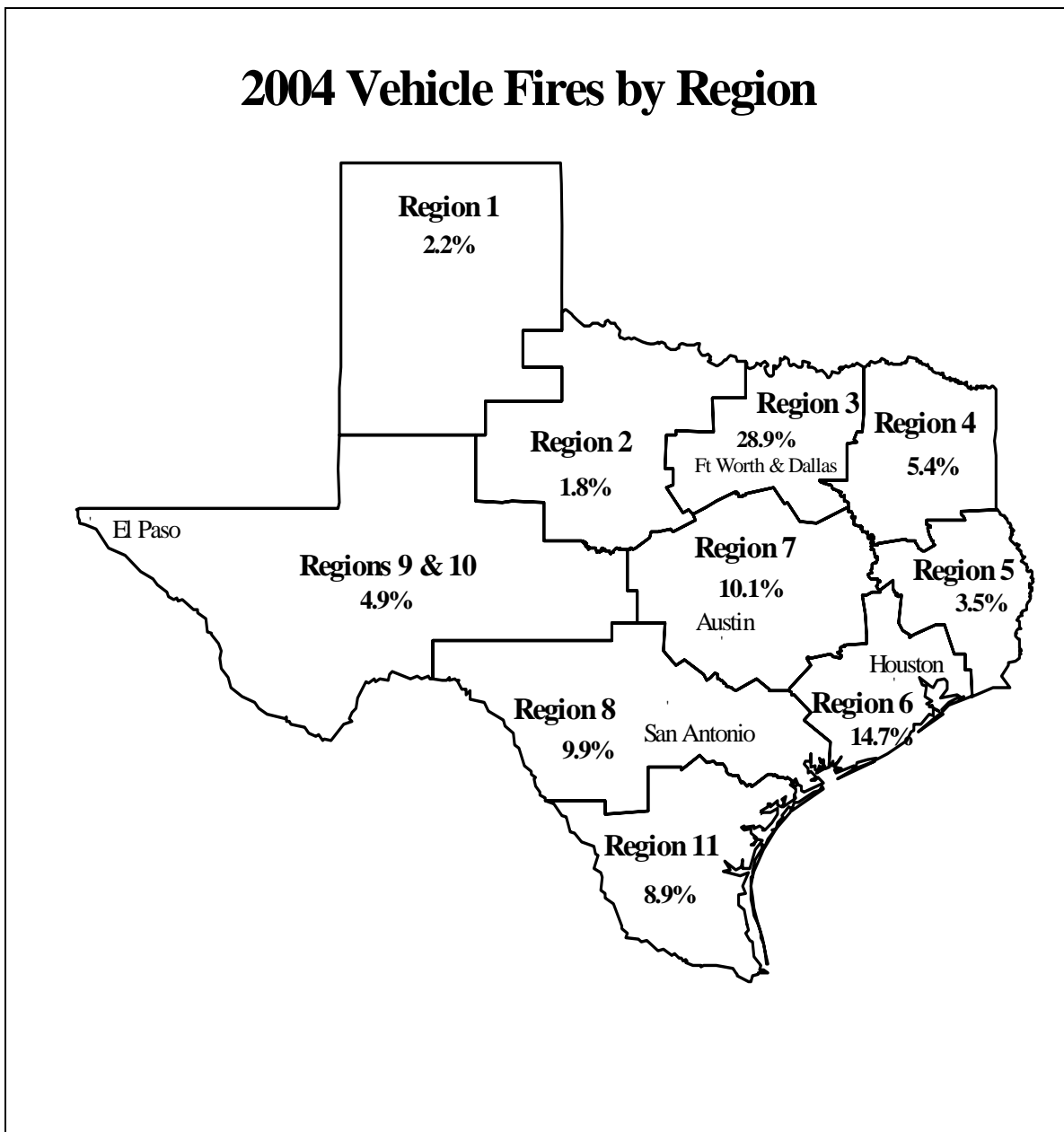

Texas fire departments reported a total of 15,130 vehicle fires.

Region 1	2.2%	372	
Region 2	1.8%	309	
Region 3	28.9%	4,845	Dallas Fire Department 1,647 (10.9% of the state total) Fort Worth Fire Department 772 (5% of the state total)
Region 4	5.4%	903	
Region 5	3.5%	581	
Region 6	14.7%	2,463	Houston Fire Department 935 (6.2% of the state total)
Region 7	10.1%	1,698	Austin Fire Department 523 (3.5% of the state total)
Region 8	4.9%	805	San Antonio Fire Department 1,074 (7.1% of the state total)
Region 9 & 10	4.9%	805	El Paso Fire Department 460 (3.0% of the state total)
Region 11	8.9%	1,493	

2004 Outside and Other Fires by Region

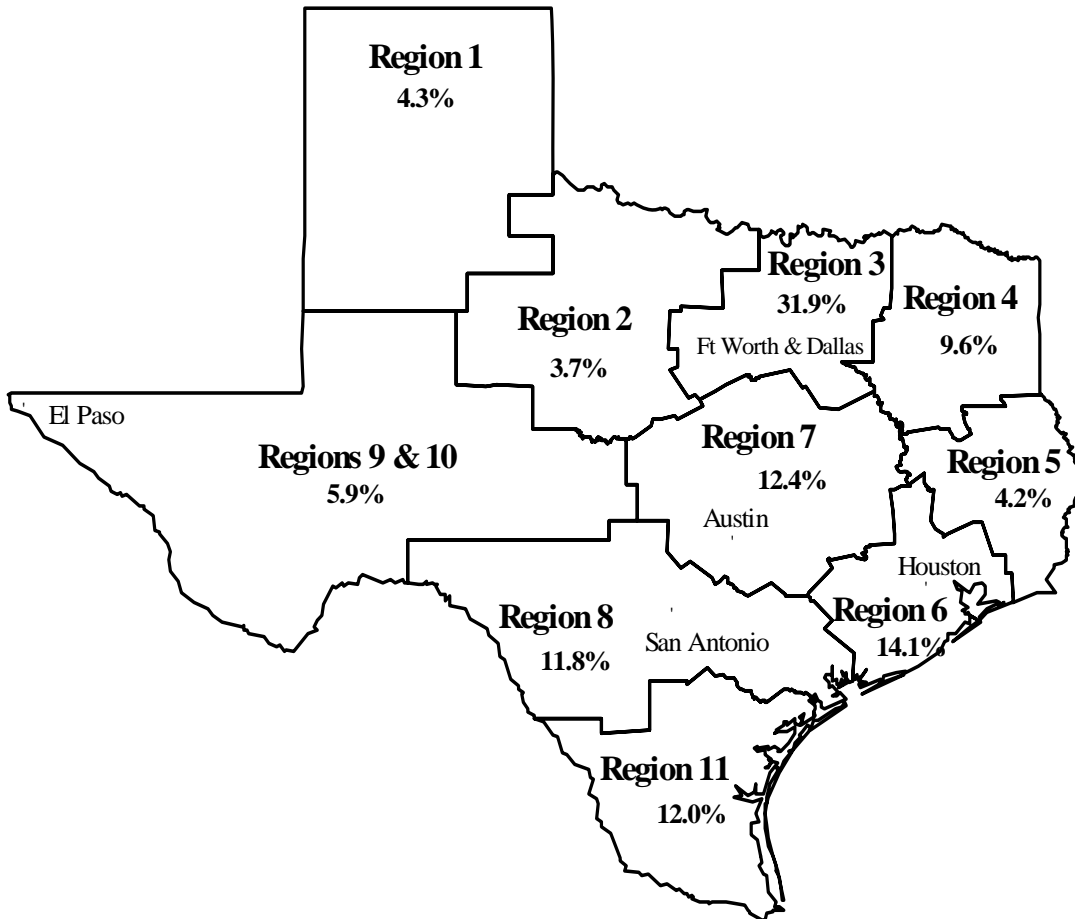

Texas fire departments reported a total of 38,723 outside and other fires.

Region 1	4.3%	1,503	
Region 2	3.7%	1,294	
Region 3	31.9%	11,232	Dallas Fire Department 2,782 (7.2% of the state total) Ft Worth Fire Department 1,381 (4% of the state total)
Region 4	9.6%	3,398	
Region 5	4.2%	1,464	
Region 6	14.1%	4,969	Houston Fire Department 1,526 (4.0% of the state total)
Region 7	12.4%	4,368	Austin Fire Department 885 (2.3% of the state total)
Region 8	11.8%	4,160	San Antonio Fire Department 2,045 (5.3% of the state total)
Region 9 & 10	5.9%	2,089	El Paso Fire Department 938 (2.4% of the state total)
Region 11	12.0%	4,246	



Participating Fire Departments

The Texas Department of Insurance would like to thank the following fire departments that submitted reports to the Texas Fire Incident Reporting System (TEXFIRS) in 2004. This report would not have been possible without their continued cooperation, efforts, and support.

- ☆ 219 VF&R
- ☆ 2604 FD
- ☆ 287 R/C Fire & Rescue
- ☆ Abilene FD
- ☆ Ables Springs FD
- ☆ Addison FD
- ☆ Alamo FD
- ☆ Alamo Heights FD
- ☆ Albany VFD
- ☆ Alice FD
- ☆ Allen FD
- ☆ Alvarado FD
- ☆ Alvin FD
- ☆ Alvord VFD
- ☆ Amarillo FD
- ☆ Anahuac VFD
- ☆ Andrews VFD
- ☆ Anna VFD
- ☆ Annville VFD
- ☆ Anson FD
- ☆ Appleby FD
- ☆ Aransas Pass FD
- ☆ Archer City VFD
- ☆ Argyle VFD
- ☆ Asherton VFD
- ☆ Atascocita VFD
- ☆ Athens FD
- ☆ Atlanta FD
- ☆ Aubrey VFD
- ☆ Austin FD
- ☆ Avalon VFD
- ☆ Avery VFD
- ☆ Azle FD
- ☆ Bacliff FD
- ☆ Bailey VFD
- ☆ Baird VFD
- ☆ Balch Springs FD
- ☆ Balcones Heights FD
- ☆ Ballinger FD
- ☆ Bangs FD
- ☆ Bardwell VFD
- ☆ Bartlett VFD
- ☆ Bastrop County Fire/Rescue
- ☆ Bastrop VFD
- ☆ Baxter VFD
- ☆ Bay City FD
- ☆ Bayside FD
- ☆ Baytown FD
- ☆ Beach City VFD
- ☆ Bear Creek VFD
- ☆ Beasley VFD
- ☆ Beaumont FD
- ☆ Bedford FD
- ☆ Bellaire FD
- ☆ Bellevue FD
- ☆ Bellmead VFD
- ☆ Bells FD
- ☆ Belmont VFD
- ☆ Belton FD
- ☆ Benbrook FD
- ☆ Benjamin VFD
- ☆ Bennette VFD
- ☆ Berlin-Mill Creek-Zion VFD
- ☆ Bertram VFD
- ☆ Bethel Cayuga FD
- ☆ Bexar Bulverde FD
- ☆ Big Spring FD
- ☆ Bishop VFD
- ☆ Black Jack VFD
- ☆ Blackjack VFD
- ☆ Blanco VFD
- ☆ Bloomburg VFD
- ☆ Blooming Grove VFD
- ☆ Bloomington VFD
- ☆ Blossom VFD
- ☆ Blue Mound FD
- ☆ Blue Ridge VFD
- ☆ Bluebonnet VFD
- ☆ Bluegrove VFD
- ☆ Blum VFD
- ☆ Boerne VFD
- ☆ Bon Wier VFD
- ☆ Bonham FD
- ☆ Bono VFD
- ☆ Booker FD
- ☆ Boonsville-Balsora VFD
- ☆ Borger FD
- ☆ Bowie FD
- ☆ Bowie Rural VFD
- ☆ Bowman VFD
- ☆ Boxelder VFD
- ☆ Boyd FD
- ☆ Bracken VFD
- ☆ Brady VFD
- ☆ Branch VFD
- ☆ Brazoria FD
- ☆ Brazos County Pct #3
- ☆ Brazos County Pct #4
- ☆ Brazos Point-Eulogy FD
- ☆ Breckenridge FD
- ☆ Bremond VFD
- ☆ Brenham FD
- ☆ Briar VFD
- ☆ Briar Oaks VFD
- ☆ Bridge City F&R
- ☆ Bridgeport VFD
- ☆ Briggs VFD
- ☆ Brinker VFD
- ☆ Bristol VFD
- ☆ Brock-Dennis VFD
- ☆ Brookshire VFD
- ☆ Brookston VFD
- ☆ Brownfield FD
- ☆ Brownsville FD
- ☆ Bryan FD
- ☆ Buckholts VFD
- ☆ Buda VFD
- ☆ Buffalo Gap VFD
- ☆ Buffalo VFD
- ☆ Bullard VFD
- ☆ Bulverde Area VFD
- ☆ Burkburnett VFD
- ☆ Burleson FD
- ☆ Burnet VFD
- ☆ Butler VFD
- ☆ C-5 VFD
- ☆ Caddo Mills F&R
- ☆ Calvert VFD
- ☆ Camelot VF&R
- ☆ Cameron VFD
- ☆ Camilla VFD
- ☆ Campbell VFD
- ☆ Canton VFD
- ☆ Canyon FD
- ☆ Canyon Lake Fire/EMS
- ☆ Carancahua VFD
- ☆ Carlisle VFD
- ☆ Carlsbad VFD
- ☆ Carlton VFD
- ☆ Carmine VFD
- ☆ Carrollton FD

☆ Carthage VFD	☆ Crabbs Prairie VFD	☆ Elgin VFD
☆ Cass County RFD #1	☆ Crafton VFD	☆ Elkhart FD
☆ Cass County RFD #2	☆ Crandall VFD	☆ Ellinger VFD
☆ Castle Hills FD	☆ Crims Chapel VFD	☆ Ellis County ESD #1/Maypearl
☆ Castroville VFD	☆ Crockett VFD	☆ Ellis County ESD#9/Palmer VFD
☆ Cat Spring VFD	☆ Crosby FD	☆ Elsa FD
☆ Cedar Hill FD	☆ Crowley FD	☆ Emhouse VFD
☆ Cedar Park FD	☆ Cuero FD	☆ Emory FD
☆ Celeste VFD	☆ Cunningham VFD	☆ Ennis FD
☆ Celina FD	☆ Cut N Shoot VFD	☆ Erath County VFD
☆ Center FD	☆ Cy-Fair VFD	☆ Etoile VFD
☆ Centerhill VFD	☆ Cypress Creek VFD	☆ Eula VFD
☆ Central Community VFD	☆ Dacasta VFD	☆ Eules FD
☆ Central Heights FD	☆ Daingerfield VFD	☆ Evant VFD
☆ Central High FD	☆ Dale VFD	☆ Everman FD
☆ Chalk Bluff VFD	☆ Dallas County F&R	☆ Ewell VFD
☆ Champions Area VFD	☆ Dallas FD*	☆ Fabens VFD
☆ Chandler FD	☆ Dalworthington Gardens VFD	☆ Fairfield VFD
☆ Charlie-Thornberry VFD	☆ Dam-B VFD	☆ Fairmount VFD
☆ Chatfield VFD	☆ Dean Dale VFD	☆ Farmers Branch FD
☆ Cherokee VFD	☆ Deanville VFD	☆ Farmersville VFD
☆ Chicota VFD	☆ Decatur FD	☆ Faught FD
☆ Childress FD	☆ Deer Park FD	☆ Ferris FD
☆ China Grove VFD	☆ DeKalb VFD	☆ Five Points VFD
☆ China VFD	☆ Denison FD	☆ Flatonia VFD
☆ Christoval VFD	☆ Denton FD	☆ Florence VFD
☆ Cibolo FD	☆ Denver City VFD	☆ Floresville VFD
☆ Circle D VFD	☆ Deport VFD	☆ Flower Mound FD
☆ Cisco FD	☆ DeSoto VFD	☆ Floydada VFD
☆ Clarksville FD	☆ Devine VFD	☆ Fordtran VFD
☆ Clarksville-Warren FD	☆ Dickinson VFD	☆ Forest Hill FD
☆ Clayton FD	☆ Dilley VFD	☆ Forney VFD
☆ Cleburne FD	☆ Dixie FD	☆ Forreston RVFD
☆ Clint VFD	☆ Dodge VFD	☆ Fort Worth FD
☆ Cloverleaf VFD	☆ Double Oak FD	☆ Franklin VFD
☆ Clute VFD	☆ Douglassville VFD	☆ Frankston FD
☆ Clyde FD	☆ Dove Creek VFD	☆ Fred VFD
☆ Coffee City VFD	☆ Driftwood VFD	☆ Fredericksburg VFD
☆ Coldspring VFD	☆ Dumas FD	☆ Freeport FD
☆ Coleman FD	☆ Duncanville FD	☆ Freer VFD
☆ College Station FD	☆ Eagle Creek VES	☆ Fresno VFD
☆ Collinsville FD	☆ Eagle Lake VFD	☆ Friendswood FD
☆ Colmesneil VFD	☆ Eagle Mountain VFD	☆ Frisco VFD
☆ Colorado City VFD	☆ Eagle Pass FD	☆ Fritch VFD
☆ Columbus VFD	☆ East Concho VFD	☆ Frost VFD
☆ Combine FD	☆ East End VFD	☆ Fruitvale VFD
☆ Comfort VFD	☆ East Tx Regional Airport PSD	☆ Ft. Stockton VFD
☆ Commerce FD	☆ East Wise F&R	☆ Fulshear Simonton VFD
☆ Conroe FD	☆ Eastland VFD	☆ Gainesville FD
☆ Converse VFD	☆ Eastside VFD	☆ Galena Park FD
☆ Cool-Garner Fire/Rescue	☆ Ector FD	☆ Galveston FD
☆ Coppell FD	☆ Edcouch VFD	☆ Garland FD
☆ Copperas Cove FD	☆ Edgewood FD	☆ Garrett Area VFD
☆ Corpus Christi FD	☆ Edinburg FD	☆ Garrett VFD, City of
☆ Corrigan VFD	☆ Edna VFD	☆ Gatesville FD
☆ Corsicana FD	☆ Edom VFD	☆ Georgetown FD
☆ Cottondale VFD	☆ El Campo FD	☆ Geronimo FD
☆ County Line VFD	☆ El Paso County ESD #1	☆ Giddings VFD
☆ County Road 143 VFD	☆ El Paso FD	☆ Gilmer FD
☆ Coupland VFD	☆ Elderville-Lakeport VFD	☆ Gladewater FD
☆ Covington VFD	☆ Eldorado VFD	☆ Glenn Heights FD

☆ Glenwood Acres VFD	☆ Humble FD	☆ Lago Vista F&R/TCESD #1
☆ Godley FD	☆ Hunt VFD	☆ Laguna Vista VFD
☆ Goldthwaite VFD	☆ Huntington VFD	☆ Lake Bridgeport VFD
☆ Gonzales FD	☆ Huntsville FD	☆ Lake Brownwood VFD
☆ Gordon VFD	☆ Hurst FD	☆ Lake Cities VFD
☆ Gordonville VFD	☆ Hutchins VFD	☆ Lake Conroe VFD
☆ Gorman FD	☆ Hwy 321 VFD	☆ Lake Dunlap VFD
☆ Graham FD	☆ Idalou VFD	☆ Lake Jackson VFD
☆ Granbury VFD	☆ Inez VFD	☆ Lake LBJ Mud FD
☆ Grand Saline VFD	☆ Ingleside VFD	☆ Lake Mexia VFD
☆ Grandview VFD	☆ Ingram VFD	☆ Lake Nacogdoches Area VFD
☆ Grangerland VFD	☆ Iola VFD	☆ Lake Palestine East VFD
☆ Granite Shoals FD	☆ Iredell VFD	☆ Lake Rayburn VFD
☆ Grape Creek VFD	☆ Irving FD	☆ Lake Tanglewood VFD
☆ Grapeland VFD	☆ Italy VFD	☆ Lakeside City VFD
☆ Grapevine FD	☆ Ivanhoe VFD	☆ Lakeside Village VFD
☆ Greenville FD	☆ Jacinto City VFD	☆ Lakeview VFD
☆ Greenwood RVFD	☆ Jackson Heights VFD	☆ Lamar Pt-Emberson-Caviness VFD
☆ Greenwood-Slidell VFD	☆ Jacksonville FD	☆ Lamesa FD
☆ Groesbeck VFD	☆ Jamaica Beach FD	☆ Lampasas FD
☆ Groves VFD	☆ Jarret VFD	☆ Lancaster FD
☆ Gruver VFD	☆ Jasper FD	☆ Land's End VFD
☆ Gunter VFD	☆ Jersey Village FD	☆ Laneville VFD
☆ Hale Center VFD	☆ Joaquin VFD	☆ Laredo FD
☆ Hallettsville VFD	☆ Johnson City VFD	☆ LaRue-New York VFD
☆ Hallsville FD	☆ Jollyville VFD	☆ Latexo VFD
☆ Haltom City FD	☆ Jonesboro VFD	☆ Leander FD
☆ Hamilton VFD	☆ Josephine VFD	☆ Ledbetter VFD
☆ Hamlin VFD	☆ Joshua FD	☆ Leon Valley FD
☆ Harker Heights FD	☆ Jourdanton VFD	☆ Levelland FD
☆ Harlingen FD	☆ Justin FD	☆ Lewisville FD
☆ Harmony VFD	☆ Karnes City VFD	☆ Liberty Chapel VFD
☆ Harper VFD	☆ Katy VFD	☆ Liberty FD
☆ Harrison County RFPD #2	☆ Kaufman VFD	☆ Liberty Hill VFD
☆ Hawley VFD	☆ Keene FD	☆ Lillian VFD
☆ Heart of the Pines VFD	☆ Keller F&R	☆ Lindale VFD
☆ Hempstead VFD	☆ Kemah VFD	☆ Linden VFD
☆ Henderson FD	☆ Kemp VFD	☆ Lindsay VFD
☆ Hereford FD	☆ Kempner VFD	☆ Lingleville VFD
☆ Hewitt FD	☆ Kendalia FD	☆ Linn-San Manuel FD
☆ Hico VFD	☆ Kennard-Ratcliff VFD	☆ Little Elm VFD
☆ Highland Village FD	☆ Kennedale FD	☆ Little River Academy VFD
☆ Hillsboro F&R	☆ Kerrville FD	☆ Littlefield FD
☆ Hilltop Lakes VFD	☆ Kicaster VFD	☆ Live Oak FD
☆ Hitchcock VFD	☆ Kilgore FD	☆ Liverpool VFD
☆ Holiday Lakes VFD	☆ Killeen FD	☆ Llano VFD
☆ Holliday VFD	☆ Kingsville FD	☆ Lockhart FD
☆ Holly Lake VFD	☆ Kirbyville VFD	☆ Lockney VFD
☆ Hollywood Park VFD	☆ Knippa ES	☆ Locust VFD
☆ Hondo VFD	☆ Kountze VFD	☆ Log Cabin VFD
☆ Honey Grove VFD	☆ Krum VFD	☆ Lohn VFD
☆ Hood County St 70 VFD	☆ La Casita FD	☆ Lone Oak FD
☆ Hoover VFD	☆ La Feria VFD	☆ Lone Oak VFD
☆ Hopewell VFD	☆ La Grange VFD	☆ Lone Pine VFD
☆ Hopkins County F&R	☆ La Joya VFD	☆ Lone Star VFD
☆ Houston FD*	☆ La Junta FD	☆ Lone Tree Community VFD
☆ Howard Wick VFD	☆ La Marque FD	☆ Longview FD
☆ Howe FD	☆ La Porte VFD	☆ Lorena VFD
☆ Hudson VFD	☆ La Villa VFD	☆ Los Fresnos VFD
☆ Hughes Springs VFD	☆ LaCoste Lions Club VFD	☆ Lott FD
☆ Hull-Daisetta VFD	☆ Lacy Lakeview VFD	☆ Lovelady VFD

☆ Lucas VFD	☆ Mountain Home VFD	☆ Ore City FD
☆ Lufkin FD	☆ Mt. Pleasant VFD	☆ Ottine VFD
☆ Luling FD	☆ Muldoon FD	☆ Overton FD
☆ Lumberton F&R	☆ Muleshoe VFD	☆ Ovilla VFD
☆ Lyford VFD	☆ Murphy F&R	☆ Paducah VFD
☆ Mabank VFD	☆ Myrtle Springs VFD	☆ Palestine FD
☆ Malakoff VFD	☆ Nacogdoches FD	☆ Pampa FD
☆ Manchaca VFD	☆ Naples FD	☆ Panhandle VFD
☆ Manor VFD	☆ Nassau Bay VFD	☆ Pantego FD
☆ Mansfield FD	☆ Natalia VFD	☆ Papalote VFD
☆ Manvel VFD	☆ Navarro Mills VFD	☆ Paradise VFD
☆ Marble Falls FD, City	☆ Navasota VFD	☆ Paris FD
☆ Marlin FD	☆ Nederland F&R	☆ Parker VFD
☆ Marshall FD	☆ Nevada FD	☆ Pasadena VFD
☆ Mart VFD	☆ New Boston VFD	☆ Pattison Area VFD Inc.
☆ Matador VFD	☆ New Braunfels FD	☆ Payne Springs VFD
☆ Matagorda VFD	☆ New Caney VFD	☆ Pearland VFD
☆ Maud VFD	☆ New Salem FD	☆ Pearsall VFD
☆ Mauriceville VFD	☆ New Summerfield VFD	☆ Pecan Creek VFD
☆ Maxwell VFD	☆ Newark VFD	☆ Pecan Grove VFD
☆ McAdoo VFD	☆ Newton VFD	☆ Pedernales ES/TCESD #8
☆ McAllen FD	☆ Nocona FD	☆ Pendleton Harbor VFD
☆ McKinney FD	☆ Nocona Rural FD	☆ Perryton FD
☆ McLean VFD	☆ Nolan VFD	☆ Pflugerville FD
☆ McQueeney VFD	☆ Nolanville FD	☆ Pharr FD
☆ Medina Lake VFD	☆ Nome VFD	☆ Pickton-Pine Forest VFD
☆ Medina VFD	☆ Noonday VFD	☆ Pilot Point FD
☆ Memphis FD	☆ Normangee VFD	☆ Pinehurst VFD
☆ Menard VFD	☆ North Fannin County VFD	☆ Pineland VFD
☆ Mercedes FD	☆ North Franklin VFD	☆ Pipe Creek VFD
☆ Merit VFD	☆ North Hays County VFD	☆ Pittsburg FD
☆ Merkel VFD	☆ North Hood County VFD	☆ Placedo VFD
☆ Mesquite FD	☆ North Hopkins VFD	☆ Plainview FD
☆ Mexia FD	☆ North Lake Travis FR/TCESD #7	☆ Plano FD
☆ Mexia State School FD	☆ North Montgomery County VFD	☆ Pleak FD
☆ Meyersville VFD	☆ North Richland Hills FD	☆ Pleasant Grove VFD
☆ Miami/Roberts County VFD	☆ North Tarrant County RFD	☆ Pleasanton VFD
☆ Midland FD	☆ North Zulch VFD	☆ Point Blank VFD
☆ Midlothian FD	☆ Northeast F&R	☆ Ponder VFD
☆ Mid-North FD	☆ Northeast Midland County VFD	☆ Ponderosa VFD
☆ Miles VFD	☆ Northwest VFD	☆ Poolville VFD
☆ Milford VFD	☆ Novice VFD	☆ Port Arthur FD
☆ Miller Grove VFD	☆ Nueces Canyon VFD	☆ Port Isabel FD
☆ Millsap VFD	☆ Nueces Co ESD #2(Flour Bluff)	☆ Port Lavaca FD
☆ Mineola FD	☆ Nursery VFD	☆ Port Mansfield VFD
☆ Mineral Wells FD	☆ Oak Hill FD/TCESD #3	☆ Port Neches FD
☆ Minerva VFD	☆ Oak Point DPS	☆ Porter VFD
☆ Mission FD	☆ Oakhurst VFD	☆ Portland VFD
☆ Mission Valley VFD	☆ Odessa FD	☆ Potter County F&R
☆ Missouri City FD	☆ Ogburn FD	☆ Pottsboro FD
☆ Moffat VFD	☆ Oglesby FD	☆ Prairie Hill VFD
☆ Moffett VFD	☆ Old River-Winfree VFD	☆ Preston FD
☆ Monahans VFD	☆ Olden FD	☆ Primrose VFD
☆ Monaville VFD	☆ Olmos Park FD	☆ Princeton FD
☆ Montalba VFD	☆ Omaha VFD	☆ Prosper FD
☆ Montana Vista FD	☆ On the Bay VFD	☆ Punkin Evergreen VFD
☆ Montgomery FD	☆ Onalaska VFD	☆ Quail Creek FD
☆ Morgan Mill VFD	☆ Orange County ESD #1	☆ Quanah FD
☆ Morgan Point VFD	☆ Orange County Rural FD	☆ Quinlan VFD
☆ Moulton VFD	☆ Orange FD	☆ Quitaque VFD
☆ Mount Vernon VFD	☆ Orchard VFD	☆ Quitman VFD

☆ Raisin VFD	☆ Sandy Oaks FD	☆ Stinnett VFD
☆ Rancho Viejo VFD	☆ Sanger FD	☆ Stockdale VFD
☆ Randall County F&R	☆ Sansom Park VFD	☆ Streetman VFD
☆ Randolph VFD	☆ Santa Fe Fire & Rescue	☆ Sugar Hill VFD
☆ Ranger FD	☆ Santa Monica VFD	☆ Sugar Land FD
☆ Ravenna VFD	☆ Saratoga VFD	☆ Sulphur Springs FD
☆ Red Oak VFD	☆ Savoy VFD	☆ Sunnyvale FD
☆ Red Springs VFD	☆ Schertz FD	☆ Surfside Beach FD
☆ Redwater VFD	☆ Schulenburg VFD	☆ Taft VFD
☆ Refugio VFD	☆ Scurry VFD	☆ Tarkington VFD
☆ Reklaw VFD	☆ SE TX Regional Airport FD	☆ Taylor FD
☆ Reno FD	☆ Seadrift FD	☆ Teague FD
☆ Reno VF&R	☆ Seagoville FD	☆ Telephone VFD
☆ Retreat VFD	☆ Sealy VFD	☆ Telferner VFD
☆ Rhome FD	☆ Seguin FD	☆ Telico FD
☆ Richards VFD	☆ Selma FD	☆ Temple FD
☆ Richardson FD	☆ Shady Oaks VFD	☆ Tennessee Colony FD
☆ Richland Hills FD	☆ Shallowater VFD	☆ Terrell FD
☆ Richmond FD	☆ Shamrock VFD	☆ Terrell Hills FD
☆ Rio Grande City FD	☆ Shavano Park FD	☆ Texarkana FD
☆ Rio Vista VFD	☆ Shelbyville VFD	☆ Texas City FD
☆ Rising Star FD	☆ Sheldon VFD	☆ The Colony FD
☆ Rivercrest/Redland VFD	☆ Shepherd VFD	☆ The Woodlands VFD
☆ Rivers End VFD	☆ Sherman FD	☆ Thomas Lake VFD
☆ Riverside VFD	☆ Sherwood Shores FD	☆ Thompsons VFD
☆ Roane VFD	☆ Shive FD	☆ Thrall VFD
☆ Roanoke VFD	☆ Silver Creek VFD	☆ Tierra Linda VFD
☆ Robert Lee VFD	☆ Silverton VFD	☆ Tiki Island VFD
☆ Robinson VFD	☆ Sipe Springs VFD	☆ Timbercreek Canyon VFD
☆ Robstown FD	☆ Sisterdale VFD	☆ Timpson VFD
☆ Rochelle VFD	☆ Slaton VFD	☆ Tin Top VFD
☆ Rockdale VFD	☆ Smithville VFD	☆ Tioga VFD
☆ Rockport VFD	☆ Snook VFD	☆ Tolar VFD
☆ Rockwall VFD	☆ Snyder FD	☆ Tomball VFD
☆ Rocky Branch VFD	☆ Somerset FD	☆ Tool VFD
☆ Rolling Oaks VFD	☆ Somerville VFD	☆ Trinidad VFD
☆ Roma FD	☆ Sonora VFD	☆ Trinity VFD
☆ Rosehill VFD	☆ Sour Lake VFD	☆ Trophy Club VFD
☆ Rosenberg FD	☆ South Brazos County FD	☆ Troup VFD
☆ Rosita VFD	☆ South Ector County VFD	☆ Troy VFD
☆ Rosser VFD	☆ South Franklin VFD	☆ Turnersville VFD
☆ Rotan VFD	☆ South Houston FD	☆ Turtle Creek VFD
☆ Round Rock FD	☆ South Montgomery County VFD	☆ Tyler FD
☆ Round Rock VFD	☆ South Nacogdoches County VFD	☆ Tynan VFD
☆ Rowlett FD	☆ South Polk County VFD	☆ Universal City FD
☆ Roxton VFD	☆ South Van Zandt VFD	☆ University Park FD
☆ Runaway Bay VFD	☆ Southeast VFD	☆ Uvalde VFD
☆ Sachse FD	☆ Southern Oaks VFD	☆ Val Verde County RVFD
☆ Saginaw FD	☆ Southlake FD	☆ Valley View FD
☆ Salado VFD	☆ Southwest Rains VFD	☆ Van Alstyne FD
☆ Salem VFD	☆ Southwest VFD	☆ Vega FD
☆ Sam Bass VFD	☆ Spearman VFD	☆ Venus VFD
☆ San Angelo FD	☆ Spring Branch FD	☆ Vernon FD
☆ San Antonio FD	☆ Spring VFD	☆ Victoria FD
☆ San Benito VFD	☆ Springtown VFD	☆ View VFD
☆ San Juan FD	☆ Spur VFD	☆ Village FD
☆ San Leon VFD	☆ St. Hedwig VFD	☆ Voca VFD
☆ San Marcos FD	☆ Stafford VFD	☆ Volente VFD
☆ San Saba VFD	☆ Stamford FD	☆ Waco FD
☆ Sand Hills VFD	☆ Star VFD	☆ Wall VFD
☆ Sandflat VFD	☆ Stephenville FD	☆ Waller VFD

- ☆ Wallis FD
- ☆ Walnut Springs VFD
- ☆ Waring VFD
- ☆ Warren VFD
- ☆ Washburn VFD
- ☆ Washington FD
- ☆ Waxahachie FD
- ☆ Wayside Emergency Team
- ☆ Weatherford FD
- ☆ Webster FD
- ☆ Weir FD
- ☆ Weslaco FD
- ☆ West Carlisle VFD
- ☆ West Harrison VFD
- ☆ West I-10 VFD
- ☆ West Mountain VFD
- ☆ West Odessa VFD
- ☆ West Orange FD
- ☆ West Shore VFD
- ☆ West Tawakoni FD
- ☆ West University Place FD
- ☆ West Valley VFD
- ☆ West VFD
- ☆ Westlake FD/TCESD #9
- ☆ Westminster FD
- ☆ Westside VFD
- ☆ Westside VFD
- ☆ White Bluff VFD
- ☆ White Oak VFD
- ☆ White Tail Ridge VFD
- ☆ Whitesboro VFD
- ☆ Whitton RVFD
- ☆ Wichita West VFD
- ☆ Wild Peach VFD
- ☆ Wildorado VFD
- ☆ Willow Park VFD
- ☆ Willowfork VFD
- ☆ Wills Point FD
- ☆ Wilmer FD
- ☆ Wimberley VFD
- ☆ Winchester Area VFD
- ☆ Windcrest VFD
- ☆ Windthorst VFD
- ☆ Winfield VFD
- ☆ Wink VFD
- ☆ Winnsboro VFD
- ☆ Wolfe City VFD
- ☆ Woodville VFD
- ☆ Woodway DPS FS
- ☆ Wylie FD
- ☆ Yantis VFD
- ☆ Yoakum FD

*Significant number of incomplete casualty and/or incident data submitted for 2004

TEXFIRS 2004

Five-Year Incident Comparison

	2000	2001	2002	2003	2004
FIRES					
Structure	21,134	21,033	20,352	22,100	19,638
Vehicle	18,440	18,118	16,747	16,760	15,130
Other Fires	<u>43,269</u>	<u>35,463</u>	<u>35,248</u>	<u>42,466</u>	<u>38,723</u>
TOTAL FIRES	82,843	74,614	72,347	81,326	73,491
TOTAL FIRE LOSS	\$ 367,632,909	\$396,384,970	\$373,020,577	\$ 382,825,032	\$ 333,745,277
OVERPRESSURE RUPTURES	2,883	3,113	3,062	3,241	2,969
RESCUE/EMS CALLS	380,675	432,331	534,866	635,726	640,966
HAZARDOUS CONDITION CALLS	43,839	49,774	52,367	58,502	62,504
SERVICE CALLS	60,596	61,280	67,017	70,583	73,540
GOOD INTENT CALLS	97,278	97,104	97,074	105,735	97,721
FALSE CALLS					
Malicious	12,830	13,235	12,733	13,834	16,182
Other False Calls	<u>102,712</u>	<u>106,621</u>	<u>106,794</u>	<u>106,936</u>	<u>108,425</u>
TOTAL FALSE CALLS	115,542	119,856	119,527	120,770	124,607
SEVERE WEATHER AND NATURAL DISASTER	164	436	729	1,025	2,168
MUTUAL AID GIVEN	19,113	18,867	23,763	29,570	34,396
ALL OTHER CALLS	11,950	12,025	8,293	4,992	4,901
TOTAL CALLS	814,883	869,400	979,045	1,111,470	1,117,263