



UNT

HEALTHTM
SCIENCE CENTER

2018 CAMPUS MASTER PLAN



Copyright © 2018 Ayers Saint Gross
All Rights Reserved.

TABLE OF CONTENTS



	MESSAGE FROM THE PRESIDENT	
	ACKNOWLEDGMENTS	
1	INTRODUCTION	
	Overview	10
	Planning Process	12
	Engagement	14
	Strategic Alignment	16
	Principles & Priorities	18
2	OBSERVATIONS	
	Regional Context	22
	Campus History	26
	Campus Today	28
	Campus Systems	37
3	FRAMEWORK	
	Connectivity Network	64
	Opens Space Network	66
	Hub Network	68
	Composite Framework	70
4	CAMPUS MASTER PLAN	
	Campus Master Plan	74
	Overview and Outcomes	78
	Development Features	82
	System Integration	98
5	IMPLEMENTATION	
	Overview	118
	Near-Term Initiatives	122
	Mid-Term Initiatives	123
	Long-Term Initiatives	124
	Future Opportunities	125
6	GUIDELINES	
	Campus Development Guidelines	128
	Planning Design Guidelines	129
	Architectural Design Guidelines	142
	Landscape Design Guidelines	150
	Planning & Design Review Process	177
7	APPENDIX	
	References and Resources	182
	Supplemental Information	184



FROM THE CHANCELLOR

The University of North Texas System is the only university system based in the robust Dallas-Fort Worth region and includes the University of North Texas Health Science Center in Fort Worth. UNT Health Science Center is one of the nation's premier graduate academic medical centers, specializing in patient-centered education, research and health care. Through extraordinary teamwork and visionary leadership, UNTHSC is defining what health care providers will look like in the future.

Situated in the nation's top job market and immersed in the ever-evolving health care industry, UNTHSC is committed to purposeful growth and development as we serve our booming region and state. To support its mission, vision, values and planned strategic growth, this 2018 Campus Master Plan aligns the aspirations of UNTHSC to its physical campus. Identifying near-term transformations, along with long-term capacities, the master plan carefully and strategically lays out the future development of the Health Science Center.

With this 2018 Campus Master Plan, the UNT Health Science Center has a clear and strategic road map to help ensure that future physical growth supports the vision of university leadership, as well as the needs of DFW and Texas.

I look forward to working together as we continue to build an extraordinary campus reflective and supportive of the visionary future of UNTHSC.



Lesa Roe
University of North Texas System,
Chancellor

FROM THE PRESIDENT



In the decades since my days as a student, I have watched this institution evolve into a growing and vibrant health science center. Today, our community has grown to over 4,000 individuals who each share our core values, a commitment to the growth and excellence of this institution, and a desire to improve the world.

Decisions made today about buildings and sites will impact us for decades to come. These decisions will have significant physical, financial, and program implications. Since 2007, when our last master plan was completed, we have established the School of Health Professions, the UNT System College of Pharmacy, constructed multiple new buildings, partnered with TCU to launch the new MD school this Fall, and ushered in a new strategic plan. With all of this growth and change, it is critical that we take a moment to evaluate not only where we are, but where we want to go and what we need to get there.

Integrated as a foundation for the master plan, UNTHSC's See 2020 strategic roadmap identifies goals that include focused growth for research and academic programs along with clinical partnerships in the coming years to expand our regional and national reputation and influence. The 2018 Campus Master Plan aligns this strategic direction with our core purpose, vision, mission, and values into a plan for the physical development of campus that will enable us to achieve the strategic roadmap goals.

The master plan process spanned nine months, capturing an incredible amount of input and feedback from a diverse representation of stakeholders. I'm impressed by the amount of participation and involvement which guided the creation of this plan every step along the way. The end result is a living document that defines a versatile framework to guide our decision making for the next decade plus. As you review this document, be mindful of our strategic goals and core values that inform its content. I am excited to share with you this commitment to our future.



Dr. Michael R. Williams
University of North Texas Health Science Center,
President



ACKNOWLEDGMENTS

UNIVERSITY OF NORTH TEXAS SYSTEM BOARD OF REGENTS

Brint Ryan
Chairman

Laura Wright
Vice Chairman

Mary Denny
Board Member

Milton B. Lee
Board Member

A.K. Mago
Board Member

Carlos Munguia
Board Member

Amanda Pajares
Student Regent

Rusty Reid
Board Member

Gwyn Shea
Board Member

B. Glen Whitley
Board Member

UNIVERSITY OF NORTH TEXAS SYSTEM

Lesa Roe
UNT System Chancellor

James Maguire
Vice Chancellor, Facilities Planning and
Construction

James Davis
Associate Vice Chancellor, Facilities
Planning and Development

Meredith Butler
Associate Director, Facilities Planning
and Development

Aubrey Jahelka
Campus Planner

UNT HEALTH SCIENCE CENTER: STEERING COMMITTEE

Dr. Michael Williams
President

Gregory Anderson
Executive Vice President,
Finance and Operations

Dr. Claire Peel
Interim Provost

Dr. Anuja Ghorpade
Vice President, Research

Jason Hartley
Vice President, Operations

UNT HEALTH SCIENCE CENTER: PLANNING RESOURCES

Jennifer Allie
Sandy Bauman
Jeff Beeson
Gary Brougham
Nicoleta Bugnariu
Amy Buresh
Daniel Burgard
Eric Carrillo
Blair Chappell
Randall Christopher
Laurie Clouse
Dean Conine
Shanika Covington
Riaz Dhanji
Patricia Dossey
Lynley Dungan
Frank Filipetto
Stuart Flynn
Elizabeth Harshman
Johnny He
Lori Knowles
Wendy Landon

Donnie Lenox
David Lipe
Shane Ludwig
David Mason
Robert McClain
Pam McFadden
Monty Mohon
Jose Munoz
Morten Ostensen
Craig Rowland
Geoffrey Scarpelli
Michael Shaffer
Bob Short
Charles Taylor
Jack Thetford
Dennis Thombs
Trisha VanDuser
Douglas White
April Wiechmann
Debra Willett
Seth Willmoth

CONSULTANT TEAM

Ayers Saint Gross
Master Planning

Caye Cook & Associates
Landscape Consultant

FocusEGD
Wayfinding & Signage Consultant

JQ Infrastructure
Civil & Structural Consultant

Purdy-McGuire
MEP Consultant

TreanorHL
Research Facilities Consultant

Walter P. Moore
Transportation Consultant

Depiction Illustration
Professional Illustrator



INTRODUCTION

2018 CAMPUS MASTER PLAN



1



INTRODUCTION



OVERVIEW

The 2018 Campus Master Plan for the University of North Texas Health Science Center (UNTHSC) crafts a detailed plan that is informed by and aligned with the purpose, vision, mission, and values of the institution. The plan addresses the near-term needs of the institution and accommodates the long-term evolution of the campus. Throughout the planning process, extensive engagement with campus stakeholders and leadership informed the evaluation of multiple scenarios to arrive at the optimal outcomes that will guide and support the transformation of the campus over the next decade and beyond.

UNTHSC is one of the nation's premier graduate academic medical centers, with five schools that specialize in patient-centered education, research, and health care.

Purpose: Transform lives in order to improve the lives of others.

Vision: One university, built on values, defining and producing the providers of the future.

Mission: Create solutions for a healthier community.

Values: Serve Others First. Integrity. Respect. Collaboration. Be Visionary.

A comprehensive initiative, the 2018 Campus Master Plan undertook an in-depth consideration of elements, both historical and forecasted, to craft a solution guiding the future development of the campus. A summary of key elements and areas of focus for the planning effort include:

- Establish guiding principles informed by goals and objectives identified by stakeholders and leadership, and in alignment with the UNTHSC strategic plan to direct the planning effort.
- Review and analyze existing campus conditions, relevant context, and physical systems to document potential constraints and opportunities to be addressed.
- Gather data related to space distribution and campus population to understand historical trends and forecast potential future projections.
- Craft a campus master plan inclusive of existing and future open space, built structures, and supporting physical systems, guided by a durable framework.
- Integrate campus physical systems, such as infrastructure and mobility, into the plan, indicating necessary upgrades or expansion of system capacities.
- Review and revise wayfinding and signage to support campus identity and branding.
- Review and revise architectural and landscape guidelines to support a cohesive character and quality in the campus built environment.
- Develop recommendations for near-, mid-, and long-term implementation of the plan along with identifying potential land acquisitions that may support the campus.

The resulting campus master plan is a holistic guide for future growth that enhances the experience of the students, staff, faculty and community engaged in learning, discovery and care.

The following is a brief synopsis of the content included in each chapter of the report.

Introduction: An overview of the planning process and engagement efforts are outlined, including the method for aligning UNTHSC strategic planning efforts with the master plan and development of a set of Planning Principles and Priorities.

Observations: A range of studies were undertaken at the outset of the planning effort to understand the existing context of the campus. These observations established a series of baselines and benchmarks from which further analysis was completed to be able to understand potential future trends and forecast future needs.

Framework: The campus framework is the conceptual plan that reflects the existing organization of the campus, revealing patterns that shape its current experience and inform its future growth. This framework is characterized by three integrated networks consisting of Open Space, Connectivity, and Hubs.

Campus Master Plan: The final plan is a synthesis of concepts that were thoroughly discussed, refined, and balanced to meet both the near- and long- term objectives of UNTHSC.

Implementation: Illustrated at full build-out, the final plan allows for adaptable implementation. This adaptability allows the institutions to respond to changing needs or new opportunities that may arise over the duration of the plan. Implementation is organized in near-, mid-, and long-term phases.

Campus Development Guidelines:

The guidelines, through a series of planning, architectural, and landscape strategies, direct campus development to ensure a high-quality physical environment is achieved across the campus.

Appendix: Additional information and further details are included in the appendix along with a list of supplementary resources.

PLANNING PROCESS

PROCESS OVERVIEW

Commonly, the process of undertaking master planning efforts at institutions will occur in a 5- to 15-year cycle with either updates to existing plans or development of new plans. These updates or new planning efforts are often prompted by significant changes occurring on campus since completion of the prior planning effort. Such changes can include, but are not limited to, implementation of substantial portions of the prior plan, program and population growth, adjustments to strategic objectives, or new market opportunities.

UNTHSC last completed a campus master plan in 2007, falling within the time frame referenced above. A number of substantial developments identified in the 2007 plan are completed or are nearing completion. A selection of these are discussed in further detail in the Observation Chapter. Additionally, UNTHSC has seen significant enrollment growth, expansion of programs, and refocused research efforts. Given the duration and changes since the last master plan, it was an optimal time for UNTHSC to undertake a new campus master plan to evaluate current and future opportunities.

To coordinate this evaluation, the 2018 Campus Master Plan was organized into four-phases across an approximate nine-month duration, running from September 2017 to May 2018. While there is a natural forward progression, the process is iterative and not strictly linear, with each phase building on the work of the previous phase. The overall process is illustrated in the graphical timeline below and describe in more detail on the following page.

CAMPUS MASTER PLAN TIMELINE

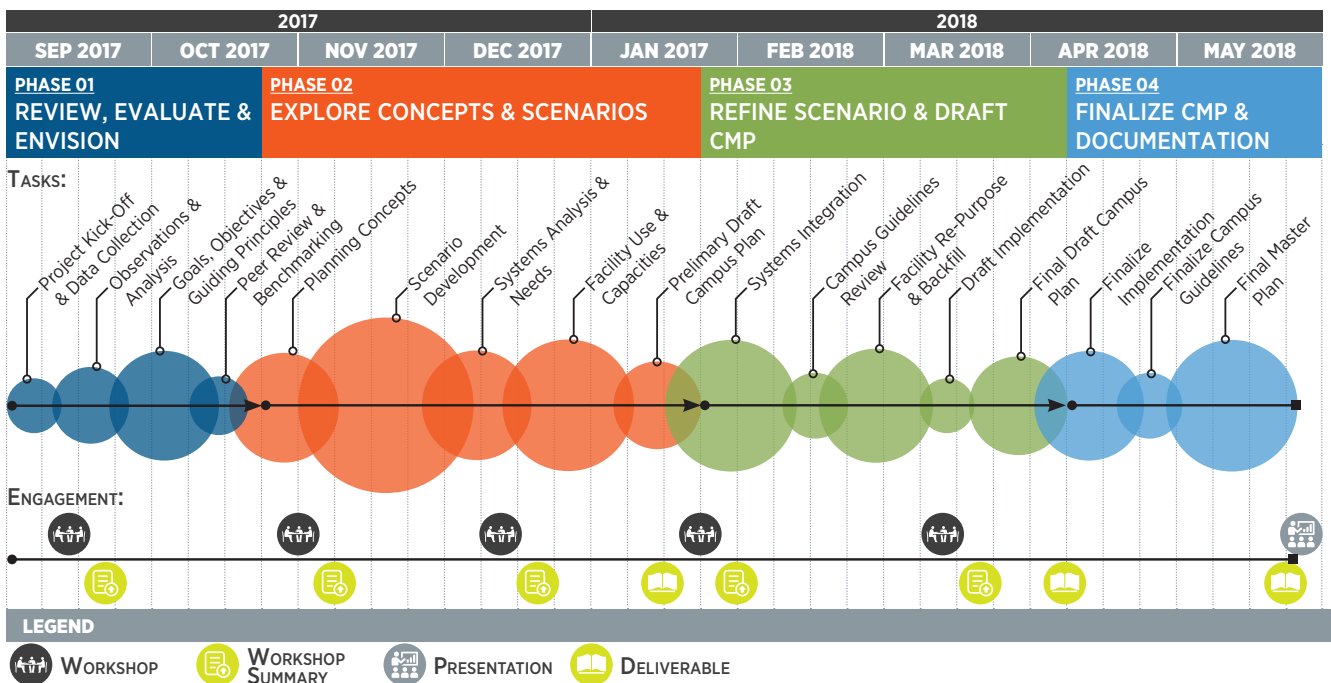

PHASE 01: REVIEW, EVALUATE AND ENVISION

During this first phase, the planning team worked with the UNTHSC stakeholders to determine planning principals and goals for the master plan. Through extensive and interactive collaborative exercises, a diverse range of input was obtained representing the perspectives of campus constituents. The planning team engaged multiple user and facilities stakeholder groups throughout this phase; utilizing a combination of workshops, formal group meetings, small group meetings, individual interviews, site tours, and surveys.

Also critical was the review and evaluation of existing conditions across multiple campus systems such as stormwater drainage, supply of hot water for heating and capacity of cold water for cooling.

PHASE 02: EXPLORE CONCEPTS AND SCENARIOS

The planning team began this phase with examining challenges within the various systems of the campus. Multiple concepts and scenarios were developed that sought to accommodate student, research, and program growth in addition to the various needs of academic units. Areas addressed included:

- Can the campus support the expected growth?
- What adjustments need to occur to support this growth?
- Do current space utilizations and efficiencies align with expected needs?
- How do we allow for new buildings while preserving the best parts of the existing campus to accommodate future research needs?

Balancing these diverse topics by developing more detailed scenarios with technical and engineering based solutions began to identify a path forward.

PHASE 03: REFINE SCENARIO AND DRAFT CAMPUS MASTER PLAN

Concepts proposed and debated during the earlier stages of the process were reconciled and synthesized into a selected scenario for further refinement. This preliminary plan showed existing and proposed buildings, parking, roads, open spaces, and pedestrian routes along with numerous other features. It served as a tool for workshops and conversations with campus constituents, and was shared on a campus website for review and comment. By combining ideas generated during the process to date, the preliminary plan helped to crystallize a vision of the campus for the future. This phase also began to study the potential implementation options for the plan along with developing various campus guidelines to direct future development.

PHASE 04: FINAL CAMPUS MASTER PLAN AND DOCUMENTATION

Information and comments from the previous phases were combined into a set of detailed recommendations for the campus that make up this final plan report. The new buildings, proposed additions, and improvements to circulation and landscape illustrated in this report represent the future of the campus as it changes over the following decades. An implementation plan shows how the final recommendations can be realized in steps over time. Design guidelines for buildings and grounds are included to support a codified system for unifying all the architectural and landscape elements of the campus.

The final report documents the master plan's story for the campus and supporters by articulating the plan's goals and illustrating a long-term vision supported by phasing and implementation scenarios as a reference for those that will guide the realization of the plan.

ENGAGEMENT

STAKEHOLDER ENGAGEMENT

Planning is both a process and a product. For the duration of the 2018 Campus Master Plan, the planning team worked collaboratively with a diverse group of stakeholders from the institution to establish priorities, scenarios, and solutions to support the current and future needs of UNTHSC.

Planning workshops held on campus were the primary vehicle for engagement. In total, the planning team held 32 workshop sessions on campus that brought together students, staff, faculty, and leadership to provide feedback, expertise, experience, and insight. Additionally, community stakeholders were invited for a session to review the progress of the planning effort and to provide their input and thoughts for consideration.

Each workshop was organized to review the work and progress of topics related to the particular phase of the planning process, allowing stakeholders to make informed decisions about the planning direction, and build understanding and consensus around the decisions being made. At the earliest stages, these groups helped to provide information and data that would become the foundation of the plan. At later stages, the outcomes of these workshops led to the final scenarios and solutions that were incorporated into the 2018 Campus Master Plan.

This experience of collective analysis and decision-making will help to facilitate the implementation of this shared vision across campus for years to come.

Overview of Workshop Sessions:

Workshop 01 (Sept. 15th-16th, 2017)

- Joint Steering & Resource Committee 1
- Resource Committee Breakout Session
- Steering Committee Breakout Session
- Joint Steering & Resource Committee 2

Workshop 02 (Nov. 1st-2nd, 2017)

- Steering Committee
- Technical Group: Landscape
- Technical Group: Wayfinding & Signage
- Technical Group: Parking & Transportation
- Resource Committee
- Technical Group: Civil & MEP

Student Leadership Forum (Nov. 7th, 2017)

- Student Leadership Organizations

Workshop 03 (Dec. 12th-14th, 2017)

- Joint Steering & Resource Committee 1
- Joint Technical Group
- Parking Task Force
- Community Session
- Faculty Session
- Joint Steering & Resource Committee 2
- Steering Committee

Workshop 04 (Jan. 23rd-24th, 2018)

- Resource Committee
- Joint Technical Group
- Parking Task Force
- Steering Committee
- Student Open House
- Faculty Open House

Workshop 05 (Mar. 14th-15th, 2018)

- Resource Committee
- Joint Technical Group
- Parking Task Force
- Steering Committee



Engagement Exercise: SWOT (Strength, Weakness, Opportunity, Threat) Analysis



Engagement Exercise: Master Plan Priorities



Engagement Exercise: Campus Open House Topic Stations

STRATEGIC ALIGNMENT

OVERVIEW & ROADMAP

The UNTHSC_SEE 2020: THE ROADMAP 2018 (illustrated on the following page and referenced as SEE 2020 for brevity) served as a starting point for instilling the institutional enterprise into the physical environment as illustrated in the 2018 Campus Master Plan. SEE 2020 expresses UNTHSC’s purpose, vision, mission, and values in more quantifiable terms with specific results, measures, and targets.

Further analysis and discussion of SEE 2020 assisted in translating these quantifiable terms into Planning Principles and Priorities, discussed in the following section, to guide the efforts of the planning team. This translation of SEE 2020 into the master plan was a collaborative effort undertaken throughout the master planning process in a series of exercises with senior leadership and campus stakeholders. The alignment between the SEE 2020 and the master plan was informed in particular by selective portions of SEE 2020:

- Analysis of the four Focus elements defined areas of inquiry that the campus master plan had an opportunity to support. The SEE 2020 Focus elements are:
 - People & Values
 - Learning & Discovery
 - Quality Experience for Lifetime Success
 - Sustainable Growth, Finance & Resources
- The Key Objectives and Initiatives further informed and refined the translation of the Focus elements and how they might be instilled in the campus master plan.
- The Desired Results illustrated components of the campus master plan that could directly or indirectly support SEE 2020.

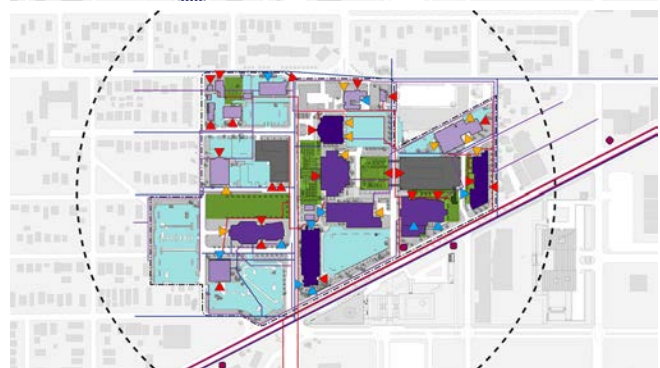
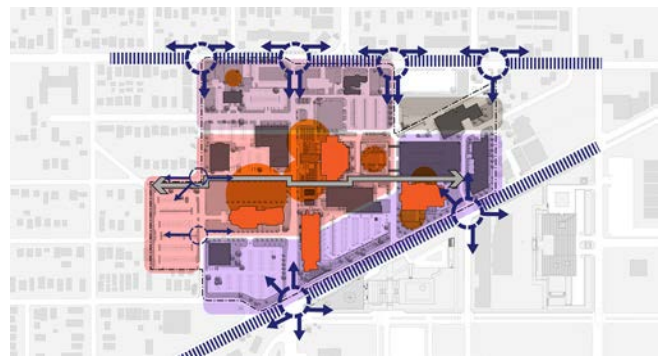

Examples: Strategic Alignment Analysis Diagrams

UNTHSC SEE_2020: THE ROADMAP 2018

HSC DIFFERENCE	PURPOSE Transform lives in order to improve the lives of others	VALUES Serve Others First Integrity Respect Collaboration Be Visionary	VISION One university, built on values, defining the providers of the future	MISSION Create solutions for a healthier community	ONE PLAN Sustainable people culture Define and produce the providers of the future Financial strength Extraordinary teamwork
	EXTRAORDINARY TEAMWORK				
FOCUS	People & Values	Learning & Discovery	Quality Experiences for Lifetime Success	Sustainable Growth, Finance & Resources	
	KEY OBJECTIVES	Create sustainable people culture		Define and produce the providers of the future	
INITIATIVES (OWNERS)	1.1 Create a nationally recognized, customer-focused best place to work environment (Hicks)	2.1 Strengthen schools & institutes to high-performing (Peel / Ghorpade / Hicks)	3.1 Improve quality of teaching and education (Peel)	4.1 Increase efficiencies (Anderson / White)	
	2018 DESIRED RESULTS	1.1.1 Improve team member engagement 1.1.2 Increase integration of Our Values 1.1.3 Develop academic leadership program 1.1.4 Improve patient experience	2.1.1 Increase school and institutes meeting high performance criteria 2.1.2 Increase research expenditures by 5% 2.1.3 Increase UNTHSC affiliated health system partners 2.1.4 Create affiliated GME sufficient to accommodate all HSC graduates	3.1.1 Increase student success 3.1.2 Enhance educational programs to prepare graduates to meet expectations of employers and national leaders 3.1.3 Prepare graduates for leadership in practice and community 3.1.4 Enhance clinical education and internship opportunities	4.1.1 Improve net financial position 4.1.2 Increase philanthropy 4.1.3 Develop meaningful management information to improve decision-making
MEASURES / TARGETS		M: Survey results - improvement in team member engagement T: 65% M: # of departments involved in values initiatives T: 81 M: # of faculty completing program T: 45 M: Patient Promoter Score T: 30% increase of Q1 baseline	M: Number of schools and institutes meeting criteria T: 5 M: Total expenditures T: \$46,800,000 M: # of hospital partners T: 6 M: # of PGY1 GME slots T: 168	M: % of graduates who seek and obtain employment in their field of study or a related field within one year of graduation T: 95% M: % of degree granting programs planning curricular content revisions based on data from employer expectations T: 100% M: % of programs with competencies in leadership, communication and teamwork integrated into curricula and assessed prior to graduation T: 40% M: % of programs demonstrating excess capacity in number of sites T: 100%	M: Primary Reserve T: 40% M: Total support given/pledged T: \$18.5M M: Areas and metrics identified for executive management dashboard T: 100%
	SEE_2020 DESIRED RESULTS	Nationally recognized as a Best Place for All Living by Our Values Have thriving Leadership Institute Known for our extraordinary service experience	Have 6 high performing schools and institutes Total research increased to \$55,000,000 The education & research partner for health systems of Tarrant County Nationally recognized Patient Safety Institute Sponsor of >300 PGY1 GME slots	National leader in Interprofessional Education / Interprofessional Practice	New donor gifts of over \$100,000,000 given / pledged

PRINCIPLES & PRIORITIES

PLANNING PRINCIPLES

Active planning must be guided by a consistent set of values and principles against which all concepts and proposed solutions are measured. Planning Principles guide the development of the campus plan and serve to evaluate outcomes.

These Planning Principles serve as a bridge between the strategic vision of UNTHSC and the physical planning of the campus environment. They directed the efforts of the planning team, and even more importantly, will guide implementation of the plan to ensure its continued alignment with the mission and vision of the institution. Emerging through the engagement process with campus stakeholders, these principles grew out of a shared understanding of the characteristics that make the campus and the community unique. As the process progressed, these principles were further clarified and filtered, evolving through multiple iterations into their final form. All future development should reinforce and align to these principles.

PLANNING PRINCIPLE #1:

Craft a Campus Framework that reinforces and expands existing connectivity, programmatic and organizational patterns to guide long-term capacity.

PLANNING PRINCIPLE #2:

Align existing and future facilities for academic, research, and clinical programs that support collaborative learning and discovery with high utilization of campus assets.

PLANNING PRINCIPLE #3:

Reinforce and expand the network of Campus Hubs to support a quality campus experience for students, staff, faculty, and community.

PLANNING PRINCIPLE #4:

Embrace the One University vision to guide the development of the physical campus environment.

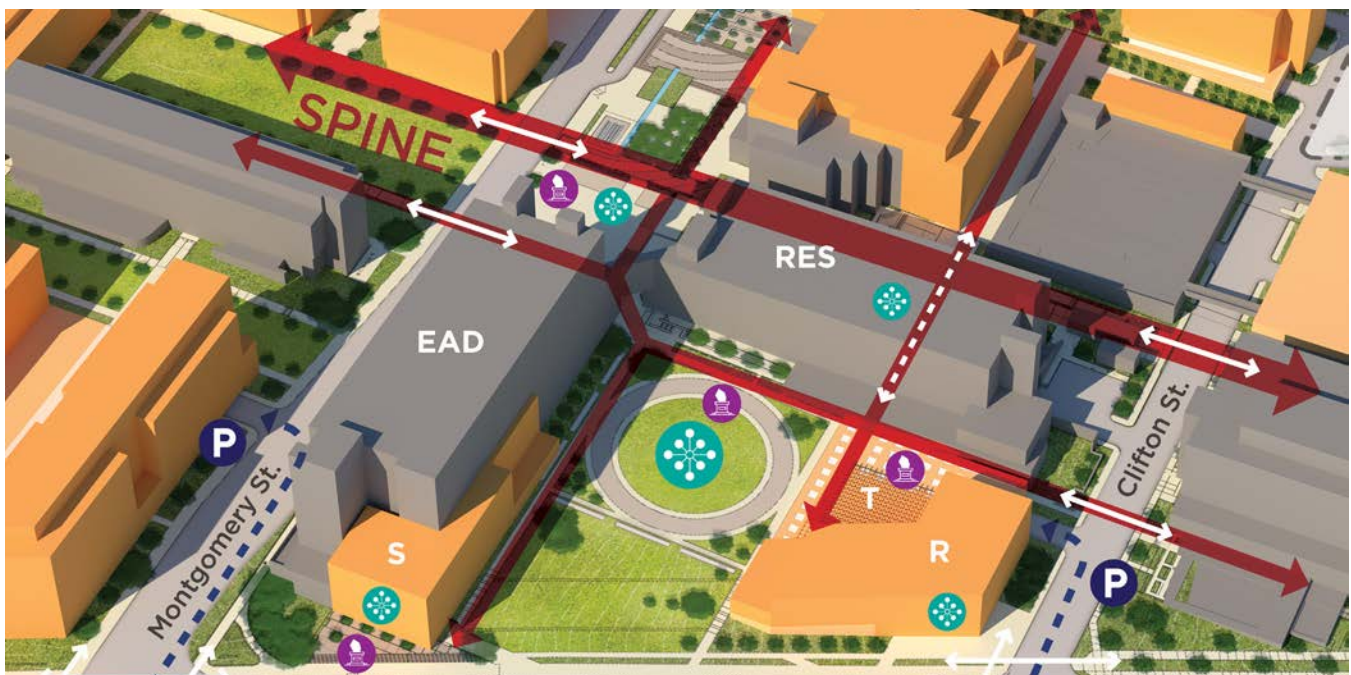

Mid-Process Example Scenario Diagram: Testing Planning Principle Integration

PLANNING PRIORITIES

Building upon the translation of SEE 2020 and the creation of the Planning Principles, the planning team led stakeholders through a series of exercises that identified and ranked a selected list of potential priorities. This intermediate exercise clarified the mapping of planning efforts to the Desired Results of the SEE 2020 plan. While all priorities were included in the campus master plan outcomes, the ranking exercise indicated areas necessitating close attention.

While not an exhaustive list of goals and objectives, the exercise informed the planning team of both near- and long-term priorities for inclusion in the master plan. Similar to utilizing SEE 2020 and Planning Principles as evaluators of proposed options, the Planning Priorities served as another gauge to determine whether proposed solutions were achieving the desired outcomes.

PRIORITY EXERCISE RESULTS

TOP PRIORITIES



ANCILLARY PRIORITIES

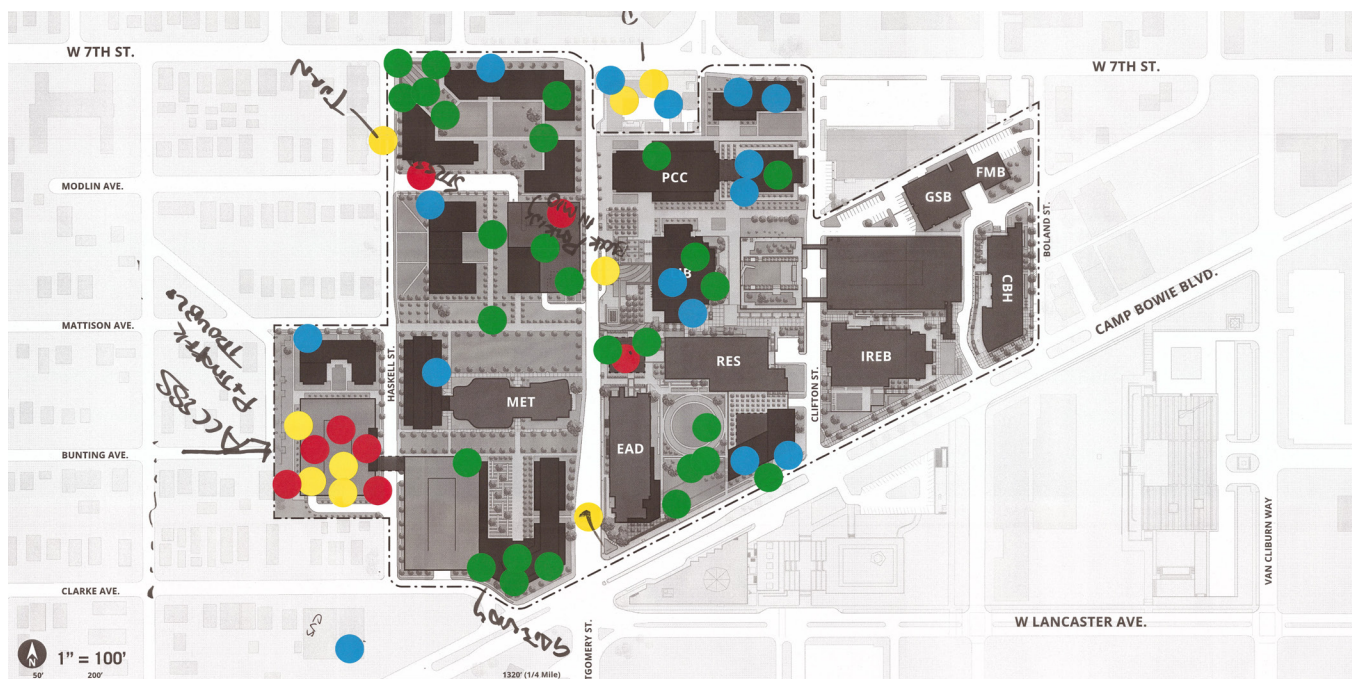
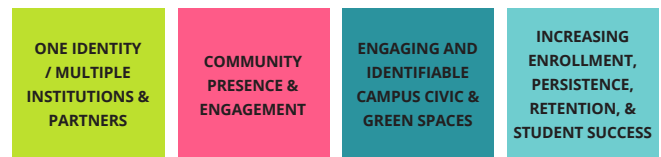

Mid-Process SWOT Exercise: Evaluating Scenario Alignment with Consideration of Planning Priorities



OBSERVATIONS

EXISTING CONDITIONS & ANALYSIS

2

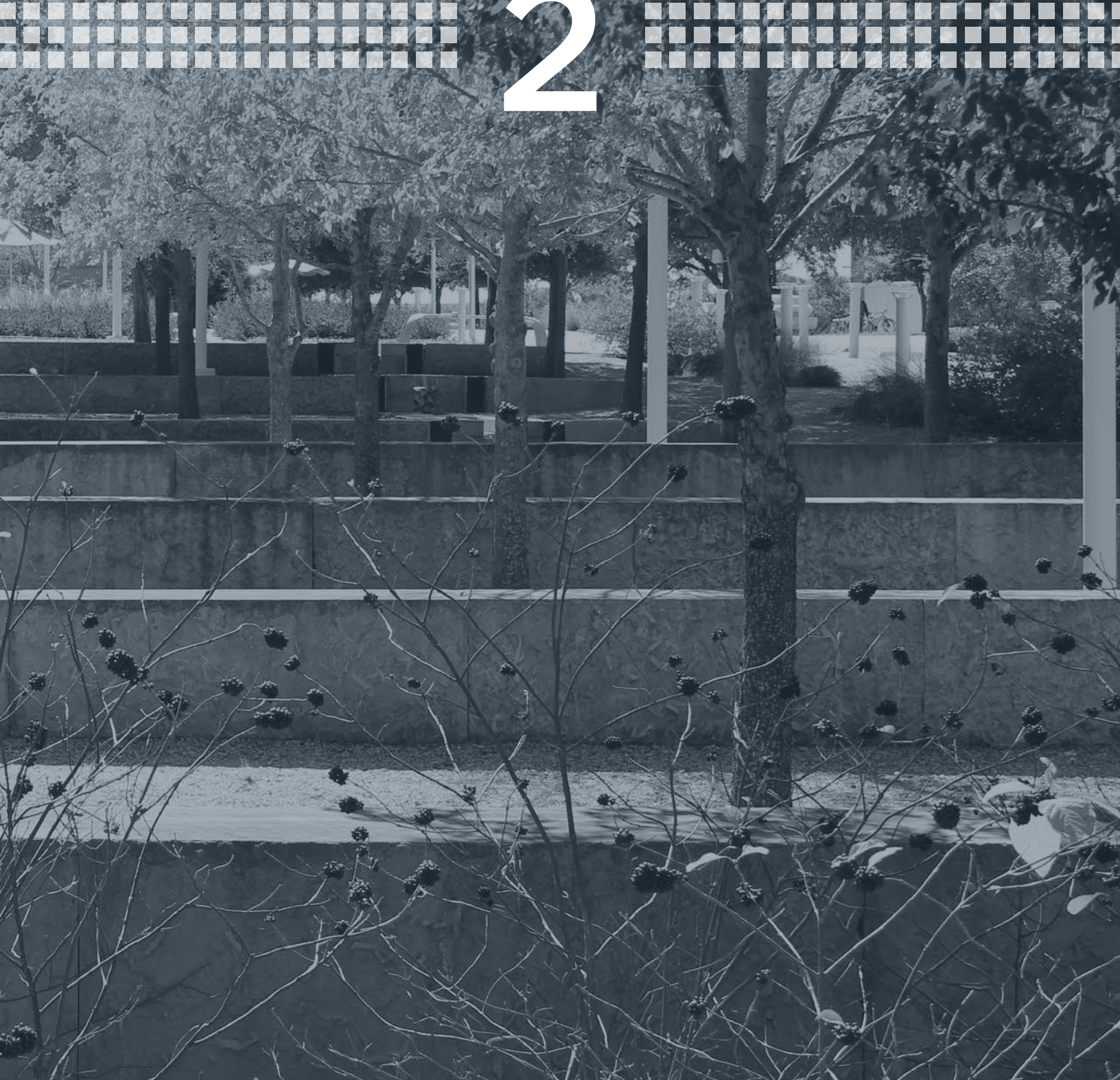

REGIONAL CONTEXT

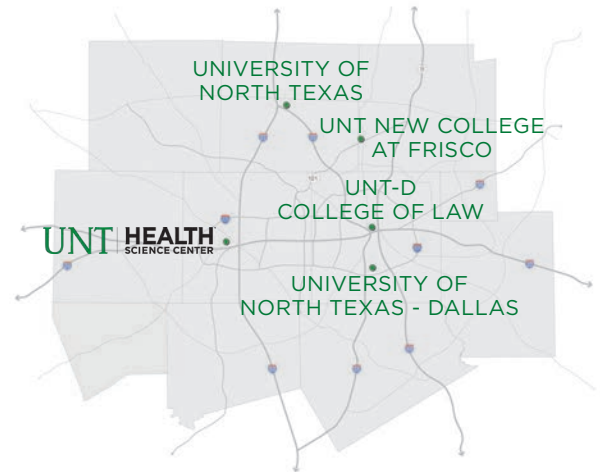
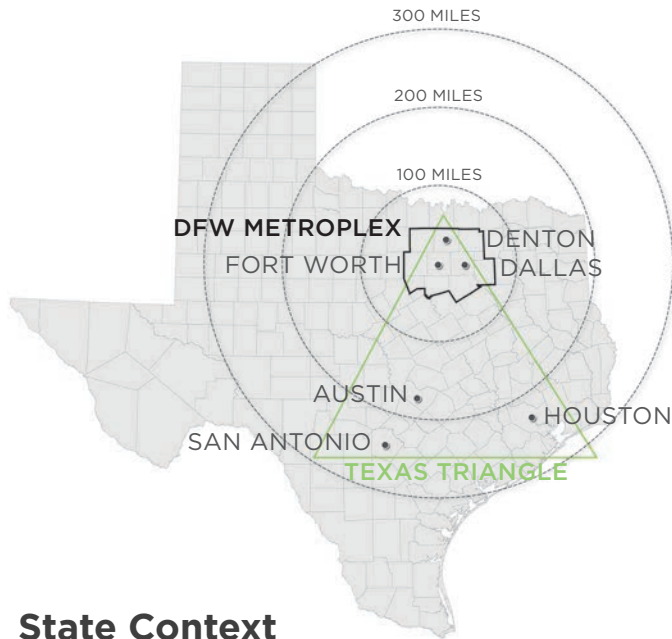

State Context

The University of North Texas Health Science Center is located in North Texas in the heart of the Dallas-Fort Worth Metroplex (DFW). This region is the northern part of what is colloquially known as the Texas Triangle (the mega-region formed between the San Antonio-Austin, Dallas-Fort Worth, and Houston metropolitan areas). Today, the Texas Triangle is experiencing dramatic population and industry growth. Especially relevant to UNTHSC, two key components of this regional demographic change are an increase in net births and significant growth in the over 65 population. To serve the unique health care needs of these two populations, Texas will increasingly require additional health care infrastructure and trained providers.

As of the 2017 5-year American Community Survey (ACS) data published by the United States Census Bureau, the State of Texas is home to 28,304,596 residents. The Dallas-Fort Worth Metroplex is the nations fourth largest metropolitan area, containing over a quarter of the states total population.

University of North Texas System

The University of North Texas System (UNTS) is the only public university system based in North Texas. It includes three independent universities spread between five major teaching locations across Tarrant, Denton, and Dallas counties. The system's independent components include the University of North Texas main campus in Denton, the University of North Texas at Dallas, and the University of North Texas Health Science Center. Combined Fall 2017 enrollment was just under 44,000 students. Responding to state and regional demand, the three primary components are each among Texas' fastest growing institutions of higher education.

Metroplex Health care Education

The Dallas-Fort Worth region offers a variety of public and private schools with programming in health care related fields. UNTHSC is locally set apart from other institutions as the only graduate focused medical center in Tarrant County, and one of only four schools in the Dallas-Fort Worth Metroplex with nationally recognized programs for innovation and academic excellence.

DFW Health care Industry

As one of the largest economic sectors in the region, the health care industry plays an essential role in the DFW economy. The scope of the health care industry in DFW is one of the largest and most diverse in the nation ranging from large hospitals, physicians and care providers, specialty care, advanced medical research, medical manufacturing, and medical administration.

A 2013-2014 Dallas Regional Chamber Health care Impact study identifies \$52 billion dollars in value contributed to the local economy, headlined by over 100 major health care related headquarters. This same report identifies over 331,000 total health care related jobs existed in the Dallas-Fort Worth Metroplex including six companies who rank in the top 25 of all employers in DFW.

Due to local population growth, the local demographic profile, the increasing role of technology in service provision and manufacturing, and new research opportunities, the DFW health care industry has been identified as fast growing. This industry context provides a positive outlook for UNTHSC graduates in the foreseeable future and potentially presents opportunities for carefully considered institutional program growth.

TOP 25 REGIONAL EMPLOYERS:

- #3.  **Texas Health Resources**
- #5.  **Baylor Scott & White HEALTH**
- #9.  **UT SOUTHWESTERN MEDICAL CENTER**
- #11. **HCA North Texas**
- #20.  **Parkland**
- #25.  **JPS HEALTH NETWORK**

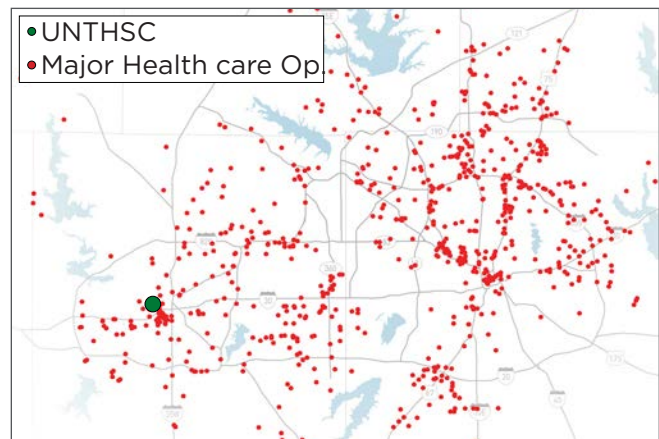

Major Health care Operations in DFW
(Graphic created by Dallas Regional Chamber)

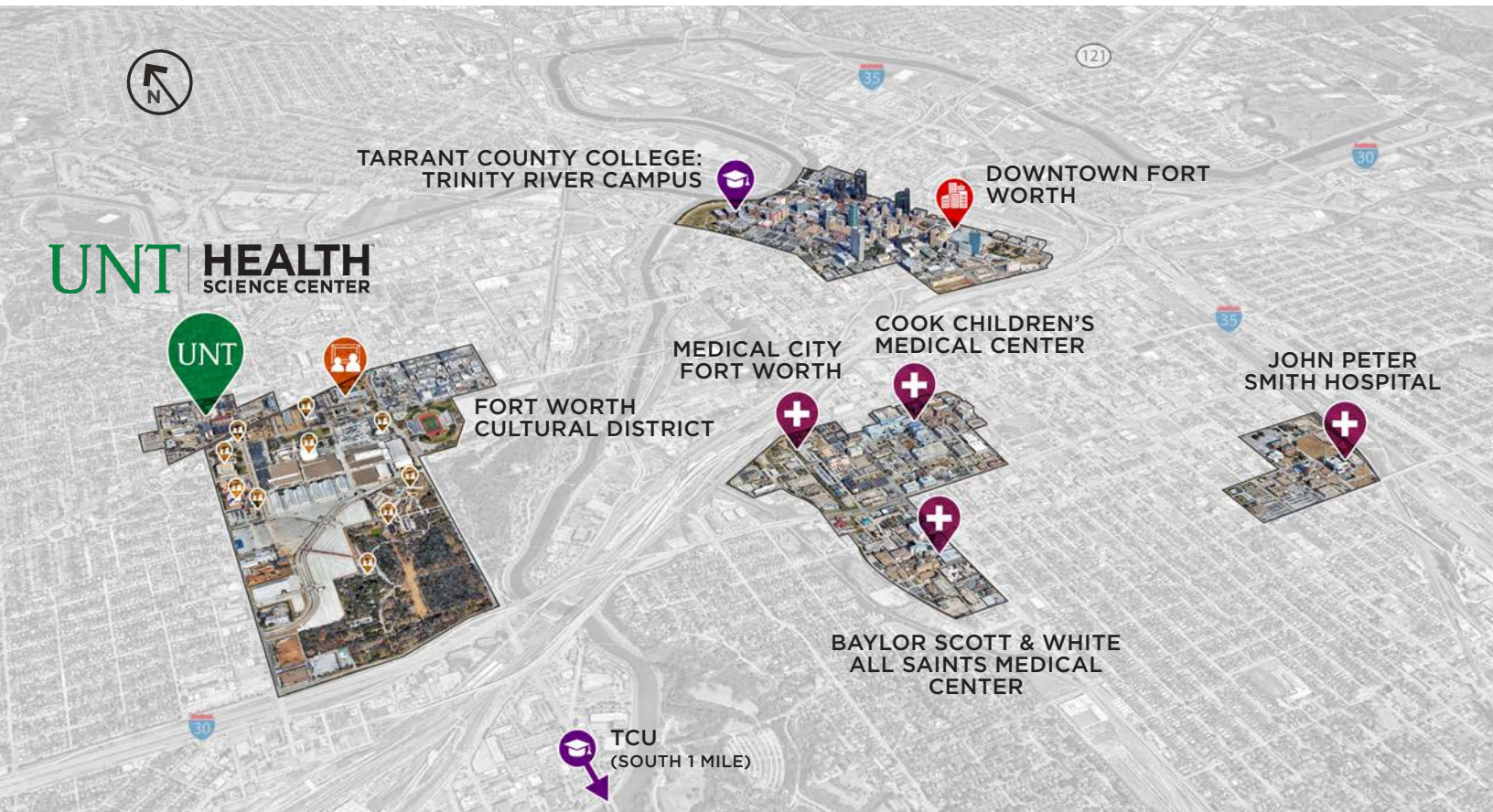

Urban Context

The UNTHSC campus is situated two miles west of downtown Fort Worth along West 7th Street. This proximity provides opportunity for strong industry, educational, and health care partnerships.

Within a three mile radius of campus, there are four major hospitals concentrated into what is known as the Fort Worth Medical Center south of Interstate 30. Historically, there have been strong ties between UNTHSC and these hospitals for clinical and graduate placement. During the master plan process however, leadership identified creating even stronger relationships with these institutions as a priority for the campus moving forward.

Immediately south of the Health Science Center is the renowned Fort Worth Cultural

District, which includes multiple world class art museums, the Will Rogers Memorial Center, the Fort Worth Botanical Gardens, acclaimed theaters and community arts centers, and many local shops and restaurants. Perhaps most important is the Camp Bowie Boulevard edge the campus shares with the Amon Carter Museum and the Kimball Art Museum. Combined, these two museums bring over 500,000 visitors to the neighborhood every year, offering an opportunity for UNTHSC brand exposure. Students, staff, and faculty frequently visit both museums for dining.

Currently under construction half a mile south of campus on Montgomery Street, the new 14,000 seat Dickies Arena is expected to open in 2019. The arena will provide a new large scale venue for concerts, conventions, exhibitions, sporting events, and the Fort Worth Stock Show and Rodeo.



Nearhood Context & Adjacent Uses

In addition to the Fort Worth Cultural District, the UNTHSC is also bounded by three distinct neighborhoods.

The North Hi Mount Neighborhood is a two-square-mile neighborhood that sits directly west of campus and is considered low density, primarily consisting of one- and two-story single-family homes. The neighborhood includes limited amounts of multifamily uses, as well as restaurants, small office spaces, and retail. These commercial uses are concentrated along the Camp Bowie corridor and on Mattison Avenue next to the campus.

The Monticello Neighborhood is the three-square-mile area north of West 7th Street. The center of the neighborhood is Monticello Drive,

whose intersection with West 7th Street forms a northern campus gateway. Similar to North Hi Mount, the neighborhood is primarily low-density, single-family residential with some limited multifamily. Its uniqueness lies in the commercial corridor along West 7th Street. This corridor creates a strong use buffer and transition between the campus and the neighborhood.

East of campus, the West 7th Neighborhood contains the West 7th District redevelopment that has taken place over the last decade. This area is considered to be a part of the Fort Worth Cultural District. Today, West 7th is primarily a high-density five- to seven-story urban mixed-use neighborhood with condos, apartments, restaurants, and retail. This high-density growth is expected to continue east of campus in the coming years.

CAMPUS HISTORY

Beginnings

Responding to the lack of a state osteopathic medical school, in 1961, the Texas Osteopathic Medical Association (TOMA) formed a committee to pursue the founding of a Texas college. This committee signified the seed that would grow into the UNTHSC.

Despite general support for the formation of a college, the committee was unable to make progress due to TOMA inaction. Recognizing the need and opportunity, three osteopathic physicians would break off and self-fund the endeavor. In 1966, George Luibel, D.D. Beyer, and Carl Everett procured a charter from the state of Texas to found the Texas College of Osteopathic Medicine (TCOM).

The Early Years

In 1970, four years after the initial charter, TCOM received provisional accreditation and opened with a class of 20 students on the fifth floor of the Texas Osteopathic Medical Center of Fort Worth (OMCT). Restricted by space, the following year TCOM purchased a nearby bowling alley and renovated it to include classrooms, labs, and office space. Supported by state funds and private donations, in 1972, the college purchased land east of the OCMT along Camp Bowie Boulevard (today the sites of EAD, RES, and a portion of IREB) to form a permanent campus. Thinking about long-term needs, the first master plan was crafted in 1972, creating a vision for these sites which included an academic building immediately east of OCMT (would become EAD) that was connected to a library, student union, and student housing.

North Texas State University

Seeking a university partner, in 1972, TCOM reached an agreement with North Texas State University to enable students to take basic science courses in Denton. This relationship continued to develop; In 1975, TCOM fully came under the umbrella of North Texas State

University (which later evolved into the UNT System). No longer was TCOM a small private college. Instead, it was a publicly supported institution with a broader mandate. Part of this broader mandate was a strong community health presence. Previously, all clinical training had taken place in the OCMT. In 1976, TCOM opened its first community clinic in Justin, TX.

A Period of Growth

The first permanent building, MEB-1, which is now known under the acronym EAD, opened its doors in 1978. The next two buildings, MEB-2 (RES) and MEB-3 (LIB), followed soon after in 1982 and 1986 respectively. Since then, campus academic, research, and clinical components have continued to grow. In 1992, the North Texas Eye Research Institute (NTERI) became the first research institute located on campus. The Health Pavilion (HP) opened in 1997, significantly increasing the number of clinical patient visits on campus.

Perhaps the most notable campus growth occurred in 2004, when OMCT closed. A year later, UNTHSC was able to acquire the property, effectively doubling the size of the campus from approximately 16 acres to 33. The hospital was quickly demolished to make room for construction of the MET, which opened in 2009.

Graduate Health Care Institution

With the establishment of the Graduate School of Biomedical Sciences in 1993, TCOM expanded into a graduate university with multiple colleges. The same year, the school changed its name to the University of North Texas Health Science Center. Since then, the school has continued to grow, adding three more schools and multiple degree offerings transforming the institution into a nationally recognized Graduate Medical Campus.

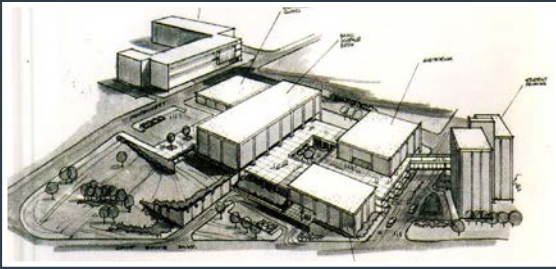

▲ 1972 CAMPUS MASTER PLAN

1972: AGREEMENT WITH NORTH TEXAS STATE (UNT) TO PROVIDE INSTRUCTION

1976: FIRST CLINIC (JUSTIN, TX)

▼ 1978: EVERETT ADMINISTRATION BUILDING (EAD) CONSTRUCTED



1993: GRADUATE SCHOOL OF BIOMEDICAL SCIENCE ESTABLISHED

1993: OFFICIALLY RE-DESIGNATED "UNIVERSITY OF NORTH TEXAS HEALTH SCIENCE CENTER"

1999: SCHOOL OF PUBLIC HEALTH ESTABLISHED



◀ 2004: CENTER FOR BIOHEALTH (CBH) CONSTRUCTED

2010: MEDICAL EDUCATION AND TRAINING BUILDING (MET) CONSTRUCTED ▶

2010: UNT BOARD OF REGENTS APPROVE DEVELOPMENT OF NEW MD PROGRAM

2011: UNT SYSTEM COLLEGE OF PHARMACY ESTABLISHED

2018 CAMPUS MASTER PLAN

2018: INTERDISCIPLINARY RESEARCH AND EDUCATION BUILDING (IREB) CONSTRUCTED

1960s

1970s

1980s

1990s

2000s

2010s

CAMPUS DEVELOPMENT TIMELINE

1961: COMMITTEE MEETS TO INVESTIGATE FEASIBILITY OF OSTEOPATHIC MEDICAL SCHOOL IN TEXAS

1966: CHARTER GRANTED FOR TEXAS COLLEGE OF OSTEOPATHIC MEDICINE

1970: TCOM OPENS ON THE 5TH FLOOR OF THE TEXAS OSTEOPATHIC MEDICAL CENTER OF FORT WORTH (OMCT)



1982: RESEARCH & EDUCATION BUILDING (RES) CONSTRUCTED

1986: GIBSON D. LEWIS LIBRARY (LIB) CONSTRUCTED

1992: NTERI BECOMES FIRST RESEARCH INSTITUTE

1997: HEALTH PAVILION (HP) CONSTRUCTED ▶



2004: OMCT CLOSSES

2005: UNTHSC REACHES AGREEMENT TO BUY OMCT LAND DOUBLING CAMPUS

2007: SCHOOL OF HEALTH PROFESSIONS ESTABLISHED

2007 CAMPUS MASTER PLAN

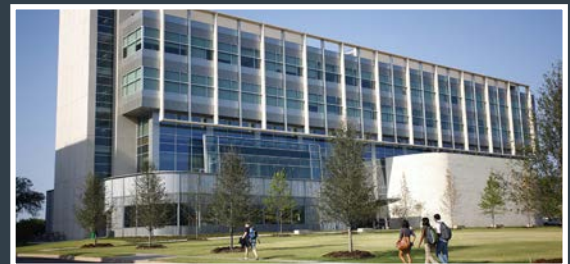

CAMPUS TODAY

Established in 1970, on the 5th floor of the Osteopathic Medical Center of Texas, the UNTHSC campus has steadily grown from a few offices into a 33.5 acre campus with 20 buildings and two parking garages, totaling over 1,475,000 gross square feet. Today, the campus is bounded by Camp Bowie Boulevard on the south, West 7th Street on the north, Boland Street on the east, and Haskell Street to the west.



-  Campus Ownership Boundary
-  Campus Owned Building
-  Campus Owned Parking Garage
-  Context Building

Key Campus Green Spaces

- A. MET Lawn
- B. Library Courtyard
- C. Community Garden
- D. Campus Spine
- E. Alumni Plaza
- F. IREB Rooftop Plaza

Campus Buildings

- 1. Student Service Center (SSC)
- 2. Medical Education & Training (MET)
- 3. Everett Education & Administration (EAD)
- 4. Research & Education (RES)
- 5. Cooling Towers
- 6. Surgery Center (SC)
- 7. Modlin Parking Garage (Lot 9)
- 8. Center for Sleep Medicine
- 9. Child Development Center (CDC)
- 10. Healthy Start
- 11. Facilities Support Annex
- 12. 3617 W. 7th Street (Leased)
- 13. Professional Offices
- 14. Gibson D. Lewis Library (LIB)
- 15. Health Pavilion (HP)
- 16. Founders Activity Center (FAC)
- 17. Geriatrics Annex
- 18. Interdisciplinary Research & Education Building (IREB)
- 19. Clifton Parking Garage (Lot 5)
- 20. General Services Building (GSB)
- 21. Facilities Management Building (FMB)
- 22. Center for BioHealth (CBH)



Campus Building Inventory

#	Building Name	Acronym	Year Built	Gross Square Feet (GSF)*
1.	Student Service Center	SSC	1981	24,292
2.	Medical Education & Training	MET	2010	115,934
3.	Everett Education & Administration	EAD	1978	194,099
4.	Research & Education Building	RES	1982	138,701
5.	Surgery Center	SC	2003	13,203
6.	Modlin Parking Garage	-	1984	138,466
7.	Center for Sleep Medicine	-	1955	3,624
8.	Cooling Towers	-	1982	N/A
9.	Child Development Center	CDC	1995	5,677
10.	Healthy Start Building	-	1955	1,577
11.	Facilities Support Annex	-	1965	3,618
12.	3617 W. 7th Street (Leased)	-	1985	1,653
13.	Professional Offices	-	1970	7,665
14.	Gibson D. Lewis Library	LIB	1986	114,064
15.	Health Pavilion	HP	1997	110,121
16.	Founders Activity Center	FAC	1955	11,617
17.	Geriatrics Annex	-	1980	1,482
18.	Interdisciplinary Research & Education Building	IREB	2018	172,922
19.	Clifton Parking Garage	-	2001	245,346
20.	General Services Building	GSB	1991	15,506
21.	Facilities Management Building	FMB	2000	7,409
22.	Center for BioHealth	CBH	2004	160,320

Source: UNTHSC, ArchiBus Facilities Inventory, dataset; UNTHSC, Property Schedule, dataset

* GSF is total of all space (assignable, circulation, mechanical, etc.) in each building registered in Archibus

Existing Total

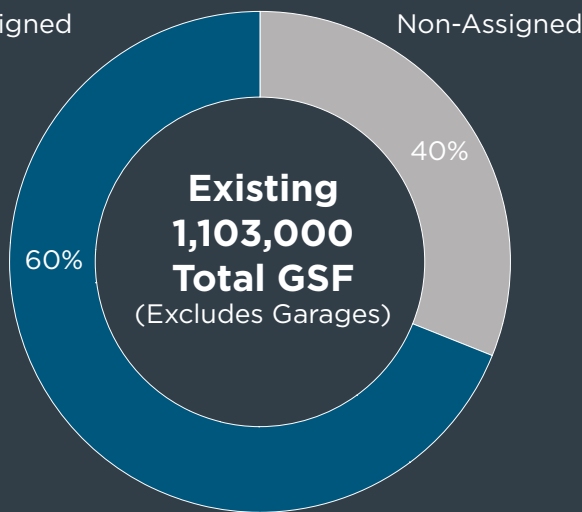

Space Type Distribution

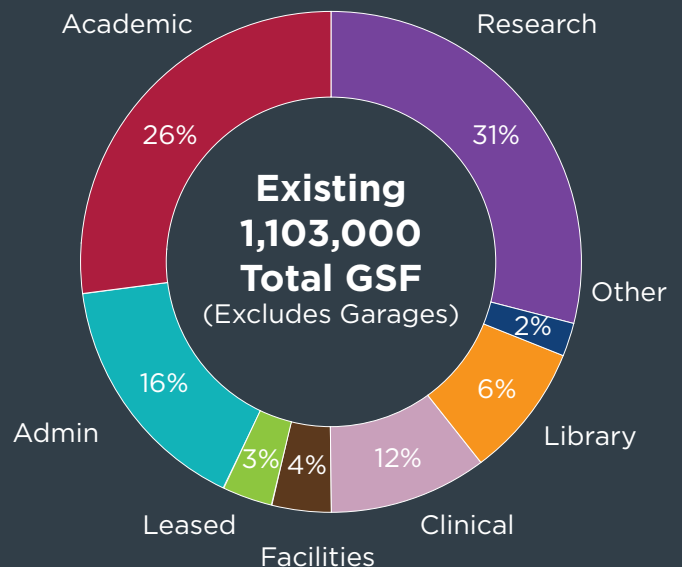

Existing Campus Profiles

Before the master planning team could begin analysis of campus systems, it was necessary to confirm the existing inventory of assets. This included confirmation of the existing campus boundary and land holdings, existing building inventory and associated quantitative data, campus population data, academic program profiles and locations, research profiles and locations, and clinical profiles and locations.

Land Area

The existing campus land ownership is 33.5 contiguous acres. Today, the campus is bounded by Camp Bowie Boulevard on the south, West 7th Street on the north, Boland Street on the east and Haskell Street to the west (with the exception of Parking Lot 7, which crosses Haskell).

As a part of the campus' growth over time, the City of Fort Worth ceded control of some interior roadways to the campus. Road ownership provides greater opportunity to close or reroute segments of a road, but changes must still be approved by the City. The master plan examines opportunities to selectively close segments of road to improve the on-campus experience and increase safety for pedestrians. UNTHSC road ownership includes:

1. Haskell Street between Clarke and Mattison Avenues
2. Bunting Avenue between Haskell and Montgomery Streets
3. Mattison Avenue between Haskell and Montgomery Streets
4. Modlin Avenue between Haskell and Montgomery Streets
5. Clifton Street between Camp Bowie Boulevard and the service drive north of the Facilities Management Building
6. Darcy Street between Camp Bowie Boulevard and Boland Street

Buildings

Today, the UNTHSC campus includes 20 buildings, totaling approximately 1,103,000 gross square feet (GSF), and two parking garages, totaling approximately 372,000 GSF.

The buildings range in age, height, and condition. Many of the structures on the north end of campus, along West 7th Street, were former single-family residences that have been converted to campus uses. The subsequent section of this chapter has analysis related building use and age.

Currently, research and academic are the largest space types on campus. The master plan examines opportunities to increase efficiencies and better utilize existing space.

Space Type	Apx. Gross Square Feet (GSF)
Academic	290,000 GSF
Research	345,000 GSF
Clinical	130,000 GSF
Admin / Support	178,000 GSF
Library	64,000 GSF
Other	17,000 GSF
Facilities	45,000 GSF
Leased	34,000 GSF
TOTAL	1,103,000 GSF

UNTHSC GSF Breakdown by Space Type

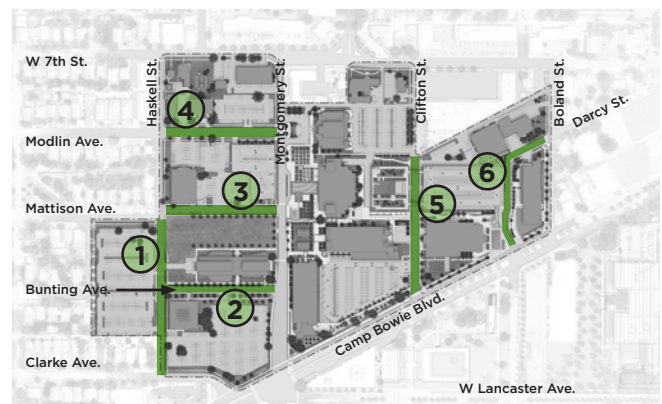

Diagram of UNTHSC Road Ownership

Population

Students (Spring 2017)



Faculty (Spring 2017)



Staff (Spring 2017)



Existing Population

Students	2,288
Faculty	356
Staff	948

TOTAL EXISTING 3,592

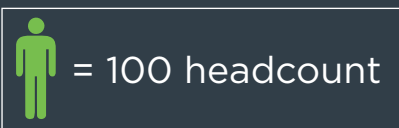

Historic Enrollment (Student Headcount)

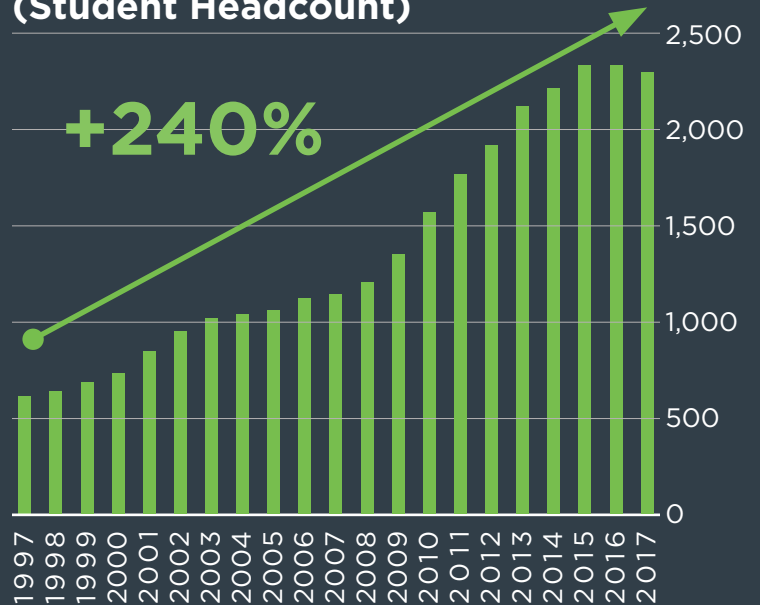

Academic Programs (Student Headcount)

Texas College of Osteopathic Medicine	914
Doctor of Osteopathic Medicine	
School of Health Professions	360
Master of Physician Assistant Studies	
Doctor of Physical Therapy	
College of Pharmacy	391
Doctor of Pharmacy	
Graduate School of Biomedical Sciences	387
Master of Science	
Doctoral Program	
School of Public Health	172
Master of Health Administration	
Master of Public Health	
Master of Science	
Doctor of Public Health	
Doctor of Philosophy	
Certificate Program	
School of Medicine (MOU with TCU)	Emerging

Sources: UNTHSC, Enrollment by Program and Class, dataset; UNTHSC, Employee Service Data, dataset

Population

Although relatively young as an institution, UNT Health Science Center has rapidly grown into one of the premier graduate medical campuses in the Central United States. Over the past two decades, enrollment has grown 240% from 672 headcount in 1997 to 2,288 headcount in 2017 (see “Historic Enrollment” table on page left). Between 2009 and 2015, this growth rate accelerated. Since 2015, the rate has plateaued. However, the total enrollment is expected to grow with a new school targeted to open in 2019. In addition to this new school, leadership is examining other opportunities for future enrollment growth. To support its current students, UNTHSC employs 356 full-time faculty members and 948 staff. In total, the on campus population is about 3,600.

Academic Programs

Since first adding the Graduate School of Biomedical Sciences to TCOM in 1993, UNTHSC has grown to five schools and colleges, offering a dozen primary programs and numerous sub-specialties. Many of these programs and specializations are nationally recognized as some of the best in the country. Soon, a sixth will be added with the emerging School of Medicine in partnership with Texas Christian University.

Due to the unique nature of health care education and accreditation, expansion of current programs and addition of new programs need to be carefully considered. Certain programs, such as TCOM, have state and federally legislated limits on maximum enrollment. Others are simply constrained by space, staff, and funding needs. Through the master plan process, opportunities to grow existing programs and study emerging program opportunities were identified.

Research Profile

A key part of the campus’ strategic plan is a commitment to research growth and recruitment/retainment of top faculty. Since 2000, UNTHSC has experienced unprecedented research growth, seeing research expenditures rise 432%, growing

from \$10,130,000 in 2000 to \$44,578,000 in 2016. Seeking to continue this trend, a goal has been identified to continue research expenditure growth by 5% annually in the coming years.

UNTHSC has long had a commitment to provide quality research space. Historically, these spaces have existed primarily in the EAD, RES, and CBH buildings, each of which were designed to primarily house labs. Today, current capacities are generally located in RES and CBH with pockets of research scattered in EAD and soon-to-be IREB. In total, there is approximately 345,000 GSF of research on campus.

Building off of this commitment, the UNTHSC has undergone a series of renovations to improve both the collaborative nature of the laboratory spaces, as well as transitioning to flexible casework systems to allow for a variety of layouts and setups specific to researchers needs. This revitalization began in 2012 with the renovation and redesign of the College of Pharmacy skills laboratory on the first floor of RES. In 2013, a portion of the third floor of RES was renovated into an open and flexible research laboratory. Then in 2014, the UNT System Board of Regents authorized the programming and design of the new Interdisciplinary Research and Education Building (IREB), which was designed to house flexible open-concept laboratories on multiple floors.

Clinical Profile

Core to the UNTHSC’s purpose, vision, mission, and values is creating solutions for a healthier community. Dating back to the campus’ early relationship with the Osteopathic Hospital, clinical provision has been a key part of curriculum and campus operation.

While UNTHSC does not have a dedicated inpatient teaching hospital on campus, outpatient facilities in the Health Pavilion and smaller clinical buildings along West 7th Street have enabled the campus to see over 500,000 patients in the past two years. Today, the campus is exploring opportunities to distribute more clinical care to various off-campus locations around Fort Worth.

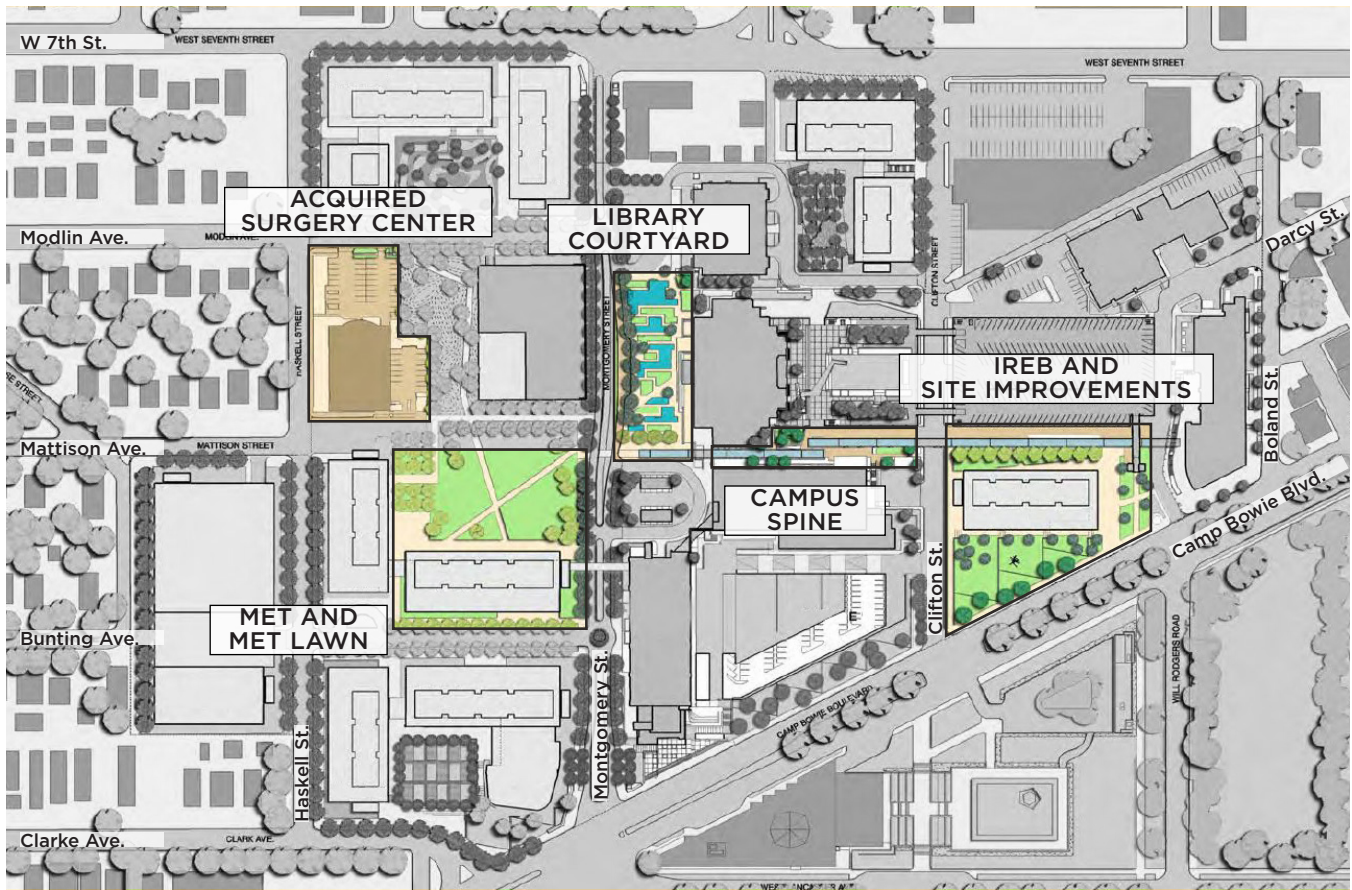

2007 Master Plan - Highlight of Implemented Projects

Recent Development

Another key topic was understanding how the campus has developed since the last master plan, and how the framework laid out by the previous plan informed campus growth. Since 2007, the campus has acquired one specialized structure and enhanced landscape features, replaced multiple aging structures, built a new academic building and research building, launched two new academic programs (the School of Health Professions and the UNT System College of Pharmacy), and are in the process of launching a new medical school.

Acquisitions

UNTHSC acquired the Ambulatory Surgical Center in 2015. Long-term, the site may be a candidate for redevelopment. However, the campus has recently reached a new lease agreement that will keep the Surgical Center occupied for the near-term.

Site and Landscape Improvements

Two major landscape projects implemented from the 2007 Master Plan have transformed the campus environment.

The first was the creation of the two-acre Library Courtyard along Montgomery Street in 2013, requiring the demolition of two single-story structures that previously occupied the site. The courtyard, programmed with a variety of outdoor space types and seating options, creates a strong north-south axis link between the Everett Administration Building (EAD), Research and Education Building (RES), Gibson D. Lewis Library (LIB), and the Health Pavilion (HP).

Second is the Campus Spine, which has been developed in multiple phases. Phase 1 was

completed between Haskell and Montgomery Streets in 2010, concurrent with the construction of the Medical Education Training (MET) building. Phase 2 was created as a part of the Library Courtyard. Phase 1 and 2 do not perfectly align, nor is there a pedestrian connection between the two elements across Montgomery Street. Phase 3 of the Campus Spine, stretching from the Library Courtyard to Darcy St., is currently under construction and is expected to fully be completed in fall of 2018. This master plan examines ways to better connect these three phases as well as complete the spine across Darcy Street into the Center for BioHealth (CBH).



Library Courtyard Offers a Variety of Space Types

Medical Education & Training Building

One of the most immediate and visible outcomes of the 2007 Master Plan was the demolition of the osteopathic hospital and subsequent replacement with a new Medical Education & Training Building (MET). Today, the MET has quickly become the academic center of campus.

Interdisciplinary Research & Education Building (Expected Completion 2018)

Currently under construction, the new Interdisciplinary Research and Education Building (IREB) is expected to be completed fall 2018. The building fronts Camp Bowie Boulevard directly north of the Amon Carter Museum and will house research laboratories, classrooms, teaching labs, collaboration spaces, public space with dining, and faculty offices. The building site was identified in the 2007 master plan.



Medical Education Training (MET) Building

Medical School Establishment

In July of 2015, the University of North Texas Health Science Center and Texas Christian University (TCU) entered into a memorandum of understanding to create a new joint medical school (MD program). The school is scheduled to open in 2019 with 60 students and will grow over time to an enrollment of 240. Initially, the program will be housed both on the third and fourth floors of IREB as well as within TCU facilities. Long-term, as the program grows, they may need new dedicated facilities.



Rendering of IREB and Phase 3 Campus Spine

GIBSON D. LEWIS
HEALTH SCIENCE LIBRARY



CAMPUS SYSTEMS

INTRODUCTION

A fundamental part of the 2018 Campus Master Plan process was the in-depth analysis of existing campus systems and features to provide a comprehensive picture of where the campus is today and how various systems function. The planning team worked closely with various members of UNTHSC and UNTS to obtain quantitative and qualitative information to develop a baseline understanding of the constraints and opportunities unique to UNTHSC.

This section of the master plan report shares some of the key observations which influenced and helped inform master plan concepts. While these systems were extracted for the report, it is also worth emphasizing that the study of existing campus systems was not limited to what is shared in this report. All analysis treats IREB as existing.

Data sources for system analysis include:

- Prior planning studies conducted by the university including the 2007 Master Plan, the Strategic Plan, Transportation Surveys, Pedestrian Safety Report, and others
- Existing spatial files from UNTHSC included AutoCAD plans, Sketchup models, and PDF documents
- Quantitative data sets with analytics on topics including demographics, enrollment, parking, research expenditures, and room inventories
- Local and national survey documents
- Interviews with campus stakeholders
- Qualitative surveys using mapping applications and first hand investigation

See the Appendix for a detailed list of data sources and reference documents.

Planning Boundary

When analyzing the campus, it is requisite to look at multiple scales. Earlier in this report, a synoptic look at regional and neighborhood context was taken. The campus systems section takes a more integrated look at the relationship between campus systems and the context. It is critical to study how campus systems interact with the adjacent neighborhoods because, invariably, many of the systems are linked to operations and elements outside of the campus border. For example, stormwater flows with topography and runs onto the campus from the adjacent neighborhoods in some locations, and from the campus into neighborhoods and other locations

To capture a full understanding of how the campus operates today, the master planning team defined a study area two blocks in all directions of the existing campus boundary. This extension beyond the campus boundary is what is called the planning boundary. The analysis in this section will use the planning boundary as a basis.

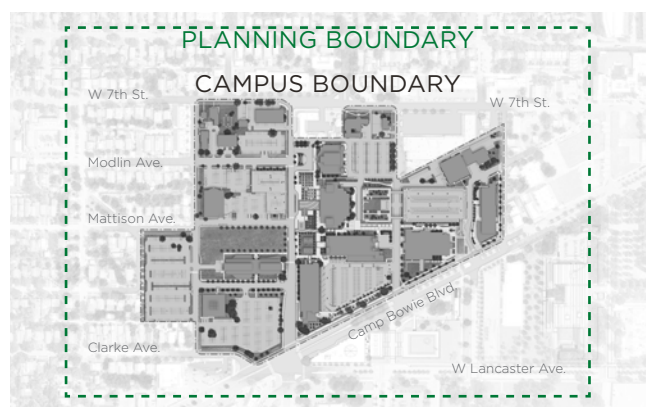
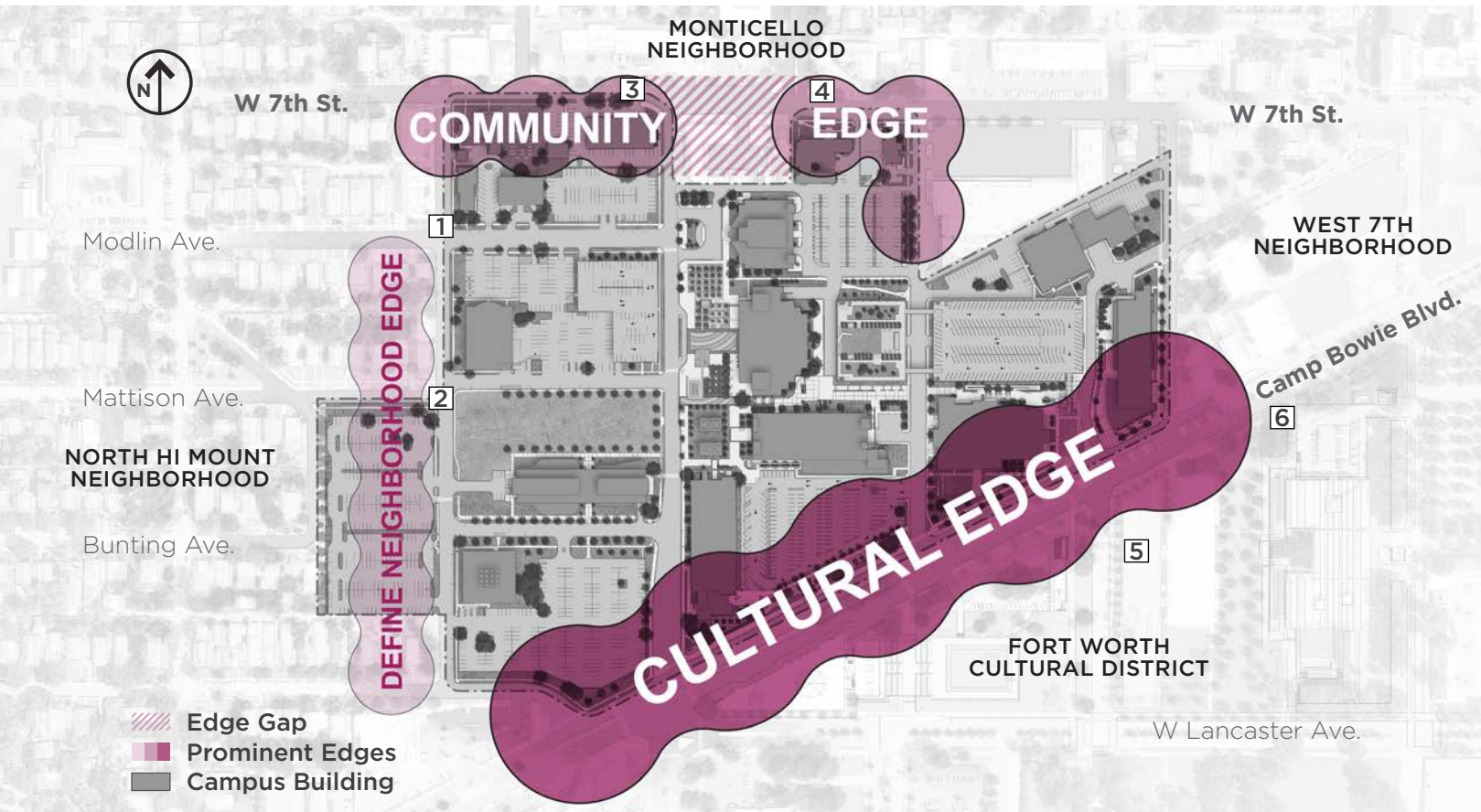

Diagram of Planning Boundary

Analysis Outcome

Revealed through this analysis, a collective understanding of the existing campus and how it functions is essential to create a plan that will allow the campus to grow successfully over time.



Edges

Campus edges are the threshold that blend campus into neighborhood. Traditionally, campuses have treated edges as barriers or buffers to clearly separate themselves from the surrounding communities. Institutions built physical and perceptual walls (such as large expanses of parking that do not welcome neighbors or uninviting facilities and service functions). Historically, UNTHSC has been characterized by these same poor edge conditions. At the time of the 2007 Campus Master Plan, surface parking or low density buildings housing support functions lined the campus edge on all sides. Recently, the campus has begun to improve these conditions. Today, campus edges are instead viewed as an opportunity to engage with neighbors and promote a positive institutional identity. Examples of this paradigm shift can be seen in the designs of CBH and IREB which created an edge condition that better engages the museums and promotes the institutional brand along a portion of Camp

Bowie Boulevard. The UNTHSC campus has three distinct edge conditions based on each of the relating neighborhood edges.

Neighborhood Edge: Edge shared with the North Hi Mount neighborhood containing mostly single family residential uses. This edge is currently undefined along the entire stretch.

Community Edge: Edge along West 7th Street. The campus side of this edge edge is poorly defined by older one- and two-story buildings that are set far back from the road. This edge has poor institutional identity and does not feel like a part of campus.

Cultural Edge: The most visible campus edge along Camp Bowie Boulevard where UNTHSC interfaces directly with the Cultural District. This edge provides the first impression of the institution to visitors. Although improved in areas, surface Lots 6 and 19 still create non-optimal edge conditions.



1. Neighborhood Edge North End of Haskell Street



2. Neighborhood Edge Haskell at Mattison Avenue



3. Community Edge Along West 7th Street



4. Community Edge Along West 7th Street



5. Cultural Edge - Kimball Art Lawn



6. Cultural Edge Along Camp Bowie Boulevard

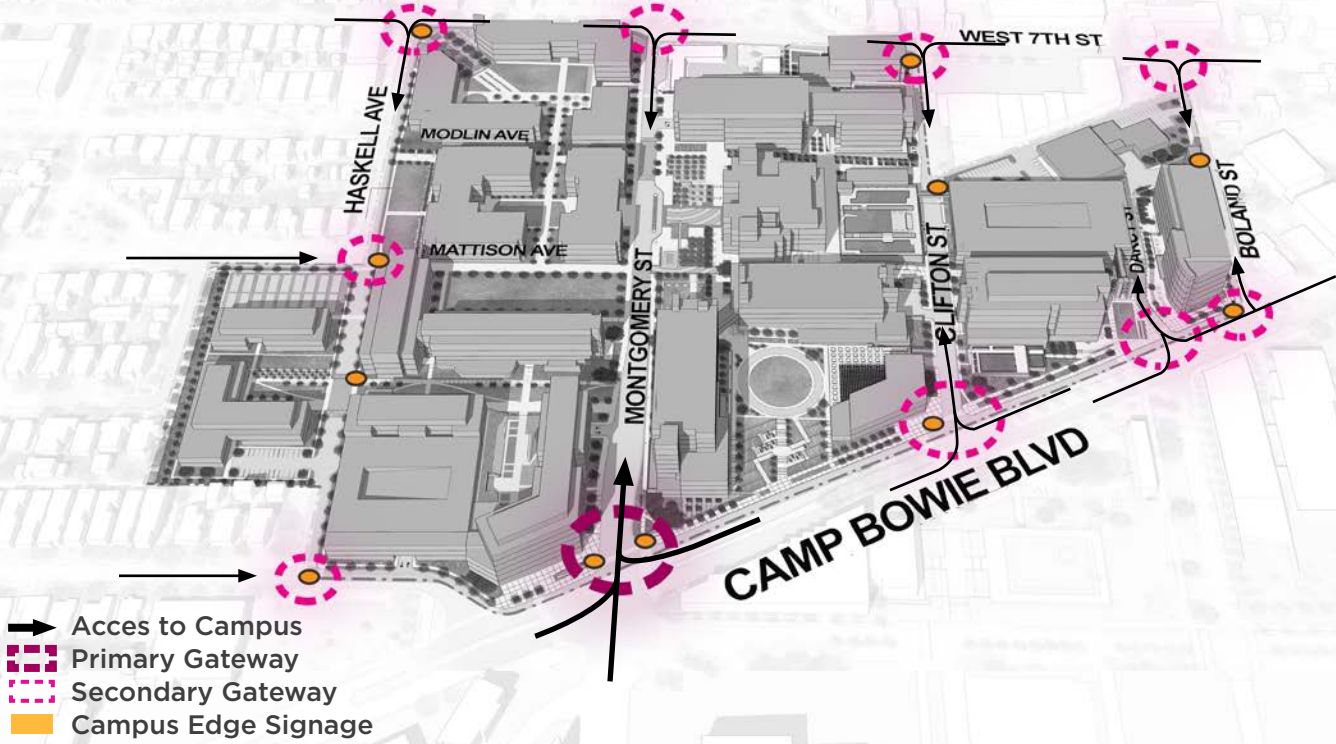

Gateways

Gateways are the physical thresholds to campus that create a sense of entry. Stakeholders identified the intersection of Camp Bowie Boulevard and Montgomery Street as the entry point that is the primary gateway to campus. However, while this intersection is perceived as the front door, most familiar daily users (students, staff, and faculty) access campus at different points to reach their preferred parking locations. These access points are the secondary gateways. Due to a variety of factors, some of these gateways are more successful than others in terms of clarity and function.

Gateways can be clearly demarcated in multiple ways. Buildings and the built environment can serve to physically frame gateways. Campus signage can also help reinforce these gateways, identify campus property, and promote the UNTHSC brand image. The campus has done a good job locating signage at gateways.



The Intersection of Camp Bowie Boulevard and Montgomery Street Serves as the Campus's "Front Door" and Primary Gateway



Open Space Network

Open Space is defined as the sections of campus without buildings or parking lots that provide space for plazas, grass, trees, or other vegetation set aside for recreational or aesthetic purposes. More broadly speaking, it includes plant and landscape features, lighting, pathways, and outdoor furniture. A high-quality open space network should be composed of a variety of space scales, uses, and physical elements to meet the diverse needs of campus users and align to a diverse set of landscape typologies. As an institution in Texas, it is also critical that the landscape on campus provide a substantial amount of shade.

Initial analysis during the 2007 Master Plan identified the campus as being deficient in green space elements and distribution. The 2007 plan identified just one major existing green space on campus (Alumni Plaza). Since the 2007 Master

Plan, the campus has placed an emphasis on creating a variety of green space and increasing the volume of landscape elements. As a result, campus character and quality has improved significantly. Today, there are six major open space elements on campus and multiple other small elements.

A unique open space feature is the the Memorial Tree program which allows donors to dedicate and plant a tree on campus in honor or memory of an event or person. This program helps to make the UNTHSC campus special and unique.

While much progress has been made since the previous plan, analysis reveals that there are still gaps in the open space network and need for a greater mixture of space types, as well as opportunities to expand the network to support a broader section of the campus.

Open Space Typologies

Open space planning focuses on the design and program of campus that includes a variety of space types. While each space is unique in design and function, the planning team has identified three general space typologies existing on campus today. These spaces will serve as typologies for expansion of the open space network in the 2018 Campus Master Plan.

Grand Spaces

Grand spaces are designed for active recreation, events, and large groups of people. Grand spaces typically have clear edges defined by building masses or alignment with roadways. They also typically share a strong indoor-outdoor connection with adjacent buildings through alignment of entrances, interior active uses, and a large number of windows overlooking the space. Grand spaces are generally intended to be very public and open to members of the campus and community.

Existing examples include the MET Lawn, which frequently hosts recreational activities such as flag football and events such as crawfish boils, and the Alumni Plaza which provides space for cookouts. The campus has a good distribution to support existing uses, but should make sure future development is supported by new grand spaces.

Intimate Spaces

Intimate spaces are smaller spaces intended to serve as places for groups or individuals to engage in passive activities. Because of their size and flexibility, these spaces can be created in many places on campus. Intimate spaces can be located at the edges of grand spaces, in building niches or courtyards, or along pedestrian routes. These spaces are typically fitted with benches and other site furnishings for relaxing, studying, or dining outdoors. Depending upon their locations, they can serve faculty, staff, students, and the adjacent community.

On-campus examples include benches placed near building entrances and the picnic tables at the edges of the Library Courtyard. There is an opportunity for UNTHSC to diversify these spaces in the future by considering new programs including (but not limited to) outdoor classrooms, patient waiting gardens, hammocking racks, outdoor dining areas, and dedicated food truck sites.

Linear Open Spaces

Linear open spaces serve as pedestrian linkages between buildings and other open outdoor spaces. These can take the form of sidewalks adjacent to the public street network or pedestrian walks and promenades within the campus interior.

To enhance campus experience, it is critical to create pedestrian-friendly spaces along roadways. Linear open spaces along roadways should include wider walk space, street trees, benches and furnishings, lighting, and specialty paving to make for a safe and enjoyable passage for pedestrians. Crosswalks, speed tables, and planted “bulb-outs” should also serve to slow traffic and make drivers more aware of the pedestrian surroundings. One strong linear open space on campus is the pedestrian paths that parallel the edge of the MET block. These pathways are served by lighting, seating, and shade trees spaced at consistent intervals. However, many of the other linear open spaces across campus could do a better job of including additional lighting, seating, and shade to ensure pedestrian-friendly open spaces adjacent to roadways.

Likewise, campus interior walks should provide shade, plantings, intermittent points of interest or resting areas. A great example of linear open space design is the Campus Spine. An illustrative plan of the design of the section north of RES and IREB is located on the adjacent page. As the primary east-west connector on campus, consideration for a variety of landscape features and seating options was integral to its design.



Small Seating Area in Alumni Plaza (Intimate Space)



MET Lawn Hosting an Event (Grand Space)



MET Lawn Supports a Variety of Activities



Illustrative Plan of Campus Spine Phase 3 Design - Under Construction 2018 (Linear Open Space)

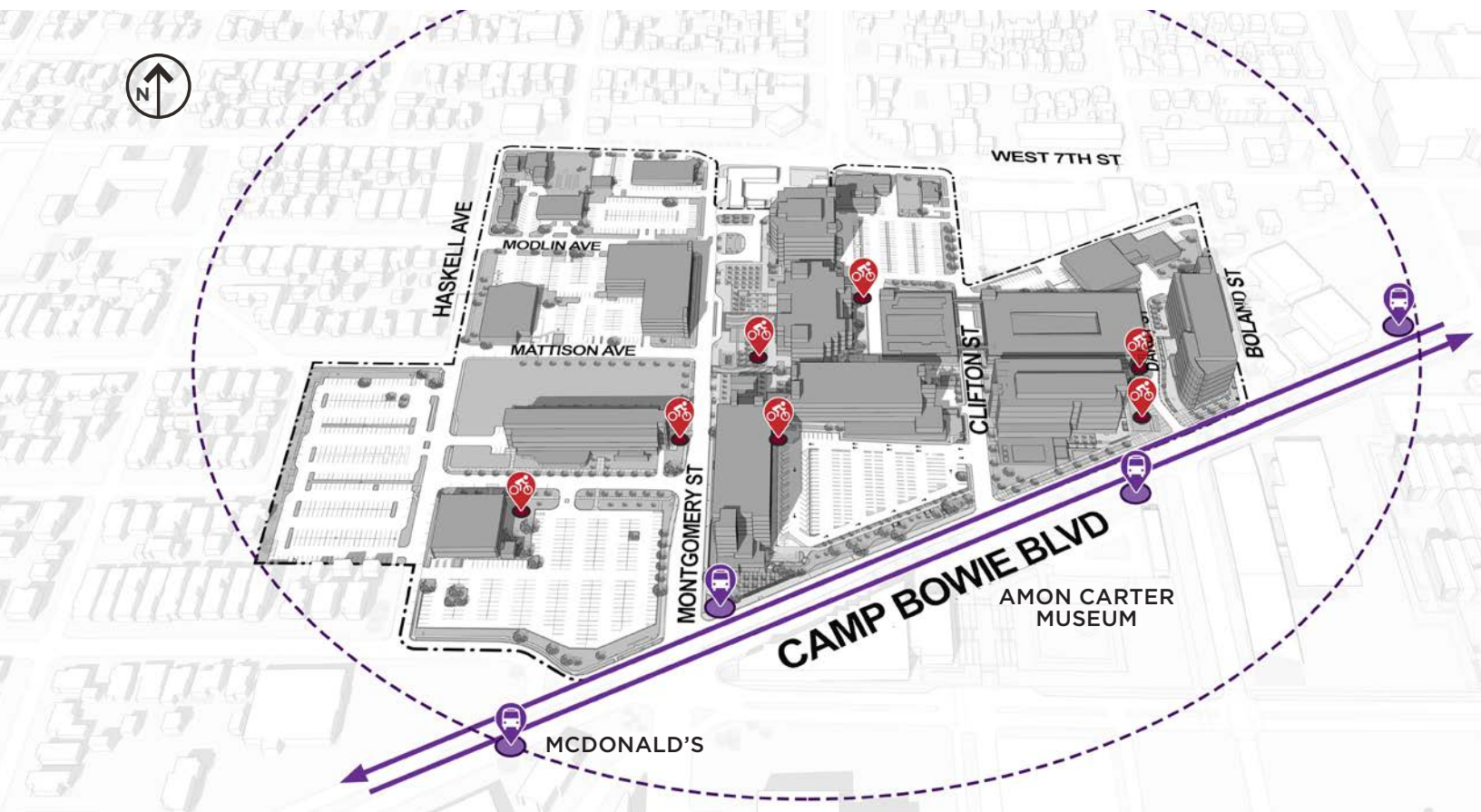

Transit & Bicycle Infrastructure

The UNTHSC campus sits adjacent to the Fort Worth Transit Authority (FWTA) Route 2 - Camp Bowie Boulevard bus line. Route 2 connects the Ridgmar Mall Transit Center to the downtown Fort Worth Transit Center, including the Trinity Railway Express with connections that include DFW airport, the Dallas Medical Center, and Downtown Dallas. Buses run every 30 minutes.

Within a quarter-mile (1/4 mile) of campus, there are two westbound and two east bound bus stops for Route 2. The westbound stops are located at the Camp Bowie Boulevard intersections of Van Cliburn Way and Montgomery Street. The eastbound stops are located adjacent to McDonald's along Camp Bowie Boulevard and the northeast corner of the Amon Carter Museum of American Art property.

- FWTA Bus Route
- FWTA Bus Stop
- 1/4 Mile (5-minute walk) Radius from Library
- UNTHSC Bicycle Rack
- Campus Building
- Context Building

Today, there are no formal bike routes on or adjacent to campus. City of Fort Worth has plans to create bike lanes along Montgomery Street, West Lancaster Avenue, and West 7th Street in the future. See the Master Plan Systems Integration section for more details.

UNTHSC has located bicycle parking at seven locations across campus to support students, faculty, and staff who do elect to bike to campus. Stakeholders identified no pressing demand for additional bicycle facilities.



Pedestrian Circulation

Pedestrian circulation routes on campus are primarily defined by the routes students, staff, faculty, and visitors take to get from parking to their initial destination. The above diagram highlights the most heavily trafficked routes today.

Historically, pedestrian circulation on campus has been fragmented, poorly aligned as a system, and confusing for users. Much of this was dictated by legacy building locations (some of which no longer exist). Since the 2007 Master Plan, the campus has made substantial improvements to pedestrian circulation. Touched on in the recent development section, creation of the campus spine has been an emphasis for the campus. Once the final section north of IREB is completed (Fall of 2018), the campus spine will run the entire length of campus connecting the campus core with a majority of the highly utilized buildings on campus and parking zones.

While this progress has been instrumental in improving the on campus experience, there are still sections of campus where pathways and crosswalks are poorly aligned. This is most visible in the area surrounding the Chilling Towers, which is one of the most heavily trafficked areas on campus. The three primary east-west pathways (Campus Spine west of Montgomery, Campus Spine east of Montgomery, and pathway north of MET) do not align. To make matters worse, the pedestrian crosswalk over Montgomery does not align with any of these, but instead, is located further south on axis with the MET building itself.

This analysis reveals a need for improvements that target creation of new north-south connections, align legacy crosswalk and pathway locations, and enhance the overall connectivity and safety of campus for pedestrians.

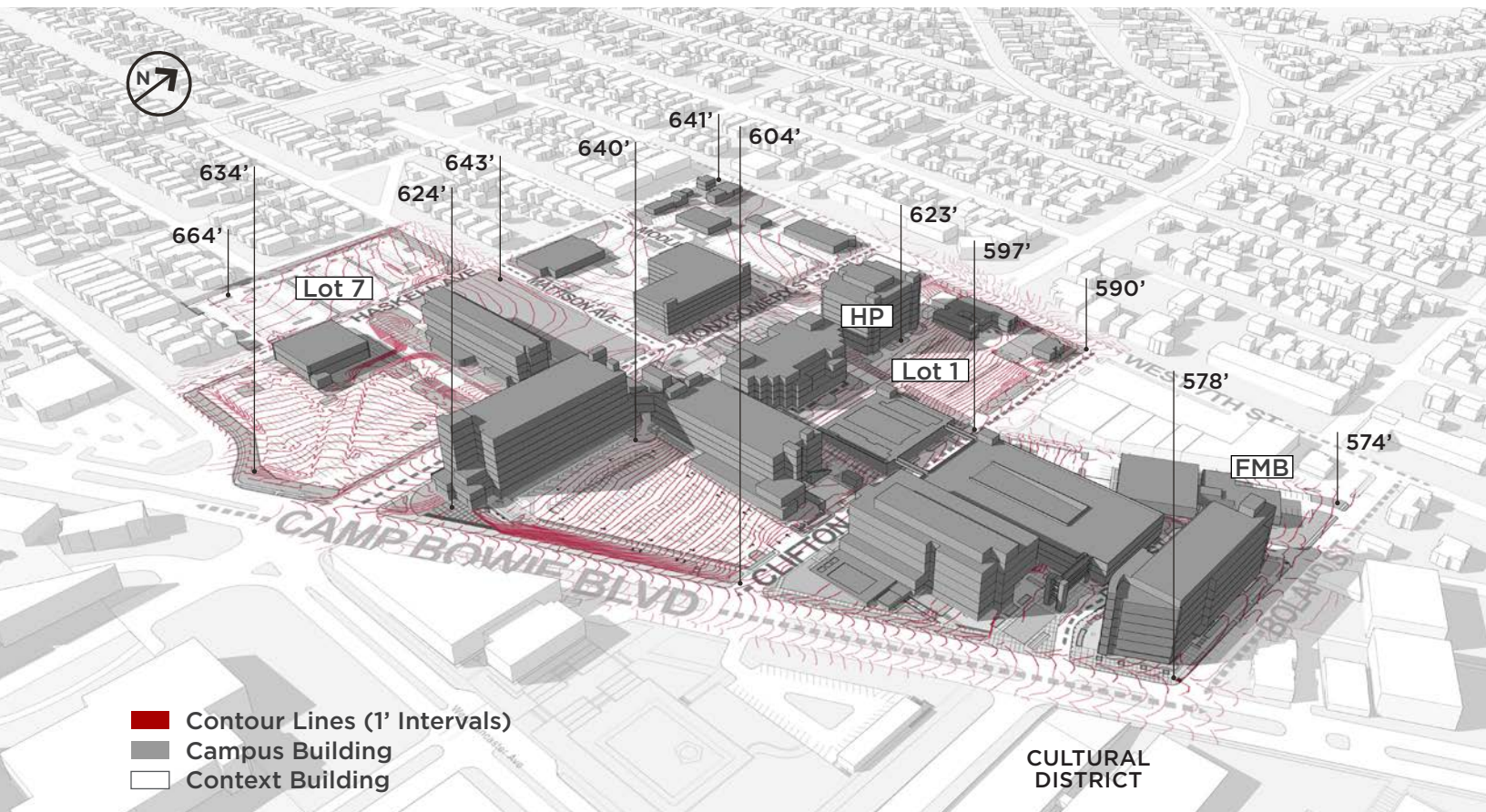

Topography

The topography of UNTHSC presents both challenges and opportunities. Due to the extreme elevation changes, it can be difficult to navigate campus. The highest point on campus is on the western edge of Lot 7, sitting at 664 feet above sea level. The low point is on the northwest lawn of FMB, sitting 574 feet above sea level. This total elevation change of approximately 90 feet significantly limits overall accessibility across campus.

Many of the buildings on campus were designed with special considerations to provide entrances at multiple levels to accommodate the exterior slope. Steep slopes also present landscape and stormwater drainage challenges. For example, the Parking Lot 1, where clinical guests park to visit the Health Pavilion, is notorious for the speed of water rushing down its slope during storm events. As a positive, the campus sits higher than Downtown and the Cultural District, providing unique views.



Topography Presents Accessibility Challenges Walking Across Campus, Impacts the Placement of Building Entrances, and Creates Steep Slopes that Water Rushes Down During Storm Events



Topography is a Barrier to Some Clinical Patients and Creates Stormwater Challenges



Retaining Walls Exist at Multiple Places on Campus to Hold Back Earth Elements



Additional Pervious Space is Desired

STORMWATER DRAINAGE

Existing Stormwater Drainage Zones

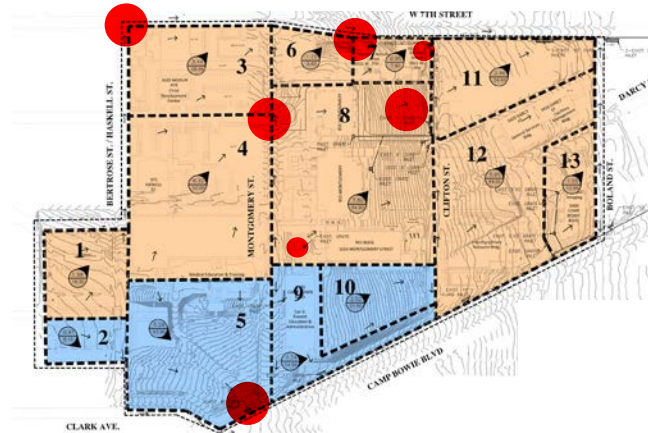

- Flows North to West 7th Street
- Flows South to Camp Bowie Boulevard
- Area Identified Having Extreme Runoff Issues

Drainage Patterns

Due to the lack storm infrastructure on campus, all water on campus flows off of buildings and land and into internal streets where it is routed to either West 7th Street or Camp Bowie Boulevard. Generally following the topography, water flows west to east before routing north or south to the two arterials listed above and into the existing public storm network of pipes, catch basins, and curb inlets. On the diagram above, orange areas flow to West 7th Street and blue areas flow to Camp Bowie Boulevard.

Based on initial analysis, the system as a whole (on and off campus) is undersized and unable to handle the current runoff. As a result, various areas throughout the campus experience flooding, ponding, and erosion during storm events. The worst are identified in red on the diagram above.

Pervious vs. Impervious Surfaces

The campus is currently 80% impervious, with paved areas (surface parking, roadways, and sidewalks) accounting for 60% of this area while building roofs account for the other 20%. Pervious surfaces, such as grass lawns and landscape beds, allow water to drain into the ground instead of pooling up and flowing on the surface.

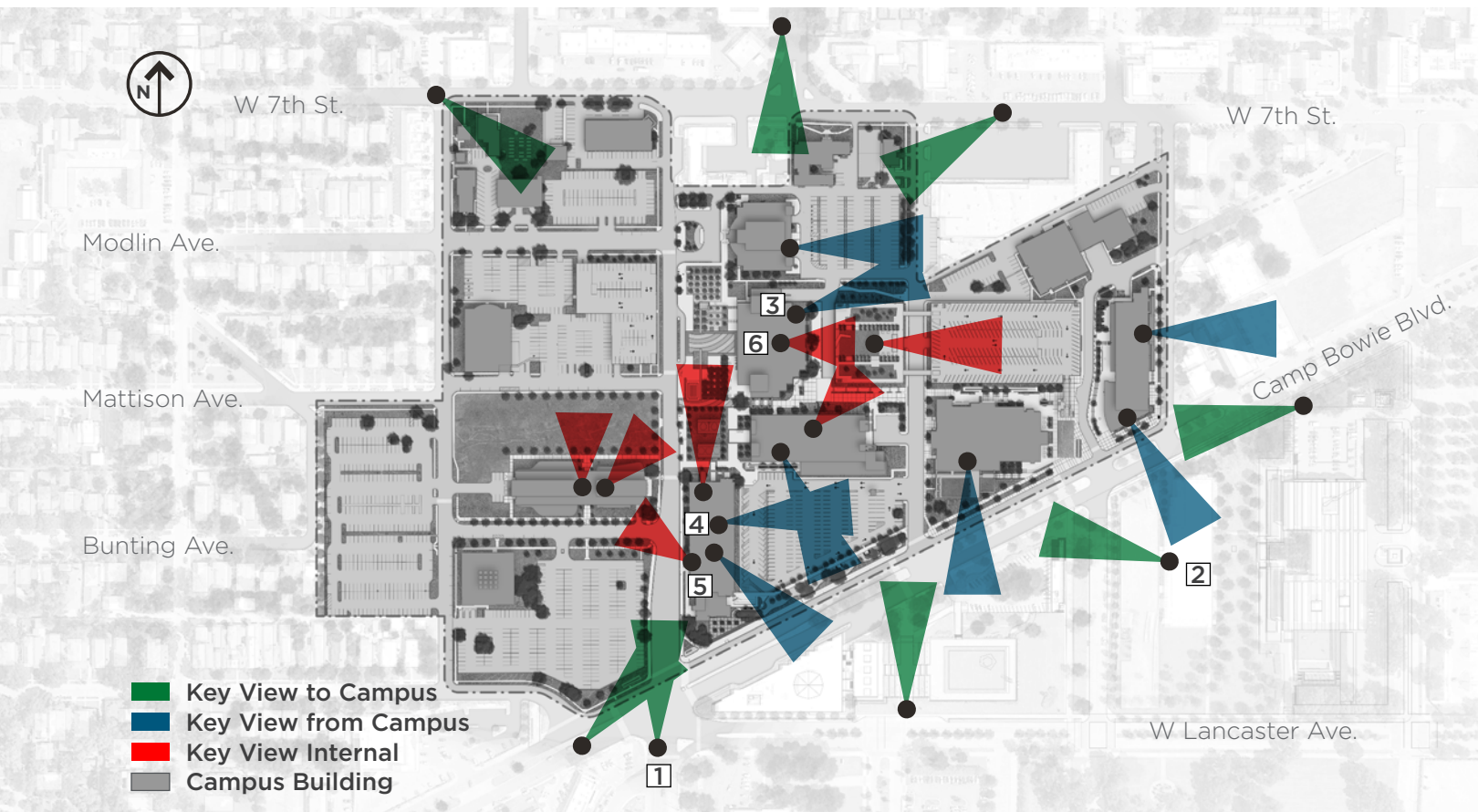

Vistas & View Corridors

Because the campus sits atop a local peak, UNTHSC is uniquely situated to have incredible vistas and view corridors. This includes views onto campus, off of campus, and internal to campus. Each view type is marked on the diagram above. Shorter lengths correspond to closer views while the longer lengths represent more distant views.

Key Views to Campus

Visitors approaching campus begin to view the campus profile long before reaching campus. MET and EAD can be seen from Interstate 30 (over a mile away) and get increasingly more prominent as visitors travel north on Montgomery Street. The campus can also be seen well in advance traveling both directions along Camp Bowie Boulevard and West 7th Street, and it sits prominently in the background of visitors to the Amon Carter and Kimbell Museums.

Key Views from Campus

Magnificent views of the downtown skyline can be seen from various floors in EAD, LIB, CBH, and HP. Equally incredible, portions of EAD, RES, IREB, and CBH have views that overlook the nearby museum grounds. Future development should not block or impede these views.

Key Views Internal to Campus

Historically, the campus has not had many internal vistas due to a lack in both architectural and landscape focal points. Since 2000, creation of the Alumni Plaza, Library Courtyard, MET Lawn, and MET building have created new engaging views and focal points internal to the campus. While internal views have been created for buildings in the core, buildings elsewhere on campus are lacking visually appealing internal views.



1. View to Campus from Montgomery Street



2. View to Campus from Kimbell Pavilion Roof



3. Views Off Campus from North Side of the Library



4. Views of Downtown and the Cultural District from EAD



5. Views of MET from EAD



6. Internal View of CBH and IREB from Alumni Plaza

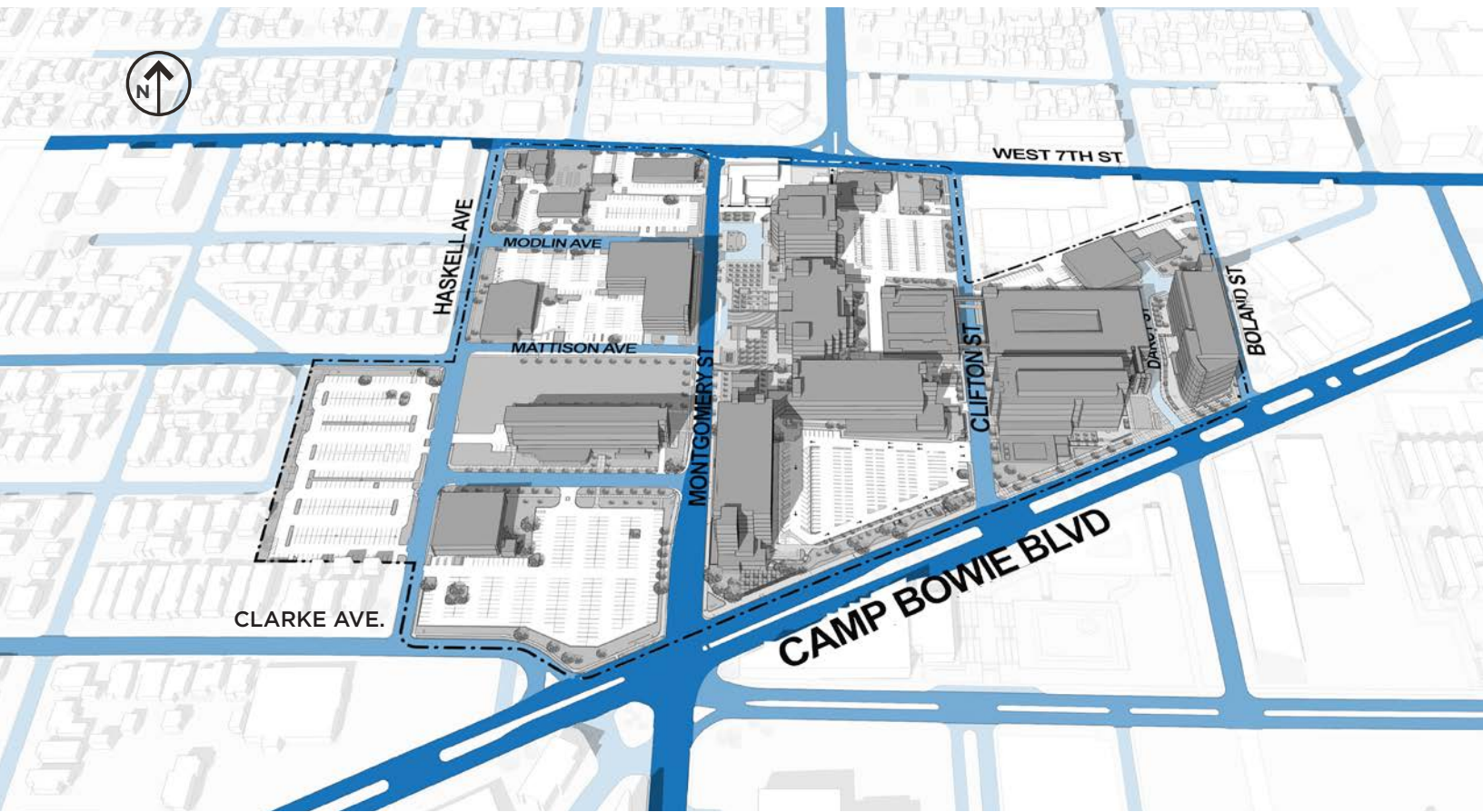

Streets & Vehicular Circulation

Understanding street hierarchy and usage is critical to campus planning. A clear and functional hierarchy helps to establish a clear campus boundary, efficiently move vehicles through campus with minimal pedestrian conflicts, and connect the campus to the students, staff, faculty, and visitors who access campus by personal vehicle. Vehicular circulation analysis typically represents the street hierarchy in three levels: Arterial roads (primary hierarchy), collector roads (secondary hierarchy), and local roads (tertiary hierarchy). Each tier is generally defined by the width of the road and the volume of traffic a road handles on a daily basis. This nomenclature is shared with the City of Fort Worth.

Arterial Roads: Arterials are high traffic and capacity roads that move traffic across cities and regions. UNTHSC is bounded by two major arterial roads that connected the campus to Downtown

- Arterial Road (Primary)
- Collector Road (Secondary)
- Local Road (Tertiary)
- Campus Building
- Context Building

Fort Worth. Camp Bowie Boulevard forms the southern edge of campus while West 7th Street is the northern edge. Additionally, Montgomery Street is a third arterial which connects campus to Interstate 30, but effectively bifurcates campus in half causing pedestrian conflicts.

Collector Roads: These roads distribute visitors from arterials. Based on layout and function, most roads on campus fall into this classification.

Local Roads: Local roads typically do not have much traffic and are only used to get to specific destinations or provide service access.

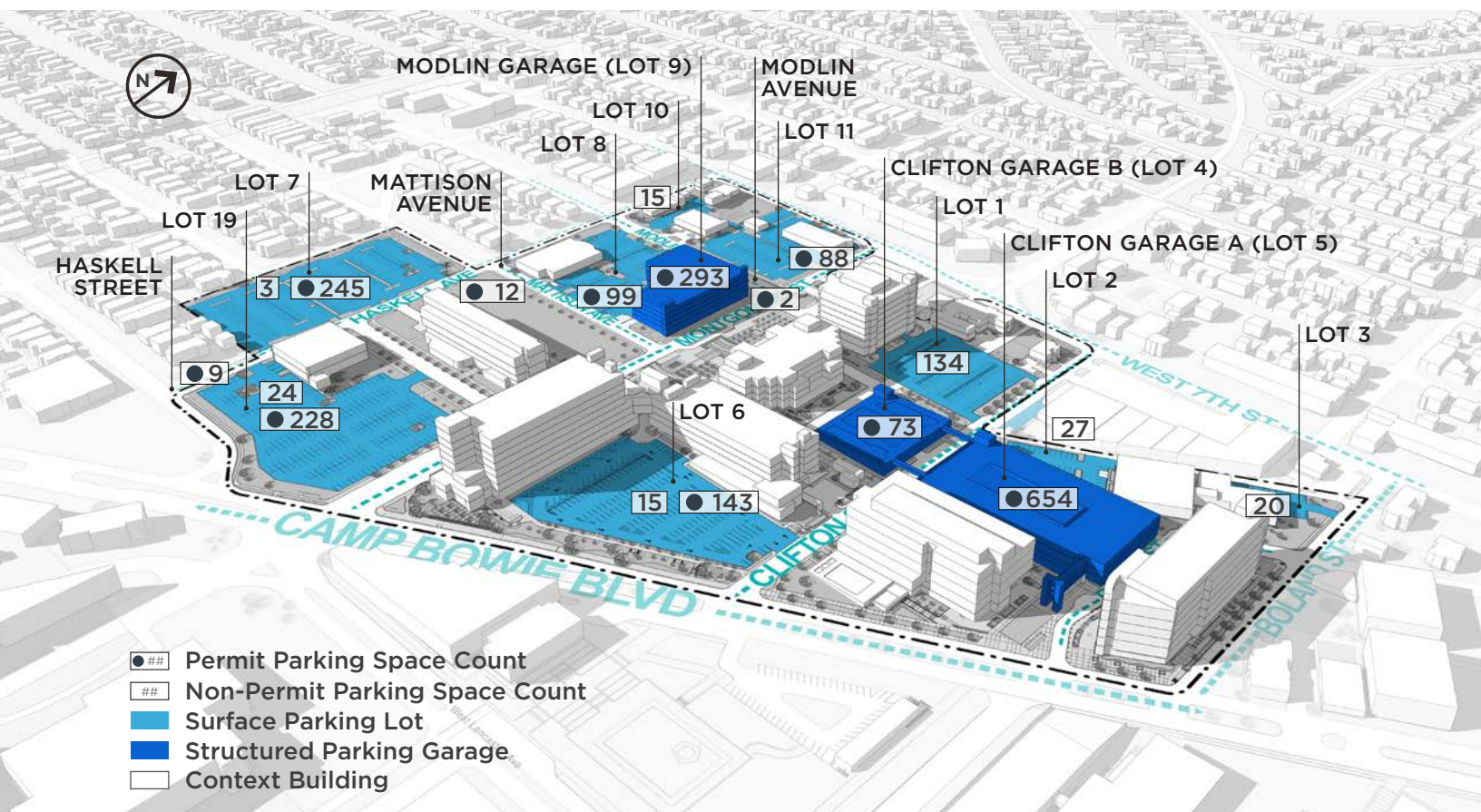

Parking

Today, UNTHSC has a mixture of parking types on campus, including surface parking lots, street parking, below building parking (at the Health Pavilion), and structured parking garages.

There are currently 1,846 permit spaces on campus. These spaces are managed by the university to serve its students, staff, and faculty. UNTHSC currently employs multiple management structures which includes some reserved spaces and some dedicated faculty lots. However a majority of the parking is open. The first table on the right breaks this space count down into surface lot, parking garage, and on street counts. This 1,846 permit count will be used as the baseline for tracking existing parking in the master plan.

The campus also has 260 non-permit spaces. This number captures visitor parking, dedicated

clinical/business parking, facilities service parking, and ADA spaces. These spaces are not open for students, staff, and faculty to park in on a daily basis and do not generate revenue. In total there are 2,106 parking spaces on campus.

UNTHSC Permit Spaces	Count
Permit - Surface Lots	803 spaces
Permit - Garages	1,020 spaces
Permit - On Street	23 spaces
TOTAL	1,846 spaces

Total Parking Spaces	Parking Spaces
All Permit Spaces	1,846 spaces
Dedicated Use Lots	204 spaces
Visitor Parking	56 spaces
TOTAL	2,106 spaces



Primary Building Use

Typically, master plans analyze the campus at the building level, where each building has one primary use. Due to the unique nature of the UNTHSC campus, which has multiple large mixed-use buildings, our analysis focuses on the primary use of each floor.

The UNTHSC campus is made up of eight primary uses: academic, research, clinical, library, administration and student support, other (such as the fitness center), facilities, and leased space totaling 1,103,000 GSF (excludes parking). The diagram above shows their distribution and overlap across campus.

Current leased space includes the St. Emillion Restaurant, cafe and coffee spaces across campus, multiple small suites within CBH, and the Surgical Center.

Space Type	Approx. Gross (GSF)
Academic	290,000 GSF
Research	345,000 GSF
Clinical	130,000 GSF
Admin / Support	178,000 GSF
Library	64,000 GSF
Other	17,000 GSF
Facilities	45,000 GSF
Leased	34,000 GSF
TOTAL	1,103,000 GSF

Identified by stakeholders during early workshops, multiple opportunities exist to realign programs campus-wide to create better adjacencies and efficiencies. These opportunities are detailed in later chapters of this report.

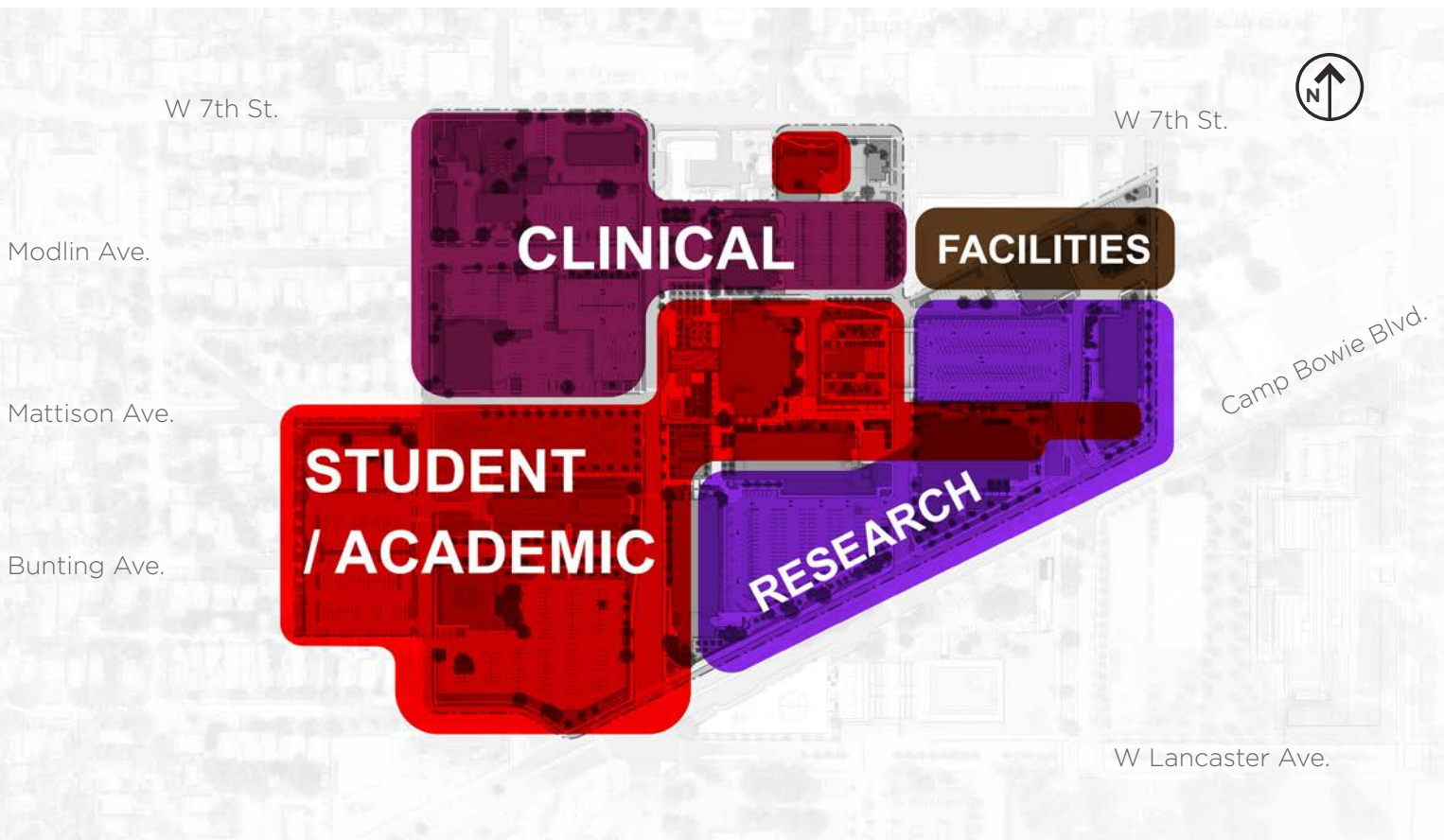

Use Districts

Perhaps more important than looking at individual building uses is understanding use districts. Each district expresses relationships of individual uses at a campus level. On many other campuses, these graphics reveal very disaggregated patterns with scattered pockets of individual uses. UNTHSC has a fairly strong pattern overall. As depicted on the diagram atop this page, each of the major functions is relatively clustered on campus.

Academic uses are primarily clustered in the campus core, with most day-to-day functions being located in MET, EAD, or LIB. Stakeholders consistently identified the library as the heart of campus and a hub of student activity. In addition to the strong core, the district stretches south and west to capture student services and parking in Lots 7 and 19 which primarily support academic functions, as well as stretching east to capture smaller academic spaces in RES, IREB, and

CBH. Today, academic and student centric spaces outside of the core are mostly removed from the ground and feel disconnected and isolated. The campus master plan advocates concentrating these uses on the first and second floor, orienting them to the campus spine, and providing high levels of visibility to strengthen the relation across campus.

Research functions are aligned to Camp Bowie. While research adjacency is good, stakeholders shared that individual departments feel very siloed. The campus master plan advocates for the creation new collaboration spaces for researchers to engage with each other and increase visibility.

Clinical functions are currently concentrated on the north side of campus in the Health Pavilion and in smaller structures spread out along West 7th Street. Though in relative proximity, these uses feel physically disconnected from each other.

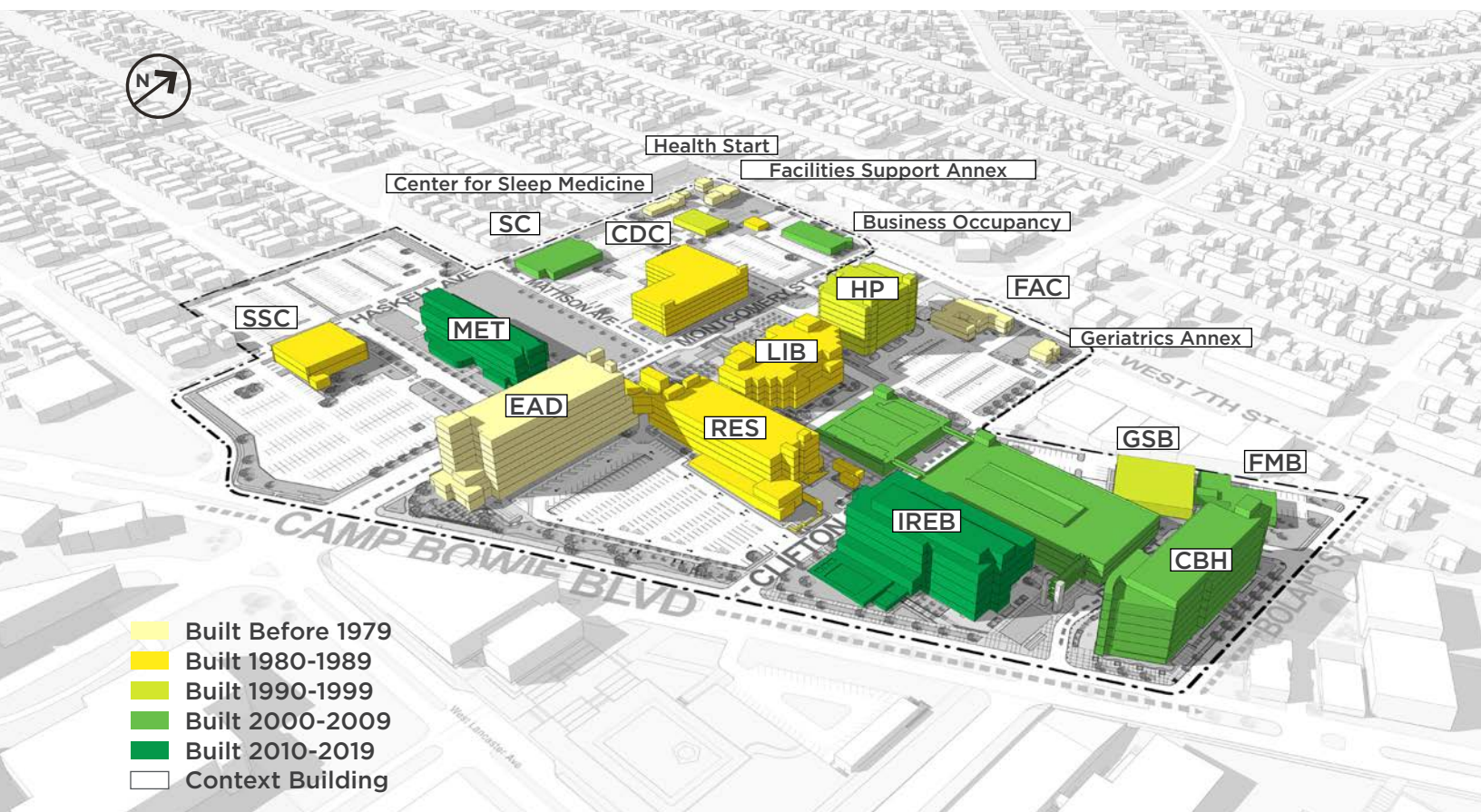

Building Age & Facility Conditions

Management of campus assets requires regular evaluation of existing facilities and building systems to identify the need for upgrading or replacement.

Today, the campus building inventory contains a range of building ages and conditions. While EAD, the first structure built by the university on campus, was constructed in 1978, the campus has acquired multiple pre-existing facilities that were built as early as 1955. Many of these buildings were constructed for other uses and have since been re-purposed for campus programs. While re-purposing an existing building is often a sustainable and cost effective option, it is not always feasible to adapt older buildings for new uses due to their age or format. This is especially true at UNTHSC with their many special uses and requirements. It is also important to consider potential best use of

sites across campus. Older, low-density buildings may need to be removed to accommodate new, larger facilities in critical locations.

Another key topic expressed by stakeholders is the varying interior quality of existing buildings. The campus has assets that have been built since 2000, and others such as the SSC and Library which have recently been renovated. These are all in good condition. However, many of the older structures across campus feel dated and have maintenance issues common in older buildings.

No formal campus-wide Facility Condition Index (FCI) survey exists for the campus. UNTHSC has performed studies on individual buildings as needs arise. The planning team recommends that the campus produce a study in the near term to better understand its assets.



MET, Constructed in 2010
Differing Exterior Character and Quality



Facilities Support Annex, Constructed in 1965
Differing Exterior Character and Quality



Student Lounge in EAD
Differing Interior Character and Quality



Multi-use Hallway in RES
Differing Interior Character and Quality



Recently Renovated Interior of SSC
Differing Interior Character and Quality

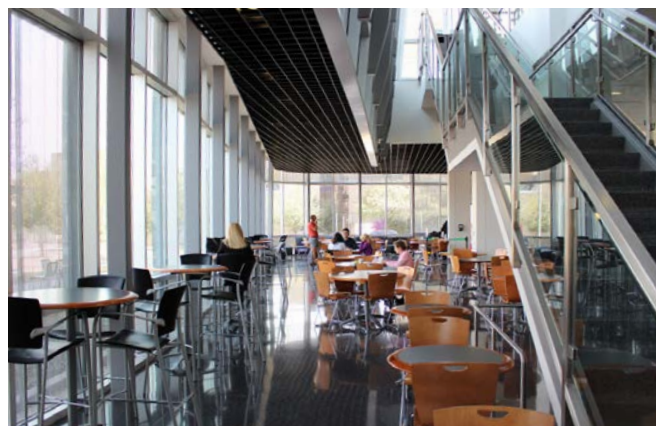

MET Common Space, Constructed in 2010
Differing Interior Character and Quality

Existing Conditions

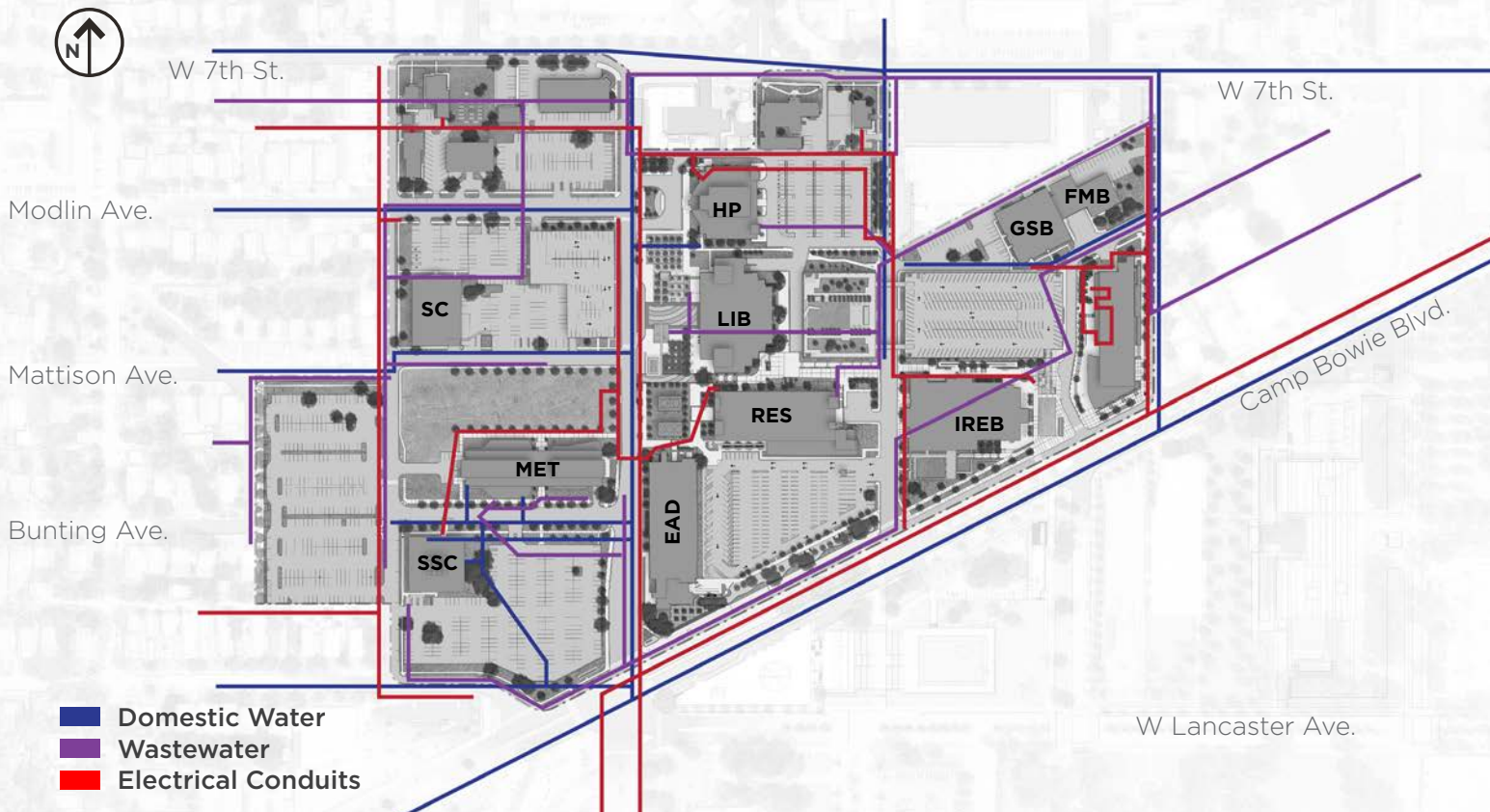

Utilities

Domestic Water

The water system on campus is currently owned and operated by the City of Fort Worth. While the building-specific supply lines are newer and in acceptable condition, many of the larger pipes beneath roadways on and around campus are over 50 years old and prone to breakages. The City of Fort Worth is responsible for the eventual replacement of these pipes. Utilizing a max daily flow model, analysis of existing campus water infrastructure determined that it is adequate to serve the campus demand today. Future development will require case-by-case analysis.

For additional details, please refer to the Water Study referenced in the Appendix.

Wastewater

Utilizing a peak factor demand model using City of Fort Worth standard criteria and assumptions, it was determined that the existing wastewater infrastructure is adequate for all of campus and substantial excess capacity exists for future development. The one exception is the shared main from the Library and RES, which will exceed capacity with any additional development in the future and will require upgrade.

For additional details, please refer to the Wastewater Study referenced in the Appendix.

Fire Coverage

Following the recent hydrant installation to support the construction of IREB, the campus now has full and adequate fire coverage across the entire campus boundary. Required fire coverage mandates that all buildings are entirely covered by a 400 linear foot radius from one or more fire hydrants (this corresponds to the length of a standard fire hose). All new development will need to verify that their massing do not impact this coverage.



Fire Hydrant Locations and Coverage

Electrical Systems

The electrical distribution system at UNTHSC are owned and operated by TXU Energy. Most of the campus is served by underground medium voltage lines, however overhead power lines still serve the smaller, low-density buildings located along Haskell Street and West 7th Street. Transformers and switchgear are located across campus on exterior pads or in below-grade utility vaults. These transformers and switchgear step down the voltage before routing it to the point of service (buildings).

Overall, the electrical utility network is in good shape. Adequate capacity exists to support the campus today, and the primary system infrastructure is appropriately sized to support future development. New development will only be required to build the necessary infrastructure to tie into the existing system. To preserve this viability, the campus should continue to keep up with recommended maintenance and required upgrades planning for future growth.



Selection of existing MEP Infrastructure

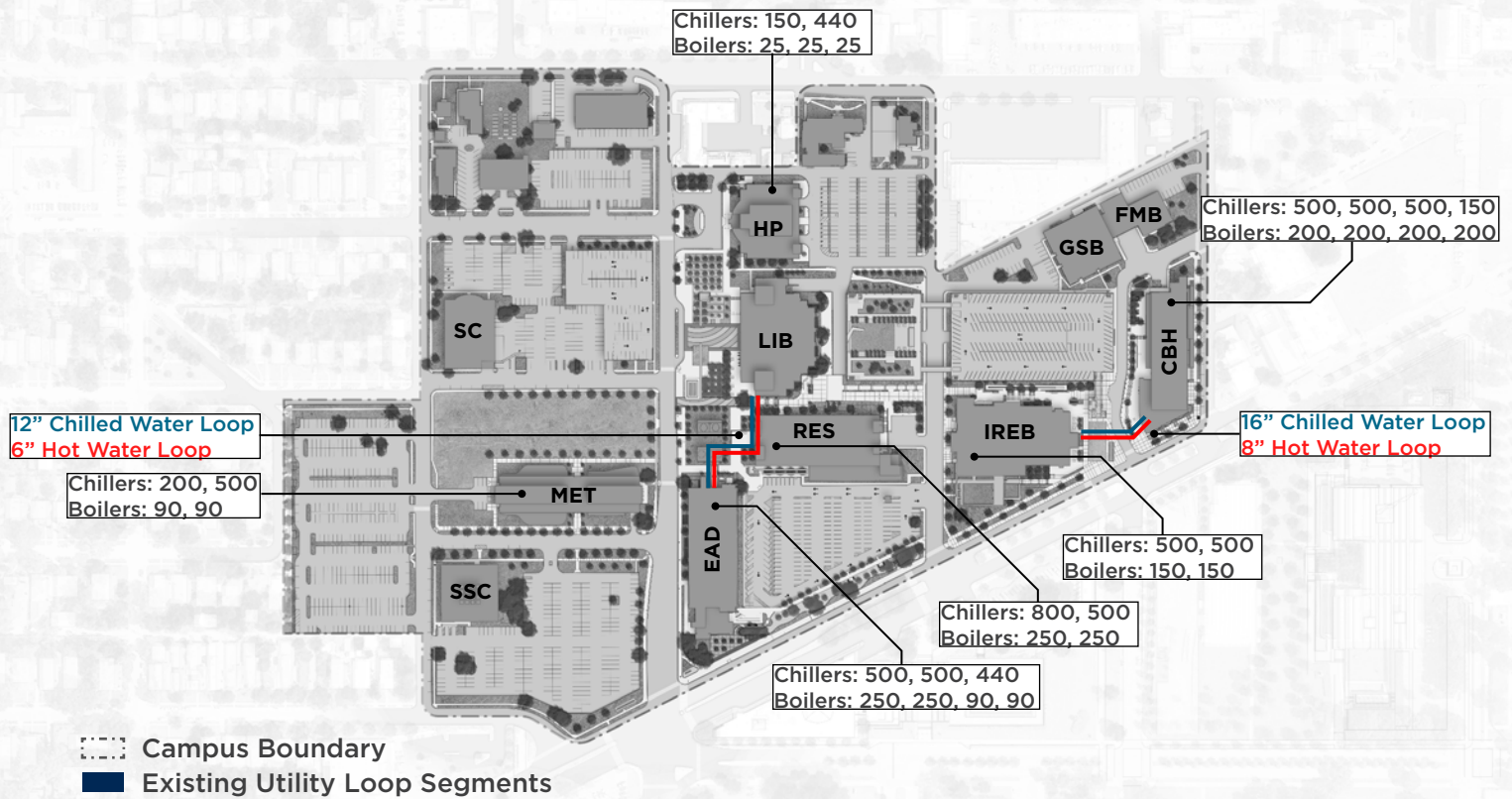

Mechanical Systems

Campus buildings are primarily served by independent hot water heating / chilled water cooling HVAC systems located independently within each building. While the campus has incrementally been working to install new chillers and boilers, many of the original systems installed during building construction still remain. Because of this, the campus has a significant number of mechanical systems that have exceeded their life expectancy and need to be replaced. Others will be reaching this point in the near future. Refer to the Appendix for more information on current system capacity and conditions.

A pair of central cooling towers located on the lawn south of the Library Courtyard serve all the Chillers in EAD and RES. Although the shared and consolidated cooling tower model is very functional, these two towers are aging and are not the highest and best use of land they sit

atop located in the core of campus. Due to the age of the cooling towers and the chillers they support, opportunities exist to consider options for relocating them.

Recently, the campus has set a goal to form an East Campus utility loop that will tie MEP capacities together between multiple buildings. Utility loops create redundant capacity that can support future buildings (if connected) and provide backup capacity when isolated elements fail. Progress has been made towards starting this East Campus loop in recent years. Today, CBH and IREB share one connection, while IREB, RES, and LIB share a separate connection. In the coming years, the campus plans to link these two segments together and expand the connection to additional buildings. Because of the shared excess capacity, there is potential to downsize or even not replace aging boilers and chillers as they reach the end of the lifespans.

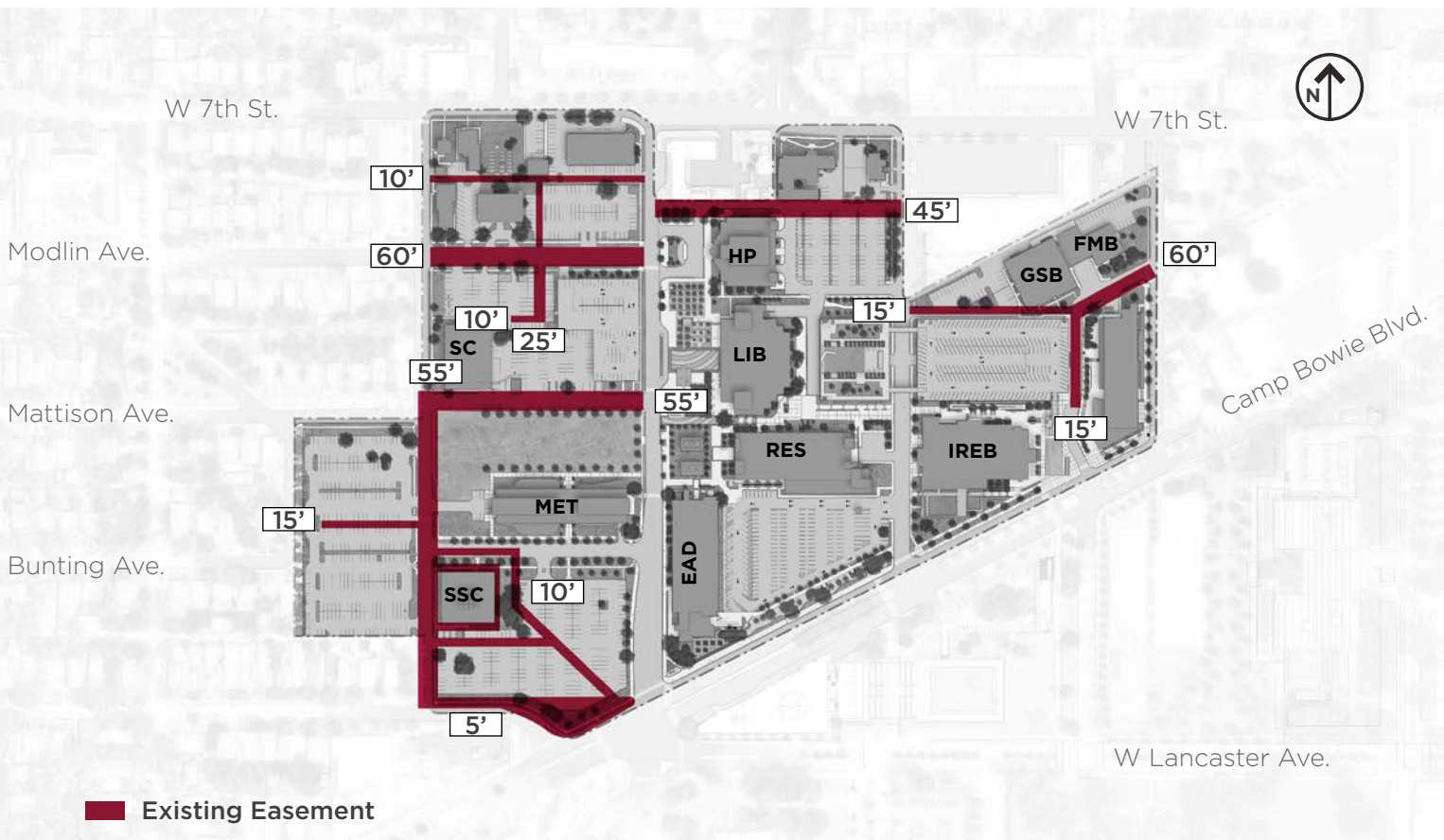

Easements

Easements are the legally defined territories or zones reserved for public or private entities to enter, use, and even alter private property. They are created at the time of original plat and stay with a parcel through covenant until a set time duration expires, an agreement is reached with the easement holder to alter the easement, or an agreement is reached to abandon the easement. Easements can range in size and impact. Typically, you are not allowed to build on top of easements. Common easements include the land area above or below public utilities (such as water pipes, storm sewer pipes, sanitary sewer pipes, etc.), the area above or below private utilities (such as telecom lines, power lines, gas lines, etc.), or areas reserved by cities for future roadway expansion.

The last formal easement survey was completed in 2007 in conjunction with the planned demolition of the osteopathic hospital and construction of the MET. The diagram above reflects the assumed

easements that still remain from the 2007 survey, however, a new survey would be required to confirm the shown information. The easements that currently exist on the UNTHSC campus are mostly concentrated west of Montgomery and correspond to below ground utility infrastructure. Across campus, easements range in size from 10' to 60'. While the location of some of these easements do potentially restrict where future development is currently allowed to be built, none of the easements relate to critical infrastructure. Working with the City of Fort Worth to alter infrastructure location and access lanes, it is very possible that a majority of these easements can either be moved or abandoned. This process was undertaken in 2017, when the city agreed to abandon an easement that existed on the site now occupied by IREB.

The planning team recommends that the campus conduct a formal easement survey in the near term to better understand its assets.

Existing Conditions



Wayfinding & Signage

In conjunction with campus edge systems and initial vistas looking to campus, the campus wayfinding and signage system provides the first impression to visitors. These systems are the institution's initial opportunity to provide a positive overall visitor experience. If guests cannot find where to park or how to reach their destination on campus, they may have a negative experience. This is especially true of clinical patients visiting campus, and equally true of every-day users familiar with the campus. Best practice wayfinding principles recommends having a clear hierarchy of sign types that engage campus users at all points ranging from their approach to campus all the way to their specific room destination on campus.

Since the 2007 Master Plan, the campus has done a wholesale update of signage on campus. Overall, the signage installed is well organized, in good condition, and functional.

While a good foundation, stakeholder feedback suggested that more signs at all scales would be beneficial in promoting campus identity and helping guests reach their desired destinations. Stakeholders shared that clinical visitors especially struggle with finding parking and how to get to their ultimate destination from parking. It was also shared that users find some of the building identification signage to be confusing. Some of these signs are located too far from their associated buildings or have an orientation on the site that can confuse visitors. Lastly, another common frustration is the convention used to identify buildings. The campus facilities team has explored options using building name, building acronym, and building addresses. Today, the system uses a combination of these which adds to confusion.

Sign Hierarchy (In order of engagement)

1. Signature Identification Signage:

Large signs attached on or near a buildings parapet. Visible from a long distance guiding visitors to campus.



2. Campus Gateway Identification:

Signs located on the campus edge at major entry points marking threshold into campus. Varying sizes can be used to denote different gateway hierarchies.



Existing Campus Gateway Sign Formats

3. Vehicular Directional Signage:

Signage visible from a long distance away that directs vehicular traffic to campus as well as within. Sign size and font must be large enough to be quickly read while driving.

4. Garage / Parking Identification:

Signage identifying the number of each parking lot or parking garage. Can be free standing or attached to the side of a garage. Some garages also include digital signs showing a count of available spaces.

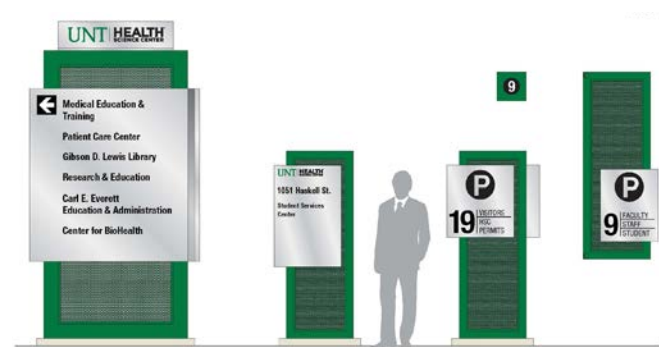

Existing Campus Vehicular Directional, Building, and Parking Identification Sign Formats

5. Pedestrian Directional Signage:

Signage located throughout campus intended to orient and direct individuals. Contains the identifying name or address of one or more buildings, as well as a directional arrow to guide visitors to that location.

6. Pedestrian Map Kiosk Signage:

Kiosk containing maps of campus and basic directional information. Can be freestanding or attached to a wall or building side.

7. Building Identification:

Demarcates an individual building entry and may include information related to accessibility. Can be freestanding or attached to a building.

8. Regulation & Educational Signage:

Smaller signs and plaques used to communicate campus rules, state law, or communicate educational information about unique campus features (such as the legacy tree program).

9. Building Interior / Room Signage:

Smaller signage located inside of the buildings. Includes interior maps, floor identification labels, and individual room signage.

Signage Materials

The existing signage system uses three different material pallets relative to the hierarchy.

Signature Identification Signage located on CBH, EAD, and HP are large aluminum panels (of varying sizes) containing a vinyl campus logo.

Campus Gateway Identification signs use regional stones providing for an “institutional” character. The use of stone for gateway signs is a traditional route used by many universities across the country. These stones evoke a clear sense of place to those passing by.

All additional exterior signs are aluminum with vinyl graphics to allow for cost effective updates and ease of maintenance. The incorporation of a logo header, along with the green, silver, and black colors are unique within the setting and assist in solidifying the UNT brand. Today, interior signs vary in material and design.



FRAMEWORK

ANALYSIS OF FRAMEWORK ELEMENTS

3

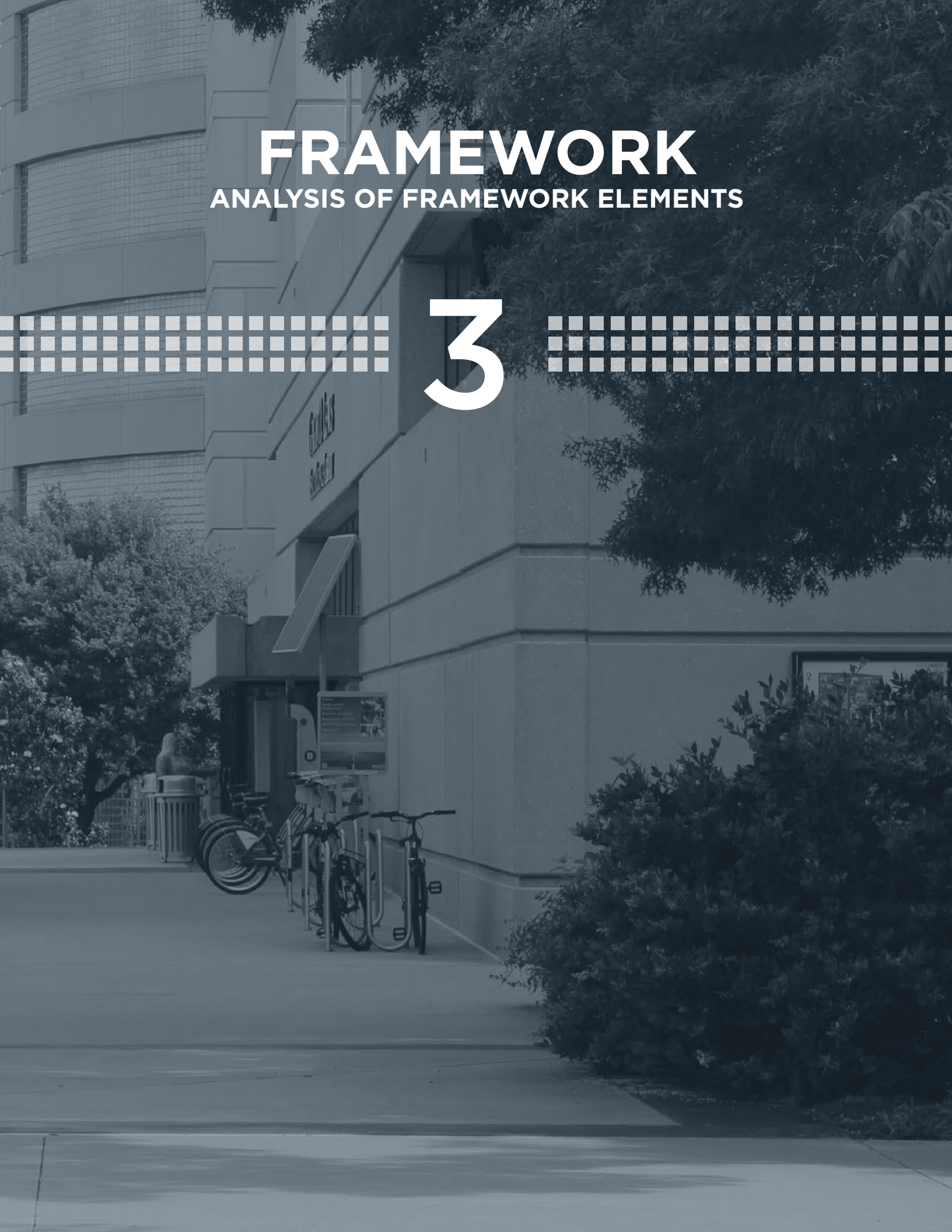

CONNECTIVITY NETWORK

INTRODUCTION

The campus-wide framework is a conceptual plan that reflects the existing hierarchical organization of campus buildings and exterior spaces, revealing patterns that help shape future growth.

The framework illustrates how campus functions integrate together, defining how the campus is used and experienced. This framework promotes connectivity, ease of access, and a long-term sense of organization that can adapt to the evolving needs of an institution.

CONNECTIVITY NETWORK

Pathways and means of circulation across campus comprise a network of connectivity and can support a positive campus experience. Often, these pathways are the primary linkages between significant buildings or open spaces on campus.

The existing connectivity across campus is based on a strong east-west pathway, commonly referred to as the 'spine' that is anchored on the western end by the MET Lawn and on the eastern end by the entry plaza to the Center for BioHealth.

The proposed Connectivity Network greatly expands and identifies the key linkages to support strong connections across the entirety of the campus. A new primary north-south 'spine' between Montgomery and Haskell Streets links the Medical Education Building to West 7th Street. A number of parallel north-south and east-west pathways are included that supplement the connectivity of the two primary spines.



Existing Connectivity Network Example

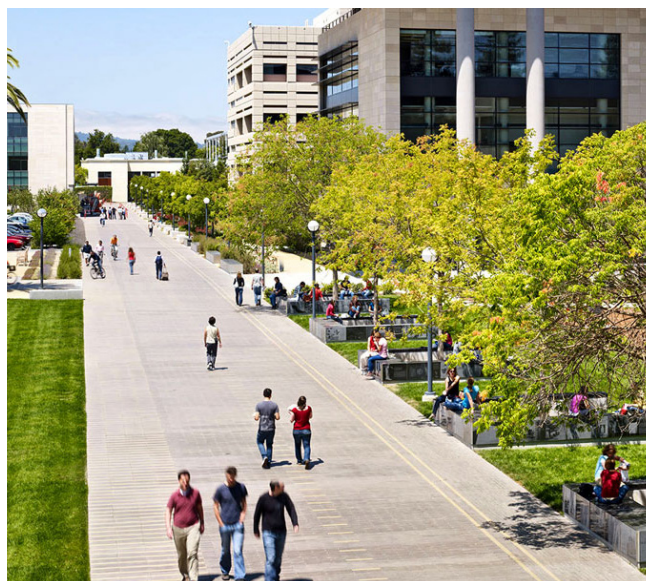

Proposed Connectivity Network Example



Existing Connectivity Network

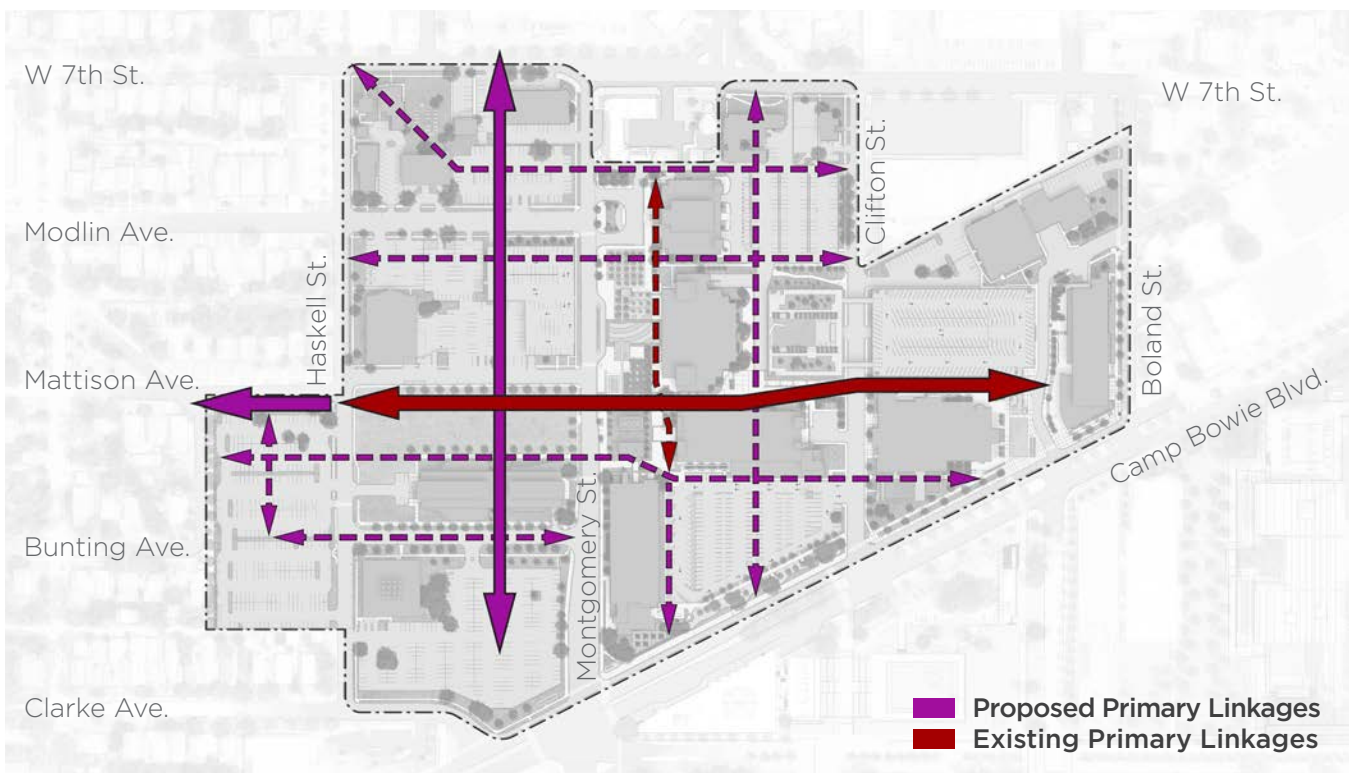

Proposed Connectivity Network Expansion

OPEN SPACE NETWORK

The balance between built and non-built areas of campus defines the Open Space Network, resulting in the identity and character of campus that is experienced by students, staff, faculty, and community. As a reflection of the institution, the Open Space Network often sets the tone for an individual's first impression of the campus.

The existing open space network is comprised of spaces that are primarily located along or connected to the spine. The primary open spaces on campus include the MET Lawn, Library Courtyard, and Alumni Plaza.

The proposed Open Space Network is comprised of a variety of scales, uses, and physical elements that define a diverse set of landscape typologies. These spaces can be used in a variety of ways by the students, staff, faculty, and community.



Existing Open Space Network Example



Proposed Open Space Network Examples



Existing Open Space Network



Proposed Open Space Network Expansion

HUB NETWORK

The Hubs describe gathering places where ideas and views can be exchanged and collaborative efforts undertaken. Depending on their specific settings, Hubs can be formal or informal. The Hubs act as nodes supporting learning, discovery, and care while also supporting the social interaction of campus users. Hubs can include both interior and exterior spaces.

The existing Hub Network is primarily centered around the interior space of the Gibson D. Lewis Library and Medical Education Building and the exterior space of the Library Courtyard and MET Lawn.

The proposed Hub Network greatly expands their distribution and frequency across campus to enhance the overall campus experience. This expanded network is intended to house a variety of spaces for formal collaboration such meeting rooms, conference space, group study rooms, and visible research, while at the same time, supporting informal social gathering with spaces for food service, wellness, and lounge areas.



Existing Hub Network Example



Proposed Hub Network Examples





Existing Hub Network



Proposed Hub Network Expansion

FRAMEWORK

As a tool, the framework will help to guide siting of buildings, influence their massing, and assist with identifying appropriate points of entry based on how they fit within the overall framework concepts illustrated here. The proposed framework captures feedback on how campus works today, feedback from stakeholders on how it should work, and creating alignment between the physical campus and the identified guiding principles.

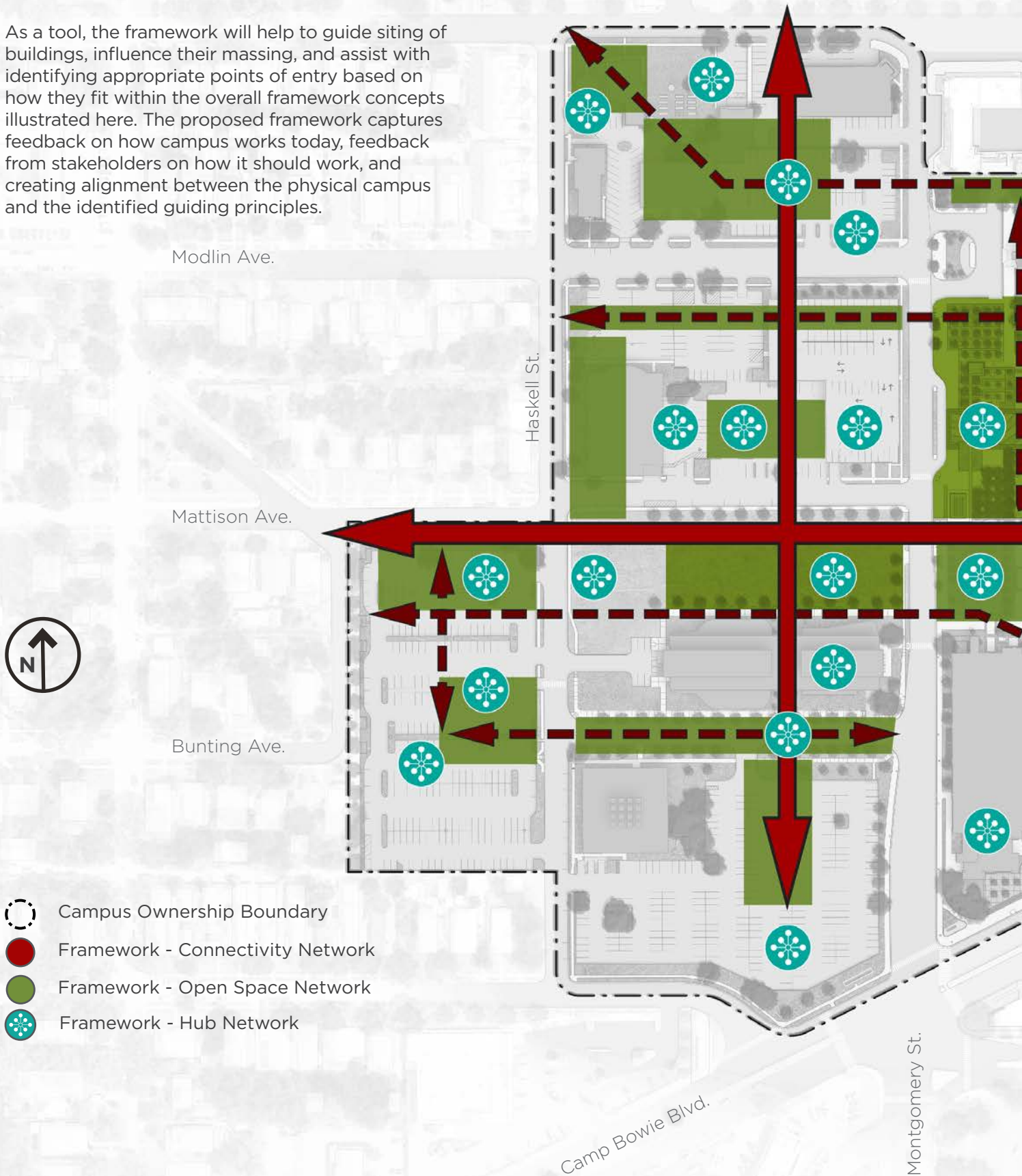

Monticello Dr.

W 7th St.

Darcy St.

Boland St.

Camp Bowie Blvd.

W Lancaster Ave.

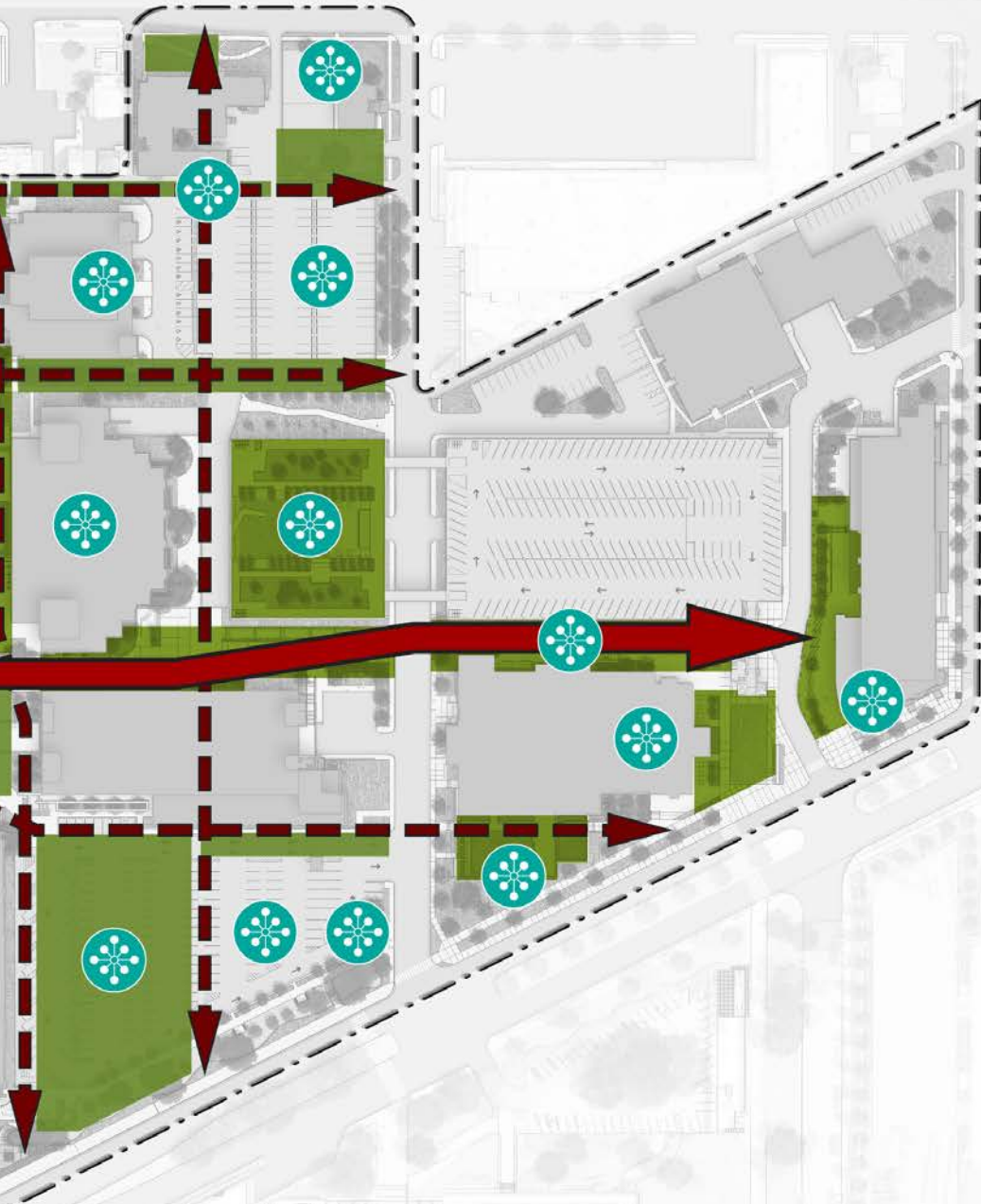



CAMPUS MASTER PLAN

OVERVIEW OF DEVELOPMENT PLAN







4



CAMPUS MASTER PLAN

The 2018 Campus Master Plan outlines a development plan for the campus that will reinforce and enhance the Framework while also supporting future user group and program needs. Suggested changes include alterations to the existing street network, expansion of green space, improved pedestrian connectivity, and the opportunity to add over 1,400,000 GSF within the existing campus boundary.



-  Campus Ownership Boundary
-  Proposed Campus Building
-  Proposed Campus Parking Garage
-  Existing Campus Building
-  Existing Campus Parking Garage
-  Context Building

Key Development Features

- 1. Improved Montgomery Gateway
- 2. New UNTHSC Front Lawn
- 3. New Campus Gateway Center
- 4. West Campus Development
- 5. Reinforced & Defined MET Lawn
- 6. Redeveloped Modlin Garage Block
- 7. Northwest Campus Gateway
- 8. Library Expansion
- 9. North Campus Redevelopment

Key Site Enhancements

- 10. Enhanced Campus Edge Conditions
- 11. Enhanced Open Space Network
- 12. Enhanced Pedestrian Connectivity







OVERVIEW AND OUTCOMES

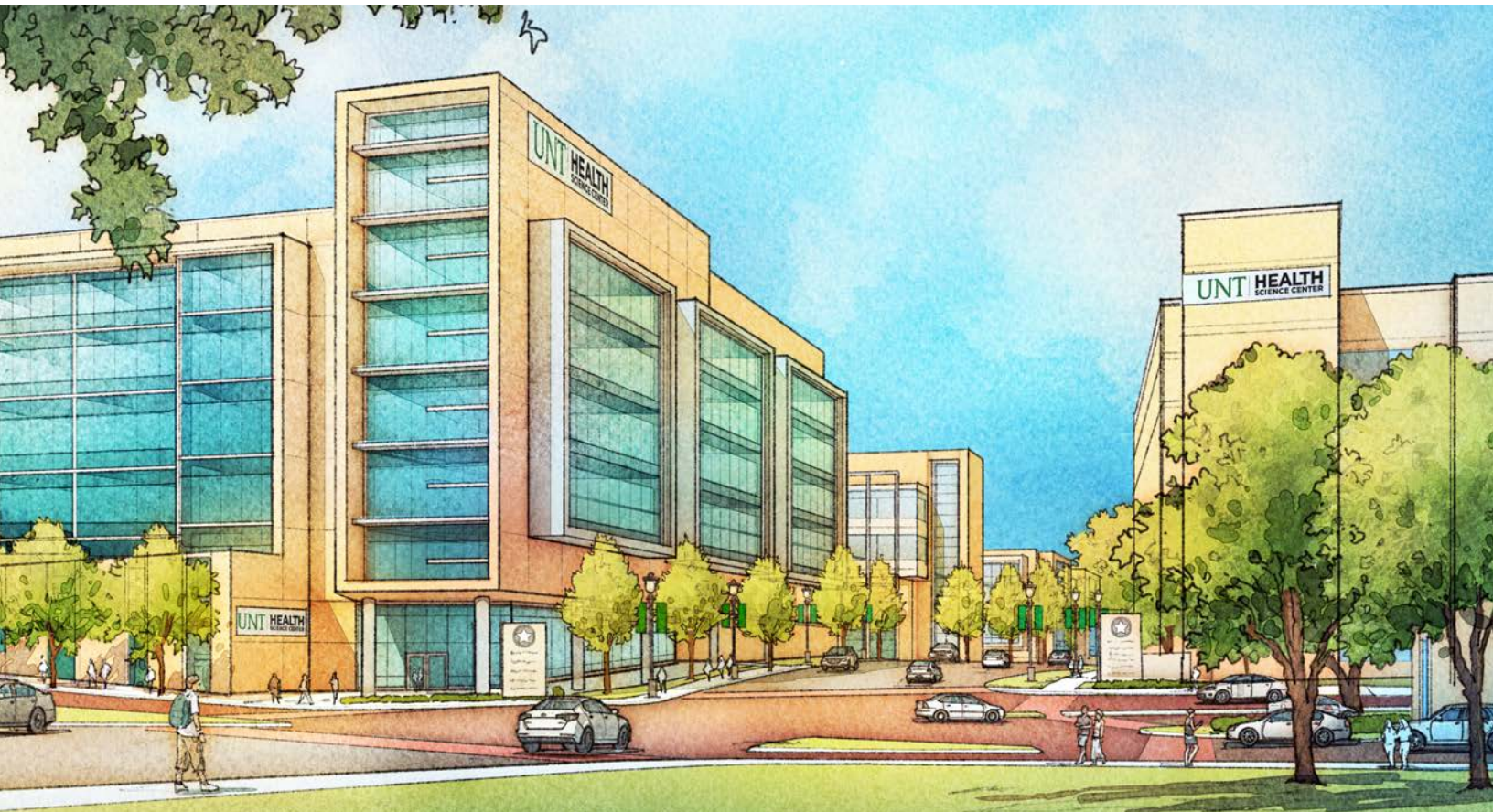

Future Montgomery Gateway

Overview

The final 2018 Campus Master Plan is a synthesis of concepts and scenarios that, by means of thorough discussion and revision, balance both the near- and long-term objectives of the University of North Texas Health Science Center. Through continual evaluation of scenarios using SEE 2020, Planning Principles, and Planning Priorities, the resultant campus master plan aligns the needs of the people, place, and purpose of the institution. While representing a snapshot in time, the campus master plan is an adaptable guide able to evolve with the changing needs of UNTHSC.

The campus is a complex entity that results from a unique combination of history, mission, climate, and culture. The master plan reflects an interrelationship between programmatic and physical planning considerations. To envision the future, the master plan considers buildings, infrastructure, open spaces, mobility, and elements distinct to the campus. Crafting the various elements into a holistic outcome establishes a path forward for UNTHSC for the coming decade and beyond. The resulting 2018 Campus Master Plan creates beautiful, functional spaces and experiences for students, staff, faculty, and the greater community.

Path to the Plan

The following section briefly recaps the efforts of the initial planning phase leading up to and informing the 2018 Campus Master Plan and outlines the contents of the plan.

The early focus of the planning team dealt with interpreting the aspirations of UNTHSC. Through extensive engagement with campus constituents via open discussion and group exercise, preliminary considerations began to emerge driven primarily by the strategic visioning document SEE 2020. These efforts led to collectively developing a set of Planning Principles that served to guide development of the master plan and Planning Priorities that served to gauge the success of potential outcomes. Each of these are summarized to the right for reference and further information. An expanded overview for each topic can be found in the Introduction Chapter.

Parallel to these visioning efforts, the planning team undertook a series of observations of the existing campus context and systems. Analysis of these observations provide the necessary technical understanding of the campus’s current conditions and capacities. For further details, refer to the Observation Chapter.

This chapter consists of several narrative and illustrative elements, each intending to aid in gaining a full understanding of the recommendations presented. The five fundamental themes summarize the alignment of the master plan to SEE 2020, the Planning Principles and the Planning Priorities. The final plan graphics show existing buildings, potential future buildings, and enhancements to open space. Area enlargements highlight key components and features for select locations across campus. System integration diagrams and data explain and reinforce major elements in the plan. Finally, renderings provide an interpretative look at the future campus.

SEE 2020: FOCUS AREAS

People & Values	Learning & Discovery
Quality Experiences for Lifetime Success	Sustainable Growth, Finance & Resources

PLANNING PRINCIPLES

PRINCIPLE #1: Craft a Campus Framework that reinforces and expands existing connectivity, programmatic and organizational patterns to guide long-term capacity.

PRINCIPLE #2: Align existing and future facilities for academic, research, and clinical programs that support collaborative learning and discovery with high utilization of campus assets.

PRINCIPLE #3: Reinforce and expand the network of Campus Hubs to support a quality campus experience for students, staff, faculty, and community.

PRINCIPLE #4: Embrace the One University vision to guide the development of the physical campus environment.

PLANNING PRIORITIES

TOP PRIORITIES



ANCILLARY PRIORITIES

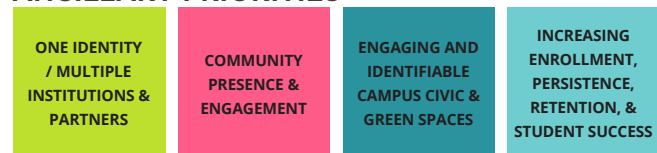

Campus Master Plan Outcomes

In aligning the campus master plan with the purpose, vision, mission, and values of the institution, five themes emerge that embody and support UNTHSC's aspirations.

Demonstrate Capacity

The master plan demonstrates the physical capacities of the campus at varying levels of detail and across multiple attributes. The plan shows the potential, at full build-out, for over 2.3 million GSF of space. This is an increase of 1.2 million GSF from the existing 1,103,000 GSF. Supporting this space capacity is the infrastructure and systems necessary for efficient and resilient operations of the campus.

The plan illustrates capacity that UNTHSC can better utilize through realignment of uses, expand selectively for near-term growth, and accommodate long-term needs within the existing campus boundaries.

Elevate Experience

The master plan significantly elevates the experience for those interacting with the campus's physical environment, whether first-time visitors or daily users. Distinct points of arrival articulate the initial point of interaction with the campus with clear, delineating wayfinding guiding users into and around campus. Expansion of the Open Space Network provides the backdrop for the activities of a dynamic and energetic campus.

Through enhancing the quality, variety, and functionality of the physical environment, the campus is a supportive and attractive place for pursuing the purpose and embodying the values of UNTHSC.

Broaden Connections

The master plan broadens the connections across campus through a network of overlapping physical linkages and collaborative places. Extension of the existing east-west Campus Spine and development of a new north-south West Campus Spine represent two primary elements of the Connectivity Network that links the physical places of the campus across its entire extents.

Broadening the physical and program connections across campus brings together the people integral to practicing an inter-professional model of learning, discovery, and care.

Stimulate Collaboration

The master plan stimulates collaboration through the distribution of places across campus, accommodating a range of activities and users. The Hub Network, encompassing both interior and exterior spaces, establishes locations for collaborative teamwork. These hubs bring together students, staff, faculty, industry, and the greater community in informal and formal settings to break down traditional siloes.

Stimulating collaboration through distinct places, allowing the open exchange of ideas and views, reinforces the vision and mission of UNTHSC.

Convey Identity

The master plan conveys a robust identity to a wide audience, through thoughtful crafting of a holistic plan that expresses the character, quality, and uniqueness of the institution. Clear articulation of the permeable campus edges, appropriate to the adjacent setting, establishes the campus as a distinct and integral component of its context that is inviting and welcoming to the greater community.

Conveying the identity through its physical environment embodies and expresses the purpose, vision, mission, and values of UNTHSC to internal and external audiences.

Mapping Outcome Alignment

The above outcomes illustrate broad alignment of the 2018 Campus Master Plan to the driving influences of the SEE 2020, Planning Principles, and Planning Priorities. Further details and examples will be found by fully exploring the master plan in the following section. The chart on the adjacent page summarizes the overlapping and supporting nature of the outcomes in relation to the high-level driving influences.

Mapping the 2018 Campus Master Plan Outcomes

	DEMONSTRATE CAPACITY	ELEVATE EXPERIENCE	BROADEN CONNECTIONS	STIMULATE COLLABORATION	CONVEY IDENTITY
SEE 2020					
People & Values		●	●	●	●
Learning & Discovery	●	●	●	●	
Quality Experiences for Lifetime Success		●	●	●	●
Sustainable Growth, Finance & Resources	●				●
PLANNING PRINCIPLES					
Principle #1: Craft a Campus Framework that reinforces and expands existing connectivity, programmatic, and organizational patterns to guide long-term capacity.	●	●	●	●	●
Principle #2: Align existing and future facilities for academic, research, and clinical programs that support collaborative learning and discovery with high utilization of campus assets.	●		●	●	
Principle #3: Reinforce and expand the network of Campus Hubs to support a quality campus experience for students, staff, faculty, and community.		●	●	●	
Principle #4: Embrace the One University vision to guide the development of the physical campus environment.			●	●	●
PLANNING PRIORITIES					
Optimize Alignment of Existing Programs & Facilities	●		●	●	
Facilities Supporting Dynamic Instruction & Active Learning	●	●	●	●	
Attracting & Retaining Top Quality Students, Faculty & Staff		●	●	●	●
Student Support Resources & Spaces	●	●	●	●	
Long-Term Capacity of Academic, Research & Clinical	●				
One Identity / Multiple Institutions & Partners		●	●	●	●
Community Presence & Engagement		●	●	●	●
Engaging & Identifiable Campus Civic & Green Spaces		●	●		●
Increasing Enrollment, Persistence, Retention & Student Success	●	●		●	●

DEVELOPMENT FEATURES

Buildings		
Proposed Buildings	Floors	Apx. GSF
A	3	74,250
B	4	90,000
C	2	25,000
D	4	138,000
E	4	96,000
F	5	95,000
G	3	40,500
H	3	68,250
I	5	72,000
J	7	180,000
K	3	18,500
L	5	66,250
M	6	191,000
N	6	72,500
O	2	7,600
P	5	64,500
Q	4	23,850
R	4	24,800
S	3	45,000
TOTAL PROPOSED		1,400,000
Existing Buildings	Floors	GSF
MET	5	115,934
EAD	8	194,099
RES	5	138,701
LIB	4	114,064
IREB	6	172,922
CBH	6	160,320
GSB	1	15,506
FMB	1	7,409
TOTAL EXISTING *		918,955
COMBINED TOTAL (approximate GSF)		2,320,000

*Total existing excludes structures replaced as a part of the full plan build out

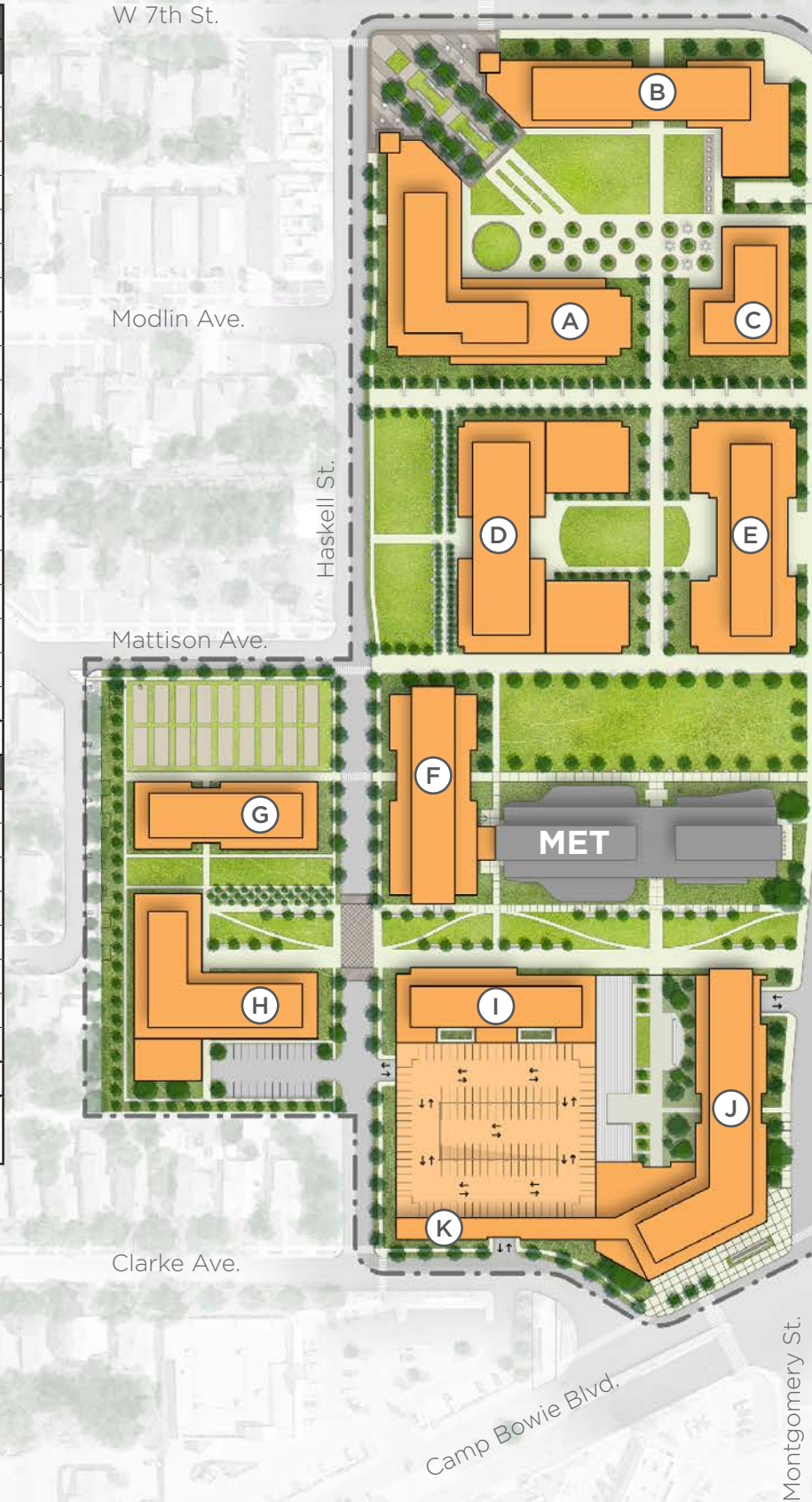



Monticello Dr.



W 7th St.

Darcy St.

Boland St.

Camp Bowie Blvd.

W Lancaster Ave.

- Campus Ownership Boundary
- Proposed Campus Building
- Proposed Campus Parking Garage
- Existing Campus Building
- Existing Campus Parking Garage
- Context Building

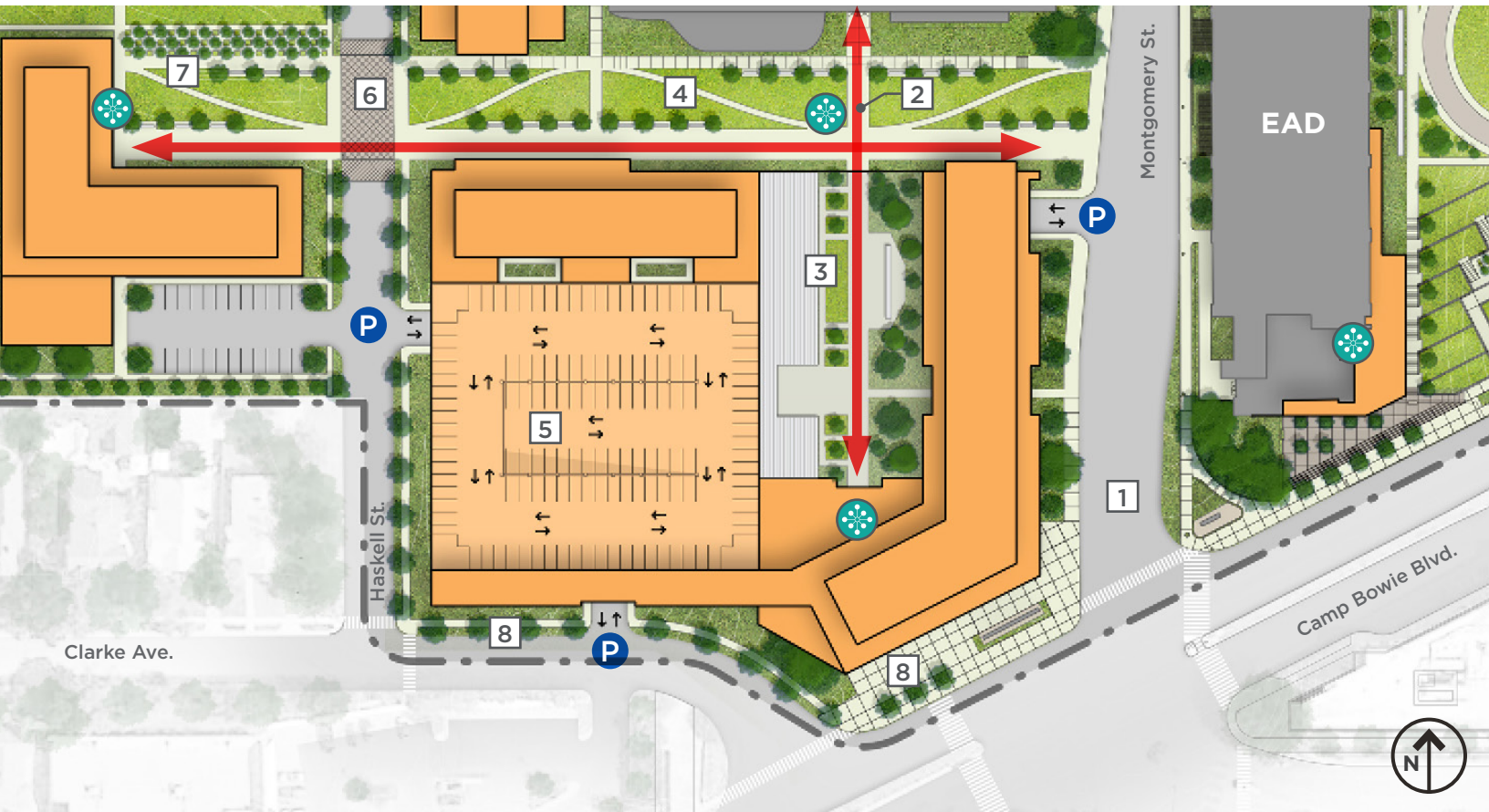

Montgomery Gateway

The Montgomery Gateway, on the north side of Montgomery Street at Camp Bowie Boulevard, defines the formal gateway into campus. Serving as the front door to campus, it asserts a strong urban presence by aligning to Camp Bowie Boulevard and Clarke Avenue. In addition to the existing Carl E. Everett Education & Administration (EAD) building, the new Montgomery Gateway Building will help to frame this campus entry and complete the western portion of the urban edge condition along the campus's Camp Bowie Boulevard boundary, reinforcing UNTHSC presence and identity.

The West Campus Mall, the new primary north-south campus linkage, has its southern terminus at the Montgomery Gateway in the Innovation Plaza. The plaza is a landscaped urban space, capping the parking garage like the existing Alumni Plaza, and serving as an exterior hub of gathering and activity.

Legend & Key Map

- Proposed Building
- Existing Building
- Proposed Parking Garage
- P Parking Entry
- ❄ Hub Location
- Connectivity Link

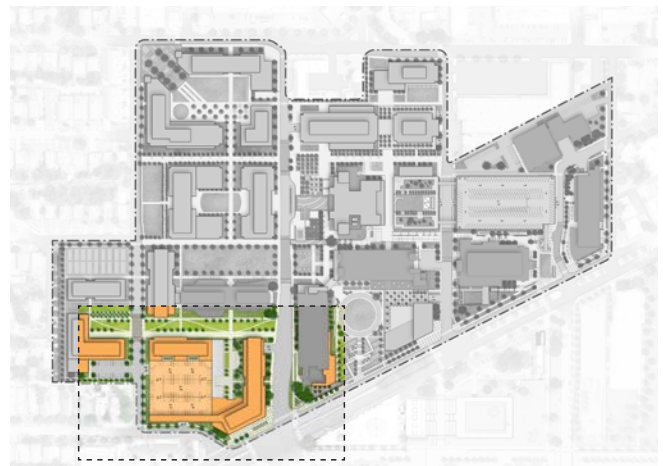

Key Components & Features

- 1 Frame Montgomery Gateway with new building west of Montgomery Avenue and existing EAD and to establish formal arrival, institutional identity, and urban edge.
- 2 West Campus Mall
- 3 Innovation Plaza will serve as a multi-functional exterior space and as a landscaped cap to the parking garage.
- 4 Academic Mall
- 5 New, multi-level parking garage with multiple entries replaces existing surface lot. Approximately 1,080 parking spaces.
- 6 Improve crossing at street and pedestrian pathway for safety.
- 7 Hi Mount Quad
- 8 Buildings align to Camp Bowie Boulevard and Clarke Avenue, creating urban edge condition.

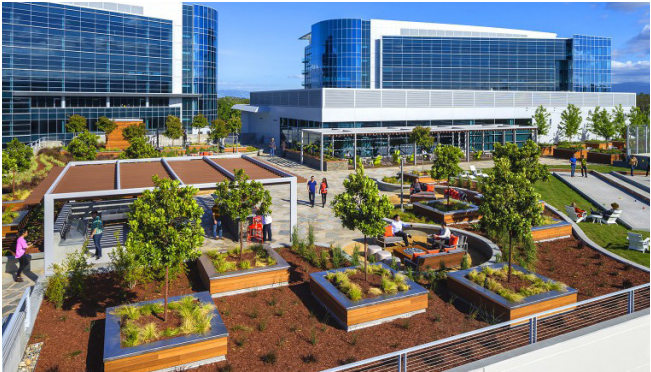

Component Precedent - Rooftop Plaza (#3 - Innovation Plaza)



Component Precedent - Rooftop Plaza (#3 - Innovation Plaza)

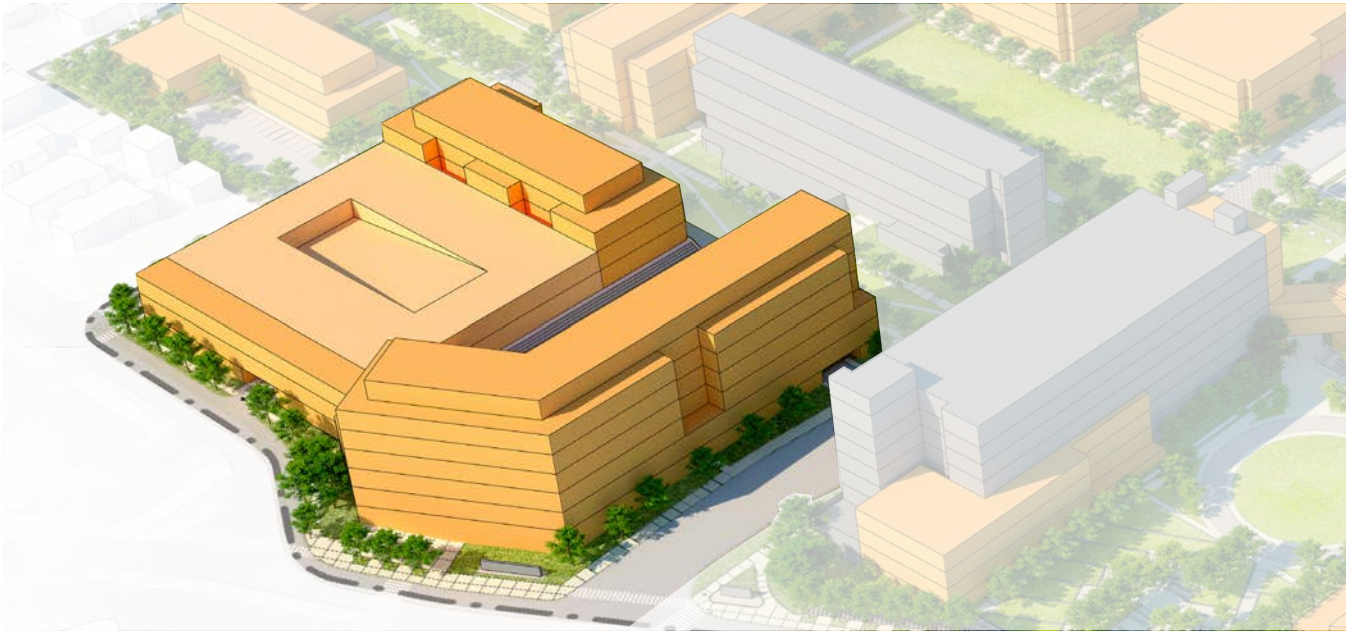

Feature Highlight - Aerial View of Montgomery Gateway

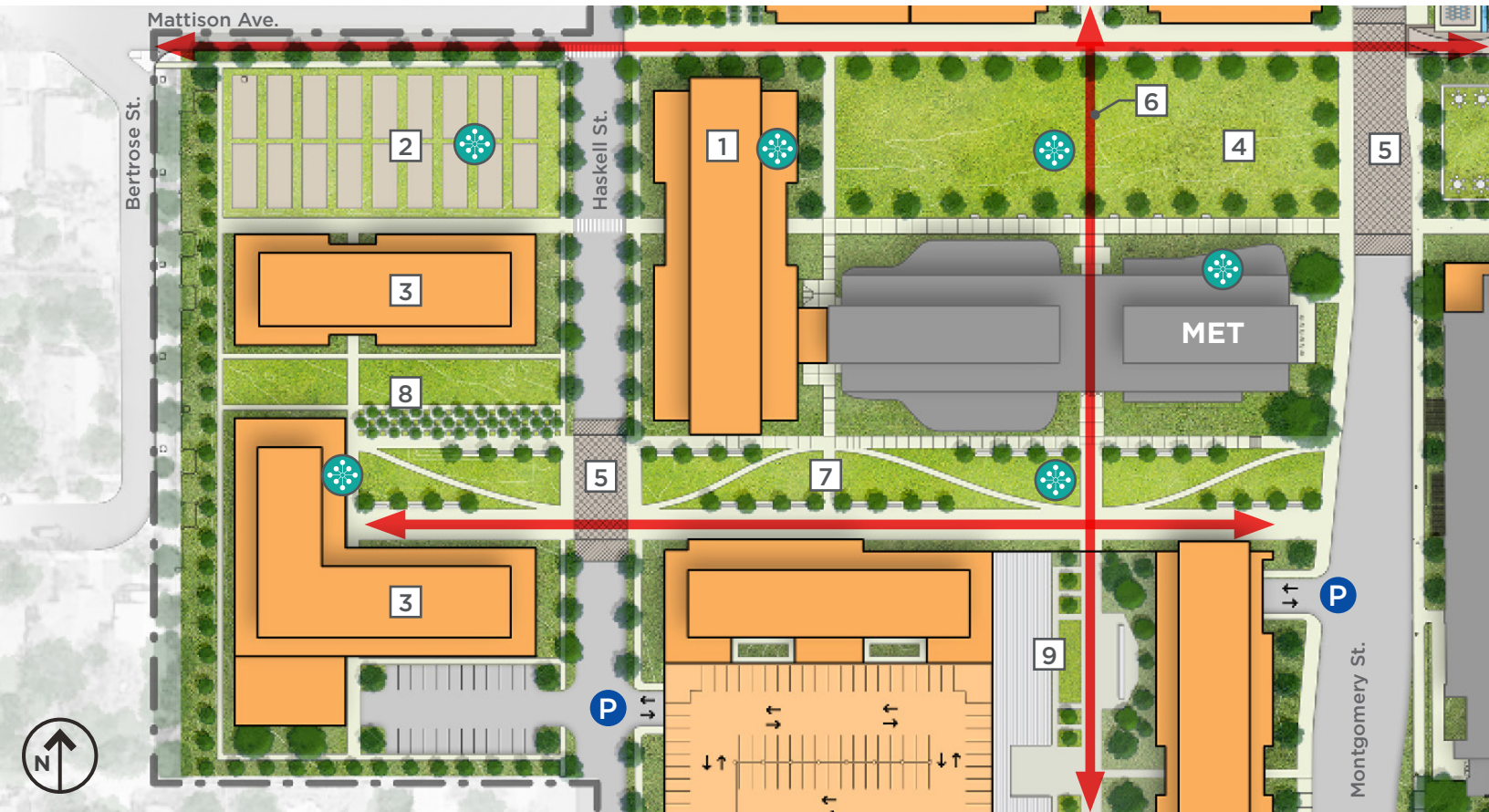

Haskell Corridor

Along Haskell Street, new facilities will line both the eastern and western sides of the street. On the eastern side, the new building will frame the MET Lawn and provide views back towards the campus. The western buildings will be of lower scale - height and size - due to their proximity to the adjacent residential neighborhoods.

Linking these western buildings to the rest of campus will be the Academic Mall, a pedestrian mall will replace Bunting Avenue and connect Innovation Plaza to Hi Mount Quad. Where the mall intersects Haskell Street, enhancements to the crossing will provide for greater pedestrian safety. At the southeast corner of Bertrose Street and Mattison Avenue, the relocated Community Garden will provide a strong link and buffer to both the neighborhoods and the campus, creating a zone for joint interaction.

Legend & Key Map

- Proposed Building
- Existing Building
- Proposed Parking Garage
- P Parking Entry
- ❄ Hub Location
- Connectivity Link

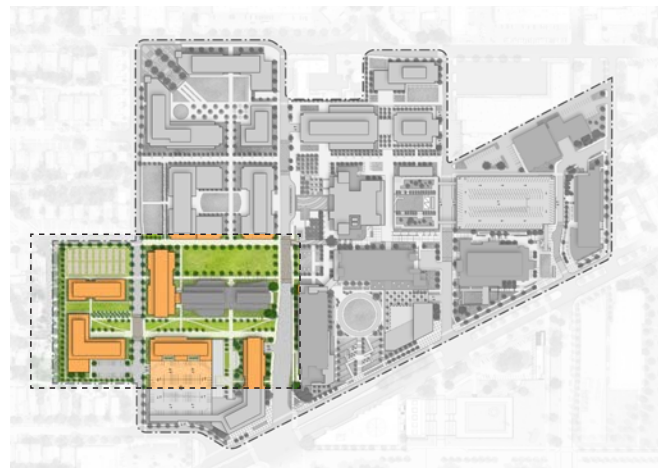

Key Components & Features

- 1 New building will frame the MET Lawn by demarcating its western edge.
- 2 Community Garden will provide a meeting point and buffer for the community and campus.
- 3 Lower-scale (size and height) facilities in proximity to adjacent neighborhoods.
- 4 Existing MET Lawn to remain as key exterior space for campus, continuing support for a multitude of functions and programs.
- 5 Improve crossing at street and pedestrian pathway for safety.
- 6 West Campus Mall
- 7 Academic Mall
- 8 Hi-Mount Quad
- 9 Innovation Plaza



Component Precedent - Gardens (#2 - Community Garden)

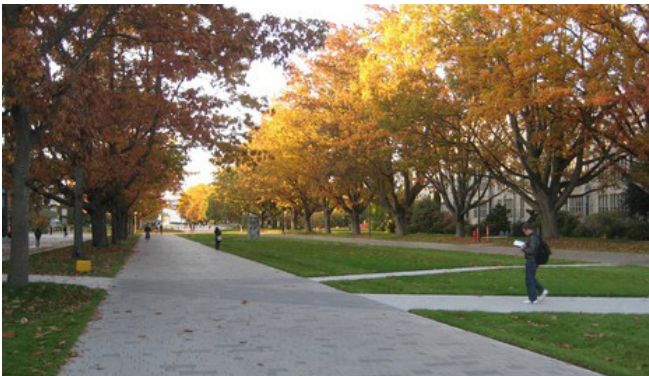

Component Precedent - Pedestrian Mall (#7 - Academic Mall)



Feature Highlight - Aerial View of Haskell Corridor

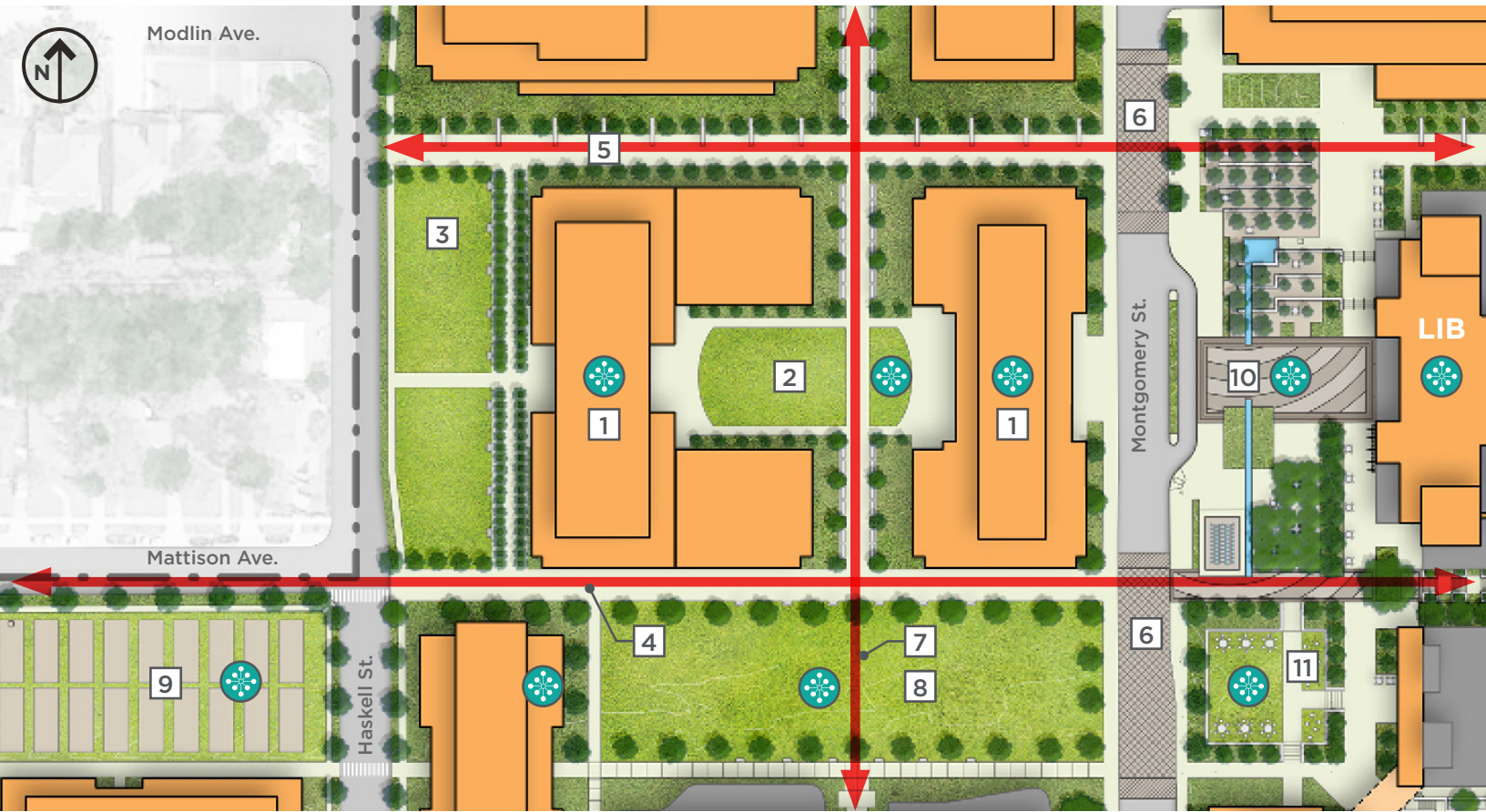

Modlin Courtyard

Aligning on axis with the Gibson D. Lewis Library, new facilities west of Montgomery Street will extend the ‘heart of campus’ that the library area represents. These facilities, along with the new Modlin Courtyard, will replace the existing parking structure. Along Haskell Street, the Community Lawn will create a green space buffer between the campus and the adjacent neighborhood.

Conversion of Mattison Avenue to a pedestrian pathway will extend the Campus Spine the entire east-west length of the campus. Similarly, converting Modlin Avenue to pedestrian use, the North Campus Mall, will increase connections across campus in the east-west direction. The West Campus Spine, running north-south, intersects each of the above pathways along with the MET Lawn and Modlin Courtyard.

Legend & Key Map

- Proposed Building
- Existing Building
- Proposed Parking Garage
- P Parking Entry
- Hub Location
- Connectivity Link

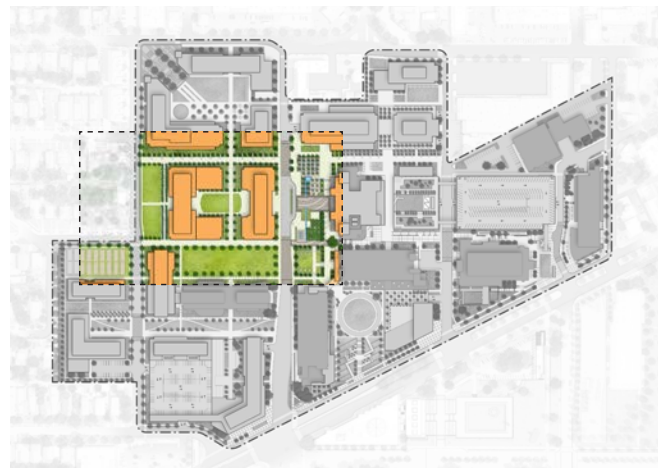

Key Components & Features

- 1 New buildings to align on axis with the Gibson D. Lewis Library extending the 'heart of campus.'
- 2 The Modlin Courtyard will provide a smaller-scale open space between MET Lawn and North Campus Green along the West Campus Spine.
- 3 Community Lawn along Haskell Street provides green space buffer between campus and adjacent neighborhood.
- 4 Campus Spine extends and replaces Mattison Avenue.
- 5 North Campus Mall will replace Modlin Avenue
- 6 Improve crossing at street and pedestrian pathway for safety.
- 7 West Campus Spine
- 8 MET Lawn
- 9 Community Garden
- 10 Library Courtyard
- 11 Reflection Courtyard



Component Precedent - Axis Alignment (#1 - 'Heart of Campus' Extension)



Component Precedent - Green Edge Buffer (#7 - Community Lawn)



Feature Highlight - Aerial View of Modlin Courtyard

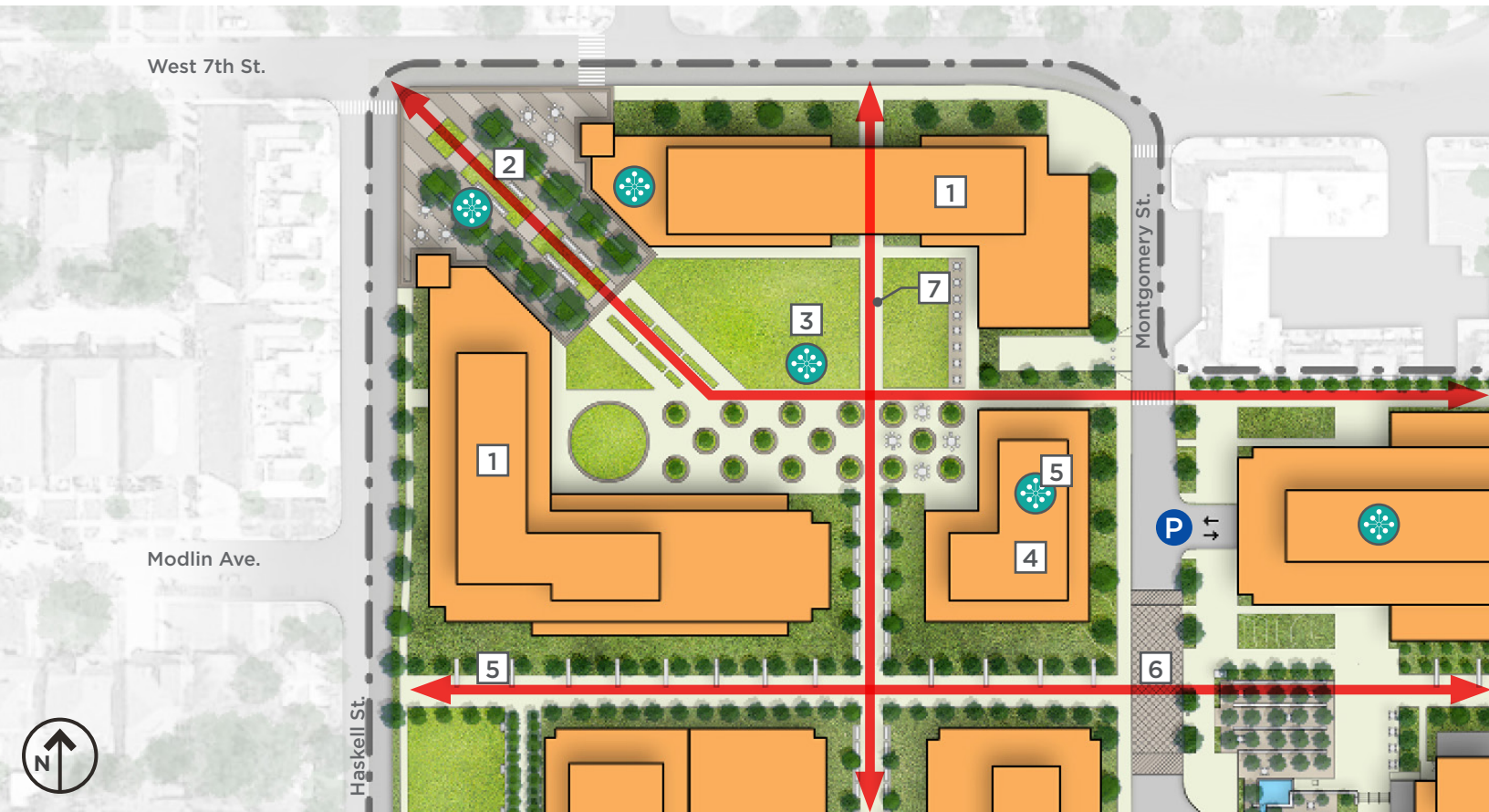

Northwest Gateway

The Northwest Gateway area represents a significant portion of the overall future campus built space capacity. Buildings will align to Haskell Street and West 7th Street to define the campus edge condition and reinforce UNTHSC presence and identity. At the intersection of Haskell and West 7th Streets, the corner will open to provide access and views into the campus extending to Gibson D. Lewis Library. This corner, the Northwest Gateway Plaza, will create a transition zone between the neighborhood and campus.

The plaza will continue into campus to meet a generous open space of similar size to MET Lawn. This space, the North Campus Green, will serve as a location for hosting large-scale community and campus events while also containing small-scale areas for daily use.

Legend & Key Map

- Proposed Building
- Existing Building
- Proposed Parking Garage
- P Parking Entry
- ❄️ Hub Location
- Connectivity Link

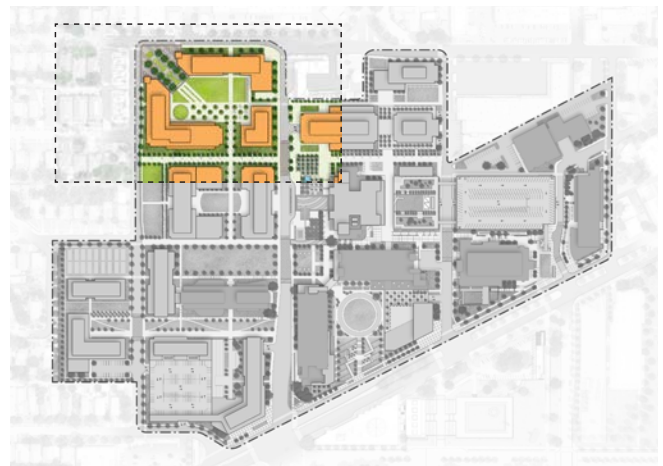

Key Components & Features

- 1 New buildings align to West 7th Street and Haskell Street to define campus edge condition.
- 2 Northwest Gateway Plaza will establish a formal transition zone between the campus and neighborhood while welcoming the community into campus.
- 3 North Campus Green will host large-scale community events and contains small-scale spaces for daily use.
- 4 Lower-height building maintains view corridors from perimeter into core of campus.
- 5 North Campus Mall will replace Modlin Avenue
- 6 Improve crossing at street and pedestrian pathway for safety.
- 7 West Campus Mall



Component Precedent - Transition Zone (#2 - Northwest Gateway Plaza)



Component Precedent - Exterior Event Space (#3 - North Campus Green)

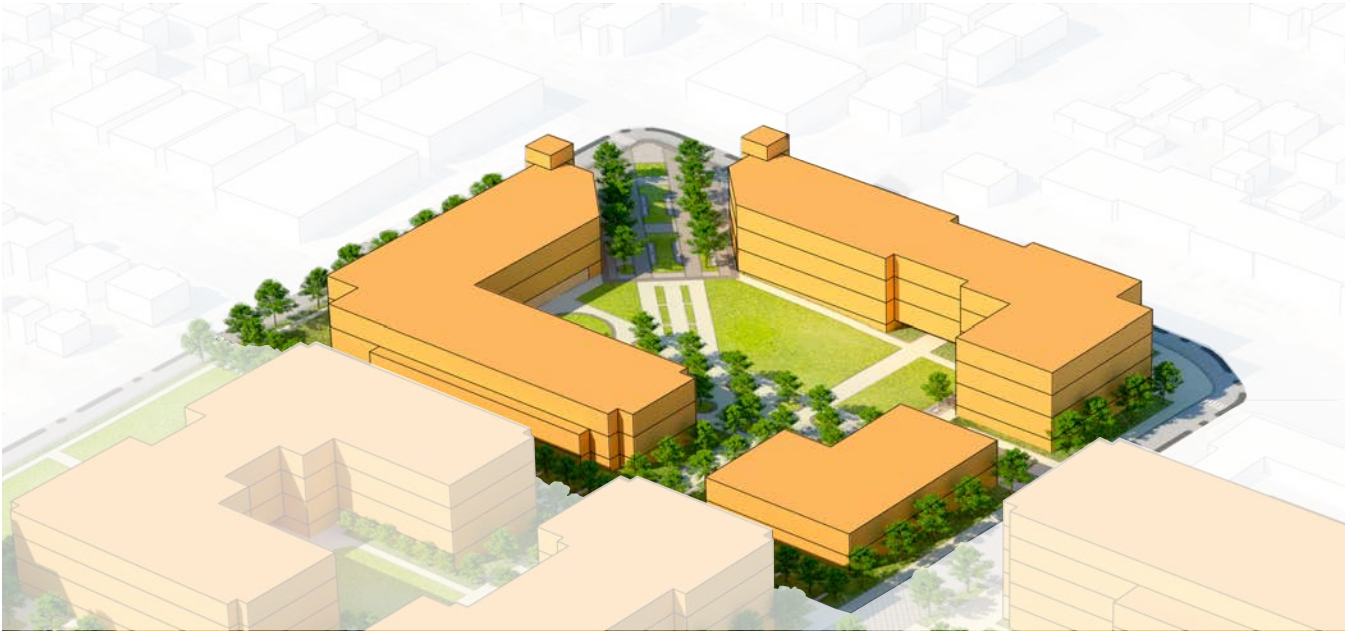

Feature Highlight - Aerial View of Northwest Gateway

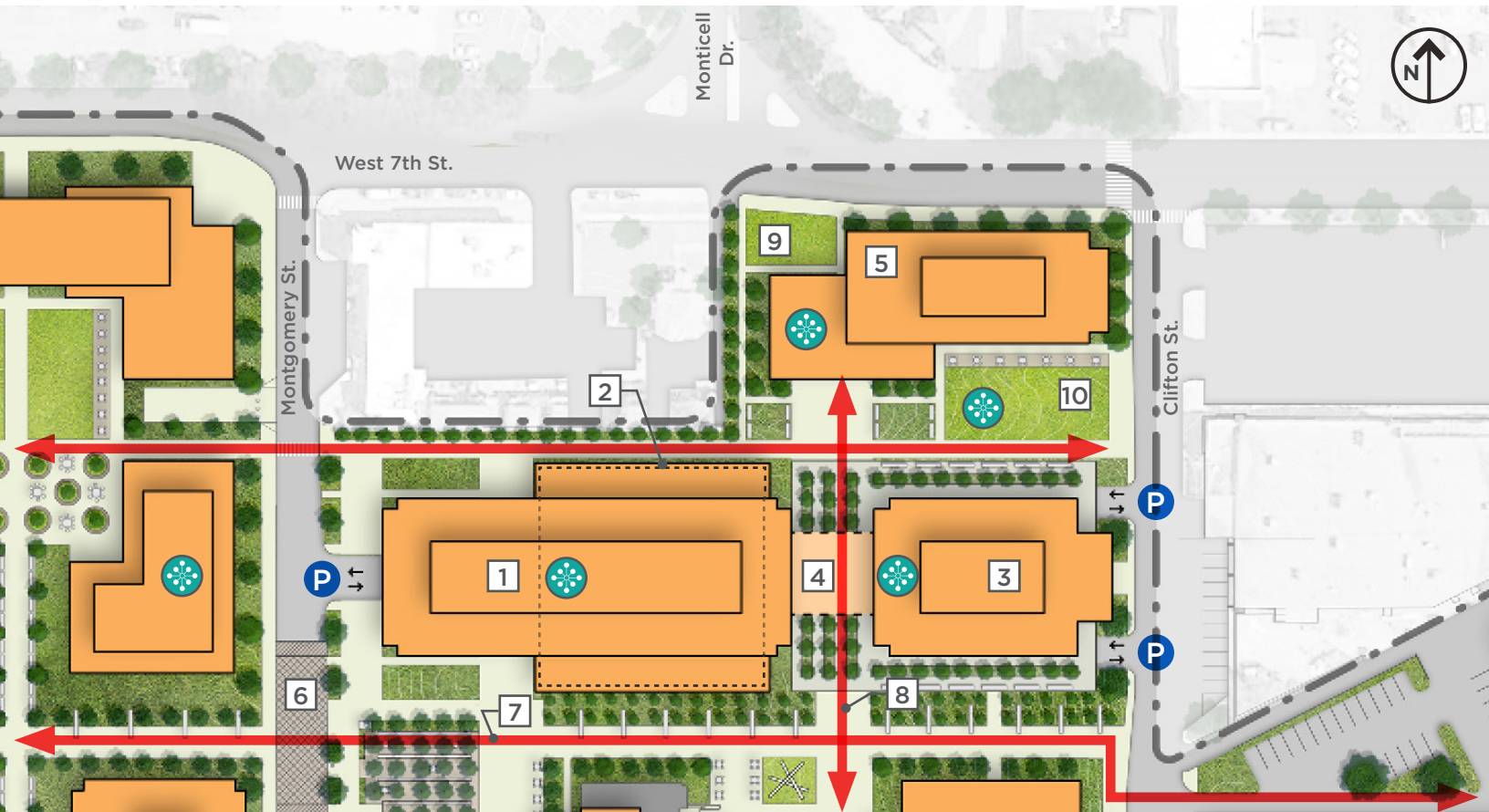

West 7th Corridor

The Health Pavilion offers alternatives for either renovation and expansion or replacement. The existing facility (shown with dashed outline in plan above) can be renovated with an addition to the western side. Alternately, the entire facility may undergo replacement dependent on UNTHSC’s needs over the long-term.

Linking via a bridge connection, a new facility to the east of the Health Pavilion will sit atop a parking garage taking advantage of the site’s topography to improve access for pedestrians and vehicles with entries at multiple levels.

Along West 7th Street, building will align with the street to define the campus edge condition and reinforce UNTHSC presence and identity with further strengthening from the Monticello Lawn that terminates the Monticello Drive view corridor.

Legend & Key Map

- Proposed Building
- Existing Building
- Proposed Parking Garage
- P Parking Entry
- * Hub Location
- Connectivity Link



Key Components & Features

- 1 Renovation and expansion or replacement of existing Health Pavilion.
- 2 Existing Health Pavilion outline shown dashed.
- 3 Parking garage, with building above, will reduce the topography impact allowing pedestrian and vehicular access at multiple levels. Approximately 864 parking spaces.
- 4 Breezeway accommodates pedestrian connectivity along Library Mall.
- 5 New building aligns to West 7th Street to define campus edge condition.
- 6 Improve crossing at street and pedestrian pathway for safety.
- 7 North Campus Mall
- 8 Library Mall
- 9 Monticello Lawn
- 10 Legacy Green



Component Precedent - Connectivity (#4 - Breezeway)



Component Precedent - Pedestrian Mall (#7 - North Campus Mall)



Feature Highlight - Aerial View of West 7th Corridor

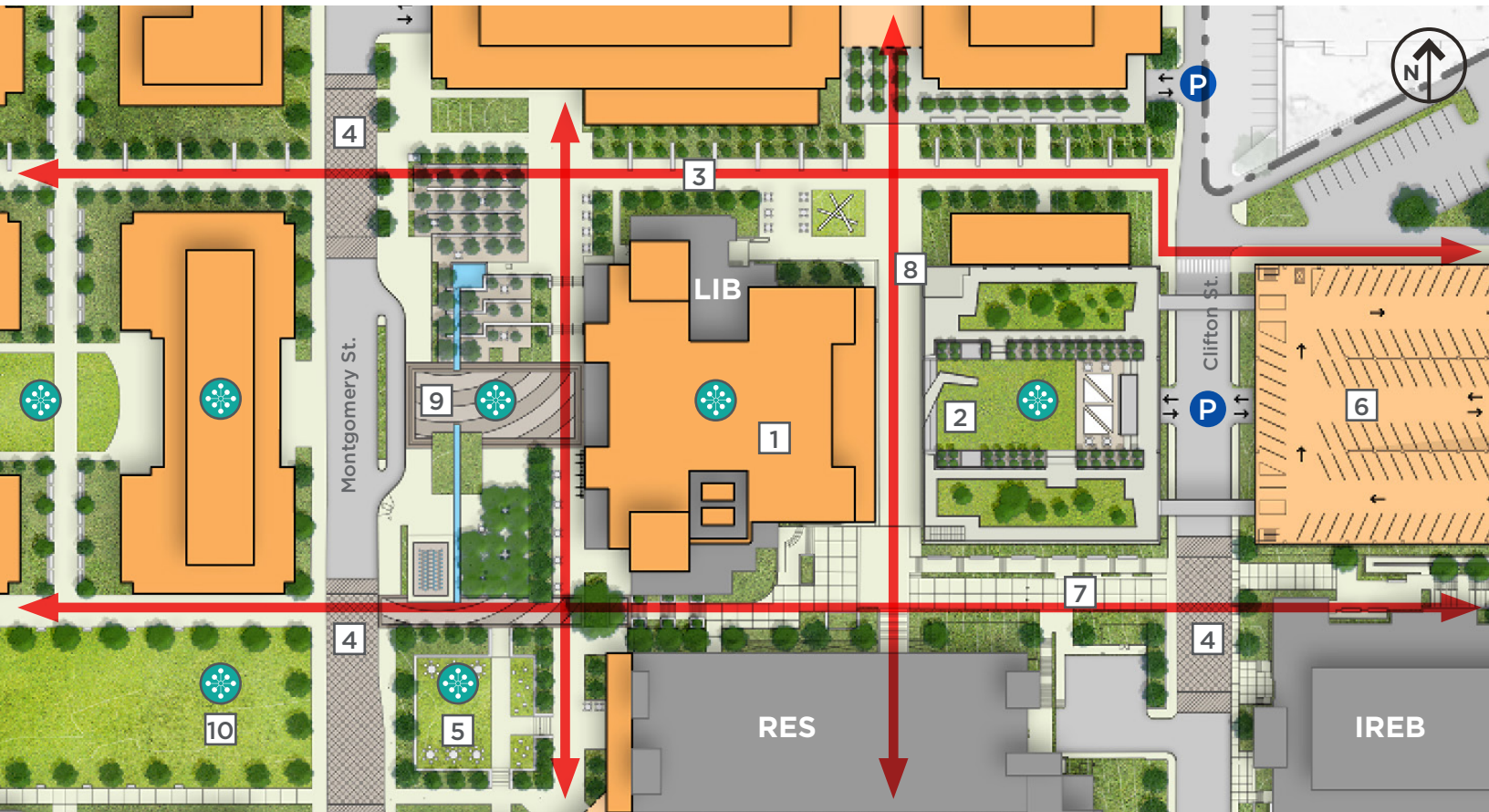

Heart of Campus

The Gibson D. Lewis Library is both the physical center and expressive heart of the campus. Expanding the library upward with an additional level, which the original building design is supports, will expand available space and provides magnificent views of campus and the Fort Worth area. Further expansion on the eastern side of the building, towards Alumni Plaza, will provide for physical and visual connectivity of the library to the campus. This connectivity will increase and enhance the use of both the library and plaza.

The library expansion will accommodate new chilling towers, allowing for the removal of the existing towers west of the Research and Education (RES) building which sit imposingly in the Alumni Plaza. Replacing these towers will be the Reflection Courtyard that serves to extend and link the MET Lawn and Library Courtyard.

Legend & Key Map

- Proposed Building
- Existing Building
- Proposed Parking Garage
- P Parking Entry
- Hub Location
- Connectivity Link



Key Components & Features

- 1 Expansion of the Gibson D. Lewis Library, including location for new chilling towers.
- 2 Activate and enhance Alumni Plaza with direct access to library eastern expansion.
- 3 North Campus Mall improves campus connectivity and provides locations for campus artwork and Legacy Tree Program expansion.
- 4 Improve crossing at street and pedestrian pathway for safety.
- 5 Reflection Courtyard connects and links MET Lawn and Library Courtyard.
- 6 Increase parking capacity adding one level to Clifton Garage. Approximately 240 additional parking spaces.
- 7 Campus Spine
- 8 Library Mall
- 9 Library Courtyard
- 10 MET Lawn



Component Precedent - Expansion (#1 - Gibson D. Lewis Library)

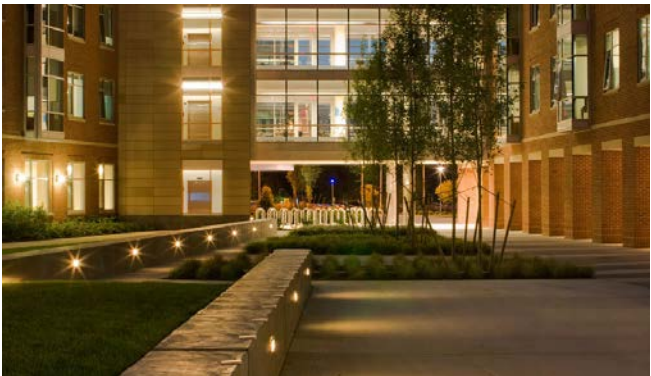

Component Precedent - Exterior Space (#7 - Reflection Courtyard)



Feature Highlight - Aerial View of Heart of Campus

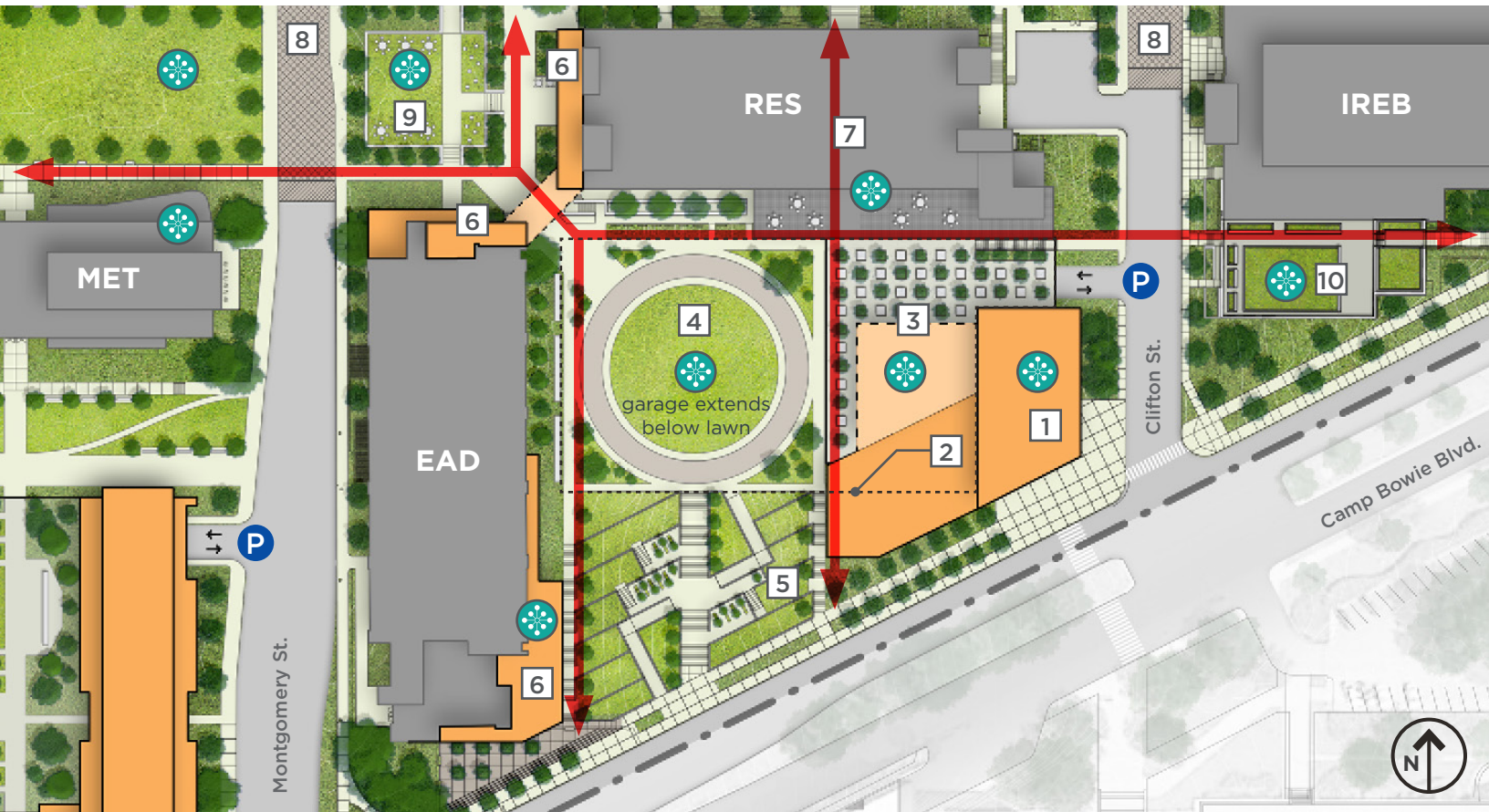

Campus Gateway Center

At the center of campus along Camp Bowie Boulevard, the Campus Gateway Center will be the outward facing representation of UNTHSC to the world and the welcoming point for those engaging with campus. The Collaboration Center will support first-time campus visitors, hold exhibitions of UNTHSC’s work, and host events that bring students, staff, and faculty together with those outside of UNTHSC.

Partially sitting on top of a parking garage, the Front Lawn is the campus’s grand formal exterior space. Tiering down to Camp Bowie Boulevard, it provides physical and visual access to and from the campus while reinforcing UNTHSC presence and identity. The shaded, outdoor Event Plaza will link the Front Lawn with the Collaboration Center. A parking garage will sit underneath the Front Lawn and Event Plaza as shown later in this chapter in the parking strategy section.

Legend & Key Map

- Proposed Building
- Existing Building
- Proposed Parking Garage
- P Parking Entry
- ❄️ Hub Location
- Connectivity Link



Key Components & Features

- 1 The Campus Gateway Center will provide a welcoming point for engagement with UNTHSC.
- 2 New Garage access on Clifton Street adds approximately +200 spaces. Garage roof is partially exposed (Event Plaza) and partially buried (Front Lawn)
- 3 Front Lawn
- 4 Event Plaza sits atop the parking garage.
- 5 Campus Portal tiers to Camp Bowie Boulevard and provides physical and visual connectivity.
- 6 Additions to EAD and RES provide visible collaboration space and indoor-outdoor linkages to new exterior spaces.
- 7 Library Mall extends through RES, linking the Front Lawn and Campus Spine.
- 8 Improve crossing at street and pedestrian pathway for safety.
- 9 Reflection Courtyard
- 10 IREB Rooftop Garden



Component Precedent - Formal Exterior Space (#2 - Front Lawn)



Component Precedent - Shaded Exterior Space (#7 - Event Plaza)



Feature Highlight - Aerial View of Campus Gateway Center

SYSTEM INTEGRATION

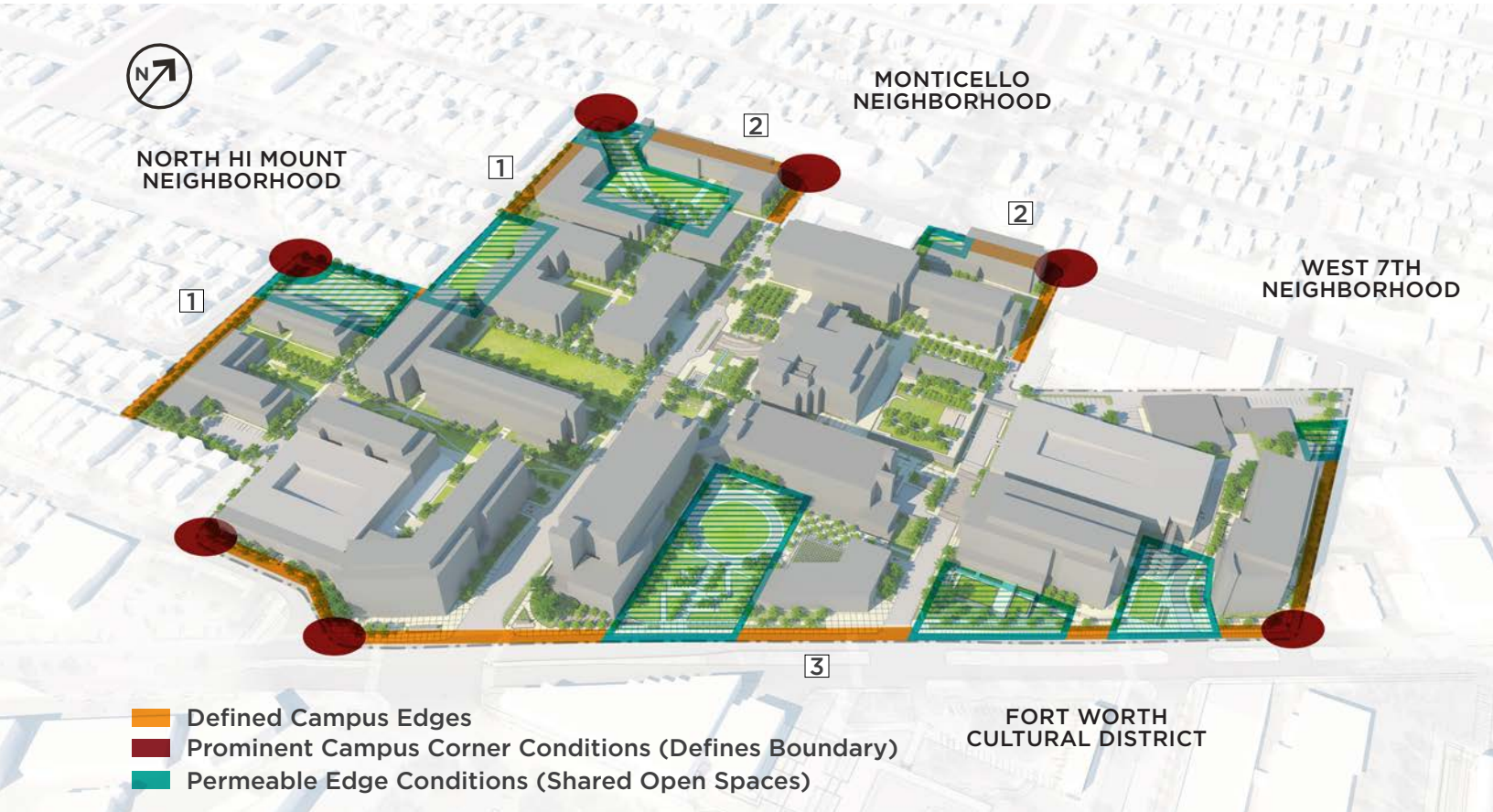

Campus Edges

Emphasized as a priority early on, the master plan carefully addresses its boundaries specific to their immediate context in order to create a welcoming edge condition around the entire campus. This carefully considered approach aims to better nurture the intersections between the campus and its neighbors. In addition to strengthening the physical interface with the surrounding community, defining the edge conditions also enhances the institutional identity, increasing visibility and recognition of UNTHSC as an integral part of the surrounding neighborhoods and districts.

After analysis, campus edges were categorized into three character groups: The Neighborhood Edge, the Community Edge, and the Cultural Edge. Analysis of existing conditions revealed that the edges are currently disengaged in many places. One of the positively identified features of the campus' existing edge conditions was the rhythm of green spaces located along the edge which are shared with the community (such as the community garden and MET lawn). Stakeholders expressed a desire for the master plan to create more of these permeable edge conditions spread across all three character groups.

The build out of the master plan arranges building forms and open space features in locations that will maximize integration with the surrounding communities while also maintaining appropriate characteristics unique to the context in each location. This will ensure a consistent and engaging presence and identity along the entire campus boundary. Below are additional details about some of the strategies employed by the master plan.

1 - Neighborhood Edge

Today, there is no clear edge definition along Haskell Street. The parking lot west of Haskell Street is effectively a program dead zone separating the campus and neighborhood. The east side of Haskell is characterized by on-street parking, buildings that house facilities and service functions, service driveways for the MET and facilities annex, and minimal landscaping. The one positive element is the MET lawn which community members frequently access.

Stakeholders identified this as an edge where UNTHSC should strive to respectfully blend in with the neighborhood. Preferred strategies include lower density, quiet uses, lower building heights, larger setbacks, screening of mechanical elements, and creation of public green spaces that can be shared between campus and community. Building off of this guidance, the master plan steps building heights down towards the one- and two-story houses located in the North Hi Mount neighborhood. While the master plan does propose development on the MET lawn where it fronts the campus edge, this space is replaced with a larger relocated community garden and a new community lawn. These two spaces enhance the pattern of shared green spaces that punctuate the edges around campus with programs intended to bring the campus and community together.

2 - Community Edge

Today, the campus side of the Community Edge is defined by older one- and two-story structures set far back from the street edge that do not contribute to the campus' character or identity. Exacerbating this lack of identity, UNTHSC does not have a continuous land ownership along West 7th Street, prohibiting the campus from creating a singular edge identity.

Unable to create this contiguous edge, it will be critical for future UNTHSC development along West 7th to have strong architectural elements on the corner to differentiate the campus properties and presence from those not owned by the campus. It is also critical for the building masses to be built to the sidewalk edge and planted with street trees to compliment the urban character that is being developed elsewhere along West 7th Street. The West 7th Street corridor is very busy, containing many commercial businesses in the vicinity of campus. Responding to this character, campus development along West 7th should include active programs on the ground floor. The campus may even consider creating retail space that can be leased to generate revenue.

3 - Cultural Edge

The most prominent and visible campus edge is along Camp Bowie Boulevard where UNTHSC interfaces directly with the Cultural District. This Cultural Edge provides the first impression of the institution to visitors. Maximizing campus visibility, branding, and accessibility along this edge is critical to creating a positive first impression.

Historically, the edge was defined by parking lots along its entire length. Today, this edge has been partially transformed as a result of the site design associated with IREB and CBH, which engage the museums south of Camp Bowie Boulevard. The master plan prioritizes completion of this transformation in the near-term. Building footprints for the Montgomery Gateway Building and Campus Gateway Center replace the existing surface lots in each location with building forms that engage the street edge. The new Front Lawn, centered on Camp Bowie Boulevard between Montgomery and Clifton Streets, provides a large and prominent campus edge green space. This lawn is similar in size to the Amon Carter Lawn across the street, creating a complimentary site feature that strengthens the bond between the campus and the Cultural District. In conjunction with these new building and open space features, the master plan also proposes new street trees and grass beds along the length of the Cultural Edge to create a consistent identity to match the segments by CBH and IREB.

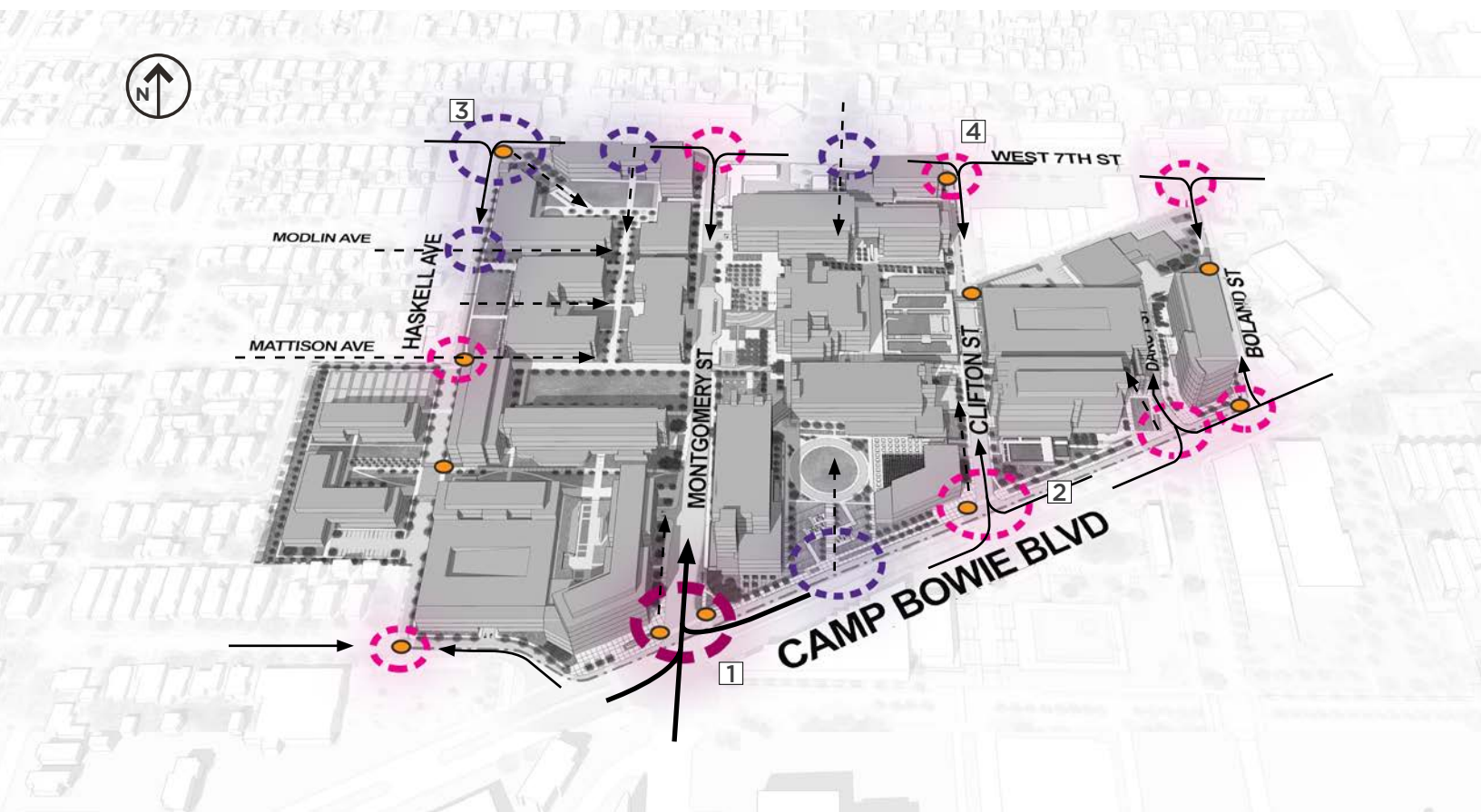

Gateways

A key master plan goal was the enhancement of existing gateways while also establishing new, clearly-defined ones. Design of strong gateways includes creation of balanced building forms scaled appropriately to match (or contrast) with surrounding context, clear signage marking the start of campus, and landscape elements and other visual cues that pull users in to campus. These three elements should each be scaled to provide hierarchy to the importance of each gateway.

Proposed UNTHSC developments at the intersections of Camp Bowie Boulevard with Clifton and Montgomery Streets will greatly enhance the campus' presence and visibility from the Cultural District. These two developments will also serve as clear beacons on where to enter campus. At Haskell and West 7th Street, Northwest Gateway Plaza will create an open and inviting pedestrian gateway with views all the way to the library. During the

- - - Pedestrian Access point to Campus
- Vehicular Access point to Campus
- ⋯ Proposed Gateway
- ▨ Existing Primary Gateway
- ⋯ Existing Secondary Gateway
- Campus Edge Signage

planning process, stakeholders identified the design of this corner as a priority. The proposed building at Clifton and West 7th Street was laid out to create a campus presence that does not exist on the site today. The current low-density structures on the site do not suggest that this area is a part of campus. By increasing building height and extending the building mass to the sidewalk, a clear gateway is created, visible up to half a mile away along West 7th Street marking the start of campus. Collectively, these gateways will help support all four planning principles and provide clear access points for guests visiting campus by foot or car.



1. Enhanced Montgomery Gateway

A new character building opposite of EAD and landscape improvements will drastically improve the campus' presence along Camp Bowie Boulevard and create a more clear front door.



2. Academic Mall
Linear Open Space - Mall



3. Northwest Gateway Plaza
New Pedestrian Gateway



4. New Building - West 7th
Establishes Campus Presence

Vistas

An important design consideration during formation of the master plan was to avoid obstructing existing vistas while also creating opportunities for new vistas. This was achieved through careful layout of building forms and heights to reinforce the outcomes of the Observations phase. Vistas are intricately tied to campus wayfinding systems. Views of campus buildings from a distance help to guide people into campus, while clear views to multiple buildings and green spaces can help guide visitors once on campus. Invariably, vistas are also related to campus brand and identity. Seeing the campus and its physical features promotes awareness of the institution's mission and values.

Below are examples of this intricate approach for the three types of vistas discussed in the Observations Chapter.

Vistas to campus: Situated just a few miles from downtown Fort Worth and adjacent to some of the most heavily trafficked museum districts in the United States, the campus is blessed with high visibility. Capitalizing on this, the master plan strategically lays out building masses in response to sight lines from the Cultural District, downtown, and the regional arterial roadways. These forms provide an opportunity to create a clear campus identity and share the UNTHSC brand with guests to the region. Vistas to campus are also a critical wayfinding device that visually guide visitors to campus.

The most prominent example of an enhanced vista to campus is the proposed Montgomery Gateway Building. Due to a variety of factors including its height, the existing setback of EAD from Camp Bowie Boulevard, and its alignment to the street, The Montgomery Gateway building will be visible over a mile away along Interstate 30, traveling north on Montgomery, traveling east and west along Camp Bowie Boulevard, and from the lawns of the Amon Carter and Kimbell Art Museums.

Vistas from Campus: One of the campus' greatest assets is the views of downtown Fort Worth and the Cultural District from EAD, RES, LIB, CBH, and HP. The master plan

carefully arranges proposed building masses to not obstruct these existing views while also capturing these same views for new buildings.

Design of the Campus Gateway Center embodies this approach. The building site at the corner of Camp Bowie Boulevard and Clifton Street will have unobstructed views of the Amon Carter and Kimbell Art Museum, as well as views of downtown. Located 35-feet down grade from EAD, the proposed three-story building mass will not obstruct any of EAD's or RES's existing views from campus.

Internal Vistas: Internal vistas are created when an interior space has windows that overlook a campus green space or frame a character building on campus. Inversely, internal vistas can also be created in exterior spaces when landscape elements frame the reciprocal view and back visually interesting building facades. Through expansion of the campus open space network, the master plan creates significantly more opportunity than exists today for existing and future buildings to have stimulating internal views.

An excellent example is the set of internal vistas created by the new Front Lawn. If you were on the fourth floor of EAD or RES today and looked down, you would see a parking lot. After completion of the Front Lawn project, both of these buildings will have considerably improved views. In addition to creating new internal vistas for existing buildings, the Front Lawn will also form a strong visual connection with the Campus Gateway Center, which will have interior and exterior spaces that will overlook the lawn.

Another example is the West Campus Mall, the long, linear open space running north-south from the Montgomery Gateway Building, through the MET lobby, to West 7th Street. Standing in the MET lobby and looking down the mall south, you will see the Montgomery Gateway Building enveloping Innovation Plaza. Standing in the MET lobby and looking north up the mall, you will be able to see all the way to West 7th Street framed by a breezeway in the northern most building on the mall axis.



Open Space Network

Building off the proposed campus Framework Open Space Network, the master plan greatly expands the open space network to include a better variety of open space types and distribution across campus. While programs for each space are not specifically identified, the intent is for each space to offer a unique and varied set of features.

Key identifying feature of the existing open space network are moments around the edge of campus where open space is used as a tool to connect the campus to the community (Community Garden, MET Lawn, IREB Courtyard). Stakeholders prioritized the extension of this around the entire campus boundary as a key design feature for the master plan. This is achieved through the new Front Lawn, relocated Community Garden, Community Lawn, Northwest Plaza, and Monticello Courtyard.

Mix of Open Space Typologies

Today, the campus does not offer a good mixture of open space typologies. Most of the campus outdoor spaces are large format (such as the Library Courtyard, Alumni Plaza, and the MET lawn), designed to support single uses, and located in or immediately adjacent to the center of campus. Guided by the Framework Open Space Network, the master plan creates and assortment of new open spaces spread to all sectors of campus. These spaces will also offer a mixture of furniture to accommodate individuals and groups of varying size, and support a broader range of outdoor programs and activities. Combined, the mixture of open space typologies will provide the UNTHSC community with a better on-campus experience and create new opportunities to study and relax outdoors.

Additional details on open space design, distribution, site features, and furniture can be found in the Design Guidelines Chapter.

Sample of Key Open Spaces

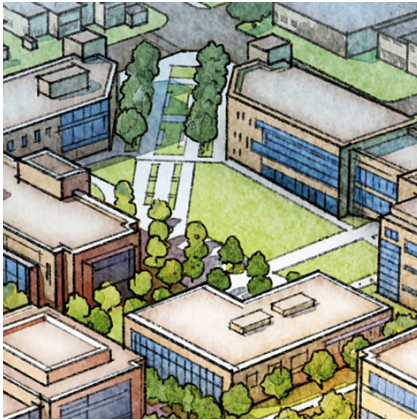

North Campus Green
Grand Space - Quad



MET Lawn (enhanced)
Grand Space - Lawn

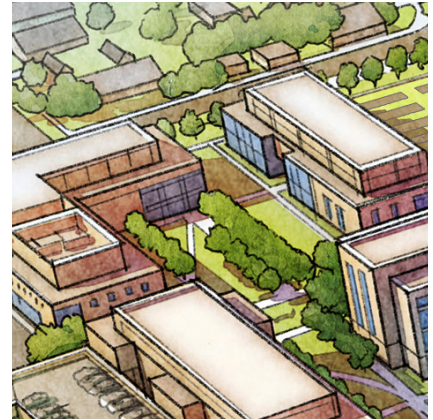

Hi Mount Quad
Grand Space - Quad

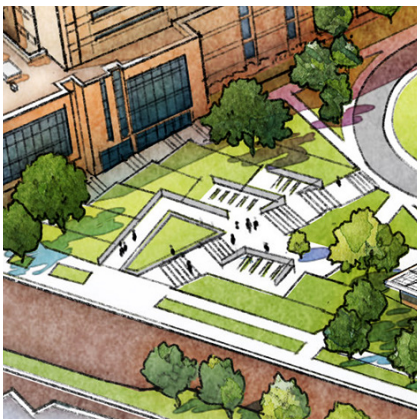

Campus Portal
Grand Space - Special

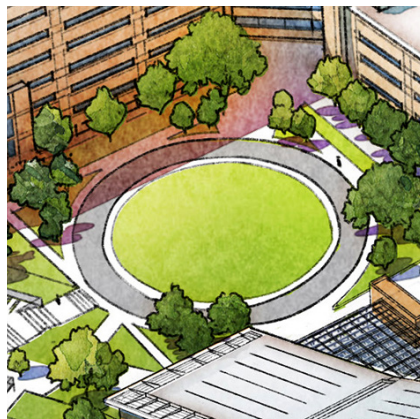

Front Lawn
Grand Space - Lawn

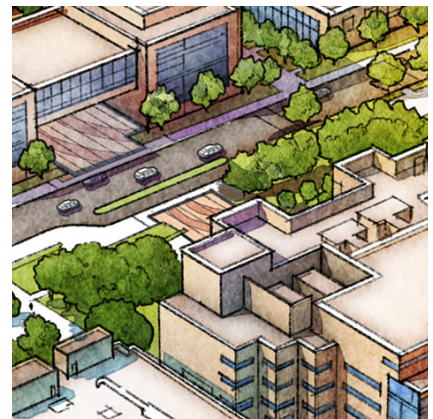

Library Courtyard
Intimate Space - Courtyard

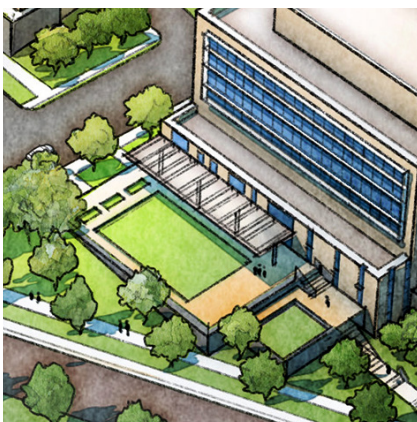

IREB Roof Garden
Intimate Space - Courtyard



East Campus Green
Intimate Space - Courtyard

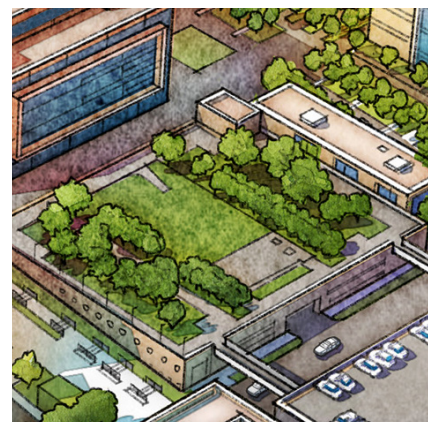

Alumni Plaza
Intimate Space - Plaza

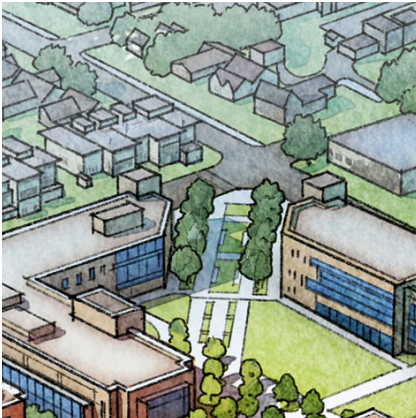

Community Plaza
Intimate Space - Plaza

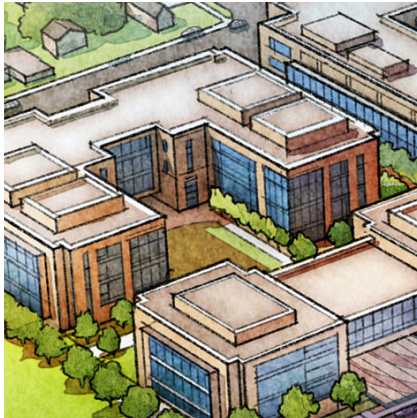

Modlin Courtyard
Intimate Space - Courtyard

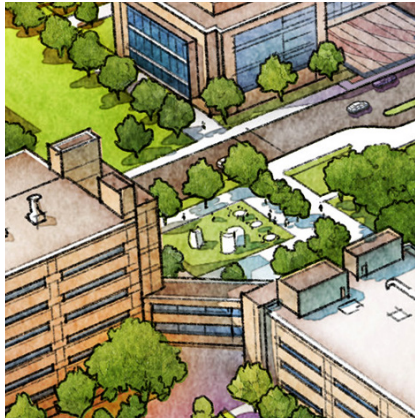

Reflection Courtyard
Intimate Space - Pocket Park



Community Garden (relocated)
Intimate Space - Pocket Park

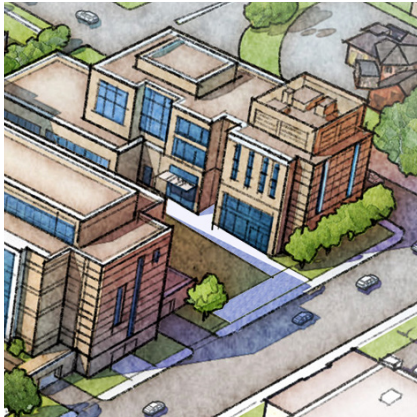

Legacy Green
Intimate Space - Pocket Park

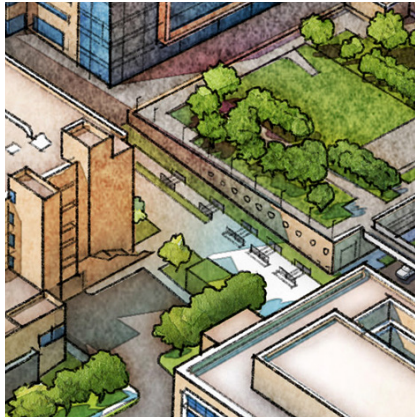

Campus Spine
Linear Open Space - Mall



Academic Mall
Linear Open Space - Mall

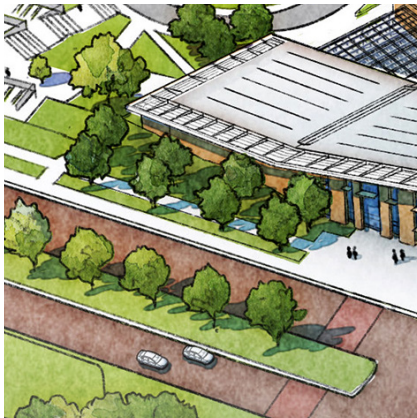

Camp Bowie Boulevard Frontage
Linear Open Space - Urban Edge

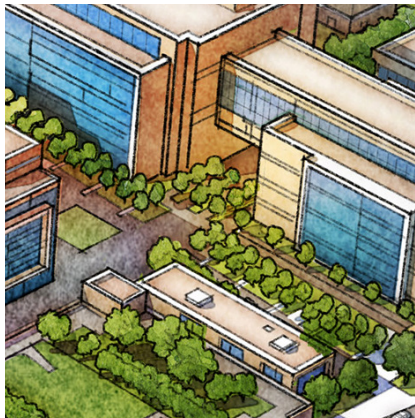

North Campus Mall
Linear Open Space - Mall

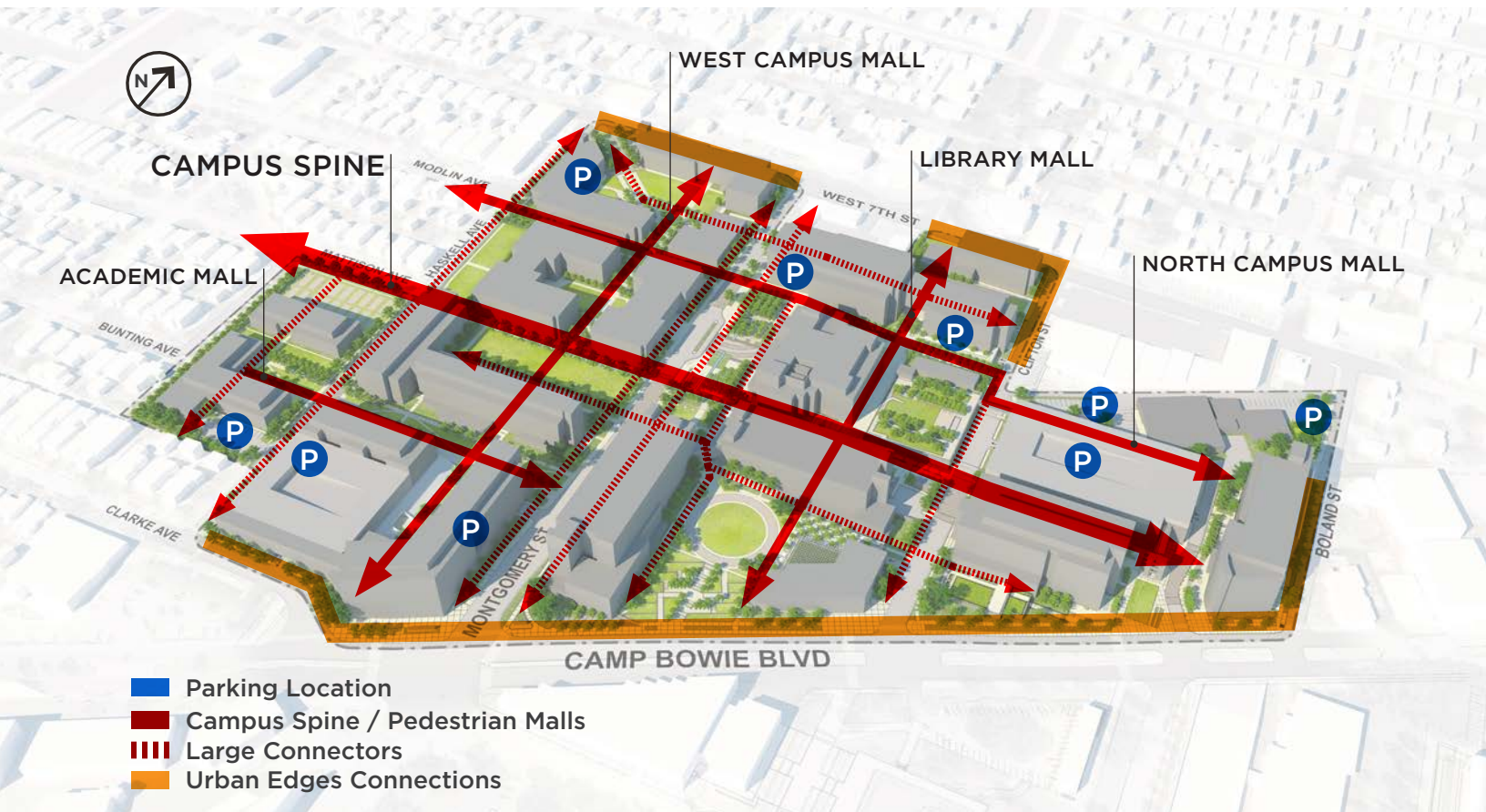

Pedestrian Circulation

Using the Framework Connectivity Network as a guide, the master plan significantly increases pedestrian connectivity throughout campus and along its edges. This is primarily achieved through converting existing interior roadways and surface parking lots into elements that are more pedestrian-friendly (pathways, green spaces, or buildings). To organize the pedestrian network and provide clear guidance for its growth, the master plan defines a pedestrian walkway hierarchy containing four types: Spine, mall, connector (large and small), and urban edges.

Spine: The term refers exclusively to the existing Campus Spine which is a special and character-defining element for the UNTHSC campus. The spine is the most heavily trafficked pedestrian path on campus and acts as a unifying feature that align the entrances and exits of surrounding buildings. Preserved as the central element of the

Framework, The Campus Spine remains the prime organizing feature for all pedestrian circulation.

The master plan strengthens the spine through two alterations. First, the existing section west of Montgomery Street (where it currently jigs to align with Mattison Avenue adjacent to the MET lawn) is shifted south to align the section on the opposite side of Montgomery Street. Second, road tables are proposed where the spine intersects Montgomery, Clifton, and Darcy Streets to calm traffic and provide a safer, elevated crosswalk. In effect, these improvements to the Campus Spine will provide a straight and uninterrupted path for pedestrians from one side of campus to the other.

Pedestrian Malls: Building off of the organizational strength of the Campus Spine, four new campus malls are proposed (two running north-south and two running east-

west). Malls act similarly to the spine in that they are designed to handle a significant amount of pedestrian traffic, connect major green spaces together, and orient building entrances.

The West Campus Mall extends north and south off of the axis created by the MET lobby. To the south, it will connect to the new buildings and parking structured identified to replace Lot 19; to the north it will extend across the MET lawn all the way to West 7th Street, passing through multiple courtyards and breezeways.

The second mall is the formalization the north-south axis that exists between the library and alumni plaza, extending it north to West 7th Street and south to Camp Bowie Boulevard (through a new interior corridor created in RES).

A third mall replaces a closed down Bunting Avenue and a portion of Parking Lot 7. The Academic Mall runs east-west from Montgomery Street, over Haskell (on a road table), and into the development area atop Lot 7. Anchored by the MET, the master plan envisions a concentration of new academic uses and student support uses aligning to this mall.

Finally, the North Campus Mall is the fourth proposed new pedestrian mall. Running east-west, similar to the Campus Spine, it is envisioned to be the primary channel for pedestrians on the north side of campus. The North Campus Mall will connect all the way from Haskell Street to CBH.

Connectors (Large and Small): Large connectors are the third largest walkway in the hierarchy. Though not as big as malls, they are still intended to move a significant number of people. Large connectors link the Campus Spine and malls to secondary buildings and parking lots, and are fairly evenly distributed across campus.

Small connectors are the smallest paths on campus located in less heavily trafficked areas. They are what might be described as “a typical sidewalk.”

Urban Edges: Urban edges are the larger sidewalk areas located adjacent to arterial roads. These areas should be uniformly planted with street trees to create a cohesive campus edge condition.



Campus Spine segment North of RES



Mall at the University of North Texas (Denton)



Large Connector West of the library

Additional information on the design of malls, connectors, and urban edges can be found in the Design Guidelines Chapter.

Bicycle Circulation

The Master Plan supports the creation of a dedicated bicycle lane along Montgomery Street identified by the 2009 City of Fort Worth Bicycle Comprehensive Plan. While campus stakeholders did not identify an immediate need for increased bicycle infrastructure today, a desire was expressed for future integration into city bicycle infrastructure to create opportunities for future students, staff, and faculty to bike to campus.

As the campus grows, bicycle racks should be included with new construction projects.

Transit Connectivity

Transit connectivity is a vital element for an increasing number of the campus population. Today, the campus is only serviced by one bus route. The City of Fort Worth is exploring the possibility of adding both a Bus Rapid Transit (BRT) line down Camp Bowie Boulevard, as well as a new dedicated shuttle that circulates between the Fort Worth Medical District, Downtown Fort Worth, and the Fort Worth Cultural District. Connection to both of these lines would greatly benefit UNTHSC students, staff, and faculty. The campus should appoint a dedicated representative responsible for staying in contact with the Fort Worth Transit Authority and attending any community meetings related to these lines to ensure that the campus has one or more stops on its boundary.

It is also encouraged that the campus continue and expand its Travel Demand Management (TDM) programs to both support students, staff, and faculty of a variety of means and encourage alternative modes of reaching campus. Current programs include subsidies for transit passes, carpooling, and electric vehicle charging.

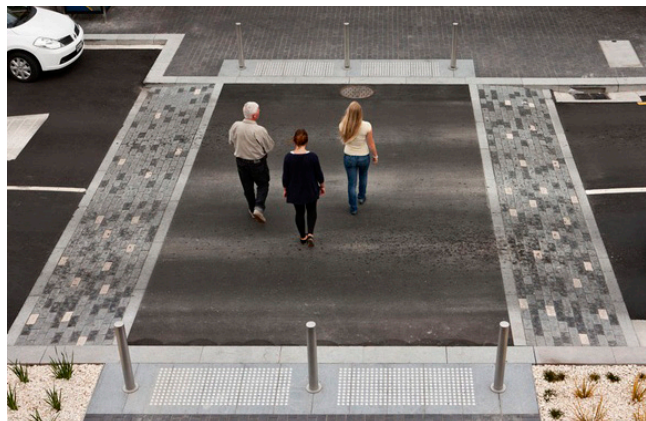

Example Pedestrian Road Table

Pedestrian Road Tables



Pedestrian road table locations are highlighted on the diagram at the top of the adjacent page

Road tables are a visual and physical mechanism that slows traffic and creates a larger and more safe crosswalks for pedestrians. Long-term, the master plan identifies five total locations along Haskell, Montgomery, Clifton, and Darcy Streets (where east-to-west pedestrian traffic is the heaviest) to create elevated road tables. Three are located along the Campus Spine (enabling it to provide an uninterrupted ground plane from one end of campus to the other) while the other two align with new campus malls.

Road tables can vary in length, however the master plan recommends they be a minimum of 30' long to ensure they are a meaningful traffic-calming element. Heights should be designed to sit flush with the adjacent sidewalks. It is important that road tables be constructed of a material that is different from both the road and the sidewalk. This visual contrast is a psychological mechanism that increases safety by ensuring that drivers and pedestrians are conscious that they are entering a shared zone.

For tables not located on owned right-of-ways (Montgomery Street), the campus will have to coordinate with the City of Fort Worth for approval.

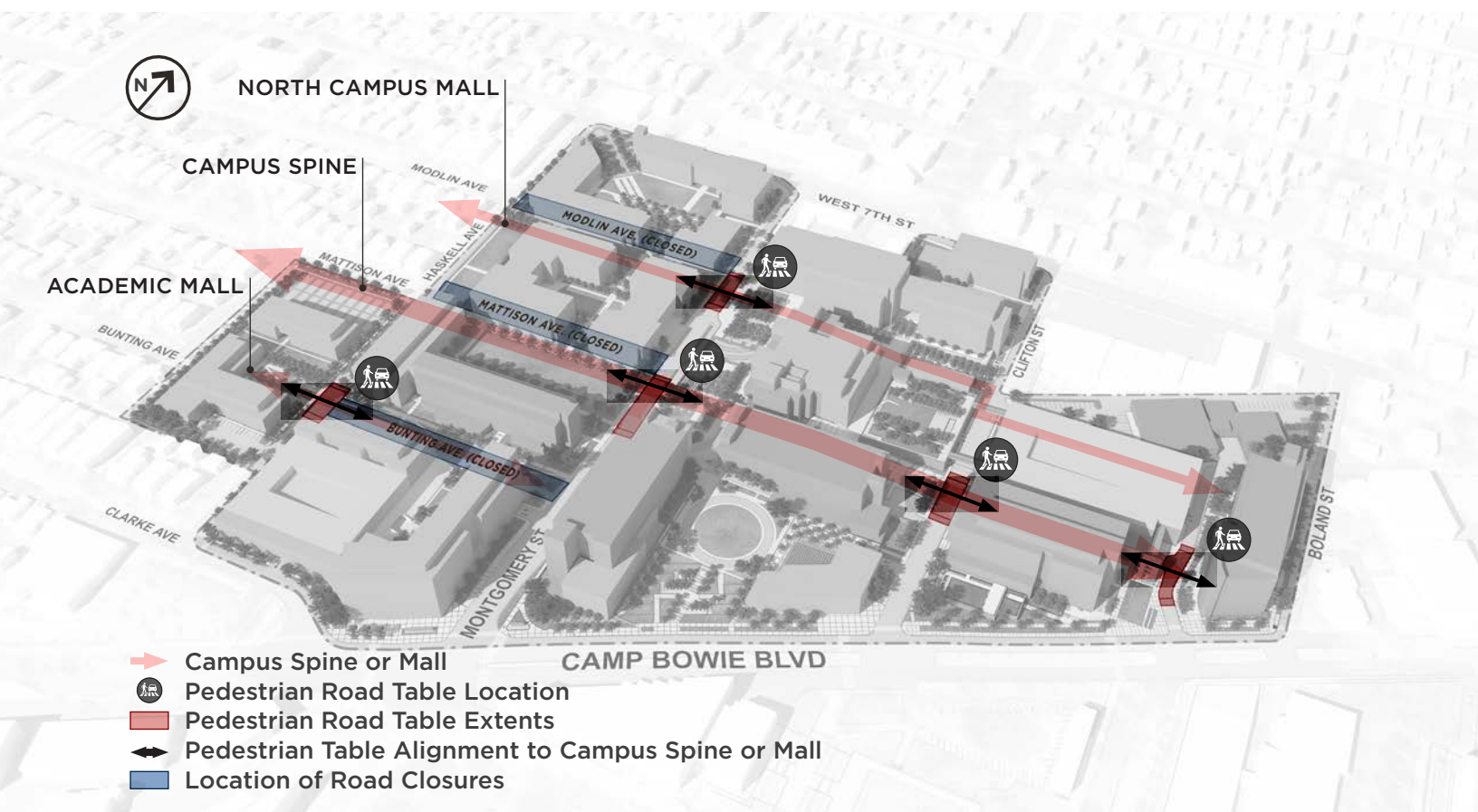

Road Closures

As a part of the full master plan build out, the segments of Bunting Avenue, Modlin Avenue, and Mattison Avenues will be closed between Haskell Street and Montgomery Street to expand the pedestrian environment on campus and increase safety. Each of these segments is owned by the campus and has relatively low traffic volumes. A majority of the existing traffic is UNTHSC students, faculty, and staff using them to reach existing surface parking lots. Over time, these surface lots will redevelop into building sites, leading to a decrease in utilization of these roads and minimal traffic disruption from closure.

The roads will be closed in phases as development occurs, giving the campus time to further assess the impacts after each stage. Only the Bunting Avenue segment is identified for closure in the near-term implementation plan.

Vehicular Circulation

Aside from the three road closures described to the left (which were identified as having minimal impact on traffic flows), vehicular circulation to and through campus will largely remain the same. UNTHSC is currently working with the City of Fort Worth on a design to eliminate one north bound lane on Montgomery Street between Camp Bowie Boulevard, and Bunting Avenue. The master plan reflects the latest designs for this project.

Over time, ingress and egress patterns will adjust as the campus shifts from a hybrid parking model (surface lots and garages) to a primarily garage based model (more information on this shift is located on the next two pages). Based on the positioning of garage entrances and exists, most vehicular traffic is still expected to enter campus on Montgomery or Clifton Streets. No other roadway alterations or capacity changes were identified as necessary for the long-term plan.

Parking Capacity

Right-sizing the campus’s parking in the near- and long-term was a key topic for the master plan. Concurrent with the master plan efforts to forecast future parking need, the UNTHSC Parking Task Force was working to identify the campus’s immediate parking needs for the next five years. These two groups also met to discuss strategies related to parking management, revenue, operations, and funding of parking assets.

Industry recommend parking ratios based on building use types, shown in table below, provide a starting benchmark for gauging UNTHSC’s parking needs. However, these ratios do not take into account the unique nature of UNTHSC’s population or use patterns. These recommendations are based on individual building use types which, if applied simplistically, would result in an oversupply of parking. For example, a single faculty member may have a dedicated office space, dedicated research space, and teach in one or more academic spaces. The industry recommendations would treat the parking need for each of these separately, however, this example faculty member does not have multiple cars to park at each building. Similarly, a single student will not concurrently occupy space in the library and a classroom simultaneously. Therefore, the industry recommendations provide limited guidance for forecasting parking needs, and a more nuanced approach is necessary.

Parking Generation Ratios Industry Recommendations (per 1,000 GSF)		
Use Type	Low	High
Academic	2.0	3.0
Research	1.5	2.0
Clinical	4.0	5.0
Admin	2.5	3.0
Average	2.5	3.25

To refine the understanding of current parking usage and potential needs, a limited number of occupancy studies were undertaken in the Spring of 2018. The existing parking supply based on overall campus building square footage was also determined.

The occupancy studies measured how many spaces were being used in each lot at different

points throughout the day. Typical of most campuses, midday between 10am and 2pm was the busiest time on campus. Due to the nature of program schedules, course timings, and user types, the occupancy studies illustrated a range of low- and high-utilization that would be expected on campus like UNTHSC. During hours with fewer course offerings, demand was lower, whereas demand peaked during exam times. Today, the existing ratio of parking spaces per 1,000 GSF is 1.67. The findings of the occupancy studies suggest that, generally speaking, the existing 1.67 ratio is right-sized for current peak demand, though improvements to management and operations could mitigate constraints at peak times.

In the near-term however, given growth projections for the MD school, management policies aimed to reduce off-campus parking in the surrounding neighborhoods, and no extra capacity to support any future development, the shared conclusion with the Parking Task Force is to recommend the campus add additional parking to the Clifton Garage (pending structural analysis confirmation) to support these changes.

The table below highlights the existing ratio and provides a general recommended range for the campus to follow near-term and long-term to support its forecasted parking needs. The near-term and long-term projections are based on the use and occupancy today, combined with considerations for the impacts of changes on campus (ex: potential reduction in clinical programs) and changes in modalities (i.e. ride share, autonomous vehicles, increased public transportation, etc.). While the master plan provides these ratios as a planning tool, it will be important for the campus to periodically obtain parking occupancy data to validate that these findings remain accurate and remain current on modality trends to keep the campus right-sized and avoid under- or over-building parking.

Campus Parking Ratios: Existing & Targets (per 1,000 GSF)		
Existing	Near-Term	Long-Term
1.67	1.5 - 2.4	1.4 - 1.6

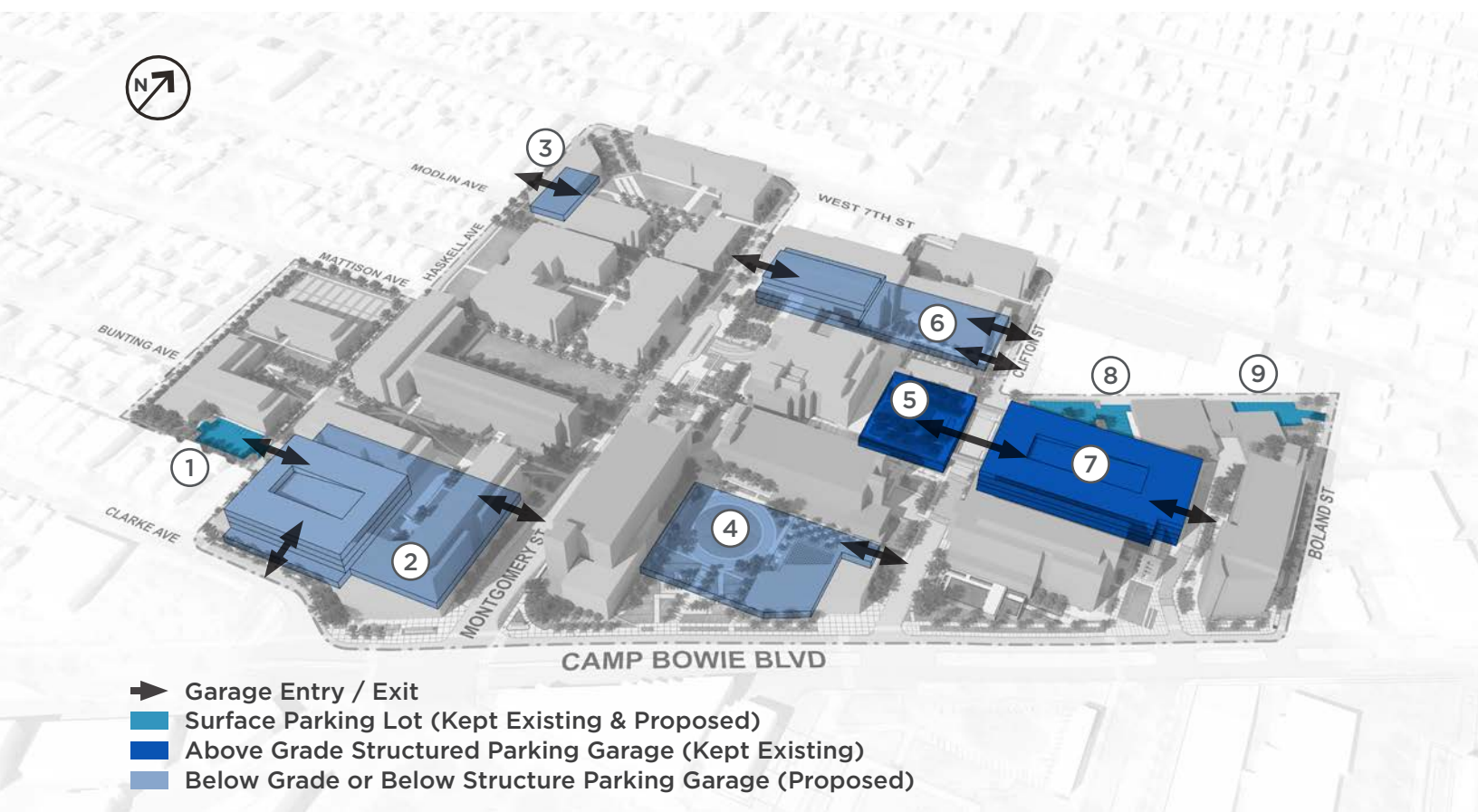

Parking Strategy

Over time, the master plan proposes that the campus gradually infill existing surface lots with new buildings, pedestrian malls, and green spaces. To remove surface lots without decreasing the overall parking count, the master plans proposes three new parking garage locations built into or under buildings. In addition, the plan also supports the Parking Task Force’s recommendation to add an additional floor to the Clifton Garage. Moving the parking model to be predominantly garage-based will help ensure that the campus is compact and connected, allowing more users to parking in close to the core while also increasing the overall campus experience through an increase in green space. This full transition will be gradual, spaced over multiple decades.

The planning of garage locations ensured that large parking structures are oriented towards the edge of campus, load and unload onto

local streets (not on to the major Camp Bowie Boulevard and West 7th Street thoroughfares), have multiple entry and exit points, and are accompanied by thoughtful pedestrian environment layouts to minimize safety conflicts.

Master Plan Parking	Count
Location 1 (New)	24 spaces
Location 2 (New)	1,080 spaces
Location 3 (New)	42 spaces
Location 4 (New)	213 spaces
Location 5 (Existing)	73 spaces
Location 6 (New)	864 spaces
Location 7 (Existing & New)	894 spaces
Location 8 (Existing)	27 spaces
Location 9 (Existing)	20 spaces
Misc. On Street (Existing)	9 spaces
TOTAL	3,246 spaces

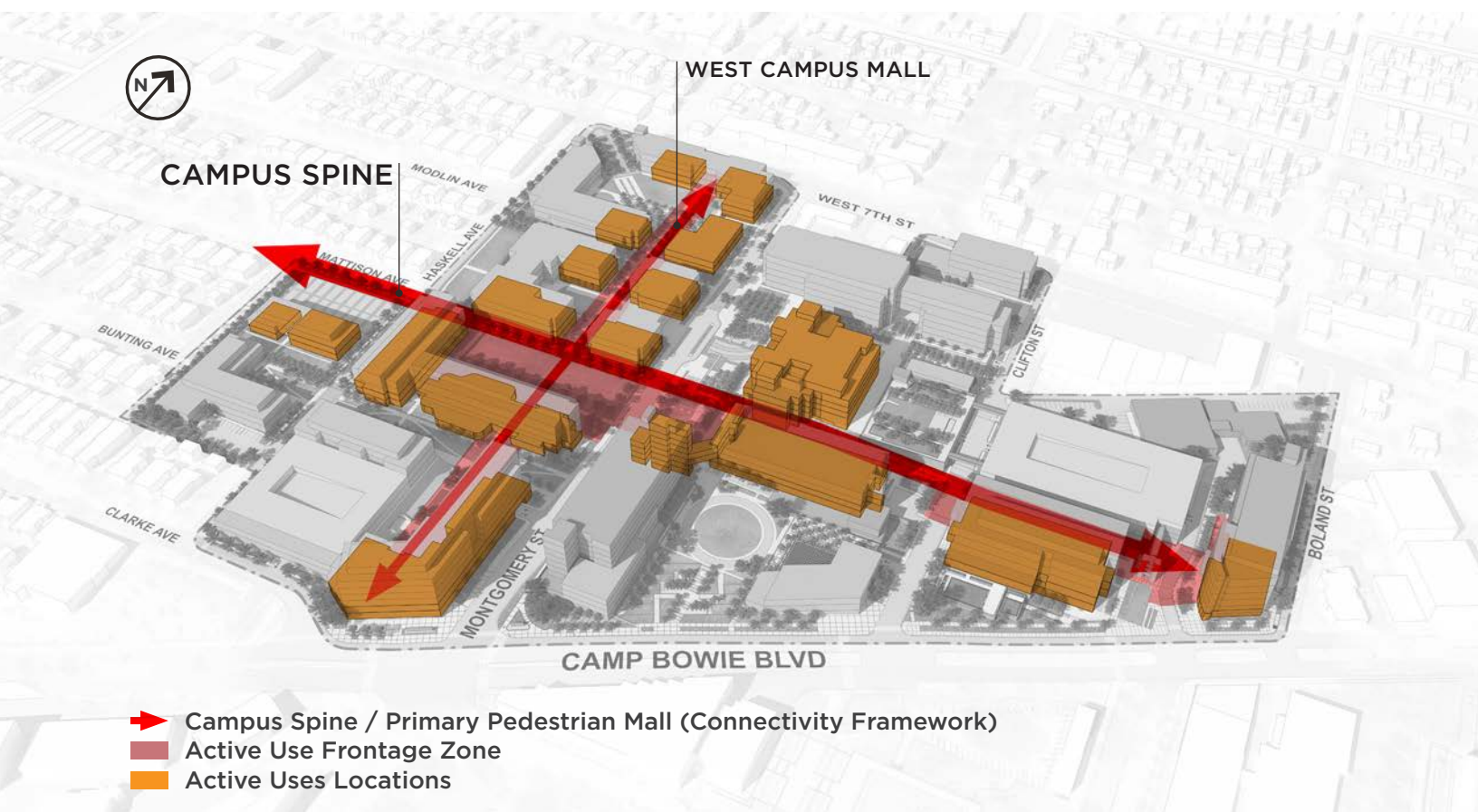

Active Ground Floors

To help strengthen program relationships across campus, a key master plan concept is aligning active programs to the first and second floor of each building located along the Campus Spine and the north-south West Campus Mall. The term “active program” describes any program or function that is used frequently throughout the day and is public, or semi-public, in nature. These spaces should be designed with curtain walls or large window bays, have entries and exits that egress into the circulation corridors, and have visible indoor-outdoor program relationships where possible. Passive uses (such as offices or secured research) should not be located in these areas.

Common examples of appropriate active uses:

- Classrooms / Lecture Halls
- Collaboration Space
- Research Display / Gallery Space
- Event Space
- Cafe / Coffee Shops / Dining
- Retail
- Recreation / Fitness Center

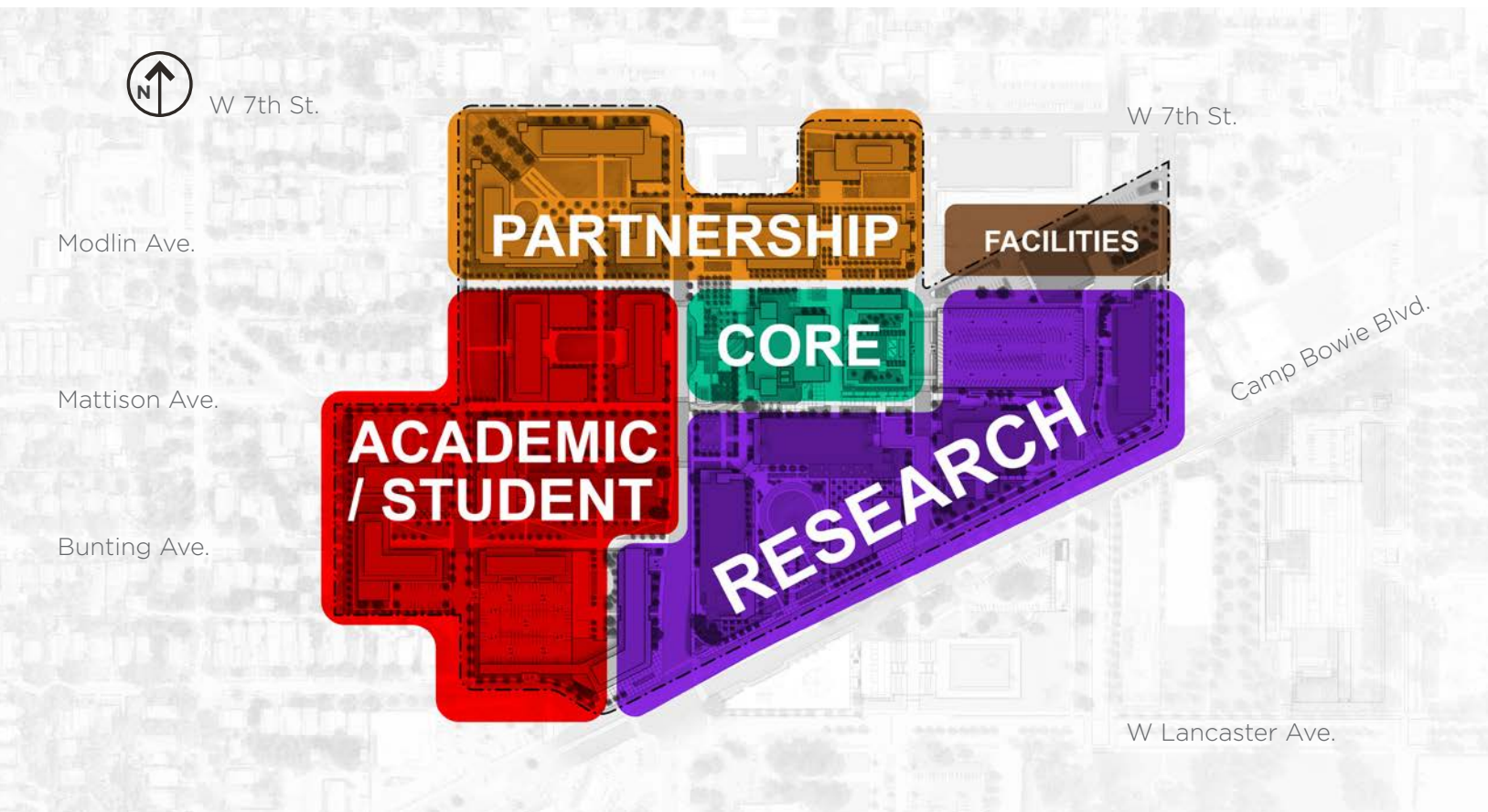

Use Districts

To provide greater flexibility and adaptability to the campus moving forward, the master plan generally does not identify uses for specific buildings. Instead, it identifies five primary use districts (Core, Academic / Student, Research, Partnership, and Facilities). These districts express programmatic relationships at the campus scale and should serve as a general guide when locating new program elements. The master plan advises that new programs be located within the appropriate zone to prevent components becoming isolated or silos (as is the case with the minimal academic space in CBH today). By grouping similar uses and programs together, operational efficiencies such as shared resources, collaboration and knowledge sharing, and increased presence and identity can be realized. Individual uses can be located outside their identified district when adequately supported by logical program adjacencies.

Core: The Gibson D. Lewis Library is the physical and social heart of campus. Programming in this area should include public and shared uses.

Academic / Student: Uses that support student learning, including (but not limited to) classrooms, faculty offices, study spaces, and student lounges.

Research: Uses that support the varied campus research initiatives and programs. Examples include laboratories, display space, and material storage.

Partnership: Spaces that support and facilitate partnerships with the community and industry, including event space, incubator space, etc.

Facilities: Campus management and operational support functions, including office space, warehousing, central receiving, and utility space.

Utilities & Civil Infrastructure

Stormwater Drainage Impacts

Invariably, the significant development proposed by the master plan will greatly effect how stormwater moves across and affects the campus. As identified in the analysis section of this report, the campus has notable stormwater issues today, including significant flooding, ponding, and erosion of landscape and built elements. The master plan addresses stormwater issues in a number of ways, including the reduction of surface parking lots and introduction of different natural stormwater systems. Expanding these controls will create more consistency across the campus and create shared efficiencies to reduce existing and future stormwater burdens. The ratio of pervious to impervious surfaces will fluctuate as existing surface lots are transformed into new buildings and green spaces. At full master plan build-out (1.4 million additional square feet), there will be a 23% decrease in impervious paved surfaces and a net increase of 10% in pervious surfaces. These two changes will have a substantial positive impact on how stormwater interacts with the site by allowing more water to infiltrate into the ground.

These impacts can be even further amplified through use of additional stormwater management techniques, detailed in the Design Guidelines Chapter. The master plan recommends that each new project utilize one or more of these techniques. Each new project should also assess its storm water impact to ensure it does not negatively affect drainage for the surrounding areas.

Water

Maximum daily water demand for the full campus master plan build-out (1.4 million additional square feet) was calculated to be 3,150 gallons per minute. This corresponds to a 192% increase over the existing demand. Each future building will have to create individual connections to the existing water infrastructure, and in some cases, the campus will have to work with the City of Fort Worth to increase the public infrastructure capacity to handle the greater loads.

For additional details, please refer to the Water Study referenced in the Appendix.

Waste Water

At full build out (1.4 million additional square feet), the campus master plan is expected to increase wastewater system demand by 191%. New development will have to provide individual connections to existing infrastructure. However, system analysis suggests that the existing infrastructure is capable of supporting the increased wastewater demand everywhere except for the shared infrastructure supporting the LIB, RES, and proposed buildings S and V. Simultaneous with the development of proposed buildings S or V, the campus will need to work with the City of Fort Worth to assess and upgrade the wastewater infrastructure beneath Clifton Street.

For additional details, please refer to the Wastewater Study referenced in the Appendix.

Fire Coverage & Fire Lanes

Per City of Fort Worth regulation, all new development must be completely covered by a 400 linear foot radius from a hydrants. The existing network of fire hydrants provides full coverage of campus today and is not expected to be altered or affected by implementation of the campus master plan. For each new project undertaken, additional analysis should be conducted to ensure that the proposed building form does not impede this.

One major impact of the campus master plan is the closure of Bunting, Modlin, and Mattison Avenues. These private right-of-ways currently serve as designated fire lanes. As these roads are closed and transformation into walkways to better support the on-campus pedestrian experience and make space for new development, it will be important that the new walkways also function as fire lanes. Current City of Fort Worth standards require fire lanes to be 20' minimum. For additional information on the development of these walkways, refer to the campus mall section of the Design Guidelines Chapter.

MEP Infrastructure

To increase operation efficiency, the master plan recommends the continued creation of one or more campus loops. There is a clear direction in place for continued development of east campus systems. However, the master plan presents three options for west campus system development to provide flexibility as the campus grows.

Chilling Tower Relocation

The two chilling towers located north of EAD are nearing the end of their life-cycle. The towers currently occupy prime real estate in the core of campus and are not visually appealing features. Because these two towers serve the chillers in EAD and RES, they must remain in close proximity, yet neither roof has the ability to hold these towers.

It was determined that the best option for replacing these chilling towers is to locate them on the south end of the library roof (built in conjunction with vertical expansion of the library). In addition to their relocation, it was also determined that their supported capacity can drop from 2,800 tons to 1,740 tons if two of the existing 500-ton chillers in EAD at the end of the life are removed and replaced with available space in IREB. Through the east campus loop, this capacity would still be shared with EAD. The final recommendation to replace the towers on the Library roof includes four 500-ton chillers covering an approximate footprint of 40' by 24'.

East Campus Development

Already started, the master plan proposes the completion of an east campus loop to connect all MEP infrastructure east of Montgomery Street. This investment will help reduce maintenance costs, eliminate the need to replace some aging infrastructure, and support some new development. Along with the underground loop and connections into currently non-connected buildings, there will also be some changes needed to pump capacities and controls to ensure that all buildings are supplying the shared loop at the same pressure. The campus should be proactive in building the missing connections in advance of future development.

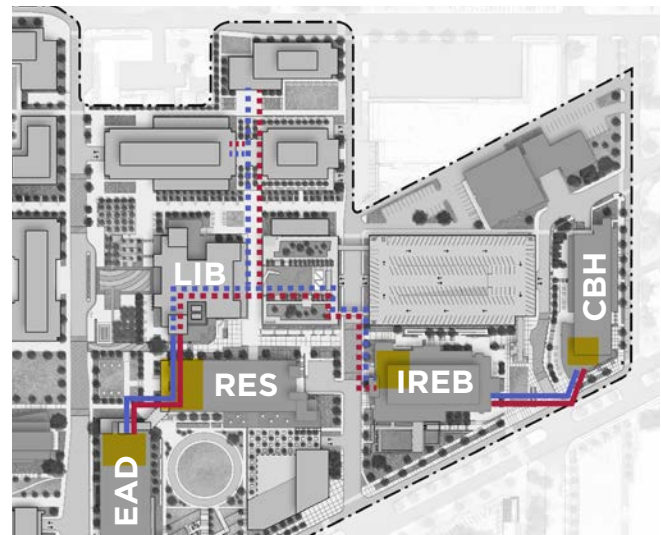

Proposed east campus loop

- Existing / Proposed Chilled Water Lines
- Existing / Proposed Hot Water Lines
- Distributed Infrastructure Locations

Electrical and plumbing infrastructure appear to be adequate for expansion. The campus should keep up with any required general maintenance.

West Campus Development

Today, the MEP systems on the west campus are handled at the building level. As this side of campus develops, new infrastructure will be necessary. Three options were explored for expanding and linking MEP infrastructure on the west campus:

1. Creation of a central utility plant in the basement of Building I
2. Ground-level central utility plant located on Parking Lot 7 (standalone or in building K or L)
3. No West Campus Plant initially, connect under Montgomery Street to East Campus capacity (capacity for 2-3 new buildings)

Each option is a viable solution. However, the final recommendation is a combination of Option 1 or 2 paired with Option 3. Additional details and analysis can be found in the Appendix.



IMPLEMENTATION

PROJECT ROAD MAP

5

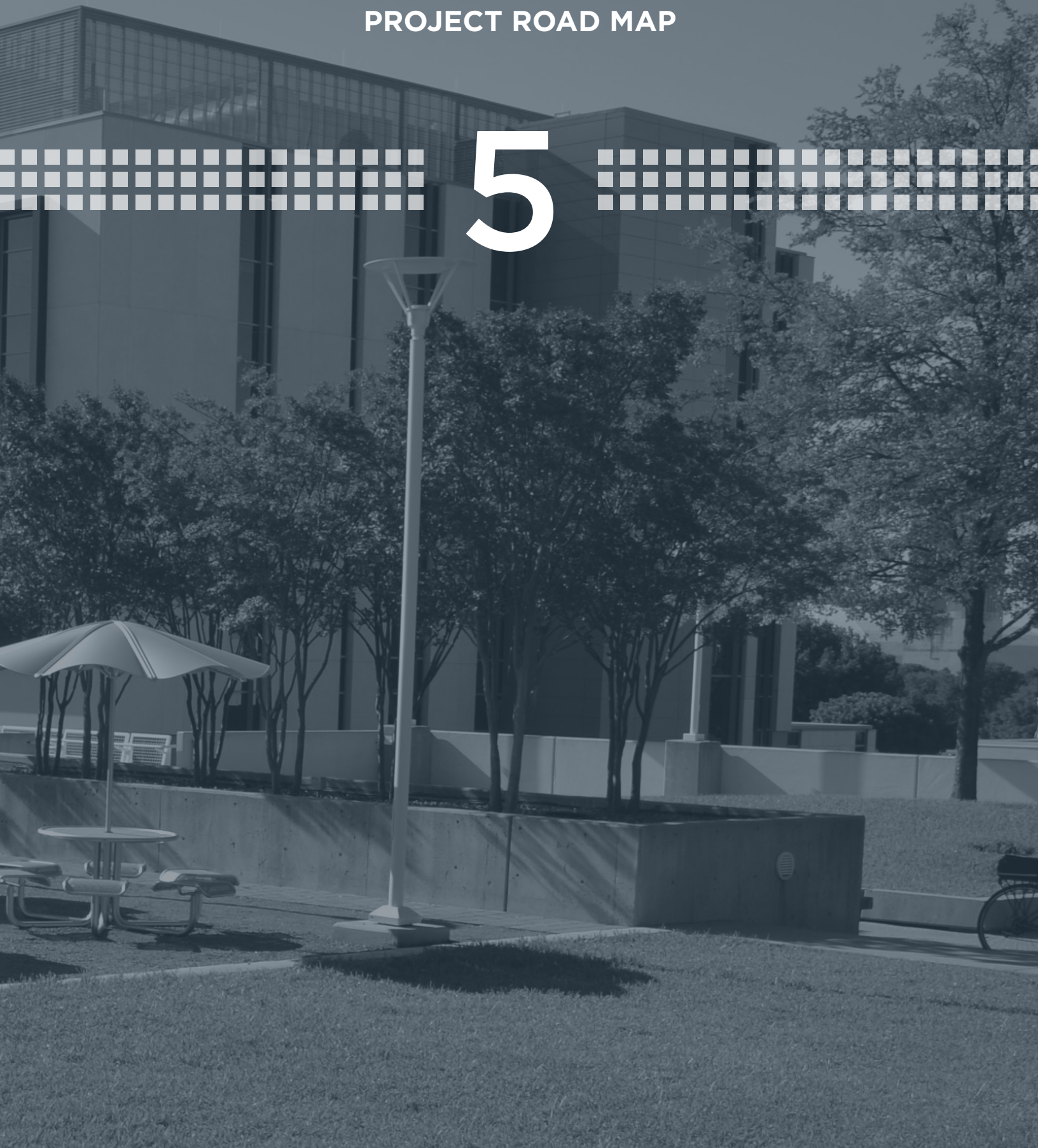

SUMMARY



Overview

While illustrated at full build-out, the 2018 Campus Master Plan supports adaptable implementation. This adaptability allows the institutions to respond to changing needs or new opportunities that may arise over the duration of the plan. Implementation is organized in near-, mid-, and long-term phases.

Shown in the greatest detail, the near-term implementation seeks to support the immediate needs and expected growth of the campus over the coming decade. This includes re-alignment of existing space to higher utilization, expanded capacity for academic and research space, increased collaboration space, and enhancements to the overall campus environment.

The mid-term implementation phase identifies a natural progression for campus growth based on the framework, while not specifying specific uses to allow UNTHSC to evaluate needs based on market demands at that time.

The long-term implementation phase illustrates the full campus build-out and proposed capacity within the existing 33-acres of the campus. While not necessary to support the campus needs, potential acquisitions adjacent to the campus were studied to provide fully informed options and understand their impact if an acquisition opportunity presents itself in the future.

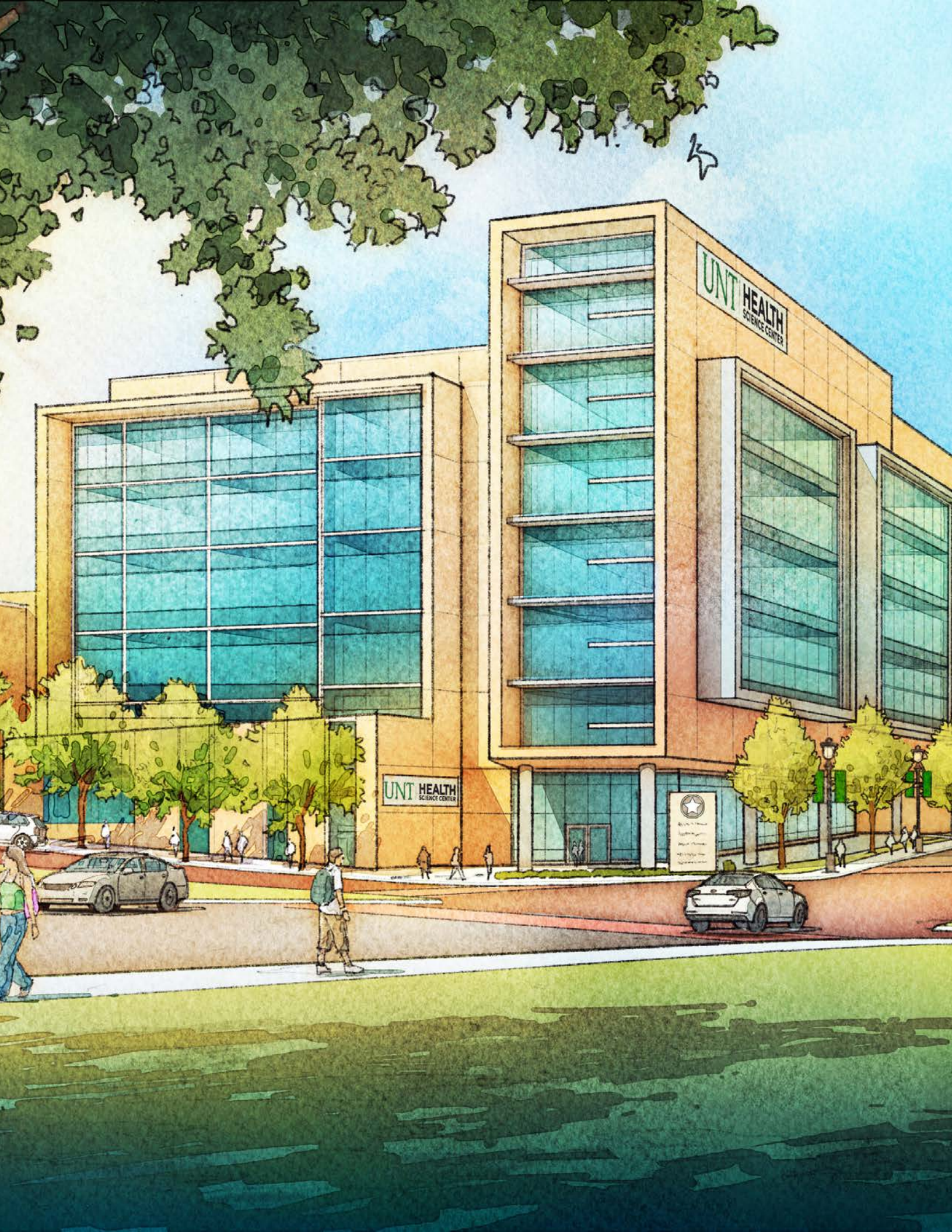

UNT HEALTH
SCIENCE CENTER

UNT HEALTH
SCIENCE CENTER



Space Needs Projections

The following space needs projections align with the 10-year time frame of the near-term implementation. The forecasted needs are influenced by multiple factors, such as policy directions, the distributed clinical model mentioned below, targeted program growth, development of new programs, emphasis on research, evolving pedagogy, inclusion of adaptable format, and numerous additional factors. These forecasts ultimately support the strategic direction of UNTHSC and allow for informed capital planning.

Methodology

Given the unique characteristic of health science centers a hybrid model of forecasting was utilized to identify the recommended space needs for UNTHSC. A select list of methods utilized include:

- Historical Trends
- Enrollment (Academic Model)
- Research Expenditure / Funding
- Population Growth
- Clinical Counts
- Planned Growth

By considering the analysis and results of the various methods, the planning team was able to identify recommendations that aligned with discussions held with key campus leadership aspirations.

Academic

UNTHSC has seen significant student enrollment growth since its inception and expects to accommodate continued growth through new programs and expansion of existing programs. This growth necessitates corresponding growth in academic space. Of the various methodologies used to analyze growth, the average of the most relevant methods indicates a recommended 5.0% annual academic space growth equated to 145,000 GSF over the 10-year time frame.

Research

With research expenditure growth, targeted at greater than 5% annually, being a central focus for UNTHSC, the need for research space is correspondingly the greatest. The recommended 5.8% annual research space growth equates to 200,000 GSF over the 10-year time frame with some of this amount potentially accommodate by utilizing re-aligned space.

Clinical

UNTHSC is currently shifting to a distributed clinical delivery model where care provision takes place off campus (accommodated by partnerships with industry). Due to this evolution in clinical practice, no additional clinical space is forecasted. In fact, this model may result in a decrease of clinical space on campus. Some clinical space will need to be maintained to support patient care, academic, and research needs.

Other Space Types & Further Analysis

Minimal growth in space is expected in other space type categories and such growth primarily occurs to support academic and research needs, along with supporting an enhanced campus experience. The total recommended space needs for all space types is 477,500 GSF.

Refer to the Appendix for further analysis of space projections and an overview of data sources.

Space Type	Proposed Additional GSF in Near Term (10 years)
Academic	145,000
Research	200,000
Clinical	0
Administration	37,500
Library	30,000
Facilities	15,000
Leased	0
New / Other	50,000
TOTAL	477,500

Space Needs Projections GROSS SQUARE FEET - (GSF)

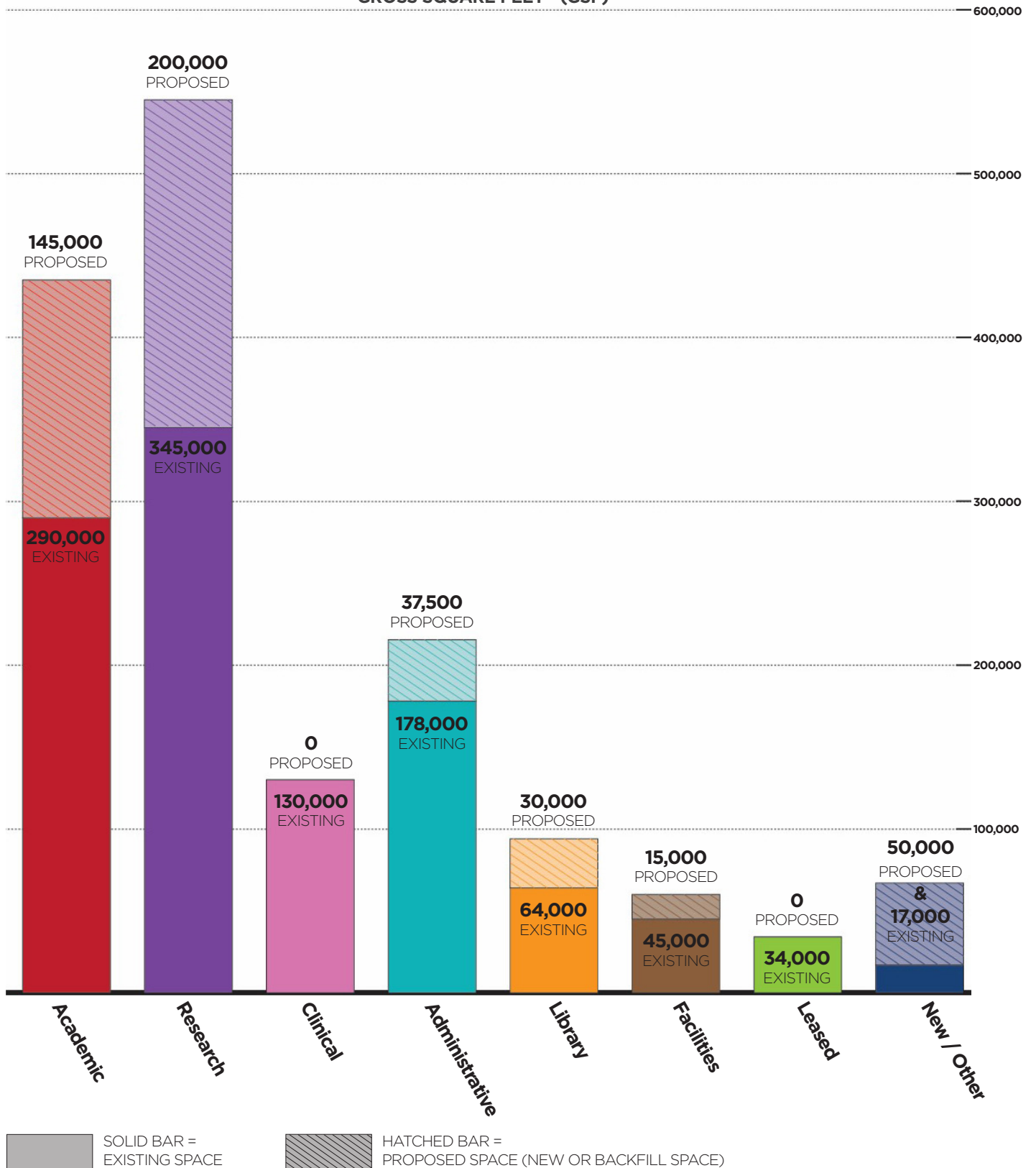

NEAR TERM INITIATIVES



Near-Term Vision

Near-term growth focuses on continuing the recent momentum created by the construction of CBH and IREB to enhance the campus’ presence along Camp Bowie Boulevard through the replacement of Lots 6 and 19 with new character buildings. The Near-term vision also provides significant opportunity to better align existing programs (Planning Principle #2) as well as create new indoor and outdoor hubs (Principle #3).

Parking counts increase significantly during this phase due to the creation of two new parking structures and expansion of the existing Clifton Parking Garage. This growth is required as a prerequisite to mid-term development which will see a net decrease in parking count.

Buildings	GSF
Existing	1,103,000
Near-term Vision (net)	437,000
TOTAL	1,540,000

Parking	Spaces
Existing	1,846
Near-term Vision (net)	1,121
TOTAL	3,338

MID TERM INITIATIVES



Mid-Term Vision

The mid-term vision for the UNTHSC campus focuses on continued build out of the central campus through redevelopment of the Modlin Garage block (academic or partnership uses), new EAD and RES entrances to the Library Courtyard (expanding out to create collaboration space) and replaced bridge, expansion of EAD’s south entry, and development on Lot 7 (campus support).

Parking counts decline as surface Lots 7 and 8 are developed upon. This development was predicated by prerequisite expansion in the near-term, which enables and supports mid-term campus development. The overall parking does not drop below the recommended ratio.

Buildings	GSF
Existing	1,103,000
Near-term Vision (net)	437,000
Mid-term Vision (net)	380,000
TOTAL	1,920,000

Parking	Spaces
Existing	1,846
Near-term Vision (net)	1,121
Mid-term Vision (net)	-625
TOTAL	2,824

LONG TERM INITIATIVES



Long-Term Vision

Long-term development focuses on the West 7th Street corridor, replacing existing low density and aging structures, and extension of the campus character north. Uses in this corridor have been preliminary identified as ideal for industry and community partnership uses and may be ideal for some ground-floor commercial integration.

Despite removing multiple surface lots, parking increases in line with the recommended ratio through the development of a new garage beneath the Health Pavilion site. Garage entry is at grade along Montgomery Street before descending down multiple levels with the grade change to also have entry at grade along Clifton.

Buildings	GSF
Existing	1,103,000
Near-term Vision (net)	437,000
Mid-term Vision (net)	380,000
Long-term Vision (net)	400,000
TOTAL	2,320,000

Parking	Spaces
Existing	1,846
Near-term Vision (net)	1,121
Mid-term Vision (net)	-625
Long-term Vision (net)	863
TOTAL	3,246

FUTURE OPPORTUNITIES



Acquisition Boundary

The 2018 Campus Master Plan illustrates capacity within the existing campus boundary to meet the Health Science Center's needs for decades to come.

The acquisition boundary is an effective long-range planning tool for the university and community's decision-making if or when particular parcels become available. Due to the fact that these parcels are not necessary for campus growth within the planning horizon detailed by this master plan, this document does not recommend acquisition of these parcels. Instead, as market opportunities arise to acquire parcels within this boundary, the campus should make individual determinations of the merit of acquisition at that point in time.

While these parcels are not required to meet campus growth needs for the foreseeable future, each area included does offer some advantage to the campus. Chief opportunities include further improvement to the campus environment and pedestrian safety, increased efficiency of future building footprints where the campus boundary currently creates difficult sites, and increasing campus presence and identity along Camp Bowie Boulevard and West 7th Street.

 Campus Boundary
 Acquisition Boundary

UNIVERSITY OF NORTH TEXAS
HEALTH
SCIENCE CENTER

CARL E. EVERETT
EDUCATION & ADMINISTRATION



CAMPUS DEVELOPMENT GUIDELINES

DESIGN ELEMENTS & LANDSCAPE MATERIALS

6

CAROL E. BERRYETT
Administration & Management

CAMPUS DEVELOPMENT GUIDELINES

Overview

The Campus Development Guidelines provide the essential high-level guidance needed to realize the vision set forth in the 2018 Campus Master Plan. These guidelines promote achieving a campus setting that is functional, maintainable, memorable, and distinct. A campus where all elements relate to establish a cohesive whole. Encouraging visual unity and functional consistency in the overall physical environment, this set of guidelines reinforces the unique character that is part of the UNTHSC identity.

Organization of the Guidelines

The Campus Development Guidelines contains three distinct sets of guidelines related to different campus systems and scales:

- 1. Planning Design Guidelines:** defines campus-wide elements necessary to implement a consistent and cohesive physical environment.
- 2. Architecture Design Guidelines:** provides the design vocabulary for the construction of new buildings and renovation of existing buildings.
- 3. Landscape Design Guidelines:** directs the application of landscaping elements and site materials to ensure a consistent open space character exists across campus.

The diagram at the top of the next column conceptually illustrates the interdependence of these three guideline sets. Applying the guidelines as a unified whole to each project will yield inclusive and comprehensive results.

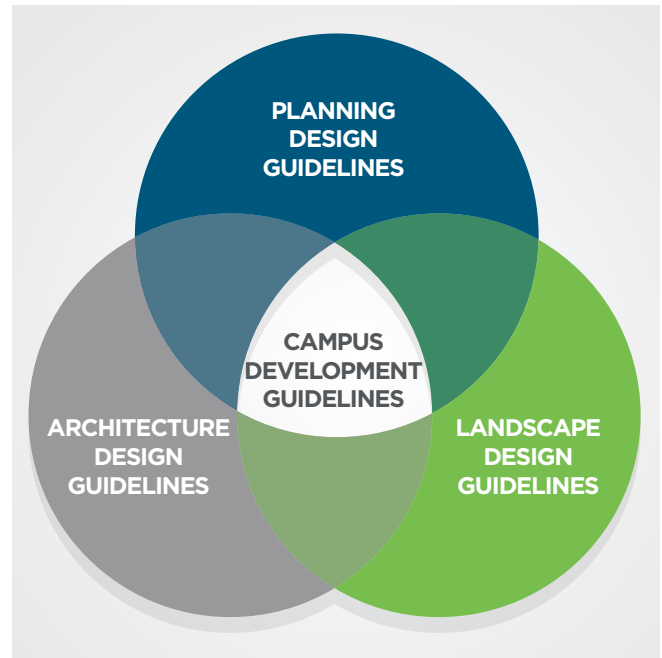

Project Compliance

The master plan and guidelines provide a foundation for the internal review of individual projects to ensure that each project advances the institution's commitment to the continued improvement of the campus' physical environment. Further details on the review and approval process for projects under the scope of the 2018 Campus Master Plan can found in this chapter starting in the Planning & Design Review Process section.

PLANNING DESIGN GUIDELINES

Overview

The Planning Design Guidelines define campus-wide elements necessary to implement a consistent and cohesive physical environment. These considerations span both exterior and interior environments to achieve unity across the campus setting. These guidelines align future buildings with the Framework Open Space and Connectivity Networks. They also extend to the campus' edge, shaping the relationship that exists between the institution's boundary and adjacent neighborhood.

The Planning Design Guidelines provide further definition of future building sites, detailing potential capacities that indicate approximate footprints and a recommended number of floors. These capacity profiles balance optimizing land use and program spaces with the Framework Networks while also responding to the unique conditions presented by the variety of edge conditions.

The Planning Design Guidelines identify key Character Components that, due to their prominence, serve an essential role in expressing the campus character and identity. Their exterior configuration, programming that includes active elements and articulation of architectural attributes, all play a crucial role in distinguishing these prominent locations from the remaining campus context.

Exterior Planning Elements

The Exterior Planning Elements direct the configuration of future projects at a scale that considers the entire campus and its immediate context. The orthogonal arrangement of buildings is the predominant organizational element

evident in the layout of the existing campus. The 2018 Campus Master Plan maintains this orthogonal alignment.

There are five categories of elements within the Exterior Planning Elements:

- Building Orientation and Capacity Profiles
- Edge Transitions
- Framework Alignment and Setbacks
- Site Entrances
- Building Typology

Interior Planning Elements

Informing the selection, inclusion, and location of specific program components on campus, where applicable, Interior Planning Elements can positively impact the success of individual building projects while simultaneously improving the overall campus experience. This is clearly evident in the successful relationship between the MET Lawn and ground-level interior spaces of the MET Building.

There are six categories of elements within the Interior Planning Elements:

- Exhibit Active Spaces
- Distribute Collaborative Spaces
- Connect Interiors Visually
- Create Permeable Ground Levels
- Display Learning and Discovery
- Share Knowledge

The Exterior and Interior Planning closely interrelate and influence one another. Application of the Planning Design Guidelines expresses the Framework networks and spans the varying physical outdoor and indoor environments found across campus.

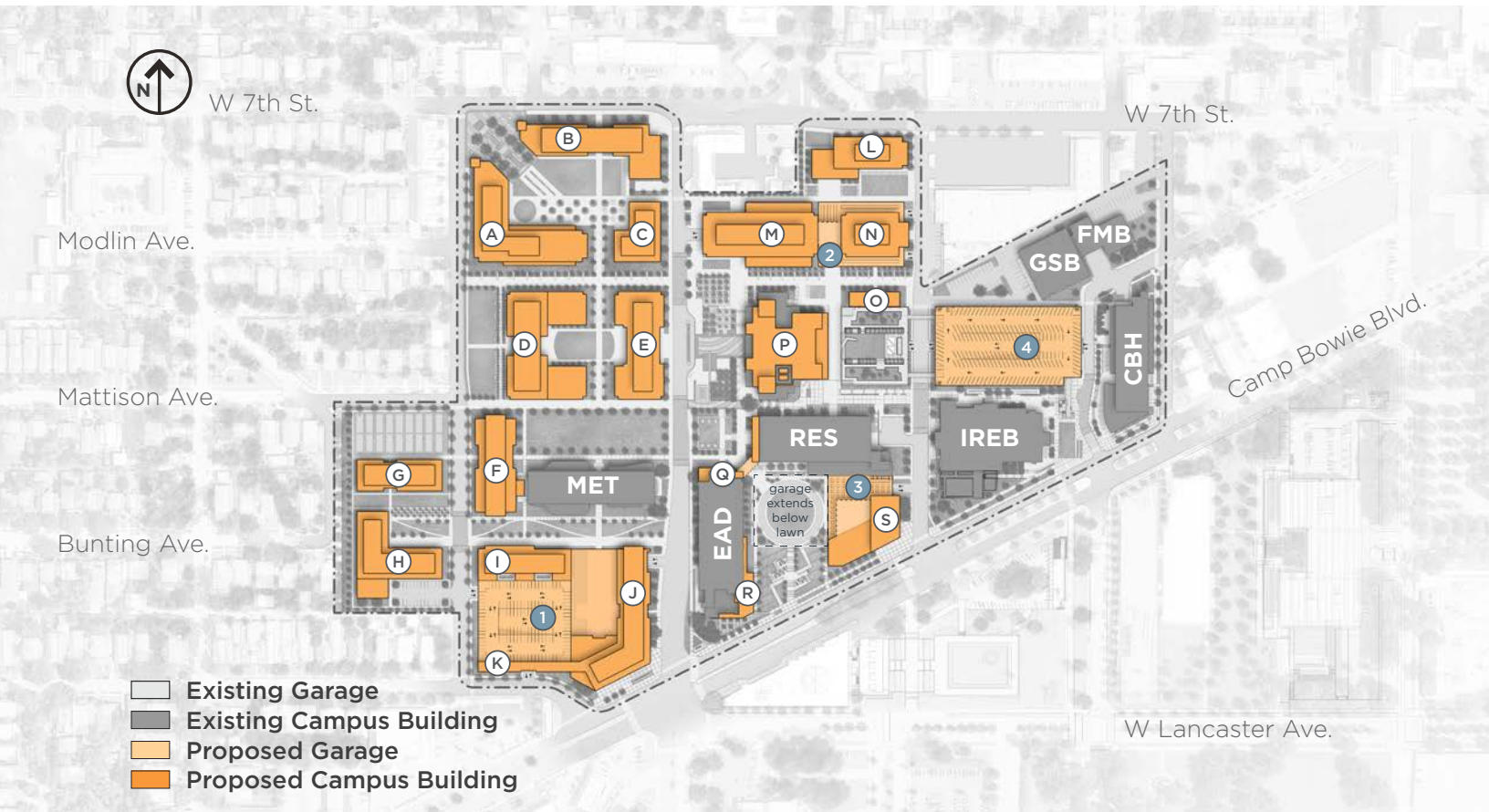

Building Position and Projected Capacities

The master plan defines a conceptual layout and orientation for future capital projects that result in approximate metrics that will help inform more detailed planning as the need for these future projects arise.

Building Orientation

The orientation of existing buildings on campus predominately mimics the orthogonal arrangement of the city street grid. There are few exceptions to this. Along Camp Bowie Boulevard, CBH responds to the non-orthogonal angle the street and sets a precedent for aligning the building edge to Camp Bowie Boulevard. Likewise, GSB and FMB are driven by boundary constraints. Whenever possible, new buildings should orient to the existing

orthogonal grid. However, it is acceptable to break orthogonal orientation along Camp Bowie Boulevard or when dealing with unique site constraints presented by campus boundaries.

Capacity Profiles

The table on the adjacent page illustrates recommended building capacity profiles for:

- Approximate Area (GSF)
- Approximate Footprint (Feet)
- Total Floors
- Assumed Levels of Parking

These capacities serve to inform ongoing capital planning and should act as the starting point for detail planning of future projects.

General Recommendations				
Proposed Building	Approximate Area (GSF)	Approximate Footprint (Feet)	Total Floors*	Assumed Levels of Parking
A	74,250 GSF	230' x 75' + 180' x 75'	3	1 (at grade)
B	90,000 GSF	335' x 75' + 50' x 75'	4	0
C	25,000 GSF	135' x 100'	2	0
D	138,000 GSF	180' x 75' + 180' x 75'	4	0
E	96,000 GSF	245' x 90'	4	0
F	95,000 GSF	225' x 90'	5	0
G	40,500 GSF	195' x 75'	3	0
H	68,250 GSF	200' x 75' + 120' x 75'	3	0
I	72,000 GSF	220' x 75'	5	1 (below grade)
J	180,000 GSF	320' x 75'	7	1 (at grade)
K	18,500 GSF	225' x 25'	3	1 (below grade)
L	66,250 GSF	220' x 75'	5	0
M	191,000 GSF	265' x 100'	6	1 (at grade) 3 (below grade)
N	72,500 GSF	150' x 100'	6	1 (at grade) 1 (below grade)
O	7,600 GSF	120' x 35'	2	0
P	64,500 GSF	160' x 155'	5	0
Q	23,850 GSF	105' x 20' + 105' x 20'	4	0
R	24,800 GSF	200' x 50'	4	0
S	45,000 GSF	175' x 65' + 45' x 65'	3	1 (partial at grade)
Garage 1	260,000 GSF	225' x 180' + 280' x 380'	-	1 (at grade) 4 (below grade)
Garage 2	175,000 GSF	460' x 180'	-	4 total (site grade varies)
Garage 3	60,000 GSF	320' x 180'	-	1 total (site grade varies)
Garage 4	60,000 GSF	335' x 180'	-	1 additional (added to existing)

* Note: Total floors excludes basements and penthouses. Inclusion of these features, in addition to the notated total floors, is permissible pending UNT System and UNTHSC approval.

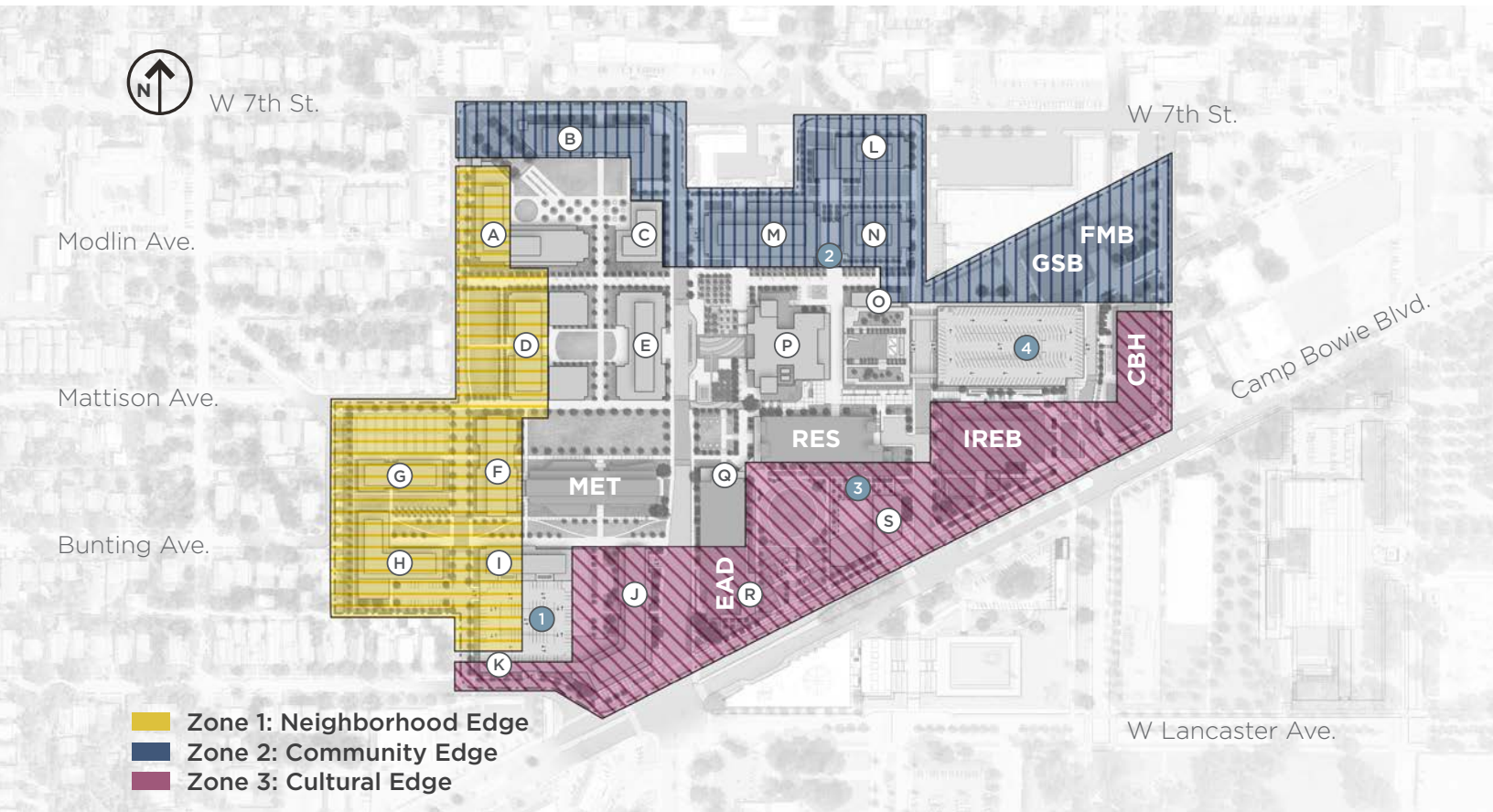

Edge Transition Zones

Campus Transition Zone 1: Neighborhood Edge

Buildings in the Neighborhood Edge transition zone must be designed to create a respectful transition from the campus to the North Hi Mount Neighborhood. To accomplish this, buildings have been planned between two stories and four stories depending on proximity to single family houses. Top floors should step back to further reduce the perceptual height of each building.

Campus Transition Zone 2: Community Edge

Future development within the Community Edge transition zone should be designed as a response to the conditions and architectural character that already exist along West 7th Street. Buildings

should be mid-density (3-5 stories), mixed-use, and have ground levels with active uses that directly front the sidewalk along West 7th Street.

Campus Transition Zone 3: Cultural Edge

The Cultural Edge transition zone contains the most visible and prominent sites on campus. New buildings and landscape elements within the zone should be designed explicitly to enhance the institution’s presence along Camp Bowie Boulevard. Key characteristics should include open spaces oriented to the adjacent civic uses, high-density buildings (4-6+ stories), exceptional architectural character and design, and clear branding. Additionally, all new buildings along Camp Bowie Boulevard should meet the Character Component designation.

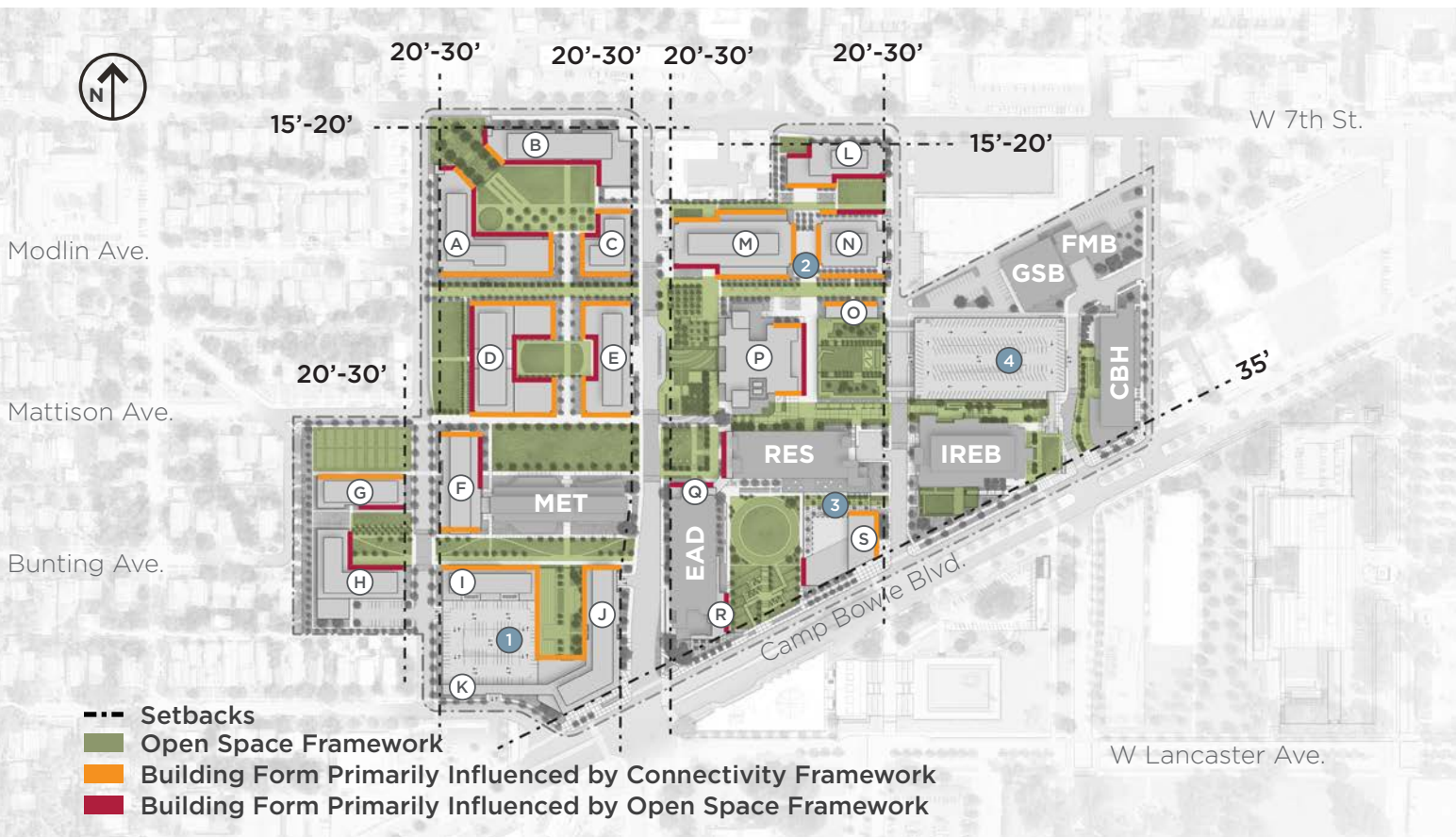

Framework Alignment & Setbacks

Framework & Building Form Alignment

Detailed in the Framework Chapter, the Open Space and Connectivity Frameworks create an organizational pattern for future growth that promotes connectivity, creates ease of access, defines and activates exterior space, and creates a positive campus experience. The diagram above identifies building faces where forms should respond to the Framework to ensure a cohesive on-campus experience. Faces primarily influenced by the Open Space Framework should use building form to define key open space elements, contain main building entrances, have a greater amount of glazing, and create strong connections to the outdoors. Faces influenced by the Connectivity Framework should use building form to reinforce exterior pedestrian movement.

Setbacks

To ensure a consistent physical identity along campus edges and interior public roadways, future development should align to the designated setbacks. The following setbacks have been determined appropriate based on City of Fort Worth requirements or alignment to existing context (both on and off campus):

- Camp Bowie Boulevard: 35' setback along the entire length (aligns with CBH).
- West 7th Street: variable 15-20' setback filled with sidewalk and plantings to create a strong urban edge.
- All other roadways: 20-30' variable setback. When present, align setback to adjacent building edges.

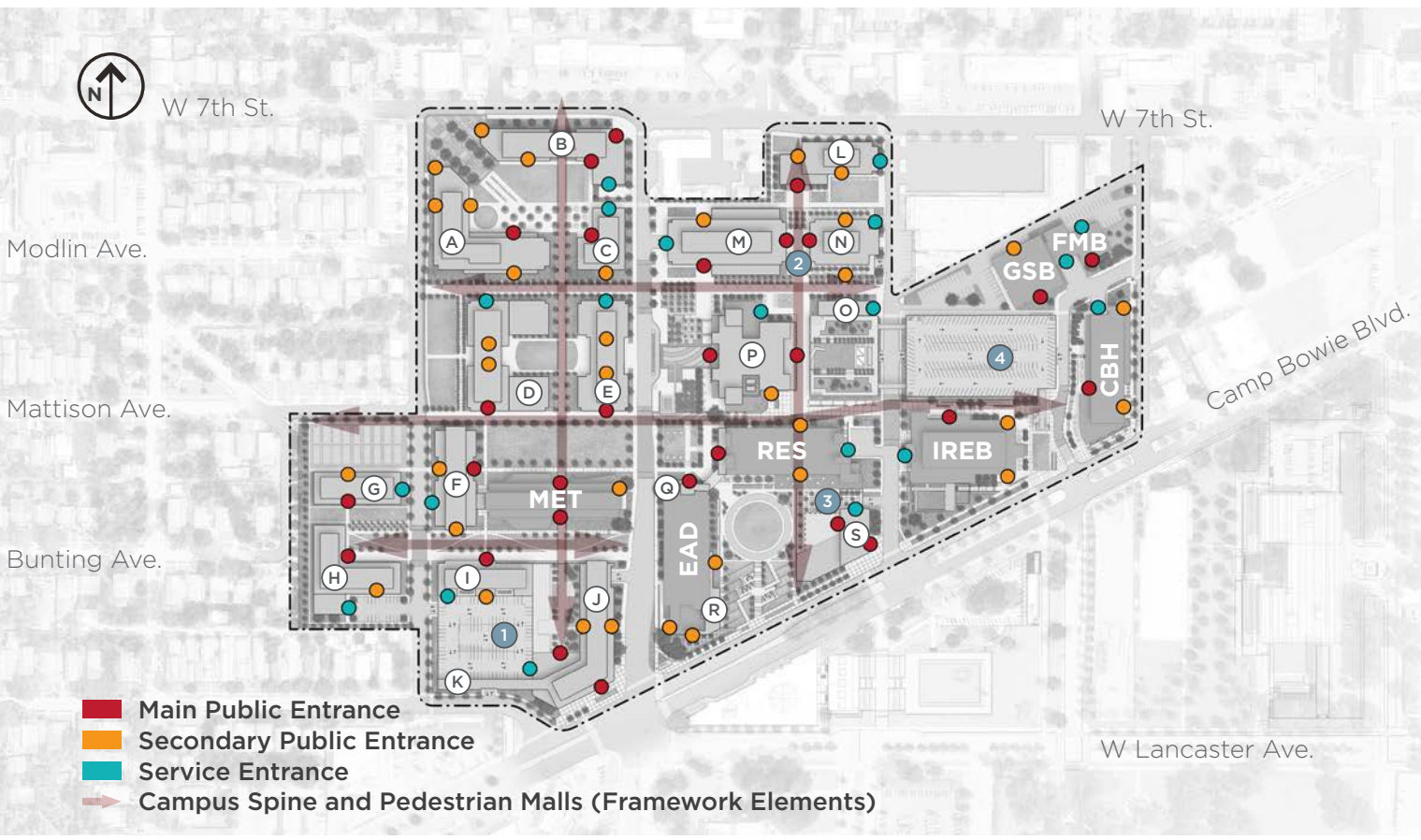

Site Entrances

The diagram above identifies a hierarchy of entrance types for each building and places them in the location that maximizes alignment with the Framework.

Main Public Entrances

Main public entrances are the intended primary entry point into every building and should align to the Campus Spine, pedestrian malls, major green spaces, or gateways. On the exterior, special elements should be added to the building face to help campus users identify the entry from a distance. Additionally, pavement material may change near the door to guide people the entrance. Main public entrances interiors should correspond to the primary building lobby, circulation core, interior wayfinding, and any active uses (dining options, collaboration spaces, display spaces, etc.).

Secondary Public Entrances

Secondary public entrances provide alternate entrances to buildings. Though typically containing less dedicated public space than the main entrances, secondary entrances should at minimum contain a small foyer that includes building-specific information and wayfinding.

Service Entrances

Service access and entries are located in positions that will minimize impact on the campus experience. Service entrances should be coordinated, aligned, or even shared with adjacent buildings when possible to minimize the disruption caused across campus. Where possible, screening elements (such as walls, screens, and landscape) should be integrated into the building design to mask service entries and elements.

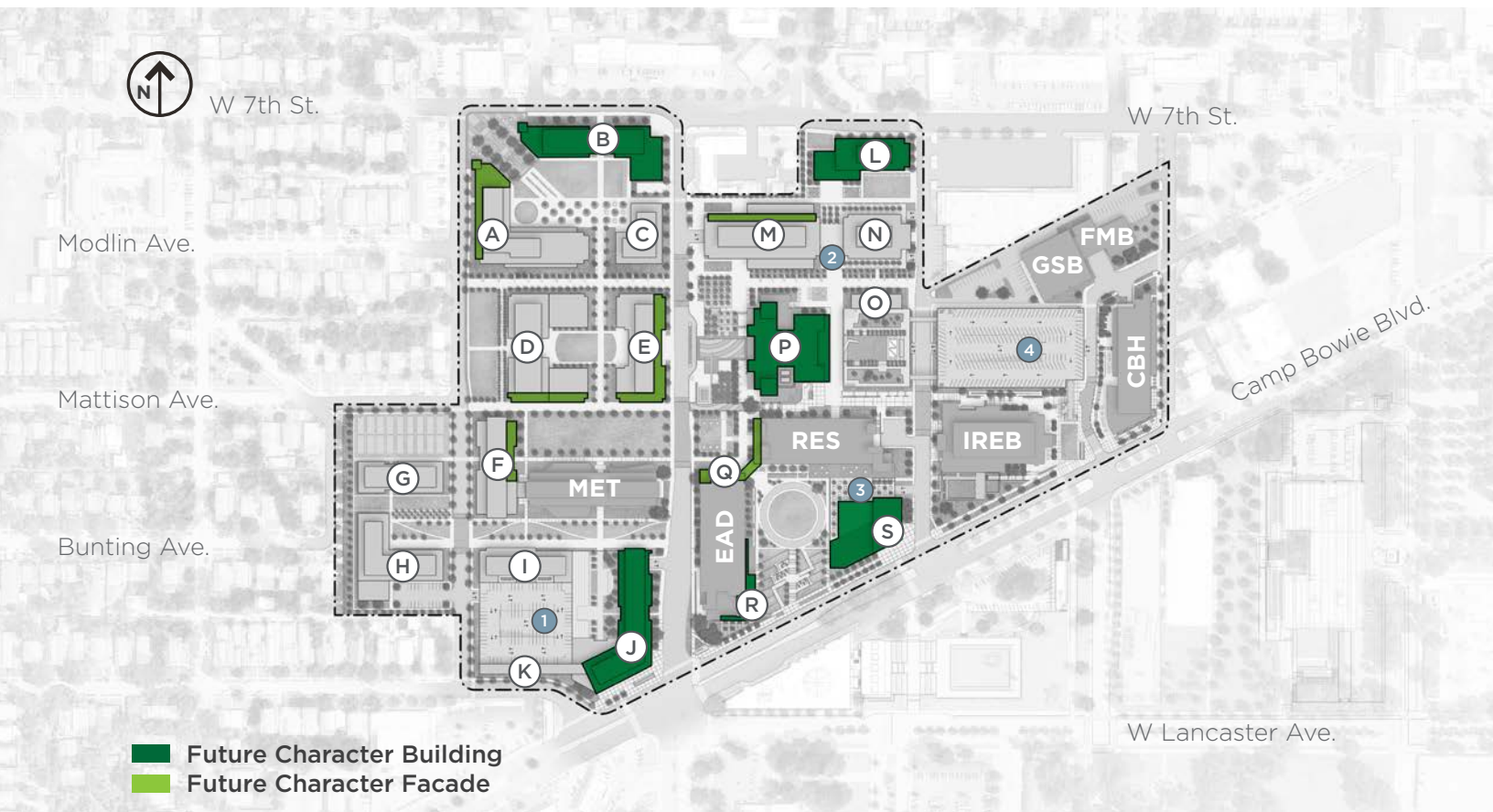

Character Components

The diagram above identifies focal buildings and facades on campus that require thoughtful attention from architects, facilities planning and construction staff, and operations staff to ensure that each site maximizes its potential contribution to the overall on-campus experience and institutional identity.

Character Buildings

Character Buildings occupy highly visible locations along the edges of campus, or in the heart of campus in the case of the library, that serve to establish and portray the identity of UNTHSC. These buildings define campus gateways, key open spaces and the overall quality and experience of campus. Character Buildings require careful consideration of program and context throughout the design and review process.

Character Facades

Character Facades are sections of building facades on Context Buildings that, due to their location and visibility, serve an important role in defining and supporting the institutional identity and overall campus experience. These Character Facades typically face prominent open spaces or are outward facing towards the community along the campus edges.

Context Buildings

Context Buildings make up the remainder of proposed buildings. While not located on prominent sites, Context Buildings still play a major role in shaping the on-campus experience and campus identity. As such, Context Buildings should meet all guidelines.

Interior Planning Elements

As an urban campus, UNTHSC buildings endeavor to support a dynamic pedestrian ground plane that links the interior and exterior activities that occur across the campus. The Interior Planning Elements outlined on the following pages express the importance of the UNTHSC enterprise by showcasing these important activities. Where appropriate, future building projects should actively work to include these elements to ensure a high-quality and vibrant campus environment that supports the desired on-campus experience for all users.

Exhibit Active Spaces:

Locate highly utilized, shared public spaces within building ground floors and adjacent to primary Framework Connectivity and Opens Space Network elements. Examples of active spaces may include lobbies and lounges, dining spaces, bookstore or campus-related retail spaces, recreation spaces, exhibit and gallery spaces, group studies spaces, and gathering areas.

Distribute Collaborative Spaces:

Collaboration is core to the UNTHSC value set. Collaborative spaces should be intermingled with or near active spaces, and distributed into buildings across campus to strengthen the Framework Hub Network. A variety of collaborative space types should be provided, including formal and informal, large and small, and hi-tech and low-tech, to meet the diverse needs and engagement styles of the campus community.

Connect Interiors Visually:

Buildings should be designed to create strong indoor-outdoor connections by showcasing the active public and collaborative spaces contained within. These uses should be apparent and visible to campus users outside of the building through architectural features, finishes, and elements that accentuate interior activities. It is also critical to consider the reverse view, looking towards the exterior from inside each building, to create strong visual connections.

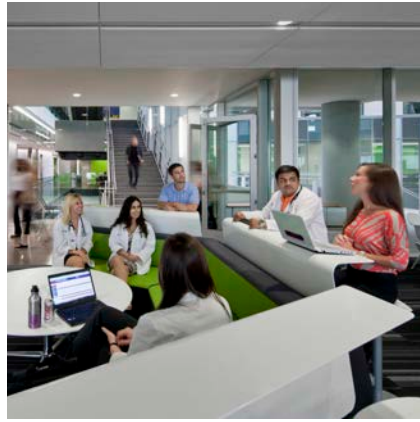
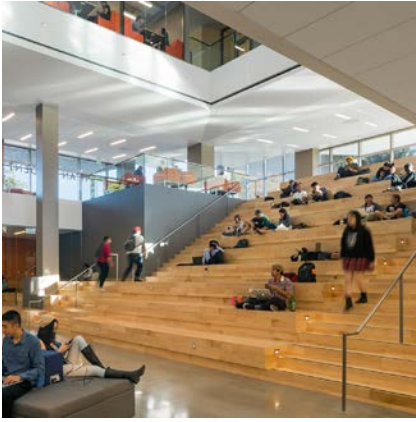

Create Permeable Ground Level:

To support visible interiors and visual connection to activities, ground levels should be visibility and physically permeable. Provide transparency through ample glazing and avoid large expanses of solid. Reinforce legibility of building entry points and connections through buildings along primary spine and mall pathways.

Display Learning & Discovery:

Discovery is fundamental to what UNTHSC does, and is a process and activity that is mutually shared and undertaken by the entire campus community. Within buildings, visibility from public space into areas of learning, research, care, and discovery directly connects people, purpose, and place together. Wherever possible, new buildings should be designed to exhibit the institution's core functions. This connection is one way that UNTHSC's enterprise can be physically expressed.

Share Knowledge:

Reinforce the visibility of UNTHSC academic, research, and clinical efforts through the incorporation of static and interactive displays within interior public spaces. These spaces should be distributed across campus and closely associated with collaborative spaces. Sharing the knowledge of UNTHSC illustrates its great value to the students, staff, faculty, and the broader community.

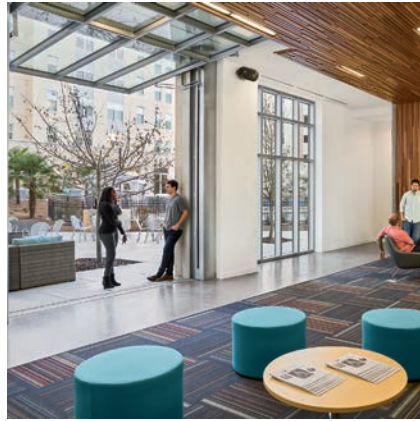

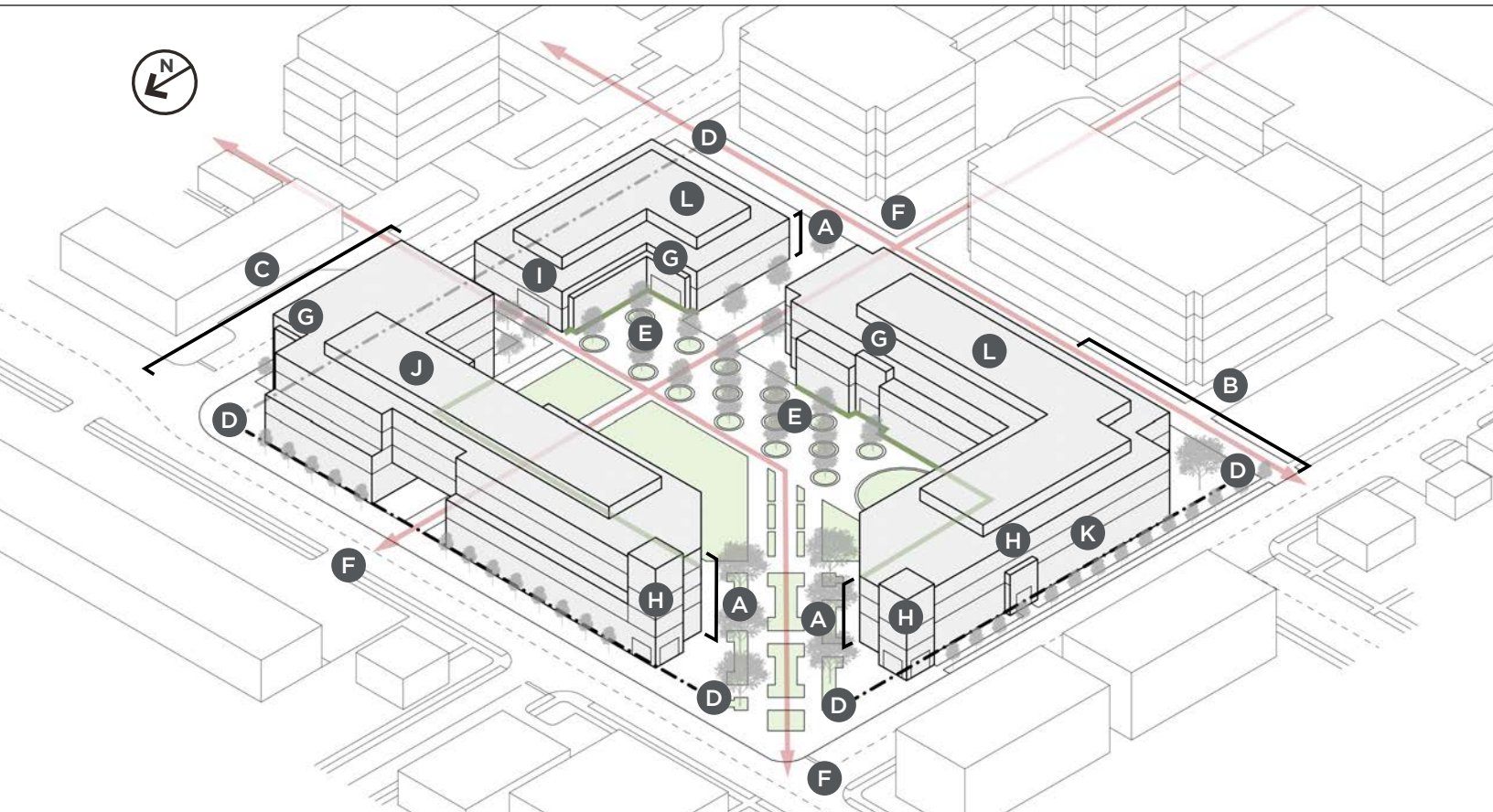

Summary of Planning Design Guidelines

Exterior Planning Elements

- | | |
|---|--|
| A Building Height | G Primary Entrance Location |
| B Transition Zone 1 Character | H Secondary Entrance Location |
| C Transition Zone 2 Character | I Servicing Location & Coordination |
| D Align to Setbacks | J Character Building |
| E Coordinate to Open Space Framework | K Character Facade |
| F Coordinate to Connectivity Framework | L Context Building |

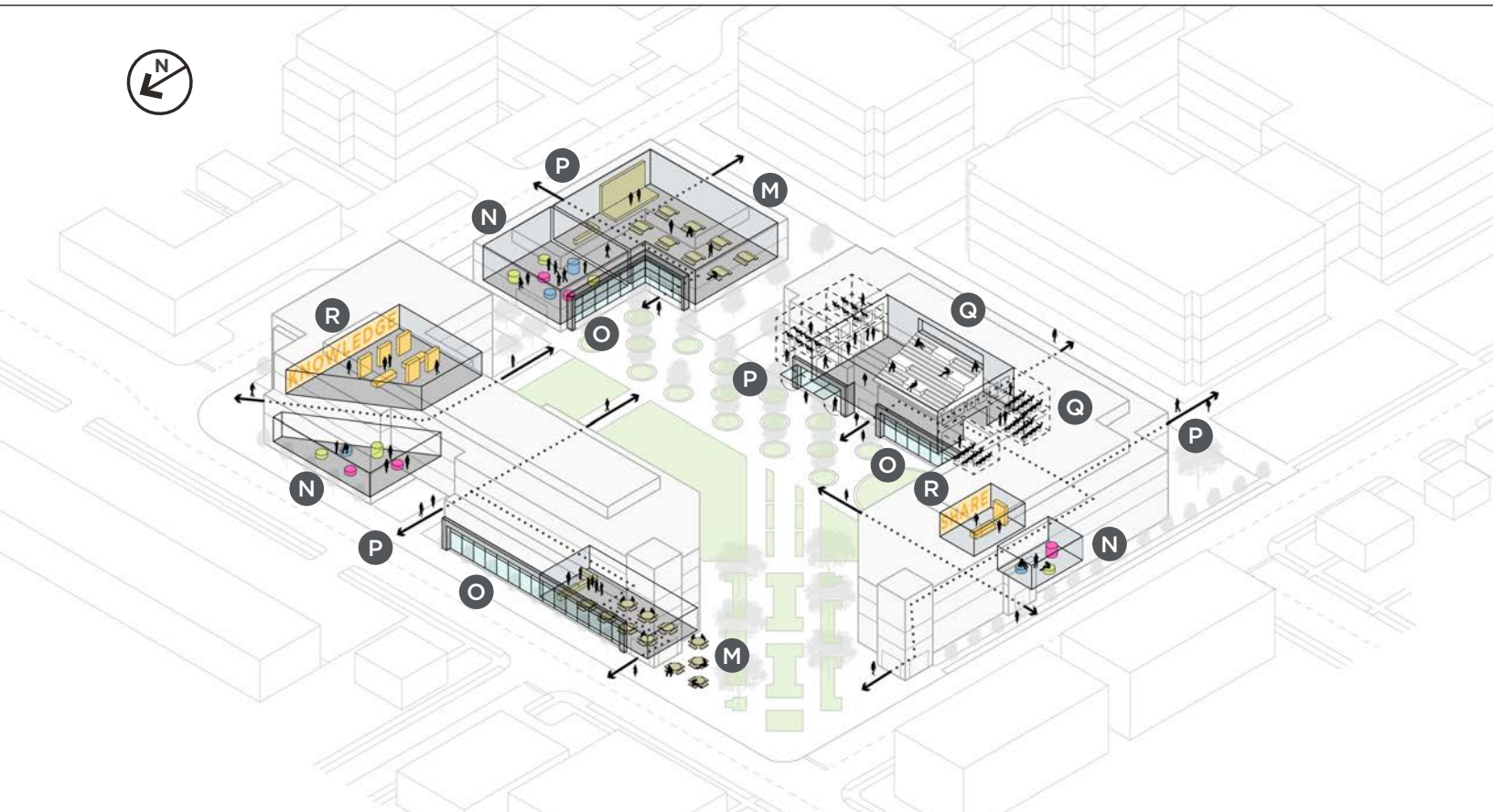

Interior Planning Elements

- | | |
|--|---|
| M Exhibit Active Spaces | P Create Permeable Ground Level |
| N Distribute Collaborative Spaces | Q Display Learning and Discovery |
| O Connect to Interiors Visually | R Share Knowledge |

ARCHITECTURE DESIGN GUIDELINES

Overview

The Architecture Design Guidelines provide a design vocabulary for the construction of new buildings and renovation of existing buildings across the campus. This design vocabulary encompasses architectural attributes that are specific to individual building projects, but directly interrelate and complement the Planning Design Guidelines and Landscape Design Guidelines.

These guidelines pursue shaping an enduring character that will steward the future of the physical environment without prescribing rigid solutions. Thoughtful application of these guidelines will appropriate the best elements of existing campus building character in future projects, while also allowing creative solutions as the campus continually evolves.

The designation of Character Buildings and Character Facades, referenced in this chapter, necessitates that these guidelines accommodate a more diverse design vocabulary than the previous master plan to support a strong institutional identity. The resulting architectural attributes in the guidelines create a structure to unify the campus environment while also acknowledging the diversification of building uses and typologies over time.

Architectural Attributes

Existing Architectural Attributes

The existing campus architectural character exhibits a number of defining attributes that contribute to its sense of consistency. Existing buildings exhibit:

- Strong volumetric forms establishing the basic massing
- Repetition of facade elements creating architectural rhythm

- Linear arrangement of windows and other elements in the building elevations
- Balance of solid and transparent materials
- Expression of vertical stair towers

Future buildings on campus will incorporate similar attributes in their design vocabulary to maintain and extend the character of the campus.

Building Massing

Simple volumetric forms with orientation reflecting the orthogonal precedent of the existing campus organization define the massing of existing buildings. Further expression of the massing, in conjunction with Building Articulation, will define the vertical hierarchy of base, body, and top.

Building Articulation

The major architectural elements of the building, along with refinement of the Building Massing, articulates the details and character of buildings. In particular, the expression of fenestration (arrangement of openings and elements on the building elevation), define the overall Building Articulation.

Building Material and Color

Simple palettes of material and color will correspond and complement the existing context of the campus. The materials and colors palettes consist of Primary, Secondary, and Tertiary components relating to and expressing the Building Massing and Articulation.

Each of the above architectural attributes - Building Massing, Articulated and Material and Color - depend upon and inform one another. Application of the Architectural Design Guidelines is an iterative balance, with each influencing the other, to arrive at an optimal outcome that reinforces the campus character.

Building Massing

Building masses should be simple volumetric forms orientated to the established orthogonal organization of campus. Further expression of the massing, in conjunction with Building Articulation, will define the vertical hierarchy of base, body and top.

Base:

The base conditions directly relates the building mass to the dominate framework elements. By coordinating the base with the Connectivity and Open Space Networks, the building form can help reinforce and enhance the pedestrian experience. The base serves as the visual and physical link between the exterior campus and building interiors, creating opportunities for visibility and permeability.

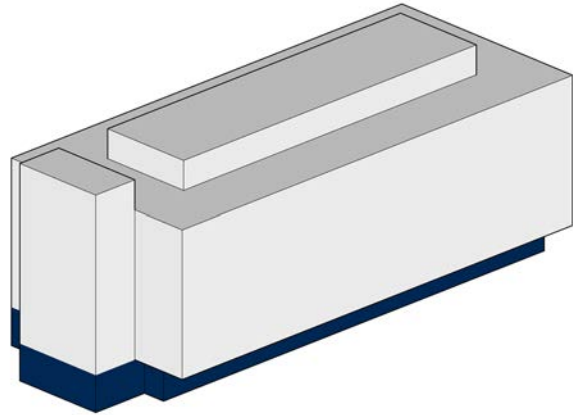

Body:

The body encompasses the most substantial portion of the building mass and is the section most expressive of the Building Articulation attributes due to the volume of fenestration. Character Buildings and Facades require further expression to the body in order to support and enhance the campus character.

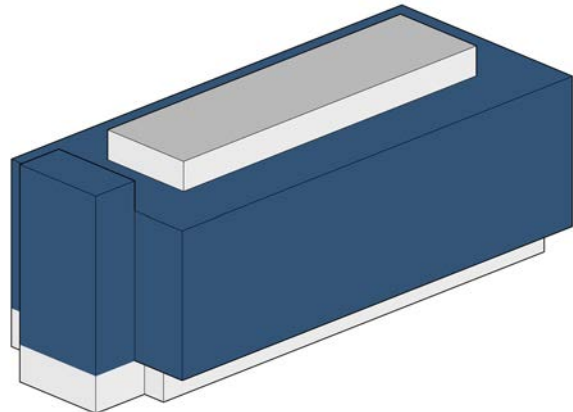

Top:

The top defines the intersection of the building with the sky through simple masses and lines. Building tops may be comprised of the top most floor, mechanical penthouses, or a combination of both. In most cases, the top should be set back from the perimeter of the body. However, in certain cases, material and fenestration changes may be enough to distinguish the top. Mechanical penthouses must be explicitly set back from the perimeter of the body to diminish their presence from the ground.

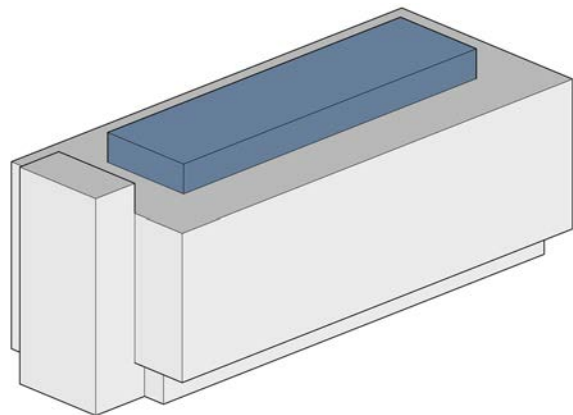

Building Articulation

Building Articulation details the character of each building through the major architectural attributes of the building through refinement of the Building Massing. In particular, the expression of fenestration (arrangement of openings and elements on the building elevation) defines the overall Building Articulation.

Base Zone:

The base zones serves as the primary experience for pedestrians and articulation of this area reinforces visual and physical connections; both between buildings and exterior / interior spaces. Active uses populate this zone to stimulate collaboration. Commonly defining a higher first floor will support interior needs. Additionally, the base zone clearly demarcates points of entry.

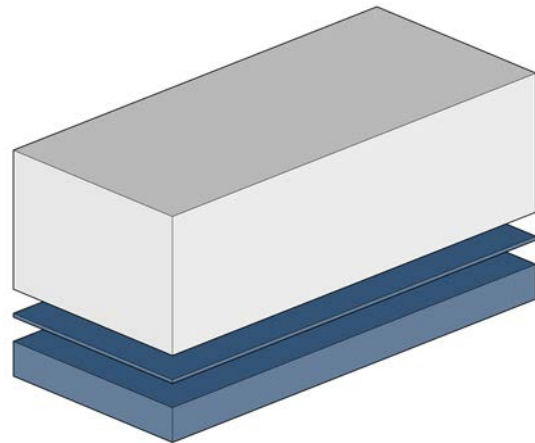

Covered Areas:

Building overhangs, loggia, canopies, and similar devices serve to provide areas of shade along key circulation routes. Covered areas can also act as transition zones between exterior and interior spaces. These areas often correspond or indicate points of entry.

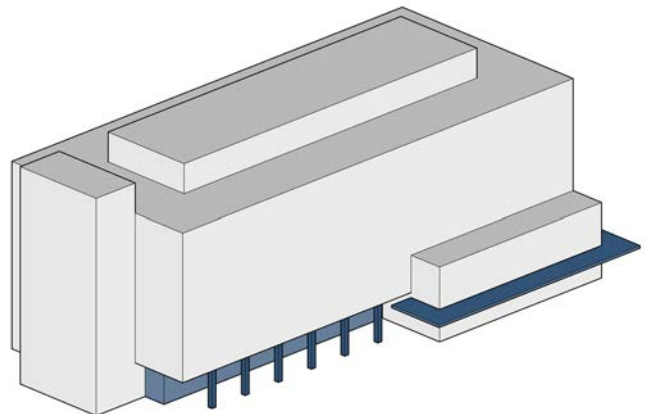

Stair Towers:

Refinement of the Building Mass occurs through articulation, detachment, and further expression of stair towers as independent building elements.

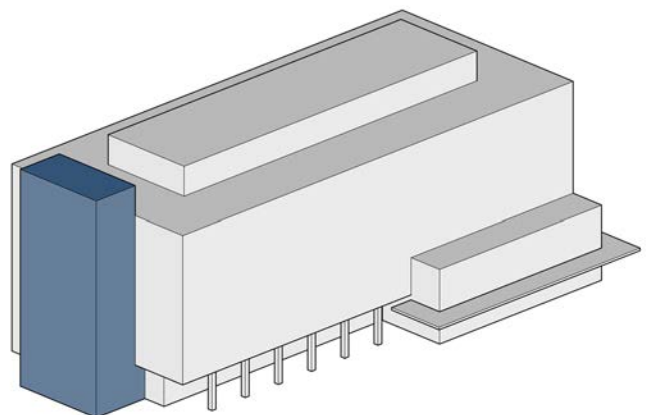

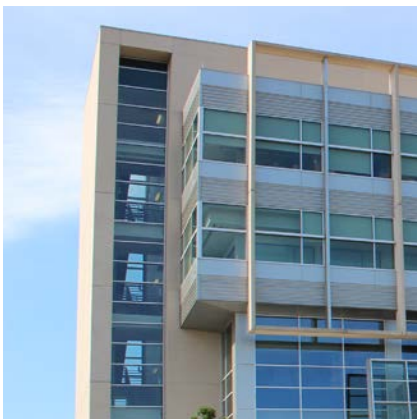
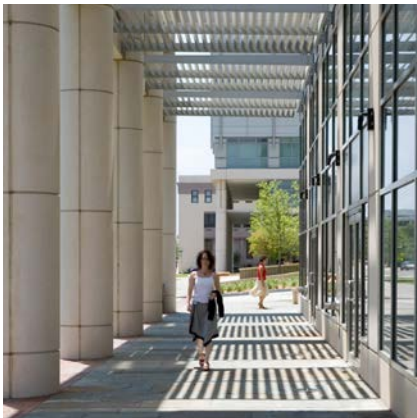

Fenestration:

Frame large expanses of windows to articulate the Building Mass while maintaining a horizontal orientation of the window pattern. Further openings in primary areas of Building Mass should maintain this horizontal orientation. The base zone allows for significant quantities of openings. Select areas may utilize vertical expression of openings and materials as architectural highlights.

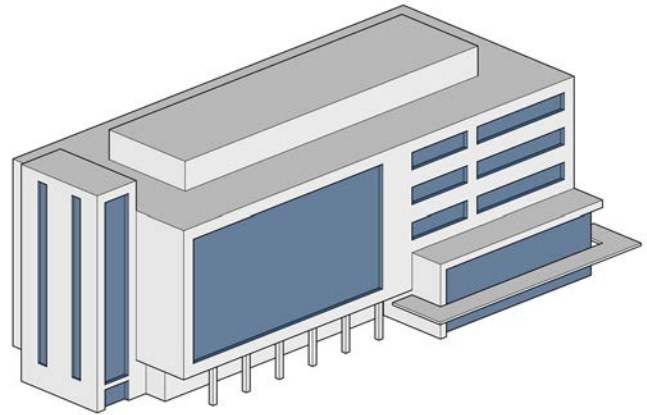

Screens and Louvers:

Incorporate screens and louvers integrally on large multi-story window and curtain wall sections that receive significant solar exposure. This is especially critical on glazed areas facing south.

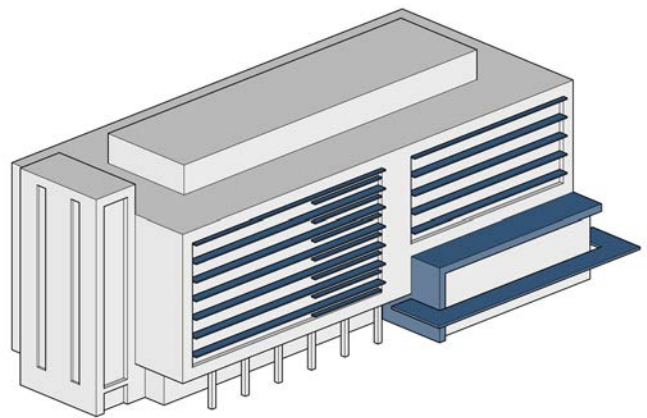

Equipment Screening:

Setback and screen all rooftop equipment through enclosure in a penthouse or with panels to minimize visibility from the ground or adjacent building. Similarly, equipment and service entries at ground level should be screened.

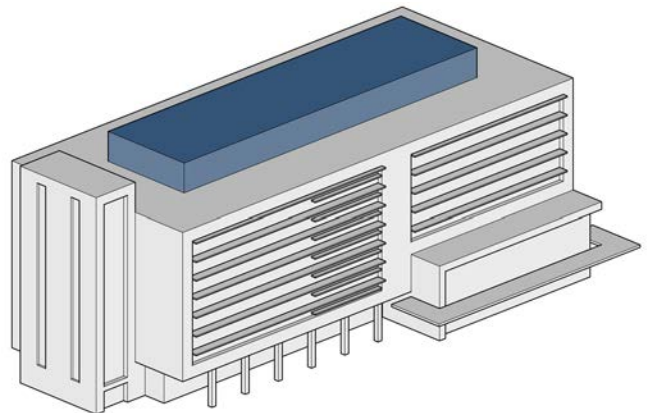

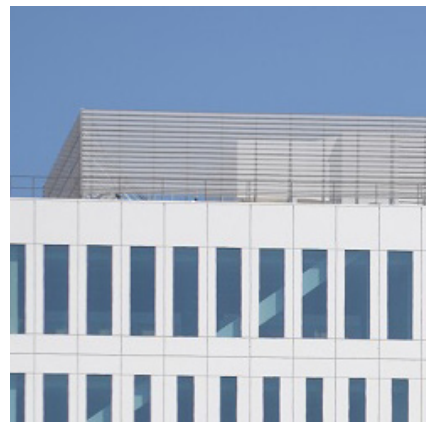
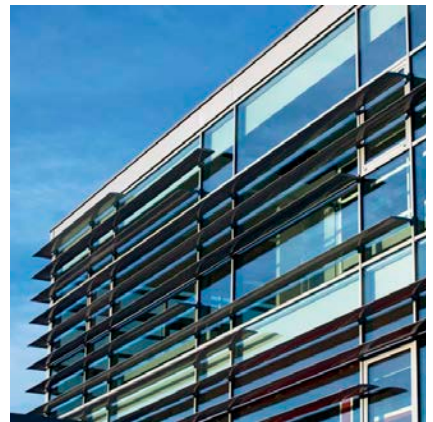
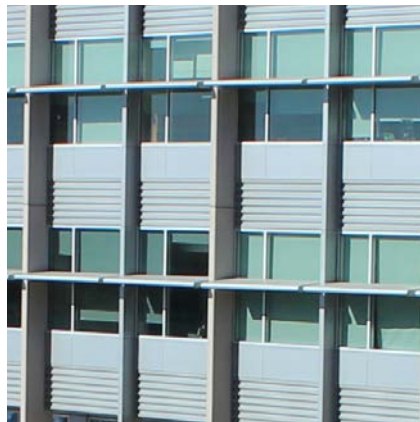
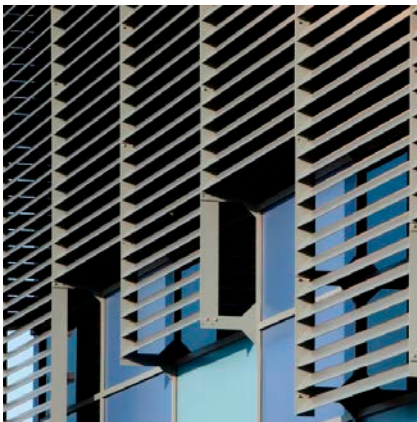

Building Material and Color

Simple palettes of material and color will correspond and complement the existing context of the campus. The materials and colors palettes consist of Primary, Secondary and Tertiary components relating to and expressing the Building Massing and Articulation.

Primary Palette:

Primary materials and colors define the main building volume and should be derived from the existing campus materials and context. These materials consist mainly of limestone, cast stone, or precast concrete.

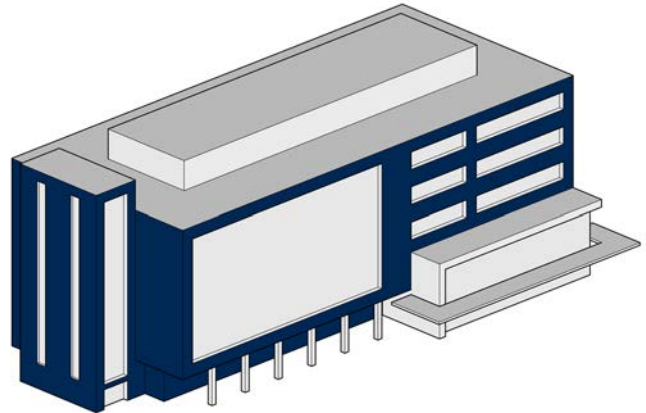

Secondary Palette:

Secondary materials and colors define those components associated with refinements of the massing and expression of the fenestration. These materials consist mainly of glass, metal panel, metal screen, and special textured precast.

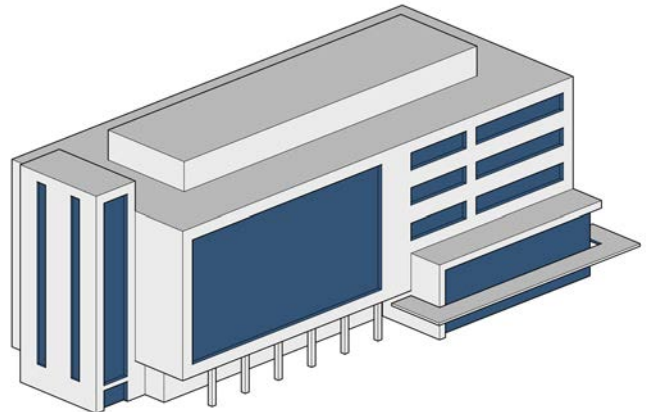

Tertiary Palette:

Tertiary materials and colors define special conditions that require distinct expression, such as pedestrian base zones, points of entry, loggia, and facade screening. Materials and colors should compliment primary and secondary palettes. Limit use of tertiary palettes.

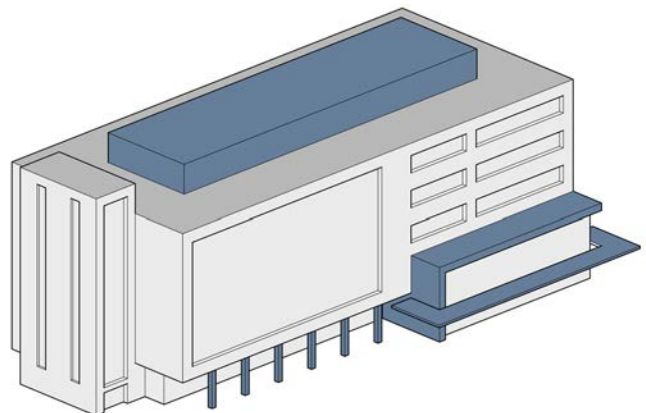

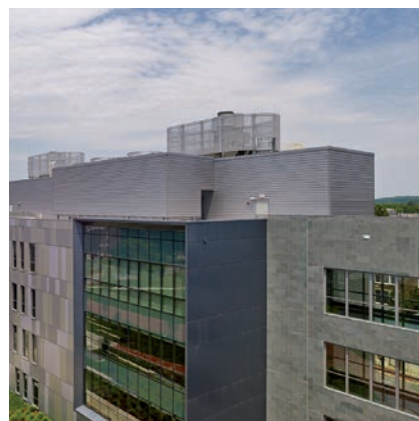
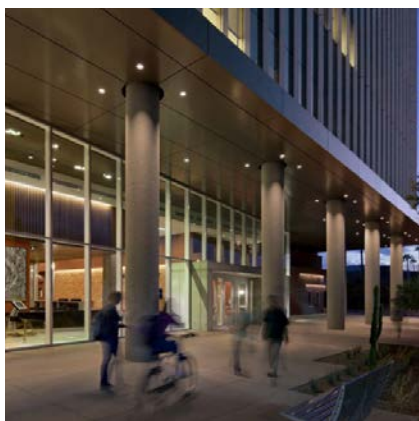
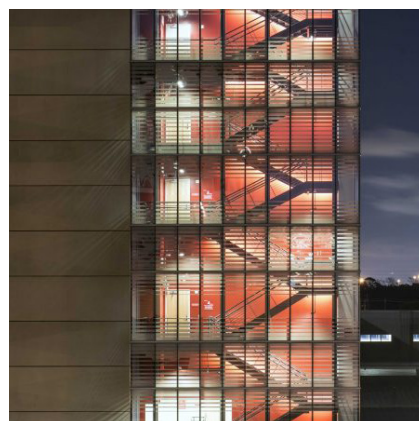
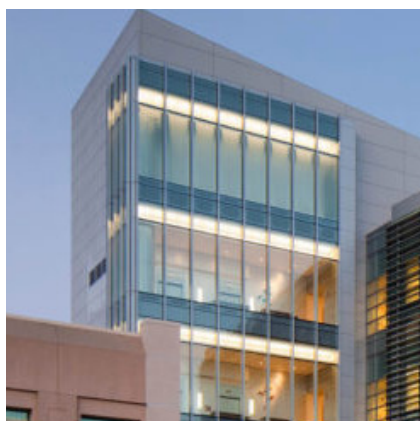
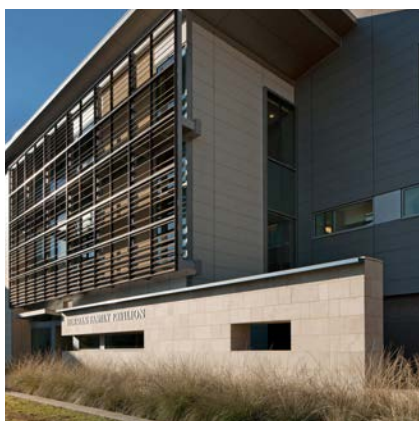
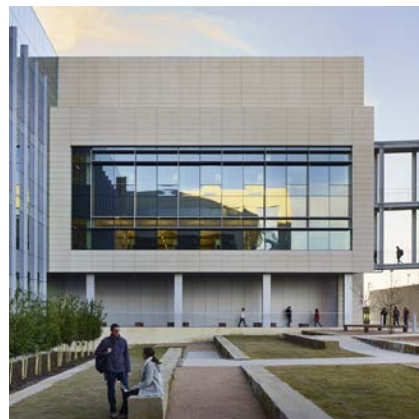
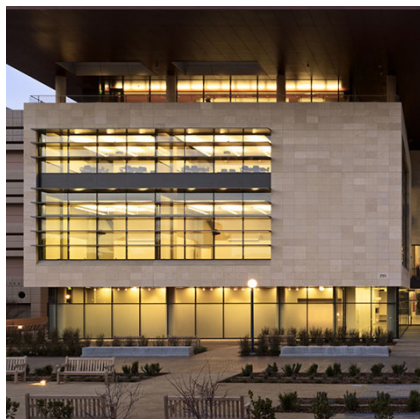

LANDSCAPE DESIGN GUIDELINES

Overview

Strong, user-friendly campus environments are made up of an array of landscape and site elements. These spaces can differ substantially in type, programming, character, size, plantings, and use, but should all be planned around a consistent set of guidelines to create one cohesive campus identity. The 2018 Campus Master Plan Landscape Design Guidelines seek to build upon existing on-campus landscape elements and amenities by enhancing them with complimentary and quality paving materials, site furnishings, lighting, and plant materials. These guidelines are intended to create clear application to ensure a consistent material and space character exists across campus, aided by the below goals:

- Define a variety of open space types for a multitude of users and uses
- Provide safe and comfortable pedestrian movement across campus
- Create a strong and cohesive campus identity using consistent materials
- Plan for ease of maintenance and sustainable practice where possible through plant selection, location, and hardscape finishes

This section will outline general guidelines and recommended materials for open space design, planting strategies and plant selection, stormwater management, paving design and materials, site furniture placement and products, lighting placement and products, and public art.

Open Space Design

Open space design is comprised of creating definition and program for a variety of spaces, including grand open spaces programmed for active recreation and events for large groups of people, intimate spaces programmed for passive activities for smaller groups of people, and linear pedestrian networks which link buildings and outdoor open spaces.

Grand Spaces: Lawns

Lawns are large, flexible gathering areas designed to support daily campus activities, recreation, and social interactions, while also providing large open space (the actual lawn) that can be used for outdoor events. To achieve this required flexibility, each lawn should contain at minimum one-half acres of open space (enough to support a casual sports match, set up multiple tents/booths, or host reception for 150-200 people). A variety of furniture should be located around the edges of the lawn to stimulate activity and interaction without preventing use of the central open space.



MET Lawn
University of North Texas Health Science Center

Grand Spaces: Quads

Campus quadrangles (quads) are created when multiple buildings come together, resulting in a space that's enclosed on three to four sides. While typically large spaces, quads are predominantly used by smaller groups of people or individuals relaxing, socializing, or studying. These areas are prime locations for multiple types of seating (movable and fixed), colorful plants, shade trees, and public art. Often, quads are designed having multiple sub-zones defined by changes in hardscape, landscape, and furniture. Quads will vary in size based on the surrounding buildings, but it is recommended that quads be at least one-half acres to provide space for multiple user groups.

Intimate Spaces: Courtyards

Courtyards are similar to quadrangles but are smaller in scale, typically enclosed on all four sides by a single building. Filling a similar function to quads, these spaces are designed to accommodate less people. The programming and design of courtyards should align with the program of the adjacent building.

Intimate Spaces: Plazas

Plazas are transitional spaces that serve to link multiple open spaces and connectors together. Programming for plazas should support small events, food trucks, group gathering, and studying, as well as provide clear connections to any attached building entrances. Plazas should be primarily hardscape with accents of plantings to provide shade and character.

Intimate Spaces: Pocket Parks

Pocket parks are small in scale and passive in nature. Typified by seating and shade, they are great areas for studying, conversing, and reading. These areas can be found within or adjacent to quads and courtyards, but more typically will be in the interstitial spaces on campus (such as in the nooks created by buildings). Size and furniture type will vary by location. The campus should foster a unique each pocket park to create a diverse character.



Quad
Coppin State University



Courtyard
Salem State University



Pocket Park
Arizona State University

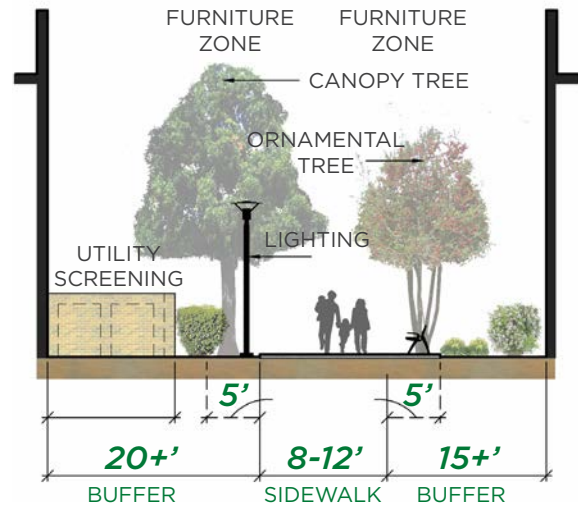
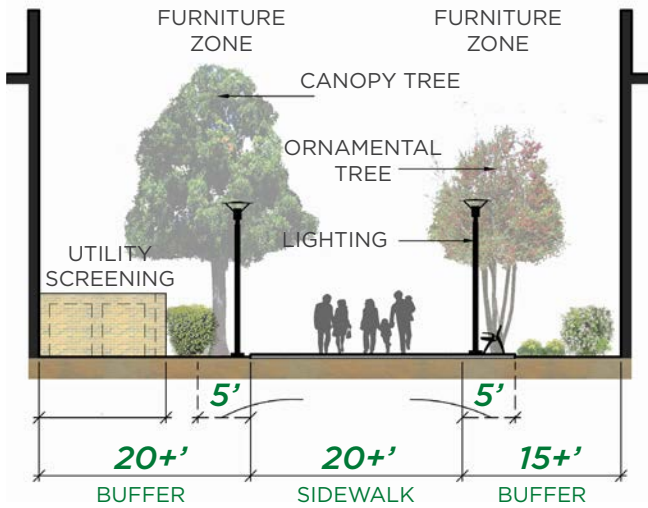

Linear Open Space: Pedestrian Malls

Pedestrian malls are prominent public walks or promenades through campus. Shade trees, lighting, and furnishings should be placed on both sides of the mall in regular increments to provide a sense of formality. Malls serve as primary circulator through campus and should align to the connectivity axis identified in the Framework Chapter. Materials may include a combination of primary hierarchy paving materials (see paving section for options).

Pedestrian malls must be designed to a minimum width of 20' to meet local requirements for emergency vehicle access and provide easy access for service vehicles. Species dependent, canopy trees should be at minimum 20' removed from buildings and ornamental trees removed at least 15' to allow for canopy growth. Lighting should be placed regularly in the form of light poles spaced 50' apart.

The 2018 Campus Master Plan proposes the closure of Bunting, Modlin, and Mattison Avenues between Haskell and Montgomery Streets, as well as the closure of the emergency drive associated with Parking Lot 1 and the Health Pavilion. Each of these closures needs to be replaced with a Pedestrian Mall to ensure continued compliance with local emergency regulations. New campus policies will be required to regulate when service vehicles can drive onto Pedestrian Malls. Many campuses restrict access during peak class hours.

Linear Open Space: Large Connector

Connectors are the interstitial linkages between buildings, quads, courtyards, malls, and along interior roadways. These walkways are meant to be multi-functional, sized to allow for large groups of pedestrians, bicyclists, and smaller emergency vehicles (namely ambulances).

Large connectors should be between 8' and 12' and be primarily made of scored concrete. At special locations (intersections, building entrances, etc...), pavement in the primary hierarchy category may replace the standard scored concrete (see paving section for options). Large connectors can have trees and 5' furniture pads on both sides of the pathway, dependent on site conditions. Species dependent, canopy trees should be at minimum 20' removed from buildings and ornamental trees removed at least 15' to allow for canopy growth. Lighting should be placed regularly in the form of light poles spaced 50' apart.

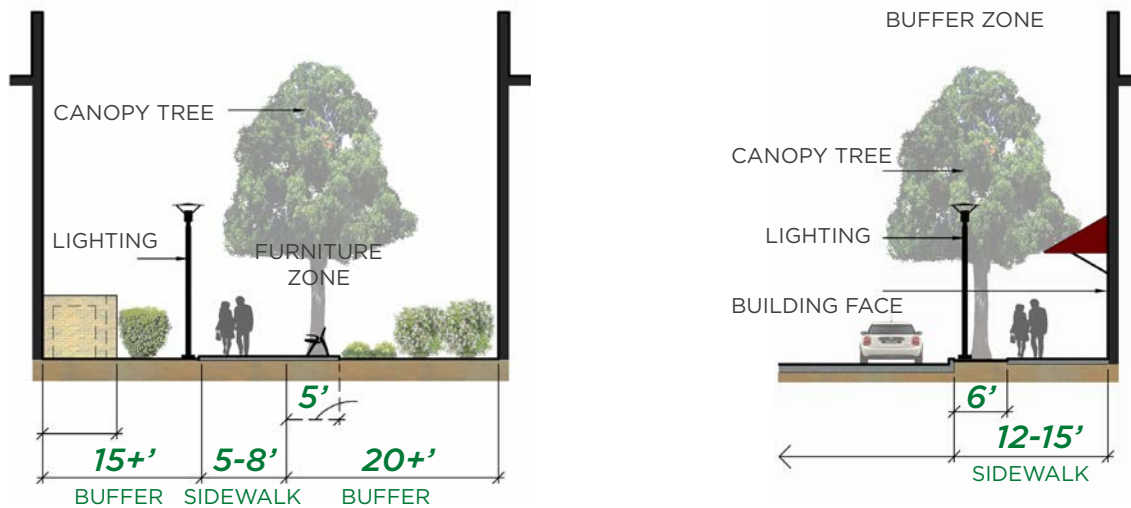

Linear Open Space: Small Connector

Small connectors are basic concrete sidewalks sized between 5' and 8'. Due to their nature, they are less suitable for seating and do not require the formality of trees placed at even intervals. Seating and trees can be spaced at greater distances and do not required specific spacing. Lighting should be placed regularly in the form of light poles, bollard, or exterior lighting elements attached to buildings. Spacing will vary based on light type.

Linear Open Space: Urban Edges

Special Consideration should be given to the urban edges along West 7th Street and Camp Bowie Boulevard. The West 7th Street edge has a unique active character created by the volume of commercial and higher density residential uses along the corridor while the Camp Bowie Boulevard edge serves as a direct interface with the Fort Worth Cultural District. The sidewalks and plantings on these urban edges take on a unique character.

Community Edge (West 7th Street): Should be designed with a 6' buffer zone between the street and sidewalk reserved for street trees, bike racks, benches, and lighting. Sidewalks will be 12' to 15' wide and run to the face of the buildings. Streetscapes are subject to City of Fort Worth development requirements.

Cultural Edge (Camp Bowie Boulevard): Due to existing building locations, the angle of the boulevard, and City of Fort Worth established setbacks, the Camp Bowie Boulevard edge is a wider and variable buffer. Today, each block has a different edge character, as the sections between Clarke Avenue and Clifton Street redevelop, these edges should be improved to compliment the block between Clifton Street and Boland Street. This section is characterized by setbacks of 35' or more, larger paved areas at street intersections, sidewalks along the street edge, a 6' grass buffer, and a second sidewalk set further in. Street trees should be staggered and may be a double alley where wide enough.

Planting Strategy & Design

Campus plantings serve to improve the aesthetic and environmental quality of campus while also providing comfort and interest for users of outdoor spaces. Selection and strategic placement of plant materials appropriate for the region and campus micro-climates will enhance the campuses character and create visual continuity for users while helping to improve the strength and longevity of the overall campus landscape.

Street Trees

Street trees are a vital part of a rich and inviting streetscape. The term street trees describes trees that line vehicular roadways which support the adjacent pedestrian areas with shade. In addition to providing shade and enhancing the pedestrian experience, street trees also help to soften the visual impact of large expanses of paving and can be a significant stormwater management tool.

General street tree guidelines:

- Trees should have 4" minimum caliper, a straight trunk, and provide 7' of clearance to lowest branch at time of planting
- Trees spaced at least 30' apart to provide space for mature canopies
- Select species tolerant of the heat island effect created by surrounding hardscape
- Select species that will tolerate pruning throughout their lifespan to ensure clearance for pedestrians and vehicles
- Diversify street tree species across campus to create an interesting character and reduce the impact of diseases and insects
- Provide soil volumes (or CU Structural Soil / equivalent) adequate to support desired canopy and accommodate mature root systems

Reference the canopy tree and ornamental tree plant lists for potential street tree species. Not all ornamental trees meet the guidelines above.

Site Trees

Site trees describe all of the trees internal to campus that are removed street edges. These include trees that line walkways, trees located on lawns, and trees placed in planter beds. Depending on location, site trees are intended to provide shade, visual aesthetic, or both. These trees provide a softening effect to the campus, reduce heat island effect, improve air quality, and can be used as a design element to create memorable spaces.

General site tree guidelines:

- Ensure biodiversity by creating a variety of species type to reduce the impacts of disease and insects
- Provide soil volume adequate to support desired canopy and accommodate mature root systems
- Consider the location of underground utilities and above ground structures when placing trees
- Flowering trees should be located away from areas where frequent outdoor dining activity is anticipated to minimize impact of bees, insects, and falling debris
- Trees removed from circulation areas that require canopy height can have as small as 2" caliper to limit shock at being transplanted and enabling quicker growth

Reference the canopy tree and ornamental tree plant lists for potential street tree species.

Understory and Accent Plantings

Understory and accent plantings describes everything beneath the tree canopy (grasses, flowers, vines, and shrubs). These plantings serve to soften hardscapes, screen undesirable views, create durable lawns, and add aesthetic interest to the campus' outdoor spaces. While often an after thought, design of these features should be carefully considered to create both large public spaces and linear connections that provide a strong sense of place and campus identity.

General understory and accent planting guidelines:

- Layer plantings with a variety of color, form, texture, and seasonal flowering times to provide for year round character.
- Group plants based on their water needs to minimize over- and under-watering
- Species selection should support accessible and usable spaces for users of all age and abilities

Reference the herbaceous grasses, herbaceous perennials, ground cover and vines, and shrubs plant lists for recommended understory and accent plantings.

Legacy Tree Program

A unique and defining characteristic of the UNTHSC campus is the legacy tree program which allows donors to plant a tree on campus in honor of a special person or occasion. Each tree is marked with an engraved granite plaque. To date, donors have been able select the location of their trees. The 2018 Campus Master Plan suggests that the campus consider an organizing structure, such as a major pathway or green space, to locate future Legacy Trees to increase awareness of the program and enhance their influence on the overall campus character. Additionally, this will minimize conflicts with future building sites.

Maintenance and Sustainability

While having a beautiful and well landscaped campus is desirable, it also requires substantial upkeep, care, and investment. These guidelines emphasis the use of native and introduced drought-tolerant plant species which are adapted to the local soil conditions. This will help create a more sustainable and lower-maintenance campus landscape that requires less manpower, reduced water use, lower maintenance requirements, and reduced plant mortality and replacement, reducing operational and capital expenses.

It is also recommended that the campus increase organic fertilizer and pest control practices to reinforce UNTHSC's mission and promote health and well-being.

Plant List

The following pages contain a series of plant lists inclusive of trees (canopy/ornamental), shrubs, perennials, vines, ground-covers, and grasses that are recommended as suitable for the UNT Health Science Center campus.

While these lists are intended guide visual continuity, character, and landscape health, it is not all-inclusive. Designers wishing to incorporate vegetative material not on this list must consult with the University of North Texas System Office of Facilities Planning & Construction or UNTHSC Facilities (as appropriate) before including it in their design.

Canopy Trees



Bald Cypress
Taxodium distichum



Cedar Elm
Ulmus crassifolia



Chinese Pistache (male)
Pistacia chinensis



Drake Elm
Ulmus parvifolia



Pecan
Carya Illinoensis



Shantung Maple
Acer truncatum



Shumard Red Oak
Quercus shumardii



Texas Red Oak
Quercus buckleyi



Trident Maple
Acer buergerianum

Canopy Trees (continued)



Heritage River Birch
Betula nigra



Live Oak
Quercus virginiana



Mondell Pine
Pinus eldarica



Slippery Elm
Ulmus rubra



Bur Oak
Quercus macrocarpa



Chinkapin Oak
Quercus muhlenbergii



Montezuma Cypress
Taxodium mucronatum



Pond Cypress
Taxodium ascendens

Ornamental Trees



Coral Bark Japanese Maple
Acer palmatum



Crapemyrtle
Lagerstroemia indica

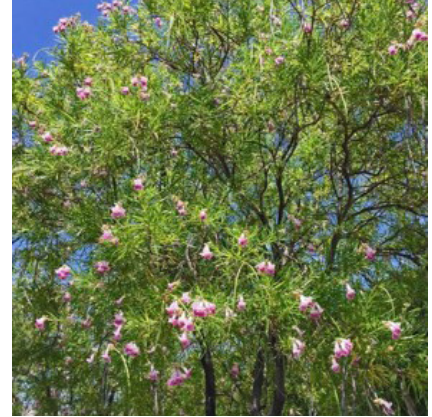

Desert Willow
Chilopsis linearis



Eve's Necklace
Styphnolobium affine



Japanese Maple
Acer palmatum



Oklahoma Redbud
Cercis reniformis oklahoma



Possumhaw
Ilex decidua



Texas Mountain Laurel
Sophora secundiflora



Vitex
Vitex agnus-castus

Ornamental Trees (continued)



Foster's Holly
Ilex x attenuate



Little Gem Magnolia
Magnolia grandiflora



Nellie R Stevens Holly
Ilex x Nellie R. Stevens

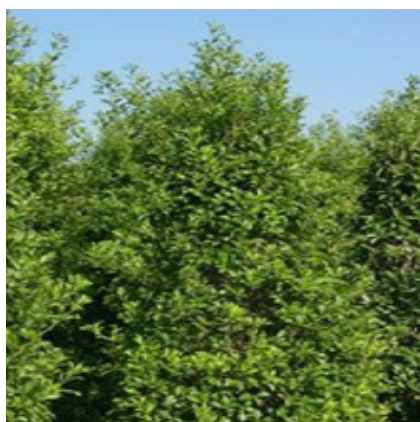

Savannah Holly
Ilex attenuata



Yaupon Holly - Male
Ilex vomitoria



Yaupon Holly - Female
Ilex vomitoria

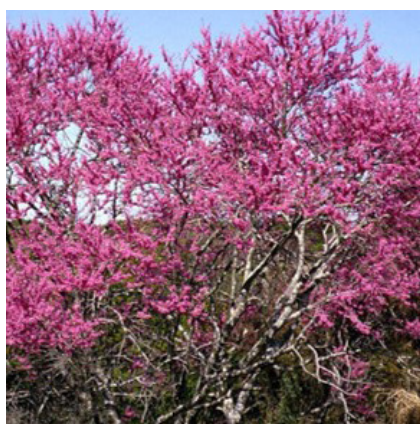

Texas Redbud
Cercis canadensis var. texensis

Shrubs



American Beauty Berry
Callicarpa americana

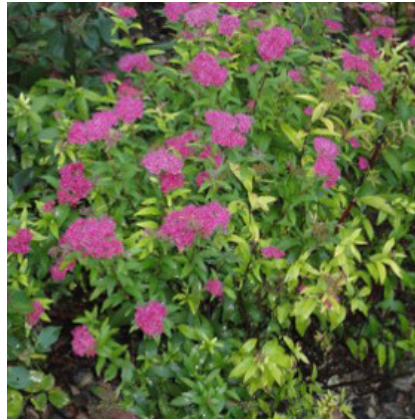

Anthony Waterer Spirea
Spirea spp.



Forsythia
Forsythia spp.



Oakleaf Hydrangea
Hydrangea quercifolia



Rock Cotoneaster
Cotoneaster horizontalis



Dwarf Burford Holly
Ilex cornuta



Dwarf Indian Hawthorn
Raphiolepis umbellata 'minor'

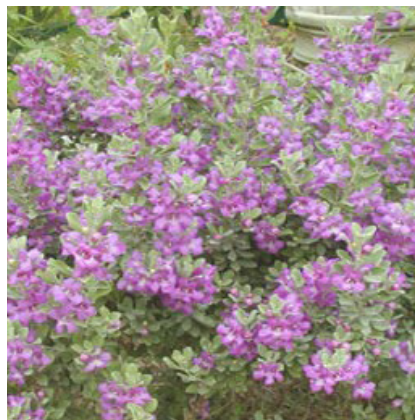

Dwarf Texas Sage
Leucophyllum frutescens



Pittosporum
Pittosporum spp.

Shrubs (continued)



Dwarf Yaupon Holly
Ilex vomitoria

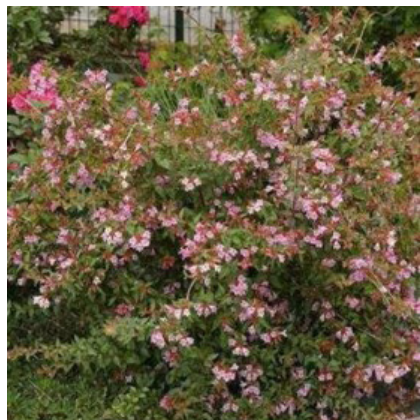

Edward Goucher Abelia
Abelia grandiflora

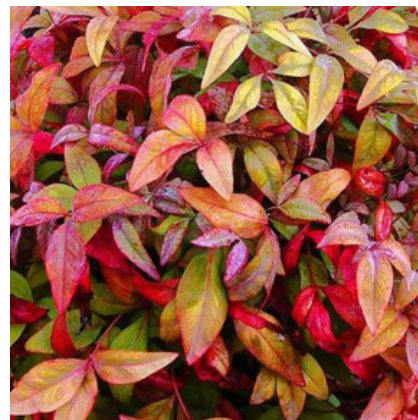

Firepower Dwarf Nandina
Nandina domestica



Glossy Abelia
Abelia grandiflora

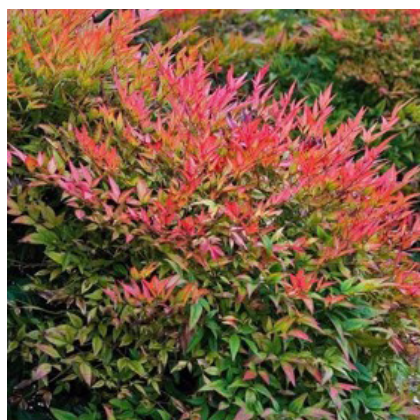

Gulfstream Dwarf Nandina
Nandina domestica



Indian Hawthorn
Raphiolepis indica



Ligustrum
Ligustrum vulgare



Purple Pixie Loropetalum
Loropetalum chinense



Heavenly Bamboo
Nandina domestica

Shrubs (continued)



Winter Honeysuckle
Lonicera fragrantissima



Red Yucca
Hesperaloe parviflora



Rosemary
Rosmarinus officinalis



Dwarf Palmetto
Sabal minor



Spineless Prickly Pear
Opuntia ellisiana



Pale Leaf Yucca
Yucca pallida

Ground Cover and Vines



Asian Jasmine
Trachelospermum asiaticum



Bar Harbor Juniper
Juniperus horizontalis



Giant Liriope
Liriope muscari 'super blue'



Variegated Liriope
Liriope spicata 'silver dragon'



Mondo Grass
Ophiopogon japonicus

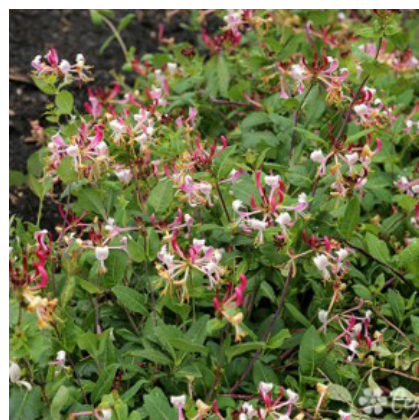

Honeysuckle
Lonicera spp.

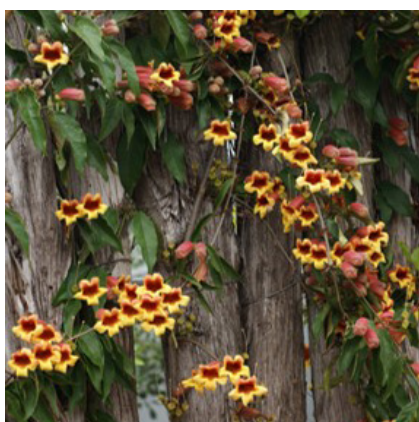

Crossvine
Bignonia capreolata

Herbaceous Perennials



Daffodil
Narcissus spp.



Blue Wonder Salvia
Salvia farinacea



Coral Bells
Huchera spp.



Autumn Sage
Ulmus parvifolia



Sedum
Sedum spp.

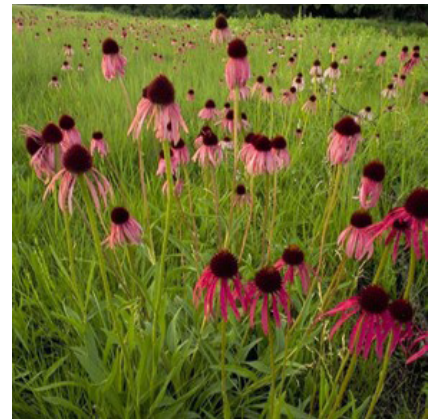

Purple Coneflower
Echinacea purpurea

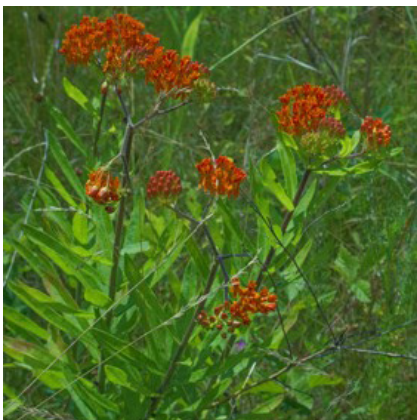

Butterfly Weed
Asclepias tuberosa



Turk's Cap
Malvaviscus drummondii



Zexmenia
Wedelia acapulcensis var. hispida

Herbaceous Perennials (continued)

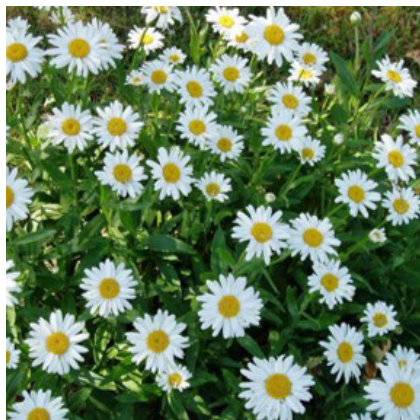

Shasta Daisy
Leucanthemum superbum

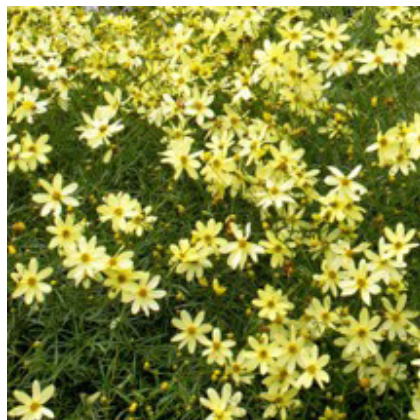

Moonbeam Coreopsis
Coreopsis verticillata 'moonbeam'

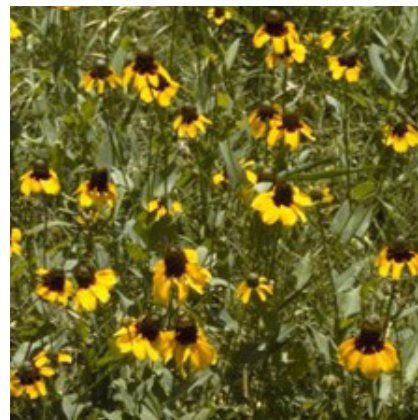

Clasp Coneflower
Dracopis amplexicaulis



Plains Coreopsis
Coreopsis lanceolate



Blackeyed Susan
Rudbeckia hirta



Scarlet Sage
Salvia coccinea

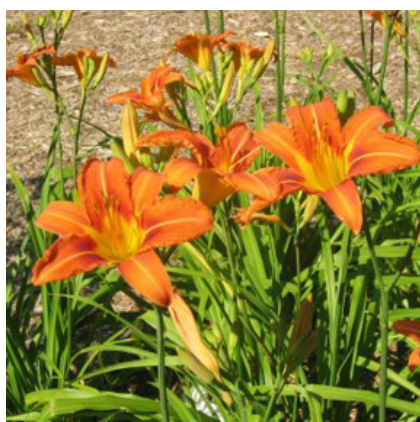

Daylily
Hemerocallis spp.



Winecup
Callirhoe involucrata



Pink Skullcap
Scutellaria suffrutescens

Herbaceous Grasses



Bermudagrass
Cynodon dactylon



St. Augustine Grass
Stenotaphrum secundatum



Tifway 419 Bermudagrass
Cynodon dactylon 'tifway 419'



Mexican Feather Grass
Nasella tenuissima



Maiden Grass
Miscanthus sinensis



Gulf Muhly
Muhlenbergia capillaris



Lindheimer Muhly
Muhlenbergia lindheimeri

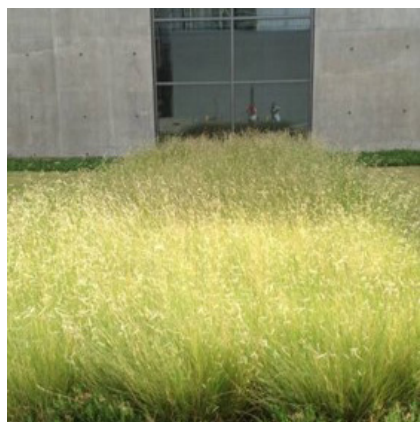

Blue Grama
Bouteloua gracilis



El Toro Muhly
Muhlenbergia emersleyi 'El toro'

Stormwater Management

Effective stormwater management layers systems and approaches at different scales. For each new project that is undertaken by UNTHSC, the effects on stormwater should be analyzed for both the immediate impact to the site and campus, as well as for future impacts. The systems below can combine in a multitude of combinations to create a comprehensive approach to managing stormwater on-site to help mitigate or solve existing issues on campus.

The master plan recommends that all new building and landscape projects include one or more of the following elements:

Engineered Bioswales and Rain Gardens

Engineered bioswales tend to direct and channel stormwater preventing it from flowing into areas that might disrupt the use of campus (such as onto walkways or roads). Bioswales should be strategically located adjacent to major pedestrian pathways or lining street edges and can be designed to be as shallow as 6" deep. Rain gardens are highly permeable areas of depressed earth that collect water and allow it to infiltrate into the ground in place.

Both of these landscape elements are also designed to filter silt (preventing erosion) and pollution, and are generally designed to handle the first 1.5" of rainfall in any given storm event. Typically, both of these features include native, deep-rooted vegetation and flowers to add aesthetic value and contribute to the overall landscape vision for campus.

Permeable and Pervious Pavement

While traditional hardscape materials do not allow water to infiltrate the soil, permeable and pervious paving allows stormwater to percolate and infiltrate the ground surface. The goal of permeable and pervious paving is to control and mitigate stormwater at the source, reducing runoff and improving water quality in substrata layers. The voids between the aggregates then allow water storage for a small storm event, or to handle the flush of a larger storm event reducing the burden on other systems across campus. Permeable paving requires regular maintenance which needs to be detailed in the project specifications as suggested by the system manufacturer.

Tree Wells or Trenches

Already used in multiple locations on campus, these two techniques use trees planted in amended soils and rocks to capture runoff from surrounding hard surfaces and hold in place to filter into the ground. These features can be single (tree wells) or interconnected (tree trenches). Their presence also helps to break up large areas of pavement and provide shade to pedestrians. Although appropriate anywhere on campus, the master plan recommends integration of tree wells and tree trenches into sidewalks that line Camp Bowie Boulevard, Montgomery Street, and West 7th Street.

Rainwater Harvesting

Rainwater harvesting is the collection and redistribution of rainwater for reuse on-site through the use of cisterns connected to a variety of catchment systems. Rainwater harvesting systems can range in size and complexity, but all systems include a catchment surface, a conveyance system, a storage container, treatment, and a distribution system for its secondary use. Cisterns can be installed above or below grade, though installation above grade makes maintenance substantially less expensive and easier. Perhaps their greatest benefit is that the captured water is appropriate for reuse in irrigation and/or toilet flushing, reducing the demand for potable water which decreases operating expenses.

Green Roofs

Green roofs manage the urban heat island effect, retain stormwater, provide habitat for butterflies and birds, add aesthetic value, lengthen the life of the roofing, and add insulation to decrease heating and cooling costs. These systems can be extensive or intensive depending on the amount of growing medium required to support plant life year round. Extensive systems are typically 4 inches (10 cm) in depth or less, can be built-in-place or pre-planted in trays, and support the growth of small plant species with limited impact on a building's structural system. Intensive systems are typically 8 inches (20 cm) or more in depth and can support a greater variety of plant species. These areas can be marketed as amenity spaces for buildings and can showcase sustainable design while being popular small gathering spaces.

Xeriscaping

Xeriscaping is the creation of small, water-absorbing landscape areas or planters filled with small pebbles, crushed rock, finely ground aggregate, natural mulch, or a system that layers more than one of these together. An on campus example of Xeriscaping is the northern section of the Library Courtyard surrounding the water feature. Their design creates areas on campus that are quickly able to absorb large quantities of water into the ground before it flows elsewhere. In addition to their stormwater management qualities, xeriscaped areas are also typically planted with drought-resistant plants which require less watering and care and reduce operational costs. Xeriscaping is particularly suitable along the edges of buildings.

Reduction in Surface Parking & Increased Green Space

The single largest impervious feature on campus today is the extent of surface parking. By consolidating surface parking into parking structures, the impervious footprint they create is reduced making way for new buildings that can utilize the range of techniques detailed in this section or new pervious green spaces. By reducing the amount of impervious surface, more stormwater will be handled, leading to less runoff, flooding, and erosion.

Stormwater Management Techniques



Engineered Bioswale



Rain Garden



Permeable Pavement



Tree Well

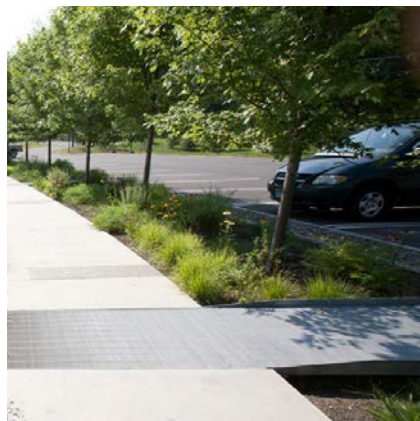

Tree Trench



Rainwater Harvesting



Green Roof



Xeriscaping

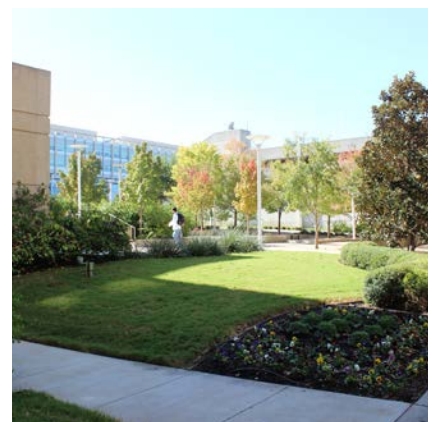

Increased Green Space

Paving

Having a good mixture of paving materials and patterns will add aesthetic appeal and call attention to specific places of interest on campus. A hierarchy of specialty paving materials, ranging from tile and pavers in a blend of natural colors to integral color concrete with specialty finishes, can reinforce the campus experience by serving as a subliminal way-finding mechanism and adding a layer of quality to outdoor spaces.

Paving Materials - Primary Hierarchy

Paving materials at primary places of interest (main building entrances, plazas, courtyards, roof gardens, and seating areas):

- Precast Concrete Pavers
- Integral Color Concrete - scored pattern, salt rock, or sand blast finishes

For each, manufacturer, color blend, and patterns should match the existing campus. Refer to Facilities Management for more details.

Paving Materials - Secondary Hierarchy

Paving materials at secondary places of interest (intersections of sidewalks, accent bands in pedestrian malls, and secondary building entrances):

- Integral Color Concrete - scored pattern, salt rock, or sand blast finishes
- Standard Gray Concrete - scored pattern, salt rock, or sand blast finishes

For each, manufacturer, color blend, and patterns should match the existing campus. Refer to Facilities Management for more details.

Paving Materials - Tertiary Hierarchy

Standard gray concrete will be used as a standard material in all other locations.



Primary Hierarchy Paving Materials
Library Courtyard at the Library entrance



Secondary Hierarchy Paving Materials
RES west entrance



Tertiary Hierarchy Paving Materials
Sidewalk wrapping Lot 6

Paving Material Palette (Select Sample)



Interlocking Precast Pavers
Single Color



Interlocking Precast Pavers
Single Color



Interlocking Precast Pavers
Color Blend



Integral Concrete
Tan - Heavy Sandblast



Integral Concrete
Light Tan - Sandblast



Integral Concrete
Dark Gray - Scored



Integral Concrete
Medium Gray - Heavy Sandblast



Integral Concrete
Standard Gray



Standard Concrete
Gray - Salt Rock

Site Furniture

Site furnishings in open spaces enhance the user experience by providing the ability for rest and relaxation and creating a unified and orderly appearance. All site furnishings, to stay in keeping with current furnishings, should be silver in color and contemporary in style. In addition to creating a unified campus aesthetic, a limited, selected furniture palette will allow campus maintenance personnel to keep readily available attic-stock for repairs and replacements. The listed furnishings below were chosen in collaboration with campus facilities staff for their appearance and durability.

Site Furniture Palette

Benches (Backed and backless):

- “Rest” Backed Bench (with extruded aluminum seat and back slats) by Landscape Forms.
- “Rest” Backless Bench (with extruded aluminum seat slats) by Landscape Forms.
- “Plexus” Bench (with end arm rests) by Landscape Forms.
- Chopped Limestone block (chipped/hammered sides, sawn and sanded top).
- Architecturally-finished cast-in-place seat/retaining walls.

Tables and Chairs (Movable):

- Parc Centre 28” Square Table with Parc Centre Chairs by Landscape Forms.
- Bar-Height by Landscape Forms

Tables and Chairs (Fixed):

- Carousel 42” Diameter Round Table with Dining (Backed) Seating by Landscape Forms

Umbrellas and Accessories:

- “Solstice Cygnus” Umbrella by Landscape Forms
- Umbrella-mount solar charging station (Aluminum, various manufacturers, must be approved by UNTHSC facilities)
- Intermediate seat dividers where benches are prone to damage by skateboards.

Litter and Recycling Receptacles:

- Scarborough Litter Receptacle (side-open) by Landscape Forms.
- Scarborough Plastic/Glass Recycling Receptacle (side-open with round opening and recycling plaque) by Landscape Forms
- Scarborough Paper Recycling Receptacle (side open with rectangular opening and recycling plaque) by Landscape Forms

Bike Parking and Racks:

- “Ring” Bike Rack (Stainless Steel) by Landscape Forms
- “Flo” Bike Rack (Stainless Steel) by Landscape Forms

Stair Railings:

- Custom Stainless Steel Railing with Integral LED down lighting (point- and wall-mount) by SC Railing Company

Site Furniture (Representative Sample)



Benches (backed and backless)
Existing on campus



Benches (backed and backless)
Existing on campus



Benches (backed and backless)
Existing on campus



Tables and Chairs
Existing on campus

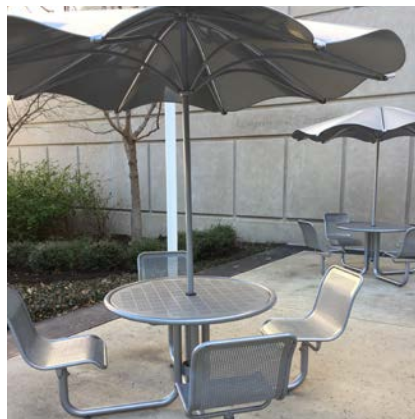

Tables and Chairs / Umbrellas
Existing on campus



Litter and Recycling
Existing on campus



Bike Parking and Racks
Existing on campus

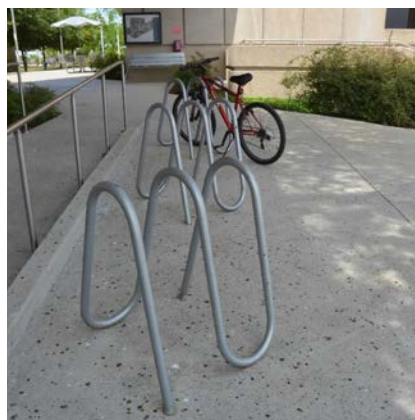

Bike Parking and Racks
Existing on campus



Stair Railings
Existing on campus

Lighting

Campus lighting is a significant and critical landscape element due to their ubiquity and role increasing campus safety. To provide nighttime safety for all campus users, the campus lighting system should be laid out to seamlessly connect all public parts of campus (walkways, parking areas, building entries, open spaces, roadway intersections, and important directional signage). To best achieve this, lights should be placed at a consistent interval to provide uniform illumination.

General lighting guidelines:

- Lighting shall be emphasized in the public realm and streetscapes to create a safe, visible, and inviting campus at all hours of the day
- Bollards should be placed 10' to 25' apart depending on adjacent uses
- Light poles should be placed at minimum 24' apart. Refer to technical specs to recommended spacing
- Lighting should highlight building entrances, prominent corners and facades, character buildings, terminated vistas, special interior spaces, or active parking structure elevations
- Banners with campus branding may be attached to light poles where appropriate
- All light poles and fixture housings should be metal containing LED lamps for increased energy efficiency and product lifetimes
- Light fixtures should be Dark Sky complaint and aim to limit light pollution, skyglow, light clutter, and light trespass
- Projects are encouraged to consult the Illuminating Engineering Society (IES) Lighting Handbook recommendations to establish target light levels and uniformities

Light Fixture Palette

All new light fixtures should meet the criteria laid out in the general light guidelines sections and match either an item on the list below, or a fixture that already exists elsewhere on campus.

Bollards:

- BEGA 7589 LED 74W 277V Exterior Bollard, White Finish

Light Poles:

- BEGA 7210LED 40W 277V, 12' Pole, White Finish



BEGA Bollard
Existing on campus

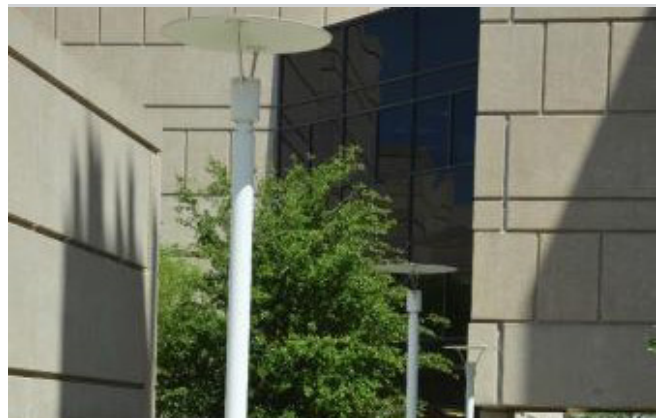

BEGA Pedestrian Lights
Existing on campus

Public Art

Public art is a term used to describe both two- and three-dimensional works of art created in traditional media (stone, bronze, etc.), environmental media (earthworks and landscape art), as well as new media (digital, video, etc.) that is installed in a public space. Functional objects (such as benches, light fixtures, etc.) which are created as unique works of art as well as the creation of an appropriate environment or site to place the art are also included in this definition. Public art serves to enrich the cultural and intellectual life of campus, as well as serve as an embodiment of the institution's mission and values.

During the 2018 Campus Master Plan process, stakeholders identified that the campus generally lacks public art, and that future inclusion of public art on campus will enhance the on-campus experience and create stronger ties to the adjacent cultural district.

Many higher education institutions require that a small percent (often 0.5% or 1.0%) of major capital project budgets be set aside to fund the creation of public art located in, or adjacent to, each project. Typically, these institutions also have a public art committee comprised of faculty and staff tasked with reviewing and selecting works appropriate for the campus. This master plan recommends UNTHSC consider a similar requirement for capital projects, and form a committee to help guide the future inclusion of public art on campus. Opportunities may exist to explore partnerships with nearby cultural institutions to bring art onto campus.

General public art guidelines:

- All permanent art should be identified with either a plaque or other appropriate signage
- Public art should be located in highly visible high-traffic areas
- If functional or interactive, land art should make ensure it is accessible for all users
- If intended to be a permanent installation, land art should be designed for easy maintenance

Public Art Examples



The Sustaining Arch - Traditional Media
University of North Texas



Checkedered Mounds - Environmental Media
Texas A&M University



Looking to the Stars - Functional Objects
Texas Tech University



PLANNING & DESIGN REVIEW PROCESS

Overview

The Campus Master Plan, which includes the Campus Development Guidelines and Design Standards, is the fundamental tool to guide the physical development of the campus in a manner which is consistent with the direction, goals, and aspirations of the University and the System. Accordingly, the integrity of the architecture and landscape character is protected through the application of understandable and enforceable standards.

The master plan is intended to govern the location of new facilities, and the guidelines and standards govern the details of placement and design of new buildings and site improvements consistent with the campus master plan. Further, they are intended to assist in outlining the key design elements of future buildings that will create a hierarchy of campus open spaces and unify the architectural expression of the campus; and with the orderly development of the campus open space and landscape-hardscaped places.

The process of reviewing and approving proposed campus improvements and new buildings and landscapes, to assure compliance with the intent of the master plan, development guidelines and the design standards, should be in accordance to System and University policies. While each new building must function for the intended uses and program, all buildings ultimately owned by the System and University must be considered as part of the campus as a whole. The System and University policies provide the framework to ensure civic, campus and urban design mission of a project, not its functional or individual mission.

Issues to be considered in the review process are the quality of public open space and landscape; a building's relationship and connection to the entrance and primary interior lobby and circulation space; exterior appearance and architectural form; and contributions to the larger campus context and the space in which it is sited. Each project should be reviewed according to primary goals as follows:

- To interpret the Campus Master Plan and determine compliance with the policies, principles, guidelines and design standards
- To recommend modifications to proposed projects as appropriate to ensure compliance
- To evaluate projects to ensure that they meet UNTHSC qualitative standards, including the University's goals and policies for sustainability

The review process is not intended to provide for the design the building or site, but to provide clear direction to the project team (architects, landscape architects, and other project representatives) through comments and suggestions.

Criteria for Project Design Review

A review is prompted by any new building project as described in the System and University policies. In general, any project changing building appearance through replacement, repair or restoration; and any improvement or construction project affecting any campus exterior public space. All major buildings and landscape improvements should be reviewed.

Smaller projects should also be considered for review, although an abbreviated administration process may be utilized at the direction of the Vice Chancellor for Facilities Planning and Construction. In some cases, smaller projects may be an opportunity to initiate a planned transformation of an existing space.

In general, review is triggered by projects that impact the quality and appearance of the campus, exterior public space, and building.

Exceptions or Modifications

Certain sites at the perimeter of the campus or at major gateways may require modifications of the guidelines in order to establish an appropriate public face for the campus or establish an individual identity for a specific gateway project while still integrating and advancing the overall campus character and composition.

The goal is to establish the appropriate flexibility in the application of the guidelines for these special projects through an exemption process at a level appropriate for the project and the degree of deviation from normal guidelines. The process may involve the Vice Chancellor for Facilities Planning and Construction, President, Chancellor, and in some cases the Board of Regents.

During the review process, exceptions to the master plan policies, principles, or guidelines after serious deliberation. But granting exceptions or modifications is the sole responsibility of the Vice Chancellor for Facilities Planning and Construction, who is responsible for the campus master plan and establishing and approving design guidelines based on the campus master plan goals, principles, and guiding values. Exceptions or modifications may require review and approval of the System Chancellor and Board of Regents.

Administrative Integration of the Design Review Process

The success of design review process is predicated on the integration into the existing University administration and policies, especially as they relate to campus development and project initiation.

The development process involves many different individuals and departments whose contributions will be more effective with clear delineation of appropriate roles, responsibilities, and interrelationships. It is expected that the office of the Vice Chancellor of Facilities Planning and Construction will define the specific roles and relationships of the following parties in the administration of the design review process:

- Design Review Committee
- Office of Facilities
- User Committees
- Architect Selection Committee
- Project Architect and Consultants

Selection of architects and other design professionals may be the most important factor in the successful implementation of the Campus Master Plan. The intentions of the master plan should be referenced in all solicitations for design professionals. Selection criteria should include an understanding and demonstrated familiarity with the campus master plan, development guidelines, and design standards.

While design professionals are selected based on qualifications and experience with the specific building and program type, they should have demonstrable understanding of the intent of the university as manifested in the Campus Master Plan. The architects should confirm their willingness to work within the UNTHSC design language and vocabulary.

Design Review Procedures

Design Review meetings should be scheduled as required by project volume and schedule. Projects will be presented as outline in the System and University policies by the participating user committee and the project design team, which might include architects, landscape architects, engineers and professional consultants. After every project review, written comments should be provided to the project design team with copies sent to the Office of the Chancellor and the President.

The sequence of actions/reviews will include, but not be limited to the following:

- Providing a complete copy of the master plan with the development guidelines and design standards to the project design team
- Require an initial meeting with the architect or designer to clarify the intent of the proposed project

- Require that the architect or professional obtain site development approval as part of the initial approval process for a new project. The proposed site plan will be compared to the master plan to demonstrate conformity with setbacks, alignments, axial view lines, service access, and other obvious context items at both immediate and larger campus scales
- Establish a schedule of reviews during the concept, schematic design and design development phases; if there are significant changes or unresolved issues, additional reviews of construction documents may be necessary
- Conduct post-construction assessment of the project.

A determination may be made at the outset of the review process that fewer steps may be undertaken if the scale or the impact of the project on the campus is deemed to be insignificant.



Valubility Honor Wall



APPENDIX

SUPPLEMENTAL MATERIAL

7



REFERENCES & RESOURCES

Supplemental Reference Documents (Stand Alone)

The below studies were produced in conjunction with the 2018 Campus Master Plan to provide additional details on specific master plan topics:

- Mechanical, Electrical, & Plumbing Study
- Parking and Transportation Study
- Research Facility Opportunity Study
- Wastewater Study
- Water Study

Requests for these documents should be directed to the UNT System Planning & Development Team.

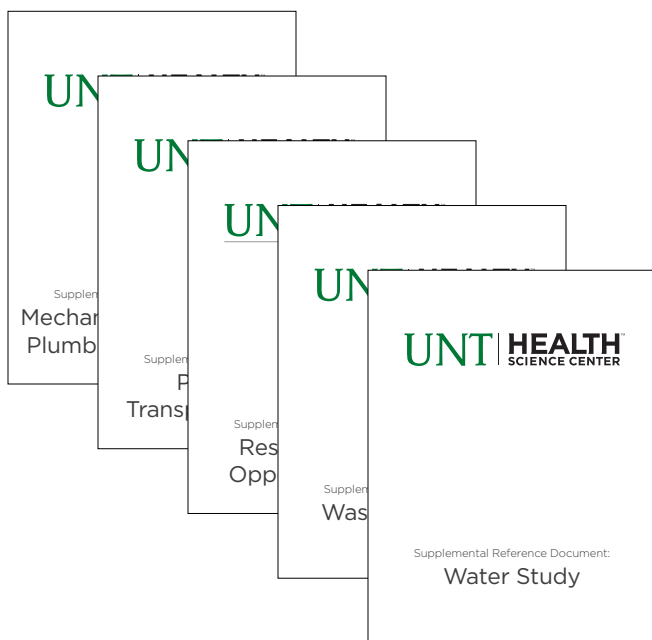

Individual Chapter References & Resources

Primary references and resources used to guide the 2018 Campus Master Plan are organized by chapter below. Some documents and data sources were used to inform multiple sections and are listed beneath each.

Chapter 1: Introduction

UNTHSC, 2018-2019 Catalog - About the UNT Health Science Center, 2018.

UNTHSC, See 2020 Strategic Plan, 2018.

Chapter 2: Observations

2018 Campus Master Plan, Wastewater Study, 2018.

2018 Campus Master Plan, Water Study, 2018.

City of Fort Worth, Bike Fort Worth Comprehensive Plan, 2009.

City of Fort Worth, Montgomery Street and Eastern Arlington Heights Improvement Projects, 2017.

Dallas Regional Chamber, The Health Care Impact Study, 2013.

Texas Higher Education Coordinating Board, Health Care Outpatient Historical Visits Data Table, 2016.

UNTHSC, Campus Master Plan, 2007.

UNTHSC, Coded Floor Plans - ArchiBUS, 2018.

UNTHSC, Employee Service Data Table, 2017.

UNTHSC, Enrollment by Program and Class Data Table, 2017.

UNTHSC, Facilities Inventory of Rooms, 2017.

UNTHSC, Historic Grant Research Expenditure Data Table, 2017.

UNTHSC, Historic Headcount Fall Terms, 2017.

UNTHSC, History and Traditions of the UNT Health Science Center at Fort Worth, 2010.

UNTHSC, Pedestrian Safety Report, 2014.

UNTHSC, Property Schedule, 2016.

UNTHSC, Sustainability Data Table, 2017.

UNTHSC, Transportation Survey, 2013.

UNTHSC, University Parking Study, 2017.

UNTHSC, University Parking Fee Study, 2016.

Chapter 4: Campus Master Plan

2018 Campus Master Plan, Mechanical, Electrical, & Plumbing Study, 2018.

2018 Campus Master Plan, Parking and Transportation, 2018.

2018 Campus Master Plan, Research Facility Opportunity Study, 2018.

2018 Campus Master Plan, Wastewater Study, 2018.

2018 Campus Master Plan, Water Study, 2018.

Chapter 5: Implementation

2018 Campus Master Plan, Mechanical, Electrical, & Plumbing Study, 2018.

2018 Campus Master Plan, Research Facility Opportunity Study, 2018.

Chapter 6: Campus Development Guidelines

UNT, Campus Master Plan Update, 2013.

UNTHSC, Campus Master Plan, 2007.

UNTHSC, Plant List, 2007.

SUPPLEMENTAL INFORMATION

Realignment of Existing Facilities

At the start of the planning process, stakeholders jointly established principles and priorities to guide the eventual master plan. A key prerogative was the optimization and alignment of new and existing facilities to maximize the overall efficiency of the institution’s space. As the campus has evolved and grown over time, spaces and assets were arranged to meet immediate needs. This has led to certain program placements that do not align to their locations highest and best use. For example, EAD, RES, CBH, and IREB were all designed as research buildings, but all house substantial academic or administrative components which are not the optimal use of each facility.

The campus master plan seeks to re-align uses so that they are located in the appropriate facilities that best support their needs while supporting the maximum facility efficiency campus wide.

The table at the bottom of this page identifies areas and functions campus stakeholders identified as potentially being misaligned or poorly located. In total, these spaces add up to over 285,000 GSF (the equivalent of two large buildings). Keep in mind that not all of these spaces could be easily be relocated today. All existing facilities to potentially move them to are occupied, and no new facilities are currently planned. However, the master plan emphasis continued evaluation of these assets as campus development occurs and recommends placing them in new structures that are properly located as the campus grows. This will free up the space they currently occupy to backfill with more optimal uses and assist with achieving near-term space needs.

Refer to the 2018 Campus Master Plan: Research Facility Opportunity Study supplemental document for additional analysis of these opportunities as they relate specifically to research backfill.

Realignment Opportunities - Summary Table

Location	Potential Action	Apx. GSF
EAD 2nd - 7th Floors	Relocate academic functions	43,500
EAD 2nd & 8th Floors	Relocate administrative functions	20,000
RES 1st & 2nd Floors	Relocate academic functions	11,250
MET 1st Floor	Reformat large lecture halls	18,000
CBH 2nd Floor	Relocate academic functions	5,500
CBH 1st Floor	Relocate / remove clinical	4,250
IREB 3rd & 4th Floors	Relocate academic functions (MD)	53,000
FAC1st & 2nd Floors	Relocate fitness center	10,000
LIB 1st Floor	Relocate administrative functions	20,000
HP 1st - 6th Floors	Relocate / remove clinical	110,121
Total		286,621

Space Need Projection Analysis Data

A high-level overview of the projected near-term (10 year) space need was provided in the Implementation Chapter. The subsequent pages provide a greater level of detail on the data, methods, and analysis used to provide space need recommendations. These forecasts are intended to support the strategic direction of UNTHSC and allow for informed capital planning over the next decade. However, it is also important to recognize that these forecasts are created based on anticipated needs projected by current data. Variable factors over the next decade may influence the actual space need to be lesser or greater.

Due to the unique characteristics of health science centers, a single projection that lumps all space types together (as is often done with large, four-year institutions) would not accurately reflect the campuses specialized space needs. Instead, the 2018 Campus Master Plan examines each primary campus space type individually and uses a variety of methods to provide a hybrid model for each space type.

The data utilized to make these projections was provided by UNTHSC or the UNT System at the start of the master plan process. The provided data varies in timeframe. Some historical data was supplied all the way back to campus formation (such as historic enrollment counts) while other data went back 20 years or less (such as research expenditures and clinical patient counts). UNTHSC also provided five-year forecasts for certain datasets (enrollment and research expenditure). These were extrapolated out to the 10-year, near-term timeframe.

For the most significant space types on campus (academic, research, and clinical), summary tables were produced comparing the growth rates for multiple methodologies. Each table provides three lens that could be used to interpret the data and guide space growth. Progressively, the space need projections refine in scope from Lens 1 to Lens 3. Within each lens, an average and a range are supplied that incorporate the respective data each represents.

Lens 1 includes all projection methods employed for the space type. While this captures a broad look at multiple projection methods, some of the methods may be less relevant to current trends due to their time frame or extreme and outlier conditions that inform them.

Lens 2 includes recommended methods for each space type based on the relevancy of the specific data sets to current or future trends. Relevancy was determined based time factors (five to ten year trends are more applicable to campus growth than 20-40 year trends), UNTHSC policy direction, targeted or identified growth, evolving pedagogy, and evolving care models. Lens 2 is intended to create a refined look at space needs and provide a likely range that the 10-year demand will fall within.

Lens 3 is the planning team's hybrid recommendation derived from consideration of multitude of variables. These figures are the targets used to create a 10-year vision for campus space needs, however it is critical to understand actual needs may be higher or lower based on the ever changing needs of the institution.

For the other space types, minimal growth is expected in these areas. The growth that does occur will be to either support academic and research needs or enhance the overall campus experience.

Combined Space Need Total

Combined, the total projected space need is 477,500 GSF of new space over the next 10 years.

Space Type	Projected Need
Academic	145,000 GSF
Research	200,000 GSF
Clinical	0 GSF
Administration	37,500 GSF
Library	30,000 GSF
Facilities	15,000 GSF
Leased	0 GSF
New / Other	50,000 GSF
TOTAL	477,500 GSF

Academic Space Growth Projections - Summary Table

Academic Space Projection Methods	Annual Growth Rate (Simple)	Method 2028 Space Need (GSF)	Lens 2 Suggested
10-year Historical Enrollment Growth	9.8%	252,300 GSF	Yes
20-year Historical Enrollment Growth	13.2%	348,000 GSF	
30-year Historical Enrollment Growth	16.5%	466,900 GSF	
40-year Historical Enrollment Growth	18.4%	481,400 GSF	
UNTHSC 5-year Enrollment Projection	2.7%	78,300 GSF	Yes
MP Process Identified Growth (over 10-years)	5.2%	150,800 GSF	Yes
MP Process Identified Growth (over 20-years)	2.6%	75,400 GSF	
10-year Academic Space Growth	5.7%	165,300 GSF	Yes
40-year Academic Space Growth	15.6%	452,400 GSF	
Lens 1: Average of All Methods	10.0%	289,033 GSF	
Lens 1: Range of All Methods	2.5% - 18.4%	72,500 - 533,600 GSF	
Lens 2: Average of Suggested Methods	5.9%	169,650 GSF	
Lens 2: Range of Suggested Methods	2.7% - 9.8%	78,300 - 284,200 GSF	
Lens 3: Hybrid Recommendation	5.0%	145,000 GSF	Recommended

Sources: varied, listed below

Academic Space Growth Projections - Simplified Datasets

Historic Enrollment Growth (latest data 2017)									
Year	1977	1982	1987	1992	1997	2002	2007	2012	2017
Fall Headcount	273	363	385	416	628	969	1,153	1,949	2,285

Source: UNTHSC, Historic Headcount Fall Terms, 2017, dataset

UNTHSC 5-year Enrollment Projection (initial data 2017)						
Year	2017	2018	2019	2020	2021	2022
Fall Headcount	2,285	2,384	2,427	2,496	2,565	2,633

Source: UNTHSC, 5-year Institution Enrollment Projection, 2017, dataset

Master Plan Process Identified Enrollment Growth Opportunities			
Year	2017	2027 (10-year horizon)	2037 (20-year horizon)
Fall Headcount	2,285	3,385	3,385

Source: Ayers Saint Gross, 2018 Campus Master Plan Workshop 05 Presentation, 2018, summary table

UNTHSC Historical Academic Space Growth (GSF)			
Year	1978	2008	2018
Academic GSF	estimated 40,000 (EAD)	185,000	290,000

Source: UNTHSC, Coded Floor Plans - ArchiBus, 2018, dataset

Academic

The hybrid space needs recommendation for academic programs weighs multiple factors. Special consideration was given to legislated limits on maximum enrollments, emerging program opportunities, targeted growth areas, current space needs and constraints, fulfillment of the master plan guiding principles and priorities, and the launch of the MD Program.

Historical enrollment (Fall headcount) growth was analyzed in 10-year, 20-year, 30-year, and 40-year increments. This analysis revealed that the campus has been experiencing significant and sustained growth. These growth rates range from 18.4% (40-year) down to 9.8% (10-year). It is recommended that the 10-year growth rate be utilized as it most accurately aligns with current institutional trends.

A second method was extrapolation of a UNTHSC provided a five-year enrollment forecast, which expects the campus to add 252 students by 2022 (2.7% growth per year). This conservative number only captures initial growth of the MD program to four classes and limited additional students in programs that have taken classes smaller than permitted by the state in recent years. While this conservative figure does capture known growth, it precludes aspirational growth on the radar of university leadership. This rate was recommended as a suggested method and factored into the hybrid recommendation because it is the assumed growth floor if no additional new programs or expansions are pursued.

A third academic space methodology was the space growth that would be needed to support the combined enrollment opportunities identified by leadership during the planning process. Though aspirational, this growth is rooted in discussions taking place on campus and academic strategic planning. This targeted growth includes expansion to existing academic programs that have to meet certain legislated limits before expanding (such as GME targets or caps), need additional space or specialized facilities to grow, or new programs that are opportunity areas for the institution. In total, the opportunities identified totaled to 1,161 potential additional headcount

(for a total campus of headcount of 3,385). This total headcount was then projected over a 10-year and 20-year time frame to get the growth rates that would be required to achieve that mark for each duration. Both the 10-year and 20-year growth rates were recommended as a suggested methods and factored into the hybrid recommendation because leadership identified each of these as opportunities if the facilities existed to support them.

Lastly, historic academic space growth was examined at a 10-year rate and a 40-year rate based on the data supplied by UNTHSC. Using the existing space data from Archibus, it was determined that the current academic GSF is 290,000 GSF. Subtracting out the academic space in the two buildings built over the last decade (65,000 GSF from the MET and 40,000 from IREB), 185,000 GSF was used as the academic space total on campus 10 years ago. Academic space has grown 57% over the last decade (5.7% per year). Over the past 40-years (dating back to 1978 when EAD was built) all existing academic space on campus has been built, averaging out to 2.5% of the total built each year. The 10-year academic space growth rate is a suggested method that influenced the hybrid recommendation due to its relevancy to recent program trends.

Recommendation: The hybrid recommendation strongly considered the four suggested projection methods (which averaged out to a suggested 5.9%), but ultimately elected for a slightly more conservative 5.0%. This reduction is due to the timing required for specialized academic planning and legislative approval that must preempt program expansion, and by default, the space growth that will support it. Because of this, the hybrid recommendation weights expects that the UNTHSC five-year enrollment projection (that only captures MD school growth) will likely be accurate, but clear academic strategic planning, coupled with facilities growth, can enable the more significant aspirational program growth identified by leadership in the second half of the 10-year window. This equates to one or two new academic buildings over the next decade.

Research Space Growth Projections - Summary Table

Research Space Projection Methods	Annual Growth Rate (Simple)	Method 2028 Space Need (GSF)	Lens 2 Suggested
5-year Grant Expenditure Historic Growth	1.2%	41,400 GSF	
10-year Grant Expenditure Historic Growth	7.1%	244,950 GSF	Yes
15-year Grant Expenditure Historic Growth	17.3%	597,540 GSF	
UNTHSC Supplied 5-year Grant Projection	3.0%	103,500 GSF	Yes
UNTHSC Strategic Plan Grant Goal	5.0% (or greater)	172,500 GSF	Yes
10-year Space Growth (IREB as built)	1.8%	61,755 GSF	
10-year Space Growth (IREB original program)	3.5%	120,405 GSF	
20-year Space Growth	4.6%	159,735 GSF	
Lens 1: Average of All Methods	5.4%	187,723 GSF	
Lens 1: Range of All Methods	1.2 - 17.3%	41,400 - 597,540 GSF	
Lens 2: Average of Suggested Methods	5.0%	173,650 GSF	
Lens 2: Range of Suggested Methods	3.0% - 7.1%	103,500 - 246,330 GSF	
Lens 3: Hybrid Recommendation	5.8%	200,000 GSF	Recommended

Sources: varied, listed below

Research Space Growth Projections - Simplified Datasets

Historic Research Expenditure Growth (latest data 2017)				
Year	2002	2007	2012	2017
Research Expenditure	\$12,347,141	\$25,914,940	\$41,954,584	\$44,420,752

Source: UNTHSC, Historic Grant Research Expenditures, 2017, dataset

UNTHSC Supplied 5-year Research Expenditure Projection - 3% Goal (initial data 2017)						
Year	2017	2018	2019	2020	2021	2022
Research Expenditure	\$44,420,752	\$45,753,375	\$47,125,976	\$48,458,598	\$49,791,221	\$51,123,843

Source: UNTHSC, 5-year Institution Grant Research Expenditure Projection, 2017, dataset

UNTHSC See 2020 Strategic Plan Research Grant Expenditure Growth - 5% Goal				
Year	2017	2018	2019	2020
Research Expenditure	\$44,420,752	\$46,641,790	\$48,041,043	\$49,482,275

Source: UNTHSC, December 2017 Strategic Plan Presentation to UNT Board of Regents, text

UNTHSC Historical Research Space Growth (GSF)			
Year	1998	2008	2018
Research GSF	180,000	292,000	345,000

Source: UNTHSC, Coded Floor Plans - ArchiBus, 2018, dataset

Research

The hybrid space needs recommendation for research programs weighs multiple factors. Due to the inherent relationship between the amount of research being done on campus (research expenditures) and the space that is required to support it, correlation between any projected growth in research expenditures and space is critical. Because of this, historic trends and institutional goals pertaining to expenditure growth were the key factors in recommending how much new research space will be needed over the coming decade.

Research expenditures have grown substantially since the turn of the century. In 2000, the campus executed just over \$10,300,000 in research. By 2017, expenditures had grown to over \$44,400,000. Incrementally, this growth corresponds to 1.2% per year over the last 5 years, 7.1% per year over the last 10 years, and 17.3% per year over the last 15 years. While expenditure growth has plateaued over the last five years (loosely corresponding to leadership transitions at multiple levels), there is a concerted effort by current campus leadership to refocus and reemphasize growth in research expenditures.

This refocusing is captured through the strategic direction campus leadership provided for research growth in the coming years. Two visions were provided to the planning team. The first was a conservative five year outlook, which projected 3.0% growth per year through 2022. This modest goal represented a baseline for the coming years. The second is the extrapolation of the 5.0% (or greater) goal established in the See 2020 Strategic Plan. Dr. Williams has emphasized this 5.0% goal to the campus community, DFW industry, and UNT System Board of Regents. Ultimately, this 5.0% goal represents the institutional priority, and ensuring that facilities exist to support it is the most critical component of the hybrid space needs projection.

Historic space growth was also examined at 10-year and 20-year intervals based on existing space data provided from Archibus. Current research space on campus is 345,000 GSF. Opening later this year, IREB is the only building containing

research space that has been built since 2008 (10-year window). As built, IREB contains about 53,000 GSF of research space, which subtracted from today's total suggests 292,000 GSF of research space existed on campus in 2008. This 10-year growth amounts to 1.8% per year.

IREB is unique in that it was designed to be primarily a research building to meet increasing demand for additional research space, but late in the design process, the program was modified to include space for the emerging MD program (academic space). If IREB had been built as originally intended, the 2018 research space total would be 395,000 GSF equating to a 3.5% per year growth rate over the last decade. While this growth rate was not included as a suggested method because of its tenuous basis as a data point, it is still an important consideration because presumably the demand for research space that predicated the buildings construction still exists.

The 20-year space growth outlook removes both IREB (53,000 research GSF) and CBH (113,500 research GSF) to suggest a total of 180,000 GSF of research space existed on campus in 1998. Over the last two decades, research space has grown at a rate of 7.1% per year.

Stakeholders shared that to-date, research space has been opportunistically assigned (researchers are placed where there is space available, not in optimal facilities or locations). While the master plan emphasis on realigning existing spaces could lead to increased space efficiencies, it was also identified that there are research support space types that do not exist today that are needed to improve collaboration, knowledge sharing, and research environment quality for students, faculty, and staff.

Recommendation: Near-term research space growth of 200,000 GSF. This captures the Strategic Plans 5.0% goal per year and adds an additional .8% to accommodate the need for new support and collaboration spaces in existing and future facilities. This adds significant realignment and backfill of existing facilities or a new research building over the next decade.

Clinical Space Growth Projections - Summary Table

Research Space Projection Methods	Annual Growth Rate (Simple)	Method 2028 Space Need (GSF)	Lens 2 Suggested
5-year Patient Visit Growth	0%	0 GSF	Yes
10-year Patient Visit Growth	27.8%	959,445 GSF	
15-year Patient Visit Growth	11.5%	397,440 GSF	
Steering Committee Defined Vision	0%	0 GSF	Yes
Lens 1: Average of All Methods	9.8%	339,221 GSF	
Lens 1: Range of All Methods	0% - 27.8%	0 - 959,445 GSF	
Lens 2: Average of Suggested Methods	0%	0 GSF	
Lens 2: Range of Suggested Methods	0% - 0%	0 - 0 GSF	
Lens 3: Hybrid Recommendation	0%	0 GSF	Recommended

Source: Texas Higher Education Coordinating Board (THECB), UNTHSC Outpatient Visits, dataset

Clinical Space Growth Projections - Simplified Datasets

Historic Patient Visits (latest data 2015)				
Year	2000	2005	2010	2015
Fall Headcount	192,839	139,164	527,017	526,150

Source: Texas Higher Education Coordinating Board (THECB), UNTHSC Outpatient Visits, dataset

Clinical

The hybrid space needs projection for clinical programs is informed by strategic direction from leadership that clinical functions will be moving off campus. In addition to the clear strategic direction provided by campus leadership, there was a 0% increase in on campus patient visits from 2010 to 2015 (the most recent data the planning team was able to access).

Many medical schools are built around large legacy teaching hospitals that anchor their clinical practice models. Today however, the modes of teaching clinical skills and academic medical care provision are evolving. According to a recent UNTHSC study, in industry, 90% of medicine is practiced in ambulatory settings. Not burdened by the commitment to an on-campus hospital, UNTHSC is uniquely positioned to adapt to these changes by forging partnerships with local and regional health care providers to shift its clinical practice and education into the community. Leadership identified this shift as the strategic direction that will be taken in the coming years.

Over the past few years, multiple new industry partnerships have been announced (in addition to multiple existing partnerships). These partnerships provide residency opportunities for students that directly align to the settings that they are most likely to practice. In February of 2018, UNTHSC announced it will be partnering with Medical City Health care to create 500 new residency positions through the next seven years. Most recently (March of 2018), UNTHSC announced a partnership with Catalyst Health Network to provide ambulatory care opportunities in its 140 office locations.

Recommendation: Zero new clinical space added to the campus in the near-term as the campus continues to forge new partnerships that will allow students residency opportunities to serve and learn off campus. As this shift continues, overall clinical space on campus may reduce.

Administration / Support

The hybrid space needs recommendation for administration / support programs is derived from opportunities to increase the efficiency of existing uses through realignment and creating new spaces to support academic and research growth (at a less aggressive rate).

Administration / Support programs refer to institution-wide management functions (such as the Office of the President, other senior leadership, the IT Department, etc.). Many existing functions are poorly located today (such as the variety of administrative functions taking up prime real estate on the ground floor of the library) and are located in spaces that were not designed to be offices. These spaces also follow the legacy model where each individual gets their own enclosed room. Current higher education trends are shifting towards more open and collaborative office environments, which, in addition to the many other benefits, are typically more space efficient than the traditional office suite models. Opportunity to realign and relocate some of these functions into more efficient locations and formats the near-term will reduce the net space need.

Projection of new Administration / Support space using traditional methods can be complicated for an established campus due to the nature of how these functions grow. Many core administrative functions (such as the Office of the President) will not grow at a rate equal to other programs because they do not get duplicated as the campus expands (you would not hire a second President). However, it is critical to build in some space growth to support the additional personnel that will be required in existing departments.

Recommendation: Forecasted near-term administration / support space need is 37,500 GSF (equal to 1.75% growth per year), capturing space to support academic and research growth, as well as increased efficiencies.

Library

The hybrid space needs recommendation for library programs is informed by three components that each suggest the need for additional space.

Historically, libraries have been about books and quiet study. Today, they are gradually evolving into learning commons where students (and faculty) can meet to work or team in a collaborative environment. Gibson D. Lewis Library began this transformation in 2014 by reducing stacks and opening up the 2nd and 3rd floors with flexible furniture arrangements that promote collaboration. Library staff shared that the transformation has been a great success, having led to increased traffic and transformed the library into the central hub on campus. Building off the success of this new model, stakeholders shared that there is existing demand for additional collaborative and team space.

A second factor for library space needs is projected increases in academic and research programs. Growth in these areas will lead to a large population on campus. It is recommended that growth to the library roughly matches growth in the overall campus population (aspirational enrollment growth by master plan stakeholders was 52% over 10 years), although a slight reduction can be realized as certain core library functions (such as the checkout desk) will not have to be duplicated with growth. Today, core functions comprise about 5% of the libraries GSF. A 47% net increase to the existing library would be 30,000 GSF.

In addition to the library's evolving role as a collaboration hub on campus, it is also seeing an expansion of its role as a knowledge repository and community center. In 2016, the National Library of Medicine designated the Gibson D. Lewis Library as one of eight regional medical libraries. This designation makes the UNTHSC library the primary partner for National Institutes of Health (NIH) community engagement and education programs in the South Central Region. Building off of this relationship, in May of 2018, the library received two grants totaling a combined \$7.9 million from the NIH to expand

community engagement around health education and access to health related information.

Recommendation: Combining increased support and demand for collaborative and teaming environments, projected academic and research growth, and the libraries role as a Regional Medical Library, the master plan recommends adding the 30,000 GSF to the library (equal to 4.7% growth per year)

New / Other

The hybrid space needs recommendation for other programs is driven by the new functions identified by stakeholders during the planning process that the campus currently lacks. These functions were identified as being critical to support and enhance the on-campus experience for students, staff, and faculty and desired for inclusion in the near-term.

Due to the campus currently having minimal space classified within the New / Other category, traditional space projection methods provided insufficient data points to make 10-year space need projections with statistical confidence. Instead, the approach is more simple than other space categories. Approximate GSF's (based on typical sizes on similar campuses) for the identified new programs was combined. The provided sizes should be used as a preliminary guideline, but the campus should undertake additional programming studies before construction to produce final numbers. Identified functions and programs include:

- Event Center / Multi-functional Community & Industry Space (~25,000 GSF New)
- Welcome Center (~10,000 GSF New)
- Exhibition Space (~15,000 GSF New distributed across campus)

Recently, there has also been significant dialog surrounding the creation of a modern recreation center to replace the functions currently in the Founders Activity Center. Preliminary analysis suggests that the current facility is right-sized for the campus population. However, it is poorly

located, in an aging structure, has an inefficient layout, and lacks some desired amenities. The near-term master plan implementation strategy would allow for the relocation of this program into the campus core, but would recommend a 1:1 replacement resulting in no additional GSF need.

Recommendation: The combined total of recommended new programs identified by stakeholders as critical in the near-term is 50,000 GSF (equal to 29.5% growth per year).

Facilities

The hybrid space needs projection for facilities programs is dictated by what is required to support the new facilities that will enable growth in the other space categories.

Historically, facility space has been added in non-standardized intervals on an as-needed basis. As the campus grows, new facilities space will be required to support new development. Rather than continue the historical trend of adding new facilities space as the need happens (and often to just support individual buildings), new facilities space should be constructed to support the creation of campus utility loops and provide capacity (or the ability to add capacity) to enable future development.

Any growth west of Montgomery Street will require new utility capacity and infrastructure. The 2018 Campus Master Plan recommends creation of a new West Campus central utility plant in the near-term to meet this need (options for which are outlined in greater detail later in this Appendix).

Recommendation: Based on the full build-out of the master plan, this new utility plant will eventually need to be 15,000 GSF (equal to 3.3% growth per year) to support all future West Campus development. It is recommended that this entire space be created near-term to provide room for expansion enabling mid- and long-term development.

Leased

The hybrid space needs projection for leased programs is informed by strategic direction from leadership to not increase space near-term.

Leased space is unique in that it is not critical to campus operation, but instead, is based on legacy uses or facilities, filling unoccupied spaces, or conscious real estate investments to generate revenue. Because of this, leased spaces are highly variable and fluctuate over time.

The master plan sets a goal to minimize or eliminate the need for leased space in the near-term through more efficient use of existing facilities and redevelopment of legacy facilities that are currently leased (such as the Surgical Center 3617 West 7th Street).

Long-term, the master plan provides a framework to bring industry partners onto campus that may lease space or even partner on the construction of entire buildings. The master plan also provides opportunity to create revenue-generating commercial spaces along the ground floor of future buildings that front West 7th. As these decisions arise in the future, leadership should carefully consider where leased space is being placed and how it integrated with the campus (both physically and programmatically).

Recommendation: Near-term space projections include zero new lease space, and potentially includes a reduction in leased space as the campus prepares for future development to replace structures currently holding leased space.

Demonstrative Implementation Strategy

Highlighted in the overview of the Implementation Chapter, at the start of the planning process UNTHSC stakeholders shared a desire to create a flexible and adaptable master plan capable of responding to ever-changing campus program and facility needs. Because of this, the master plan is defined by the Framework (which gives organizational form to campus patterns that will support the desired physical environment) rather than specific regulated building uses. To achieve this desire for a flexible campus plan capable of evolving to meet future needs, the program of no future building is dictated as a part of the overall master plan. Instead, the master plan defines general use districts to ensure complimentary adjacencies are maintained as the campus develops. These use districts reinforce Planning Principle #2, which characterizes the desire to align existing and future functions with the correct locations on campus and in the correct facilities.

While this flexibility is important, the planning team also wanted to demonstrate one possible scenario that could meet the forecasted space needs outlined previously in this chapter. The subsequent four pages demonstrate this potential strategy based on assessment of current and projected needs. As demand creates need for expansion, further analysis should be taken at the onset of each project to ensure that the correct programs are being located within each building.

Although the shown approach is currently recommended, this is just one possible scenario. As the campuses needs change and evolve, numerous alternative implementation approaches may be preferable to best meet the campus's needs.

How to interpret these pages:

A. Graphic illustration of step: Illustration shows existing buildings and campus grayed out. At each step, colored elements are added to the diagram showing new buildings, associated site and landscape projects, and backfill renovations to existing buildings. Colors match the primary space types presented in the Observations Chapter (and also detailed in element C).

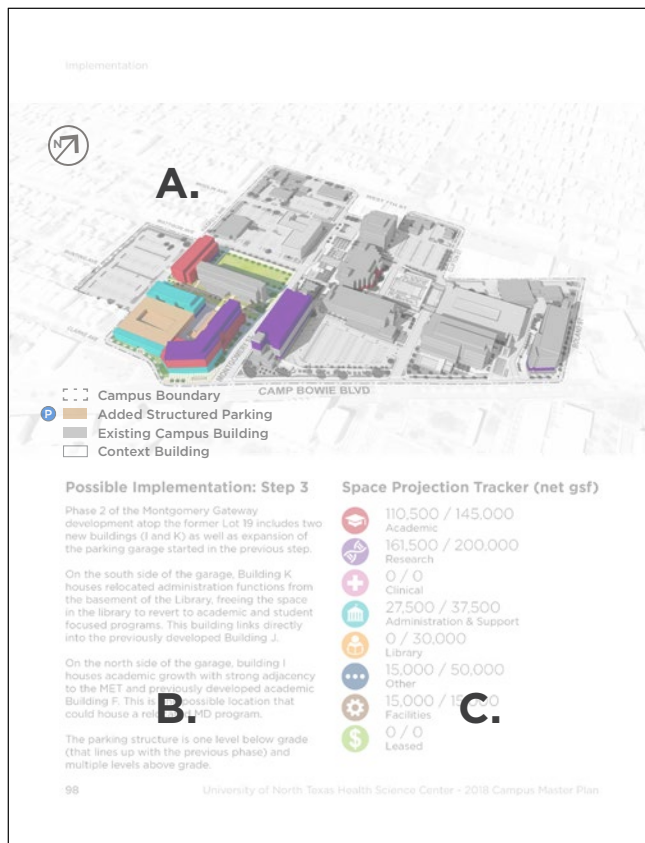
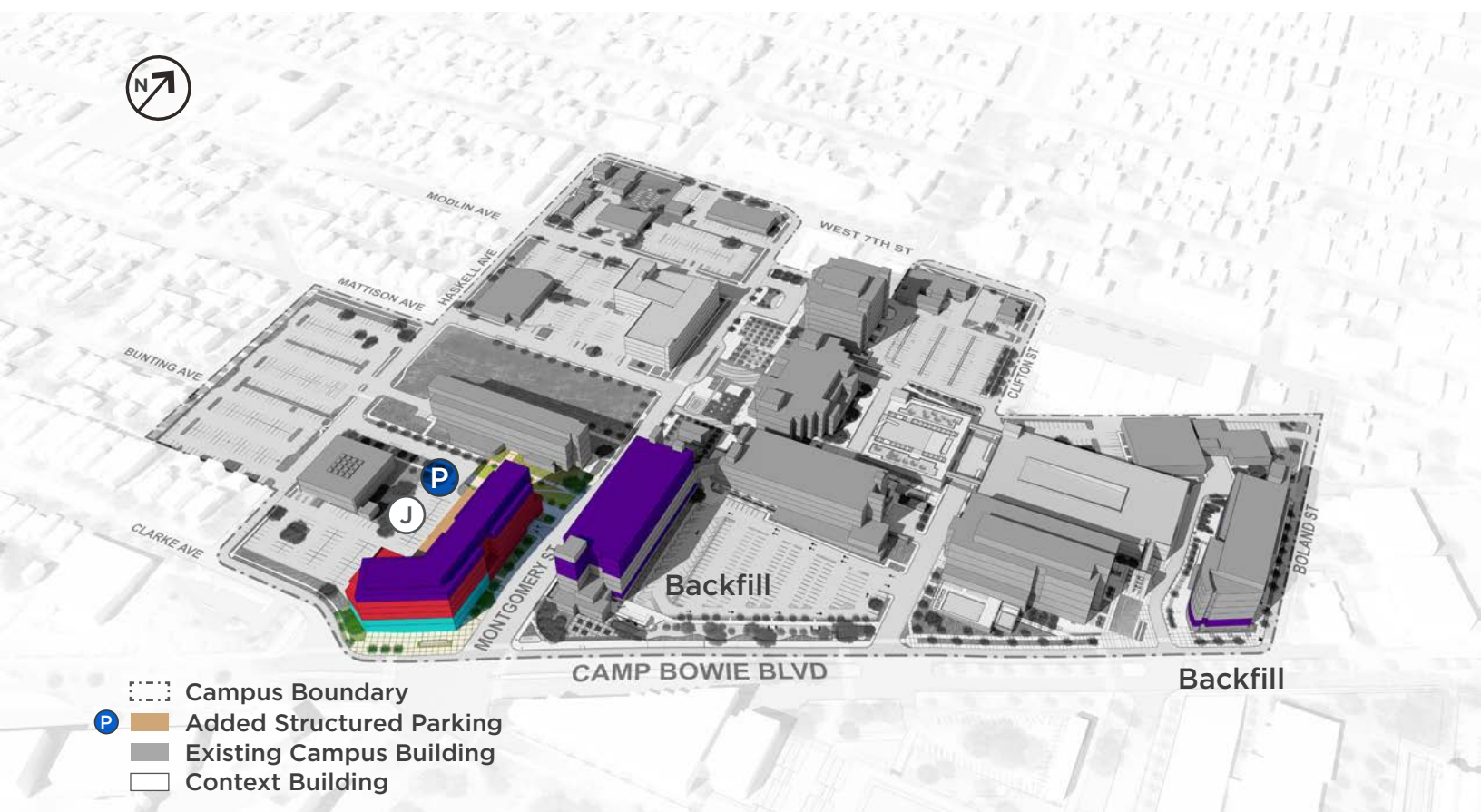

Diagram detailing how to interpret subsequent implementation pages

B. Step Overview: Summary explanation of what is accomplished during each step.



C. Space Projection Tracker: Shows the net GSF increase for all changes shown for a given step. The eight primary space types are shown with their color corresponding to the graphic illustration above on the page. Each space category has two numbers. The first is the net increase in square footage for each space type over existing space. This number does not reflect when existing uses are relocated into new buildings (because that is not new space). Instead, the space type that backfills the vacated increases as it is increasing in total space. The second number is the total space need recommended for each space type based on the hybrid of methodologies outlined previously.



Possible Implementation: Step 1

Restricted by a lack of existing swing space on campus which could be used to decant existing misaligned programs into, the planning team identified the proposed Montgomery Gateway Building (Building J) as a possible first move that could provide maximum benefit. Building J would enable UNTHSC to relocate existing academic spaces in EAD and CBH, as well as existing administrative functions in EAD and SSC, into the new building. This would free up the vacated spaces in existing buildings to backfill more appropriate research functions, creating better programmatic adjacencies, alignment, and efficiencies across campus. Totalling 180,000 GSF, the recommended program is mixed-use comprised of containing academic and student-focused administration functions on floors one to five, new research functions on the top two floors, and a one story at-grade garage that will be expanded into a larger garage in step 2. The MD school could potentially be relocated to Building J.

Space Projection Tracker (net gsf)

	41,000 / 145,000 Academic
	126,000 / 200,000 Research
	0 / 0 Clinical
	20,000 / 37,500 Administration & Support
	0 / 30,000 Library
	2,500 / 50,000 Other
	0 / 15,000 Facilities
	0 / 0 Leased

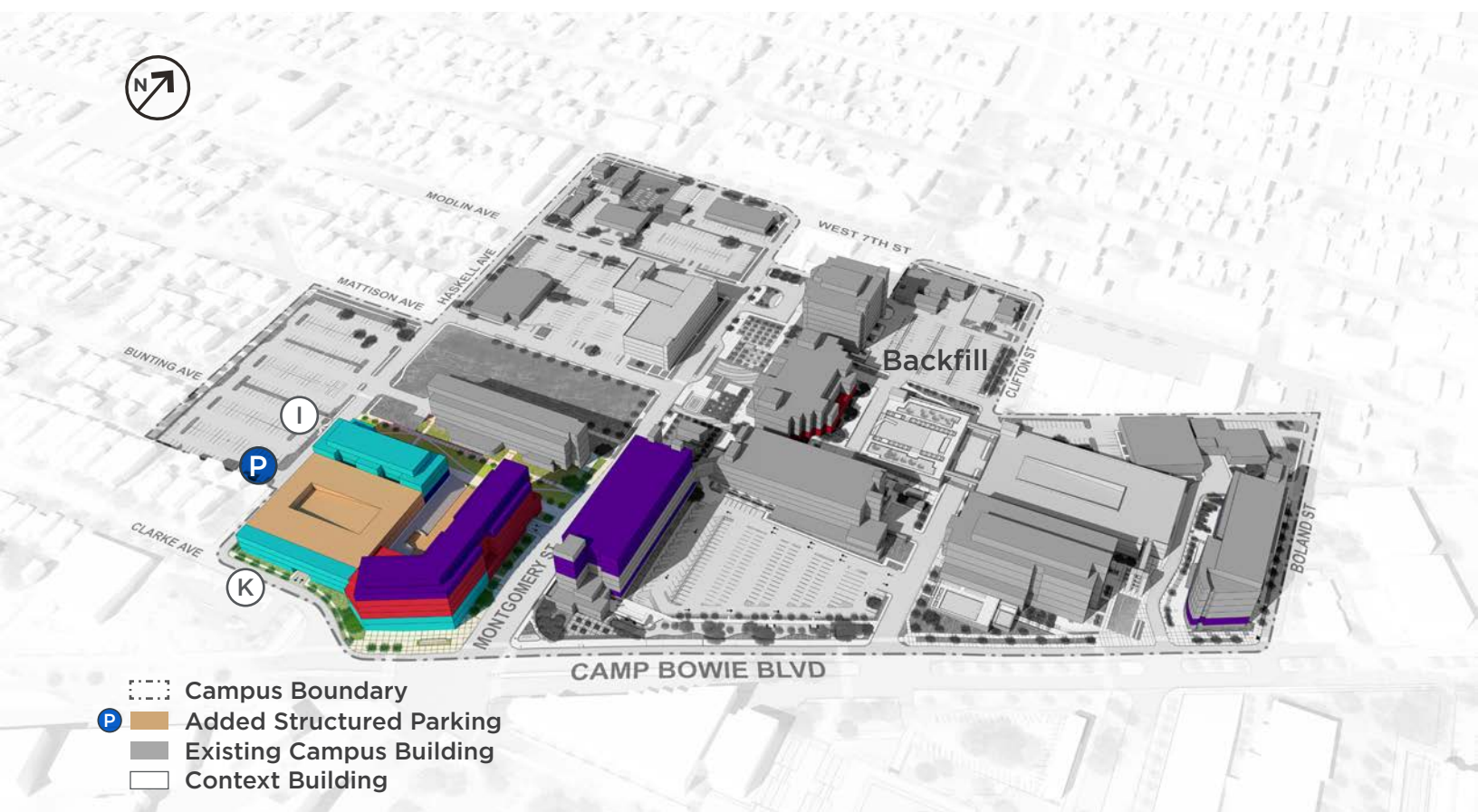









Possible Implementation: Step 2

Phase 2 of the Montgomery Gateway development atop the former Lot 19 includes two new buildings I and K as well as expansion of the parking garage started in the previous step. To meet long term parking needs, it is recommended that the parking structure be one level below grade (due to the site topography, this would line up with the at-grade garage constructed in the previous phase) and multiple levels above grade. Lining the south side of the garage, Building K houses relocated administration functions from the basement of the Library, freeing the space in the library to revert to academic and student-focused programs. This building links directly into the previously developed Building J.

On the north side of the garage, Building I could house new functions such as a fitness center or larger public functions that support collaboration, space for administrative growth, and a new West Campus utility plant.

Space Projection Tracker (net gsf)

	61,000 / 145,000 Academic
	126,000 / 200,000 Research
	0 / 0 Clinical
	28,500 / 37,500 Administration & Support
	0 / 30,000 Library
	15,000 / 50,000 Other
	15,000 / 15,000 Facilities
	0 / 0 Leased

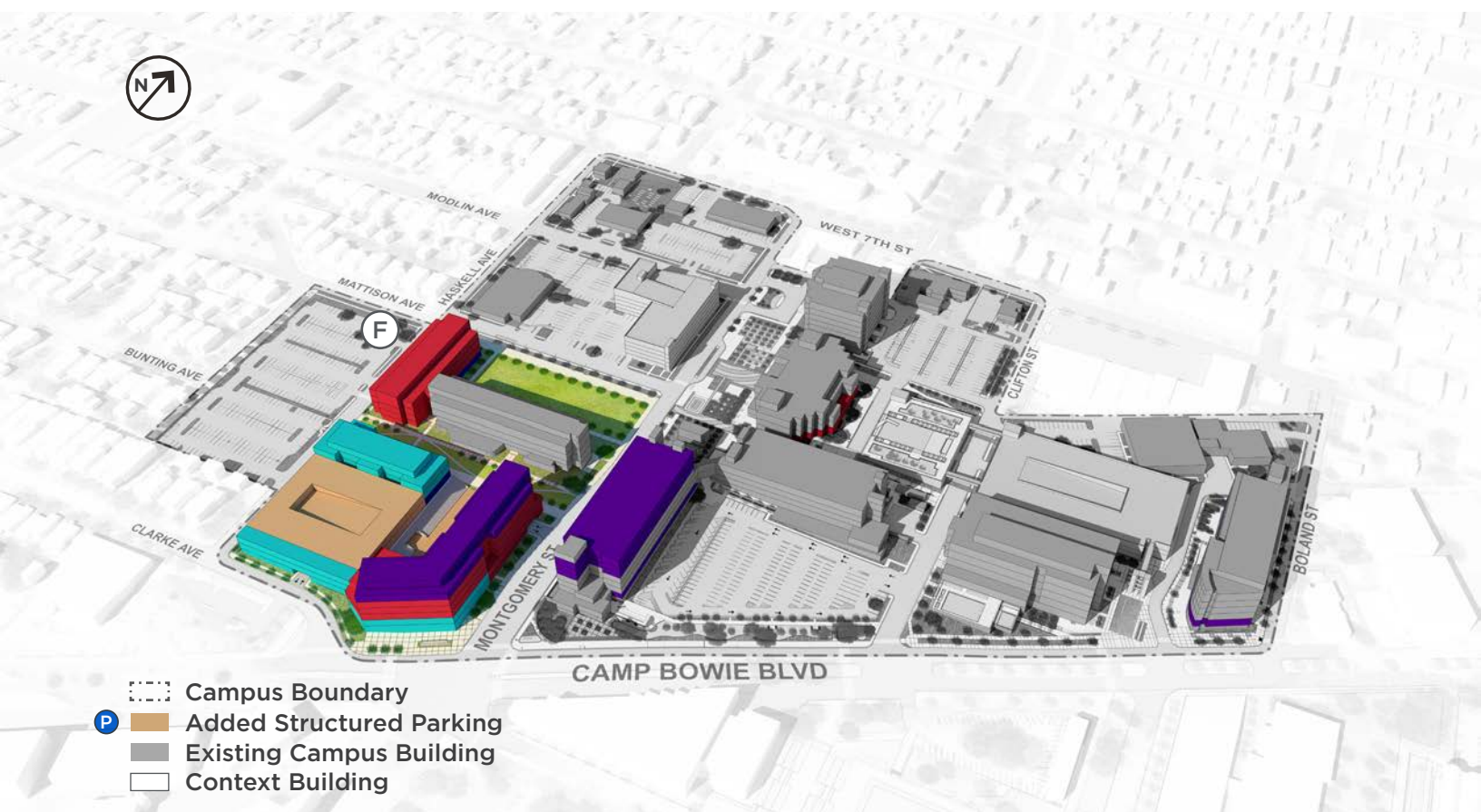









Possible Implementation: Step 3

Towards the end of the near-term period, an additional academic building is anticipated to meet space needs. Proposed Building F, located on the western side of the MET, totals 95,000 GSF. It is recommended that this building be primarily academic, with other student-centered support spaces (such as collaboration and teamwork spaces) located on the ground floor overlooking the MET Lawn. To prevent walling campus off from the North Hi Mount neighborhood and Parking Lot 7, the ground level of building F should be highly permeable and have visible interiors. Entrances should be located on all four sides creating connections to the Campus Spine, Academic Mall, MET Lawn, and Haskell Street.

Building F is another possible location to relocate the MD program into.

Space Projection Tracker (net gsf)

	145,00 / 145,000 Academic
	126,000 / 200,000 Research
	0 / 0 Clinical
	28,500 / 37,500 Administration & Support
	0 / 30,000 Library
	20,000 / 50,000 Other
	15,000 / 15,000 Facilities
	0 / 0 Leased



Possible Implementation: Independent Projects

The below independent projects help complete the projected space needs, meet campus needs, and can proceed at any point.

Library Addition: Expansion vertically and horizontally to create new academic and library space. New entrance onto Alumni Plaza.

Campus Gateway Center: New character building housing a welcome center, flexible event and conference space, industry space, a parking structure, and senior administration office suites.

Clifton Garage Expansion: Additional floor to meet near-term parking needs.

MD Program Relocation: As the program grows it is anticipated it will need additional space. Relocation allows IREB to increase research space.

Space Projection Tracker (net gsf)

	150,000 / 145,000 Academic
	200,000 / 200,000 Research
	0 / 0 Clinical
	37,500 / 37,500 Administration & Support
	30,000 / 30,000 Library
	50,000 / 50,000 Other
	15,000 / 15,000 Facilities
	0 / 0 Leased

Existing Mechanical System Inventory & Conditions

Building	Equipment	Date Purchased	Life Expectancy	End of Life	Condition	Capacity
EAD	Chiller 1	1998	20	2018	Fair	500 Tons
EAD	Chiller 2	1978	20	1998	Poor	500 Tons
EAD	Chiller 3	2011	20	2031	Excellent	440 Tons
EAD	Boiler 1	1993	30	2023	Poor	250 HP
EAD	Boiler 2	1996	30	2026	Poor	250 HP
EAD	Boiler 3	2011	30	2041	Excellent	90 HP
EAD	Boiler 3a	2011	30	2041	Excellent	90 HP
RES	Chiller 4	2000	20	2020	Good	800 Ton
RES	Chiller 5	2000	20	2020	Good	500 Tons
RES	Steam Boiler 1	1981	30	2011	Good	250 HP
RES	Steam Boiler 2	2001	30	2031	Good	250 HP
HP	Chiller 1	1997	20	2017	Fair	150 Tons
HP	Chiller 4	2011	20	2031	Excellent	440 Tons
HP	Hot Water Boiler 1	1997	30	2027	Fair	25 HP
HP	Hot Water Boiler 2	2005	30	2035	Good	25 HP
HP	Hot Water Boiler 3	2005	30	2035	Good	25 HP
CBH	Chiller 1	2004	20	2024	Good	500 Tons
CBH	Chiller 2	2004	20	2024	Good	500 Tons
CBH	Chiller 3	2004	20	2024	Good	500 Tons
CBH	Chiller 4	2010	20	2030	Excellent	150 Tons
CBH	Boiler 1	2004	30	2034	Good	200 HP
CBH	Boiler 2	2004	30	2034	Good	200 HP
CBH	Boiler 3	2004	30	2034	Good	200 HP
CBH	Boiler 4	2004	30	2034	Good	200 HP
MET	Chiller 1	2004	20	2034	Good	200 Tons
MET	Chiller 2	2009	20	2039	Excellent	500 Tons
MET	Boiler 1	2009	30	2039	Good	90 HP
MET	Boiler 2	2009	30	2039	Good	90 HP
IREB	Chiller 1	2018	20	2038	Excellent	500 Tons
IREB	Chiller 2	2018	20	2038	Excellent	500 Tons
IREB	Boiler 1	2018	30	2048	Excellent	50 HP
IREB	Boiler 2	2018	30	2048	Excellent	50 HP

Total Existing Chiller Capacity	6,680 Tons
Total Existing Boiler Capacity	2,335 HP

- Systems past their life expectancy or in poor condition
- Systems nearing the end of their life expectancy or in sub-par condition

Master Plan Utility Capacity Demand & Loop Concepts

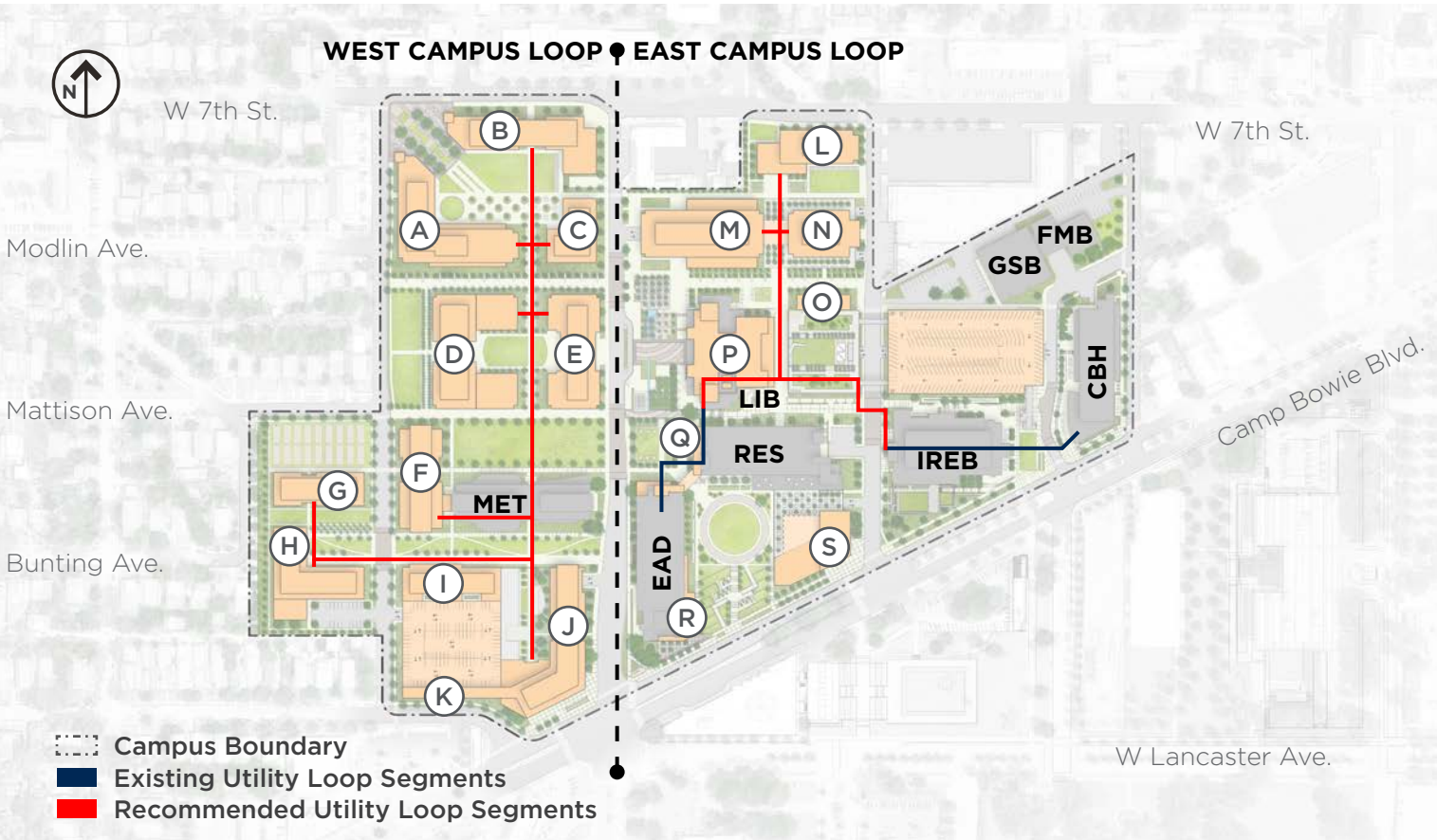

WEST CAMPUS: CHILLER DEMAND			
Building Name	GSF	SF/TON	TONS
Proposed A	90,000	275	327
Proposed B	74,250	275	270
Proposed C	25,000	275	91
Proposed D	138,000	275	502
Proposed E	96,000	275	349
Proposed F	95,000	275	345
Proposed G	40,500	275	147
Proposed H	68,250	275	248
Proposed I	72,000	275	261
Proposed J	180,000	275	655
Proposed K	18,500	275	67
MET	115,934	250	483
TOTALS	1,013,500		3,745

EAST CAMPUS: CHILLER DEMAND			
Building Name	GSF	SF/TON	TONS
Proposed L	66,250	275	241
Proposed M	191,000	275	694
Proposed N	72,500	275	264
Proposed O	7,600	325	23
Proposed P	64,500	325	198
Proposed Q	23,850	275	86
Proposed R	24,800	275	90
Proposed S	45,000	275	163
EAD	194,099	250	925
RES	138,701	250	583
LIB	114,064	300	454
IREB	172,922	300	576
CBH	160,320	175	927
GSB	15,506	0	0
FMB	7,409	0	0
TOTALS	1,300,000		5,224

West Campus Central Utility Plant (CUP) Study



- CUP Plant Option
- Existing Segments
- Recommended Segments

Option 1:

Creation of a central utility plant in the basement of one of the first new West Campus buildings

Near-term Rough Order of Magnitude Cost Estimate:

\$35,000,000 - 55,000,000+ *

Key Pros:

- Combines with cost of larger building project (easier to build)
- Location / timing in first proposed building

Key Cons:

- Requires additional acoustic insulation
- Most difficult to access

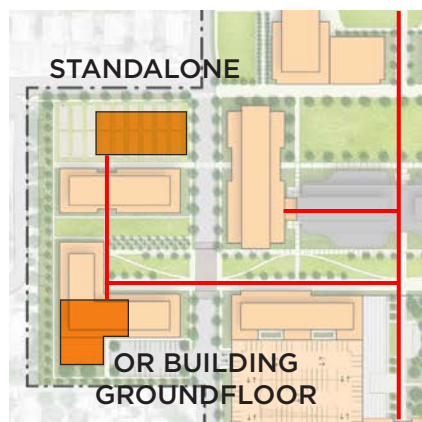

- CUP Plant Option
- Existing Segments
- Recommended Segments

Option 2:

Stand-alone, ground level central utility plant on existing Lot 7

Near-term Rough Order of Magnitude Cost Estimate:

\$25,000,000 - 45,000,000+ *

Key Pros:

- Easiest to service
- Cheaper to build than basement option

Key Cons:

- Architectural / neighborhood adjacency issues
- Harder to fund stand alone plant building

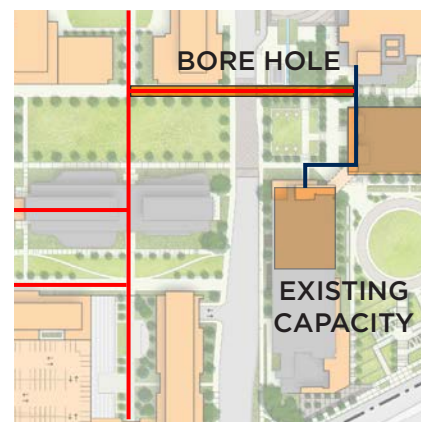

- CUP Plant Option
- Existing Segments
- Recommended Segments

Option 3:

No initial West Campus plant, connect to existing east campus capacity under Montgomery

Near-term Rough Order of Magnitude Cost Estimate:

\$4,000,000 - 6,000,000+ *

Key Pros:

- Lowest up front cost
- Can serve first two to three buildings and pushes decision “down the road”

Key Cons:

- Most complicated
- Highest long-term cost (will still require a plant)

* Note: Provided costs are rough order of magnitude estimates based on high-level conceptual analysis of the three options. Additional feasibility and cost studies are required before proceeding.

Option 1:

Creation of a central utility plant in the basement of one of the first new West Campus buildings

Considering that any buildings added to West Campus will be required to add MEP capacity to support itself, it is logical and efficient to consider building additional MEP space in one of the first new buildings to create a West Campus central utility plant. This plant will initiate a West Campus loop to serve all future development west of Montgomery Street. Building I is recommended for near-term implementation plan, and is identified to possibility to be one of the first buildings added to West Campus. The basement of Buildings I is large enough to accomplish this and house up to 5,000 tons in the future, which exceeds the total future need for West Campus. Building I is also well located for servicing ease and will not be visible or disruptive to key campus spaces or operations.

At minimum, a West Campus central utility plant located in a basement will need to be 40' wide by 150' long with a 12' ceiling height. The footprint of Building I is approximately twice this size, which would allow for the campus to either not develop a basement under the entire building, or allow for the creation of space for other facility functions (such as material storage). Shafts through the building would be required to connect the basement to necessary infrastructure on the roof, slightly reducing the available square footage on every floor. If Building I is not the first building built, any preceding new West Campus buildings should create space for MEP infrastructure to be self-supporting until the basement plant is constructed. These stand-alone systems must be capable of linking into the eventual loop long-term.

If built in the near-term, a basement central utility plant may only require a fraction of the total expected tonnage demand initially. The master plan recommends modules for the West Campus plant be no less than 500 tons (preferably, 1000 tons) for efficiency and redundancy, shell space should be left to add modules over time.

Pros:

- Allows project cost to combine into the project costs of an academic building
- Building I is centrally located to support future West Campus development
- Proximity to MET makes it easy to create the first West Campus loop segment
- Avoids having a stand alone central utility plant building that takes up valuable space and is unsightly
- Allows operations to remain out of sight from students, staff, and faculty

Cons:

- Would require large shafts running from the basement to the roof that would reduce the assignable square footage on floors above
- Potential noise issues that will need to be accounted for with additional sound insulation during design
- Hardest for facilities staff to access and will require special design consideration to ensure the ability to add / remove / service equipment in the future
- Building in a basement will be the highest rough order of magnitude cost

Option 2:**Stand-alone, ground level central utility plant on existing Lot 7 (alternatively could be located on the ground floor of building G or H with dedicated outdoor yard space)**

The second option is creating an efficient stand-alone central plant building located somewhere on the existing Parking Lot 7. This plant could also be located on the ground floor of one of the proposed buildings west of Haskell Street if accompanied by dedicated outdoor space. One of the challenges for this option is that architecture of plant buildings is typically utilitarian and unappealing. Due to the sites proximity to the adjacent neighborhood, special care should be given select facades and additional landscape screening elements included to reduce the visual harshness of the program. This facility will also increase maintenance traffic close to the neighborhood, which may be undesired. Another challenge (as opposed to option 1) will be justifying the cost of a stand alone building and oversized chiller in conjunction with the first new building on West Campus.

Sizing for a standalone structure would ideally be 100' by 50' with 24' ceilings to make room for larger 1000-ton chillers, which are more efficient to operate. This layout would allow for a mezzanine to enable easy access to and servicing of equipment. The 24' ceilings would also leave room for pumps, piping, and electrical gear above the chillers. Cooling towers would be located on the roof and require screening to mask them from all angles. A plant this size could house up to five 1000-ton chillers. At maximum build-out, West Campus is projected to need 3,745 tons. This excess would allow for system redundancy as chillers age or taken off line. Depending on when the plant is built, only one or two chillers may be required initially. Removed from the largest buildings identified for West Campus, this option will require more underground piping (under Haskell Street) be created initially to connect the plants capacity to the core of West Campus.

Pros:

- Easiest for facilities staff to service and operate due to extra ceiling height and not having to lower equipment below ground
- Least complicated design (soft costs)
- Construction cost per square foot cheaper than a basement option
- Could easily be designed large to include other facilities programs
- Easy to expand or modify in the future

Cons

- Architectural / neighborhood adjacency issues, may require design considerations that increase cost
- Depending on location, may reduce or eliminate the community garden location identified in the master plan
- Potentially increases traffic near the neighborhood, including occasional large service vehicles and equipment deliveries
- Harder to fund stand-alone plant building with excess capacity in conjunction with the first academic building (when the capacity would be needed)
- Requires development of more underground loop infrastructure on the front end (long-term, the same amount of infrastructure will be needed for all three options)

Option 3:

No initial West Campus plant, connect to existing east campus capacity under Montgomery

Another option is a scenario where no West Campus central utility plant is created in the near-term. Instead, the campus could create a bore hole under Montgomery Street to connect into existing East Campus capacity. Currently, there is enough surplus capacity to support the first two to three new buildings on West Campus. Long-term, Option 3 would still require a dedicated West Campus plant be created in the mid-term (Option 1 or 2).

Preliminary analysis suggests that directional boring equipment could be set up in the space north of the existing chilling towers. These machines could bore west under Montgomery Street and come up in the eastern portion of the MET Lawn. A 10” bore hole is the recommended size to support the first few West Campus buildings. Although the process of creating a bore hole avoids having to close down Montgomery Street for an extended period of time to dig up and install utilities, this option does still present some challenges. Option 3 would require coordination and approval from the City of Fort Worth, create noise pollution for nearby buildings during construction, involve up-sizing of existing underground piping on the east side of campus, and would likely require tearing up portions of the Campus Spine and MET lawn.

Eventually, this scenario would still require the creation of a central utility plant on West Campus to support all future development west of Montgomery Street. The value of this option is that it has a lower near-term cost than creating an entire central utility plant and enables the decision about the location and size of a new West Campus plant to be pushed into the future. Long-term, this 10” bore hole could serve as an emergency backup for the separately operated (but joined) east and west campus utility loops.

Pros:

- Existing East Campus capacity is enough to support the next two to three West Campus buildings if connected via a loop under Montgomery, enabling the campus to wait years before adding new chillers
- Delays decision about plant location and size, giving the campus the maximum amount of flexibility; but will have to combine with Options 1 or 2 to meet demand at full build-out; This gives the campus the greatest flexibility in selecting a solution
- Lowest upfront rough order of magnitude cost
- Long-term, the bore hole can serve as an emergency backup connecting both campus loops

Cons:

- Requires complicated engineering to bore under Montgomery Street and will require coordination and approval from the City of Fort Worth
- Cannot serve all West Campus development long-term without the creation of a central utility plant (Options 1 or 2) in the mid- or long-term
- Highest expected long-term cost as a Option 1 or 2 will still be required



60 E. Rio Salado Parkway
Suite 701
Tempe, AZ 85281



480.921.1515
tempeinfo@asg-architects.com
www.asg-architects.com